

POPULAR MECHANICS MAGAZINE

WRITTEN SO YOU CAN UNDERSTAND

REG. TRADE MARK, GREAT BRITAIN, NO. 410426

REG. U.S. PAT. OFF.



**BOMBER CARRIES
JET FIGHTERS
PAGE 112**

It's Here! The New '48 Whizzer Bike Motor

Latest in the great series of WHIZZER Bike Motors, it's the finest WHIZZER ever built! Packed with all-star features! The product of 10 years of specialized bike motor engineering experience! Better-than-ever performance! All the famous WHIZZER thrift! See this new 1948 model WHIZZER at your Dealer's NOW!

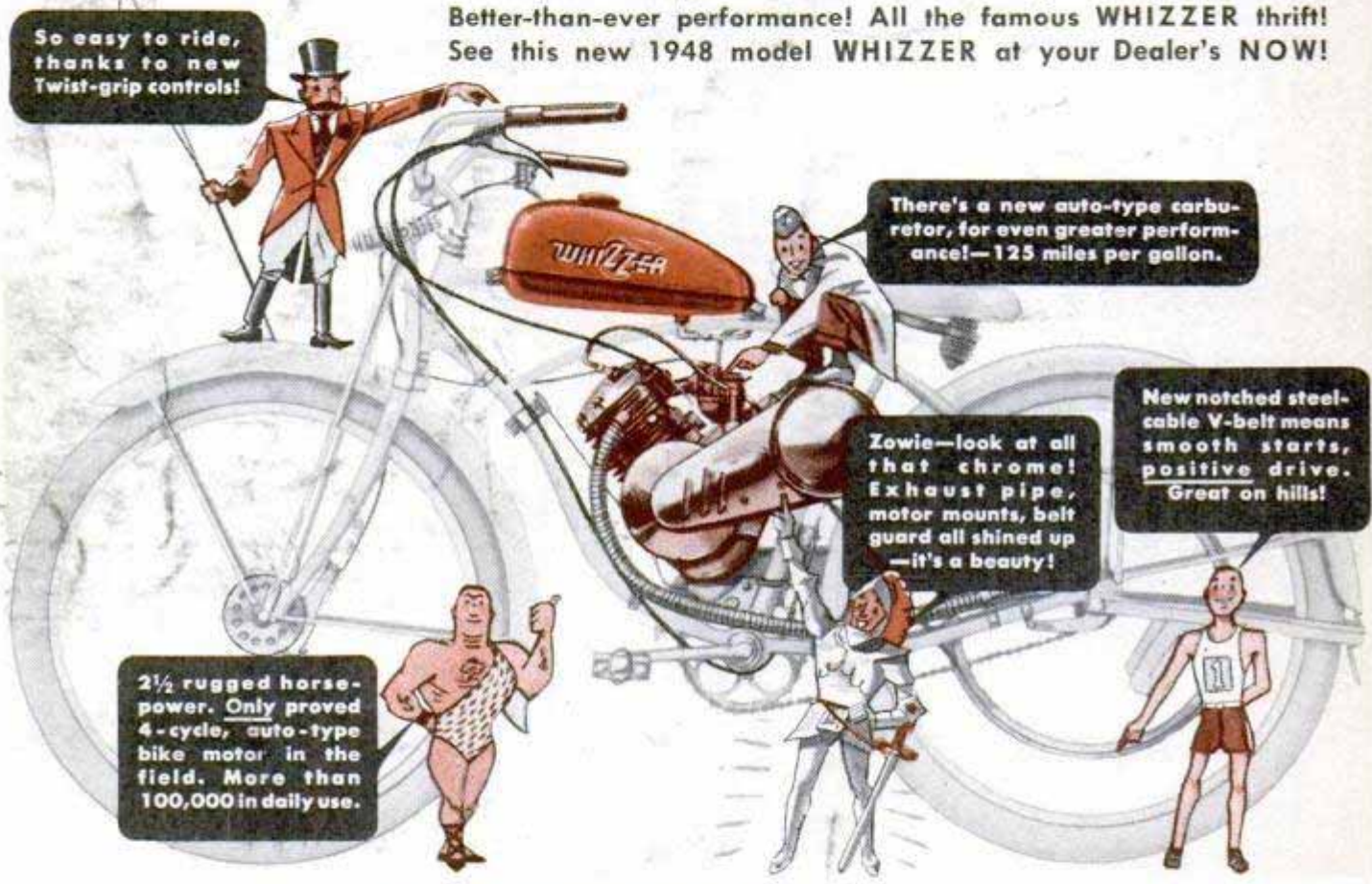

So easy to ride, thanks to new Twist-grip controls!

There's a new auto-type carburetor, for even greater performance!—125 miles per gallon.

New notched steel-cable V-belt means smooth starts, positive drive. Great on hills!

Zowie—look at all that chrome! Exhaust pipe, motor mounts, belt guard all shined up—it's a beauty!

2½ rugged horsepower. Only proved 4-cycle, auto-type bike motor in the field. More than 100,000 in daily use.

It's Wise To Go
WHIZZER
 America's Thriftiest Power Transportation

Ye'll r-r-ride five miles for a penny! And look at th' price—still only \$97.55! Complete with all necessary attachments, too! I'm headin' for the WHIZZER Dealer!

Fits all popular makes of men's balloon tire bikes. Over 3,500 Whizzer Dealers, at your service

Still Only
\$97.55
 Plus tax,
 F. O. B.
 Pontiac,
 Mich.

Your Whizzer Dealer is as near as your telephone . . . or write Whizzer Motor Co., Pontiac, Mich.—For 10 years the world's largest bike motor builder!



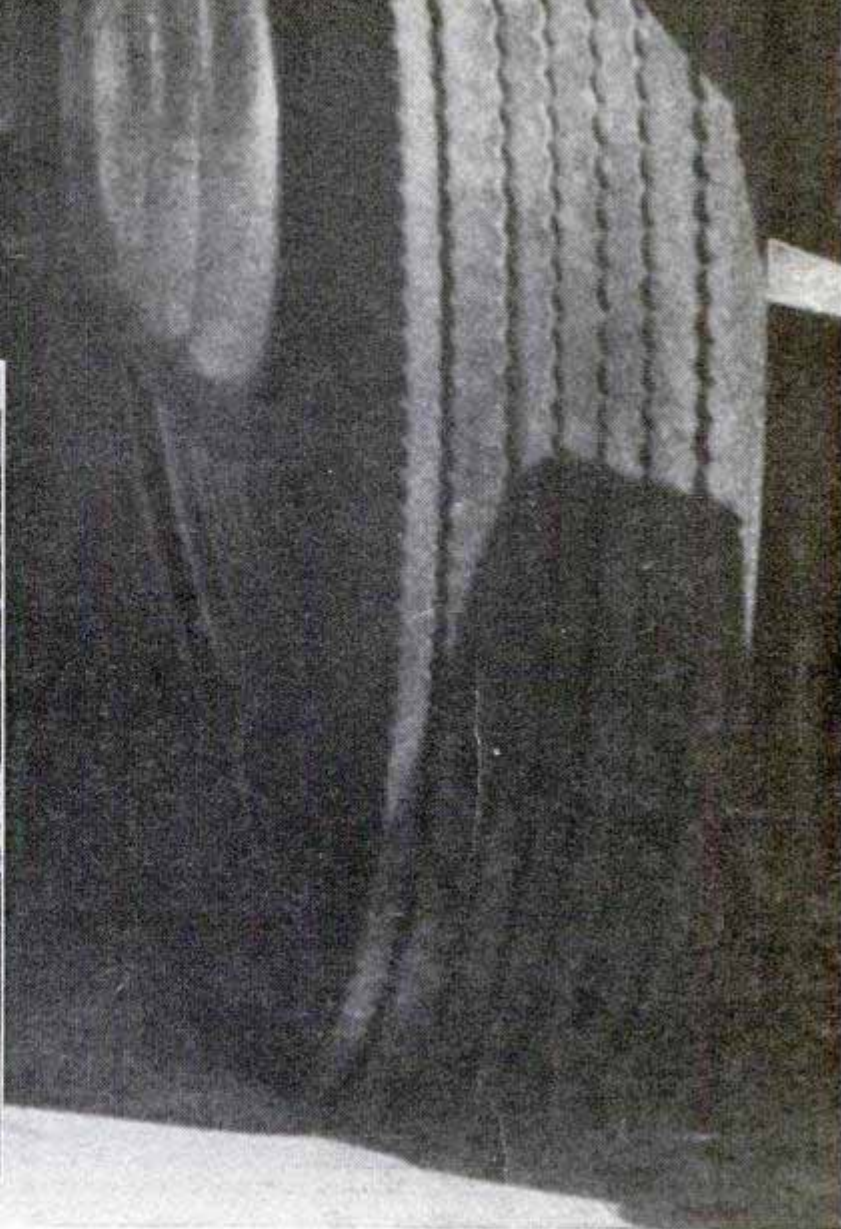

Typical example: user's experience with B. F. Goodrich tires

INSTEAD of changing tires on his car, citrus fruit farmer Howard Johnson of Escondido, California, changed the car on his tires. He bought his first set of B. F. Goodrich Silvertowns in May, 1946. His father has used nothing but B. F. Goodrich tires for fifteen years.

When Howard had rolled up 19,870 miles on his B. F. Goodrich tires, he bought a later model car. He switched the old tires to his new car, and they've travelled 14,000 miles since. That makes a total of

33,870 miles altogether.

As the picture shows, these tires still look like new. They show none of the wear you might expect from other tires after nearly 34,000 miles.

B. F. Goodrich tires outwear prewar tires. Inside and out, they're built to stay new longer. With a broader tread that grips the ground, weight is spread more evenly, shoulder to shoulder. Wear is slower, more even. The tire body is made with more cords, stronger cords for longer life. And a tough break-

er strip underneath the tread takes care of road shocks.

Right now, B. F. Goodrich dealers are offering the best tire buys anywhere. You'll be surprised at how much your old tires are worth on a trade-in. For the address of your nearest B. F. Goodrich dealer, look under *Tires* in the yellow pages of your phone book. *The B. F. Goodrich Company, Akron, Ohio.*

B.F. Goodrich
FIRST IN RUBBER



An entire season of baseball action—from Opening Day to World Series—is yours with RCA Victor television.

You're right in the game—with Television

Comes the shout "Play Ball!" and there you are—on top of every play.

Through television developments in RCA Laboratories, all the action is yours—the crack of bat against ball—every step of fast infield plays—even sidelights in bull pen, dugout, grandstand and bleachers.

At the ball park, RCA Image Orthicon television cameras—

rivalling the human eye in sensitivity of "vision"—get all the action in day or night games. Shifts from over-all views of the field, to "close-ups," are swift and revealing . . .

And at the *receiving end*—your RCA Victor "Eye Witness" home television set gives you brighter, clearer pictures. You can see the ball that the batter misses, or you can watch his home-run sail over the fence.

Today, because of the original and continuing work of RCA scientists, millions can enjoy sports, entertainment, educational and news events, on television. Research at RCA Laboratories—always a "step ahead"—enters every instrument marked RCA or RCA Victor.

When in Radio City, New York, be sure to see the radio, television and electronic wonders at RCA Exhibition Hall, 36 West 49th Street. Free admission. Radio Corporation of America, RCA Building, Radio City, N.Y. 20.



RADIO CORPORATION of AMERICA

Popular Mechanics Magazine

Registered in U. S. Patent Office and Canada

H. H. WINDSOR, Founder

H. H. WINDSOR, Jr., Editor and Publisher

WHEN a Californian lets loose a few superlatives on a region outside his home state—that's news. For proof of this, turn to our western editor's account of America's "last frontier" on page 132.

EVER have a piece of what looks like junk breeze past you on the highway at 80 m.p.h.? The probable explanation for this phenomenon is revealed on page 114.

NEXT MONTH we'll take you for an exhilarating sailboat ride on the world's fastest catamaran. The story comes from Honolulu. Another July feature may start a "gold" rush. There's a district near San Diego, Calif., where one farmer grossed \$2300 an acre raising celery! Look for "Pay Dirt in Chula Vista."

WHAT'S MORE refreshing on a hot day than a dip in a pool? A story in the Craftsman section next month tells how to build your own, whether you want a wading pool for the small fry or an ornate pool for a formal garden.

THE SIZE of your pocketbook need not prevent you from satisfying a yen to be a member of a Yacht Club. Next month an amateur yachtsman tells how you can learn to sail small boats, and start your own club inexpensively.

EVER GET stuck for a tow bill when your car quit on the road? An article in July will help you do your own trouble shooting next time you're in difficulty miles from a garage.

IN THE July Shop Notes section, an experienced machinist explains the intricacies of taper turning in a lathe. Three common methods of doing this work are explained.

RADIO beginners will find an easy-to-build 1-tube a.c.-d.c. loudspeaker set in the Radio and Electronics section next month.

Volume 89 JUNE 1948 Number 6

Managing Editor.....Roderick M. Grant
Assistant Managing Editor.....Wayne Whittaker
Shop Notes and Crafts Editor.....James R. Ward
Radio and Electronics Editor.....Frank L. Brittin
Aviation Editor.....Aubrey O. Cookman, Jr.
Associate Editor.....Clifford B. Hicks
Eastern Editor.....Bill Reiche
Western Editor.....Thomas E. Stimson, Jr.
Art Director.....Frank Beatty

Assistant Editors

Donald R. Brooks Arthur R. Railton

Assistant Editors, Shop Notes and Crafts

W.Clyde Lammey Wayne C.Leckey Frank N.Stephany A.E.Youngquist

In This Issue

Palomar Opens Its Eye	81
Take the Wheel of a New Hudson	88
Sternwheelers Still Rule the River	92
Attacking the Mysteries of the Atom	98
Torpedo Speedway	104
Jet Roost on a Flattop	108
Detroit Never Satisfies Them	114
Judging the Olympics	122
Wilderness Unspoiled	132
Can We Save Our Trees?	145
Portrait of the "Constitution"	156
Lion Hunt	161

For the Craftsman

Tuckaway Picnic Furniture	170
Model Your Home Before You Build	184
"Sea Craft"—Cabin Cruiser Part IV	203
Spreader for Dry Fertilizer	209
Watch Out for Warping	217
Radio and Electronics	221
Clinic for Homemakers	234

Table of Contents continued on page 8

Published monthly by POPULAR MECHANICS COMPANY, 200 East Ontario Street, Chicago 11, Ill. H. H. Windsor, Jr., president; Paul H. Dunakin, vice president and general manager; D. F. Windsor, vice president and secretary-treasurer; William Harrison Petridge, vice president and assistant to the publisher; Clover L. Perkins, advertising manager; Alan M. Deyoe, circulation manager. Single copy in the United States and Canada, 25 cents; subscription rates in United States and possessions, Canada, Philippines and countries of the Pan-American Postal Union, 1 year, \$2.50; 2 years, \$4.50; 3 years, \$6.00. To all other countries add \$1.00 a year over United States prices for overseas postage. If you plan to move, notify us at least 30 days in advance so you will not miss an issue. Give both old and new addresses. Entered as Second Class Matter, September 15, 1905, at the Post Office at Chicago, Illinois, under Act of March 3, 1879. Entered as Second Class Matter at Post Office Dept., Canada. Copyright 1948 by Popular Mechanics Company. Copyright under International Copyright Union. Copyright in France. All rights reserved under Pan-American Copyright Union. Printed in the United States of America.

How'll you have your snow?



Deep or shallow? Crisp or damp? Falling straight down or angling in at 80 miles an hour?

No joke! The Army Signal Corps has push-button weather the whole year round — and right at Fort Monmouth, New Jersey!

These versatile Army weathermen don't stop at mere blizzards. In their new equipment torture-chamber, they can yank the temperature down to an unearthly 100 degrees below zero or boost it to a broiling 190 degrees above. They can make rain like a Rangoon monsoon, hail like cherrystones, fog like London's, hurricanes and typhoons and desert dust storms like nothing civilized man has ever seen!

Here's the recipe for snow. In a chamber the size of a 4-room house, they yank the temperature down to minus 40 with huge ammonia compressors powered electrically with 700 horsepower. Then they shoot in saturated steam which quickly turns to fog and drops

to the freezing point where it forms a super-cooled cloud. At 5 or 10 degrees above zero, Signal Corps engineers induce nucleation by shaking a thimble-size bag of dry ice. When the cloud gets down to minus 40, the water vapor crystallizes into billions of snow crystals which fall to the floor or can be blown about with a high-speed propeller.

In a single week, military equipment can be tested in every conceivable kind of weather — testing which otherwise would take many years and millions of dollars to accomplish.

Do you like this sort of forward-looking achievement? Nowhere is science getting a bigger run for its money than in the technical services of the U. S. Army. The ambitious young scientist has his choice of technical schools galore! If you are 17 to 34, ask your nearest Recruiting Officer if you measure up to the Army's high standards.

**U. S. ARMY AND U. S. AIR FORCE
RECRUITING SERVICE**

CAREERS WITH A FUTURE

**U. S. Army and
U. S. Air Force**

ex-pe'ri-ence*

BUILDS BETTER

CRESCENT TOOLS

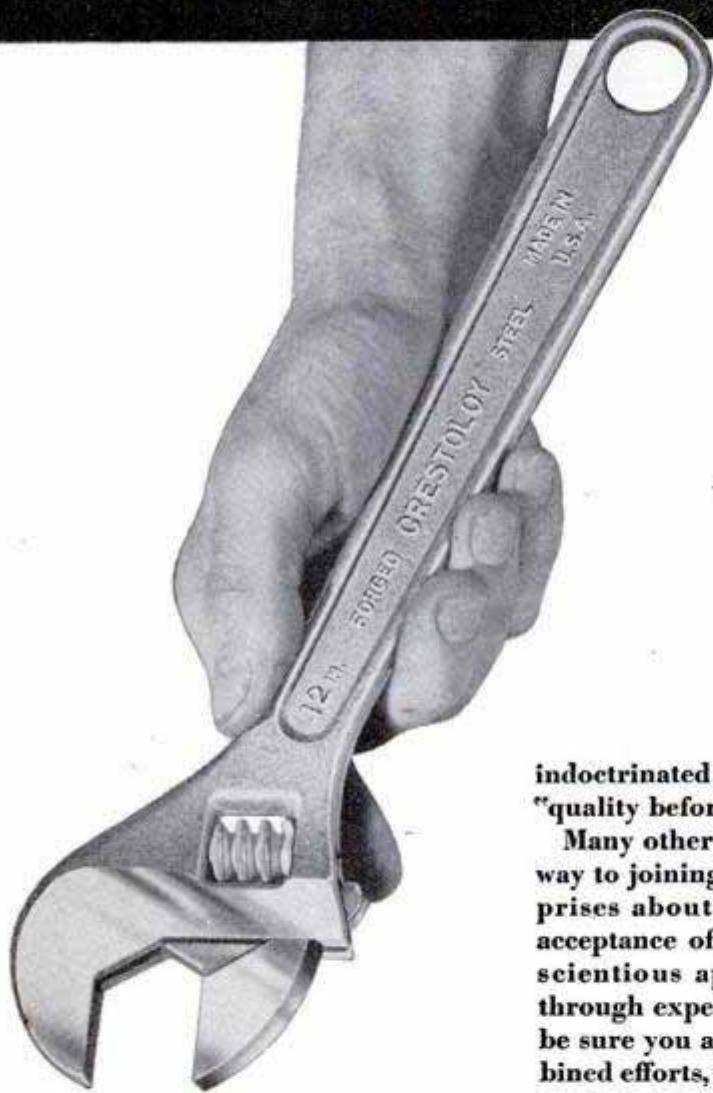

* "State, extent, or duration of being engaged in a particular study or work; knowledge, skill or technique resulting from experience."

— WEBSTER

● Symbolic of the vast amount of experience accumulated by Crescent workers, are hands which have increased in skill with years of doing. Owners of such hands have seen the Company grow immensely in capacity and precision production since its incorporation in 1907. Many old-timers, with service records from 20 to 40 years and more, are still active members of the Crescent staff. It is this group which helped make quality a Crescent tradition, and which indoctrinated its younger fellow workers with the credo of "quality before quantity".

Many other members of the Company are well on their way to joining the Crescent long-service group, which comprises about 25% of the entire personnel. World-wide acceptance of Crescent Tools has been built upon the conscientious application of skill and knowledge gained through experience. When you specify "Crescent", you may be sure you are getting quality tools produced by the combined efforts, skill and experience of all Crescent employees.

CRESCENT TOOL COMPANY
JAMESTOWN, N. Y.

CRESCENT TOOLS
Give Wings to Work



* "CRESCENT" is our trade-mark registered in the United States and foreign countries for wrenches and other tools. "Crescent" tools are made only by Crescent Tool Company of Jamestown, N. Y., and are sold by leading distributors everywhere.

This One



EYVA-B7I-SD7V

UNSUSPECTED POWER



The Mysterious Influence In The Air You Breathe!

THE SOUL OF THE UNIVERSE is in the air you breathe. Deposited in your blood—with each inhalation you take—is *the intelligence* that directs the course of the planets through the misty reaches of space, and the strange phenomenon of life itself.

What is it that causes your heart to beat, your lungs to expand and contract? What mind directs *the cells* of your being, each in their purpose—some to create bone, others tissue and hair? What *consciousness* pervades these vibratory *globules of life* and gives them awareness of their Cosmic function?

Are you one of the millions who have looked *beyond yourself* for some external Divine Power or agency? Have you searched in vain for some outer sign or word of Divine assurance when in doubt or in need? Now learn of the *unsuspected power* that exists in every simple breath—and that becomes *part of you*. The ancient Egyptians believed that the essence of life was borne on the wings of the air. The Bible pro-

claims that with the first breath man becomes not just an animated being—but a “*living soul*.” Try *this experiment*, and prove a Vital Life Force exists in the air. When you are in pain or despondent take a deep breath. Hold it as long as comfortable—then notice the momentary relief.

This Amazing Free Book

Would you seriously like to know how to draw upon this Intelligence of the Cosmic, with which the air is permeated? You can use it to awaken the creative powers of your mind, and for making life an experience of *achievement*. Use the coupon below for a free copy of the book, “The Mastery of Life.” It tells how in the privacy of your home *you may learn* to use these simple, useful, *natural laws*.

-----USE THIS GIFT COUPON-----
Scribe E. G. Y. The Rosicrucians (AMORC)
Rosicrucian Park, San Jose, California
I am sincerely interested in learning how to use the
mysterious influences of the universe in the betterment
of my life. Please send me a free copy of the book,
“The Mastery of Life.”
NAME _____
ADDRESS _____
Rosicrucians are NOT a religious organization

THE ROSICRUCIANS (AMORC) SAN JOSE, CALIFORNIA, U. S. A.

Become an EXPERT ACCOUNTANT through LASALLE'S PROBLEM METHOD

WHAT is the LaSalle Problem Method of acquiring Higher Accountancy Training?

Certainly not the dull routine associated with ordinary study—not “book-learning” in the theoretical sense.

Under the Problem Method each week you are given an important accounting principle—then shown how the principle is applied. You are given a problem and its solution. After you fully understand the principle and its application, you are then given a problem which you work out for yourself and send in to LaSalle. Your solution is returned to you with comments. If it has not been properly solved you are shown your error and the correct method.

The entire procedure is practically first-hand personal experience gained by you direct from capable accountancy instructors. These men take an interest in you, check your individual needs and work with you step by step as you progress.

You study and learn under a tested, proven plan built around the Problem Method. You continuously learn by actually handling important accountancy problems, analyzing, working them out and thinking out your own decisions.

Thus you are coached in the practical solving of the very problems you face in a higher accountancy position. Step by step you work mat-



More Money—A Better Position

ters out for yourself. At the end of your training, you have real ability and practical experience—the kind which fits you for positions that business is glad to reward with real money.

Don't confuse Accountancy with bookkeeping. The Accountant is the executive, the man who makes the big money—the bookkeeper does only the detail routine jobs at low pay.

You can become an expert accountant through the LaSalle Problem Method without any preliminary knowledge of bookkeeping.

You will be given whatever basic training, instruction or review on the subject of bookkeeping you need. Mail the coupon now for full information.

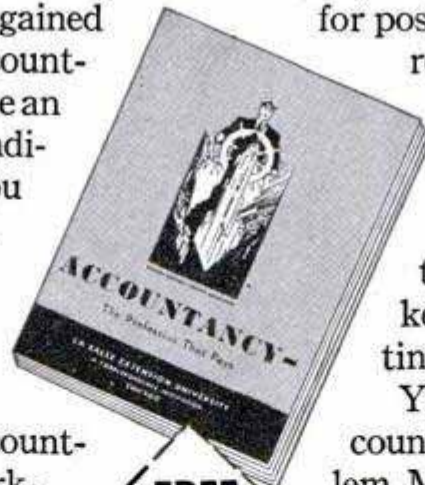

FREE ACCOUNTING BOOKLET

Send me, without obligation, your 48-page booklet "Accountancy, the Profession that Pays."

NAME.....

POSITION.....AGE.....

ADDRESS.....

CITY.....ZONE.....STATE.....

LASALLE EXTENSION UNIVERSITY Dept. 664-H
A Correspondence Institution Chicago 5, Ill.

GET STARTED NOW

Send for the Facts TODAY!

SMOOTH

inside
and out



You may keep your car bright and shiny and feel that you are doing all you can to keep it smooth looking on the highways. But to be really smooth, your car must also be smooth running and trouble free. *And it is easy with Pyroil.*

Pyroil gives oil the property of clinging to cylinder walls so that every stroke of the cylinder, from the time you step on the starter, moves on a cushion of lubrication. Pyroil prevents wear—it dissolves sludge.

Ask your gas station attendant to add Pyroil . . . and add smooth miles to your car.

GIVEN! An attractive Pyroil metal savings bank—takes coins up to 50c pieces—is yours for the asking—sent postage paid.

PYROIL for Aircraft Engines

Use Aircraft Pyroil B for lubricating oil, Aircraft Pyroil A for gasoline.

Manufactured and Guaranteed by Pyroil Company, 80 Pyroil Bldg., La Crosse, Wisconsin.

Canadian Distributors:
Central Purchasing Agencies, Ltd., Toronto, Canada

PYROIL COMPANY

80 Pyroil Bldg., La Crosse, Wisconsin

I want my car to last and run properly. Please tell me more about Pyroil and how it can accomplish this for me.

Name _____

Address _____

City or Town _____ State _____



TABLE OF CONTENTS (Continued)

AUTOMOTIVE

Top of low-slung Italian car is only 54 inches off ground.....	121
High school students drive "cars" in classroom.....	155
Brake lock holds car on grade.....	155
Snap-on initials for automobile.....	166

AVIATION

Bomber carries jet fighters.....	112
Flight-time recorder.....	143
Lens quadruples air camera's scope.....	151

BOATS AND BOATING

"Beauty shop" for boats.....	86
Boats speed over water with V-shaped "wings".....	129
Seaworthy boat hulls molded of plywood.....	131
Stripped landing craft becomes car ferry.....	139
"Strapping" a tanker.....	142
Flattop dons civvies as speedy freighter.....	144
Sun visor protects yachtsmen from direct and reflected rays.....	153

ELECTRICAL

Electric motor drives bicycle.....	87
Electric guillotine "finishes off" obsolete planes.....	103
Big or little electric engines made from "packaged" trucks.....	143
Motor-driven sweeper cleans an acre an hour.....	150
"Lipstick" flashlight to fit purse uses special midget battery.....	152
Electronic calculator has 12,500-tube brain.....	168

FARM

Activated charcoal protects young plants.....	97
Plastic covers for seed beds.....	103
Billions of bees shipped to northern orchards.....	107
Hose sprayer mixes insecticide.....	150
Fertilizer spreader uses tiller frame.....	151
"Air war" on sagebrush.....	160
Silage loader.....	160
Tiller does three jobs.....	160

HOUSE AND HOME

"Marathon" phonograph.....	107
Two buses plus porch make attractive home.....	113
What's new for your home.....	140
Rainfall gauge for home use reads like a thermometer.....	155

INDUSTRY

Oil mixture in magnetic clutch "solidifies" to transmit power.....	97
Prefabricated roofs.....	113
"Elevator" trucks load baggage.....	129
House of steel.....	130
Plastic newspaper cuts made in four minutes.....	131
Warm air for respirators.....	138
Crusher flattens cans.....	139
Pre-cut paper letters set by hand as type for printing.....	142
Typesetting is simplified by small color press.....	152
Tubes judge cotton fibers.....	166
Huge bridge girder spans five flatcars.....	167

TOOLS

Tension tester for hacksaw blade.....	87
Starting tool locks in screw.....	153
Combination drafting tool has wide variety of uses.....	153
Diamond tool turns out eyeglass lenses to prescription.....	168

TRANSPORTATION

Iron pack horse.....	128
British motorcycle folds for storage.....	138
Bicycle built for five.....	160
Rail recreation car.....	167

MISCELLANEOUS

Spray gun supplies own pressure.....	87
Pipe has built-in cleaner.....	87
Plastic parts give "X-ray" view of weapons and engines.....	121
Fountain toothbrush.....	138
Rubber mask and throat bag give hot and cold treatments.....	138
Chart adds fractions.....	144
Coin-operated shoe polisher shines two shoes a minute.....	150
Four-lens turret for Cine Special.....	151
Transparent diving helmet permits all-around vision.....	152
Pocket kit for fishermen has transparent case.....	153
Fisherman's page.....	154
Harness-race starting gate has telescoping arms.....	166

Craftsman and Shop Notes Index

BOATS AND BOATING

Wire and battery clip hold funnel to fill outboard-motor tank.....	177
Burned-in name identifies car.....	180
Steering gears for outboards.....	181
Safety rope attached to boat transom prevents losing outboard motor.....	188

ELECTRICAL

Inexpensive ceiling fixture.....	176
Repairing broken battery post.....	180
Self-adjusting motor mount gives constant belt tension.....	183

FARM

War-surplus ship's bell serves as dinner bell.....	188
Pulley reduces bending of pruning pole.....	189

(Continued to page 10)

There's **BIG MONEY** in

PLASTICS

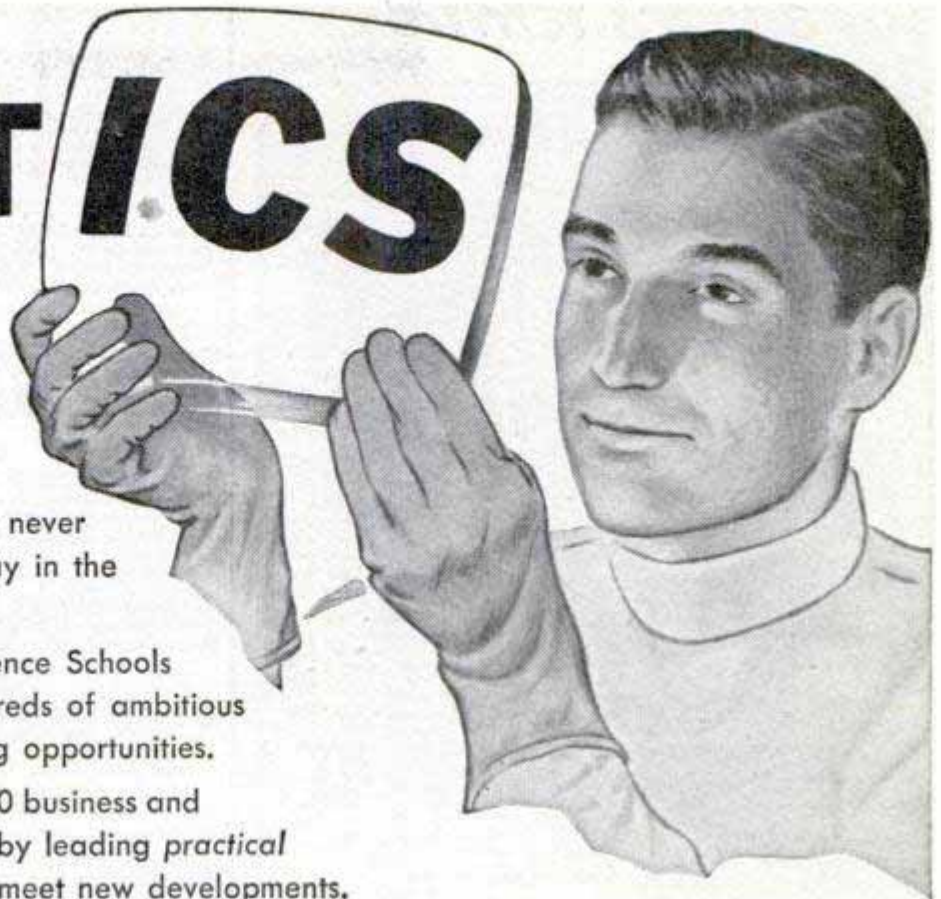

- Your chances for success have never been greater than they are today in the field of plastics.
- The International Correspondence Schools Course in Plastics is fitting hundreds of ambitious men for these great and growing opportunities.
- All I.C.S. Courses (covering 400 business and technical subjects) are prepared by leading practical authorities, constantly revised to meet new developments. Yet the cost of I.C.S. training is surprisingly low.
- Join the men who will be tomorrow's leaders. Mail this coupon today!

Inspecting a plastic lens similar to type used to magnify television images.

INTERNATIONAL CORRESPONDENCE SCHOOLS



BOX 5629-K, SCRANTON 9, PENNA.

Without cost or obligation, please send me full particulars about the course BEFORE which I have marked X:

- | | | | |
|--|---|---|--|
| <p><input type="checkbox"/> PLASTICS</p> <p><input type="checkbox"/> Air Conditioning and Plumbing Courses</p> <p><input type="checkbox"/> Air Conditioning <input type="checkbox"/> Plumbing</p> <p><input type="checkbox"/> Heating <input type="checkbox"/> Steam Fitting</p> <p><input type="checkbox"/> Refrigeration <input type="checkbox"/> Steam Fitting</p> <p><input type="checkbox"/> Chemistry Courses</p> <p><input type="checkbox"/> Chemical Engineering</p> <p><input type="checkbox"/> Chemistry, Analytical</p> <p><input type="checkbox"/> Chemistry, Industrial</p> <p><input type="checkbox"/> Chemistry, Mfg. Iron & Steel</p> <p><input type="checkbox"/> Petroleum Refining</p> <p><input type="checkbox"/> Pulp and Paper Making</p> <p><input type="checkbox"/> Civil Engineering, Architectural and Mining Courses</p> <p><input type="checkbox"/> Architecture</p> <p><input type="checkbox"/> Architectural Drafting</p> <p><input type="checkbox"/> Bridge and Building Foreman</p> <p><input type="checkbox"/> Building Estimating</p> <p><input type="checkbox"/> Civil Engineering <input type="checkbox"/> Coal Mining</p> <p><input type="checkbox"/> Contracting and Building</p> <p><input type="checkbox"/> Highway Engineering</p> <p><input type="checkbox"/> Reading Structural Blueprints</p> <p><input type="checkbox"/> Sanitary Engineering</p> <p><input type="checkbox"/> Structural Drafting</p> | <p><input type="checkbox"/> Structural Engineering</p> <p><input type="checkbox"/> Surveying and Mapping</p> <p><input type="checkbox"/> Communications Courses</p> <p><input type="checkbox"/> Electronics</p> <p><input type="checkbox"/> Practical Telephony <input type="checkbox"/> Radio, General</p> <p><input type="checkbox"/> Radio Operating</p> <p><input type="checkbox"/> Radio Servicing</p> <p><input type="checkbox"/> Telegraph Engineering</p> <p><input type="checkbox"/> Electrical Courses</p> <p><input type="checkbox"/> Electrical Drafting</p> <p><input type="checkbox"/> Electrical Engineering</p> <p><input type="checkbox"/> Electric Light and Power</p> <p><input type="checkbox"/> Lighting Technician</p> <p><input type="checkbox"/> Practical Electrician</p> <p><input type="checkbox"/> Internal Combustion Engines Courses</p> <p><input type="checkbox"/> Auto Technician <input type="checkbox"/> Aviation</p> <p><input type="checkbox"/> Diesel-Electric</p> <p><input type="checkbox"/> Diesel Engines <input type="checkbox"/> Gas Engines</p> <p><input type="checkbox"/> Mechanical Courses</p> <p><input type="checkbox"/> Aeronautical Engineer's, Jr.</p> <p><input type="checkbox"/> Aircraft Drafting</p> <p><input type="checkbox"/> Flight Engineer</p> <p><input type="checkbox"/> Forging <input type="checkbox"/> Foundry Work</p> <p><input type="checkbox"/> Heat Treatment of Metals</p> | <p><input type="checkbox"/> Industrial Engineering</p> <p><input type="checkbox"/> Industrial Metallurgy</p> <p><input type="checkbox"/> Machine Shop</p> <p><input type="checkbox"/> Mechanical Drafting</p> <p><input type="checkbox"/> Mechanical Engineering</p> <p><input type="checkbox"/> Mold-Loft Work</p> <p><input type="checkbox"/> Patternmaking—Wood, Metal</p> <p><input type="checkbox"/> Reading Shop Blueprints</p> <p><input type="checkbox"/> Sheet-Metal Drafting</p> <p><input type="checkbox"/> Sheet-Metal Worker</p> <p><input type="checkbox"/> Ship Drafting <input type="checkbox"/> Ship Fitting</p> <p><input type="checkbox"/> Tool Designing <input type="checkbox"/> Toolmaking</p> <p><input type="checkbox"/> Welding Engineering</p> <p><input type="checkbox"/> Welding—Gas and Electric</p> <p><input type="checkbox"/> Railroad Courses</p> <p><input type="checkbox"/> Air Brake <input type="checkbox"/> Car Inspector</p> <p><input type="checkbox"/> Diesel Locomotive</p> <p><input type="checkbox"/> Locomotive Engineer</p> <p><input type="checkbox"/> Locomotive Fireman</p> <p><input type="checkbox"/> Locomotive Machinist</p> <p><input type="checkbox"/> Railroad Section Foreman</p> <p><input type="checkbox"/> Steam Engineering Courses</p> <p><input type="checkbox"/> Boilermaking</p> <p><input type="checkbox"/> Combustion Engineering</p> <p><input type="checkbox"/> Engine Running</p> <p><input type="checkbox"/> Marine Engineering</p> | <p><input type="checkbox"/> Steam Electric <input type="checkbox"/> Steam Engineer</p> <p><input type="checkbox"/> Textile Courses</p> <p><input type="checkbox"/> Cotton Manufacturing</p> <p><input type="checkbox"/> Loom Fixing <input type="checkbox"/> Rayon Weaving</p> <p><input type="checkbox"/> Textile Designing</p> <p><input type="checkbox"/> Woolen Manufacturing</p> <p><input type="checkbox"/> Business and Academic Courses</p> <p><input type="checkbox"/> Accounting <input type="checkbox"/> Advertising</p> <p><input type="checkbox"/> Bookkeeping</p> <p><input type="checkbox"/> Business Administration</p> <p><input type="checkbox"/> Business Correspondence</p> <p><input type="checkbox"/> Certified Public Accounting</p> <p><input type="checkbox"/> Commercial <input type="checkbox"/> Commercial Art</p> <p><input type="checkbox"/> Cost Accounting <input type="checkbox"/> Federal Tax</p> <p><input type="checkbox"/> First Year College</p> <p><input type="checkbox"/> Foremanship <input type="checkbox"/> French</p> <p><input type="checkbox"/> Good English <input type="checkbox"/> High School</p> <p><input type="checkbox"/> Higher Mathematics</p> <p><input type="checkbox"/> Motor Traffic <input type="checkbox"/> Postal Service</p> <p><input type="checkbox"/> Retailing</p> <p><input type="checkbox"/> Retail Store Management</p> <p><input type="checkbox"/> Salesmanship <input type="checkbox"/> Secretarial</p> <p><input type="checkbox"/> Sign Lettering</p> <p><input type="checkbox"/> Spanish <input type="checkbox"/> Stenography</p> <p><input type="checkbox"/> Traffic Management</p> |
|--|---|---|--|

Name _____ Age _____ Home Address _____

City _____ State _____ Present Position _____

Employed by _____ Working Hours _____ A.M. to _____ P.M.

Special tuition rates to members of the Armed Forces. Special discount to World War II Veterans.
Canadian residents send coupon to International Correspondence Schools Canadian, Ltd., Montreal, Canada.

COLOR FANS

say it's terrific

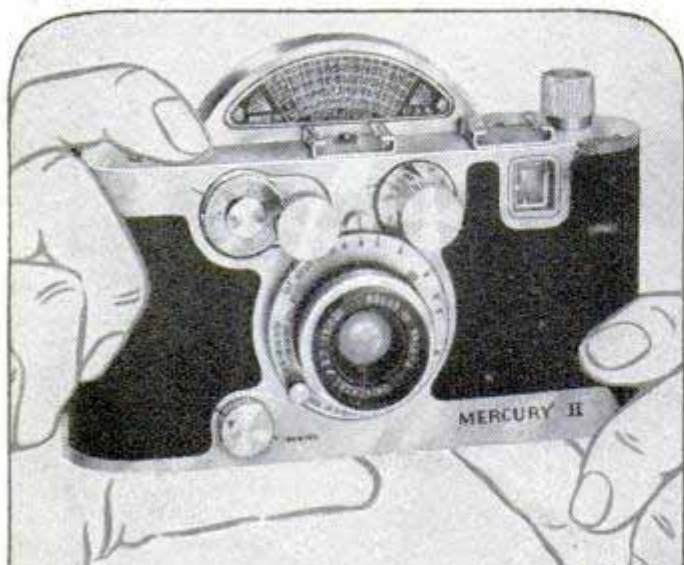

UNIVERSAL'S
MERCURY II
 —the candid with single frame as
 used in Hollywood movie cameras.
 Coated f2.7 lens....82.90

THE best color shots I've ever seen." . . . "Nothing can touch it for color . . . even the background is crisp and sharp." . . . "The best color camera, American or foreign, that I've used, regardless of price."

When experts . . . camera fans who have tried them all . . . write such glowing tributes to Universal's Mercury II, it must have something special!

It has! It has single frame design, the same miracle single frame that all Hollywood movie cameras use. Result: the lens is 30% closer to the film; depth of focus is unparalleled; you don't even need a range finder. At all reliable dealers.

UNIVERSAL CAMERA CORPORATION
 New York, Chicago, Hollywood



NEW! UNIVERSAL'S UNIFLEX
 "The expert's reflex." 17 expensive features. UNIFLEX I—Coated f4.5 viewing, f5.6 taking lens 48.00
 UNIFLEX II—f3.8 viewing, f4.5 taking lens.....75.00



NEW! UNIVERSAL'S ROAMER
 More "good picture" features than any other folding camera. ROAMER I—Coated, color corrected lens 29.75
 ROAMER II—Coated f4.5 lens, speeds to 1/200th, 48.00

For Pictures that *Click*...click a **UNIVERSAL**

(Continued from page 8)

Iron pipe protects wagon endgate.....	202
Hay barrack has adjustable roof.....	213
Sludge will not freeze to the inside of door having tar-paper cover	214
Tin-can protector for seedlings.....	216

FISH AND FISHING

Name inscribed on bamboo rod is permanent identification.....	176
Turtles caught with rattrap.....	180
Outsmarting the catfish.....	190
Self-adjusting float permits reeling bait to rod tip when casting	191
Keeping crawfish in warm weather.....	200
Fishline can be dried on rod with clothespin reel.....	200

HOUSE AND HOME

Shades kept at uniform height with gummed-paper markers.....	172
Solving home problems.....	174
Safety-first for baby's swing.....	196
Nail rides coil window balance to take up side play.....	200

LAWN AND GARDEN

Lawn roller helps control fire when burning weeds or grass.....	180
Attracting birds to new houses.....	189
Lawn-sprinkler shutoff.....	193
Portable trellis easily moved into sun or shade.....	196

OUTDOOR RECREATION

Fun galore with this inner-tube beach raft.....	177
Bar-B-Q cart	178
Children's seesaw utilizes oil drum.....	189
Aluminum caddy cart.....	198

PAINT AND PAINTING

Rim of paint can kept clean to effect tight seal.....	172
Line on partially filled paint can shows color and amount.....	180
Adjustable hanger aids painting screens and storm sash.....	200

PHOTOGRAPHY

Photograph your favorite flowers.....	194
Film-tank agitator of pipe is motor driven.....	197
Static electricity better than brush to remove dust from negatives	197

RADIO AND ELECTRONICS

Lightweight FM handle talkie.....	221
Three-way four-tube portable vacation receiver.....	222
Large-screen television	224

TOOLS

Altered hammer head speeds nail-pulling.....	172
Flat file forms substitute tool to knuri soft brass.....	176
Doubling use of small C-clamps.....	188
Easy tests for dull tool blades.....	192
Cleaning silicon-carbide stones.....	192
Electrician's tape kept available on screwdriver handle.....	192
Gauge blocks—a standard for measurement.....	201
Chain attachment adapts bench vise for holding pipe and rod stock	202
Hoist attached to barn-door hanger serves as overhead stock crane	212
Lathe lubricant applicator.....	212
Adjustable hold-down clamp.....	212
Fixture aids accurate setting of shaper knives.....	213
Shaper cutter mounted in lathe tool post permits turning uniform beads and coves.....	214
Dual tool-bit holder.....	214
Repairing carbide-tipped tools.....	214
Letter press of pipe fittings for the home shop.....	215
Ribbon tabs aid in removal of button dies.....	216
Center-punch mark locks nut.....	216
Razor-blade gasket cutter.....	220
Mass-producing slotted dowels.....	220
Special tool for internal chamfering.....	220
Metal threads polished in lathe with wooden block.....	220

WOODWORKING

Wood turnings sanded safely by using abrasive holder.....	172
Neat wall shelf has secret drawer.....	183
Scalloped boards made easily by drilling holes and sawing apart	215

MISCELLANEOUS

Automatic pencil holds wire solder.....	172
Oilcloth wrapper protects blueprints when on construction job.....	173
Two desk accessories from scraps of plastic.....	173
Wrench provides comfortable grip for pail with wire bail.....	176
Putty kept from hardening.....	180
BB shot used to force dirt from kinked fuel-oil line.....	192
Substitute friction catch.....	192
Cardboard pipe-cleaner holder protects pocket lining.....	192
Shrinking model-airplane paper.....	196
"Pin-up" candlestick.....	196
Luminous paint applied to flashlight aids finding it in dark.....	196
Converted farm-machine seat makes useful shop chair.....	212
Medicine dropper dispenses ink.....	216
Tape protects fender bead when pounding out dent.....	216

IMPORTANT NOTICE—It is the intention of this magazine to provide its readers with information regarding the latest developments in the mechanical arts. We take no responsibility as to whether the disclosures contained in our articles are covered by patents and advise readers to investigate this subject before making, using, or selling any of the products, machines, or processes described in order to avoid possible liability for patent infringements.

AUDELS REFRIGERATION & AIR CONDITIONING GUIDE.....\$4

New from Cover to Cover—1280 Pages, Fully Illus. Covering basic principles, servicing, operation & repair of household, commercial & industrial refrigeration & air conditioning. A gold mine of essential important facts for engineers, servicemen, users.

AUDELS CARPENTERS & BUILDERS GUIDES—4 Vols.\$6

A practical illustrated trade assistant on modern construction for carpenters, joiners, builders, mechanics and all woodworkers. 4 vols., 1600 pages, 3700 illustrations, flexible covers. Pocket size. Each volume sold separately \$1.50 a vol.

AUDELS AUTOMOBILE GUIDE.....\$4

A practical quick ready reference book for auto mechanics, service men, operators & owners. Explains theory, construction & servicing of modern motor cars, trucks, buses & auto type Diesel engines. 1700 pages, fully illustrated. 55 chapters. Indexed. A standard book for mechanics. New fluid drive covered.

AUDELS DIESEL ENGINE MANUAL..\$2

A practical, concise treatise with questions and answers on the theory, operation and maintenance of modern diesel engines including General Motors 2 cycle Diesel. 384 pages, fully illus., flexible binding, pocket size. All details plainly brought out, this book is of extreme value to engineers, operators & students.

AUDELS WIRING DIAGRAMS.....\$1

210 Pages. Illustrated. Gives practical facts on wiring of electrical apparatus. It shows clearly how to wire apparatus for practically all fields of electricity. Each diagram is complete & self-explanatory. Highly Endorsed Pocket Companion.

AUDELS PLUMBERS & STEAMFITTERS GUIDES—4 Vols.\$6

A Practical Trade Assistant & Ready Reference. Explains in plain language & by clear illustrations, diagrams, charts, graphs, pictures principles of modern plumbing practice including Marine Pipe Fitting and Air Conditioning. 4 Vols.—1670 Pages—3642 Diagrams. Pocket size. Each Vol. Sold Separately \$1.50 a Vol.

AUDELS SHEETMETAL WORKERS HANDY BOOK.....\$1

Practical inside information. Fundamentals of Sheet Metal Work. 388 pages. Illustrated. 11 sections. Clearly written. Essential & important facts, figures, pointers in everyday language. Ref. Index.

AUDELS SHEETMETAL PATTERN LAYOUTS.....\$4

Developed by Experts for Sheet Metal Workers, Layout Men & Mechanics. A Practical Encyclopedia in 10 Sections, size 7 x 10 x 2—1125 Pages—350 Layouts—1600 Illustrations. 1001 Key Facts. Fully indexed for ready reference in answering your layout problems. Covers all phases of sheet metal work including Pattern Cutting, Pattern Development & Shop Procedure.

AUDELS ANSWERS ON BLUE PRINT READING.....\$2

For Mechanics & Builders. Covers all types of blue print reading including ship & airplane. 416 pages, fully illustrated.

AUDELS NEW MACHINIST & TOOLMAKERS HANDY BOOK.....\$4

Covers modern machine shop practice in all its branches. 5 practical books in 1. New from cover to cover. Tells how to set up & operate lathes, screw and milling machines, shapers, drill presses and all other machine tools. 1600 pages, fully illustrated, 5 x 8 1/2 x 2. Indexed. 5 sections. 1—Modern Machine Shop Practice. 2—Blue Print Reading & How to Draw. 3—Calculations & Mathematics for Machinists. 4—Shop Physics. 5—How to Use the Slide Rule. 60 chapters. Easy to read and understand. A shop companion that answers your questions.

AUDELS MATHEMATICS & CALCULATIONS FOR MECHANICS \$2

Mathematics for home study or reference. 700 pages, 550 illus. Practical mathematics from beginning. How to figure correctly. Easy, correct methods covering complete review. Illus. & Indexed.

AUDELS HANDY BOOK OF PRACTICAL ELECTRICITY.....\$4

For maintenance engineers, electricians & all electrical workers. 1440 Pages, 2600 Illus. Covers important electrical information in handy form—including Marine Wiring, Radio Principles, Welding. Indexed. A Key to a practical understanding of electricity.

AUDELS RADIOMANS GUIDE.....\$4

A key to the practical understanding of radio including Frequency Modulation, Television, etc., Aircraft & Marine Radio. For radio engineers, servicemen, amateurs, 914 Pages, 633 Illustrations & Diagrams. Photos. Review Questions & Answers, Reference Index. Authentic, clear, concise.

AUDELS ELECTRONIC DEVICES.....\$2

Tells What You Want to Know About Electric Eye. Easily Understood. Covers photo-electric cells & their applications. Amplifiers, illumination, frequencies, voltage, photocell, tubes, Ohm's Law, wiring diagrams, etc.

AUDELS WELDERS GUIDE.....\$1

A concise, practical text on operation & maintenance of all welding machines for all mechanics. Over 400 pages, illustrated. Covers all methods of electric and acetylene welding including airplane work.

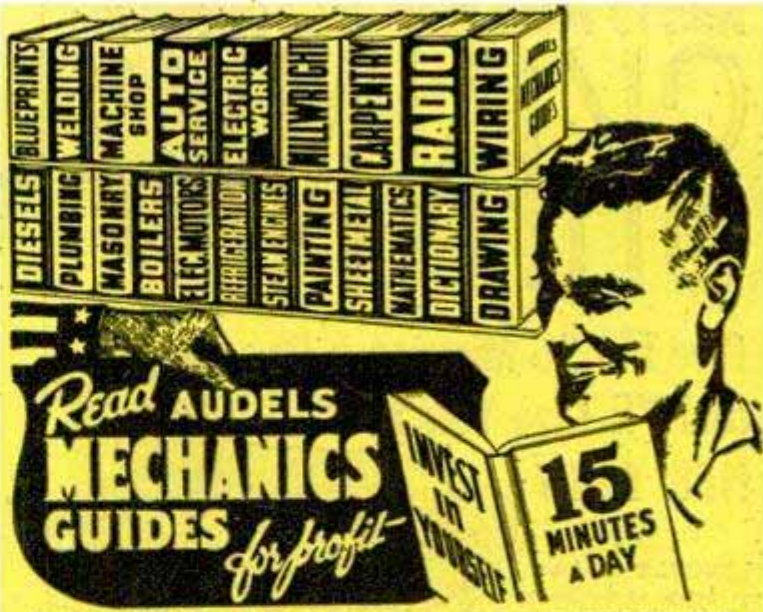

AN AUDEL GUIDE IS A GOOD FRIEND!

Step Up Your Own Skill with the Practical Facts and Figures of Your Trade. Save time and money with right methods, short cuts, labor saving ideas. CHECK NOW! You can look over any Audel Guide in your home. Start the Easy Payments if satisfied.

CUT HERE MAIL ORDER

THEO. AUDEL & CO., 49 W. 23 St., New York 10, N. Y.

Please mail me for 7 days' free examination the books marked (X) below. I agree to mail \$1 in 7 days on each book or set ordered, and to further mail \$1 a month on each book or set ordered until I have paid purchase price.

If I am not satisfied with Guides I will return them.

- Audels ELECTRIC MOTOR GUIDE \$4.
- Audels OIL BURNER GUIDE 1.
- Audels REFRIGERATION & Air Conditioning Guide 4.
- Audels POWER PLANT ENGINEERS GUIDE 4.
- Audels PUMPS, HYDRAULICS & AIR COMPRESSORS 4.
- Audels WELDERS GUIDE 1.
- Audels BLUE PRINT READING 2.
- Audels SHEET METAL WORKERS Handy Book 1.
- Audels SHEET METAL PATTERN LAYOUTS 4.
- Audels AIRCRAFT WORKER 1.
- Audels MATHEMATICS and CALCULATIONS 2.
- Audels MACHINISTS & TOOLMAKERS Handy Book 4.
- Audels MECHANICAL Dictionary 4.
- Audels AUTOMOBILE GUIDE 4.
- Audels DIESEL ENGINE MANUAL 2.
- Audels MARINE ENGINEERS Handy Book 4.
- Audels MECHANICAL DRAWING GUIDE 1.
- Rogers MECHANICAL DRAWING and DESIGN 2.
- Audels MILLWRIGHTS and Mechanics Guide 4.
- Audels CARPENTERS and Builders Guides (4 vols.) 6.
- Audels PLUMBERS and Steamfitters Guides (4 vols.) 6.
- Audels MASONS and Builders Guides (4 vols.) 6.
- Master PAINTER and DECORATOR 2.
- Audels GARDENERS & GROWERS GUIDES (4 vols.) 6.
- Audels ENGINEERS & FIREMANS EXAMINATIONS 1.
- Audels ENGINEERS and Mechanics Guides 12.
- Nos. 1, 2, 3, 4, 5, 6, 7 and 8 complete 12.
- Audels Answers on Practical ENGINEERING 1.
- Audels ELECTRICIANS EXAMINATIONS 1.
- Audels WIRING DIAGRAMS 1.
- Audels Handy Book of PRACTICAL ELECTRICITY 4.
- Audels ELECTRICAL POWER CALCULATIONS 2.
- Audels ELECTRONIC DEVICES 2.
- Audels ELECTRIC Dictionary 2.
- Audels RADIOMANS GUIDE 4.
- Audels NEW ELECTRIC LIBRARY at \$1.50 a Volume 4.

Name _____

Address _____

Occupation _____

Employed by _____

PM

AUDEL, Publishers, 49 W. 23 St., N. Y. 10

And to think they used to call me
SKINNY!

Give Me 15 Minutes a Day
and I'll Give You a
NEW BODY

PEOPLE used to laugh at my skinny 97 lb. body. I was ashamed to strip for sports or for a swim. Girls made fun of me behind my back. THEN I discovered my muscle-building system—"Dynamic Tension." It turned me into such a complete specimen of MANHOOD that today I hold the title "THE WORLD'S MOST PERFECTLY DEVELOPED MAN."

That's how I traded in my "bag of bones" for a barrel of muscle! And I felt so much on top of the world in my big new, husky body that I decided to devote my life to helping other fellows change themselves into "perfectly developed men."

What's My Secret?

When you look in the mirror and see a healthy, husky, strapping fellow smiling back at you—then you'll be astonished at how short a time it takes "Dynamic Tension" to GET RESULTS! "Dynamic Tension" is the easy, NATURAL method and you can practice in the privacy of your own room—JUST 15 MINUTES EACH DAY—while your scrawny shoulder muscles begin to swell . . . those spindly arms and legs of yours bulge . . . and your whole body starts to feel "alive," full of zip and go!

Thousands are becoming marvelous physical specimens—my way. I give you no gadgets or contraptions to fool with. With "Dynamic Tension" you simply utilize the dormant muscle-power in your own body—watch it increase and multiply into real, solid LIVE MUSCLE.

FREE Book

Mail coupon right now for my illustrated book, "Everlasting Health and Strength." Tells all about my "Dynamic Tension" method. Shows actual photos of men I've made into Atlas Champions. It's a valuable book—and it's FREE. Mail coupon to me personally. CHARLES ATLAS, Dept. 8F, 115 East 23rd St., New York 10, N. Y.



CHARLES ATLAS, Dept. 8F
115 East 23rd Street, New York, N. Y.

I want the proof that "Dynamic Tension" will help make a new man of me—give me a healthy, husky body and big muscle development. Send me your free book, "Everlasting Health and Strength."

Name _____ Age _____
(Please print or write plainly)

Address _____

City _____ State _____

WAR SURPLUS
NYLON THREAD



Amazing Strong Thread used to sew Parachutes

GIANT SPOOL
only
\$1.49
BLACK or WHITE
APPROX 4800 FEET

NOW AVAILABLE

Hundreds of Uses . . .

This genuine Du Pont Nylon thread is practically unbreakable. What every hobbyist, sportsman, sailor, camper, wants. Used in model making, sail mending, tent repairing, bow and arrow winding, bamboo rod wrapping, kite flying and repairing, and many other uses. Used by Air Force on parachutes because of its amazing strength and dependability. Here is your chance to get a giant spool of 4800 feet—almost a mile of Nylon thread—at the sensational low war surplus close-out price of only \$1.49. Black or white. Order TODAY.

SEND NO MONEY, TEST AT OUR RISK

Just send your name and address. Specify white or black or two giant spools for only \$2.89. On arrival, deposit only \$1.49 per spool (\$2.89 for two spools) plus C.O.D. postage on our guarantee if you are not delighted, you can return in 10 days and your money back. Cash with order, we pay postage. Only limited amount available. Order Today.

LEEWARD PRODUCTS

Dept. 49-H, 189 W. Madison St., Chicago 2, Ill.

MAKE \$ MORE
MONEY

Applying or Selling

CORKSTONE

A General Purpose Magnesium Oxychloride Flooring

THE MODERN PLASTIC FLOORING

EASY TO APPLY
Here's your opportunity to get into business for yourself applying or selling Corkstone, the economical, top-grade plastic flooring. Plenty of profit Act without delay!



Dealers & Agents Wanted

WRITE FOR DETAILS

LASTING PRODUCTS COMPANY

Franklintown Road Plant,

Baltimore 23, Md.

LEARN RADIO

BY PRACTICING IN SPARE TIME

As part of my Course, I send you the speaker, tubes, chassis, transformer, loop antenna, EVERYTHING you need to build this modern, powerful Radio Receiver! In addition I send you parts to build other real Radio circuits, some of which are pictured below. You use material to get practical Radio experience and make EXTRA money fixing neighbors' Radios in spare time.

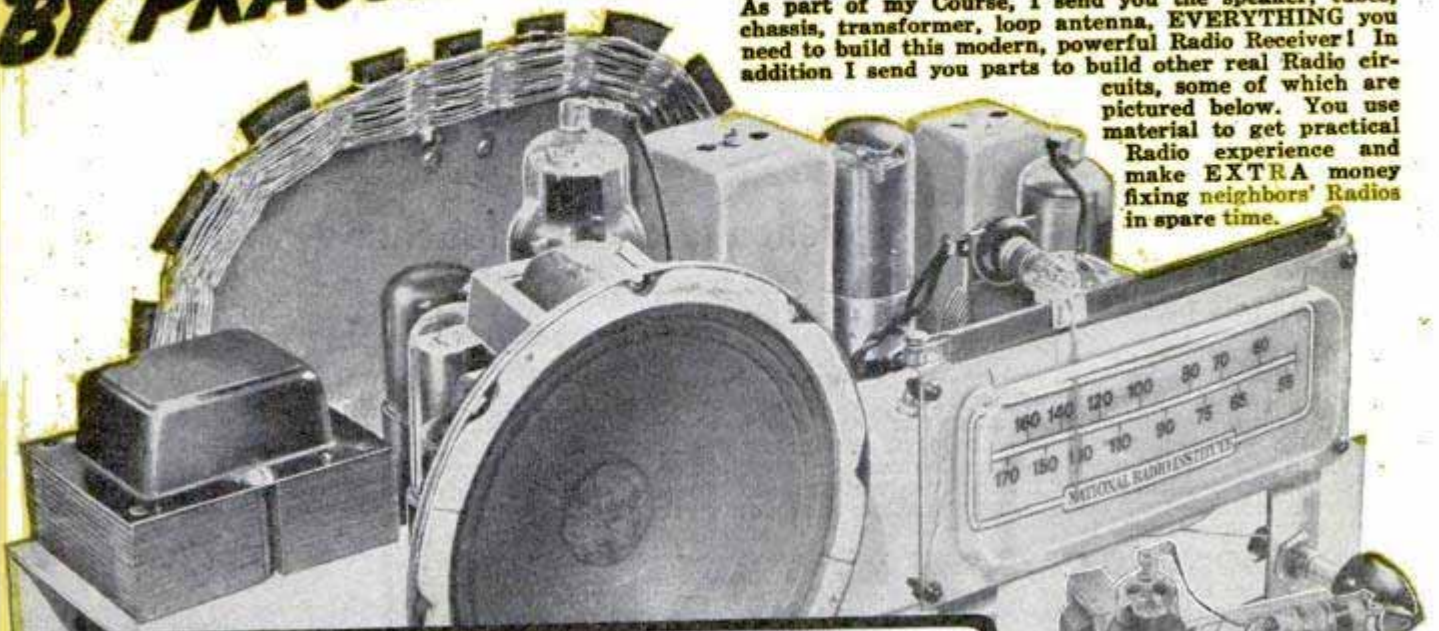

You Build and Experiment With This MODERN RADIO AND MANY OTHER CIRCUITS WITH KITS OF PARTS I SEND YOU



J. E. SMITH, President National Radio Institute

Want a good-pay job in the fast-growing Radio Industry—or your own Radio Shop? Mail coupon for Actual Lesson and 64-page book, "How to Be a Success in Radio-Television-Electronics." Both FREE! See how I train you at home—how you get practical Radio experience building, testing Radio circuits with BIG KITS OF PARTS I send.

booming. Trained Radio Technicians find profitable opportunities in Police, Aviation, Broadcasting, Marine Radio, Public Address work. Think of even greater opportunities as demand for Television, FM, Electronic Devices keeps growing!

SEE What NRI Can Do For You!

Mail Coupon for FREE Lesson and 64-page book. Read details about my Course, letters from men I trained about what they now earn. See how quickly, easily you can get started. No obligation! Mail Coupon in envelope or paste on penny postal. Send NOW!

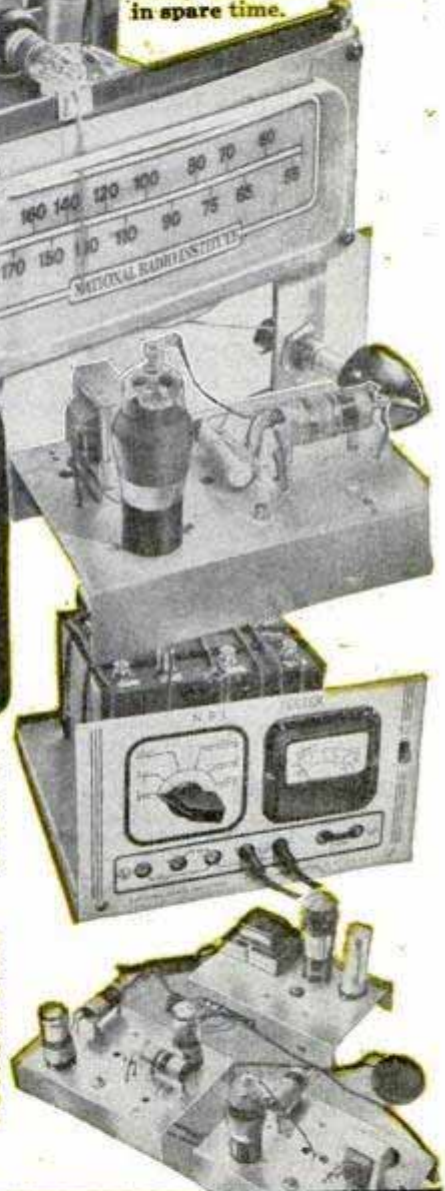

I TRAINED THESE MEN



Appliance Co.—W. A. ANGEL, Blythesville, Arkansas.

"AM NOW GETTING \$60 a week and over-time as Radio Serviceman for Hardaway

Make EXTRA Money While Learning

The day you enroll I send EXTRA money manuals, you how to make EXTRA money fixing neighbors' Radios in spare time. It's probably easier than ever to start now, because Radio Repair Business is



work. I have more than paid for my Course and about \$200 worth of equipment." —RAYMOND HOLT-CAMP, Vandalia, Ill.

"KNEW NOTHING ABOUT RADIO when I enrolled. Now am doing spare time

VETERANS

You can get this training under G. I. Bill. Mail Coupon.



Good for Both—FREE

MR. J. E. SMITH, President, Dept. 8FP NATIONAL RADIO INSTITUTE, Washington 9, D. C. Mail me FREE, Sample Lesson and 64-page book. (No salesman will call. Please write plainly.)

Age _____
 Name _____
 Address _____
 City _____ Zone _____ State _____
 Check if Veteran

My Course Includes Training in TELEVISION • ELECTRONICS FREQUENCY MODULATION



It's YOUR future
Here are 11 ways to make the most of it

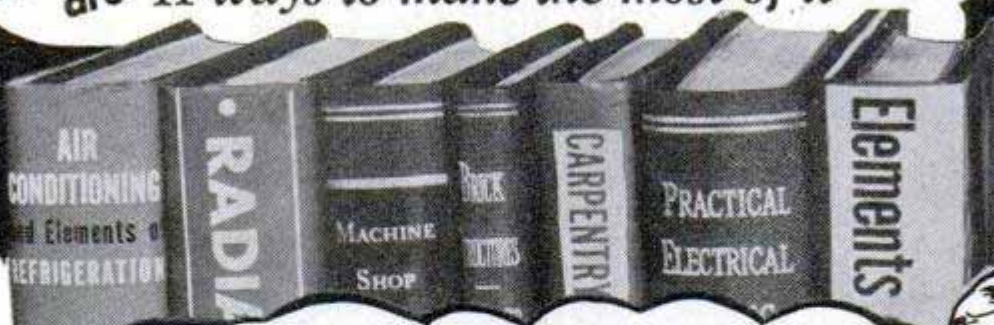

Prepare yourself now for higher pay and job security with these practical handbooks...

Experience is a great teacher —
BUT — you can learn quicker
and cheaper from books



You're up against tough competition... and to beat that competition you've got to know *more about your job than the next fellow*—or lose out. There is no quicker way—no cheaper way—to learn the expert techniques and modern methods in any type of work than by the use of authoritative, up-to-date books. The books listed on this page are the result of years of practical experience and intensive research—they contain information that would take you a lifetime to get by *experience alone*.

SEE ANY BOOK 10 DAYS FREE You risk no money. Just check over the titles and choose the books that fit your needs. Fill out the coupon and send it to us today. After you've inspected your selections for 10 full days, either remit in accordance with the terms outlined or return the books to us without obligation.

Which of these HOME-STUDY LIBRARIES do you want to see for 10-DAY FREE TRIAL

ELECTRICAL MAINTENANCE and REPAIR LIBRARY

5 volumes, 2042 pages, 1721 illustrations

1 This big library gives you the largest collection of electrical repair and maintenance information ever put into book form. Tells how to rewind motors and generators... how to install electrical machinery... how to diagnose and correct trouble. **Easy terms—\$2.50 in 10 days and \$3.00 per month. Full price \$17.50.**

AMERICAN MACHINISTS' LIBRARY

6 volumes, 2368 pages, 2516 illustrations

2 Puts the mastery of machine shop work at your fingertips. Covers every phase of metal cutting, grinding, drilling, forming, finishing, etc. Shows modern methods for setting up work... how to operate every major machine... everything you need to gain the technique and ability that open the way to quick advancement. **Easy terms—\$4.00 after ten-day trial and \$4.00 per month. Full price \$20.00.**

The Library of POWER PLANT PRACTICE

By Terrell Croft

6 volumes, 2477 pages, 2440 illustrations

3 Here is a complete education in power plant practice. Covers everything—selection of equipment, operation of turbines, principles of steam engine design, boilers, etc. Easy to understand—authoritative information—practical answers to your problems. **Only \$3.50 in 10 days and \$3.00 per month. Full price \$18.50.**

The Hool and Kinne
STRUCTURAL ENGINEERS' LIBRARY

6 volumes, 3763 pages, 2719 illustrations

4 This famous set includes the latest engineering practices in excavation, foundations, steel and timber construction, concrete and masonry work, and other phases of building. Contains the sound information of 63 experts. Here is unequalled opportunity to benefit from the experience of top men in the field. **Only \$4.75 in 10 days, and \$5.00 per month. Full price \$29.75.**

McGRAW-HILL BOOK CO., Inc.
330 W. 42d St., New York 18

Send me the books corresponding to the numbers encircled below for 10 days' examination on approval. In 10 days I will either remit payment for the books as outlined in this advertisement, or return the books postpaid.

1 2 3 4 5 6 7 8 9 10 11

Name _____

Address _____

City and State _____

Company _____

Position _____

PM-6-48

Choose the books that meet your needs

- 5. PRACTICAL ELECTRICAL WIRING**, by H. P. Richter. \$3.75
- 6. CARPENTRY FOR THE BUILDING TRADES**, by E. A. Lair. \$2.50
- 7. ELEMENTS OF RADIO SERVICING**, by W. Marcus and A. Levy. \$4.50
- 8. BRICK STRUCTURES—How to Build Them**, by R. Stoddard. \$2.20
- 9. AIR CONDITIONING and Elements of REFRIGERATION**, by S. P. Brown. \$6.00
- 10. RADIANT HEATING**, by R. W. Shoemaker. \$4.00
- 11. MACHINE-SHOP ESTIMATING**, by W. A. Nordhoff. \$6.00

For FREE BOOK CATALOG check here
Fill in your field of interest below



INVENTORS



Learn how to protect your invention. The U. S. Patent Laws provide that any new and useful art, machine, article of manufacture, or composition of matter, or any new and useful improvement thereof, may be patented if the act of invention is involved. Therefore, every inventor with a valuable invention should take advantage of the Patent Laws and proceed for patent protection in order to safeguard his rights.

A patent gives the inventor the exclusive right to prevent others from making, using, or selling the invention claimed in the patent for a period of seventeen years.

The Patent Laws were enacted for the benefit of the inventor to give him protection for the features of his invention which are patentable. These features must be properly and concisely set forth and claimed in a formal application for patent, in order to comply with the requirements of the U. S. Patent Office. For that reason, the Patent Office advises the inventor, unless he is familiar with such matters, to engage a competent registered patent attorney or agent to represent him. We maintain a staff of registered patent attorneys ready to serve you in the handling of your patent matters.

A specially prepared booklet entitled "Patent Guide for the Inventor", containing detailed information with respect to patent protection and procedure, together with a "Record of Invention" form will be promptly forwarded to you without obligation upon request.

**Registered
Patent
Attorneys**

CLARENCE A. O'BRIEN & HARVEY B. JACOBSON
Registered Patent Attorneys
81-F District National Bldg., Washington 5, D. C.

Please send me copy of "Patent Guide for the Inventor" and also "Record of Invention" form. This request does not obligate me.

Name _____

Address _____

City _____ State _____

(Please write or print plainly.)

**CLARENCE A. O'BRIEN
& HARVEY B. JACOBSON**

81-F District National Building + Washington 5, D. C.

I Put You to Work with Your Hands to LEARN RADIO!
 You Build Receivers! You Make Typical Defects Occur
 and Make Tests to Prove the Theory!



F. L. SPRAYBERRY, PRESIDENT OF THE SPRAYBERRY ACADEMY OF RADIO. This is the man who directs your study. His years of experience and Radio "know-how" assure you of the finest in home Radio Training!

YOU GET
8 BIG KITS OF RADIO PARTS & EQUIPMENT
 including
2-BAND SUPER RECEIVER!
 and **16 RANGE METER FOR TESTING**

LEARN RADIO to MAKE MONEY!

LOW COST TRAINING—EASY PAYMENT PLAN!

You Learn at Home How to Build and Test Dozens and Dozens of Circuits—Simple and Complex!

YOU DO
 OVER 175
 INSTRUCTIVE
 EXPERIMENTS



YOU BUILD ALL THESE TESTERS AND MORE!



I give you a fine, moving-coil type Meter Instrument on Jewel Bearings— with parts for a complete Analyzer Circuit Continuity Tester. You learn how to check and correct Receiver defects with professional speed and accuracy.

You'll get valuable experience and practice building this Signal Generator and multi-purpose Tester. Makes a breeze out of fixing Radios and you don't have to spend money on ready-made Equipment.

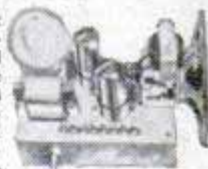

Soldering, wiring, connecting Radio parts . . . building circuits with your own hands—you can't bear this method of learning. When you construct this Rectifier and Filter, Resistor and Condenser Tester, etc., you get a really practical slant on Radio that leads to a money-making future.



Set has Long and Short Wave Tuning. All Sprayberry Equip. is yours for KEEPS.

SPRAYBERRY HOME TRAINING is PLANNED to MAKE MONEY for you FAST!

I train you with regular professional Radio Equipment. I tell you exactly what to do . . . how to do it. You handle Radio Parts, see them operate, learn what they're for. With the fine Kits I supply, you learn how to build Radio Circuits, construct your own Test Equipment. I'll show you how to cause typical Radio defects so you can watch and see how they act. You learn the latest methods for trouble-shooting and repair. All this adds up to

the finest kind of "bench" experience. And you get it right in your own home. In no time at all, you'll be ready for a business of your own or a good job in Radio, FM, Television, Radar, Industrial Electronics, etc. Now's the time to get started!



VETERANS!

Approved for
G. I. Training Under Public Laws 16 and 346

SEND FOR MY VALUABLE FREE BOOKS!

"How To Read Radio Diagrams and Symbols"
 A wonderfully complete new book, which explains in simple English how to read and understand any Radio Set Diagram. Includes translation of all Radio symbols. Send for this volume at once! It's free! With it I'll send you another Big Free Book, describing in detail my Radio Electronic Training!

SPRAYBERRY ACADEMY OF RADIO

F. L. Sprayberry, President
 1068 Sprayberry Building, Pueblo, Colorado

Please rush my FREE copies of "How to MAKE MONEY in RADIO, ELECTRONICS and TELEVISION" and "How to READ RADIO DIAGRAMS and SYMBOLS."

Name _____ Age _____

Address _____

City _____ State _____

Check here if a veteran.

(Mail in envelope or paste on penny postcard)

INVENTORS

patent laws encourage the development of inventions

The Rules of Practice of the U. S. Patent Office advise—unless an inventor is familiar with such matters—that he employ a competent registered attorney or registered agent, as the value of patents depends largely upon the skillful preparation of the specifications and claims.

The firm of McMorrow, Berman and Davidson is registered to practice before the U. S. Patent Office. Additionally, it maintains a staff of attorneys able to readily understand inventors' disclosures, to advise concerning patentability, and to prepare appropriate specifications and claims for filing with the Patent Office.

If an inventor believes he has an invention, a search of the most pertinent prior U. S. patents should be made and a report obtained relative to its patentability. Where such report indicates that the invention appears patentable, in order to secure protection, diligence should be exercised in making application for a patent.

McMORROW, BERMAN & DAVIDSON

Registered Patent Attorneys

PATENTS • TRADE MARKS • COPYRIGHTS

135-K VICTOR BUILDING, WASHINGTON 1, D. C.

McMORROW, BERMAN & DAVIDSON

Registered Patent Attorneys

135-K Victor Building, Washington 1, D. C.

Send me further particulars as to patent protection and procedure and "Invention Record" form at once. I understand that this request does not obligate me.

Name _____

Address _____

City _____ State _____

(WRITE OR PRINT NAME CLEARLY)



AIRPLANE and ENGINE MECHANICS

COMPLETE PILOT TRAINING

SEND COUPON FOR BOOKLET IN COLOR

EMBRY-RIDDLE OFFERS:

- MODERN hangers, classrooms, shops and airplanes
- EXPERIENCE gained over a quarter of a century of aviation training
- LIVING Facilities on the airport
- GLAMOROUS MIAMI -- where aviation training keeps pace with aviation.

Embry-Riddle graduates get good jobs!
DON'T DELAY -- WRITE TODAY!

Dean of Enrollments -- Dept. 69
Embry-Riddle School of Aviation
MIAMI 30, FLORIDA
Please Print

NAME _____

ADDRESS _____

City _____

State _____ Age _____

Veteran Non-Veteran } Check One

TECHNICAL COURSES

- Airplane and Engine Mechanics (A&E).....[]
- Design Engineering & Maintenance.....[]
- Aeronautical Drafting & Design.....[]
- Radio & Electronics.....[]

COMBINATION COURSES

- Flying Mechanic.....[]
- A&E with Commercial.....[]

FLIGHT COURSES

- Private Pilot.....[]
- Commercial Pilot.....[]
- Flight Instructor.....[]
- Instrument Rating.....[]
- Multi-Engine Rating.....[]



TRAIN IN MIAMI -- AIR CAPITAL OF THE WORLD

Invitation to success

HUNDREDS of readers will answer this invitation. For the most part, they will be men of average intelligence, average means. Yet here is a prediction*:

Within ten years, a number of these men will have advanced to important, high-salaried positions in business and industry.

Why? Because they are ambitious. Because they realize that advancements go only to trained men. Because they know that I. C. S. can help them obtain the practical, authoritative training required for success.

Here is the coupon being mailed by these leaders of tomorrow. And this is your chance to be one of them.

*Based on the records of 5,000,000 I.C.S. students



INTERNATIONAL CORRESPONDENCE SCHOOLS



BOX 5630-K, SCRANTON 9, PENNA.

Without cost or obligation, please send me full particulars about the course BEFORE which I have marked X:

- | | | | |
|--|---|--|--|
| <p>Air Conditioning and Plumbing Courses</p> <input type="checkbox"/> Air Conditioning
<input type="checkbox"/> Heating
<input type="checkbox"/> Refrigeration
<input type="checkbox"/> Plumbing
<input type="checkbox"/> Steam Fitting <p>Chemistry Courses</p> <input type="checkbox"/> Chemical Engineering
<input type="checkbox"/> Chemistry, Analytical
<input type="checkbox"/> Chemistry, Industrial
<input type="checkbox"/> Chemistry, Mfg. Iron & Steel
<input type="checkbox"/> Petroleum Refining
<input type="checkbox"/> Plastics
<input type="checkbox"/> Pulp and Paper Making <p>Civil Engineering, Architectural and Mining Courses</p> <input type="checkbox"/> Architecture
<input type="checkbox"/> Architectural Drafting
<input type="checkbox"/> Bridge and Building Foreman
<input type="checkbox"/> Building Estimating
<input type="checkbox"/> Civil Engineering
<input type="checkbox"/> Coal Mining
<input type="checkbox"/> Contracting and Building
<input type="checkbox"/> Highway Engineering
<input type="checkbox"/> Lumber Dealer
<input type="checkbox"/> Reading Structural Blueprints
<input type="checkbox"/> Sanitary Engineering
<input type="checkbox"/> Structural Drafting | <p><input type="checkbox"/> Structural Engineering
 <input type="checkbox"/> Surveying and Mapping</p> <p>Communications Courses</p> <input type="checkbox"/> Electronics
<input type="checkbox"/> Practical Telephony
<input type="checkbox"/> Radio, General
<input type="checkbox"/> Radio Operating
<input type="checkbox"/> Radio Servicing
<input type="checkbox"/> Telegraph Engineering <p>Electrical Courses</p> <input type="checkbox"/> Electrical Drafting
<input type="checkbox"/> Electrical Engineering
<input type="checkbox"/> Electric Light and Power
<input type="checkbox"/> Lighting Technician
<input type="checkbox"/> Practical Electrician <p>Internal Combustion Engines Courses</p> <input type="checkbox"/> Auto Technician
<input type="checkbox"/> Diesel-Electric
<input type="checkbox"/> Diesel Engines
<input type="checkbox"/> Gas Engines
<input type="checkbox"/> Aviation
<input type="checkbox"/> Gas Engines <p>Mechanical Courses</p> <input type="checkbox"/> Aeronautical Engineer's, Jr.
<input type="checkbox"/> Aircraft Drafting
<input type="checkbox"/> Flight Engineer
<input type="checkbox"/> Forging
<input type="checkbox"/> Foundry Work
<input type="checkbox"/> Heat Treatment of Metals | <p><input type="checkbox"/> Industrial Engineering
 <input type="checkbox"/> Industrial Metallurgy
 <input type="checkbox"/> Machine Shop
 <input type="checkbox"/> Mechanical Drafting
 <input type="checkbox"/> Mechanical Engineering
 <input type="checkbox"/> Mold-Loft Work
 <input type="checkbox"/> Patternmaking—Wood, Metal
 <input type="checkbox"/> Reading Shop Blueprints
 <input type="checkbox"/> Sheet-Metal Drafting
 <input type="checkbox"/> Sheet-Metal Worker
 <input type="checkbox"/> Ship Drafting
 <input type="checkbox"/> Ship Fitting
 <input type="checkbox"/> Ship Fitting
 <input type="checkbox"/> Tool Designing
 <input type="checkbox"/> Toolmaking
 <input type="checkbox"/> Welding—Gas and Electric</p> <p>Railroad Courses</p> <input type="checkbox"/> Air Brake
<input type="checkbox"/> Car Inspector
<input type="checkbox"/> Diesel Locomotive
<input type="checkbox"/> Locomotive Engineer
<input type="checkbox"/> Locomotive Fireman
<input type="checkbox"/> Railroad Section Foreman <p>Steam Engineering Courses</p> <input type="checkbox"/> Boilermaking
<input type="checkbox"/> Combustion Engineering
<input type="checkbox"/> Engine Running
<input type="checkbox"/> Marine Engineering
<input type="checkbox"/> Steam Electric
<input type="checkbox"/> Steam Engines | <p>Textile Courses</p> <input type="checkbox"/> Cotton Manufacturing
<input type="checkbox"/> Rayon Weaving
<input type="checkbox"/> Textile Designing
<input type="checkbox"/> Woolen Manufacturing <p>Business and Academic Courses</p> <input type="checkbox"/> Accounting
<input type="checkbox"/> Advertising
<input type="checkbox"/> Arithmetic
<input type="checkbox"/> Bookkeeping
<input type="checkbox"/> Business Administration
<input type="checkbox"/> Business Correspondence
<input type="checkbox"/> Certified Public Accounting
<input type="checkbox"/> Commercial
<input type="checkbox"/> Commercial Art
<input type="checkbox"/> Cost Accounting
<input type="checkbox"/> Federal Tax
<input type="checkbox"/> First Year College
<input type="checkbox"/> Foremanship
<input type="checkbox"/> French
<input type="checkbox"/> Good English
<input type="checkbox"/> High School
<input type="checkbox"/> Higher Mathematics
<input type="checkbox"/> Motor Traffic
<input type="checkbox"/> Postal Service
<input type="checkbox"/> Secretarial
<input type="checkbox"/> Sign Lettering
<input type="checkbox"/> Spanish
<input type="checkbox"/> Stenography
<input type="checkbox"/> Traffic Management |
|--|---|--|--|

Name _____ Home Address _____
 City _____ State _____
 Age _____ Present Position _____ Working Hours _____ A.M. to _____ P.M.

Special tuition rates to members of the Armed Forces. Special discount to World War II Veterans.
 Canadian residents send coupon to International Correspondence Schools Canadian, Ltd., Montreal, Canada.

PATENT PROTECTION *for* INVENTORS

A PATENT IS A VALUABLE RIGHT

On the basis of a provision in the Constitution of the United States, Congress has established a system under which inventors may secure the exclusive right to prevent the unauthorized use, manufacture and sale of their inventions for periods of seventeen years. The inventor secures this protection by obtaining a patent from the United States Patent Office.

Victor J. Evans & Co. . . . has a staff of experienced registered patent attorneys, available to assist inventors in the preparation and prosecution of their cases before the Patent Office. Detailed information and the steps to be taken in obtaining patent protection will be furnished upon request.

FORM BELOW FOR MAILING CONVENIENCE

VICTOR J.
EVANS & Co.

Merlin M. Evans
REGISTERED PATENT ATTORNEY
330-F Merlin Building, Washington 6, D. C.

Please forward to me detailed information regarding procedure to obtain Patent Protection, together with your convenient "Evidence of Invention" form.

Name _____

Address _____

City and State _____

PATENTS . . . TRADEMARKS . . . COPYRIGHTS

These Men are Learning

ELECTRICITY

ON REAL EQUIPMENT

in the GREAT SHOPS of COYNE



**Why Spend Years Preparing for a Good Job?
Train Quickly at COYNE—Be Making Real
Money While Others are Still Puttering Along!**



B. W. COOKE

Yes, you can get ready for Good Pay—a Big Future in ELECTRICITY—by coming to COYNE in Chicago to train on actual equipment! Here you work on real motors, armatures, switchboards—do actual wiring and trouble-shooting—get the "all-around" training you need.

Not a "Home-Study" Course

We do not teach by mail. All training is given in our Great Shops, plus necessary theory. Expert instructors guide you. No advanced education or previous experience needed.

EARN WHILE LEARNING

If you need part-time work to help out with living expenses while at Coyne, we'll help you get it. Don't be held back by lack of money.

COYNE B. W. COOKE, Pres.
ELECTRICAL AND RADIO SCHOOL

500 S. Paulina St., Dept. A8-72, Chicago 12

This modern fireproof building is occupied entirely by COYNE. Located in Chicago, the Electrical Center of the World.

FOUNDED 1899



Electrical Refrigeration Included

Added training now included in great new field of Electric Refrigeration—Industrial Electronics also included. Both mean added opportunities.

GI Approved—Finance Plan for Non-Vets

COYNE is authorized to train men under the G.I. Bill. Non-veterans may enroll now, pay most of tuition after graduation. Whatever your problem, COYNE can help you! Mail the coupon now.

GET THE FACTS!

BIG FREE BOOK tells all about your future in Electricity and how you can get ready quickly at COYNE. Dozens of pictures. Rush coupon today!

**PREPARE FOR PERMANENT
JOBS LIKE THESE**

- Light and Power Wiring
 - Power Plant Work
 - Armature Winding
 - Substation Operator
 - Maintenance Electrician
 - Electrical Testing
 - Signal Maintenance
 - Industrial Electronics
 - Electric Refrigeration
 - and many others
- Our Employment Bureau for graduates gives FREE Lifetime Job Service.

**FREE
BOOK**



B. W. COOKE, Pres.
COYNE ELECTRICAL
AND RADIO SCHOOL, Dept. A8-72
500 S. Paulina St., Chicago, 12, Ill.

Send me your big FREE BOOK on ELECTRICITY and tell all about your training offer. This does not obligate me in any way and no salesman will call on me.

NAME.....
ADDRESS.....
CITY.....STATE.....



AVIATION Career

MAXIMUM TRAINING IN MINIMUM TIME

CAL-AERO TECH TRAINING will add dollars to your pay check all the rest of your life. Specializing in AERONAUTICAL ENGINEERING and MASTER AVIATION MECHANICS since 1929, Cal-Aero Tech training is carefully designed for just one thing—TO MAKE MORE MONEY FOR YOU. An alumni of over 6000 successful graduates proves our career training is unsurpassed.

VETERANS —Write us about Aviation Training, as provided under "G.I. Bill of Rights."



CAL-AERO TECHNICAL INSTITUTE
 MAJOR C. C. MOSELEY PRES. SINCE 1929
 FORMERLY CURTISS-WRIGHT TECHNICAL INSTITUTE
 GRAND CENTRAL AIR TERMINAL
 GLENDALE 1, CALIFORNIA
 LOS ANGELES COUNTY

MAIL THIS COUPON TODAY!

Cal-Aero Technical Institute, Grand Central Airport, Glendale 1, California
 Please send full information on Aviation Training FREE—without obligation. Dept. PM-6

Name _____ Birth Date _____
 Street _____
 City _____ State _____

AUDELS' Carpenters and Builders Guides 4 vols. \$6

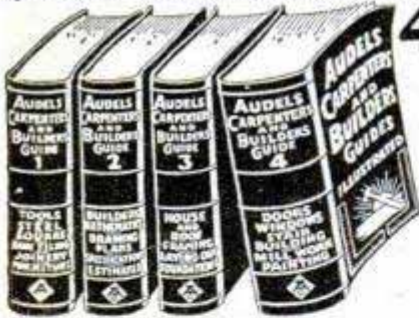

Inside Trade Information for Carpenters, Builders, Joiners, Building Mechanics and all Woodworkers. These Guides give you the short-cut instructions that you want—including new methods, ideas, solutions, plans, systems and money saving suggestions. An easy progressive course for the apprentice and student. A practical daily helper and Quick Reference for the master worker. Carpenters everywhere are using these Guides as a Helping Hand to Easier Work, Better Work and Better Pay. To get this assistance for yourself, simply fill in and mail the FREE COUPON below.

Inside Trade Information On:

How to use the steel square—How to file and set saws—How to build furniture—How to use a mitre box—How to use the chalk line—How to use rules and scales—How to make joints—Carpenters arithmetic—Solving mensuration problems—Estimating strength of timbers—How to set girders and sills—How to frame houses and roofs—How to estimate costs—How to build houses, barns, garages, bungalows, etc.—How to read and draw plans—Drawing up specifications—How to excavate—How to use settings 12, 13 and 17 on the steel square—How to build hoists and scaffolds—skylights—How to build stairs—How to put on interior trim—How to hang doors—How to lay floors—How to paint



AUDEL, Publishers, 49 W. 23rd St., New York 10, N. Y.
 Mail Audels Carpenters and Builders Guides, 4 vols., on 7 days free trial. If OK I will remit \$1 in 7 days and \$1 monthly until \$6 is paid. Otherwise I will return them. No obligation unless I am satisfied.

Name _____
 Address _____
 Occupation _____
 Employed by _____ PM



LEARN PHOTOGRAPHY
in the Professional manner!

Approved for Veterans

GET FREE CATALOG M

Prepare NOW for a profitable career. Basic and Advanced Courses in Portrait, Commercial and Color work. Well-established, nationally-known school. Day or evening classes. Immediate enrollment if you hurry! Write today for details.

BALTIMORE INSTITUTE OF PHOTOGRAPHY

N. Charles at 24th St., Baltimore 18, Md.

ANALYZE Handwriting

Uncrowded, fascinating field. Gratifying earnings reported by graduates in Employment, Credit, Social Service, Police and Entertainment fields. Others have developed profitable private practice, full or spare time, as Personal Problem and Vocational Counselors. Send for 3000 word TEST LESSON and Grapho Analyst FREE.



A.I.G.A. Inc.

Wilhoit Bldg., Dept. 120 Springfield, Mo.

DO YOU LOVE HORSES?

• ARE YOU INTERESTED IN HORSE TRAINING AND MANAGEMENT?

SUBSCRIBE FOR The "EXPERT HORSEMAN"

2 YEARS \$7.00



FREE BOOK—You will also receive a booklet that tells how you can learn to break colts, gait show horses, train rodeo, stock, and race horses, break bad habits, handle any horse and train circus trick horses.

SEND \$1.00 TODAY

ANIMAL LOVERS ASSOCIATION
 Box No. KA111, TARZANA, CALIFORNIA

The American Institute of Specialized Watch Repair
 270-276 East Building GRAND RAPIDS 6, MICHIGAN
 A Fully Accredited School

Write for Free Circular

You can learn this highly fascinating and profitable trade through this Institute, either at home by correspondence... or at the resident school. Earn While You Learn



Learn WATCH REPAIRING

LEARN TO WRITE

a Good Hand!

FOR BUSINESS AND SOCIAL SUCCESS!

Easy to improve your handwriting at home quickly with my new instruction books just off the press. Master all the secrets of better penmanship. Simple and easy, fully illustrated, highly endorsed. Begin today. Write for: New Free Book, "How to Become a Good Penman," or check books wanted, \$1.00 each. Business Writing Artistic Writing Card Writing Engraving Alphabets Bird and Design Flourishing Complete Set \$4.50 Enclose 10¢ for your name beautifully written and special penpoint for started writing. S. A. Ziller, President, TAMBLYN SCHOOL OF PENMANSHIP, 441 Ridge Bldg. In Business Over 52 Years Kansas City, Mo., U.S.A.

PULVEX FLEA POWDER

TWO KINDS

WITH 5% DDT
 ... for dogs. Kills fleas and lice quick. Keeps fleas off 5-7 days. Many home uses.

OR WITH ROTENONE
 ... for cats, dogs. Quickly kills fleas, lice. Kills fleas when put on a single spot. Pre-war formula.

EITHER KIND: 25¢ & 50¢



REPLACEMENT OR REFUND OF MONEY
 Guaranteed by Good Housekeeping
 IF NOT AS ADVERTISED THEREIN

WHICH OF THESE *Opportunities* INTERESTS *You* MOST?

Accounting
Air Conditioning
Architecture & Building
Automotive Engineering
Aviation—Practical
Aviation Drafting & Design
Better Foremanship
Bookkeeping
Business Management

Contracting
Diesel Engineering
Drafting & Design
Electrical Engineering
Electricity—Practical
Electronics, Industrial
High School Courses
Machine Shop Operations
Mechanical Engineering

Plastics Engineering
Plumbing—Practical
Private Secretary
Radio Operating & Servicing
Railway Training
Refrigeration
Sheet Metal Pattern Drafting
Shop Management
Tool Making

THINK! LOOK FORWARD!

Business is making big, new plans

Men and Women are preparing for the future

WHAT ARE YOU DOING ABOUT YOUR TOMORROWS?

● *Today*, choose the job you want—and prepare for it. Or if you are already engaged in the work you like best, start training *now* for quicker promotion. Acquire the knowledge that will help you to get ahead faster, make more money and have greater security.

Invest part of your spare time in more rapid progress. Start training now, in spare time in your own home. Be ready to grasp your opportunity and step out ahead of those who lack the ability you have attained.

American School, founded in 1897 as an educational institution *not for profit*, can help you to reach your goal just as it has helped others during the past fifty-one years. Give serious thought to the list above. Pick one or more subjects that interest you. Then check the coupon at right, add your name and address and mail it at once. The school will send you details on its training plan and outline of study prepared by specialists. There is no charge, no obligation, so send the coupon immediately.

PRACTICAL, EFFECTIVE HOME - STUDY TRAINING SINCE 1897

Take This First Easy Step

CHECK, CLIP AND MAIL COUPON NOW

AMERICAN SCHOOL, Dept. GA45, Drexel at 58th, Chicago 37, Ill.
Without obligation, Please send FREE and postpaid, bulletin and details of the Subject checked.

- | | | |
|--|--|--|
| <input type="checkbox"/> PLASTICS ENG'R | <input type="checkbox"/> Accounting | <input type="checkbox"/> Drafting and Design for Men and Women |
| <input type="checkbox"/> Refrigeration | <input type="checkbox"/> Electrical Engr. | <input type="checkbox"/> Radio |
| <input type="checkbox"/> Architecture and Building | <input type="checkbox"/> Electricity-Pract. | <input type="checkbox"/> High School |
| <input type="checkbox"/> Contracting | <input type="checkbox"/> Electronics, Industr. | <input type="checkbox"/> Air Conditioning |
| <input type="checkbox"/> Practical Plumbing | <input type="checkbox"/> Bookkeeping | <input type="checkbox"/> Mechanical Eng. |
| <input type="checkbox"/> Automotive Engineering | <input type="checkbox"/> Private Secretary | <input type="checkbox"/> Shop Management |
| <input type="checkbox"/> Aviation Drafting | <input type="checkbox"/> Diesel Engineering | <input type="checkbox"/> Tool Making |
| <input type="checkbox"/> Aviation | <input type="checkbox"/> Sheet Metal | <input type="checkbox"/> Better Foremanship |
| <input type="checkbox"/> Business Mgmt | <input type="checkbox"/> Pattern Drafting | <input type="checkbox"/> Machine Shop Operations |
| <input type="checkbox"/> Railway Training | | |

Name..... Occupation.....

Address..... Age.....

City..... State.....

AMERICAN SCHOOL

Dept. GA45, Drexel at 58th Street, Chicago 37

HOW TO Fight! Wrestle! Jiu-Jitsu!

FREE!



Plus Weight Lifting! Strong Man Stunts!

Be prepared to protect your family, friends, yourself in any emergency! Be admired! George F. Jowett, Champion of Champions, gives you free his "SMASHING CHAMPION SECRETS." Contains many "HOW-TO-DO-IT" pictures that quickly and simply show you how to powerfully deliver a knockout, how to break any hold, how to overpower any opponent plus weight lifting and strong man stunts! Inside professional "Tricks of the Trade" proved successful by police, armed forces, fighters, wrestlers, etc. Free for a limited time with this sensational offer!

You Need He-Man Fitness to Handle Any Tough Situation!

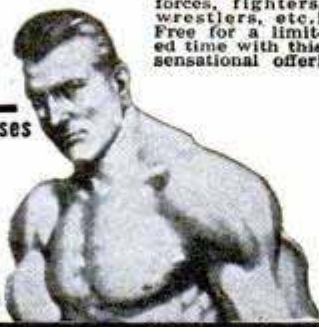

NOW! All 5 Famous Jowett Courses

IN 1 COMPLETE MUSCLE BUILDING VOLUME! **FOR ONLY 25c**

Let Me Prove I Can Make You—

COMMANDO-TOUGH OR IT WON'T COST YOU A CENT!

says: *George F. Jowett* WORLD'S GREATEST BODY BUILDER

Give Me 10 Minutes a Day Learn My Time Tested Secrets of Strength

I'll teach you the "Progressive Power Method" that rebuilt me from a physical wreck condemned to die at 15, to the holder of more strength records than any other living athlete or teacher! Has proven it builds the strongest, hardiest men in the world. Let me prove on a money back basis—that no matter how flabby or puny you are I can add inches to your arms, broaden your shoulders, give you a man-sized chest, powerful legs and a rock-like back—in fact power pack your whole body so quickly it will amaze you—right in your own home! I'll bring to life new power in you inside and out, until YOU are satisfied you are the man you want to be.

PROVE IT TO YOURSELF IN ONE NIGHT

Send only 25c for my 5 easy-to-follow, picture-packed courses now in 1 complete volume, "How to Become a Muscular He-Man." Try it for one night! Experience the thrilling strength that surges through your muscles.

TO DAY TRIAL!

Think of it—all five of these famous courses now in one picture-packed volume for only 25c. If you're not delighted with this famous muscle-building guide—if you don't actually FEEL results within ONE WEEK, send it back and your money will be promptly refunded!

Photo Book of Famous Strong Men!

FREE!

Photos that inspire you to might and muscle. Free with order.

I am making a drive for thousands of new friends fast—REGARDLESS OF COST!

SO GET NOW MY 5 Muscle Building COURSES
(Valued at \$5 each)

All in 1 Great Complete Volume Packed With How-To-Do-It Pictures!

Now, this "get-acquainted," extremely low price of only 25c is your chance to build a body you'll be proud of! Follow Jowett's easy method of muscle building NOW!

For Only 25c

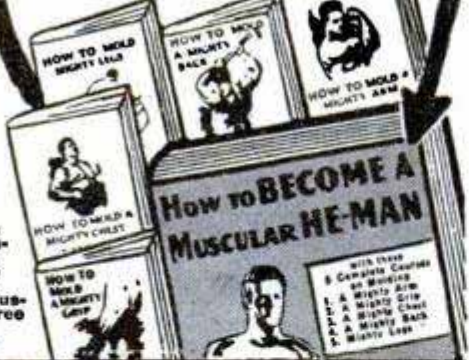

2 FREE GIFTS!

Jowett Institute of Physical Culture
230 Fifth Avenue, New York 1, N. Y. Dept. PM-86

George F. Jowett: Please send by return mail, post-paid, FREE "Smashing Champion Secrets" and FREE Jowett's Photo Book of Strong Men, along with all 5 Muscle Building Courses, 1. Molding a Mighty Chest. 2. Molding a Mighty Arm. 3. Molding a Mighty Grip. 4. Molding a Mighty Back. 5. Molding Mighty Legs—Now all in One Volume "How to Become a Muscular He-Man." Enclosed find 25c. NO C.O.D.'s.

NAME _____ AGE _____
(Please Print Plainly, Include Zone Number)
ADDRESS _____

Let's Make A LOT OF Things

CRAFTS FOR HOME CAMP AND SCHOOL

Written and illustrated by **HARRY ZARCHY**. An experienced crafts teacher gives clearly illustrated, step-by-step instructions for working in METAL, CLAY and LEATHER—how to make BILLFOLDS, ASH TRAYS, JEWELRY, LAMPS and many other things. \$2.50 at your bookshop, or from **ALFRED A. KNOPF, 501 Madison Avenue, N. Y. 22.**

LEARN WATCH REPAIRING



AT HOME. By our modern and original system of instruction you can learn every part of the **WATCH REPAIRING TRADE AT HOME.** Prepare yourself for a well-paying position or start in business after completing our course of instruction. Good watch repairers are in demand and generally earn very good salaries. For particulars apply to the Wisconsin School of Watch Repairing 759 North Milwaukee St., Milwaukee 2, Wis.

WANTED DISTRICT PURCHASING AGENTS

No experience or money required. Exceptional opportunity for those who want to establish themselves in a steady, year 'round, well paying business.

For details: Write

PURCHASING MANAGER, DEPT. C
2719 LAWRENCE AVE. CHICAGO 25, ILL.

MONEY for MEN ALL FREE!

THE PLASTEX Industry needs manufacturers on small scale and for big production of Lamp and Clock Stands, Art Goods and Novelties in Plastex and Marble imitation. Experience unnecessary, 1/2c material makes regular 10c store sellers. Rubber molds furnished for speed production. Small investment brings good returns. Big chain store orders now being placed. Ambitious men have chance for real prosperity. Our Free booklet will interest and benefit you.

PLASTEX INDUSTRIES, Dept. A
3400 Third Ave. New York 56, N. Y.

The HAMSTER MANUAL



By Albert F. Marsh

READ THE HAMSTER MANUAL

The most complete guide book on the successful breeding and raising of Syrian Golden Hams. Tells all about this new, last growing, profitable and interesting hobby industry. Reveals all the secrets of the largest breeder of these delightfully profitable pets and laboratory animals. 34 Chapters

chuck-full of information gleaned from actual experience as a breeder. Twenty Pages of illustrations. A few subjects are: history, housing, three methods of breeding, easy to get feeds, sexing, fertility vitamins, handling, educational, scientific projects, crating, profits and selling, where to buy and how to sell hamsters. Sent postpaid for \$1.00.

Albert F. Marsh, 1522 Basil St., Mobile, Alabama

Say You Saw It in Popular Mechanics

E. B. De Vry, President
DeForest's Training, Inc.



HERE'S YOUR
Big Chance

Profit Through Training in **RADIO-ELECTRONICS**

Prepare at HOME or in our CHICAGO LABORATORY to get REAL MONEY, a BETTER JOB, or a BUSINESS OF YOUR OWN

Our business is helping men . . . and young men . . . get into a well-paying future in the highly profitable fields of RADIO-ELECTRONICS. During the past sixteen years we have trained many men who desired better jobs or businesses of their own. We can effectively provide you with this same opportunity either in our new, modern Chicago laboratories or in the privacy of your own home.

TAKE YOUR CHOICE

If you choose to come to Chicago, we shall find comfortable living quarters for you. If you train at home, we shall send you modern, practical equipment. In either of these two methods, you will have the supervision of some of the finest instructors in the country. Fill in coupon below and we shall send you, absolutely FREE, full information about our program of building men for better opportunities in RADIO-ELECTRONICS. DeForest's Training, Inc. also includes instruction in FM Radio, Television and Industrial Electronics.

If you prefer to remain at home, you receive eight (8) big kits of radio parts and assemblies from which you can work out dozens of fascinating radio circuits to gain practical experience in your own home. In addition, you receive a 16 mm. motion picture projector and 12 information-packed reels of film which help you learn faster . . . easier. You also get modern looseleaf lessons with handy fold-out diagrams.

EMPLOYMENT SERVICE

When you complete your training our effective Employment Service helps you get started toward a real future. Mail coupon below today . . . do not delay

VETERANS

Both our (1) Chicago Laboratory and (2) Home Study training are accepted under the "G. I. Law." If you qualify, the Government will pay cost of either training you select.

MAIL THIS OPPORTUNITY COUPON NOW!

Mr. E. B. De Vry, President
DeForest's Training, Inc.
2533 N. Ashland Ave., Dept. PM-EG
Chicago 14, Illinois

Please show me how I may get started toward a good job or a business of my own in Radio-Electronics.

Name.....Age.....

Address.....Apt.....

City.....Zone.....State.....

If under 16, check here
for special information.

If a discharged Veteran of World War II
check here.

DeForest's Training, Inc.

CHICAGO,
ILLINOIS

Associated with the DeVRY Corporation
Builders of Movie & Electronic Equipment

MASONS



& BUILDERS GUIDES

Inside Trade Information for Bricklayers, Cement Workers, Plasterers, Tile & Stone Setters.

Covering:—
BRICK LAYING
tools, materials, bonding mortars,

designs, setting Frames, Foundations, Arches, Chimneys and Repairing old brick work. **GLASS BRICK** and **TILE SETTING**, hollow tile, walls, roofing. Placing re-inforced work, stucco, water-proofing, Plastering in all its branches, wall board. Stone Masonry, Mosaic and Steel Construction. **INCLUDING CONCRETE MIXING—CONCRETE BLOCK CONSTRUCTION**

1100 Pages, 2067 illustrations, Handy Size. HIGHLY ENDORSED. ASK TO SEE THEM! TO GET THIS ASSISTANCE FOR YOURSELF FILL IN AND

MAIL ORDER

AUDEL, Publishers, 49 W. 23rd St., New York 10, N. Y. Mail Audel's Masons and Builders Guides, 4 vols. on 7 days' free trial. If O.K. I will remit \$1 in 7 days and \$1 monthly until \$6 is paid. Otherwise I will return them. No obligation unless I am satisfied.

Name _____
Address _____
Occupation _____
Employed by _____ PM

Learn this Profitable Profession

IN 90 DAYS AT HOME

Money-Making Career Open to Men and Women, 18 to 50

Hundreds of men and women between 18 and 50 make \$10 to \$20 in a single day giving scientific Swedish Massage and Hydro-Therapy treatments. There is big demand from doctors, hospitals, sanatoriums and clubs. Graduates earn large full time incomes from these or in private practice in their own offices. Others make good money from home treatments given in spare time. Learn this in-making profession in your own home, through our home study course. Same instructors as in our nationally known resident school. You can win independence and prepare for future security by qualifying for your Diploma. Course can be completed in 3 to 4 months. Many earn while they learn. Begin your training at once.



Anatomy Charts & Booklet FREE

Enroll now and we will include, at no extra cost, many needed supplies. Fit yourself to help meet growing demand for Scientific Swedish Massage. Send the coupon at once for complete details. Anatomy Charts and 32-Page Illustrated Booklet, FREE, postpaid.

THE COLLEGE OF SWEDISH MASSAGE
Dept. 864-G, 100 East Ohio St., Chicago 11, Illinois

Please send me FREE and postpaid, Anatomy Charts, 32-page Booklet and complete details on Home Training.

Name _____
Address _____
City _____ State _____

PRINT YOUR OWN POST CARDS

COMPLETE OUTFIT
only
\$7.50



Amazing results in sales, inquiries and contacts... saves time and money... very easy to use **GEM STENCIL DUPLICATOR** is ideal for Advertising, Announcements, Notices, Labels, Forms, Price Lists—hundreds of uses for every type of business and organization. Comes complete with all supplies, instructions and 60-page Book of Ideas.

FREE TRIAL OFFER: Try it before you buy it! Write and a GEM OUTFIT will be sent you postpaid. After 10 days, send only \$7.50 or return the GEM, no questions asked. The GEM must sell itself; you be the judge.

BOND EQUIPMENT CO. • Dept. 135
513 Olive St. • St. Louis 1, Mo.

SEND NO MONEY • FREE TRIAL OFFER

MAKE JEWELRY AND NOVELTIES AT HOME!

Work right on your kitchen table! No tools or experience needed. Learn-earn within a week. Complete home instruction course, beautifully photographed, shows how to make 138 designs of pins, earrings, sprays, hair-do's, bracelets, candy dishes, jewel boxes, wall plaques, perfume bottles, novelties, etc. Shows over 100 kinds of Sea Shells and Plastics often used. Explains fully home methods of dyeing, pearlizing, gilding, tinseling, frosting and luminous processes. Lists 200 kinds of raw materials with wholesale prices. Complete course only \$1. Beginner's Kit, \$3 (Foreign \$4), Prepaid.

HOUSE OF GIFTS, Box 4550-RM, Coral Gables, Fla.

"YOU ARE UNDER ARREST!"



Help Bring Crooks to Justice Through Scientific CRIME DETECTION!

We have taught thousands this exciting, profitable, pleasant profession. Let us teach you in your own home. Learn Finger Printing, Firearms Identification, Police Photography, Secret Service Methods thoroughly, quickly, at small cost. Over 800 of all American Bureaus of Identification employ I. A. S. students or graduates. We can prepare you for this fascinating work, during spare time. Write today, stating age, for "Blue Book of Crime."

INSTITUTE OF APPLIED SCIENCE, 1920 Sunnyside Ave., Dept. 935A, Chicago 40, Ill.

SHOE REPAIR OFFERS BIG INCOME

LEARN IN 12 WEEKS TIME

In 12 weeks time you can own your own shop or earn big income as skilled shoe repairman. Growing demand everywhere at top wages for men who know how. We teach you quickly by actually working on shoes and modern machines. Costs nothing under G.I. Bill of Rights. We help you get big pay job or start your own shop in 12 short weeks. School open to all from 18 to 60 years of age. FREE BIG 16 PAGE BOOK explains everything. Send for your copy today.

MODERN SHOE REBUILDING SCHOOL

Established 1927

2937 Belmont Ave., Chicago, Ill. RUSH POSTCARD TODAY

STAMMER ?

This new 128-page book, "Stammering, Its Cause and Correction," describes the Bogue Unit Method for scientific correction of stammering and stuttering—successful for 47 years. Benj. N. Bogue, Dept. 4824, Circle Tower, Indianapolis 4, Ind.

GET THIS FREE BOOK!



Thrilling Work COLORING PHOTOS

Fascinating vocation learned at home by those with aptitude. Thrilling pastime. National method brings out life-like colors. Free booklet.

NATIONAL PHOTO COLORING SCHOOL
1315 S. Michigan, Dept. 135A, Chicago 5

NEW! LOW COST! RESPIRATOR

Wear when sanding, grinding, paint spraying, sweeping, dusting, furnace cleaning, etc. Handy as a pair of glasses. Just keep mouth closed and breathe through nose as all you do to operate. Protects against nuisance dusts, lint, coal, cement, grain dust, hay fever pollen. Has 9 sq. in. filter. For EYE protection against paint spray, dusts, gases, fumes, smoke, order our Fog-Proof Rubber GOGGLES. \$2.00 p.p.

JERRY BRYANT, Dept. PM
919 N. Michigan Ave. Chicago 11, Ill.



Order Today \$1.00 POST PAID

PRACTICAL TECHNICAL TRAINING

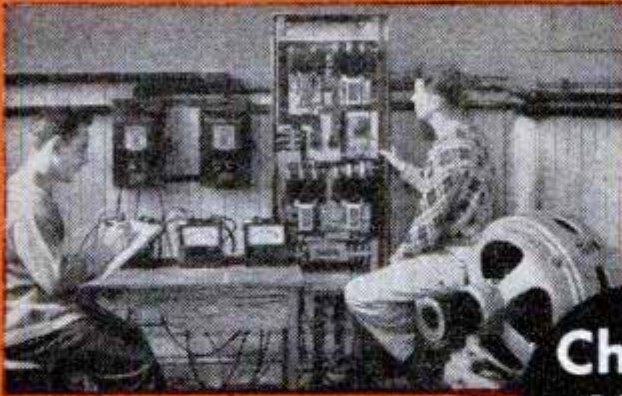

ELECTRICAL ENGINEERING

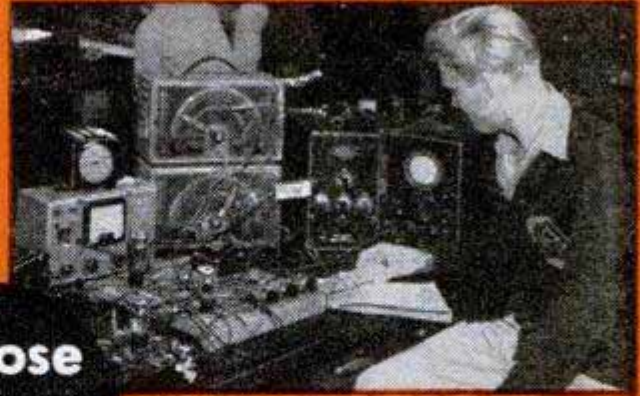

RADIO AND ELECTRONICS

**Choose
Your
Career**

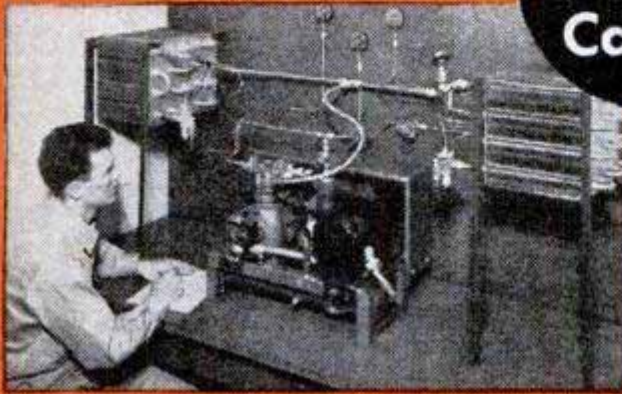

REFRIGERATION & AIR CONDITIONING



GAS AND ARC WELDING

CONCENTRIC CURRICULUM



Our time-tested CONCENTRIC SYSTEM enables you to build your career step by step. Each 6-month course is complete in itself. Stay as long as circumstances permit — until you reach your desired occupational objective.

COURSES

SERVICE . . . 6 to 12 Months.

Practical Electricity
Practical Welding,
Refrigeration Service
Heating Service

TECHNICIAN . . . 1 to 2 Years

Electro Technician
Radio Technician
Electronics Technician
Refrigeration, Heating, and
Air Conditioning Technician

PROFESSIONAL . . . 3 Years

Electrical Engineering
Bachelor of Science Degree — Major
in Machinery or Electronics

★ SPECIALIZE in 6 months to 3 years

Of utmost importance to anyone considering a technical school, is that school's history, facilities, faculty, and record of successful alumni. The Milwaukee School of Engineering was founded 44 years ago to train men for specific and substantial careers in industry. More than 35,000 former students in industries the world over attest the school's career-building value through its exceptional facilities in laboratories, class rooms, faculty of 72 specialists, and its comprehensive technical courses. 1,538 students now enrolled from 48 states and 13 overseas countries. World-wide alumni counselor committee. Terms start JULY, September, January. SEND COUPON TODAY!

MILWAUKEE
SCHOOL of ENGINEERING
A Technical Institute

Milwaukee School of Engineering,
Dept. PM-648, N. Broadway and E. State, Milwaukee, Wis.

Without obligation, send me free booklet "Career Building" and more details on course in _____

Name _____ Age _____

Address _____

City _____ State _____

Do you want

- ..to go to College?
- ..or to enter a Profession?
- ..or get an Office Position?

(Such as Accounting, Architecture, Nursing, Dentistry; Teaching, Social Work, Osteopathy, Beauty Culture, Optometry, Embalming, Chiropody, Law, Medicine, etc.)

To get anywhere, you practically **MUST** finish High School **FIRST**. You can complete our simplified High School Course in SPARE time at home, as **FAST** as your time and abilities permit. Equivalent to resident school work—prepares you for college, pre-professional examinations, business, industry. Standard texts furnished. Diploma. Credit for H. S. subjects already completed. Single subjects if desired. Low tuition, easy terms. American School, Chicago, est. 1897—endorsed by educators. Finish your high school education **NOW**, Write **TODAY!**

High School Course at Home

Many Finish in 2 Years

American School, Dept. HA45, Drexel Ave. at 58th St., Chicago 37, Ill.

Gentlemen: Send me **FREE** information covering special training in subjects checked below. No obligation on my part.

- | | |
|--|--|
| <input type="checkbox"/> High School Course | <input type="checkbox"/> Diesel Engineering |
| <input type="checkbox"/> Architecture and Building | <input type="checkbox"/> Drafting and Design for Men & Women |
| <input type="checkbox"/> Automotive Engineering | <input type="checkbox"/> Plastics |
| <input type="checkbox"/> Business Management | <input type="checkbox"/> Private Secretary |
| <input type="checkbox"/> Electrical Engineering | <input type="checkbox"/> Mechanical Engineering |
| <input type="checkbox"/> Elec. and Gas Refrigeration | <input type="checkbox"/> Aviation |
| <input type="checkbox"/> Air Conditioning | <input type="checkbox"/> Salesmanship |
| <input type="checkbox"/> Railway Training | <input type="checkbox"/> Radio |
| <input type="checkbox"/> Electronics, Industrial | |

Name.....

Address.....

PLUMBERS & STEAM FITTERS



AUDELS PLUMBERS & STEAM FITTERS GUIDES. This valuable set explains in practical concise language the principles, advances and shortcuts of the trade—based on good practice. Includes careful detailed instructions on how to figure & calculate various jobs. A quick reference: saving time & money. A complete Trade course.

Over 1,670 Pages—
3,642 Trade Illustrations

PRACTICAL TRADE INFORMATION ON:

Soldering, tinning, Joint wiping, bending, beating Pipe—iron—steel, threading. Mathematics, tables, physics. Materials—iron, steel, copper, brass, lead, tin, antimony; etc. Sheet metal—galvanized—plate. Sanitation, syphonage, tanks, Drainage, sewage, purification. Fixtures—bath—kitchen. Pipe fittings, soil pipe, tools. Laying out work. Roughing. Screwed fittings, flanges, joints. Pipe bending, examples. Elbows. Heating, ventilation, air conditioning, refrigeration. Water supply, mains, wells, tanks. Gas-fittings. Sheet metal work, problems, methods. Brazing, heating, lead burning. Welding, various welds, methods. Blacksmithing, forges, tools. Copper Tubing. Marine Pipe Fitting & Oil Burners. **HIGHLY ENDORSED—ASK TO SEE THEM. TO GET THIS ASSISTANCE FOR YOURSELF, FILL IN AND**

MAIL ORDER

AUDEL, Publishers, 49 W. 23rd St., New York 10, N. Y. Mail Audels Plumbers' Guides, 4 vols. on 7 days' free trial. If O. K. I will remit \$1 in 7 days and \$1 monthly until \$6 is paid. Otherwise I will return them. No obligation unless I am satisfied.

4 \$6
VOL. 6
COMPLETE

Name.....

Address.....

Occupation.....

Employed by..... P M

4 \$6
VOL. 6
COMPLETE
PAY ONLY
\$1 A MO.

Refit and Tighten



FALSE TEETH

With **AMAZING PLASTI-LINER**

If your plates are loose and slip or hurt; **refine them better than new**, with this pliable, non-porous strip. Just lay on plate, bite and it molds perfectly, hardens for lasting fit and comfort. Ends forever the mess, bother and expense of temporary applications that last only a few hours or few months. Will not injure plates, and **guaranteed to give satisfaction or your money back**. Write for Plasti-Liner today. Pay postman \$1.25 for one reliner, \$2.25 for both upper and lower—or send money now; save C.O.D. charges. **PLASTI-LINER CO., Dept. 43D, Buffalo 2, N. Y.**



Bar Bells

Buy Direct From Factory

Write for free booklet **\$8.95** up and price list

INDEPENDENT IRON WORKS
2416 East 23rd Street, Dept. B
Los Angeles 11, Calif.

INVENTIONS

WANTED AT ONCE

Patented or unpatented inventions, all types needed by manufacturers. Write for free booklet "MARKETING YOUR INVENTION" and Protective Disclosure Form. We have a tremendous list of firms who may pay cash or royalties for good inventions. For full particulars, write today.

NATIONAL INVENTION SERVICE

1404 Mitchell Street, Dept. S Oakland 1, Calif.

APTITUDE TESTS

discover the kind of work or studies best for your success! You get a personal report—a guide for life—more happiness—more prosperity. For men, women, boys and girls. Write for complete facts.

VOCATIONAL COUNSELING INSTITUTE
956 Maccabees Bldg., Detroit 2, Michigan

Learn BAKING At Home

Baking is one of America's high industries in wages. Nearly depression-proof. Thorough basic home course lays sound foundation. If you have aptitude, write for **FREE BOOKLET**, "Opportunities in Commercial Baking." National Baking School, 1315 Mich. Ave., Dept. 135A, Chicago 5



FIBRE ARMS AND LEGS!

Light, correctly fitted, strong and comfortable. Natural appearance. Braces for all deformities. Scientific design. Fair Terms. **BUCHSTEIN-MEDCALF** 223 S. 6th St., Minneapolis, Minn.

Say You Saw It in Popular Mechanics

Photography



for

PLEASURE or PROFIT

Learn at home. Spare time. Practical basic training. Long-established school. Many have earned while learning. Send coupon below for free booklet, "Opportunities in Modern Photography" and full particulars.

AMERICAN SCHOOL OF PHOTOGRAPHY

1315 Michigan Avenue Dept. 135A Chicago 5, Illinois
Send booklet, "Opportunities in Modern Photography," full particulars and requirements. No salesman will call.

Name..... Age.....

Address.....

City..... Zone..... State.....

AMERICA'S
FOREMOST SCHOOL OF
PRACTICAL TRAINING
IS READY TO
PREPARE YOU
NOW FOR A
GOOD JOB IN—

REFRIGERATION AIR CONDITIONING

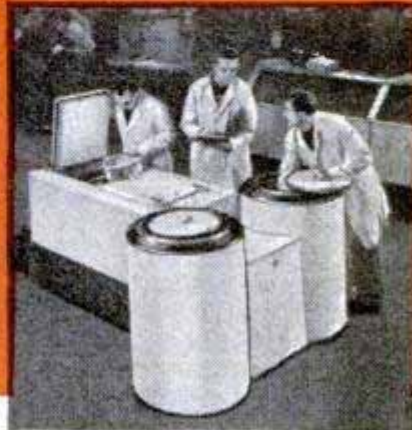
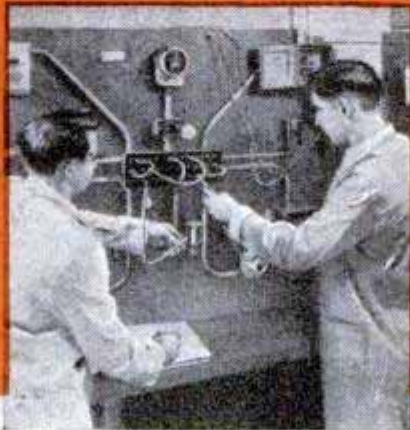

TRAIN BOTH AT HOME



AND IN IT'S BIG SHOPS



What's YOUR ambition? Better pay? An interesting job? Your own business? They're all waiting for you **right now** in Refrigeration and Air Conditioning! The tremendous growth of this great industry is almost unbelievable... and a growing industry needs trained men. If you're mechanically inclined and like to work with tools... Refrigeration and Air Conditioning offers you a bright future. In a few short months Industrial Training Institute... America's foremost school of practical training—will prepare you to step into a good paying job with plenty of opportunity to advance.

Home and Shop Training

Under the famous ITI 2-Way Plan you get all the fundamentals of Refrigeration and Air Conditioning at home... during spare hours. Keep your present job and income while training. Upon completion of your ITI Home Study you come to Chicago, with transportation paid, for a FULL FOUR WEEKS of practical training in our great shops. You actually work with the same kind of equipment you'll meet on the job.

WARM AIR HEATING INCLUDED

ITI Training is best for you because it's really complete... including the huge field of Warm Air Heating to boost your income. You learn both the "how" and the "why" of servicing, repairing, installing and rebuilding both home and commercial equipment. The ITI graduate is qualified to handle any practical job in the industry.

AN OLD ESTABLISHED SCHOOL

Established in 1916, ITI has given training to over 400,000 men. Thousands of its graduates hold key jobs at top income. This great school, occupying five large buildings with over \$500,000.00 invested in training equipment and facilities, offers you the training you need for a flying start to success.

ITI TRAINING 100% PRACTICAL

You need no special schooling or experience. ITI training is easy to grasp, simple, 100% practical. No dull mathematics or complicated theory. ITI lesson Work Sheets are written in simple English. After graduation, ITI's Job Placement Help Department will help you find the job you want.

GET THE FACTS NOW—Mail Coupon!

Find out what's ahead for you in Refrigeration and Air Conditioning. See how simple it is to study at home and prepare yourself for a fine job with a splendid future. It's all in our fascinating, illustrated FREE book, "Your Future in Refrigeration and Air Conditioning." Just fill out and mail the coupon for your FREE copy. Take this first step today.

VETERANS:

ITI Residence Training is fully approved under the G.I. Bill.

ITI also TRAINS AMBITIOUS MEN FOR GOOD JOBS in...

- Electricity and Industrial Electronics
- Machine Drafting & Design
- Precision Instruments

MAIL COUPON TODAY FOR

FREE BOOK!

Mr. C. H. Smith, President,
INDUSTRIAL TRAINING INSTITUTE
2150 Lawrence Ave.,
Dept. F-1, Chicago 25, Ill.

Please send me FREE the ITI book, "Your Future in Refrigeration and Air Conditioning" and information about the opportunities for trained men in this fast growing field. I understand I'm under no obligation.



NAME _____ AGE _____

ADDRESS _____

CITY _____ ZONE _____ STATE _____

ARE YOU A VETERAN? _____



INDUSTRIAL TRAINING INSTITUTE

Formerly the L. L. Cooke School of Electricity & Refrigeration & Air Conditioning Institute
Dept. F-1, 2150 LAWRENCE AVE., CHICAGO 25, ILL.

DIESEL

IS GOING
PLACES
ARE YOU?



Look around—you will see Diesel Power in action all about you! In tractors, trucks, buses, trains, boats, power and lighting plants, farm and road equipment. Diesel's the Field of the Future! Low cost dependable power—new uses are constantly developing—and every Diesel engine increases the need for Diesel-trained men!

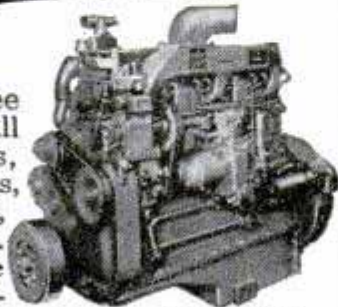

LEARN DIESEL AT HOME IN SPARE TIME!

If you are over 17, under 60, and mechanically inclined, you can get thorough Diesel instruction right at home. With U.E.I. balanced training, you learn fundamentals first, through home study. Practical, easy-to-understand lessons explain DIESEL operation... fuel systems... how to make repairs... auxiliary equipment, etc.

ACTUAL SHOP PRACTICE



START AT HOME
FINISH IN OUR SHOP

Then, you finish your training on actual engines in our Shop. You work on costly equipment under expert Diesel men who know latest techniques. On graduation, you get job-placement assistance. U.E.I. has 20 years of successful experience in fitting thousands for employment in new opportunity fields.

GET THE FACTS It costs you nothing to get full information on Diesel opportunities and how they can apply to you! **FULL FACTS SUPPLIED FREE.** Simply mail the coupon below now!

**UTILITIES ENGINEERING INSTITUTE
DIESEL DIVISION**

GET THE
FACTS
FREE

FOUNDED
1927



MAIL THIS COUPON TODAY!

UTILITIES ENGINEERING INSTITUTE, Diesel Division, Dept. 168-D
2521 SHEFFIELD AVE., CHICAGO 14, ILLINOIS

Please send me FREE FACTS about U.E.I. Training Opportunities. I am interested in:

DIESEL REFRIGERATION
 AUTO BODY & FENDER REPAIR AIR CONDITIONING

NAME _____

ADDRESS _____

CITY _____ ZONE or COUNTY _____ STATE _____

Check here for special information if you are under 17.

Be A MASTER PLUMBER

Earn \$15 To \$50 A Day

DON'T ENVY THE PLUMBER — BE ONE

Every skilled workman will tell you that Plumbers have the best of it. WINTER and SUMMER the Plumber is busy at top wages. No skilled Plumber is ever out of a job—compare his opportunities with any trade, plus the opportunities of having your own shop. We teach you Plumbing with TOOLS (not books) under Licensed Master PLUMBERS in one of the finest equipped schools in America. We make you a Plumber, every branch is taught thoroughly—Lead Work—Blueprint for plan reading—all other tricks.

LEARN IN 30 WEEKS WITHOUT PREVIOUS EXPERIENCE

If you like to work with tools you owe it to yourself to investigate. No need to ever work as an apprentice. Get free bulletin. Write now! G.I. APPROVED. Our 24th year.

UNIVERSAL PLUMBING SCHOOL
815 HOLMES STREET KANSAS CITY, MO.

SHORTHAND in 6 Weeks at Home

Famous Speedwriting system. No signs; no symbols; no machines; uses ABC's. Easy to learn; easy to write and transcribe... get preparation for a job. Surprisingly low cost, 100,000 taught by mail. Used in leading offices and Civil Service. Write for free booklet. **SPEEDWRITING, Dept. 1506-8, 55 West 42 St., N. Y. 18**

\$1500 FOR 1¢

Many valuable coins may be slipping through your fingers. Here are some possible values: 1926 S. Buffalo Head Nickel \$35.00; 1894 S Dime \$200.00; 1827 Quarter \$1000.00; 1938 O Half Dollar \$2000.00. We publish a Coin Encyclopedia which lists hundreds of premiums paid for coins. We do not purchase coins. The values listed in our coin encyclopedia have been compiled from the foremost Coin Dealers.

Send \$1.00 for Your Copy of the Standard Coin Encyclopedia to **BLUE BIRD BOOKS, Inc., Dept. AA, 373 Broadway, N. Y. 13, N. Y.**

THERE'S MONEY IN CARTOONS!

RAYE BURNS will teach you HOW to CREATE ORIGINAL CARTOONS at home that you may SELL! Course contains 26 lessons and over 600 illustrations. All for Only... **\$2.85**

Send name and address for free details. **RAYE BURNS SCHOOL, Dept. M, Box 3583, CLEVELAND, OHIO**

HOW TO CUT RAFTERS

New vest pocket book gives lengths, side cuts, plumb cuts, deductions. For all rafters for any building from one inch to forty feet wide. Gives numbers to cut on square. Also degrees for same cuts for Radial Saws. All standard pitches from 1/8 to 5/8. Just open book to pitch page and there are your lengths, side cuts, etc. Anyone who knows what a jack rafter is can frame a roof if he has this great book. Price one dollar, (\$1.25 in Canada). Builders' Topics, Dept. 5, Lock Box 828, Seattle, Washington. CARPENTERS, PLUMBERS, PLASTERERS, ELECTRICIANS, ETC. subscribe for Builders' Topics, the monthly magazine for HE-MAN CONSTRUCTION WORKERS. Only \$1.00 per year, (in Canada—\$1.25). Sample copies 25c.

\$ AGENTS 300% Profit SIGN LETTERS
For Store Fronts and Office Windows. Anyone can put them on. Free Samples. Liberal Offer to General Agents.
METALLIC LETTER CO., 430 N. Clark, Chicago 10

RUPTURED?

Get Relief This Proven Way

Why try to worry along with trusses that gouge your flesh—press heavily on hips and spine—enlarge opening—fail to hold rupture? You need the Cluthe. No leg-straps or cutting belts. Automatic adjustable pad holds at real opening—follows every body movement with instant increased support in case of strain. Cannot slip whether at work or play. Light. Waterproof. Can be worn in bath. Send for amazing FREE book, "Advice To Ruptured," and details of liberal truthful 60-day trial offer. Also endorsements from grateful users in your neighborhood. Write: **CLUTHE SONS, Dept. 31, Bloomfield, New Jersey**



Learn BUILDING

AT HOME • All Blue Print Building Plans, Specifications, Lessons Furnished

FIND OUT ABOUT TRAINING AND OPPORTUNITIES FOR YOU IN BUILDING

Established in 1904, Chicago Technical College offers you thorough, practical training in Building, by home-study. Mail coupon for free information. See what this Course has done for others, what it can do for you. Read what Chicago Tech graduates say about their work, earnings, success. Learn the rewards awaiting you as a trained builder — and how quickly, easily you can get started. Simply MAIL COUPON TODAY in an envelope or paste on a penny postcard.



Earn more money as a building tradesman. Prepare for advancement and increased pay as a building foreman, superintendent, inspector, estimator, material buyer or salesman. Train to be a building contractor, have your own money-making business in this busy, prosperous building field.

More than 19 million new homes needed in U. S., say experts. New building now at rate of one million homes a year, plus 200,000 commercial buildings, plus expanding farm building construction.

Mail coupon today. FREE book tells how you learn Building Construction — How to Read Blue Prints, and Estimate Building Costs — at home in your spare time. Learn modern construction methods and materials, how to lay out work and direct all building operations. This is the training needed for rapid advancement to higher-paid jobs, or your own successful building business.

CHICAGO TECHNICAL COLLEGE
6-152, Tech Building, 2000 South Michigan Ave.
Chicago 16, Illinois

MAIL COUPON NOW

CHICAGO TECHNICAL COLLEGE
6-152, Tech Bldg., 2000 So. Michigan Ave.
Chicago 16, Illinois

Mail me FREE building Lesson with information about big opportunities in BUILDING and how I can train at home.

Name _____ Age _____

Address _____

City _____ Zone _____ State _____

Made to U. S. Army Specifications!

16-JEWEL

ELGIN
\$19⁹⁵



Sturdy 16-Jewel ELGIN men's wrist watches. Water-repellent. Sweep second hand. Stainless Steel back. Unbreakable crystal. QUALITY! American made. Fully reconditioned with ONE YEAR GUARANTEE! Made for the U. S. Army Air Corps. They HAD to be good. SEND NO MONEY. Simply pay postman \$19.95 plus 10% tax and postage on delivery. Cash orders sent postpaid. Limited supply. UNITED PRODUCTS CO., 7941 S. Halsted St., Dept. RES-809, Chicago 20, Ill.



TALK-SING thru your own radio with **RADIO MICROPHONE**



Be the life of the party. Put on your own broadcasts at home. Talk-Sing make announcements from any room. Wonderful voice practice. Microphone easily attached to any radio. Follow enclosed instructions. SEND NO MONEY—pay postman \$2.25 plus postage. Send Money Order or check and save postage.

EMPIRE RADIO & TELEVISION CO. (Dept. M1) 1521 Bedford Ave. Brooklyn 16, N. Y.

INVENTING

—FOR PROFIT! If you have an inventive turn of mind, write for free 28-page booklet explaining how the Institute of American Inventors is helping inventors pre-test the profit possibilities of proposed devices to fill today's unprecedented demand for useful new inventions.

INSTITUTE OF AMERICAN INVENTORS
Dept. 4, 1926 Eye St., NW, Washington 6, D. C.

Get 'em now for July Fourth! FIREWORKS



Super All Noise Ass't

Retail \$11.26 • Your Cost \$4.95

- | | |
|-------------------------------|------|
| 72 Kannon Kracker Salutes | 3.60 |
| 72 Extra Loud Bulldog Salutes | 2.16 |
| 160 Chinese Firecrackers | 1.50 |
| 1 Whistling Aerial Bomb | .25 |
| 1 3 Shot Repeat Bomb | .50 |
| 50 3" Flash Salutes | 1.50 |
| 5 2 Shot Bombs | .75 |
| 50 2" Satutes | 1.00 |
| 120 Chinese Ladycrackers | Free |

Regular Retail Price \$11.26

Save More Than 1/2 Only . . . **\$4.95**

Holiday Ass't

- 690 Pieces
- Regular Retail \$13.80
- Beautiful night displays
- Rockets — Roman candles, aerial Bombs — Firecrackers
- Your price **\$5.00**

Send check or M. O. with order. Hurry!

EXPRESS COLLECT — F.O.B. ATLANTA

ACME SALES CO.

P. O. Box 53—Sta. D., Atlanta, Georgia

Learn RADIO -TELEVISION



in the GREAT SHOPS OF COYNE

Get ready for a better job, bigger pay NOW in Radio. Cash in with "All-around" knowledge of Radio-Television-F.M. Coyne is G.I. Approved. Finance plan for non-veterans. Many earn while learning. Free employment service to graduates. Thousands of graduates in Industry.

Not a "Home-Study" Course!

You get actual shop work on full-size equipment plus necessary theory. You learn easier and quicker at Coyne because it's real shop training.

SEND FOR FREE BOOK

Get the facts! BIG FREE BOOK tells about your future in Radio and Television and how you can prepare at Coyne. Dozens of pictures. No obligation—no salesman will call.

Established 1899

MAIL COUPON TODAY!

B.W. COOKE, President
COYNE Electrical and Radio School
500 S. Paulina St., Dept. A8-3H, Chicago 12, Ill.

Please send me your Big Free Radio and Television Book and all the facts.

NAME.....

STREET.....

CITY..... STATE.....



Why Pay More?

SEND THIS AD
WITH ORDER

EVERY TIRE GUARANTEED
98% NON SKID, ORIGINAL TREAD
TRIPLE INSPECTED DEMONSTRATORS

Positively Not Re-caps!

600-16	\$6.42	700-15	\$8.42
650-15	7.12	700-16	8.82
650-16	7.42	750-16	9.42
900-16	\$ 9.52	900-20 ...	\$17.52
650-20	9.52	1000-20 ...	17.52
700-20	12.52	1100-20 ...	17.52
750-20 (8) ..	12.52	32x6 (8) ...	12.52
750-20 (10) ..	14.52	32x6 (10) ..	14.52
825-20	16.52	34x7 (10) ..	14.52

7.50-20 MILITARY 8 PLY \$17.52

1/2 million tires shipped to satisfied customers. Trial will convince you.
Mail Orders Rushed on Receipt of Check or Money Order.

STANDARD
834 N. Broad St. Phila. 30, Pa.

"How to Make Money With Simple Cartoons"

A book everyone who likes to draw should have. It is free; no obligations. Simply address
CARTOONISTS' EXCHANGE

Dept. 96-D

Pleasant Hill, Ohio



SPATTER CRAFT

Learn for fun and profit! Produce color effects on wood, cloth, or paper impossible any other way. Sunfast, wash-proof, too. Kit has GUN; 5 BOTTLES of COLORED INK; STENCIL PAPER; many PATTERNS and DESIGNS; and 22-page TEXTBOOK in full color. Just \$2.50 postpaid.

CRAFT CATALOG FREE with order. (If W. Va. add 5c Sales Tax)
DWINNELL CRAFT SHOP, Dept. P-86, Elm Grove, Wheeling, W. Va.

Free Book

MOUNT BIRDS, ANIMALS, FISH

Yes, FREE. Explains Taxidermy. Tells how to learn at home by mail to mount birds, animals, heads... to TAN skins and furs. Great for MEN and BOYS. Few! Also earn money in spare time. WRITE TODAY—NOW—for free book containing 100 game pictures. State AGE. N.W. School of Taxidermy, Dept. 937A, Omaha, Neb.



BE A REAL ESTATE BROKER PAYS BIG!

EASY TO LEARN—Start and run your own business quickly. Many graduates report making up to \$1000 a month. Course of study covers Sales, Property Management, Appraising, Loans, Mortgages and hundreds of related subjects. Course offered in home study or residential classrooms.

Big new illustrated catalog from this nationally known school. Send Post Card Today. G. I. Approved.

WEAVER SCHOOL OF REAL ESTATE

Dept. PM-1, 15 E. Pershing Road Kansas City, Mo.



BUILD YOUR OWN ZEOLITE WATER SOFTENER

You can do it inexpensively with only a wrench and a little spare time. Same Zeolite process as used by other leading water softeners. Send \$1 for easy-to-follow directions and list of materials. (Materials available locally or from us.) Your money back if not satisfied.

LAKE REGION MFG. CO.

4184-A Xenwood Ave. Minneapolis 16, Minn.



THESE 5 TRADES ASSURE YOU

HIGH PAY • Future Security

- **PLUMBING** Every phase of plumbing: Pipe-Cutting and Installations, Completed Installations of entire plumbing systems, Threading, Lead-Wiping, Rough-in Projects on Blueprint reading, Estimating.
- **DRAFTING** College-level courses in General Machine and Architectural Drafting, with fundamentals in Drafting Mathematics—all under graduate engineers.
- **SHOE REPAIRING** From simplest repairs on boots and shoes to the finest details of reconditioning and rebuilding, under expert craftsmen.
- **ELECTRICAL** Technical and shop training include Basic Electricity, Residential Wiring, Industrial Wiring, General Testing and Trouble Shooting, and Appliance Repair.
- **AUTOMOTIVE & TRACTOR** Applied training on latest model automobiles and tractors, including engine overhaul, transmission and differentials, carburetion, generator and ignition systems, engine tune up, Hydramatic and Vacumatic Transmissions, and general service.

"There's Always a Demand for the Man who KNOWS!"

CHOOSE ONE OF THESE 5 LEADING TRADES

Get Out of that Rut... Be a Skilled Tradesman! Have a Lifetime Career... Own Your Own Business and Be Secure in Your Old Age.

NOW while Enrollment is still open, send for FREE information.

THE 5 DIVISIONS OF

NATIONAL TRADE SCHOOL

2610 Grand Ave., Kansas City 8, Mo.

- Plumbing
- Drafting
- Shoe Repairing
- Electrical
- Automotive & Tractor

NAME _____

ADDRESS _____

CITY _____

STATE _____

VETERAN _____

OCCUPATION _____

Choose One of these 5 Essential Trades

Our complete courses of thorough training prepare you to go right into the field as a Qualified Tradesman at High Pay in only 34 weeks (39 in Shoe Repair). All courses under especially trained instructors with practical experience. 6 Hour Classes 5 Days a Week. Our Employment Department helps you.

VETERANS "Approved for veterans' training by the State Department of Education under Public Law 346." "Approved for veterans' training by the Veterans' Administration under Law 16."

Send Coupon for Free Information Now

NEW WRITERS NEEDED

New writers needed to re-write ideas in newspapers, magazines and books. Splendid opportunity to "break into" fascinating writing field. May bring you up to \$5.00 per hour spare time. Experience unnecessary. Write today for FREE details. NO OBLIGATION. Postcard will do.

FREE DETAILS

COMFORT WRITER'S SERVICE

Dept. 11, 200 South 7th St. St. Louis, Mo.



LEARN MEAT CUTTING At Home—In Spare Time

Get into the vital meat industry. Concise, practical Home Training based on 25 years proven instruction methods used at National's famous resident school. Prepares you for bigger pay as Meat Cutter, Supervisor, market manager or more money in your own store. Go as rapidly as your spare time permits. Diploma. Start NOW to turn your spare hours into money. Send for FREE bulletin today. No obligation.

National School of Meat Cutting, Inc., Div. U-94, Toledo 4, Ohio

Semi-machined DRILL CHUCK ARBORS



For fitting drill chucks and other tools to lathe spindle or turret head. Made of steel with ground shank. You machine to fit chuck or other tools.

SOUTH BEND LATHE WORKS
455A East Madison Street, South 22, Indiana

- ARBORS with**
- No. 2 taper shank . . \$0.85
 - No. 3 taper shank . . . 1.30
 - 5/8" straight shank . . 1.15
 - 3/4" straight shank . . 1.20

See your dealer—or sent direct postpaid.

SOUTH BEND

SAY YOU SAW IT IN POPULAR MECHANICS

WANT A GOVERNMENT JOB?

START AS HIGH AS \$3,021

Many Permanent Appointments Being Made

VETERANS GET SPECIAL PREFERENCE

Many Government Jobs. City and Rural Carriers—Postoffice Clerks—Storekeeper-Gaugers—Meat Inspectors—Accountants—Stenographers—Typists—etc. Prepare now for next Examinations.

FRANKLIN INSTITUTE,
Dept. C85, Rochester 4, N. Y.
(Not Government Controlled)

Sirs: Rush to me, without charge, copy of 40-page book, "How to Get a U. S. Government Job," list of positions, and full particulars telling how to qualify for them.

NAME _____

ADDRESS _____

VET? _____





AUTO BOOKS ON APPROVAL



SEND NO MONEY. Just mail the coupon for a complete set of 4 Big, Thick Auto Books. 20th Edition. Over 2700 Pages! Whether you are a mechanic or helper, expert or apprentice, auto owner or driver, take immediate advantage of this FREE EXAMINATION OFFER.

MAKE GOOD MONEY NOW HOLD A PERMANENT JOB

America wants its automobiles kept in good repair. Men with "know how" are in demand, at big pay. These books will help you get and hold an important job, or give you a chance to go into business for yourself now or later. Any man who half tries to improve himself can learn auto servicing and repairing by this quick reference method. Use the JIFFY INDEX to find easily understood answer to any auto problem. These wonder books prepared by eleven of America's great automobile engineers. Many hundreds of valuable illustrations. Send the coupon TODAY.

A year's consulting privileges with our engineers now given with these books without extra charge.
Vocational Publishers Since 1898

CAN YOU FIX IT?

These wonder books tell step by step HOW to make difficult repairs and adjustments, how to keep a car at maximum efficiency, including latest improvements in car design and operation. Engine troubles and how to correct them well covered.

4 BIG, THICK VOLUMES

Over 2700 pages, 2000 illustrations, wiring diagrams, etc., including Diesel engines. Beautiful modernistic, washable cloth binding.

AMERICAN TECHNICAL SOCIETY, Dept. AA-19
Drexel Ave. at 58th St., Chicago 37, Ill.

I would like to examine your 4-Volume Set of Auto Books. I will pay the delivery charges only, but if I choose I may return them express collect. If after 10 days' use I prefer to keep them, I will send you \$2 and pay the balance at the rate of only \$3 a month until \$24.80 has been paid. Include consulting service as offered above.

Name _____

Address _____

City _____

State _____

Please attach letter stating age, occupation, employer's name and address and name and address of at least one business man as reference. Men in service, also please give home address.

New BRUSH Electroplater

ESPECIALLY BUILT FOR MECHANICS, MODEL MAKERS HOME CRAFTSMEN



Easy to Plate GOLD, SILVER, NICKEL, COPPER, etc... For Pleasure and Profit!

If you have a workshop—at home or in business—you need this new Warner Electroplater. At the stroke of an electrified brush, you can electroplate models and projects—you can replate worn articles, faucets, tools, fixtures, silverware, etc. with a durable, sparkling coat of metal... Gold, Silver, Nickel, Copper, Cadmium, and after a bit of practice, even Chromium! Everything furnished—equipment complete, ready for use. By doing a bit of work for others, your machine can soon pay for itself. So make your shop complete by getting a Warner Electroplater right away. Send today for FREE PLATING SAMPLE and illustrated literature. ACT AT ONCE.

WARNER ELECTRIC CO., Inc., Dept. S-14
1512 Jarvis Ave., Chicago 26, Illinois

FREE Details & Sample!

WARNER ELECTRIC CO., Inc., 1512 Jarvis Ave., Chicago 26, Ill., Dept. S-14
Gentlemen. Send Free Sample and Details to:

Name _____

Address _____

City _____

State _____

PROTECT LIVES and PROPERTY with these

LOW COST FIRE EXTINGUISHERS

A little foresight now may save LIVES and PROPERTY later. Equip your home, your garage, your office, your boat with **AutoFyrstop**, the modern fire extinguisher and alarm that is setting new records... Write for FREE literature today.



KILLS FIRE BY ITSELF



MONEY MAKING OPPORTUNITY

We have openings for high grade salesmen in choice territories. If interested in outstanding money-making opportunity, write for plan TODAY!

AUTOFYRSTOP CO., Dept. PM-648
2035 Washington Ave., Philadelphia 46, Pa.

CHEMISTRY

LEARN AT HOME... Chemical knowledge is essential for thousands of good jobs in industry, business, science. IPC enables you to master practical chemistry. It's the ONLY home study chemistry course which enables you to learn by performing actual experiments—using chemicals and apparatus supplied with the course—in addition to your IPC textbook studies. Compares with recognized college courses in General Chemistry. Write today for free descriptive booklet.

INSTITUTE OF PRACTICAL CHEMISTRY
3 PROSPECT AVENUE, HAGERSTOWN, MD.

Master Watchmaking

The life-long profitable trade of thousands as taught by the Sweazey System.

"FAMED THE WORLD OVER"

CHICAGO SCHOOL OF WATCHMAKING

Founded in 1908 by Thomas B. Sweazey
1608 N. Milwaukee Ave., Dept. 168 Chicago 47, Ill.

DEVELOP RUGGED STRENGTH!



Strong Men's Club of America offers FREE Membership!

Send for your personal membership card and Strength Secrets. No dues! No obligations! Many valuable privileges! Send name, address, age, on penny postcard.

JOE BONOMO Strong Men's Club of America
Director (Dept. PM-6) 1841 Broadway, N. Y. 23, N. Y.

TRI-STATE COLLEGE

B. S. Degree in 27 months in Civil, Electrical, Mechanical, Chemical, Aeronautical, Radio Engineering; Bus. Admin., Aec't and Sec. Science. Graduates successful. 64th year. Enter June, Sept., Jan., March. Catalog. 468 College Ave., Angola, Ind.



LEARN MOVIE PROJECTION THEATRE MANAGEMENT

The Motion Picture Theatre Business offers big opportunities for trained men. Get into a fascinating field with a promising future. Train at home in spare time. Free Catalog. Established 20 years.

THEATRE SCHOOL, 370 Washington St., Elmira, New York



SALES ENGINEER MOLD DESIGNER RESEARCHER FABRICATOR LAMINATOR PARTS INSPECTOR MOLDING TECHNICIAN YOUR OWN BUSINESS

WHICH CAREER IN PLASTICS DO YOU WANT?

Plastics is one of the fastest growing industries—offering you unusual opportunities for an interesting, successful career and security in the years ahead. Trained men, with plastics know-how will fill the important, well-paying positions. YOU can be one of them. Mail the coupon below for a big, colorful, free catalog on Plastics and complete de-

tails about Plastics Institute, America's oldest and largest plastics school. Resident School located in beautiful Southern California. Comprehensive Home Training Courses to prepare you in your spare time at home for a career in plastics. You can enroll immediately! Write Plastics Institute, Dept. PM-68, 1601 S. Western Ave., Los Angeles 6, California.



LEARN BY DOING

To give you practical experience we supply colorful plastics to make useful, attractive creations. You can also make and sell plastics articles to earn while learning.

APPROVED FOR VETERANS

Plastics INDUSTRIES TECHNICAL INSTITUTE

NEW YORK CHICAGO LOS ANGELES



PLASTICS INSTITUTE in the heart of sunny Los Angeles. Here modern laboratories and shops give Resident School students facilities for practice on the finest of industry-type plastics equipment. Also the headquarters for HOME TRAINING.

Plastics Industries Technical Institute
Dept. PM-68, 1601 S. Western Ave., Los Angeles 6, Calif. Mail in Envelope or paste on penny postcard

Gentlemen: Please send me free literature and information on your Resident School Course Home Training Courses. I understand there is absolutely no obligation.

Name (PRINT) _____ Occupation _____

Street (PRINT) _____ Age _____

City _____ Zone _____ State _____

Important: Please fill out coupon completely. If non-veteran, please check. If in Armed Services now, please check.

FREE BOOKLET

ELECTRICIANS' SCHOOL

HOUSE AND COMMERCIAL WIRING • MOTOR REPAIR AND REWINDING • ELECTRIC REFRIGERATION

Approved for Veterans Training

PENNSYLVANIA INSTITUTE SCHOOL OF ELECTRICITY
42nd and SPRUCE STS. PHILADELPHIA 4, PENNA.

ENGINEERING DEGREE IN 27 MONTHS

INDIANA TECHNICAL COLLEGE

Aeronautical, Chemical, Civil, Electrical, Mechanical, and Radio Engineering (inc. television), Drafting, 1-yr. Gov't approved for G.I.'s. Low rate. Earn board. Large industrial center. Students from 48 states, 18 countries. Demand for graduates. Enter June, September, December, March. Catalog.

568 E. Washington Blvd., Ft. Wayne 2, Ind.

RESORT OPERATION AND MANAGEMENT



INCLUDING AUTO COURT and TRAILER PARKS
A book that deals with Resort Management, solving many of its difficult problems. Discs the way to profitable operation. "Must" guide for beginners and the resort owners "bible." Send \$2.00 postpaid.

WOODBEEK PUBLISHING CO.
WINCHESTER BLDG. GRAND RAPIDS, MICH.

Big Money for Workers In Home or Shop



Licensed Concrete Specialists wanted. No experience needed. Make Colorglazed concrete pottery without molds. New, low cost, patented method. Cemetery products, novelties, tiles, etc. Basement leaksealing. Other big pay projects. Booklet, details free. Men only.

NATIONAL POTTERIES COMPANY
415 Third Avenue, W. Grand Rapids, MINNESOTA

ORDER NOW! JULY 4th **FIREWORKS**

WHOLESALE PRICE 470 PIECES \$4.98

ACTUAL RETAIL VALUE \$13.55

YES SIR! 470 OR MORE NOISE AND BEAUTY PIECES FOR ONLY \$4.98. Magnificent assortment—each a knockout! Gorgeous, colorful, NEW displays—intricate artistic effects—all merchandise brand-new! For only \$4.98 you'll get—Sparklers, Salutes, Red Trail Blazers, Roman Candles, Two-Shot Repeaters, Magic Black Snakes, Cones, Dago Flash Bombs, Three-Shot Automatics, Magic Flames, Airplane Flares, Chinese Rockets, Red Rocket Sky Whistle Bombs, "T-N-T" Flash Salutes, Z-Brand Chinese Firecrackers, Happy Chinese Firecrackers, FREE PUNK!

Order this wonderful over-470-Piece Fireworks Bargain TODAY! Send money order, bank draft, or certified check for \$4.98. Do NOT send cash. NO C.O.D. orders! PRINT name and address plainly. Give name of your Express office. Fireworks cannot be mailed. All shipments by Express, F.O.B. at Fort Worth.

Stars and Stripes Fireworks Co.
P. O. BOX 486, DEPT. PM
FORT WORTH 1, TEXAS

NOT INTENDED TO OFFER FOR SALE IN LOCALITIES WHERE REGULATIONS PROHIBIT

ASK FOR FREE CATALOG
MANY OTHER ASSORTMENTS

SAY YOU SAW IT IN POPULAR MECHANICS

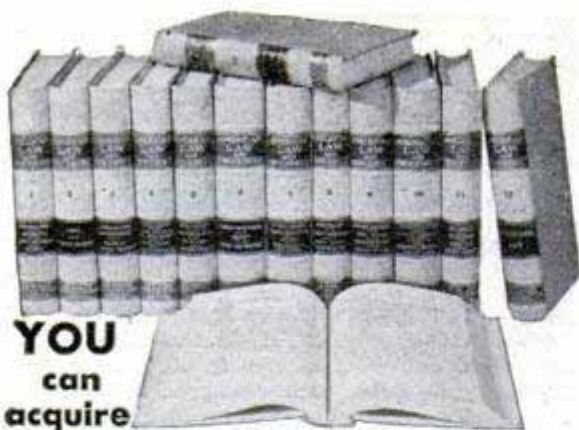

YOU
can
acquire

LAW NIGHTS AT HOME! L.L.B. DEGREE

LaSalle's famous Law Library—used as reference in many Law libraries and Law offices—has enabled thousands to master Law surprisingly fast, in spare hours at home, for business and professional advancement.

These 14 remarkable volumes, compiled by leading professors and lawyers, cover the whole basic field of Law in condensed, orderly, simplified manner.

You advance rapidly with this great library, plus special lectures furnished. We guide you step-by-step with personalized Problem Method of instruction . . . you learn by doing—handling legal problems—not by memorizing rules.

Send for two FREE 48-page booklets, "Law Training for Leadership," and "Evidence," answering questions about Law and its value to you, and telling how LaSalle Law graduates are winning rapid advancement in business and public life. Mail coupon below. No obligation.

LA SALLE EXTENSION UNIVERSITY A Correspondence Institution

417 S. Dearborn St. Dept. 664-L Chicago 5, ILL.

Send me your two FREE booklets described above, without obligation.

Name.....Age.....

Street.....

City, Zone & State.....

LEARN } ACCOUNTING SALESMANSHIP SECRETARIAL WORK

Assure Your Future Now!

Hill's, one of America's outstanding Business Schools, offers you the opportunity to enter one of the three fields acknowledged to hold substantial earnings and a secure future. Our FREE book, "Through Hill's to Success," tells how and where the best positions are found and how you can qualify for them by study at home or in our resident school. We have thousands of successful graduates and maintain nationwide employment service. G. I. Approved.

FREE
WRITE
TODAY

USE THIS HANDY COUPON

HILL'S EXTENSION SCHOOL Dept. PM-6
AND BUSINESS UNIVERSITY
619 W. Main St., Oklahoma City 2, Okla.
Please send me your Free book, "Through Hill's to Success."

NAME.....

ADDRESS.....

CITY.....STATE.....

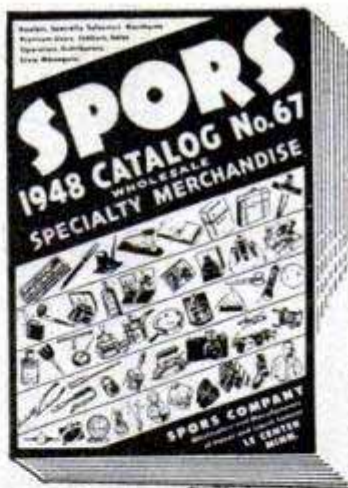

SPORS CO. 4-48 Dodge Le Center, Minn.

6000 SMASH HITS— IN 324 PAGE Wholesale Book

Dealers, agents, salesmen and jobbers, you will find this book bulging with Tested Money Makers. Latest catalog shows average price reductions about 21% on many items. A guarantee of satisfaction stands back of every purchase you make from us. 25c brings you this latest 1948 wholesale catalog of Tested Sellers. You may take credit for the 25c on your first order. In that way the Book will not cost you any money. Get your copy now, before supply is depleted.

SUCCEED IN THE POULTRY BUSINESS!



Poultry is providing many trained men and women with a good, comfortable living, either part or full time. For 27 years our Home Study Course has been helping thousands obtain training and "know how" that means extra income from the start. Don't delay—Write today for prospectus describing courses, methods, service, opportunities.

DEPT. 50 NATIONAL POULTRY INSTITUTE
ADAMS CENTER, N. Y.

YOU CAN BE AN ELECTROPLATER



Be your own boss or work for big pay. Make money while you learn at home in spare time. Interesting, uncrowded field. Plate with chrome, nickel, silver, gold, etc. Money making trade secrets furnished. Send postcard for FREE idea booklet today!
HYDE SCHOOL OF ELECTROPLATING
432 F Street, Room 520, San Diego 1, California

GET THIS FINE SUIT NO MONEY TO PAY!



BIG CASH EARNINGS, TOO!

Big news! This fine tailored suit yours without paying one cent—and big cash earnings, too! It's easy! Just take a few orders. Earn up to \$10 in a day and get your own suit as extra bonus. Dozens of rich new fabrics, superbly tailored in latest styles, at low prices produce orders on sight. Money-back guarantee. FREE SAMPLES! Write today giving name, address, age, samples and details of amazing new BONUS SUIT and money-making plan—All Sent Free! No experience. SEND NO MONEY!
W. Z. GIBSON, Inc. 500 S. Throop, Dept. F-516, Chicago 7, Ill.

LEARN WATCH and CLOCK REPAIRING

Start training now for a better paying job or your own profitable business. Qualified Watch Makers are in demand . . . Unlimited opportunities. Intensive practical training by experienced watch makers. Approved for Veterans. Write for full details. Indicate if Veteran.
SCIENTIFIC SCHOOL OF WATCH MAKING, Dept. PM-6
3923 San Fernando Road Glendale 4, Calif.



RID YOUR DOG OF
WORMS
USE
PARKE-DAVIS
NEMA
WORM
CAPSULES

KEEP YOUR DOG FRISKY!

Dependable, easy to give, scientifically prepared and low in cost, NEMA Worm Capsules effectively remove large round worms and hookworms in dogs and cats.
FREE! Send for illustrated, helpful worm booklet.
PARKE, DAVIS & CO., DETROIT 32, MICH.
DRUG STORES SELL PARKE-DAVIS PRODUCTS



Learn RADIO

TELEVISION, ELECTRONICS *by* SHOP METHOD HOME TRAINING

Let NATIONAL SCHOOLS, of Los Angeles, a practical Technical Resident Trade School for over 40 years, train you for today's unlimited opportunities in Radio

You receive all parts, including tubes, for building this fine, modern Superheterodyne Receiver. This and other valuable standard equipment becomes your property.

these two FREE books will tell you how

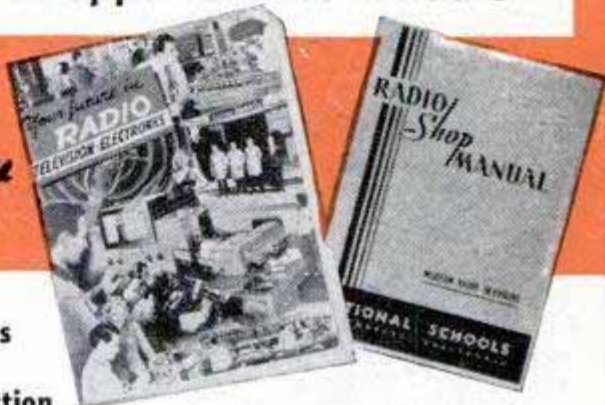

GOOD JOBS AWAIT THE TRAINED RADIO TECHNICIAN

You are needed in the great, modern Radio, Television and Electronics industry! Trained Radio technicians are in constant and growing demand at excellent pay—in Broadcasting, Communications, Television, Radar, Research Laboratories, Home Radio Service, etc. National Schools Master Shop Method Home Study Course, with newly added lessons and equipment, can train you in your spare time, *right in your own home*, for these exciting opportunities. Our method has been proved by the remarkable success of National Schools-trained men all over the world.

You Learn by Building Equipment with Standard Radio Parts We Send You

Your National Schools Course includes not only basic theory, but *practical* training as well—you learn by doing. We send you complete standard equipment of professional quality for building various experimental and test units. You advance step by step until you are able to build the modern superheterodyne receiver shown above, which is yours to keep and enjoy. You perform more than 100 experiments—build many types of circuits, signal generator, low power radio transmitter, audio oscillator, and other units. The Free Books shown above tell you more about it—send for them today!

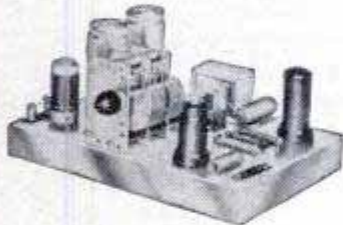

NOW! NEW PROFESSIONAL MULTITESTER INCLUDED

This versatile testing instrument is portable and complete with test leads and batteries. Simple to operate, accurate and dependable. You will be able to quickly locate trouble and adjust the most delicate circuits. You can use the Multitester at home or on service calls. It is designed to measure AC and DC volts, current, resistance and decibels. You will be proud to own and use this valuable professional instrument.



Lessons and Instruction

Material Are Up-to-Date, Practical, Interesting

National Schools Master Shop Method Home Training gives you basic and advanced instruction in all phases of Radio, Television and Electronics. Each lesson is made easy to understand by numerous illustrations and diagrams. All instruction material has been developed and tested in our own shops and laboratories, under the supervision of our own engineers and instructors. A free sample lesson is yours upon request—use the coupon below.

Here's Just a Few of the Interesting Facts you Learn with the

FREE MANUAL

1. Routine for diagnosing Radio Troubles.
2. Preliminary inspection of Receivers.
3. How to Test and Measure Voltages.
4. How to Test Speaker in Audio Stages.
5. How to Trace the Circuit and Prepare Skeleton Diagram.
6. Complete Reference Table for Quickly Locating Receiver Troubles.

Both Resident and Home Study Courses Offered

APPROVED FOR VETERANS

CHECK COUPON

G. I. APPROVED

NATIONAL SCHOOLS
LOS ANGELES 37, CALIFORNIA EST. 1905



MAIL OPPORTUNITY COUPON FOR QUICK ACTION

National Schools, Dept. PM-6
4000 South Figueroa Street
Los Angeles 37, California

(Mail in envelope or paste on penny postcard.)

Mail me FREE the books mentioned in your ad including a sample lesson of your course. I understand no salesman will call on me.

NAME _____ AGE _____

ADDRESS _____

CITY _____ ZONE _____ STATE _____

Operate Your Own Business!

18
YEARS
OF
PROVEN
SUCCESS



Clean and Mothproof Rugs and Upholstery

- Nationally Advertised Services
- Big Profits
- Repeat and Voluntary Orders
- No Experience Needed

If you are dependable, honest and willing to work, send today for details on how to become financially independent in a profitable, growing business of your own. Choose an

open territory anywhere in United States, Canada, Mexico or foreign countries. Services rendered in homes, offices, clubs or public buildings.

DURACLEAN cleans by absorption. **NO SCRUBBING.** No soaking or shrinkage. This modern safe cleaning process uses mild solvents. Dirt, grease and many unsightly spots vanish as if by magic. Wool fibers come to life . . . matted pile rises . . . colors revive. Upholstery and floor coverings last longer.

DURAPROOF is another year 'round service. Not only kills moths and carpet beetles but makes materials resistant to both. Protects furnishings, clothing and auto interiors. Guards against mildew, too. **DURAPROOF**, to our knowledge, is the only moth-proof service backed by a National MONEY BACK, 4 YEAR WARRANTY.

Leading furniture and department stores recommend **DURACLEAN** Dealer's service. Almost every building in your territory houses a potential customer needing one or both these Nationally Advertised services. Even auto dealers buy your service to revive upholstery in used cars.

Easy to learn. No shop needed. Operate from your own home. We furnish enough material to return your TOTAL investment. Gross profits up to \$15 and \$20 a day on EACH of your service men.

Start full or part time. Territories are limited! Write immediately for **FREE** Booklet explaining details. Easy terms.

Duraclean Co. 16 - 6 Ct. DEERFIELD, ILL.

PRACTICAL AUTO INFORMATION

Keeps Cars Rolling by Making Repairs
and Adjustments Easy!

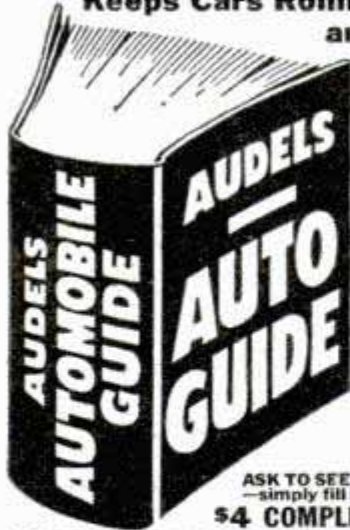

AUDELS AUTO GUIDE
For Every Mechanic, Driver,
Owner and Repair Shop.

Sent on 7 Days Approval
Shows How to Tune Up—Keep
Brakes Safe—Batteries Power-
ful—Tire Mileage Up—Save
Gas—Lubricate Correctly.

ANSWERS YOUR QUESTIONS
Contains all you need to know
about 1—Construction, 2—Operation, 3—Service,
4—Repair of Modern Motor
Cars, Trucks, Buses & Diesel
Engines in every detail.

NEW FLUID DRIVE TREATED
Easy to understand—
1540 Pages, 1540 Illustrations.
Gives definite directions on
How to handle service jobs.

ASK TO SEE IT—Get this information for yourself
—simply fill in and mail coupon today.
\$4 COMPLETE • PAY ONLY \$1 A MO.

AUDEL, Publishers, 49 West 23rd St., New York
Mail **AUDELS AUTOMOBILE GUIDE** (\$4) for free examination. If O. K., I
will send you \$1 in 7 days; then remit \$1 monthly until \$4 is paid.
Otherwise, I will return book promptly.

Name _____
Address _____
Occupation _____
Reference _____ PM

Have an OFFICE of YOUR OWN!

LEARN NEW PROFITABLE PROFESSION
At Home in 60 Days, Men & Women, 18 to 70!

Be Your Own Boss and
the Boss of Others. Be
Respected. Meet Inter-
esting People.

Earnings of men and women in this profession run as high as \$5,000-\$15,000 yearly. Others make good money in spare time. Little money needed to start. A business where your earnings begin sooner. Easy to learn. No selling or goods to buy. No experience necessary. A depression-proof business. A course of action to guide you step by step as you earn. All 53 lessons sent at once to use as operating manuals. Easy terms. Diploma. Money-back agreement. Write for **FREE BULLETIN.**



FRANKLIN CREDIT SCHOOL
Dept. 75-F ROANOKE 7, VIRGINIA

BY MAIL in
Easy Lessons

Learn to MOUNT BIRDS



Tan SKINS, make up FURS

Be a Taxidermist. Double your hunting fun. We teach you at Home. Mount Birds, Animals, Fish, Heads, common specimens. Fun and profits. Decorate home and **MAKE MONEY.** Mount game, tan for others. Big profits in spare time. **WRITE TODAY.** 100 game pictures in **FREE BOOK.** Now Free. Send post card. State your AGE. **NORTHWESTERN SCHOOL OF TAXIDERMISTRY** Dept. 337-A Omaha, Nebraska

TRAIN Your VOICE!

Results GUARANTEED

We build, strengthen the vocal organs—not with singing lessons—but by sound, scientifically correct silent and vocal exercises and absolutely **unusually** complete satisfaction with results. Write for Voice Book, **FREE.** Sent to no one under 17 years old unless signed by parent. Perfect Voice Studios, Studio 135-A, Kimball Hall Bldg., Chicago 4, Ill.

THRILLS Plus CASH!

YOURS WITH SKY-EYE AERIAL PHOTOGRAPHY

Get thrilling aerial photos that sell with the new positive SKY-EYE system of manual shutter control when used on high flying camera carrying kites. No free swinging camera with SKY-EYE. Use same system for releasing model planes, gliders, parachutes, etc. from great heights. Completely illustrated instructions of the SKY-EYE system plus **FREE** detailed illustrated plans for two, easy to build, powerful six foot military type, camera carrying kites—kind used by scientists. Both roll up into 6" x 3 1/2" bundles. **BUILD—SELL—Only \$1.00 postpaid.**

SKY-EYE PHOTOGRAPHY, 3 Landon Hill Road, Chestertown, New York

LEARN MEAT CUTTING

through actual practice. Profitable Meat Cutting and Successful Meat Merchandising taught easily, quickly. **LEARN BY DOING** at Toledo in just six short weeks under actual market conditions. For beginners or men with experience. All subjects taught thoroughly and completely. Diploma. Job help. Get store of own. People must eat. School in operation nearly 25 years. Approved for GI training. Send today for **FREE** literature. No obligation.

NATIONAL SCHOOL OF MEAT CUTTING, Dept. 50-B, Toledo 4, Ohio

WANTED OLD BROKEN JEWELRY

In any condition, Gold prices today are the highest in history. Our high prices will surprise you. Cash mailed same day. Mail gold teeth, crowns, watches, rings, diamonds, eyeglasses, silverware, platinum or ANYTHING. Reliability **GUARANTEED.** If not satisfied, your articles returned. Surprise Gift and Free information for new customers. **Universal Guarantee Co., Dept. 100, 600 S. Michigan Ave., Chicago 5, Ill.**

Say You Saw It in Popular Mechanics

FREE BOOK RAISE HAMSTERS

The new wonder animals from Syria. Often called Toy Bears. Delightful pets. Everyone wants them. Laboratories need thousands. Clean, odorless. Raise anywhere. A profitable and interesting hobby or business. We furnish breeding stock with manual of instructions.

Write today for free illustrated literature.
GULF HAMSTERY, 1536 BASIL, MOBILE, ALA.





GET INTO DRAFTING

The Draftsman Plays a most Important Part in INDUSTRY

DRAWING OUTFIT INCLUDED with Drafting courses

All the tools you need including folding drawing table. With them you can put your ideas on paper quickly and with accuracy. With training you are all set to master Drafting in months, — not years — at home.

Learn in Spare Time—At Home!

(or at the College in Chicago)

A few hours of pleasant home study every week — that's all. With Chicago Tech's help, you train yourself step by step. This tested method — developed over 44 years of C.T.C. progress — prepares men for good positions in industry.



MAIL COUPON NOW

Chicago Technical College
G-211 Tech Bldg., 2000 So. Michigan Ave.
Chicago 16, Illinois

Mail me FREE Drafting Lesson with information about big opportunities in DRAFTING and how I can train at home.

- Architectural Drafting Electrical Drafting
 Machine Drafting Structural Drafting
 Builders' Course

Name _____ Age _____

Address _____

City _____ Zone _____ State _____

**CHICAGO
TECHNICAL COLLEGE**
G-211 Tech Building, 2000 South Michigan Ave.
Chicago 16, Illinois

ELECTRICAL TRAINING

For Men of Ambition and Limited Time - Train for Successful Careers in Electricity

BLISS

Intensive 32 weeks residence course in fundamentals of industrial electrical engineering, including radio and electronics. Extensive laboratory practice in electrical measurements; testing power equipment; circuit tracing; wiring techniques; radio and industrial electronics; use of machine tools; motor construction; drafting. A basic training meeting industry's requirements for engineering

aides, laboratory assistants; operating, production and maintenance technicians; customer engineers; draftsmen. Graduates hold responsible technical and executive positions.

Modern buildings, dormitories, dining hall, campus. Moderate cost. 54th year. Classes begin July 26; Nov. 22. For catalog write 7634 Takoma Avenue, Washington 12, D. C.

ELECTRICAL SCHOOL
A TECHNICAL INSTITUTE



22 Big Money-Makers in a Single Line! Amazing New Fluorescent Lights with Circular Tubes

THE
HOMELITER



**FREE Sales
Outfit**

Don't send a penny. Sample Outfit is FREE. Rush name on penny post card for money-making facts about sensational new "CIRCLINE" Fluorescents. Latest scientific development gives you 22 new type circular tube fixtures for kitchens, dinettes, halls, and play rooms. Also Floor and Table lamp for living rooms and pin-ups for shaving and vanity tables. Sells on sight to homes, restaurants, stores, offices. No other fluorescents like CIRCLINE. Salesmen who order samples quickly reorder in large quantities. All fixtures complete with tubes. No waiting. Also immediate delivery on all standard type Fluorescent Fixtures. This is too good to miss. Big, quick profits waiting. Rush name on postcard today for FREE Sales Outfit.



**NEW MAXILUME
PIN-UP
MIRROR LIGHT**

MAXILUME COMPANY • 125 W. HUBBARD • DEPT. 86 • CHICAGO 10, ILLINOIS



START AS HIGH AS \$3021 YEAR

Many Early Examinations Expected. Prepare NOW! Veterans Get Special Preference! 40-Page Civil Service Book FREE.

Although not Government controlled, this can help you get a Government job.

Mail Coupon Today SURE

Franklin Institute
Dept. C86
Rochester 4, N. Y.

Gentlemen: Rush to me, FREE of charge, list of U. S. government big pay jobs. Send FREE 40-page book describing salaries, vacations, hours, work, etc. Tell me how to qualify for one of these jobs.

COUPON
Name _____

Address _____ Vet? _____



MADE \$14 PER DAY While Still Learning

"By the time I finished half your course, I was making \$14.00 per day. I have made enough on the side to more than pay for the course —"

T.E.H.—West Virginia

LEARN ELECTRIC APPLIANCE

We Teach
How to Repair
Washing Machines
Vacuum Cleaners
Electric Ranges
Lamps
Motors
Irons, etc.
Refrigeration and
House Wiring
At Home
In Your SPARETIME!

REPAIR & SERVICE

For a man handy with tools, and happiest when working with his hands. OPPORTUNITY is Wide Open Today in this great and growing field. Everyone is a customer for the man trained to service electric appliances.

OPEN YOUR OWN SHOP

Our practical HOME COURSE teaches you this business from A to Z—preparing you to take a well paid job or open your own shop. You can actually start in your basement or garage with the tools I send you . . . before finishing.

I INCLUDE A
BIG KIT
of special appliance tools at
NO EXTRA COST

MAIL THIS COUPON for FREE BOOK

PACIFIC TRAINING SCHOOL
7217 So. Broadway, Dept. P-86, Los Angeles 3, Calif.

Dear Sirs: Please send me, without obligation, your free booklet and complete details.

Name _____

Address _____ Zone _____

City _____ State _____

STUDY AT HOME

With An Educational Institution

Men with specialized training win higher positions, insure larger earnings, and are bigger successes in business and public life. Opportunities NOW greater than ever before. Send for our Catalog.

ARTS and SCIENCES

Courses in Philosophy; Education; Letters; Public Health; Medical Jurisprudence; Psychology; Sociology; Physics; Chemistry; Plastics; Geology; Political Science; Theology; Business and Commerce; Accounting; Mathematics; Statistics; Agriculture.

ENGINEERING

Courses in Electrical, Civil, Mechanical, Drafting, Architectural, Steam, Aeronautical, Radio, Structural, Mining, Industrial, Petroleum, Marine, Chemical, Diesel, Automobile, Refrigeration, and Air Conditioning Engineering.

LAW

Complete Professional Law Course includes 18 Hornbook Series college grade textbooks. Courses also in Commercial Law, Patent Law and Medical Jurisprudence.

McKinley-Roosevelt Incorporated, 4610-K, Sheridan Rd., Chicago 40, Ill.



DEALERS WANTED

MUFFLERS

STEELS and ALUMINUMS with a motorboat tone

SINGLES, Chev., V-8, Plymouth, Steels \$5.50, Aluminum \$7.00. Chry., Olds., Buicks, etc., Steels \$7.50, Aluminum \$9.00. V-8 and MERCURY DUALS, Steel \$17.50, Aluminum \$21.00. Split Manifold Sets, Steels \$35.00, Aluminum \$45.00. Aluminums are guaranteed for life of your car.

SANDEE MUFFLER CO.
BOX 296 LA TIJ., LOS ANGELES 43, CALIF
2624 W. SLAUSON AVE., LOS ANGELES, CALIF.

FOREIGN STAMPS

Enormous Bargain! 2,000 foreign stamps, \$1.00, 5,000 \$2.00. Order now!

AMERICAN STAMP CO., Dept. A-4214, Wilmington 99, Del.

I'LL SHOW YOU how to MAKE MONEY in WATCH REPAIR

Learn watch repair—make money in your own business or job. No age or physical limits. Estimated 20,000 watchmakers needed. Nationally accredited school—in cool Denver, Colo. Veteran approved. Send postcard for free book. FREE BOOKLET.

AMERICAN ACADEMY INC. — SCHOOL OF HOROLOGY
1549 LAWRENCE STREET DENVER 2, COLO.

OLD GOLD JEWELRY WANTED

Dental gold teeth, plates and bridges with metal attached. Any broken pieces of gold jewelry. Immediate payment and free mailing container to you or your friends upon request. LOWES. DEPT PM Holland Bldg., St. Louis 1, Mo.

FIREWORKS

601-PIECE ALL-NOISE ASSORTMENT

includes half gross Cherry Bombs, many Chinese crackers, Lady Crackers, Salutes, Little Red Devils, etc. Shipped by Express same day order is received. Name nearest Express office. No C.O.D. Supply Limited. Order Early only \$3.95!

JAYHAWK FIREWORKS

BLUE RAPIDS, KANSAS

SUCTION SPONGE



AUTO WASHER

Slide across surface and presto! New "Suction" Auto Washer shampoos cars like magic. Dust, dirt, grease, grime disappear in jiffy. Automobiles gleam like a mirror.

SAMPLES FOR AGENTS

Sample offer sent immediately to all who send name at once. A penny postal will do. Send No Money — JUST YOUR NAME. KRISTEE CO., 684 Bar St., Akron, O.

QUICK EASY!

NOW YOU CAN "Breeze Through" ANY AUTO REPAIR JOB!

Free 7-DAY OFFER!

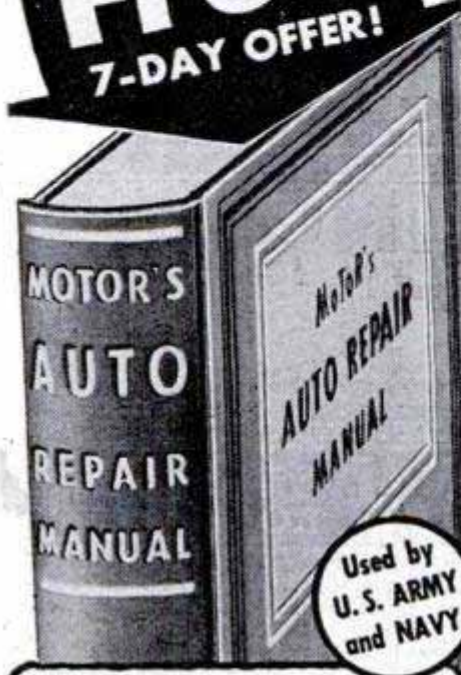

Yes—EVERY Auto Repair Job is a "Snap"—with This Big Time-Saving, Money-Saving Manual. It Shows You How to Service and Repair ANY Part of ANY Standard Car!

DON'T squander time and patience trying to "dope-out" difficult car repairs! With this amazing new book you can "whiz" through ANY job confidently—in almost no time! Just look up make, model, and the job in MoToR's AUTO REPAIR MANUAL—and every repair job from radiator to rear end becomes a "push-over"!

Try It FREE For 7 Days!

Nothing like MoToR's AUTO REPAIR MANUAL has ever been published! It's just as if plain-talking engineers from every auto plant in America actually got together to show you everything you need to know about the cars they themselves designed. Every sentence, every picture, is crystal clear—easy-to-follow. That's why the publishers say: Try this big, 701-page book FREE for 7 days. Put it to every possible test in the shop, or on your own car. Then, unless you're convinced beyond doubt that this book is the greatest time-saver and money-saver you've ever seen, just return it. You pay nothing—you owe nothing.

See How Much You Get!

This book combines information from over 150 Official Factory Shop Manuals. OVER 200,000 service, repair, adjustment, replacement, tune-up facts on all makes and models, 1935 to 1948. More than 1700 cut-away photos, diagrams, drawings show you exactly WHAT to do and HOW to do it. Used by U. S. Army, tech schools; thousands of auto servicemen.

Published by MoToR, the leading Automotive Business Magazine. MoToR's manuals assure high standards of repair work.



WORTH BIG MONEY TO:

- Mechanics
- Handymen
- Garagemen
- Farmers
- Repair Men
- Service Station Operators
- Taxi Owners
- Part-Time Mechanics
- Army and Navy Personnel

WHAT USERS OF THIS BOOK SAY:

"A boy can easily follow its instructions. I fixed a motor on which another mechanic had worked half a day. With your Manual, I did it in 30 minutes."

—C. Auberry, Tenn.



"MoToR's Manual paid for itself on the first two jobs and saved me valuable time by eliminating 'guess work.'"

—W. Schrop, Ohio



"Have done jobs with this Manual that I would not have attempted without it. Explanations are easy to understand and complete."

—C. L. Vanerstrom, Mich.



SEND NO MONEY

Without risk, see for yourself how quickly this book covers every job on every car! Just mail coupon—without money—for FREE 7-Day Trial. Unless you're convinced it's worth many times its cost, return book in 7 days and pay nothing! MoToR Book Dept., Desk 1G, 572 Madison Ave., New York 22, N. Y.

MAIL COUPON NOW FOR 7-DAY FREE TRIAL

MoToR BOOK DEPT., Desk 1G, 572 Madison Ave., New York 22, N. Y.

Rush to me at once: (check box opposite book you want)

MoToR's AUTO REPAIR MANUAL. If O.K. I will remit \$1 in 7 days (plus 35c delivery charge), then \$2 monthly for 2 months and a final payment of 95c a month later. Otherwise I will return book postpaid in 7 days. (Foreign price, remit \$8 cash with order.)

MoToR's TRUCK REPAIR MANUAL. (Described at left.) If O.K. I will remit \$2 in 7 days, and \$2 monthly for 3 months, plus 35c delivery charges with final payment. Otherwise I will return book postpaid in 7 days. (Foreign price, remit \$10 cash with order.)

Print Name _____ Age _____

Print Address _____

City _____ Zone No. _____ (if any)

State _____ Occupation _____

Check box and SAVE 35c delivery charge by enclosing WITH coupon entire payment of \$5.95 for Auto Repair Manual (or \$8 for Truck Repair Manual). Same 7-day return-refund privilege applies.

Clear, Pictured Instructions on Every Job on Every Car Built from 1935 to 1948!

- American Bantam • Auburn • Austin
- Buick • Cadillac • Chevrolet
- Chrysler • Cord • Crosley • De Soto
- Dodge • Ford • Frazer • Graham
- Hudson • Hupmobile • Kaiser
- Lafayette • La Salle • Lincoln
- Lincoln Zephyr • Mercury • Nash
- Oldsmobile • Packard • Pierce Arrow
- Plymouth • Pontiac • Reo
- Studebaker • Terraplane • Willys.

Nearly 200,000 service and repair facts on all 32 makes. 701 big pages; including 70 pages of carburetor text covering all models. Over 200 charts, tables; Tune-up Chart; Valve Measurements; Torque Wrench Reading; Starting Motor; Engine Clearances; Generator; Body Service; Dash Gauges; Brake Specifications; Front End Measurements; etc., Engines, Electric, Fuel, Cooling, Lubricating Systems; Transmissions; Universals; Front Ends; Wheels; Rear Ends, etc.

Same FREE 7-Day Offer Applies on

MoToR's TRUCK REPAIR MANUAL



Covers EVERY job on EVERY truck made since 1936! 1400 pictures, 952 pages, 300,000 facts. Used by Armed Forces.

All types Gasoline Engines, Diesels, Hesselman. Fuel Systems, Generators, Clutches, Transmissions, Axles, Torque Dividers, Transfer Cases, Brakes, Steering, etc.

ALSO SERVICES buses, farm and industrial tractors, etc. (on all parts described in Manual). Check box in coupon.

FREE

get it now

ALLIED'S NEW 1948 RADIO CATALOG!

172
Value-Packed
Pages



EVERYTHING
IN RADIO AT
LOWEST PRICES



TELEVISION AND
NEW HOME RADIOS



SERVICE SUPPLIES
BUILDERS' SUPPLIES



AMATEUR GEAR



SOUND SYSTEMS

Radio's Great Buying Guide

Send today for your FREE copy of Radio's Leading Catalog! It's the preferred Buying Guide for Servicemen, Dealers, Engineers, Soundmen, Amateurs, Builders and Experimenters. Shows everything you want in Radio and Electronic equipment—all the newest releases—complete, highest quality stocks at low, low prices that save you money on every purchase!

World's Largest Stocks!

You'll find *everything* in the new 172-page ALLIED Catalog—television receivers, latest home radios and radio-phonos, Ham receivers and station equipment, test instruments, public address equipment, new builders' kits, thousands of parts, tubes, tools, radio books, diagrams. Get the speedy, reliable service and expert help you want from ALLIED—Radio's Largest Supply House! Be sure to send today for your FREE copy of ALLIED'S new 1948 Buying Guide!

ALLIED RADIO

ALLIED RADIO CORP.
833 W. Jackson Blvd., Dept. 5-F-8
Chicago 7, Illinois

Rush FREE 1948 ALLIED Catalog

Name

Address

City.....Zone.....State.....

FREE
CATALOG

Out of Pawn!

GENUINE DIAMONDS

Direct to You—Save up to 50% and more on fine quality, Genuine Diamonds, reset in beautiful modern mountings, styled for Ladies and Men—Sold with an Iron-Clad Money-Back Guarantee. Over 100,000 satisfied customers. Order now from this ad. Write us for FREE ILLUSTRATED CATALOG of other Unredeemed Diamond Pledges from \$5.00 to \$5000. Send today. Reference: Dun and Bradstreet or your own local bank.

1/5 CARAT
\$125 Value

\$49
Tax incl.

1/2 CARAT
\$200 Value

\$95
Tax incl.

BERMAN'S COLLATERAL LOAN BANK

Dept. P-10, 636-38 W. Balto. St. Baltimore 1, Md.

BEARINGS

Bore	O.D.	Type	Price, each
.250	.750	Ball	\$0.15
.1575	.6299	Ball	.15
.1895	.500	Needle	.15
.1895	.625	Needle	.15
.2495	.625	Needle	.15
1"	1 1/4"	Needle	.15
1 1/4"	3"	Ball	1.25

All Brand New—Minimum order 10 bearings.

BENJAMIN SALES CO.

8774 Linwood Ave. Dept. M Detroit 6, Mich.

Fafnir,
N. D.,
S. K. F.,
Torrington,
Schatz &
Norma

LAW FREE BOOK



Write today for FREE 48-page book, "THE LAW-TRAINED MAN," which shows how to learn law easily in spare time at home through the Blackstone course prepared by 60 well-known law authorities. We furnish all material including 18-volume Modern American Law library. Many successful attorneys among our graduates. LL.B. degree. Moderate cost; easy terms; Money-Back Agreement.

BLACKSTONE COLLEGE OF LAW

225 N. Michigan Ave., Dept. 50-A, Chicago 1, Ill.

A Correspondence Institution Founded in 1890

Ottawa Self-Propelled Buzz Master

CLEAR LAND FAST! Powerful 7-HP motor with friction clutch for safe operation. Cuts down timber, brush and hedge; turn blade vertically and saw logs to length. Also furnished with post hole diggers. Has clutch pulley for belt work.



OTTAWA MFG. CO., 1-827 Brush Ave., Ottawa, Kansas

GLOWS
in the DARK

FREE
Sample!

Be the first to sell luminous house numbers, light switch plates, wall protectors, pull cords. Also luminous pictures, statues, decals, and a host of religious, nursery and other objects that glow in the dark. Get into this new and growing industry. Enormous demand... no competition... sensational demonstration... big profits. Represent a large manufacturer, established over 34 years. Write today for liberal money-making offer and free sample to show how they glow in the dark.

MADISON MILLS, 303 Fourth Ave.
Dept. F-4, NEW YORK 10, N. Y.



Let me send you this amazing- ELECTRONIC KIT!

OWN THIS ELECTRONIC KIT

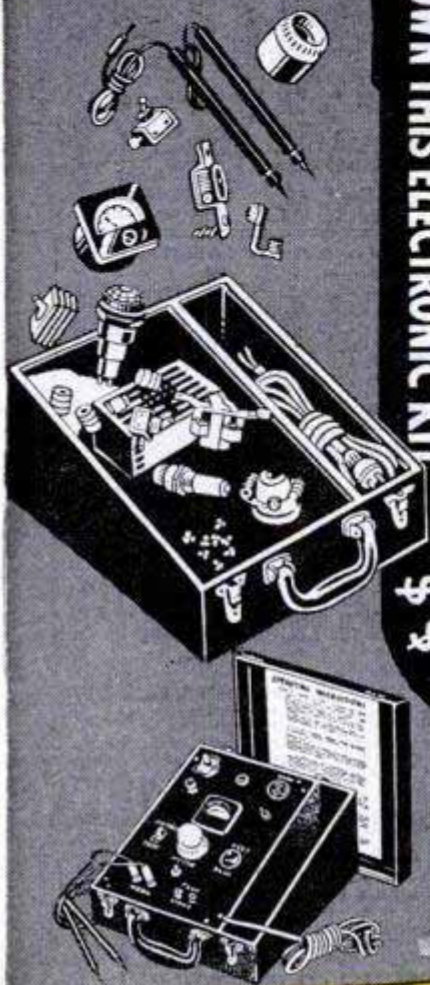

\$\$\$

GET IN ON THE BIG MONEY NOW! Assure Financial Security—Independence

My Christy Electronic Kit checks and tests electrical equipment, current consumption, heat controls, shorts, motor winding, etc., and reveals where repairs are needed! Electrical appliance repairing is a fascinating, big money-making business. Millions of appliances now in daily use will eventually require repair. Thousands of new appliances sold daily in all parts of the country! These unlimited prospects mean you always will have places to do profitable jobs. If you are mechanically inclined (can hold and use tools), you can qualify for this big steady-paying field. It is not unusual for appliance repairmen to charge on the basis of \$5.00 to \$6.00 an hour! Whether you want a lifetime business of your own or a better job testing factory equipment or household appliances, you will want my Christy Electronic Kit.



S. T. Christensen

REPAIR ELECTRICAL EQUIPMENT!

ILLUSTRATED COURSE SHOWS EVERYTHING

The Christy Electrical Appliance Repair Course is written in simple, easy-to-understand language. It is profusely illustrated with photographs and drawings. It shows you each and every step! What trouble to look for and then how to quickly fix it. In addition, our thorough course shows you how to build at low cost any power tools you may need! Should intricate technical problems arise or the need for a special repair part, simply call on us, for we offer YOU our FREE Advisory Service for LIFE! We teach you how to solicit business and how to keep business coming to you! Not a theory course, but a practical, honest-to-goodness course written by and used by repairmen all over the country. The combination of our Electronic Kit will go a long way toward ASSURING YOUR SUCCESS.



3 EASY STEPS TO SUCCESS

- ① WE SEND YOU AN ELECTRIC KIT
- ② WE TEACH YOU ELECTRICAL APPLIANCE REPAIRING
- ③ WE GIVE YOU LIFE-TIME ADVISORY SERVICE

RUSH THIS COUPON TODAY!

Mr. S. T. Christensen, President
Christy Supply Co., Dept. D-5803
2835 N. Central Ave., Chicago 34, Ill.

Mail me FREE without obligation complete illustrated information on how to get the Christy Electronic Kit and Christy Appliance Course.

Name _____ Age _____

Address _____

City _____ State _____



FREE!

Write for Dr. Brager's free 36 page booklet today.



GENUINE SURGICAL ELASTIC

"Bub" Durilknit SUPPORTER

Get new vigor—paunch flattened, "energy region" cradled, back firmed. "Bub" is guaranteed to outlast, out-laundry any 3 other supporters. Buy "Bub" at sporting goods, drug, men's wear, dept., surgical appliance stores. Or mail coupon.

JOHN B. FLAHERTY CO., INC.
616 E. 133rd St., Bronx 54, N. Y.

Send Dr. Brager's free 36 page booklet.

Send waist size _____ "Bub" as checked in quantities indicated. I enclose check or money order. In N. Y. C. add 2% city sales tax.

(NONE C.O.D.) CANADA 50c ADDITIONAL

_____ 10" waist band (illus. above) \$4.50 ea.

_____ 6" waist band \$2 ea.

_____ 4" waist band \$1.50 ea.

Detachable pouch in 10" model

Name (PRINT) _____

Street _____ City _____ State _____

FREE!

CANVAS SHOULDER STRAP BAG WITH EVERY OFFICIAL O.C.D. U. S. GOV'T WAR SURPLUS

GAS MASK

2 FOR \$1

Shipped prepaid anywhere in the U. S. A.

GAS MASK CAN BE USED FOR

- Spraying Insecticides and Paints
- Protection While Working on Machinery
- Cannister of Activated Charcoal makes an Efficient Ice Box Deodorant

CARRYING BAG CAN BE USED AS

- School Bag for Children
- Hunting and Fishing
- Tool, Utility Bag, Etc.

Every "Red Blooded" Boy Will Want One As a Toy

Gas masks are brand new flexible rubberized fabric body . . . elastic adjustable head bands . . . plastic shatter proof goggles . . . filter cannister with air intake valve.

Big, roomy canvas shoulder bag with snap-button fastener. Bag can be used for hundreds of utility purposes.

SEND ONE DOLLAR TO

BOB SALES CO., INC.

1608 S. Wabash Ave.

Chicago, Illinois

A Few Dealer Territories Are Still Available . . .

Write for Details

SAY YOU SAW IT IN POPULAR MECHANICS

MEN'S FULLY GUARANTEED NEW \$13.95 PLUS TAX

15-JEWEL WRIST WATCH

ORIGINALLY sold up to \$55

Sacrificed because they're post-war surplus **LOOK AT THESE FEATURES:**

Luminous dial . . . sweep second hand . . . waterproof . . . shockproof . . . anti-magnetic . . . imported Swiss precision movement and case. You get them now for a small fraction of original prices. Don't delay! Order now . . . while they last. Send only \$1 down payment with order. Pay balance to postman on arrival, plus postage. Or we pay postage if you enclose \$13.95 plus \$1.39 Fed. Tax.

Receive Reg. \$2 expansion band FREE with prepaid order. Money back in 5 days if not delighted. Order now.

MARYLAND DISTRIBUTORS, Dept. 56
501 E. Balto. St. Balto. 2, Md.



HY-SCORE

World's Most Powerful AIR PISTOL

ACCURATE! FAST! HARD-HITTING . . . Expensively made piston-type pistol for use by experts. No pumping. 30½ oz. 10¼" long. Cal .177 or .22. \$19.85 for set including Hy-Score Pellets and darts*. Extra ammunition per box of 500 rounds, \$1.49 for cal .177, \$1.88 for cal .22.

*When available.

Use HY-SCORE Pellets for best air pistol shooting.

If your dealer cannot supply, write for free booklet, Dept. PM6
HY-SCORE ARMS CORP., BROOKLYN 1, N. Y.

EXPERT PHOTOGRAPHY MADE EASY

LEARN PHOTOGRAPHY NOW

—for both a sound and secure future and immediate opportunities. Ever-increasing demand for trained men and women. Excellent earnings. Resident or home study. 38th year. Write for full details.

NEW YORK INSTITUTE OF PHOTOGRAPHY

Dept. 49, 10 West 33 Street

New York 1, New York

BAR BELLS

Buy Direct From Factory **\$8.95**
Save 20% to 30% **8up**

Write for Free Booklet and Price List

INDEPENDENT IRON WORKS
2440 EAST 23RD STREET, DEPT. 13
LOS ANGELES, CALIFORNIA

\$13.50 Value for Only \$1.95

8000 ohm impedance Headphones, produced to Air and Signal Corps specs. Extremely sensitive, lightweight (only 9 oz.) With 5½ ft. cord, plug, jack and ear cushions. **BRAND NEW.**

No. 17A37 Spec., Per Pair... **\$1.95** Plus 25c each for Postage.

FREE Catalog on Everything in Radio and Electronics.

Burstein-Applebee Co. 1012 McGee, Kansas City 6, Mo.

Fit-Rite makes False Teeth **TIGHT**

Makes loose dental plates fit snugly and comfortably.

LASTS for MONTHS!

Simply squeeze on dental plate and put it in your mouth. Hardens and becomes part of plate. Money-back guarantee.

FREE Generous package of Dental Plate Cleanser with each order. Send \$1.00 or mailed parcel post collect.

Fit-Rite Co., 1557 Milwaukee Ave. Dept. 6-PM, Chicago, Ill.

POPULAR MECHANICS

ACE Hollywood Experts WILL TRAIN YOU AT HOME to MAKE GOOD in

RADIO TELEVISION-ELECTRONICS

through practical EXPERIMENTS

with

10 BIG KITS of RADIO PARTS R.T.A. GIVES YOU!



YOU WILL DO SCORES OF PRACTICAL JOBS AND EXPERIMENTS

The 10 BIG KITS RTA GIVES YOU enable you to do many practical jobs. Illustrated above are only a few of the many job-exercises you do. You build a TRF Receiver, a High-Frequency Converter, a complete, powerful 6 Tube AC-DC Superheterodyne receiver, and perform more than a hundred other fascinating and valuable experiments. These jobs you do give you ACTUAL SHOP EXPERIENCE so vitally necessary to future success. Thus RTA methods assure you BALANCED TRAINING—Theory PLUS Real Experience.

TEAR OUT COUPON AND MAIL TODAY

MASTER HOLLYWOOD TECHNICIANS Guide You

It was no accident that RTA — RADIO TRAINING ASSOCIATION OF AMERICA — chose HOLLYWOOD as their headquarters. Hollywood has long been recognized as the very heart of America's Broadcasting, Television, Radio and Sound industries. Thus, RTA is right "on-the-spot" where new technical improvements are introduced, and is in the best possible position to bring students ACTUAL METHODS and TECHNIQUES developed by the RADIO-TELEVISION industry, leading to real money-making opportunities!

OPPORTUNITIES NOW WIDE OPEN for Properly Trained Men

Latest reports estimate 400 MILLION new radio and television sets will be built in the next ten years... and more than 72 million dollars is being spent RIGHT NOW just for radio repairs ALONE! When you are

thoroughly trained by RTA's Hollywood Experts—who have their fingers on the pulse of the Radio-Television industry—you can imagine what undreamed-of opportunities await you in Your Own Radio Sales & Service Business, Television, Aviation, FM, Manufacturing and Communications, etc.

EARN EXTRA MONEY while learning AT HOME

Under RTA's amazingly easy, practical home-training plan there is no need for you to quit your present job. You study in SPARE TIME ONLY and RTA's Hollywood Experts show you how to earn WELCOME EXTRA CASH, even BEFORE FINISHING YOUR TRAINING! In fact, when friends and neighbors know you are studying Radio-Television you may—like many RTA students—actually get MORE REPAIR WORK THAN YOU CAN HANDLE.

25 Year Success Record

Backed by more than 25 years of experience in the home

training field, RTA's practical "learn by doing" methods assure you quick, step-by-step progress. So begin preparing for your future in Radio-Television NOW, while the time is ripe. If you are at all mechanically inclined, and have a grammar school education, RTA can teach you how to MAKE GOOD as a Radio-Television technician.

R. T. A. GRADUATES SAY:

- ★ Thanks to R.T.A. I started my own radio store... am making 220 percent more than when I enrolled.—W. E. Thon, Chicago.
- ★ Truly thankful for the day I enrolled for R.T.A. Course... it fitted me splendidly for my present position.—N. R. Hoffman, Radio Station WCOD, Harrisburg.
- ★... R.T.A. sure opened my eyes to big money... thanks for all you have done for me.—Ernest Lancott, Cleveland.

GET FACTS! SEND FOR FREE BOOK!

telling all about RTA's streamlined home-training plan, developed by technicians in the heart of the booming Radio-Television field. Fill out the coupon TODAY and your FREE BOOK, entitled "How To Make Good In Radio-Television" will go out to you AT ONCE! No Obligation. RTA APPROVED FOR VETERANS.



**RADIO TRAINING ASSOC. OF AMERICA, DEPT. PMF
5620 Hollywood Blvd., Hollywood 28, Calif.**

Send FREE BOOK showing how to make good in Radio-Television through training by Hollywood experts.

NAME _____ AGE _____

ADDRESS _____

CITY _____ ZONE _____ STATE _____

Check box if VETERAN of World War II

THE CHAMPS SET THEIR RECORDS WITH LOUISVILLE SLUGGERS



Every important batting record in Baseball has been made with a Louisville Slugger bat. Look for the H&B oval trademark and a famous player's written signature on the barrel end.

The 1948 edition of H&B's Famous Slugger Year Book is ready now.



Get your copy from your Louisville Slugger dealer or send 5c direct to us (stamps or coin) to cover mailing. Address Dept. P-31, Hillerich & Bradsby, Inc., Louisville 2, Ky.



Louisville SLUGGER BATS

FOR BASEBALL & SOFTBALL

REDUCE GARDENING AND MOWING TO TAKING A WALK

Just guide ROTO-ETTE. Thrill as it responds to do nearly all your irksome garden work. Makes deep-tilled, ready-to-plant seed beds. Furrows, hills, tills, cultivates, dusts. Cuts hay and weeds, mows lawns, saws wood, plows snow, hauls loads, powers sprayers and pumps. Cuts food costs; reduces work to play.

WRITE DEPT. N
ROTOTILLER, Inc., TROY, N. Y.

ROTO-ETTE

Reg. U. S. Pat. Off.
THE ALL-PURPOSE
POWER GARDENER



Worth an
EXTRA MAN
Anytime

Famous BANNER FIREWORKS

OH-BOY! Don't be disappointed. Get the best for your money. Famous Banner Fireworks have all the ZIP, BOOM, BANG you expect of fireworks. This year several new creations have been added. You'll thrill to every last piece in this Big Bargain Assortment.

BIG SPECIAL DEAL—ONLY \$4.95

Retail value \$11.25. Buzz Bombs—Star shells Block Busters—Zig-Zag Whistles—Flashlight Crackers—Sky Rockets—Roman Candles—Repeating Aerial Bombs, Sparklers and many others. Over 500 pieces in all. Rush order today. Supply limited. Send money order, bank draft or currency. No C. O. D.'s. Catalog FREE.

BANNER FIREWORKS MFG. CO., INC., DEPT. 142
446 Capistrano Toledo 12, Ohio

New Designs in FRANZITE GRIPS

Modernize Your Gun! Improve Your Score!

Most durable grips made. Positively unbreakable! For Colt, Smith & Wesson, Hi-Standard, Ortigas, Luger & Mausers in a wide choice of beautiful designs in ivory, pearl, walnut, onyx, etc. Low prices. FREE CATALOG. Dealers Wanted.

SPORTS, INC. (Mrs.) 5501 Broadway, Dept. P-6, Chicago 40, Ill.

Learn to Write

You can become a good Business Writer, and you can learn Shaded Writing also at home during spare time by my Simplified Method, without cost of going away to school. Easy Lessons. Diploma. Write for my FREE BOOK, "How to Become an Expert Penman," which shows what others have learned. Send 10c for Special Penpoint and your name with a flourished bird written on a card. Write TODAY.

T. M. TEVIS, BOX 25K, CHILLICOTHE, MO.

TRAIN TIME

Time now to build up your road. Spoonley has all equipment and is roundhouse for repairs of all Lionel and American Flyer models.

SPOONLEY
"The Train Man"
37 CHOATE AVE., BUFFALO 20, N. Y.

SAVE'S Genuine Quality GABARDINE Dress Trousers

\$11.95 VALUE! Order by mail and SAVE! Firmly woven virgin wool and fine-spun rayon. Twill weave resists wrinkles. Holds crease, gives amazing wear. Expert fashion tailored for perfect fit. Zipper front. Roomy pockets, bar-tacked for double strength. Blue, Tan, Sand, Lt. Brown, Dk. Brown, Blue-Gray.

WAIST SIZES: 28-36 pleated—38-44 plain.

SEND NO MONEY Send name, waist size, color. Pay postman only \$6.95 plus C.O.D. Or, send money and save C.O.D. Money-Back Guarantee!

LINCOLN TAILORS Dept. PM-6 Lincoln, Nebr.

Only \$6.95 PR.

TO THOSE WHO THINK LEARNING MUSIC IS HARD

Just strike these notes and you're playing the beginning of the 'Merry Widow' Waltz

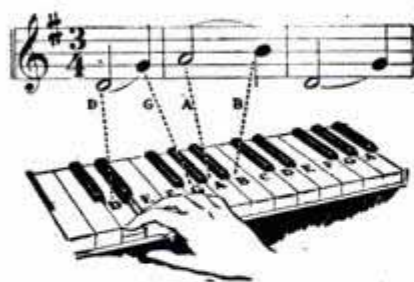

Look at the diagram. The first note of the music is "D." Following the dotted line to the keyboard you'll find "D" is the white key between the two black keys near the middle of the keyboard. Now read below how you can learn to play any instrument quickly and easily.



EASY AS A-B-C—COSTS JUST A FEW CENTS A DAY!

• Perhaps you think learning music is a tedious grind. It isn't any longer! Long hours of practicing scales and monotonous exercise are over.

You have no excuse for not getting started toward musical good times now! For through an easy method you can now learn to play right at home—without a teacher—for a few cents a day.

Learn to Play by Playing

The lessons come to you by mail from the famous U. S. School of Music . . . complete instructions, clear diagrams, and all the music you need. You learn to play by playing real tunes by note. First you are told how to do a thing. Then a picture shows you how. Then you do it yourself and hear it. Remember, don't confuse our method with any system claiming to teach music "by ear" or by trick methods. We teach you to play only from real notes!

SUCCESS!

Here's what one of our thousands of pupils writes: "I learned more from your course than many of my friends who studied under private teachers have for years. The fact that I've already taken 2 courses and am now enrolling for a third should speak for itself." F. A. S., Indiana.

Then you do it yourself and hear it. Remember, don't confuse our method with any system claiming to teach music "by ear" or by trick methods. We teach you to play only from real notes!

Don't delay. Send now for our illustrated Free Booklet and "Print and Picture" Sample which fully explain this remarkable method. So decide which instrument you want to play and mail the coupon today. U. S. School of Music, 76 Brunswick Bldg., New York 10, N. Y. (Successful 50th Year)

FREE PRINT AND PICTURE SAMPLE

U. S. School of Music, 76 Brunswick Bldg., New York 10, N. Y.

Please send me Free Booklet and Print and Picture Sample. I would like to play instrument checked below.

<input type="checkbox"/> Piano	<input type="checkbox"/> Saxophone	<input type="checkbox"/> Modern Elementary
<input type="checkbox"/> Guitar	<input type="checkbox"/> Trumpet, Cornet	<input type="checkbox"/> Harmony
<input type="checkbox"/> Hawaiian Guitar	<input type="checkbox"/> Reed Organ	<input type="checkbox"/> Mandolin
<input type="checkbox"/> Violin	<input type="checkbox"/> Tenor Banjo	<input type="checkbox"/> Practical Finger
<input type="checkbox"/> Piano Accordion	<input type="checkbox"/> Clarinet	<input type="checkbox"/> Control

Name _____ Have You Instrument? _____

Address _____

City _____ State _____

Save 2c—Stick Coupon on Penny Postcard

How to Write

The demand for writers is creating great new opportunities for people with an urge to write. It's not as hard to succeed as you may imagine. Most famous authors come from ordinary walks of life. At home, you too may learn fiction writing, the best basis for all fields—short stories, novels, features, articles, radio scripts. Palmer Institute's Home Study Training (Established 1917) is endorsed by Rupert

Short Stories, Mysteries, Novels, Articles—at home in spare time

Hughes, Ruth Comfort Mitchell, Gertrude Atherton, Katharine Newlin Burt and other famous authors and by scores of successful graduates. Complete instruction material, professional coaching develop your own style. FREE book and lesson show how you may enjoy an ideal part time or full time career. Write today (no salesman will call). Veterans: advise us if you are eligible for G.I. Training.

PALMER INSTITUTE OF AUTHORSHIP • Desk T-68 • 1680 N. Sycamore • Hollywood 28, Calif.



FIX SEWING MACHINES

BIG MONEY. Spare or full time. Open your own neighborhood shop. Thousands need repairs. Send for complete Service Manual—only \$1.98 postpaid. Money back guarantee.

SEWING MACHINE SERVICE CO., Hamilton 25-BB, Ohio

MAKE up to 600 an hour DO RUG WEAVING AT HOME!

Start your own business at home weaving rugs, carpets, etc. The DEEN ALL-WEAVE LOOM turns out 2-3 rugs every hour. No experience needed. Ideal for handicapped people. Small investment gets you started. Write today for FREE booklet.

THE GIBSON COMPANY
123 Gibson Building Lake Ozark, Missouri



Raise Broilers in 7-8 Weeks

BROWER BATTERY BROODERS

Raise broilers and pullets with this three deck automatic electric heated 40-a-month broiler plant. Made of steel and aluminum . . . Price, \$40.95. Other batteries from \$15.95 up. All capacities . . . Write for free battery brooder and poultry supply catalog.

Brower Mfg. Co., Box 161, Quincy, Ill.

World's Largest Line of Poultry Supplies

SAY YOU SAW IT IN POPULAR MECHANICS



DRAW for MONEY . . . Be an ARTIST!

Trained Artists are Capable of Earning \$60-\$75 or More a Week

You can learn to draw at home in your spare time the well-known WSA way. **COMMERCIAL ART, DESIGNING, CARTOONING**—all in one complete course. No previous art experience necessary—we teach you step-by-step. Prepare now for a fascinating hobby or profitable career. For 34 years WSA graduates have been making good—WHY NOT YOU?

Veterans! WSA is approved for G.I. training

Write today for FREE BOOK, "Art for Pleasure & Profit," it fully describes our well-known course, instruction service, and commercial opportunities for you. TWO ART OUTFITS included with training.

WASHINGTON SCHOOL OF ART, Studio 126M
1115—15th St., N. W., Washington 5, D. C.

Please send me full information and your Free Book, "Art for Pleasure and Profit."

Name _____ AGE _____
Street _____
City _____ Zone _____ State _____

I am entitled to training under the G. I. Bill



WAR SURPLUS OPTICAL BARGAINS

ASSEMBLE YOUR OWN BINOCULARS!

Save More Than 1/2 Regular Cost



GOVERNMENT'S 7X50 BINOCULARS

Complete Optics!
Complete Metal Parts!
We supply full instructions

METAL PARTS—Set includes all Metal Parts—completely finished—for assembly of 7 X 50 Binoculars. No machining required. Bodies have been factory hinged and covered. A sturdy Binocular Carrying Case is optional with each set of Metal Parts.

Stock # 842-H \$39.40
Postpaid, plus \$4.80 for Case—Total \$44.20

OPTICS—Set includes all Lenses and Prisms you need for assembling 7 X 50 Binoculars. These are in excellent condition—perfect or near-perfect—and have new low reflection coating.

Stock # 5102-H \$25.00 Postpaid

NOTICE! If you buy both Binocular Optics and Binocular Metal Parts, add 20% Federal Excise Tax to above prices.

ARMY'S 6x30 BINOCULARS

COMPLETE OPTICS & METAL PARTS—Model M-13A1, 6 X 30 Binoculars. (Waterproof Model). Everything you need—ready for assembly. When finished will look like a regular factory job costing \$102. to \$120. The Optics are new, in perfect or near-perfect condition. Have new low reflection coating. Metal Parts are new and perfect, all completely finished. No machining required. Bodies factory hinged and covered. Complete assembly instructions included.

Stock # 830-H \$40.00 Postpaid
plus \$8.00 tax—Total—\$48.00

TERRIFIC BARGAIN—BUBBLE SEXTANT

These Army Air Forces Bubble Sextants cost Govt. about \$125 each. Bargain at our price of \$12.50. Wooden carrying case included. Wartime used but **COMPLETELY REPAIRED AND COLLIMATED**. Return within 10 days for full refund if dissatisfied. Directions for use accompany shipment.

Stock # 924-H \$12.50 Postpaid

Same SEXTANT as above, but **BRAND NEW** and with Automatic Averaging Device and Illuminated Averaging Disc for nighttime use. Govt. cost \$217. Perfect working order guaranteed.

Stock # 933-H \$22.50 Postpaid

6 POWER GALILEAN TELESCOPE—(Commercial Surplus) 28mm dia. Achromatic Objective Lens. Sturdily constructed of Aluminum. 7" long, extends to 9". Complete with carrying case.

Stock # 941-H \$3.00 Postpaid

We have literally millions of war surplus lenses and prisms for sale at bargain prices ranging 10c and up. Write for Catalog "H"—Sent Free!

Order by Stock No. Satisfaction Guaranteed

EDMUND SALVAGE COMPANY

P. O. AUDUBON, NEW JERSEY

POPULAR MECHANICS FARM MANUAL

**A Thousand Ideas You Can Use Every Day
on the Farm. Only \$3. Mail Coupon**

POPULAR MECHANICS PRESS, Dept. 671
200 East Ontario St., Chicago 11, Ill.

- Send _____ copies of the Farm Manual at once.
- Remittance (\$3.00 each) enclosed. Send postpaid. Add 15% if outside U.S.A.
 - Send C.O.D. (\$3.00 each) plus delivery charges. U.S.A. only.
 - If sent as a gift to another, send name and address on separate sheet.

Name _____
Address _____
City _____ Zone or Route _____ State _____



284
Fact-
Packed
Pages

COVERS: Farm Machinery and Implements, Farm Workshop Equipment and Repairs, Poultry and Livestock Care, Vegetable Storage, Freezing, Canning, Farm Home Improvements and 40 pages of farm hints and kinks.

A Must for Every Farm Family! Saves Money for City Home Owners!

Here is the experience of hundreds of successful farm operators—in one handy, easy-to-read, easy-to-use, working handbook with hundreds of illustrations, by the editors of Popular Mechanics. It is brimful of short cuts, labor-saving ideas, ingenious apparatus that you can use to simplify the day's work and lighten some of the more tedious chores, make money and save money. Every department of the farm is covered in the Farm Manual. Every member of the family, including city dwellers too, will find in it something that he or she can use to tremendous advantage. Of interest equally to the woman looking for home improvement, beauty and convenience and the man striving for easier and more profitable operation.

Mail the coupon today. Only \$3 postpaid. If you have folks on a farm, send a copy to them.

POPULAR MECHANICS
PRESS
200 E. Ontario St., Chicago



Have you?

A PRODUCT!
AN IDEA!
A PATENT!
OR APPLICATION!

We Have Complete Manufacturing, Engineering Development And Sales Facilities.
We Are Interested On The Basis Of Outright Sale, Royalty Or Franchise For Manufacture And Sale.

Write Complete Details To—

DRAPER MOTORS CORPORATION

9680 Grinnell Ave., Detroit 13, Michigan

Be an INVESTIGATOR

JAMES S. BOLAN, FORMER POLICE COMMISSIONER OF NEW YORK CITY offers **MEN & WOMEN** an attractive opportunity to prepare for a future in *Investigation & Criminology* by comprehensive Home Study Course. Free placement service assists graduates to obtain jobs. **APPROVED UNDER G. I. BILL OF RIGHTS.**

Write for Free Booklet P.M.

THE **BOLAN ACADEMY, INC.**
EMPIRE STATE BLDG., NEW YORK 1, N. Y.



CARTOONING

THERE'S BIG MONEY in CARTOONS! Cartooning now made "easy-to-learn" for **BEGINNERS!** New, different, simple as A-B-C Course in 25 lessons, tells how! It's really easier than you think! **Learn and earn!** Complete Course only \$1.98 with **KEY** instructions. Money back if not satisfied. Interesting details free, if desired.

WADO SERVICE, 91 East Main St., Brocton, N. Y.

REFRIGERATION and AIR CONDITIONING

REFRIGERATION
TRAINING
Since 1927



MECHANICAL units everywhere need servicing. Soon new units will require installation service. You can be ready with reliable pay-knowledge of this big income field. Unique home study-plus actual practice-plan prepares you to enter servicing or installing field or get into business of your own. Great opportunities now and later. Get facts **FREE**. Write today!

UTILITIES ENGINEERING INSTITUTE

Dept. 168, 2525 Sheffield Ave., Chicago 14, Ill.

**WORLD'S
BEST
WANT AD
MEDIUM**

CLASSIFIED Advertisements



Advertisements in this section 75 cents per word, each insertion, minimum 10 words, payable in advance
To be inserted under proper classification, copy must be in our office the 22nd of the
second month preceding date of issue

F. W. Johnson, Manager, Classified Advertising
Popular Mechanics Magazine, 200 East Ontario Street, Chicago 11, Illinois

1124

**CLASSIFIED
ADVERTISEMENTS**

1124

**OPPORTUNITIES
FOR YOU**

AUTOMOBILES, MIDGET CARS

"SPEED & Power Handbook"—Very latest methods! Construct your own super-chargers, water injectors, compression heads, fuel saving devices—easily! Get racing speed, acceleration, dynamic power increases from any automobile! Build stock conversions! Fast roadsters! Includes "Economy Information," ingenious formulas! Illustrations! Mileage tricks! Tuning techniques! Ignition, Fuels, Manifolds, Carburetion, Speed secrets! Including "Re-styling Ideas," photographs! Streamlining! Model revising, Customizing, Hot-rods, Sport changes, Accessories! Parts lists! Drawings! \$1.98 complete, Newhouse Industries, 5941-B2 Hereford, Los Angeles 22.

MODEL A Ford instruction book. Complete details care, maintenance, 35 charts, drawings. A must for "A" owners. \$1.00 postpaid. Clymer, Dept. A-6W, 2125 W. Pico, Los Angeles 6, Calif.

DUALTONE Chrystalline packed California mufflers for all automobiles. Large chromed tailpipe extensions. Spinners. Tailored shackles. Dual manifolds. Hi-compression heads. Fender skirts. Send 20c illustrated catalogue, deduct 20c from first order. Dualtone Mufflers, 2636C India Street, San Diego 1, California.

HIGH Compression heads, V-8. More speed, acceleration, power. Offenhauser or Edlebrock \$75.00 complete set. Dual manifolds complete with throttle kit, fuel lines. Edlebrock \$49.00, Offenhauser \$55.00. Give make, model V-8. Catalog 10c. Clymer, Dept. A-63, 2125 W. Pico, Los Angeles 6, Calif.

"POWERIZER" Water injector—Increases speed, acceleration, mileage to 30%. Easily assemble yourself for few cents! Sensational performance! Prevents wear, knock, oil pumping! "Installation Manual" includes "hop-up" tips. \$1. Alquist Engineering, Milford 11, Pennsylvania.

CLYMERTONE, Twin muffler sets, beautiful sound, complete with necessary welded pipes, E-Z installation. Ford V-8, \$20.00. Chevrolet set with split manifolds, \$37.50. Specify car model. Clymer, Dept. A-64, 2125 W. Pico, Los Angeles 6, Calif.

"SPEED & Mileage" manual—Obtain greater speed, mileage, racing performance from any automobile! "Original" book shows easiest soup up methods! Speed tuning! Mileage secrets! Complete data! Photographs! Instructions on building speed equipment, economizers, mufflers, "water injectors," manifolds, superchargers, fuels, heads, "Hot rods," speedsters, fast conversions, engines! Latest "Hollywood customizing" information, catalogues, parts lists! \$1.98. Alquist Engineering, Milford 11, Pennsylvania.

RACING Car builder book, 22 drawings. Racing rules. Contains information on cams, compression, balance, midgets, big cars, roadsters, V-8 speed data. \$2.00 postpaid. Clymer, Dept. A-RB, 2125 W. Pico, Los Angeles 6, Calif.

RACING Equipment and doll up accessories. Hi-compression heads, dual intake manifolds, fender skirts, spotlights, dual mufflers for Ford and Mercury, single mufflers for all cars, chrome station wagon stacks, air horns, racing cam shafts. Everything to make your car fast. Everything to make your car sharp. Send 10c for latest price sheets. Bill J. Jones, 2300 S.W. 29th, Oklahoma City, Okla.

FOREIGN Car books. British sports cars, 96 makes described, fine illustrations, specifications \$2.00. Post-war British cars, 34 makes illustrated, specifications, \$2.00. British Motor Industry from 1896 to 1946. 176 photos, drawings, \$1.50 postpaid. Clymer, Dept. A-6Y, 2125 W. Pico, Los Angeles 6, Calif.

DOBLE Steam automobile engine. Two large black-line prints showing cross-sections, elevations, approx. half size. Parts numbered. Postpaid \$10.00 per set. O. Herman, Box 32, Mokenca, Illinois.

"CUSTOM Styling" manual—Easily make car look Hollywoodized, custom, ultra-beautiful by quick inexpensive methods! 100 photographs, instructions on customizing, restyling, streamlining; new and old cars. Also model, sport, conversions; accessories; mufflers; engine "soup up" specifications! Most complete book \$2. Alquist Engineering, Milford 11, Pennsylvania.

CLYMER'S Indianapolis Race History Book. Complete details every race held 1909 to date. 352 large pages, 1100 illustrations. Postpaid \$3.50. Deluxe edition fabricoid binding, gold lettering \$5.00. 1946 and 1947 race books \$1.00 each. Complete driver history book \$1.50. Specify ones wanted. Clymer, Dept. A-6U, 2125 W. Pico, Los Angeles 6, Calif.

CALIFORNIA Doll-up accessories—steel fender skirts, solid hood sides, grille panels, custom supplies, speed equipment. Buy direct and save. Illustrated catalogue with scores of items, 25c. Eastern Auto Supply, 3319a S. Grand, Los Angeles 7, Calif.

FAMOUS Car catalog reprints. Duesenberg, Italian Maserati racing and new Sport car, Mercedes-Benz, new rear-engined Isotta-Fraschini V-8, Rolls-Royce "Silver Wraith," Miller Race Cars, Cord, Rayfield Cyclecar, V-8 Chevrolet, Stanley Steamer, Doble Steamer. Specify catalog desired. \$1.00 each postpaid. Clymer, Dept. A-6X, 2125 W. Pico, Los Angeles 6, Calif.

HIGH Compression; Done yourself. Instructions \$1.00. Hotrod Engineer, Deadwood, S. Dakota.

INDIANAPOLIS Model racer. Beautiful polished aluminum. Rubber tires. \$2.50 postpaid. S. & P. Sales, 12199 Flanders, Detroit, Mich.

MIDGET Auto. Build from surplus airplane belly tanks. Complete plans, instructions, \$2.00. Abco, 1032 62nd Street, Oakland 8, California.

PROFESSIONAL Midget racer, motor-scooter, midget roadster, midget motorcycle. Plans, specifications contained in illustrated handbook, 25c. Directory of bargain priced used motors, motorscooters, Servicycles, etc., included free! Midwest, 3839 Drummond, Toledo, Ohio.

HOT Rod racing book. 90 photographs, illustrations famous record holders used California Dry Lakes. Contains hotrod tips, closeup action shots, specifications, 8 beautiful drawings suitable framing, \$1.50 postpaid. Clymer, Dept. A-6V, 2125 W. Pico, Los Angeles 6, Calif.

"NEW-LOOK" Washes, cleans, shines cars. Sample, Box 394, Union, N. J.

GREASE Car yourself. Fast, easy, clean centralized system reduces repairs. Useful information, free. H. B. Rodd, Box 305, Trona, California.

CALIFORNIA Speed equipment—Dual, single mufflers, doll'em up accessories. Save freight cost, midwest warehouse. Catalog 25c coin. Von Esser's, 2840 No. Kedzie, Chicago 18, Illinois.

"VAPO-STEAMATIC" Water Injection. Thousands using this famous automatic system. Easily assembled (for less than \$1.00). Saves gasoline! Engineering triumph; up to 33 miles per gallon. Reduces wear! Greatly increases horsepower! Speed! Longer engine life! Smoother performance! Copyrighted "Installation Handbook." Diagrams, Illustrations. Including "Vapo-Injection;" tractors, motorcycles, trucks, airplanes. \$1.00 complete. Newhouse Industries, 5941-B1 Hereford, Los Angeles 22.

MIDGET Car book—Complete plans for easily building inexpensive midget racers, two passenger highway roadsters, 3-wheel cars, scooters, etc. Motor data, supply sources. 75 photographs, blueprints! \$1.98. Alquist Engineering, Milford 11, Pennsylvania.

FORD Racing manifolds. The famous Columbia Ford racing manifolds, increased speed and efficiency for 60-'85' Fords and Mercurys. Now only \$32.50 for 85' Fords and Mercurys. \$27.50 for 60' Fords. Write for free circular. P. O. Box 2372, Portland, Oregon.

FORD—Mercury owners 1938-1948, give your engine that "Nu-Look," install our polished aluminum cylinder head covers over original heads! 10 minute installation! Gives engine that expensive appearance yet costs only \$9.00 complete. Tarzian Automotive, 730 Ellis St., San Francisco 9, California.

1948 SUPERIGNITIONITER. Atomic starting, pep, mileage \$5.50. EG Mfg., Elmsford, N. Y.

DIRECT From California—Beautiful dress-up accessories! Speed equipment for all passenger automobiles! Power! Mileage! We pay shipping costs! Picture-catalogue 25c. Newhouse Automotive Industries, 5941-B3 Hereford, Los Angeles 22.

MAKE Your Ford fast! Complete details, photographs. How to construct 120 m.p.h. Hotrod. \$1 postpaid. California Bill, Box L-1 Eaglerock, Los Angeles 41, Calif.

INTERCHANGEABLE Parts book. New book tells every automobile part that interchanges with others. Same parts many times vary 100% in price. This book enables garages, mechanics, dealers, owners to buy under cheapest listing. Tremendous savings for users. \$15.50 postpaid. Clymer, Dept. A-IP, 2125 W. Pico, Los Angeles 6, Calif.

FORD—Mercury owners attention! Supertone dual exhaust systems. Reduce back pressure 50%. Increase gas mileage. Pleasing tone. Free catalog. Super Tone Mufflers, 2470 E. Slauson, Huntington Park 3, Calif.

FORD Mercury owners. Attention! Give your car that knee-action ride. Restore arch to flat springs. Eliminate side-sway. Free literature. Supertone Mufflers, 2470 E. Slauson, Huntington Park 3, Calif.

MAKE Your Model "A" do 100 m.p.h. Lightning acceleration, breath-taking top speed. Complete details, photographs. \$1 postpaid. Four Barrel, Box L-1, Eaglerock, Los Angeles 41, Calif.

INSTALL V-8 engine in your Model A for extreme acceleration, more top speed, smoother performance. Complete details, photographs. \$1 postpaid. A-V-8, Box L-1, Eaglerock, Los Angeles 41, Calif.

WE Sell direct to customers over 200 speed equipment parts manufactured by us. Ford A-B-V8-6-4-(Ferguson), Studebaker Champion, Chevrolets and Willys. Cylinder heads, dual intake manifolds, flywheels, oversize valves, compound springs, camshafts and other supplies. Complete engines ready for race for cars, boats and midgets. \$1.00 to cover illustrated literature and price sheet. R & R Mfg. Co., Robert M. Roof, Box 546, Anderson, Indiana.

FROM Speedway to roadway! Track-proved hi-speed heads and manifolds now available for your passenger car! No special tools needed! Increase horsepower 25%! Astounding getaway! Free illustrated catalog. Speedsport, 5747AA Waveland, Chicago 34.

SEE Our ad under motorscooters for midget car bargains. Midget Motors Directory, Athens, Ohio.

AUTOMOBILE Racing, Sixth Edition. 100 illustrations. Working drawings with building instructions for Ford-60 midget, California roadster, Offenhauser racer. Details on racer parts. Sample entrance blank. World's record 158.5 m.p.h. rear engine four-wheel drive car. Interesting information for fans, drivers, mechanics. \$2.00 postpaid; \$2.25 c.o.d. Ray Kuns, Department 63, Cincinnati 27, Ohio.

BUILD Speedy midget track racer from castoff parts! Plans, specifications, construction information, \$1.00. Motor Supply, Box CS-1682, Toledo, Ohio.

AUTOMOBILE Racing book, fifth edition, well illustrated. Instructions on building bodies, frames, engines. Ford A and B conversions. Plans. AAA rules, specifications. Roadster racing. Indianapolis cars. \$1.00 postpaid, \$1.30 C.O.D. Ray Kuns, Dept. 47, Madisonville, Cincinnati 27, Ohio.

HOT-ROD Manual, fast Fords, photos, instructions, \$1.50. Airmailed \$1.75. Racing parts list 25c. Hollywood Hot-Rod, Los Feliz, Box 9626P, Hollywood 27, California.

AUTO SUPPLIES AND EQUIPMENT

LOOSE Insert main bearings to fit into Ford A blocks, \$13.00 for upper set. Send bottom caps for complete set of three mains, \$16.75 complete set. Standard or undersize ready to install. No outright sales on bottom caps until we can buy more old caps. Wellens Auto Supply Co., 417 N. P. Ave., Fargo, North Dakota.

NEW And used automobile and truck parts. Lowest prices. Complete stock. Prompt reply. Babbitt Auto Parts, 2833 W. Chicago Ave., Chicago 22.

GAIN 2 Miles per gallon, with Air-Flow Needles. Free trial in your car. Remit only \$1.50 per needle, (8 cyl. cars take 2). Advanced Automotive Products, 563-9 Lake Road, Webster, N. Y.

CAR-BED. Make it yourself. Inexpensive. Fits any 2 or 4 door sedan. Detailed plans \$2.00, easy to follow. Martin's, Box 297, Upper Darby, Penna.

PAINT Your car—Wipe it on, \$3.75 postpaid. Guaranteed two years. Literature, 15 samples free. Distributorships. Cover-Nu, 1911-N, Lubbock, Texas.

NEW Grilles for all cars. 1940: 1941, Plymouth shells. We ship c.o.d. Wagner Grille Co., Route 2, Bernville, Penna.

"SPEED" Handbook—The original "hop up" publication! Easily increase speed, power, mileage to 30%! Non-technical information on engine tuning, speed data, racing secrets, carburetion, compression, formulae, balancing, fuels. How to build power equipment. Fast conversions. "hot rods," economizers, superchargers, mufflers, manifolds, water injectors. Streamlining-customizing methods, photographs, catalogues, etc. \$2.00. Alquist Engineering, Milford 11, Pennsylvania.

AUTO Parts. We have them. New or rebuilt. Prompt shipment. Save money, buy direct. Factory warehouse. Write requirements. Specify car make. Mechanics Auto Parts, 3807-PM N. Ashland Ave., Chicago 13.

HOLLYWOOD Wolf whistles postpaid \$4.00. Lenvor Distributing Company, Geary, Oklahoma.

ATTENTION: Pistons, cast, Lynite, Std., O.S., Semi. 1916 to 1947 cars, trucks and tractors. Also rings. Zrubek, Pratt, Kans.

ELECTRIC Pencil—Writes, engraves all metals. 110 volts. \$2.95 postpaid. Reb Industries, Elmhurst 2, Illinois.

WASH Your car with "Quick Easy" streakless car wash. Modern, safe, sure. Send \$1.00 for 5 packages to wash 8 to 10 cars. Schuttig Patent Co., Box 305, Ridgefield Park, N. J.

CONVERTIBLE Tops. Ready made. Easily installed. Reasonable prices. Free literature. Rio Top Company, 1370 Roanoke, Newport News 8, Virginia.

SAVE Gas! Instant starting. Power! "Lektron" spark intensifier. Easily installed. \$1.25 plus C.O.D. Guaranteed! State make car. Electronic Industries, Cleveland 11, Ohio.

MOTORISTS Save gasoline by Vacuumating overrich mixtures. Fits all cars. For free particulars write Vacuumatic, Dept. 1339, Wauwatosa, Wis.

FREE Details: How to paint your car—factory finish. Bass Company, 35-C West 32nd, New York.

ELECTRIC Windshield wipers. New American Bosch Neverstall in 6, 12, or 24 volts. List \$12.25, each \$6.45, lots of 6—\$5.95. Generator Service Co., 7059 Indiana Ave., Chicago 37, Illinois.

WELDING Bodies and blocks, repairing fenders easy with Hobart Welders. Low cost, adds profits. Catalog free. Write Hobart Welders, Box M-682, Troy, Ohio.

SPRAY Paint your automobile. Complete professional instructions, \$1.00. 155 Tasso, Palo Alto, California.

AMAZING New invention! Quick-charges; controls; protects; conditions battery and generator while in car! Sensational low price; write quick for free demonstrator offer! Gen-O-Batt, 1136A Dodge, Evanston, Ill.

QUALITY Pistons for less. Money-back guarantee. Any piston made. Marvin Merryman, Lawndale, Calif.

AUTO Parts for all cars, transmissions, motors, differentials, fenders, carburetors. Security Auto Parts, 1923-PM Grace, Chicago 13.

GRILLES For all cars. Meyers Auto Parts, 820 Dryades, New Orleans, La.

PLATING Outfits for auto parts. Connect to a battery. No tanks used. Free particulars and proofs. Gunmetal Co., Ave. J, Decatur, Ill.

AUTO TRAILERS

MODERN Trailer coach book tells all. Designing, building, traveling. New circular illustrating 8 designs 20c. Craftsmann Books, Box 1153, Milwaukee 1, Wisconsin.

ACTUAL Photographs and detailed plans for 12' camp and travel trailer \$1.00. Many new features. Ed. Christensen, Box 687, Thief River Falls, Minn.

BUILD Your own trailer! Save money! Have every feature you want! Plans for house, sport, camp and utility trailers. Catalog describing 9 models 10c. 15c in Canada and overseas. Jim Dandy, Box 125-A, Wausau, Wisconsin.

MOTORCYCLES, BICYCLES, MOTORSCOOTERS AND SUPPLIES

MIDGET Car \$12, motorbike \$15, servicycle \$30, brand new Regal motorscooters \$37.50, less motors. Midget motorcycle \$35, Motorscot \$25, Salisbury \$50, Whizzer motorbike \$55, Twin Harley \$60, all complete. Gasoline engines \$3 up. Plenty brand new 2 h.p. engines in original crates. 5500 small balloon tires \$1 up. Mailorder only. Send 25c for big war-bargain catalogue Number 25, just out, listing the above and almost 400 other bargains in new and used motors, motorscooters, midget cars, parts, etc. (35c by First Class Mail). Midget Motors Directory, Athens, Ohio.

KING Midget, factory built—\$40. 6 h.p. Fairbanks Morse motor, \$40. Three speed motorcycle transmission, \$12.50. Factory built scooter, \$75. 1½ h.p. Clinton motor \$30. Professional race cars, midgets and big cars. Send 25c in coin for our bulletin containing loads of other bargains. Behnke's, Dept. B, 5721 Leland Ave., Chicago 30, Illinois.

MIDGET Automobile \$15, Cushman motorscooter \$20, Indian motorcycle \$30, tires 75c. Send 25c for printed catalog listing sensational bargains in motorscooters, Servicycles, midget cars, used motors, parts. Associated, Box CS-1764, Toledo, Ohio.

MOTOR Scooters, bicycle engines. 120 miles gallon. Dime for catalog. Clymer, Desk A-65, 2125 W. Pico, Los Angeles 6, Calif.

172 BRIGGS Motors. List 15c. Plans for motorscooter 50c. Donz, 1252 Thurman, Camden, N. J.

MIDGET Racer \$40, Cushman motorscooter \$15, motorbike outfit \$15, Harley-Davidson motorcycle \$35. Send 25c for new catalog listing amazing bargains in motorscooters, motorbikes, midget cars, motors, parts. Gall, 538 Erie, Toledo, Ohio.

HARLEY-Davidson "45" engines. Govt. surplus, rebuilt with generator and carburetor. Few left, close out \$39.00. Clymer, Dept. A-6Z, 2125 W. Pico, Los Angeles 6, Calif.

MOTORCYCLE News, monthly. Yearly subscription \$1.00. Latest worldwide information. Motorcycle News, 5424-A Sawyer, Chicago 25.

BICYCLE Supplies, wholesale, retail. List. 10c. Universal, 4713 Virginia, St. Louis, Missouri.

TIRES And industrial wheels, suitable for scooters, wheelbarrows, farm equipment, etc. All sizes. Bicycles and accessories. Largest assortment in America. Send dime for list. Cycle Transport Company, 1241 So. Michigan Ave., Chicago 5, Illinois.

BICYCLES, Tricycles, parts, accessories. Send 10c for bulletin. Propp's, 2202 Fondulac, Milwaukee, Wis.

MOTORCYCLISTS Chromium accessories. New and reconditioned motors. Complete stock Indian parts. Expert motor rebuilding. Indian Motorcycle Sales, Kansas City 1, Missouri.

MOTORCYCLE Cams ground for speed and power. Write Harold Schaller, Box 31, Turlock, Calif.

HARLEY-DAVIDSON Supplies, parts, accessories, oil service, tires all sizes, repaired 45" motors. Send \$2.25 for Army Motorcycle Manual, 10c for bulletin. Knuth's (Harley-Davidson Dealers), 2491 Fondulac, Milwaukee, Wis.

HARLEY-DAVIDSON Parts, accessories, batteries, and tires. 24 hour service. Authorized factory dealer. Philadelphia Harley-Davidson Company, 857 North Broad Street, Philadelphia 23, Penna.

WHEELS! Build wagons, scooters, mowers, trailers, wheelbarrows, grocery carts, baby carts, play pens, baby carriages. 4" to 16". Free list. Trulsen Mfg. Co., 811 E. 31, Kansas City, Mo.

FLAT Rate repair manual for Harley-Davidsons. Gives flat rate charge for every operation. Every dealer, owner, mechanic needs this new book. \$2.00 postpaid. Clymer, Dept. A-FR, 2125 W. Pico, Los Angeles 6, Calif.

SCHWINN Bicycles. All sizes. Wholesale. Retail. Bulletin 10c. Century Cycle, 3447 Lawrence, Chicago 25, Illinois.

AVIATION

VETERANS: Flight training under the G. I. Bill. Tuition paid. Private, commercial, flight instruction, instrument and multi-engine ratings. Opportunities to work for living expenses or tuition, if not a veteran. Write Gottschalk School of Aeronautics, Adrian, Mich.

FAMOUS "Zweng books" include: Mechanic's Manual with examinations \$3.00; Flight Engineer \$4.00; Aviation Dictionary \$6.00; Link Instructor \$4.00. (Free folder.) Pan American Navigation Service, 12021-C, North Hollywood, Calif.

GENUINE U. S. Navy target kite. Blue nylon 5-foot diamond shaped. Looks and can be controlled like airplane. Sensational limited offer, \$3.50 postpaid. Buddy's, 186 Mitchell St., Atlanta.

PROPELLERS, Plans for ice sleds, snow sleds, air boats. Catalog 10c. Banks-Maxwell, Ft. Worth.

LIGHTPLANE Blueprints, manuals. Circular illustrates designs, motors. 20c. Craftsmann Books, Box 1153, Milwaukee 1, Wisconsin.

WEATHER Instruments, thermometers, barometers, rain gages, wind instruments. Catalog PM. Science Associates, 401 N. Broad St., Philadelphia 8, Penna.

PROPELLERS—2 & 3 Blade, for snow-ice sleds, boats. Catalog. Standard Aircraft, Box 387, Ft. Worth, Texas.

ELECTRICAL SUPPLIES

WATTHOUR Meters. West., G.E., 115v. \$2.95. T. Price, 310 14th, Raymond, Wash.

BATTERIES, Thousands, sealed, protected, ½ price, all sizes. ABC A-B, satisfaction guaranteed, free list. Box 74, Oak Ridge, Tennessee.

ELECTRICAL Repair men, send for literature on motor winding tester and A. C. motor winder. Motor Industries, Quincy, Illinois.

MAGNETS—All types. Write for free catalog. Engineered Products Company, Sandusky 1, Ohio.

MAGNET Wire, 400 ft. coils, #20 h.f., 5 for \$3.50. Small 100v. fan motors. \$3.00. John Weeks, 527 Worden, Grand Rapids 7, Mich.

LAMPS—All parts to build or repair. Illustrated catalog 10c. Gyro Lamps, 5402 Clark, Chicago 40.

ELECTRIC Fans? Assemble your own. 16" correctly balanced aluminum fan blade, 1/2" bore, \$2.25. 18" all welded guard, \$2.50. Use any ordinary motor. No c.o.d. Ted Riseman, 207 North Fifth, Springfield, Illinois.

ELECTRIC Pencil: Engraves all metals. \$1.00 postpaid. Beyer Mfg., 229-H Dixon, Uniontown, Penna.

LAMP Sockets, mogul sockets, three way switches, tumbler switches, receptacles, cord sets, electrical repair parts, lamp parts, etc. Catalog 10c. Gearon Company, 6405 North Oakley, Chicago.

TATTOOING Machines, outfits. Free catalogue. Jensen, 120 West 83rd Street, Los Angeles 3.

ALNICO Magnets, free list. Terry Sales Company, 3726 South Detroit Avenue, Toledo 9, Ohio.

LAMPS—Build own originals, parts wholesale any amounts. Catalogue 10c. Brown Lamp Co., Box 501, Wellston, St. Louis 12, Mo.

INTER-COMMUNICATION System complete. Made by Dictograph. New and perfect. Thousands in use. 2 units, 50 ft. wire and batteries. (Nationally advertised at \$17.50); now \$9.75 postpaid. Money back guarantee. Kinney Brothers, 200-A No. Ave. 18, Los Angeles 31.

WELDING, SOLDERING, PLATING

ACETYLENE Welding outfits, new, \$54.50; Arcwelders; Eagle Welding, Dept. PM, 5085 Broadway, Chicago 40, Ill. Distributors wanted.

OWN Mirror shop. Resilver mirrors. Glass sign making. Electroplating. Supply prices. John Sprinkle, V55, Marion, Indiana.

GENERATORS — 200 Amp., slightly used. Write, Harold Morgan, R2, West-erly, R. I.

COMPLETE Guaranteed portable welder. Amazing value. Only \$19.95, postpaid. Write for full details. Grenville, G.P.O. Box 1011, New York City 1.

WELDING Rods, gas, electric. Steel, 6c lb.; stainless steel, 25c; Monel, nickel, 40c; aluminum, 30c; flux, 30c; welding goggles, 50c. Smith, Box 74, Oak Ridge, Tennessee.

RECTIFIERS: Ramyr Selenium platers, 10, 30, 50, 100 amp. sizes. Immediate shipment. Complete line of bronze baby shoe mounts. Write for list. Hollywood Bronze Supply, 1770 N. Vermont, Hollywood 27, Calif.

WELDERS For all requirements. Free catalog. Write Hobartweld, Box M-684, Troy, Ohio.

WELDERS!—New portable Champion special transformer welder; 110/120 volts, a.c. 8 heat stages. Welds, brazes, solders, cuts all metals. Complete with electrode holder, helmet, rods, carbons, fluxes, cables. Also special flame weld torch. Easy to use. Full directions. Splendid for shop, farm and home repairs. Guaranteed. Only \$27.50. Money back guarantee. Also resistor model, now \$14.95. Magic Welder Co., 239 MP Canal St., New York, N. Y.

"BUILD-UR-OWN" a.c. welder and a.c. power plant combination. Weld, run tools, lights, motors away from power lines. Save \$350. Easy with Hobart generator plus auto engine. Free instruction book. Write Hobart Welders, Box M-683, Troy, Ohio.

TRANSFORMER Welders 110 v. Welds 1/2" steel, \$29. Morris Welding Service, 1850A State, Schenectady 4, N. Y.

NEW Airplane tires, tubes, wheels, bearings, spindles. For harvesters, implements, lawnmowers. Free pictures. World's largest stock. Airplane Tire Company, Dept. 3, Box 89, Merced 3, California.

WELDING Shop operators, four machines you can build and sell in your shop. Plans \$1.00. W. Randle, 625 Gerard, Santa Rosa, Calif.

WELDING—A profitable trade. Demand for trained men. Learn quickly at best equipped school in U. S. Non-profit. G.I. approved. Catalog free. Write Hobart Welding School, Box M-685, Troy, Ohio.

MACHINERY, TOOLS, SUPPLIES

BACK-GEARED Metal and wood-cutting 12" band saw. Lowest priced practical all purpose machine on market. Write for circular. Backus Machine Co., Boyd, Wisconsin.

ARMATURE Support chuck—New style, low cost, free literature. Gaston Products, Box 749, Clinton, Iowa.

QUICK Change disc sander \$2.95. Circular free. Wasco Manufacturing, Box 111 Dept. A, Blue Island, Illinois.

WAR Surplus in small tools for machine shop. Send 15c for bulletin. Travers Tool Co., Dept. P, 5 Court Square, Long Island City 1, N. Y.

ELECTRIC Drills, 1/2", 3/4", 1". Thor. Skillaw, B & D, \$20 to \$75. Aluminum wire, 1/8", 3/32", 40c lb. Commander vacuum cleaners, \$25. Grinding stones. Smith, Box 74, Oak Ridge, Tennessee.

DRILL Grinder for twist drills, \$2.95. See ad on page 258.

SPECIAL Sale—Power tools. Saw, jointer, lathe, jig-saw, sander, shaper—complete with line, shafting, belts and pulley, all for \$39.50! 1/4 hp. motors \$14.95 (motors sold only with above). Send \$10.00—balance c.o.d. Skarie, Inc., 707 N. Howard St., Baltimore, Md.

ELECTRIC Pencil—Writes, engraves all metals. 110 volts, \$2.95 postpaid. Reb Industries, Elmhurst 2, Illinois.

MACHINE Tools released for private industry. South Bend quick change bench lathe \$325. 14" loose change lathe \$160. 6 ft. quick change lathe \$440. 36" band saw \$180. Bullard 24" boring mill \$620. #2 Cincinnati miller \$840. Small milling machine \$180. 26" Upright drill, back-geared, power feed \$190. 20" drill \$140. 14" Crank shaper \$540. Money back guarantee. Conversion Parts Co., 278 Adams St., Boston 22, Mass.

CHUCKS. (Genuine Wescott) Independent, Universal, threaded 1 1/2"-8 for South Bend, Atlas, Logan, Clausing, Craftsman lathes. Also other chucks to 16". Top value. Free literature. Wescott Chuck Co., 3600 Walnut, Oneida, N. Y.

ANYONE Can sharpen saws using the 35c Teeho-Tool! Saving time, money! Information? 316 North 2, Maywood, Illinois.

T HANDLE Tap wrench, 1/2" capacity \$1.89. 4 1/2" 110 A.C. bench grinder \$14.95. Shopmaster power tools. Lifelong carbide scriber \$1.25. All purpose hammer, set of three, 87c. Whitney #5 punch set \$7.86. Craftsman Supplies, Box 895, Rockford, Illinois.

MOTORS, New 1/4 H.P. \$11.95. Standard makes, all sizes. Kalder Engineering, Grand Rapids 6, Michigan.

HARDWARE, Tools, taps, dies, electric motors, brass, steel, drill rod. Free catalog. Terek, 6304 Patterson, Chicago 34.

POWER Tools. Build your own with Lewis Castings. Save up to 80%! Complete castings, materials and blueprints supplied for 23 woodworking and metal-working tools. Free catalog. Write today. Lewis Machine Tool Co., 3217 Union Pacific Avenue, Dept. M, Los Angeles 23, Calif.

0-1/2" CAPACITY Drill chuck and adapter, fits your Sunbeam Mixmaster. \$2.95. O. Nahser, 248 San Gabriel Court, Sierra Madre, Calif.

HOME Workshop bench belt sander. Plans \$1.00. Fred Young, Sandy Spring, Md.

HOME Lathe owners—Build your own attachments. Send for picture, sample of work and list of blueprints. Cut gears, ratchets, etc. Make neat screws easy way. The Home Shop, 415 Raymond Ave., Glendale 1, Calif.

SHEBEL Saw filer. Files all saws. Circular. A. P. Shebel, 730 B. So. 2nd St., Milwaukee 4, Wis.

CONCRETE Block machines \$39.50 up. Catalog free. Concrete Machine Company, 5466 Gravois, St. Louis 16, Missouri.

DRILL Grinder—Grinds drills to factory accuracy. Calipers with direct reading scales. Circle cutters. New Tool grinder. Lowest prices. Free literature. Factory, 811-B East 31st, Kansas City 3, Mo.

BAND Saw—Special \$14.95. Ideal for hobbyists and home workshop. Circular free. Woodcraft Tools Inc., 147 E. Lake, Minneapolis, Minn.

WOODWORKING Machinery, grinders, drills, taps, dies, drill rod, machinists' mechanics' tools. Catalog 10c. Refunded. Precision Tool Service, Dept. M, 55 E. Washington, Chicago 2, Ill.

BALL Bearings one-fourth list price. Free list. Burgess, Box 168, Ferguson, Mo.

HYDRAULIC Leather cups for jacks, lifts, presses. Write for prices. Beerman Precision Machine Works, 2000 So. Claiborne, New Orleans, La.

ENGINES, MOTORS, DYNAMOS

IMPLEMENT Dealers, magneto repairmen, send for magneto tester circular. Abbott Electric Co., Quincy, Ill.

MOTORS, Generators; any H.P., voltage; A.C. or D.C. Rebuilt. Year guarantee. Roberts Electric, 7232 Madison, Forest Park 2, Illinois.

WELDING Generators, 150 ampere \$47.50, 1/2 horse 1725 r.p.m. motors \$24.50. Compressor twin cylinder \$22.50. Butler, 1885 Milwaukee, Chicago.

"BUILD-UR-OWN" Portable gas drive arc welder. Save \$350 with Hobart generator plus auto engine. Free instruction book. Write Hobart Welders, Box M-686, Troy, Ohio.

MOTORS! 1/2 H.P. D.C. converted to A.C. All new. High speed 110 volt, 25 or 60 cycle, ball bearing motors. Actual value about \$75.00. Now \$15.00 each or 3 for \$40.00. With forward and reverse switch \$19.50, 3 for \$50.00. Countless uses for home mechanics. Can be used in any position. Order today! Immediate delivery! No c.o.d. orders. "Amazing Bachman's," 27 Herman Street, Rochester 5, New York.

BARGAINS In war surplus hydraulic transmissions, switches, motors, geared speed reducers, aviation instruments, etc. Delta Sales, P.O. Box 968, Shreveport, Louisiana.

WINDING Data, listing 225 motors, single and three phase, \$1.00. Motor Data Co., Box 7631, Kansas City 3, Mo.

RANGER Engine-Aircraft—All new in original case. 570 h.p. 12 cyl. V type air-cooled. Engine Spec. No. 177. Complete with spark plugs. Original government cost over \$12,000.00 each. Special offer \$200. Crated weight 1200 lbs. No c.o.d. Write for complete description. "Amazing Bachman's," 23 Herman Street, Rochester 5, N. Y.

BOATS, OUTBOARD MOTORS

SURPLUS New D-4 magnetic compass \$24.50; Bausch-Lomb sextant \$32.50; Fairchild \$12.50; Ships chronometers \$47.50; Chelsea clocks \$47.00. (Free folder.) Pan American Navigation Service, 12021-C, N. Hollywood, Calif.

ATTENTION Sportsmen! Assemble kayak from easy-construction kit. Complete! Nothing additional needed. Play-yacks, Dedham, Mass.

BOAT Steer wheels, windshield brackets \$8.95. Modern hardware kits, bargains galore, folder. Marine, Box 681, Mendota, Minnesota.

BUILD Your boat from full size paper patterns, boats representing forty years careful designing. Send 10c for folders. Up to the minute book on small boat construction, \$1.50 postpaid. Germain Boat Company, Dept. 3, Saginaw, W. S., Mich.

MARINE Conversions and reverse gears for all Ford and Jeep engines. Catalog 25c. Dept. P, Arthur Gershel, 51 Chambers St., New York 7.

BUILD Your own boat by the Welch System, ready cut parts. No experience necessary. Save 2/3 cost. Rowboats to cruisers. Illustrated catalog 25c. Midwest Boat Company, Menomonee Falls, Wis.

ASK About Osco Electric Tachometer for all popular makes of outboard motors. Oscomotors, 2020B E. Orleans St., Philadelphia 34.

MARINE Supply catalog. Thousands of deliverable items, priced and beautifully illustrated. Send \$1. Arthur Gershel, 51 Chambers St., New York 7.

P-38 Belly tank speed boat. Complete plans, instructions \$1.00. Twintank Boat Company, 1032 62nd Street, Oakland, California.

BOAT Building plans: Runabouts, cruisers, sail boats. Wood, plywood, and welded steel construction. Illustrated book, "Modern Designs For Boats And Yachts" \$1.00. John B. Clark, Yacht Designer, 329 Kenmore Drive, Bay Village, Ohio.

OUTBOARD Motors—Good values, used motors. Also used parts for most makes and models. Crandall-Hicks Co., 911 Commonwealth, Boston, Mass.

P-38 BELLY Tanks, new, steel, 10 ft. 2 in. 165 gallon \$9.95. Anzio Boat Co., Box 89H, Merced, Calif.

BARGAIN \$20. Make your own boat now with readymade streamlined laminated one piece hull as developed for Navy. Light, sturdy, leakproof. Anyone can convert into dinghy, outboard scooter, cartopper, other craft, 9'x4'. Write Warwood, 480 Lexington, New York 17.

BELLY Tanks—75 gallon, new, steel, 6 ft. 4 in. \$7.50. Anzio Boat Co., Box 89H, Merced, Calif.

NEW, Used, rebuilt marine motors. Marine conversions, fittings. Free catalog. Stokes Marine Supply, Dept. 24, Coldwater, Michigan.

BOAT Designers are highly paid professionals. Complete course by mail. Catalog. Westlawn, Montville, N. J.

MARINE Conversions for Ford and Jeep engines. Catalog 10c. Lehman Manufacturing Company, Department D, Newark 2, New Jersey.

MARINE Fir plywood for boat building. Send 10c today for complete stock and price list. Trans-Marco Corporation, 70 East 45th Street, New York 17, N. Y.

ATHLETIC EQUIPMENT, BODY BUILDING COURSES

BARBELLS! 95 Pound set \$9.80; extra plates 9c pound. Send for free course and catalog. Bur Barbell Company, Lyndhurst, N. J.

BARBELLS, Exercise equipment. Courses. Free booklet. Good Barbell Co., Reading, Penna.

SPORTING GOODS, GUNS, FISHING TACKLE, ARCHERY, TRAPPING

FLIES—6 Trout 25c, bass guinea 25c ea. (coin). M. Pflieger, 6410 Arsenal St., St. Louis 9, Mo.

BASEBALL, Softball equipment, uniforms, supplies. Catalog ready. Sportsman Headquarters, 670 East 42, Brooklyn 3, N. Y.

REPROCESSED Golf balls—Guaranteed satisfactory. \$3.95 dozen c.o.d. Indianapolis Golf Co., 4903 Brookville, Indianapolis.

AMMUNITION, 75 Sizes in stock. Dime for list. Central Sports, Delphos 5, Ohio.

PISTOLS: Walthers, 32/7.65mm. calibre, double-action hammer, automatic, perfect, \$50.00. J. P. Shuer 32/7.65mm. calibre, double-action hammerless, automatic, perfect, \$50.00. Mausers, 32/7.65mm. calibre, excellent, \$40.00. Smith-Wesson .38 specials, military-police, 5 inch barrels, excellent, \$55.00. Complete firearms-ammunition lists postpaid 25c. Frank Farish, Vicksburg, Mississippi.

SCORE Baseball games as you watch or listen with own scorecards and official scoring instructions. 75 scorecards in handy folio, \$2 postpaid, reorders \$1.50. Paragon Novelties, 1513 Waverly, Toledo, Ohio.

ARCHERY Catalogue 25c. "The most complete line in the world." Gassman's Archery Center, 1724 Fredericksburg Road, Dept. PM, San Antonio, Texas.

BOOKS On gunsmithing. Catalog 10c. W. Joseph O'Connor, Baker, Oregon.

SHOTGUNS, Rifles, handarms, ammunition, rods, reels. List 10c. Rudolph's, Atchison, Kansas.

FIREARMS—Ammunition; complete list 25c. Satisfaction. Frank Farish, Vicksburg, Miss.

5000 BARGAINS, Firearms, binoculars, war relics. Catalog 40c. Smith Firearms, Runnemede, New Jersey.

FISHERMEN! Make real savings on your tackle needs. Get our catalog. Snap swivels 3 for 10c. Jointed cane poles \$1.95; floating minnow buckets \$2.49. Hundreds of other bargains just like these. Send for free catalog today. Write Dept. PM, Andy Anderson's Sporting Goods Co., 124 W. Grand, Oklahoma City 2, Okla.

BOWS—Arrows, write headquarters for archery equipment. Quality products. Popular prices, catalog 10c. Large illustrated handbook instructions, aiming and shooting, 50c. Archery, 617-B So. State, Chicago 5.

SHOTGUNS, Rifles, revolvers, over 500 modern, obsolete. Also cartridges, list 10c coin. Ed Howe, 52 Main, Coopers Mills, Maine.

FIELD GLASSES, TELESCOPES, MICROSCOPES, MAGNIFIERS

POWERFUL Astronomical telescopes easily made. Perfect lenses and instructions. 100 power \$3.00. 100 and 200 power \$4.00. 100, 200 and 400 power \$6.00. Clear vision and full power guaranteed. Instructions alone 10c. Suffolk Science Service, Manorsville, N. Y.

ASTRONOMICAL Telescopes, binoculars, microscopes; bought, sold, repaired. Books. Lists 10c. Rasmussen-Reece, Amsterdam, N. Y.

BINOCULARS, Telescopes, watches. Buy, sell, trade. Paul Schweer, Donnellson, Iowa.

TELESCOPES, Binoculars, microscopes, big bargain catalog free. Brownscope Company, 24 West 45th Street, New York.

REFRACTING Telescopes, accessories; highest quality workmanship. Catalog 10c. Janan Instrument Company, 76 Interhaven Avenue, Plainfield, N. J.

GOVERNMENT Surplus. Terrific bargains, telescopes, binoculars, lenses, prisms, send stamp for catalogue. H. Jaegers, 123-26 Rockaway Boulevard, South Ozone Park 20, New York.

INFRA-RED Filters, glass 1 1/4" (40 mil) diameter, mounted. Snap on camera or binocular, \$1.00 per set. Variable density filter with eyecups to fit 7x50 binoculars. Control light and glare to assure best conditions. Adaptable for photography. Complete \$1.50. Buy both \$2.00 postpaid. Ross, 68 West Broadway, Section N, New York, N. Y.

ASTRONOMICAL Telescope lens kit. 50X-100X-200X-400X powers \$3.00. Microscope lens kit. 50X-100X-200X-400X-800X \$2.00. Plans included. Pfeiffer Optical Co., PM-6, Sunbury, Penna.

DOGS, PETS, BIRDS, RABBITS

RAISE Chinchilla rabbits. Year-round money-makers from furs, meat, breeders. Experience unnecessary. Write today. Willow Farm, Sellersville 15, Penna.

RAISING Rabbits, cavies, hamsters, chinchillas is profitable. Big demand. Magazine 10c. Instruction book and magazine 25c. Book and magazine (monthly) one year, \$1. Address. Small Stock Farmer, Fairlawn 2, New Jersey.

RAISE Guinea pigs. Make money at home. Big demand. Booklet free. Taylor, Box 426A, Hapeville, Georgia.

REPTILE Catalogue 10c. Biological hobby catalogue 10c. Reptile bulletin 5c. Chameleon 25c; alligator \$1.75; turtle 35c. Quivira Specialties, Topeka, Kansas.

ANGORAS, Giant Chinchillas, White Giants—World's most profitable rabbits. Finest pedigree, heavy-producing, prize-winners. Literature free. Grinsteads, Edwardsville, Illinois.

\$3000 YEARLY Raising Angoras. Circular free. Vaughn's Rabbitry, Otley, Iowa.

ZOOLOGICAL And pet animals for sale. Illustrated catalogue, literature, 25c. Trails End Zoo-5, St. Stephen, S. C.

CONTINUOUS—Profitable market for your production. Raise New Zealand and Chinchilla rabbits for us. Order our "7 Hints To Success" \$3.00 with credit coupon, or send 25c for catalog "Successful Rabbit Raising." Drake's Outdoor Enterprises, Park Ridge 8, N. J.

RAISE Guinea pigs. Make money. Write Winfield Harrison, Fitzgerald, Ga.

INCREASE Your income by raising domestic rabbits. Small space needed. Ready market for delicious meat, fur and wool. Largest magazine in the industry tells you how. \$1.50 per year. Sample 15 cents. No stamps. Small Stock Magazine, Lamoni 20, Iowa.

\$3000 YEARLY Raising Angora rabbits. We buy your output. Contract particulars free. Kise's Enterprises, St. Paul 8, Minn.

\$250.00 MONTHLY Raising Angora rabbits. Particulars free. White's Rabbitry, Newark, Ohio.

MONEYMAKING Opportunity raising Giant Chinchilla Rabbits. Waters Rabbit Farm, Glennville, Georgia.

\$50.00 WEEKLY Raising Angoras for us. Free literature. Angoraville, 1215-34th Northeast, Cedar Rapids, Iowa.

RAISE Rabbits, market provided. Breeding stock furnished on production pay plan. Literature 25c, with hutch plans \$1. Hansen's Rabbit Institute, 1347 Miller Avenue, Salt Lake City 6, Utah.

SEEDS, NURSERY AND GARDEN SUPPLIES

CACTUS—8 Rio Grande varieties; \$1.00 postpaid. Pickwell Cactus Acres, Harlingen, Texas.

FARMS, FARM LANDS, REAL ESTATE

THERE'S A farm in your future—and you'll find it in the exciting pages of United's new free summer catalog of up-to-the-minute bargains! Farms with crops and gardens growing, ranches, orchards, groves, lake-shore and riverfront summer homes, resorts, tourist courts, service stations, stores, etc.; over 110 pages, nearly 1,000 fully-described bargains, some equipped and ready to go. Many photographs; covering many states from Great Lakes to famous Ozarks, southwest to glamorous California. Write for free copy today. United Farm Agency, 1408PM Consumers Bldg., Chicago 4, Ill.

LOTS \$300—Convenient payments. California's finest garden section. On Morro Bay's scenic shores. Wonderful fishing, hunting, boating, bathing. Fertile soil, softest water, temperate climate, congenial community. Free literature. Richard Otto, Department M, San Luis Obispo, California.

WEST'S Latest catalogue. Time and money-saver; over 1000 farm and business bargains, over 200 representatives, 19 states. Free. West's Farm Agency, HE-17, Pittsburgh 17, Penna.

STROUT'S Farm catalog—Free! Many equipped. Reduced prices! Over 2800 bargains. Coast to coast. Write today. Strout Realty, 255-P 4th Ave., New York 10, N. Y. 20 W. 9th St., Kansas City 6, Mo. 453 S. Spring, Los Angeles 13, Calif.

OZARK Spring time—Beautiful color photos. Farming lands, timber lands, \$5 acre. Lowest terms, complete information. Full descriptions. Write, Mr. Armstrong, Shock, Missouri.

CHEAP Homes: Stock, dairy, garden, fruit, poultry farms for retiring strong, sick, folks for hunting, fishing, long livy, health, happiness, in scenic, mild, Ozarks. Write G. W. Starr, Ozone, Ark.

GOVERNMENT Lands \$2.00 acre up. Information all states twenty-five cents. National Tax Service, 834-A Majestic Bldg., Detroit.

HUGE Profits! California, Oregon, Washington tax delinquent properties; 25c to \$3 acre minimum bid. Send 10c (coin) for circulars and maps. Pacific Lands, Box 2350 PM, Hollywood 28, Calif.

\$5.00 MONTHLY Buys 40 Acres, near town. Price \$200.00. Free list. Box 425-P, Carthage, Mo.

GOOD Farms—Ranches. Washington, Minnesota, Montana, Idaho, Oregon, North Dakota. Dependable crops, favorable climate. Write for literature, lists describing typical farm opportunities. Specify which state. J. W. Haw, 119 Northern Pacific Ry., St. Paul 1, Minn.

OZARK Lands for all purposes. Actual river frontages, 5 acres \$90.00 and upwards. Free list and literature. Hubbard, 424-I Minnesota Ave., Kansas City 4, Kansas.

FARMS, Ranches. All kinds, sizes. Choice of location, climate, production. Information on irrigation projects Columbia and Missouri River Basins. Resorts, summer homes, Milwaukee Railroad territory: Washington, Idaho, Montana, Dakotas, Wisconsin, Upper Michigan, Central corn belt. Free folders, price lists. L. H. Robbins, 604 Union Station, Chicago 6, Illinois.

FARM MACHINERY AND SUPPLIES

FREE—Big 1948 new and used tractor parts catalog. Satisfaction guaranteed. Write Irving's Tractor Lug Company, Fargo, North Dakota.

POULTRY, FARM SUPPLIES

RAISE Fryers new easy way. One-man home plant earns \$500 monthly. Booklet free. Poultry Guild, 1046-A So. Olive, Los Angeles 15, California.

KNOW How to raise poultry for profit. Read Northeastern Poultryman. Every issue packed with helpful hints and practical suggestions. Latest articles on breeding, feeding and management. Subscribe now. 1 year 65c. 2 years one dollar, foreign subscriptions \$1.00 a year. Northeastern Poultryman, Dept. P.M., 376 Boylston St., Boston 16, Mass.

PROFITABLE OCCUPATIONS

ELECTRIC Clocks are every where you go, buildings, homes, parking lots, factories. Repairs increasing. Our easy to learn course with pictures and drawings teach you how to repair these clocks. Electronic Supply Co., P.O. Box 2350A, Houston 1, Texas.

LEARN Piano tuning and repairing at home. Write Karl Bartenbach, 1001-H Wells Street, Lafayette, Indiana.

LEATHERCRAFT Supply catalog 10c. Art Craft Supply, 1205 Throckmorton, Fort Worth, Texas.

LEARN To paint signs of all kinds at home. Ben Kerns, Box 812, Dept. 102, Greenville, S. C.

WANT Pleasant outdoor work in a business of your own? Good profits selling over 200 widely advertised Rawleigh home/farm necessities. Pays better than most occupations. Hundreds in business 5 to 20 years or more! Products-equipment on credit. No experience needed to start; we teach you how. Write today for full particulars. Rawleigh's, Dept. F-145-PPM, Freeport, Ill.

LUMINOUS Paint, silver-plating, invisible ink, 500 formulas, money back guarantee, \$1.00 postpaid. Millard, Box 972, Wheeling, W. Va.

HYDROPONICS, Soilless vegetables, cheap chemicals, 25c. Box 57, Bristol, Virginia.

OWN Mirror shop, Resilver mirrors, Glass sign making, Electroplating. Supply prices. John Sprinkle, V50, Marion, Ind.

AUSTRALIA! Opportunities, wages, prices, etc., Complete report by ex-G. I. migrants, \$2.00. Box 1360, San Francisco, Calif.

MAKE Extra money spare time using directories, 25c. Keene, Dover, Penna.

TYPEWRITER Repairmen urgently needed. Earn \$40 to \$50 weekly spare time. Our easy to learn home study course teaches how to repair typewriters. Write for free information. Houston Typewriter Repair Service, P.O. Box 5357A, Houston 12, Texas.

WANTED—Fabric experts! High income immediately. No selling. Lifetime profession, revitalizing house-furnishings. Training, equipment, \$250.00. Information free. Weber, 1271 North Seventeenth, Allentown, Pennsylvania.

MUSHROOMS Grown. Boxes. Barrels. Instructions 50c. Spawn \$1.00. Mushrooms without manure \$2.50, complete \$2.50. Gordon, 553 William, Winnipeg, Manitoba.

RINGNECK Pheasants and Chukar partridge. Raise and sell these profitable colorful game birds. Send \$1.00 for new booklet "A Profitable Hobby" containing complete instructions for raising, handling and selling. Will also send prices on eggs, chicks and grown pheasants and partridge for your beginning stock. Blue Lakes Game Farms, Inc., Fairmont, Minnesota.

PROFITABLE Business in making and building with interlocking blocks. Delaware Industries, Dept. 10, Muncie, Indiana.

INTERESTED in Latin American and foreign employment? \$1 brings copyrighted Foreign Service Directory listing firms with interests in construction, oil, mining, aviation, manufacturing by personnel expert. Hot list of companies hiring. Global Reports, P.O. Box 883, Hollywood 28, Calif.

WOULD You pay 3%—first \$350 made? Color-illustrated book "505 Odd, Successful Enterprises" free! Some offer occasional "day off." Work home. Expect something odd! Pacific, Oceanside, Calif.

\$40.00 WEEKLY Made growing mushrooms, fresh, dried. Dominion patent 331583. Free spawn. North American, 169P Yonge, Toronto, Canada.

FOREIGN Employment? Brief directory, companies with foreign projects or branches \$1 or c.o.d. Foreign Service Institute, Box 3934, Miami 24, Fla.

"ALASKA" The last frontier offers unlimited opportunities. \$1 brings official government map and copyrighted report with listing of firms: Fishing, construction, mining, aviation, homestead lands, prospecting business. Alaska Opportunist, P.O. Box 883, Hollywood 28, Calif.

START Lamp factory. Profitable, fascinating, easy to learn. Illustrated course teaches you. General instructions, wholesale catalog \$1.00. Gearon Company, 6405 North Oakley, Chicago.

MAKE Flexible molds! Few cents each! Cast plaques, novelties, bookends! Free sample! H. Tooker, Hamilton 9, Ohio.

LOCKSMITHING Secrets—Key fitting, lock opening, repairing, prices to charge, supply sources. Illustrated book only \$1.00. Wechsler Supply, 7 W. 36, New York City.

LEARN To build architectural scale models. A well paying, interesting, and dignified profession. Any normal high school boy or girl will qualify. Send for literature and particulars. Elliott Hollywood Studios, Box 57, Hollywood 2, Florida.

CURE Your lean purse today. Write Douglass, 3231B 40 Avenue Southwest, Seattle 6, Washington.

CONCRETE Block machines all sizes, mixers, conveyors, ornamental forms, tile and brick machines, motors, gas engines. Madison Equipment Co., Madison, Tenn.

YOU Can make real money raising Golden Hamsters, the new amazing tiny animal. Food costs less than 10c month per animal. Breeds in 16 days! Easily raised in basement, attic, garage, barn, or shed. Write for convincing details. Hudson Hamstery, R.F.D. #1, Newfoundland, N. J.

EARN \$100 Week laying cement blocks. Learn easily. Professional instructions \$1.00. Block Masons, 1256 Amanda, San Bernardino, Calif.

PERMANENTLY Stops chimney creosote—down draft. Profitable. Wig. Abington, Mass.

BE The Popular Mechanics representative in your neighborhood and earn big profits in your spare time. Write Popular Mechanics Magazine, Room 408, 200 E. Ontario Street, Chicago 11.

BOOKS, PERIODICALS, PICTURES, POSTCARDS

TRADE Magazines—Business, vocational, diversion. Current single copies. All fields. Price list free. Commercial Engraving Publishing Co., 34C North Ritter, Indianapolis 19, Indiana.

BOOKS, All subjects, promptly supplied. Alta Book Service, Box 258-H, Waterbury, Conn.

"INSIDE Los Angeles Chinatown \$2.00." Also free catalogue, interesting books. A. Fallor Company, 201 Dewey Street, Newark 8, New Jersey.

NATIONAL Geographic Magazine, 1888-1945, any issue, Periodical Service, Dept. PM, Swarthmore, Penna.

BOOKS, Out-of-print. Hard-to-find. Any book. Aames Book Co., Dept. O, 1857 No. Ave. 52, Los Angeles 42, Calif.

BOOKS And novelties. Booklet free. E. Wainwright, 505 E. Gadsden St., Pensacola, Fla.

5000 BOOKS Absolutely free. Where? 25c. Shwindt, 69-12 Cooper, Brooklyn 27, New York.

625 STORY Books, 6c each. List free. Wood, 921P Jackson, Tulsa, Oklahoma.

BOOKHUNTERS! All subjects. Send wants! Jaher Book Service, 620-P East 178 Street, New York 57.

BOOKFINDERS! (Scarce, out-of-print, unusual books.) Quickly supplied. Send wants. Clifton Company, Box 1377pm, Beverly Hills, Calif.

SELF-EXPLAINING Bible: Illustrated circular free. Box 446-P, Minneapolis, Minn.

BIG Sparetime profits taking magazine subscriptions. Complete supplies, confidential catalog free. Cassell Publishers Service, Westfield, New Jersey.

BOOK Reading made easier, more pleasant and comfortable using amazing new bookholder. Postcard brings descriptive literature. Book Saver Products, 1318-P North Wolcott, Chicago 22, Ill.

BACK-DATE Magazines, Books. Specific issues! years. Arkell's, Tarzana 1, Calif.

WE Can supply you with almost any book. (Magazine subscriptions.) House of Kilroy (Booksellers), Box 772, Detroit 31, Mich.

MAGIC TRICKS, PUZZLES, JOKER NOVELTIES

ELECTRIC Bow tie—Sensational, mystifying. Concealed battery control. \$1.69 plus postage. Order now. Supply limited. Selrah Distributors, Box 2021, Dept. K, South Bend, Ind.

MAGIC Envelope 10c. Insert penny, extract dollar. Fool everybody. Wade, 1423 Palou, San Francisco 24, Calif.

VANISHING Half dollar trick and catalog 25c. Sterling Magic Co., Royal Oak, Mich.

MAGIC Catalog and card trick 25c. Stivers, 40 Salem, Medford, Mass.

MAGICIAN'S Pin, ghost illusion, magic book, large catalog. Everything complete 25c. Magic Wand-M, 9 W. Colorado, Pasadena, California.

MAGIC Tricks, fun novelties, lists 10c. Buzzing, vibrating handshaker, 50c. "Mar-ean," 2200 Gordon, Hopewell, Virginia.

ILLUSTRATED Catalogue. Best pocket, parlor, stage tricks. 10c. DeLuxe Magic Studio, Box 2606, New Orleans, La.

EARN Money in any crowd. Call names of strangers, tell unspoken questions. Professional course mind reading, faked spiritualism, etc. \$1. Reiss, 3017-G Ocean Parkway, Brooklyn 24, N. Y.

PROFESSIONAL Catalog, 128 pages, 25c. Williams, 900 Plymouth, Ellwood City, Penna.

LARGE 160 Page catalog, just published, 35c. We have supplied the best tricks to beginners and professionals for 38 years. Chicago Magic Company, 2300-E No. Mason Avenue, Chicago 39.

COIN And ring trick, 25c with pamphlet of magic and joke items. Powell's, P. O. Box 2155(P), Potomac Station, Alexandria, Virginia.

FREE Pack trick cards with catalog 25c. 12 Churchlane, Philadelphia.

TRICKY Magic matchbox. It turns around, it stands, it opens, Confuses, amuses everyone, easy to do. Free to you if you send 25c for big illustrated catalog of 425 magic tricks. Magician, 2463-C Kensington Ave., Philadelphia 25, Penna.

MAGICIANS' Headquarters. 400-page professional catalogue, pocket, parlor, stage tricks. World's finest magic. Send \$1.00 for catalogue (refunded first \$5.00 order). Kanter's, M-1311 Walnut, Philadelphia 7, Penna.

LARGE Catalogue of the best magic for professionals and amateurs. Send 25c. Mazda Magic Co., 1135 Westgate Ave., Oak Park, Ill.

"VENTRILLO," Professional voice-throwing instrument and illustrated catalog 25c. POB-971, Philadelphia.

LEARN Magic, ventriloquism, mind-reading. Write for particulars. Quackenbus, Big Flats, N. Y.

BIG Magic magazine, trick and price lists—25c. Lloyd M. Jones, 4064 39th Avenue, Oakland 2, California.

VENTRILLOQUISM Taught, 3c stamp bring particulars. Smith, 801 Bigelow, Peoria 5, Ill.

SNEEZING, Itching powders, eighteen other tricks, free with joker's catalog 25c. 2404-N Fifteenth, Philadelphia.

WORLD'S Largest professional magic shop, keeps you in touch with latest tricks. To receive mailings, send 35c for new catalog. Holden's, M220 West 42nd St., New York.

MAGIC Tricks, puzzles, books, cards, punch boards. Catalog 10c. Specialty, Box 671, St. Louis 1, Mo.

500 TRICKS. Send only 10c for Douglas' famous 112-page catalog 500 tricks. New magic for amateur, professional. America's fastest service for 25 years. Douglas Magicland, Dept. 1, Dallas, Texas.

DOLLAR Magic set free with gigantic catalog 25c. Mysto, 4462 Germantown, Philadelphia.

BE A magician. Large professional magic catalog of latest tricks, 35c. Ireland, C-109 North Dearborn, Chicago 2.

COINS, TOKENS, CURRENCY

4-IN-1 Special \$1.00 bargain offer: (1) United States 1893 Columbian world's fair half dollar; (2) album for holding coins; (3) large 56 page coin catalog; (4) genuine wooden nickel. Yes! All four items for only \$1.00. Order today. Money back if not pleased. Ben's Coin Company, 72 W. Washington, Chicago 2, Illinois.

OLD Money wanted. Will pay \$100.00 for 1894 dime, S. mint, \$50.00 for 1913 Liberty head nickel (not buffalo). Big premiums paid for all rare coins. Send 4c for large coin folder. May mean much profit to you. Numismatic Co., Dept. 20, Fort Worth, Texas.

MEXICAN Coins—1 Peso, 50c, 20c silver; 10c, 5c nickel; 20c, 5c, 2c, 1c bronze. Nine pieces. Fine to unc., \$1.65 postpaid. The Border Coin Co., Station A, Box 3535, El Paso, Texas.

COIN Bargain list for stamp. Toivo Johnson, East Holden, Maine.

12 DIFFERENT Coins, 25c; 30 diff. \$1.00. Bishop, Box 2201, Kansas City, Mo.

ILLUSTRATED Information—U.S. coins, collectors and dealers prices, 302 pages, \$2.00. Hobby Helpers, Dept. K, Box 665, Washington 4, D. C.

WANTED Gold coins of numismatic value. Crites, 2766 North 10th Street, North Sacramento, California.

SOUTH Africa. Rhodesia coins. Set \$3.00. McDonald, 30 Rosetta Street, Regents Park, Johannesburg, Africa.

25 COINS And bills, 25c. Oddehon, Box 482, St. Louis, Mo.

GET Profit and pleasure in collecting old coins. Send 10c for 56 page illustrated coin catalog. You'll be delighted with it. Send for it now. B. Max Mehl, 370 Mehl Bldg., Fort Worth, Texas. Largest rare coin establishment in U. S. Established 48 years.

FREE! Foreign coin, banknote and coin collectors illustrated catalog to approval service applicants. Send 3c postage. Tatham Coinco, Springfield-125, Mass.

COMMEMORATIVE 1/2, Oregon, Texas, Kentucky, Cleveland, Long Island, \$2.00 ea. Illustrated catalogue 25c. Norman Shultz, Salt Lake 9, Utah.

COINS Wanted, will pay up to \$2000 for certain coins, send 25c for catalogue. Burton's, 111 So. Third, Columbus, Ohio.

35 WORLD Coins \$1.00. Harry Elsholz, Box 9014, Pittsburgh 24, Penna.

WE Pay \$2.00 to \$200 each for hundreds of old or odd coins. Indianhead, Lincoln and foreign wanted. Many valuable coins. Keep all until posted. Send 20 cents for illustrated coin value book. 4x6. Buying and selling prices. 40 years in business. Coin Exchange, (7) Le Roy, N. Y.

STAMP COLLECTING

SENSATIONAL! Set Capejuby, Brunei, Perak, Honduras, Paraguay, Nigeria and over 100 different others. Everything 10c with approvals. D. O'Keefe, 7517 Merrill Ave., Chicago, Ill.

DIME. Plus 100 different returns you hundred different. Also magnificent approvals. Job-Oyd's Stamps, 476 Metairie Road, New Orleans 20, Louisiana.

BIG Money in stamps. Buy at low cost. Sell at big profit. New book "How to Sell Stamps by Mail" reveals startling stamp secrets. Free particulars. No obligation. Donald Kelly, Publisher, L-9544 Whitcomb, Detroit 27, Michigan.

1/2c UP U. S. or foreign approvals. Free list. Hurt & Fosse, Box 102, Blue Ridge, Virginia.

COLORFUL Chinese "victory" set, complete, mint, catalogs \$2.30, only 10c with approvals. Kalumet Stamps, 523 Detroit, Hammond, Ind.

POSITIVELY Greatest free offer—Latest Scott's International \$6.00 stamp album—covering entire world, contains 36,000 illustrated descriptive spaces; Scott's 1948 standard \$7.00 catalogues "Philately's Encyclopedia"—absolutely free to applicants for foreign approvals becoming customers. Plymouth Speciality Company, Dept. A9, Bell, California.

VICTORY Packet free—Includes stamps from Tanganyika, British Cayman Islands, animal, scarce babyhead, Coronation, early Victorian, airmail, map stamps. Including big illustrated catalogue. Send 5c for postage. Gray Stamp Company, Dept. PM, Toronto, Canada.

FREE! Mint British Colonies from Solomon Islands, Caymans, Grenada, Dominica, Turks, Caicos. Absolutely free to new approval applicants. Viking, 130-Z Clinton St., Brooklyn, N. Y.

2000 DIFFERENT Stamps, free bonus. 3c postage. Bryant, Box 1892, San Diego 1, California.

ALBUMS. Used, new 25c up. Lists 3c. Alatalo, Maynard 14, Mass.

NEWFOUNDLAND And foreign stamps. Dollar packets. Free premium with each. Eldon Decker, Bear Island, Ontario, Canada.

FREE, 5 Large mint pictorials with our attractive approvals. Fields, 1939 E. 85th, Cleveland 6, Ohio.

FREE, Triangle, Roosevelt, Vatican, Ethiopia, Hitler heads. Request approvals. Florida Stamp Company, Box 807, Miami 5, Fla.

BARGAIN! 2,000 Foreign stamps \$1.00; 5,000, \$2.00. American Stamp Company, Wilmington A-4215, Delaware.

BOX U. S. used commemoratives. All different \$1.00. Leavitt, Rockaway, Lynn, Mass.

25 FASCINATING Pictorials, commemoratives 25c, approvals. Kenda, 82 New Jersey Avenue, Brooklyn 7, New York.

50 DIFFERENT French 10c with approvals. Independent Stamp Company, 209 Crouse Avenue, Johnstown, Penna.

WORLDWIDE Different—500, 44c; 1000, \$1.50; 2000, \$3.45. Big free list. Florman, 2401 Davidson, Bronx 53, N. Y.

SPANISH Air set free to approval applicants. Flamingo Stamp Company, Box 4038, Pinewood Station, Miami 38, Florida.

APPROVALS One cent and up. L. Erickson, 1516 South Cushman, Tacoma, Wash.

FIFTY Stamps from fifty countries! 10c. Garrow, 84-R Montevista, Chula Vista, California.

INFORMATIVE Monthly illustrated price list free. Frances Reese, Martinsville, Indiana.

FIVE Large mint pictorials free to approval applicants. Postage paid both ways. Rush postcard to Phipps, 10993-M Wellworth, Los Angeles 24, Calif.

500 WORLD Wide 50c. Approvals 1/2c up. Pelton, 8500 Chalmers, VanDyke, Mich.

15 DIFFERENT U. S. over 40 years, 10c. Special with bargain U. S. approvals. Bill Portney, 1806R E. 22 St., Brooklyn 29, N. Y.

500 MIXED Stamps from all parts of the world, 10 cents to approval applicants. Daniel W. Menge, 827 North Lime Street, Lancaster, Penna.

30 SCANDINAVIA 10c. To approval applicants only. Bjorn Nielsen, Monmouth 1, Maine.

FREE! Hindenburg set, 6 different stamps, with approvals. Martin, Box 1128, Miami Beach, Florida.

ILLUSTRATED Monthly bulletin free. Approvals if requested. Weckerling, 821 N. Main, Altus, Okla.

EVEN Roosevelt didn't have this! Makes a full page in your collection! Only 3c. Approvals included! George Wentz, San Marcus, Texas.

WORLD—500 Diff. 50c, 1000 \$1.25, 75 Canada 25c, approvals, lists. Victoria Stamp Co., London 4, Canada.

LIBERIAN Triangulars, 10c with approvals. Vargo Stamps, 6044 South Fairfield, Chicago 29, Illinois.

DOLLAR'S Worth for a dime. Superior packet cataloging over one dollar—only 10c to approval applicants. Thiem, 200 Hermitage, Rochester 12, New York.

MEDIUM-PRICED And penny approvals. Texas Stamp Service, Schulenburg, Texas.

CROATIA Set complete free, approvals. Thode, 14302K 119 Avenue, So. Ozone Park 20, N. Y.

50 DIFFERENT Belgium stamps and our price list, one silver dime. Stampsales, Box 1649P, Oakland 4, California.

FREE: Twenty different foreign commemorative stamps to new approval applicants. Modern Stamp Service, Box 12, Wakefield Station, N. Y.

HISTORICAL Collection! Cavalry charge! Bulgaria. Flaming sword! Ireland. Big She-wolf! Italy. Fort! Dominican Republic. Field Marshall! New Zealand. Pitcairn Mutiny Island! Commemoratives! Pictorials! Only 3c. Approvals. Star Stamps, Lakewood, New York.

FREE! Complete Balkan aviation set with approvals. Beaman, Leeds, Alabama.

75 UNSORTED Newfoundland 25c. Real value. Mayfair, Regal Rd., Toronto 10, Canada.

FREE! Tiny Chinese "midget" war set. Approvals. Seminole, Leeds, Alabama.

PENNY Approvals that satisfy. Neil Gronberg, Box 5441-P, Philadelphia 43, Penna.

STAMP Agents wanted. Generous commissions. We finance. Write for details. Barrington Smith Co., Halfwaytree 20, Jamaica, B.W.I. (Postage 5c).

FREE Stamps to approval applicants. Surf Stamp Co., Box 2296, Miami Beach, Fla.

MAGNIFICENT! United States Civil and Spanish War revenues. 50 to 87 years old. 10 different. 5c to approval applicants. AAA Stamp Company, Arcade Building, St. Louis 1, Missouri.

U. S. APPROVALS, Used or mint. Panthers, Box 52-P, Dorchester 24, Mass.

10 DIFFERENT Iraq 5c to approval applicants. Jeffery Stamp Co., 9726 Chappel, Chicago 17, Illinois.

TOPS, Tops in value, priced to please. United States approvals. Jarr, Box 217, Madison Square, New York 10.

BEAUTIFUL Packets, 10c and up! Bargains! Sent on approval. New Hampshire Philatelic Ass'n., Inc., Deerfield, N. H.

SOUTH Africa, 24 unused stamps. Send \$1.00. McDonald, 30 Rosetta, Regents Park, Johannesburg, South Africa.

SUPERB Approvals, net prices. Stamps 1/3 to 1/2 catalog. P. G. Beals, 170A Tremont St., Boston, Mass.

FREE Monthly illustrated bulletin showing recent issues. Penny approvals on request. Reed Company, Box 980, Chicago 90, Illinois.

WORLDWIDE Packet 50 stamps 5c with approvals. Carlins Approval Service, Box 307, Fresno, Calif.

FREE, Irish commemorative collection, including rebellion issue with approvals. Raymax, 123-Z William St., New York City 7.

FLAG Stamp free with U. S. approvals. Wenigman, 929 Oakdale, Chicago.

FREE—\$25.00 Stamp collector outfit—Finest, most complete outfit ever offered: Large Scott album, valuable collection of 1050 "different stamps, airmails, odd-shapes, hi-values, "Stamp Finder," watermark, magnifier, perf-gauge, tongs and hinges. Actually over \$25.00 value absolutely free when regular customer. Mail application now for foreign approvals. Bargain Stamp Service, Dept. "D," Santa Ana, California.

5 DIFFERENT United States \$5.00 stamps 10c to approval applicants. Mohawk, Box 524, Albany, New York.

25 ALL Different stamps 10c. Tunis, Wakeman Ave., Newark 4, New Jersey.

MIXTURES. Worldwide. 1,500, \$1.00. Missions Outlet, Reverend Marshall, Paterson 1, New Jersey.

MINT Hitler heads, 18. Scott's #506-523 for only 25c. Blocks of four \$1.00. Reich Stamp Co., 4647 Kenmore, Chicago 40, Ill. Dept. M16.

200 DIFFERENT Stamps—Cataloging up to 15c each, only 3c to approval applicants! Littleton Stampco, Littleton 42, N. H.

ZOWIE-E! A barrel of fun for only a dime. 500 United States stamps—absolutely unpicked and unsorted—just as received from church missions. Many varieties, including large commemoratives, airmails, high denominations up to \$5.00! Stampdom's biggest package of fun—and you might find something really valuable! Price only 10c to serious approval service applicants. Money back if not delighted. Illustrated bargain lists with each order. Mystic Stamp Company, Dept. 80, Camden, New York.

25 UNUSED Stamps. Pictorials, airmail, triangle, etc., only 3c with approvals. Paul Bauer, 31 Wilkshire, Lancaster, N. Y.

WOW! \$10.00 Worth of fun. Only 10c! What a treasure hunt! Big package 500 foreign stamps from foreign missions, other sources. Includes stamps from Africa, South America, Free French, Somali, Palestine, etc. Includes airmails, commemoratives and stamps worth up to 50c. This offer sent for 10c to approval applicants only. Jamestown Stamp Co., Dept. 22, Jamestown, N. Y.

COLLECTORS Outfit, album, hinges, gauge, detector, 50 different stamps, 2 mint sets. All 10c, approvals. Cornett, 228 West 25th, New York 1.

ILLUSTRATED Stamp Magazine, 26 weeks 25c. Stamp Journal, Kalamazoo, Michigan.

CHOICE Of 35c worth of stamps from our first U. S. selection free to applicants enclosing 3c postage. Large selection to choose from. Act now! S. C. Engel & Co., 38 Park Row, New York.

200 DIFFERENT, Including Roosevelt triangle, 5c to approval applicants. H. Avalon Stamp Co., Springfield, Mass.

WORLD'S Largest stamp (7 1/2 x 14 inches). A real curiosity! Retail for 50c, only 3c to approval applicants. Tatham Stamp Co., Springfield 30, Mass.

DANDY United States approvals. Write immediately. Sullivan, Endicott Building, St. Paul, Minnesota.

50 DIFFERENT United States 10c. No approvals. Seidenberg, Cassopolis, Mich.

FREE—Famous Americans set, plus Flag Set, plus the National Parks Set, plus the Presidential Set to the \$5. A total of 90 stamps absolutely free to customers for our unsurpassed U. S. or foreign selections. Send 3c postage for 15 of the above mentioned stamps and full particulars. Triboro Stamp Company, 145 Nassau St., Dept. 112, New York.

FREE! 100 Worldwide different stamps to approval buyers. Big U.S. and illustrated bargain lists sent with approvals. Bookman, Maplewood, N. J.

128-PAGE United States catalog—1000 illustrations, 10c. Harris & Co., 202 Transit Bldg., Boston.

50 DIFFERENT Stamps, triangle, airmails, etc., 5c with approvals. Carlton's, 10243 Silverton, Tujunga, California.

BRITISH, Spanish and French Colonies. Vatican. Hitler heads, and airmail packet free with approvals. Pan-American Stampco, Box 145, New York 33, N. Y.

STAMP Collections wanted. Complete collections, duplicate lots, surplus stock, mint and used. Prefer trade for printing or other items, buy outright if priced right. What have you, what's wanted? Vanroy Shirk, Lebanon, Penna.

U. S. Price list. Send postage. State Stamp Service, 1225 Park Building, Pittsburgh 22, Penna.

DEALERS—Wholesale list. Postage 3c. Frank, 5031 Queensberry, Baltimore 15, Md.

\$1 STAMP, 100 Different U. S.; 25c with approvals. Miller, Box 600, Palo Alto, California.

319 ALL Different stamps from Vatican City, Palestine, Cyprus, San Marino, etc., with our sensational new illustrated 32 page Stamp Finder. It identifies all difficult stamps immediately. All for only 10c to approval applicants. A tremendous bargain. Garcelon Stamp Company, Box 800, Calais, Maine.

FIRST Day covers on approval. Knobel, 1918 S.W. 12th Street, Miami 35, Florida.

U. S. Price list. Send postage. Stanley Gibbons, 38-P Park Row, New York.

FREE! Crystal-mount samples! Har-risco; 202 Transit Bldg., Boston.

UNITED States approvals complete coverage, fine quality, attractive prices. Semiole Stamps, Box 1138-P, Coral Gables, Florida.

"GOYA Nude" set complete 35c. Approvals. Royal Stamp Company, Tamaqua, Penna.

FIRST Day cover service. L. Best, 696 Greene, Brooklyn 21, New York.

YOU'LL Like our American and British Colonial approvals. Write now. Chesapeake Stamps, 748 Overbrook, Baltimore 12, Maryland.

50 DIFFERENT Norway only 10c to approval applicants. Floyd Frederick, 513 1/2 Green Street, Lancaster, Penna.

UNITED States unused. Complete set 13 flag stamps plus 5c China commemorative only \$1.00. Fine approvals. Willett Stamps, Box 507, Port Chester, N. Y.

FREE Beautiful airmails. Commemoratives, pictorials, eight countries. Approvals enclosed. Green and Company, Norwood 12, Ohio.

ROOSEVELT, Hitlers, etc. 110 different 15c. Buckley, PM-208 Ludlow Bldg., Dayton 2, Ohio.

WHOOPIE! Wow! 25c worth of stamps free to buyers. Write M & N Co., 742A Sheffield Ave., Brooklyn, N. Y.

200 DIFFERENT. Catalog \$5.00, only 10c with approvals. Bert Soika, Box 146-M, Jackson Heights, N. Y.

STAMPS Wanted by thousands of our readers. Your ad in this space will bring you some nice orders. One advertiser sold 150,000 stamps. Write for positive proof. F. W. Johnson, Classified Advertising Manager, Room 301, 200 East Ontario St., Chicago 11.

ANTIQUES, RELICS, INDIAN GOODS, CURIOS

180 PAGES Antique and modern pistol, sword, etc. values, 50c. Robert Abels, A860 Lexington Ave., New York 21.

PRECIOUS STONES, MINERALS

ZIRCONS, Mined, mastercraftsman cut in Siam. Diamond like brilliance, sparkle. 2 samples \$1.00. 1 carat \$2.00. 2 carat beauty \$5.00. Others. Imhusex PM, Box 232, White Plains, N. Y. Agents wanted.

COLLECT Minerals and gems as a hobby. Free list. Elbert McMacken, Route 2, Box 177, Escondido, Calif.

ZIRCONS, Loose. Pure white. Special: 3 zircons approximate total weight 3-kts. \$6.00. We can supply zircons in all sizes and mountings of all types. Send order or write for details today. B. Lowe, Holland Bldg., Dept. P.M., St. Louis, Mo.

"GENUINE" Deep red Arizona rubies (garnets), send quarter for packet. Mineral Specimens Company, P.O. Box 2651, Phoenix, Arizona.

GEMSTONES—Rough or polished. Custom cutting. Crystallized specimens. Information free. Plummer's, 5068 Brighton, San Diego 7, Calif.

METAL Detectors. The very latest circuit. Free literature. Hedden Metal Detectors, 3329 Liberty Avenue, Pittsburgh 1, Penna.

BEAUTIFUL Arizona agates, polished samples and listings \$3.00. Unpolished samples \$1.00. Arizona Agate Mines, Cave Creek, Arizona.

HOBBIES AND COLLECTIONS

WOOD And ivory carvings made to order. Hermania Anslinger, 918 West 4th Ave., Spokane, Wash.

HOBBIES Catalog for stamp. Hobby Sales, 709-8th St. S.E., Washington, D. C.

5 OKINAWA Sea shells \$2.50. Free lists. John Burch, 4206 Halldale, Los Angeles.

MEDALS, Foreign campaign bars, samples, catalogue, 25c. Insigniacrafts, 236 28th Avenue N.W., Calgary, Canada.

WANTED Old cigarette cards. Write Charles Bray, East Bangor, Penna.

UNUSED Match book covers. 100 all different \$1.00. Free catalog. Charles Edelman, 1311C East 84, Cleveland 3, Ohio.

INVENTING Can be an interesting and profitable hobby. Write for complete particulars. Institute of American Inventors, Dept. 40-E, 1926-Eye St. N. W., Washington 6, D. C.

50 DIFFERENT Army embroidered patches \$1. Other bargains. Insignia Mart, 703A Broadway, New York 3, N. Y.

MAKE Money building bird houses. Illustrated instruction book. 25c. Popular Mechanics Press, (C-43), 200 E. Ontario, Chicago.

CAMERAS, PHOTO SUPPLIES

FREE! 116-Page illustrated photographic catalog, send 3c stamp. Bloom's Camera Center, 1657 Main, P.M., Springfield, Mass.

CAMERA "Specials" for P.M. readers. Argus, Revere, Kodak. Buy, sell, write or wire. Charles Wolfe, 167 Canal St., New York 13, N. Y.

PHOTOGRAPHY For pleasure or profit. Learn at home. Practical basic training. Long established school. Write for booklet. American School of Photography, 1315 Michigan, Dept. 3432, Chicago 5.

WANTED—Used Kine Exakta. Give details, price. John Dalen, 2453 North Kilpatrick, Chicago 39.

HAVE You a camera? Improve your hobby of photography and learn how to make better pictures. Write today for our latest free book catalog. Enclose 10c if you desire recent copy of American Photography, containing articles and pictures by the world's foremost writers and photographers. 602 Camera House, 353 Newbury St., Boston 15, Mass.

YOU Make breathtaking, long treasured, prize winning photo enlargements easily, economically with the New Precise Photo Enlarger, only \$22.20 complete, postpaid, nothing else to buy. Send postcard for details. Tam Products CM6, 3814 Wrightwood, Chicago 47.

STOPWATCHES. Government surplus; 15-jewel Elgins. Brand new, \$12.95; used, reconditioned, \$9.95. Write for free brochure. Brovar Distributors, 630 Oppenheimer Bldg., San Antonio, Texas.

PRINT Your own photos. Photoprint set \$1.00 p.p. Westland, Box 1176, Omaha, Nebr.

WORLDY Wise—See world through three-dimension color pictures. Optical "View Master Stereoscope" including sixty-three colored views, \$5.00 complete including mailing. Sorry, no c.o.d.s. Send remittance advance. Mercury Photo, 319 South Market St., Chicago 6, Illinois.

SPECIAL! Buy one. Get another, free! Finegrain. Superspeed. Fresh. Nationally advertised, guaranteed. 1-620, 33c. 1-616, 38c. 36 ex. 35mm. cartridge, 50c. 127, 27c. Postage, 5c extra. No quotas. Box 591, Pittsburgh 30, Penna. Dealers, agents, wanted.

SNAPSHOOTERS: Learn develop your own; all materials, instructions, 5 undeveloped pictures \$1.00. Davis, 538 Palisades, Akron 3, Ohio.

INFRA-RED Film makes for unusual pictures! Eastman Kodak, 35mm Infra-red, four 36 exposure reloaded cartridges, \$2.50 postpaid. Short-dated but guaranteed. Delta Photo Supply, 690-M Third Ave. New York 17, N. Y.

MAKE Your own photocopies with the Cop-Ez Printer, only \$15.00. Cop-Ez Equipment Co., 4864 Woodward, Detroit 1, Mich.

PICTURES Never before possible! 35mm. Tri-X film, Weston speed 200 daylight, 160 Tungsten. Guaranteed. 36 exposure cartridges, 4 for \$2.50. Per dozen, \$7.50 postpaid. Delta Photo Supply, 690-M Third Ave., New York 17, N. Y.

ENLARGER? Build your own cheap. We show you how. Complete plans \$1.00. Somerset Specialties, 10514 Somerset, Detroit 24, Mich.

KODABROMIDE Enlarging paper—4 1/4" x825 feet rolls. Enough for almost 2,000 4x5 enlargements. Single weight. Actual tests prove its worth. Fully guaranteed. Reduces printing costs to a fraction of a cent apiece. Value over \$35.00, our price \$2.25 postpaid in U.S.A. Delta Photo Supply, 690-M Third Ave., New York 17, N. Y.

FILM Bargain—12 rolls war-surplus #120 Super-XX postpaid \$3.00. \$6.62 value 35mm. bulk film daylight loader \$4.80 plus 20c postage. 100' 35mm. Kodak or Ansco film \$1.75 plus 20c postage. Loader and film, both postpaid \$6.50. Great savings on non-surplus color film. All guaranteed. Write for free copy current News Letter. Sterling-Howard, Dept. PM68, 1900 Monterey, New York 57.

K-21 AAF Aerial Combat Cameras, manufactured by Graflex; motor driven, with flexible shaft; 24 volt operation; including step-down transformer to 110 voltage; may be manually operated. Complete except for lens and filters. New, original government packaging; positively the lowest price in the country, for a limited time only, \$39.50. An amazing value from Amazing Bachman's, Dept. PM, 27 Herman Street, Rochester 5, N. Y.

BUILD Your own enlarger. Takes negatives up to 4"x5". Detailed plans one dollar. Emby Co., Birmingham 5, Michigan.

200X TELEPHOTO Camera easily made. Trifling cost. Telephoto lens and instructions \$3.00 postpaid. Instructions alone 10c. Suffolk Science Service, Manorsville, N. Y.

OIL Coloring photographs can be a fascinating hobby or profitable sideline for those with artistic talent. Learn at home. Easy simplified method. Send for free booklet. National Photo Coloring School, 1315 Michigan, Dept. 3432, Chicago 5, Ill.

BASS Says! At the sign of the old "Horse Trader," 37th year. Thousands of satisfied customers everywhere! Finest brands including Kodak, Bell & Howell, Argus, Zeiss, Leitz, etc. Satisfaction always guaranteed, or your money back! Bass buys 'em, sells 'em, trades 'em. Write or wire. Bass Camera Company, Dept. AG, 179 W. Madison St., Chicago 2.

PHOTO FINISHING

MOEN'S Sensational 50th anniversary super-size prints! Our amazing new \$15.-000 equipment will produce better, sharper super-size prints and faster, no longer need you wait. Send film today and see the difference, be the first to show your friends. 8 exposure rolls all super-size genuine Moentone Varigam prints only 35c; 12 exposure 55c; 16 exposure 65c. Moen Photo Service, 18 Moen Bldg., La-Crosse, Wis.

OVERSIZE Prints; overnight service; 35c. Films developed and 8 prints near postcard, only 35c. Electronic process, non-fade, glossy pictures. Write for free mailers. Peachtree Photo Finishers, Dept. PM, P.O. Box 4324, Atlanta, Georgia.

8 BILLFOLD Size black and white copies from your favorite portrait \$1.00. Jean Anne Jacob, 125 N. 4th Ave., Morton, Illinois.

WALLET Sized photocopies sealed in plastic from your priceless photographs. Free details. Madfis Specialty, 175F Tremont St., Boston 11, Mass.

YOU'LL Be delighted. Eight Never-fade prints now only 25c. Two prints each only 35c. Free mailers and price list showing other services. Write today. Hammond Sales Co., Hannibal, Mo.

OLD Photos restored. Free estimates. R. Daly, Box 91, Ansonia Station, New York 23.

PORTRAIT Quality 5x7 enlargements 15c, 2 for 25c. NuTone Fotos, Box 228, Pottstown, Penna.

BARGAINS—24 prints from roll 37c; 16, 25c. reprints 2c; 100—\$1.50; 16 3x4 enlargements 50c. Ten 4x6 50c. Five 8x10s \$1.00. Studio, Albany 16, Wisconsin.

JUMBO Or photo pack prints, 8 exp. roll 35c. 16 exp. roll 65c. NuTone Fotos, Box 228, Pottstown, Penna.

8 HOUR Service, Box 468, San Francisco. Your 8 exposure roll printed jumbo or regular size 30c; 12 exposures 35c; 16 exposures 50c; 36 exposures \$1.00. Reprints, jumbo or regular 3c. Regular prints deckled. Fine grain developing. Send for free mailers. Quality Photo Service, Box 468, San Francisco 1, Calif.

CUSTOM Photo service, "your nearest postal port." With this advertisement free air mail return to you. Eight exposures 30c, 12 exposures 40c, 16 exposures 60c. Jumbo or regular size (deckled). Reprints 4c each. 36 exposures \$1.00. Guaranteed fresh 35mm., 50c per cartridge. Your work returned in 4 days Guam, 5 days Tokyo. Box 567, San Francisco, Calif.

ROLLS Developed and enlarged 2 to 6 times larger. 8 exposures 25c coin, 12 exposures 35c. 16 exposures 50c. Enlarged reprints 3c each. Aiden Photos, 94-3 Astor Station, Boston, Mass.

NEW Process developing and printing. 8 exposure rolls 35c. Mayfair Photo Service, Box 261K, Toledo, Ohio.

ENLARGEMENTS In album form developed and printed in one continuous story-telling arrangement. Any 8 exposure roll reproduced thus novel, loose-leaf way for only 30c. Reprints 4c each. Extra prompt service! Clip this ad for free mailers. Larga-Pic, Box 22, Brookline, Mass.

"BETTER Photo finishing." Jumbo prints 40c a roll. Reprints 3c. Best by test. 35mm. positives \$1.50 strip. 36 ex. Sealstone Photo, Box 468, Seal-Beach, Calif.

ENLARGEMENTS. 5x7 15c. 8x10 25c. Glossy or dull. Oil colored, 50c extra. Negatives made 50c. Roll film developed and printed, 25c. L & R, P.O. Box 1476; Milwaukee Wis.

EVERY Picture an enlargement! New electronic developments give you bigger and better enlargements at the same low prices. Any 8 exposure roll developed and printed enlarge size, only 30c; reprints 4c each. Fast, accurate service guaranteed. Send for free mailers today! Enlarge Photo Service, Box 791-D, Boston 2, Mass.

8 BEAUTIFUL Double size pictures and roll developed 30c. 8 hour service. Free mailers. Pacific Photo Service, Box 666, San Francisco, Calif.

PHOTOGRAPHY For pleasure or profit. Learn at home. Practical basic training. Long established school. Write for booklet. American School of Photography, 1315 Michigan, Dept. 3451, Chicago 5.

8 PRINTS All enlarged to nearly postcard size from your roll or negatives 25c; 16-50c. (Trial offer). Willard Studios, Box 3535A, Cleveland, Ohio.

16 DECKLEDGE Prints from any standard 8 exposure roll 25c. Quick service. Professional work. Skrudland, Lake Geneva, Wis.

FREE Price list on quality developing, printing, enlarging. Write for it today. Bryan's Photo Shop, Dept. M, Panama City, Florida.

BUTONE Jumbo prints are different. Any 8 exposure roll developed and one Butone Jumbo print each, only 30c; additional Jumbo prints 4c each. Butone bargain: Any 8 exposure roll developed and two regular size prints each 25c; additional regular size prints only 3c each. All work guaranteed. Butone Finishers, Box 1777, Wichita, Kansas.

FASTER High quality photo finishing. Trial eight exposure roll developed, printed, 15c with this adv. Hollytints, Hollywood, California.

MOTION PICTURES AND SOUND EQUIPMENT

MOVIE Film processing—Finest automatic machine processing, 8mm., 16mm., 48 hour service. Also duplicating, editing, titling, other lab. services. Send for list of prices. Fotoshop, Inc., Room 154, 18 E. 42nd Street, New York City 17.

I BUY, exchange, swap movies. What have you? What do you want? Lowest exchange rates in world. Catalogue \$1.00. Refundable. Harvey Iris, Box 539, Brockton, Mass.

ENLARGEMENTS From your movie film. Send one dollar and frames. Curio-photo, 1187 Jerome, New York 52.

MAKING Movie titles, free booklet. Westwood Company, 635 Victoria Street, San Francisco, California.

BRAND New 16mm. sound projectors \$129.50. Send 10c for 16mm., 8mm. catalogue. Sterling's, 679 Northampton, Easton, Pennsylvania.

EARN \$8.00 To \$10.00 daily with your movie projector. Details free. Meicall (PM), 10806 Glenroy, Chicago, Ill.

MOVIES—8-16MM. variety "subjects, rare, cold, or indifferent;" silent and sound. Free lists. AeroTraders, Adams, Mass.

EXCLUSIVE Movies, projectors, accessories. Catalog free. Home Pix, 1674 Broadway, New York 19.

ELECTRIC Movie cameras, 16mm., Army GSAP, original condition, value \$200, complete with 1/3.5, new \$32.50, used \$19.50. Accessories available for home conversion. Free literature. Completely converted Lektro, 16mm. ready-to-operate \$59.50 guaranteed. Magazine film for same, \$2.50, includes processing. Fotoshop, Room 130, 18 E. 42nd St., New York City 17.

MOVIE Film at tremendous savings! Kodak Super X, govt. stock, tested, guaranteed! 16mm. 100 ft., \$2.95; 50 ft. magazine, \$2.50; Double 8mm. 25 ft. \$1.65. Super XX, 50c add'l. each roll. Free processing. Fast service. Photo Surplus Sales, Box J-10, 12 Duane St., New York City.

KODAK Super-X movie film at give away prices! Govt. surplus but good as gold! Tested and fully guaranteed. 16mm. 100' \$2.95; 50' magazine \$2.50; 8mm. 25' Double 8 \$1.65. Processing included. Stock up for summer shootin'! Fotoshop, Room 178, 18 E. 42 St., New York City 17.

GUARANTEED Fresh anti-halo outdoor movie film! Weston 12! Daylight loading! Processing free! Three spools double 8 mm. \$3.45! Six single 8 mm. for Univex, \$4.60! Postpaid! Catalog. Eso-S, 47th Holly, Kansas City 2, Missouri.

FREE Movie list. Superior Film Service, Box 713, Troy, N. Y.

LEARN Professional motion picture technique at home. Approved for veteran training under G.I. Bill. Free catalog. Motion Picture Institute, Birmingham 4, Mich.

LEARN Movie projection, management. Free catalog. Theatre Institute, Elmira, N. Y.

8-16MM. Silent-sound films. Complete rental library. All latest subjects. Free catalogue, (sample film 10c). Garden Film, 317 West 50th, New York 19.

BASS Says! 37 years of leadership means satisfaction to you! Finest equipment, 8 and 16 mm., sound cameras, sound projectors. Bass buys 'em, sells 'em, trades 'em. Satisfaction always guaranteed, or your money back! Bass Camera Company, Dept. A, 179 W. Madison St., Chicago 2.

BEAUTIFUL Kodachrome slide and lists 25c. Slide Supply Service, 3111 West Tuscarawas, Canton, Ohio.

SURPLUS 16mm. Eastman Super X on 50' cores, 50c postpaid! 12 rolls \$5.00! Outdated but tested and guaranteed! 100' camera spools 25c postpaid! Processing, 75c. Filmercraft, 47th Holly, Kansas City 2, Missouri.

16MM. Sound films. Real bargains in used cartoons, musicals, sports, novelties. Big list for stamp. Blackhawk Films, Davenport, Iowa.

SOUND, Silent movie film, 8mm, cartoons, 16mm. comedies, 35mm. shorts. Simpson, 155 High, Dayton, Ohio.

35MM. Silent sound films, projectors. Bedner, 5300 So. Talman, Chicago.

MOVIES Enlarged! Two 5x7 photographs \$1.00. Artcraft, Midwood, Brooklyn 30, N. Y.

DEVELOP Your own movie film. Literature. Duro Products, 1519 Eggert, Buffalo 21, N. Y.

FREE. Movie catalog; sample films, 10c. Goodwill Company, Jackson, Tennessee.

MUSICAL AND MUSICAL INSTRUMENTS

SWISS Musical units \$3.50. Musical albums, boxes, 131 West 42nd, New York 18.

SAXOPHONES, Clarinets overhauled carefully, reasonably. Master Repair, 29 Hunter, Glens Falls, N. Y.

HILLBILLY, Western records, late numbers, 29c. Catalogue 3c. F-L Shop, Box 19-L, New York 35, N. Y.

GUARANTEED Satisfactory piano score arranged, \$6.00. Lee, 344 Primrose, Syracuse 5, N. Y.

CHURCH Organist 35 years composes music, prints music. Reginald Belcher, 14 Harrison Street, Morristown, New Jersey.

SONG Titles and poems wanted for immediate consideration. Examination without charge. Send best material today. Special Service, 2115 Kenilworth Ave., Berwyn, Ill.

MUSICAL Movements \$2.00. Free photo. Pevar's, Dept. PM, 4218 Viola, Philadelphia 4, Penna.

GUITAR Beginners: Newest western style uses Mel-O-Chord automatic chord-changer. Complete with 40 lessons, \$8.95. (Guitar included \$25). Part One "Chords by Ear." \$4.95. Other popular music supplies. Guitar Headquarters, Box 886, Ventura, California.

SONGWRITERS Attention! The amazing demand for phonograph records, accelerated by countless juke-boxes, warrants your immediate investigation. We are offering new writers the rare opportunity of having celebrated "hit" composer furnish music on reduced percentage basis for any likely poems received this month. The Petrillo ban does not affect us. Recola Records, Hollywood 28, Calif.

1948 ACCORDIONS — Wholesale. Free catalog. American Accordion Center, 39 So. Kedzie, Chicago.

SONGWRITERS: Honest outstanding music writing offer. Len-Tex Studios, Leonard 2, Texas.

AMPLIFY Your accordion with our new mike \$22.50. Sounds like organ. Installed in minute. Use any amplifier. Amplifier and mike \$72.50. Write Del Principe, 307 So. Wabash Ave., Chicago.

BE Independent, tune pianos, music unnecessary. Practical Piano Tuning shows you how. \$2.00 postpaid. Chord-Slide Co., P3122 Lawrence Drive, Corpus Christi, Texas.

POEMS Set to music. Experienced composer. Free folder. Moquin, 5333 La Cresta Ct., Hollywood, Calif.

SONGWRITERS! Ethical composing offer. Hibbeler, C5, 2157 N. Avers, Chicago.

ACCORDIONS, Streamline, wholesale. Request circular. Metro Accordion, 44 North Albany, Chicago.

MUSIC Arranged. Songs printed. Frank Wildt, Music Publisher, Lancaster, Penna.

SONGWRITERS—Protect your songs. Get the facts first. Free booklet, attractive offer. Song Service, 331-C West 46th, New York.

POEMS Wanted for musical setting. Send poems for free examination. Five Star Music Masters, 630 Beacon Bldg., Boston, Mass.

POEMS Wanted for musical setting! Send poem for immediate consideration. Hamann Service, 614 Manhattan Building, Milwaukee, Wisconsin.

POEMS Wanted to be set to music. Free examination. Send poems. McNeil, Master of Music, 510-PM S. Alexandria, Los Angeles, California.

SONGWRITERS: Send poems for free examination and outstanding offer. United Music Service, 150, Salem, Indiana.

WRITE Songs. Big money and reputation. Write for information. J. Gordon Pub. Co., 201 N. Hoyne Ave., Chicago.

ACCORDIONS—Guitars, trumpets and all musical instruments, new and used. Direct from national distributors, cash and terms. Save money. Del Principe, 307 So. Wabash Ave., Chicago.

SONGWRITERS. Have your songs recorded. Music or lyrics written for uncompleted songs. Information. Dixon, 634 Common, New Orleans, La.

POEMS Wanted for musical setting. Send poems for free examination. Thompsons, 409-D S.E. 1st, Evansville, Indiana.

SONGWRITERS—Publication, collaboration. Newart Publications, GPO Box 1226, Syracuse, N. Y.

RADIOS, SUPPLIES, INSTRUCTION

BUILD Your own precision volt-ohm-capacity meter. Complete set of plans 50c. Bradshaw Instruments, 348 Livingston St., Brooklyn 17, N. Y.

RCA Tubes manual 55 cents postpaid. Claudio, 67 West 101 Street, New York.

24 PAGE Plans "18 long distance crystal sets," including "Radiobuilder"—25c. Laboratories, Eye-c, San Carlos, Calif.

26 YEARS Experience radio repairing at your fingertips. I've repaired 45,000 radios. Have perfected simple system you can follow step by step. No calculations or formulas. Total price \$2.00 postpaid or c.o.d. Moneyback guarantee. Ross Radio, 14615-M Grandriver, Detroit 27, Michigan.

MAKE Simple, tubeless, batteryless, distance-getting crystal radios. Crystal and illustrated instructions 25c postpaid. Allen, 427-P, Clinton, Missouri.

RADIOS, Record players, tubes, parts. Send for free bargain list. Hallmark, 594A Communipaw, Jersey City 4, New Jersey.

FIX Any radio. Amazing new instrument locates radio troubles double quick. Simple instructions show you how. Thousands in use. Write today for 24-page booklet, "The Inside Story," Feller Engineering Co., 945 George St., Dept. PM, Chicago 5, Illinois.

LEARN Radio. Design and sell crystal radios. Fun and profit. Complete instructions, 15c. Tomas Laboratories, 77 Lowell, Rochester, N.Y.

BUILD "Loudest" crystal radio. Instructions, loud crystal, catalog; 25c. Amorose, Route Four, Richmond, Virginia.

BUSINESS OPPORTUNITIES

VENDING Machines earn big money! An investment as low as \$10.50 will start you in this fascinating, profitable business that can lead you to the road of success and independence. Routes can be established and operated in either full or spare time with no experience needed. Write for full details and our free catalog illustrating our nut, candy, gum and stamp vendors; also slot machines, amusement games, etc. Parkway Machine Corporation, 623 W. North Avenue, Dept. 7, Baltimore 17, Maryland.

START Home manufacturing business making Cleaning Compounds, Soaps, Insecticides, Cosmetics, Polishes, Food Flavors. No machinery. Literature free. Kemix, Park Ridge, Ill.

START A clock shop. Fascinating, easily learned profitable business requiring little capital. We teach you how to repair all kinds of clocks. Information free. Houston Clock Shop, P. O. Box 5086A, Houston 12, Texas.

PIANO Tuners are in demand making big money. Learn piano tuning at home. Write Evansville School of Piano Tuning, Dept. B, 714 S.E. Second Street, Evansville, Ind.

PARATOL Supreme "706" molder. The toughest rubber ever made for molding purposes. There is no substitute. Prices: \$1.90 per quart, 1 gal. cans \$6.20, 5 gal. cans \$5.60 per gal. On request 4 oz. samples at 25c to cover mail handling. Shipments U.S.A. and Canada only. Testworth Laboratories, Inc., 407 S. Dearborn Street, Chicago 5, Illinois.

OWN Your business. 10 bubble gum vendors as low as \$11.00 new, or \$7.50 reconditioned. 3/4", 1.40 to pound, 3,500 per case, from \$5.75 to \$10.00. No gum better than our Tot Brand. Price and circulars free. T. O. Thomas Co., 1572 Jefferson, Paducah, Ky.

START A home business in spare time. Make extra money. Experience not essential. Literature free. Kellar Enterprises, 3 Turner Avenue, Toronto 3, Canada.

LOOK Here! Wanted—Men to start in business on our capital. Sell some 200 farm-home products. Thousands our dealers now make quick sales, big profits. For particulars write Rawleigh's, Dept. F-192-PPM, Freeport, Ill.

NO Selling, operate vendors, amazing prices, details free. Silver-King, 622 Diversey, Chicago 14, Ill.

EARN Money with textile painting course. Details. Gundrum, LeRoy, Michigan.

MAILORDER Business builders! Guaranteed successful letters, mailing pieces, complete campaigns prepared. Investigate! Finkle Advertising, 1201 1/2 South Ogden, Los Angeles 35.

LOOK! For your real start in profitable mail order business write, Harris, 2616 1/2 Cochran, Los Angeles 16, Calif.

ENGRAVE New plastic displays, nameplates with "pantograver" attachment, fits "Handee," "Dremel," "Craftsman" motor tools. Details, sample engraving 25c. Desco Products Distributors, 6334 Sepulveda, Van Nuys, Calif.

SPECIAL Rubber for making molds. Literature and sample free. Universal, Box 1076-A, Peoria, Ill.

PLASTER Paris gets hard as stone. Just mix in "ROC," amazing new chemical—Air bubbles come to surface, disappear. Finished casts hard, ring like a bell. Enough for 2,000 casts only \$1.00 postpaid. Money back guarantee. So-Lo Works, Dept. E-200, Loveland, Ohio.

BE Independent—Operate America's lowest price penny vending machine. Big profits. Immediate shipments. Write for bulletin and prices. Fielding Mfg. Co., Desk (648), Jackson, Mich.

YOUR Own plastic business at home. Learn to produce costume jewelry, novelties. Use flexible molds, liquid plastic—marble. Write for free book. American Trades, Box 89-A-7, Cincinnati 29, Ohio.

"PLIASTONE"—New building material. Resurface old homes, build new ones. Composition floors; colored tile. Particulars free. Marbleized Service, Edwardsville, Illinois.

CO-PUBLISH For profit. Big mail of opportunities, magazines, co-publishing details 10c. Browning, Box 4001, Miami 25, Fla.

SELL Brilliant new Curv-O-Syns, any copy, one price. Callas Co., 2832K-Hamilton, Detroit 1, Mich.

CREATE Your own products. Our "Flexible Mold Master" teaches amazingly simple method for making flexible molds for plaster novelties. Complete with illustrations, \$1.00. Emco Enterprises, 6750 Stony Island Ave., Chicago 49, Ill.

PROFITABLE Home business plans. P. King, Box 427, Los Angeles 53, California.

EARN Money manufacturing candy preserves from grapefruit-skin, (something new). \$1.00. Burke, 1212 Franklin Ave., Bronx 56, N. Y.

START A home business in spare time. Make extra money. Literature free. McPherson, 510 S.W. 7th Court, Miami 36, Fla.

IF You are interested in legitimate, permanent business of your own, starting \$5000, increasing steadily, write us. Magic Plastics Corp., Forest Park, Ill.

"UNDERSTANDABLE" (Sample) business magazine." Plus details 25c. Mailomart, West New York, New Jersey.

POTTERY—Made without molds! Self-hardening, no firing. Gorgeous colors. Bird baths, wishing wells, benches, cemetery products. Particulars free. Rapid Pottery System, Edwardsville, Illinois.

LIQUID Marble—Colorful, glossy! Molded, brushed, sprayed. Cast novelties, statuary, colored tiles. Flexible molds. Composition floors. Particulars free. Marbleizing Service, Edwardsville, Illinois.

METALIZE Baby shoes, make rubber stamps, silver mirrors, make plaster novelties. Catalogue of "20 ideas" free. Universal, Box 1076-A, Peoria, Ill.

BIG Money in vending machines. Smallest capital start brings immediate profits that build permanent profitable business. Starting instructions free. Becker Vendors, 105-A Dewey, Brillion, Wis.

INCOME From leisure hours—Small investment in coin operated radios you place in cabins, tourist camps, hotels, clubs, YMCA's and hospitals brings steady returns. Box 150, Manchester, N. H.

START Your own business. Formulas, duplicated products. Marchild Service, P.O. Box 166, Plymouth, Mass.

POPCORN Machines, peanut roasters, caramelcorn equipment, griddles, gasoline, bottled gas appliances. Northside Sales, Indianola, Iowa.

BOOKKEEPING Service bulletin lists and evaluates available systems. Free. Publishers, Box #33, Forest Hills, N. Y.

START Electrifying sewing machines. Free details. Pasaak's, Box 153-M, Canal Station, New York 13, N. Y.

RIGHT Way to sell by mail! Get booklet "How to Sell by Mail." Quarter, postpaid. Phipps, 10993-B Wellworth, Los Angeles 24, Calif.

DON'T Chance an income, guarantee it. Free. Roard, 629 Drexel Building, Philadelphia 6, Penna.

OPERATE Profitable mail order business. Write. Rutledge Enterprises, Keyville, Virginia.

HOW And where to obtain capital. Small and large loans. Free particulars. Star Service, Wapakoneta, Ohio.

OWN Mirror shop. Resilver mirrors. Glass sign making. Electroplating. Supply prices. John Sprinkle, V60, Marion, Indiana.

YOU Can build a successful mail order business at home! Free "how" information. Scott, P.O. Box 151, Morningside Station, New York 26.

COSMETICS. Your label. Eight cents jar, up. Thompson, 1566 East 18th St., Cleveland 14, Ohio.

DOLLARS In your own business at home. Literature free. Frank Webster, Box 1972A, Hollywood, Calif.

ONYX And plastic mountings for bronzed baby shoes, hardening solution. Also complete bronzing service. Wholesale. Box 2095, Wichita, Kansas.

RUBBER Stamp agency's details. 3c. Velazquez, Box 55P, Hamilton Grange, New York 31.

"OPPORTUNITIES for You in Modern Electroplating." Full or part time. Free illustrated booklet. Write Joseph B. Kushner, Metal Finishing Engineer, Stroudsburg 8A, Pennsylvania.

BRONZING Baby shoes is big business. Start your own business for \$3.95, everything furnished. Metaloids, Box 2095, Wichita, Kansas.

"VEL-TEX" Beautiful new velvet-like finish on anything. Patented spray gun. Men, women, lifetime business. Order now! Complete professional kit \$7.95, postpaid. Pagewood Products, 632 N. Clark, Chicago 10, Ill.

SAWDUST. Turn it into cash. Six methods. Instructions 25c. Charles, 12-BG, Norwood, Ohio.

UNPAINTED Figurines. Wholesale, retail. Plastercraft, 643-W Canada, St. Paul 1, Minnesota.

HANDKERCHIEFS Direct from manufacturer. Tremendous opportunity. Price list available. Mfg. Sales Co., 60 East 12th Street, New York 3, N. Y. Dept. 40.

RENEK Guaranteed best liquid rubber for flexible molds. Earn money. Write Renflex, Box 74, Queens Village, N. Y.

FREE Sample liquid plastic; new flexible molds cured in 20 minutes. Liquid marble formula. Sales market furnished. Materials wholesale. Plastic Service, P.O. Box 106, Revere 51, Mass.

RUBACREAM! Natural rubber latex! Makes molds quicker! Thicker! Free sample convinces! Cascraft Studios, 509-P Fifth Avenue, New York 17.

WHOLESALE Source 100,000 items 10c. Wilborn, 316-P Judson Rives Bldg., Los Angeles 13.

BUILD Your own mail order business! Noted specialist's 10,000-word treatise shows, step by step, how to make it pay, on small capital start. 25c. satisfaction guaranteed. Edmonson, 1327 Miller Reed, SE, Atlanta, Ga.

MAILORDER Offers increased income! Free details. Cox, 14 Church, Saugus 10, Massachusetts.

MAKE \$5,000 Yearly "cashing in on fluorescent lighting." Start profitable maintenance and fixture fix-it business without capital. Make beautiful lights (complete) for 50c each and less. Hurry for amazing illustrated literature and sensational free gift offer. Willis Service, 101 York Street, Brooklyn 1, New York, Dept. C.

HANDY Men—Make quick, easy profits repairing leaking water faucets with Economy Renewable Seat Tools. Build valuable sales and service business in your spare time. Territories open, literature free. See our display ad this issue. Economy, 3122 N. California, Chicago 18.

LEARN To publicize yourself for increased income and rapid advancement. Details free. Publicity Systems, Box 322-A, Jacksonville, Illinois.

"YOUR Own boss with a guaranteed regular income" is free booklet explaining how you easily earn \$500 to \$1000 monthly year after year. Write: Auditax System, 4513-A Sunset, Los Angeles 27.

FLOCK, Flock adhesive, liquid rubber, moulding compound, plaster hardener—samples, each 25c, all \$1.00. Kalamazoo Mail Order, 705 Barney Road, Kalamazoo 84, Michigan.

NEW Liquid plastic. Earns money for you at home. Make plastic containers for the drug and cosmetic trade. Terrific demand. You make them, we sell them. You can earn a minimum of \$50.00 per week at home. No machinery or experience required. We supply raw materials and instructions; or you can come to our laboratories and receive personal instruction and contract. Write for full details. Travaco Laboratories, P.O. Box 1883, Boston 5, Mass.

BE A used car dealer, guaranteed plan \$1.00. Edw. Smith, 17A Rockland, Yonkers, N. Y.

WATCHES. Wholesale: Rebuilt Elgins, Walthams, Bulovas, etc., new and used railroad, diamond, rhinestone, lapel, \$9.50 up. Catalogue free. Brookings, B-D1975, Little Rock, Ark.

MAKE Profits in mail order business. Astounding plans describing method sent free. Jimton Service, Lock Box 1373P Mobile 8, Ala.

ELECTRIC Pencil—Writes, engraves all metals. 110 volts. \$2.95 postpaid. Reb Industries, Elmhurst 2, Illinois.

BIG-PAYING Home mailorder business! Write immediately. Jackson, Newfoundland, Kentucky.

LOOKING For a profitable sideline? Metallize baby shoes! Good profits. Small investment. Easy work. Free details. Joseph B. Kushner, Metal Finishing Engineer, Stroudsburg 8, Pennsylvania.

MAKE Beautiful vari-colored, highly glazed concrete pottery. Amazing profits. Small capital starts. Write for samples and photographs. Ozark Enterprises, Lock Box 273, St. Charles, Mo.

LIQUID Marble—Make in any color. Soundproof plastic flooring. Flexible molds. Cast novelties, plaques, statuary. Big money—your own business. Catalog free. Write — Bing Products, 88-A6A Broad Street, Boston 10, Mass.

AMAZING Mail profits! Produce selling letters, circulars, with Roll-O-Press, 5000 per hour automatically. Only \$32.50. Free literature. United Technical Laboratories, Morristown 11, N. J.

ELECTROPLATING Booklet tells how to start your own business or work for others at big pay. Learn at home in spare time. Send postcard for free copy today. Hyde School of Electroplating, Room 521, 432 F Street, San Diego 1, California.

MONEY For you in your own business. Many surprising opportunities. Free information. Empire, Box 1340-C, St. Louis, Mo.

MOLD Makers. Genuine natural latex for rubber molds, only two coats needed for thick mold. Reproduce statuary, plaques. Inexpensive. Write Major Chemical Co., 131A Inman Street, Cambridge 39, Mass.

FOR More business, operate an individual business office, exclusively under your name. Rates, \$12.00 and \$18.00 yearly. Co-operative Office Service, 126 Lexington Avenue, New York 16.

INVENTIONS Protected in 30 days. Patents for sale. Patent News, 12M, Washington, D. C.

\$100 BUYS Ten year license to sell copyrighted mailorder article. Make full profit ten years. Free particulars. Robert J. Drummond, 33 North St., Stoneham 80, Mass.

MAKE Money at home like I do. Write immediately. Dueffy, Covington, Ky.

BRONZED Baby shoe mountings and supplies. All metal bronze bookends, picture frames, ash trays, etc. Onyx ash trays, desk sets, plaques. Hardening solution, 30-amp. plating rectifiers with powerstat control, \$85.00. Geared motors for agitation \$20.00. Lead lined tanks. Write for list. Hollywood Bronze Supply, 1770 N. Vermont, Hollywood 27, Calif.

NEW Proven business. Only expense advertising. Clean, light, pleasant work. Full instructions \$3.00. Germaine, 1450 E. 19th Ave., Columbus 11, Ohio.

AMAZE Others. Add columns instantly. Add faster than adding machine. Free details. P. Math Institute, Box 463, Nashville 2, Tenn.

SELL Greeting cards, pictures, signs, novelties, books! Large profits! Catalog free! Elfco, 434 North Wells Street, Chicago 10.

MAKE Money making new greasene doughnuts at home on electric machine. Wholesale to grocers, drug stores, cafes, hamburger shops. Send for free recipes and plans. M. Ray Company, 3605 South 15 Ave., Minneapolis 7, Minnesota.

FIREWORKS Wholesale: Sample parcel 80, 10c. Packages of 16 (1280 firecrackers) \$3.00. No C.O.D.'s. Dealers wanted. Crawford's Fireworks, St. Helens, Oregon.

YOUR Own business in plastics. Details free. Harco, Edgewood, Maryland.

ADVERTISE Your business—5,000 6x9 circulars \$14.00 postpaid. Journal Printing Co., Newark, Ark.

HELP Wanted to operate our successful mail business. Free details. Reynolds, Box 103Y, McAlisterville, Penna.

START Business! "with \$1.00." Money-maker! Free sample! Stephens, Grand Junction, Colorado.

FREE Details—"200 profitable" mail order opportunities. Wayne Burger, Baltic, Ohio.

LEARN Auctioneering by mail. Sample lesson free. Nelson Auction School, Renville, Minnesota.

A FACTORY in your home garage! Mfg. and sales rights, mechanics' waterless hand cleaner, \$500-\$800 monthly. No special equipment necessary. Western Aircraft Mfg., Dept. D, Los Angeles 6, Calif.

DO It with sea shells. Profitable easy home work. Free lesson. A. Werts, Sharp Park, California.

MAKE Perfumes. Big money. Write Macias, 1207-13th Avenue, Tampa, Florida.

INCORPORATE Your business, free details. Tax Research Bureau, Inc., Delaware Trust Building, Wilmington, Delaware.

MAKE Liquid marble, artificial marble flooring, flexible molds, statuary, art goods, novelties. Literature free. Kemico, Park Ridge 50, Ill.

TEN Money-making home business opportunities. Details, 25c. Crawford, Box 1161-PM, Bridgeport, Conn.

EARN \$200 Weekly installing new amazing "Styron" plastic wall tile in homes, offices. Easily applied. Tile your own kitchen, bathroom, too. Instructions, everything furnished. Literature free. U. S. Tile Co., 30 W. Washington St., Chicago 2, Ill.

GET Hundreds money making deals, business ideas, plans and manufacturing. Amazing folio free. Austin Mail Service, 5538 Lexington, Chicago, Illinois.

UNPAINTED Bookends, plaques, statues, figurines. List. Havery Products, 1219 8th Ave., Altoona, Penna.

INCOME From local information. No selling. Neher Co., LaVerne, Calif.

PRIVATE Label service. Complete line cosmetics, flavorings, specialties. You furnish labels, we label, or will ship unlabeled and you label. Can supply complete line labeled our Victor's label. Also big line flavor concentrates and flavor ingredients. Hindman Products, Inc., 917-200 College Avenue, Morgantown, W. Va.

MAKE Money by mail, every month. Spare time business. Small capital required. Tuff, 429 Robison Ct., Pittsburgh 19, Penna.

YOUR Opportunity to become independent. In a profitable mail order business of your own. Details free. Yaniv Distributors & Publishers, Box 2453, Youngstown, Ohio.

BABY Shoes preserved. Formulas, instructions \$1.00. Reilly, 5432 Malcolm St., Philadelphia, Penna.

NEW Low prices. Complete line cosmetics, flavorings, specialties. Distributors, jobbers, agents wanted. Victor's Products Company, 917-201 College Avenue, Morgantown, W. Va.

GET \$1.25 Guaranteed fire extinguishers. Scheall, Box 225X, Duluth, Minnesota.

START Real estate business. America's finest profession spare time. Details free. Educational Book Co., 2907 Berwick Ave., Baltimore 14, Md.

BALLOONS. All kinds. Rubber dolls, balls, fireworks. Profits plenty. Ellsworth Factory Distributors, LaJunta, Colorado.

EASY \$500 Month profits. Men or women. Your own distributing business. Not house to house. Nationally distributed, fast selling line cosmetics, flavorings, specialties. Sales or business experience desirable. High school or equal education. Car and extensive traveling required. New, profitable, proven sales plan by telephone. Investment secured by merchandise required, or credit arranged. Victor's Products Company, 917-202 College Avenue, Morgantown, W. Va.

QUICK Money. "Repairing car batteries." At home! Easy too! Batteryman, Grand Junction, Colorado.

WANTED Unused U. S. postage stamps, small discount. Advance Stamp Company, 24 East 23rd Street, New York.

MAKE And sell candy professionally, inexpensive to start, information free. Box 670, Kissimmee, Florida.

FOR An extremely profitable lifetime business operate a collection agency; credit bureau. Easily learned. Free folder. Cole & Associates, Syracuse 2, N. Y.

GOLDEN Opportunity "How to Establish and Operate a Successful Mail Order Business." Free information. Palmer Publications, 4219-A Southwest Marigold, Portland 1, Oregon.

HOME Workers wanted to hand-spin Angora wool. Either sex. House of Angora, Springfield, Illinois.

AGENT Or exclusive distributor for cigarette lighter mfg. MacGregor, Tahoe Valley 16, Calif.

OWN—Operate ball gum, nut, cigarette vending machines. Amazing profits, no selling. Write for free details. Cameo Vending, Dept. P, 432 West 42nd, New York.

METALIZE Baby shoes. Excellent profits. New system assures success. Free details. Treasures Forever, 89 Henry Ave., Lynn, Mass.

BELTS! Make'm and make money. No tools! Sample 50c. Artnie Leather, 411 Joseph Ave., Rochester 5, N. Y.

BABY Shoes preserved. Formulas, instructions \$1.00. Supplies and bases. Novelty Bronzing, Box 56, Hyde Park 36, Mass.

START Home business making statuettes, plaques, artificial marble flooring, liquid marble, flexible molds, metalizing baby shoes. Amazing profits. Folder free. Creative, 236-L, Winnetka, Illinois.

MAKE Flexible molds! Few cents each! Cast plaques, novelties, bookends! Free samples! H. Tooker, Hamilton 44, Ohio.

RUBBER Molds, natural liquid rubber, flock filler (for making sectional molds), statuary plasters, felt finishes for novelties. Catalog and "Plastercraft" course free. Blue Rapids Supply, Blue Rapids, Kansas.

POPCORN Machines. Potato chip outfits. Long Eakins Company, 4860 Hi Street, Springfield 99, Ohio.

OPERATE Profitable mail order business. Splendid opportunity. For details write V. M. McKinley, 76 Ave. "A," Battle Creek, Mich.

READ "Advance"—The voice of mail order. Offers money-making opportunities, sources of supply, personal guidance, etc. Issued monthly. Sample copy 25c. Yearly subscription \$2.00. American Mail Trade Association, 313 East 21st Street, Suite 450, New York 10, N. Y.

\$46 FROM Square foot plywood. Jigsaw necessary. Write, Woodarts, X-38, Bridgewater, Mass.

OPERATE Profitable mail order business. Write Walter Service, 4159-A East 112th, Cleveland 5, Ohio.

RAISE Earthworms. Instructions \$1.00. Huffman's Worm Ranch, R.R., Rives Junction, Michigan.

RE-NEW Leather and leatherette—Make cloth into imitation leather with plastic discovery called Leather-New. Opportunity to make real profits taking care of sales resulting from national advertising. Write for free sample of Leather-New covered material and complete deal. 4723A Troost, Kansas City, Missouri.

EXTRA Money? Free details. Trable, 1018 1/2 Elm Street, Dallas, Texas.

MAKE Perfume. Complete outfit \$7.50. Information free. Walter Lawson, 21 Joiner, Saint Augustine, Florida.

LEARN Piano tuning, repairing, at home. Tremendous field! Piano parts, tools furnished. Established 1935, Empire School of Piano Tuning, 606-B East University Ave., Champaign, Ill.

RECAST Old batteries into new. Latest achievements. Battery Laboratories, Minneapolis.

MAKE Money casting new 1948 metal toys and novelties. Latest scale model autos, original ashtrays, savings banks, water pistols, etc. Enormous wholesale and chain store demand keeps manufacturers busy. Spare or full time. No experience or special place necessary. Write for details and illustrations of patterns needed. Metal Cast Products Co., Dept. A, 1696 Boston Road, New York 60, N. Y.

MAIL Order businesses bought, sold, brokered. Write for free bulletin of exclusive opportunities. Turnipseed, Inc., Box 681, St. Louis, Mo.

START Home plaster novelty business. Amazing course tells how. Literature free. Kemo-Courses, 4862 Catalpa, Chicago 30, Ill.

COLORGLAZED Concrete pottery made without molds. Patented method. Cemetery products, novelties, tiles. Basement leak-sealing. Money-making projects. Booklet, details free. Men only. National Potteries Company, Grand Rapids, Minnesota.

START Mailorder bookshop—Everything furnished. 25c brings booklet, samples, exciting ideas. General Publications, Ossining, N. Y.

LIQUID Rubber for making flexible molds. Cast novelties. Sample bottle 25c. Free literature. Chaney, 1130 E. 16th St., Jacksonville 6, Fla.

TWO Amazing new typing opportunities. Earn up to several dollars hour, right at home. New, exclusive, different. Write Schroder, 221 E. Bush, Covington, Ky.

OPERATE Profitable home business selling merchandise by mail. Fast sellers. Large profits. Powell Service, 5713 Euclid, Cleveland 3, Ohio.

SPECIALTY Manufacturing, the big money business that can be operated anywhere, start on a very small capital; we supply dependable formulas and complete instructions; get interesting free booklet, "Money-making Opportunities in Specialty Manufacturing." Howard Robinson, Ph.G., 1300-A South Ohio Street, Sedalia, Mo.

COPUBLISH Leading m.o. paper. Latest copy Mail Sale Advertiser and proposition, commemorative stamp. Vanroy Shirk, Lebanon, Penna.

\$25 WEEKLY Working two hours daily. No canvassing. No manufacturing. Lycke, Box 2471, Cleveland 12, Ohio.

137 WAYS To make money, in home or office, business of your own. Full particulars free. Elite Co., 220 Grand St., New York 13.

BRUSH Plating outfits connect to a battery. No tanks necessary. Good paying business at home plating autoparts, bathroom fixtures, bicycles, reflectors, silvering mirrors. No shop or experience required. Outfits furnished. Free booklet. Gunmetal Co., Ave. H, Decatur, Ill.

WOULD You pay 3%—first \$350 made? Color-illustrated book "505 Odd, Successful Enterprises" free! Some offer occasional "day off." Work home. Expect something odd! Pacific, Oceanside, Calif.

MAILING Postcards selling repeat merchandise is profitable. Everything supplied. Details free. Gordan Publishers, Box 23, Pawtucket, R. I.

CO-PUBLISH And advertise in The Central Mail Advertiser. Sample copy for stamp. Low rates. Large circulation. Bagby Printing Co., Georgetown, Ohio.

WHITE Liquid rubber for making flexible molds! Quick drying! Safe! For home, classroom, or industry! Quart \$2.00. Gallon \$5.95. Full instructions! Beginner's booklet on molding and plaster casting 25c. Free with order! Plastercraft Supply Company, 1406 East 43rd Street, Cleveland 3, Ohio.

MAIL Order opportunities. Full or spare time. Hundreds of chances. No charge. Postal brings copy. Blackstone Press, Somerville, New Jersey.

MACHINES Available for making new designs of interlocking concrete building blocks. Delaware Industries, Dept. 11, Muncie, Indiana.

START Plating business at home. Amazing profits. Make own outfit. Inexpensive. Illustrated instruction booklet 25c. Popular Mechanics Press, (C-43), 200 E. Ontario, Chicago.

MONEYMAKING OPPORTUNITIES

START Your own business on our capital. Always your own boss. Hundreds average \$6,000 to \$25,000 annual sales year after year. We supply stocks, equipment on credit. 200 home necessities. Selling experience unnecessary to start. Wonderful opportunity to own pleasant, profitable business backed by world-wide industry. Write Rawleigh's, Dept. F-U-PPM, Freeport, Ill.

SEA Shells. Interested in making shell jewelry, lamps, novelties. We have all supplies at wholesale. Write for price list. Sea Shells, 269 W. Flagler Street, Miami, Fla.

CO-OPERATIVE Publishing pays! Co-publish "Progressive" for profits, prestige, independence! Complete instructions, 25c. Kimball, 31-P Norway, Berlin, N. H.

THOUSANDS Articles wholesale. "Supply Source Directory" 10c. Ideal Service, Park Ridge 40, Illinois.

HOW To make money at home spare time. P. O. Box 8357, Chicago.

EARN Up to \$520 month part or full time keeping books for small firms. Simplified system. Write Tax-Saver System, Dept. S, Ft. Worth, Texas.

DOLLARS For spare time. Complete instructions \$1.00. Hasco, 119 Ravine, Matawan, New Jersey.

24 MONEY Makers and formulas—25c. Blickenderfer, Cloverleaf, Verona, Penna.

PUT Your wife in business! Sell home decorations. 200% profit, everyone buys, no investment. Campet Company, 126 N. Springfield, Chicago, Ill.

CONDUCT Profitable mailorder business. Sell books. Dealers wanted. Extra! Publish your own. 25c brings booklet, exciting details. Graphic Publications, Manchester, N. H.

HOME Spare time work mailing magazines. Instructions, sample magazine. 25c. DePalma Service, R.D. 3, Middletown, N. Y.

"HOW I Made Fortune Raising Frogs"—New book \$1.00. Satisfaction guaranteed. Marlboro, 1035 Marlborough, Detroit 15, Michigan.

UNPAINTED Plaster ornaments. Beautiful designs easily decorated with water colors or oil paints. Profit or hobby. Illustrated list free. Midwest Novelty Mfrs., 108-A Cedar Street, Anaconda, Montana.

CONCRETE Block molds, 8x16x4 \$6.70, others, literature free. Lehnert, Norwood 2, N. J.

RUBBER Stamps. Sell locally or by mail. Stamp brings details. Carb, 2739-R Magnolia, Chicago 14, Ill.

SCOOP! \$3 Hourly with my "Specialty Repair Kit." Revolutionary idea. Write Bob Cooper, East 2224 Joseph, Spokane 14, Washington.

PROFITABLE Money-making information plus 64 page mailorder magazine 10c. Crown Company, 507-C Fifth Ave., New York City.

REPAIR Leaking faucets easily with our repairing kit. Write for details. Great Lakes Metal Specialty Mfg. Co., 1450W North Ave., Chicago 22, Ill.

SELL Snowballs, \$1 starts you 400% profits. Particulars free. Snowball Company, Jacksonville, Florida.

MAIL Beginners! Free information guide. Leese, 4718 North Laverne, Chicago 30.

START Your own business! Big money manufacturing novelties, plaques, statuary. Free catalog. Write Bing Products, 88-A6B Broad Street, Boston 10, Mass.

RESILVER Mirrors at home. Formula 25c. Ideal Service, Park Ridge 6, Illinois.

PRIZE Contest bulletin gives various contests now operating, and valuable hints. 3c stamp. National Contest Bulletin, Box 2685P, Miami, Florida.

WIN Contest money. Send 25c complete instructions for writing winning answers. Winacontest, 22P Westlake Ave., Auburn, N.Y.

WINDSHIELD Wiper rebuilding brings big profits. Free particulars. H & H Products, Box 430, East Akron 5, Ohio.

MAKE—Sell new amazing auto paint you simply wipe on. Complete formula \$1.00. Ideal Service, Park Ridge 8, Ill.

WIN Contest prizes, cash! "Here's how." Alfred Novak, 2601-M Division, Cleveland 13, Ohio.

SELLS Like mad! Show it once—smacko! It's grabbed! No sales talk. Costs \$2. Brings \$5. Just one of those inexplicable successes. Inquire Stampico, 8837 Quincy, Detroit 4, Mich.

ANALYZE Handwriting for profit! Complete outfit \$1.00. Graphologists, POB-971, Philadelphia.

TECHNICAL Bulletin listing 24 opportunities. Free. Public Educational Service, 493 Irving, Bridgeton 2, N. J.

EARN Money at home! Thousands do! "Home Worker Magazine" tells how. Sample, 25c. Sizemore, Box 7, 4917 Kostner, Chicago 30, Ill.

WIN Contest money. General Contest Magazine gives hundreds of tips. Lists current contests and rules. Sample 25c. General Contests, 1609½ East 5th, Duluth, Minn.

WOULD You pay 3%—first \$350 made? Color-illustrated book "505 Odd Successful Enterprises" free! Proven! Work at home, office. Expect something odd! Pacific, Oceanside, Calif.

PUBLISH Your own magazine. Hand-some 52 page format, well edited, illustrated. Cost low as \$1.00 month. Brings you prestige, profits. 25c brings sample. details. National, Ord. Nebr.

FORMULAS, PLANS, ETC.

MEN—Women—"Most everybody likes candy." Learn to manufacture in a professional manner. (Our 38th year.) Ragsdale Candies, D4, East Orange, N. J.

TESTED Formulas—Genuine manufacturing processes. Literature free. Chemical Service, Edwardsville, Illinois.

FORMULAS For twenty-five useful products. One dollar. Chemist, Box 274, West De Pere, Wisconsin.

24 MONEYMAKING Formulas 50c postal note. C. Bibbs, P.O. Box 5157, Indianapolis, Ind.

MAKE—Sell cleaners, soaps, polishes, flavors, cosmetics. Literature free. Kemico, Park Ridge 16, Illinois.

21 POPCORN, Candy apple, etc. formulas. All money-makers. \$1.00. We can supply equipment. Concession Supply Co., Dept. "A," Box 133 Sta. "B," Toledo, O.

10,000 FORMULAS And trade secrets. Free literature. Stillman, 555 Kingston Ave., Brooklyn 3, N. Y.

REAL Manufacturing formulas. Lists free. Cummings, Chemist, Gordon Ave., Syracuse 4, N. Y.

PLASTICS

PLASTICS—Sheets, rods, tubing, coatings. Shells, findings, dyes, craft supplies. Lucite scrap 25c-65c pound. Illustrated fabricating manual, price list, 10c. Lucite sample, 35c. Courtesy to dealers. Gem-O-Lite, 5350F Riverton, North Hollywood, Calif.

PLASTICS For fun and money. Build a business in your home with Parrokit—contains materials for production of buttons, toys, and novelty jewelry. Complete instructions guaranteed. \$5.00 f.o.b. factory. Parrot Plastics, Inc., 143 Heckel St., Belleville 7, N. J.

LUCITE, Plexiglas, Masked sheets. All sizes. Cost square foot (12" x 12") 1/16" 90c; 1/8" \$1.16; 3/16" \$1.43; 1/4" \$1.68; 5/16" \$2.09. Include 10% postage. Almac Plastics Inc., 230 Fifth Avenue, New York 1, N. Y.

AMAZING Liquid plastic pours without heat. Beautiful castings within half hour. Clear, colors. Embed photographs, coins, flowers, keepsakes. Complete kit \$2.90 (U.S.A.) Kristalon Plastics, Dept. A-6, Box 29, Wilmette, Ill.

INTERNAL Carved wild-life pins \$1.50. Rose costume jewelry sets \$1.75. Crystal Floral Novelty Co., Somerville, New Jersey.

PLASTIC Injection machine, plexiglas, jewelry findings, dyes, cements, tools, drills. New catalog. G. Baker Company, River Edge, New Jersey.

SUMMER Special. Prime quality masked Lucite. 3/16", 16" square \$2.45 postpaid. Free catalogue. Craft-Plastics, Somerville 1, New Jersey.

INTERESTED In new ideas in plastics? Information free. Designers Group, Box 363, Pleasantville, New Jersey.

PLASTIC Materials. Cements, dyes, findings, internal carving drills. Send 10c for catalog and floral carving instructions. Locket with internally carved rose and bud 50c less findings. Art Plastics of Calif., 8125 East 14th Street, Oakland 3, Calif.

BARGAINS In plastics. Lucite, Plexiglas, Catalin. Many colors and sizes. Details free. George Plastics, 6938A George St., Chicago 34, Ill.

RENEW Leather and leatherette—Make cloth into imitation leather with plastic discovery called Leather-New. Opportunity to make real profits taking care of sales resulting from national advertising. Write for free sample of Leather-New covered material and complete deal. 4723B Troost, Kansas City, Missouri.

PLASTIC—Sheets, rods, tubes, etc. Free list. Plastic Supply Co., 2618 St. Louis Ave., St. Louis 6, Mo.

CHEMISTRY

CHEMICALS, Ounce quantities. Catalogue 5c. CJ Chemicals, 19165 Gallagher, Detroit 34, Mich.

LEARN Chemistry at home, from the house of Winn. Home of supplies for student chemists. New idea chemical and apparatus outfits for home experimenting. Photographic scales, semi-professional microscopes and accessories. Send 15c for retail catalogue. Established 1931. John H. Winn, 124A West 23 Street, New York 11, N. Y.

ENJOY Educational recreation with a home laboratory. Catalogue of chemist's and apparatus 15c. Microscopic stains and preparations 20c. Both 25c. National Scientific Company, Established 1908, 2204 W. North Ave., Chicago 47, Ill.

CHEMICALS And apparatus for industrial, analytical and private laboratories. Complete supply service for correspondence school students. Send 10c for catalog. Dept. M-43, Biological Supply Co., 1176 Mt. Hope Ave., Rochester 7, New York.

FREE Catalog: Chemistry, mineralogy, physics, biology. Tracey Laboratories, Evanston, Illinois.

APPARATUS, Chemicals, ounce quantities, catalog 10c. Fleischer's Laboratories, Everett 49, Mass.

HANDBOOK For chemical experimenters, illustrated, hundreds of experiments, 50c. Experiment booklet 15c. Supply catalog 5c. Reading Scientific Company, Reading, Penna.

HELP WANTED

EARN \$25.00 Quickly with fast-selling Writewell stationery and greeting cards. Costs nothing to try. Samples on approval. Writewell Co., 143 Transit Bldg., Boston.

BOYS Wanted. Over \$50 week! Sell name plates for front doors. Write National, 214-CC Summer, Boston, Mass.

AGENTS WANTED

AGENTS—Call on garages, filling stations with \$24.50 quality wheel balancer. Competing models to \$2,000. Virgin market. Five minute demonstration means sales. \$10 cash commission. Twenty sales possible daily. Exclusive territory. Write B & B Mfg. Co., Box Z 816, Sioux City, Ia.

SALESMEN: \$20 To \$30 a day easy. Sensational new raised letter metal nameplate, beautifully framed in mahogany. Amazing seller to homes, stores, offices, etc. No deliveries. Get our tested plan. Write Raised Letter Metal Co., Dept. 2288 Fox Bldg., Philadelphia 3, Penna.

NO Summer slump in magazine sales! Make money year 'round taking new renewal orders from neighbors, friends. Helps furnished. Free catalog. Write McGregor Magazine Agency, Dept. 12, Mount Morris, Illinois.

AGENTS—Unbelievable, until you have tried this self selling foot bath powder. 98% people need it. 50% profits. Excellent repeater. Rush name for free sample. Saari, 1916 Sheffield, Chicago 14.

SELL Ultra blue stock signs to stores, 1000 slogans, comedy, general, religious. 7x11, cost 6c, sells 35c. Make money. Sample free. Lowy, 8 West Broadway, Dept. 384, New York City 7.

IF You are a sales-producer you'll be interested in an exclusive territory on a fast-moving, easy-selling household item—one you're proud to sell. Users enthusiastically endorse it—and we mean it! Not sold in stores. Protected territory, generous commission to aggressive agents. If you can sell house-to-house, this is your deal! Write us today for details. The Sheldon Company, 1223 So. 23rd Street, Milwaukee 4, Wisconsin.

\$1 STARTS You in business. Sell deluxe ties, 100% wool interlining. Costs you only \$7 per dozen, you make \$5.00 dozen. Send \$1.00 for special introductory offer two deluxe ties. Catalog complete line free. Philip's Neckwear, 20 West 22nd St., Dept. K-24, New York 10.

MEN—Women. New sensational floor mop. So clean to use women can wash floors in evening gown. No splash or drip. Magic Mop, 8427 So. Chicago, Dept. PM, Chicago.

PROFIT Now! Substantial earnings made in magazine subscription sales. Trade price list and supplies free. Instructor Subscription Agency, Dept. PM, Dansville, New York.

WANT Pleasant outdoor work in a business of your own? Good profits selling over 200 widely advertised Rawleigh home/farm necessities. Pays better than most occupations. Hundreds in business 5 to 20 years or more! Products—equipment on credit. No experience needed to start—we teach you how. Write today for full particulars. Rawleigh's, Dept. F-145A-PPM, Freeport, Ill.

BIG Money selling plastic tablecloths—from \$6.00 dozen. Also curtains, aprons. Fast sellers! Free details. Durever, 255C East 95 Street, Brooklyn, N. Y.

AMAZING "Shampoo" auto washer. New invention. Lightning seller. Automobiles gleam like mirror. Samples sent on trial. Kristee 123, Akron, Ohio.

REMNANTS—Amazing values. Housewives buy on sight. Good profit. Write B & M Textiles, 78 N. Main St., Paterson, New Jersey.

ALIVE—Permanizing salesmen. Dodge Studio, 37 Gravel St., Meriden, Conn.

SELL! Novel writing pads. MacLeay, 18 Central St., Windsor, Vermont.

AMAZING Foot lotion. Agents, crew managers, distributors. Big profits. Militer Products, 216 Jackson, Chicago 6, Ill.

SAVE! Million articles wholesale. Directory 10c. Publishers, Box 1302-P6, Detroit 31.

EARN \$5.00 With every ten \$1.00 boxes of everyday cards you sell. Also new plastic cards, personalized stationery, note paper and wrappings. Send for samples today. Howard P. Ellis, Dept. PM-7, Pittman, N. J.

MAKE Sensational profits! New, sell-on-sight plastic line: tablecloths, aprons, many other splendid fast-selling items, novelties. Postal brings free details, special deals. Hurry! Royalty, Box K-748, Passaic, N. J.

100% PROFIT! More! Photofilm. Factory prices. HG-591, Pittsburgh 30, Penna.

FREE Nylons given if Kendex hosiery runs or snags! World's only women's hosiery sold with a written guarantee that amazes everybody. Mere words could not possibly express the almost unbelievable opportunity you now have to make money. Fantastic and "impossible" earnings now become a reality. Can you imagine a guarantee that replaces hosiery regardless if damage is due to use or abuse and regardless whether it is the fault of the hose or the wearer? Here is sales dynamite that will blast your earnings to the sky! Even if you never sold a thing in your life, three magic words: "guaranteed against everything" will open doors for you—will make women listen and will pour money in your pocket. Kendex stockings are not sold in stores, so you have no competition. Complete line includes beautiful sheer nylons; long wearing, durable service nylons; three different lengths; genuine outsize nylons; latest shades; choice of full fashioned with seams or seamless; lowest priced rayons. Also separate complete line of men's hosiery including nylon, lisle, rayon, cotton, mixtures etc.; plain and fancy; long and short. Thousands of pairs shipped daily. No money or experience needed. Nothing to invest or risk. No samples to buy. Nothing to pay, now or later! Simply write orders. We deliver and collect. Liberal advance cash plus huge cash bonus. Write orders spare or full time; exclusively or as a side line. Become a manager and appoint others to sell for you with steady income on their sales! Complete money-making outfit, including salesbooks in color, samples cut from actual hose, instructions, order blanks etc. furnished free and prepaid. Rush name and address on postcard and start making money next week. Kendex Co., Babylon 147, New York.

PAINT, White house paint, for wagon jobbers and auctioneers, 95c gallon in 5-gallon cans, single gallons \$1.00. Minimum 50 gallons, f.o.b. Kansas City. Surplus black enamel 75c gallon. Aluminum paint for every purpose, \$1.50 gallon. Packed 4-gallon in carton. Mail check or money order for immediate shipment. No correspondence. Trading Post, 2032 Burlington, North Kansas City, Mo.

SILVERWARE Cleaning, plating, polishing. Liquid (NuSilver). Apply with cloth. Contains genuine silver. Renewes silver-plated ware, articles, pieces. Silverplates brass, copper, bronze. Part, full-time, agents wanted. NuProcess-Products, Aurora, Ill.

LADIES Leather handbags \$5.50, retails \$12.50. Caspy, 239 Dumont Ave., Brooklyn 12, N. Y.

DISTRIBUTORS, Agents, salesmen 28% to 75% profit selling dependable Reflex spark plugs along with other lines. Exclusive territory. Reflex Spark Plug Co., 10902 Madison, Cleveland 2, Ohio.

SWISS Watches direct from factory. \$1 starts you in business. Sell rings, earrings, chains, pearls. Costs you only \$7 per dozen, you make \$12.00 dozen. Send \$1.00 for special introductory offer two articles. Ergim Lady Watch 14K gold, 17 jewels costs you only \$16.50; Men's wrist watch \$14.50, 17 jewels 10K RGP. Big profits for salesmen. Catalogue free. Ergim Swiss Watch Company, 833 Columbus Ave., New York City.

MAGIC Cleaner—Laundry soap deal. Hotter than a firecracker. Big profits. Sample free. Bestco, 4642 No. Central, Chicago.

CANVASSERS Request information. Long handle Dust-Ball duster. Biggest profits direct from manufacturer. Whitaker, Philadelphia 24, Penna.

FACTORY Outlet. Power mower (Maytag engine). Extra discount. Rotacut, M-2006, Excelsior Springs, Mo.

BIG Profits. Sell outstanding photo enlargements. Richphoto, 215 W. 98th, New York 25.

BUY Thousands of nationally advertised products direct from manufacturers. Write for "Buy Direct and Save." Consumers Ass'n., 287-A-Lebanon Ave., Mt. Lebanon, Penna.

AGENTS For educational institution New York City area; liberal commission; no investment. Box 686, Journal Square Station, Jersey City 6, N. J.

SELL The famous \$3 "Fire-Killer" extinguisher with bracket, wholesale or direct; exclusive territory. "Fire-Killer," Syracuse 1, N. Y.

THERE'S Money in chemical specialties! National mail order tests brought thousands of orders for Liquid Plastic Tarnish Preventive and Rub On Silverplating Fluid. Agents and distributors now offered long discounts. Sell dealers, industrials, better homes. Write for sales plan. Samples \$1.00 postpaid, (refundable). United Technical Laboratories, Morristown 9, N. J.

AGENTS: Stamping names on pocket-key protectors. Sample check with your name, address, 25c. Stamping outfits. Emblem checks, check-fobs, name plates. Hart Mfg. Co., 303 Degraw St., Brooklyn, N. Y.

SELL Gold embossed monogram stationery. Sample free. Dunbars, Sanford, Florida.

EARN Big money year 'round. Be a one-person-department-store. Take orders for shirts, ties, hosiery, lingerie, household linens, etc. For information, Corporate Merchandisers, Dept. PM 3, 110 West 34 Street, New York City 1.

MAKE More money selling personal initialed individualized belts, buckles, cap badges, tie holders, name plates, 2,000 emblems to choose. Big profits, whole or part time. Write today; special outfit offer. Hookfast Specialties, Box 1425, Dept. 6, Providence, Rhode Island.

GUARANTEED Product in protected territory, if you are now selling or intend to sell house-to-house. For full 1 qt. sample amazing High Shine Windsor No Rubbing Wax, send only 25c covering handling and postage. (Sells for \$1.25.) Windsor Wax Co., Inc., Dept. P.M.-2, Hoboken, N. J.

AMAZING Invention needed by thousands. 500% profit; send quarter for samples. Full details. Refundable. Krueger, Box 812P, Oakland 4, Calif.

90c PROFIT Each \$1 sale! Sell real mothproofing solution. Employ agents. Experience unnecessary; we tell you how. Kinford, Wayne 3, Penna.

POCKET Pal: Replaces pocket knives. New, safe, beautiful. Always razor sharp. 50c seller. 231% profit. \$15.00 or more daily. Agents, salesmen, distributors. Sample 10c. Nelson Mfg. Co., 222 W. Kellogg, St. Paul 2, Minn.

BIG Profits selling beautiful imprinted stationery, greeting cards, etc. Free samples. The Ed-Brite Co., 435 North Terrace Ave., Mount Vernon, New York, Dept. 15.

AGENTS Make big profits selling sensational new diapers which require no folding. Every new mother a prospect. Rush name for free sample. Fred Dexter and Staff, 234 West 17th, Houston 8, Texas.

FREE Sample! Big profit opportunity with amazing glow-in-the-dark house numbers, switch plates, pictures, decals, religious articles. Represent large manufacturer. Madison Mills, 303 Fourth Avenue, New York, N. Y.

FREE Water and our concentrates, makes flavors, lotions, shampoos, 72 products, labels, bottles furnished. Qualco, E-20030 Russell, Detroit.

INFORMATION—Wholesale supply sources. Moneymaking plans. Increase your income! Write Reynard Service, Smithfield 3, Ohio.

100% PROFIT With new electric gas lighter, eliminates matches, pilot. Write Optical Research Products, Fairview, N. J.

EXCELLENT Sideline for printing and advertising salesmen. Decalomania name plates in small quantities. Great demand. Also, make money with our line of automobile initials and sign letters. Free samples. "Ralco" XL-Roxbury, Boston 19, Mass.

AGENTS—300% Profit selling genuine gold window letters; stores and offices. Free samples. Metallic Letter Co., 438-B North Clark, Chicago.

GOLD Lacquered window sign letters. Large sizes penny each. New foils. Absolutely beautiful. Free samples. Atlas, 544 W. 79th, Chicago 20.

HIGH-GRADE SALESMEN

SELL Over 1100 items—Electric flasher signs, adding machines, tags, tape, all printed necessities, pencils, restaurant supplies, and many others. Free sales portfolio. No experience necessary. David Lionel Press, 312AL So. Hamilton Ave., Chicago 12, Ill.

YOU can earn 49%! Salesman wanted to sell nationally advertised desk model portable adding machine. Priced \$12.95, fully guaranteed. Not a toy. Easy to operate and in demand everywhere. You can make 49%! For complete details and full size color illustration, write today to: Lightning Adding Machine Co., Inc., Dept. ZD2, 543 So. Spring Street, Los Angeles 13, Calif.

LOOK Here! Wanted—Men to start in business on our capital. Sell some 200 farm-home products. Thousands our dealers now make quick sales, big profits. For particulars write Rawleigh's, Dept. F-192A-PPM, Freeport, Ill.

LOW Priced leather work gloves. Beat competition! Sell stores, factories. Volume! Mail repeats. Permanent business. Briggs, 635 Second Ave. N., Minneapolis 3, Minn.

EARN \$25 A day and more selling nationally advertised aluminumware, silverware, pressure cookers and jewelry. It is simple, let us show you how to make big profits with no investment. Write Continental Products, Dept. I-6, 30 Ormsbee Avenue, Providence, R. I.

SELL Delicious candies, nuts, gum. Immediate delivery. Write Casterline, 2031-PH Sunnyside, Chicago 25, Illinois.

MEN'S Shirts, pajamas, ladies' house-dresses priced right. Steady commissions. Free selling outfit. Jarod Mfg. Corporation, Roekville Centre 30, New York.

AMAZING Discovery. Miracle glaze permanent brilliant glass-like surface for cars. Free sample; information; big profits. Miracle Glaze Company, 9714 S. Austin Ave., Oaklawn, Illinois.

WANTED. Experienced decalomania salesmen. Liberal commission. Jobbers and agents welcome. Lac-ed Decal, 59 E. Illinois St., Chicago 11, Ill.

NEON Tubing. Ten separate five foot lengths General Electric fluorescent tubing. Choice 6 colors. Transformer, all accessories included, complete ready to install. Genuine bargain price \$50. Attention compelling borders, building trim, hundreds advertising uses, every business. Enormous profits for live salesmen. Post card brings literature. Thos. McCurley, Pensacola, Fla.

SALESMEN—Sell calendars, adv. novelties. Season on. Buyers everywhere. Low prices. Big commissions advanced, bonuses. Samples free. Consolidated-Modern Press, 329-B So. Wood, Chicago 12.

ADVERTISING Book matches—Cash in on political campaigns; sell union label matches. Cuts for all businesses, political parties. Free powerhouse selling kit, low prices, protection guaranteed on repeat orders. Cash commissions. Superior Match Co., Dept. M68, 7530 Greenwood, Chicago.

PENCILS. Advertising and office, full or part time. Excellent commission, protected territory. Universal Graphite Pencil Co., Dept. D, Clinton, N. J.

BIG Money quickly and easily taking orders for complete line personalized initial buckles, belts, cap badges, 2,000 emblems. Fast repeats. Write today, Hook-Fast Company, Box 480-PM, Roanoke, Virginia.

NEW Opportunity—Earn big profits. Mailing and shipping cartons are used in every business. Salesmen—saleswomen, we will help you make easy sales, steady commissions on quickly repeating orders. \$1.00 good faith deposit brings sales kit. Corrugated Paper Products, Inc., 619 Brooklyn Ave., Brooklyn 3, N. Y.

\$240.49 IN One week—Unusual? Not at all! Just look at one week's earnings of these representatives. WWS \$290.99, JMH \$229.75, RJR \$262.47, VJM \$275.95, JEA \$240.49, RWP \$231.21. Direct mail campaign brings hot leads right into your home. Remarkable product does part of 10 men's work; a "natural" during these labor problem days. Has perfect sales story; sells year round. As modern as radar! Special demonstrator offer. We extend credit, deliver and collect. No capital required; no experience necessary. You make big profit on first sale and full credit on repeat business. Every business, store, factory, etc. are prospects. Write John Porter, 2433 Indiana, Dept. 308, Chicago 16.

SALESMEN—Put yourself in line for big money and real future. Keep stores supplied with 5c-10c counter goods. Nationally advertised merchandise. Top profits for you and merchants. Liberal deals boost sales. Sideline or full time. World's Products, Dept. 10-D, Spencer, Ind.

FANS—Fans. Salesmen making \$50 to \$100 per day selling our electric fans, sump pumps, and portable water softeners. Have also, all kinds of fan parts; build your own. Write Universal Fan Co., Peru, Ind.

PHOTO-SALESMEN—Agents. Sell beautiful hand colored plastic enlargements. Collect deposit, we deliver. Profitable sideline. Send card, for free sample kit. Novel Portrait, 3343 North Ave., Chicago, Illinois.

BIG Profits daily taking every family's magazines subscriptions. Give unlimited choice of valuable books free. Publishers, 323-5 Hammond, Cincinnati 2, Ohio.

CASH Profit—Big earnings; selling personalized buckles, belts, cap-badges, tie clasps. 2000 emblems, caps, shirts, ties. Write Hook-Fast Products, Dept. A, Columbus 6, Ohio.

WAGON Salesmen—Fast moving carded goods and 10c line. Long profits. Free facts. Peerless, 2720 Dodier, St. Louis 7, Mo.

JOBS Open in selling! Send name, address for free copy Opportunity Magazine, listing hundreds of companies who need men now, full or spare time. Experience not essential. Opportunity, 28 E. Jackson, Dept. 17, Chicago 4, Ill.

BIG Money taking orders. Shirts, ties, Sox, pants, jackets, sweaters, shoes, uniforms, etc. Sales equipment free. Experience unnecessary. Nimrod, 4922-AN Lincoln, Chicago.

SELL Calendars—Every business a prospect. Also wholesale to printers; calendars, sheet pictures. Fleming Calendar Co., 6540 Cottage Grove, Chicago 37.

EDUCATIONAL AND INSTRUCTION

LEARN—Auto body, mechanics, elec. appliance, refrigeration. GI Bill provides subsistence, tuition, tools. We assist to find part time jobs, rooms. Stevinson's, Established 1922, 2008 X Main, Kansas City, Missouri.

GOOD Jobs and a sound substantial future await you in hotel and institutional field. Men and women—all ages—needed for well-paid positions that offer color, excitement, ever-new and fascinating duties. Record-breaking travel means even greater opportunities for trained men and women in hotels, clubs and institutions. Lewis School receiving calls for managers, assistant managers, stewards, hostesses, purchasing agents and 55 other types of important positions! From coast to coast there are important positions that offer splendid opportunities for advancement in a business where you are not dropped because you are over 40. Previous experience proved unnecessary! No need to leave your job to qualify. A good grade school education plus Lewis Training qualifies you at home, in spare time. Our National Placement Bureau helps to place you—and our amazing Certified Job Plan—actually certifies you will "make good" when placed. Write today for free book! Veterans: Course approved for veteran's training. Lewis Hotel Training School, Room NH-368, Washington 7, D. C. (First and only School of its kind—now in its 32nd year.)

AMAZE Others. Add columns instantly. Add faster than adding machine. Free details. P. Math Institute, Box 463, Nashville 2, Tenn.

COURSES In jewelry instruction: watchmaking, engraving, jewelry repairing, G.I. approved. Two fine schools—Pittsburgh, Pa., and Warren, Ohio. Write for free illustrated catalog. Immediate enrollment. Veteran housing available. Low rates. A. W. Thacker Academy for Jewelers, Dept. P, 423 Federal Street, Pittsburgh 12, Penna.

SPEED And skill in radio code to qualify for amateur or commercial radiotelegraph license. Learn at home with the famous Candler System used to train radiotelegraph experts and champions. Good pay or fascinating and profitable hobby. Free book. Candler, Dept. 5-G, Box 928, Denver, Colorado.

MEDICAL Laboratory technicians in great demand. We train you in your own home, in your spare time. Also home study course in general chemistry. Free catalogue. Imperial Technical Institute, Box 973-J, Austin, Texas.

NOW You can have an office. Learn credit-collection business by new home study course. Many earn up to \$5000-\$15,000 annually. Free bulletin. Franklin Credit School, Dept. 202P, Roanoke 7, Va.

VALUABLE Information on your memory, famous feats of memory; super-memory; free. Write today. Thor Books, CM6, Box 1210, Chicago.

WANT U. S. civil service job? Big starting pay. Security. Men-women. Prepare now for next examinations. 40-page book—details free. Write Franklin Institute, Dept. C24, Rochester, N. Y.

"**MOST** Everybody likes candy." Learn to manufacture in a professional manner. (Our 38th year.) Ragsdale Candies, D2, East Orange, N. J.

WANT More money? Send \$1.00 today for easy showcard and sign painting course. Adam Spoor, 218 So. 4th St., Geneva, Illinois.

LEARN To dance from nature—Man's first teacher! Results guaranteed! \$2.00. Silvers Publications, 804 5th Avenue, Youngstown, Ohio.

USED Correspondence courses and educational books, bought, sold, rented. Catalog free. Educational Exchange, Summerville, Ga.

3800 CORRESPONDENCE Courses. Cat. 50c. Barbells; courses. EG, Elmsford, N. Y.

SHADOWING—Interesting, illustrated instructions by veteran investigator. \$2.00. Sheldon Hutchins, Box 4921-P, Los Angeles 1, California.

BOOKKEEPING Doubled my income! Three hours interesting reading teaches bookkeeping completely. Auditax Systems, 4513-H Sunset, Los Angeles 27.

LEARN Typewriter repairing under G.I. bill. Adding machine and calculator courses available. For information write Dept. PM-6, Capitol School of Typewriter Mechanics, 1328 New York Avenue, N.W., Washington, D. C.

BOOKKEEPERS! Increase your earnings! Operate your own simplified "dollar-a-week" bookkeeping and tax service. Full or spare time. Details free. No obligation. Ellis, Box 200, Cedar Grove, North Carolina.

GRADUATE Work in all subjects. Degrees available in one year. Resident and extension classes. Golden State University, Hollywood, Calif.

USED Correspondence courses and books bought, sold, rented and exchanged. Catalog free. Lee Mountain, Pisgah, Alabama.

LINGUAPHONE Makes languages easy. At home learn to speak Spanish, Portuguese, Italian, French, German, Russian, by quick, easy Linguaphone Conversational Method. Save time, work, money. Linguaphone correspondence courses are available to veterans under G.I. bill of rights. Send for free book. State if G.I. Linguaphone Institute, 83 RCA Bldg., New York, 20, N. Y.

INVESTIGATOR Training. Phillips Secret Service, 1917B North Kenneth, Chicago 39, Illinois.

LEARN Photo-engraving at home or in oldest, largest school in America. Work for newspaper or establish own profitable business. New Tasope' Photo-Engraving equipment available soon. Write for information. Veterans ask about G.I. training. The Aurora School of Photo-Engraving, Tasope' Bldg., Aurora, Mo.

HOME Study course, drugless therapy. Free literature. Institute of Drugless Therapy, Tama, Iowa.

SECRET Investigation. Experience unnecessary. Investigators particulars free. George Wagner, M 125 West 86th, New York.

PLAYS, STORIES, MANUSCRIPTS

I WANT New writers to cash hundreds of checks for \$1 to \$100, offered each month. The easiest way to write for pay. No previous experience necessary. Send for free details. No obligation. Saunders M. Cummings, 467-M Independence Bldg., Colorado Springs, Colo.

BUSINESS SERVICE

MONTREAL, Canada. Postmark your mail. Letters mailed here 25c—Postcards 15c. Complete (receiving, reforwarding) service. \$2.00 monthly. Samson, 7425 Henri-Julien.

REMAILED Letters and cards, 10 cents each, Washington. Stamped envelope for reply. Arthur Simmons, General Delivery, Washington, D. C.

COMPLETE Container service for mail order trade. Request folder. Corrugated Paper Products, Inc., 619 Brooklyn Ave., Brooklyn 3, N. Y.

SPECIAL SERVICES

WE Mail, receive, forward. Letters 25c. Photographic postcards 15c. M. Gotro, 5420 Franklin, New Orleans, La.

VISIT Nation's birthplace by proxy. Letters remailed 25c. Historical information. The Pilgrim, P.O. Box 166, Plymouth, Mass.

PHOTOSTATIC Copies. Write for prices. Hamy, 214 Robinson, Hudson 1, N. Y.

PANAMA Canal Zone, letters remailed, forwarded, 75c. King, Box 685, Crundu, Canal Zone.

POSTMARK Your mail Shanghai, China. Letters mailed 50c; airmailed \$1.00. Information, personal questions about China answered \$2.00. Remit bank money order only. "Oriental," P.O. Box 2348, Shanghai, China.

CALIFORNIA'S Vacationland beach. Letters remailed 25c. Three scenic cards 25c. Shopping service. Free list Redwood novelties. Collins, Rt. 1, Box 820, Santa Cruz, California.

GUAM, M. I. Your personal questions about Guam answered promptly. \$1.00. E. L. Osborn, M. K. P. K., Station 15, Guam, Guam, M. I.

MAIL Forwarded each letter 25c. Monthly \$2.00; 5 postcards \$1.00. Also "Special Services." P. O. Box 246, Tacoma 9, Wash.

WE Receive, reforward letters; \$3.00 monthly or 25c each. "Hawkins," 1300 Taylor-p, Washington 11, D. C.

INFORMATION

LATIN-AMERICAN Opportunities. Accurate, concise, directory of American companies exporting and trading with South America. Compiled by research expert. Send \$1.00 now. C. Bachman, Box 1321, Reading, Penna.

OVERSEAS Employment for you. Excellent permanent job opportunities for U.S. citizens. Wages 20% higher, less taxation, lower living costs. Improved social position. Transportation and housing furnished. Latin America and Far East. Send \$1.00 for copyrighted Digest showing oil, shipping, construction, etc., companies working and hiring. Includes sample application letter, etc. World Wide Company, Dept. M, Madison 1, Wisconsin.

CARTOONING, COMMERCIAL ART, SHOWCARD WRITING, SIGN PAINTING

SIGNS Made easily. Instructions and ten sets modern alphabets, numerals, patterns. Sizes up to eight inches. All for \$1.00. Co-operative Business, 7 West Madison, Chicago 2.

"**HOW** To Make Money With Simple Cartoons"—a book everyone who likes to draw should have. It is free; no obligation. Simply address Cartoonists' Exchange, Dept. 96C, Pleasant Hill, Ohio.

LEARN Showcard writing at home in spare time. Free information. Sherwood Publishing Company, Irvington, 11-U, N. J.

PAINT Signs—New method \$2.00. Particulars free. Haines System, Sabina 4, Ohio.

SIGN Painting taught at home by an old master. Ben Kerns, Box 812, Greenville, S. C.

CARTOON Students—Interesting book cartoons 50c coin. Box 263, Wilmette, Illinois.

9 ALPHABET 3 Numeral pattern sets and catalog, \$1.00. Sign Letter Distributors, P.O. Box 101, Mineola, N. Y.

CHALK Talks. Laugh producing program, \$1.00. Catalog 10c. Balda The Cartoonist, Oshkosh, Wisconsin.

ADVERTISING AGENCIES, LETTER WRITERS, FOR ADVERTISERS

300 CERTIFIED Opportunity seekers \$1.00. Trable, 1018 1/2 Elm, Dallas, Texas.

ADVERTISE In "Mail Sale Advertiser," circulation 25,000—28 pages. Inch display (60 words) \$4.00, 6 times \$20.00. Martin's Service, Box 295P, Bassett, Va.

ART, Layout, cut service for advertisers. Lowest rates. George Brashear, Holland Building, St. Louis 1, Mo.

ADVERTISE: 24 Words, 40 newspapers, \$3.50. Lists free. Advertising Bureau, 229-C Dixon, Uniontown, Penna.

AD Layouts, copy, art. Placed in any magazine, newspaper. Sherman Advertising, 5741 McPherson, St. Louis 12, Mo.

BUSINESS Building - sales literature written by direct mail specialist. Sales letters as low as \$3.00. Stamp brings complete price-list. Paul Wallace, Box 143, Sheboygan 5, Wis.

ADVERTISING Sensation! Reach 2,100,000 families, \$32.90 inch. Display, classified, ratebook (newspapers, magazines, mailing lists), advertising assistance, free. Chicago Advertising Agency, 20-PM West Jackson, Chicago 4.

ADVERTISERS! Reach nearly 18,000,000 readers, 25 Sunday national key newspapers, 18 words, \$47.75. "Terrific pullers." 20 popular newspapers, \$9.75. "Free booklet." Special—One inch display 2.-\$21.198 circulation, \$42.00. Newmark's Advertising Agency, (Established 1893) 217-7th Ave., New York 11.

ADS Placed in out of town newspapers and magazines. Low rates. Catalogue free. Ideas that pay. Baker Advertising Agency, Successors Ankrum Agency, 189 W. Madison, Chicago 2.

MAILING Lists, certified, productive, inexpensive, \$5.00 1000. Homeworkers, agents, buyers, etc. Write Dixie Service, King, N. C.

24 WORDS In 64 weeklies \$4.96. H. J. Darnell, 730 Hays, Jackson, Tenn.

TYPEWRITERS, DUPLICATORS, OFFICE DEVICES

DUPLICATORS \$9.95 Up. (New.) Immediate delivery. "Free circular." Rucker, 2836-PM Slevin, Louisville 12, Ky.

"PRINTOMATIC" Selffeeding post card stencil printing duplicators \$9.50 up. Office size duplicators. Speedoprints, Hilcos, Excellographs \$33.41 up. Literature free. Pittsburgh Typewriter Supply, 336-WK Fourth Avenue, Pittsburgh 22, Penna.

RECONDITIONED Typewriters, mimeograph, multigraph printing devices, appliances, supplies. Catalog. Dixiegraph Service, King, N. Carolina.

RUBBER STAMPS AND OFFICE SUPPLIES

DE LUXE Cushioned, indexed, knob handle; three lines \$1.00, two 75c. Quick service. Catalog 10c. Warner Stationery, Box D-43, Havre de Grace, Maryland.

3 LINES 2" \$1.00. Paid, mailed, etc. 50c. Pelton, 8500 Chalmers, VanDyke, Mich.

"NEW" Rubber stamp. Prints blue airmail inside red arrow, one impression. Mailed anywhere \$1.00 or write for free illustrated folder. Multi-Color Stamp Co., Keene 3, Texas.

3 LINES Cushioned, indexed, 50c; Pads 35c. Stampright, Wauwatosa, Wis.

QUALITY Stencils, inks, priced right, Riddle, 360 S. Hill, Los Angeles 13.

MERCHANTS. Perpetual inventory system stops disappearing stock. Sample free. Inventory Record Co., Box 5912, Kansas City, Mo.

LINE 20c; 2-35c; 3-50c. Stamp Works, Auburn, Nebraska.

RUBBER Stamps, Illustrated literature free. Lee-Vall Press, Dept. 7-A, Box 1242, Indianapolis 6, Indiana.

2 LINES 35c, 3 Lines 50c. Newman, Box 284, Fort Collins, Colo.

PRINTING, MULTIGRAPHING, MIMEOGRAPHING, GUMMED LABELS

100 BEST-EVER Calling cards, with your name. Use for graduations, etc. Free case 75c. Personalized pencils, 12 for \$1; in gift box. Dept. PM, Stuart Imprints, 923 West Market St., Scranton 8, Penna.

SAMPLE Price; printed stationery, 1000 business cards \$2.25. Crane, 272 No. Mountain, Montclair, N. J.

SIXTY Letterheads and forty envelopes, beautifully printed \$1.00; 500 6 3/4 quality envelopes \$2.45. Calder's, Box 3422-MP, Philadelphia 22, Penna.

CUTS \$2.00 Up. Free estimates. Schumacher, 1418 Franklin Street, Oakland, California.

MIMEOGRAPHING — Lowest prices, samples free. Pelton, 8500 Chalmers, VanDyke, Mich.

1000 BUSINESS Cards \$2.00. F. Copper, 1318 Logan Ave., Youngstown 4, Ohio.

QUALITY Printing: Business, personal stationery. State requirements. Samples. Mero Products, 100 Morrison, Punxsutawney, Penna.

1,000 6 3/4 printed envelopes \$3.50, 5,000 \$2.75 per thousand. Two color quality letterheads 500 for \$4.95. Low quantity prices. Samples free. Boone, 435 No. Terrace Avenue, Mt. Vernon, N. Y.

100 ENVELOPES Imprinted with your name, address \$1.00; 500, \$2.85. Letterheads same. Advocate, 130 Eureka, Greenville, Miss.

MIMEOGRAPHING Specialists — Any copy, amount, color. Free samples, price list. Schools Mimeo Service, P.O. Box 192A, Van Nuys, California.

DISTINCTIVE Business stationery. Quality and service. Bolton Print, Bolton Landing, N. Y.

QUALITY Printing at low prices! Send for price list today! Nationwide Printing Company, Dept. PM, 2337 Bath Avenue, Brooklyn 14, N. Y.

100 BUSINESS Cards 75c, printed prepaid. W. Davis, 935 Maxwell, Chicago 8.

SELL Printing. Amazing profit. Mango, 555-A South 20th, Newark 3, N. J.

WRITE For samples, prices attractive letterheads, cards, circulars. Journal Printing Co., Newark, Arkansas.

5000 6 3/4 ENVELOPES Printed \$2.75 per thousand, price list free. Michel, Box 76F, New York 16.

100 8 1/2x11 HAMMERMILL Letterheads and envelopes \$1.98. Herbert Hudson, 261 Woonasquatucket, Centredale, R. I.

500 3/4x2 1/4 FOUR Line gummed stickers 35c; red border 50c. Moritz Printery, Saginaw, Mich.

1000 BUSINESS Cards, \$2.50, prepaid. Samples free. Reliable Print Shop, 905 E. Jefferson, Louisville 6, Ky.

SEND 10c Now, for our 48 page 1948 price list—refunded first order. McCall Press, 1326 South 27th, Omaha, Nebraska.

BETTER Grade printing reasonable. Estimates on anything. Economic Press, Leona, N. J.

QUALITY Printing—Reasonable prices. Fast service on catalogs, folders, publications. Write for prices. Bagby Printing Co., Georgetown, Ohio.

MIMEOGRAPHING—Letters, pricelists, formulas, instructions. Lowest prices. Lem's Letter Shop, 5710 Stanton, Detroit 8.

PRINTING OUTFITS AND SUPPLIES

PRESSES, Type, cabinets, supplies. List for stamp. Lincoln Press Company, 220B Hartwell, Fall River, Mass.

BARGAINS—Presses, equipment, paper. Catalogs 10c. Customprint, 211, Springfield 4, Missouri.

GOLD Imprinter \$3.25. Samples 10c. Garza, 8 Walden, Cambridge 40, Mass.

(9x13) JOB Press, motor, counter, throw-off, \$315.00. Mail Products, Mendota, Ill.

BUILD Own workable printing press. Details free. Otancop, Box 114E, Akron 5, Ohio.

PRINTING Presses, type, supplies. Lists 3c. Turnbaugh Service, Loysville, Penna.

PRINTING Presses, type, supplies. Send dime for complete illustrated printer's supply book, details and press samples. Kelsey, Inc., A-11, Meriden, Connecticut.

INEXPENSIVE Home-made printing press. Details free. Novelty Shop, Downsville, Louisiana.

PATENT ATTORNEYS

INVENTORS—Patent Laws encourage the development of inventions. The Rules of Practice of the U. S. Patent Office advises; unless an inventor is familiar with such matters; that he employ a competent registered attorney or registered agent, as the value of patents depends largely upon the skillful preparation of the specifications and claims. Write for further particulars as to patent protection and procedure and "Invention Record" form at once. No obligation. McMorro, Ber- man & Davidson, Registered Patent Attorneys, 134-D Victor Building, Wash- ington 1, D. C.

PATENT Protection—The U. S. Patent Office recommends—"an applicant is advised, unless familiar with such matters, to employ a competent registered Patent Attorney or registered Patent Agent, as the value of patents depends largely upon the skillful preparation of the specifica- tion and claims." Preliminary steps to take to obtain patent protection will be sent upon request. Victor J. Evans & Co., 331-F Meriin Building, Washington 6, D. C.

REGISTERED Patent attorney offers services. H. Sanders, 6430 Evans, Chi- cago 37.

PATENTS—Trade marks. Irving L. McCathran, 315 McLachlen Bldg., Wash- ington 1, D. C. Registered Patent Attorney.

INVENTORS: Learn how to protect your invention. The United States Patent Office advises the inventor, unless fam- ilar with such matters, to engage a competent registered patent attorney or agent to represent him. We maintain a staff of registered patent attorneys ready to serve you in the handling of your patent matters. Special booklet "Patent Guide for the Inventor" containing de- tailed information concerning patent pro- cedure with "Record of Invention" form will be forwarded upon request, without obligation. Clarence A. O'Brien & Harvey Jacobson, Registered Patent Attorneys, 81B-D District National Building, Wash- ington, D. C.

C. A. SNOW & Co.—M-427, Snow Build- ing, Washington 1, D. C. Registered Pat- ent Attorneys. Write for information.

INVENTORS. For "Record of Inven- tion" form, contact Carl Miller, Regis- tered Patent Attorney, Woolworth Build- ing, New York.

INVENTORS: Without obligation, write for information explaining the steps you should take to secure a patent. John N. Randolph, Registered Patent Attorney, 203 Columbian Bldg., Washington 1, D. C.

INVENTORS: When you are satisfied that you have invented something of value write me, without obligation, for information as to what steps you should take to secure patents or trademarks. Write Patrick D. Beavers (Formerly Ran- dolph & Beavers) Registered Patent Atty., 935 Columbian Bldg., Washington 1, D. C.

PATENT Practice before U. S. Patent Office. Validity and Infringement inves- tigations and opinions. Booklet and form "Evidence of Conception" forwarded upon request. Lancaster, Allwine & Rommel, Registered Patent Attorneys, Suite 411, 815-15th Street, N.W., Washington 5, D. C.

"INVENTOR'S Guide" free on request. Frank Ledermann, Registered Patent At- torney, 154 Nassau St., New York 7, N. Y.

PATENTS. "Proof of Invention" folder mailed without obligation. E. E. Vrooman, Registered Patent Attorney, 871 Wood- ward Building, Washington 5, D. C.

INVENTORS: Write for free brochure "Evidence of Invention." Labiner, World Building, New York 7.

FOR INVENTORS

PATENT Protection—The U. S. Patent Office recommends—"an applicant is ad- vised, unless familiar with such matters, to employ a competent registered Patent Attorney or registered Patent Agent, as the value of patents depends largely upon the skillful preparation of the specifica- tion and claims." Preliminary steps to take to obtain patent protection will be sent upon request. Victor J. Evans & Co., 332-F Merlin Building, Washington 6, D. C.

NEED Help in making detail drawings or calculating invention problems? Use our confidential, friendly and experienced engineering service, details free. Machine Design Service, 416 Madison Avenue, Rah- way, New Jersey.

PATENTED, Unpatented inventions promoted. M. Joyce Humphries, 1424 Landtittle, Philadelphia 10, Penna.

INVENTORS—Patent Laws encourage the development of inventions. The Rules of Practice of the U. S. Patent Office advises—unless an inventor is familiar with such matters—that he employ a competent registered attorney or registered agent, as the value of patents depends largely upon the skillful preparation of the specifications and claims. Write for further particulars as to patent protection and procedure and "Invention Record" form at once. No obligation. **McMorrow, Berman & Davidson**, Registered Patent Attorneys, 134-E Victor Building, Washington 1, D. C.

FREE Two months on trial. Patent News, Washington, D. C. 12.

INVENTORS: Without obligation, write for information explaining the steps you should take to secure a patent on your invention. **John N. Randolph**, Registered Patent Attorney, 202 Columbian Bldg., Washington 1, D. C.

INVENTORS: The usual first step is to have a search of the U. S. Patents conducted, so I can report on patentability. Write, without obligation. **Patrick D. Beavers** (Formerly Randolph & Beavers), Registered Patent Atty., 936 Columbian Bldg., Washington 1, D. C.

INVENTORS: If you have an invention for sale, patented or unpatented, write **Institute of American Inventors**, Dept. 40A, 1926 Eye St. N.W., Washington 6, D. C.

"**INVENTOR'S Guide**" free on request. **Frank Ledermann**, Registered Patent Attorney, 154 Nassau St., New York 7, N. Y.

INVENTORS! Have you good, patentable ideas? Write Patent Agent **Metzlerr**, 11 West 42nd, New York.

CASH For your idea. 280 manufacturers need inventions, patented or unpatented. List free. **Invention Bureau**, 208M Clinton, Oak Park, Illinois.

PATENT Searches; reliable, efficient, air-mail service; \$6.00. Write for free invention protection form. **Patent Research Service**, 703P Albee Bldg., Washington 5, D. C.

RELIABLE Patent and trade-mark searches made in U. S. Patent Office \$6.00. Invention protection forms with Certificate of Search free. Write **Raymond L. Smith**, Patent Searcher, 410-M Bond Building, Washington 5, D. C. (Formerly with U. S. Patent Office.)

INVENTORS: Learn how to protect your invention. The United States Patent Office advises the inventor, unless familiar with such matters, to engage a competent registered patent attorney or agent to represent him. We maintain a staff of registered patent attorneys ready to serve you in the handling of your patent matters. Special booklet "Patent Guide for the Inventor" containing detailed information concerning patent procedure with "Record of Invention" form will be forwarded upon request, without obligation. **Clarence A. O'Brien & Harvey Jacobson**, Registered Patent Attorneys, 81A-D District National Building, Washington, D. C.

FREE Pamphlet "P" will tell you how we have helped others develop their ideas into worthwhile patented inventions ready for market. **Ele Development Co.**, 29-28 41st Ave., Long Island City, N. Y.

I SELL Patents. Established in 1900. **Charles A. Scott**, 773PM Garson Ave., Rochester, N. Y.

INVENTIONS WANTED

HIGHEST Royalties—Cash. Free literature. **Universal Marketing Co.**, 126 Lexington Ave., New York 16, N. Y.

SELL Your invention! Patented or unpatented. Free information. **Sales Research Company**, Suite 1102, Chicago Building, State & Madison Streets, Chicago 2, Illinois.

MANUFACTURERS Want patented or patent pending inventions! Send details. **Universal Guaranty Company**, Lakewood, New York.

CASH For your idea. 280 manufacturers need inventions, patented or unpatented. List free. **Invention Bureau**, 208M Clinton, Oak Park, Illinois.

INVENTIONS Wanted. Patented or pending only. **Inventors' Exchange-B**, Hartford 1, Conn.

INVENTORS: Hundreds of manufacturers have requested our assistance in locating marketable new products. Complete information, free. **Institute of American Inventors**, Dept. 40-D, 1926-Eye St. N.W., Washington 6, D. C.

SMALL Inventions wanted by manufacturers. I'll help you sell your invention. Write for circular. **Stanley Hull**, 7829 Euclid, Cleveland, Ohio.

WE Are a young and growing manufacturing concern, having six plants in Grand Rapids, Michigan. If you have made application for a patent, or have a patented item, regardless of size, at present we will be glad to hear from you or talk to you regarding it. We sell nationally and internationally. If you would like to check us, refer to **Dun & Bradstreet** or **Grand Rapids Chamber of Commerce**. Remember, if you invent something you are entitled to your share, the same as we are entitled to our share for manufacturing it. **Helms Industrial Development Co.**, 2145 Edgewood N.E., Grand Rapids, Michigan.

PATENTED, Unpatented inventions wanted. We have tremendous lists of manufacturers who may pay cash royalties. Descriptive booklet free. **National Invention Service**, 1404-T Mitchell St., Oakland 1, Calif.

PATENTS FOR SALE

FOR SALE—Patent pending, beautiful flower stand. Address **F. Solak**, P.O. Box 826, Klamath Falls, Oregon.

PENDING—Chain coupling for auto. Push pull it's on. Address **Box 168, Rahns**, Penna.

WALL-Type jar opener. Opens quart jars or any size. **J. J. Panik**, 13946 Kercheval, Detroit 15, Michigan.

PENDING—Self cleaning non-skid cross link for auto chains. Address **Box 168, Rahns**, Penna.

WAGON. Pumping handle propels wagon. Irish mail and wagon combined. **J. J. Panik**, 13946 Kercheval, Detroit 15, Mich.

(**PENDING**). Accelerator pedal attachment. **Rodd**, Box 305, Trona, California.

INVENTORS: Test the commercial value of your patented or unpatented inventions, quickly and inexpensively. Write for free information. **Institute of American Inventors**, Dept. 40-B, 1926-Eye St. N.W., Washington 6, D. C.

MANUFACTURING

OPEN Time. All types of silk screen work, decals, posters, glass, wood, plastics, or what have you. Estimates cheerfully given. **Lac-ed Decal**, 59 E. Illinois St., Chicago 11, Ill.

PATENT Models, experimental devices constructed. Reasonable. **Nelson Manufacturing**, Woodburn, Oregon.

PRECISION Dies, gears, parts, inventions, manufacturing. **Baum's Metal Specialties**, Kansas City, Mo.

SMALL Lot production wanted. Aluminum castings; stampings; screw machine; plastics. **J and M Company**, Burlington, Kentucky.

PRECISION Casting of small parts in non-ferrous metals (not sand casting). Send sample or drawing for estimate. Circular on request. **Southwestern**, Box 1399, El Paso, Texas.

DEPENDABLE Source, tools, dies, manufacture, engineering, designing. **Porsberg**, Northfield, Ohio.

MODELS—Small lot manufacturing. Metals, plastics, etc. **Milburn**, Burlington, Kentucky.

MODELS, MODEL SUPPLIES

BUILD Historic ship models, complete kits 39c to \$8.50; send 10c for catalog. **Ideal Models**, 19 West 18th Street, New York 11, N. Y.

MINIJET Engine kit now \$9.95 pp. U.S.A. Assemble real pulse-jet at home. Send m.o. today. No c.o.d.'s. **Minijet Motors Sales Company**, Box 406, Pasadena, California.

GIVE Your work professional finish with pure colorless plastic. Brush, spray, wipe. No heat, dries fast. Large bottle \$1.00. **Eljay Products**, Box 5, Baltimore 18, Md.

STEAM Boiler for model engines. Uses "Sterno." Withstands 300 lb. pressure. Cast bronze, silver soldered. Complete with pressure gauge and fittings. \$22.50. The miniature steam engine. Working model. Brass and iron. Bore 9/16; stroke 11/16; weight 2 lb. Assembled \$17.50. **Ross**, 68 West Broadway, Section N, New York, N. Y.

INVESTIGATE "S" gauge before starting your model railroad! Illustrated circular listing 174 3/16" scale items. 20c (Refunded with order). **Midgage Models, Inc.**, Dept. PM, Box 1044, Portsmouth, Rhode Island.

SHIP And yacht model fittings; blueprints. Send 25c for illustrated catalog No. 21—listing hundreds of items. **A. J. Fisher**, 1002-1 Etowah Ave., Royal Oak, Mich.

MODEL Railroads exclusively—Complete stock scale; **Lionel**, American Flyer. Send for catalog, 15c, state gauge. **Eric Fuchs**, 26 Tremont Street, Boston 8, Mass.

RADIO Control planes. Complete. Less than \$100.00. 10c please. **Hobby Center**, 12240 Gratiot, Detroit.

STEAM Engines, fast twins, 3/4" by 3/4", 11,000 r.p.m. at 50 lb. Drawings, instructions \$2.00. Any size designed. **Gleason**, 2119 Kinney Ave., N.W., Grand Rapids 4, Michigan.

MINIATURE Steam locomotives, 1/4", 1/2", 3/4" scales. Castings, parts, rail, steam fittings! Thorough drawings with instructions. **Catalog 25c**. **Little Engines**, Wilmington, Cal.

RAILWAY Models, complete informative catalog HO and O gauge. 132 pages, 50c. **Walthers**, 247 Erie, Milwaukee, Wisconsin.

POWER Models—Steam and gasoline engines, steam traction engine, metals, tools. **Catalog 35c**. **Chas. Cole**, Ventura, Calif.

LANDLOCKED Sailors! Here's a beautiful, richly illustrated, fully descriptive catalogue of famous model ships—whalers, slavers, corvettes, etc., authentic in every detail. Send for it today. Only 25c. **Halesite Yacht Service, Inc.**, Halesite, Huntington, N. Y.

FUN Building models—Airplanes, trains, ships. Everything furnished. **Giant catalog 10c**. **Ben's Hobby Shop**, 72 West Washington, Chicago 2, Illinois.

SHIP Models and yacht supplies complete. Large 64 page catalogue 30c. **Bill Wild's**, 510 East 11 St., New York City 9.

HOME CRAFTSMEN

BLACK Palm—Beautiful, rare tropical wood. Sample, literature. **Dollar bill**. **Carmen de Pugh**, Apartado 896, Colon, Panama.

LEATHERCRAFTERS—1948 edition—The leatherworkers' bible! Completely illustrated catalogue and textbook. Instructions, descriptions, and actual leather samples. Guaranteed to exceed any expectation or your money refunded. \$1.00 postpaid. **Artcraft Leather**, 271 12th St., Dept. PM-6, Oakland 7, California.

BEAUTIFUL Hand carved and tooled western belts. Mens, womens. \$8.00. State size wanted. **George Brady**, P.O. Box 26, Wadsworth, Ohio.

PLASTIC Jewelry supplies. Free catalog. **J & M Novelties**, Box 464P, Griffith, Indiana.

FULL Size patterns. **Priscilla** cradle, doll stroller, go-cart, hobby horse, and 10 lawn ornaments. Good sellers. \$1.00 postpaid. **Lincoln Craft Studio**, Farmington, Conn.

LEATHERCRAFTERS: "California" designs. Just published, original folio of 58 patterns for carving or tooling. \$1.00, mailed free. **Leather Specialties Shop**, 358 East Broadway, Long Beach 2, California.

LAWN Chairs, toys, novelties, garden figures, furniture, etc. 68 popular plans and patterns, \$1.00. **Mastercraft 6M**, 7041 Olcott, Chicago 31, Ill.

LEATHERCRAFTERS! Free catalog! Leathers, tools, supplies. **Rosenblum Leather**, 518 N. 8th, Sheboygan, Wis.

OREGON Myrtlewood and other unusual woods. Prices on request. **M. Weaver**, 3923 S. E. Tibbetts, Portland 2, Oregon.

PATTERNS: Lawn ornaments, weather-vanes, letters, numerals, silhouettes, plaques, frames, toys, jig and bandsawed plywood novelty furniture. **Craft-hobby** books, booklets, decals, tools, etc. Further details free. **Wo-Met Shop**, Ashburn, Ga.

VIZA-JARS, Repairshops and hobbyists. Keep your small parts within your vision. **Drop postcard**. **Dratz**, Lake Geneva, Wis.

PLAYSWINGS—Build your own outdoor units. Full size patterns giving correct saw cuts and measurements. Complete instructions. Stands 9 foot high with two swings, one trapeze, and ladder. Mail \$1.00 to **Wood Products**, Grundy Center, Iowa.

MAKE Your own jewelry! Findings in metal and plastics; earwires, pinbacks, cameos, stones, beads, clasps, sprays, combs, hairbars, plastic and metal chains. **Hobby Art Corp.**, Dept. 7, P.O.B. 276, New York 18, N. Y.

BIRDHOUSES: Actual size patterns and instructions of 4 latest styles. Just send \$1.00 to **Tru-Copies**, P.O. Box 210, Cherokee, Iowa.

125 **TOY** Plans. Send 10c for illustrated catalog. **Continental Homecrafters**, 907 Birch, Eau Claire 3, Wisconsin.

HOBBE-TOOL—New, low cost home workshop multi-purpose unit. Buy complete set or individual tools singly. Central power unit to work with your motor. \$53.20 buys complete unit—7" bench saw with 45° tilt; face plate lathe; 7" disc sander; 20" jig saw; grinder and drill chuck attachments. Prices for individual tools on request. At any local hardware store or write Wadsworth Wampler Co., 1155 Hillside Avenue, Plainfield, N. J.

ELECTRIC Pencil—Writes, engraves all metals. 110 volts. \$2.95 postpaid. Reb Industries, Elmhurst 2, Illinois.

CHAIR Cane, long selected, fine \$3.25, medium \$3.75, common \$4.25 hank. Fine woven cane \$1.50 square foot postpaid. Gocart Shop, 5 Sears Court, New Bedford, Mass.

PROJECT Specials in mahogany, walnut lumber. Turning blocks and squares, veneers. Sedlo Company, P. O. Box 7161, New Orleans, La.

EYELET Kit, tool and generous supply assorted eyelets for hobbies, models, etc. \$2.00 postpaid. Porter, 89 Forest St., Middleboro, Mass.

SCRAP Leather for leather workers. Assorted colors. 4 lbs., \$1.00. Lowest leather prices. List free. Cunningham Enterprises, 3-A Marble St., Haverhill, Mass.

SCRAP Leather, large sizes; assorted colors. 5 lb. \$3.95. Enterprise, Sheboygan, Wisconsin.

SHELLS, Plastics, metal findings. Hobby Lobby, Box 486 Station "A," St. Petersburg, Fla.

VELVET Flock—Newest finish. 10-color sampler with instructions, patterns. \$1.00. Sparks, 1145 Queen Ann, Los Angeles 6.

PATTERNS—45 Pictures of new jigsaw projects. Illustrated folder 10c. Joannes Patterns, P. O. Box 141, Omaha 7, Nebr.

ARTIFICIAL Flower, novelty, making. Wonderful home business pays excellent profits. Literature free. Velva Artcrafts, 324-M East 14, New York 3, N. Y.

KNOCKDOWN Cedar chests. Lumber and veneers. Free price list. Giles & Kendall Company, Huntsville, Ala.

LEATHERCRAFT! Complete stocks of leathers, tools, supplies. Immediate shipment. Free catalog. Kit Kraft, 3203 W. Washington Blvd., Los Angeles 16, California.

COPPER And brass materials. Complete line for craftsmen and workshops. Catalog A free. Groundmaster Company, Boulder, Colorado.

METAL Craft! Brass, copper, instruction books, supplies. Immediate shipment. Free catalog. Kit Kraft, 3203 W. Washington Blvd., Los Angeles 16, California.

LEATHERCRAFTERS! Belt kits, projects, leather, supplies. Free catalog. Art Leather, 411 Joseph Ave., Rochester 5, N. Y.

\$46.00 FROM Square foot plywood. Jigsaw necessary. Write. Woodarts, H-38, Bridgewater, Mass.

SPECIAL 77 Full sized patterns. Lawn ornaments, toys and novelties \$1.00. Modern Woodcraft, Saginaw, Michigan.

CERAMIC Jewelry supplies, bar pins, ear screws, for ceramic and woodworkers; also glass and seashell assemblers. Free catalog. Philadelphia Badge Co., Dept. B-1, 1007 Filbert St., Philadelphia, Penna.

SHELLS, Plastics, findings. Lowest prices. Free catalog. Frances Jones, Box 251, Sarasota, Fla.

MAKE IT YOURSELF

STREAMLINED, Built-in kitchen cabinets to fit any kitchen. Complete, easy to understand detailed plans and specifications showing "professional" construction methods. All for \$1.00. Thombert Co., Box 447B, Newton, Iowa.

BUILD Your own tilting table power saw. We furnish plans and metal parts. Write for free circular. William H. Crandall Company, 1009 Fruitvale Ave., Oakland, California.

MODERNIZE—Make fluorescent lamps. Send \$1.00 for plans. R. F. Guthrie, Rm. #937, Webster Hall, Detroit 2, Mich.

RESTFUL, Hands-free book-magazine holder, adjusts to many locked reading positions, sitting and lying. Drawings, instructions \$1.00. Atlick, 2217A E. 68, Chicago 49.

BENCH Milling machine, build your own. Light or heavy duty, no castings, cost low. Blue print \$3.00. Eclipse Machinery Co., 6020 Colbert St., New Orleans, La.

MAKE Your own 17-pound Modulite concrete blocks. Build for less. How booklet 25c. Particulars stamp. Peerless, New Lenox, Illinois.

MAKE Drill press, under \$10. Complete plans and instructions \$2. Taylor, 4994 Vincent, Los Angeles 41, Calif.

AIR Conditioners or attic fans, build your own. Plans free. Mills, 108 North Commerce, Fort Worth 2, Texas.

BUILD Electric water heater from present range boiler. Element, thermostat complete \$9.50. Inemco, Allegan, Mich.

MAKE Plastic wallets. Everything furnished. Details free. Lakeshore Supply, 534 Surf St., Chicago 14, Ill.

"CONCRETE" Block homes. 32 page booklet: drawings, instructions on how to build. \$1.00. H. C. Lightfoot, Civil Engineer, Richboro 1, Penna.

WATCHES, OLD GOLD, JEWELRY

HIGHEST Cash for old, broken jewelry. Mail gold teeth, watches, rings, silverware, diamonds, spectacles. Satisfaction guaranteed. Free information. Rose Smelting Co., 29-A East Madison, Chicago.

EXPERT Watch repairing by master watchmaker. 6 mo. written guarantee. Genuine factory parts for all makes American or Swiss watches. Reasonable prices. Send insured mail for prompt estimate—no obligation. Ask for catalog of watches and gifts. Bonded Watch Repair Co., Dept. 20, 219 W. Chicago Ave., Chicago 10, Ill.

WATCH Repairing easy learned by our home study course. Watch repairers are in demand and are among the highest paid craftsmen today. Write for free information. Houston Chronometer & Watch Co., P. O. Box 1140A, Houston 1, Texas.

WATCHMAKERS, Beginners; watches; movements. Price list! Box 1874, Chicago 90, Ill.

CASH Air-mailed for old gold, jewelry. Rywell, Harriman, Tennessee.

SEND Your discarded jewelry, watches, crowns, bridges, spectacles, silver, etc., for cash offer. Goods returned promptly if offer unsatisfactory. Old State Metal Co., P. O. Box 1054, Houston 1, Texas.

RHINESTONES, Moonstones, pearls, ear-wires. Free literature. Herber, 1360-A Hicks, New York 67.

WATCHES, Wholesale: Rebuilt Elgins, Walthams, Bulovas, etc. New and used railroad, diamond, rhinestone, lapel, \$9.50 up. Catalogue free. Brookins, B-1975D, Little Rock, Ark.

JEWELERS Findings, supplies. Latest catalog, 10c. George Sassen, 154 Nassau Street, New York 7.

STUN Your friends with genuine, sparkling, brilliant-white zircons. Cut, polished, mounted just like diamonds. Amazing diamond-like appearance. Top-quality. Hard for even experts to tell the difference. Beautiful settings 14K gold. Over 100 gorgeous latest-style rings to choose from. Attractive low prices. Send for big free catalog. U. S. Zircon Syndicate, 139 N. Clark, Dept. 15, Chicago 2.

GEMS, Precious and semi-precious, all genuine, from world wide sources. Deal direct, no overhead, save money. Catalog 10c. Hill Co., Route 7, Salem, Oregon.

TOBACCO, SMOKERS' SUPPLIES

PIPEMAKING Kits 75c. Briar blocks, bits, instructions. Seconds \$5.00 pipes 65c. Free literature. Carvapipe, 2829-G Dixie, Hamilton, Ohio.

FOR THE HOME

LIGHT-FLEX Is a new and modern method of light concentration—a revolutionary, decorative compound which will give up to 84% more light when applied to the ordinary household light bulb. This scientific development reflects the light and beams it where you want it. You can get more from your electric light dollar with Light-Flex. The \$1.00 kit treats over twenty bulbs and lasts as long as the bulbs. Ask your dealer or send \$1.00 for this handy household kit to Light-Flex Co., Inc., 607 Powers Bldg., Rochester, N. Y.

WE Insulate our windows without storms. No frost, steam. Successful plans \$1.00. Blue Square, Excelsior, Minn.

SCALES—Household (25 lb.) \$6.95. Baby weighing scales, \$9.95. Ideal for gifts. Immediate delivery. Cameo, 432 West 42d St., New York.

ELECTRIC Radiant heat is wonderful. Installed cheaply. Blue, Excelsior, Minn.

FOR SALE — MISCELLANEOUS

HULL Automobile Compass, value \$4.95, brand new, \$2.50. Prisms for 6X 30 or 8X 30 binoculars, brand new, \$1.50 each. Off set prisms to be attached to 7X 50 B & L binoculars, gives double the field of the ordinary 7X 50 binocular. Cost \$98.00, special \$25.00. Green sunshades for binoculars, size 6X 30 and 7X 50, snap on type, value \$7.50, special \$1.25 per pair. Forward money order. No c.o.d. shipments. Send 25c for catalog of new and used guns, ammunition, binoculars and powder flasks. Public Sport Shops, 11 S. 16th Street, Philadelphia, Penna.

OUTBOARD Motor, "Firestone" 3½ horse-power \$99.99. Auto floor-mats., universal for all cars, good rubber, felt back, \$2.49. Firestone Products, 3843 W. 25, Cleveland, Ohio.

BARGAINS In war surplus. Write for free catalog. Pacific Fur & Wool Co., Box 926-PM, Sacramento, California.

PLASTIC Flashlight, replica of Walt Disney's Pluto. Cherry red. 4¾" long. Standard battery and bulb. Complete \$1.00. 3 for \$2.50. Stivers, 40 Salem, Medford, Mass.

GOVERNMENT Surplus, camping equipment, civilian bargains, work clothes, general merchandise, free circular. Baseball caps 59c, 89c, 98c; sunglasses 75c, \$1.75, \$2.45; white sailor pants \$1.45, caps 55c; include postage. Imperial Outlet Co., 529 Nostrand Ave., Brooklyn 16, N. Y. Dept. B.

KNIVES—Automatic, pen, pocket, hunting, fishing. Large selection, lowest prices. Free catalogue. Knifemaster, 1441 Prospect Place, Brooklyn, N. Y.

SURVEYING INSTRUMENTS

GUARANTEED Factory rebuilt transits and levels, sale, or rent, with purchase option. We will repair, trade or buy old instruments. Write for list M-48. Warren-Knight Co. (Manufacturers of Surveying Instruments), 136 North 12th St., Philadelphia 7, Penna.

WANTED—MISCELLANEOUS

QUICKSILVER (Mercury) urgently needed! Immediate payment. Wholesale Terminal, Norwood, Massachusetts.

PERSONAL

YOUR Handwriting reveals much. Amazing facts sent free. C. Fletcher, 2516A West 82nd Street, Chicago 29, Ill.

IMPRESS Friends. Pretend vacationing elite Lake George! Ten enchanting view cards, \$1.00. You address, return; we re-mail. Lakevue Mailers, Box 489, Lake George, New York.

TIE-X-CHANGE. Send six ties and \$1.00. Receive six, 1834 Madison, Eugene, Oregon.

PRETEND Visiting Europe. Send letter and \$1 to H. Tewnls, 800-80 St., North Bergen, N. J. Guarantee remailing within two weeks from Hague, Holland.

SPOKANE, Remailing, letters 25c Mim's Service, 2404 W. Pacific, Spokane, Wash.

BORROW By mail. Loans \$50.00 to \$300.00 to employed men and women. Easy, quick. Completely private, confidential. No endorsers. Repay in convenient monthly payments. Details free in plain envelope. Write State Finance Co., 216 Savings & Loan Bldg., Dept. F-14, Des Moines 8, Ia.

HOW You can find out! Information discreetly developed, any matter, person, problem, anywhere. Personal-business assignments, representations undertaken. Nation-wide. Officially licensed, bonded service established 1922. Reasonable. Confidential. William Herman, 170 Broadway, New York.

TRADE Neckties. Mail one-to-six ties you're sick of. Receive pronto same number handsomely cleaned different ties we got same way. Pay postman \$1. Tie-Trade Co., 2356 Minto St., Augusta, Ga.

FREE 10 Professional photo stamps, postcard brings particulars. Groot, 159 East 34, New York 16.

EXCHANGE Neckties! Mail us one to six ties you're sick of. You'll quickly receive same number of handsomely cleaned different ties we got same way. Then you pay postman \$1.00 plus mailing charges. Tie Exchange, Box 422, Bayonne, N. J.

WHAT Does your last name mean? Complete report on origin and meaning, 25c coin. (Print name plainly.) Surname Research Bureau, 104-A North Pear Street, Olympia, Wash.

BEAUTIFULLY Engraved—Your name, initials, on polished plastic name plates, purse pulls, buttons, etc. Full information free. Agents inquiries acknowledged. 'K' of Hollywood, 1315 Colorado, Los Angeles 41.

HAIR Falling? Dandruff? Write Trichologist, 137 Lewis St., Phillipsburg, N. J.

HOW To get a job by mail. You'll welcome valuable help offered. Model letters for any job \$1. Sell out list of other books free. Lefterts, Box 121, Brooklyn 25, N.Y.

TRADE Six ties you don't like for six that are different. Specify color. \$1.00 c.o.d. Tie Exchange, 38 Cherokee Station, Louisville, Ky.

SWAP! Trade! Anything, everything. Free information. "Swappers" Gazette-PM, Louisville 12, Kentucky.

RUPTURED? Positive comfort, no understraps, no steel, no elastic. Write Smith Manufacturing Company, Preston, Ontario.

MISCELLANEOUS

AMAZING Scientifically designed portable charcoal grille. Free circular. Char-Kola, St. Paul 9, Minnesota.

MEDICAL Laboratory technicians in great demand. We train you in your own home, in your spare time. Also home study course in general chemistry. Free catalogue. Imperial Technical Institute, Box 973-J, Austin, Texas.

NEW Rust solvent, removes severely rusted and corroded bolts, nuts, etc., pronto! Heat necessary. Also tends to prevent and reduce further rusting. \$1.00 a pint or \$1.75 a quart. Postpaid. Rust Solvent Co., P.O. Box 93, College Park Station, Detroit 21, Mich.

NEW Razor blades, double edged, \$1.00 per hundred, postpaid, guaranteed. Scheffeld Company, Box 754, Lansing 3, Mich.

TATTOOING Equipment. List free. Northeast Tattoo Supply, 18 Monument Sq., Portland, Maine.

WANTED 1000 Foot sufferers to test Kindschi foot balancers at my risk. Rush name for free trial offer. Kindschi Foot Appliances, Dept. A6, 321 W. Jefferson, Dallas 8, Texas.

WOULD You like a change from your present ties? Send six and \$1.00, receive six in exchange, cleaned, or will send c.o.d., Necktie Exchange, 825 N. San Jose, Stockton, Calif.

HOBBY And opportunity big mail—10c. Dr. Kørstøft, Randers, Denmark.

FLINT—Pound or carload. Harry R. Johnson, R. 1, Box 463, Tucson, Arizona.

YOUR Initial on beautiful burl "tree key chain" 40c. Redwood novelty list free. Gifford's, 1230 William, San Jose 12, Calif.

GRAPHOCHART. Analyze your handwriting with a graphochart. Price 25c. Bright-Wood Publications, Box 6255, Pittsburg 12, Penna.

HEAVY Metal storage chest. 20 1/2 long x 16 wide, 16 high. Hinged carrying handles and cover, hasp, baked on grey enamel, net weight 31 lbs. \$3.75 each, no cod. Shipped express or freight collect. Polomyers, Inc., 81 Reade St., New York 7, N.Y.

LUCITE Bar, name pin, safety clasp. Price \$2.00. Made to order. Nightingale Pin Co., P. O. Box 1772, West Palm Beach, Florida.

SWAP Ties you are sick of. Send one to six and a dollar bill and I'll send you the same number of different ties cleaned and pressed. D. Kelley, P.O. Box 3681, Oklahoma City, Oklahoma.

36,000 PATENTS, 7,000 Formulas seized. Foreign royalty available to you. For information read Defeat. 50 cents. Box 267, Waltham 54, Mass.

IRON Railings made! Send for free photos, prices. Men, erect rails in spare time in your locality! For details write Attleboro Forge, Attleboro, Mass.

ULTRA-VIOLETTE: Amazing new ultra-violet ray tube, complete, 110 volts a.c., d.c. Experimenters: discover Uranium bearing ores. Locate fluorescent objects in home or field. Learn to make your own fluorescent paint. Numerous other uses. Instructions. Guaranteed. Only \$1.00 postpaid. Ultra-Violet Co., 4420 Washington, St. Louis 8, Mo.

DANCE Instruction in the privacy of your own home. Booklet free. Engstrom Dance Studios, PM3, Box 358, Grand Island, Nebr.

ARROWHEAD, Beautiful rainbow colored transparent plastic, purse or key charm and chain. Sample 35c. Your name molded inside 75c. Moore's Plastic Service, 1205 Pershing Road, Zanesville, Ohio.

FREE Fertile lands, yielding four annual crops, obtainable in Latin-America. Homesteads, large plantations, 25,000 acre ranches obtainable free. Make your fortune growing sugarcane, tobacco, cereals, bananas, coffee, fruits, timber, cattle, sheep. Send 25c for illustrated booklet "100,000 Square Miles Free!" Valles, 395-XT Broadway, New York 13.

"HOW To Win Prize Contests." Amazing booklet \$1.00. Box 28-EPM, Jackson Heights, New York.

CEMENT Or concrete waterproofed with Ce-Arid. Send one dollar for enough to paint average sized basement walls when mixed with plain cement and water. Guaranteed for new or old work. P.O. Box 232, Freeport, Illinois.

MAKE Chemical cleaners, soaps. 36 page instruction booklet. 100 formulas. No machinery needed. \$1.00. C & B, 9111 Hoyne, Chicago 20.

RECEIVE Giant mails, samples galore! Two-year listing \$1.00, nine-month 50c, three-month 25c. Stanford, 6220-M 16th, Philadelphia 41.

SEND Me 1 to 6 ties you hate! I'll return same amount of gorgeous but different ties. You pay \$1.00. Try it! Tie, Box 3875, Philadelphia, Penna.

REVOLVING Hardware dispenser. Sixteen 4 ounce glass jars. Holds hundreds items. Mounts anywhere. \$2.50 postpaid. Lyle Baker, Bismarck, Missouri.

LAUGH At pickpockets. A practical ingeniously designed locked pocket, easily attached in trouser pocket opening, quickly accessible to wearer. Once used, indispensable. Money back guarantee. Send 98c to Security Pocket Products Co., 1051 Le Claire Pl., Los Angeles 6, Calif.

SWAP Neckties. Write for information about this amazing offer. P.O. Box 3494, Mdse. Mart, Chicago 54, Illinois.

CAN You tie this? Send up to six neckties you are tired of. Return same number cleaner, different ties received same way. You pay mailman \$1.00. Deal? Tiechange, Box 3368-M, Columbus 11, Ohio.

ABACUS. Now improved and easier to use. An interesting way to learn arithmetic. A fast way to add, subtract, multiply, divide, and extract square roots. Specially illustrated instructions show how. New model, \$3.50. Send for free lesson and details. Loy's Chinese Calculator, Dept. 84M, 1317 Rhode Island Ave., N.E., Washington 18, D.C., Agents wanted.

BALLOONS \$2.50 Gross. Price list. Johnson, 2611PM Harriet, Minneapolis, Minnesota.

EXCHANGE Neckties. Want something different? Send 4 to 8 ties that you are tired of. We mail you same number of freshly cleaned different ties we got same way. Then you pay postman \$1.00. The Tie Exchange, 1015 Fort Park, Lincoln Park 25, Mich.

MEXICAN Jumping beans. July crop. Dozen 25c, hundred \$1.00. Also wholesale. Mexican Products Co., 126 No. Main, Tulsa 3, Oklahoma.

"RECEIVE Mail." Moneymaking offers, opportunities, catalogs. Name listed 10c. Ideal Service, 100, Park Ridge, Ill.

TEPEE Novelty Shop, Ipswich, So. Dak., Box 236D. Has beautiful Indian teepee lamp shades, in bright colors, designs. Sparkling glossy finish. Details free.

BIG Mails 10c. Year 50c. Name listed directory 25c. Harvey Teeple, Decatur, Indiana.

APPLIANCE And building repairs. Own your own business. Free particulars. C. A. Griffith, 132 Water St., Fredonia, N. Y.

MEN! Large size shoes, large size Sox! We specialize large sizes 10 to 16, widths AA-EEE. Oxfords, hitops, work shoes. Guaranteed extra quality. Free catalog. Kingsize, 469, Brockton, Mass.

TREASURE Finders! Goldak's new 11 pound lightweight, gold, silver and mineral locator, money-back guaranteed superior any other device. Free information. The Goldak Co., 1542 West Glenoaks Blvd., Glendale 1, Calif.

BOOKFINDERS! (Scarce, out-of-print, unusual books) Quickly supplied. Send wants. Clifton Company, Box 1377 pmm, Beverly Hills, Calif.

M-SCOPE Metal, mineral locators sensational new electronic lightweight models, immediate shipment. Fisher Research Laboratory, Inc., manufactures some of the finest metal locators for the U. S. Army. Built for Arctic, Tropic use. Unsurpassed efficiency, low prices. Time-payment plan available. Send for free 16-page illustrated booklet. Fisher Research Laboratory, Inc., Palo Alto, Calif.

TATTOOING Outfits, supplies. Illustrated list free. Zeis, 728 Lesley, Rockford, Illinois.

70 BIBLE Lessons, 25c. Bulletin, Box 87, Cathedral Station, New York 25.

BE The Popular Mechanics representative in your neighborhood and earn big profits in your spare time. Write Popular Mechanics Magazine, Room 408M, 200 E. Ontario St., Chicago, Ill.

FREE—"Amazing New Book"—"Profits From Classified Advertising." Tells how and what to advertise. Be sure to read this book before you invest one cent in advertising. Remember—it's free! Write for your copy now. F. W. Johnson, Classified Advertising Manager, 200 East Ontario Street, Chicago 11, Illinois.

Sensational New Electric **WELDER** **CUTTER!** BOTH only \$12

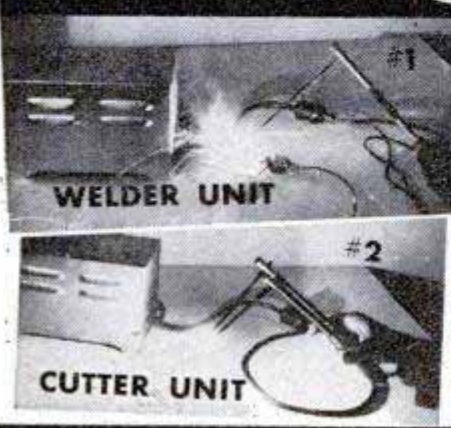

Uses 110-115 AC or DC • INSTRUCTIONS INCLUDED
WELD - BRAZE - CUT - MELT - SOLDER - HEAT TREAT

The WELDRITE combination—tested and proven by countless commercial and amateur users, is now offered direct to you at the amazingly low price of only \$12.00. No Gas—No Gauges—No Spark Lighter needed. Always ready for immediate use—Just plug WELDRITE into 110-115 AC or DC outlet. Uses standard welding and brazing materials available at all welding supply stores. WELDRITE furnished complete with Converter Unit, #1 Single Holder with attached Alligator clip, for welding metal up to 3/16" thickness, using up to 3/32" rod, and #2 Double Holder with Copper Tipped Dual Carbon Electrodes for Cutting. Brazing, Heat Treating, Soldering, etc. Starting welding materials and instructions included.

and fender shops, garages, repair and machine shops, manufacturers, etc.

SEND NO MONEY! 5 DAY TRIAL OFFER
Order your WELDRITE Electric WELDER-CUTTER C. O. D. today. Pay postman \$12 plus postage charges (wt. 4 lbs.) or send \$12 and we pay postage. Either way, if not satisfied, return WELDRITE in 5 days, and money will be refunded. WELDER HOOD—Approved lens found in hoods costing to \$10—only \$2.95. California orders please add 2 1/2% sales tax.

CALIFORNIA TECHNICAL PRODUCTS CO.
448 So. Hill St., Los Angeles 13, Calif. Dept. A-6

NEW SERIES 16 IMPROVED NO-DRIFT FM
in the Sensational 1948 MIDWEST RADIOS.



5 WAVE BANDS

Separate Chassis Like the Powerful Series 16 AM-FM Above, or Beautiful Radio-Phono Consoles Available

The SYMPHONY GRAND RADIO-PHONOGRAPH AM-FM CONSOLE



A truly magnificent instrument that offers new, improved No-Drift FM, 5 Wave Bands, Automatic Intermix Record Changer that handles both 10" and 12" records, 14 1/2" Panasonic Speaker, and exclusive Midwest Tri-Magnadyne Coil System and Color-Ray Tone Selection. Luxurious Cabinets. Other Console and Table Models with Series 16, 12, and 8 Chassis.

EASY TERMS
30 DAYS TRIAL

SEND FOR FREE CATALOG BUY DIRECT FROM FACTORY AND SAVE
 FILL IN COUPON AND MAIL TODAY OR JUST SEND YOUR NAME AND ADDRESS ON 1c POSTCARD.

MIDWEST RADIO CORPORATION

Dept. 25-X, 909 Broadway, Cincinnati 2, Ohio

Please send me your new FREE 1948 Catalog.

NAME

STREET

CITY.....ZONE.....STATE

AIR RIFLES BENJAMIN AIR PISTOLS
PIONEERS - LEADERS

SEND FOR FREE FOLDER OF LATEST MODELS TODAY
 If you want a REAL GUN for PRACTICAL USE inside or outdoors get a SAFE - CLEAN - ECONOMICAL - BENJAMIN with Adjustable Power and Amazing Accuracy. For BEST RESULTS use BENJAMIN H-C PELLETS. WRITE AT ONCE, BENJAMIN AIR RIFLE CO., 812 MARION ST., ST. LOUIS 4, MO.

Get Popular Mechanics Fascinating New Book for all Outdoor Men

A Handbook of Helpful Hints for the Hunter, Fisherman, Trapper, Camper, Archer, Boatman and Others

Now ready! The helpful, informative book sportsmen long have waited for. Compiled by the editors of Popular Mechanics to help you get more out of your sports and hobbies. It's a practical, helpful book with hundreds of ideas on fishing gear of all kinds, hunting, guns, traps and trapping, marketing furs, sailing sail and other boats, outboard motors, camp equipment and camping hints, archery equipment and how to use it. 160 pages in cloth binding with 334 illustrations, many in color.



OUTDOOR SPORTS MANUAL

Only \$2.00 Postpaid Mail Coupon

Use the handy coupon now. Get your copy of Outdoor Sports Manual today and enjoy the great outdoors more than ever before.



POPULAR MECHANICS PRESS, Dept. 672
 200 East Ontario St., Chicago 11

Send at once _____ copies of OUTDOOR SPORTS MANUAL at \$2.00 each. Remittance enclosed. Outside U.S.A. add 15%.
 Send C.O.D. postage extra.

Name _____

Address _____

City _____ Zone _____ State _____

POPULAR MECHANICS

DRAFTING

Plan for a TOP PAY JOB · Drafting Outfit Included
SEND FOR FREE LESSON

Here is a modern practical way to learn Drafting right in your own home. You are furnished all the instruments and supplies you need to actually do the assignments, and the entire Drafting Outfit is included at no extra cost. Visual aid instruction helps you learn quickly, easily—you receive projector and slides. Draftsman has Key Job in industry—many executives advanced to present top positions with aid of a knowledge of Drafting. Find out about this up-to-date C.T.I. training program in Drafting. Write today for FREE lesson and full information. No obligation.

COMMERCIAL TRADES INSTITUTE, Dept. J2-6
 1400 W. Greenleaf Chicago 26, Ill.

LEARN EXPORT



Buy and sell world-wide without capital. Travel abroad if desired. Export men and women in demand. Your own business — profits unlimited. Salaried jobs — up to more than \$10,000 a year Practical, low cost WORLD TRADE COURSE teaches you quickly at home in spare time. No previous special experience or schooling needed. World Trade Certificate awarded. Write today for FREE DETAILS. No obligation. Please state age. Air-mail reaches us overnight. **THE MELLINGER CO., Exporters-Importers, 1422-AC Westwood, Los Angeles 24, Calif.**

AVIATION TRAINING

AERONAUTICAL ENGINEERING AIRCRAFT and ENGINE MECHANICS (A & E)

Train on famous Northrop Field — New classes starting soon.
 Write for illustrated catalog.

Northrop Aeronautical Institute

1527 E. BROADWAY Division of Northrop Aircraft, Inc. LOS ANGELES COUNTY HAWTHORNE CALIFORNIA

APPROVED FOR VETERANS

PRACTICAL MATHEMATICS LIBRARY

Easy self-instruction in 25 branches by college experts. Helps you qualify for better job. 4 volumes, 1300 pages, 600 illustrations. Sent for free trial. Only \$2.00 down, \$2.00 a month; total \$9.80 plus postage. (Cash price \$9.50, postage free.) 160-page Logarithm book free with order. National Educational Alliance, Inc., Dept. 566, 37 West 47th St., New York 19, N. Y.



AMAZING DISCOVERY! Corrects poor penmanship in few days — big improvement in three hours. Now it's fun to become an expert penman. TEN DAYS' TRIAL ALLOWED. Write Immediately.
 C. J. OZMENT, 34-X, St. Louis, Mo.

DO ANY JOB EASIER MAKE MORE MONEY

Used by Army, Navy, Other Government
Depts., 200 Schools and Industrial Firms.

Mail Coupon

FREE
TRIAL in Your Home.

Send No Money!

We Ship C.O.D. in U. S.
and Will Refund Money
if Not Satisfied.



Get Ready for BIGGER OPPORTUNITIES and BEST PAYING JOBS

Do it now! Get the better pay that goes to men with specialized knowledge. Get into one of these big opportunity fields. Big money and many other advantages await you if you prepare now. Here is the help you need—EASY—QUICK—AT LOW COST. Thousands of men have already used these famous books. Beginners and experienced men alike have doubled and tripled their earnings with this help. You too, can now get the special knowledge you need for top pay, better jobs, or a business of your own. This is your GOLDEN OPPORTUNITY.

AIR CONDITIONING

Big air conditioning boom interrupted by war now bigger than ever and alive with new opportunities! Get this non-technical book by international authority and be ready for your share of millions to be spent. Covers whole field. 450 pages. Illustrated. \$4.00.

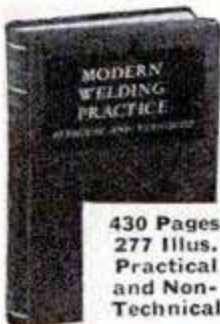

MODERN WELDING PRACTICE

Newest book on all types of welding and heat treatment of metals. Written by recognized specialists in training men for production jobs. Practical and Non-Technical.

430 Pages
277 illus.
Practical and Non-Technical

Covers everything you need to know. Prepare for best pay jobs now. Price \$4.00.

SHEET METAL LAYOUT

Makes sheet metal layout work so simple that anyone can learn. Get this new instructor and get into the easiest, cleanest and best paying part of all sheet metal work. 143 jobs worked out in drawings and carefully explained. Gives standard for all sheet metal fittings. \$3.50.



AUTO BODY and FENDER REPAIR

Opens the Door to One of the Big Opportunity Fields of the Day

THE LOW COST, EASY WAY TO A GOOD PROFITABLE BUSINESS OF YOUR OWN

Owners will spend big money to keep their good older cars looking like the new ones coming out. This is a practical money-making guide. Ideal for shop owners and every man who wants a share of the millions to be spent in keeping old cars looking new. Tells how to get a good job or start business of your own with small capital. Covers everything including tools, methods and materials. Only book of its kind. 325 pages, 232 illustrations. \$3.50.

HOUSE WIRING LATEST EDITION

Get this sixth edition of this standard and practical electrical wiring book. It gives complete practical instruction on every phase of house wiring in one handy volume. Goes further than most books on subject. Hand-book style. Gives National Electric Code. 400 pages, 669 illustrations. Electrical work will reach a new high with millions of new homes to be built. Get started now. \$3.00.

DYKE'S FAMOUS CARBURETOR BOOK

This famous book has been the standard guide in the best paying auto work for a generation. It has helped thousands of men make money. New edition covers engine tune-up, compression, ignition, carburetion, fuel pump valves, etc. Use this book to specialize in this big field. 244 pages, 549 illustrations. \$3.50.

Modern Gas and Electric REFRIGERATION

New Printing—Almost 1000 Pages,
408 Pictures, 17 Diagrams in Colors

The Book of the Hour

Thousands of Refrigerators need repairs! Owners will pay big for competent service. Get this non-technical guide to all types of refrigerators and get your share of this new profit. Get a job or start your own service business. This book will help you make money anywhere. Price \$5.00.

Make Big Money
Keeping Old Cars
Looking New. Get
This Book Today!



**BIG
20th
EDITION**
Leading
Auto
Book
for Over
36 Years

World's Greatest AUTO BOOK

New Material on Transmissions,
Trucks, Tractors, Diesels, Air-
craft and Auto Engines

Now with millions of cars needing repairs and thousands of men needed to do the work, you need the famous DYKE Auto Book more than ever before. This big 20th Edition covers all principles, construction, repair, adjustments, testing, troubles and remedies of all cars. Over a half million copies of 20 editions of Dyke's have been sold. Gives specifications of old and newer cars. World's biggest book value, \$7.00. This big book, a complete auto library in one volume, has 1483 pages—4600 illustrations and diagrams—weighs 6 lbs.—equal to 4 ordinary books.

BAILEY'S HANDBOOK For Engineers and Firemen

World famous handbook of universal questions and answers for Stationary, Marine and DIESEL engineers and firemen. Prepares for any license examination. This is the one book that men should have if they want to reach the top in installation, maintenance and operation of Diesel and steam plants. Pocket size, \$2.00.

Goodheart-Willcox Co., Inc.
1321 S. Michigan Ave., Dept. 1A, Chicago 5, Ill.

SEND NO MONEY! Mail Coupon

GOODHEART-WILLCOX CO.,

1321 S. Michigan Ave., Dept. 1A, Chicago 5, Ill.

Send books checked, C.O.D. I will pay postman, plus few cents charges. If not satisfactory I will return books in 5 days and you will refund money paid. (Outside U.S. or possessions remit with order.)

- | | |
|--|--|
| <input type="checkbox"/> Gas & Electric Refrigeration \$5.00 | <input type="checkbox"/> Air Conditioning \$4.00 |
| <input type="checkbox"/> Dyke's Auto Book \$7.00 | <input type="checkbox"/> Engineers Handbook \$2.00 |
| <input type="checkbox"/> Dyke's Carburetor Book \$3.50 | <input type="checkbox"/> Body and Fender Repair \$3.50 |
| <input type="checkbox"/> Modern Welding \$4.00 | <input type="checkbox"/> Shop Math. (2 vols.) \$3.00 |
| <input type="checkbox"/> Airplane Welding \$3.50 | <input type="checkbox"/> House Wiring \$3.00 |
| <input type="checkbox"/> Sheet Metal Layout \$3.50 | <input type="checkbox"/> A.C. Power Wiring \$4.00 |
| | <input type="checkbox"/> D.C. Power Wiring \$4.00 |

If remittance accompanies order we will pay all postage charges under same return privilege.

Name _____
Address _____
City _____ State _____

Be a NEON Expert

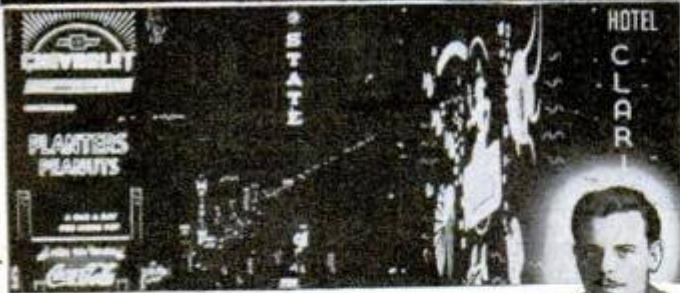

I'll Show YOU How to
Make \$100 a Week
and UP in **NEON**



C. C. Blakely, Executive Director
Acme Neon Institute

★ Today's wide open field for ambitious men who want to make \$100, \$150 and more per week is the colorful, exciting business of Neon. I'll train you for a highly paid place in America's most fascinating industry. At Acme you become a Master Neon Technician. Learn Neon Tube Bending, Color Gassing, Neon Glass Blowing, Cold Cathode Lighting, Bombarding, other important skills.

COAST-TO-COAST OPPORTUNITIES

Demand for Acme Trained Men is greater than we can supply. We're getting calls from coast-to-coast. Today beginners have a once-in-a-lifetime chance to master an art and learn a profession that will pay big dividends for life. Our practical, intensive 500 hour course prepares you for thousands of BIG MONEY opportunities. Get a fine job, or go into business. Other Acme Trained Men are succeeding. So can you. Room Assistance for out-of-town students.

ACME NEON INSTITUTE
328 S. Paulina St. Chicago, Ill.
APPROVED UNDER G.I. BILL

FREE FACTS

Acme Neon Institute
Dept. F-3, 328 S. Paulina St.
Chicago 12, Illinois

Send me the FREE FOLDER, "Your Big Opportunity" plus facts about training me for a highly paid job in Neon.

Name _____
Street _____
City _____



THOUSANDS OF SUFFERERS USE

BREATHEASY

FOR

ASTHMA

CARRY IT WITH YOU
USE IT ANYWHERE

*Sold on Money-Back
Guarantee*

Write To Dept. PM

BREATHEASY DISTRIBUTORS, INC
65 CEDAR STREET
SEATTLE 1 WASHINGTON

DON'T BE A JOB SLAVE!

LEARN WATCH REPAIRING AT HOME

WITH OUR SELF TRAINING KIT

Get started NOW in this uncrowded field! EASY to learn! BIG MONEY! SECURE FUTURE! Earn while you learn! Even as a sideline you can make \$50.00 and up each week. Our new PRACTICAL SELF-TRAINING KIT is all you need to start. Contains set of PROFESSIONAL TOOLS: (Loupe, 3-4 power; complete set of 6 special screw drivers—finest tempered steel blades; Tweezer AA; Plastic material tray) and COMPLETE BOOK on Modern Watch Repairing. Fully illustrated, easy to understand, shows every step in repair, adjustment and use of tools. Only **\$6.45** Post Paid

(If C.O.D., plus charges.) Money Back Guarantee.
If ordered separately: book \$3.25; set of tools, \$3.95.

MODERN TECHNICAL BOOK & TOOL CO.
Dept. MMG, 55 W. 42nd Street, New York 18, N. Y.

NEW ALL-INCLUSIVE TOOL, MATERIAL CATALOG
Revised and Enlarged for Watch-Clockmakers, Jewelers, Toolmakers, Handicrafters. Over 500 ILLUSTRATIONS and IDENTIFICATION CHART. NEW REDUCED PRICES. All books in these fields; write for literature. SEND 50c for catalog—FREE with order

AUTO BODY & FENDER REBUILDING

Tired of Working for the Other Fellow?
Be Your Own Boss
A Big Field for Your Future

Body & Fender Rebuilding is one of the best paid branches of the automobile industry. Go into business for yourself or prepare for good job opportunities. Train at home or in our big shops. Approved for Veterans. (Non-Veterans inquire about our Low Payment Plan and Pay After Graduation Plan.) Send for FREE Booklet and full information. No obligation.

COMMERCIAL TRADES INSTITUTE, Dept. F-2-6
1400 W. Greenleaf Avenue, Chicago 26, Ill.

LOCKSMITHING & Key Making

PRACTICAL UP-TO-DATE COURSE

Easy-to-learn modern information for self-instruction. How to work on locks, de-code, make master-keys, repair, install, service, etc. For every handyman, home owner, carpenter, mechanic, service station operator, fix-it shop, hardware dealer, gunsmith. 53 plain illustrated lessons. Full price only \$3.95. SEND NO MONEY. Just pay postman plus C.O.D. postage. Or send \$3.95 with order, we'll ship postpaid. Satisfaction guaranteed or refund.

NELSON-HALL CO., 1139 S. Wabash Ave., Dept. F-02, Chicago 5, Ill.

NOW! MAKE YOUR OWN

LEATHER BELTS & HANDBAGS

Portfolio of 10 NEW handbag patterns, full size, easy to follow instructions for transferring, tooling, etc. No. 332 only \$1.30
47 NEW Western and Novelty Belt Designs No. 397 set only 75c

A full stock of quality leather and lucite fittings. Large catalog included with first order for materials.

OSBORN BROS., Dept. M, 225 W. Jackson Blvd., Chicago 6, Ill.

LEARN MONEY-MAKING CARTOONING

IN SPARE TIME — by Easy Picture Chart Method

Some Simplified Method that has helped train creators of "Terry & Pirates," "Freckles," "Out Our Way," "Winnie Winkle," "Regular Peppers," "Strange As It Seems," "The Neighbors," and many others. Earn while learning. Send 10c for Picture Chart (to test your ability), and full details. (State age.)

THE LONDON SCHOOL, 4806 Cleve. Transit Bldg., Cleveland, O.

Now CHEAP OIL BURNER

FOR HEATING AND COOKING STOVES-FURNACES
HEAT YOUR HOME, COOK YOUR MEALS WITH CHEAP FURNACE OIL

NO MORE SHOVELING COAL OR ASHES. Sensational Fuelizer Starter Vaporizing System turns Cheap No. 1 Furnace Oil, also Range, Heater, Tractor Distillate, Kerosene and like oils into oil heat—one of the quickest, hottest fires known. **LIFETIME GUARANTEE. \$1.00 Bonus Offer for Testing.** We will let you try it in your own stove or furnace for one month. Get yours for introducing. Big profits QUICK. Be first. Send in your name today for details and cash in on the tremendous demand for this Amazing Invention.

NORTHWEST MFG. CO., 608-G, Mitchell, S. Dak.

LEARN ALL ABOUT DIESEL Train at Home in Spare Time

AUTOMOTIVE & ALLIED MECHANICS

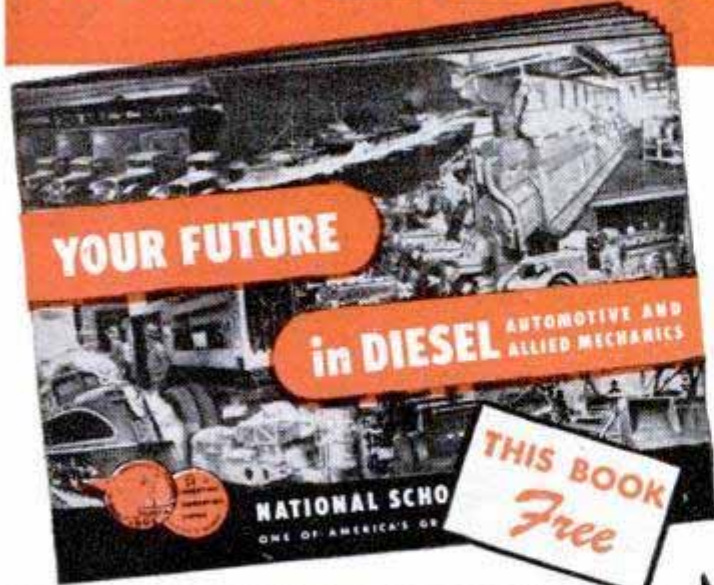

Diesel is becoming more and more important in transportation, industry and agriculture all over the world. With National Schools' tested and proved Master Shop Method Home Training, you can become a qualified Diesel, Automotive and Allied Mechanics Technician equipped to step right into this opportunity field on a sound, practical basis.

National Schools-trained Diesel and Automotive Technicians Are in Demand

Established in 1905, this great Technical Trade School has the modern facilities to help you secure an attractive position with manufacturing organizations, railroads, oil and construction companies, garages and many other branches of the industry, or you can build a substantial business of your own. Here is thorough, practical, authoritative training that has helped National Trained Men win success everywhere!

G. I. APPROVED

NATIONAL SCHOOLS

LOS ANGELES 37, CALIFORNIA EST. 1905



MAIL THIS COUPON

Find out what National Schools can do for you . . . Learn how you can grasp opportunity in the great Diesel and Automotive Industry. Send the coupon below for a **Sample Lesson** from National Schools' Shop Method Home Training, and an illustrated **Book of Facts** giving you complete information to build an interesting career.

Shop Method Home Training comes out of the **Famous National Schools' Training Shops and Laboratories**. National Schools instructors are daily training resident students in our modern, fully equipped Shops and Laboratories, using the same instruction methods and lessons you study at home. These expert instructors know how to qualify you for success . . . Get the facts **TODAY!**

MAIL OPPORTUNITY COUPON FOR QUICK ACTION

NATIONAL SCHOOLS, Dept. PMD-6
4000 South Figueroa Street
Los Angeles 37, California

(Mail in envelope or paste on penny postcard)

Mail me **FREE** the book, **YOUR FUTURE IN DIESEL**, together with the **Sample Lesson**. I understand I may keep and use the information with no obligation.

NAME _____ AGE _____

ADDRESS _____

CITY _____ ZONE _____ STATE _____

Check here if Veteran of World War II

BE A GOVERNMENT LICENSED AIRPLANE AND ENGINE MECHANIC
Train Now at **LINCOLN**
EARN BIG PAY IN AVIATION

Our new enlarged school now offers these courses: **MASTER AVIATION MECHANICS**, CAA Approved 1 Yr. Airplane & Engine Mechanics Course, **REFRESHER AIRPLANE & ENGINE MECHANICS**. Designed for veterans with aviation mechanics experience. Either course is available to veterans under the G. I. Bill of Rights. Write today for complete information.

LINCOLN AVIATION INSTITUTE

UNION AIR TERMINAL DEPT. P-6 LINCOLN, NEBRASKA

LAW STUDY AT HOME for Personal Success and **LARGER EARNINGS**. 39 years expert instruction — over 114,000 students enrolled. LL.B. Degree awarded. All text material furnished. Easy payment plan. Send for **FREE BOOK**—"Law and Executive Guidance."

AMERICAN EXTENSION SCHOOL OF LAW
Dept. 90-PM, 646 N. Michigan Ave. Chicago 11, Ill.

BE A REAL ESTATE BROKER PAYS BIG! EASY TO LEARN—Start and run your own business quickly. Many graduates report making up to \$1000 a month. Course of study covers Sales, Property Management, Appraising, Loans, Mortgages and hundreds of related subjects. Course offered in home study or residential classrooms.

FREE Big new illustrated catalog from this nationally known school. Send Post Card Today. G. I. Approved.



WEAVER SCHOOL OF REAL ESTATE

Dept. PM-1, 15 E. Pershing Road Kansas City, Mo.

NEW 1948 Enlarged Edition AUTO PAINTING Now Included
Make More Money **SPRAY PAINTING**
Learn **QUICK EASY, LOW COST**

Other Valuable Painting Books

House Painting Methods — with Brush and Spray Gun. 400 pages, over 150 illus. and color chart. Only \$2.50. Book No. 2.

Cyclopedia of Painting and Decorating. 350 pages, 288 illus. Best all around book on painting ever published. Only \$3.50. Book No. 3.

Complete Instruction for Professional Use and 'Round-the-House Jobs

Get this new 1948 spray painting book to help you on the job. Use it also for better and time-saving paint work around the home. Thoroughly practical—covers every phase of spray painting technique — industrial, commercial, auto, studio and sign work, interior decorating and exterior painting. Tells what paint or other finish to use, how to mix colors, how to use all types of equipment, how to make new flock and suede finishes.

NEW EDITION NOW READY

New edition has added chapters on Auto Painting, Electrostatic Spray Painting, Agricultural Spraying and Automatic Spraying. If you do any kind of painting you need this book. Over 160 pages, cloth binding, illustrated. Only \$2.00 postpaid. Check number 1 on coupon below.

MAIL COUPON Money Back if Not Satisfied

Frederick J. Drake & Co., Dept. 1A
600 W. Van Buren Street, Chicago 7

Please send me the books checked below. If not satisfied I will return them in 5 days and money will be refunded.

1 2 3 (Circle numbers wanted)

Check or money order enclosed \$_____ Send books postpaid.

Send C.O.D. plus postage.

Name _____

Address _____

City _____ State _____

Drake Books are Sold by Leading Booksellers

SAY YOU SAW IT IN POPULAR MECHANICS

**QUICKLY
SAFELY**

STEAMING HOT WATER

All You Need For 101 Uses!

**ANYTIME
ANYWHERE**

For
SHAVING



For
THE
KITCHEN



For
WASHING



On
THE
FARM



For
THE
BATH

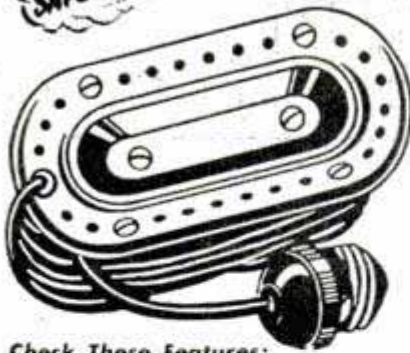

With This New Improved PRESTO-ELECTRIC WATER HEATER

For a Limited Time Only **\$4.98** POST PAID
2 for \$9

FAST... CONVENIENT... SURE

Now you can enjoy the luxury of steaming hot water... anytime, anywhere... and you don't have to heat your house to get it! Simply plug heater's cord in socket and presto: you have the hot water you want "in no time at all!" Completely portable and lightweight. Carry it anywhere! Use it for everything from boiling eggs to taking a bath. Immediate delivery guaranteed **only if you act now!**

SEND NO MONEY: Merely pay post-man \$4.98 plus postage on delivery. Or send cash and we pay postage. If not delighted, return in 5 days for refund.

Check These Features:

- * FACTORY GUARANTEED FOR 1 YEAR!
- * UNDERWRITER'S APPROVED CORD!
- * Quickly heats water as desired!
- * Fully insulated for assured safety!
- * Plugs in any AC or DC socket!
- * Completely portable; carry it anywhere!

AMERICAN MERCHANDISING COMPANY, INC., 9 Madison Avenue, Montgomery 4, Ala. Dept. PH171



NEW 30" SHEET METAL BRAKE

Forms angles, channels, vees, flanges, locks, zees, boxes. Handles 26 gage sheet steel, heavier gages of aluminum, copper, plastic, etc. Portable. Can be held in a bench vise, or bolted down. All steel construction. Wt. 40 lbs.

\$24.50

Shipped exp. collect. ONLY \$14.50 PP.

12" BRAKE. Cast iron and steel construction. Forms difficult bends. \$14.50 PP.
18" CURVE FORMER. Forms cylinders, round corners and cones in sheet metal and strap iron. Price, \$10.00 PP.
WISE IRON BENDER. Forms rings, hooks, eyelets, etc. in 1/2" round or square; 1/4" up to 2" wide in bar iron. Price \$10.00 PP., with attachment to bend 1/2" pipe, \$12.50.

Immediate delivery. Order direct, cash or C.O.D., or send for folder.

WISE BRAKE MFG. CO.

1318 So. 30th Ave. Dept. P6 Omaha 5, Nebr.



SAY YOU SAW IT IN POPULAR MECHANICS

INVENTORS

When you are satisfied that you have invented a matter of value—write me, without obligation, for full information as to what steps you should take to secure a Patent or Trademark.

The usual first step is to have a search of the prior U. S. Patents conducted, so that I can report to you on the question of Patentability.

PATRICK D. BEAVERS

(Formerly RANDOLPH & BEAVERS)

Registered Patent Attorney

934 Columbian Building Washington 1, D. C.

PATRICK D. BEAVERS, Registered Patent Atty.
934 Columbian Bldg., Washington 1, D. C.

Please send me full information on how to secure Patent Protection.

Name _____

Street _____

City _____ State _____

How To Make Liquid Marble

And BIG PROFITS In Your Own Business

Amazing Liquid Synthetic Marble can be made at home without machinery. Needs no heat or pressure. Can be poured into molds for casting expensive novelties. Liquid Synthetic Marble can be made in any color. It is even more beautiful than genuine marble because of its highly glazed finish. Costs far less. **FLEXIBLE MOLDS:** Make your own Flexible Molds. Cast novelties, statuary, desk sets, book-ends, etc. out of Liquid Marble, plaster and many other molding compositions. A large sized mold costs but a few cents. Hundreds of casts can be taken from a single mold. **UNLIMITED MARKET:** You will find steady year-round demand in your own community. No selling problem. We supply names of buyers for your finished products. Let **BING PRODUCTS** show you how to start with a small investment and build a permanent, independent, profitable business! Write now for **FREE CATALOG!**

BING PRODUCTS: Dept. PM-6A 88 BROAD STREET BOSTON 10, MASS.



CORRESPONDENCE COURSES IN
RADIO and ELECTRICAL ENGINEERING

Tuition
\$25

ELECTRICAL ENGINEERING. Get good grasp of wide electrical field. Modern. Very understandable. Theory made easy.
RADIO ENGINEERING. Extra new course in radio, public address, photo-electric work. Trains you to be super-service man, real vacuum tube technician. Tuition ONLY \$25, either course. Deferred payment plan. Servicemen needed badly.
FREE Write for free copies of school catalogs, student magazines, etc.
LINCOLN ENGINEERING SCHOOL, Box 931-P114, Lincoln, Nebr.

PATENTS

AND TRADE MARKS

C. A. SNOW & CO.

REGISTERED PATENT ATTORNEYS

WRITE FOR INFORMATION TO

428 SNOW BUILDING, WASHINGTON 1, D. C.

INVENTORS

IF YOU WISH TO PROTECT YOUR INVENTION, You should take steps to protect it by a U. S. Patent. Write me for "Record of Invention" form.

CARL MILLER
REGISTERED PATENT ATTORNEY

Woolworth Bldg., 35th Floor, Dept. 68A, New York City
Please send me "Record of Invention" form.

NAME _____

ADDRESS _____

Now Easy to Start A BIG BUSINESS in Spare Time

**Metalizing
BABY SHOES
AND OTHER
KEEPSAKES**



**MAIL COUPON TODAY for NO RISK OFFER
of COMPLETE PLAN**

DO YOU want extra money right away in a business you can run from your house with no house-to-house selling? Do you want to start small—the easy, inexpensive way—and watch how our guidance jumps you into bigger and bigger profits every week? Do you want a business that the whole family can help with—a business that is stable, permanent, steady—with a life-time certainty of good income?

DON'T WASTE A MINUTE GET THE FACTS ON METALIZING

My own shop does big business by same methods I will reveal to you. Exclusive Warner Electroplating Process—trade secrets available for first time—puts coating of actual metal (22K Gold, Genuine

**WARNER ELECTRIC CO., Dept. 36,
1512 JARVIS AVE., CHICAGO 26, ILLINOIS**

Silver, or Bronze) on Baby Shoes or other keepsakes. Amazing results, yet so simple and easy by my plan that you can become an Expert Metalizer in a few days.

SEND NO MONEY Just Your Name—but Quick

Find out fast how the love every mother has for her baby's first shoes can be turned into quick cash—big profits—a permanent lifetime business for you. Complete step-by-step Business System sent to you on no risk trial—costs nothing if you return it. But get the Free facts first. Then decide. Send penny postcard or coupon today. Time is precious!



**3¢ MAY START
A FORTUNE**

WE SHOW YOU

- How to start at home in spare time
- How to Metalize the easy Warner way
- How to bring in the business
- How to start at low cost
- How to pyramid profits



WE FURNISH EVERYTHING

All supplies and mountings from one source, for quick shipment, keeps investment low!

**Ray Brandell, Mgr., Warner Electric Co.,
1512 Jarvis St., Dept. 36, Chicago 26, Ill.**

Don't send the PLAN. First send all facts free. I'll decide after I investigate. Everything you send now is FREE. No obligation.

Name _____
Address _____
City _____ Zone _____ State _____

WATCHMAKING

JEWELRY ENGRAVING AND REPAIR

Enter this high-paying, time-honored profession, or prepare for a business of your own. Watchmakers in great demand. More jobs than qualified workers. Study under expert instructors in a long-established, nationally recognized school. Receive recognized diploma and certificate. Placement service. Approved under G. I. Bill. Write for FREE booklet.



The Baronian School, Inc.

2116 WALNUT ST. (DEPT. C) PHILA. 3, PA.



COMBAT JUDO

Fiercest fighting technique known. Learn trick knock-outs, police tactics, and the art of Defense and Attack. Expert instructions in THREE volumes with 200 photographs and illustrations. Complete...only \$2.25

VARIETY HOUSE

Box 46-BA Wall St. Sta., New York 5, N. Y.

CARTOONING

Learn cartooning, drawing, sketching, etc. 48 lessons, 617 illustrations, including drawing paper, pens, pencils. \$1.00 complete. Order today!

AMERICAN STAMP CO.

DEPT. 4213-C

WILMINGTON 99, DEL.

Profit with LARSON Leathercraft

Make as gifts—or to sell—practical leather items. Complete stock of leathers, tools and accessories. No experience necessary. Instructions with materials. Send ten cents for new catalog of 101 money-making ideas.

J. C. LARSON COMPANY

824 S. Tripp Ave.

Chicago 24, Illinois

Learn A Trade NOW! PRACTICAL SHOP TRAINING!

In Our Chicago Shops

- AUTO MECHANICS
- DIESEL MECHANICS
- REFRIGERATION
- WELDING—ARC and GAS
- MACHINIST
- PIANO TUNING
- BODY-FENDER

Above Approved For G. I.'s and Civilians
One of America's Leading Practical Schools
7 Floors of Fully Equipped Shops
Over 48,000 Successful Graduates
Expert Individual Instruction
Learn by Doing—Low Living Expense
Established 1902—Day and Evening Classes

Also the following Home Study Courses

- PLASTIC
- REFRIGERATION
- DIESEL

—CALL IN PERSON OR MAIL THIS AD TO— GREER SHOP TRAINING

(Dept. PM-268) 460 South State St., Chicago 5, Ill.

Please send without obligation free information regarding trade checked above. (Specify whether you are a Veteran or Civilian)

Name _____ Age _____
Address _____
City _____ State _____

Say you saw it in Popular Mechanics!

BEST BUY UNDER THE SUN!

U. S. ARMY AIR FORCE TYPE
SUN GLASSES

Men's and Women's sizes



REGULAR \$15.00 VALUE

including convenient leather case

\$2.49 postpaid.

Super-Sensationally Priced at only.....

- ★ Ground and polished 4 base lenses.
- ★ Gold plated adjustable frames.
- ★ Pearloid sweatband and pads.
- ★ Made to highest optical standards.
- ★ U. S. Gov't. approved for absorption of ultra-violet and infra-red rays.

LIFETIME GUARANTEE { At any time during life of these sun glasses, we will fix them for a nominal service charge of 50c.

MAIL THIS COUPON TODAY!

AMERICAN HANDICRAFTERS, Dept. PM6
2905 W. Madison St., Chicago 12, Ill.

Please send me.....men's.....women's SUN GLASSES

Send C.O.D.
 Enclosed find check or money order for \$2.49 each, postpaid.

Name.....
Address.....
City & State.....

ANCIENT EASY-CARVING STONE

Beautiful in grain and color. Permanent stone. Cuts with pocket-knife. Rivals jade. File, sandpaper, steel wool plus oil gives excellent finish! Turns easily on lathe. *Endorsed by Professionals!*

KITS \$1.60 & \$2.60 R.Pd. East of Mississippi River. INSTRUCTIONS No C.O.D. VARIOUS SIZE STONES AVAILABLE. Send for prices.

FAR EASTERN SCULPSTONE CO. 1 East 42 St. New York 17, N.Y.

Make Your Own WORK BENCH
In Less Than 30 Minutes
HOLLOWELL BENCH LEGS

Are welded rigid assembly steel bench legs providing support for storage platforms, wood tables and steel benches, 40 1/2" wide, 31 1/4" high, 2 1/2"x14" gauge steel channel. Each leg will safely hold 5,000 lbs.

2 LEGS MAKE A 6-FT. BENCH
Also Other Sizes
Shipping Charges Collect

\$3.49
EACH F.O.B. K.C.MO.

WINDSHIELD WIPER KIT

Complete. Wiper, wiper bracket, switch and blade. 1/8 Hp. 24 volt DC motor. 5000 reverse or 10,000 forward RPM with flexible shaft and switch circuit breaker. Only **\$6.95**

Shipping Charges Collect
No COD's. Write for catalog of Surplus Bargains

ATLAS SALVAGE & EQUIPMENT CO.
229 SW. BLVD. KANSAS CITY, MO.

Work Table LAMP

Overall dimensions, 24 1/2" wt. 1 lb. Has 3 flexible ball joints, 110 volt. Less bulb and plug. Real sur- **\$2.95** plus bargain. Only Bulbs 38c extra Add 25c handling and mailing

PNEUMATIC AIR TOOLS
At a Saving of \$64.00 and Up!

Ideal fender and bumping hammers, and for riveting brake lining, concrete breaking and many other uses. Like new. At these unheard of low prices it pays to order a good supply.

RIVETER & CHIPPING HAMMER
Ingersoll-Rand AVC-11 with air control, push button throttle, takes up to 5/32 rivet. Like new. Weight 5 pounds. List Price \$73.00—Special Price..... **\$7.95**

RIVETER & CHIPPING HAMMER
Chicago pneumatic CP4 with air control, push button throttle, takes up to 3/16 rivet. Weight 6 lbs. List Price \$73.00—Special Price.... **\$8.95**

Chicago Pneumatic RIVETER & CHIPPING HAMMER
CP9X offset handle, with air control. Takes up to 1/4" rivet, weight 8 lbs. List Price \$79.00. Special Price..... **\$10.95**

THOR PNEUMATIC ALLIGATOR Squeezer and Compression Riveter
Model PRS-10, Alligator jaws, or PRS-10, "C" Type Yoke. Weight 5 lbs. List Price \$93.00—Special Price..... **\$12.95**

PRICES ARE F.O.B. CHICAGO. Immediate delivery. **SOLD ON MONEY BACK GUARANTEE.** Send check or money order today.

C & M EQUIPMENT COMPANY 1831 S. State St. Chicago 16, Ill., Dept. D-6

LEARN TO MOUNT BUTTERFLIES
and Moths for Pleasure and Profit. Complete Entomology Kit and Instructions. Ready to start. Only \$1.00. Order today.

ENTOMOLOGY SUPPLY CO.
Dept. 101 Medina, New York

EASY! Make Pottery and Ceramic Jewelry Send for book! **LEARN! EARN MONEY at Home!**

Send for book "Simplified Ceramic Art" \$1.25 ppd. Step-by-step patterns and drawings. **FREE** with order. Ceramic Jewelry Patterns and 30 pg. Handbook & Price List. Make money at home!

JANE GRIFFITH POTTERY HOUSE
23 MAPLEWOOD AVENUE, DEPT. P, PHILADELPHIA 41, PA.

Learn LANDSCAPE GARDENING

A thorough, interesting, home study course for those who wish to become LANDSCAPERS, GARDENERS, DESIGNERS, etc., for profit or pleasure. Write today for FREE BOOK to

NATIONAL LANDSCAPE INSTITUTE
Dept. P-6, 310 So. Robertson, Los Angeles 36

APPROVED FOR VETERANS

WANTED—MEN WITH CARS!
TO OPERATE S-I-P MOBILE PAINT STORES

Make big money; sell paint this NEW way. We need men now to serve open territories. No experience or capital. We train you, furnish everything needed. Write Dept. S-3

COMPLETE WORKING KIT FURNISHED
STANDARD INDUSTRIAL PRODUCTS, Inc., Evansville 4, Indiana

ONE-MAN SAWMILL LESS THAN \$200.00
Easy To Turn Trees Into Money

Makes lumber, ties, shingles, crates, lath, studding.

Belsaw Models in 10 to 24 foot sawing lengths. **MECHANICAL FEED**, accurate set works and positive dogs. Use tractor or old auto engine for low cost power. Thousands used for commercial sawing. Pays for itself quickly. Send post card today for FREE booklet, "How To Make Lumber" and Catalog of Woodworking Equipment.

BELSAW MACHINERY CO., 811-E Field Bldg.
315 Westport Road Kansas City 2, Mo.

INCREASED GAS MILEAGE! FREE TRIAL IN YOUR CAR!

Smoother Motor; Easier Starting; Faster Pickup; Slower Idling; with GANE AIR-FLOW NEEDLE for your Carburetor. \$1.75 each installed by YOUR Service Station, Garage, Car Dealer on 10-Day Free Trial Money Back Guarantee, or Order Direct. Mail card for Free Data.

OCTA-GANE
2425 E. 57th St., Los Angeles 11

AMERICA'S GREATEST ELECTRICAL SCHOOL OFFERS YOU

MORE EQUIPMENT!

MORE SPACE!

MORE TRAINING!



OVER
1000

PIECES OF ACTUAL
ELECTRICAL EQUIP-
MENT TO WORK ON!

Learn **ELECTRICITY**

It's Easy - "LEARN-BY-SEEING" MOVIES
It's Fast - "LEARN-BY-DOING" METHODS

and its THOROUGH! . . . There is no other place—no other way to get the same all-around training you get at M.T.I. NOT A HOME STUDY COURSE! . . . You get actual "hands-on-equipment" training in great MODERN SHOPS in Detroit. No previous experience necessary. Learn HOUSE WIRING, A.C., D.C. MOTORS, ARMATURE WINDING, POWER PLANT WORK, etc. New classes start every few weeks. Part time work available. Living arrangements made.

NO COST TO VETERANS Train at Gov't. expense. Receive \$75 to \$120 month while learning. Coupon brings details.

In
**NATION'S
LARGEST
EXCLUSIVE
ELECTRICAL
SCHOOL**



**MAIL TODAY
FOR QUICK
ACTION!**

MICHIGAN TECHNICAL INSTITUTE, Dept. PM-6
2281 W. Fort St., Detroit 16, Michigan

- Send me catalog and complete information.
 I am a GI. Send special information.
 Married. Single

NAME _____
ADDRESS _____
CITY _____ ZONE _____ STATE _____

MICHIGAN TECHNICAL INSTITUTE

Department PM-6, 2281 West Fort Street, Detroit 16, Michigan

Get Ready for Big Opportunities!

Signma 1466

**TOOLS AND EQUIPMENT
SENT WHEN YOU START**

Get a better job with more pay and pleasant working conditions. Get into Drafting—where all products start. I will train you at home—give you experience—on the same kind of jobs you will do with the best paying firms. I furnish instruments and all equipment when you start. Write today for vital facts and FREE book. Give age.

ENGINEER DOBE • Div. 1A • Libertyville, Ill.

I Will Train You at Home
Until You Get a

**GOOD PAY JOB in
DRAFTING**

Write for **FREE
Illustrated
Brochure**

PHOTO NEGATIVE RETOUCHING

Five week home study course in photo negative retouching, including all equipment \$21.50 and instructions

MARSHALL PHOTOGRAPHERS, INC., SCHOOL DIVISION
Dept. PM-6a, 162 N. State St. Chicago 1, Ill.

Famous **BAILEY DIESEL SCHOOLS**

Now Accepting

CIVILIAN STUDENTS!

Bailey has a national reputation for "finest training methods." Bailey teaches you fundamentals, plus the practical application of theory in plenty of actual shop work. Bailey is approved by industry. Bailey graduates get the jobs!

Civilian men and boys over 17 who are ambitious to get ahead will act now. Send for FREE catalog. No salesman will call.

BAILEY TECHNICAL SCHOOLS

1655 So. Grand Blvd., St. Louis, Mo.

VETERANS Learn WATCHMAKING

A Lifetime Career

No Age, nor Physical
Limitations

**YOUR OPPORTUNITY
To Lift Yourself from a
Futureless Job**



Approved
G. I. Training

LEARN WATCHMAKING

and earn from the start, higher than average pay . . . easy hours . . . ideal working conditions . . . be prepared to establish your own business.

WATCH REPAIRING — JEWELRY — ENGRAVING
Always in Demand

Requests for our Graduates from Everywhere. Permanent positions (no layoffs) \$75.00—\$100 per week for trained men. Write today for latest FREE Catalog.

KANSAS CITY SCHOOL OF WATCHMAKING

America's Most Progressive Horological School
617-621 Wyandotte St. Kansas City 6, Mo.

THE GREATEST THING

IN PLASTICS!

PLASTICAST



PLASTICAST is a liquid plastic; can be poured into ANY kind of mold or container. Hardens in a few minutes into a transparent solid, clear-as-glass, tough-as-steel plastic. No tools or machinery required. As easy to use as pouring water out of a glass! Ideal for imbedding flowers, butterflies, photos, souvenirs, and for making beautifully brilliant jewelry, gems, displays, fishing lures, magnifiers, lenses, knick-knacks and novelties. Easily cast into sheets, rods or blocks, ANY shape, ANY color. **EVERYTHING FURNISHED**, including molds for making **PENDANT HEARTS, ENCHANTED GARDENS, MAGNIFYING GLASSES**, etc., sufficient materials for making about \$100.00 worth of attractive novelties! The ONLY outfit on the market containing molds! C.O.D. orders accepted with \$1.00 deposit.

COMPLETE MASTER OUTFIT \$3.50
Postpaid U.S.A. and Canada only

FREE

A very attractive and useful novelty made of one of our products given absolutely free with every one of our catalogs! Catalog lists many new materials for making **MOLDS and CASTINGS** with Liquid Plastics, Liquid Ivory, Liquid Marble, Wax, Latex, Metal, Cast-wood, Plaster, etc.; also many molds listed. Price of catalog only 10c coin or stamps.

PLASTICAST CO. (Dept. C)

5961 Madison St. Chicago 44, Illinois We have no retail store—order by mail only. P. O. Box 987 Palo Alto, Calif.

EMERGENCY SUPPLY TANK



Fill at any gas station. 150 lbs. airs 5 flat tires. Inflates rubber boats. Use for touch-up spray jobs, tire service truck, air horns, dust out motors, machinery, etc. Shatterproof 12"x24" stainless steel tank with carry handle, check valve, two foot hose and tire filling chuck. Only \$795

Tank only 12"x24", tapped each end 1/4 pipe thread. 500 lb. pressure. Build your own. Ideal for paint spray, air receivers, net floats, buoys, etc. Each \$475
Small size tank, 6"x24". Only \$298

PRICES FOB, K. C. WRITE FOR NEW CATALOG.

MIDWEST SURPLUS SALES CO.

2531 INDIANA KANSAS CITY, MO.

- ★ WRIST WATCH
- ★ STOP WATCH
- ★ TELEMETER
- ★ TACHOMETER

Phenomenal Value!
17 JEWEL • 2 PUSH BUTTON
CHRONOGRAPH

ONLY \$29⁷⁵ PLUS 10% TAX

INCABLOC SHOCK RESISTANT FEATURE
• Sweep Second Hand
• Radium Dial • Anti-Magnetic • Unbreakable Crystal. (formerly \$71.50)
IDEAL FOR
• Physicians • Engineers
• Radio Men • Sportsmen
• Photographers • Aviators

OUR GUARANTEE

MONEY BACK IN 10 DAYS

If not satisfied for any reason

ADLEW JEWELERS
Dept. PM 5

117 W. 42nd St., N. Y. C. 18

Mail Orders Promptly Filled • Shipped C.O.D. or send check or money order.

Address mail-orders to:
ADLEW JEWELERS (Dept. PM-5)
152 West 42nd St., N.Y.C. 18

Also available in 18-k Gold Case. \$64.50 (plus 10% tax), formerly \$125.

Learn NEON IN 10 WEEKS

You can earn high wages in this young, fast-growing industry. Absolutely no previous knowledge is necessary.

Learn from experts the techniques of neon glass blowing, color gassing, etc.

This course is complete and concentrated. You will receive actual shop training here in everything you need to know on the job. Exceptional job opportunity for YOU in this field NOW. Every effort made to place graduates nationally.

Approved for veterans under G. I. Bill. Licensed by the State of N. Y. Write now for Booklet P.

NEON SCHOOL OF NEW YORK

3534 Broadway

New York 31, N. Y.

LEARN CARPENTRY AND MASONRY

Write for FREE Catalog

Train in Big Shops. G.I. Approved

MIDWEST SCHOOL OF BUILDING TRADES, Dept. A-16

411 N. Center St.

Bloomington, Ill.

RADIO ENGINEERING, Broadcasting, Television, FM, Servicing, Electronics, Aviation, Marine & Police Radio taught thoroughly. Engineering course equivalent to 3 years' college radio work. Approved Veteran Training. Catalog free.
VALPARAISO TECHNICAL INSTITUTE, Dept. D, Valparaiso, Ind.

LEARN AND EARN AT HOME

Learn **SCREEN PROCESS**, the modern machineless method of printing. Uncrowded, profitable field where trained men are always in demand. 2 BIG KITS OF SUPPLIES we send start many of our students making money even before finishing home study course. Write today for FREE BOOK giving full details. APPROVED FOR VETERANS.

CALIFORNIA SCHOOL OF SCREEN PROCESS

3740 Overland Avenue, Dept. M-68

Los Angeles 34

ARTISTS MAKE MONEY

Do you like to draw? Send name, address, age and occupation for FREE ART TEST, to find out your ability.

ART INSTRUCTION, Inc.

6138 ART INSTRUCTION BLDG., MINNEAPOLIS 15, MINN.

Become a Doctor of PSYCHOLOGY

Win the degree of Ps.D. Teach the secret of contentment, happiness. Solve mental worries. Experience the revelation of truth. Chartered college. Individual help. Write for FREE book. **COLLEGE OF UNIVERSAL TRUTH, 5153-B North Clark St., Chicago.**

How to Become a Good Person
Free Book tells all
Write for your copy now
The American School of Postmanship P-441
Ridge Building, Kansas City, Mo., U.S.A.

BUY A STONE
MARK LOVED ONES GRAVES
Special prices. Freight paid. Erected. Write for our BIG FREE Book.
U. S. MARBLE & GRANITE CO., ONECO, 19, FLORIDA

AN ASTONISHING MEMORY
Wonderful new memorizing tricks. Pass examinations, give shows, make stunning public speeches, remember anything. Your success in life depends on your memory. . . . only \$1
LYTTON BOOKS, Dept. 1, 1216 Park Row Bldg., New York 7, N. Y.

NYLON FISH LINE \$1.98
Approximately 1500 Feet
2 ply (25 pound test) — rubberized — waterproof — long life. Send remittance — postage prepaid.
ALLENDER & CO., Dept. 809
2346 So. Dearborn St. Chicago 16, Ill.

SIGNS EASILY AND EXPERTLY PAINTED WITH LETTER PATTERNS
AND SHOWCARDS MANY SIZES & STYLES WRITE FOR FOLDER!
JOHN F. RAHN
1330-31 N. Central Ave. CHICAGO 51, ILL.

HELPFUL BOOKS
Send post card asking for FREE catalog
Popular Mechanics Press, 200 E. Ontario, Dept. 601, Chicago 11

LEARN **DIESEL** THE QUICK, EASY WAY



THE FAMOUS HEMPHILL WAY!

Wherever Diesels are used, the name "HEMPHILL" is famous. It stands for TRAINED MEN—men who *know* Diesel. Many trained Diesel graduates of Hemphill Schools are successfully engaged in work where their Diesel training is "paying off." Perhaps they are assembling Caterpillar Tractors, or servicing Cummins-powered trucks, or installing and maintaining General Motors' Diesels. Perhaps they are working with these and other makes of Diesel engines in trains, ships, drilling rigs, sawmills or construction equipment—but no matter what the Diesel job, Hemphill trained men

have the "know how" to handle it.

Prepare YOURSELF for the great industrial swing to Diesel power which is now here. Get complete details of Hemphill Diesel training now!

STUDY AT HOME—Learn Diesel AT HOME in your spare time, without interfering with your present activities. Prepare for a bigger future this quick, easy way. Mail the coupon below for complete details and free literature. Or attend 34 weeks resident classes at schools listed below.

APPROVED FOR VETERANS

AUTOMOTIVE TUNE-UP SPECIALIST TRAINING at Memphis and Los Angeles. Check coupon.

NEW YORK 31-28 Queens Blvd. Long Island 1, N. Y.	LOS ANGELES 1601 S. Western Ave. Los Angeles 6, Calif.	MEMPHIS 311 S. Main St. Memphis 3, Tenn.
---	---	---

34 weeks practical training. If you would prefer to train at one of these three schools, indicate by check on coupon.

HEMPHILL DIESEL AND AUTOMOTIVE SCHOOLS

Administrative Office: 1601 South Western Ave., Dept. PM-68
Los Angeles 6, California

Gentlemen: Please send me FREE BOOKLET and information on your Diesel Course. I am interested in Home Study Resident School at New York Memphis Los Angeles (Check school desired.) Auto Tune-up L.A. Memphis

Name _____ Age _____
Street _____ Zone _____
City _____ State _____
Veteran _____ Non-Veteran _____

MAIL COUPON NOW!

SEE PAGE 44 THIS ISSUE

For U. S. War Surplus Gas Masks. Special price to industrial users. Packed 20 masks and carrying bags to a case . . . \$5.00 per case. F.O.B. Chicago. For paint spraying, insecticides, granaries, and protection while working on machinery.

BOB SALES CO., INC.

1608 S. Wabash Chicago, Ill.

ACCOUNTING

STUDY AT HOME for C.P.A. and BIG PAY Accounting opportunities with 44 year old school. No previous training needed. Texts furnished. EASY PAYMENTS. Send for FREE BOOK. G. I. Approved.

MacCORMAC EXTENSION SCHOOL
Dept. M 1170 E. 63rd St. Chicago 37, Ill.



MAKE UP TO \$5⁰⁰ AN HOUR In Your Own YEAR ROUND Business!

ONLY A FEW DOLLARS PUTS YOU IN BUSINESS!

Many Clearing as High as \$20 to \$30 a Day NET Renewing Rugs, Carpets, Upholstery. New Method Now Used for Auto Upholstery. Write for Facts About Quick, Easy Way to Get Started

Here is the chance you've been looking for to step into a pleasant, dignified, big-pay business of your own that offers you a steady, year 'round income. Start on "a shoestring," full or spare time, right from your own home. Equal opportunities for men and women, young or old, in small towns or big cities. No experience needed. Many making big money with new Americlean System just cleaning auto upholstery. Easy to learn. We send you complete instructions and quick-cleaning supplies so you can start making money the very first day! Quick method cleans upholstery, rugs and carpets like new without taking off floor! Tremendous demand in homes, apartments, hotels, stores, office and public buildings. Steady repeat business. Territories going fast. Write today for full FREE facts. No cost or obligation. Rush letter or postcard now to AMERICLEAN CO., Inc.; Dept. G-18; 211 North 7 St.; St. Louis 1, Mo.

WRITE FOR FREE DETAILS NOW!

YOU CAN

MAKE \$50 A DAY!

Be INDEPENDENT in your own business



with our
**15
TRADE
SECRETS**

START your own business in your spare time with our 15 private manufacturing processes—like THERMO-SOL Fireproofing Material.

In your own home—garage, basement, kitchen, fill the demand for this amazing fire-proofer—it leaves materials soft and flexible—and 14 other wanted products.

We tell you ALL! How to MAKE. Where to BUY simple inexpensive materials. How to Package, Promote, SELL. If you can follow simple directions, here are 15 roads to success. We give you full details on all 15 processes!

The public NEEDS these 15 products. You, yes you, can make them. And you can have OTHERS SELL THEM for you, too.

Lose no time! Write for details!

CHEMICAL RESEARCH CO.

214 West 42nd St. New York 18, N. Y.

SAY YOU SAW IT IN POPULAR MECHANICS

Govt. Surplus TRUCK Parts and Equipment

For military type trucks and cars. We have available for immediate delivery genuine parts for all makes and models, 4x2 - 4x4 - 6x4 - 6x6. All models from 1/4 ton to 20 ton. All makes: Autocar, Biederman, Brockway, Chevrolet, Diamond T, Dodge, Federal, Ford, GMC, International, Mack, Oshkosh, Reo, Studebaker, White, Willys, and Jeeps.



30 DAY SPECIALS

The exceptionally low prices on the parts listed below will be in effect for this month for the benefit of our old customers and to acquaint new customers with our service.

MUFFLER

New heavy duty Truck Muffler. An exceptional value. Can be used on any truck with 2 1/2 inch inlet pipe. Specifications — Overall length 28 inches, Diameter 10 inches, Inlet connection 2 1/2 inches, tail pipe connection 2 inches. List \$12.00. Our price, each **\$1.95**

PISTON RING SETS

These ring sets are well known brands. Ring Set for Dodge: all models with 3 1/4 bore .020, .030, .040 over-sizes, state model. Set **\$1.95**

HEADLAMP ASSEMBLY

Complete assembly with bulbs and parking light for GMC and Chevrolet Trucks (except Cab over engine models), 1941-1946. List price, per pair, \$26.00. Our price, per pair **\$8.00**

TRAILER AXLE

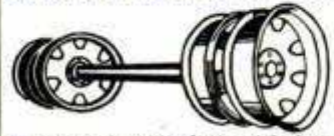

Heavy duty trailer axle suitable for many types of trailer construction. Also excellent for building of heavy farm trailers and wagons. It is a 15,000 lb. capacity square type straight trailer axle complete with bearings, hubs and 6 hole 750 x 20 Budd Wheels. Without brakes. Axle is 2 1/2 inches square and 70 inches between wheel mounting flanges. Std. width. An Excellent Buy.

With Single Wheels. \$49.50 With Dual Wheels. \$59.50
WRITE FOR CATALOG. STATE MAKE CAR OR TRUCK.
F.O.B. K. C., Mo. 25% Deposit Required on COD Orders.

AMERICAN AUTO PARTS CO., Inc.

1830 LOCUST KANSAS CITY, MO.

HOT WATER

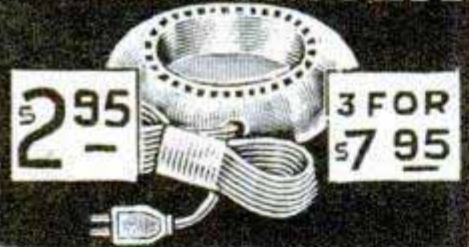

**SHAVE
•
BATH
•
WASH**

2.95 **3 FOR \$7.95**

Don't use chilling cold water when instant hot water makes shaving, bathing, washing easier and pleasanter. Just plug into electric 110 AC or DC and you have your instant hot water when and where you want it on our 10-day guarantee. Send no money — just your name and address on postcard. We ship C.O.D. plus few pennies postage. Or we ship postpaid your order if cash accompanies.

MIDWEST MERCHANDISE MART

Dept. 41-11 ELKHORN, WIS.

THIS IS THE BUSINESS YOU DREAM ABOUT

QUICK STEADY PROFITS

CORADIO

The Coin Operated Radio

IT'S the new, fast-growing, depression-proof business. Coin operated radios are

placed in hotels, tourist courts, clubs, hospitals, etc. on a commission basis—play 1 or 2 hours for 25c and produce immediate profits. The best coin operated radio is CORADIO

ACT NOW

Start your own lifetime business, full or part time.

Send For Free Catalogue And Complete Information.

WRITE TODAY Dept. P. M.



CORADIO

COIN OPERATED RADIO
108 W. 31st ST. N.Y. 1, N.Y. WISCONSIN 7-5902

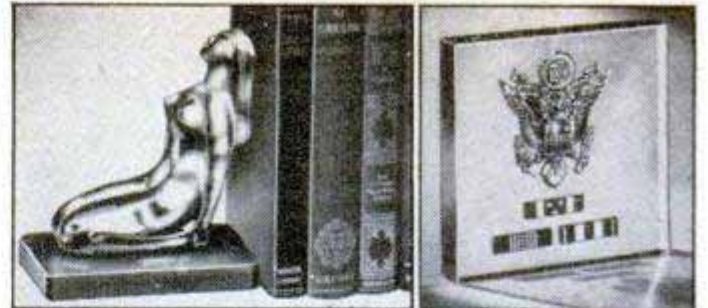

NEW LIQUID PLASTIC

Makes Fine Gifts, Novelties, Things to Sell

Have fun, make extra money, with CASTOLITE, crystal clear liquid plastic. Pours without heat, sets at low temperatures. Make book-ends, wall plaques, jewelry, tiles, figurines, coasters. Embued real flowers, butterflies, coins, medals. Preserve treasured photos. CASTOLITE can be sawed, carved, turned, drilled. Can be mixed with CASTOLITE DIES for brilliant color effects. It's easy to do.

You can have the thrill of making things the very first day. No tools are needed.

20-PROJECT CASTO-KIT \$3.50

(W. Coast, Can., Mex., \$3.75)
CASTO-KIT contains materials and instructions for making useful objects at once. Send check or M.O. for postpaid Kit today, or order C.O.D. For Manual alone, 25c. DEALERS—write for details.

THE CASTOLITE CO., Dept. G-1 Box 211, Kenilworth, Ill.

Learn about Earning Opportunities in THE BUILDING TRADES

FREE—Important Information Telling How to Get Started. Do you want to be on the inside in the building boom — where big money is made? This is your chance now. HOME TRAINING prepares you for these big opportunities. Course recognized by Building Industry. (Approved for Veterans.) Write today — no obligation.



COMMERCIAL TRADES INSTITUTE, Dept. D2-6, 1400 W. Greenleaf, Chicago 26, Ill.

MAKE BIG MONEY



Your own business. Start a route of "Hi-Ho JR." TRAY VENDOR

Small investment. Vends almonds, candy, nuts. Write today.

LEON "HI-HO" SILVER, INC.

760 HAYES ST.

SAN FRANCISCO, CAL.

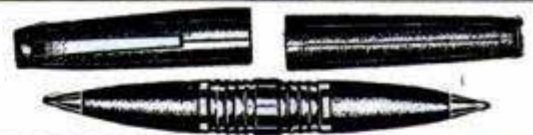

TU-COLOR-BALL PEN • Writes Red . . . Writes Blue Refills—39¢ each. Leak Proof. Rugged construction . . . Add 25c for postage and handling.

KERBY JEWELERS, 42 S. 7th ST., PHILA. 6, PA.



A and N SUPPLY CO.

Thousands of Bargains in Military, Outdoor & Sport Goods for Hunter, Farmer, Scout. Send 10c for NEW 32-page catalog, just issued, returned with first order.

A and N SUPPLY CO.
4720 Lester St. Richmond 15, Va.



Balance 4" x 9" Base. With either Metric or Avoirdupois Weights .. \$7.00

Catalog with 3000 Illustrations of laboratory apparatus, and over 10,000 prices sent for \$1.00.

LABORATORY MATERIALS CO.
7321 Vincennes Ave. Chicago 21, Ill.

In General-Purpose 4-Ohm Intermittent Tests THE "EVEREADY" NO. 950 FLASHLIGHT BATTERY OUTLASTS ALL OTHER BRANDS!

TENTS

Small and large, new and used. Army surplus. Also canvas covers, hammocks, canvas cots, clothing, paints. Lowest prices. Free circular.

MORSAN SALES

10-15G 50th AVE., LONG ISLAND CITY 1, N. Y.

Paint Your Car for ONLY \$3.95

ONE QUART DOES ENTIRE JOB
2 FULL COATS

WITH **WYPE** TRADE MARK REG.

NO SPRAYING · NO MASKING · NO BRUSHING

AMAZING NEW BRUSHLESS AUTO ENAMEL
You JUST WIPE ON
with a POWDER PUFF
instead of Brushing or Spraying



ANYONE CAN DO BEAUTIFUL JOB

Get Beautiful Mirror Like Finish That Looks Like Spray Job!

Dries Dust Free One Hour · No Streaks or Lapmarks

At last! Practically anyone can now paint his car with WYPE! No previous car-painting experience necessary. You get a beautiful high-gloss job that gives you an expensive finish such as is sprayed on by Professional Auto Painters—at a fraction of regular cost! With WYPE you need **NO BRUSH, NO SPRAY, NO MASKING!** Just **WIPE ON** with Powder Puff—which we furnish at no extra charge. You get a brilliant, glossy finish that is truly "factory-like." No streaks. No lap-marks. Guaranteed for **TWO** years not to crack, peel, chip or fade, if simple directions are followed. Takes about an hour to apply. Dries dust-free in an hour. WYPE comes in nine most popular shades including those on newest model cars. Goes over any other color, lacquer or enamel.

MOST POPULAR COLORS

- Black Brewster (dark) Green
- Maroon Jewel (light) Green
- Red Washington (dark) Blue
- Gray Monticello (light) Blue
- Sun Beige (light) Tan

\$3.95 Per Quart

SEE YOUR DEALER or ORDER DIRECT SEND NO MONEY · Get WYPE Today!

If your dealer can't supply you, just send us a postcard. We'll ship C.O.D. Just pay mailman for Wype, plus postal charges. Or send remittance with order and WE pay postage.

You're SURE You Are SAFE when You Paint with WYPE HERE'S WHY!

TESTED BY U. S. Testing Co., Inc.

Leading Scientific Testing Laboratory

Report No. 87496 Jan. 5, 1948 and found to conform to the claims and guarantee of the Wype Corporation.

No higher or more rigid standards are set by any Testing Laboratory. United States Testing Company conducts scientific tests for the world's foremost organizations and is accepted as a leading authority on such tests.

For Your Protection Before you buy any automobile paint, ask for proof that it has passed tests by a nationally known testing laboratory. Remember the value of your car! You can TRUST Wype.

2-YEAR GUARANTEE We Guarantee WYPE against cracking, peeling, fading or chipping for two years after application, if applied according to directions furnished. Your money cheerfully refunded if WYPE does not live up to this Guarantee.

COPYRIGHT 1948, WYPE CORP



APPLY in ONE HOUR — DRIES to GLISTENING PROFESSIONAL FINISH

WYPE is a new Miracle Enamel for Autos. It is NOT a wax or polish but a hard high lustre ENAMEL finish! With WYPE, ANYONE can do a beautiful job! Order a quart to paint your car or to get started in this BIG-MONEY Business!

NO STREAKS OR LAPMARKS LOOKS LIKE SPRAY JOB

OVER 125,000 CARS PAINTED WITH WYPE

by the end of last season, and thousands more being painted every week. The final test of customer satisfaction—thousands of our new customers are being sent to us by old customers!

Used WYPE—Sold Car For \$200.00 More

"Congratulations to Wype for production of the marvelous new paint, Wype. Wype has been definitely satisfactory. Needless to say, my husband was astonished, but, oh, so pleased. We realized about \$200.00 more profit on our car when we sold it. Any lady, who can apply her own make-up, can certainly paint her own car!" — Mrs. Noma M. Burnette, Parris Island, S. C.

Some of the FAMOUS DEPARTMENT STORES that Sell WYPE

VISIT or PHONE THE STORE IN YOUR CITY...

If you live in one of the cities shown here, it will be more convenient to buy from your favorite department store. Ask your dealer! Leading merchants everywhere sell WYPE.

- Akron: M. O'Neil Co.
- Baltimore: May Co.
- Boston: Jordan Marsh Co.
- Buffalo, N. Y.: J. N. Adam & Co.
- Chicago: Goldblatt's 15 Dept. Stores (Goldblatt's, also, at Joliet, Ill.; Hammond, Gary & South Bend, Ind.)
- Cincinnati: Fair Store Co.
- Cleveland: May Co.
- Dallas: Sanger Bros. Inc.
- Denver: May Co.
- Detroit: People's Outfitting Co.
- Ft. Worth: W. C. Stripling Co.
- Grand Rapids, Mich.: Herpolzheimer Co.
- Hackensack, N. J.: Packard-Bamberger Co.
- Houston: Foley's
- Indianapolis: Wm. H. Block Co.
- Kansas City, Mo.: Jones Store Co.
- Los Angeles: May Co.
- Louisville: Kaufman-Straus Co.
- Memphis: B. Lowenstein & Bros.
- Milwaukee: Ed. Schuster & Co., Inc.
- Minneapolis: Donaldson's
- Montgomery: Montgomery Fair Store
- New Orleans: Maison Blanche Co.
- Newark, N. J.: Bamberger's
- New York: Gimbel's
- Philadelphia: Lit Brothers
- Pittsburgh: Kaufmann's
- Providence, R. I.: The Shepard Co.
- Richmond, Va.: Miller & Rhoads, Inc.
- Rochester, N. Y.: Sibley, Lindsay & Curr
- St. Louis: Famous-Barr Co.
- St. Paul, Minn.: The Golden Rule
- San Antonio: Joske's of Texas
- San Diego: Whitney's
- Syracuse, N. Y.: Dey Bros. & Co.
- Toledo: Lion Dry Goods Co.
- Washington, D. C.: Lansburgh & Bro.
- Youngtown, O.: Strouse-Hirschberg Co.

WYPE CORP. Dept. 16-F 2214 DOLMAN ST. ST. LOUIS 4, MO.

Yours FREE

VALUABLE BOOK OF

150 ELECTRICAL SHOP PRINTS AND WIRING DIAGRAMS



THE COUPON BELOW BRINGS YOU THIS BOOK FREE . . . YOU PAY NOTHING BUY NOTHING!

FULL SIZE DIAGRAMS — COMPLETE EXPLANATIONS

This big, useful book contains 150 NEW ELECTRICAL SHOP PRINTS AND WIRING DIAGRAMS—and it's yours absolutely free for the asking. Contains full 8 1/2"x11" black on white SHOP PRINTS and DIAGRAMS fully explained in an easy-to-read, easy-to-understand way.

A TIME-SAVING, LABOR-SAVING HELP ON THE JOB

Diagrams cover Wiring Circuits, Motors, Starters, Generators, Transformers, Radio Circuits, Frequency Modulation and many others. Many electricians and radio men have paid 10c to 25c apiece for prints like these. Here are 150 bound into one handy volume—and it's FREE. You'll want to keep it in your work kit to save valuable time on the job.

Here's Why We Make This Amazing Offer

We want you to get acquainted with Coyne—we'd like to know you. We feel you should know about Coyne's practical books—backed by 49 years shop training experience—and how they may help you improve your skill, increase your earnings. Therefore, you will also receive free, full information on Coyne's practical "get ahead" books for electricians and radiomen. Remember, you buy nothing—you return nothing. So send the coupon now. You simply accept this FREE BOOK to see for yourself the kind of practical books Coyne publishes.

Practical Books Backed by Coyne School's 49 Years of Shop Training Experience

SEND FOR YOUR FREE BOOK

TODAY Don't miss out on this liberal FREE BOOK OFFER. Present stock of Shop Prints Books is limited so act today. Fill out and mail the coupon below RIGHT NOW before the supply is exhausted.

EDUCATIONAL BOOK PUBLISHING DIVISION

COYNE ELECTRICAL AND RADIO SCHOOL
500 S. Paulina Street, Dept. A8-R6,
Chicago 12, Illinois



CLIP COUPON AND MAIL—TODAY!

Educational Book Publishing Division
COYNE ELECTRICAL AND RADIO SCHOOL, Dept. A8R6
500 S. Pauline Street, Chicago 12, Illinois

Please rush me my FREE COPY of Coyne's bound volume of 150 NEW Electrical SHOP PRINTS and WIRING DIAGRAMS. I am under no obligation to pay anything . . . buy anything. No salesman will call.

NAME _____ AGE _____

ADDRESS _____

CITY _____ ZONE _____ STATE _____

OCCUPATION _____

Say You Saw It in Popular Mechanics

Earn BIG PAY Now!
thousands of ambitious men helped

FREE EMPLOYMENT SERVICE
LEARN THESE TRADES IN THE BIG ALLIED SHOPS

- Choose one of these 6 LEADING TRADES
- Machinist Trade
- Tool & Die Making
- Tool, Die & Machine Designing
- Drafting (all branches)
- Tool Engineering
- Industrial Product Design & Illustration

APPROVED FOR VETERANS
WRITE TODAY: A 1c Postcard will do.

ALLIED SCHOOL OF MECHANICAL TRADES
1338-1340-1342 So. Michigan Ave. — Est. 1928
426 Allied Bldg. CHICAGO 5, ILL.

BIG SHOP TRAINING
Largest School of its Kind in the World
FREE! BIG METAL TRADES ILLUSTRATED BOOK

REFRIGERATION

AIR CONDITIONING—Trained men paid well to service, install, maintain, repair, rebuild household and commercial refrigerators. Opportunity for full time, spare time earnings. Train at home or in our big shops. Approved for Veterans. (Non-Veterans inquire about our Low Payment Plan and Pay After Graduation Plan.) Send for FREE BOOK-LET AND FULL INFORMATION. No obligation.

COMMERCIAL TRADES INSTITUTE, Dept. A2-6
1400 W. Greenleaf Chicago 26, Illinois

make MONEY CASTING AT HOME



Make your own rubber molds quickly, cheaply with X.L. RUBBER. Cast thousands of perfect figurines, book ends, plaques, ornaments, ash trays, etc. **GREAT PROFITS!**

GET FREE FACTS TODAY.
X.L. Rubber, Pts. \$2.00; Qts. \$3.50; Gallons \$8.95; Models and enough rubber for 3 molds \$1.00 — Foreign \$1.50.

FACTS SENT FREE

PLASTIC ARTS STUDIO Route 2 • Dept. 2 • Muncie Ind.

FLOYD CLYMER'S unbiased book
"INDEPENDENT TEST REPORT ON KAISER-FRAZER CARS"



Read what 3000 owners now think of their K-F cars. Expert, part-by-part analysis. 100 photos. Tells all. 3000-mile test run, Pike's Peak closed car record, gas mileage. Thousands are buying. Order now. \$1.50 postpaid. \$2.50 deluxe ed. Cash, money-order, or specify C.O.D. Moneyback guarantee. Clymer, Publisher, Dept. PM6, 1268 S. Alvarado St., Los Angeles 6, Calif.

RAISE PROFITABLE CHIN-CHINS



No experience needed. A few minutes daily, a few feet of backyard space. Several females and a male starts a large, money making herd. WE FURNISH ALL INSTRUCTIONS.

Free booklet explains tremendous demand for live youngsters, delicious meat, gorgeous fur. Write today.

WILLOW BROOK FARM, R-36. SELLERSVILLE, PENNA.

COMMERCIAL ART
APPLIED ART ACADEMY 248 Carroll Street, Akron 4, Ohio.
18 Month Diploma Courses. 12 Modern Fully equipped studios. Located in the Rubber Center of the World. Approved by the Ohio State Department of Education for Veteran and Civilian Training. New Classes beginning every month. Inquire Immediately. Telephone HE-7661.

RUPTURED?
HERE'S COMFORTABLE, SAFE RELIEF!



Made of molded rubber, soft and pliable, this form-fitting truss is bringing new comfort, with safe protection, to thousands. Based on nature's way, WEB TRUSS gives strong support without painful pressure. Has no springs or leather, is completely washable. Under money-back guarantee of satisfaction, you run no risk. Write today for FREE illustrated literature.

WEB TRUSS CO. Dept. M-8 Hagerstown, Md.

AVIATION CABLE

Flexible 133 strand wire cable, 5/32 in. diam., 3300 lb. break test. Lengths up to 450 ft. Use for tow rope, guy wire, clothes line, etc. Wgt. per 100 ft. 4 lbs. Specify length wanted. No. 421—Per Ft. **4c**

Ind. Goggles
Large, shatterproof, clear lenses, plastic frame with side guards. Brand new! Protect your eyes from flying chips, dust, dirt, etc. Wgt. 1 lb. No. 422—Each **98c**

MESS KITS
Regulation two-piece Army Mess Kits with folding handle. Used, but perfect. Weight 2 lbs. No. A116—Each **69c**

CANTEENS
Reg. U. S. issue canteens. Plastic screw top chained to body. Slightly used but perfect. Wgt. 1 lb. A117—Metal **69c**
A118—Plastic—Each **69c**

CANTEEN CUPS
All metal. Folding handle. Wgt. 1 lb. No. A120—Each **25c**
CANTEEN COVERS
Heavy canvas. Button fastener. New No. 530—Each **69c**
Used, No. 119—Each **35c**

WIRE CUTTER
Heavy duty, compound leverage. Cuts up to 1/4 inch wire. Upper jaw acts as feeder to cutting edges. Insulated handles. Ideal for farm fence work and shop use. Shp. wgt. 2 lbs. Stock No. 392—Each **\$1.95**

Heavy Duty RUBBER GLOVES
BRAND NEW
Extra heavy—extra long. Brand new, high quality gum rubber for softness and ease in use. Designed for heavy duty industrial service—protection in handling chemicals, acids, etc. A real bargain at this low price. Stock No. 295—Per Pair, Only **79c**

AMMUNITION BOX
Used for 50mm ammunition. Heavy, all metal design with latching top and folding handle. Provides safe, fireproof storage for valuables, etc. Measures 12x 6x7 1/2 inches. Used but in new condition. Shp. Wgt. 8 lbs. No. 338—Each **79c**

ARMY AIR CORPS TYPE SUN GLASSES
Ideal for driving, sun glare, sports and work. 24 carat gold plate frames with Pyralin sweat bar—adjustable nose bands. Large aviation type lenses. Case included. Shp. wgt. 1 lb. No. 238—Per Pair **\$2.95**

PLASTIC BOX
Clear transparent plastic, 4 1/4 x 7 1/2 x 1 1/2 in., with 17 compartments, hinged lid. Use for fishing tackle, jewelry, small parts, etc. Shp. wgt. 1 lb. No. 260—Each **98c**

Waterproofing Compound
Gov't. surplus! A clear, liquid formula for tents, tarpaulins, canvas clothing, etc. Use on old or new materials. Gallon covers 100 to 120 sq. ft. Stays flexible—will not peel or chip. Shp. wgt. 10 lbs. No. 423—Per Gallon **\$1.49**

WAR SURPLUS AND HUNDREDS OF OTHER BARGAINS

POPULAR RECORD ASSORTMENT
Fifty records of modern dance, race, blues and hillbilly selections. No two alike. Famous name bands and artists included. Used in juke boxes, but guar. perfect. Shipped exp. collect only—no exchanges or refunds. Wgt. 28 lbs. No. A303—50 records **\$9.64**

No. A300—25 Records. All Dance. Wgt. 14 lbs. \$4.88	No. A301—25 Records. Hillbilly, Race and Blues. Wgt. 14 lbs. Set \$4.88	No. 302—25 Records. All Hillbilly numbers. Wgt. 14 lbs. Set \$4.88
--	--	---

STIRRUP PUMP
Works with any pail or bucket. Shoots a high pressure stream up to 30 feet. Use it for spraying garden and trees, for whitewashing, fire fighting, drainage, etc. Complete with 10 feet flexible hose. All brand new. Regular \$3.80 value. No. 244—Each **\$1.49**

15 JEWEL STOP WATCH
U. S. AIR CORPS SURPLUS
Genuine Elgin 15 Jewel movement. Ideal for split second timing in racing, sports, time study, etc. Full sweep split second hand graduated in 1/10th seconds. Stem wind, start, stop and reset. Used but guaranteed perfect. Wgt. 1 oz. No. 200—Each **\$9.95**

VEEDER ROOT COUNTING MACHINE
Five wheel type—counts to 99,999 and repeat. Nickel finish case. Has 1/8 inch round shank. Use it for any counting job. Brand new. Shp. wgt. 1 lb. No. 241—Each **98c**

ARMY TENTS
16x16 Ft.
A value you can't beat. Big 16x16 ft. pyramid tent with 4 foot drop wall. Used but in excellent condition. Poles not included. Fine for camping out, carnivals, etc. Wgt. 100 lbs. Stock No. 521—Each only **\$35.00**
Center and corner poles. Express collect. No. 500—Only **\$3.00**

27 LENSES, ALL NEW, PERFECT.
For experimental work in optics. Consists of 27 precision ground and polished prisms and lens elements in assorted diameters and focal lengths. Big variety, positive, negatives, etc. Actual value over \$100.00. A519—27 PIECES **\$7.95**

McCLELLAN SADDLE
Brand new! Top grade cowhide, 12 inch seat. Hair girth. Has straps for blanket roll and sabre loops. Shipping weight 15 lbs. Stock No. A145. Each **\$16.95**

BAYONET BLADE
Fine forged steel. Ground but not polished. May be made into throwing or hunting knife or spear. Blade 6 3/4 x 7 1/2 inches, 1 1/4 inches overall. Will take and hold a fine edge. Shp. wt. 1 lb. No. 664-R—Each **49c**

RUBBER OVERBOARD SUIT
Here is a buy! Fits over your regular clothes and shoes. Can be cut apart for waist high waders, hip high or knee high boots, also arm length rubber gloves. Heavy gum rubber over fabric. Fine for commercial fishermen, sewer diggers, etc. Use it as is or cut it up for waders. All brand new! Wgt. 14 lbs. No. 183, Each **\$4.95**
Please include 75c for postage.

7 LB. EXPERIMENTER PARTS ASSORT. KIT

A "gold mine" for the radio serviceman. Hundreds of valuable radio parts, new radar and electronic parts and sub-assemblies, coils, resistors, trimming condensers—worth many times this low price. A130R—7 lbs. **\$1.79**

SACHEL POUCH
Heavy canvas pouch. Ideal for toting lunches, shopping, books, etc. Has 11x12 inch pocket. Brand new, guaranteed perfect. Has over-size flap with single strap fastener. A113—Each **\$1.69**

Officers Watch Compass
Brand new gov't. surplus. Army-Navy model. Single jewel mounted needle. Silver colored dial. A splendid value. Shp. wgt. 1 lb. A174—Each **98c**

OXYGEN TANK
Loaded with aviator's breathing type oxygen at 1800 pounds pressure. Tank measures 13 1/2 x 3 1/2 inches with rounded ends. Tank is of solid metal fitted with brass release valve at top. Brand new! Loaded—ready for all types of emergency use. Shp. wgt. 13 pounds. Ship exp. only. Stock No. 390—Each **\$3.50**

AVIATOR'S OXYGEN
Bail out type. Consists of all metal tank, release valve, gauge and breather hose, all enclosed in khaki colored cloth bag. These tanks are loaded with oxygen at 1800 pressure. Ideal for use as reserve oxygen supply for all types of emergency use. Shipping weight 4 pounds. All brand new. Stock No. 391—Each **\$4.95**

HIGH PRESSURE SHATTERPROOF TANKS

TYPE D2 A high pressure shatterproof tank of 500 cubic inch capacity—for 50 pound pressure or 6.3 cubic feet. All metal—measures 6 1/2 x 2 1/2 inches. Threaded plug end vents. Shp. wgt. 6 lbs. No. 388—\$2.45 Each	TYPE F1 A high pressure shatterproof tank of 1000 cubic inch capacity—for 50 pound pressure or 13.8 cubic feet. All metal—measures 9 1/2 x 1 1/2 inches. Threaded plug end vents. Shp. wgt. 1 1/2 lbs. No. 389—\$3.75 Each
--	--

WILLARD 1 1/2 VOLT STORAGE BATTERY
A rechargeable, wet plate battery good for years of service. Brand new. Battery is shipped dry but fully charged any battery station will add acid. Use singly or in multiples for radio sets, bell circuits, alarm systems, etc. Measures 5 1/4 x 4 3/8 inches. Bail floats indicate condition of charge. Shp. wgt. 4 lbs. Stock No. 297—Each Only **\$2.95**

ORDER DIRECT FROM THIS AD
Values galore! Hundreds of hard-to-find items for home, shop and outdoors. Make remittances by money-order, bank draft or personal check. Send 25% deposit on C.O.D. orders. No C.O.D.'s on orders for less than \$5.00. Include sufficient postage on parcel-post orders—any overage will be promptly refunded. All quotations F.O.B. Chicago. Used items and materials are guaranteed serviceable and as described. Your money back if not more than satisfied.
SEND 10c TO COVER POSTAGE AND MAILING ON BIG CATALOG—READY IN ABOUT 60 DAYS
Stark's Dept. PM6
509 So. State St.
CHICAGO 5, ILL.

You're sure of a good reception
when you've got P.A.*

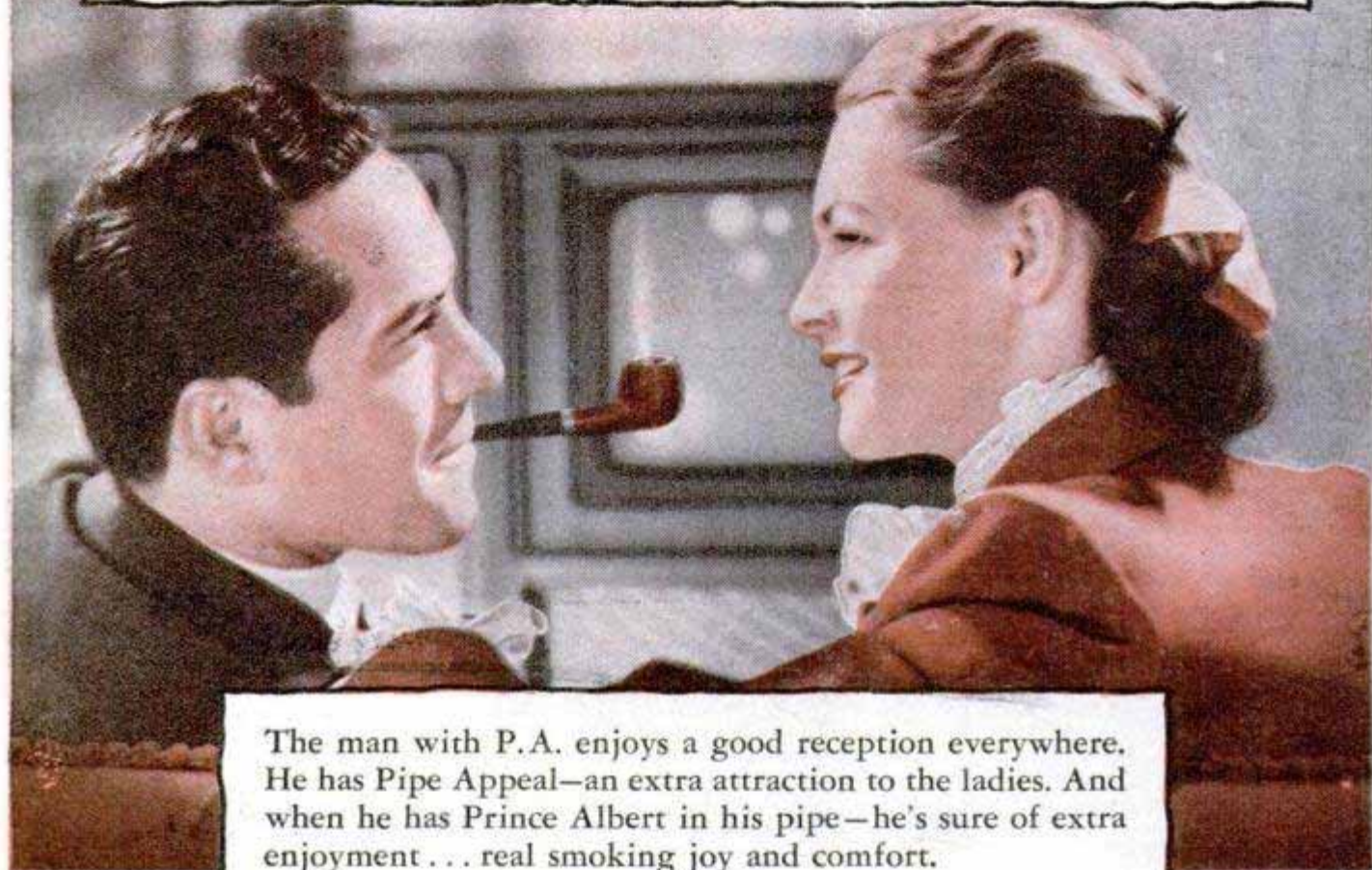

The man with P.A. enjoys a good reception everywhere. He has Pipe Appeal—an extra attraction to the ladies. And when he has Prince Albert in his pipe—he's sure of extra enjoyment . . . real smoking joy and comfort.

P.A.* means Pipe Appeal
P.A. means Prince Albert



● Prince Albert has been getting a great reception from pipe smokers all over the country for years and years. They like P.A. because it's so rich tasting . . . so mild and tongue-easy. That choice crimp cut tobacco is specially treated to insure against tongue bite. Try P.A.—and see for yourself why it's America's largest-selling smoking tobacco!

R. J. Reynolds Tobacco Company, Winston-Salem, N. C.

*"GIVE ME P.A. FOR CIGARETTE
MAKIN'S. IT'S CRIMP CUT...
ROLLS UP FAST AND EASY!"*



THE NATIONAL JOY SMOKE

PALOMAR

opens its
eye

POPULAR JUNE
MECHANICS 1948
NO. 6

WRITTEN SO YOU CAN UNDERSTAND IT
VOL. 89

NO. 6

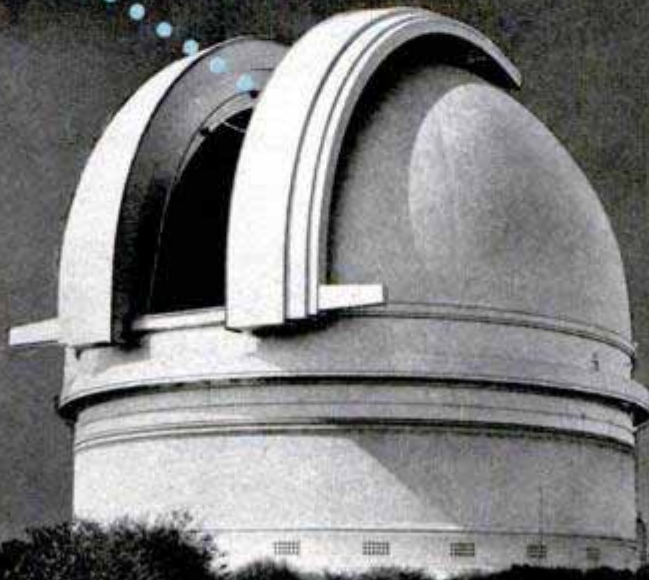

With shutters rolled open, the largest telescope ever made stands ready to give man a long look into space



THE 200-INCH Palomar telescope now is ready for man to peer a billion light years into space—twice as far as any astronomer has ever seen before.

Some evening early this month a scientist will climb to the small cage atop the giant eye and prepare the instrument for use. He'll pause for a glance into the open top of the pedestal, where the light from the big mirror narrows to a focus. It's a spectacular reflection of a small portion of the sky above him, extremely bright because of the power of the telescope.

His first task will be to bring the top of the pedestal, where the photo plate will be exposed, into sharp focus. Next, he'll move a microscope attached to the pedestal until

Light-beam telephones eventually may enable scientists at Palomar to talk with those at Mt. Wilson

MT. WILSON
ELEVATION 5704 FT.

PALOMAR
ELEVATION 5565 FT.

ABOUT 90 MILES

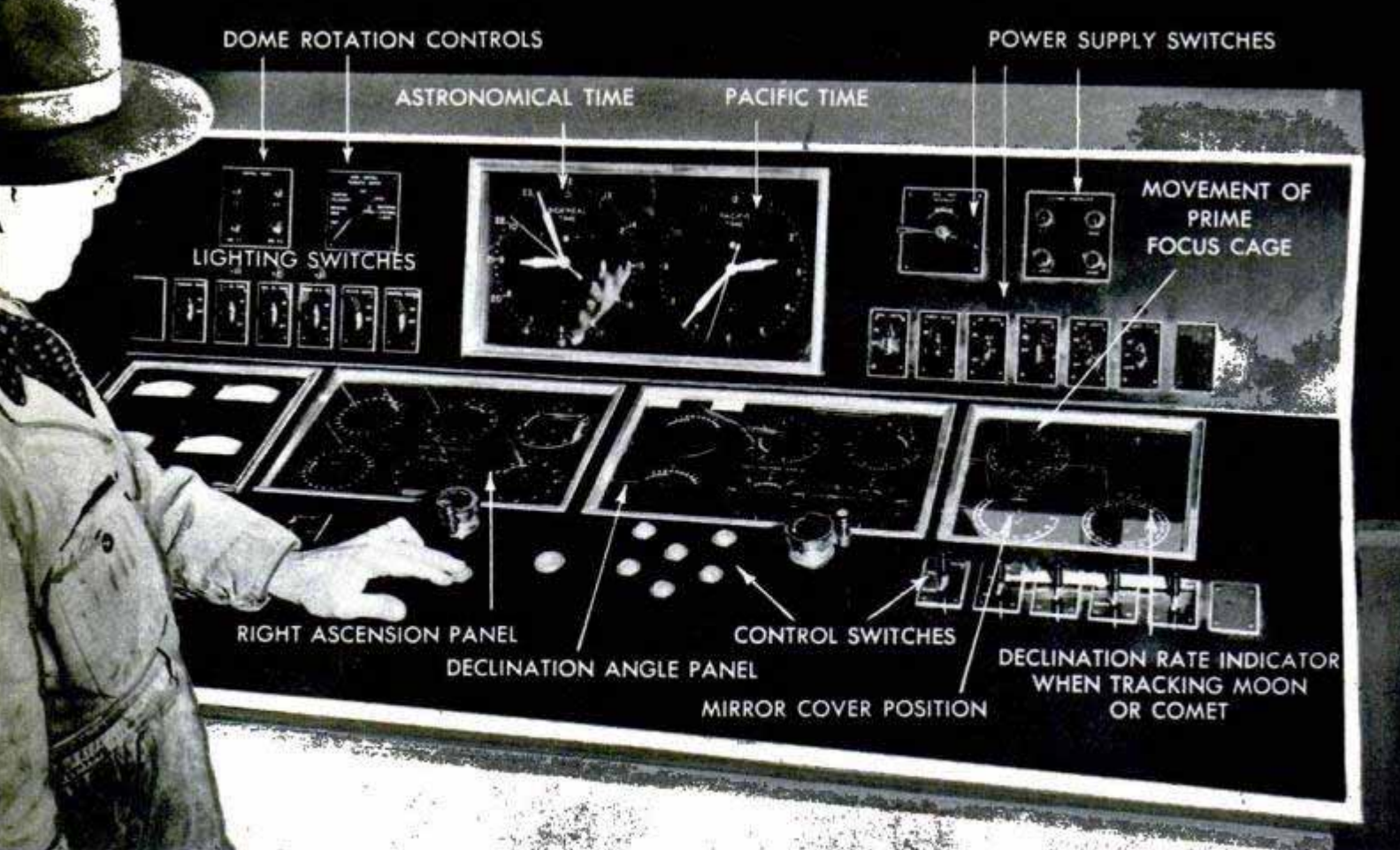

Controls permit observer to track star. Both star and earth are moving constantly

↓ Temporary hood across top of tube allows testing of all parts of the mirror to bring them all into focus

he pin-points a convenient bright star that he can use as a guide star during the exposure. For a few moments he will watch the star against the illuminated cross hairs of the microscope to make certain that the telescope is tracking properly and, if necessary, push buttons to correct the telescope's motion.

Finally he will insert the photo-plate holder and pull the slide. For the next hour, if the exposure is to be that long, he

will sit with his eye glued to the microscope, watching his guide star dance and shift about. Radiation and other atmospheric conditions keep star images on the move and the astronomer's constant task during the exposure will be to reduce this motion as much as possible by manipulating hand knobs that can move the microscope and photo plate a thousandth of an inch.

Meanwhile at Mt. Wilson 90 miles to the northwest another astronomer undoubtedly will be making a duplicate photograph of the same portion of the sky.

It will be extremely interesting to compare the two pictures, one made with the 100-inch telescope that until now was the world's largest and the other made with the new 200-inch companion. Although an hour's exposure is not enough to test the limits of either telescope, the Palomar picture should show stars that are only half or a quarter as bright as the faintest stars on the Mt. Wilson photograph.

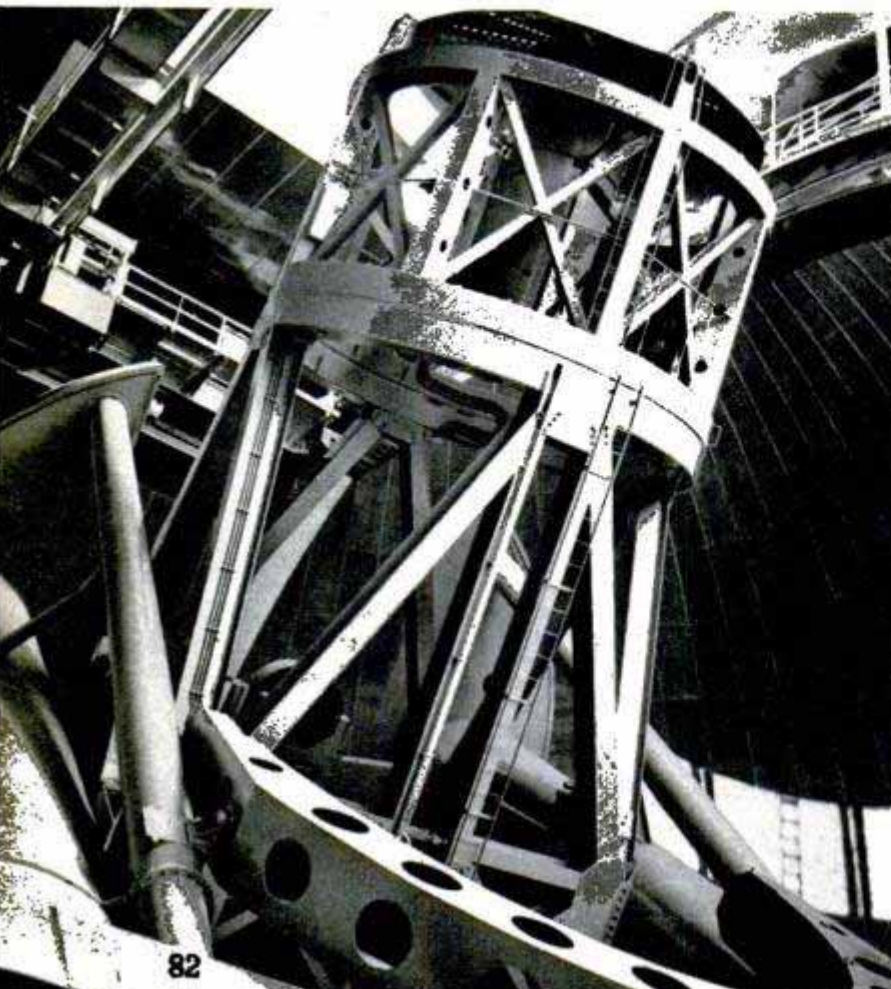

Translating light into distance, the Mt. Wilson telescope has reached half a billion light years into space. The telescope on Palomar should see twice as far, multiplying by eight times the volume of space that can be examined.

That range and scope permits photographs that should confirm or disprove a number of theories about space and the bodies that inhabit it. Is the shift to the red in the spectra of distant nebulae and galaxies a true indication that the universe is expanding? If so, are nebulae as uniformly distributed through the outer reaches of space as they appear to be closer to us? The 200-inch telescope will be able to reach a large enough section of the universe to permit a fair sampling of it.

What are the stars made of? Mostly of hydrogen, to the best of our knowledge, but the question is whether hydrogen and other elements are distributed uniformly in the different stars even though the physical conditions of the stars vary widely. By being able to widen the spectra of distant stars so that the spectral lines can be studied in detail, the Palomar eye may vastly increase our information. This information, in turn, may help answer two basic questions—the source of stellar energy and the origin of chemical elements.

What about Mars? While the 200-inch telescope is intended for long-range studies, it undoubtedly will be used occasionally for photographing objects in our own neighborhood. Most photographs of Mars made in the past have been time exposures that were unavoidably fuzzy. No photograph has revealed the "canal" system with the amount of detail that many observers have reported.

Technically it will be possible with the giant eye to make motion pictures of Mars at normal exposures, with a good chance that one frame in a thousand or so will have been exposed at a time when there was no shimmer or twinkle in the atmosphere. One clear sharp photograph should disclose whether the so-called canals exist. If they ever show up in a photograph it would be strong evidence that intelligent life exists on that planet or existed in the past.

Some night when the bright full

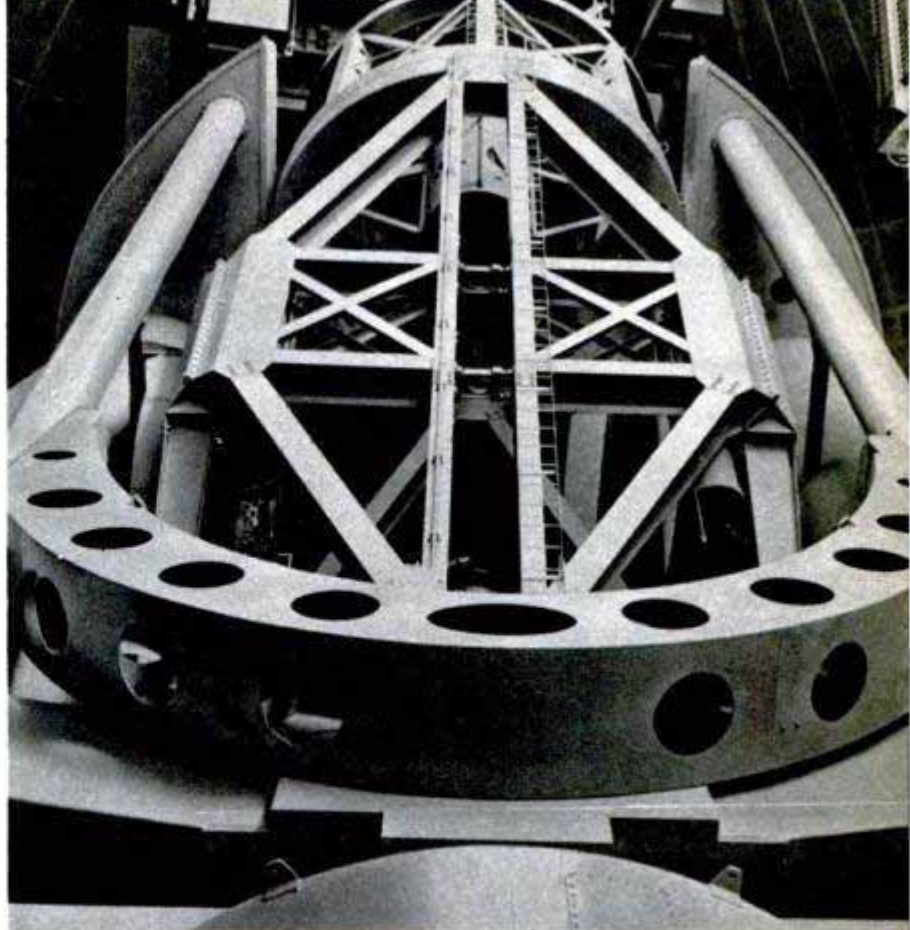

View of telescope inside its mounting shows the horseshoe-type bearing. In this position telescope is pointed at North Star

moon spoils conditions for long-distance photography we can expect that an astronomer will take a close-up portrait of the earth's satellite. The field of view of the 200-inch is so small that it will be necessary to take five or more pictures and piece them together to get the entire moon.

The complete picture will be four feet seven inches across, equal to a view of the moon from only 500 miles away. By careful enlargement it will be possible to bring out details of the moon's surface as seen from an altitude of 100 miles or less.

The new Palomar telescope is a versatile

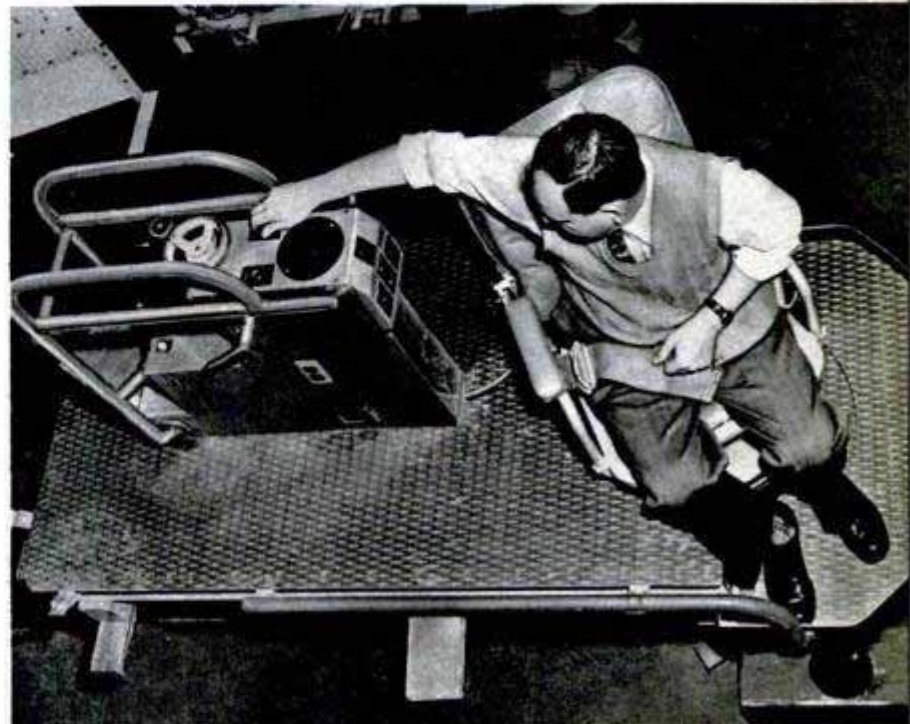

Platform to be placed on mobile tower permits observations from floor under tube

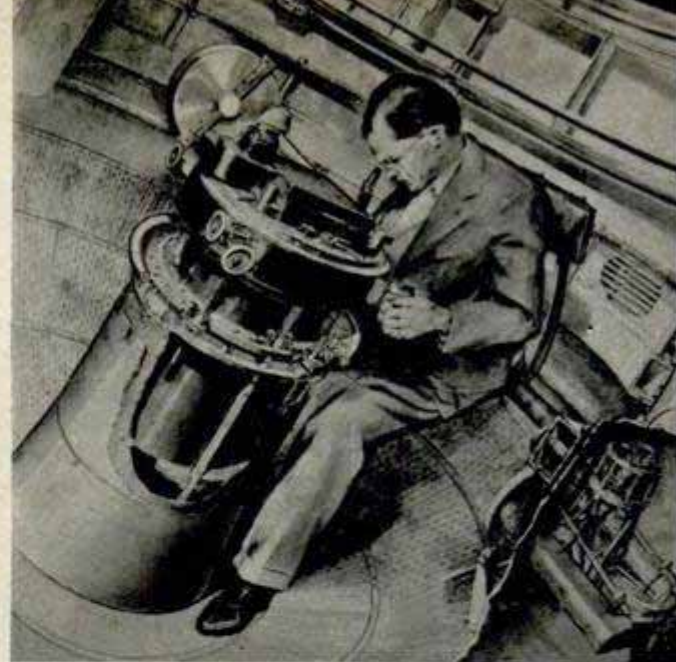
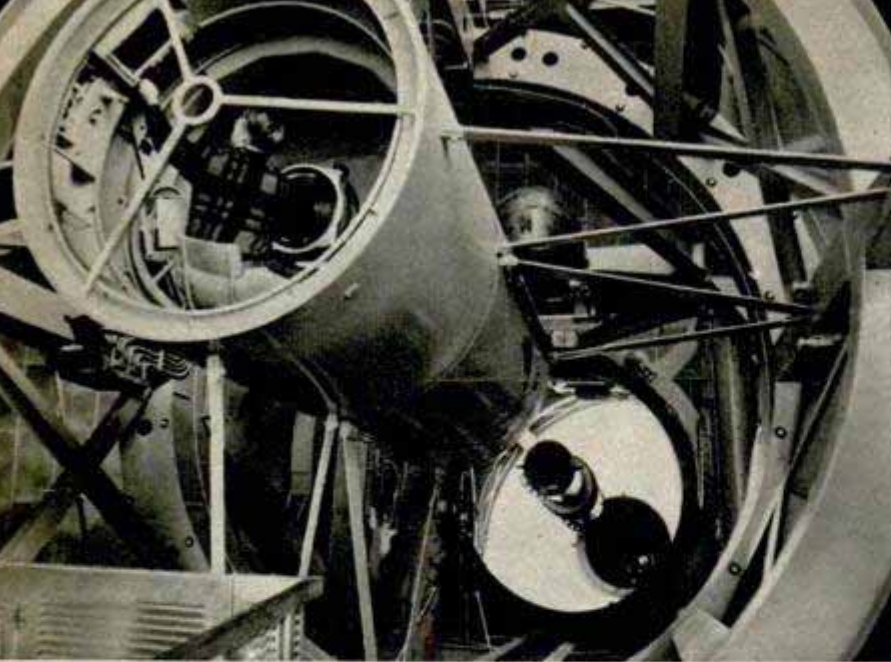

† Photo plate is mounted in front of operator inside cage at the prime focus of the huge mirror. Right, drawing shows astronomer in the cage atop the telescope. By moving knobs he adjusts for atmospheric tremor

instrument. Actually it is three telescopes in one, or will be when all of its auxiliary mirrors are installed.

The prime focus is the point high above the mirror at which reflected light from the stars comes to a sharp focus. It provides the strongest light and will be used for rapid photography. The photographs of

star images made at the prime focus can be enlarged many times or examined under a microscope.

Next is the Cassegrain focus below the center of the big mirror itself. Light that is reflected upward from the 200-inch mirror is caught by a smaller hyperbolic mirror that swings into place and directs the light

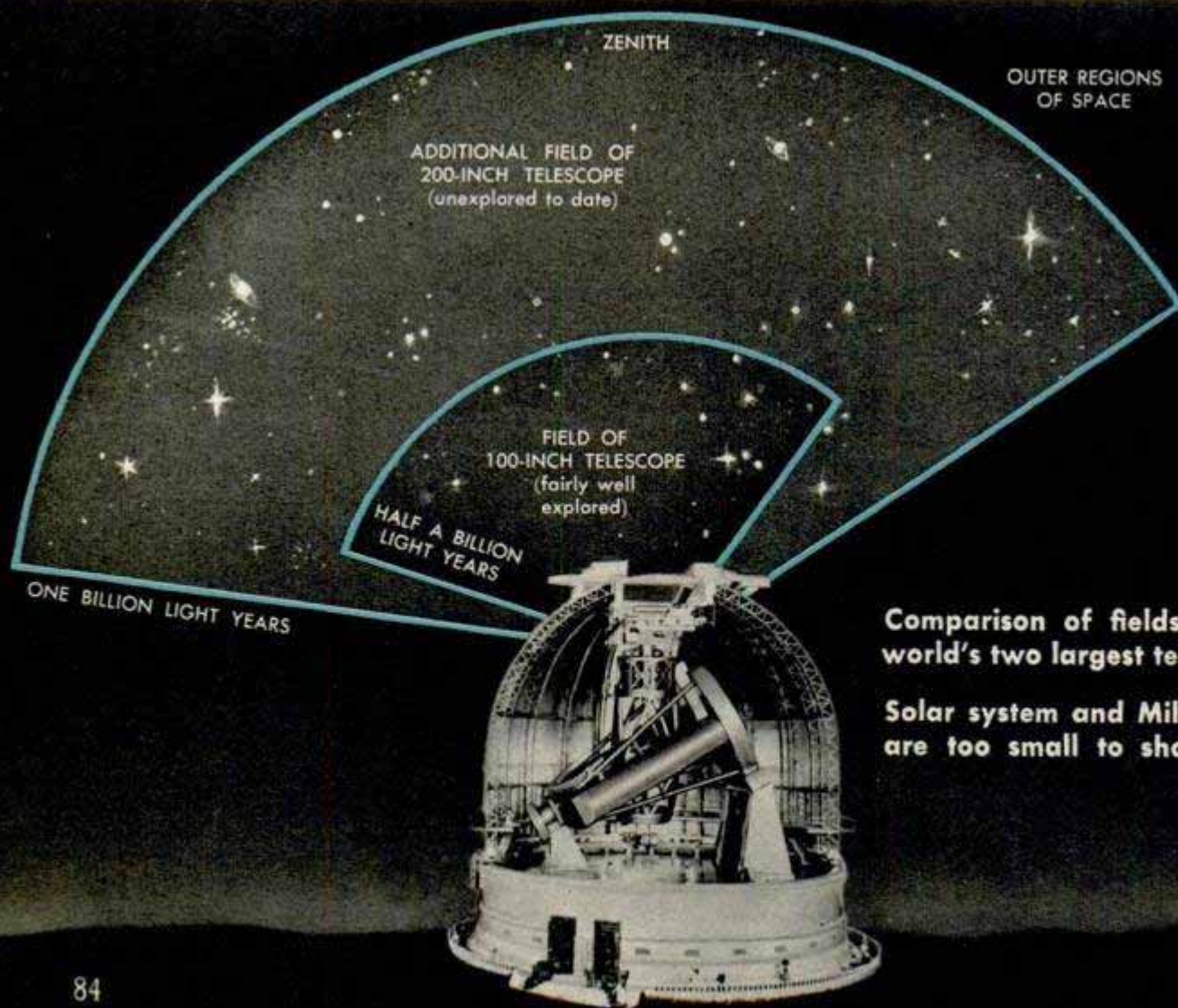

Comparison of fields of the world's two largest telescopes

Solar system and Milky Way are too small to show here

downward again through a tube in the center of the big mirror. Images are five times larger than at the prime focus but the intensity of light is less. The Cassegrain focus will be used principally for spectroscopic work, studying the elements that make up the stars.

The third optical system employs other mirrors that lead the light from the big reflector into a constant temperature room where spectroscopic studies will be made and some photography will be done. Called the Coude focus, this system provides large images of reduced brilliance.

In all there will be eight mirrors mounted in the tube and on the yoke of the telescope. Each of the seven auxiliaries is a large mirror in itself; two of the mirrors used in the Coude system, for example, having diameters of 48 and 36 inches. Small counterbalances are attached behind the auxiliary mirrors to prevent distortion of focus when the mirrors are moved.

The same type of counterbalancing system is used with the 200-inch mirror itself. Without it the 17-foot-diameter glass disk would sag and bend in different positions. If the big mirror were supported only at its edges, for instance, its middle would sag a fifth of a thousandth of an inch, a huge quantity optically and about 1000 times the allowable error.

Each of the auxiliary mirrors also has an additional counterbalance to offset its weight so that there is no effect on the alignment of the telescope or on its balance when a mirror is swung into place or out of the way by its own crane and motor.

Mechanically the telescope is about as fine an instrument as science and engineering can build. In spite of its enormous weight it is designed to move with utmost smoothness when tracking a star and to avoid any flexure that would affect its optical systems. The skeleton tube, its mirror and prime-focus cage weigh 140 tons and can be pointed in any angle from the North Star almost to the southern horizon without distortion from gravity.

The entire moving weight consisting of the telescope and its equatorial mounting is some 500 tons, and this weight floats, literally, on thin films of oil that permit smoother motion than would be possible with ball or roller bearings. The 14-foot worm wheels that turn the telescope were cut in a special temperature-controlled



Complex system of counterbalances under the 200-inch mirror keeps the surface from distorting as the mirror is shifted

machine shop on the California Institute of Technology campus and errors in spacing the teeth were kept to less than one ten-thousandth of an inch. Even the thrust bearings of hard tool steel were especially treated to insure smoothness of movement. Ordinary machining was not good enough. To reduce friction to a minimum the bearing surfaces were polished in an optical polishing machine with the same care given the telescope mirrors themselves.

All these efforts to achieve a perfect instrument would be defeated if temperature variations inside the observatory dome should have an effect on the telescope's optics. Elaborate precautions are taken to avoid this. In the first place the dome shutters are kept closed during daylight hours. The dome is really a double dome separated by a four-foot air space

(Continued to page 252)

Worm gear is cut to accuracy of less than one ten-thousandth of an inch per tooth, permitting the exact tracking of a star

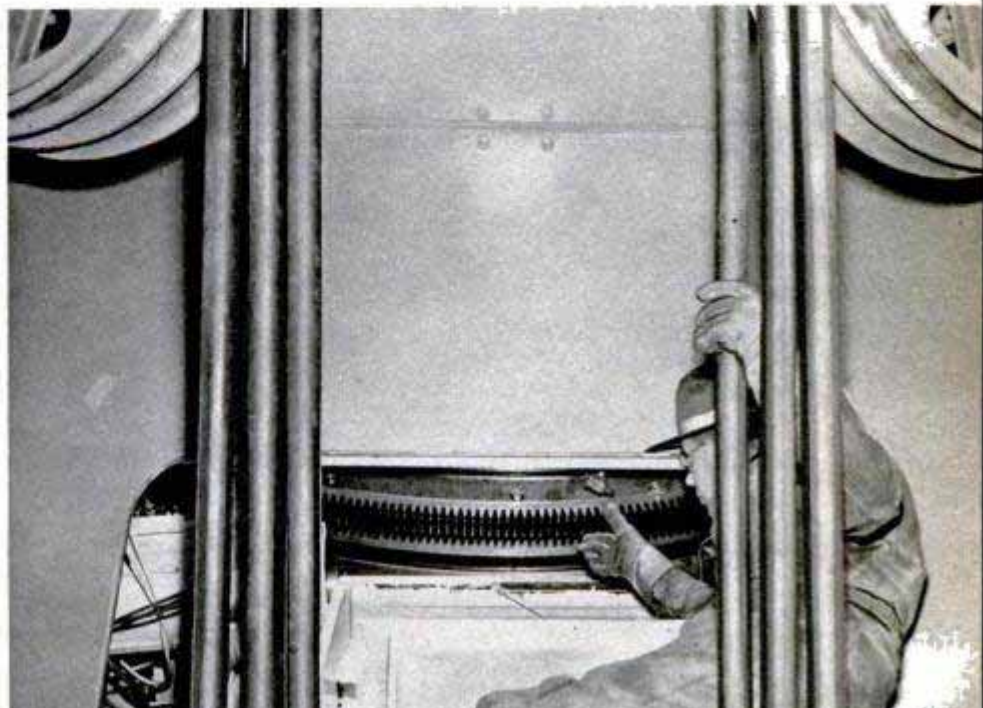

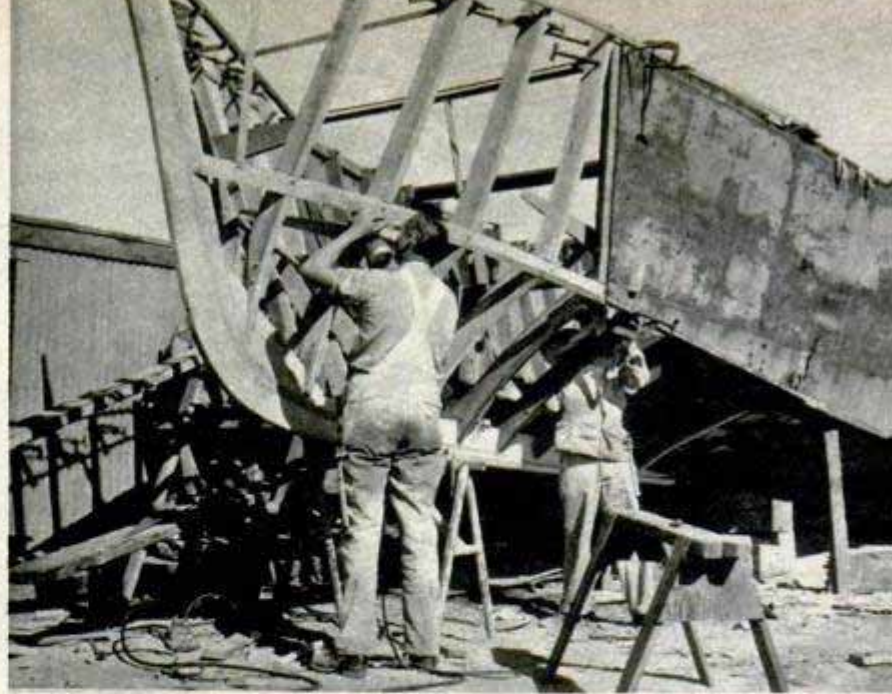

↑ Surplus boat looks like a derelict washed ashore. Right, a new bow is built out from the battered hull



Senior Chaffee and his three sons operate the unique drydock. Below, finished pleasure craft sleeps three to five, has washroom and galley, and makes 20 knots

'Beauty Shop' for Boats

Battered landing craft—the ugly ducklings of the war—are converted into sleek cabin cruisers through the combined efforts of the Chaffee family of San Diego, Calif. John Chaffee and his three sons operate a “beauty shop” where the scarred vessels are given a face lifting to fit them for use as pleasure craft. The senior Chaffee takes charge of the stockroom, one son is a carpenter, another a welder and the third a machinist. The battered craft are on sale as war surplus for about \$750 apiece. After one surplus sale the family found 27 of the LCVPs awaiting rejuvenation. A new bow is built around a steel gig, and a cabin is erected, including three to five bunks, a galley and washroom. The re-conversion cost varies from \$400 to \$7000, depending on labor involved. The finished craft, with extra fuel tank, has a 1400-mile range, a speed of 20 knots and enough eye appeal for any yachtsman.

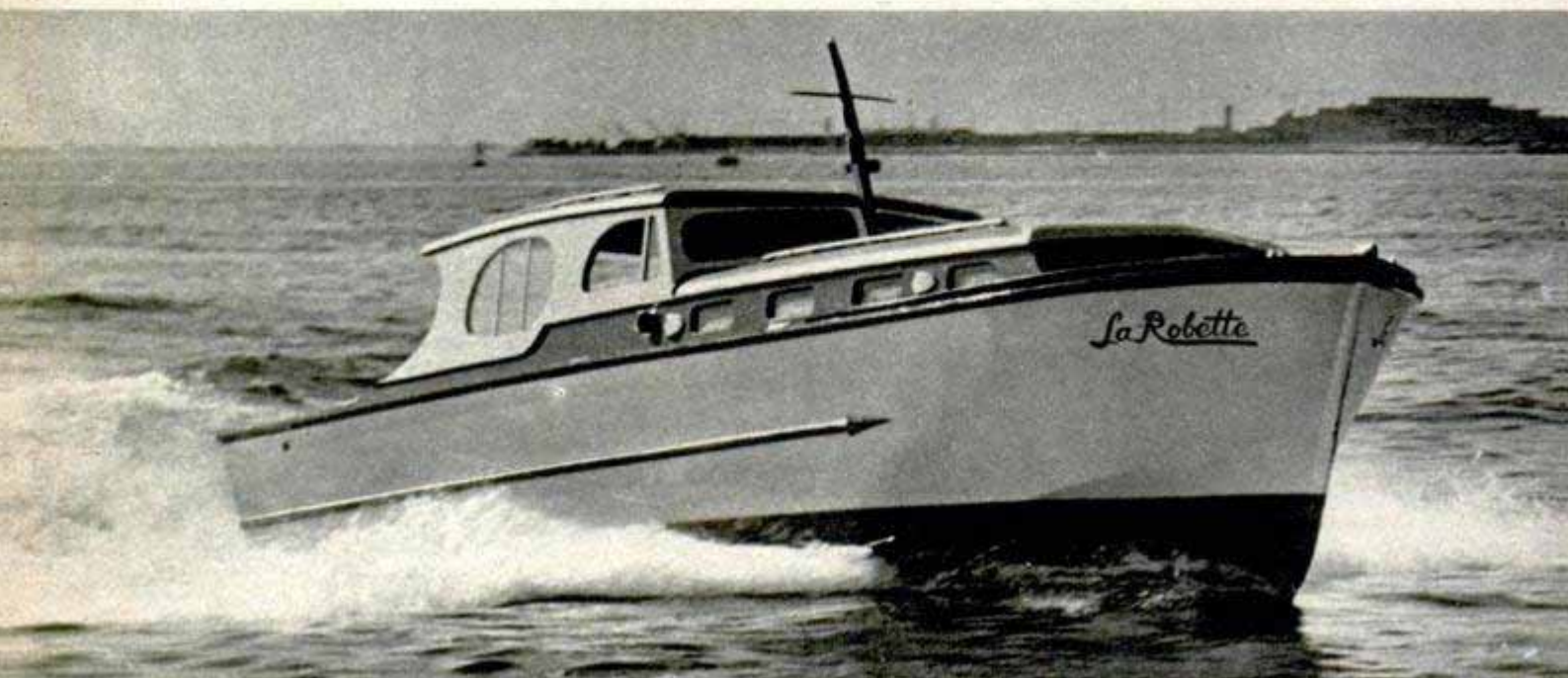



Spray Gun Supplies Own Pressure

Touch-up painting and other small paint jobs can be accomplished quickly with a self-contained spray gun that requires no compressor or air lines. Pressure is provided by a carbon-dioxide cartridge that fits into the hollowed handle and is punctured when the handle is screwed on the gun. Made of cast aluminum with brass and stainless-steel precision parts, the gun weighs only 26 ounces.



Electric Motor Drives Bicycle

Gasoline rationing doesn't bother the Britisher who built a tiny sidecar for his bicycle and mounted an automobile starter motor and storage battery on it. The motor drives the rear wheel by link chain and a control lever is located on the handle bars. Noiseless, the motor bike climbs steep hills easily and rolls along at 20 miles an hour. The 12-volt battery also powers the lights and horn.

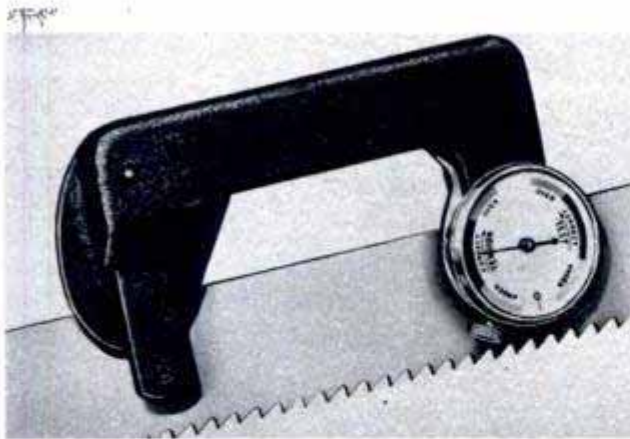

Tension Tester for Hacksaw Blade

Tensions of hacksaw blades are checked by a tester with an easy-to-read dial. The meter is fastened to the blade, which then is tightened to the proper tension. Blades of any thickness, length or width can be checked with the tester. Proper tension of the blade produces straight cuts and prolongs the blade's life.

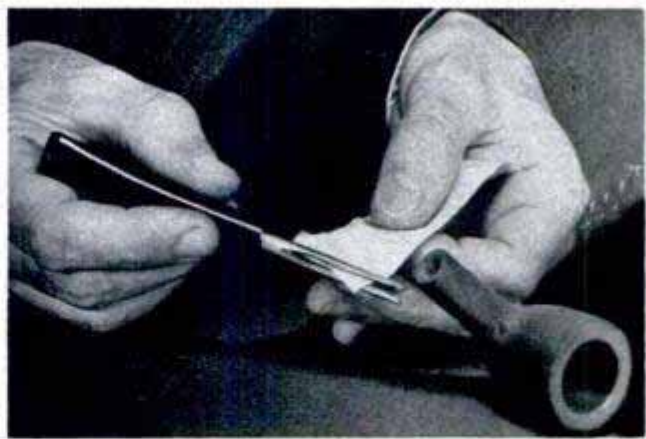

Pipe Has Built-In Cleaner

Pipe smokers who like to keep their pipes clean will find it is easy to do with a new pipe that has a built-in clip for holding cleaning tissue. The forked metal clip takes the place of the usual filter inside the pipe stem. Small pieces of tissue are inserted in the clip and used to wipe out the bowl and stem in ramrod fashion.

This is the first of a series of "behind the wheel" articles on new cars. The next article will be devoted to another real postwar automobile

Hudson rear seat is wider than the car is high! The 16-inch armrest folds down from the seat-back cushion. Note recessed door panels

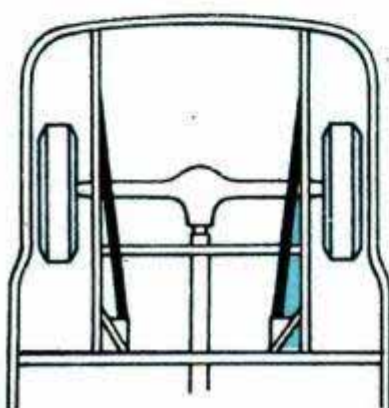

Above, leaf springs in rear set at slight angle and coil springs (below) in front ease car over bumps

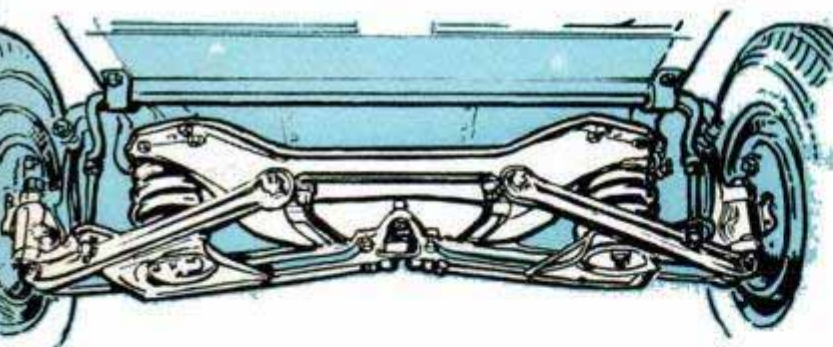

TAKE THE WHEEL

By Wayne Whittaker

STEP RIGHT UP, mister, and get behind the wheel of that new Hudson at the top of the opposite page.

Our objective is to take you on a 150-mile drive through city traffic, over country roads, bumps and smooth pavement, around sharp curves, up and down hills, through rain and shine. We received the full cooperation of the weatherman in providing the rain and shine for your first ride. The purpose is not to sit in judgment on the new Hudson and tell you that it's good or bad. YOU take the wheel and decide for yourself from the actual performance of the car.

All set? First, meet Milton S. Bald, veteran service engineer for Hudson who handles all field contacts in the engineering department.

"I'm just along for the ride and to answer

Below, the new Hudson frame cradles riders within box-steel girders. Floor is several inches lower than door sill

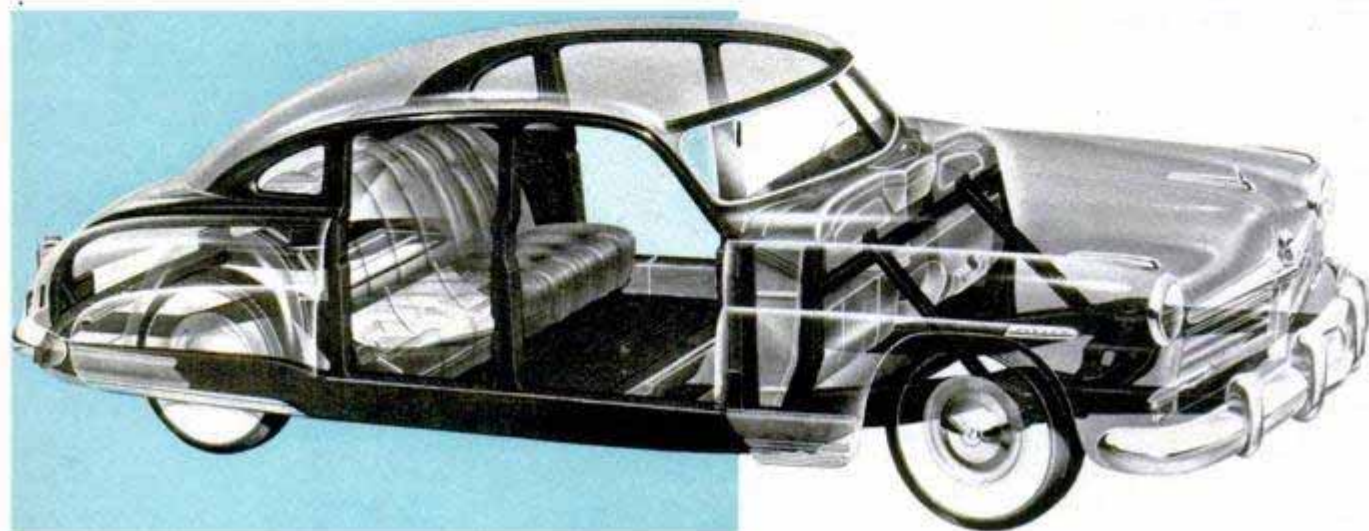

At your service—a nicely broken-in six-cylinder new Hudson equipped with semi-automatic Drive-Master shift



OF A NEW HUDSON

any questions," Bald explains. "Don't let me cramp your style in putting this car through its paces."

The car you are going to drive is a six-cylinder four-door sedan—just what you asked for.

"Did you know," asked Bald, "our Six is the largest six-cylinder engine built for a passenger car today? It has so much zip—121 horsepower—that most drivers can't tell it from an Eight except at very high speeds."

You press the trigger-release of the fixed door handle and step in—or more correctly down—to enter the car and take your place behind the wheel. The first impression is one of sitting closer to the ground than you do in other cars. Your shoulders are about level with the lower ledge of the window.

"Feel like you're sitting on the floor?" Bald asks.

"Nope," you reply, "visibility is too good for that. Besides, it's comfortable and I got in easily without knocking my hat off. That's something these days."

Bald laughed. "Fine! The reason for the headroom is that you are sitting so low. Remember the car is only five feet high. Floor and seats are down inside the frame. This is where we get that step-down feature. That new frame is a beauty and actually combines body and frame in a single all-steel unit. I'll show you some cutaways of this when we get back to the office and you can decide for yourself whether or not it looks like a good safety feature."

The car you are about to drive is well broken in—9000 miles. It is equipped with

Left, phantom feet show hydraulic and mechanical brake positions—the latter operates with pedal all the way down. Right, Milton S. Bald, Hudson field engineer, checking engine after a test drive of 150 miles



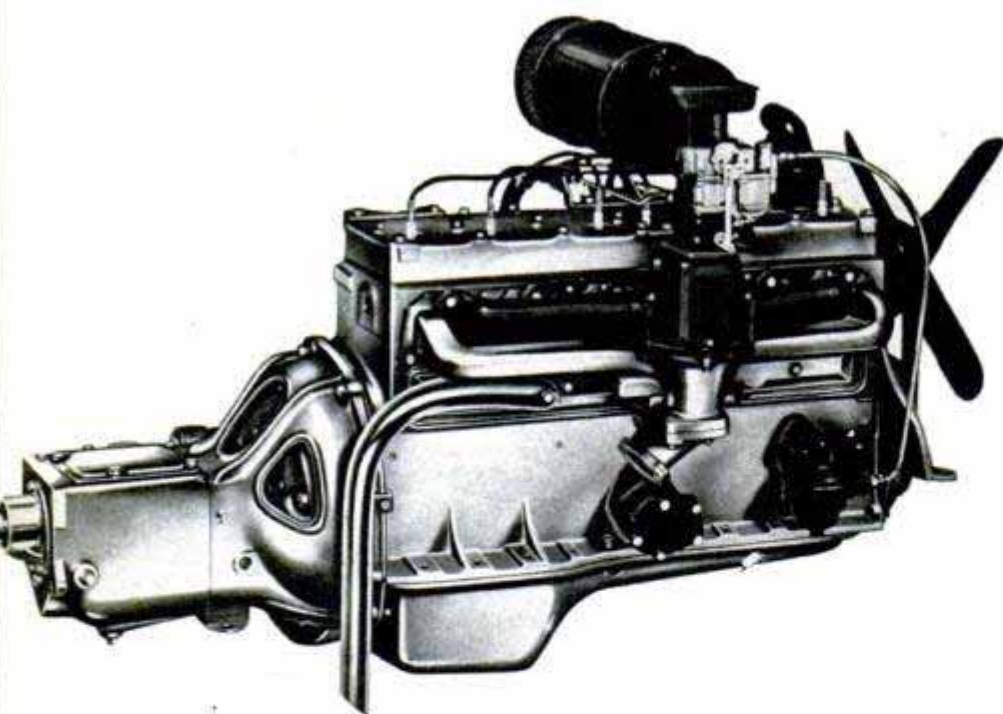

New Hudson Super-Six engine is most powerful (121 horsepower) of any engine its size on market. The L-head motor is pressure lubricated at 41 points. Bore is 3-9/16 inches; stroke 4 1/8 inches

a Hudson Drive-Master transmission in addition to the manual controls. You press the starter button and nothing happens. Bald explains that on the Drive-Master cars you have to throw in the clutch before the starter will operate. This affords double assurance that the car is in neutral when you start up.

"If you've been driving a car without automatic shift," says Bald, "you'll find yourself making a lot of false motions with your left or clutch-operating foot."

Now you study the Drive-Master control knob on the instrument panel and are swamped at

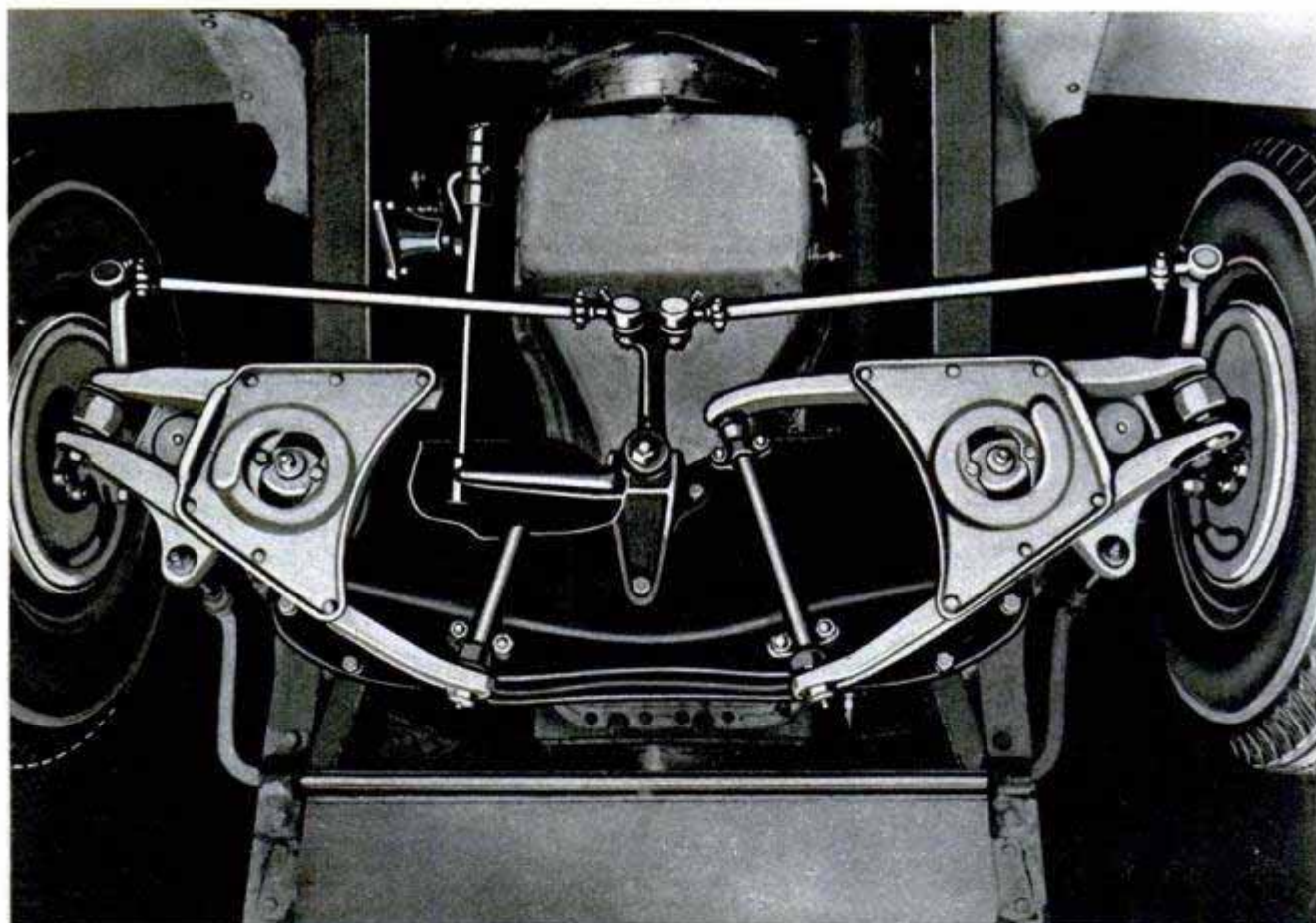

Steering system is perfectly balanced to end "roaming" and "wheel fighting." Hudson's Center-Point steering operates from exact center of the car and affects both front wheels equally

Sketch at right shows how new Hudson frame extends outside of wheels, also lowering of floor for more headroom. At far right, the "new" sketch shows rear seat moved forward

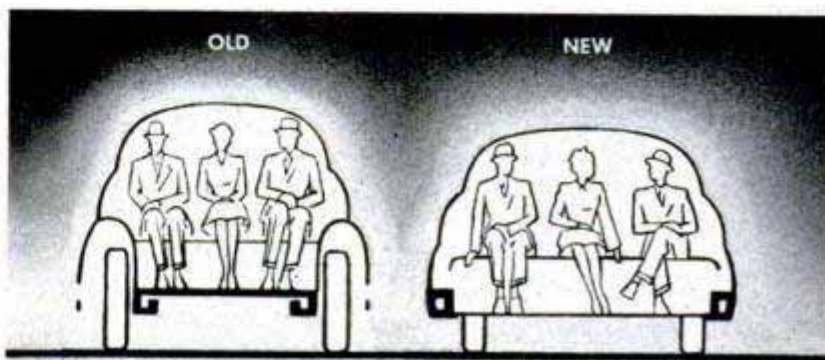



Low center of gravity helps the new Hudson hug the road on sharp curves; tires are all super cushion

first by a choice of three shift arrangements: (1) conventional manual control with normal clutch and hand shift; (2) something they call Vacuumotive Drive which means manual shifting with automatic clutch, and (3) Drive-Master in which you put the shift lever in high position and step on the gas.

Your indecision as to which to try out first is ended by Bald, who says: "Of course, you'll want to use Drive-Master. This actually amounts to starting off in second and any time after the speed is above 13 miles an hour just lift your foot all the way up on the accelerator pedal and you'll be in third. When you want to stop just step on the brake. Simple, isn't it?"

You decide that with all this automatic equipment it is a relief to know that all you have to do is flip a switch to get back to the familiar conventional hand-and-foot shift. Besides, it seems logical that conventional shift might be handy on an icy pavement or if you got stuck someplace.

All right. You put the shift lever in high. The road ahead is clear. With your left

foot feeling neglected, you press down on the accelerator pedal and the car moves smoothly away. At 25 m.p.h. you release your foot from the accelerator and you are in high. After a short distance you decide to try a stop to test Bald's instructions. You slow down and then apply the brake. The car stops. There is no creep. You step on the gas again and move out into traffic.

Bald grins. "I can see automatic shift has made another convert."

You decide it would be awfully easy to get spoiled by an automatic transmission. Bald reminds you that the Drive-Master costs only \$99.92 additional.

As you head north out of Detroit you come across a section of pavement that the Michigan Highway Department forgot. The car rides smoothly over holes in the pavement that are fully 2½ inches deep. There is no rumble, no rattle and no bouncing around. You are driving 50 miles an hour.

"Jam the brakes on," says Bald.

You do. The car comes to a smooth and steady halt. There is no pitch. The Hudson

(Continued to page 248)

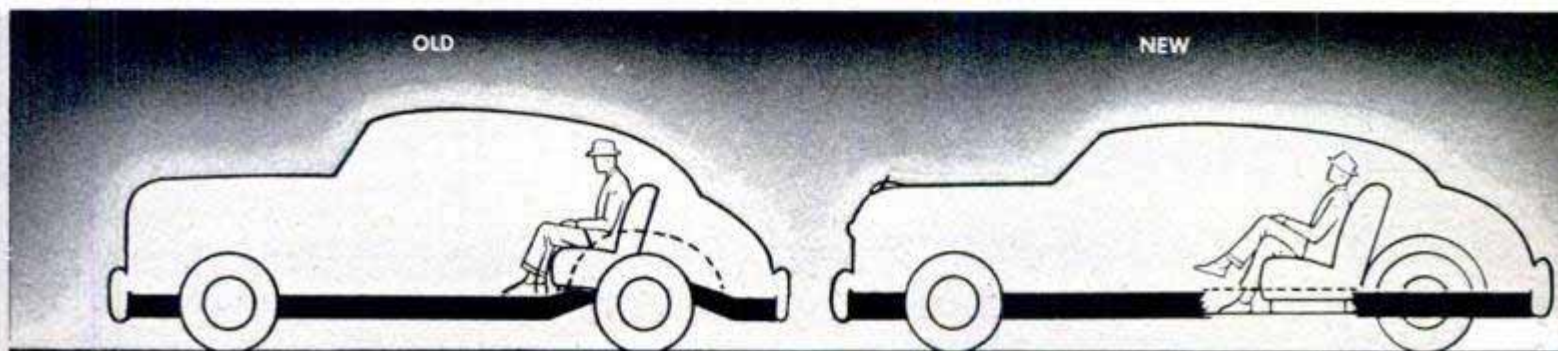

The Sternwheeler Still Rules the River

IN THE YEAR 1890, tense crowds on the banks of the Columbia River held their breath as the sternwheeler Harvest Queen swooped past. On that day, clocked by officials, the old sternwheeler actually ran a measured four miles through the treacherous cascades of the Columbia in four minutes flat—60 miles per hour!

By Tom Riley

rapids. "That's the point," say the rivermen, "she was able!"

The Harvest Queen was one of the fastest sternwheelers, yet she could actually do only about 23 to 25 miles an hour. It required the dangerous help of a rapids at flood stage, plus a stern wind, plus a skillful pilot, to boost her to that mile-a-minute speed. But it also took a highly maneuverable, shallow-draft ship to challenge those

The Harvest Queen was unmistakably able and so were all the other old packets that were so successful on the wild rivers of the West. They were specialized ships—slender, fast boats with huge engines and great maneuverability. They carried fewer passengers and less cargo than the famous sternwheelers of the Mississippi. They had to be faster and more maneuverable to run those narrow, treacherous channels.

Today you can still see these ships on the Pacific coast. Sternwheelers are no longer the main method of transportation—the railroads, the highways and airlines have

Queen of the Columbia and Willamette Rivers is the new Portland, modern and efficient, yet patterned after sternwheelers built at turn of the century. Designers could make few improvements on yesterday's vessels



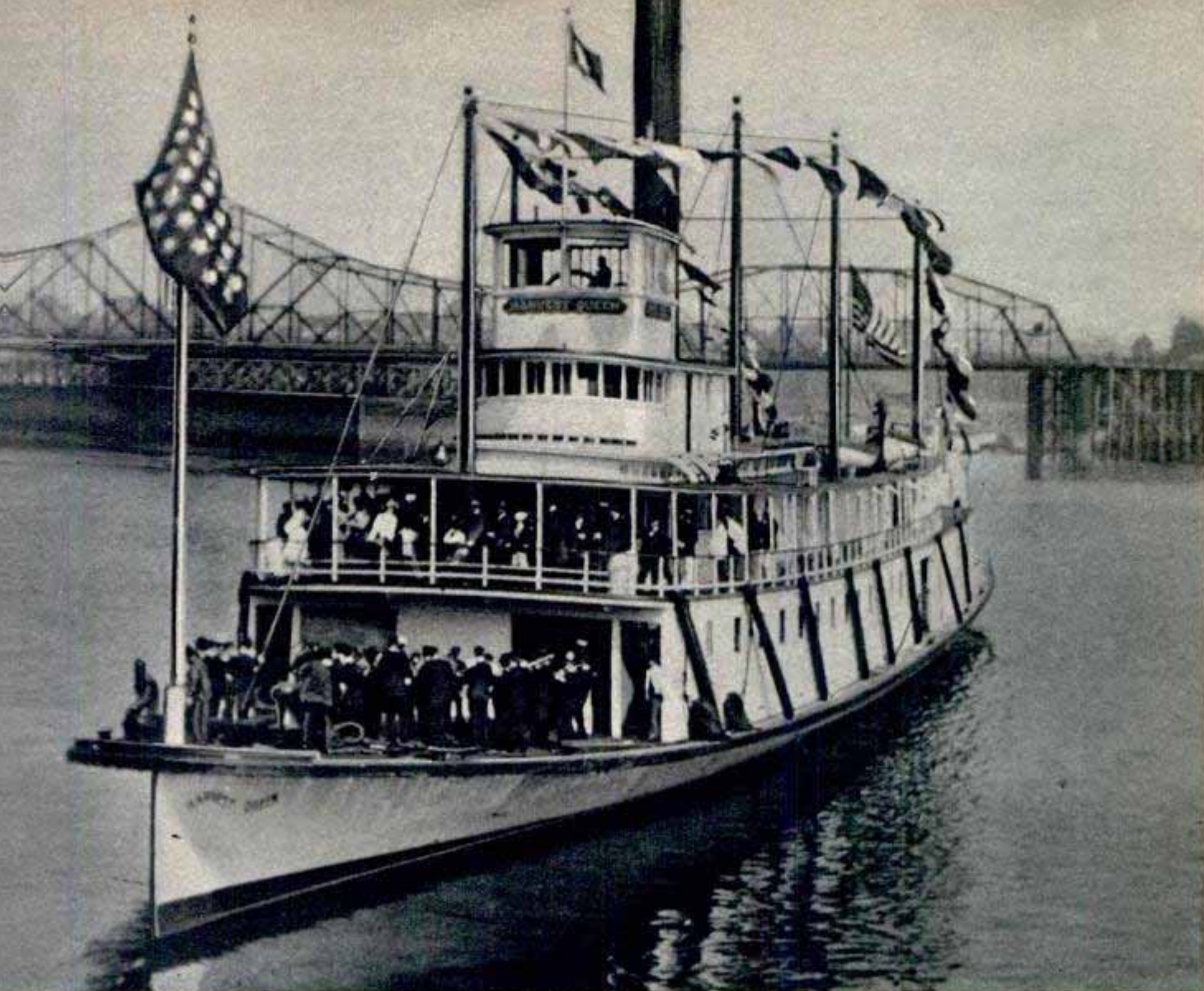

With brass band playing, Harvest Queen starts Sunday excursion in 1890. She still holds speed record. Left, diagram shows how wheel thrusts against rudders whether the ship moves backward or forward

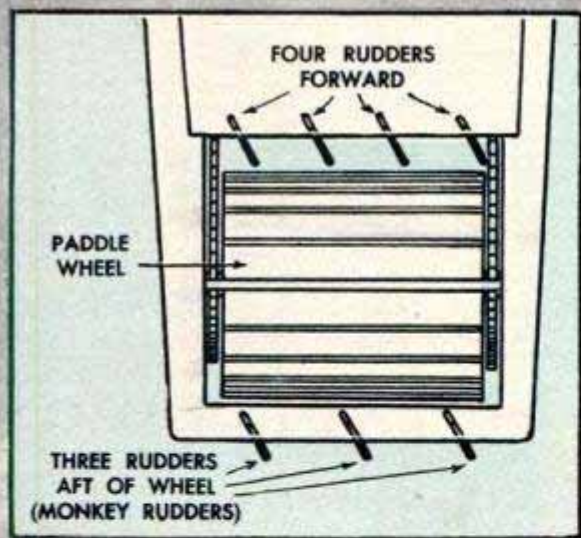

taken over—but the sternwheeler is still queen of the western tugboats.

She is queen because of her inherent "ableness." It is an important trait at the seaport of Portland, Ore. There the clumsy ocean liners are helpless. They cannot turn nimbly in the swift currents of the Columbia and Willamette Rivers nor can they maneuver alongside the crowded docks and berths. And when they are moved to and from the drydocks they are "dead" ships, ships without steam in their boilers. They must be towed.

The 19th-century skippers would be astonished by the number of big ships that must be towed today. One sternwheeler on the Willamette, the old Henderson, handled more than 5000 ships by herself during the recent war and is still going strong, even though she was built in 1912 with engines taken from a still older ship. Her old days of racing other paddlewheelers up the river, spilling the morning coffee on the houseboats along the banks, and making



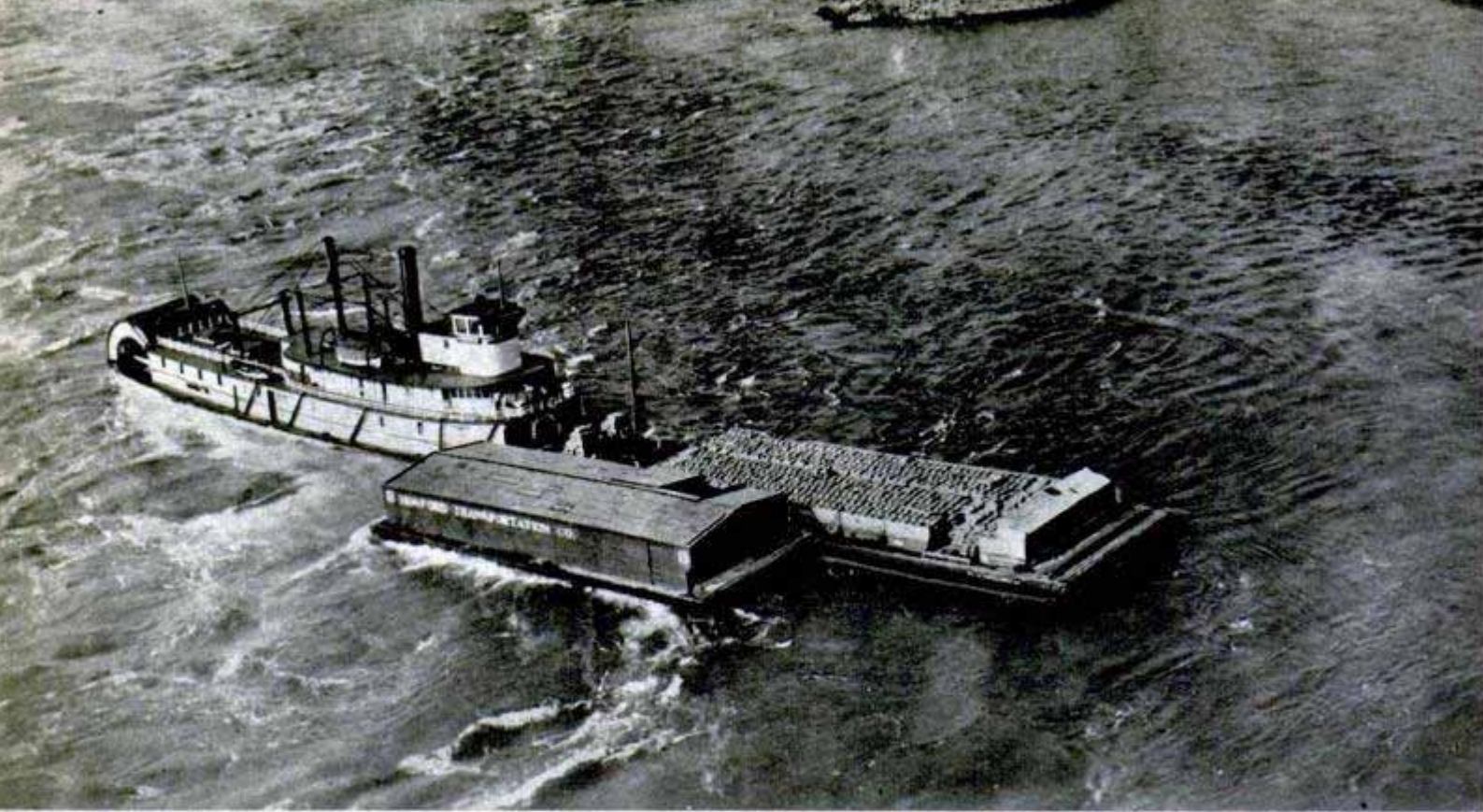

Paddle wheel churning, the Cascades guides two barge loads of wheat through rapids of Columbia River

leisurely Sunday excursions with the brass band playing are gone. She and the others must have steam up day and night. They must be ready at all times to assist the big ships into their berths. It's a different job, but the skippers are proud of their packets, now queens in a new trade.

Last fall the old design proved itself again, a half-million dollar's worth of proof. The City of Portland decided to replace an old municipal-owned sternwheeler, the Portland, which had been berthing ships on the rivers for 30 years. A modern Diesel tug was recommended but experienced river pilots quietly asked if anyone had looked at the sternwheelers lately. The pilots admitted that Diesel tugboats were cheaper to build nowadays but argued for sternwheelers because of the greater maneuverability that was needed in fast currents. They proved it takes only one of even the oldest sternwheelers to handle a ship, instead of the two to four Diesel tugs that are required. They proved from records that the sternwheeler has much less maintenance and breakdown. After long testing and planning, a modern sternwheeler, the second Portland, was built.

Perhaps the most interesting feature about this new ship is that neither its builders nor its designers could find any major improvement to make over the ships built at the turn of the century. They will frankly admit that the greatest change is in the price, the new Portland costing

\$500,000 while the most elegant packet of the 1900s cost only \$45,000. The designers of those old-time ships can receive no better praise.

The new Portland has been improved, of course. She has an all-steel welded hull instead of a wooden one and she has double the horsepower of the older sternwheelers. Her oil-fired boilers are compact and extremely efficient, about half the size she would have needed for her 2000-horsepower 20 years ago. The gingerbread dec-

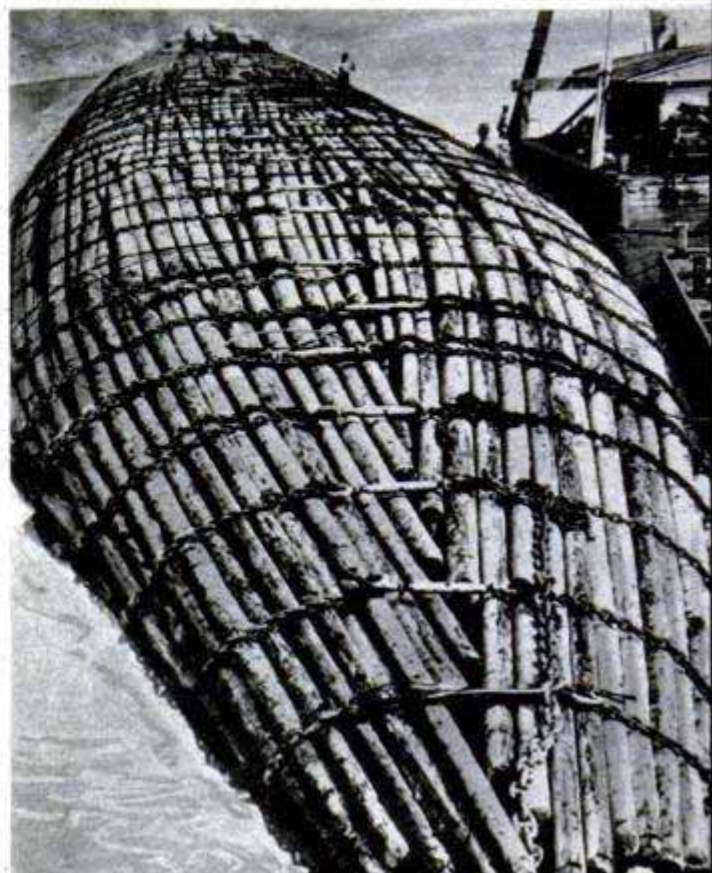

Log raft is given a final lashing of chains. For decades sternwheelers towed such rafts down the river

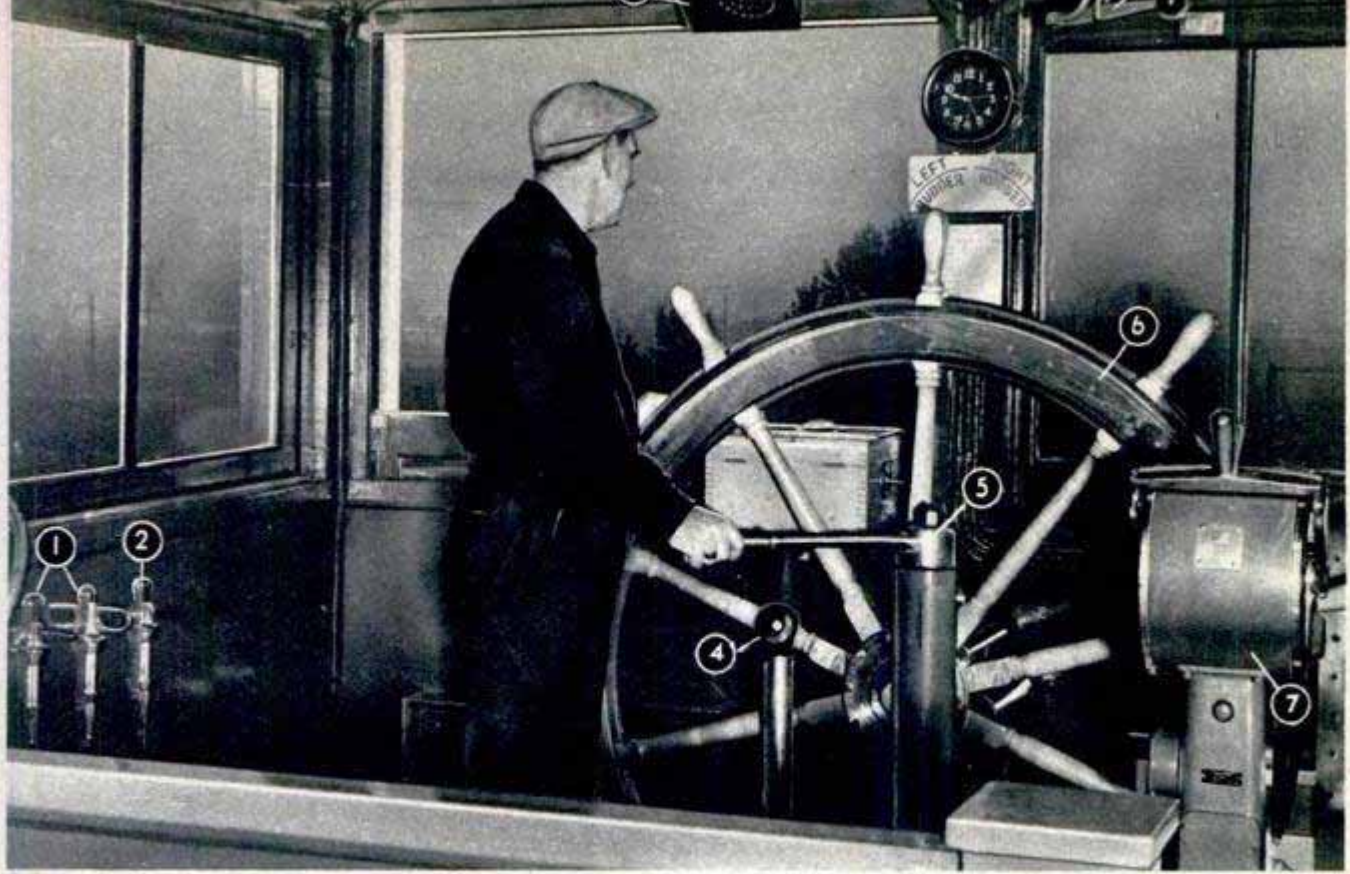

Bridge controls include: 1, signals to engine room; 2, deck whistle; 3, intercom speaker; 4, mike to deck speakers; 5, steam-powered steering lever; 6, emergency wheel; 7, engine-room telegraph; 8, searchlight control

orations that the early skippers cherished are gone and the congested deck spaces have been eliminated. But the basic design is the same—little improvement has been found for the shape of the hull, superstructure, huge paddle wheel, rudders and design of the engines.

The new Portland's pilothouse contains some of today's aids to navigation. Loran and radar have not been installed, as this

ship operates only along the waterfront of a busy port. But the power steering is improved with the latest in steam-operated rudder engines that enable the pilot to turn the ship by moving a small lever. Throughout the craft, intercommunication systems carry the skipper's instructions to his crew. Even the deck winches have intercoms alongside to transmit orders from the pilothouse. With the flip of a switch,

Photo taken in 1889 shows sternwheeler carrying covered wagons. Note the similarity to today's river tugs

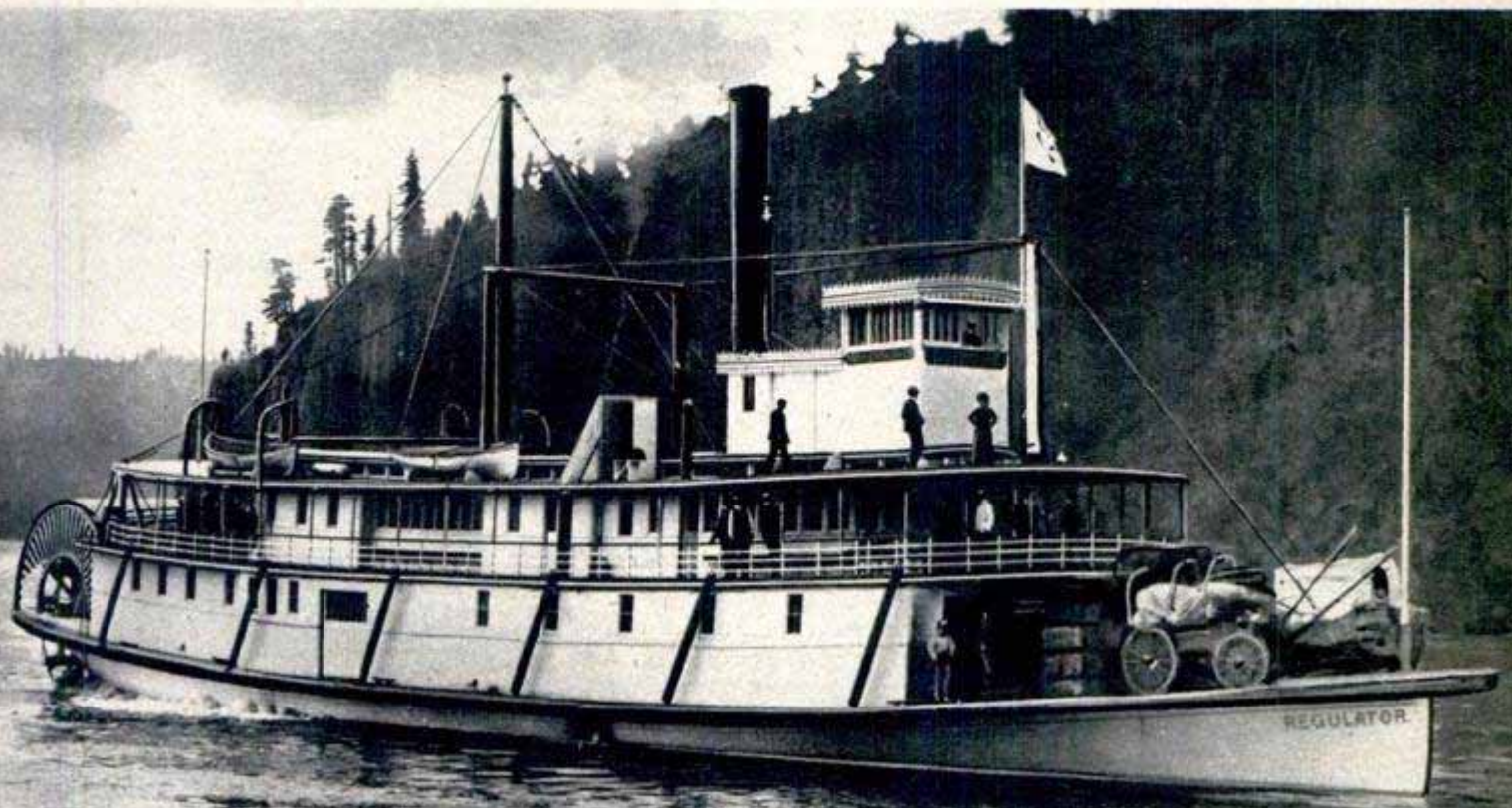

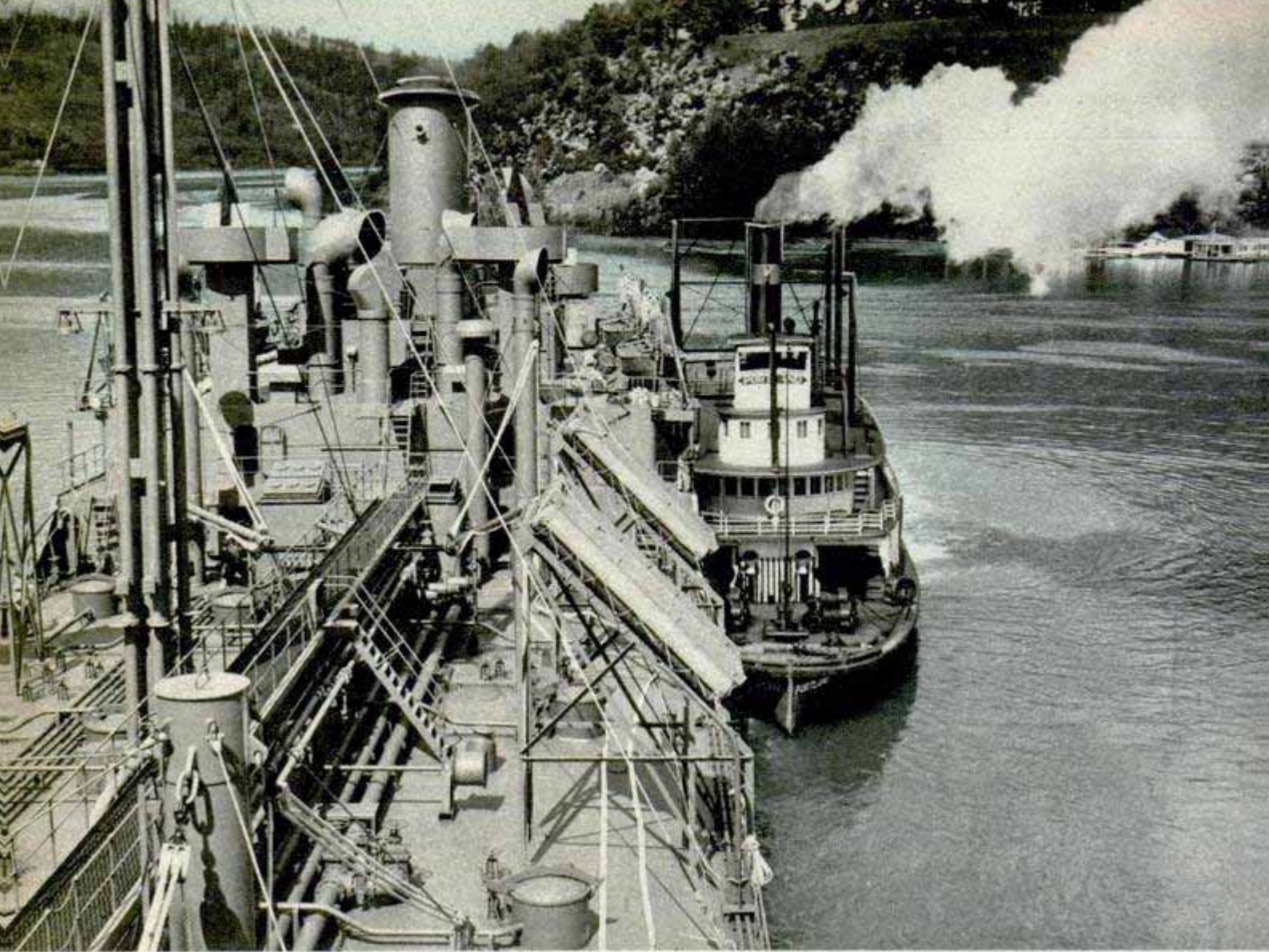

Portland noses tanker up the river. Below, diagram shows how the tug is lashed to steamer for berthing

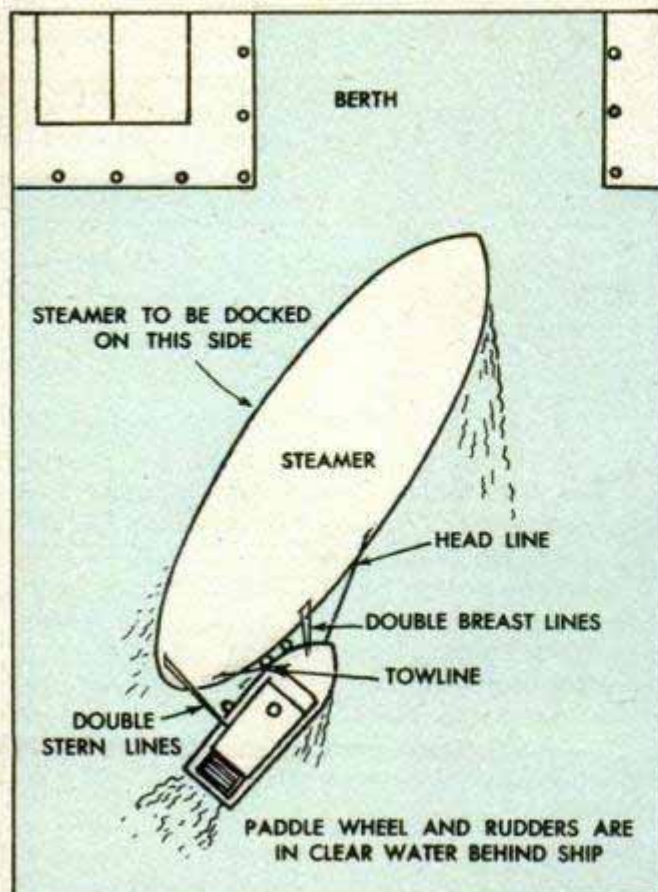

the skipper can project his instructions through a large amplifying loudspeaker to the crew of the steamer being towed. A ship-to-ship telephone has been installed on the new Portland. On 500 feet of wire, one phone is passed aboard the towed vessel so that the pilots can have direct communication for difficult maneuvers.

With its great flexibility and power the new sternwheeler now is handling steamers easily by itself. No fleet of tugboats are needed as in eastern ports. Capt. Sidney J. Harris, master of the Henderson (the oldest on the river) agrees when Capt. Robert Williamson of the new ship explains:

"She just handles a liner better. We call it rudder power because her power to maneuver is obtained from the thrust of the wide paddle wheel on several rudders.

"Say you turn a ship with an ordinary tugboat. The only turning force or rudder power you have is the water moving against one rudder. If you must stop your tug and then turn, the only rudder power you get is the little bit of water that's pushed by the propeller against that one rudder. It's not enough out here. You'll

(Continued to page 232)

Fluid in Magnetic Clutch "Solidifies" to Transmit Power



Fluid mixture of fine iron powder and oil such as used in new clutch "solidifies" in magnetic field

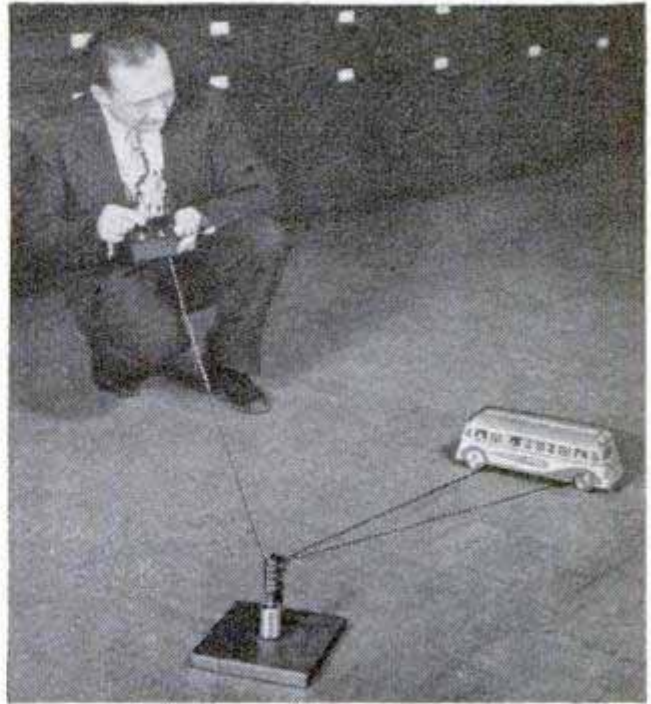

Model bus equipped with magnetic fluid clutch and brake (see below) is demonstrated by the inventor

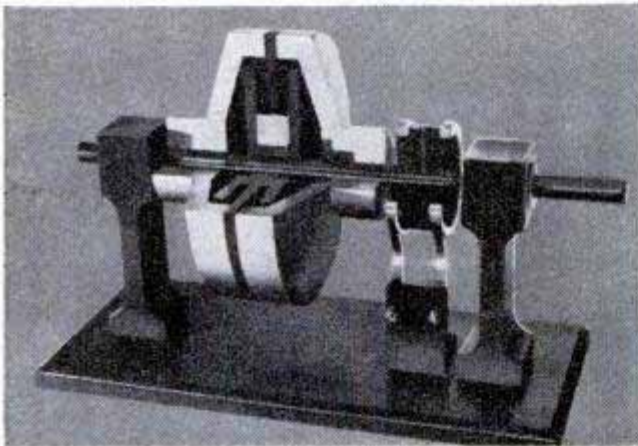

Cutaway of clutch with electromagnet in center. Magnetic action on fluid locks the two plates together

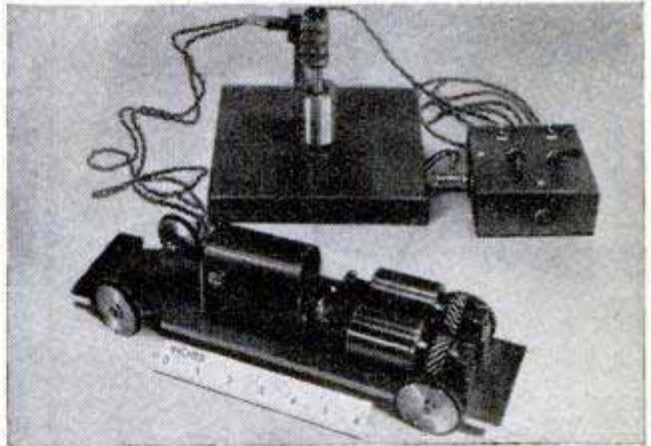

Two cylinders on bus chassis are magnetic clutches, one of which is locked to frame to act as a brake

Particles of iron dust which are affected by electric power form the heart of a new magnetic fluid clutch that is simple to build and gives jerk-free operation. The clutch, invented by Jacob Rabinow of the National Bureau of Standards, can be applied to servo mechanisms which automatically control mechanical equipment, to automobiles and many control devices. The clutch consists of a driving shaft with a plate at its end and a driven shaft and plate. Between these two elements is an oil bath which contains millions of metal particles. As electric power is applied between the plates, the particles form chains which lock the two plates together as strongly as though they were clamped. The amount of magnetization controls the strength of the bond, so that a gradual increase produces a smooth clutch action. When the clutch is

fully engaged there is no slippage and wear is held to a minimum. Any wear which may occur simply adds to the supply of metal particles. The clutch principle is equally applicable to brakes. Rabinow has assigned patent rights to the government.

Activated Charcoal Protects Young Plants

Treating the roots of young plants before setting with powdered activated charcoal protects them from harm by 2, 4-D used for killing weeds. Tests made on sweet-potato sprouts showed that untreated plants suffered a high mortality when planted in 2, 4-D-poisoned soil. The treated plants, though sustaining some losses, survived much better. The experiments were made by the Department of Agriculture and the Mississippi Agricultural Experiment Station.

Attacking the Mysteries of

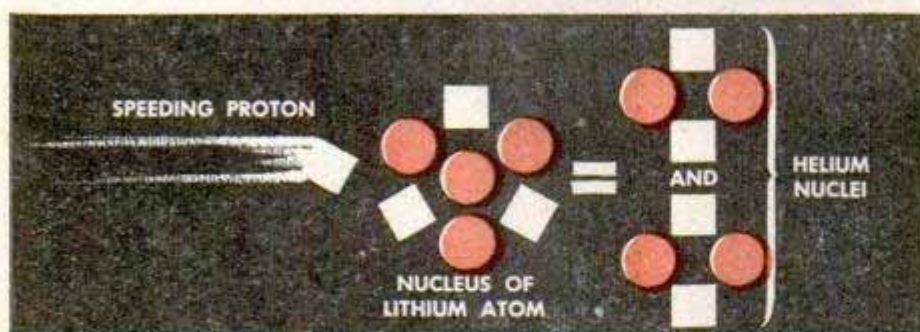

Left, drawing of what occurs when nucleus of a lithium atom is hit by a speeding proton. Result: two helium nuclei

↓ Cyclotron at the University of California has a 4000-ton electromagnet. In it, mesons were man-made for first time

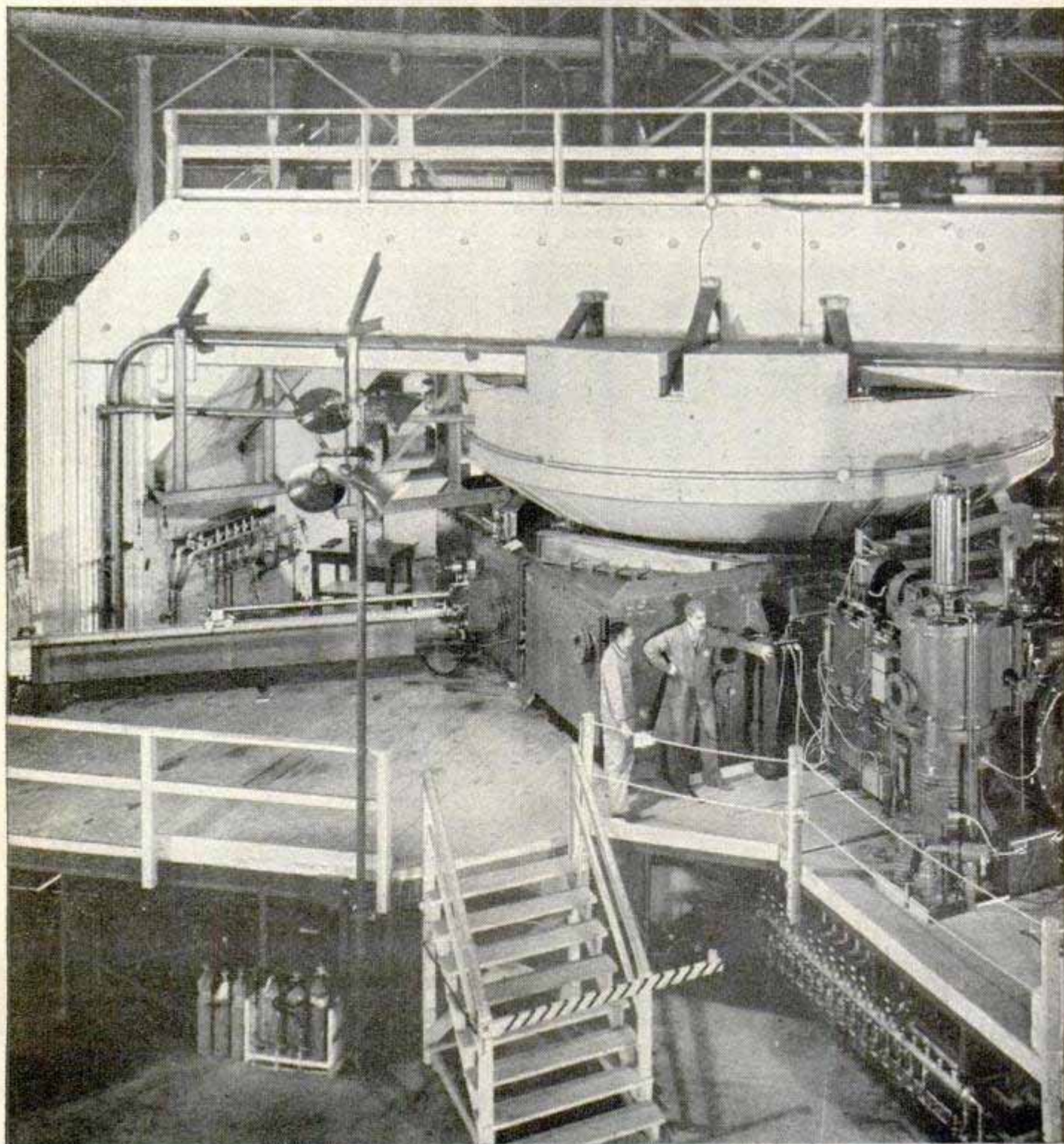

the Atom

By Thomas E. Stimson, Jr.



Used in plant experiments, radioactive carbon dioxide is trapped in spiral glass tube by plunging it into a beaker of liquid nitrogen where it freezes

ONE OF THE LAST great mysteries of the universe, the nature of the powerful "glue" that holds matter together, is being studied at a dozen laboratories.

This glue is the force that binds protons and neutrons together to form the nucleus of an atom. It is so strong that only cosmic rays or other high-speed particles such as are accelerated in a cyclotron can overcome it.

Except for this binding force it is possible that everything in the universe including the earth and yourself would consist of a thin homogeneous cloud of identical atoms, possibly of hydrogen since that is the simplest atomic form.

Practically all science knows about the force can be stated in a few words: It is millions of times stronger than gravitational attraction or magnetism and hence isn't either of these; nor does it seem to be electrical in nature.

The atom bomb was only a milestone in atomic research and today more attention than ever before is being directed toward discovering the basic laws of matter and energy. More information about how a nucleus is bound together is one goal; more understanding about the steps that occur when matter is transmuted from one element into another is a second; and more knowledge of everyday things that can be gained with new atomic tools is a third.

Much of this research is centered on the West Coast. At the University of California at Los Angeles, for instance, Dr.

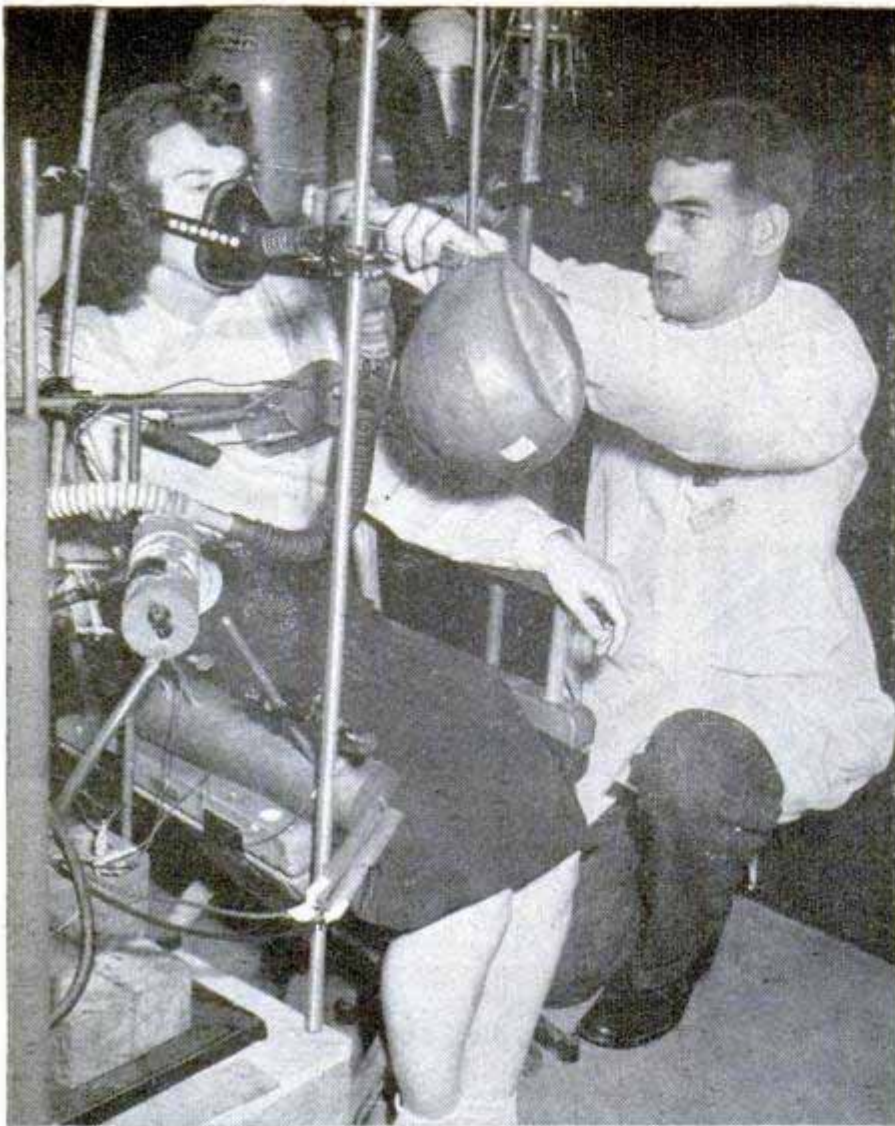

Path of radioactive material, inhaled through mask, is plotted by gamma-ray counters directed at the chest, abdomen and legs of girl volunteer

Reginald Richardson is seeking more information about the mysterious nuclear glue. He is using the original cyclotron that was invented by Dr. Ernest O. Lawrence and that has just been moved to the campus at Los Angeles.

are limited to observing the results that occur when nuclei are bombarded. These observations are made by means of cloud chambers, proportional counters and photographic emulsions. Such an emulsion is placed alongside the cyclotron beam and is

A pygmy by comparison with the giants that have been built since or are now under construction, the pioneer cyclotron has been converted into a stronger synchrocyclotron by powering it with frequency-modulated current. Particles that are emitted by the synchrocyclotron have an energy of some 15 million electron volts, which is more than enough for smashing nuclei.

The frequency-modulation apparatus consists of a 36-toothed wheel that rotates at up to 2000 r.p.m. in a vacuum chamber. Each tooth serves as a condenser as it speeds past a ring of stationary plates, permitting the tuning of the resonant circuit of the cyclotron through a wide frequency range. This mechanical apparatus does as good a job as would electronic FM equipment that would require 50 times more power.

No nuclear studies are possible by direct observation so Doctor Richardson and his associates

Photographs show radioactive absorption by plants as white areas. Left, tomato slices with concentration in seeds, skin. Right, placed on top leaf, radioactive material followed stems of leaves outlined by dotted lines

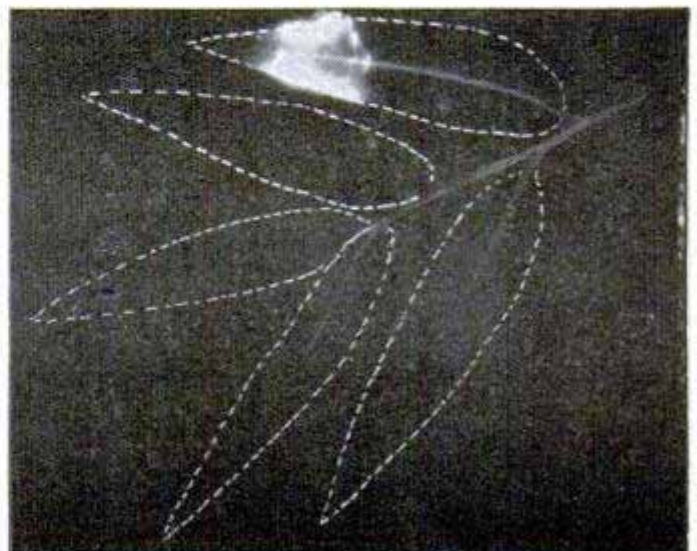
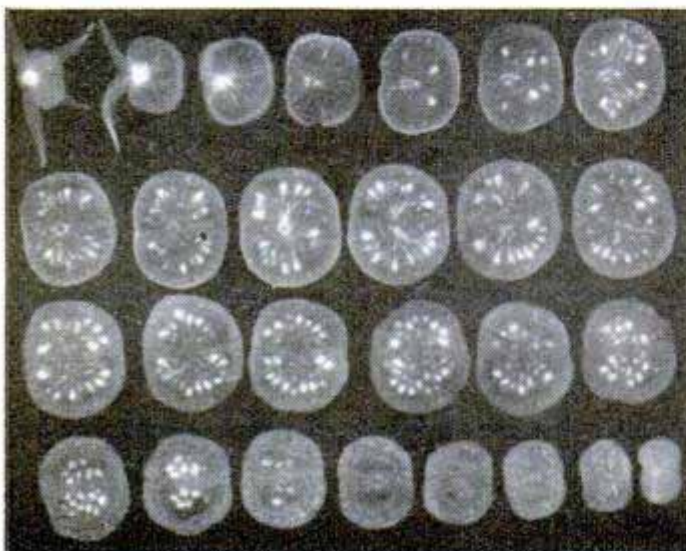

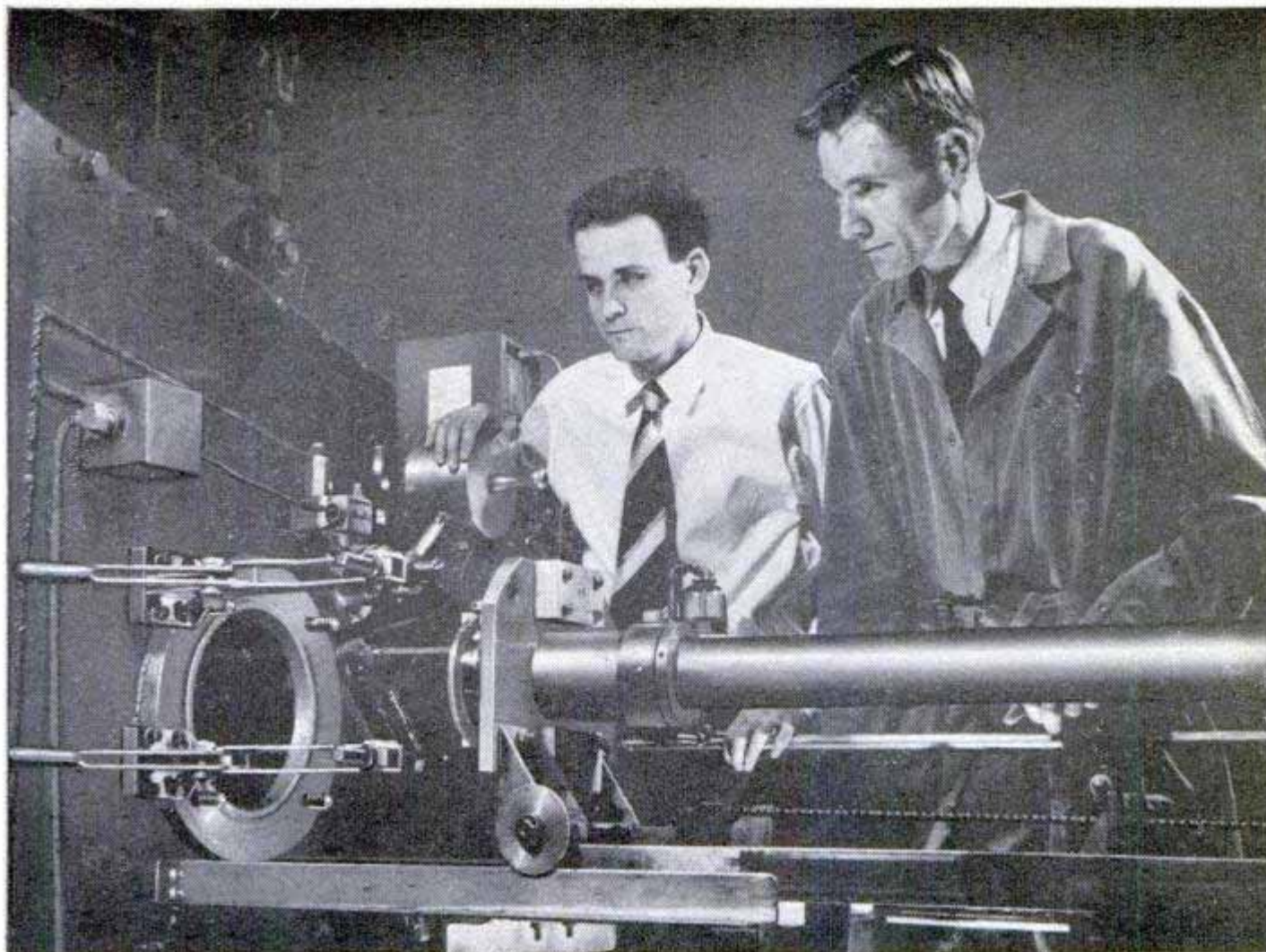

↑ Scientists who produced first man-made mesons prepare cyclotron for experiment. Right, lateral line made by meson before exploding in "star" at the left edge of photomicrograph

developed after some of its silver grains have been ionized by flying particles. The photograph is then examined under a microscope.

"An understanding of the force that binds a nucleus together is perhaps the most fundamental problem in nuclear physics," Doctor Richardson states. "However, no one expects to solve the mystery this year or next. Only after the work at numerous laboratories has been completed and the results compared can we anticipate understanding how the force operates."

Attacking the same problem from a different angle, scientists at the Berkeley campus of the university recently were able to manufacture a powerful particle called the meson, or mesotron, for the first time. Until now this particle had been created only by cosmic rays in the upper atmosphere. Artificially created mesons are a new and powerful bullet for blasting open atomic nuclei. Although they live for only a fraction of a second they may be-

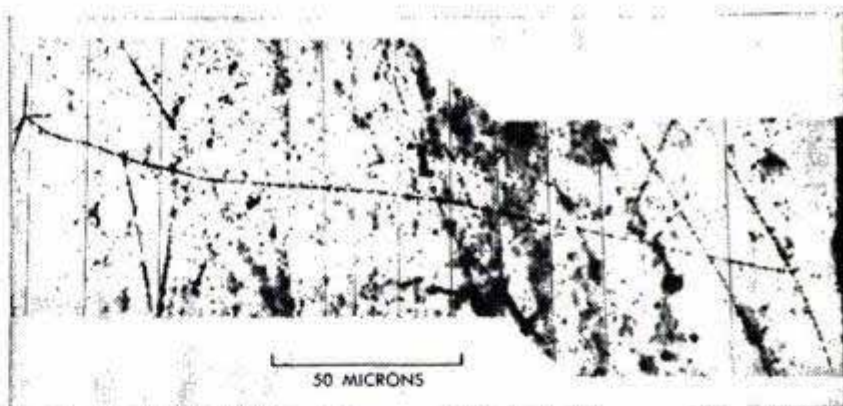

come an important tool in studying the forces that hold the atomic heart together. Too, there seems to be a possibility that the meson can be used to start a chain reaction in some heavy elements, adding to the number of elements from which energy may be taken.

Atomic scientists are still in the exploration stage. What seem to be new types of particles and stages of energy are being discovered all the time. The meson, for instance, now is believed to have four or more different varieties. The job of classifying energy states is a tremendous one and, as a division of this work, the Kellogg Laboratory of Radiation at the California Institute of Technology and other laboratories are making precise studies of the



Cut barley leaves in an atmosphere of radioactive carbon dioxide are exposed to light for varying time periods in study of plant photosynthesis

various states in which the nuclei can exist.

Once it was thought that each element had only one form, then it was learned that there can be different isotopes or varieties of the same element, each with the same atomic number but containing different numbers of neutrons. Many of these isotopes are unstable or radioactive and some 400 useful radioactive isotopes are known. It is believed that each element can exist in many different excited forms, some of which have an observable life and some of which last only a fraction of a second.

To observe these states, various elements are bombarded with streams of protons, deuterons or other particles and the results examined by means of a magnetic spectrograph that consists of a magnetic lens and a counter somewhat similar to a Geiger counter.

These streams of particles are accelerated in a huge electrostatic generator, not nearly so powerful as a cyclotron, that has the advantage of providing a beam that is extremely well defined, is constant and can be concentrated at small targets. Because of this low intensity and lack of scattering, research workers do not have to observe the extreme precau-

Rotary condenser creates frequency modulated current in cyclotron

tions against radiation sickness necessary around large cyclotrons.

Atomic energy has been a Pandora's Box to humanity so far but scientists believe that vast good is to come of it offsetting the atomic bombs and radioactive poisons of war. Harmless radioactive isotopes that are manufactured in cyclotrons and uranium piles, for instance, are pointing the way toward better health and better living.

These tracer atoms now permit research that wasn't practical before. The tagged atoms give off emanations that can be detected by tiny vacuum tubes, making it possible to follow their paths through many involved

chemical and physiological processes.

Petroleum researchers are using tagged atoms in seeking new cheap ways of combining hydrogen and carbon into synthetic fuels and oils. Similar research with radioactive atoms of metals may improve the strength, weight and other characteristics of many metals in common use.

At the Berkeley campus of the University of California a diversified program of atomic research with tracer elements is now being conducted under the auspices of such agencies as the International Cancer Research Foundation, the Atomic Energy

(Continued to page 244)

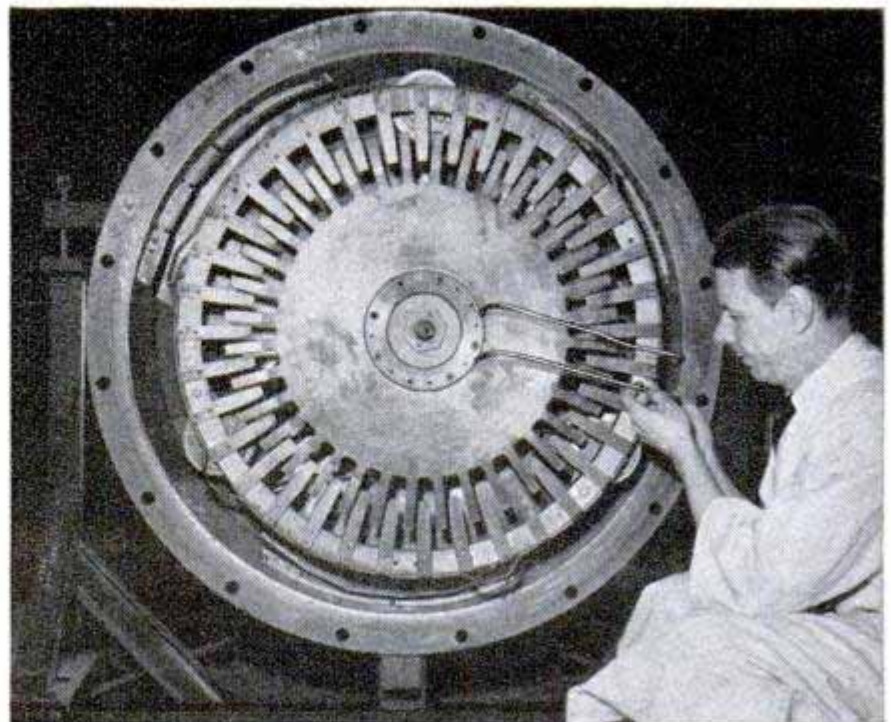

Plastic Covers For Seed Beds

Seed beds with plastic covers are hailproof, shatterproof and light in weight. The covers, made of Celanese Vimlite, a plastic-coated wire mesh weighing less than glass, pass on to the plants most of the sun's ultraviolet and infrared rays. Instead of pivoting on hinges, the covers slide to the rear. The beds are made of aluminum and are three feet square, sloping from 15 inches high at the back to nine inches at the front. They are assembled without bolts and can be folded flat when prepared for storage.

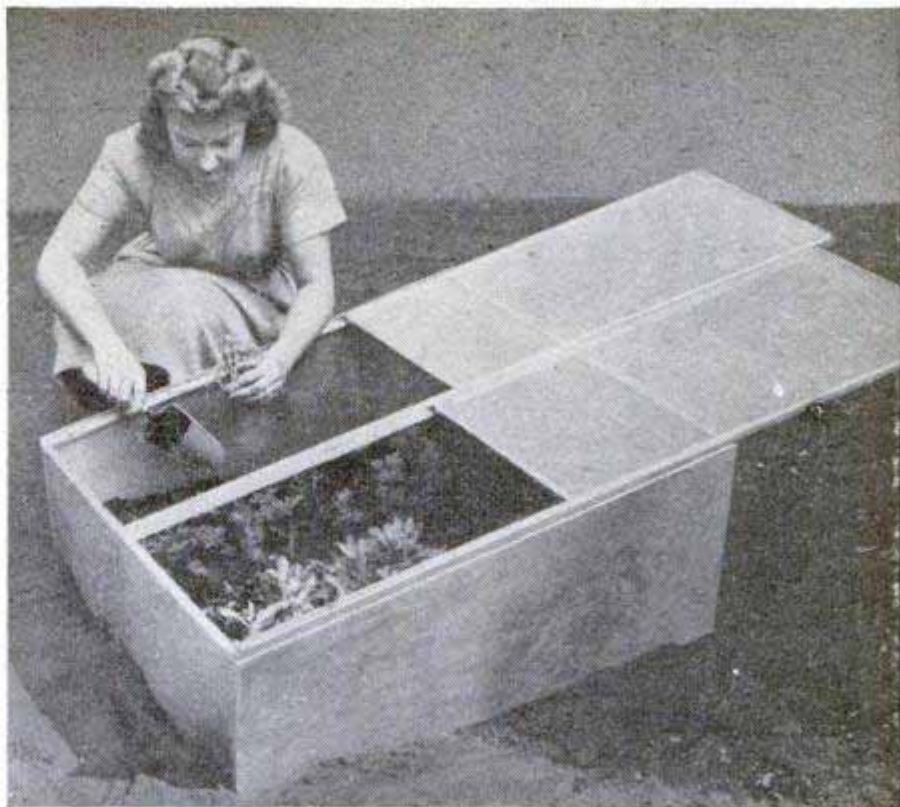

Electric Guillotine "Finishes Off" Obsolete Navy Planes

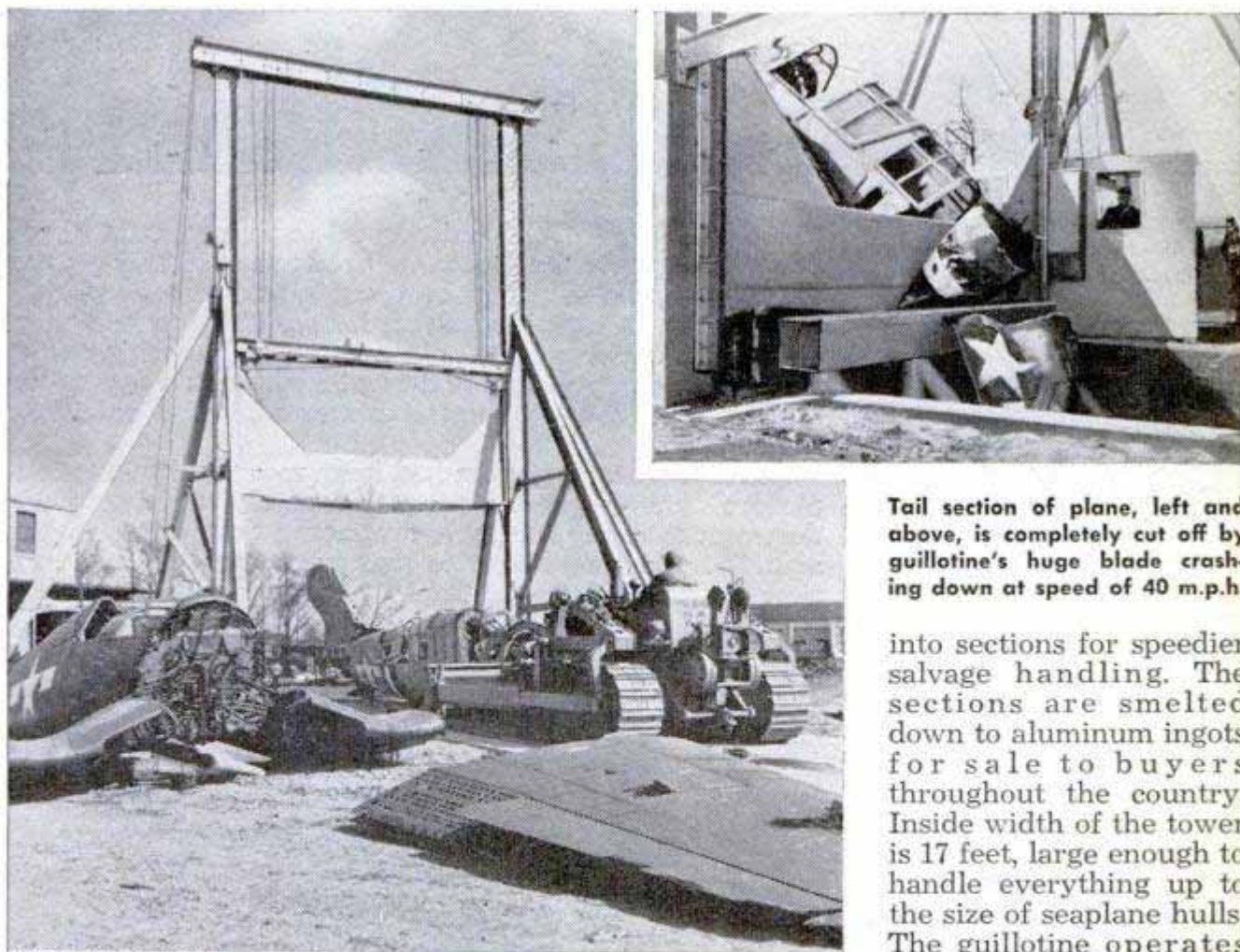

Tail section of plane, left and above, is completely cut off by guillotine's huge blade crashing down at speed of 40 m.p.h.

into sections for speedier salvage handling. The sections are smelted down to aluminum ingots for sale to buyers throughout the country. Inside width of the tower is 17 feet, large enough to handle everything up to the size of seaplane hulls. The guillotine operates on 16 planes daily, making it four times faster than the former method of cutting the scrapped aircraft hulls with a torch.

Official photo U. S. Navy

Obsolete and wrecked planes are the "victims" of an electrically operated guillotine at the Norfolk, Va., Naval Air Station. Its 6100-pound cutting blade, made from two thicknesses of two-inch armor plate, drops 26 feet to slice aircraft



Arrow marks a torpedo launched from 300-foot tube running down a hillside at Morris Dam range

"THE NEXT SHOOT will be an experimental torpedo beefed up to take the shock and fired at a speed far greater than it could be launched from a standard torpedo plane!"

There was a warning blast from the air horn and then, two seconds later, a giant splash in the surface of the quiet reservoir. Barely visible underwater, the dim shape of the torpedo sped down the range and then bobbed quietly to the surface.

Its underwater progress had been measured by motion-picture cameras pointed down toward the surface, by underwater cameras and by hydrophones that picked up the sounds from dynamite caps that were exploded one at a time inside the missile. These records would enable the

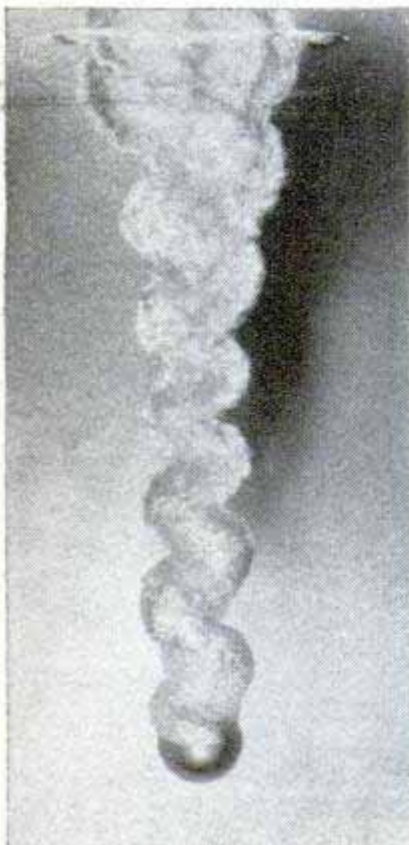

Left, fast revolving steel balls are shot into a tank to get hydrodynamic data. Below, nose of test torpedo breaks water

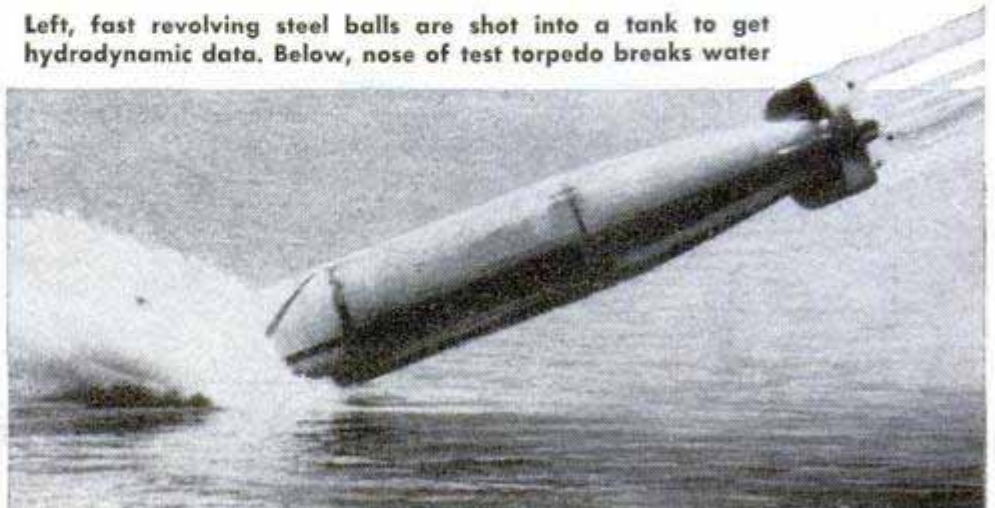

underwater ballistics experts to determine the exact path that the torpedo followed.

The experimental torpedo carried no war head or propulsion motor. It had been launched into the water from the open mouth of a 300-foot-long tube by a charge of compressed air. The shoot had been made to study the effect of high-speed water entry upon that design and to learn whether the torpedo would run true or would hook or broach to the surface.

Ever since 1943 the Navy has been quietly conducting research in torpedoes and underwater missiles in an eight-mile-long reservoir behind Morris Dam near Azusa, Calif. During the war more experimental torpedoes were launched into the reservoir than the total number that was fired from aircraft against Japanese targets. The information acquired from the tests contributed greatly to the accuracy of our air-launched torpedoes during the latter part of the war.

Today at the same reservoir the Navy is expanding its research program. Modern designs of high-speed torpedo aircraft, for instance, impose new problems on designing and shaping of torpedoes and there are numerous new ideas concerning under-

water missiles that must be investigated.

The launching tube now in use slants down the side of a hill to the water surface at a fixed angle of 19 degrees. Compressed air blows the torpedo down the tube, through the air and into the water when the firing officer pulls a valve. In the water the torpedo travels along a buoy-marked course and, when the missile is equipped with a propulsion motor, toward a white target at water level a mile away.

Basic data on water-entry problems are studied not only by the launching of torpedoes but also by the launching of so-called plugs down the tube. A plug is a 300-pound hollow aluminum shape, similar to the nose of a torpedo. It strikes the water with such force that it is shattered into hundreds of pieces, many of which fly through the air with the force of shrapnel.

Not only must the effects of speed in hitting the water be studied but the angle at which a missile is dropped into the water is also important. To learn more about the best angles for dropping missiles from aircraft the Navy is now completing a variable-angle launching tube that, with its supporting structure, looks like an engineer's weird dream.

Compressed air forces missiles down the 300-foot tube. None carry explosive heads. Black striping on nose helps cameras trace rotation

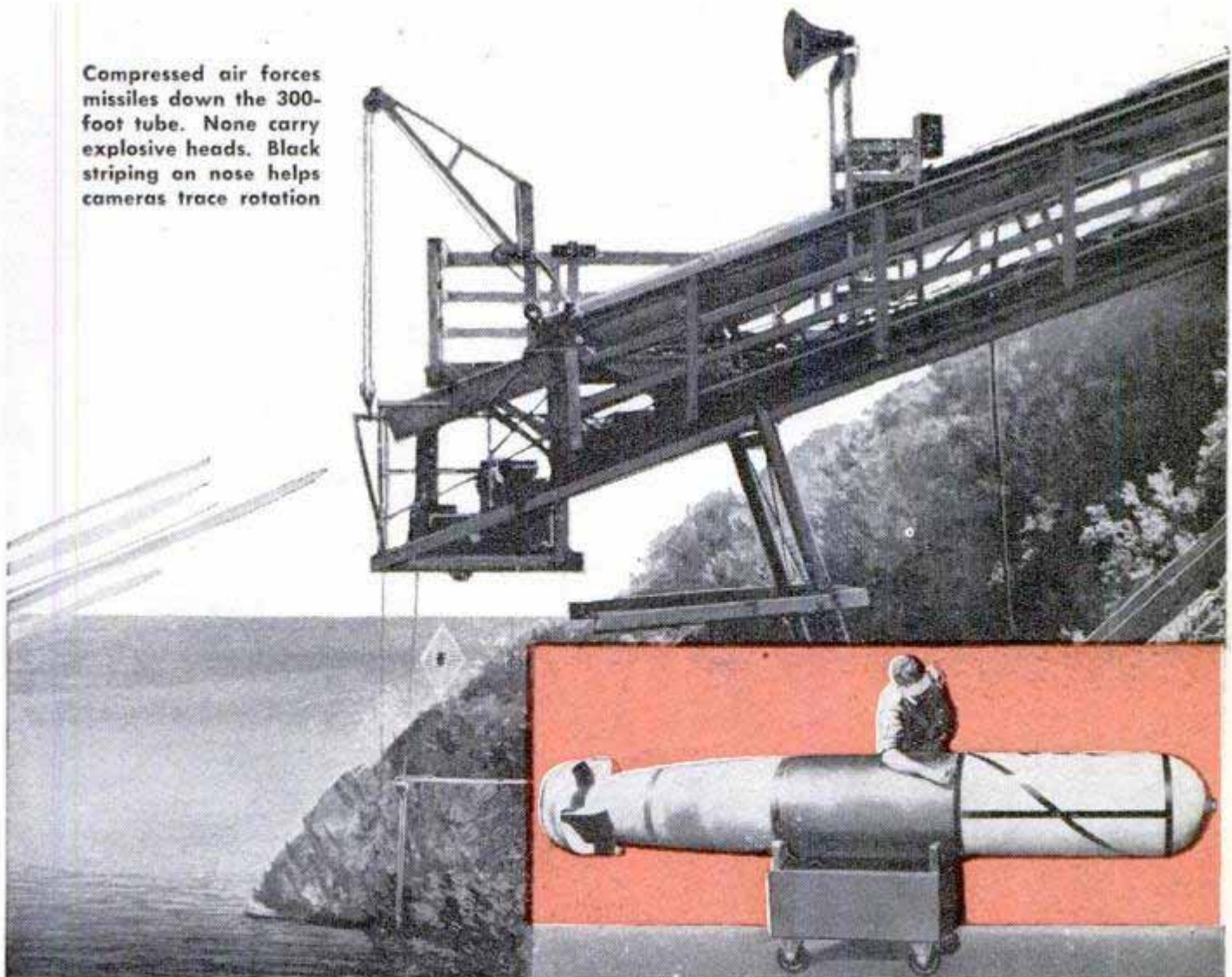

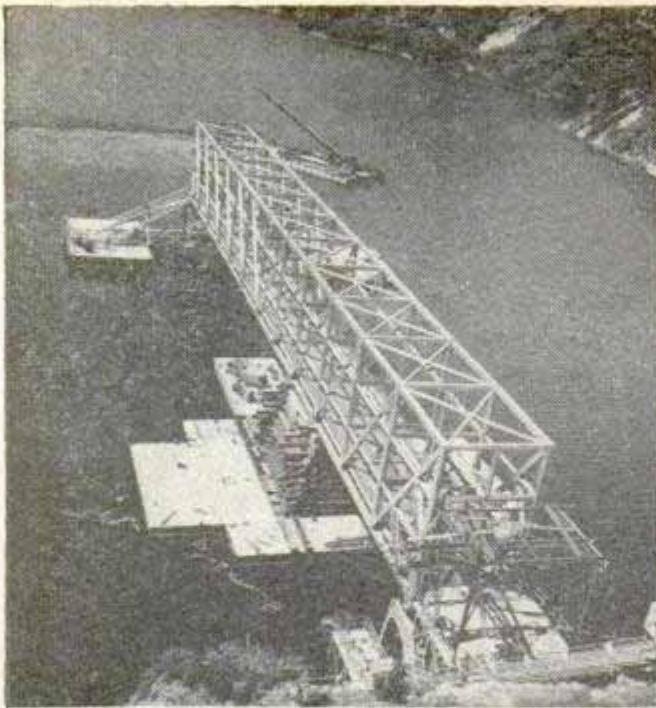

Left, now under construction, variable-angle launcher will test best speeds and angles for planes to drop missiles. Right, from water's surface to top of cableway for the torpedo speedway is 220 ft.



Tube for the variable-angle launcher is in bridgelike member. It is held in place by steel cables attached to counterweight that slides up and down concrete runway on the far side of the hill

The tube itself is 300 feet long. It is supported inside a welded-steel bridgelike structure, one end of which rests on floats on the surface of the reservoir and the other end of which is hauled up a steep concrete runway built into the side of a hill.

A huge wheeled car that may be loaded to a weight of 600 tons is positioned on a similar runway on the other side of the hill to act as a counterbalance, being joined to the launching tube and structure by means of sixteen $2\frac{1}{8}$ -inch extra flexible strands of wire rope that are led up over the crest of the hill. Because of this counterbalancing it will be possible to haul the free end of the launching tube uphill by means of a single 100-horsepower electric motor.

The Morris Dam experimental torpedo range operates as a

(Continued to page 252)

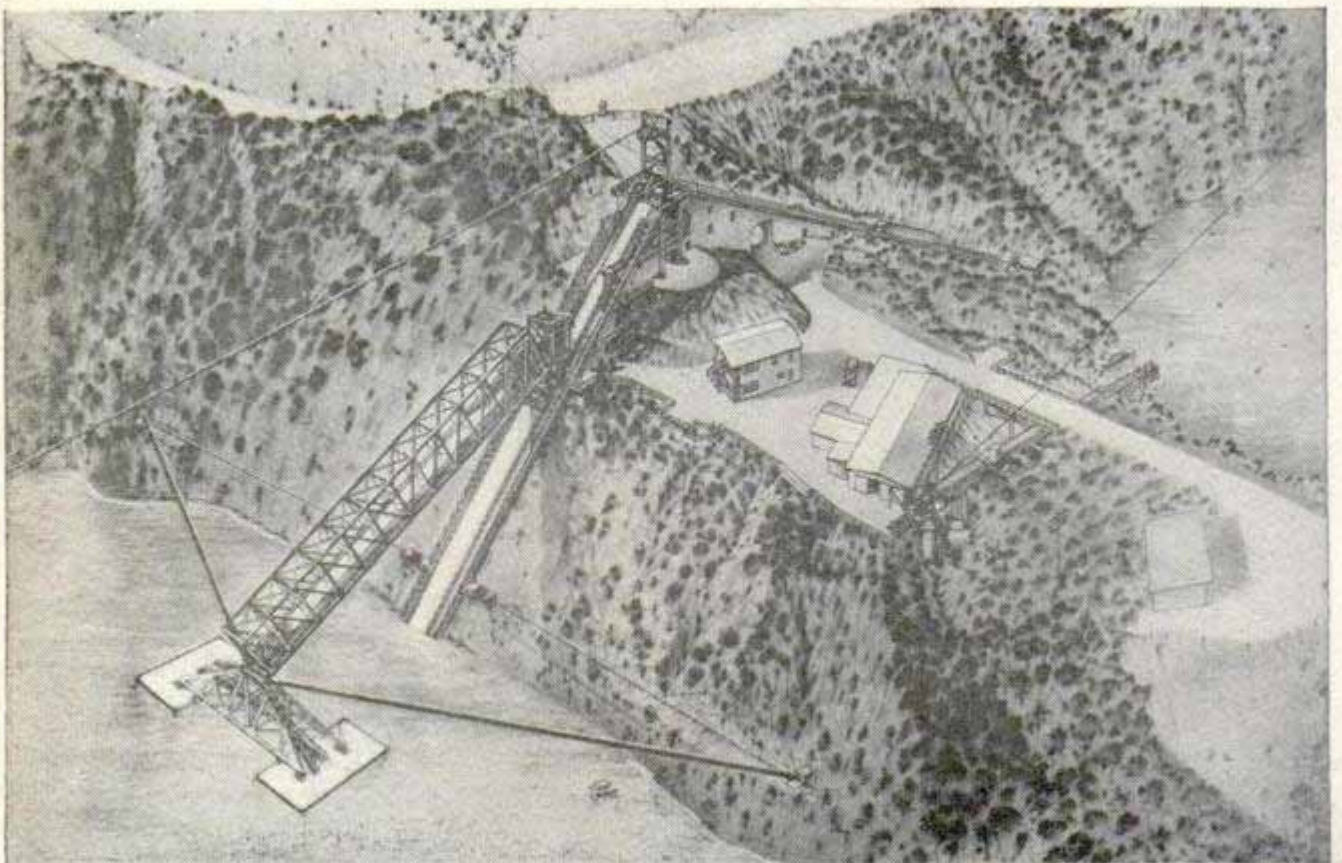

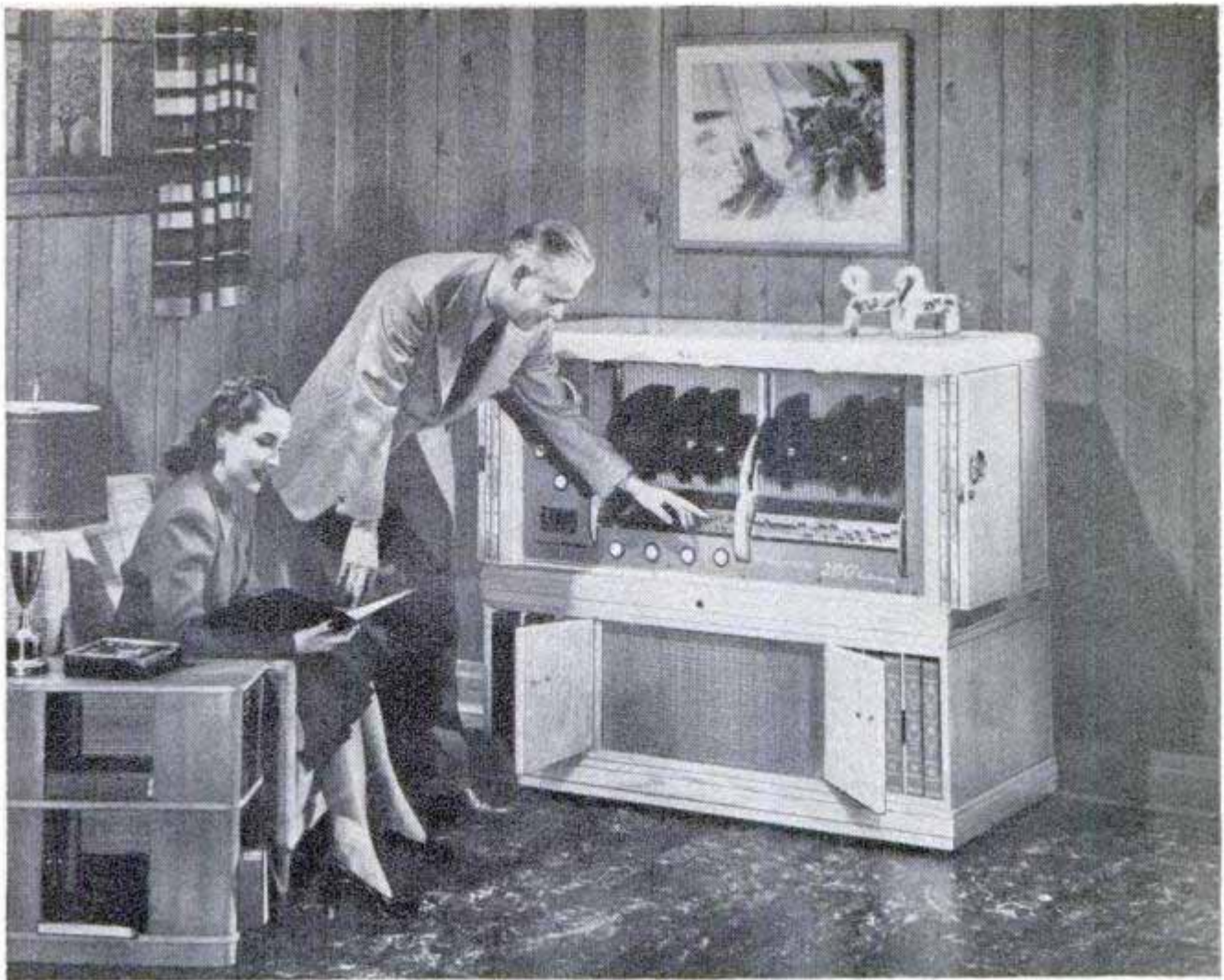

"Marathon" Phonograph

More than 14 hours of continuous music can be played on a new record changer without repeating a selection and without touching the records. The changer removes the record from the library, plays it on a vertical turntable and returns it to the library. Records are stored in a rack which holds 100. By pushing buttons beneath the records the operator can select the program he desires and the turntable and pickup arm move along a track to play them. Both sides of a record can be played on the vertical turntable without turning the record over. One model of the changer is designed for homes and small installations. It is available either with or without an amplifier and speaker, and may be

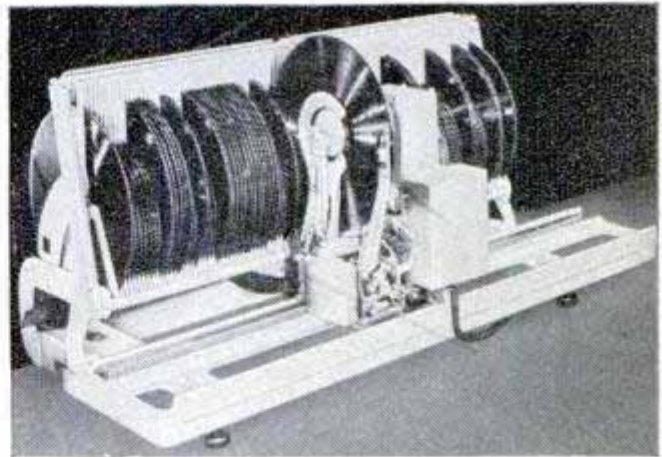

played over existing sound systems or through any radio set. A model for industrial use has a microphone for making announcements throughout a building.

Billions of Bees Shipped to Northern Orchards in Wire Cages

Six billion baby bees were shipped this spring from southern states to northern destinations where they replaced colonies killed during the winter. According to the Department of Agriculture, 1,375,000 pounds of bees were shipped in 1947, and this year's shipments were about four percent higher. Although the bees are only a week old when they leave the South, they

go to work immediately after reaching their destination, producing honey and pollinating fruit trees in northern orchards. Package bees travel in wire cages and are fed syrup during the trip. Some packages contain a queen, although queen bees are also available in individual cages. More than a million queens were shipped in 1947 and even more in 1948.



With arresting gear picked up by the tail hook, jet is being slowed to stop on flattop. They come in at speeds above 100 miles an hour

Left, with its jet engine roaring, an FJ-1 is catapulted from bow of USS Boxer. At this position plane's speed is about 130 miles an hour

Lower left, jets require a longer approach glide than piston-engine craft because they get no braking effect from propeller on way down

Below, as emergency stopper for those that fail to catch arresting gear, Davis barrier rigging snaps up to halt the main landing wheels



ROOST ON A FLATTOP



North American Aircraft photo

With nose gear "bending at the knee," an FJ-1 nears upright position where it'll lock into its normal place

PREPARING for the day when all Navy carrier-based planes will be jets, pilots of Squadron VF-5A, "Fighting Able Squadron," have been using the 800-foot-long USS Boxer for operational tests off the Pacific Coast.

Purpose of the flights is to explore the need for possible changes in carrier design to accommodate jets, as well as to give pilots practice in jet landings and take-offs at sea. The Boxer trials were preceded by months of practice on a small field near San Diego, Calif., which simulated the deck of a carrier and was equipped with arresting gear.

The squadron's North American FJ-1 Furies weigh 12,697 pounds, have a top speed above 550 miles an hour, carry six .50-caliber machine guns and have a range of more than 1500 miles. With short, stubby wings, the FJ-1 looks like a high-flying bomb. In place of folding wings it has a "kneeling wheel" that lowers the front part of the plane and raises the rear of the fuselage so that other aircraft can be parked close behind on crowded carrier decks.

One change necessary on the carrier was the installation of a Davis barrier, designed as an emergency stopper for jets that fail to engage the arresting gear. It consists of

Rows of radio antennas, usually sticking up in the air, have to be cranked down when planes are landing

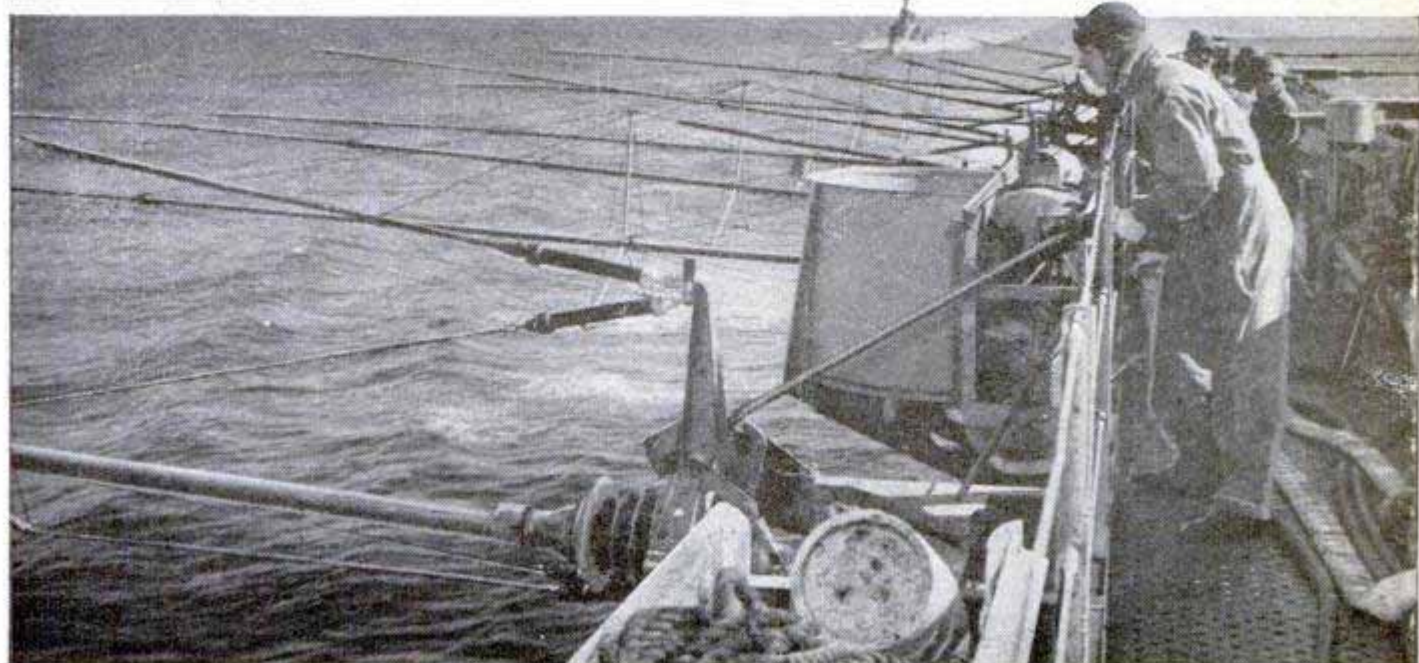

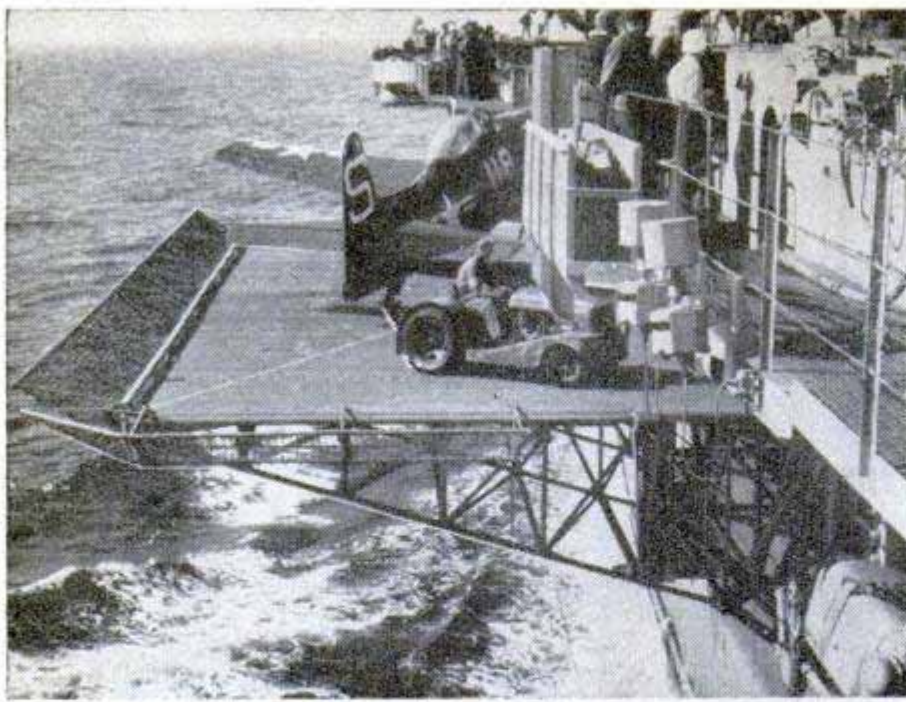

Left, side elevator takes jets from hangar deck below, where fueling, servicing and inspection are performed, to flight deck

Four Furies fly over the Boxer just prior to landing. This type plane made its initial flattop landings during Pacific trials



a heavy Nylon rope stretched 3 feet high across the deck. When the rope is struck by a nose wheel, a heavy steel wire immediately snaps up in front of the plane's main landing wheels, stopping them. The barrier design change was necessary because the FJ-1s and other jets are of the nose-wheel type.

In the test operations, pilots were able to snag the first or second wire of the arresting gear for landings, often with rolls of only about 60 feet. To make up for the lack of braking effect supplied by propellers, the pilots began their approach glide about 200 yards sooner than is customary with piston-engine fighters. They were landing at a little less than 110 miles an hour after most approaches.

Take-offs were made a few times within 700 feet of the deck's length, but most of the time planes were put in the air from catapults built into the forward part of the deck. On some fly-offs the jets used about 800 feet, meaning that the entire deck had to be cleared. A piston-engine aircraft needs only the forward half or third of the deck, allowing storage of a considerable number of aircraft behind it.

Catapulting, on the other hand, requires only a limited space in the bow and allows considerable deck storage space for additional planes. The indications are that aircraft carriers on which jets are based will be redesigned to provide for more than two deck catapults, or to allow catapulting

(Continued to page 246)

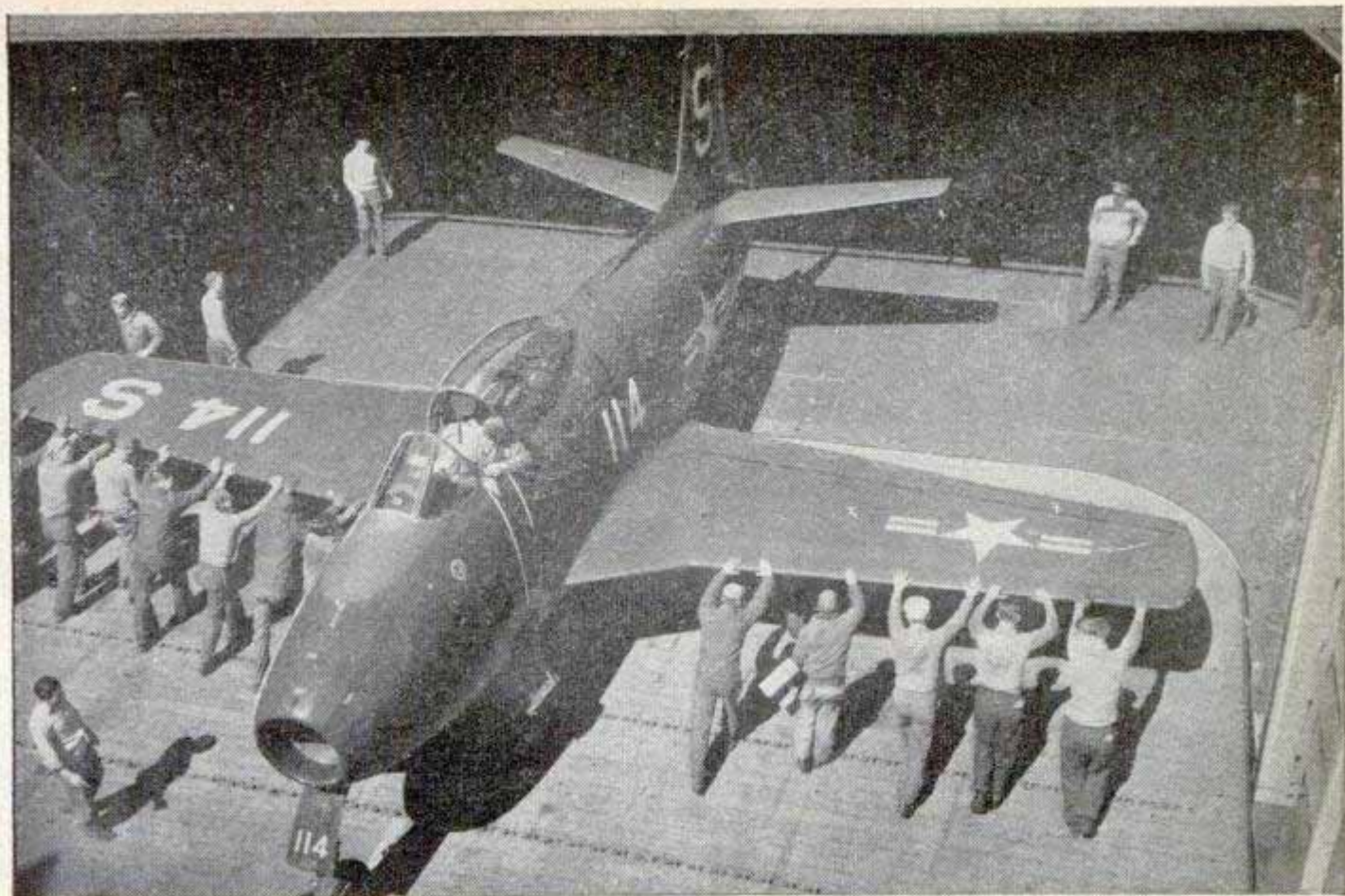

Flight operations are speeded by using the deck elevator, above, for hangar-bound craft, side elevator for planes about to fly

Right, carriage over which catapult cable is strung travels only nine feet before it is halted by buffer pistons, like one at right

Lower right, preparing to catapult jet from carrier bow. With its pull and help from wind, plane leaves deck at about 130 m.p.h.

Below, sailor attaching a catapult rope to shuttle that travels along 90-foot slot in deck

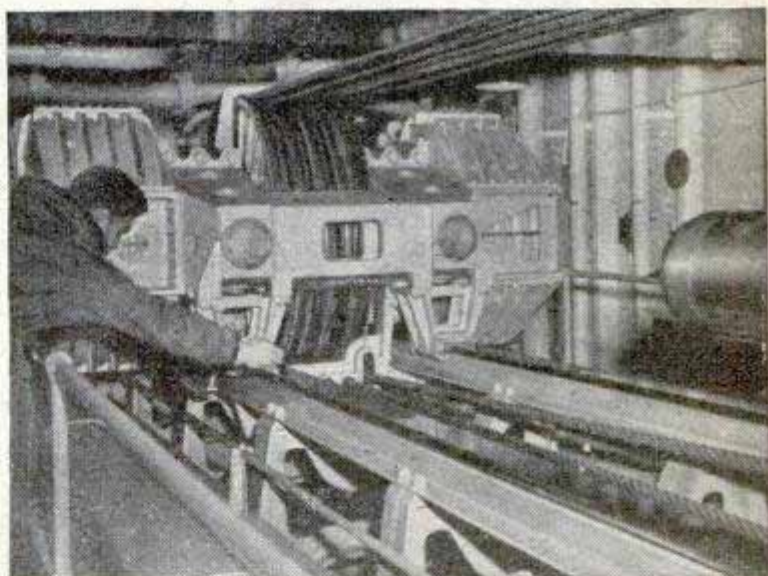

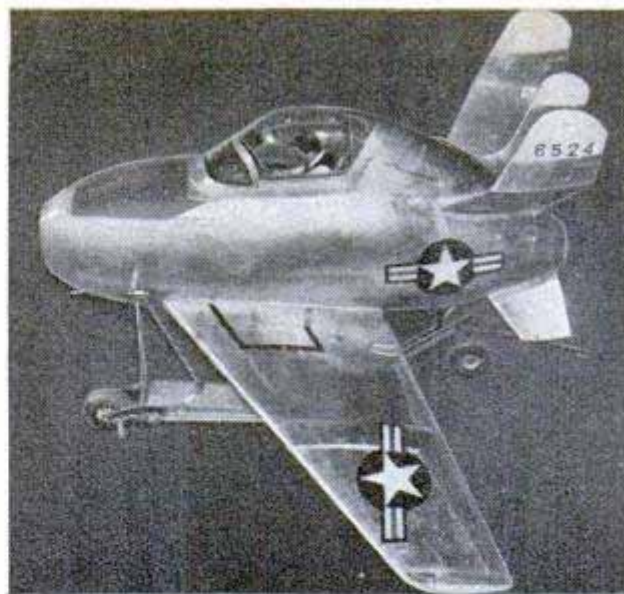
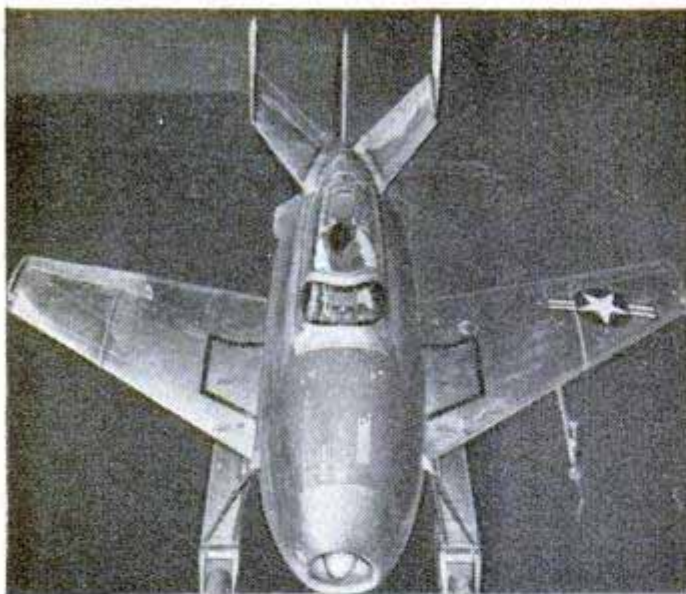

Above, odd-shaped tail assembly of the stubby XP-85 was necessary to provide maximum stability and still fit in bomb bay's tight space

BOMBER CARRIES JET FIGHTERS

One of man's most spectacular dreams, fighter planes that ride to and from battle inside long-range bombers, has become a reality. Called the XP-85, the U. S. Air Force's tiny jet "parasite" travels faster than 600 miles an hour. Unlike other fighters, it will only have to carry enough fuel to fly during the brief moments of actual combat, and none for the long trips to and from the target. The deadly mite is 15 feet long. The wings, spanning 21 feet, fold so that a mooring hook can bring the plane in and out of the bomb bay.

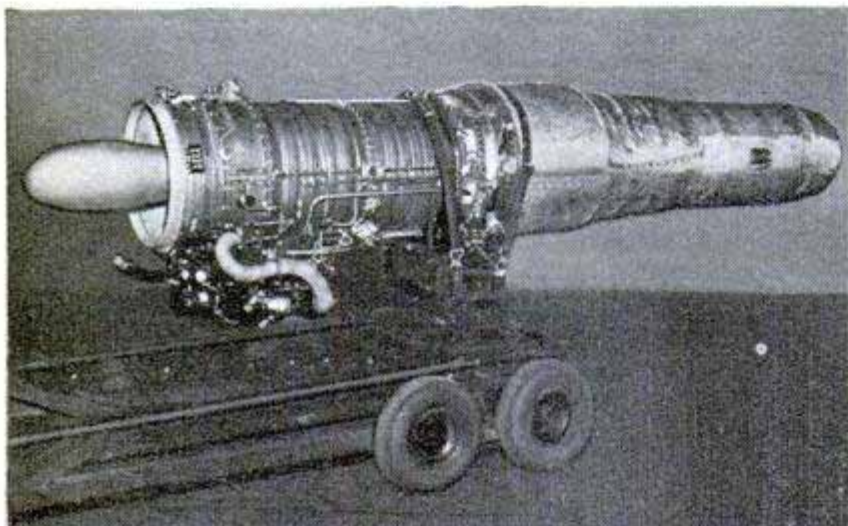

U. S. Air Force photos

Frontal area of XP-85 Westinghouse jet engine, above, offers least wind resistance and makes speed of over 600 miles an hour possible. Below, "parasite" fighters will be lifted in and out of bomb bays by a mooring hook. The McDonnell-built plane has no landing gear

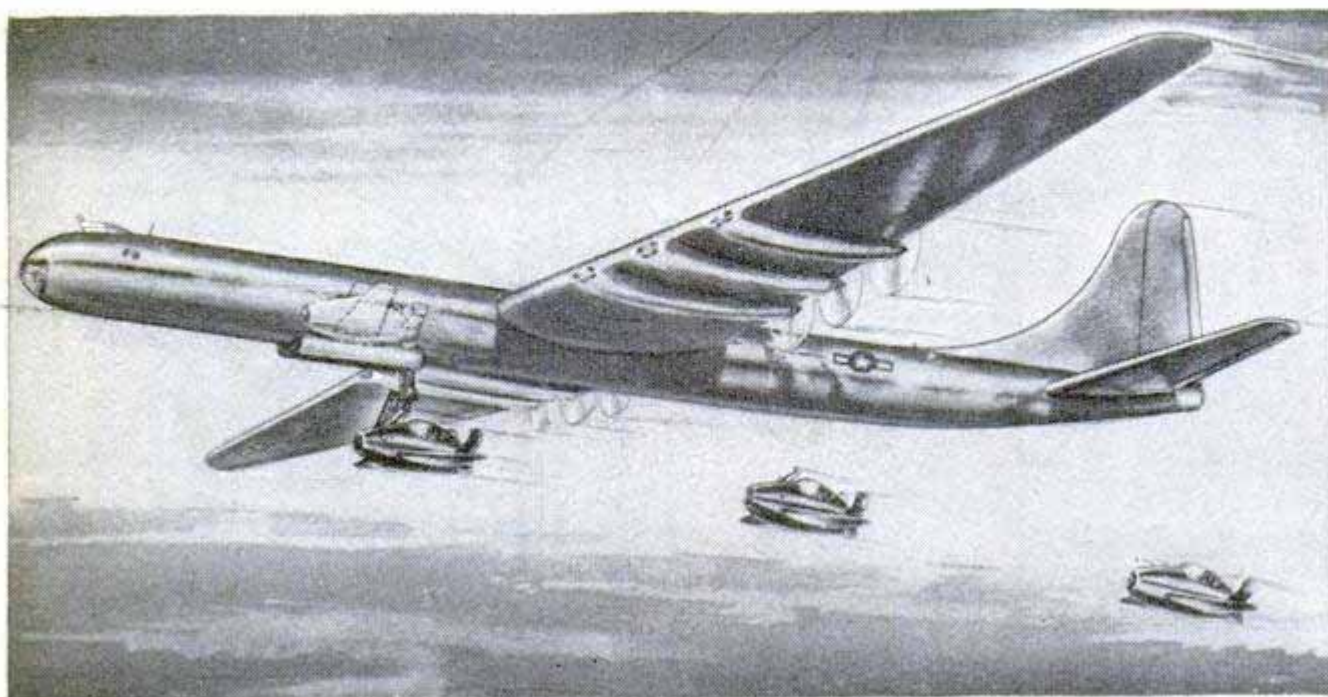

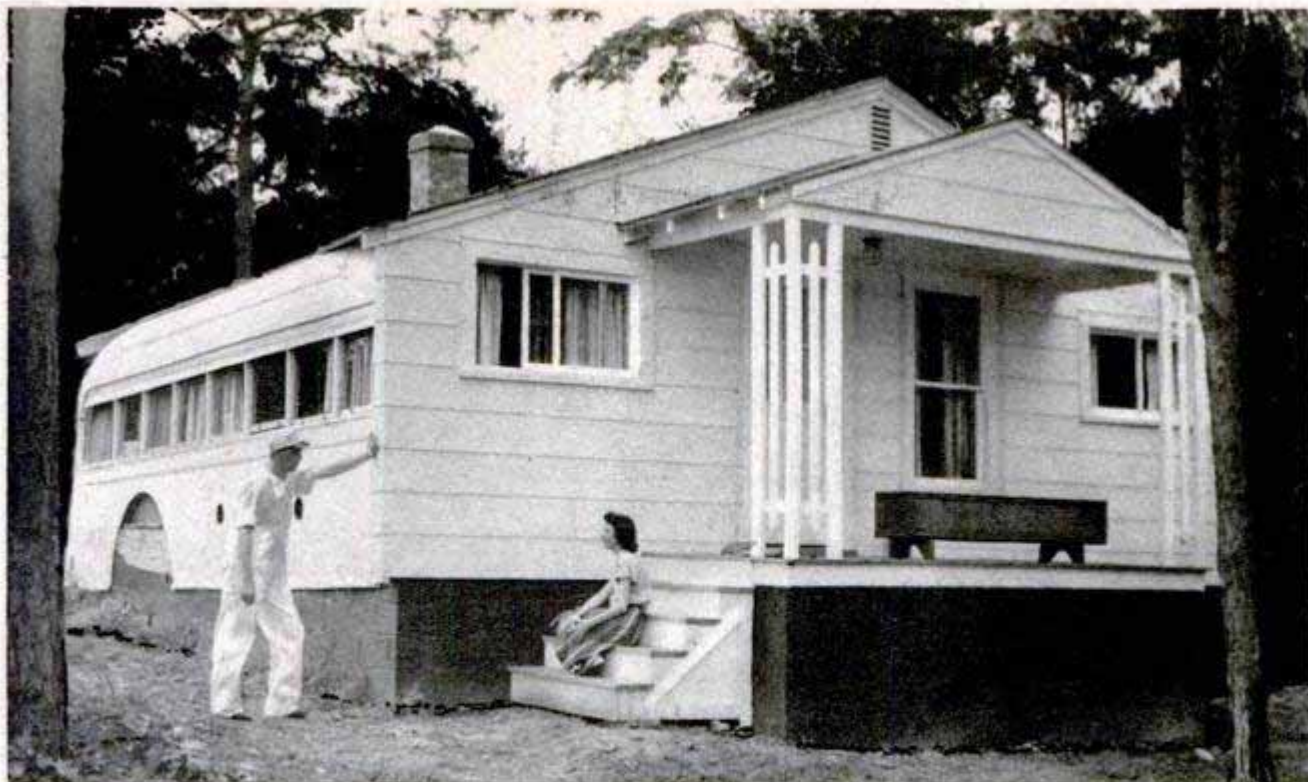

Two Buses Plus Porch Make Attractive Home

When the housing shortage faced Pete McBride of Winston-Salem, N. C., he built a cottage out of two discarded buses. McBride hauled the buses to his vacant lot and mounted them side by side on a concrete-block foundation. He added a front porch and a false front that resembles a bungalow to complete his home. McBride's wife has windows lining the walls on all four sides of her new house.

Top, the discarded buses were mounted side by side and a false front was added. Left, the bedroom has plenty of windows



Prefabricated Roofs

Prefabricated roofs that can be easily transported and erected to form open sheds are being manufactured by British firms. The metal roof is supported by a tubular framework. Beneath the outer shell is an inner roof, providing an insulating space required in tropical climates. The roof will be used in British developments in Africa including a project to grow nuts on 3,250,000 acres.





No two look alike, but the engine of each is souped up to deliver as much as twice its original power

Detroit never satisfies them

The "hot rod" fans are always taking their stock cars apart and souping them up for faster and more economical travel

THERE are hundreds of passenger cars on the road today that can do an honest 90 or 100 miles per hour, get upwards of 25 miles per gallon of gas at highway cruising speeds, and can outperform any stock car on the market.

Most of these automobiles are completely conventional in appearance—but you whistle with surprise when you raise the hood. Inside is a chrome-plated engine, festooned with special carburetors and manifolds. The creation looks like a racing engine and that, in essence, is what it is.

Rebuilding and reworking stock engines to deliver as much as 170 percent or more of their original horsepower has been a fascinating hobby among amateur automotive engineers. "Hot rod" enthusiasts spend thousands of hours designing and building engines to their own specifications, then installing them in ordinary cars or in

special jobs that are lightened and streamlined for speed.

The sport had its start early in the 1900s when some of the owners of newfangled horseless carriages got together for road races and endurance runs. The owners who hired mechanics to tune up their engines soon had their own heads under the hoods and were starting to tinker.

In the early '30s, in southern California, automobile drivers found that on the flat pavements of dry lake beds in the desert they had ideal proving grounds for testing their car speeds, and they have been using the dry lake beds ever since. The first reworked cars were clocked at around 70 miles per hour, then the speeds started going up and today the record stands at 140 miles per hour.

Three hundred or more cars may be entered in one of the time-trial meets now

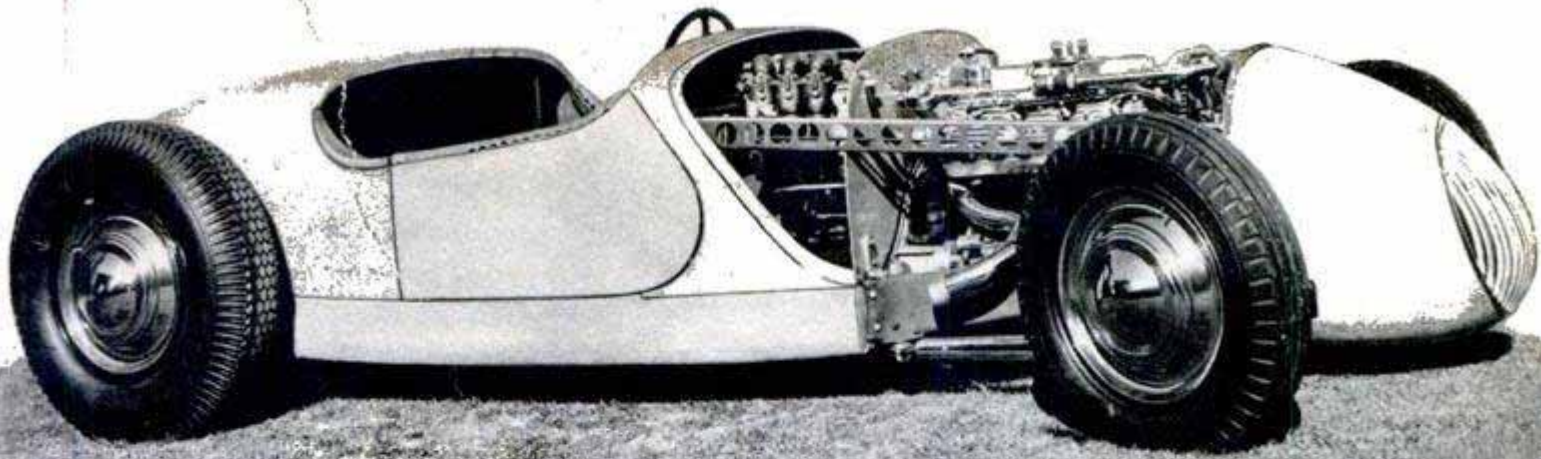

Speed car with all-aluminum body, ready to be fitted with windshield or a transparent bubble-type canopy

held several times a year on a dry lake bed by the Southern California Timing Association, with 10,000 or more spectators in attendance. Most of the cars are roadsters, divided into classes according to engine specifications. A special streamliner class is unlimited, both as to body and engine specifications. Prizes are awarded in each class for the fastest average of two runs, one in each direction.

Last winter the S.C.T.A. held a three-day exhibition in Los Angeles of some of the best looking cars, and no group was more surprised than the drivers themselves when an estimated 50,000 people turned out to examine the hopped-up engines and the special chromed and painted chassis and bodies. Now the S.C.T.A. is thinking about a national organization that would conduct and govern local speed tests in other parts of the country, wherever there are enough interested owners. Today this hobby is developing into an industry and there are a dozen or so manufacturers who are building special manifolds, high-compression heads, and other equipment for drivers who want more speed or economy.

Police cars use the converted engines for speed and power. Taxi fleets equipped with rebuilt engines are able to save on gasoline, and commercial-vehicle operators find that they can move heavier loads without loss of speed when engine horsepower

↓ Roadster with V-8 engine, running "wide open" in a time trial, has been clocked at 125 miles an hour



Owners like the one above spend thousands of hours installing disk brakes, rebuilt springs and shocks

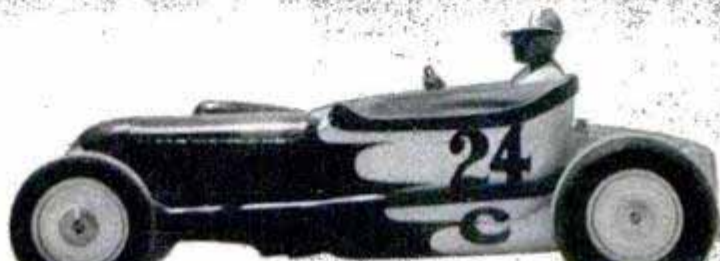



Rebuilt engine above now goes 25 miles on gallon of gas

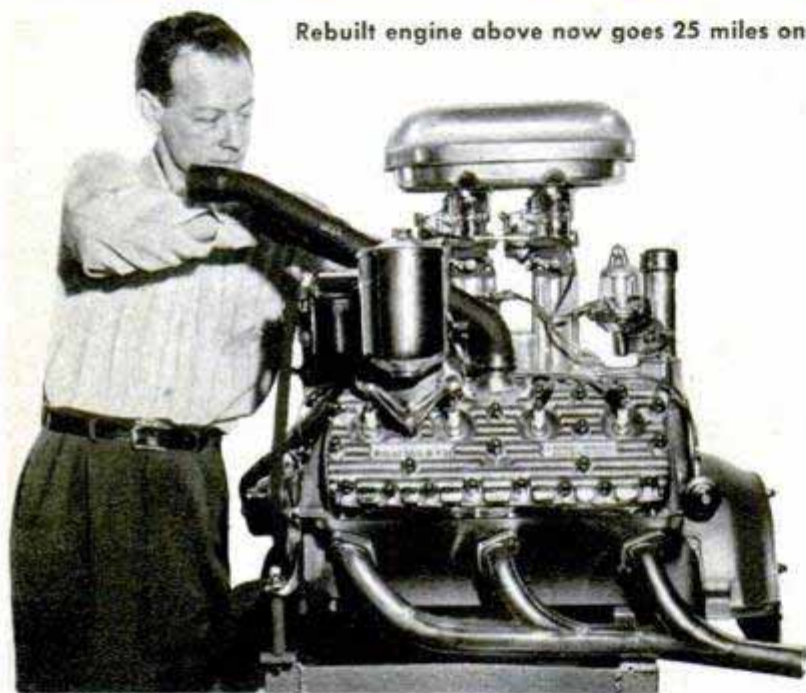

Typical V-8 revamped for more power and economy, above, has twin carburetors and reworked ignition



is increased. Scores of private owners and hot-rod enthusiasts soup up their engines simply because of the greater performance that they obtain. Trailer-coach owners find that they can maintain better highway speeds when towing a trailer and can climb grades in higher gears when they rework their engines to produce more horsepower. Boiling the radiator is still a common problem on a long pull in the mountains, however, and one driver solved this by attaching an electric fuel pump with a very small orifice in front of his radiator. With a special one-gallon reservoir of water, the fuel pump now sprays water over the radiator and helps keep it cool by evaporation whenever the driver turns the special switch on his instrument panel.

Special equipment that provides about 20 percent more horsepower costs \$200 or less. For around \$500 an engine can be radically reworked to deliver a 70-percent power increase on premium fuels. Some of the extra power is obtained by increasing the efficiency of the engine, which in turn results in more miles per gallon under normal driving conditions. The conversion equipment is available for various popular makes of 6 and 8-cylinder engines, although most manufacturers confine themselves to equipment designed for Fords and Mercurys, the engines on which most experimental work has been done.

Ten percent or more power is obtained merely by adding one carburetor and a special manifold that insures an even and adequate flow of fuel at a high number of revolutions per minute. When this installation is combined with a high-compression head of about 8 to 1 a power increase of around 20 percent is obtained, equal to 3 or 4 additional miles per gallon with normal driving. In one 1500-mile test run that included speeds of up to 75 miles per hour an engine converted in this way is said to have averaged 22.3 miles per gallon of gasoline.

Most of the conversions include a reworked ignition system that produces a hotter spark. Usually, double coils and double condensers are used, as well as

Left, block with cylinders bored (3) to take 3½-inch piston, considerably larger than stock size being held in piston. White ring chalked around intake port (1) reveals how its diameter will be enlarged. Whitened area of combustion chamber (2) indicates where metal will be removed to allow an easier flow of gases into and from the chamber to the valves



Above, an airplane belly tank mounted on Ford frame, this streamlined "hot rod" has topped 139 miles an hour

Right, belly-tank Ford has a six-inch drive shaft, an inverted Mercury motor in the tail and is steered with a stick

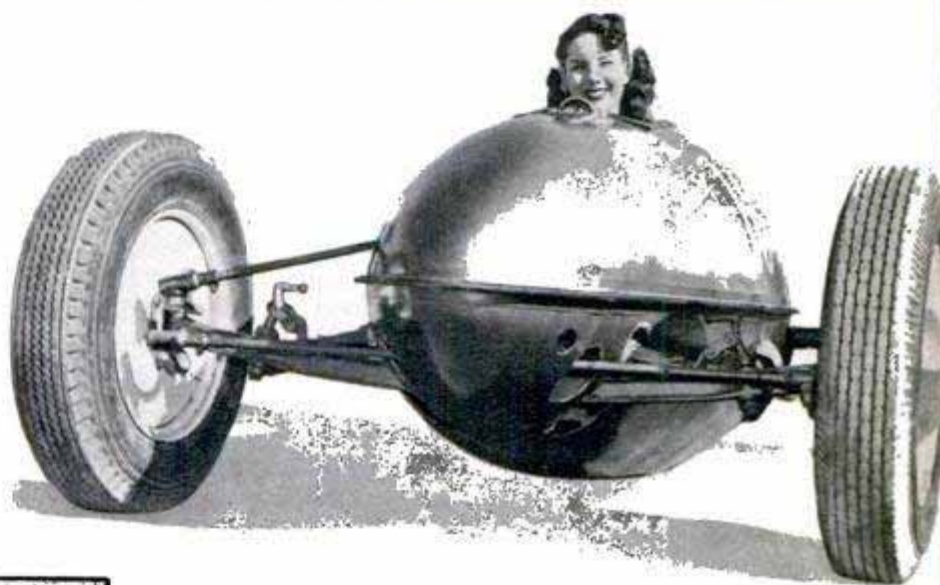

Curves A to E in graph below indicate horsepower increases for 100-hp. Ford engine at various stages of souping up process. Curve E represents power gain after engine was completely reworked
Dynamometer chart compiled by Vic Edelbrock

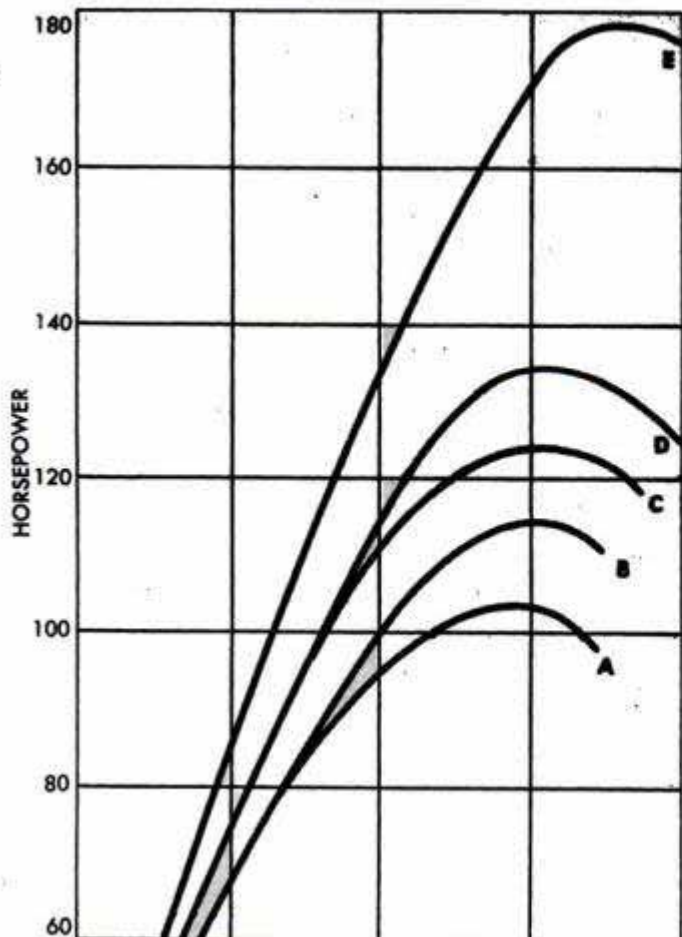

fast-action distributor springs and magneto-type breaker points. A good rebuilt ignition system will jump a $\frac{1}{2}$ -inch spark at 8000 r.p.m. and will operate at compression ratios as high as 15 to 1. Stock ignition systems that are adequate at low speeds often can be improved for high speeds by using stronger or double distributor springs.

Members of the Southern California Timing Association and the other experimenters try out every idea that they can dream up in the constant quest for more power and efficiency. Some design "hot" manifolds to vaporize the fuel, others use "cold" manifolds that are intended to supply more fuel to the combustion chambers. Various compression ratios and various fuel mixtures of gasoline and alcohol are tested. One designer may like a small water jacket to insure a high engine temperature, while another may double the usual water capacity in the head so that the engine won't overheat even though he discards the fan.

Side-draft carburetion, double overhead



Young designer holds a fuel-injection system that replaces usual carburetor. Fuel metering changes automatically as butterfly valves open and close

intake valves coupled with a single exhaust valve in the block, pistons that push up into the combustion chambers almost to the roofs, water injection, supercharging, firing the cylinders of a V-8 in pairs, and odd firing sequences coupled with new designs of crankshafts; all of these ideas are tried and then adopted or discarded.

Four or five thousand hours of labor may

Drawings by Tattersfield Manifold Division,
Electric & Carburetor Engineering Co.

Drawing of typical stock intake manifold, with each port feeding two combustion chambers of 6-cylinder engine. More fuel is supplied to the near cylinders than to the distant cylinders, producing an unbalanced power flow

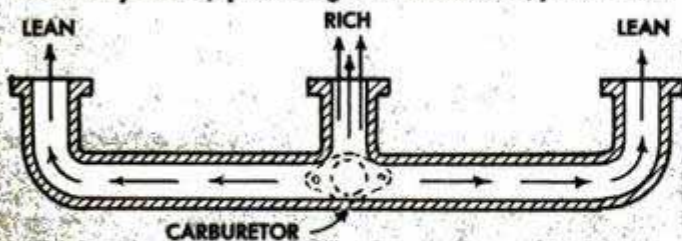

This drawing shows dual carburetors and special manifold for the same engine, arranged so each cylinder draws an equal amount of fuel and performs equal share of the work. The open slot between the two carburetors is a balance tube that insures equal pressures

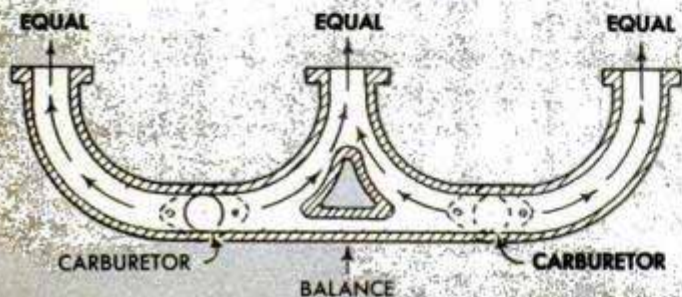

be spent on an engine and car and then, on its first run against time, the engine may fly to pieces. Most experienced hot-rod builders can point to a pile of junk behind the shop that contains smashed blocks, cracked heads, melted pistons and twisted connecting rods.

The most radical jobs, designed for high speed alone, are hardly satisfactory for highway driving. They are apt to be rough in the low-speed range and they wear out in possibly a tenth of the mileage that is expected from a stock engine. In some cases the horsepower is almost doubled.

To begin with, an entirely reworked engine is fitted with dual, triple or quadruple carburetors plus a special manifold. A high-compression head with a compression ratio as high as $9\frac{1}{2}$ to 1 may be used, plus race-type ignition. Weight of the flywheel is reduced or

else replaced by an aluminum flywheel.

The cylinders are bored out to greater diameter. Next the stroke is increased a full $\frac{1}{8}$ inch by grinding the crankshaft bearings off-center. Metal is removed from the inner surface of the bearing and the bearing is then reshaped, creating a longer stroke. Special "stroker" pistons, with pins set lower than usual, are installed. Next, a "super-race" camshaft that offers considerable overlap is fitted into the engine.

The diameter of the intake ports in the block are enlarged to permit an easier flow of fuel, and the combustion chambers are "relieved" by grinding away metal from the valve area to the cylinder. Stronger valve springs are installed.

All rotating parts, plus the connecting rods and pistons, are then balanced dynamically to within three grams.

The whole job costs \$500 or more, plus installation labor. Depending on the techniques used and the special equipment that is chosen, this reworking raises the power of a 100-horsepower engine to a total of from 165 to 185 horsepower. Hot-rod enthusiasts who use an engine like this on the highway are apt to find that they can accelerate so rapidly that they snap a rear-end gear or an axle. To forestall this they install truck components.

Instead of using standard carburetion, one young experimental engineer designed and built a fuel-injection system for a V-8 that operates on the continuous-flow principle. The fuel is sprayed under pressure directly into the intake ports above the valves. The air-fuel ratio remains constant

all through the throttle range. On its first trials an engine equipped with the injection system was clocked at 136 m.p.h. and the inventor is now trying further refinements to the equipment.

Another offshoot of hot-rod engineering is a rocker-arm overhead-valve system for jeep engines. Now in production, the assembly includes an aluminum-alloy engine head of 7 to 1 compression ratio, aluminum side plates and cover, and an optional single or dual water-heated manifold plus the overhead valves themselves. The installation can be made in a few hours and produces 80 horsepower at 4000 r.p.m.

Still another inventor has produced a simplified rear end that delivers power to each rear wheel at all times and yet has 100 percent differential. The rear wheels adjust their speed as usual in making turns and corners and yet each rear wheel has traction at all times, permitting one wheel to pull the other out of mud or across slippery pavement.

The superflexible springs and soft shock absorbers of stock cars provide a floating ride at low speeds but reduce a car's roadability on the highway, and this is another problem on which the amateur engineers are working. The ultimate, for cars built only for time trial runs, has been to bolt the chassis directly to the axles without any provision for ironing out the bumps, or at least to use only a skeletonized spring suspension. Such a car rides hard at low speeds but smooths out and remains stable at speeds in excess of 100 m.p.h.

It wouldn't be too difficult, some of the hot-rod enthusiasts believe, to design shock absorbers that are soft at low speeds and that automatically tighten up when speed is increased. A stock car equipped with such shocks should be easy to handle all through its speed range.

Many of the hot-rod enthusiasts think that Detroit is behind the times. But the fact is that the big manufacturers

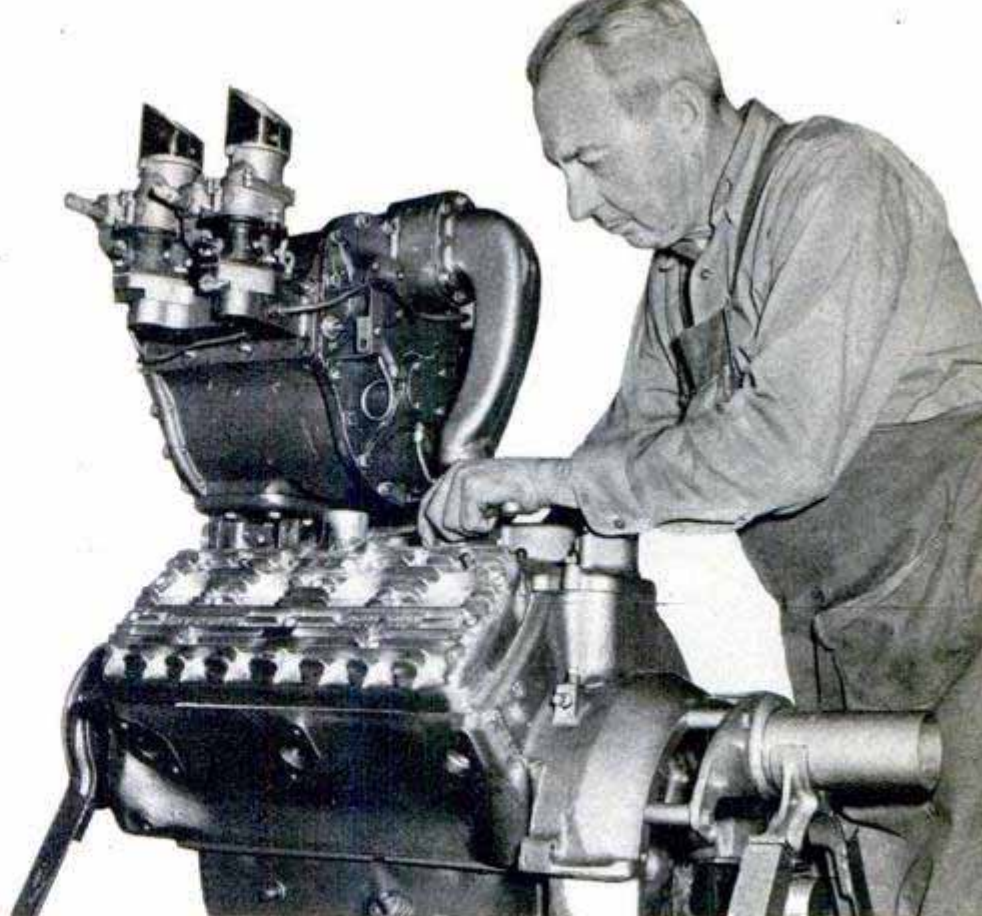

Horsepower of small V-8 is almost doubled by use of an experimental supercharger. Too bulky to install under hood of conventional autos, it is now being redesigned smaller

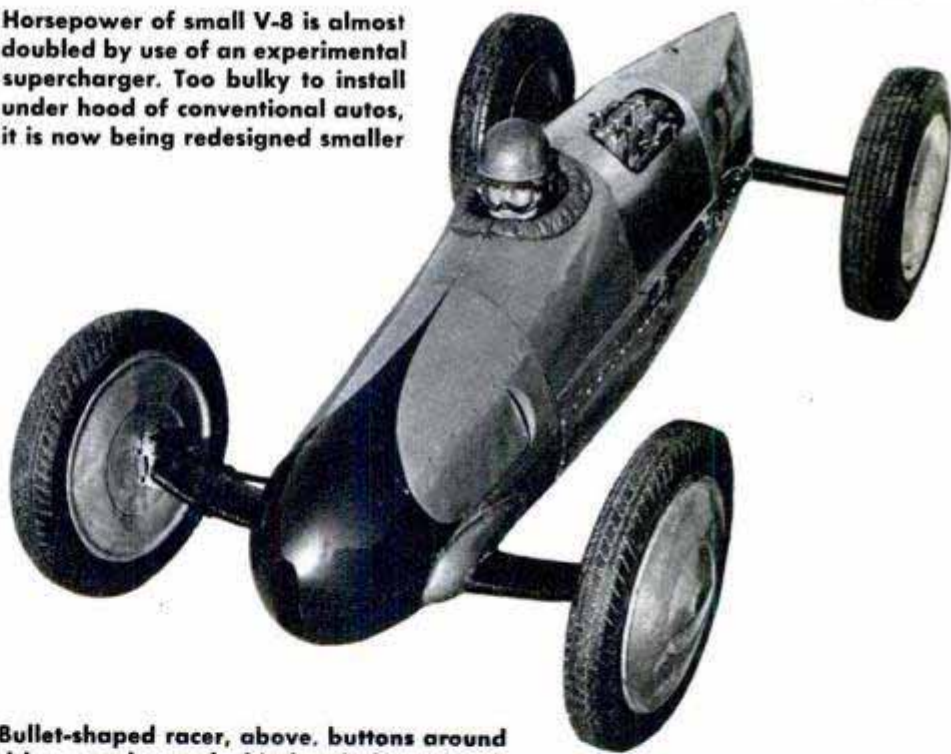

Bullet-shaped racer, above. buttons around driver so that only his head shows. Both side plate and steering wheel have to be removed for him to enter. Time car below has springs in rear, but none in the front

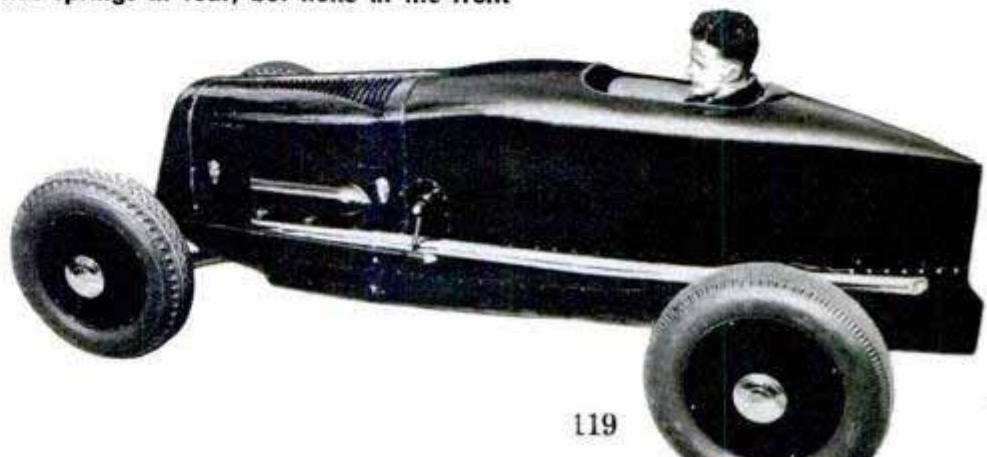

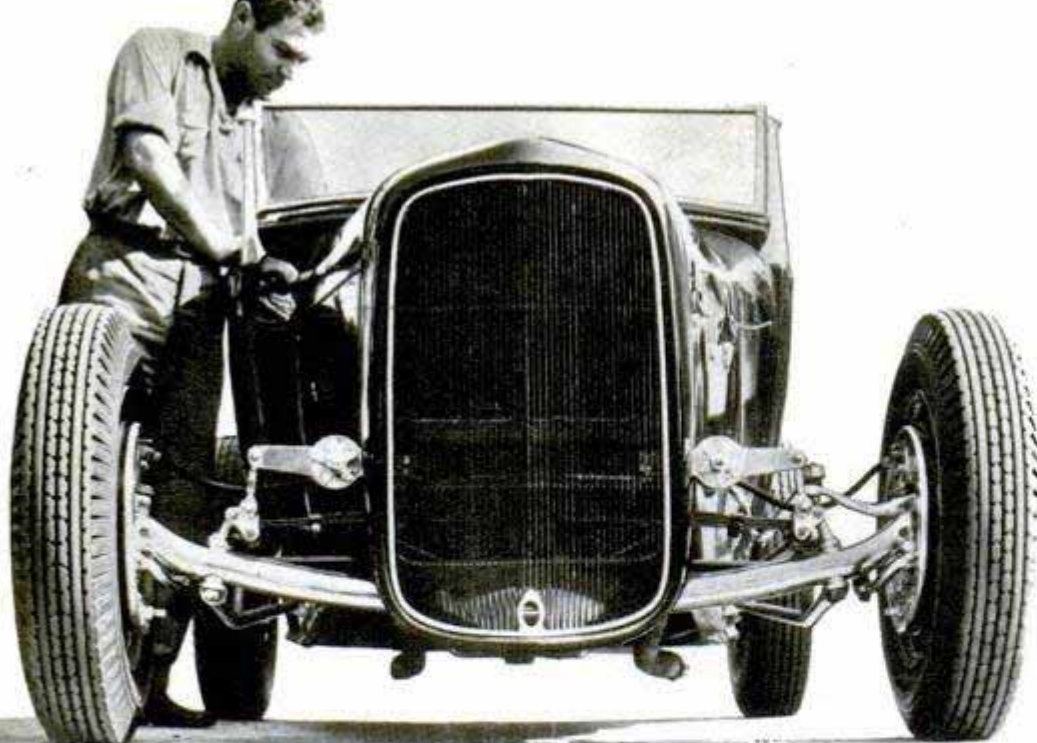

Tubular front axle is used on roadster, above, built up principally from 15 and 20-year-old Ford and Chevrolet parts. It was timed at 124 m.p.h.

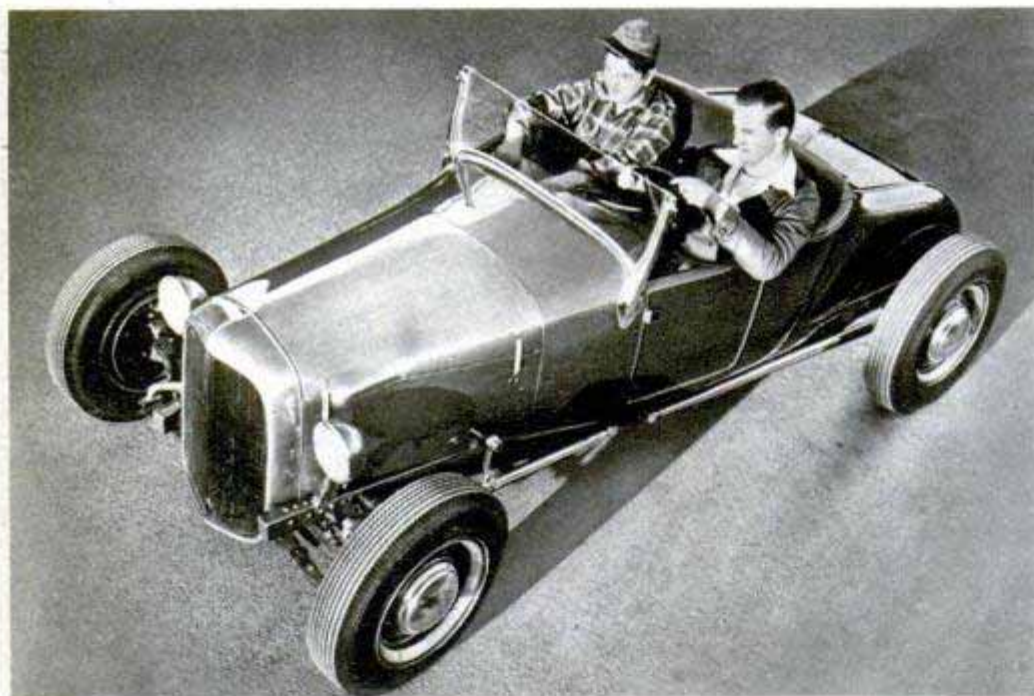

Mercury-Ford combination, above, has 1927 body riding on a 1932 chassis. Below, souped up engine of this small roadster delivers over 150 horsepower

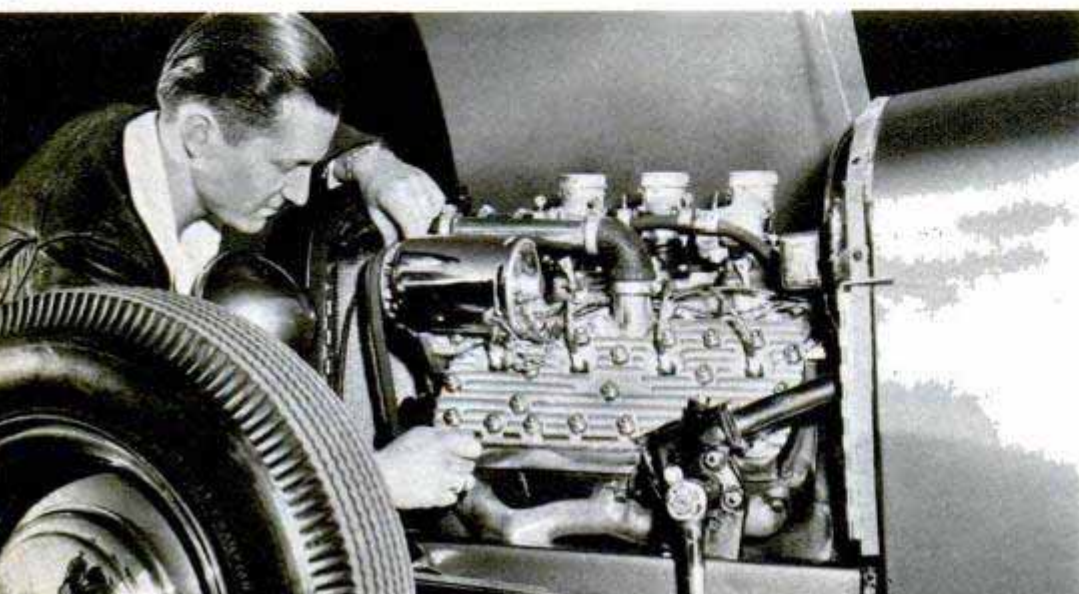

have problems that the amateur engineers don't appreciate. Detroit must build cars and engines that will operate satisfactorily for all kinds of people under a wide range of climatic, topographical and traffic conditions.

With all factors considered, it would be hard to improve on Detroit's mass-produced automobiles. It can be done, however, and the seriously minded amateur engineers point to various slight changes that they have been making to engines for a number of years that have only recently been incorporated in the engines that Detroit produces.

Along those lines, one of the principal objectives of the S.C.T.A. is to get its mechanically inquisitive members to develop both parts and improvements that can be used by the major automotive manufacturers.

Some of their recommendations that might improve present engines include the use of hard liners for cylinder walls, good enough for 100,000 miles of use; better points, better bearings, and better workmanship in the ignition distributor to provide more positive firing under all conditions; more uniform cooling of the cylinder block and head; and, in the case of some engines, slight design modifications in combustion-chamber design and porting. At a cost of no more than \$12 or \$15 per car, the amateur engineers assert, stock engines could be improved considerably in efficiency and resistance to wear.

In a sense, hot-rod enthusiasts are serving as vital test engineers for the entire American automotive industry.

Plastic Parts Give Soldiers "X-Ray" View of Weapons and Engines

Transparent plastic parts permit soldiers at the Armored Center, Fort Knox, Ky., to watch the mechanism of weapons and motors in actual operation. Small arms parts that obstruct the view, such as the stock and outside plates, are accurately made of plastic and fitted to the weapons. Engines made almost entirely of plastic are used in training soldiers in the care and maintenance of vehicles. With a small motor attached to the drive shaft, the engines simulate actual operation to demonstrate the action and timing of valves and pistons. A complete cooling system is run by another motor. A small amount of air is left in the radiator so that the bubbles are visible as the water circulates.



Signal Corps photos

↑ Plastic stocks on weapons permit students to observe functions of parts. Below left, water circulates through cooling system of plastic engine. Below, transparent engine is built full size

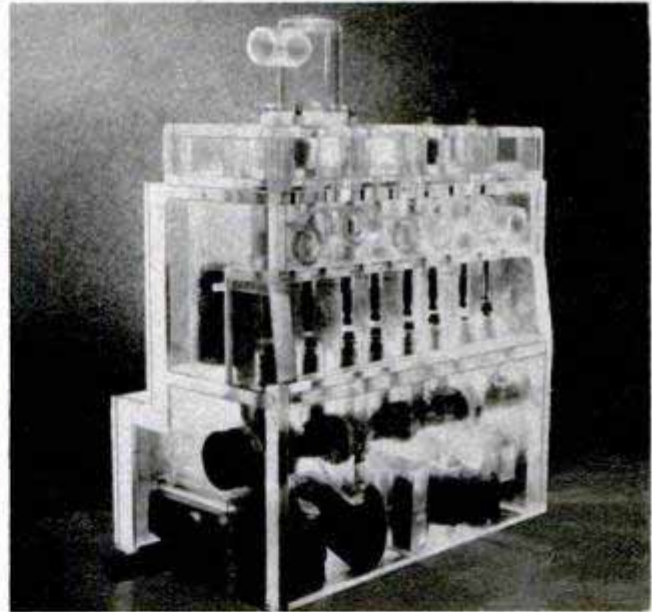
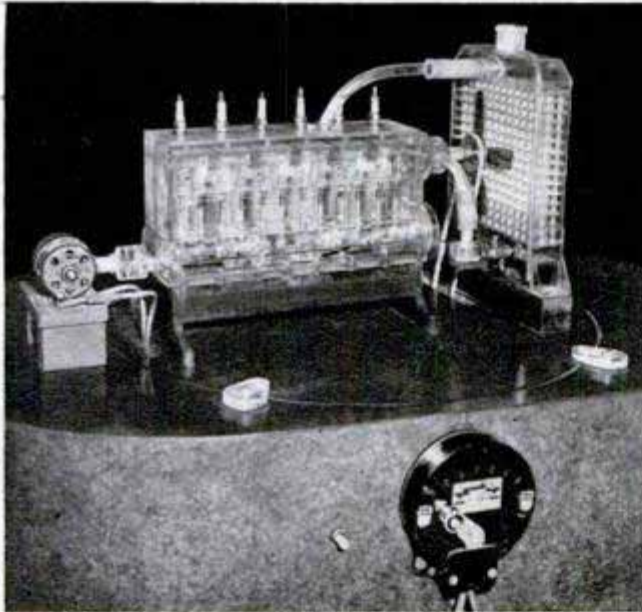

Top of Low-Slung Italian Car Is Only 54 Inches Off Ground

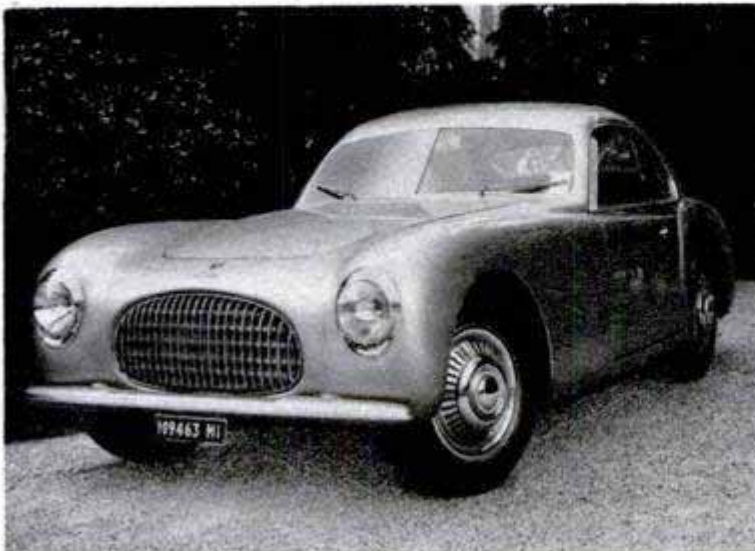

Sleek lines are emphasized in the Cisitalia car, a sports coupe that is being manufactured in Italy. At its highest point the body stands only 54 inches from the ground and the front fenders project above the level of the hood. The car, powered by a four-cylinder high-compression engine, has a top speed of 100 miles per hour.

Names and addresses of manufacturers of new products featured in this issue will be supplied promptly by Bureau of Information, Popular Mechanics Magazine, 200 E. Ontario St., Chicago 11

JUDGING THE OLYMPICS

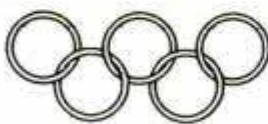

G. H. DAVIS, the noted English artist, was specially commissioned by *Popular Mechanics* to illustrate for its readers on these six pages the unique mechanical devices that will insure correct selection of winners at the Olympic games in London, July 29 to August 13. Unlike visual judgment, they won't be affected by tricky circumstances that often deceive the eye. In addition to photo finishes for the foot races, an electrical signaling system will register the votes of weight-lifting judges, and fencers will be "wired" so that every touche is automatically recorded. In the broad jump, where smoothness of the sand is an important factor in judging, a new leveling bridge and a measuring gauge, both riding on rails, will be used. The sand will be dusted with blue powder to emphasize the jumper's heel marks.

From a box 10 feet above the surface of the Thames, the crew-racing judge will "sight" the finish through a pair of diamond-shaped frames. Pressing a button at his right will halt a stop watch, set in motion by signal from the starting mark, as each crew finishes



AS FIRST BOAT CROSSES LINE THE JUDGE, SIGHTING THROUGH FRAMES, PASSES BUTTON STOPPING WATCH, REPEATING AS EACH CREW FINISHES. THIS RECORDS EACH BOAT'S TIME AND MARGIN BETWEEN THEM

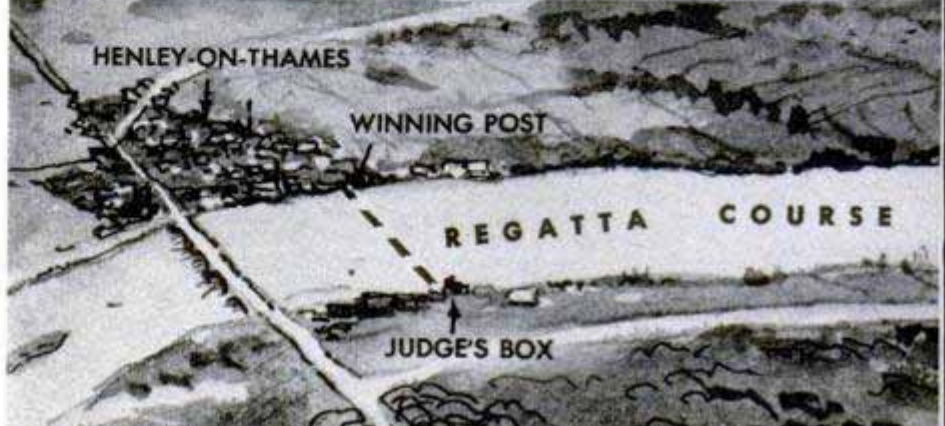
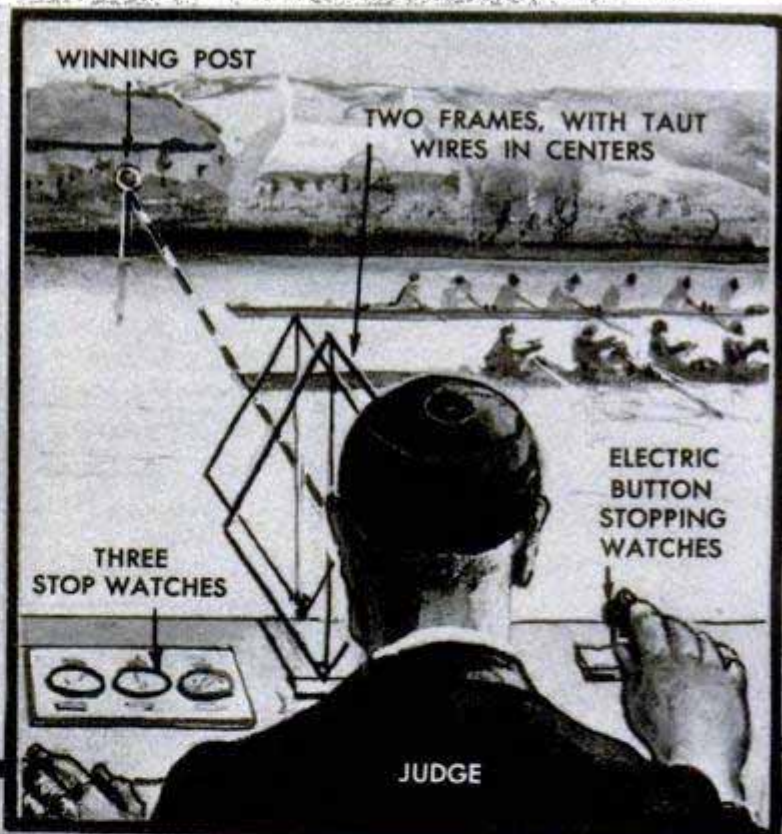

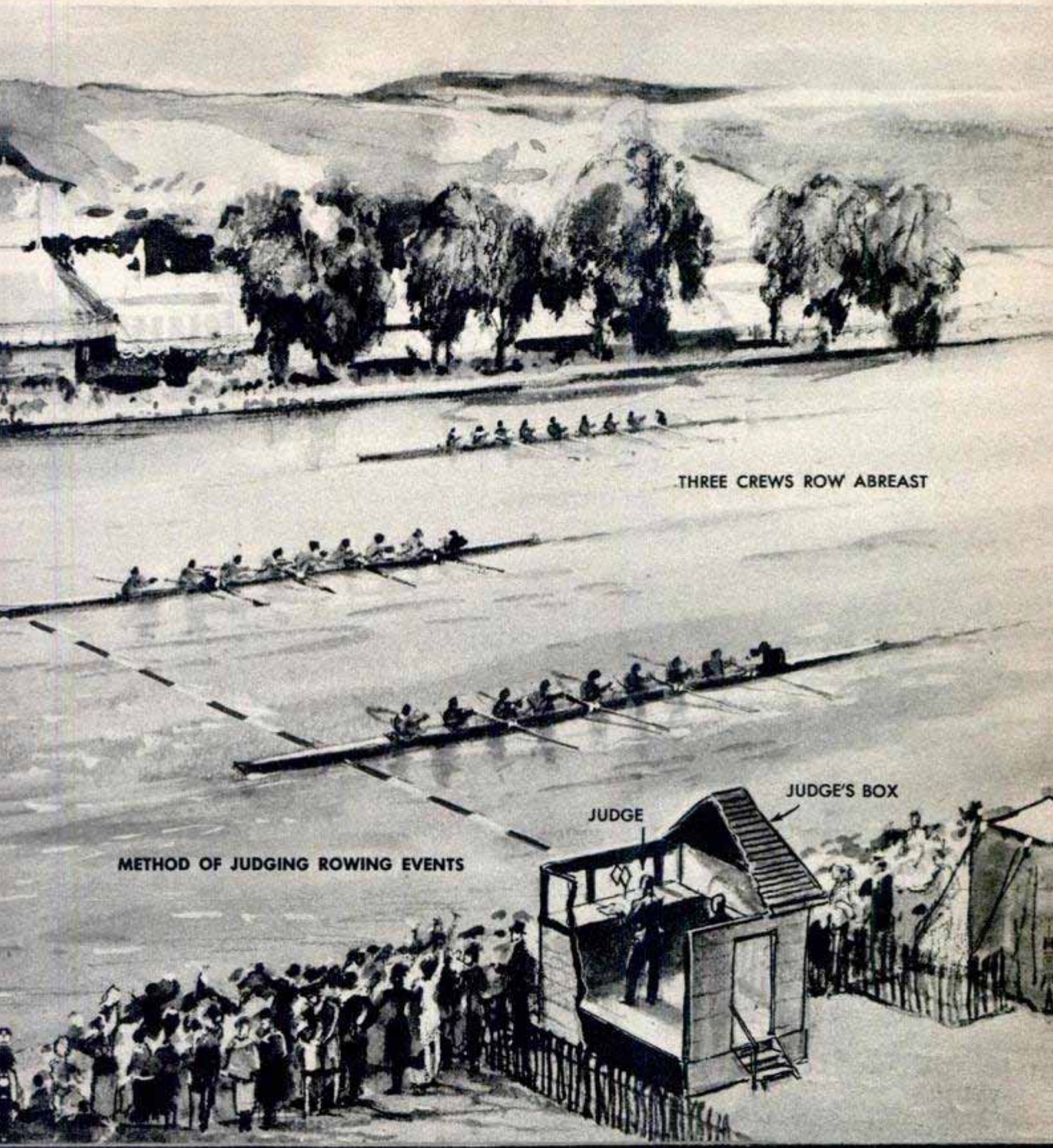

THREE CREWS ROW ABREAST

METHOD OF JUDGING ROWING EVENTS

JUDGE

JUDGE'S BOX



FAWLEY COURT

START

RIVER THAMES

TEMPLE ISLAND

ON WORD "GO" OFFICIAL PASSES
BUTTON STARTING STOP WATCHES
IN JUDGE'S BOX

SIGNAL LIGHTS FOR JUDGING WEIGHT-LIFTING CONTESTS

UPPER LIGHTS WHITE,
SIGNALING "PASS"—
LOWER LAMPS RED,
SIGNALING "FAIL"

JUDGE

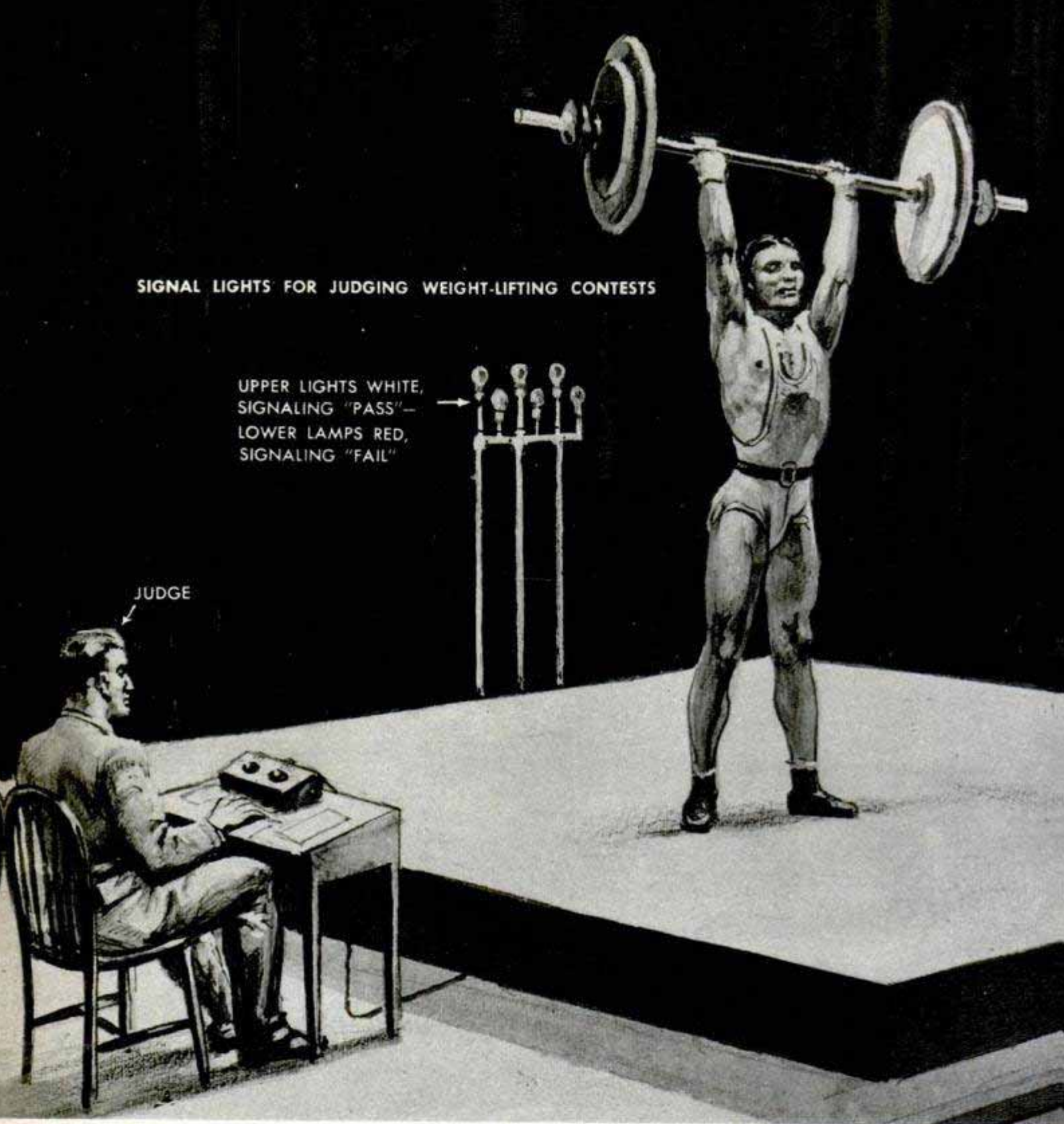

BROAD JUMP MEASURING AND SAND LEVELING GEAR

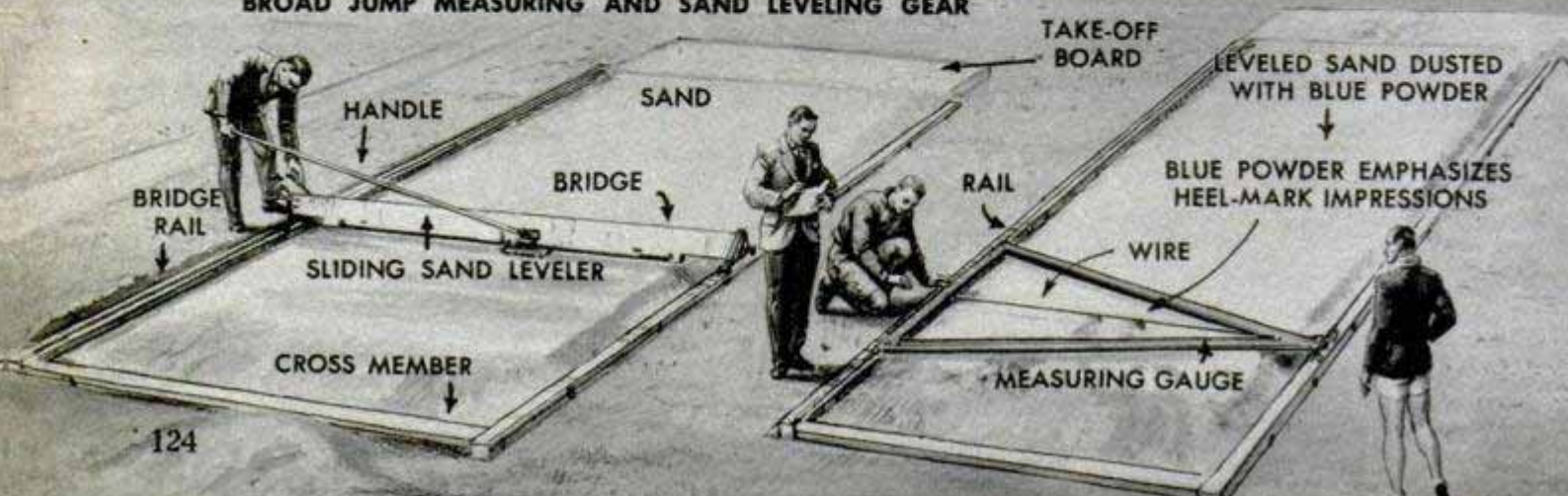

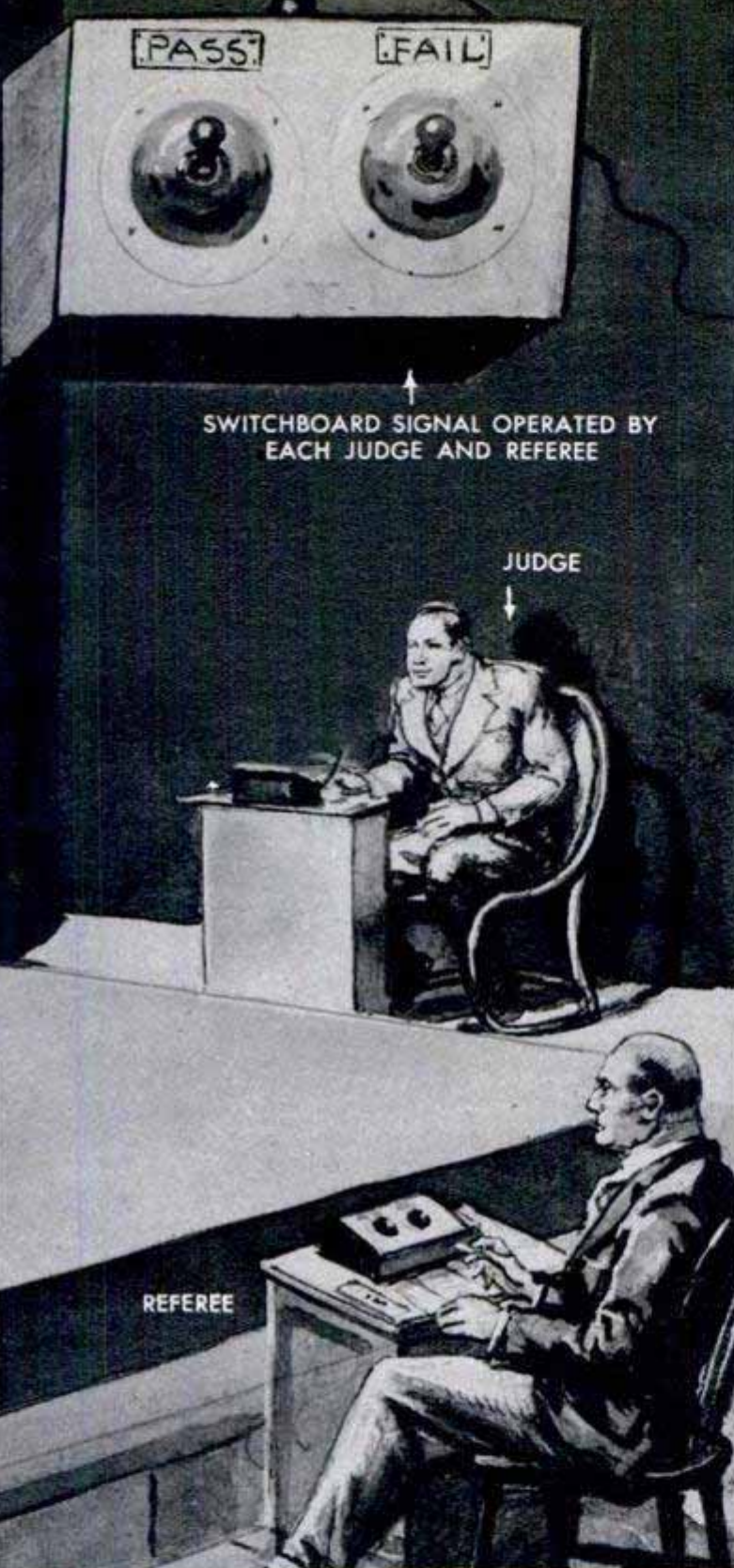

Above, judges' decisions in weight-lifting contests will be known instantly by the spectators. Using an electrical voting machine, each judge makes his vote visible when he throws a switch (see insert, top) at his table. The switches control two rows of electric lights behind the performer. The top row denotes passing votes, while the bottom row is for failing votes

Left, keeping the sand in the broad-jump pit level is important in the Olympics. A one-inch bulge reduces the distance jumped by two inches since the athlete's heels touch ground sooner. A special leveling device that runs on tracks (far left) will keep Olympic pits level to within one eighth of an inch. A triangular measuring device computes the jump distance accurately

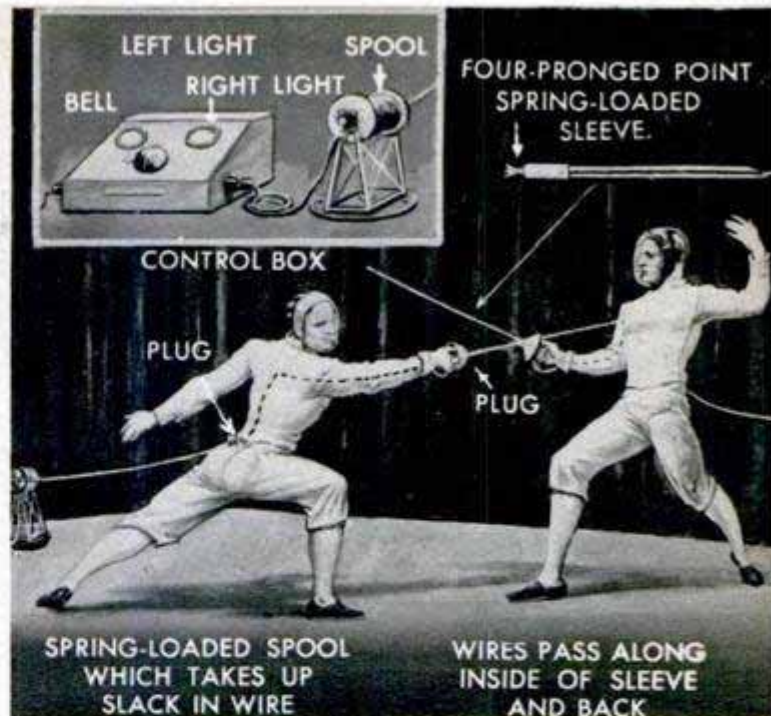

Above, there's no doubt about touches with this electric scorer to be used in the epee fencing matches. A four-pronged point (top right) on the epee closes an electrical circuit when a touche is made. This moves the needle on one of the two dials in the control box (shown at the top left)

Below, long throws of the javelin and discus are measured quickly with a curved scale (foreground) staked down an exact distance from the throwing point. Length of toss is computed by measuring distance from end of toss to scale (see drawing) and then subtracting this from overall distance

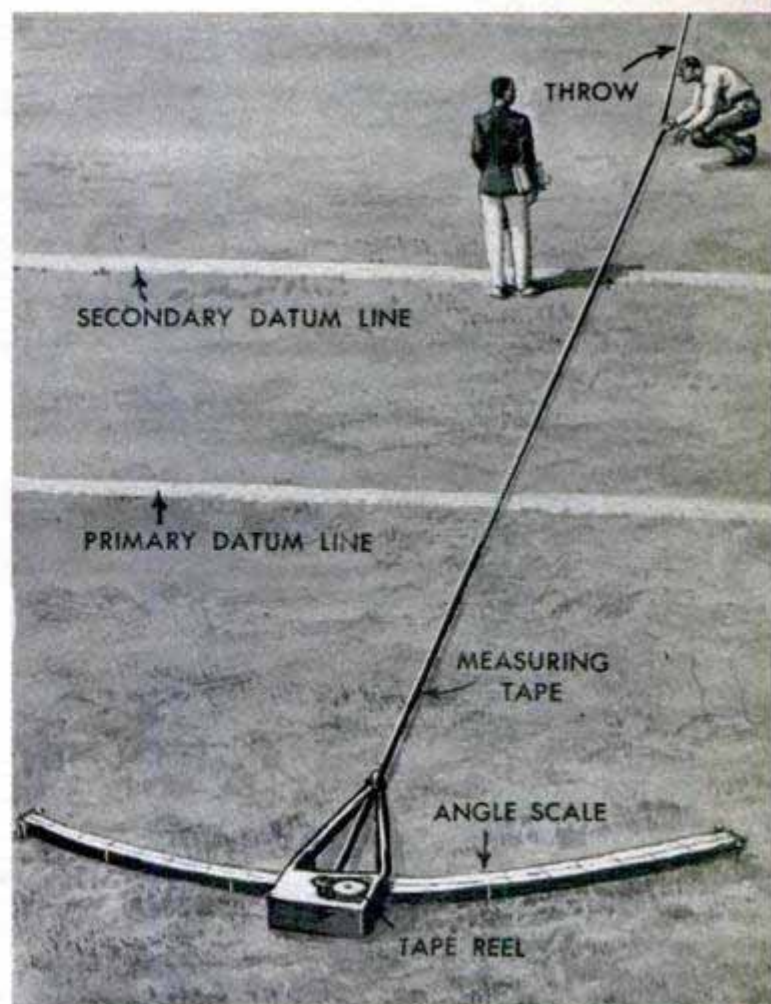

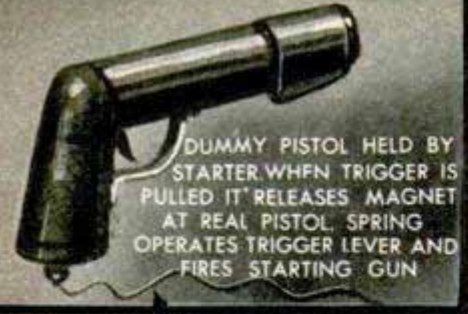

CABLE TO STARTING GUN

STARTER PLACED SO THAT HE CAN WATCH STARTING POSITION OF EACH COMPETITOR

STARTING LINE DRAWN TO ALLOW FOR DIFFERENCES IN DISTANCE TO BE COVERED

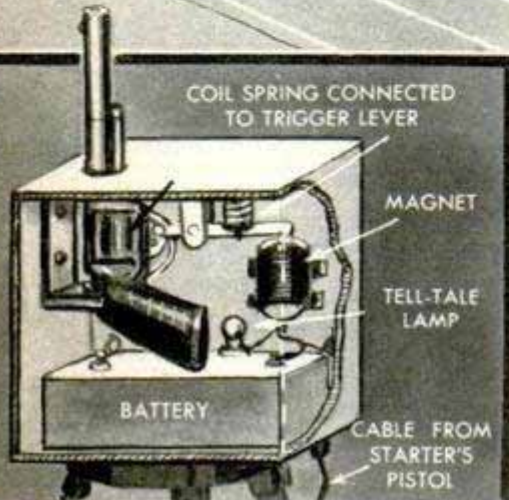

CABLE TO STARTING GUN

STARTER'S ASSISTANT

STARTING GUN APPROXIMATELY EQUIDISTANT FROM ALL COMPETITORS

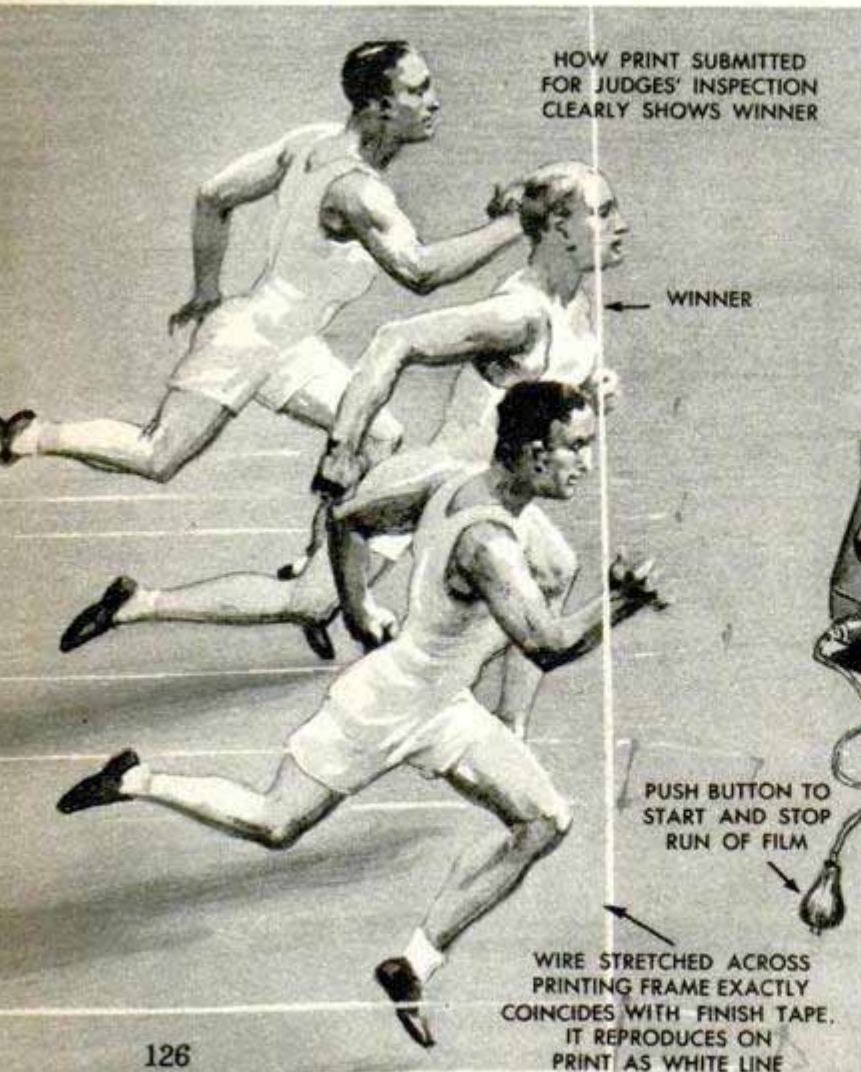

Above, location of starting gun is important because of time required for sound to travel to runners' ears. Olympics' starters will use remote-controlled gun to give every runner an even start. Starting posts are staggered due to longer distances around outer lanes. Below, long a "must" at horse races, the photo-finish camera will be on duty at Olympic foot races

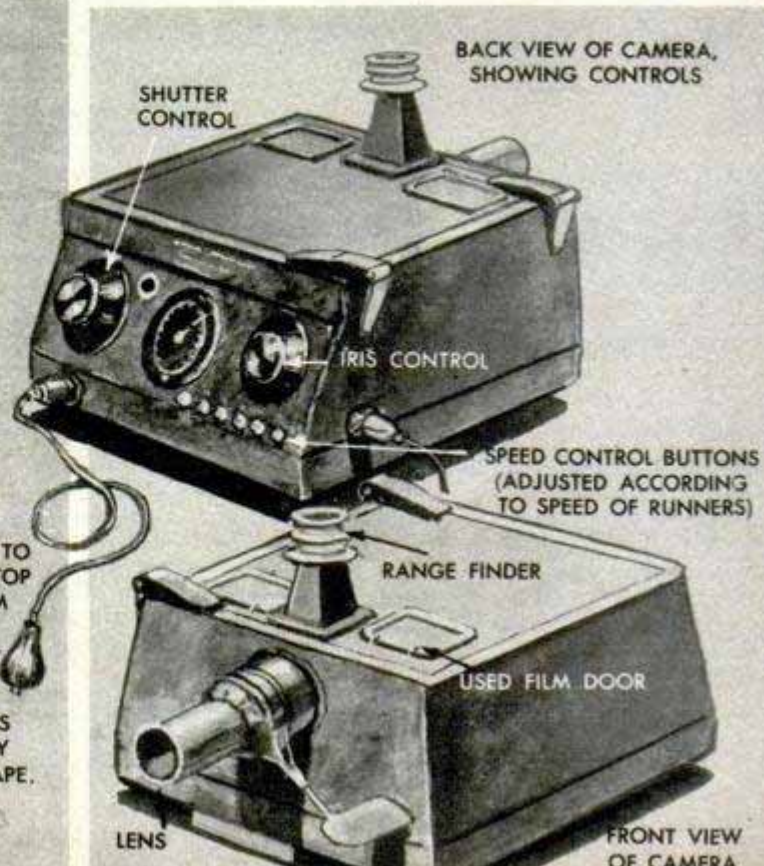

GENERAL VIEW OF OLYMPIC STADIUM GRANDSTAND IN LONDON, SHOWING POSITION OF CAMERA OPERATING ROOM

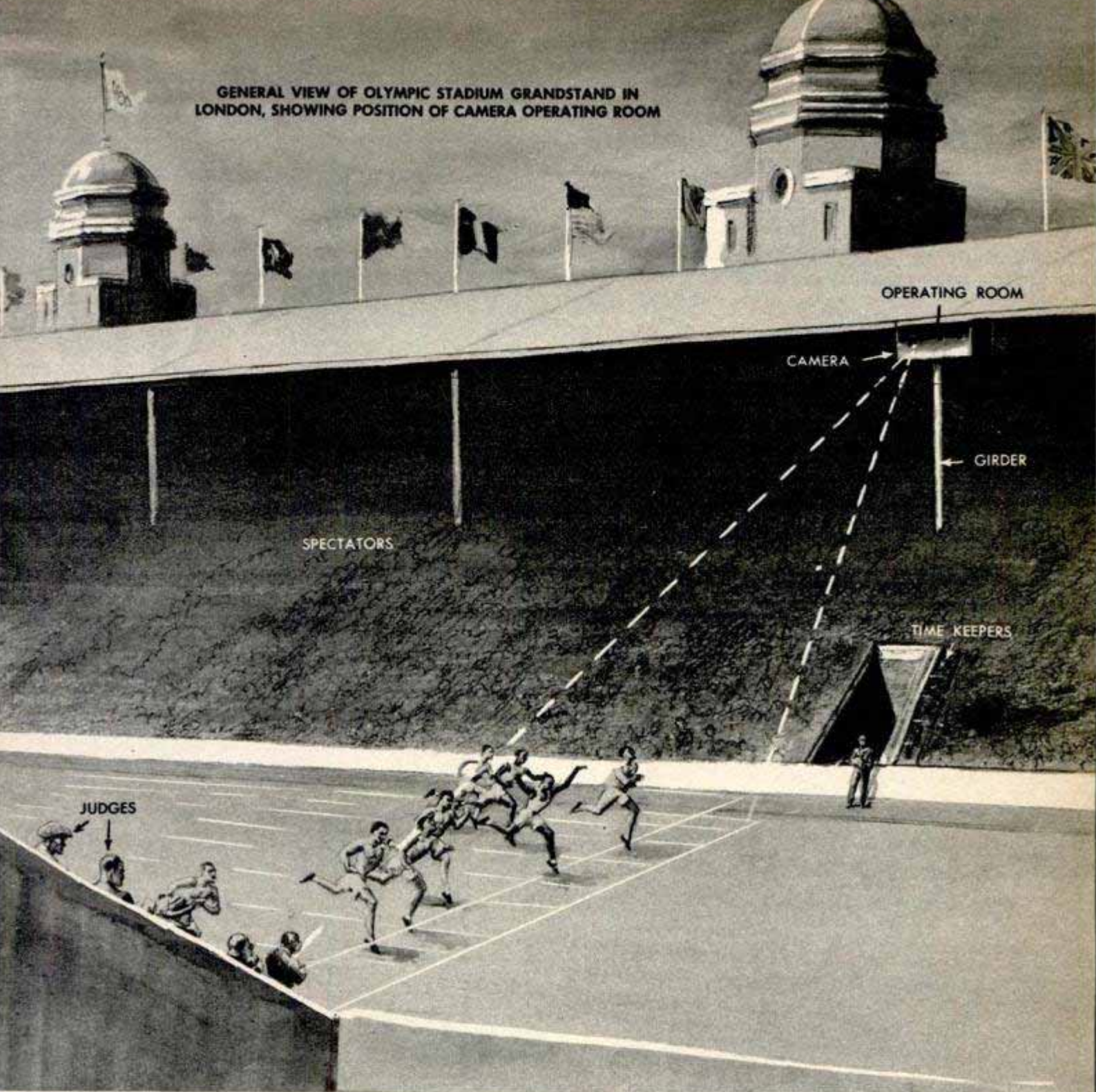

Above, photo-finish camera, mounted high on the grandstand, uses no shutter. Film rolls past a narrow slit inside the camera continuously at a speed relative to that of the runners. Drawing of the grandstand at Olympic Stadium in London also shows the areas reserved for judges and timers

Right, photographs of the finish showing the exact position of the runners can be delivered to the judges' stand in about 90 seconds. During this time, the film is developed and an enlargement made. Entire processing is done in this room adjacent to the camera room above the grandstand

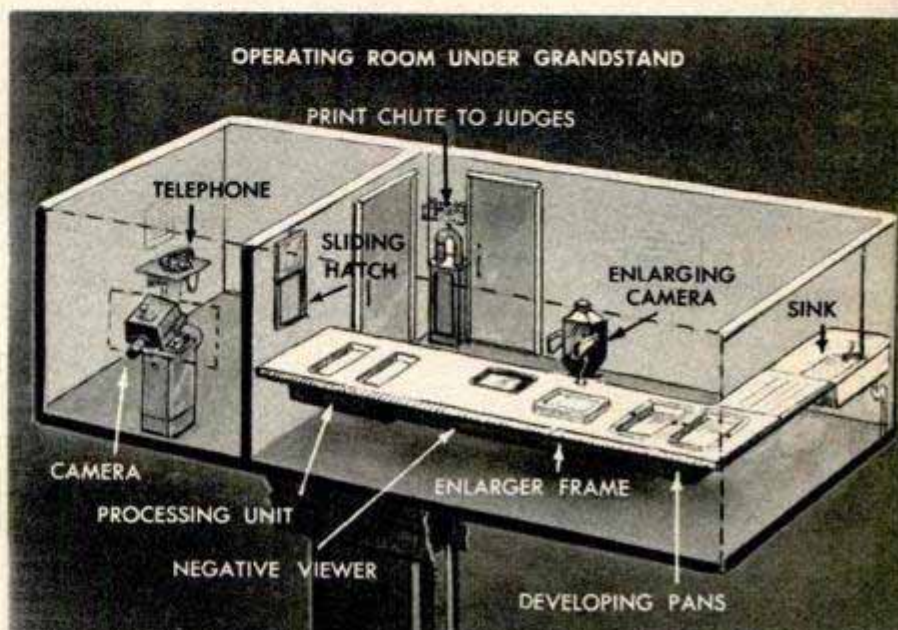

IRON PACK HORSE

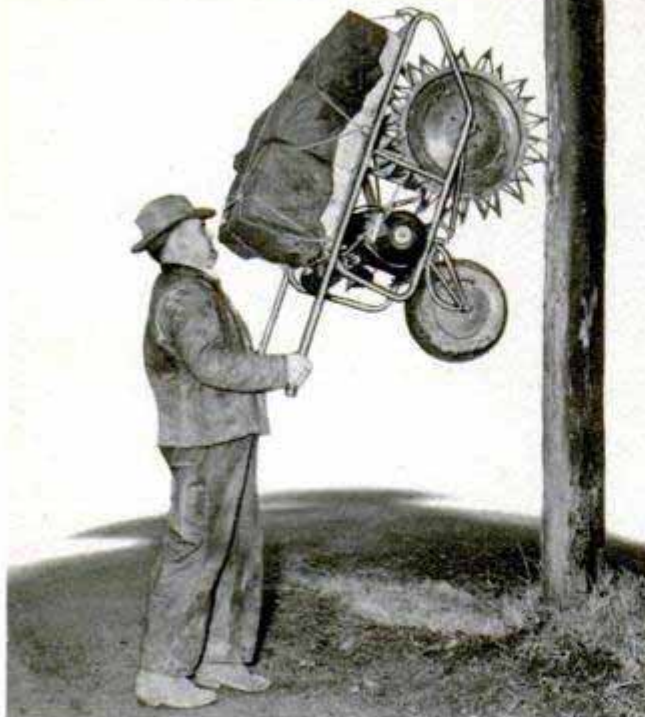

Called the "Motorized Jackass," a two-wheeled gasoline pack horse does the heavy hauling for hunters and workmen who carry heavy equipment. It carries up to 400 pounds over roughest country. Claws of spring steel on the front wheel make the "beast of burden" more agile than a mountain goat. It climbs telephone poles like a lineman (above). A 1½-horsepower air-cooled motor, controlled by a handle-bar throttle, develops speeds up to 300 feet a minute



The right handle lowers to serve as a parking stand. Power is transmitted to the front wheel by a V-belt and chain drive. Throttle is on the left handle bar



Above, weighing only 125 pounds unloaded, it can be carried in the trunk of a car. Below, try this with a real, live horse. The mechanized burro is easily guided across a log bridge. Its rubber-tired rear wheel swivels to permit easy maneuvering

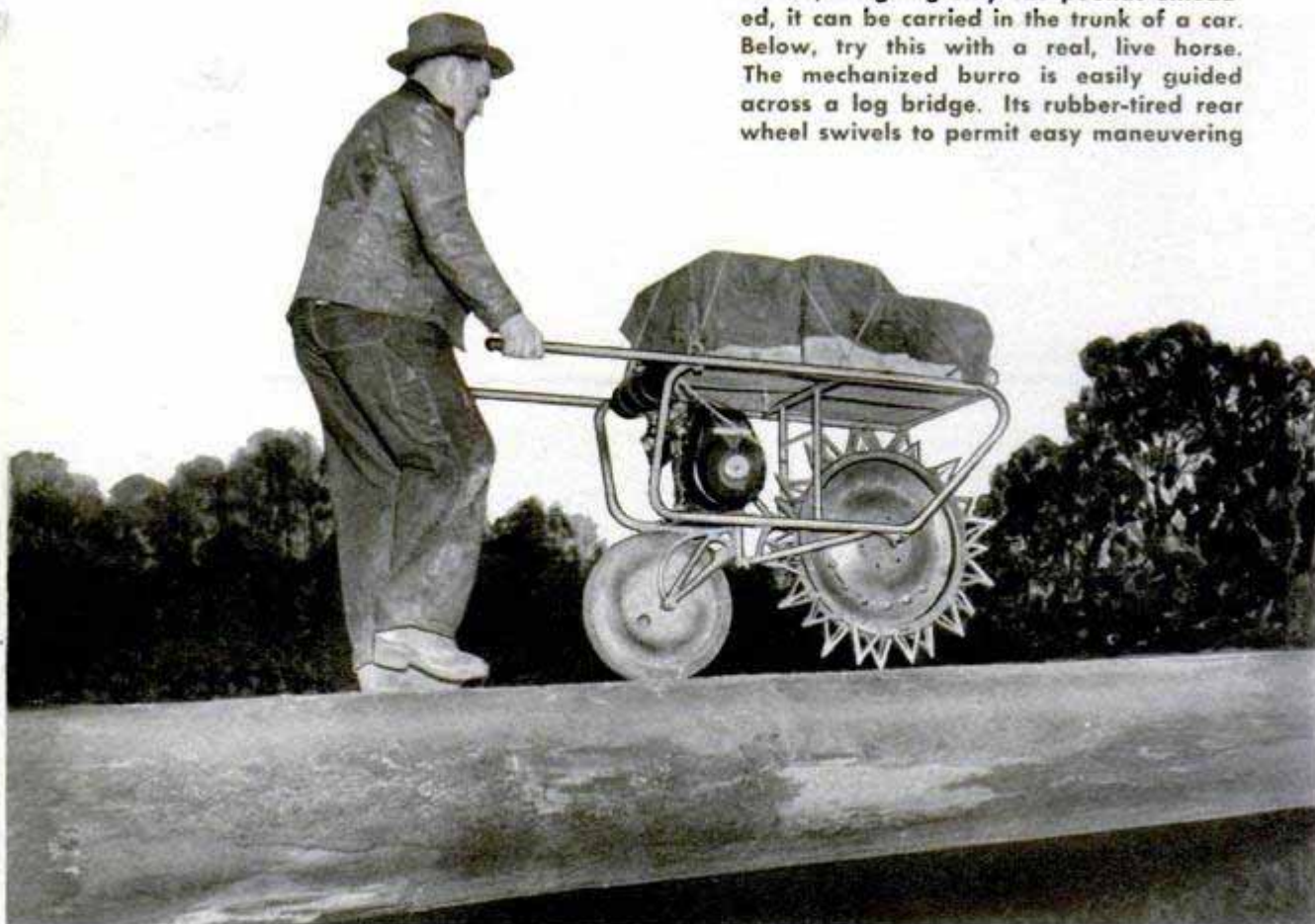

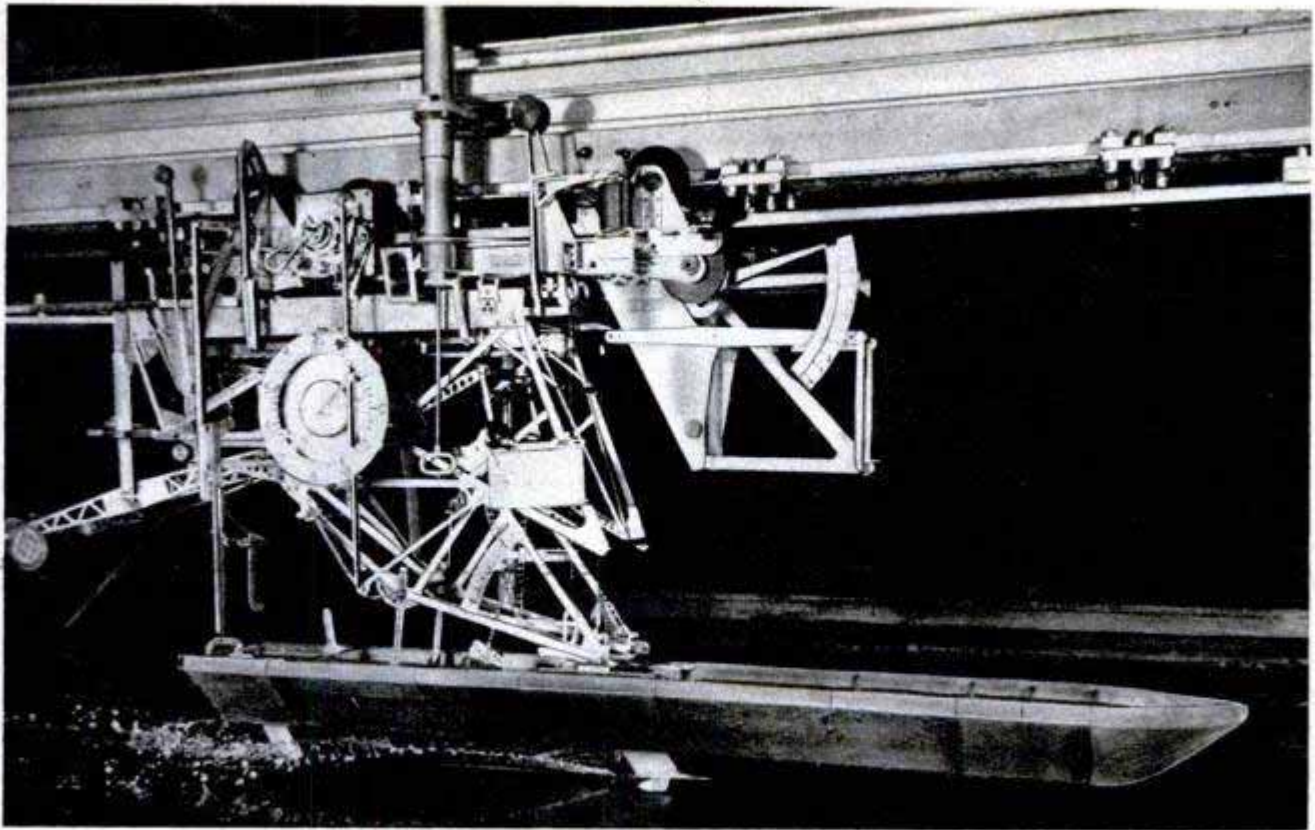

Boats Speed Over Water With V-Shaped "Wings"

Boats that "fly" a few inches above the water at high speeds may soon be built for the U. S. Navy. Two hydrofoils support the hulls, which float on the water only at low speeds or when stationary. These V-shaped fins support the boat above the surface and greatly reduce drag. Higher speeds than are possible with conventional hulls are expected with the same power. Tank models are undergoing tests to determine the best shape and location of the hydrofoils. At present, two are used—the main hydrofoil near the

↑ Complex instruments measure the lift of hydrofoils as hull model is tested in tank. Below, test model mounted on stand

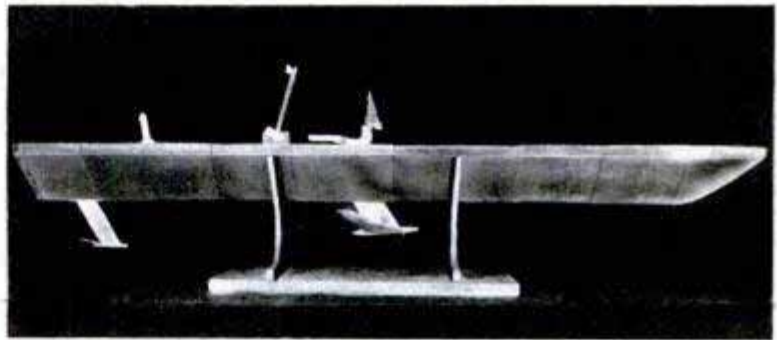

center of the hull which carries most of the weight and a stern foil which adds stability. Research for the Navy is being conducted at Stevens Institute of Technology.

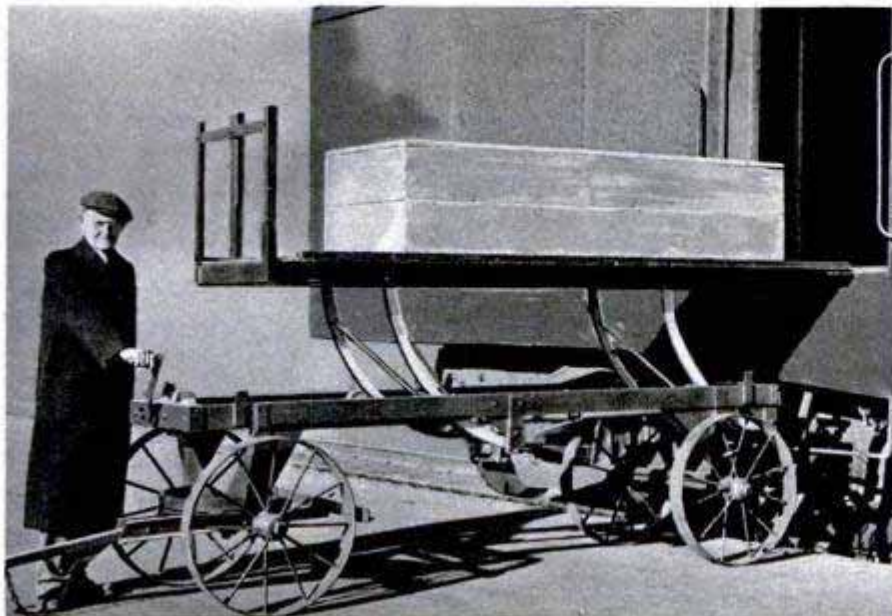

"Elevator" Trucks Load Baggage

Express shipments are loaded and unloaded by "elevator" when a new hand truck is used. Conventional express trucks are about 18 inches lower than the baggage car floor, requiring shipments to be lifted by hand. To make loading easier, Noah Swartz of Pueblo, Colo., has developed a truck with an elevating platform. Turning a crank rotates a screw gear to raise the platform.

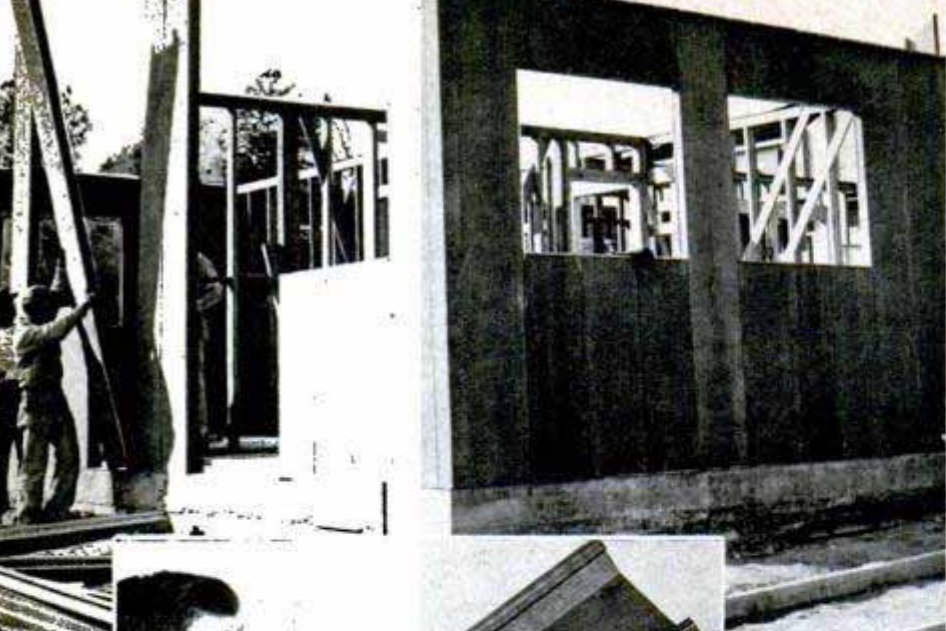

Above left, steel panels interlock to form the exterior walls. Above right, mailbox and door chimes are installed at the plant and go up with the walls. Left, close-up shows layer of Fiberglas laid above ceiling as insulation

HOUSE of STEEL

Walls, ceiling and roof of a new prefabricated house are made of steel panels which interlock and are bolted in place. All the factory-cut parts can be fitted together on the site in two days. Layers of Fiberglas across the ceiling and aluminum foil in the walls provide insulation and soundproofing for the attractive four-room bungalow. The house is built on a concrete-slab foundation. Gypsum wallboard is nailed to furring strips to form the interior partitions. About 550 man-hours of on-the-job labor are required to complete the house, which has a total of 855 square feet of floor area.



← Steel window sash fits into frame of extruded aluminum
 ↓ Completed bungalow, erected in two days, has a large living room, two bedrooms, kitchen, service porch and bath





Plastic Newspaper Cuts Made in Four Minutes

Photos can be made into plastic one-column newspaper cuts in less than four minutes by a new photoelectric engraving machine. Its vital parts are an electric eye, a microscope, two cylinders and a red-hot stylus or needle that jabs a sheet of plastic 350 times a second. A positive photographic print, the same size as the cut desired, is attached to one cylinder and a sheet of plastic to the other. Flanking the latter is the engraving stylus. As the photo revolves on its cylinder the electric eye scans it, transforming light and dark values into impulses controlling the stylus.

When viewing light areas, the scanning unit signals for deeper cuts, removing larger amounts of the printing surface than it does when looking at dark areas. The operator uses the microscope to make adjustments corresponding to the tonal values of the picture. It produces a 65-line halftone, as large as 8 by 10 inches, which is mounted with adhesive on a metal base and locked into the page form. The cuts can be printed direct or matted. The machine was introduced by the Fairchild Camera and Instrument Corporation and is being tested by 26 newspapers.



Seaworthy Boat Hulls Molded of Plywood

Seven layers of wood $\frac{1}{8}$ inch thick are being molded into seaworthy hulls by a New England shipbuilder. Each successive glue-impregnated thickness is laid over a mold at a 45-degree angle to the previous

one, making calking and puttying of the seams unnecessary. The plywood's final bonding is done in a large cylinder by steam at 75 pounds pressure and over 300 degrees in temperature.

WILDERNESS UNSPOILED

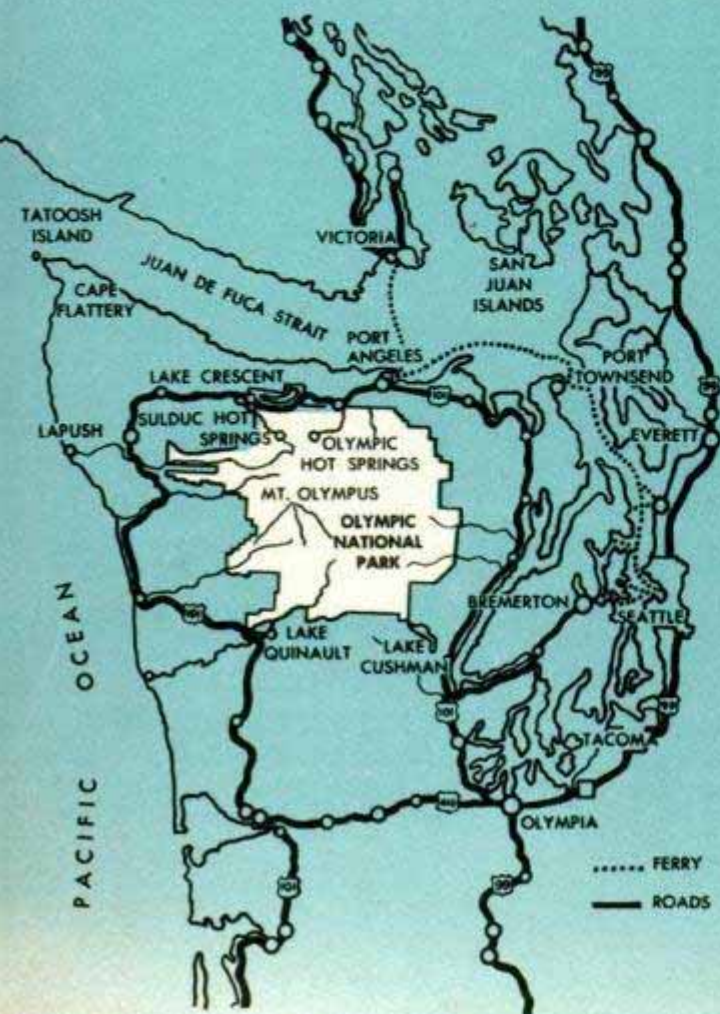

AMERICA'S "last frontier," the Olympic peninsula at the extreme northwest corner of the United States, is becoming one of the great scenic attractions of the West.

This year several hundred thousand visitors will travel through the newly dedicated Olympic National Park that occupies the heart of the peninsula. In preparation for them, Superintendent Preston P. Macy's construction crews are oiling the park's dirt roads, adding to the 570 miles of mountain trails that traverse the park, and building more shelters along the trails. Accommodations at the numerous resorts are being increased.

So large and rugged that the park rangers depend more on radiophone than they do on telephone for communication, the 848,000-acre preserve encloses the snow-capped Olympic Mountains that stretch up to lofty Mt. Olympus, 7954 feet in elevation. A dozen or more glaciers, two of which extend down to the 3400-foot level, blanket the slopes of the higher peaks. Also under the jurisdiction of the park service are many miles of wild sea-coast on the western side of the peninsula.

↓ Hiker studies Mt. Olympus, star attraction of our new national park (shown in white on map)

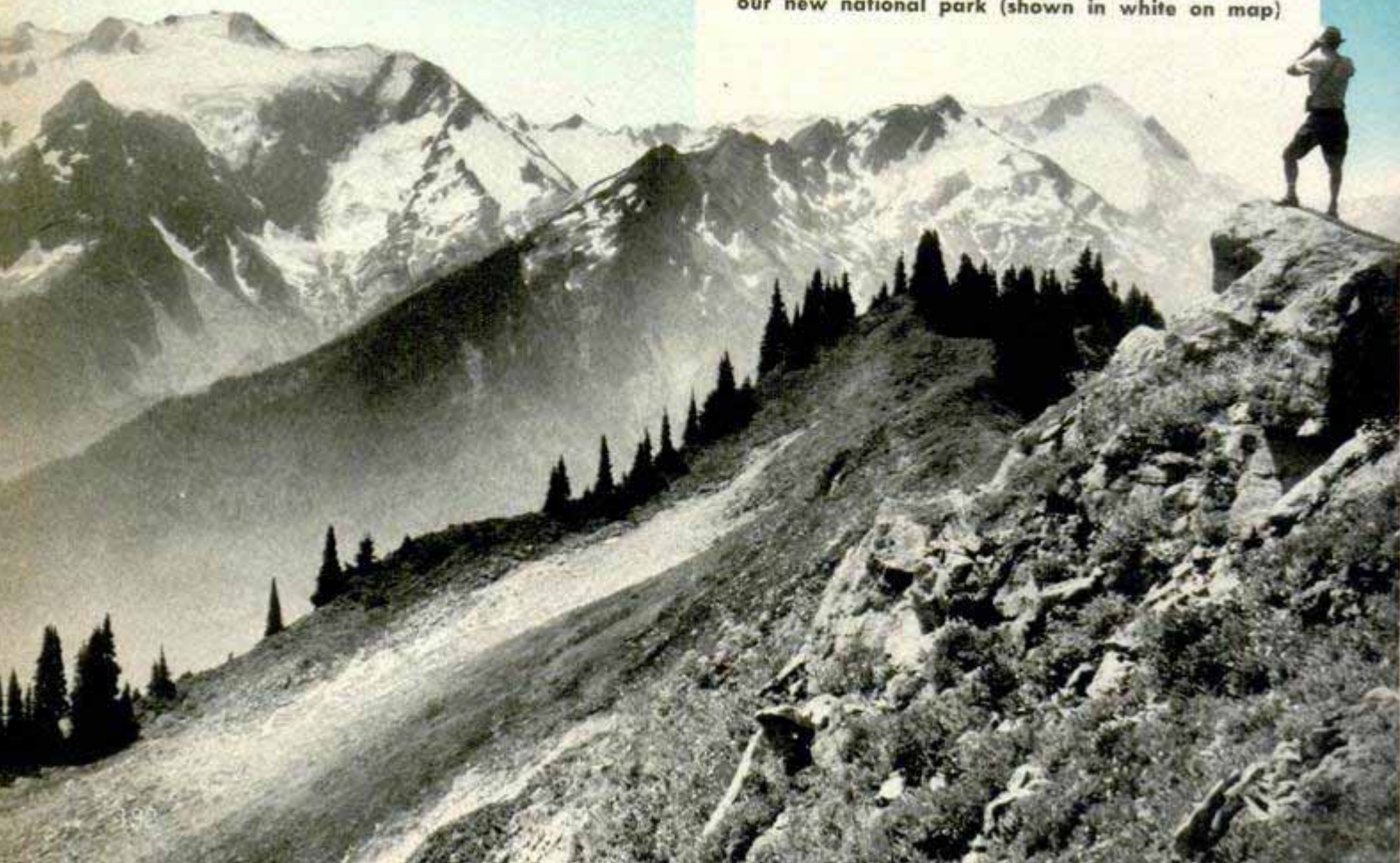



↑ Destruction Island with its lighthouse stands six miles off the coast of the rugged peninsula and is lashed by storms that sweep down from Aleutians

↓ Park ranger loops the antenna of his mobile radio around the roots of a weatherbeaten tree on the Pacific beach. There are 18 radio stations in the park

The park contains the most magnificent stand of timber that remains untouched in the country. It will serve future generations as an example of unspoiled native wilderness. Although much of the peninsula's timber has been cut, the lands that now make up the park were set aside as a national monument in 1909 before logging operations had moved into the area.

Included in the thousands of acres of fir, pine, cedar, hemlock and spruce in the park is the largest known Douglas fir, 17 feet 8 inches in diameter and more than 200 feet tall. A gigantic western red cedar 20 feet in diameter and a western hemlock 9 feet in diameter also have been found.

Bands of elk still roam the park's forests; deer and black bear are numerous, and coyotes and cougar occasionally are seen. Mink, otter and beaver also abound. The entire park is a wildlife sanctuary.

No roads cut through the park; instead, visitors have their choice of a dozen entrances from U. S. Highway 101 that loops around the park borders. From the south, two roads lead up past Lake Quinault to

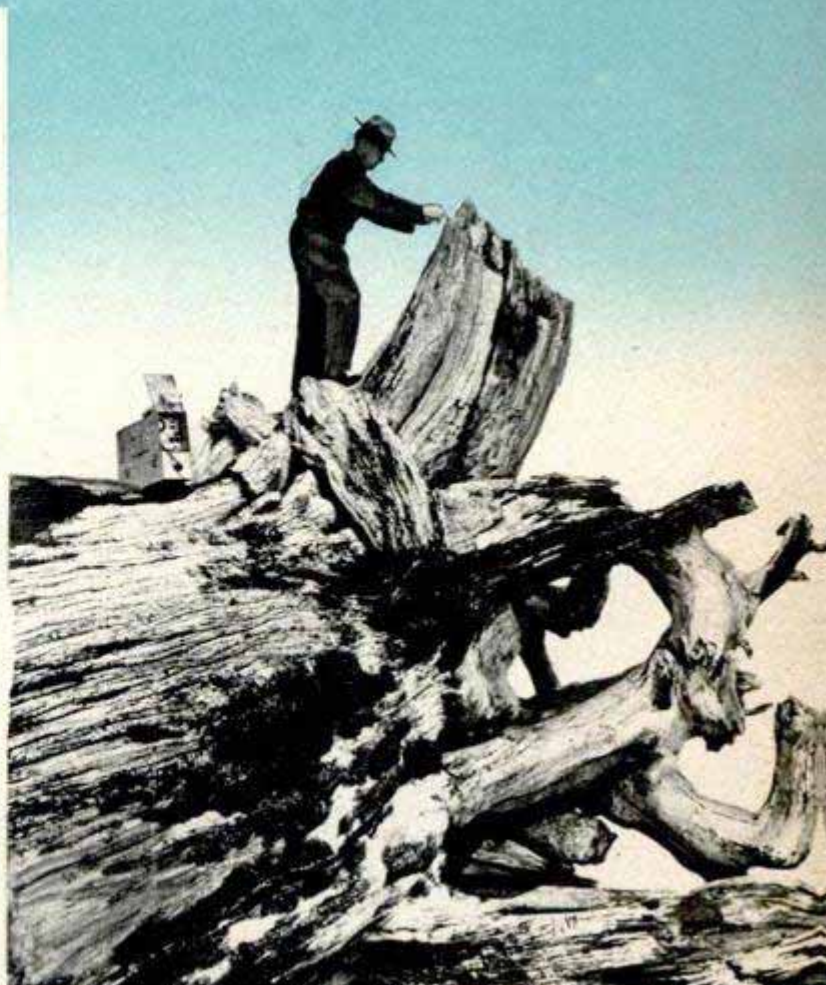



Halfway up one of the mountains, two winter-sports fans pause a moment to enjoy the spectacular view

camp grounds and to resorts where meals, lodging and horses are available. On the east side, roads follow the Skokomish, Duckabush, and Dosewallips Rivers from the highway into the park, and on the north are spur roads that lead to Sol Duc and Olympic Hot Springs, Hurricane Ridge where skiing is a winter pastime, and to Deer Park, another winter-sports center. Roads from the west follow the Bogachiel, Hoh and Queets Rivers into the park. Many of the place names on the peninsula are native Indian words. Along most of the roads are public camp grounds equipped with water, picnic tables, rest rooms and sheltered kitchens. Headquarters of the park are at Port Angeles.

An incongruity of the peninsula is that one broad section receives an average of 12 feet of rain per year while less than 50 miles away the summer climate is so dry that crops must be irrigated. The heavy precipitation occurs on the western side of the Olympics and is caused by warm Pacific air masses coming in contact with the

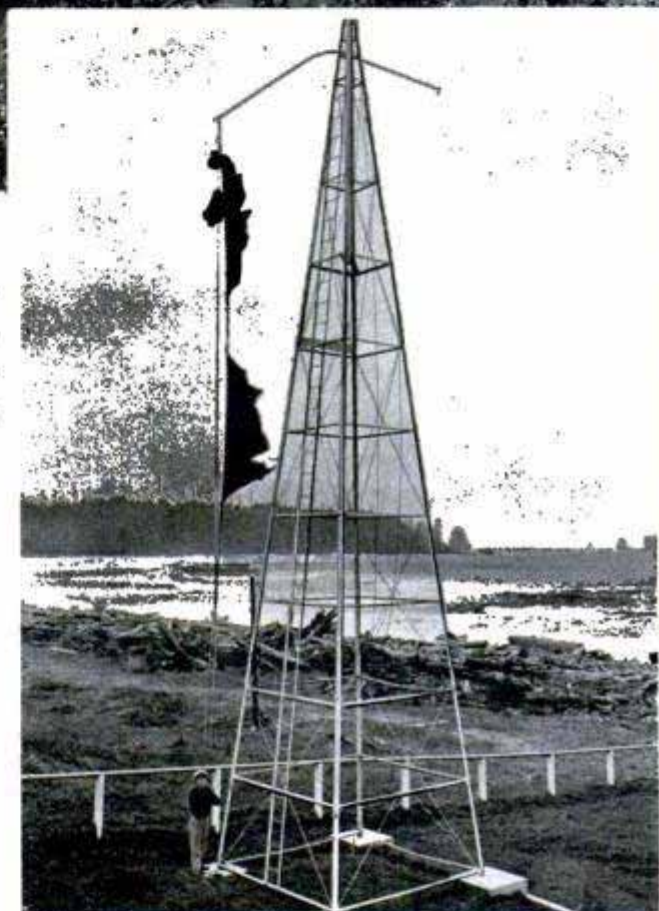

Coastguardsman lowers tattered storm flags for replacement. Note driftwood deposited by other storms

Long arm of a derrick hoists supplies to the lonely lighthouse on Tatoosh Island near Cape Flattery



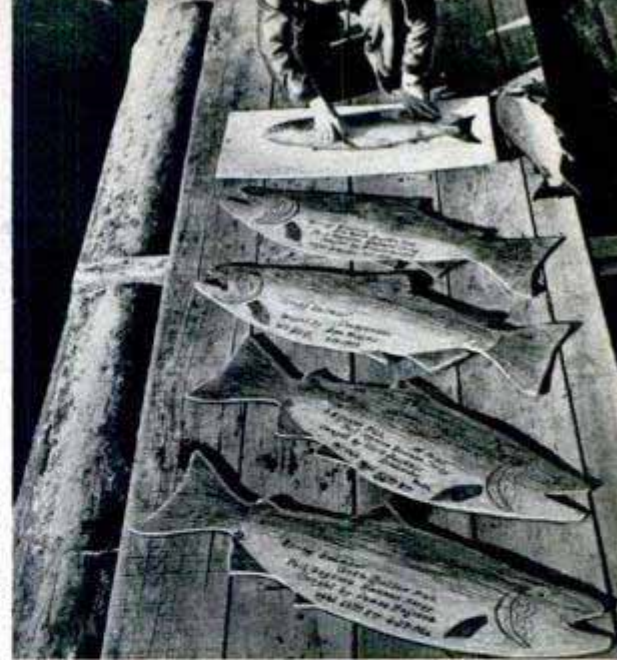

mountains. Winter is the rainy season. July and August are usually the driest months. The intense rainfall produces luxuriant "rain forests" of fast-growing trees and underbrush. Underfoot, the ground is carpeted with moss three to six inches deep.

Among the oddities found in the rain forests are long, straight rows of giant trees that apparently were planted that way. Centuries ago a number of seedlings took root on the trunk of some fallen tree. Rotting away through the years, the old trunk sustained the new trees until they got their roots into the ground to grow in a perfectly straight line.

The national park is only one of the attractions the peninsula offers. Along the ocean coast you may watch the Quillayute Indians or the Makahs still building their seagoing canoes by hollowing out giant cedar logs with an ax and hatchet. The 24-foot dugouts are stable and seaworthy craft that the Indians prefer over small boats fabricated of boards. Once the dugouts were used for sealing and whaling; now the Indians use them principally for salmon fishing.

At Port Angeles you may visit the Salmon Club on Ediz Hook and spend the day trolling for 50-pound Chinook

Above left, salmon boats tie up in the protection of a lagoon. Above, prize salmon is outlined on a plywood panel which will become a trophy like those in foreground. Below, highway winds along Lake Crescent shores



salmon in the Strait of Juan de Fuca. Salmon fishing is practically a year-around sport in the whole Puget Sound region. If you prefer fresh-water fishing you may try for native cutthroat or the rare Beardslee trout in the lakes and streams.

Tatoosh Island at the tip of Cape Flattery and the whole rugged coast are lashed each winter by storms that sweep down from the Aleutians. Shipwrecks have been fairly common in the past. In addition to numerous lighthouses and other aids to navigation, the Coast Guard maintains lifeboat stations at Neah Bay and at Lapush. The Puget Sound itself is virtually an inland sea. The wooded islands, coves and headlands in the southern part and the many San Juan islands to the north make it a yachtsman's paradise.

The recorded history of the peninsula began in 1592 when a Greek pilot who used

the Spanish name of Juan de Fuca sailed north from Mexico in search of the fabled Straits of Anian that were thought to connect the Pacific and Atlantic Oceans. De Fuca found the strait that now bears his name although it was not until 197 years later an American pilot sailed up the coast to confirm the discovery.

Exploration parties from Mexico and the United States in the next few score years charted the waters of Puget Sound and mapped the principal mountains. Following the 1849 gold rush to the West Coast, fur trappers moved into the region.

Logging the vast forests of the peninsula became a big industry early in this century and continues to be a major industry today. There are hundreds of thousands of acres of timber outside the borders of the national park. Most of these were cut years ago but lumberjacks still find stands of the huge trees that originally covered the peninsula. These are cut and trucked to tide water where they are made up into rafts to be towed to the lumber mills. Second-growth timber now blankets many of the hills and mountains and provides the raw materials for the region's newsprint and pulp mills. Due to the mild climate and the heavy rainfall, reforestation of the forests proceeds automatically.

The small lumber and fishing towns of

← Indian applies a coat of paint to his dugout canoe

↓ Native in a 24-foot dugout puts out to sea. The canoes are built by hollowing out a giant cedar log



the peninsula are booming today although the area has had its share of depressions. According to a local story, money once was so scarce that only one \$20 bill existed in the town of Port Angeles. The bill was extremely useful, moving from hand to hand in payment of debts. One day it was discovered that the bill was a counterfeit. Everyone decided, however, that the note was a necessary part of the town's economy and so the butcher, grocer, teamsters and loggers continued to use it at face value.

Once residents of the peninsula had visions that it would become an industrial center. Great office buildings were erected on the site of Port Townsend and scores of pretentious mansions were built on the surrounding hills. Then industry settled in Seattle, Tacoma and the other mainland cities, by-passing the peninsula. By no means a ghost town today, Port Townsend remains as a quiet city of aged grandeur.

The peninsula is reached via modern highways from Olympia, the capital of Washington, or by crossing the sound on automobile ferryboats from Seattle. Its residents have always boasted of their tumbling streams and quiet lakes, their ever-green forests and snowy mountains. Occasionally they complain that photographs of the peninsula have been used to advertise the scenic attractions of California!

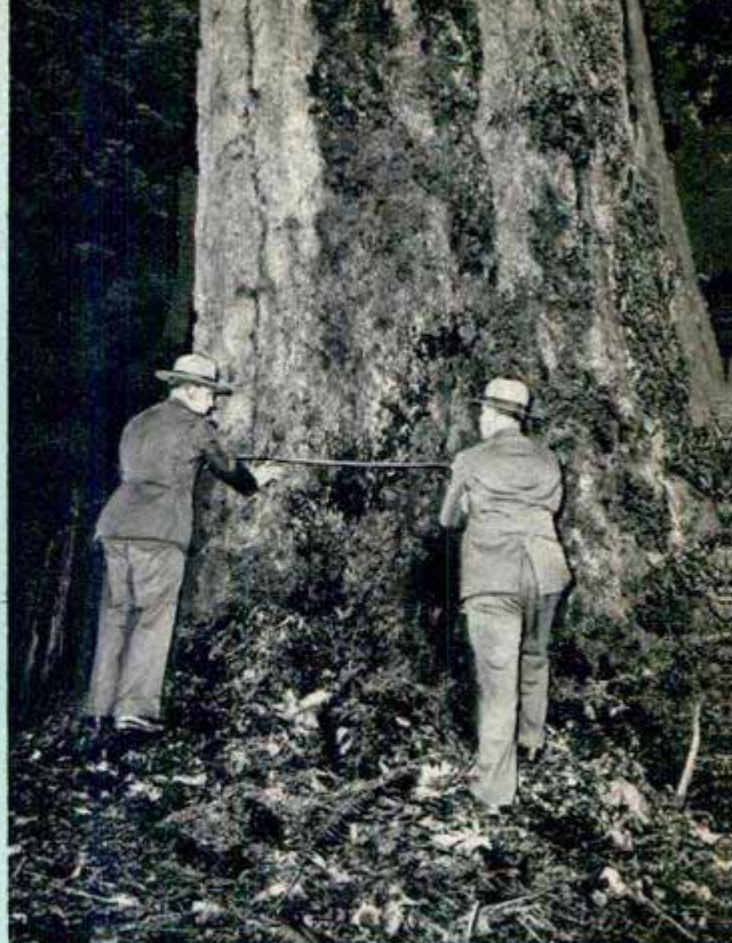

Rangers measure a giant cedar tree. One such tree has a diameter of 20 feet. Below, when houseboat stranded on a sand spit, it was converted to quarters for pilots of ocean ships





British Motorcycle Folds for Storage

Adapted from a collapsible model used by airborne troops, a small motorcycle being produced in England can be folded and stored in the corner of a room. The seat and handle bars lower for storage. It has a speed of 30 miles an hour and travels more than 100 miles on a gallon of gasoline. Throttle, clutch control and brake lever are mounted on the handle bars.

Rubber Mask and Throat Bag Give Hot and Cold Treatments

Hot and cold treatments are given with two rubber pain-relieving devices. One is a face mask that provides warming relief from sinus pains and the other is a wrap-around ice bag for treating sore throats.

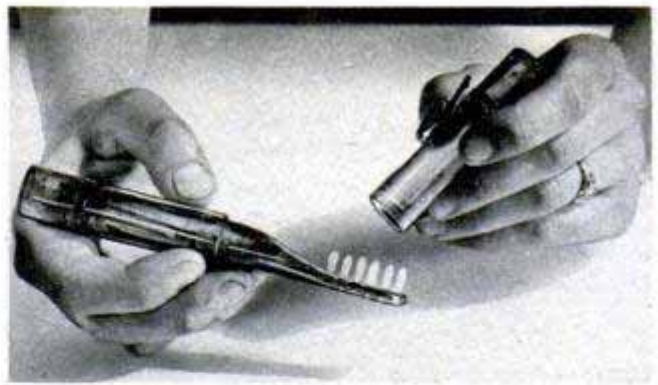

Fountain Toothbrush

Holding several weeks' supply of liquid dentifrice in its hollow handle, a fountain toothbrush, shaped like a fountain pen, can be carried in the pocket ready for use at any time. The dentifrice is forced onto the bristles when a thumbscrew under the cap at the end of the handle is turned. A larger cap, equipped with a pocket clip, covers the bristles when the brush is carried in the pocket. The bristle end can be replaced when worn out.

Warm Air for Respirators

Air fed to men working outdoors in winter or in refrigerated rooms is warmed by a unit that clips to the rear of the user's belt. A thermostatically controlled heater and a heat exchanger are enclosed in a rubber cylinder 2½ inches wide and 11 inches long. The complete unit weighs only four pounds.





Stripped Landing Craft Becomes Car Ferry

Cars instead of tanks roll off a combat landing craft converted to a ferry. Three conventional boats were unable to handle the traffic across Florida's Tampa Bay, so the St. Petersburg Port Authority obtained the navy-surplus landing craft and rebuilt it into a ferry. The 205-foot boat was stripped of its stern bulkhead, landing ramp and much of the superstructure. Converted at a cost of \$75,000, the new ferry can carry 35 autos each trip along the 10-mile water route.

Sleek car ferry shown at top bears little resemblance to landing craft. Right, ramp was taken off to provide loading platform



Crusher Flattens Cans

Tin cans are smashed flat for salvage by a crusher operated by a long lever. The crusher, made of cast iron, is fastened to the top of any barrel or drum by a single screw. The can is placed between two plates and held by a riveted ridge. A notched arm falls into place under its own weight, and pressure on the lever crushes the can flat. Crushed cans require only one fifth as much space as ordinary cans.

Names and addresses of manufacturers of new products described in this issue may be obtained by writing to Bureau of Information, Popular Mechanics Magazine, 200 E. Ontario St., Chicago 11

WHAT'S NEW For Your Home

Sources of supply for these products may be obtained from Bureau of Information, Popular Mechanics Magazine



CLOTHESLINE SAG is eliminated when an adjustable plastic connector is used to join the two ends

SUDS FROM NOZZLE convert garden hose into a pressure washer. Detergent stick fits inside nozzle

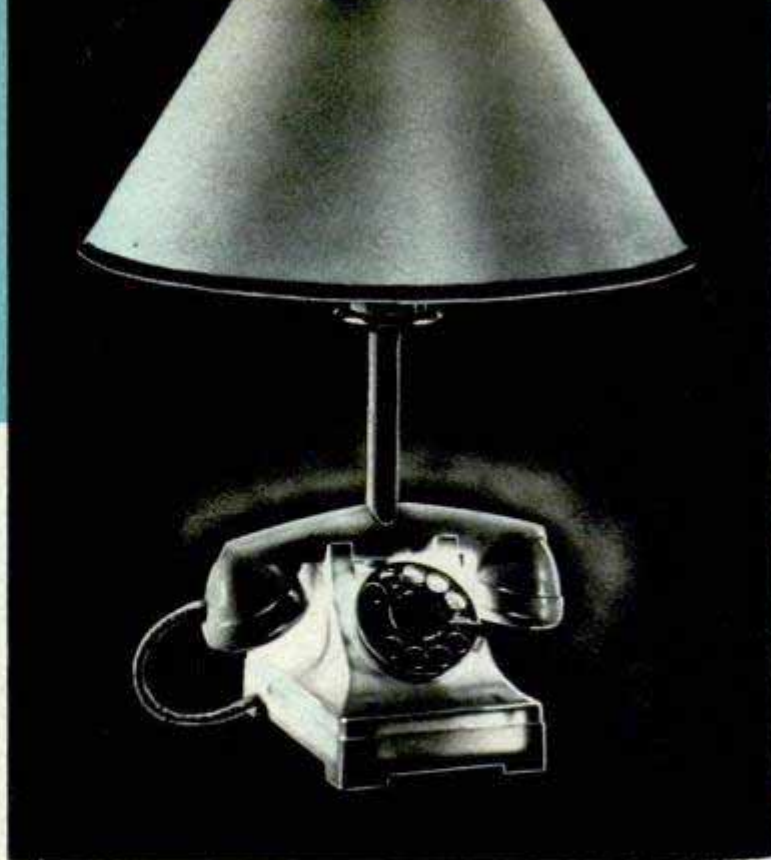
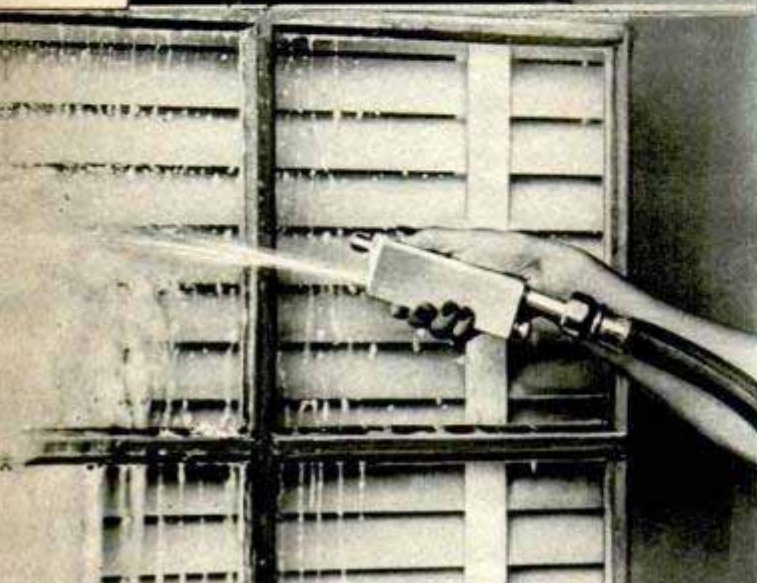
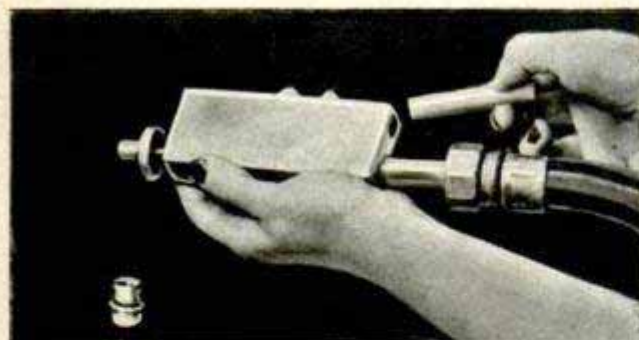

DUMMY TELEPHONE base of reading lamp lights up for use as night light. Dial serves as the switch



KITCHEN SLIDE RULE tells housewife the proper amounts to use when increasing or decreasing recipe

HEAT WITHOUT DRAFTS is what you get from this new space heater. Blast of fan, blowing through a concentric heat exchanger, is diffused by louvers

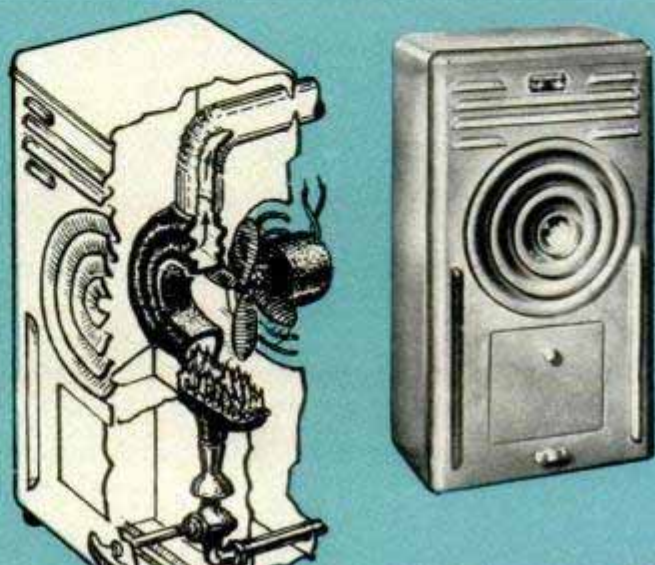

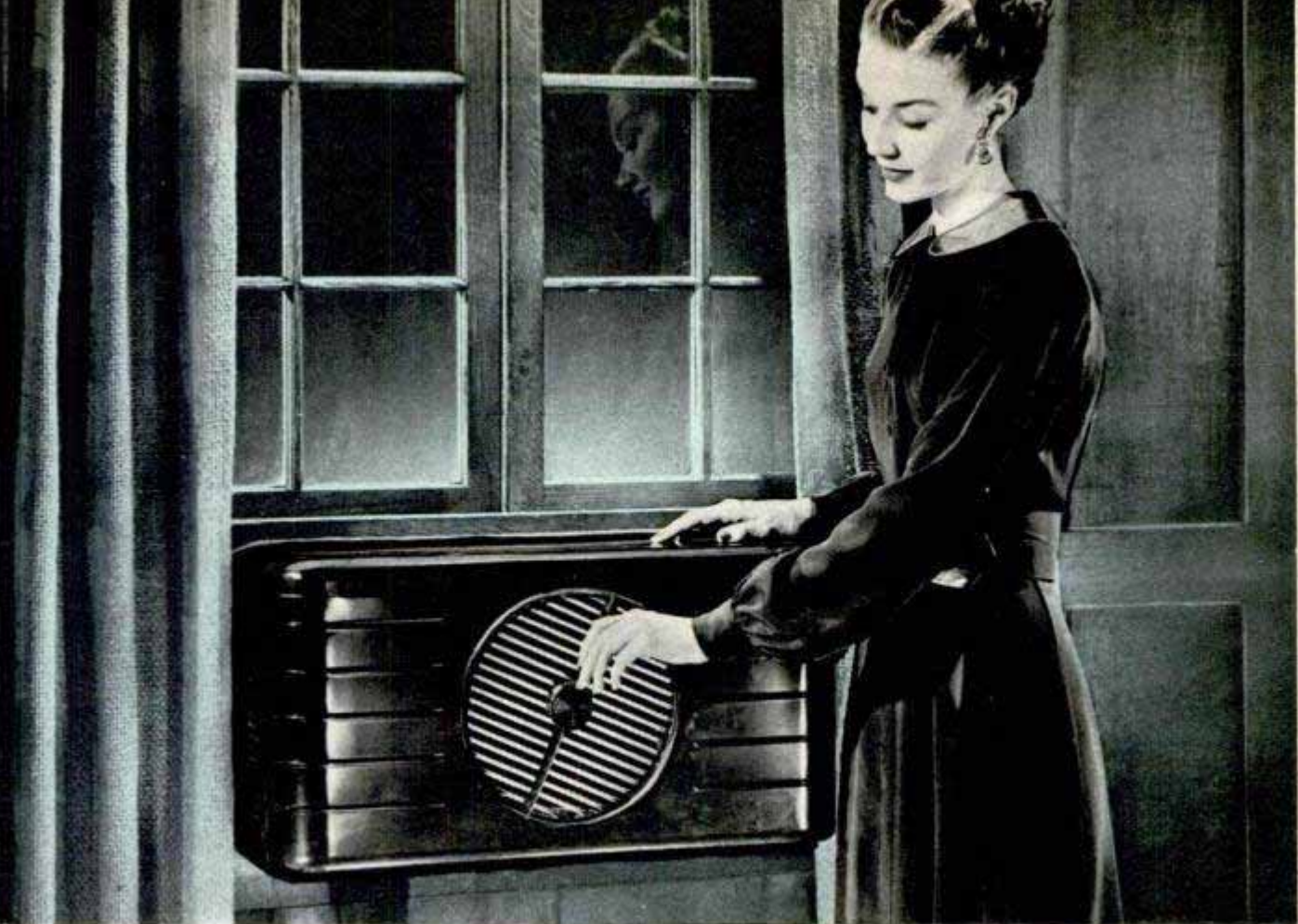

AIR CONDITIONER for homes has a movable Tenite grille to direct filtered air up, down or to either side. Unit is electrically operated

ONE-WAY-GLASS insert in door knocker lets you see the caller before you open the door. He can't see in. You can talk through it, too



WRIST ACTION is all you need to juice oranges on a hand-operated juicer. Pressure on the fruit spins burr in manner similar to system used in spiral screwdrivers



BURGLAR ALARM that winds like a clock protects door or window. When rubber-tipped arm is tripped, the alarm goes off

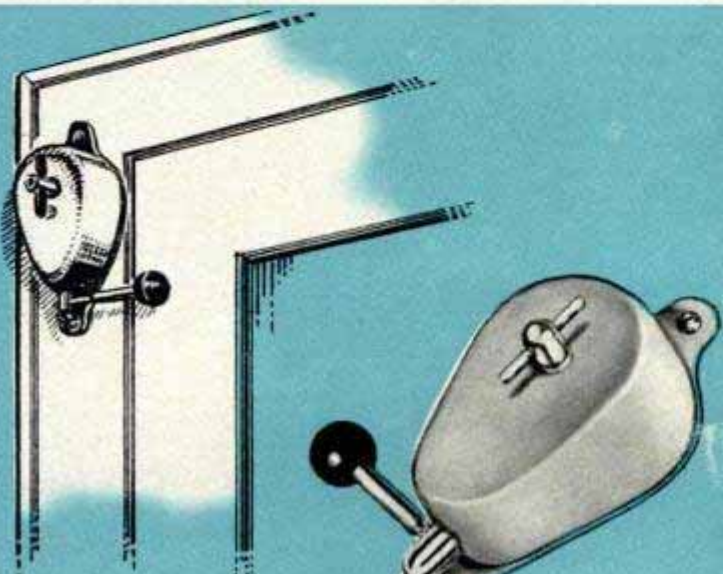

"Strapping" a Tanker

WELDING the seams of big tankers makes tighter and stronger joints, but it has one disadvantage—the seams don't "give" as do riveted joints. In rough seas, this characteristic sometimes results in cracking. Because the hull can't yield to the battering of waves, the ship splits open. A serious crack can split the ship in two. To prevent this, eight heavy steel straps were riveted over longitudinal slits cut in the tanker Elk Basin at the Bethlehem Steel Shipyard in San Francisco. The strapping operation won't eliminate cracking, but will arrest cracks so they won't split the ship wide open. When heavy seas open a crack, it travels across the hull until it runs into the crack arrester. There it is stopped by the longitudinal cut and riveted straps. Thus any crack can travel only one eighth of the way around the hull.

First step in the strapping operation is making eight precision flame cuts lengthwise in the hull (left). The perforated strap fits over each slit (below). Holes are drilled through the hull prior to the temporary bolting. The bolts are removed and rivets driven (top) making the straps permanent additions to the tanker's hull

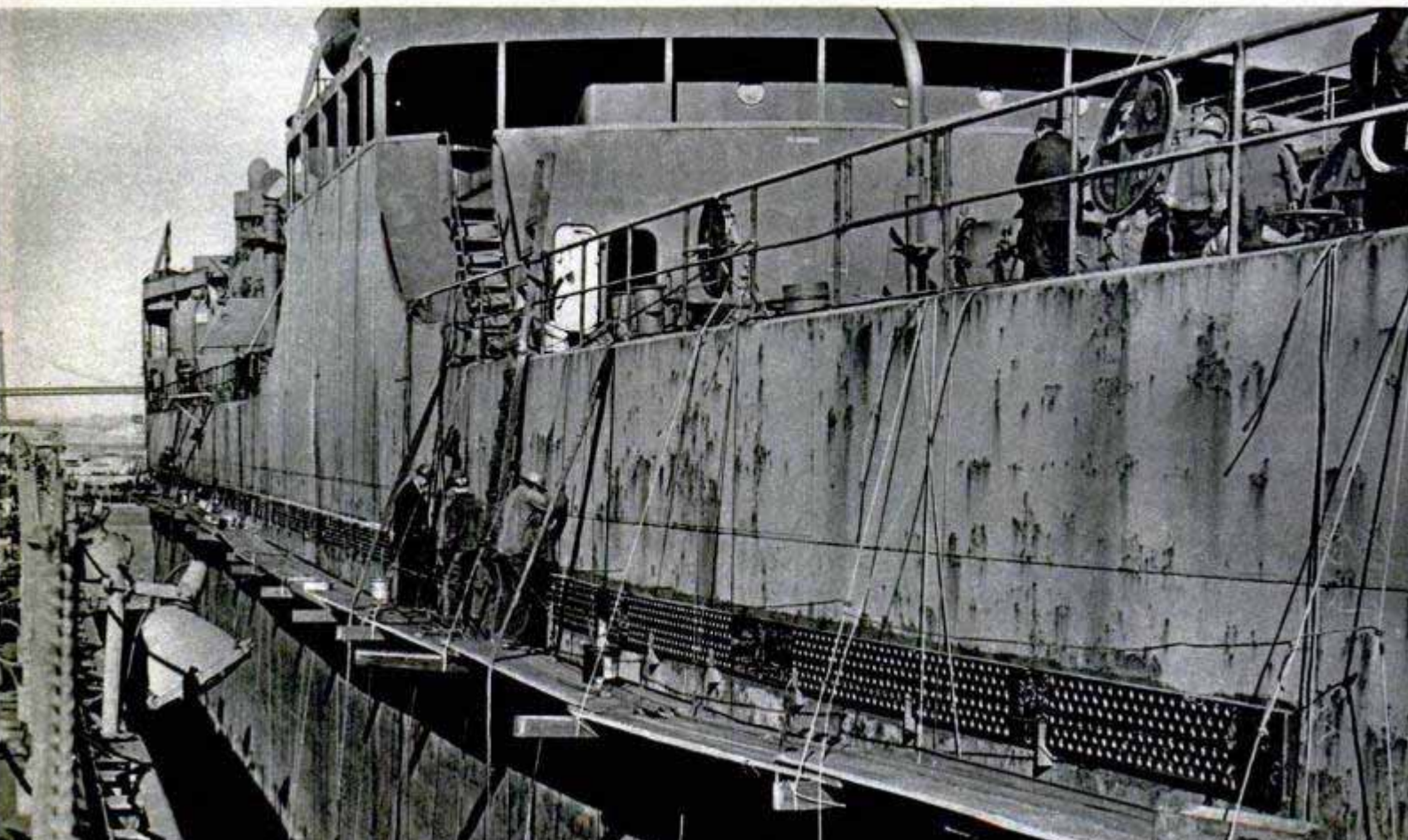

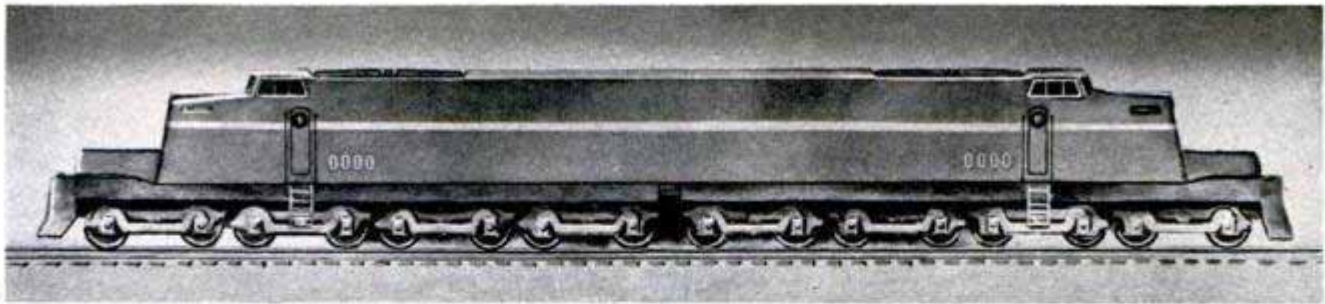

Big or Little Electric Engines Made From "Packaged" Trucks

Electric locomotives with truck units that can be put together like building blocks to form small switch engines or powerful freight engines are being planned by Westinghouse. The basic parts, such as wheels, trucks and motors, are identical for all sizes, the only difference being in the number used and the body design. Each four-wheel truck has two electric motors of 469 horsepower each. Repairs and maintenance are possible with almost no interruption in service since individual trucks can be removed and replaced quickly. Another advantage, Westinghouse engineers state, is the broad distri-

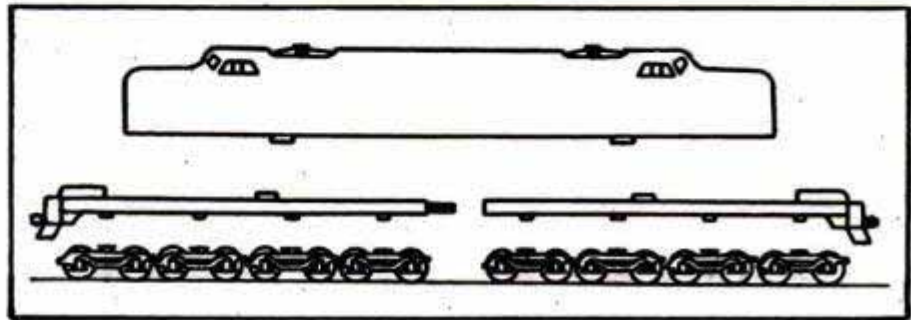
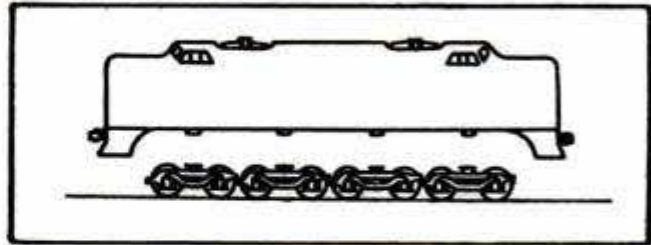

bution of locomotive weight over many axles providing faster and smoother operation and better traction. By using eight trucks a locomotive can be built with 7500 continuous horsepower at the rails.

Precut Paper Letters Set by Hand as Type for Printing

Type proofs can be set by inexperienced personnel with a pad of precut letters, a composing stick and a roll of cellulose tape. The paper letters are die-cut to assure alignment and are available in 50 type styles and sizes. They are removed from the pad and inserted in the composing

stick, which has an adjustment for holding them at the proper tension. After the line has been set and spaced, the letters are covered with a piece of the tape and trimmed across the bottom and top. When the tape is removed the letters adhere to it and can be fastened in place on

the layout without additional adhesive. This method is useful in composing type lines for offset, zincs, silkscreen, blueprints or movie titles.

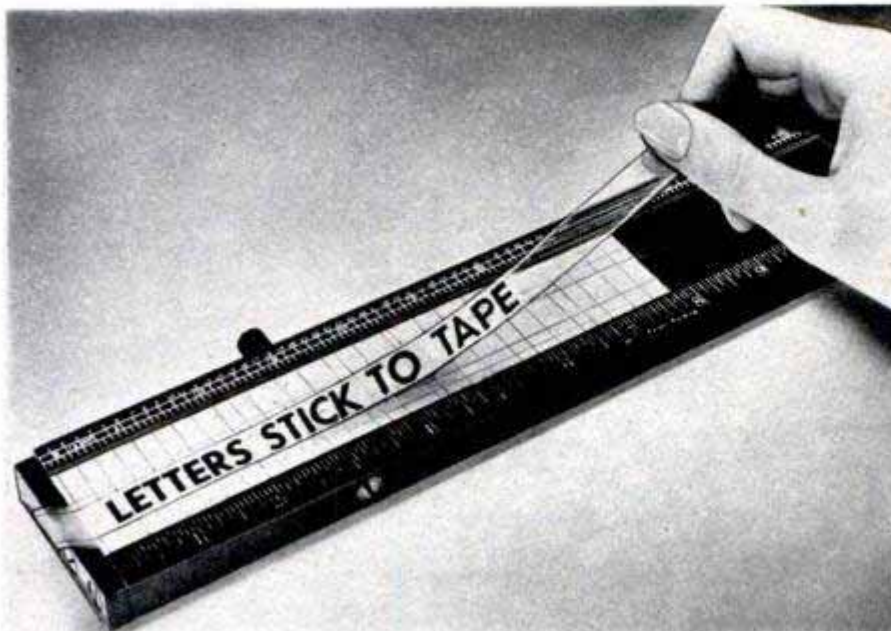

Flight-Time Recorder

When the propeller airstream reaches 40 miles an hour it begins to register hours and minutes on a new aircraft flight-time recorder. The unit's large, luminous sweep hand revolves hourly. Weighing less than a pound, the instrument is spring driven and has to be wound every 30 hours.



Flattop Dons Civvies as Speedy Freighter

Discharged from active duty as a baby flattop, the aircraft carrier Chaser has been converted to a speedy merchant ship and renamed the S. S. Aagtekerk. The ship is the third of 11 carriers being re-

modeled for freight service by the Gulf Shipbuilding Corp. Being completed at the rate of one a month, the freighters are 492 feet long and each has accommodations for 12 passengers in addition to crew.



Copyright Howard M. Edmunds

Chart Adds Fractions

Fractions are added or subtracted at a glance on a printed chart of fraction combinations. There are no moving parts and no written or mental computation is necessary. The fractions to be added are selected on two edges of the chart and the lines from these fractions are followed to their intersection. From this point a diagonal line leads directly to the answer. For subtraction, the procedure is reversed.

☐ A lightweight fiber concrete, several times more resistant to damage by fire than normal sand-cement concrete, has been developed at the University of Michigan.

Can we save our trees?



↓ Of 35,000 seedlings exposed to disease, this elm is only one that survived. It may become granddaddy of new strain to replace elms like one above

USDA photos



By Clifford B. Hicks

TREES with naked limbs and rotting trunks are no strange sight in Columbus, Ohio. The city pays out more than a million dollars a year to haul away elm trees that have been attacked by a deadly disease called phloem necrosis. It's an epidemic that stalks up one street and down another, threatening every elm in Columbus—and every elm in the country.

Yet the elm tree, under attack by both phloem necrosis and the dreaded Dutch elm disease, is only one of our many shade, forest and fruit trees threatened by powerful organisms that could bring extinction. Across the United States only a few scattered American chestnuts remain—most have been wiped out by a fungus. White pines from Maine to Minnesota and southward to Virginia are dying at an alarming rate. The giant cactus of Arizona and the West-Coast orange trees are under attack.

Why are diseases cutting down our green giants at such an alarming rate? Many new diseases that roam the country are speeded on their deadly job by the modern system of planting many trees of the same species in the same area.

There are grave doubts that some species can be saved from extinction. Yet some of



USDA photos

Bagging flowers on Asiatic chestnut prevents them from pollinating, one step in breeding new strain. Below, dead stand of chestnut shows why new strain is necessary. Disease has killed almost every American chestnut

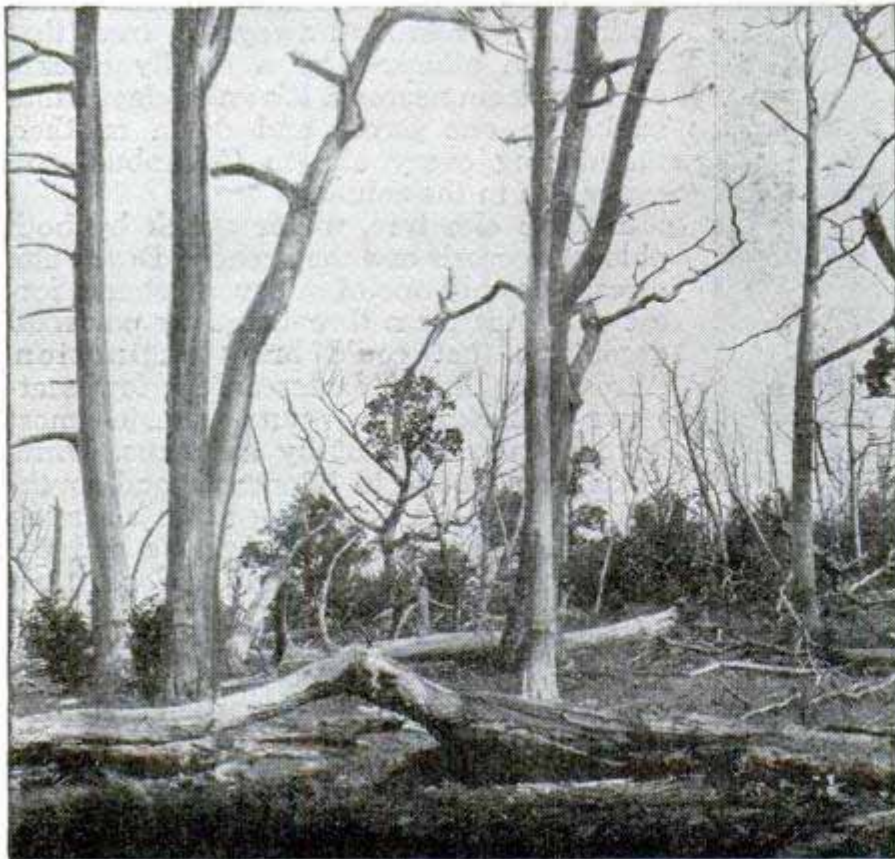

the diseases have been stopped cold and others may yield soon to the wizardry of scientists of the Department of Agriculture's Division of Forest Pathology. These men are not tree doctors, but research specialists who toil to discover what bit of living death lashes out at our trees. In the division's headquarters at Beltsville, Md., and the 15 field stations scattered across the country they probe the private lives of all kinds of trees suspected of being sick.

Results of this research are distributed through literature and through disease-resistant tree specimens. The scientists make no claim that they can eradicate a disease completely—you can't quarantine every elm tree in the country. Their work is aimed at establishing enough control to prevent serious loss.

Not only virus and fungus-type diseases, but greedy insects cause untold damage yearly. For example, a spruce beetle has destroyed more than four billion board feet of timber since 1940. But the battle against insects is waged by another division, Forest Insect Investigations. The Division of Forest Pathology is concerned only with diseases.

Because trees can't talk and don't mature as fast as humans, diagnosis is a tough problem and treatments may take many years to work out. Dr. Lee M. Hutchins, director of the division, points to some of the work which he terms "hundred-year projects."

Take the case of the Dutch elm disease. This disease, carried by bark beetles, has been rampaging across the country since 1930, killing thousands of our most beautiful shade trees. Ef-

forts to wipe out the disease have failed, so the USDA scientists have turned their magic toward developing a new type of elm that is resistant to this disease and phloem necrosis.

Of 35,000 seedlings that originally showed promise of resistance, only one has withstood three consecutive seasons of heavy inoculations. Yet the scientists are not disappointed, for this lone seedling may become one of the parents of a hybrid strain that can fight off both diseases.

The division casts a watchful eye on diseases that are on the rampage halfway around the world, for such diseases easily could slip into this country. Once such a disease gets a foothold it may spread across the continent. About 50 years ago some unknown nursery imported an Oriental chestnut for breeding. That chestnut was infected with a fungus. Today practically every chestnut in the natural range of this tree has been killed. Now scientists are attempting to breed a new type of chestnut that will resist the disease. Their efforts show such promise that pollen from



From their perch atop a mobile power sprayer, workers send a mist of death down on the codling moths infesting a big walnut grove

Infected seedlings from a nursery could spread a disease across the entire country. Here pine seedlings are sprayed as protection from rust

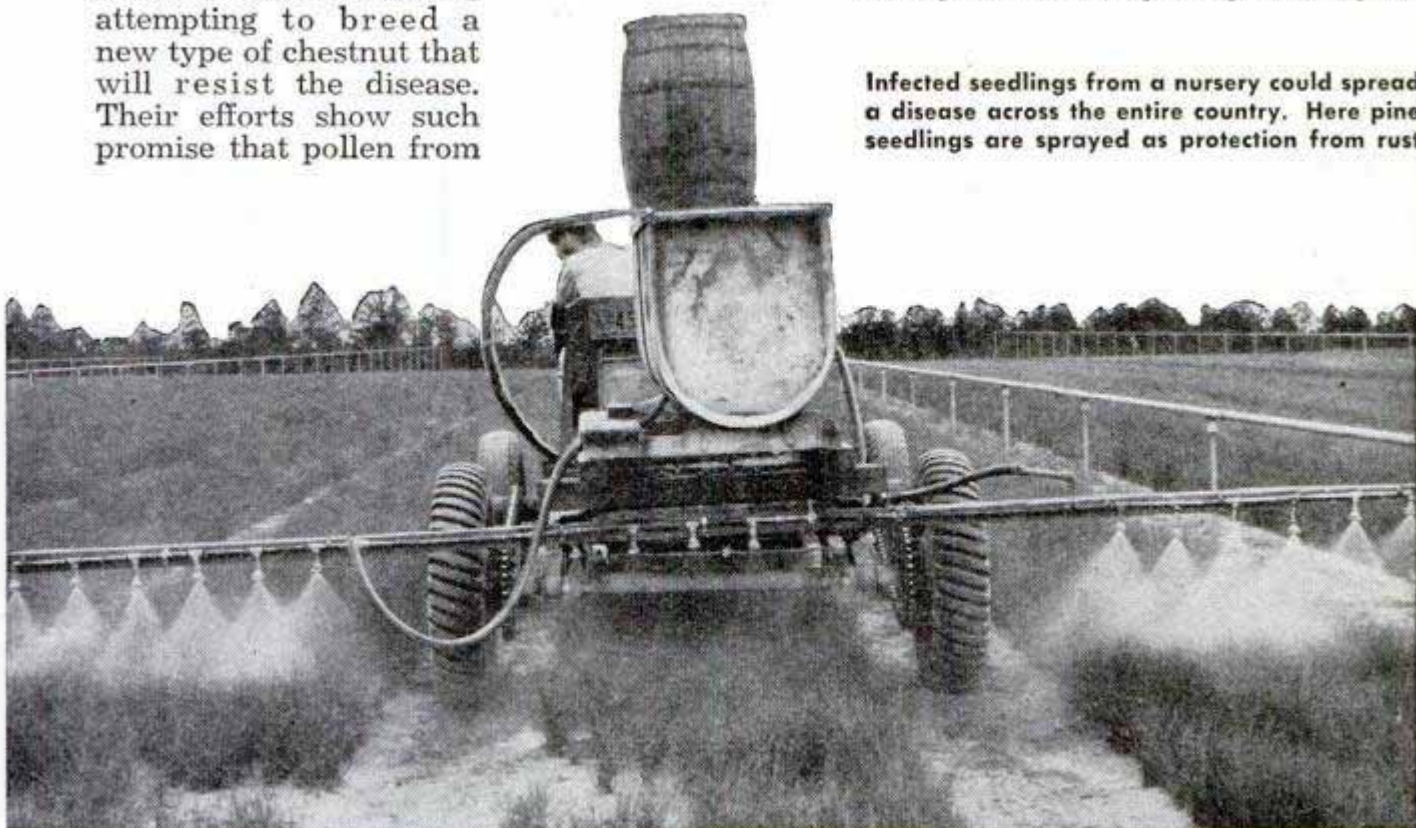

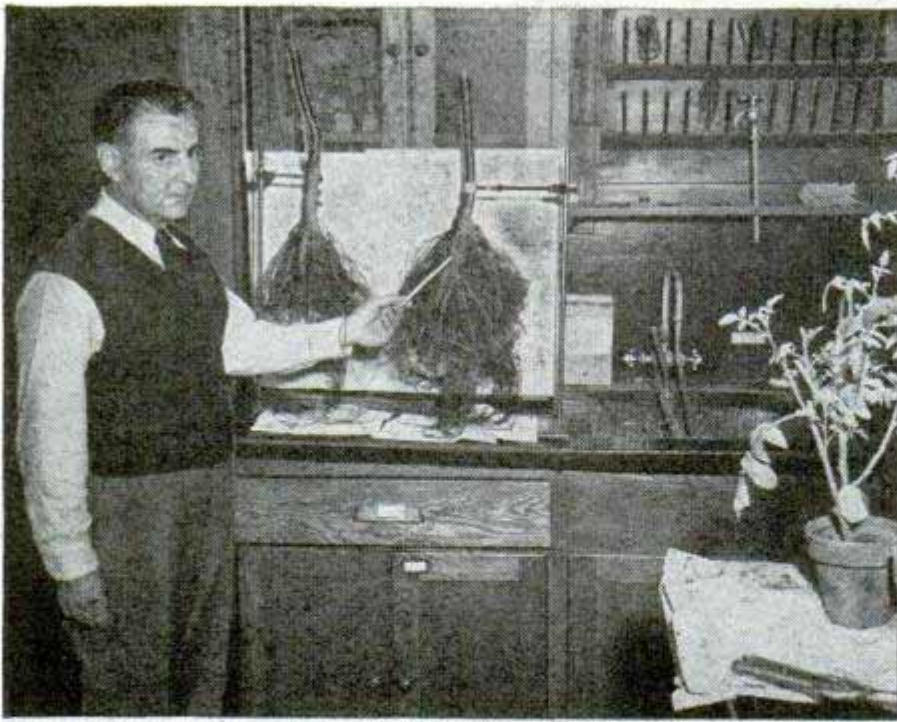

Dr. Pierre Miller, UCLA scientist, points to gall on roots of a peach tree caused by worms. He kills worms with hot water

mined definitely that they are free of disease.

Among the most popular shade trees in eastern seaboard cities is a species of sycamore called the London planetree. An estimated \$1,500,000 has been spent in planting these trees to beautify our cities. Yet within the past few years a deadly fungus has been racing down the city streets killing many of them.

The first step of the USDA scientists in battling a disease is to find out how it is carried. In

some of the hybrids was flown a few months ago to scientists in Italy, where the same disease now is raging.

Since the turn of the century more than a dozen new diseases have slipped into the country on imported seedlings or lumber. In recent years strict quarantine laws have kept plants off our shores until it is deter-

the case of the planetree they have discovered that the disease cannot readily move by itself but is spread mechanically by such instruments as infected pruning tools. It has been demonstrated that a wandering boy who jabs his pocketknife into a diseased tree and then sticks it into other trunks can infect every planetree in his

By selection and treatment of seedlings in western nurseries, new diseases can be stopped in their tracks



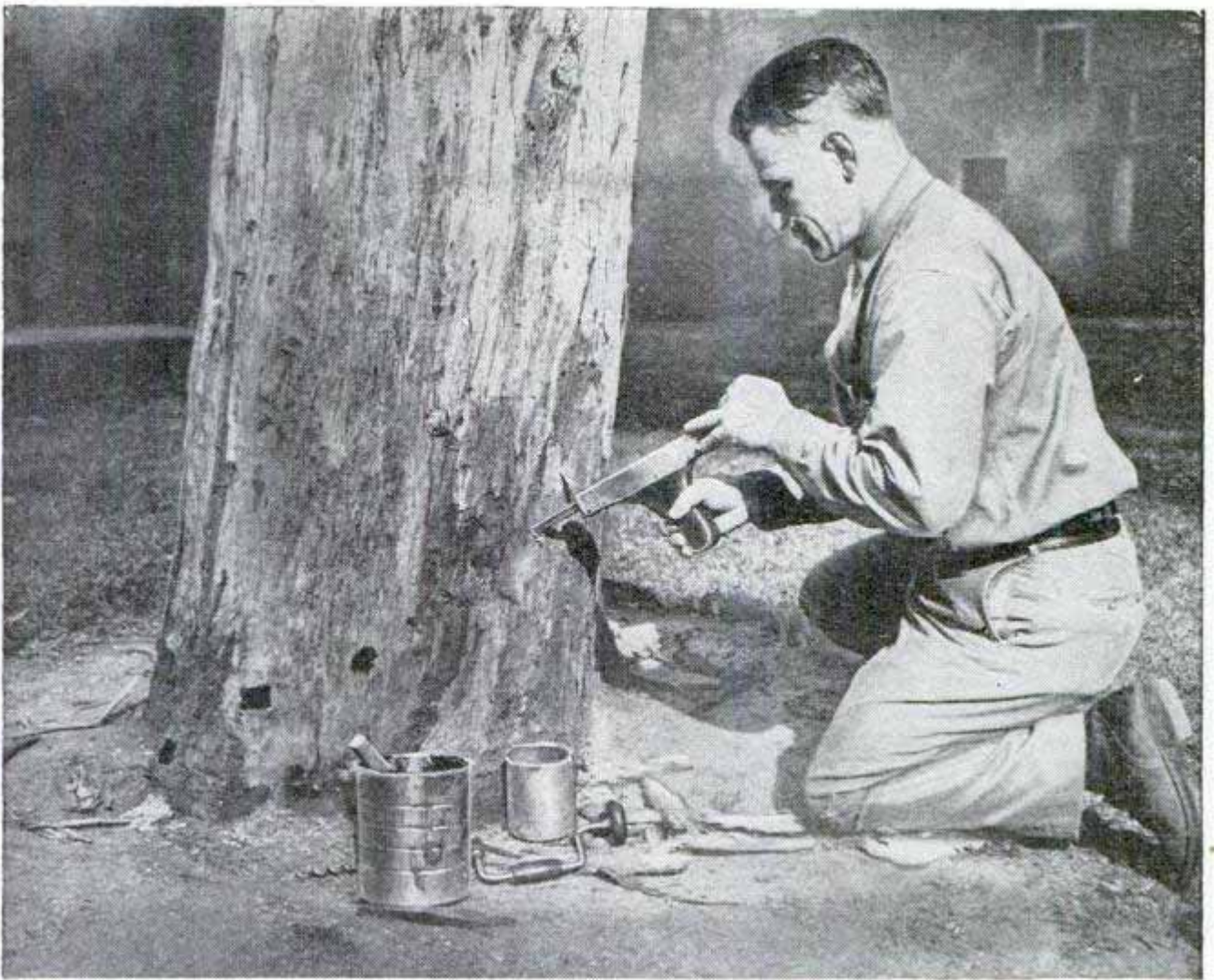

Tree surgeon of Los Angeles administers shots of iron citrate to eucalyptus tree to cure an iron deficiency

path. Others have been fatally inoculated when a youth carved his girl's initials in their bark. Through recent efforts of the USDA and complete cooperation of the cities, many of the planetrees have been saved. Linemen and tree surgeons should use only sterilized equipment when working on the London planetree. This disease so far has been confined to the eastern states and Mississippi.

Farther west in Arizona, the saguaro or giant tree cactus is being felled by a tiny bacterium that causes a soft rot in the trunk and huge arms. Scientists fear that the finest stands of this towering symbol of the Southwest may be ruined within a few decades. This strange disease, thought to be carried by a night-flying moth, is killing cacti by the hun-

dreds. Mature saguaros more than 100 years old are the chief victims. No way has been found to prevent the disease from eating the heart out of these old-timers. And few young cacti are springing up. Saguaro seeds are sought by birds and rodents, and only a few survive the rigors of the desert. Those seeds that live and germinate do so

(Continued to page 240)

USDA photo



Elm disease has killed the trees on one side of this street and now is starting down other side



Coin-Operated Shoe Polisher Shines Two Shoes a Minute

Coin-operated, a shoeshine machine puts a polish on both shoes in one minute for a dime. The machines are labeled according to the color of polish used. A timing device shows the customer when it's time to change from one shoe to the other.

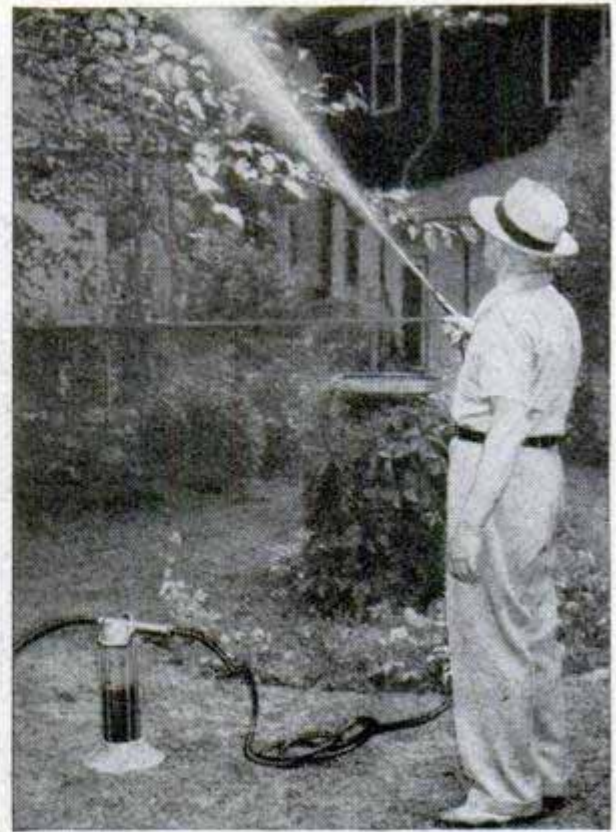

Hose Sprayer Mixes Insecticide

Attached to the garden hose, a lawn sprayer automatically mixes an insect-killing solution of any desired strength and sprays it in a fine mist or a steady stream. The full-strength solution is poured into a glass container to which the hose is attached. Water pressure through the hose forces the solution up a tube and into the water stream. A dial on top of the container regulates the strength of the mixture. The sprayer also can be used to disinfect poultry houses, barns and other farm buildings, and to spray livestock.

Motor-Driven Sweeper Cleans an Acre an Hour

Driven like an automobile, a high-speed vacuum sweeper picks up dust and litter at a rate of 44,000 square feet an hour. Powered by a six-horsepower gasoline engine, the sweeper has a combination revolving brush and vacuum-fan cleaning system. The sweeper compartment is 36 inches wide and is "sealed" to the floor by a flexible rubber skirt. Material that is picked up is collected in a removable hopper. Light dust is collected in a fabric bag. The cleaner travels up to six miles an hour.

Scientists report that the most abundant chemical elements are hydrogen and helium, followed in order by oxygen, nitrogen, carbon and neon.

Fertilizer Spreader Uses Tiller Frame

By combining parts of a duckfoot tiller and a potato planter, South Dakota farmers made a subsurface fertilizer spreader for use in soil-conservation tests. The fertilizer attachment from the potato planter was mounted on the tiller frame and the shovels of the duckfoot cut down and rearranged so fertilizer can be deposited between corn rows. Four tubes from the two boxes direct the fertilizer behind the shovels.

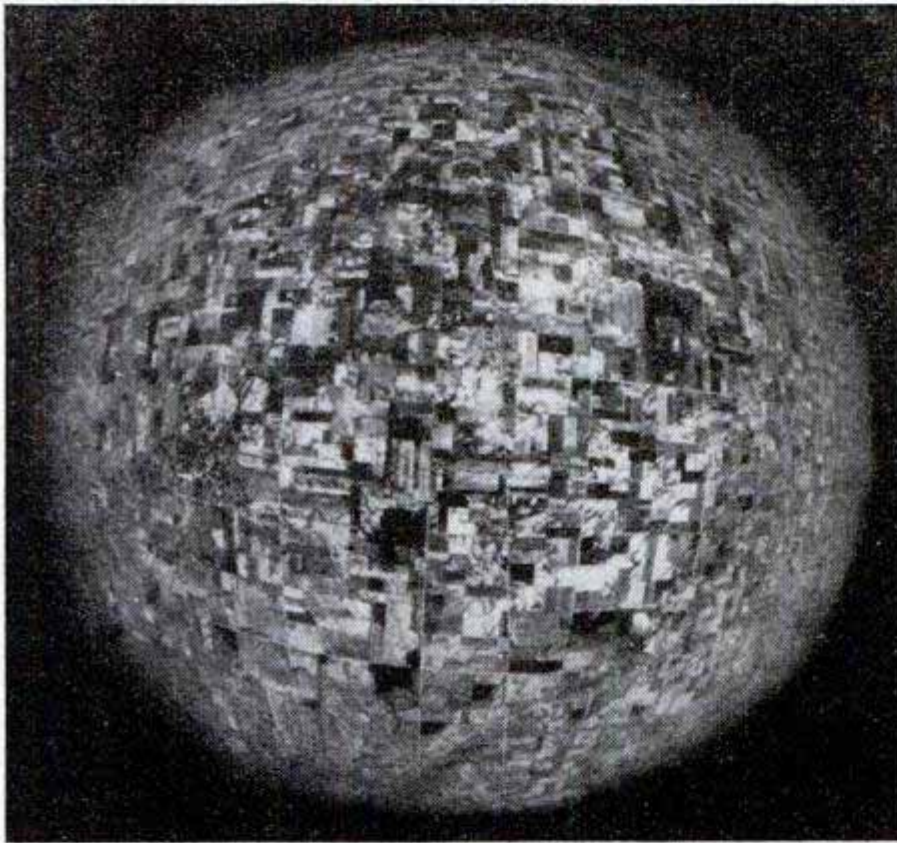
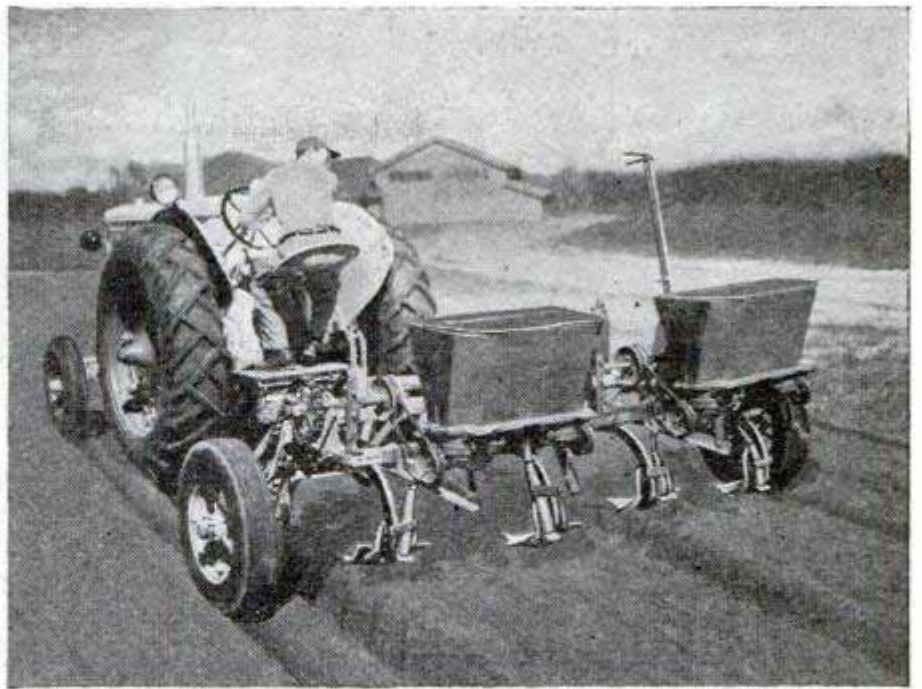

Lens Quadruples Air Camera's Scope

Almost four times the area photographed by orthodox aerial cameras is embraced by a new wide-angle lens revealed by the National Bureau of Standards. It gives the region covered by the lens the curved appearance of a giant golf ball. Effective exposure is at its maximum at the center and decreases rapidly towards the edges of the target area. The new lens is expected to be of great value in future mapping operations. It was tested at 10,000 feet over Dayton, Ohio, site of the Air Force's principal aerial photography experimentation center.

Four-Lens Turret for Cine Special

Users of the Cine Special with its two-lens turret can now use any combination of four lenses with a special custom-made turret. There is no interference in the fields of view even when using the wide-angle lens and six-inch lens on the same camera. No changes are made in the camera during conversion and the original turret can be replaced at any time.

☐ The new passenger liner Lurline, sailing between Honolulu and San Francisco, has two giant evaporators capable of supplying 80,000 gallons of fresh water per day.





Transparent Diving Helmet Permits All-Around Vision

There are no blind spots in a plastic diving helmet designed by a marine photographer in Rochester, N. Y. Air is pumped into the helmet through the hose connection above the left ear. Heavy weights press the helmet down against the shoulders and chest and air pressure inside the helmet holds back the water.

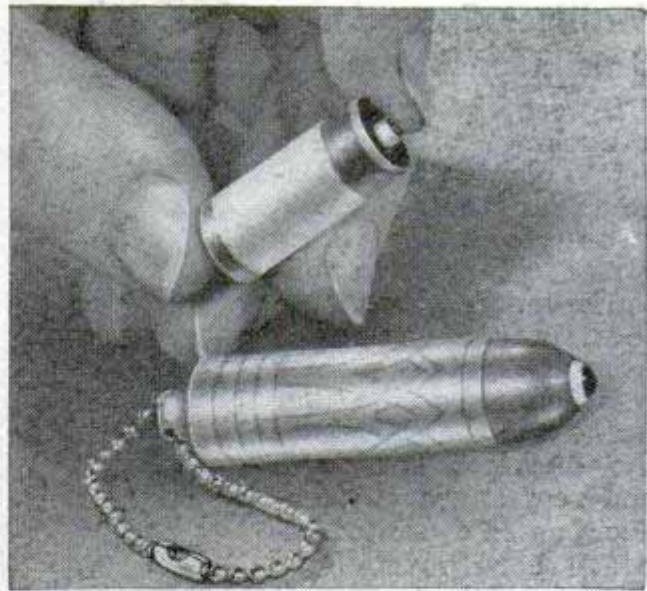

"Lipstick" Flashlight to Fit Purse Uses Special Midget Battery

Convenient to carry in the purse or pocket is a tiny flashlight about the size of a lipstick case. Only $\frac{1}{2}$ inch in diameter and two inches long, the flashlight uses a special small-size battery. The light is available in sterling silver, solid gold and jeweler's metal. Chains, key rings and name tags may be attached to the flashlight.

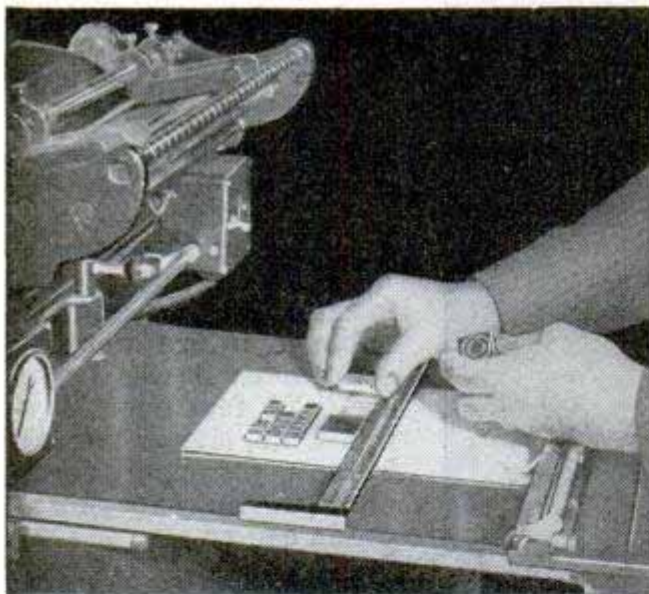

Typesetting Is Simplified By Small Color Press

Color printing on any material from tissue paper to metal six inches thick can be done with a new British printing press that is little larger than a typewriter. Colors are printed with rolls of colored foil that feed into the press automatically. Typesetting is simplified. Pieces of type are set on the platen in normal reading order. The letters are etched on the back of the type and the operator spells out the words from left to right or merely places the type over



Left, type is placed upside down on a layout sheet. An adhesive transfers it to top platen. Right, the operator removes a color-printed poster from press

the artist's layout. When the type is set, a sheet of adhesive paper is placed over it and the platen slid into the machine. A combination of heat and pressure transfers the type to the top platen, leaving the printing surfaces of the type in position for the impression. Because of its simplified operation, the press makes possible economical printing of one or two copies of each run. When used with an etching process, it also prints color on metal.

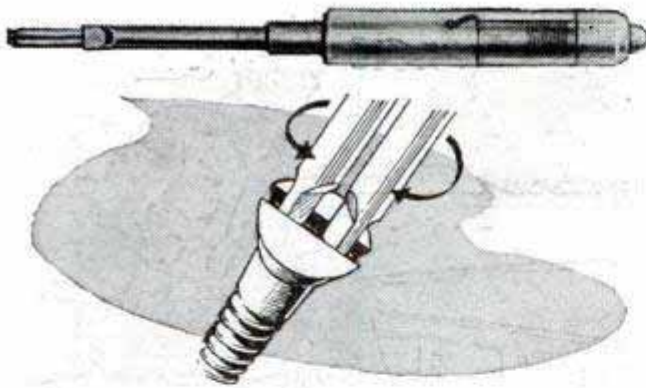

Starting Tool Locks in Screw

Screws can be started in confined places by a tool that locks in the slot of the screw while acting as a screwdriver. The head of the tool has two small blades which rotate in opposite directions when pressure is applied to the handle. This action locks the blades in the slot. A release mechanism in the handle permits the blades to be disengaged. The handle of the screw-starter is made of nonconducting plastic.

Pocket Kit for Fishermen Has Transparent Case

Fishermen can carry hook, line and sinker in their hip pocket safely when a kit that includes a Tenite-plastic carrying case is used. Its two transparent tubes are joined by a flat section of the same material. In the kit are 30 feet of line which wraps around the middle section and two snelled hooks, leader, split shot, clincher sinker and a cork float with a screw eye, all carried in the tubes. The handy case is not affected by salt water.



Sun Visor Protects Yachtsmen From Direct and Reflected Rays

Consisting of two Polaroid filters, a sun visor for boats holds back the harsh glare of sunlight reflected by the water, but permits useful light to pass through. The smaller visor filters direct glare when the sun is low in the sky, while the larger filter protects the yachtsman from reflected glare. When the sun is high in the sky, the larger filter is used alone.

Combination Drafting Tool Has Wide Variety of Uses

Eliminating the need for several triangles, a new drafting tool draws all the basic 15-degree angles. In addition, it locates center points for radii and divides angular lines in the center. A float on top of the tool is used with its protractor scale to provide any angle and its 90-degree complement. A full 7-inch scale and a 14-inch half scale are provided on the outside edges of the tool.

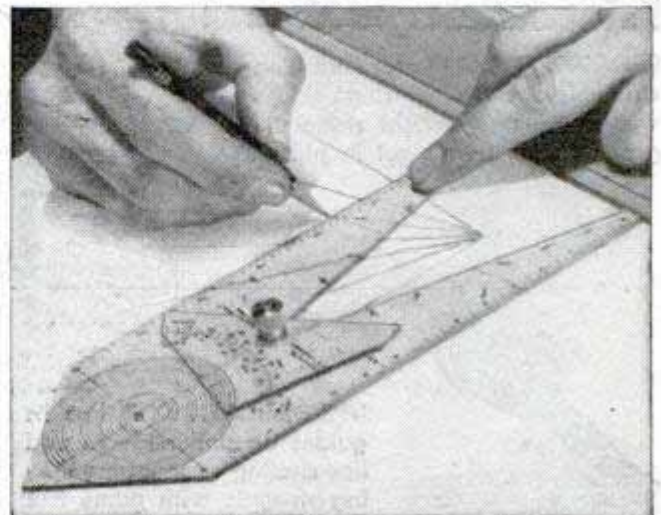



LEG POWER spins the propeller of this motorless boat by pedal action. Being silent, it's ideal for trolling



BILGE PUMP is also powered by foot. Its pumping rate is about $3\frac{1}{2}$ gallons of water per minute

fisherman's page



REFLECTING BUOY for marking channels or net anchorings shines when rays of spotlight strike the ground-glass beads set in plastic

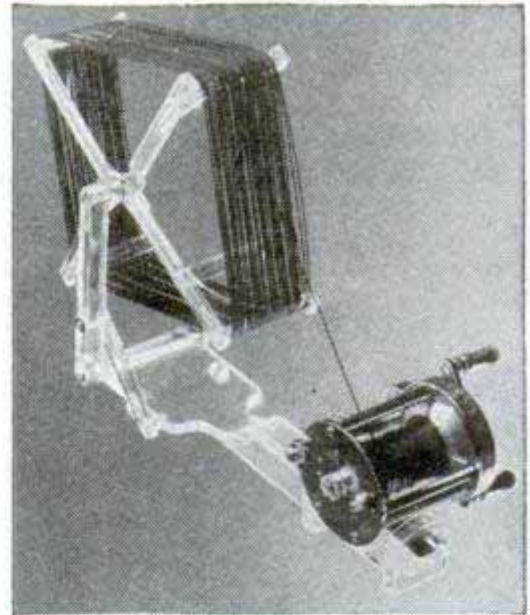
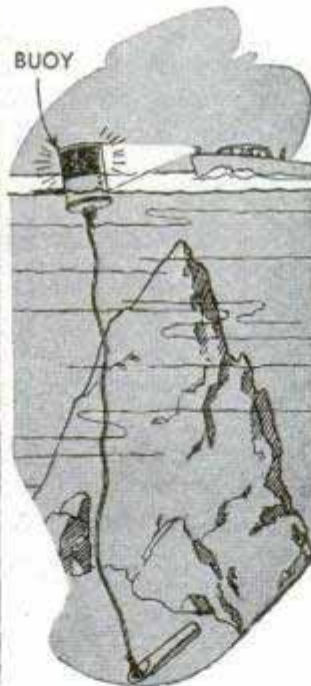

LINE DRIER has a built-in reel holder. When folded, it fits into the coat pocket

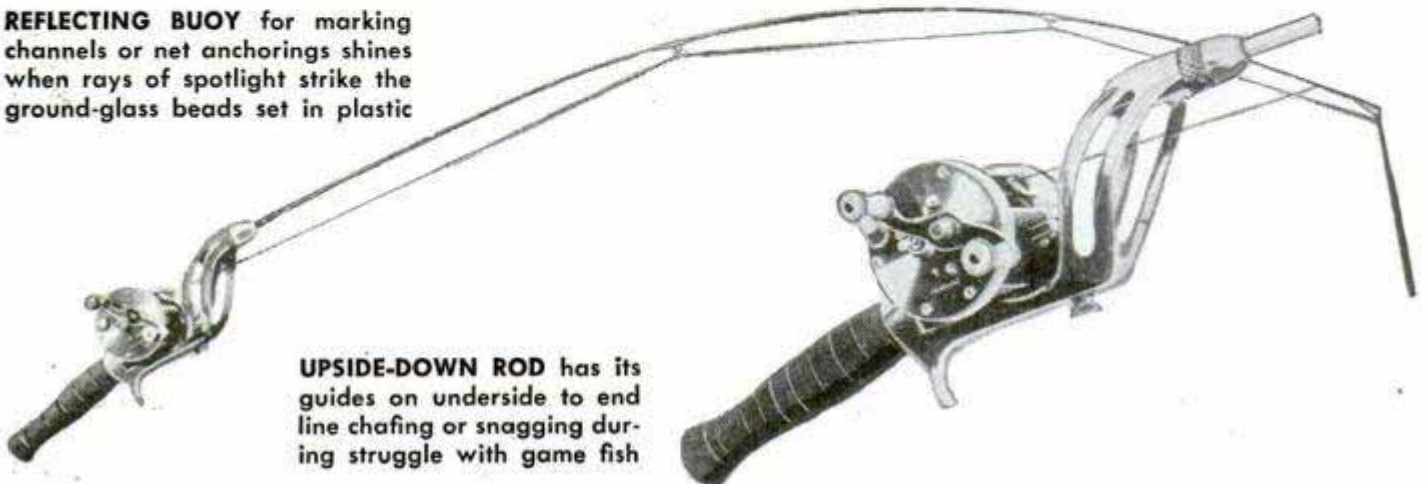

UPSIDE-DOWN ROD has its guides on underside to end line chafing or snagging during struggle with game fish



High School Students Drive "Cars" in Classroom

Model automobile steering wheels that look like the real thing are aiding a high school instructor at Bloomington, Ind., in teaching students to drive. Each seat in the classroom is constructed like a driver's seat complete with steering wheel, brake, clutch, accelerator and gearshift. Wires

connect the seats with an electric panel in front of the instructor. As he describes traffic situations, the students "drive" along to solve the problems. The electric panel gives the instructor a check on each student's reaction. The models were built by boys in the school.

Rainfall Gauge for Home Use Reads Like a Thermometer

Rainfall is measured in inches by a gauge that can be read like a thermometer. The gauge, consisting of a scale, rain catcher and plastic tube, is mounted in the yard as far as possible from high objects. Rain falls into the funnel-like catcher and collects in the tube. The reading then is taken from the scale along the side of the tube. The gauge is designed on a ratio of four to one—one inch of rainfall measures four inches in the tube, but is read directly from the scale as one inch. A record book with the gauge provides space for recording the rainfall for 11 years.

Brake Lock Holds Car on Grade

Operating only when the clutch pedal is depressed, a brake lock prohibits cars from rolling backward or forward even though the brake pedal is not held down. The lock leaves the driver's right foot free to rest on the accelerator for smooth starts. Depressing the clutch prepares the lock for operation, but the brake pedal must be depressed once before the lock actually becomes effective. When the clutch pedal is released, the lock immediately disengages so that it cannot interfere with normal operation.

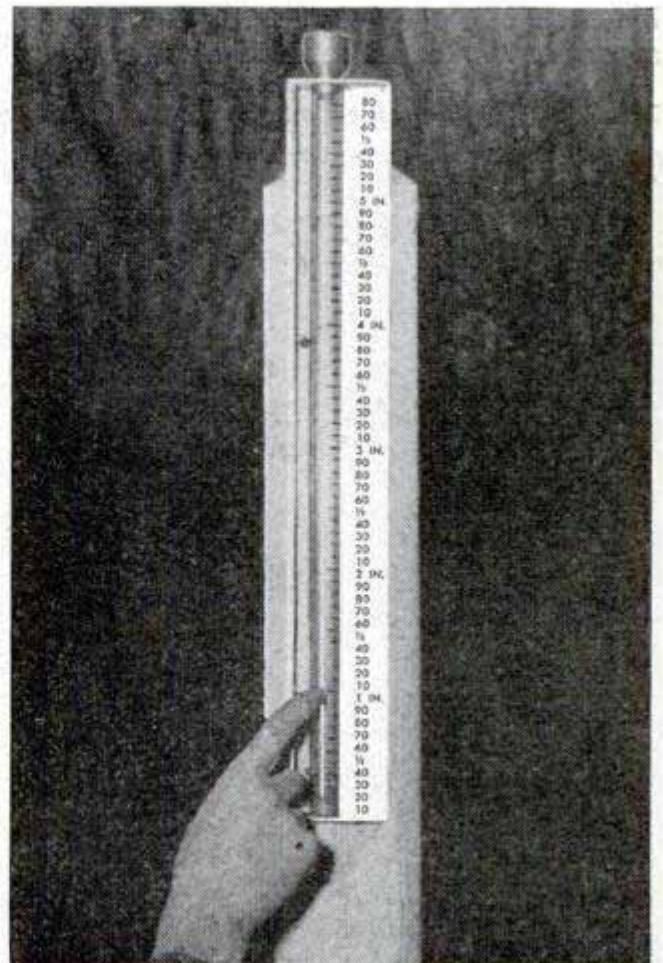

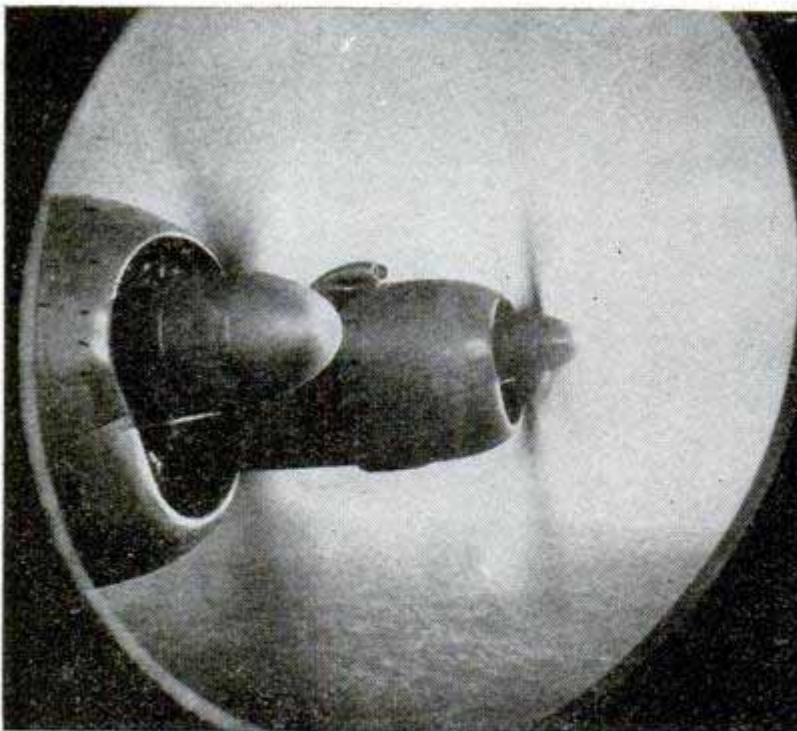

Portrait of the "Constitution"

A four-page album of pictures of the U. S. Navy's double-deck flying transport, the 180-passenger Lockheed "Constitution"

Lockheed Aircraft photos

THE NEW air queen of the Navy is the most easily controlled plane I've ever flown," said Lockheed's chief test pilot when he stepped out of the 92-ton "Constitution." Despite its great weight, the plane can get off the ground in 27 seconds from 1820 feet of runway! At a top speed of 300 miles an hour it is about 20 times faster than its namesake, the most famous warship in U. S. Navy annals, generally referred to as "Old Ironsides." With a double-deck fuselage 189 feet long and wings spanning 156 feet, it seats 180. In an emer-

gency 400 can be accommodated. A specially designed four-wheel truck-type landing gear on each side distributes the weight sufficiently to allow use of most large airfields. The multiple wheels also reduce the effect of tire blowouts to a minimum, permitting landings under favorable conditions with any two tires deflated on a single main landing gear. Four 3500-horsepower Pratt and Whitney Wasp Major engines have replaced the original 3000-horsepower engines. It was designed to use gas-turbine engines when they are available.

Passengers can be carried on two decks. The wing design anticipates later installation of gas turbines



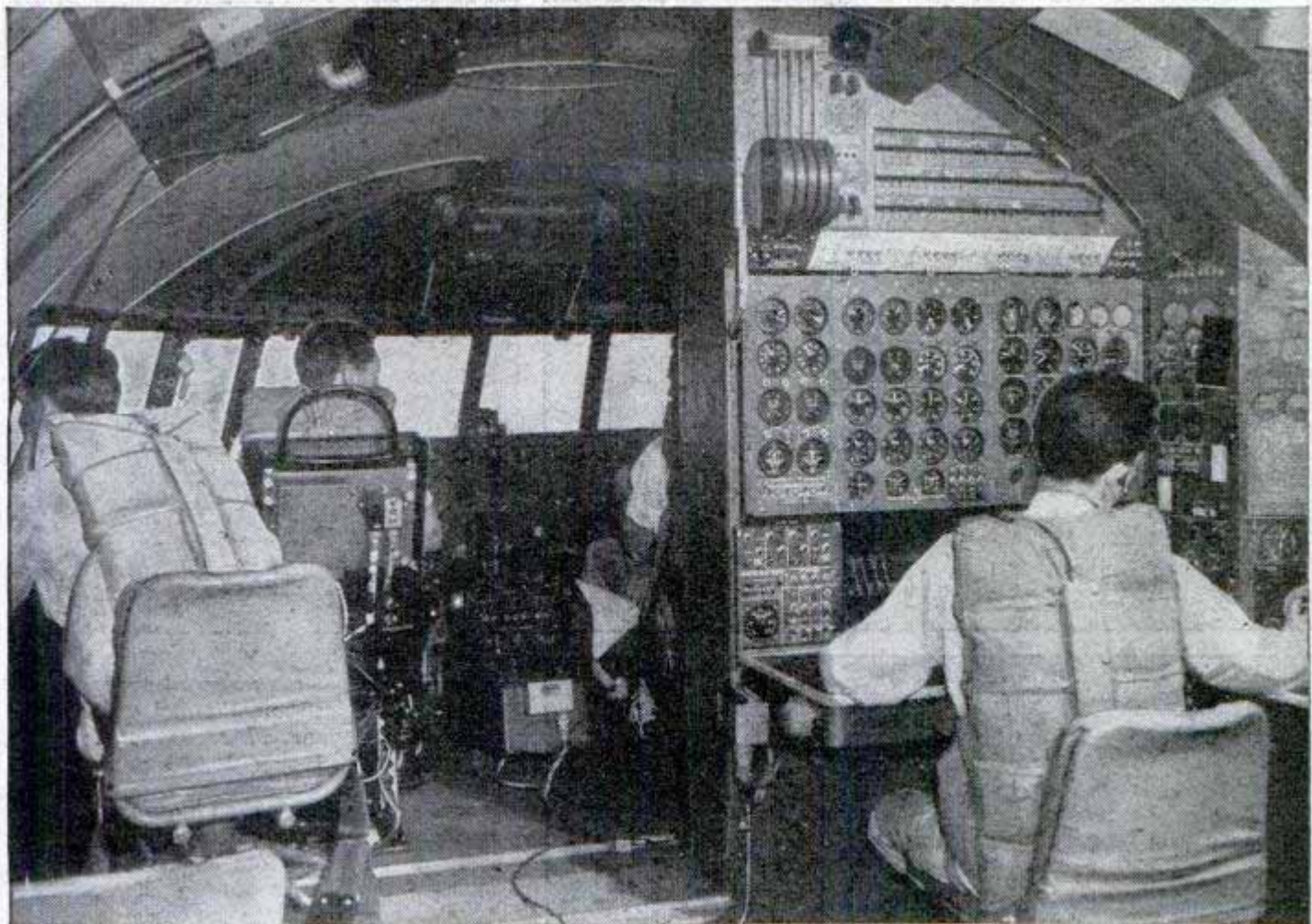

Flight engineer, right, handles all engine controls, except on take-off and landing. Another man runs electrical controls

Right, 30 of huge ship's 180 riders sit in upper deck area beneath the 50-foot-high tail



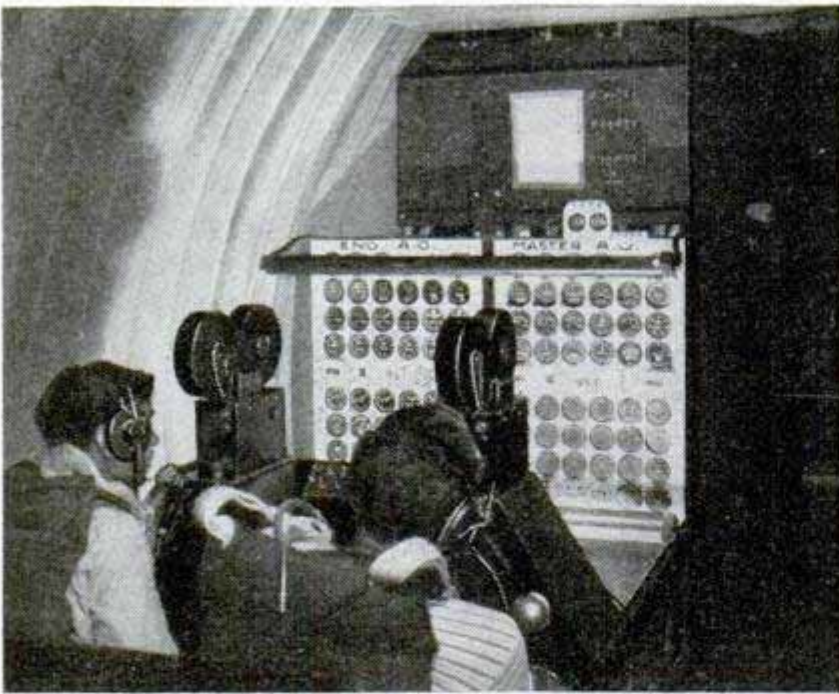

Above left, cameras recorded every response on instrument panel during plane's year of flight tests, when it logged over 20,000 miles

Above right, wings are so large that mechanics can walk or crawl inside them to get at all four engines for maintenance chores during flight. Tunnel doors open into the fuselage

Left, largest passenger section is a 92-seat area midway in second deck. "Figure 8" fuselage is pressurized both in passenger and cargo spaces for flying at 25,000-foot altitude

Below, because the 'Constitution' will be called on for constantly varying transport roles, it was designed for speedy conversions. The lower deck accommodates cargo, seats, benches or litters in different combinations

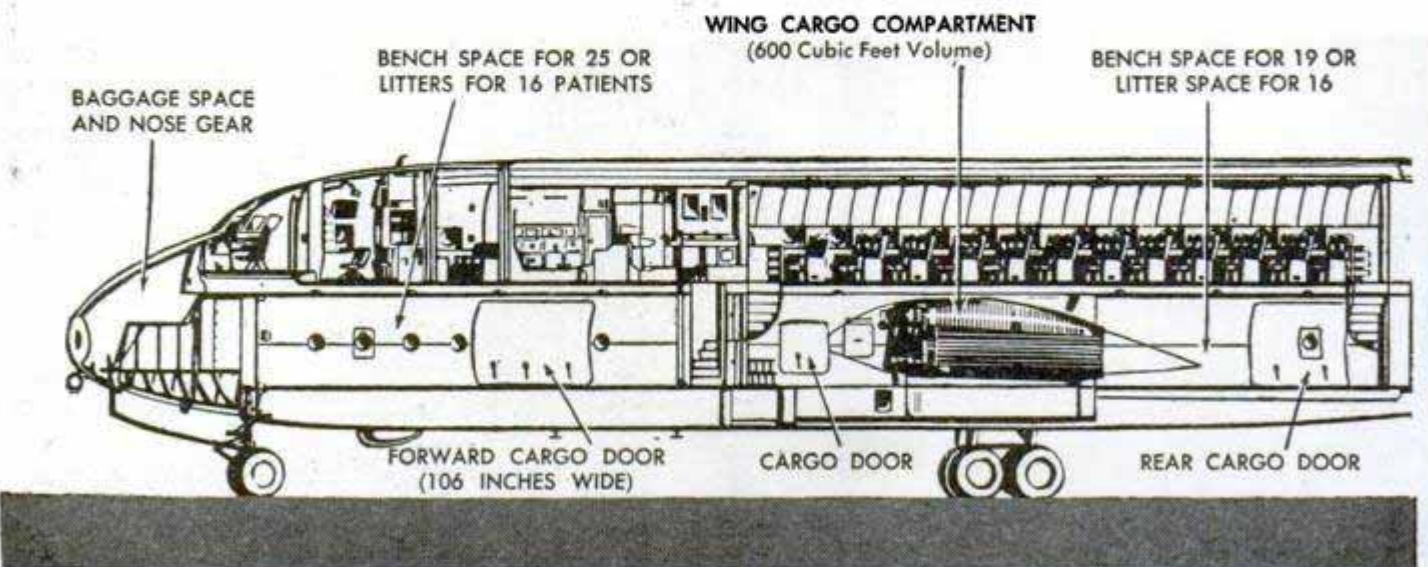

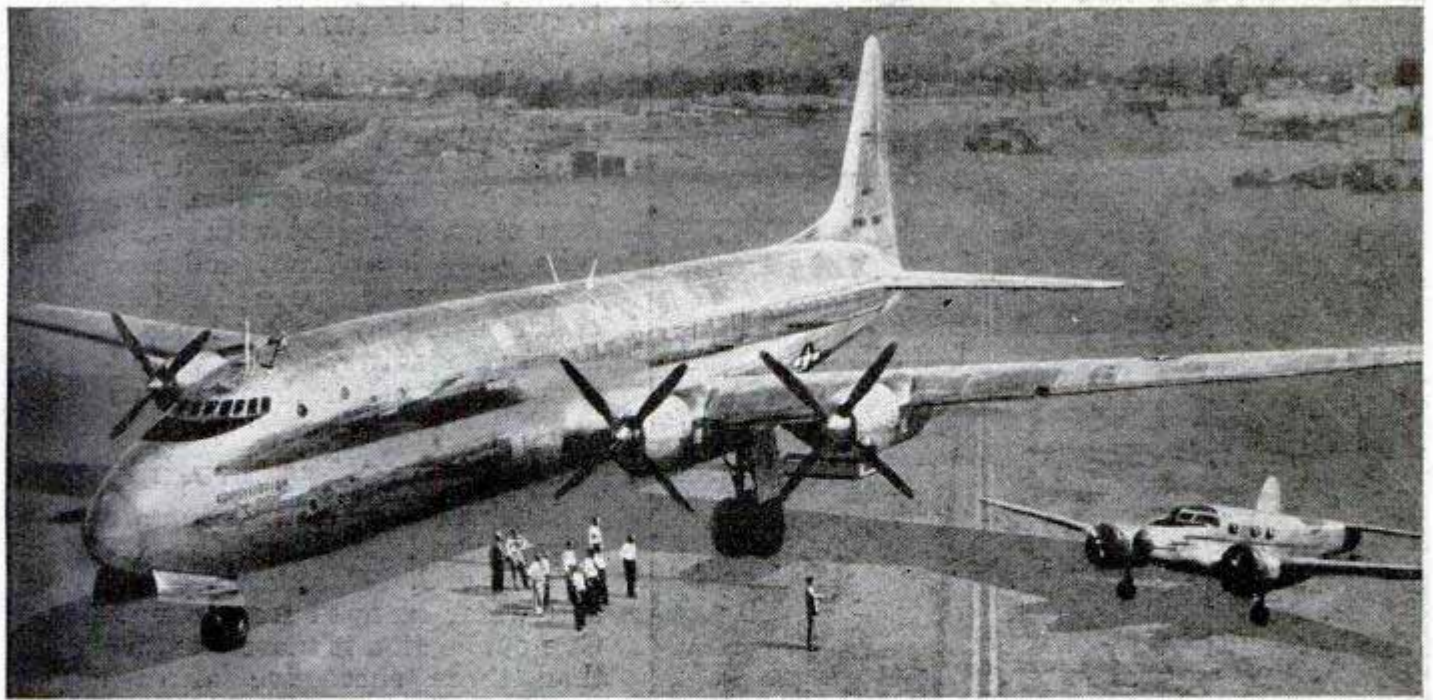

The new queen of Navy air dwarfs not only spectators, but a 39-foot transport built away back in 1936

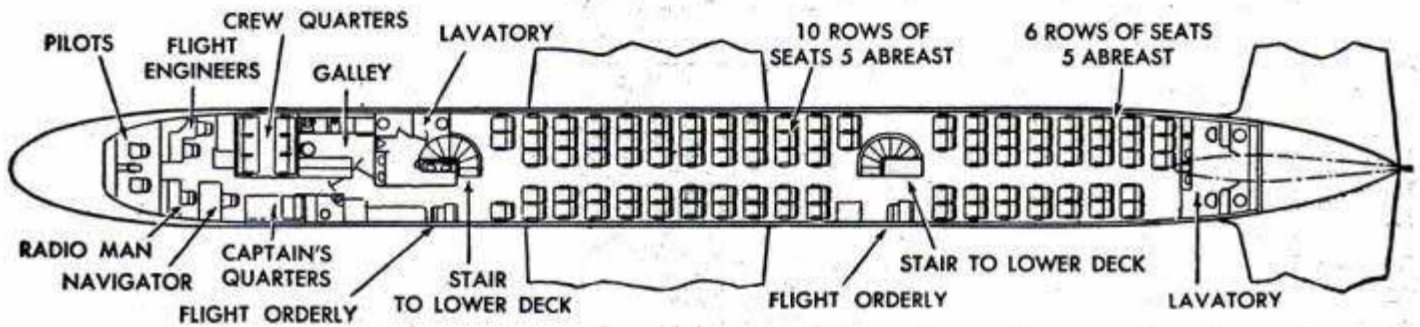

Right, spiral staircases link upper and lower decks of giant air carrier. A proposed commercial version of Lockheed-built craft would sleep 100 passengers

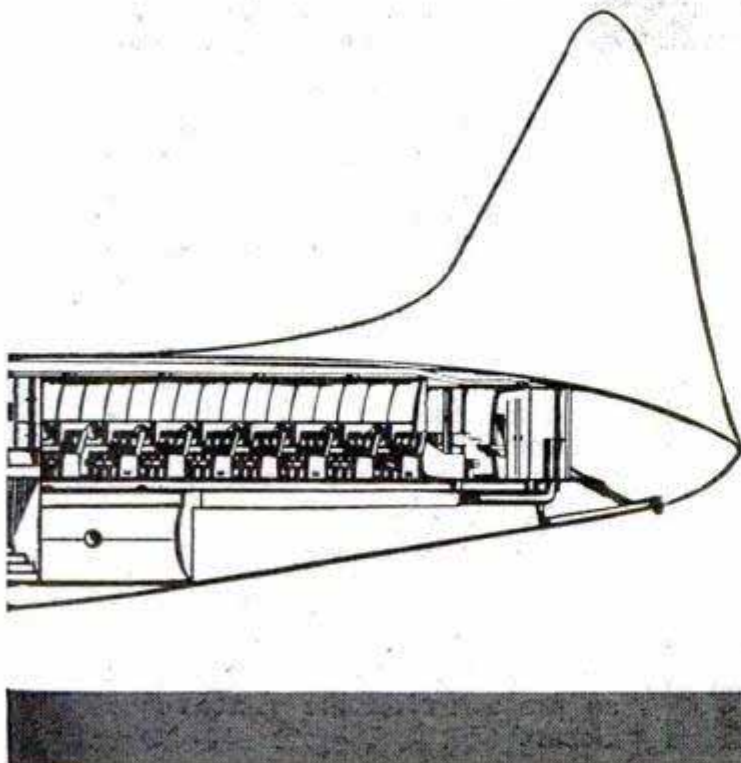



Bicycle Built for Five

When youngsters at a Dutch school miss the regular bus they don't have to walk home. The school janitor gives them a ride on his bicycle built for five. Tandem seats, equipped with safety rails, over both front and rear wheels provide space for four children. It may be hard pedaling for the janitor, but the youngsters like it better than the bus.

"Air War" on Sagebrush

Sagebrush is being cleared from range land with a low-cost mixture of 2, 4-D, soda, Diesel oil and water sprayed from planes. One application is more effective than three successive annual mowings of the woody weeds, according to the U. S. Department of Agriculture.

Silage Loader

With a "wrap around" loader developed in England, silage can be quickly and conveniently moved with a minimum of handling. The loader consists of five flat metal sections joined by hinges. It is drawn behind the tractor by a tow rope and wraps itself around the silage, making a bundle which can be dragged across the ground.



Tiller Does Three Jobs

Plowing, disking, harrowing and fertilizer spreading are performed in one operation by the soil tiller, a new device for gardeners and small-scale farmers. It shreds and mixes weeds and cover crops into the top soil as it moves along at speeds up to 2½ miles an hour. Fertilizer is spread from a hopper and agitator attachment just ahead of the tines, which work it into the soil. The tiller weighs 225 pounds and runs four hours on a gallon of gasoline.

☐ Ocean wave-bands detected on the southwestern coast of England have been traced to their origins as far away as the Antarctic Ocean.

LION HUNT

Call him cougar, mountain lion or panther — he's still the meanest citizen of the West. The modern sportsman tracks him with a pack of dogs and a hearing aid

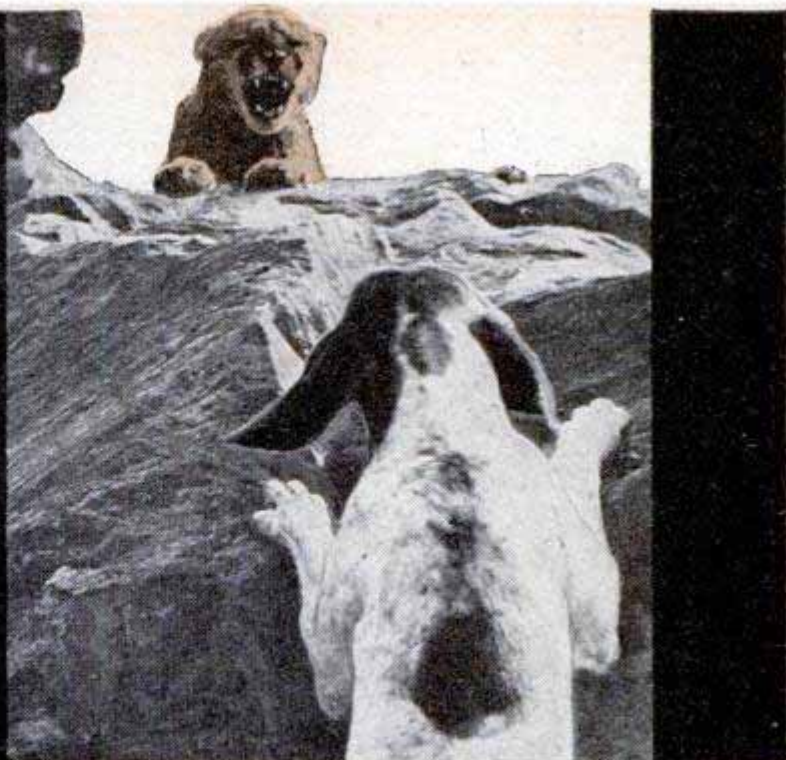

TEN MINUTES after the dogs had been released from their trailer they pounced on a hot scent and began to track it across the dry wash, running in a group. They sounded like they meant business.

Bill Archer watched them until they were out of sight. "They've found a cougar," he said. "It's an open trail from the way the dogs are running and yet they don't have their heads up the way they follow a bear. We might as well relax for an hour."

The hunter waited an hour and then pulled from his pocket an electronic hearing aid, the type used by the hard of hearing. Holding it along the barrel of his gun and using the gun as a pointer, he slowly turned his shoulders and swept the horizon. Soon,

Face to face with 180 pounds of snarling mountain lion, this dog won't give an inch

Drop the tailgate of their trailer and the dogs leap out in search of fresh lion scent

By
Thomas E. Stimson, Jr.

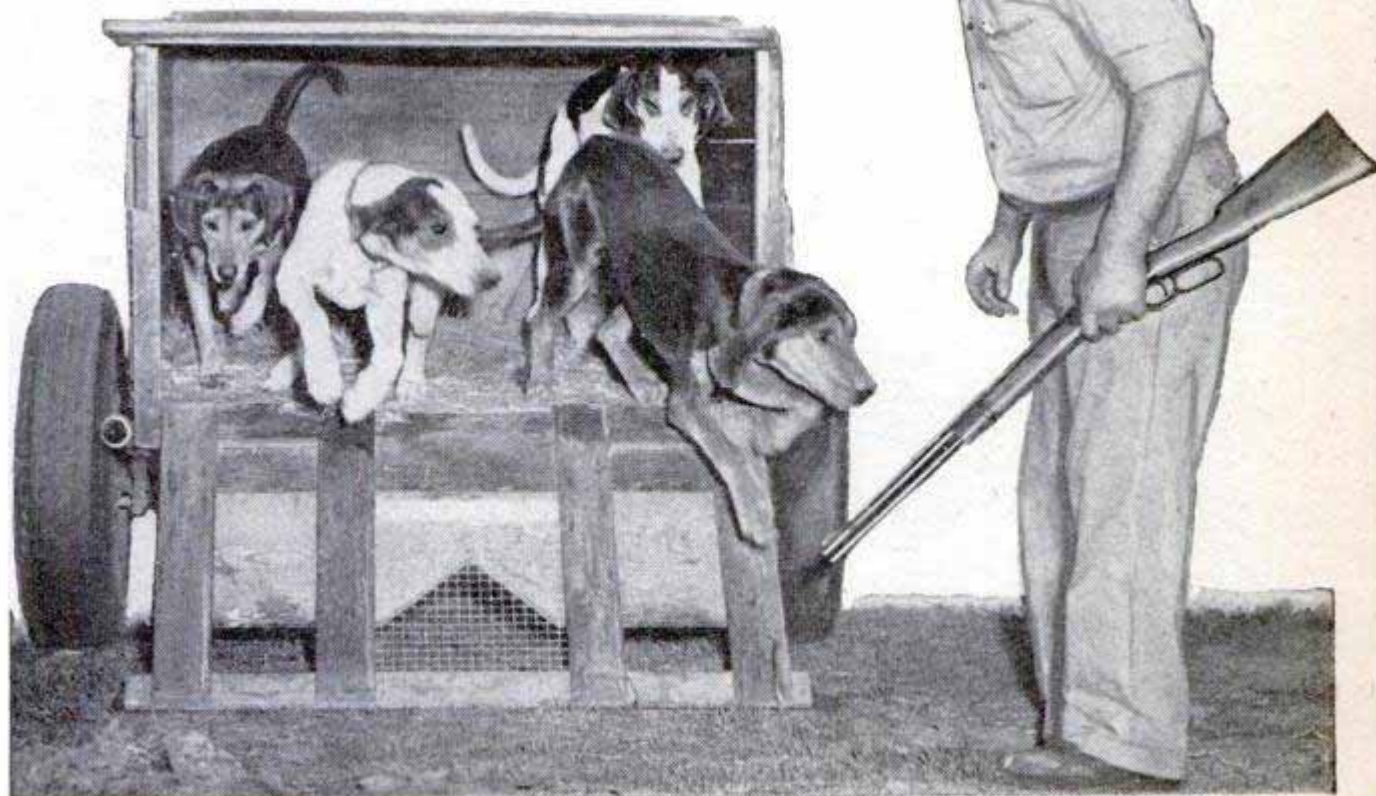



With hearing aid beside his rifle the hunter pivots in a circle until he focuses on sound of yapping dogs, then takes off across country toward pack



In night hunting a spotlight is thrown on lion attracted by penned sheep
 ↓ Grown lion is held at bay by dogs wary enough to stay out of claw range



over the magnified roar of the stiff breeze and the clashing of leaves, he picked up a faint yapping. It was the dogs. "They've circled around to the north," he reported, "and it sounds like they have the cat up a tree. Let's go."

The cougar or puma is the most ferocious native animal of North America. It is a big beast, averaging 150 pounds. Some specimens in excess of 225 pounds have been taken. A large tawny-colored lion may stand hip high and eight feet long. Also called mountain lion, panther, painter or catamount, it roams over most parts of the West.

The cougar is one of the few wild animals on which there is no closed season. It is an outlaw, the king of predators, and its regular ration is one full-grown deer or the equivalent in sheep or cattle every week. Strong enough to knock down an animal several times its size, it has heavy shoulders, large retractile claws with terrific ripping power and a heavy-boned jaw

for slashing and biting. It makes a stealthy approach on its big cushioned feet, pounces, and kills with claws and teeth.

Professional hunters are always on its trail and lately more and more sportsmen have taken up cougar hunting.

Archer and his friends Jack Cunningham and Phil Rickman of North Hollywood, Calif., are among the latter group. In the last 10 years Archer's pack of hounds has captured 25 cougar in addition to 100 bear and 175 bobcat. Running the dogs is a strenuous sport and until recently Archer and his friends used to wear themselves out. Three hours or more of jogging along canyon bottoms, climbing across mountains and plowing through brush will tire anyone. Now the hunters have a stunt that saves breath and shoe leather.

The electronic aid more than doubles the acuity of the sense of hearing and allows a hunter to locate his dogs when they are well beyond normal listening range. Quite often the pack chases an animal for 10 or 15 miles on a circular trail that winds up only a few miles from the starting point. Instead of following his dogs, Archer gives them time to tree their quarry and then listens in, locates the pack and hikes straight to it.

The hearing aid is fairly directional and usually the hunter can spot the dogs by their barking. If it's hard to get a good bearing in mountainous country, one of the hunters takes a second hearing aid and walks about a quarter of a mile away. Both he and Archer tune in on the dogs and then by triangulation they pinpoint the pack.

Virtually extinct in the eastern states, cougars are most abundant in the Rocky Mountain region and in the desert areas of Texas, New Mexico and Arizona. They are found all through the Pacific Coast states. There are stories that they have attacked grown men and occasionally have killed and eaten children. A big mountain lion can kill a large calf, sling it over its back and run off. Cougars prey on mares, colts, young cattle, sheep, goats and pigs.

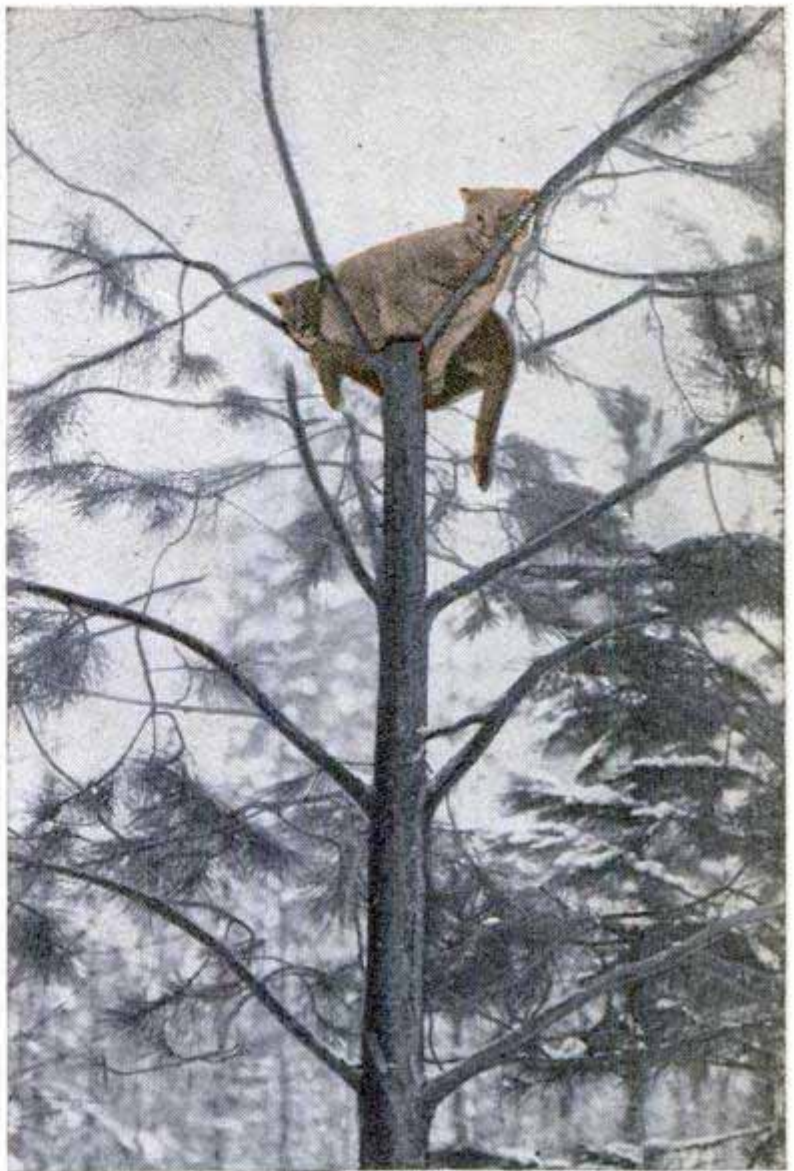

Two lions rest in a treetop in Glacier National Park. Such parks are the only areas where these vicious predators can't be hunted

Kneeling on a ground cloth, a hunter sets a trap for a bobcat. Large trap at right will be set in an effort to trap a cougar





Hunter will reach up with chain snare on rod to catch wildcat

Sportsman shows off large bobcat shot with high-powered rifle

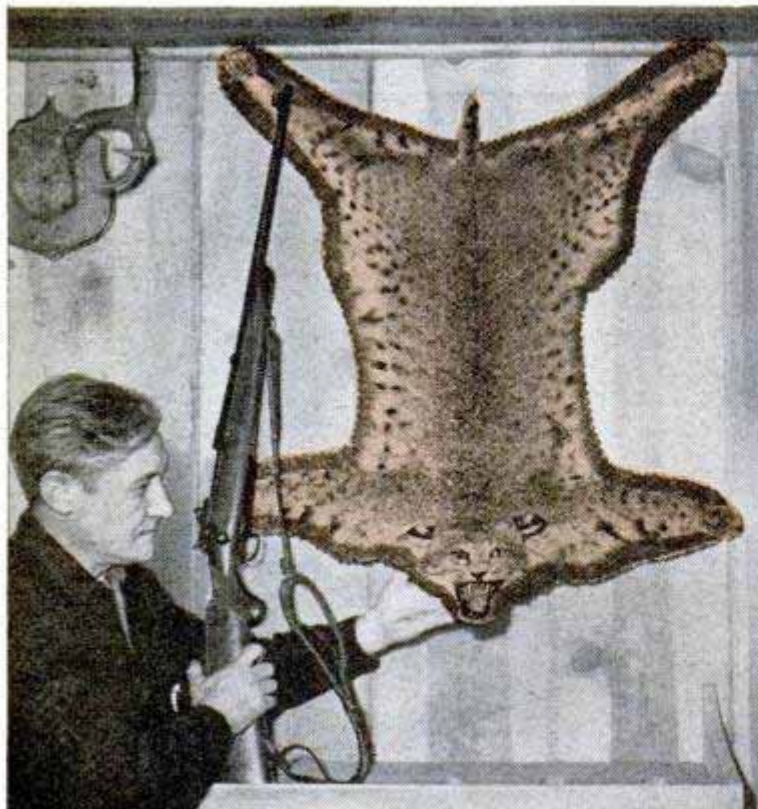

A cougar that gets into a herd of sheep is apt to go on a rampage and kill ruthlessly until exhausted. Ten sheep were killed in 10 minutes by one cougar that was driven away before it could do more harm. Another cougar slew 192 unguarded ewes in one night.

Capturing one of these outlaws alive is a risky undertaking, yet it can be done. Roy Johnson of Provo, Utah, is said to have captured 75 of them, mostly for zoos and Lions Clubs.

Recently Johnson captured a 190-pound male after his dogs had pursued it for five hours. The lion was perched in a tree when the hunting party approached. The animal sprang down into the center of the group of men, horses and dogs. After scattering the hunters the big cat climbed another tree. Johnson started up the tree with a wire-reinforced rope and the cougar jumped again, running a short distance and taking shelter in a third tree.

Johnson climbed to within eight feet of the beast, got the rope around its neck and dropped the rope to his helpers on the ground. They pulled the animal out of the tree and Johnson grabbed its long tail, stretching the animal out until it was helpless. The fore paws were tied together, the hind paws lashed with rope and a stick was thrust between the animal's jaws and tied down. Trussed like this, the cougar was brought out of the mountains on horseback.

A grown cougar rarely can be tamed and must be kept caged. The exception is the big cougar that you occasionally see in motion pictures. It was captured when only a few weeks old after its mother, a notorious cattle killer, was tracked down and slain in Oregon. Curley Twiford of Hollywood raised the cub, gentled it and trained it to work in pictures. Some day it may revert to its traditional temperament, but so far it has been well behaved.

The campaign against cougars never lets up in the cattle states. They may be shot on sight, anytime, anywhere except in national parks and monuments. They are hunted with dogs, poisoned, trapped and shot after dark with the aid of spotlights, a practice that is illegal for taking most kinds of



game. Nevertheless, they seem to be holding their own.

In California, for instance, the state has paid bounties on 9905 mountain lions since 1907 and still some 250 fresh pelts continue to be turned in each year to the Bureau of Game Conservation. The California state bounty is \$60 on females and \$50 on males. Other states post similar bounties and some counties offer additional rewards. Salaried state and federal predator hunters trail the lions with dogs or set traps for the animals.

(Continued to page 232)

One of the few mountain lions ever trained is this specimen which appears in the movies. Raised by Curley Twiford, it is accustomed to studio lights and turns in the performance of a veteran actor

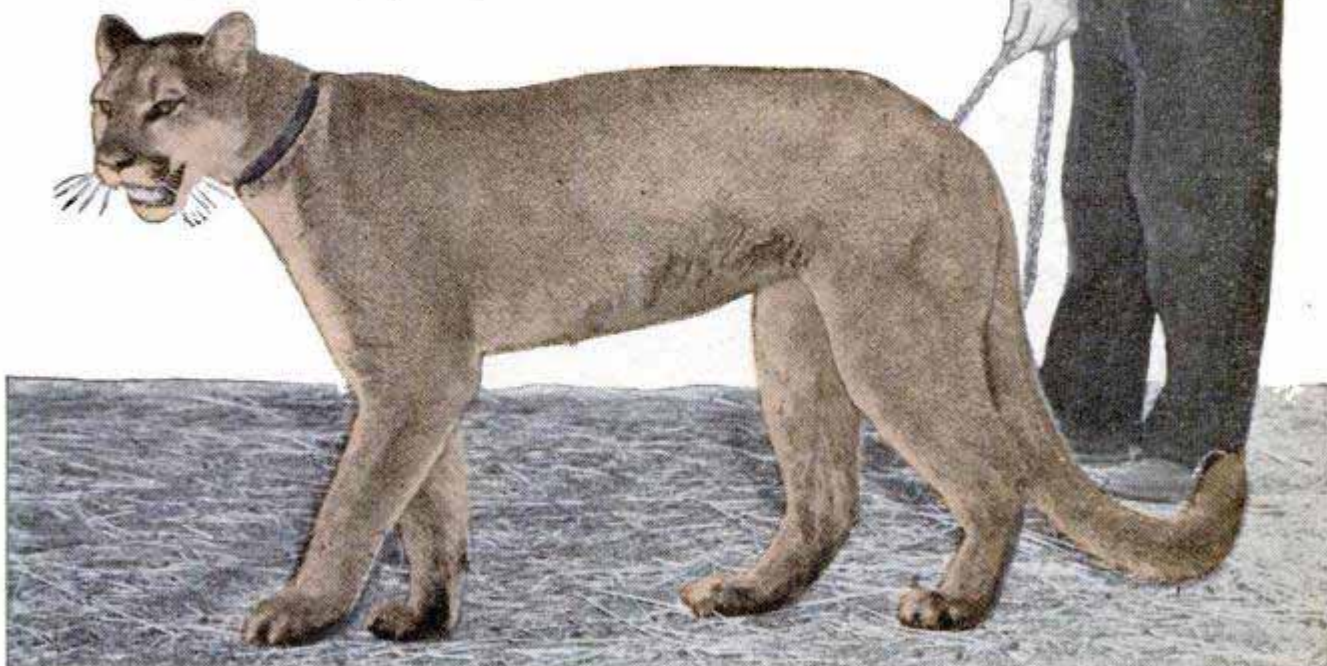
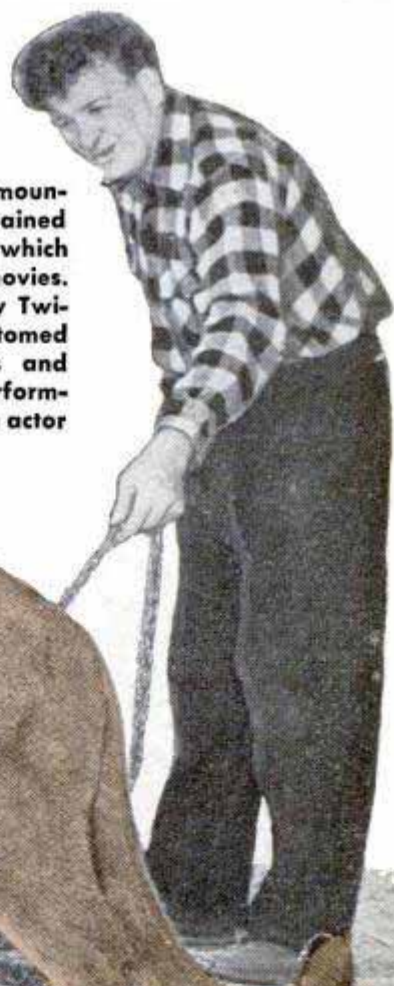



Harness-Race Starting Gate Has Telescoping Arms

Mounted on the rear of a convertible, telescoping arms with an 80-foot "stretch" comprise the newest starting barrier for big-league harness horse racing. The sectioned arms are extended from their closed width of approximately eight feet by air pressure and are drawn back by electrically operated wind-up steel cables. All con-

trols are centered on a pulpit panel, where the starter sits facing the racers. The car is specially equipped with a high-ratio drive so that it can pull away from the starting horses, which quickly reach a speed of 30 miles an hour. A light on the dashboard signals the driver when the arms are drawn in.



Snap-On Initials for Automobile

Motorists can personalize their automobiles with a chrome-plated initials holder that attaches to the car with two self-threading sheet-metal screws. Three initials are provided with the set. They are embossed on brass sheets and crimped over the spring-prong buttons. Both the black lacquer background and the brass letters are lacquer coated to prevent corrosion. The holder is placed just below a window or on any flat surface of the car.

Tubes Judge Cotton Fibers

Cotton fibers are measured quickly and accurately by an electronic instrument that takes over the laborious work of classing fibers by projection. The information is vital to the textile industry. Samples of parallel cotton fibers are clamped in the instrument, which scans them with light-sensitive photo tubes. The machine traces a curve on a sheet of paper which gives information on the fibers including average length and variance.

Half of the 6,000,000 farm families in the United States now rent frozen-food lockers in the nation's 9500 freezing plants.





Rail Recreation Car

Time passes quickly aboard a recreation car that provides entertainment for adults and a playroom for the youngsters. The car is one of three that will be in daily service for the Pennsylvania Railroad between New York and St. Louis. At one end of the car is a miniature theater where the latest newsreels are shown continuously by an automatic projector. In a buffet section built below the level of the floor, passengers can order sandwiches and refreshments. A compartment for radio, sound reproduction and public-address equipment separates the lounge from the playroom. Inside the playroom are a miniature table and chairs, blackboard, upholstered play pen, tiny sofa and an ample

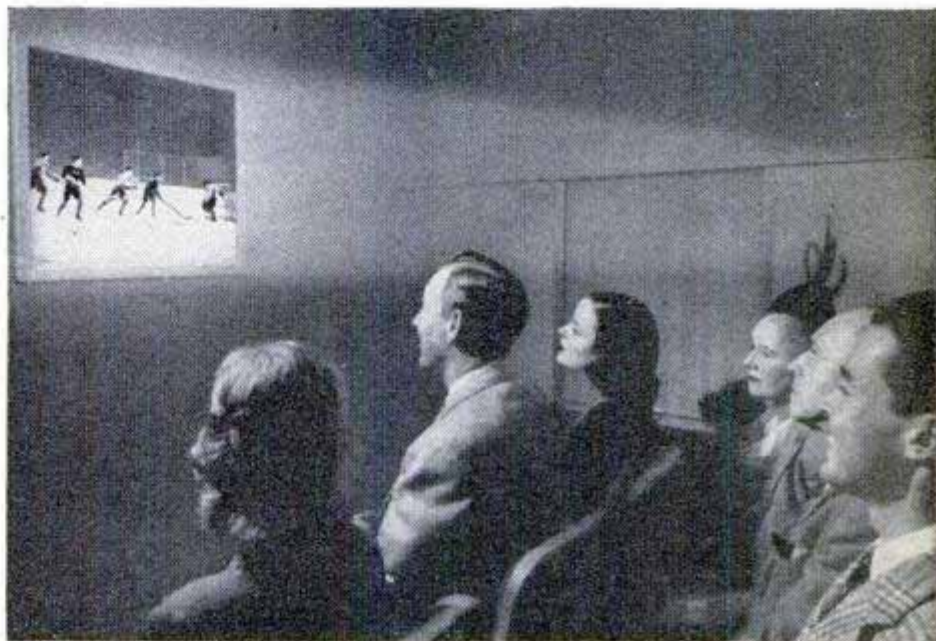

Top left, stewardess reads to children in playroom and at right, refreshments are served in buffet. Above, in tiny theater newsreels are shown continuously

stock of toys. A stewardess takes care of children in the room. At the end of the car is a game and reading room with facilities for card playing, and letter writing. Parents in this room can watch their children through a large window.



Huge Bridge Girder Spans Five Flatcars

One of the largest girders ever fabricated needed five flatcars for its ride to the Sheboygan River in Wisconsin, where the Chicago & North Western Railway is building a bridge near Sheboygan. Fabricated by the American Bridge Company at Gary, it is 162 feet long and weighs 150 tons.

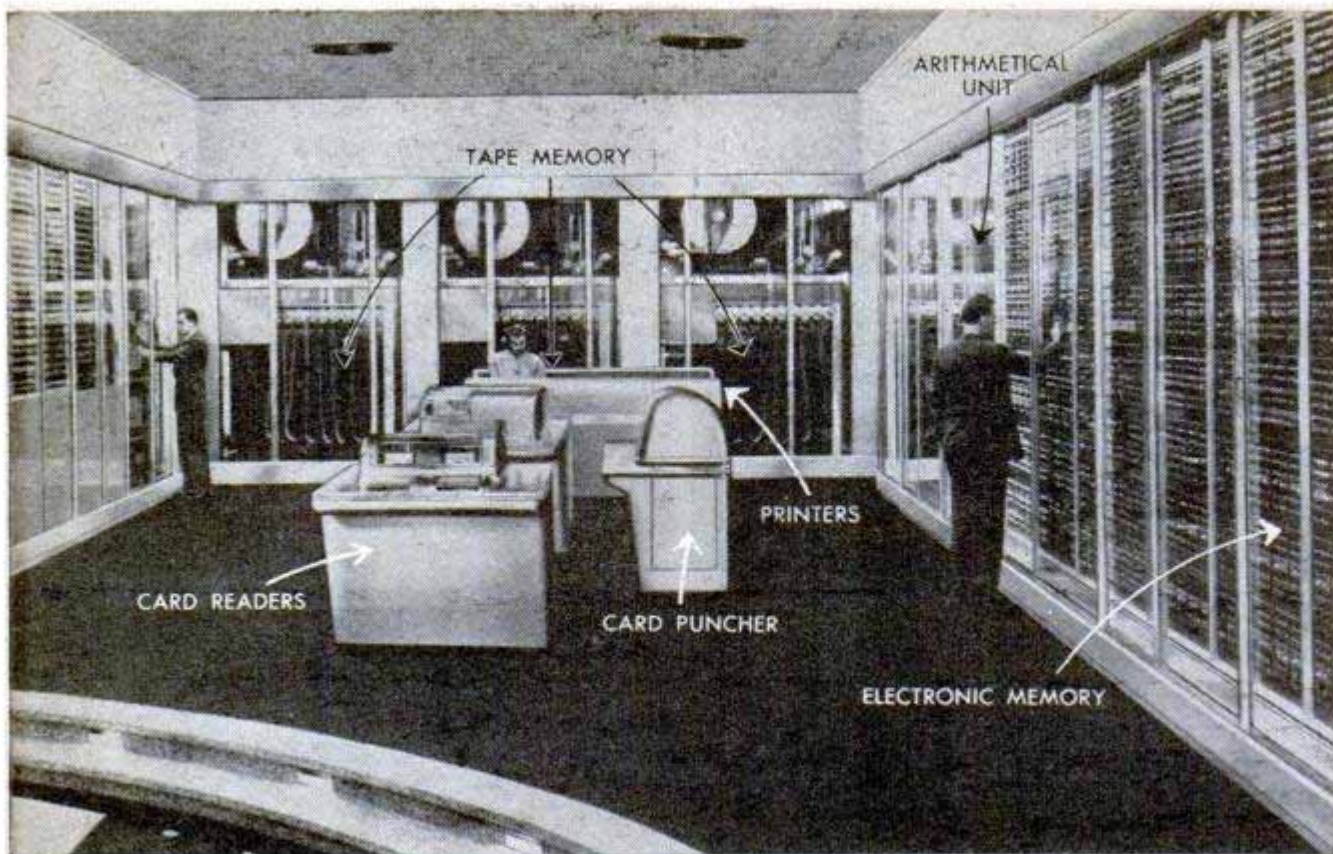

Electronic Calculator Has 12,500-Tube Brain

Remembering a telephone number is simple for a new electronic calculator with a memory capacity of 400,000 digits. The new machine, built by International Business Machines Corp., is the first to combine electronic calculating speed, vast memory capacity and highly flexible facilities. Numbers to be recalled most quickly are held in electronic circuits while others are stored in relays and as holes in continuous paper tapes. By using punch cards, its

memory capacity is almost limitless. It can add or subtract every second 3500 numbers of 19 digits each; it can multiply every second 50 numbers of 14 digits each or divide 20 numbers of 14 digits. To make this possible it has a circuit containing 12,500 tubes. The machine will eliminate much expensive experimentation by finding the answer mathematically. Heretofore such "testing" has been too laborious and time-consuming to be practical.

Diamond Tool Turns Out Eyeglass Lenses to Prescription



Spectacle lenses are cut accurately and automatically by a diamond-impregnated tool that doubles the production of hand-grinding methods. The tool is held in a machine that is preset to cut both spherical and cylindrical curves on the lens surface in one operation. A scale guides the operator in turning the machine's head until the tool is at the proper angle to cut the desired combination of curves. The lens is embedded in pitch during the grinding. Because of the wide range of curves that can be cut with the machine, 92 percent of all eyeglass prescriptions can be handled without hand grinding.

Information, including manufacturers' names, concerning products described in this issue may be obtained by writing Bureau of Information, Popular Mechanics, 200 E. Ontario St., Chicago 11, Ill.

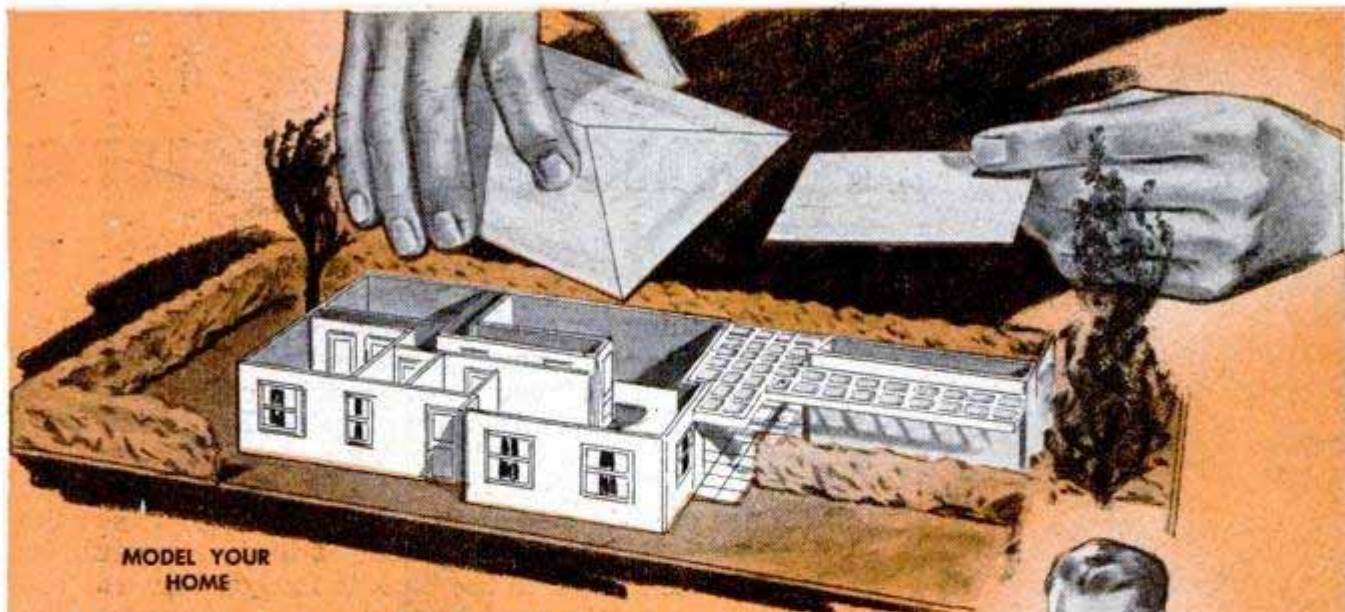

MODEL YOUR HOME

The CRAFTSMAN

★ A new angle in home planning is scale-modeling the structure before it is built. From this you get a realistic, three-dimensional view of your dream home just as it will appear when finished. You then can study it at leisure, make changes without additional cost, "plant" trees and shrubs wherever you like—all before the carpenter drives a single nail. By following details of the story on page 184 you can build a scale model of your home during one week end.

★ An aluminum caddie cart providing separate racks for woods and irons, and locker space for accessories should fulfill the needs of any golfer. A good way to get one is to study the constructional details on page 198, and then build it yourself.

★ Farmers confronted with the job of applying dry fertilizer will find it profitable to build the spreader described on page 209.

★ Look for the shop feature on page 217. It deals with methods of preventing warped boards, building up wide, nonwarping panels from narrow strips, etc.



AVOID WARPING



CADDIE CART

DRY FERTILIZER SPREADER

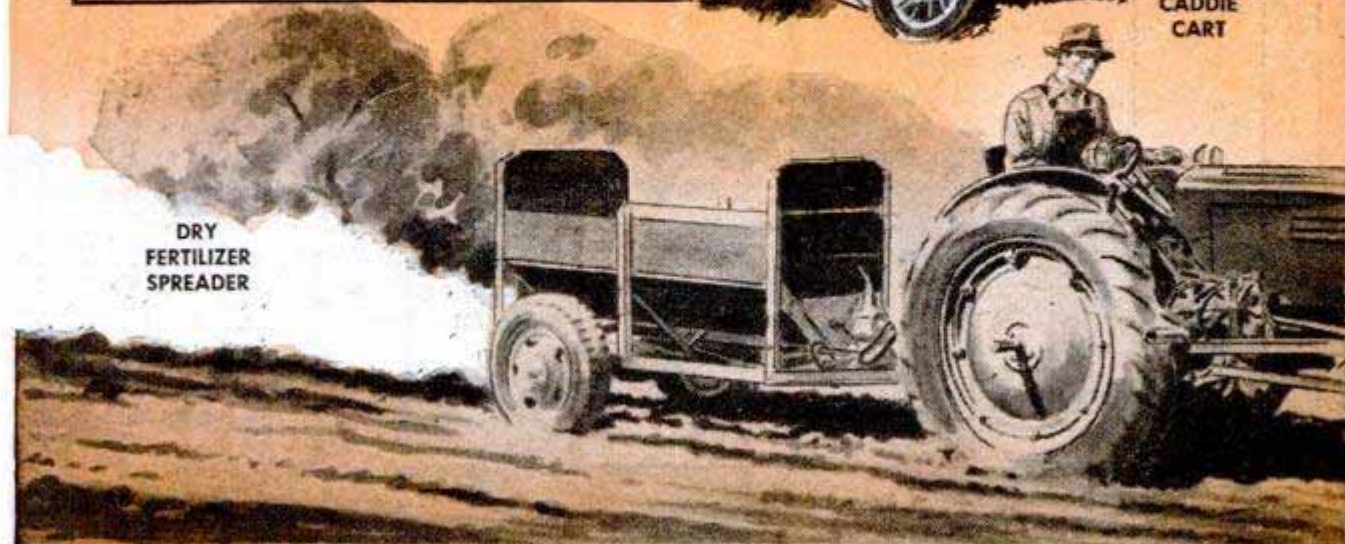

Tuckaway Picnic Furniture

By Keith Vining



The chair goes together in a jiffy. Just open up the sides, raise the seat, insert the back in the slots and push down to interlock the parts



JUST the thing for outdoor dining in your back yard or on a picnic, this novel plywood table-and-chair set comes apart so that it can be transported easily or tucked away in the fall in a minimum of space. Each chair consists of four parts, the sides being exactly alike, except for the slots. Fig. 3 gives the patterns for the parts which are cut out of $\frac{3}{8}$ -in. waterproof plywood. The sides of the chair are mortise-hinged together at the front, while its seat is surface-hinged to the back to fold downward. The slots must be cut to slant inward and accommodate the chair back. Cut them slightly oversize to allow for coats of paint or varnish. To set up a chair, you merely open its sides, Fig. 1, lift up the seat, engage the back piece in the slots and then push down on the back to interlock all of the parts as in Fig. 2.

The top of the table is a piece of plywood, 36 in. square, supported by "frame" legs, one frame being made in two separate parts which slide together in a dovetail groove on the underside of the top, Fig. 4, and interlock the complete assembly. The only fastening used is a removable dowel which pins the sliding legs together. The frames are assembled with open-mortise corner joints, as detailed in Fig. 5. Note that the crossrails of the solid frame are notched to take the ends of the sliding frame. The sliding frame has a dovetail tenon cut in the top edge to match a dovetail groove in the table top. The best way to cut the groove is with a portable router, equipped with a dovetail cutter, guiding it along a straightedge placed diagonally across the plywood and clamped. After the groove is made, the top is cut exactly in half and surface-hinged. When the table is assembled, a hole is drilled through the cross joint formed by the two frames and a dowel is inserted in the hole to lock the parts together. The dowel can be tied to the legs for safekeeping.

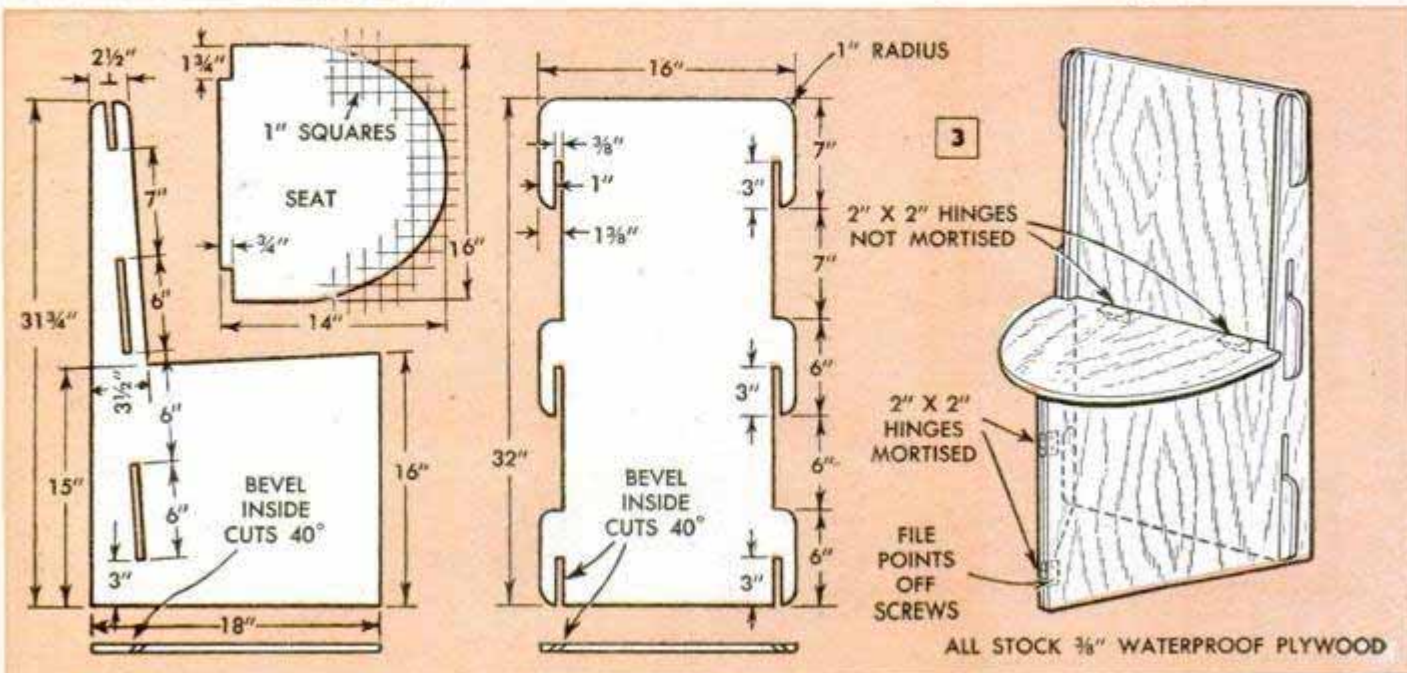



Although outdoor plywood is recommended for this furniture, it should be protected against moisture by finishing both sides and all edges of the parts with two coats of weather-resistant spar varnish. Sand the parts first, and as a touch of decoration, decals can be applied when the first varnish coat is dry. Then the second coat will protect the decals and keep them looking bright. Avoid making the sliding joints too snug as they should be a loose fit. Waxing will help if the parts do not slide freely

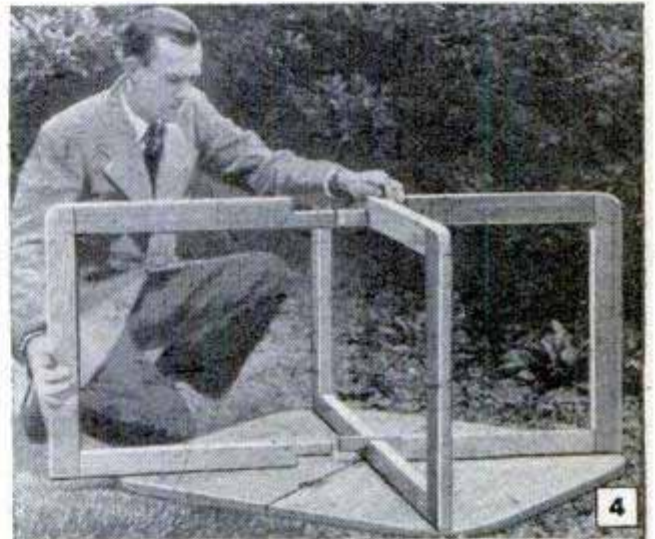

4

LOOSE FIT DOWEL JOINT TO LOCK LEGS

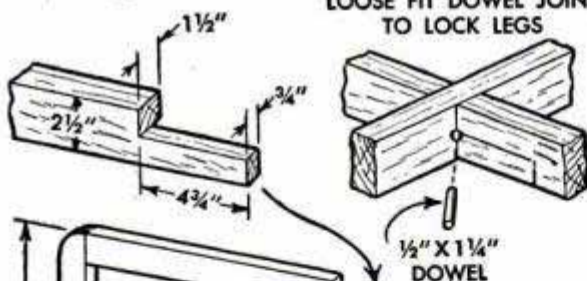

1/2" X 1 1/4" DOWEL

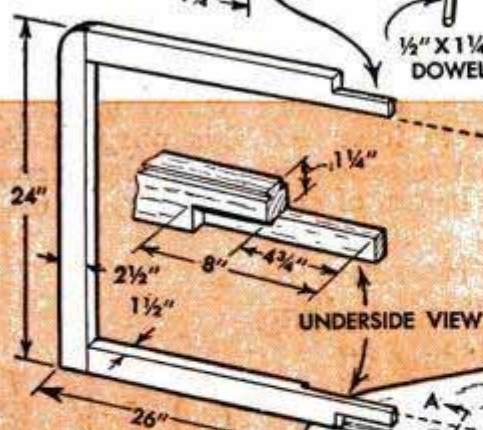

UNDERSIDE VIEW

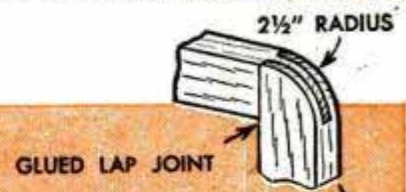

GLUED LAP JOINT

2 1/2" RADIUS

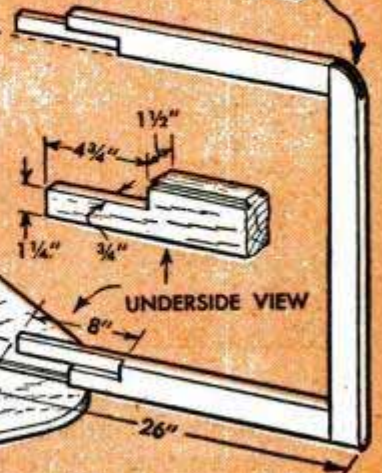

UNDERSIDE VIEW

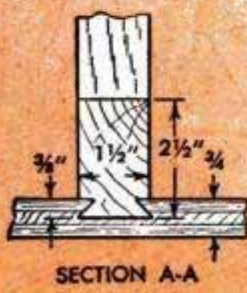

SECTION A-A

3/4" PLYWOOD TABLE TOP 36" X 36"

8" RADIUS

UNDERSIDE VIEW

BUTT HINGE 4 REQD.

Wood Turnings Sanded Safely By Using Abrasive Holder

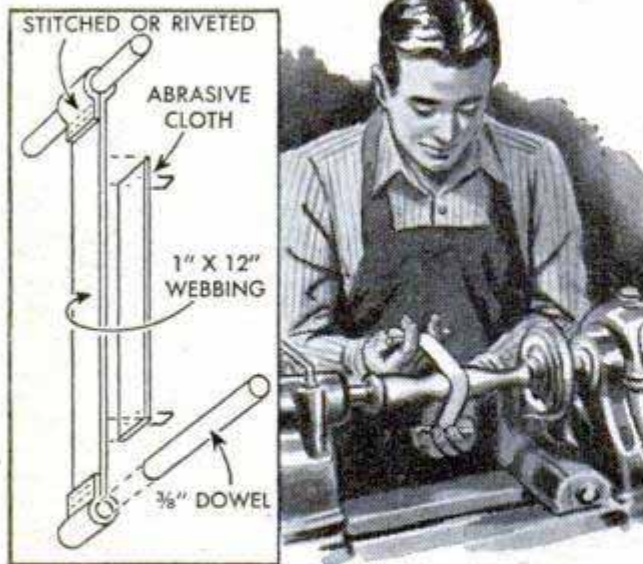

Using narrow strips of abrasive cloth to finish wood turnings in a lathe may be dangerous because the cloth, unless held carefully, may wrap around the work and catch the fingers. With this holder, however, the chances of injury are lessened. Two $\frac{3}{8}$ -in. dowels are used for handles and a 1 by 12-in. strip of webbing with the ends stitched or riveted around the handles serves as backing for the abrasive cloth. Staple the cloth to the webbing so that it can be removed easily.—Albert M. Lindner, Jr., Cold Spring, N. Y.

Automatic Pencil Holds Wire Solder

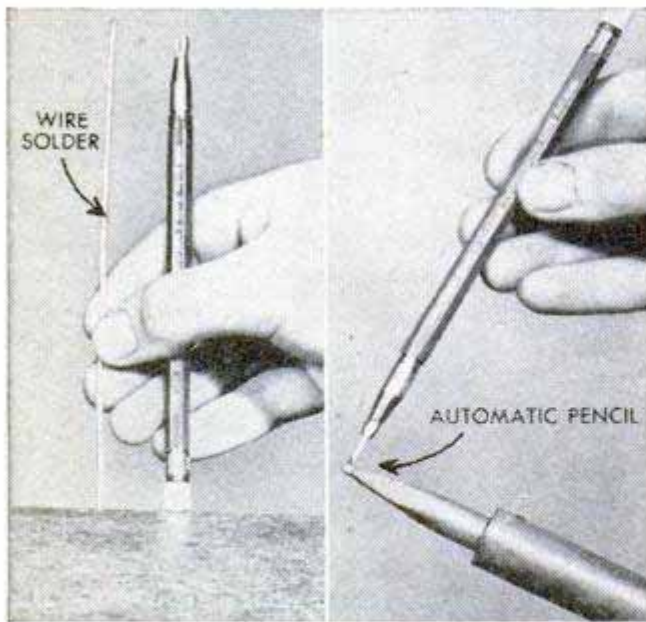

An automatic pencil that will accommodate large-sized leads can be used to hold and dispense solid wire solder. This is a convenient way to carry solder for small repair jobs. Cut the wire solder to the same length as the pencil lead, and insert

it in the pencil barrel with about $\frac{1}{2}$ in. projecting. Solder is fed from the pencil in the same manner as the lead.

H. Leeper, Canton, Ohio.

Shades Kept at Uniform Height With Gummed-Paper Markers

Keeping window shades in your home at the same height is easy if small paper dots are glued to the stop along one side of each window and used as guide markers. Beginning at the top of the window, space a row of dots 3 or 4 inches

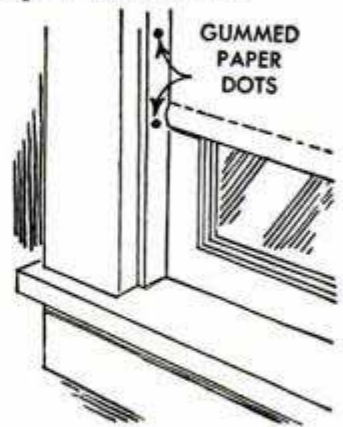

apart, or merely place one dot at the position where you prefer to keep the shade. While the paper guide markers will not be noticeable behind curtains or drapes, it is best to use dots of an inconspicuous color.

Rim of Paint Can Kept Clean To Effect Tight Seal

To keep the rim of a can of paint free of hardened paint accumulations so that the cover will make a good seal, fill the groove with a length of plastic weather strip each time before you paint from the can. Rope-



type calking compound which is sold in roll form is ideal for this purpose. Although not as satisfactory as a plastic compound, a length of cord also may be used.

Altered Hammer Head Speeds Nail Pulling

By grinding off the neck and poll of an old claw hammer you can improvise a handy nail puller. The increased leverage afforded by the rounded head makes pulling nails easy.—H. C. Kenly, Summit, N. J.



Two Desk Accessories From Scraps of Plastic

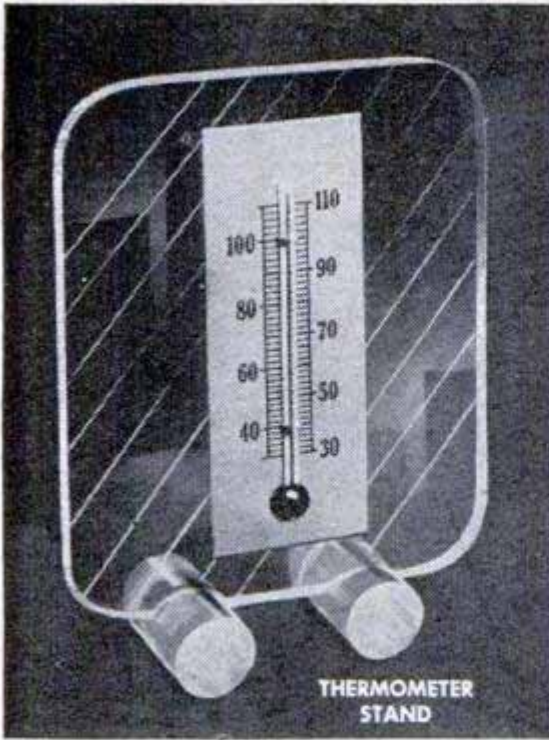

THERMOMETER STAND

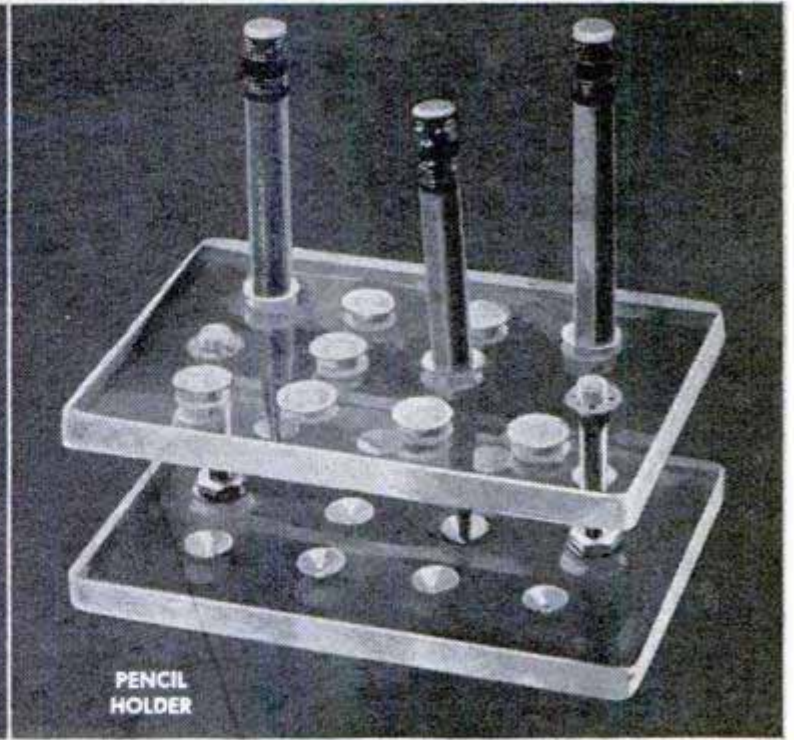

PENCIL HOLDER

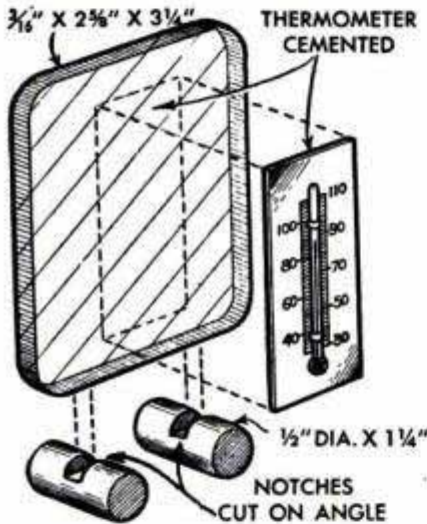

THERMOMETER STAND requires 3 pieces. The corners of the panel are rounded and then lines are scribed diagonally across the rear surface with a pointed tool. The feet are notched at an angle to give the stand a backward slant. The thermometer is cemented in place

PENCIL HOLDER accommodates 10 pencils. Holes are drilled completely through the top piece, while those in the bottom piece are made blind to take the pencil points. Machine screws, with the heads cut off, are turned into tapped holes to space top and bottom about 2 in. apart

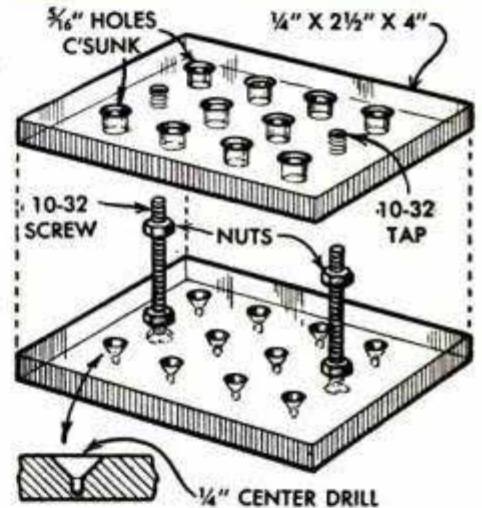

Oilcloth Wrapper Protects Blueprints When on Construction Job

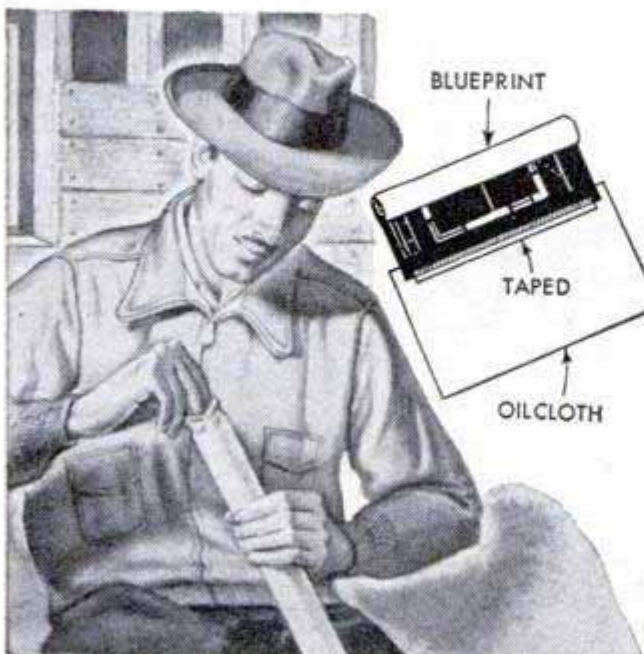

Blueprints are less likely to become soiled and torn on the job while not in use if an oilcloth wrapper is provided in which they can be rolled. The wrapper should be slightly wider than the blueprints and about half as long. It is attached with cellulose tape to the bottom sheet of the set of prints opposite the stapled end. After rolling the blueprints, continue to roll them in the oilcloth wrapper to form a protective cover. The ends of the cloth are tucked in to prevent unrolling. This also is a good way to protect blueprints when in storage.

When painting a small room where the odor of paint is objectionable, you can effectively kill the turpentine odor by adding a teaspoonful of vanilla extract to each gallon of paint. The vanilla will not discolor even white paint.

SOLVING

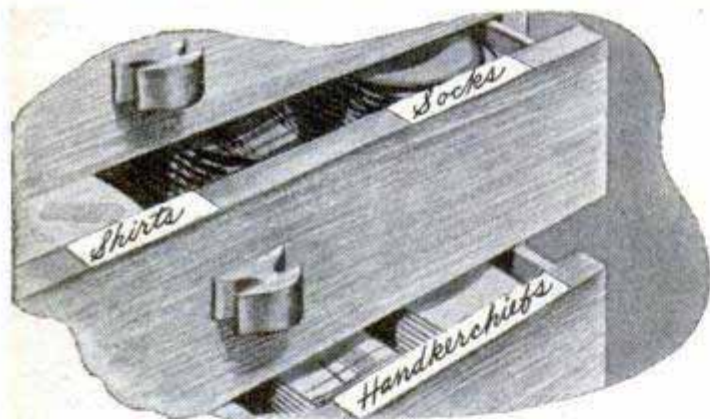

Picking up a phonograph-record album upside down and having the records fall out can be prevented if the top of each album is marked with a tab of adhesive tape. The tape indicates at a glance which end is right side up. This precaution prevents breakage when replacing the albums

Contents of a chest of drawers (left) are kept in order by labeling each drawer. Simply write the name of the article, such as socks, shirts, and handkerchiefs, on a strip of adhesive tape and apply it to the top edge of each drawer where it will not show when drawer is closed

Bed slats are made nonsliding by wrapping each end with a strip of rubber and tacking it to the slat. Rubber from an inner tube will do as it will provide a friction surface to keep the slats from shifting and falling out

A good way to store a small step-ladder when not in use is to hang it between two slanting cleats attached to a wall or door. Space the cleats so that they hook under the top step, and fasten with screws

Roach powder is safe to use in a pantry if it is placed in an open-end can tacked to the underside of a shelf. Held in this manner, it is away from food yet still attracts roaches

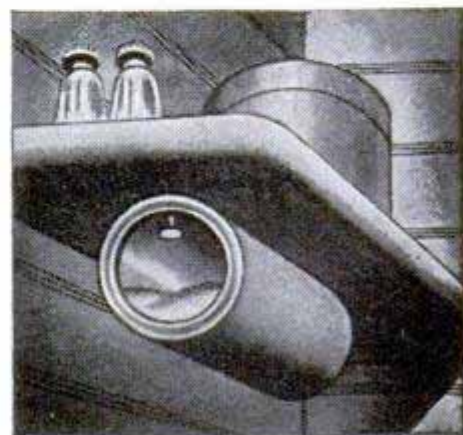
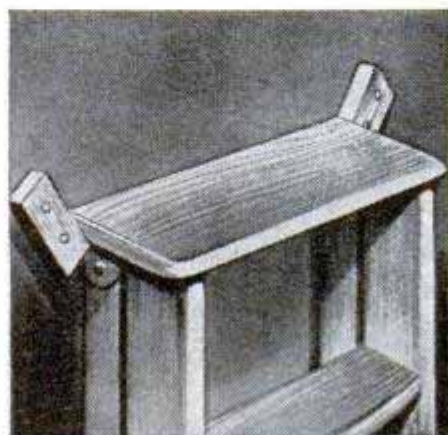
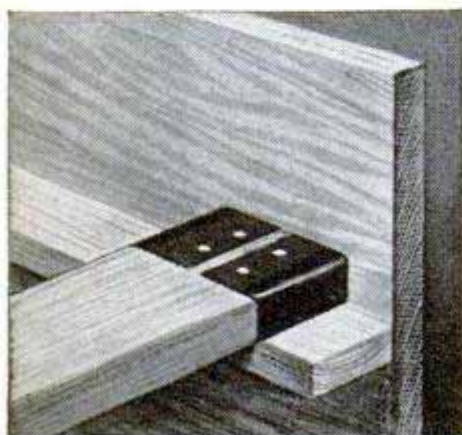

HOME PROBLEMS

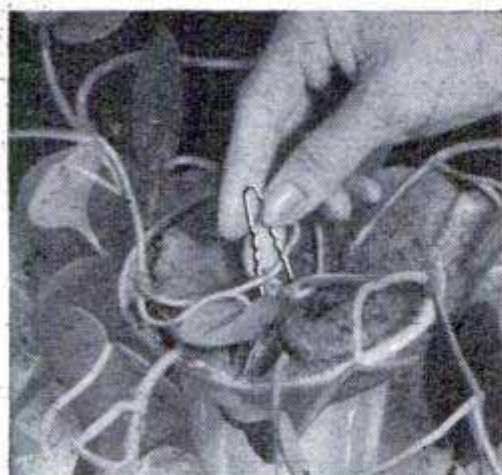

If you want to root cuttings of a plant having a jointed stem, use hairpins to anchor the cuttings in the soil at the proper depth. The pins are inconspicuous, will not injure tender shoots and are removed when the cuttings have taken healthy root

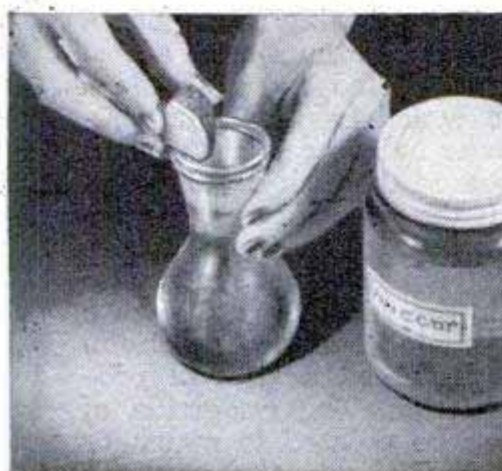

To clean the inside of a vase having an odd shape, place small pieces of raw potato in the vase and fill it with vinegar. Let it stand overnight. Shake vigorously, wash in soap suds and rinse in water

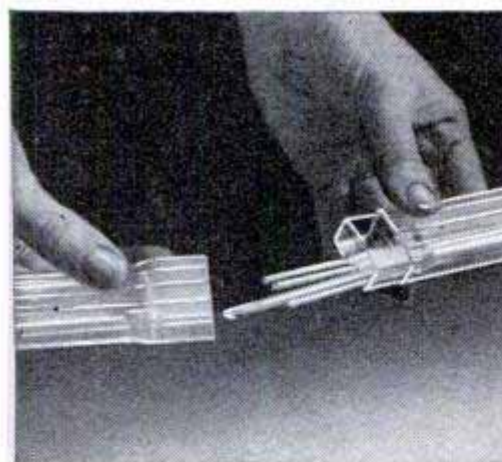

Plastic toothbrush containers make excellent protective cases for storing crochet hooks. Being transparent, the case permits selection of the hook desired without removing it to see the size number

Baby's bibs, rattles and toys (right) can be kept handy by hanging them on screw hooks installed on the back of the high chair. If the points of the screws project through, file them off



When the lifting tab on a milk-bottle cap tears off, don't use a fork to remove it each time. Instead, wrap the cap in a piece of wax paper and twist the corners to form a convenient handle. The paper will not interfere with capping of the bottle

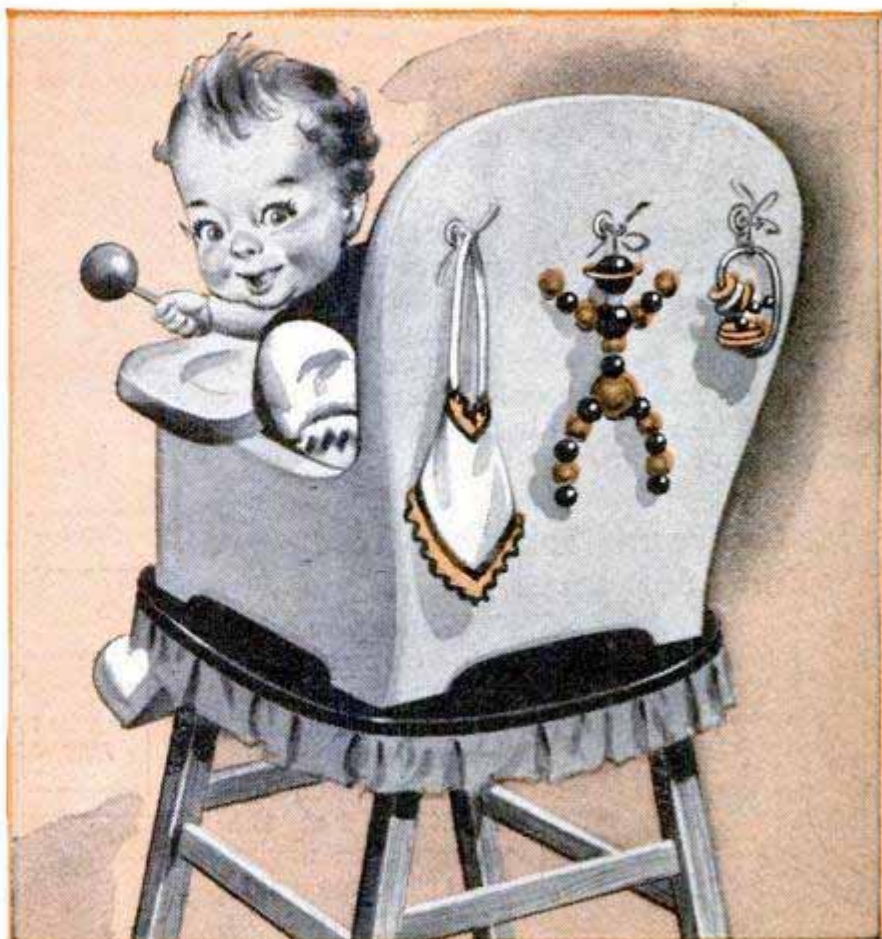

Name Inscribed on Bamboo Rod Is Permanent Identification

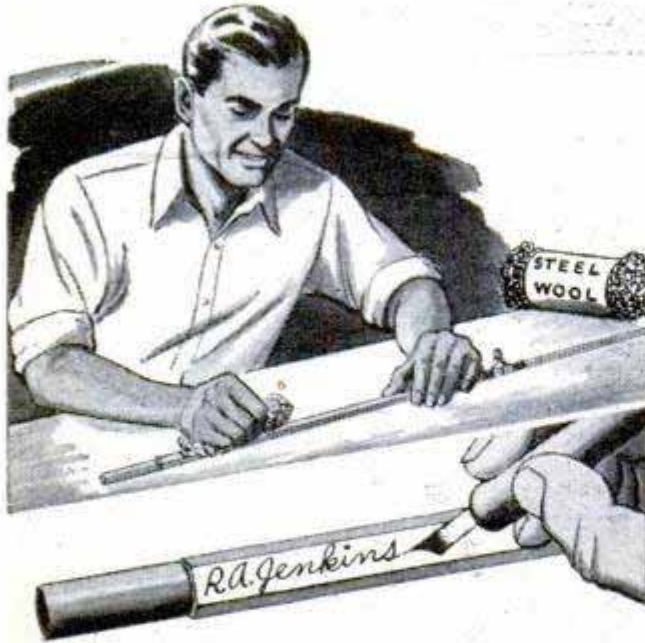

Bamboo fishing rods may be identified permanently by autographing them with your own name or initials. First, rub a small area of the rod with fine steel wool to remove the varnish, and then write on this part with India ink. After the ink has dried, cover it with a coat of varnish.

R. A. Jenkins, St. Louis, Mo.

Wrench Provides Comfortable Grip For Pail With Wire Bail



When carrying heavy material in a pail that does not have a wooden handgrip, the wire bail can be prevented from "cutting" your fingers if a handle is improvised by placing an alligator-type wrench

or a common end wrench under the bail as shown. The wide, flat handle of the wrench provides a comfortable handgrip.

Flat File Forms Substitute Tool To Knurl Soft Brass

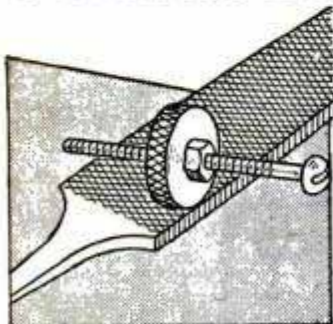

Where you have an occasional knurling job which does not warrant investing in knurling equipment, a flat file clamped in a vise will produce a satisfactory knurl in

soft brass or plastic. If a diamond-pattern knurl is desired on a small handwheel, roll the part along on a double-cut file while exerting a steady downward pressure. If the knurl is not deep enough after the first pass, roll the work back along the file without moving it out of position. To make a straight knurl, use a single-cut file and slide the part back and forth parallel with the cut of the file, gradually turning it. If the work is drilled through the center, it can be made easy to rotate and manipulate by mounting it on a machine screw with a nut on each side, so that the ends of the screw serve as handles.

Inexpensive Ceiling Fixture

If you are fixing up a basement recreation room and are looking for an inexpensive indirect-lighting fixture, here's one that is modern in appearance and extremely easy to make. It's nothing more than a 24-in. disk of sheet aluminum, with a hole in the center, supported by a standard bowl-type bulb which has a silver coating over the lower half to reflect the light upward. The hole in the disk should be of a size to permit the reflector to rest horizontally on the bulb at the point where it is coated. Galvanized sheet metal also can be used for the reflector, although a highly polished metal, such as aluminum or tinplate, is preferred as it will provide better reflection. The underside of the reflector can be painted to match or harmonize with the color treatment of the room. Silver-coated bulbs can be purchased at any electrical store.

Elmer T. Prill, Detroit, Mich.

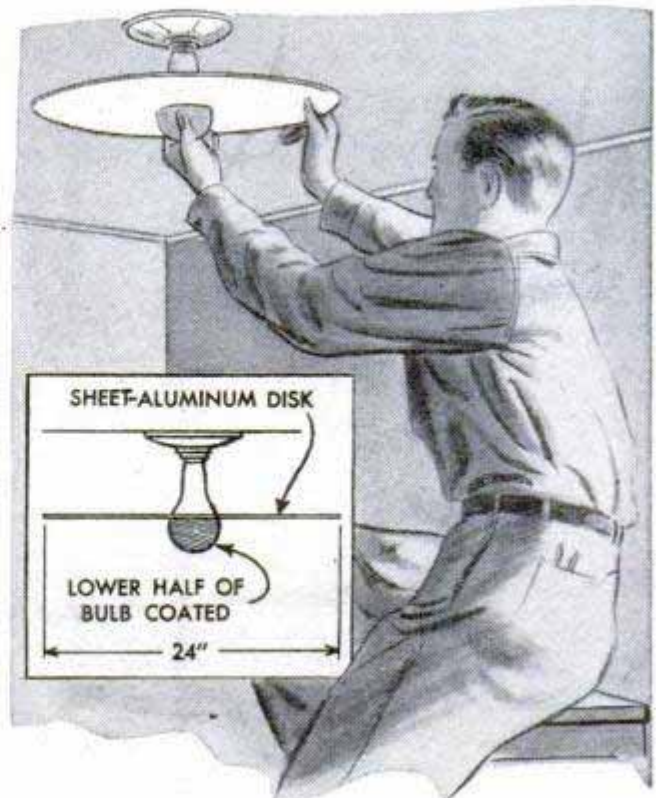

Fun Galore With This Inner-Tube Beach Raft

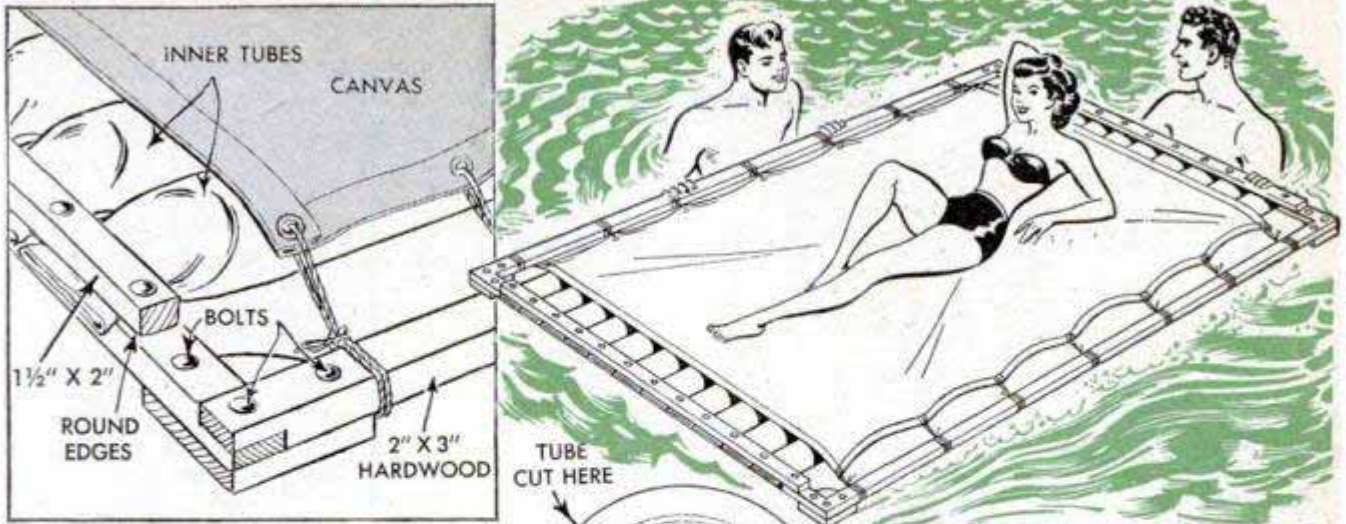

Inflated inner tubes stretched and clamped to a hardwood frame provide a novel way of rigging a lightweight raft for your back-yard pool or for use at the beach. If standard 6.00x16 tubes are used, the raft can be made about 4½ ft. long. A longer one may be had by using tubes of larger size. The width of the raft depends on the number of tubes. The frame corners are half-lapped, as shown, and bolted to hardwood blocks placed on the underside. Hardwood strips, which clamp the ends of the tubes to the frame, are drilled for carriage bolts, the holes being spaced to straddle each tube. Aligning bolt holes are drilled through the frame at the same time and the bottom edges of the clamping strips are rounded to prevent them from cutting the rubber.

The tubes are cut at the point indicated and are placed in the frame so that the valve stems point downward. To assure an airtight seal, the ends of the tubes should be vulcanized or cemented shut by rough-

ening contacting surfaces and coating generously with tire-patch cement. A wooden hand screw, or a vise, will be helpful in clamping the ends after the cement is applied. Before clamping the tubes to the raft frame, inflate each one and test it underwater to see if it leaks, and then deflate it. Line up the tubes side by side and bolt on the clamping strips. Bolt the two side members to one end member and then, with someone to assist, force the opposite end member in position. Inflate the two outside tubes first, then two adjacent tubes at the center of the raft. Finally, inflate those remaining. A canvas cover, fitted with grommets along two sides, is drawn over the tubes and lashed to the frame.

C. L. Meehan, Lakeview, Ont., Can.

Wire and Battery Clip Hold Funnel to Fill Outboard-Motor Tank

If you have ever run out of gas and have had to fill the tank of an outboard motor in choppy water, you'll appreciate this simple stunt for preventing the funnel from jumping out of the filler hole. Drill a small hole near the rim of the funnel and attach a short length of trolling wire of the braided type. Then solder a small battery clip to the other end of the wire. In use, the clip is attached to any convenient place on the motor. The stiffness of the wire will keep the funnel in the filler hole and yet will allow it to be removed readily and clipped to the handle of the gasoline can for safekeeping.

Martin L. Spangler, Knoxville, Tenn.

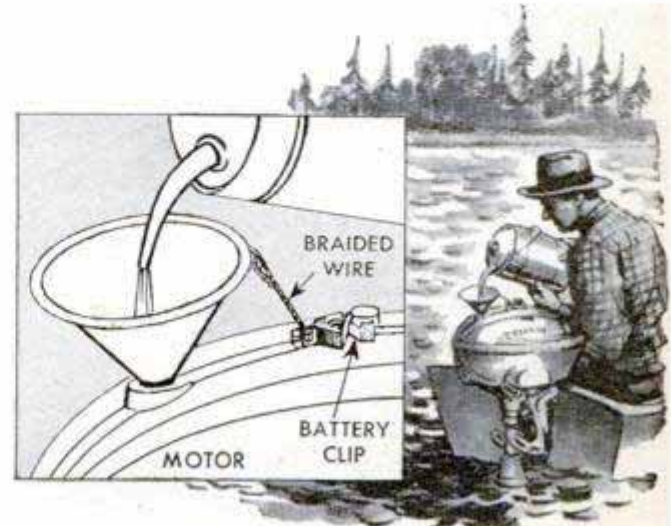

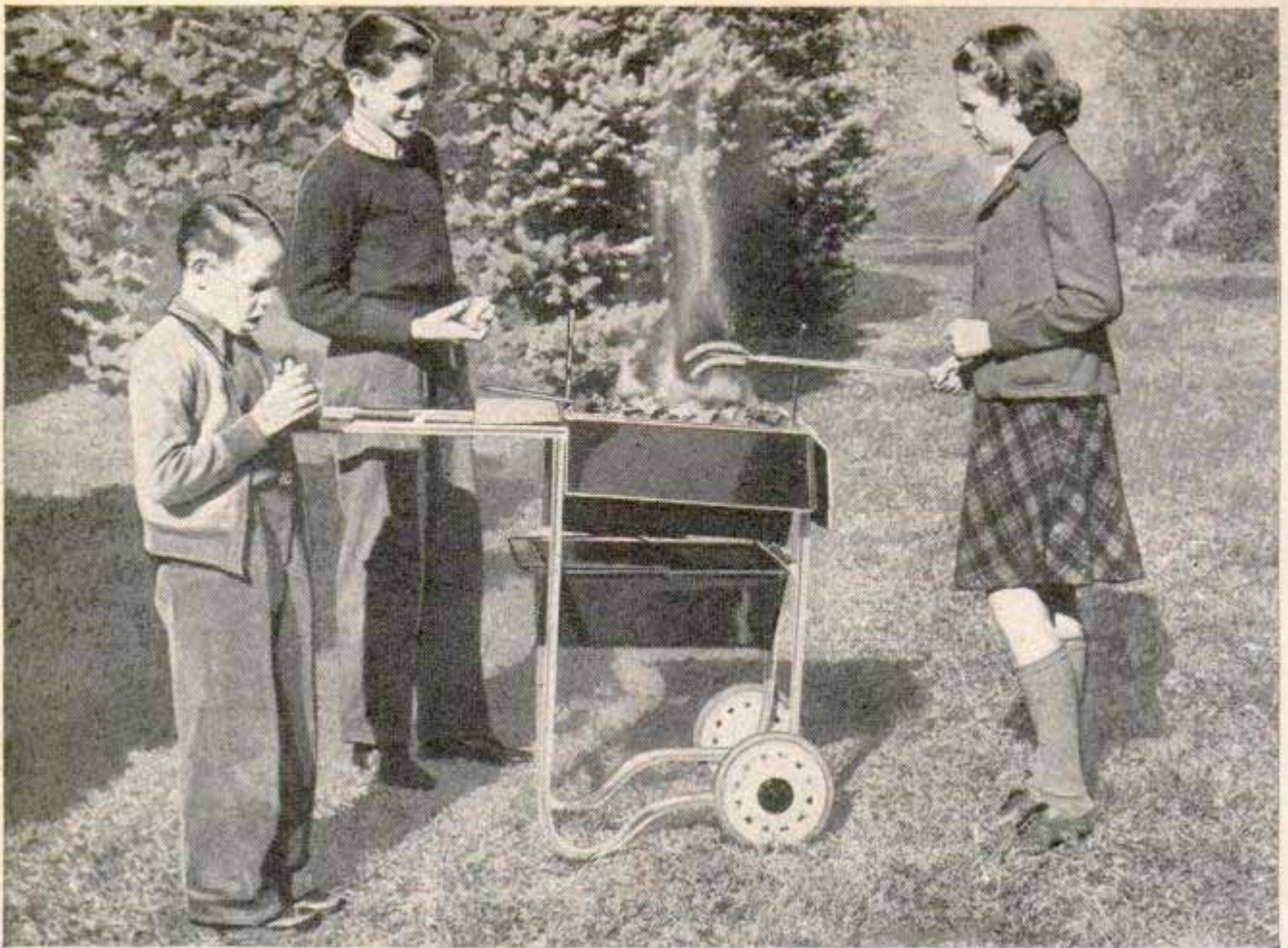

BAR-B-Q CART

By Benjamin Nielsen

PICNICS where you want 'em — that's the feature of this rolling outdoor grill, for not only can you wheel it to any spot in the back yard, but you can take it with you on camping trips. The frame of the cart is bent cold from rigid electrical conduit, then welded and equipped with rubber-tired coaster-wagon wheels. Both the firebox and ash pan of the original were made from metal salvaged from discarded

auto hoods, making use of the hinged parts to provide folding windshields. However, the firebox can be formed from sheet metal and the windshields hinged with small butt hinges. Note that friction tabs are formed on the front windshield.

Draft holes are punched in the sloping sides of the firebox and corresponding holes are made in a draft regulator which, in use, remains inside the firebox and is shifted back and forth to control the draft. Note also that an opening is made in the bottom of the firebox for dumping the ashes. Ash pan and firebox are riveted together, and two notched posts support a spit at different heights above the coals.

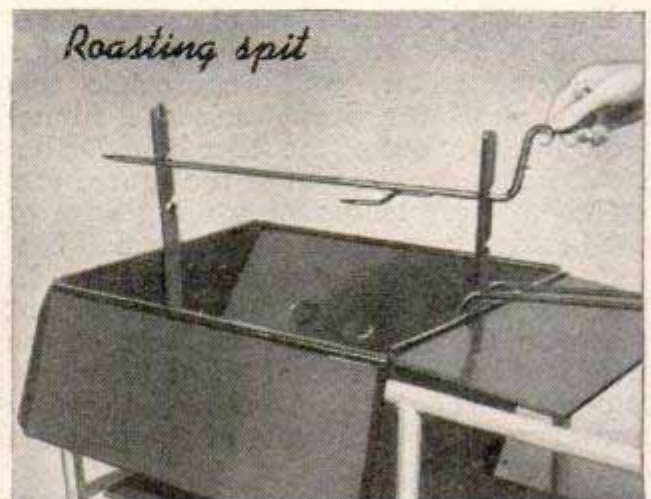

Lawn Roller Helps Control Fire When Burning Weeds or Grass



Spread of the fire when burning off grass or weeds may be checked by means of a heavy lawn roller. If the fire begins to get out of control, just push the roller over the spreading flames and they will be snuffed out effectively.

M. K. Voedisch, Rockford, Ill.

Line on Partially Filled Paint Can Shows Color and Amount

The next time you use part of a can of paint—before putting it away—draw a line on the outside with a match stick that has been dipped in the paint to indicate the level of the remaining amount. Then, without removing the lid, you can tell at a glance how much paint there is and also the color of the contents.

William Swallow, New York City.

Turtles Caught With Rattrap

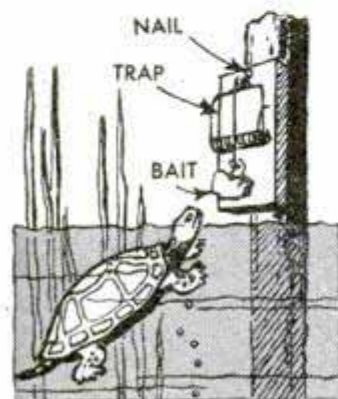

Spring-type rattraps are an effective means of disposing of turtles which menace game fish in a pond or lake. Set several posts in shallow water near the shore. They should be long enough so

that the tops will project a foot or more above the water. Nail a rattrap to each post with the bait pan at, or slightly above, the water level and bait the traps with raw meat or chicken heads. When a turtle grabs the bait the trap will be sprung.

Putty Kept From Hardening

Putty may be kept in workable condition over a period of time by storing it in a water-filled jar. Use a fruit jar with a screw-type lid, and roll the putty into balls small enough to slip through the opening of the jar. The putty should be rolled in the hand until an oily film forms over the entire surface. Fill the jar half full of water, place the balls of putty in it, and add water until it covers the putty at least 1 in. Then screw the cap on the jar tightly. Shake excess water from the balls of putty before using, or pat dry with a cloth.

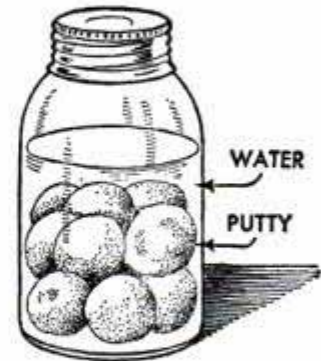

Burned-In Name Identifies Oar

To assist in the return of lost or misplaced oars, burn your name and address into the blades. If no regular burning equipment is available, a soldering iron or a length of heated rod will serve for this purpose. Be

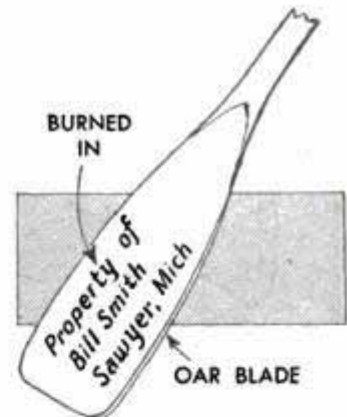

sure to cut the letters deep enough so that they cannot be removed by sanding. If you have several boats with different names or numbers, burn this identification into the blades also and it will be easy to match a pair of oars with the boat to which it belongs.

Repairing Broken Battery Post

When a battery terminal post breaks off, a satisfactory repair can be made in the following manner: File the broken post and the terminal on the battery until they are square and butt perfectly. Drill a 1/4-in. hole lengthwise through the post and about 1/2 in. into the terminal. Then tap the hole in the terminal, insert a bolt in the post and screw it in place.

Orville Kellman, Kenosha, Wis.

STEERING GEARS

for

OUTBOARDS



By Thomas E. Riley

CORRECT steering-gear installation in outboard motorboats, especially those in the more powerful runabout classes, is extremely important not only to obtain maximum efficiency from the motor but also to insure the safety of the occupants of the boat. A good steering-gear arrangement should have a minimum of slack in the cables. Slack cables may foul the gear or produce a slow response to the controls, both of which can be hazardous. The system must be smooth and reliable. Any tendency to steer hard in one direction should be reduced, along with the strain of motor torque on the steering gear itself. The arrangement should permit easy attaching and detaching of the motor, allow the motor to tilt readily, and must not interfere with cranking it.

The manufactured auto-type wheel with a grooved aluminum drum and housing is the most suitable steering wheel for a runabout. However, if well constructed, a homemade drum 3 or 4 in. in dia., attached to an auto steering wheel, will operate satisfactorily. A conventional spoked wheel is permissible on a slow outboard cruiser or fishing craft, but one should never be used on a runabout, as the whirling spokes will cause trouble on a fast turn. Both for protection and appearance, the drum and cables should be placed under the dash whenever this can be done. The best cable to use is $\frac{1}{4}$ or $\frac{5}{16}$ -in. bronze-core tiller cable. This type is strong and long lasting, will not shrink or expand, and it will not jam in the pulleys. Brass pulleys, $1\frac{1}{2}$ to 2 in. in dia., are preferred to galvanized ones as they will not rust. However, if galvanized pulleys are used, be sure to oil them occasionally.

Where to attach the pulleys and run the cables, of course, depends entirely on the boat. If possible, run a cable along each side of the boat to eliminate a reverse turn in one of them at the stern. The cables may be attached to the motor either by a bracket mounted on the regular tiller at

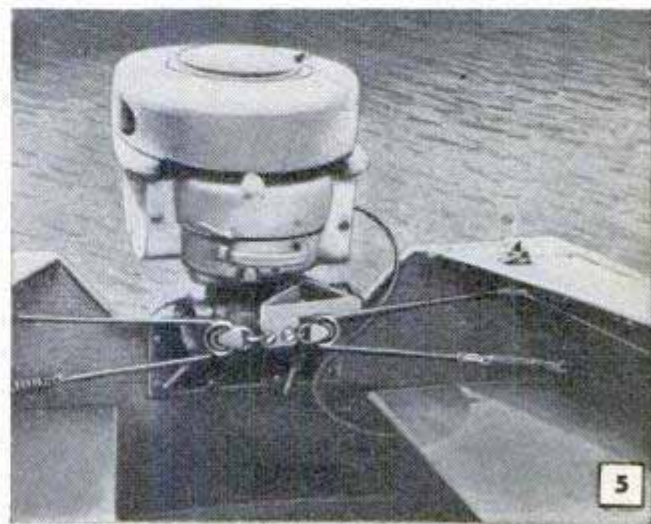
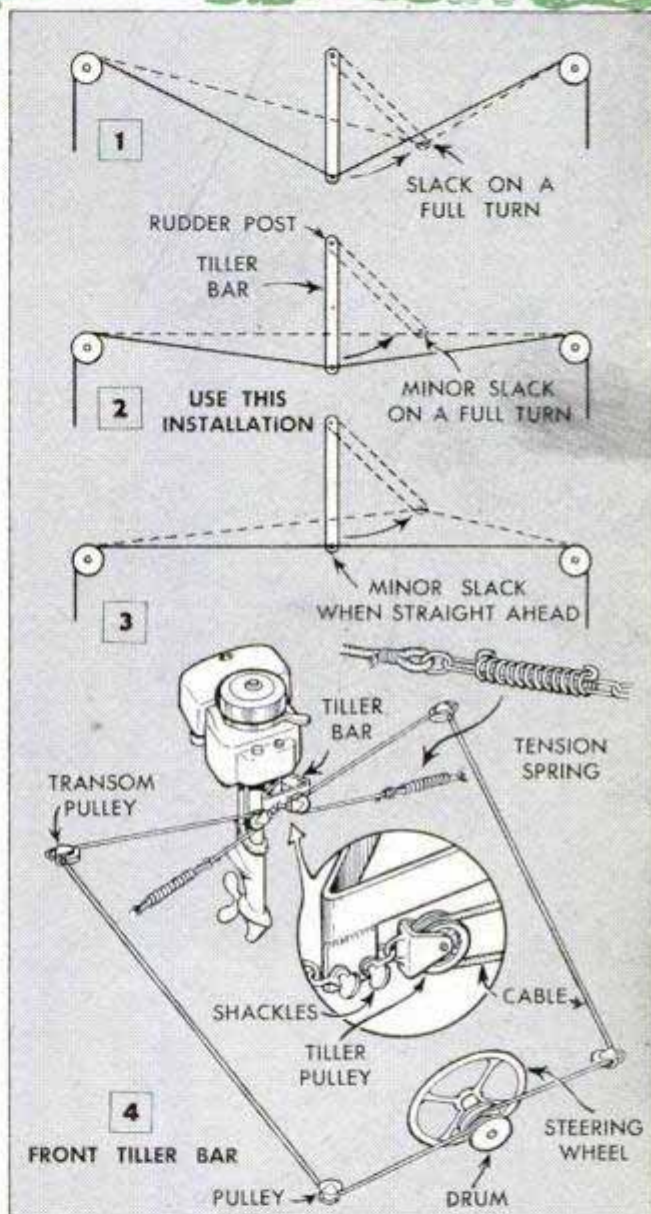

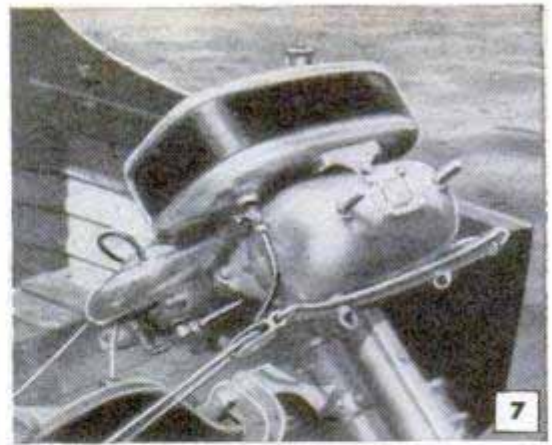
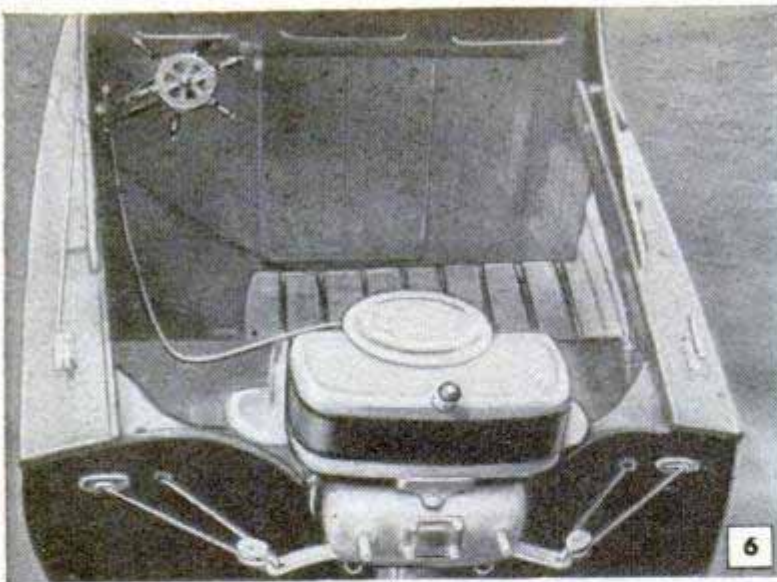

Left, method of connecting tiller cable to rear tiller bar. Pulleys are mounted on bar and in transom. Above, tiller bar is fastened under muffler on this motor

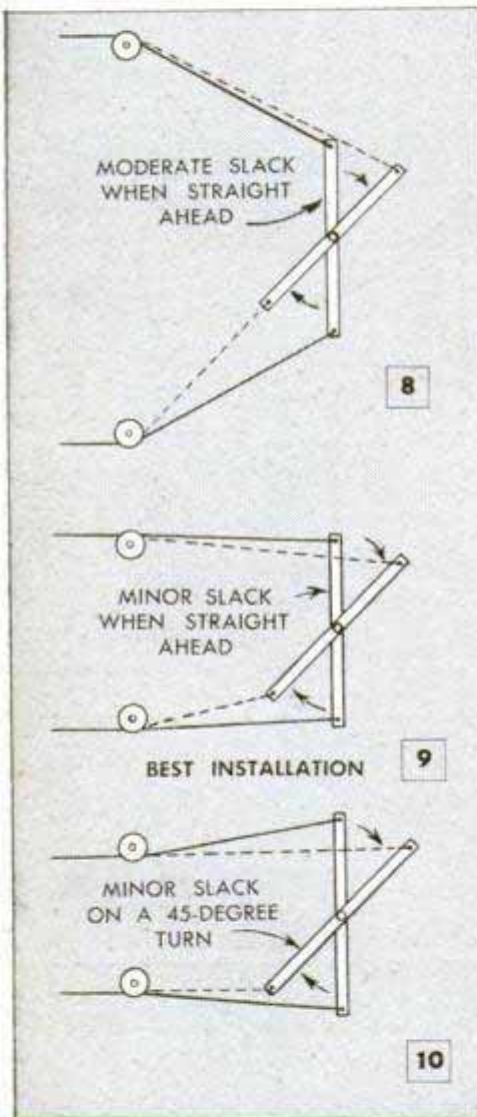

the front, Fig. 5, or on a tiller bar fastened to the rear of the motor so that it projects from both sides. Before deciding which method to use, it is advisable to consider that, if the cables must be placed low along the sides of the boat, the front installation will allow the motor to tilt upward without stretching the cables and pulleys. For the same reason, the rear installation is preferable if the cables are most easily placed higher along the gunwales.

Figs. 1, 2 and 3 show a front tiller bar in straight-ahead and full-turn positions with different pulley locations. Note that the installation in Fig. 2 is the best one to use, as it is a compromise between the leverage and slack factors, giving a fair amount of leverage with a minimum of slack. Figs. 8, 9 and 10 show the effects of different pulley locations using the rear method of connecting the cables to the motor. If you use this method, make the installation similar to that shown in Fig. 9, because it provides good leverage on the tiller bar and a minor amount of slack in the straight-ahead position. If you use the front method of connecting the cables to the motor, the tiller bar should extend an inch or so beyond the joint in the regular steering handle, and the cables should be centered in front of the motor. If the rear method is used, the bar should be mounted low on the motor, as in Fig. 7, and each end of the bar should be bent to the rear, Fig. 6, to prevent the pulleys on the bar from striking the stern of the boat on a turn.

Fig. 4 shows installation of cables, pulleys and tension springs when using the front tiller bar. Fig. 11 shows the installation for the rear tiller bar, running both cables along the port side of the boat. Pulleys are fastened to both types of tiller bar with shackles, as indicated in the circular detail, Fig. 4. The ends of the cables are attached to tension springs anchored to the hull near the transom pulleys or somewhere in line with them to eliminate slack in the cable.

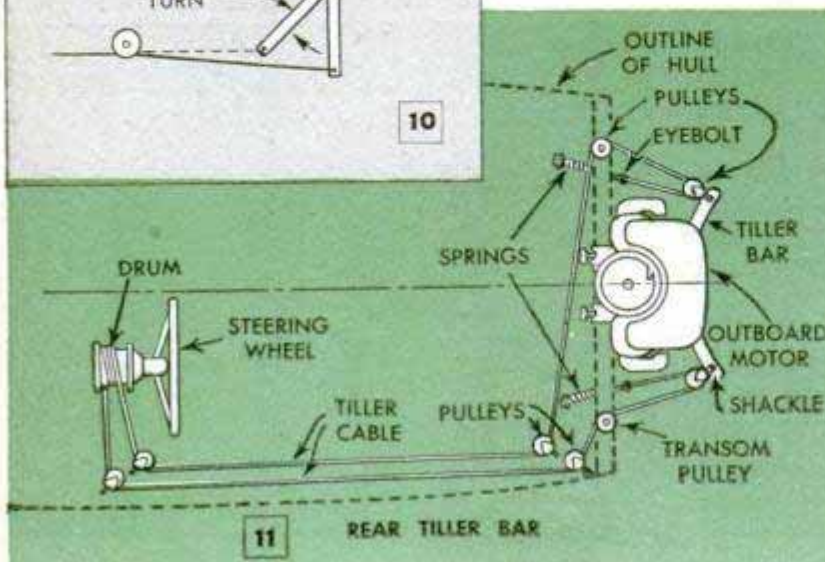

Neat Wall Shelf Has Secret Drawer

Designed to appear as a solid unit, this attractive little wall shelf contains a secret drawer that one would never suspect. Ideal for storing small valuables, the drawer is made inconspicuous by representing the front of the shelf. All the parts except the front leg and the top, which are cut from $\frac{3}{4}$ -in. material, are sawed from $\frac{1}{4}$ -in. stock. The ornamental buttons on the legs may be cut from $\frac{1}{2}$ -in. dowel and glued in place. The drawer is fashioned so that its front overlaps the sides of the box slightly more than the thickness of the wood, to provide clearance for end strips of molding fastened to the corners. If the molding and the $1\frac{3}{8}$ -in. disks are attached to the drawer as indicated, they will convey the impression that the rack is solid.—R. W. Madden, Palatine, Ill.

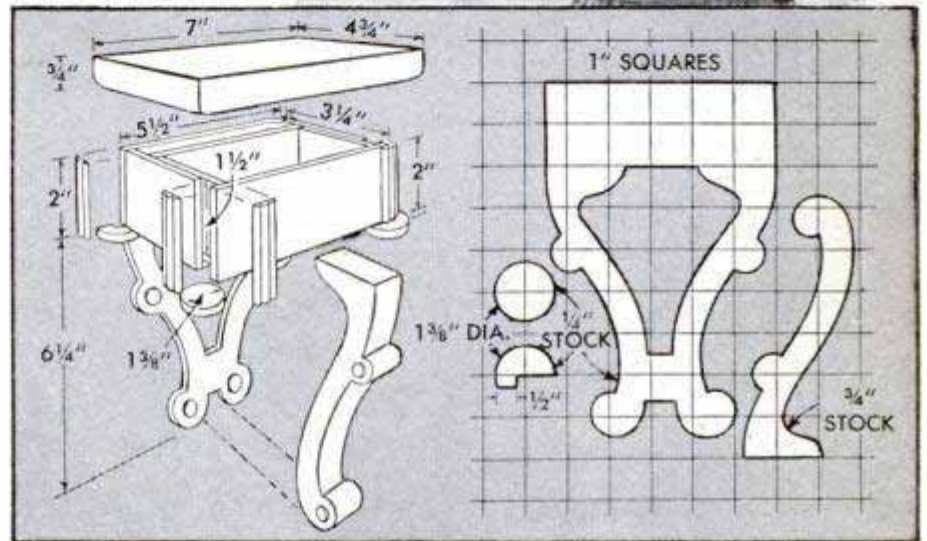

This Self-Adjusting Motor Mount Gives Constant and Uniform Belt Tension

Ideal for use where one motor is employed to operate several different machines individually, this self-adjusting motor mount is designed to provide constant belt tension without undue strain on both motor and machine bearings. The motor is bolted to a hardwood base, two edges of

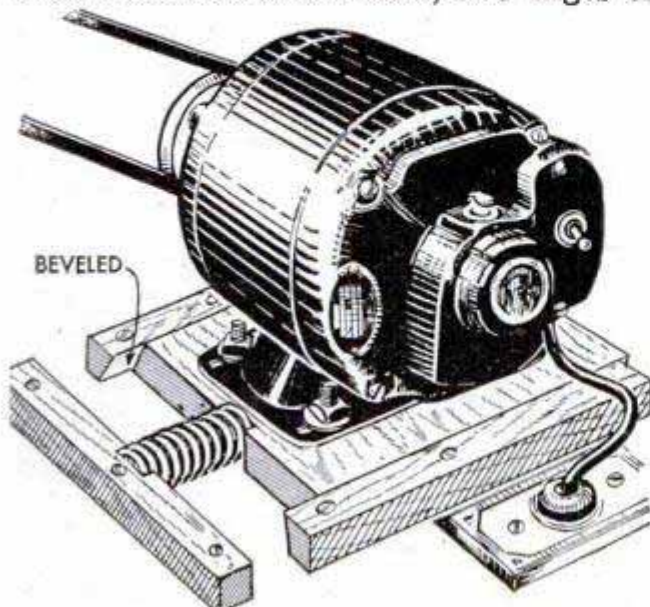

which are beveled and a notch cut in the front edge to take the end of a compression spring. The spring is made a permanent part of the motor base by stapling it to the edge. In this way, one spring will do for each setup. Two cleats, each having one edge beveled, are inverted and screwed to the bench top to provide guides for the motor base, as shown. Cleats are adjusted to provide a snug, sliding fit for the base and are located to align the motor pulley. Waxing the edges of the base and cleats gives an easy sliding movement. The stop cleat for the coil spring should be located at a point where minimum tension will prevent belt slippage. After much use, it may be necessary to readjust this cleat to take up slack in the belt, which stretches after prolonged use.—William R. Forder, North Bay, Ont., Can.

☞ To assure long life for pillow cases, always select cases that are slightly oversize for the pillow being used. When the pillow is forced into the pillow case, it will wear out sooner.

MODEL YOUR HOME

before you build

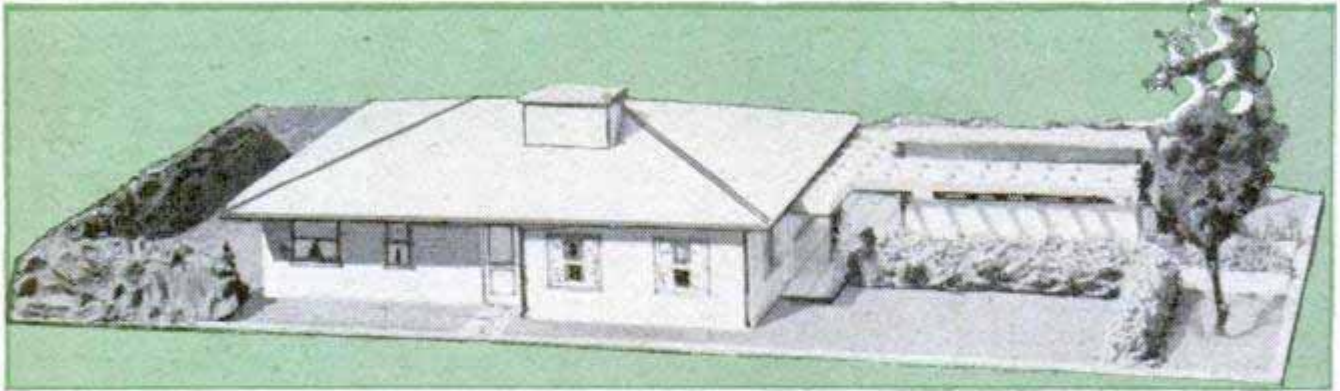

By Richard W. Emery

USING inexpensive materials and the simplest of tools, you can build, in a few hours, a true scale model of that home you have planned. A model of cardboard, even a simple one, not only gives a realistic, three-dimensional view of the home before it is built, but a careful study of the model may save you a lot of money by showing up impractical or costly features before actual construction of the house begins. In a simple floor-plan sketch it may appear that you have all that you desire in convenience and comfort, but a scale model likely will show minor changes, which will make the arrangement even better. On the other hand, it may reveal beforehand structural defects or a faulty room or interior arrangement. With the four walls of a model in place in a scale reduction of a plan, you can determine size, location and number of windows and doors, locate partitions and decide on room sizes and ar-

range easily, because you can see how these details will appear in the full-size structure. It's quite as easy to pick the type of roof, the most advantageous location of the house on the lot and the height of the chimney in relation to the ridge. It's also possible to decide on the smaller exterior details and the color of the paint job as well. All these points should be decided definitely before you build.

To lay out a plan accurately to scale you will need a draftsman's T-square, a 45-deg. triangle, a pair of dividers, a small drawing board, thumbtacks and a triangular scale showing common scale reductions.

Begin by thumbtacking a piece of illustration board to the drawing board. Then, with the scale, lay out the size of the lot, using a scale of $\frac{1}{4}$ in. equals 1 ft. For some types of construction a scale reduction of $\frac{1}{8}$ in. equals 1 ft. is practical. Mark the property boundaries on the board. Then, using the same scale reduction, lay out the floor plan of the house on another sheet of

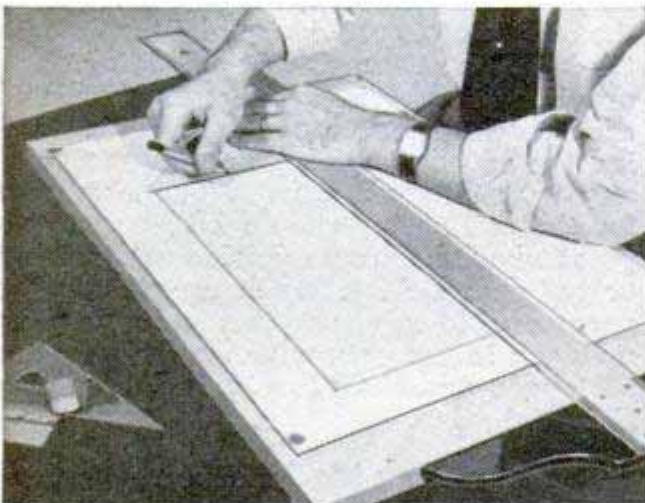

Lay out the exact scale size of your lot on heavy illustration board and mark boundary lines in pencil. Use the common reduction of $\frac{1}{8}$ or $\frac{1}{4}$ in. to 1 ft.

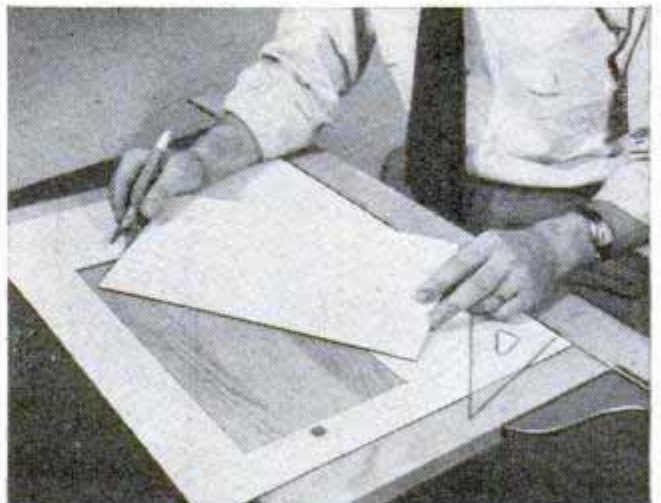

Cut out the lot, using a metal-edged ruler and a sharp, thin-bladed knife. Hold the blade in a vertical plane so the edges of the board will be square on all sides

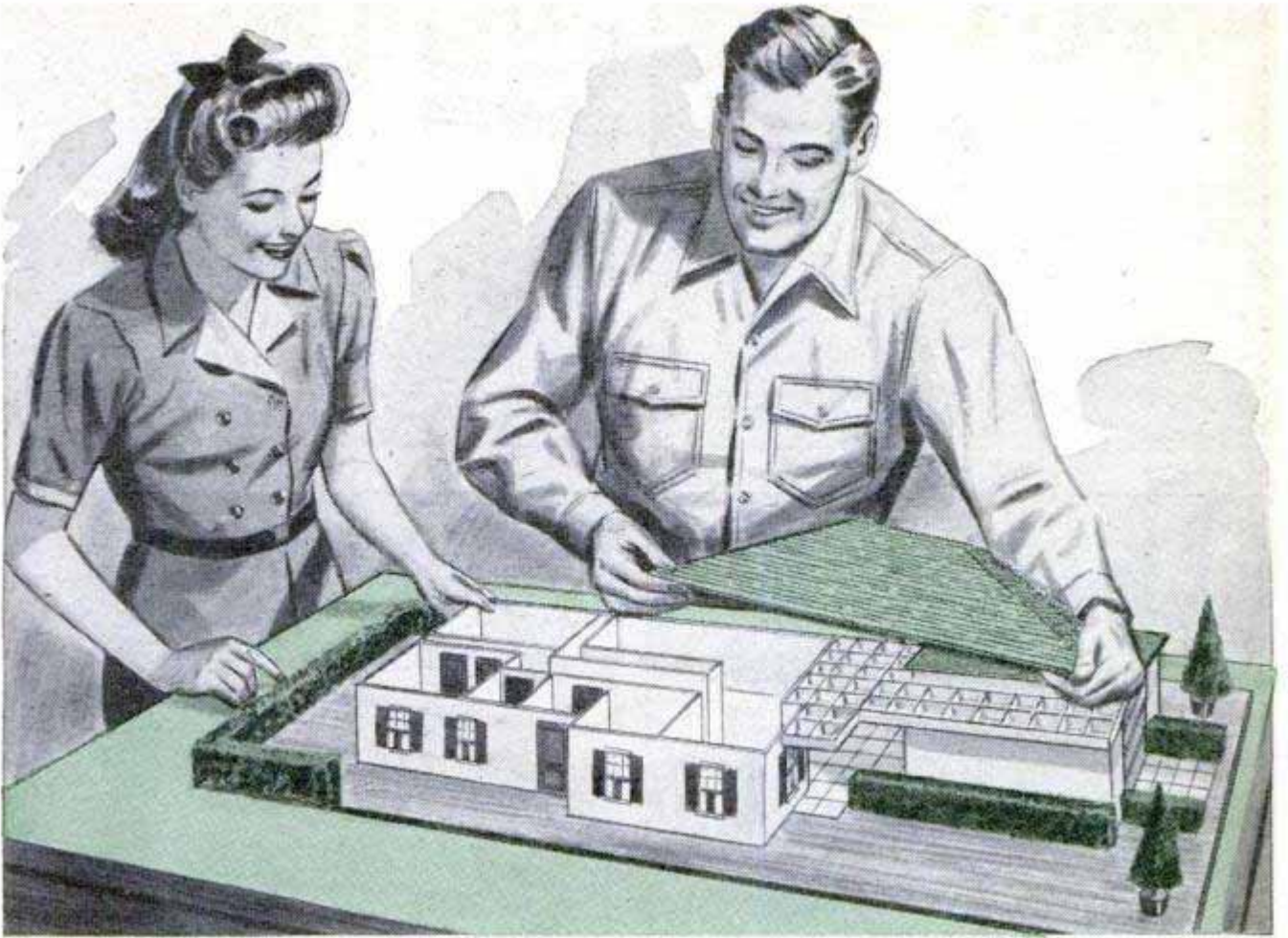
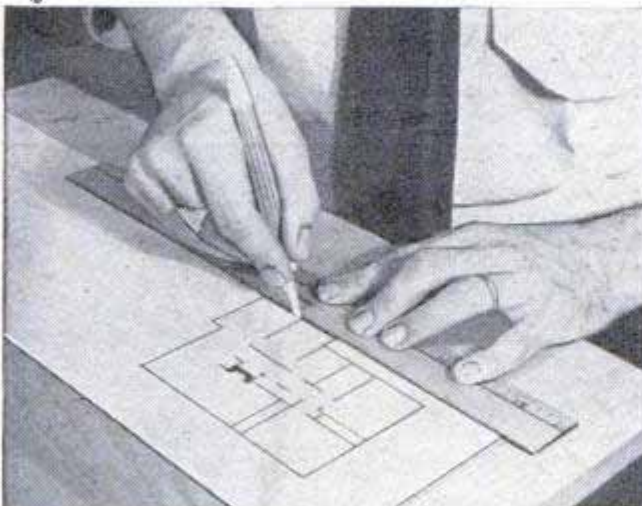
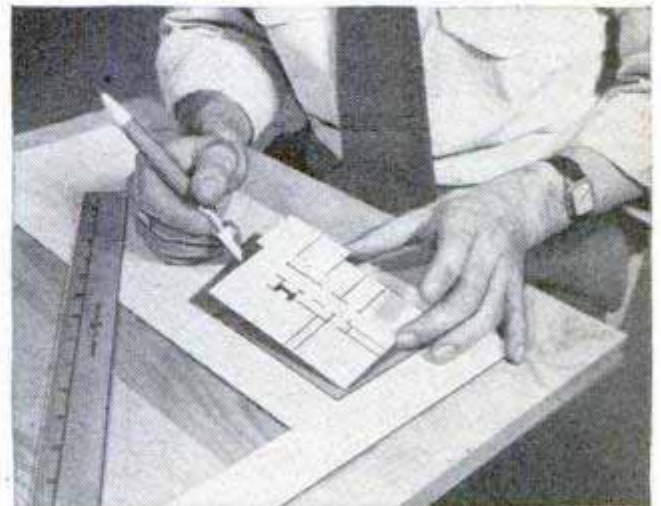

illustration board. Scale the thickness of the walls and mark the inside over-all dimensions of the floor plan. Then cut on the inside lines. Cement this cutout in place on the plan of the lot in exactly the same location as the full-size house is to be. This method of cementing the floor-plan piece to the board on which the lot plan is laid out makes it easier to position the walls. Use your T-square and triangle to get parts laid out exactly at right angles and be careful about the measurements. Lay out the

location of the partitions next. Photos on page 186, beginning at the top and reading left to right, show the use of draftsman's dividers in laying off measurements accurately when locating partitions and other plan details. The next two photos left to right, show the house plan being cemented in place on the lot. Use airplane cement for this purpose as it sets quickly and does not discolor. Next, determine the scale height of the outside walls and partitions. Mark off and cut strips of the illustration board



On another board lay out the house plan. Mark the partitions. Plan should be an exact scale reduction of the inside dimensions measured from wall to wall



Then cut out the floor plan on the lines, being very careful to hold the knife perpendicular to the board so the edges of the cutout will be square and smooth

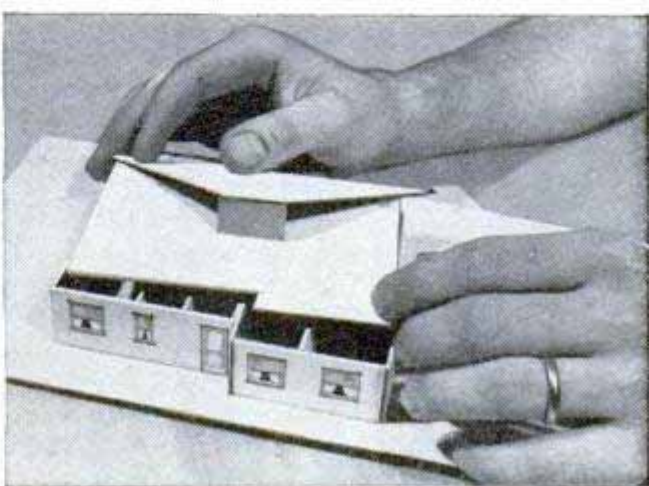
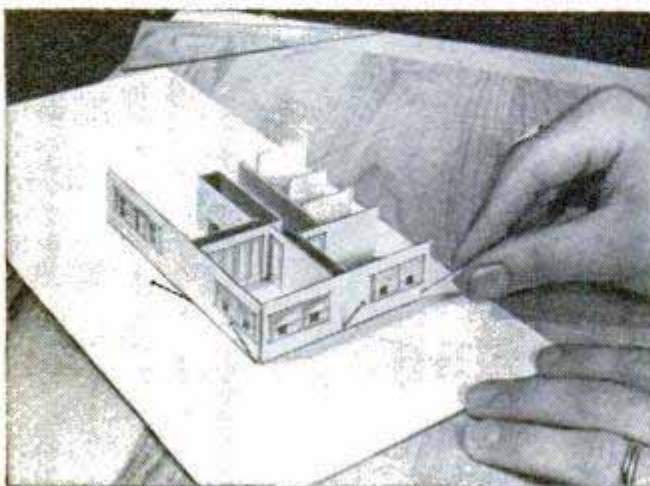
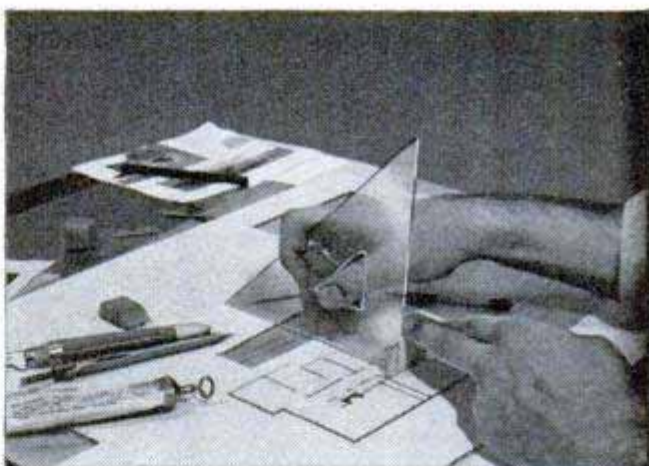
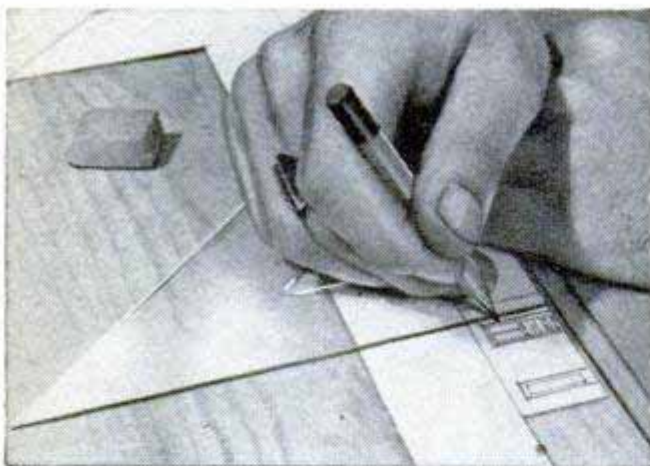
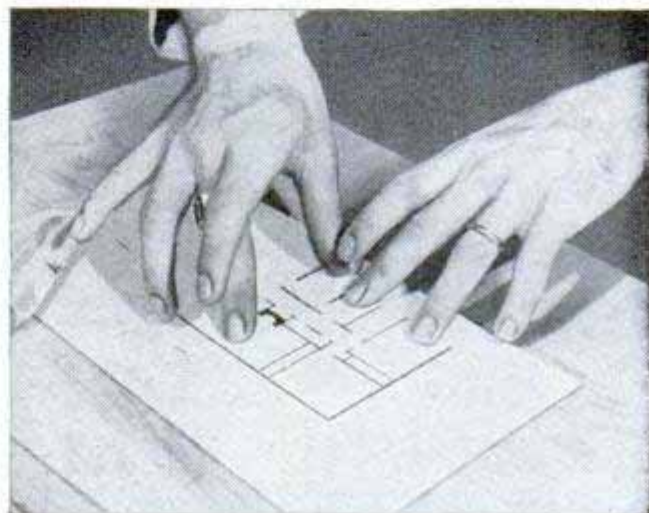
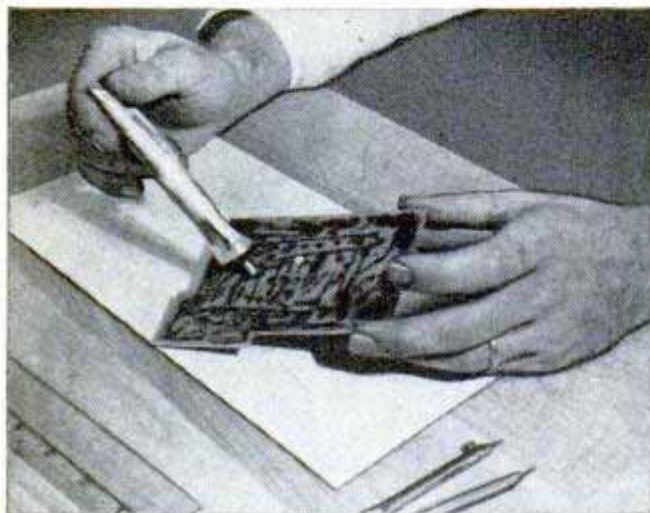
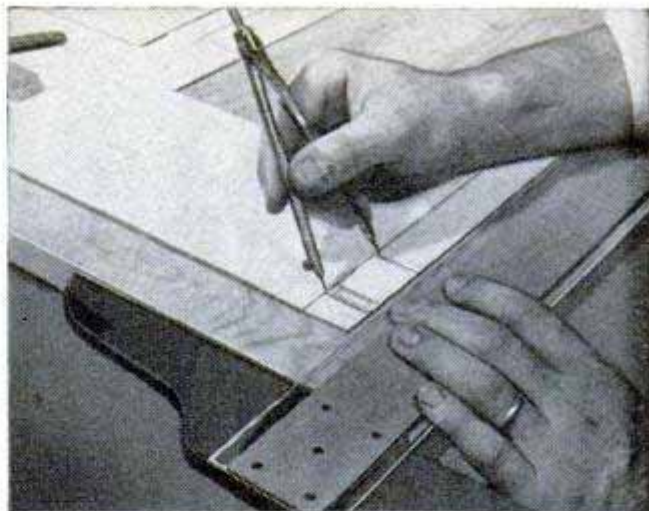
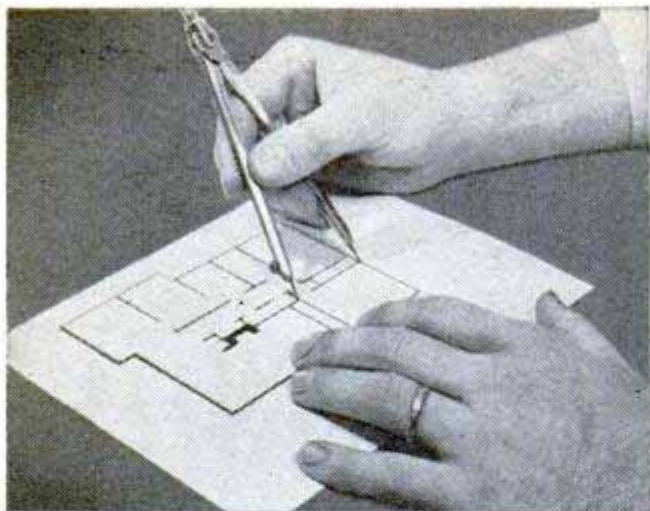

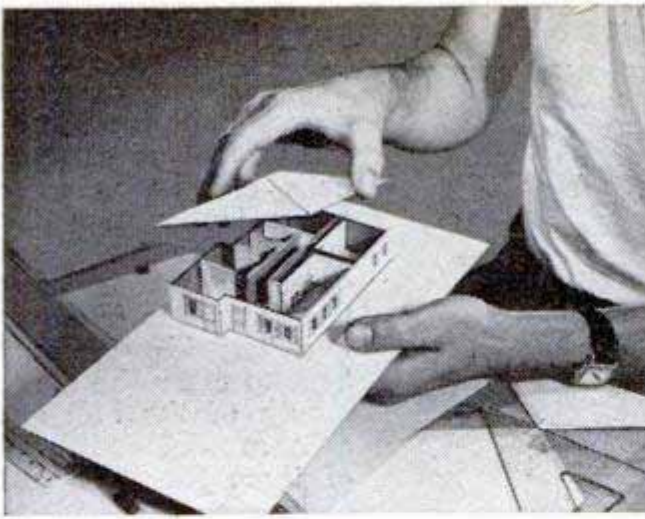

The ceiling and roof are made as a separate unit to lift off, exposing the arrangement of the rooms

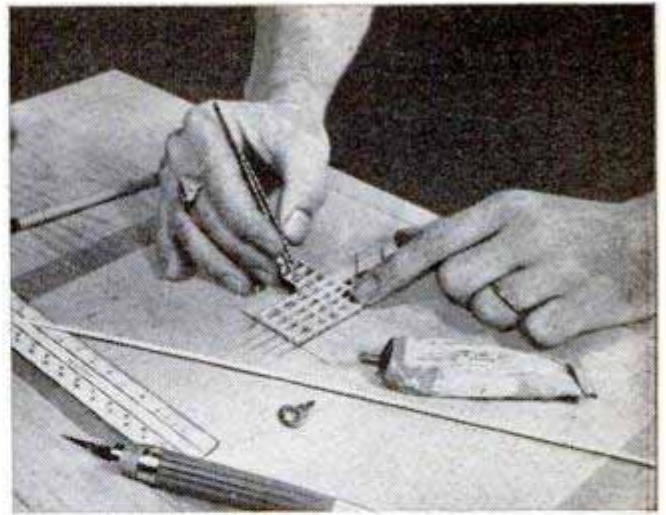

A trellis, arbor or fence can be built from strips of pine or balsa wood, cemented together in sections

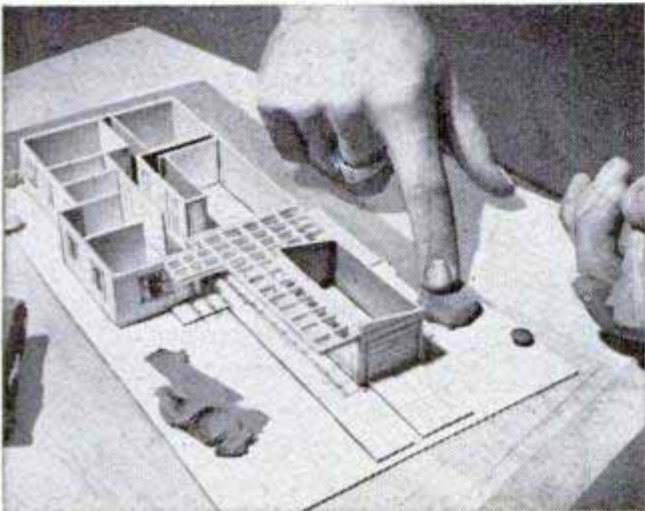

Colored modeling clay is used to form shrubbery and hedges. Strips cut from a sponge also can be used

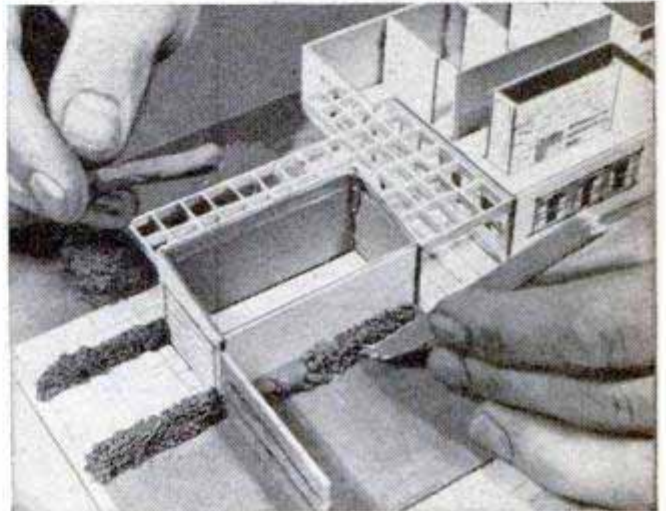

Finishing the modeling-clay shrubbery with the splinted end of a stick gives a realistic effect of foliage

so that you can cut pieces of partition and wall stock as required. Remember that the height of the partition strips must allow for the thickness of the cemented floor plan so that outside walls and partitions will be the same height when assembled. Scale-sized windows and doors are represented by drawing the outlines directly on the walls with black ink, or with pencil, as in the left-hand photo, third row, page 186. When setting up partitions and walls, use the triangle as in the right-hand photo, third row, so that when the cement dries the parts will stand true vertically. Hold the outer walls with pins as in the lower left-hand photo. On most plans you can cement all the partitions in place before setting the outside walls. At this stage, with the exterior walls in place, cut a ceiling piece of the exact outside dimensions of the floor plan so that it overlaps the thickness of the walls on all sides. This gives you a foundation on which to build the roof. If the house has a boxed cornice, then the ceiling piece should extend beyond the outer walls a scale distance equal

to the overhang of the cornice. Build the roof in sections as in the lower right-hand photo, page 186, using small blocks of wood to elevate the sections to the correct pitch. Carve the chimney top from a small block of wood to scale size, score it, or line with ink to represent bricks, and cement it to the roof. By this method of construction the roof and ceiling can be lifted off as a unit to show the room interiors.

The garage, sidewalks, service court, yard fences, trellis or pergola, trees, shrubs and the garden are exterior details on which you will have to use your own ingenuity, as the details and plantings will vary with the lot and locality. Hedges and shrubs can be worked out with modeling clay. Artificial trees are available, trellises and fences are easily carved from pine or balsa wood. Build the garage from the house materials and lay out and assemble it in the same way. Paint the model with painter's oil colors thinned with turpentine to an easy brushing consistency. Use soft-bristle brushes to spread the paint in a uniform coating on the small surfaces.

War-Surplus Ship's Bell Serves as Dinner Bell When Mounted on Brackets Near Farmhouse Door

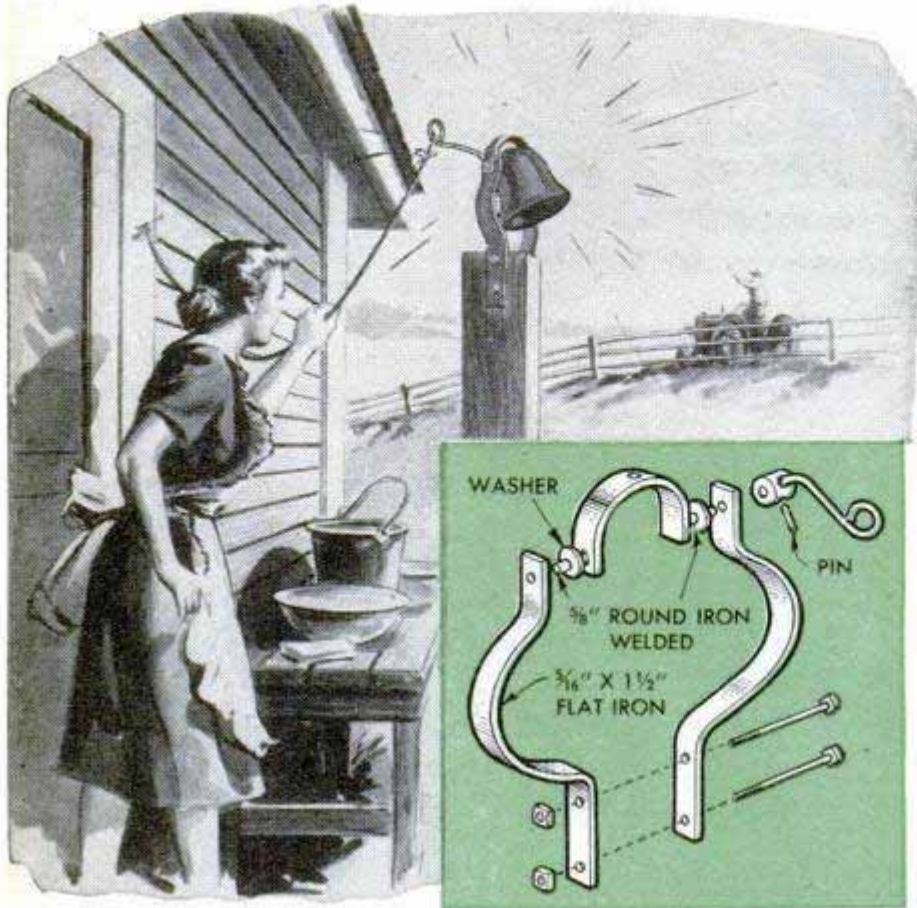

Ship's bells now being sold as war-surplus items make excellent dinner bells for use on the farm. One of these bells can be mounted conveniently on a post outside the farmhouse door by means of a bracket made from flat iron. The side pieces are bent to clear the flared mouth of the bell and holes are drilled in each of them for bolts and stub axles. Short pieces of iron rod brazed to a curved flat-iron cross member serve as the stub axles. Washers provide clearance, and a heavy wire arm is brazed to a piece of rod, drilled and cross-pinned to one of the axles. The bell is attached with a screw inserted through a hole drilled in the top of the cross member.—Hi Sibley, Nuevo, Calif.

Safety Rope Attached to Boat Transom Prevents Losing Outboard Motor

There will be no need to worry about losing an outboard motor in the event it should work loose and fall into deep water, if it is fastened securely to the boat with a length of strong, tarred rope. Turn a large screw eye into the transom of the boat, and tie one end of the rope to the screw eye and the other end to the mounting bracket of the motor. If the motor is a heavy one, use an eyebolt instead of a screw eye in the transom to be sure it will not pull out under the weight of the motor.

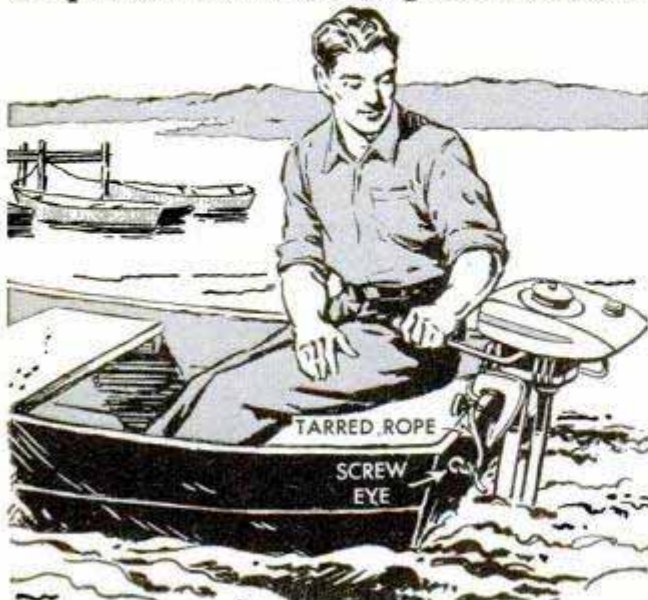

To facilitate removal of the motor, the rope can be attached to the screw eye by means of a spring or bolt-type snap hook.

Doubling Use of Small C-Clamps

When gluing together the parts of drawers, boxes, etc., and the C-clamps at hand are a little too small to be used singly, simply hook two of them together as shown and use as one clamp. While the two clamps will stay hooked together when they are tightened, they can be temporarily wired together to facilitate applying them singlehandedly. In addition, if a long bar-type clamp is needed for clamping large frames, two C-clamps linked together by a piece of wood which has a hole in each end can be used to improvise a clamp of practically any length.

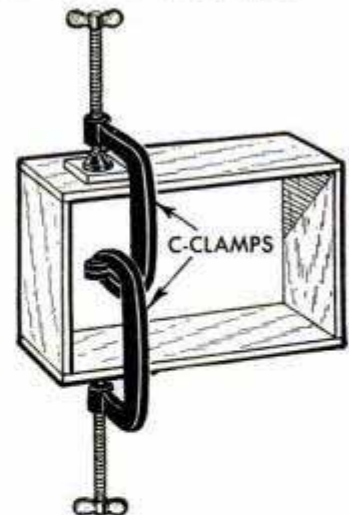

Thomas B. Owens, Cleveland, Ohio.

Children's Seesaw Utilizes Oil Drum

This portable seesaw, which consists merely of a plank balanced on an empty oil drum, is both inexpensive and easy to build. As the drum is not fastened to the ground, the seesaw may be moved about the yard, or taken into the basement on rainy days. To make it, cut two wooden blocks to fit the curvature of the drum and screw them to the plank. Then bolt the plank and blocks to the drum, first cutting a hole in one end of the drum to allow tightening the bolts from the inside. If you wish, place a handhold near each end of the seesaw plank. Although a suitable handhold can be made by driving a piece of broomstick into an undersize hole, a T-shaped handhold, which is much safer, may be fashioned from pipe fittings, using a short nipple and tee for the vertical member. This is screwed into a pipe

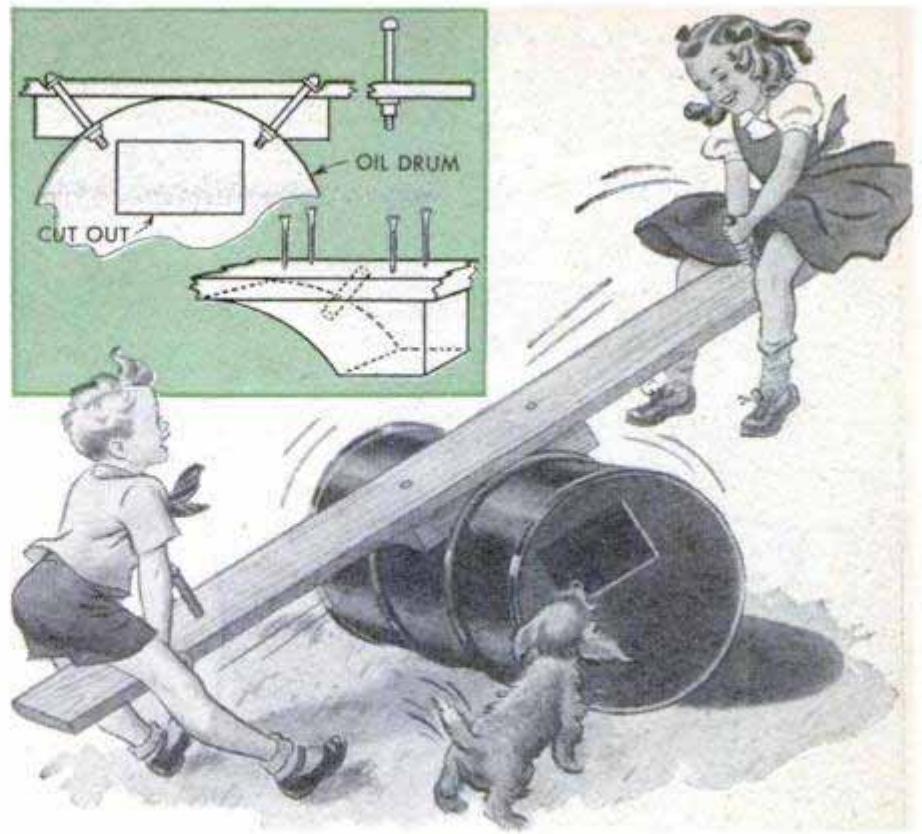

flange attached to the plank. Pipe nipples turned into the tee at the top of the pipe serve as handles. Be sure there are no sharp corners or projections that could cause possible injury.

E. W. Moses, Jr., Blacksburg, Va.

Pulley Reduces Bending Of Pruning Pole

By equipping a pruning pole with a pulley and running the pull rope as shown, undue bending of a lightweight pole is reduced and leverage is greatly increased. The pulley is attached to the arm of the cutting head. Then the rope is passed through it and fastened to a screw eye located on the pole about a foot or so from the top. Due to the increased leverage, care must be used not to bend the cutting head.

L. T. Bruhnke, Wauwatosa, Wis.

Attracting Birds to New Houses

To interest prospective feathered tenants in a new birdhouse, decorate the entrance and perch with several tufts of grass and a few bits of down. Sight of the grass and feathers will induce the birds to nest. If the house has been painted, let it dry out for several days before erecting.

Dale Van Horn, Lincoln, Nebr.

¶ You can save time in seasoning food and do it more satisfactorily by preparing a mixture of salt, 6 parts, and pepper, 1 part, which can be kept on hand in a shaker ready for immediate use.



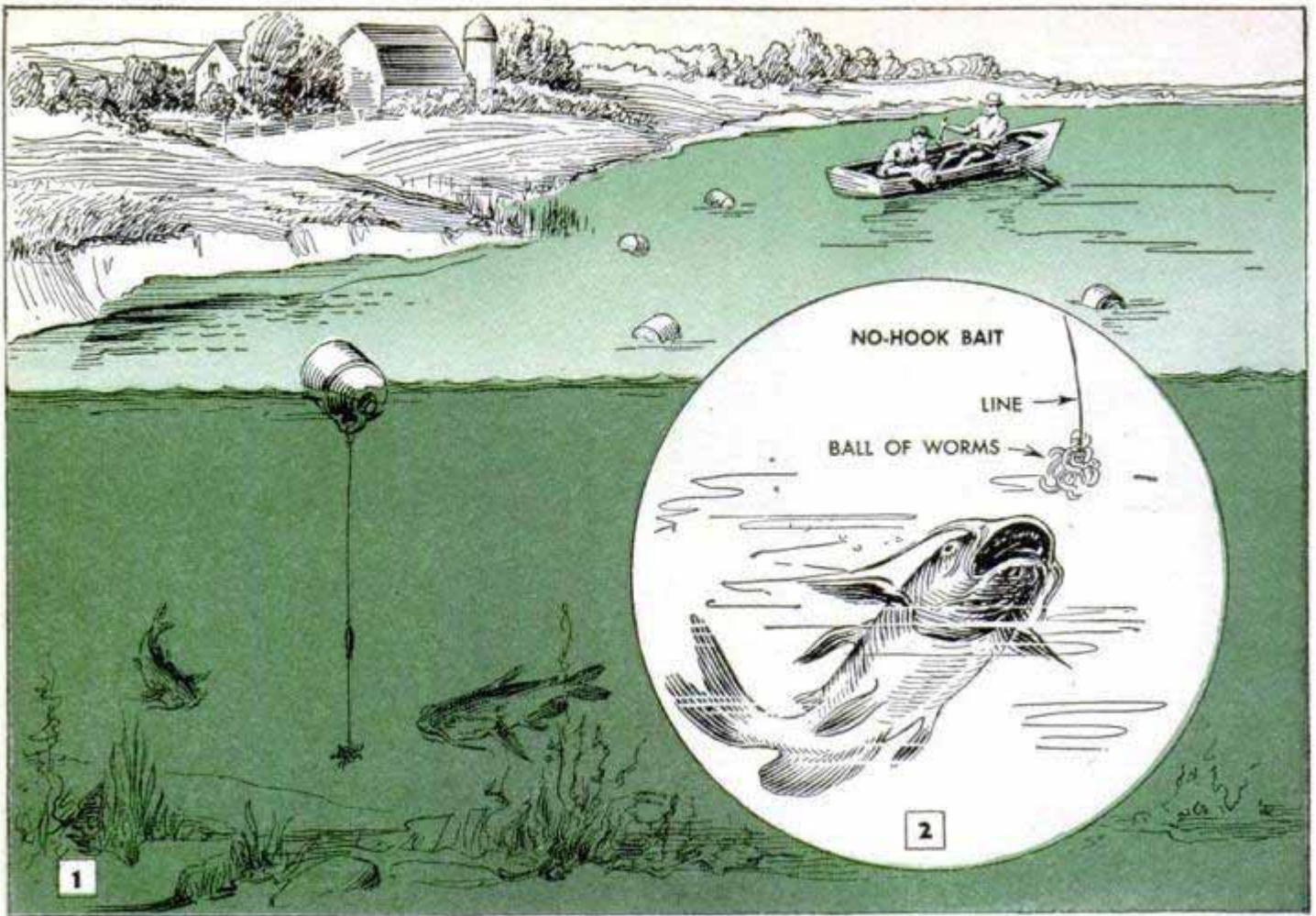

OUTSMARTING THE CATFISH

CATCHING bullheads and channel "cats" calls for more than one trick in the bag. The secrets are in the careful preparation of special baits and the methods of fishing catfish waters effectively.

Jugging for catfish: Tie a 36-in. length of line to the handle of a half-gallon glass or earthenware jug. Attach a sinker, a 12-in. wire leader and a hook baited with earthworms. Any number of jugs can be used. Set the jugs adrift to float downstream with the current so that they will be carried over any likely spots, Fig. 1. When fishing a lake or pond in this manner, set the jugs adrift so that offshore winds will carry them slowly across to the other side and follow the floating jugs closely in a boat.

Hookless bullhead bait: Tie several large earthworms with thread to the end of a line long enough to reach near the bottom of the stream or pond, Fig. 2. If in a stream, and the current is rather swift, use a sinker sufficiently heavy to carry the line to the bottom. No hook is used, but any fish taking the bait can be pulled gently within reach of a landing net.

Dough-ball bait: These are made by mix-

By R. A. Jenkins

ing equal parts of white flour and cornmeal, or cottonseed meal, with sufficient water to make a rubbery dough when kneaded. Shape the dough into balls about $\frac{3}{4}$ to 1 in. in dia. and drop them into boiling water. Keep the dough balls moving in the water so that they do not stick together or scorch. When they float to the top, remove them immediately with a spoon and allow to drain. After the baits have cooled, pack them in fruit jars and seal to prevent drying out. In fishing for cats use hooks with a short shank, No. 2-0 to 4-0 size, depending on the size of the fish you expect to catch. If you work carefully when baiting, the dough ball can be made to cover the hook entirely, leaving only the eye and the line exposed. This is the trick in taking the wary channel cat with dough-ball baits. These baits may be fished from the bank of a stream or from the shore of a pond, using a bamboo pole and line long enough to get the bait well out from shore. As a rule, channel cats will be taken in comparatively quiet water, in eddies and backwaters especially, but often they are caught in mid-channel where the current is quite strong. Here you will need a heavy sinker to carry the

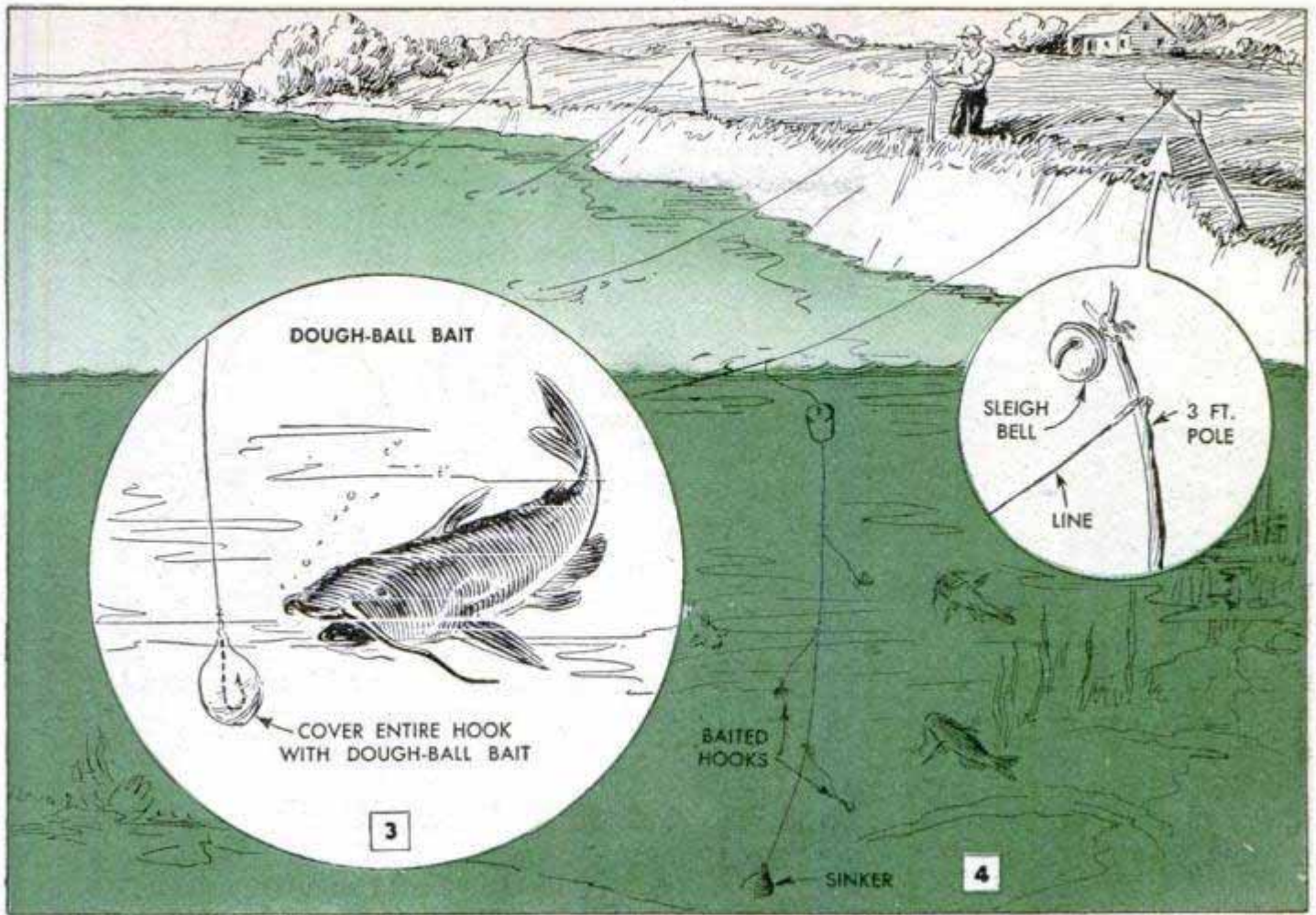

line well down against the pull of the current. Ordinarily the dough-ball bait should be fished deep.

Catfish set line: A good set-line rig for fishing deep water off a dirt bank is shown in Fig. 4. The throw lines should be long enough to reach out from 15 to 30 ft. from the bank. To work this rig at full effectiveness you should know the approximate depth of the water where you are going to set the lines. Attach a heavy sinker to the end of the line. Then attach hooks and

leaders to the line above the sinker as shown in Fig. 4. Bait with dough balls or earthworms. Attach a large cork float to the line at a distance above the sinker which is about equal to the depth of the water. This arrangement will hold the line vertically and fairly taut. Attach the free ends of the lines to short poles driven into the bank along the edge, and tie a sleigh bell to each pole. Before jugging or using set lines, check your state laws governing methods of taking game fish.

Self-Adjusting Float Permits Reeling Bait to Rod Tip When Casting

Difficulty experienced in casting when using a fishing float is avoided with this self-adjusting one, which permits the bait to be reeled to the rod tip. When cast, the float automatically adjusts the bait to a predetermined depth. To make this float, glue a reed pipestem in a hole through the center of a piece of cork. String a small bead on the line, run the line through the pipestem and attach the swivel sinker and leader. Then knot the line above the bead at a point that will allow the hook to sink to the desired depth. The swivel will stop the float from sliding down onto the leader when casting, and the bead-and-knot combination will prevent the line from running out past the setting. Tie a small knot that will not snag in the rod guides.

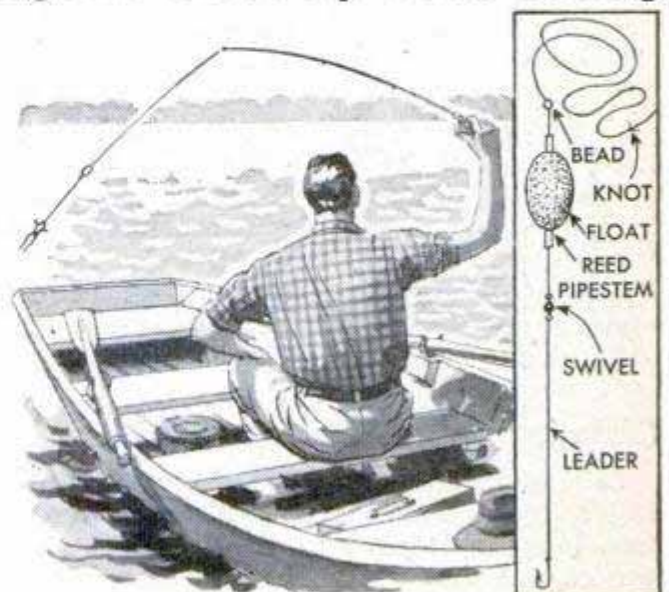

BB Shot Used to Force Dirt From Kinked Fuel-Oil Line

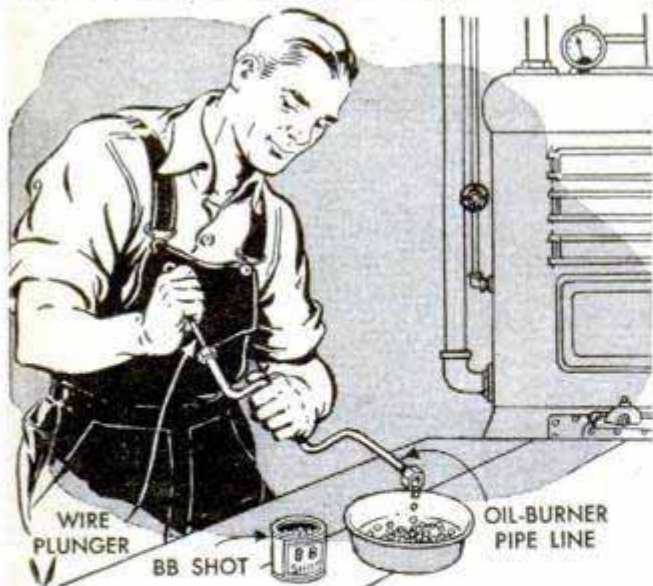

Until I hit upon the idea of using BB shot, I was at a loss to find a way to remove dirt and lint from the fuel line of my oil burner. Usually, all that is required is to run a wire through the line, but in my case, the fuel line had several sharp bends around which the wire would not pass. I solved the problem by pouring BB shot into the tubing until nearly full and tamping it down with a short length of wire until the shot gradually was forced through the obstruction. Be sure to use shot of a size that will roll freely through the tubing.

G. E. Hendrickson, Argyle, Wis.

Easy Tests for Dull Tool Blades

Because dull blades of wood chisels and knives produce inaccurate and slipshod work, it is wise to test the edges of the blades for sharpness before using. One way to do this is to note if a white line is visible along the cutting edge. If so, the blade is dull. Another way is to run the cutting edge of the blade upward on the thumbnail as shown. If the edge slides on the thumbnail without catching, the tool needs sharpening.—J. Modroch, Danbury, Conn.

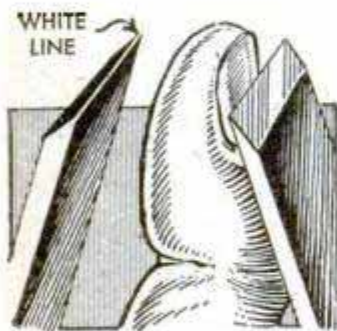

Cleaning Silicon-Carbide Stones

Silicon-carbide stones used for sharpening knives and axes will, after repeated use, become clogged with oil and dirt to the extent that the surface is glazed and

ineffective as a sharpening agent. The stone can be restored to its original condition by heating it sufficiently to burn off the accumulated oil and dirt.

D. E. Horn, River Forest, Ill.

Electrician's Tape Kept Available On Screwdriver Handle

To save time and inconvenience when an occasional small piece of tape is needed, one electrician keeps several turns of tape wrapped around the handle of his screwdriver. In addition to keeping the tape at hand, this method also adds to the gripping surface of the handle.

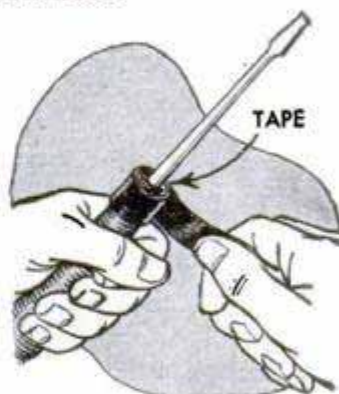

P. R. Wilson, Brooklin, Ont., Can.

Substitute Friction Catch

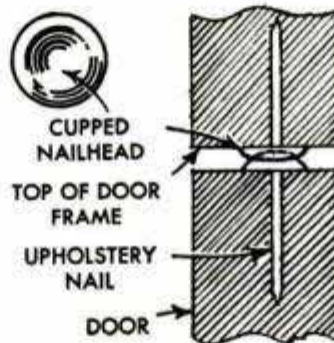

If there is a faulty catch on one of your cupboard or cabinet doors, it can be replaced with a friction catch made from two upholsterer's nails. Drive one of the nails into the edge of the door where

you wish to locate the catch, and drive the other nail into the frame directly opposite the first one. Then, with a ball-peen hammer, cup the nail driven into the frame.

Cardboard Pipe-Cleaner Holder Protects Pocket Lining

The wire centers of pipestem cleaners carried loosely in a pocket may eventually tear the lining. To avoid this, insert the cleaners in a piece of corrugated cardboard cut a little shorter than the length of the cleaners and trimmed to fit the pocket snugly. In addition to protecting the lining from wear, the holder will save the lining from being soiled.

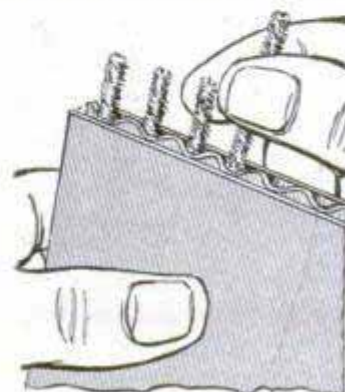

LAWN-SPRINKLER SHUTOFF

This novel lawn-sprinkler shutoff automatically waters your lawn during early morning hours when sprinkling is not restricted, or during a hot dry spell when you are away from home over a week end. The device can be regulated to open and close a valve alternately and repeat a slow cycle continuously. It can also be set to turn on the sprinkler during the night, or it can be adjusted to shut off the water after it has been turned on manually. The shutoff operates by action of water dripping from pet cocks into pails hanging from the ends of a crossarm attached to a quick-acting-type steam cock. To set the device so that it turns a sprinkler on and off at intervals, open each pet cock to drip at the desired rate. With the steam cock closed and the sill faucet open, water will drip from the right-hand pet cock and into the pail. Weight of the water will cause the pail to lower and, in turn, to open the steam cock. This starts the sprinkler and at the same time starts water dripping from the other pet cock. Simultaneously, water in the lowered pail escapes through a valve in the bottom, and the cycle repeats. To set the device to turn off the sprinkler, the right-hand pet cock is closed. To turn the sprinkler on for continuous operation, the right-hand pet cock is opened and the other one is closed.—Everett W. Williams, Chicago.

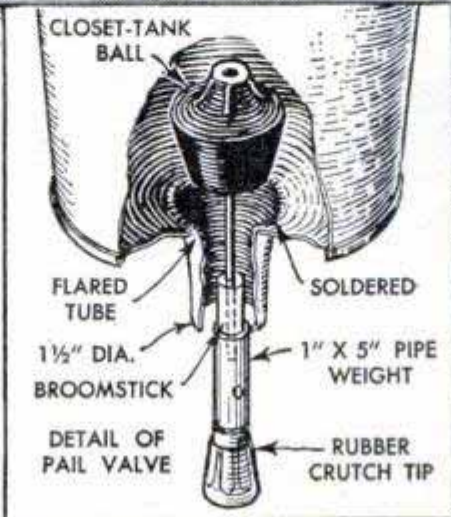
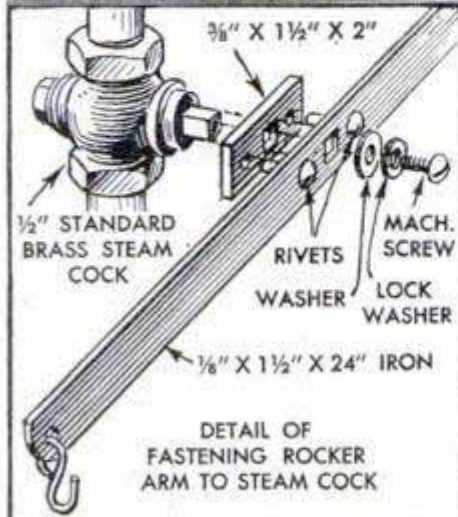
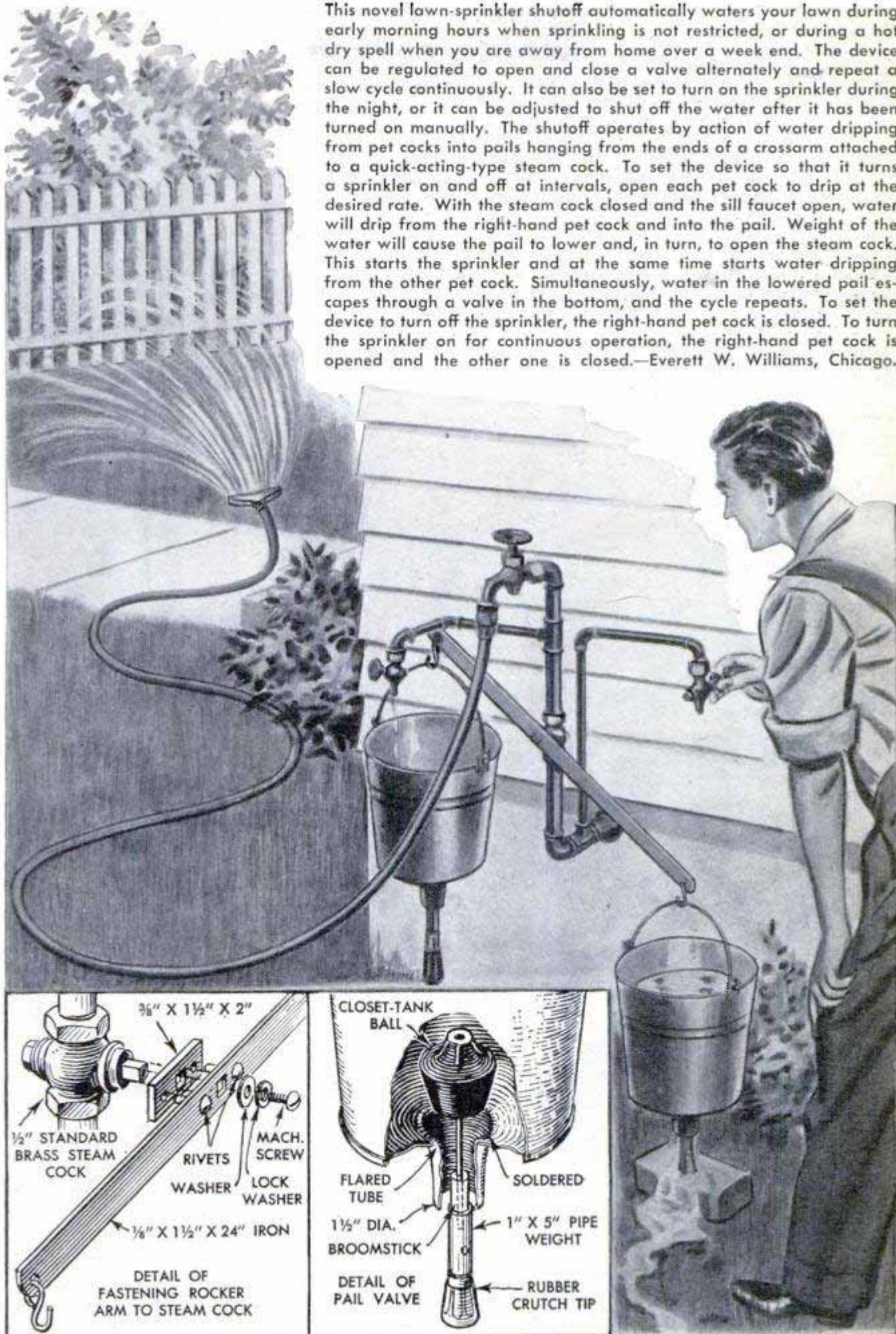

PHOTOGRAPH YOUR

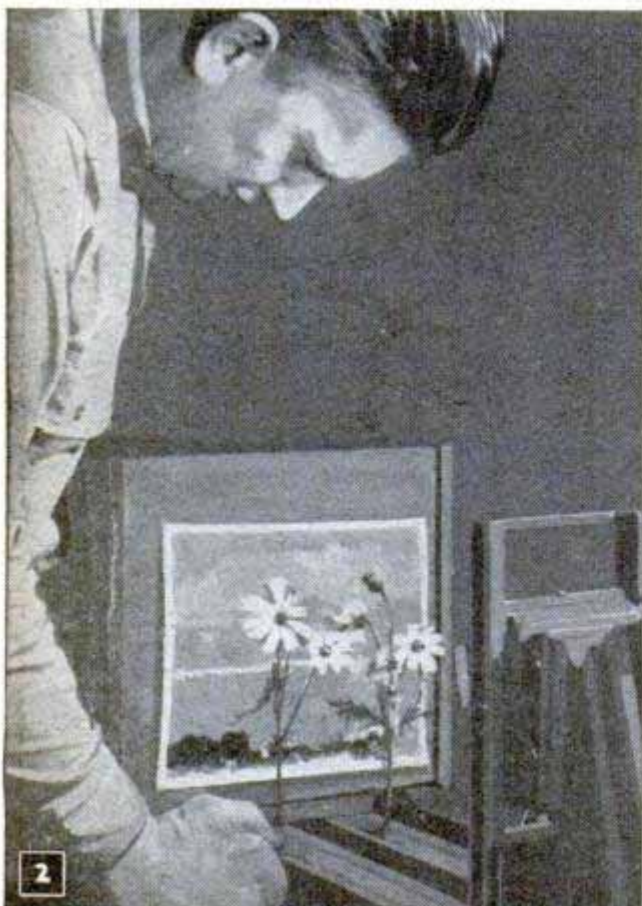
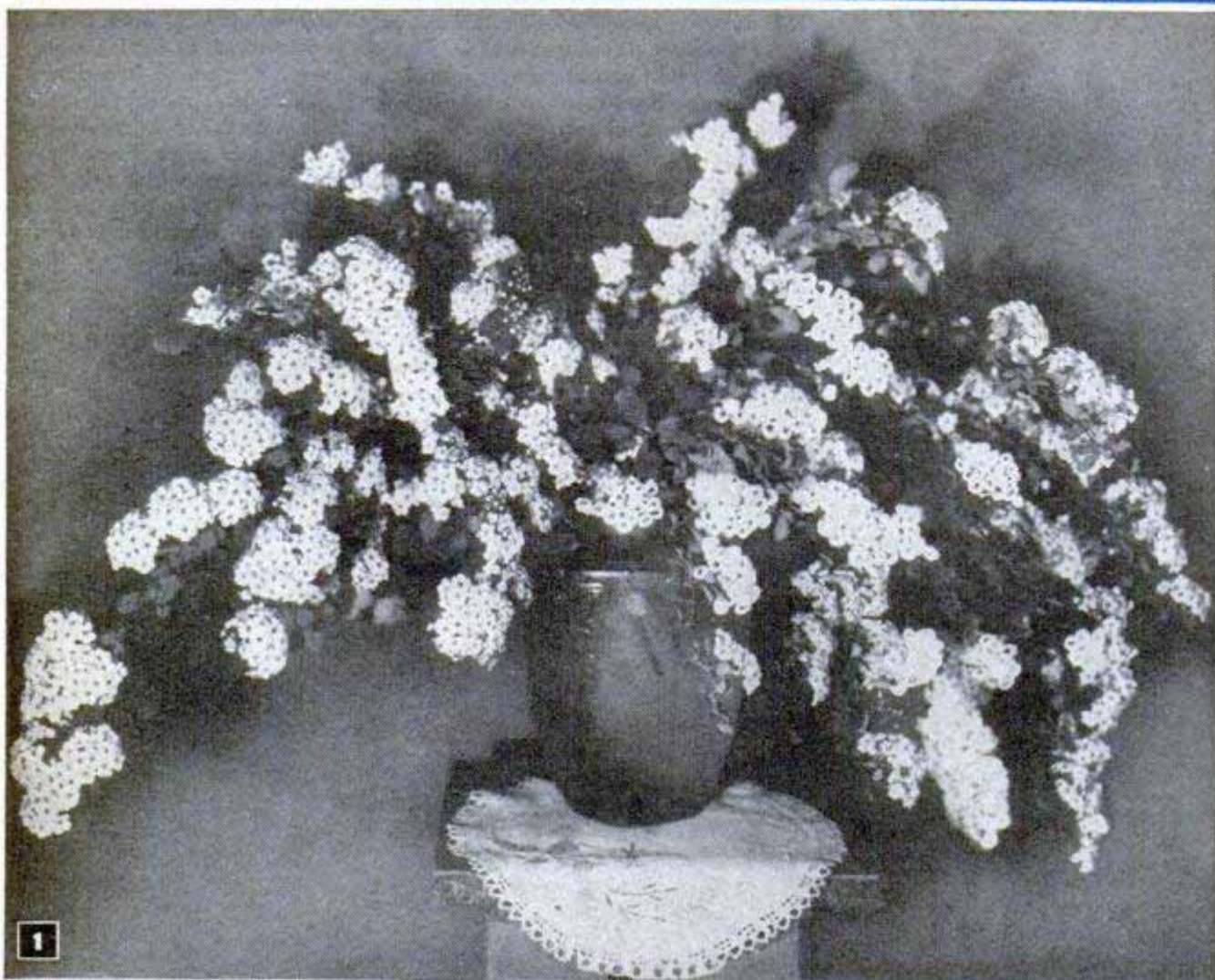

By Paul Hadley

PHOTOGRAPHING flowers requires careful camera technique. Figs. 1 to 8 inclusive show prints that result from studied selection of the background. For example, to get depth you can use a large cloud print as in Fig. 2. The photo taken with this setup is shown in Fig. 3. Although the cloud detail is greatly subdued it gives sharper definition. The bouquet setup in Fig. 7 was purposely arranged to give out-of-focus background detail and a natural side lighting from sunlight. For average work on single blossoms and small clusters, such as those in Figs. 4, 5, 6 and 8, use plain cardboard backgrounds colored black, white and a neutral gray or brown. Use a camera with a double-extension bellows. Usually a medium-speed "pan" film gives best results, and a light-yellow filter gives a better rendering of the color values on black-and-white film. Large bouquets, like that in Fig. 1, should be arranged so that all the blooms are as nearly as possible in a plane parallel with the film. In this way each of the flower clusters will be within the area of sharp focus.

FAVORITE FLOWERS

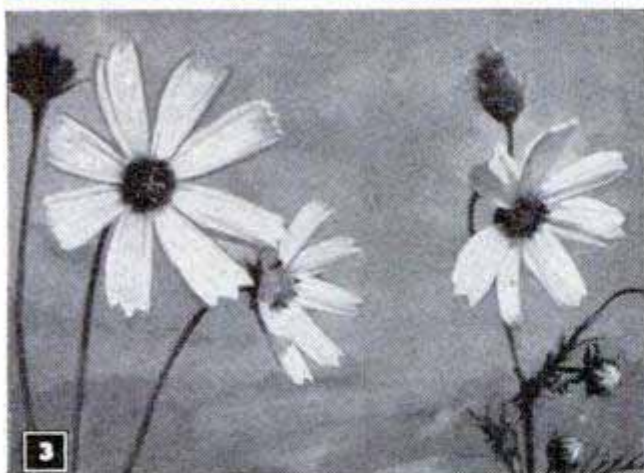

A cloud background gives blossoms individuality and at the same time a feeling of depth and naturalness. Photo was taken with the setup shown in Fig. 2

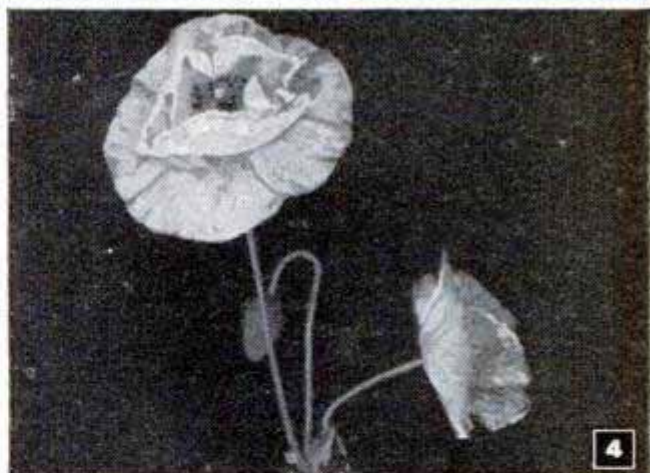

As a rule, large blossoms with brightly colored petals photograph best against a medium-dark background. Flowers should not be grouped in large bouquets



Above and below, two ways of photographing blossoms that flower in clusters where foliage must be included. Shoot close-up, as above, or arrange an open bouquet with subdued background detail (below)

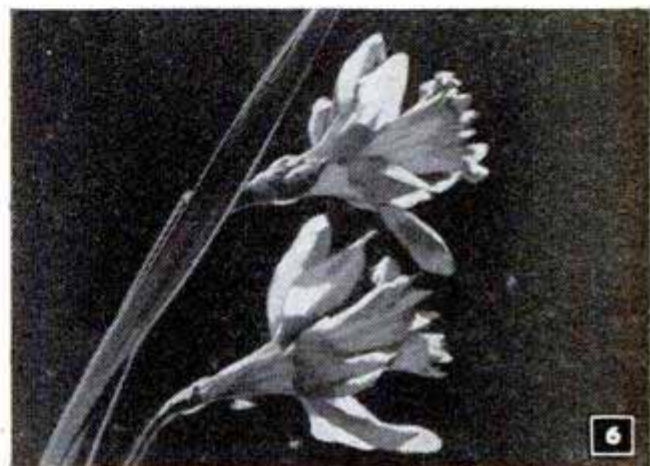

Above, notice how back lighting is used to outline detail in the blossoms and stems. Dark background "hardens" the outlines. Below, careful lighting renders fine detail, but be sure there are no shadows

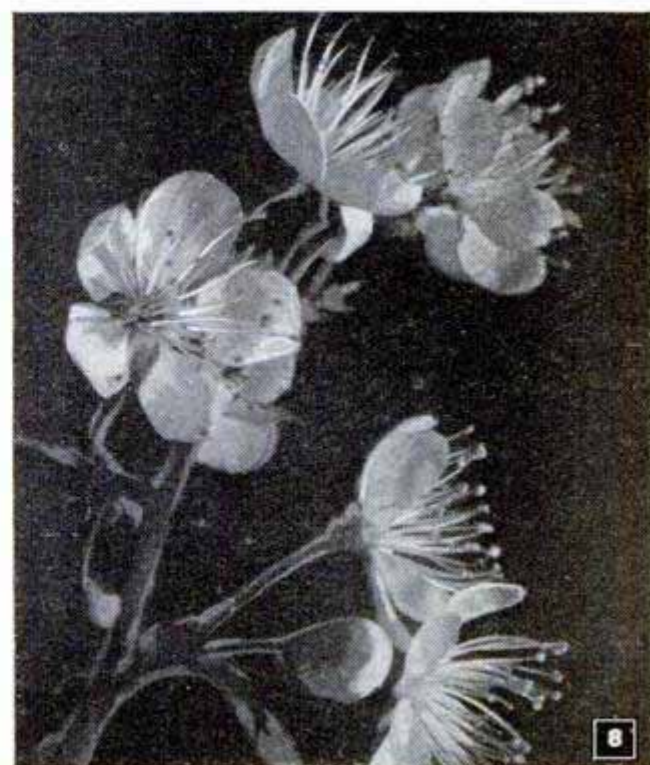

Portable Trellis on Weighted Bases Easily Moved Into Sun or Shade

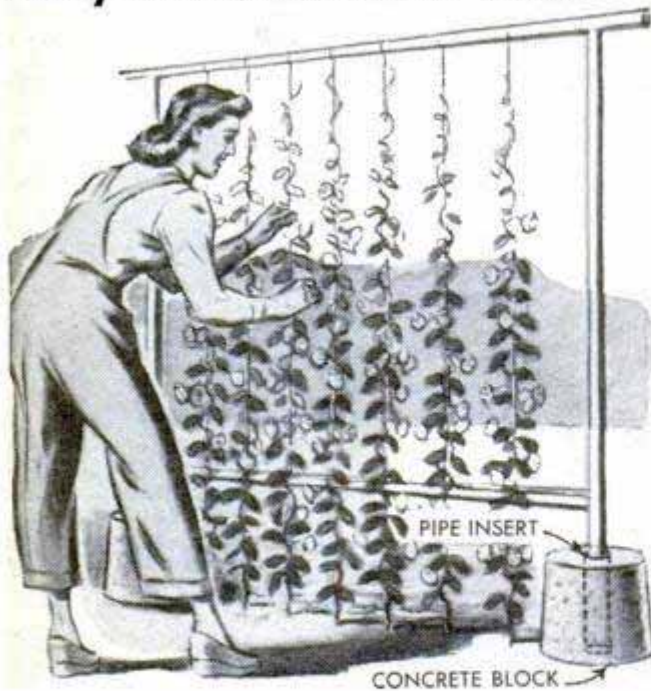

Here's a portable trellis that has a distinct advantage over a fixed one in that it can be moved easily to meet the sun or shade requirements of any particular plant. If you wish to grow a certain ivy or climbing rose which must have shade, it's a simple matter to set up the trellis in a shaded spot and vice versa for plants requiring sun. Concrete blocks set on top of the ground are cast around pipe sockets in which the uprights are inserted. If cylindrical-shaped concrete blocks are used, they may be rolled from place to place in the yard.—Opie Read, Jr., Chicago.

Shrinking Model-Airplane Paper

One model-airplane builder found that throat swabs are handy for applying water to shrink the paper covering on wings and fuselage surfaces. However, any similar stick can be used if one end is wrapped with cotton. The swab spreads the water evenly and prevents tearing the paper.

"Pin Up" Candlestick

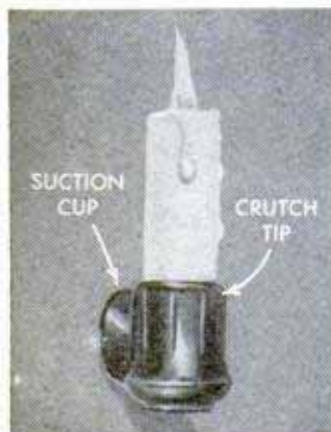

When the lights fail, or where electricity is not available, here's a handy candlestick that can be stuck to a wall right where you want it when making emergency plumbing or electrical repairs in a basement. It consists

of a rubber suction cup attached to a rubber crutch tip. Use a suction cup which has a machine screw embedded in it and fasten it to the crutch tip by inserting the screw through a hole and tightening a nut on the inside. The suction cup should be a size that will hold the candle far enough from the wall to prevent the flame from scorching paint. Wetting the suction cup will help to make it adhere.

Herman Klein, Pittsburgh, Pa.

Luminous Paint Applied to Flashlight Aids Finding It in Dark

Much time can be saved and trouble avoided when trying to find a flashlight in the dark, if luminous paint has been applied to the rim of the flashlight-lens holder. Most paint of this type will retain its luminosity for a considerable length of time. A small artist's brush may be used to apply the paint to the rim.

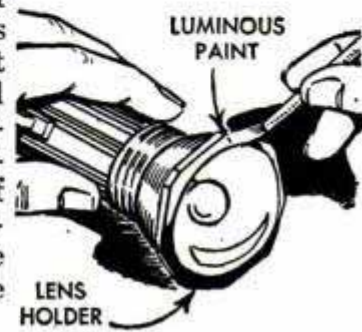

Safety-First for Baby's Swing

Eliminate the possibility of the baby's swing jumping off the hook from which it is suspended by placing a screw eye at

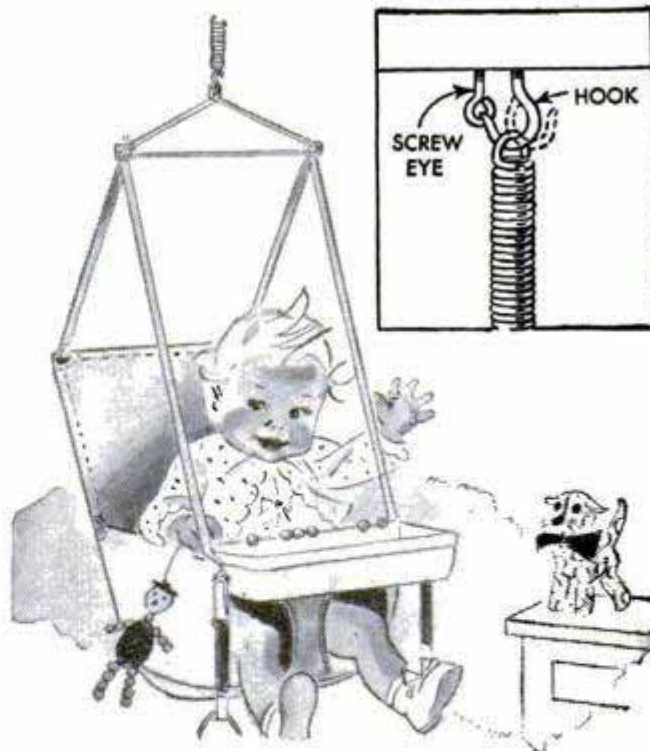

the end of the hook as shown. This arrangement will prevent the loop at the end of the spring from becoming disengaged. To remove the swing, merely turn the hook away from the screw eye.

Film-Tank Agitator of Pipe Is Motor Driven

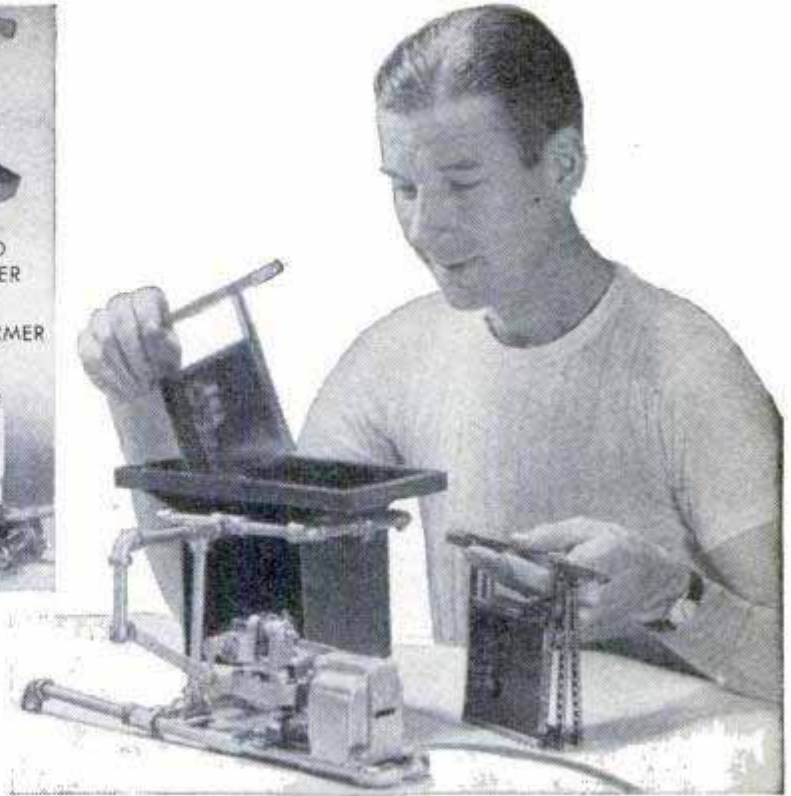
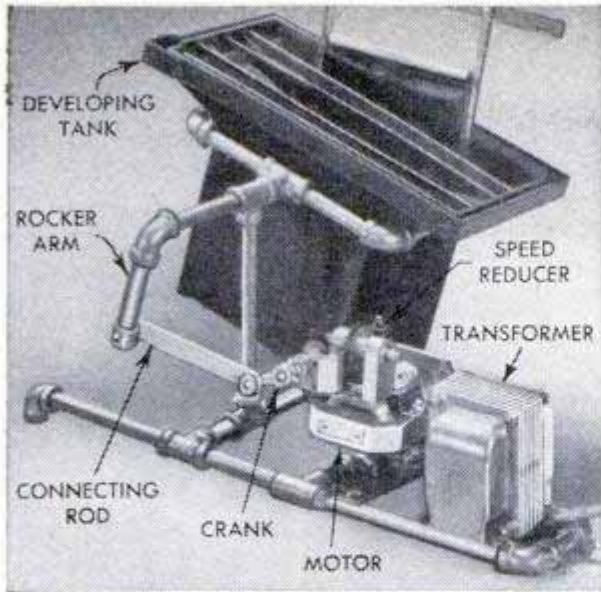

Made entirely from standard pipe nipples and fittings, this film-tank agitator is operated by a speed reducer coupled to a small 6-volt electric motor and transformer. The speed reducer (60 r.p.m.) and motor, which are available at electrical stores, actuate the film-tank cradle by a flat-iron connecting rod. Although designed for a standard cut-film tank, the unit also will accommodate a roll-film tank if a circular opening is cut in a piece of plywood for the tank which then is placed on top of the cradle. Reamed pipe tees form bearings or pivot points for the shafts of the cradle, the latter being assembled in one piece by means of two unions. The shaft to which the rocker arm is fastened is attached after the cradle is in position. Note that the base of the agitator requires soldering or welding two of the connections; otherwise all pipe parts merely are threaded into one another. The transformer and motor are anchored to the frame with machine screws.—Del Naylor, Chicago.

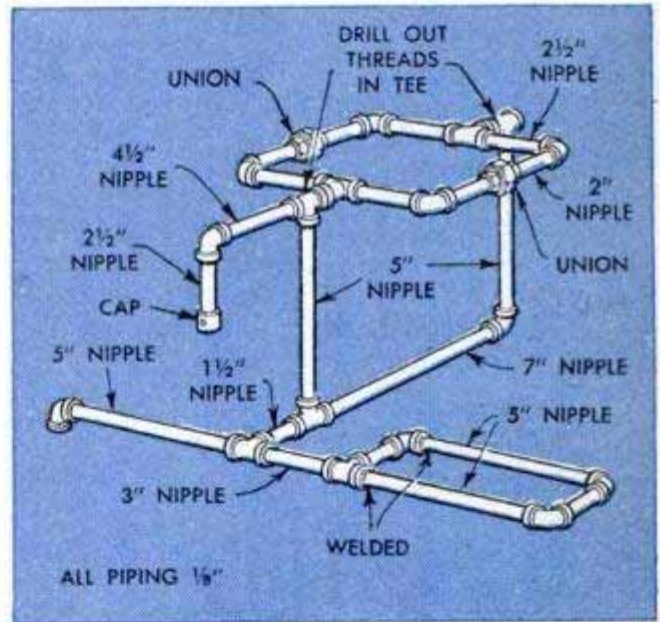

Static Electricity Better Than Brush to Remove Dust From Negatives

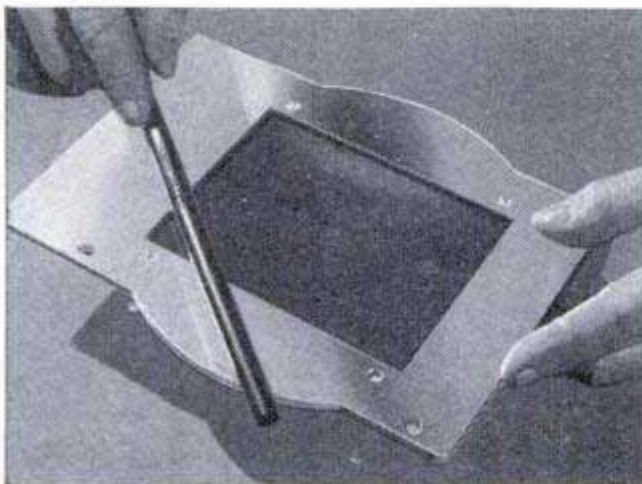

When dusting a negative before making an enlargement, a small brush is sometimes used which merely spreads the dust around instead of removing it. However, if a hard-rubber rod or a comb is charged with static electricity by rubbing it briskly on woolen clothing, and then passed over the negative, it will pick up the particles of dust, leaving the surface clean.

☐ If for any reason regular lens-cleaning tissues are not available, the soft filter paper that is used in glass coffee makers provides a good substitute. This paper is sold in most grocery stores.

IT'S FOR GOLFERS ONLY

DIFFERING from the usual caddie cart which carries the golf clubs in a bag, this one carries them handle-end up, Fig. 1, for easy and quick selection. In addition, the cart has a built-in locker for storing golf balls, shoes, etc., and a protective cover which can be provided for the clubs in case you are caught in the rain. The cart has two club racks, one for the woods and putter and the other for the irons. Its body of $\frac{1}{16}$ -in. sheet aluminum is mounted on a sturdy flat-iron chassis equipped with 14-in. rubber-tired wheels.

To start building the cart, form the chas-

sis from flat iron, Fig. 3. Two flat-iron braces, 14 in. long, and an axle are bolted crosswise to the side members. The sheet aluminum covering the bottom and sides of the chassis is cut in one piece, following the squared pattern in Fig. 2. Rivet this piece to the underside of the chassis, but do not bend up the flaps. Bend the body next, rounding the top and shaping the lower portions for the club racks. The

By Everett W. Williams

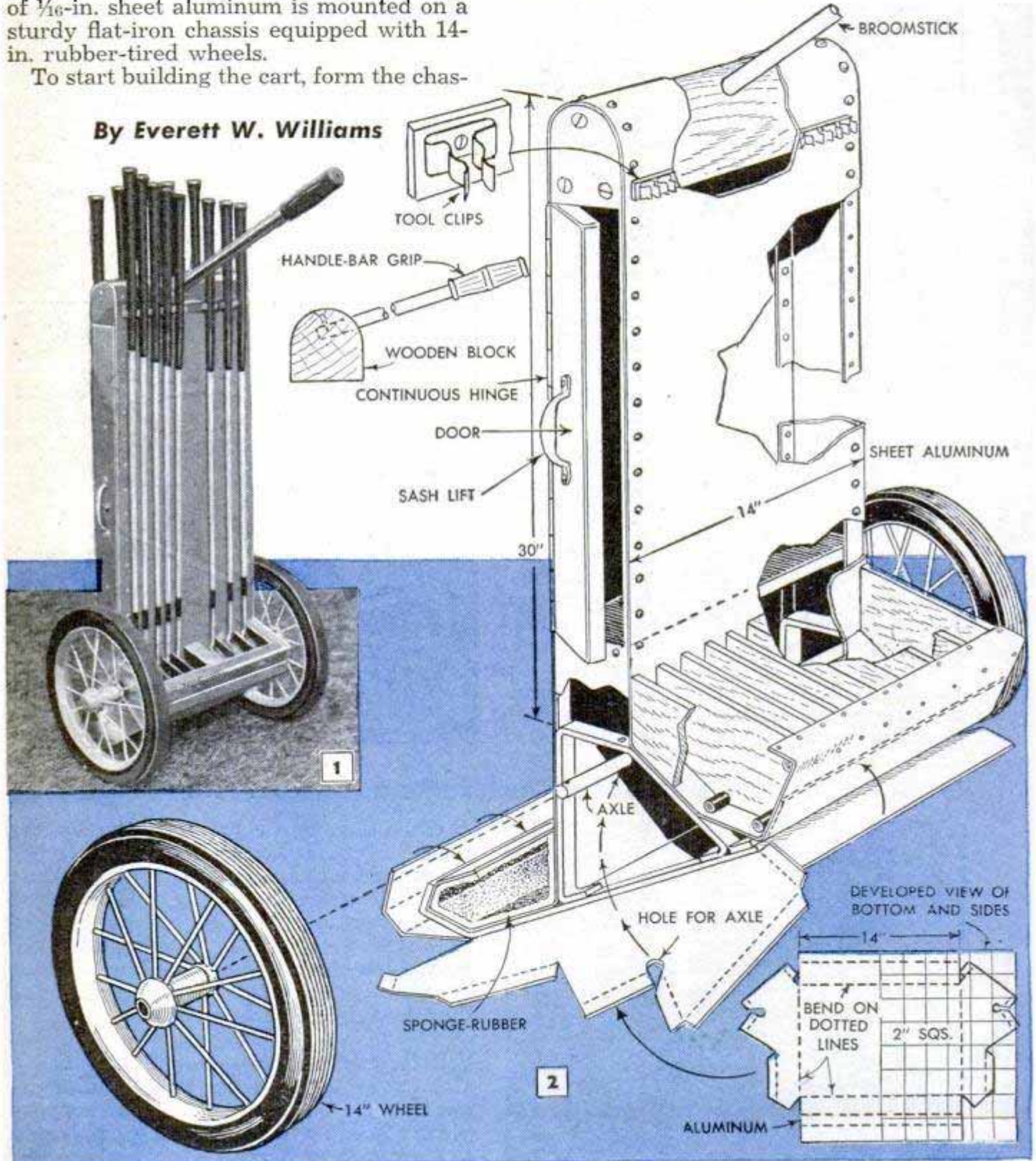

wooden block at the top of the body and all the club-rack spacers, except those on the outside edges, must be screwed in place at this time. Note that the center spacer in the front rack is thicker than the others to compensate for the width of the handle. Before inserting the club spacers, make bumpers for the front rack, Fig. 3, by pushing lengths of dowel inside $\frac{1}{4}$ -in. hose. The spacers are notched to hold the bumpers in place. Reinforce the sides of the body along the locker door with pieces of flat iron extending from the top of the chassis to the underside of the wooden block. The support along the front wall is riveted from the bottom of the block to the locker-floor line. The locker door is fashioned from a piece of aluminum by bending the edges square and aluminum-soldering or riveting the corners. After attaching the door to a continuous hinge, rivet together the hinge leaf, the flat-iron support and the rear wall of the body all at one time, but do not rivet below the locker-floor line.

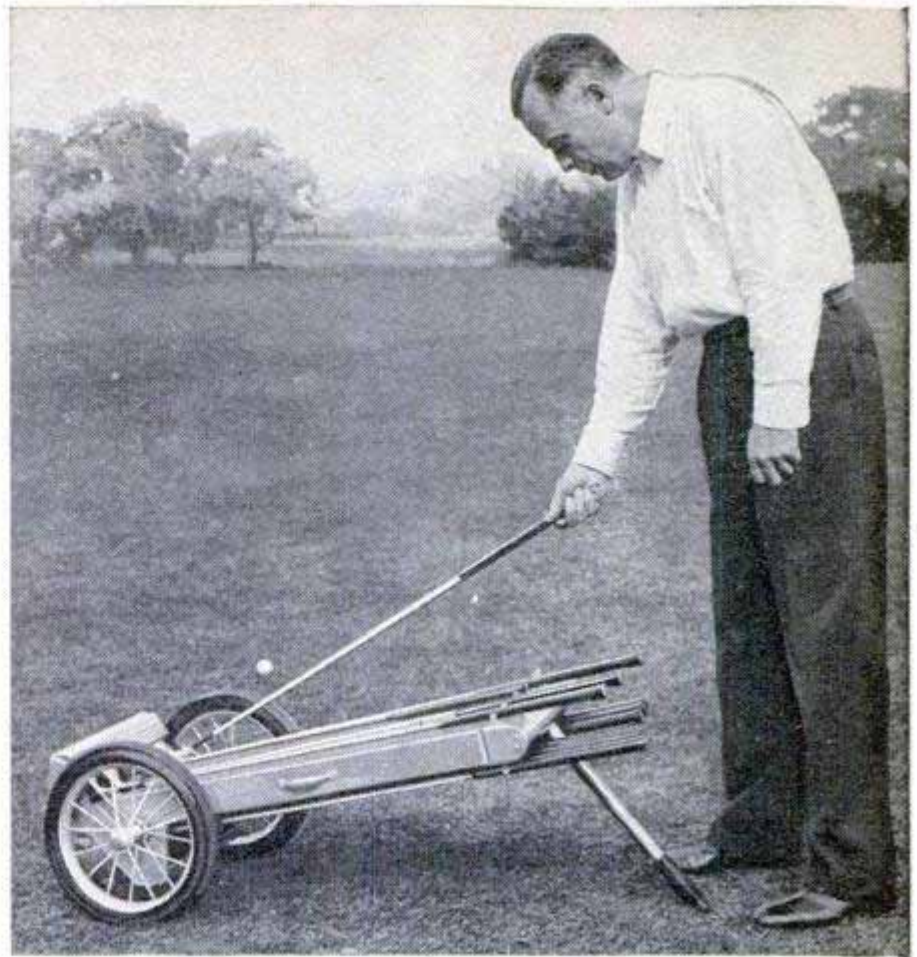

Now, form a long, channel-shaped piece of aluminum to enclose the opposite side of the body. A tab to cover the end of the body block, similar to the one at the opposite end, is included at the top of this piece. When riveting the channel in place, allow for inserting side-flap tabs later.

When the body is completed this far, rivet it to the chassis. Then bend the side and end flaps, install the outer spacer blocks and fasten the flaps and tabs with screws and rivets. Fit a wooden floor in the locker, fastening it with roundheaded screws, and rivet a small aluminum panel below the locker door. Sponge-rubber padding is glued between the spacers of the rear club rack. Drill a hole in the top of the unit for the broomstick handle, which is anchored with a countersunk flat-headed screw. The end of the broomstick is fitted with a bicycle handle-bar grip. Tool clips are screwed to the body block to hold the golf-club handles.

Aluminum rivets and cadmium-coated bolts and screws should be used throughout, or if metal screws are used instead of rivets, these also should be cadmium coated.

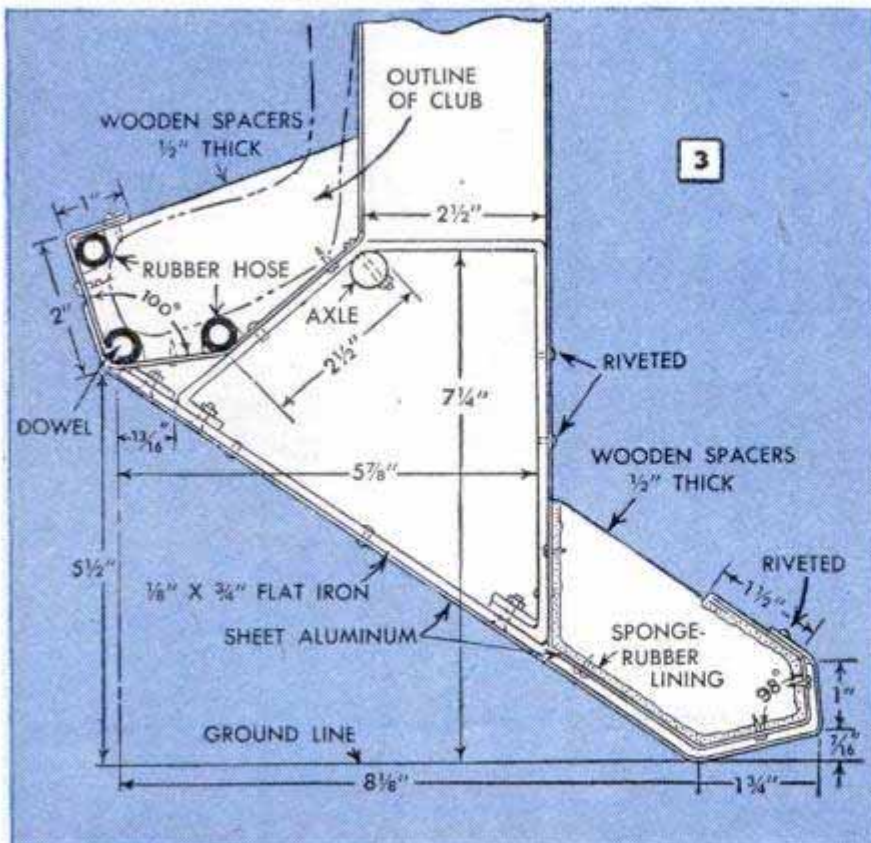

Fishline Can Be Dried on Rod With Clothespin Reel



For convenience, it's hard to beat this method of drying a fishline. All that's needed are two spring-type clothespins, which are clipped to the rod several feet apart so the line can be wound over them as it is unreeled.

Keeping Crawfish in Warm Weather



In warm or hot weather, it's easy to keep crawfish alive in this improvised "ice-box." One fisherman uses a pail, packs the bottom with ice, and then covers it with screen wire and a layer of grass. The crawfish are

placed on top of the grass and, in turn, are covered with several thicknesses of newspaper and a wet burlap sack. This will keep them lively for some time.

Nail Rides Coil Window Balance To Take Up Side Play

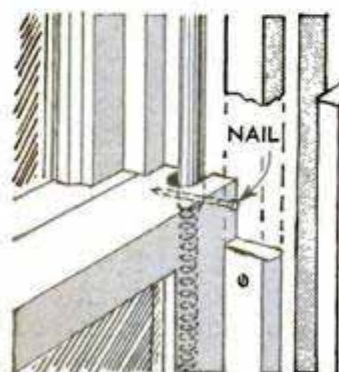

If window sash are grooved too deeply when cutting a track in the edge for a spring-type sash balance, you can take up the play of the balance in the groove by driving a nail crosswise

through the lower sash as shown. The nail is located to ride freely against the tubular casing of the balance when the sash is raised and lowered. It prevents the end of the tubing from digging into the sash and making it difficult to raise. Remove the window stop, and with the sash in a closed position, drive the nail only part way so that it can be removed if it interferes at any point with the opening and closing of the window. Slide the sash up and down several times to be sure it does not bind. If desired, a small metal plate can be used instead of the nail. The plate is notched to fit around the tubing with slight clearance and is screwed in position to the top edge of the sash.

Adjustable Hanger Aids Painting Screens and Storm Sash

You'll find it more convenient to paint both sides of window screens and storm sash if they are hung from this simple hanger which is fastened to a basement joist. It consists of a wooden strip to which are screwed the hook parts of a screen-and-sash hanger set. One hook is fastened in a fixed position and the other slides in a slot to accommodate screens of different widths. Wing nuts make it easy to adjust the sliding hook. When the distance between the hooks suits the spacing of the eye plates on the screen itself, the screen is hung on the hanger the same as on a window. When both sides are painted, the screen is lifted off ready for the next one.

Samuel Silberman, Bayside, L. I., N. Y.



GAUGE BLOCKS

a standard for measurement

By Alexander Maxwell

PRECISION gauge blocks are used in all well-equipped shops to establish basic measurements for the purpose of laying out and producing parts of identical size. When critical measurements are necessary in laying out work on which machine operations are to be held within extremely close limits, the use of gauge blocks speeds up the preliminary operations and practically eliminates the reworking of jobs due to faulty scales or an error in taking readings.

When a number of blocks are to be used together to establish a measurement or to check the accuracy of other measuring instruments, they should be cleaned thoroughly with a soft tissue or chamois. Blocks from which the protective coating of grease or light oil has not been removed, cannot give accurate measurements. After cleaning, the blocks must be "wrung" together as in Fig. 4, steps A, B and C. Although easy to do, the process of wringing gauge blocks requires delicate finger work. First, the two blocks are placed together centrally, as in A, to prevent scratching one block with a corner of

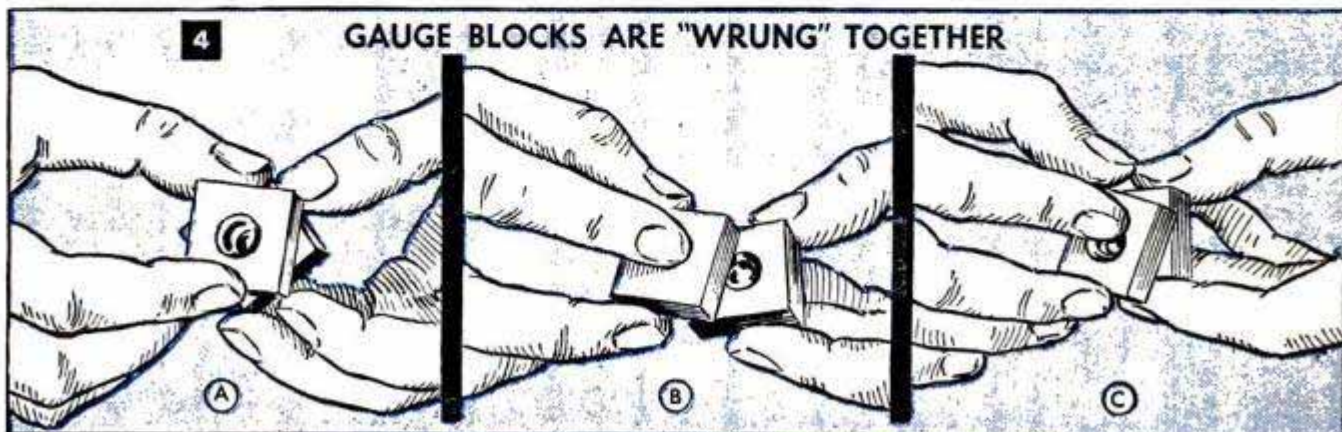
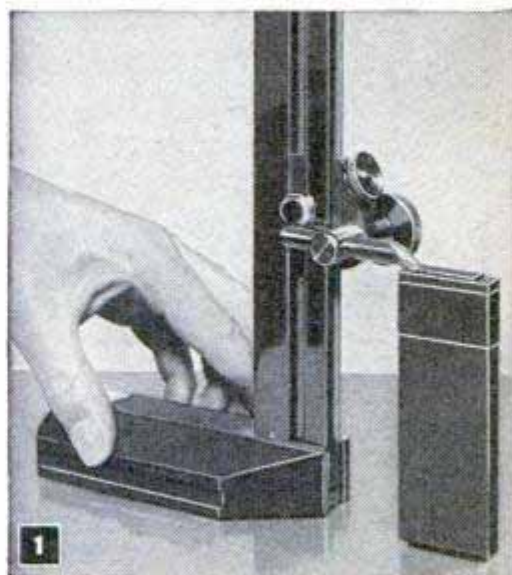

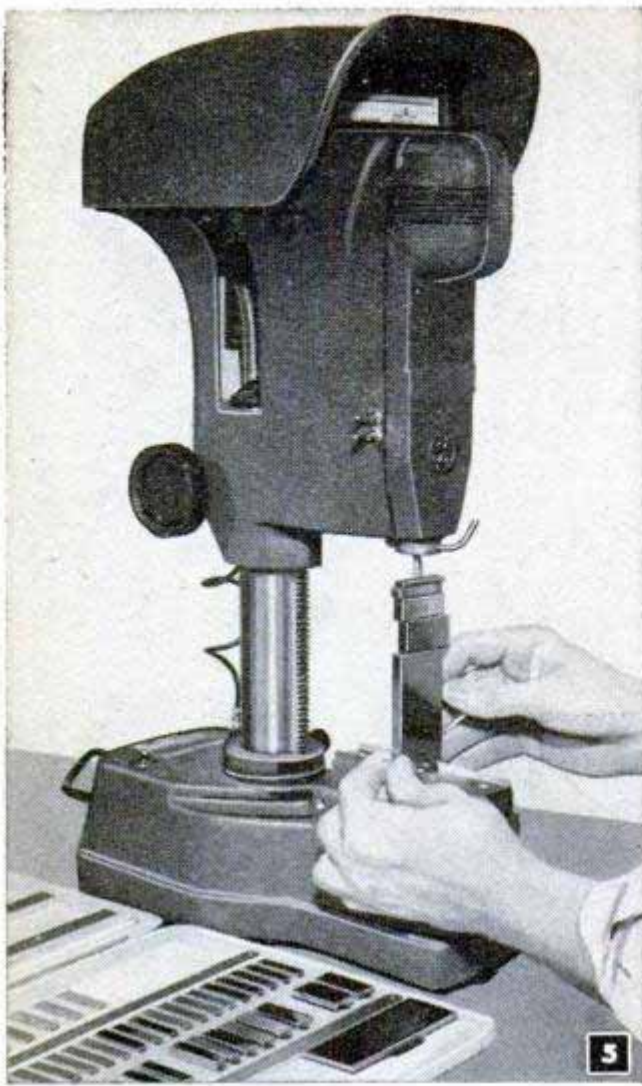

the other. Then the blocks are given a quarter turn and slid partially apart, as in B. Note that the blocks are only a little more than half out of engagement in this second position. In the third step, detail C, the blocks are slid back into full contact, being given a slight twist simultaneously so that the edges of both blocks are squared one with the other. This simple procedure excludes all air between the meeting surfaces and gives the complete metal-to-metal contact so essential to accurate work. Never leave the blocks wrung together for more than a few hours at a time. If left for longer periods it will be difficult to separate them. If it is necessary to use the same stack of blocks over a longer period of time, they should be separated and wrung together again. Always separate blocks by reversing the process of wringing together. Coat with grease when not in use.

Several common applications of gauge blocks are shown in Figs. 1, 2, 3 and 5. In Fig. 1, the height of the scribe point is being set accurately with a stack of blocks, both scribe pedestal and blocks being placed on a surface plate. Fig. 2 shows one method of setting an adjustable snap gauge, while in Fig. 3 a single block is used to check the accuracy of a small micrometer. Sensitive limit gauges are set with blocks as in Fig. 5. The accuracy of the setting is dependent on the scale reading and the sensitivity of the instrument.

Chain Attachment Adapts Bench Vise for Holding Pipe and Rod Stock

There's double duty to be had from a machinist's vise when it is equipped with this auxiliary attachment, as it then can be used for holding pipe and rod stock. The attachment is operated by movement of the vise jaws, and it pivots on a steel pin pressed in the side of the movable jaw.

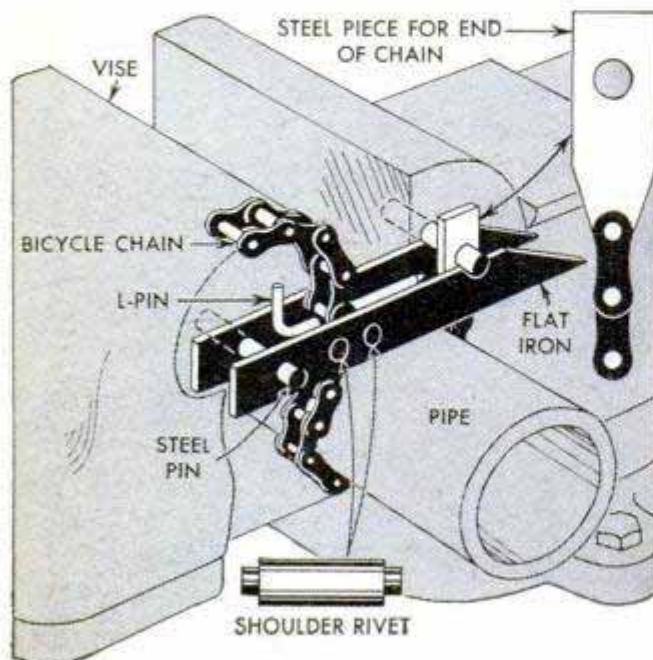

Two flat-iron pieces are spaced apart by two shouldered rivets and a length of bicycle chain is passed between the two rivets and held with an L-pin which provides the necessary adjustment. The opposite end of the chain is riveted to a flat-iron link which fits over a pin in the rear jaw. Note that at the rear the flat-iron members bear against the underside of the pin. In use, the chain is wrapped snugly around the pipe and is held with the L-shaped pin. A slight pressure on the vise handle causes the chain to grip the pipe tightly and prevent it from turning.

Iron Pipe Protects Wagon Endgate

To prevent damage to the front endgates of his wagon when using it behind a mechanical cornpicker, one farmer mounted a length of iron pipe across the front of the wagon box above the endgate. He supported the pipe by a piece of flat iron bolted vertically to each side of the wagon so that it projected about 2 in. above the top of the wagon box. The flat iron is drilled to take an endgate rod which is passed through the pipe to hold it in place.

Sea Craft

a 25-ft.

CABIN CRUISER

Part IV

BY EDWARD COLBY



Top of engine compartment in cabin serves as table when preparing food

THE SIZE of the cabin and the arrangement of the bunks, cabinets and bulkheads is a matter of personal choice and may be changed without affecting the performance of the boat. If more headroom is required, the cabin sides can be made higher or, if less headroom is desired, the cabin floor may be raised slightly. Also, the length of the cabin can be shortened to provide a larger open cockpit. However, regardless of the changes made, the methods of construction shown in the drawings should be followed. All structural members must be fastened to the frames, never directly to the hull planking. Stock-size fir or spruce can be used for most of the framing and the plywood must be of the type made especially for marine use.

Sea Craft's forward deck extends from the bow to station 2. Two deck stringers,

shown in the upper drawing of Fig. 42, are bolted to the aft and forward sides of the frames at stations 1 and 2 as shown in Fig. 38 of Part 3. The top edges of the stringers are notched for the cradle of the freshwater tank and a 1½ by 6-in. center beam, which is bolted to the stringers as shown in Figs. 30 and 38 of Part 3. The shape of the cradle, which is made of 1½ by 3-in. oak, must be determined by the tank dimensions. Refer to the perspective drawing, Fig. 33, for clarification. The frame for the hatchway opening, indicated in Fig. 38, projects 2 in. above the stringer. This opening gives access to the chain locker, which is floored and partitioned as shown in Figs. 30 and 42. Cleats of 1 by 1-in. stock, screwed to the sides of the hatchway frame flush with the top edge of the stringer, support the ¼-in. plywood, which is screwed

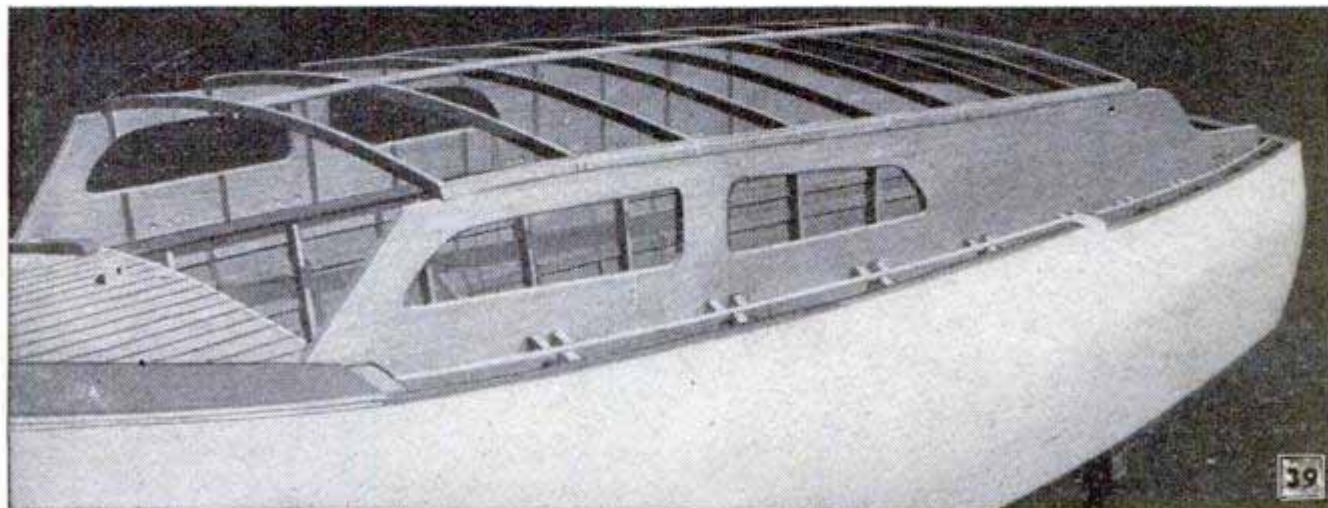

40 PLAN VIEW—CABIN TOP, SHELF AND STERN DECK REMOVED ON STARBOARD SIDE

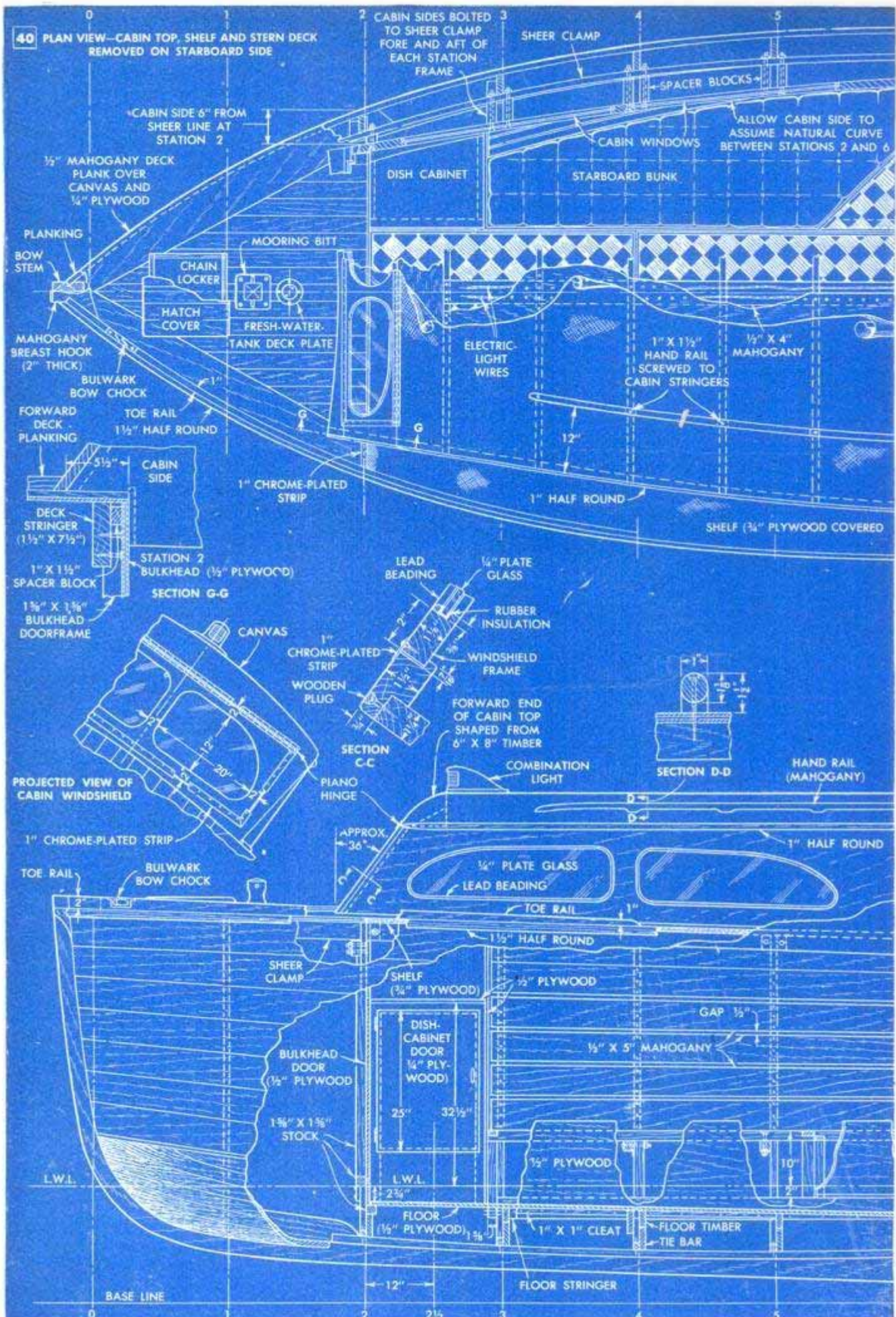

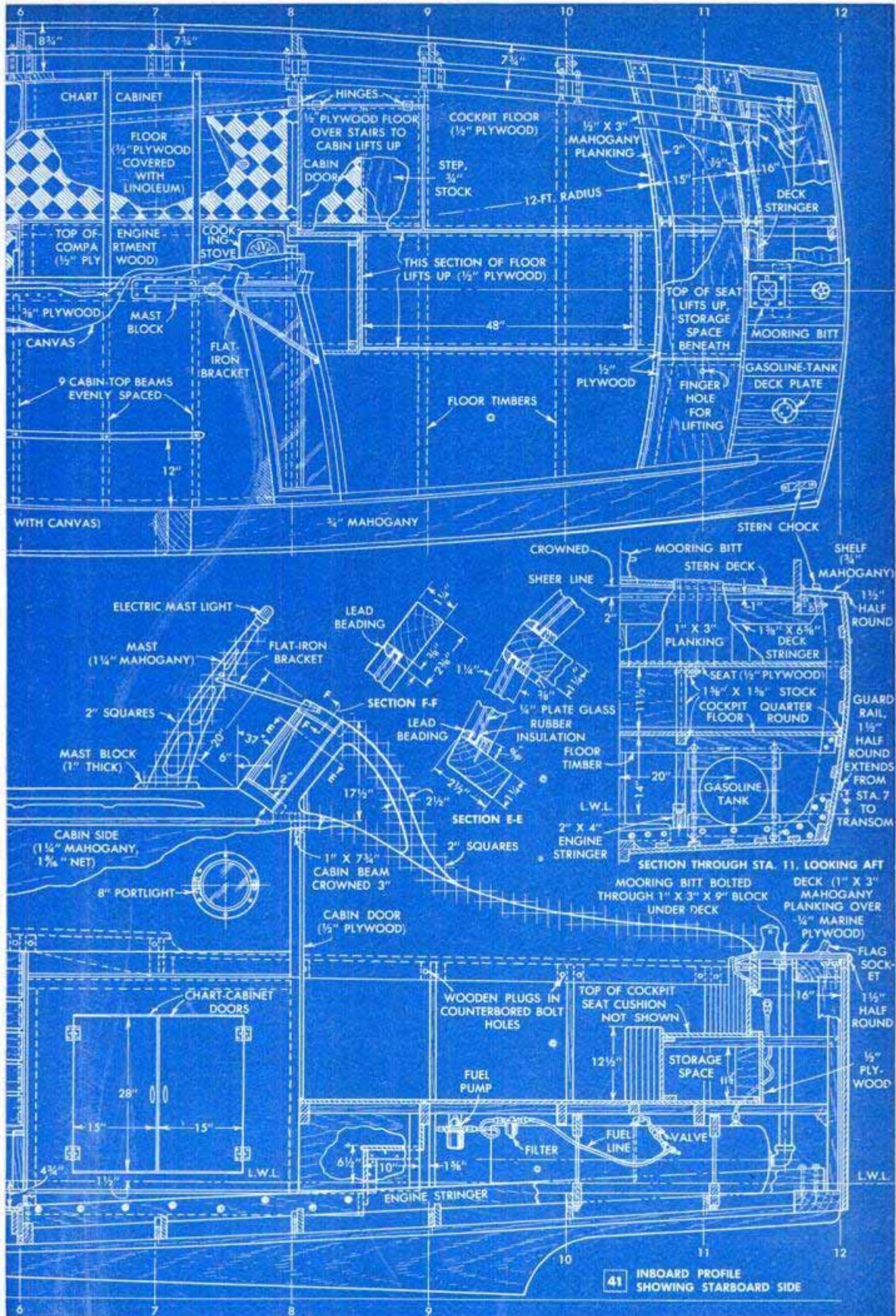

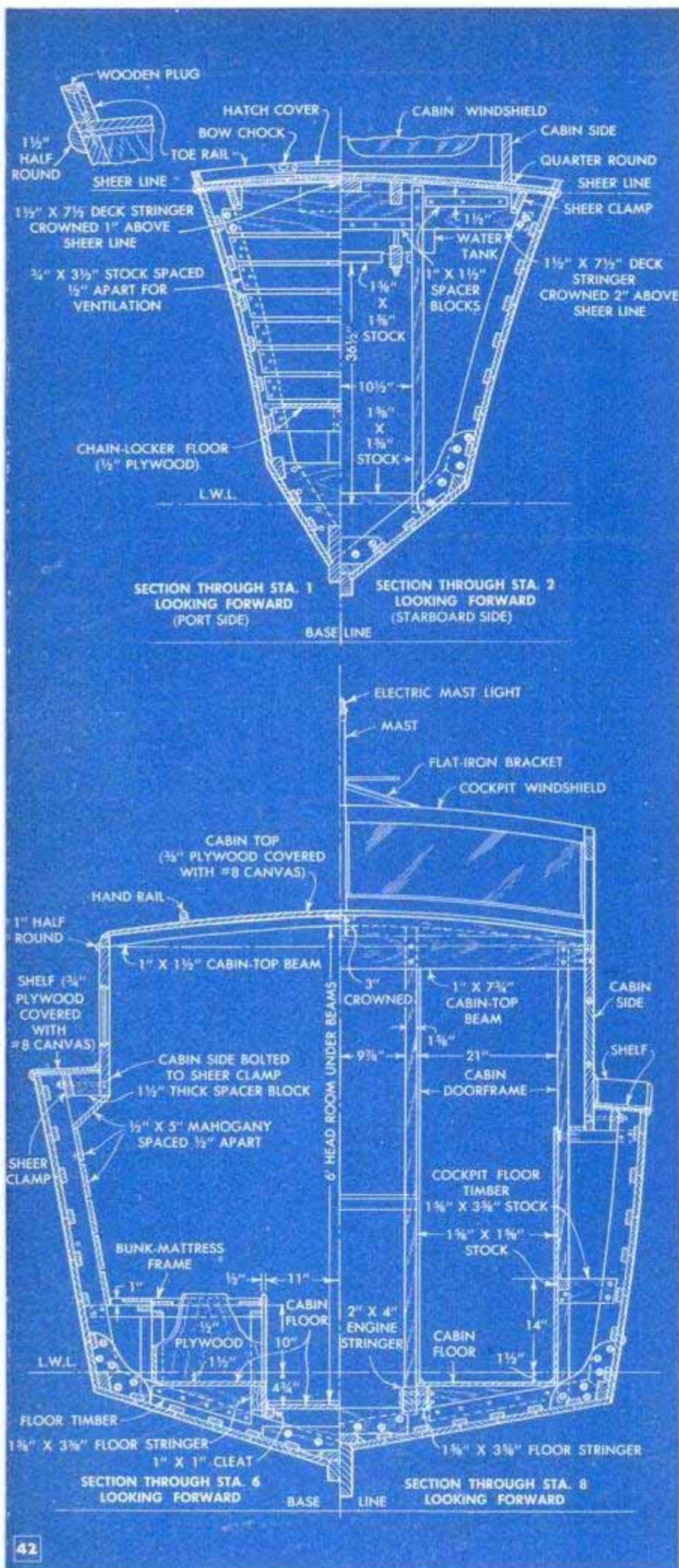

down to cover the entire deck area. After the plywood has been covered with marine glue and canvas, it is planked with 1/2 by 3-in. mahogany. The white lines between the planks are made by beveling the planks slightly, as for calking, and then filling the resulting grooves with sealing compound. Although the 3-in. planking can be laid to the sheer line, a margin plank on each side, as in Fig. 40, will improve the appearance. Details of the bulkhead at station 2 are given in Figs. 41, 42 and 43 and also in Fig. 34 of Part 3.

The cockpit floor is supported by timbers which extend athwartships and bolt to the forward sides of frames 9, 10 and 11 and the aft side of frame 8. A portion of the cockpit floor timber at station 8 is sawed out later for the stair well to the cabin. Note in Fig. 40 that the center section of the floor is removable and that it rests on two strips of 1 5/8 by 1 5/8-in. stock which are notched into the athwartship floor timbers. The outboard edges of the strips are located directly above the engine stringers. These pieces extend from station 8 to the vertical transom braces. Fig. 37 of Part 3 shows this section of floor removed.

The stern-deck stringer, which is crowned 2 in., the same as the top transom timber, is placed 16 in. forward of the transom and lag-bolted to a 3-in. knee block fastened to the sheer clamp and transom timber as indicated in Figs. 40 and 41.

The cabin sides are installed next. First make the 1 1/2-in.-thick spacer blocks shown in Fig. 40. Considerable fitting will be required when installing the blocks. The in-board edges of the blocks must be perpendicular to

the base line and their top edges must be on a slight downward angle to the sheer line to coincide with the 2-in. crown of the decks. When fitted, toenail them to the sheer clamp. Note that the dimensions for the blocks at stations 3, 4 and 5 have been omitted. These blocks are installed after the cabin sides have been clamped in position.

Each cabin side is made up of three pieces of $1\frac{1}{4}$ -in. ($1\frac{3}{16}$ in. net) mahogany, splined and glued as indicated in Fig. 31 of Part 3. The total width of the glued-up boards should be not less than 28 in. If three $9\frac{1}{2}$ -in. boards are used, each side will require two pieces 20 ft. long and one piece 16 ft. long. However, if the headroom is to be increased, the width of the cabin sideboards must also be increased. To lay out the shape of the sides, joint the seam edges of the boards and lay them together on a flat surface. As the lower corners of the cabin sides are notched to fit $3\frac{1}{2}$ in. below the sheer line between the bulkhead at station 2 and the stern-deck stringer, the developed length must be obtained. This can be done best by fairing a batten against the blocks and cutting it off to fit between the bulkhead and the stringer.

With the batten in place, mark the position of each station on it, then remove, place on the cabin sideboards and transfer the station locations to the sideboards. Draw lines across the boards perpendicular to the seams at the station marks and ends of the batten. Note in Fig. 40, section G-G, that the cabin side projects over the forward deck $5\frac{1}{2}$ in. A chalk line parallel with and $6\frac{1}{4}$ in. above the L.W.L. is

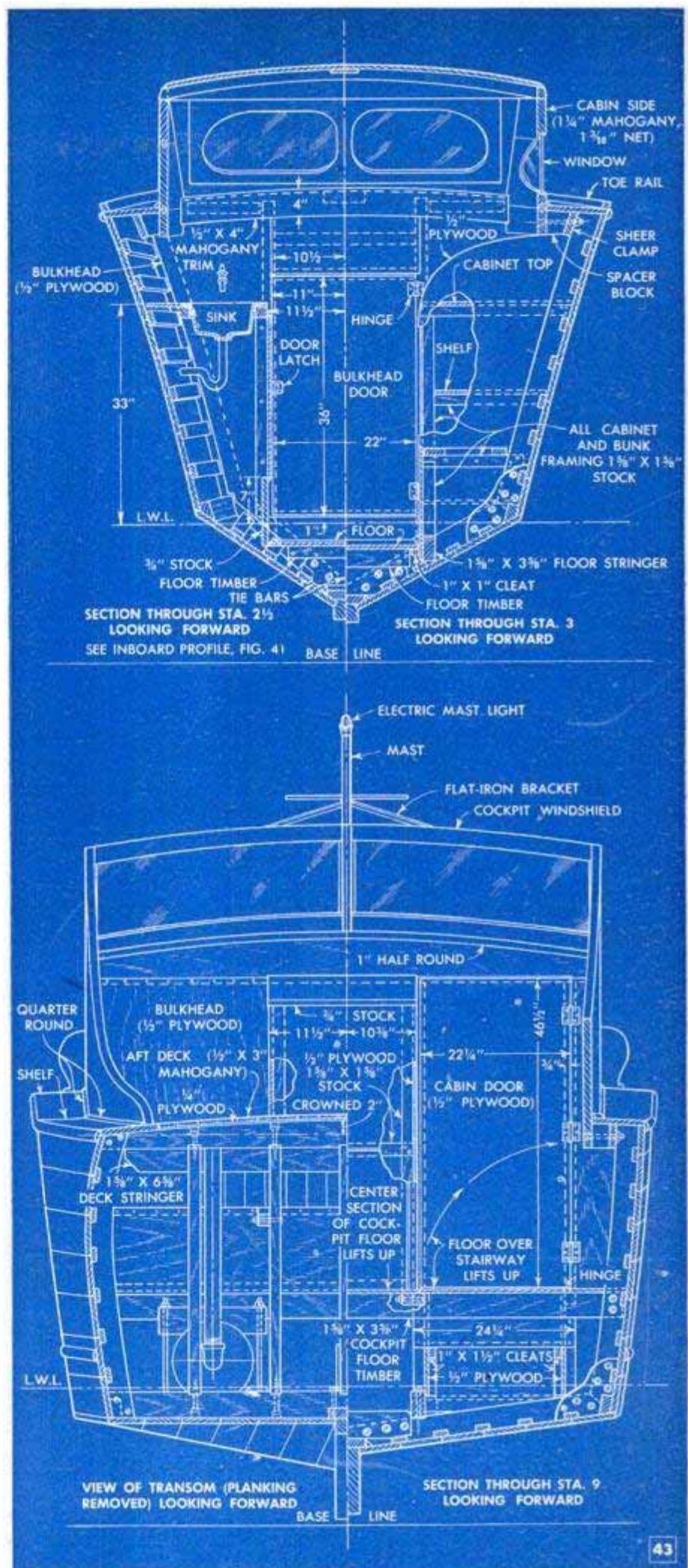

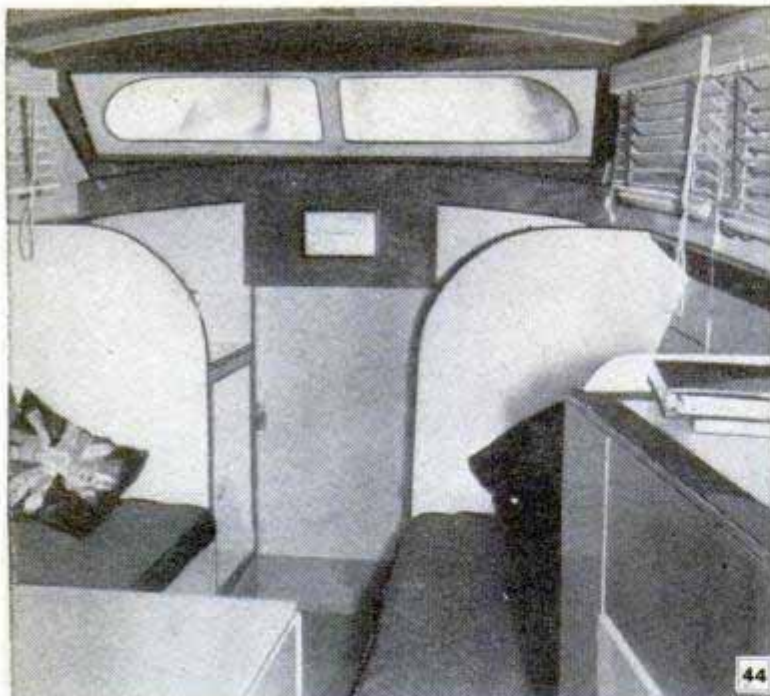

View showing interior of cabin, looking forward. Top corner of engine compartment at left foreground, chart cabinet at right

stretched between two temporary upright braces at station 2 and the transom to represent the top of the cabin sides. The distance between the chalk line and the bottom of the sheer clamp or blocks at each station is measured and transferred to the cabin sideboards. A line connecting these points gives the bottom cutting line of the cabin side. The line between stations 6 and 7 drops abruptly because of the sheer drop. The curved lines of the cockpit sides and cutouts for the windows are drawn free-hand with aid of a pattern of squared lines drawn lightly on the boards as in Figs. 30 and 41. The aft ends of the cabin sides project about $1\frac{5}{8}$ in. over the stern deck. When cutting the spline grooves, stop them so they will not run out in the end grain of the windows and the curve of the cockpit sides. The forward edge can run out as it is covered by the windshield frame. When assembling the boards, use marine glue and clamp securely until dry. Then lay out the port-light hole and the forward end which slopes about 36 deg. off the vertical. After sawing, rabbet the edges of the window openings as shown in Fig. 31 of Part 3, to take the plate-glass windows, which are installed later. As both cabin sides are the same, the completed one can be used as a pattern to lay out the second side. Care should be taken to make the rabbeted edge around the window openings on the outside of each piece.

When installing the cabin sides, nail temporary tie bars across frames 5, 6 and 7 just below the sheer clamps, and use timbers and wedges or automobile jacks at stations 6 and 7 to force the cabin sides against the spacer blocks. Before making the spacer

blocks for stations 3, 4 and 5, wedge and clamp the cabin sides until they are fairly straight between stations 2 and 5 so the window glass will seat tight against the rabbeted edges. When the sides are clamped firmly in position, bolt them to the sheer clamps at each spacer block with large-headed, $\frac{3}{8}$ -in. galvanized carriage bolts. Countersink all bolts and plug the holes for neat appearance.

Before removing the clamps, install the cabin-top beams shown in Fig. 40 and Fig. 35 of Part 3. The forward beam is placed $7\frac{1}{4}$ in. aft of the forward top corners of the cabin sides. The other frames are spaced uniformly with one directly above the frame at station 6. They are screwed to the top edge of the cabin sides and have filler blocks between them as in Fig. 39 and Fig. 31 of Part 3. The aft beam is

cut off flush with the inboard sides of the cabin sides and screwed to the 1 by $7\frac{3}{4}$ -in. beam shown in Figs. 41 and 42. The top sides of the beams are notched in the center to take a $\frac{1}{2}$ by 4-in. piece of mahogany as shown in Fig. 40.

Stock-size lumber is used for the cockpit-bulkhead framing dimensioned in section 8 of Fig. 42. The framing for the engine compartment, toilet room and chart cabinet, shown in Figs. 30 and 35 of Part 3, is an integral part of the bulkhead framing and should be installed at this time.

(To be continued)

Large Fuel-Settling Bowl Made From Fruit Jar

For a boat where water in the gasoline is a problem and the small sediment bowl requires constant attention, an efficient settling bowl of larger capacity can be made from a quart-size fruit jar. Obtain a jar with a screw-type

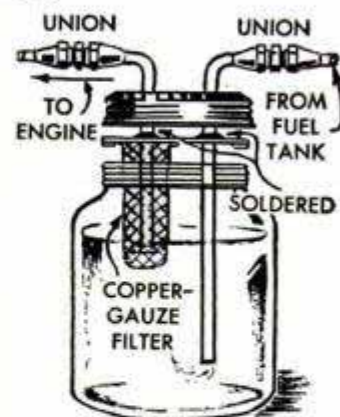

metal cap and two pieces of copper tubing, one long enough for the intake and a shorter piece for the outlet. Solder the tubing to a metal disk as indicated, and cover the outlet tube with fine copper gauze to filter foreign matter that may not settle in the tank. Mount the jar in a convenient position in the fuel line.

SPREADER for DRY FERTILIZER

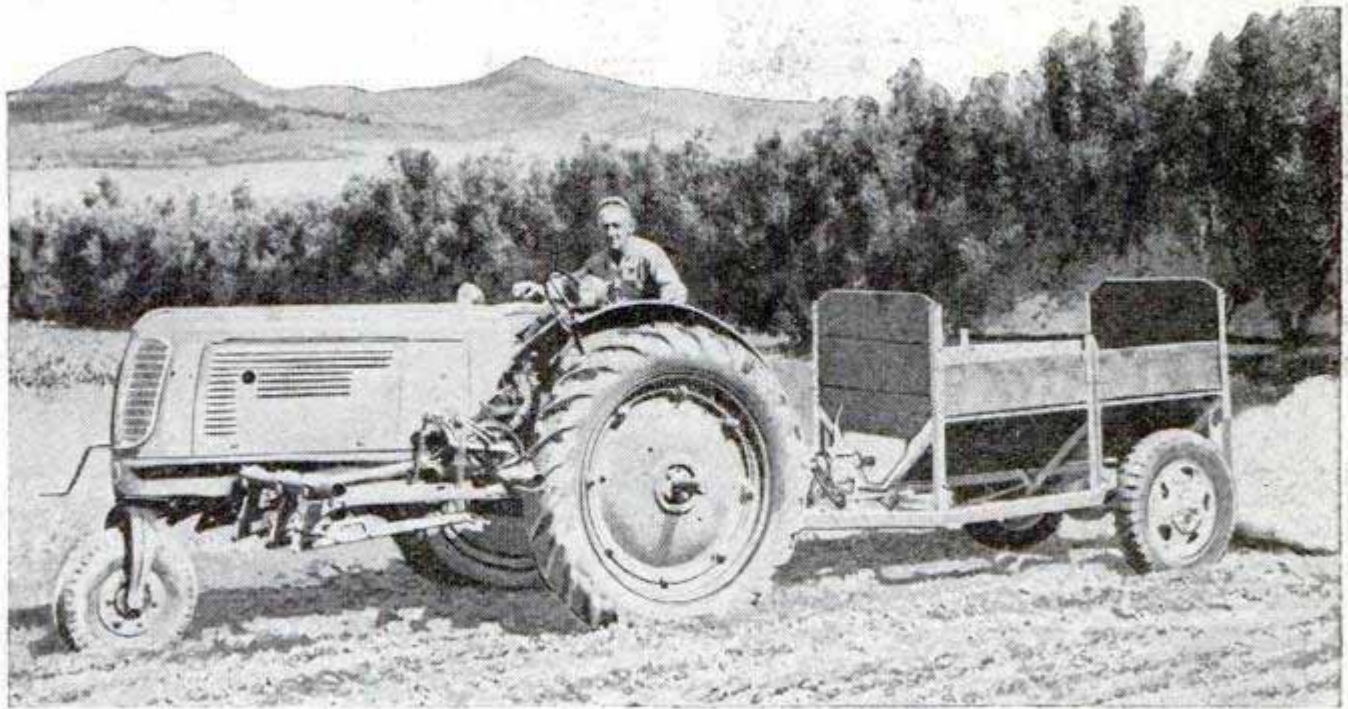

By Hi Sibley

BUILT by Viking Ramsing of Nuevo, Calif., and assembled from discarded automobile and farm-implement parts, this labor-saving spreader enables one man to apply gypsum, lime, sulphate of ammonia and other concentrated plant foods quickly and evenly at tractor speeds. It consists of a hopper of 2-ton capacity mounted on a heavy two-wheel trailer. A 5-in. materials auger in the bottom of the hopper, Fig. 4, carries the contents to an endgate-type distributor or spreader which is mounted on the rear of the trailer frame and ground-driven from one of the trailer wheels. The hopper screw is chain-driven from the trailer axle through an auto transmission from which the reverse gear has been removed. The whole thing can be towed by any small tractor and is easily maneuvered on its two wheels.

The transmission is taken from a Model-A Ford, the axle from a 1932 Cadillac and

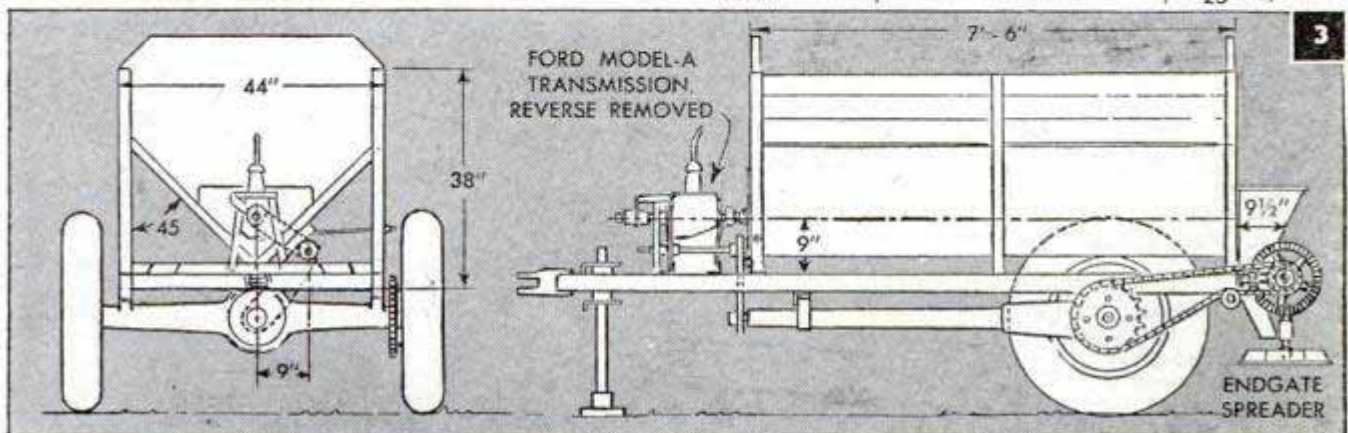
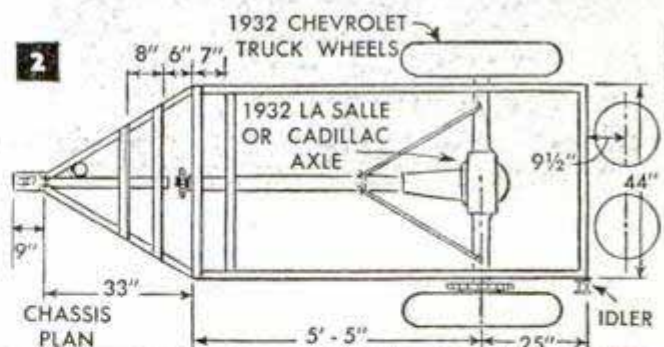
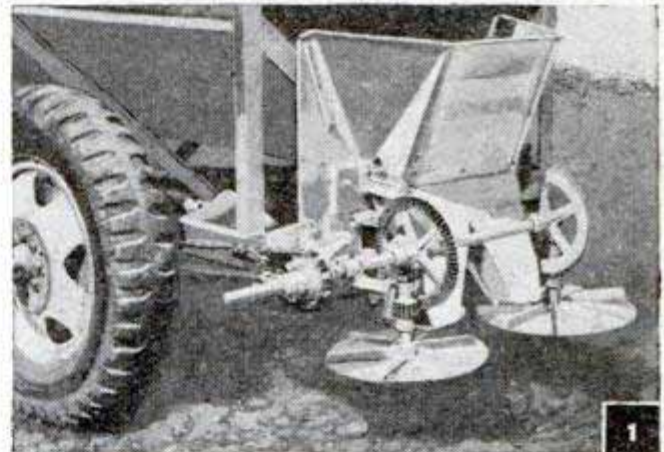

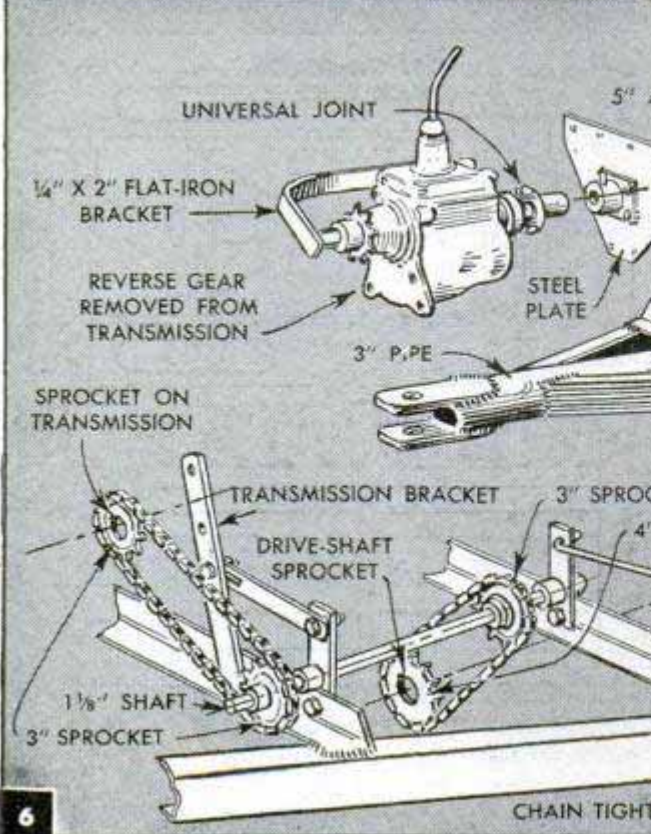
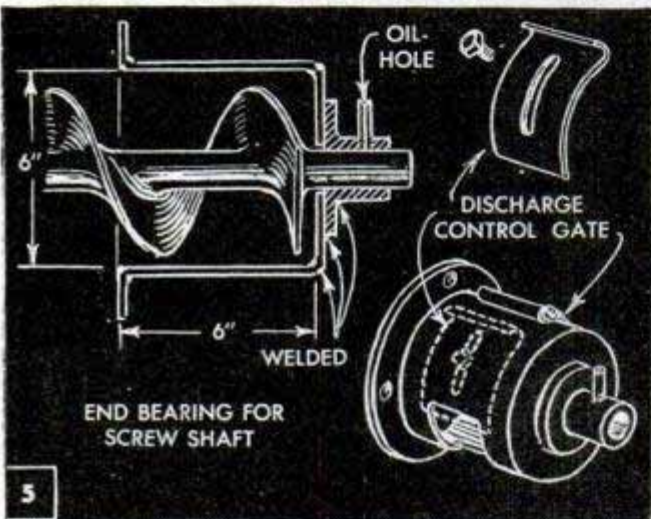
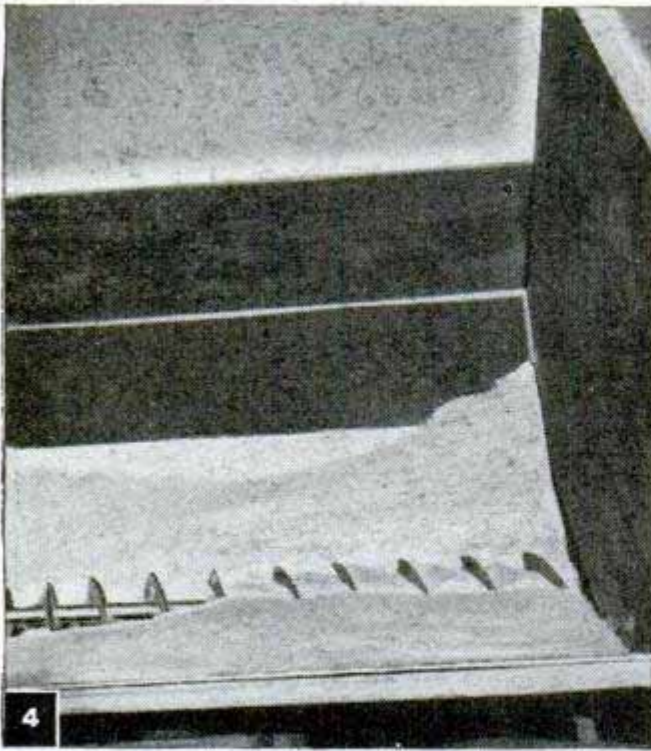

the wheels from a 1932 Chevrolet truck. The endgate distributor, Fig. 1, is a standard unit. A plan view of the chassis is shown in Fig. 2, while front and side views are shown in Fig. 3. The jack at the forward end, Figs. 3 and 7, is made from two pieces of pipe, the sliding member or leg being cut from 1½-in. pipe. This telescopes into a sleeve of 2-in. pipe welded to the drawbar. Holes are drilled in the two members to take adjusting pins, Fig. 7. Side members of the frame are 3-in. steel channels strengthened by angle-iron cross braces, or spreaders. The legs of both channels are notched at a point near the forward ends and the channels are bent inward, the ends being welded to a length of 3-in. pipe to form the drawbar. Dimensions are not given on these parts as size must be determined during assembly.

Note that the frame for the wooden hopper is made from angle iron, with a channel formed in the upright angle at each corner by welding in a strip of flat iron as in the upper detail in Fig. 6. Ends of the wooden sideboards fit loosely in these channels. In order to drive the auger in a counterclockwise direction through the transmission, the Cadillac rear axle is in-

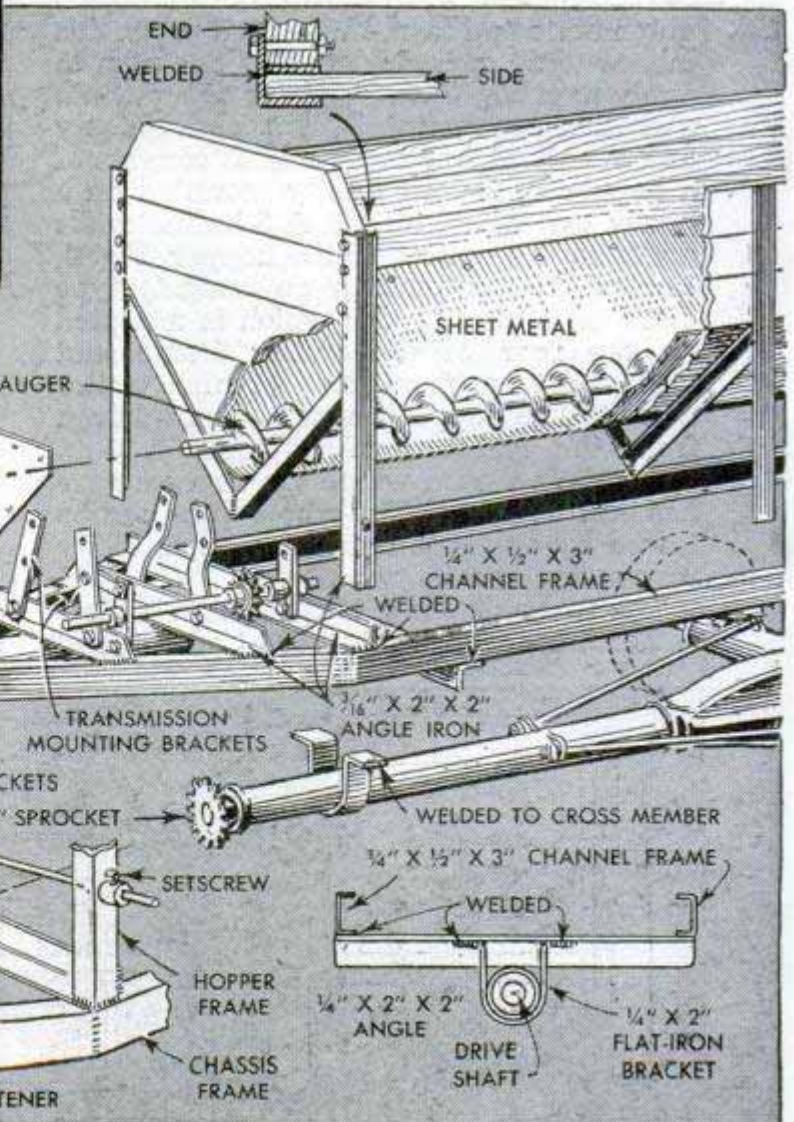

stalled upside down, the spring seats being welded or bolted to the trailer frame. A U-shaped strap welded to an angle-iron cross brace of the frame supports the drive-shaft housing, Fig. 6. A 4-in. drive sprocket is fitted on the end of the drive shaft. This drives a countershaft which, in turn, drives the transmission. The drive assembly is shown in the lower left-hand detail, Fig. 6. The bracket and support arrangement shown in Fig. 6 must be fitted to the transmission at the time of assembly.

The hopper bottom boards are set at a 45-deg. angle with the sides and are covered with sheet metal. Rear end of the auger carries the hopper contents into a cylinder or distributor head, made from 6-in. pipe to which a flange is welded as in Fig. 5. Holes are drilled in this flange so that it may be bolted to a triangular-shaped steel plate which, in turn, is bolted to the end of the V-section of the hopper in the same manner as a similar plate is attached to the opposite end of the hopper back of the transmission. Flanged bearings attached to the plate at the front of the hopper and to the back of the distributor head carry the auger shaft. Square openings are cut in the distributor head, Fig. 5,

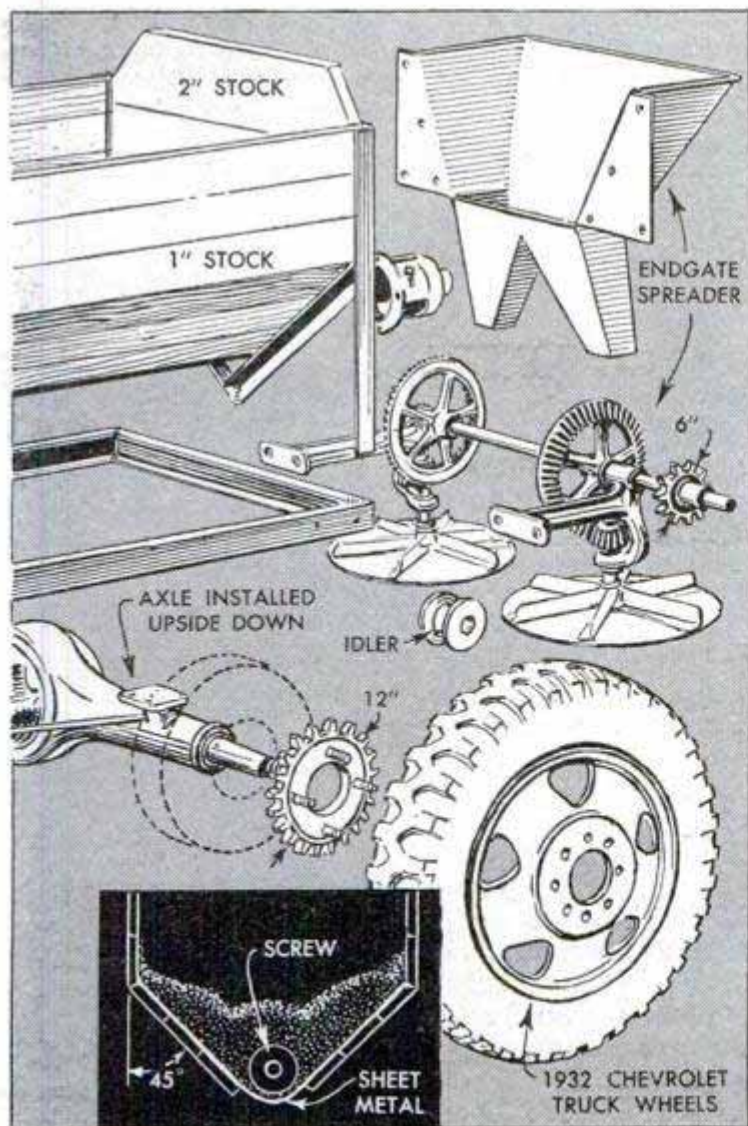

and adjustable sheet-metal gates fitted over these openings control the amount of material fed to the spreader hopper. The adjustment of these gates provides for feeding various materials to the spreader in sufficient amounts to maintain a uniform rate of spreading. Usually, the spreader unit is provided with an adjustable gate with which settings can be made by means of a scale and pointer to distribute varying quantities of material per acre. The three-speed auto transmission permits changing the speed of the auger. This provision, in addition to the control gates in the distributor head and the variable-gate settings in the spreader, gives a range of adjustment which makes it possible to spread almost any quantity of fertilizer per acre. The drive chain for the spreader is carried over an idler mounted on the rear of the frame, Fig. 3. Although the drive sprocket is shown mounted inside the trailer wheel, some users will prefer to have it mounted outside the wheel so that the chain can be removed when the trailer is to be used for other purposes or hauled idle for long distances. With minor changes in dimensions, other auto parts can be substituted for those specified. However, the ones specified were found to be best suited for the purpose. When the unit is to be stored, oil all metal parts to prevent corrosion.

Hoist Attached to Barn-Door Hanger Serves as Overhead Crane

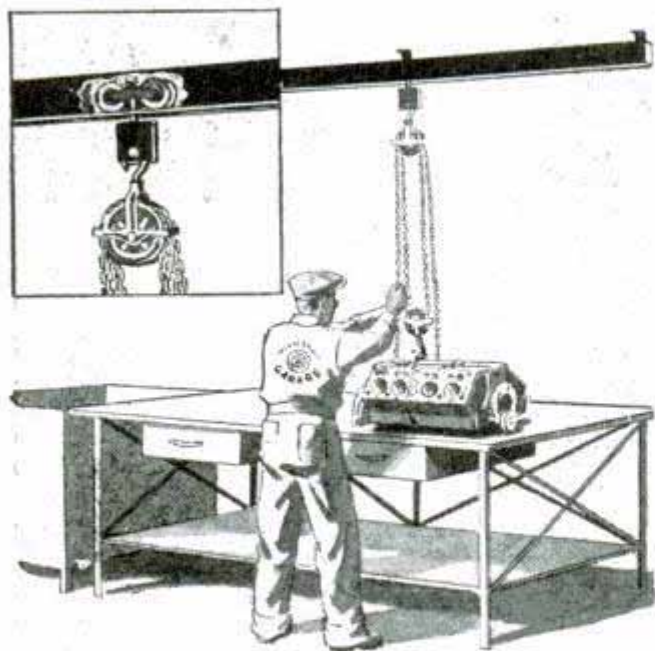

When hoisting engine blocks and other heavy parts from a hand truck to the workbench, one mechanic attaches a chain hoist to a barn-door hanger of the type that runs in a square track. The track is bolted to the ceiling joists. For convenience in lifting machinery from the truck, extend the track beyond one end of the bench. Caps are provided at each end of the track to serve as stops.

Jerome Ford, Lancaster, Ohio.

Converted Farm-Machine Seat Makes Useful Shop Chair

Constructed from an old farm-implement seat, several pieces of flat iron and two lengths of pipe, this sturdy chair will find many uses where durability is more desirable than appearance. Bend three flat-

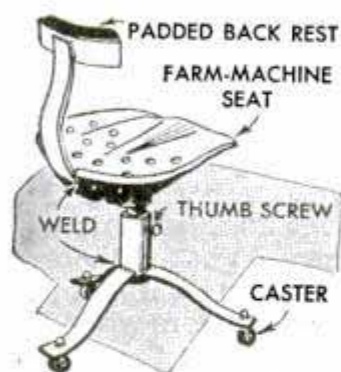

iron legs as shown, drill them to hold casters and weld to the end of a short length of pipe. Obtain an old tractor seat of the type having a separate back rest and weld the back rest to the seat. Then, get a length of pipe that is a

slide fit in the first one and weld it to the bottom of the seat. The length of the pipe, of course, will determine the height of the chair. The height can be made adjustable by drilling and tapping the base pipe to take a thumb screw, or by drilling one hole in the base pipe and several in the sliding pipe and setting the height with

a pin. If you do not want the height of the chair to be variable, make the inside pipe a little longer than the base pipe and thread the end for a pipe cap. This will keep the seat from pulling out when lifted. To make the chair comfortable, pad the back rest and use a cushion.

Elmer Vandrey, Truman, Minn.

Lathe Lubricant Applicator

Made of either metal or plastic, this convenient applicator for lathe-center lubricant keeps the lubricant clean and makes it easy to apply. It's designed so that the knurled handwheel, which can be of hardwood or plastic, also serves as a base for the unit when not in use. The barrel and plug are threaded and when the barrel is turned the plug

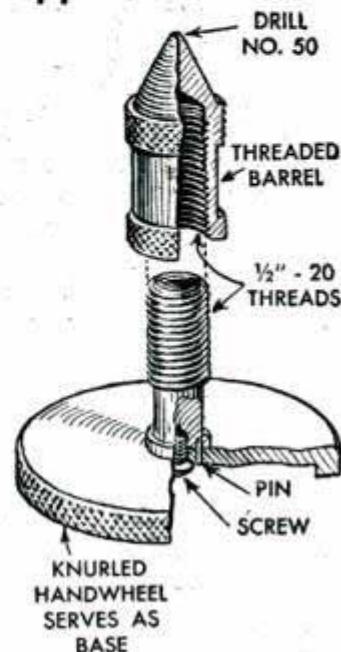

forces the lubricant out of a small hole drilled through the tip of the barrel. The handwheel is attached to the plug with a machine screw, and is pinned. A good lubricant is made by mixing equal parts of graphite grease and white lead.

Adjustable Hold-Down Clamp

To save searching for a spacer block to level a strap-type hold-down clamp, here's a clamp that gives you the height you want merely by slipping packing strips, or spacer blocks, through a slot in the clamp

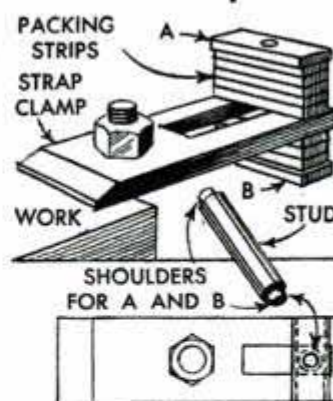

jaw. Cut the packing strips from heavy-gauge sheet metal, making the end strips, A and B, larger than the slot and the others small enough to pass through the slot. Drill the end strips to fit over tenons turned on a stud and drill the remaining strips to turn freely on the stud. Then, assemble the stud and packing strips on the strap clamp, and peen the tenons of the stud to hold the end strips permanently in place.—H. Moore, Leeds, England.

Fixture Aids Accurate Setting of Shaper Knives

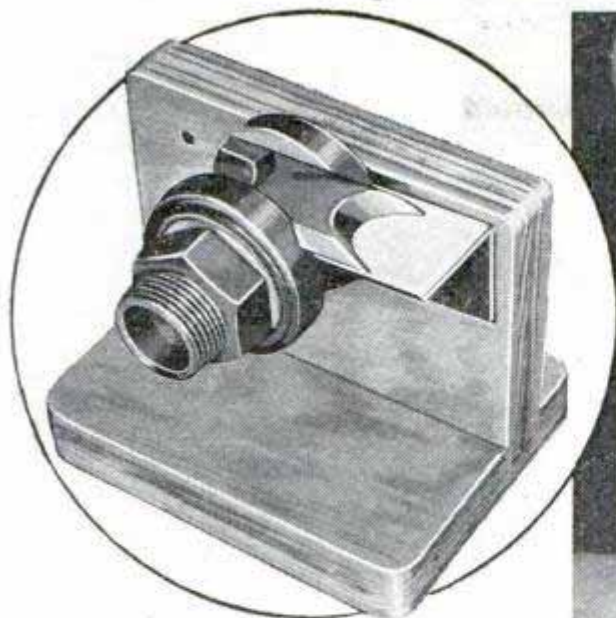

This handy fixture permits quick and accurate depth-setting of shaper knives held between collars, and also serves as a template for grinding identically the lips on common three-bladed cutters. As knife collars vary in design and size, exact dimensions for the fixture are not given. The base and upright are of plywood and a steel shaft to fit the cutter head is pressed into an undersize hole in the upright. An adjustable sheet-metal stop is fastened with a bolt and wing nut on either side of the shaft to accommodate both right and left-hand cutter heads. To use the fixture, a piece of paper is glued to the stop. The cutter head is placed on the shaft, held firmly against the upright and the outline of the cutting edge of one of the knives is traced on the paper. Then, the other knife is adjusted to the exact same depth by bringing the edge of it to the traced outline.

Richard Hanscom, Elmhurst, Ill.

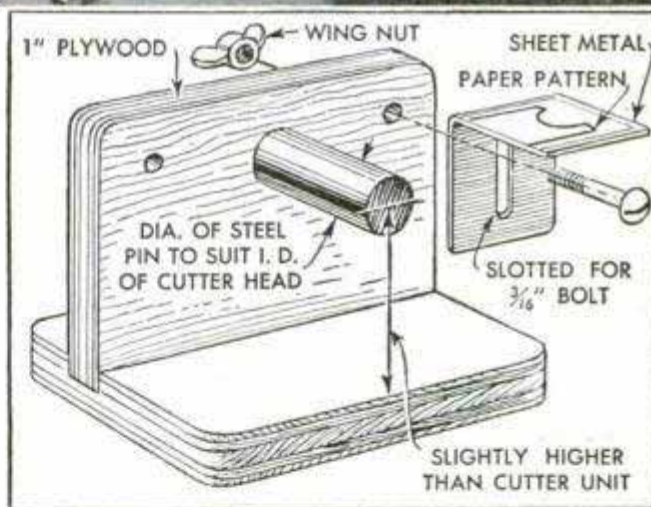

Hay Barrack Has Adjustable Roof

This unusual hay barrack with a roof that can be raised or lowered to various heights was built by one farmer in his cattle-feeding yard. The hay is pitched from the top of the stack to a manger fenced off around the bottom. As the height of the haystack decreases, the roof is lowered to provide the greatest possible amount of protection for the hay. The four long poles at the corners of the barrack are drilled at convenient intervals to take pins which support the roof at the desired height. A door and a short hay track are built into the gable. A block and tackle is used at each corner to raise the roof.

A. M. Wettach, Mt. Pleasant, Iowa.

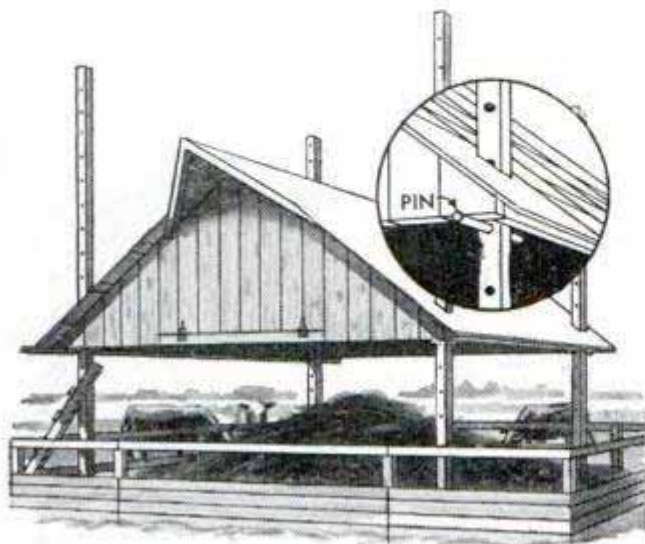

Shaper Cutter Mounted in Lathe Tool Post Permits Turning Uniform Beads and Covs

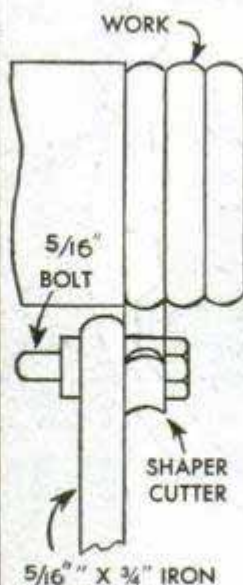
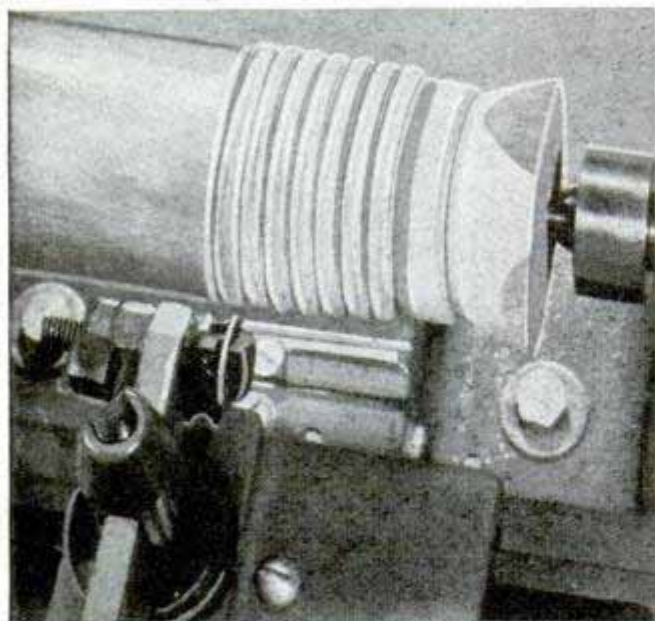

Turning small beads and covs and spacing them uniformly is easy to do if a shaper cutter is used. To do this, bolt a small cutter of the desired profile to a piece of $\frac{5}{16}$ by $\frac{3}{4}$ -in. flat iron. The end of the flat iron should be rounded and the cutter mounted near enough to it to allow the rounded end to serve as a depth stop. Then fasten the unit in the tool post in the usual manner. To obtain the best results on wood, set the cutter on the work center line, but when using the cutter on plastics, set it at approximately a 10-deg. negative rake.

Silage Will Not Freeze to the Inside of Door Having Tar-Paper Cover

If you want to keep silage from freezing to the doors in cold weather, next time you fill the silo, try covering each door on the inside with tar paper. In most cases this will keep the silage from freezing and sticking to the door so that it has to be chopped away. Ordinary roofing nails are used to fasten the paper in place and it should be left there permanently.

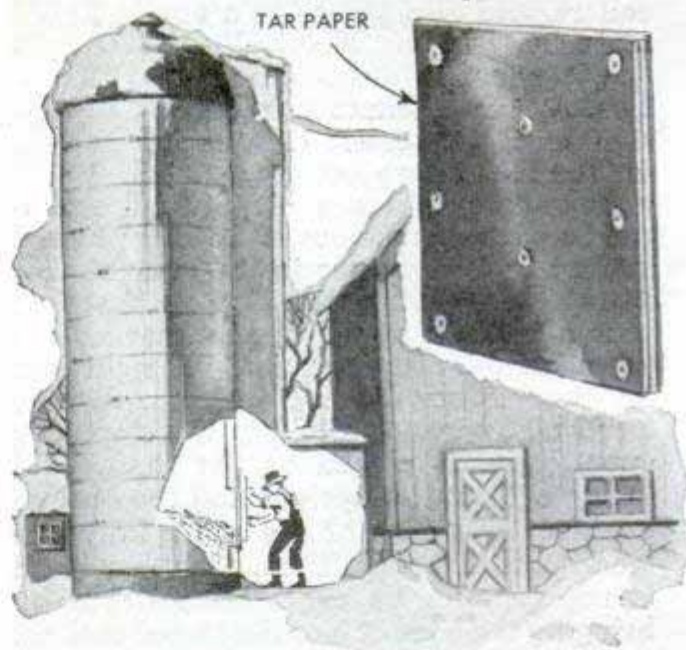

Dual Tool-Bit Holder

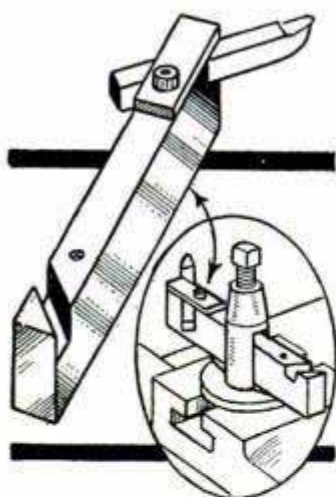

Saving the expense of a separate right and left-hand tool-bit holder, this holder incorporates both in one tool. It is made from cold-rolled bar stock and machined to fit the lathe tool post. Notches are cut and filed in each end at a 45-deg. angle to receive standard $\frac{3}{16}$ or $\frac{1}{4}$ -

in. tool bits. An interchangeable clamping pad locks the bit securely in either end. Positive clamping is assured by filing the notches to a depth slightly less than the thickness of the tool bit. A machine screw tightens the clamping pad.

Try lubricating an electric drill by dipping the bit into a can of oil. This will save time and dissipate heat effectively.

Repairing Carbide-Tipped Tools

When a large carbide tip on a high-speed bit has broken and the bit underneath the tip is damaged, one machinist repairs the expensive tool in the following manner. First, he anneals the end of the bit and cuts out the damaged portion. Then he cuts a piece of steel to replace the removed part of the bit and brazes this and a new carbide tip to the original bit.



Harold Peterson, N. Troy, N. Y.

Letter Press of Pipe Fittings for the Home Shop

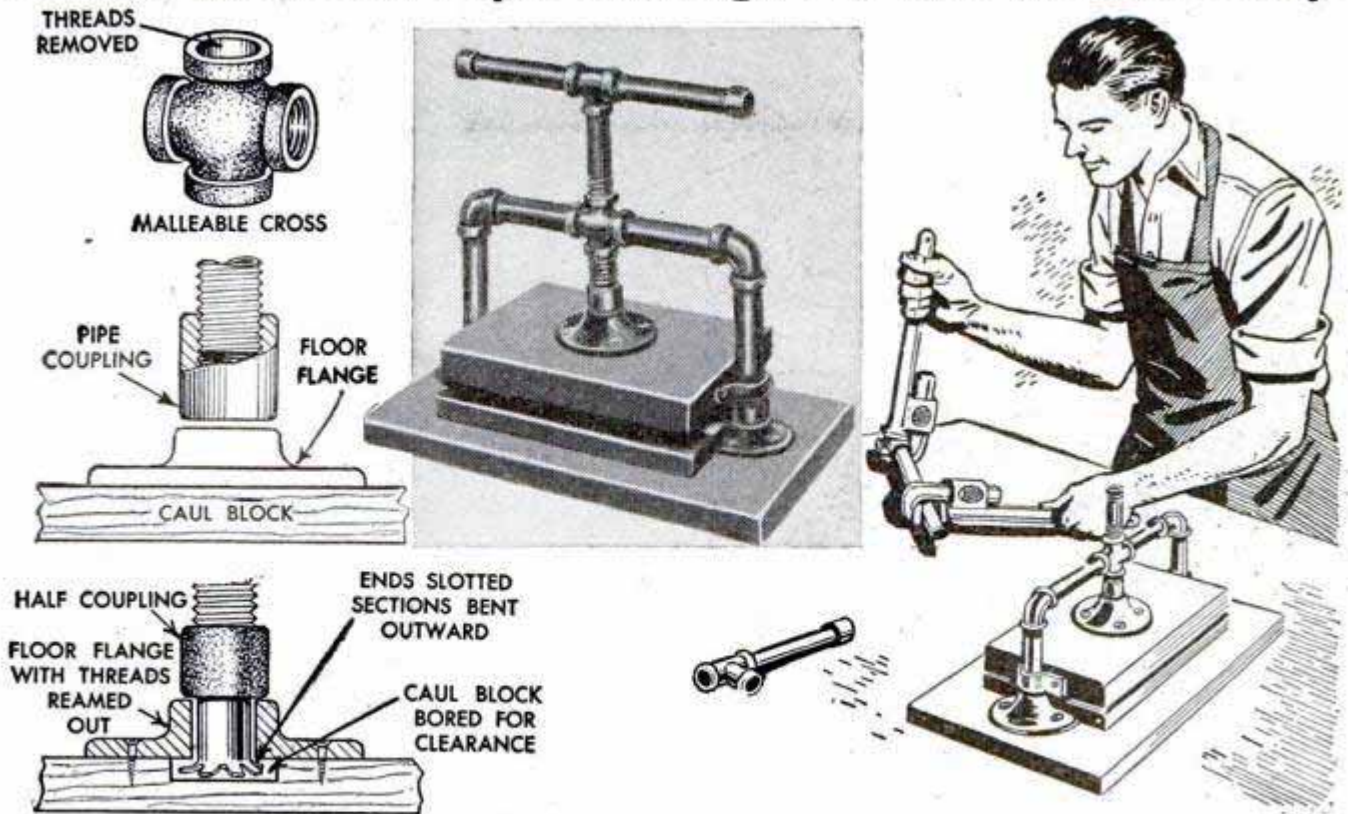

There's nothing quite so handy in the home workshop as a letter press when it comes to veneer work and other small gluing jobs. Commercial presses are expensive, but you can have this sturdy press in your shop just for the cost of a few pipe fittings. The fittings needed are three floor flanges; two elbows; six nipples, or seven if you use the method of mounting the spindle on the caul block shown in the lower left-hand detail; two pipe caps; two tees, or one tee and a cross; and a length of threaded pipe for a spindle. To make the press, fashion the base, caul block and base block of thick hardwood. Screw the flanges and base block to the base and assemble the frame. If a cross is used to take the spindle, the threads must be removed from the top opening. These may be bored out on a lathe, or you can take the cross to a local plumbing shop and have the threads

reamed out. If a tee is used instead of a cross, drill a hole through the top of the tee to permit insertion of the spindle. The caul block is guided between the vertical nipples of the frame by means of pipe straps fastened to the ends of the block. A pipe coupling is turned on the lower end of the spindle to press down on a floor flange fastened to the top of the caul block. If this method is used, the caul block will have to be raised by hand. However, if you wish the spindle to raise the caul block, have the threads of the flange reamed out and turn a nipple into the bottom of the spindle coupling. The lower end of the nipple is slotted and the sections bent outward to hold it to the flange. The caul block must be recessed to clear the pipe-nipple sections. The handle is made from two nipples, two pipe caps and a tee.

John Wolff, Palisades Park, N. J.

Scalloped Boards Made Easily by Drilling Holes and Sawing Apart

Here is an easy way to make identical, evenly spaced scallops in boards for decorative molding and window valances. First, a line is scribed lengthwise along the center of a board. Equidistant points are marked along this line, and then a series of holes is drilled through the board at the points marked. The size of the holes determines the width of the scallops. After the holes are drilled, the board is sawed in half along the scribed line. This will result in two identically scalloped boards.

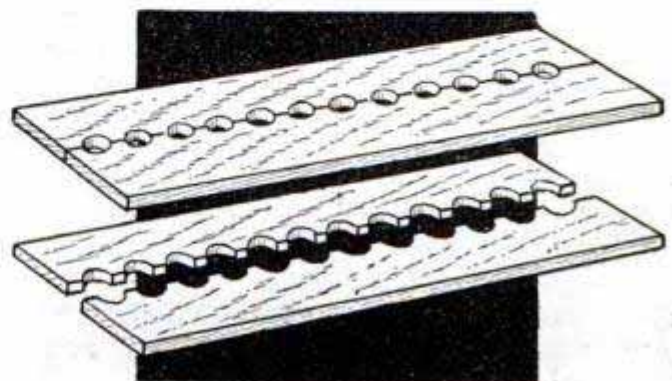

Ribbon Tabs Aid in Removal Of Button Dies



Finding it irksome to remove snug-fitting button dies from the recesses of the case, I thumbtacked one end of a piece of ribbon near each recess and simply pushed the die in place over the ribbon as shown. The free end of the ribbon provides a convenient tab with which to lift the die.

Ray Harrison, Dafoe, Sask., Can.

Tape Protects Fender Bead When Pounding Out Dent

Here's a way to avoid splitting or cracking the bead on a fender when pounding out a dent. Simply apply masking tape along the bead near the dent. Use $\frac{3}{4}$ -in. tape and apply three or four layers. Be

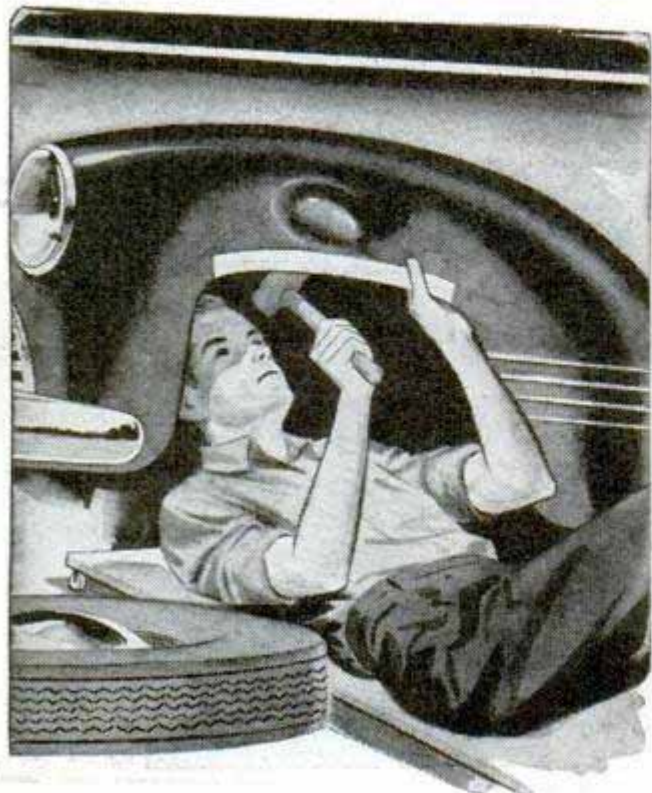

sure that the surface of the bead is cleaned thoroughly before the tape is applied; otherwise it may not adhere firmly.

Medicine Dropper Dispenses Ink

An ordinary medicine dropper and a cork will serve to make a dispenser that will accurately meter the amount of India ink put into a ruling pen. Remove the regular quill and select a cork to fit the bottle. Drill a hole in the center of the cork to take the dropper tube tightly. Then adjust the height of the tube so that the lower end is slightly above the bottom of the bottle when the cork is pressed tightly in place.

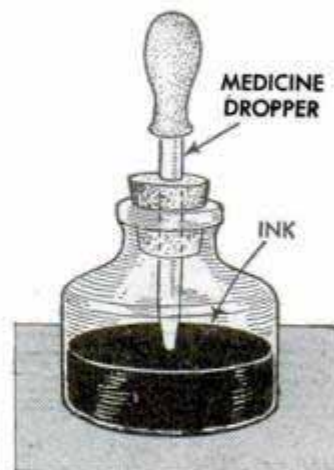

Julius R. Jung, Jr., New Orleans, La.

Tin-Can Protector for Seedlings

To protect seed plantings of chestnuts and similar varieties of trees subject to attack by rodents, the tin-can method has been developed. Use No. 2 cans and cut a cross in the bottom. The open end is forced into the ground over the plant or seed until the top is at ground level. Then the four points of the cross are turned up to allow space for the plant to grow. The sharp points discourage digging by rodents. The can will rust away before it interferes with the growth of the plant.

Center-Punch Mark Locks Nut

A lock washer usually will score soft metals badly. To avoid this damage, lock a nut this way: File or grind a short groove in the threaded end of the bolt. Then run the nut down and draw it tight. Place a center punch on top of the nut at a point opposite the groove in the bolt. Incline the punch slightly away from the bolt and strike lightly with a hammer. This will indent the nut sufficiently to force a small lug of metal into the groove. This lug will prevent the nut from loosening due to vibration.

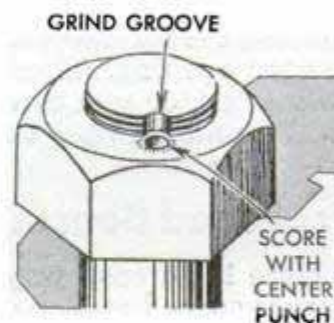

Earl R. Goddard, Denver, Colo.

Watch Out for WARPING!

by Sam Brown

WARPING is one of the home craftsman's biggest headaches. After spending considerable time, money and painstaking care in producing a fine piece of furniture, it is disheartening and a keen disappointment to have it later warp and shrink and come apart. But shrinkage and warpage can be held to a minimum by proper conditioning of the wood and by maintaining a close check of its moisture content at the time it is fabricated.

How wood warps: Wood shrinks and warps in definite relation to the direction of the annual rings, and shrinkage is about twice as great when the direction is parallel with the rings as when it is across them. This basic principle is illustrated in Fig. 4. Quartersawed (edge-grain) lumber shrinks the least because the heaviest shrinkage takes place across the narrow dimension of the board. Flat-cut boards have the greatest shrinkage across their wide dimension where it is more noticeable. Also note, Fig. 3, that flat-cut boards tend to cup away from the heart side. This is an important point and should be remembered in joinery.

Detecting warp: Any irregularity caused by warp should be removed because a board that is warped even slightly will continue to twist no matter how it is used. Cup warp, Fig. 8, is detected with a straightedge placed across the board, whereas twist or wind is determined with a pair of winding sticks, Fig. 1, or by placing a straightedge from corner to corner, as shown in Fig. 7. Both methods will reveal two high corners if twist is present, and consequently planing should be done diagonally from high corner to high corner.

Conditioning: Conditioning means seasoning the wood to the proper moisture content (M.C.) to correspond



1

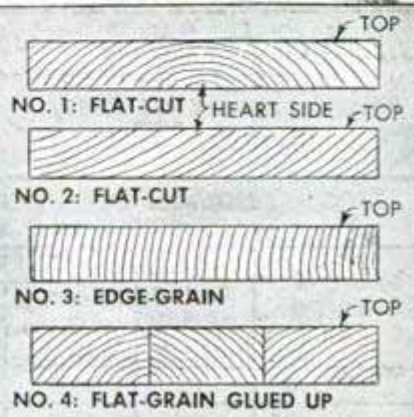

Can You Pick the Best Table Top?

★ TO SCORE 100 IN THIS TEST, YOU SHOULD BE ABLE TO TELL PROBABLE WARPING ACTION OF ALL BOARDS SHOWN. END GRAIN IS KEY TO SELECTION. YOU WILL KNOW WHY IF YOU READ THE STORY

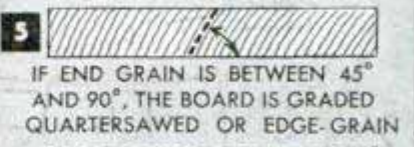
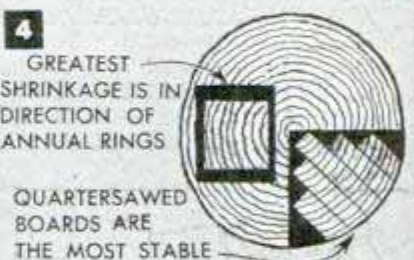
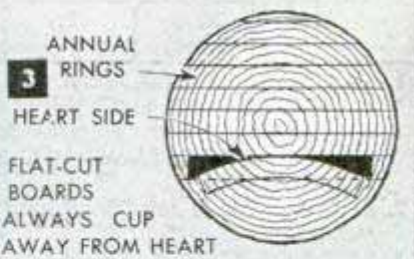

A TYPICAL FLAT-CUT BOARD — NOTE CUP WARP AWAY FROM HEART SIDE

STRAIGHTEDGE IN DIAGONAL POSITION WILL TEST BOARD FOR TWIST



8

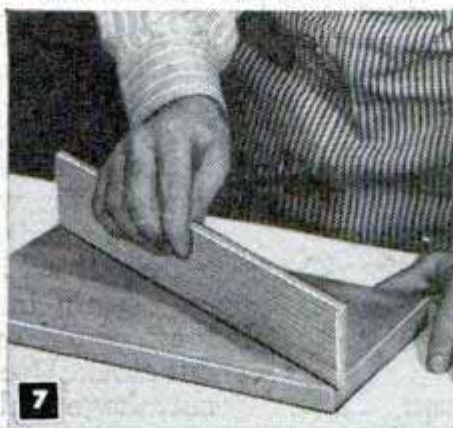

7

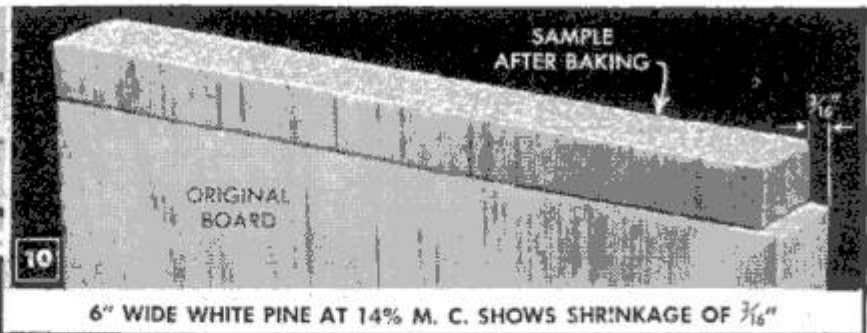

BAKING WOOD SAMPLE TO FIND MOISTURE CONTENT

M.C. Calculation

WEIGHT AT START 155 UNITS
 WEIGHT OVEN-DRY 136 UNITS
 DIFFERENCE 19 UNITS

$$\frac{19}{136} = \frac{14}{100} = 14\%$$

TABLE 1 MOISTURE CONTENT OF WOOD AS AFFECTED BY HUMIDITY

Humidity of Surrounding Air ②	Moisture Content of Wood ③	SHRINKAGE	
		Percentage of Green Wood Size	Shrinkage in 10" Wide Board
0	0%	6.7%	1 1/16"
Winter Indoors	10	3%	5/8"
	20	4 1/2%	3/8"
	30	6 1/2%	1/2 +"
Average Indoors	40	8%	1/2 -"
	50	9 1/2%	3/8"
Average Outdoors	60	11 1/2%	3/8"
	70	13 1/2%	3/8"
Summer	80	17%	1/4"
	95 (Green)	30%	1/4"

Average Seasonal Cycle For Furniture and Woodwork

1. THIS TABLE CAN BE USED AS A GENERAL AVERAGE FOR ALL WOODS. IT IS SPECIFICALLY FOR YELLOW PINE AND DOUGLAS FIR. FIGURES ARE FOR FLAT-CUT BOARDS—QUARTERSAWED WILL RUN LESS SHRINKAGE (ABOUT 60%).
2. RELATIVE. 100 IS AIR COMPLETELY SATURATED WITH MOISTURE.
3. WOOD CONSTANTLY SURROUNDED BY AIR OF AVERAGE TEMPERATURE (ABOUT 70°) AT A CERTAIN HUMIDITY WILL EVENTUALLY STABILIZE AT A DEFINITE M. C. AS SHOWN IN THIS COLUMN. THE TIME REQUIRED FOR COMPLETE EQUILIBRIUM WILL VARY WITH KIND OF WOOD, PROTECTION, THICKNESS, ETC. (Data adapted from tables prepared by U. S. Forest Products Laboratory.)

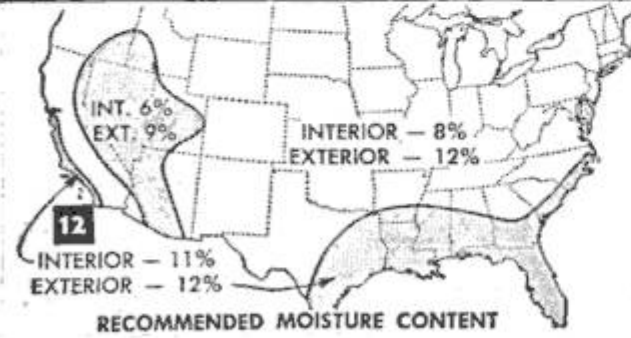

with the humidity of its permanent location. The map, Fig. 12, shows proper M.C. for various sections of the country, based on year-round humidity. A variation of 3 percent either way is permissible. Suppose, for example, that you live in a state where the humidity is about 40 percent indoors all year round. Table 1, Fig. 11, shows that the moisture content for furniture under such conditions should be 8 percent. If the wood is 8 percent M.C. to start with, it will be stable and will shrink and expand little even during the cycle of seasonal changes.

Determining M.C.: It is interesting and instructive to make a moisture-content test. Cut a strip about 1/2 in. wide from the center or about 1 ft. from the end of your lumber. Weigh the sample carefully, using a small scale reading grams or grains. Place the sample of wood in the kitchen-stove oven set at 220 deg. F. and weigh it every 20 minutes until it stops losing weight. This will take about 1 1/2 hrs. Then, work out the calculation given in Fig. 11, and you will have the M.C. The amount of shrinkage of a test sample is graphically illustrated in Fig. 10. Although the sample is now bone dry, it won't stay that way. Within three or four hours it will regain approximately half of its lost moisture and size, and in a few weeks will be nearly normal. This verifies the fact that wood is never truly seasoned—lumber 100 years old will absorb 16 to 18 percent moisture if stored outdoors. The best place to store your wood is in a location where the humidity is about the same as where the finished product will be used. Storing for several weeks in a warm, dry location is a good conditioning treatment.

Surfacing: Warped wood must be surfaced. This job is done on the jointer if the stock is within jointer capacity; otherwise with a planer head, Fig. 14. If the piece is badly twisted, guide runners should be nailed to the edges, Fig. 13, to form a flat base for the work. In using a planer head, be sure to adjust it to take a light cut.

Play it safe: If you have a choice, use edge-grain instead of flat-cut lumber. At least, avoid extreme grain angles in flat-cut stock. Use a wood known to have low shrinkage and good stability, Table No. 2.

Woods marked "poor stability" often are suitable if properly conditioned. Be sure your wood is 8 percent M.C. You will note in Table 1 that if wood is 8 percent M.C., the initial shrinkage of a 10-in. board from green wood will be $\frac{1}{2}$ in. scant. The board also will be subjected to a seasonal cycle of about $\frac{1}{16}$ additional shrinkage and the same amount for expansion. However, you will note that near the end of a humid summer, doors and drawers will swell and bind, and that in the dry indoor air of winter they return to their original M.C. and work smoothly. Some of this normal shrinking and expanding can be stabilized by reinforcing and solidly anchoring the wood in assembly. Thus, if humidity is not excessive, the wood will compress within itself and follow the path of least resistance. However, if you fabricate wood having a 16-percent M.C., the strain of stabilization at 8 percent is just too much, and "pop" go your glue joints and fastenings.

Retarding warping: The end grain of stock roughly cut into turning squares and stored for future use should be given a protective coating of shellac, varnish or oil paint to prevent checking. Lumber salvaged from old furniture and resurfaced on one side only is more apt to warp than if surfaced on both sides, as freshly dressed surfaces invite rapid absorption of moisture. Furniture should be finished as soon as possible after it is completed. Linseed oil, shellac, varnish and other finishes, when applied to the surface of the wood, form a practically airtight covering through which moisture penetrates slowly. Finishing coats retard swelling and shrinking to the point that if the humidity increases 10 percent for a couple of days, there will be no appreciable change. If your wood is conditioned to 8 percent M.C., it will remain fairly close to 8 percent and you will not be troubled with warping. Ideas in Fig. 15 are worth noting in preventing warping and shrinking. Notice how cupping of a table top is avoided.

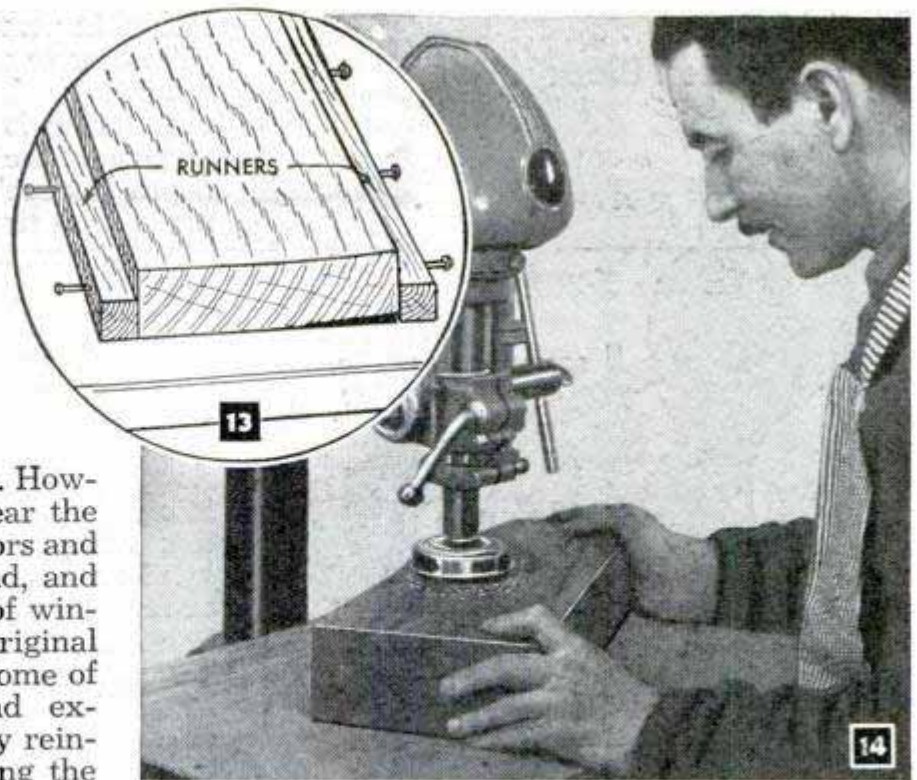

PLANER HEAD DOES CLEAN JOB OF SURFACING WARPED WOOD

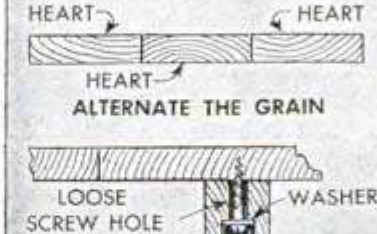
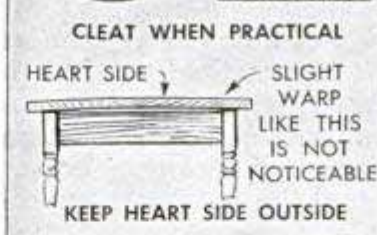
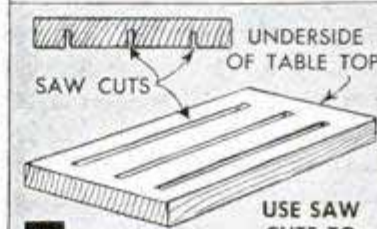

TABLE 2		SHRINKAGE OF WOODS*		General Stability
WOOD	Shrinkage From 12% to 6% Moisture Content		Percent	
	Percent	In. in 10"		
ASH	1.8	$\frac{3}{16}$ "	BEST	
BASSWOOD	2.3	$\frac{1}{4}$ "	GOOD	
BEECH	2.7	$\frac{1}{4}$ "	POOR	
BIRCH	2.2	$\frac{7}{32}$ "	GOOD	
CEDAR	1.3	$\frac{3}{8}$ "	GOOD	
CHERRY	1.8	$\frac{3}{16}$ "	GOOD	
CHESTNUT	1.7	$\frac{3}{16}$ "	BEST	
CYPRESS	1.5	$\frac{5}{32}$ "	GOOD	
ELM	2.3	$\frac{1}{4}$ "	POOR	
FIR (Douglas)	1.8	$\frac{3}{16}$ "	FAIR	
GUM (Red)	2.5	$\frac{1}{4}$ "	POOR	
HEMLOCK	1.8	$\frac{3}{16}$ "	FAIR	
MAHOGANY	1.2	$\frac{1}{8}$ "	BEST	
MAPLE (Hard)	2.4	$\frac{1}{4}$ "	GOOD	
MAPLE (Soft)	1.9	$\frac{3}{16}$ "	GOOD	
OAK (Red)	2.2	$\frac{7}{32}$ "	BEST	
OAK (White)	2.3	$\frac{1}{4}$ "	BEST	
PINE (Yellow)	1.8	$\frac{3}{16}$ "	FAIR	
PINE (White)	1.6	$\frac{3}{16}$ "	GOOD	
POPLAR	1.8	$\frac{3}{16}$ "	BEST	
REDWOOD	1.1	$\frac{1}{8}$ "	BEST	
SPRUCE	1.7	$\frac{3}{16}$ "	BEST	
SYCAMORE	1.9	$\frac{3}{16}$ "	POOR	
WALNUT	1.8	$\frac{3}{16}$ "	BEST	

* FLAT-CUT STOCK. SHRINKAGE OF QUARTERSAWED WOOD WILL RUN $\frac{1}{2}$ TO $\frac{3}{4}$ OF THESE FIGURES (From Table by U. S. Forest Products Laboratory)

Metal Threads Polished in Lathe With Wooden Block



After threads have been given a smooth finishing cut they can be polished in the lathe with medium and fine grinding compound and a softwood block. To do this, clamp a steel rod in the tool post to serve as a rest for the wooden block and apply the grinding compound to the thread. Turn on the lathe and press the block against one end of the thread, working toward the other end so that the thread will form a corresponding thread in the wood. Repeat the operation until the thread is thoroughly polished.

Special Tool for Internal Chamfering

Chamfering the inside edge of holes in a yoke or other slotted work is practically impossible with an ordinary boring bar, especially when the space between the holes will not permit adjustment of the bit. However, with this boring tool the bit can be set easily from the outside of the work. This is done by drilling holes diagonally

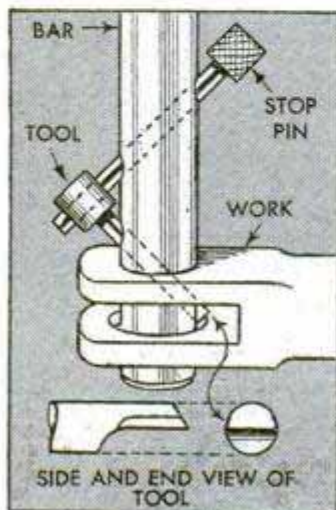

from opposite directions to take the tool bit and a stop pin. Both are almost alike, except that the tool bit is ground for a cutting edge and its head is drilled through for the end of the stop pin. In use, the boring bar is advanced through one hole, the tool bit inserted in the boring bar and

locked in place with the stop pin. It takes little time to set the bit as the stop pin automatically locates it in position. The chamfering is done in the usual way by advancing the boring bar until the desired depth is reached. A new setup must be made each time for holes of varying size.

Mass-Producing Slotted Dowels

After giving considerable thought to speeding up a dowel-slotting operation in my shop, I used this simple jig which has increased production many times. The jig was made by slotting a piece of wood to clear

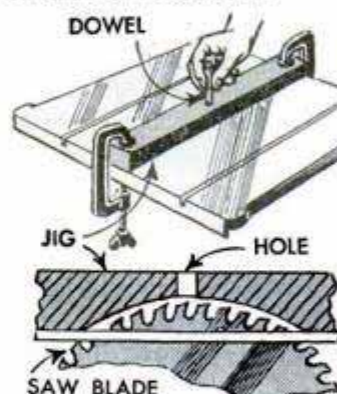

the saw blade when it is set for the desired depth. Then, I drilled a hole, having a diameter slightly larger than that of the dowels, through the top of the block, so that when the jig is in place, the hole is centered directly over the saw blade. The jig is held to the saw table with C-clamps. With the blade rotating, I merely press the dowels down through the hole.

R. F. Klemowicz, Camden, N. J.

Razor-Blade Gasket Cutter

A handle from a discarded safety razor and a double-edged blade are integral parts of a circular-gasket cutter that provides four interchangeable cutting edges. The cutter is made by turning and threading the end of a $\frac{3}{8}$ -in. iron rod, about 13 in. long, to fit the razor handle. Next, a flange is machined as shown, and counter-bored to take the shouldered and threaded end of the rod. The razor blade is clamped between the flange and a metal washer by screwing the handle on the rod and tightening it against the washer. A pointed center post, which is drilled to slide over the other end of the rod, is fastened with a setscrew. The cutter is used by adjusting it to the desired radius of the gasket and holding the center post with one hand while pulling the cutter around with the other hand. Avoid possible injury by covering the edge of the razor blade which projects at the top of the flange with two or three layers of adhesive tape.

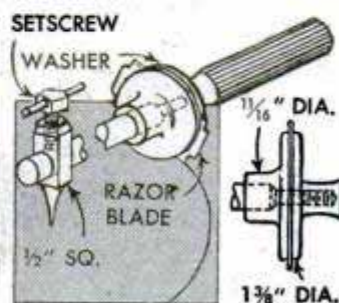



Lightweight FM Handie Talkie

WEIGHING only 8½ pounds, this brief-case size portable FM transmitter and receiver may be carried in the hand, on the shoulder, or as a back pack. Utilizing a superheterodyne circuit of high sensitivity and stability, it will provide reliable two-way communication in excess of two miles between units.

Photos A, C and D show practical applications where this means of on-the-spot communication serves to save time and protect property and lives. Railroad men can now expedite freight in busy yards under any weather or lighting condition. Fire fighters can dispatch orders to pump operators a block or more away, and the fire marshall can radio impending danger to firemen inside or behind a building. Many other applications include ship-to-shore communication. The top section of the portable unit, photo B, houses the combination Motorola transmitter and receiver which employs 11 sub-miniature tubes in the receiver, and 7 in the transmitter; a lower section holds portable-type dry batteries. When carried by hand or on the shoulder, a push-to-talk handset is employed; a lapel microphone with ear plug is used when the unit is carried on the back. Designed to operate in the 25 to 44-megacycle band, transmission range between units varies depending upon local conditions of terrain and noise.

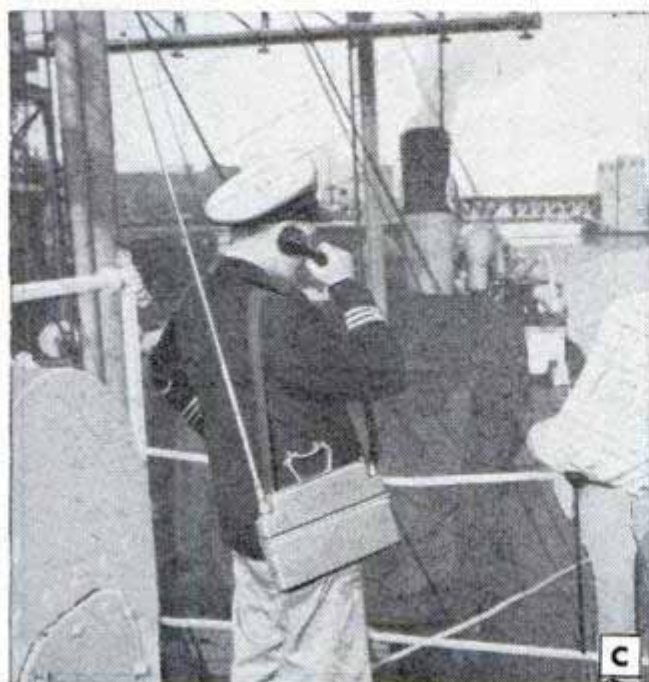
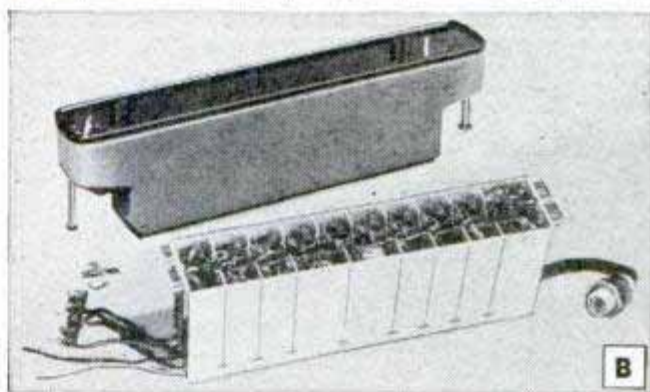

PORTABLE VACATION RECEIVER ★ ★ ★ ★ ★



in the center of each socket acts as a shield and may be used for a common ground tie point. The $\frac{1}{16}$ -in. sheet-aluminum chassis base is detailed in Fig. 1. This base is quite simple and may be formed over a block of wood clamped in a vise. The brackets are cut from the same material. Photos A, B, C, D and E show various views of the completed set.

Wire the filament circuit and filament
(Continued to page 226)

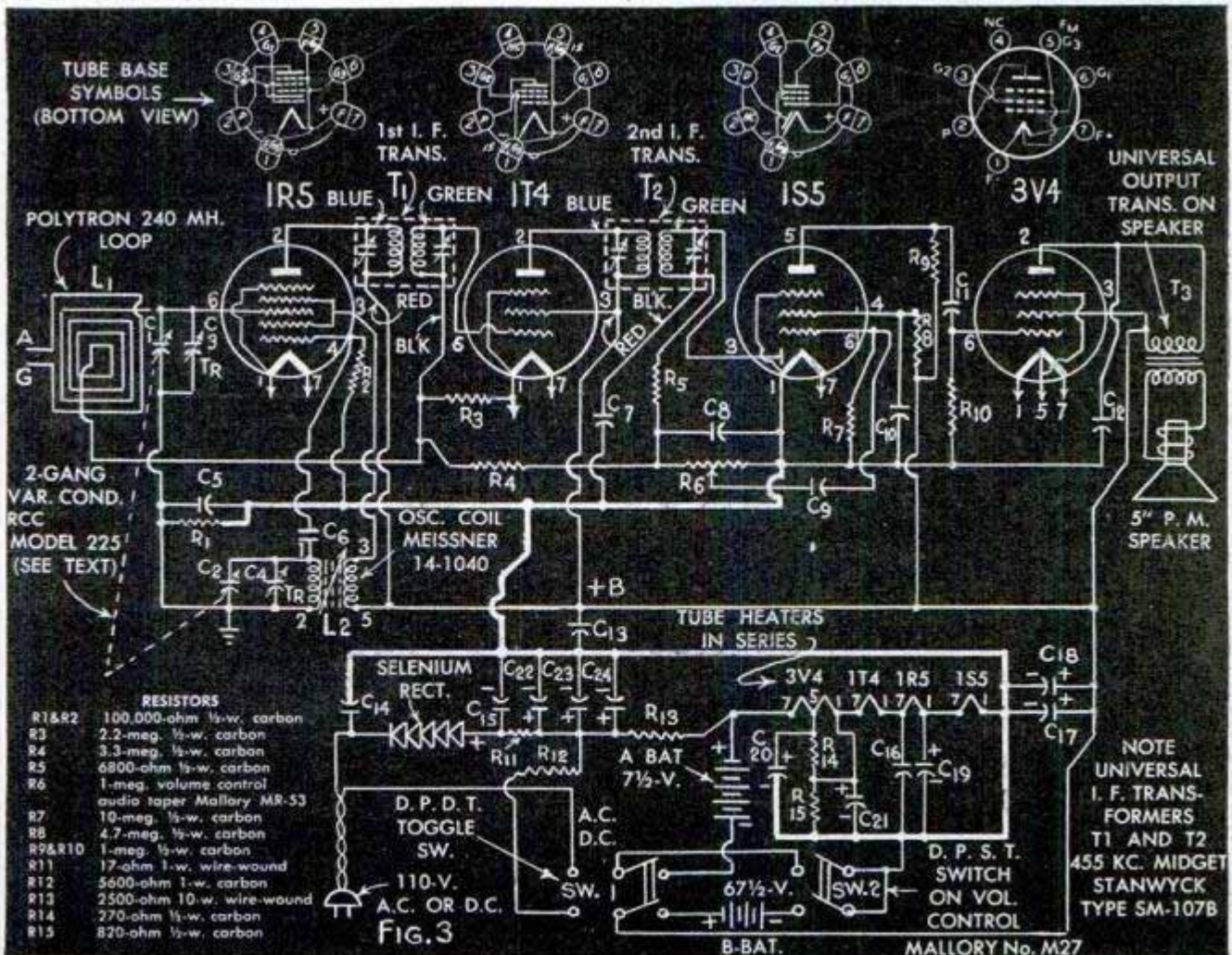
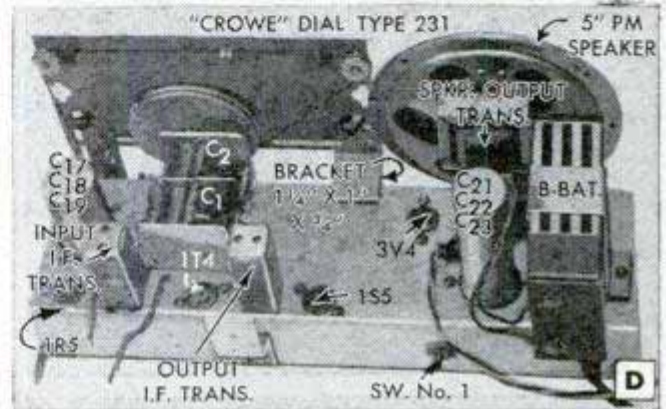

LARGE-SCREEN TELEVISION

By *F. L. Brittin*

THEATER television in which the screen image is approximately equal to that of present-day movies in size and brilliance has been demonstrated with an experimental large-screen television projector in the laboratories of the RCA Victor Division. Based on the highly efficient Schmidt-type optical system used by astronomers for astrophotography, this reflective optical system, adapted by RCA engineers for projection TV systems, collects the light rays from a comparatively small picture tube and directs them to the screen, properly focused. In home television sets this system provides 15 by 20-in. pictures. Now greatly enlarged, this same optical system makes possible bright, clear pictures of high quality that fill an 18 by 24-ft. theater screen, as illustrated in photo A.

Photo B shows the high-intensity cathode-ray tube being inserted in the large-screen projector. The optical system in this projector employs a 42-in. spherical mirror and a 36-in. aspherical correcting lens. The projection distance, or throw, is 40 feet. The magnifying power of the spherical mirror is illustrated in photo C; engineer I. G. Maloff holds the cathode-ray tube. The aspherical correcting lens compensates for natural errors in the spherical mirror, thus insuring clear picture images on the final viewing screen. The shape of the lens is such that the light rays coming from any point on the inner face of the projector kinescope (cathode-ray tube) will, after reflection, be optically forced to converge at a single point on the viewing screen. This action is illustrated in Fig. 1 by light rays 5, 6 and 7 which all originate at the same point on the picture-tube face.

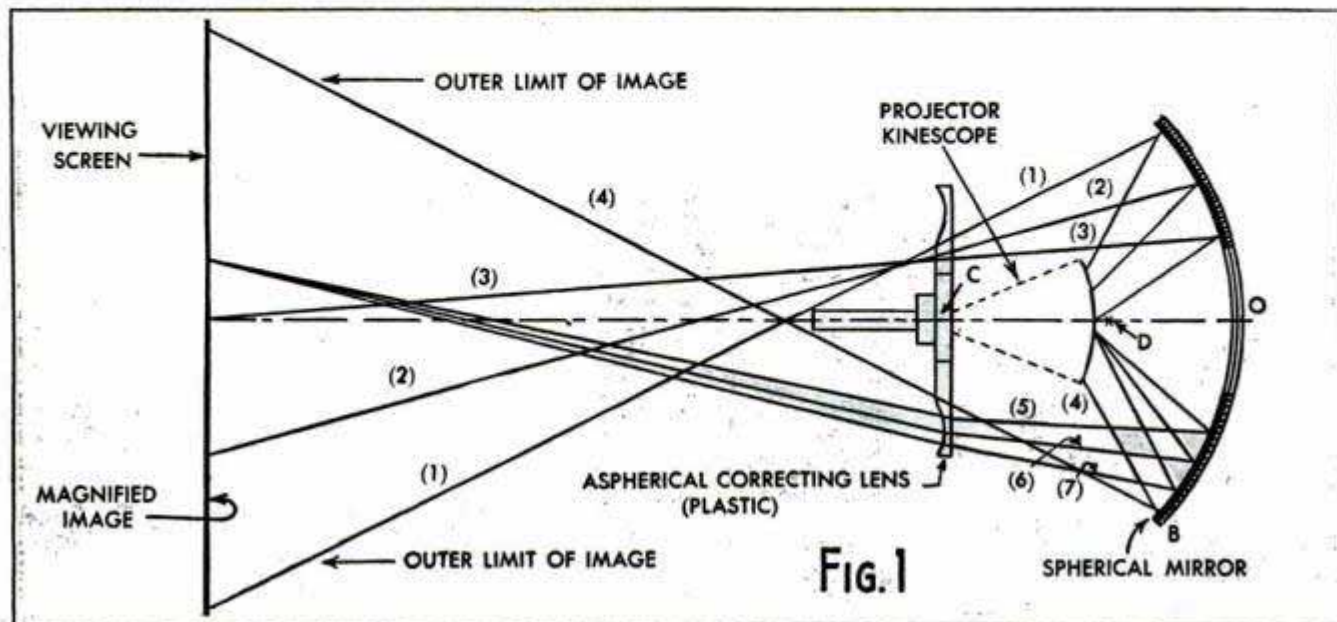
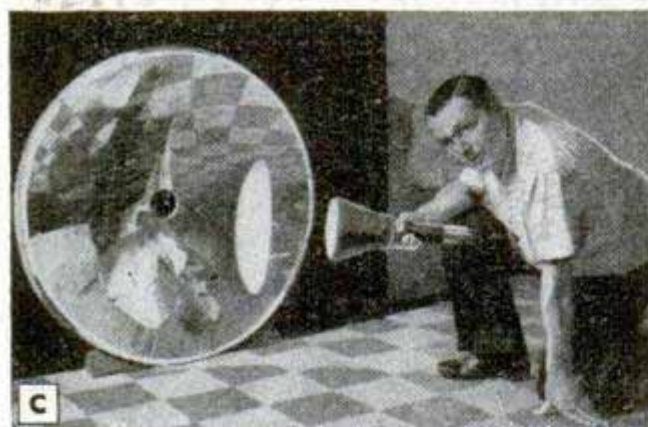
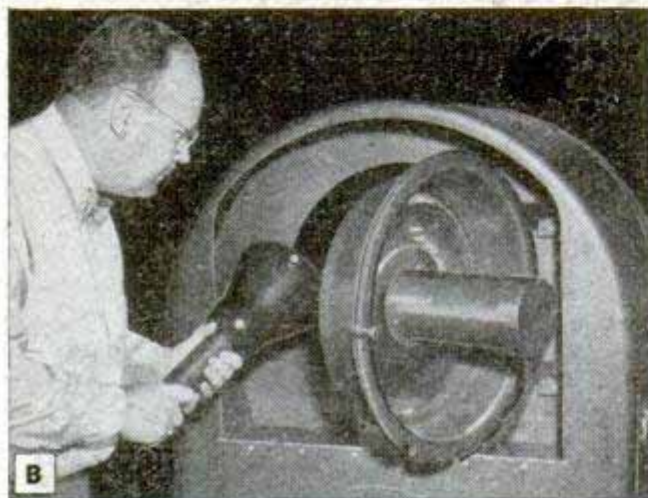

PUT SNAP AND SPARKLE IN YOUR NIGHTTIME PICTURES

KODAK VARI-BEAM STANDLIGHT

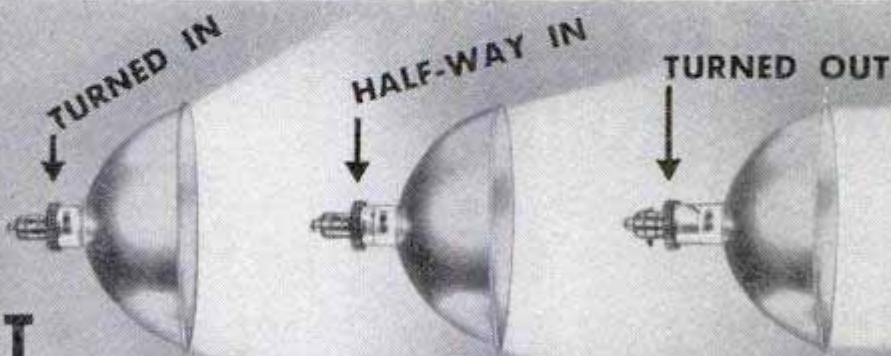

Wide beam for general still work

Moderately narrow beam for your movies

Extra narrow beam for glamour shots

FEATURES

12-INCH REFLECTOR . . . with No. 2 Photoflood lamp, gives powerful illumination.

FIRM STEEL BASE . . . 4½ pounds, has special rubber rim for protecting furniture and floors.

TELESCOPIC COLUMN . . . easy to adjust lamp for any height from 3 to 5½ feet.

CONVENIENT HANDLE FOR AIMING LAMP . . . clamping knob quickly adjusts tension.

Price—\$15

KODAK VARI-BEAM CLAMPLIGHT—

Lamp unit has all the features of the Vari-Beam Standlight unit, but is mounted on flexible bracket. Padded clamp attaches quickly and securely to chair backs, table tops, and tubular surfaces.

Price—\$9.75

KODAK PHOTO FLASHER—

Brilliant indoor flash pictures are easy to take with this self-contained unit. Specially designed for any camera with "time" or "bulb" setting. Simply open shutter . . . shoot the Flasher . . . close the shutter, and you have the picture.

Price—\$1.25 (plus tax)

Prices subject to change without notice

"Kodak" is a trade-mark
EASTMAN KODAK CO.
ROCHESTER 4, N. Y.

Kodak

Portable Vacation Receiver

(Continued from page 223)

CONDENSERS (Fig. 4)

- 1—Two-gang variable condenser with cut-plate oscillator section Radio Condenser Corporation model 225, type CN825171 C1, C2 and trimmers C3, C4
- 6—.05-mfd. 400-v. paper-type condensers C5, C10, C13, C14, C15 and C16
- 1—50-mmfd. mica-type condenser C6
- 2—100-mmfd. mica-type condensers C7 and C8
- 2—.01-mfd. 400-v. paper-type condensers C9 and C11
- 1—.005-mfd. 400-v. paper-type condenser C12
- 1—Mallory-type FP302 electrolytic condenser unit: 15-15 mfd. 150-v. C17 and C18; 1000-mfd. 2-v. C19
- 1—50-mfd. 25-v. electrolytic condenser C20
- 1—Mallory-type FP309 electrolytic condenser unit: 100-mfd. 25-v. C21; 50-mfd. 150-v. C22; 30-mfd. 150-v. C23. Note—both Mallory units have 3 sections
- 1—50-mfd. 150-v. electrolytic condenser C24

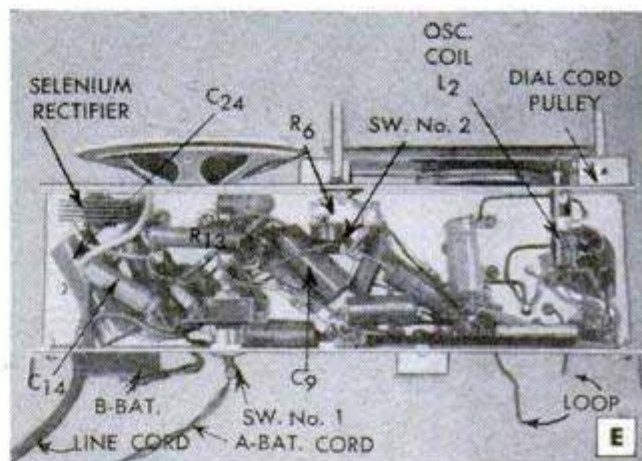

supply first, and keep all wiring short and as close to the chassis as possible. Leave the tubular paper condensers and resistors until all other wiring is completed. The schematic circuit diagram appears in Fig. 3. Use No. 20 or smaller hookup wire and rosin-core wire solder for the circuit. As the terminals on the tube sockets are small and may require several connections, care must be taken in soldering. Be careful that excess solder does not run down the terminals, touch another terminal or the chassis to cause a short. Always connect the outside foil of paper-type condensers to common ground when they are used as screen by-pass or AVC filter condensers; for fixed condenser values see Fig. 4. The Crowe dial comes with complete instructions for stringing the dial and cutting the panel hole in the cabinet. Complete details for the cabinet and A-battery case are given in Fig. 2. The cabinet is constructed of 1/4-in. plywood and strips of 1/2 by 1/2-in. pine. All

(Continued to page 228)

5



GREAT MODELS

Model HD	Small Alternate Firing Twin	2.5 H.P.
Model TD	Medium Alternate Firing Twin	5.0 H.P.
Model KD	Large Alternate Firing Twin	9.8 H.P.
Model SD	Super Alternate Firing Twin	16.0 H.P.
Model PO	Heavy Duty Opposed Twin	22.0 H.P.

All ratings are OBC Certified Brake H.P. at 4000 r.p.m.



The finest motors Johnson ever built—each one proved by years of use in the hands of thousands of owners. Packed with fine performance features, which *keep on* performing season after season. Ask your Johnson Dealer to show you. Look for his name under "Outboard Motors" in your classified phone book.



MODEL TD

Yours for Years

OF SWEET PERFORMANCE



FREE Handy Chart

Write for the new 1948 Sea-Horse Handy Chart. Illustrates, charts the 5 great Johnson motors for '48. Sent free.

JOHNSON
SEA-HORSES
for *DEPENDability*

JOHNSON MOTORS 400 PERSHING RD., WAUKEGAN, ILLINOIS
Johnson Motors of Canada, Peterboro, Canada

Exclusive Du Pont Formula Makes Polishing

EASY!

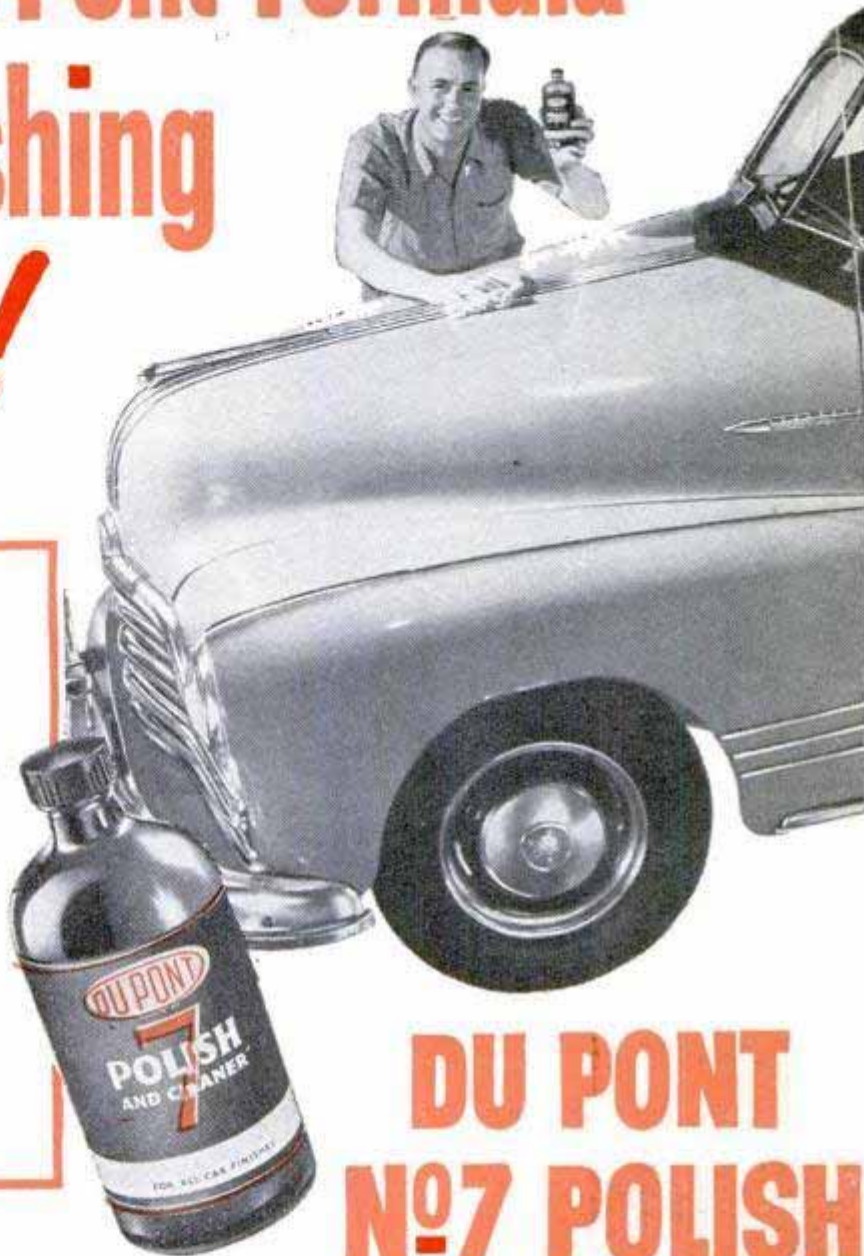

A small section of the surface of an average car magnified 20 times. The left side is shown still covered with Traffic Film. The right side has been cleaned with Du Pont NO. 7 POLISH.

DU PONT NO. 7 POLISH

Contains "stroke saving" methyl cellulose

Save work, save time, give your car a brilliant shine . . . with easy-working Du Pont NO. 7 POLISH! It is made by a patented formula . . . loosens dirt and grime quickly . . . cleans up *fast* without streaking . . . produces a high, dry gloss. Use NO. 7 POLISH to restore original color and lustre—the *easy way!*



BETTER THINGS FOR BETTER LIVING
••• THROUGH CHEMISTRY



**Attention . . .
NEW CAR OWNERS!**

Here's a wax-polish made especially for new cars—and others whose finish is in first class condition. It cleans and wax-polishes in one easy operation. Produces a brilliant, lasting lustre. Keeps cars looking new.

DU PONT SPEEDY WAX

ALWAYS READY
FOR ACTION!



KIEKHAEFER

MERCURY LIGHTNING

Full-Jeweled Power

(Ball and Roller Bearings Throughout)

Proved through OVER 10,000 HOURS
OF CONTINUOUS PERFORMANCE

The 10 hp. Mercury Lightning steps out, ready to deliver outstanding performance at top speeds . . . slowest trolling. Tested and proved, Full-Jeweled Power is a Kiekhaefer engineering triumph that reduces wear, gives Mercury parts an anti-friction ride on Ball and Roller Bearings . . . assures greater power — longer life. See the complete Mercury line at your dealer. Drive a Mercury and you'll learn why it's MATCHLESS in OUTBOARD EXCELLENCE.

KIEKHAEFER CORPORATION, Dept. N, Cedarburg, Wis., U.S.A.

Write for FREE Illustrated Brochure and name
of your nearest Mercury dealer.

NAME

ADDRESS

CITY.....STATE.....

joint is glued and nailed with brads. The cabinet is given a thin coat of shellac, then stained any desired color. The final finish coat is a flat lacquer which is later polished with a heavy coating of paste floor wax. The handle is a dime-store chrome drawer pull. The A-battery case must slide easily in and out of the cabinet to prevent injury to the dial mechanism. Five 1½-volt No. 2 flashlight A-batteries are connected in series either by directly soldered connections, or phosphor-bronze spring clips, if preferred. To change the A-batteries, remove the two control knobs on the front and the two small angle brackets at the back of the chassis and pull the receiver partially out of the cabinet. Have the A-battery leads long enough to remove the case and be careful that they do not short on the chassis or any other wires or terminals in the set. Snap-clip leads are used on the 67½-volt B-battery. All tubes must be in their sockets when this set is operated on the 110-volt line. The A and B-batteries need not be in place but tape their leads to prevent shorts. To place the set in operation, throw switch No. 1 to the position for the type of power used and then turn on switch No. 2. The set will begin to play as soon as a station is tuned in. Very little adjustment of the I.F. transformers is required as they are pre-tuned at the factory. Tune the set to a station at about 600 kc. and adjust the I.F. trimmer condensers for maximum volume. Loosen the dial drum on the variable-condenser shaft and move the dial pointer so that it reads the frequency of the station tuned in. Now tighten the dial drum and tune in a station at about 1400 kc. and check the frequency of the station on the dial. If it is not correct, adjust trimmer C4 on the 19-plate 170.7 to 8.7-mmfd. oscillator section C2, until the reading is correct. The oscillator coil has a powdered iron-core slug that will now have to be adjusted with a small screwdriver to secure the proper dial readings in the middle of the dial. These last adjustments may have to be repeated several times to insure proper tracking over the entire dial. Finally adjust trimmer condenser C3 on section C1 of the 2-gang condenser for maximum volume, the capacity of the 27-plate section C1 is 431 to 11 mmfd. Terminals A and G on the loop antenna are for external antenna and ground connections if required in remote locations. Two short machine screws are used to mount the loop on the rear chassis bracket. Detailed student material list R-367 is available from Popular Mechanics Radio and Electronics department upon receipt of ordinary letter postage.



**LET YOUR SEALED POWER
FRANCHISED DEALER HELP YOU**

GET THAT "NEW-CAR FEEL" AGAIN!

NOW—after a hard winter—have your Sealed Power Franchised Dealer give your engine a thorough check-up. He can help you get that NEW-CAR FEEL again, right now! And you will get more mileage on gas and oil.

You remember when that car was new—how you thrilled to that surge of eager power. That's the NEW-CAR FEEL. Let your Sealed Power Dealer restore it to your old engine.

He has a set of Sealed Power Piston Rings specifically engineered to do the best possible job in your engine, whatever the make, model or cylinder wear condition. When he in-

stalls new Sealed Power Rings and overhauls your engine, you will know that NEW-CAR FEEL again—and new-car operating economy, too!

Sealed Power Piston Rings are the best rings made, the choice of leading engine builders for 37 years. Sealed Power Ring Sets include the famous MD-50 Steel Oil Ring—the only ring with the Full-Flow Spring. See your dealer!

Send a postal for illustrated, informative new booklet on 7 ways to save oil. It's free and may save you real money. Sealed Power Corporation, Dept. G6, Muskegon, Michigan. In Canada: Stratford, Ontario.

Your Sealed Power Franchised Dealer also handles Sealed Power Pistons, Cylinder Sleeves, Valves, Water Pumps and Chassis Parts.



© Sealed Power Corp. 1948

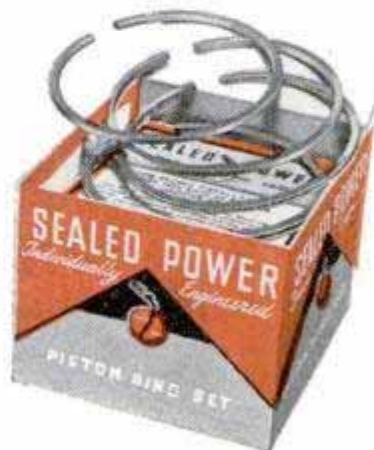

Sealed Power
PISTON RINGS

BEST IN OLD CARS!

BEST IN NEW CARS!

**"That hammer?
You're kidding!"**



FRED: It's a fact, Bill. I've been using this same hammer for 29 years. It helped to build the house you were born in.

BILL: Well, I don't know how you do it. I hardly ever *use* a hammer, and yet I've broken two of them in the last year or so.

FRED: That so? What kind of hammers were they? What brand, I mean.

BILL: Gosh, I don't know. Guess they didn't *have* any brand names. But they were good bargains.

FRED: That's where the trouble is, Bill. Look . . . see the name on this hammer? Whenever you see that brand name, you

know it's a good hammer. Stick to the well-known, advertised brands when you buy tools, and in the long run you'll save a lot of money.

BILL: That makes sense, Fred. I'll remember it.

FRED: And do your buying at the hardware store, where they don't try to sell you anything but quality tools. That way you'll always get your money's worth.

Your **HARDWARE DEALER** sells **QUALITY tools**
and hardware . . . Buy from HIM



POPULAR MECHANICS

"Raw North proves Scott-Atwater reliability . . ."
says Charlie Gillham, Arctic Explorer

"Since coming to the Arctic, my Scott-Atwater has always been on the job. Starts right off the bat. Runs all day long without a sputter. A motor in the Arctic takes a terrific beating from extreme temperatures, severe storms and salt water, but Scott-Atwaters really stand up!"
 Yes! And Scott-Atwater owners in 48 states and 37 foreign countries confirm Charlie's hearty endorsement of Scott-Atwater's reliability.

Backed by the superior production machinery and years of experience that made Scott-Atwater one of the world's largest producers of outboards, Scott-Atwater motors introduce standards of precision and dependability normally found only in aircraft engines or fine automobiles.
 For a new experience in outboard motoring, take Charlie Gillham's advice. See the new 1948 Scott-Atwater at your dealer's now.



CHARLIE GILLHAM
 Arctic Explorer,
 hunter, fisherman,
 author of the
 current best seller,
 "Raw North".

Two Great New Motors

Scott-Atwater 1-12 AND 1-20

A New Experience in Outboard Motoring!

One mph trolling
 Twelve mph top speed

One mph trolling
 Twenty mph top speed

Scott-Atwater's sensational performance is the result of a unique combination of advanced engineering designs. ✓ Multiple Feather Valves automatically change timing to admit optimum fuel charge at all speeds. ✓ Full Expansion Exhaust reduces back-pressure to an absolute minimum. ✓ New Type Magneto shoots hot spark for one-pull starting. ✓ High-Pressure Water Pump gives 60% more circulation for ever-cool trolling. These features produce a motor which will start with one short pull (8 inches will do it!), idle down to "nothing" (a mile an hour), speed up to 12 or 20 miles an hour (depending on model).

You'll like Scott-Atwater's all-weather, bother-free reliability (see below), as well as its "ABC" simplicity and distinguished styling. Best of all, though, your dollar buys *more* OBC Certified Horsepower in a Scott-Atwater. Look in the Yellow Pages of your phone book for the name of your nearest Scott-Atwater dealer or write Dept. PM68 for illustrated literature.

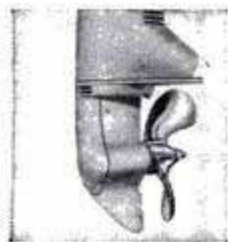
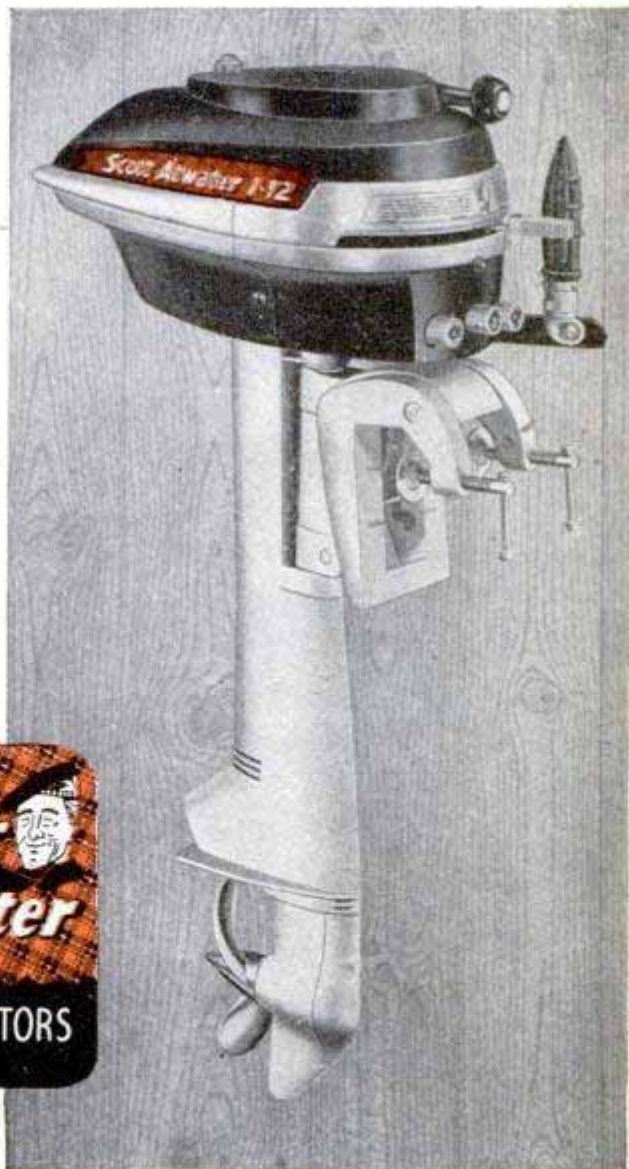

Super-Sealed Lower Unit—New brass encased grease seal impregnated with synthetic rubber keeps grease in, water out. Check twice a year.



All-Weather Operation Lightweight aluminum skirts protect carburetor and ignition from the elements. Magneto fully enclosed and water-proof. Dependable in heavy rain and high waves.



Super Fuel Filter—Scott-Atwater's new porous metal filter keeps all foreign matter, even water, out of fuel system. New type swivel gas cap swings out of way. New type magneto keeps spark plugs clean all season.



Steel Connecting Rods—Scott-Atwater's drop-forged connecting rods are virtually unbreakable. 24 roller bearings on crank pin. Heat-treated lynite aircraft pistons.

Scott-Atwater 1-12
 Deluxe Single
 with Auto. Recoil
 Starter, 3.6 h.p.
 (OBC Certified
 @ 4,000 rpm).
 Also available,
 Scott-Atwater 1-20
 Deluxe Alternate
 Firing Twin, 7½ h.p.
 (OBC Certified
 @ 4,200 rpm).

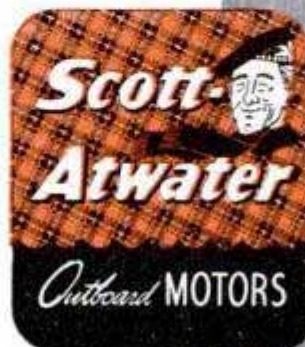

© 1948 Scott-Atwater
 Manufacturing Co., Inc.
 Minneapolis 13, Minn.

**INSTANTLY CONVERTS
LINEAR FEET
TO BOARD FEET**

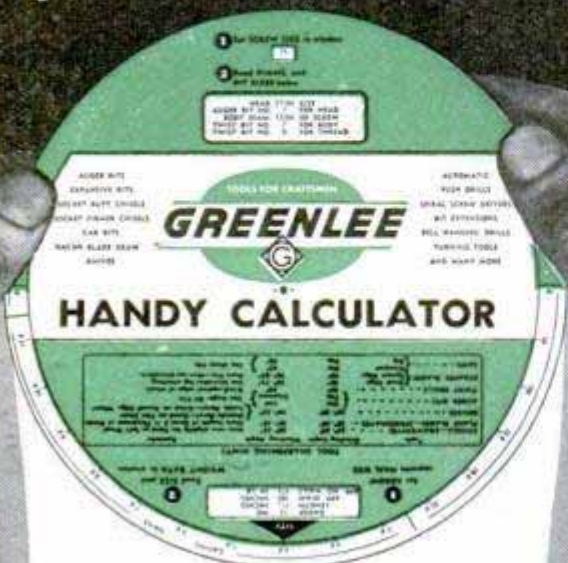

**Solves many other
woodworking problems
in seconds**

only 10¢

Easy to use. Fast . . . simply set dial of GREENLEE Handy Calculator to get measurements; slope per foot in degrees; comparative hardness, weights and workability of various woods; bit sizes; nail specifications; tool sharpening hints. 6" diameter heavy varnished cardboard. Special offer by maker of famous GREENLEE tools. Send 10¢ to Greenlee Tool Co., 2106 Columbia Avenue, Rockford, Illinois.

TOOLS FOR CRAFTSMEN
GREENLEE



Lion Hunt

(Continued from page 165)

It takes a smart hunter to trap a mountain lion. Usually the animal ranges back and forth over the same territory and develops a route that takes about a week to cover. The trapper tries to learn the lion's schedule and then starts one day ahead of him, setting several traps on the trail that the lion uses. Heavy bear traps that can break a man's leg are most often used, placed under a barricade. Other animals will jump the barricade but the cougar usually slinks under it. The trapper posts signs to warn humans of the traps.

The trick in making a good set is to use a trowel to dig the hole, scooping the displaced earth onto a ground cloth. This avoids disturbing the natural appearance of the surroundings. The smart trapper, of course, wears gloves to minimize the odor he leaves. Instead of attaching the trap to a stake most trappers chain it to a small grappling hook and a heavy weight. The hook will catch in the brush and hold. All displaced earth is carefully sifted over the buried trap with just enough dirt on top to conceal the trap. Catnip oil or some other scent is used as the lure.

The lion is the biggest predator of the West, but the coyote and the bobcat are even more destructive because of their numbers. Bobcats are members of the lynx family. They take large numbers of game birds, and both bobcats and coyotes kill fawns and calves. Coyotes also do considerable agricultural damage, especially to fruit crops. They live on cultivated grapes for weeks at a time, destroy tons of ripe watermelons in the field by taking a bite out of each, and climb into the branches of low trees to eat or damage the fruit.

A good professional trapper can expect to average one coyote a day and from 50 to 150 bobcats per year when working in territory that hasn't been heavily trapped. Some 4000 coyotes and 1200 bobcats are trapped in California each year.

Sternwheelers Still Rule the River

(Continued from page 96)

have to get help from other tugs to swing a big ship in these currents. But a sternwheeler's different. With her seven rudders she'll twist a liner around in a bathtub. Even if she's dead in the water (fully stopped), you still have rudder power because the paddles still push water against some of the rudders—even in reverse!"

The two skippers explain how important

(Continued to page 238)

LOOK AT ALL THE JOBS MULTI-TOOL WILL DO FOR YOU

Trade Mark Reg.



A CONTINENTAL
Red Seal
PRODUCT

Multi-Tool is the portable, self-contained, power source that will drive a wide range of machines and shop tools. Controlled speed range of 100 to nearly 10,000 r.p.m. is available on pulley-and-belt drive, and 1,600 to 2,600 r.p.m. on direct drive. Any machine or tool needing up to 1 1/2 h.p. can be driven by Multi-Tool. Write for literature. See how Multi-Tool will save you time, money, labor.

FOR A HUNDRED AND ONE JOBS

Simply take Multi-Tool to the job—wherever it is. ONE Multi-Tool will run dozens of different machines—cut equipment costs—eliminate drudgery. Use it for grinding, drilling, sawing, and for running feed grinders, corn shellers, cement mixers, forges and dozens of other uses.

This compact power source is reliable, easy starting, modern in every way. Operates for a few cents an hour. Three-step pulley integral with Multi-Tool automatic transmission.

SPEED CONTROL. Fingertip dial permits you to select speed you need for any job, and Multi-Tool will hold to that speed. Automatic transmission permits engine to idle while you change tools or belts.

Up to 1 1/2 h. p., Multi-Tool will do dozens of jobs for you. Get literature today.

DEALER INQUIRIES INVITED

Continental Motors Corporation

Multi-Tool Division 620F Ford Building
DETROIT 26, MICHIGAN

Portable

Multi-Tool is easily carried. Has easy-grip hand hold at either end.



IN THE SHOP
Drives lathes off belt, run drills off flexible shaft at same time. Special utility base and grinding head available.



POWERS MANY MACHINES
Cement mixers, corn shellers, pumps, and many other farm machines usually run by hand can be easily driven by Multi-Tool.



STAND BY POWER
When line power fails, Multi-Tool can operate generator or can be belt connected to pumps, milking machines, etc.

FREE MAIL TODAY

CONTINENTAL MOTORS CORP.
MULTI-TOOL DIVISION

620F Ford Building Detroit 26, Mich.

Please send complete, free, Multi-Tool catalog

Name _____

Address _____

City _____ State _____

NOW—For the First Time a SCREW-STEM FILTER PIPE for \$1

Royalton
FILTERWELL
With *Ajustomatic* Stem

Patented

AJUSTOMATIC STEM NEVER LOCKS OUT OF LINE

FILTER ABSORBS TARS & JUICES

IMPORTED BRIAR

Never before a screwstem pipe with all these features: patented free-turning self-aligning *Ajustomatic* stem—an easy-to-replace Filter—choice of smart styles in fine imported briar—and a low, low price making it the best buy in pipe history! At Better Stores . . .

\$1

HENRY LEONARD & THOMAS, INC. OZONE PARK 17, N. Y.

THE NEW
MONARK
Super Deluxe

ONE YEAR'S FIRE AND THEFT INSURANCE INCLUDED In Purchase Price

Dream bike of the century! Super streamlined "air flow" design with new "Air-Wing" head shield and dozens of other exciting new features. New mar proof and chip resistant finish. For sale by better dealers everywhere.

MONARK SILVER KING, INC.
6501 West Grand Avenue, Chicago 35, Illinois
Send Free Folder B-63 showing complete new Monark line in full color.

NAME _____
ADDRESS _____
CITY _____ STATE _____

Which of these new drills catches your eye?

Which of these slick new hand-drills would you like to have at your work-bench right now? Both have that clean, solid *look* of a good tool that any craftsman recognizes. Hard to choose between them? Why deny yourself either one, when you can own *both* for so little! They're the finest looking drills we've *ever* made, released now to celebrate Millers Falls' 80th Anniversary. At your hardware store.

Machine-cut gears; "Oilite" spindle bearing with ball thrust; true-running 1/4" chuck with 3 hardened jaws. Easy-grip plastic handle holds 8 standard points (1/16" to 11/64").

Millers Falls
1/4" **HAND DRILL**
#104 \$5.00

Slightly higher
in the west.
Complete with
8 drill points.

Millers Falls
**AUTOMATIC
DRILL**
#100 \$3.50

Slightly higher
in the west.
Complete with
8 drill points.

Exposed metal parts nickel plated steel and buffed aluminum. Right-tension spring gives quick handle return. Eight drill points (1/16" to 11/64") in rugged plastic handle. Dial the drill you want, and out it drops.

Millers Falls Tools



Millers Falls Company • Greenfield, Mass.

Celebrating 80 Years of Toolmaking

Clinic



for Homemakers

As a service to our readers in solving the hundreds of problems pertaining to a home—inside or out—the editors of *Popular Mechanics* invite you to present your problems to The Clinic Editor for help and advice. Address your questions to The Clinic Editor, *Popular Mechanics Magazine*, 200 East Ontario Street, Chicago 11, Ill.

Condensation in Gas Hot-Water Heater

Q—My gas hot-water heater is installed in the kitchen and vented to the chimney with a 4-in. vent pipe. When the heater is on the pipe sweats and drips water. Can you explain and tell me how to correct this trouble?

V. D.—Chicago.

A—One of the products of combustion is water vapor. This condenses on the surface of the vent pipe which is cooler than the gases passing through it. Usually pitching the horizontal run of pipe at a steeper angle cures this trouble.

Removing Enamel From Wall

Q—I want to remove enamel from one wall of my bathroom. I tried a paint remover but when brushed on, this runs down the wall to the floor and does not soften the enamel. How should I do this?

R. M.—Seattle, Wash.

A—Paint removers are made in both liquid and paste forms. The latter is a fairly heavy paste and is made especially for removing paints and enamels from vertical surfaces. Apply with a wall scraper or a wide wooden paddle and be sure that you cover the surface uniformly. Allow the remover to work for 10 to 30 minutes, then scrape off with a beveled scraper. The softened enamel will come off with the remover. Where there are several coats, two or more applications of remover will be necessary.

Seeding a Lawn Terrace

Q—For two seasons I have tried unsuccessfully to seed a terrace across the front of my lawn. During a heavy rain both soil and seed washed away, leaving the slope ridged and gullied. I filled and leveled the slope with new soil and reseeded, rolling the seed bed after seeding to pack it. The same thing happened again. I would like to retain the terrace if possible, but how can I get grass started on this slope?

C. A.—Cleveland, Ohio.

A—There is an open-mesh fiber matting available, which is made especially for holding soil on lawn terraces. Prepare the soil on the terrace slope and seed it in the usual way. Then cover the seeded area with the matting, making sure that it is laid flat, without wrinkles or folds. Roll immediately, using a light roller, its weight not exceeding 75 lbs. This will press the matting into the surface sufficiently to hold it in place. The coarse mesh of the matting will hold both soil and seed on the slope until the latter germinates and strikes root. Do not remove the matting. Simply leave it in place as it will slowly disintegrate.

(Continued to page 236)

Now-A New Kind of Screening

**STAINPROOF-RUSTPROOF
-LASTS A LIFETIME**



Handsome

Good looks are just a part of this amazing new screen material. Because it is absolutely rustproof... corrosion proof, LUMITE can never stain the sills or side-walls of your house—never become ugly-looking or discolored.



Tough

Here's the screen you would never have believed possible . . . that always stays taut and firm! Punch it, bump it, lean on it—it gives—then snaps right back when mounted properly. Lasts as long as your house,



Different

Made from saran plastic, the fibres of this amazing material give LUMITE qualities never before imagined in an insect screen. Imagine—if you can—a screen completely unaffected by water sun, smoke, soot, acid fumes, or salt spray. That's LUMITE! Sold by leading Hardware, Lumber or Building Supply dealers

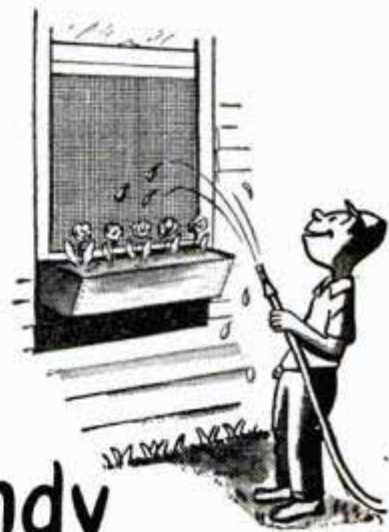

Handy

Perfect for the man-about-the-house, LUMITE is the no-upkeep screen. It never needs painting or any protective coating. It's amazingly easy to handle—you can cut it with ordinary scissors . . . no special tools. No scratched fingers.

For information and free sample write Dept. 52, Lumite Division
Chicopee Manufacturing Corporation
47 Worth Street, New York 13, N. Y.

Screen once and for all with

LUMITE*

Woven of saran



THE RIGHT FILE FOR THE JOB

is a "must" in saw sharpening

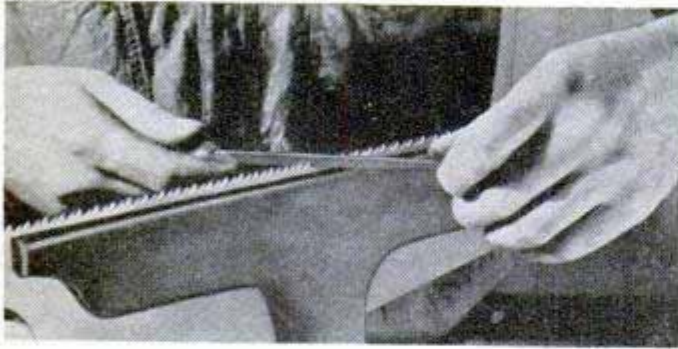

NUMBER OF SAW POINTS PER INCH

USE

5	7" REGULAR TAPER
6	7" or 8" SLIM TAPER
7	6" or 7" SLIM TAPER
8	7" EXTRA SLIM TAPER; 6" SLIM TAPER; or 8" DOUBLE EXTRA SLIM TAPER
9	6" EXTRA SLIM TAPER; or 7" DOUBLE EXTRA SLIM TAPER
10	5" or 6" EXTRA SLIM TAPER

In filing a handsaw, two things are important toward making it "zing" through the wood true and fast: The file must be the *right size* and a *good brand*. The table above tells you about the sizes. The trade-marks below tell you the brands widely considered *best in the world*.

Count the teeth per inch in your handsaws, band saws, miter saws; take the table with you to your hardware dealer; ask for Nicholson or Black Diamond brand—and equip yourself with the most efficient saw-sharpening files you've ever used! *Free booklet*, "File Philosophy," tells about saw filing and about files in general.



NICHOLSON FILE COMPANY
22 Acorn St., Providence 1, R. I.
(In Canada, Port Hope, Ont.)



NICHOLSON FILES

FOR EVERY PURPOSE

Drilling Holes in Plaster

Q—I need to drill several small holes in a plastered wall. I tried several methods but the plaster cracks and chips each time near the hole. How should I do this?

G. B.—Brooklyn, N. Y.

A—The simplest method is to cut the head from a small finishing nail which is slightly smaller than the diameter of the hole required. Hold the pointed end of the nail on an anvil or other metal surface and flatten it slightly with a light hammer blow. Drive this improvised drill with a hand drill, working slowly until the drill point breaks through the finish coat of plaster.

Removing Whitewash

Q—I want to remove whitewash from a masonry wall and from the wooden posts of an ornamental fence. The wall has been whitewashed several times and the coating is quite thick. What will take it off?

J. R.—Dallas, Tex.

A—Soak the whitewash with a solution made by dissolving 1 lb. of potash in 10 quarts of water. A thorough application of this solution will soften the coating so that it may be removed quite easily with a scrubbing brush or a worn broom. Use a long-handled cloth swab to apply the remover to the whitewashed surface.

Removing Soot From Chimney

Q—We have two chimneys which seem to become clogged with soot, requiring cleaning out every two or three weeks. One chimney is lined with 6-in. round flue liners. Flue size of the other is 7 by 15 in. What is causing this trouble and how can we remedy it?

P. V.—Batavia, Ohio.

A—There are various soot removers available which are quite effective in removing soot accumulations from chimneys and flues. However, we assume from the way you describe the problem that there is something wrong with the draft, that is, somewhere along the column of hot gases passing up the chimney there is an eddy which causes soot, fly ash, and other larger particles to accumulate rapidly. This may be due to some peculiarity of the flue construction. The type of flue which is built into the masonry or brick walls of some older homes frequently gives this trouble, especially where the stovepipe opening is only a few inches above the bottom of the flue. Also, an exposed chimney, which cools rapidly when the fire is checked, favors the deposit of soot in quantity. We think it would be a good idea to investigate these possibilities. One of the best and cheapest ways to remove soot deposits (not fly ash, which is another by-product of combustion) is to place a quantity of granulated rock salt on a hot bed of coals and immediately open all drafts so that the fumes are carried up the flue. This must be done often during the season. Use a pound or more of the salt for each treatment.

Cause of Paint Failure

Q—I paint my home every two years. After a year or so the paint chips and peels in spots back to the bare wood. These spots seem to take paint again quite well but after a year or so it cracks and peels much the same as before. What can I do to prevent this?

R. F.—Lincoln, Neb.

A—We think the origin of your trouble goes back to the original primer. For some good reason the primer did not bond to the wood. There are, of course, various causes of paint failure, but judging from your description we believe the first primer was not sufficiently reduced to penetrate the wood. If a heavy primer is applied the oils will be absorbed by the wood, leaving the pigment on the surface. The only practical procedure we can recommend, other than removal of all the paint to the bare wood, is to prime the bare spots with a specially reduced primer to which is added benzol at the rate of $\frac{1}{2}$ pint per gallon of primer. Do not add benzol to the finishing coats; only to the primer. Allow the primer to dry for at least two weeks. Succeeding finish coats should be reduced with turpentine and oil to an easy brushing consistency and then brushed out to a thin, uniform film.

SPARTAN power SPRAYER ROUTS WEEDS AND FLIES —

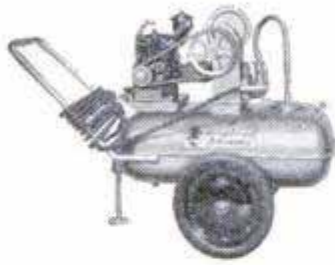

PROTECTS TREES

New Spartan portable power sprayer provides best way to apply weed killers or insecticides. Delivers up to 3 gal. per min. of 10 to 200 lbs. pressure. Sturdy, reliable Spartan will win your battle against pests! Find out what Spartan will do for you.

able Spartan will win your battle against pests! Find out what Spartan will do for you.

SPARTAN PORTABLE POWER SPRAYER

KILLS WEEDS quicker, easier. **ROUTS FLIES** and mosquitoes from barns, homes, resorts! **DISINFECTS** poultry houses! **FIGHTS ROACHES** and other indoor pests effectively! **SPRAYS CATTLE** for more meat and milk production! Send for free catalog!

BUSINESS OPPORTUNITY!

Make big profits by starting Custom Spraying business. Write for information.



JOHN BEAN
DIVISION OF FOOD
MACHINERY CORP.
Lansing 4, Michigan

NOW you can PREVENT RUST and SCALE from forming in your AUTO RADIATOR



KEEP WATER CRYSTAL CLEAR. Installed in radiator hose, Butler De-Scaler's Galvanic Cell Action prevents **RUST** and **SCALE** throughout the entire cooling system. Causes the removal of **OLD RUST AND SCALE.**

PROTECT your new car's cooling system from the start . . . end radiator rust-ups in your old car. Butler De-Scaler has been used with great success industrially for over ten years . . . proven in thousands of truck and bus fleets. Now available for car owners. Unconditionally guaranteed . . . for one year . . . will not interfere with Anti-freeze or stop leak. Easily installed . . . available at service stations, garages, and car dealers everywhere. If no dealer near you, write **BUTLER ENGINEERING CO., 2622 Rousseau St., New Orleans 11, Louisiana.**

New Fair Trade List Price \$2.95

Butler De-Scalers are also available for use in boilers, home hot water systems, Diesels, etc.



BUTLER De-scaler

JUNE 1948

HAPPY HOURS and Miles of Fun with a HARLEY-DAVIDSON

This year take a vagabond vacation! See America's outdoor wonderland from a new and thrilling vantage point . . . the saddle of a smooth-riding, fleet-footed Harley-Davidson! Discover the delights of "gyp-sying" along strange highways, of roaming down wilderness byways . . . with a pal or a gal, and the whole world unfolding before you! Visit scenic splendors, faraway places — take in exciting race-meets, endurance runs, hillclimbs. Make your holidays happier, every spare moment memorable, in the world's greatest sport . . . motorcycling! See your dealer today. Mail coupon now.



HARLEY-DAVIDSON MOTOR CO.
Dept. P, Milwaukee 1, Wis.

Send free copy of **ENTHUSIAST** magazine, filled with motorcycle action pictures and stories; also literature on latest models.

Name.....

Street or R.F.D.....

City.....Zone.....State.....

PERFORMANCE GOES UP IN SMOKE . . .

"Drop the extinguisher, Joe..."

he needs

**FEDERAL-MOGUL
ENGINE BEARINGS"**



**WORN
CONNECTING ROD
BEARINGS
CAUSE
OIL PUMPING**

When the connecting rod and crankshaft bearings in your car are worn, they let excess oil reach combustion chambers. You burn up dollars when power and pep pour out the tailpipe as smoky exhaust.

To restore quick pick-up, power and performance, replace with Federal-Mogul Oil-Control Bearings. They're engineered for the job — ask your mechanic.

FEDERAL-MOGUL SERVICE

(DIVISION OF FEDERAL-MOGUL CORPORATION)
COLDWATER, MICHIGAN

Replace in Sets with Genuine
FEDERAL-MOGUL
Oil-Control Bearings
in your car



reversing is. A sternwheeler pushes the water straight backwards or forward with her paddle wheel. She has four rudders ahead and three aft of the wheel—it makes no difference which direction she is going, some rudders are always receiving the solid thrust of water from the paddle wheel. The conventional ship has only one propeller and rudder. When reversing, the propeller is throwing the water away from the rudder, which then has little effect in steering. And to complicate the problem further, the propeller also throws water to the starboard side when reversing. This pushes the ship to the port (left) side and is difficult to counteract. This "crabbing" is not present in ships with twin propellers and is not as noticeable in small tugs, but it does prevent most freighters from reversing to starboard to help a small tug. And even a twin-screw ship is hard to manage in reverse unless she has considerable space to maneuver in.

Captain Harris recalls one deep-water skipper who brought his ship up the Columbia for the first time in 1944. "He said we made him dizzy, the way the Henderson threw his ship around. Couldn't understand it until I took him aft and showed him our rudder power."

The new Portland has performed admirably since her first test run last August. She and the old Henderson are handling a majority of the ships that enter the Portland harbor. Several other old sternwheelers are also berthing ships as well as towing log rafts and sawdust barges up and down the river.

One job was taken from these sternwheelers by the late war. Huge "cigar" log rafts formerly were wrapped with massive chains like gargantuan packages and towed by the paddle wheels down to the Pacific Ocean from where they were towed by sea-going tugs to San Diego, Calif. Their vulnerability to enemy submarines stopped this towing during the war and closed the mills that used the logs. Today, plans are being made to tow similar rafts from Alaska to the States. Transporting such a huge quantity of lumber in one load is an extremely economical method of transportation. Amazingly, the greatest danger is not of the rafts breaking up out at sea. The danger is of fire.

When buffeted constantly by the heavy Pacific swells, friction among the logs of the cigar rafts sometimes becomes so intense that the logs will burn deep inside the raft, usually charring or destroying a good portion of the load.

The old sternwheelers have played a

(Continued to page 240)

No Rod Can Touch WONDEROD'S ACTION and POWER!



Shakespeare's
**RESINATED GLASS FIBER
MAKES THE DIFFERENCE**

Fish-tested by thousands of commercial and sport fishermen—the unanimous opinion is —FINEST ROD EVER MADE for ACTION and POWER. You'll cast more accurately, and WONDEROD will take all Mr. Fish dishes out. Won't rust, rot or set. Resinated glass fibers, produced by exclusive HOWALD Resinating Process, gives amazing resiliency, strength—is secret of WONDEROD'S ACTION and POWER. Buy at your sports store.

Shakespeare

**FINE
FISHING
TACKLE**
HONOR BUILT for
FIFTY YEARS

FREE TACKLE BOOK and Pocket Fishing Calendar. Tells how to bait and fly cast. Reels, Rods, Lines, Accessories. Write for yours—SHAKESPEARE COMPANY, Dept. 86, Kalamazoo 2, Michigan.

PRESSURE QUEEN FOUR CYLINDER PORTABLE AIR COMPRESSOR SPRAY PAINTING OUTFIT

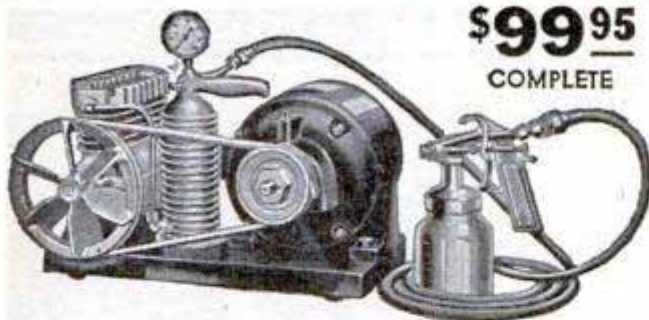

\$99⁹⁵
COMPLETE

COMPACT • RUGGED • POWERFUL

The ideal air supply for home and farm workshop, machine shop, garage, service station and contracting painter. Inflates tires; refinishes automobiles, trucks, implements and furniture. Paints buildings better, faster and at lower cost than brush work. Compressor has 4 cylinders, drop forged crankshaft, heat treated valves and pistons, bronze bearings, forced feed lubrication. 50-60 lbs. pressure without pulsation. Price includes compressor as shown, with air gauge, 15 ft. hose, spray gun and 3/4 h.p. motor; fully guaranteed. With 1/2 h.p. motor—\$109.95.

IF YOUR DEALER DOES NOT SELL
PRESSURE QUEEN WRITE DIRECT.

THE CAMPBELL-HAUSFELD CO.
1046 RAILROAD AVE. HARRISON, OHIO

STANLEY

**No. 233
LEVEL**

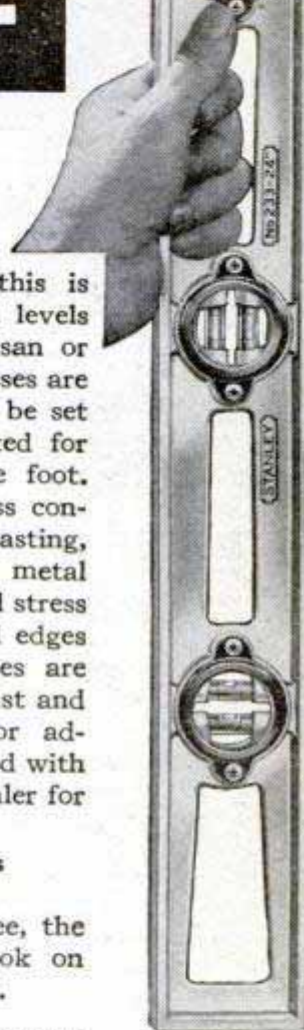

Made of aluminum, this is one of the most useful levels on the market for artisan or home owner. Its six glasses are fully adjustable — can be set at any angle or adjusted for degree of pitch to the foot. Frame is a strong, truss construction, aluminum casting, light in weight. Extra metal around glasses and at all stress points. Square ends and edges for scribing. Level cases are gasketed to keep out dust and moisture. Directions for adjusting glasses are packed with each level. Ask your dealer for Stanley No. 233.

Send coupon for this
BOOK BARGAIN

Two books . . . one free, the other a famous textbook on woodworking for just \$1.

THE TOOL BOX OF THE WORLD

STANLEY

Reg. U.S. Pat. Off.

HARDWARE • HAND TOOLS • ELECTRIC TOOLS

Stanley Tools, 168 Elm St.,
New Britain, Conn.

Please send by return mail:

- FREE booklet: "The Joy of Accomplishment".
- 188-page book: "How to Work with Tools and Wood". \$1.00 enclosed.

(In Canada: Send order to Stanley Tool Co. of Canada, Ltd., Roxton Pond, Quebec.

Name.....

Address.....

City..... State.....

SAY YOU SAW IT IN POPULAR MECHANICS



MORE SOCK!
in
hexagon
power sockets made by
Plomb Tool Company



Extra strong, extra tough—these husky, single-hexagon power sockets are a perfect supplement for thin-walled, double-hexagon (12-point) designs that might be too light for really tough jobs. Available in 3/8" and 1/2" drive sizes, they are also suitable for most

power nut-running tools—used to speed production in industry.



Buy them today from your dealer.



4883

PLOMB TOOL CO.

2255U Santa Fe Avenue, Los Angeles 54, Calif.

major part in the development of the Pacific Northwest. Their history goes back to 30 years after the expedition of Lewis and Clark. It was in 1835 that a sway-backed compromise between a sidewheeler and a sternwheeler blundered around the Horn from England to Hudson Bay's Fort Vancouver on the Columbia. This was the Beaver, built on the Thames River for the fur traders. She sailed to the Pacific coast with her paddle wheels in the hold—no one trusting the new-fangled steam. But her steam-powered paddles were so successful that others were built and improvements made, resulting in the sleek packets of the turn of the century.

The rivermen now admit that the railroads are better for hauling freight. And they admit that one ocean freighter did navigate a portion of the dangerous waters above Portland. That ship, the Wheeler, made the trip up the Columbia in 1937 to The Dalles, Ore., 100 miles above the main sea channel at Portland. That stretch of the upper river was really not dangerous in 1937 as the Bonneville Dam has changed its rapids into a placid lake. Even so, two sternwheelers, the Cascades and the James W., were chartered to go along to keep the freighter out of trouble. No ocean ship, before or since, has attempted the now-easy trip, although huge locks were built in Bonneville Dam for the purpose.

The rivermen were not disgruntled when the Wheeler made the trip. The presence of the Cascades and the James W. justified their creations. And the spanking new Portland is paying an honest tribute from the marine engineers of today to the designs of yesterday.

Can We Save Our Trees?

(Continued from page 149)

only because they fall by accident beneath some protecting shrub, weed or tuft of grass. This low growth must be encouraged if the giant tree cactus is to reproduce in its desert home.

On the West Coast a mystery disease called "quick decline" is striking through the orange groves. Quick decline affects only orange trees, and of those only the trees having sour root stock. In the past two years, about 40,000 trees have been affected or killed by the disease. Scientists have learned that quick decline is caused by a virus, and have tried treating the trees with penicillin and sulfa drugs. The work is under way at present and results have not yet been announced. No insect carrier for the virus has been found, but the

(Continued to page 242)

Dependable

CHAMPION

America's Favorite Spark Plug



Keep your eye on the track!
Most racing drivers use Champion Spark Plugs
because they have found that they
insure better, more dependable engine
performance. Most motorists have
likewise found this to be true—and have
made Champion America's Favorite Spark Plug
—for every engine!

CHAMPION SPARK PLUG COMPANY, TOLEDO 1, OHIO



FOLLOW THE EXPERTS

DEMAND NEW DEPENDABLE CHAMPIONS FOR YOUR CAR

Listen to the CHAMPION ROLL CALL . . . Harry Wismer's fast sportscast every Friday night, over the ABC network

research workers are reasonably sure that such a carrier exists.

One disease which blankets much of the country is white-pine blister rust. It covers the lake states, the eastern seaboard as far south as Virginia, and the great forests of the Northwest. Blister rust is an example of how a foreign disease can be introduced into this continent. The disease first was reported in 1906. Investigators learned that infected seedlings had been imported from a single nursery in Germany and distributed to 200 different localities across North America. Thus the disease had an opportunity to strike on 200 different fronts at one time.

Today after years of research the Division of Forest Pathology has the answers to control of blister rust. The fungus requires currant or gooseberry bushes as an alternate host—it will not survive unless it can go from white pine to bush and back to the tree again. Farmers, foresters and nurserymen all over the country are removing such bushes from the vicinity of white-pine trees. Rust-resistant pines are being developed for future plantings.

Within the past few years a mystery disease has been killing thousands of oak trees in the Middle West. Once it strikes a tree it can turn the leaves brown within a week. Research workers have found and

identified the fungus that causes it and are delving into this new threat in an effort to discover how it is spread.

What is most feared by these guardians of our trees is the introduction of some foreign insect or fungus which could gain a foothold and then rage through the thousands of square miles of Douglas fir stands. Our recent years of lumber shortage would seem like years of plenty if this occurred. And any disease that crops up unannounced in a forest-tree nursery might be shipped unwittingly to hundreds of different localities.

Agencies other than the USDA are aiding the fight to save our trees. Commercial tree surgeons are helping solve local problems. Universities and state departments of agriculture have done valuable work on trees within particular regions. Dr. Pierre Miller of UCLA has developed a "hot water" treatment that kills tiny roundworms causing wartlike growths on peach trees. The Los Angeles City Tree Surgeon administers shots of iron-citrate crystals into the city's eucalyptus trees to cure them of an ailment brought on by an iron deficiency in the soil. Although this deficiency is not a disease, it can so weaken trees that they will die or become subject to disease.

Insect pests that cause damage or carry

(Continued to page 244)



MARTIN
"40"
4½ H.P.
35½ pounds

MARTIN "60"
7.2 H.P.
43 pounds

MARTIN "20"
2½ H.P.
29½ pounds

MAN A MARTIN for thrilling top speed performance. MARTIN's exclusive patented, mechanically-controlled poppet valves set a new standard of performance in outboard motors.

MAN A MARTIN for smooth, unbelievably slow trolling speeds. MARTIN's sputter-free operation at slow speeds adds to fishing pleasure.

MAN A MARTIN for more family pleasure on the water. MARTIN has the features for all around easy handling by any member of the family.

For outboard motoring at its best . . .

MAN A Martin

There's a choice of three great outboard motors, when you decide to MAN A MARTIN, and enjoy outboard motoring at its best. A MARTIN combines *all* the finest features you would expect in a great outboard PLUS exclusive features which have enabled it to set new performance records. Take a tip from America's keenest sportsmen, who say—"for tops in outboarding . . . Man a Martin!"

MARTIN MOTORS, Eau Claire, Wis., Division National Pressure Cooker Company
Canadian Sales by: **MARTIN MOTORS,**
Wallaceburg, Ontario, Division National Pressure Cooker Company (Canada) Ltd.

The NEW Standard of Performance!



"Slickest Set
A Man
Could Own!"

HERE'S
WHAT YOU
GET!

a new Ferret Set by **Snap-on**

A new design... strong... adaptable...
they squeeze into close places easily

(All units $\frac{3}{8}$ " Square Drive)
 $\frac{1}{4}$ " and $\frac{5}{16}$ " Single Broached Sockets
 11 — Double Broached Sockets
 "from $\frac{3}{8}$ " to $\frac{7}{8}$ "
 1—Speeder Wrench 1—8" Ratchet
 1—Sliding Tee 1—Nut Spinner
 1—Universal Joint
 3", 6", and 12" Extensions
 —Complete in a metal box,
 19 $\frac{1}{2}$ " x 5 $\frac{3}{4}$ " x 1 $\frac{3}{8}$ " — specially
 designed for this set.
 Rich red enamel finish.

Yes, a new Ferret Set... new in design... way over
 par in performance — and they're twice as strong as
 you would expect such slim, slender handles and thin-
 walled sockets to be.

They squeeze into tight places and get those hard-
 to-reach nuts and bolts that defy the ordinary type
 wrench. Newly designed by Snap-on engineers, they
 make quick easy work on many of the tough jobs on
 modern motors and engines.

Be sure to ask your "Snap-on" man to show
 this set the next time he calls.



SNAP-ON TOOLS CORPORATION

8062-F 28th Avenue • Kenosha, Wisconsin
 INTERNATIONAL DIVISION: KENOSHA, WISCONSIN, U. S. A.

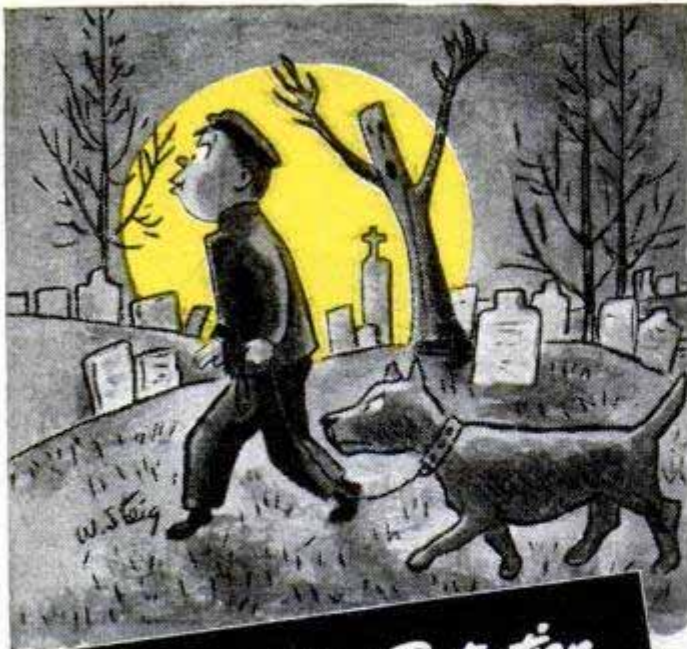

**What's Extra Protection
Worth to You?**

★ To keep your motor alive and powerful—give it Casite's extra protection.

Casite cuts engine wear and cuts repair bills because it improves lubrication. No matter what kind of motor oil is being used, Casite helps it get around—quickly and into the tight spots. It retards the formation of sludge and gum . . . frees sticking valves and rings . . . cleans your motor and keeps it clean.

Get Casite today—and get Better Motor Performance or Double-Your-Money-Back. The Casite Corporation, Hastings, Michigan, and the Casite Division, Hastings Ltd., Toronto.

75¢ A PINT
95¢ in Canada

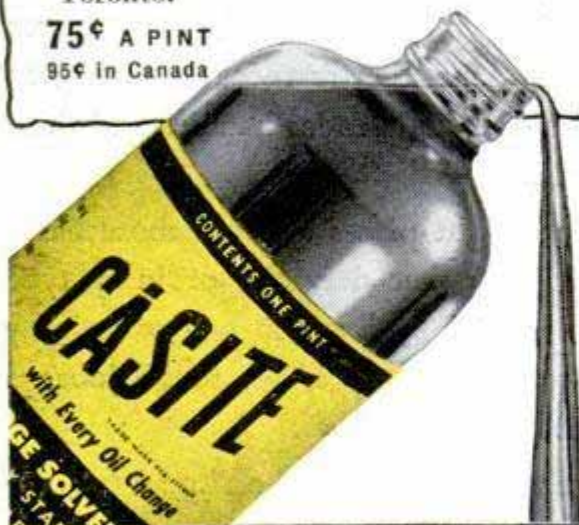

**IMPROVES LUBRICATION
CUTS ENGINE WEAR**

diseases somehow develop a relative immunity to poisons by evolving new strains. This is one of the reasons why the codling moth is still a pest in American apple orchards. Thus the enemy of the USDA scientists may undergo a change in the middle of the battle. Fighting such an enemy is a job requiring patience measured in centuries rather than years. Yet it's essential if we are to save our forest and shade trees from these fifth-column diseases, which cause a greater loss in lumber each year than the total loss from forest fires.

Attacking the Mysteries of the Atom

(Continued from page 102)

Commission and Office of Naval Research.

One interesting use concerns the feeding of radioactive carbon dioxide to plants in studies aimed at solving the mystery of photosynthesis. The problem is to learn the process by which a plant transforms carbon dioxide into carbohydrate. A possible offshoot of the work will be to learn how to control plant enzymes and this offers the attractive speculation that someday it may be possible to reduce drastically the growing season of valuable food plants without affecting their other qualities.

Radio-iron is being employed in tests for determining the best conditions under which blood transfusions should be made as well as the best conditions under which human blood should be stored. Radio-iodine is being used to study goiter and other thyroid diseases, and other radioactive isotopes are proving valuable as diagnostic aids against some kinds of malignant tumors as well as disorders of the circulatory system.

The tracers allow scientists to study the paths of different minerals and chemicals in the body and to learn what uses are made of them. Poisonous substances as well as nourishing materials can be studied in the same way. Everyone knows, for example, that an overdose of carbon monoxide is lethal and now the scientists are trying to discover what organs are affected by carbon monoxide and just what the reactions are.

Their technique is to place a small amount of radioactive Carbon 11 in the atmosphere that a volunteer is breathing and then to trace the distribution of the tagged atoms through the body by means of gamma-ray counters placed close to the body. Carbon 11 has a half life of only 20 minutes and so a research worker stands ready at the University of California cyclotron while the tracer material is being

(Continued to page 246)

WHEN **Winter Weary** WIRE NEEDS REPLACING

Switch to **AUTO-LITE**

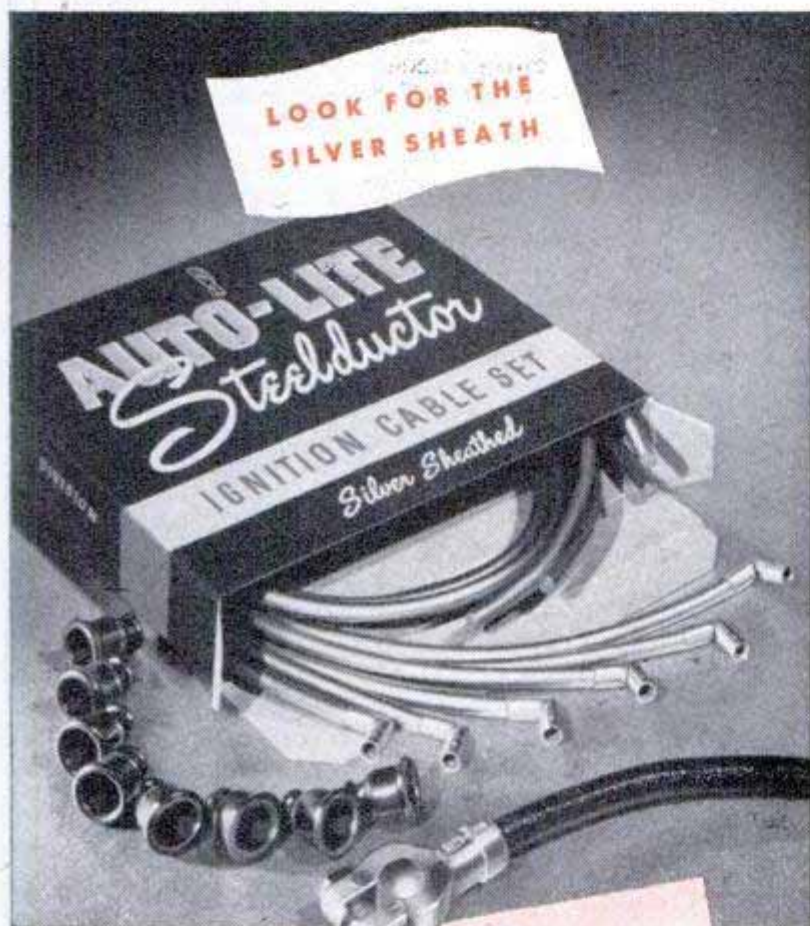

LOOK FOR THE
SILVER SHEATH

AUTO-LITE
Steelductor
IGNITION CABLE SET
Silver Sheathed

NEW AUTO-LITE

Steelductor
SPARK PLUG WIRE

RESISTS MOISTURE,
HEAT, OIL and ABRASION

If your car's wiring is winter-weary, replace it with Auto-Lite Steelductor, the seven-strand stainless steel wire used on war planes, that offers marked advantages in shielded systems. Steelductor is available on spools or in packaged sets, cut-to-length with terminals, for all popular makes of cars.

You can count, too, on Auto-Lite full-gauge Battery Cable with Anti-Corrode Terminals for best results in your car.

THE ELECTRIC AUTO-LITE COMPANY

Toronto, Ontario

Toledo 1, Ohio

New Auto-Lite
Battery Cable Helps
Prevent Ruinous
Corrosion Like This



Properly installed, Auto-Lite Battery Cable with the revolutionary Anti-Corrode Terminal, helps prevent resistance-building corrosion that restricts proper current flow to the starter and other electrical units.

MONEY CANNOT BUY BETTER WIRE AND CABLE

Tune in the Dick Haymes Show, for Auto-Lite Thurs., 9:00 P. M., E. T., CBS

The Real Ticket for fishing fun!

It's Head of the Class

— America's favorite "Four" . . . the silky, sparkling Zephyr! On fishing waters everywhere, it is known for superb performance, and for bonus features that add to fishing fun. Try the Zephyr on a boat . . . then decide if you'd settle for less than four cylinder smoothness — four cylinder starting ease . . . four cylinder flexibility and low trolling speed! See your Evinrude dealer . . . he will gladly arrange a demonstration of the Zephyr, or its swift and spirited companion model, the Lightfour.

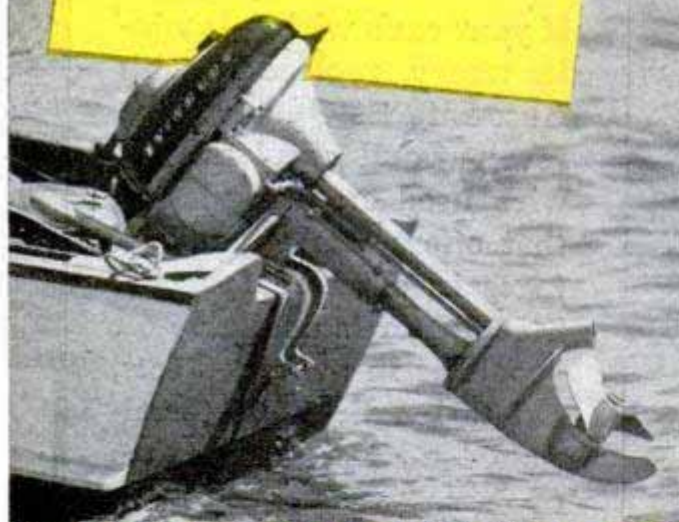

EVINRUDE

★★Two new stars in the light motor field . . . the new Sportwin and Sportsman. Both offer the revolutionary FISHERMAN DRIVE . . . weedless, shoal-riding, snag-proof . . . the real ticket for fishing in shallow or weedy waters. See your dealer — look for his name under "Outboard Motors" in the yellow pages of your phone book. *Catalog free* — write for it today! EVINRUDE MOTORS, 5788 North 27th Street, Milwaukee 9, Wisconsin.

In Canada: Evinrude Motors, Peterboro, Ont.

FIRST IN OUTBOARDS • 39th YEAR

manufactured and then runs with it to an adjoining building where the carbon monoxide setup is ready and waiting for the experiment.

Contributing to the accuracy of physiological studies has been the development of small vacuum-tube counters that can be placed directly against the skin or even placed inside the mouth for close observations. The tubes for detecting some kinds of radiation need no shielding. Tubes for detecting gamma rays are placed inside a heavy lead shield with one opening at the bottom so as to insulate them against stray "background" radiations.

Radioactive arsenic is being used in the treatment of leukemia and Hodgkin's disease with some success. Arsenic has been used for treating leukemia for many years, but the radioactive use is new. It is being tried in the hope of obtaining both the chemical effect of arsenic and the radiation effect of the radioactive chemical.

The mysteries of the atom are still far from solved. To many people the atom means only the threat of mass destruction by atomic bombs. But to the scientists, working on the constructive use of atomic power, the mysteries of the atom, once solved, will open the door to a better life.

Jet Roost on a Flattop

(Continued from page 110)

from the hangar deck as well as from the flight deck.

The jet pilots greatly prefer catapulting to flying off the deck. A catapulted plane leaves the ship with an air speed of 120 or 130 m.p.h. and in case of engine failure has a wide, easy gliding range. But if an engine fails during a deck fly-off the jet falls into the sea, right in front of the carrier.

Pilots maintain that carrier landings are easier with jets than with piston-engine aircraft, mainly because of their increased visibility. For the first time, they say, they can see the deck ahead of them and below them as they come in, instead of peering along the side of a big engine that gives them a view only of the landing officer and the port side of the ship. And because of this better view the pilot can align himself more accurately with the ship and there are fewer wave-offs.

Other reasons carrier pilots like jets for landings are that they don't have to fight engine torque that tends to slide the plane toward the right and also there's no chance of oil fouling up their windshields and obscuring the view.

Because of its changed center of gravity

(Continued to page 248)

IF YOU CRAVE ACTION YOU WANT THE *Pacemaker*

SPEED GRAPHIC!

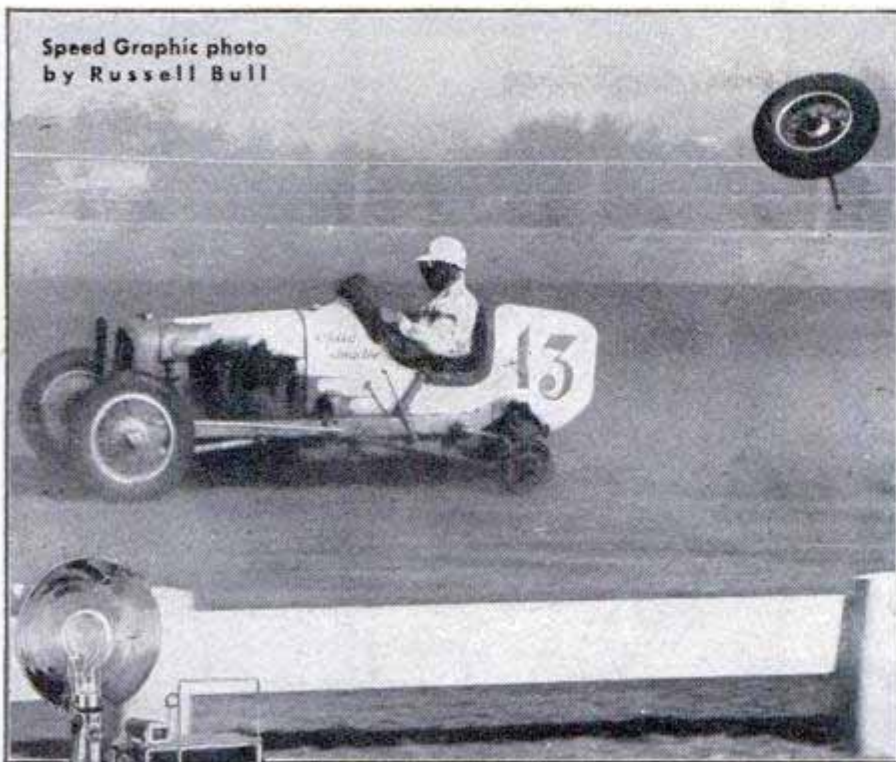

Speed Graphic photo
by Russell Bull

You want the one camera that does justice to a hobby that can be the most exciting in the world! Events that are packed with action take place every minute in every day. And you can get an everlasting record of *action*—sports, public events, racing fire-fighters—with the SPEED GRAPHIC . . . the camera press photographers use!

That's because the SPEED GRAPHIC is the camera with the new, simplified focal-plane shutter with governed speeds—and governed speeds mean *accurate* exposures, and more and better pictures! The camera that takes any kind of picture with the greatest of ease! See your dealer today! For descriptive literature, write to Room 41, Graflex Inc., Rochester 8, New York.

Graphic cameras and accessory photo-products are manufactured only by Graflex, Inc., Rochester 8, New York.

Western Division Office: 3045 Wilshire Boulevard, Los Angeles, California

GET PRIZE-WINNING PICTURES WITH

GRAFLEX



SANDING FURNITURE



SANDING WOODWORK



REFINISHING CARS

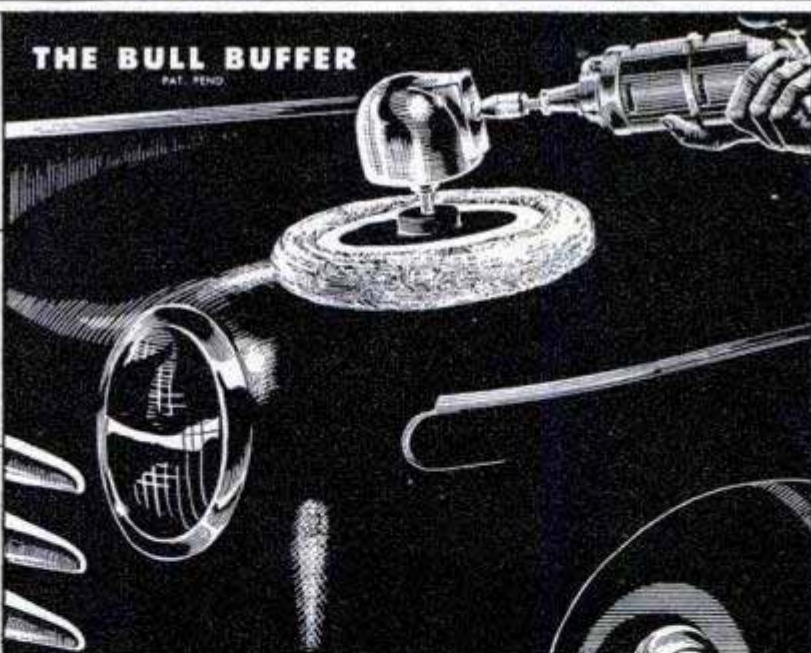

THE BULL BUFFER
PAT. PEND.



POLISHING CARS



POLISHING FLOORS



POLISHING FURNITURE

The *very first time* you polish your car, sand your own floors, refinish furniture, this tool has *more than paid for itself*. And what a kick you'll get out of doing all the polishing and sanding jobs that used to cost lots of money! With the Bull Buffer, you can do beautiful, *professional* work—make your car, furniture, floors, woodwork gleam like new. You'll find no limit to the ways Bull Buffer will save time and money in your home and business.

- Used in
- HOMES
- FARMS
- FACTORIES
- GARAGES
- OFFICE BLDGS.
- STORES
- SHOPS
- SERVICE STATIONS
- CABINET SHOPS
- METAL SHOPS
- UPHOLSTERING SHOPS

THE BULL BUFFER FITS ANY CHUCK ON AN ELECTRIC DRILL (OR FLEXIBLE SHAFT). Attach it quickly . . . polish and sand . . . then disconnect it and use your drill for any other purpose.

HIGHLY MANEUVERABLE. EASY TO OPERATE. Holding drill stationary, buffer can be turned in a

BERTRAM B. ENGINEERING COMPANY

3034 MAIN ST.

DEALERS WRITE FOR INFORMATION

complete circle. Bull Buffer easily reaches *all curved or flat surfaces*. It's RUGGED — POWERFUL — BUILT TO LAST A LIFETIME. Sturdy aluminum casting houses self-lubricated bearings and steel gears that operate in a bath of oil. All materials and workmanship are *guaranteed*.

The sooner you order, the sooner you'll have this handy new tool in your hands. It's a real bargain—only \$9.95, complete with five-inch rubber disc, sheepskin bonnet, and 2 sanding discs. (Extra bonnets, \$1.25—extra medium and coarse sanding discs, 10c each.) If your dealer doesn't stock, send cash, check or money order for \$9.95, postage prepaid. C.O.D. plus postage.

\$9.95

KANSAS CITY, MO.

DOUBLE ACTION!

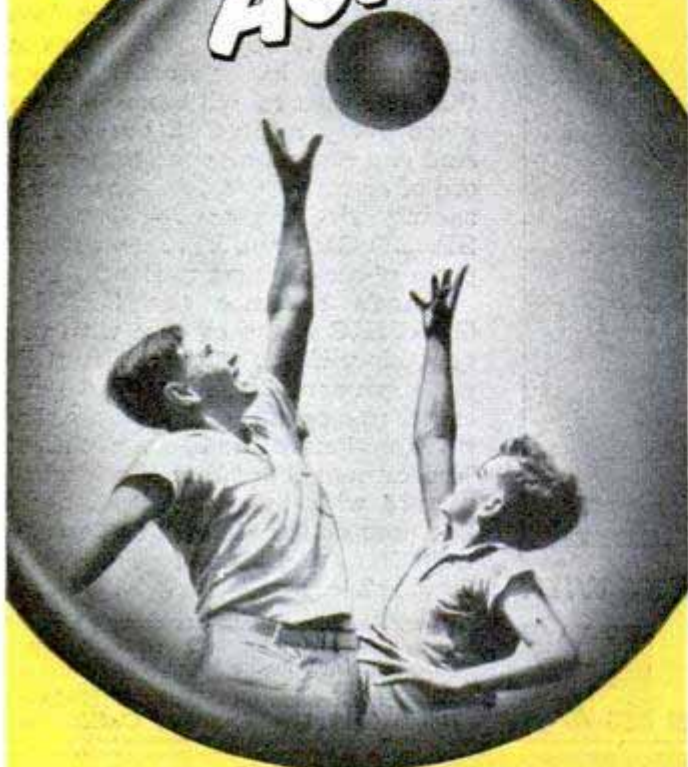

PENNZOIL

MOTOR OIL

FLOWS FAST-STAYS TOUGH!

Safeguard your engine for summer with instant and lasting protection. You get them both with double-action Pennzoil!



At this sign of better dealers, coast to coast

*Registered Trade Mark

Member Penn. Grade Crude Oil Ass'n., Permit No. 2

Tough-film PENNZOIL* gives all engines an extra margin of safety

a jet aircraft handles differently when low on fuel than it does when fully loaded, altering the maneuvering and landing characteristics. To minimize shifting, the Fury retains all its spent shell cases on board and has a fully automatic fuel transfer system that moves the supply around from tank to tank as it is consumed, to retain the original center of gravity.

Carrier deck crews have to observe special precautions while working around jets. They can crawl under planes but may not pass close around the front or rear of them. They can't wear protruding pencils or handkerchiefs that may be sucked out of their pockets into a jet's intake. For the same reason they must wear their hats turned down.

Take the Wheel of a New Hudson

(Continued from page 91)

maintains an amazingly even keel. You try the same stop again. The result is identical. No pitch at all.

"How come?" you ask Bald.

"A good many things combine to make a car ride like this," he says. "There's the single unit frame and body structure, direct-action shock absorbers, the low center of gravity and almost perfect balance. The engine has been moved forward a little and the back seat is no longer over the rear axle but moved forward even ahead of the rear wheels. There are coil springs in front and leaf springs in splayed position—slightly at an angle—in the rear. Get in back once and let me drive for a mile or so over this rough stuff."

You soon discover that the wide back seat of this car offers you a "front seat" ride in smoothness.

"While you're back there I'll turn the radio on," says Bald. "Notice how low the volume is and the fact that you can hear easily in the back. The reason is that the speaker is here on top of the instrument panel and throws the sound upward."

Back at the wheel you start off like a veteran Hudson driver. The car hugs the road. At 60 m.p.h. you meet a huge trailer truck and feel no push of air against your car. Mile after mile the road to Port Huron, Mich., spins by. Suddenly you are shocked to look at the speedometer and see it registering 90 m.p.h. You quickly lift your toe from the accelerator.

"Felt like only 70," you apologize to Bald.

He smiles. "A good many people make that mistake and it may be because we are sitting closer to the ground."

An absent-minded driver creeps onto the

(Continued to page 250)

ELECTRONIC KITS

For HOBBYISTS and EXPERIMENTERS

INTERPHONE 2-WAY CALL SYSTEM KIT



Shipping Wt. 5 lbs.
\$14.50

Ideal call and communication system for homes, offices, factories, stores, etc. Makes excellent electronic baby watcher, easy to assemble with every part supplied including simple instructions. Distance up to 1/5 mile. Operates from 110-V A.C. 3 tubes, one master and one remote speaker.

GN58 GENERATOR

Makes excellent home lighting plant, operated by wind propeller, waterfall, gas engine, or hand crank. Reduction gear allows full output at slow speed; supplies 6 volts at 2.45 amp., 425 volts at .115 amp. New. Add postage for 28 lbs.

\$7.95



DYNAMOTORS

An electric motor operating a generator on same shaft—hundreds of uses—gives high voltage from storage battery.

Dynamotor C—Input 28 volts, output 220 volts at 60 MA. Add postage for 6 lbs.

Dynamotor A—Input 12 volts, output 1000 volts at 350 MA. Shipping weight, 72 lbs.

Dynamotor B—Input 6 or 12 volts, output 500 volts at 160 MA. Shipping weight, 30 lbs.



\$1.95

\$5.95

\$5.95

GENERAL ELECTRIC TRANSMITTER-RECEIVER FOUNDATION

A beautifully constructed tuner containing the best in variable condensers, coils, vernier dials, etc., at least \$30.00 worth of parts, complete with conversion instructions to transmitter and receiver. Add postage for 20 lbs.

\$2.49



GENERAL ELECTRIC BC 645 TRANSCIVER

A brand new two-way communication set which cost the Army over \$400.00 and is ideal for two way communication between house and cars, office, service trucks, ambulances, boats, etc. Range up to 15 miles in the 450 to 500 Megacycle band. Operates in the new citizens band. Supplied complete with 15 tubes and conversion instructions to operate from 110 V A.C. Add postage for 25 pounds.

ACCESSORIES NEEDED

PE101C Dynamotor for 12 or 24 Volt storage battery operation \$3.95

110 V A.C. Power Supply to operate BC 645 from house current \$11.95

T-32 Table Microphone \$2.95

Microphone Transformer \$1.00

5" PM Speaker for BC 645 \$2.80



10 times as powerful as a walkie talkie

\$14.95

2 for **\$27.00**

HEATHKIT 3-TUBE ALL-WAVE RADIO

110-volt AC operation

\$8.75

An ideal way to learn radio. This kit is complete ready to assemble, with tubes and all other parts. Operates from AC. Simple, clear detailed instructions make this a good radio training course. Covers regular broadcasts and short wave bands. Plug-in coils. Regenerative circuit. Operates loud speaker. Battery model for use where no AC house current is available. Add postage for 3 lbs.

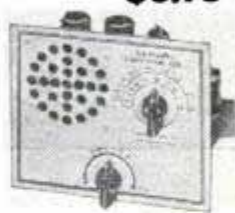

Heathkit Beginners' Radio 110-volt type **\$8.75**

Heathkit Beginners' Radio, battery type (2 tubes, no rectifiers) **\$8.75**

Headphones for either type HS 30 per set **\$1.00**

2 1/2" permanent magnet loudspeaker for either type **\$1.95**

Batteries, complete kit for battery type set **\$3.25**

MIDGET TRANSMITTER KIT

Complete kit to assemble a 1 Watt battery operated amateur 80 meter transmitter, including tube and crystal. Range up to 500 miles. Only accessories needed are sending key and batteries. Complete instructions supplied. Add postage for 2 lbs.

Key—add postage for 2 lbs. **\$1.00**

Batteries—add postage for 4 lbs. **\$3.25**

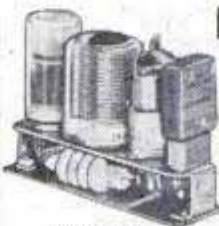

\$3.95

THE NEW 1948 HEATHKIT 5" OSCILLOSCOPE KIT

Complete kit to build a beautiful 5" oscilloscope. Ideal for studying and servicing television and FM radio. 6 tubes including 5BP1 cathode ray tube. 1500-volt power supply operates from 110-V 60 cy A.C. Has compensated vertical and horizontal amplifiers and 15 cy to 30 KC sweep generator. Detailed instructions make assembly easy. Shipping weight, 35 lbs. Nothing else to buy

\$39.50



WRITE FOR LITERATURE ON HEATHKIT SERVICE INSTRUMENTS

MINIATURE HEADPHONES

\$1.00

Hearing aid type, comfortable, keeps out outside noise, one of the army's best types. Add postage for 2 lbs.



T32 TABLE MICROPHONE

One of the army's finest built by Kellogg. Ideal for public address, transmitters, etc.

Add postage for 5 lbs. **\$2.95**



G. E. CIRCUIT BREAKER

\$2.95

Protect your electrical equipment, eliminate fuses. 50 AMP 220 Volt rating. Add postage for 4 lbs.



MINIATURE MOTOR

24V. D.C. size 1 1/4" x 1" x 2" Add postage for 1 lb.

\$2.95



ORDER DIRECT FROM THIS AD
Include postage for weight shown. Print name and address. No orders under \$2.00



The **HEATH COMPANY**

DEPT. M . . BENTON HARBOR, MICH.

Riegel WORK GLOVES

tops in...

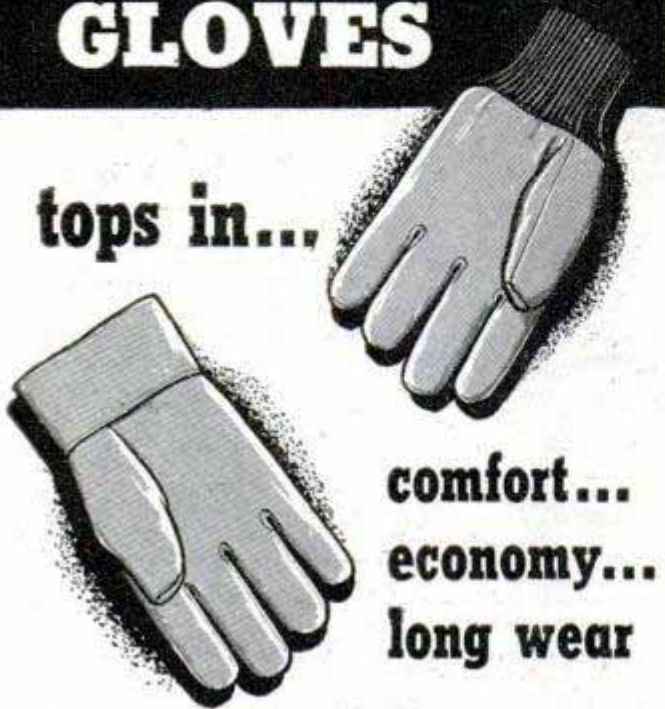

comfort...
economy...
long wear

Enjoy the genuine comfort and protection of Riegel Work Gloves. They cost no more . . . and you'll find them tops in working ease and rugged resistance to wear. Made from raw cotton to finished glove, in America's largest work glove plant.

STYLES TO FIT EVERY NEED

canvas, jersey, leather . . . knit wrist, band top, gauntlet . . . double-palm, reversible, quilted . . . for factory, farm and home.

Ask for the Riegel brand wherever work gloves are sold. Full descriptive literature sent free, if requested on business letterhead.



Riegel Textile Corp.
342 Madison Ave.
New York 17, N. Y.

"THIS TRADE MARK IS YOUR GUARANTEE OF VALUE"

highway from a side road. You quickly apply the hydraulic brakes.

"Where do you think you'd be if the hydraulic brakes failed?" Bald asks.

"Probably at a harp counter," you guess.

"Not in this car," Bald says, "you'd be right here slowed up just the way you are. When the brake pedal goes all the way down it engages reserve mechanical brakes. We've been using these for years."

You try a few curves at reasonably high speed. There is no top-heavy feeling about this steady low-slung car.

"The fact that the car is low is not the only reason it takes curves like this," Bald explains. "The front and rear stabilizer bars help resist sideways."

Now for some pickup tests. Successive trials with Drive-Master shift show that the car accelerates from 10 to 40 m.p.h. in 15 seconds; 10 to 50 m.p.h. in 19 seconds; 10 to 60 m.p.h. in 29 seconds. From a dead stop the car accelerates to 40 m.p.h. with Drive-Master in 12 seconds, and in conventional shift (through three speeds) from 0 to 40 m.p.h. in about the same time.

Returning from Port Huron the skies open up and rain comes down in sheets. This pleases Bald who opens the cowl ventilator which lets fresh air in and drains out the rain.

"Sorry it isn't cold enough to turn on the heater," says Bald, "so I could show you our special Weather-Control which not only warms the air but filters and circulates it and keeps it constantly fresh."

Miles farther on you turn into a side road in the quest of hills or deep ruts. The car takes the steepest hill you can find with the ease of a veteran mountain climber. A couple of times in deep ruts and chuck holes the car scrapes the road.

"Not a good car for a farmer or rancher who lives on a back road," you suggest.

"As good as any modern car," says Bald. "Despite the extra-low appearance of the car, our ground clearance is average."

By the time you are back in the heavy 5-p.m. traffic of Jefferson Avenue in Detroit you are handling the new Hudson, Drive-Master and all, as if you had driven it for months—and you wish you had.

HUDSON SPECIFICATIONS

Engine.....	L-head, 6 or 8 cyl.
Compression ratio.....	6.50 to 1
Wheelbase.....	124 in.
Over-all length.....	207½ in.
Height.....	60 in.
Body width.....	77-1/6 in.
Front seat.....	64 in.
Rear seat.....	63 in.
Weight (4-door Commodore Six).....	3540 lbs.
Front springs.....	coil
Rear springs.....	leaf
Ground clearance.....	.8 in.
Speed.....	100+ m.p.h.
Tires.....	Super cushion 7.10 x 15



HOW MANY
GOOD PICTURES
DO YOU GET?

Sparkling, brilliant pictures result from accurate exposure. For determining exposure there is no better meter than the new Norwood Director. Perfect for black and white—a must for color—movies and stills.

YES, WITH THE

NORWOOD Director
EXPOSURE METER

**EVERY EXPOSURE YOU MAKE
CAN BE A PERFECT ONE!**

The meter with the revolutionary Photosphere* and simplified dial provides the most consistent, most accurate, quickest, and easiest method of determining exposure. See your photographic dealer or write for illustrated booklet, "How To Determine Exposure Correctly."

*Reg. U. S. Pat. Off.

AMERICAN BOLEX COMPANY, INC.
521 FIFTH AVENUE NEW YORK 17, N. Y.

**Cracked
Water Jacket
SEALED
TIGHT**

Use Smooth-On No. 1 Iron Cement to seal cracks in cast metal parts such as water jackets, crank cases, gear cases, etc. This quick-hardening cement stops leaks and holds tight—for it expands slightly as it sets. Use it, too, to stop leaks in radiators, gas tanks, heating, cooling and exhaust systems. Keep Smooth-On No. 1 handy for many auto and household repairs. Buy it in 1-, 5- or 20-lb. size at your hardware store. If they haven't it, write us.



FREE 40-Page Repair Handbook

Shows, besides above repairs, many time-saving, money-saving household uses. Heating and plumbing system leaks stopped. Loose hinges, handles, parts tightened. 170 illustrations. Write for your free copy TODAY.

SMOOTH-ON MFG. CO., Dept. 37F
570 Communipaw Ave., Jersey City 4, N. J.

Do it with
SMOOTH-ON
THE IRON CEMENT OF 1000 USES



SAY YOU SAW IT IN POPULAR MECHANICS

JUNE 1948

**New Way to Own
AN AMAZING
New Hearing Aid!**

- Comes to you by mail
- Satisfaction Guaranteed
Or Your Money Back
- Just Clip Coupon Below



Single Unit.
This is all you wear.
\$75 Complete.

New Radionic **Zenith "75"**

THE HEARING AID THAT
NEEDS NO "FITTING"

So good we can offer you this
MONEY-BACK TRIAL!

Wear the Zenith "75" at home, at work, anywhere. If it isn't better than you ever dreamed ANY hearing aid could be, return it within 10 days of receipt and Zenith will refund your money in full.

Saves you over \$100, too! Because the new Zenith "75" needs no "fitting," it saves you embarrassing visits to salesrooms and annoying sales pressure. Also, it saves you over \$100 cash money. If its price had to include conventional selling costs and profits, this top quality hearing aid would have to sell for \$195 instead of \$75! So do as tens of thousands have already done. Find new happiness and success by mailing the coupon below—right now!

BY THE MAKERS OF THE WORLD-FAMOUS ZENITH RADIOS

Look only to your doctor
for advice on your ears and hearing



MAIL THIS COUPON TODAY

Zenith Radio Corporation
Hearing Aid Division, Dept. PM68
5801 Dickens Avenue, Chicago 39, Illinois

I enclose check or money order for \$75* for one Zenith "75" Hearing Aid. Unless I am completely satisfied and find the Zenith "75" superior to any other hearing aid, I may return it within ten days of receipt and get my money back in full.

*Plus tax of \$1.50 in Illinois or New York City; \$1.88 in California, except Los Angeles, \$2.25.

Please send me free descriptive literature.

Name.....

Address.....

City.....State.....

"LOOK HOW
SIMONIZ KLEENER
WIPES AWAY DULLNESS
AND GRIME!"



You can now Simoniz your car in 1/2 the time!

It's true—in less time than ever your car can have that lasting, "brighter-than-new" look! The first quick step is Simoniz Kleener (liquid if slightly dull—paste if unusually drab). This brings out all the brilliance and luxurious color you've dreamed of. Then, to protect the glamorous new finish and keep colors from fading—apply famous Simoniz. After that only a dry cloth is needed to preserve this wondrous new beauty for months.



If you want your car Simonized for you, go to a Certified Simoniz Service Station. You are then assured of genuine Simoniz Products and factory approved methods.

THE SIMONIZ COMPANY, CHICAGO 16, ILL.



Motorists Wise

SIMONIZ

TRADE MARK REG.

GIVES CARS LASTING BEAUTY

Palomar Opens Its Eye

(Continued from page 85)

and insulated with aluminum foil. Hot air between the double wall escapes through openings in the top of the dome. Ventilating fans are used after dark to fill this space with cool night air.

The dome shutters are opened just after sundown so that during the next hour any slight difference between outside and inside temperature can be brought into balance. Floodlights inside the dome are housed in insulated cells that prevent radiation of heat from the lamps, even though the floodlights are never used when the telescope is at work.

The Mt. Wilson and Palomar Mountain telescopes will cooperate in astronomical and astrophysical research and, in fact, are to be placed under a single administrative management financed by the Carnegie Institute of Washington and the California Institute of Technology. Ordinarily each will be concerned with its own program of research but on occasions when different types of observations of the same body must be made simultaneously the two telescopes will be turned toward the same portion of the sky. Eventually, the observatory council expects, a modulated light-beam telephone will connect the two domes so that astronomers at work at each telescope can discuss their expeditions in space.

Torpedo Speedway

(Continued from page 106)

division of the Inyokern Naval Ordnance Test Station in the California desert, which also has a huge Pasadena laboratory known as the Underwater Ordnance Division. In effect the torpedo range is the proving ground for ideas developed in the Pasadena laboratory.

The lab fires torpedoes in miniature, using scale models of suggested shapes and designs. They are fired into water tanks so that their underwater travel can be recorded by high-speed cameras that make exposures as short as a 500,000th of a second and can take 500 individual pictures in a second's time.

One problem has been to eliminate the cushion of air that is carried underwater when a torpedo hits the surface. Unimportant though this air might seem to be, it could slightly affect the missile's course. One suggestion has been to provide numerous small holes or indentations in the outer skin of the torpedo, into which the

(Continued to page 254)

AMERICA'S BIGGEST WAGON VALUE!

Manufacturer's Close-out
You Save 35%!



Features Completely
Guaranteed as Advertised

A once-in-a-lifetime buy! A wagon you will be proud to own! Actually sold for \$19.95 in retail stores!

Not a cheap tin wagon, but a real, strongly built wagon that supports 1/4 ton load. Body is extra-heavy gauge rustproof steel and solid oak.

Safe! Non-tilting — turns at a 90° radius without tipping. Patented hub-less wheels do not injure shins or tear clothes.

HURRY—only 2500 of these wagons available. Freight cost is low! Send cash, money order or check. No C. O. D.'s, please. ORDER NOW!

WAS
\$19.95
RETAIL
NOW ONLY
\$12.95
You Pay Freight

Plus Features

1. Big 16"x 36" body
2. 10"x 1 3/4" Firestone demountable tires
3. Chrysler Oilite bronze bearings
4. Auto-type steering gear
5. Metal parts cadmium and nickel plated
6. Chromium plated channeled steel handle

MARKWARDT MANUFACTURING COMPANY
1937 WEST CANAL STREET • MILWAUKEE 3, WISCONSIN

FREE value packed RADIO CATALOG

write for it today!

Lafayette Radio

DEPT. LF8, 100 SIXTH AVE., NEW YORK 13

36-PAGE CASCO

PROJECT BOOK!

YOURS FOR 10¢



Gives you plans and diagrams for wood, plastic, metal, glass! 5-pages on internal carving of plastics! Full of ideas for gifts, hints for model builders, ways you can make money in spare time!

DON'T MISS THIS BIG CASCO OFFER!

"Things to make and how to make them" is a 36-page Project Book no craftsman should be without. Now you can get your copy—just for the dime it costs to cover handling and mailing! This helpful book also tells you about an easier, faster way to get professional results on any project you start!

IT'S CASCO'S BIG NEW 21-pc. ELECTR-O-TOOL KIT...

Value-priced portable workshops that belong on every work bench!



14.95

Only famous Casco gives you a heavy-duty electric power-head, all the popular accessories, and a sturdy carrying case for this amazing low price! Now on sale at all leading stores!

First choice with craftsmen! Every Casco kit is precision built, laboratory checked — proved in exhaustive tests by professionals in industry. Genuine fractional HP AC-DC motor. Smooth vibrationless operation at 20,000 RPM. 14-part ribbed commutator turned within .0005. Handles like a pencil—on-off switch for one-hand control. Oilless bearings. Unbreakable Tenite plastic case. Special safety sleeve and shaft lock. Non-slip check. Triple cooling for steady performance under load. 90-day guarantee. Complete facts in CASCO PROJECT BOOK. Write for yours now!



Drills & routs metals



Carves & saws wood



Shapes plastic



Etches glass



Polishes and grinds



Sands and sharpens

FILL OUT! GET YOUR PROJECT BOOK!

Casco Products Corp., Dept. M6, Bridgeport, Conn.

Enclosed is 10¢ to cover cost of mailing my 36-page Casco PROJECT BOOK. My hobby is _____

Name _____

Address _____

City _____ State _____

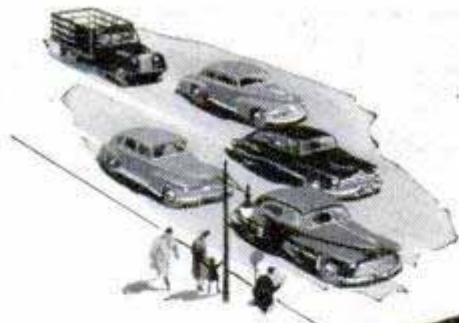

**in Original
Factory-Equipment
Choice**

More than 50% of all cars and trucks built during the past 10 production years have been factory-equipped with AC Spark Plugs. The choice of responsible engineers is your assurance of utmost reliability and top performance.

You can continue to have such reliability and performance by buying AC—the original factory-equipment choice in spark plugs.

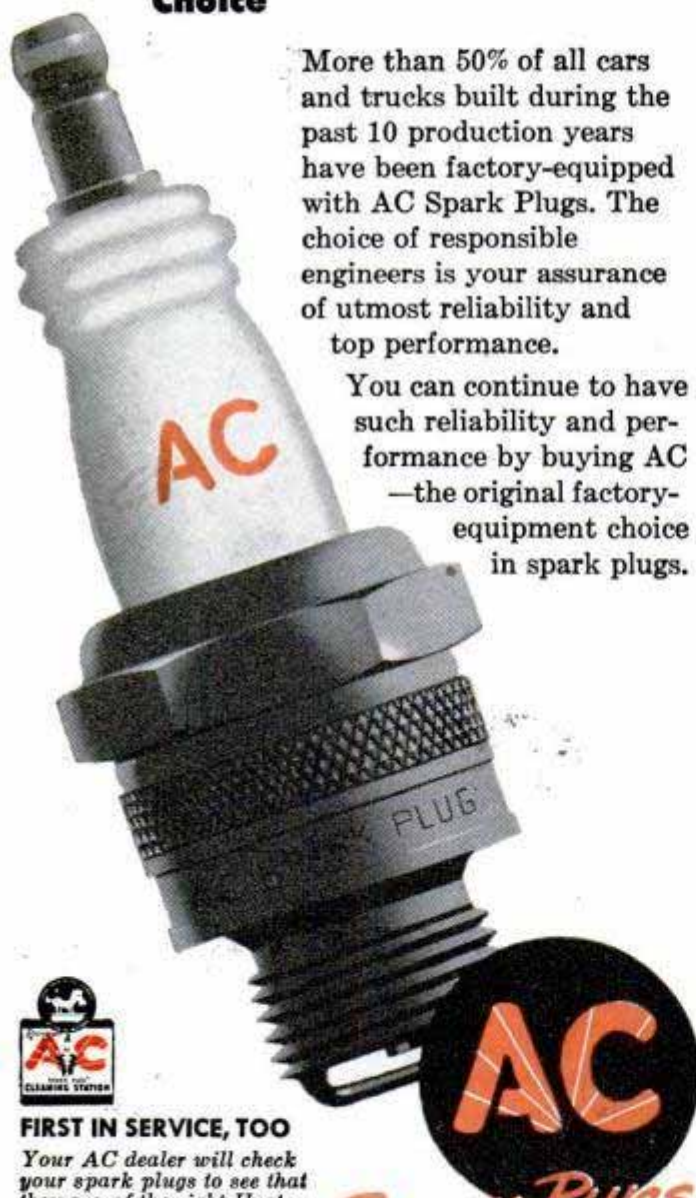

FIRST IN SERVICE, TOO

Your AC dealer will check your spark plugs to see that they are of the right Heat Range.

SPARK PLUGS

AC SPARK PLUG DIVISION • GENERAL MOTORS CORPORATION

air could be compressed. Another has been to band the torpedo with a series of small ridges behind which the air could escape upward to the atmosphere.

Actually very little information on the effects of air, water turbulence and other phenomena on the movement of underwater missiles was available until the Navy laboratory was established. The shapes of torpedoes were designed by the trial-and-error method, then this was improved upon slightly by the testing of models in towing basins and channels. Not until high-speed cameras and high-speed light flashes were sufficiently developed was it possible to actually observe scientifically the behavior of submarine bodies in motion. With these new tools the Navy has obtained basic data that is having an effect on the missiles it is now designing. What these missiles are, what they will do, what they look like, all is secret information.

Handle Locks Flush With Surface

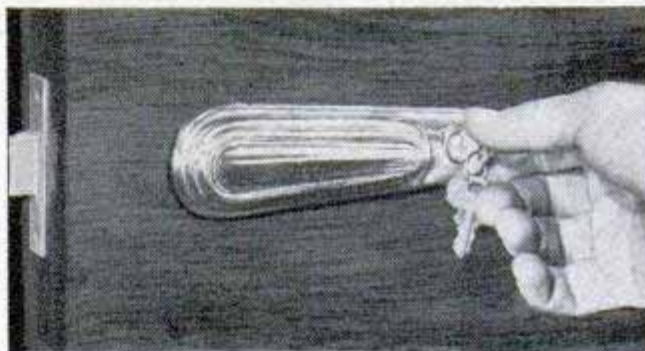

With flush-type locks there's no doubt about whether or not the door is locked—if the handle is pushed in, the door is locked. When the key is turned, the handle springs out. No key is required for locking the door. Presenting a flush surface, the lock eliminates the hazards of torn clothing and personal injuries. Primarily used on trailer coaches, the locks can be installed on station wagons and automobiles. A new model, designed for lockers in schools and gymnasiums, eliminates the necessity for padlocks and protruding handles. The chrome locks require only four small holes for installation.



**You Can Make Up
to \$5.00 Per Hour
with the IDEAL**

There are hundreds of lawnmowers in your neighborhood that will need sharpening at least once or twice each season. You can build up a profitable business with the Ideal Lawnmower Sharpener, and earn up to \$5.00 an hour while doing it.

You need no experience to operate the Ideal Lawnmower Sharpener. Just place the lawnmower in the Ideal, make a few simple adjustments, and in a few minutes you have a smooth-running, perfect-cutting lawnmower. The Ideal is not a "make-shift" sharpener, it has 45 years of engineering design behind it, . . . is sturdily built, and grinds both straight blade and reel knives to a precision-cutting edge. Write today and learn what the Ideal Lawnmower Sharpener can do for you.

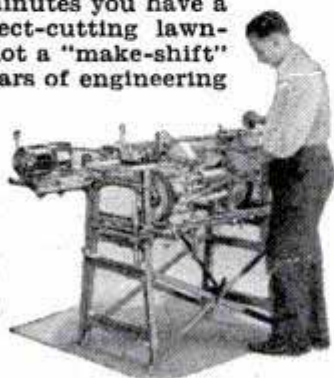

DON'T DELAY

Send For FREE Book

The FATE-ROOT-HEATH CO.

DEPT. D-3, PLYMOUTH, OHIO



32
DRAWER
UNIT
\$4.95

64 DRAWER \$8.95

*for home
or shop*

THE JIFFY METAL CABINET

WITH LAMINATED FIBRE BOARD DRAWERS

**THE HANDY WAY TO KEEP SMALL PARTS, WASHERS,
NAILS, SCREWS, NUTS, BOLTS AT HAND**

**APPROXIMATE
DRAWER SIZE**

1 1/4" DEEP
3" WIDE
6" LONG

CABINET SIZE

32 Drawer Unit

6" DEEP
12 3/4" WIDE
15 1/4" HIGH

Shipping Weight
approx. 9 lbs.

64 Drawer Unit

6" DEEP
25 1/2" WIDE
15 1/4" HIGH

Shipping Weight
approx. 18 lbs.

For small items, the low-cost Jiffy Cabinet, 32 or 64 drawer units that put office, shop, work bench, household and hobbyist needs at your fingertips. Metal flange drawer guides. Spot welded metal cabinet with laminated fibre board drawers insures long time-saving service. Why fumble? With the Jiffy you know where it is. 32 drawer unit—\$4.95; 64 drawer unit—\$8.95. Send check or money order—No C.O.D.'s please. Ohio orders please add 3% Sales Tax. Shipping charges parcel post collect.

KAYTEE PRODUCTS

Dept. M, Box 588

Canton, Ohio

ANCO® RAIN-MASTER®

**WINDSHIELD WIPER
BLADES and ARMS**

**Blade snaps on—Stays put
Can't fall off—Can't blow off**

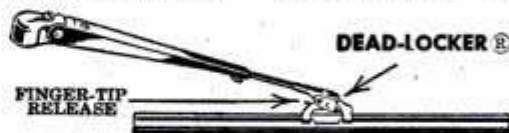

Don't Blame Your Gas-Pump Man!

Sure, he knows how dangerous it is for you to drive your car . . . in stormy weather . . . with dull old windshield wipers that *smear* and **SMEAR!**

He'll gladly put on for you—quickly—a pair of keen new ANCO RAIN-MASTER Blades—or Blades and Arms.

HE NEGLECTS YOU?

He has RAIN-MASTERS . . . But he forgets to remind you? Too busy?

After all it's *YOUR* car to protect. . . So, *YOU* ask *HIM* for RAIN-MASTERS next time you buy gas. . . Patented features. . . Original equipment on DeLuxe Models of high-grade cars . . . because RAIN-MASTERS *Clean quicker—Clean cleaner—Last longer.*

*Get yours—next time you buy gas.
May save you a costly smashup!*

Made by ANCO . . . makers of the new CLEAR-FLEX* Wiper Blade—the only Blade worth more than RAIN-MASTER. Costs more. Ask your good ANCO dealer to show you why.

*Trade Mark

**Quality Protected Under Fair Trade Laws
ANCO Patented Products—Patents Make Jobs**

THE ANDERSON COMPANY
Established 1918
GARY, INDIANA

AMERICA'S FINEST HOUSEHOLD OIL



**NOW!
SENSATIONALLY
IMPROVED**

NEW anti-sludge ingredients, new rust-inhibiting agents, greater penetrating power and balanced viscosity make famous 3-IN-ONE *better than ever*. There are hundreds of uses for regular 3-IN-ONE Oil around the home, office, workshop and garage. Buy a can today!

For guns, tools, workshop and farm equipment, always use

3-IN-ONE HEAVY BODY OIL

Lubricates, prevents rust and tarnish, is non-sludging and will not run-off.



BUY BOTH TODAY!

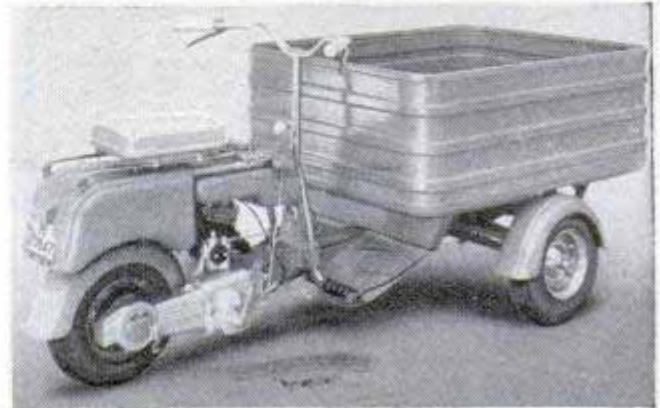

Scooter Goes 140 Miles Per Gallon

Weighing only 120 pounds, a motor scooter now being produced in Italy goes 140 miles on a gallon of gasoline and has a top speed of 40 miles an hour. Drum brakes on both wheels insure quick stops. Its three speeds are selected by a foot shift and the clutch is operated by a hand lever. The two-stroke one-cylinder motor is easily accessible when the rear portion of the body is swung forward on tubular supports pivoted in front of the motor. The rear wheel is removed from the side for quick tire changes. A three-wheeled delivery scooter made by the same company has a 1/4-ton capacity and brakes on all wheels. Both models have heavy sheet-steel frames formed to provide maximum strength without excessive weight.

Almost-Pure Helium for Welding

Virtually pure helium produced by the Bureau of Mines is being distributed commercially for the first time. Helium for commercial use previously has been 98.2 percent pure, but the new gas is within 0.2 percent of being absolutely pure. It is produced by passing the gas through refrigerated coconut charcoal, which absorbs the impurities — nitrogen and hydrogen — while taking up very little helium. The gas probably will be used chiefly in a shielded arc-welding process to prevent oxygen in the air from uniting with heated metals to produce oxidation.

Cushman

MOTOR SCOOTER

75

MILES PER GALLON

"HERE'S MY SECOND CAR"



Side-Kar attachment quickly makes an all-purpose vehicle of any 2-wheel model.

CUSHMAN ENGINES

For 47 years Cushman has produced high quality small air-cooled and water-cooled engines. These engines are available to original equipment manufacturers and other users.

Write for details.

Try the new ride! Enjoy 75-mile per gallon economy... 35 mile an hour speed... easy parking. The Cushman Motor Scooter is a handy "second car" the whole family can use. You need it in your business, too. Sturdily built; powered by the famous Cushman 4 H.P. "Husky" engine.

Dealers Everywhere.

200 Lb. Payload or an extra passenger is easily carried. Attach or detach Side-Kar in a few minutes.

3 Cu. Feet of storage space. Solves delivery problem for drug, grocery, service station, farm, factories, small businesses.

FREE. Descriptive folders, name of your nearest Cushman Dealer and coupon good for Free Demonstration Ride - write today.

CUSHMAN MOTOR WORKS, INC., Dept. M-600, Lincoln, Nebr.

Keep Brushes like New

BEFORE

AFTER

• 5c
• 10c
• 25c

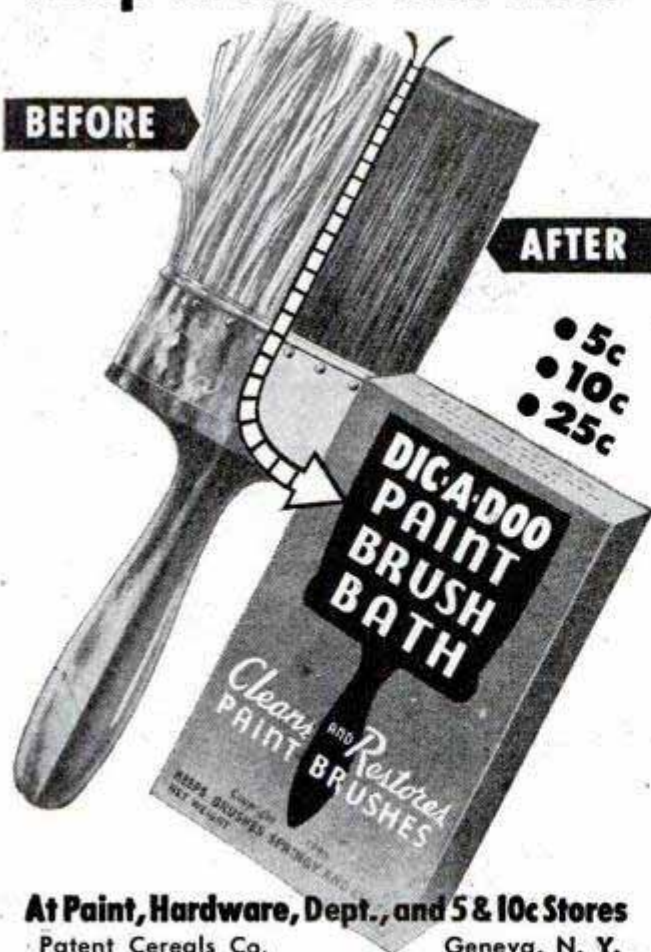

At Paint, Hardware, Dept., and 5 & 10c Stores
Patent Cereals Co. Geneva, N. Y.

Speed Sweep

THE BRUSH WITH THE STEEL BACK



Sweeps cleaner, faster -
Outlasts ordinary brushes 3 to 1!

Mail Coupon Today

Milwaukee Dustless Brush Co.
530 N. 22nd St., Milwaukee 3, Wis.

Please send me complete information about Speed Sweep brushes.

Name _____

Street Address _____

City, State _____

Yes, only \$18.95
Home Utility 1/4" Electric Drill

--and Made by **BLACK & DECKER**

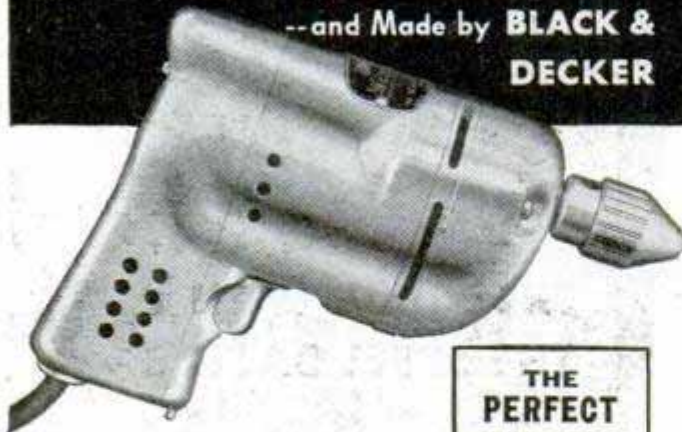

Makes or mends things better, faster —for Homes, Farms, Workshops, Repair kits!

THE PERFECT GIFT FOR FATHER'S DAY JUNE 20

Here's a Drill that's sure to help you turn out better work at top speed . . . in everything from building furniture to repairing farm machinery and appliances . . . whether it's for fun or profit! This versatile Home-Utility 1/4" Drill drives twist drills and augers, wire brushes, sanding attachments and light grinding wheels. It's equally productive in metal, wood or plastics. It's well-built by BLACK & DECKER, leading makers of quality industrial tools for 37 years. And the handy Bench Stand (for only \$11.45) quickly makes the Drill a useful drill press. For heavier work, there's a Home-Utility 1/2" Drill at only \$35.95. See your hardware, electrical or implement dealer for HOME-UTILITY Tools.

ELECTRIC HOME-UTILITY TOOLS

Products of THE BLACK & DECKER MFG. CO.
Dept. H-6M, Towson 4, Maryland

SAY YOU SAW IT IN POPULAR MECHANICS



WRITE FOR YOUR **FREE** COPY OF THE NEW **KRW HYDRAULIC PRESS BOOK**

Describes all manner of Production and Shop Work on KRW Hydraulic and Bench Type Arbor Presses. 32 pages illustrating the new KRW Hand-operated, Electric-operated and Air-operated Hydraulic Presses.

Write for your copy today.



K. R. WILSON, DEPT. 17, 215 MAIN ST., BUFFALO 3, N. Y.

Builders of Shop Equipment for Ford Dealers Since 1916

CENTER DRILL HOLDER



Rigid and accurate. Holds combination center drill and countersink in tail-stock or headstock spindle of lathe. Made of steel. Shank precision ground.

Taper Shank	Drill Dia.	Price
No. 2 M T	13/64"	\$2.50
2	3/10	2.50
2	7/16	2.50
3	13/64	3.25
3	3/10	3.25
3	7/16	3.25

SOUTH BEND LATHE WORKS
455A East Madison Street
South Bend 22, Indiana

See your dealer — or sent direct postpaid.

SOUTH BEND



NOW! YOU CAN HAVE YOUR OWN ELECTRO-PLATING Business

Plate GOLD - SILVER - CHROMIUM, etc.
It's Profitable - Simple - Pleasant

Do as hundreds of successful men are now doing — start your own business! You can plate on metals and non-metals with the VARI-PLATER. Your cost is low, profits are BIG! Don't let this money-making opportunity go by!



FREE! Write now for descriptive information and complete price list!

The VARI-PLATER — **\$55.00**
110 V., A.C., complete

LEWIS ELECTRICAL MFG. CO. 1943-A Walton Ave. New York 53, N. Y.

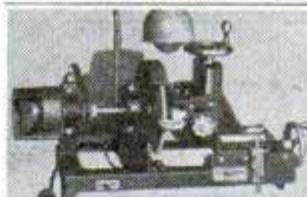

Pat. applied for

J. C. MOORE INDUSTRIES P. O. Drawer 276 FREDONIA, PA.

Start a NEW BUSINESS Or Add to Your Present Repair Business
Sharpen Dull Pipe Wrenches
Pipe Taps & Dies
"Gum" Circular Saws
Write for information.

NONE BETTER! SUPER DRILL GRINDER



Sharpens round shank drills from 3/32" to 1-1/16" in diameter, up to 11" long. Grinds old drills like new in 4 different point angles, using hand or power grinding wheels. Money-back guarantee.

Price only \$2.95

At Dealers or Postpaid

CRANDALL MFG. CO. 1512 W. Slauson, Dept. FA-30, Los Angeles 44, Calif.





How One Tube of Tip-Top Solder Stopped the Leak in a 5,680 Gallon Gasoline Tank!

"About a year ago with one tube of Tip-Top Liquid Solder, I stopped a small leak in a 5,680 gallon galvanized storage gasoline tank. You can guess what this would have cost to fix with a welding torch."

Mr. R. H. E., Minnesota

Tip-Top Liquid Solder saves you big money on repair bills, makes home mending easier. This amazing Liquid Solder forms a perfect joint in metals, wood, leather, paper, glass, china . . . most any material. Tip-Top is water and gasoline proof . . . has outstanding adhesive properties.

Always keep a tube handy on your work bench, in the kitchen, and in your car for emergency repairs. You can get Tip-Top Liquid Solder at your hardware dealer today, or write Tip-Top Products, Omaha. Always insist on TIP-TOP . . . the original and superior Liquid Solder.



LIFETIME BRONZE ANCHOR FOR FISHING & HUNTING BOATS

Non-rusting, non-corrosive . . . single cast assembly . . . "nothing to come apart."

Weight: 9 lbs.
Arms: 9 1/2" (length)
Flukes: 2 3/8"
Over-all length: 17"
Swivel shank in 6 1/2"
self-cleaning housing. Will not foul ropes.

\$3.50
FOB
IMMEDIATE DELIVERY

CALDWELL & WARD BRASS CO.
SYRACUSE, NEW YORK

CONVERT HAND MOWERS TO POWER MOWERS
Takes Less than 3 hours

Handy-Dandy Lawn Mower Kit fits any hand mower from the 16 to the 20 inch size. Kits furnished separately or with power units.

NOW AVAILABLE — Maytag, Power Products, Lauson Engines, and the Penn. Great American 12" Lawn Mower with sprocket mounted with all steel tubular handle.

DEALERS WANTED

LECLAIRE MFG. CO., LeClaire, Iowa Write Dept. P.M. 45

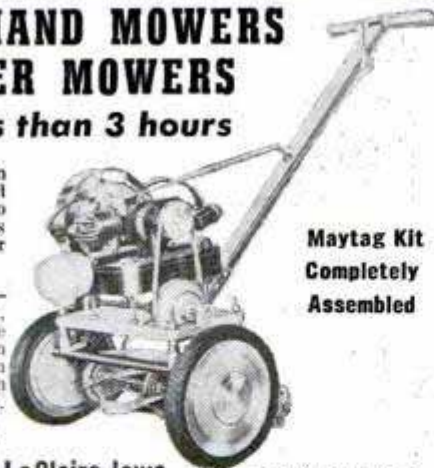

Maytag Kit
Completely
Assembled

AUTOMOTIVE ELECTRIC MOTOR

12 VOLT — 2350 R.P.M.

Manufactured by Stewart Warner Corp. Can be used for heaters, defrosting fans, wipers and many other purposes.

Each \$2.45

Lots of 24 \$1.95 ea.

Lots of 50 \$1.75 ea.

Send check or money order. We pay postage. C.O.D. You pay postage.

WABASH TRUCK PARTS CO.
1718 S. State Street, Chicago 16, Illinois



ELECTRIC PAINTER

Now you can get professional results in painting, even if you've never painted before! The new Lowell Electric Painter actually gives a fine "factory-finish." Paints rooms, furniture—even your car! At stores, everywhere.

PAINTS BEHIND RADIATORS!



Lowell Electric Painter actually atomizes paint. Covers area in a minute. Directional nozzle sprays paint straight ahead, up, down or sideways.

FURNITURE PAINTING EASY!

Use any kind of paint with the Lowell Electric Painter—enamel, flat paint, or varnish. Holds a quart. Easy to use. Small, efficient AC/DC motor. Weighs 8 lbs.



FASCINATING BOOKLET

Write for fascinating, new booklet: "40 Ways to Beautify Your Home." Send 10c to Lowell, Dept. 72, 589 East Illinois Street, Chicago 11, Illinois.

© 1947 L.M. Co.
Guaranteed

"Thoro-Spray"™

Electric Painter COMPLETE
No Extras To Buy

\$34.95

Slightly higher in western territories.



*T. M. REG. U. S. PAT. OFF.

LOWELL
Manufacturing Co.

World's Largest Manufacturer of
Sprayers and Dusters Exclusively

**THEY
GO
TOGETHER**



A PERFECT

And here's a match for you! The .22 caliber rifle and a Mossberg 4-power telescope sight. A wonderful combination. Shooting is more fun. Weak eyes are made better and good shooters become crack shots.

For the best shooting ever with your .22 caliber rifle put a Mossberg scope on it. Mossberg scopes, with the wonder-



PAIR!

ful, exclusive Internal Adjustment feature, fit most all rifles up to .25-20 caliber.

Illustrated: Mossberg 4-power scope model #5M4, for low mounting. Model #8M4 is identical except for high mount. Each \$9.95. Rifle is Mossberg #46B. \$23.90 (\$24.60 west of the Rockies).

**SEE THEM AT
YOUR DEALER'S**

Send for free descriptive folder
(No sales at the factory)



86506 St. John St., New Haven 5, Conn.

No other tool like it!
BURGESS
vibro-tool

Writes on . . .

- Watches
- Glassware
- Tools
- Leather
- Plastics
- Costume Jewelry
- Pots and Pans
- Sporting Equipment

\$7.50

Engrave your name . . . etch letters or designs . . . place permanent identification marks on anything with this unique hand tool. Carves wood and linoleum, cuts cardboard and balsa, tools leather. Just plug in on any 110 volt AC line. No home shop is complete without a Burgess Vibro-Tool. See your dealer or write for information.



DELUXE KIT
Vibro-Tool complete with 22 attachments in handsome, polished wood chest. . . . \$16.50

BURGESS Vibro-Tool Division
LAKE ZURICH, ILLINOIS

Electrically Welded Endless
Paramount
BAND
SAW
BLADES



Made in widths from 1/8" to 1-3/4"

Make your band saw do more work for you. The proper width of blade will extend the scope of this important machine. Burrill's Paramount Blades are made from tough Nickel Alloy Steel properly tempered. Teeth accurately set and filed, and all saws carefully straightened. Send order and check today. Delivery will be made as promptly as conditions permit, from a few days to a week or two. You can obtain these saws at the following prices:

3/8"-3/16"-3/4"-3/8" wide, 5'6" long	\$1.04 each
3/8"-3/16"-3/4"-3/8" wide, 6'6" long	\$1.16 each
3/8"-3/16"-3/4"-3/8" wide, 7'6" long	\$1.27 each

Other sizes at proportional prices
NO C.O.D. SHIPMENTS ACCEPTED
State Make of Machine
Your satisfaction is guaranteed
BURRILL SAW & TOOL WORKS
407 E. Main St., Ilion, N.Y.

A 10-Ton Press
at Low Cost

Pressing, separating, bending, and straightening jobs in your shop are easy with this press. Ten-ton capacity provides ample pressure. Adjustable table takes work up to 18 inches wide and 11 1/2 inches high. Send for free bulletin showing press and wide variety of accessories.
UT-10A Press f.o.b. factory \$31.00



DAKE ENGINE COMPANY
624 Seventh Street, Grand Haven, Michigan

NEW P-38 BELLY TANK \$9.95

Build, sell, Boats, Midget Autos, Ice sleds, etc. Resistance welded (no bolts). 10 ft. 2 in. by 2 ft. 4 in., 120 lbs., 165 gal. capacity. Write penny card for list 100 projects FREE. Plans, blue prints at small cost.

BUCK'S AUTO PARTS, Dept. 1A, Merced, Calif.

PAINT
COMES OFF
without hard scraping!



Cracked or peeling paint, varnish, enamel, shellac, or lacquer must be removed before the surface can be refinished properly. Wonder-Paste Remover makes this job easy. Simply apply Wonder-Paste with a paint brush directly over the old finish. It will not run! When penetration is complete, the old finish is reduced to a soft sludge that slides off like wet snow.

Write for Literature
We'll be glad to advise you on your particular removing problem, and to send you literature on Wonder-Paste . . . At paint and hardware stores.

WONDER-PASTE

Wilson-Imperial Company, 119 Chestnut Street, Newark 5, N. J.

Mows and Trims Lawns



In One Simple
Easy Operation
8 1/4 Lbs.

Save Time
and Labor with a

MONTAMOWER

New model. New type metal handle has special device to adjust cutting height. Drive shaft now mounted on free rolling, factory lubricated, sealed ball bearings. No tired backs or aching arms. 8 1/4 lbs. live precision made mechanism that first gathers, then cuts smoothly a clean 16" swath through grass, dandelions, spike grass, lawn weeds. No noise or clatter. As modern and efficient as your electric razor. Cuts right up to walls, fences, trees or posts; leaves no fringes to be trimmed by hand. Cutters self-sharpening. Built to last many years. Many thousands in use. Sold direct from factory for 26 years. Costs little. Write at once for trial on your own lawn "approval offer," guarantee information and literature.

MONTAMOWER DISTRIBUTING CO.

820 Keeler Bldg.

GRAND RAPIDS 2, MICHIGAN

TX-5 GEIGER COUNTER

for Locating
RADIOACTIVE MINERALS

The TX-5 is light weight, battery operated. Locates deposits of radioactives. Simply switch "on"—clicks in headphones indicate presence of radioactives. Extra sensitive, yet ruggedly built.

Each unit comes complete with headphones, probe, batteries and manual. For prospecting and mining operations. Write for details and price. Address TX-5 Geiger Counter

Geiger Counters for every purpose...

- OIL PROSPECTING
- MINERAL LOCATION
- HOSPITAL WORK
- INDUSTRIAL USE

OMAHA SCIENTIFIC SUPPLY CORP., 3623 LAKE, OMAHA 4, NEBR.

THE GIFT FOR DAD

THAT KEEPS ON GIVING Hull Automobile Compass

Makes knowing the way sure, safe and easy. Beaconlite illuminated. \$5.95; Streamline standard, \$3.95. At your dealer's. Write for circular.

HULL MFG. CO., P.O. Box 246-D7, Warren, Ohio

SAFE • EFFICIENT • SIMPLE

KUT-RITE (Patented)

LAWN MOWER SHARPENER

Keeps Mower Cutting Right. 3 Popular Sizes. Retail Prices: 14" - \$1.40; 16" - \$1.50; 18" - \$1.60. Replacement Emery Cloths, 50c each Plus Postage from Milwaukee, Wis. Weight 2 lbs. each.

AGENTS WANTED —
Write for Details
ACCURATE SHARPENER
MFG. CO., DEPT. PM2
Milwaukee 12, Wisconsin

Use it
anywhere!

-in your shop-
-on location

This one unit gives
(1) A.C. power and lights
plus (2) A.C. welding

Get these
EXTRA PROFIT advantages
with just one low investment

Make More \$\$\$ With Alternating Current Welding. Do arc welding anyplace with this portable gas engine drive A.C. Arc Welder. In the shop or in the field you'll find more welding advantages in this newly developed rotary A.C. Ideal in the field where electric power is not available, especially for inert-gas-shielded arc welding requiring A.C. for hard to weld metals.

Save More \$\$\$ With Alternating Current Power. This same machine is converted, by simply flipping a switch, to a portable Alternating Current Power Unit to furnish lights and power to operate electrical tools and equipment. A real value in case of normal power failure—prevents loss of production time, makes you independent of power supply.

You Can "Build Your Own" Or Buy Complete. You can buy this unit as a generator only for connecting to your own power source or you can buy it complete, ready to go to work. Either way you get a combination alternating current arc welder and alternating current power unit. Two machines built into one and for a little more than the price of one. Return coupon today for information on this revolutionary new machine. It can make and save you many \$\$\$.

**HOBART BROTHERS CO., Box M-68,
Troy, Ohio**

Electric Drive

Build Your Own

AC Welder

Hobart "one of the
world's largest builders of arc welders"

Hobart Trade School

Yes... I want to know more about... **FREE!**
Vest Pocket Guide..

—the new Hobart A.C. Arc Welder and A.C. Power Unit Combination. Send information on items checked:

<input type="checkbox"/> A.C. Welder-A.C. Power	<input type="checkbox"/> Industrial A.C. Welder
<input type="checkbox"/> Build Your Own D.C. Welder	<input type="checkbox"/> Shop Type A.C. Welder
<input type="checkbox"/> Shaft Extension Electric Drive	<input type="checkbox"/> Hobart Trade School

Hobart Brothers Company, Box M-68, Troy, Ohio

Name _____

Address _____

City _____ State _____

SAY YOU SAW IT IN POPULAR MECHANICS

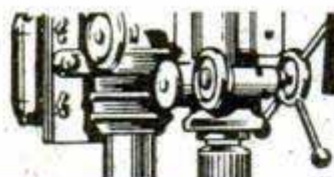

NEW!

HANDY, FLEXIBLE SHAFT

Converts Any Motor, Drill Press, Electric Drill, Electric Fan Into A Handy Rotary Tool

Attach ROTA-SHAFT in a Jiffy. Can Be Used for Grinding, Polishing, Sharpening, Cleaning, Engraving, Marking Tools, Carving, On Metal, Plastic, Wood, Glass.

Yes! Only \$2.95 and ROTA-SHAFT turns your old motor, drill press, electric drill or electric fan (10 inch or larger) with blades removed, into an efficient, versatile Flexible Shaft Tool for doing hundreds of grinding, polishing, sharpening jobs, especially in hard-to-get-at places. Attaches to motor shaft or in chuck. Convenient handpiece for ease of handling. Generous 40-inch overall length. Comes complete with buff and sanding disc ready to use in a drill press chuck. Order today.

SEND NO MONEY! Just mail order. Pay postman only \$2.95 plus postage on delivery, or send \$2.95 and we pay postage. Try 10 Days — if not delighted return for money-back.

If you order Rota-Shaft for use on motor add 35c for Special Coupling and State Shaft Diameter. **MAIL ORDER NOW!**

STRADER PRODUCTS CO., Dept. D-101
259 Strader Ave. Cincinnati 26, Ohio

ONLY \$2.95



OLD FAN MOTOR

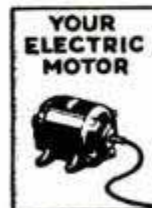

YOUR ELECTRIC MOTOR



VACUUM CLEANER MOTOR

NEW! SPEED MARVEL BAND SAW GEARED SPEED REDUCER

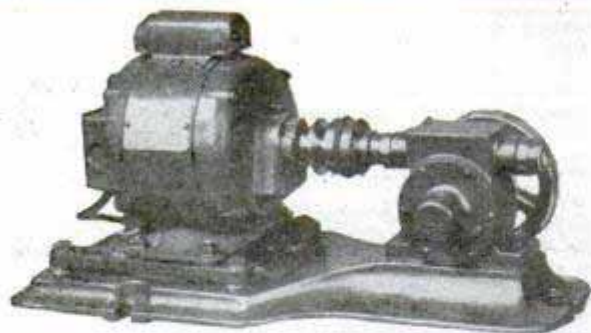

Cut wood or metal on same machine. Convert your present Band Saw from wood to metal cutting by use of this REDUCER and still use your present motor. \$32.75 F.O.B., Norristown, Pa.

Write for free descriptive literature

HUTCHINSON MFG. CO.

NORRISTOWN PENNSYLVANIA

ASSEMBLE

King Midget



45 MILES AN HOUR

90 MILES A GALLON

New, low cost transportation. Practical. Safe. A pleasure to drive. Home assembly keeps cost low. Just bolt together our factory built units. Immediate delivery. Send 25c for detailed circular with 8x10 picture, 4-view drawings, price of all parts. Or send for actual Assembly Book with 42 photographs, blueprints, drawings, sketches AND above literature — all for \$1 (refunded first order).

MIDGET MOTORS MFG. CO. Athens, Ohio

FIND UNDERGROUND MINERALS and METALS with M-SCOPE

New sensational lightweight models, unsurpassed efficiency
Low prices. Time-payment plan. Write for free 16 page booklet.

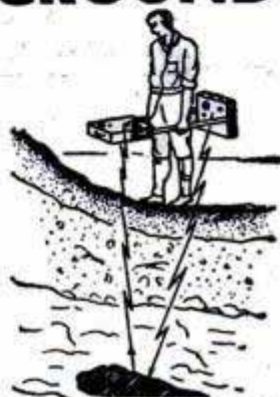

FISHER RESEARCH LABORATORY, INC.
PALO ALTO CALIFORNIA



PISTON TYPE COMPRESSOR

EASY PROFIT IN PAINT SPRAYING

Paints walls, ceilings, screens, furniture and machinery faster, better. All complete as shown less motor. Carry anywhere. Fully guaranteed. Could be used with 1/4 H.P. motor or less. Price \$35.00 less motor F.O.B. Chicago. \$5.00 deposit balance C.O.D. or see your dealer. With motor \$55.00.

IDEAL AUTOMATIC PUMP CO., Dept. P.M. 8

801 W. Washington Blvd.

Chicago 7, Ill.

MICROSCOPES SUPPLIES-ACCESSORIES & SCIENTIFIC INSTRUMENTS

BELL SPENCER BOUGHT-SOLD-EXCHANGED-REPAIRED **LEITZ ZEISS MEDICAL INDUSTRIAL AMATEUR**

NEW & USED

Send for **FREE LIST**

NATIONAL SCIENTIFIC INSTRUMENT CO. 119 CHAMBERS ST. N.Y. 7

Do You Ride a Bike? Here's the Real



SHOCKMASTER for all Bicycles

- LEVELS ROUGH ROADS
- PREVENTS BROKEN SPOKES, WHEELS, FORKS
- MAKES RIDING SMOOTHER, SAFER
- EASY TO INSTALL

A Shockmaster and front wheel shock absorber. Ruggedly constructed of nickel plated steel and engineered for years of real service. It'll pay for itself in added pleasure, saves tires and eliminates many costly repair bills. 20,000 satisfied users. Order yours today. Only \$3.69 postpaid. No C.O.D.'s. Complete satisfaction or money back. Dealers Wanted.

H. M. GIBB and COMPANY

1304 PENOBSCOT BLDG. DEPT. A DETROIT 26, MICH.

Your weight does the work
with a "YANKEE"
**QUICK-RETURN SPIRAL
SCREW DRIVER**

● Save your wrist: drive and draw screws faster. Just push on a "Yankee" 130A Spiral Driver. Your weight and the spiral turns the screw without blisters or fatigue. Quick-return spring in handle holds blade in slot and returns the handle after every stroke.

★
Write for the
"YANKEE"
Tool Book
... FREE ...

"YANKEE" TOOLS
NOW PART OF
STANLEY
THE TOOL BOX
OF THE WORLD

**NORTH BROS.
MFG. CO.**
Philadelphia 33, Pa.

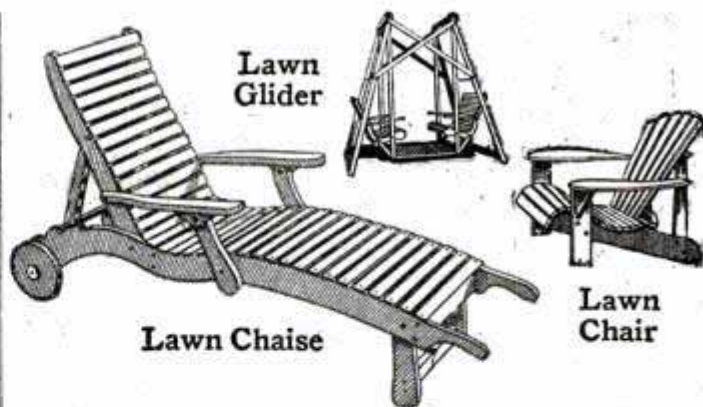

**SAVE MONEY, HAVE FUN,
BUILD LAWN FURNITURE.**

with **EASI-BILD* Full-Size Patterns**

You can build this lawn furniture at less than 1/2 the store cost—without special tools or skill! Easi-Bild Full-Size Patterns are easy to use. It's the dress pattern idea applied to flat lumber. Just trace, saw, and assemble. And for stronger joints throughout, use **CASCOPHEN**, Casco's new, waterproof glue.

*Reg. U. S. Pat. Off. by Easi-Bild Pattern Co.

How to choose a glue!

Follow these directions and you'll solve all your gluing problems:



For boats, outdoor furniture, sports equipment—joints that must withstand outdoor exposure—Cascophen (Resorcin Resin Glue). The first completely durable glue available to home-craftsmen!



For furniture, toys, heavy-duty home repairs—strong, stainfree, moldproof, highly water-resistant Cascamite (Urea Resin Glue). Mixes quickly with cold water!



For Models, photo prints, labeling—general home, school, or office gluing, use the new, clean, white, fast-setting Cascorez (Polyvinyl Resin Glue). Liquid, ready to use!

Send Coupon for Furniture Patterns to

Casco Pattern Dept. PM-68.
P. O. Box 215, Pleasantville, N. Y.

Enclosed is _____¢ for patterns checked below.

- () Lawn Chair, Pattern #32—25¢
- () Lawn Glider, Pattern #155—50¢
- () Lawn Chaise, Pattern #78—35¢
- () Please send free folder illustrating 100 patterns and free gluing chart.

Name _____
Address _____
City _____ Zone _____ State _____

THE BORDEN CO. • CHEMICAL DIVISION
Makers of Casco Glues

Say You Saw It in Popular Mechanics

**IT STAYS STUCK!
WITH ... MULTI-PURPOSE AMBROID**



If you want permanent results from an adhesive, you can't equal multi-purpose Ambroid liquid cement—for home workshop, household or factory. A quality leader for 37 years, ready-to-use Ambroid is waterproof, transparent, quick-drying, extra strong. Flexible, heat- and corrosion-resistant. For assembling, repairing or mending jobs, keep Ambroid handy. At your dealer's, or send 25¢ for big 2-oz. tube postpaid. Money back guarantee.

Also 50¢ 4-oz. tube. Pts., qts., gals., for industrial use.



303 Franklin St., Boston 10, Mass.

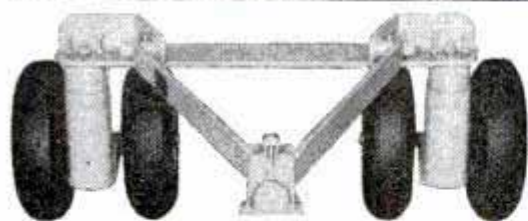

4 WHEELER
(Illustrated)
\$175

Cap. 1200 lbs.

2 WHEELER
\$125

Cap. 600 lbs.

WATSON DOUBLE-ACTION HYDRAULIC TRAILER DOLLY

60 miles per hour SAFELY — all day

THE WATSON AUTOMATIC MACHINE CO.

Glendale, Calif.

Mansfield, Ohio

CLEANS HARDEST PAINT BRUSHES

IN LESS THAN 1 HOUR!

TIME SAVER
Liquid
BRUSH
CLEANER
mfd. by
CELCO
CORP.



Cleans wet brush for change of color or lay-up almost instantly ... Use over and over again.

If not available at Paint or Hardware stores—send 60¢ for full pint—postpaid, U.S.A. only.

Also at 50¢ for a full pint.

TIME SAVER PAINT REMOVER

"A Little Removes a Lot of Old Paint!"

110 E. 42nd ST.
NEW YORK 17, N. Y.

SATISFACTION GUARANTEED ... Dealers, ask your jobbers!



**MEDICO
FILTERED
SMOKING**

Frank Medico pipes have the replaceable filter that

- absorbs juices
- collects flakes and slugs
- reduces tongue bite



Not a hollow tube!
Only this patented filter has the 66 baffles that whirl smoke cleaner and cooler into your mouth. Replace when discolored.

Frank Medico V.F.Q. (Very Fine Quality)
Bowls of rich-grained beauty. Wide variety of shapes. With 10 filters. . . . **\$2**

Frank Medico Standard Quality, still . . . \$1

S. M. FRANK & CO., INC., NEW YORK 22

SAY YOU SAW IT IN POPULAR MECHANICS

Protect Your Child
with the Positive
Auto Door Lock



Guaranteed to prevent accidental opening of 4-door car doors. Saves lives and prevents damage. Slips on and off without use of tools. Set of two for \$1.

AGENTS: send for samples and information on high-profit deals,
SHURLOCK CORP. • Waco, Texas

100% Fireproof Roofing



MIX yourself from local supplies. Apply like plaster. Slate like and insulates six times better. One half inch thick. Costs approx. same as asphalt. No more lifting shingles. Any color.

WE TELL YOU HOW. \$1.00
Complete instruction

NO AGENTS
RAV ROOFING CO.
P. O. BOX #255, PETERSBURG, N. Y.

WOODWORKERS . . . Get this
CONSTANTINE MASTER MANUAL



Get the Most Fun From Your Hobby
Indispensable to woodworkers. Newest, biggest edition, more pages, more color, helpful how-to-do-it articles, pre-war and new items, more bargains. Send 25c today and we will include **FREE! FULL YRS. SUBSCRIPTION** to Chips and Chats, published bi-monthly. Keeps you up-to-date on everything in woodworking, offers big money-saving bargains. Send now.

ALBERT CONSTANTINE & SON, Inc.
791-B 135th Street, New York 54, N. Y.

Make your own Gems 29.50
F.O.B.



All necessary lapidary equipment is furnished, including a super-charged diamond blade for sawing, and all wheels for grinding, shaping and polishing; also complete instructions. The complete equipment as shown, less motor and belt, for only \$29.50, f.o.b., Burlington, Wisconsin. Write today for information and literature.

B&I MANUFACTURING CO.
Dept. S Burlington, Wis.

FISH POLE or SKI CARRIERS



A "must" for Sportsmen! Genuine rubber suction cups for fenders or car top. Rigid, safe carrier for fish poles, skis, etc. \$1.50 per set delivered post-paid cash with order. No Stamps.

\$1.50 PER SET

THOMPSON ENGINEERING CO.
DEPT. 70 GRAND RAPIDS, MICH



2 POWER RANGES
1½ to 2H.P. 2½ to 3H.P.

NATIONAL
CLINTON
Month
MAY 15 TO JUNE 15

Ask the CLINTON Dealer in your community to show you one of these Super Power Plants that are the first choice for dependable power. Before buying an engine or any equipment, be sure you get the CLINTON Facts for only CLINTON gives you all of these better features: (1) Sure Spark Magneto; (2) Patented Finned Manifold; (3) Top-Fill Oil Filler; (4) Automobile-Type Carburetor-float fed; (5) Centrifugal Governor.

For full information write Dept. 101 PM

CLINTON MACHINE CO.
CLINTON, MICHIGAN

IT'S POWERED BEST WHEN CLINTON POWERED

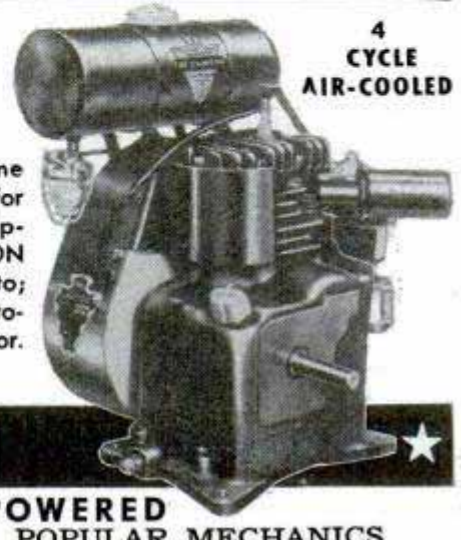

For Outdoor Fun and Adventure . . . Ride a **Royal Enfield**

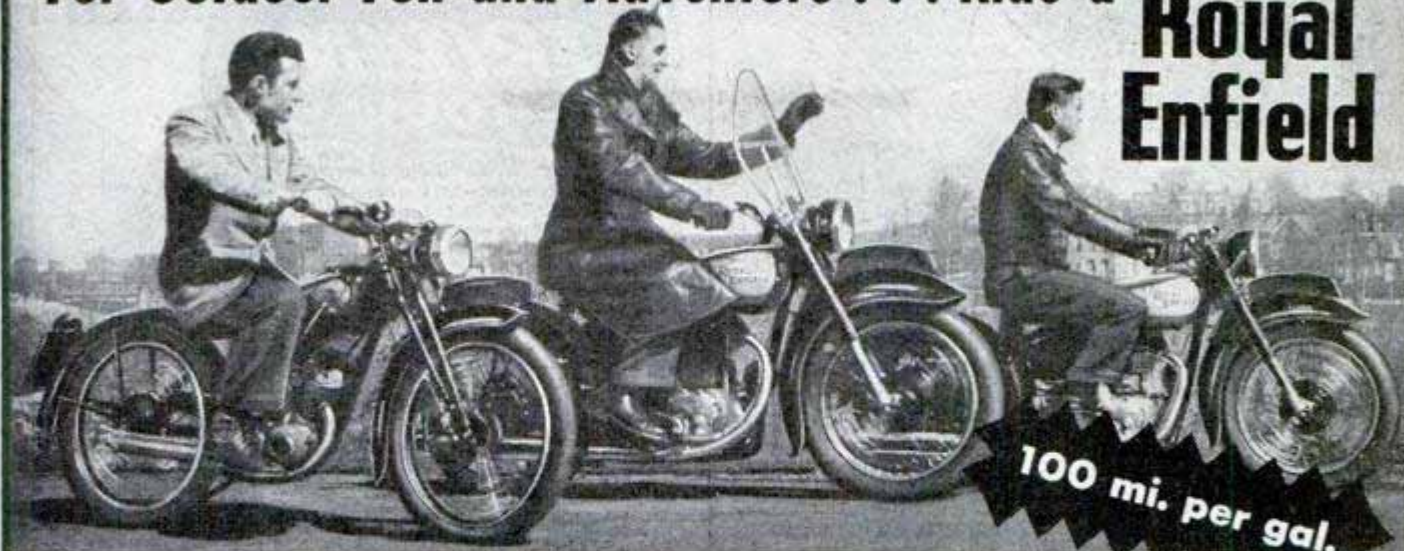

100 mi. per gal.

MODEL R. E.

MODEL G. 1

MODEL J. 2

THE WORLD'S MOST COMPLETE LINE OF MOTORCYCLES

Outdoor enthusiasts acclaim the new Royal Enfield Motorcycles. They are easy to ride whether you prefer the famous R. E. Lightweight or the Standard Models. Exclusive, precision-machined features assure dependable performance, outstanding riding comfort and economy of operation. For fun and adventure see your Royal Enfield dealer or write for folder "P" for complete details.

Dealer inquiries given prompt attention.

WHITEHALL DISTRIBUTORS, Inc.

1385 Commerce Avenue, New York 61, N. Y.

Model R.E. 125 c.c. Two-Stroke. 3-speed gearbox in unit construction with engine—aluminum alloy cylinder head—needle jet carburetor, twist grip throttle—kick starter.

Model G. 1 316 c.c. Overhead Valves. Push rods totally enclosed, automatically lubricated. AMAL carburetor, automotive type air cleaner. Cradle type frame; exclusive Telescope Front Fork and Neutral Finder.

Model J. 2 499 c.c. Overhead Valves. Push rods totally enclosed, automatically lubricated. High compression engine for top performance. AMAL carburetor, automotive type air cleaner. Cradle type frame; exclusive Telescope Front Fork and Neutral Finder. Two port exhaust system, chromed.

WHIPS THE DARK!

800 foot spot, or handy floodlight. Dozens of uses! Stands, hangs at any angle. 80-100 hrs. on 6-volt battery. A genuine Delta. At hdwe., sport, elec. \$4.25 stores. Less battery



Delta ELECTRIC CO.
MARION, INDIANA

POWERlite 2-LITE ELECTRIC LANTERN

The SPEED SAW FILER

Saves You Time, Money

Now you can do expert saw filing at home. Lifetime tool makes precision filing easy for even the most inexperienced. Two simple adjustments make it fit any type hand saw. Keep your saws extra sharp and true-cutting with a Speed Saw Filer. Complete with file, ready to use. Money back guarantee. Cash with order, prepaid (C.O.D. postage extra.)

THE SPEED CO., Dept. PM
2025 N.E. Sandy, Portland 12, Ore.

Now FILE Your OWN SAWS

ORDER NOW!

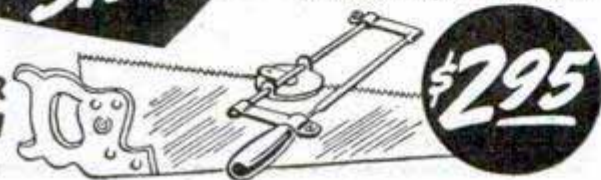

\$2.95

5 BIG TYPING FEATURES with a Smith-Corona PORTABLE TYPEWRITER



84 CHARACTER KEYBOARD . . . same as on big office machines

1. TOUCH SELECTOR
2. VARIABLE LINE SPACER
3. FLOATING SHIFT
4. ONE STROKE RIBBON REVERSE
5. TYPEBAR SPEED BOOSTER

ASK DEALER FOR DEMONSTRATION

Smith-Corona
PORTABLE TYPEWRITER

SAY YOU SAW IT IN POPULAR MECHANICS



Become a skilled woodcarver in 20 minutes!

— with the amazing Dumore Carvit: a delightful hobby, complete in one tool!

Carve useful ornaments for the home — distinctive gifts — fine carvings that *sell*! The Carvit reproduces models (from dime store or gift shop) in beautiful mahogany and other fine woods. Just trace the model. The Carvit does the rest. With an index attachment, you can carve objects like busts and statuettes. It's great fun! See it at your hardware or department store today, or write for full details.

Tear Out This Coupon and Mail Today!

THE DUMORE CO., Dept. F-58, Racine, Wis.

Check

- Please send me complete information on the Carvit.
- Please send me one Carvit, \$48.50 enclosed.
- Please send one Carvit with index attachment, \$58.25 enclosed. Shipping charges C.O.D.

Name _____

Address _____

City _____ () State _____

F-58

PAINTERS' STRIPING TOOL

A TOOL... NOT A BRUSH

NEW, IMPROVED

Modern—streamlined—fits the hand like a fountain pen! Easy to use as a pencil. Draws parallel lines—straight, curve or circular. Does expert job on autos, furniture, toys, bikes, model planes, signs, bulletins, linoleum. (Makes wall board look like tile.) Every painter and craftsman needs one! Type "M" MASTER Painters' Striping Tool complete with tip for 1/16" stripe, \$1.00. Extra tips 1/64", 1/32", 3/64", 1/16", 5/64", 3/32", 1/8"—75c each. Tool with complete set of 7 tips \$5.00. (C.O.D. orders 25c extra.) Paint dealers, write!

EASY AS USING A PENCIL!

\$1.00 POST PAID

WENDELL MFG. CO.

4234-B Lincoln Ave., Chicago 18, Illinois

AIR COMPRESSORS

Model 2-U-S-4-V-A Bendix-Westinghouse 4 cu. ft.

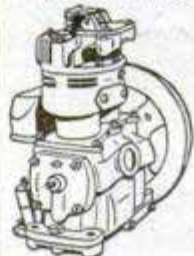

Govt. Surplus, 2 cylinder Bus and Truck Type. Ball bearing crank shaft. Pressure feed oil system. Positively one of the finest and most accurately built air compressors on the market.

Original Cost Over \$140.00

In good operating condition with 30 day written guarantee... \$3450
Special Low "as is" price... \$2950

Accessories available for compressors, air regulators, safety valves, air gauges, control governor, misc. fittings, hose, paint guns. Write for Prices and Catalogue

MIDWEST SURPLUS SALES CO. 2531 INDIANA KANSAS CITY, MO.

SANDING FASTER and BETTER

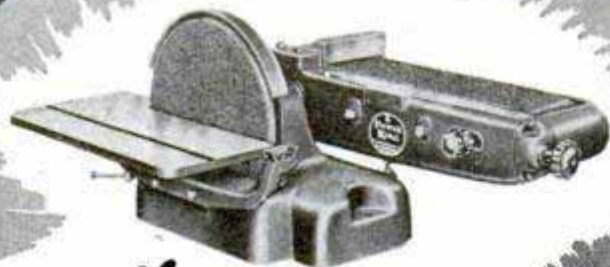

NEW POWER KING BELT and DISC SANDER

• Now you can get that professional "factory finish" on your fine woodworking projects — and in minutes instead of hours. This new heavy-duty belt and disc sander has 10" diameter disc, 4" belt, precision ball bearings, tilting table. It sands any width boards, angles, curves — metals, plastics. See it at your Power King dealers, or send for illustrated catalog sheets.

NOW ONLY \$57⁷⁵



POWER KING TOOL CORP.
620 Cleveland Street
WARSAW, INDIANA
Division of ATLAS PRESS COMPANY

F.O.B. Warsaw less motor

★ ★ ★ ★ ★ ★ ★ ★ ★ ★ ★ ★ ★ ★ ★ ★

MOTORS - PLANES - CARS - BOATS - MODELS

400 Pictures — 2,000 Model Items

A Bible for wide-awake modelers. Model gas engines, planes, boats, cars, rubber-powered planes, jet models, accessories, etc., PLUS articles and stories on building and flying. Send only 10¢, stamps or coins. Also free catalog available.

SPECIAL: U-Control or Free Flight Flying Outfit, complete with motor, plane and over 30 needed accessories.

Only \$10 COMPLETE

★ 1/6th h.p. Engines: Thor \$9.95; Genie \$6.95; Judco \$7.25

AMERICA'S HOBBY CENTER, INC. DEPT. B68 156 WEST 22 ST., N. Y. 11

★ ★ ★ ★ ★ ★ ★ ★ ★ ★ ★ ★ ★ ★ ★ ★

Say You Saw It in Popular Mechanics

BE YOUR OWN BOSS DO WELDING for PROFIT

Just Assemble these NECESSARY PARTS NO SPECIAL TOOLS NEEDED!

PROFITS IN WELDING! Increase your earnings this easy way. Do welding in your home or shop. Repair farm equipment, home appliances, tanks, tools. Everyone has something that needs welding. Get started today!

IDEAL HEAVY-DUTY WELDER for all-purpose are welding. Safe, rugged, compact and EFFICIENT. WILL OPERATE FOR ONLY A FEW CENTS PER DAY.

Plugs into either 110 or 220 AC line. Can be used consistently on 30 amp. fuse. ALL PARTS DESIGNED TO GIVE LIFETIME SERVICE. ORDER WITH CONFIDENCE!

Try your ATOMIC WELDER for 30 days. If not satisfied, return as is. Your money will be refunded with no questions asked. What could be fairer than that?

Immediate Delivery — Write for Fully Illustrated Booklet P-18.

ATOMIC WELDER COMPANY
1038 So. 19th St. Omaha, Nebraska

60 LBS. READY MADE PARTS Only \$24⁹⁵

STOPS LEAKS PERMANENTLY

Cut your fixture replacement, water and fuel bills with Economy Renewable Seats. Make economical, permanent repairs quickly and easily with the Junior Kit (illus.). Repair bathroom, kitchen and laundry fixtures. Everything you need included in steel box. This is a natural for the "Fixit" shops—get extra income from making permanent repairs on your customers' faucets.

Senior Master Kit also available—repairs faucets and valves up to 1" pipe. At Better Jobbers and Hardware Stores . . . or Write Direct

See our ad under **BUSINESS OPPORTUNITIES**

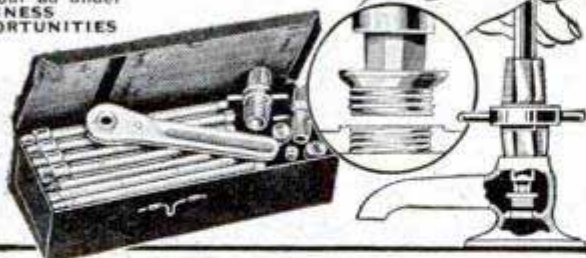

ECONOMY VALVE SEAT CO.

3122 N. California Ave. Chicago 18, Ill.

The EXCEL HACKSAW

IS JUST WHAT YOU'VE NEEDED FOR THOSE TOUGH, TEDIOUS METAL SAWING JOBS.

Only quality draw-cut, automatic shut off hacksaw at this amazingly low price.

Saws stock up to 4" diameter. Vise angles up to 45°.

Write Dept. PM-68 for free Bulletin.

EXCEL MACHINE TOOLS

Designed and Manufactured by

COVEL MANUFACTURING COMPANY

BENTON HARBOR,

MICHIGAN

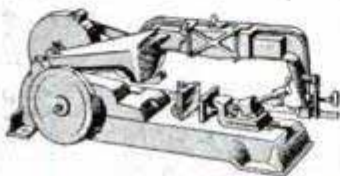

ONLY \$44.75

LESS MOTOR, FOB, BENTON HARBOR, MICHIGAN.

STROP YOUR RAZOR AS A BARBER DOES!



Get quicker, easier shaves at a saving



STROPS—CLEANS WITHOUT REMOVING BLADE

RAZOR, STROP AND 5 VALET BLADES

\$1.25

SELF-SHARPENING . . . ONE PIECE

NEW!

112 PG. MARINE EQUIPMENT CATALOG

for BOAT OWNERS, BOAT ASSEMBLERS, HOME CRAFTSMEN

A handy, valuable guide for boat kit assemblers and boat owners. Completely illustrated. Reserve your catalog now. Send only 25c to help cover costs.

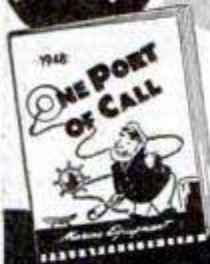

OLUF MIKKELSEN COMPANY

393 Fourth Avenue, New York 16, N. Y.

A Genuine Satin HOLLYWOOD CHAMPION JACKET in your own school colors!

Here's a buy, fellows! Just check these features! 1. Your own school, team, or club colors. 2. Val-dyed, water repellent satin. 3. Fully lined. 4. Free action raglan sleeves. 5. Sizes 8-16, only \$9.95. Sizes 34-44, \$10.95.

SEND NO MONEY!

When jacket arrives, pay postman \$9.95 or \$10.95, plus few cents postage. Or send cash with coupon and we pay postage.



9.95 & 10.95

JACKETS FOR YOUR WHOLE TEAM AT SPECIAL RATES!

Write for information!

Hollywood Champions, Dept. P M P.O. Box 1333, Hollywood 28, Calif.

Please send me _____ jackets, size _____, in color combination of _____ and _____.

Put the name _____ on jacket. (Sizes 8-16, \$9.95. Sizes 34-44, \$10.95.) Add 3% sales tax in California.

Name _____

Address _____

City & State _____

HOLLYWOOD CHAMPIONS

YOUR NAME FREE

RUSH COUPON FOR PROMPT DELIVERY!

Satisfaction Guaranteed or Money Refunded

Our Finest Precision REBUILT
MOTOR BLOCK ASSEMBLIES

Carries the Same
90 DAY GUARANTEE
As a New Motor Assy.



\$5.00
Crating
Charge

Sold Outright or Exchange

Rebuilt by skilled mechanics. Assembly has Reborn Block with New Pistons, Pins, Rings, Reground Crankshaft, all New Bearings. Guaranteed 90 Days.

Allowance on Old Motor

We ship at outright price. Send your motor prepaid, must be suitable for rebuilding. Send in notarized bill of sale showing title number if any. We refund difference when we receive your motor.

BUICK Outright Exch.
34-47 8 cyl. \$199.00 \$160.00

CHEVROLET Outr. Exch.
29-47 6 cyl. 117.50 87.50

CHRYSLER Outright Exch.
34-47 6 cyl. 162.50 130.00
35-47 8 cyl. 199.00 160.00

DE SOTO Outright Exch.
34-47 6 cyl. 162.50 130.00

DODGE—3 1/4" bore Exch.
35-47 6 cyl. 144.00 109.00

3 3/8" bore Outright Exch.
34-47 6 cyl. 162.50 130.00

FORD Outright Exch.
28-31 4 cyl. 119.00 87.00

FORD Outright Exch.
32-34 V8 .. \$139.00 \$ 99.00
35-47 V8 .. 149.00 99.00

HUDSON-TERRA. Outright Exch.
35-47 6 cyl. 175.00 135.00

MERCURY Outright Exch.
39-47 V8 .. 149.00 99.00

Oldsmobile Outright Exch.
37-47 6 cyl. 175.00 135.00
35-47 8 cyl. 199.00 160.00

PLYMOUTH Outr. Exch.
35-47 6 cyl. 139.00 109.00

PONTIAC Outright Exch.
37-47 6 cyl. 175.00 135.00
35-47 8 cyl. 199.00 160.00

Studebaker Outright Exch.
35-47 6 cyl. 175.00 135.00
35-47 8 cyl. 199.00 160.00

We Can Supply REBUILT ENGINES, TRANSMISSIONS, REAR ENDS, etc., for Cars and Trucks. Also JEEP ENGINES. Write for Prices!

60 HP. JEEP Engines



\$5.00
Crating
Charge

Reconditioned, Tested and Guaranteed in perfect running order and ready to run. Every part is checked to be perfect and carries a 90 Day Guarantee same as a new engine.

COMPLETE with . . . Generator, Starter, Distributor, Coil, Fan and Fan Belt, Water Pump, Fuel Pump, Intake and Exhaust Manifolds, Carburetor, Oil Filter, Spark Plugs, Flywheel, Clutch and Pressure Plate, Wiring.

Outright, **\$198⁵⁰**
PG58R-003, Ea.

65 KW. 225 Volt D.C. DIESEL ELECTRIC GENERATING UNIT

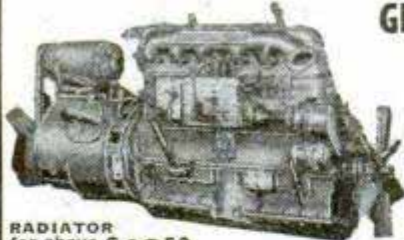

RADIATOR for above Unit. . . . \$69⁵⁰

RECONDITIONED

Equipped with 6 cyl. DIXIE Hercules DIESEL engine, 4 3/4" bore, 5 1/4" stroke, 120 H.P. at 2000 R.P.M. Complete with injector, pump, nozzles and electrical equipment. Generator attached to engine. Complete as shown.

PG60R-193 **\$1095⁰⁰**
Each

SEND 25% CASH WITH ORDER, BALANCE C.O.D.

J.C. WHITNEY & Co.

1917 Archer Ave. Chicago 16, Ill.

NU-WAY HEAVY DUTY CUTTING UNIT with Timken Roller Bearings

PRICE

\$16.50

WHY PAY MORE



Build your own rotary type lawn or weed cutter.

Take the hard work out of weed cutting. Build yourself an up-to-date weed and lawn mower with the Nu-Way heavy duty unit.

Write for Free Circular—We Supply Cutting Unit Complete

TRACTOR-LITE MFG. CO., Spirit Lake, Iowa

AUTOMOBILE OWNERS ATTENTION!

Auto Sluggish
Troubled with Carbon
Spark Plugs Foul and Burn
Ping in Your Motor
Valves Sticking
Cylinders Showing Wear
Want More Miles Per Gallon



USE



The Modern Motor Vitelizer

A Secret Formula Developed During the War

ONLY 1 OZ. NEEDED IN 10 GAL. OF GASOLINE

Ask Your Service Station Operator or Write Us

LENZ TESTING LABORATORIES

ARMORY PLACE

LOUISVILLE 2, KY.



NEW SAW EASY HANDLING BIG POWER

New American Portable Electric Saw saves time, labor and money in production work. Not a hobby tool. One hand operation. Cuts any angle. 8" blade. Write . . . give occupation.

AMERICAN

FLOOR SURFACING MACHINE COMPANY
535 So. St. Clair St. Toledo 3, Ohio



REAL DIESEL ENGINE

For Model Planes, Boats and Race Cars

Now you can own and run a real miniature diesel engine that operates by the heat of compression. No coil, condenser, wires, or annoying ignition failures. Simply flip the prop or flywheel to start. It's the new DEEZIL—a .125 cu. in. displacement, 5 oz. engine that runs at 8000 RPM. Order today; only \$12.95 p.p., less tank. Every engine fully tested and guaranteed. DEEZILMIX

FUEL \$1.00; PROP 50c. Send for valuable free price list!
GOTHAM HOBBY CORP.
107 East 126th Street New York 35, N. Y., Dept. "P"

EVERY TYPE OF METAL for EVERY TYPE OF SHOP!

- STAINLESS STEEL
- TOOL STEEL
- ALUMINUM
- BRASS

FREE

New Catalogue and Price List

Write BESSEMER STEEL CO. of AMERICA
Dept. FG-18, 3417-25 W. 27th St. Chicago 4, Ill.

CATCH FISH With The FISHIN' GADGET



ON POLE—BANK—TROT LINE

Sets Hook Automatically

The greatest fishing invention since the fish-hook! Automatically sets the hook on fish that bite. First day's results insure lifetime use. Will last for years. Made of non-corrosive metal. Use on any line . . . for any kind of fishing. See your dealer or send coupon and \$1 bill for your Fishin' Gadget . . . Now!

MONEY-BACK GUARANTEE

BRONSON MFG. CO.
1405-7 Walnut St., Kansas City 6, Mo.

HERE IS \$1. Send Me 1 FISHIN' GADGET
HERE IS \$5. Send Me 12 FISHIN' GADGETS

NAME

STREET

TOWN

STATE

Send Coupon and \$1 Bill

Sent Postpaid Get Yours Now!

Portable Paint Sprayers

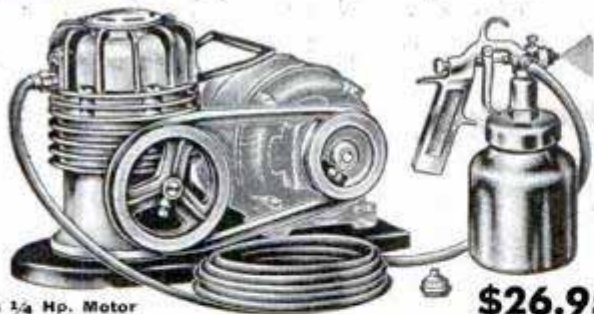

Uses 1/4 Hp. Motor

\$26.95

Complete as illustrated, less motor. Sprays all kind of paint, lacquer, varnish and etc. Oil-less ball bearing compressor. 2 cu. ft. air per minute. 15 to 50# pressure. Sprays paint 5 times faster than hand brushing.

No. 890—Outfit complete as shown, with "V" belt, motor pulley, 15 ft. high test air hose and No. 112 gun, but without motor. **\$26.95**

No. 444—Outfit, twin cyl. 4 cu. ft. production type gun, 15 ft. air hose, reg. and gauge, V belt and motor pulley. Complete less motor. **\$47.50.** Uses 1/2 Hp. motor.
HOME UTILITY BLACK & DECKER DRILLS
 —110 AC-DC—With Jacobs Hex Key Chuck—Pistol grip, 1/4", 2250 rpm. **\$18.95**
 1/2" 375 rpm spade grip **\$35.95**

Immediate delivery — check or M.O. with order shipped prepaid, cod's plus chgs.

INDIANA APPLIANCE CO.

20 EAST SYCAMORE DEPT. PM548 EVANSVILLE, IND.

**GIVES YOU 2
DRILLS IN 1**



Converts any 1/4 inch Electric Drill to 1/2 inch capacity. Reduction gears reduce speed 5 to 1, the average speed of 1/2 inch Drill thereby increasing power.

Jobbers write Price \$11.95 for proposition

M.O. or check with order

G. M. CO. MANUFACTURING, INC.

1308 43rd Avenue
Long Island City 1, New York

ZIPSCOOT \$49.75

America's Outstanding Scooter Value!
 This smart looking speedster is easily and quickly assembled from our factory finished kits. Uses standard gasoline motor. Speeds up to 30 miles per hour. 100 miles per gallon of gas. Send 25 cents for assembly information, drawings, and illustrations. Kits available for immediate shipment.

Zipscot Company, Toledo 6, Ohio



You'll be Glad

YOU BOUGHT A SCHULT



**IT'S "TOPS" FOR LIVING
AND TRAVEL VALUE!**

Wherever you take your Schult, you'll have every facility of a completely furnished, well-insulated, all-season home. Backed by more than a decade of research, your Schult is a *quality* product . . . it offers many *plus-values* that add to comfort and privacy. Ask your Schult dealer, *now*, to show you latest livable 1948 models. Schult Corporation, Dept. 3206, Elkhart, Indiana. *In Canada:* John Inglis Co., Ltd., Toronto.

Free

Illustrated catalog with full details of 1948 Schult models...also name of nearest dealer.

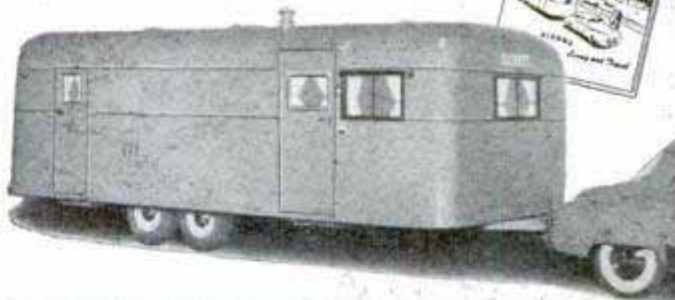

SCHULT *Trailer Coaches*

GIVE YOUR CAR THE "WOLF CALL"

of Deep Tone DUAL MUFFLERS

The rich, low, mellow sound of "straight thru" ADVANCE mufflers is something all your friends will admire.

Also greater power, speed, and economy result from the reduced back pressure of this scientific design. Rugged steel tube throughout (no aluminum); blowout-proof.

SIMPLE TO INSTALL. No welding, cutting, or holes to drill. Complete with rubber mounted clamps (no rattle) and all necessary fittings.

ADVANCE MUFFLERS, 6800 S. Vermont Ave., Dept. PM 68, Los Angeles 44, Calif.
 Send Check, Money Order, or we will mail C.O.D.
 You pay postage upon receipt.

Dual Muffler Set (Ford, Mercury only) \$20.00 Single Muffler (other makes) \$5.50
 Single Muffler (Ford, Chev., Plym.) 4.86 2 1/2" Chrome tail pipe tips 1.75

Car make _____ Year _____ Model _____

Name _____

Address _____ City _____ State _____



ADVANCE MUFFLERS

6800 S. Vermont Ave., Los Angeles 44, Cal.

Free! New CONCORD RADIO Catalog



The ONLY Complete
Up-to-the-minute Catalog of
RADIO PARTS • RADIO SETS
KITS • HAM GEAR • TESTERS

The greatest, latest complete presentation of radio, electronic and television equipment and supplies in Concord history! Packed from cover to cover with thousands of items—160 pages of everything in Radio and Electronics. Special bargain section of hundreds of money-saving values. Scores of

new items from famous makers. Parts, blueprints for famous Popular Mechanic and many other kits. Mail coupon for your FREE copy.

CONCORD RADIO CORP.
CHICAGO 7 ATLANTA 3
901 W. Jackson Blvd. 265 Peachtree Street
Downtown Chicago Branch: 229 W. Madison
LAFAYETTE RADIO CORPORATION

CONCORD RADIO CORP., Dept. 106
901 W. Jackson Blvd., Chicago 7, Ill.
Yes, rush FREE COPY of the comprehensive new Concord Radio Catalog.

Name _____
Address _____
City _____ State _____

All These Jobs With One Tool SANDS • POLISHES



SANDER-POLISHER
\$36⁵⁰

(F. O. B. Muskegon)
Accessories listed above — \$28.90
Sander-Polisher with accessories
\$65.40

Sanding and polishing—easy and fast with the Duo Portable Electric! Use it on wood, metal, plastics. Accessories quickly change it to a drill, grinder, buffer, mixer, brush or steel wooler—the most versatile tool you ever saw. Ideal for work on autos, furniture, boats, building, farms—for all types of refinishing and repair. Lightweight, powerful, rugged. Listed by Underwriters' Laboratories, Inc. AC or DC.

Get the Duo at your nearest hardware, paint, appliance store—or order direct with coupon below.

CLARKE SANDING MACHINE CO. — Muskegon, Mich.

Please ship Duo Portable Electric Machines Complete with all accessories \$65.40 Sander-Polisher (only) \$36.50
Ship C.O.D. plus shipping charges Postpaid. Money order enclosed Send information on individual accessories.

Name _____
Address _____
City _____ Zone _____ State _____

ELECTRICITY Anywhere

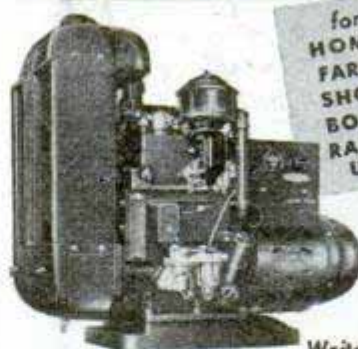

for
HOMES
FARMS
SHOPS
BOATS
RADIO
USE

Onan gasoline-engine-driven Electric Plants supply reliable, economical electric service for any use. Portable, stationary or stand-by models. Water or air-cooled, compact and rugged.

A.C.: 350 to 35,000 watts in all standard voltages and frequencies. D.C.: 600 to 10,000 watts. 115 and 230 volts. BATTERY CHARGERS: 500 to 3,500 watts; 6, 12, 24, 32 volts.

Write for folder

D. W. ONAN & SONS INC.
2542 Royalston Ave., Minneapolis 5, Minn.



YOU NEED THIS!

Today, tomorrow, next week — sometime — you wouldn't trade this tool for a hundred dollars. It's different—better than anything you have ever seen in its field — a hydraulic bumper utility jack that picks up loads from 8" below its base to 22" above. raises load a full 17". It's the famous American Hydraulic Bumper Utility Jack with chain and grab hook attachment. It's the bumper jack that's safe. Grab hook can't slip off bumper or bracket. Chain and grab hook pull fence posts, pipe, small trees, roots, forms, rocks. Hundreds of uses — and at all times the greatest tire-changing jack you've ever seen. 3,000 lb. capacity. If your dealer can't supply you today with the American with 30" chain and grab hook, write direct. Change tires safely, easily on any make car. Jack fully guaranteed. Order today. Enclose draft or money order for **\$15.95**. We will ship immediately, post paid. Address: **AMERICAN HYDRAULICS, Inc., Sheboygan, Wis.**

MAKES DRIVING EASIER



Automatic accelerator control! Pedal stays put in any position. No more cramped leg from constant pressure on accelerator. Disengages immediately when brake is applied. May also be engaged and disengaged at will, by touch of foot. Drive for miles with both feet free. Save gas by steady driving. Safe, Economical. Easy to install. Mailed complete, postpaid, for **\$2.98**, with full instructions. Folder on request.

AUTOMATIC ACCELERATOR CONTROL, Inc.
MONROE, MICHIGAN



Ask Your Hardware Store for
FULLER'S
Unbreakable Amber Handle
SCREW DRIVERS

America's most popular line of moderately-priced screw drivers! Wide range of sizes.
FULLER TOOL CO., Inc., 911 Faile St., New York 99
World's largest maker of Amber-Handle Tools

PLASTIC TOYS

Ideas or finished items, applicable for children from one to five years
WANTED

by a well-rated manufacturer of high reputation, on royalty basis; would consider buying outright. General information in first letter.
ADDRESS: PLASTIC, Box 27, Arlington, N. J.

83 OPERATIONS \$34⁹⁵

Do woodworking—have fun—make money! 5 power tools in one unit: lathe, drill press, circular saw, grinder and sander. Complete, only **\$34.95**. Does heavy, expert work—83 different operations. Uses 1/4 h.p. motor. Send \$17.50 (balance c.o.d.) on **FREE** trial, money-back guarantee. Or write us today for **FREE** illustrated literature.



5 Power Tools in 1

EMRICK, INC., 1736 Clinton, Kalamazoo, Mich.

DOUBLE SHAFT AC MOTOR

1750 R. P. M.—60 CYCLE
115 VOLTS
1/3 H. P.
CORD
and
SWITCH



IDEAL FOR WORKSHOP, FARM and APPLIANCES.

Use as power unit with pulley. Use as utility grinder with Safety Guard. Use wire brush for cleaning, burnishing, etc. Use cloth buffing wheel for polishing. Well made to stand up. Brand new, made by CANATSEY. 1 year guarantee on workmanship and materials.

MOTOR ONLY... \$17.00

ADAPTOR for wheels... 80c
GUARD..... \$1.50
3 WHEELS..... \$4.00

COMPLETE—
Motor, Adaptor, guard,
3 wheels, only... **\$21.95**
(Save \$1.35)

Send \$5.00 with order, balance plus shipping charges, C.O.D. Or we pay shipping charges if check or money order, full amount, accompanies order.

CANATSEY ENG. CO. 100 Dept., 2201 McGee St.
Kansas City, Mo., U. S. A.

Give Your Lawn that 'Golf-Green' Look with a

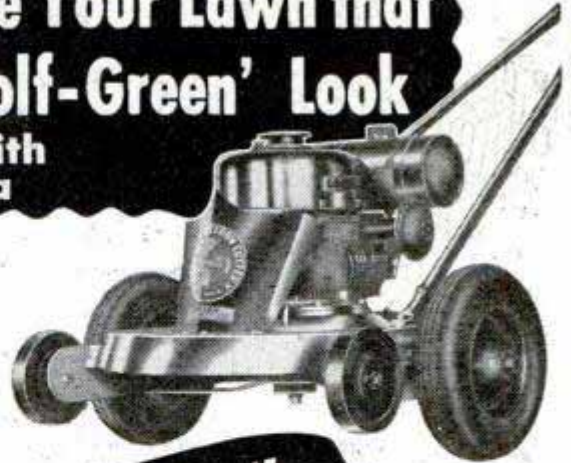

ENDS GRASS-CUTTING DRUDGERY You take it easy behind a GOODALL Rotary Power Mower... it cuts your lawn in 1/3rd time, cuts any height grass or tough weeds... cuts on any terrace or hillside... gets into hard-to-reach places easily.

NOTE: GOODALL is the original U.S. patent holder of direct vertical drive — at better dealers everywhere.

Cuts Grass Velvety Smooth in 1/3 time



EXTRA FEATURES
GOODALL is the one and only 4 CYCLE—VERTICAL CRANK-SHAFT—DIRECT DRIVE Rotary Cutter manufactured... successfully used by thousands from coast to coast.
Precision built for years of low cost service... Two wheel flexibility.

Many imitations...
No successful duplications!

Write for Picture Folder and name of nearest dealer

Goodall MANUFACTURING CORPORATION
DEPT. PM, WARRENSBURG, MO.

Learn More About YOUR HEARING!

- New booklet brings you interesting facts about hearing problems. Fully illustrated. Learn what causes deafness—how science can overcome it. Western Electric will gladly send this valuable book, free, to any hard-of-hearing person. Use the coupon today.



FREE!

Western Electric, Dept. 380-PM6
195 Broadway, New York 7, N. Y.

Please send me, free, your booklet, "Modern Science and Your Hearing." Include information about new hearing aids now available.

Name _____
Address _____
City _____ Zone _____ State _____

Distributed in Canada through Northern Electric Co., Ltd.

NEW! BUILD YOUR OWN TRAILER



\$26.35

Minus
Tires and Tubes
10% with Order
Bal. C.O.D.

Ideal for building stock and boat trailers, spray carriers, feed, fence, post, horse or general utility trailer, and for mounting under elevators.

Timken bearings, 59" tread, 16" demountable wheels, solid steel 1 1/2" square axle. NEW—we manufacture these—NOT SURPLUS ITEM! Stub assemblies also available.

DEALERS! Write for Discounts
STANDARD EQUIPMENT CO., Cedar Rapids, Iowa

NEW SANDER READY!

Now ready for hobbyists, craftsmen, model makers, pattern makers, workshops! Mead's sensational new BANDSANDER quickly shapes, curves, sands and polishes WOOD, METAL and PLASTIC PROJECTS! Cuts fast and clean on ENCLOSED EDGES, intricate scrolls, curves, tilting table. Saves hours of tiresome hand work. Does better job. Nothing else like it! Order yours now only \$14.95 FOR Chicago. Try it 5 Days, then, if not perfectly satisfied, return it and we'll refund \$14.95 your money promptly!

FREE! Or write for Free Circular describing, illustrating how this amazing new BANDSANDER invention saves time, money, trouble. Write now—a post-card will do!

Mead Specialties Co., 4114 No. Knox Ave., Dept. 168, Chicago 41, Ill.

LUMINOUS TELEPHONE DIAL

Slips over present dial, making letters and numbers visible at night. Simple and practical. No electricity, applied without tools. Lasts indefinitely.

Send 25 cents in coin, no stamps, to

MODERN DEVICES, INC.

1260 West Fourth Street Cleveland 13, Ohio

Say You Saw It in Popular Mechanics

Sand Casting — Forging — Heat Treating — Case Hardening BRONZE FOUNDRY



In your own workshop allows you to design and build your own GASOLINE ENGINES, STEAM ENGINES, STATUARY ART OBJECTS, SPECIAL TOOLS, NEW INVENTIONS, ETC. You can also make forgings and case harden steel. Your shop is not complete without a FOUNDRYETTE. Three sizes are available capable of making bronze castings of 1 1/2, 3 and 6 pounds weight, aluminum copper, brass, etc., \$22.50, \$29.50, \$42.00 f.o.b. Kansas City. Domestic gas supply and 110 volt AC or DC energy required for operation. Write for circular.

KANSAS CITY SPECIALTIES CO.
Box 6022, Dept. P-5 Kansas City, Mo.



Hands Never Touch the Water—Can be put in Boiling Water. Housewives Like It.

48" Long Handle

Sales QUICK, EASY Every Locality

SALES ARE EVERYWHERE . . . Sells quick to Taverns, Clubs, Hotels, Hospitals, Stores, Restaurants, Large and Small Buildings and the Homes . . . Scores can be sold on a single street . . . Note the Drain Bracket in the illustration . . . This squeezes out the water so thoroughly that HANDS NEVER TOUCH THE WATER . . . Makes no difference what you ever sold, you will like this proposition . . . Your name on a Post Card will bring you FREE PARTICULARS.

CELL-U-MOP CO., Dept. P-6 FREEPORT, Ill.

Quick Easy Way to BIG PROFITS

Read What Others Are DOING!

"Enclosed you will find 56 orders representing 9 1/2 hours' work on Monday and Tuesday."

"Enclosed are twelve orders secured after supper this p.m."

Housewives are Enthusiastic

Everyone that sees this outstanding Cell-U-Mop immediately wants one . . . That's the reason why our distributors are so successful . . . You also have the advantage of our other QUICK SELLING PRODUCTS that step up your Volume Sales and Profits.

• We Teach You How •

Gets down under and around for MOPPING, DUSTING or WASHING

DOES THE WORK OF 6 TOOLS IN 1

Get Choice Territory NOW!

Holds 20 times its weight in water.



Don't Risk Engine Overheating

Keep cooling systems ALWAYS up to par with regular

Warner care



Warner Liquid Solder (Non-Metallic)

• Deposits tiny fibers to repair leaks anywhere in the cooling system.

Warner Radiator Cleaner

• Thoroughly cleans cooling system of rust, oil muck and grease.

Warner Cooling System Protector

• Prevents rust, scale and corrosion.

No delays—just pour in and keep on driving. Do it yourself, or ask your service man.



Warner-Patterson Co., 920 S. Michigan Ave., Chicago 5

ELECTRIC SHEAR SHARPENER

Over 35,000 Sold — It Must Be Good!



Genuine Carborundum wheel ideal for shop or home use. Send remittance with order and shipment will be made at once, prepaid to your door, complete with electrical goods catalogue.

MOTOR DRIVEN

\$9.75 complete with vise

WILLIAM MARVY COMPANY
479 West St. Peter Street St. Paul 2, Minn.

Woodworth

INDICATOR CALIPERS



A spring actuated indicator hand enclosed in one of the hollow legs has a pointer which comes to the outside through a slot and moves across the indicator marks giving about 20 to 1 multiplication of the movement at the contacting end of the hand.

Bright stainless steel throughout. 4 inch size, either inside or outside \$2.75 each postpaid.

DISTRIBUTORS WANTED

WOODWORTH SPECIALTIES CORP.
BINGHAMTON, N. Y.

If you're building a

WHIRLBLADE POWER LAWNMOWER

Why don't you buy the bearing and cutter attachment that has the engine base as part of the casting. You build a power mower easier, faster, stronger, with less weight and with less expense. Standard widths of cut 16", 18" and 20". Let us know width of cut desired and engine you will use. Order now—\$16.50 postpaid. 10" wheels to match \$3.00 each. Front swivel wheel \$3.00. Streamlined fenders \$1.50 pair. Also, complete mowers and new gasoline engines ready for delivery. Special list for dealers, shops and mfrs.

703 E. Poplar Avenue WEBB MFG. CO. Arkansas City, Kansas

WITH MOLLY YOU CAN FASTEN ANYTHING and do it quickly, neatly and safely. MOLLY will hold fixtures securely to floors, ceilings or any hollow wall construction . . . Simple to install, all you need is a screw driver. Sold by leading hardware stores everywhere.

Write for Free Descriptive Folder

PLACE FIXTURE FIXTURE MOUNTED

MOLLY
SCREW ANCHORS

MOLLY CORP.
522 COURT STREET
READING, PA.

You Can Afford an Underground
Lawn Sprinkling System with

AQUA-Spray

SELF-DRAINING SPRINKLER HEADS



EASILY INSTALLED BY ANYONE

All bronze. Exclusive self-draining feature protects against freezing. Adjustable to any shape lawn. Six heads required to spray 500 square feet. **\$149**

Write for Descriptive Literature **1491 - 194910**
AQUA-SPRAY LAWN SPRINKLER CO.
439 E. FORT ST. DETROIT 26, MICHIGAN

AQUA-SPRAY
AUTOMATIC RELAY VALVE
Easily attached to present water outlet. Boosts spraying capacity 6 to 8 times. Automatically sprays sectionalized areas. All bronze—needs no motor. **\$75.00** PREPAID

MARCOT KEY MACHINES

MARCOT No. 8 KEY MACHINE, mounted on Cabinet \$ 82.50
Auto Code Book and Auto Depth Keys 12.50
1,944 Popular Cylinder Key Blanks 77.75
Set — Key File, Follow-Through Rods, Lock Picks, Bit Key Gauge, Thimble, Pins, Springs.. 10.50
"Locksmith Trade Books": How to Open Locks without Keys or Picks; Secret of Locksmithing; How to Make Keys by the Impression Method; Master Key Systems. **TOTAL COST..... \$190.00**

The \$77.75 cost of the Key Blanks would return to you \$486.00 or more. This would more than pay for your entire KEY MACHINE OUTFIT. IMMEDIATE DELIVERY—Motors available with Key Machine Orders. **1200 N. KEDZIE AVE. A. J. MARCOTTE CO. DEPT. PM, CHICAGO 51, ILL.**

BUILD AN ARC WELDER FROM OLD GENERATOR

For Light or Heavy Work. 75-200 amps. No previous experience needed. Complete PLANS and valuable Catalog 35c. **LEJAY MANUFACTURING CO. 1347 LeJay Bldg., Minneapolis 8, Minn.**



PESCO AIRCRAFT ELECTRIC MOTOR PUMPS

Complete with 1/4 HP Electric Motor Self Contained Explosion-Proof
Ideal for pumping Gasoline, Oils, Water, Liquids, Farms, Cottages, Basements, Laboratories, Boats, 24 Volt Ac. or Dc. can be converted to other Voltage. **\$15.00 FOB Detroit, Mich.**



BENJAMIN SALES COMPANY
8774 L'NWOOD DEPT. M DETROIT 6, MICHIGAN

Say You Saw It in Popular Mechanics

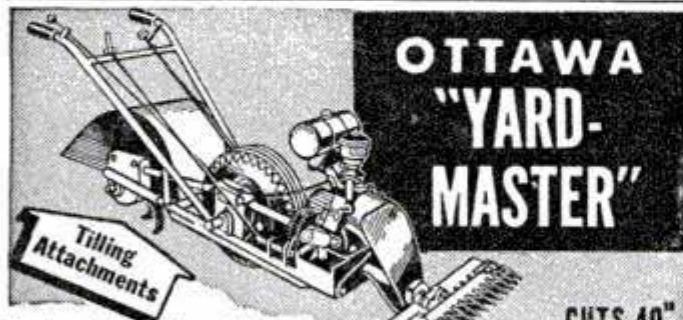

OTTAWA "YARD-MASTER"

CUTS 40" SWATH

Most useful machine of its kind. Powerful 2-HP motor. It mows grass or weeds, tills soil and cultivates (see picture), moves snow, pumps water, runs a grinder, etc. **TWO SPEEDS** and Free Wheeling. Nothing else like it. "YARD-MASTER" is much needed year 'round machine. Mows close to trees and under fences. Follows ground contour. One man mows 3 to 6 acres a day. Boy or woman operates easily. Designed for private homes, estate, etc. Sold direct to user. Free details with low prices. **OTTAWA MFG. CO., 3-827 Lawn Ave., Ottawa, Kansas**

WAR SURPLUS AND OTHER BARGAINS

TRANSFORMER

Jefferson Electric step up or step down transformer. Input, primary 110-117 Volts A.C. Output, from 5 Volts to 650 Volts. Suitable for use with war surplus gadgets, heater relays, radio test filaments, electric trains, house chimes, etc. Weight 10 Lbs. **New \$7.95 Each**



BLOWER COOLER or HEATER: For trailers, autos, offices, darkrooms, homes. DUMORE Motor, 1/6 cont. HP, Amperage 7.5, RPM 6400, 24 Volts. May also be used as dryer. Simple installation, radiator type, copper coils. Transformer advertised in this ad will operate this unit from house current. Weight 13 Lbs. **New, \$15.00**
SEND CHECK, MONEY ORDER or CASH

SCOOP! We have been awarded 100,000 genuine briar pipes by Quartermaster Corps. Assorted shapes and sizes. All popular makes. Set of 6, **\$3.50**



MICROMETER
Chrome plated, precision engineered and carefully tooled to give long life .. all new. 0-1" capacity, **\$2.25.** 1-2" capacity, **\$3.50 Each.**



EMERSON 3 HP MOTOR: AAF Type D50. This motor can also be used as generator when driven by another motor. Ideal for portable welder, etc. 28 Volts, D.C. Compound, 3800 RPM, 115 AMP, windings glass-insulated, blower cooled, shaft dimension 5/8". Weight 27 Lbs. **New. \$13.95 each**

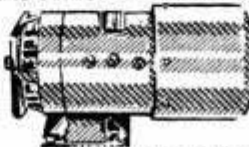

CONDUIT WRENCH: Mfd. by JOAR. Jaws pass over conduit, pipe or tubing, slips down to snugly encircle fittings. Slight pressure tightens or loosens fittings. Will not mar or kink material. Set of 8. All new wrenches, Nos. 4-6-7-8-10-14-22-28, (Reg. cost \$50.00), **\$10.00 per set.** Wght 4 Lbs.



25% DEPOSIT REQUIRED ON C.O.D. ORDERS

GOGGLES: Designed for paratroopers. Great for motorcycling, speed boating, hot-rod driving, etc. (One polarized and one clear) All new..... 2 pair for **\$1.00.**



MARINE TYPE LAMP — For patios, boy's rooms, rumpus rooms, dens, doorways, gates. Solid brass, 11" high, 6 1/2" diameter. Clear, red or blue glass. May be suspended from ceiling or wall bracket (not included). Wired. Takes any size standard bulb. **New. Weight 2 Lbs. Ea. \$5.95**



4 in 1 SCREWDRIVER— 3 smaller sizes fit into 6" overall size. Fine steel bits. Solid brass handles. All new **Each \$1.00**



ALL PRICES F.O.B. CULVER CITY, CALIF.

SHIP'S BELL: U. S. Navy Surplus. Solid Brass with smooth polished finish. 5" Diameter. Great for Patios, Doorways, in Dens, Ranches, etc. Matching solid brass wall bracket included. Weight 3 1/4 Lbs. All New. **\$5.95 Each.**



FISHING AND HUNTING KNIFE
Hollow ground 6" blade of bright finish, high quality, tempered steel. Non-slip cowhide handle, with hand finished metal guard and butt. Stitched and riveted genuine leather sheath. It's a knife you'll be proud of! All New... **\$1.50 Each.**



CLIPS: Adel Aluminum Co., Rubber lined, hundreds of uses in any shop. Assorted sizes, all new. . . . 5 Doz. **\$1. — 500 \$5.**

PHOTO PAPERS: 1946-47 Dating. Guaranteed.
4x5 E. K. Aero Contact — S. W. Contr. 1 & 2 Minimum 3 gross — gross 47c
10 gross lots — gross 35c
9 1/2"x200' Defender Velour Black enlarging semi-matte Contr. 2-3-4 roll **2.50**
9 1/2"x200' E. K. Aero enlarging S. W. semi-gloss Contr. 1-2-3-4 roll **1.95**

AIRBORNE SALES CO., INC. DEPT. PM 6-8 CULVER CITY, CALIF.

Save a "fortune" ON THESE
BRAND NEW... GUARANTEED
WAR SURPLUS ITEMS!



Rock Island VISE \$ **38.**
\$104. VALUE...

Has 6" jaw-10" opening,
swivel base. Replaceable
jaw faces of crucible steel

Greenfield TAP & DIE SET
VALUE OVER \$ **18.**
\$30.

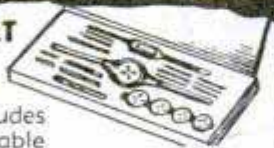

Nat'l fine thread set includes
15 taps, 5 rounds adjustable
dies, all drills necessary for tapping 1/4" to 1/2"

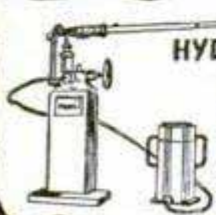

WATSON-STILLMAN 60TON
HYDRAULIC PRESS UNIT \$ **89.**
\$280. VALUE...

Build your own press at low
cost with this 2 piece, 60 ton
cap. unit. Free plans and par-
ticulars with jack and pump-
ing unit included

Hauk .. Kerosene
BLOW TORCH \$ **15.**
VALUE OVER \$30.

Economical. Generates in-
tense heat. No preheating
required. Use with air com-
pressor. Ideal for all heating
in shop and garage



Double-Action HAND OIL PUMP \$ **1.**
\$6.00 VALUE...

Garage utility tool for
autos. Useful for removing oil from marine
engine crankcases. Angle spout included. Brass,
stainless steel or galvanized steel

Highly Polished 12" CALIPERS \$ **1.**
\$5.00 VALUE

For inside measurements. Lock joint design.



Farm-Home-Shop
GENERATING SET \$ **240.**
VALUE OVER \$500.

2500 watt-110 volt-60 cycle AC-6 1/2
HP Briggs and Stratton air cooled gas
engine — approx. 300 lbs. crated-sl.
used. Dep. of \$80 with order. Bal. on delivery.

MAIL YOUR ORDER ... NOW!

Enclose personal check, money order or bank
draft. All prices F.O.B. Hackensack, N. J.
Reference - CITY NATIONAL BANK &
TRUST CO., HACKENSACK, N. J.

BERKELEY DISTRIBUTORS INC.

16 Johnson Ave., HACKENSACK, N. J. - Dept. PM6

WALKIE- TALKIES!

Radio Telephone Sends And Receives Several Miles



This is the light weight battery-
operated radio that was used so
successfully by the Army. One
knob tunes both transmitter and
receiver. Sends and receives
merely by pushing a button.
Recommended for amateurs, ex-
plorers, police and Government
services, etc. Shipped ready to
operate, complete with tubes,
telephone handset, telescoping
antenna, and new batteries. Re-
built by the Government and
guaranteed. Price only \$45.00
each or \$90.00 per pair F. O. B.
Chicago.

Extra Batteries (80 hours con-
tinuous service) \$4.75 each.

Parts and Accessories for Walkie Talkies

We maintain complete stocks of replacement
parts, batteries, antennas, chassis, etc., for
Army Walkie Talkies and Handie Talkies.
Write for Special Listing No. 20.

WELLS
SALES, INC.

320 N. La Salle St., Dept. P-6
Chicago 10, Illinois

HUSKY COMPOUND VISE

"The Vise for a Thousand Jobs"



DOUBLE YOUR INCOME on welding jobs
by doing them to perfection in half the
time! This is a sturdily constructed set of
twin vises, swivel-mounted, with the right-
hand vise on screw feed longitudinal and across. The
Husky Compound Vise is EXTREMELY FLEXIBLE. Vis-
es can be placed in practically any desired position. SAVE THE
COST OF EXPENSIVE MACHINERY for cutting key seats,
shaping iron, surface grinding, and light milling. SAVE
the time and money needed to make expensive jigs. NO
LIMIT to its uses in the shop! It's as convenient as an ex-
tra hand! Length of bed: 33". Weight: 180 lbs. Vise jaws
open to 4 3/4" x 4". Send for free illus-
trated literature showing you how to do
jobs for only a few dollars with the Husky
Compound Vise that ordinarily require
expensive machinery.

\$ **60⁷⁵**

HUSKY MACHINE CO.
WARROAD, MINN.

Metal Strips Frighten Garden Pests

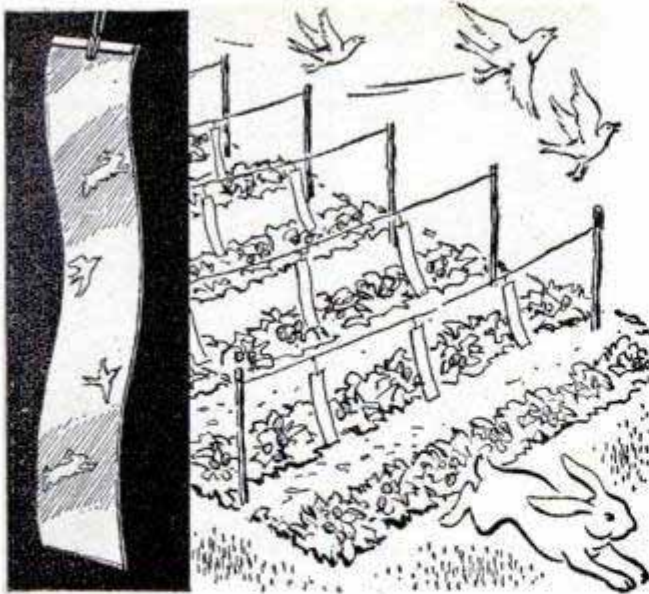

"Scarecrows" in the form of thin aluminum strips frighten birds, rabbits and other garden pests by fluttering in the breeze to give off flashes of light and a tinkling noise. The strips are 15 inches long and are hung on a cord suspended from sticks. Fruit crops can be protected by tying the noise-making strips in the branches of the trees.

Magnetic Tool Drives Brads With One Easy Push

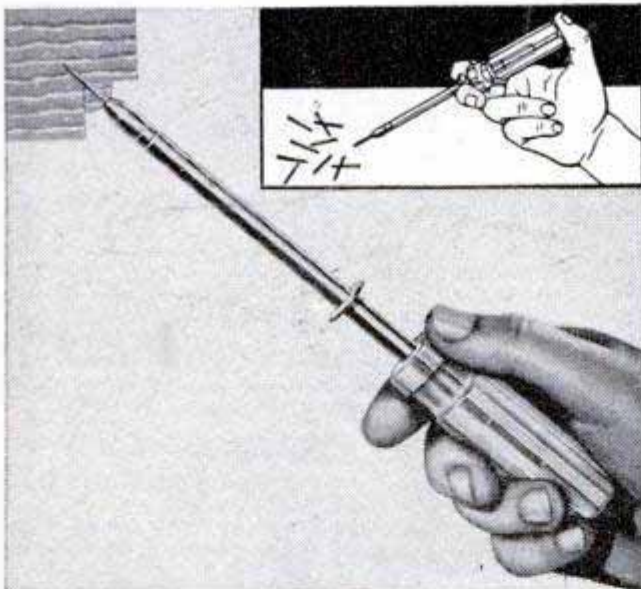

There's no danger of bending brads or marring woodwork when a magnetic tool that pushes them in straight and countersinks the heads is used. All brads up to one inch in length are driven with only one push on the handle. The narrow shank permits use in corners and other hard-to-reach places. The magnetic head holds the brad in the end of the tool.

 A collage of images and text promoting Baltimore. At the top left is a checkered floor. In the top center is a statue of a man in academic regalia. To the right is an aerial view of a city. Below these are several text boxes:

- Visitors never forget rows of white, scrubbed, gleaming marble steps.
- Johns Hopkins — renowned medical research and education center.

 The central text reads:

The Lords Baltimore would be proud today...

For the city, named in their honor, is one of America's busiest and most important seaports. Going through by train or automobile, one sees little of the charm of this fascinating city — but Baltimoreans experience it every day. They know the fine art of gracious living. Rarely, in other cities, will you find one who "used to live in Baltimore," because it is too good a place to leave.

Beech-Nut Beechies

are Baltimore's favorite Candy Coated Gum

BEECH-NUT GUM in stick form is popular in all the U. S.

 Below the gum box are several images of Baltimore landmarks:

- A monument on a hill: *The first monument in memory of George Washington, at Mt. Vernon Square.*
- A ship at sea: *In sight of Fort McHenry the Star Spangled Banner was written.*
- A city skyline: *Baltimore's Skyline. Ships from all over the world unload their rich cargoes at this gateway to the Chesapeake Bay country.*

BUILD YOUR OWN DISAPPEARING STAIRWAY



SAVE
With

**MYER-LEE
DISAPPEARING
STAIRWAY
HARDWARE
COMPLETE SET**
\$29.75

SHIPPING Wt. 28 lbs.
COMPLETE
INFORMATION
FURNISHED

- EASY TO BUILD
- EASY TO INSTALL
- EASY TO OPERATE

When ordering state
floor to ceiling height

FOLDAWAY STAIRWAY CO.
813 Seaboard Street
PORTSMOUTH, VIRGINIA

**America's Lowest Priced
TILTING BAND SAW**
Engineering Features Found Only In Highest Priced Saws **NOW ONLY \$16.95**

Practical, modern design. Accurate, smooth operation. Cuts to center of 14" circle, 2 1/2" thick. Genuine "Oilite" bearings, adjustable ball bearing blade guide. Blade tension adjustment. Safe, fully enclosed mechanism. Thoroughly proved construction, ruggedly designed of sturdy laminated plywood. Stands 24" overall. As illustrated, blade included. Immediate Delivery. Factory Guarantee. Price FOB, St. Louis. Shipping weight 14 lbs.

Dealers Solicited Inquiries
THE JAY-KAY COMPANY
P.O. BOX 234 KANSAS CITY, MO.

PIPE CENTERS for Lathes



Fit head or tail spindles.
Centers revolve on shank.

No.	For Pipe	Shank Req'd	Price
2160	1/2" to 3"	2172-NR	\$4.50
2161	3" to 5"	2172-TH	6.00
2162	5" to 8"	2173-TH	9.00

Shank 2172-NR No. 2 Taper \$4.50
Shank 2172-TH No. 3 Taper 4.50
Shank 2173-TH No. C Taper 7.50
f. o. b. factory

SOUTH BEND LATHES WORKS

455A E. Madison St.
South Bend 22, Ind.

LAUGH AT FLAT TIRES



When that tire goes flat don't worry or lose your temper. Just place the ROLAWAY in front of the flat—drive onto it and continue on to the nearest service station. In use on toll bridges and tunnels where traffic must move fast. A necessity for all motorists. Sells on sight. Retail for \$23.85. Distributors' price \$14.50 FOB Chicago.

ROLAWAY DISTRIBUTORS

Suite 807, 30 N. LaSalle St. Chicago 2, Illinois

**FAST CUTS FOOD COST
NETS \$9 A CASE
SALES**

JELD Ltd., Burbank, California Dept. J

Make your STOP LIGHT SHOUT!

AMAZING STOP LIGHT FLASHER!
Make Your Stop Light Flash 115 Times Per Min.
A SENSATION! Automatic. Instant acting when foot brake applied. Attracts attention. Warns car behind. Non-Rusting. Dust, Oil, Vapor and Waterproof. Used by police and fire depts. Attach in 5 min. Approved by leading safety engineers.

FREE WITH ORDER. "HOW TO SAVE MONEY ON CAR 'Motoring Hints' BOOKLET." ACT NOW! If dealer can't supply send \$3.00 cash or M.O. We pay postage.

"STOP-IT" makes stop light flash 115 times per min.

MACCHI & CO.
Dept. MJ,
927 Larkin St. San Francisco, Calif.

Woodworkers!!
Make your circular saw the
most versatile tool you own!

CUT GROOVES LIKE THIS

**\$4.95
SET**

POSTPAID
INCLUDING TAX



WARREN DADO SAWING WASHERS WILL FIT THE ARBOR OF ANY POWER CIRCLE SAW AND CAN BE USED WITH ANY DIAMETER SAW BLADE. . . CUTS GROOVES CLEANER, EASIER AND FASTER THAN AND DADO CUTTER ON THE MARKET. . . MICROMATIC ADJUSTMENT PERMITS A CUTTING ANGLE CHANGE IN 15 SECONDS. . . SAW BLADE HELD RIGID. . . WILL NOT CHATTER. . . WARREN DADO SAWING WASHERS CAN BE LEFT ON THE ARBOR OR QUICKLY REMOVED FOR CUT OFF SAWING.

ORDER YOUR SET OF FOUR WASHERS TODAY. TRY THEM FOR TEN DAYS, IF NOT SATISFIED, YOUR MONEY WILL BE REFUNDED IN FULL. DEALER INQUIRIES INVITED



DADO SAWING WASHERS
Warren

Arbor 1/2 3/4 1
Sizes 3/8 1
 Free Circular
 Check
 Money Order

Gentlemen:— Please send _____ sets of sawing washers.
Name _____
Address _____
City _____ State _____
ALL SETS SHIPPED POSTPAID

WARREN DADO SAWING WASHERS CO.
P. O. BOX 98 NORTH END STATION
DETROIT, MICHIGAN

SAY YOU SAW IT IN POPULAR MECHANICS

Aero-Tone Rear Seat Car Radio Speaker only \$8⁵⁰

POST PAID



(Postage and handling extra on C.O.D. orders)

EQUAL IN EVERY WAY TO UNITS COSTING UP TO \$25

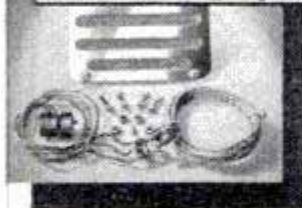

Quickly, easily installed... MONEY-BACK GUARANTEE

Aero-Tone brings new pleasure from car radios. Three-way switch lets you use rear speaker only, front speaker only, or both speakers together. All passengers can hear clearly on low volume. No front seat speaker blast. Send for this new, sensationally low-priced kit. Install it yourself in a few minutes. Test it. Five-day money-back guarantee. Send \$8.50 now or order C.O.D. Write for free literature.

AERO DISTRIBUTING CO.

P. O. BOX 2057, DETROIT 31, MICH.

COMPLETE SAIL BOAT
\$69.90

8 FT. PRAM BOAT
Easily assembled in few hours. Holds 5 persons — It's a Rowboat — Sailboat — or Outboard. Waterproof plywood 8' x 4' x 15" only 75 pounds. Boat Kit \$34.95. Sail-rig \$34.95. Floorboards \$5.00 extra all job factory.

\$34.95

LIGHT STRONG KAYAK
\$14.95

Wood Frame. Canvas Cover. All parts supplied.
8' 3" Kayak \$14.95. 12' Kayak \$24.95. 10' Kayak \$26.50. Sail-rig \$34.95 extra.

Send Check or Money Order. All Kits shipped express collect.

TIMELY PRODUCTS CO.
Arlington 74, Mass.

Easy and Cheap to Operate

SAVE TIME, WORK, MONEY!

SHAW "DU-ALL"

and "PEPPY PAL" TRACTORS

PLOW

These rugged walking or riding tractors ideal for farm, truck garden, orchard, poultry farm. They operate on a few cents an hour. A child can handle them.

DO DOZENS OF JOBS
The Shaw Du-All or Peppy-Pal does many jobs quickly and easily. Plows, cultivates, harrows, disks, bulldozes, sprays, hauls, grinds, and saws wood.

BUILT FOR RUGGED WORK
Sturdy, extra-strength construction means low upkeep, long life. Full year's guarantee.

LOW FACTORY PRICES
Buy direct or through your dealer! Almost anyone who owns a garden can afford a Shaw Du-All or Peppy Pal. Mass production holds prices down — quality up.

RIDING TRACTORS
4 models, from 5 to 12½ H. P., 58 in. wheel-base, 36 in. wide, 24 in. plant clearance. Hand or electric starter. Improved steering device, brakes enclosed in differential housing. Heavier frame and bearings. Standard hitch for trailers and wagons. Plow, harrow, cultivator, cutter bar, snow plow, bulldozer available.

CULTIVATE

MOW

FREE: Illustrated folders giving complete details and price lists—write today!

4536 Front St., Galesburg, Kan.
668-G North 4th St., Columbus, O.

RIDE

SHAW MFG. CO.



Nationally Known SILVER SEAL Rebuilt Engines SHIPPED TO ALL PARTS OF THE WORLD

PRECISION REBUILDING AND EXPERT CRAFTSMANSHIP make the nationally known Silver Seal engine the outstanding rebuilt engine in the automotive industry.

MOST LIBERAL WRITTEN GUARANTEE ever offered on any engine—new or rebuilt.

FULL ALLOWANCE ON OLD MOTOR if not cracked or welded, no charge off for excessive wear, etc.

YOU PAY VERY LITTLE MORE, YOU GET A LOT MORE.

Make	Exchange Price	Trade-In Deposit
FORD Mod. A & B	96.50	28.00
FORD V8 all	108.50	48.00
CHEV. 6 cyl., all	96.50	28.00
PLYM. 6 cyl., all	118.00	20.00
DODGE, CHRYSL., DE SOTO	124.50	35.00
All 6 cyl. PONT., OLDS, STUDE, NASH, PACKARD, HUDSON	134.50	45.00
All 8 cyl. BUICK, PONT., OLDS, STUDE NASH, PACKARD, HUDSON	159.50	40.00

If old engine does not accompany order—add trade-deposit to exchange price. Deposit will be promptly refunded upon receipt of your old engine.



Du-All Converters \$28⁵⁰ for Dual Wheels

You can install Dual wheels on your Farm Wagon, Trailer, Pick-up Truck, or Jeep in less than ten minutes. Du-All Adapters eliminate expense of changing to truck-type wheels and hub. Use your spares for duals! Guaranteed to do the job or your money back.

G. I. MILITARY TRUCK PARTS

Axes, Trunnion Bars, Pillow Blocks, Transfer Cases, Gears, Wheels, and every part for every G.I. type vehicle from jeep to 20 ton prime mover. 6x6 Stude. GMC, Dodge; 4x4 Chev, Dodge, Ford. Auto car, Half track, Scout car, etc.

LOOK AT THESE WAR SURPLUS BUYS!

Winches for Trucks
New Gar Wood model 3U-615, 20,000 lb. cap. for front or rear mounting on any truck. List \$390.00. Our price **\$158.50**

Winch Cable Set. 200 ft., ½", 6 strand, 14 wire plow share steel, rope center, chain and hook. **\$22.50**

NEW GENUINE BENDIX Hydrovac Assembly No. 373163

Fits most trucks 2 tons and up. Standard Equipment on most new trucks. Easily installed on those not already equipped. Priced at less than a repair job. \$78 value, for. **\$28.50**

Power Take Off
2 & 3 speeds with reverse.

Gar Wood, Spicer, Hiel brands. List price up to \$135.00. Price. **\$64.50**

Drive shaft & both Universal joints for winch. List price \$38.70 our price. **\$12.50**

Genuine 14 m. m. Firestone Spark Plugs 21c

Typical War Surplus buy, per hundred **\$17.50**

SEND FOR FREE 64 PAGE CATALOG FOR OTHER GREAT MONEY SAVING BUYS!

The NORTHWESTERN Auto Parts Co.

834 North 7th Street • Minneapolis 11, Minnesota

Say You Saw It in Popular Mechanics

IMMEDIATE DELIVERY!

Complete
as shown



\$24.95

F. O. B. ROYERSFORD, PA.



BENCH SAW

CUTS THROUGH 2⁵/₁₆"

UNCONDITIONALLY GUARANTEED ONE YEAR

Comes complete with Floating motor mount—miter gauge with adjustable stop—aluminum guard—soft aluminum insert—spring steel splitter—heavy gray iron fence—(no motor—no blade). Table 12" x 14". Tilts to 45°—Oilite bearings. Shipping Wt. 48 lbs.

AMERICAN MACHINE & TOOL CO. Inc.

DEPT. 100

ROYERSFORD, PA.

WRITE FOR FREE BOOKLET AND GUARANTEE BOND.

MOW-MASTER

Rotary Mower

Cuts Tall Grass and Weeds Easily--Quickly

LOW PRICED

The new, improved MOW-MASTER makes an easy, quick job of grass and weed cutting. Sturdily built for years of reliable service. Precision engineered. Easy and safe to operate... with adjustable handle. Powered by famous easy-starting, smooth-running POWER-PAK 2 h.p. air-cooled gasoline engine with muffler... automatic governor and manual control.



Keeps lawns velvety smooth. Turn the hard, long job of lawn mowing into real fun.

Lightweight... a woman can operate the MOW-MASTER. Adjustable cutting bar for short or long grass and weeds. Cuts 21 inch swath.

Dealers: a few choice territories still available.

SEE YOUR DEALER or Mail Coupon

PROPULSION ENGINE CORP.

Dept. 203, 7th & White Eagle Rd., Kansas City, Kan.

Please send me Free Folder on the MOW-MASTER Rotary Mower and location of nearest dealer.

NAME _____

STREET _____

CITY _____ STATE _____

Ball-Bearing SPEED WHEELS

Juvenile wheels, solid tire—No Bearings

7" wheels 60c
6" wheels 50c
4" wheels 30c

Semi-pneumatic tired wheels

12 x 1.75" \$3.25
10 x 1.75" \$2.75
10 x 1.25" \$2.00
8 x 2" \$2.00

Industrial wheels for heavy loads

Semi-Pneumatic
400 x 8, 2 ply tire and tube \$12.50
12 x 3.00", bolt hub, ea. \$9.75
10 x 2.75" Hollow Core \$6.75
10 x 2.75" Single Tube \$7.25
8 x 2.50" \$4.90
6 x 2" lug base \$3.30
6 x 2" \$2.80



DEALERS WANTED
MANUFACTURERS
INQUIRIES INVITED

Free blueprints with all wheel orders.

Send check with order. Shipments f.o.b. Akron.

JIM BROWN TOY COMPANY

1097 Home Ave.

Akron 10, Ohio



Better Saws from Better Heat Treating

Heat-treating is an important phase of saw making. Skilled heat-treaters, supervised by a competent metallurgist insure the quality of every Chicago Saw.

Send for Bulletin 107



CHICAGO SAW WORKS

5044 S. Wentworth Ave., Chicago 9, Ill.

for AMAZING acceleration

DIXIE-WESTERN

DUAL INTAKE MANIFOLDS for V-8 FORDS AND MERCURYS

\$15.00 Gas Line and Throttle Kit \$2.50 extra

Chrome Plated Velocity Stocks — \$1.50 ea.

By Test: Increased Acceleration by 26%
Increased Power and Speed by 11%

All DIXIE-WESTERN manifolds are brightly polished cast aluminum.

DIXIE-WESTERN MANIFOLD CO.
Box 364 • Los Angeles 43, California

Dealers Wanted

LOW PRICED STEAM CLEANER

Jenz Super Chief

Portable—No moving parts—Cleans anything—Motors—Chassis—Machinery—Floors—Buildings—Remove wallpaper—Dairy & Creamery—Oil Rigs etc. Oil fired—Economical—fully tested and warranted. 75# Steam in less than 10 min. Model 70. Complete as illustrated. **\$276.50**

F.O.B. factory.

HI-PURE LABORATORIES
EVANSVILLE, IND.

WAR SURPLUS SPECIALS

Navy Hunting Knife (7" blade, leather sheath) \$1.00
Army Medical Dept. First Aid Kit (12 units in Metal Case) \$2.00
Navy Blue All Wool Turtle-neck Sweater \$3.00
Navy White Hammock, complete with clews \$4.00
Army Pup Tent, with stakes and poles \$5.00

All New Merchandise! Send check or money order. Shipped express collect.

BALTIMORE LUMBER CO., WAR SURPLUS DIVISION
418 N. HOWARD ST. BALTIMORE 1, MARYLAND

**SPECIAL OFFER! SAVE 1/2
PORTABLE AIR COMPRESSOR
SPRAY PAINTING OUTFIT**

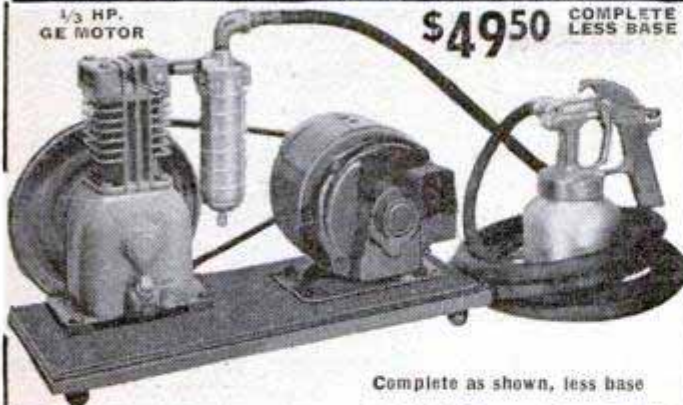

\$49.50 COMPLETE LESS BASE

Complete as shown, less base

2.8 C.F.M. DISPLACEMENT COMPACT POWER PLUS

Here is what you get: 1/2 HP. GE motor or equal, 110 volt, 60 cycle, 1 phase, 1750 RPM, with 6 ft. cord and plug; Compressor, 2 x 1 3/4 piston type; Spray gun with qt. cup, 2 nozzles, round-fan spray, air filter, 15 ft. hose and fittings; belt and pulley. All bolts necessary for mounting on base. We pass the big saving in labor on to you. All you have to do is mount on base as shown. Complete operating instructions furnished. Weight 50 lbs.

Special Price \$49.50

SOLD ON MONEY BACK GUARANTEE. Prices F.O.B. Chicago. Immediate delivery. Send check or money order today. Dealers write.
C & M EQUIPMENT COMPANY 1831 S. State St. Chicago 16, Ill., Dept. D-6



CLOSEOUT!
in original cartons

**BRAND NEW DELCO
TWIN SQUIRREL-CAGE BLOWERS**

\$13.95
post paid

- 110 v. 60 cycle — 2800 RPM — 120 CFM
- Complete with cord, plug and mounting bracket
- Ideal for darkroom — furnace draft — hair dryers, etc.
- No C.O.D.'s — send check or money order to:

P & K DISTRIBUTING CO. • 6135 Manchester • St. Louis 10, Mo.

**FIRE PROTECTION
THERMOSTATS**

Attached across bell makes a fine fire alarm.



POST PAID

Navy Type **\$1.29**
G. M. 105°F

RADIO CENTER

2530 E. Davison • Detroit 12, Mich.

Dado any width with a DA-DALL

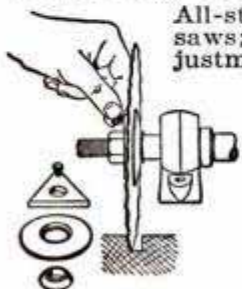

All-steel attachment for circular power saws; dados any width with one adjustment. Safe, easy to install and use.

STANDARD (for saws to 10" diam.)..... \$4.75

HEAVY DUTY (for saws over 10")..... \$8.75

(Specify arbor size when ordering.)
Money-back guarantee. Write for free pamphlet, or order now (no c.o.d.'s, please . . . California buyers, add sales tax).

PACIFIC COAST TOOL CO.
1711-A Webster St., Oakland 12, Calif.

• Dealer Inquiries Invited.

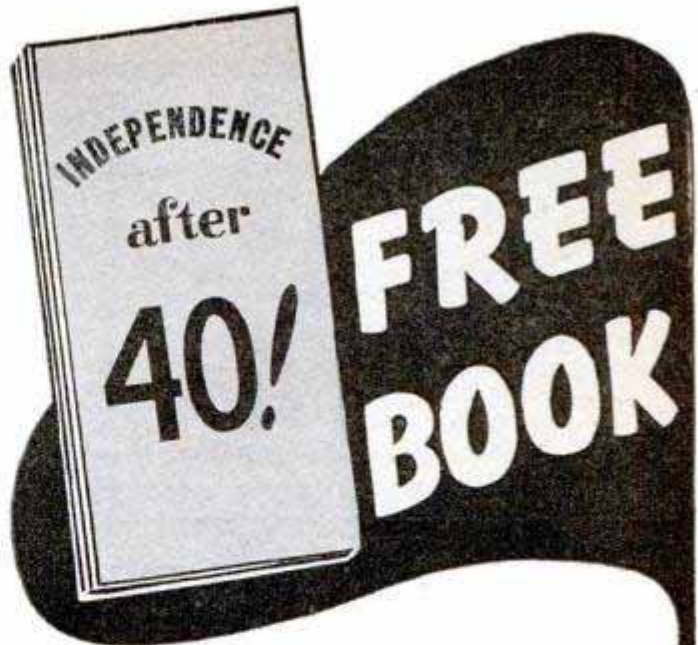

**Shows how to win
Independence after 40!**

Do you dream of independence and freedom from money worries for yourself and your family? The best way to become independent is to have a business of your own. This FREE book "INDEPENDENCE AFTER 40" shows you a proven, practical, profitable way to start in spare time, with a necessary service in every community—sharpening saws with a Foley Automatic Saw Filer.

**Start your own Business with
SMALL CAPITAL**

Here is a steady, repeat CASH business you can start in your basement or garage, with a modest investment and no overhead expense or stock of goods to carry. Machine saw filing pays up to \$2 or \$3 an hour — it is easily possible to make \$20 to \$30 a week or more in spare time. There are thousands of saws in every community to keep sharp. This business is a money-maker in both large and small towns.

"INDEPENDENCE AFTER 40" shows you how to get plenty of saws to file without canvassing, and after you get a start how you can develop into a general repair shop business also sharpening lawn mowers, skates, scissors, making keys, repairing vacuum cleaners, etc. Other men have made themselves independent — you can too! The way to do it is all planned out for you in this practical book—send for your free copy today!

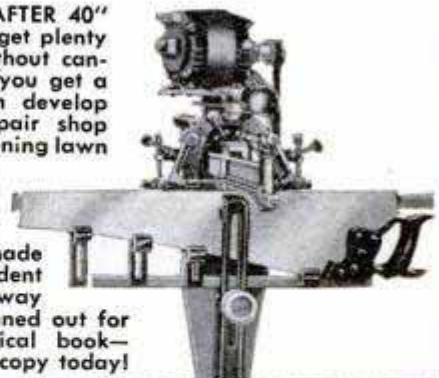

Send Coupon for FREE BOOK

**FOLEY MFG. CO., 616-8 Foley Bldg.,
Minneapolis 18, Minn.**

Send me free book "INDEPENDENCE AFTER 40!"

Name _____

Address _____

Speed Thrills!

MINIATURE RACING with JET POWER and ENGINES



Thimble Drome Racer GAD-JET RACER

Power with Gas or Jet Engine. Free Instructions with Each Car

\$4.25
POSTPAID

New scale model of midget racer, the classiest thing you ever laid eyes on. Die Cast aluminum body, turned aluminum, rubber-tired wheels with treads. Chrome exhaust stacks. Wobble pump. Simulated leather seat and back. Instrument panel and numbers. Equipped with bridle lugs for cable track racing. Car is 9 3/8" long, 4" high, weighs 18 oz. Can be powered with CO2 engine or most gas engines. Instructions accompany each car. Only \$3.95. Postage 30c additional.

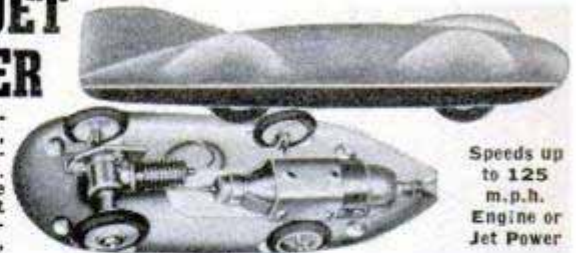

Speeds up to 125 m.p.h. Engine or Jet Power

All metal miniature racer, ultra streamline design. Aluminum, die cast, two-part body, aluminum wheels, rubber tires. Completely finished, ready to go, with clip for jet cartridge racing, only \$1.50. Same, with OK CO2 engine and conversion kit for installing engine at home, \$6.95. Add 20c for postpaid delivery either model.

Rush Order to Address Below. If you prefer C.O.D. Delivery send \$1.00 deposit with order.

HOME SHOP PRODUCTS COMPANY, Dept. 1A, 4821 Sheridan Road, Chicago

SMART NEW



POWERBIKE

gets you there safely and economically

The motor is in the rear, mounted low to aid balance and handling. No grease to rub off on your legs, no hot fumes blowing in your face. 100 miles per gallon, 30 MPH. 1 1/2 HP fan cooled engine, kick starter, automatic clutch, fits any man's or woman's balloon-tire bike. See your dealer or write direct. TERRITORIES AVAILABLE.



SAGINAW PRODUCTS CORP. • SAGINAW, MICHIGAN

BRIGGS-STRATTON ENGINES

1 1/2 HP. MODEL N - GOVT. SURPLUS

Special Low "as is" price **\$34⁵⁰**
Only.....

In good operating condition with 30 day written guarantee..... **\$44⁵⁰**

Engines will develop almost 2 Hp. at 3600 RPM. Hurry don't wait, buy now while limited supply lasts. Suitable for lawn mowers, garden tractors, motor bicycles and scooters, midget cars, etc. Will power many kinds of machinery.

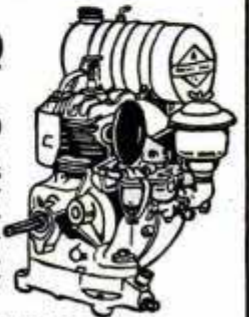

Write for Descriptive Circular

MIDWEST SURPLUS SALES CO. 2531 INDIANA KANSAS CITY, MO.

CUBIC-INCHER RADIO SET \$2³⁹

SIGNAL-POWERED NO ELECTRICITY



Entire set less than one cubic inch in size, rests in bowl of teaspoon! Radar 1N34 detector, world's best for crystal sets. Works anywhere—never wears out—costs nothing to operate. Safe and foolproof. Reception is guaranteed. With connecting leads and complete directions, \$2.39 postpaid without phone. \$3.19 postpaid with phone. Foreign orders 10% extra, p. paid only.

CARING PRODUCTS Dept. M1, Box 1308 Chicago 90, Ill.

FULLSIZE, CUT-TO-SHAPE BOAT PATTERNS



and specifications. Designed by Naval Architect. Cruisers, runabouts, sloops, outboards, sailing canoe, etc. Low prices. Send 10c (coin) for illustrated catalog. SPECIAL: Send \$1.00 for "HOW TO BUILD BOATS" book, postpaid.

Cleveland Boat Blueprint Co. Dept. 666, Cleveland 13, Ohio

SAY YOU SAW IT IN POPULAR MECHANICS

WAR SURPLUS VALUES

NAVY T-SHIRT

Brand New. First quality. Soft knit cotton. Sizes small, med., large.



3 for \$2

PUP TENT

Army surplus. Full size. Used—guaranteed perfect condition. Complete with poles and pins.



3⁹⁵

SLEEPING BAG

100% wool, mummy type. 30" zipper. Reissue—guaranteed like new. Complete with water repellent cover.

3⁹⁵

MILITARY TYPE WRIST WATCH



Brand New. Fully guaranteed. Jewel movement. Luminous radium dial. Stainless steel back. Waterproof. anti-magnetic. Genuine leather strap.

Plus 10% Fed. tax **21⁹⁵**



Air Corps SUNGLASSES

New Air Corps Type. 24 Karat gold plated frame. 4 base optically ground lens. Pearloid brow rest. Complete with case.

2²⁵

NAVY KNIFE

Laminated leather grip handle. Complete with sheath.

98^c

ORDER FROM THIS AD

Send check or cash—Shipped prepaid. COD's sent postage collect.
NATIONAL JOBBING COMPANY
1703 No. 24th St. Dept. N Omaha, Nebr.



*"We needed some extra rooms in a hurry,
so when we found out that Weldwood Glue is so strong..."*

When you want a wood to-wood bond that will really hold... remember Weldwood Glue. It's quick to mix... easy to use... tremendously strong... stain-free... rot-proof... and permanent. At hardware stores, lumber yards, chain stores, in 15¢, 35¢, 65¢, 95¢ and larger sizes.



WELDWOOD
PLASTIC RESIN GLUE

United States Plywood Corporation, New York 18, N. Y.

RIG Your Own TRAILER

Universal TRAILER CHASSIS 3000 LB. CAPACITY

FOB E. Boston, Mass. **\$59.95** Plus 7% Federal Tax

Consists of rugged tubular all-steel frame, heavy-duty forged steel spindles, Timken tapered roller bearings, drop center wheels, dust-seal hub covers, extension gooseneck car-hitch, safety chain and parking stand.

2 Tires with Tubes \$31 extra

(4-ply 600x16 standard make tires, mounted)
Tires sold only with chassis

Make your own unbelievably rugged trailer at a fraction of regular cost! Three heavy welded studs on frame provide ideal locations for attaching rigging for your platform, boat cradle, box-body, etc. Use your old tires (16 in. rims), or order our standard makers' tires and tubes. Standard auto wheel track.

TERRIFIC BUY—Immediate Delivery AT NET MANUFACTURER'S PRICES

Universal's trailer chassis is sold and guaranteed direct by manufacturer. Remittance of \$20 must accompany order. Balance, including freight from E. Boston, plus U. S. tax to be paid C.O.D.

Universal Mfg. Co.

EAST BOSTON (28) MASS. DEPT. P6

JUNE 1948



for **DOZENS**
of **HAULING USES**

USE
YOUR OLD TIRES
OR OUR NEW TIRES

MAKE YOUR OWN
BOAT CARRIER



MOUNT YOUR OWN BOX BODY



RIG YOUR OWN LUMBER CARRIER



\$3.15
Fenders Pair Extra
Single fenders \$1.75 each

for Sportsmen Contractors
Vacationists Farmers
Boatsmen Business etc.

ORDER NOW! DIRECT FROM MANUFACTURER

UNIVERSAL MFG. CO. 160 Prescott St., E. Boston 28, Mass.

Send.....Trailer Chasses, @ \$59.95 FOB E. Boston, plus 7% Tax.

Send.....Trailer Chasses, with 2 tires & tubes @ \$90.95 FOB E. Boston plus tax

Send.....Fenders, @ \$3.15 pair FOB E. Boston Plus Tax

I enclose \$..... Will pay balance, freight and tax on delivery.

Name

Address

SEND FOR FREE CATALOGUE
AND MANUAL

QUALITY

Aluminum Guard Easily Removed
For Dadoing



NEW IMPROVED TABLE MODEL TILT-ARBOR SAW

OIL IMPREGNATED BRONZE BEARINGS OR DOUBLE
SHIELDED BALL BEARINGS, BOTH WITH THE PATENT-
ED BALL BEARING TRANS-AXIAL MOTOR DRIVE

MODEL #2021X AS SHOWN WITH COMPLETE MITRE
GAUGE. Precision etched scales show angles on mitre
gauge and saw cradle. STEEL BAR RIP FENCE, ALUMI-
NUM SAW INSERT AND GUARD. STEEL SPLITTER.
BALL BEARING TRANS-AXIAL DRIVE $\frac{5}{8}$ " GROUND
ARBOR. "COMPO" OIL IMPREGNATED BRONZE BEAR-
INGS WITH OIL CHAMBER AND CUP. (OR, DOUBLE
SHIELDED BALL BEARINGS, \$5 EXTRA). TABLE 18"
x 16". BUILT IN SWITCH. Depth of Cut $2\frac{3}{16}$ ". Shipping
Wt. 110 lbs. Requires $\frac{1}{2}$ or $\frac{3}{4}$ H.P. Motor.

(BALL BEARING FLOOR MODEL WITH 18" x 32" TABLE
INCLUDING EXTENSION \$79.50)

AMERICAN MACHINE & TOOL CO., Inc.
DEPT. 111 ROYERSFORD, PA.

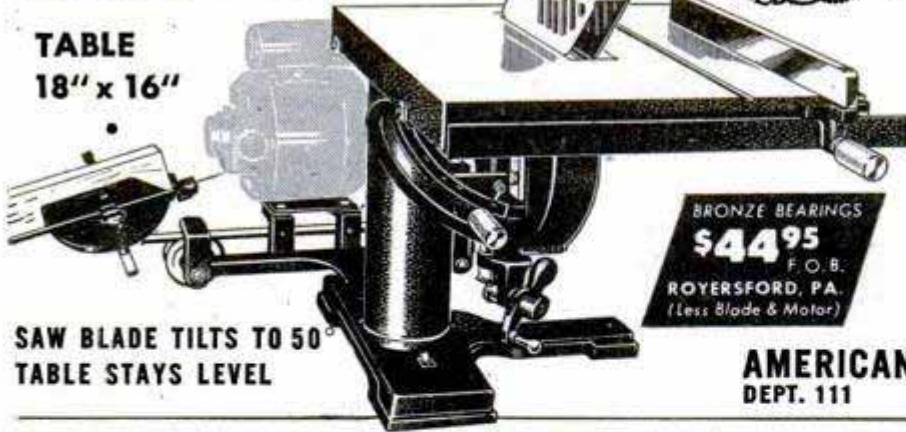

TABLE
18" x 16"

SAW BLADE TILTS TO 50°
TABLE STAYS LEVEL

BRONZE BEARINGS
\$44.95
F.O.B.
ROYERSFORD, PA.
(Less Blade & Motor)

EARN BIG MONEY
AND BE YOUR OWN BOSS
Sharpening Lawn Mowers

THE UNIVERSAL GRINDER PUTS YOU INTO BUSINESS WITH SMALL INVESTMENT

Earn as much as \$400.00 a month in
your basement or garage. Mr. Felber of
Ind., writes, "MY UNIVERSAL
GRINDER is faster and more accurate
than any other grinder. Its efficiency en-
abled me to sharpen 450 mowers in
4½ months. More than paid for itself
the first month. Every customer satis-
fied." Mr. Hardy of Mississippi writes,
"Received my Universal Grinder the
first part of May and by August 18 had
sharpened over 1000 mowers." Mr. Ba-
con of California writes, "The lawn
mower business, with my Universal
Grinder, has been a gold mine these
last two years."



Only on the UNIVERSAL GRINDER can the inside face,
the edge of the stationary blade, and the reel blades,
be ground to proper clearance ALL IN ONE SET-UP
WITHOUT REMOVING ANY BLADE FROM THE MOWER
Free Folder

Rogers Mfg. Co., Dept. M-68, Lindsey, Ohio

SEND TODAY FOR FULL DETAILS

ROGERS MFG. CO., Dept. M-68, Lindsey, Ohio
Please send me without obligation complete details about how I
can earn BIG Money with the Universal Grinder.

Name _____
Address _____
City _____ Zone _____ State _____

G. E. AIR COMPRESSOR



Brand New. $\frac{3}{4}$ hp 27 volts DC-AC. 2 stage
piston type. 1000 lbs. per sq. inch rated
pressure. Approx. 2 CFM. 17 amps series
wound motor. Pressure tank and fittings in-
cluded. Equipped with fan for cooling. Can
be used direct from Delco system. Can be
adapted to 110 V AC with 27 volts trans-
former. Perfect for low-pressure paint spray
gun, inflating tires, spraying trees, air
horns, laboratory use. Ship-
ping weight 25 lbs. Cost Govt.

over \$200.00. Our price, FOB, K. C., Mo.,
only **\$17.95**

TRANSFORMER: New 27 volts for use with compressor or
other uses. Weight 20 lbs. Our price, FOB, K. C.,
Mo., only **\$14.95**

Write for latest circular of surplus bargains

NATIONAL SURPLUS SALES CO. 723 E. 18th Street
Kansas City, Missouri



ALL-PURPOSE CUTTER YOU NEED!

Cuts holes, discs, grooves, beads—
routs—rabbets in wood, plastic, even soft
metal. "Wouldn't take \$100 for it," say
users. No drill press or home workshop
is complete without it. ONLY
Send check or money order to

**SOUTHERN ENGINEERING
& METAL PRODUCTS**
21 N. E. 17th Terrace, Miami, Florida

\$1.00
with
3 Bits

NEW LOWEST-PRICED ARC WELDER

Makes All Types of Welding Easier

Here is the world's easiest welding . . . the new "Linc-
welder" 180 AC. Its exclusive "Arc Booster" makes
arc striking as easy as striking a match. Simplifies
welding of all kinds.

Safe to operate . . . open circuit voltage never exceeds
52 volts. Built for rural power lines . . . draws less than
37 amps. when welding at 180 amps. Approved by
power companies and REA. Of highest quality indus-
trial-type construction . . . yet sells for only \$150, the lowest
price of any welder of this capacity. Full details in Bulletin
370. Write your local Lincoln Welder or The Lincoln
Electric Company, Dept. 332, Cleveland 1, Ohio.

PRICE
\$150
FREIGHT
PREPAID



SEE IT...
TRY IT
"Lincwelder"
180 AC with
the amazing
"Arc Booster"

Accessories at slight extra cost.

SAWMASTER

Power Hack Saws

\$49.85

FOB OMAHA

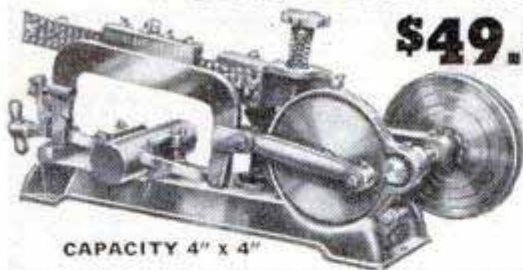

CAPACITY 4" x 4"

Especially designed for farm and home work shops.

WRITE FOR CIRCULAR

MILLER-KNUTH MFG. CO.

2814 No. 20th St.

Omaha, Nebr.

Guides you to hobby happiness

Woodworking handbook and catalog of **Homecraft®** Power Tools

Shows how you can have a complete home shop without spending a lot of money! Gives you useful information: Plan for woodworking bench. Handy hints on using a band saw. Reference charts on screws, bolts, board measure. Dimensions for power-tool stands. Method of enlarging plans and drawings. Names of helpful books. Get your copy of Catalog HC-1!

Ask us for your Homecraft dealer's name.

DELTA MFG. DIV., 681 F. E. Vienna Ave., Milwaukee 1, Wis.

Send for your copy today!

10¢
Postpaid

Original HOLLYWOOD WOLF WHISTLE

CAR HORN

Give the WOLF CALL



You, too, can become a Hollywood Wolf. Give the wolf call and make other weird noises with the original HOLLYWOOD WOLF WHISTLE on your car. Precision made. Works off the intake manifold. Easily installed in 15 minutes.

Works in trucks, motorcycles, motor boats, outboard motors, too. Guaranteed. If your dealer cannot yet supply you, order direct, giving us your dealer's name. No COD's or stamps. No individual foreign orders. AUTOMOTIVE DEALERS & JOBBERS write for information on this fast selling, proved item.

YODER MFG. COMPANY

2403-21 East 103rd St., Los Angeles 2, California

DESCRIPTIVE LITERATURE ON REQUEST

Build Your Own Trailer with NATIONAL'S Simplified Plans

Beat the housing shortage with a full-size house on wheels or add new pleasure to your vacations and week-ends with a sleek sport trailer. Step-by-step instructions and complete bill of materials with every plan. *Three different models.*

NATIONAL MODEL 27: A 27-ft. luxury liner with 3 rooms, lavatory, sleeping space for six. Plans **\$1.00**

NATIONAL MODEL 28: A 20-ft. cabin trailer that's good-looking and sturdy, with beds for four. Plans **\$1.00**

NATIONAL CAMPER: The sport trailer you've wanted for hunting, fishing, vacations. Sleeps two. Plans **.50**

ORDER ALL THREE—AND GET ONE FREE Complete set \$2.00

Big parts catalog FREE with any order!

NATIONAL TRAILER STORES

Dept. 51 • Box 2353 Terminal Annex • Los Angeles 54, Calif.

Compare and BUY!

Order Direct from this Ad.



Sherill AUTO COMPASS
Dependable and serviceable, liquid type, airplane style for use on auto, plane or boat. Foolproof, easy to install. Shpg. wt. 1 1/2 lbs. Each... **\$179**

Nationally Advertised AIR COMPRESSOR
For Home Craftsmen, Model Builders, Hobbyists... for jobs around the home, garage, shop, farm and factory. Use it with paint spray guns, garden sprayers, to inflate tires, etc. Delivers 1 1/2 cu. ft. of air per min. at 35 lbs. pressure. Hgt. 9 in. Shpg. wt. 11 lbs. Our low price includes gauge. Each, complete... **\$995**

WIG-WAG Safety Signal
A moving stop light that operates automatically when the brakes are applied. Non-breakable ruby lens. Sturdy electric motor. Easily installed. Shpg. wt. 8 oz. Each... **\$189**

Hydraulic BUMPER JACK
Smooth action pump type bumper jack... fast, efficient and easy to operate. All working parts fully enclosed—dirt and dust proof. Lifting capacity 2500 lbs. Full 18 inch lift. A top quality jack at a sensational low price. Compare! Shpg. wt. 8 lbs. Each... **\$487**

ALL TRADES 3 TON Hyd. JACK
Handles all loads up to 6000 lbs. with ease and speed. Made of treated steel for dependable performance. Shpg. wt. 17 lbs. Each... **\$745**



BATTERY Heavy Duty CHARGER
Here is an unbeatable value... You save more than half by buying Now. Compare! Charges 1 to 24 batteries at full 6 amp. rate. Size 20 1/4 in. wide, 7 in. high, depth over plug, 10 1/2 in. 105-115 volt, 50-60 cycle A.C. current. A heavy duty charger that is quality built thru and thru. Shpg. wt. 59 lbs. Each, complete with tubes... **\$3950**



Chrome Plated WHEEL TRIM
For CHEVROLET 1937-38
You can modernize your car, give it style and snap at low cost. Fits around hub caps, easily installed in a jiffy. Compare our low price and Buy Now. Shpg. wt. 6 lbs. Set of 4... **\$489**



POLISH-GRINDING HEAD
Takes standard accessories. Equipped with needle bearings and 3/4 in. Jacobs Hand-Tite Chuck. 1/2 in. shaft of cold rolled steel. Frame is one piece cast aluminum. Red enamel finish. Height 6 in. Shpg. wt. 6 lbs. **\$648**

FENDER FLAPS
Protects fenders from tar, mud, slush and stones. Made of durable black rubber with chrome trim and 3 ruby jewels. Fit all cars. Mounting brackets included. Compare and buy! Shpg. wt. 2 lbs. Per Pair... **79c**

Outdoor AUTO-KOOK STOVE
New and different! A trim, cast aluminum stove that you can carry right along in your car... provides hot meals by simply attaching to rear bumper and exhaust pipe. Complete assembly... fits any car. Priced at less than half. Each... **\$998**

COMPARE! Flexible POWER SHAFT
Only **\$695**

Fit motor with 1/2 in. drive shaft. Overall length 50 inches. Inner core 5/16 in. diam.—sound of transverse layers of high carbon steel wire for greatest strength and flexibility. Outer casing is of flexible steel wire. Headpiece has 1/2 in. x 20 thread arbor, and will accommodate any tool with this size thread or hole. Shpg. wt. 5 1/2 lbs.



NOJAX Emergency Wheel
Eliminates flat tire emergencies on dangerous highways or city streets. Just take NOJAX out of car trunk, put it under flat tire and drive to your home or nearest garage. Wheel automatically locks into place—can't come out. Rugged steel construction—will carry cars and trucks up to 5000 lbs. Hard rubber tired wheels. Play safe! Compare! **\$998**
Buy Now, Each...

TERMS
F.O.B. Chicago. 25% deposit with C.O.D. orders. No C.O.D. order for less than \$2.00.
All items guaranteed to be brand new.—Money back in 5 days if not satisfied.
ORDER TODAY! SHIPPED TODAY!

COMPARE and BUY!
Chrome License Plate Fasteners, Famous Palnuts... 17c
No rough ends. Set of 4... 16c
Pin Type Battery Jumper, Each... 34c
"Duce" Bug Remover. Cleans bug residue from auto finishes... 62c
Booz Angle Wrench, Grips like a vise... 42c
Lo-Bay Wheel Spinner, Tennis Knob... 29c
Heavy Duty Tractor Wheel Spinner, Red Enamined Maple Knob... 89c
Small Gear and Bearing Puller, Zinc Plated Carbon Steel... 89c

CLINTON MOTIVE SALES Co.
545 W. ROOSEVELT ROAD
DEPT. M-5 - CHICAGO 7, ILL.

SAY YOU SAW IT IN POPULAR MECHANICS

**THIS
5
ROOM**

ALADDIN \$1396

**FREIGHT
PAID**

**HOW TO BEAT
THE BUILDING GAME**

The Aladdin Readi-Cut System of construction enables you to save 18% lumber waste and up to 30% labor costs, and guarantees you will receive the highest quality lumber and a COMPLETE house as specified, shipped anywhere.



81 DESIGNS TO CHOOSE FROM—HERE'S WHAT YOU GET



You get all the lumber cut to fit by fast machinery-production line methods—marked and numbered, ready to erect practically without the use of a saw; also siding, flooring, trim, all millwork, doors, windows, glass, hardware, nails, roofing, paint and complete drawings with instructions. Many Aladdin home buyers erect their own houses.

"BUILD IT YOURSELF" SEND 25c FOR CATALOG R
THE ALADDIN CO. BAY CITY, MICHIGAN

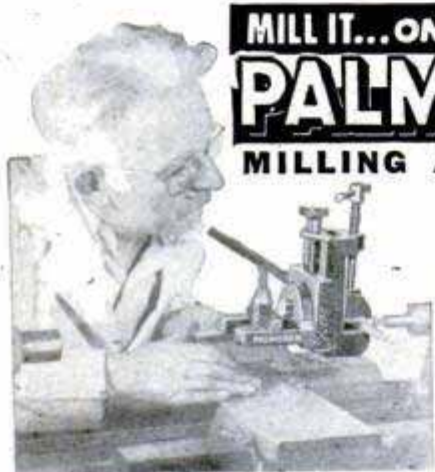

**MILL IT... ON YOUR LATHE!
PALMGREN
MILLING ATTACHMENT**

3 SIZES
No. 250 Illustrated
2 1/2" JAW
Only **\$24.75**
**CONVERT LATHE
IN 10 SECONDS**

Now you can Mill, Slot, Grind, Groove, Square Shafts, Saw at Angles, Recess and many other important jobs. SAVE TIME and MONEY! Why send work out or use costly methods when a PALMGREN MILLING ATTACHMENT will solve your problem. Precision built, it has accurate graduations for rotary angle adjustments, also graduated vertical feed screw. Fits South Bend, Atlas, Craftsman, Logan, Sheldon and all other lathes. Thousands now in use in small and large machine shops, repair shops, railroads, schools, home work shops, etc. ORDER SIZE NEEDED TODAY!—it will quickly pay for itself.

IMMEDIATE DELIVERY

Nos.	Width Jaws	Depth Jaws	Jaws Open	Weight Pounds	Fits Tool Post	Price F.O.B. Factory
150	1 1/2"	1"	1 5/8"	6 1/2	1" Dia.	\$18.75
250	2 1/2"	1 7/16"	2 1/2"	11	1 1/4" Dia.	24.75
400	4"	1 1/2"	4"	25	2" Dia.	39.75

Order From Your Dealer or Jobber: Write for Circular No. 351
Mfrs. of PALMGREN PRODUCTS Since 1915
CHICAGO TOOL and ENGINEERING CO. 8365 South Chicago Ave. Chicago 17, Ill.

JUST A FEW OPERATIONS YOU CAN DO ON YOUR LATHE!

HEAVY CAST ALUMINUM BLOWER
Now Only **\$10.00**

SINGLE EXHAUST BLOWER DELIVERS 100 CU. FT. AIR PER MINUTE. Ready to install yourself with any household tools. It's built for that. Housing is solid cast aluminum to last indefinitely. 110 V., A.C., 50-60 cycles. Cont. duty motor.

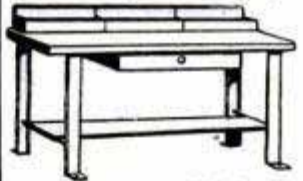
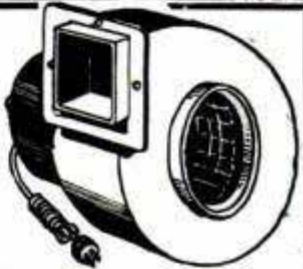

DOUBLE EXHAUST BLOWER
Only **\$15.85**
On Blowers, add 50c for handling; \$1 West of Mississippi.

Only **\$15.35 F.O.B. YONKERS** or send \$5 and bal. C.O.D.

WORK BENCH
With All Welded Steel Legs

Ideal for Mechanics, Hobby Shops, Craftsmen. A super value! Legs are welded steel. Top is 2" solid plank stock. Bottom shelf 1" pine. Large, roomy tool rack and bins for nails, nuts, bolts are pine. 32" high, 60" long x 23" wide with lower shelf and big drawer. Wt. approx. 100 lbs. . . . Shipped KD with bolts, nuts, screws for easy assembly. ALL PRODUCTS CARRY MONEY-BACK GUARANTEE! Send check, money order. Free Literature. **UNIVERSAL YONKERS CORP. (M-6)** 137 Alexander St. Yonkers 2, N. Y.

FENDER SKIRTS \$17.20 PER PAIR

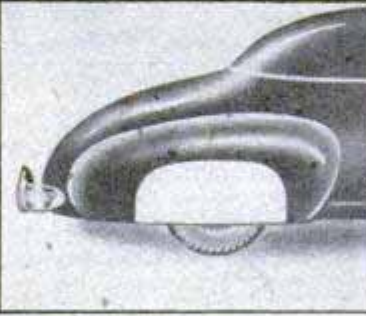

For Ford, Chev., Merc., Plymouth, DeSoto, Chry., Dodge Kaiser-Frazer and Buick. Beautifully you can bring out the flowing lines inherently designed there. Sparkling beauty you'll like. Constructed of heavy gauge body steel, finished in prime, perfect fit.

SANDEE MUFFLER CO.
Box 296, La Tijera Sta. Los Angeles 43, Calif.
Gentlemen: Please send me one set of Sandee Fender Skirts to fit my _____ (year and make of car)
 Check for \$17.20 enclosed
 Ship C.O.D.

YOU ASKED FOR IT— HERE IT IS!



STRATIN DRILL JIG PATENT PENDING

Stratin allows you to drill those "Hard to Drill" holes along thin edges, cross grains, end grains, veneer and plastic that are as thin as 3/32 of an inch thick. No more spoiled work. Send check or money order.
CORLAM MANUFACTURING CO., 119 Franklin St., New York 13, N.Y.

Golfers!

ASSEMBLE GOLF-CART YOURSELF... FOR ONLY



\$17.50

Assemble GOLF-CART in 15 minutes with ordinary household tools. Order direct from factory and save middleman's markups and extra labor costs. Never before has a golf club carrier of this quality been offered at this sensationally low price. Special aluminum-alloy construction—light but strong. Easy-rolling, ball-bearing wheels. Full cushion pneumatic tires. Folds for compact storage without pressure on clubs. Instantly adjustable for any size bag. Ample storage space for raincoats, etc. Unconditionally guaranteed one year against mechanical defects. Dealers Wanted.

SAVE UP TO \$1500

SHIPPED PREPAID FOR \$17.50
Complete in Carton (Add \$1 postage east of Mississippi)
SEND CHECK OR MONEY ORDER — NO C.O.D.'s

WESTERN GOLF-CART CO. 229 N.W. 10th Avenue
PORTLAND 9, OREGON

JUST OUT — HARD-TO-FIND NEW PORTABLE RADIO ANTENNAS

Gov't. Surplus as used on Army Tanks. Telescopic—Rust Proof—have tremendous pick-up. Eliminate dangerous wiring.

NOISE FREE RECEPTION
\$13.50—9 FT. SOLID BRASS Now \$3.95
 (9 Sections) with clamps, Nut, Lug wire (Postpaid)
\$12.50—9 FT. ALUMINUM Now \$3.95
 (8 Sections) with clamps, Nut, Lug, wire (Postpaid)
\$12.00—7 FT. SOLID BRASS Now \$3.45
 (9 Sections) with Lo-Loss Lead and Mounting Bracket (Postpaid)

FOR HOMES, BOATS, AUTOS
 Exceptionally rugged sections. Handy for camping also useful for transmitting, F.M. and Television Sets. Each securely packed. Easy to install anywhere.

QUANTITY LIMITED ORDER TODAY—Mail check or money order—State Antenna desired. All prices postpaid or sent C.O.D. plus postage. SPECIAL 10% DISCOUNT ON ORDERS FOR 3 OR MORE. Money Back in 10 Days if not satisfied.

RADIO HOSPITAL 442 East 86th St., Dept. A18
New York 28, N. Y.

LAWN ORNAMENT-NOVELTY PATTERNS

28 Lawn Ornament Patterns, 25c. Other patterns: 15-20" high; Dutch Girl, Dutch Boy, Pirate, Bull Terrier, Mexican Girl, Mexican Boy, Dwarf, Penguin, Flower Girl, 10c each. 25 Novelty Patterns, 30c. All 62 Full Size Patterns, \$1.00 Postpaid. Strother Pattern Service, Dept. AM-8, Box 383, Belington, W. Va.

MORE POWERFUL PORTABLE BENCH GRINDER—\$13.50

FULL 1/12 H.P. MOTOR AT 3450 R.P.M. BY DYNAMOMETER TEST

With adjustable tool rests and removable cast wheel guards for buffing. Diamond-trueed 4" x 1/2" coarse and fine wheels . . . dust proof bearings . . . off-on switch . . . 6 ft. rubber cord . . . baked hammertone finish . . . 110-120 volts a.c., 60 cycle . . . guaranteed one year against defective workmanship or materials. Send check or money order, we prepay postage.



ALHAMBRA PRODUCTS, BOX 328, ALHAMBRA, CALIF.

WAR Surplus AND OTHER BARGAINS!

U.S. Navy SUN GLASSES 66¢
 New. Genuine Navy issue. Polished and ground lenses. Plastic natural color frames, wire core. Complete with handy case. Add 5c postage.

AVIATORS Style 283
 24K GOLD PLATED RIMS
 Made according to Government standard. Full size 61mm lenses, ophthalmic ground 4-base curve, shuts out more than 96% of the ultra-violet rays. Adj. nose piece, pearl sweatband, 24k g.p. rims. Handsome leatherette case. Add 8c postage.

SPECIALS

DOWN & FEATHER SLEEPING BAGS 13.99
 Brand new. Full size. Complete in one piece. Water repellant poplin outside, down and chicken leather filled. Zipper opening. Weighs only 7 1/2 lbs. Add 40c postage.

NAVY STYLE WHITE T-SHIRTS 69¢
 New. Fine combed cotton yarn. Sizes small, medium, and large. Add 3c postage.

O. D. WOOL PANTS 2.95
 Used, perfect. 100% all wool serge. Cleaned and pressed by the O. M. Corps. Add 12c postage.

O. D. WOOL SHIRTS 2.69
 USED - PERFECT SIZES - 13 to 15

59¢

Gen. NYLON PARACHUTE CORD
 50 ft. long, 3/8" diameter. White and olive drab. Ideal for clotheslines, drapery and venetian blind cords, etc. 550 lb. tensile strength. Add 6c postage.

Surplus DUST MASKS 33¢

Brand new. For paint or insect spraying. For millers and farmers. Perfect dust protection. Add 5c postage.

GREATEST WATCH VALUE in the U.S.A!

17 JEWEL NOW ONLY 19.95



PLUS 10% FED TAX

Khaki SUN TAN BRAND NEW SHIRTS 14 to 17 2.99

PANTS 28 to 42 3.79

Brand new. Pants made of 8 oz. and shirts of 6 oz. mercerized khaki suntan twill materials. Well tailored. Add 5c per garment postage.

Think of it! Here is a genuine 17-jewel wrist watch with a **GUARANTEED SWISS MOVEMENT, WATER & DUST REPELLANT, SHOCK-PROOF, ANTI-MAGNETIC, RADIUM DIAL and SWEEP SECOND HAND.** Set in a genuine stainless steel case with a fine leather strap. Save at least \$15.00. If you don't think this the greatest value in the U.S., return it for refund.

MAIL ORDERS
 Please send remittance with order. Include postage. Order will be sent C.O.D. plus C.O.D. fee. Satisfaction or your money back.

Send for FREE SURPLUS CIRCULAR

This circular lists and illustrates OVER 150 WAR SURPLUS BARGAINS, also many other startling values.

SIoux FALLS SURPLUS STORE
SIoux FALLS, S. DAK.

SAY YOU SAW IT IN POPULAR MECHANICS

Floralite

Your Garden **FOR ONLY \$5.00**



DON'T LET NIGHT-TIME BLACKOUT THE BEAUTY OF YOUR GARDEN

Can you picture the magic of an electric-lighted garden? Roses, azaleas, iris, shrubs, take on new glory when back-lighted, or high-lighted with FLORALITE. Flower gardens that ordinarily lose loveliness after dark now become the center of attraction. Just place FLORALITE near your favorite garden spot, plug in cord, and your garden fairly glows with nighttime splendor! Amber light of FLORALITE does not attract insects. Height 24", plus 8" push-in-ground base. Approved all-weather electric cord. On sale at electric, hardware, department stores, and florists everywhere!

Write for **FREE** folder today!

STEBER MFG. CO.
Dept. 85, Maywood, Illinois

PROFITS AND SPEED

THE MODERN
LAWN MOWER
SHARPENER

PRICE **\$241.50**
LESS MOTOR

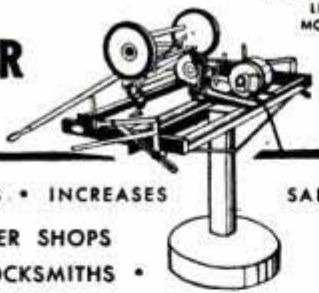

INCREASES PROFITS • INCREASES SALES!
FOR LAWN MOWER SHOPS
FIXIT SHOPS • LOCKSMITHS •
HARDWARE STORES • GOLF COURSES • SCHOOLS
PARKS • PLAYGROUNDS • INSTITUTIONS •
CEMETERIES • AND ALERT INDIVIDUALS!

Sharpens All Reel Type Mowers • Hand, Power or Gang • 10 to 20 Minutes • No Dismantling • No Extra Attachments Needed

All reel type mowers, from 5-inch edgers to 36-inch power mowers, are quickly sharpened to extreme ends of both left and right twist reel blades. Handle, wheels, roller and motor remain in place when sharpening is in process. Bed knife is sharpened in same brackets that hold mower in grinding position. No extra attachments required. One lever puts mower or bed knife in grinding position. 100% steel construction. Grinding head rides on five ball bearing races. Small, compact, easy to operate. Sharpens wood chisels, joiner knives and planer blades without extra attachments.

ORDER NOW
Immediate Delivery

Skate Sharpener Attachment Available
Send For Free Bulletin No. 10B

MODERN MFG. CO. 160 N. FAIR OAKS AVE. PASADENA, I. CALIFORNIA

IDEAL FOR FIELD USE!



KETT PORTABLE POWER SAW

Cut straight lines or curves. No starting holes to drill. No slowing up for understructure, leaves "milled edge" finish. Adjustable blade cuts through mild steel, aluminum, plastics and other material. Blades replaced in half a minute.

FOR HOME, SHOP OR PLANT!

KETT PORTABLE TALL REACH BORER



Drills holes high, low, or in "hard" corners, in wood, metal, or masonry. 80% time savings over hand boring. Extension converts tool to tall reach borer that drills ten feet above floor. Bits available.

FOR HOME, SHOP, ELECTRICIANS & PLUMBERS

WRITE FOR CAT. P AND NAME OF NEAREST DEALER

THE KETT TOOL COMPANY
5 EAST THIRD STREET CINCINNATI 2, OHIO

ACE LATHE TOOL SET

Be permanently tooled-up for every operation on your Metal Cutting Lathe



The ACE Set is complete—there's nothing more to buy. Drop forged by the manufacturers of cutting tools used by 96 per cent of the plants and shops in industry they are correctly designed, are of special steel, are finely finished, are stronger—will last a lifetime. You can cut easier, faster and more accurately with ACE TOOLS. At your Hardware Store—

ARMSTRONG BROS. TOOL CO.
"The Tool Holder People"
5268 W. Armstrong Ave., Chicago 30, U.S.A.

3 Turning Tools, 2 Cutting Tools, Knitting Tool, Boring Tool, Threading Tool, High Speed Steel Cutters and Blades, and 2 Wrenches in Fitted Steel Case.

SAY YOU SAW IT IN POPULAR MECHANICS

CARBURETOR TOO RICH MAKES MOTORIST TOO POOR



Car owners who are wasting money and not getting proper gas mileage due to over-rich mixtures will be pleased to learn how to save gasoline by VACU-MATING over-rich mixtures. VACU-MATIC fits all cars, trucks and tractors. It is automatic and operates on the supercharge principle. Easily installed in a few minutes.

SALESMEN WANTED! Big Profits! Send name, address on penny postcard for free particulars and how to get yours for introducing.
VACU-MATIC CO., 7617-1335 W. State St., WAUWATOSA, WIS.

PETROSLIPS IMPROVE your gas mileage



PROVEN PERFORMANCE good for 500 miles!

98¢ for box 12 tablets

Petrolslips are made in England by SLIP Products as an efficient upper cylinder lubricant in tablet form. Petrolslips reduce carbon formation • increase horsepower development • save gas and lube oil • help easier starting • prevent valve stems and piston rings from gumming • increase the life of the engine. One tablet per 5 gal. gas.

WHITEHALL DISTRIBUTORS, Inc., 1385 Commerce Avenue New York 61, N. Y.

Send C.O.D. Money Order enclosed for boxes each containing 12 PETROSLIPS good for 500 miles.

Name
Address

A TOOLSHOP IN YOUR HAND



THERE'S ONLY ONE GENUINE HANDEE

First tool of its kind—today's finest. Smooth, steady power at your fingertips. Easy to handle. Make ship, plane and train models, bookends, costume jewelry. Grinds, drills, polishes, routs, carves, sands, saws, engraves on metal, wood, plastic, glass, leather, etc. 25,000 r.p.m. AC or DC. Wt. 12 oz. With 7 accessories \$20.50. In case with 40 accessories \$27.50. At stores or sent postpaid. A fine gift for a friend or yourself. CHICAGO WHEEL & MFG. CO., 1101 W. Monroe St., Dept. PM, Chicago 7, Ill. Free 52-page manual.

HANDEE TOOL OF 1001 USES

Adjustable ALL ALUMINUM SUN VISOR

Universal—will fit popular cars. NO HOLES TO DRILL. Simple to Install. WILL NOT RUST, TEAR, or WARP. Chrome plated fittings. Custom-built to contour of car. Relieves eye strain. Gives clearer vision in fog, rain or sleet. ALL ALUMINUM. Lasts for years. Prime finish. \$29.95 Value. Our low price saves you **\$1345** 50%

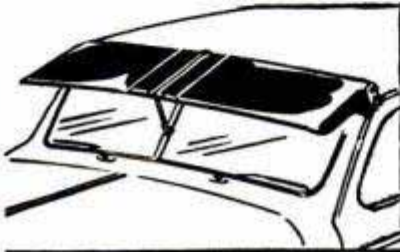

WE ARE FACTORY DISTRIBUTORS. Our stock Guaranteed Brand New. (Not Surplus or Distressed.) Prices F.O.B. Chicago. 25% Cash with Order. Balance C.O.D. plus charges. Or Deduct 2% Discount If Full Remittance Accompanies Order. Illinois residents add 2% for state tax.

WANTED SALEMEN FREE! Send name and address—we will mail latest bargain bulletins with money saving values!

SEL-LO DISTRIBUTORS

MAIL ORDER DIVISION
LOCK BOX 8191 DEPT. PM-6 CHICAGO, ILL.

60 POWER TELESCOPE \$2.95

VARIABLE EYEPIECE 20X-40X-60X

NEW! Three telescopes in one, 3 different magnifications. 20 power for ultra-bright images with 40 and 60 power for extra long range. Guaranteed to bring distant objects, people, sports events, ships, moon, stars, etc., 60 times as close.



Most powerful for anywhere near the money. 5 sections. Closes to 1 ft. long. Contains 4 ground and polished lenses. Also used as a powerful compound microscope. Directions included. Mass production enables us to offer this high-powered instrument at the amazing price of only \$2.95. We pay the postage. Get yours immediately.

BROWSCOPE CO. Dept. 6M 24 West 45 St. New York 19, N. Y.



Accurately calibrated throughout the 360° of rotation.

Here is a modern and accurate tool having features obtained only in much higher priced and larger tool room equipment. The outstanding features make it an indispensable table for tool rooms and model shops. Unique design and extensive tooling make its low price possible.

THE ERWOOD COMPANY
214 WOODSTOCK STREET
CRYSTAL LAKE, ILLINOIS

Write for
Free Literature
Today

PUTS THIS Atlas PRECISION LATHE IN YOUR SHOP

\$10475*

with these STANDARD Features

- Timken Tapered Roller Bearings; Precision Ground Bed
- Reversible Automatic Longitudinal Power Feed
- 16 Speeds — 54 to 3225 RPM
- Cuts 8 to 96 Standard Threads Per Inch
- V-belt Backgeared Drive
- 60-Hole Indexing Mechanism

This Atlas 6" lathe is America's lowest priced precision lathe. If your work comes within its 6" swing, 4 1/8" over carriage, and 18" between centers, you can machine just as quickly and accurately as on a larger lathe — and save many dollars. It has the same thorough engineering as the Atlas 10" lathes. It is built to the same precision standards — checked by the same performance tests. Large bearing surfaces assure long-lived accuracy under heavy loads. Ask your Atlas distributor, or send for latest catalog, for full details.

*Price F.O.B. Kalamazoo, less motor.



ATLAS PRESS COMPANY

643 N. Pitcher St., Kalamazoo 13D, Mich.

Clip and Mail for Free Literature

ATLAS PRESS CO., 643 N. Pitcher St., Kalamazoo, Mich.

Send me literature about the 6" LATHE and other Atlas Tools.

Name _____

Address _____

City, Zone, State _____

New All-Purpose STEEL SHELVING

FOR FACTORIES,
OFFICES, WORKSHOPS
and HOME USE

Low as **\$18.00**

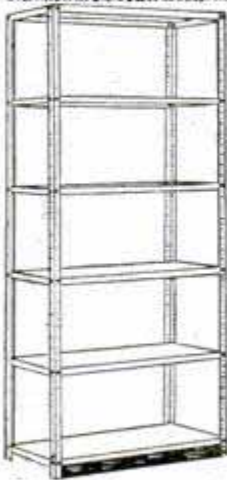

Immediate delivery for these fine pre-war quality REMLE Utility Steel Shelvings. Hundreds of uses in factories, basement shops, homes, garages, offices, grocery shops, doctor's and dentist's offices, warehouses, storerooms, etc.

Quickly assembled sections can be bolted together for combination use. Shelving heights adjustable for changing conditions.

**7 FT. HIGH - SIX SHELVES PER SECTION
HOLDS 150 LBS. TO 300 LBS. PER SHELF
SHELF HEIGHTS ADJUSTABLE!**

Angle post construction provides maximum strength and rigidity. Four posts support each unit independent of adjoining units. Not necessary to bolt to floor or wall.

Each standard assembly consists of six 36" wide shelves (3 depths available), four 83" angle corner posts punched on 1" centers and one 2x36" kick plate. Finished in standard green baked enamel. All shelves channeled—of heavy galvanized steel.

A-1220	12"x36"—20 Ga. Shelves	\$18.00
A-1818	18"x36"—18 Ga. Shelves	24.50
A-1816	18"x36"—16 Ga. Shelves	27.00
A-2416	24"x36"—16 Ga. Shelves	31.75

PARTS FOR BINS
Adapt standard units into bins. Write for special parts list.

EXTRA PARTS LIST

1x2x39 Angles	\$.10	36x83 Back Sheet	\$6.00
1x2x83 Angles	1.65	12x83 End Panel	2.05
2x36 Kick Plate	.35	18x83 End Panel	3.10
Bolts and Nuts	1.25	24x83 End Panel	4.15
12x36—20 ga. shelf	18x36—18 ga. shelf	3.10
18x36—18 ga. shelf	18x36—16 ga. shelf	3.85
18x36—16 ga. shelf	24x36—16 ga. shelf	4.40

All Prices F.O.B. Wayne, Michigan. Send cash with order. Shipped Freight Charges Collect.

IF OUR STANDARD UNITS DO NOT FIT YOUR NEEDS, WRITE US.

Remle CORPORATION

Dept. PM-6 5408 W. Center St. Milwaukee 10, Wis.

AMERICA'S FINEST INDUSTRIAL EQUIPMENT

PATENTS

TRADEMARKS

Patrick D. Beavers

REGISTERED PATENT ATTORNEY
929 COLUMBIAN BUILDING

416 5TH ST. N.W.

WASHINGTON 1, D. C.

BARGAIN 3X ARMY TELESCOPE

Original Cost \$150.00 — Our Price \$7.50



ALL COATED LENSES — BRAND NEW

An ideal gift for viewing objects, landscapes, seashores, etc. The high resolving power of the six coated lenses, five of them achromats will bring out great details. For the experimenter it can be dismantled and used for hundreds of projects. Length 22½ inches. 36° Field. Postpaid \$7.50.

500,000 Lenses and Prisms. Send 3c stamp for "Bargain" List

A. JAEGER'S

123-26P ROCKAWAY BLVD., SO. OZONE PARK 20, N. Y.



TORNADO GAS TORCH

The Modern Way of Soldering

Ideal for hard and soft soldering. Will heat quickly; solder will flow freely and smoothly. No compressed air required. Self-adjusting. Safe. Economical. Can be used for annealing small parts and bending metal parts. Generates a heat of 1700° F. Simply connect to any illuminating gas jet with a rubber hose and operate. Tornado Torch No. 119 comes with three tips, (1/8", 1/4", 3/8" blast).

Tornado Gas Torch No. 119 — Complete with 2 tips, for Natural Gas or Bottled Gas; with 3 tips for Manufactured Gas. \$2.95 per set. See your dealer or order direct. Send check or money order — post paid.

Robco Corporation, 202 E. 44th Street, New York 17, N. Y.

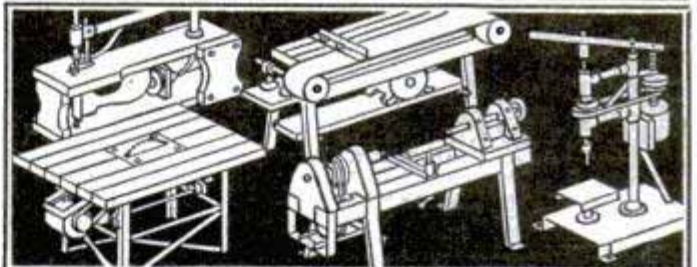

MAKE YOUR OWN POWER TOOLS FROM SCRAPS, SAVE HUNDREDS OF DOLLARS

Complete constructional details on five sturdy power tools you can make at small cost from old auto parts, pipe fittings, wood, etc. . . . PRECISION DRILL PRESS, WOOD LATHE, HIGH SPEED JIGSAW, LARGE CAPACITY BELT SANDER, CIRCULAR SAW WITH EXTRA LARGE TABLE. Set of five easy-to-follow plans only \$2.00 postpaid. Clip this ad and mail with check or currency TODAY. Money-back guarantee.

CRAFTPLANS, Dept. P-120, 7241 Madison, Kansas City 5, Mo.

BALL BEARING STEEL WHEELS

Complete With Wheels, Tires & Bearings

Made To Outwear Other Type Wheels

SIZE	TIRE	BEARINGS	LOAD	ONE	TWO	FOUR
12"x2½"	Semi-Pneumatic	Ball ½" or 5/8"	150 lbs.	\$ 5.50	\$10.00	\$18.00
12"x2½"	Semi-Pneumatic	Ball ½" or 5/8"	225 lbs.	\$ 6.00	\$11.00	\$20.00
12"x3"	Semi-Pneumatic	Ball ½"				
		Bronze ¾"	340 lbs.	\$ 7.00	\$13.50	\$26.00
10"x1¾"	Semi-Pneumatic	Ball ½" or 5/8"	125 lbs.	\$ 3.00	\$ 5.50	\$10.00
10"x2½"	Semi-Pneumatic	Ball 5/8"	250 lbs.	\$ 5.50	\$10.00	\$18.00
8"x17/8"	Solid	Ball ¾"	640 lbs.	\$ 8.00	\$15.00	\$29.00
6"x2"	Solid	Ball ½"				
		Bronze ¾"	340 lbs.	\$ 4.00	\$ 7.50	\$14.00
4.00"x8"	Pneumatic	T.R. 1"	700 lbs.	\$13.50	\$26.00	\$50.00
	16" O.D.					
5.00"x8"	Pneumatic	T.R. ¾"	700 lbs.	\$15.50	\$30.00	\$59.00
	16" O.D.					

The above Pneumatic Wheels are Complete With Wheels, Bearings, Tires and Tubes . . . 4 Ply Tires for ¾" and 1" Straight Axles. (Also 18", 21" and 23" High Speed Auto Type Wheels.)

SEND 10c FOR CIRCULAR: On Power Racers, Steering Wheel Assemblies, Auto Type Axles, Parts, Sulkies, Etc.

OSBORN WHEEL COMPANY, 115 So. Main St., Dept. P-6, Doylestown, Penn.



— NEW —

1948 Model Racers

MODEL "A" CHASSIS . . . Price \$39.75
with 10" Semi-Pneumatic Wheels.

MODEL "B" CHASSIS . . . Price \$56.00
(shown above) 12" Semi-Pneumatic Wheels.

MODEL "D" CHASSIS . . . Price \$139.50
with 5.00"x8" (16" dia.) Pneumatic Wheels.

Less Engines and Transmissions

Also sold Complete With 1 H.P. to 6.6 H.P. Gasoline Engines

25% DEPOSIT ON C.O.D. ORDERS

ORDER NOW

Add 10% for Prepaid Shipping in U.S.A.

New Direct Mail Plan Saves You Big Money!

DE LUXE QUALITY SCOTCH PLAID

Fibre AUTO SEAT COVERS



*Slips on
in a Giffy!*

Check These QUALITY Features

- ★ Colorful, Water Repellant Scotch Plaid Fibre
- ★ Rich Leatherette inserts at points of greatest strain
- ★ Elasticized slip-over sides for snug, smooth fit
- ★ Heavily stitched seams for extra long wear

Check YOUR CHOICE OF Front Seat STYLE



A SOLID BACK
For 4-door
Sedan.

**SOLD ONLY
BY MAIL**
Order Direct
and Save



**B DIVIDED BACK
SOLID SEAT**
For Coupe or
Coach front.



**C INDIVIDUAL
SEATS**
For divided
back and seat.

Sedans
and Coaches
COMPLETE SET
Front
and Back
Seat **\$7.98**
POST
PAID

For Coupes and
All Front Seats

Unbeatable
Low
Price **\$3.98**
POST
PAID

Fits most Cars!

RICHLY GRAINED LEATHERETTE TRIM

We challenge comparison because nowhere... but nowhere will you get these fine seat covers at our low price! Yes, thanks to our amazing direct-from-distributor-to-you plan, you can now own long-wearing DeLuxe Auto Seat Covers at much lower prices than you'd expect to pay. And don't let our low price lead you to confuse our fine covers with other auto slip-covers being sold elsewhere. No indeed! These are top quality, DeLuxe Seat Covers master-tailored of rugged, water-repellent scotch-plaid fibre and richly grained leatherette. Their smooth fit and handsome appearance will vastly improve the looks of your car, make it easy for you to slide in and out, protect your clothing and upholstery, and check driving discomfort. **SEND NO MONEY...** pay postman \$3.98 plus postage or send cash and we pay postage. If not completely delighted return within 5 days for refund under our **you must be pleased — or money-back guarantee!**

American Merchandising Co., Dept. SC113, 9 Madison Ave., Montgomery 4, Ala.

Please send me the DeLuxe Seat Covers for car checked off below: Price in Canada add 50c. No C.O.D.'s

Make _____ Model _____ Year _____

FRONT SEAT TYPE—A _____ B _____ C _____

CHECK I am enclosing \$ _____ in full payment. Send Postpaid.
ONE Send C.O.D. I will pay postman \$ _____ plus postage

Name _____

Address _____

City _____ Zone _____ State _____

AMERICAN MERCHANDISING COMPANY, 9 Madison Avenue, Montgomery 4, Ala. Dept. SC113



Gerstner TOOL CHESTS

Better, finer Gerstner Chests are preferred by good machinists and toolmakers everywhere. Free catalog.

GERSTNER TOOL CHESTS
448 Columbia St. Dayton 7, Ohio

SAY YOU SAW IT IN POPULAR MECHANICS

BUILD YOUR OWN FAST FREEZER

PLANS \$1



It's easy to build this household appliance with LeJay Plans. Made from new or used parts. Save up to 75%. No expert knowledge needed. Plans show 5 sizes and are easy to follow. All details clearly explained. Enjoy making one of these freezers. Mail \$1 for set of plans and catalog. **LEJAY MFG. CO., 447 LeJay Bldg., Minneapolis 8, Minnesota**

A Practical JET ENGINE for Modelers



The M. E. W. 601 engine is easily and quickly built at amazingly low cost. Engine uses gasoline... runs from 3 to 5 minutes. Complete, copyrighted plans, \$1.00 postpaid. Individual parts are available.

MINNESOTA ENGINE WORKS
387 UNIVERSITY AVE. • ST. PAUL 3, MINN.

A "HONEY" for MAKING EXTRA MONEY

IT'S FUN — IT'S EASY — IT'S PROFITABLE — AN IDEAL GIFT Exquisitely Designed Ebony Black Plastic Case. Precision Made for Dependable Accuracy. Complete. Ready to Assemble.

MAKE EXTRA MONEY DURING YOUR SPARE TIME by assembling and selling this distinctive pendulum clock to friends and neighbors.

FUN FOR THE WHOLE FAMILY. The whole family will see for themselves what makes a clock "tick". There's a thrill a minute in this Wilcox; build a clock, adventure that reveals the secret of constructing accurate timepieces... yet it's so simple, so easy the Wilcox way.

BOYS. Here's an ideal gift for Mother and Dad. Build it yourself and surprise them. Something they will appreciate, remember and keep always.

WILCOX "Build-a-Clock"
971 Goodrich Blvd.
Los Angeles 22, California



Build this Clock Yourself for

ONLY \$3.95 POST-PAID

MOTHERS AND DADS. Here's an educational and practical clock building project that your boy (or girl) will enjoy and at the same time secure valuable and worthwhile mechanical knowledge. Watch him glow with pride as he builds his first clock... and you'll be proud too, and a little breathless at the amazing result.

NO SPECIAL TOOLS REQUIRED. A small screwdriver is the only tool required. Complete, easy-to-read directions furnished.

WILCOX, Inc., Dept. P, 971 Goodrich Blvd., Los Angeles 22, Calif.

Dear Sir: Please send me _____ Wilcox, "build-a-clock" sets of \$3.95 each.

_____ Check or M. O. Enclosed _____ Send C. O. D. plus postage

Name _____

Address _____

City _____ Zone _____ State _____

DRILL YOUR OWN WELLS!

The "CONSOL" Well Driller with IMPROVED DRILL HEAD with removable insert at point will drill through many feet of rock without resharpening. Do the work yourself—easily, quickly, inexpensively.

Sturdily Made
 Hundreds of Satisfied Customers
 Fully Guaranteed
 Price Complete with drill, bailer & cable \$385.00
 F.O.B. Factory less Motor

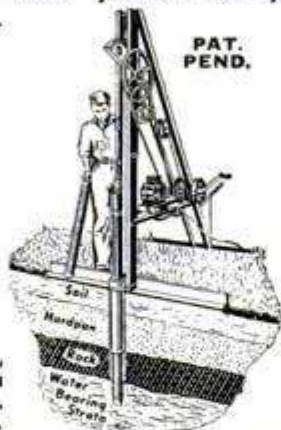

Extra cable, casings, etc. available at extra cost. We offer 3/4 H.P. Electric Motor or 1 1/2 H.P. Gas Engine to operate Driller at 38 strokes per min.

Get needed water now—before planting time—for next summer's dry spell!

Drill outside—in the cellar—in the barn!

Dept. PM



CONSOLIDATED INDUSTRIES
 West Cheshire, Conn.

I want to know more about this improved Well Driller. Please mail free descriptive booklet to:

NAME

ADDRESS

Here's the Outstanding Value in Target Pistols

The Crosman

"Bullseye" Adjustable "power without

powder" for accuracy with safety indoors and out! No noise, no recoil, no odor, no cleaning! Perfect balanced

Rifled barrel! Fine gunsmithing! Low cost! THAT'S what you get in this new .177 cal. single-shot pistol of regulation target type and weight. Shoots Crosman Super-Pells at 1/4 cent per shot. No wonder they say no other pistol provides so much fun at such small cost. At your sporting goods or hardware dealer's . . . or write direct.

Crosman Silent RIFLE



. . . most amazing gun ever invented for target shooting indoors or out and for small game! Adjustable "power without powder" . . . no noise, recoil, odor or cleaning. Rifled barrel. Shoots low-cost Super-Pells. .177 or .22 cal. single-shot or magazine models. At your dealer's . . . or write direct.

CROSMAN ARMS CO., INC.
 3 HENRIETTA ST. • ROCHESTER 7, N. Y.

New! BLACK & DECKER

HOME-UTILITY
 1/4 INCH
 ELECTRIC DRILL



This portable electric drill handles hundreds of "odd jobs" in homes, hobby shops, farms, repair kits. Only 7 3/8" long, weighs 3 1/4" lbs. Will drill to 1/4" in steel. Has fast-operating Jacobs hex-key chuck and an instant-release trigger switch. Operates from any 110 volt A.C. or D.C. circuit at 2250 RPMs. Order today for \$18.95

Immediate delivery \$18.95
 Postpaid upon receipt of check or M.O.; C.O.D. you pay postage.

For General "all-purpose" drilling from 1/8" to 1/2" order the Black & Decker Home-Utility 1/2 inch Electric Drill. . . \$35.95

ASTORIA REFRIGERATOR EXCHANGE

25-57 Steinway St. Dept. M-6 Long Island City 3, N. Y.

15 H.P. TWIN CYL. "V" ENGINES

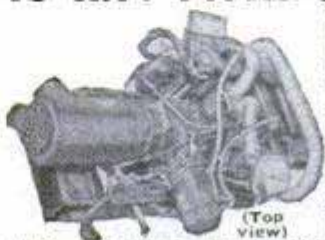

Famous Andover make. Fine for Midgets, welding outfit, boats, mills, saws, etc. 32" long, 22" wide, 18" high. 4 pt. mountings (flat) 14" apart ea. way. 3600 max. RPM. 31.91 cu. in. Wt. abt. 100#. Fitted with 28.5 generators which makes fine welders, or remove for other use. 2 3/4" bore—2-11/16" stroke. Dual carb. Shielded ign. and fuel system. Governor (removable). Some prac. new. All useable. No junk. Parts obtainable. Cost U.S. Govt. over \$1400 each. Our price \$81.50 while they last. Two or more \$75.50 ea. Guaranteed as advertised or money refunded. Runs like a Rolls-Royce! You've seen our ads since 1941.

FEDERAL IDENTIFICATION CO. 1910 CLASSEN BLVD. OKLA. CITY, OKLA.

BUILD YOUR OWN POWER LAWN MOWER

WHY BREAK YOUR BACK MOWING FIELD OR LAWN?

WRITE FOR FREE LITERATURE The Rite-Way Mower Attachment Ball Bearing



SAVE MONEY SAVE TIME

Now anyone can save time and effort mowing field or lawn by building their own whirl type power mower. Build according to your own ideas and needs at small cost. Cut close to fences, walks, buildings, etc. Build in short time with parts and instructions we furnish. Save hours of time and back breaking labor. Write today for FREE information.



IT'S FUN TO BUILD

T & H MFG. Co., Dept. MP-12
 811 E. 31, Kan. City 3, Mo.

MAGNET WIRE HEAVY FORMVAR IN LB. LOTS

A.W.G. size 8 to 19	\$1.00 per lb.
20 to 24	\$1.25 per lb.
25 to 29	\$1.65 per lb.
30 to 34	\$2.25 per lb.
35 to 39	\$3.50 per lb.

PETERS ELECTRIC CO., P. O. 89, Royal Oak, Mich.

NEW BOMB HOISTS—WINCHES

New shipment. 2,500 lb. lifting capacity. Small, compact. Light weight, only 16 lbs. 20 feet of cable with hook. Three speed crank handle. May be motor driven. 20 to 1 ratio. Release pin type cable reel out. Load held any position. FOB. K. C., Mo. Only

\$14.98

Mounting Bracket and Hanger \$1.98 for quick attachment

Send ck. or M. O. Please no COD's.

MIDWEST SURPLUS SALES CO.

2531 INDIANA

KANSAS CITY, MO.



SMALL VERTICAL SPEED REDUCER

Just the thing for Home and Shop Bench work. Animated and Revolving Displays, Revolving Antennae, Light Production work. Sturdy, compact, (see dimensions), efficient. Case of aluminum, gears of specially selected nickel bronze; worm of hardened steel. Roller bearings throughout. Torque capacity, 25 to 150 inch lbs. Available in 4 different assemblies (see below) and in these standard ratios:

4-1	25-1	64-1	200-1
8-1	30-1	75-1	300-1
10-1	40-1	80-1	400-1
16-1	50-1	100-1	600-1
20-1	60-1	150-1	800-1
		1600-1	

When ordering be sure to specify assembly and ratio required. Shipping weight in carton $8\frac{1}{2}$ lbs. Prompt delivery. Full Money Back Guarantee.

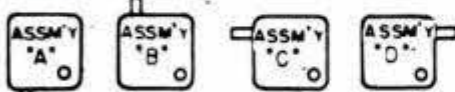

THE OHIO GEAR CO.

1405 EAST 179th ST. - CLEVELAND 10, OHIO



\$26.75 postpaid

WEST OF ROCKIES

\$27.50

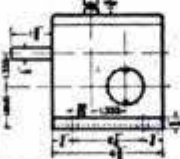
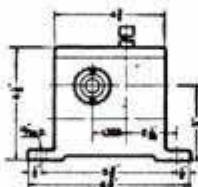

Announcing SHAPER and MOLDING Cutters FOR ALL MAKES OF DRILL PRESSES!



NO SET SCREWS TO LOOSEN! BLADES AUTOMATICALLY ADJUSTED. CANNOT SLIP OR FLY OUT!

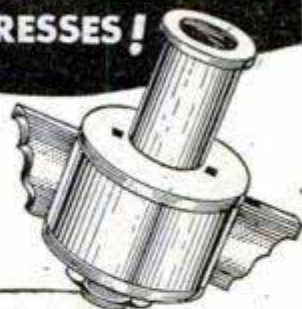

OTHER EXCLUSIVE FEATURES

Blades instantly replaceable—automatically drop into position—cannot loosen or fly out . . . quickly rehone or re-ground. Variety of blade shapes for varied contours. Balanced, concentric, built for lifetime use. One locking nut only. Fits tapered, threaded, or $\frac{1}{2}$ " I.D. spindles. Specify type and size spindle.

\$9.00

Complete as illustrated with 3 sets of blades. Full Money-Back Guarantee.



ROTARY WOOD PLANER

Most sensational, versatile drill press tool ever built. Planes, trues-up, tenons, panels, rabbets, grooves, beads, bevels, etc. An all purpose, lifetime tool. Complete.

\$7.50



\$7.95

ALL-METAL SHAPER FENCE

For use with shaper and molding cutters, planers and drum sanders. Fits all drill presses and shapers. Complete—with tempered hold down springs. Fully rust proofed. A real buy.



2 1/2" DRUM SANDER

\$3.95

with 5 Sleeves



4" ROTARY SANDER

Sands wood and plastic surfaces to agate smoothness. Available for hand drills, flexible shafts and drill presses. Two size arbors $\frac{1}{4}$ " or $\frac{1}{2}$ ". Complete with 20 discs. **\$5.95**

FULL 10 DAY MONEY-BACK GUARANTEE

FREE Workshop Catalog →

BARRON TOOL COMPANY, INC.

569 Architects Bldg.: Detroit 1, Mich.



BARRON PRECISION TOOLS WORK SHOP

FASTEST PLANER in the WORLD at this Low Price... \$195.00

BELSAW Multi-Duty Planer

Speed up production! Increase your profits! BELSAW power self-feeds at 24 feet per minute . . . The lowest-priced surfacer that will handle 12 x 6 in. stock. Planes green or dry sawed lumber into smooth, worked forms. Three high-speed steel knives make 42 cuts per inch. Multi-duty BELSAW takes inexpensive attachments for all planing mill operations—Jointing, Rabbeting, Grooving, Matching. BELSAW is the **only** 12 in. planer providing **attachments for jointing and grinding its own knives**. Start planning NOW for BIGGER VALUE and BETTER PERFORMANCE, with BELSAW. Write for FREE specifications, illustrations and low prices.



● LARGER CAPACITY ● FASTER OUTPUT ● KNIFE SHARPENING ATTACHMENT

BELSAW MACHINERY CO B-1017 Field Bldg., 315 Westport Rd., Kansas City, Mo.

7 BIG SPECIAL BARGAINS at LOW PRICES

110 Volts D.C.



Made For the Government: All NEW . . . Never Used

BRIGGS & STRATTON Portable Lighting Plant priced at a fraction of the original cost. Built to rigid Government requirements. Especially built for Field Use or for permanent installation in Cottage, Farm, Trailer, Boat, etc. Complete with 1 3/10 H.P. Gasoline Engine, Hand Starter, Rated 250 Watts will develop 500 Watts. With Spare Parts and Tools. Mounted on permanent base . . . Rubber cushioned . . . Ready for Immediate Use anywhere . . . At this LOW PRICE they won't last long . . . Better Hurry only **\$129.50**.

SPERRY S-1 BOMB SIGHT—Here is an unusual opportunity to get one of these MARVELOUS Precision Mechanical Instruments . . . Marvelous beyond description. Contains hundreds of parts usable in 1001 ways . . . Regular and Bevel Gears, Shafts, Approx. 100 Roller Bearings, Electrical Parts, Precision Lenses and Prisms, Countless Gears, Dials, Knobs, Switches, Polaroid Filter, Calibrated Dials for Air Speed, Drift Indicator and Illuminated Spirit Level, Gyroscope, etc. . . . Excellent for Inventors, Experimenters, Hobbyists. Schools use for Study Demonstration. Only **\$49.50**.

Cost U. S. Gov't \$4,500
OUR LOW PRICE



ONLY

\$49.50

F.O.B. Chicago

SPERRY S-1 Bomb Sight—Same As Above But Used.

ONLY **\$29.50**

COMPLETE WITH POWER PLANT, Only **\$129.50** F.O.B. Chicago

MOMENTARY SWITCH

Made by Cutler Hammer. Excellent for Photo Flash Gun, Testing Circuits, Microphones, etc. Only **\$1.25** Postpaid



LENSATIC COMPASS (used)

With Sight Finder and Stop Button. In Case with Folding Cover. Perfect for travel.

Only **\$1.59** ea. Postpaid



PISTOL GRIP SWITCH (new)

Double Contact Switch. Trigger Action for ON and OFF. Complete with 6 ft. Insulated Lead Wires. Any circuit to 115 Volts. Only **\$1.19** ea. Postpaid



BAUSCH & LOMB SAFETY GLASSES

Indestructible; with Side Shields. For Grinding, Stone Cutting, Chipping, etc. Brand New! With Metal Case. A Bargain!

Only **\$1.49** ea. Postpaid



ACE SURPLUS SALES CO., INC., 1449 West 69th St., Dept. P-6, Chicago 36, Ill.

AMAZING NEW WAY TO WASH YOUR CAR

PISTOL GRIP VALVE CONTROLS FLOW FROM HOSE



ONLY \$9.95 P.P.D.

IT SCRUBS, SOAKS AND RINSES NO DRYING, NO WIPING

TOWN & COUNTRY WASHER

The "TOWN & COUNTRY WASHER" reaches every part of car, quickly and easily. In a few minutes all dirt, grime, grease is removed and car sparkles. Best of all you remain DRY. Pays for itself in a few washes. Practical to clean walls, windows, porches, boats and use in garden. It's guaranteed.

INCLUDED FREE generous box of **MAGIC FLAKES** with your order for "TOWN & COUNTRY WASHER" \$9.95 ppd. 3 ft. extension tube for washing upper windows, trailers, buses, etc. \$2.00 extra.

Dealer Inquiries Invited

CRAIG-MARK CORPORATION

Dept. PM, 286 Fifth Ave New York 1, N. Y. LOngacre 4-4638

YOU'LL SAY "IT'S WONDERFUL!"

That's what owners say about Garden-All!

Write for Folder

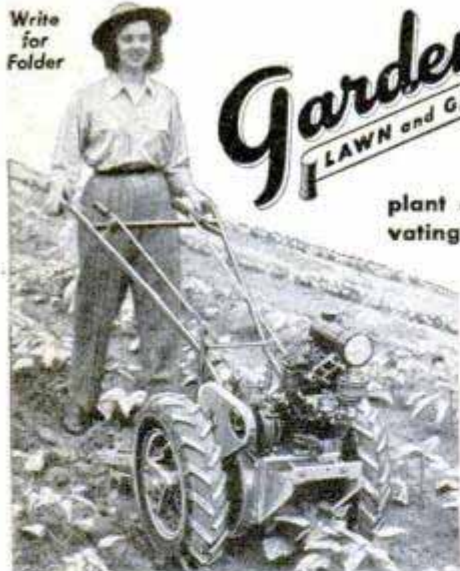

Garden-All

LAWN and GARDEN TRACTOR

High Arch Feature assures maximum plant clearance for cultivating crops until maturity.

Variety of cultivating shapes available for specific cultivation requirements.

There's nothing at all like Garden-All!

It's a joy to cultivate your garden when you have Garden-All to do the work! Exclusive Depth Control allows cultivation to any desired depth! High plant clearance—16 inches on 1½ h.p. model and 19 inches on 3 h.p. model—enables you to cultivate plants until maturity! Garden-All supplies a complete line of attachments...ten in all...for every lawn and gardening need for every season. Before you buy see Garden-All!

GARDEN-ALL TRACTOR, INC.

Dept. P, 100 W. UNION STREET, LIBERTY, INDIANA

SAY YOU SAW IT IN POPULAR MECHANICS

For Spring and Summer Enjoyment!



CAMERA-RADIO COMBINATION

Brand New — Portable — GUARANTEED
Ideal for outings, beach, etc. 5-tube superheterodyne, specially developed guaranteed miniature tubes. Includes pentode amplifier, 3" Alnico speaker, slide rule tuning. Attractive case with shoulder carrying strap. Clear reception. Camera takes 16 exposures, standard film, graphlex view finder. Worth many times more than....

\$32.95 each

AUTO RADIO

Fits all model cars

BRAND NEW . . . 6-tube superheterodyne. 6 volt battery operation. Single unit construc. 5" Alnico speaker, slide rule tuning, beautifully finished case. Complete—ready for YOU to install and save money. For clear reception. GUARANTEED. ONLY

\$32.95 each

Prepayment saves ship. costs. Otherwise 25% deposit with order, bal. C.O.D. Illinois orders add 2% sales tax.

WALTON SALES COMPANY, Dept. M-6
936 N. Michigan Ave. Chicago 11, Ill.

DIE-LESS DUPLICATING

Many small parts can be formed without dies, to duplicated accuracy of .001" with DI-ACRO Precision Machines. — Benders, Brakes, Shears. Save die expense and time delay. Ideal for experimental and research work, making samples, models, etc., as well as regular production runs. Write for descriptive literature.

O'Neil-Irwin Mfg. Company

341 8th Ave. Lake City, Minnesota



SHEAR

BENDER

BRAKE

WHEELS

Spotwelded Heavy Gauge Steel LOWER PRICES!

5"—5½" solid tire, 3/8" bushing, ea. 49c
8" with 1" solid tire—
—1½" OR 3/8" steel bearing, ea. 99c
—with 7/16" bronze bearing, ea. 99c
—with 7/16" KILIAN BALL B'R'GS, ea. 1.19
—with 1½" KILIAN Ball B'R'GS, ea. 1.25
10" with 1½" KILIAN BALL B'R'GS, and 1.75 semi-pneumatic tire, ea. 2.29

ADD 10% to ALL prices for P.P.; 15% West of Miss. Send check or nonorder only. We guarantee satisfaction. Mail order NOW!

C. W. YOUNG MFG. CORP.
208 BURNET AVE. SYRACUSE, N. Y.

NEW! Way to Wash Autos QUICK

No chamois necessary—Dries Bright Without Wiping

REMOVES: SOIL, DIRT, GREASE, GRIME, Etc. ● **ZIPP-KLEEN** ● 12 Washes in each 6 oz. Can
1-6 oz. Sample Can 50c Postpaid
3-Cans Only \$1.00 Postpaid
Distributors 12-Cans Only \$2.50 f.o.b. Chicago
Wanted . . . Sorry No C.O.D.'s Please
ORDER YOURS TODAY

AMALGAMATED LABORATORIES 2239 So. Michigan Ave., CHICAGO 16



V-8 DUALS & SINGLES

MUFFLERS

STEELS and ALUMINUMS with a motorboat tone

SINGLES, Chev., V-8, Plymouth, Steels \$5.50, Aluminum \$7.00. Chry., Olds., Buicks, etc., Steels \$7.50, Aluminum \$9.00. V-8 and MERCURY DUALS, Steel \$17.50, Aluminum \$21.00. Split Manifold Sets, Steels \$35.00, Aluminum \$45.00. Aluminum are guaranteed for life of your car.

DEALERS WANTED

SANDEE MUFFLER CO.

BOX 296 LA TIJ., LOS ANGELES 43, CALIF.
2624 W. SLAUSON AVE., LOS ANGELES, CALIF.

FLATFISH!

The "Action" Lure!

What a fish wants above all else is ACTION. That's why it goes all-out for the Flatfish. World's largest selling lure. Over 3,000 sold every day. Lures in 21 colors. Underwater, surface and trolling models. \$1.35 each. Musky, \$1.45. Plyrod size, \$1.10. Send 20c for 48-page booklet with plug-fishing instructions by famous anglers.



HELIN TACKLE CO.

6342 Pulford
Detroit 7, Mich.

Send 20¢ for
CATALOG!

FOOT OPERATED SWITCH

Leaves both hands FREE for controlling drill press, saw, photo dark room etc. 10 Amp. 125 Volt AC-DC complete with \$7.95 cord and plug....
ASK FOR CATALOG



NAKEN ENG. & MFG. CO., 25 N. Franklin St., Chicago 6, Ill.

LAW STUDY AT HOME for Personal Success and LARGER EARNINGS. 39 years expert instruction—over 114,000 students enrolled. LL.B. Degree awarded. All text material furnished. Easy payment plan. Send for FREE BOOK—"Law and Executive Guidance."

AMERICAN EXTENSION SCHOOL OF LAW
Dept. 90-PM, 646 N. Michigan Ave. Chicago 11, Ill.

PALMGREN Rotary, Indexing, Milling TABLE

DUAL CROSS FEED and ROTARY FEED
Has 8" table, 360° movement and 4" cross feed travel. Adjusting wheels and dials graduated in degrees and thousands. Slotted for bolting to table. No. 83 Priced \$49.50. No. 82 without rotary feed \$39.75.
Write for Circular No. 10
CHICAGO TOOL and ENGINEERING CO.
8365 South Chicago Ave., Chicago 17, Ill.



DECORATIVE ORNAMENTS

FOR CRAFTSMEN MAKING LAMPS, BOXES, FRAMES, JEWELRY, ETC.
Brass Filigree Stampings, Fancy Chains, Imitation Miniatures and Cameos, Sterling Silver Castings, Etc. Free Catalog.
TRINITY • 2498 65th ST. • BROOKLYN 4, N. Y.

MAKE THESE LEATHER and LEATHERETTE ITEMS LIKE NEW

With New Plastic LEATHER-NEW
Covers leather, leatherette and cloth and gives new finish and color—wears like leatherette. Easily applied with brush—quickly renews with liquid artificial leather. Write for FREE sample.

Own Your Own LEATHER-NEW Contracting Business—Big Profits
Rene equipment for Bars, Restaurants, Hotels, etc. Profits possible up to \$125.00 on a single job... write for details.

FREE Sample of coated material—Write for it—No Obligation
LEATHER-NEW, 4723A Troost, Kans. City, Mo.

- Leather Covered Furniture
- Grille and Cafe Equipment
- Any Leather or Leatherette Item

BARGAINS OF A LIFETIME!

PISTON TYPE AIR COMPRESSOR

Piston type, size 2 x 1 3/4, head in valves, bronze bearings, splash lubrication, "V" Belt drive. Intake muffler and cleaner. Capacity 2.8 c.f.m. at 100 lbs. continuous pressure or 150 lbs. Intermittent, with 1/2 HP motor. Can be used with 1/4 HP or 3/4 HP at lower speed. Weight 14 lbs. Operating instructions furnished.

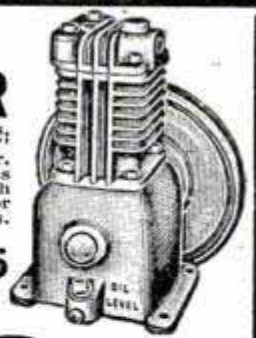

Immediate delivery. **\$17.95**
Price only



1/4" REDUCING VALVE & GAUGE

Oil resistant, pressure 0-to-200 lb. Reduced pressure 0-to-75 lb.; 3 outlets 1/4".
Wt. 2 lbs. **\$5.75**



DASH POT CHECK VALVES

Prevent leakage after compressor stops.
1/4" Check Valve.... **\$2.50**
1/2" Check Valve.... **\$4.25**



AIR GAUGE

Standard air gauge. 2 1/2" diameter. 0-200 lb. pressure. **\$1.75**



POP TYPE VALVES

Has a close range of closing after pop-off pressure is reached. 1/4" pipe thread. Only.... **\$1.50**



Only \$8.95
AUTOMATIC PRESSURE SWITCH WITH UNLOADER
125-150 lb. pressure. Uses 1/4 to 5 H.P. unit

Flexible Shaft Unit

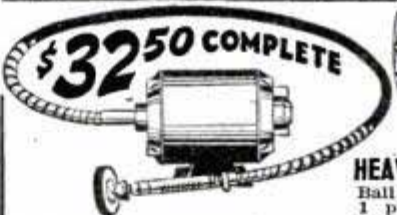

1/3 H.P. General Electric Motor—110 volt—60 cycle—1750 RPM; 6 foot Stow or Mall heavy duty shaft, 3/8" core, ball bearing handle and arbor, 4" wire brush. Weight 32 pounds.
\$32.50
Special Price



HEAVY DUTY ELECTRIC MOTORS

Ball Bearing 110/220 volts—1 phase—60 cycle—1750 RPM—Continuous duty, 300% full load starting Torque, outlet box, operates clockwise or counter-clockwise, carries one year guarantee, against mechanical defects.
1/4 HP Wt. 30 lbs. **\$24.00**
1/2 HP Wt. 33 lbs. **\$28.00**
1/2 HP Wt. 36 lbs. **\$34.50**
3/4 HP Wt. 50 lbs. **\$44.00**
1 HP Wt. 80 lbs. **\$70.00**
These motors also furnished in 3450 R.P.M. at same price.

MOTOR BARGAIN \$2.45



USE AS 6 VOLT GENERATOR—Generate your own power. Can be operated on your bicycle wheel. Furnishes sufficient power for two 6 volt bulbs. Resistor furnished free with each motor enables you to maintain constant voltage. Special Price **\$2.45**, or 4 for \$7.50, or 24 for \$36.00.

PRICES ARE F.O.B. CHICAGO: Immediate delivery. SOLD ON MONEY BACK GUARANTEE. Send check or money order today.

C & M EQUIPMENT COMPANY 1831 S. State St., Dept. D-6 Chicago 16, Ill.

MAKE YOUR OLD SEWING MACHINE INTO AN ELECTRIC!



Please send me a kit of the following parts to electrify my old machine: Light and bulb, motor, belt, pulley, bracket, foot control, cord set, and COMPLETE INSTRUCTIONS. Check or money order enclosed OR SEND C.O.D. MONEY BACK IF NOT SATISFIED

NAME _____
ADDRESS _____

HOME SERVICE CO. 4146 Beverly Blvd. Los Angeles 4, Calif.

\$17.25
COMPLETE Plus Postage
90 DAY GUARANTEE

EASILY INSTALLED IN FEW MINUTES ON ANY MACHINE. ALL ITEMS GOOD QUALITY—LONG WEARING

ELECTRIFY Your Sewing Machine

with a
SEWING MACHINE MOTOR KIT

NEW
LOW PRICE
\$16.75
COMPLETE

90 DAY
Guarantee



**ANYONE CAN INSTALL IT... QUICKLY!
FITS ANY TYPE OF SEWING MACHINE!**
Convert your old sewing machine into a modern electric sewing machine... at a fraction of the cost of a new machine.

- COMPLETE SET CONSISTS OF: MOTOR — fan-cooled, Universal AC or DC, 60 cycles, 115 volts.
- BELT — Long wearing rubber
- PULLEY — Single grooved, steel hubbed
- FOOT CONTROL — New sturdy 7 step rheostat
- CORD SET — Extension cord with plug and socket
- BRACKET — New improved mounting bracket to fit your type of machine
- Complete instruction sheet.

FULL SATISFACTION OR MONEY BACK!

BROWNELL DISTRIBUTORS, INC. PM-6
308 Canal St., New York 13, N. Y.

Please rush your kit at \$16.75. The make of my machine is Handwheel turns: towards me away from me.

NAME.....

ADDRESS.....

CITY.....ZONE.....STATE.....

To save postage and C.O.D. charges, I am enclosing \$16.75 , check , money order . Send C.O.D. I'll pay postman \$16.75 plus C.O.D. fees

DEVOE IZAAK WALTON VARNISH
Means Long Life for Rods!

New ELLIS CONTOURLINER

- Mounts on hood of tractor.
- Gauge shows "0" when tractor is traveling level.
- When tractor deviates from level, gauge shows you how much and which way to turn to get back to contour.
- Works in any temperature.

RUN YOUR CONTOUR LINES FROM YOUR TRACTOR SEAT with the Contourliner!

NO WALKING • NO STAKING • NO SURVEYING

Mount Contourliner on any tractor... run accurate contour lines whenever you need them. Saves time, eliminates unnecessary work... makes high-profit contour farming easy for you. Contourliner gives accurate guide lines for contour plowing or planting, running lateral irrigation ditches, drilling or discing in all small grain crops on the contour, field planning, pasture furrowing and range grooving. Low cost! Guaranteed! Approved by leading "Ag" Colleges and soil experts.

FREE LITERATURE! Write for new booklet on Contourliner and experiences of users in laying contour lines.

THE ELLIS SALES CORP., Dept. PM-6, FAIRFIELD, IOWA



Original
WAR SURPLUS!
JUNGLE HAMMOCKS
EASILY WORTH \$25!
BRAND New!
ONLY \$4.99 COMPLETE

Get Set For A Summer of Fun!

A complete bed with upper and lower canopy. A perfect way to relax in the cool shade, zipped in safe from pestering insects. A 43" zipper slide opening and hanging ropes.

SEND NO MONEY! Send Name and Address and on delivery, pay postman \$4.99 plus C.O.D. charges plus 40c for mailing and handling charges. Satisfaction guaranteed or money refunded.

The DRAKE COMPANY, Dept. PM-34
1380 MILWAUKEE AVENUE CHICAGO, ILLINOIS

METALS

sold in small quantities for the home workshop. Steel, Brass, Copper, Aluminum, etc. In Bars, Shapes, Tubes and Sheets. Write for free price list.

CASHMETALS CO., 2720 California Ave., Pittsburgh 12, Pa.

It's Easy- BUILD SHIP IN A BOTTLE
WHEN YOU KNOW HOW

Authentic, full-rigged models of famous sailing ships in a bottle. No special bottle required. Money-maker. Fascinating hobby. Not collectors' item. Complete kit - Carved and drilled hull and masts - Blue prints and instructions - Special inserting tool. Everything except bottle and stand.
ALL FOR \$3.95 postpaid - No COD's Please

THE OLD MARINER • Box 2095 • WICHITA, KANSAS

WAR SURPLUS! HIGH SPEED DRILL BITS

LIKE NEW! Original value over \$16.00. 25 assorted sizes and lengths. **\$2.50**
Send check, money order or cash.
Shipped F.O.B. Culver City, Weight 1 Lb.
DEPT. PM-8-8
AIRBORNE SALES CO. INC. CULVER CITY, CALIF.

Say You Saw It in Popular Mechanics

RUGGED? YOU BET!
BELL WATER-SHOCK
RESISTANT

Handsomely styled, precision tested, built to take hard usage, ready to go places. No. CM220—ALL-STAINLESS STEEL CASE, 17 jewels, anti-magnetic, radium dial and hands, unbreakable crystal, sweep second hand. (Price Includes Fed. Tax \$29.95 and Postage).....



NOW AT NEW LOW PRICES

Order Direct from BELL. Mail check, money order or pay C.O.D. Write for FREE Booklet "CM"

BELL WATCH COMPANY, INC.

9 Rockefeller Plaza, Suite 909, New York 20, N.Y.



Actual Photograph
Ht. 7 in.
Wt. 36 oz.

**7x50 PRISM
BINOCULARS**

MILITARY
SPECIFICATIONS
BRAND NEW
WITH LEATHER CASE

Coated \$58

Uncoated \$48

Plus 20% Tax

DESCRIPTIVE LITERATURE ON REQUEST

BROWNSCOPE CO.

Dept. 6M 24 West 45 St.
New York 19, N. Y.

**NEW Family SAFETY JIG SAW
READY!**

At last—a revolutionary, new electric jig saw small children may use, yet powerful enough to be the basic tool in Dad's workshop! Make "Standing Photo Silhouettes" of favorite snap shots... fancy what-nots, toys, for fun and profit! Handy as a hammer—just plug in! No motor to buy—no oiling. Thousands sold. Use in living-room, apartments, etc. Patented. Nothing else like it. Mail postal NOW for illustrated, Free Circular, low price! (Dealers write!)



SYNGRO SAW CORP., DEPT. A-68 ROCHESTER, MICH.

**NEW CROSLLEY
STATION WAGON**



Smart styling. All steel. Seats 4, or 2 with 1/4 ton load. Priced \$600 to \$700 less than any other station wagon, costs about 1/2 as much to run. Typical owner's report:

Ray L. Beaulieu, 79 Knox St., Lewiston, Maine, drove his Crosley 5,000 miles, averaged 35 to 40 miles per gallon. Total cost, \$24.00.



Convertible: If you love sun and air.

Panel Delivery: Full 1/4 ton capacity.



Sedan: Over 20,000 now on the road.

Pickup: Cuts service and delivery costs.



Sports-Utility: Rear seat obtainable. Lowest priced Crosley—\$130 less than station wagon.

CROSLLEY
a FINE car

For beautiful full-color catalog, write: Crosley Motors, Inc., 2532-HM Spring Grove Ave., Cincinnati 14, Ohio

Sensational
Super

FOLBOT

FAST • with Paddles
SMART • with Sails
SNAPPY • with Motor

17 1/2 ft. of stately, streamlined Craft, wide beam, large decks, low center of gravity, for steady, sturdy Performance with greatest Safety record. Weighs only 59 lbs., loads 750 lbs. — 2 or 3 persons plus gear and duffle galore; but 1 person easily handles it. Readily packed, stored, fits inside trunk, or rides erected on cartop. Drive or hike it anywhere, for delightful cruising, wonderful hunting, grand fishing, exploring, etc. Excellent in open and stormy seas, surf and rapids, rocky waters, shallows and marshes. Ingenious design, practical construction and very substantial materials make Folbot durable, stronger, smarter, rock-resistant and leak-proof. No upkeep or fees. Folbot is most versatile for independent and expense-free boating. Folbot Corp., L.I.C., N.Y.

Large Craft folds into
2 small bags.
Sets up in a jiffy.
IDEAL ATOP CAR

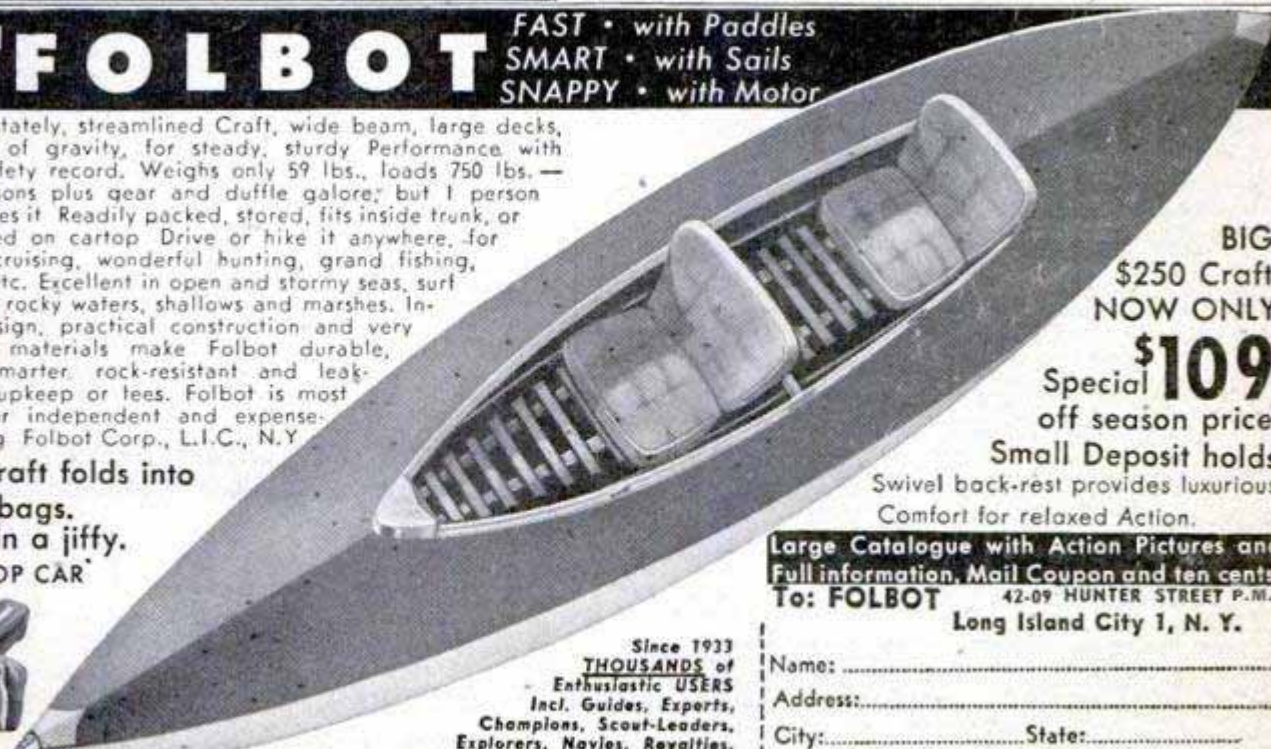

BIG
\$250 Craft
NOW ONLY
\$109

Special off season price
Small Deposit holds

Swivel back-rest provides luxurious
Comfort for relaxed Action.

Large Catalogue with Action Pictures and
Full information. Mail Coupon and ten cents.

To: FOLBOT 42-09 HUNTER STREET P.M.
Long Island City 1, N. Y.

Since 1933
THOUSANDS of
Enthusiastic USERS
Incl. Guides, Experts,
Champions, Scout-Leaders,
Explorers, Navies, Royalties.

Name:
Address:
City: State:

WAR SURPLUS BARGAINS

GET YOUR SHARE NOW BEFORE STOCKS ARE EXHAUSTED

NEW BOMB CABLE HOIST



Mighty handy for snop, garage or home. Can be used as winch. Hooks on wall, beam, tripod or trolley. Lifts or pulls 350 pounds. 20 ft. multistrand lifting cable and heavy chain. **\$8.99**

Each. Wt. 6 lbs.

NEW ALUMINUM TANKS



5 gal. capacity, complete with screw cap and chain, standard 1/4" pipe thread fittings on top and bottom. Ideal for reserve tanks on midjet racers, boats and cars; also for water reservoirs when camping. 20" long, 9 1/2" in dia. **\$4.95**

sh. wt. 3 1/2 lbs., special

Seat Cushions

For cars, fishing, baseball games, gardens, etc. Size 2" x 14" x 14" - olive drab. Used, excellent condition, each... **75c**

O. D. cushion with 5 snap straps on the back, size 12" x 24" x 1" added comfort on boats, at sports events and outdoor concerts. Each **95c**



PARACHUTE HARNESS SEAT PACK

Swell swing for youngsters. Complete with seat and back cushions. Wt. 10 lbs. **\$1.75** Only.....

CHEST OR BACK PACK

Many feet of webbing, useful for tow rope, many clamps and buckles. Wt. 9 lbs. **\$1.50** lbs. Each.....



TOY CHUTES

Silk or nylon, spring steel frame - pops open like parachute. Swell toy, each... **75c**



POSITION AND RUNNING LITES

6 or 12 volts, 15 candle power, clear lens, tubular mounting, standard double contact bulb, excellent for boats, trucks, trailers, cabs and cars. State voltage desired. Sh. wt. 1 lb., each **\$2.25** only.....



14 1/2" MECHANICAL FINGERS

Flexible for reaching things that drop or have to be set around corners. Only... **\$1.05**

Rigid for reaching places your fingers can't. Only... **95c**



MOTOR SCOOTER TIRES

New 6:00 x 6, 4-ply rib tread Firestone each **\$1.095**

FARM IMPLEMENT-MIDGET RACER TIRES

New 6:50 x 10, 6-ply smooth and non-skid treads, each... **\$1.95**

New 6:50 x 10, Tube... **\$2.25**



GENUINE TROPICAL SUN HELMETS

Light weight durable composition, covered with water repellent cloth. Adjustable chin strap. Sweat band. Sizes 6 3/8 to 7 7/8. For outdoor summer wear. A bargain! **\$1.95** Each.....



STEEL PRESSURE TANKS

Tapped with 1/4" pipe thread on both ends of the 500 cu. in., 1000 cu. in. and the 2100 cu. in. Smaller tanks, 1/4" pipe thread one end. For compressors, pneumatic units, hydraulic, liquids, or portable air storage for tires, etc. Tested to 500 pound pressure per sq. inch. Used.

Size	Wt. lbs.	Internal Volume	Capacity Under Pressure
7 1/2" x 5 1/4"	1 1/2	104 cu. in.	1.4 cu. ft. \$1.25
14 1/2" x 5 1/2"	3 1/2	280 cu. in.	3.8 cu. ft. \$2.00
24" x 6"	5	500 cu. in.	6.9 cu. ft. \$2.50
45" x 6"	11	1000 cu. in.	13.8 cu. ft. \$4.50
24" x 12"	18	2100 cu. in.	29.0 cu. ft. \$5.50

All prices f.o.b. Chicago. Please include enough postage with all paid parcel post orders. On C. O. D. orders please include 25% of purchase price, balance C. O. D. WRITE FOR FREE ILLUSTRATED CIRCULAR.

U. A. S. CORPORATION
5637 W. 63rd PL. PM2 CHICAGO 38, ILLINOIS

Electrify MOTHER'S OR WIFE'S SEWING MACHINE

MAKES SEWING A PLEASURE!

COMPLETE WITH SEWING LIGHT **\$15.95**

SEWING LIGHT

BELT BRACKET

PULLEY

AC-DC UNIVERSAL 1/20 H.P. MOTOR

PORTABLE CASE FOR ANY TYPE MACHINE **\$12.50** SPECIFY MAKE & NUMBER.

FOOT CONTROL RHYTHOSTAT

ANYONE CAN INSTALL

OUTFIT CAN BE USED FOR HOBBY WORK, SHOP, ETC.

Free Catalogue Dealers Write

PASAAK'S

Include Postage Case 7 lbs. Kit 6 lbs.

P. O. Box 153-M Canal St. Sta. New York 13, N. Y.



Build Your Own ROTARY POWER LAWN MOWER & WEED CUTTER with the Wind-King MOWER SPINDLE & BLADE

\$18.75 FOR Merrill, Iowa

- Timken Bearing equipped
- Smooth operation at high speed
- Spindle unconditionally guaranteed
- 20-inch tooth steel blade - easily sharpened
- Precision built with quality materials
- Designed for efficient, long-lasting lubrication

For further information, write to:

WIND-KING ELECTRIC MFG. CO.
Merrill, Iowa



"YOU ARE UNDER ARREST!"

Help Bring Crooks to Justice Through Scientific **CRIME DETECTION!**

We have taught thousands this exciting, profitable, pleasant profession. Let us teach you in your own home. Learn Finger Printing, Firearms Identification, Police Photography, Secret Service Methods thoroughly, quickly, at small cost. Over 800 of all American Bureaus of Identification employ I. A. S. students or graduates. We can prepare you for this fascinating work, during spare time. Write today, stating age, for "Blue Book of Crime."

INSTITUTE OF APPLIED SCIENCE, 1920 Sunnyside Ave., Dept. 135A, Chicago 40, Ill.

TRO-TON All Metal SANDER - SCRAPER

Smooth-quick-slick! Flip of the wrist from Sander to Scraper. Easy-grip handle. Double-edge blades. Abrasive rolls changed easily. Ideal for cabinet maker, pattern maker, auto shops, home craftsmen. At your dealer or **\$1.95** postpaid. Salesmen and distributors write.

DENVER FLOOR AND SAFETY SUPPLY CO.
P. O. Box 1497, Denver 1, Colo.



ELECTRIC LIGHT JAZZ BOW TIE!

Astonish, amaze your friends. Be the life of the party. Have lots of fun. Easily put on. Flashes on and off by simply pressing battery button hidden in your pocket. Complete with attractive bow tie, cord, two bulbs and battery. **SEND NO MONEY.** Order your tie today, pay postman \$1.95 plus postage and C.O.D. charges when delivered or send \$1.98 and we pay postage. Special prices to dealers.

\$1.95

BERNARD FINE CO., INC.
501 Sixth Ave., Dept. PM13, New York 11, N. Y.



COMPLETE FLEXIBLE SHAFT MACHINE only

WITH PENCIL-SIZE HANDPIECE for "FINGER-TIP" CONTROL. Performs countless tasks quickly, easily! Use FORE-DOMS on wood, metal, glass, plastics, etc. Provides easy accessibility, unobstructed view. Grinds, polishes, drills, mills, engraves, sharpens, slots, sands, carves, etc., etc. Complete \$19.95. 50-Pc. Accessory Set \$1.50 additional. Order today. **FREE CATALOG.**

FOREDOM ELECTRIC CO., Dept. F-117, 27 Park Pl., N. Y. 7

HYDRAULIC CYLINDERS



Powerful, double acting hydraulic units, all brand new. Length closed—3'. Extended—5'3". Makes a fine portopower for auto body work, hydraulic lifts, presses, etc. Where positive power movement in two directions is desired, Gov't surplus. Only a few at \$12.50 ea. Shipping wt. 10 lbs. Send check or money order to:

MICHEHL INDUSTRIES

ATLANTIC BLDG.

WASHINGTON, D. C.



A BUSINESS OF YOUR OWN

Use simple home-made equipment. Make **HOLLYWOOD STYLE** cement pottery, birdbaths, benches, mantels, coffee tables, miniature castles. Also rustic garden walks, steps, stucco-rock walls, imitation marble. Chemical coloring, formulas & instructions. 10c brings pictures, sample, details.

HOLLYWOOD CEMENTCRAFT

8529 Wonderland Ave., Hollywood 46, Calif.

New 1948 PLASTICS SUPPLIES CATALOG

Just off press. Full details on Plexiglas, Lucite, rods, sheets, tubes, Acetates, cements, dyes, buffs, molding sets, tools, carving kits, accessories. Everything in plastics. Gives prices, sizes, colors, etc. Price 10c, stamps or coin, with ad for catalog.

PLASTICS MFG. & SUPPLY CORP.

DEPT. M-6 • 4707 EUCLID AVE. • CLEVELAND 3, OHIO

MAGNETS OF ALL TYPES—10c UP AMAZINGLY POWERFUL!
5 oz. Alnico Magnet, lifts 10 lbs. \$1.00. Our Leader, 15 oz. Magnet, lifts 40 lbs. \$1.95. New alloy—will not weaken! Useful for lifting valuables from tanks, lakes, or rivers easily! 7 small magnets \$1.00 with list of many shop and home uses. Satisfaction guaranteed.
R. EYRICH, 2566 N. 49TH ST., MILWAUKEE 10, WIS.

WOOD SHAPER \$29.50
9" x 16" surface ground cast iron table. Cast iron base and guard. Rail heating 1/2" spindle. 3/4" x 1/4" mitre groove NOT A TOX. SW. 10 lbs. E.O.B. Memphis. Write for descriptive folder. (PAT. PENDING)
V. J. Gegumis & Sons, 2564 Everett, Memphis, Tenn.

BRUSH PLATING OUTFITS

for re-plating articles in the home and shop. No tanks necessary. Free particulars.

GUNMETAL CO., AVE. M, DECATUR, ILLINOIS

Now A DYNAMIC Industrial Transformer Type Super Charged WELDER ONLY

FOR AUTO—HOME APPLIANCE & FARM IMPLEMENT REPAIRS! \$28.50
WORKS ON IRON, STEEL & other metals . . . does work you'd expect from a larger, costlier machine; portable, easily carried; OPERATES FROM ANY properly wired 110 VOLT LINE. Also available for 220 volt operation at slight additional cost; has 8 metallic & carbon arc welding heat stages. EASY TO OPERATE TRANSFORMER TYPE WELDER—If inexperienced you can learn to do professional work by following the SIMPLIFIED WELDING & OPERATING INSTRUCTIONS FURNISHED—comes complete ready to operate with helmet, rods, cable, instructions. SAVE TIME AND MONEY—Do your own welding—Just a few repair jobs will pay for this machine. A practical and profitable machine tool for any workshop. Make money doing repair work for others. Write today for full particulars and 10 DAY FREE TRIAL OFFER.

DYNAMIC WELDER CO., 15 E. 23rd St., H, Chicago 16, Ill.

JUNE 1948

amazing ... new

M & M Auto Polish

cleans, polishes... all in 1 operation



New, different M&M cleans as it polishes! So easy! Just wipe on and wipe off! No backbreaking rubbing, buffing, polishing! You don't even have to wash your car, just rub off dust and apply! Scum and dirt disappear like magic. M&M polished surfaces won't rain spot . . . dirt dusts off in a jiffy! Try M&M on your own car. Satisfaction guaranteed or money refunded!

MAIL COUPON

Today!

M&M PRODUCTS, Dept. PM-1
4342 Ainslie St., Chicago 30, Ill.

Please rush me full pint can of M&M Polish & Cleaner.

I enclose \$1.00, you to pay postage.

Please send C.O.D. I'll pay postman \$1.00 plus charges.

NAME _____

ADDRESS _____

CITY _____

ZONE _____

STATE _____

CANNON SURPLUS STORES

325 West Madison St. Chicago 6, Ill.

LOOK!
\$3.99
PLUS 10% FED. TAX

WRIST WATCHES

FOR MEN, WOMEN BOYS AND GIRLS



The lowest price in America today. Genuine imported. Made by Swiss Craftsmen. For men, women, boys and girls. Sweep second hand. Unbreakable crystal. Beautiful chrome case. Genuine leather straps. Radium dial and numerals. Precision made extra strong stem.
THE LOWEST PRICE IN AMERICA TODAY

Air Corps Style SUN GLASSES



Complete with case. Gold plated frames. Adjustable nose pads. 4 power ground lenses to Bureau of Standard's requirements.
\$1.88

CANNON SALES
325 W. Madison St., Chicago 6, Ill.

Enclosed is Check Money order for SUN GLASSES WRIST WATCH

NAME _____

ADDRESS _____

CITY _____

STATE _____

Add 20c for postage and handling.

MAIL THIS COUPON TODAY

SAY YOU SAW IT IN POPULAR MECHANICS

NONE BETTER AT ANY PRICE!

PAINT YOUR CAR WITH

KAR-WIPE

NEW AUTO ENAMEL SENSATION

WIPE IT ON!
NO SPRAYING!

NO BRUSHING!

GUARANTEED
2 FULL YEARS \$1.95



No Lap Marks

No Masking

No Streaks

YOU CAN DO A FACTORY LIKE JOB

One Quart Covers Average Car With Two Gleaming Coats. A Glowing Professional Finish!

Not a streaky wax or polish. KAR-WIPE is the new miracle high lustre auto enamel that is so easy to use. Anyone can do a professional looking job quickly.

Almost anyone can get high-gloss job that looks like a Professional finish. KAR-WIPE does the trick!

Easy to apply! No brush! No masking! Simply WIPE IT ON with the applicator that we give you FREE. Get a

factory-like finish that's GUARANTEED against chipping, cracking, peeling, fading when simple directions are followed. Dries dust free quickly. In newest colors., SEND NO MONEY! Order one or more quarts today. Just mail postcard Pay postman plus C.O.D. upon delivery. Send remittance, save postage.

SEND NO MONEY! ORDER Kar-Wipe TODAY! In Black, Grey, Firey Red, Brewster Green, Washington Blue, Maroon... \$1.95 per qt.

KAR-WIPE CO., Dept. P6, 828 S. 18th St., St. Louis, Mo.

NO MORE BACK BREAKING MOWER PUSHING

Build a POWER LAWN MOWER yourself from your old HAND MOWER



Free Wheeling and Chain Drive

Clutch →

PRECISION BUILT To Last A Lifetime

We supply complete ATTACHMENT that needs no welding. Easy to install in less than an hour. fits any make or size of mower for Electric Motor or Gasoline Engine.

ENGINE:

OUR 1 1/2-2 H.P. 4 Cycle Air Cooled with High and low Adjustable Jets Dependable Starting. Light weight, 30 lbs. Both the ATTACHMENT and the ENGINE are ABSOLUTELY GUARANTEED, you are getting the very best that money can buy at a price you can afford. Orders filled in seven days. Send for FREE FOLDERS.

ROYAL-OAK LAWN MOWER SHOP

Box 48

Royal-Oak, Mich.

Thompson BEATS the World on BOATS



Better Built Lower Prices



Safe Boats With Full Length Spray Rails

Keep passengers perfectly dry—even at high speeds. Catalog also shows two new models of "Take-Along" Boats. Two big factories—save you freight.

CATALOG FREE Write for your copy. State kind of boat in which you are interested.

THOMPSON BROS. BOAT MFG. CO. (151) 213 Ann St. PESHIGO, WIS. (Write to either place) 113 Elm St. CORTLAND, N.Y.

COMPLETE OUTFIT TO DRILL THROUGH CHINA, GLASS, or POTTERY

\$1.00 — Postpaid. Guaranteed.

LANG LAMP COMPANY, Dept. PM 1245 BELLEVUE AVE. EAU CLAIRE, WISCONSIN

RACING CAR EQUIPMENT FOR ALL CARS

Engines, Racing Heads, Manifolds, Carburetors, Mufflers, etc. Speed Instructions and literature \$1.00—refunded first order.

LEE MOTORCRAFT CO. 1412 Great Northern Bldg. Chicago, Ill.

LOOK! At These Bargains—

SCREWS, NUTS, BOLTS, WASHERS, Etc., Etc. Assorted Sizes. Approximately 300 Pcs. Each Pkg. for: Shops, Mechanics, Homes, Etc. 1—Sample Package Only 65c postpaid 3—Packages Only \$1.50 6—Packages Only \$2.75 12—Packages Only \$5.00 Plus Postage

25% Deposit on C.O.D. Orders. RUSH YOUR ORDER TODAY ORIOLE INDUSTRIES, 2239 So. Michigan Ave., CHICAGO 16

NEWEST OTTAWA LOG SAW

SELF-PROPELLED — MOVES ANYWHERE on OWN POWER

World's fastest Log Saw. Powerful 6 H-P air-cooled motor. Attachments for sawing down trees, buzzing limbs, post hole digging and pulley for belt jobs. Big demand for wood, pulp, posts. Make big money sawing wood this easy way. Low factory-to-user prices. Nothing like it. FREE details. OTTAWA MFG. CO., 7-827 Pine St., Ottawa, Kansas



BUILD THIS CONCRETE BLOCK MACHINE

Sell blocks; or build your home, garage, barn at 1/2 cost by making and laying your own blocks. This simple machine which you can build yourself at a cost of about \$15 (excluding motor) will make a block in 30 seconds using only one form. 2 to 4 forms can be used on each vibrator. Power driven concrete mixer plans also. Send dime for details and "How to Make and Lay Blocks."

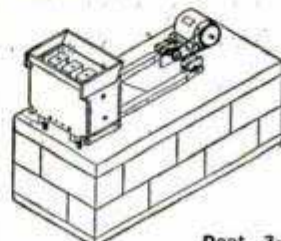

U-BUILD-IT SERVICE Dept. 3-A, 206 West Wilder Ave., Tampa 3, Fla. POPULAR MECHANICS

CANOE - CRUISING OUTFITS RENTED

ON LAKE GEORGE

CAMP ON STATE OWNED ISLANDS, FREE.

Complete outfits rented — Canoe, tent, lantern, cot, dishes, axe, grate, etc. Send for folder "M."

\$30. per week for 2 persons

CRAIG-WALKER CO. Bolton Landing, N.Y.

WORLD'S LOWEST PRICED ADDING MACHINE

VEST POCKET SIZE

IDEAL FOR BUSINESS OR PERSONAL USE

FREE TRIAL ONLY \$2.95 TOTAL COST SEND NO MONEY FREE!!

Each Baby Calculator in Beautiful, rich-looking Leatherette case—at no extra cost.



Fits vest pocket or purse. Guaranteed accurate. Operated as easily, and as reliable, as machines costing many times as much. Not a toy. Precision made, very durable—guaranteed for life against defects in construction. You positively can't buy a calculator of equal quality for as little money. ACCEPTED AS THE FINEST LOW PRICED CALCULATOR FOR OVER 35 YEARS! Operates with a flick of your finger. Adds, subtracts, multiplies, divides—counts up to one billion. Pays for itself over and over in mistakes avoided, and time saved. MAKES IDEAL GIFT.

Sold on a positive money back guarantee. Send only \$2.95. Calculator sent postpaid, or send name and address and pay postman \$2.95 plus postage. MONEY BACK IN 10 DAYS IF NOT DELIGHTED! (If outside U. S., send \$3.50.) AGENTS WANTED.

CALCULATOR MACHINE CO., (Mfrs.)

Dept. 203, P. O. Box 248, Glenview, Illinois

GROBAN'S SURPLUS BARGAINS!

BRAND NEW

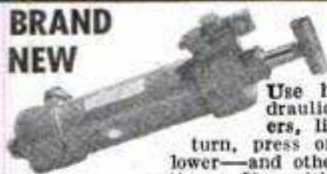

AIR OR OIL HYDRAULICS

Use hydraulics on arbor presses, hydraulic presses, hay lifts, manure loaders, lift trucks—push or pull, tilt or turn, press or squeeze, open or close, lift or lower—and other hydraulic and industrial applications. Use with either air or oil . . . of finest precision workmanship.

1. Double action, 3" bore, 12" stroke. All steel hydraulic cylinder, will lift up to 12,000 lbs. (7000 lbs. in 3 seconds with Vickers Pump). \$78.00 **\$19.50** paid value. Wt. 12 lbs.
2. Double action, 1½" bore, 27" stroke. (Will lift 1760 lbs. in 2 seconds with Vickers Pump). Wt. 8 lbs. A \$55.00 hydraulic cylinder value **\$12.95** paid value for only
3. Double action, 2¾" bore, 8" stroke. (Will lift 4400 lbs. in one second with Vickers Pump). Will withstand 1500 P.S.I. against wall. A \$65.00 **\$14.50** post-value, available now at

BRAND NEW HYDRAULIC CONTROL VALVES

With built-in relief valve. Use them manually or automatically for single or double action cylinders. Inlet port 9/16", outlet port 3/4", cylinder port 3/4". Complete with ILLUSTRATED instruction sheet. 6 in. by 3½ in. by 3¼ in. Wt. 2 lbs. A \$21.00 value, available now at **\$5.95** paid



VICKERS MF6 HYDRAULIC PUMP OR MOTOR

Compact, powerful, rated 1,000 P.S.I., .507 cu. in. per revolution, 8 gal. per min. at 3750 r.p.m. Change rotation by reversing flow. Delivers up to 6 H.P. BRAND NEW. Wt. 4½ lbs., \$60.00 value for **\$14.95** Postpaid

½ H.P. — A.C.

ELECTRIC MOTOR

(Capacitor Type) BRAND NEW

For the Farm, Home, Factory, Workshop

- Here Are a Few of Many Uses:
- Pumps
 - Stokers
 - Oil Burners
 - Unit Heaters
 - Air Compressors
 - Refrigeration Units
 - Conveyors
 - Blowers—Fans
 - Machine Tools



¾" Keyed Shaft; 115-230 Volt; 60 cycle; 1725 R.P.M. Single Phase—alternating current; capacitor start—induction Run—Resilient Mount and Protector—Reversible Rotation—High Starting Torque—Magnetic Starting Switch. Cooler Operation— **\$34.95** Dynamic Balance—Compact Design. F.O.B. Chicago

VACUUM-AIR HYDRAULIC GENERAL PURPOSE PUMP

Original Cost

\$45.00

Now Only

\$9.95

Prepaid in

U.S.A.

BRAND NEW!

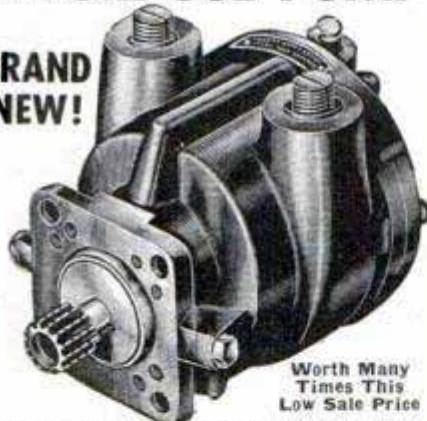

Worth Many Times This Low Sale Price

• Originally cost \$45.00. May be used as air or fluid pump—for pressure or vacuum. Standard ¾ inch pipe thread with interchangeable ports. Will pump 7¼ gal. SAE 30 oil per minute at 300 RPM. Builds air pressure of 30 lbs. per sq. in. at 1000 RPM. Vacuum will draw 26 inches of mercury at 1750 RPM. Develops up to 120 lbs. per sq. inch of hydraulic pressure, which in conjunction with a 3 inch hydraulic cylinder will lift 840 lbs. minimum. Runs forward or reverse. Self aligning shaft. Die cast aluminum housing 6x4x4 inches. Has stainless alloy steel vanes and impeller. Made by Bendix Avia, Corp. Spline terminal for direct drive—readily replaced with a pulley. Recommend a ½ H.P., or stronger electric motor. Rated capacity 1500 RPM with high overload factor. Special price for quantity users. Complete illustrated engineering report and instruction booklet FREE with every pump. Send check or money order today! Postpaid in U.S.A. **\$9.95**

PRESSES, etc.

BRAND NEW ALL-PURPOSE WATER PUMP

Ready for use on any pumping need

Use it for: DRAINING BASEMENTS

HOME WATER SYSTEMS

FIRE PROTECTION

PRESSURE BOOSTER

IRRIGATION

DRAINING PONDS, TANKS, etc.

SPRINKLING SYSTEMS

STOCK WATERING

INDUSTRIAL PUMPING

Complete with pulley and mounting brackets, ready for use.

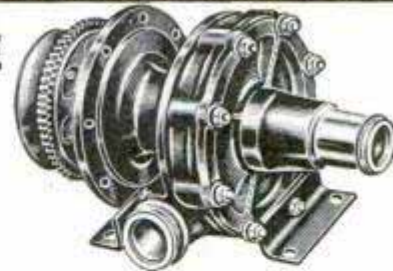

Belt Driven — Centrifugal Pump

An extraordinary value for all types of intermittent or continuous pumping in the home . . . farm . . . factory. Built to exact specifications of Packard Motor Car Co. for use in Rolls-Royce Merlin Aircraft Engines. May be run with electric motor, gas engine or power take-off on tractor. Delivers up to 25 gallons a minute with ¼ H.P. motor; 80 gal. a min. with one H.P. motor. Will deliver up to 44 ft. head or 25 ft. suction. Use 1" outlet hose; 1" or 1½" inlet hose (recommended).

COMPLETE ENGINEERING REPORTS AND OPERATING INSTRUCTIONS FREE WITH PUMP

Has cast aluminum housing, accurately machined 5" bronze impeller; 3½" V belt pulley and mounting brackets. Shaft rotates on ball bearing; has grease gun fitting.

Original cost approx. \$88.00. Shipping weight 10 lbs. A REAL BUY. Satisfaction guaranteed. Mail orders filled promptly.

\$21.50

F.O.B. Chicago

Here is YOUR identification stencil set! Ideal for all industries in marking boxes and packages, identifying inventory, numbering doors, etc. GUARANTEED. Saves time, money and effort, easy to use, pays for itself. Metal letters, INTERLOCKING to make words. Comes in handy wooden box with sliding top.

STENCIL

OUTFIT



CONTAINS
1 stencil brush;
1 can paint,
stencil paste;

1 complete set of metal letters, figures, punctuation and spacers

COMPLETE KIT with 1" letters **\$2.50** Pre-paid

COMPLETE KIT with 2" letters **\$3.95** Pre-paid

U.S. SURPLUS BARGAIN

Polaroid Goggle Kit

USE THEM FOR ALL OUT-DOOR SPORTS, BEACH, MOTORING, BOATING—ANYTHING.



Brand New! In original packing. Each with four interchangeable lenses. Shock Proof Frame. Shatterproof Lenses.

Heavy windproof sponge rubber ventilated frame with snap button lens retainers! Adj. elastic head band. Clear, red, green, amber, flexible, shatterproof lens, all instantly interchangeable, with carrying case. **\$1.00** Prepaid in U.S.A. They won't last long at this price—it's smart to buy an extra.

GROBAN SUPPLY CO. DEPT. PM-6, 1507 S. MICHIGAN AVE., CHICAGO 5, ILL.

U.S. NAVY 7X50

PRISM BINOCULARS WITH COATED OPTICS



Used but in Excellent Condition
\$95.00

Complete with leather carrying case and sling

Universal, 6x30 Navy Prism Binoculars, used but in excellent condition, complete with leather case and sling straps.....**\$42.50**

With Coated Optics, \$10 Extra.

Field Glass, 4X 40 Wollensak. Ideal for bird study. Brand New.....**\$17.95**

NEW U. S. GOVERNMENT SURPLUS

TRIPODS

Purchased by Government for engineers levels and transits. Adjustable to any height. Threaded head for levels or transits. Value \$75. SPECIAL **\$13.50**

WHEATSTONE BRIDGES

Portable. Used, in excellent condition. Manufactured by Thompson Lever Mfg. Co., Philadelphia. Value \$150.00. Special.....**\$49.50**

Engineers All Metal Army Type Hand-Sighting

LEVELS

\$2.00 PRECISION QUALITY



Send 25c for catalog of new and used guns, ammunition, binoculars and powder flasks.

PUBLIC SPORT SHOPS

11 S. 16th St., Phila. 2, Pa.

No COD's

NEW! Nothing else like it!
Thrilling, live 5-ft. action—
Yet only 21 in. long!

Trade Mark

Stubcaster

CASTING AND TROLLING ROD

- Sensational coil spring gives full length rod action!
- Shortened arc gives greater accuracy—maximum distance
- Fits your tackle box—21" overall breaks to 14"
- Reduces backlash!
- Cast "close in" streams, overhand or underhand—no foliage interference
- Cast 3 or 4 in a boat without tangling lines!
- Brings fish right to net; fewer losses
- U. S. Patents Pending!

\$5.95
without reel



Money back guaranteed if dealer can't supply, send check or money order to

WALTCO PRODUCTS, Dept. 68-G

2300 W. 49th Street • Chicago 9, Ill.

SAY YOU SAW IT IN POPULAR MECHANICS

AUTOMATIC SAW SET

HAND AND BAND SAWS

Set Saw TEETH Automatically—400 per minute without effort. Perfect hammer and anvil action sets teeth uniformly—tensions metal. No tooth breakage. Write today!

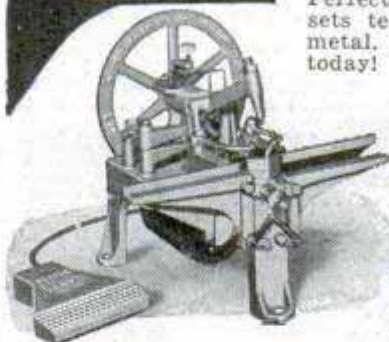

Retooth Saws Automatically—with Burr Retooler. Cuts new teeth in 50 seconds—any size 4 to 16 points. Old teeth fall off as chips. Easy to operate. A perfect job. Write for literature on Circular Saw Sharpener.

VALUABLE BOOK

Order Burr's Blue Book **25c** of Coast to Coast Prices for Saw Shop Services.

BURR MFG. COMPANY

8933-R Venice Blvd.
Los Angeles 34, Calif.

FLASH THAT VOLTAGE

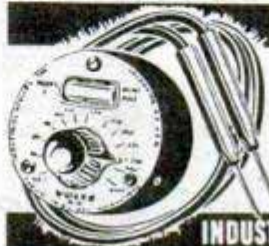

Turn that knob, Extinguish the neon glow. Instantly read voltage off dial. MINI-VOLT model 400B measures 65 to 660 V. AC. Also DC. Tella AC or DC. Virtually burn-out proof. Guaranteed for 10,000 hours. 12" test leads. A "must" in electrical and radio work. At dealers or postpaid \$2.50. (C.O.D. 25c extra.)

INDUSTRIAL DEVICES, INC., EDGEWATER 1, N. J.

POWER MOWERS

Save up to 75% by assembling



1948 Master Kit and have one of the finest power mowers money can buy.

KIT consists of heavy cast aluminum ball bearing center post, 18" or 20" tool steel blade; one 8" semi-pneumatic B.B. wheel with cast aluminum swivel unit complete; two 10" heavy duty semi-pneumatic B.B. rear wheels and axle; plans and instructions.

SPECIAL FACTORY PRICE... \$28.75

Send only 25c for complete plans and instructions to build TRIANGLE'S Master Mower, on complete mowers, kits, parts, engines, wheels and other items.

For prepaid shipment add 10%. Your money refunded if not satisfied. **TRIANGLE MANUFACTURING CO., Dept. 6PM, Box 185, Fort Scott, Kan.**

★ LOOKS ★ SMELLS ★ TASTES

★ LIKE REAL SHRIMP

★ HAVE YOU GOT YOURS?

★ FISH WITH SHRIMP

★ KING OF BAIT "They Can't Catch Me!"

★ \$1.50

★ IF YOUR DEALER CAN'T SUPPLY YOU... ORDER DIRECT!

MANNING'S Tasty SHRIMP LURE CO.
828 GRAVIER ST. NEW ORLEANS 12, LA.

TYPEWRITERS!



ALL MAKES — REBUILT LIKE NEW

For Business, School or Home Use

Write for Information

M & M TYPEWRITER CO.

84 W. Washington St. Chicago, Ill.

EXTRA POWER for V8 Fords and Mercurys

SHARP TRIPLET INTAKE MANIFOLD

SPEED.. ACCELERATION.. ECONOMY!

Dual or triplet manifold, made of cast aluminum.

Write for free catalogue or see your speedshop.

INDEPENDENT IRON WORKS
6225 Wilmington Ave. Dept. A
Los Angeles • • • California

New IMPROVED Electric MOTO-SAW

ONLY \$585
(with 3 Saw
Blades) Postpaid

SAFE AS A HAND SAW
JUST GUIDE IT!

More like magic than any tool you ever saw. Imagine an electric scroll saw only slightly heavier than a hand coping saw... a tool that takes no effort to run, no pressure to feed. Works at any angle—on big assembly jobs or on the tiniest piece you can hold in your fingers. Runs 7200 strokes a minute... so fast the blade seems to stand still. Sturdily built... only two moving parts... never needs oiling. Easily cuts intricate designs—so smooth it eliminates sanding. Novice or craftsman, a thrill awaits you when you get a Moto-Saw in your hand.



THOUSANDS OF SATISFIED USERS
U. S. Patent 2233862
Other Patents Pend.
Dremel Mfg. Co.
Dept. S-118-F
Racine, Wisconsin

No Limit to Length of Stock it Will Cut. Saws to Center of 19" Widths.

It's fast... cuts on an average of 1 ft. per minute up to 3/4" medium hard wood. Operates on 110-120 V. 50 or 60 cycle alternating current. If your dealer does not yet have Moto-Saw, send \$5.85... we'll pay postage. Or send \$1. pay postman balance plus postage. MONEY BACK if not delighted after 5 days' trial.

SCREWY-MIX BARGAINS HANDY WORKSHOP KITS—ALL NEW FINEST QUALITY

- 1—Assorted machine screws, sheet metal screws and bolts, sizes 2-56 to 3/8-24, various type heads. Three pounds \$1.15. Five pounds \$1.50.
- 2—Mixed Steel Rivets 1/16" to 1/4" diameter, various lengths, round and flat heads—five pound pkg. \$1.00.
- 3—Mixed aluminum rivets—50c lb. Mixed cotter pins 35c lb. Minimum order one item \$1.00—mixed items minimum \$1.50.

ADD 15c POSTAGE PER ORDER

JAY-CEE SALES CO., 4554 Grand River Ave., Detroit 8, Mich.

RENOVATE YOUR JACKET



Leather or Sheeplined Leather Jackets completely reprocessed and renovated to look like new. Complete service includes cleaning, refinishing, waterproofing, replacement of broken zippers, and repairs to rips, tears, etc. only \$3.85 plus postage.

Berlew Mfg. Co., Inc.

2-8 N. Merrick Avenue
Merrick, N. Y.



HAIR-LINE CARBURETOR IDLING ADJUSTMENT—NOW POSSIBLE—



WITH AMAZING NEW GANE Air Flow Needles For Cars, Trucks, Tractors

MORE MILES PER GAL. SMOOTHER RUNNING. EASIER PICKUP. FASTER STARTING. PERFECT IDLING. REPLACES PRESENT-ORDINARY IDLING SCREW. ORDER DIRECT. GIVE MAKE, MODEL, YEAR, KIND OF CARB. REMIT \$1.50 PER NEEDLE (8CYL. CARS TAKE 2, DUAL CARBS. TAKE 4) SEND CHECK—MONEY ORDER TO CAMERON COMPANY 535 East Adams PHOENIX, ARIZONA

Write today for booklet on the new FLEX-O-SHAFT Tool Kit, illustrating this improved all-purpose power machine with the hand-piece that works as easily as a pencil. Motor with switch, foot-operated rheostat, and 66 accessories, all at a special low price. FLEX-O-SHAFT SALES CO., Dept. C, Prairieview, Illinois.

OTTAWA POST HOLE DIGGER

There is No Other Like It!



Here's the tractor digger you have been waiting for. Quickly hitched to most any farm tractor with power take-off. Fastest power auger return—pull cord control. Heavy hi-speed two-flight auger—leaves hole clean. Castor wheels permit fast and accurate settings. Safety clutch prevents damage, eliminating shear pins. Strictly a one-man digger. All controls from driver's seat. Short-cut to labor problems where holes are needed. Trench digging attachment. Get up-to-the-minute facts by sending for descriptive matter and low factory-to-user prices. Serving farmers for 44 years.

OTTAWA MFG. CO., 6-827 Elm St., Ottawa, Kan.

Another GREAT NECK First!

ALL NEW!

REVOLUTIONARY
MAXIMUM-GRIP
PLASTIC HANDLE
SCREW DRIVER



★ Unbreakable!
★ Twistproof!
★ Modern Design!

Blade lengths from 4" to 10"



GREAT NECK—leader in tool design—offers the new, handsome maximum-grip screw driver you've been waiting for! Richly colored unbreakable plastic handle is slip-proof, non-explosive, non-absorbent to grease or oils. Entire blade is of specially hardened and oil tempered quality alloy tool steel, highly mirror-polished. Bit is precision-ground to exact size. Blade is deeply embedded and twistproof. Here is a beautiful engineered tool to give good service for many years!

THE QUALITY TOOL FOR CRAFTSMEN, MECHANICS, HOBBYISTS—EVERYONE!

ASK FOR GREAT NECK TOOLS BY NAME

NOW AT HARDWARE COUNTERS

GREAT NECK SAW MFRS., INC. • MINEOLA, N. Y.

AMAZING MYSTERY BUTTON

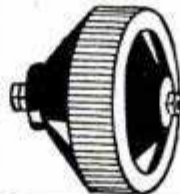

Startles Everybody. With this Electronic Button you can make your own Telephone Amplifier—Detectaphone. Attach this button to piece of cardboard—transmit conversation to another room. Music also transmitted to distant places. Most interesting electrical apparatus ever discovered. Enables you to perform hundreds of experiments. So tiny it can be concealed in dozens of places. A Pre-War Product. Electronic Button including 5000 word instruction booklet with 50 illustrated experiments, postpaid, only \$1.00. Electronic Products Company, Saint Charles 5, Ill.

GARAGE HOME MECHANICS



Need A Motor Rebuilt?

LET JACOBY DO IT!

SAVE TIME, TROUBLE, MONEY

Let experts do the job! A. Jacoby & Sons, Inc. have been in business for over twenty-five years—operating a complete automotive machine shop specializing in rebuilding Ford and all other types of motors. We also maintain a complete stock of automotive parts and accessories. You can do your own motor overhauling and general repair; all parts at a substantial discount.

Write for information and price, specifying job or repair you intend to do, giving year, make and model of vehicle.

A. JACOBY & SONS, Inc.
8620 18th Avenue, Brooklyn 14, New York

HOW TO Stop Costly Leaks!

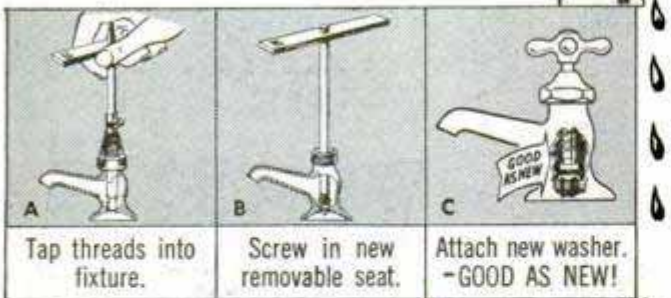

Annoyed with dripping faucets and constantly changing washers? Then get the new No. 300 "SPEEDY" RESEATING SET and permanently end faucet drip by inserting new seats.

Handy metal case contains 3 different popular sizes of finest quality steel taps, extra seats, washers and necessary tools, and directions for many faucet and valve repairs. Does the job right, quickly, easily, economically. Savings pays for the set many times over.

Ask your dealer for "SPEEDY" RESEATING SET. If he cannot supply you, we'll send it postpaid. No C.O.D. orders. Mention dealer's name.

Only \$6.95



No. 300 "SPEEDY" RESEATING SET

CHICAGO SPECIALTY MFG. CO., 2954 W. Lawrence Ave. Chicago 25, Ill. Manufacturers of Quality Plumbing Specialties

NEW CURVED TOOL HOLDER FITS 1" TOOL POSTS!

Grind Tool bits! Turn large Discs! Many other uses! See your dealer or send \$2.65 direct for complete kit postpaid.

HURON FACTORY SERVICE CO. Dept. 5 505 Lafayette Bldg. Detroit, Mich.



Do a Better Job WITH ONE OF THESE EMPIRE LEVELS

Smallest, most handy and accurate Level made. "Cigar-shaped"—no sharp corners to tear pocket. Aluminum stock. Only 3 oz. wgt. 9" long. Has Level, Plumb, 45° Vials. No. 26 \$2.00



ALUMINUM LEVEL — No. 151
Cast and Machined, a Beautiful Tool, with Patented, Removable Level and Vial. With 2 Plumb, 2 Levels, 2 — 45° Vials. 18" \$6.00
24" \$6.50 28" \$7.00

Order EMPIRE LEVELS from your local dealer. Write direct for literature.

EMPIRE LEVEL MFG. CO.

BOX 97, DEPT. P-252, MILWAUKEE 13, WISCONSIN

\$3000. FOR \$17.50 !!



K-4 SPERRY COMPUTING SIGHT
GADGETS GALORE OVER 200 GEARS, WORMS & DRIVES, 110 PRECISION BEARINGS, 24 V. MOTOR, 6" ACHROMATIC LENS & MORE & MORE BRAND NEW IN ORIGINAL BOXES WAR SURPLUS THESE ARE THE LAST OF THEM!

(FOB LOS ANGELES)

Symbol ASSOCIATED SURPLUS Co. 10838 VENTURA BLVD. NORTH HOLLYWOOD, CALIF.



SPEED REDUCER

Made of bronze and steel. Size 3" x 1 3/4", weight 1 1/4 pounds. Rugged 5/16" shaft. Ratio: 1 to 1, 10 to 1 or 20 to 1 (please specify). Complete with knuckle joint, \$7.50; without knuckle joint, \$6.50; knuckle joint alone, \$1. Mailed postpaid on receipt of Money Order.

WAK INDUSTRIES CHARLOTTE, N.C.

WAR SURPLUS

Hundreds Sensational Values!
Scarce, Hard-to-Find Items

OXFORDS—Navy Style



\$6.88 pr.

Color black. Brand New. Constructed first quality. Can be worn for dress or work. Are comfortable and easy on your feet. Order a pair today. Can be had in sizes 6-12, all widths.



Officers' Pink TROUSERS
Only \$8.95 pair

Beautifully tailored, long wearing. Fine appearing pink elastic. They come in sizes 30-42 in assorted lengths. Scarce item. Order while supply lasts.

TRENCH COATS Only \$12.95 ea.

Officers style, all weather trench coat. Made of beautiful gabardine with officers epaulettes on shoulders. Has an all-around belt, two slash pockets and storm tab. Sizes 34-46.



NAVY RAINCOATS \$2.95 ea.

Gray with corduroy collar made to government specifications for heavy rains, sleet storms, etc. Sizes 34-46. Brand New.

AIR FORCE TYPE SUN GLASSES



\$1.95 each

Precision Made with a 24 K gold plated frame. 4 base, ground and polished lens. Made to specifications of Bureau of Standards for maximum optical benefits.

Jungle Hammocks Only \$5.95

Brand new, complete with mosquito netting, tie ropes, rain-proofing, etc. Excellent for fishing and hunting trips. Cost government over \$20.00 to make.

All Merchandise Brand New In First Class Condition

NOVELTIES

NAVY TARGET KITES \$2.95 each
5' x 5'. They soar at 40 miles an hour in a 20 knot wind, complete with rudder.

MARINE HUNTING KNIVES Only \$1.95 ea.
Complete with a genuine leather scabbard.

SUN HELMET \$1.25 each
Jungle tropical, similar to the Famous Frank Buck helmet with adjustable sweat band.

PISTOL BELTS Only 49c each
Web style with brass buckle, used to hold canteens, holsters, etc.

15 Jewel Swiss WATERPROOF WRISTWATCH \$12.95
Sweep second hand. Stainless Steel back. Radium dial.

12 MAN LIFE RAFT
4 ton capacity, 120 ft. long, 6 ft. wide. Original govt. cost \$525—our price \$98.50
Brand new, packed in wooden crates.

TENTS only \$24.95



9 ft. x 9 ft. wall tents, waterproof, mildew proof, etc. Complete with grommets, tie ropes, poles, etc. These tents are brand new.

TENTS Only \$29.50

16 x 16 ft. pyramidal tents, used but in a perfect condition. This is the famous Army practice 8 man tent, made for all weather conditions. They are complete with center pole and steel pins.

PUP TENTS Only \$2.95

Shelter halves, used and in perfect condition. Complete with pins. (Same tent, brand new, Only \$4.95 each.)

Cash orders Rushed F.O.B. Chicago. C.O.D.'s sent plus charges.

HURRY! SUPPLY LIMITED!
LEONARDS & LEE SURPLUS SALES
Dept. 150

3400 W. Armitage Ave. Chicago 47, Ill.

BUILD & RACE The Thrilling New Bee-Line Jets

Speed Up To 125 M.P.H. SUPER SONIC STREAK

You'll Get The Thrill Of A Lifetime Building And Racing These Sensational New BEE-LINE JETS. They whiz through the air on a fine steel guide wire at terrific speeds up to 125 M.P.H. Realistic jet power is supplied by CO2 Fire Cartridges which are simple and safe to use.

Slick As A Whistle Fast As Lightning



Both Only \$1.50 P.P.

FLASH ROCKET



Thrilling As A Trip To The Moon

JIFFY-BUILT KITS
Balsa Wood Bodies Completely Formed, Sanded And Drilled For CO2 Cartridges. All Other Parts Semi-Finished. Complete Plans and Instructions. One CO2 Cartridge. For Racing Models. 75¢ Each Postpaid

Victor Stanzel & Co., Schulenburg, Texas

DUAL TAIL PIPE EXTENSION

Fits all cars — chrome plated

DEEP TONE

produced by 2 1/2 inch outlets **\$2.95**

Postage free on prepaid orders

DEALER INQUIRIES INVITED

LYONS PRODUCTS COMPANY

PAT. PEND. 2319 Ridgeley Drive, Dept. PM6, Los Angeles 16, Calif.

HEATERS

Gasoline, burning 40,000 B.T.U., built by Stewart Warner for USAAF as cabin and engine heaters. Brand new and in original cases. Small modification makes ideal installation in trucks, buses, trailers; boats, small buildings, etc. No exposed flame. Crated shipping wt. — 40 lbs. A bargain at **\$28.50 ea.** FOB Wash., D. C.

MICHEHL INDUSTRIES

ATLANTIC BLDG. WASHINGTON, D. C.

BIG PROFITS RESTRINGING RACKETS

AT HOME! WRITE US!

Earn big profits restringing tennis rackets at home. Easy work. Experience unnecessary. Save on your tennis, badminton, squash! Send for FREE CATALOG of Tennis Equipment—Hurry!
H. E. Wills Co., 1047 W. 47th St. Dept. PM-68, Chicago, U. S. A.

Save On GUT!
—Buy Direct from Factory
SILK!

LIQUID MARBLE Composition Floors

Mold, Brush, Trowel, Spray It!

Flexible Molds

MOLD Novelties, Statuary, Art Goods in Flexible Plastic Molds; 5¢ material makes \$1 seller. Make Marbleized Floors, Tile Walls, Colorful, glossy, amazing! Easily learned; start in garage or basement. Particulars free. **MARBLEIZING SERVICE, Dept. PM, Edwardsville, Ill.**

OHMITE POTENTIOMETER

Model N—300 watt, 1.65 amp. 300 and 125 ohm; 6 inch diameter. Special price **\$4.25**

G. I. SQUARE MOTOR

110-115 volt, 60 cycle, .65 amp., 1650 RPM. Ideal for wire recording. Special **\$4.25**

Send check or M.O. Will ship postage paid.

J. SEGAL 321 Canal St. New York 13, N. Y.

PRECISION JEWELERS SCREW DRIVERS

Complete Set of 8 for Every "Hobbyist"



At last—a complete set of precision screw drivers to meet the needs of every model builder. Not a miniature but the same type set used by U. S. Navy for precision instruments and watches during the war. Brass knurled handles, hexagon heads, finest tempered steel blades. Sizes 2-9. Never before a set of this quality and precision at such a low price. Your money back if not satisfied. C.O.D. \$2.00 plus postage or send \$2.00 and we pay postage.

PINE WATCH CO., Rm. 40A, 29 Eldridge St., New York 2, N. Y.

U.S. Gov't Surplus TWO-WAY PRIVATE SPEAKING SYSTEMS



Talk or listen from Master Station to any one of 5 sub-stations or from any sub-station to master

This exceptional unit was built to U. S. Army Signal Corps specifications at an original cost to the government of over \$225. Several new features have been added during its conversion. Now it does the same job as a \$500 to \$1000 intercommunication system installation.

Unit consists of 1 master amplifier, one combination microphone speaker and 100 feet of wire. You can talk or listen to any one station or all stations at one time as you desire. Any one station or call station can talk back or originate a call to the master station from as far as 75 ft. away without switching the sub station. As many as 5 sub stations can be used in your system. Each station will furnish clear tones from as far as 20 feet to 5 miles distance. Very simple installation.

110-120 volt AC or DC. No batteries needed. Satisfaction guaranteed. All parts are standard and brand new. Complete unit with all instructions ready to use.

1 master amplifier and 1 sub station, and 100 ft. of wire.

\$69.95

Additional sub stations

\$8.95



Edward E. Gurian and Co. Inc.
2011 South Michigan Ave., Dept. A
Chicago 16, Illinois

Gentlemen: Please enter our order for the following

— 2 way private intercommunication systems **\$69.95** each
— Additional combination speaker (substations) **\$8.95** each

Name _____

Address _____

City _____ Zone _____ State _____

Enclosed please find \$ _____

Ship post paid.

— Ship C. O. D. We will pay post-

man \$ _____ plus postage.

Net weight per unit is 25 lbs.

EXTRAORDINARY GOV'T RELEASE!

All-Purpose STIRRUP PUMP

Shoots a high pressure stream 30 feet!

- PERFECT FOR**
- Spraying Trees
 - Whitewashing
 - Firefighting
 - Washing Cars
 - Bailing Boats & Basements

COMPLETE with 10 ft. of flexible hose



Thousands sold at **\$3.80**

NOW LOOK! only **\$1.49**

SATISFACTION GUARANTEED Or Your Money Back!

EACH plus 25c for postage and handling.



MAIL THIS COUPON RIGHT NOW!

AMERICAN HANDICRAFTERS, INC., Dept. PM6
2905 W. Madison St., Chicago

Send me.....All-Purpose STIRRUP PUMPS at \$1.49 each plus 25c for postage and handling.

Enclosed find check money order.

Send C.O.D. I will pay small C.O.D. charge.

Name.....

Address.....

City & State.....

AMERICAN HANDICRAFTERS, INC.

2905 W. Madison St.

Chicago 12, Ill.

MASTER CRAFTSMEN

use these finest fillers!

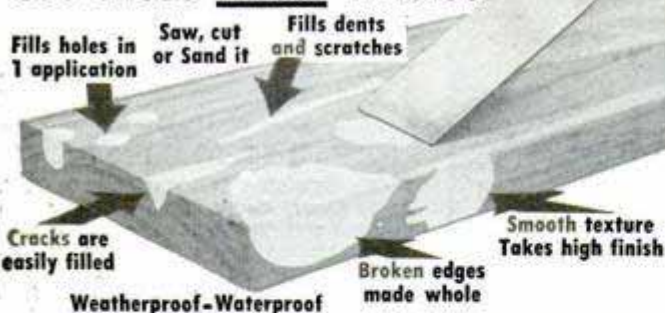

- SAVES TIME
- SMOOTH TEXTURE
- EASIER TO WORK
- SHRINKS ONLY 1%
- STAYS IN

FOR a perfect surfacing job on wood, metal or plastic—use the expert's choice—Duratite. Easy to use—faster—shrinkage is so slight, it fills completely in just *one* application—stays in! 7 wood colors. Ask your dealer or send for large tube.

WEBB PRODUCTS COMPANY

228 S. G St., San Bernardino, Calif.
Enclosed find 25c, send large tube Duratite Wood Dough.

Name _____
Address _____
City _____ State _____

SEND FOR LARGE TUBE



Now for EVERY WORK SHOP!

NEW Invention Electroplates by BRUSH



Easy to Plate CHROMIUM GOLD, SILVER, NICKEL, COPPER
... For Pleasure and Profit!

If you have a workshop—at home or in business—you need this new Warner Electroplater. At the stroke of an electrified brush, you can electroplate models and projects—you can replate worn articles, faucets, tools, fixtures, silverware, etc. with a durable, sparkling coat of metal... Gold, Silver, Chromium, Nickel, Copper or Cadmium. Method is easy, simple, quick. Everything furnished—equipment complete, ready for use. *By doing a bit of work for others, your machine can pay for itself within a week.* So make your shop complete by getting a Warner Electroplater right away. Send today for FREE SAMPLE and illustrated literature. ACT AT ONCE! Mail Coupon.
WARNER ELECTRIC CO., DEPT. S-11
1512 Jarvis Avenue, Chicago 26, Ill.

FREE Details & Sample!

WARNER ELECTRIC CO., 1512 Jarvis Avenue, Chicago 26, Dept. S-11
Gentlemen: Send Free Sample and Details to:

Name _____
Address _____
City _____ State _____

HANDY TOOL

reconditions battered threads and makes quick repairs without dies. Repairs 1/4", 5/16", 3/8", 7/16", 1/2", 5/8", and 3/4" threads. SPECIFY U.S.S. or S.A.E. SATISFACTION GUARANTEED
ADVANCE SUPPLY CO.
Dept. PM
3243 Joy Road Detroit 6, Mich.



BUILD HEAVY DUTY MACHINES



SAVE UP TO 90%— You can build, using our practical, easy-to-read plans, all kinds of machines, for home, farm or shop—scooters, portable sawmills, metal working machines, concrete machinery of all kinds, printing equipment, woodworking machines, midge autos, dish washers, farm equipment, freezers, tractors.

FREE CATALOG HANDBOOK
183 SETS OF PLANS
VALUABLE INFORMATION

NICHOLS EQUIPMENT COMPANY
D-1110 PURVIS, MISS.

Don't Wait Till It's Too Late... ORDER YOUR TIRE CHAINS NOW!



Don't be caught short again this winter by shortages—play safe by ordering these strong steel chains today. Quantities limited; orders filled as received. Check tire size, inclose this ad with money order or check. Money back guaranteed. No C.O.D.

- 600-15 600-16 650-16

Only **\$8.95** per inc. adjusters EXPRESS PREPAID

A. A. A. TIRE CHAIN CO. 129 Madison St., B'klyn 16, N. Y.

A Perfect Tool Holder

for Home Workshop Lathes

Holds 3/16", 1/4", and 5/16" tool bits, round or square. Holds all bits in four or more positions. This one holder will take place of R.H. Offset—L.H. Offset—Straight and Boring Bar holders. Shank size 7/8" x 3/8". Other sizes available.



EDWARD BLAKE COMPANY

634 Commonwealth Ave., Newton Centre 59, Mass.

MELLO-TONE Tail Pipe Extension

- Makes deep mellow tone.
- Triple plated for long life.
- Installed in 30 seconds.



Send check or money order with car make and year. No COD.

BECKER INDUSTRIES 1835-P Univ. Ave. St. Paul 4, Minn.

Pat. Pend.

Make **BIG MONEY**... in



Send for **FREE CATALOG**

WRITE NOW!
No obligation

Learn how YOU can start your own profitable Plastics business for just a few dollars. No experience necessary, we teach you how, furnish you with all supplies and Marketing Helps. This is your opportunity! **DON'T DELAY!**

COLONIAL PLASTICS CO. 216 S. 7th St., St. Louis, Mo. Dept. M-3

BUILD AN ELECTRIC LAWN MOWER



Make this Battery-Driven, Rotary-Blade mower from an old auto generator and inexpensive parts. Cuts forward, backward, grass or weeds, any height. Plans complete, easily followed.

PLANS ONLY
35¢
WRITE TODAY

LEJAY MFG. CO., 847 LeJay Bldg., Minneapolis 8, Minn.

WOOD WORKERS

LUMBER - PLYWOOD AVAILABLE
Harold Hunt wants to send new No. 15 catalog. Over 148 pages of woodworking ideas. **UNEQUALED BARGAINS** in imported and American woods, supplies, hard-to-find hardware. Send only 15c to cover postage and handling.

CRAFTSMAN WOOD SERVICE CO.
2729 S. Mary St., Dept. A-94, Chicago 8, Ill.

only **15¢**



NOW! SAVE 2/3 ON GENUINE ARMY AIR CORPS TYPE

SUN GLASSES!



BE
FIRST
TO GET
YOURS

LOWEST PRICE IN THE NATION!

For your own protection, get these army-proved Sun Glasses now. Use for driving, boating, fishing, farming and a hundred other outdoor uses!

FULLY GUARANTEED!

Your delight and satisfaction are guaranteed . . . test them at OUR RISK! Compare with any now being sold elsewhere for many times the low cost!

LOOK AT THESE FEATURES!

- Large Aviation Type for Men
- Smaller Size for Ladies
- Ophthalmic Lenses
- Pearloid Sweat Bar
- LEATHERETTE CASE INCLUDED

A & T WAR SURPLUS
2464 LINCOLN AVE. DEPT. PM
CHICAGO 14, ILL.

\$10.00 value
now \$2.88
PLUS POSTAGE
LIMITED
SUPPLY!

SEND NO MONEY!

Your name and address on post-card brings your pair—deposit only \$2.88 plus COD fees with postman. (To save COD fees, send only \$3.13 and we ship fully postpaid). WEAR FOR 5 DAYS AT OUR RISK!

BUILD YOUR OWN TILTING TABLE SAW!



- 21x27 in. table tilts full 45°
- 8 in. blade cuts from 0 to 2 1/2 in.
- Ball bearing arbor, precision machined, ready to run
- Self-aligning and indexed rip fence and miter gauge

SAVE
\$50
OR MORE

- Sturdy wood, steel, and aluminum construction
- No machining—build easily with hand tools
- GIL-BILT Step-by-Step Plans—simplified perspective drawings, full size patterns, 15 actual photographs. . . . \$ 1.00
- GIL-BILT Special Metal Parts Kit—includes Plans, ball bearing arbor, all other metal parts (less blade). . . . \$14.95
- Same Kit with 8" combination blade. . . . \$18.95

GILLIOM POWER TOOLS P. O. Box 1-B, Lambert Field St. Louis 21, Missouri

Only \$16.95 COMPLETE ALL-PURPOSE SPRAY GUN



for FLOCKING or SAND BLASTING
USES ONLY 25 LBS. AIR PRESSURE
The Blasto Spray Gun for either flocking or sand blasting. Operates off small air compressors, using only 25 to 30 pounds of air pressure. Over 101 uses around the home, shop, garage. A syphon-type gun. Uses standard mason jars for easy, simple replacement when changing colors and convenient for storage. An ideal spray gun for spraying smooth, velvet finish surfaces, sand blasting glass, cars, tools, wood designs. Made of Aluminum Alloy Casting, brass fittings, chrome molybdenum heat treated nozzle and air jet. Only \$16.95 complete with flock and ready to use. 5-Day Money Back Guarantee. Cash, or money orders postpaid in U.S.A. California orders add 2 1/2% Sales Tax. Or write for free information.

BLASTO SPRAY GUN MFG. Dept. PM-6, 7007 Haas Avenue Los Angeles 44, Calif.

11 Piece 1/4" SOCKET WRENCH SET



Ideal for repairing Carburetor, Refrigerator, Ignition Systems or Radio. Contains complete range of 11 sockets from 13/16 to 7/16, spintite handle and sliding tee handle, especially valuable for reaching countersunk nuts and bolts which ordinary wrenches cannot reach. \$2.00
We Pay Postage — No C.O.D.'s.
Send Cash, Check or Money Order.

INDUSTRIAL SUPPLY COMPANY | 312 EAST 33rd ST. NEW YORK 16, N. Y.



HANDY ANDY AIR COMPRESSOR

Heavy cast iron frame and cylinder, semi-steel piston, two heavy duty piston rings. Single cylinder piston type. Bore 2 1/4" x 2 1/4" stroke. Complete with tank, pop valve and gauge. Builds 120 lbs. pressure with a 1/2 hp motor. Well made, simple, efficient. \$17.50

Weight 20 lbs. Made to sell for \$29.50. Our price while supply lasts

FOB, Kansas City, Mo. Please no COD's.

MIDWEST SURPLUS SALES CO.
2531 INDIANA KANSAS CITY, MO.

GROBAN'S SURPLUS BARGAINS!

WAR SURPLUS BARGAIN SPECIAL!

Brand New — Genuine Westinghouse

AIR COMPRESSOR

2 Cylinder Piston Type

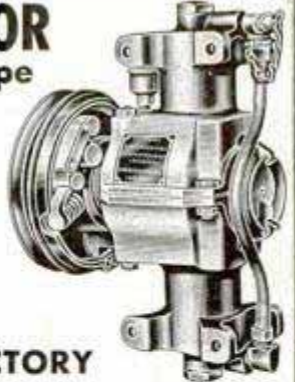

Ideal for:

- Paint Spraying
- Industrial Uses
- Tire Inflating
- Spraying Insecticide
- Operating Air Tools

FOR THE HOME

... FARM ... FACTORY

Designed for automotive truck or tractor mounting. Can be run off fan belt or power takeoff. Comes with automatic clutch. Can be installed for use on: farm trucks, jeeps, tractors, tire or garage service trucks, contractor or road building machinery, pneumatic devices, etc. Has 2 inch bore—1 1/2 inch stroke. Can be operated with 1/2 H.P. or more electric motor or equivalent portable gas engine.

Light weight, compact and versatile unit . . . delivers "oil free air" . . . simple in operation; requires minimum of maintenance; operates under all climatic conditions; suggested operating pressure 75 P.S.I.; equally efficient operation in either direction of rotation; approx. displacement 3.27 CFM at 600 RPM, 6.54 CFM displacement at 1200 RPM; Overall dimensions: width 9", height 11 7/8", depth 6 3/4"; approx. wt. 23 lbs.

A REAL BUY . . .
worth many times
this price

\$26.95

Send check or money order today.
SATISFACTION GUARANTEED.

F.O.B. CHICAGO

REGO REGULATORS

OXYGEN — MODEL 1601

INLET 967

BRAND NEW

UNDERWRITERS APPROVED

For the Workshop — Home —
Factory — Farm



Designed for precision, gas pressures; meet the heavy demands of cutting and welding in shops, ship and scrap yards, mills, etc. REGO REGULATORS deliver an ample supply of gases at constant, even pressures.

Manufactured by Bastian-Blessing Company. This highly dependable accurate instrument is modern in design—diaphragms are 2 3/8" in diameter; two brass gauges are each 2 1/2" in diameter; 0-400 P.S.I. and 0-3000 P.S.I. Ship, wt. 7 lbs.
ORIGINALLY WORTH MANY TIMES MORE

\$12.95

F.O.B. CHICAGO

GROBAN SUPPLY CO.
DEPT. PM-6, 1507 S. MICHIGAN AVE., CHICAGO 5, ILLINOIS



GRINDING WHEELS

Actually Worth \$50.00

A wonderful buy! 350 pieces incl. 35 ass't. Grinding and Cut-off wheels up to 10 inches diameter. 1 1/16 to 1 1/4" face, 1/8 to 3 in. holes. Ass't. grits—all brand new—Made by Norton, Carborundum, Macklin, Bay State, etc. Also included are 100 slotted disc cloths; 100 paper discs; 10 pencil rolls; 20 abrasive strips; 2 felt bobs; 2 felt wheels; 1 4" rag buff; 3 honing stones; 10 abrasive sleeves; 10 mounted stones, 1/8 and 1/4" shank; 2 mandrels; 2 rotary files, 1/4" shank; 50 abrasive discs; 2 72" abrasive belts; 5 9x11 abrasive sheets. Satisfaction Guaranteed.
350 Pieces — Ass't. sizes FOB Chicago — All for
Only \$6.95

GROBAN SUPPLY CO.
DEPT. PM-6, 1522 S. MICHIGAN AVE., CHICAGO 5, ILL.

NEW Electric SANDER



Only \$14.85
POSTPAID

Amazing MOTO-SANDER Saves Time - Saves Effort

Now Sanding is Fun! Dremel has developed an electric Sander for home or shop... so easy to handle that a child can use it. New, inexpensive "Moto-Sander" delivers 7,200 strokes a minute. (Short, rapid stroke frees dust from sandpaper... makes it last longer). **Moto-Sander** does a magically smooth job of sanding... gets into places other sanders can't reach. Rubber cushioned sanding pad measures 2 1/4" x 5 1/2". Cam-Type-Clamp paper holder permits changing sandpaper in seconds. **Moto-Sander** has only two moving parts... never needs oiling... weighs only 2 1/2 lbs. Stroke adjustment compensates for changes in voltage. Uses 110-120 volt A.C. (only). Gives no radio interference. Comes with 8 ft. (Underwriters' Approved) rubber cord plus 6 sheets assorted grade Garnet paper, plus 1/8" thick felt pad for wax polishing.

FINE FINISH - FAST!
Use **Moto-Sander** to get satin smooth finish on woodwork, stairways, doors, furniture; ideal for sanding boats, gun stocks or scale models. Just guide it. Uses #2/0 Garnet paper or finer. For speedy, effortless polishing of waxed furniture and other surfaces, use felt pad (furnished) in place of sanding paper. **Moto-Sander** is the lightest, most practical electric sander on the market—the only one of its kind.

MONEY-BACK GUARANTEE: If your dealer does not yet have **Moto-Sander**, send only \$14.85... we'll pay postage. Or send \$2 now, and pay postman balance plus postage. Money back if not delighted after 5 days' trial.

DREMEL MANUFACTURING CO.
Dept. 5A-118-F • Racine, Wis.

TRAILER BUILDERS' SUPPLIES!
TO BUILD, REPAIR OR MODERNIZE!
And save money. You must have our big Catalog. We are the largest and most complete trailer supply house in the States. Our new large 1948 catalog 10c; blue prints and building instructions, 25c.
NATIONAL TRAILER EQUIPMENT CO., 1007 N. Water St., Milwaukee 2, Wis.

SAY YOU SAW IT IN POPULAR MECHANICS

Brand New Govt. Surplus FIRE EXTINGUISHERS Save Lives — Business and Property



SAVE OVER \$25.00

Foam Type (Steel) 2 1/2 gallon Extinguishers. A recent government release now available for immediate delivery in original cartons.

SIMPLE TO HANDLE — EASY TO OPERATE
Fire can strike anywhere, quickly. Be prepared with this "Quick as a Flash" Fire Extinguisher. Perfect for use in homes, apartments, garages, hotels, stores, theatres, airports, filling stations, factories, warehouses, farms, ranches, etc. Manufactured by leading Fire Extinguisher Company. Comes complete with chemical charge and wall bracket.

MONEY BACK GUARANTEE: To be as represented or money refunded. **ORDER TODAY, NOW.** Supply limited. Never again such a value. Regular list on this type: \$37.00. A Real SAVINGS. Price FOB, K. C., Mo.

\$10.95

Underwriters Labeled

Send ck. or M.O. for Quick Delivery.
THOMAS EQUIPMENT CO. 2462 Grand Ave. VI. 3506
Kansas City, Mo.

A REAL PUMP BARGAIN WITH OR WITHOUT ELECTRIC MOTOR.



PUMP—Water capacity—10 gals./min. @ 50 lb. head, or oil—3 1/2 gals./min., 1000 psi Gerotor Type. Trouble-free continuous operation. Brand new. Tested by independent engineering concern for performance. Suitable for home, farm, shop, store, marine or aviation. A rare bargain. Will pump gas also.

ELECTRIC MOTOR—New, 1/3 HP. Capacitor Starting for heavy starting torque. designed for continuous duty, with Lifetime Ball Bearings, Dynamic balance, Precision-built, for 110-120V AC 60 cycles.

Pump with pulley only, Brand New. **\$15.95**
Each

Pump with Electric Motor, Brand New. **\$39.50**
Each

SURPLUS ASSETS CORP.
2315 W. OGDEN AVE. CHICAGO 8, ILL.

MARVELOUS! Waterless Hand Cleaner

USE NO WATER... Helps Smooth and Soften Rough Dry Skin

Dissolves: INK, GREASE, PAINT, Etc. • **MIRA-KLENE** • Leaves Hands Clean & Soft Contains No harsh chemicals

CLEANS AND HEALS 8 oz. Jar Only \$0.50 Postpaid
3 Jars Only \$1.25 Postpaid
12 Jars Only \$3.60 FOB Chicago

ORDER YOURS TODAY

AGENTS WANTED— Sorry No C.O.D.'s Please
ORIOLE CHEMICAL CORP'N, 2239 So. Michigan Ave., Chicago 16

CASTING REEL

No Fancy Gadgets! Just a Well Built Conventional Level Wind Fishing Reel!

Highly plated brass construction. Smooth click. Adjustable tension. Capacity 100 yds. 25 lb. test line. Money back guarantee. Send check or money order.

Direct Factory Sales Make This Price Possible
\$3.95
POSTPAID

Mohawk Products Co., 235 SARGENT ST., HARTFORD, CONN.

BAND SAW BLADES

• • • FOR FACTORY AND HOMEOWNERS • • •
One skip tooth band for most everything. Straight and Contour Cutting all woods, bakelite, brake lining, sand castings, rubber, lead, Zinc, carbon.

RUBBER BAND SAW TIRES
5'6" to 6'5" x 1/4 \$1.42 . . x 1/2 \$1.52
6'6" to 7'5" x 1/4 \$1.54 . . x 1/2 \$1.65
WE PREPARE THE POSTAGE

LASSEN SAW & SUPPLY
2125 Leland Ave. Chicago 25, Ill.

"Paint-it-Yourself" with **NU-ENAMEL**
ONE COAT COVERS NO BRUSH MARKS
NU-ENAMEL DEALERS EVERYWHERE

Print Your Own

Cards, stationery, circulars, tags, labels, photo and movie titles, advertising, etc. Save money. **Print for Others, Good Profit!** easy rules sent. Raised Printing like Engraving, too. Send dime for press samples, supply book, all details and advice on your needs. No obligation. **KELSEY INC., B-37, Meriden, Conn.**

POWER LAWN MOWER CHASSIS

Complete With Handle and Clutch, **LESS MOTOR.** Bright Red Enameled, many new, some demonstrators with less than 8 hrs. use. Easily converted to gas or electricity. Single spiral full 20" cutting blade, adjustable to various cutting heights. Supply limited—order today.

\$39.50
Descriptive Circular
WARWICK GUN SHOP DENBIGH, VA. F.O.B.

Double Chemical Cartridge PAINT RESPIRATOR Only \$1.95



Industrial painters' respirator at less than manufacturer's cost. War Surplus. Plenty of space for breathing. Price includes facelet and two extra valve discs. Also effective against low concentrations of creosote, gasoline, naphtha, kerosene, various grain dusts, etc. Extra Chemical Cartridges, 4 for \$1.20. Send check or M. O. Add 10% for Postage. Tested, B. of M. approved, nationally known respirator. Not a gadget.

VAN BRUNT SALES CO.
3018 VAN BRUNT KANSAS CITY, MO.

GENERAL ELECTRIC RT-1248 15-TUBE TRANSMITTER-RECEIVER

TERRIFIC POWER — (20 watts) on any two instantly selected, easily pre-adjusted frequencies from 435 to 500 Mc. Transmitter uses 5 tubes including a Western Electric 316 A as final. Receiver uses 10 tubes including 955's, as first detector and oscillator, and 3—7H7's as IF's, with 4 slug-tuned 40 Mc. IF transformers, plus a 7H7, 7EG's and 7F7's. In addition unit contains 8 relays designed to operate any sort of external equipment when actuated by a received signal from a similar set elsewhere. Originally designed for 12 volt operation, power supply is not included, as it is a cinch for any amateur to connect this unit for 110V AC, using any supply capable of 400V DC at 135 MA. The ideal unit for use in mobile

or stationary service in the Citizen's Radio Telephone Band where no license is necessary. Instructions and diagrams supplied for running the RT-1248 transmitter on either code or voice in AM or FM transmission or reception, for use as a mobile public address system, as on 80 to 110 Mc. FM broadcast receiver, as a Facsimile transmitter or receiver, as an amateur television transmitter or receiver, for remote control relay hookups, for Geiger-Mueller counter applications. It sells for only **\$29.95** or two for **\$53.90**. If desired for marine or mobile use, the dynamotor which will work on either 12 or 24V DC and supply all power for the set is only **\$15.00** additional.

PE-109 32-VOLT DIRECT CURRENT POWER PLANT

This power plant consists of a gasoline engine that is direct coupled to a 2000 watt 32 volt DC generator. This unit is ideal for use in locations that are not serviced by commercial power or to run many of the surplus items that require 32V DC for operation. The price of this power plant is only **\$58.95**. We can also supply a converter that will supply 110V AC from the above unit or from any 16-32V DC source for **\$12.95**.

(Due to the fact that the PE-109 comes to us sealed in heavy steel strapped govt. cases we are unable to determine whether the individual units are new or used or what the condition is if used, and consequently must sell them as is. In general, they represent a terrific bargain.)

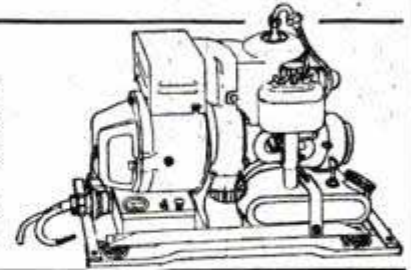

**GENERAL ELECTRIC
150 WATT TRANSMITTER**

COST THE GOVERNMENT \$1800.00

COST TO YOU BRAND NEW \$67.50!!!

This is the famous transmitter used in U.S. Army bombers and ground stations, during the war. Its design and construction have been proved in service, under all kinds of conditions, all over the world. The entire frequency range is covered by means of plug-in tuning units which are included. Each tuning unit has its own oscillator and power amplifier coils and condensers, and antenna tuning circuits—all designed to operate at top efficiency within its particular frequency range. Transmitter and accessories are finished in black crackle, and the milliammeter, voltmeter, and RF ammeter are mounted on the front panel. Here are the specifications: **FREQUENCY RANGE:** 200 to 500 KC and 1500 to 12,500 KC. (Will operate on 10 and 20 meter band with slight modification.) **OSCILLATOR:** Self-excited, thermo compensated, and hand calibrated. **POWER AMPLIFIER:** Neutralized class "C" stage, and equipped with antenna coupling circuit which matches practically any length antenna. **MODULATOR:** Class "B"—uses two 211 tubes. **POWER SUPPLY:** Supplied complete with dynamotor which furnishes 1000V at 350 MA. Complete instructions are furnished to operate set from 110V AC. **SIZE:** 21 1/2 x 23 x 9 1/4 inches. Total shipping weight 200 lbs., complete with all tubes, dynamotor power supply, seven tuning units, antenna tuning unit and the essential plugs.

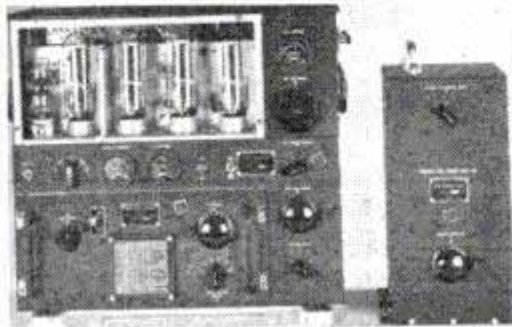

**1948 MODEL OUTBOARD MOTOR
at Dealer Wholesale Price!!**

Powerful deluxe twin cylinder outboard motor with automatic starter (no fumbling for a rope), a positive cooling unbreakable water pump, and an improved magneto for sensationally quick starts as well as smooth, efficient operation at slowest trolling speed or with the throttle wide open. Dozens of additional outstanding features are provided, such as corrosion resistant aluminum alloy castings, to protect the engine and give the unit a sleek, streamlined appearance; hardened alloy steel connecting rods with roller bearings; and a rugged, perfectly balanced crankshaft. Delivers a full 7.5 H.P.—52 lb., gross shipping weight including free steel storage stand—100 lb. For a limited time we are selling this motor, which is produced by the world's second largest maker of outboards to sell for more than \$30.00 above our price — for only **\$139.00**, FOB Buffalo.

Terrific Value — Portable Electric Drill

(Sold at less than established factory price so we cannot mention brand name)

Only **\$19.95** equipped with 1/4" Jacobs Geared Chuck and Key. Not an intermittent duty drill, but a full size rugged tool. Most convenient type switch, natural grip handle, and balance like a six shooter. Precision cut gears — turbine type cooling blower — extra long brushes. No stalling under heaviest pressure because of powerful 110 Volt AC-DC motor and multiple ball thrust bearing. Other bearings self-aligning lifetime-lubricated Chrysler Oilite type. Made for toughest year-in and year-out service in plant or on construction jobs. **Amazing perpetual factory guarantee** assures you of a lifetime of trouble-free use. **25% deposit on C.O.D.'s.** Full refund (you pay transportation) if not pleased with drill after trial.

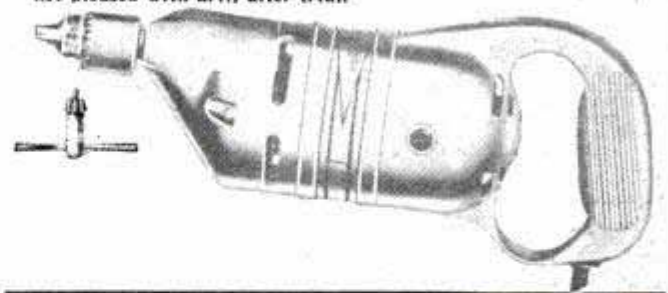

ALUMINUM GEAR BOX 18x8x7 that contains two powerful electric motors and two matched gear trains, 62 gears in all varying in size from 1/2 to 4 inches in diameter. This unit is readily converted to rotate a beam antenna or for any other similar use. **\$3.00**

AUTO RADIO DEALERS! ATTENTION!

Nationally advertised brand of 1948 car radio which will fit practically any car and every pocketbook. Six tube superhet with three gang condenser and 6 1/2" speaker. **\$32.20** for sample.

\$995

**TAKES
ALL THREE
BIG BARGAINS**

- 1. AUDIO AMPLIFIER** Undreamed of value. Uses 6V6's. Has 4 microphone inputs brought to jacks at rear panel. Various output impedances available at rear panel connections. Steel case with chrome handles. 9" long x 9" high x 6" deep. Tubes included. New in original carton. Shipping weight 20 lbs. **SUPER SPECIAL—\$4.95** while supply lasts.
- 2. RADIO HEADSETS** Latest supersensitive type with rubber earpieces. Every pair guaranteed perfect. **\$.59 per pair OR 3 PAIRS FOR \$1.00.**
- 3. HOME WORKSHOP AT BARGAIN PRICE** Accurate and precise 2 speed guaranteed hobby lathe, the essential machine for the home workshop. Sturdy enough for light production work or factory standby service, supplied with 56" of belt for connecting to any available electric motor or power take-off, such as on a jeep or tractor. Also included in this unbelievable offer are such accessories as a 3/8" drill chuck with specially hardened tool steel jaws, a 3/8" electric furnace high speed grinding wheel, a cotton buffing wheel with a large supply of buffing compound and a 4" steel wire scratch brush. Your cost **\$6.00**. Sole export agent. Distributor inquiries invited.

ORDER NOW — DON'T DELAY

Minimum order \$3.00 — All prices subject to change — 25% deposit with C.O.D. orders.

BUFFALO RADIO SUPPLY, 219-221 Genesee St., Dept. 5-M, BUFFALO 3, N. Y.

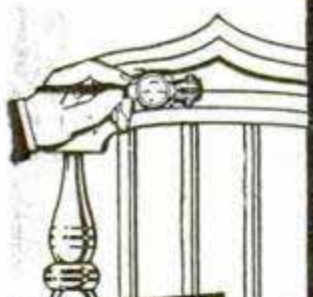

LOOK! 3-PIECE PAINT STRIPE SET

Only
\$1.00
for Set of 3

Each Tool Makes Different Thickness

Hobbyists! Painters! Home craftsmen! Here's the paint-stripping set you want—three different tools, each one making a different thickness of line—AND THE COMPLETE SET OF 3 PAINT-STRIPING TOOLS, ONLY

\$1.00! Yes, for only \$1.00 you get 3 separate tools—one for 1/8" lines, another for 1/16", and another for 1/32". Stripe lines with any paint, lacquer, or enamel—straight, circular, or wavy—to beautify furniture, toys, signs, autos, bicycles, walls, panels, etc. Make imitation tile. Use different colors. These paint-stripping tools are as easy to use as drawing with a pencil along straight edge. Everything complete. Nothing else to buy. Full simple instructions included.

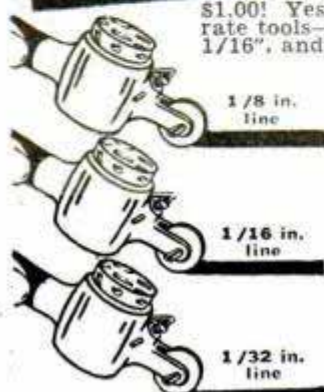

1/8 in.
line

1/16 in.
line

1/32 in.
line

SEND NO MONEY

Mail your name and address for 3-piece Paint-Stripe Set of tools. Pay postman only \$1.00 plus postage. Use 3 days. If not delighted, return set and money will be refunded. Order now.

STRADER MFG. CO.

259 Strader Ave., Dept. A-351

Cincinnati 26, Ohio

Announcing the NEW HURRICANE '48 Model PORTABLE ROUTER and Shaper

Motor: Universal, 110 volt AC-DC, 1 1/4 HP. Speed, 18,000 r.p.m. no load. Weight 11 1/4 lb., height 9 inches, diameter 4 inches. Switch conveniently located on body of motor with plug-in cable.

Cooling: Air cooled, turbine mounted.

Bearings: New Departure sealed ball bearings.

Construction: Outer Housing chrome plated.

Template Guide: One 5/8" furnished with machine.

Gauges: Straight and circular of aluminum.

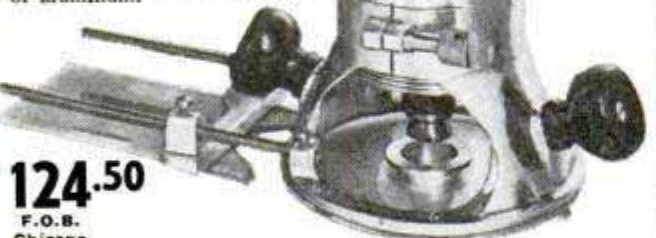

124.50

F.O.B.
Chicago

A beautifully constructed precision machine for professional use. ORDER NOW at your dealer or direct. Firms not rated. 25% deposit required. Bal. C.O.D.

HURRICANE MACHINE WORKS

6316 WENTWORTH AVE.

CHICAGO 21, ILLINOIS

NEW EASY WAY TO MAKE MONEY at HOME

Your cost only 5c
You get \$5.00.

Full or spare time.

It's easy to Bronze Baby Shoes. Business still in infancy. Get in on ground floor and skim cream of profit from rich and never-ending market. No experience needed. Learn in one week. Income up to \$1,000 a month full time—\$50 to \$75 weekly in spare time. We furnish complete kit and full instructions. Simple as A B C to become an expert.



FREE FACTS. Write today. Don't send a penny. Just name and address in letter or post card. Be the first in your territory to reap rewards waiting. Costs only 5c to bronze shoes. Sell for \$5.00! This is too good to miss. Get facts today. Write to

KIKTAVI COMPANY

Dept. 27, 8620 So. Ruthelen

Los Angeles 44, California

BUILD YOUR OWN FAN

One-piece cast aluminum propellers for cooling and ventilating.



Size Inches	2 Blade	3 Blade	3 Blade	3 Blade	3 Blade	Bore Inches
15	\$3.00	\$4.00	\$2.50	\$3.00	1/2	5/8, 3/4
18	3.75	4.50	3.00	3.50	1/2	5/8, 3/4
20	4.00	5.00	3.25	4.00	1/2	5/8, 3/4
24	4.50	5.50	4.00	4.50	1/2	5/8, 3/4

Let us give you our prices on your aluminum castings.

Write for pamphlet on larger fan blades, wire guards, fan bases, shutters, pillow blocks, exhaust fan frames, etc., shipped prepaid if money accompanies order. Dealers write for discount.

KLOPPENBORG ALUMINUM FDY., Dept. PM68, Davenport, Iowa

TRAILER BUILDERS!

BUILD or BUY... SPECIFY

• Torq-Less Axles • Bull Dog Hitches and Parking Jacks, Safety-Engineered by HAMMER BLOW TOOL COMPANY Dept. 123 Wausau, Wisconsin

Send for FREE Catalog

MOTOR and GENERATOR

G.E. #5AM31NJ9A

AMPLIDYNE

Use as 1/2 Hp., 24/32 vdc. motor or 0-60 vdc., 9 amp. dc generator. Complete instructions furnished. Excellent condition. Write for free illustrated list.



\$2.95
F.O.B.
Everett, Wash.

SATISFACTION GUARANTEED OR YOUR MONEY BACK
DICK ROSE—ERECO, 2912 HEWITT AVE., EVERETT 21, WASH.

DRAINS CELLARS, WASH TRAYS CIRCULATES OIL

Pumps 1800 GPH 300 gal. 30' high, use 1/4 to 1/2 HP motor. Will not clog. **\$6.50**



Postpaid if cash with order. (Add 50c for west of the Mississippi.)

Thousands in use since 1936

LABAWCO PUMPS, BELLE MEAD 7, N. J.

ARMY SURPLUS A-C PLANTS

Nation's greatest bargains in 110-volt, 60-cycle, 2500 and 600-watt plants. Also plants without engines. FREE CATALOG!

LECO ENGINEERING CO., Box 908-PM6, Lincoln, Nebr.

ARMATURES

Rebuilt and guaranteed like new, factory methods only used in our plant. Money back guarantee. Send us your old armature. Ford, Chevrolet, Plymouth, and all popular makes of cars 1937 and down... \$3.35 ea. 1938 to 1948... \$4.45

OTHER ARMATURES AT CORRESPONDINGLY LOW PRICES

DELTA ARMATURE CO.

1400 W. 8 Mile Rd.

Ferndale, Mich.

Amazing 2 for 1 Offer!

Paint Your Car with LUSTR-WIPE

THE MIRACLE NEW AUTO ENAMEL THAT
WIPES ON WITH A POWDER PUFF!

Fix Body and Fenders WITH DURO AUTO BODY SOLDER AT NO EXTRA COST!

BOTH
 LUSTR-WIPE New
 Auto Enamel and
 DURO Auto Body Solder
AT ONE PRICE
 only \$ **3.95**
 Applicator
 Furnished

**SEND
 NO
 MONEY
 MAIL
 COUPON
 NOW**



**ONE QUART OF
 LUSTR-WIPE
 PAINTS YOUR ENTIRE CAR
 Anyone Can Do a Beautiful Job**

LUSTR-WIPE is different than any auto enamel you ever tried. WORKS LIKE MAGIC! Almost ANYONE can paint his own car and get a high gloss finish that looks like a professional spray job. JUST WIPE IT ON with a powder puff. NO BRUSH, NO SPRAY, NO MASKING. NO STREAKS, NO LAPMARKS. Takes about an hour to get a brilliant "factory-finish." Dries dust-free in an hour. Goes over any enamel or lacquer.

- 10 POPULAR COLORS**
- BLACK \$3.95 Qt.
 - GREY (Gunmetal-Dark or Air Wing-Light) 3.95 Qt.
 - GREEN (Browster Dark or Jewel-Light) 3.95 Qt.
 - BLUE Washington-Dark or Monticello-Light 3.95 Qt.
 - RED or MAROON or SUN BEIGE (tan) 3.95 Qt.

- NO BRUSHING**
- NO SPRAYING**
- NO MASKING**
- NO STREAKS**

SEND NO MONEY! ORDER TODAY!
 Mail penny postcard. Then pay postman for LUSTR-WIPE plus postal charges. DURO Auto Body Solder will be included AT NO EXTRA COST. Or if you send money with order, WE pay postage.

GUARANTEED FOR 2 YEARS
 Not to crack, chip, peel or fade if simple directions are followed. LUSTR-WIPE is NOT a wax or polish but a marvelous Auto Enamel.

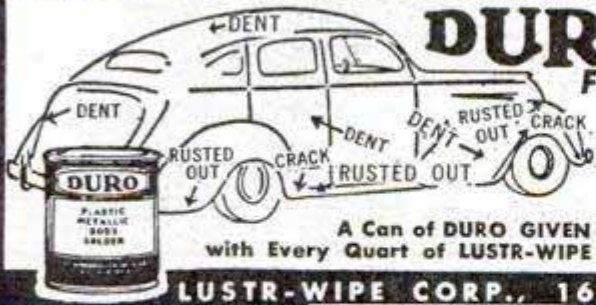

DURO PLASTIC METAL BODY SOLDER

FIXES FENDERS AND BODIES LIKE NEW

DURO is foolproof—EASY TO USE. Fixes rust spots, cracked and dented fenders, body dents and rusted out holes QUICK AND EASY. Just apply right out of the can with putty-knife. Dries to metallic hardness overnight. Can be filed down smooth, sanded to the same finish as metal and painted. You never know it's there.

**Fenders
 Rusted
 Out?**

**A Can of DURO GIVEN
 with Every Quart of LUSTR-WIPE**

LUSTR-WIPE CORP., 166 W. WASHINGTON ST., CHICAGO 2, ILL.

**AGENTS AND
 DISTRIBUTORS
 WANTED**
 Write for tried and tested money-making plan. Also our special quantity prices.

LUSTR-WIPE CORP., 166 W. WASHINGTON, DEPT. 62, CHICAGO 2, ILL.
 Please send me _____ qts. of LUSTR-WIPE Auto Enamel at \$3.95 Qt.
 With each quart include a can of DURO Auto Body Solder AT NO EXTRA COST.

COLORS _____ **NAME** _____
 Send Postpaid, Full Payment of \$ _____ (Check or M.O.) Enclosed **ADDRESS** _____
 Send C. O. D. plus Postal Charges **CITY** _____ **ZONE** _____ **STATE** _____
 Send Information for Agents

Compare These Prices

If We Haven't
Got It . . .
No One Has



JEEP PARTS

Write Today for Your Special Needs

Foreign or Domestic

WILLYS No.	FORD No.	DESCRIPTION	PRICE EA.
A7498	GPW6038A	Motor mount insulator	\$.50
116110	GPW6149	Piston rings (standard)	3.75
638121	GPW6303A	Crankshafts	22.50
A7238	GPW6675	Oil pan assembly	2.50
A638879	GPW6710	Oil pan gasket	.15
A1537	GPW18387	Valve gasket sets	1.25
638992	GPW7563	Clutch pressure plate, Exchange \$8.40. Outright	9.50
A7833	GPW18359B	Clutch release & pressure kit used to repair pressure plates	1.50
A1268	GPW9280	Fuel gauge Auto Light No. 10313A	1.50
A8188	GPW10883	Heat Indicator Auto Light No. 10312A	3.65
A1573	GPW11350	Bendix drive starter	2.69
A1424	GPW12000	Ignition coils—IG—4070L	3.75
A1658	GPW12200	Rotors—IG1657	.50
A1631	GPW12300	Condensers IGW3139	.50
A1033	GPW13007	Seal beam units (standard) Mazda—4031	1.65
A1064	GP13405	Tail and stop light	2.25
A1687	GPW18354	Distributor points IGP-3028FS	.70
	GPW18361	Wiring harness complete	4.00
639992	GPW8501	Water pumps (reprocessed). Exchange \$4.50. Outright	5.50
A8323	GPW9320	Fuel pumps	4.35
A998	GP7743	Intermediate shaft for transfer case	1.25
A7445	GPW18317	Transfer case oil seal set	1.25
A1145	GPW7000	Complete transmission (reprocessed). Exchange \$65.00. Outright	72.50
A5553	GPW7015	Main drive gear and bearing assembly	9.75
A5554	GPW7017	Transmission main drive gear	4.25
638948	GPW7111	Countershaft	.60
A739	GPW7113	Cluster gear	9.75
A1433	GPW18397	Universal joint journal Service package	3.25
A6029	GPW3001	Complete front ends (reprocessed)	82.50
A6030	GPW3207	Front axle shaft—long	17.50
A1708	GPW3279	Tie rod assembly with both ends	3.00
A1704	GPW3280	Tie rod assembly with both ends	3.00
A1544	GPW18365-B	Front axle gasket set (less oil seals)	.35
116551	GP2021	Brake lining set (set of 4 wheels)	3.50
A5500	GPW4000	Complete rear end (reprocessed)	70.00
A788	GPW4207	Complete differential	19.95
A6743	GPW18389	Spider gears and differential repair kit	3.25
A8250	GPW3304	Steering connecting rod	1.50
A593	GPW5182	Pintle Hooks	3.50
A612	GPW5311	Spring—front—new	4.50
A614	GPW5560	Springs—rear—new	4.95
A1215	GPW8100A	Pressure radiator caps	.60
		Speedometer cables, complete 1267, GPW-17255	.35
A2909		Top (good used—Summer)	12.50
Trico—SP—2467X		Dual windshield wiper kits with 2 motors. Complete	5.45

All Exchanges Must be Shipped to Us Prepaid
25% Deposit with order . . . Balance C.O.D. F.O.B. Chicago

World's Largest Stock of Jeep Parts!

BERG TRUCK & PARTS CO.
1608 S. WABASH AVE. • CHICAGO

SAY YOU SAW IT IN POPULAR MECHANICS

KAYAKS

U-MAK-IT BOATS

Easy to Build

Cut-To-Fit for Quick Assembly. Everything Complete plus Illustrated Instructions. No Experience Necessary. Simple as A. B. C.

25¢ COIN FOR ALL THREE

AQUAMOBILE V-18

V-23 CRUISER

KAYAKS
ROWBOATS
DINGHIES
INBOARDS
OUTBOARDS
RUNABOUTS

SEND 25¢ POSTAGE (COIN) TODAY FOR 3 MONEY SAVING ILLUS. CATALOGS Showing all '48 Models (marine plywood) & construction details.

KAYAK BOAT CO. 703 P. WHITTIER ST. NEW YORK 59, N. Y.

HIGH PRESSURE HYDRAULIC PUMP

FOR HOME, SHOP AND FARM USE

Genuine Vickers constant displacement high pressure pump. Use it for any type of liquid pumping job. Will pump 400 gal. per hour at 3750 R.P.M. Precision piston type design provides 1000 lbs. per square inch pressure. Self priming. Standard thread 3/8 inch intake and discharge ports. With 3/8 inch splined shaft — just add pulley and power and you're ready to go.

HAS HUNDREDS OF USES

These pumps are brand new. Original acquisition cost approx. \$100.00. Can also be used as hydraulic motor; for rams, opening doors, hydraulic lifts, etc.—also for any liquid transporting job. War surplus, but brand new. Shp. wgt. 7 lbs. Send check or money order. Satisfaction guaranteed. Each only.

\$9.95

SOUTHWEST AERO SUPPLY, Dept. PM6
Drawer 488 South Houston, Texas.

E-Z THREAD QUICK CHANGE GEAR BOX

To fit SOUTH BEND 9", LOGAN 9" and 10", POWR-KRAFT, CLAUSING and SHELDON LATHES. Will cut 78 threads. Aluminum casting with fourteen Torrington needle bearings, heat treated shafts and cut steel gears. Easily installed. Special 30 day offer. Send for literature.

MONGE MACHINE SHOP
NORTH CHICAGO, ILL.

WRITE NOW FOR FREE CATALOG SHEETS

THE FOSTER LINE

POWER TOOLS

FOSTER MFG. CO., 1 KINSEY AVE., BUFFALO 17, N. Y.

BUILD YOUR POWER TOOLS

WITH OUR GUARANTEED INDUSTRIAL POLY BALL BEARING ARBORS

New Departure Self Lubricating Bearings 10,000 R.P.M.

(No extra charge for left hand threads)

B33—\$4.95 PP. C4—1/2x12 1/2 spindle, housing 2x8 \$7.95 PP.
5/8 x 4 1/2 Spindle C5—5/8x12 1/2 spindle, housing 2x8, \$8.25 PP.
B15 Plain Spindle C6—3/4x12 1/2 spindle, housing 2 1/4x8, \$9.25 PP.
D8—1x17 1/2 spindle, housing 2 5/8x11 \$17.00 PP.
— 1 INCH BETWEEN WASHER AND COLLAR

SHAPER ARBORS 3 inches between collars, C4-1/2 \$14.25, C5-5/8 \$14.25, C6-3/4 \$15.25, D8-1 \$23.00, B25—1 1/2x2 1/2 cap, flange mount \$5.50.
SPECIAL SAW ARBOR LENGTHS for 1/2, 5/8, 3/4, add \$1.50.
PILLOW BLOCKS—Ball Bearing, 1/2 \$3.50, 3/8 \$3.50, 3/4 \$4.25.

POLY PRODUCTS, 2032-A E. Walnut, Pasadena 8, Calif.

UP TO
SAVE 85%

in WAR SURPLUS...SENSATIONAL VALUES
at "GADGETEER'S HEAVEN"
IN MANY ITEMS WE HAVE
THE WORLD'S LARGEST SUPPLY

NEW HYDRAULIC CYLINDERS, VALVES, PUMPS, FITTINGS, HOSE & TANKS



51 sizes & types.
World's Largest Supply
1001 Labor Saving Adaptations for pulling, pushing, lifting operations. Finest precision workmanship and materials. Liquid and or air operation, developing terrific power.

20,000 Available WRITE FOR CATALOGUE
PRICED TO SELL AT 15% GOV'T. COST.

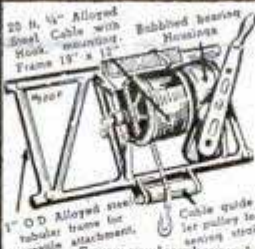

WINCH HOIST

now equipped with mounting frame, handle, cable, etc. complete. Thousands of Satisfied Users! Hundreds have written, telling us it's the most wonderful tool in the world!
Capacity 2500 lbs. 20-1 ratio
Bronze Worm Gear
Ideal for Garages, Truck loading, Machine Shops, Boat Builders, etc.
Our Price **\$15.59**

PNEUMATIC AND AIR TOOLS

10,000 in various popular makes, sizes, types, Cleco, Aro, Ingersoll Rand, Chicago, Pneumatic, Buckeys, etc.

RIVET
#180
#181 Pistol

GUNS
Pistol & Goose-neck Type
101 Use, Chipping, Drilling, Hammering, Breaking cement and auto body work.

Chicago Pneumatic, Cleco, Ingersoll Rand
E3, E2, 3X, 2X, OY
\$55 Value
\$8.95

#188 PNEUMATIC SQUEEZER \$80 Value #189 SQUEEZER **\$15.95**

PUMPS

HYDRAULIC, VACUUM, AIR
For every purpose at 15% of Value.
P-1 Hydraulic Penco Type
Positive displacement gear type.
Capacity: 1 gal. per min. at 1500 R. P. M. at 1500 P. S. I.
Operating speed: 3750 R. P. M. Intermittent maximum 4500 R. P. M. Rotation either direction with slight adjustment.

P-4 VICKERS
Positive displacement angle piston type.
HYDRAULIC
Capacity: 4 gal. per min. at 3000 R. P. M. at 1500 P. S. I.
Operating Speed: 3750 R. P. M. Intermittent maximum 4500 R. P. M. Rotation either direction with slight adjustment.

PV-1
May be used as air or fuel pump for pressure or vacuum.
Will pump 7 1/2 quils. oil at 300 R. P. M. Builds air pressure 20 lbs. per sq. in. at 1500 R.P.M. Vacuum draws 25 in. of mercury at 1750 R. P. M.

ROMECH FUEL
800 GPH at 30 PSI can also be used as hydraulic for 4 GPM at 400 PSI or for Vacuum drawing 15 in. mercury at 1500 RPM.

New Electric Motors
#500 new 1/2 H.P. 27 Volt D. C. 24 Volt A. C. This motor can be readily adapted to 110 A. C. by the simple method of rearranging armature brush leads. We furnish free diagram of instructions with each order. A Sensational Value @ **\$5.95**

#502 - 2 H.P., 24 V.D.C.M. used, **\$8.95**

Just received new shipment of that popular 1000 lb. pressure COMPRESSOR, complete with 1/2 H. P., 27 V. D. C. Motor, Tank and Fittings. While they last at the old **\$17.95** ea.

HOBBYISTS!
An Unequaled Value!
GADGET MIX
Rivets, spacers, Clamps, bolts, nuts, Radio parts, gears, etc.

A gold mine... 5 lbs. **\$1.19**

BEARING MIX
Needle, ball and roller bearings in excellent assortment. Sizes from 1/2" to 2".
#170 Introducing this treasure chest assortment of 75 Bearings at **\$2.95**

SPRING MIX
Torsion, compression and tension springs. Assorted sizes. #206
2 lbs. **89c**
A treasure chest for emergency!

Here's a Real "Lite Special"

Farm, Auto, New U. S. Navy Portable Pistol Grip. Sealed Beam, 12v. Search Spot, or Emergency, Light - featherweight Gov. Cost our price **\$2.95**
3 Extra fillers - Red, Green & Amber 93c Set

NEW FLEXIBLE GOOSENECK LAMP
110 V. A. C. 13 ft. wire with socket, switch and plug. In mounting bracket suitable for home or workshop. Wire alone worth our price of **99c** each.

BATTERIES
NEW! FULL STRENGTH FOR PORTABLE RADIOS, SIGNAL LAMPS, BOATS, ELECTRIC TRAINS, ETC.
#516 9 Volt 8 1/2" x 6 x 4 in. **79c**
These batteries are especially suited to portable radios.
#517 6 7/8" x 1 1/2" Volt Battery **69c**
#515 90 x 1 1/2" Volt **69c**

VALUABLE GEARS BARGAINS!
8 to 1 ratio, spindle drive **#110 \$2.98**
8 to 1 with screw shaft **#111 \$4.98**
85 to 1 (can be used for radio, antenna, etc.) **#112 \$3.95**
#G-11 10-1 gear ratio **\$3.95**
2 to 1 ratio 90° right angle **#113 \$4.95**
10 tooth bevel steel boxed gear **\$4.95**
113a 6 to 1 ratio 90° right angle **\$4.95**

Flexible Gear Shafts With End Drives
115 - 30" **69c** ea.
115a - 60" **99c** ea.
Radio tuning shafts that can be used as flex gear drives **#115a 12 ft. 1/2" nut -15 tooth internal spline \$1.95** ea.
#115b 25 ft. 1/2" nut 12 tooth with internal spline \$4.25

NEW PRESSURE TANKS
Stainless steel - Shatter proof. Rustless. 10,000 available in 4 different sizes, 5000 near.
G-1 12 1/2" x 24 inches - 3100 Cu. in. capacity **\$4.75**
23 cu. in. **\$2.49**
F-1 - 12" x 18" 1000 Cu. in. Capacity **\$3.95**
F-2 6 x 45 in. - 1000 Cu. in. capacity **\$3.95**
14 cu. in.
Perfect portable air tank to carry in car or trailer. Ideal for painting, cooking, spraying, ocean buoy.

4 INCH PAINTERS DUSTER BRUSH Only **59c** ea.
PEXTO PLIERS Side cutting beveled head a \$3.50 Value Only **\$1.79**

PLASTIC MALLET
11/2" diam. with 2" dia. x 4 1/2" head, 12" handle. For soft metal or plastic work where line non-marking or tapping is desired. A \$2.50 Value for Only **79c** ea.
METAL SNIPS Compound action. Hard steel blades. Expansion spring. Locking device. Right Hand and Left Hand **\$2.59**

DC GENERATOR 140 AMP Direct Current Generator, especially suited for adaptation to homemade welding unit. A fast moving item at **\$15.95**

R-1 GENERATOR 300 AMPS. **\$29.50** ea.
Holtzer INVERTER
750 Volts-Amperes
24 Volts - DC
36 Amperes
in. 26 Volts - 400 Cycle - Single Phase
250 Volts - Amperes - 40% P. F.
Out 115 Volts - 400 Cycle - Single Phase
500 Volts - Amperes - 90% P. F.
Type MG-149 **\$9.75** each

Electric GYRO PILOT Assembly Part 2 solenoids for reverse and forward motor control. 2 solenoids throw clutch to engage drive. With brake assembly. Can be used as boat rudder control, converted for lathe tapping and slow speed motor tool. Wt. 29 lbs. Finest precision workmanship. Cost 1000's **\$8.95** ea. Our Price **\$8.95** ea. #512a smaller edition but as complete weighing 11 lbs. **\$4.95**

JEEP CANS
Used but good condition, non-leak.
5 gal. gas or oil, self-locking screw cup type 18" x 6 1/2" x 13" Wide **\$1.19** ea.
In lots of 5 **\$1.09** ea.
25 or more **\$1.05** ea.

Self locking, flexible screw spouts with brass filter at end. 1" L.D. x 16" lg. **39c**

DC GENERATOR 140 AMP Direct Current Generator, especially suited for adaptation to homemade welding unit. A fast moving item at **\$15.95**

R-1 GENERATOR 300 AMPS. **\$29.50** ea.
Holtzer INVERTER
750 Volts-Amperes
24 Volts - DC
36 Amperes
in. 26 Volts - 400 Cycle - Single Phase
250 Volts - Amperes - 40% P. F.
Out 115 Volts - 400 Cycle - Single Phase
500 Volts - Amperes - 90% P. F.
Type MG-149 **\$9.75** each

4 INCH PAINTERS DUSTER BRUSH Only **59c** ea.
PEXTO PLIERS Side cutting beveled head a \$3.50 Value Only **\$1.79**

PLASTIC MALLET
11/2" diam. with 2" dia. x 4 1/2" head, 12" handle. For soft metal or plastic work where line non-marking or tapping is desired. A \$2.50 Value for Only **79c** ea.
METAL SNIPS Compound action. Hard steel blades. Expansion spring. Locking device. Right Hand and Left Hand **\$2.59**

NEW PRESSURE TANKS
Stainless steel - Shatter proof. Rustless. 10,000 available in 4 different sizes, 5000 near.
G-1 12 1/2" x 24 inches - 3100 Cu. in. capacity **\$4.75**
23 cu. in. **\$2.49**
F-1 - 12" x 18" 1000 Cu. in. Capacity **\$3.95**
F-2 6 x 45 in. - 1000 Cu. in. capacity **\$3.95**
14 cu. in.
Perfect portable air tank to carry in car or trailer. Ideal for painting, cooking, spraying, ocean buoy.

4 INCH PAINTERS DUSTER BRUSH Only **59c** ea.
PEXTO PLIERS Side cutting beveled head a \$3.50 Value Only **\$1.79**

PLASTIC MALLET
11/2" diam. with 2" dia. x 4 1/2" head, 12" handle. For soft metal or plastic work where line non-marking or tapping is desired. A \$2.50 Value for Only **79c** ea.
METAL SNIPS Compound action. Hard steel blades. Expansion spring. Locking device. Right Hand and Left Hand **\$2.59**

PLASTIC PARALLEL STRAIGHT EDGE with knobs & rubber pads for non slippage on each section. A must for navigators, mechanics, draftsmen, Engineers... You've never seen 'em at **97c** ea.

AIR DRILLS OR MOTOR SPECIAL
with 1/4" JCB Chuck Straight **\$12.95**

PNEUMATIC ANGLE DRILL
With Terry Adapter ea. **\$12.50**

CHI. PNU. IMPACT WRENCH
Model 337r 3 8" sq. dr. fwd. & revrs. 6 spd. cntnl. **\$17.50**

HIGH PRESSURE OXYGEN BOTTLE
New. Will hold up to 3,000 lbs. PSI with Co2 used as tire inflator or fire extinguisher, with oxygen for sick room or deep-water diving, etc. Completely equipped with brass valve, 3/8" hose, dial gauge, & canvas bag **\$1.95** ea.

FIRE EXTINGUISHER Kiddie Lux Co2 Type. Built to Gov't spec. 2 1/2 lb. wirebound shatterproof heavy case 20" x 4". Trigger controlled with horn. Fully recharged. 47B Type **\$30.00** value #81A **\$11.75**
2 1/2 lb. CO2 Type **\$22.50** value #82 **\$8.75**
3 lb. Chod. CO2 with Hose **\$60.00** value #83 **\$24.50**
15 lb. Chod. CO2 with beam. **\$80.00** Value #805 **\$27.50**
indispensable for small or large planes, trucks, auto, home, factories.

FILES NEW NICHOLSON & KEARNEY & FOOTE CO.
12" Amer. Std. Flat 2nd cut dbl. cut sq. 49c ea.
14" Amer. Std. Mill type, bastard single cut. sq. edge, temp. res. shd. tang new **69c** ea.

AIRCRAFT CABLE
Alloyed steel, rust resistant, 3/16" dia 18' ft. long, with tumbuckle ends. **99c**
On reels in any length **9c** ea.
1/16" 3c ft. 5/32" 5c ft.
3/32" 4c ft. 3/16" 6c ft.
1/8" 4 1/2c ft. 9/32" 8c ft.

RUBBER GOODS
NEOPRENE SHEET RUBBER
Thick. Approx. Price per sq. yd.
#325 .020" 1/64 36" **.75**
#326 .037" 1/32 36" **1.00**
#327 .064" 1/16 36" **1.75**
#329 .125" 1/8" 46" **\$4.75**
Item #329 is laminated rubber sheet with cloth center. Flexible but very fine for dry, wear.

ORDER DIRECT FROM THIS AD All sales final. Make remittances by money-order, bank draft or personal check. Purchase orders acceptable from D & B firms. All quotations F. O. B. Los Angeles.
FREE LARGE ILLUSTRATED CATALOGUE Send 1/2 deposit with C. O. D. orders. Also Complete Aircraft Supplies

PALLEY SUPPLY CO. THE LARGEST FIRM OF ITS TYPE IN THE WORLD DEPT. P. M. 68 — 6321 SAN FERNANDO RD. GLENDALE 1, CALIFORNIA



THE
BASIC
SHOP TOOL

A Few of the Many
Operations You Can Perform



TURNING

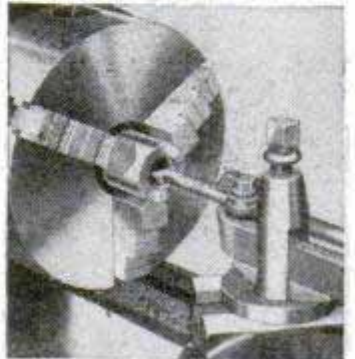

BORING

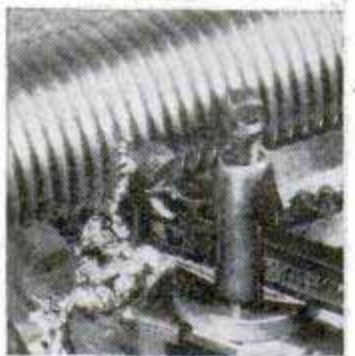

THREADING



FACING

9" x 3' Model C Bench Lathe—\$171.60
complete with 1/4 h. p. motor and drum switch

9" SOUTH BEND LATHE

This South Bend 9" Precision Lathe is the basic tool for your shop. It enables you to perform accurately the same full range of operations done on South Bend Lathes in industry. Also, operations ordinarily performed on other machine tools are made possible through the use of efficient attachments. You get more for your money in a South Bend 9" Lathe.

Write for Catalog 9-F or see local distributor—you will find his name under "Machine Tools" or "Lathes" in your classified telephone directory.

NEW 14" DRILL PRESS — a ruggedly built tool unsurpassed for accuracy and dependability. Prices start at \$98.00, f.o.b. factory.



SOUTH BEND LATHE WORKS

Building Better Tools Since 1906

455 EAST MADISON STREET, SOUTH BEND 22, INDIANA



MILLING



GRINDING

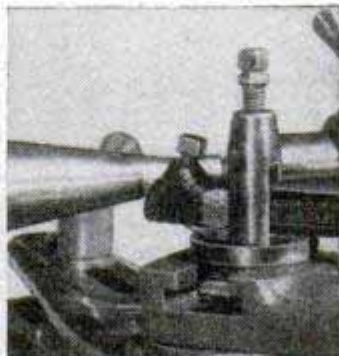

TAPER TURNING

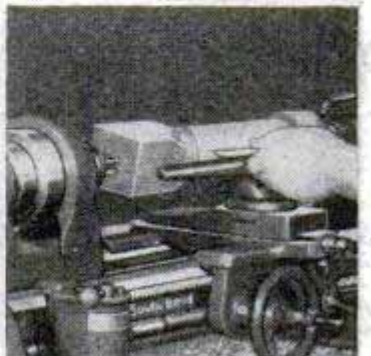

WOOD TURNING

Printed by Popular Mechanics Company, Chicago, Ill., U. S. A.

Helpful house painting hints



Before painting, nail down all loose boards, siding. Fill nail holes with putty, and let dry thoroughly before painting. Professional painters find that white lead putty gives the best results.

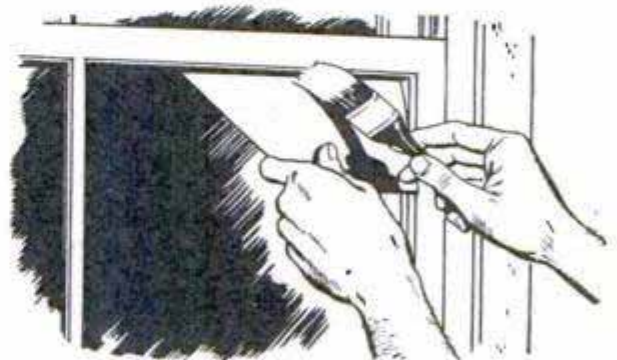

When painting window frames, use the correct technique. Paint sash bars first, then frames, next casings, and last the sill and apron. A shield cut out of tin, or heavy cardboard, will speed the painting.



For house painting, there's no better paint than white lead. As shown in this microphoto, white lead pigment *combines chemically* with the linseed oil vehicle. The chemical reaction helps to form a durable, *elastic* paint coat that won't get brittle, crack or scale.



And now white lead paint comes all ready to use! Eagle RTU is factory-mixed to perfect painting consistency. You just open, stir and apply. It brushes evenly and easily, making a smooth, tough coat of *whiter* white that stays white *longer* because it's pure white lead.

Eagle RTU makes any exterior paint job easier

Yes, it's true. Now you can get famed, durable, beautiful white lead paint that's all ready to use. Eagle RTU is *pure* carbonate of white lead, in *pure* linseed oil. It's carefully formulated and mixed for instant, easy use. Eagle RTU has the opacity, covering power and endurance qualities that only pure white lead paint gives—*plus* the convenience of being ready-mixed.

It's made by the Eagle-Picher Company, makers of quality white lead paint since 1843. Two forms: Primer Sealer, Outside White Finish Coat. Quarts, one, two, and five gallon cans.



EAGLE-PICHER



FREE

Hints on House Painting for Homeowners.

Eagle-Picher, Cincinnati 1, Ohio

Dear Sirs: Please send me a copy of your booklet, "Helpful Hints on House Painting."

Name.....

Address.....

.....



VALIANT TUCKAWAY ENSEMBL
 Pen, \$12.50—Pencil, \$5.00
 Complete set, \$17.50; no fed. tax

*Only Sheaffer's Finest
 Bear This  Mark of
 Distinction*

LOOK FOR THE WHITE DOT!

As graduation, wedding or anniversary gifts, (or to treasure as your own, for that matter) Sheaffer's writing instruments get a warm and lasting welcome. Their functional beauty, their writing performance and their inherent quality engender intense pride of possession. You readily can identify Sheaffer's finest writing in-

struments by the White Dot—a Mark of Distinction found on no others. And if you'll make comparisons, you'll conclude, we think, that Sheaffer's finest are the world's finest. W. A. Sheaffer Pen Company, Fort Madison, Iowa—Malton, Ontario, Canada.

Listen Every Sunday to SHEAFFER'S PARADE with Eddy Howard—NBC Network: 3 P.M. Eastern Daylight Time—
 2 P.M. Eastern Standard Time

Sheaffer Pens, \$3.50 up; Sets, \$6.50 up; Desk Sets, \$10.00 up.

SHEAFFER'S