

ANC



POPULAR MECHANICS

MAGAZINE

WRITTEN SO YOU CAN UNDERSTAND IT

REG. U.S. PAT. OFF.

REG. U.S. PAT. OFF.

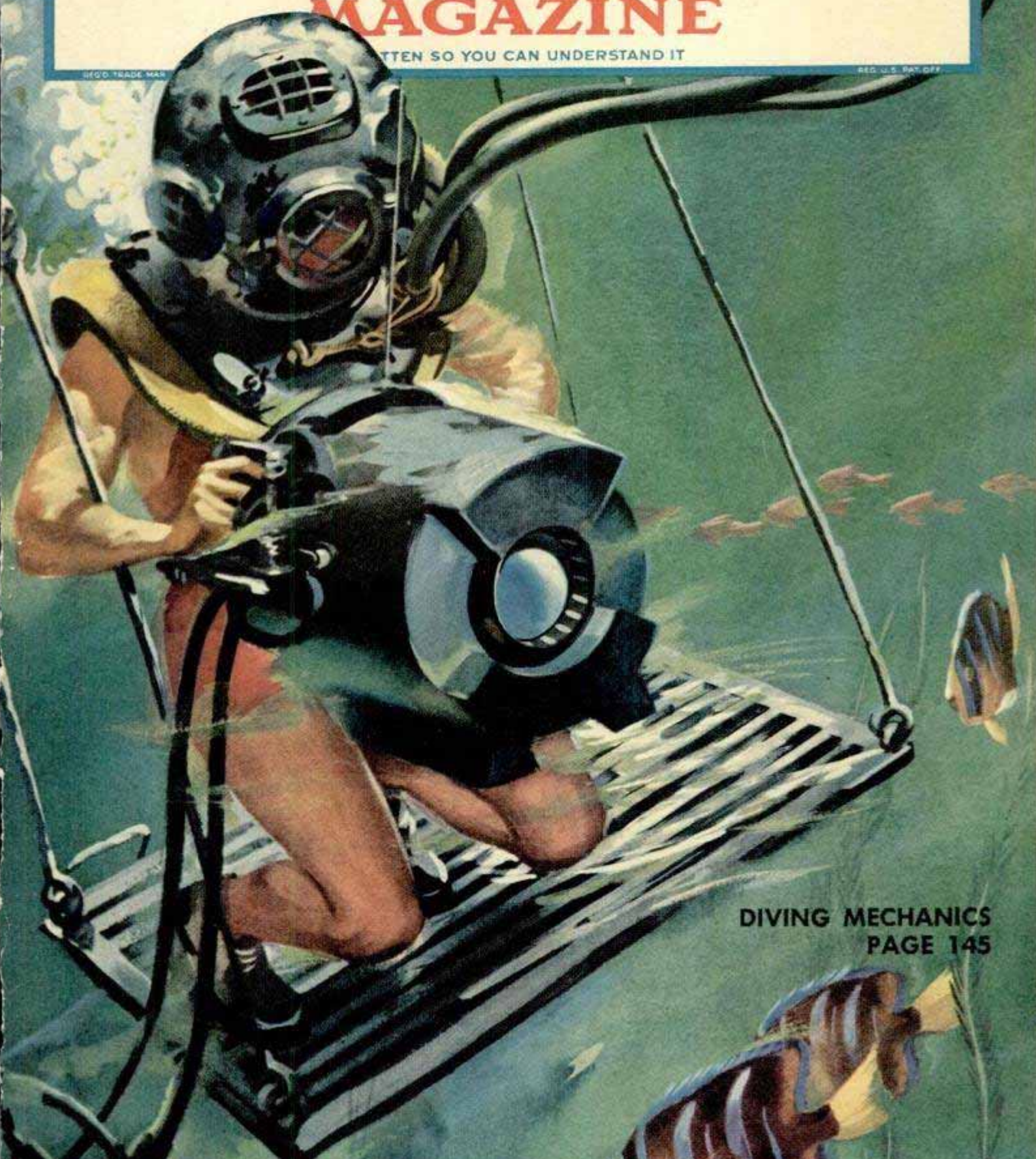

DIVING MECHANICS
PAGE 145

only \$287.50

COMPLETE

Revere

16 MM SOUND PROJECTOR

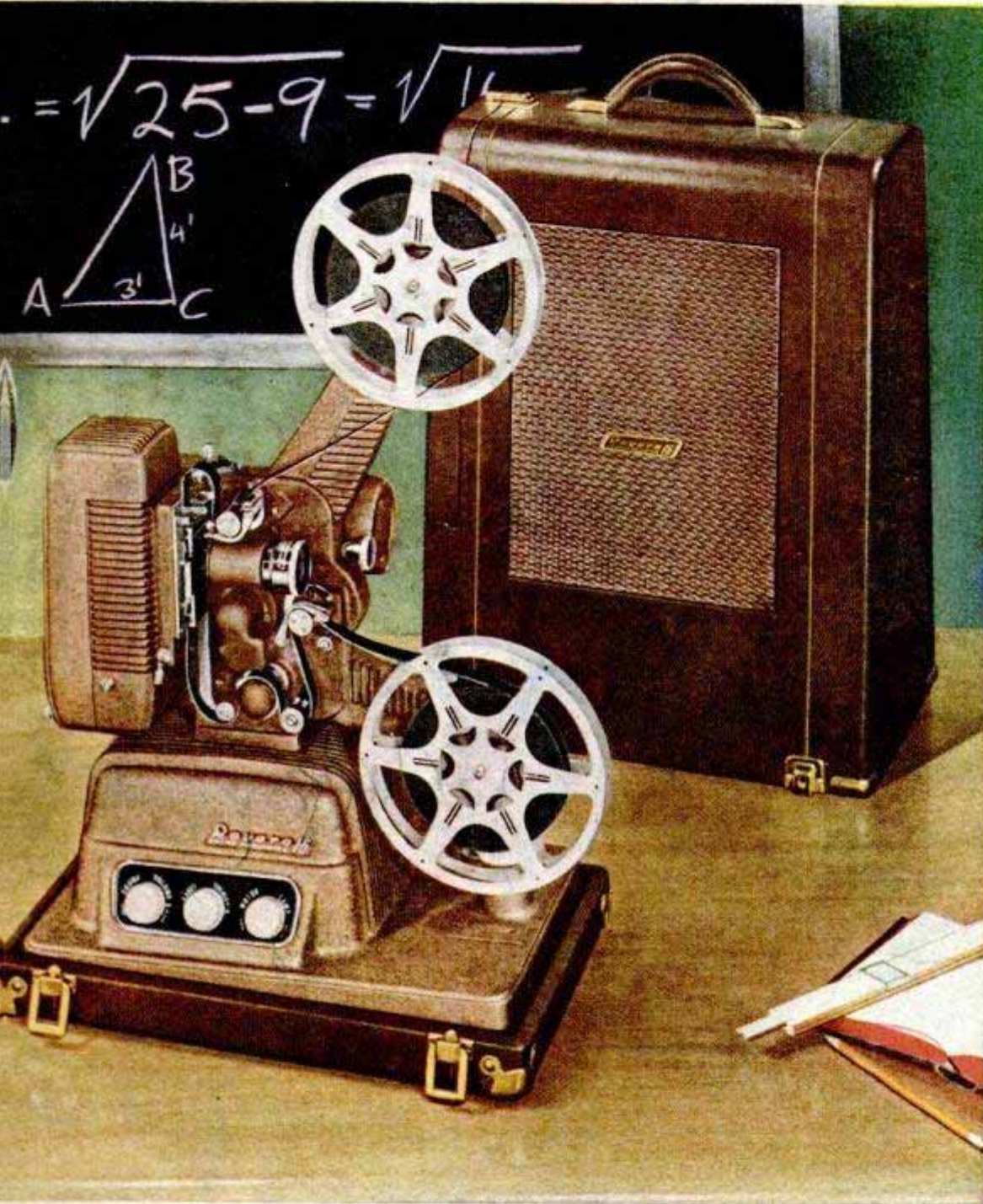

A SINGLE LIGHT-WEIGHT UNIT!

"Theatre-Tone" speaker serves also as carrying case for projector and all accessories. Makes a single compact unit weighing only 33 pounds!



OPERATES ON AC OR DC!

Simple 4-point threading is so easy a child can do it. Other "easy" features are positive automatic re-wind. Control panel visible in dark. Quick 400 to 1600 foot reel change.



FLAWLESS VOLUME AND BRILLIANCY!

Perfect sound and tone control for large room or small . . . 750-watt brilliancy . . . Fast F1.6 coated lens . . . Microphone and phonograph pickup connections. Sound or silent.



NEW 16MM REVERE MAGAZINE CAMERA

At the price of an "eight," it has rapid magazine loading . . . built-in, Micromatic, telescopic view-finder . . . five speeds . . . single frame exposure . . . continuous run . . . ratchet winding key . . . exposure guide . . . with F 2.5 Wollensak coated lens . . . including tax, \$127.50

Revolutionary in design and operation, the Revere 16mm Sound Projector brings professional quality sound movies within the reach of all. Now more homes, schools, lodges, churches and industries can afford the entertainment and educational advantages of sound movies at their very best. The rich, theatre-like tone . . . brilliant projection . . . amazing ease of operation . . . and exceptional, light-weight portability of the Revere "16" have been enthusiastically acclaimed by noted educators and audio-visual authorities. You, too, will agree that the Revere 16mm Sound Projector is a remarkable achievement.

\$287.50, complete

REVERE CAMERA COMPANY
CHICAGO 16, ILLINOIS

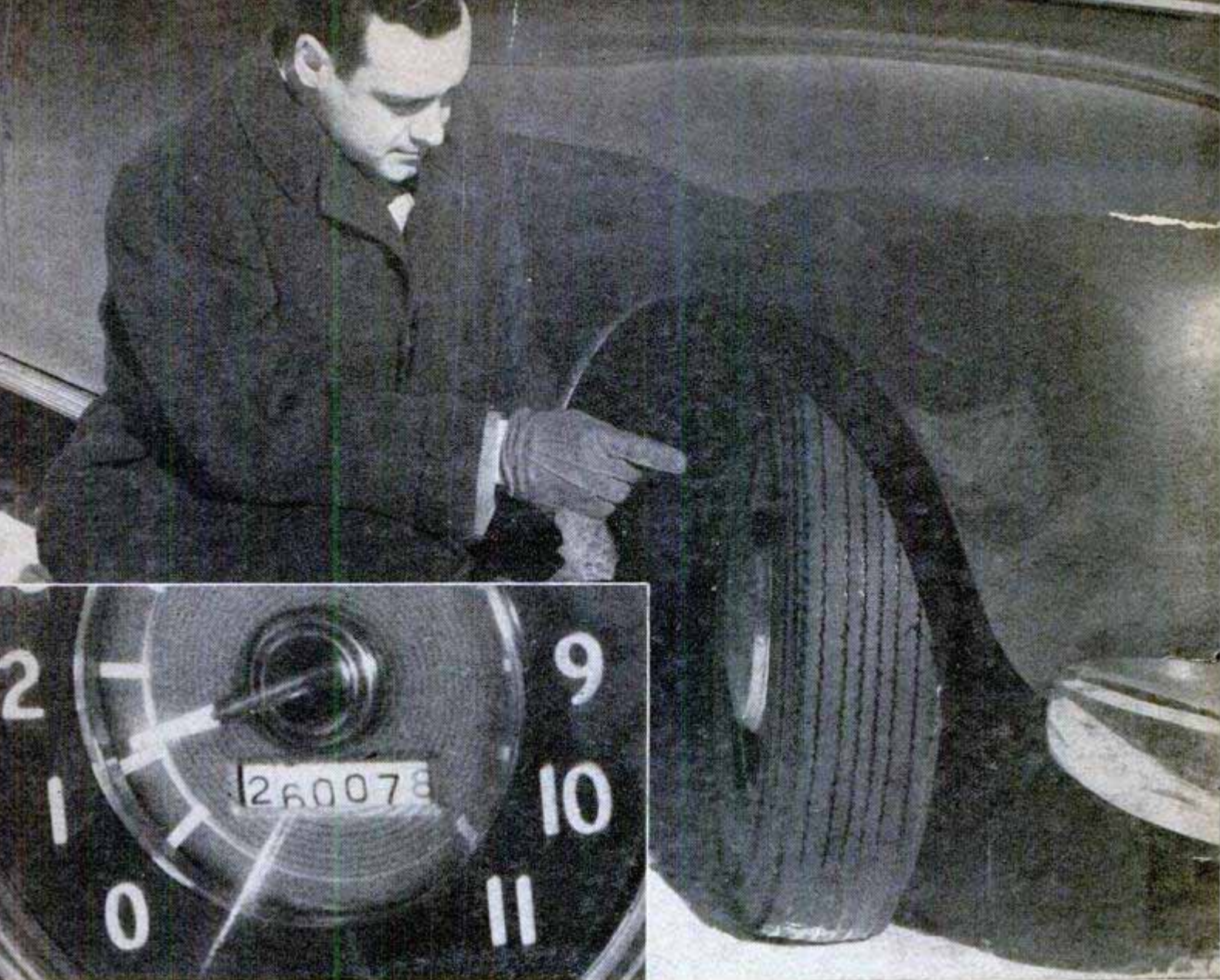

Typical example: user's experience with B. F. Goodrich tires

DR. H. C. BAUMANN of Pottstown, Pennsylvania (above) thought we ought to know about his experience with B. F. Goodrich tires. He wrote:

"I have been noticing your advertisements . . . relative to the good use automobile owners are experiencing with your tires. I feel my tires have done as well as most in your advertisements . . . At the present time, my speedometer reads 24,380 miles, and my only care for the tires was regular pressure checks." (When this picture was taken his speedometer read 26,007.)

"The car has been used every-

day, in all kinds of weather", Dr. Baumann continued, "and a good deal of the time on highways at the faster speeds. Very much of my driving is done on rural macadam roads. The tires have not even been off the wheels! And they still have *plenty* of good tread left. In fact, my friends find it hard to believe they are the original tires."

Hundreds of enthusiastic B. F. Goodrich owners have written us, telling that their B. F. Goodrich Silvertowns outwear other tires, including prewar tires.

Because the tread is wider,

car weight is spread over more tread; wear is slower, more even. The tire body lasts longer because it has more and stronger cords to take road shocks.

If you need tires, visit your B. F. Goodrich dealer. He'll give you a good trade-in allowance on your present tires. Convenient terms can be arranged. If you don't know his address, look under *Tires* in the yellow pages of your phone book. *The B. F. Goodrich Company, Akron, Ohio.*

B.F. Goodrich
FIRST IN RUBBER

Traffic is heavy under the street, too

Surely the busiest thoroughfare in the world is a telephone cable. But it is more than "telephone"; for these thousand or more wires, carrying sound and pictures at lightning speed, are highways for many services.

Each one of these presents its own problems to Bell Laboratories scientists and engineers: for the telephone differs from television, and television differs from a radio program. And yet they have an essential unity: they involve

transmission of alternating currents, with frequencies from zero up to several million cycles. Each calls for new thinking, new ideas, new goals of accomplishment.

The diversity of the cable's many services speaks for the unity of Bell Laboratories' purpose. That is, to know the theory and practice of communication so thoroughly that any transmission of sight or sound can reach its destination clearly, quickly, economically.

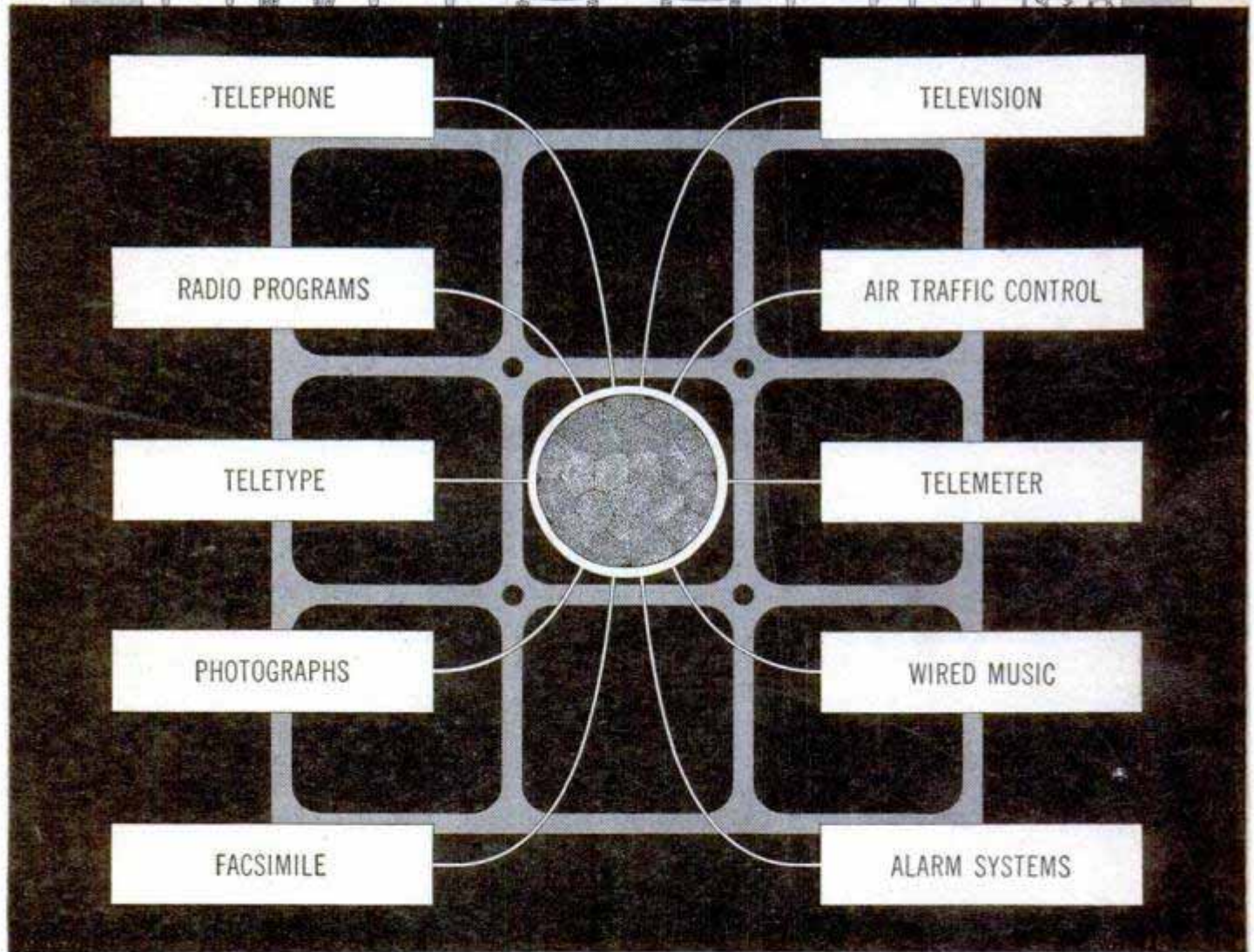
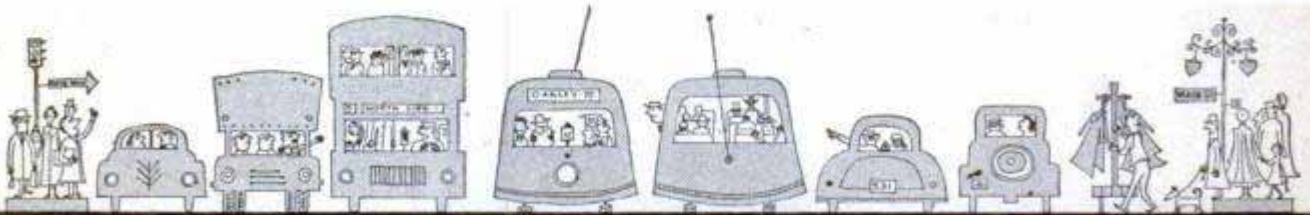

BELL TELEPHONE LABORATORIES

Exploring and inventing, devising and perfecting for continued improvements and economies in telephone service



Popular Mechanics Magazine

Registered in U. S. Patent Office and Canada

H. H. WINDSOR, Founder

H. H. WINDSOR, Jr., Editor and Publisher



MOST talked about automotive feature today is the automatic transmission—and the least understood. For that reason we invited L. H. Nagler (above), member of the Society of Automotive Engineers and a nationally-known authority on transmissions, to explain in simple, unbiased language the various kinds of automatic transmissions now in use. This outstanding article begins on page 102.

NEXT MONTH you will be intrigued by six pages of drawings on "Judging the Olympics" by G. H. Davis, noted London artist. Also in the June issue, Tom Stimson, western editor, will take you on a mountain-lion hunt. The ingenious hunters use an electronic hearing aid to help track their prey. Another June feature—on the serious side—tells why the atom bomb was only a milestone in atomic research and how our leading scientists are "Attacking the Mysteries of the Atom."

HOME BUILDERS can construct three-dimensional models of their dream houses with realistic interior and exterior features by following a new planning system outlined in the June Craftsman section. Another timely feature tells how to build a golfer's caddy cart with racks for clubs and plenty of storage space.

RADIO experimenters will find a new compact three-way portable receiver in next month's Radio and Electronics section.

| | | |
|------------------------------------|------------------------|----------|
| Volume 89 | MAY 1948 | Number 5 |
| Managing Editor..... | Roderick M. Grant | |
| Assistant Managing Editor..... | Wayne Whittaker | |
| Shop Notes and Crafts' Editor..... | James R. Ward | |
| Radio and Electronics Editor..... | Frank L. Brittin | |
| Aviation Editor..... | Aubrey O. Cookman, Jr. | |
| Associate Editor..... | Clifford B. Hicks | |
| Eastern Editor..... | Bill Reiche | |
| Western Editor..... | Thomas E. Stimson, Jr. | |
| Art Editor..... | Frank Beatty | |

Assistant Editors

Donald R. Brooks Arthur B. Railton

Assistant Editors, Shop Notes and Crafts

W. Clyde Lammey Wayne C. Lecky Frank N. Stephany A. E. Youngquist

In This Issue

| | |
|------------------------------------|-----|
| College on Ice - - - - - | 81 |
| Mercy Jumpers - - - - - | 92 |
| How Your Car Shifts for Itself - - | 102 |
| Stepping Up the Speedboats - - - | 108 |
| The Workshop Rolls to School - - | 114 |
| Hungry Plants Guide Prospectors - | 130 |
| The Old Red Barn is Vanishing - - | 137 |
| Diving Mechanics - - - - - | 145 |
| Doll Doctor - - - - - | 152 |
| Hotel to the Orient - - - - - | 156 |
| Feudal Craftsmen of the Movies - | 163 |

For the Craftsman

| | |
|---|-----|
| All-Purpose Kneehole Desk - - - | 177 |
| Row Your Canoe - - - - - | 185 |
| Slide Projector - - - - - | 194 |
| Watch Your Spark Plugs - - - | 204 |
| Edge-Lighted Signs in Plastic - - | 209 |
| "Sea Craft"—Cabin Cruiser Part III - - - - - | 214 |
| Radio and Electronics - - - - - | 221 |
| Clinic for Homemakers - - - - - | 234 |

Table of Contents continued on page 8

Published monthly by POPULAR MECHANICS COMPANY, 200 East Ontario Street, Chicago 11, Ill. H. H. Windsor, Jr., president; Paul H. Dunkin, vice president and general manager; D. F. Windsor, vice president and secretary-treasurer; William Harrison Fetridge, vice president and assistant to the publisher; Clover L. Perkins, advertising manager; Alvin M. Deyoe, circulation manager. Single copy in the United States and Canada, 25 cents; subscription rates in United States and possessions, Canada, Philippines and countries of the Pan-American Postal Union, 1 year, \$2.50; 2 years, \$4.50; 3 years, \$6.00. To all other countries add \$1.00 a year over United States prices for overseas postage. If you plan to move, notify us at least 30 days in advance so you will not miss an issue. Give both old and new addresses. Entered as Second Class Matter, September 15, 1903, at the Post Office at Chicago, Illinois, under Act of March 3, 1879. Entered as Second Class Matter at Post Office Dept., Canada. Copyright 1948 by Popular Mechanics Company. Copyright under International Copyright Union. Copyright in France. All rights reserved under Pan-American Copyright Union. Printed in the United States of America.

BOMBS GO ON A BAT!



THIS big, bat-like flying wing is the YB-49. All by itself it could conduct a bombing raid undreamed of a few years ago.

It is designed to lift ten thousand pounds of bombs into the air, fly five thousand miles to its target, drop its bombs and fly all the way back to its home base.

It measures 172 feet from wing-tip to wing-tip. It is powered by eight giant jet engines. And it can fly so fast that only the fastest jet fighter planes could catch up with it.

This is an all-metal hint of some of the great things coming in the future of aviation. It is a working model of the research being conducted for the U. S. Air Force for the security of the United States.

The U. S. Air Force needs young men who have the inner urge to keep pace with the progress of aviation. It needs special-

ists in all phases of aviation. In turn, it will give them a background of aviation education that can't be had anywhere else in the world today.

There's an opening for every physically and mentally fit young man in the United States in the U. S. Air Force. Get the details of the many opportunities open to you at your U. S. Army and U. S. Air Force Recruiting Station.

**U. S. ARMY AND U. S. AIR FORCE
RECRUITING SERVICE**

CAREERS WITH A FUTURE
**U. S. Army and
U. S. Air Force**

*Used on
more new cars
-sold by more
dealers!*



replace with a
DELCO
BATTERY

DELCO-REMY WHEREVER WHEELS TURN OR PROPELLERS SPIN



What Strange Powers Did The Ancients Possess?

EVERY important discovery relating to mind power, sound thinking and cause and effect, as applied to self-advancement, was known centuries ago, before the masses could read and write.

Much has been written about the wise men of old. A popular fallacy has it that their secrets of personal power and successful living were lost to the world. Knowledge of nature's laws, accumulated through the ages, is never lost. At times the great truths possessed by the sages were hidden from unscrupulous men in high places, but never destroyed.

Why Were Their Secrets Closely Guarded?

Only recently, as time is measured; not more than twenty generations ago, less than 1/100th of 1% of the earth's people were thought capable of receiving basic knowledge about the laws of life, for it is an elementary truism that knowledge is power and that power cannot be entrusted to the ignorant and the unworthy. Wisdom is not readily attainable by the general public; nor recognized when right within reach. The average person absorbs a multitude of details about things, but goes through life without ever knowing where and how to acquire mastery of the fundamentals of the inner mind—that mysterious silent something which “whispers” to you from within.

Fundamental Laws of Nature

Your habits, accomplishments and weaknesses are the effects of causes. Your thoughts and actions are governed by fundamental laws. Example: The law of compensation is as funda-

mental as the laws of breathing, eating and sleeping. All fixed laws of nature are as fascinating to study as they are vital to understand for success in life.

You can learn to find and follow every basic law of life. You can begin at any time to discover a whole new world of interesting truths. You can start at once to awaken your inner powers of self-understanding and self-advancement. You can learn from one of the world's oldest institutions, first known in America in 1694. Enjoying the high regard of hundreds of leaders, thinkers and teachers, the order is known as the Rosicrucian Brotherhood. Its complete name is the “Ancient and Mystical Order Rosae Crucis,” abbreviated by the initials “AMORC.” The teachings of the Order are not sold, for it is not a commercial organization, nor is it a religious sect. It is a non-profit fraternity, a brotherhood in the true sense.

Not For General Distribution

Sincere men and women, in search of the truth—those who wish to fit in with the ways of the world—are invited to write for a complimentary copy of the sealed booklet, “The Mastery of Life.” It tells how to contact the librarian of the archives of AMORC for this rare knowledge. This booklet is not intended for general distribution; nor is it sent without request. It is therefore suggested that you write for your copy to Scribe J.P.E.

The ROSICRUCIANS
[AMORC]

San Jose

California

**"What's he got
that I haven't got?"**

LOOK at the successful men you know. "What have they got" that you haven't?

Very little, probably. In most ways these men are no brighter or naturally more capable than average. Many of them probably have no more formal education or better natural aptitudes than you.

But that little extra they have is important. They have the special knowledge and ability for which business is glad to pay well—they know the what, why and how of business. They have also the confidence and aggressiveness which come from knowing that they know and can apply their knowledge.

You may add that extra—may get that same profitable knowledge and ability—that same confidence and aggressiveness—if you are willing to pay the price in earnest, necessary study. For LaSalle has spent 38 years developing, testing and proving, with over a million student members, spare-time success training in certain specialized business fields. What scores of thousands of men and women—many just like you—have done, you should be able to do.

You need not leave your home or interrupt your job; you need pay comparatively little money. But you must be ambitious and willing to study seriously. And soon after you start training, the results will begin to show up in your own confidence and in your work. For what you learn at home tonight is so practical that often you can apply it on the job tomorrow.

How much do you want success—more money, a promotion or a new job, prestige and responsibility? If you really want it, you will use the coupon below to find out what LaSalle training can do for you. It costs only a postage stamp, but a coupon like it has been the starting point to real success for scores of thousands—and can be for you.



LA SALLE Extension University
A Correspondence Institution

Dept. 564-R • 417 S. Dearborn • Chicago 5, Ill.

I want to know how LaSalle can help me win success in the field I have checked below. Please send me your free 48-page booklet about that field and your success training in it.

- | | |
|--|--|
| <input type="checkbox"/> Accountancy | <input type="checkbox"/> Salesmanship |
| <input type="checkbox"/> Bookkeeping | <input type="checkbox"/> Effective Speaking |
| <input type="checkbox"/> C.P.A. Coaching | <input type="checkbox"/> Business Management |
| <input type="checkbox"/> Business English | <input type="checkbox"/> Industrial Management |
| <input type="checkbox"/> Law: LL.B. degree | <input type="checkbox"/> Traffic Management |
| <input type="checkbox"/> Foremanship | <input type="checkbox"/> Stenotypy (Machine Shorthand) |

Name.....Age.....

Position.....

Address.....

City, Zone and State.....

LA SALLE EXTENSION UNIVERSITY
A Correspondence Institution

This One



WSH8-B6J-DNZT

Check List for Folks who do not use

PYROIL

Does Pyroil reduce wear by maintaining a film of oil on cylinder walls? yes no

Does Pyroil prevent corrosion and rust by protecting cylinder walls from attack? yes no

Does Pyroil permit easy starting by reducing friction load of "dry starts"? yes no

Does Pyroil eliminate accumulation of dirt, sludge, gum in crank case? yes no

Is Pyroil easily available? yes
—ask your gas station attendant.

PYROIL

for Aircraft Engines

Use Aircraft Pyroil B for lubricating oil, Aircraft Pyroil A for gasoline. Manufactured and guaranteed by Pyroil Company, 79 Pyroil Bldg., La Crosse, Wisconsin.

Canadian Distributors: Central Purchasing Agencies, Ltd., Toronto, Ontario

GIVEN!

An attractive PYROIL metal savings bank — takes coins up to 50¢ pieces — is yours for the asking — sent postage paid.



PYROIL COMPANY

79 Pyroil Bldg., La Crosse, Wisconsin

I want my car to last and run properly. Please tell me more about Pyroil and how it can accomplish this for me.

Name _____

Address _____

City or Town _____ State _____



TABLE OF CONTENTS (Continued)

AUTOMOTIVE

| | |
|--|-----|
| He can blow back at autos..... | 86 |
| Dispenser ends fumbling for cigarette by driver..... | 97 |
| Shopping list for motorists..... | 98 |
| Heading for the speedway..... | 101 |
| Fingertip brake control ends stop-light "creep"..... | 107 |
| Raincoats for spark plugs..... | 107 |
| 1949 Lincoln and Mercury..... | 112 |
| Dispenser packs wheel bearings..... | 118 |
| Meter judges auto speed by radio..... | 136 |
| "Okay pass" signal..... | 167 |

AVIATION

| | |
|---|-----|
| Rocket test tunnel "climbs" to 50 miles..... | 90 |
| Plane's wheels slide back to lessen shock of landing..... | 117 |
| Zipper bags protect aircraft to be stored for short time..... | 118 |
| Global sphere charts..... | 119 |
| Supersonic "sleds"..... | 134 |

ELECTRICAL

| | |
|------------------------------------|-----|
| Reel for long extension cords..... | 87 |
| Motor dwarfed by diamond..... | 123 |
| School for linemen..... | 129 |

FARM

| | |
|--|-----|
| Gas unit for powering tools can be moved between jobs..... | 100 |
| Two-wheeled sulky for small tractor..... | 119 |
| Bath preserves pine posts..... | 128 |
| Jeep mower's blade "rides" the contours..... | 135 |
| Shallow planting cuts seed costs..... | 143 |
| Knives shred stalks to return soil food..... | 143 |
| Vine-cutting sled..... | 150 |
| Milk-fed vegetables..... | 161 |

FISH AND FISHING

| | |
|--|-----|
| Hook, line and sinker..... | 88 |
| Spring-powered gig reels in fish..... | 113 |
| Fish-bowl incubator reveals entire hatching operation..... | 118 |
| America's kingfish!..... | 168 |

HOUSE AND HOME

| | |
|---|-----|
| What's new for your home..... | 120 |
| Upholstered pianos match walls..... | 128 |
| Aluminum shingles reflect 95 percent of heat..... | 144 |

INDUSTRY

| | |
|--|-----|
| Giant "dozer" chops roots below ground..... | 87 |
| Bundled newspapers counted..... | 113 |
| Packaging machine..... | 117 |
| Conveyor bales leaves picked up in street..... | 123 |
| Bailey bridge becomes office building..... | 125 |
| Gauge uses X-rays to detect tiny thickness variations..... | 125 |
| Earth mover loads in reverse..... | 155 |
| Paperlike insulation defies flame..... | 167 |

OUTDOOR RECREATION

| | |
|---|-----|
| Retractable wheels for bike..... | 135 |
| Telescoping camp trailer "shrinks" for traveling..... | 144 |
| Bicycle power unit replaces pedal crank..... | 162 |
| Mirrors form sight for golf club..... | 167 |

PAINT AND PAINTING

| | |
|--|-----|
| Paint scraper blade won't dig into wood..... | 97 |
| Antidote for lewisite gas becomes lead-poisoning cure..... | 97 |
| Wood-knot sealer..... | 143 |
| Underwater paint..... | 161 |

PHOTOGRAPHY

| | |
|---|-----|
| Airplane gun camera converted for peace..... | 86 |
| Fire fighter turns to snow for Hollywood cameras..... | 136 |
| Diffused enlargements made with wire screen..... | 136 |
| Bus converted to mobile cartoon theater for youngsters..... | 150 |

TOOLS

| | |
|---|-----|
| Amputees grip hand tools securely with holding devices..... | 86 |
| "Fist grip" drill..... | 91 |
| Quick-action clamps..... | 100 |
| Bandsaw "brake" permits metal cuts..... | 107 |
| Drill blade cuts putty..... | 119 |
| Sawing is like drawing with a spiral bandsaw..... | 124 |
| Miniature compass draws 12-ft. circle..... | 135 |
| Mobile tool shop..... | 151 |
| Quick-change spindle for polishing wheels..... | 155 |
| Curved wires aid drawing..... | 161 |
| Press reshapes piano hammers..... | 162 |
| All-metal shaper fence for drill presses and small shapers..... | 166 |
| Portable drafting kit folds like a notebook..... | 167 |
| Wheelbarrow has mixing hopper..... | 167 |

TRANSPORTATION

| | |
|--|-----|
| Train "space" board spots empty seats..... | 90 |
| "Walking barge" can haul 60 tons..... | 91 |
| Railroad track ballaster..... | 122 |
| Electrical giant hauls coal trains..... | 161 |
| Traveling classroom for Casey Jones..... | 166 |

MISCELLANEOUS

| | |
|--|-----|
| "Striking" paint for match covers..... | 90 |
| Trolley fire ladder..... | 91 |
| Flexible aluminum shoes..... | 97 |
| Quarter in slot operates recorder, out drops "voice letter"..... | 113 |
| Safety "valve" on fire hose..... | 118 |
| Rubber lung replaces iron lung..... | 118 |
| Stone-wall garden grows better crop..... | 122 |
| Terrain models of rubber..... | 126 |
| Ground generators produce rain..... | 135 |
| Portable planetarium weighs only 25 pounds..... | 155 |
| Mobile service station..... | 162 |

(Continued to page 10)

There's BIG MONEY in ADVERTISING!

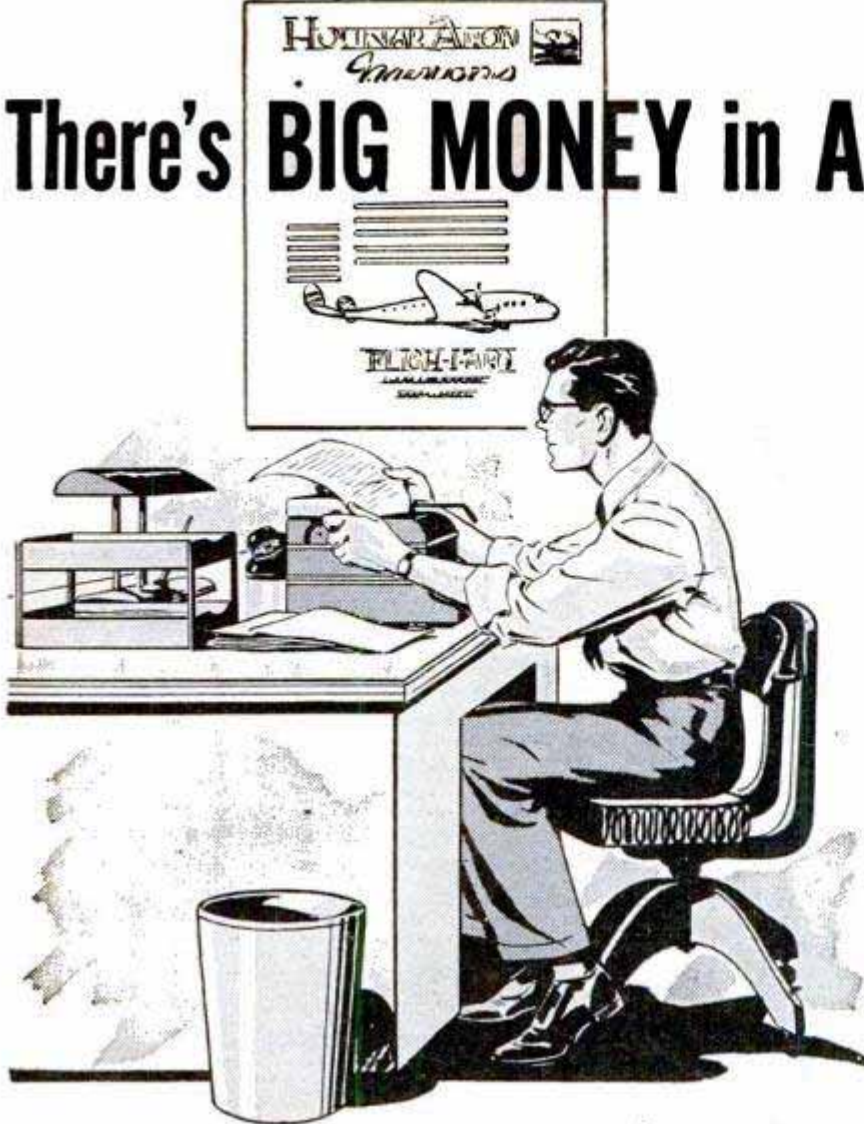

Don't waste your creative ability in uncongenial work! With I.C.S. training you can put your talent to work in advertising.

The I.C.S. Advertising Course covers the whole of this richly rewarding field. Here's instruction in writing advertisements for publication in national magazines. You learn about display, illustration, type.

"Specialty" subjects are included... retail and department store advertising, advertising letters, catalogs, booklets, folders, "house organs."

In many cases, I. C. S. students take positions before they have completed their courses. They make good in the world of advertising because they have learned by DOING.

Mark and mail the coupon for full information. Do it now!

INTERNATIONAL CORRESPONDENCE SCHOOLS



BOX 5627-K, SCRANTON 9, PENNA.

Without cost or obligation, please send me full particulars about the course BEFORE which I have marked X:

- | | | | |
|---|---|--|---|
| <p>Business and Academic Courses</p> <ul style="list-style-type: none"> <input type="checkbox"/> Accounting <input type="checkbox"/> Advertising <input type="checkbox"/> Arithmetic <input type="checkbox"/> Bookkeeping <input type="checkbox"/> Business Administration <input type="checkbox"/> Business Correspondence <input type="checkbox"/> Certified Public Accounting <input type="checkbox"/> Commercial <input type="checkbox"/> Commercial Art <input type="checkbox"/> Cost Accounting <input type="checkbox"/> Federal Tax <input type="checkbox"/> First Year College <input type="checkbox"/> Foremanship <input type="checkbox"/> Good English <input type="checkbox"/> Higher Mathematics <input type="checkbox"/> Motor Traffic <input type="checkbox"/> Salesmanship <input type="checkbox"/> Sign Lettering <input type="checkbox"/> Spanish <input type="checkbox"/> Stenography <input type="checkbox"/> Traffic Management <p>Air Conditioning and Plumbing Courses</p> <ul style="list-style-type: none"> <input type="checkbox"/> Air Conditioning <input type="checkbox"/> Heating <input type="checkbox"/> Refrigeration <input type="checkbox"/> Plumbing <input type="checkbox"/> Steam Fitting | <p>Chemistry Courses</p> <ul style="list-style-type: none"> <input type="checkbox"/> Chemical Engineering <input type="checkbox"/> Chemistry, Analytical <input type="checkbox"/> Chemistry, Industrial <input type="checkbox"/> Chemistry, Mfg. Iron & Steel <input type="checkbox"/> Petroleum Refining <input type="checkbox"/> Plastics <input type="checkbox"/> Pulp and Paper Making <p>Civil Engineering, Architectural and Mining Courses</p> <ul style="list-style-type: none"> <input type="checkbox"/> Architecture <input type="checkbox"/> Architectural Drafting <input type="checkbox"/> Building Estimating <input type="checkbox"/> Civil Engineering <input type="checkbox"/> Coal Mining <input type="checkbox"/> Contracting and Building <input type="checkbox"/> Highway Engineering <input type="checkbox"/> Lumber Dealer <input type="checkbox"/> Reading Structural Blueprints <input type="checkbox"/> Sanitary Engineering <input type="checkbox"/> Structural Drafting <input type="checkbox"/> Structural Engineering <input type="checkbox"/> Surveying and Mapping <p>Communications Courses</p> <ul style="list-style-type: none"> <input type="checkbox"/> Electronics <input type="checkbox"/> Practical Telephony <input type="checkbox"/> Radio, General <input type="checkbox"/> Radio Operating | <ul style="list-style-type: none"> <input type="checkbox"/> Radio Servicing <input type="checkbox"/> Telegraph Engineering <p>Electrical Courses</p> <ul style="list-style-type: none"> <input type="checkbox"/> Electrical Drafting <input type="checkbox"/> Electrical Engineering <input type="checkbox"/> Electric Light and Power <input type="checkbox"/> Lighting Technician <input type="checkbox"/> Practical Electrician <input type="checkbox"/> Power House Electric <input type="checkbox"/> Ship Electrician <p>Internal Combustion Engines Courses</p> <ul style="list-style-type: none"> <input type="checkbox"/> Auto Technician <input type="checkbox"/> Diesel-Electric <input type="checkbox"/> Diesel Engines <input type="checkbox"/> Gas Engines <p>Mechanical Courses</p> <ul style="list-style-type: none"> <input type="checkbox"/> Aeronautical Engineer's, Jr. <input type="checkbox"/> Aircraft Drafting <input type="checkbox"/> Flight Engineer <input type="checkbox"/> Forging <input type="checkbox"/> Heat Treatment of Metals <input type="checkbox"/> Industrial Engineering <input type="checkbox"/> Industrial Metallurgy <input type="checkbox"/> Machine Shop <input type="checkbox"/> Machine Shop Inspection | <ul style="list-style-type: none"> <input type="checkbox"/> Mechanical Drafting <input type="checkbox"/> Mechanical Engineering <input type="checkbox"/> Mold-Loft Work <input type="checkbox"/> Patternmaking—Wood, Metal <input type="checkbox"/> Reading Shop Blueprints <input type="checkbox"/> Sheet-Metal Drafting <input type="checkbox"/> Sheet-Metal Worker <input type="checkbox"/> Ship Drafting <input type="checkbox"/> Ship Fitting <input type="checkbox"/> Tool Designing <input type="checkbox"/> Toolmaking <input type="checkbox"/> Welding—Gas and Electric <p>Railroad Courses</p> <ul style="list-style-type: none"> <input type="checkbox"/> Air Brake <input type="checkbox"/> Car Inspector <input type="checkbox"/> Diesel Locomotive <input type="checkbox"/> Locomotive Engineer <input type="checkbox"/> Locomotive Fireman <input type="checkbox"/> Railroad Section Foreman <p>Steam Engineering Courses</p> <ul style="list-style-type: none"> <input type="checkbox"/> Boilermaking <input type="checkbox"/> Combustion Engineering <input type="checkbox"/> Engine Running <input type="checkbox"/> Marine Engineering <input type="checkbox"/> Steam Electric <input type="checkbox"/> Steam Engines <p>Textile Courses</p> <ul style="list-style-type: none"> <input type="checkbox"/> Cotton Manufacturing <input type="checkbox"/> Rayon Weaving <input type="checkbox"/> Textile Designing <input type="checkbox"/> Woolen Manufacturing |
|---|---|--|---|

Name _____ Home Address _____
 City _____ State _____
 Age _____ Present Position _____ Working Hours _____ A.M. to _____ P.M.

Special tuition rates to members of the Armed Forces. Special discount to World War II Veterans.
 Canadian residents send coupon to International Correspondence Schools Canadian, Ltd., Montreal, Canada.

FUSSY FANS

pleased as punch!



UNIVERSAL'S
Cinémaster II
best buy in home movies... all
the film you want right now!

GOOD movies all the time make Cinémaster II loads of fun. Easy to load, a pleasure to operate, costs less to use. You'll take movies of your family... vacations... parties, pets and picnics. And there's never a shortage of film - Cinémaster uses all makes of color or black and white including UniveX Single 8 film. At every reliable camera store. *With f3.5 lens, \$1.90... f2.5, \$66.65... f1.9, \$96.75*

UNIVERSAL CAMERA CORPORATION
New York, Chicago, Hollywood

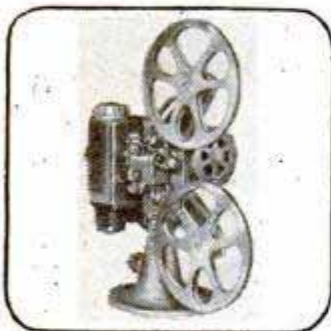

UNIVERSAL'S CINÉMATIC
Best buy in 8 mm. home projectors. Quiet; completely gear-driven. Brilliant movies. Extra capacity 400 ft. reels. Coated f1.6 lens... \$135.00

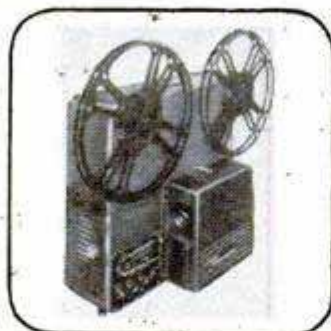

UNIVERSAL'S TONEMASTER
Best buy in 16 mm. sound projectors. Combines 24 features formerly available only at much higher prices. Reel capacity, full hour... \$350.00

For Pictures that *Click*...click a **UNIVERSAL**

(Continued from page 8)

Craftsman and Shop Notes Index

| | |
|--|-----|
| AUTOMOTIVE | |
| Removing rusted bolts from car springs..... | 173 |
| Locating inner-tube leaks..... | 182 |
| Race of broken pilot bearing removed easily with machine bolt..... | 200 |
| Red core in car-battery post identifies positive terminal..... | 201 |
| Eliminating whistle in car louvers..... | 212 |
| FARM | |
| Wire hook on oil drum holds can for filling..... | 173 |
| Farm truck has hydraulic lift..... | 199 |
| This low-lift platform trailer hitched to your tractor or truck..... | 201 |
| Roosts divided into stalls prevent crowding..... | 201 |
| Flat-topped sunshade for hogs moved by small tractor..... | 208 |
| Sturdy hinges for floodgates..... | 212 |
| Driver to set steel fence posts made of shaft and pipe..... | 212 |
| Cattle sprayer is power driven..... | 213 |
| Oil-soaked burlap tied to rope lubricates hay carriage..... | 220 |
| FISH AND FISHING | |
| Graphite restores fly line..... | 184 |
| Split shot saves time and bother when attaching lures or fishhooks..... | 190 |
| Fish lure made of bright stainless-steel beads..... | 190 |
| Pencil-tip erasers reduce rod-tip breakage..... | 190 |
| Small corks protect agate guides on casting rods..... | 190 |
| Light bulb as mold for casting lead sinkers..... | 190 |
| An underwater flashlight..... | 190 |
| HOUSE AND HOME | |
| Screen wire stretched firmly by covering two frames at a time..... | 172 |
| Four-section bin stores vegetables..... | 173 |
| Solving home problems..... | 174 |
| Renovating Venetian blinds..... | 176 |
| Chairs form improvised pen for small baby..... | 176 |
| Small table lamps easily modernized to give soft indirect light..... | 182 |
| Modern entryways enliven homes..... | 184 |
| Colored-bead telltale indicates when wall-type clock needs rewinding..... | 187 |
| LAWN AND GARDEN | |
| Outdoor fireplace of poured concrete..... | 170 |
| Garden-hose ring supports bushes..... | 176 |
| Meat tenderizer prepares ground when reseeded lawn..... | 176 |
| Multiple lawn sprinkler on rollers moved without damaging sod..... | 182 |
| Three-wheel garden barrow..... | 183 |
| Wild flowers for "tame" gardens..... | 188 |
| Garden lounging chair has barrel-stave seat..... | 193 |
| Outdoor "sitting room" in tree provides restful retreat..... | 198 |
| METALWORKING | |
| Hammered copper bowls..... | 181 |
| Handy tray for small parts from length of gutter..... | 187 |
| Copper tubing bent without kinking..... | 192 |
| Smooth-working pivoted joint..... | 203 |
| Slots cut through steel plate aid bending it..... | 208 |
| RADIO AND ELECTRONICS | |
| Eliminating television "ghosts"..... | 221 |
| Four-tube super broadcast tuner for use with any audio amplifier..... | 222 |
| Practical radio suggestions..... | 224 |
| TOOLS | |
| Typewriter eraser saves fingers when starting small brads..... | 182 |
| Quick-change attachment for pin-end blades fits scrollsaw chuck..... | 192 |
| Purse serves as tool bag..... | 198 |
| Electrician's test light built from stock parts..... | 203 |
| Lands on facets of mandrel nut prevent punch from slipping..... | 208 |
| Removing corrugated roofing in usable condition..... | 208 |
| Bench vise with calibrated jaw speeds small cutoff jobs..... | 208 |
| Stud-upsetting tool..... | 212 |
| Hand grinder removes small taps broken below work surface..... | 220 |
| Suction cup lifts corners of stacked metal sheets..... | 220 |
| WOODWORKING | |
| Shiplap gives bevel-siding effect..... | 172 |
| Plaster-of-paris sanding block molded to match contour of work..... | 172 |
| Wooden strip guides large work when sawing tapered edge..... | 184 |
| Clothes hamper..... | 191 |
| MISCELLANEOUS | |
| Self-setting garage-door prop..... | 173 |
| Button on safety pin protects clothing..... | 176 |
| Progress made in tracing patterns easily seen by using colored pencil..... | 184 |
| Pad altered for outdoor sketching..... | 186 |
| Camp stove from ammunition can..... | 187 |
| Channel runway aids wheeling bike up or down steps..... | 192 |
| Ticking of clock soothes small puppy or kitten during first nights..... | 193 |
| Mounting pads for small motors cut from fuller balls..... | 198 |
| Grease pencil marks glass when cutting freehand..... | 198 |
| Match-book flap is resetting target for outdoor use with air rifle..... | 198 |
| Silicon-carbide dispenser..... | 208 |
| Hive cover held by coil spring..... | 212 |
| Hinged poultry-wire frames display garden tools..... | 220 |

IMPORTANT NOTICE—It is the intention of this magazine to provide its readers with information regarding the latest developments in the mechanical arts. We take no responsibility as to whether the disclosures contained in our articles are covered by patents and advise readers to investigate this subject before making, using, or selling any of the products, machines, or processes described in order to avoid possible liability for patent infringements.

AUDELS REFRIGERATION & AIR CONDITIONING GUIDE.....\$4

New from Cover to Cover—1280 Pages, Fully Illus. Covering basic principles, servicing, operation & repair of household, commercial & industrial refrigeration & air conditioning. A gold mine of essential important facts for engineers, servicemen, users.

AUDELS CARPENTERS & BUILDERS GUIDES—4 Vols.\$6

A practical illustrated trade assistant on modern construction for carpenters, joiners, builders, mechanics and all woodworkers. 4 vols., 1600 pages, 3700 illustrations, flexible covers. Pocket size. Each volume sold separately \$1.50 a vol.

AUDELS AUTOMOBILE GUIDE.....\$4

A practical quick ready reference book for auto mechanics, service men, operators & owners. Explains theory, construction & servicing of modern motor cars, trucks, buses & auto type Diesel engines. 1700 pages, fully illustrated, 55 chapters. Indexed. A standard book for mechanics. New fluid drive covered.

AUDELS DIESEL ENGINE MANUAL..\$2

A practical, concise treatise with questions and answers on the theory, operation and maintenance of modern diesel engines including General Motors 2 cycle Diesel. 384 pages, fully illus., flexible binding, pocket size. All details plainly brought out, this book is of extreme value to engineers, operators & students.

AUDELS WIRING DIAGRAMS.....\$1

210 Pages. Illustrated. Gives practical facts on wiring of electrical apparatus. It shows clearly how to wire apparatus for practically all fields of electricity. Each diagram is complete & self-explanatory. Highly Endorsed Pocket Companion.

AUDELS PLUMBERS & STEAMFITTERS GUIDES—4 Vols.\$6

A Practical Trade Assistant & Ready Reference. Explains in plain language & by clear illustrations, diagrams, charts, graphs, pictures principles of modern plumbing practice including Marine Pipe Fitting and Air Conditioning. 4 Vols.—1670 Pages—3642 Diagrams. Pocket size. Each Vol. Sold Separately \$1.50 a Vol.

AUDELS SHEETMETAL WORKERS HANDY BOOK.....\$1

Practical inside information. Fundamentals of Sheet Metal Work. 388 pages. Illustrated. 11 sections. Clearly written. Essential & important facts, figures, pointers in everyday language. Ref. Index.

AUDELS SHEETMETAL PATTERN LAYOUTS.....\$4

Developed by Experts for Sheet Metal Workers, Layout Men & Mechanics. A Practical Encyclopedia in 10 Sections, size 7 x 10 x 2—1125 Pages—350 Layouts—1600 Illustrations. 1001 Key Facts. Fully indexed for ready reference in answering your layout problems. Covers all phases of sheet metal work including Pattern Cutting, Pattern Development & Shop Procedure.

AUDELS ANSWERS ON BLUE PRINT READING.....\$2

For Mechanics & Builders. Covers all types of blue print reading including ship & airplane. 418 pages, fully illustrated.

AUDELS NEW MACHINIST & TOOLMAKERS HANDY BOOK.....\$4

Covers modern machine shop practice in all its branches. 5 practical books in 1. New from cover to cover. Tells how to set up & operate lathes, screw and milling machines, shapers, drill presses and all other machine tools. 1600 pages, fully illustrated, 5 x 6 1/2 x 2. Indexed. 5 sections. 1—Modern Machine Shop Practice. 2—Blue Print Reading & How to Draw. 3—Calculations & Mathematics for Machinists. 4—Shop Physics. 5—How to Use the Slide Rule. 60 chapters. Easy to read and understand. A shop companion that answers your questions.

AUDELS MATHEMATICS & CALCULATIONS FOR MECHANICS \$2

Mathematics for home study or reference. 700 pages, 550 illus. Practical mathematics from beginning. How to figure correctly. Easy, correct methods covering complete review. Illus. & Indexed.

AUDELS HANDY BOOK OF PRACTICAL ELECTRICITY.....\$4

For maintenance engineers, electricians & all electrical workers. 1440 Pages, 2600 Illus. Covers important electrical information in handy form—including Marine Wiring, Radio Principles, Welding. Indexed. A Key to a practical understanding of electricity.

AUDELS RADIOMANS GUIDE.....\$4

A key to the practical understanding of radio including Frequency Modulation, Television, etc., Aircraft & Marine Radio. For radio engineers, servicemen, amateurs. 914 Pages, 633 Illustrations & Diagrams. Photos. Review Questions & Answers, Reference Index. Authentic, clear, concise.

AUDELS ELECTRONIC DEVICES.....\$2

Tells What You Want to Know About Electric Eye. Easily Understood. Covers photo-electric cells & their applications. Amplifiers, illumination, frequencies, voltage, photocell, tubes, Ohm's Law, wiring diagrams, etc.

AUDELS WELDERS GUIDE.....\$1

A concise, practical text on operation & maintenance of all welding machines for all mechanics. Over 400 pages, illustrated. Covers all methods of electric and acetylene welding including airplane work.

AUDELS, Publishers, 49 W. 23 St., N. Y. 10



AN AUDEL GUIDE IS A GOOD FRIEND!

Step Up Your Own Skill with the Practical Facts and Figures of Your Trade. Save time and money with right methods, short cuts, labor saving ideas. CHECK NOW! You can look over any Audel Guide in your home. Start the Easy Payments if satisfied.

CUT HERE MAIL ORDER

THEO. AUDEL & CO., 49 W. 23 St., New York 10, N. Y.

Please mail me for 7 days' free examination the books marked (X) below. I agree to mail \$1 in 7 days on each book or set ordered, and to further mail \$1 a month on each book or set ordered until I have paid purchase price. If I am not satisfied with Guides I will return them.

- Audels ELECTRIC MOTOR GUIDE \$4.
- Audels OIL BURNER GUIDE 1.
- Audels REFRIGERATION & Air Conditioning Guide 4.
- Audels POWER PLANT ENGINEERS GUIDE 4.
- Audels PUMPS, HYDRAULICS & AIR COMPRESSORS 4.
- Audels WELDERS GUIDE 1.
- Audels BLUE PRINT READING 2.
- Audels SHEET METAL WORKERS Handy Book 1.
- Audels SHEET METAL PATTERN LAYOUTS 4.
- Audels AIRCRAFT WORKER 1.
- Audels MATHEMATICS and CALCULATIONS 2.
- Audels MACHINISTS & TOOLMAKERS Handy Book 4.
- Audels MECHANICAL Dictionary 4.
- Audels AUTOMOBILE GUIDE 4.
- Audels DIESEL ENGINE MANUAL 2.
- Audels MARINE ENGINEERS Handy Book 4.
- Audels MECHANICAL DRAWING GUIDE 1.
- Rogers MECHANICAL DRAWING and DESIGN 2.
- Audels MILLWRIGHTS and Mechanics Guide 4.
- Audels CARPENTERS and Builders Guides (4 vols.) 6.
- Audels PLUMBERS and Steamfitters Guides (4 vols.) 6.
- Audels MASONS and Builders Guides (4 vols.) 6.
- Master PAINTER and DECORATOR 2.
- Audels GARDENERS & GROWERS GUIDES (4 vols.) 6.
- Audels ENGINEERS & FIREMANS EXAMINATIONS 1.
- Audels ENGINEERS and Mechanics Guides Nos. 1, 2, 3, 4, 5, 6, 7 and 8 complete 12.
- Audels Answers on Practical ENGINEERING 1.
- Audels ELECTRICIANS EXAMINATIONS 1.
- Audels WIRING DIAGRAMS 1.
- Audels Handy Book of PRACTICAL ELECTRICITY 4.
- Audels ELECTRICAL POWER CALCULATIONS 2.
- Audels ELECTRONIC DEVICES 2.
- Audels ELECTRIC Dictionary 2.
- Audels RADIOMANS GUIDE 4.
- Audels NEW ELECTRIC LIBRARY at \$1.50 a Volume Vols. I, II, III, IV, V, VI, VII, VIII, IX, X, XI, XII

Name _____

Address _____

Occupation _____

Employed by _____



Blueprints guide today's spectacular aircraft developments...and the brilliant future of all aviation. Back of those blueprints is the Aeronautical Engineer—whose creative genius, technical knowledge, and professional skill bring about the improved designs, the new aircraft, the new power plants...that advance aviation so swiftly.

A career in this fascinating, profitable profession can be YOUR blueprint for a bright future. You will be in Aviation—a field in which the possibilities have barely been scratched. You will be in a profession vital to that field—Aeronautical Engineering. The door is wide for contributing your own original ideas to the progress of Aviation...for reaching the heights of personal achievement...for gaining security and success.

Train at Northrop

...birthplace of the great Flying Wings and other famous aircraft. Here your training is conducted by a division of Northrop Aircraft, Inc.—in the midst of a busy center of important research and development work. In only 2 years (less time, with advanced standing) you can complete the Northrop Aeronautical Engineering Course—a technical institute curriculum accredited by the Engineers' Council for Professional Development.

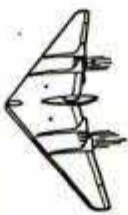

The Northrop course in Aircraft and Engine Mechanics (approved by the Civil Aeronautics Administration) requires only 1 year. Both courses are based on Northrop's long experience as a major employer of engineers and mechanics. Get complete information on the broad opportunities open to you in Aviation with Northrop training—send coupon now.

APPROVED FOR VETERANS

NORTHROP
Aeronautical Institute
Division of Northrop Aircraft, Inc.
1527 East Broadway
Hawthorne, Los Angeles County
California

Please send me the Institute catalog and complete information, including starting dates of classes. I am interested in Aeronautical Engineering Aircraft and Aircraft Engine Mechanics (A&E)

Name _____
Address _____ Age _____
City _____ Zone _____ State _____
Check one: Veteran In Service Civilian

STUDY AT HOME

With An Educational Institution
Men with specialized training win higher positions, insure larger earnings, and are bigger successes in business and public life. Opportunities NOW greater than ever before. Send for our Catalog.

ARTS and SCIENCES

Courses in Philosophy; Education; Letters; Public Health; Medical Jurisprudence; Psychology; Sociology; Physics; Chemistry; Plastics; Geology; Political Science; Theology; Business and Commerce; Accounting; Mathematics; Statistics; Agriculture.

ENGINEERING

Courses in Electrical, Civil, Mechanical, Drafting, Architectural, Steam, Aeronautical, Radio, Structural, Mining, Industrial, Petroleum, Marine, Chemical, Diesel, Automobile, Refrigeration, and Air Conditioning Engineering.

LAW

Complete Professional Law Course includes 18 Hornbook Series college grade textbooks. Courses also in Commercial Law, Patent Law and Medical Jurisprudence.

McKinley-Roosevelt Incorporated, 4610-K, Sheridan Rd., Chicago 40, Ill.

DEVELOP RUGGED STRENGTH!



Strong Men's Club of America offers FREE Membership!

Send for your personal membership card and Strength Secrets. No dues! No obligations! Many valuable privileges! Send name, address, age, on penny postcard.

JOE BONOMO Strong Men's Club of America
Director (Dept. PM-5) 1841 Broadway, N. Y. 23, N. Y.

Learn ORNAMENTAL HORTICULTURE

A thorough, constructive home training for employment or advancement in Nursery Operations, Park Supervision or maintenance, Landscape Designing or Landscape Gardening. My 3 way Plan shows you how to start your own business, get a better job, or earn extra money in spare time. Send for Free Book. APPROVED FOR VETERANS.

NATIONAL LANDSCAPE INSTITUTE
Dept. P-5, 310 So. Robertson Los Angeles 36, California

LEARN MONEY-MAKING CARTOONING

IN SPARE TIME — by Easy Picture Chart Method
Same Simplified Method that has helped train creators of "Terry & Pirates," "Freckles," "Out Our Way," "Winnie Winkle," "Reg'lar Fellers," "Strange As It Seems," "The Neighbors," and many others. Earn while learning. Send 10c for Picture Chart (to test your ability), and full details. (State age.)



THE LANDON SCHOOL, 4805 Clevel. Transit Bldg., Cleveland, O.

LEARN THE SECRET OF CONTENTMENT, HAPPINESS!

Free book tells how to solve mental worries, gain peace of mind thru META-PHYSICS, PSYCHOLOGY. Win the degree of Ps.D. or Ms.D. Experience the revelation of truth. Chartered college. Write

COLLEGE OF UNIVERSAL TRUTH, 5153-V North Clark St., Chicago

SAY YOU SAW IT IN POPULAR MECHANICS

- How he rose from the Sandlots of San Francisco to "tops" in Big League Baseball.
- True facts and inside stories about 150 of the stars Joe has played with and against!
- What was said and scrapped over in hotel rooms, locker rooms and dugouts!
- Famous throws, hits, and "tight spots," described by the player who was IN them!
- PLUS—A wonderful section of secrets of fielding, swatting, and winning the game.

"JOLTING" JOE DIMAGGIO'S OWN STORY!



READ "Lucky To Be a Yankee" Smash-Hit Baseball Book 34 illus.—244 Pages
SEND CHECK, CASH OR M. O.
H. LEV, Dept. PM, 409 Milford St., Brkly. 8, N. Y.
Please rush me at once Joe's Book.
 paper-Cover Edition, \$1.00 postpaid.
 De-Luxe cloth Ed. \$2.00 postpaid.

NAME _____
ADDRESS _____
CITY _____ ZONE _____ STATE _____

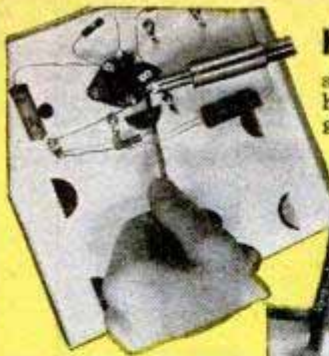

KIT 1 (left) I send you Soldering Equipment and Radio Parts; show you how to do Radio Soldering, how to mount and connect Radio parts; give you practical experience.



KIT 2 (left) Early in my course I show you how to build this N.R.I. Tester with parts I send. It soon helps you fix neighborhood Radios and earn EXTRA money in spare time.



VETERANS

You can get this training in your own home under G.I. Bill. Mail coupon for full details.

Be a RADIO Technician

Learn by PRACTICING in Spare Time

with **BIG KITS** of **RADIO PARTS** I send you

KIT 3 You get parts to build Radio Circuits; then test them; see how they work; learn how to build special circuits, how to locate and repair circuit defects.

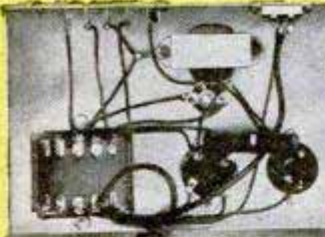
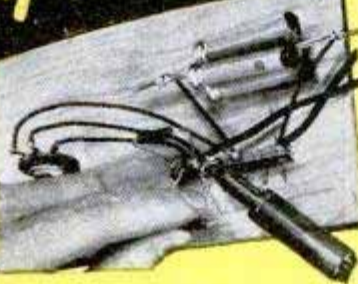

KIT 4 You get parts to build this Vacuum Tube Power Pack; make changes which give you experience with packs of many kinds; learn to correct power pack troubles.

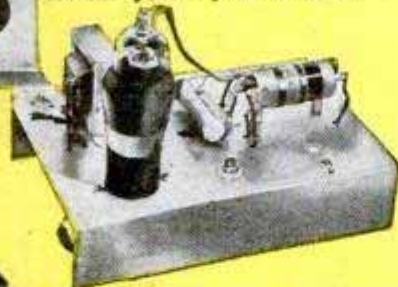

KIT 5 Building this A. M. Signal Generator gives you more valuable experience. It provides amplitude-modulated signals for many tests and experiments.



KIT 6 You build this Superheterodyne Receiver circuit. You conduct FM (Frequency Modulation) experiments. You get more experience to help you win success in Radio.

Do you want a good-pay job in the fast-growing Radio Industry — or your own Radio Shop? Mail the Coupon for a Sample Lesson and my 64-page book, "How to be a Success in RADIO—Television, Electronics," both FREE. See how I will train you at home—how you get practical Radio experience building, testing Radio circuits with **BIG KITS OF PARTS** I send!



J. E. SMITH, Pres. National Radio Institute

Many Beginners Soon Make Extra Money in Spare Time While Learning

The day you enroll I start sending EXTRA MONEY manuals that show you how to make EXTRA money fixing neighbors' Radios in spare time while still learning! It's probably easier to get started now than ever before, because the Radio Repair Business is booming. Trained Radio Technicians also find profitable opportunities in Police, Aviation, Marine Radio, Broadcasting, Radio Manufacturing, Public Address work. Think of even greater opportunities as Television, FM, and Electronic devices become available to the public! Send for FREE books now!

Find Out What NRI Can Do For You

Mail Coupon for Sample Lesson and my FREE 64-page book. Read the details about my Course, letters from men I trained; see how quickly, easily you can get started. No obligation! Just MAIL COUPON NOW in envelope or paste on penny postal. J. E. SMITH, President, Dept. SEP, National Radio Institute, Pioneer Home Study Radio School, Washington 9, D. C.

Sample Lesson **FREE**
64 Page Book

Mr. J. E. SMITH, President, Dept. SEP
National Radio Institute
Washington 9, D. C.

Mail me FREE Sample Lesson and 64-page book. (No salesman will call.)

Age _____

Name _____

Address _____

City _____ Zone _____ State _____

Check If Veteran

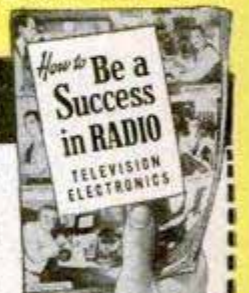

My Course
Includes Training in
TELEVISION • ELECTRONICS
FREQUENCY MODULATION

FREE

get it now

ALLIED'S NEW 1948 RADIO CATALOG!

172
Value-Packed
Pages



EVERYTHING
IN RADIO AT
LOWEST PRICES



TELEVISION AND
NEW HOME RADIOS



SERVICE SUPPLIES
BUILDERS' SUPPLIES



AMATEUR GEAR



SOUND SYSTEMS

Radio's Great Buying Guide

Send today for your FREE copy of Radio's Leading Catalog! It's the preferred Buying Guide for Servicemen, Dealers, Engineers, Soundmen, Amateurs, Builders and Experimenters. Shows everything you want in Radio and Electronic equipment—all the newest releases—complete, highest quality stocks at low, low prices that save you money on every purchase!

World's Largest Stocks!

You'll find *everything* in the new 172-page ALLIED Catalog—television receivers, latest home radios and radio-phonos, Ham receivers and station equipment, test instruments, public address equipment, new builders' kits, thousands of parts, tubes, tools, radio books, diagrams. Get the speedy, reliable service and expert help you want from ALLIED—Radio's Largest Supply House! Be sure to send today for your FREE copy of ALLIED'S new 1948 Buying Guide!

ALLIED RADIO

ALLIED RADIO CORP.
833 W. Jackson Blvd., Dept. 5-E-8
Chicago 7, Illinois

Rush FREE 1948 ALLIED Catalog

Name.....

Address.....

City.....Zone.....State.....

FREE
CATALOG

SALESMEN— earn more money!!

Now—make *real* money in selling . . . prepare quickly for today's new money-making opportunities.

LaSalle's new plan trains you rapidly, thoroughly, at home. Low cost—easy terms. Over 200,000 salesmen trained by LaSalle for all lines . . . and big corporations have paid over a million dollars for use of same sales principles now available to you.

FREE 48-PAGE BOOKLET—"Salesmanship, the Power that Wins Success"—tells today's big opportunities, and how you can prepare for large earnings in this profitable profession. Write for your copy today—without cost or obligation.

LASALLE Extension University, 417 So. Dearborn St.
A Correspondence Institution Dept. 564-LS, Chicago 5, Ill.

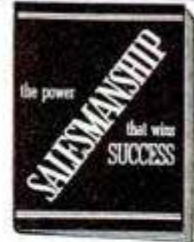

WATCHMAKING

JEWELRY ENGRAVING AND REPAIR

Enter this high-paying, time-honored profession, or prepare for a business of your own. Watchmakers in great demand. More jobs than qualified workers. Study under expert instructors in a long-established, nationally recognized school. Receive recognized diploma and certificate. Placement service. Approved under G. I. Bill. Write for FREE booklet.



The Baronian School, Inc.

2116 WALNUT ST. (DEPT. C) PHILA. 3, PA.



A BUSINESS OF YOUR OWN

Use simple home-made equipment. Make HOLLYWOOD STYLE cement pottery, birdbaths, benches, mantels, coffee tables, miniature castles. Also rustic garden walks, steps, stucco-rock walls, imitation marble. Chemical coloring, formulas & instructions. 10c brings pictures, sample, details.

HOLLYWOOD CEMENTCRAFT
8529 Wonderland Ave., Hollywood 46, Calif.

LEARN MEAT CUTTING At Home—In Spare Time



Get into the vital meat industry. Concise, practical Home Training based on 25 years proven instruction methods used at National's famous resident school. Prepares you for bigger pay as Meat Cuts, Supervisor, market manager or more money in your own store. Go as rapidly as your spare time permits. Diploma. Start NOW to turn your spare hours into money. Send for FREE bulletin today. No obligation.

National School of Meat Cutting, Inc., Div. U-93, Toledo 4, Ohio

LEARN MOVIE PROJECTION THEATRE MANAGEMENT



The Motion Picture Theatre Business offers big opportunities for trained men. Get into a fascinating field with a promising future. Train at home in spare time. Free Catalog. Established 20 years.

THEATRE SCHOOL, 370 Washington St., Elmira, New York



DEALERS WANTED

MUFFLERS STEELS and ALUMINUMS with a motorboat tone

SINGLES, Chev., V-8, Plymouth, Steels \$5.50, Aluminum \$7.00. Chry., Olds., Buicks, etc., Steels \$7.50, Aluminum \$9.00. V-8 and MERCURY DUALS, Steel \$17.50, Aluminum \$21.00. Split Manifold Sets, Steels \$35.00, Aluminum \$45.00. Aluminums are guaranteed for life of your car.

SANDEE MUFFLER CO.
BOX 296 LA TIJ., LOS ANGELES 43, CALIF
2624 W. SLAUSON AVE., LOS ANGELES, CALIF.



INVENTORS



Learn how to protect your invention. The U. S. Patent Laws provide that any new and useful art, machine, article of manufacture, or composition of matter, or any new and useful improvement thereof, may be patented if the act of invention is involved. Therefore, every inventor with a valuable invention should take advantage of the Patent Laws and proceed for patent protection in order to safeguard his rights.

A patent gives the inventor the exclusive right to prevent others from making, using, or selling the invention claimed in the patent for a period of seventeen years.

The Patent Laws were enacted for the benefit of the inventor to give him protection for the features of his invention which are patentable. These features must be properly and concisely set forth and claimed in a formal application for patent, in order to comply with the requirements of the U. S. Patent Office. For that reason, the Patent Office advises the inventor, unless he is familiar with such matters, to engage a competent registered patent attorney or agent to represent him. We maintain a staff of registered patent attorneys ready to serve you in the handling of your patent matters.

A specially prepared booklet entitled "Patent Guide for the Inventor", containing detailed information with respect to patent protection and procedure, together with a "Record of Invention" form will be promptly forwarded to you without obligation upon request.

**Registered
Patent
Attorneys**

CLARENCE A. O'BRIEN & HARVEY B. JACOBSON
Registered Patent Attorneys
81-E District National Bldg., Washington 5, D. C.

Please send me copy of "Patent Guide for the Inventor" and also "Record of Invention" form. This request does not obligate me.

Name _____

Address _____

City _____ State _____

(Please write or print plainly.)

**CLARENCE A. O'BRIEN
& HARVEY B. JACOBSON**

81-E District National Building + Washington 5, D. C.

HOW TO MAKE MONEY
in RADIO
ELECTRONICS
TELEVISION

HOW TO READ
RADIO DIAGRAMS
AND SYMBOLS

SPRAYBERRY
P. O. BOX 1058

SPRAYBERRY
ACADEMY
of RADIO

GET THESE 2 BIG BOOKS

FREE.

IF YOU
WANT TO LEARN
RADIO!

I Train You RIGHT by Sending You 8 BIG KITS of Radio Equipment
including A POWERFUL 6 TUBE SUPERHET
RECEIVER and 16 RANGE TEST METER!

Find out NOW how Sprayberry Training prepares you for a Radio Service Business of your own — or a good pay Radio job. Just mail the coupon for a FREE Sample Lesson and my big FREE book, "How To Make Money In Radio, Electronics, Television." I train you at home during spare hours by putting you to work building, testing, repairing,

no previous experience in Radio. My famous *Business Builders* help you earn EXTRA CASH getting and doing neighborhood Radio Service jobs while learning. You couldn't pick a better time to get into Radio. Good Radio Service and Repair Shops are needed everywhere as millions of new sets are in use. Trained men are wanted for opportunities in Police, Aviation and Marine Radio, F.M., Standard Broadcasting and Television. Mail coupon today for my FREE Books.

working with 8 big kits of Radio parts I supply. You build a powerful 6 tube superhet Radio, a 16-range test meter, perform over 175 interesting, practical experiments. My lessons are easy and interesting . . . you need

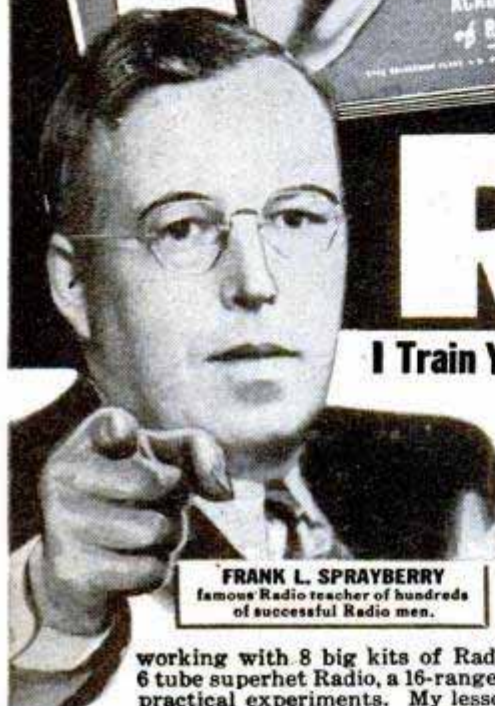

FRANK L. SPRAYBERRY
famous Radio teacher of hundreds
of successful Radio men.

LEARN HOW TO BUILD-TEST-REPAIR RADIOS By Working with YOUR HANDS!

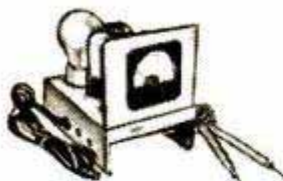

I give you a fine, moving coil type Meter—with parts for a complete analyzer and Circuit Continuity Tester. "Trouble-shoot" with professional accuracy.

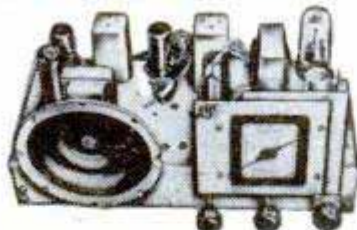

You really learn Radio the PRACTICAL way . . . when you build this big, powerful 6-tube Superhet Radio from parts I send you.

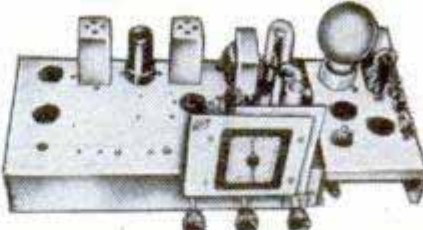

You don't have to buy expensive ready-made equipment. You get valuable experience building this Signal Generator and Multi-purpose Tester.

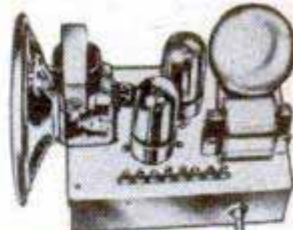

You construct this rectifier, filter, resistor and condenser tester, and really get on the Practical end of Radio.

LOW COST RADIO TRAINING STUDY AT HOME IN SPARE HOURS

Easy monthly payments, if desired. Everything you need is furnished — nothing else to buy. The equipment I send you is yours "for keeps" — to use in your business or job. I have trained thousands of successful Radio men — and I can help you, too. Get the facts about Sprayberry Training — it's your first step to success, security and a bigger income. Fill out and mail coupon today. I'll rush my 2 Free books to you by return mail.

VETERANS: Approved for G. I. Training under Public Laws 16 and 346.

SPRAYBERRY ACADEMY of RADIO
F. L. SPRAYBERRY, President
Room 1058, Sprayberry Bldg., Pueblo, Colorado

RUSH COUPON Today!

SPRAYBERRY ACADEMY OF RADIO
F. L. SPRAYBERRY, President
Room 1058, Sprayberry Bldg., Pueblo, Colorado
Please rush my FREE copies of "How To Make Money In Radio, Electronics and Television" and "How To Read Radio Diagrams and Symbols." No salesman will call.

Name _____ Age _____

Address _____

City and Zone _____ State _____

CHECK HERE IF A VETERAN
(Mail in an Envelope or Paste on Penny Postcard)



Trained Radio men can step into their own profitable Radio Service Shop — or



New developments constantly open new big pay job opportunities in Radio.

INVENTORS

patent laws encourage the development of inventions

The Rules of Practice of the U. S. Patent Office advise—unless an inventor is familiar with such matters—that he employ a competent registered attorney or registered agent, as the value of patents depends largely upon the skillful preparation of the specifications and claims.

The firm of McMorrow, Berman and Davidson is registered to practice before the U. S. Patent Office. Additionally, it maintains a staff of attorneys able to readily understand inventors' disclosures, to advise concerning patentability, and to prepare appropriate specifications and claims for filing with the Patent Office.

If an inventor believes he has an invention, a search of the most pertinent prior U. S. patents should be made and a report obtained relative to its patentability. Where such report indicates that the invention appears patentable, in order to secure protection, diligence should be exercised in making application for a patent.

McMORROW, BERMAN & DAVIDSON

Registered Patent Attorneys

PATENTS • TRADE MARKS • COPYRIGHTS

135-H VICTOR BUILDING, WASHINGTON 1, D. C.

McMORROW, BERMAN & DAVIDSON

Registered Patent Attorneys

135-H Victor Building, Washington 1, D. C.

Send me further particulars as to patent protection and procedure and "Invention Record" form at once. I understand that this request does not obligate me.

Name _____

Address _____

City _____ State _____

(WRITE OR PRINT NAME CLEARLY)

The 97 Pound Weakling

who became "The World's Most Perfectly Developed Man"

"I'll Prove that YOU, too, can be a NEW MAN!"

Charles Atlas

I KNOW, myself, what it means to have the kind of body that people pity! Of course, you wouldn't know it to look at me now, but I was once a skinny weakling who weighed only 97 lbs.! I was ashamed to strip for sports or undress for a swim. I was such a poor specimen of physical development that I was constantly self-conscious and embarrassed. And I felt only HALF-ALIVE.

Then I discovered "Dynamic Tension." It gave me a body that won for me the title "World's Most Perfectly Developed Man."

When I say I can make you over into a man of giant power and energy, I know what I'm talking about. I've seen my new system, "Dynamic Tension," transform hundreds of weak, puny men into Atlas Champions.

Only 15 Minutes a Day

Do you want big, broad shoulders—a fine, powerful chest—biceps like steel—arms and legs rippling with muscular strength—a stomach ridged with bands of sinewy muscle—and a build you can be proud of? Then just give me the opportunity to prove that "Dynamic Tension" is what you need.

No "ifs," "ands," or "maybes." Just tell me where you want handsome, powerful muscles. Are you fat and flabby? Or skinny and gawky? Are you short-winded, pepless? Do you hold back and let others walk off with the prettiest girls, best jobs, etc.? Then write for details about "Dynamic Tension" and learn how I can make you a healthy, confident, powerful HE-MAN.

"Dynamic Tension" is an entirely NATURAL method. Only 15 minutes of your spare time daily is enough to show amazing results—and it's actually fun! "Dynamic Tension" does the work.



CHARLES ATLAS
Holder of title, "The World's Most Perfectly Developed Man."

Send for FREE BOOK



Mail the coupon right now for full details and I'll send you my illustrated book, "Everlasting Health and Strength." Tells all about my "Dynamic Tension" method. Shows actual photos of men I've made into Atlas Champions. It's a valuable book! And it's FREE. Send for your copy today. Mail the coupon to me personally. CHARLES ATLAS, Dept. 8E, 115 East 23rd Street, New York 10, N. Y.

CHARLES ATLAS, Dept. 8E,
115 East 23rd St., New York 10, N. Y.

I want the proof that your system of "Dynamic Tension" will help make a New Man of me—give me a healthy, husky body and big muscular development. Send me your free book, "Everlasting Health and Strength."

Name _____ Age _____
(Please print or write plainly)
Address _____
City _____ State _____

Famous **BANNER**

FIREWORKS

OH-BOY! Don't be disappointed. Get the best for your money. Famous Banner Fireworks have all the ZIP, BOOM, BANG you expect of fireworks. This year several new creations have been added. You'll thrill to every last piece in this Big Bargain Assortment.

BIG SPECIAL DEAL—ONLY \$4.95
Retail value \$11.25. Buzz Bombs—Star shells Block Busters—Zig-Zag Whistles—Flashlight Crackers—Sky Rockets—Roman Candles—Repeating Aerial Bombs, Sparklers and many others. Over 500 pieces in all. Rush order today. Supply limited. Send money order, bank draft or currency. No C. O. D.'s. Catalog FREE.

BANNER FIREWORKS MFG. CO., INC., DEPT. 141
446 Capistrano Toledo 12, Ohio

INVENTING

—FOR PROFIT! If you have an inventive turn of mind, write for free 28-page booklet explaining how the Institute of American Inventors is helping inventors pre-test the profit possibilities of proposed devices to fill today's unprecedented demand for useful new inventions.

INSTITUTE of AMERICAN INVENTORS
Dept. 4, 1926 Eye St., NW, Washington 6, D. C.

"YOU ARE UNDER ARREST!"

Help Bring Crooks to Justice Through Scientific **CRIME DETECTION!**

We have taught thousands this exciting, profitable, pleasant profession. Let us teach you in your own home. Learn Fingerprinting, Firearms Identification, Police Photography, Secret Service Methods thoroughly, quickly, at small cost. Over 800 of all American Bureaus of Identification employ I. A. S. students or graduates. We can prepare you for this fascinating work, during spare time. Write today, stating age, for "Blue Book of Crime."

INSTITUTE OF APPLIED SCIENCE, 1920 Sunnyside Ave., Dept. 1355, Chicago 40, Ill.

CORRESPONDENCE COURSES IN RADIO and ELECTRICAL ENGINEERING

ELECTRICAL ENGINEERING. Get good grasp of wide electrical field. Modern. Very understandable. Theory made easy. **RADIO ENGINEERING.** Extra fine course in radio, public address, photo-electric work. Trains you to be super-service man, real vacuum tube technician. Tuition ONLY \$25, either course. Deferred payment plan. Servicemen needed badly. **FREE** Write for free copies of school catalogs, student magazines, etc. LINCOLN ENGINEERING SCHOOL, Box 931-P113, Lincoln, Nebr.

Photography

for **PLEASURE or PROFIT**

Learn at home. Spare time. Practical basic training. Long-established school. Many have earned while learning. Send coupon below for free booklet, "Opportunities in Modern Photography" and full particulars.

AMERICAN SCHOOL OF PHOTOGRAPHY
1315 Michigan Avenue Dept. 1355 Chicago 5, Illinois
Send booklet, "Opportunities in Modern Photography," full particulars and requirements. No salesman will call.
Name _____ Age _____
Address _____
City _____ Zone _____ State _____

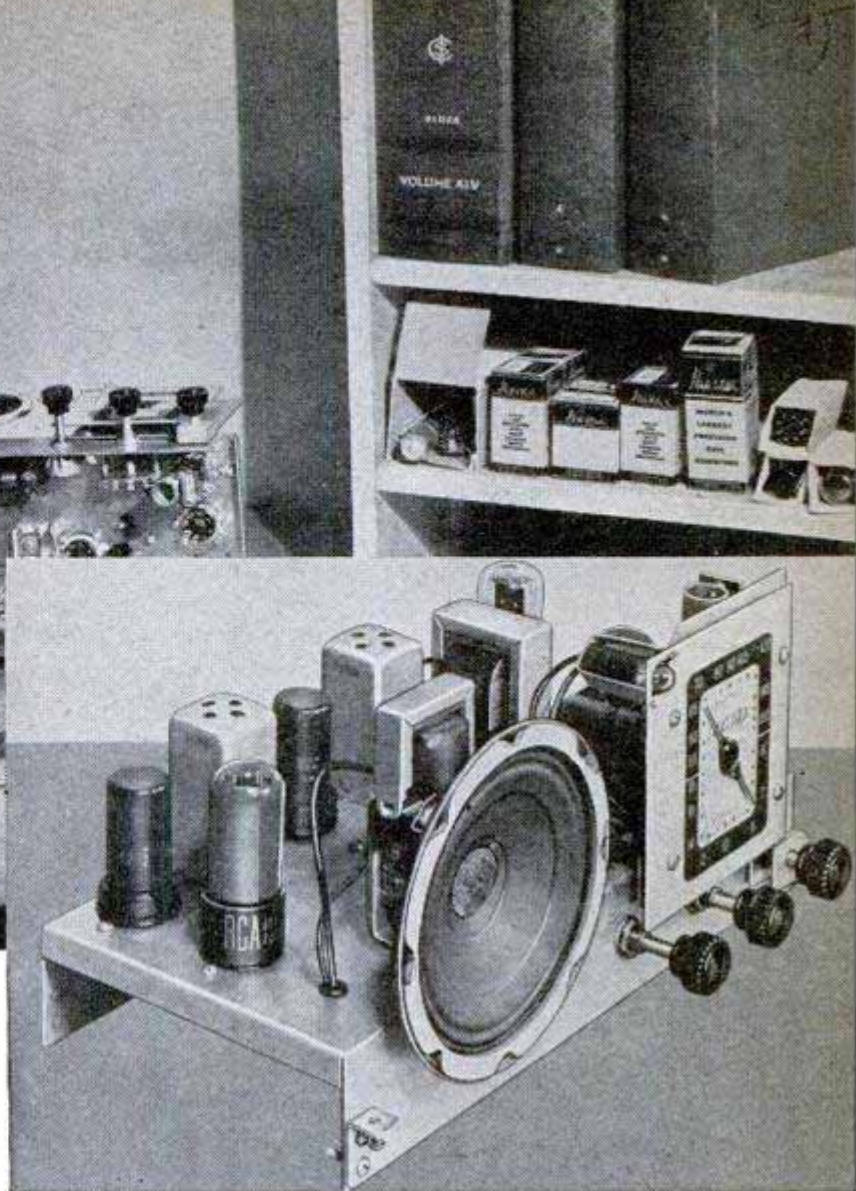

New I. C. S. Course Simplifies Radio Training

THE BEGINNER IN RADIO no longer has to stumble over technical explanations — or sidestep involved theories — in acquiring the training he needs to become a successful repairman.

These are carefully worked out for him in clear, simple language in a new home-study course developed by International Correspondence Schools.

But the student doesn't stop here. He puts principles and theories to work —

using professional-quality tools and radio equipment supplied with the course. During his studies he assembles, wires and tests a modern 6-tube, 2-band receiver.

Long before his last lesson, the average student is in a position to start making his training pay. And by the time he completes the course, he is well equipped — in knowledge, tools and radio parts — for a good job in radio or a profitable service business of his own.



**INTERNATIONAL
CORRESPONDENCE SCHOOLS**
Box 5628-K, Scranton 9, Pa.

Without cost or obligation please send me full information on the courses before which I have marked X.

- | | |
|--|--|
| <input type="checkbox"/> RADIO SERVICING (with training equipment) | <input type="checkbox"/> Electrical Engineering |
| <input type="checkbox"/> Radio, General | <input type="checkbox"/> Lighting Technician |
| <input type="checkbox"/> Radio, Operating | <input type="checkbox"/> Practical Electrician |
| <input type="checkbox"/> Electronics | <input type="checkbox"/> Business Administration |
| <input type="checkbox"/> Practical Telephony | <input type="checkbox"/> Salesmanship |
| <input type="checkbox"/> Telegraph Engineering | |

Those who want to make good in Radio—who want a course that is complete, up-to-date, extremely practical — would do well to mail this coupon. Do it now!

Name _____

Address _____

City _____ State _____

Age _____ Occupation _____ Working Hours _____ A.M. to _____ P.M.

PATENT PROTECTION *for* INVENTORS

A PATENT IS A VALUABLE RIGHT

On the basis of a constitutional provision Congress has established a system under which inventors may secure the exclusive right to prevent the unauthorized use, manufacture and sale of their inventions for periods of seventeen years. The inventor secures this protection by obtaining a patent from the United States Patent Office.

THE UNITED STATES PATENT OFFICE RECOMMENDS in its Rules of Practice that "an applicant is advised, unless familiar with such matters to employ a competent registered patent attorney or registered patent agent, as the value of patents depends largely upon the skillful preparation of the specifications and claims."

WE RECOMMEND that you authorize us to conduct a search through the U. S. Patents pertinent to your invention and submit a report setting forth our opinion regarding its patentability.

Victor J. Evans & Co. has a staff of experienced registered patent attorneys, available to represent inventors in the preparation and prosecution of their cases before the Patent Office. Detailed information and the steps to be taken in obtaining patent protection will be furnished upon request.

FORM BELOW FOR MAILING CONVENIENCE

. . . . VICTOR J.
EVANS & CO.
Merlin M. Evans
 REGISTERED PATENT ATTORNEY
 330-E MERLIN BUILDING, WASHINGTON 6, D. C.

• Please forward to me detailed information regarding procedure to obtain Patent Protection, together with your convenient "Evidence of Invention" form.

• Name.....

• Address.....

• City and State.....

. PATENTS . . . TRADEMARKS . . . COPYRIGHTS

Get Training *QUICK* in the Great Shops of **COYNE**

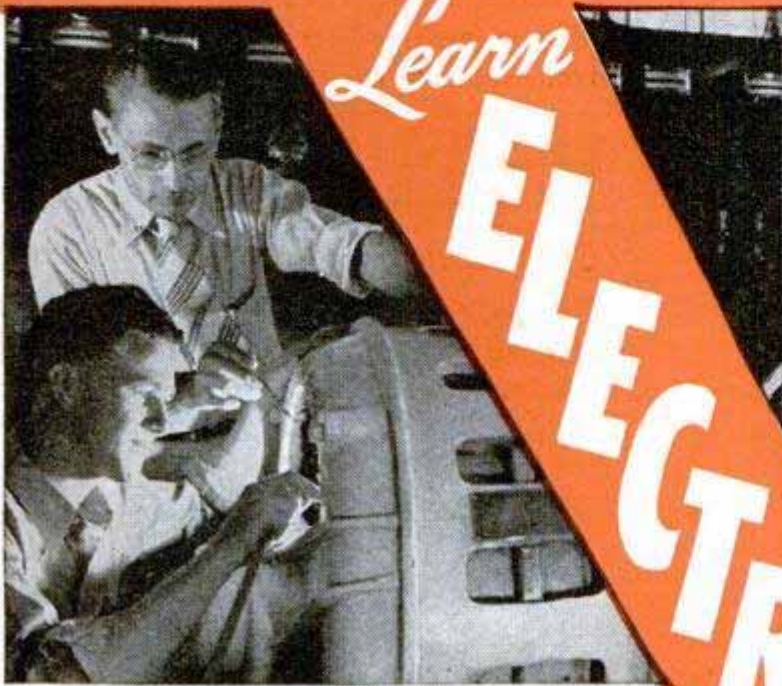

Learn **ELECTRICITY**

NOT a "Home-Study" Course!

Practical training pays! Thousands of successful electricians—men earning good money, with steady jobs and a real future—recommend the COYNE Shops in Chicago. We do not teach by mail. All instruction is given in our own big building in the heart of the World's Electrical Center. You make rapid strides here because it's a **shop** course.

Work on Full-Size Equipment!

In our great shops you actually operate, test, repair the same kinds of electrical apparatus you'll use later on the job. You do **REAL** house wiring; rewind **REAL** armatures; run a **REAL** switchboard. All this plus needed theory makes it easy for you to learn Electricity quickly here at COYNE. Get the facts now!

No Experience Necessary

Many Coyne students have never had previous electrical experience. Others have had a smattering of it in one or two branches, but realize their need for "All-Around" training. We not only train you for a good job, we help you get it. Lifetime Free Employment Service to Coyne graduates.

SEND FOR FREE BOOK

Yours for the asking—big 40-page book on Coyne Electrical Training. Filled with fascinating pictures of our great shops and our plans to help you. Get your copy free. No cost or obligation; no salesman will call. Mail the coupon today!



COYNE Shop Training Includes:

Alarm and Signal Work
D.C. Motors, Generators, Controls
A.C. Motors, Generators, Controls
House Wiring
Armature Winding
Stator Winding

Transformers
Switchboards
Home Appliances
—and many other branches including added training in Industrial Electronics and Electric Refrigeration.

NOW IN OUR 49th SUCCESSFUL YEAR



B. W. Cooke

Since 1899, Coyne has been training men and young men for practical, better-paying jobs. Here in our great Chicago Shops you will find the equipment, the friendly expert instructors, to prepare you for a real future in Electricity. Coyne graduates are in demand by many leading electrical firms. Coyne men are trained to make good in their own electrical shops. Come to COYNE!

VETERANS!
Coyne is authorized to accept Veterans for G. I. training. Coupon brings special G. I. Bulletin.

NON-VETERANS WHO ARE SHORT OF CASH

Don't let lack of money hold you back. You can finance most of your tuition and pay it in easy monthly payments after graduation. Many students earn while learning. We'll help you get part-time work while here if you need it to help defray living expenses.

B. W. COOKE, President

COYNE ELECTRICAL AND RADIO SCHOOL
Dept. 58-72
500 S. Paulina St., Chicago 12, Ill.

B. W. COOKE, President,
Coyne Electrical and Radio School, Dept. 58-72,
500 S. Paulina St., Chicago 12, Illinois

Send me your Free Book and tell me about your plans to help me—including Student Finance and added Training in Industrial Electronics and Electric Refrigeration. Mail coupon today.

NAME.....
ADDRESS.....
CITY.....STATE.....

MASONS



& BUILDERS GUIDES

Inside Trade Information for Bricklayers, Cement Workers, Plasterers, Tile & Stone Setters.

Covering:—**BRICK LAYING** tools, materials, bonding mortars,

designs, setting Frames, Foundations, Arches, Chimneys and Repairing old brick work. **GLASS BRICK and TILE SETTING**, hollow tile, walls, roofing. Placing re-inforced work, stucco, waterproofing, Plastering in all its branches, wall board. Stone Masonry, Mosaic and Steel Construction. **INCLUDING CONCRETE MIXING—CONCRETE BLOCK CONSTRUCTION**

1100 Pages, 2067 illustrations, Handy Size. HIGHLY ENDORSED. ASK TO SEE THEM! TO GET THIS ASSISTANCE FOR YOURSELF FILL IN AND

MAIL ORDER

AUDEL, Publishers, 49 W. 23rd St., New York 10, N. Y. Mail Audel's Masons and Builders Guides, 4 vols. on 7 days' free trial. If O.K. I will remit \$1 in 7 days and \$1 monthly until \$6 is paid. Otherwise I will return them. No obligation unless I am satisfied.

Name _____
 Address _____
 Occupation _____
 Employed by _____ PM

Learn this Profitable Profession

IN 90 DAYS AT HOME

Money-Making Career Open to Men and Women, 18 to 50

Hundreds of men and women between 18 and 50 make \$10 to \$20 in a single day giving scientific Swedish Massage and Hydro-Therapy treatments. There is big demand from doctors, hospitals, sanatoriums and clubs. Graduates earn large full time incomes from these or in private practice in their own offices. Others make good money from home treatments given in spare time. Learn this interesting, money-making profession in your own home, through our home study course. Same instructors as in our nationally known resident school. You can win independence and prepare for future security by qualifying for your Diploma. Course can be completed in 3 to 4 months. Many earn while they learn. Begin your training at once.



Anatomy Charts & Booklet FREE

Enroll now and we will include, at no extra cost, many needed supplies. Fit yourself to help meet growing demand for Scientific Swedish Massage. Send the coupon at once for complete details. Anatomy Charts and 32-Page Illustrated Booklet, FREE, postpaid.

THE COLLEGE OF SWEDISH MASSAGE
 Dept. 864-E, 100 East Ohio St., Chicago 11, Illinois
 Please send me FREE and postpaid, Anatomy Charts, 32-page Booklet and complete details on Home Training.

Name _____
 Address _____
 City _____ State _____

Learn to Write

Short Stories, Mysteries, Articles

Free Lesson Shows How You Learn at Home

The demand for writers is creating great new opportunities for people with an urge to write. It's not as hard to succeed as you may imagine. At home, you too may learn fiction writing, the best basis for all fields—short stories, novels, features, articles, radio scripts. Palmer Institute's Home Study Training (Est. 1917) is endorsed by Rupert Hughes, Ruth Comfort Mitchell, Gertrude Atherton, Katherine Newlin Burt and other famous authors, and by scores of successful graduates. Complete instruction material and professional coaching to develop your own style. FREE book and sample lesson with typical writing assignment show how you may enjoy an ideal part time or full time career. No salesman will call. Send today. Veterans: advise us if you are eligible for G.I. Training.

PALMER INSTITUTE OF AUTHORSHIP, Desk T-58

1680 N. Sycamore

Hollywood 28, Calif.

LAW FREE BOOK



Write today for FREE 48-page book, "THE LAW-TRAINED MAN," which shows how to learn law easily in spare time at home through the Blackstone course prepared by 60 well-known law authorities. We furnish all material including 18-volume Modern American Law library. Many successful attorneys among our graduates. LL.B. degree. Moderate cost; easy terms; Money-Back Agreement.

BLACKSTONE COLLEGE OF LAW

225 N. Michigan Ave., Dept. 55, Chicago 1, Ill.

A Correspondence Institution Founded in 1890

Master Watchmaking

The life-long profitable trade of thousands as taught by the Sweazey System.

"FAMED THE WORLD OVER"

CHICAGO SCHOOL OF WATCHMAKING

Founded in 1908 by Thomas B. Sweazey

1608 N. Milwaukee Ave., Dept. 158

Chicago 47, Ill.

YOU CAN BE AN ELECTROPLATER



Be your own boss or work for big pay. Make money while you learn at home in spare time. Interesting, uncrowded field. Plate with chrome, nickel, silver, gold, etc. Money making trade secrets furnished. Send postcard for FREE idea booklet today!
HYDE SCHOOL OF ELECTROPLATING
 432 F Street, Room 520, San Diego 1, California

THERE'S MONEY IN CARTOONS!

RAYE BURNS will teach you HOW TO CREATE ORIGINAL CARTOONS at home that you may SELL! Course contains 26 lessons and over 600 illustrations. All for Only...

\$2.85

Send name and address for free details.

RAYE BURNS SCHOOL, Dept. M, Box 3583, CLEVELAND, OHIO

ARTISTS MAKE MONEY

Do you like to draw? Send name, address, age and occupation for FREE ART TEST, to find out your ability.

ART INSTRUCTION, Inc.

5138 ART INSTRUCTION BLDG., MINNEAPOLIS 15, MINN.

DO YOU LOVE HORSES?

• ARE YOU INTERESTED IN HORSE TRAINING AND MANAGEMENT?

SUBSCRIBE FOR The "EXPERT HORSEMAN"

2 YEARS \$1.00



FREE BOOK—You will also receive a booklet that tells how you can learn to break colts, gait show horses, train rodeo, stock, and race horses, break bad habits, handle any horse and train circus trick horses.

SEND \$1.00 TODAY

ANIMAL LOVERS ASSOCIATION
 Box No. KA111, TARZANA, CALIFORNIA

WHICH OF THESE *Opportunities* INTERESTS *You* MOST?

Accounting
Air Conditioning
Architecture & Building
Automotive Engineering
Aviation—Practical
Aviation Drafting & Design
Better Foremanship
Bookkeeping
Business Management

Contracting
Diesel Engineering
Drafting & Design
Electrical Engineering
Electricity—Practical
Electronics, Industrial
High School Courses
Machine Shop Operations
Mechanical Engineering

Plastics Engineering
Plumbing—Practical
Private Secretary
Radio Operating & Servicing
Railway Training
Refrigeration
Sheet Metal Pattern Drafting
Shop Management
Tool Making

THINK! LOOK FORWARD!

Business is making big, new plans

Men and Women are preparing for the future

WHAT ARE YOU DOING ABOUT YOUR TOMORROWS?

● *Today*, choose the job you want—and prepare for it. Or if you are already engaged in the work you like best, start training *now* for quicker promotion. Acquire the knowledge that will help you to get ahead faster, make more money and have greater security.

Invest part of your spare time in more rapid progress. Start training now, in spare time in your own home. Be ready to grasp your opportunity and step out ahead of those who lack the ability you have attained.

American School, founded in 1897 as an educational institution *not for profit*, can help you to reach your goal just as it has helped others during the past fifty-one years. Give serious thought to the list above. Pick one or more subjects that interest you. Then check the coupon at right, add your name and address and mail it at once. The school will send you details on its training plan and outline of study prepared by specialists. There is no charge, no obligation, so send the coupon immediately.

PRACTICAL, EFFECTIVE HOME - STUDY TRAINING SINCE 1897

Take This First Easy Step

CHECK, CLIP AND MAIL COUPON NOW

AMERICAN SCHOOL, Dept. G545, Drexel at 58th, Chicago 37, Ill.
Without obligation. Please send FREE and postpaid, bulletin and details of the Subject checked.

- | | | |
|--|--|--|
| <input type="checkbox"/> PLASTICS ENG'G | <input type="checkbox"/> Accounting | <input type="checkbox"/> Drafting and Design for Men and Women |
| <input type="checkbox"/> Refrigeration | <input type="checkbox"/> Electrical Engr. | <input type="checkbox"/> Radio |
| <input type="checkbox"/> Architecture and Building | <input type="checkbox"/> Electricity-Pract. | <input type="checkbox"/> High School |
| <input type="checkbox"/> Contracting | <input type="checkbox"/> Electronics, Industr. | <input type="checkbox"/> Air Conditioning |
| <input type="checkbox"/> Practical Plumbing | <input type="checkbox"/> Bookkeeping | <input type="checkbox"/> Mechanical Eng. |
| <input type="checkbox"/> Automotive Engineering | <input type="checkbox"/> Private Secretary | <input type="checkbox"/> Shop Management |
| <input type="checkbox"/> Aviation Drafting | <input type="checkbox"/> Diesel Engineering | <input type="checkbox"/> Tool Making |
| <input type="checkbox"/> Aviation | <input type="checkbox"/> Sheet Metal | <input type="checkbox"/> Better Foremanship |
| <input type="checkbox"/> Business Mgmt | <input type="checkbox"/> Pattern Drafting | <input type="checkbox"/> Machine Shop Operations |
| <input type="checkbox"/> Railway Training | | |

Name..... Occupation.....
Address..... Age.....
City..... State.....

AMERICAN SCHOOL

Dept. G545, Drexel at 58th Street, Chicago 37

AUDELS Carpenters and Builders Guides

4 vols. \$6



Inside Trade Information for Carpenters, Builders, Joiners, Building Mechanics and all Woodworkers. These Guides give you the short-cut instructions that you want—including new methods, ideas, solutions, plans, systems and money saving suggestions. An easy progressive course for the apprentice and student. A practical daily helper and Quick Reference for the master worker. Carpenters everywhere are using these Guides as a Helping Hand to Easier Work, Better Work and Better Pay. To get this assistance for yourself, simply fill in and mail the FREE COUPON below.

Inside Trade Information On:

How to use the steel square—How to file and set saws—How to build furniture—How to use a mitre box—How to use the chalk line—How to use rules and scales—How to make joints—Carpenters arithmetic—Solving mensuration problems—Estimating strength of timbers—How to set girders and sills—How to frame houses and roofs—How to estimate costs—How to build houses, barns, garages, bungalows, etc.—How to read and draw plans—Drawing up specifications—How to excavate—How to use settings 12, 13 and 17 on the steel square—How to build hoists and scaffolds—skylights—How to build stairs—How to put on interior trim—How to hang doors—How to lay floors—How to paint



AUDEL, Publishers, 49 W. 23rd St., New York 10, N. Y. Mail Audel's Carpenters and Builders Guides, 4 vols., on 7 days free trial. If OK I will remit \$1 in 7 days and \$1 monthly until \$6 is paid. Otherwise I will return them. No obligation unless I am satisfied.

Name _____
 Address _____
 Occupation _____
 Employed by _____ PM

AVIATION Career

MAXIMUM TRAINING IN MINIMUM TIME

CAL-AERO TECH TRAINING will add dollars to your pay check all the rest of your life. Specializing in AERONAUTICAL ENGINEERING and MASTER AVIATION MECHANICS since 1929, Cal-Aero Tech training is carefully designed for just one thing—TO MAKE MORE MONEY FOR YOU. An alumni of over 6000 successful graduates proves our career training is unsurpassed.

VETERANS —Write us about Aviation Training, as provided under "G.I. Bill of Rights."



CAL-AERO TECHNICAL INSTITUTE
 MAJOR C. C. MOSELEY PRES. SINCE 1929
 FORMERLY CURTISS-WRIGHT TECHNICAL INSTITUTE

GRAND CENTRAL AIR TERMINAL
 GLENDALE 1, CALIFORNIA
 LOS ANGELES COUNTY

MAIL THIS COUPON TODAY!

Cal-Aero Technical Institute, Grand Central Airport, Glendale 1, California
 Please send full information on Aviation Training FREE—without obligation, Dept. PM-5

Name _____ Birth Date _____
 Street _____
 City _____ State _____

FUN!

MAKE THIS Squirrel Lamp
 Yes sir, out of a real squirrel! Also make ash-trays, book-ends, etc., using rabbits, frogs, etc. LEARN AT HOME TO MOUNT BIRDS, ANIMALS & FISH; tax skins and make rugs. Decorate your room. It's FUN! BIG profits in spare time!
 Free book tells how.

FREE BOOK! Write TODAY for beautiful free book telling how to learn this fine hobby. Book is free. Contains many fine pictures. STATE YOUR AGE.

N. W. SCHOOL OF TAXIDERMY, Dept. 3375, Omaha, Nebr.

Learn to Write

Good Penmanship makes favorable impressions and helps you win success. Poor penmanship contributes to failure. It makes no difference how poor you now write, you can quickly and easily learn Business Writing, and you can learn Shaded Writing also right in your own home during spare time by my Simplified Method, without cost of going away to school. Easy Lessons. Diploma.

BEGIN NOW! Write for my FREE BOOK, "How to Become an Expert Penman," which contains valuable information and many specimens of that show what others have learned by taking my Courses. If you enclose 10c, I will send you one of my Favorite Penpoints suitable for plain or shaded writing, and your name with a beautiful flourished bird written on a card. Write TODAY.

T. M. TEVIS, BOX 25K, CHILLICOTHE, MO.

LAW

STUDY AT HOME for Personal Success and LARGER EARNINGS. 39 years expert instruction—over 108,000 students enrolled. LL.B. Degree awarded. All text material furnished. Easy payment plan. Send for FREE BOOK—"Law and Executive Guidance."

AMERICAN EXTENSION SCHOOL OF LAW
 Dept. 89-PM, 646 N. Michigan Ave. Chicago 11, Ill.

"How to Make Money With Simple Cartoons"

A book everyone who likes to draw should have. It is free; no obligations. Simply address

CARTOONISTS' EXCHANGE
 Dept. 95-D Pleasant Hill, Ohio

The HAMSTER MANUAL

READ THE HAMSTER MANUAL

The most complete guide book on the successful breeding and raising of Syrian Golden Hamsters. Tells all about this new, fast growing, profitable and interesting hobby industry. Reveals all the secrets of the largest breeder of these delightfully profitable pets and laboratory animals. 34 Chapters chuck-full of information gleaned from actual experience as a breeder. Twenty Pages of illustrations. A few subjects are: history, housing, three methods of breeding, easy to get feeds, sexing, fertility vitamins, handling, educational, scientific projects, crating, profits and selling, where to buy and how to sell hamsters. Sent postpaid for \$1.00.

By Albert F. Marsh

Albert F. Marsh, 1522 Basil St., Mobile, Alabama

Now IN YOUR OWN HOME Learn

RADIO ELECTRONICS

The Practical
"HOME-TESTED"
Modern "A-B-C" Way

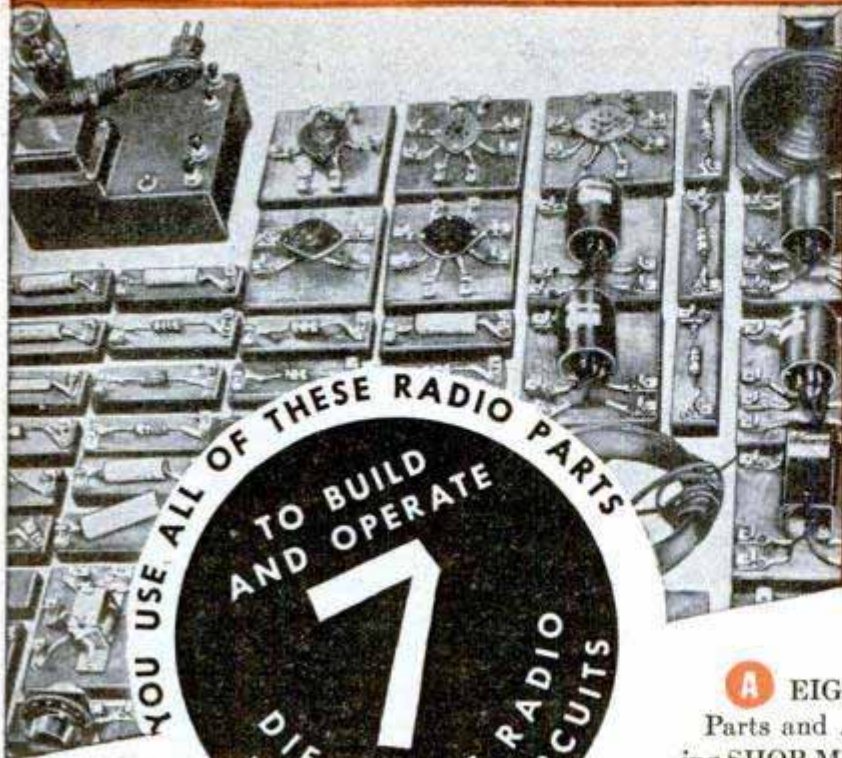

YOU USE ALL OF THESE RADIO PARTS
TO BUILD AND OPERATE
7
DIFFERENT RADIO RECEIVING CIRCUITS

NO PREVIOUS RADIO OR ELECTRICAL EXPERIENCE NECESSARY

DeForest's Training, Inc. provides every major home study aid to help you learn Radio-Electronics rapidly and thoroughly . . . to give you the experience and confidence needed for a responsible, Good-Pay Job, or to Start a Business of Your Own! Here is a REAL opportunity field for YOU . . . when you are a trained Radio-Electronics man! Just think of the tremendously exciting future ahead of FM Radio, Aviation and Broadcast Radio, Sound Motion Picture Equipment, Servicing and Sales of Radio Equipment, etc. Put yourself in this picture . . . See how you can benefit from a PRACTICAL training in this fascinating work! Think, too, of the coming possibilities ahead of Radar, Facsimile and Television. Send TODAY for the interesting, opportunity-revealing book, "Victory for You!" See how others probably no more talented or ambitious than you, have advanced in earning power after this training . . . how YOU can do it too! Mail the coupon NOW!

INCLUDING:

1. Simple Receiver
2. Two Tube Receiver
3. Tuned Radio-Frequency Receiver
4. Short Wave Receiver
5. Aviation Band Receiver
6. 4-Tube Superheterodyne
7. 5-Tube Superheterodyne with Magic Tuning Eye

••• PLUS SCORES OF OTHER FASCINATING, INSTRUCTIVE RADIO-ELECTRONIC EXPERIMENTS

WITH THE HELP OF

A EIGHT Big Kits of Actual "Learn-by-Doing" Radio Parts and Assemblies with which you make 133 fascinating SHOP METHOD EXPERIMENTS in your own home! Imagine building 7 different Radio Receivers that operate!

B A 16 mm Home Movie Projector and Twelve Reels of "Learn-by-Seeing" Home Movie Films . . . for picture-clear, fast understanding of Radio Fundamentals!

C Modern, well-illustrated, Loose-leaf Lessons, prepared in clear, simple, understandable language . . . to guide you throughout your training!

THEN GET THE HELP OF OUR EFFECTIVE EMPLOYMENT SERVICE

16 MM MOVIE PROJECTOR



YOU USE "LEARN-BY-SEEING" MOVIES

DEFOREST'S TRAINING, INC. INCLUDES INSTRUCTION IN MOTION PICTURE SOUND EQUIPMENT, FM RADIO AND TELEVISION . . . RESIDENTIAL TRAINING IN OUR MODERN CHICAGO LABORATORIES ALSO AVAILABLE—ASK US FOR INFORMATION!

VETERANS!

Big things are happening at DeForest's Training, Inc. for veterans! See how you can prepare yourself WITHOUT COST for a GOOD JOB or a BUSINESS OF YOUR OWN in the vast Radio-Electronic opportunity field.



E. B. DEVRY, President
DEFOREST'S TRAINING, INC.
2535-41 North Ashland Ave., Dept. PM-E5
Chicago 14, Illinois, U.S.A.

Send FREE "VICTORY FOR YOU!" BOOK, showing how I may make my start in Radio Electronics.

Name _____ Age _____
Address _____ Apt. _____

City _____ Zone _____ State _____

If under 16, check here for special information.

If a discharged Veteran of World War II, check here.

DeFOREST'S TRAINING, INC.
CHICAGO 14, ILLINOIS

Do you want

- ..to go to College?
- ..or to enter a Profession?
- ..or get an Office Position?

(Such as Accounting, Architecture, Nursing, Dentistry, Teaching, Social Work, Osteopathy, Beauty Culture, Optometry, Embalming, Chiropody, Law, Medicine, etc.)

To get anywhere, you practically **MUST** finish High School **FIRST**. You can complete our simplified High School Course in **SPARE** time at home, as **FAST** as your time and abilities permit. Equivalent to resident school work—prepares you for college, pre-professional examinations, business, industry. Standard texts furnished. Diploma. Credit for H. S. subjects already completed. Single subjects if desired. Low tuition, easy terms. American School, Chicago, est. 1897—endorsed by educators. Finish your high school education **NOW**. Write **TODAY!**

High School Course at Home

Many Finish in 2 Years

American School, Dept. H545, Drexel Ave. at 58th St., Chicago 37, Ill.

Gentlemen: Send me **FREE** information covering special training in subjects checked below. No obligation on my part.

- | | |
|--|--|
| <input type="checkbox"/> High School Course | <input type="checkbox"/> Diesel Engineering |
| <input type="checkbox"/> Architecture and Building | <input type="checkbox"/> Drafting and Design for Men & Women |
| <input type="checkbox"/> Automotive Engineering | <input type="checkbox"/> Plastics |
| <input type="checkbox"/> Business Management | <input type="checkbox"/> Private Secretary |
| <input type="checkbox"/> Electrical Engineering | <input type="checkbox"/> Mechanical Engineering |
| <input type="checkbox"/> Elec. and Gas Refrigeration | <input type="checkbox"/> Aviation |
| <input type="checkbox"/> Air Conditioning | <input type="checkbox"/> Salesmanship |
| <input type="checkbox"/> Railway Training | <input type="checkbox"/> Radio |
| <input type="checkbox"/> Electronics, Industrial | |

Name.....

Address.....

PRACTICAL AUTO INFORMATION

Keeps Cars Rolling by Making Repairs and Adjustments Easy!

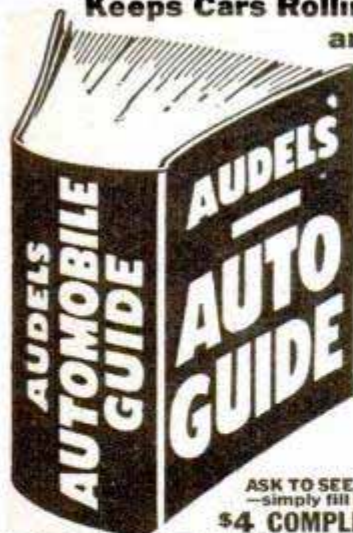

AUDELS AUTO GUIDE
For Every Mechanic, Driver, Owner and Repair Shop.

Sent on 7 Days Approval
Shows How to Tune Up—Keep Brakes Safe—Batteries Powerful—Tire Mileage Up—Save Gas—Lubricate Correctly.

ANSWERS YOUR QUESTIONS
Contains all you need to know about 1—Construction, 2—Operation, 3—Service, 4—Repair of Modern Motor Cars, Trucks, Buses & Diesel Engines in every detail.

NEW FLUID DRIVE TREATED
Easy to understand—1540 Pages, 1540 Illustrations. Gives definite directions on How to handle service jobs.

ASK TO SEE IT—Get this information for yourself—simply fill in and mail coupon today.

\$4 COMPLETE • PAY ONLY \$1 A MO.

AUDEL, Publishers, 49 West 23rd St., New York
Mail AUDELS AUTOMOBILE GUIDE (\$4) for free examination. If O. K., I will send you \$1 in 7 days; then remit \$1 monthly until \$4 is paid. Otherwise, I will return book promptly.

Name.....
Address.....
Occupation.....
Reference.....PM

Have an OFFICE of YOUR OWN!

LEARN NEW PROFITABLE PROFESSION
At Home in 60 Days, Men & Women, 18 to 70!

Be Your Own Boss and the Boss of Others. Be Respected. Meet Interesting People.



Earnings of men and women in this profession run as high as \$5,000-\$15,000 yearly. Others make good money in spare time. Little money needed to start. A business where your earnings begin sooner. Easy to learn. No selling or goods to buy. No experience necessary. A depression-proof business. A course of action to guide you step by step as you earn. All 53 lessons sent at once to use as operating manuals. Easy terms. Diploma. Money-back agreement. Write for **FREE BULLETIN**.

FRANKLIN CREDIT SCHOOL

Dept. 75-E ROANOKE 7, VIRGINIA

BY MAIL in Easy Lessons

LEARN WATCH REPAIRING



AT HOME. By our modern and original system of instruction you can learn every part of the **WATCH REPAIRING TRADE AT HOME.** Prepare yourself for a well-paying position or start in business after completing our course of instruction. Good watch repairers are in demand and generally earn very good salaries. For particulars apply to the **Wisconsin School of Watch Repairing** 759 North Milwaukee St., Milwaukee 2, Wis.

ANALYZE Handwriting

Uncrowded, fascinating field. Gratifying earnings reported by graduates in Employment, Credit, Social Service, Police and Entertainment fields. Others have developed profitable private practice, full or spare time, as Personal Problem and Vocational Counselors. Send for 3000 word **TEST LESSON** and Grapho Analyst **FREE**.



A. I. G. A. Inc.

Wilhoit Bldg., Dept. 120 Springfield, Mo.



COMBAT JUDO

Fiercest fighting technique known. Learn trick knock-outs, police tactics, and the art of Defense and Attack. Expert instructions in **THREE** volumes with 200 photographs and illustrations. Complete.. **only \$2.25**

VARIETY HOUSE

Box 46-BA Wall St. Sta., New York 5, N. Y.

TRI-STATE COLLEGE

B. S. Degree in 27 months in Civil, Electrical, Mechanical, Chemical, Aeronautical, Radio Engineering; Bus. Admin., Acc't and Sec. Science. Graduates successful. 64th year. Enter June, Sept., Jan., March. Catalog. 458 College Ave., Angola, Ind.

STAY HOME AND MAKE MONEY!

—Men! Women! Get into profitable, uncrowded profession you can operate from your home or small office after short home training course. No capital required. No goods to buy. No age limit. Others earn \$50.00 to \$100.00 per week making famous Stephenson corrective foot devices to order. Foot sufferers everywhere pay gladly for relief. Send today for **FREE BOOKLET**.

STEPHENSON METHOD, Established 1894, 12-28 S. Market St., Boston, Mass.

SAY YOU SAW IT IN POPULAR MECHANICS

RUPTURED?

Get Relief This Proven Way

Why try to worry along with trusses that gouge your flesh—press heavily on hips and spine—enlarge opening—fail to hold rupture? You need the Cluthe. No leg-straps or cutting belts. Automatic adjustable pad holds at real opening—follows every body movement with instant increased support in case of strain. Cannot slip whether at work or play. Light. Waterproof. Can be worn in bath. Send for amazing **FREE** book, "Advice To Ruptured," and details of liberal truthful 60-day trial offer. Also endorsements from grateful users in your neighborhood. Write: **CLUTHE SONS, Dept. 31, Bloomfield, New Jersey**



1 FIRST: You get vital basic knowledge at home—during spare hours. Train as fast or as leisurely as you like.



2 THEN: You come to ITI's giant shops in Chicago—for a Full Four Weeks of practical instruction and actual work on newest, most modern equipment.



REFRIGERATION—Trained men needed to handle service and repair jobs.



AIR CONDITIONING—Plenty of opportunity in this great industry for trained men.

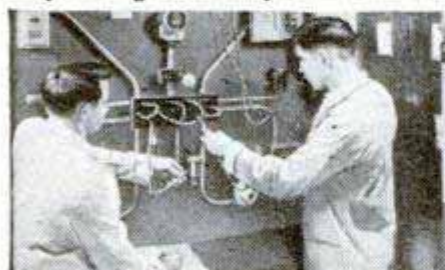

HEATING—ITI trains you in this big pay field to handle essential service work.

Prepare NOW—Start Training in Spare Time for a **BETTER JOB** in

REFRIGERATION AIR CONDITIONING

Good Practical Training Pays Rich Rewards in **BIGGER PAY** and Steady Advancement

AMERICA'S FOREMOST SCHOOL of PRACTICAL TRAINING
preparing ambitious men for greater opportunities since 1916

••• Now is the time to lay your plans for a better job at better pay! Get the facts about your future in the amazingly FAST GROWING field of Refrigeration, Air Conditioning and Heating! Men who know how to install, repair, rebuild and maintain this equipment are going ahead FAST! But many more fine jobs are open NOW in this rapidly expanding industry in both the home and commercial equipment fields. Experts say the opportunities are almost unlimited... BUT ONLY THE PROPERLY TRAINED MEN CAN QUALIFY!

Train at Home and in ITI's Huge Shops

Investigate the Industrial Training Institute's 2-Way Course in Refrigeration, Air Conditioning AND Heating. In a few months this training gives you solid, practical, down-to-earth knowledge and experience you need. You don't have to leave home or give up your present job. Then you come to the huge ITI shops in Chicago for FOUR FULL WEEKS of action-packed practical experience!

Interesting, Practical Course

You don't need any special schooling or experience to master the ITI course. Just a desire to learn and advance. Useless theory and dull mathematics have been reduced to a minimum. ITI lesson Work Sheets are easy to read, interesting and 100% practical. The ITI trained man is ready to handle any practical job in the industry. And ITI helps you find your job!

TRAINING MEN FOR INDUSTRY SINCE 1916!

ITI Training is backed by more than 30 years of success and experience. We have given training to over 400,000 men since 1916. Today thousands of ITI graduates hold down top paying jobs. ITI occupies five large buildings, with over \$500,000.00 invested in shops and training facilities. Instruction staff of more than 150 men. ITI is recognized as the world's foremost school of practical training!

Mail Coupon for FREE Facts!

Find out about ITI Training. See for yourself how easy and simple it is to start at home, in your spare time, and prepare yourself for a fine job with a real future. It's all in ITI's fascinating, illustrated FREE book, "Your Future in Refrigeration & Air Conditioning." Just fill out and mail the coupon below NOW! Take this first step toward success TODAY!

VETERANS:

ITI Residence Training is fully approved under the G.I. Bill.

ITI also trains ambitious men for good pay jobs in . . .

- Electricity & Industrial Electronics
- Machine Drafting & Design
- Precision Instruments

MAIL COUPON TODAY FOR **FREE BOOK!**

Mr. C. H. Smith, President,
INDUSTRIAL TRAINING INSTITUTE
2150 Lawrence Ave.,
Dept. E-1, Chicago 25, Ill.

Please send me FREE the ITI book, "Your Future in Refrigeration and Air Conditioning" and information about the opportunities for trained men in this fast growing field. I understand I'm under no obligation.

NAME _____ AGE _____

ADDRESS _____

CITY _____ ZONE _____ STATE _____

ARE YOU A VETERAN? _____



INDUSTRIAL TRAINING INSTITUTE
Formerly the L. L. Cooke School of Electricity & Refrigeration & Air Conditioning Institute
Dept. E-1, 2150 LAWRENCE AVE., CHICAGO 25, ILL.

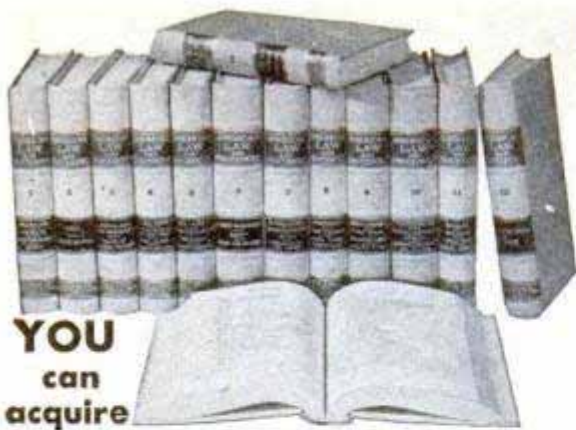

YOU
can
acquire

LAW NIGHTS AT HOME!
L. L. B. DEGREE

LaSalle's famous Law Library—used as reference in many Law libraries and Law offices—has enabled thousands to master Law surprisingly fast, in spare hours at home, for business and professional advancement.

These 14 remarkable volumes, compiled by leading professors and lawyers, cover the whole basic field of Law in condensed, orderly, simplified manner.

You advance rapidly with this great library, plus special lectures furnished. We guide you step-by-step with personalized Problem Method of instruction . . . you learn by doing—handling legal problems—not by memorizing rules.

Send for two FREE 48-page booklets, "Law Training for Leadership," and "Evidence," answering questions about Law and its value to you, and telling how LaSalle Law graduates are winning rapid advancement in business and public life. Mail coupon below. No obligation.

LA SALLE EXTENSION UNIVERSITY

A Correspondence Institution

417 S. Dearborn St. Dept. 564-L Chicago 5, ILL.

Send me your two FREE booklets described above, without obligation.

Name..... Age.....

Street.....

City, Zone & State.....

LEARN } **ACCOUNTING**
SALESMANSHIP
SECRETARIAL
WORK

Assure Your Future Now!

Hill's, one of America's outstanding Business Schools, offers you the opportunity to enter one of the three fields acknowledged to hold substantial earnings and a secure future. Our FREE book, "Through Hill's to Success," tells how and where the best positions are found and how you can qualify for them by study at home or in our resident school. We have thousands of successful graduates and maintain nationwide employment service. G. I. Approved.

FREE
WRITE
TODAY

USE THIS HANDY COUPON

HILL'S EXTENSION SCHOOL Dept. PM-5
AND BUSINESS UNIVERSITY
619 W. Main St., Oklahoma City 2, Okla.
Please send me your Free book, "Through Hill's to Success."

NAME.....
ADDRESS.....
CITY..... STATE.....

SUCCEED IN THE POULTRY BUSINESS! 

Poultry is providing many trained men and women with a good, comfortable living, either part or full time. For 27 years our Home Study Course has been helping thousands obtain training and "know how" that means extra income from the start. Don't delay—Write today for prospectus describing courses, methods, service, opportunities.

NATIONAL POULTRY INSTITUTE
DEPT. 50 ADAMS CENTER, N. Y.

LEARN TO WRITE
a Good Hand!

FOR BUSINESS AND SOCIAL SUCCESS!
Easy to improve your handwriting at home quickly with my new instruction books just off the press. Master all the secrets of better penmanship. Simple and easy fully illustrated, highly endorsed. Begin today. Write for: New Free Book, "How to Become a Good Penman," or check books wanted, \$1.00 each. Business Writing Artistic Writing Card Writing Engraving Alphabets Bird and Design Flourishing Complete Set \$4.50 Envelope 10c for your name beautifully written and special penpoint for shaded writing.
S. A. Ziller, President, TAMBLYN SCHOOL OF PENMANSHIP
441 Ridge Bldg. In Business Over 52 Years Kansas City, Mo., U.S.A.

WANTED
DISTRICT PURCHASING AGENTS

No experience or money required. Exceptional opportunity for those who want to establish themselves in a steady, year 'round, well paying business.

For details: Write

PURCHASING MANAGER, DEPT. C
2719 LAWRENCE AVE. CHICAGO 25, ILL.

BE A REAL ESTATE BROKER
PAYS BIG! **EASY TO LEARN**—Start and run your own business quickly. Many graduates report making up to \$1000 a month. Course of study covers Sales, Property Management, Appraising, Loans, Mortgages and hundreds of related subjects. Course offered in home study or residential classrooms.

FREE Big new illustrated catalog from this nationally known school. Send Post Card Today. G. I. Approved.

WEAVER SCHOOL OF REAL ESTATE
Dept. PM-1, 15 E. Pershing Road Kansas City, Mo.

GREATEST MOVIE EVER MADE
ATOMIC FURY
Bikini atom bomb tests in thrilling Kodachrome
8mm., 50 ft., \$6.50
16mm., 100 ft., \$13.00 (Silent)
83 Subject Catalog - 10c
ORDER DIRECT FROM
World In Color Productions, Elmira, N. Y.

Thrilling Work COLORING PHOTOS

Fascinating vocation learned at home by those with aptitude. Thrilling pastime. National method brings out life-like colors. Free booklet.
EASY TO LEARN **NATIONAL PHOTO COLORING SCHOOL**
1315 S. Michigan, Dept. 1355, Chicago 5

STAMMER? **GET THIS FREE BOOK!**
This new 128-page book, "Stammering, Its Cause and Correction," describes the Bogue Unit Method for scientific correction of stammering and stuttering—successful for 47 years. Benj. N. Bogue, Dept. 4824, Circle Tower, Indianapolis 4, Ind.

MONEY for MEN ALL DATA **FREE**
THE PLASTEX Industry needs manufacturers on small scale and for big production of Lamp and Clock Stands, Art Goods and Novelties in Plastex and Marble Imitation. Experience unnecessary. 1gc material makes regular 10c store sellers. Rubber moulds furnished for speed production. Small investment brings good returns. Big chain store orders now being placed. Ambitious men have chance for real prosperity. Our Free booklet will interest and benefit you.
PLASTEX INDUSTRIES, Dept. A
3400 Third Ave. New York 56, N. Y.

NOW... YOU CAN LEARN

WATCH REPAIRING

In Your Spare Time At Home

FROM THE LARGEST APPROVED SCHOOL OF ITS KIND

HOME TRAINING WITH TOOLS

Lets You EARN While You Learn
Enroll NOW For

BIG PAY PROFESSIONAL FUTURE
In An Uncrowded Field

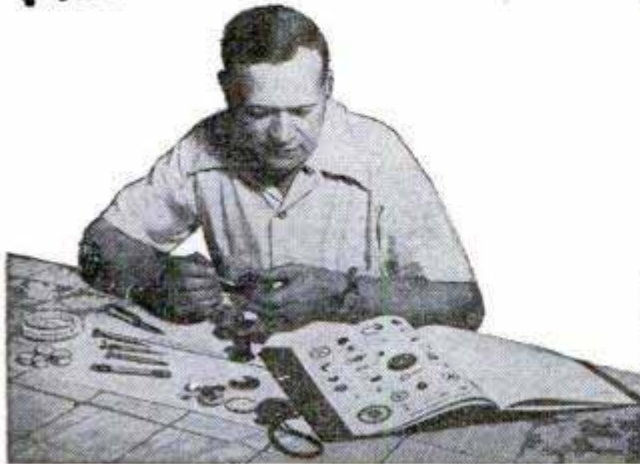

The Illinois School of Watch Repairing offers you an opportunity NOW . . . to learn the fascinating art of WATCH REPAIRING in your spare time at home . . . and thus insure your future

earning power. No loss from your present work! No previous mechanical experience needed! As an expert Watch Maker you can enter an uncrowded field with big pay possibilities unlimited.

Actual Watch Repairing With Each Lesson

Our spare time Home Training thoroughly instructs you in all the rudiments of practical Watch Repairing. Enables you to master the complete 10-Lesson Course quickly, easily—earning as you learn with actual repair jobs—with a Diploma issued upon your graduation. We furnish all necessary tools and watch and teach you actual repairing with the use of these tools. You learn how to take any watch apart and put it together in fine working order—to make part replacements—to clean and expertly repair any watch. Ours is a proven course. It has taught and is teaching expert watch repairing. It can do the same for you.

Testimonials From Our Students

"I have repaired 63 watches and have more than paid for Course." C. Fuller, Texas. "Every promise made by the School to me has been faithfully performed." S. A. McCulla, Calif. "Your lessons are the most complete and easy to understand that I have ever studied." C. L. Doud, Oreg. Many more letters from our enthusiastic students in our files.



Would Your Earning Power Be Cut Off

NO HELP WANTED

- if factories closed
- if offices closed
- if sales forces were reduced
- if unemployment swept the country

if crops failed?

Your Safeguard is . . . a Specialized Education

Trained Watch Makers Now in Demand

BE YOUR OWN BOSS

FREE WATCH and WORKING TOOLS
included as part of your course

MAIL COUPON NOW FOR FREE FACTS

ILLINOIS SCHOOL OF WATCH REPAIRING
2870-CP ELSTON AVE., CHICAGO 18, ILL.

Kindly send me FREE LITERATURE on your Spare Time Home Training Course in WATCH REPAIRING. I understand no salesman will call on me.

Name _____

Address _____

City _____ Zone _____ State _____

ILLINOIS SCHOOL OF WATCH REPAIRING
2870 ELSTON AVENUE
CHICAGO 18, ILLINOIS

HOW TO Fight! Wrestle! Jiu-Jitsu!

FREE



Plus Weight Lifting! Strong Man Stunts!

Be prepared to protect your family, friends, yourself in any emergency! Be admired! George F. Jowett, Champion of Champions, gives you free his "SMASHING CHAMPION SECRETS." Contains many "HOW-TO-DO-IT" pictures that quickly and simply show you how to powerfully deliver a knockout, how to break any hold, how to overpower any opponent plus weight lifting and strong man stunts! Inside professional "Tricks of the Trade" proved successful by

You Need He-Man Fitness to Handle Any Tough Situation!

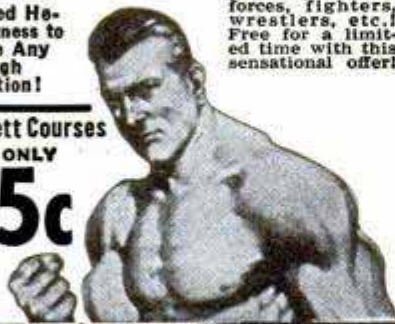

police, armed forces, fighters, wrestlers, etc.! Free for a limited time with this sensational offer!

NOW! All 5 Famous Jowett Courses

IN 1 COMPLETE MUSCLE BUILDING VOLUME! **FOR ONLY 25c**

Let Me Prove I Can Make You—

COMMANDO-TOUGH OR IT WON'T COST YOU A CENT!

says George F. Jowett WORLD'S GREATEST BODY BUILDER

Give Me 10 Minutes a Day Learn My Time Tested Secrets of Strength
I'll teach you the "Progressive Power Method" that rebuilt me from a physical wreck condemned to die at 15, to the holder of more strength records than any other living athlete or teacher! Has proven it builds the strongest, handsomest men in the world. Let me prove on a money back basis—that no matter how flabby or puny you are I can add inches to your arms, broaden your shoulders, give you a man-sized chest, powerful legs and a rock-like back—in fact power pack your whole body so quickly it will amaze you—right in your own home! I'll bring to life new power in you inside and out, until YOU are satisfied you are the man you want to be.

PROVE IT TO YOURSELF IN ONE NIGHT

Send only 25c for my 5 easy-to-follow, picture-packed courses now in 1 complete volume, "How to Become a Muscular He-Man." Try it for one night! Experience the thrilling strength that surges through your muscles.

10 DAY TRIAL!
Think of it—all five of these famous courses now in one picture-packed volume for only 25c. If you're not delighted with this famous muscle-building guide—if you don't actually FEEL results within ONE WEEK, send it back and your money will be promptly refunded! Photo Book of Famous Strong Men!

FREE!



I am making a drive for thousands of new friends fast—REGARDLESS OF COST! **SO GET NOW MY 5 Muscle Building COURSES** (Valued at \$5 each) **All in 1 Great Complete Volume Packed With How-To-Do-It Pictures!** Now, this "get-acquainted," extremely low price of only 25c is your chance to build a body you'll be proud of! Follow Jowett's easy method of muscle building NOW!

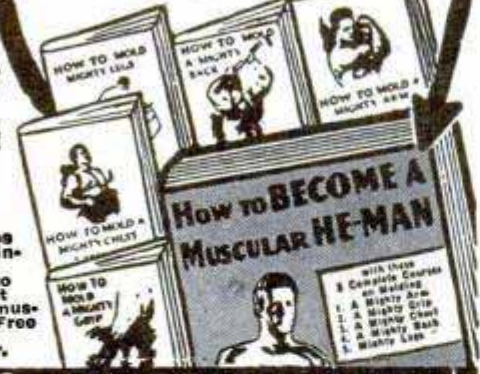

2 FREE GIFTS!

Jowett Institute of Physical Culture Dept. PM-85
230 Fifth Avenue, New York 1, N.Y.

George F. Jowett: Please send by return mail, post-paid, FREE "Smashing Champion Secrets" and FREE Jowett's Photo Book of Strong Men, along with all 5 Muscle Building Courses. 1. Molding a Mighty Chest. 2. Molding a Mighty Arm. 3. Molding a Mighty Grip. 4. Molding a Mighty Back. 5. Molding a Mighty Leg—Now all in One Volume "How to Become a Muscular He-Man." Enclosed find 25c. NO C.O.D.'s.

George F. Jowett Champion of Champions

NAME _____ AGE _____
(Please Print Plainly, Include Zone Number)
ADDRESS _____

Famous BAILEY DIESEL SCHOOLS

Now Accepting CIVILIAN STUDENTS!

Bailey has a national reputation for "finest training methods." Bailey teaches you fundamentals, plus the practical application of theory in plenty of actual shop work. Bailey is approved by industry. Bailey graduates get the jobs!

Civilian men and boys over 17 who are ambitious to get ahead will act now. Send for FREE catalog. No salesman will call.

BAILEY TECHNICAL SCHOOLS
1655 So. Grand Blvd., St. Louis, Mo.

Be A MASTER PLUMBER

Earn \$15 To \$50 A Day

DON'T ENVY THE PLUMBER — BE ONE

Every skilled workman will tell you that Plumbers have the best of it. WINTER and SUMMER the Plumber is busy at top wages. No skilled Plumber is ever out of a job—compare his opportunities with any trade, plus the opportunities of having your own shop. We teach you Plumbing with TOOLS (not books) under Licensed Master PLUMBERS in one of the finest equipped schools in America. We make you a Plumber, every branch is taught thoroughly—Lead Work—Blueprint for plan reading—all other tricks.

LEARN IN 30 WEEKS WITHOUT PREVIOUS EXPERIENCE

If you like to work with tools you owe it to yourself to investigate. No need to ever work as an apprentice. Get free bulletin. Write now! G.I. APPROVED. Our 24th year.

UNIVERSAL PLUMBING SCHOOL
815 HOLMES STREET KANSAS CITY, MO.

SHORTHAND in 6 Weeks at Home

Famous Speedwriting system. No signs; no symbols; no machines; uses ABC's. Easy to learn; easy to write and transcribe. Fast preparation for a job. Surprisingly low cost. 100,000 taught by mail. Used in leading offices and Civil Service. Write for free booklet. **SPEDWRITING, Dept. 1505-8, 55 W. 42 St., N. Y. 18**

APTITUDE TESTS

discover the kind of work or studies best for your success! You get a personal report—a guide for life—more happiness—more prosperity. For men, women, boys and girls. Write for complete facts.

VOCATIONAL COUNSELING INSTITUTE
956 Maccabees Bldg., Detroit 2, Michigan

How to Become Good Penman
Free Book tells all
For fun & profit \$1.00
The Tilden School of Penmanship F-441
Ridge Building, Kansas City, Mo., U.S.A.

FIBRE ARMS AND LEGS!
Light, correctly fitted, strong and comfortable. Natural appearance. Braces for all deformities. Scientific design. Fair Terms.
BUCHSTEIN-MEDCALF 223 S. 6th St., Minneapolis, Minn.



ZIRCONS

LOOK SO MUCH LIKE REAL DIAMONDS
Your friends won't know, if you don't tell 'em! Inexpensive, too! Write now for free catalog of jewelry—set with this remarkable gem. **Catalog FREE!**
NATIONAL JEWELRY CO. DEPT. 21-W, WHEELING, W. VA.

AMERICA'S GREATEST ELECTRICAL SCHOOL OFFERS YOU

MORE EQUIPMENT!

MORE SPACE!

MORE TRAINING!



Learn **ELECTRICITY**

It's Easy - "LEARN-BY-SEEING" MOVIES
It's Fast - "LEARN-BY-DOING" METHODS

and its THOROUGH! . . . There is *no other place*—no other way to get the same all-around training you get at M.T.I. NOT A HOME STUDY COURSE! . . . You get actual "hands-on-equipment" training in great MODERN SHOPS in Detroit. No previous experience necessary. Learn HOUSE WIRING, A.C., D.C. MOTORS, ARMATURE WINDING, POWER PLANT WORK, etc. New classes start every few weeks. Part time work available. Living arrangements made.

NO COST TO VETERANS Train at Gov't. expense. Receive \$75 to \$120 month while learning. Coupon brings details.

9th NATION'S LARGEST EXCLUSIVE ELECTRICAL SCHOOL



OVER **1000** PIECES of ACTUAL ELECTRICAL EQUIPMENT to WORK ON!

MAIL TODAY FOR QUICK ACTION!

MICHIGAN TECHNICAL INSTITUTE, Dept. PM-5
2281 W. Fort St., Detroit 16, Michigan

- Send me catalog and complete information.
- I am a GI. Send special information.
- Married. Single

NAME _____
ADDRESS _____
CITY _____ ZONE _____ STATE _____

MICHIGAN TECHNICAL INSTITUTE
Department PM-5, 2281 West Fort Street, Detroit 16, Michigan

The American Institute of Specialized Watch Repair
270-276 East Building GRAND RAPIDS 6, MICHIGAN
A Fully Accredited School

You can learn this highly fascinating and profitable trade through this Institute either at home by correspondence . . . or at the teacher school.

Earn While You Learn

Write for Free Circular

Learn WATCH REPAIRING

SHOE REPAIR OFFERS BIG INCOME
LEARN IN 12 WEEKS TIME

In 12 weeks time you can own your own shop or earn big income as skilled shoe repairman. Growing demand everywhere at top wages for men who know how. We teach you quickly by actually working on shoes and modern machines. Costs nothing under G.I. Bill of Rights. We help you get big pay job or start your own shop in 12 short weeks. School open to all from 18 to 60 years of age. FREE BIG 16 PAGE BOOK explains everything. Send for your copy today.

MODERN SHOE REBUILDING SCHOOL
Established 1927

2937 Belmont Ave., Chicago, Ill. RUSH POSTCARD TODAY

GLOWS in the DARK

FREE Sample!

Be the first to sell luminous house numbers, light switch plates, wall protectors, pull cords. Also luminous pictures, statues, decals, and a host of religious, nursery and other objects that glow in the dark. Get into this new and growing industry. Enormous demand . . . no competition . . . sensational demonstration . . . big profits. Represent a large manufacturer, established over 34 years. Write today for liberal money-making offer and free sample to show how they glow in the dark.

MADISON MILLS, 303 Fourth Ave. Dept. E-4, NEW YORK 10, N. Y.

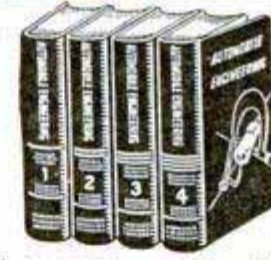

AUTO BOOKS ON APPROVAL



SEND NO MONEY. Just mail the coupon for a complete set of 4 Big, Thick Auto Books, 20th Edition. Over 2700 Pages! Whether you are a mechanic or helper, expert or apprentice, auto owner or driver, take immediate advantage of this FREE EXAMINATION OFFER.

MAKE GOOD MONEY NOW HOLD A PERMANENT JOB

America wants its automobiles kept in good repair. Men with "know how" are in demand, at big pay. These books will help you get and hold an important job, or give you a chance to go into business for yourself now or later. Any man who half tries to improve himself can learn auto servicing and repairing by this quick reference method. Use the JIFFY INDEX to find easily understood answer to any auto problem. These wonder books prepared by eleven of America's great automobile engineers. Many hundreds of valuable illustrations. Send the coupon TODAY.

A year's consulting privileges with our engineers now given with these books without extra charge.
Vocational Publishers Since 1898

CAN YOU FIX IT?
These wonder books tell step by step HOW to make difficult repairs and adjustments, how to keep a car at maximum efficiency, including latest improvements in car design and operation. Engine troubles and how to correct them well covered.

4 BIG, THICK VOLUMES
Over 2700 pages, 2000 illustrations, wiring diagrams, etc., including Diesel engines. Beautiful modernistic, washable cloth binding.

AMERICAN TECHNICAL SOCIETY, Dept. A519
Drexel Ave. at 58th St., Chicago 37, Ill.

I would like to examine your 4-Volume Set of Auto Books. I will pay the delivery charges only, but if I choose I may return them express collect. If after 10 days' use I prefer to keep them, I will send you \$2 and pay the balance at the rate of only \$3 a month until \$24.80 has been paid. Include consulting service as offered above.

Name _____
Address _____
City _____ State _____

Please attach letter stating age, occupation, employer's name and address and name and address of at least one business man as reference. Men in service, also please give home address.

SAY YOU SAW IT IN POPULAR MECHANICS

Learn RADIO -TELEVISION



in the GREAT SHOPS OF COYNE

Get ready for a better job, bigger pay NOW in Radio. Cash in with "All-around" knowledge of Radio—Television. Train on actual equipment. You learn easily at COYNE because it's real shop training. Thousands of graduates in Industry.

Not a "Home-Study" Course!

You get actual shop work on full-size equipment plus necessary theory. Whether you had previous experience or not makes no difference at Coyne.

Easy To Start Own Shop

Right along with our course, we include special training on how to operate your own Radio Shop.

GI Approved—Finance Plan for Non-Vets EARN WHILE LEARNING

If you need part-time work to help out with living expenses while at Coyne we'll help you get it. Don't be held back by lack of money. Free employment service to graduates.

SEND FOR FREE BOOK

Get the facts! BIG FREE BOOK tells about your future in Radio and Television and how you can prepare at Coyne. Dozens of pictures. No obligation—no salesmen will call.

Established 1899

MAIL COUPON TODAY!

B.W. COOKE, President
COYNE Electrical and Radio School
500 S. Paulina St., Dept. 58-3H Chicago 12, Ill.

Please send me your Big Free Radio and Television Book and all the facts.

NAME.....

STREET.....

CITY..... STATE.....

COYNE

Gives You All-Around Radio Training
RADIO MFG.
TELEVISION
FREQUENCY MODULATION (FM)
RADIO SERVICE (Your own shop)
SOUND SYSTEMS



SAY YOU SAW IT IN POPULAR MECHANICS



Carbide Tipped Centers

Essential for metal working lathes where high speeds or extreme cutting pressures are encountered. Tungsten carbide tip will withstand more wear than any other metal. Entire center precision ground.

No. 2 Morse Taper postpaid \$4.50
No. 3 Morse Taper postpaid \$8.00

SOUTH BEND LATHES WORKS

455A E. Madison St.
South Bend 22, Ind.

ENGINEERING DEGREE IN 27 MONTHS

INDIANA
TECHNICAL
COLLEGE

Aeronautical, Chemical, Civil, Electrical, Mechanical, and Radio Engineering (inc. television). Drafting, 1-yr. Gov't approved for G.I.'s. Low rate. Earn board. Large industrial center. Students from 48 states, 18 countries. Demand for graduates. Enter June, September, December, March. Catalog.

558 E. Washington Blvd., Ft. Wayne 2, Ind.

EXPERT PHOTOGRAPHY MADE EASY LEARN PHOTOGRAPHY NOW

—for both sound, secure future and immediate opportunities. Ever-increasing demand for trained men and women. Excellent earnings. Resident or home study. Write for full details.

NEW YORK INSTITUTE OF PHOTOGRAPHY

Dept. 49, 10 West 33rd Street

New York 1, New York



Bar Bells

Buy Direct From Factory

Write for free booklet **\$8.95** up
and price list

INDEPENDENT IRON WORKS
2416 East 23rd Street, Dept. B
Los Angeles 11, Calif.

MAKE BIG MONEY IN REAL ESTATE

Be your own boss! Some report they make as high as \$1000 a month. Simplified home study course in Real Estate covers Selling, Listings, Appraisals, Loans, Mortgages, all essentials. A SHORT CUT TO PERMANENT PROSPERITY it quickly qualifies you for big earnings. START NOW! Send postcard for prospectus and complete information. DO IT TODAY!

PHOENIX REALTY MART-EDUCATIONAL DIVISION
Dept. AB, 923 No. Fourth St., Phoenix, Ariz.



RID YOUR DOG OF WORMS

USE PARKE-DAVIS

NEMA

WORM CAPSULES

KEEP YOUR DOG FRISKY!

Dependable, easy to give, scientifically prepared and low in cost, NEMA Worm Capsules effectively remove large round worms and hookworms in dogs and cats.

FREE! Send for illustrated, helpful worm booklet.

PARKE, DAVIS & CO., DETROIT 32, MICH.
DRUG STORES SELL PARKE-DAVIS PRODUCTS

POPULAR MECHANICS

They Never Knew It Was SO EASY To Play

**Thousands Now Play Popular Songs
Who Didn't Know a Note of Music Before**

**You, too, can learn your favorite
instrument at home, without
a teacher, this quick,
easy, money-saving way**

THINK of the fun YOU are missing! The popularity, friendship, good times! Why? Because you think it's hard to learn music. You have an idea that it's a slow, tedious task, with lots of boring drills and exercises.

That's not the twentieth-century way! Surely you've heard the news! How people all over the world have learned to play by a method so simple a child can understand it—so fascinating that it's like playing a game. Imagine! You learn without a teacher—in your spare time at home—at a cost of only a few cents a day! You learn by the famous print-and-picture method—every position, every move before your eyes in big, clear illustrations. You CAN'T go wrong! And best of all, you start playing real tunes almost at once, from the very first lesson.

No needless, old-fashioned "scales" and exercises. No confused, perplexing study. You learn to play by playing. It's thrilling, exciting, inspiring! No wonder hundreds of thousands of people have taken up music this easy way. No wonder enthusiastic letters like those reproduced here pour in from all over the world.

Sound interesting? Well, just name the instrument you'd like to play and we'll prove you CAN! (Instruments supplied when needed, Cash or Credit.) Mail the coupon or write. Do it now! 50th year.

**U. S. SCHOOL OF MUSIC
75 Brunswick Bldg.
New York 10, N. Y.**



Learned Quickly at Home. "I didn't dream I could actually learn to play without a teacher. Now when I play for people they hardly believe that I learned to play so well in so short a time." *H. C. S., Calif.



Music is the magic key to friendship, fun, romance. The person who can play a musical instrument is always sure of a welcome. Why not let music open up a new world for you. Thousands have discovered unexpected pleasure and profit in music, thanks to the unique method that makes it amazingly easy to learn.

**Send for FREE Booklet and
Print and Picture Sample**

See for yourself how this wonderful self-instruction method works. Sit down, in the privacy of your own home, with the interesting illustrated booklet, "How to Learn Music at Home." No salesman will call—decide for yourself whether you want to play this easy way.



Invited to Parties. "Before I took your course I didn't know one note of music. Then three months later I started to play for dances. I've been invited to many parties. The course is easy and interesting." *R. M., Vancouver, B. C.



Well Worth Money. "The course is fully self explanatory. When one is finished with it there is little one need learn. It is well worth the money and I fully believe you have the finest course on the market today." *R. E. G., Clarksburg, W. Va.



Surprised Friends. "People who hear me play don't understand how I do it. They ask if I haven't had lessons from a teacher. To their surprise they find I haven't. I'm glad to be a student of your School." *M. H., Athol, Kans.

**U. S. SCHOOL OF MUSIC
75 Brunswick Bldg., New York 10, N. Y.**

I am interested in music study, particularly in the instrument indicated below. Please send me your free booklet, "How to Learn Music at Home" and the free Print and Picture Sample.

Piano
Guitar
Hawaiian Guitar
Violin
Piano Accordion
Saxophone
Trumpet, Cornet

Reed Organ
Tenor Banjo
Ukulele
Clarinet
Trombone
Flute
Piccolo

Modern
Elementary
Harmony
Mandolin
Practical Finger
Control

Name _____ Have You This Instr.?
(PLEASE PRINT)

Address _____

City _____ State _____

Note: If you are under 16 yrs. of age, parent must sign coupon.

SAVE 2c—Stick coupon on penny postcard.

8 BIG BUILDING BOOKS

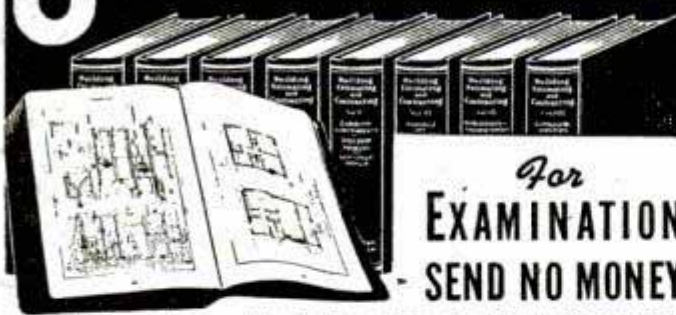

For
EXAMINATION
SEND NO MONEY

Learn to draw plans, estimate, be a live-wire builder, do remodeling, take contracting jobs. These 8 practical, profusely illustrated books cover subjects that will help you to get more work and make more money. Architectural design and drawing, estimating, steel square, roof framing, construction, painting and decorating, heating, air-conditioning, concrete forms and many other subjects are included.

BETTER JOBS — BETTER PAY UP-TO-DATE EDITION

The postwar building boom is in full swing and trained men are needed. Big opportunities are always for MEN WHO KNOW HOW. These books supply quick, easily understood training and handy, permanent reference information that helps solve building problems.

These books are the most up-to-date and complete we have ever published on these many subjects.

Coupon Brings Eight Big Books for Examination

AMERICAN TECHNICAL SOCIETY Vocational Publishers since 1898
Dept. G519 Drexel at 58th Street Chicago 37, Ill.

You may ship me the Up-to-Date edition of your eight big books, "Building, Estimating and Contracting," without any obligation to buy. I will pay the delivery charges only, and if fully satisfied in ten days, I will send you \$2.00, and after that only \$3.00 a month, until the total price of only \$34.80 is paid. I am not obligated in any way unless I keep the books.

Name _____

Address _____

City _____ State _____

Please attach a letter stating your age, occupation, employer's name and address, and name and address of at least one business man as a reference. Men in service, also please give home address.



GOVERNMENT JOBS START

As High As \$3,021.00 Year
Veterans Get Preference

MEN—WOMEN

- Clerks
- Statistical Clerks
- Postoffice Clerks-Carriers
- Railway Postal Clerks
- Customs Inspectors
- Stenographers-Typists
- Many Other Jobs

GET READY
IMMEDIATELY

Common Education
Usually Sufficient

Mail
Coupon
TODAY—
SURE

Name _____

Address _____ Vet? _____

Franklin Institute
(Not Government Controlled)
Dept. B86
ROCHESTER 4, N. Y.

Gentlemen: Rush to me, FREE of charge, list of U. S. Government big pay jobs. Send FREE 32-page book describing salaries, vacations, hours, work, etc. Tell me how to get one of these jobs.

ASTHMA-HAY FEVER ATTACKS WHY TAKE A CHANCE?

MAKE US PROVE
AT OUR EXPENSE!
PUT YOUR FINGER ON

Selrodo

RELIEF



TEN DAYS FREE TRIAL

Selrodo Inhalant Set in your own home

NEVER BEFORE SUCH A STARTLING OFFER

If not completely satisfied return to us—If SELRODO benefits you as it does thousands

SEND \$7.50

at the end of 10 days free trial

(CAUTION: Use Only As Directed)

C-L-I-P THIS ADVERTISEMENT and send it with your name and address to:

STANSBURY CHEMICAL CO.
1929 Aurora Avenue, Seattle

Dept. 481A



SPATTER CRAFT

Learn for fun and profit! Produce color effects on wood, cloth, or paper impossible any other way. Sunfast, wash-proof, too. Kit has GUN; 5 BOTTLES of COLORED INK; STENCIL PAPER; many PATTERNS and DESIGNS; and 22-page TEXTBOOK in full color. Just \$2.50 postpaid.

CRAFT CATALOG FREE with order. (If W. Va. add 5c Sales Tax)
DWINNELL CRAFT SHOP, Dept. P-85, Elm Grove, Wheeling, W. Va.

INVENTIONS

WANTED AT ONCE

Patented or unpatented inventions, all types needed by manufacturers. Write for free booklet "MARKETING YOUR INVENTION" and Protective Disclosure Form. We have a tremendous list of firms who may pay cash or royalties for good inventions. For full particulars, write today.

NATIONAL INVENTION SERVICE

1404 Mitchell Street, Dept. 5

Oakland 1, Calif.



TALK-SING thru your own radio
with
RADIO MICROPHONE



Be the life of the party. Put on your own broadcasts at home. Talk-Sing make announcements from any room. Wonderful voice practice. Microphone easily attached to any radio. Follow enclosed instructions. SEND NO MONEY—pay postman \$2.25 plus postage. Send Money Order or check and save postage.

EMPIRE RADIO & TELEVISION CO. (Dept. M1) 1521 Bedford Ave. Brooklyn 16, N. Y.

Please Mention Popular Mechanics When Answering Ads

PULVEX FLEA POWDER

TWO KINDS

WITH 5% DDT

... for dogs. Kills fleas and lice quick. Keeps fleas off 5-7 days. Many home uses.

OR WITH ROTENONE

... for cats, dogs. Quickly kills fleas, lice. Kills fleas when put on a single spot. Pre-war formula.

EITHER KIND: 25c & 50c



Guaranteed by
Good Housekeeping



REFRIGERATION



ELECTRONICS



WELDING

PRACTICAL TECHNICAL TRAINING

Train for a substantial career in industry . . . or a business of your own. Our time-tested Concentric System enables you to build your career step by step. Each 6-month course is complete in itself, yet prepares you for advanced courses. Stay as long as circumstances permit, until you reach the top step in your technical training. More than 1,538 students now enrolled from 48 states and 13 overseas countries. Faculty of 72 specialists. World-wide alumni counselor committee. Terms start July, September, January. **SEND COUPON TODAY!**

MILWAUKEE SCHOOL OF ENGINEERING A Technical Institute

Milwaukee School of Engineering
Dept. PM-548, N. Broadway and E. State, Milwaukee, Wis.
Without obligation send me free booklet "Career Building" and more details on course in _____

Name _____ Age _____

Address _____

City _____ State _____

SPECIALIZE In 6 Months to 3 Years COURSES

- SERVICE**
6 to 12 Months
- Electricity
 - Welding
 - Refrigeration
 - Heating
- TECHNICIAN**
1 to 2 Years
- Electricity
 - Radio
 - Electronics
 - Refrigeration, Heating, and Air Conditioning
- PROFESSIONAL**
3 Years
- Electrical Engineering Bachelor of Science Degree Major in Machinery or Electronics



LEARN MEAT CUTTING

through actual practice. Profitable Meat Cutting and Successful Meat Merchandising taught easily, quickly. **LEARN BY DOING** at Toledo in just six short weeks under actual market conditions. For beginners or men with experience. All subjects taught thoroughly and completely. Diploma, Job help. Get store of own. People must eat. School in operation nearly 25 years. Approved for GI training. Send today for **FREE** literature. No obligation. **NATIONAL SCHOOL OF MEAT CUTTING, Dept. 50-A, Toledo 4, Ohio**



**\$10.15
FOR ONE
DRAWING**

Be an ARTIST!

Learn at home in your spare time
Prepare now for a fascinating and profitable Art career. Our practical method has trained men and women since 1914. **COMMERCIAL ART, CARTOONING, and DESIGNING** all in one complete course. Trained Artists are capable of earning \$60, \$75 or more a week. No previous Art experience necessary. We teach you step-by-step. **FREE BOOK, "Art for Pleasure and Profit"** describes course, commercial opportunities, and **TWO ART OUTFITS** included with training.
VETERANS! Course G.I. Approved.

FREE BOOK gives details!

**Washington School of Art, Studio 125M
1115—15th St., N.W., Washington 5, D. C.**
Please send me full information and your Free Book, "Art for Pleasure and Profit."

Name _____ AGE _____

Street _____

City _____ Zone _____ State _____

I am entitled to training under G. I. bill.

Learn A Trade NOW! PRACTICAL SHOP TRAINING!

In Our Chicago Shops

- AUTO MECHANICS
- DIESEL MECHANICS
- REFRIGERATION
- BODY-FENDER
- WELDING—ARC and GAS
- MACHINIST
- PIANO TUNING

Above Approved For G. I.'s and Civilians
**One of America's Leading Practical Schools
7 Floors of Fully Equipped Shops
Over 45,000 Graduates
Expert Individual Instruction
Learn by Doing—Low Living Expense
Established 1902—Day and Evening Classes**

Also the following Home Study Courses

- PLASTIC
- REFRIGERATION
- DIESEL

CALL IN PERSON OR MAIL THIS AD TO GREER SHOP TRAINING

(Dept. PM-258) 460 South State St., Chicago 5, Ill.
Please send without obligation free information regarding trade checked above. (Specify whether you are a Veteran or Civilian)

Name _____ Age _____

Address _____

City _____ State _____



Become an Expert Accountant

The Profession That Pays

The demand for skilled accountants—men who really know their business—is increasing. National and state legislation is requiring of business—both big and small—much more in matters relating to Auditing, Cost Accounting, Business Law, Organization, Management, Finance. Men who prove their qualifications in this important field are promoted to responsible executive positions—given an opportunity to earn real salaries. The range is from \$3,000 to \$10,000 a year, even to higher income figures.

Send for Free Book—

"Accountancy, the Profession That Pays"

Why let the other fellow walk away with the better job, when thru home-study you can equip yourself for a splendid future in this profitable profession?

Knowledge of bookkeeping unnecessary. We train you from ground up, or according to your individual needs. Low cost; easy terms.

Send for free 48-page book describing the LaSalle accountancy training and the opportunities in this highly profitable field.

If you have the urge, the will to increase your income, mail the coupon NOW.

LASALLE EXTENSION UNIVERSITY

A CORRESPONDENCE INSTITUTION

Dept. 564-HR, 417 S. Dearborn St., Chicago 5, Ill.

Please send my copy of "Accountancy, the Profession That Pays," without obligation.

Higher Accountancy

Other LaSalle Opportunities:

If interested in the fields below, check and mail now.

- | | |
|--|--|
| <input type="checkbox"/> Business Management | <input type="checkbox"/> Sales Training |
| <input type="checkbox"/> Business Correspondence | <input type="checkbox"/> Law—LL. B. Degree |
| <input type="checkbox"/> Expert Bookkeeping | <input type="checkbox"/> C. P. A. Coaching |
| <input type="checkbox"/> C. P. A. Coaching | <input type="checkbox"/> Business English |
| <input type="checkbox"/> Effective Speaking | |

Name.....

Street.....

City, Zone & State.....

AIR RIFLES BENJAMIN AIR PISTOLS

PIONEERS - LEADERS

SEND FOR FREE FOLDER OF LATEST MODELS TODAY
If you want a REAL GUN for PRACTICAL USE inside or outdoors get a SAFE - CLEAN - ECONOMICAL - BENJAMIN with Adjustable Power and Amazing Accuracy. For BEST RESULTS use BENJAMIN H-C PELLETS. WRITE AT ONCE. BENJAMIN AIR RIFLE CO., 812 MARION ST., ST. LOUIS 4, MO.

BLISS

ELECTRICAL SCHOOL

Intensive 32 weeks' residence course in fundamentals of industrial electrical engineering, including radio and electronics. Extensive laboratory, shop work, drafting. Prepares for electrical technician and engineering aides

Make This Amazing Astronomical Telescope For As Little As \$6.00



Now you can afford to own the telescope you always wanted. A fine dependable scientific instrument which will give endless pleasure and education to you and your friends.

Positively no special tools or skills required. Full instructions included . . . Built in four hours as described in a recent national scientific magazine.*

3" reflector accurately ground, polished and hard aluminized plus flat and 3 eyepiece lenses. All ready for you to assemble into an achromatic (color free) distortionless instrument.

This wonderful 'scope guarantees success for the beginner. Without rainbow effects or fuzziness, gives hard, sharp, clear images. Easy to make; material for tube and the few other parts can be found around every home or may be purchased for a few cents.

\$6.00 for the 3" diameter kit and instructions.

*Reprint available upon request for 6c

Telescopes — Microscopes — Scientific & Laboratory Apparatus

HARRY ROSS 68 West Broadway, Sect. N., N.Y. 7, N.Y.

Made to U. S. Army Specifications!

16-JEWEL

ELGIN

\$19.95



Sturdy 16-Jewel ELGIN men's wrist watches. Water-repellent. Sweep second hand. Stainless Steel back. Unbreakable crystal. QUALITY! American made. Fully reconditioned with ONE YEAR GUARANTEE! Made for the U. S. Army Air Corps. They HAD to be good. SEND NO MONEY. Simply pay postman \$19.95 plus 10% tax and postage on delivery. Cash orders sent postpaid. Limited supply. UNITED PRODUCTS CO., 7941 S. Halsted St., Dept. RES-709, Chicago 20, Ill.

in communications, power, manufacturing, business machines, sales, service. 54th year. Classes begin July 26, Nov. 22. Catalog. 7632 TAKOMA AVENUE, WASHINGTON 12, D. C.

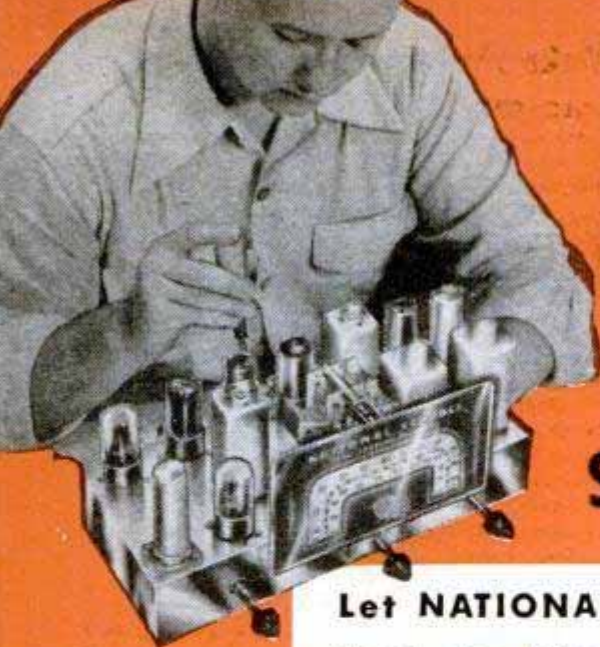

Learn RADIO

TELEVISION, ELECTRONICS by SHOP METHOD HOME TRAINING

Let NATIONAL SCHOOLS, of Los Angeles, a practical Technical Resident Trade School for over 40 years, train you for today's unlimited opportunities in Radio

You receive all parts, including tubes, for building this fine, modern Superheterodyne Receiver. This and other valuable standard equipment becomes your property.

these two **FREE** books will tell you how

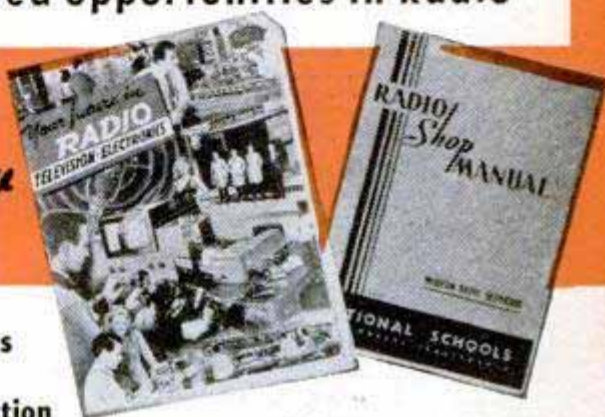

GOOD JOBS AWAIT THE TRAINED RADIO TECHNICIAN

You are needed in the great, modern Radio, Television and Electronics industry! Trained Radio technicians are in constant and growing demand at excellent pay—in Broadcasting, Communications, Television, Radar, Research Laboratories, Home Radio Service, etc. National Schools Master Shop Method Home Study Course, with newly added lessons and equipment, can train you in your spare time, *right in your own home*, for these exciting opportunities. Our method has been proved by the remarkable success of National Schools-trained men all over the world.

You Learn by Building Equipment with Standard Radio Parts We Send You

Your National Schools Course includes not only basic theory, but *practical* training as well—you learn by doing. We send you complete standard equipment of professional quality for building various experimental and test units. You advance step by step until you are able to build the modern superheterodyne receiver shown above, which is yours to keep and enjoy. You perform more than 100 experiments—build many types of circuits, signal generator, low power radio transmitter, audio oscillator, and other units. The Free Books shown above tell you more about it—send for them today!

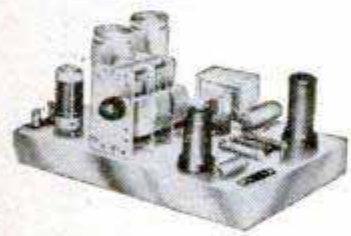

NOW! NEW PROFESSIONAL MULTITESTER INCLUDED

This versatile testing instrument is portable and complete with test leads, batteries. Simple to operate, accurate and dependable. You will be able to quickly locate trouble and adjust the most delicate circuits. You can use the Multitester at home or on service calls. It is designed to measure AC and DC volts, current, resistance and decibels. You will be proud to own and use this valuable professional instrument.



Lessons and Instruction Material Are Up-to-Date, Practical, Interesting

National Schools Master Shop Method Home Training gives you basic and advanced instruction in all phases of Radio, Television and Electronics. Each lesson is made easy to understand by numerous illustrations and diagrams. All instruction material has been developed and tested in our own shops and laboratories, under the supervision of our own engineers and instructors. A free sample lesson is yours upon request—use the coupon below.

Here's Just a Few of the Interesting Facts you Learn with the

FREE MANUAL

1. Routine for diagnosing Radio Troubles.
2. Preliminary Inspection of Receivers.
3. How to Test and Measure Voltages.
4. How to Test Speaker in Audio Stages.
5. How to Trace the Circuit and Prepare Skeleton Diagram.
6. Complete Reference Table for Quickly Locating Receiver Troubles.



VETERANS

If you are a veteran, qualified for training under the G.I. Bill, check the coupon for a Special Bulletin.

G. I. APPROVED
NATIONAL SCHOOLS
LOS ANGELES 37, CALIFORNIA EST. 1905



MAIL OPPORTUNITY COUPON FOR QUICK ACTION

National Schools, Dept. PM-5
4000 South Figueroa Street
Los Angeles 37, California

(Mail in envelope or paste on penny postcard.)

Mail me FREE the books mentioned in your ad including a sample lesson of your course. I understand no salesman will call on me.

NAME _____ AGE _____

ADDRESS _____

CITY _____ ZONE _____ STATE _____

Check here if veteran of World War II

Yours to examine
FREE
for 10 days

The book that describes
and shows how to use
every commonly-used tool

**600 STEP-BY-STEP
ILLUSTRATIONS**

The essential book for every man who works or relaxes at carpentry, woodworking, or metalworking. **The complete, practical, authoritative tool-encyclopedia.** Full directions, complete instructions on newest methods, techniques, proper care. *Tells and shows* the right way to use each tool. How to get **BEST RESULTS** with least effort. **HOW TO BUY**, protect, and sharpen tools. Covers hammers, nails, screws, screwdrivers, hand saws, planes, chisels, smoothing, glass-cutters, glues, metal-sawing, wrenches, cold chisels, measuring-tools, metal-bending, riveting, etc. Thorough, easy to read, ideal for hobbyists as well as professional carpenters and machinists.

FREE EXAMINATION IF YOU MAIL COUPON NOW
Full refund if not completely satisfied.

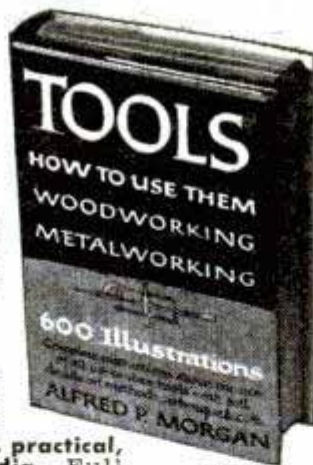

ONLY
\$3.00

Crown Publishers, 419 4th Ave., N. Y. 16 PM
Please rush me _____ copy(ies) of **TOOLS AND HOW TO USE THEM** @ \$3.00. I may return for complete refund within 10 days.

Check or M.O. enclosed (Postage free) C.O.D. (Postage extra)

Name _____

Address _____

City _____ Zone _____ State _____

PLUMBERS & STEAM FITTERS



AUDELS PLUMBERS & STEAM FITTERS GUIDES. This valuable set explains in practical concise language the principles, advances and shortcuts of the trade—based on good practice. Includes careful detailed instructions on how to figure & calculate various jobs. A quick reference; saving time & money. A complete Trade course.

Over 1,670 Pages—
3,642 Trade Illustrations

PRACTICAL TRADE INFORMATION ON:

Soldering, tinning. Joint wiping, bending, beating Pipe—iron—steel, threading. Mathematics, tables, physics. Materials—iron, steel, copper, brass, lead, tin, antimony; etc. Sheet metal—galvanized—plate, Sanitation, siphonage, tanks, Drainage, sewage, purification. Fixtures—bath—kitchen. Pipe fittings, soil pipe, tools, Laying out work, Roughing, Screwed fittings, flanges, joints, Pipe bending; examples. Elbows, Heating, ventilation, air conditioning, refrigeration. Water supply, mains, wells, tanks. Gas-fittings. Sheet metal work, problems, methods. Brazing, heating, lead burning. Welding, various welds, methods. Blacksmithing, forging, tools, Copper Tubing, Marine Pipe Fitting & Oil Burners. **HIGHLY ENDORSED—ASK TO SEE THEM. TO GET THIS ASSISTANCE FOR YOURSELF, FILL IN AND**

MAIL ORDER

AUDEL, Publishers, 49 W. 23rd St., New York 10, N. Y.
Mail Audels Plumbers' Guides, 4 vols. on 7 days' free trial. If O. K. I will remit \$1 in 7 days and \$1 monthly until \$6 is paid. Otherwise I will return them. No obligation unless I am satisfied.



4 \$6
VOLS. 6
COMPLETE
PAY ONLY
\$1 A MO.

Name _____
Address _____
Occupation _____
Employed by _____, PM

PROTECT LIVES and PROPERTY with these

LOW COST FIRE EXTINGUISHERS



A little foresight now may save LIVES and PROPERTY later. Equip your home, your garage, your office, your boat with **AutoFyrstop**, the modern fire extinguisher and alarm that is setting new records . . . Write for **FREE** literature today.



We have openings for high grade salesmen in choice territories. If interested in outstanding money-making opportunity, write for plan **TODAY!**

AUTOFYRSTOP CO., Dept. PM-548
2035 Washington Ave., Philadelphia 46, Pa.

REFRIGERATION

AIR CONDITIONING—Trained men paid well to service, install, maintain, repair, rebuild household and commercial refrigerators. Opportunity for full time, spare time earnings. Train at home or in our big shops. Approved for Veterans. (Non-Veterans inquire about our Low Payment Plan and Pay After Graduation Plan.) Send for **FREE BOOK-LET AND FULL INFORMATION.** No obligation.

COMMERCIAL TRADES INSTITUTE, Dept. A2-5
1400 W. Greenleaf Chicago 26, Illinois

8 ways to make a FRIENDLIER YARD
... JUST 10¢



STANLEY PLAN SET No. 14

Reg. U. S. Pat. Off.

● Lure the birds you like by building them a home . . . pleasure and a better yard. Send 10c for Plan Set No. 14 and list of others. Stanley Tools, 158 Elm St., New Britain, Conn.

BE A REAL ESTATE BROKER PAYS BIG! EASY TO LEARN—Start and run your own business quickly. Many graduates report making up to \$1000 a month. Course of study covers Sales, Property Management, Appraising, Loans, Mortgages and hundreds of related subjects. Course offered in home study or residential classrooms.

FREE Big new illustrated catalog from this nationally known school. Send Post Card Today, G. I. Approved.

WEAVER SCHOOL OF REAL ESTATE
Dept. PM-1, 15 E. Pershing Road Kansas City, Mo.

ACCOUNTING

STUDY AT HOME for C.P.A. and **BIG PAY** Accounting opportunities with 44 year old school. No previous training needed. Texts furnished. **EASY PAYMENTS.** Send for **FREE BOOK.** G. I. Approved.

MACCORMAC EXTENSION SCHOOL
Dept. M 1170 E. 63rd St. Chicago 37, Ill.

SAY YOU SAW IT IN POPULAR MECHANICS

WAR SURPLUS

Lathes, Milling Machines, Drill Presses, Sawing equipment, Motors and thousands of miscellaneous items. Also information on Helicopters, Sleeper Trailers, Garden Tractors, Power Lawn Mowers, Welders, Jet Impulsion for Cars and Tractors etc. Rush name for free literature. **THE WAYNE ENGINEERING CO., DEPT. 1139, GREENVILLE, OHIO**





Learn BUILDING

AT HOME • All Blue Print Building Plans, Specifications, Lessons Furnished

FIND OUT ABOUT TRAINING AND OPPORTUNITIES FOR YOU IN BUILDING

Established in 1904, Chicago Technical College offers you thorough, practical training in Building, by home-study. Mail coupon for free information. See what this Course has done for others, what it can do for you. Read what Chicago Tech graduates say about their work, earnings, success. Learn the rewards awaiting you as a trained builder — and how quickly, easily you can get started. Simply MAIL COUPON TODAY in an envelope or paste on a penny postcard.



CHICAGO TECHNICAL COLLEGE
 E-152, Tech Building, 2000 South Michigan Ave.
 Chicago 16, Illinois

MAIL COUPON NOW

CHICAGO TECHNICAL COLLEGE
 E-152, Tech Bldg., 2000 So. Michigan Ave.
 Chicago 16, Illinois

Mail me FREE building Lesson with information about big opportunities in BUILDING and how I can train at home.

Name _____ Age _____
 Address _____
 City _____ Zone _____ State _____



OPEN YOUR OWN SHOP Be Independent!

Here's a great growing field that's getting bigger every day as more houses are wired for electricity. You can start small—even in your spare time—with the tools we send you—in your basement or garage and GROW AS BIG AS YOU LIKE, with NO FEAR OF LOSING YOUR JOB in a depression. Or, you can take a well paid job, to start, as there is a big need for service mechanics. Let's talk it over by mail.

New Book
"HOW TO START YOUR OWN BUSINESS"
 Sent if you act promptly

This valuable book covers locating your shop, contains drawings of how to build and wire workbenches, where and how to advertise, what to charge, how to hire solicitors, etc. Sent to students who enroll promptly.

Would You Like To Work for Yourself? Then Learn ELECTRIC APPLIANCE Repair & Service

Recent University Discoveries prove that one of three major classifications of men are only thoroughly happy when working with their hands. This doesn't mean they don't use their heads, too. But it does mean that nature intended A BIG GROUP of men to be the builders, makers, fixers and servicers of life. If you are in this group—not completely happy in your present work—seeking increased income, and handy with tools—A SUGGESTION: Get into electrical appliance service and repair.

LEARN AT HOME In Your Spare Time

Our practical, thorough course teaches you this interesting, good paying business AT HOME—During Your Spare Time. A Grade School education is all you need. We teach repairing washing machines, vacuum cleaners, electric ranges, lamps, irons, motors, etc., REFRIGERATION and HOUSE WIRING. Our lessons are understandable and easy to grasp. You'll enjoy every minute of them. And you'll enjoy the work itself when you get into it.

I include
A BIG KIT
 of Special
APPLIANCE TOOLS
 at NO
EXTRA COST



H. T. Armstrong, General Manager
PACIFIC TRAINING SCHOOL — Dept. P-85
 7217 So. Broadway, Los Angeles 3, Calif.

Please send me your FREE BOOKLET:
 "Today's Big Opportunity — Appliance Servicing"

NAME _____ AGE _____
 ADDRESS _____
 CITY _____ STATE _____

MAIL COUPON for FREE BOOKLET

a small investment
will establish you in . . .

Your OWN Business

We are NOW enlarging our organization of U.S.A. and Canadian DURACLEAN dealers, in territories still open. Here is an opportunity to BE YOUR OWN BOSS . . . become financially independent with a business of your own!

You become a fabric specialist, providing the proper cleaning and moth protection for upholstery and floor coverings. You use the proven, successful methods of established dealers. Service is rendered right in the home, office or public buildings without removing furnishings.



Write for
FREE
Booklet

Patented

DURACLEAN Service was established 18 years ago as an improved method for cleaning and revitalizing rugs and furniture. No harsh machine rubbing. No soaking or shrinking. No inconvenience for your customers. Dirt, grease and many unsightly spots vanish as if by magic.

DURAPROOF makes fabrics and rugs repellent to moths and carpet beetles. You give a 4-YEAR Warranty of Protection. Guards against mildew, too. These services have a waiting market . . . a big repeat business. Profits up to \$15 and \$20 a day on EACH of your service men. Write today! A letter and 16 page illustrated booklet will explain everything. 18 years of proven success.

- No Overhead Expense
- No Shop Necessary
- No Experience Needed
- You Learn Quickly, Easily
- Short Hours . . . Large Profits
- Service Nationally Advertised

Don't delay! Territories are limited. Remember, just a moderate payment, easy terms, and the opportunity to become financially independent in YOUR OWN BUSINESS! Start full or part time.

DURACLEAN CO., 16-5 Ct., Deerfield, Illinois

ELECTRICIANS

Get this Great Book

Book of 150
Shop Prints,
Wiring
Diagrams,
Full Size
8 1/2" x 11"



FREE

For Merely Examining
Coyne's NEW Pay Raising

8 Volume Set APPLIED ELECTRICITY

Here's a brand new set of electrical books to give you the "know how" on all branches of electricity from appliance repairing to D.C. and A.C. equipment, electrical refrigeration, Industrial Electronics, etc. 3,400 subjects, 11,500 facts, latest methods explained in easy to follow instructions. To prove how valuable and Practical this set can be to you, I'll give you a FREE copy of my book "150 Shop Prints and How to Read Them" just for looking over this set. Written by the Coyne Staff and backed by 47 years' experience, this set has helped many ambitious electrical workers to bigger pay and added opportunity.

OFFER LIMITED • ACT NOW! If you act promptly, I'll send you the 8 volume set Applied Practical Electricity for 7 days FREE examination . . . together with the 150 Shop Print Book. Look the set over 7 days. If you like it send either \$22.75 cash or \$35.00 after 7 days and \$3.00 per month until \$24 is paid. If you don't want the set, return it and YOU OWE NOTHING. In either event you keep the 150 Shop Print Book absolutely FREE.

Coupon below is just a request to see the books free and to get my gift book for doing it. ACT—Send coupon Today!
Technical Book Div. COYNE ELECTRICAL SCHOOL
500 S. Paulina St., Dept. 58-R6, Chicago 12, Ill.

FREE BOOK
Coupon



SEND NO MONEY

B. W. Cooke, Director COYNE ELECTRICAL & RADIO SCHOOL
500 S. Paulina St., Dept. 58-R6, Chicago 12, Ill.

O. K. send me, postpaid, Coyne's new 8 volume, "Applied Practical Electricity" for 7 Days FREE TRIAL per your offer. Also send, absolutely FREE, the book of 150 Shop Prints as a gift.

Name _____ Age _____
Address _____
Town _____ Zone _____ State _____

PRINT YOUR OWN POST CARDS

COMPLETE
OUTFIT
only
\$7.50



Amazing results in sales, inquiries and contacts . . . saves time and money . . . very easy to use GEM STENCIL DUPLICATOR is ideal for Advertising, Announcements, Notices, Labels, Forms, Price Lists—hundreds of uses for every type of business and organization. Comes complete with all supplies, instructions and 60-page Book of Ideas.

FREE TRIAL OFFER: Try it before you buy it! Write and a GEM OUTFIT will be sent you postpaid. After 10 days, send only \$7.50 or return the GEM, no questions asked. The GEM must sell itself; you be the judge.

BOND EQUIPMENT CO. • Dept. 135
513 Olive St. • St. Louis 1, Mo. •

SEND NO MONEY • FREE TRIAL OFFER

CARBURETOR TOO RICH MAKES MOTORIST TOO POOR



Car owners who are wasting money and not getting proper gas mileage due to over-rich mixtures will be pleased to learn how to save gasoline by VACU-MATING over-rich mixtures. VACU-MATIC fits all cars, trucks and tractors. It is automatic and operates on the supercharge principle. Easily installed in a few minutes.

SALESMEN WANTED! Big Profits! Send name, address on penny postcard for free particulars and how to get yours for introducing.

VACU-MATIC CO., 7617-1329 W. State St., WAUWATOSA, WIS.

Send for Amazing New 144-Page Catalog of ART SUPPLIES!

Gold mine for professional or amateur! Complete descriptions of all items used by artists; prices; full index. Yours for only \$1—refunded with first order. Also entitles you to professional consultation by Toby Moss, noted art director. Offer limited; act now! Write Dept. D-1.

ZEAL-ART Inc., 20 E. 49th St. New York 17, N.Y.



NEW! LOW COST! RESPIRATOR

Wear when sanding, grinding, paint spraying, sweeping, dusting, furnace cleaning, etc. Handy as a pair of glasses. Just keep mouth closed and breathe through nose is all you do to operate. Protects against nuisance dusts, lint, coal, cement, grain dust, hay fever pollen. Has 9 sq. in. filter. For EYE protection against paint spray, dust, gases, fumes, smoke, order our Fog-Proof Rubber GOGGLES . . . \$2.00 p.p.

JERRY BRYANT, Dept. PM
919 N. Michigan Ave. Chicago 11, Ill.



Order Today \$1.00
POST PAID



makes False Teeth TIGHT

Makes loose dental plates fit snugly and comfortably.

LASTS for MONTHS!

Simply squeeze on dental plate and put it in your mouth. Hardens and becomes part of plate. Money-back guarantee.

FREE Generous package of Dental Plate Cleanser with each order. Send \$1.00 or mailed parcel post collect.

Fit-Rite Co., 1557 Milwaukee Ave.
Dept. 5-PM, Chicago, Ill.



FREE BOOK

RAISE HAMSTERS



The new wonder animals from Syria. Often called Toy Bears. Delightful pets. Everyone wants them. Laboratories need thousands. Clean, odorless. Raise anywhere. A profitable and interesting hobby or business. We furnish breeding stock with manual of instructions.

Write today for free illustrated literature.
GULF HAMSTERY, 1536 BASIL, MOBILE, ALA.

MAKE \$ MORE MONEY

Applying or Selling

CORKSTONE

A General Purpose Magnesium Oxychloride Flooring

THE MODERN PLASTIC FLOORING

EASY TO APPLY
Here's your opportunity to get into business for yourself applying or selling Corkstone, the economical, top-grade plastic flooring. Plenty of profit Act without delay!

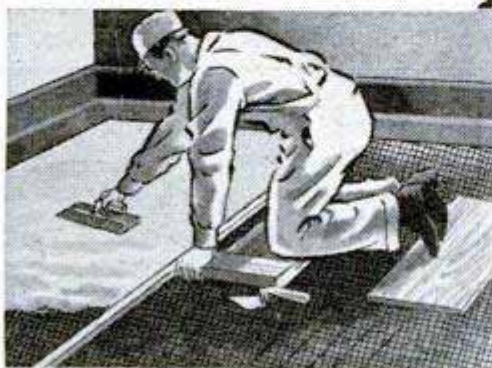

Dealers & Agents Wanted

WRITE FOR DETAILS

LASTING PRODUCTS COMPANY

Franklinton Road Plant, Baltimore 23, Md.

RESORT OPERATION AND MANAGEMENT



INCLUDING AUTO COURT and TRAILER PARKS
A book that deals with Resort Management, solving many of its difficult problems. Directs the way to profitable operation. "Must" guide for beginners and the resort owners "bible." Send \$2.00 postpaid.

WOODBECK PUBLISHING Co.
WINCHESTER BLDG. GRAND RAPIDS, MICH.

MAKE JEWELRY AND NOVELTIES AT HOME!

Work right on your kitchen table! No tools or experience needed. Learn-earn within a week. Complete home instruction course, beautifully photographed, shows how to make 138 designs of pins, earrings, sprays, hair-do's, bracelets, candy dishes, jewel boxes, wall plaques, perfume bottles, novelties, etc. Shows over 100 kinds of Sea Shells and Plastics often used. Explains fully home methods of dyeing, pearlizing, golding, tinseling, frosting and luminous processes. Lists 200 kinds of raw materials with wholesale prices. Complete course only \$1. Beginner's Kit, \$3 (Foreign \$4), Prepaid.

HOUSE OF GIFTS, Box 4550-RM, Coral Gables, Fla.

NEW YORK SCHOOL of MECHANICAL DENTISTRY

SINCE 1920—The outstanding Training Center for all phases of Dental Laboratory Technology. Licensed by New York and New Jersey States Approved for Veterans P.L. 346 and P.L. 16 Visitors Welcome. Ask for Free Bulletin "P."

NEW YORK SCHOOL OF MECHANICAL DENTISTRY

America's Oldest School of Dental Technology
138 Washington St. NEWARK 2, NEW JERSEY
Also: 125 W. 31 Street NEW YORK 1, N. Y.
Immediate Enrollment — Day and Evening

Write Like This

AMAZING DISCOVERY! Corrects poor penmanship in few days — big improvement in three hours. Now it's fun to become an expert penman. **TEN DAYS' TRIAL ALLOWED.** Write Immediately.
C. J. OZMENT, 34-X, St. Louis, Mo.

ACE Hollywood Experts
WILL TRAIN YOU AT HOME...
NOW YOU CAN MAKE GOOD IN

RADIO

TELEVISION
ELECTRONICS

Through Practical
Experiments With

10

**BIG KITS
R.T.A.
Gives you!**

You Do
Scores of
Practical
Experiments

Illustrated above are only a few of the many job-exercises you do, through RTA's "shop-type" home training method. You build a TRF Receiver, a High-Frequency Converter, a 6-tube AC-DC Superhet Receiver, plus dozens of other interesting jobs.

These jobs give you actual **SHOP EXPERIENCE** necessary to your success.

**FILL OUT
COUPON
AND MAIL
TODAY!**



YOU WORK
ON REAL
EQUIPMENT

Opportunities Wide Open

400 MILLION new radio and television sets will be built within ten years. 72 MILLION dollars are being spent RIGHT NOW for radio repairs alone! When you are trained by RTA's Hollywood Experts, you too can qualify for big, interesting GOOD-PAYING technicians jobs, or YOUR OWN profitable radio-television repair business.

Extra Cash in Spare Time

RTA's Hollywood Experts show you how to earn welcome EXTRA CASH, while you learn. In fact, like many RTA students, you may actually get MORE spare time work than you can handle.

25 Years of Success

RTA's long years of experience assure you quickest progress. If you are at all mechanically inclined, RTA can teach YOU to MAKE GOOD in Radio-Television.

**SO GET THE FACTS!
SEND FOR FREE
30-PAGE BOOK
TODAY!**



APPROVED FOR VETERANS

RADIO TRAINING ASSOC. OF AMERICA, DEPT. PME
5620 Hollywood Blvd., Hollywood 28, Calif.

Send FREE BOOK showing how to make good in Radio-Television through training by Hollywood experts.

NAME _____ AGE _____
ADDRESS _____
CITY _____ ZONE _____ STATE _____

Check box if VETERAN of World War II



OPPORTUNITIES AHEAD

For Men Who are Trained in AUTO BODY & FENDER WORK

Men 18 to 60. Want a future with good pay, perhaps a business of your own later? If you are mechanically inclined, start now to learn to become an auto body mechanic and fender repair man. This fast growing field has great possibilities for trained men with experience. U. E. I. spare time, home-study training combined with actual shop practice gives you sound, basic knowledge of latest, best methods so you may get the experience which may bring you big pay. Capable instructors supervise your studies and actual practice. Course includes acetylene welding, spray painting, use of hand and power tools, etc.

THOROUGH, RELIABLE TRAINING

U. E. I. has trained men for new opportunity fields since 1927 and many students are now making good. Auto body and fender repairing is one of the best profit-makers in any garage or service station. Little capital required. Free placement service, or we will show you how to start your own shop. Get the facts FREE, without obligation. Write today.

Training approved under G. I. Bill

UTILITIES ENGINEERING INSTITUTE

AUTO-CRAFTS DIVISION

2523 Sheffield Ave., Dept. 158-X, Chicago 14, Ill.

Gentlemen: — YES! I want to get into profitable Auto Body and Fender Repair Work. Please send me FREE FACTS at once.

Name _____ Age _____
 Address _____
 City _____ Zone or County _____ State _____
 Check here for Special Information if under 17.

Men's Fully Guaranteed NEW \$13.95 PLUS TAX 15-JEWEL WRIST WATCH

ORIGINALLY sold up to \$55
 Sacrificed because they're post-war surplus

LOOK AT THESE FEATURES:

- Luminous dial . . . sweep second hand . . . waterproof . . . shockproof . . . anti-magnetic . . . imported Swiss precision movement and ease.
- You get them now for a small fraction of original prices. Don't delay! Order now . . . while they last. Send only \$1 down payment with order. Pay balance to postman on arrival, plus postage. Or we pay postage if you enclose \$13.95 plus \$1.39 Fed. Tax.



Receive Reg. \$2 expansion band FREE with prepaid order. Money back in 5 days if not delighted. Order now.

MARYLAND DISTRIBUTORS, Dept. 55

501 E. Baltimore St. Baltimore 2, Md.

★ Have **FUN** with **POCKET X-RAY!**

MAGIC! MIRACLE!
 YOU WON'T BELIEVE YOUR EYES!

Like **STARTLING** effects? **POCKET X-RAY** is a picture-panic! When you turn the little disc the surprise is **GUARANTEED!** Works slick as magic—custom-made for parties and get-togethers! Just \$1 prepaid, or 3 for \$2.50. (Write for wholesale prices).

STAR SPECIALTY CO.
 DEPT. PM3 BUTLER, PENNA.

ORDER NOW! **JULY 4th** **FIREWORKS**
WHOLESALE PRICE **470 PIECES \$4.98**

ACTUAL RETAIL VALUE \$13.55

YES SIR! 470 OR MORE NOISE AND BEAUTY PIECES FOR ONLY \$4.98. Magnificent assortment—each a knock-out! Gorgeous, colorful, NEW displays—intricate artistic effects—all merchandise brand-new! For only \$4.98 you'll get—Sparklers, Salutes, Red Trail Blazers, Roman Candles, Two-Shot Repeaters, Magic Black Snakes, Cones, Dago Flash Bombs, Three-Shot Automatics, Magic Flames, Airplane Flares, Chinese Rockets, Red Rocket Sky Whistle Bombs, "T-N-T" Flash Salutes, Z-Brand Chinese Firecrackers, Happy Chinese Firecrackers, FREE PUNK!

Order this wonderful over-470-Piece Fireworks Bargain TODAY! Send money order, bank draft, or certified check for \$4.98. Do NOT send cash. NO C.O.D. orders! PRINT name and address plainly. Give name of your Express office. Fireworks cannot be mailed. All shipments by Express, F.O.B. at Fort Worth.

ASK FOR FREE CATALOG MANY OTHER ASSORTMENTS

Stars and Stripes Fireworks Co.

P. O. BOX 486, DEPT. PM FORT WORTH 1, TEXAS

NOT INTENDED TO OFFER FOR SALE IN LOCALITIES WHERE REGULATIONS PROHIBIT

ELECTRICIANS' SCHOOL

HOUSE AND COMMERCIAL WIRING • MOTOR REPAIR AND REWINDING • ELECTRIC REFRIGERATION

Approved for Veterans Training

PENNSYLVANIA INSTITUTE SCHOOL OF ELECTRICITY

42nd and SPRUCE STS. PHILADELPHIA 4, PENNA.

Learn about Earning Opportunities in THE BUILDING TRADES

FREE—Important Information Telling How to Get Started. Do you want to be on the inside in the building boom—where big money is made? This is your chance now. HOME TRAINING prepares you for these big opportunities. Course recognized by Building Industry. (Approved for Veterans.) Write today—no obligation.



COMMERCIAL TRADES INSTITUTE, Dept. D2-5 Chicago 26, Ill. 1400 W. Greenleaf

CARTOONING

Learn cartooning, drawing, sketching, etc., 31 lessons, 600 illustrations, including drawing paper, pens, pencils, \$1.00 complete. Order now!

AMERICAN STAMP CO., Dept. C-4212 WILMINGTON 99, DEL.

LIQUID MARBLE and PLIASTONE FLOORS

Mold, Brush, Trowel, Spray It! MOLD Novelties, Statuary, Art Goods makes \$1 seller. Make Marbleized floors, Tile Walls. Colorful, glossy, amazing! Easily learned; start in garage or basement. Particulars free. MARBLEIZING SERVICE, Dept. PM, Edwardsville, Ill.

SAY YOU SAW IT IN POPULAR MECHANICS

10¢ EACH LITTLE BLUE BOOKS

Send postcard for our FREE CATALOGUE. Thousands of bargains. Address: HALDEMAN-JULIUS CO., Catalogue Dept., Desk M-2463, GIRARD, KANSAS

NOW ANY Auto Repair Job is a "Cinch" for YOU!

MoToR's AUTO REPAIR MANUAL is Showing Thousands of Men How To Handle ANY Job on ANY Car—Faster and Easier! Now Let It Go to Work For YOU!

Actual Size
A Big 8 1/2 x 11 Inches



"A boy can easily follow its instructions."—Curtis Auberry, Murfreesboro, Tenn.



"MoToR's Manual paid for itself on the first two jobs and saved me valuable time by eliminating 'guess work.'"—Wilson J. Schrop, Akron, Ohio.



"I have done jobs with this Manual that I would not attempt without it."—C. L. Vanerstrom, Hazel Park, Mich.



"Instructions so clear, I have no trouble learning anything about any car."—Sam Ordenez, Cal.

WITH MoToR's amazing AUTO REPAIR MANUAL you can whiz through ANY job—in LESS time, and with LESS work! Just look up make, model, and job—and go to it! With this easy-to-follow book, any job—from radiator to rear end—becomes a pushover for you!

"EVERYTHING You Need to Know about EVERY Make and Model Car Since 1935!"

Nothing like MoToR's AUTO REPAIR MANUAL has ever been published! It's just as if plain-talking engineers from every auto plant in America got together to show you everything you need to know about the cars they themselves had designed. It brings you the complete "dope" from over 150 Official Factory Shop Manuals, boiled down in simple easy-to-read and easy-to-understand language.

Here, right at your fingertips—are over 200,000 service, repair, adjustment, replacement, tune-up facts on all standard makes and models built from 1935 to 1948! More than 1700 cut-away photos, diagrams, and drawings SHOW you exactly what the clear text TELLS you! Used by the U. S. Army and Navy and technical schools! No wonder thousands of auto repairmen call it their auto "Bible"!

Why Thousands Rave About It

Thousands of men have already discovered what a

WORTH BIG MONEY TO:

Mechanics Repair Men
Handymen Service Station
Garagemen Operators
Farmers Taxi Owners

Free
7-DAY
OFFER

timesaver MoToR's Auto Repair Manual is. (At the left are just a few who have told us they just "wouldn't be without it.")

This is a BIG 700-page book, measuring 8 1/2 x 11 inches. Simple to use, too, because it opens flat for "working while you read." All you have to do is look up the quick index—and it leads you to the right page in a jiffy. Then you just follow the simple instructions, step by step. Everything is set forth so clearly you simply CAN'T go wrong!

SEND NO MONEY

Find out for yourself—without risking a cent—how this book pays for itself the first few times you use it. Mail the coupon, without money. Try it out—FREE—for 7 days. Then,

if not convinced it's the greatest time-saver and work-saver you ever saw, return the book and pay nothing. MoToR Book Dept., Desk 1E, 572 Madison Ave., New York 22, N. Y.

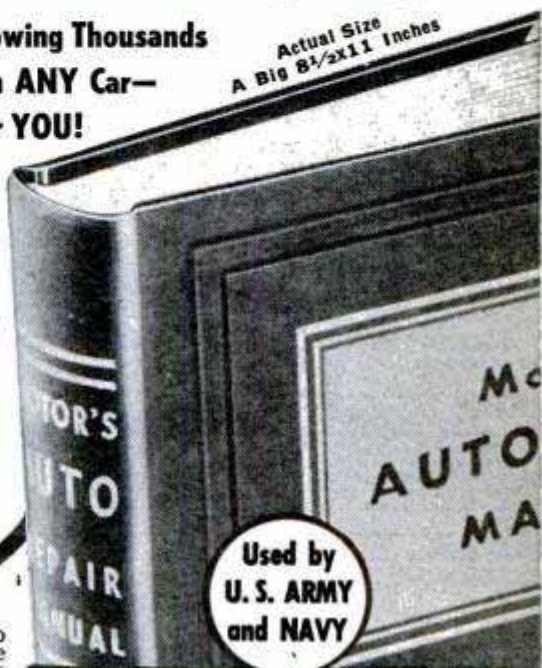

Used by
U. S. ARMY
and NAVY

Covers Every Job on Every Car Built from 1935 to 1948!

Nearly 200,000 service and repair facts on all these makes:

| | | |
|-----------|----------------|------------|
| American | Ford | Nash |
| Bantam | Frazer | Oldsmobile |
| Auburn | Graham | Packard |
| Austin | Hudson | Pierce |
| Buick | Hupmobile | Arrow |
| Cadillac | Kaiser | Plymouth |
| Chevrolet | Lafayette | Pontiac |
| Chrysler | La Salle | Reo |
| Cord | Lincoln | Studebaker |
| Crosley | Lincoln Zephyr | Terraplane |
| De Soto | Mercury | Willys |
| Dodge | | |

MAIL COUPON NOW FOR 7-DAY FREE TRIAL

MoToR Book Dept., Desk 1E, 572 Madison Ave., New York 22, N. Y. Rush to me at once (check box opposite book you want):

MoToR's AUTO REPAIR MANUAL. If O.K., I will remit \$1 in 7 days (plus 35c delivery charges), \$2 monthly for 2 months and a final payment of 95c one month after that. Otherwise I will return book postpaid in 7 days. (Foreign price, remit \$8 cash with order.)

MoToR's TRUCK REPAIR MANUAL. (Described at left.) If O.K., I will remit \$2 in 7 days, and \$2 monthly for 3 months, plus 35c delivery charges with final payment. Otherwise I will return book postpaid in 7 days. (Foreign price, remit \$10 cash with order.)

Print Name _____ Age _____

Print Address _____

City _____ State _____

Check box and save 35c delivery charge by enclosing WITH coupon entire payment of \$5.95 for Auto Repair Manual (or \$8 for Truck Repair Manual). Same 7-day return-refund privilege applies.

Same FREE 7-DAY Offer Applies On MoToR's TRUCK REPAIR MANUAL



Covers EVERY job on EVERY truck made since 1936! 1400 pictures, 952 pages, 300,000 facts. Warranted to contain every essential fact you need.

Covers all types Gasoline Engines; Diesels and Hesselmans. Fuel Systems, Governors, Lubrication Systems, Ignition Systems, Starters, Generators, Clutches, Transmissions, Axles, Torque Dividers, Transfer Cases, Brakes, Steering, etc. Offered on same FREE 7-day examination as Auto Repair Manual. Check box in coupon.

Increasing your hold on your job and giving yourself a chance for advancement

Few men deliberately plan to work persistently on self-improvement. If progress comes naturally, they're happy; if it doesn't, they worry or ignore the situation. Yet it is possible to pay attention to self-improvement with considerable hope of success. A noticeable degree of advancement is practically assured any one who will make an intelligent and persistent effort. Thousands of men have proved this for themselves, with:



The Croft Library of Practical Electricity

The Croft Library is a complete electrical educator. It is founded on practice—on 20 years of shirt-sleeve experience—on work as it is actually done. It is jammed from cover to cover with the kind of hard-headed facts you want. Written so that the beginner can easily understand it, yet so sound, so thorough, that it is the daily guide of 59,000 highly paid electrical workers and engineers. Croft tells you the things you need to know about motors, generators, armatures, commutators, transformers, circuits, switchboards, distribution systems—electrical machinery of every type—wiring for light and power—wiring of finished buildings—underwriters and municipal requirements—illumination in its every phase—the most improved methods of lighting lamps—and lamp effects, etc.—how to do a complete job, from planning it, to completion.

No money down — easy payments

Fill in and mail the coupon attached and we will send you the entire set of seven volumes for ten days' examination on approval. We take all the risk—you assume no obligation. If you decide to keep the books, send \$3.50 in ten days and the balance at the rate of \$4.00 a month. Send the coupon NOW and see the books for yourself.

McGraw-Hill Book Co., 330 W. 42nd St., New York 18, N. Y.
Send me for ten days' examination on approval the Croft Library of Practical Electricity, 7 vols. If satisfactory I will send you \$3.50 in 10 days and \$4.00 monthly until the price of \$19.50 is paid. If not wanted, I will return the books postpaid.

Name _____
Home Address _____
City and State _____
Company _____
Position _____ PM-5-48

NOW! Build Your Future On



DIESEL Opportunities

LOOK around you. See the way tractors, trucks, buses, railroads, ships, power plants and equipment of many kinds are "going Diesel." Every day new opportunities are opening—in industrial and farming communities—for trained men who can install, maintain, operate and repair Diesel engines. Plan now to build your future in this growing field.

Diesel Knowledge is Earning Power

You don't have to give up your present job. Now, you can begin learning DIESEL in spare time at home. UEI practical training teaches you, step by step, how Diesel engines operate, how fuel systems work, repairs, accessories and auxiliary equipment; a world of Diesel "know how." Includes actual practice on Diesel equipment in our shop under expert guidance. UEI training methods are successful. For 20 years they have helped mechanically inclined men better themselves.

NOW IT'S UP TO YOU!

Coupon below brings you all the facts without cost or obligation. Get going today! MAIL COUPON NOW.

UTILITIES ENGINEERING INSTITUTE Diesel Division
Founded 1927
2521 Sheffield Ave., Dept. 158-D, Chicago 14, Ill.

Send Coupon for FREE FACTS

UTILITIES ENGINEERING INSTITUTE, Diesel Division
2521 Sheffield Ave., Dept. 158-D, Chicago 14, Ill.
Please send me Free Facts about Diesel opportunities and training.

NAME _____ Age _____
ADDRESS _____
CITY _____ Zone or County _____ STATE _____
 Check here for special information if you are under 17.

NEW EASY WAY TO MAKE MONEY at HOME

Your cost only 5c
You get \$5.00.
Full or spare time.



It's easy to Bronze Baby Shoes. Business still in infancy. Get in on ground floor and skim cream of profit from rich and never-ending market. No experience needed. Learn in one week. Income up to \$1,000 a month full time—\$50 to \$75 weekly in spare time. We furnish complete kit and full instructions. Simple as A B C to become an expert.

FREE FACTS. Write today. Don't send a penny. Just name and territory to reap rewards waiting. Costs only 5c to bronze shoes. Sell for \$5.00! This is too good to miss. Get facts today. Write to

KIKTAVI COMPANY
Dept. 24, 8620 So. Ruthelen Los Angeles 44, California

A PROFITABLE TRADE! AN EXCITING HOBBY!



Learn... PHOTO NEGATIVE RETOUCHING

Increase your income. Improve the quality of your own photography. New 5-week home study course—1 lesson each week—will teach you how. Complete course and all necessary equipment only \$17.50. For FREE brochure and complete details write today!

MARSHALL PHOTOGRAPHERS, Inc., School Division
162 North State Street, Dept. PM-6, Chicago 1, Illinois

Get Ready for Big Opportunities!

Equip. Dobe

TOOLS AND EQUIPMENT SENT WHEN YOU START

Get a better job with more pay and pleasant working conditions. Get into Drafting—where all products start. I will train you at home—give you experience—on the same kind of jobs you will do with the best paying firms. I furnish instruments and all equipment when you start. Write today for vital facts and FREE book. Give age.

ENGINEER DOBE • Div. 15 • Libertyville, Ill.

I Will Train You at Home

Until You Get a

GOOD PAY JOB in DRAFTING

FIREWORKS

601-PIECE ALL-NOISE ASSORTMENT

includes half gross Cherry Bombs, many Chinese crackers, Lady Crackers, Salutes, Little Red Devils, etc. Shipped by Express same day order is received. Name nearest Express office. No C.O.D. Supply Limited. Order Early only \$3.95!

JAYHAWK FIREWORKS

BLUE RAPIDS, KANSAS



COMB-A-TRIM The New Quick Trimmer

Something New! Trim your hair without any experience. It's easy! The excess hair comes off smoothly and easily by just pulling trimmer through hair like an ordinary comb. Also removes hair from legs—armpits. Save on haircut bills. . . . Trim your own hair or the whole family's. Send 50c and your Comb-A-Trim will be sent at once.

SPECIAL OFFER Send \$1.00 for 2 Comb-A-Trim and save 18c. **2 for \$1** 5 Extra Blades (Year's Supply) **25c**

COMB-A-TRIM CO., 1734 Carew Tower, Dept. R-27, Cincinnati, O.

EASY WAY TO MAKE YOUR OWN LAWN FURNITURE!

Simple as ABC with our EXACT SIZE patterns. Nothing complicated—just cut out and put together. Get started now. Send for free illustrated catalog of this summer's furniture. For hobby and PROFIT, too.

CRAFTSMAN DESIGN SERVICE, Dept. P-10
823 ECKART ST. FORT WAYNE 5, IND.

GET THIS FINE SUIT NO MONEY TO PAY!



BIG CASH EARNINGS, TOO!

Big news! This fine tailored suit yours without paying one cent—and big cash earnings, too! It's easy! Just take a few orders. Earn up to \$10 in a day and get your own suit as extra bonus. Dozens of rich new fabrics, superbly tailored in latest styles, at low prices produce orders on sight. Money-back guarantee. **FREE SAMPLES!** etc. for big complete outfit of actual samples and details of amazing new **BONUS SUIT** and money-making plan—All Sent Free! No experience. **SEND NO MONEY!** W. Z. GIBSON, Inc. 500 S. Throop, Dept. E-516, Chicago 7, Ill.

THESE 5 TRADES ASSURE YOU
HIGH PAY • Future Security

- **PLUMBING** Every phase of plumbing: Pipe-Cutting and Threading, Lead-Wiping, Rough-in Projects on Installations, Completed Installations of entire plumbing systems, Blueprint reading, Estimating.
- **DRAFTING** College-level courses in General Machine and Architectural Drafting, with fundamentals in Drafting Mathematics—all under graduate engineers.
- **SHOE REPAIRING** From simplest repairs on boots and shoes to the finest details of reconditioning and rebuilding, under expert craftsmen.
- **ELECTRICAL** Technical and shop training include Basic Electricity, Residential Wiring, Industrial Wiring, General Testing and Trouble Shooting, and Appliance Repair.
- **AUTOMOTIVE & TRACTOR** Applied training on latest model automobiles and tractors, including engine overhaul, transmission and differentials, carburetion, generator and ignition systems, engine tune up, Hydramatic and Vacumatic Transmissions, and general service.

"There's Always a Demand for the Man who KNOWS!"

CHOOSE ONE OF THESE 5 LEADING TRADES

Get Out of that Rut... Be a Skilled Tradesman! Have a Lifetime Career... Own Your Own Business and Be Secure in Your Old Age.

NOW while Enrollment is still open, send for FREE information.

THE 5 DIVISIONS OF

NATIONAL TRADE SCHOOL

2610 Grand Ave., Kansas City 8, Mo.

- Plumbing
- Drafting
- Shoe Repairing
- Electrical
- Automotive & Tractor

NAME _____
 ADDRESS _____
 CITY _____ STATE _____
 VETERAN _____ OCCUPATION _____

Choose One of these 5 Essential Trades

Our complete courses of thorough training prepare you to go right into the field as a Qualified Tradesman at High Pay in only 34 weeks (39 in Shoe Repair). All courses under especially trained instructors with practical experience. 6 Hour Classes 5 Days a Week. Our Employment Department helps you.

VETERANS "Approved for veterans' training by the State Department of Education under Public Law 346."
 "Approved for veterans' training by the Veterans' Administration under Law 16."

Send Coupon for Free Information Now

CHEMISTRY

LEARN AT HOME... Chemical knowledge is essential for thousands of good jobs in industry, business, science. IPC enables you to master practical chemistry. It's the ONLY home study chemistry course which enables you to learn by performing actual experiments—using chemicals and apparatus supplied with the course—in addition to your IPC textbook studies. Compares with recognized college courses in General Chemistry. Write today for free descriptive booklet.

INSTITUTE OF PRACTICAL CHEMISTRY
 3 PROSPECT AVENUE, HAGERSTOWN, MD.

SAY YOU SAW IT IN POPULAR MECHANICS

FEET HURT?

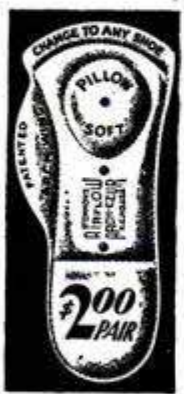

WEAR AIRFLOW ARCH-EZURS

You get more than a mere arch support—they are designed with pockets underneath—with extra inserts to adjust for high or low arches and to changing conditions of the feet. Don't be fooled by the low price—we specialize on this high grade support. Send today, your name, shoe size and whether

for men or women. We pay postage if money accompanies the order. Write to factory direct.

C. H. STEMMONS MFG. CO.
 321 E. 71st St., Dept. 15, Kansas City, Mo.



WANT A U.S. Government JOB?

START As High As \$3,021.00 Year
Veterans Get Preference

MEN—WOMEN

Thousands Appointments Each Year. Get ready immediately. Common education usually sufficient.

FRANKLIN INSTITUTE
 (Not Government Controlled)
 Dept. B87
 ROCHESTER 4, N. Y.

Gentlemen: Rush to me, FREE of charge, list of U. S. Government big pay jobs. Now obtainable. Send me FREE 32-page book describing salaries, vacations, hours, work. Tell me how to qualify for one of these jobs.

Mail Coupon Today—SURE

Name _____
 Address _____ Vet? _____

WAR SURPLUS OPTICAL BARGAINS

ASSEMBLE YOUR OWN BINOCULARS!

Save More Than 1/2 Regular Cost



GOVERNMENT'S 7X50 BINOCULARS

Complete Optics, new and ready for assembly. We supply full instructions. Limit—1 Set of Metal Parts and 1 Set of Optics to a customer.

METAL PARTS—Set includes all Metal Parts—completely finished—for assembly of 7 X 50 Binoculars. No machining required. Bodies have been factory hinged and covered. A sturdy Binocular Carrying Case is optional with each set of Metal Parts.

Postpaid, plus \$4.80 for Case—Total.....\$44.20

OPTICS—Set includes all Lenses and Prisms you need for assembling 7 X 50 Binoculars. These are in excellent condition—perfect or near-perfect—and have new low reflection coating.

Stock # 5102-H\$25.00 Postpaid

NOTICE! If you buy both Binocular Optics and Binocular Metal Parts, add 20% Federal Excise Tax to above prices.

ARMY'S 6x30 BINOCULARS

COMPLETE OPTICS & METAL PARTS—Model M-13A1, 6 X 30 Binoculars. (Waterproof Model). Everything you need—ready for assembly. When finished will look like a regular factory job costing \$102. to \$120. The Optics are new, in perfect or near-perfect condition. Have new low reflection coating. Metal Parts are new and perfect, all completely finished. No machining required. Bodies factory hinged and covered. Complete assembly instructions included.

Stock # 830-H\$40.00 Postpaid plus \$8.00 tax—Total—\$48.00

TERRIFIC BARGAIN—BUBBLE SEXTANT

These Army Air Forces Bubble Sextants cost Govt. about \$125 each. Bargain at our price of \$12.50. Wooden carrying case included. Wartime used but COMPLETELY REPAIRED AND COLLIMATED. Return within 10 days for full refund if dissatisfied. Directions for use accompany shipment.

Stock # 924-H\$12.50 Postpaid

Same SEXTANT as above, but BRAND NEW and with Automatic Averaging Device and Illuminated Averaging Disc for nighttime use. Govt. cost \$217. Perfect working order guaranteed.

Stock # 933-H\$22.50 Postpaid

6 POWER GALILEAN TELESCOPE—(Commercial Surplus) 28mm dia. Achromatic Objective Lens. Sturdily constructed of Aluminum. 7" long, extends to 9". Complete with carrying case.

Stock # 941-H\$3.00 Postpaid

We have literally millions of war surplus lenses and prisms for sale at bargain prices ranging 10c and up. Write for Catalog "H"—Sent Free!

Order by Stock No. Satisfaction Guaranteed

EDMUND SALVAGE COMPANY

P. O. AUDUBON, NEW JERSEY

22 Big Money-Makers in a Single Line!

Amazing New Fluorescent Lights with Circular Tubes

THE HOMELITER



FREE Sales Outfit

Don't send a penny. Sample Outfit is FREE. Rush name on penny post card for money-making facts about sensational new "CIRCLINE" Fluorescents. Latest scientific development gives you 22 new type circular tube fixtures for kitchens, dinettes, halls, and play rooms. Also Floor and Table lamp for living rooms and pin-ups for shaving and vanity tables. Sell on sight to homes, restaurants, stores, offices. No other fluorescents like CIRCLINE. Salesmen who order samples quickly reorder in large quantities. All fixtures complete with tubes. No waiting. Also immediate delivery on all standard type Fluorescent Fixtures. This is too good to miss. Big, quick profits waiting. Rush name on postcard today for FREE Sales Outfit.



NEW MAXILUME PIN-UP MIRROR LIGHT

MAXILUME COMPANY • 125 W. HUBBARD • DEPT. 85 • CHICAGO 10, ILLINOIS



Why Pay More?

SEND THIS AD WITH ORDER

EVERY TIRE GUARANTEED
98% NON SKID, ORIGINAL TREAD
TRIPLE INSPECTED DEMONSTRATORS

Positively Not Re-caps!

| | | | |
|-------------|--------------|-----------|--------------|
| 600-16 |\$6.42 | 700-15 |\$8.42 |
| 650-15 |7.12 | 700-16 |8.82 |
| 650-16 |7.42 | 750-16 |9.42 |
| 900-16 |\$ 9.52 | 900-20 |\$17.52 |
| 650-20 |9.52 | 1000-20 |17.52 |
| 700-20 |12.52 | 1100-20 |17.52 |
| 750-20 (8) |12.52 | 32x6 (8) |12.52 |
| 750-20 (10) |14.52 | 32x6 (10) |14.52 |
| 825-20 |16.52 | 34x7 (10) |14.52 |

7.50-20 MILITARY 8 PLY \$17.52

1/2 million tires shipped to satisfied customers. Trial, will convince you. Mail Orders Rushed on Receipt of Check or Money Order.

STANDARD
834 N. Broad St. Phila. 30, Pa.

Learn MAIL ORDER ADVERTISING

And How To Start Your Own Business at Home!

Our thorough home-study course prepares you to engage in Mail Order Advertising as a profession... as well as how to make good money OPERATING YOUR OWN MAIL ORDER BUSINESS. Can be started at home with little capital. Write for free booklet to

At Home in Your Spare Time!
FREE BOOK

ARMSTRONG SCHOOLS

Dept. 85-L, 7217 So. Broadway, Los Angeles 3, Cal.

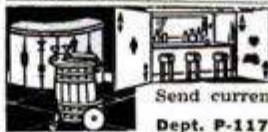

HOME BARS 25 DESIGNS

HOME BARS for genial hosts. Fun to make and use. 25 designs... built-in, portable bars; cellarettes, only \$1.00. Send currency or check today. Money-back guarantee.

HOMECRAFT PLANS
Dept. P-117 7241 Madison Kansas City 5, Mo.



Tired of Working for the Other Fellow?

Be Your Own Boss

A Big Field for Your Future

Body & Fender Rebuilding is one of the best paid branches of the automobile industry. Go into business for yourself or prepare for good job opportunities. Train at home or in our big shops. Approved for Veterans. (Non-Veterans inquire about our Low Payment Plan and

Pay After Graduation Plan.) Send for FREE Booklet and full information. No obligation.

COMMERCIAL TRADES INSTITUTE, Dept. F 2-5

1400 W. Greenleaf Avenue, Chicago 26, Ill.



GET INTO DRAFTING

The Draftsman Plays a most Important Part in INDUSTRY

DRAWING OUTFIT INCLUDED with Drafting courses

All the tools you need including folding drawing table. With them you can put your ideas on paper quickly and with accuracy. With training you are all set to master Drafting in months, — not years — at home.

Learn in Spare Time—At Home!

(or at the College in Chicago)

A few hours of pleasant home study every week — that's all. With Chicago Tech's help, you train yourself step by step. This tested method — developed over 44 years of C.T.C. progress — prepares men for good positions in industry.



**CHICAGO
TECHNICAL COLLEGE**
E-211 Tech Building, 2000 South Michigan Ave.
Chicago 16, Illinois

Practically everything that's built or manufactured these days is constructed from blue print drawings prepared by the draftsman. He is the KEY man in industry. No new machines can be built, no bridges erected, no buildings constructed until the draftsman has completed his work.

Drafting is clean, interesting, professional-type work. The draftsman is paid well to start. And he has real opportunities for advancement to high-pay jobs in Engineering. The tremendous production programs ahead in industry will require more draftsmen than ever before.

Send today for free information. See what this training has done for others, what it can do for you. Simply MAIL COUPON TODAY in an envelope or use a penny postcard.

MAIL COUPON NOW

Chicago Technical College
E-211 Tech Bldg., 2000 So. Michigan Ave.
Chicago 16, Illinois

Mail me FREE Drafting Lesson with information about big opportunities in DRAFTING and how I can train at home.

- Architectural Drafting Electrical Drafting
 Machine Drafting Structural Drafting
 Builders' Course

Name _____ Age _____

Address _____

City _____ Zone _____ State _____

MAKE MAGIC YOUR HOBBY
BE A MAGICIAN FOR FUN OR PROFIT!
Rush 25c for a sample copy of "MAGIC IS FUN," magazine that teaches how to do tricks with coins, cards, ropes, etc. FREE, with order, large catalog of magical apparatus. D. Robbins & Co., Dept. M-162, 152 W. 42 St., N. Y. 18, N. Y.

**LEARN TO PLAY THE ACCORDION
THRU THE "SEE & HEAR" SYSTEM**

This unique system of study enables you to be "Your Own Teacher." The course consists of recorded lessons and instruction method. The "SEE & HEAR" system is an easy, pleasant and effective way of learning to play the Accordion.

Write for complete details, Dept. P
O. PAGANI & BRO., INC.
289 BLEECKER STREET • NEW YORK 14, N. Y.

SPORS
1948 CATALOG No. 67
WHOLESALE
SPECIALTY MERCHANDISE

SPORS CO. 3-48 Dodge Le Center, Minn.

6000 SMASH HITS— IN 324 PAGE Wholesale Book

Dealers, agents, salesmen and jobbers, you will find this book bulging with Tested Money Makers. Latest catalog shows average price reductions about 21% on many items. A guarantee of satisfaction stands back of every purchase you make from us. 25c brings you this latest 1948 wholesale catalog of Tested Sellers. You may take credit for the 25c on your first order. In that way the Book will not cost you any money. Get your copy now, before supply is depleted.

U.S. GOVERNMENT JOBS!

AS HIGH AS \$3,021 FIRST YEAR

Many Permanent Appointments Being Made



Veterans Get
Special
Preference

Many Govern-
ment Jobs. City and
Rural Carriers—Post-
office Clerks—Meat In-
spectors — Accountants —
Stenographers — Typists —
etc. Prepare now for next
Examinations.

FRANKLIN INSTITUTE,
(Not Government Controlled)
Dept. B85, Rochester 4, N. Y.

Sirs: Rush to me, without charge, copy of 32-page book, "How to Get a U. S. Government Job," list of positions, and full particulars telling how to prepare for them.

Name _____

Address _____ Vet? _____

START NOW TOWARD A FUTURE IN REFRIGERATION and AIR CONDITIONING

Refrigeration and Air Conditioning are among the giant Industries of America. Such industries need men who KNOW. Many men servicing and installing equipment are making large incomes.

Spare Time Training

If mechanically inclined, get the training you need to qualify for experience installing & servicing Refrigeration and Air Conditioning in stores, offices, homes.

Then you should have no difficulty getting started in these great industries. As experience, tools and a personal following are acquired; you may find it practical, later, to start your own REFRIGERATION and AIR CONDITIONING SHOP.



Rush Coupon Below Today!

Practical Interesting Training

You'll like our way of training—through capable home-study instruction followed by practice on actual equipment under watchful eyes of seasoned Refrigeration and Air Conditioning men in our shops. You'll get top-rate instructions—the easy way. So get the facts now—FREE of obligation. Write TODAY—SURE!

GET VALUABLE FACTS FREE

UTILITIES ENGINEERING INSTITUTE, Dept. 158,
2525 Sheffield Ave., Chicago 14, Ill.

Please send me the Free FACTS about opportunities in Air Conditioning and Mechanical Refrigeration. I marked the one that interests me most.

Air Conditioning Mechanical Refrigeration

NAME _____ Age _____

ADDRESS _____

CITY _____ Zone _____ STATE _____

"TOOK IN \$217 FIRST 10 DAYS"

Some Make More,
Some Less... We Help
You to Start Your
Own All-Year
Business, Make
Big Money!

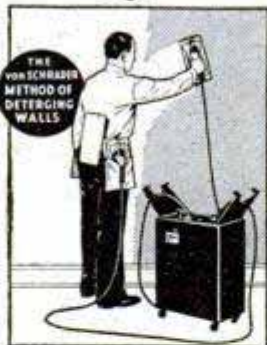

With our easily operated, highly efficient wall washer, Chas. Stelle took in \$217 gross in first ten days. E. L. Goss took in more than \$10,000 in one year. E. C. Taber wrote, "I made \$400 gross in two weeks." And no wonder—this machine washes walls 6 times faster and better than by hand.

Your Money-Making Opportunity

We want more men to go into this profitable business for themselves and enjoy independence. There are customers everywhere—homes, offices, schools, churches, hotels, stores, etc. What you take in is mostly profit, for material costs are low. And there's no need to rent a shop or office. Operate your business from your home.

Lose no time. Get all facts without obligation. WRITE FOR FREE INFORMATION. Ask for Wall Washer Details at once.

VON SCHRADER MFG. CO., C51, RACINE, WIS.

VETERANS Learn WATCHMAKING

A Lifetime Career

No Age, nor Physical Limitations

YOUR OPPORTUNITY
To Lift Yourself from a Futureless Job



Approved G. I. Training

LEARN WATCHMAKING

and earn from the start, higher than average pay... easy hours... ideal working conditions... be prepared to establish your own business.

WATCH REPAIRING — JEWELRY — ENGRAVING
Always in Demand

Requests for our Graduates from Everywhere. Permanent positions (no layoffs) \$75.00—\$100 per week for trained men. Write today for latest FREE Catalog.

KANSAS CITY SCHOOL OF WATCHMAKING

America's Most Progressive Horological School
617-621 Wyandotte St. Kansas City 6, Mo.

CODE SPEED SHORT CUT

Be an expert. Learn to be a Telegraph or Radio Operator. Quality for amateur or commercial license. Intensely interesting work—good pay. Learn at home or wherever you are, quickly, easily with the famous Candler Speed System. Book of particulars Free.

CANDLER SYSTEM CO., Dept. 5-E, Box 928, Denver 1, Colo., U.S.A.

RAISE PROFITABLE CHIN-CHINS



No experience needed. A few minutes daily, a few feet of backyard space. Several females and a male starts a large, money making herd. WE FURNISH ALL INSTRUCTIONS.

Free booklet explains tremendous demand for live youngsters, delicious meat, gorgeous fur. Write today.

WILLOW BROOK FARM, R-36, SELLERSVILLE, PENNA.

New Government LIFE RAFTS

Comes with compressed air cylinder paddles and cover. Guaranteed. Folds up to 15"x15"x4". Original cost \$75.00 to \$500.00. 1-MAN RAFTS at only... **\$19.95**



5-MAN RAFTS—Perfect, never used in water. Packed in carrying case with cylinder and paddles. Each... **\$44.75**

JUNGLE HAMMOCKS

For the home, yard, farm, camping, scouting and many other uses. Can also be used for Pup Tents. Made of high grade Poplin for the U. S. Army. Complete with ropes and canopy for protection against mosquitoes and other insects. Comes individually packed. Ready for immediate shipment. Order yours today. Only... **\$6.95**



R o K o C O.

809 CHERRY KANSAS CITY, MO.

**WORLD'S
BEST
WANT AD
MEDIUM**

CLASSIFIED Advertisements



Advertisements in this section 75 cents per word, each insertion, minimum 10 words, payable in advance
To be inserted under proper classification, copy must be in our office the 22nd of the
second month preceding date of issue
F. W. Johnson, Manager, Classified Advertising
Popular Mechanics Magazine, 200 East Ontario Street, Chicago 11, Illinois

1190

CLASSIFIED ADVERTISEMENTS

1190

OPPORTUNITIES FOR YOU

AUTOMOBILES. MIDGET CARS

MIDGET Car book—Complete plans for easily building inexpensive midget racers, two passenger highway roadsters, 3-wheel cars, scooters, etc. Motor data, supply sources. 75 photographs, blueprints! \$1.98. Almqvist Engineering, Milford 10, Pennsylvania.

INTERCHANGEABLE Parts book. New book tells every automobile part that interchanges with others. Same parts many times vary 100% in price. This book enables garages, mechanics, dealers, owners to buy under cheapest listing. Tremendous savings for users. \$15.50 postpaid. Clymer, Dept. A-IP, 2125 W. Pico, Los Angeles 6, Calif.

FORD—Mercury owners attention! Supertone dual exhaust systems. Reduce back pressure 50%. Increase gas mileage. Pleasing tone. Free catalog. Super Tone Mufflers, 2470 E. Slauson, Huntington Park 3, Calif.

"CUSTOM Styling" manual—Easily make car look Hollywoodized, custom, ultra-beautiful by quick inexpensive methods! 100 photographs, instructions on customizing, restyling, streamlining; new and old cars. Also model, sport, conversions; accessories; mufflers; engine "soup up" specifications! Most complete book \$2. Almqvist Engineering, Milford 10, Pennsylvania.

DON'T Waste money on your car troubles. You do if you don't know these 100 dollar saving answers. 25c. Sterling, 210 5th Ave., Suite 1102, New York.

CRASH! Will you be the next victim of sleepy driving? Amazing alarm recently developed and road-tested. Bell rings, motor skips, when driver sleepy. No attachments to driver. Easily made in home shop. So simple it is unbelievable. Plans available only \$1.00 postpaid. No stamps. Jap Developing Co., 2 Virginia Rd., Reading, Mass.

KAISER-FRAZER. Floyd Clymer's new book (no connection with Kaiser) gives uncensored, impartial report 3000-mile test including Pikes Peak, Kansas City-Denver record runs, economy test. Part by part equipment analysis. Good, bad comments, no punches pulled. \$1.50 postpaid. Clymer, Dept. A-51, 2125 W. Pico, Los Angeles 6, Calif.

DON'T Buy any car until you read "Buyer's Manual!" Fully copyrighted charts, instructions, etc. expose dealers' secrets. \$1.00 postpaid. Groben, 21 Lansing, Auburn, New York.

"SPEED & Mileage" manual—Obtain greater speed, mileage, racing performance from any automobile! "Original" book gives easiest methods! Simplified speed tuning! Racing secrets! Mileage tips! Instructions on building speed equipment, economizers, mufflers, "water injectors," manifolds, superchargers, fuels, heads, "hotrods," speedsters, fast conversions, engines! Also "Hollywood Customizing" information, photographs, catalogues, parts lists! \$1.98. Almqvist Engineering, Milford 10, Pennsylvania.

SAVE Money. Convert your car to burn kerosene. Easily installed unit. Agnts wanted. Buckley Company, Taunton, Mass.

HIGH Compression heads, V-8. More speed, acceleration, power. Offenhausser or Edlebrock \$75.00 complete set. Dual manifolds complete with throttle kit, fuel lines. Edlebrock \$49.00, Offenhausser \$55.00. Give make, model V-8. Catalog 10c. Clymer, Dept. A-53, 2125 W. Pico, Los Angeles 6, Calif.

BRITISH Sports cars. New book. 96 makes described. Fine illustrations, specifications. \$2.00, deluxe edition \$3.00 postpaid. Clymer, Dept. A-57, 2125 W. Pico, Los Angeles 6, Calif.

USED-CAR "Buyer's Handbook." Save money, grief! Photographs, dealers' tricks, complete tests, instructions. \$1, postpaid. Post Publications, Box 723-TE, Arcadia, California.

NO. 4 Clymer Historical Scrapbook. Entirely new, different. 224 pages, advertisements, photographs 250 early automobiles, motorcycles. \$1.50, deluxe edition \$2.50 postpaid. Clymer, Dept. A-58, 2125 W. Pico, Los Angeles 6, Calif.

FORD Mercury owners. Attention! Give your car that knee-action ride. Restore arch to flat springs. Eliminate side-sway. Free literature. Supertone Mufflers, 2470 E. Slauson, Huntington Park 3, Calif.

RACE Driver History. Complete information every driver competing Indianapolis "500," 1911 to present. 313 drivers performance records every year alphabetically arranged. \$1.50 postpaid. Clymer, Dept. A-RD, 2125 W. Pico, Los Angeles 6, Calif.

CUSTOM-CAR Books: Complete, comprehensive (50 photographs) "Master Restyling Manual." Also fascinating, photograph-packed "custom album." \$1 each, postpaid. Post Publications, Box 723-GE, Arcadia, California.

SENSATIONAL! The new night glow rear-view mirror with illuminated rim! Protects your car at night! Visible to cars 1/4 mile behind you! Warns drivers approaching from rear! Beautifully chrome-plated! Easy to install! Order yours today! \$6.95 each prepaid. A. Ward Shanen, 2444 South Orkney Street, Philadelphia 48, Penna.

"POWERIZER" Water injector—Increases speed, acceleration, mileage to 30%. Easily assemble yourself for few cents! Sensational performance! Prevents wear, knock, oil pumping! "Installation Manual" includes "hop-up" tips. \$1. Almqvist Engineering, Milford 10, Pennsylvania.

DUALTONE Chrystalline packed California mufflers. Single or twin for all automobiles. Dual manifolds, hi-compression cylinder heads, heavy chromed 3" single or double, tailpipe extensions. Fender skirts. Send 20c for catalog and deduct from first order. Dualtone Mufflers, 2636C India Street, San Diego 1, California.

NEW Ford 1/2-ton pick-up trucks! Chrome-plated 150 h.p. V-8 engines! Special deluxe equipment! The most powerful; most beautiful; most economical units in the country! For those who want the finest pick-ups in the entire U.S.A.! List price, \$1,995.00 each. F.O.B. Philadelphia, Penna. Set of photos and specification sheets, \$1.00. A. Ward Shanen, 2444 S. Orkney St., Philadelphia 48, Penna.

MIDGET Auto. Build from surplus airplane belly tank. Complete plans, instructions \$2.00. Abco, 1032 62nd Street, Oakland 8, Calif.

CLYMERTONE, Twin muffler sets, beautiful sound, complete with necessary welded pipes, E-Z installation. Ford V-8, \$20.00, Chevrolet set with split manifolds, \$37.50. Specify car model. Clymer, Dept. A-54, 2125 W. Pico, Los Angeles 6, Calif.

MAKE Your Model "A" do 100 m.p.h. Lightning acceleration, breath-taking top speed. Complete details, photographs. \$1 postpaid. Four Barrel, Box L-1, Eagle-rock, Los Angeles 41, Calif.

"SPEED & Power" handbook—Very latest methods! Construct your own superchargers, water injectors, compression heads, fuel saving devices; easily, practically without cost. Get racing speed, acceleration, dynamic power increases from any automobile! Includes "Economy Information;" ingenious formulas! Tuning techniques! Mileage! Ignition! Carburetion tricks. Fuels! Lubricants! Literature! Illustrations! Speed secrets. Including "Restyling Ideas;" streamlining! Model revising! Customizing! Sport changes. Hotrods! Accessories! Photographs! Parts lists! \$1.98 complete. Newhouse Industries, 5941-B2 Hereford, Los Angeles 22.

BRITISH Cars. New, unique book illustrates, describes 34 British postwar cars, all makes, models. 67 beautiful photographs. A real catalog. Just out. \$2.00, deluxe edition \$3.00 postpaid. Clymer, Dept. A-PW, 2125 W. Pico, Los Angeles 6, Calif.

STUDEBAKER Champion speed and power equipment: Heads, dual manifolds, cams, distributors, mags, carburetors for gas or alcohol, light flywheels, oversize valves, special pistons, ring sets, 6000 r.p.m. engines 135 and 176 inch. Free list and engineering help. Frank Morgan, Studebaker Dealer, Marysville, California.

WRITE Us your needs. Full line of popular speed equipment, fender skirts, Hollywood hub caps; dual, single, mufflers etc. Save freight, midwest warehouse. Catalog 25c cash. VonEsser's, 2840 North Kedzie, Chicago 18, Ill.

1948 HOLLYWOOD Dress-up accessories; direct! Mileage, power, speed equipment; for all passenger cars! We pay the freight. Picture-catalogue 25c. Newhouse Automotive Industries, 5941-BB Hereford, Los Angeles 22.

INSTALL V-8 engine in your Model A for extreme acceleration, more top speed, smoother performance. Complete details, photographs. \$1 postpaid. A-V-8, Box L-1, Eaglerock, Los Angeles 41, Calif.

"VAPO-STEAMATIC" Water injection. Thousands using this famous automatic system. Easily assembled (for less than \$1.00); no machining. Engineering triumph; burns 15% water! Saves gasoline! Reduces wear! Greatly increases horsepower! Speed! Prevents sludge! Eliminates carbon! Smoother performance! Copyrighted "Installation Handbook;" with diagrams. Including "Injectors;" tractors, trucks, lightplanes, motorcycles. Illustrations! Lists! \$1.00 complete. Newhouse Industries, 5941-B2 Hereford, Los Angeles 22.

MAKE Your Ford fast! Complete details, photographs. How to construct 120 m.p.h. Hotrod. \$1 postpaid. California Bill, Box L-1 Eaglerock, Los Angeles 41, Calif.

PROFESSIONAL Midget racer, motor-scooter, midget roadster, midget motorcycle. Plans, specifications contained in illustrated handbook, 25c. Directory bargain priced used motors, motorscooters, servicycles, etc., included free! Midwest, 3839 Drummond, Toledo, Ohio.

DUESENBERG Catalog reprint. Complete data, 32 photographs various body styles, views. Complete engine specifications, includes supercharger information. \$1.00 postpaid. Clymer, Dept. A-56, 2125 W. Pico, Los Angeles 6, Calif.

WE Sell direct to customers over 200 speed equipment parts manufactured by us. Ford A-B-V8-6-4- (Ferguson), Studebaker Champion, Chevrolets and Willys. Cylinder heads, dual intake manifolds, lynch flywheels, oversize valves, compound springs, camshafts and other supplies. Complete engines ready for race for cars, boats and midgets. \$1.00 to cover illustrated literature and price sheet. R & R Mfg. Co., Robert M. Roof, Box 546, Anderson, Indiana.

FROM Speedway to roadway! Track-proved hi-speed heads and manifolds now available for your passenger car! No special tools needed! Increase horsepower 25%! Astounding getaway! Free illustrated catalog. Speedsport, 5747AA Waveland, Chicago 34.

SEE Our ad under motorscooters for midget car bargains. Midget Motors Directory, Athens, Ohio.

GREASE Car yourself. Illustrated conversion system, \$2. Rodd, Trona, California.

AUTOMOBILE Racing, Sixth Edition. 100 illustrations. Working drawings with building instructions for Ford-60 midget, California roadster, Offenhauser racer. Details on racer parts. Sample entrance blank. World's record 158.5 m.p.h. rear engine four-wheel drive car. Interesting information for fans, drivers, mechanics. \$2.00 postpaid; \$2.25 c.o.d. Ray Kuns, Department 63, Cincinnati 27, Ohio.

BUILD Speedy midget track racer from castoff parts! Plans, specifications, construction information, \$1.00. Motor Supply, Box CS-1682, Toledo, Ohio.

AUTOMOBILE Racing book, fifth edition, well illustrated. Instructions on building bodies, frames, engines. Ford A and B conversions. Plans, AAA rules, specifications. Roadster racing. Indianapolis cars. \$1.00 postpaid, \$1.30 C.O.D. Ray Kuns, Dept. 47, Madisonville, Cincinnati 27, Ohio.

HOT-ROD Manual, fast Fords, photos, instructions, \$1.50. Airmail \$1.75. Racing parts list 25c. Hollywood Hot-Rod, Los Feliz, Box 9626P, Hollywood 27, California.

AUTO SUPPLIES AND EQUIPMENT

SPRAY Paint your automobile. Complete professional instructions, \$1.00. 155 Tasso, Palo Alto, California.

AMAZING New invention! Quick-charges; controls; protects; conditions battery and generator while in car! Sensational low price; write quick for free demonstrator offer! Gen-O-Batt, 1136A Dodge, Evanston, Ill.

REPAIR Dents and holes in auto bodies with Duro Plastic Metallic Auto Body Solder. Applied with putty knife. Pints \$1.50, quarts \$2.50 prepaid. Leonard Sales Company, Box 6412, Cleveland, Ohio.

BRUSHLESS Auto enamel, \$3.95 postpaid. Very best. Samples. Distributors wanted. Cover-Nu, 1911-N, Lubbock, Texas.

FREE Trial in your car. Gane air flow needles for all cars: Smoother motor; easier starting; faster pick-up; better idling; and from one to four miles more per gallon. Remit only \$1.50 per needle. (8 cyl. cars use two.) Advanced Automotive Products, 563-B Lake Road, Webster, N. Y.

CAR-BED. Make it yourself. Inexpensive. Fits any 2 or 4 door sedan. Plans \$2.00, easy to follow. Martins, Box 297, Upper Darby, Penna.

GRILLES For all cars; 1940 Plymouth shells. Wagner Grille Co., Route 2, Bernville, Penna.

BURN Water in your car. Costs less than gas. More power, cleaner motor. Mail card for data on \$17.50 Octa-Gane Water Injecting Carburetor. Advanced Automotive Products, 563-2 Lake Road, Webster, N. Y.

WASH Your car with Quicky. Easy streakless car wash. Modern, safe, sure. Send \$1.00 for 5 packages to wash 8 to 10 cars. Schuttig Patent Co., Box 305, Ridgefield Park, N. J.

MOTORISTS Save gasoline by Vacuumating overrich mixtures. Fits all cars. For free particulars write Vacuumatic, Dept. 1332, Wauwatosa, Wis.

READY-MADE Convertible tops. Easily installed. Reasonable prices. Free literature. Rio Top Co., 1370 Roanoke, Newport News 6, Va.

AUTO Parts; new, used or rebuilt; anything for motor or body, any model car or truck. Reasonable. Immediate shipments. What do you need? Write Byron Motors, 5280 W. Pico, Los Angeles, Calif.

QUALITY Pistons for less. Money-back guarantee. Any piston made. Marvin Merryman, Lawndale, Calif.

WELDING Bodies, repairing fenders pays good profits. Easy with Hobart Arc Welders. A.C. or D.C. Catalog free. Write Hobart Welders, Box M-582, Troy, Ohio.

AUTOMOBILE Shatterproof glass! Rubber mats! Shock absorbers! Direct factory savings. Write requirements. Immediate quotations. Cooper's, 3135 Lawrence, Chicago 25.

AUTO Parts. New or rebuilt. Prompt shipment. Write requirements. Save money, buy direct. Factory Warehouse, Mechanics Auto Parts, 3807-PM North Ashland Ave., Chicago 13.

AUTO Parts for all cars, transmissions, motors, differentials, fenders, carburetors. Security Auto Parts, 1923-PM Grace, Chicago 13.

GRILLES For all cars. Meyers Auto Parts. 820 Dryades, New Orleans, La.

NEW And used automobile and truck parts. Lowest prices. Complete stock. Prompt reply. Babbitt Auto Parts, 2833 W. Chicago Ave., Chicago 22.

PLATING Outfits for auto parts. Connect to a battery. No tanks used. Free particulars and proofs. Gunmetal Co., Ave. J, Decatur, Ill.

CAR Trouble? Million new used parts. Describe needs. Automotive, 2928A North Western, Chicago 18.

AUTO TRAILERS

COMPLETE Foundation for your trailer home. Chassis frames, tor-q-les axles with springs, wheels, hitches, parking jacks. Literature on request. General Trailer, 412 South Barstow, Eau Claire, Wis.

BUILD Your own trailer! Save money! Have every feature you want! Plans for house, sport, camp and utility trailers. Catalog describing 9 models 10c. 15c in Canada and overseas. Jim Dandy, Box 125-A, Wausau, Wisconsin.

DESIGN, Build trailers to 30 ft. Circular illustrating 8 designs, 20c. Craftsmann Books, Box 1153, Milwaukee, Wisconsin.

TRAILER Plans, parts, accessories. Complete line. Catalog plus booklet "Trailer Building" \$1.00. Marine Mart, Buffalo 7B, N. Y.

MOTORCYCLES, BICYCLES, MOTORSCOOTERS AND SUPPLIES

MIDGET Car \$12, motorbike \$15. Servicycle \$30, brand new Regal motorscooters \$37.50, less motors. Midget motorcycle \$35, Motoscoot \$25, Salisbury \$50, Whizzer Motorbike \$55, Twin Harley \$60, all complete. Gasoline engines \$3 up. Plenty brand new 2 h.p. engines in original crates. 5500 small balloon tires \$1 up. Mailorder only. Send 25c for Big War-Bargain catalogue Number 25, just out, listing the above and almost 400 other bargains in new and used motors, motorscooters, midget cars, parts, plans, etc. (35c by first class mail). Midget Motors Directory, Athens, Ohio.

CHROME Plating on all motorcycle parts. Doll up your bike. Free literature. Master Silverplaters, 2033 Caniff, Detroit 12, Michigan.

TIRES, Inner tubes, wheels, for small trucks, wheelbarrows, power scooters, farm equipment, carts, etc. Sizes 8" to 18" o.d. first-line quality tires, with removable inner tubes and heavy duty demountable wheels. Free circular and prices. Jahant Co., 626 East Exchange Street, Akron 6, Ohio.

MOTORCYCLE News, monthly. Yearly subscription \$1.00. Latest worldwide information. Motorcycle News, 5424-A Sawyer, Chicago 25.

BOYS, Bicycle repair manual, "illustrated," \$1.00. Klausner Cycles, Shelbyville, Illinois.

MOTORIZED Your bike. Easy, simple method. No welding, no cutting. Complete diagrams, instructions, pictures, all for \$1. Dunakin Shops, 819 Golf Lane, Wheaton, Ill.

BICYCLE Supplies, wholesale, retail. List. 10c. Universal, 4713 Virginia, St. Louis, Missouri.

TIRES And industrial wheels, suitable for scooters, wheelbarrows, farm equipment, etc. All sizes. Bicycles and accessories. Largest assortment in America. Send dime for list. Cycle Transport Company, 1241 So. Michigan Ave., Chicago 5, Illinois.

BICYCLES, Tricycles, parts, accessories. Send 10c for bulletin. Propp's, 2202 Fondulac, Milwaukee, Wis.

MOTORCYCLISTS Chromium accessories. New and reconditioned motors. Complete stock Indian parts. Expert motor rebuilding. Indian Motorcycle Sales, Kansas City 1, Missouri.

MOTORCYCLE Cams ground for speed and power. Write Harold Schaller, Box 31, Turlock, Calif.

MIDGET Automobile \$15, Cushman motorscooter \$20, Indian motorcycle \$30, tires 75c. Send 25c for Spring catalog #940 listing sensational bargains in motor-scooters, Servicycles, midget cars, used motors, parts, Associated, Box CS-1764, Toledo, Ohio.

HARLEY-DAVIDSON Supplies, parts, accessories, oil service, tires all sizes, repaired 45" motors. Send \$2.25 for Army Motorcycle Manual, 10c for bulletin. Knuth's (Harley-Davidson Dealers), 2491 Fondulac, Milwaukee, Wis.

MIDGET Racer \$40, Cushman motorscooter \$15, motorbike outfit \$15, Harley-Davidson motorcycle \$35. Send 25c for new catalog #12 listing amazing bargains in motorscooters, motorbikes, midget cars, motors, parts. Gall, 538 Erie, Toledo, Ohio.

HARLEY-DAVIDSON Parts, accessories, batteries, and tires, 24 hour service. Authorized factory dealer, Philadelphia Harley-Davidson Company, 857 North Broad Street, Philadelphia 23, Penna.

WHEELS! Build wagons, scooters, mowers, trailers, wheelbarrows, grocery carts, baby carts, play pens, baby carriages. 4" to 16". Free list. Trulsen Mfg. Co., 811 E. 31, Kansas City, Mo.

FLAT Rate repair manual for Harley-Davidsons. Gives flat rate charge for every operation. Every dealer, owner, mechanic needs this new book, \$2.00 postpaid. Clymer, Dept. A-FR, 2125 W. Pico, Los Angeles 6, Calif.

MOTORCYCLE Pistons and parts, new, used. Harley, Indian, Henderson, Super-X. List 10c. Ballak, 811 N. 9th, St. Louis 1, Mo.

CUSTOM Motorcycle accessories. Leather jackets, men, women, \$36.95. New seat covers, bright colors, molded cushions, \$6.75. Sideshow, British machines, \$10.50. Free folder! Pacific Cycles, Dept. A6, 1208 Pine, Seattle, Washington.

SCHWINN Bicycles. All sizes. Wholesale. Retail. Bulletin 10c. Century Cycle, 3447 Lawrence, Chicago 25, Illinois.

"WHIZZER" New 1948 bike motors, \$97.55 express prepaid, 20% with order, balance c.o.d. Lakeland Sporting Goods, Fort Atkinson, Wis.

MOTOR Scooters, bicycle engines, 120 miles gallon. Dime for catalog. Clymer, Desk A-55, 2125 W. Pico, Los Angeles 6, Calif.

AVIATION

WEATHER Instruments, thermometers, barometers, rain gages, wind instruments. Catalog PM, Science Associates, 401 N. Broad St., Philadelphia 8, Penna.

AVIATION "Quiz System" famous Zweng books with examinations as follows: A. & E. Mechanic Manual \$3.00; Flight Engineer \$4.00; Aviation Dictionary \$6.00; War surplus now ready: Fairchild sextant \$12.50; Astro compass \$8.50; Aerial camera \$139.00; new Keystone cameras \$49.50; projectors \$119.50. Free catalog. Pan American Navigation Service, 12021-C Ventura Blvd., N. Hollywood, Calif.

LIGHTPLANE. Blueprints, manuals. Circular 20c. Craftsmann Books, Box 1153, Milwaukee, Wisconsin.

PROPELLERS-2 & 3 Blade, for snow-ice sleds, boats. Catalog. Standard Aircraft, Box 387, Ft. Worth, Texas.

GIANT Kites. Only \$20. Fraction government's cost. 10x14 ft. double tier. This monster tows cars, skiers, skaters, canoes. Lifts light persons, antennas, advertising, cameras. Pleasure. Profit. Great-Northern Mart, North Adams, Mass.

BATTERIES, GENERATORS

NEW Double voltage generators, 115 volt x 1200 watt a.c. s.p. and 28.5 volts x 200 amp. d.c. Excellent for welding generators, lighting plants and experimental work. No conversion necessary. Shipping weight 60 lbs. Only \$19.75 f.o.b. For illustrated list of surplus items send 25c. Surplus Sales, 24th Street and Cud-back Avenue, Niagara Falls, N. Y.

ELECTRICAL SUPPLIES

LELAND Electric generators, 2.5 KVA, 120 volt, 60 cycle single phase with radio filter. Turn at 1800 rpm, producing 2500 watts. \$125.00 freight prepaid. Hopier & Company, 3124 East 14th Street, Oakland, California.

ELECTRIC Pencil: Engraves all metals. \$1.00 postpaid. Beyer Mfg., 229-H Dixon, Uniontown, Penna.

LAMP Sockets, mogul sockets, three way switches, tumbler switches, receptacles, cord sets, electrical repair parts, lamp parts, etc. Catalog 10c. Gearon Company, 6405 North Oakley, Chicago.

TATTOOING Machines, outfits. Free catalogue. Jensen, 120 West 83rd Street, Los Angeles 3.

ALNICO Magnets, free list. Terry Sales Company, 3726 South Detroit Avenue, Toledo 9, Ohio.

ELECTRIC Pencil—Writes, engraves all metals. Ideal for marking tools, etc. 110 volts. \$2.95 or 2 for \$5.00 postpaid. (C.O.D.s plus postage.) Battery model \$1.00. Reb Industries, Dept. 265-DD, Elmhurst, Ill.

LAMPS—Build own originals, parts wholesale any amounts. Catalogue 10c. Brown Lamp Co., Box 501, Wellston, St. Louis 12, Mo.

ELECTRICAL Supplies—Lowest prices! Wiring devices, switches, plugs, heating elements, electric range units, repair kits, parts electrical appliances, flux, oil lamp to electric conversion parts, sewing machine lamps, etc. Also saw handles, electric hair clippers, scissor sharpeners, storage racks, tape, etc. Many below wholesale prices. Complete illustrated bargain catalog 25c. Refunded first order. Christy Supply, 2835 N. Central, Dept. C-101, Chicago 34.

MAGNETS—Write for free catalog. Engineered Products Company, Dept. MM, Sandusky, Ohio.

LAMP Makers, hobbyists: We carry largest variety lamp parts. Any part, any lamp. Harps, finials, vase caps, etc. Special attention small orders. 24-hour service. Illustrated catalog 10c. Gyro Lamps, 5402P Clark Street, Chicago 40.

WELDING, SOLDERING, PLATING

30 AMP. Selenium plating rectifiers with Powerstat control, \$85.00. Lead lined tanks, geared motors for agitation. Complete line of bronzed baby shoe mounts. Hollywood Bronze Supply, 1770 N. Vermont, Hollywood 27, Calif.

WELDERS!—New portable Champion special transformer welder; 110/120 volts, a.c. 8 heat stages. Welds, brazes, solders, cuts all metals. Complete with electrode holder, helmet, rods, carbons, fluxes, cables. Also special flame weld torch. Easy to use. Full directions. Splendid for shop, farm and home repairs. Guaranteed. Only \$27.50. Money back guarantee. Also resistor model, now \$14.95. Magic Welder Co., 239 MP Canal St., New York, N. Y.

OWN Mirror shop. Resilver mirrors. Glass sign making. Electroplating. John Sprinkle, V55, Marion, Indiana.

NEW Airplane tires, tubes, wheels, bearings, spindles. For harvesters, implements, lawnmowers. Free pictures. World's largest stock. Airplane Tire Company, Dept. 3, Box 89, Merced 3, California.

WELDING Shop operators, four machines you can build and sell in your shop. Plans \$1.00. W. Randle, 625 Gerard, Santa Rosa, Calif.

"BUILD-UR-OWN" Portable arc welder. Save \$300. Easy with Hobart generator plus auto engine. D.C. welders, or a.c. welder—A.C. power plant combination. Free instruction book. Write Hobart Welders, Box M-583, Troy, Ohio.

ACETYLENE Welding outfits, new, \$54.50; arcwelders. Eagle Welding, Dept. PM, 5085 Broadway, Chicago 40, Ill.

TRANSFORMER Welders 110 v. Welds 1/2" steel, \$29. Morris Welding Service, 1850A State, Schenectady 4, N. Y.

SOLDERING. Learn at home, increase your earnings. Complete instructions and formulas \$1. Taylor, 53 Woodland Ave., Clementon, N. J.

MACHINERY, TOOLS, SUPPLIES

POWER Tools. Build your own with Lewis Castings. Save up to 80%! Complete castings, materials and blueprints supplied for 23 woodworking and metalworking tools. Free catalog. Write today. Lewis Machine Tool Co., 3217 Union Pacific Avenue, Dept. M, Los Angeles 23, Calif.

AIR Compressors, for service stations, garages, shops and paint spraying. Attractive dealer offer. Betco, 619 North Broadway, Oklahoma City, Oklahoma.

FOOT Switch—Operates any 110 volt motor, power tool or device, large or small. Guaranteed. \$3.95 or 2 for \$6.50 postpaid. (C.O.D.s plus postage.) Reb Industries, Dept. 265-DH, Elmhurst, Illinois.

PORTABLE Shop fans. Something different. Dealers wanted. Betco, 619 North Broadway, Oklahoma City, Oklahoma.

\$25 AND Up paid for Singer sewing machine heads, mail serial number to Box 8, Station P, Brooklyn 12, N. Y.

0-1/2" CAPACITY Drill chuck and adapter, fits your Sunbeam Mixmaster. \$2.95. O. Nahser, 248 San Gabriel Court, Sierra Madre, Calif.

HOME Workshop bench belt sander. Plans \$1.00. Fred Young, Sandy Spring, Md.

WAR Surplus special: Big 50 lb. box popular size bolts, nuts, washers, screws, clamps, etc. \$6.85. War Surplus Co., Box 910, New Brunswick, N. J.

HOME Lathe owners—Build your own attachments. Send for picture, sample of work and list of blueprints. Cut gears, ratchets, etc. Make neat screws easy way. The Home Shop, 415 Raymond Ave., Glendale 1, Calif.

SHEBEL Saw filer. Files all saws. Circular. A. P. Shebel, 730 B. So. 2nd St., Milwaukee 4, Wis.

CONCRETE Block machines \$39.50 up. Catalog free. Concrete Machine Company, 5466 Gravois, St. Louis 16, Missouri.

DRILL Grinder—Grinds drills to factory accuracy. Calipers with direct reading scales. Circle cutters. New Tool grinder. Lowest prices. Free literature. Factory, 811-B East 31st, Kansas City 3, Mo.

YOUR Plans and ideas made into professional drawings. Abert Engineering, Box 2091, Phoenix, Arizona.

BENCH Saws \$17.50. band saws, \$25.00. Bargain lists 3c. Sunshine, Berkshire Heights, Penna.

MECHANICS—We have tool kits to hold your equipment. Free catalog. Sheldon Products Co., 179 N. Wells, Chicago.

TEMPERING Chisels, dies, etc. Dollar brings proven formula and instructions. Struve, 308 West 6th, Fremont, Nebr.

ELECTRICAL Tools, motors, gas and electric motor cars, drills. Sale! Jim Gills, Whitethorn, Bluefield, W. Va.

DRILL Glass, china articles for lamps without breakage. Drillpress attachment 3/8" 1/4 \$1.00, both \$1.95. Glendon Tools, 1318 Asbury, Evanston, Illinois.

BAND Saw—Special \$14.95. Ideal for hobbyists and home workshop. Circular free. Woodcraft Tools Inc., 147 E. Lake, Minneapolis, Minn.

WOODWORKING Machinery, grinders, drills, taps, dies, drill rod, machinists' mechanics' tools. Catalog 10c. Refunded. Precision Tool Service, Dept. M, 55 E. Washington, Chicago 2, Ill.

ANYONE Can sharpen saws using the 35c Teeho Tool! Information? Teeho, 316 North 2, Maywood, Illinois.

SALVAGE High speed steel tools, drills, end-mills, bits. List free. Sample drills 15c. J. Dickey, Newfield, N. Y.

TUNGSTEN Carbide tipped tools and high speed drills. Tool Supply Co., 3370 N. 53 St., Milwaukee 10, Wis.

SAW, Scissor supplies. List free. Overland Saw Service, Independence, Iowa.

DRILL Grinder for twist drills, \$2.95. See ad on page 246.

LIFELONG Carbide scribes \$1.25. Magnetic Recipro etching tool \$15.00. Miller Supply Co., 1831 Hancock St., Rockford, Illinois.

MACHINE Tools released for private industry: South Bend Quick-Change bench lathe \$325. 12" loose change lathe \$160. 6 ft. Quick Change lathe \$440. 28"x 14" heavy duty lathe \$1140. Bullard 24" boring mill \$620. #2 Cincinnati miller \$840. Small milling machine \$180. 23" upright drill, back-geared, power feed. \$190. 20" drill \$140. 14" crank shaper \$540. Money back guarantee. Conversion Parts Co., 278 Adams Street, Boston 22, Mass., U.S.A.

DIFFERENT Cement block maker \$79.95. Makes color or insulation face blocks. Blue, Excelsior, Minnesota.

BALL Bearings one-fourth list price. Free list. Burgess, Box 168, Ferguson, Mo.

HARDWARE, Tools, pattern supplies, motors, electrical equipment, drills, belts, pulleys, brass, steel, drill rod. Catalog 5c. Terek, 6304 Patterson, Chicago 34.

HYDRAULIC Leather cups for jacks, lifts, presses. Write for prices. Beerman Precision Machine Works, 2000 So. Claiborne, New Orleans, La.

DOLLAR Surplus bargain! Wire cutter, stripper, screw driver, punch, steel rule, hacksaw blades—guaranteed—all for \$1.00 postpaid. Leonard, 1300-B Douglas, Los Angeles.

BOATS, OUTBOARD MOTORS

OUTBOARD Motor parts. New-used, all makes. New pistons (standard, oversize). Cylinders rebored. Outboard Motor Mart, 309 Atlantic Ave., Boston 10, Mass.

P-38 Belly tank speed boat. Complete plans, instructions \$1.00. Twintank Boat Company, 1032 62nd Street, Oakland, California.

MARINE Supply catalog. Thousands of deliverable items; illustrated and priced. Send 75c. Arthur Gershel, 51 Chambers St., New York City.

BOAT Building plans: Runabouts, cruisers, sail boats. Wood, plywood, and welded steel construction. Illustrated book, "Modern Designs For Boats And Yachts" \$1.00. John B. Clark, Yacht Designer, 329 Kenmore Drive, Bay Village, Ohio.

OUTBOARD Motors—Good values, used motors. Also used parts for most makes and models. Crandall-Hicks Co., 911 Commonwealth, Boston, Mass.

P-38 BELLY Tanks, new, steel, 10 ft. 2 in. 165 gallon \$9.95. Anzio Boat Co., Box 89H, Merced, Calif.

BARGAIN \$20. Make your own boat now with readymade streamlined laminated one piece hull as developed for Navy. Light, sturdy, leakproof. Anyone can convert into dinghy, outboard scooter, cartopper, other craft. 9'x4'. Write Warwood, 480 Lexington, New York 17.

BELLY Tanks—75 gallon, new, steel, 6 ft. 4 in. \$7.50. Anzio Boat Co., Box 89H, Merced, Calif.

NEW, Used, rebuilt marine motors. Marine conversions, fittings. Free catalog. Stokes Marine Supply, Dept. 24, Coldwater, Michigan.

BOATS And all about them. How to select, build, repair and operate. For 40 years the leading practical boating magazine. Half price trial subscription. 12 issues for \$1.00. Motor Boat, 62 Gold Street, New York 7.

BOAT Designers are highly paid professionals. Complete course by mail. Catalog. Westlawn, Montville, N. J.

BUILD Your own boat by the Welch system, knock-down kits. No experience necessary. Save 2/3 cost. Rowboats to cruisers. Illustrated catalog 25c. Midwest Boat Company, Menomonee Falls, Wisconsin.

GIANT Size rubber rafts. Holds five people. Great for fishing and swimming. Only \$29.95 f.o.b. Franklin Weber, 6115A North Clark Street, Chicago.

PLANS Eighteen foot plywood or welded steel runabout, six dollars. Boat book and plan list, one dollar. Atkin, Naval Architect, Darien, Conn.

BOAT Plans by professional naval architects. All sizes and types. Free circular. Westlawn Associates, Montville 5, N. J.

MARINE Conversions for Ford and Jeep engines. Catalog 10c. Lehman Manufacturing Company, Department D, Newark 2, New Jersey.

BOAT And yacht owners—Get unusual sparkling beauty inside and out with Dover-Lac Marine White Enamel and Super Spar Varnish. Dependable finishes since 1886. Order by mail and save. Quarts \$2.75, gallons \$10.05, plus 25 cents postage. Dover-Cliffs Paint Sales, Marine Division, 134 East 10th Street, Dover, Ohio.

BOAT Patterns, kits. See display adv. page 246. Marine Mart, Buffalo 7B, N. Y.

10' OR 15' Folding kayak plans \$1.00. Foldcraft, 1702 Washington, Houston 10, Texas.

MARINE Fittings, accessories; thousands of items. (Pictured, priced.) Prompt delivery. Catalog \$1.00. Marine Mart, Buffalo 7B, N. Y.

MARINE Fir plywood for boat building. Send 10c today for complete stock and price list. Trans-Marco Corporation, 70 East 45th Street, New York 17, N. Y.

ENGINES, MOTORS, DYNAMOS

MOTORS! 1/2 H.P. D.C. converted to A.C. All new. High speed 110 volt, 25 or 60 cycle, ball bearing motors. Actual value about \$75.00. Now \$15.00 each or 3 for \$40.00. With forward and reverse switch \$19.50, 3 for \$50.00. Countless uses for home mechanics. Can be used in any position. Order today! Immediate delivery! No c.o.d. orders. "Amazing Bachman's," 27 Herman Street, Rochester 5, New York.

WELDING Generator, 150 ampere, \$47.50. 1/2 horse 1725 r.p.m. a.c. motor, \$24.50. Butler, 1885 Milwaukee, Chicago.

MOTORS—Used vacuum cleaner motors for blowers, fans, etc. \$3.75. 5 day money-back guarantee. Send check, money-order. We pay postage. Lipkin Appliance, 559 E. Tremont Ave., New York 57.

MOTOR Repair men, get our bulletins on stator winding tester and a.c. motor winder. Motor Industries, Quincy, Illinois.

BARGAINS In war surplus hydraulic transmissions, switches, motors, geared speed reducers, aviation instruments, etc. Delta Sales, P.O. Box 968, Shreveport, Louisiana.

DEALERS—Sell electric motors, gas engines, light plants, generators. Wholesale catalog, 10c. CMCO, 3546 Fullerton, Chicago.

RANGER Engine-Aircraft—All new in original case. 570 h.p. 12 cyl. V type air-cooled. Engine Spec. No. 177. Complete with spark plugs. Original government cost over \$12,000.00 each. Special offer \$200. Crated weight 1200 lbs. No c.o.d. Write for complete description. "Amazing Bachman's," 23 Herman Street, Rochester 5, N. Y.

WINDING Data, listing 225 motors, single and three phase, \$1.00. Motor Data Co., Box 7631, Kansas City 3, Mo.

NEW Electric motors at lowest prices. Stamp for list. Wagner & Co., Route 2, Bernville, Penna.

$\frac{1}{4}$ H.P. Rebuilt motors \$12.50. $\frac{1}{2}$ h.p. \$24.50, sizes to $7\frac{1}{2}$ h.p. List 10c. A. C. Motors, 3101 N. 32nd, Philadelphia 32, Penna.

"BUILD-UR-OWN" Combination a.c. welder and a.c. power plant. Welding plus power to run tools, lights, motors. Portable. Save \$350. Easy with Hobart generator plus auto engine. Free instruction book. Write Hobartweld, Box M-584, Troy, Ohio.

ATHLETIC EQUIPMENT, BODY BUILDING COURSES

ATHLETES! Learn nature's speed secrets! \$1.00! Silvers Publications, 804 5th Ave., Youngstown, Ohio.

BARBELLS, Exercise equipment. Courses. Free booklet. Good Barbell Co., Reading, Penna.

SPORTING GOODS, GUNS, FISHING TACKLE, ARCHERY, TRAPPING

EDWARDS Attachments double power of scopes. Finest glareproof $1\frac{1}{4}$ " hard coated, sliding lens. Improves target and varmint shooting. Install yourself. Write for information. Edward's Sights, Union City 2, Indiana.

AMMUNITION, 75 Sizes in stock. Dime for list. Central Sports, Delphos 5, Ohio.

FISHERMEN—Handmade split bamboo (tonkin) rods, any type or to your specifications. Rod building supplies. Free literature. Aaron G. West, 4144 Marion Street, La Mesa, California.

BOOKS On gunsmithing. Catalog 10c. W. Joseph O'Connor, Baker, Oregon.

SHOTGUNS, Rifles, handarms, ammunition, rods, reels. List 10c. Rudolph's, Atchison, Kansas.

FIREARMS—Ammunition; complete list 25c. Satisfaction. Frank Farish, Vicksburg, Miss.

5000 BARGAINS, Firearms, binoculars, war relics. Catalog 40c. Smith Firearms, Rummende, New Jersey.

FISHERMEN! Make real savings on your tackle needs. Get our catalog. Snap swivels 3 for 10c. Jointed cane poles \$1.95; floating minnow buckets \$2.49. Hundreds of other bargains just like these. Send for free catalog today. Write Dept. PM, Andy Anderson's Sporting Goods Co., 124 W. Grand, Oklahoma City 2, Okla.

WHOLESALE List of golf equipment 10c. Golfer's Sport Shop, 356 North Root St., Aurora, Illinois.

BOWS—Arrows, write headquarters for archery equipment. Quality products. Popular prices, catalog 10c. Large illustrated handbook instructions, aiming and shooting, 50c. Archery, 617-B So. State, Chicago 5.

FACTORY Seconds—Hardly noticeable defects, beautifully painted. Owl decoy-size $6\frac{1}{2} \times 8\frac{1}{2} \times 16\frac{1}{2}$, \$2.00 each. Crow decoy-size $4\frac{1}{2} \times 4\frac{1}{2} \times 16\frac{1}{2}$, 50c each. Prices f.o.b. factory. Swan-Douglas Mfg. Co., 21 Main St. N.E., Minneapolis 13, Minn.

SHOTGUNS, Rifles, revolvers, over 500 modern, obsolete. Also cartridges. List 10c coin. Ed Howe, 52 Main, Coopers Mills, Maine.

"SEND For it" new catalog, fishing tackle, sporting goods, outboard motors, guns, ammunition, all standard brands, over 400 items, save 20%. Lakeland Sporting Goods, Fort Atkinson, Wis.

MAKE Your own bows, arrows. Beautiful catalog 5c; handbook 94 pages 50c. Stemmler Archery, Manorville, N. Y.

ARCHERY Equipment. Free catalogue. Sports Equipment Center, 5 Cherry Lane, West Haven, Conn.

NYLON Fishing line, 1500 ft. \$2.25. Vinick, 1468 Montpelier, Baltimore 18, Md.

FIELD GLASSES, TELESCOPES, MICROSCOPES, MAGNIFIERS

POWERFUL Astronomical telescopes easily made. Perfect lenses and instructions. 100 power \$3.00. 100 and 200 power \$4.00. 100, 200 and 400 power \$6.00. Clear vision and full power guaranteed. Instructions alone 10c. Suffolk Science Service, Manorville, N. Y.

ASTRONOMICAL Telescopes, binoculars, microscopes; bought, sold, repaired. Books. Lists 10c. Rasmussen-Reece, Amsterdam, N. Y.

BINOCULARS, Telescopes, watches. Buy, sell, trade. Paul Schaefer, Donnellson, Iowa.

TELESCOPES, Binoculars, microscopes, big bargain catalog free. Brownscope Company, 24 West 45th Street, New York.

ASTRONOMICAL Telescope lens kit, 100X, 200X, 400X powers \$3.00. Microscope lens kit, 100X, 200X, 400X, 800X \$2.00. Plans included. Pfelegor Optical Co., PM-5, Sunbury, Penna.

INFRA-RED Filters glass $1\frac{1}{4}$ " (40 mil) diameter, mounted. Snap on camera or binocular. \$1.00 per set. Variable density filter with eyecups to fit 7x50 binoculars. Control light and glare to assure best conditions. Adaptable for photography. Complete \$1.50. Buy both, \$2.00 postpaid. Ross, 68 West Broadway, Section N, New York, N. Y.

GOVERNMENT Surplus—Telescopes, binoculars, lenses, prisms. Send stamp for "bargain" list. Hobbyist lens set—Magnifiers, reducing lenses, positives, negatives, 10 piece set, \$1.00. H. Jaegers, 123-26 Rockaway Boulevard, South Ozone Park 20, New York.

DOGS, PETS, BIRDS, RABBITS

ANGORAS, Giant Chinchillas, White Giants. World's most profitable rabbits. Finest pedigree, heavy producing, prize-winners. Literature free. Grinsteads, Edwardsville, Illinois.

INCREASE Your income by raising domestic rabbits. Small space needed. Ready market for delicious meat, fur and wool. Largest magazine in the industry tells you how. \$1.50 per year. Sample 15 cents. No stamps. Small Stock Magazine, Lamoni 20, Iowa.

\$3000 YEARLY Raising Angora rabbits. We buy your output. Contract particulars free. Kise's Enterprises, St. Paul 8, Minn.

REPTILE Catalogue 10c. Biological hobby catalogue 10c. Reptile bulletin 5c. Chameleon 25c. Quivira Specialties, Topeka, Kansas.

RAISE Guinea pigs. Make money at home. Big demand. Booklet free. Taylor, Box 426A, Hapeville, Georgia.

\$250.00 MONTHLY Raising angora rabbits. Particulars free. White's Rabbitry, Newark, Ohio.

MONEYMAKING Opportunity raising Giant Chinchilla Rabbits. Waters Rabbit Farm, Glennville, Georgia.

\$50.00 WEEKLY Raising Angoras for us. Free literature. Angoraville, 1215-34th Northeast, Cedar Rapids, Iowa.

GUARANTEED Chin-Chin Giant Chinchilla rabbits. Greatest amount of delicious meat. Largest, finest, most valuable furs. Tremendous demand for breeding stock. We buy youngsters. Contact world's largest breeder. Willow Brook Farm, R15, Sellersville, Penna.

DOLLAR Bill brings literature, booklet on free start with registered Chinchilla Giants. Pay with youngsters. Booklet only, 25c. (Refundable). Behrens Farms, Pearl River 4, New York.

67 VARIETIES? Pigeons, bantams, pigs, peafowls. Catalogue 10c. Houck Farm, Tiffin 4, Ohio.

RAISE Rabbits, market provided. Breeding stock furnished on production pay plan. Literature 25c, with hutch plans \$1. Hansen's Rabbit Institute, 1347 Miller Avenue, Salt Lake City 6, Utah.

SEEDS, NURSERY TREES AND SHRUBS SUPPLIES

RAISE Your own trees and shrubs from seed for shade, windbreak, snow fence, etc. For prices and information write Woodlot Seed Co., Norway 1, Michigan.

SOILLESS Gardening. Complete illustrated book \$1.00. Send card for details. Malcolm Tabor, Park Hills, Huntington, W. Va.

FARMS, FARM LANDS, REAL ESTATE

HUGE Profits! California, Oregon, Washington tax delinquent properties; 25c to \$3 acre minimum bid. Send 10c (coin) for circulars and maps. Pacific Lands, Box 2350 PM, Hollywood 28, Calif.

GOVERNMENT Land and isolated tract parcels available throughout Northern California. Send for free folder giving full particulars to Government Lands, Dept. P., P.O. Box 476, San Francisco 1, California.

\$5.00 MONTHLY Buys 40 Acres, near town. Price \$200.00. Free list. Box 425-P, Carthage, Mo.

THERE'S A farm in your future—and you'll find it in the exciting pages of United's new free summer catalog of up-to-the-minute bargains! Farms with crops and gardens growing, ranches, orchards, groves, lake-shore and river-front summer homes, resorts, tourist courts, service stations, stores, etc.; over 110 pages, nearly 1,000 fully described bargains, some equipped and ready to go, many photographs—covering many states from Great Lakes to famous Ozarks, Southwest to glamorous California. Write for free copy today. United Farm Agency, 1408-PM Consumers Bldg., Chicago 4, Ill.

$\frac{1}{2}$ **OIL-MINERAL** Rights on 2300-acre Oklahoma land, \$5 acre. Clyde Lee, Mountain View, Okla.

OZARK Lands—All types, lowest terms. Mr. Armstrong, Shook, Mo.

SPRING Farm catalog—Free! New 136-page Green Book, just out! Don't be without it; write today! Over 2800 super-duper bargains, 34 states, coast to coast. Strout Realty, 255-P 4th Ave., New York 10, N. Y. 20 W. 9th St., Kansas City 6, Mo. 453 S. Spring, Los Angeles 13, Calif.

GOOD Farms—Ranches, Washington, Minnesota, Montana, Idaho, Oregon, North Dakota. Dependable crops, favorable climate. Write for literature, lists describing typical farm opportunities. Specify which state. J. W. Haw, 119 Northern Pacific Ry., St. Paul 1, Minn.

OZARK Lands for all purposes. Actual river frontages, 5 acres \$90.00 and upwards. Free list and literature. Hubbard, 424-I Minnesota Ave., Kansas City 4, Kansas.

FARMS, Ranches. All kinds, sizes. Choice of location, climate, production. Information on irrigation projects Columbia and Missouri River Basins, Resorts, summer homes, Milwaukee Railroad territory: Washington, Idaho, Montana, Dakotas, Wisconsin, Upper Michigan, Central corn belt. Free folders, price lists. L. H. Robbins, 604 Union Station, Chicago 6, Illinois.

CHEAP Homes, farms, stock ranches, peach orchards. Valley farms, wonderful free range, mild, pleasant winters, cool summers in beautiful, healthy Ozarks. Free literature, land lists. Write G. W. Starr, Ozone, Arkansas.

WEST'S Latest catalogue. Time and money-saver; over 1000 farm and business bargains, over 200 representatives, 19 states. Free. West's Farm Agency, HE-16, Pittsburgh 17, Penna.

FARM MACHINERY AND SUPPLIES

FREE—Big 1948 new and used tractor parts catalog. Satisfaction guaranteed. Write Irving's Tractor Lug Company, Fargo, North Dakota.

POULTRY, FARM SUPPLIES

WHITE African guineas—Closing out sale. Baby guineas, eggs, stock. Catalogue free. Goshen Poultry Farm, Goshen, Indiana.

RAISE Turkeys the new way. Write for free information explaining how to make up to \$3000.00 in your own backyard. Address National Turkey Institute, Dept. 3, Columbus, Kansas.

BABY Chicks, champion mated, 25 varieties, 6 hybrids, licensed inspected, blood-tested, Rush postal, large colored book free, low prices. Berry's Farm, Route 12, Clarinda, Iowa.

CHICKS—\$3.75-100, \$7.00-200. Empire Hatchery, Seward, N. Y.

RAISE Fryers new easy way. One-man home plant earns \$500 monthly. Booklet free. Poultry Guild, 1046-A So. Olive, Los Angeles 15, California.

KNOW How to raise poultry for profit. Read Northeastern Poultryman. Every issue packed with helpful hints and practical suggestions. Latest articles on breeding, feeding and management. Subscribe now. 1 year 65c. 2 years one dollar, foreign subscriptions \$1.00 a year. Northeastern Poultryman, Dept. P.M., 376 Boylston St., Boston 16, Mass.

EARN \$4 To \$12 hourly. Chick and turkey sexing, culling and caponizing—G.I. approved. Pilch's School, Box P.M., Thompsonville, Connecticut.

PROFITABLE OCCUPATIONS

PROFITABLE Business in making and building with interlocking blocks. Delaware Industries, Dept. 10, Muncie, Indiana.

INTERESTED In Latin American and foreign employment? \$1 brings copyrighted Foreign Service Directory listing firms with interests in construction, oil, mining, aviation, manufacturing by personnel expert. Hot list of companies hiring. Global Reports, P.O. Box 883, Hollywood 28, Calif.

WOULD You pay 3%—first \$350 made? Color-illustrated book "505 Odd, Successful Enterprises" free! Some offer occasional "day off." Work home. Expect something odd! Pacific, Oceanside, Calif.

\$40.00 WEEKLY Made growing mushrooms, fresh, dried. Dominion patent 331583. Free spawn. North American, 165P Yonge, Toronto, Canada.

NO Selling, operate vendors, amazing profits, details free. Silver-King, 622 Diversey, Chicago 14, Ill.

FOREIGN Employment? Brief directory, companies with foreign projects or branches \$1 or c.o.d. Foreign Service Institute, Box 3934, Miami 24, Fla.

"ALASKA" The last frontier offers unlimited opportunities. \$1 brings official government map and copyrighted report with listing of firms: Fishing, construction, mining, aviation, homestead lands, prospecting business. Alaska Opportunist, P.O. Box 883, Hollywood 28, Calif.

START Lamp factory. Profitable, fascinating, easy to learn. Illustrated course teaches you. General instructions, wholesale catalog \$1.00. Gearon Company, 6405 North Oakley, Chicago.

MAKE Beautiful mirrors from inexpensive window glass. No special equipment required. Details free. Tes-Co, Box 189-MP, Wilkes-Barre, Penna.

EXTRA Money? Free details. Trable, 1018 1/2 A Elm Street, Dallas, Texas.

MAKE Flexible molds! Few cents each! Cast plaques, novelties, bookends! Free sample! H. Tooker, Hamilton 9, Ohio.

LOCKSMITHING Secrets—Key fitting, lock opening, repairing, prices to charge, supply sources. Illustrated book only \$1.00. Wechsler Supply, 7 W. 36, New York City.

LEARN To build architectural scale models. A well paying, interesting, and dignified profession. Any normal high school boy or girl will qualify. Send for literature and particulars. Elliott Hollywood Studios, Box 57, Hollywood 2, Florida.

OWN Mirror shop. Resilver mirrors. Glass sign making. Electroplating. John Sprinkle V50, Marion, Indiana.

MUSHROOMS Grown, boxes, barrels. Instructions 50c, spawn \$1.00. Mushrooms without manure. Instructions. Materials \$2.50. Gordons, 553 William, Winnipeg, Manitoba.

CURE Your lean purse today. Write Douglass, 3231B 40 Avenue Southwest, Seattle 6, Washington.

CONCRETE Block machines all sizes, mixers, conveyors, ornamental forms, tile and brick machines, motors, gas engines. Madison Equipment Co., Madison, Tenn.

LOOK Here! Wanted—Men to start in business on our capital. Sell some 200 farm-home products. Thousands our dealers now make quick sales, big profits. For particulars write Rawleigh's, Dept. E-192-PPM, Freeport, Ill.

1947-1948 LEATHERCRAFT Supply catalog 10c. Art Craft Supply, 1205 Throckmorton, Fort Worth, Texas.

"FROG-RAISING"—New book explains everything! Marlboro, 1035 Marlborough, Detroit 15, Michigan.

GROW Soilless vegetables, cheap chemicals. 25c. Box 57, Bristol, Virginia.

LEATHERCRAFT. Try Tandy Leather, Tulsa 1, Oklahoma, for supplies. Catalog free upon request.

PERMANENTLY Stops chimney creosote—down draft. Profitable. Wig, Abington, Mass.

BEGINNERS New mail order plan. Details free. A. Marks, 540 Blaine, South Bend 16, Ind.

YOU Can make real money raising Golden Hamsters, the new amazing tiny animal. Food costs less than 10c month per animal. Breeds in 16 days! Easily raised in basement, attic, garage, barn, or shed. Write for convincing details. Hudson Hamstery, R.F.D. #1, Newfoundland, N. J.

BE The Popular Mechanics representative in your neighborhood and earn big profits in your spare time. Write Popular Mechanics Magazine, Room 408, 200 E. Ontario Street, Chicago 11.

EARN \$100 Week laying cement blocks. Learn easily. Professional instructions \$1.00. Block Masons, 1256 Amanda, San Bernardino, Calif.

BOOKS, PERIODICALS, PICTURES, POSTCARDS

625 STORY Books, 6c each. List free. Wood, 921P Jackson, Tulsa, Oklahoma.

BOOKHUNTERS! All subjects. Send wants! Jaher Book Service, 620-P East 178 Street, New York 57.

BOOKFINDERS! (Scarce, out-of-print, unusual books.) Quickly supplied. Send wants. Clifton Company, Box 1377pm, Beverly Hills, Calif.

SELF-EXPLAINING Bible: Illustrated circular free. Box 446-F, Minneapolis, Minn.

BIG Sparetime profits taking magazine subscriptions. Complete supplies, confidential catalog free. Cassell Publishers Service, Westfield, New Jersey.

BOOKS. All subjects, promptly supplied. Argus Book Service, Box 258-H, Waterbury, Conn.

BOOK Reading made easier, more pleasant and comfortable using amazing new bookholder. Postcard brings descriptive literature. Book Saver Products, 1318-P North Wolcott, Chicago 22, Ill.

KEEP Informed on technical ideas overseas. Practical Mechanics, Britain's No. 1 technical monthly, only journal of its kind, brings experts' information on atomic energy, rocket propulsion, television, aeronautics, science, engineering, electronics, models, photography, home workshop, etc. Lavishly illustrated. Many plans, diagrams. Yearly (12 issues) only \$2.00. From Practical Mechanics, U. S. Subscription Office, (Dept. P.M. 5), 126 Lexington Avenue, New York City, N. Y.

BACK-DATE Magazines, Books. Specific issues; years. Arkell's, Tarzana 1, Calif.

WARMONGERS "Coup de Maitre" photos. \$1.50 per set. Bilich, 427 E. 77 St., New York 21.

ART Anatomy of the human figure \$1.00. Including free catalogue, interesting books. A. Faller Company, 201 Dewey Street, Newark 8, New Jersey.

TRADE Magazines—Business, vocational, diversion. Current copies 1000 publications, all fields, through easy get acquainted plan. Price list free. Commercial Engraving Publishing Co., 34C North Ritter, Indianapolis 19, Indiana.

BOOKS Galore: Extra fine, unusual books. Catalog free. Superior Distributors, 916 Hayes Street, San Francisco 17, Calif.

WE Can supply you with almost any book. (Magazine subscriptions.) House of Kilroy (Booksellers), Box 772, Detroit 31, Mich.

MASTER Dream book. Send 25c today. Essenkey, Box 2156-M, Houston 1, Texas.

BACK Number magazines, reasonable. Reedmore, 240 East 9th, New York, N. Y.

MAGIC TRICKS, PUZZLES, JOKER NOVELTIES

LARGE 160 Page catalog, just published, 35c. We have supplied the best tricks to beginners and professionals for 38 years. Chicago Magic Company, 2300-A No. Mason Avenue, Chicago 39.

TRICKY Magic matchbox. It turns around, it stands, it opens. Confuses, amuses everyone, easy to do. Free to you if you send 25c for big illustrated catalog of 425 magic tricks. Magician, 2463-C, Kensington Ave., Philadelphia 25, Penna.

FREE Pack trick cards with catalog 25c. 12 Churchlane, Philadelphia.

ASTOUND Everybody. Hollywood Tie-Popper raises any tie automatically. Used by magicians. Satisfaction guaranteed, \$1 postpaid. Craig Magic, 1956 Franklin Circle, Hollywood, Calif.

MAGICIANS' Headquarters. 400-page professional catalogue, pocket, parlor, stage tricks. World's finest magic. Send \$1.00 for catalogue (refunded first \$5.00 order). Kanter's, M-1311 Walnut, Philadelphia 7, Penna.

MAGIC Has vast opportunities. Illustrated catalogue 25c. Hall Magic Co., 345 John R, Detroit 26, Michigan.

LARGE Catalogue of the best magic for professionals and amateurs. Send 25c. Mazda Magic Co., 1135 Westgate Ave., Oak Park, Ill.

"VENTRILLO," Professional voice-throwing instrument and illustrated catalog 25c. POB-971, Philadelphia.

LEARN Magic, ventriloquism, mind-reading. Write for particulars. Quackenbus, Big Flats, N. Y.

200 ELECTRIC Stunts, 110 volts. \$1. Kutting Sons, Campbell, Calif.

BIG Magic magazine, trick and price lists—25c. Lloyd M. Jones, 4064 39th Avenue, Oakland 2, California.

VENTRILLOQUISM Taught. 3c stamp bring particulars. Smith, 801 Bigelow, Peoria 5, Ill.

SNEEZING, Itching powders, eighteen other tricks, free with joker's catalog 25c. 2404-N Fifteenth, Philadelphia.

WORLD'S Largest professional magic shop, keeps you in touch with latest tricks. To receive mailings, send 35c for new catalog. Holden's, M220 West 42nd St., New York.

MAGIC Tricks, puzzles, books, cards, punch boards. Catalog 10c. Specialty, Box 671, St. Louis 1, Mo.

500 TRICKS. Send only 10c for Douglas' famous 112-page catalog 500 tricks. New magic for amateur, professional. America's fastest service for 25 years. Douglas Magician, Dept. 1, Dallas, Texas.

DOLLAR Magic set free with gigantic catalog 25c. Mysto, 4462 Germantown, Philadelphia.

FREE! Large catalog of magical apparatus if you remit 25c for "Magic Is Fun" magazine. Robbins Co., 152-F West 42nd Street, New York.

DIMINISHING Wand. Diminishes from 6" to 3". 75c. Stivers, 40 Salem, Medford, Mass.

REMARKABLY Inexpensive pocket tricks! Catalogue, 5c. Postways, Box 5325-D, Philadelphia 42.

MYSTIFYING Tricks 100 for only 25c. Win wagers, entertain crowds. Easily done. No apparatus needed. O'Donohue, Box 588, Brooklyn 1, N. Y.

DRIBBLING Perfume joke and catalogue, 10c. Exploding booby trap, 50c. Cohen, Sutherland, Brookline 46, Mass.

MAGIC Monthly. Year 25c. Sample and 1948 magic catalogue free. Magic Shop, Minneapolis 2, Minn.

USED Magic bought, sold, Welmade, 124-C West Fourth, Los Angeles 13, California.

SEND 25c Coin for surprise magic trick to W. Bogdan, 34 Taylor, Westfield, Mass, before June 1st.

FAMOUS Nickels to dimes trick, with instructions, \$1.00 postpaid. Buddy Toyland, Atlanta, Ga.

MAGIC Tricks. Magic books, illustrated list 10c. "Marean," 2200 Gordon, Hopewell, Virginia.

MAGIC As a hobby, 108 easy to learn tricks, \$1.00 manual now 50c. Albert Peek, 1514 Driscoll, Houston 6, Texas.

PROFESSIONAL Catalog, 124 pages, 25c. Williams, 900 Plymouth, Ellwood City, Penna.

BE A magician. Large professional magic catalog of latest tricks, 35c. Ireland, C-109 North Dearborn, Chicago 2.

MAGIC That mystifies. Free information. Walker, Box 394, Union, N. J.

COIN And ring trick, 25c with pamphlet of magic and joke items. Powell's, P.O. Box 2155(F), Potomac Station, Alexandria, Virginia.

COINS, TOKENS, CURRENCY

SOUTH Africa. Rhodesia coins. Set \$3.00. McDonald, 30 Rosetta Street, Regents Park, Johannesburg, Africa.

25 COINS And bills, 25c. Oddehon, Box 482, St. Louis, Mo.

GET Profit and pleasure in collecting old coins. Send 10c for 56 page illustrated coin catalog. You'll be delighted with it. Send for it now. B. Max Mehl, 370 Mehl Bldg., Fort Worth, Texas. Largest rare coin establishment in U. S. Established 48 years.

FOR Sale: 1893 Columbian World's Fair half dollar, 75c; U. S. 2-cent pieces or 3-cent pieces, 25c each; 50 assorted Indian head cents, \$1.25; large 50 page U.S. coin catalog, listing thousands of coins for sale at reasonable prices, 25c; Giant 72 page foreign copper-silver-gold catalog listing over 10,000 coins for sale, 25c. Ben's Coin Company, 72 West Washington, Chicago 2, Illinois.

FREE! Foreign coin, banknote and coin collectors illustrated catalog to approval service applicants. Send 3c postage. Tatham Coinco, Springfield-125, Mass.

COMMEMORATIVE $\frac{1}{2}$, Oregon, Texas, Kentucky, Cleveland, Long Island, \$2.00 ea. Illustrated catalogue 25c. Norman Shultz, Salt Lake 9, Utah.

COINS Wanted, will pay up to \$2000 for certain coins, send 25c for catalogue. Burton's, 111 So. Third, Columbus, Ohio.

12 DIFF. Coins 25c; 32 diff. \$1.00. Bishop, Box 2201, Kansas City, Mo.

OLD Money wanted. Do you know that coin collectors pay up to \$100.00 for certain U. S. cents? And high premiums for all rare coins? We buy all kinds. Send 4c for large coin folder. May mean much profit to you. Numismatic Co., Dept. 20, Fort Worth, Texas.

INDIAN Head penny with list 10c. Charles Banker, Salina, Kansas.

WE Pay \$2.00 to \$200 each for hundreds of old or odd coins, Indianhead, Lincoln and foreign wanted. Many valuable coins. Keep all until posted. Send 20 cents for illustrated coin value book, 4x6. Buying and selling prices, 40 years in business. Coin Exchange, (7) Le Roy, N. Y.

25 DIFFERENT Indian cents, \$1.00. 2 genuine Roman coins 2000 years old, \$1.00. 10 different \$4.00. DelMonte, 725 W. 172, New York 32.

BARGAINS—All different dates, 3 large cents \$1.00; 20 Indian head cents \$1.00; 4 copper-nickel cents \$1.00; 4-3c nickels \$1.00; 4-2c pieces \$1.00; 4 Whitman coin folders \$1.00; handbook 75c; 254 page guide book \$1.50; our large retail catalogue 15c. Entire lot \$7.60. Bebee Coin Company, 1180 East 63rd, Chicago 37, Illinois.

12 DIFF. Coins 25c; 20 diff. 50c. Bishop, Box 2201, Kansas City, Mo.

30 MIXED Indian cents \$1.00. 33 diff. foreign coins \$1.00. International, 656 W. 171st, New York 32.

35 WORLD Coins \$1.00. Harry Elsholz, Box 9014, Pittsburgh 24, Penna.

INFORMATION About U. S. coins, collectors and dealers prices, generously illustrated, 302 pages. \$2.00. Hobby Helpers, Dept. H, Box 665, Washington 4, D. C.

STAMP COLLECTING

FREE Monthly illustrated bulletin showing recent issues. Penny approvals on request. Reed Company, Box 980, Chicago 90, Illinois.

15 DIFFERENT U. S. over 40 years, 10c. Special with bargain U. S. approvals. Bill Portney, 1806P E. 22 St., Brooklyn 29, N. Y.

WORLDWIDE Packet 50 stamps 5c with approvals. Carlins Approval Service, Box 307, Fresno, Calif.

FREE. Irish commemorative collection, including rebellion issue with approvals. Raymax, 123-Z William St., New York City 7.

FLAG Stamp free with U. S. approvals. Wenigman, 929 Oakdale, Chicago.

"CONFEDERATE States." Twelve different unused 10c. approval applicants only. "Stamps," Box 87, Albany 1, New York.

FREE! San Marino airmail set, mint. Approvals. Standard, Box 1616, Miami Beach 39, Florida.

1000 MIXED U. S. old and new—25c; 2 lb. \$1.25. Weatherby, Medina, Ohio.

FREE—\$25.00 Stamp collector outfit—Finest, most complete outfit ever offered: Large Scott album, valuable collection of 1050 different stamps, airmails, odd-shapes, hi-values, "Stamp Finder," watermark, magnifier, perf-gauge, tongs and hinges. Actually over \$25.00 value absolutely free when regular customer. Mail application now for foreign approvals. Bargain Stamp Service, Dept. "D," Santa Ana, California.

10 ALL Different Iraq only 5c to applicants for approvals containing airmails, commemoratives, and pictorials. Jeffery Stamp Co., 9726 So. Chappel, Chicago 17, Illinois.

5 DIFFERENT United States \$5.00 stamps 10c to approval applicants. Mohawk, Box 524, Albany, New York.

BIG Money in stamps. Buy at low cost. Sell at big profit. New book "How to Sell Stamps by Mail" reveals startling stamp secrets. Write: Donald Kelly, 9544 Whitcomb, Detroit 27, Michigan.

77 DIFFERENT United States. Many commemoratives included. 17c to approval applicants. Standard, 3817 Sackett, Cleveland 9, Ohio.

STAMP Remover 25c. Free with approvals. L. White, Box 922, Pittsfield 3, Mass.

25 ALL Different stamps 10c. Tunis, Wakeman Ave., Newark 4, New Jersey.

MIXTURES. Worldwide. 1,500, \$1.00. Missions Outlet, Reverend Marshall, Paterson 1, New Jersey.

MINT Hitler heads, 18. Scott's #506-523 for only 25c. Blocks of four \$1.00. Reich Stamp Co., 4647 Kenmore, Chicago 40, Ill. Dept. M16.

200 DIFFERENT Stamps—Cataloging up to 15c each, only 3c to approval applicants! Littleton Stampco, Littleton 42, N. H.

MAP Stamps, 15 different plus world's smallest triangle, scarce, only 5c with approvals. R. George, Box 2774, Phoenix, Arizona.

ZOWIE-E! A barrel of fun for only a dime. 500 United States stamps—absolutely unpicked and unsorted—just as received from church missions. Many varieties, including large commemoratives, airmails, high denominations up to \$5.00! Stampdom's biggest package of fun—and you might find something really valuable! Price only 10c to serious approval service applicants. Money back if not delighted. Illustrated bargain lists with each order. Mystic Stamp Company, Dept. 80, Camden, New York.

25 UNUSED Stamps. Pictorials, airmail, triangle, etc., only 3c with approvals. Paul Bauer, 31 Wilkshire, Lancaster, N. Y.

WOW! \$10.00 Worth of fun. Only 10c! What a treasure hunt! Big package 500 foreign stamps from foreign missions, other sources. Includes stamps from Africa, South America, Free French, Somali, Palestine, etc. Includes airmails, commemoratives and stamps worth up to 50c. This offer sent for 10c to approval applicants only. Jamestown Stamp Co., Dept. 22, Jamestown, N. Y.

COLLECTORS Outfit, album, hinges, gauge, detector, 50 different stamps, 2 mint sets. All 10c. approvals. Cornett, 228 West 25th, New York 1.

ILLUSTRATED Stamp Magazine, 26 weeks 25c. Stamp Journal, Kalamazoo, Michigan.

CHOICE Of 35c worth of stamps from our first U. S. selection free to applicants enclosing 3c postage. Large selection to choose from. Act now! S. C. Engel & Co., 38 Park Row, New York.

200 DIFFERENT, including Roosevelt triangle, 5c to approval applicants. H. Avalon Stamp Co., Springfield, Mass.

WORLD'S Largest stamp (7 $\frac{1}{2}$ x14 inches). A real curiosity! Retail for 50c, only 3c to approval applicants. Tatham Stamp Co., Springfield 30, Mass.

DANDY United States approvals. Write immediately. Sullivan, Endicott Building, St. Paul, Minnesota.

NICARAGUA "Tin Pan Alley" diamond, Ecuador showing George Washington, and American flag in natural colors. Fezzan, Trieste. "American Army" stamp, first U. S. commemorative, \$100.00 Shanghai, Corsica, Anzac, Antique, others. All 5c. Approvals. Capital Stamp Co., Dept. 2, Little Rock, Ark.

50 DIFFERENT United States 10c. No approvals. Seidenberg, Cassopolis, Mich.

GIANT Bicolored royal visits, Malta pictorials, gorgeous Guianas, Goose airmail, Scandinavian packet and illustrated stamp publication, 10 cents with approvals. Crown Stamps, Box 331, Toronto, Canada.

FREE—Famous Americans set, plus Flag Set, plus the National Parks Set, plus the Presidential Set to the \$5. A total of 90 stamps absolutely free to customers for our unsurpassed U. S. or foreign selections. Send 3c postage for 15 of the above mentioned stamps and full particulars. Triboro Stamp Company, 145 Nassau St., Dept. 112, New York.

FREE! Triangle Roosevelt, Vatican, Ethiopia, Hitler heads, with approvals. Florida Stamp Company, Box 807, Miami 5, Fla.

FREE! 100 Worldwide different stamps to approval buyers. Big U.S. and illustrated bargain lists sent with approvals. Bookman, Maplewood, N. J.

CANADA—75 Diff. 25c. Approvals, Lists. Victoria Stamp Co., London 4, Canada.

128-PAGE United States catalog—1000 illustrations, 10c. Harris & Co., 202 Transit Bldg., Boston.

50 DIFFERENT Stamps, triangle, airmails, etc., 5c with approvals. Carlton's, 10243 Silverton, Tujunga, California.

BRITISH, Spanish and French Colonies, Vatican, Hitler heads, and airmail packet, free with approvals. Pan-American Stampco, Box 145, New York 33, N. Y.

STAMP Collections wanted. Complete collections, duplicate lots, surplus stock, mint and used. Prefer trade for printing or other items, buy outright if priced right. What have you, what's wanted? Vanroy Shirk, Lebanon, Penna.

U. S. Price list. Send postage. State Stamp Service, 1225 Park Building, Pittsburgh 22, Penna.

DEALERS—Wholesale list. Postage 3c. Frank, 5031 Queensberry, Baltimore 15, Md.

STAMP Magazine—Copy free! "Stamp Post," Station A, Pasadena, Calif.

OLD Scarce U. S. seconds on approval, slightly defective, specially priced. Hernefield, 551 Clinton, Newark 8, N. J.

FIRST Day covers on approval. Knobel, 1918 S.W. 12th Street, Miami 35, Florida.

MINT Sheets United States. Collectors-Investors. Free list. No approvals. Kenda, 82 New Jersey Avenue, Brooklyn 7, New York.

\$1 STAMP, 100 Different U. S.; 25c with approvals. Miller, Box 600, Palo Alto, California.

REAL Good U. S. approvals. Used or mint. Panthers, Dorchester Center, Mass.

FREE, China airmail set, large pictorials, if you request streamlined approvals for general collectors. Fields, 1939 E. 85th, Cleveland 6, Ohio.

FREE, Illustrated magazine featuring stamp news and price lists. On request only, approvals for Part I or II Junior International Album at 50% discount from catalog. Specify which wanted. Ganesia Enterprises, 1566 58th Street, Brooklyn 19, New York.

FREE U. S. price list, postage 3c. Mark Hanna, 335 5th Ave., Pittsburgh 22, Penna.

319 ALL Different stamps from Vatican City, Palestine, Cyprus, San Marino, etc., with our sensational new illustrated 32 page Stamp Finder. It identifies all difficult stamps immediately. All for only 10c to approval applicants. A tremendous bargain. Garcelon Stamp Company, Box 800, Calais, Maine.

ABSOLUTELY Free! 25 different valuable mint Chinese new issues with approvals. Barton, Box 321, Elizabeth, N. J.

72 DIFFERENT U. S., 10c with approvals. Album Service, Soledad 6, Calif.

POSITIVELY Greatest free offer—latest Scott's International \$6.00 stamp album—covering entire world, contains 36,000 illustrated descriptive spaces; Scott's 1948 Standard \$7.00 catalogues "Philately's Encyclopedia"—absolutely free to applicants for foreign approvals becoming customers. "Approval Service," Box 1700, San Francisco, California.

GIBRALTAR Packet free—Nice collection Gibraltar, New Zealand Centennial, British Uganda, French Colonials, early British Colonial, West Indies, South American, war stamps plus Philatopic Monthly Magazine. All for 5c postage. Empire Stamp Company, Dept. PM, Toronto 5, Canada.

FREE! Canadian sets, royal visit, George VI, George V, coronation, jubilee, others, to approval applicants. Ensign, Box 118-M, South Orange, N. J.

EXCHANGE Stamps universe. Particulars free. "Exchangers," Bry 126, Seine, France.

U. S. Price list free. Slikes, 1831 E. Allegheny, Philadelphia 34, Penna.

FINE U. S. foreign approvals. Roesom, 218 West 59th St., Chicago 21, Ill.

FREE! Spanish Morocco airmail set, mint, with approvals. Martin, Box 1128, Miami Beach, Fla.

NINE Argentine statesmen stamps, only 10c with approvals. Legend Stamps, East Troy, Wisconsin.

BET You haven't these! South Georgia, South Orkneys, Grahamsland, South Shetlands, Shortlived Falkland Dependencies. Everything 3c with approvals. Viking, 130-Z Clinton St., Brooklyn, N. Y.

ROOSEVELT Greece complete mint plus 300 mixed, 20c; approvals. Ajax, Box 6009, Kansas City 4, Missouri.

25 FASCINATING Stamps 5c. Approvals. Adventure, Box 22, Madison 1, Wisconsin.

FREE Valuable packet, illustrated lists. Postage 3c. Wilhelm, 14646 58th Road, Flushing, N. Y.

GET "How To Make Money in Stamps." Write George Wentz, San Marcos, Texas. U. S. Price list. Send postage. Stanley Gibbons, 38-P Park Row, New York.

FREE! Crystal-mount samples! Har-risco; 202 Transit Bldg., Boston.

UNITED States approvals complete coverage, fine quality, attractive prices. Seminole Stamps, Box 1138-P, Coral Gables, Florida.

RARE British Americas mixture: Over 20 small colonies (no Canada). 500 stamps, \$2.00. Stamp sales, Box 1649U, Oakland 4, California.

BREAKING Up large collection. Approvals by countries. Lion, 200 W. 81, New York 24.

"GOYA Nude" set complete 35c. Approvals. Royal Stamp Company, Tam-maqu, Penna.

FREE Surprise packet, request approvals. Schmidie, Box 2551, Portland 3, Ore-gon.

FIRST Day cover service. L. Best, 696 Greene, Brooklyn 21, New York.

NICARAGUA Diamond (Managua) set, 10c with approvals. Vargo Stamps, 6044 South Fairfield, Chicago 29, Illinois.

\$1500.00 NEW Chinese colorful com-memoratives, large complete set, free with approvals. Gerhardt, 2804 Rio Grande, Austin, Texas.

SOUTHERN Rhodesia 56-63 anniversary commems mint \$1.00. Earle Hall, Winchendon, Mass.

NAME Your favorite countries. Stamps sent for 5c with approvals. C. H. Brooke, 427 W. Sedgwick, Philadelphia 19, Penna.

SEND 10c And receive unused Nicar-agua Will Rogers set plus low priced ap-provals. Third Co., 101 3rd Ave., Newark 4, New Jersey.

POPULAR U. S. stamps, popular prices; premiums. Jarr, Box 217-d Madison Sq., New York 10.

LATEST Offer, Elbe book with spaces for 200 stamps, perforation gauge, stamps cataloging over \$1; 5c to approval ap-plicants. Moulblow, 740 Hegney, Bronx 56, New York.

300 U. S. Commemoratives, etc. 25c. Approvals. Box 457, Newark 1, New Jer-sey.

50 DIFFERENT Hungary stamps and our price list, one silver dime. Stamp-sales, Box 1649P, Oakland 4, California.

YOU'LL Like our American and Brit-ish Colonial approvals. Write now. Ches-apeake Stamps, 748 Overbrook, Balti-more 12, Maryland.

NEW Just issued. Austria Reconstruc-tion set. Ten large beautiful worthwhile additions to your collection. Priced at only 25c to sincere new approval ap-plicants. Jack Dudak, Streater 5, Illinois.

50 DIFFERENT Norway only 10c to ap-proval applicants. Floyd Frederick, 513½ Green Street, Lancaster, Penna.

FRANCE 50 Different 5c. approvals. Broad, 2945 Doris, Detroit 6, Michigan.

SPECIAL! 100 Different British Colon-ies. 70c. Rumont Stamp, Dept. 12, O'Brien, Bayonne, N. J.

UNITED States unused. Complete set 13 flag stamps plus 5c China commemo-rative only \$1.00. Fine approvals. Willett Stamps, Box 507, Port Chester, N. Y.

CHINA 50th Postal anniversary. Com-plete set. Mint. 6c to approval applicants only. GeeKay Stamps, 13 Overlea Ave., Baltimore 6, Md.

FREE Beautiful airmails. Commemora-tives, pictorials, eight countries. Appro-vals enclosed. Green and Company, Nor-wood 12, Ohio.

\$1.00 COLLECTIONS: 100 Airmails; 100 Bohemia-Moravia; 100 Chile; 200 China; 50 Vatican; 50 Liechtenstein. Veritas, 35 Williston Way, Pawtucket, R. I.

1500 MIXED. All clean, \$1.00. Barnaby, 16 Aerial, Arlington, Mass.

FRANCE Coat-of-arms, Italy airmails. China victory set (cat. \$2.48) 20c. With approvals that satisfy at half catalog. Charles Streff, 1419 N. American St., Philadelphia 22, Penna.

WORLDWIDE. Fifty different, free. Additional fifty, up to 1,000 different, 10c per fifty. Approvals included. Jack Du-dak, Streater 5B, Illinois.

SWITZERLAND: All different, 25-10c, 50-25c, 100-45c, 200-\$2.45, 300-\$6.75. Stamp sales, Box 1649U, Oakland 4, Cali-fornia.

TRIANGLES! Diamonds! Octagons! Midgets! Roosevelts! Hitlers! \$1000.00 stamps! Everything 5c! Thrifty Stamps, Silver Spring, Maryland.

SEND Dime and one hundred different stamps for hundred different. Job-Oyd's Stamp Exchange, 476 Metairie Road, New Orleans 20, Louisiana.

ROOSEVELT, Hitlers, etc. 110 different 15c. Buckley, PM-208 Ludlow Bldg., Day-ton 2, Ohio.

FREE: Twenty different foreign com-memoratives stamps to new approval ap-plicants. Modern Stamp Service, Box 12, Wakefield Station, N. Y.

WHOOPIE! Wow! 25c worth of stamps free to buyers. Write M & N Co., 742A Sheffield Ave., Brooklyn, N. Y.

200 DIFFERENT, Catalog \$5.00, only 10c with approvals. Bert Soika, Box 146-M, Jackson Heights, N. Y.

TERRIFIC! Globe girdling packet from fifty countries 10c. 1000 mixed U.S. 50c. Approvals accompany. AAA Stamp Com-pany, Arcade Building, Saint Louis, Mis-souri.

THREE Exciting collections for 10c! Collection No. 1; 25 all different from Hungary. (Colorful.) Collection No. 2; 10 all different from Free French Colonies! (Big colorful pictorials.) Collection No. 3; Our historical collection containing calvary charge, flaming sword, etc. All three collections for only 10c to approval applicants! Star Stamp Co., Jamestown, New York.

150 NEW Zealand and Pacific Island commemoratives, airs, healths, jubilees, pictorials, centennials, peaces, lighthouses. Over 50 different guaranteed \$1. Lovell's, Taupiri, New Zealand.

HOBBIES AND COLLECTIONS

LET'S Trade pencils with your ad. Macomb Bike Shop, Macomb, Ill.

MEDALS, Foreign campaign bars, samples, catalogue, 25c. Insigniacrafts, 236 28th Avenue N.W., Calgary, Canada.

WANTED Old cigarette cards. Write Charles Bray, East Bangor, Penna.

UNUSED Match book covers, 100 all different \$1.00. Free catalog. Charles Edel-man, 1311C East 84, Cleveland 3, Ohio.

INVENTING Can be an interesting and profitable hobby. Write for complete partic-ulars. Institute of American Inventors, Dept. 40-E, 1926-Eye St. N. W., Washing-ton 6, D. C.

UNUSED Match book covers, 100 all different, \$1.00. Barneby, 16 Aerial, Ar-lington, Mass.

50 DIFFERENT Army embroidered patches \$1. Other bargains. Insignia Mart, 703A Broadway, New York 3, N. Y.

COPUBLISH Hobby magazine. Samples, details, 25c. 1326 South 27th, Omaha 5, Nebraska.

GEM-CUTTING Is profitable. Learn now. Subscribe to "Lapidary Journal." Fully illustrated, Bi-monthly. \$2.00 year-ly. Geminlap, 4604 S. 49th, Milwaukee 14, Wisconsin.

ANTIQUES, RELICS, INDIAN GOODS, CURIOS

SWORDS, Rapiers, daggers, pistols, armor. Illustrated catalog 50c. Robert Abels, 860-A Lexington Ave., New York.

PRECIOUS STONES, MINERALS

GOLD—Genuine gold ore samples sent you in attractive collectors flask. Send \$1.00 to Black-Hills Enterprises, Box 412, Deadwood, South Dakota.

ZIRCONS, Diamond like sparkle, ready to set. 2 samples \$1.00. 5 samples \$2.00. Others. Imhuxex, PM, Box 232, White Plains, N. Y. Agents wanted.

METAL Detectors. The very latest cir-cuit. Free literature. Hedden Metal De-tectors, 538 N. Homewood Ave., Pitts-burgh 8, Penna.

GEMSTONES, Rough or polished. Min-eral specimens. Custom cutting. What are your needs? Plummer's, 5068 Brighton, San Diego 7, Calif.

ZIRCONS — Guaranteed! Mounted or unmounted. Lowest prices—highest qual-ity! 10c brings you colorful illustrated cat-alog. Write today. Dept. P, Orlando Cre-ations, Inc., 112 Prospect Ave., Cleveland 15, Ohio.

ROUGH Australian opal, \$20.00 per ounce. African Tigereye, \$5.00 per pound. Lawrence Gem, Box 1396, Milwaukee, Wis.

BEAUTIFUL Arizona agates, jaspers, petrified woods, chrysocholla with blue agate and green malachite. Listings and polished samples, \$2.00, unpolished sam-ples, \$1.00. Arizona Agate Mines, Cave Creek, Arizona.

CAMERAS, PHOTO SUPPLIES

BUILD Your own enlarger. Takes neg-atives up to 4"x5". Detailed plans one dollar. Emby Co., Birmingham 5, Mich-igan.

BUY Direct! Cameras, equipment. Save dealer's profit. New directory 25c. "Came-ra," 126-M Lexington Ave., New York 16, N. Y.

200X TELEPHOTO Camera easily made. Trifling cost. Telephoto lens and instruc-tions \$3.00 postpaid. Instructions alone 10c. Suffolk Science Service, Manorsville, N. Y.

ANSCO Superpan Supreme. Original factory packing, frame numbered 36 ex-posure cartridges. Fully guaranteed. Regu-lar price \$1.10. Our special price 50c each; 12 for \$5.50. Delta Photo Supply, 690-M Third Avenue, New York 17, N. Y.

OIL Coloring photographs can be a fas-cinating hobby or profitable sideline for those with artistic talent. Learn at home. Easy simplified method. Send for free booklet. National Photo Coloring School, 1315 Michigan, Dept. 3432, Chicago 5, Ill.

BASS Says! At the sign of the old "Horse Trader," 37th year. Thousands of satisfied customers everywhere! Finest brands including Kodak, Bell & Howell, Argus, Zeiss, Leitz, etc. Satisfaction al-ways guaranteed, or your money back! Bass buys 'em, sells 'em, trades 'em. Write or wire. Bass Camera Company, Dept. AG, 179 W. Madison St., Chicago 2.

NYLON Thru-Vision screen, 36x48, in automatic lift-up box type stands. Suita-ble for either conventional front or rear projection with 8 or 16m.m. movie or slide projectors. Made for government use, available from surplus, brand new, at a mere fraction of their cost. Supplied with tripod stand, \$22.50. Delta Photo Supply, 690-M Third Avenue, New York 17, N. Y.

PHOTOGRAPHY For pleasure or profit. Learn at home. Practical basic training. Long established school. Write for booklet. American School of Photography, 1315 Michigan, Dept. 3432, Chicago 5.

INFRA-RED Film makes for unusual pictures! Eastman Kodak, 35mm. Infra-Red, four 36 exposure reloaded cart-ridges, \$2.50 postpaid. Short-dated but guaranteed. Delta Photo, 690-M Third Avenue, New York 17, N. Y.

KODABROMIDE Enlarging paper—4½x825 feet rolls, enough for almost 2,000 4x5 enlargements. Single weight. Actual tests prove its worth. Fully guar-anteed. Reduces printing costs to a frac-tion of a cent apiece. Value over \$30.00. Our price \$2.25 postpaid in U. S. A. Delta Photo Supply, 690-M Third Avenue, New York 17, N. Y.

MONEY-SAVING** Values—Kodak filter test chart, 89c postpaid; Defender Farm-er's reducer, 15c size, 24 for \$1.00 post-paid; Pelouze "extra-sensitive" laboratory scales, \$4.75 plus 25c postage; 4x5 Day-light Kodachrome (surplus), list \$7.68 pkg. of 6, only \$2.95 postpaid, 35mm. bulk film bargain—100' roll any Ansco or East-man emulsion, money-back guaranteed war-surplus stock, \$7.43 value, \$1.75 per roll plus 20c postage. (Quantity prices on request.) Daylight bulk film loader, value \$6.62, only \$4.80 plus 20c postage. Com-bination special—100' roll any emulsion and loader, only \$6.20 plus 30c postage. Write for free current News Letter listing hundreds more. Sterling-Howard, Dept. PM-68, 1900 Monterey Avenue, New York 57, N. Y.**

PICTURES Never before possible! 35-m.m. Tri-X film, Weston speed 200 day-light, 160 Tungsten. Guaranteed. 36 ex-posure cartridges, 4 for \$2.50. Per dozen \$7.50 postpaid. Delta Photo Supply, 690-M Third Avenue, New York 17, N. Y.

SAVE ½ On new Micro "16" camera. Smaller than a package of cigarettes. Takes large, sharp 2¼ x 3¼ pictures. For-merly \$29.50, now only \$19.95. Black and white film \$1.00 roll, processing free, Color film, \$1.00. Flash gun \$8.50. Order with confidence on 10-day money back trial. Free catalog on request. Conway Camera Company, 34 N. Clark, Chicago 2.

8M.M. Kodak Super XX Kodak Revers-ible, includes Kodak processing, 100' rolls. Suitable for 16m.m. cameras or Bolex H8. Short-dated but fully guaranteed. \$4.95 each. \$50.00 per dozen. Delta Photo Sup-ply, 690-M Third Avenue, New York 17, N. Y.

"NOGLARE" Beaded movie screen case and stand complete 40"x40". Sets up in three seconds. Send \$16.50 on a money-back guarantee. We pay express. 3 Di-mension Mfg. Co., 1346 N. La Brea, Hol-lywood 28, Calif.

RUBBER Gloves, impermeable, acid resistant. Save your hands. Safe for all solutions. Brand new! Worth much more. Special price \$1.09 per pair postpaid. Delta Photo Supply, 690-M Third Avenue, New York 17, N. Y.

AMATEUR Photographers—Buy it or sell it through the Camera Directory. No charge for listing items for sale. 25c per copy. The Camera Directory, Box 204, Olney, Ill.

PHOTO FINISHING

SENSATIONAL Introductory offer! Send snapshot or negative, this ad and 10c. We'll send you a beautiful 7x5" enlargement! Or, Kodak roll developed and printed (with free coupon) only 25c; or 8 giant prints from roll, 30c. Reprints from negatives, any quantity, regular size, 3c; Giant size 4c. Candid rolls—36 exp. 35mm. developed, vaporated, enlarged to 3x4, \$1.00, 18 exp. 50c. Free mailers. Free premium offers sent on request. American Studios, Dept. 364, La Crosse, Wisconsin.

NEW Process developing and printing. 8 exposure rolls 35c. Mayfair Photo Service, Box 261K, Toledo, Ohio.

CUSTOM Says! We pay air mail (overseas) for GI's and civilians. Your pictures back four days Guam, five days Tokyo. Custom Photo "your nearest postal port." See our offers below.

ENLARGEMENTS In album form developed and printed in one continuous story-telling arrangement. Any 8 exposure roll reproduced this novel, loose-leaf way for only 30c. Reprints 4c each. Extra prompt service! Clip this ad for free mailers. Larga-Pic, Box Z2, Brookline, Mass.

CUSTOM Says! Eight hour service. Standard rolls 30c. 12 exposures 40c. 16 exposures 60c. Deckled (regular) or jumbo reprints, 4c each. Custom Photo, Box 567, San Francisco 1.

EVERY Picture an enlargement! New electronic developments give you bigger and better enlargements at the same low prices. Any 8 exposure roll developed and printed enlarge size, only 30c; reprints 4c each. Fast, accurate service guaranteed. Send for free mailers today! Enlarge Photo Service, Box 791-D, Boston 2, Mass.

"BETTER Photo finishing." Jumbo prints 40c a roll. Reprints 3c. Best by test. 35mm. positives \$1.50 strip, 36 ex. Sealstone Photo, Box 468, Seal-Beach, Calif.

BEAUTIFUL Enlargement from each picture on roll 25c. Cut Rate Photos, Dept. B4, Janesville, Wis.

TWO Beautiful prints from each picture on roll 25c. Twenty-seven years of satisfied customers. Quick service. Lens Photos, Dept. J4, Janesville, Wis.

ENLARGEMENTS, 5x7 15c, 8x10 25c. Glossy or dull. Oil colored, 50c extra. Negatives made 50c. Roll film developed and printed, 25c. L & R, P.O. Box 1476, Milwaukee Wis.

CUSTOM Says! One buck! 36 jumbo prints from 35mm. I'll reload your cartridge, fresh panchromatic film, half a buck. Custom Photo, Box 567, San Francisco 1.

8 BEAUTIFUL Double size pictures and roll developed 30c. 8 hour service. Free mailers. Pacific Photo Service, Box 666, San Francisco, Calif.

ROLL Developed, 8 prints and two enlargements 25c. Trial offer. Young Photo Service, 405-C Albany 2, N. Y.

PHOTOGRAPHY For pleasure or profit. Learn at home. Practical basic training. Long established school. Write for booklet. American School of Photography, 1315 Michigan, Dept. 3451, Chicago 5.

8 PRINTS All enlarged to nearly postcard size from your roll or negatives 25c; 16-50c. (Trial offer). Willard Studios, Box 3535A, Cleveland, Ohio.

16 DECKLEDGE Prints from any standard 8 exposure roll 25c. Quick service. Professional work. Skrudland, Lake Geneva, Wis.

FREE Price list on quality developing, printing, enlarging. Write for it today. Bryan's Photo Shop, Dept. M, Panama City, Florida.

HOW'S This: One price for all. Three cents per print—three cents. All sizes jumbo or regular on deckledge paper. Developing free. Your film in mail to you in eight hours after we receive it. Ask for free handy mailer. Quality Photo, Box 468, San Francisco 1.

PHOTOGRAPHS, Documents, photocopied to wallet size and sealed in plastic. Details free. Madfis Specialty, 175 Tremont St., Boston 11, Mass.

ENLARGEMENTS Best in U.S.A. 5x7 25c, 8x10 35c. Write for price list. Crumley's Photo Place, 1637 42nd Street, Birmingham 8, Alabama.

LOOK! Return mail service. Film developed plus 8 jumbo prints 25c. Gage Photos, Box 131-P, Racine, Wisconsin.

8 PRINTS Enlarged double size and 5x7 enlargement from your roll or negatives 30c. (Trial offer.) Fast service. Snapshot Service, BO 688, Alliance, Ohio.

BUTONE Jumbo prints are different. Any 8 exposure roll developed and one Butone Jumbo print each, only 30c; additional Jumbo prints 4c each. Butone bargain: Any 8 exposure roll developed and two regular size prints each 25c; additional regular size prints only 3c each. All work guaranteed. Butone Finishers, Box 1777, Wichita, Kansas.

FASTER High quality photo finishing. Trial eight exposure roll developed, printed, 15c with this adv. Hollytints, Hollywood, California.

24-HOUR Film service. 8 exposures 25c. Quality prints mailed within 24 hours after film received. York Photo Finishing Service, Box 1469, York, Penna.

MOTION PICTURES AND SOUND EQUIPMENT

TRICK Titles, dissolves, titler stand, centering, developing, pictures galore. 85 page book \$1.00, folder if requested. Westwood Corporation, 635 Victoria St., San Francisco, California.

SEND 10c For 8mm., 16mm., catalogue. Sterling's, 679 Northampton, Easton, Pennsylvania.

GUARANTEED Fresh anti-halo outdoor movie film! Weston 12! Daylight loading! Processing free! Three spools double 8 mm. \$3.45! Six single 8 mm. for Univex, \$4.60! Postpaid! Catalog. Eso-S, 47th Holly, Kansas City 2, Missouri.

SURPLUS Laboratory supplies, 8mm.-16mm. silent; sound recording. Lists free. Fischer Photographic Laboratories, 1731 North Mobile, Chicago 39, Illinois.

FREE Movie list. Superior Film Service, Box 713, Troy, N. Y.

LEARN Professional motion picture technique at home. Approved for veteran training under G.I. Bill. Free catalog. Motion Picture Institute, Birmingham 4, Mich.

I BUY, Exchange, swap movie films. Rental catalogue 25c Harvey Iris, Box 539, Brockton, Mass.

RARE 8-16MM. Silent-sound films. International, 2120 Strauss, Brooklyn, N.Y.

LEARN Movie projection, management. Free catalog. Theatre Institute, Elmira, N. Y.

8-16MM. Silent-sound films. Complete rental library. All latest subjects. Free catalogue. (sample film 10c). Garden Film, 317 West 50th, New York 19.

BASS Says! 37 years of leadership means satisfaction to you! Finest equipment, 8 and 16 mm., sound cameras, sound projectors. Bass buys 'em, sells 'em, trades 'em. Satisfaction always guaranteed, or your money back! Bass Camera Company, Dept. A, 179 W. Madison St., Chicago 2.

BEAUTIFUL Kodachrome slide and lists 25c. Slide Supply Service, 3111 West Tuscarawas, Canton, Ohio.

SURPLUS 16mm. Eastman Super X on 50' cores, 50c postpaid! 12 rolls \$5.00! Outdated but tested and guaranteed! 100' camera spools 25c postpaid! Processing, 75c. Filmcraft, 47th Holly, Kansas City 2, Missouri.

GIANT Film offerings, 5c. American Films, 6711 Sunset, Hollywood 28, Calif.

16MM. Sound films. Real bargains in used cartoons, musicals, sports, novelties. Big list for stamp. Blackhawk Films, Davenport, Iowa.

SOUND, Silent movie film, 8mm. cartoons, 16mm. comedies, 35mm. shorts. Simpson, 155 High, Dayton, Ohio.

COMPLETE Stocks always of Castle, Official, Pictorial films, 8mm., 16mm., sound. Musical, soundies, free catalogs. We exchange your films and equipment, or buy them for cash. Frank Lane, 5 Little Bldg., Boston, Mass.

35MM. Silent sound films, projectors. Bedner, 5300 So. Talman, Chicago.

35MM. Sound films. Big list free. U. S. Films, Passaic, N. J.

BARGAINS! Films, Equipment. Catalog free! Towers, 935 North 40th, Philadelphia 4.

MOVIES Enlarged! Two 5x7 photographs \$1.00. Artcraft, Midwood, Brooklyn 30, N. Y.

"THE World's Greatest Passion Play" State projector. Rent or purchase. Write Hemenway Film, 33-F Melrose St., Boston 16, Mass.

YOU Develop it. Get a 33 ft. developing rack, safe light, all chemicals, trays and instructions for \$5.85. Fully guaranteed. Free circulars and film samples. Fromader Genera, Davenport 4, Iowa.

POORMAN, Schuylkill Haven, Penna.! Latest movies, equipment! Save! Catalog, sample, dime!

FREE Lists. Exclusive home movies, projectors, cameras. Special discounts. Home Pix, 1674 Broadway, New York 19, N. Y.

DEVELOP Your own movie film. Literature. Duro Products, 1519 Eggert, Buffalo 21, N. Y.

FREE, Movie catalog; sample films, 10c. Goodwill Company, Jackson, Tennessee.

8-16 MM. Silent, sound films, cartoons, musicals, comedies. F. Fischer, 2948 N. Albany, Chicago 18, Ill.

MUSIC AND MUSICAL INSTRUMENTS

GUITAR Beginners: Newest western style uses Mel-O-Chord automatic chord-changer. Complete with 40 lessons, \$8.95. (Guitar included \$25). Part One "Chords by Ear," \$4.95. Other popular music supplies. Guitar Headquarters, Box 886, Ventura, California.

SONGWRITERS Attention! The amazing demand for phonograph records, accelerated by countless juke-boxes, warrants your immediate investigation. We are offering new writers the rare opportunity of having celebrated "hit" composer furnish music on reduced percentage basis for any likely poems received this month. The Petrillo ban does not affect us. Recola Records, Hollywood 28, Calif.

MUSIC Printing \$5-100. Composing, arranging, publishing. Auto-Litho, Jensen, Fla.

LEARN Piano playing quickly. New speed method. Very simple. Public schools approve. Literature free. Speed Method, 435 Abiso, San Antonio 5, Texas.

1948 ACCORDIONS—Wholesale. Free catalog. American Accordion Center, 39 So. Kedzie, Chicago.

SONGWRITERS: Honest outstanding music writing offer. Len-Tex Studios, Leonard 2, Texas.

AMPLIFY Your accordion with our new mike \$22.50. Sounds like organ. Installed in minute. Use any amplifier. Amplifier and mike \$72.50. Write Del Principe, 307 So. Wabash Ave., Chicago.

ACCORDIONS—Guitars, trumpets and all musical instruments, new and used. Direct from national distributors, cash and terms. Save money. Del Principe, 307 So. Wabash Ave., Chicago.

BE Independent, tune pianos, music unnecessary. Practical Piano Tuning shows you how. \$2.00 postpaid. Chord-Slide Co., P3122 Lawrence Drive, Corpus Christi, Texas.

POEMS Set to music. Experienced composer. Free folder. Moquin, 5333 La Cresta Ct., Hollywood, Calif.

SONGWRITERS! Ethical composing offer. Hibbeler, C5, 2157 N. Avers, Chicago.

ACCORDIONS, Streamline, wholesale. Request circular. Metro Accordion, 44 North Albany, Chicago.

MUSIC Arranged. Songs printed. Frank Wildt, Music Publisher, Lancaster, Penna.

SONGWRITERS—Protect your songs. Get the facts first. Free booklet, attractive offer. Song Service, 331-C West 46th, New York.

POEMS Wanted for musical setting. Send poems for free examination. Five Star Music Masters, 630 Beacon Bldg., Boston, Mass.

POEMS Wanted for musical setting! Send poem for immediate consideration. Hamann Service, 614 Manhattan Building, Milwaukee, Wisconsin.

POEMS Wanted to be set to music. Free examination. Send poems. McNeil, Master of Music, 510-PM S. Alexandria, Los Angeles, California.

SONGWRITERS: Send poems for free examination and outstanding offer. United Music Service, 150, Salem, Indiana.

WRITE Songs. Big money and reputation. Write for information. J. Gordon Pub. Co., 201 N. Hoyne Ave., Chicago.

POEMS Wanted for publication consideration, details free. J. Barnes, Publisher, Box 490 Times Sq. Station, New York 18, N. Y.

PHONOGRAPH Records 20c. Catalogue. Paramount, MQ-313 East Market, Wilkes-Barre, Penna.

SONGWRITERS. Have your songs recorded. Music or lyrics written for uncompleted songs. Information. Dixon, 634 Common, New Orleans, La.

SWISS Music movements; Single tune \$3.00. Two tunes \$4.00. Postpaid. Choice of popular or waltz. Grons, 3017 Wellington, Chicago 18.

HARMONICAS—Hohner \$2.90, \$5, \$7.75, \$9.75. Chromatics \$12, \$15, \$25. Bargain instrument catalog 25c. Musician's Shop, 2 E. Centre St., Baltimore 2, Md.

POEMS Wanted for musical setting. Send poems for free examination. Thompsons, 409-D S.E. 1st, Evansville, Indiana.

TERRY'S Tune Service, 709 1/2 North Broadway, Oklahoma City, Okla. Send poems. Free booklet.

SONGWRITERS—Publication, collaboration. Newark Publications, GPO Box 1226, Syracuse, N. Y.

TRUMPETERS—Melodious fundamentals; lip flexibilities. Acclaimed greatest beginner and professional methods. \$1.00 each. Sample exercises free. Charles Colin, 111-P West 48 Street, New York City.

SONGWRITERS! Outstanding service. Free letter-folder describes vital brochure. Clarion-Note Music Co., 2012 1/2 Fairfield Ave., Fort Wayne 6, Indiana.

RADIOS, SUPPLIES, INSTRUCTION

FM Tuner kit. Everything including walnut cabinet, easy instructions, \$9.95 postpaid. No radio knowledge needed. Marsh Electronics, 6059 Waveland, Chicago 34.

26 YEARS Experience radio repairing at your fingertips. I've repaired 45,000 radios. Have perfected simple system you can follow step by step. No calculations or formulas. Total price \$2.00 postpaid or c.o.d. Moneyback guarantee. Ross Radio, 14615-M Grandriver, Detroit 27, Michigan.

MAKE Simple, tubeless, batteryless, distance-getting crystal radios. Crystal and illustrated instructions 25c postpaid. Allen, 427-P, Clinton, Missouri.

RADIO Technician and radio service courses. Training for federal licenses. American Radio Institute, 101 W. 63 St., New York City. Approved under G. I. Bill of Rights.

RADIOS, Record players, tubes, parts. Send for free bargain list. Hallmark, 594A Communipaw, Jersey City 4, New Jersey.

FIX Any radio. Amazing new instrument locates radio troubles double quick. Simple instructions show you how. Thousands in use. Write today for 24-page booklet, "The Inside Story." Feller Engineering Co., 945 George St., Dept. PM, Chicago 5, Illinois.

BUILD Marvelous, tiny, concealed, 21 ounce, 4 tube superheterodyne. Astonishes radio engineers. Plans, photographs, \$2.00. World famous pocket radio plans, \$1.00. United Manufacturing Associates, 3605 Canyon Ridge, Fort Worth 3, Texas.

LEARN Radio. Design and sell crystal radios. Fun and profit. Complete instructions, 15c. Tomas Laboratories, 77 Lowell, Rochester, N. Y.

BUILD One tube radio. World wide reception guaranteed. Plans, instructions, data, 25c. Artlin, Knickerbocker Station, Box 25, New York 2.

BUILD "Loudest" crystal radio. Instructions, loud crystal, catalog: 25c. Amorose, Route Four, Richmond, Virginia.

RADIO Tubes. Large stock. Big discounts. Sent C.O.D. prepaid, or, "postcard" us for quote on one or more. Beacon Radio, 649 Anderson, Cliffside, N. J.

FREE Catalog 64 pages for home experimenters, workshop owners and hobbyists. Shows radios, electronic supplies, tools, electrical repair needs, appliances. Low prices. Send today. Radolek, 603 Randolph, Chicago, Illinois.

BARGAINS—Complete crystal radio kit with headphone, aerial, illustrated instructions, only \$2.95. Free list. Radios, phonographs, supplies. Al's Radio Service, Sioux City 7, Iowa.

TELEVISION Set, 10 inch, \$225.00 complete. Write for free circular. Radolek, 601 Randolph, Chicago, Illinois.

24 PAGE Plans "18 long distance crystal sets" catalog, "Radiobuilder," all 25c. Laboratories, Eye-c, San Carlos, California.

MAKE Selective distance getting crystal radios. One tube radios. Improved designs. Instructions, crystal, 25c. Radio Leader, LaVerne 4, Calif.

BUSINESS OPPORTUNITIES

UNPAINTED Plaster, plaques, bookends, statuettes, popular sellers. List free. Wert Novelties, 539 Fern Ave., Reading, Penna.

FASCINATING Mailorder big-profit plans. Instruction manual free. Warren, Freeland 1, Mich.

LIQUID Marble—Colorful, glossy! Molded, brushed, sprayed! Cast novelties, statuary, colored tiles. Flexible molds. Composition floors. Particulars free. Marbleizing Service, Edwardsville, Illinois.

SELL Greeting cards, pictures, signs, novelties, books! Large profits! Catalog free! Elfco, 434 North Wells Street, Chicago 10.

MAKE Money making new greasless doughnuts at home on electric machine. Wholesale to grocers, drug stores, cafes, hamburger shops. Send for free recipes and plans. M. Ray Company, 3605 South 15 Ave., Minneapolis 7, Minnesota.

DON'T Guess or wonder any longer about what to sell by mail. Sell names. A concise and practical business course, with sound and proved methods, plans, successful ideas. \$1.00 postpaid. M. T. Clements, Avon Park, Florida.

FIREWORKS Wholesale: Sample parcel \$0, 10c. Packages of 16 (1280 firecrackers) \$3.00. No C.O.D.'s. Dealers wanted. Crawford's Fireworks, St. Helens, Oregon.

YOUR Own business in plastics. Details free. Harco, Edgewood, Maryland.

ADVERTISE Your business—5,000 6x9 circulars \$14.00 postpaid. Journal Printing Co., Newark, Ark.

PLASTER Paris gets hard as stone. Just mix in "ROC," amazing new chemical—Air bubbles come to surface, disappear. Finished casts hard, ring like a bell. Enough for 2,000 casts only \$1.00 postpaid. Money back guarantee. So-Lo Works, Dept. D-200, Loveland, Ohio.

START Your own business on our capital. Always your own boss. Hundreds average \$6,000 to \$25,000 annual sales year after year. We supply stocks, equipment on credit. 200 home necessities. Selling experience unnecessary to start. Wonderful opportunity to own pleasant, profitable business backed by world-wide industry. Write Rawleigh's, Dept. E-U-PPM, Freeport, Ill.

GUARANTEED Successful mailorder letters, circulars, campaigns created. Long successful experience. Reasonable. Pinkie Advertising, 1201 1/2 South Ogden, Los Angeles 35.

MAKE Profits in mail order business. Astounding plans describing method sent free. Jimton Service, Lock Box 1373L, Mobile 8, Ala.

FIVE Money-making books, \$2.00. Valuable plans, formulas, ideas. Free literature. Write Greene, 1035 East 10th Street, Brooklyn 30, N. Y.

BECOME A finance man. Particulars free. George Lenhoff, Lincoln 8, Nebr.

ESTABLISH Profitable mail order business. Our experience can start you successfully. Ray-Bar Co., 4501 Oakmont St., Philadelphia 36, Penna.

HELP Wanted to operate our successful mail business. Free details. Reynolds, Box 103Y, McAllisterville, Penna.

NEW Mailorder sellers! Tremendous profit possibilities for everyone. Ground-floor opportunity. Write: Bryden, Columbus 16, Ohio.

WANTED! Distributors—All makes nationally advertised rebuilt vacuum cleaners. Guaranteed like new! Catalog available. Bilmor Bros., 711 W. Lake St., Dept. 17, Chicago 6, Ill.

START Business! "with \$1.00." Money-maker! Free sample! Stephens, Grand Junction, Colorado.

RUBBER Molds, slightly used, \$1.00 each, big selection. Guaranteed Malaya liquid self-curing rubber, 25c jar, \$1.95 qt. \$5.95 gallon with instructions and confidential trade secrets free. Southern Service, Box 3303-A, Jacksonville, Fla.

OPERATE Profitable mail order business. Splendid opportunity. For details write: H. D. Rutledge Enterprises, Keysville, Virginia.

BUY Nationally advertised merchandise for others. Radios, refrigerators, washers, sweepers, appliances, etc. Low wholesale prices. Make commission on each purchase. Up to \$5,000 year possible. Easy, fascinating new business. Free information. Cox, 14 Church, Saugus 10, Massachusetts.

OPERATE Profitable mail order business. Splendid opportunity. For details write, Wm. Wilson, Box 78, Peru, Indiana.

COMPLETE Mail order business. Write Joseph Vassar, 312 Harden Street, S.E., Atlanta, Ga.

INCORPORATE Your business, free details. Tax Research Bureau, Inc., Delaware Trust Building, Wilmington, Delaware.

SELL Office supplies by mail from home. Descriptive literature free. Glenn Snyder, 5-B Spring, Beachwood, New Jersey.

EMPLOYMENT Agency, operate your own. Large profits, small investment. Free details. Jack Sellars, Box 822, Coos Bay, Oregon.

BE Your own boss. Send for our easy instruction course of cleaning and pressing and start your profitable business. Free literature. R. N. Raymond, 1790 W. Hancock, Detroit 8, Mich.

"HARNESSING The Earthworm." Author will mail valuable free booklet: "Successful Earthworm Breeding." Thomas J. Barrett, Dept. 14-B, Box 488, Roscoe, Calif.

1100 NAMES Recent opportunity seekers \$1.00. J. Hass, 8030 Kenwood, Chicago 19.

NU-STONE Homes—New building material. Resurface old homes, build new ones. Molded on job—stonelike appearance. Particulars free. Marbleized Service, Edwardsville, Illinois.

FREE Details—"200 profitable" mail order opportunities. Wayne Burger, Baltic, Ohio.

UP To \$1500 yearly selling by mail in spare time interest you? New ideas and plans every month. Details free. Biom Club, Box 871-E, Stillwater, Okla.

REBUILT Champion-AC spark plugs, 12c each. Finished, boxed like new! Guaranteed. Big profit selling dealers. Exclusive territory. Standard Parts, 3033 Main, Kansas City, Mo.

LEARN Auctioneering by mail. Sample lesson free. Nelson Auction School, Renville, Minnesota.

A FACTORY In your home garage! Mfg. and sales rights, mechanics' waterless hand cleaner. \$500-\$800 monthly. No special equipment necessary. Western Aircraft Mfg., Dept. D, Los Angeles 6, Calif.

AMAZING New slide rule adds hours and minutes. Used by timekeepers everywhere. Send for yours, \$1.00 each, c.o.d. Allied Research Corp., Box 17, Somerville, Mass.

BE Independent—Operate America's lowest price penny vending machine. Big profits. Immediate shipments. Write for bulletin and prices. Fielding Mfg. Co., Desk (548), Jackson, Mich.

PLASTIC Tablecloth covers, curtains, drapes, baby pants, bowl covers and other plastic articles selling like wildfire! Make big money now! Free details. Write Plastics, Dept. 58-E, 206 N. Fourth, St. Louis, Mo.

YOUR Own plastic business at home. Learn to produce costume jewelry, novelties. Use flexible molds, liquid plastic—marble. Write for free book. American Trades, Box 89-A-6, Cincinnati 29, Ohio.

START A home business in spare time. Make extra money. No experience needed. McPherson, 510 SW 7th Court, Miami 36, Fla.

BECOME A real estate broker. A profitable lifetime career in one of America's finest professions. Many make fortunes. Free literature. R. N. Raymond, 1790 W. Hancock, Detroit 8, Mich.

OWN A mail-order paper products business. Sell envelopes, tags, bags, boxes—wholesale. Tremendous demand. Steady profits. No capital necessary. Omaha Envelope Service, Dept. 247, 4721 California, Omaha 3, Nebraska.

WATCHES, Wholesale. Rebuilt Elgins, Walthams, Bulovas, etc., \$9.75 up; new and used diamond, railroad, 21J wrist. Catalogue free. Brookings, B-C1975, Little Rock, Ark.

START Home manufacturing business making Cleaning Compounds, Soaps, Insecticides, Cosmetics, Polishes, Food Flavors. No machinery. Literature free. Kemix, Park Ridge, Ill.

SAWDUST. Turn it into cash. Six methods. Instructions 25c. Charles, 12-BE, Norwood, Ohio.

FOR More business, operate an individual business office, exclusively under your name. Rates, \$10.00 and \$18.00 yearly. Co-operative Office Service, 126 Lexington Avenue, New York 16.

DO It with sea shells. Profitable easy home work. Free lesson. A. Werts, Sharp Park, California.

10 ORIGINAL, Money-making business plans, 50c. Work full or part time. Ruehl, 1311-A Widener Bldg., Philadelphia 7.

MUMMIFY Flowers in natural colors! Tints, pearl, metal! Details free. R. O. Morgan, 6230 Myrtle Ave., Long Beach 5, California.

EARN Money at home. Sell folios. "How to have your own books, plans, folios, courses printed and published free." This folio \$1.00 postpaid. Seymour Service, 2236P So. 27th, Milwaukee 7, Wis.

MAKE Perfumes. Big money. Write Macias, 1207-13th Avenue, Tampa, Florida.

ELECTRODEPOSITION Is vital in peace and war. Get the professional "know-how" of this expanding, profitable field easily, quickly, from a nationally recognized authority. Free particulars. Joseph B. Kushner, Metal Finishing Engineer, Stroudsburg 7, Penna.

LATEX For molds. Lowest prices. Major Chemical Co., 131 Inman, Cambridge, Mass.

START Profitable mailorder business. Everything furnished. Free literature. Wolf's, 3240 Glenview St., Philadelphia 24, Penna.

BABY Shoe metallizing. Easily learned. No experience needed. Schoettle, Friendship, Ohio.

MANUFACTURE And sell to bars, stores and restaurants. Adjustable floor mats. Details and plans \$1.00. G. T. Wax, 645 N. 11th Street, Baton Rouge 8, Louisiana.

MAKE Money selling army and navy surplus to your friends, customers, fellow students and co-workers. We sell you govt. war surplus wholesale. No order too big or too small. Hard-to-get items available. A postcard brings free information regarding samples and prices. Jackson Surplus, 3258-82nd Street, Jackson Hts., Long Island, N. Y.

INCORPORATE Your business, free details. Tax Research Bureau, Inc., Delaware Trust Building, Wilmington, Delaware.

"FOR Rent"—Fifty 5c nut vending machines, only 4c per day. That's ten modern machines for less than a cent. Nemece, Box 767, Milwaukee 1, Wisconsin.

MAKE Liquid marble, artificial marble flooring, flexible molds, statuary, art goods, novelties. Literature free. Kemico, Park Ridge 50, Ill.

SAVE! Million articles wholesale. Directory 10c. Lawson, Box 1302-P5, Detroit 31.

WRITE For details to start your own business, full, spare time, operating Deluxe Vendors in your territory. Large profit small investment. Venmaco Corporation, 135 Headley Terrace, Union, New Jersey.

ROLL-ON Curtain pinner. 25c postpaid. Salesmen, m.o. dealers 150% profit. Yarger Tool Co., Dept. M, Morgantown, W. Va.

TEN Moneymaking home business opportunities. Details, 25c. Crawford, Box 1161-PM, Bridgeport, Conn.

EARN \$200 Weekly installing new amazing "Styron" plastic wall tile in homes, offices. Easily applied. Tile your own kitchen, bathroom, too. Instructions, everything furnished. Literature free. U. S. Tile Co., 30 W. Washington St., Chicago 2, Ill.

MAKE Big earnings. Operate an S.I.P. Mobile Paint Store as our franchised representative. Make your car earn money for you. No experience required. We train you and furnish the capital to get you started right. Full time and part time positions now open. A clean, interesting, healthy and profitable business. Write Standard Industrial Products, Inc., Box 325, Evansville, Indiana.

GET Hundreds money making deals, business ideas, plans and manufacturing. Amazing folio free. Austin Mail Service, 5538 Lexington, Chicago, Illinois.

100 BRAND New products directory, wholesale prices 50c, 3 months \$1.00. Ruehl, 1311-B Widener Bldg., Philadelphia 7.

UNPAINTED Bookends, plaques, statuettes, figurines. List. Haverly Products, 1219 8th Ave., Altoona, Penna.

MANUFACTURE Phonograph recording discs; sell wholesale, retail music, radio dealers. Terrific demand. Start small, grow big; we teach how. Send \$3 for complete instructions, plans, specifications. Nu-Tone Records, Box 895, Los Angeles 35, Calif.

LIQUID Marble—Make in any color. Soundproof plastic flooring. Flexible molds. Cast novelties, plaques, statuary. Big money—your own business. Catalog free. Write — Bing Products, 88-A5A Broad Street, Boston 10, Mass.

INCOME From local information. No selling. Neher Co., LaVerne, Calif.

SELLS On sight sensational luminous powders that shine in the dark throughout the night. Enormous demand. No competition. Big profits to agents and users. Free listing of colors and information with your special trial order for \$1.00. Glowell Engineering Company, 475 Fifth Avenue, Dept. A, New York 17, N. Y.

PRIVATE Label service. Complete line cosmetics, flavorings, specialties. You furnish labels, we label, or will ship unlabeled and you label. Can supply complete line labeled our Victor's label. Also big line flavor concentrates and flavor ingredients. Hindman Products, Inc., 917-200 College Avenue, Morgantown, W. Va.

MAKE Money by mail, every month. Spare time business. Small capital required. Tuft, 429 Robison Ct., Pittsburgh 19, Penna.

START Successful mail order business on one dollar. Free details. Worthington, Broomall, Penna.

YOUR Opportunity to become independent. In a profitable mail order business of your own. Details free. Yaniv Distributors & Publishers, Box 2453, Youngstown, Ohio.

BABY Shoes preserved. Formulas, instructions \$1.00. Reilly, 5432 Malcolm St., Philadelphia, Penna.

BOOKKEEPERS—Operate own bookkeeping and tax service. Part or full time. Free course, "How to Operate a Contract Bookkeeping Service." A. J. Hawthorne, Public Accountant, Decatur, Ala.

BE A used car dealer. Tested plan \$1. Smith, 17A Rockland, Yonkers, N. Y.

AUTOMATIC Rhinestone machine attaches rhinestones to dresses, scarfs, blouses, etc. Makes it possible for women to transform low cost items into glamorous accessories. Rhinestone setter comes complete with quantity of rhinestones. Unbelievably fast seller at \$1.95. We are appointing distributors now. Write for details. Kapner Distributing Co., Dept. 57, 2248 Second Ave., New York 29, N. Y.

DON'T Chance an income, guarantee it. \$1 starts you. Roard, 629 Drexel Bldg., Philadelphia 6, Penna.

NEW Low prices. Complete line cosmetics, flavorings, specialties. Distributors, jobbers, agents wanted. Victor's Products Company, 917-201 College Avenue, Morgantown, W. Va.

GET \$1.25 Guaranteed fire extinguishers. Scheall, Box 225X, Duluth, Minnesota.

FIFTY Plans to help you earn more money \$3.00. Sample Capeners Magazine 10c. 849 Almaden, San Jose, Calif.

START Real estate business. America's finest profession spare time. Details free. Educational Book Co., 2907 Berwick Ave., Baltimore 14, Md.

YOU Make them. We sell them! New liquid plastic makes many items. Terrific demand! Earn minimum of \$50.00 per week at home. No experience or machinery required. We supply raw materials and instruction. Write Travaco Laboratories, P.O. Box 1883, Boston 5, Mass.

LEARN Upholstering—Book, 300 pages, 200 photographs \$4.00. Wynn & Graff, Nashville 9, Tenn.

BALLOONS, All kinds. Rubber dolls, balls, fireworks. Profits plenty. Ellswood Factory Distributors, LaJunta, Colorado.

EASY \$500 Month profits. Men or women. Your own distributing business. Not house to house. Nationally distributed, fast selling line cosmetics, flavorings, specialties. Sales or business experience desirable. High school or equal education. Car and extensive traveling required. New, profitable, proven sales plan by telephone. Investment secured by merchandise required, or credit arranged. Victor's Products Company, 917-202 College Avenue, Morgantown, W. Va.

QUICK Money. "Repairing car batteries." At home! Easy tool! Batteryman, Grand Junction, Colorado.

DOLLARS In your own business at home. Literature free. Frank Webster, Box 1972A, Hollywood, Calif.

RUBBER Molds. Illustrated list free. Oman, 642-P Broadway, St. Paul 1, Minn.

WANTED Unused U. S. postage stamps, small discount. Advance Stamp Company, 24 East 23rd Street, New York.

GOODYEAR—Has natural Malaya 75% heavy brushing rubber for molds. Trial half pint, 50c. Write for full particulars. Goodyear, Lake Geneva, Wis.

MECHANICALLY Inclined? Resurface butcher blocks. Lifetime business. Roy Crawford, Keyport, New Jersey.

MAKE And sell candy professionally, inexpensive to start, information free. Box 670, Kissimee, Florida.

FOR An extremely profitable lifetime business operate a collection agency; credit bureau. Easily learned. Free folder. Cole & Associates, Syracuse 2, N. Y.

SILVER Plating, new way. Big profits. Fairchild Company, Mt. Vernon, Ohio.

OWN Mirror shop. Resilver mirrors. Glass sign making. Electroplating. John Sprinkle, V60, Marion, Indiana.

WALL Plaques, figurine, rubber molds. Emersen, 142 Bay 14, Brooklyn 14, N. Y.

GOLDEN Opportunity "How to Establish and Operate a Successful Mail Order Business." Free information. Palmer Publications, 4219-A Southwest Marigold Portland 1, Oregon.

HOME Workers wanted to hand-spin Angora wool. Either sex. House of Angora, Springfield, Illinois.

METALIZE Baby shoes for pleasant profits. Write Enterprise, Box 189-MP, Wilkes-Barre, Penna.

AGENT Or exclusive distributor for cigarette lighter mfg. MacGregor, Tahoe Valley 16, Calif.

ONYX And plastic mountings for bronzed baby shoes, also hardening solution. Box 2095, Wichita, Kansas. (Wholesale.)

OWN—Operate ball gum, nut, cigarette vending machines. Amazing profits, no selling. Write for free details. Cameo Vending, Dept. P, 432 West 42nd, New York.

METALLIZE Baby shoes. Excellent profits. New system assures success. Free details. Treasures Forever, 89 Henry Ave., Lynn, Mass.

AT Home—Your own manufacturing business; making popular \$1.00 novelties. Cost you 3c to 15c. Everything supplied. Write So-Lo Works, Dept. D-600, Loveland, Ohio.

BELTS! Make 'em and make money. No tools! Sample 50c. Artinc Leather, 411 Joseph Ave., Rochester 5, N. Y.

BABY Shoes preserved. Formulas, instructions \$1.00. Supplies and bases. Novelty Bronzing, Box 56, Hyde Park 36, Mass.

BRONZING Baby shoes is big business. Start your own business for exactly \$3.95. Particulars free. "Metalsealed," Box 2095, Wichita, Kansas.

START Home business making statuettes, plaques, artificial marble flooring, liquid marble, flexible molds, metalizing baby shoes. Amazing profits. Folder free. Creative, 236-L, Winnetka, Illinois.

SIGNS Made easily. Instructions and ten sets modern alphabets, numerals, patterns. Sizes up to eight inches. All for \$1.00. Co-operative Business, 7 West Madison, Chicago 2.

COLOR Concrete with chemicals. Formulas, instruction. Sample 10c. Hollywood Cementcraft, 8527-A Wonderland, Hollywood 46, Calif.

FORTIFY The future—Start own business, home or office; no peddling, little or no investment. Collection describes 137 money plans. Full particulars free. Wilson, Box 3272, Chouteau Sta., St. Louis 10, Missouri.

MAKE Flexible molds! Few cents each. Cast plaques, novelties, bookends! Free samples! H. Tooker, Hamilton 44, Ohio.

EXTRA Money? Free details. Trable, 1018 1/2 Elm Street, Dallas, Texas.

RUBBER Molds, natural liquid rubber, flock filler (for making sectional molds), statuary plasters, felt finishes for novelties. Catalog and "Plastercraft" course free. Blue Rapids Supply, Blue Rapids, Kansas.

POPCORN Machines. Potato chip outfits. Long Eakins Company, 4860 Hi Street, Springfield 99, Ohio.

OPERATE Profitable mail order business. Splendid opportunity. For details write V. M. McKinley, 76 Ave. "A," Battle Creek, Mich.

READ "Advance"—The voice of mail order. Offers money-making opportunities, sources of supply, personal guidance, etc. Issued monthly. Sample copy 25c. Yearly subscription \$2.00. American Mail Trade Association, 313 East 21st Street, Suite 450, New York 10, N. Y.

\$46 FROM Square foot plywood. Jigsaw necessary. Write, Woodarts, X-38, Bridgewater, Mass.

OPERATE Profitable mail order business. Write Walter Service, 4159-A East 112th, Cleveland 5, Ohio.

HANDYMEN—Earn money home operating Community "Fix-It" Shop. Write Stafford, 708 Rawlings, Carbondale, Ill.

RAISE Earthworms. Instructions \$3.00. Huffman's Worm Ranch, R.R., Rives Junction, Michigan.

RE-NEW Leather and leatherette—Make cloth into imitation leather with plastic discovery called Leather-New. Opportunity to make real profits taking care of sales resulting from national advertising. Write for free sample of Leather-New covered material and complete deal. 4723A Troost, Kansas City, Missouri.

MAKE Perfume. Complete outfit \$7.50. Information free. Walter Lawson, 21 Joiner, Saint Augustine, Florida.

MEN And women wanted to place self-selling coin machines in stores, hotels, filling stations, etc. New machine earns up to \$6.00 weekly—costs only \$10.50. We furnish supplies and machines for nuts, gum, candy, stamps, scales and amusements. Free details of tested selling plan. Write Dept. P, Parkway Machine Corp., 623 W. North Ave., Baltimore 17, Md.

LEARN Piano tuning, repairing, at home. Tremendous field! Piano parts, tools furnished. Established 1935. Empire School of Piano Tuning, 606-B East University Ave., Champaign, Ill.

RECAST Old batteries into new. Latest achievements. Battery Laboratories, Minneapolis.

MAKE Money casting new 1948 metal toys and novelties. Latest scale model autos, original ashtrays, savings banks, water pistols, etc. Enormous wholesale and chain store demand keeps manufacturers busy. Spare or full time. No experience or special place necessary. Write for details and illustrations of patterns needed. Metal Cast Products Co., Dept. A, 1696 Boston Road, New York 60, N. Y.

LEARN To publicize yourself for increased income in your business or profession. Details free. Publicity Systems, Box 322, Jacksonville, Illinois.

MAIL Order businesses bought, sold, brokered. Write for free bulletin of exclusive opportunities. Turnipseed, Inc., Box 681, St. Louis, Mo.

START Home plaster novelty business. Amazing course tells how. Literature free. Kemo-Courses, 4862 Catalpa, Chicago 30, Ill.

NATURAL Molding Latex. Extra thick. Free sample. W. Wooley, 115-A Donald, Peoria, Ill.

COLORGLAZED Concrete pottery made without molds. Patented method. Cemetery products, novelties, tiles. Basement leak-sealing. Money-making projects. Booklet, details free. Men only. National Potteries Company, Grand Rapids, Minnesota.

MAKE Rubber stamps. Metalize baby shoes, silver mirrors, make plaster novelties. Catalogue of "20 Ideas" free. Universal, Box 1076-A, Peoria, Ill.

START Mailorder bookshop—Everything furnished. 25c brings booklet, samples, exciting ideas. General Publications, Ossining, N. Y.

LIQUID Rubber for making flexible molds. Cast novelties. Sample bottle 25c. Free literature. Chaney, 1130 E. 16th St., Jacksonville 6, Fla.

START Your own electroplating business, highly paid, uncrowded field. Learn at home in spare time. Send postcard for free electroplating booklet and proof. Plater-Hyde, Room 521, 432 "F" Street, San Diego 1, California.

RUBACREAM! Natural rubber latex! Makes molds quicker! Thicker! Free sample convinces! Castcraft Studios, 509-P Fifth Avenue, New York 17.

TWO Amazing new typing opportunities. Earn up to several dollars hour, right at home. New, exclusive, different. Write Schroder, 221 E. Bush, Covington, Ky.

BRONZED Baby shoe mountings and supplies. All metal bronze bookends, picture frames, ash trays, etc. Onyx ash trays, desk sets, plaques. Hardening solution. 30 amp. plating rectifiers with powerstat control. \$85.00. Geared motors for agitation. \$15.00. Lead lined tanks. Write for list. Hollywood Bronze Supply, 1770 N. Vermont, Hollywood 27, Calif.

ELITE Collection contains 137 practical money-making plans; local and mail order. New edition. Particulars free. Elite Co., 220 Grand St., New York 13.

OPERATE Profitable home business selling merchandise by mail. Fast sellers. Large profits. Powell Service, 5713 Euclid, Cleveland 3, Ohio.

SPECIALTY Manufacturing, the big money business that can be operated anywhere, start on a very small capital; we supply dependable formulas and complete instructions; get interesting free booklet. "Money-making Opportunities in Specialty Manufacturing." Howard Robinson, Ph.G., 1300-A South Ohio Street, Sedalia, Mo.

COPUBLISH Leading m.o. Latest copy Mail Sale Advertiser and proposition, commemorative stamp. Vanroy Shirk, Lebanon, Penna.

HOW And where to obtain capital. Fully explained. Particulars free. Star Service, Wapakoneta, Ohio.

\$25 WEEKLY Working two hours daily. No canvassing. No manufacturing. Lycke, Box 2471, Cleveland 12, Ohio.

137 WAYS To make money, in home or office, business of your own. Full particulars free. Elite Co., 220 Grand St., New York 13.

BRUSH Plating outfits connect to a battery. No tanks necessary. Good paying business at home plating autoparts, bathroom fixtures, bicycles, reflectors, silvering mirrors. No shop or experience required. Outfits furnished. Free booklet. Gunmetal Co., Ave. H, Decatur, Ill.

WOULD You pay 3%—first \$350 made? Color-illustrated book "505 Odd, Successful Enterprises" free! Some offer occasional "day off." Work home. Expect something odd! Pacific, Oceanside, Calif.

MAILING Postcards selling repeat merchandise is profitable. Everything supplied. Details free. Gordan Publishers, Box 23, Pawtucket, R. I.

CO-PUBLISH And advertise in The Central Mail Advertiser. Sample copy for stamp. Low rates. Large circulation. Bagby Printing Co., Georgetown, Ohio.

WHITE Liquid rubber for making flexible molds! Quick drying! Safe! For home, classroom, or industry! Quart \$2.00. Gallon \$5.95. Full instructions! Beginner's booklet on molding and plaster casting 25c. Free with order! Plastercraft Supply Company, 1406 East 43rd Street, Cleveland 3, Ohio.

MAIL Order opportunities. Full or spare time. Hundreds of chances. No charge. Postal brings copy. Blackstone Press, Somerville, New Jersey.

MACHINES Available for making new designs of interlocking concrete building blocks. Delaware Industries, Dept. 11, Muncie, Indiana.

LEARN Direct advertising, letter shop business. Free booklet. Armstrong, 7219 Broadway, Los Angeles 3.

MONEYMAKING OPPORTUNITIES

PRIZE Contest bulletin gives various contests now operating, and valuable hints. 3c stamp. National Contest Bulletin, Box 2685-P, Miami, Florida.

FLUORESCENT Lighting sensation. Make \$100 weekly cashing-in 16 different ways without capital. Make beautiful 20 and 40 watt lights (complete) from discarded materials. Amazing illustrations free. Willis Fluorescent, 101 York St., Brooklyn 1, N. Y., Dept. C.

WANT Pleasant outdoor work in a business of your own? Good profits selling over 200 widely advertised Rawleigh home/farm necessities. Pays better than most occupations. Hundreds in business 5 to 20 years or more! Products-equipment on credit. No experience needed to start—we teach you how. Write today for full particulars. Rawleigh's, Dept. E-145-PPM, Freeport, Ill.

NEW Original cooperative home manufacturing plan. Amazing details from actual manufacturers. Rolls Enterprises, 115 D West 16, New York 11, N. Y.

WIN Contest money. Send 25c complete instructions for writing winning answers. Winacontest, 22P Westlake Ave., Auburn, N. Y.

SEWING Machine repairmen make big money lifetime. Start neighborhood shop. Complete service manual, covering all makes, \$1.98 postpaid. Money back guarantee. Sewing Machine Serviceman, Hamilton 9-AA, Ohio.

WINDSHIELD Wiper rebuilding brings big profits. Free particulars. H & H Products, Box 430, East Akron 5, Ohio.

MAKE—Sell new amazing auto paint you simply wipe on. Complete formula \$1.00. Ideal Service, Park Ridge 8, Ill.

UNPAINTED Plaster ornaments: Beautiful designs, easily decorated with water colors or oil paints. Profit or hobby. Illustrated list free. Distributors of new Loxite, a Firestone product for molds. Midwest Novelty Mfgs., 108A Cedar, Anaconda, Montana.

FISHWORMS. Easy raise, sell hundreds, millions. Instructions 25c. Charles, 12-BF, Norwood, Ohio.

EARN Extra money. Publish, sell, your own self-help folios by mail. Free details. Seymour Service, 2236M So. 27th, Milwaukee 7, Wis.

THOUSANDS Articles wholesale. "Supply Source Directory" 10c. Ideal Service, Park Ridge 40, Illinois.

FILLING Stations need long life "Skap" rubber toilet bowl brush. Sample 25c, refundable. Complete line available. Skasol, Webster Groves 19, Missouri.

BECOME Successful mailorder bookdealer! Particulars free. 25c brings booklet, cooperative starting setup. Graphic Publications, Box 867, Manchester, N. H.

SELL Watches and jewelry. Illustrated booklet free. The Jewelbox, 2-W Stone St., New York 4.

RESILVER Mirrors at home. Formula 25c. Ideal Service, Park Ridge 6, Illinois.

WIN Contest prizes, cash! "Here's how." Alfred Novak, 2601-M Division, Cleveland 13, Ohio.

START Your own business! Big money manufacturing novelties, plaques, statuary. Free catalog. Write Bing Products, 88-A5B Broad Street, Boston 10, Mass.

EARN Up to \$520 month part or full time keeping books for small firms. Simplified system. Write Tax-Saver System, Dept. N, Ft. Worth, Texas.

EARN Money evenings, copying and duplicating comic cartoons for advertisers. Adservice, Argyle 1, Wisconsin.

DOLLAR Brings pair seashell earrings and parts for three more. Beasley, 3218 Wisconsin Avenue, Washington, D.C.

MAIL Beginners! Free information guide. Leese, 4718 North Lavergne, Chicago 30.

SELLS Like mad! Show it once—smacko! It's grabbed! No sales talk. Costs \$2, Brings \$5. Just one of those inexplicable successes. Inquire Stampico, 8837 Quincy, Detroit 4, Mich.

MECHANICALLY Inclined? Resurface butcher blocks. Lifetime business. Roy Crawford, Keyport, New Jersey.

INSTRUCTIONS: How to make rubber stamps, luminous paints, money from sawdust, resilver mirrors, raise earthworms. 25c each. All five \$1.00. Davies, Box 1087-PM, Kingston, Penna.

DOLLARS For spare time. Send postcard. Free details. Hasco, 119 Ravine, Matawan, New Jersey.

ANALYZE Handwriting for profit! Complete outfit \$1.00. Graphologists, POB-971, Philadelphia.

TECHNICAL Bulletin listing 24 opportunities. Free. Public Educational Service, 493 Irving, Bridgeton 2, N. J.

EXTRA Money? Free details. Trable, 1018½A Elm Street, Dallas, Texas.

METALLIZE Baby shoes. Further information—3c stamp. Metal Crafts, Box 125-R5, Tampa 4, Florida.

EARN Money at home! Thousands do! "Home Worker Magazine" tells how. Sample, 25c. Sizemore, Box 7, 4917 Kostner, Chicago 30, Ill.

WIN Contest money. General Contest Magazine gives hundreds of tips. Lists current contests and rules. Sample 25c. General Contests, 1609½ East 5th, Duluth, Minn.

WOULD You pay 3%—first \$350 made? Color-illustrated book "505 Odd Successful Enterprises" free! Proven! Work at home, office. Expect something odd! Pacific, Oceanside, Calif.

FORTIFY The future! Start own business; home, office. Booklet describing "Collection of 137 Tested Plans" free. Elite Co., 220-A Grand St., New York 13.

PUBLISH Your own magazine. Handsome 52 page format, well edited, illustrated. Cost low as \$1.00 month. Brings you prestige, profits. 25c brings sample, details. National, Ord, Nebr.

FORMULAS, PLANS, ETC.

TESTED Formulas—Genuine manufacturing processes. Literature free. Chemical Service, Edwardsville, Illinois.

MAKE—Sell cleaners, soaps, polishes, flavors, cosmetics. Literature free. Kemico, Park Ridge 16, Illinois.

MAKE Your own cosmetics, stain remover, remedies, insecticides. Real manufacturing formulas. Tested approved. \$1.00. Afink Chemists, 4 Clark Place, New York 52, N. Y.

PAINT Baby's room, etc., without paint odor. Simple formula 50c. Veltman & Callahan, Box 906 Station A, St. Petersburg, Fla.

21 POPCORN, Candy apple, etc. formulas. All money-makers. \$1.00. We can supply equipment. Concession Supply Co., Dept. "A," Box 133 Sta. "B," Toledo, O.

FORTUNES in formulas. Ten thousand trade secrets, recipes, processes. 900 pages. Only \$3.00 postpaid. Natco Supply, Dept. PM, 1090 West 43rd, Norfolk 8, Va.

10,000 **FORMULAS** And trade secrets. Free literature. Stillman, 555 Kingston Ave., Brooklyn 3, N. Y.

REAL Manufacturing formulas. Lists free. Cummings, Chemist, Gordon Ave., Syracuse 4, N. Y.

PLASTICS

PLASTIC Materials. Cements, dyes, findings, internal carving drills. Send 10c for catalog and floral carving instructions. Locket with internally carved rose and bud 50c less findings. Art Plastics of Calif., 8125 East 14th Street, Oakland 3, Calif.

TABLE Tops, cupboards, heat resistive lifetime plastic sheet. Many colors. 15c brings you samples. Box 19, Eau Claire, Wis.

DYP-DYE Plexiglas, Lucite. Common ingredients, very inexpensive formula, instructions 25c. Hank's, D-1 Box 124, Bristol, Penna.

PLASTICS—Sheets, rods, tubing, coatings. Shells, findings, dyes, craft supplies. Lucite scrap 25c-65c pound. Illustrated fabricating manual, price list, 10c. Lucite sample, 35c. Courtesy to dealers. Gem-O-Lite, Box 686F, North Hollywood, Calif.

LUCITE, Plexiglas masked sheets. All sizes. Cost square foot (12"x12") 1/16" 90c; 1/8" \$1.16; 3/16" \$1.43; 1/4" \$1.68; 5/16" \$2.09. Include 10% postage. Almac Plastics Inc., 230 Fifth Ave., New York 1, N. Y.

PLASTICS—Eight colors. Stamp brings price list. Hanson Plastics, 7625 South Parkway, Dept. X, Chicago 19.

MOLDS, Highest quality, lowest prices. Plastic-Plaster. Large selection best sellers mailed monthly, 75c 1 year. Plastic supplies, coating resins. Literature 25c. Apex Art Plastics, 2126 Marconi, St. Louis, Missouri.

LUCITE And Plexiglas remnants, masked. Generous assortment \$1.00 postpaid. Industrial Engineering, Box 5989, Metropolitan Station, Los Angeles 55, Calif.

EMBED Keepsakes, charms, flowers, biological specimens. Amazing liquid plastic (clear, colors) produces beautiful castings within half hour. Complete kit \$2.90 (U.S.A.). D. B. Munson, Dept. A-5, Box 401, Evanston, Ill.

INTERNAL Carved swans, bluebirds, goldfish, butterflies, etc., pins, \$1.50. Rose or daisy costume jewelry sets, \$1.50 less findings. Also gifts and novelties. Crystal Floral Novelty Co., Somerville, New Jersey.

PLASTIC Injection machine, Plexiglas, jewelry findings, self designing paints, chrome initials, internal carving drills, kits. Catalog, G. Baker Company, River Edge, New Jersey.

BARGAINS in plastics. Lucite, Plexiglas, Catalin. Many colors and sizes. Details free. George Plastics, 6938A George St., Chicago 34, Ill.

PLASTICS Trade secrets. Write for free information. Enclose 25c if you would like plastics samples. Plastics Research, Box 346, Alhambra, Calif.

RENEW Leather and leatherette—Make cloth into imitation leather with plastic discovery called Leather-New. Opportunity to make real profits taking care of sales resulting from national advertising. Write for free sample of Leather-New covered material and complete deal. 4723B Troost, Kansas City, Missouri.

PLEXIGLAS—Masked sheets, 12"x12". 1/16"—\$1.00, 1/8"—\$1.25, 3/16"—\$1.55, 1/4"—\$1.85, include 10% postage. Internal carvings, Drills, dyes, Luminous powders, rods, tubes, cements, jewelry findings. Free catalogue. Craft Plastics, Somerville, N. J.

PLASTIC—Sheets, rods, tubes, etc. Free list. Plastic Supply Co., 2618 St. Louis Ave., St. Louis 6, Mo.

CHEMISTRY

LEARN Chemistry at home, from the house of Winn. Home of supplies for student chemists. New idea chemical and apparatus outfits for home experimenting. Photographic scales, semi-professional microscopes and accessories. Send 10c for retail catalogue. Established 1931. John H. Winn, 124A West 23 Street, New York 11, N. Y.

LABORATORY Supplies: Chemicals, glassware, etc. low prices. Large catalog 15c. Microscopic stain catalogue 20c. Both for 25c. National Scientific Company, Established 1908, 2204 W. North Ave., Chicago 47, Ill.

CHEMICALS And apparatus for industrial, analytical and private laboratories. Complete supply service for correspondence school students. Send 10c for catalog. Dept. M-43, Biological Supply Co., 1176 Mt. Hope Ave., Rochester 7, New York.

FREE Catalog: Chemistry, mineralogy, physics, biology. Tracey Laboratories, Evanston, Illinois.

CHEMICALS—LAB. Supplies. New catalog 10c. Mel-Glo Chemical Co., 258 Fourth Avenue, Brooklyn 15, N. Y.

APPARATUS, Chemicals, ounce quantities, catalog 10c. Fleischer's Laboratories, Everett 49, Mass.

HANDBOOK For chemical experimenters, illustrated, hundreds of experiments, 50c. Experiment booklet 15c. Supply catalog 5c. Reading Scientific Company, Reading, Penna.

HELP WANTED

INSTALLATION And service men wanted now by authorized Iron Fireman dealers. Stokers, oil and gas burners, automatic coal, oil, gas furnaces, boilers, electric controls. Steady work. Good wages. Advancement opportunities. Write, stating experience and locality preferred. Address Engineering Service Department, Iron Fireman Mfg. Co., 3186 West 106 St., Cleveland, Ohio.

RELIABLE Man with car wanted to call on farmers. Wonderful opportunity now. \$15-\$20 in a day. No experience or capital required. Permanent. Write today. McNess Co., Dept. 78, Freeport, Ill.

BOYS Wanted. Over \$50 week! Sell name plates for front doors. Write National, 214-U Summer, Boston, Mass.

AGENTS WANTED

WHERE To buy 800,000 articles (household appliances, clothing, etc.) wholesale! Write for your free club membership. Glass Pub. Co., Dept. 102, Ellwood City, Penna.

AGENTS: Stamping names on pocket-key protectors. Sample check with your name, address, 25c. Stamping outfits, Emblem checks, check-fobs, name plates. Hart Mfg. Co., 303 Degraw St., Brooklyn, N. Y.

LOOK Here! Wanted—Men to start in business on our capital. Sell some 200 farm-home products. Thousands our dealers now make quick sales, big profits. For particulars write Rawleigh's, Dept. E-192A-PPM, Freeport, Ill.

AGENTS, 400% Profit on every sale. Latex products. 24 samples and wholesale list sent for \$3. Sample gross \$6. Vassarco, Box 1734, Cleveland 5, Ohio.

MEN'S Shirts, ladies' nylon slips, pinafores. Earn liberal commission. Free selling outfit. Jarod Manufacturing Corporation, Rockville Centre 8, N. Y.

AMAZING Discovery. Miracle glaze permanent brilliant glass-like surface for cars. Free sample; information; big profits. Miracle Glaze Company, 9714 S. Austin Ave., Oaklawn, Illinois.

DENTAL-STERO—The new toothbrush holder and sterilizer for money-making salesmen. Used in every home! Big profits. Write Dental-Stero Company, 3906 Secor Road, Toledo 6, Ohio.

EARN \$25 A day and more selling nationally advertised aluminumware, silverware, pressure cookers and jewelry. It is simple, let us show you how to make big profits with no investment. Write Continental Products, Dept. B5, 30 Ormsbee Avenue, Providence, R. I.

GET In the magazine subscription-renewal business. Pays liberal commissions. No capital needed. Helps furnished. Repeat sales come automatically. Wholesale catalog free. Write McGregor Magazine Agency, Dept. 12, Mount Morris, Illinois.

SELL Ultra blue stock signs to stores, 1000 slogans, comedy, general, religious, 7x11, cost 6c, sells 35c. Make money. Sample free. Lowy, 8 West Broadway, Dept. 379, New York City 7.

SENSATIONAL Household item sells on sight under \$1.00. Palmer Co., 2305 Monroe, Detroit, Mich.

SILVERWARE Cleaning, plating, polishing, liquid (NuSilver). Apply with cloth. Contains genuine silver. Renews silverplated ware, articles, pieces. Silver-plates brass, copper, bronze. Part. full-time agents wanted. NuProcess Products, Aurora, Illinois.

SELL Gold embossed monogram stationery. Sample free. Dunbars, Sanford, Florida.

\$1 STARTS You in business. Sell deluxe ties, 100% wool interlining. Costs you only \$7 per dozen, you make \$5.00 dozen. Send \$1.00 for special introductory offer two deluxe ties. Catalog complete line free. Philip's Neckwear, 20 West 22nd St., Dept. K-23, New York 10.

SELL Alarm to freezer owners. Details. Box 577, Freeport, Illinois.

EARN Big money year 'round. Be a one-person-department-store. Take orders for shirts, ties, hosiery, lingerie, Household linens, etc. For information, Corporate Merchandisers, Dept. PM 3, 110 West 34 Street, New York City 1.

DOUBLE Duty shopping bag. Zips open. Instantly changes from small to large size. Lightning seller. Samples sent on trial. Kristee, 122, Akron, Ohio.

MAKE More money selling personal initialed individualized belts, buckles, cap badges, tie holders, name plates, 2,000 emblems to choose. Big profits, whole or part time. Write today; special outfit offer. Hookfast Specialties, Box 1425, Dept. 6, Providence, Rhode Island.

A Dress yours with every 3 you order for yourself and family. Amazing new bonus plan. Everything free. Harford Frocks, Dept. M-9128, Cincinnati, Ohio.

POWER Lawn mowers, electric refrigerators, deep freeze, washers, oil furnaces. O. C. Harris, Summitville, Ind.

MAKE Sensational profits! New, sell-on-sight plastic line: Tablecloths, aprons; many other splendid fast-selling items, novelties. Postal brings free details, special deals. Hurry! Royalty, Box K-748, Passaic, N. J.

AMAZING Daily profits, big repeat business selling top-quality, lowest priced men's guaranteed hosiery: full, part-time. Experience, investment unnecessary. Free selling outfit. Coltsos, 242-J5 Purchase, Boston 10, Mass.

EARN \$5.00 With every ten \$1.00 boxes of everyday cards you sell. Also personalized stationery, note paper and wrappings. Send for samples today. Howard P. Ellis, Dept. PM-6, Pitman, N. J.

\$25 PROFIT On 50 \$1 boxes. Show beautiful greeting cards, stationery, gift wrappings, to friends, neighbors, coworkers. Free literature shows easy way making money. Approval samples. Torres Company, 8B St. Francis Place, Brooklyn 16, N. Y.

COSMETICS. Your label. Eight cents jar, up. Thompson, 1566 East 18th St., Cleveland 14, Ohio.

AMAZING New scientific invention uses powerful infra-red heat plus massage to bring quick relief from aches and pains. Excellent for facial massage, too. Big profits. Details free. Neubauer Company, 4815 "A," Philadelphia 20, Penna.

FAST Selling new idea! Women rave about glamorous scent given lingerie, accessories by new method. Liquid sachet, 50c. Gorgeous sample card of twelve bottles, \$3.00. Moneyback guarantee. Low wholesale. Parfums Varre, Inc., 381 Fourth Avenue, New York 16, N. Y.

PERTO-POTS: DDT; 2.4-D; BHC; Antu; Rotenone. Write, Allen Co., Pitts-town, N. J.

NEW Items, novelties, salesboards, coin machines, opportunities featured big spring special magazine. Four big issues only \$1. Billboard, 4161 Patterson, Cincinnati 21, Ohio.

MPGR'S. Agents wanted for new type automotive and industrial lighting units. Write for details. Pho-Tel Products, 621 So. Lebanon St., Los Angeles 14, Calif.

BIG Profits fast! Sell beautiful plastic table covers, curtain drapes, garment bags. Twenty other terrific sellers. Free swatches. Star, 261 Fifth Avenue, New York, Dept. M.

\$1 STARTS You in business. Sell rings, earrings, chains, pearls. Costs you only \$7 per dozen, you make \$12 dozen. Send \$1 for special introductory offer two items. Silver Screen Fashions, 833 Columbus Ave., New York City.

DIRECT From factory. Start in business. Swiss watches; samples supplied. No money required. Big profits for ambitious salesmen; territories open. Ergim Swiss Watch Co., 833 Columbus Ave., New York City.

GUARANTEED Product in protected territory, if you are now selling or intend to sell house-to-house. For full 1 qt. sample amazing High Shine Windsor No Rubbing Wax, send only 25c covering handling and postage. (Sells for \$1.25.) Windsor Wax Co., Inc., Dept. P.M.-2, Hoboken, N. J.

MAKE Money at home like I do! Write immediately. Duffy, Covington, Ky.

AMAZING Invention needed by thousands. 500% profit; send quarter for samples. Full details. Refundable. Krueger, Box 812P, Oakland 4, Calif.

FREE Nylons given if Kendex hosiery runs or snags! World's only women's hosiery sold with a written guarantee that amazes everybody. Mere words could not possibly express the almost unbelievable opportunity you now have to make money. Fantastic and "impossible" earnings now become a reality. Can you imagine a guarantee that replaces hosiery regardless if damage is due to use or abuse and regardless whether it is the fault of the hose or the wearer? Here is sales dynamite that will blast your earnings to the sky! Even if you never sold a thing in your life, three magic words: "guaranteed against everything" will open doors for you—will make women listen and will pour money in your pocket. Kendex stockings are not sold in stores, so you have no competition. Complete line includes beautiful sheer nylons; long wearing, durable service nylons; three different lengths; genuine outsize nylons; latest shades; choice of full fashioned with seams or seamless; lowest priced rays. Also separate complete line of men's hosiery including nylon, lisle, rayon, cotton, mixtures etc.; plain and fancy; long and short. Thousands of pairs shipped daily. No money or experience needed. Nothing to invest or risk. No samples to buy. Nothing to pay, now or later! Simply write orders. We deliver and collect. Liberal advance cash plus huge cash bonus. Write orders spare or full time; exclusively or as a side line. Become a manager and appoint others to sell for you with steady income on their sales! Complete money-making outfit, including salesbooks in color, samples cut from actual hose, instructions, order blanks etc. furnished free and prepaid. Rush name and address on postcard and start making money next week. Kendex Co., Babylon 137, New York.

90c PROFIT Each \$1 sale! Sell real mothproofing solution. Employ agents. Experience unnecessary; we tell you how. Kinford, Wayne 3, Penna.

SELLS At sight. Stainless steel carving sets \$21 doz. Samples available. 125 other fast sellers. Manufacturers, 264-5th Ave., New York.

WHOLESALE! Balloons, novelties, watches, jewelry, premium goods. Collins Co., Forsyth, Georgia.

POCKET Pal: Replaces pocket knives. New, safe, beautiful. Always razor sharp. 50c seller. 231% profit. \$15.00 or more daily. Agents, salesmen, distributors. Sample 10c. Nelson Mfg. Co., 222 W. Kellogg, St. Paul 2, Minn.

PROFITS To 100% selling everyday greeting card box assortments. Birthday, convalescent, wrappings, stationery, etc. Details and assortment on approval. Glorian, Dept. 22, 515 East 45th Street, Brooklyn 3, N. Y.

BIG Profits selling beautiful imprinted stationery, greeting cards, etc. Free samples. The Ed-Brite Co., 435 North Terrace Ave., Mount Vernon, New York, Dept. 15.

AGENTS Make big profits selling sensational new diapers which require no folding. Every new mother a prospect. Rush name for free sample. Fred Dexter and Staff, 234 West 17th, Houston 8, Texas.

UP To 122% profit! "Mad-Nets," \$1.00 novelty magnets. Free bulletin. Frederick, 4 South, Stamford, Conn.

\$3 FIRE Extinguisher; quick sales, wholesale or direct; liberal profits. "Fire-Killer," 109 N. Franklin, Syracuse 1, N. Y.

BIG Money selling tooth powder. Write today. James Walker, 633 Plymouth Ct., Chicago, Ill., Dept. 1.

FREE Sample! Big profit opportunity with amazing glow-in-the-dark house numbers, switch plates, pictures, decals, religious articles. Represent large manufacturer. Madison Mills, 303 Fourth Avenue, New York, N. Y.

FREE Water and our concentrates, makes flavors, lotions, shampoos, 72 products, labels, bottles furnished. Qualco, E-20030 Russell, Detroit.

INFORMATION — Wholesale supply sources. Moneymaking plans. Increase your income! Write Reynard Service, Smithfield 3, Ohio.

100% PROFIT With new electric gas lighter, eliminates matches, pilot. Write Optical Research Products, Fairview, N. J.

MAGIC Cleaner and laundry soap deal. Hotter than a firecracker. Big profits. Sample free. Bestco, 5007 Irving Park, Chicago.

EXCELLENT Sideline for printing and advertising salesmen. Decalomania name plates in small quantities. Great demand. Also, make money with our line of automobile initials and sign letters. Free samples. "Ralco" XL-Roxbury, Boston 19, Mass.

137 COMPLETE Plans for starting own business: local—mail order. Particulars free. Elite Co., 220 Grand St., New York 13.

AGENTS—300% Profit selling genuine gold window letters; stores and offices. Free samples. Metallic Letter Co., 438-B North Clark, Chicago.

GOLD Lacquered window sign letters. Large sizes penny each. New foils. Absolutely beautiful. Free samples. Atlas, 544 W. 79th, Chicago 20.

BIG Profits. Sell photo enlargements. Richphoto, 215 W. 98th, New York City.

HIGH-GRADE SALESMEN

UNBELIEVABLE Earnings, salesmen, crew managers, taking orders for bronzing baby shoes. Every mother definite prospect. \$1.00 deposit (refundable) brings complete selling outfit, including sample "Metalsealed" baby shoe. Photograph shows how men make \$50.00 a day. Metalsealed, Box 2095, Wichita, Kansas.

SELL Nationally known brands furniture and appliances for large retail store. Box 21, Fairfield, Penna.

YOU Can earn 49%! Salesman wanted to sell nationally advertised desk model portable adding machine. Priced \$12.95, fully guaranteed. Not a toy. Easy to operate and in demand everywhere. You can make 49%! For complete details and full size color illustration, write today to: Lightning Adding Machine Co., Inc., Dept. ZD1, 543 So. Spring Street, Los Angeles 13, Calif.

START Your own business on our capital. Always your own boss. Hundreds average \$5,000 to \$25,000 annual sales year after year. We supply stocks, equipment on credit. 200 home necessities. Selling experience unnecessary to start. Wonderful opportunity to own pleasant, profitable business backed by world-wide industry. Write Rawleigh's, Dept. E-U1-PPM, Freeport, Ill.

SELL To stores—Stationery, advertising tape, restaurant items, tags, labels, and hundreds of other fast-selling business necessities. Big cash profits. Free sales outfit. Willens & Co., 2130-AK Gladys Ave., Chicago 12, Ill.

BIG Money quickly and easily taking orders for complete line personalized initialed buckles, belts, cap badges, 2,000 emblems. Fast repeats. Write today. Hook-Fast Company, Box 480-PM, Roanoke, Virginia.

SALESMEN: Big money showing building owners sensational product; cuts essential repair cost up to 75%. Six average orders weekly pay you over \$190.00. Age: 30 or over. Get money-making facts. Write, Zone Co., Dept. E-6, Box 789, Ft. Worth 1, Texas.

ADVERTISING Book matches—Cash in on political campaigns; sell union label matches. Cuts for all businesses, political parties. Free powerhouse selling kit, low prices, protection guaranteed on repeat orders. Cash commissions. Superior Match Co., Dept. M58, 7530 Greenwood, Chicago.

SELL Delicious candies, nuts, gum. Immediate delivery. Write Casterline, 2031-PG Sunnyside, Chicago 25, Illinois.

AMAZING Daily profits, steady repeat business selling famous Colt shoes direct. Exclusive features make selling easy. Experience unnecessary. Patented Footograph assures accurate fitting. Free selling outfit. Colt Shoes, 601-J5 Atlantic, Boston 10, Mass.

MAKE \$500.00 A week! Be first with "Neo-Fluorescent." Revolutionary invention! New type fluorescent sign replacing neon. Fantastic virgin market with dealers. Mfgs. distrib. nets fabulous profits. Free sample offer. H. Rose Co., 539-B So. Franklin, Chicago.

POWER Mower (Maytag)—\$99.50. Sensation. Display kit, free. Rotacut, M-2005, Excelsior Springs, Mo.

SALESMEN: Excellent openings now with authorized Iron Fireman dealers. Attractive salary and commission. Make good money selling top quality, nationally advertised Iron Fireman coal stokers, oil and gas burners, automatic coal, oil, gas boilers and furnaces. Excellent individual sales training course and selling equipment. Write for information, stating locality preferred. Iron Fireman Mfg. Co., 3188 West 106 St., Cleveland 11, Ohio.

SALESMEN—Distributors. Sensational new fluorescent changeable letter sign. Change message in a minute. Priced very low. 40% comm.; easily earn \$200 per week. Territory going fast. Write or wire Signcraft Co., P.O. Box 8341, Los Angeles 21, Calif.

FANS—Fans. Salesmen making \$50 to \$100 per day selling our electric fans, sump pumps, and portable water softeners. Have also, all kinds of fan parts; build your own. Write Universal Fan Co., Peru, Ind.

\$240.49 IN One week—Unusual? Not at all! Just look at one week's earnings of these representatives. WWS \$290.99, JMH \$229.75, RJR \$262.47, VJM \$275.95, JEA \$240.49, RWF \$231.21. Direct mail campaign brings hot leads right into your home. Remarkable product does part of 10 men's work; a "natural" during these labor problem days. Has perfect sales story; sells year round. As modern as radar! Special demonstrator offer. We extend credit, deliver and collect. No capital required; no experience necessary. You make big profit on first sale and full credit on repeat business. Every business, store, factory, etc. are prospects. Write John Porter, 2433 Indiana, Dept. 307, Chicago 16.

DISTRIBUTORS Only. Sensational dwelling unit for automatic fire protection. Top and complete line. 65% possible. Freight free. Red Ball Co., Box 1552, Salt Lake City.

PHOTO-SALESMEN—Agents. Sell beautiful hand colored plastic enlargements. Collect deposit, we deliver. Profitable sideline. Send card, for free sample kit. Novel Portrait, 3343 North Ave., Chicago, Illinois.

BIG Profits daily taking every family's magazines subscriptions. Give unlimited choice of valuable books free. Publishers, 323-5 Hammond, Cincinnati 2, Ohio.

CASH Profit—Big earnings; selling personalized buckles, belts, cap-badges, tie clasps, 2000 emblems, caps, shirts, ties. Write, Hook-Fast Products, Dept. A, Columbus 6, Ohio.

WAGON Salesmen—Fast moving carded goods and 10c line. Long profits. Free facts. Peerless, 2720 Dodier, St. Louis 7, Mo.

JOBS Open in selling! Send name, address for free copy Opportunity Magazine, listing hundreds of companies who need men now, full or spare time. Experience not essential. Opportunity, 28 E. Jackson, Dept. 17, Chicago 4, Ill.

BIG Money taking orders. Shirts, ties, socks, pants, jackets, sweaters, shoes, uniforms, etc. Sales equipment free. Experience unnecessary. Nimrod, 4922-AN Lincoln, Chicago.

SELL Calendars—Every business a prospect. Also wholesale to printers; calendars, sheet pictures. Fleming Calendar Co., 6540 Cottage Grove, Chicago 37.

EDUCATIONAL AND INSTRUCTION

DYNAMIC Thought—The secrets of mental fascination. Improve your mental powers, be a success in business, earn more money. Send today for this amazing new book. \$3.98 postpaid. Milton T. Clements, Avon Park, Florida.

BOOKKEEPERS! Increase your earnings! Operate your own simplified "dollar-a-week" bookkeeping and tax service. Full or spare time. Details free. No obligation. Ellis, Box 200, Cedar Grove, North Carolina.

WHAT'S Wrong with your job? Get a gov't. job. Big starting pay. Security. Qualify for next examinations. 32-page book. Details free. Write Franklin Institute, Dept. B24, Rochester, N. Y.

"HUMOR Business" comedy journal, sample, 25 cents. \$2.50 per year, biggest fun buy. 104 East Fortieth, New York City 16.

ASSOCIATE In arts diploma earned by correspondence. University Foundation, PM, St. Augustine, Florida.

PAINT Beautiful pictures quickly, easily, inexpensively. Free literature. Art Book Shop, Arnold, Mo.

BECOME A Doctor of Psychology or Metaphysics. Teach secret of contentment, happiness. Win degree of Ps.D. or Ms.D. Solve mental worries. Free book. College of Universal Truth, 5153-C North Clark, Chicago.

DENTAL Technician training. Easy home study. Details. Dental Crafts And Sciences, P.O. Box 1321A, Palo Alto, Calif.

NOW You can have an office. Learn credit-collection business by new home study course. Many earn up to \$5000-\$15,000 annually. Free bulletin. Franklin Credit School, Dept. 202E, Roanoke 7, Va.

STAMMERING Corrected. Booklet gives full information. Write: William Dennison, 543-A Jarvis St., Toronto, Ont.

SHOE Repair school. Teach you quickly! Age 18 to 80. In 12 weeks you can be skilled. Modern Shoe Rebuilding, 4577 Hollywood Blvd., Los Angeles; 2935 Belmont, Chicago.

STEP-UP Your brains, income. Amaze with Super-memory. Facts, figures, faces stick like burrs. Write for free details. Thor Books, CM-5, Box 1210, Chicago.

GET A better job by writing the proper letter. Booklet shows how. 7 day free examination. Pay \$1 only if fully satisfied. VGB. Publishing Co., 2020 Boston Road, New York, N. Y.

EXPERT Bookkeeping, easily learned. 15 lesson course \$5. introductory lesson 35c. Bernard Buchalter, 1280 Ocean Ave., Brooklyn 30, N. Y.

WELDING—A profitable trade. Demand for trained men. Learn quickly at best equipped school in U. S. G. I. approved. Catalog free. Write Hobart Welding School, Box M-585, Troy, Ohio.

GRADUATE Work in all subjects. Degrees available in one year. Resident and extension classes. Golden State University, Hollywood, Calif.

USED Correspondence courses and books bought, sold, rented and exchanged. Catalog free. Lee Mountain, Pisgah, Alabama.

LINGUAPHONE Makes languages easy. At home learn to speak Spanish, Portuguese, Italian, French, German, Russian, by quick, easy Linguaphone Conversational Method. Save time, work, money. Linguaphone correspondence courses are available to veterans under G. I. bill of rights. Send for free book. State if G. I. Linguaphone Institute, 83 RCA Bldg., New York, 20, N. Y.

INVESTIGATOR Training. Phillips Secret Service, 1917B North Kenneth, Chicago 39, Illinois.

NEW Writers needed. Want to cash editors' checks? If you can read, we can teach you how to write for pay. Earn as you learn. First lesson free on request. No obligation. Send postcard today. Comfort Writer's Service, 200 S. 7th St., Dept. 11, St. Louis 2, Mo.

LEARN Photo-engraving at home or in oldest, largest school in America. Work for newspaper or establish own profitable business. New Tasope' Photo-Engraving equipment available soon. Write for information. Veterans ask about G. I. training. The Aurora School of Photo-Engraving, Tasope' Bldg., Aurora, Mo.

HOME Study course, drugless therapy. Free literature. Institute of Drugless Therapy, Tama, Iowa.

MEDICAL Laboratory technicians in great demand. We train you in your spare time, in your own home. You can practice while studying. Write for free catalogue. Imperial Technical Institute, Box 973-E, Austin, Texas.

SECRET Investigation. Experience unnecessary. Investigators particulars free. George Wagner, M 125 West 86th, New York.

PLAYS, STORIES, MANUSCRIPTS

I WANT New writers to cash hundreds of checks for \$1 to \$100, offered each month. The easiest way to write for pay. No previous experience necessary. Send for free details. No obligation. Saunders M. Cummings, 467-M Independence Bldg., Colorado Springs, Colo.

BUSINESS SERVICE

HOLLYWOOD Postmark. Letters re-mailed, 25c each. Arr. P.O. Box 17, North Hollywood, Calif.

CHICAGO Address. Mail, telegrams, received. Forwarded. Confidential. Faultless, 3439 Michigan Ave.

SPECIAL SERVICES

MAIL Forwarded, each letter 25c, monthly \$2.00. 5 postcards, \$1.00. Also special services. P.O. Box 246, Tacoma 9, Wash.

POSTMARK Your mail. "Montreal." Letters mailed here, 25c each. Complete (receiving, reforwarding) service, \$3.00 monthly. General Business Service, 7425 Henri-Julien, Montreal, Canada.

MFG.-WHOLESALE Sources. Most any item. "Service," 1332D Findlay, New York City 56.

SPECIAL Supply source information on anything made in United States \$2.00. Unable furnish information money refunded. Business Service, 1101 Kings Highway, Shreveport, Louisiana.

PHOTOSTATIC Copies. Write for prices. Hamy, 214 Robinson, Hudson 1, N. Y.

WE Receive, reforward letters, \$3.00 monthly or 25c each. "Hawkins," 1300 Taylor—o, Washington 11, D. C.

PANAMA Canal Zone, letters remailed, forwarded, 75c. King, Box 685, Crundu, Canal Zone.

MAINTAIN New York office address. Mail received, forwarded. Confidential. Free details. Arlington, 131-H West 42nd, New York 18.

CARTOONING, COMMERCIAL ART, SHOWCARD WRITING, SIGN PAINTING

PAINT Signs—New method \$2.00. Particulars free. Haines System, Sabina 4, Ohio.

CARTOON Course—Earn big money. 22 easy lessons. Nearly 200 sketches. 50c coin. Snack-Pack Co., Box 412, Indianapolis, Ind.

"HOW To Make Money With Simple Cartoons"—a book everyone who likes to draw should have. It is free; no obligation. Simply address Cartoonists' Exchange, Dept. 95C, Pleasant Hill, Ohio.

SIGN Painting taught at home by an old master. Ben Kerns, Box 812, Greenville, S. C.

CARTOON Students—Interesting book cartoons 50c coin. Box 263, Wilmette, Illinois.

TEST Free to prospective art students. American, Box 8066, Dallas 5, Texas.

MAKE Up to \$100 weekly cartooning, illustrating, designing and lettering at home. No experience necessary. Big, new, simplified method shows you how. Rush name for free trial offer. National Artists Bureau, Box 4248-M, Dallas 8, Texas.

9 ALPHABET 3 Numeral pattern sets and catalog, \$1.00. Sign Letter Distributors, P.O. Box 101, Mineola, N. Y.

CHALK Talks. Laugh producing program, \$1.00. Catalog 10c. Balda The Cartoonist, Oshkosh, Wisconsin.

ADVERTISING AGENCIES, LETTER WRITERS, FOR ADVERTISERS

SAN FRANCISCO Mailing lists. Pera, Dept. B1, P.O. Box 5047, San Francisco.

ADVERTISING: Placed in any publication, anywhere. Write for mail-order rate sheet "M." LeGrand Advertising Agency (established 1923), Floral Park, N. Y.

AD-CUTS Art-designed \$4. (Engraving included.) Samples, details, free. Fischer, 711 So. Boulevard, New York 55.

ADVERTISE: 24 Words, 40 newspapers, \$3.50. Lists free. Advertising Bureau, 229-C Dixon, Uniontown, Penna.

AD Layouts, copy, art. Placed in any magazine, newspaper. Sherman Advertising, 5741 McPherson, St. Louis 12, Mo.

MAILING List, 1000 names for \$5.00 cash, from a community of 30,000,000 manufacturers and consumers of New York, New Jersey, Pennsylvania, Connecticut. Joseph Galea, 505-5 Avenue, New York City, N. Y.

BUSINESS Building sales literature written by direct mail specialist. Sales letters as low as \$3.00. Stamp brings complete price-list. Paul Wallace, Box 143, Sheboygan 5, Wis.

FREE: Want ad advertising rate bulletin covering the southern states. Alabama Advertising Agency, Exchange Building, Birmingham 3, Alabama.

ADVERTISING Sensation! Reach 2,100,000 families, \$32.90 inch. Display, classified, ratebook (newspapers, magazines, mailing lists), advertising assistance, free. Chicago Advertising Agency, 20-PM West Jackson, Chicago 4.

ADVERTISERS! Reach nearly 18,000,000 readers. 25 Sunday national key newspapers, 18 words, \$47.75. "Terrific pullers," 20 popular newspapers, \$9.75. "Free booklet." Special—One inch display 2-821,198 circulation, \$42.00. Newmark's Advertising Agency, (Established 1893) 217-7th Ave., New York 11.

ADS Placed in out of town newspapers and magazines. Low rates. Catalogue free. Ideas that pay. Baker Advertising Agency, Successors Ankrum Agency, 189 W. Madison, Chicago 2.

MAILING Lists, certified, productive, inexpensive, \$5.00 1000. Homeworkers, agents, buyers, etc. Write Dixie Service, King, N. C.

24 WORDS In 64 weeklies \$4.96. H. J. Darnell, 730 Hays, Jackson, Tenn.

LEARN Direct advertising, letter shop business. Free booklet. Armstrong, 7219 Broadway, Los Angeles 3.

TYPEWRITERS, DUPLICATORS, OFFICE DEVICES

DUPLICATORS Reduced. Ink \$1.29 lb. Wisuri, 10-B Railroad, Maynard, Mass.

MULTIGRAPH Machine at sacrifice—real bargain. George Wentz, San Marcus, Texas.

STANDARD Typewriters \$17.50 up; new duplicators \$9.50; adders \$12.50; electric irons \$3.50. Ship anywhere. Typewriter Service, 118 Spruce, Wichita, Kansas.

DUPLICATORS \$9.95 Up. (New.) Immediate delivery. "Free circular." Rucker, 2836-PM Slevin, Louisville 12, Ky.

"PRINTOMATIC" Selffeeding post card stencil printing duplicators \$9.50 up. Office size duplicators, Speedprints, Hilcos, Excellographs \$33.41 up. Literature free. Pittsburgh Typewriter Supply, 336-WK Fourth Avenue, Pittsburgh 22, Penna.

RECONDITIONED Typewriters, mimeograph, multigraph printing devices, appliances, supplies. Catalog. Dixiegraph Service, King, N. Carolina.

RUBBER STAMPS AND OFFICE SUPPLIES

CUSHIONED, Indexed, 3 lines \$1.00. Akorn Enterprises, 92 Church St., Mt. Clemens, Mich.

LINE 20c; 2-35c; 3-50c. Stamp Works, Auburn, Nebraska.

MAGIC Mailer envelope sealer \$4.95; office equipment; rubber stamps; school supplies. Agents wanted. Speed-Dee Sales, 3229 Sheffield, Chicago 13.

RUBBER Stamps. Illustrated literature free. Lee-Vall Press, Dept. 7-A, Box 1242, Indianapolis 6, Indiana.

2 LINES 35c. 3 Lines 50c. Newman, Box 284, Fort Collins, Colo.

PRINTING, MULTIGRAPHING, MIMEOGRAPHING, GUMMED LABELS

DISTINCTIVE Business stationery. Quality and service. Bolton Print, Bolton Landing, N. Y.

QUALITY Printing at low prices! Send for price list today! Nationwide Printing Company, Dept. PM, 2337 Bath Avenue, Brooklyn 14, N. Y.

500-EA. Letterheads, billheads, envelopes, cards, \$10. Star Printing, 166 So. Washington St., Pottstown, Penna.

PENCILS—Up to 45 characters same imprint. 2 dozen \$1.00, 4 dozen \$1.75. Cash, postpaid. James Virtue, 5301 Atlantic Ave., Ventnor, N. J.

1000 BUSINESS Cards, raised letter printing, \$3.75. Weldon-A-2, Box 5082, Long Beach 5, Calif.

100 BUSINESS Cards 75c, printed prepaid. W. Davis, 935 Maxwell, Chicago 8.

SIXTY Letterheads, forty envelopes, both beautifully printed \$1.00. Calder's, Box 3422-PM, Philadelphia 22, Penna.

SELL Printing. Amazing profit. Mango, 555-A South 20th, Newark 3, N. J.

ENVELOPES; Hammermill letterheads; 100-\$1.00. Benneville, Box 1931, Pittsburgh 30, Penna.

BUSINESS Cards, 1000 \$2.45, prepaid. Madison Printing Service, Madison, Ohio.

1000 BUSINESS Cards (embossed) \$2.95 postpaid. 1000 #6 3/4 white envelopes \$5.50 postpaid. Zephyr Printing, Box 312pmm, Venice, California.

MIMEOGRAPHING Experts. Samples free. Martin Mimeographing, 3212 Harper, Saint Louis 7, Missouri.

WRITE For samples, prices attractive letterheads, cards, circulars. Journal Printing Co., Newark, Arkansas.

1000 BUSINESS Cards \$2.25 prepaid. Messina, 7801 18th Ave., Brooklyn 14, New York.

5000 6 3/4 ENVELOPES Printed \$2.75 per thousand, price list free. Michel, Box 76F, New York 16.

MAKE Your own labels! Samples free. Buckley, 2539 Devon, Chicago 45.

100 8 1/2 x 11 HAMMERMILL Letterheads and envelopes \$1.98. Herbert Hudson, 261 Woonasquatucket, Centredale, R. I.

1,000 BUSINESS Cards \$2.95; 1,000 6 3/4 white envelopes \$5.50. Crowe, Boelus, Neb.

CUTS Made, art work. Free estimates. Webb, 2708 Ross, Dallas, Texas.

QUALITY Printing: business, personal stationery. State requirements. Samples. Mero Products, 100 Morrison, Punxsutawney, Penna.

500 3/4x2 1/4 FOUR Line gummed stickers 35c; red border 50c. Moritz Printery, Saginaw, Mich.

1000 BUSINESS Cards, \$2.50, prepaid. Samples free. Reliable Print Shop, 905 E. Jefferson, Louisville 6, Ky.

SEND 10c Now, for our 48 page 1948 price list—refunded first order. McCall Press, 1326 South 27th, Omaha, Nebraska.

BETTER Grade printing reasonable. Estimates on anything. Economic Press, Leonia, N. J.

QUALITY Printing—Reasonable prices. Fast service on catalogs, folders, publications. Write for prices. Bagby Printing Co., Georgetown, Ohio.

MIMEOGRAPHING—Letters, pricelists, formulas, instructions. Lowest prices. Lem's Letter Shop, 5710 Stanton, Detroit 8.

LEARN Direct advertising, letter shop business. Free booklet. Armstrong, 7219 Broadway, Los Angeles 3.

PRINTING OUTFITS AND SUPPLIES

BUILD Own workable printing press. Details free. Otanop, Box 114E, Akron 5, Ohio.

PRINTING Presses, type, supplies. Lists 3c. Turnbaugh Service, Loysville, Penna.

PRINTING Presses, type, supplies. Send dime for complete illustrated printer's supply book, details and press samples. Kelsey, Inc., A-11, Meriden, Connecticut.

INEXPENSIVE Home-made printing press. Details free. Novelty Shop, Downs-ville, Louisiana.

PATENT ATTORNEYS

INVENTORS—Patent Laws encourage the development of inventions. The Rules of Practice of the U. S. Patent Office advises; unless an inventor is familiar with such matters; that he employ a competent registered attorney or registered agent, as the value of patents depends largely upon the skillful preparation of the specifications and claims. Write for further particulars as to patent protection and procedure and "Invention Record" form at once. No obligation. McMorrow, Berman & Davidson, Registered Patent Attorneys, 134-C Victor Building, Washington 1, D. C.

PATENT Protection—The U. S. Patent Office recommends—"an applicant is advised, unless familiar with such matters, to employ a competent registered Patent Attorney or registered Patent Agent, as the value of patents depends largely upon the skillful preparation of the specification and claims." Preliminary steps to take to obtain patent protection will be sent upon request. Victor J. Evans & Co., 331-E Merlin Building, Washington 6, D. C.

REGISTERED Patent attorney offers services. H. Sanders, 6430 Evans, Chicago 37.

PATENTS—Trade marks. Irving L. McCathran, 315 McLachlen Bldg., Washington 1, D. C. Registered Patent Attorney.

INVENTORS: Learn how to protect your invention. The United States Patent Office advises the inventor, unless familiar with such matters, to engage a competent registered patent attorney or agent to represent him. We maintain a staff of registered patent attorneys ready to serve you in the handling of your patent matters. Special booklet "Patent Guide for the Inventor" containing detailed information concerning patent procedure with "Record of Invention" form will be forwarded upon request, without obligation. Clarence A. O'Brien & Harvey Jacobson, Registered Patent Attorneys, 81B-D District National Building, Washington, D. C.

C. A. SNOW & Co.—M-427, Snow Building, Washington 1, D. C. Registered Patent Attorneys. Write for information.

INVENTORS. For "Record of Invention" form, contact Carl Miller, Registered Patent Attorney, Woolworth Building, New York.

INVENTORS: Without obligation, write for information explaining the steps you should take to secure a patent. John N. Randolph, Registered Patent Attorney, 203 Columbian Bldg., Washington 1, D. C.

INVENTORS: When you are satisfied that you have invented something of value write me, without obligation, for information as to what steps you should take to secure patents or trademarks. Write Patrick D. Beavers (Formerly Randolph & Beavers) Registered Patent Atty., 935 Columbian Bldg., Washington 1, D. C.

PATENT Practice before U. S. Patent Office. Validity and infringement investigations and opinions. Booklet and form "Evidence of Conception" forwarded upon request. Lancaster, Allwine & Rommel, Registered Patent Attorneys, Suite 411, 815-15th Street, N.W., Washington 5, D. C.

"INVENTOR'S Guide" free on request. Frank Ledermann, Registered Patent Attorney, 154 Nassau St., New York 7, N. Y.

PATENTS. "Proof of Invention" folder mailed without obligation. E. E. Vrooman, Registered Patent Attorney, 871 Woodward Building, Washington 5, D. C.

INVENTORS: Write for free brochure "Evidence of Invention." Labiner, World Building, New York 7.

FOR INVENTORS

NEED Help in making detail drawings or calculating invention problems? Use our confidential, friendly and experienced engineering service. Details free. Machine Design Service, 416 Madison Avenue, Rahway, New Jersey.

INVENTORS—Patent Laws encourage the development of inventions. The Rules of Practice of the U. S. Patent Office advises—unless an inventor is familiar with such matters—that he employ a competent registered attorney or registered agent, as the value of patents depends largely upon the skillful preparation of the specifications and claims. Write for further particulars as to patent protection and procedure and "Invention Record" form at once. No obligation. McMorrow, Berman & Davidson, Registered Patent Attorneys, 134-B Victor Building, Washington 1, D. C.

INVENTORS! Have you good, patentable ideas? Write Patent Agent Metzler, 11 West 42nd, New York.

PATENT Protection—The U. S. Patent Office recommends—"an applicant is advised, unless familiar with such matters, to employ a competent registered Patent Attorney or registered Patent Agent, as the value of patents depends largely upon the skillful preparation of the specification and claims." Preliminary steps to take to obtain patent protection will be sent upon request. Victor J. Evans & Co., 332-E Merlin Building, Washington 6, D. C.

CASH For your idea, 280 manufacturers need inventions, patented or unpatented. List free. Invention Bureau, 208M Clinton, Oak Park, Illinois.

PATENT Searches; reliable, efficient, air-mail service; \$6.00. Write for free invention protection form. Patent Research Service, 703P Albee Bldg., Washington 5, D. C.

YOU Need us for quick profit. Complete assistance. Inventors and Manufacturers Creative Service, 312 Fay Bldg., Los Angeles 13, Calif.

INVENTORS—Let our graduate engineers solve your difficult technical problems. Write for details. Dayton Inventors Laboratory, 1941 Riverside Drive, Dayton 5, Ohio.

RELIABLE Patent and trade-mark searches made in U. S. Patent Office \$6.00. Invention protection forms with Certificate of Search free. Write Raymond L. Smith, Patent Searcher, 410-M Bond Building, Washington 5, D. C. (Formerly with U. S. Patent Office.)

INVENTORS: Learn how to protect your invention. The United States Patent Office advises the inventor, unless familiar with such matters, to engage a competent registered patent attorney or agent to represent him. We maintain a staff of registered patent attorneys ready to serve you in the handling of your patent matters. Special booklet "Patent Guide for the Inventor" containing detailed information concerning patent procedure with "Record of Invention" form will be forwarded upon request, without obligation. Clarence A. O'Brien & Harvey Jacobson, Registered Patent Attorneys, 81A-D District National Building, Washington, D. C.

FREE Pamphlet "P" will tell you how we have helped others develop their ideas into worthwhile patented inventions ready for market. Elo Development Co., 29-28 41st Ave., Long Island City, N. Y.

I SELL Patents. Established in 1900. Charles A. Scott, 773PM Garson Ave., Rochester, N. Y.

INVENTORS: Without obligation, write for information explaining the steps you should take to secure a patent on your invention. John N. Randolph, Registered Patent Attorney, 202 Columbian Bldg., Washington 1, D. C.

INVENTORS: The usual first step is to have a search of the U. S. Patents conducted, so I can report on patentability. Write, without obligation, Patrick D. Beavers (Formerly Randolph & Beavers), Registered Patent Atty., 936 Columbian Bldg., Washington 1, D. C.

INVENTORS: If you have an invention for sale, patented or unpatented, write Institute of American Inventors, Dept. 40A, 1926 Eye St. N.W., Washington 6, D. C.

"INVENTOR'S Guide" free on request. Frank Ledermann, Registered Patent Attorney, 154 Nassau St., New York 7, N. Y.

INVENTIONS WANTED

HAVE \$1,500 To invest in patent or patentable invention for household device or gadget. Prefer outright purchase of patent. Address Mr. Kelley, 2448 Cedar Street, Berkeley, California.

MANUFACTURERS Want patented or patent pending inventions! Send details. Universal Guaranty Company, Lakewood, New York.

FREE Service. U. S. Industrial Research Committee, 23 Nelson Ave., Staten Island 8, N. Y.

PATENTED And pending commercial items for manufacture and distribution. Charges from royalties only. Inventors-Manufacturers Associates, Dept. P.M., 5 Beekman Street, New York.

WE Are a young and growing manufacturing concern, having six plants in Grand Rapids, Michigan. If you have made application for a patent, or have a patented item, regardless of size, at present we will be glad to hear from you or talk to you regarding it. We sell nationally and internationally. If you would like to check us, refer to Dun & Bradstreet or Grand Rapids Chamber of Commerce. Remember, if you invent something you are entitled to your share, the same as we are entitled to our share for manufacturing it. Helms Industrial Development Co., 2145 Edgewood N.E., Grand Rapids, Michigan.

SELL Your invention! Patented or unpatented. Free information. Sales Research, Inc., Suite 1102, Chicago Building, State and Madison Streets, Chicago 2, Illinois.

CASH For your idea, 280 manufacturers need inventions, patented or unpatented. List free. Invention Bureau, 208M Clinton, Oak Park, Illinois.

INVENTIONS Wanted. Patented or pending only. Inventors' Exchange-B, Hartford 1, Conn.

MANUFACTURERS Want patented or patent pending inventions! Write, Universal Guaranty Company, Lakewood, New York.

INVENTORS: Hundreds of manufacturers have requested our assistance in locating marketable new products. Complete information, free. Institute of American Inventors, Dept. 40-D, 1926-Eye St. N.W., Washington 6, D. C.

SMALL Inventions wanted by manufacturers. I'll help you sell your invention. Write for circular. Stanley Hull, 7829 Euclid, Cleveland, Ohio.

PATENTED, Unpatented inventions wanted. We have tremendous lists of manufacturers who may pay cash royalties. Descriptive booklet free. National Invention Service, 1404-T Mitchell St., Oakland 1, Calif.

PATENTS FOR SALE

MY Screen door hook will not mar the door. Hook will not lock one out. Invention is screwed to door with two screws. Arthur Brophy, 137 Towne Terrace, Santa Cruz, Calif.

OSCILLATING Sprinkler, multiplies pressure in power. Ray Swank, Lewiston, Idaho.

PATENTED. Closure control for cat-sup bottles, metal stamping or plastic. Simple, sanitary, fast selling article. A. Olson, 4657 Magnolia Ave., Chicago, Ill.

INVENTORS: Test the commercial value of your patented or unpatented inventions, quickly and inexpensively. Write for free information. Institute of American Inventors, Dept. 40-B, 1926-Eye St. N.W., Washington 6, D. C.

MANUFACTURING

PATENT Models, experimental devices, designed, constructed. Nelson Manufacturing, Woodburn, Oregon.

PRECISION Casting of small parts in non-ferrous metals (not sand casting). Send sample or drawing for estimate. Circular on request. Southwestern, Box 1399, El Paso, Texas.

DEPENDABLE Source, tools, dies, manufacture, engineering, designing. Porsberg, Northfield, Ohio.

EXPERIMENTAL Work, models, small lot manufacturing. Halfer Eng. Co., 5238 W. Chicago Ave., Chicago, Ill.

SMALL Lot production wanted. Aluminum castings; stampings; screw machine; plastics. J and M Company, Burlington, Kentucky.

MODELS—Small lot manufacturing. Metals, plastics, etc. Milburn, Burlington, Kentucky.

MODELS, MODEL SUPPLIES

PLASTIC Model buildings. Three kits \$1. Johnson, 366 Freeman, Long Beach 14, Calif.

ATTENTION! Hobby supplies of all kinds. Planes, motors, racers, ships. Drake Hobby Supply, 4937 North Monticello, Chicago 25, Illinois, Dept. 51.

BASSWOOD Sheets, select, satin smooth, $\frac{1}{8}$ "x $3\frac{1}{4}$ "x18" works easily, lightweight, rugged, uniform. Send \$1.00 dozen sheets; 6 dozen \$5.00. Whittiers-craft, Box 981-B, Providence, R. I.

LIONEL Train sets, accessories available. Lists furnished. Roundhouse, Box 273A, Newark, N. J.

STEAM Boiler—for model engines. Uses "Sterno." Withstands 300 lb. pressure. Cast bronze, silver soldered. Complete with pressure gauge and fittings \$22.50. Miniature steam engine. Working model. Brass and iron. Bore $\frac{9}{16}$ "; stroke $\frac{11}{16}$ "; weight 2 lb. Assembled \$17.50. Ross, 68 West Broadway, Section N, New York, N. Y.

SHIP And yacht model fittings; blueprints. Send 25c for illustrated catalog No. 21—listing hundreds of items. A. J. Fisher, 1002-1 Etowah Ave., Royal Oak, Mich.

MODEL Railroads exclusively—Complete stock scale; Lionel, American Flyer. Send for catalog, 15c. state gauge. Eric Fuchs, 26 Tremont Street, Boston 8, Mass.

RADIO Control planes. Complete. Less than \$100.00. 10c please. Hobby Center, 12240 Gratiot, Detroit.

STEAM Engines, fast twins, $\frac{3}{4}$ " by $\frac{3}{4}$ ", 11,000 r.p.m. at 50 lb. Drawings, instructions \$2.00. Any size designed. Gleason, 2119 Kinney Ave., N.W., Grand Rapids 4, Michigan.

ONE Request brings list of Lionel or American Flyer available equipment monthly. 25c brings scale catalog with refund coupon. Tri-Lor's, State Road, North Dartmouth, Mass.

FREE! Big train folder, packed with new Lionel cars, sets and accessories. Madison Hardware Co., 103 East 23rd, New York 10.

MINIATURE Steam locomotives, $\frac{1}{4}$ ", $\frac{1}{8}$ ", $\frac{3}{4}$ " scales. Castings, parts, rail, steam fittings! Thorough drawings with instructions. Catalog 25c. Little Engines, Wilmington, Cal.

RAILWAY Models, complete informative catalog HO and O gauge. 132 pages. 50c. Walther's, 247 Erie, Milwaukee, Wisconsin.

BRASS Gears and model supplies for the inventors. Send 10c for catalog. Pierce Model Works, Tinley Park, Ill.

POWER Models—Steam and gasoline engines, steam traction engine, metals, tools. Catalog 35c. Chas. Cole, Ventura, Calif.

LANDLOCKED Sailors! Here's a beautiful, richly illustrated, fully descriptive catalogue of famous model ships—whalers, slavers, corvettes, etc., authentic in every detail. Send for it today. Only 25c. Halesite Yacht Service, Inc., Halesite, Huntington, N. Y.

FUN Building models—Airplanes, trains, ships. Everything furnished. Giant catalog 10c. Ben's Hobby Shop, 72 West Washington, Chicago 2, Illinois.

SHIP Models and yacht supplies complete. Large 64 page catalogue 30c. Bill Wild's, 510 East 11 St., New York City 9.

HOME CRAFTSMEN

CATALOG: Fullsize patterns plywood novelty furniture, lawn ornaments, weathervanes, letters, numerals, silhouettes, plaques, frames, toys, 150 craft-hobby books-booklets, decals, tools, picture frame mouldings, etc. Hundreds illustrations, 25c; refunded first order. (No stamps please.) Wo-Met Shop, Ashburn, Georgia.

OREGON Myrtlewood turning squares for sale. M. Weaver, 3923 SE Tibbetts, Portland 2, Oregon.

EVERYTHING For the shellcrafter. Wholesale only. Beachcomber Novelty Company, Box 551, Fort Myers, Florida.

FLOCK (Rayon) lb. \$2.75. Smaller amounts 25c oz. State color. Kalamazoo Mail Order, 705 Barney Road, Kalamazoo 84, Michigan.

VELVET Flock—Newest finish. 10-color sampler with instructions, patterns. \$1.00. Sparks, 1145 Queen Ann, Los Angeles 6.

PATTERNS—45 Pictures of new jigsaw projects. Illustrated folder 10c. Joannes Patterns, P.O. Box 141, Omaha 7, Nebr.

ARTIFICIAL Flower, novelty, making. Wonderful home business pays excellent profits. Literature free. Velva Artcrafts, 324-M East 14, New York 3, N. Y.

SHELLCRAFT—Create attractive jewelry from shells. Instruction book free or send \$1 for 450 Carribean shells and findings to make \$6 worth. Shell Company, Miami 36, Florida.

CRAFT Woods: Myrtle, Western Juniper, Redwood; lumber and squares; prices and particulars on request. Oregon Craft Woods Company, Grants Pass, Ore.

LAWN Chairs, toys, novelties, garden figures, furniture, etc. 62 popular plans for \$1.00. Mastercraft 5M, 7041 Olcott, Chicago 31, Illinois.

CASE-HARDENING Powder; easy to use and safe. Sample with instructions for \$1.00. Satisfaction guaranteed. P. Howell, Brook, Indiana.

KNOCKDOWN Cedar chests. Lumber and veneers. Free price list. Giles & Kendall Company, Huntsville, Ala.

CELLULOID—New postwar, beautiful assortment. Mottles, opaques, onyx, pearls. Used by ring makers everywhere. One pound assortment—pieces approximately 30 sq. in. each. Price \$1.00. Please add 10c for postage. Craft Service, 337 University Avenue, Rochester 7, N. Y.

MAKE Amazing hands-free bookholder. Many locked adjustments assure good line of vision sitting or lying. Page turning two-finger operation. Restful reading always. Home workshop models performing excellent service. Drawings, instructions \$1.00. Attick, 2217 E. 68, Chicago 49.

LEATHERCRAFTERS—Just out! 1948 edition—The Leatherworkers' bible! Completely illustrated catalogue and textbook. Instructions, descriptions, and actual leather samples. Guaranteed to exceed any expectation or your money refunded. \$1.00 postpaid. Artcraft Leather, 271 12th St., Dept. PM-5, Oakland 7, California.

METALCRAFT Ancient chariot 5x2x2 \$1.75. Kit \$1.00. Toy mould \$1.00. Catalog 10c. Dandridge, 1557 Essex St., Rahway, N. J.

PRECIOUS, Semiprecious stones, plastic-metal findings, list 10c refundable with first order. Pickwick Findings, Box 780-H, Stamford, Conn.

AMAZING New crafts—Also weaving, kites, leathercraft, metalcraft, intarsia. Free catalogue. Pickwick, 725 West 172nd, New York 32.

GOLD Strike! For hobby jewelry makers. Findings from tables of large manufacturers. Make two dozen bracelets, pins, earrings, necklets, 2 lb. sample box, \$3.00 (prepaid only). Allied Arts, 2871-A Lincoln Ave., Chicago 13.

OUTDOOR Furniture. Lawn chairs, benches, tables with wheels. 7 different plans \$1.50, 15-\$3.00. Summcraft Studio, 42 Vernon St., Dept. KN, Newton 58, Mass.

48 DRILLS, $\frac{3}{32}$ " Shaft, assorted sizes and shapes, will cut metal, wood, carve plastic, \$2.25. Twelve mounted stones \$2.25 postpaid. Drills, cutters, diamond stones, accessories. Schrader Instrument Company, Independence, Iowa.

WOOD Novelty sign manufacturing course. Alphabets, panels, designs. Winkler, 2822 Harney, Omaha, Nebraska.

CRAFTSMEN'S Deals—Exotic veneers, turning squares, blocks. Cabinet lumber, plywood, hardware. Sedjo Company, P. O. Box 7161, New Orleans, La.

RHINESTONES, Moonstones, pearls, earrings. Free literature. Herber, 1360-A Hicks, New York 67.

LEATHERCRAFT: Free! Two billfold designs with latest illustrated price list. Enclose 10c for handling charges. Leather Specialties Shop, Dept. M, 358 East Broadway, Long Beach 2, California.

LEATHERCRAFTERS! 10 Different lacing methods 10c. Buckley, 2539 Devon, Chicago 45.

LEATHERCRAFT! Complete stocks of leathers, tools, supplies. Immediate shipment. Free catalog. Kit Kraft, 3203 W. Washington Blvd., Los Angeles 16, California.

COPPER And brass materials. Complete line for craftsmen and workshops. Catalog A free. Groundmaster Company, Boulder, Colorado.

METAL Craft! Brass, copper, instruction books, supplies. Immediate shipment. Free catalog. Kit Kraft, 3203 W. Washington Blvd., Los Angeles 16, California.

BUILD Fully-rigged ship in bottle. Big money full or spare time. Fascinating hobby. Blue prints and instructions \$1.00. Mariner, Box 2095, Wichita, Kansas.

SHELL Jewelry. Findings, Hobby Lobby, Box 486, Sta. A, St. Petersburg, Fla.

LEATHERCRAFTERS! Belt kits, projects, leather, supplies. Free catalog. Art Leather, 411 Joseph Ave., Rochester 5, N. Y.

SOUTHERN Woods: Texas ebony, mesquite, Brazil, catsclaw, Guayacan, Huisache, many others. Working supply, \$1.00 each prepaid; sample, dime each; details, stamp. StarCraft 1, Edinburg, Texas.

LEATHERCRAFT—Tools, dies. Made to order. Belt tapers, billfolds, key cases. Louis Jones, 1405 Throckmorton, Ft. Worth, Texas.

\$46.00 FROM Square foot plywood. Jigsaw necessary. Write. Woodarts, H-38, Bridgewater, Mass.

SPECIAL 77 Full sized patterns. Lawn ornaments, toys and novelties \$1.00. Modern Woodcraft, Saginaw, Michigan.

SHELLS, Plastics, findings, Beginner's kit \$3.00. Free catalog. Stelle's, 230 Randall Avenue, Trenton 10, New Jersey.

35 PATTERNS Toy furniture, action toys, etc. \$1.00. Continental Homecrafters, 907 Birch, Eau Claire 3, Wisconsin.

LEATHER, Retail, mail orders, catalog, tools, lacing, supplies. National Handicraft Co., 30 Frankfort St., New York City 7.

CERAMIC Jewelry supplies, bar pins, ear screws, for ceramic and woodworkers; also glass and seashell assemblers. Free catalog. Philadelphia Badge Co., Dept. B-1, 1007 Filbert St., Philadelphia, Penna.

SHELLS, Plastics, findings. Lowest prices. Free catalog. Frances Jones, Box 251, Sarasota, Fla.

MAKE IT YOURSELF

BUILD Powerful toy tractor. Buy nothing. Instructions 25c. Hobbycraft, Rt. 3, Box 798, Renton, Washington.

AIR Conditioners or attic fans, build your own. Plans free. Mills, 108 North Commerce, Fort Worth 2, Texas.

BUILD Electric water heater from present range boiler. Element, thermostat complete \$9.50. Inemco, Allegan, Mich.

HANDY Clothes line reel. Dollar brings pattern and instructions. K. Spade Products, Box #70A, Mendon, Michigan.

ZEOLITE Water softener. Original plans for building your own, \$1. Materials available from us. Lake Region, Box 2732-T, Minneapolis 7, Minnesota.

OUTDOOR Grilles, fireplaces. Necessary finished castings and parts to make barbecues. Bulletin upon request. Smith Matthews Foundry, 6636 Charlevoix Ave., Detroit 7, Mich.

PLAYHOUSES And doghouses, scientifically designed. Plans and material list for 4 sizes of either. \$1.00 postpaid. Miller & Wutkee, 254-C Conant Hotel, Omaha, Nebr.

CONCRETE Block molds, 8x16x4 \$6.70, others, literature free. Lehnert, Norwood, N. J.

BUILD Better tilting table circular saw. Details 10c, refundable. Ward Manufacturing Co., Walsenburg, Colo.

BOYS—Be first with super New-Spin mechanical starter for gas model engines. No winding, no batteries, continuous action. Plan \$1.00. New-Spin, Box 836, Cleveland 22, Ohio.

BUILD Cuban sugar cane cart. Size $18\frac{1}{2}$ " x $8\frac{1}{2}$ ". Complete instructions and working chart. Retail value when finished \$6.95. Ornamental, useful. Send only 25c name and address to Starr Productions, Dept. 45, 4117 N. Monitor, Chicago 34, Ill.

"MOST Everybody likes candy." Learn to make delicious confections the Ragsdale Way. (Our 38th year.) Ragsdale Candies, D-107, East Orange, N. J.

MAKE Your own rotary lawnmower, plans \$1.00. Catalogue free. Engineering & Drafting Service, 1201 Annapolis Drive, Corpus Christi, Texas.

"RADIANT Heat for small homes" increases comfort, child safety, beauty, cleanliness. Complete instructions \$2. Elspec, 12434 Culver, Venice, Calif.

ATTENTION. Your lingerie, hosiery, finest silks, curtains, drapes, your best woollens, all can be washed in your own machine without harm to cloth or fiber contents, in half time now required. No dry cleaning. Complete plans \$1.00. Write Gustav Lavrenz, 113 Main St., Campbellsville, Wis.

MAKE Plastic wallets. Everything furnished. Details free. Lakeshore Supply, 534 Surf St., Chicago 14, Ill.

"CONCRETE Block homes." 32 page booklet: drawings, instructions on how to build. \$1.00. H. C. Lightfoot, Civil Engineer, Richboro 1, Penna.

MAKE Your own 14 pound modulate concrete blocks. Build for less. How booklet 25c. Peerless, New Lenox, Ill.

WATCHES, OLD GOLD, JEWELRY

EXPERT Watch repairing: Rapid service, guaranteed work, reasonable prices. Each watch received insured to \$100. Genuine factory parts for American or Swiss movements, stop watches, chronographs. Send insured mail for prompt estimate. No obligation. Jewelry repaired also. Agents wanted. Bonded Watch Repair Company, Dept. 20, 219 W. Chicago Avenue, Chicago 10, Illinois.

WATCHES Wholesale. Rebuilt Elgins, Walthams, Bulovas, etc., \$9.75 up; new and used diamond, railroad, 21J wrist; catalogue free. Brookins, B-1975C, Little Rock, Ark.

CASH For old, broken jewelry. Highest prices paid immediately. Mail gold teeth, watches, rings, silverware, diamonds, spectacles. Satisfaction guaranteed. Information free. Rose Smelting Co., 29-A East Madison, Chicago.

RHINESTONES, Pearls, jewelry, findings; most complete line. Instructive list 10c. Kits \$1. Doremby Co., Chisholm, Maine.

EXPERT Guaranteed watch cleaning, overhauling, crystals, mainsprings, \$1.50 and up. Box 6535, Philadelphia, Penna.

WATCHMAKERS' Journal contains valuable information for watchmakers. Send 15c for new April issue. Dean Co., 116 Nassau St., New York 7, N. Y.

JOBGING Stones for rings, earrings, costume jewelry, etc., assorted sizes and colors. \$3.00 per 100. Morrison's Jewelry, Flanagan, Ill.

JEWELRY Findings, lowest prices. George Sassen, 154 Nassau Street, New York 7.

GEMS, Precious and semi-precious, all genuine, from world wide sources. Deal direct, no overhead, save money. Catalog 10c. Hill Co., Route 7, Salem, Oregon.

TOBACCO, SMOKERS' SUPPLIES

CIGARS, 100 Full size \$4.79. S. & E. Co., Fed Lion, Penna.

REJECTS \$5.00 Pipes 65c. Briar blocks, bits. Literature free. Carvapipe, 2829-H Dixie, Hamilton, Ohio.

FOR THE HOME

KWIK-KLIP Hair trimmer, \$1 post-paid. Smith, 149 W. 75th St., New York City.

FLOORS—Asphalt tile 9" x 9" blocks 10c. Beautiful colors easily installed yourself. Star, Franklin Ave., Aliquippa, Penna.

ELIMINATE Storm windows, frost, steam. Install insulating glass yourself. Proven plan \$1.00. Blue Square, Excelsior, Minnesota.

SCALES—Household (25 lb.) \$6.95. Baby weighing scales, \$9.95. Ideal for gifts. Immediate delivery. Cameo, 432 West 42d St., New York.

FOR SALE — MISCELLANEOUS

SURPLUS New electric hand drills 1/4" capacity, (a.c.-d.c.), 110 volts, 60 cycles. Year guarantee. Special \$14.95. Leonard, 1300 Douglas, Los Angeles 26.

BIG Money making the new plastic balloon material. Complete formula and source of ingredients. \$2.00. Concrete Machinery Co., Hickory, N. C.

HULL Automobile compass, value \$4.95, brand new, \$2.50. Prisms for 6x30 or 8x30 binoculars, brand new, \$1.50 each. Offset prisms to be attached to 7x50 B. & L. Binoculars, gives double the field of the ordinary 7x50 binocular. Cost \$98.00, special \$25.00. Green sunshades for binoculars, size 6x30 and 7x50, snap on type, value \$7.50, special \$1.25 per pair. Forward money order. No c.o.d. shipments. Send coin \$1.50 for Third Annual Edition of Gun Digest together with our complete catalog of new and used guns, ammunition, rifles, binoculars and powder flasks. Our separate catalog 25c. Public Sport Shops, 11 S. 16th Street, Philadelphia, Penna.

STEEL Pipe. Immediate delivery. Herman Sales Company, 1428 North Washington, Minneapolis, Minnesota.

BORDEN Dust collector, motor \$75.00. B & S #2 turret taper box tool 3" length \$75.00. Battery commanders binocular telescope 10 power, 4 filters, tripods, all adjustments \$200.00. Ajax, Fairview, Erie County, Penna.

ARMY Tents, covers, clothing, hammocks, paints. Jarashow, 10-15G 50th Avenue, Long Island City 1, N. Y.

KNIVES—Automatic, pen, pocket, hunting, fishing. Large selection, lowest prices. Free catalogue. Knifemaster, 1441 Prospect Place, Brooklyn, N. Y.

WANTED—MISCELLANEOUS

QUICKSILVER (Mercury) urgently needed! Immediate payment. Wholesale Terminal, Norwood, Massachusetts.

PERSONAL

LIVE Longer, feel better. Free information. Fairchild Company, Mt. Vernon, Ohio.

ENGLISH Holiday. Three postcards of London for reposting by usual system and novel suggestion, \$1 bill. Cater, 38 Bertha Road, Birmingham 11, England.

CALIFORNIA On your mind? 1948-49 Almanac State Fact Book, Illustrated, 570 pages, \$2.00. Bartel, 647 Maltman, Hollywood 26, Calif.

"BIG Mails," moneymaking offers, magazines, samples, catalogs. Listing 10c. Bentz, Jr., Chatava 9, Mississippi.

GLOBAL Viewcard supply; worldwide letter remailing service. Free particulars. Travelpost, Box 1436, Brawley, California.

WHAT Does your last name mean? Complete report on origin and meaning, 25c coin. (Print name plainly.) Surname Research Bureau, 104-A North Pear Street, Olympia, Wash.

SWAP Ties! Mail me six ties and \$1.00. I'll return six different ties cleaned. Wiltshire, 1586 Buena Vista, Detroit 6, Michigan.

BORROW By mail. Loans \$50.00 to \$300.00 to employed men and women. Easy, quick. Completely private, confidential. No endorsers. Repay in convenient monthly payments. Details free in plain envelope. Write State Finance Co., 320 Securities Bldg., Dept. E-14, Des Moines 9, Iowa.

THE Best shave you have ever had. Free sample blade. Specialty Suppliers, 434 East High Street, Lexington 35, Kentucky.

TIE Exchange service. Send six neckties. Receive six different ties, beautifully cleaned, c.o.d. 8101 Roanoke St., Philadelphia 18, Penna.

BEAUTIFULLY Engraved—Your name, initials, on polished plastic name plates, purse pulls, buttons, etc. Full information free. Agents inquiries acknowledged. 'K' of Hollywood, 1315 Colorado, Los Angeles 41.

CANADIAN Address. Mail received, forwarded. Three postcards 50c, remailed free. Box 104, Niagara Falls, Canada.

MEXICAN Mailing address. Letters received, forwarded 25c. Photographic postcards 15c. Remailed free. Remit stamps. Tillotson, Apartado 1405, Guadalajara, Jalisco, Mexico.

NECKTIES Swapped! Mail us 2-to-6 usable ties you're tired of—receive equal number freshly-cleaned, different ties. Pay postman \$1. Ty-Trade, Box 489, Lake George, New York.

CREATIVE Psychology can change your world as you would wish to have it. New, different—gets results. Thrilling details free. Beacom, Box 177, New Brighton, Penna.

HOW To get a job by mail. You'll welcome valuable help offered. Model letters for any job \$1. Sell out list of other books free. Lefferts, Box 121, Brooklyn 25, N. Y.

TRADE Six ties you don't like for six that are different. Specify color. \$1.00 c.o.d. Tie Exchange, 38 Cherokee Station, Louisville, Ky.

"BROOKLYN" Remail service. Mystify your friends. 3 postcards 25c. You address, return. I remail free. Letters forwarded 25c. Box 8, Station P, Brooklyn 12, N. Y.

HOW You can find out! Information discreetly developed, any matter, person, problem, anywhere. Personal-business assignments, representations, undertaken. Nation-wide. Officially licensed, bonded service established 1923. Reasonable. Confidential. William Herman, 170 Broadway, New York.

MEXICAN Law. General practice attorney, 1203 Arizona Street, El Paso, Texas.

SWAP! Trade! Anything, everything. Free information. "Swappers' Gazette-PM" Louisville 12, Kentucky.

HAIR Falling? Dandruff? Write Trichologist, 137 Lewis St., Phillipsburg, N. J.

LOSING Hair? Have dandruff? Write for free, confidential booklet on care of scalp and hair. Eugene Burt, 1926 State Blvd., Kansas City, Kansas.

RUPTURED? Positive comfort, no understraps, no steel, no elastic. Write Smith Manufacturing Company, Preston, Ontario.

MISCELLANEOUS

INDIAN And Eskimo moccasins, dolls, baskets. Northwest Indian Novelities, 2136 N.W. Gilsan, Portland 10, Oregon.

PANNING Gold—Two instruction books 25c. Old Prospector, B-111, Dutch Flat, Calif.

CALIFORNIA Redwood novelties. Your initial on "tree key chain" 40c. Big novelty list free. Gifford's, 1230 William, San Jose 12, California.

BED Size electric warmer insures sound comfortable sleep year around. A boon to sick folks and many other uses. Nationally advertised \$25.00, limited number available at amazing low price of \$12.95, complete with automatic controls. Gessick, Box 528, 710 Lake Shore, Chicago 11, Ill.

ABACUS. Add with the abacus, world's oldest calculator. Now improved. Adds, subtracts, multiplies, divides lightning fast. Illustrated instructions show how. Send for free lesson and details. Loy's Chinese Calculator, Dept. 84M, 1317 R.I. Ave. N.E., Washington 18, D. C.

MEXICAN Jumping beans, July crop. Dozen 25c, hundred \$1.00. Also wholesale. Mexican Products Co., 126 No. Main, Tulsa 3, Oklahoma.

"RECEIVE Mail." Moneymaking offers, opportunities, catalogs. Name listed 10c. Ideal Service, 100, Park Ridge, Ill.

AGED Wisconsin cheeses. Moderately priced. Write for literature. Peter Lang Co., Box 62-B, Wausau, Wis.

PHOSPHORESCENT Paint. Glows for hours in total darkness. Lasts indefinitely. Recommended for pictures, fish-baits, switches, dark-rooms, etc. Bottle phosphorescent. Bottle clear lacquer. Both for \$1.20. Postpaid anywhere. Send cash or money order. Black Light Specialties, 4829 Woodward Ave., Detroit 1, Michigan.

KNOW Keys by color and name. Keys turn inside brass holder, having colored plastic label covers and swivel carrying ring. Two holders different colors, complete \$1.00. "Unoke," 230 C Street, South San Francisco, California.

TEPEE Novelty Shop, Ipswich, So. Dak., Box 236D. Has beautiful Indian teepee lamp shades, in bright colors, designs. Sparkling glossy finish. Details free.

PENCILS Imprinted with your name, 20 for \$1.00. Andrews, 275 Bittersweet, Berea, Ohio.

MOST Amazing souvenir ever sold! Good-Luck non-breakable transparent key-chain disc. Contains the soil of every state in the Union! Guaranteed authentic. Copy-righted, 50 cents. The Plesko Company, Station B, Superior, Wisconsin.

NATIONALLY Advertised cameras, cosmetics, jewelry, etc. Send for free catalogue. Dale Leland Co., 143 Federal, Dept. P5, Boston, Mass.

TIRED Of your ties? Exchange them now for freshly cleaned and pressed ones. Send one to six ties; pay postman only \$1.00 when he brings you the same number of different ties. Larry's Tie Exchange, 3126 Eastwood, Chicago 25, Ill.

SOAPMAKING. Instructions. Formula. No machinery needed. \$1.00 anywhere. C. Brown, 9111 Hoyne, Chicago 20.

WATCHES—"How to take care of them." Send 10c for booklet. Thousands of satisfied customers. Poynter's, 310 Thirteenth Street, Richmond, Calif.

BIG Mails 10c. Year 50c. Name listed directory 25c. Harvey Teeple, Decatur, Indiana.

LET'S Swap ties. Send us one to six ties you're tired of, and \$1. We'll return same number beautifully cleaned different ties. Or we'll send c.o.d. Tieshop, Box 499-6, Denison, Texas.

MEN-Women—"Most Everybody Likes Candy." Learn to make delicious confections the Ragsdale Way. (Our 38th Year.) Ragsdale Candies, D4, East Orange, N.J.

ELECTRIC Purse! Lights up automatically, guaranteed forever. Write, samples-plans, Robert Smith, Mount Pleasant 3, N. C.

BEAUTIFUL Hand carved and tooled western belts. Mens, womens. \$8.00. State size wanted. George Brady, R-1, Medina, Ohio.

LIKE Good coffee. New flavor insurance method. Details free. Hdwe. Distrs., 1519 Como, Minneapolis.

APPLIANCE And building repairs. Own your own business. Free particulars. C. A. Griffith, 132 Water St., Fredonia, N. Y.

RECEIVE Free samples, magazines, money-making opportunities! Malls galore! Two-year "surefire" Directory listing \$1.00, 9-month 50c, 3 month 25c. Stanford, 6220-M 16th, Philadelphia 41, Penna.

MYSTERY Ostrich drinks from glass. No spring, etc. Amazes everybody. Sent postpaid \$1.50. No c.o.d. Ray Beers, 78 Grassy Plain, Bethel, Conn.

IS Your home safe? Amazing facts will surprise you. Write Retals Trades, Lock Box 101, Atlantic City, N. J.

MAKE Your own printing cuts. Newly invented plexiplat process. Plexiservice, Argyle 1, Wis.

MAKE Your will. You owe it to your family. A legal will insures your estate will go to the ones you love most after your death. Blank legal will document with instructions for making out your own legal will. \$1.00 postpaid. Saves many court costs. Legal Document Service, R-407 S. A. & K. Bldg., Syracuse, N. Y.

MEN! Large size shoes, large size socks! We specialize large sizes 10 to 16, widths AA-EEE. Oxfords, hitops, work shoes. Guaranteed extra quality. Free catalog. Kingsize, 469, Brockton, Mass.

WANTED 1000 Foot sufferers to test Kindschi Foot Balancers at our risk. Rush name for free trial offer. Kindschi Foot Appliances, Dept. A6, 321 W. Jefferson, Dallas 8, Texas.

BERMUDA Grass destroyed by nature, no digging, no chemicals. New method clears garden of this pest. Guaranteed instructions one dollar. The Plan Service, Box 451, Douglas, Arizona.

QUALITY Highly buffed, solid stainless steel knives, forks and spoons. Rust-proof, tarnishproof. No polishing necessary. Send postcard for free folder. Kolk Mfg. Co., 363-A Old Falls Blvd., North Tonawanda, N. Y.

TREASURE Finders! Goldak's new 11 pound lightweight, gold, silver and mineral locator, money-back guaranteed superior any other device. Free information. The Goldak Co., 1542 West Glenoaks Blvd., Glendale 1, Calif.

BOOKFINDERS! (Scarce, out-of-print, unusual books) Quickly supplied. Send wants, Clifton Company, Box 1377 pmm, Beverly Hills, Calif.

M-SCOPE Metal, mineral locators sensational new electronic lightweight models, immediate shipment. Fisher Research Laboratory, Inc., manufactures some of the finest metal locators for the U. S. Army. Built for Arctic, Tropic use. Unsurpassed efficiency, low prices. Time-payment plan available. Send for free 16-page illustrated booklet, Fisher Research Laboratory, Inc., Palo Alto, Calif.

BE The Popular Mechanics representative in your neighborhood and earn big profits in your spare time. Write Popular Mechanics Magazine, Room 408M, 200 E. Ontario St., Chicago, Ill.

TATTOOING Outfits, supplies. Illustrated list free. Zeis, 728 Lesley, Rockford, Illinois.

70 BIBLE Lessons, 25c. Bulletin, Box 87, Cathedral Station, New York 25.

FREE Recipes for peoples and animals. Stamp for information. Barr's Service, Drawer B, Shamokin, Penna.

LUMINOUS Paper coated with Glo-Brite; glows in the dark! 9 sheets totaling over 300 square inches in assortment of flashing colors with commercial and decorative uses, postpaid \$1.00. Scientific Research, 1842-PM Byron, Chicago 13, Ill.

FREE—"Amazing New Book"—"Profits From Classified Advertising." Tells how and what to advertise. Be sure to read this book before you invest one cent in advertising. Remember—it's free! Write for your copy now. F. W. Johnson, Classified Advertising Manager, 200 East Ontario Street, Chicago 11, Illinois.

MONEY MAKING OPPORTUNITIES



Crammed full of original promotional ideas PLUS exclusive supply sources, Personal Guidance Bureau and many related benefits to start you off in a profitable mail order business.

"ADVANCE" — Voice of Mail Order is the official magazine and the Leader in the field.

One Year Subscription—\$2.00. Monthly Copy—25c

ADVANCE PUBLISHING CO.

303 Fourth Ave., Suite 411, New York 10, N. Y.

Keep Well-Informed of Latest Tips on Mail Order Selling

send **25¢** for **"ADVANCE"** Voice of Mail Order

Issued Monthly (Yearly Sub. \$2.00)

Other Books: "315 Opportunities To Make Money"—\$1.00; "Advertising Tips on Selling by Mail"—\$1.00

FLOYD CLYMER'S unbiased book

"INDEPENDENT TEST REPORT ON KAISER-FRAZER CARS"

Read what 3000 owners now think of their K-F cars. Expert, part-by-part analysis. 100 photos. Tells all. 3000-mile test run, Pike's Peak closed car record, gas mileage. Thousands are buying. Order now. \$1.50 postpaid. \$2.50 deluxe ed. Cash, money-order, or specify C. O. D. Money-back guarantee. Clymer, Publisher, Dept. PM5 2125 W. Pico, Los Angeles 6, Calif.



U.S. NEW SURPLUS CLOTHING BARGAINS

- T. SHIRTS**, white, all sizes 3 for \$2
 - SHORTS**, white knitted cotton, size 34 to 40... 3 pr. \$1.25
 - RAINCOATS**, U. S. Army, brand new, all sizes... \$4.19
 - BOOT SOX**, 75% heavy knit wool, size 10-11... 3 pr. \$2
 - SUN GLASSES**, ground, polished lenses, excellent frame, leather case, \$1.19; **GOGGLES**, polaroid, extra lenses 89c.
 - FIELD JACKETS**, olive green, water repellent poplin, wool lined, zipper front, sz. 34 to 38... \$5.95
 - OVERALLS**, heavy whipcord, wool lined, zipper front, all szs... \$4.29
 - SWEATERS**, pullover type, 4 button front, long sleeves, O.D. medium weight, all wool, all szs... \$3.29
- Money back guarantee, \$1. Deposit or we pay postage on cash orders.

NEW YORK CLOTHING CO., 2079A Second Ave., N. Y. 29, N. Y.

OLD GOLD JEWELRY WANTED

Dental gold teeth, plates and bridges with metal attached. Any broken pieces of gold jewelry. Immediate payment and free mailing container to you or your friends upon request. **LOWES, DEPT PM** Holland Bldg., St. Louis 1, Mo.

LEARN EXPORT

Buy and sell world-wide without capital. Travel abroad if desired. Export men and women in demand. Your own business — profits unlimited. Salaried jobs — up to more than \$10,000 a year. Practical, low cost **WORLD TRADE COURSE** teaches you quickly at home in spare time. No previous special experience or schooling needed. World Trade Certificate awarded. Write today for **FREE DETAILS**. No obligation. Please state age. Air-mail reaches us overnight. **THE MELLINGER CO., Exporters-Importers, 1422-R Westwood, Los Angeles 24, Calif.**



GREAT PROFITS

MAKE YOUR OWN RUBBER MOLDS

X.L. RUBBER MOLDS

will realize your great profits quickly!

THE OPPORTUNITY OF A LIFETIME.

YOU can EASILY learn to cast thousands of perfect plaques, book ends, figurines, ash trays, etc. IT'S EASY, FUN, PROFITABLE!

X.L. Rubber, Pts. \$2.00; Qts. \$3.50; Gallons \$8.95; Models and enough rubber for 3 molds \$1.00—Foreign \$1.50.

PLASTIC ARTS STUDIO • Route 2 • Dept. 2 • Muncie, Ind.

SEND FOR FREE FACTS

SAY YOU SAW IT IN POPULAR MECHANICS

DO ANY JOB EASIER MAKE MORE MONEY

Used by Army, Navy, Other Government
Depts., 200 Schools and Industrial Firms.

Mail Coupon

FREE TRIAL in Your Home.
Send No Money!
We Ship C.O.D. in U. S.
and Will Refund Money
if Not Satisfied.



Get Ready for BIGGER OPPORTUNITIES and BEST PAYING JOBS

Do it now! Get the better pay that goes to men with specialized knowledge. Get into one of these big opportunity fields. Big money and many other advantages await you if you prepare now. Here is the help you need—EASY—QUICK—AT LOW COST. Thousands of men have already used these famous books. Beginners and experienced men alike have doubled and tripled their earnings with this help. You too, can now get the special knowledge you need for top pay, better jobs, or a business of your own. This is your GOLDEN OPPORTUNITY.

AIR CONDITIONING

Big air conditioning boom interrupted by war now bigger than ever and alive with new opportunities! Get this non-technical book by international authority and be ready for your share of millions to be spent. Covers whole field. 450 pages. Illustrated. \$4.00.

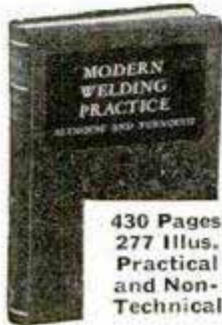

MODERN WELDING PRACTICE

Newest book on all types of welding and heat treatment of metals. Written by recognized specialists in training men for production jobs. Practical and Non-Technical.

430 Pages
277 Illus.
Practical and Non-Technical

Covers everything you need to know. Prepare for best pay jobs now. Price \$4.00.

SHEET METAL LAYOUT

Makes sheet metal layout work so simple that anyone can learn. Get this new instructor and get into the easiest, cleanest and best paying part of all sheet metal work. 143 jobs worked out in drawings and carefully explained. Gives standard for all sheet metal fittings. \$3.50.



AUTO BODY and FENDER REPAIR

Opens the Door to One of the Big Opportunity Fields of the Day

THE LOW COST, EASY WAY TO A GOOD PROFITABLE BUSINESS OF YOUR OWN

Owners will spend big money to keep their good older cars looking like the new ones coming out. This is a practical money-making guide, ideal for shop owners and every man who wants a share of the millions to be spent in keeping old cars looking new. Tells how to get a good job or start business of your own with small capital. Covers everything including tools, methods and materials. Only book of its kind. 325 pages. 232 illustrations. \$3.50.

HOUSE WIRING LATEST EDITION

Get this sixth edition of this standard and practical electrical wiring book. It gives complete practical instruction on every phase of house wiring in one handy volume. Goes further than most books on subject. Hand-book style. Gives National Electric Code, 300 pages, 669 illustrations. Electrical work will reach a new high with millions of new homes to be built. Get started now. \$3.00.

DYKE'S FAMOUS CARBURETOR BOOK

This famous book has been the standard guide in the best paying auto work for a generation. It has helped thousands of men make money. New edition covers engine tune-up, compression, ignition, carburetion, fuel pump valves, etc. Use this book to specialize in this big field. 244 pages. 549 illustrations. \$3.50.

Modern Gas and Electric REFRIGERATION

New Printing—Almost 1000 Pages,
408 Pictures, 17 Diagrams in Colors

The Book of the Hour

Thousands of Refrigerators need repairs! Owners will pay big for competent service. Get this non-technical guide to all types of refrigerators and get your share of this new profit. Get a job or start your own service business. This book will help you make money anywhere. Price \$5.00.

Make Big Money
Keeping Old Cars
Looking New. Get
This Book Today!

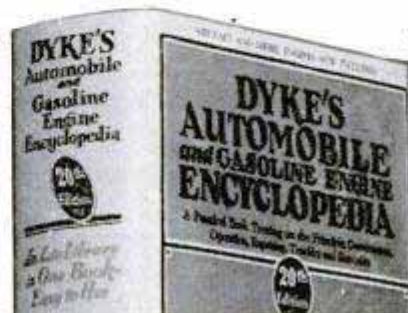

BIG 20th EDITION
Leading Auto Book for Over 36 Years

World's Greatest AUTO BOOK

New Material on Transmissions, Trucks, Tractors, Diesels, Aircraft and Auto Engines

Now with millions of cars needing repairs and thousands of men needed to do the work, you need the famous DYKE Auto Book more than ever before. This big 20th Edition covers all principles, construction, repair, adjustments, testing, troubles and remedies of all cars. Over a half million copies of 20 editions of Dyke's have been sold. Gives specifications of old and newer cars. World's biggest book value. \$7.00. This big book, a complete auto library in one volume, has 1483 pages—4600 illustrations and diagrams—weighs 6 lbs.—equal to 4 ordinary books.

BAILEY'S HANDBOOK For Engineers and Firemen

World famous handbook of universal questions and answers for Stationary, Marine and DIESEL engineers and firemen. Prepares for any license examination. This is the one book that men should have if they want to reach the top in installation, maintenance and operation of Diesel and steam plants. Pocket size, \$2.00.

Goodheart-Willcox Co., Inc.
1321 S. Michigan Ave., Dept. 15, Chicago 5, Ill.

SEND NO MONEY! Mail Coupon

GOODHEART-WILCOX CO.,

1321 S. Michigan Ave., Dept. 15, Chicago 5, Ill.

Send books checked, C.O.D. I will pay postman, plus few cents charges. If not satisfactory I will return books in 5 days and you will refund money paid. (Outside U.S. or possessions remit with order.)

- | | |
|--|--|
| <input type="checkbox"/> Gas & Electric Refrigeration \$5.00 | <input type="checkbox"/> Air Conditioning \$4.00 |
| <input type="checkbox"/> Dyke's Auto Book \$7.00 | <input type="checkbox"/> Engineers Handbook . . . \$2.00 |
| <input type="checkbox"/> Dyke's Carburetor Book . \$3.50 | <input type="checkbox"/> Body and Fender Repair . \$3.50 |
| <input type="checkbox"/> Modern Welding \$4.00 | <input type="checkbox"/> Shop Math. (2 vols.) . . . \$3.00 |
| <input type="checkbox"/> Airplane Welding \$3.50 | <input type="checkbox"/> House Wiring \$3.00 |
| <input type="checkbox"/> Sheet Metal Layout . . . \$3.50 | <input type="checkbox"/> A.C. Power Wiring . . . \$4.00 |
| | <input type="checkbox"/> D.C. Power Wiring . . . \$4.00 |

If remittance accompanies order we will pay all postage charges under same return privilege.

Name _____
Address _____
City _____ State _____

HOW TO GET THE BIG PAY IN METAL WORKING



YOU can take a big step toward the high pay that master machinists and set-up men command—

by knowing the secrets of modern engine lathes. MAKE this book your key to that knowledge. Here in one volume, nearly a thousand 3-dimension drawings and photographs show you what lathes can do and HOW TO DO IT! Here are a few of the chapter headings:

1. Getting Acquainted with an Engine Lathe.
2. Getting Acquainted with Lathe Tools.
3. Performing Common Lathe Operations.
4. Common Lathe Jobs and How to Produce Them.
5. Getting the Most Out of an Engine Lathe.
6. Cutting Fluids.

7-day Free Examination—send no money

YOU MUST SEE this book to understand how simple and easy even the most difficult operations become when explained by 3-dimension drawings and photos. That's why we offer the 7-DAY FREE EXAMINATION—if you don't agree that this book is worth many times \$6.95 send it back to us without any obligation.

Business Collaborators, Inc., Shell Bldg., St. Louis, Missouri. Please send me my copy of "Changing the Shape of Metals with an Engine Lathe." I agree to send you \$6.95 or return the book within 7 days after receiving it.

Name _____
Address _____
City _____ Zone _____ State _____

Now for EVERY WORK SHOP!

NEW Invention Electroplates by BRUSH



Easy to Plate CHROMIUM GOLD, SILVER, NICKEL, COPPER ... For Pleasure and Profit!

If you have a workshop—at home or in business—you need this new Warner Electroplater. At the stroke of an electrified brush, you can electroplate models and projects—you can replate worn articles, faucets, tools, fixtures, silverware, etc. with a durable, sparkling coat of metal... Gold, Silver, Chromium, Nickel, Copper or Cadmium. Method is easy, simple, quick. Everything furnished—equipment complete, ready for use. *By doing a bit of work for others, your machine can pay for itself within a week.* So make your shop complete by getting a Warner Electroplater right away. Send today for FREE SAMPLE and illustrated literature. ACT AT ONCE! Mail Coupon.

WARNER ELECTRIC CO., DEPT. 5-10
1512 Jarvis Avenue, Chicago 26, Ill.

FREE Details & Sample!

WARNER ELECTRIC CO., 1512 Jarvis Avenue, Chicago 26, Dept. 5-10
Gentlemen: Send Free Sample and Details to:

Name _____
Address _____
City _____ State _____

Earn BIG PAY Now!

thousands of ambitious men helped

FREE EMPLOYMENT SERVICE
LEARN THESE TRADES IN THE BIG ALLIED SHOPS

BIG SHOP TRAINING

Choose one of these 6 LEADING TRADES

- Machinist Trade
- Tool & Die Making
- Tool & Die Machine Designing
- Mechanical Drafting
- Tool Engineering
- Industrial Product Illustration

Largest School of its Kind in the World

FREE! BIG METAL TRADES ILLUSTRATED BOOK

APPROVED FOR VETERANS
WRITE TODAY: A 1c Postcard will do.

ALLIED SCHOOL OF MECHANICAL TRADES
1338-1340-1342 So. Michigan Ave. — Est. 1928
425 Allied Bldg. CHICAGO 5, ILL.



Learn TRIG.

Get correct answers fast and easy with JOSSELYN'S "QUICK TRIGONOMETRY." Improve your Trig at once! For shop, toolmaking, carpentry, drafting, design, physics, land measure, etc. Simple & clear, & for All Students. Great "Magic Circle," all 82 Basic Formulas; plus Natural Functions tables. Experts recommend; so solve fast your Plane Trig problems. Helps exams. You can honestly depend on our concise, reliable Short-cut—it has what you want. It must satisfy you or 5 day refund guar. Send No Money; pay postman \$2.00 plus postal fees. Or just send \$2.00 now and we rush all fully paid.

EDCO SCIENTIFIC MFG. CO.
Box 531, Hollywood Station 28 Hollywood, Calif.

LOCKSMITHING & Key Making

PRACTICAL UP-TO-DATE COURSE

Easy-to-learn modern information for self-instruction. How to work on locks, de-code, make master-keys, repair, install, service, etc. For every handyman, home owner, carpenter, mechanic, service station operator, fix-it shop, hardware dealer, gunsmith. 53 plain illustrated lessons. Full price only \$3.95. SEND NO MONEY. Just pay postman plus C.O.D. postage. Or send \$3.95 with order, we'll ship postpaid. Satisfaction guaranteed or refund.

NELSON-HALL CO., 1139 S. Wabash Ave., Dept. E-02, Chicago 5, Ill.

PRACTICAL MATHEMATICS LIBRARY

Easy self-instruction in 25 branches by college experts. Helps you qualify for better job. 4 volumes, 1300 pages, 600 illustrations. Sent for free trial. Only \$2.00 down, \$2.00 a month; total \$9.80 plus postage. (Cash price \$9.50, postage free.) 160-page Logarithm book free with order. National Educational Alliance, Inc., Dept. 565, 37 West 47th St., New York 19, N. Y.

LEARN AND EARN AT HOME

Learn SCREEN PROCESS, the modern machineless method of printing. Uncrowded, profitable field where trained men are always in demand. 2 BIG KITS OF SUPPLIES we send start many of our students making money even before finishing home study course. Write today for FREE BOOK giving full details. APPROVED FOR VETERANS.

CALIFORNIA SCHOOL OF SCREEN PROCESS
3740 Overland Avenue, Dept. M-58 Los Angeles 34

Learn BAKING At Home

Baking is one of America's high industries in wages. Nearly depression-proof. Thorough basic home course lays sound foundation. If you have aptitude, write for FREE BOOKLET, "Opportunities in Commercial Baking."

National Baking School, 1315 Mich. Ave., Dept. 1355, Chicago 5

LEARN CARPENTRY AND MASONRY

Write for FREE Catalog
Train in Big Shops. G.I. Approved

MIDWEST SCHOOL OF BUILDING TRADES, Dept. A-15
411 N. Center St. Bloomington, Ill.

WATCH FORD IN '48

SPECIAL! LOW PRICES ON—
Natural Rubber Latex FOR BETTER MOLDS

This new molding compound with 70% natural rubber concentration is easier to use, gives cleaner, sharper, more profitable castings. Order now at these low prices: \$3 Qt., \$5 1/2-Gal., \$8.50 Gal., \$7.50 per Gal. in 5-Gal. Cans. Send check or m.o. New Molding Manual sent with each order.

FRANCIS RUBBER PRODUCTS CO.
Dept. E-3, 1836 E. Fulton Columbus 9, Ohio

HOW to Make ART OBJECTS with RUBBER MOLDS

4 Career Ways to Success

CHOOSE THE ONE THAT FITS YOU BEST

APPROVED FOR TRAINING THE YOUNG MEN OF AMERICA — VETERAN AND NON-VETERAN

WATCHREPAIRING — A CAREER FIELD!



WORK — and plenty of it — Millions of watches and clocks need fixing. An interesting and needed service in the top-pay bracket, or start an independent business of your own. ALL TRAINING TOOLS provided. Special list

of tools becomes student's property upon graduation. A training system unsurpassed anywhere. Free information. Send coupon in envelope or paste on penny postcard.

AMERICAN SCHOOL OF WATCHMAKING,
Dept. PM-58-4, 5145 W. San Fernando Rd., Los Angeles 26, Calif.
Gentlemen: Please send me free booklet and information on your training.

Name (PRINT) _____

Street _____ Age _____

City _____ State _____

Veteran _____ Non-Veteran _____

PLASTICS — MAGIC WORD!

Here at Plastics Institute in Los Angeles, men are learning the secrets of this glamorous industry for which the future seems unlimited. Hundreds of new products are being made of plastics requiring trained men to develop and fabricate them. Plastics Institute is the pioneer and leader in the field of plastics instruction. Its faculty and directors are leaders in the industry.



Write for beautiful four-color catalog today. No obligation. Courses available either residential or study at home. Mail coupon in envelope or paste on penny postcard.

PLASTICS INDUSTRIES TECHNICAL INSTITUTE,
Dept. PM-58-4, 1601 S. Western Ave., Los Angeles 6, Calif.

Gentlemen: Please send me free booklet "World of Plastics" and information on your training.

Name (PRINT) _____

Street _____ Age _____

City _____ State _____

Veteran _____ Non-Veteran _____

Residence School _____ Home Study _____

BE AN INSTRUMENT TECHNICIAN



Do you like to take things apart and see what makes them tick? Then be the important man who knows how to install, service and maintain delicate instruments in airplanes and industrial equipment. The instrument field offers many opportunities to trained men.

Aircraft Instruments specializes in this important field, and does a fine job for you in only 34 weeks. Many graduates in industry or have own business. Write today for free booklet. Send coupon in envelope or paste on penny postcard.

AMERICAN SCHOOLS OF AIRCRAFT INSTRUMENTS,
Dept. PM-58-4, 5145 W. San Fernando Rd., Los Angeles 26, Calif.
Gentlemen: Please send me free booklet on your training.

Name (PRINT) _____

Street _____ Age _____

City _____ State _____

Veteran _____ Non-Veteran _____



BE A DIESEL EXPERT the Hemphill Way

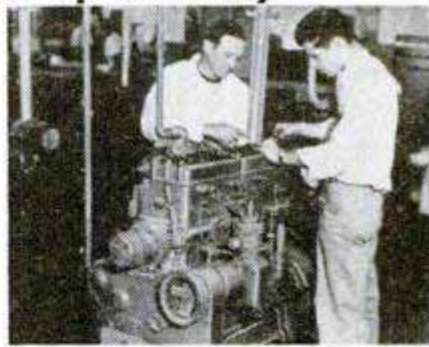

Wherever Diesels are used the name "Hemphill" means TRAINED MEN who know Diesel. Many graduates successfully employed in Diesel industry or have own business. You can get this training at home NOW, without interfering with your present activity. Or study in Hemphill shops at New York, Memphis, or Los Angeles. Check preference on coupon below. Prepare yourself for the great swing to Diesel this quick, easy way. Mail coupon for complete information.

HEMPHILL DIESEL & AUTOMOTIVE SCHOOLS,
Dept. PM-58-4, 1601 S. Western Ave., Los Angeles 6, Calif.
Gentlemen: Please send me information on your

Home Study Course _____ Shop training _____ in

New York _____ Memphis _____ Los Angeles _____

Name (PRINT) _____

Street _____ Zone _____

City _____ State _____

Veteran _____ Non-Veteran _____

ALL ARE MEMBERS NATIONAL COUNCIL OF TECHNICAL SCHOOLS

SEND COUPON TODAY

THE ONLY GENUINE WEBSTER IS THE

Merriam

WEBSTER

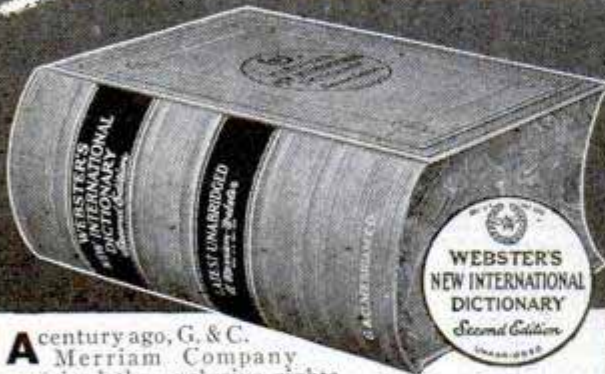

A century ago, G. & C. Merriam Company acquired the exclusive rights to publish Webster's Dictionary. Through the years, with each new edition, Merriam has constantly enlarged the scope and usefulness of Noah Webster's original work, until today the names MERRIAM and WEBSTER are equally important in identifying "The Supreme Authority." Ask for WEBSTER'S NEW INTERNATIONAL DICTIONARY, Second Edition—the great unabridged Merriam-Webster.

G. & C. MERRIAM Co., Springfield 2, Mass.

Buy Give-a-Book Certificates at Your Bookseller

"THE SUPREME AUTHORITY"

INVENTORS

When you are satisfied that you have invented a matter of value—write me, without obligation, for full information as to what steps you should take to secure a Patent or Trademark.

The usual first step is to have a search of the prior U. S. Patents conducted, so that I can report to you on the question of Patentability.

PATRICK D. BEAVERS

(Formerly RANDOLPH & BEAVERS)

Registered Patent Attorney

934 Columbian Building Washington 1, D. C.

PATRICK D. BEAVERS, Registered Patent Atty.
934 Columbian Bldg., Washington 1, D. C.

Please send me full information on how to secure Patent Protection.

Name _____

Street _____

City _____ State _____

LEARN WATCH REPAIRING



AT HOME, WITH OUR NEW KIT

Get started NOW in this uncrowded field! EASY to learn! BIG MONEY! SECURE FUTURE! Earn while you learn! Even as a *sideline* you can make \$50.00 and up each week. Our new PRACTICAL SELF-TRAINING KIT is all you need to start. Contains set of PROFESSIONAL TOOLS: (Loupe, 3-4 power; complete set of 6 special screw drivers—finest tempered steel blades; Tweezer AA; Plastic material tray) and COMPLETE BOOK on Modern Watch Repairing. Fully illustrated, easy to understand, shows every step in repair, adjustment and use of tools. Only **\$6.45** Post Paid

(If C.O.D., plus charges.) Money Back Guarantee. If ordered separately: book \$3.25; set of tools, \$3.95. MODERN TECHNICAL BOOK & TOOL CO. Dept. MHC, 55 W. 42nd Street, New York 18, N. Y.

NEW ALL-INCLUSIVE TOOL, MATERIAL CATALOG For Watch-clockmakers, Jewelers, Handicrafters. Over 450 ILLUSTRATIONS and IDENTIFICATION CHART. NEW REDUCED PRICES. All books in these fields; write for literature. SEND 50c for catalog—FREE with order

"PLASTICS"

Work in a fascinating and profitable hobby. Just out—our latest fabricating manual. Tells you how to work with Plastics. Our new Catalogue provides all needed materials: Plexiglas—Lucite—Tenite—Catalin—Acetate—all in sheets, rods, and tubes. Complete line of cements, dyes, accessories and supplies. Send 20c today for Fabricating Manual and Catalog. We apply this amount on initial order.

HOUSE OF PLASTICS

8648 Linwood Avenue P. M. Dept. Detroit 6, Michigan

15 H.P. TWIN CYL. "V" ENGINES

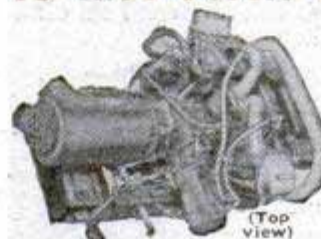

(Top View)

Famous Andover make. Fine for Midgets, welding outfit, boats, mills, saws, etc. 32" long, 22" wide, 18" high. 4 pt. mountings (flat) 14" apart ea. way. 3600 max. RPM. 31.91 cu. in. Wt. abt. 100#. Fitted with 28.5 generators which makes fine welders, or remove for other use. 2 3/4" bore—2-11/16" stroke. Dual carb. Shielded ign. and fuel system. Governor (removable). Some prac. new. All useable. No junk. Parts obtainable. Cost U.S. Govt. over \$1400 each. Our price \$81.50 while they last. Two or more \$75.50 ea. Guaranteed as advertised or money refunded. Runs like a Rolls-Royce! You've seen our ads since 1941.

FEDERAL IDENTIFICATION CO. 1910 CLASSEN BLVD. OKLA. CITY, OKLA.

COMMERCIAL ART

APPLIED ART ACADEMY 248 Carroll Street, Akron 4, Ohio. 18 Month Diploma Courses. 12 Modern Fully equipped studios. Located in the Rubber Center of the World. Approved by the Ohio State Department of Education for Veteran and Civilian Training. New Classes beginning every month. Inquire Immediately. Telephone HE-7661.

LEARN WATCH and CLOCK REPAIRING

Start training now for a better paying job or your own profitable business. Qualified Watch Makers are in demand. . . . Unlimited opportunities. Intensive practical training by experienced watch makers. Approved for Veterans. Write for full details. Indicate if Veteran.

SCIENTIFIC SCHOOL OF WATCH MAKING, Dept. PM-5 3923 San Fernando Road Glendale 4, Calif.

PATENTS

AND TRADE MARKS

C. A. SNOW & CO.

REGISTERED PATENT ATTORNEYS

WRITE FOR INFORMATION TO

428 SNOW BUILDING, WASHINGTON 1, D. C.

INVENTORS

If you wish to protect your invention, you should take steps to protect it by a U. S. Patent. Write me for "Record of Invention" Form.

CARL MILLER REGISTERED PATENT ATTORNEY

Woolworth Bldg., 35th Floor, Dept. 58A, New York City
Please send me "Record of Invention" form.

NAME _____

ADDRESS _____

MAKE UP TO \$5⁰⁰ AN HOUR In Your Own YEAR 'ROUND Business!

ONLY A FEW DOLLARS PUTS YOU IN BUSINESS!

Many Clearing as High as \$20 to \$30 a Day NET Renewing Rugs, Carpets, Upholstery. New Method Now Used for Auto Upholstery. Write for Facts About Quick, Easy Way to Get Started

Here is the chance you've been looking for to step into a pleasant, dignified, big-pay business of your own that offers you a steady, year 'round income. Start on "a shoe-string," full or spare time, right from your own home. Equal opportunities for men and women, young or old, in small towns or big cities. No experience needed. Many making big money with new American System just cleaning auto upholstery. Easy to learn. We send you complete instructions and quick-cleaning supplies so you can start making money the very first day! Quick method cleans upholstery, rugs and carpets like new without taking off floor! Tremendous demand in homes, apartments, hotels, stores, office and public buildings. Steady repeat business. Territories going fast. Write today for full FREE facts. No cost or obligation. Rush letter or postcard now to **AMERICLEAN CO., Inc.; Dept. G-17; 211 North 7 St.; St. Louis 1, Mo.**

WRITE FOR FREE DETAILS NOW!

Save Money-Make Money with LARSON Leathercraft

For gifts or for sale—make easy-to-assemble leather items. Complete stock leathers, tools, accessories.

Send ten cents for new catalog of 101 money-making ideas.

J. C. LARSON CO. 824 S. Tripp Ave. Chicago 24, Illinois

A PENNY POSTCARD MAY CHANGE YOUR FUTURE . . .

Get full information on the coin-operated vending machine industry. Start with a few machines and build to a wonderful future. We'll give you complete advantage of our "know-how." Send For Free Booklet Today—No Routes Sold!

PIONEER VENDING SERVICE

Address all mail to Dept. PM
461 SACKMAN ST. • BROOKLYN 12, N. Y.

SUNGLASSES \$2.38



WITH CASE
Air Corps style—made to AAF specifications. Ground and polished 4 base curve lenses. Eliminate harmful rays. Gold plated metal frames. Sweat bar. Leatherette case included. Ideal for sports, driving, etc. Ladies style available same price.

Write for FREE illus. list Army surplus.

Orders sent postpaid except C.O.D. Satisfaction or Money Back.
CONSUMERS CLOTHING CO., INC.
BOX 5-P, 26 GREENE ST. NEW YORK 13, N. Y.

HOW TO CUT RAFTERS

New vest pocket book gives lengths, side cuts, plumb cuts, deductions. For all rafters for any building from one inch to forty feet wide. Gives numbers to cut on squares. Also degrees for same cuts for Radial Saws. All standard pitches from 1/4 to 5/8. Just open book to pitch page and there are your lengths, side cuts, etc. Anyone who knows what a jack rafter is can frame a roof if he has this great book. Price one dollar, (\$1.25 in Canada). Builders' Topics, Dept. 5, Lock Box 828, Seattle, Washington. CARPENTERS, PLUMBERS, PLASTERERS, ELECTRICIANS, ETC. subscribe for Builders' Topics, the monthly magazine for HE-MAN CONSTRUCTION WORKERS. Only \$1.00 per year, (in Canada—\$1.25). Sample copies 25c.

WAR SURPLUS BARGAINS

9 PIECE SPARK PLUG SOCKET SET



Mfg'd. by Duro Chrome, 1/2" Drive, 12 pt. extra deep to reach deep recessed spark plugs, also ideal for other work where a long reach is necessary. Sizes 1/2", 9/16", 5/8", 11/16", 3/4", 25/32", 13/16", and 7/8". Also all handle and metal box. \$4.25 Each

SEND CHECK OR MONEY ORDER, WE PAY POSTAGE OR C.O.D., PLUS POSTAGE

INDUSTRIAL SUPPLY COMPANY | 312 EAST 33rd ST. NEW YORK 16, N. Y.

LEARN ELECTRICITY AND HOUSE WIRING

Conforms With 1947 National Electric Code

NEW 1948 BOOK BIGGER! BETTER! Old Price—Only \$2



Save Money - Make Money - With This Help

Drake Books will help you make money on any job—help you save money doing work on your own home. Order this famous electric and house wiring book, and other books you need today. No need to study an entire book to learn to do home jobs. Just read the part you want. Circle number wanted.

ORDER ON COUPON BELOW

Electricity and House Wiring. Covers all phases of everyday electricity and house wiring with latest 1947 methods. Special emphasis on electrical alterations. Bigger book, now 287 pages, 254 illustrations. Same old price—Only \$2.00. Book No. 1

Building. by Siegele. Practical book of instruction. Especially fine for small houses. Includes stair building and roof framing. 210 pages, 495 illustrations. \$2.50. Book No. 2

Plumbing, Installation and Repair. Expert instruction enables inexperienced to plan and install simple plumbing and hot water systems according to good practice. 256 pages, 162 illustrations. \$2.00. Book No. 3

Heating, Cooling, Air Conditioning. Specially prepared for those with no experience. Covers computation, planning, selection of equipment, installation and operation. A real how-to-do-it book. 700 pages, 350 illustrations. \$4.00. Book No. 4

Painting and Decorating. A book for painters and home owners. Covers methods, tools and materials for every branch of painting and decorating. 350 pages, 288 illustrations. \$3.50. Book No. 5

Frederick J. Drake & Co., Dept. 15 1 2 3 4 5
600 W. Van Buren Street, Chicago 7, Ill. (Circle number)

Send me the books checked. If not satisfied I will return them in 5 days and money will be refunded.

Check or Money Order enclosed \$_____. Send books postpaid.
 Send C.O.D. plus postage.

Name _____

Address _____

City _____

State _____

Drake's Books are Sold by Leading Booksellers

SAY YOU SAW IT IN POPULAR MECHANICS

ELECTRIFY YOUR SEWING MACHINE

IDEAL GIFT FOR MOTHER, WIFE OR SISTER . . .

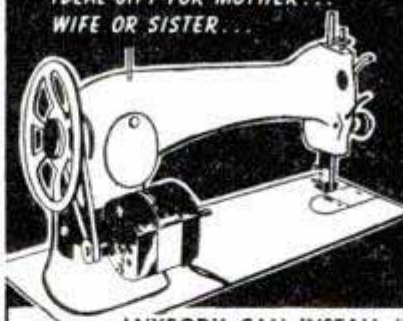

SEWING MACHINE MOTOR KIT . . .

ANYBODY CAN INSTALL IT!

SPECIAL NOTE: This 1/20 H.P. motor with rheostat can be used in all hobby workshops for flexible shaft attachments, grinding, drilling, etc.

NEW Low Price
\$16.⁷⁵
Complete

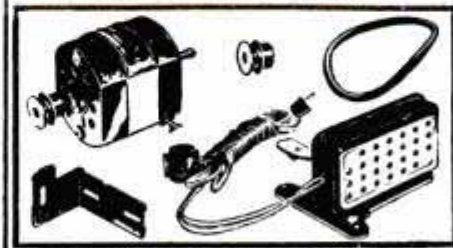

- COMPLETE SET CONSISTS OF:**
- MOTOR—Universal AC or DC, 60 cycle, 115 volts.
 - BELT—Long wearing rubber belt.
 - PULLEY—Single grooved steel hubbed pulley.
 - BRACKET—New and improved.
 - FOOT CONTROL—7 step rheostat.
 - CORD SET—Extension cord with plug and socket.
 - Installation Instruction Sheet.

SPECIAL OFFERING TO DEALERS!

MAIL THIS COUPON
DEPT. PM-5A **BROWNELL DISTRIBUTORS, INC.**
308 CANAL STREET, NEW YORK 13, N. Y.

Please rush _____ motor kits at \$16.75 ea. (postage prepaid) NAME _____

in: money order or check ADDRESS _____

send C.O.D. and I'll pay postman \$16.75 plus C.O.D. fees. CITY _____ ZONE _____ STATE _____

Amazing NEW TOY GUN



COMPLETELY SAFE

Here is the gun that will thrill every boy. When you pull the trigger, it cracks out like a real gun and smoke puffs out of the muzzle. The American Rangers Automatic is a quick acting, repeating pistol that never misses. It shoots 60 to 75 shots without re-loading. Looks like a real gun. Absolutely SAFE. Contains no explosives. Each gun comes boxed with 10,000 shots of smoke powder or enough ammunition to last a full year. This smoke powder is harmless. Will not hurt the eyes and may even be eaten. Only \$1.00 each or 3 guns for \$2.00. Only limited quantity available. Write for yours NOW.

SEND NO MONEY Try 10 Days - At Our Risk

Just send name and address. On arrival deposit only \$1.00 plus C.O.D. postage for one gun or \$2.00 plus C.O.D. postage for three guns. If not completely satisfied return and your money refunded. Save money. If you send cash with order, we pay postage. Write TODAY.

SPECIALTIES MFG. CO., Dept. 508-A

1367 N. Sedgwick Chicago 10, Ill.

THE GREATEST
THING

IN
PLASTICS!

PLASTICAST



PLASTICAST is a liquid plastic; can be poured into ANY kind of mold or container. Hardens in a few minutes into a transparent solid, clear-as-glass, tough-as-steel plastic! As easy as pouring water out of a glass! No tools or machinery required. Ideal for imbedding flowers, butterflies, photos, souvenirs, and for making beautifully brilliant jewelry, gems, displays, fishing lures, magnifiers, lenses, knife-knives and novelties. Easily cast into sheets, rods or blocks, ANY shape, ANY color. EVERYTHING FURNISHED, including molds for making PENDANT HEARTS, ENCHANTED GARDENS, MAGNIFYING GLASSES, etc., dozens of attractive and valuable articles! For FUN or PROFIT, start TODAY! C.O.D. orders accepted with \$1.00 deposit.

COMPLETE MASTER OUTFIT \$3.50
(Postpaid U.S.A. & Canada Only)

PLASTIGLASS Make extremely beautiful, colorful Ornaments, Jewelry, Butterflies, Tropical Fish, Birds, Carscapes, etc., simply by bending wire to outline of subject desired and dipping in PLASTIGLASS! No heat, catalyst or tools required. Complete Outfit with materials for making hundreds of remarkably beautiful novelties only \$4.00 ppd.

A very attractive and useful novelty made of one of our plastics given absolutely free with every one of our catalogs! Catalog lists many new materials for making **MOLDS and CASTINGS** with Liquid Plastics, Liquid Ivory, Liquid Marble, Wax, Latex, Metal, Castwood, Plaster, etc.; also many molds listed. Price of catalog only 10c coin or stamps.

PLASTICAST CO. (Dept. C)
(We have no retail store—order by mail only)
5961 Madison St. Chicago 44, Illinois P. O. Box 987 Palo Alto, Calif.

Say You Saw It in Popular Mechanics

BE A GOVERNMENT LICENSED AIRPLANE AND ENGINE MECHANIC

Train Now at LINCOLN



EARN BIG PAY IN AVIATION

Our new enlarged school now offers these courses: MASTER AVIATION MECHANICS, CAA Approved 1 Yr. Airplane & Engine Mechanics Course, REFRESHER AIRPLANE & ENGINE MECHANICS. Designed for veterans with aviation mechanics experience. Either course is available to veterans under the G. I. Bill of Rights. Write today for complete information.

LINCOLN AVIATION INSTITUTE

UNION AIR TERMINAL DEPT. P-5 LINCOLN, NEBRASKA

BAR BELLS

Buy Direct From Factory Save 20% to 30% \$8⁹⁵ up
Write for Free Booklet and Price List
INDEPENDENT IRON WORKS
2440 EAST 23RD STREET, DEPT. B
LOS ANGELES, CALIFORNIA

Learn the LETTER SHOP and DIRECT MAIL ADVERTISING BUSINESS

We teach you this interesting business by mail from A to Z—including MIMEOGRAPH, MULTI-GRAPH, etc. Ideal for men or women—husbands and wives, in small or large towns. Takes little capital to start. Write today for FREE BOOKLET to—

At Home in Your Spare Time!
FREE BOOK

ARMSTRONG SCHOOLS

Dept. L85, 7217 So. Broadway, Los Angeles 3, Cal.

INSTANT NICKEL NO CURRENT OR BATTERIES USED

Rub, New INSTANT NICKEL on iron, steel, brass, aluminum, bronze or copper and INSTANTLY it takes on a permanent heavy plating with REAL NICKEL! Makes old, worn, articles look like new. No mercury or cyanide in it. No copper plating necessary. Patented. Re-nickel for friends, neighbors, at profit. \$2.50 postpaid, C.O.D.'s few cents extra. Money back Guarantee.

COMPLETE \$2⁵⁰ POST PAID COVERS 10 FEET AGENTS WANTED

INSTANT PLATING, Dept. 1, 1216 Park Row Bldg., New York 7, N. Y.

SAGENTS 300% Profit SIGN LETTERS

For Store Fronts and Office Windows. Anyone can put them on. Free Samples. Liberal Offer to General Agents.

METALLIC LETTER CO., 430 N. Clark, Chicago 10

BRUSH PLATING OUTFITS

for re-plating articles in the home and shop. No tanks necessary. Free particulars.
GUNMETAL CO., AVE. M, DECATUR, ILLINOIS

AIR COMPRESSORS

Model 2-U-S-4-V-A Bendix-Westingshouse 4 cu. ft.

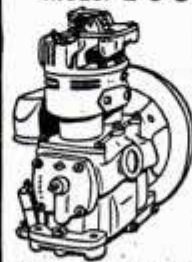

Govt. Surplus, 2 cylinder Bus and Truck Type. Ball bearing crank shaft. Pressure feed oil system. Positively one of the finest and most accurately built air compressors on the market.

Original Cost Over \$140.00

In good operating condition with 30 day written guarantee \$3450 Special Low "as is" price \$2950

Accessories available for compressors, air regulators, safety valves, air gauges, control governor, misc. fittings, hose, paint guns. Write for Prices and Catalogue

MIDWEST SURPLUS SALES CO. 2531 INDIANA KANSAS CITY, MO.

SURPLUS SALE!

BRAND NEW

45 X 3.5

Liko BINOCULARS

with INTERPUPILLARY ADJUSTMENT and COATED OPTICS

Only \$6.98

IMMEDIATE DELIVERY



First Time in America! Now you can get close-ups of all events with these all-purpose heavy duty binoculars. Coated precision lenses.

interpupillary adjustment and other features found only in high price binoculars. Carrying case and shoulder straps included. 10 day no risk money back trial. Ideal gift. **SEND NO MONEY!** Pay postman on delivery plus charges. Send payment with order and we mail postpaid. Be sure to add 20% Fed. tax (\$1.40). Act now.

VETERAN'S EMPORIUM, Dept. B-51

1148 W. CHICAGO AVE. CHICAGO 22, ILL.

New "DRIVE-EZ" ARM REST

• For Greater Safety and Driving Comfort.

• Fits seat of any car, truck, boat, trailer . . . home uses.



The "Drive-Ez" Arm Rest gives arm chair comfort to the motorist . . . relieves driving strain and promotes greater safety. Foam filled, with velon cover. Cash with order we pay postage. C.O.D. send 25% deposit. Price complete, each **\$3.50**

"DRIVE-EZ" ARM REST CO.

DEPT. PM-5

545-49 Roosevelt Rd. Chicago 7, Ill.

THROAT MICROPHONE



Straps onto neck. Allows free hands and head movement. Used but in good condition. Ideal for experimental work. Each . . . **\$1.00**

CORD, SWITCH AND PLUG FOR ABOVE

Rubber covered cord with plug and phone jack. Includes finger control switch with loop for hanging on neck or clothes. Each \$1.25. Both microphone and cord assembly \$2.00 postpaid.

AERO PARTS SUPPLY, DEPT. PMS

MUNICIPAL AIRPORT, HOUSTON 12, TEXAS



HOW TO SUCCEED WITH BEES

By E. WATKINS-K. HAWKINS



RAISE BEES SELL HONEY MAKE MONEY!

Get How to Succeed with Bees, written by two experts, which tells you all you need to know. Contains 190 tested successful plans to produce big crops of honey. Easy work and little capital required. There is always a ready market for honey and working with bees is fascinating. This 96-page well-illustrated book is only \$1.00 and is absolutely guaranteed to satisfy you or we shall refund your money. *Send for your copy today!*

POPULAR MECHANICS PRESS

200 E. ONTARIO STREET CHICAGO 11, ILLINOIS

2 Tons Cutting Power!

IT'S THE NEW MANCO JR. CUTTER.

No Workshop Complete Without It!



DOES MORE COSTS LESS **\$3.50**

List Price

Compound Leverage . . . only 50 lbs. pressure at the handles gives 2 tons cutting force at the jaws . . . plenty of power to cut easily and quickly mild steel bolts up to 1/4" diameter, screws, rivets, nails, fencing—of any material up to the hardness of heat treated steel. Nickel-plated, with heat treated alloy tool steel jaws.

It's a Tool of 1001 Uses!

Indispensable for Automotive, Farm, and Home Workshop. Convenient tool box size . . . only 12" overall. Made by foremost manufacturer of hand operated cutting tools. **SEE YOUR DEALER** . . . or order direct if your dealer is not stocked. Only \$3.50 C.O.D.

Dealer and Jobber Inquiries Invited

MANCO MFG. CO. BRADLEY, ILL.

Gentlemen: Please rush me _____ Manco Jr. Cutters @ \$3.50 each plus postage, C.O.D.

Name _____

Street _____

City _____ State _____

ORDER YOUR MANCO JR. NOW!



SWISS MUSIC MOVEMENTS



Make your toys and novelties musical with these fine imported units. Wide variety of folk songs, waltzes and popular tunes. Please specify category when ordering. Complete unit at wholesale price of \$2.25 postpaid.

SOME AGENCY TERRITORIES AVAILABLE

MARQUESA • 15 East 60th St. • New York 22, N. Y.

YOU CAN GLAMORIZE ANY SURFACE or ARTICLE WITH THE New VELVET FLOCK FINISH



FLOK-KRAFT is the proven method by which YOU can spray that velvety, plush surface you are familiar with on phono turntables, bookends, car dashes, etc. Now YOU can do a beautiful job on any surface or object for less than 3c sq. ft. with RAYON FLOCK.

FLOK-KRAFT KIT \$7.95 ppd.

Complete Kit includes two beautiful colors of flock, Undercoat to match, reducer, brush, SPRAY GUN, and easy instructions, all guaranteed! Send \$7.95 now for your FLOK-KRAFT KIT postpaid. Or order C.O.D. and START FLOCKING!

EARN BIG MONEY Get in this fascinating new business NOW, while you have a head start! Send for FREE illus. Folder and details of Powerful Money-Making Plan. But why wait? Start NOW by ordering your FLOK-KRAFT KIT today.

COAST INDUSTRIES

Dept. 23N, 1509 W. Manchester, Los Angeles 44

**Order Today! Send No Money!
Save! WAR SURPLUS!**

Genuine U. S. AIR CORPS Style SUN GLASSES



No sun glare. No eye strain. For driving, for work, for beach, for sports, 4 base polished and ground lenses in gold plated frame. Pearloid sweat bars and nose pads. Leather case included.

\$249
pair

GUARANTEED FOREVER
Yes forever, not for months or years. No more breakage worries. Guarantee certificate enclosed with each pair.



FREE!
Genuine Air Corps overseas cap sent FREE with each pair sun glasses.

PITH HELMETS . . . \$1.00
SLEEPING BAGS . . . \$2.88
O.D. 100% Wool
Mummy type with zipper
MAE WESTS . . . \$1.88
Issued not used
life preservers

SHELTER HALVES
Perfect. Two halves make a roomy tent. Set of 2 for **\$295**

**For Fun! For Health! For Safety!
New! DUAL TUBE LIFE BELTS**



Brand new pneumatic tubes, simple to inflate. Two individual tubes combined into a unit. Even a child can inflate them.

\$1.00

individually packed in a carton.

For these and other uses
Used singly or in multiples.

- head rest
- play boat
- beach mattress
- portable raft
- canoe safety
- belt type float

JUNGLE HAMMOCKS
Ideal for outdoor relaxation. Complete with protective net. Used by our armed forces in jungle areas. They're brand new! **\$4.88**



Brand New! War Surplus

5-Man RUBBER BOATS

Made for our armed forces, so they must be good. A comfortable, 5 man craft complete with 4 oars and a pump. Add thrills and enjoyment to your summer vacationing.

\$3900

1-Man BOAT complete \$17.88



SEND NO MONEY Order today. Pick your items. Send name and address. Pay postman when package arrives plus C.O.D. fees. **WE GUARANTEE YOUR SATISFACTION ON FULL FIVE DAYS TRIAL.**

ADDRESS YOUR ORDERS TO DEPT M-5

INTERNATIONAL SALES CO.
657 W. MADISON ST. • CHICAGO 6, ILL.

SPORTSMEN ALL SPECIAL IN ONE SPECIAL

Nothing Like It Has Ever Been Offered Before



All Wool O.D. Sleeping Bag **\$3.95**
New Goggles, Flexible, rubber lined, extra lenses . . . **\$1.00**

Pup Tent \$2.95
Mess Kit 60c
Plastic Water Bottle . \$1.95
Canteens 60c
Swimmers Ear Plug Kit 55c
\$5.00 Value Smoking Pipes . \$2.00

Entire **\$13.60** Value in one package for only **\$10.00**

Order now — if you prefer certain items listed above, order separately at low prices quoted on each.

PYRAMIDAL TENTS—16'x16', 8 man tent, perfect. Of heavy duck. **\$24.95**
WALL TENT—14'x14', 9'x9' **\$14.75**
WALL TENT—14'x14', 9'x9' **\$22.75**
Add 10% for handling and mailing. No COD's.

AMERICAN SUPPLY CO.
329 W. 5th ST. KANSAS CITY, MO.

Genuine Swiss 2-Push Button CHRONOGRAPH WRIST WATCH



ONLY \$9.95

IT HAS EVERYTHING
Note These Features

- IT'S A TIMEKEEPER
- IT'S A STOP WATCH
- IT MEASURES DISTANCE
- IT MEASURES SPEED OF AIRPLANES, CARS, RACE HORSES, Etc.

It has SWEEP SECOND HAND, CHROME CASE, PRECISION WORKMANSHIP. **NOT IN YEARS** have you seen such a precision timepiece at such a sensationally low price.

FREE
Stainless steel matching expansion bracelet with each chronograph

SEND NO MONEY

Rush order today. Pay postman only \$9.95 plus 10% tax and postage. Satisfaction guaranteed or money refunded if returned within 10 days.

COLEMAN SALES, Dept. PM
1335 S. CALIFORNIA AVE. CHICAGO 8, ILL.

RADIO ENGINEERING, Broadcasting, Television, FM, Servicing, Electronics, Aviation, Marine & Police Radio taught thoroughly. Engineering course equivalent to 3 years' college radio work. Approved Veteran Training. Catalog free. VALPARAISO TECHNICAL INSTITUTE, Dept. D, Valparaiso, Ind.

WOO-WEE AUTO HORN
wolf whistle



Reproduces "Wolf Whistle" better than any sailor. Screeches, barks, whistles, imitates siren, moves any "road hog" off the highway in "double quick plus." Attract more attention than by driving a yellow Cadillac. Operates from manifold. Installed on any car in 15 minutes. Sturdily constructed. Cleverest novelty since the use of the auto. Be the first user in your neighborhood. Absolute money back guarantee. 6 dollars each. Order today. Ohio orders add 3% tax. Write for free literature on our Chrome Air Horns. **THE PROTECTUROD COMPANY - Dept. 101**
4033 Windsor Road - Youngstown 7, Ohio

LAZY MAN SWITCH
A HOME COMFORT SENSATION

STAY IN BED or YOUR FAVORITE CHAIR and turn ON or OFF your RADIO—TOASTER—PERCOLATOR—ELECTRIC HEATER—LAMP or any other electrical household appliance with a flick of the LAZY-MAN SWITCH.

ATTACHED IN AN INSTANT—JUST PLUG IN
Send Cash or Money Order **Only \$2.50** Post Paid in U.S.A.

AGENTS WANTED
BARTON SMOOT

L.M.S. NATIONAL DISTRIBUTOR
601-19TH ST. N.W. WASHINGTON 6, D.C.

TWIN LENS REFLEX CAMERA
The FOTO-FLEX



- Actual Size Viewfinder.
- Universally-focussed lens.
- 12 Exposures with standard films.
- Meniscus lens for sharp images.
- Money back **\$3.85** pre-graduate paid

DOMEX MAIL ORDER CO., Dept. M
170 Broadway New York 7, N. Y.

UNITED STATES

MONUMENTS AND MARKERS are good. We erect anywhere. Write for FREE Catalog. **U. S. MARBLE & GRANITE CO., Oneco, 18, Florida.**

Say You Saw It in Popular Mechanics

CRESCENT TOOLS
Give Wings to Work
ASK YOUR HARDWARE DEALER

Out of Pawn!

GENUINE DIAMONDS

Direct to You—Save up to 50% and more on fine quality, Genuine Diamonds, reset in beautiful modern mountings, styled for Ladies and Men—Sold with an Iron-Clad Money-Back Guarantee. Over 100,000 satisfied customers. Order now from this ad. Write us for **FREE ILLUSTRATED CATALOG** of other Unredeemed Diamond Pledges from \$5.00 to \$5000. Send today. Reference: Dun and Bradstreet or your own local bank.

1/5 CARAT
\$125 Value
\$49
Tax incl.

1/2 CARAT
\$200 Value
\$95
Tax incl.

BERMAN'S COLLATERAL LOAN BANK
Dept. P-9, 636-38 W. Balto. St. Baltimore 1, Md.

GENUINE ARMY AIR CORP. SUN GLASSES

THEY SOLD IN THE PX STORES FOR \$10.00

ALL BRAND NEW

MONEY BACK GUARANTEE



THE BEST YOU CAN BUY — FOR WORK OR PLAY

These are genuine Air Corp. glasses — not the Air Force type. Made by a famous Optical Co. to Gov't. specifications—metal frame—plastic sweat bar—large aviation type lenses. Case included. Brand new! These are the glasses that Gen. Hap Arnold was so lavish in his praise about. Use them for sport, sunbathing, driving, etc. Money back guarantee. Two pair \$9.00. One pair, postpaid \$4.95.

\$4.95

CARLETON HOUSE 3312 LINCOLN AVE., Dept. PM5
CHICAGO 13, ILLINOIS

HI-SPEED DRILL BARGAINS

25 Re-Conditioned Number and Fractional Drills—mixed assortment—Sizes to 1/4" \$2.00, to 3/8" \$3.00, to 1/2" \$5.00. H. S. Tap assortment — 10 for \$3.50, all sizes N. C. and N. F. 1/4" thru 1/2".

"Free Decimal Tap and Drill chart with orders." Send check, money order or cash.

LAMPKE SURPLUS TOOLS

11607 LINWOOD AVE. DETROIT 6, MICH.

HOW TO SUCCEED WITH BEES



BEE RAISING PAYS BIG PROFITS

Get HOW TO SUCCEED WITH BEES, written by two outstanding experts, which gives more than 190 successful plans to produce big crops of honey. Join the ranks of spare time moneymakers and send for this guaranteed 96-page book today. Tells all about queens, equipment, summer, winter and spring management, swarming, increasing colonies, how to produce section honey and extracted honey, etc. 19th edition, fully revised, only \$1.00.

POPULAR MECHANICS PRESS
200 E. Ontario St. Chicago 11, Ill.

Outdoor Sports Manual!

All sportsmen, attention! Here are 156 pages of helpful hints for the Hunter, Fisherman, Trapper, Camper, Archer, and Boatman. How to make your own decoys, recondition your fishing rod, outwit the fur bearers, make an insect and vermin proof tent, shoot a modern crossbow, and service your outboard motor. These and a pack bag full of other articles for outdoor men. Your News Dealer has it in the 60c paper edition and we can supply the beautifully bound \$2.00 library edition.

POPULAR MECHANICS PRESS
200 E. ONTARIO ST. CHICAGO 11

AIRCRAFT GALLEY STOVE

ARMY SURPLUS ITEMS

NEW
\$19.95 EACH

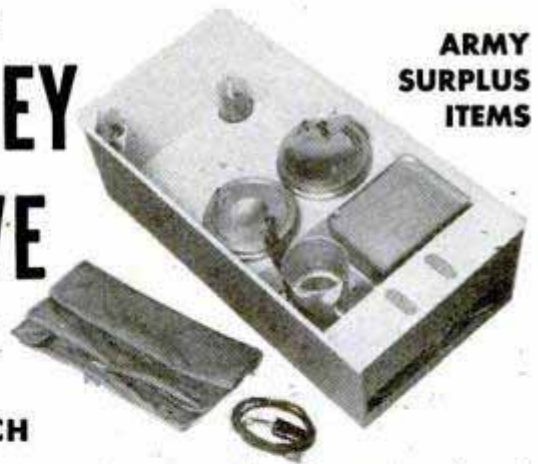

Operates on 110 and 24 volts. Fine for trailers, boats, camps, etc. Includes steam table, hot cup, and grille. New, complete with all accessories.

SERVO UNIT

Control for the automatic pilot. Makes good hoist or water pump. Operates on 24 volts. New, complete with 1/4 H. P. motor.

\$4.95 EA.

MOTOR & GEAR ASSEMBLY

Adaptable for garage door openers, electric hoists, rotating radio beams, etc. Lifts 2800 lbs. Operates on 24 volts. New, complete with 1/8 H.P. motor.

\$4.95 EA.



LIGHT FIXTURES

New, complete with 2 FOR bulb. Operates on 110 volt. **\$1.95**

All prices F.O.B. Detroit. Send cash or money order. No C.O.D.'s—Orders shipped by railway express.

RADIO CENTER

2530 E. Davison

Detroit 12, Mich.

- ★ WRIST WATCH
- ★ STOP WATCH
- ★ TELEMETER
- ★ TACHOMETER

Phenomenal Value!
17 JEWEL • 2 PUSH BUTTON
CHRONOGRAPH



ONLY **\$29.75** PLUS 10% TAX

INCABLOC SHOCK RESISTANT FEATURE
• Sweep Second Hand
• Radium Dial • Anti-Magnetic • Unbreakable Crystal. (formerly \$71.50)
IDEAL FOR
• Physicians • Engineers
• Radio Men • Sportsmen
• Photographers • Aviators

OUR GUARANTEE
MONEY BACK IN 10 DAYS

If not satisfied for any reason

ADLEW JEWELERS
Dept. PM 4

117 W. 42nd St., N. Y. C. 18

Mail Orders Promptly Filled • Shipped C.O.D. or send check or money order. Address mail-orders to: ADLEW JEWELERS (Dept. PM-4) 152 West 42nd St., N.Y.C. 18

Also available in 18-k Gold Case. \$64.50 (plus 10% tax), formerly \$125.

WAR SURPLUS NYLON THREAD



Amazing Strong Thread used to sew Parachutes

GIANT SPOOL

only **\$1.49**
BLACK or WHITE
APPROX 4800 FEET

NOW AVAILABLE

Hundreds of Uses . . .

This genuine Du Pont Nylon thread is practically unbreakable. What every hobbyist, sportsman, sailor, camper, wrights. Used in model making, sail mending, tent repairing, bow and arrow winding, bamboo rod wrapping, kite flying and repairing, and many other uses. Used by Air Force on parachutes because of its amazing strength and dependability. Here is your chance to get a giant spool of 4800 feet—almost a mile of Nylon thread—at the sensational low war surplus close-out price of only \$1.49. Black or white. Order TODAY.

SEND NO MONEY, TEST AT OUR RISK

Just send your name and address. Specify white or black or two giant spools for only \$2.89. On arrival, deposit only \$1.49 per spool (\$2.89 for two spools) plus C.O.D. postage on our guarantee if you are not delighted, you can return in 10 days and your money back. Cash with order, we pay postage. Only limited amount available. Order Today.

LEEWARD PRODUCTS

Dept. 49-E, 189 W. Madison St., Chicago 2, Ill.



Original WAR SURPLUS! **JUNGLE HAMMOCKS**
EASILY WORTH \$25!

ONLY **\$4.99** COMPLETE

BRAND New!

Get Set For A Summer of Fun!

A complete bed with upper and lower canopy. A perfect way to relax in the cool shade, zipped in safe from pestering insects. A 43" zipper slide opening and hanging ropes.

SEND NO MONEY! Send Name and Address and on delivery, pay postman \$4.99 plus C.O.D. charges plus 40c for mailing and handling charges. Satisfaction guaranteed or money refunded.

The DRAKE COMPANY, Dept. PM-27
1380 MILWAUKEE AVENUE CHICAGO, ILLINOIS

How To Make Liquid Marble

And BIG PROFITS In Your Own Business

Amazing Liquid Synthetic Marble can be made at home without machinery. Needs no heat or pressure. Can be poured into molds for casting expensive novelties. Liquid Synthetic Marble can be made in any color. It is even more beautiful than genuine marble because of its highly glazed finish. Costs far less. **FLEXIBLE MOLDS:** Make your own Flexible Molds. Cast novelties, statuary, desk sets, book-ends, etc. out of Liquid Marble, plaster and many other molding compositions. A large sized mold costs but a few cents. Hundreds of casts can be taken from a single mold. **UNLIMITED MARKET:** You will find steady year-round demand in your own community. No selling problem. We supply names of buyers for your finished products. Let BING PRODUCTS show you how to start with a small investment and build a permanent, independent, profitable business! Write now for FREE CATALOG!

BING PRODUCTS: Dept. PM-5A 88 BROAD STREET BOSTON 10, MASS.

GOVT. SURPLUS TRUCK PARTS AND EQUIPMENT

Military Type. We have for immediate delivery genuine parts for all makes and models. 4x2—4x4—6x4 and 6x6. All models from 1/2 ton to 20 ton. All Makes: Jeeps, Fords, Chevrolet, GMC, Studebaker, Reo, Auto Car, Federal, Diamond T, Brockway, Bierderman, Macks, Oshkosh, Dodge, White and Sterling.

Government Surplus — New DOLLY—TRAILER CONVERTER

Convert your semi-trailer into a full trailer with this new HEIL Model DC-6-2M Dolly complete with 33" fifth wheel and 4 NEW 900 x 20 Military Tread Tires.

Dolly has a Timken model T-2090-NX3 round type Trailer Axle without Brakes, and is equipped with dual 10 hole 20 inch Budd Wheels, Springs, overload Springs and SAFETY Chains.



Specifications:

Dolly wght. unloaded . . . 2,000 lbs. Loading Height . . . 54 in.
Overall Length 9 feet Overall Width 92 in.

This Dolly can be easily converted to a pole or pipe hauling unit; or can also be disassembled and the parts used for constructing trailers of many types.

AN EXCEPTIONAL BUY. \$750.00 VALUE AT ONLY \$400.00

WRITE FOR NEW 1948 CATALOG
FOB, K. C., Mo. 25% Deposit Required on COD Orders.

AMERICAN AUTO PARTS CO., Inc.
1830 Locust Kansas City, Mo.

Be an INVESTIGATOR

JAMES S. BOLAN, FORMER POLICE COMMISSIONER OF NEW YORK CITY offers MEN & WOMEN an attractive opportunity to prepare for a future in *Investigation & Criminology* by comprehensive Home Study Course. Free placement service assists graduates to obtain jobs. APPROVED UNDER G. I. BILL OF RIGHTS.

Write for Free Booklet PM.

THE BOLAN ACADEMY, INC.
EMPIRE STATE BLDG., NEW YORK 1, N. Y.

HIGH PRESSURE HYDRAULIC PUMP FOR HOME, SHOP AND FARM USE



Genuine Vickers constant displacement high pressure pump. Use it for any type of liquid pumping job. Will pump 400 gal. per hour at 3750 R.P.M. Precision piston type design provides 1000 lbs. per square inch pressure. Self priming. Standard thread 3/4 inch intake and discharge ports. With 3/8 inch splined shaft — just add pulley and power and you're ready to go.

HAS HUNDREDS OF USES

These pumps are brand new. Original acquisition cost approx. \$100.00. Can also be used as hydraulic motor; for rams, opening doors, hydraulic lifts, etc.—also for any liquid transporting job. War surplus, but brand new. Stp. wgt. 7 lbs. Send check or money order. Satisfaction guaranteed. Each only **\$9.95**

SOUTHWEST AERO SUPPLY, Dept. PM5
Drawer 488 South Houston, Texas.

Paint Your Car for **\$3.95** ONLY

2 FULL COATS ONE QUART DOES ENTIRE JOB

WITH **WYPE** TRADE MARK REG.

NO SPRAYING · NO MASKING · NO BRUSHING

AMAZING NEW BRUSHLESS AUTO ENAMEL
You JUST WIPE ON
with a POWDER PUFF
 instead of Brushing or Spraying



ANYONE CAN DO BEAUTIFUL JOB

Get Beautiful Mirror Like Finish That Looks Like Spray Job!

Dries Dust Free One Hour · No Streaks or Lapmarks

At last! Practically anyone can now paint his car with WYPE! No previous car-painting experience necessary. You get a beautiful high-gloss job that gives you an expensive finish such as is sprayed on by Professional Auto Painters—at a fraction of regular cost! With WYPE you need **NO BRUSH, NO SPRAY, NO MASKING!** Just **WIPE ON** with Powder Puff—which we furnish at no extra charge. You get a brilliant, glossy finish that is truly "factory-like." No streaks. No lap-marks. Guaranteed for **TWO** years not to crack, peel, chip or fade, if simple directions are followed. Takes about an hour to apply. Dries dust-free in an hour. WYPE comes in nine most popular shades including those on newest model cars. Goes over any other color, lacquer or enamel.

MOST POPULAR COLORS

- Black Brewster (dark) Green
- Mazoon Jewel (light) Green
- Red Washington (dark) Blue
- Gray Monticello (light) Blue
- Sun Beige (light) Tan

\$3.95 Per Quart

SEE YOUR DEALER or ORDER DIRECT SEND NO MONEY · Get WYPE Today!

If your dealer can't supply you, just send us a postcard. We'll ship C.O.D. Just pay mailman for Wype, plus postal charges. Or send remittance with order and WE pay postage.

You're SURE You Are SAFE when You Paint with WYPE HERE'S WHY!

TESTED BY U. S. Testing Co., Inc.

Leading Scientific Testing Laboratory

Report No. 87496 Jan. 5, 1948 and found to conform to the claims and guarantee of the Wype Corporation.

No higher or more rigid standards are set by any Testing Laboratory. United States Testing Company conducts scientific tests for the world's foremost organizations and is accepted as a leading authority on such tests.

For Your Protection Before you buy any automobile paint, ask for proof that it has passed tests by a nationally known testing laboratory. Remember the value of your car! You can TRUST Wype.

2-YEAR GUARANTEE We Guarantee WYPE against cracking, peeling, fading or chipping for two years—after application, if applied according to directions furnished. Your money cheerfully refunded if WYPE does not live up to this Guarantee.

COPYRIGHT 1948, WYPE CORP



APPLY in ONE HOUR — DRIES to GLISTENING PROFESSIONAL FINISH

WYPE is a new Miracle Enamel for Autos. It is NOT a wax or polish but a hard high lustre ENAMEL finish! With WYPE, ANYONE can do a beautiful job! Order a quart to paint your car or to get started in this **BIG-MONEY** Business!

NO STREAKS OR LAPMARKS LOOKS LIKE SPRAY JOB

Win \$2,500 Cash!

\$5,000 Cash Prizes in All Win \$2,500 cash writing best letter telling your experience with Wype!
Just 3 Easy Steps
 1. Write letter: "My Experience with Wype."
 2. Enclose one of following: Sales check or receipt you got when purchasing Wype; or powder puff used to paint your car; or reasonable facsimile of Wype can. (When you order direct, we send official entry blank—dealers also have blanks.) 3. Mail to us.
\$5,000 CASH PRIZES
 1st Prize, \$2,500 Cash!
 2nd Prize, \$500 Cash!
 3rd Prize, \$250 Cash!
 5 Prizes, ea. \$50 Cash!
 100 Prizes, ea. \$10 Cash!
 100 Prizes, ea. \$5 Cash!
Anyone May Win!
 Letters considered best by judges get prizes! Judges' decisions final. Duplicate awards in case of ties. No entries returned. All entries must be postmarked before midnight June 30, 1948, and received before July 14, 1948. Full details at dealers or write us.

Some of the FAMOUS DEPARTMENT STORES that Sell WYPE

- VISIT or PHONE THE STORE IN YOUR CITY...**
- Akron: M. O'Neill Co.
- Baltimore: May Co.
- Baton Rouge, La.: D. G. Rosenfield Co.
- Buffalo, N. Y.: J. N. Adam & Co.
- Chicago: Goldblatt's 15 Department Stores (Goldblatt's Department Stores, also, at Joliet, Ill., Hammond, Ind., Gary, Ind., South Bend, Ind.)
- Cincinnati: Fair Store Co.
- Cleveland: May Co.
- Dallas: Sanger Bros., Inc.
- Denver: May Co.
- Detroit: People's Outfitting Co.
- Ft. Wayne: Wolf-Dessner Co.
- Ft. Worth: W. C. Stripling Co.
- Hackensack, N. J.: Packard-Bamberger
- Houston: Foley's
- Indianapolis: Wm. H. Block Co.
- Kansas City Mo.: Jones Store Co.
- Los Angeles: May Co.
- Louisville: Kaufmann-Straus Co.
- Memphis: B. Lowenstein & Bros.
- Milwaukee: Ed. Schuster & Co., Inc.
- Minneapolis: Donaldson's
- Montgomery: Montgomery Fair Store
- New Orleans: Maison Blanche Co.
- Newark, N. J.: Bamberger's
- New York: Gimbel's
- Philadelphia: Lit Brothers
- Pittsburgh: Kaufmann's
- Richmond, Va.: Miller Rhoads, Inc.
- St. Louis: Famous-Barr Co.
- St. Paul, Minn.: The Golden Rule
- San Antonio: Joske's of Texas
- San Diego: Whitney's
- Syracuse, N. Y.: Dey Bros. & Co.
- Toledo: Lion Dry Goods Co.
- Washington, D. C.: Lansburgh & Bro.
- Youngstown, O.: Strouss-Hirschberg

WYPE CORP. Dept. 16-E 2214 DOLMAN ST. ST. LOUIS 4, MO.

Free! New CONCORD RADIO Catalog



The ONLY Complete
Up-to-the-minute Catalog of
RADIO PARTS • RADIO SETS
KITS • HAM GEAR • TESTERS

The greatest, latest complete presentation of radio, electronic and television equipment and supplies in Concord history! Packed from cover to cover with thousands of items—160 pages of everything in Radio and Electronics. Special bargain section of hundreds of money-saving values. Scores of

new items from famous makers. Parts, blueprints for famous Popular Mechanic and many other kits. Mail coupon for your FREE copy.

CONCORD RADIO CORP.

CHICAGO 7 **ATLANTA 3**
901 W. Jackson Blvd. 265 Peachtree Street
Downtown Chicago Branch: 229 W. Madison
LAFAYETTE RADIO CORPORATION

CONCORD RADIO CORP., Dept. 105
901 W. Jackson Blvd., Chicago 7, Ill.
Yes, rush FREE COPY of the comprehensive new Concord Radio Catalog.

Name _____
Address _____
City _____ State _____

EARN MORE

\$\$\$.\$



SEND FOR THIS FREE BOOK NOW!

• Increase your earning power. Become thoroughly trained in a well-paid profession. Without obligation, find out about the opportunities in Electrical, Mechanical, Plastics, Civil, Mining and other engineering fields. Our free 118-page handbook, lists details of home study courses, compiled by world authorities. See for yourself how you can soon earn more dollars. Write today, to: Canadian Institute of Science and Technology, Ltd., 453 Century Building, 412, 5th Street, N.W., Washington, D. C.

MAIL THIS COUPON NOW

Canadian Institute of Science & Technology, Ltd.,
453 Century Building, 412, 5th Street N.W.,
Washington, D.C.

Please forward free of cost or obligation of any kind your 118-page handbook "Engineering Opportunities".

Name _____ Age _____
Address _____

CANADIAN ENQUIRIES: 219 Bay Street, Toronto 1.

Aviation GENERATOR



- Type 314 Model 31
- 30 Volt 50 ampere
- Length 14" Dia. 6"
- 7/8 O.D. 1" Length Shaft
- Made by Eclipse
- Guaranteed Brand NEW and perfect
- In original crates

ORIGINAL COST \$170.00 EACH!

Cash or Check with order prepaid in U.S.A., C.O.D.'s F.O.B. Chicago, must be accompanied by \$5.00 check or Money Order. Net Weight 34 lbs. Ship. Weight 50 lbs.

\$20.00
each

NORTH AMERICAN SALES CO., PM-32
8 S. DEARBORN STREET • CHICAGO 2, ILL.

NEW Family SAFETY JIG SAW READY!

At last—a revolutionary, new electric jig saw small children may use, yet powerful enough to be the basic tool in Dad's workshop! Make "Standing Photo Silhouettes" of fancy what-nots, toys, for fun and profit! Handy as a hammer—just plug in! No motor to buy—no oiling. Thousands sold. Use in living-room, apartments, etc., patented. Nothing else like it. Mail postal NOW for illustrated, Free Circular, low price! (Dealers write!)

SYNGRO FREE CIRCULAR!

SYNGRO SAW CORP., DEPT. A-58, ROCHESTER, MICH.

NEW WAR SURPLUS

AAF LEATHER A-2 JACKET
GENUINE COWHIDE.
INSIGNIA ON SLEEVE
Only \$14.95

SUNGLASSES
4 BASE LENS. GOLD PLATED. 2.29
MOTHER '60 PEARL BROW BAR, PADS

AAF Trouble LIGHT
FLEXIBLE GOOSE NECK
1.49 with 2 Bulbs!

RUBBER Gloves
NEOPRENE For CHEMISTS, SHOP, etc. 69¢

ARMY COTS
HEAVY QUALITY KHAKI CANVAS Reinforced LEGS 4.95

COAST GUARD Approved LIFE VESTS
2.95 KAPOK FILLED. ADJ. BELT, TIES

ARMY FIELD JACKET
ZIPPER FRONT. BELT BACK. WOOL LINED 7.50 EA.

FEATHER FILLED Sleeping Bag
ZIPPER CLOSING 14.95

100% WOOL BAG
WITH ZIPPER 3.49
WATER-REPELLENT BAG COVER 1.49 (USED) WITH SNAPS

FOX HOLE SPADE
18" HANDLE 89¢

U.S.M.C. UTILITY JACKETS
H.B. Twill... 1.49
SIZES 36 to 44

GOOD YEAR COMBAT BOOTS
Comp. Sole 6.45 PR.

NAVY Style BLACK OXFORDS
• OAK BEND SOLES
• FINE CALF LEATHER
• RUBBER HEELS. D & E WIDTHS. 6.49

DUST RESPIRATOR
U.S. MODEL M1 Adj. Head Straps 29¢

No. C.O.D. TOWNE TRADING Corp.
P.P. Extra 280 8'WAY-NEW YORK 7

OXYGEN TANK



Loaded with aviator's breathing type oxygen at 1800 pounds pressure. Tank measures 13 1/2 x 5 1/2 inches with rounded ends. Tank is of solid metal fitted with brass release valve at top. Brand new! Loaded—ready for all types of emergency use. Shp. wgt. 13 pounds. A real value! **Stock No. 390—Each, \$3.50 only.**

MESS KITS

Regulation two-piece Army Mess Kits with folding handle. Used, but perfect. Weight 2 lbs. **No. A116—Ea. 69c**



CANTEENS

Reg. U. S. issue canteens. Plastic screw top chained to body. Slightly used but perfect. **Wgt. 1 lb. 117—Metal 69c**
118—Plastic—Ea. 69c



CANTEEN CUPS

All metal. Folding handle. **Wgt. 1 lb. No. A120—Each... 25c**

CANTEEN COVERS

Heavy canvas. Button fastener. **New No. 530—Each... 69c**
Used No. 119—Each... 35c

WIRE CUTTER

Heavy duty, compound leverage. Cuts up to 1/4 inch wire. Upper jaw sets as feeder to cutting edges. Insulated handles. Ideal for farm fence work and shop use. **Shp. wgt. 2 lbs. Stock No. 392—Each \$1.95**



HEAVY DUTY RUBBER GLOVES
BRAND NEW

Extra heavy—extra long. Brand new, high quality gum rubber for softness and ease in use. Designed for heavy duty industrial service—protection in handling chemicals, acids, etc. A real bargain at this low price. **Stock No. 295—Per Pair, Only \$79c**

AMMUNITION BOX

Used for 50mm ammunition. Heavy, all metal design with latching top and folding handle. Provides safe, fireproof storage for valuables, etc. Measures 12x 6x7 1/2 inches. Used but in new condition. **Shp. Wgt. 8 lbs. No. 338—Each... 79c**



ARMY AIR CORPS TYPE SUN GLASSES

Ideal for driving, sun glare, sports and work. 24 carat gold plate frames with Pyralin sweat bar—adjustable nose bands. Large aviation type lenses. Case included. **Shp. wgt. 1 lb. No. 238—Per Pair \$2.95**

WAR SURPLUS AND HUNDREDS OF OTHER BARGAINS

POPULAR RECORD ASSORTMENT

Fifty records of modern dance, race, blues and hillbilly selections. No two alike. Famous name bands and artists included. Used in juke boxes, but guar. perfect. Shipped exp. collect only—no exchanges or refunds. **Wgt. 28 lbs. No. A303—50 records \$9.64**

| | | |
|--|--|---|
| No. A300—25 Records. All Dance. Wgt. 14 lbs. \$4.88 | No. A301—25 Records. Hillbilly, Race and Blues. Wgt. 14 lbs. Set... \$4.88 | No. 302—25 Records. All Hillbilly numbers. Wgt. 14 lbs. Set... \$4.88 |
|--|--|---|

STIRRUP PUMP

Works with any pail or bucket. Shoots a high pressure stream up to 30 feet. Use it for spraying garden and trees, for whitewashing, fire fighting, drainage, etc. Complete with 10 foot flexible hose. All brand new. Regular \$3.80 value. **No. 244—Each... \$1.49**



15 JEWEL STOP WATCH

U. S. AIR CORPS SURPLUS
Genuine Elgin 15 Jewel movement. Ideal for split second timing in racing, sports, time study, etc. Full sweep split second hand graduated in 1/10th seconds. Stem wind, start, stop and reset. Used but guaranteed perfect. **Wgt. 1 lb. No. 200—Each... \$9.95**



27 LENSES, ALL NEW, PERFECT.

For experimental work in optics. Consists of 27 precision ground and polished prisms and lens elements in assorted diameters and focal lengths. Big variety—positive, negatives, etc. Actual value over \$100.00. **A519—27 PIECES... \$7.95**



MCCLELLAN SADDLE
Brand new! Top grade cowhide, 12 inch seat. Hair girth. Has straps for blanket roll and knapsack. Gun boot and sabre loops. **Shipping weight 15 lbs. Stock No. A145... \$16.95**
Each... **\$16.95**

BAYONET BLADE

Fine forged steel. Ground but not polished. May be made into throwing or hunting knife or spear. Blade 6 3/4 x 7 1/2 inches, 1 1/4 inches overall. Will take and hold a fine edge. **Shp. wt. 1 lb. No. 664-R—Each... 49c**

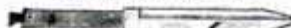

VEEDER ROOT COUNTING MACHINE

Five wheel type—counts to 99,999 and repeat. Nickel finish case. Has 1/8 inch round shank. Use it for any counting job. Brand new. **Shp. wgt. 1 lb. No. 241—Each 98c**



ARMY TENTS

A value you can't beat. Big 16x16 ft. pyramid tent with 4 foot drop wall. Used but in excellent condition. Poles not included. Fine for camping out, carnivals, etc. **Wgt. 100 lbs. Stock No. 521—Each only \$35.00**
Center and corner poles. Express collect. **No. 500—Only \$3.00**



RUBBER OVERBOARD SUIT

Here is a buy! Fits over your regular clothes and shoes. Can be cut apart for waist high waders, hip high or knee high boots, also arm length rubber gloves. Heavy gum rubber over fabric. Fine for commercial fishermen, sewer diggers, etc. Use it as is or cut it up for waders. All brand new! **Wgt. 14 lbs. No. 183, Each \$4.95**
Please include 75c for postage.



HIGH PRESSURE SHATTERPROOF TANKS

TYPE D2
A high pressure shatterproof tank of 500 cubic inch capacity— for 50 pound pressure or 8.9 cubic feet. All metal—measures 6 1/2 x 2 1/2 inches. Threaded plug end vents. **Shp. wgt. 6 lbs. No. 388— \$2.45**
TYPE F1
A high pressure shatterproof tank of 1000 cubic inch capacity— for 50 pound pressure or 13.8 cubic feet. All metal—measures 9 1/2 x 17 inches. Threaded plug end vents. **Shp. wgt. 11 1/2 lbs. No. 389— \$3.75**



DECORATIVE CHROME STRIPS

For your car, boat, furniture, etc. Highly polished chrome finished strips with clinched edges for flush mounting to any surface. The 3 pound kit provides approx. 15 pieces in lengths from 6 inches to 3 feet and average 3/4 inches wide. **Wgt. 4 lbs. No. R224. \$2.00**
3 lb. Assort. only.



ORDER DIRECT FROM THIS AD

Values galore! Hundreds of hard-to-find items for home, shop and outdoors. Make remittances by money-order, bank draft or personal check. Send 25% deposit on C.O.D. orders. No C.O.D.'s on orders for less than \$3.00. Include sufficient postage on parcel-post orders—any overage will be promptly refunded. All quotations F.O.B. Chicago. Used items and materials are guaranteed serviceable and as described. Your money back if not more than satisfied.

SEND 10c TO COVER POSTAGE AND MAILING ON BIG CATALOG—READY IN ABOUT 60 DAYS

STARK'S
Dept. PM5
509 So. State St.
CHICAGO 5, ILL.

7 LB. EXPERIMENTER PARTS ASSORT. KIT



A "gold mine" for the radio serviceman. Hundreds of valuable radio parts, new radar and electronic parts and sub-assemblies, coils, resistors, trimming condensers—worth many times this low price. **A130R—7 lbs. \$1.79**

AVIATOR'S OXYGEN

Ball out type. Consists of all metal tank, release valve, gauge and breather hose, all enclosed in khaki colored cloth bag. These tanks are loaded with oxygen at 1800 pressure. Ideal for use as reserve oxygen supply for all types of emergency use. Shipping weight 4 pounds. All brand new. **Stock No. 391—Each... \$4.95**



SATCHEL POUCH

Heavy canvas pouch. Ideal for taking lunches, shopping, books, etc. Has 11x12 inch pocket. Brand new, guaranteed perfect. Has oversize flap with single strap fastener. **A113—EACH \$1.69**



FLEXIBLE NECK FLASH LIGHT

Ideal trouble shooter's flash light. Flexible neck lets you direct light around corners and inaccessible spots. Brand new! Plastic case with BX type neck. Uses 2 standard flash light batteries (less batteries). **Shp. wgt. 2 lbs. No. 205—Each... \$1.39**



Officers Watch Compass

Brand new gov't. surplus. Army-Navy model. Single jewel mounted needle. Silver colored dial. A splendid value. **Shp. wgt. 1 lb. A174—Each... 98c**



TRAILER UNDER-CARRIAGE

Build your own trailer for boat, camping gear or delivery service. Fitted with 26 x 2.125 U. S. Royal Tires. Motorcycle type wheels. Solid steel axle, leaf type springs and body mounting brackets. All brand new! Hitch not included. Folds to fit trunk of car. Shipped express collect **only. No. 199—Each... \$24.95**



OVERSIZE TIRES

Score another hit for the man with **P.A.***

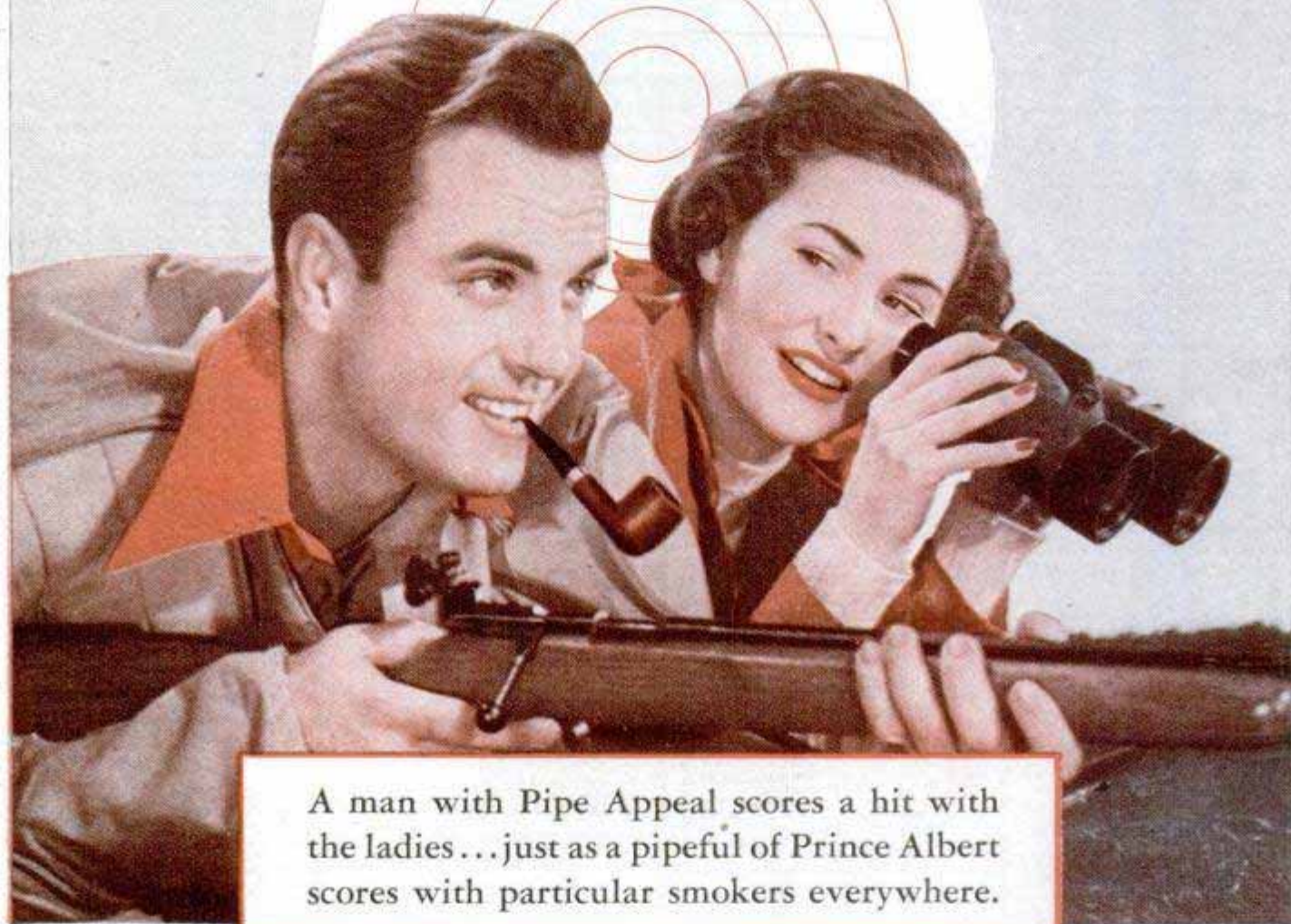

A man with Pipe Appeal scores a hit with the ladies... just as a pipeful of Prince Albert scores with particular smokers everywhere.

P.A.* means Pipe Appeal
P.A. means Prince Albert

R. J. Reynolds Tobacco Co.
Winston-Salem, N. C.

FOR CIGARETTE 'MAKIN'S,
P.A. SCORES A HIT WITH ME!
IT'S SMOOTH ROLLING—
GRAND TASTING!



● When you try Prince Albert — you'll understand why it's America's largest-selling smoking tobacco! It tastes rich. It smokes cool. It's mild and tongue-easy. For P.A.'s choice tobacco is crimp cut and specially treated to insure against tongue bite. For smoking joy and comfort — try P.A.!

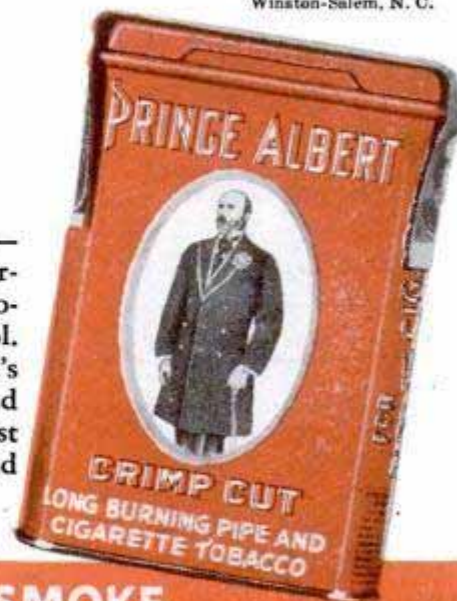

THE NATIONAL JOY SMOKE

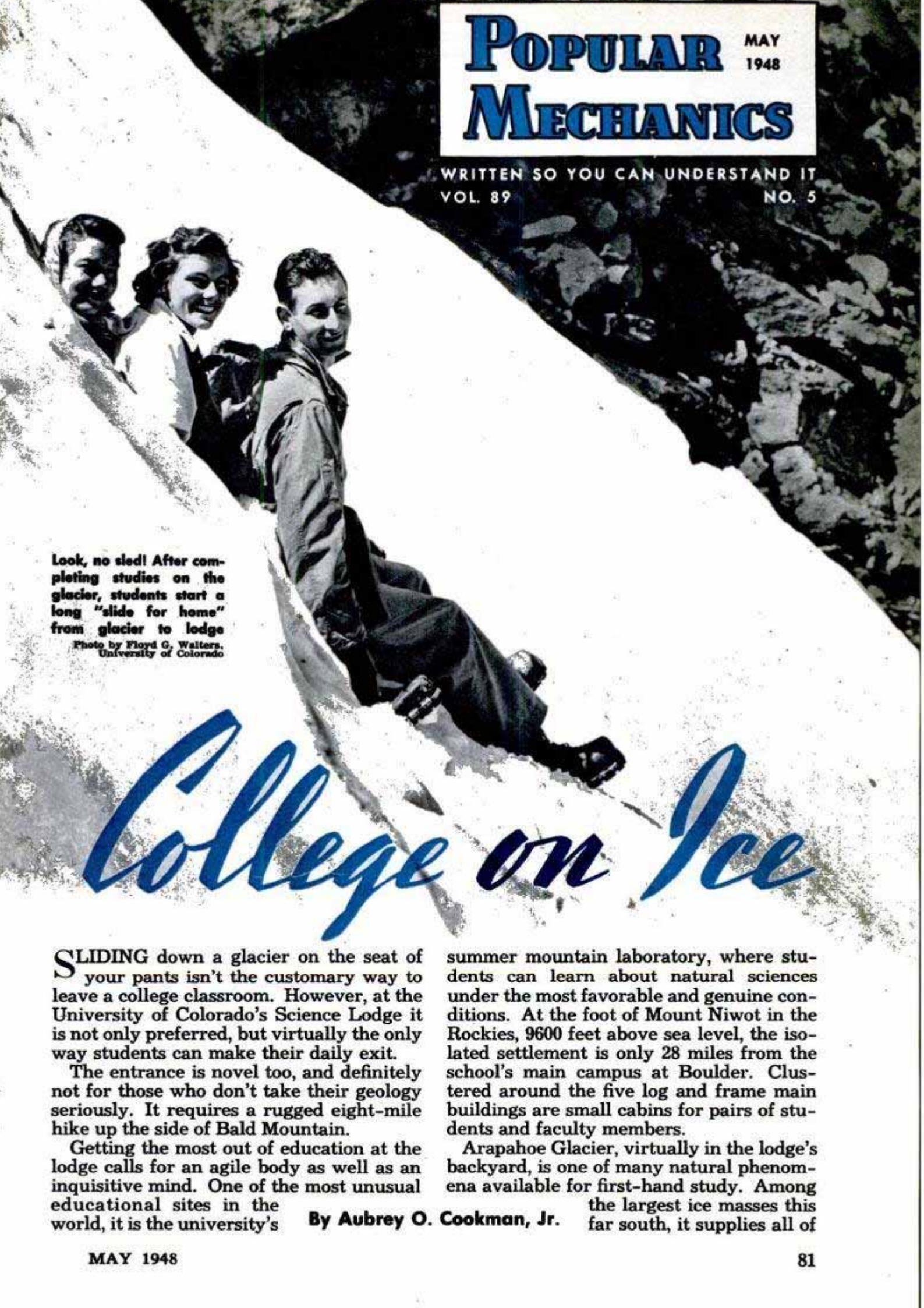
A black and white photograph showing three people sliding down a steep, snow-covered glacier. They are dressed in heavy outdoor gear. The person in the foreground is a man in a dark jacket and pants, sliding on his back. Behind him are a woman and another man, also sliding. The glacier is a mix of white snow and dark rocks. The background shows a rocky mountain slope.

Look, no sled! After completing studies on the glacier, students start a long "slide for home" from glacier to lodge

Photo by Floyd G. Walters,
University of Colorado

College on Ice

SLIDING down a glacier on the seat of your pants isn't the customary way to leave a college classroom. However, at the University of Colorado's Science Lodge it is not only preferred, but virtually the only way students can make their daily exit.

The entrance is novel too, and definitely not for those who don't take their geology seriously. It requires a rugged eight-mile hike up the side of Bald Mountain.

Getting the most out of education at the lodge calls for an agile body as well as an inquisitive mind. One of the most unusual educational sites in the world, it is the university's

summer mountain laboratory, where students can learn about natural sciences under the most favorable and genuine conditions. At the foot of Mount Niwot in the Rockies, 9600 feet above sea level, the isolated settlement is only 28 miles from the school's main campus at Boulder. Clustered around the five log and frame main buildings are small cabins for pairs of students and faculty members.

Arapahoe Glacier, virtually in the lodge's backyard, is one of many natural phenomena available for first-hand study. Among the largest ice masses this far south, it supplies all of

By **Aubrey O. Cookman, Jr.**



University of Colorado photos

Young scientist checks dew at 10,000-foot elevation with instrument of his own design. Inset at right, a student weighs a young seedling to measure the amount of moisture cold winds have sucked from it

Boulder's water. Those who've spent hours trudging around it say they have a better appreciation of how these giant frozen bodies reshaped the earth's surface than those whose glacier study has been confined to steam-heated classrooms.

Variety is probably the laboratory's most important asset. Within hiking or short bus distance, geology students can examine varying rock formations present in over a mile of the earth's thickness. Bare, rugged

Using a micro-measurement instrument, a girl works out her thesis on tree measurements in the mountains



↓ Student bores a tree for study of its growth rings. Borer brings out the "core" without harming the tree

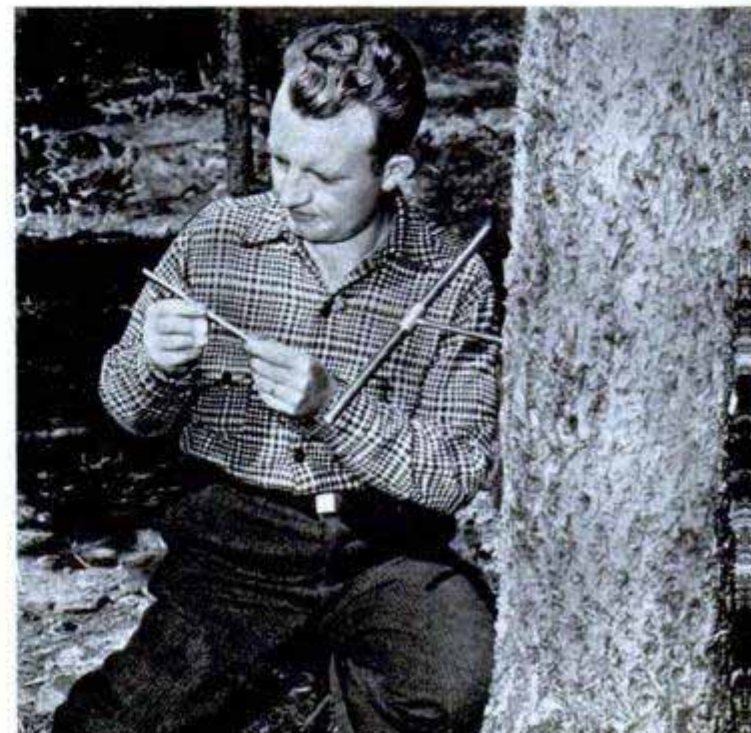



There's nothing like the outdoors for a study of nature. Here a university instructor lectures a field class assembled on a mountainside. Inset shows girl students using a plane table for mapping the area

peaks along the Continental Divide go to heights above 14,000 feet and then, eastward, gradually give way to the foothills and hogbacks bordering the western edge of the high plains.

In this area that is often described as a geologist's paradise can be seen exposed metamorphic rocks at the Divide, evidence of volcanic action at Specimen Mountain, intrusive igneous rocks in the foothills and the stratified sedimentary formations of the plains. Classes visit tungsten, coal and silver mines, oil and gas fields, and many kinds of quarries.

The front range of the Rockies unfolds a tale tens of thousands of years long about drainage, glaciation, lake sedimentation and the constant movement of the earth's "skin." Some collect as many as 200 speci-

mens of rocks, ores, minerals and fossils in a single summer.

Biology students explore plant life and fauna found over a vertical span of elevation of 8000 feet. In a single day they can visit places with climates varying as sharply as those of Denver and northernmost Canada. Field trips take them to the tundra above timber line, through the lakes, ponds and streams of the mountains, and finally down to the short grass plains, where cactus and sagebrush divide attention with prairie dogs, jackrabbits, snakes and extensive bird life.

Special stress is laid in learning a new and different technique in biology research methods. A weather station has been set up at Ward, and hourly readings are taken over a large area to map the distribution



of plants, and to help check the abundance of different growths, their frequency and conformation. When field work is finished, the research continues in fully equipped labs at the lodge.

Class sizes have to be kept down because accommodations at the lodge are limited. This year's session, from June 21 to August 27, will include only 60 students, 40 in geology and 20 in biology. A ratio of four men to each woman in the former is exactly reversed in the latter. The work in each section follows entirely different lines, but both emphasize field problems.

In keeping with the outdoor setting, dress is thoroughly informal. There, nearly two miles above sea level, the usual campus attire gives way to thick boots and socks, blue jeans, heavy coats and jackets, and hats that will shield from the frequent rains and the sun's glare. For those in biology, who probe into aquatic life, bathing suits are recommended additions.

With a permanent camp staff handling all the chores, practically the entire time of students is free for research projects. All the meals are served at a central

Students hike back down the mountain after a study of the glacier. Below left, a professor checks the temperature of a drift from top to bottom. Right, students measure speed of wind and rate of water loss in plants

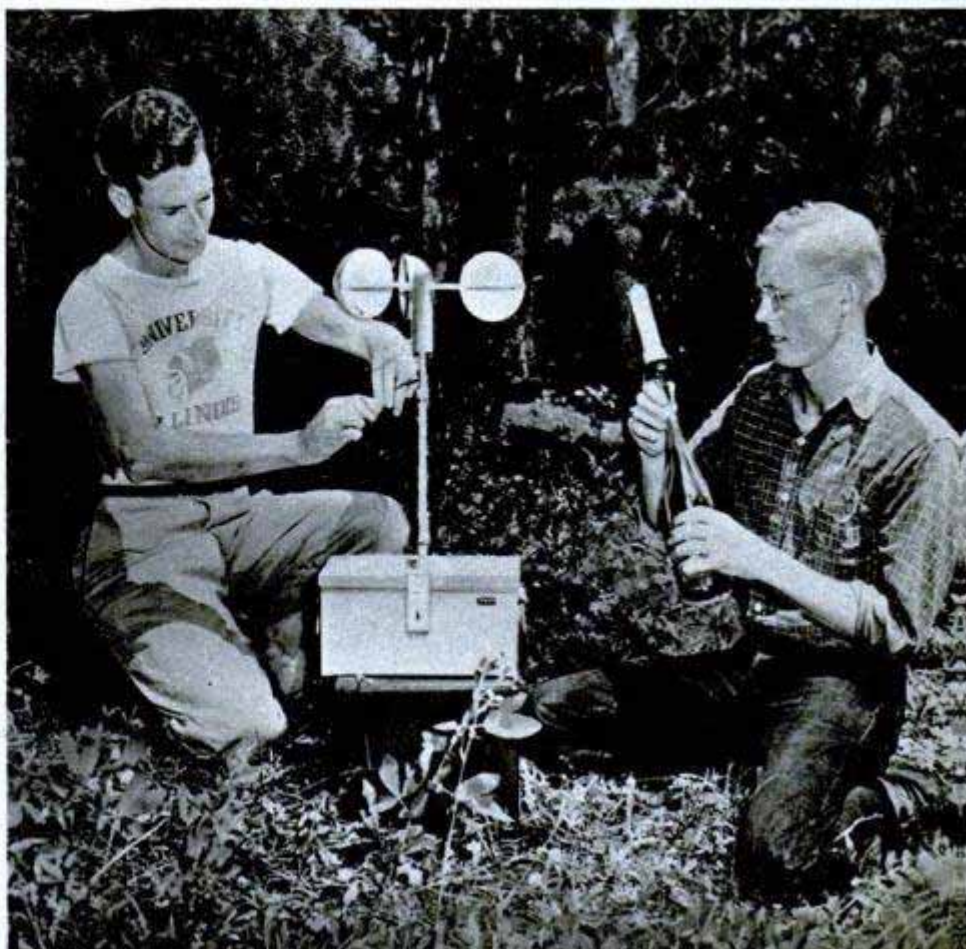

dining hall, where pack lunches are doled out in the mornings for those leaving on all-day field jaunts. Trips by bus and on foot are taken three days a week, alternating with three days in camp.

One class for graduate students roves constantly. Its 10 or 12 members are away for six weeks with full camping equipment, often ranging as far as 200 miles.

Science Lodge came into being in a completely unacademic way, as a week-end and vacation retreat for men who wanted to get away momentarily from the rigors of college teaching. A half dozen Colorado faculty members started it about 30 years ago as a place to relax and from which they could start their fishing, hunting and hiking trips.

Word spread and the university became interested too, finally using a \$1000 grant in 1921 for the first purchase of ground for the present laboratory site. Later, when the area's potential usefulness as an outdoor research center became apparent, the university traded other land it held to the government for 80 acres around the lodge. Now it owns 1100 acres of forest land in which to carry on the research work.

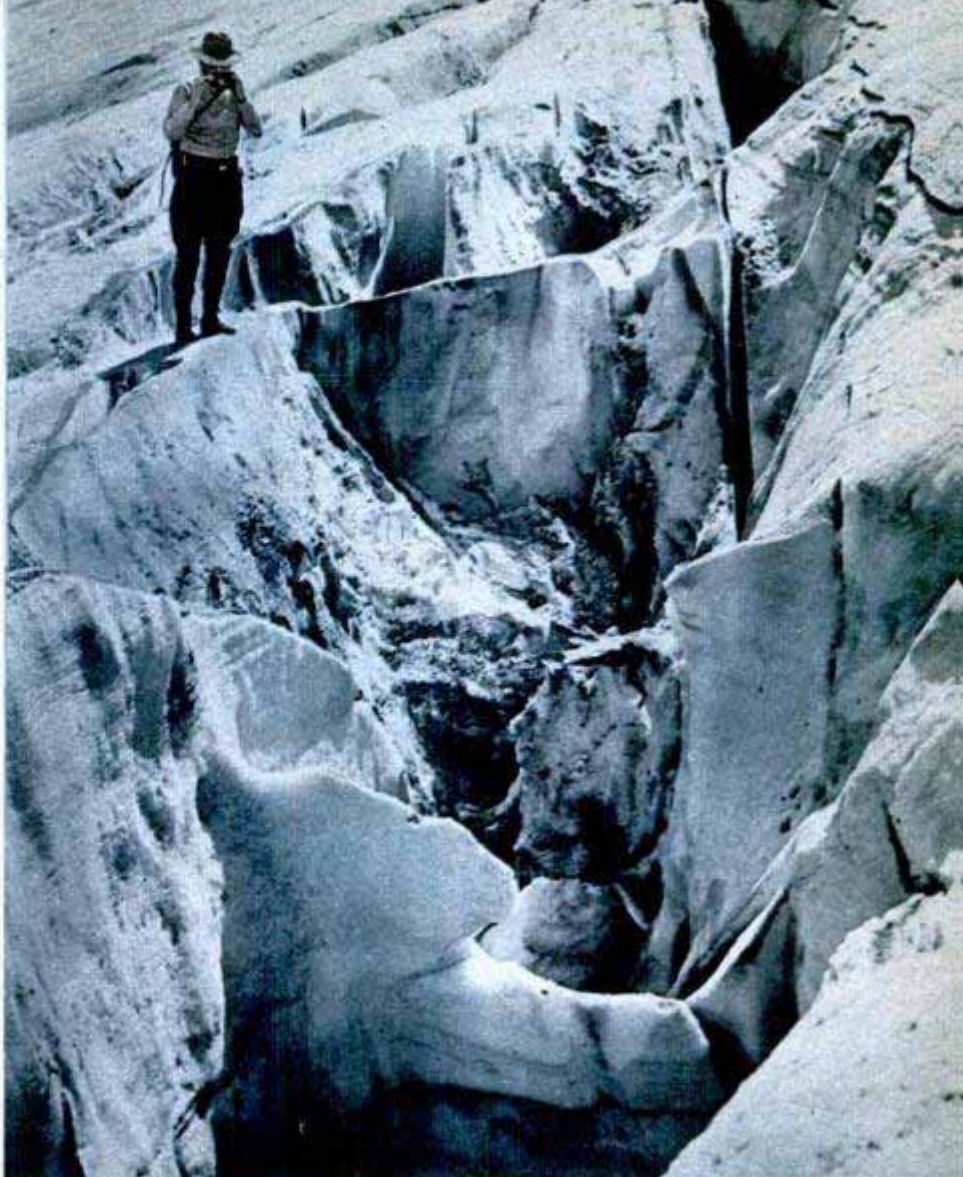

Photo by Bruce R Snow, Boulder, Colo.

Above right, during a field trip to Arapahoe Glacier a scientist studies one of the crevasses. Below, student pulls a rubber raft through Red Rock Lake, high in Rockies, while his companion takes notes on marine growth





He Can Blow Back at Autos

When Hilton Tupman noticed that motorists frequently sound their horns at pedestrians without excuse, he decided to give the man on foot a chance to strike back. The Los Angeles auto dealer came up with a pedestrian horn which blasts right back at inconsiderate drivers. The tooter is built of war-surplus materials and a pair of bus horns. When a trigger is pulled, air under 500 pounds pressure rushes through the horns, which can be heard for a mile.

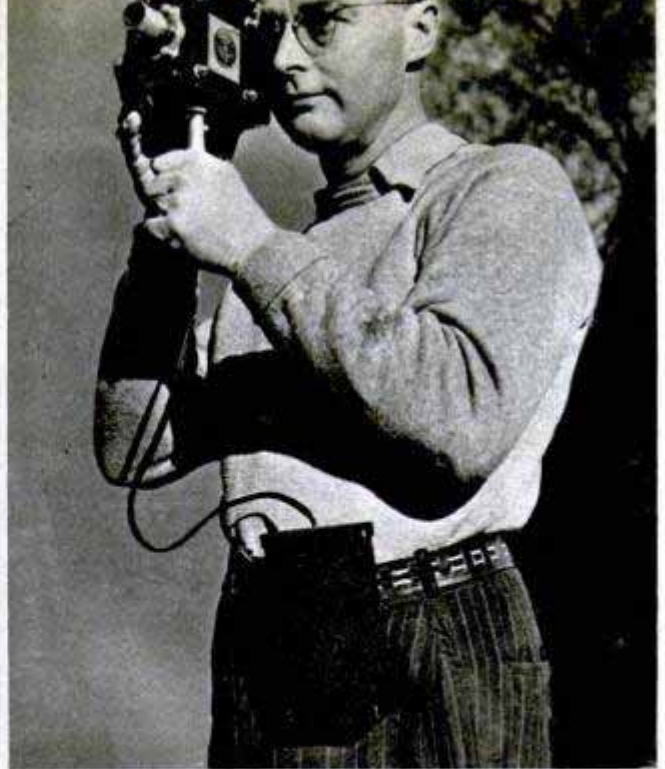

Airplane Gun Camera Converted for Peace

Airplane gun cameras, used during the war on fighter planes, are converted to practical 16-mm. motor-driven movie cameras by a kit now on the market. The kit includes a battery case, view finder, handle and tripod bracket, lens shade and a focusing element for the lens. A few simple changes inside the camera are necessary to convert it for amateur use. The battery case is carried on the belt.

Amputees Grip Hand Tools Securely With Holding Devices

With a set of holding devices designed for use with any standard artificial arm, handicapped persons can grip hand tools securely. Gripping pressure is adjustable and a lever instantly releases the tool. In

the kit are three holding devices: a vise wrench, pliers with a screw adjustment for clearance, and spring-pressured pliers requiring no adjustment. An adapter that fits into the artificial arm is also provided.

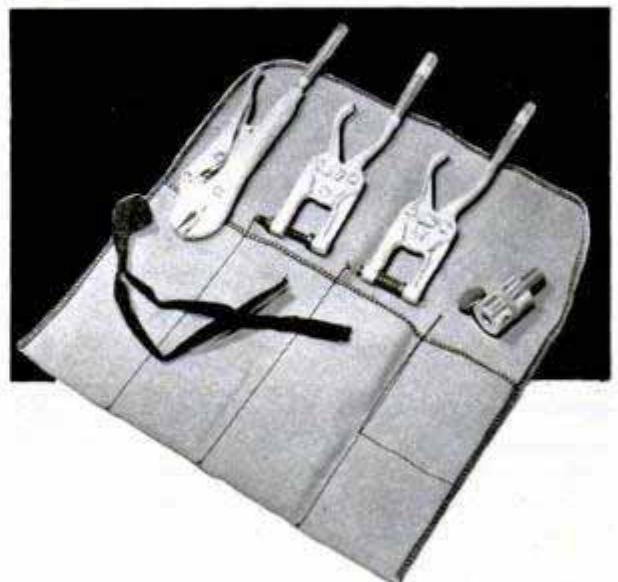

By attaching holders (above) to his artificial arm, amputee (left) uses hand tool efficiently

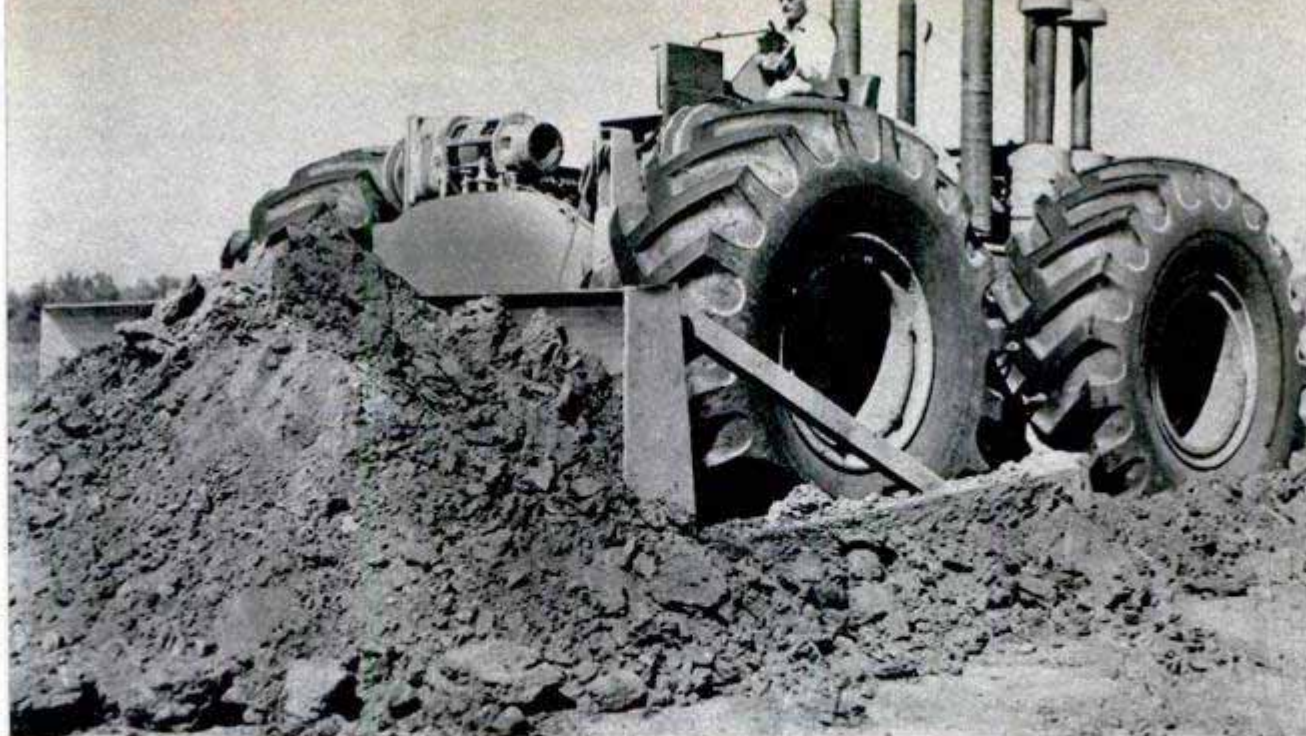

Complementing 16-foot blade at front end of dozer, one at the rear the same width chops off roots 18 inches below surface. Four 30 by 33 tires support the huge pusher, which has about 700 horsepower and is easily maneuvered forward or backward.

700-Horsepower "Dozer" Chops Roots Below Ground

Even the roots are chopped off by a giant butane-powered pusher called a Tornadoizer. The "dozer" blade pushes over trees and brush, and a 16-foot cutter, hanging at the rear, lifts the earth slightly as it slices to a depth of 8 to 18 inches and lays it back down in its wake. It has about 700 horsepower and moves either forward or backward. The 50-ton-capacity vehicle rides on 30 by 33 tires, has a maximum speed of 16 miles an hour and is easily maneuvered.



Reel for Long Extension Cords

Long extension cords remain untangled and easy to handle when kept on a reel that takes lengths up to 400 feet. A constant-contact conductor feeds current to the cord continuously. The reel swivels on its base to align with the direction of unreeling. Weighing less than 15 pounds without cord, the unit is easily carried from job to job. The cord is rewound by a handle on the drum.

Orders for Diesel locomotives by American railways in 1947 reached 2075, nearly double the highest previous year (1104 in 1941) and comparing with 79 new steam engines ordered.

Names and addresses of manufacturers of new products in this issue will be supplied promptly by the Bureau of Information, Popular Mechanics Magazine, 200 East Ontario Street, Chicago 11, Ill.

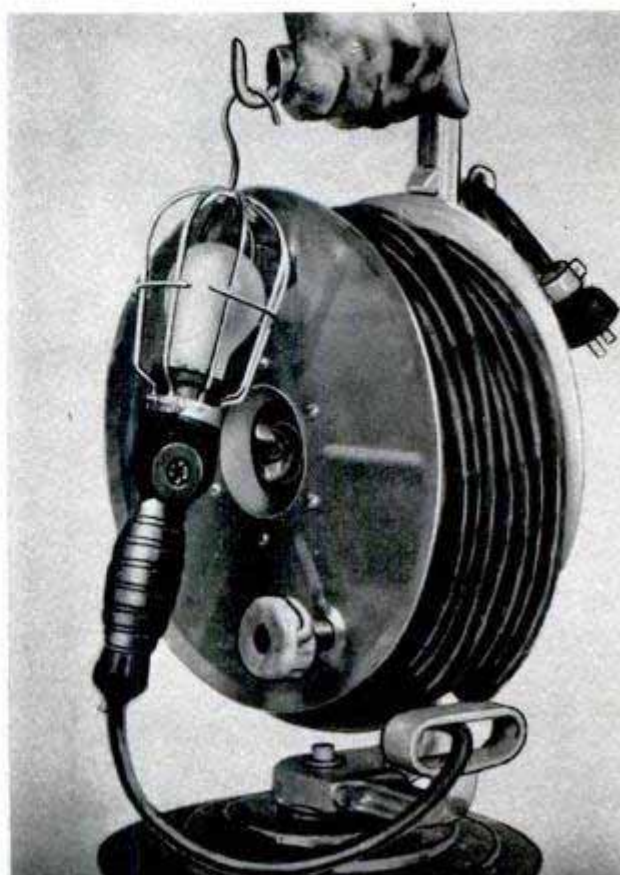

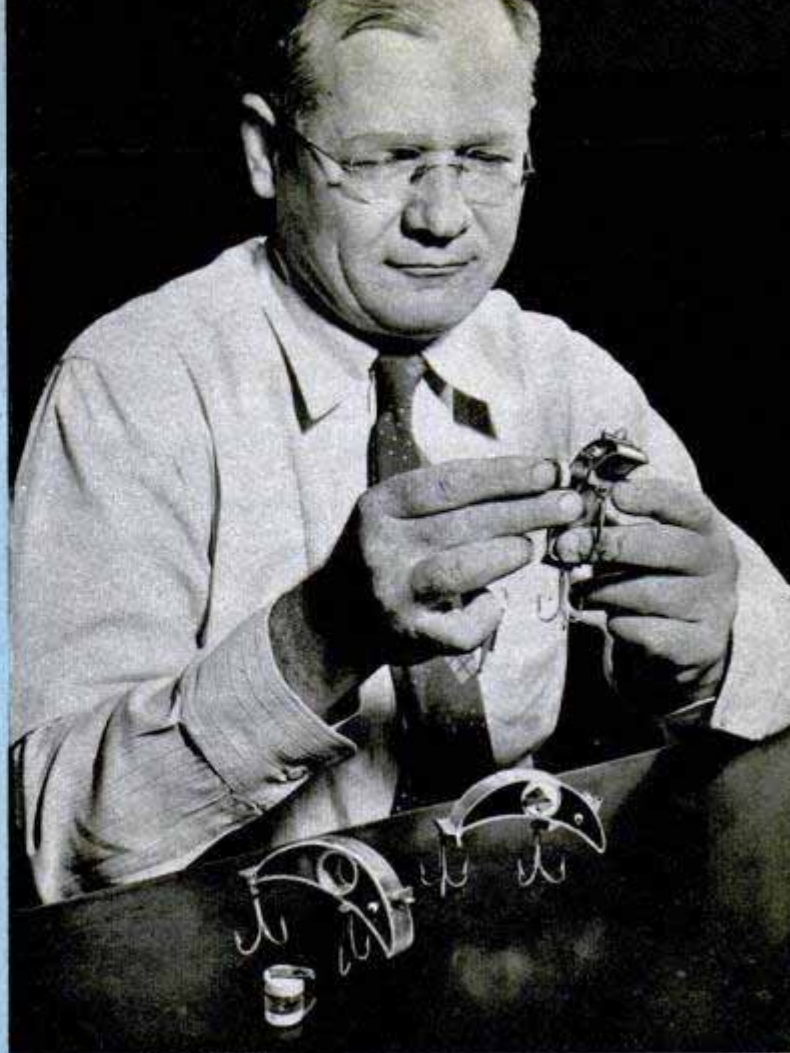
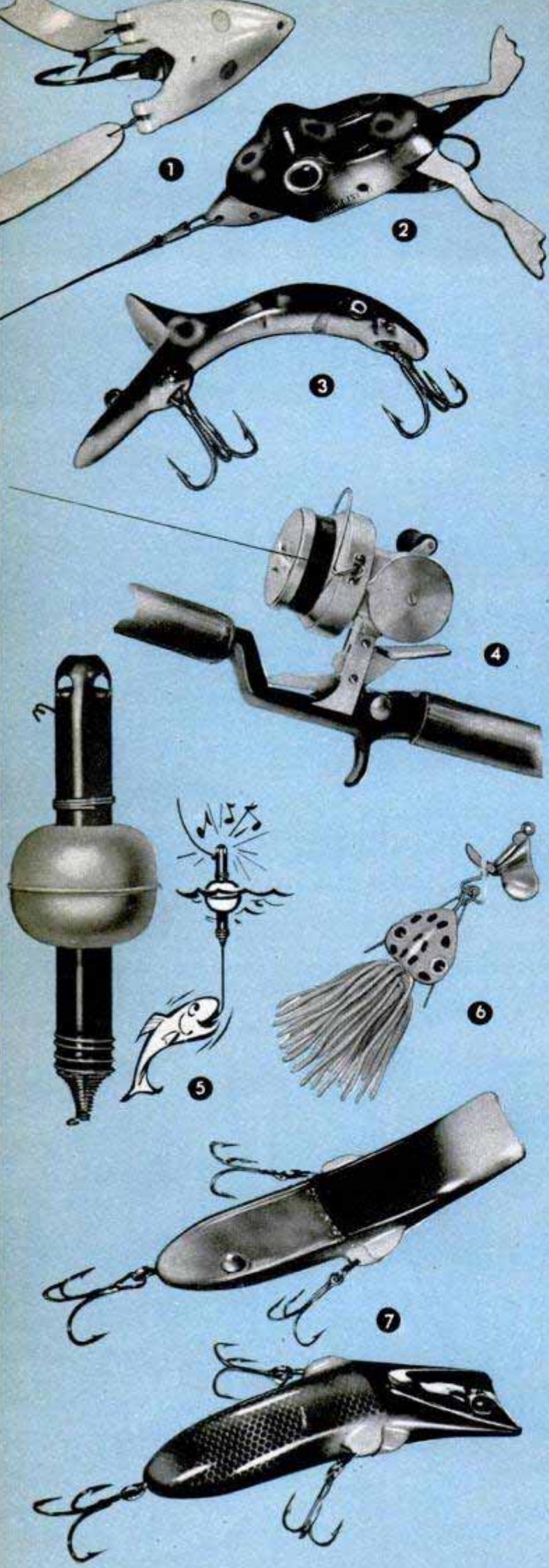

↑ Even the smartest fish will have trouble recognizing this lure. It contains a chemical capsule that reacts with water, producing a stream of bubbles to make it look just as inviting as a real live minnow

1. Made of a lightweight, buoyant plastic painted in lifelike colors, this skate lure can't snag in thick weeds because of an unusual toggle mechanism

2. Like the skate lure above, this lifelike frog is designed to prevent tangling in weeds. Its plastic body takes rough usage without cracking or breaking

3. Scientifically balanced for trolling, this lure, called the Shedevel, also has a molded plastic body. For use in deep-water fishing, sinkers can be added

4. Because the spool doesn't revolve there is no backlash with this slip-cast reel. Line slips off end of spool and is controlled by trigger-operated wire bale that rotates to rewind the line on spool

5. Fishermen who like to nap between bites will welcome this bobber that whistles when the fish grabs the hook. It also solves the night-fishing problem

6. Sound effects are provided by this lure. Spinner rotates to make a noisy sputter as it is retrieved

7. Containing a globule of mercury, these lures of Tenite plastic wriggle and dart like a frightened minnow as the mercury rolls around inside the body



Hook, Line and Sinker

SUMMER is almost here and, as usual, fishermen all over the country are making plans to outsmart the crafty finned creatures. This year manufacturers have produced the largest assortment of tackle in history to help anglers tempt the big ones to grab a hook.

More than 18,000,000 fishermen are getting their tackle in shape for the all-out campaign. Among them will be some 3,000,000 new anglers who will discover for the first time the thrill of a strike. For the first season since 1941, the sportsman, veteran or novice, will be able to pick and choose from a wide variety of items. The old-line companies have expanded their production to help satisfy what is expected to be the greatest demand of all time. Nearly 100 new companies have entered the field since the war.

Some of the latest items that will tempt the fisherman in the sporting-goods shop and the fish in the water are shown here. With these, the Izaak Waltons hope to increase their chance of bringing home that "big one" that always seems to get away.

Above, rough life in the woods is made comfortable by an enclosed body for pickup trucks. Its waterproof top is supported by an aluminum frame. There are two bunks and lots of luggage space in the unit

Below, with this fly-fishing reel, the angler can retrieve his line manually or by a finger-operated trigger that rotates the spool. The trigger swings out of the way when take-up is being done manually. When a change of line is desired, a new spool is inserted in the reel after one screw has been removed



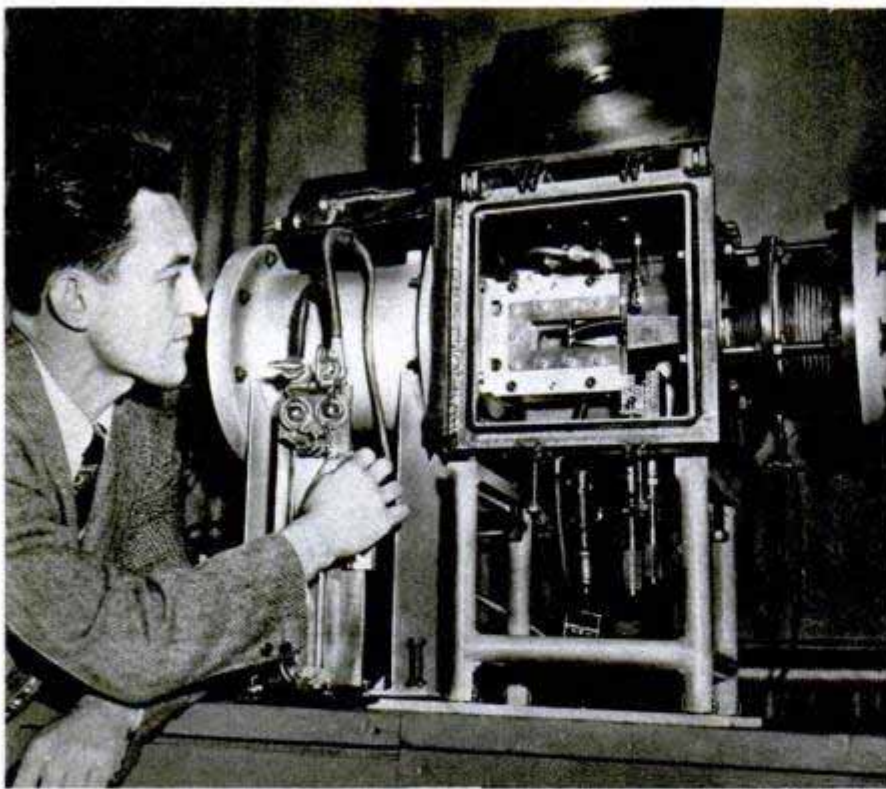

Rocket Test Tunnel "Climbs" to 50 Miles

Duplicating pressure conditions at altitudes up to 250,000 feet, a pilot model of a low-pressure, supersonic wind tunnel is being tested at the University of California. In the pilot model the test section is only an inch square, but a 10-inch model is now under construction. Scientists will use the larger tunnel to study design features of rockets, airplanes and other missiles traveling faster than sound at the extremely low pressures and temperatures found from 50,000 to 300,000 feet above the earth.

Train "Space" Board Spots Empty Seats

Train reservations are made quickly by operators seated in front of revolving "space" boards at the Chesapeake and Ohio Railroad's reservation bureau, Huntington, W. Va. A person in any city along the line who desires a reservation can dial a number and be connected with a Huntington operator who can tell from the board what space is available.

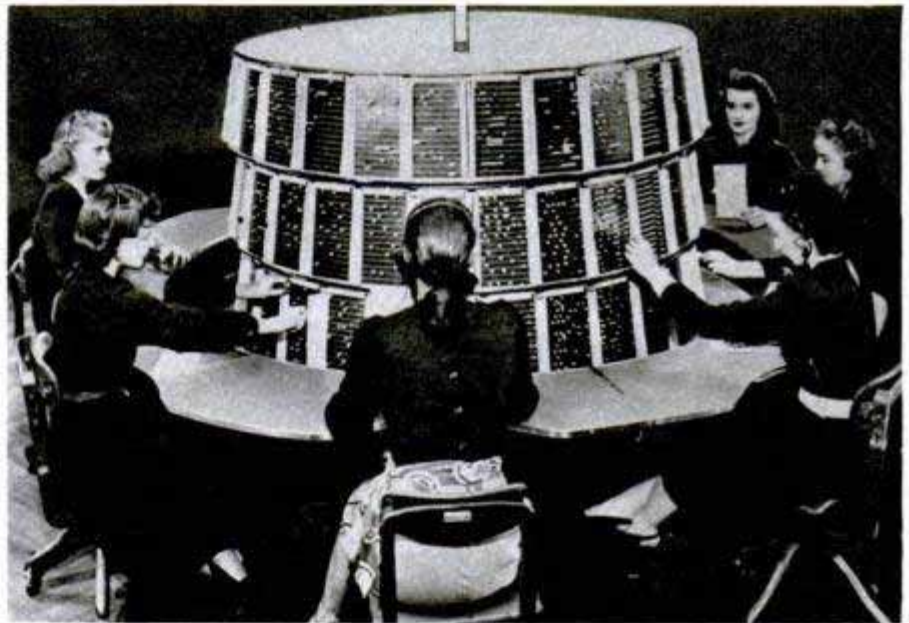

"Striking" Paint For Match Covers

Photo covers for paper matches are given a professional appearance with a paint that forms the striker surface. Double-weight matte paper, cut to proper size, is used and folded while still damp to avoid cracking the paper. Matches, removed from an ordinary book, are stapled to the cover. The striker surface can be applied with brush or spray.

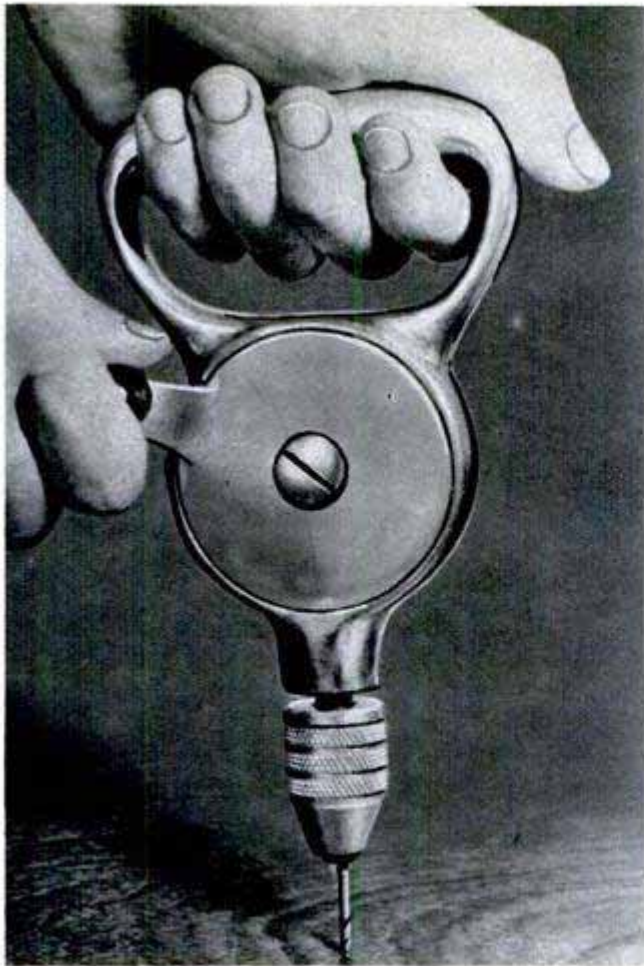

"Fist Grip" Drill

Firm control of a small hand drill is assured by a "fist grip" that permits steady pressure on top of the tool without wobble or shimmy. The drill's gears are enclosed to prevent snagging of fingers or clothing. The drill has an aluminum body with a 1/4-inch capacity steel chuck.



Trolley Fire Ladder

Two thousand pounds is supported by a continuous, flexible fire ladder with a governor that lowers users at a safe speed. When weight pulls one side down the other side goes up. It hangs from a track 18 inches from the wall and is pushed from window to window.

"WALKING BARGE" developed by the Navy can haul 60 tons through surf, soft mud and quagmires. It humps itself forward like a frog over unfirm ground and is propeller-driven in water. In leapfrogging, the center pontoon rises 17 inches, moves forward 10 feet. The outer two pontoons, decked over to carry load, follow

U. S. Navy photo



Mercy Jumpers

Dramatic rescue of Canon Turner, dangerously wounded at isolated Moffet Inlet, turns spotlight on heroic work of Canada's expertly trained search-and-rescue squads



OPERATION CANON" is completed, and modern air-rescue technique measured up to a real-life emergency as tough as any which the fertile minds at search-and-rescue schools could devise.

Canon John H. Turner went seal hunting. Returning to his tiny Church of England mission at Moffet Inlet, he met an Eskimo girl carrying a bucket of ice to be melted for drinking water. The kindly churchman stopped to relieve her of the burden. Entering the doorway of his home thus encumbered, the trigger of his rifle apparently caught in a fold of his native-style fur clothing. The slug pierced his nose and lodged in an almost inaccessible part of the brain.

This happened not in the well-traveled western Arctic, where chains of war-built airports and other modern developments have practically banished isolation. Moffet Inlet lies far to the east, in Baffin Land, where an annual supply ship may or may not reach the scattered settlements. The Eskimos, except for rifles, live much as their ancestors did. The mission is one of the most northerly, inaccessible outposts of the Arctic Archipelago.

Mrs. Joan Turner found her husband lying unconscious in a pool of blood. With the aid of frightened natives, she fashioned a stretcher of blankets and carried the 230-pound man indoors. Except for her two small daughters, there wasn't another white

For protection on jumps over rugged country, para-rescue airmen wear rugby-type helmets with a steel wire mask

Royal Canadian Air Force photo



person within 70 miles. Fortunately, Joan Turner had been trained as a nurse before her girlhood sweetheart returned to Suffolk, England to marry her four years ago.

Mrs. Turner sent an Eskimo to her nearest white neighbor, Hudson Bay post manager John Cormack at Arctic Bay. The native did well to make the 70-mile journey, over treacherous new ice, in two days. Cormack radioed for help and returned to Moffet with the messenger.

Rescue preparations immediately got under way at Winnipeg and Rivers, Manitoba, nearly 2000 miles from Moffet Inlet, where the Canadian army and the RCAF have a joint search-and-rescue school. Mrs. Turner anxiously awaited further word.

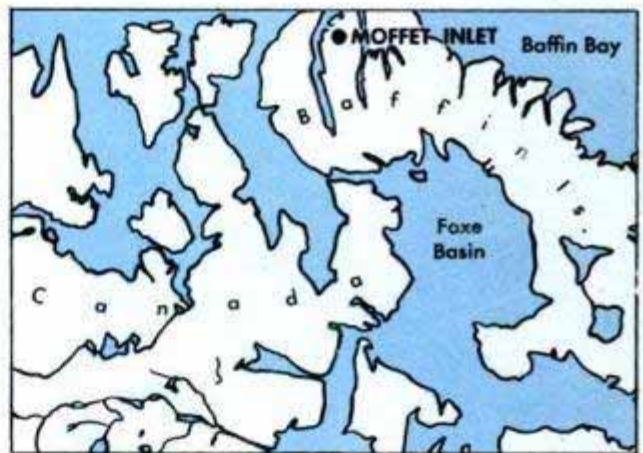

Top, loading Canon Turner into plane at Moffet Inlet. His wife and one small daughter are the fur-bundled figures in foreground. Below, getting set for take-off

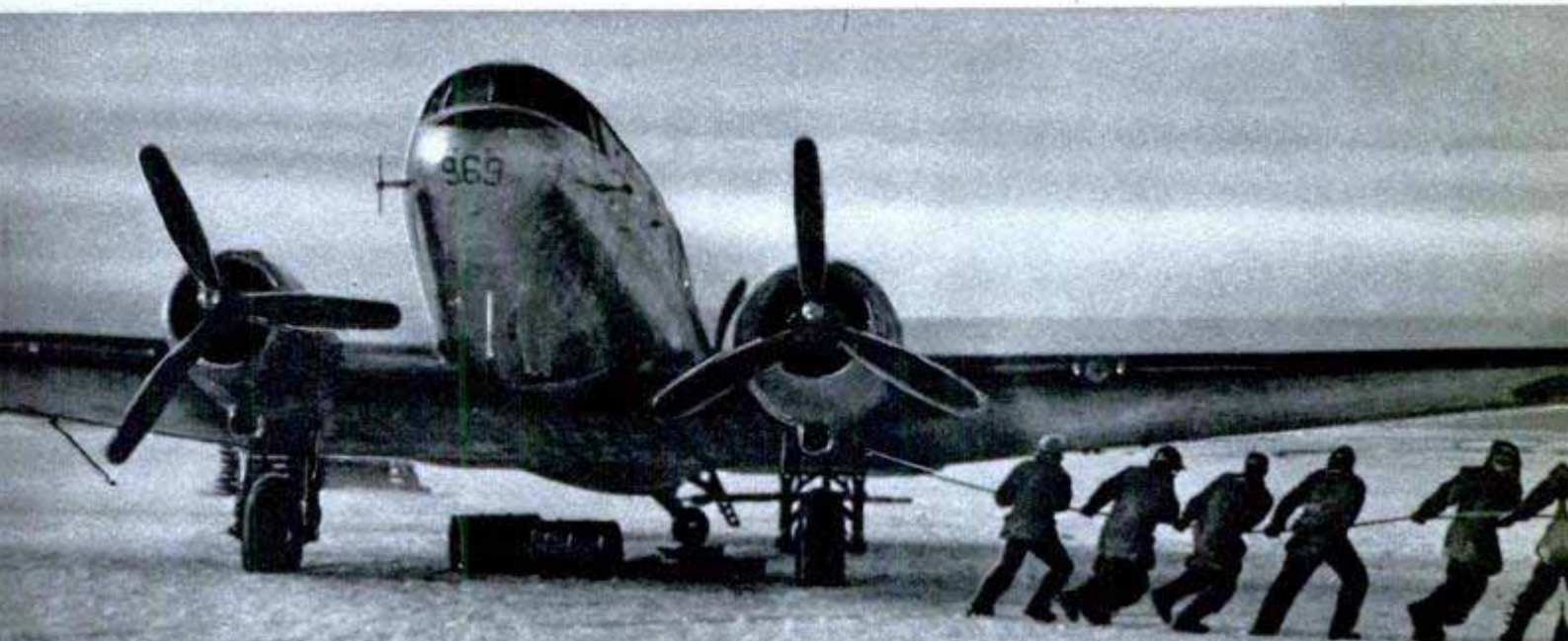



Lowering to ground after landing in a tree. Colored cloth on tree at left signals plane that he landed safely. Below, trainee pulls himself up glacier ice



Her husband lay paralyzed on the left side; he could not speak; he developed spasms, and had greater difficulty in breathing. On her radio set she was now receiving medical advice, though the outside world knew only that the Canon was wounded in the head. Mrs. Turner administered morphine and sulfathiazole.

On the tenth day after the accident, a plane circled overhead. It was an RCAF Dakota DC-3 transport. Mrs. Turner signaled with colored streamers as instructed, that her husband was still alive. This was the fall of the year; jagged, treacherous ice made a pontoon landing impossible, but there was as yet no ice strong enough to support a ski plane. The nearest practicable landing place was at Coral Harbor on Southampton Island, 600 miles south, where the plane had taken off.

On the frozen surface of a small lake near the mission the Dakota dropped medical supplies. Next came a heavy gasoline tin to test the strength of the ice for parachutists, and a smoke bomb to indicate wind speed.

Four men then made the perilous jump. In command was Capt. Guy D'Artois, a French-Canadian who, with his English wife, had made pre-invasion parachute landings in France to work with the underground. With him were Capt. Ross Willoughby, an army doctor, and two radio-men, Sergeants Judd and Cook. The doctor, less experienced in parachuting than his companions, missed by only a few feet death or injury on the jagged rocks at the edge of the tiny, frozen lake some miles from the mission, which was their target. Radio equipment, including a 400-pound battery and a 390-pound transmitter, floated down with them.

The plane circled back to Coral Harbor. For four days there was no word from Moffet, the radio equipment having been damaged. Authorities, fearing serious mishap, prepared to send another party to rescue the rescuers. Then the Dakota, returning at the first break in the weather, circled the mission once again. Faint signals were picked up from a small set devised by the two sergeants. One of their first requests was for tobacco and knives to reward Eskimos for cheerful aid.

At first, Dr. Willoughby thought that his patient had little chance for recovery. Then Canon Turner slowly began to show signs of improvement. He regained the will to live, his speech improved, the paralysis left his arm. For weeks, day and night, he was given penicillin every three hours.

Meanwhile the other paratroopers searched the district for a possible landing strip. Weeks passed before the ice was safe for a landing. Then the Baffin region's

notorious weather set in to prolong the delay. When a take-off from Coral Harbor was possible, a blizzard raged at Moffet; when the Inlet, where the sergeants worked incessantly to correlate weather reports from surrounding areas, was able to report "all clear," visibility fell to zero at the base.

An attempt had been made during the lull to evacuate the party by motorboat to Arctic Bay, where a landing might have been possible much earlier. Driven back by shifting ice and storms after a night in the open, that expedition alone was a grim experience even for the healthy members of the party. That the wounded man survived seems almost like a miracle.

The vigil of the paratroopers kept up for seven weeks. It was real winter now in the Arctic; temperatures hovered around 25 below zero and a glass of water at the bedside froze solid in the night. Flying Officer Bob Race and his six-man crew meanwhile flew the Dakota Snowbird 11,000 air miles on reconnoitering or supply-dropping missions to Moffet, or back south for supplies and consultations. Time was running out; the arctic night would make rescue before spring all but impossible.

Paratroopers finally reported the completion and marking of a crude landing strip on a lake 26 miles from the mission. A break in the weather came at last and once again the Dakota winged northward, squeezed between lowering clouds and the rocky hills, and landed perfectly.

By dog sled the party sped from the mission in record time while the crew manhandled the big plane into position for a tricky take-off. After a night of rest at Coral Harbor came the final 1200-mile hop to Winnipeg, where the patient continued his stubborn fight for life in a hospital. Thousands who had anxiously followed the story of "Operation Canon" breathed a prayer of thanksgiving.

"I want to go back north," says John Turner. "He has a chance to do it," says Captain Willoughby—"on crutches."

Episodes like this, while rarely as dramatic as Canon Turner's, are occurring regularly in the north country. To make them possible Canada has carefully built up one of its proudest services, the hand-picked search-and-rescue organization, coordinated by the Royal Canadian Air Force. One of its most "exclusive" courses is given at the para-rescue school near Jasper, Alberta, to students chosen for their brush experience, physical ruggedness and ability to cope with situations that may range from succoring victims of plane crashes on mountain tops to delivering babies in sections quickly accessible only by parachute.

The school operates from a small natural



"Patient" bridging narrow gorge on litter made from two small spruces and a Nylon sheet. Para-rescuers, below, have over 100 hours of first-aid instruction



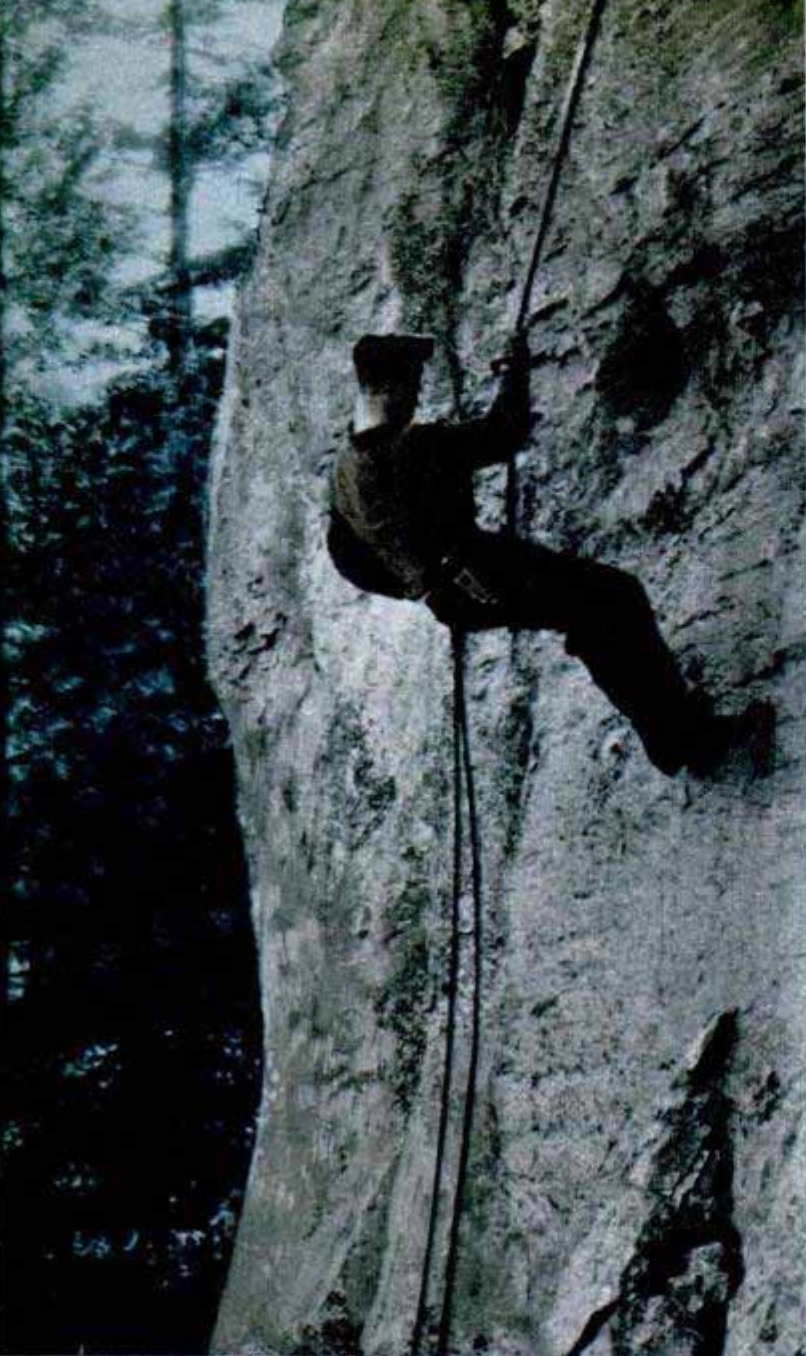

Above, steel-cleated student making way up a sheer rock face. Logs on floor of tepee, below, keep beds of spruce boughs from falling into small fire built in center. Bush shelter, right, is kept warm by heat reflected back from fire by log barricade at right

airfield in a valley surrounded by towering mountains. There the men are tutored in controlled parachute jumping until they can make nearly perfect spot landings. Ten passing jumps, four into heavily timbered country and the rest over mountains, have to be made before they earn badges.

Landing close to targets is important. In addition to the possible danger to jumpers, who might land in water or on a steep mountain slope, a miss of a mile from crashed aircraft might entail precious hours of searching on the ground before locating it, especially in heavily timbered, rugged country. Fully equipped rescuers are loaded down with 60 pounds of gear and clothing, further complicating their movement.

Mountain climbing means more to trainees than just scrambling up steep slopes. They are intensively schooled in techniques of snow, ice and rock work, and in evacuating injured from mountains and cliffs, through bush and heavily wooded country, and across streams and rivers. They are taught to improvise stretchers from materials at hand, and the 100 feet of Nylon rope they carry comes in for some surprising uses.

A master woodsman shows students how to make an ax serve in lieu of a score of tools. Under him they learn to erect bush shelters, build tents from parachutes and make a 14-foot log raft, capable of carrying four men and all their equipment, without benefit of rope or nails.

Their equipment is custom-made for the job. Special tinted glasses that protect against glare and snow blindness can be hammered against rock without even being blemished. The heavy duck jump suits are doubly reinforced by straps. Head and face are shielded by a helmet, similar to those worn by rugby players, with a steel wire-grid mask that balks injuries from snags and tree tops.

Canada is training her "Mercy Jumpers" to do their work well, and come back intact.

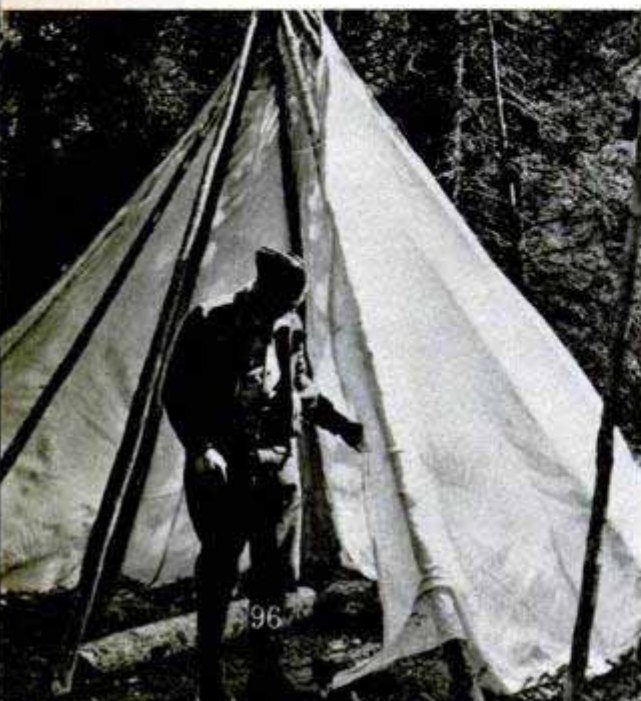

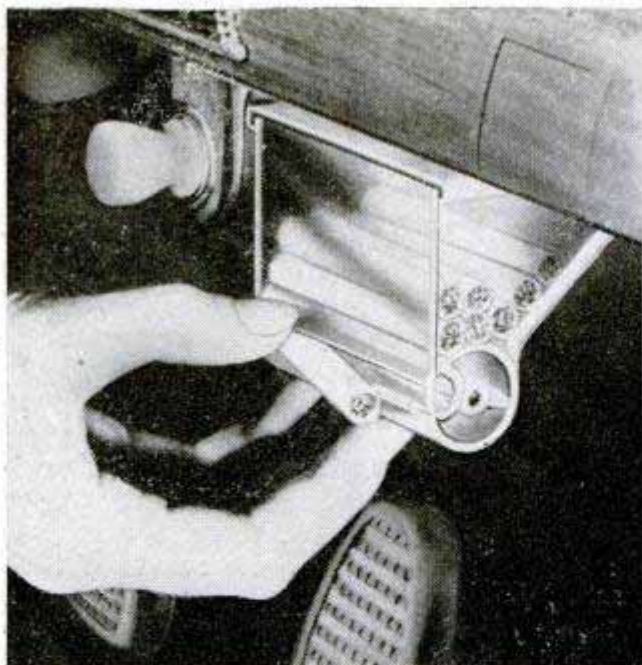

Dispenser Ends Fumbling For Cigarette by Driver

Motorists don't have to fumble for a cigarette when they have a convenient cigarette dispenser mounted on the dashboard. Made of transparent plastic, either plain or colored, the dispenser rolls out cigarettes singly at the touch of a finger. Only one bolt is used for installation.

Antidote for Lewisite Gas Becomes Lead-Poisoning Cure

Lead poisoning, the painters' disease, is cured by British anti-lewisite, a chemical developed during the war to combat poison gas. The chemical, known as BAL, forces the lead out of the bones and tissues of the body. Prior to this discovery, lead poisoning was considered a hopeless disease.



Flexible Aluminum Shoes

As a result of the leather shortage, Germans are walking the streets of Berlin on shoes made of aluminum. Three enterprising residents invented the metal shoes, which they say will last 10 years and are much less expensive than leather shoes bought at black-market prices. The soles and heels are made of aluminum and the uppers of synthetic leather. The connecting parts are spaced far enough apart to permit flexibility.

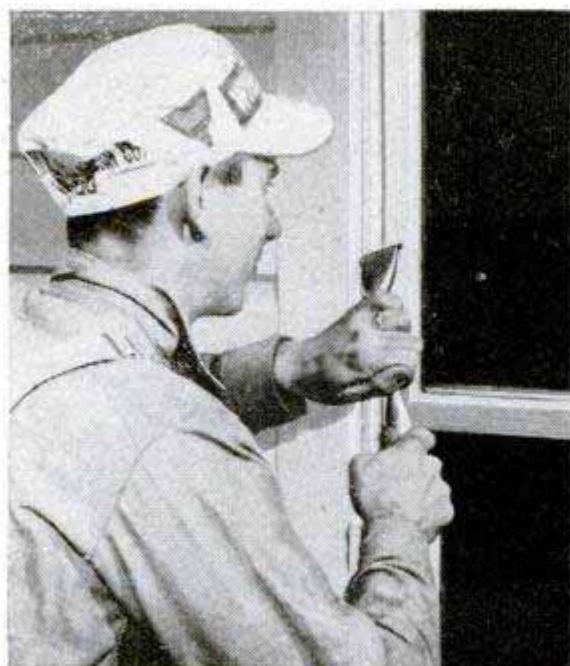

Paint Scraper Blade Won't Dig Into Wood

Scraping paint is made easier by a new tool that has an adjustable and removable blade of Carboloy cemented carbide, the hardest of man-made metals. The blade's shape prevents it from cutting into the surface beneath the paint. Because of its extreme hardness, the scraper can be used to remove dried plaster or cement.

Information, including manufacturers' names, concerning products described in this issue may be obtained by writing Bureau of Information, Popular Mechanics, 200 E. Ontario, Chicago 11

SHOPPING

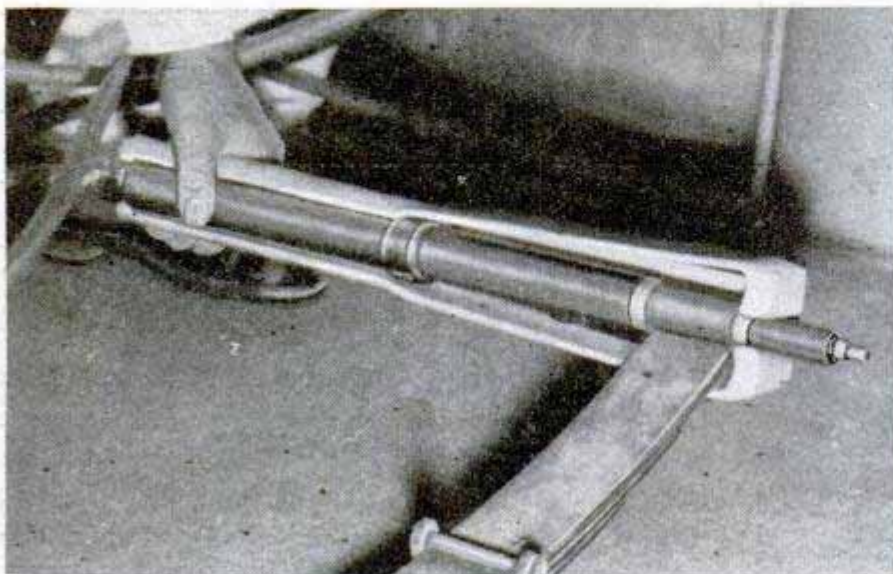
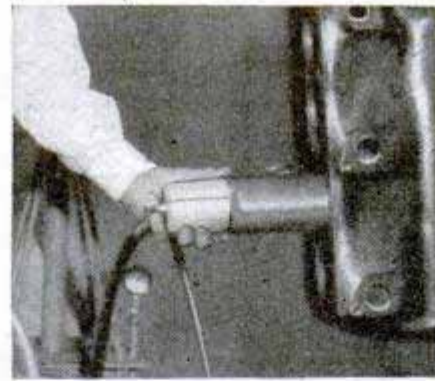
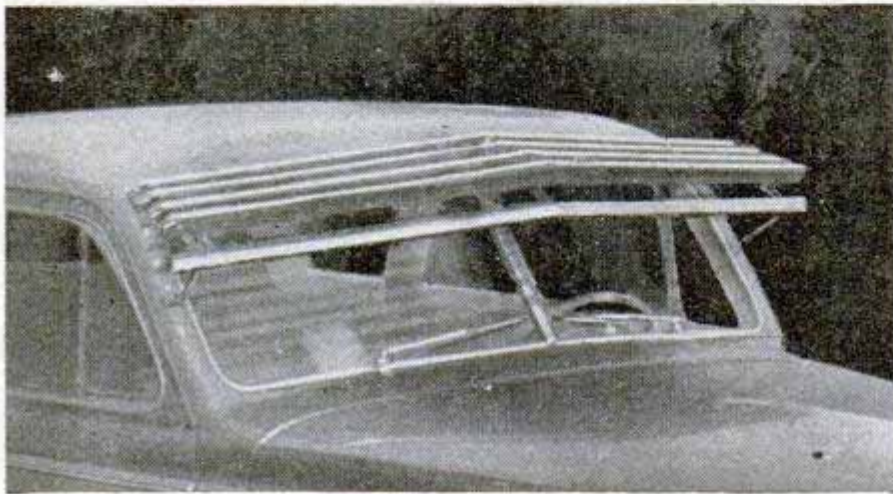
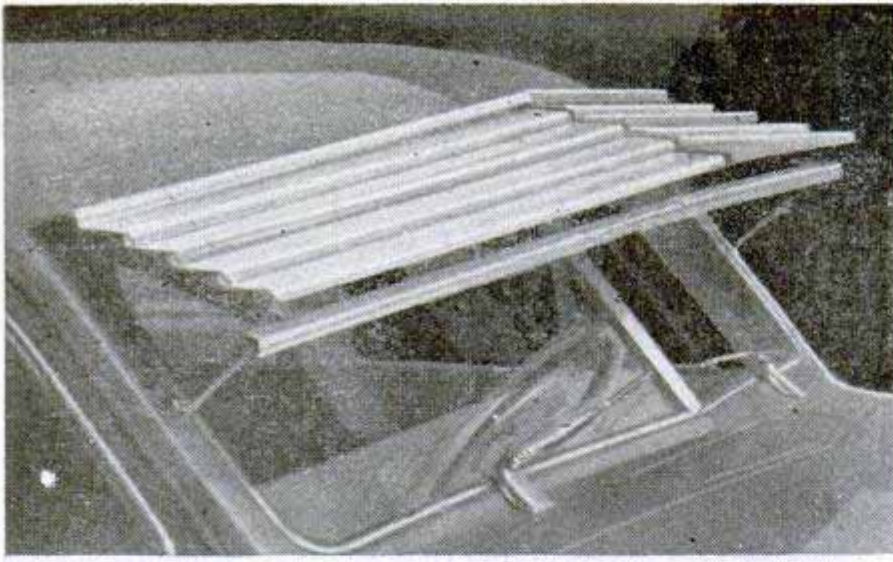

Adjustable sun visor for automobiles can be opened and closed like Venetian blinds. A knurled control knob just below the rear-vision mirror extends or retracts the all-aluminum shade. The upper side of the visor is polished to match the chrome trim on the car. To reduce glare, the underside has a dull finish. While retracted, the visor does not interfere with the driver's vision, but it can be opened to provide relief from the bright rays of the sun. According to the manufacturer, the sunshade will not rattle or vibrate in any of its many positions.

Hydraulic ram exerting up to eight tons of pressure can be used to remove or insert cylinder sleeves in three minutes. The ram is operated by a standard air compressor and each pound of air pressure develops 115 pounds of hydraulic pressure. It is lightweight and easily operated by any mechanic. Adapters can be obtained to convert the power ram for use in removing worn and broken shackle bolts. The manufacturer also plans to market an assortment of adapters that will be used for removing valve guides, wheel hubs and gears. It is also planned to develop an adapter to permit the use of the ram in arbor presses.

LIST for MOTORISTS

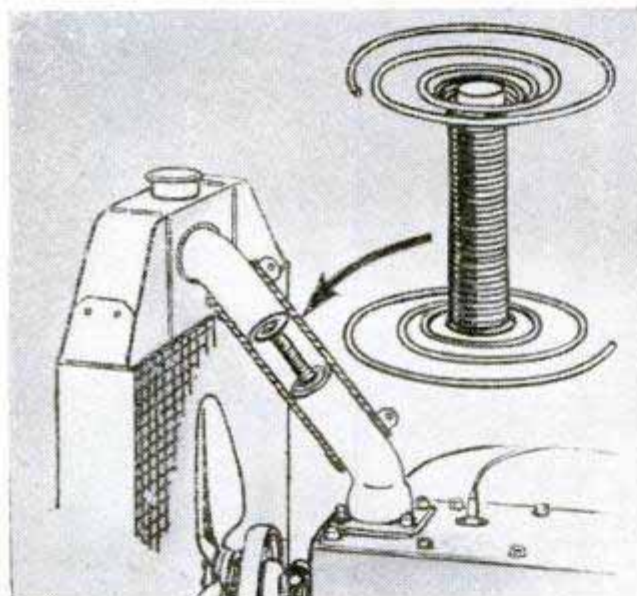

Emergency wheel eliminates the need for a jack or spare tire when you have a flat. Made in two sections, the rubber-tired aluminum wheel attaches to the rim and you drive safely to the first service station. One wheel section slips over the rim and the car is driven forward until it rests upon it. Then the second half is attached securely by means of two bolts.

Cooling-system de-scaler keeps car circulation channels in condition by dissolving any accumulated scale and preventing formation of new deposits. A silver-plated wire coil holds an alloy cartridge and together they eliminate scale-forming chemical reactions. The de-scaler is placed in the upper hose or inside the radiator shell above the tubes.

Motorcycle trailer is large enough when opened to provide sleeping space for two people. Built by two motorbike enthusiasts who are using it on a trip from Florida to California, it is 3½ feet wide and 4½ feet long when folded. Two side flaps swing outward to provide enough room for two full-length beds. The waterproof tarpaulin provides privacy and protection from the weather for the sleepers.



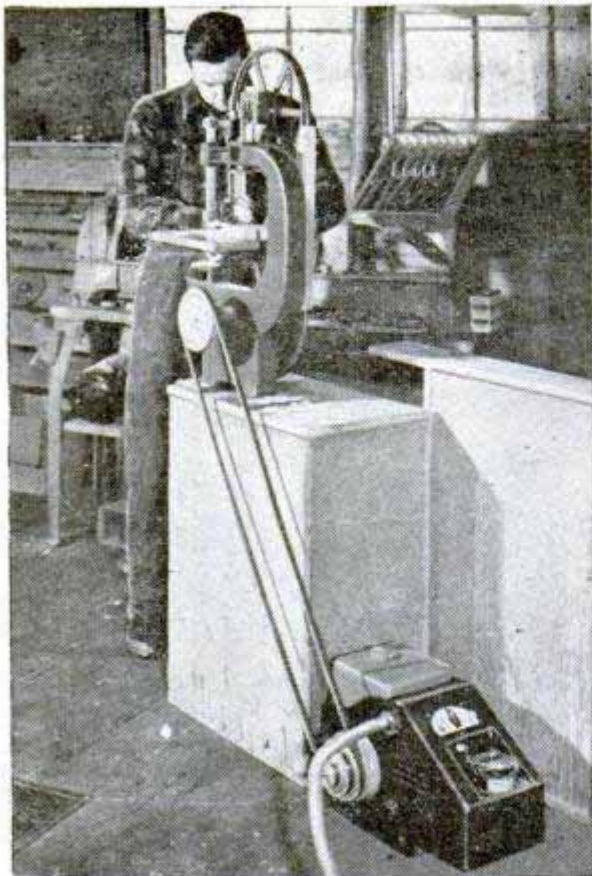

↑ Unit transmits power through a belt to workshop tools. Above, right, with a flexible shaft it grinds and buffs. Right, dial on case regulates unit's speed

Gas Unit for Powering Tools Can Be Moved Between Jobs

Designed for farm and workshop, a portable gasoline power unit can be carried from job to job and serves as stand-by power when electricity sags or fails. The 1½-horsepower unit weighs 50 pounds in its compact case. A speed-control dial regulates driving speeds from 1600 to 2600 revolutions per minute. Power is transmitted direct or through an optional transmission. With a utility shaft the unit will bore holes, sand, grind and operate shears. It can be belted to most power tools.

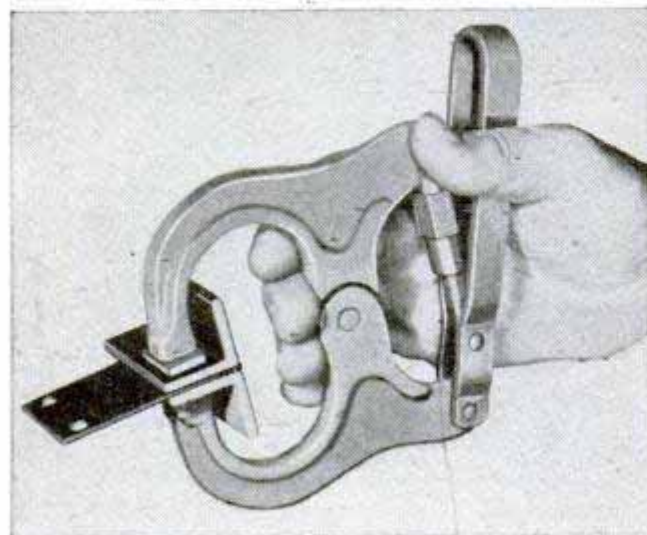

Quick-Action Clamps

C-clamps are now available that can be snapped into place with one hand, leaving the other hand free to hold the material in the proper position. The jaws can be opened to 2½ inches for clearance over angles and flanges before they are set. Material up to one inch in thickness can be held in the jaws. An adjustable toggle handle is squeezed to tighten the clamp.

☐ In the year 1932 only 12 locomotives were ordered by American railroads—lowest number in modern railway history; it was the first year in which orders for Diesel engines (7) exceeded steam (5).

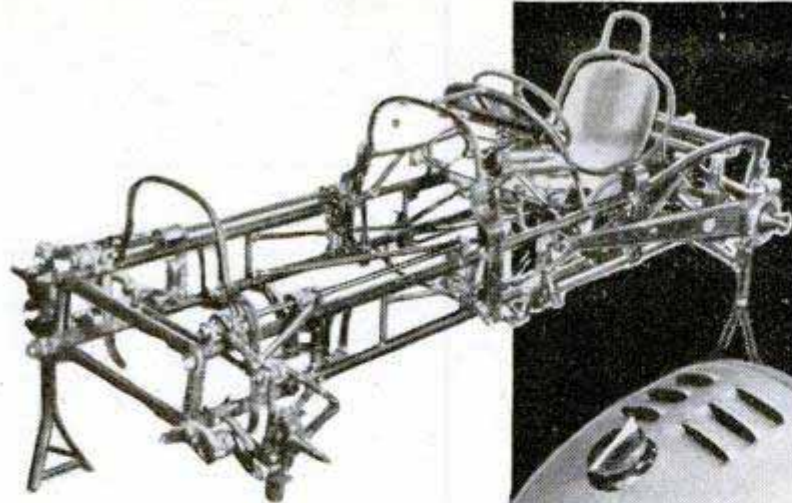

↑ Tubular-steel frame of the Kurtis car is a single welded unit. Below, the same car with motor and body in place

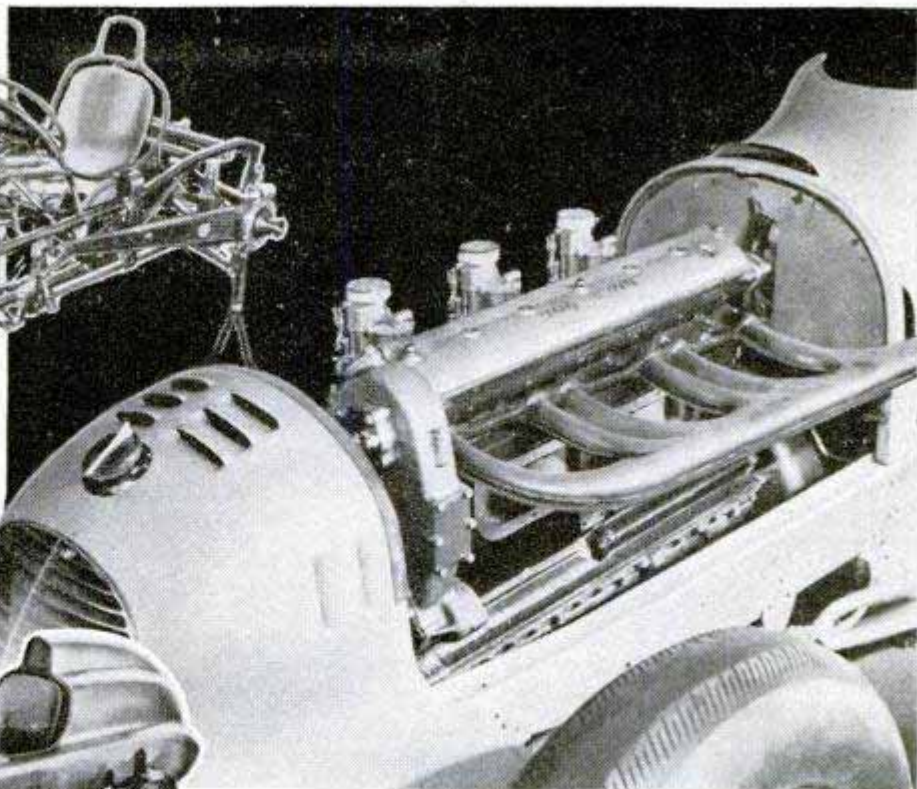
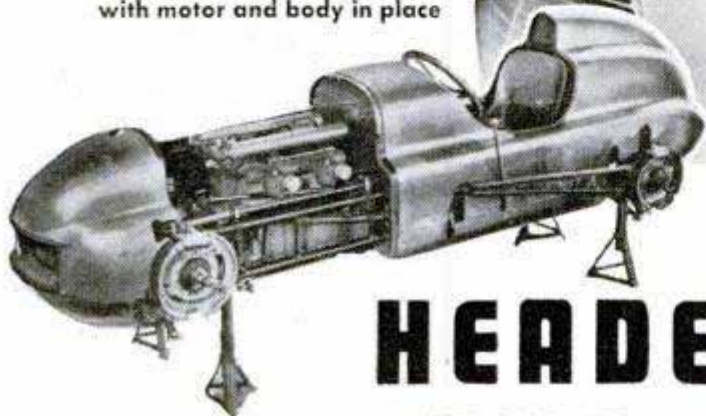

↑ The Twin-Coach entry uses a bus engine modified for top speed. It has an all-aluminum block and three carburetors

HEADED FOR THE SPEEDWAY

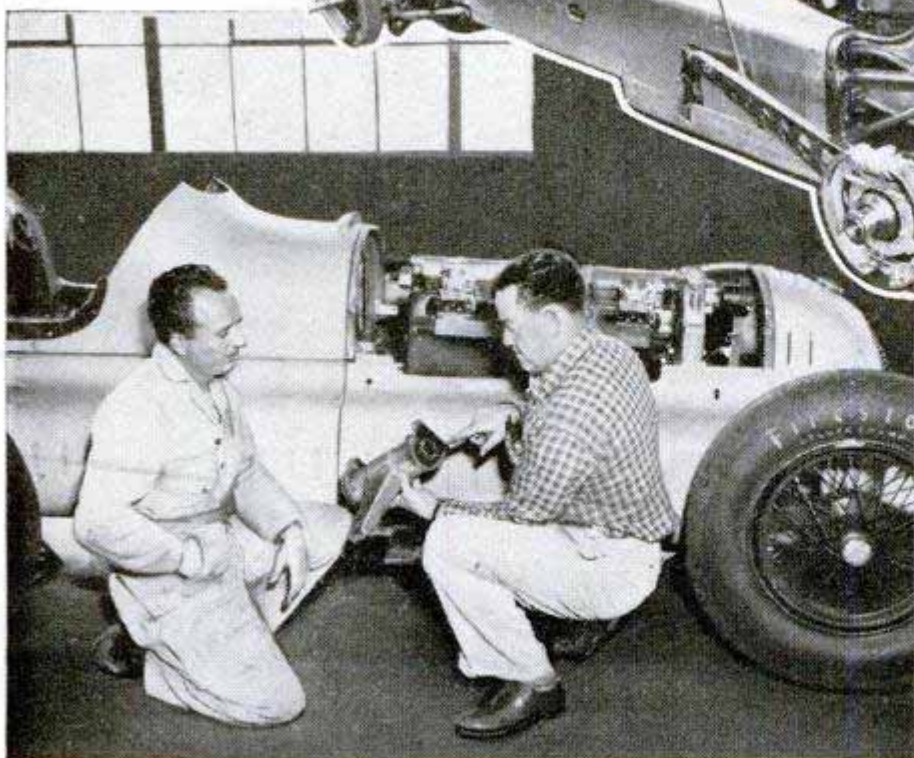
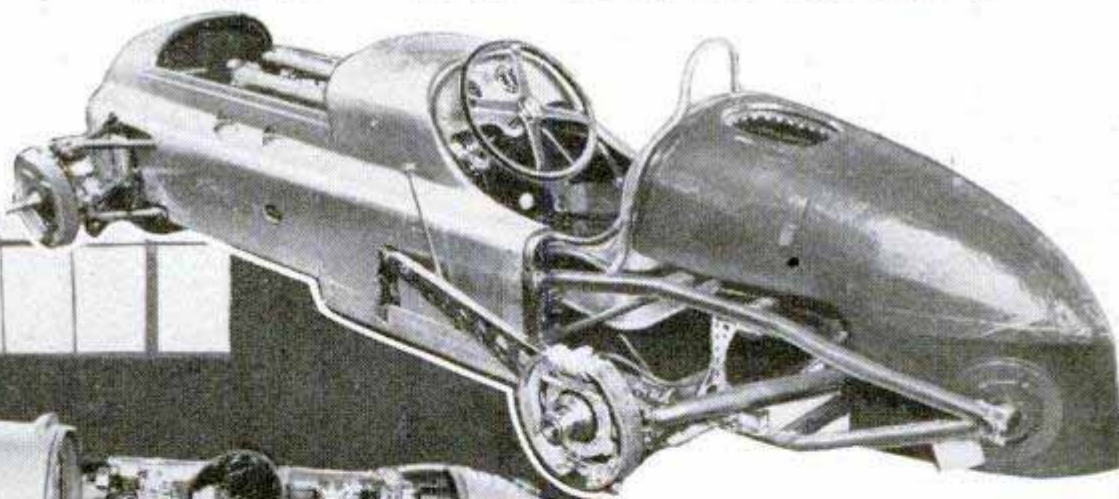

For 500 brutal miles, men and machines roar around Indianapolis Speedway in a test of stamina and speed. Each year brings new designs in engines and bodies to help the driver in his struggle to be first to see the checkered flag. This year is no exception. Here is a pair of racers that may be among the winners. Above, the Kurtis-Kraft car has a vulcanized-plastic gas tank that may eliminate breakdowns due to seams opening during the race. Left, torsionless wheel suspension may bring the Fageol Twin-Coach car down the home stretch leading the pack of speedsters

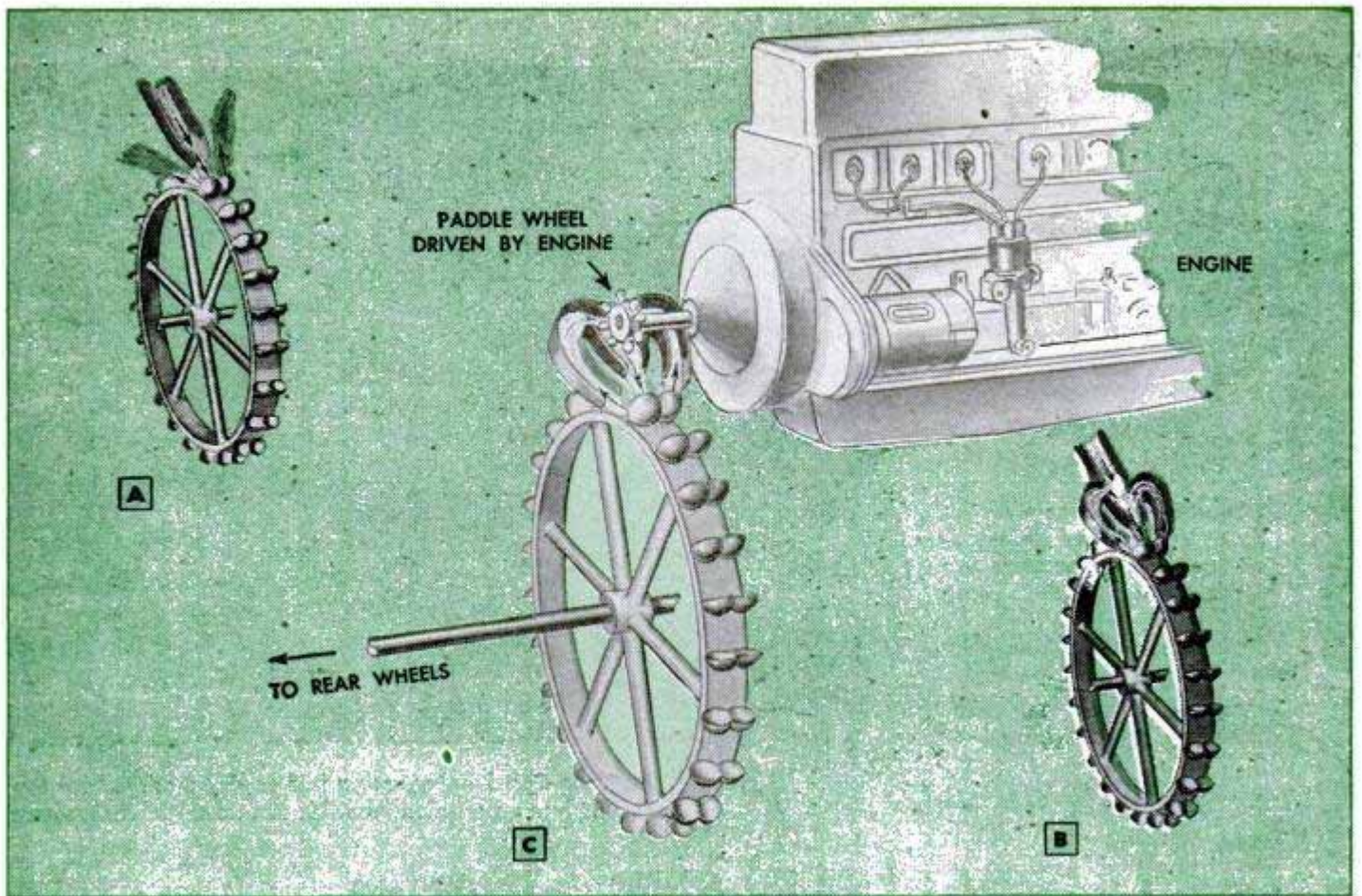

These drawings present a simple hydraulic explanation of torque-converter action of Buick's Dynaflow transmission. "A" shows water striking curved buckets of water wheel which redirects flow in a backward direction. This reverse flow exerts double pressure on water wheel; thus its torque or turning effect is double that produced by water striking a flat blade. "B" shows how the flow of water is redirected back to buckets to build up added force, and "C" explains how the hydraulic torque converter multiplies turning effort in a similar manner. Fluid is re-used and is enclosed to prevent waste. An engine-driven pump maintains circulation; the driven member (turbine) corresponds to the water wheel, and the stator to the redirecting chutes

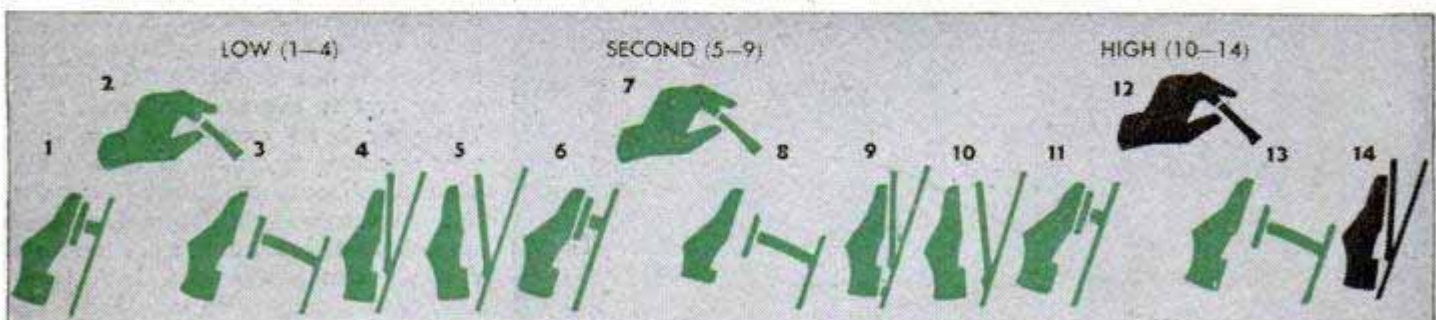
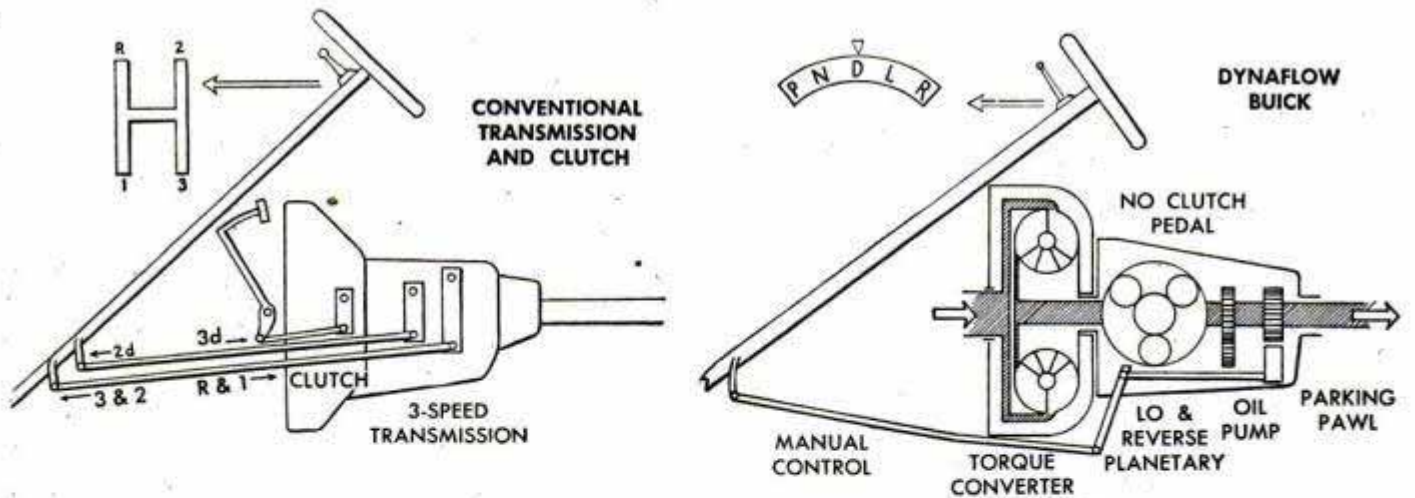

Fourteen operations are required to get conventional car shift into high compared with two for automatic

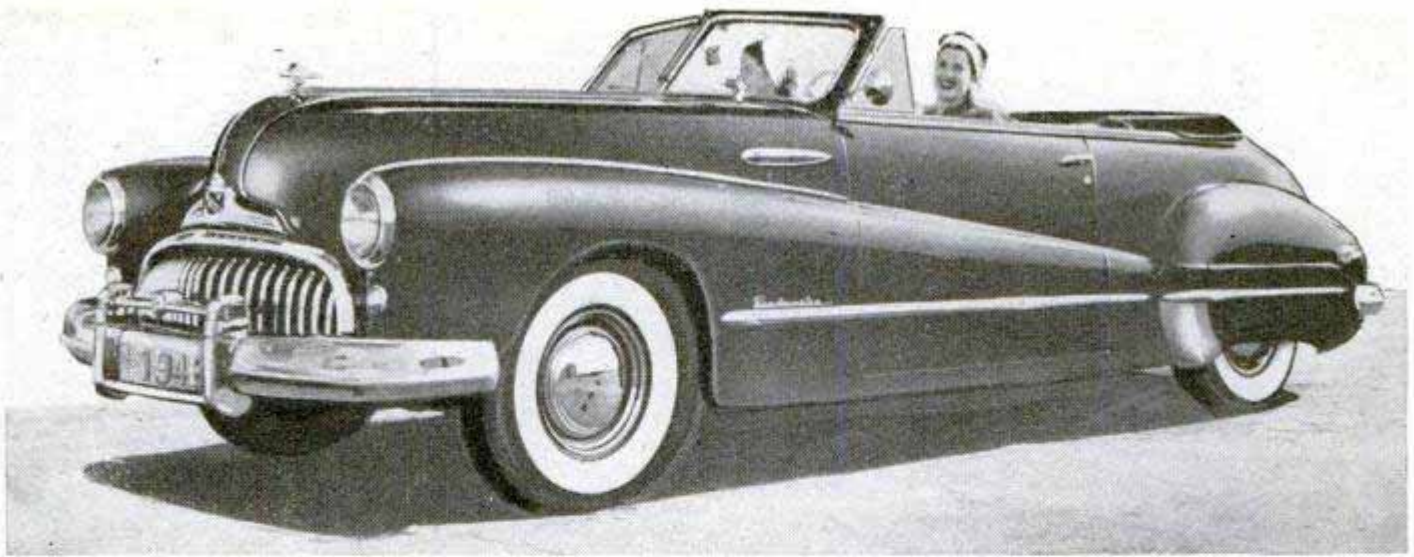

How Your Car Shifts for Itself

By L. H. Nagler

Member of the Society of Automotive Engineers

SELF-SHIFTER transmissions are now in about the same stage of development as the self starter in 1920. Starters, now well standardized and fundamentally alike, differ only in construction of actuating mechanism and location of controls. Many years will elapse before any similar situation will be possible in automatic transmissions. Eventually a few standard types may predominate.

Automotive engineering frequently is described as a continuous series of compromises. Engineers must balance one feature against another—performance against economy, styling against accessibility, strength and durability against weight and cost. The all-important cost factor seriously limits full use of technical advances.

Automatic transmissions have taxed the ingenuity of engineers in selecting acceptable compromises. The same weeding-out processes will continue for many years, at least until the public, and the engineers, decide what features should be emphasized and which can safely be sacrificed.

In recent months, attention has been focused on an entirely new type of automatic transmission. The hydraulic torque converter, now available on the Buick Roadmaster, is claimed by its promoters to represent **THE** automatic transmission of the future. If the concentration of engineering effort and expense on the converter is any indication, its backer's claims may be justified. Several other automotive manufacturers are expected to start production of torque converters in the next 12 months.

Advocates for the hydraulic torque converter in automobiles claim: (1) Absolu-

tely smooth acceleration, without interruption while the gears shift. (2) Simplicity—both of power flow mechanism and control devices. (3) "Packaged" construction, with sealed-in adjustments and built-in operating characteristics.

Although the hydraulic torque converter, as typified by the Buick Dynaflow, seems to be a leading candidate for **THE** future automatic transmission, other types

Buick Roadmaster above is first passenger car with the torque converter automatic transmission (below)

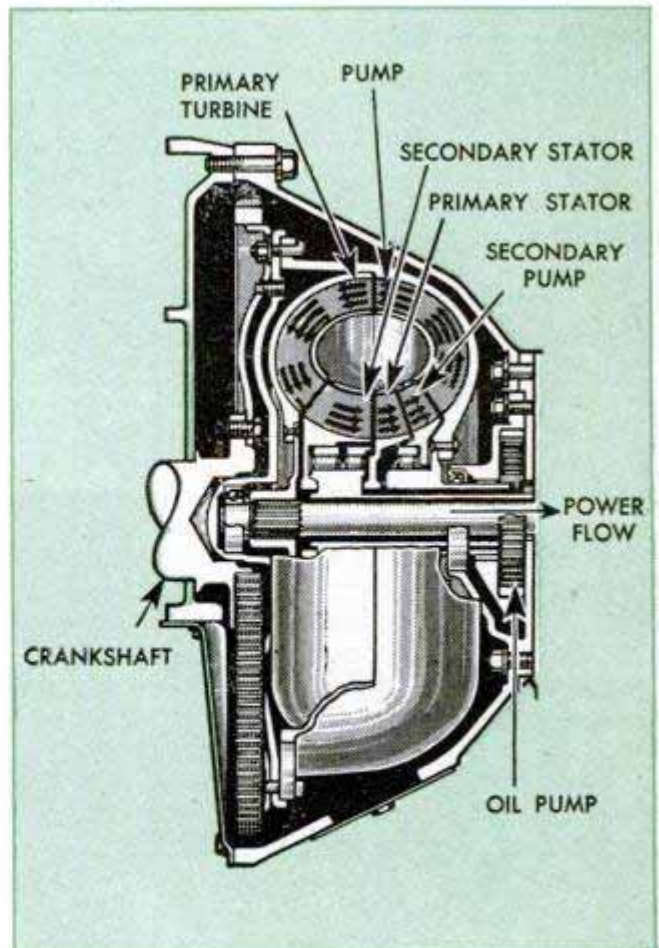

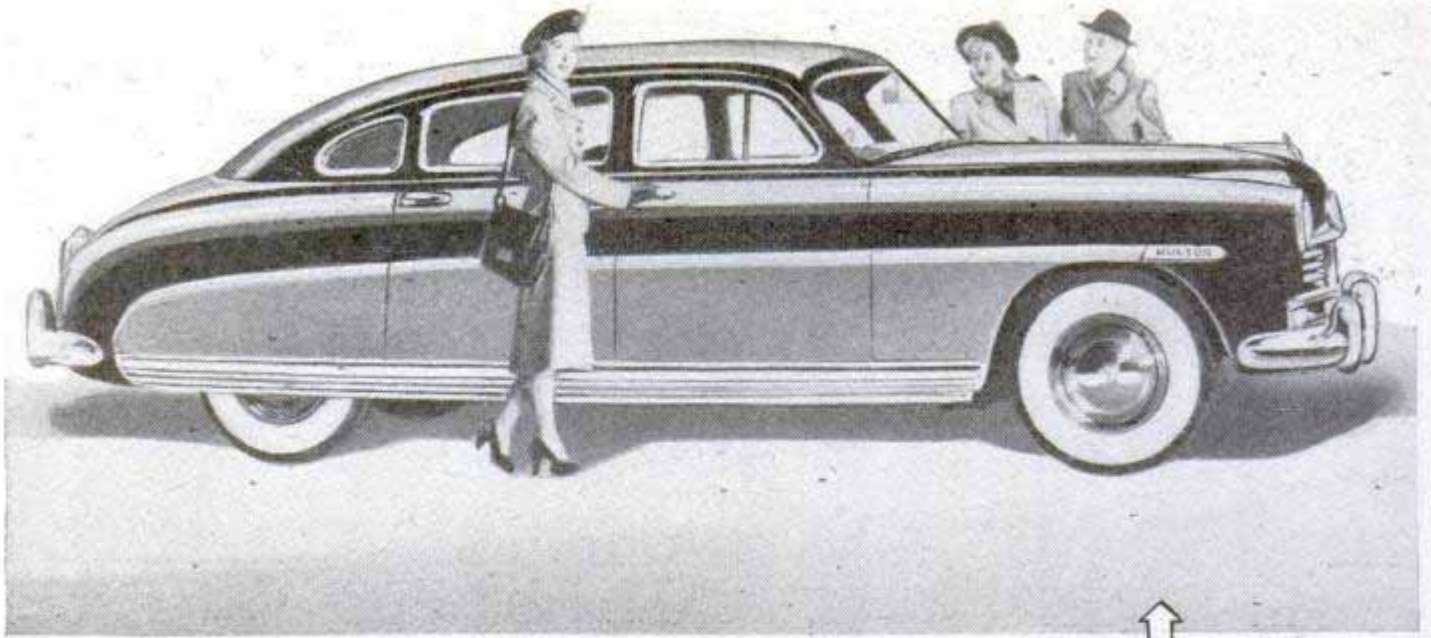

are by no means obsolete. Competing designs still claim many points of superiority. The torque converter has several inherent disadvantages, particularly relatively low efficiency under certain driving conditions. Incidentally, all automatic transmissions now in production are reliable and relatively trouble-free in service. This has not always been true of automatic shifters.

Until the announcement of the Dynaflow, all production automatic transmissions operated by use of added machinery to shift gears and engage clutches. In some designs the added machinery was applied to conventional three or four-speed transmissions. In others the basic construction was changed extensively to accommodate the needs of automatic shifting.

The simplest automatic shifter, and one still popular, consists of an overdrive gear unit mounted back of a regular transmission. This construction is available on several car makes (Nash, Studebaker, Packard, Hudson, Frazer and Mercury) at less than half the cost of more completely automatic jobs.

The overdrive provides automatic shifts between the two top "gears" (direct and overdrive) and thereby relieves the driver of considerable clutch operation and gear shifting. The foot clutch still is needed for starting from a standstill. With car in motion, however, many of the shifts can be made without declutching. The overdrive unit itself is shifted by accelerator-pedal operation.

Another automatic shifter built around a regular transmission is the Hudson Drive Master. In this design the clutch is operated automatically by a vacuum cylinder and piston arrange-

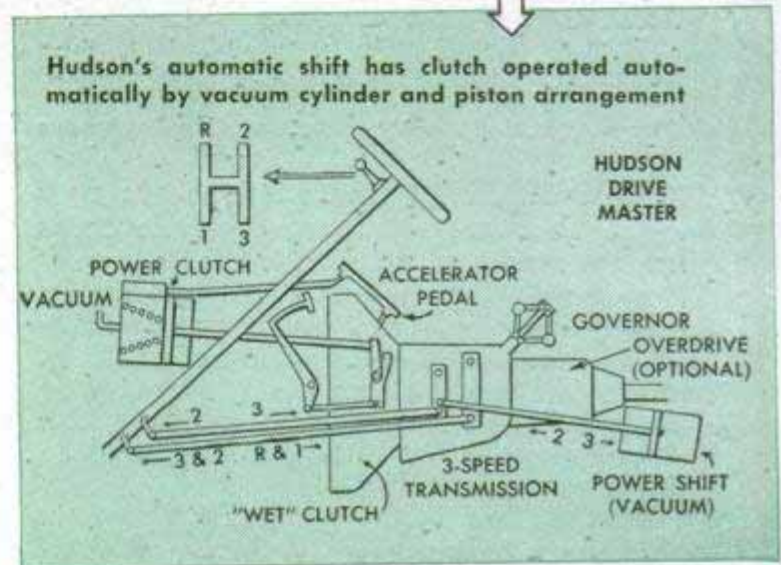

ment. Another vacuum cylinder shifts the second and third-speed gears.

With this installation, normal starts are made in second. The transmission shifts to third (high) above a minimum speed, about 13 miles per hour, whenever the accelerator pedal is momentarily released. Downshift to second is possible for increased acceleration by flipping the manual lever to the second-speed position.

The Drive Master retains the usual clutch and gearshift lever. A selector switch is provided to give the driver the option of (1) full automatic drive, (2) vacuum clutch only (automatically disengages whenever the accelerator pedal is released at low speeds), and (3) conventional operation (using both clutch and gearshift in the regular way). In addition an automatic overdrive frequently is installed back of the Drive Master. This arrangement provides in effect a three-speed automatic transmission, with reduced engine speed for economy when in top "gear."

The Chrysler Fluid Drive consists of a special four-speed, two-range gearbox,



The 1948 Pontiac above has G. M. Hydra-Matic shift diagramed below. Clutch is eliminated and fluid coupling permits smooth operation

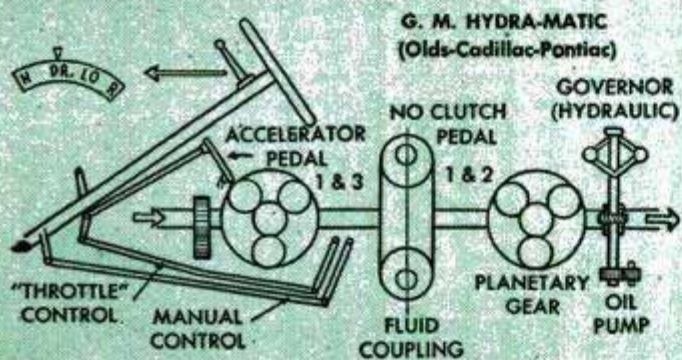

G. M. HYDRA-MATIC
(Olds-Cadillac-Pontiac)

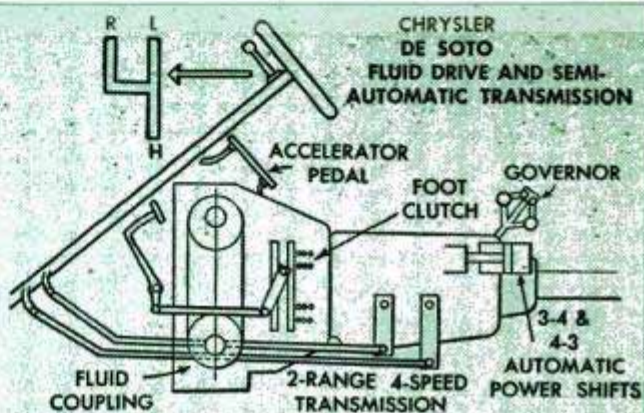

CHRYSLER
DE SOTO
FLUID DRIVE AND SEMI-AUTOMATIC TRANSMISSION

Chrysler below uses Fluid Drive automatic transmission diagramed above and provides four speeds

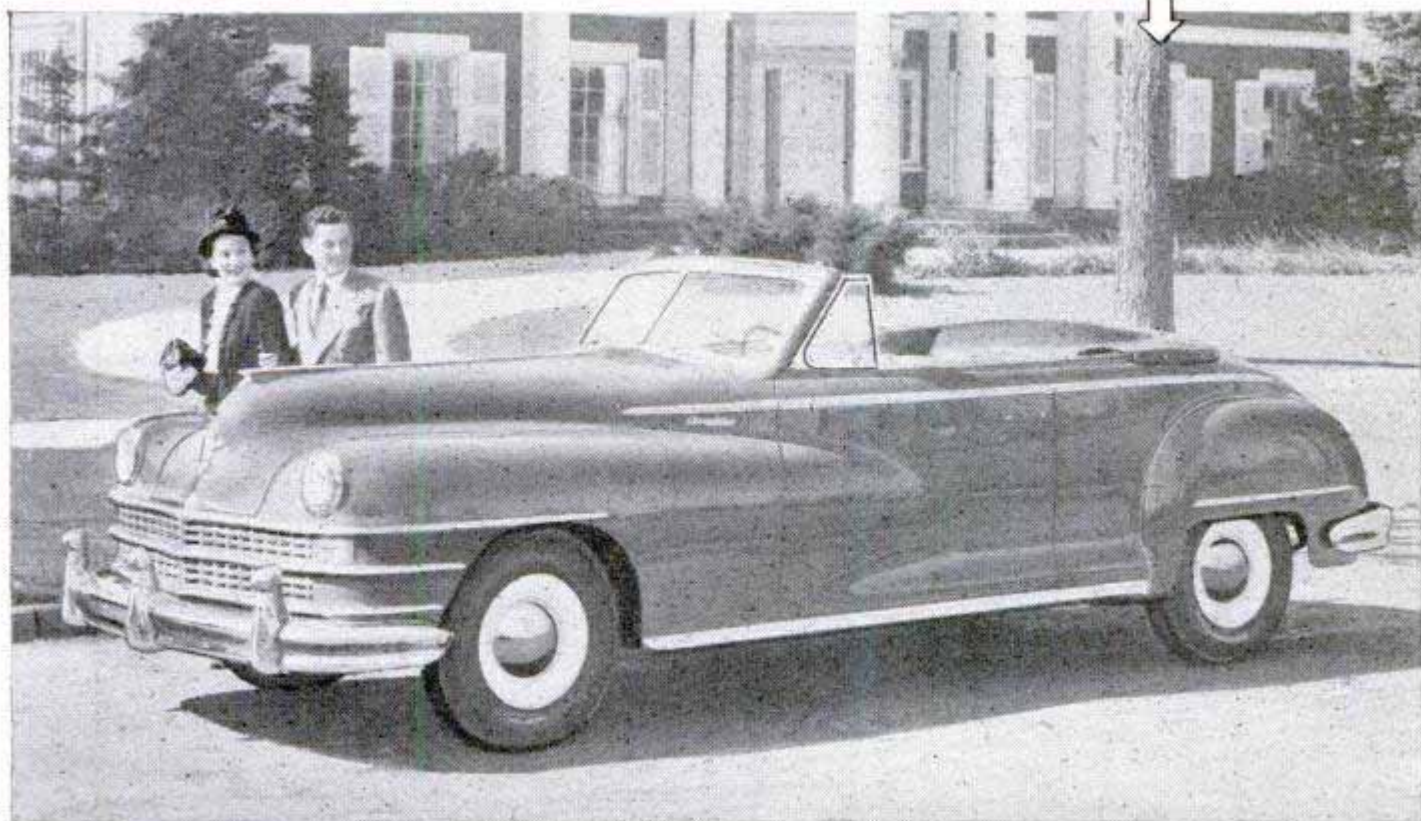

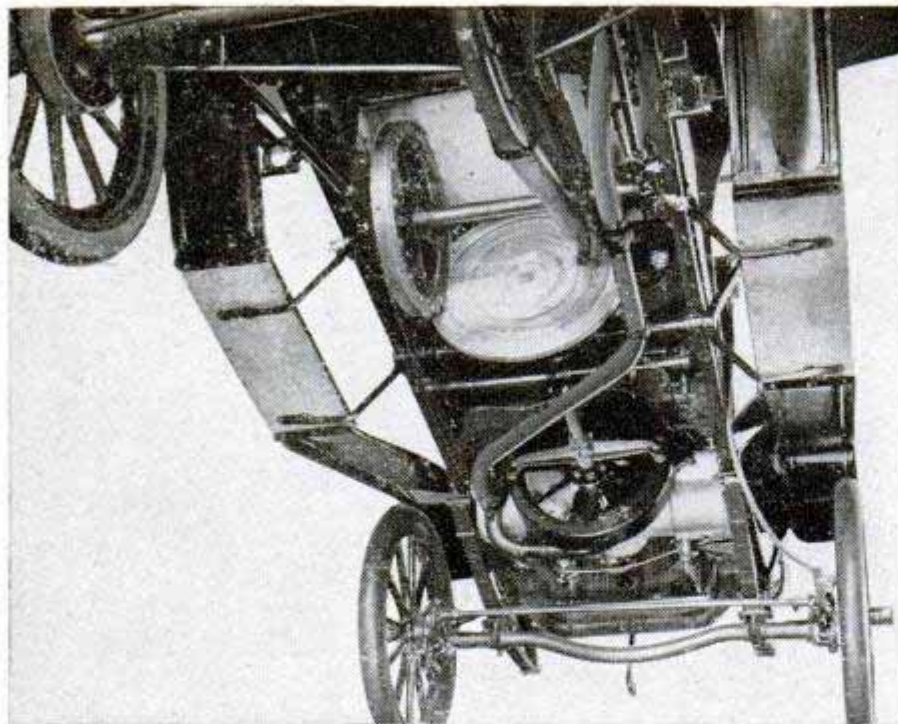

Carter (1909) used friction transmission. Large disk driven by engine contacted friction-faced wheel connected by chain to rear axle of car. Wheel moved across face of disk to get variable ratio and even reverse!

mounted behind a fluid coupling and a conventional foot clutch. Introduced in 1940, this design is also available on the DeSoto. A variety of names has been applied—Vacamatic, Simplimatic and Tip-Toe Shift. This automatic transmission is different from the fluid coupling arrangement used on the Dodge, also termed a "Fluid Drive."

The foot clutch is needed for the initial shift from neutral to high range, but thereafter all normal driving is done with-

out touching either gear-shift lever or clutch.

With selector lever in high range, starts are made in third, which is next-to-top gear. The shift to fourth, above a certain fixed minimum speed, is made merely by releasing the accelerator pedal. Then a free-wheeling device in the transmission releases the drive in third, and a hydraulic piston actuates the shift to fourth speed.

When in fourth, a "kick down" shift to third is made by depressing the accelerator pedal all the way. A special switch disconnects the ignition circuit for a few explosions, thereby causing a momentary "break" in the power flow. During this interval the shift to free-wheeling third is completed by the hydraulic piston.

The fluid coupling permits gradual application of engine power when starting from a standstill. It also cushions the power flow. The fluid coupling acts like a slipping clutch, with diminishing slip as car speed increases. Unlike a mechanical clutch, the fluid coupling does not wear out by slipping, as slip takes place in a body of circulating oil.

(Continued to page 264)

COMPARATIVE CHART OF AUTOMATIC TRANSMISSIONS

| | FLUID DRIVE (Chrysler, DeSoto) | DRIVE MASTER (Hudson) | HYDRA-MATIC (Cadillac, Oldsmobile, Pontiac) | DYNAFLOW (Buick Roadmaster) |
|----------------------------------|--------------------------------------|---------------------------|--|-----------------------------------|
| Foot Clutch | Yes | Yes (automatic) | No | No |
| Hand Control | Modified "H" | Standard | N D L R* | P N D L R* |
| Acc. Pedal— Lift to Shift | Yes | Yes | No | No |
| Automatic Shift | Hydraulic | Vac. clutch Vac. shift | Hydraulic | Torque converter |
| Up-Shift Speeds— Automatic | 3-4 | 2-3 | 1-2-3-4 | Infinite |
| Forward Speeds— Manual Shifts | Lo-Hi | 1-2-3 | Lo-Dr | Lo-Dr |
| Park in Gear | No | Yes | Yes (Rev.) | Special position |

* N—neutral, D—drive, L—low, R—reverse, P—parking.

Bandsaw "Brake" Permits Metal Cuts

Wood-cutting bandsaws can be converted to metal cutting with a speed reducer that gives a reduction ratio of 30 to 1. The $\frac{1}{4}$ or $\frac{1}{3}$ -horsepower motor is mounted permanently on a base which also supports the reducer. When the saw is used for normal wood cutting, the base is set with the motor shaft at right angles to the saw, and the belt is installed in the usual manner. To convert the saw to metal cutting, the entire base and motor are turned 90 degrees and the speed reducer is connected to the shaft with a flexible coupling. Worm gears inside the reducer then cut the blade speed to approximately 180 feet per minute. With the correct cutting blade this is the proper

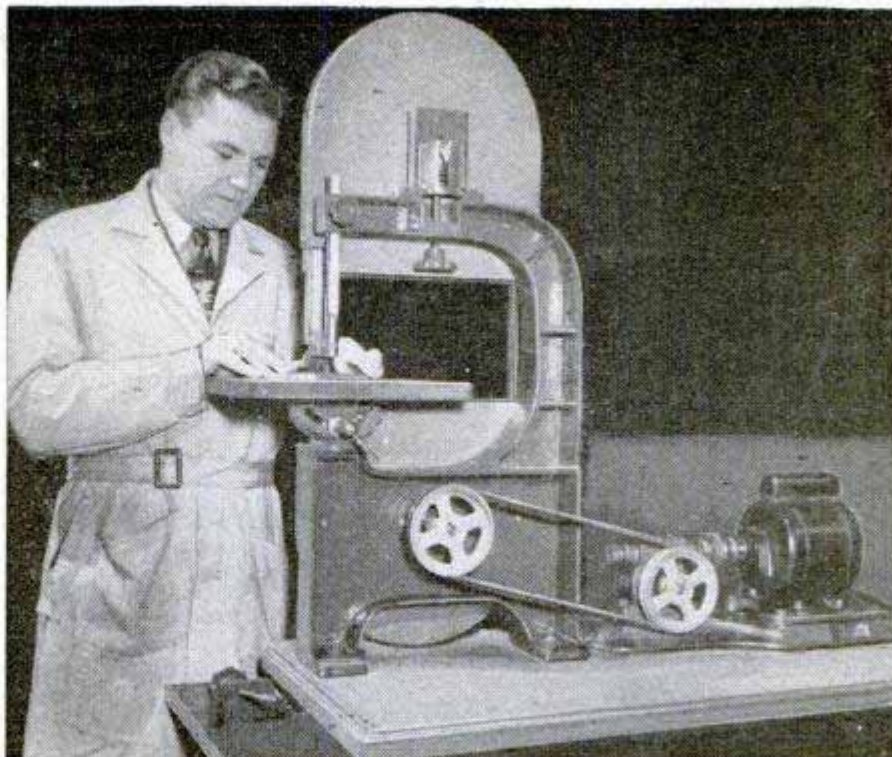

speed for cutting soft and low-carbon steel, copper, brass, bronze and aluminum. Variations in speed are possible by using other pulleys on the reducer and the saw.

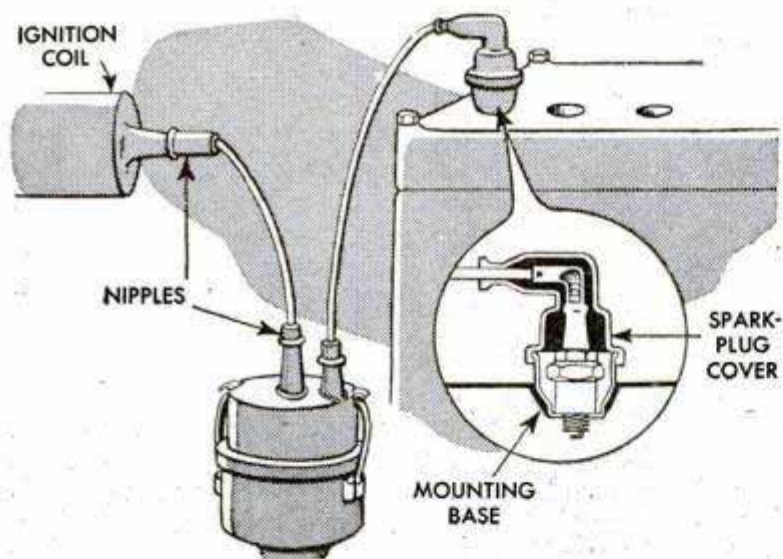

Raincoats for Spark Plugs Keep Ignition System Dry

Miniature shields for spark plugs protect ignition systems from water during rainy weather. A kit for installation includes mounting bases of cadmium-plated steel serving as spark-plug gaskets, right-angle covers made of synthetic rubber which fit like raincoats over the plugs, and flexible plastic ignition coil and distributor-cap nipples. The parts are made for cars built by the Chrysler Corporation.

Fingertip Brake Control Ends Stop-Light "Creep"

Your car won't roll on grades while you wait for the stop light to change if it is equipped with a fingertip-control braking device. Operated electromagnetically, the device holds hydraulic brakes on until released by a control on the shift lever. A red light on the dash glows when the brake is on. The unit is installed in the hydraulic system near the master cylinder and is wired through the ignition switch so that it cannot be left on unintentionally when the automobile is parked.

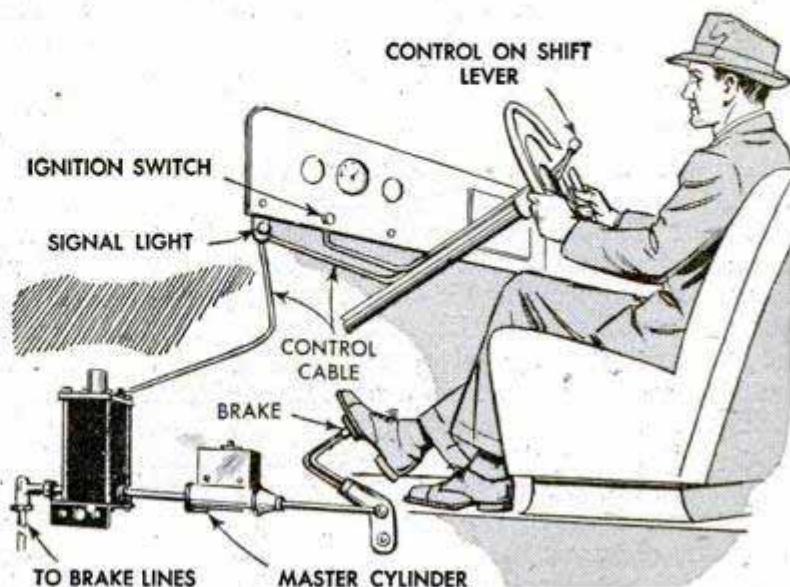



At this speed a boat doesn't draw much water! With fins out of water, the Li'l Injun is almost airborne

Stepping Up the

MOTORBOAT pilots are revving up their water-borne power plants these days, determined to exceed in 1948 the pace set on a western racing course last October. When the two-day meet ended, 14 new world records were on the books. In three classes that set new marks on the mile straightaway, the powerful boats rode their struts and little else three quarters of the distance.

For the men who live largely just to get more miles per hour out of limited displacement boats, those were jubilant days. But there was plenty of need for reflection.

They realized then that if hydroplanes were to go any faster without flying or becoming sheer suicide buggies, some changes had to be made. They also realized that runabouts (fun boats rather than race boats) were still terrific speedboats.

When Tommy Caldwell's rakish Blue Blazes streaked 88.782 miles per hour to a new world mark for 135-cubic-inch hydroplanes, and Tommy Hill in California Kid, a 225-cubic-inch hydro, reached 90.114, racing experts learned one important thing: the thin, aircraft-plywood hulls of step-bottom, lightweight hydroplanes had taken all the punishment they could from the power load of motors not yet peaked, without changes in design.

Then when Lorin Pennington's Copper-

By Bob Ruskauff

head, a Class-E racing runabout, raced to a world record of 70.245 miles per hour, a theory that had been accepted as revolutionary a few years back had to be discarded. When "three point" hydroplanes first entered the field it was generally predicted that the runabout hull, for speed competition, was doomed. But Copperhead and a half dozen other boats in her class that went almost as fast, proved otherwise. The Copperhead, although trimmed for racing, was actually a boat of basic hull plan identical with many built and used strictly for utility, ski-towing and other pleasure purposes!

So what does the speedboat future hold?

Four Californians whose achievements with marine speed have become internationally known were asked this question. They are Clay Smith, motor expert, and Joe Guess, hull designer, of the 225-cubic-inch series of Guess Who hydroplanes; Bill Campbell, runabout designer, and Harold J. (Hi) Johnson, propeller wizard.

Like most top men of the motorboat world, all are now in the midst of long-range experimental work.

They concurred in several general beliefs: (1) Limited displacement racing boats within this year or the next will reach speeds possibly 10 percent greater than the records of 1947. This applies both

to the three-point step-hydroplanes and the racing runabouts. (2) Development of propellers, which must drive whatever load the engine and hull designers bring out, is vital. (3) Success will come because, more than ever in the past, designers of motors, hulls and propellers are working together to solve the problem. (4) Lighter, stronger materials both in hulls and power plants will play a big role. (5) Strangely enough, numerous ideas, such as the transfer drive, discarded a few years ago as impractical, will be resurrected because engineers have learned how to apply them.

What about the runabout? This class has most interest for the fast-boat owner who wants high speed

Right, Harold Johnson, propeller designer, checks blade pitch with gauge he invented. Below, racers put their boats in the water

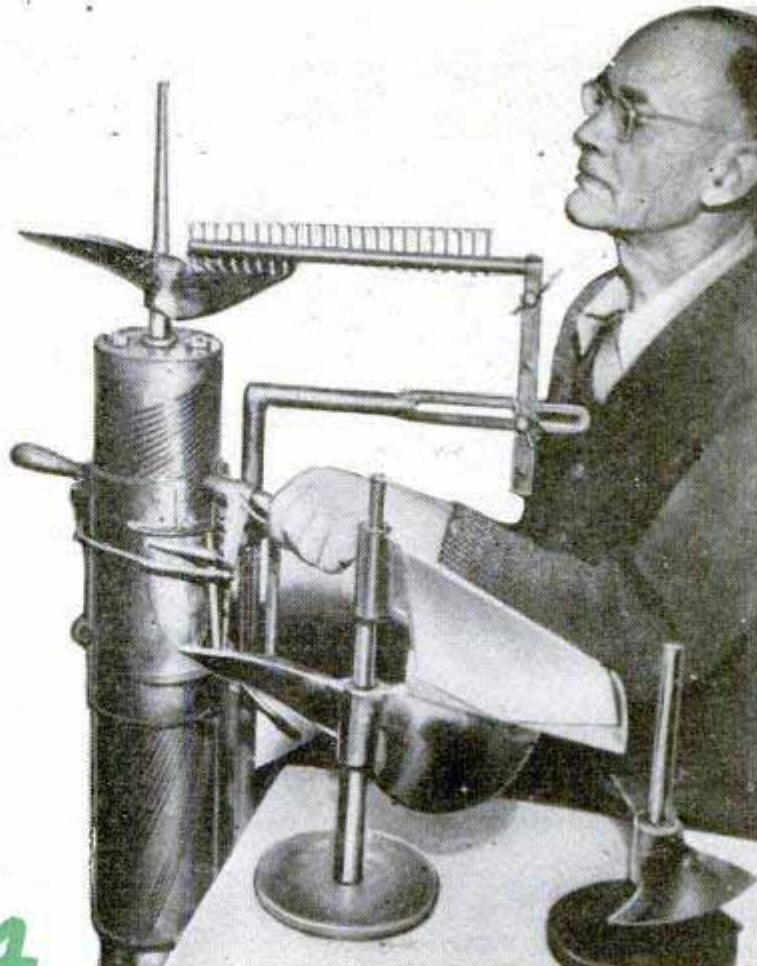

Speedboats





This record-setting racer skims along at 73 miles an hour. Note that one propeller blade is out of water.

with safety in a sport boat but doesn't care for an outfit designed only for racing.

Campbell, who evolved the Class-E racing runabout hull plan after five years experimentation, says that any basic hull change can await developments in motors and props. The hull has yet to be strained to its limit or peaked, as designers say.

The veteran designer and builder says: "When Copperhead and Duz broke world records, with at least five boats in the E-racing-runabout class hard on their transoms, the speeds and consistency in the class indicated that the runabout hull has not been peaked.

"The whole design of the E fares from the bottom lines and in all the plans the lines were allowed to build the boat. With the conventional direct drive, runabouts

will reach within five miles of what Copperhead did and still remain fast, maneuverable play boats. You can carry three people, haul water skiers and control the boat at trolling speeds.

"On the other hand, we've only begun to realize the high-speed potentials of the V-drive. For an extra cost of \$350, the driver can shift his motor forward or back of the driving cockpit to achieve perfect balance and maneuverability at high speed, while maintaining a correct shaft angle necessary to get that speed.

"To achieve the type of E-racing runabout which hit 70, the boat in plan was reduced from several fairly successful runabouts. It was diminished in all sizes. We lowered the freeboard. We shortened the hull, lightened it and added relief

chines to increase stability. While making it lighter we also made it stronger by using laminated woods.

"The runabout which will go 10 or 15 percent faster than Copperhead can retain the basic plan, but will have some changes. These include lower freeboard, increased lamination and less weight and a lighter, more compact gear box to handle the transfer drive. It will house a more powerful motor within the displacement restrictions. It will pos-

"Cleaver" propeller of new design (top) compared with conventional blade



sibly have a more perfect propeller setup. Beyond that, I wouldn't predict!"

Another new development is the wafer-thin hull that Clay Smith and Joe Guess use in Guess Who III. This 225-cubic-inch hydroplane might be the first in the small displacement field to hit 100 miles per hour (10 miles faster than the California Kid traveled). She is a successor to the famed 225, Guess Who II, that Smith drove through two undefeated seasons of racing and once held (at 79.840 m.p.h.) the world record that California Kid later lifted to over 90.

The new boat is a radical departure. Smith and Guess are installing a Ford-6 power plant, but not conventionally. The motor will be mounted on its side! This will reduce frontal resistance by decreasing the size of the metal cowling or "blister." Only the manifold will be above deck. Lowering of gravity weight center will decrease tipping and rocking. Rigidity is gained by resting the motor on a metal truss of lightweight chrome molybdenum tubing of high tensile strength, rather than on wooden stringers. From topside, the new boat resembles the half-section of a Bartlett pear.

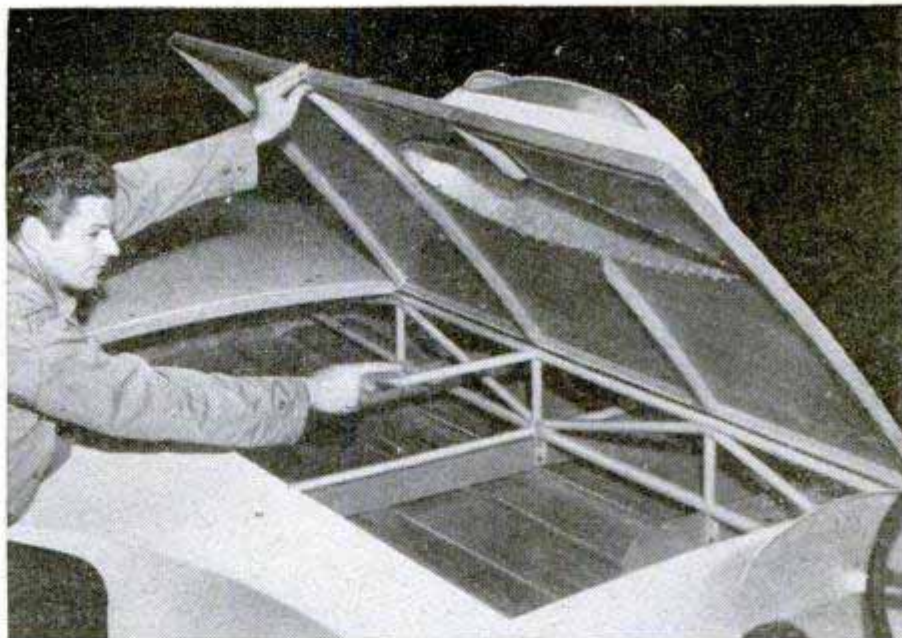

Engine will rest on its side in shallow compartment of racer shown below

"She's deceiving," Guess said. "There's much closed-in area and a lot of hardwood (vertical-grain fir, with a $\frac{5}{16}$ -inch bottom), but she's light—about 375 pounds." Yet the hull is 15 feet 6 inches long, 30 inches longer than Guess Who II. From extreme width of 103 inches she tapers to only 54 inches at the stern.

Propeller design is vital in high-speed racing boats. Without a propeller the best racing boat in the world is as useless as a rowboat without oars. In this field one of the outstanding developments is a new propeller developed by Hi Johnson.

Johnson's propeller has a thick trailing

(Continued to page 260)

Guess Who III, potential 100-m.p.h. hydroplane, is wafer-thin. Blister on engine hatch covers manifold

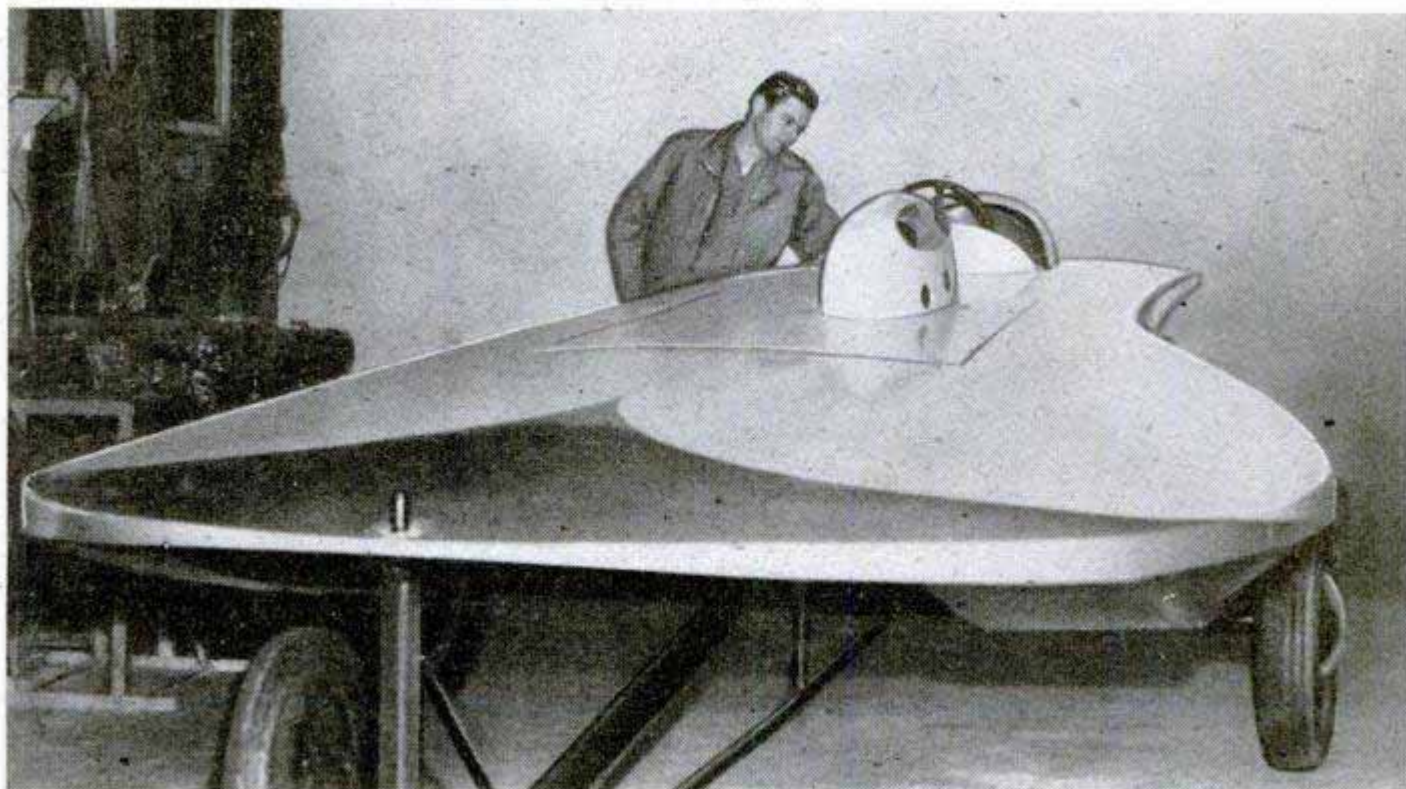



1949 LINCOLN

First of the 1949 luxury cars to make their bow are the Lincoln and Lincoln Cosmopolitan models styled in the modern trend—low and wide with long sweeping lines and “picture window” visibility. Both models are powered by a new 152-horse-

The 1949 Lincoln Cosmopolitan town sedan is one of eight new models with new engine, chassis and body

power V8 L-head engine. The Cosmopolitan model, which has a wheelbase of 125 inches, is four inches longer than the Lincoln. All Lincoln Cosmopolitan models have automatic overdrive which is optional equipment on the Lincolns.



1949 MERCURY

Second product of the Ford Motor Company's 100-million-dollar new-car program is the 1949 Mercury presented in four body styles: four-door sport sedan, six-passenger coupe, six-passenger convertible, and station wagon. The new Mercury has a

The 1949 Mercury six-passenger coupe is wider and lower with big windows for all-around view of road

110-horsepower V8 engine, 118-inch wheelbase and is only five feet two inches high. The front seat is eight inches wider than in previous models. An overdrive unit, installed as optional equipment, becomes operative at speeds over 25 m.p.h.



Spring-Powered Gig Reels in Fish

Fish and frogs are "shot" with a miniature harpoon invented by 13-year-old Billy Taylor of Brookhaven, Ga. When the fisherman hits his target he merely reels in the fish or frog with a conventional fishing reel. The gig is "loaded" by inserting it in the rod, which compresses a strong spring. The line from the reel is then attached to the harpoon. When a trigger is pulled, the harpoon shoots into the water toward the target. Young Taylor has offers from fishing-equipment manufacturers, suppliers, sportsmen and even the Coast Guard. He says he will send the first gig to "the country's number one fisherman, President Truman."



Bundled Newspapers Counted

William Barnwell of the Pueblo (Colo.) Star-Journal and Chieftain has invented a way to check the number of newspapers in a bundle. Presses automatically count them but errors are sometimes made in bundling odd numbers. With Barnwell's system, the stack is put under a measuring rod and weight forced down on it by a lever. The indicated figure is then checked against a table that shows the sizes of all editions from eight to 56 pages.



Quarter in Slot Operates Recorder, Out Drops "Voice Letter"

Two-minute phonograph records in the form of "voice letters" and holiday greetings are cut by a coin-operated machine that is completely automatic. Upon insertion of a quarter, a fiber disk drops on the turntable and an illuminated panel gives instructions to the operator. "Mike fright" is eliminated by a conventional hand telephone instead of a microphone. A voice adapter automatically adjusts the machine to compensate for too strong or too weak voices. After the record is cut the machine replays it either through the telephone for private listening or through a loudspeaker before delivering it to the customer. The record can be replayed on any phonograph.

The Workshop Rolls to School

By Joseph S. Baer

FOR THE NATION'S three million kids attending one-teacher schools—among whom might be another Edison or Ford—the “shopmobile” means better instruction coupled with a holiday from classes.

The shopmobile brings children in under-equipped, country schools the opportunity to work with tools.

Here's the birth of the idea: When the War Assets Administration recently offered complete mobile shops for sale, 18 small school districts under the leadership of Dr. John S. Carroll, superintendent of San Diego County schools, jumped at the chance.

For years educators have realized that the one-teacher school doesn't give children a fair shake in equipment. Limited finances in smaller districts prohibit purchase and installation of expen-

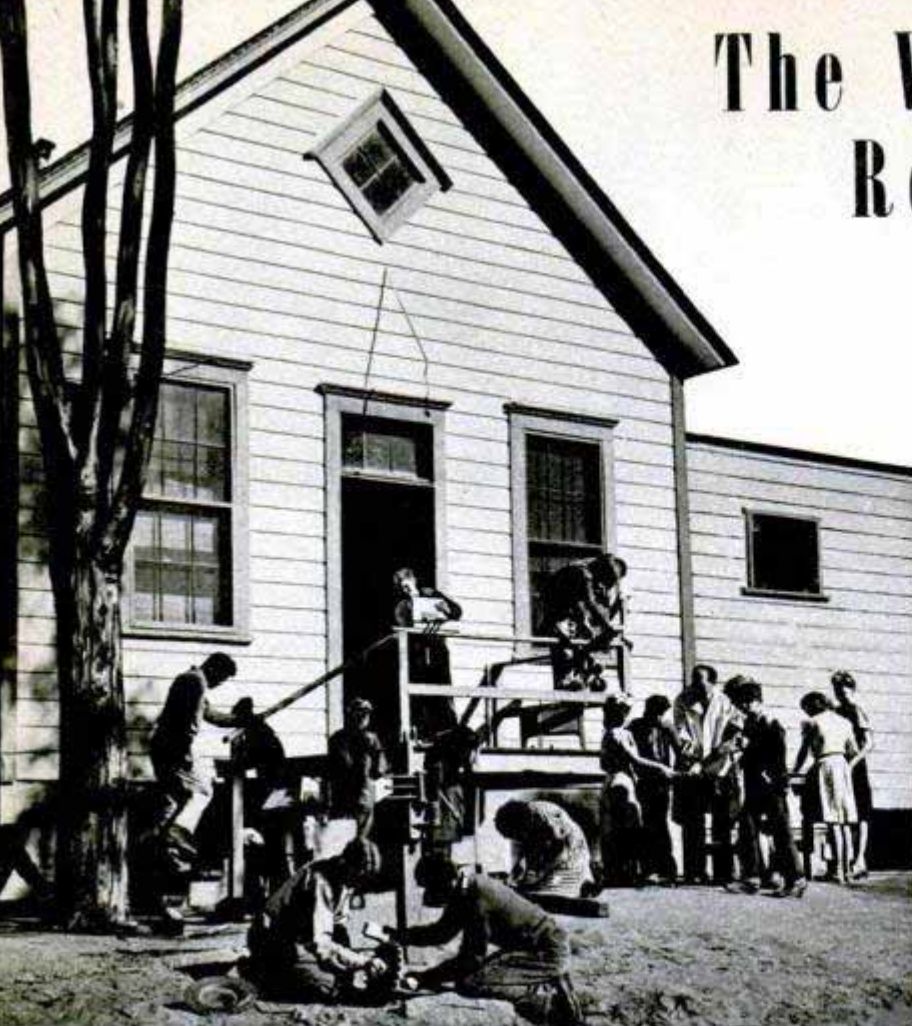

Photos by Jack House and Bob Montague

Give the youngsters tools and even a school porch will serve as a workshop. Tools in the shopmobile are distributed for outdoor work. Below, individual instruction can be given inside the truck. Here the instructor checks student's first efforts with a jigsaw

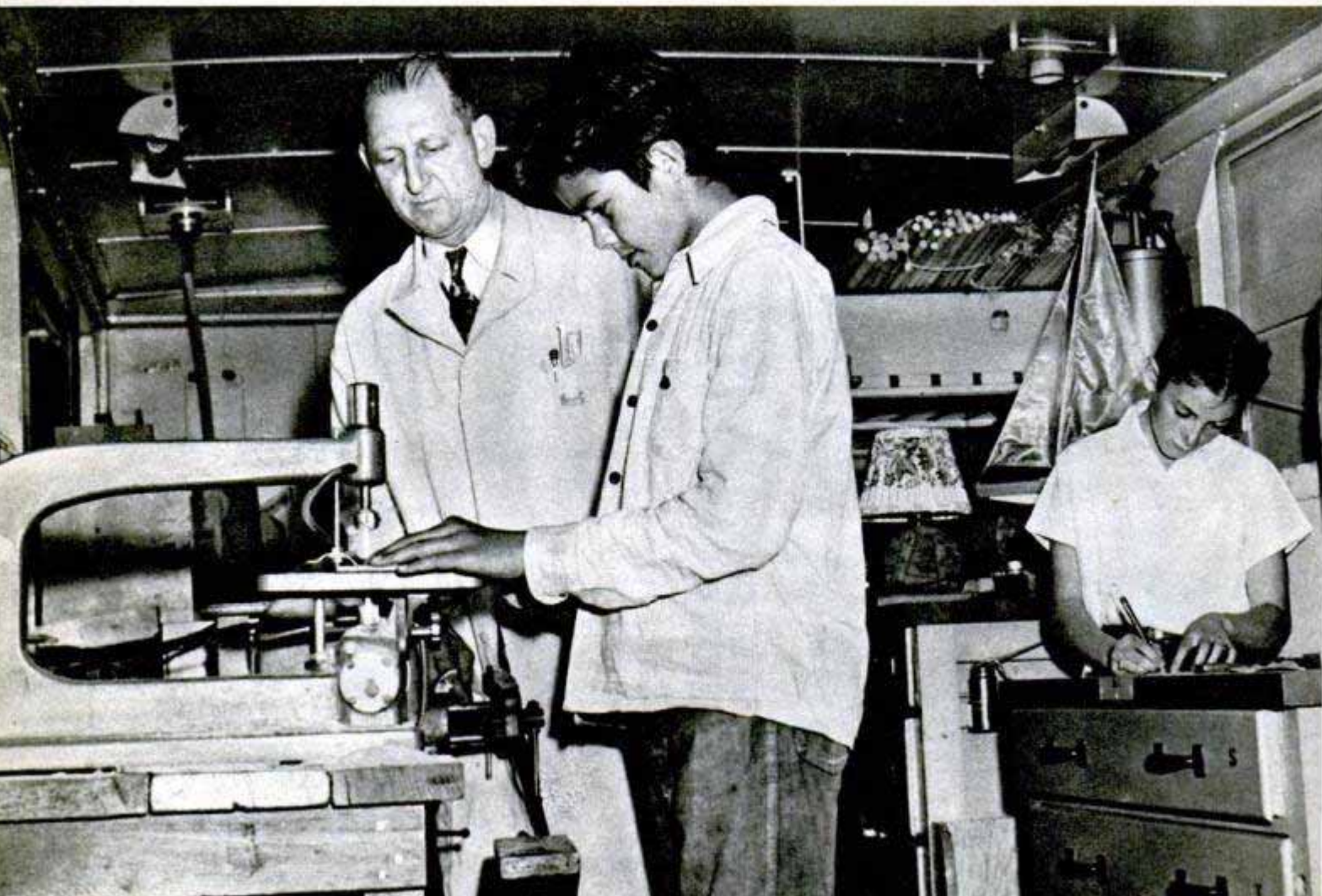

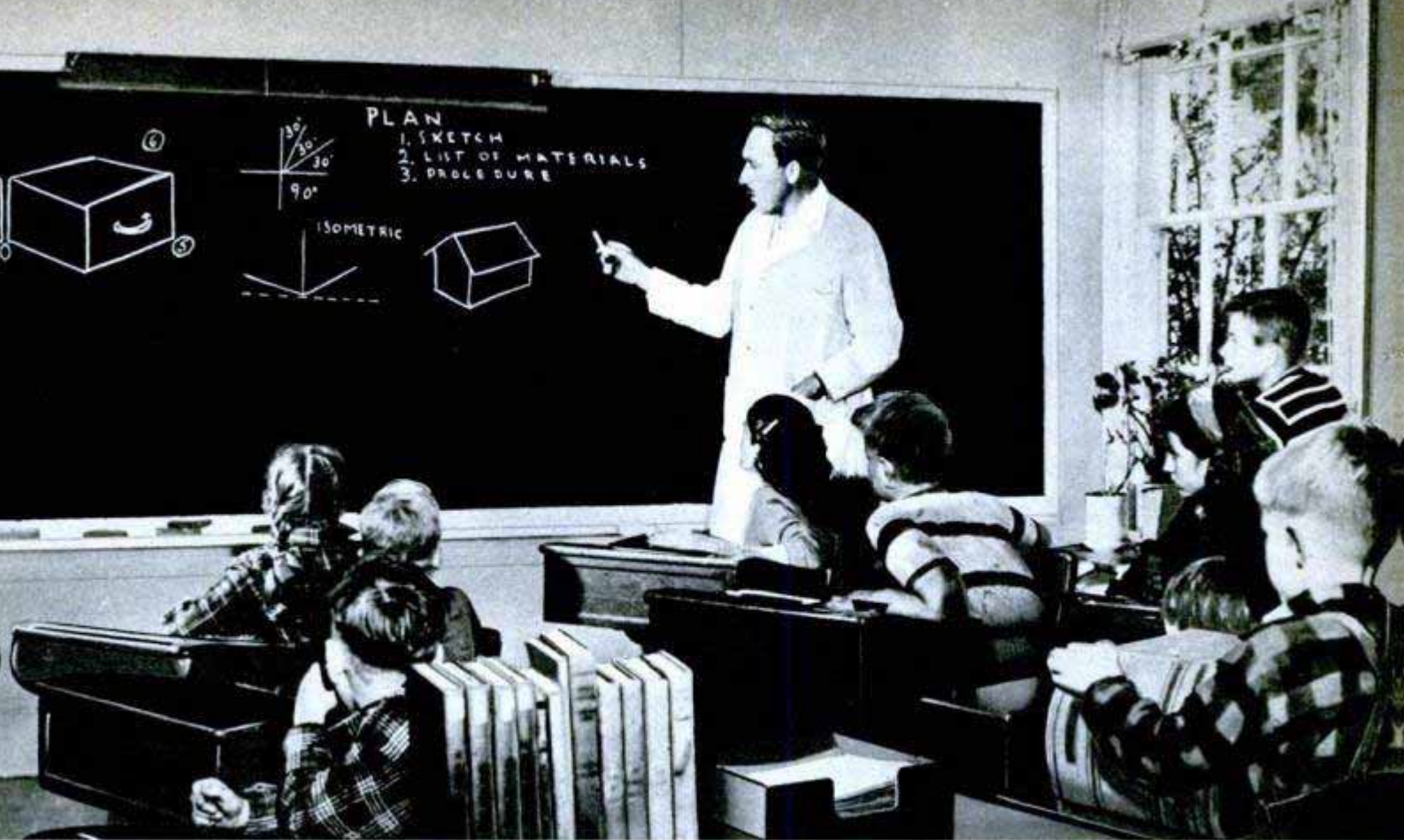

On a weekly visit to a rural school a driver-instructor shows pupils how to prepare plans for their projects

sive equipment that the city pupil takes for granted. And the one-room teacher can't be expected to teach the three R's and also be a specialist in industrial arts.

So the 18 school districts bought four of the war-surplus trucks at an average cost of \$450 apiece. But these aren't ordinary trucks—they are rolling machine shops equipped with all essential tools. And they

are sturdy trucks that absorb the impact of several hundred enthusiastic students each week. They are the 2½-ton, six-wheel van-type vehicles, bought at less than five percent of their original cost.

School crews remodeled the trucks, painted them bright aluminum and replaced some of the heavy tools used by amphibious forces with complete sets of hand

Shopmobile with flaps open offers a compact workshop equipped with sets of hand tools for all kinds of craftwork

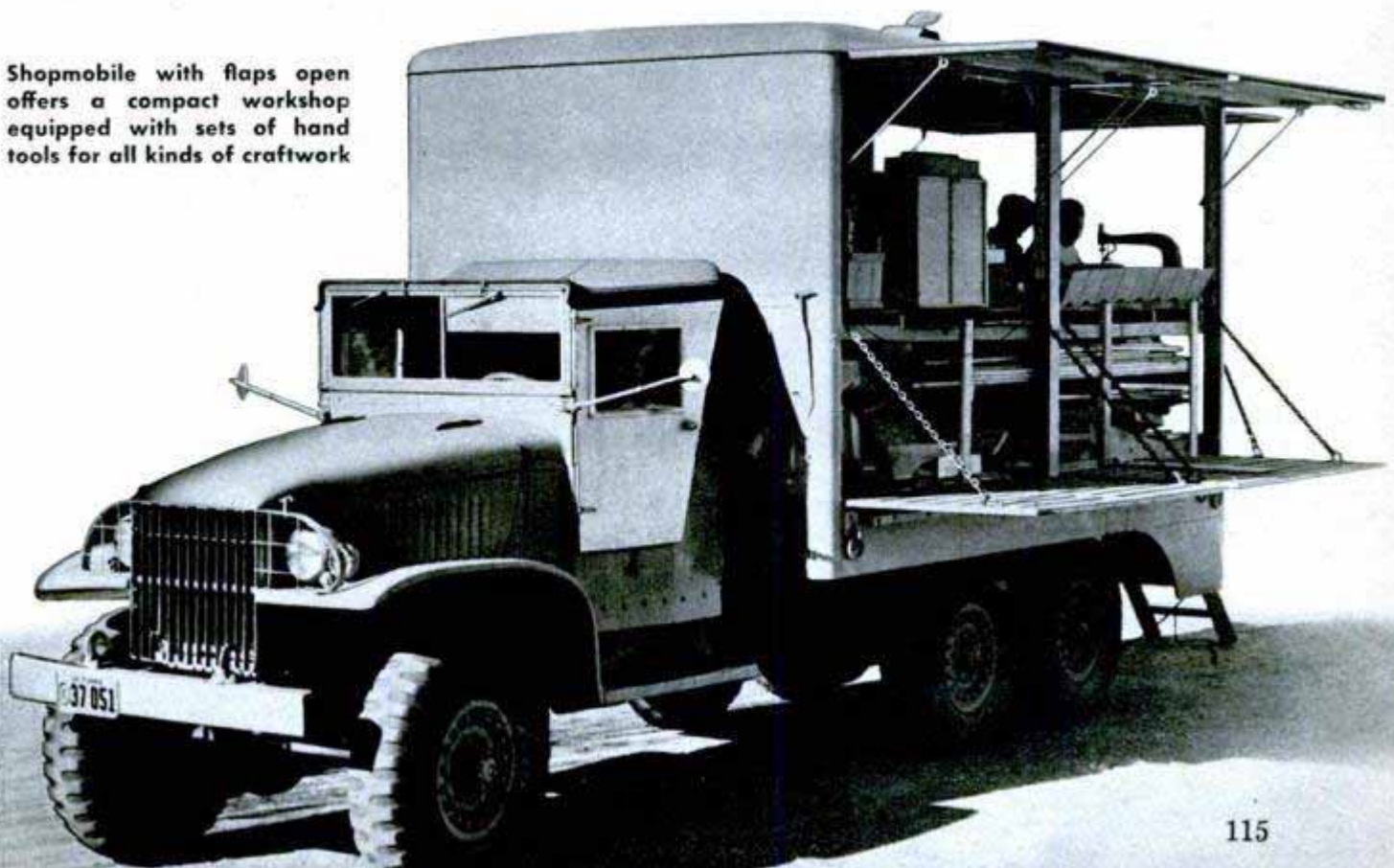

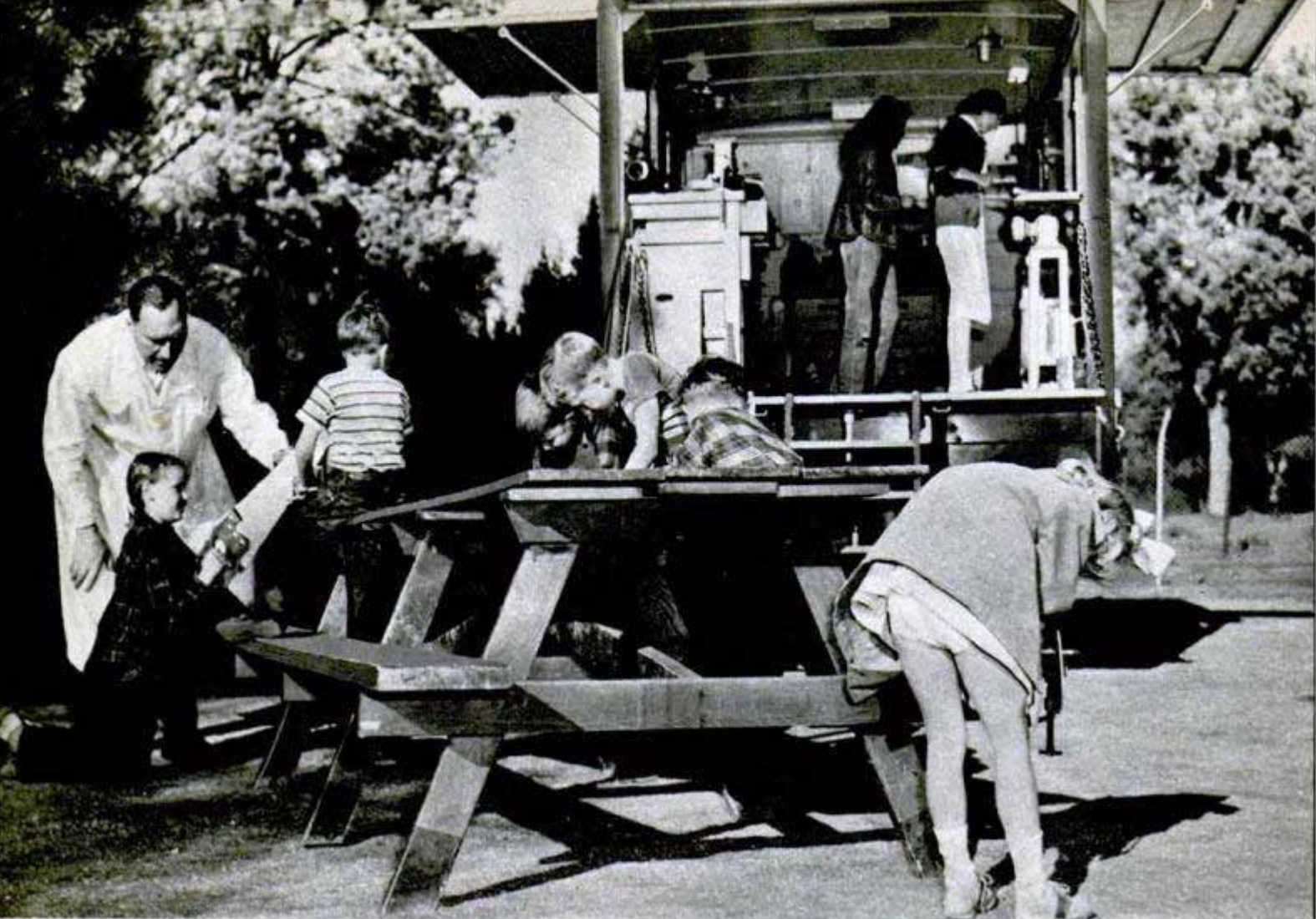

Even a rough picnic table makes a good workbench for the pupils. Girls as well as boys take the shop course

tools. Among these are tools for working with plastic, wood, pottery, leather and metal. One power jigsaw was left in each truck. The shopmobiles, already wired, can be plugged into any electric system.

Two trucks were placed in service. Each is driven by a circuit-rider who is a specialist in teaching industrial arts. The instructors work out of a central point in the county and usually spend a half day at each school on the circuit per week.

When the shopmobile rolls up to a school the driver-teacher lets down the truck flaps and opens shop. At small schools where attendance is light, youngsters leave the classroom and work right in the shopmobile, weather offering few obstacles in mild southern California.

Occasionally, classwork is done inside where the teacher can draw simple plans on the blackboard. After a short period of instruction the students go to work building birdhouses, cabinets and shelves.

The mobile shop's visit ties in construction work with book "larnin'." For example, if the class is studying early California history, children use the tools to construct models of covered wagons, adobe houses or ox carts. Children enjoy this method of

dramatizing their studies because it translates a textbook fact into a reality.

Driver-teachers also give the regular teachers pointers on carrying on the construction work after the shopmobile rolls away until the following week. And teachers may be given instruction too. The instructor shows them how to build simple teaching aids that demonstrate visually, for example, how a unit can be broken into fractions.

Enthusiasm for the shopmobiles is high among children, teachers and school administrators. Plans are afoot to use the trucks for adult classes and for Boy and Girl Scouts interested in craftwork. And the other two trucks probably will be equipped and rolling the roads soon.

At present the cost of operating one truck is estimated at almost \$5000 a year, which includes the instructor's salary. By pooling resources with other schools, each school can have the shop service a half day each week for only \$500 a year.

As children become more skillful in handling the tools, more power tools can be added—lathes, drill presses and joiners—which were removed from the trucks and stored for future use.



Plane's Wheels Slide Back To Lessen Shock of Landing

For added safety, all Constellations are being modified so that the landing-gear wheels can move back about six inches when the big planes touch down at 100 miles an hour. The hydraulic damping device, replacing a rigid brace, cuts down the momentary initial load peak nearly a third. It also reduces the lurching sensation on landing about one fourth. Massive 40-foot towers that look like modern guillotines were used in tests for the new device. The wheels were spun 100 miles an hour in reverse and weighted above with lead to simulate landings.



Lockheed Aircraft photos

Above, on "guillotine" used in perfecting new landing aid, wing lift was duplicated by metal straps from top of tower to gear absorbing some of shock



Packaging Machine

To speed the packaging of screws, bolts, nuts and washers that are packed with heat-control instruments, the Minneapolis-Honeywell Regulator Company has devised a machine that is 18 times faster than a worker operating by hand. The machine, operated by one person, is adjusted to drop the required number of pieces into an envelope. It then closes the flap and staples the envelope. The output of six girls who formerly packed the parts has been tripled by the machine.

☐ Milk cans may eventually be coated with an enamel made from milk itself, according to the U. S. Bureau of Dairy Industry.

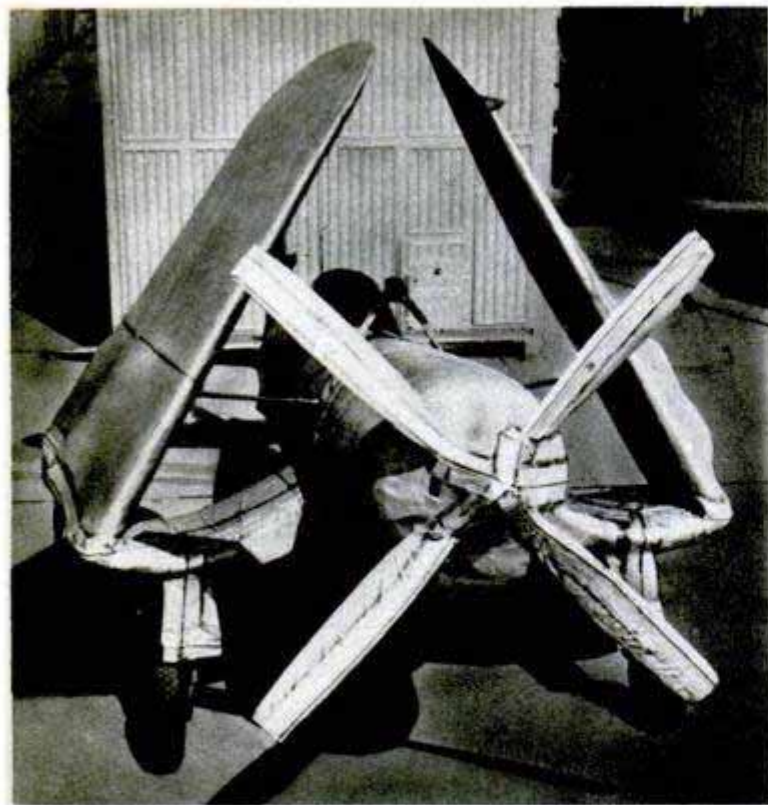

U. S. Navy photo

Zipper Bags Protect Aircraft To Be Stored for Short Time

Form-fitting zipper bags made of plastic-coated Fiberglas fabric will protect Navy planes in short-term storage. Inside the waterproof covers, chemicals will absorb moisture. They can be put on and taken off in one fourth the time required for present preservative measures. The tailored bags cover the entire plane, whereas present methods protect only the critical parts through applications of oil, grease and preservative compounds.

RUBBER LUNG equipped with a rubber bellows can be used instead of the iron lung in producing artificial breathing for victims of infantile paralysis

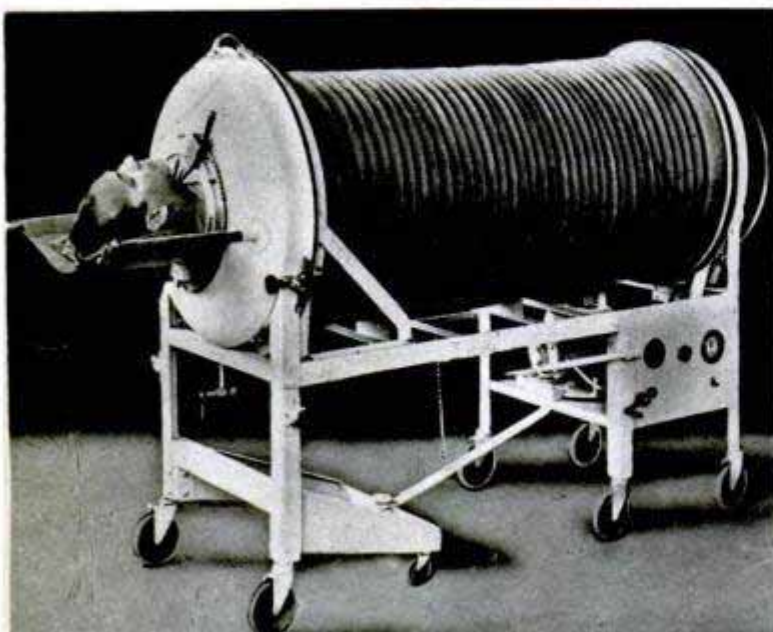

Dispenser Packs Wheel Bearings

Wheel bearings are lubricated thoroughly but without waste by a manual dispenser that forces grease between the races. Pressure is provided by turning a screw at the end of the dispenser. It services roller or ball bearings on all makes of passenger cars and light trucks. Quickly filled by suction, the dispenser holds enough grease to pack 40 average bearings.



Safety "Valve" on Fire Hose

Firemen are protected from the danger of bursting hose by a sealed air chamber that reduces the pressure wave of water when it is shut off at the nozzle. The chamber, developed at Northwestern University, also eliminates vibrations and knocks heard in home plumbing systems when faucets are turned off. It is a metal cylinder a foot in diameter and from 9 to 18 inches high connected to the fire-truck pump or in plumbing systems to the pipe near the faucet. Inside the chamber is a bellows sealed into a pocket of compressed air. When the nozzle or valve is closed the pressure wave rushes into the bellows and is absorbed by the compressed air. In the past, many firemen have lost their lives when water pressure burst a hose.

FISH-BOWL INCUBATOR has a transparent cover through which entire hatching operation can be seen. The incubator is heated and controlled electrically



Two-Wheeled Sulky For Small Tractor

Garden tractor users can sit down and ride if they have a sulky chassis that gives the small tractor two additional wheels and a spring seat. A dump-cart body that fits over the chassis converts the tractor into a small truck. The cart body takes loads up to seven cubic feet. Equipped with pneumatic tires and a foot brake, the chassis is also designed for use with a five-foot hayrake, or a mower can be attached for cutting the lawn.



Drill Blade Cuts Putty

Hardened putty is cut from window sash by a rotating blade attached to a standard electric drill. The cutter, designed for glass shops, contractors and remodelers, has a movable head which guides the carbide steel blade around the edge of the sash to cut away the putty. A fixed guide on the head is placed against the glass and an adjustable table is set to expose the cutter. The machine is held in this position as it is guided around the pane. The blade is adjustable from $\frac{3}{8}$ to 1-inch rabbet depth.

Global Sphere Charts

Distortions that characterize maps in attempting to project a curve onto a flat surface are overcome by a sphere chart. Designed by an Air Force officer for global navigation, they are actually plastic sections of a large globe. Two of the sections, 24 inches long and 12 inches wide, can cover a flight from San Francisco to Hawaii. They are lightweight, fit conveniently on a navigator's desk and can be made to any scale.



WHAT'S NEW *For Your Home*

Sources of supply for these products may be obtained from Bureau of Information, Popular Mechanics Magazine



POTATO BAKER needs no oven. Designed for baking a single potato, aluminum holder bakes over an open flame. The potato is held by a perforated spit that speeds cooking of center

← **FOOD SHREDDER** is also a slicer and grater. The Tenite plastic unit won't chip and comes in several colors. Cutting blades are interchangeable to permit three different operations

• **SHARPENER** for shears has no moving parts. Its carbide element sharpens scissors when the blades are drawn through a slot in the plastic case. Two quick strokes are enough

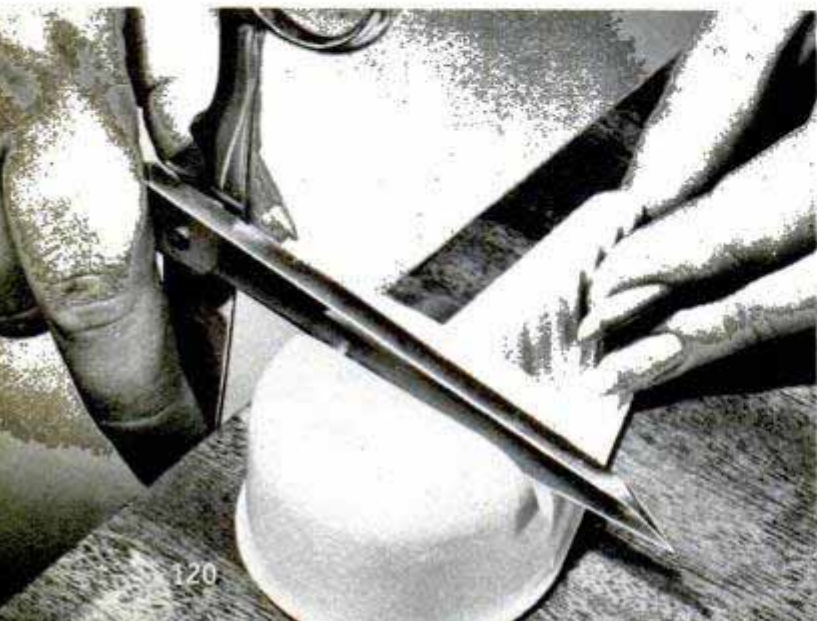

NURSING BOTTLE HOLDER makes pillow propping and other makeshift arrangements unnecessary. Made of Celanese plastic, the holder clamps the bottle firmly. During feeding, the bottle tilts forward so the milk flows easily, thus eliminating air sucking

OPEN-WINDOW LOCK prevents further opening of a window from the outside. A rubber roller within the lock runs against the frame. When the window is moved, the metal core of the roller locks against a serrated track until the unlocking lever is moved

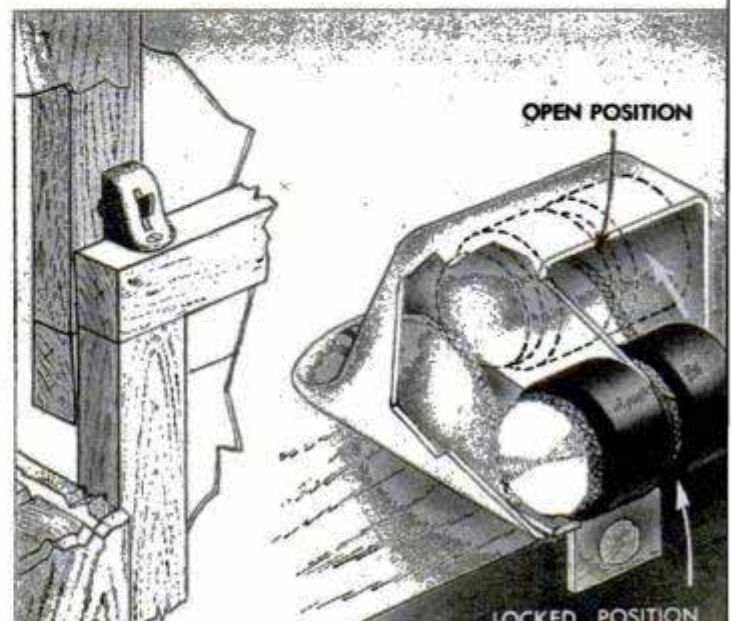

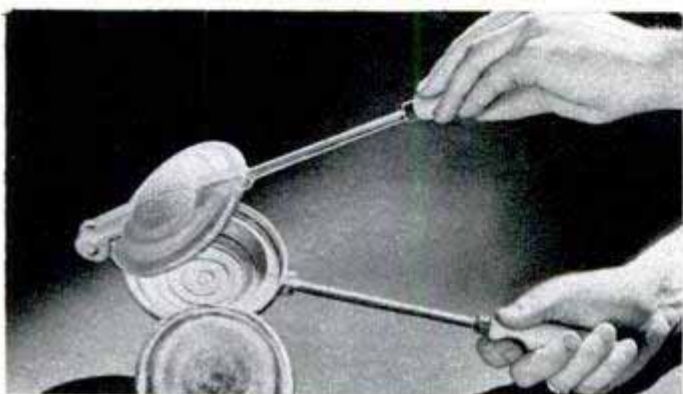

SANDWICH SEALER prevents juicy filling from squirting out when you bite into the sandwich. It seals the bread by compressing the edges and toasting. When the two halves of the sealer are closed, the bread is cut into circular pieces. It can be used over any flame and for any toasted sandwich

FRUIT JUICER with a top that tilts backward when raised is said to extract all of the juice from the fruit with less than one turn of the lever. Very little pressure is required to operate it. The strained juice runs into a built-in container in base

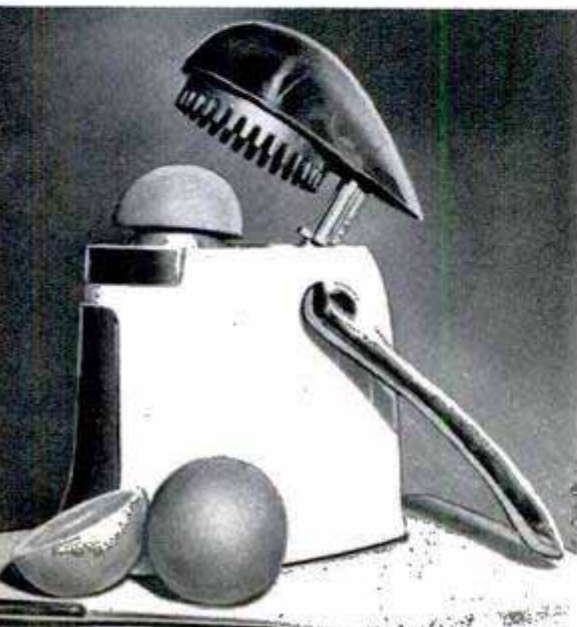

BATHROOM MIRROR, attached to the medicine cabinet by an extension bracket, can be adjusted to any angle. For normal use, it opens in the regular manner

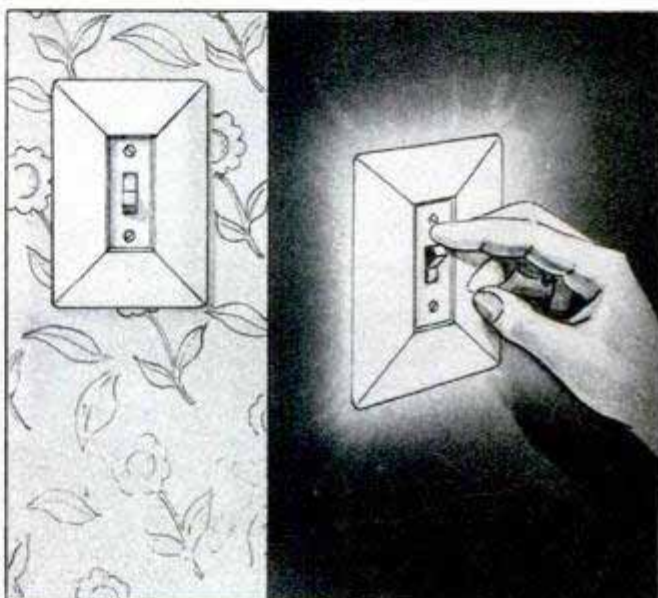

GLOWING LIGHT SWITCH shines in the dark for hours after each exposure to light. Made of plastic, it is a complete plate that attaches in the usual way

WINDOW WASHER requires only one hand to operate and eliminates dripping sponges and clothes. Water is sprayed on by a plunger pump, wiped off by squeegee

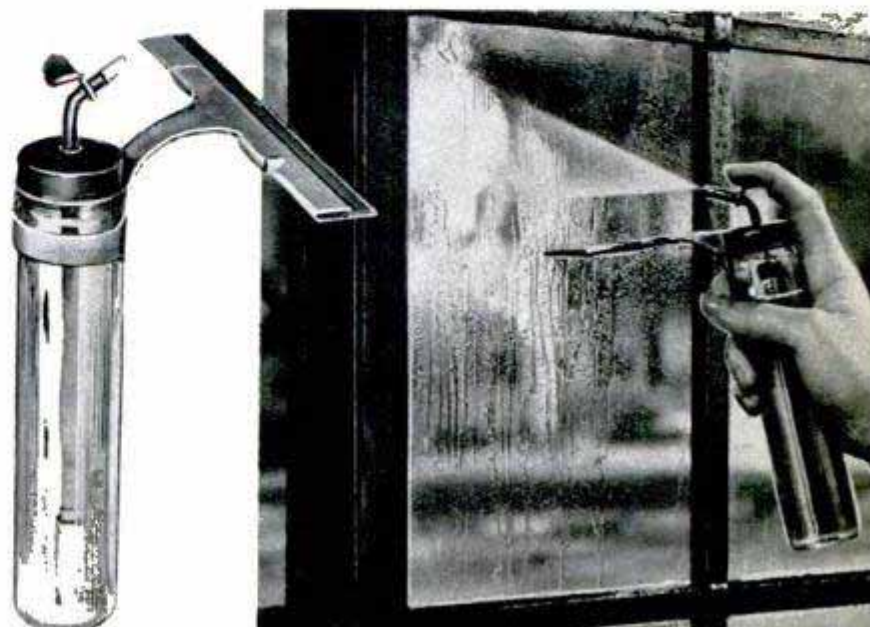

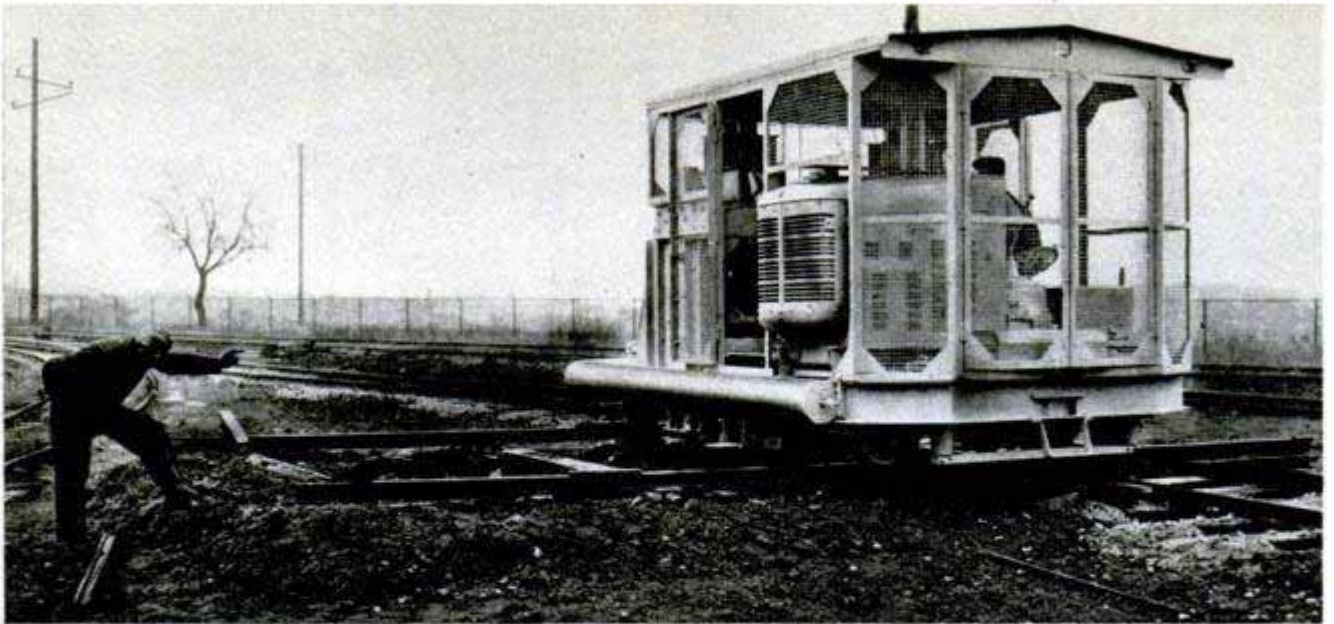

Pullman-Standard Company photos

Built-in lift raises track ballaster, above, allowing sidewise movement off rails when main-line trains approach. Below, shoes forcing ballast beneath ties



Railroad Track Ballaster

Rail-track ballaster is tamped down more than three times faster by a car now in service on the New York Central. It has a 2½-ton crosshead bar with 32 tamping shoes, which is motor-lifted and then dropped with a pile-driving action. The operator positions the tampers over a tie by looking through an opening in the floor. Then, while four helpers shovel in stone, cinder or gravel ballast, he lets the cross-head drop the number of blows required to pack it firmly. The ballaster can also straighten crooked ties. To get the car off the tracks, compressed-air cylinders force two horizontal bars down on the rails to raise the machine. Workers then slide rails under extra pairs of wheels at each end.

Stone-Wall Garden Grows Better Crop

If you don't have room for a strawberry patch in your backyard, you can tip the garden upright and grow a better crop. That's what one California resident discovered when he planted strawberry vines in a vertical wall. The wall is made of two layers of concrete blocks with soil and moss between them. The vines are planted in openings in the wall. A water pipe at the top provides moisture. Because birds have no place to perch, they can't damage the berries as they do in patches.

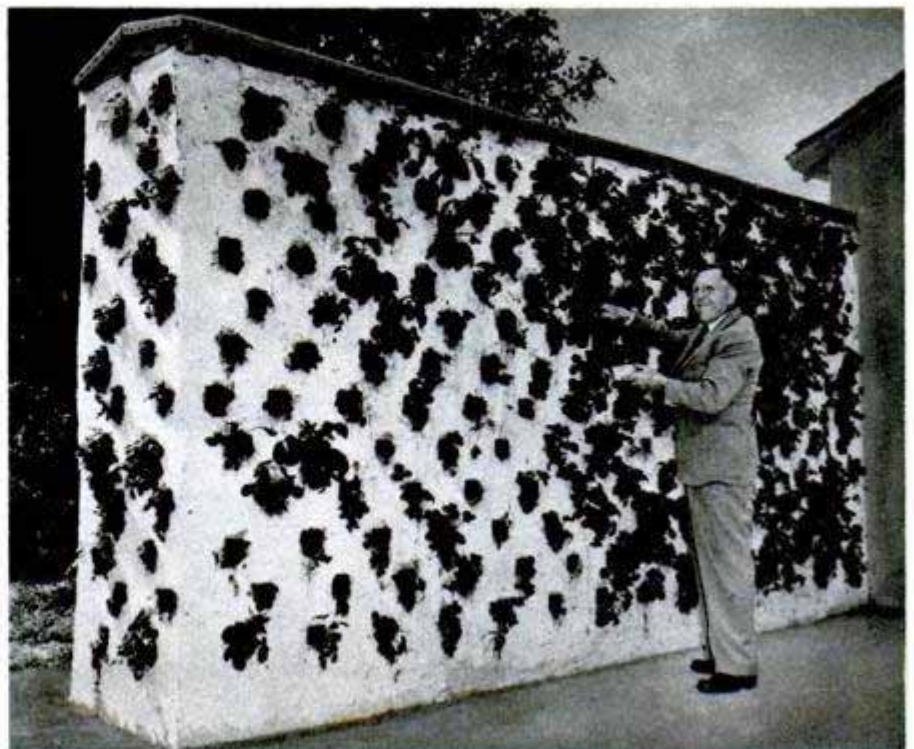



Conveyor Bales Leaves Picked Up in Street

Gathering leaves from street gutters and parks presented a problem in Pueblo, Colo., until Herman Klipfel, highway commissioner, hitched a pick-up conveyor to an old hay baler. The machine gathers and bales the leaves in one operation. A grader shoves the leaves away from the curb. The system is faster and less expensive than sweeping up the leaves and loading them on trucks. Two men now do a job that formerly required a fleet of trucks, loading machine and several men.

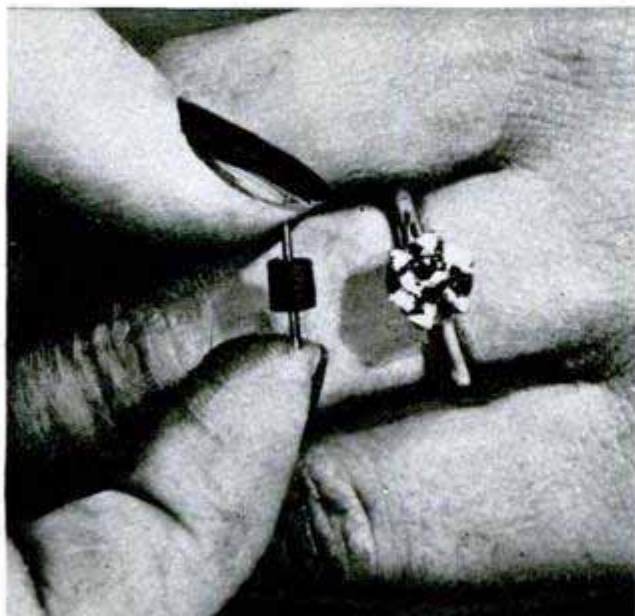
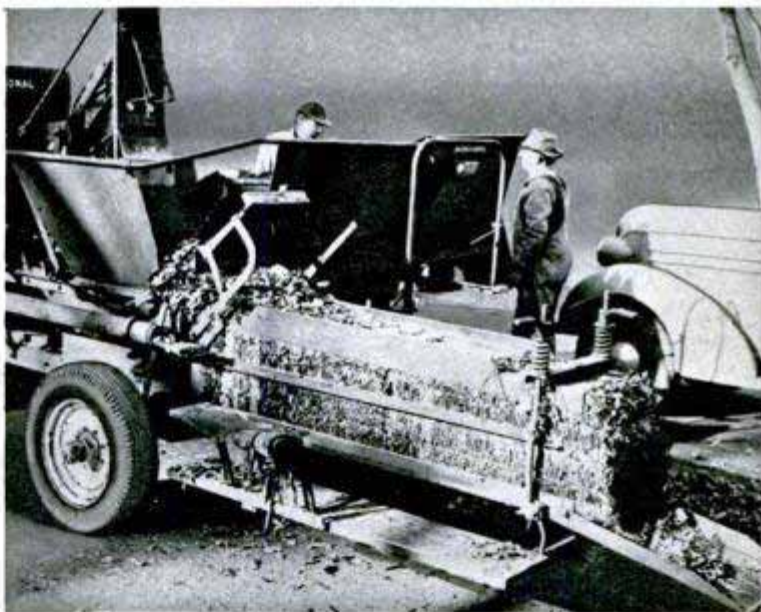

Motor Dwarfed by Diamond

Dwarfed by a 1.4-carat diamond is an electric motor that weighs less than a gram. It is the smallest of a series of sub-miniature motors being made by the U. S. Instrument Corporation for use in moving-picture cameras, mechanical toys and animated Christmas-tree ornaments. It measures only $\frac{3}{16}$ inch in length and diameter, requires $1\frac{1}{2}$ volts and runs with high efficiency at 7000 revolutions per minute.

Popular Mechanics is always ready to supply further information to readers about various products described in any issue. Just write to Bureau of Information, Popular Mechanics, 200 East Ontario Street, Chicago 11, for a prompt reply

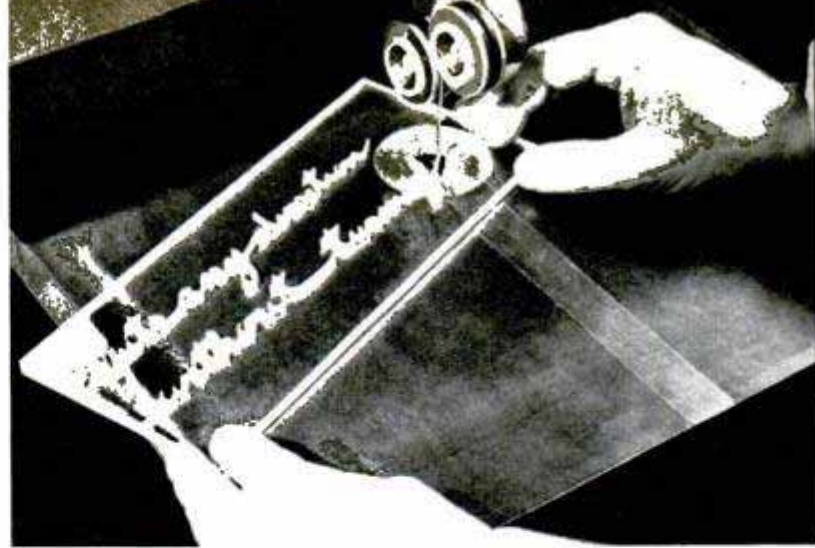

Left, the spiral saw can be used with a master pattern for sawing duplicates. Note the sharp turns made by the blade. Right, turning the work is unnecessary when "writing" in sheet plastic with 360-degree saw

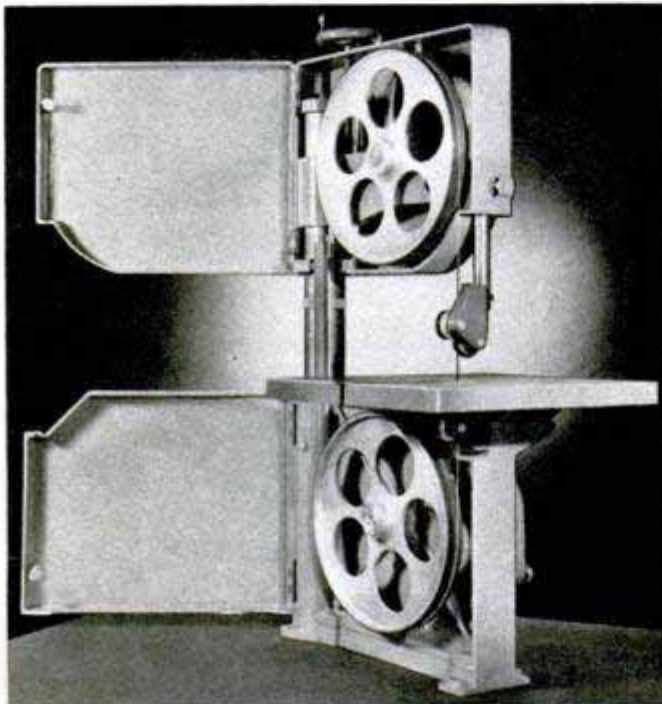

Sawing Is Like Drawing With a Spiral Bandsaw

Using a spiral blade that cuts in any direction without the work being turned, a new bandsaw will follow any line you can draw. To change the direction of cut, you merely guide the work along the line. Sawing is continuous. Thus, you have a 360-degree saw that cuts its way in and out of complicated fretwork with no backtracking. It saws wood, metal and plastics without chipping or grabbing. Even soft rubber can be cut leaving clean, square edges. It is safe to operate because the spiral blade won't grab or tear the hands. The saw is 36 inches high with a 12-inch throat. Blade speeds are changed by shifting the drive belt on a four-step cone pulley.

Above, neatly designed, the bandsaw is 36 inches high. A vertical post supports the upper housing. Below, rubber-tired rollers guide the .040-inch blade. Here are samples of its work. Insert shows shape of blade

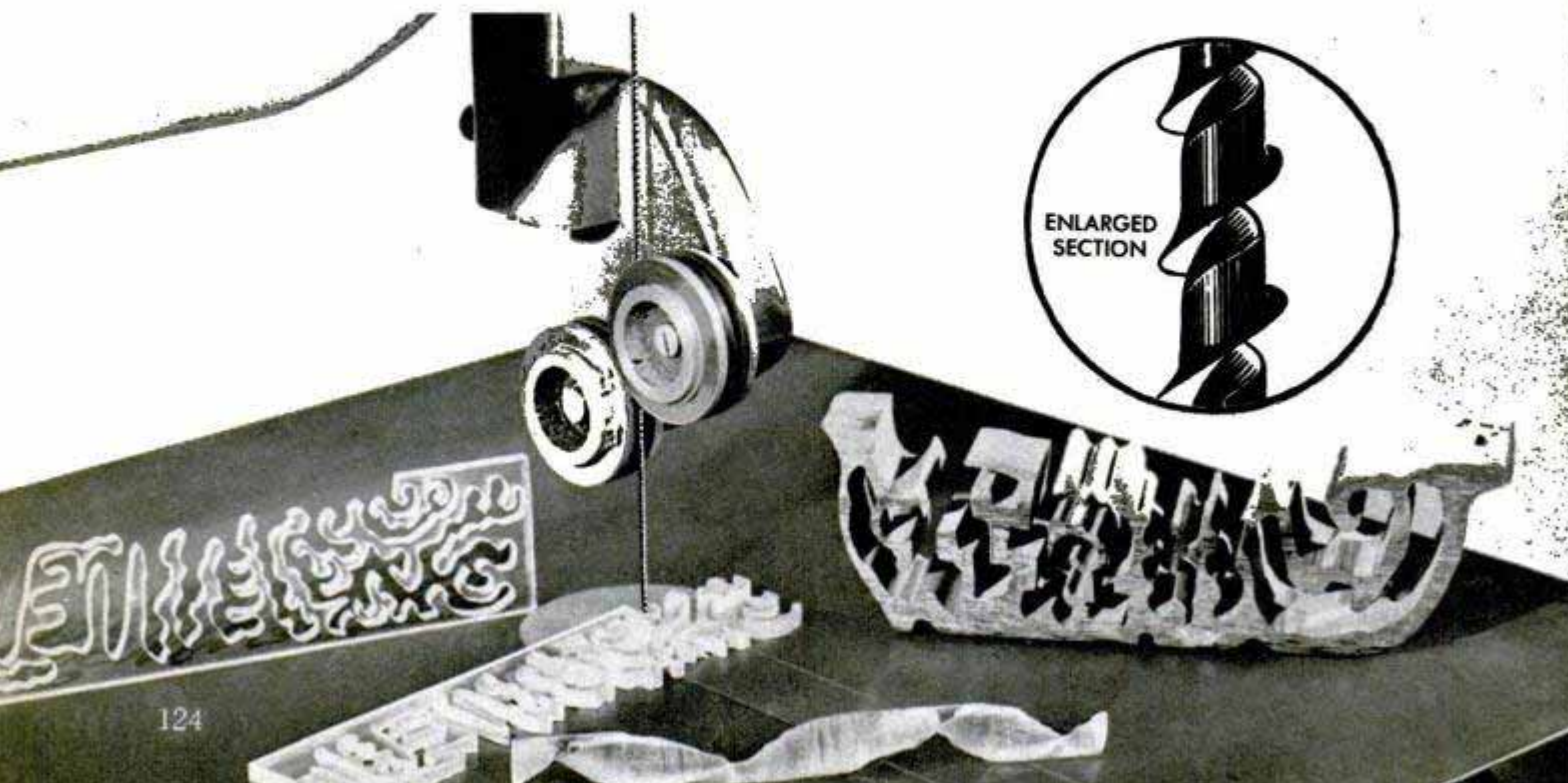

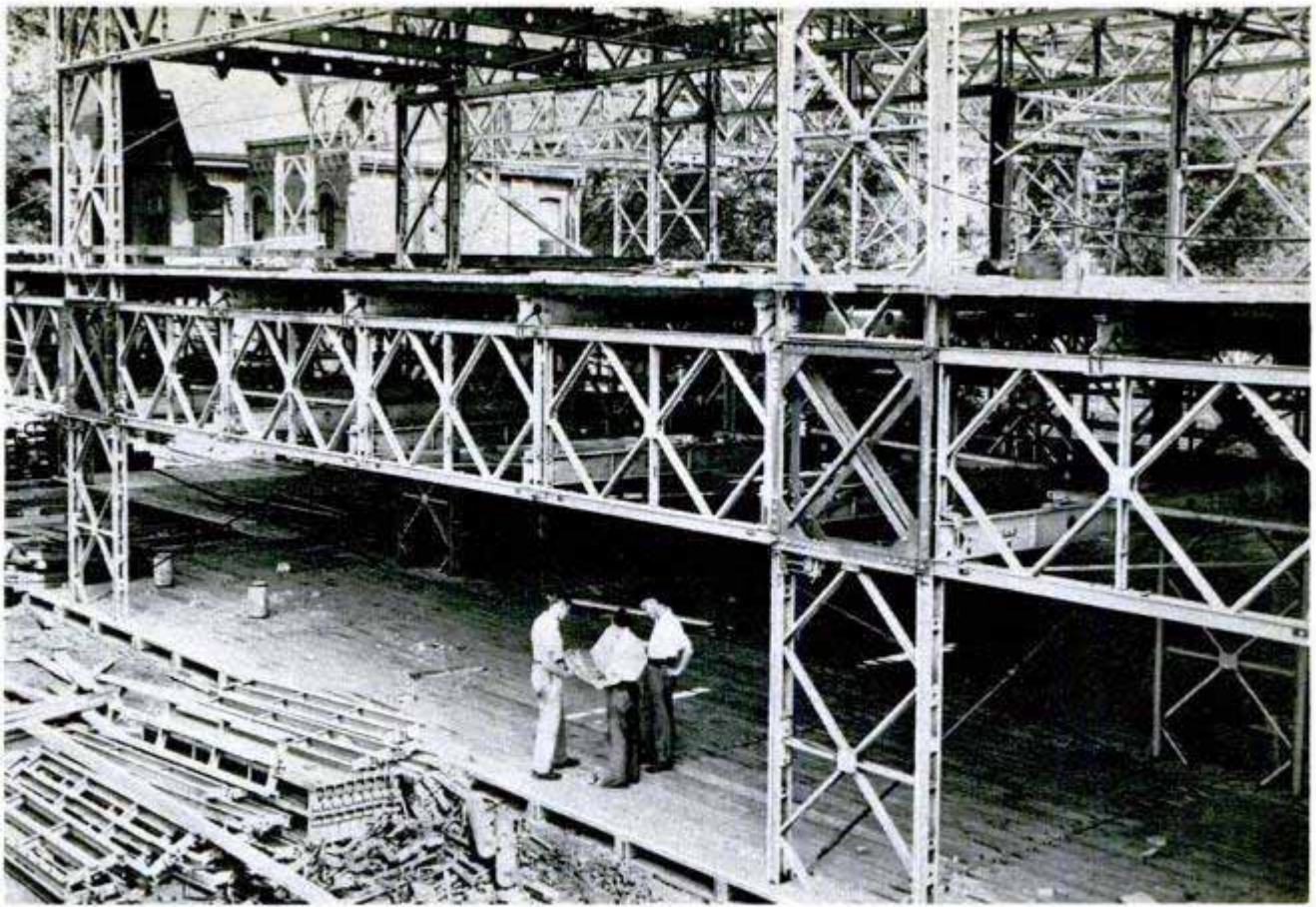

BAILEY BRIDGE BECOMES OFFICE BUILDING

Army bridge sections like that below converted into framework of office building to solve steel shortage

Bailey bridges — the spans quickly thrown across European streams by the Army during the war—are being converted into the framework for an office building in Toronto. The bridge is a package of interchangeable steel parts. The Hydro-Electric Power Commission of Ontario required a new office building but could not locate material for the framework because of the steel shortage. The Commission solved the problem by buying all available Bailey bridge material from the Canadian War Assets Corporation. The parts are being used as uprights and girders in the new two-story building which will

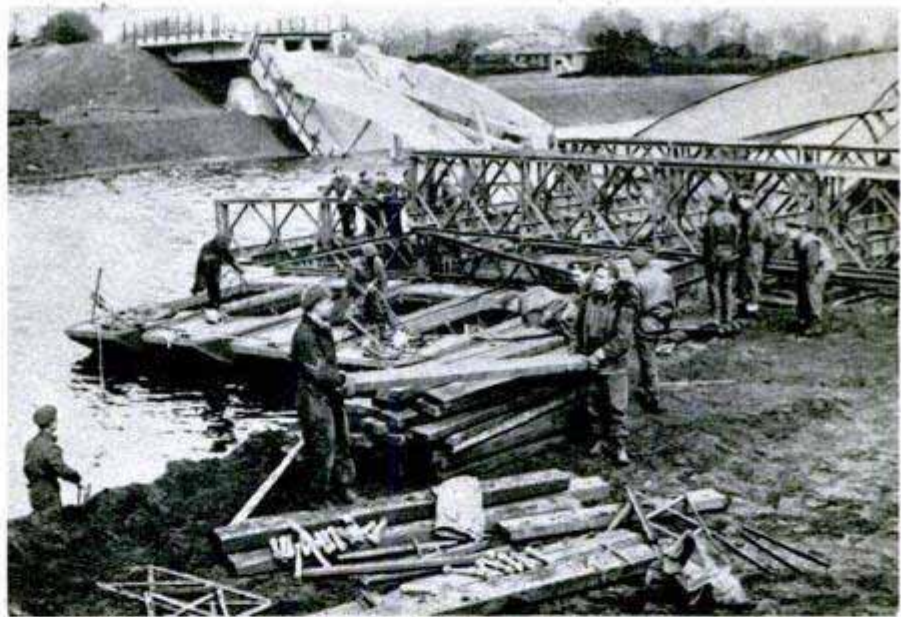

have 20,000 square feet of floor space. The Commission also is building bridges at dam sites with the parts.

Gauge Uses X-Rays to Detect Tiny Thickness Variations

Using X-rays, a thickness gauge that does not touch the material being tested can indicate a thickness variation of .000005 of an inch. It consists of two X-ray sources transmitting rays through a sample of known thickness and through the test ma-

terial. When the two are of equal thickness, the X-rays passing through them are equal. Variations show up instantly on the gauge. Designed by Westinghouse, the gauge will be used in the production of cold-rolled steel, paper and other materials.

Terrain Models of Rubber

MOUNTAINS" of cardboard, plaster and foam rubber are used in building the first "world" that many Navy trainees see. Those who give them their first look at faraway places on the globe are workers at the Naval Photographic Interpretation Center, Anacostia, Md., headquarters for the construction of rubber terrain models. No region in the world is too difficult for them to simulate with exactness. There is a continuing need in peacetime training activities for the models that were so widely used in wartime naval and military planning. Hundreds of the lightweight miniatures, which can be rolled up for mailing, were constructed of the Normandy coast and such islands as Kiska, Guam, Saipan and Iwo Jima. Technicians doing the job at Anacostia, some of whom are former movie-studio artists and museum sculptors, use a wide variety of materials that include burlap, plaster, rubber latex, paints and modeling clay. On these two pages are shown steps in the preparation of the rubber terrain models.

Official U. S. Navy photos



1—Determining exact area to be covered and assembling necessary information about it are the first steps for Navy men building rubber terrain models

2—Next step is to convert map's contour lines into solid, three-dimensional forms. Heavy cardboard cut into strips is used to depict elevation's interval of rise

3—The cardboard is arranged like terraced land, then secured with rubber cement and tacked to baseboard

4—Space between cut contours is then filled with modeling clay to simulate area's appearance from air

5—Modeler next adds cultural detail such as city patterns, textures to imitate vegetation and roads

6—A splash coat of plaster is laid over the model. Into it is laid a light, coarse fabric called scrim

7—Reinforced ribs of burlap dipped in plaster are anchored to casting and frame to make it stronger

8—The negative plaster cast is then lifted off the original terrain model and given thin coat of paint

9—Several coats of rubber latex are sprayed on the negative cast, each drying before next is applied

10—A batch of foam rubber is poured over thinly coated cast and struck off even with edges of form

11—The sponge-rubber relief map is cured during 24-hour exposure to 180-degree steam. When pulled away from negative, a perfect scale model results

12—Final touch is duplicating with extreme accuracy color of earth and vegetation in the sector modeled



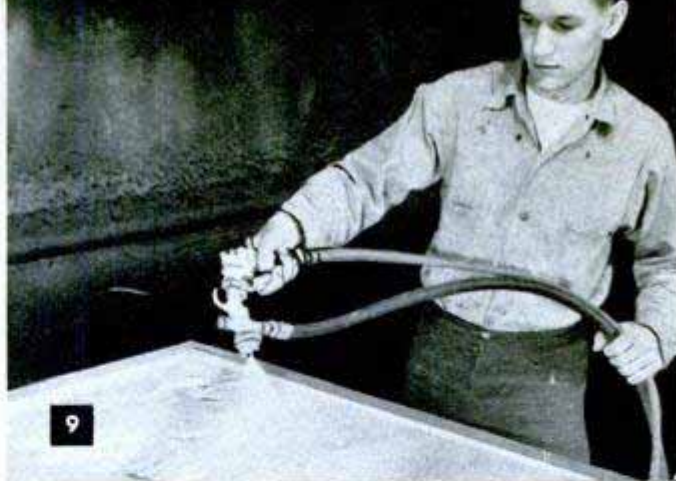



Upholstered Pianos Match Walls

Pianos are upholstered to match the decorative scheme of any room by craftsmen in Beverly Hills, Calif. Old pianos are cut down to the smaller modern size. Then the instrument is upholstered in much the same manner that a chair is reupholstered. Upholstery tacks give the piano an attractive finish. Materials are chosen to match

the drapes, tapestries or walls of the room. A motion-picture studio ordered a piano upholstered to match the satin costumes of the dancers in a musical number. Finishing materials include genuine and synthetic leather, plastic, velvet, brocade, satin, silk, glass and tile. Initials, names and decorations often are worked into the decorative scheme. The average cost of refinishing a piano is about \$125.

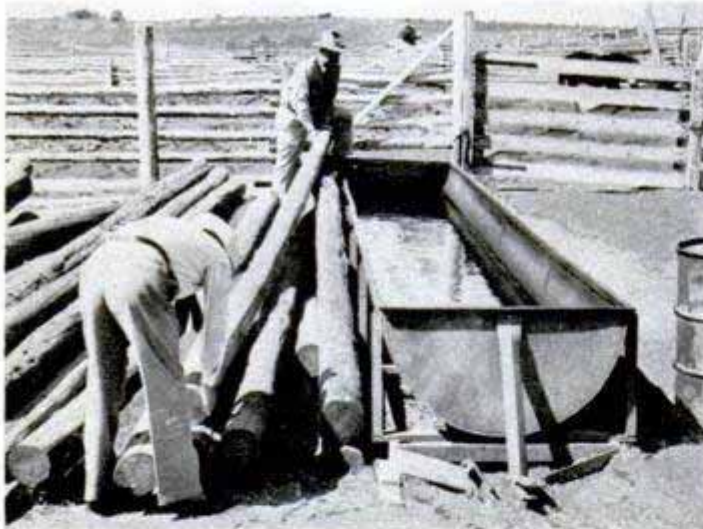

Bath Preserves Pine Posts

Lodgepole pines, long considered a secondary species of wood, are being soaked in a preservative to produce long-lasting fence posts that are much less expensive than cedar posts. The preservative, called pentachlorophenol, is easy to apply and lengthens the life of the post by three or four times. Tall lodgepole pines are cut and stripped of their bark, then seasoned for several months. They are cut, punched at the base and soaked in the preservative

for several hours. One gallon of the chemical solution is mixed with 10 gallons of stove or Diesel oil. Many farmers of the West are cutting and treating their own fence posts in this way instead of buying cedar posts. Treating each post costs about 10 cents. No sticky residue is left on the post, the chemical will not corrode metal and can be covered with paint. Because pentachlorophenol is practically odorless, the treated timbers can be used in potato cellars and vegetable bins where wood treated with creosote is unsuitable.

SCHOOL FOR LINEMEN

Telephone linemen, like squirrels, have to scamper up and down poles quickly and safely. On the West Coast, student linemen practice in "classrooms" that are fields sprouting telephone poles. Courses cover everything from connecting cables to lowering victims of electrocution to the ground. Initially, they practice on crossarms close to the ground and gradually move up to the top of the pole. They learn to keep their knees stiff and away from the pole when working; to keep their toes pointed up when climbing, and how to take good care of their safety belts.

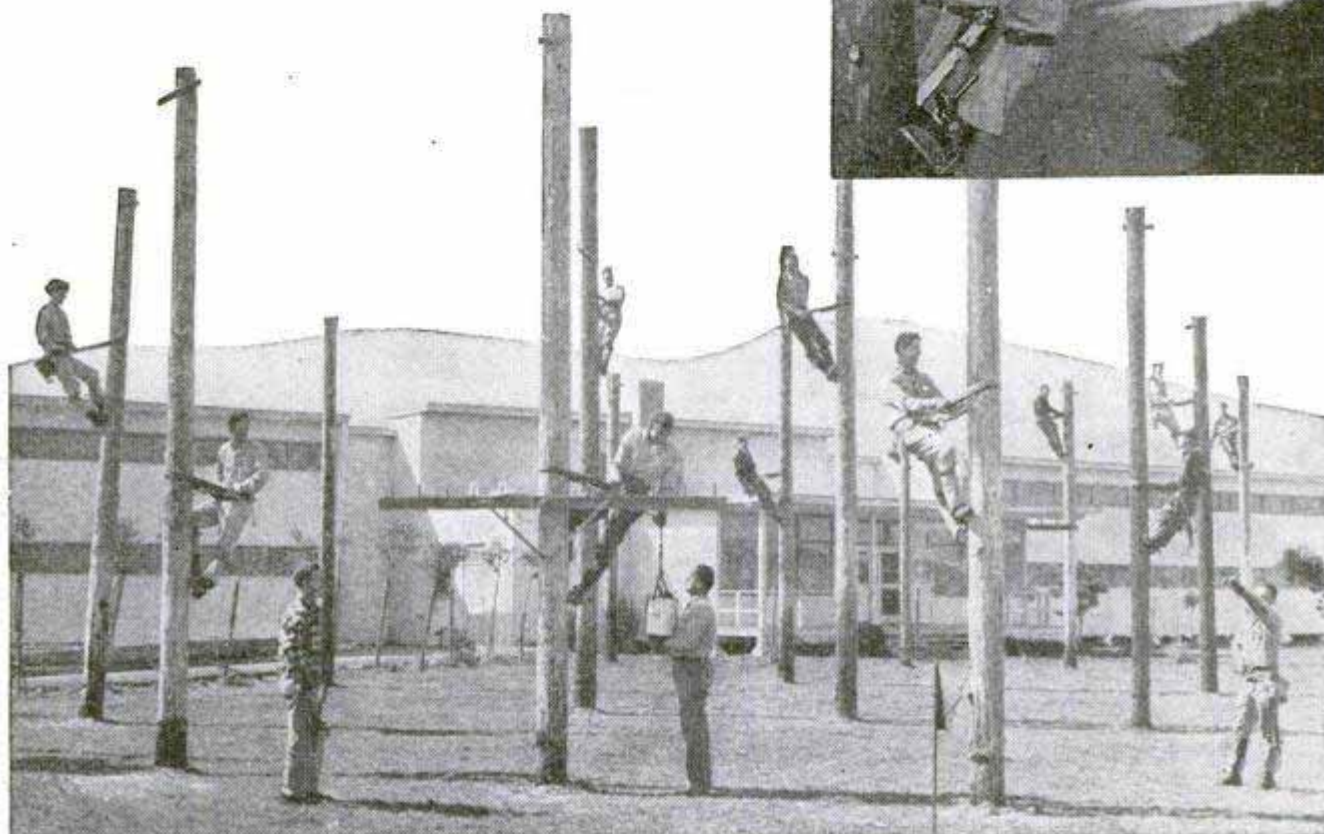

Learning to use "climbers" on practice poles, student linemen will someday be as handy with hooks as the veteran troubleshooter working high above the street in the top picture. Below, students learn close to the ground. Left, apprentice hooks up a terminal box. Right, two others tie in wire on crossarm



Hungry Plants Guide the Ore Prospector



Flowers make a tireless search for valuable minerals, too. By following botanical signposts, one prospector found a fortune in gold through the stem of a "horsetail" weed

By Maxwell Reid Grant

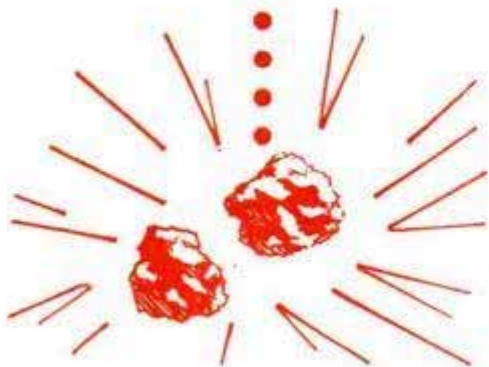

Glass jars have taken the place of pick and shovel or gold pan in modern prospecting. Leaf and stem specimens are slipped into the jars for later study



On a map of the area prospectors mark the spot where each sample is found. If assayer's report is favorable, area is searched for ore bodies. Below, streams may carry minerals, so water samples are collected





Leaves at "location 27" showed that a mineral might be found nearby, so prospector turns to pick and shovel

IF YOU should see a prospector filling his sample bags with leaves and flowers, don't laugh.

He's one of the new "geobotanical" experts who apply laboratory magic to plants and trees, extracting clues to hidden mineral treasure.

There's the Finnish mining engineer, Kalervo Rankama, who used the spectrograph and the leaves of a birch tree to locate a copper and nickel-ore body buried beneath a thick blanket of glacial debris. And the Chilean prospectors who were led by a common weed to rich copper ore in the high slopes of the Andes.

Then there's the incredible but authentic case of the man who assayed a batch of leaves and stems from the plant known as "horsetail" and discovered gold in the ashes to the value of nearly \$100 to the ton!

If you should assay a potato and discover silver, don't get excited. Potatoes, wher-

ever they grow, contain a small amount of the white metal, says Dr. John Herman, Los Angeles chemist, who has assayed potatoes from all over the world in his research in this new branch of prospecting. There's never enough, however, to make you rich, for the potato stores up only the amount of silver it needs for growth.

This hunger of plants for certain minerals is the secret of the new geobotanical prospecting. In their search for minute quantities of metals which they must have to grow, trees and plants send their roots probing far beneath the earth's surface.

Up from the depths the moving sap brings these "trace metals," concentrating them in the leaves, fruit and flowers. That's why you may see the geobotanical prospector stop every few feet to pick leaves and stems, pop them into a numbered bottle and jot the number on a map.

In the laboratory the assayer burns the

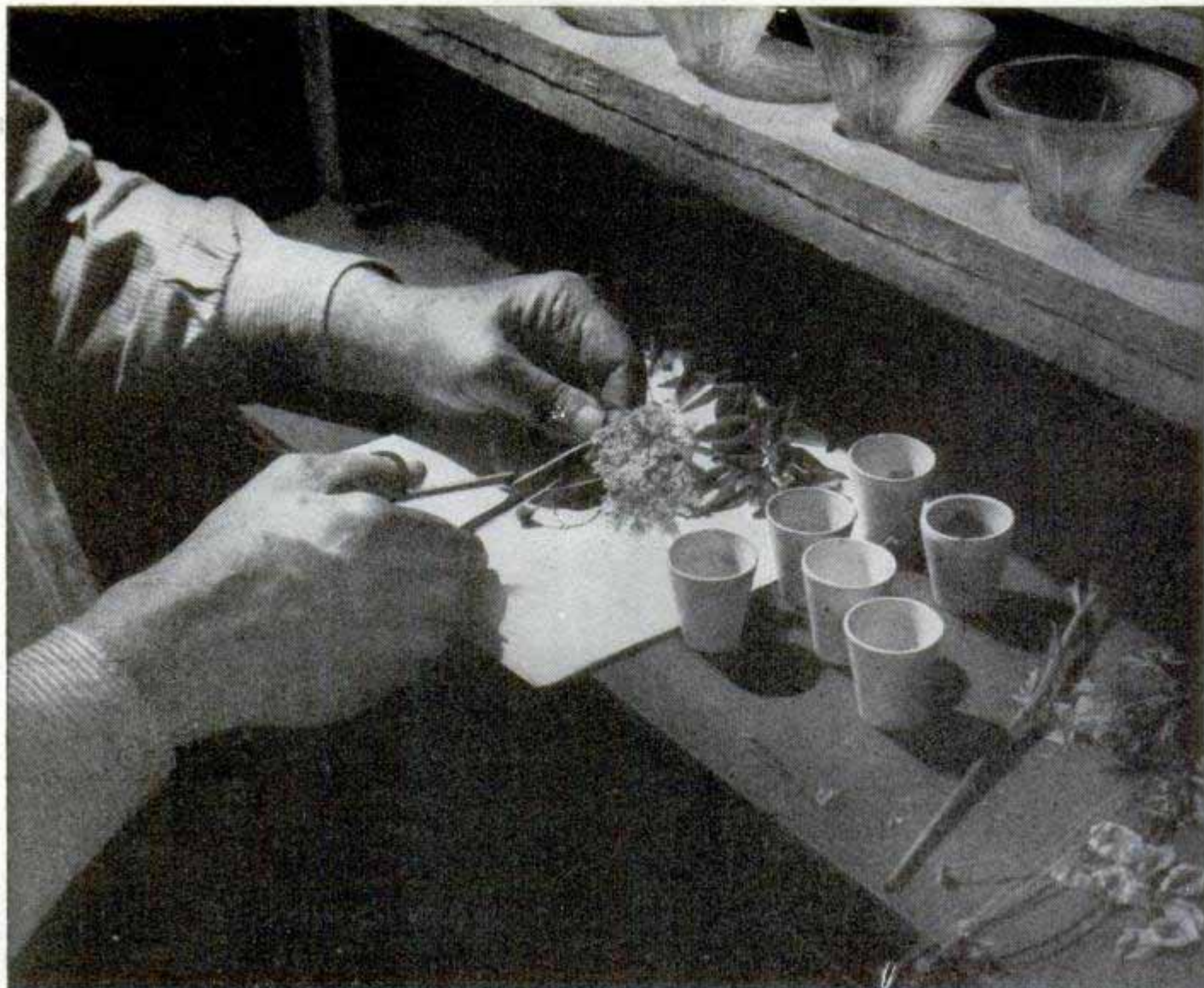

Leaves, flowers and stems are shredded to bits and placed in crucibles as the first step in assaying plants

leaves in an electric furnace, then crams the tiny pinch of ash into the cupped carbon electrode of the spectrograph. He throws a spectrographic pattern upon photo film. From the telltale black bars on his developed negative, he reads a record of all metals in the sample.

The "indicator" plant may be expected to show a certain amount of the trace element in its leaves and flowers, but if these showings are unusually strong, the prospector knows he is on the right track. Perhaps he's gathered leaves of the lupine, knowing that the blue-flowered plant requires manganese for its development. Marking the results of the assay on his map, he can pin-point areas where manganese showings seem to be concentrated.

Where did the lupines get their manganese? From here on, he must depend on his knowledge of the plant's habits, plus prospector's horse sense, to find the right answer. Merely digging at the base of the richest bushes may reveal no ore, for the mineral may have been carried a long distance in solution and absorbed by the plant

in its "drinking water." The prospector then must follow the water to its source.

Many springs may honeycomb the area, but the prospector walks up slopes and takes samples of water from a number of sources, marking each spot on his map. Now he returns to the laboratory and a new instrument comes into play—the polarograph, which uses an infinitesimal electric current flowing from a dripping stream of mercury to register the resistance of solutions containing various chemical elements. Each element in solution is known to break down abruptly when a particular voltage is applied. Graphing this action, the chemist obtains a pattern as characteristic as a fingerprint. The test is one of the most sensitive known to chemical science. For instance, Dr. Herman, who in his Los Angeles laboratory has performed hundreds of such analyses, has been able to identify minerals in water to the unbelievably small proportion of a few parts in 100,000,000.

Armed with the reports on his water samples, the prospector refers to his map,

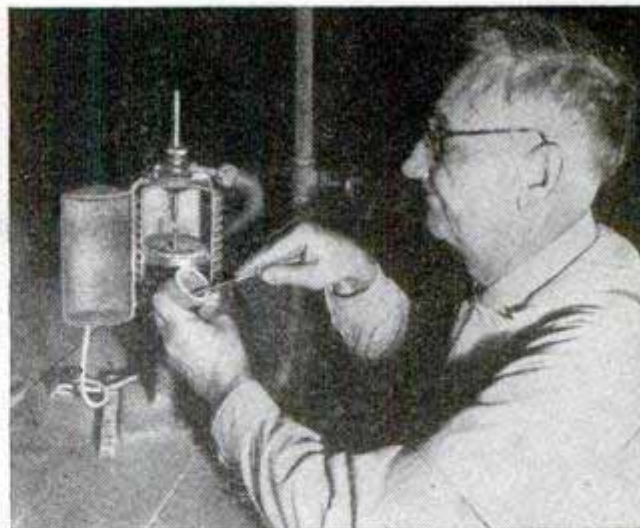
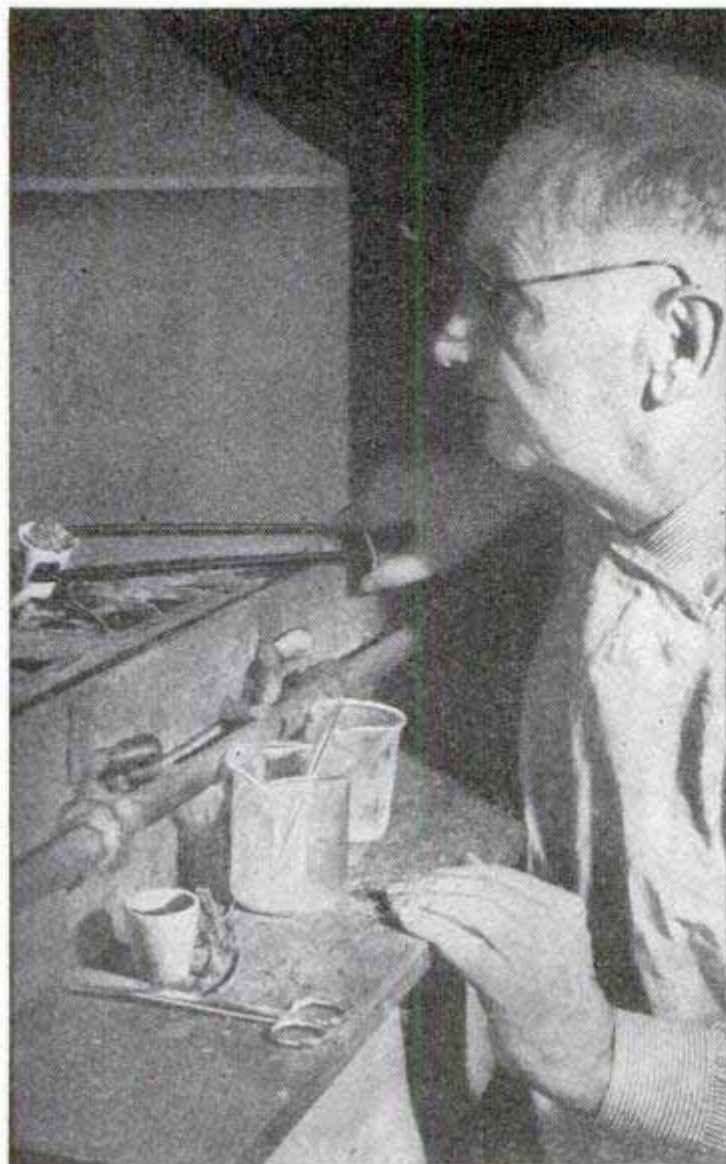

Slipping the ash of the plant into a clean cup, the assayer prepares it for study with a spectrograph

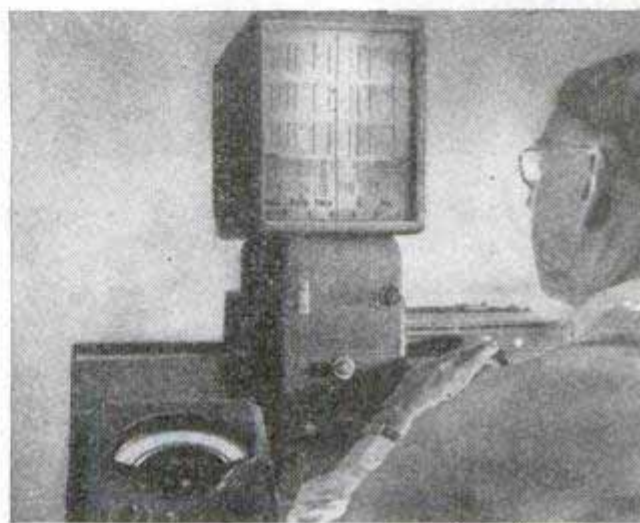

↑ Cuttings are heated to reduce them to ash. Right, spectrograph shows telltale pattern when mineral is present

follows the natural drainage and discovers where rain and melting snow have leached out minerals, carrying them down to the telltale plants. This clue now leads him directly to the vein.

Like most human beings, different plants have different tastes. One craves a mineral which may be poison to another. For instance, if a prospector discovers patches of a certain wild pansy where little else is growing, he may well suspect that zinc-bearing ores are nearby. Another plant, known to science as *Amorpha canescens*, flourishes in Missouri near galena deposits and is considered a valuable clue in prospecting for lead. Two other plants are so hungry for copper that they threaten to drive out other plants in soil rich in copper.

Unusually bright flowers or foliage often contain high percentages of the trace elements—a valuable clue to the prospector. Young, vigorously growing leaves seem to contain more of the trace elements than older, yellowing ones.

A strange phenomenon of geobotany is the natural enrichment of deposits on the

forest floor. As time goes on, rains dissolve soluble elements from the fallen leaves and carry them deeper into the ground. Left behind on top layers are the less soluble minerals, especially gold, manganese, cobalt, nickel and others.

Geobotanical prospectors have used their skill to locate tin and tungsten in the British Isles, chromium in Greece, silver in Sweden and copper in Chile and Australia. U. S. experts have tracked gold, zinc, lead and molybdenum in many states.

Geobotany may be applied not only to ore prospecting, but also to curing diseases afflicting farm plants. Deficiency of manganese, zinc, boron, copper and molybdenum contributes to a long list of plant diseases ranging from deformities and weakness in zinc-hungry apricots, peaches and maize, to dying branches and falling fruit on tomato vines pining for molybdenum. So far, relatively few of the earth's millions of plant varieties have been catalogued to learn their peculiar tastes in minerals, but the growing list is valuable new lore for the scientific prospector.

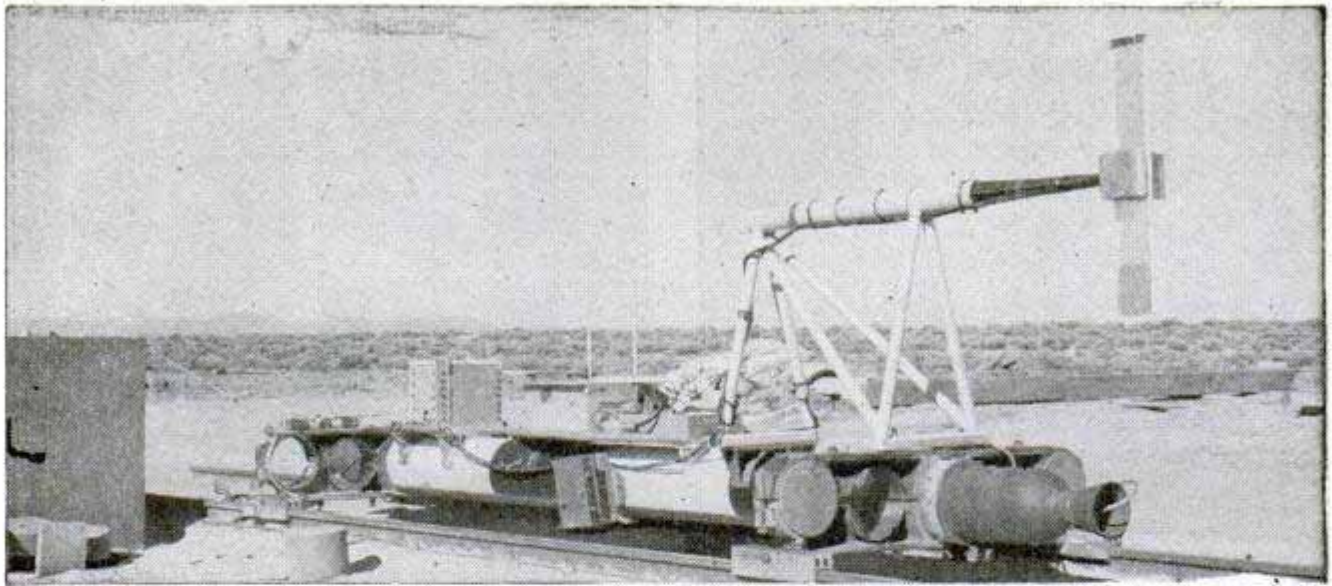

Northrop Aircraft photos

SUPERSONIC "SLEDS"

Rocket-propelled "sleds" traveling over 1000 miles an hour are serving as outdoor "wind tunnels" for supersonic speed experiments at Muroc, Calif. They reverse the system used in indoor tunnels, where air is rammed past suspended models. Fifteen feet long, the sleds skid over 2000 feet of standard-gauge track on spring-lined "slippers," magnesium runners with flanges that hug the rails. They carry experimental sections of airfoil or wing, mounted on a boom, and electronic measuring devices. At the California Institute of Technology the problem is being studied from another angle by squeezing air through a flexible 12-inch nozzle at over 1500 miles an hour.

Snow isn't needed for USAF's rocket-propelled "sled" above to travel over 1000 miles an hour in testing supersonic airfoils

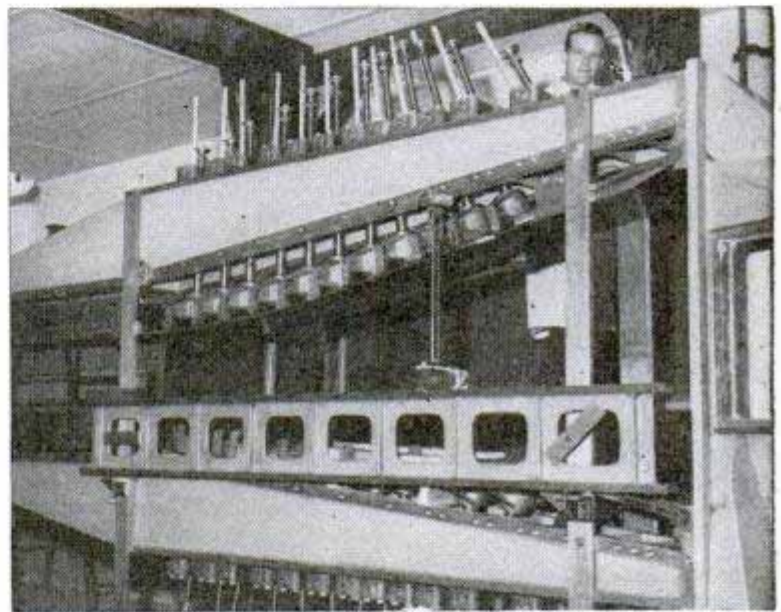

California Institute of Technology photo

Above, air is squeezed through flexible nozzle of CalTech's 12-inch tunnel to simulate speeds of over 1500 miles an hour

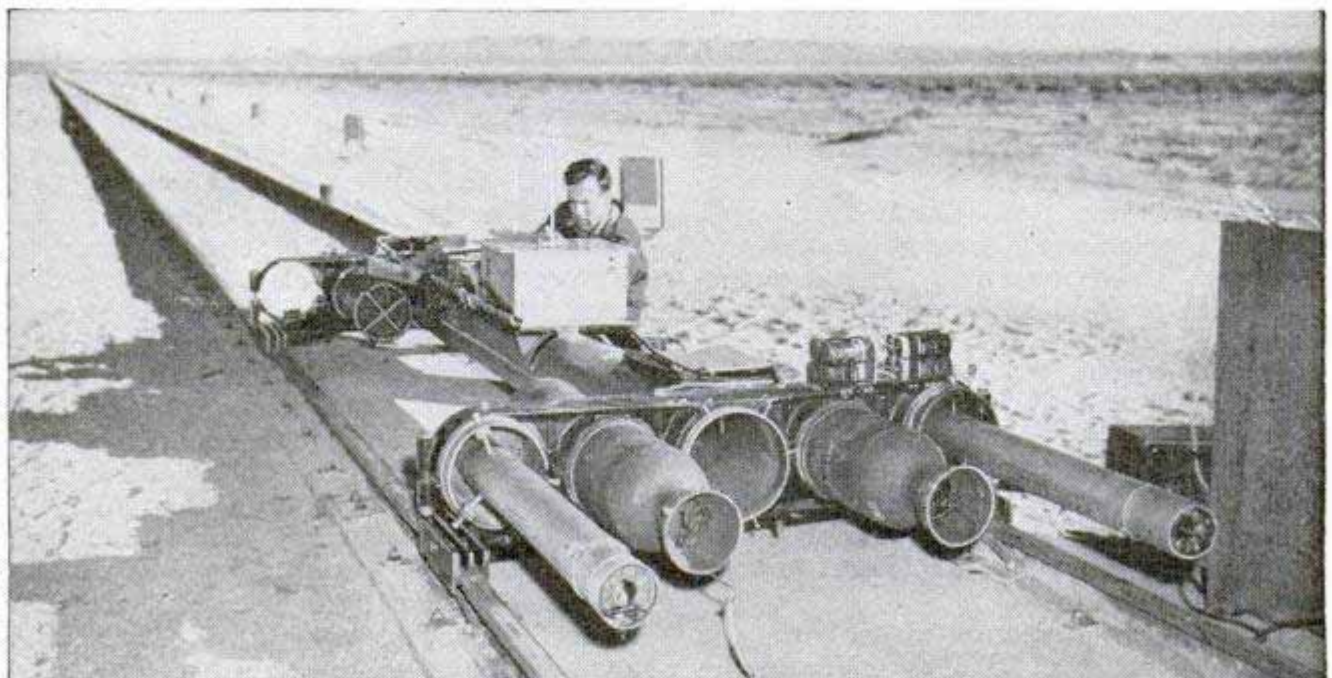

Jeep Mower's Blade "Rides" the Contours

Always in full view of the operator is a six-foot sickle bar that attaches to the front of jeeps and other vehicles. The blade, controlled from the driver's seat, can be set to cut directly ahead or to the left or right front. It locks in any position to follow the contour of the ground. Only two bolts are used in attaching and detaching the mower after the original installation has been completed.



Retractable Wheels for Bike

Two retractable wheels attached to his bicycle make cycling safe for Edward Dyksma of Harvey, Ill., who was crippled by infantile paralysis when he was two years old. Dyksma found that he could not ride a standard bike because of the hazards of starting and stopping. He invented the retractable wheels, which fold up after the bicycle is in motion and can be lowered as the rider slows down. Dyksma plans to give a sample of his invention to a nearby Veterans Administration hospital.

Ground Generators Produce Rain

Rain making from the ground may be possible by means of silver-iodide generators, according to the Department of Commerce. Experiments in producing rain and snow by seeding with Dry Ice from airplanes flying above the clouds have been successful, but the new method, using silver-iodide particles instead of Dry Ice, will produce similar effects over larger areas much more cheaply than by seeding clouds from an airplane.

Miniature Compass Draws 12-Ft. Circle

Circles from 2 inches to 12 feet in diameter can be drawn with the aid of a compass that fits the vest pocket. The compass is an aluminum cylinder enclosing a reel of linen line controlled by a button. To draw a circle, a push pin is pressed into the drawing board and the compass placed over the pin, which becomes the center of the circle. After pressing the

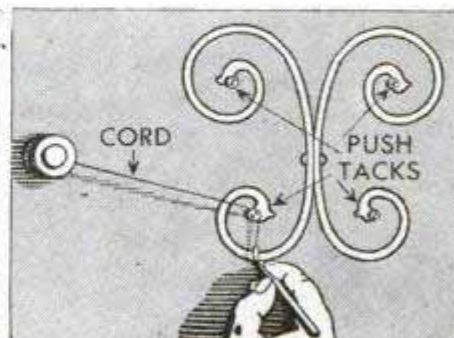
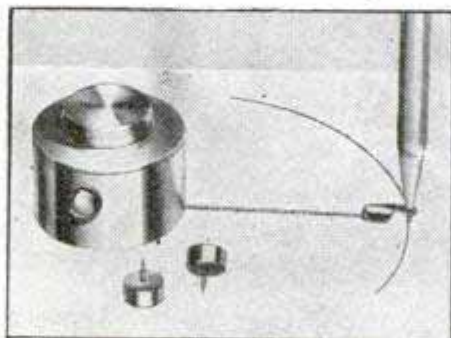

button, the operator pulls out the line to the desired radius. A pencil point then is inserted in an eye on the end of the line and the circle is drawn.

Meter Judges Auto Speed by Radio

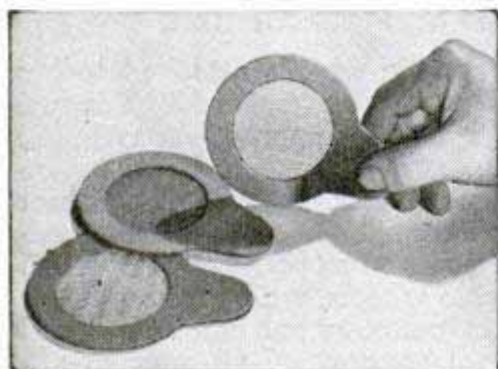
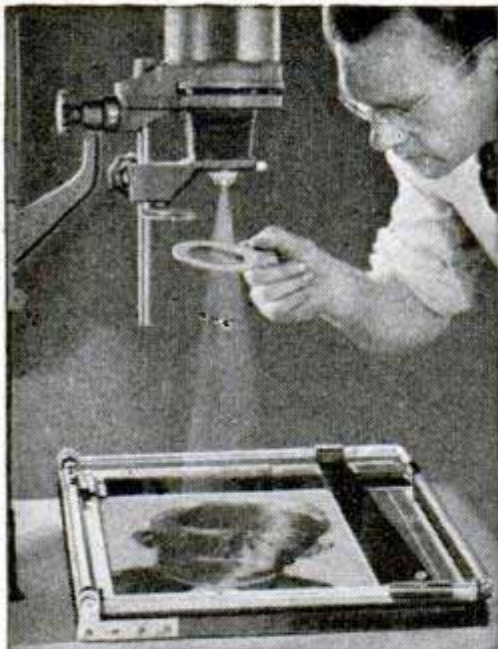

DIFFUSED ENLARGEMENTS are made by projecting the light rays through a wire screen. A kit of three diffusers containing screens of different meshes enables the photographer to select the degree of diffusion desired. Carboard frames protect the screens during use



Auto speeds are determined by a meter which actually is a complete broadcasting and receiving set powered by a car's electric system. The meter, based on the Doppler principle, is used by highway engineers to determine safety factors in designing safer highways. More accurate than an ordinary speedometer, the meter sends out waves which are reflected back to the set by approaching vehicles. The time intervals are converted into miles per hour and register on a dial. The meter is so compact it can be carried in a suitcase. Because it is a broadcasting set, it must be licensed by the Federal Radio Commission.

Fire Fighter Turns to Snow For Hollywood Cameras

Originally produced as a fire-fighting material, Foamite also makes realistic snowstorms that can be turned off and on for the benefit of Hollywood cameras. Released under high pressure in front of a huge fan, the Foamite solidifies in flakes that swirl and fall like nature's own. With the fan spinning at high speed, blizzards are created, while at low speed the flakes fall evenly and lazily on the set.

Information, including manufacturers' names and addresses, concerning the products described in this issue may be obtained by writing to the Bureau of Information, Popular Mechanics, 200 East Ontario Street, Chicago 11. Your letter will be answered promptly

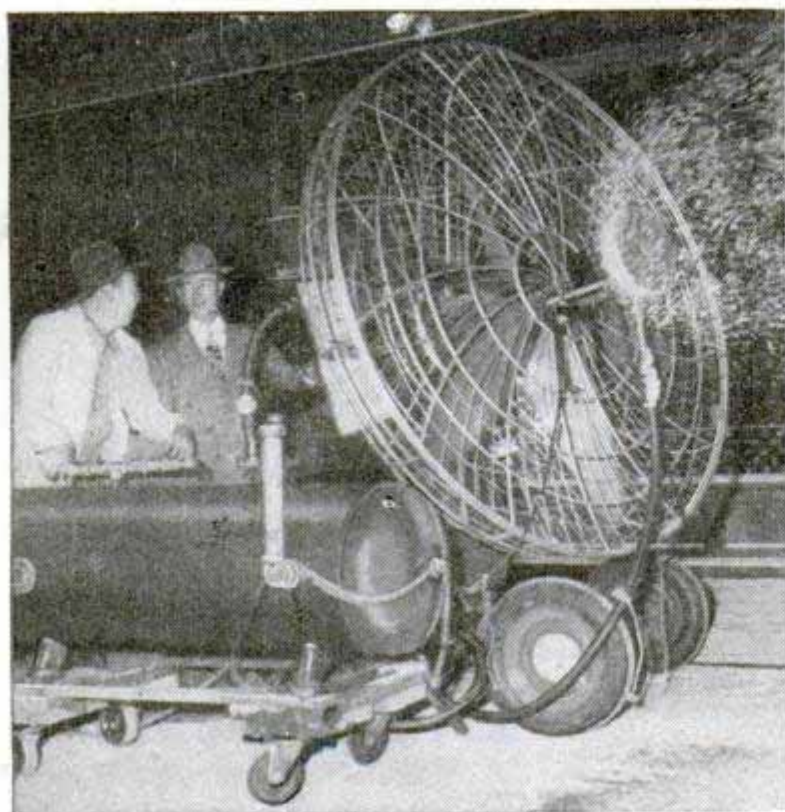



The Old Red Barn Is Vanishing

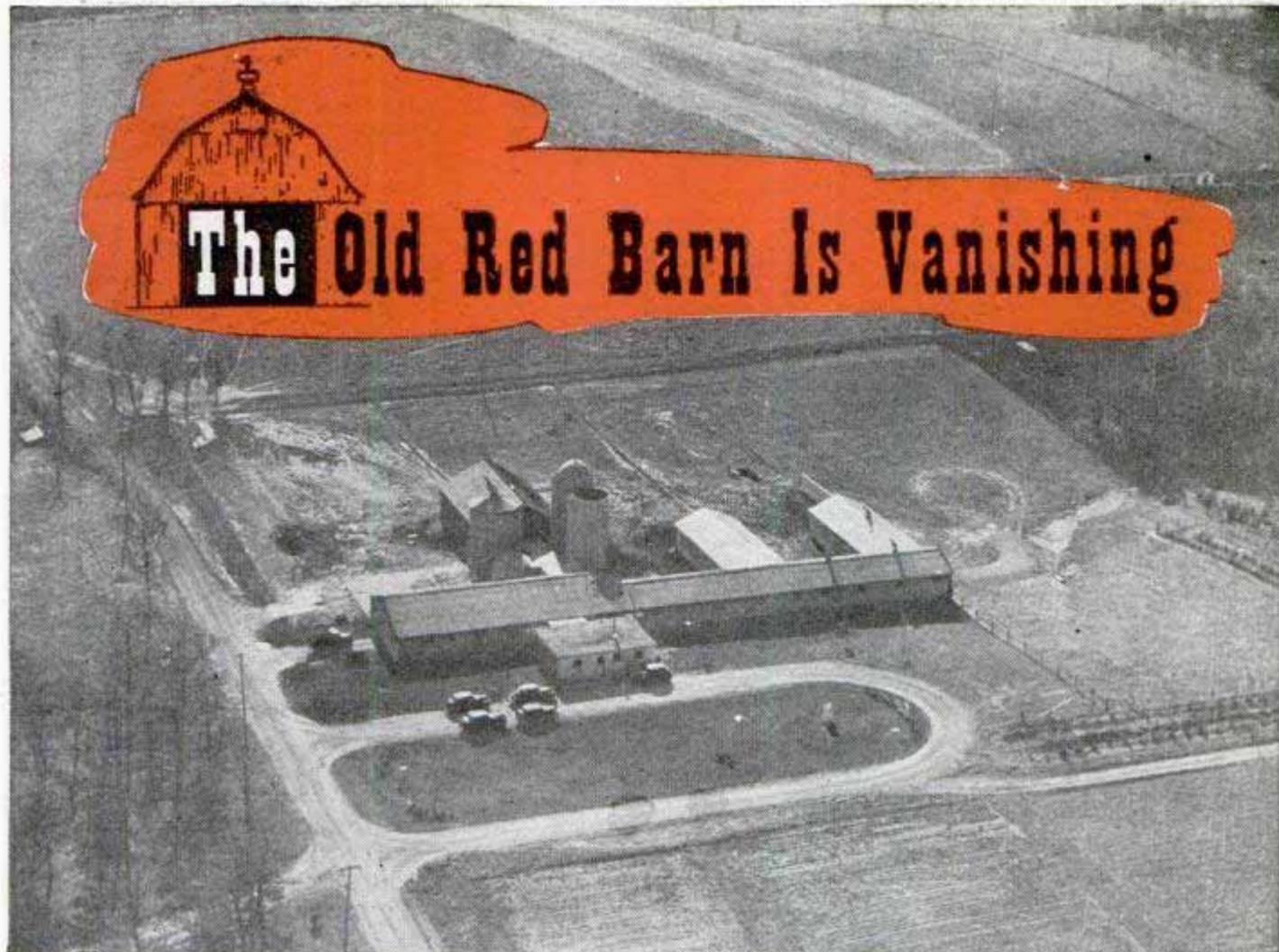

Carnegie-Illinois Steel photo

Site-welded of steel, this one-story barn at the University of Wisconsin points way to better farm structures

THERE'S a halo of nostalgia around the old red barn, that traditional landmark of farm country from Pennsylvania to Kansas. The old barn is fast disappearing, and the nation's farms are in for a face-lifting. Agricultural experts hope to replace old-style barns with 5,000,000 gleaming buildings made of materials tailored to farm needs.

By Clifford B. Hicks

"Inefficient," say today's farm experts, pointing to the time and effort wasted in the wood-frame barn. Stalls for horses that were sold long ago, and a mow for Dobbin's feed, represent waste space. Other farm structures show the same inefficiency. Corn raised and harvested by the latest mechanical methods still is stored in sagging cribs where rats gobble up 20 percent of the kernels.

Agricultural experts from the government, universities and industry are teaming up to give the farm a "new look" that will save money for Old MacDonald, savings that can be passed on to the public. The experts aren't dreamy professors, but down-to-earth specialists who consult the farmer as to his needs.

Research men have plowed up some interesting farm facts recently. With stopwatches clicking they timed to the second every movement of the farmer and his hired hands. These time studies show that the farmer is growing away from his land. The dairy farmer, for example,

Department of Agriculture workers erect steel grain bins for study
USDA photo

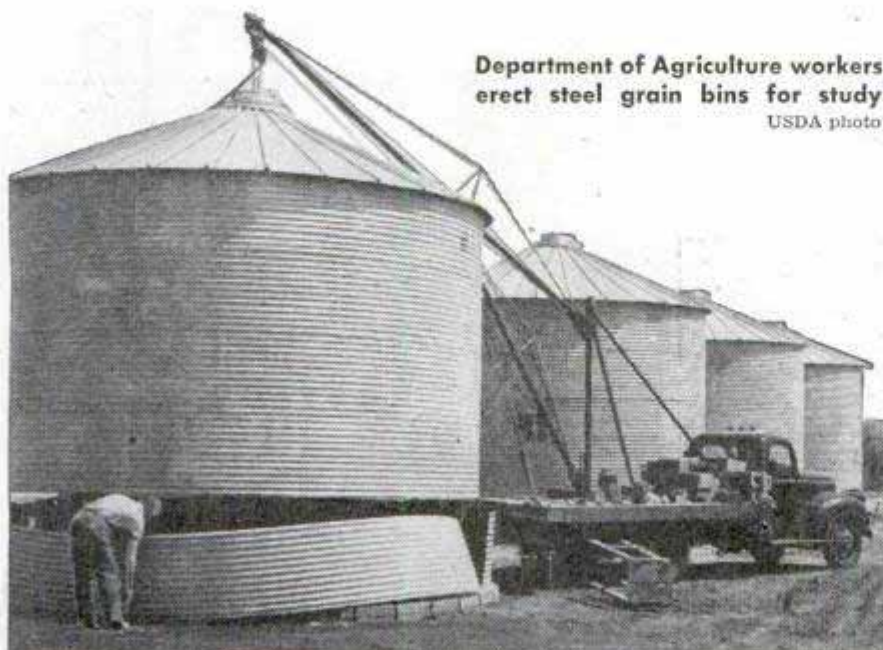

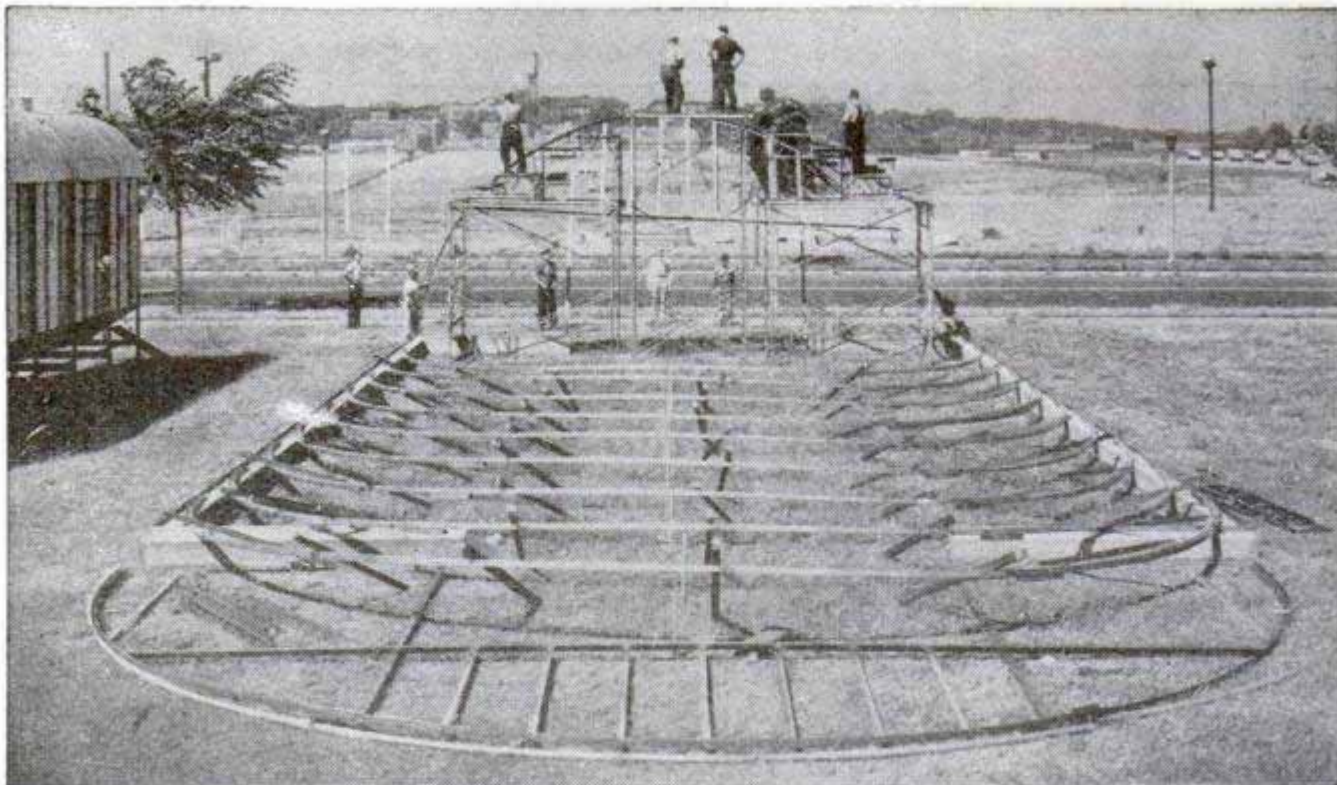

Reynolds photos

Frame of aluminum building is assembled on ground. Below, flanged sheets slip into frame to form the walls



spends more than 80 percent of his time in and around the barn. Obviously the old red barn won't serve a modern layout. The planners have come up with interesting answers.

For example, an experiment at the University of Wisconsin completely changes the character of the dairy barn. The experiment has proved that cows don't need stalls; that the living area of a barn needs to be cleaned only once or twice a year; and that cows in an unheated enclosure in subzero weather give as much milk as those carefully tended in a heated barn.

An all-steel, one-story barn has



Right, builder tightens bolts across arch of roof. Below, same arch in cross section showing: A, bolt holding assembly together; B, arch cover called the "hat"; C, flanged sheet; D, arch frame; E, support member

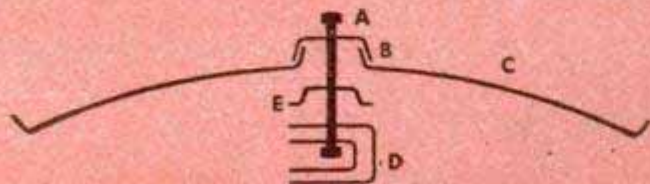

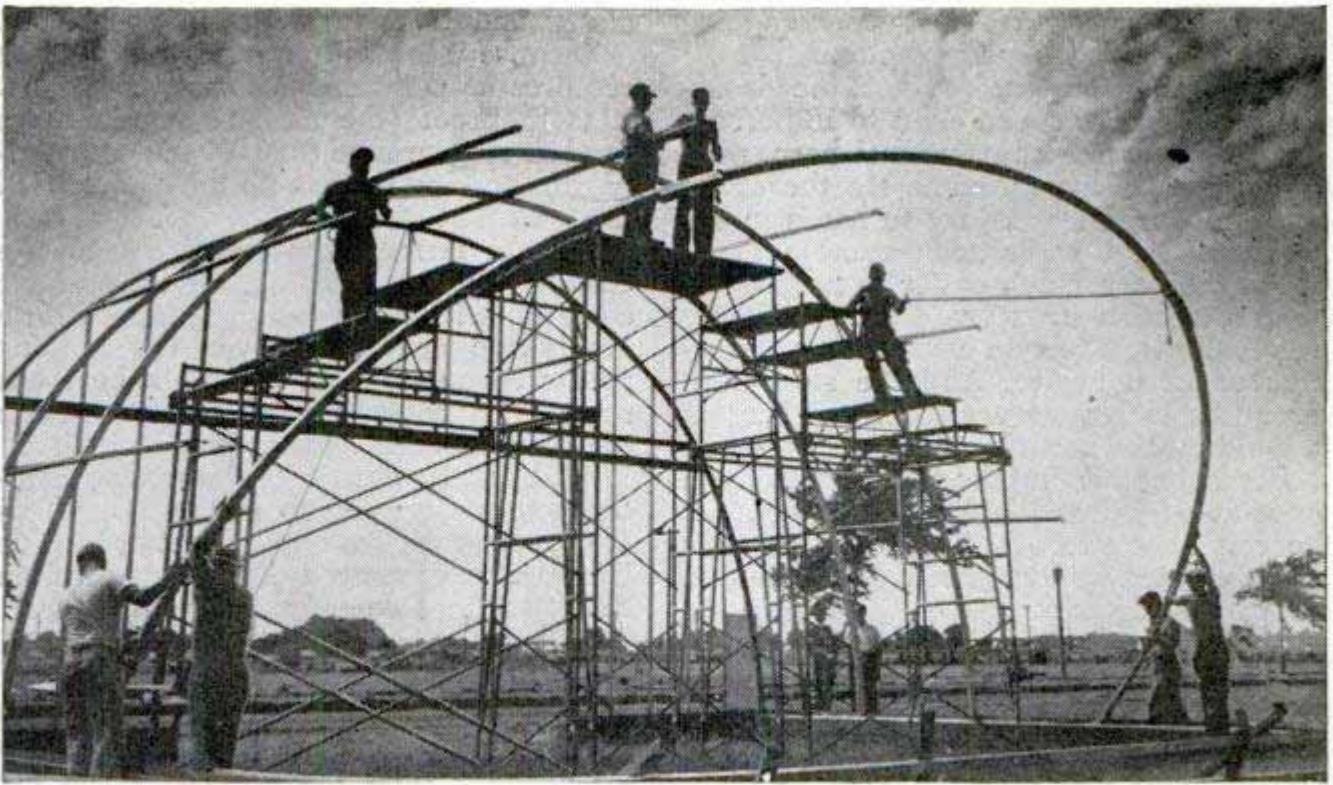

Additional arches are fastened together on the ground, then raised and tied in position with spacer bars

been erected at the university for long-term study. Carnegie-Illinois Steel Corporation put up the building with a cost-cutting process of site welding.

A previous study showed that 150 man-hours were required to tend each cow properly every year. If the chores could be made as efficient as growing corn, the time could be reduced to 30 man-hours per Bossy. So the planners decided on the "loose housing" type of barn. In this kind of structure much of the barn area is a big "living room" in which the cows may

room at will. The door is left open summer and winter so the cows can step outside for exercise.

In one end of this lounge is the "dining room" where the cattle eat while awaiting their turn in the "milking parlor," a separate room. Only in the parlor are stanchions provided. The layout caters to Bossy and should increase her contentment.

In order to test the efficiency of the loose-housing design the barn was split three ways. One herd was housed in the unheated area, another in a conventional

Completed aluminum building, erected in 150 man-hours, has big doors, over 2000 square feet of floor area



stanchion barn that was heated, and a third in a heated loose-housing section.

Research men report that the loose-housing sections saved eight to 18 percent in labor over the conventional barn, milk production was approximately the same, and there was less injury to herds in the lounges. Steel walls and concrete floors made the barn much easier to keep clean than a wooden structure. Heat apparently has had little effect on either milk production or herd health. And the steel barn promises to last several times as long as the old timber barn.

Replacing his buildings is generally a once-in-a-lifetime job for the farmer. Yet he can knock together some of the new prefabricated buildings in a few days and they'll last decades.

Specialty of the Reynolds Metals Company is a sparkling all-aluminum prefab—a general utility building recommended as an implement shed, cattle shed, crop storage barn, tool house or workshop.

Of the arched-roof type, the building is 36 by 60 feet with the entire floor area clear of posts or other interior supports. The building can grow with the farmer. If he prospers and needs more storage space, one end of the building can be lopped off, six-foot sections

↓ Drier is wheeled up to a steel grain bin and connected by canvas tube. Diagram shows heat being forced through false floor

American Rolling Mill photo

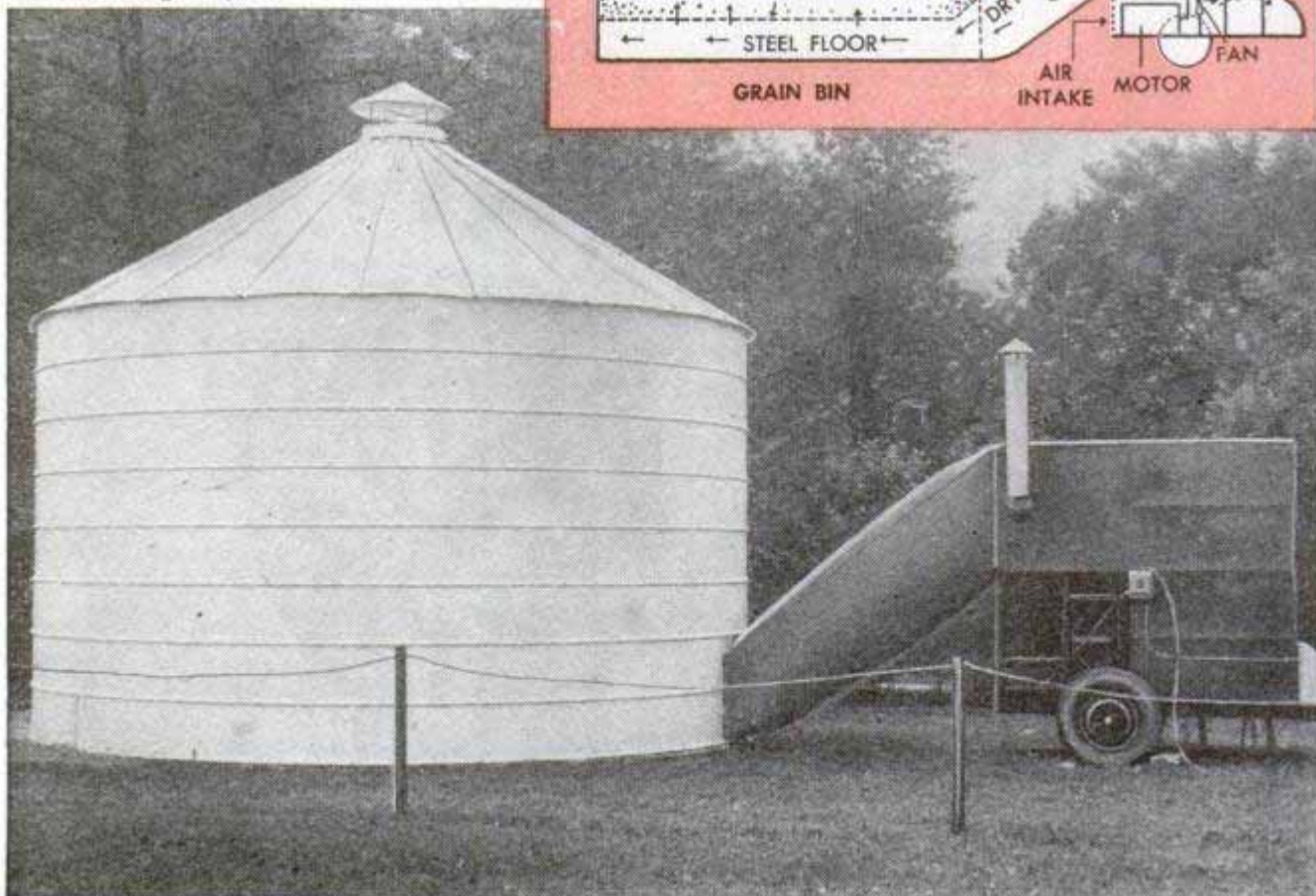

added, and the end fastened in place again.

Because it is all aluminum, the building requires no paint and will not rust or rot. It is fireproof (the nation's annual farm fire loss runs around \$100,000,000), virtually ratproof and reflects up to 95 percent of the heat that strikes it.

For the farmer who wants a complete change in all his buildings, designers have come up with a one-building farm with a family-size apartment over the milking parlor. As a step-saver it can't be beat, but some farm wives may object to cows in the basement and hens across the hall.

In order to outwit the weather, more farmers are turning to artificial methods of drying grain. An experiment at Purdue University sponsored by the American Rolling Mill Company shows that grain with high moisture content can be dried by artificial methods without spoilage. Such systems cost the farmer about three cents a bushel, which he can mark off as insurance against wet weather when the crop should be drying under the sun.

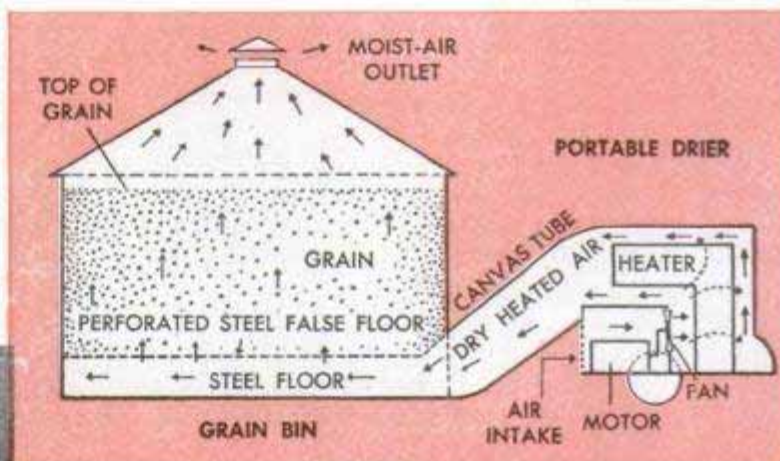



Cows are not confined in stanchions but allowed to roam through unheated "living room" of loose-housing barn

As a result of the Purdue experiments, engineers have devised a grain-storage bin with a built-in drying system. The steel bin has a perforated false floor.

A portable heating and ventilating unit can be wheeled up to the building, attached by means of a canvas tube, and started in operation. An oil-burning heater forces air through the tube and up through the false floor to dry the grain. The lid of the crib is bolted down and the farmer can store his grain until he chooses to sell. The drier may make it possible to shell corn as it is harvested, which would subtract many hours from the farmer's work. The same heating unit, used as a handyman, will dry hay in the mow, warm the machinery shed when repairs are required, and heat the hog house and dairy barn. One farmer has estimated that the unit would pay for itself in three years. To date the project is experimental, but the units are expected to be available this year.

In some cases, experts point out, sturdy barns of the old type can be remodeled with new equipment to provide almost as much efficiency as a completely new metal layout. One problem always has been the drying of hay inside the barn. A farmer who depends upon nature to dry his hay before bringing it to the mow is flirting with a loss of much of his crop. One answer is a permanently installed mow drier. Most driers consist of ducts usually made of wood through which air is circulated to dry the hay from the bottom up. Such sys-

tems often are clumsy and occupy a great deal of space even when not in use.

Experiments at Iowa State College with a prefabricated drier made of sheet metal may point the way to an inexpensive drier with great efficiency. The drier is a network of nesting ducts with one main tunnel. As the hay is used, individual ducts can be removed and tossed on top of each

Milk production in the steel barn is recorded daily



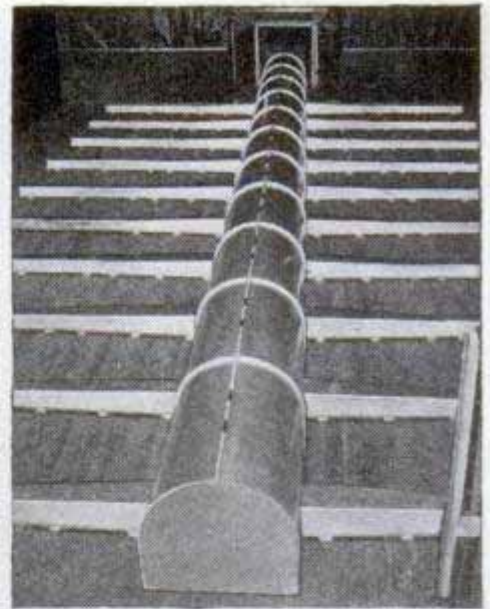
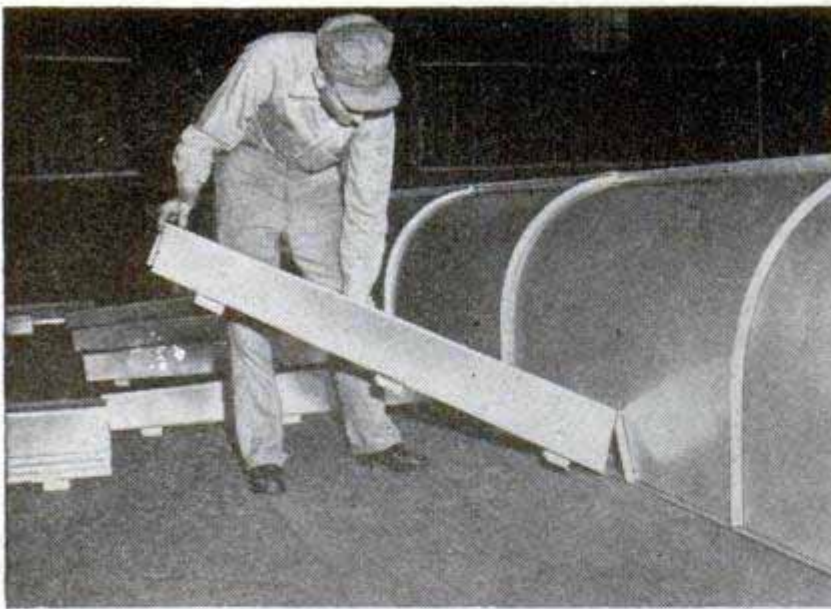

Louden photos

Prefab mow drier distributes heat through the hay. Ducts can be removed and stacked up as the hay is used

other to leave the mow floor free. Both loose and baled hay can be dried in this manner.

Farmers are buying buildings today through mail-order catalogues. The order will be delivered in a few days with the building ready for erection either by company workmen or by the farmer.

One building offered in a mail-order catalogue is a frame utility structure 16 feet square designed for use as a small barn, poultry house or storage house. The basic unit is like an accordion—extra sections can be added to increase its size.

Specialists from the Department of Agriculture are designing tomorrow's farm buildings today. Experimental steel grain bins have been erected for study of the

best means of storing grain. Requirements for poultry houses and livestock sheds are being sought so the farmer can tell whether a building will suit his climate.

Still other plans are afoot to change the rural landscape. New products include a glass-lined silo that isn't affected by chemical attack, aluminum roofing that makes any farm building up to 15 percent cooler, and a gleaming prefab equipment shed.

Even the old milking stool is disappearing. Many of the new barns have "elevated cow stalls" in the milking parlor, a setup where the farmer stands in a pit so he won't have to bend over while he's milking. The farm cat that begs a squirt will have to learn to take it from long range on tomorrow's farm.

Mail-order building made of wood is quickly erected
Sears Roebuck & Co. photo



Knives Shred Stalks To Return Soil Food

Cornstalks are shredded into small pieces by a tractor-drawn cutter. The machine operates from the power take-off and prepares the stalks for plowing under. Arms on each side of the cutter guide the stalks into slots, where eight knives whirling at 1000 revolutions per minute cut them into small pieces, scattering them evenly over the ground. Six V-belts, which deliver power to the cutting blades, can be adjusted so that the machine can be used with most tractors, large or small. The machine is seven feet wide, weighs 620 pounds and can be adjusted to any desired cutting height. Cornstalks are plowed under to replace food value in the soil. In addition, corn borers can be eliminated by burial.

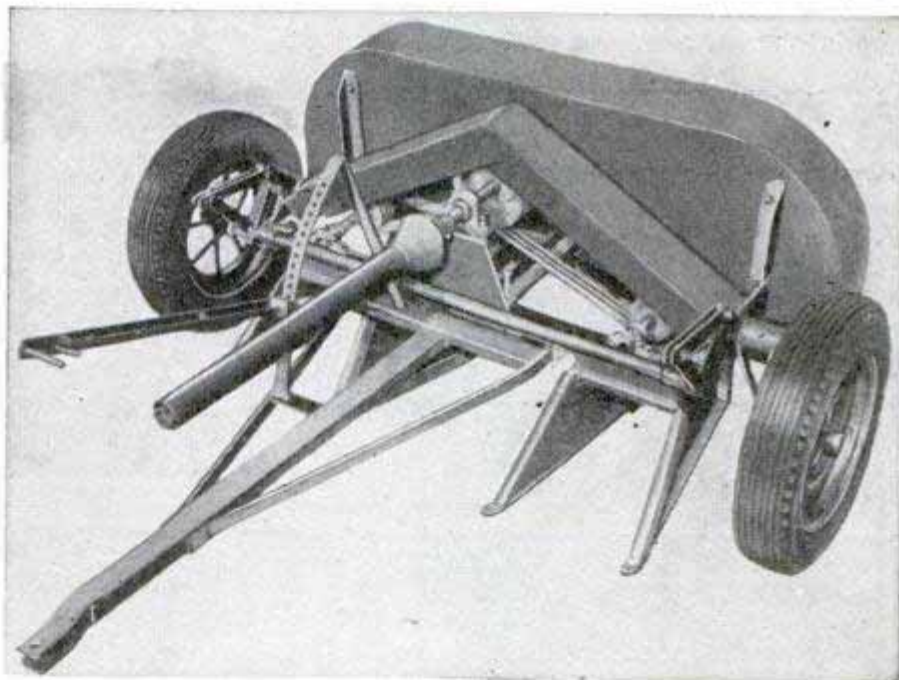

Wood-Knot Sealer

Low-cost lumber serves longer as exterior siding material when its many "live" knots are sealed with Bakelite and Vinylite resins before painting. The two plastics resist the paint-destroying pitch and volatile substances exuded from the knots.

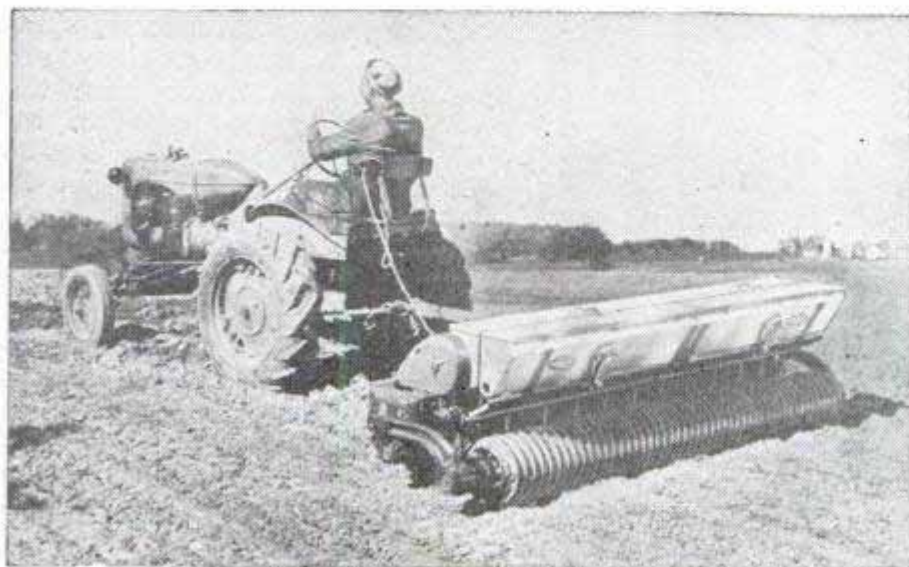

Shallow Planting Cuts Seed Costs

Savings of five pounds of seed an acre are predicted by the manufacturer of a grass seeder with wheels spaced only two inches apart. Each wheel rolls independently to permit easy turns. The front wheels form shallow grooves into which seed drops. Covered lightly by the rear wheels, the seed has early germination.



Telescoping Camp Trailer "Shrinks" for Traveling

In two minutes, a large "box" on wheels can be transformed into a comfortable trailer that accommodates four persons. Built by an Iowa businessman, Clay E. Murray, the trailer contains a refrigerator, stove, sink, cabinets and two beds that protrude from the sides when made up for sleeping. A hand crank at the left rear raises the roof section to make the trailer high enough for comfort. When collapsed, the trailer tows much more easily than a full-sized model and is low enough to go under any bridge that will clear the car.

↑ For travel, the trailer is low and compact. By turning the crank at the rear, the owner raises it to full size (below)



Aluminum Shingles Reflect 95 Percent of Heat

Better insulation and protection against lightning as well as the ordinary elements is claimed for newly developed aluminum shingles. Self-aligning, they are mounted raised away from the roof sheathing to form an air pocket that reflects as much as 95 percent of the heat from either direction. The shingles are corrosionproof, and can be installed either painted or unpainted.

☐ The Naval Air Transport Service flew over 320,000 passengers nearly 500,000,000 passenger miles in 1947 without a passenger fatality, about 75 percent of the route miles being outside the continental United States.



DIVING MECHANICS

By Andrew Hamilton

ARISTOCRATS of the construction world are the deep-sea divers. They are often pictured in helmets and lead shoes prowling around the watery hulks of sunken ships in search of Captain Kidd's gold. Treasure hunting may lure some, but most present-day divers find cash and satisfaction in licking a dangerous underwater job.

They weld, cut and burn metal, do carpentry work, shore up bulkheads, pour cement, rig equipment, lay pipe, make repairs in steel and wood, set dynamite and operate cameras.

Nothing so difficult about any of these jobs—except that they're done beneath 10 to 300 feet of murky water inside a diving suit that weighs 190 pounds, and is almost as constricting as a strait jacket.

↑ Training barge deliberately is anchored in murky waters. Divers learn to work in dark

↓ Prowling the ooze of the ocean floor, this diver has nearly 200 feet of water above him

Photos by Don English

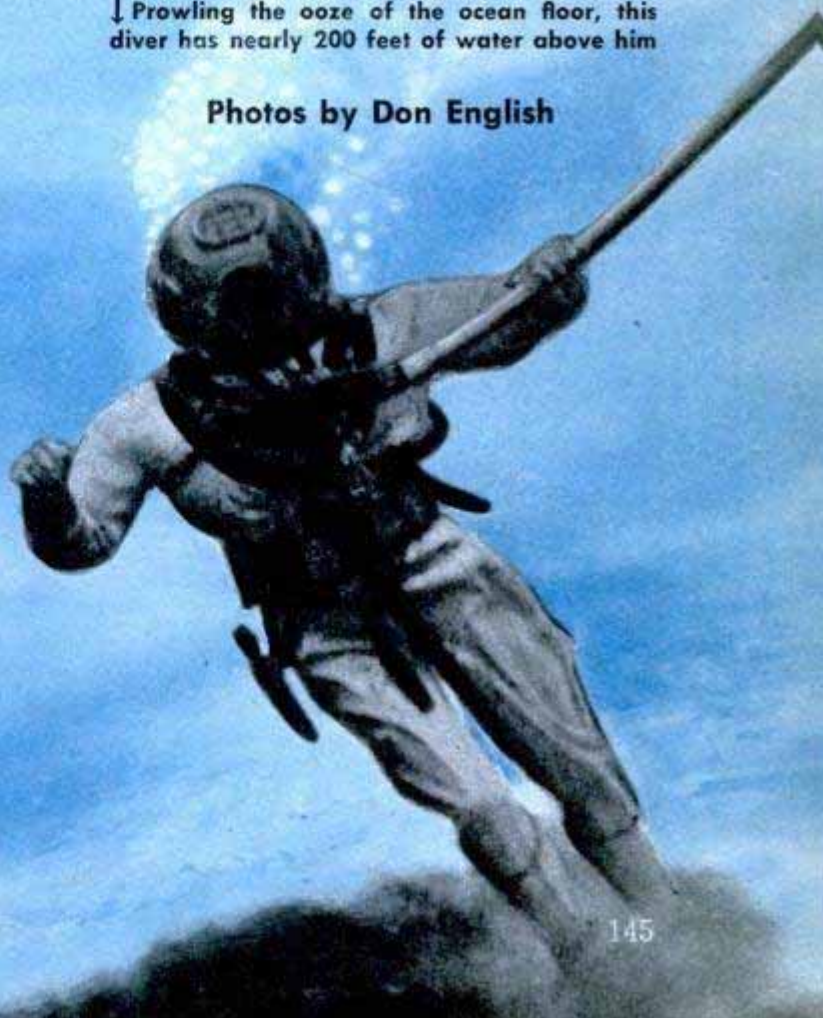

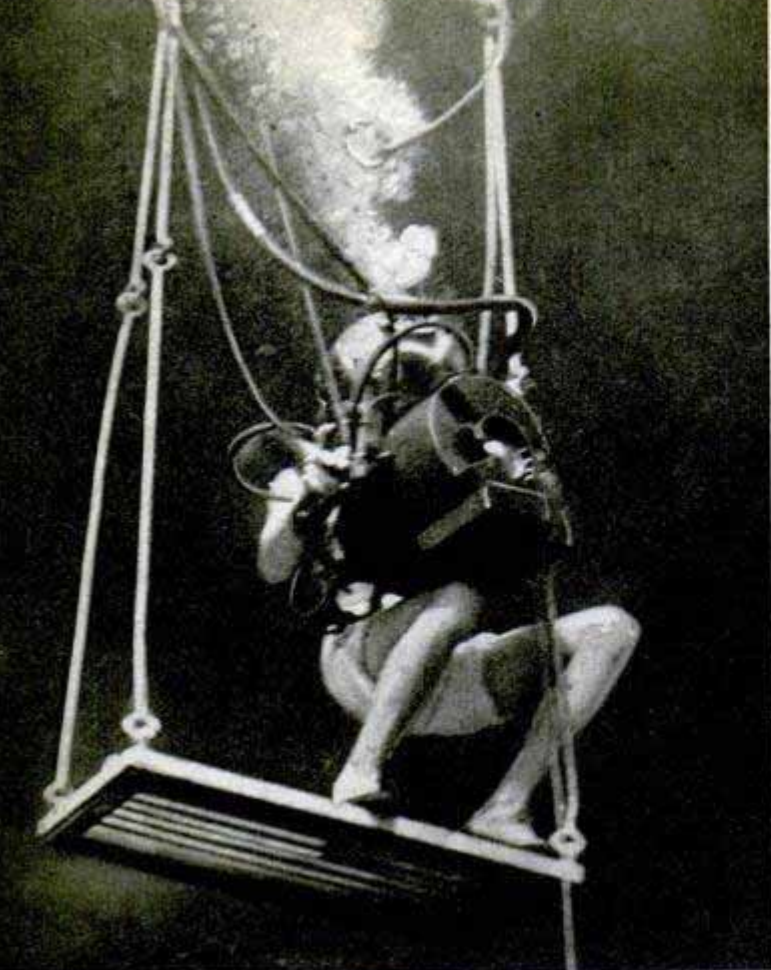

With an underwater camera, diver records life around decompression stage suspended far below surface

In addition to being a jack-of-all trades, a diver must be in top-notch physical condition, possess cool judgment and have a taste for adventure. Wages range from \$20 a day for a man working in shallow water without his own equipment to \$200 a day for a diver using his own gear in very deep water. Most divers average around \$10,000 a year.



There is an increasing demand for well-trained divers. Petroleum companies now need divers for new offshore drilling. Breakwater, bridge and dam engineers require underwater craftsmen. Salvage and ship-repair outfits depend heavily upon such skills. Insurance companies hire divers to identify sunken ships or automobiles. The sponge-fishing industry in Florida and the abalone-fishing industry in California could not exist without divers. More and more construction and engineering outfits are paying high wages to mechanics and riggers who can also dive when the occasion demands.

Although several thousand divers were trained by the Army and Navy during the war, deep-sea diving is a profession that is still wide open. Many emergency trained divers couldn't stand the gaff and have gone into other lines of work.

How does a young man step into this exciting game?

Many of America's best divers are former Navy men. About 1912, when the submarine began to show promise, the U. S. Navy began to give diving instruction. Since then it has developed the finest program in the world. The Navy today maintains diving schools at Bayonne, N. J., and Washington, D. C. Army divers are trained in Navy schools.

The only civilian school in the United States at present is the Sparling School of Deep Sea Diving in Wilmington, Calif., which packs a three-year course into 20 concentrated weeks. It is certified under the GI Bill of Rights and many of its students are veterans.

This school is run by Lt. (j.g.) E. R. Cross, USNR, an ex-Navy diver of 14 years experience. He made his first dive from the destroyer tender USS Dobbin and since then has gone down approximately 2000 times. During the war he was an instructor on the Normandie job and served on salvage vessels in the Atlantic and Pacific. During the atom-bomb tests at Bikini in 1946 he was Flag Secretary to the Commander of the Salvage Unit and made several dives into radioactive water.

"Modern engineering," Cross declares, "requires that a man not only have the guts to go down—but to know what he's doing when he gets there."

The ideal age for a student diver is between 20 and 30. Applicants must be muscular because it requires considerable strength and stamina to walk and handle tools in deep water. They should not be overweight because fatty tissue absorbs and retains harmful nitrogen. Above all, a

Even a short hike is too far in diver's shoes. Each weighs 17½ pounds, has a lead sole, brass toe cap

diver cannot be nervous because his life may depend upon calm thinking and sound decisions.

After five days of preliminary instruction, a student undergoes his first "elimination" dive. If he shows extreme excitability or talkativeness, he is advised to take up some other line of work. One in about every 30 students decides that diving is not the career for him.

From then on a student works long and hard. He learns the history and physics of diving, first aid and accident prevention, the use of salvage tools, the care and upkeep of diving equipment, above water and underwater cutting and welding, seamanship and underwater rigging, demolition and the use of explosives, general salvage work, marine specimen collection, and pearl, abalone and sponge fishing.

What Navy men have called "one of the best training devices in existence" has been developed at the Sparling School of Deep Sea Diving. It consists of a \$30,000 doughnut-shaped tank—30 feet across and 10 feet high. Students submerge in the area represented by the dough and the instructors watch them from outside portholes and from a compression chamber inside the doughnut's "hole."

When deep dives from a barge in the ocean begin, a few more enthusiasts are washed out. A student may be a master in the diving tank, but when he reaches 100-foot ocean depths where inky blackness enfolds him, rocks foul his lines, seaweed grabs at his legs and great sea creatures slither past, his courage sometimes fails.

Upon graduation, the novice diver finds a wide field of opportunity awaiting him. A bridge is being built in Sydney, Australia, and divers are needed to erect coffer dams for the foundation. Pipe is being laid in Venezuelan offshore oil wells. A hulk is blocking the entrance to the Thames River and must be removed. The University of California is interested in a peculiar type of seaweed that grows in the warm waters of the Gulf of California. New York police suspect that a murder weapon, a revolver, has been thrown off the George Washington Bridge. A salvage company is clearing Manila Harbor.

The tools of a diver's trade are the standard ones of the construction business—plus some underwater specialties. Small tools are carried in a canvas bag that holds up to 200 pounds of equipment. Larger tools are lowered on a line.

Special tools for underwater work include an underwater knife with a saw blade on one edge; a cement gun for grouting work; power tools for cable-cutting, pipe bonding, wire-rope bonding and rivet expanding and removing; washing nozzles or



Student at left wears light suit for shallow work, while "deep sea" man at right wears 190-pound rig. Diver is given final instructions on the use of oxy-hydrogen underwater cutting torch for salvage work.



lances for slipping a cable beneath a sunken ship; and pontoons of various sizes and dimensions.

The most useful tools of the diver, perhaps, are his torches. These are of three types—the oxyhydrogen cutting torch, oxyelectric cutting torch and electric arc welder. There is little difference in the theory and technique of welding whether done on dry land or in Neptune's watery kingdom.

But how can a diver use a cutting or welding torch under water?

When the oxyhydrogen torch is used below the surface, the water immediately around it is forced away in all directions by compressed air to form a four-inch bubble in which the flame burns. Underwater torches are equipped with special tips called "bubble nuts" which hold the flame the correct distance from the metal. The electric arc burns inside a bubble of gas in much the same way.

Salvage is one of the significant phases of deep-sea diving. World War II was responsible for 600 sunken ships along the Atlantic coast, 113 in the Caribbean and 40 in the Pacific. In less than 100 fathoms of water, these sunken hulls contain crude rubber from South America, ore from Europe and U. S.-built, wartime equipment in waterproof coverings.

The master mechanics of the deep also play an important role in ship repair. Often underwater damage as a result of collision or stranding requires repairs to enable a ship to reach dry dock. Small holes and ruptured plate seams are repaired with pneumatic metal calking tools and soft-wood patches and calked with oakum or tallow. Medium sized holes are closed temporarily with blankets, mattresses or collision mats. Large holes are more difficult and compli-

↓ Instructor gives pointers over a diver's telephone to a student in the training tank. Below right, inside the pressure chamber a veteran diver checks a student's progress in underwater arc welding through a porthole



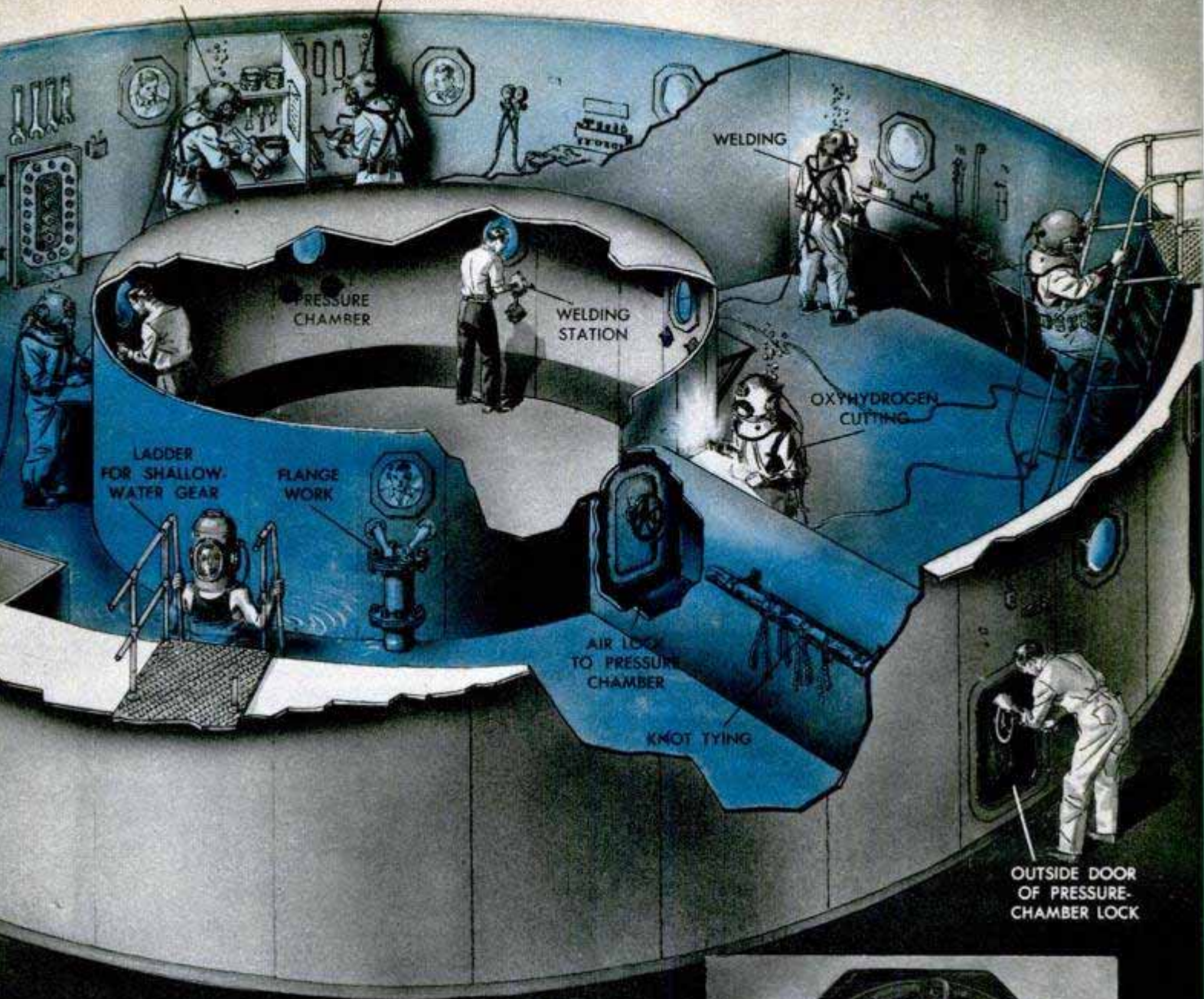

cated. First a diver goes down, clears away all fractured or torn plate and measures the hole. A template is constructed under water to the dimensions of the hole and the curvature of the hull. On deck a patch is built from the template and lowered to the diver who bolts it in place. When a ship reaches a repair yard, permanent repairs are made.

A knowledge of carpentry and shoring up bulkheads often comes in handy. In salvage and repair operations, for example, it is sometimes necessary to construct bulkheads of various sizes by spiking horizontal tongue-and-groove planking on vertical timbers. The planking always is fitted on the pressure side of the bulkhead. For large jobs, timbers up to 12 by 12s are used.

A skillful deep-sea diver knows almost as much about seamanship as a Navy boatswain's mate and must be a skilled rigger. This involves a familiarity with knots, splices, guy lines, shackles, block and tackle, scaffolding and slings. A rigger does not play hunches. He makes sure he is right by checking his

(Continued to page 232)

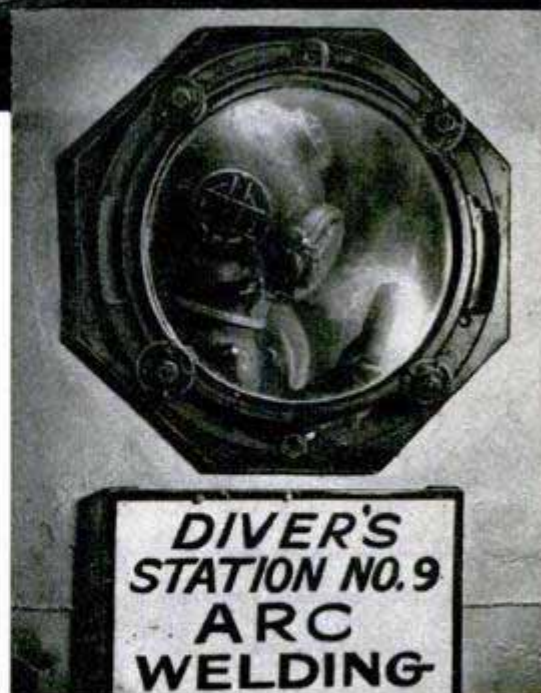

Drawing shows "doughnut" training tank where students practice almost any type of underwater work from knot tying to rivet cutting. Insets show portholes through which instructors check students

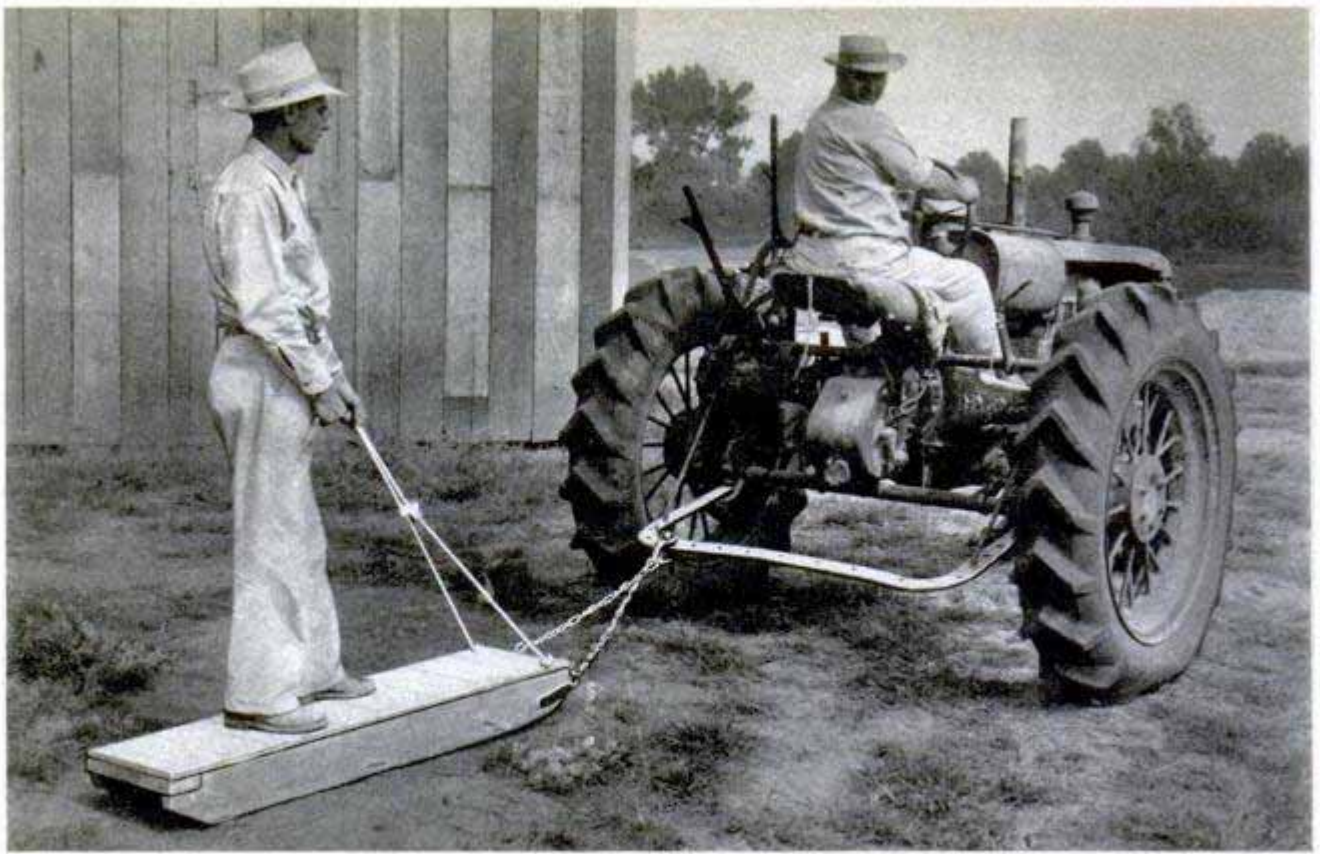

Vine-Cutting Sled

Sweet-potato vines on a state farm in Louisiana are cut at harvest time by a sled with runners made of mowing-machine knife sections. In an hour it does work that takes 30 to 40 men half a day. The sled straddles rows of vines and, bearing a man's weight to aid cutting, is pulled by a tractor. It is 4½ feet long, 16 inches wide and weighs about 50 pounds. The knives are attached to the runners with long spikes.

Discarded mowing-machine knife sections, nailed to sled runners, speed sweet-potato vine cutting on state farm in Louisiana

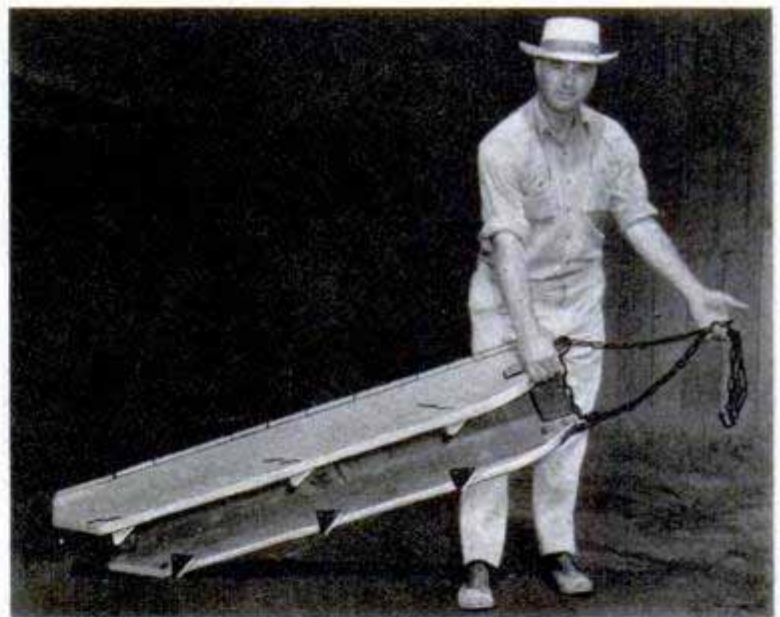

Bus Converted to Mobile Cartoon Theater for Youngsters

When J. K. Venard of National City, Calif., drives up in his bus, the children from the neighborhood come on the run.

Venard has converted a war-surplus Navy bus into a mobile theater and travels a regular route showing 16-mm. cartoons to

the children. He has added a trailer to the bus to serve as a ticket booth, loading platform and projection room. Most stops on the route are in federal-housing projects and the children have learned what day and hour to expect the mobile theater. The bus seats 80 children or 60 adults, who also attend the movies.



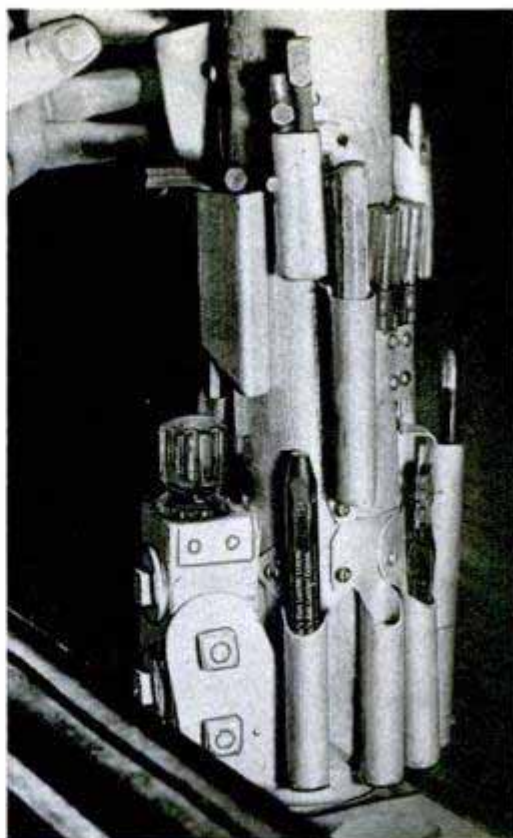
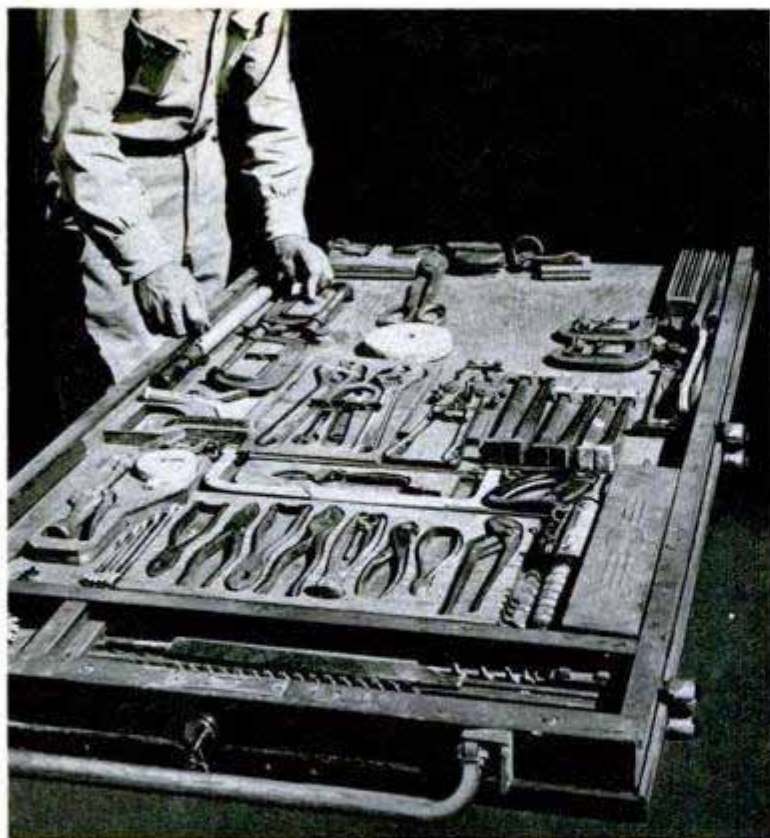

Left, drawer has tool compartments cut to exact shape. Above, small carpenter tools slip into aluminum tubing

MOBILE TOOL SHOP

Every tool has a fitted "home" in a tool-house truck designed by a Los Angeles cement contractor. The truck supplies 15 workmen with all the tools required for excavating, building forms and pouring concrete. A rear tool drawer made of heavy plywood slides out to reveal all the small tools required on the job. The tools fit into compartments cut to exact shape. A glance at the drawer at the end of working hours reveals immediately whether any tool is missing. Shovels, saws and other large tools are slipped into fitted racks. The truck bed with fittings costs about \$650.

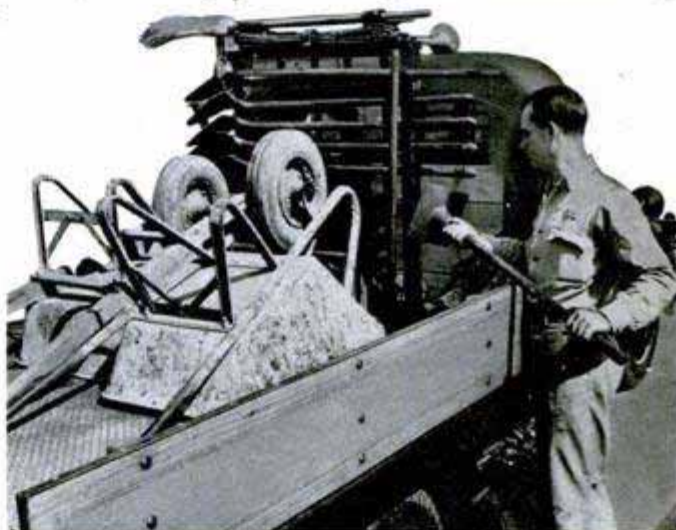

↑ Heavy tools fit on bed of truck. Below, truck's compact racks give ample room

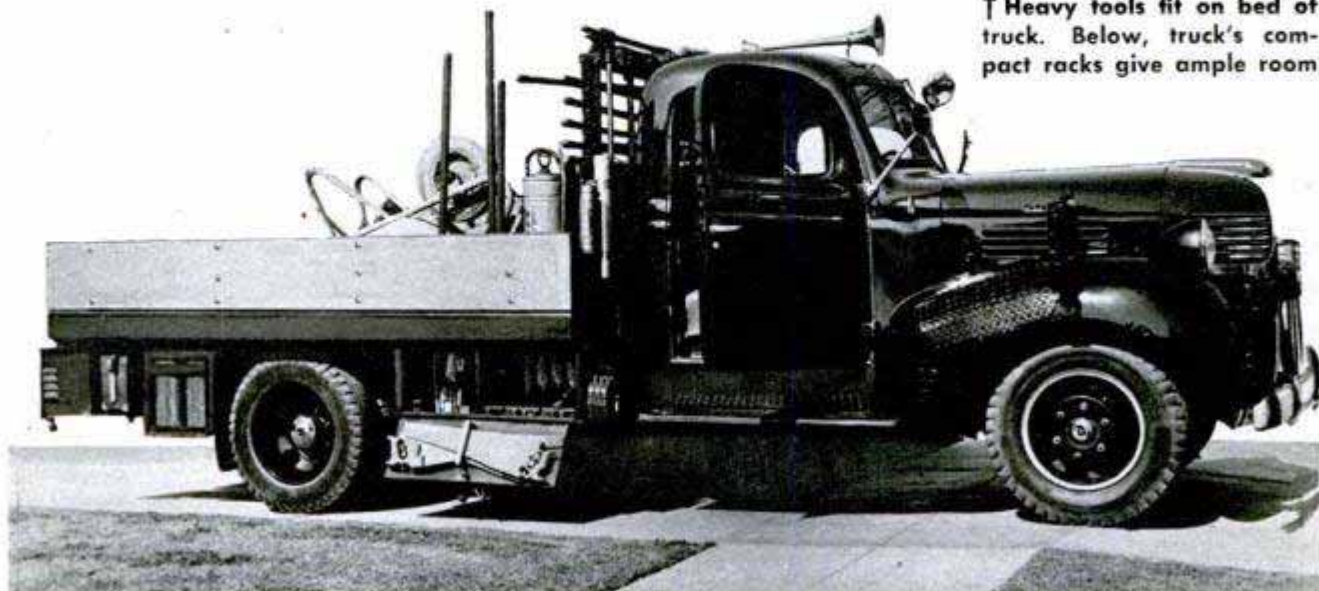

Doll Doctor



"Doc" Nash gives his patients a 'post-operative examination after they have recuperated in his hospital

By Walter E. Burton

A MAN with a sick wife and 50 ailing dolls on his hands was the unexpected key that enabled George A. Nash of Conneaut, Ohio, to make a childhood dream come virtually true.

When Nash was in that period where a boy is expected to make up his mind about a lifetime occupation, he wanted to become a doctor—either a physician or a dentist. But his father ruled against it. "Too much

hard work, too-long hours," he declared. So Nash, now 46 years old, obeyed his father's wishes and went into business. But he never lost his desire to be a doctor.

Eventually Nash became vice-president of a concern manufacturing electronic equipment. He developed an assortment of hobbies which included horses, painting, guns, stamp collecting and a home workshop. The rush of the war years, coupled perhaps with a deep-rooted dissatisfaction with a field of work that was not his primary choice, damaged his health. So he resigned his position. This gave him, for the first time in years, an abundance of hobby time to dabble in paints or putter with his lathe, drill press or jigsaw.

One day an acquaintance said to him, "George, I'm on a spot, and I think you can help me off it." Then he told his story. His wife had been sick for months. She had built up a business repairing dolls, and when she became sick she had about 50 broken ones on hand. The owners had been pestering him for six months. He couldn't fix a doll on a bet, but he thought that George, who was handy with tools and



Among tools are real surgical instruments. Flexible shaft in foreground operates dental burrs for carving

knew paints and color, might have time to tinker with them. Nash, not suspecting what lay ahead, agreed to take on the work.

Before long, it began to become apparent that, after all, he had become a doctor—a doctor of ailing dolls. Since then—that was in 1946—he has decided that this profession has certain unique advantages over other fields of medicine. It has, too, some similarities. For example, he keeps about as lengthy hours as any doctor, although he doesn't make emergency middle-of-the-night calls.

Nash went to work on the 50 distressed dolls, developing his technique as he progressed. His pay was entirely in experience. The dolls' owners were pleased with the complete recuperation, and they told other doll owners about it. Almost before he knew what was happening, Nash had been propelled into the doll-repair business. The work came in rapidly. Sick dolls, like humans, must have a place in which to regain

Right, "surgeon's" skillful hands resting a patient on the miniature operating table
↓ In repainting the tiny facial features, the doll doctor uses waterproof enamels

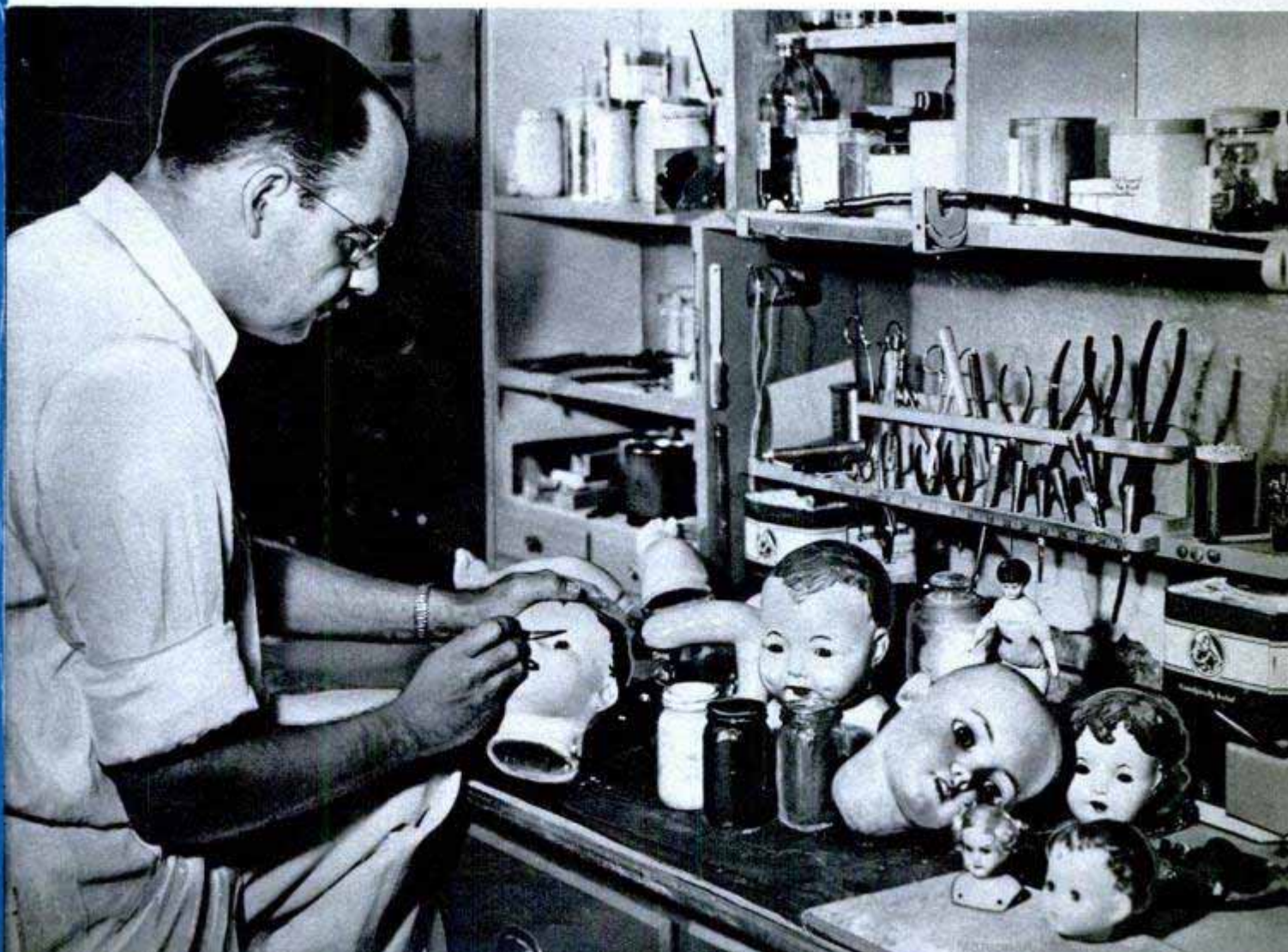
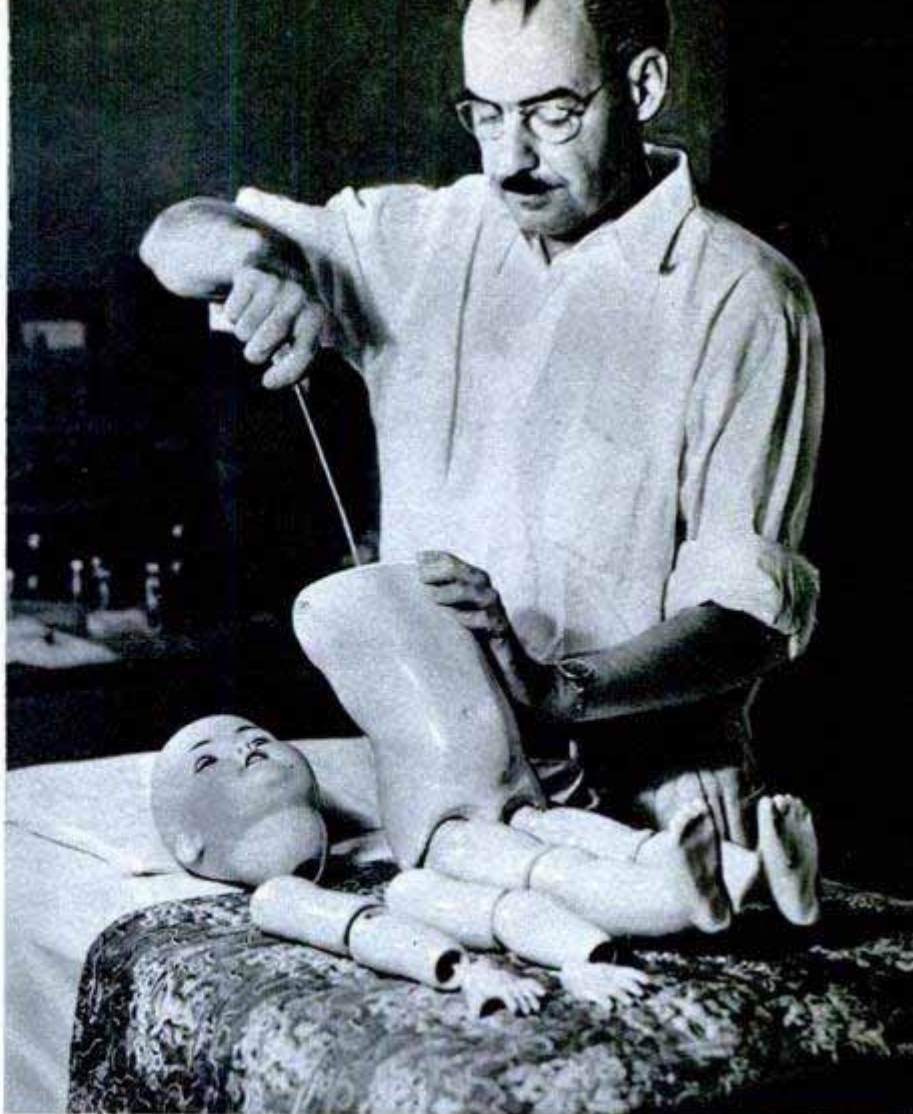



Old-fashioned medical containers hold the hospital supplies

health, so Nash decided to open a permanent doll hospital.

There are quite a variety of "doll hospitals" in this country. Nash has visited a number of them. Many, he reports, are primarily small retail shops where doll repairing is a sideline. None that he has heard about measures up to his conception of a real "hospital." Not one of the places he has visited has an actual operating table, or genuine surgical instruments!

Today, Nash has what he believes to be the only true-to-life doll hospital in the country—an institution complete with genuine pill and medicine bottles, actual surgical and dental instruments, an operating table and a special operating-room chandelier (from an old dental office). The staff consists of "Doc" Nash and his wife. At first, Mrs. Nash's interest in dolls was negligible, but constant association with the innumerable characters that moved through the operating room and repair wards, plus the fact that the work was becoming too much for one person to handle, persuaded her to become an active partner. Today she is busy making doll clothes and wigs, tinting faces, taking care of visitors and doing other hospital work.

The Nash hospital occupies the second floor of an old building behind the Nash home. Two of the five rooms vie for top rating in visitor interest. One is the display room where several dozen finished dolls, some in pert new costumes, some wearing only a wig, are grouped. There also are a number of china, bisque, and metal doll heads and some stock accessories such as doll shoes and gold-finished under-bed plumbing.

This room doubles as a business office and reception center.

The other room that attracts attention is the main operating room. Near its center stands a tiny operating table, illuminated by the dental chandelier. The medicine cabinet in one corner contains a collection of old-fashioned druggist's herb and pill jars and bottles which earn their keep by holding hospital supplies.

(Continued to page 244)

When doll's arm is missing, Nash carves a new one from wood. Right, dental burr shapes finger on new hand

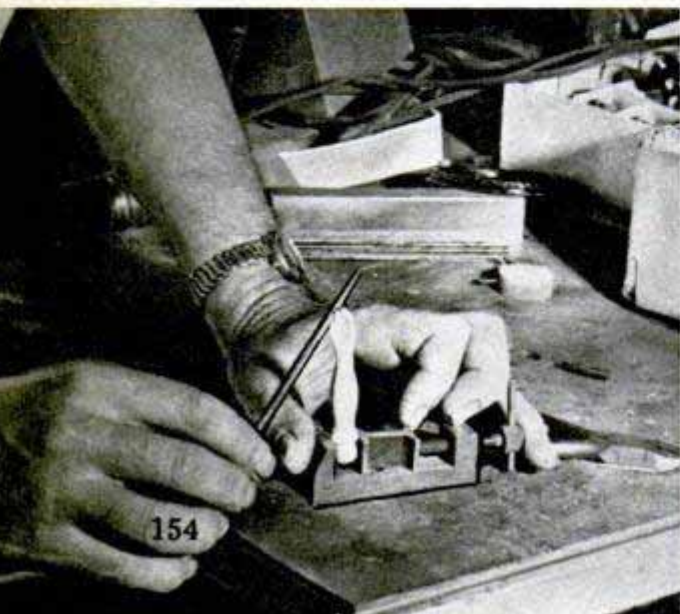

Earth Mover Loads in Reverse

Handling of bulk materials is sped up and improved by a device that enables tractor-mounted earth movers to load in reverse. With it, movers can be backed in close to buildings, fences, stock piles or excavations, eliminating the need for hand shoveling. The scoop takes a bite 24 inches wide. Loads are picked up and carried, instead of dragged, and dumped in a pile or spread and leveled.

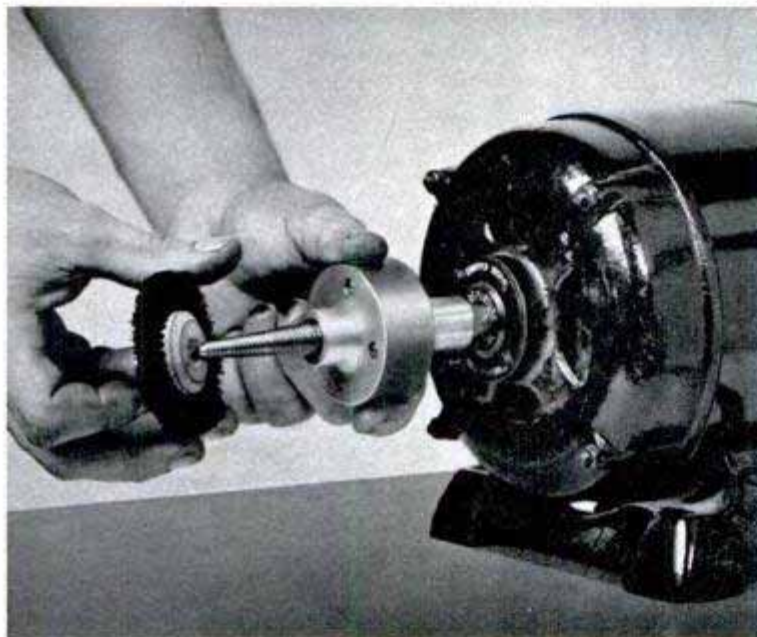

Quick-Change Spindle For Polishing Wheels

Polishing and buffing wheels can be put on and off the shaft without stopping the electric motor when a free-spinning spindle is used. To stop the spindle the operator grasps the large collar behind the threads. This does not affect the spinning shaft. The spindle has tapered threads for quick changing of the wheels.

☐ Metal tags were attached to the flippers of nearly 20,000 seal pups in the north Pacific to start a check on their migratory habits that will be completed when they are ready for killing in 1950.

Portable Planetarium Weighs Only 25 Pounds

Only three feet high, a portable planetarium can be used in schools or homes for studying the paths of the stars in the sky. The 25-pound unit projects images of all stars down to the fourth magnitude or most of those that are seen by the naked eye. The 12-sided housing, made of Vinylite plastic, contains a special bulb that projects its light through holes punched in the plastic. While the planetarium can be used on a flat ceiling, portable domes that give greater fidelity are available.

☐ Radarproof canisters prevent ignition of photoflash bulbs by radar waves during air shipment.

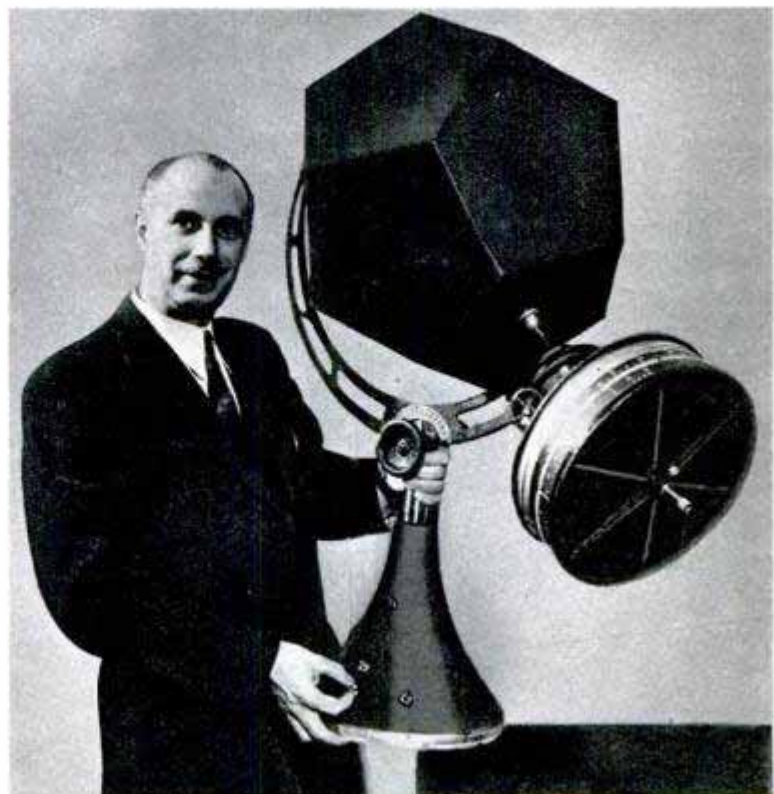

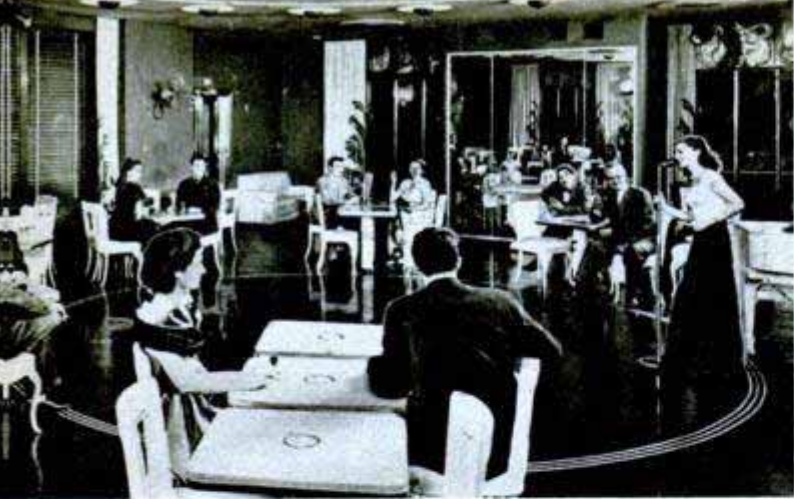

Passengers won't be bored during their trans-Pacific voyage. There's entertainment galore. Marine veranda (above) is a combination night club and movie theater

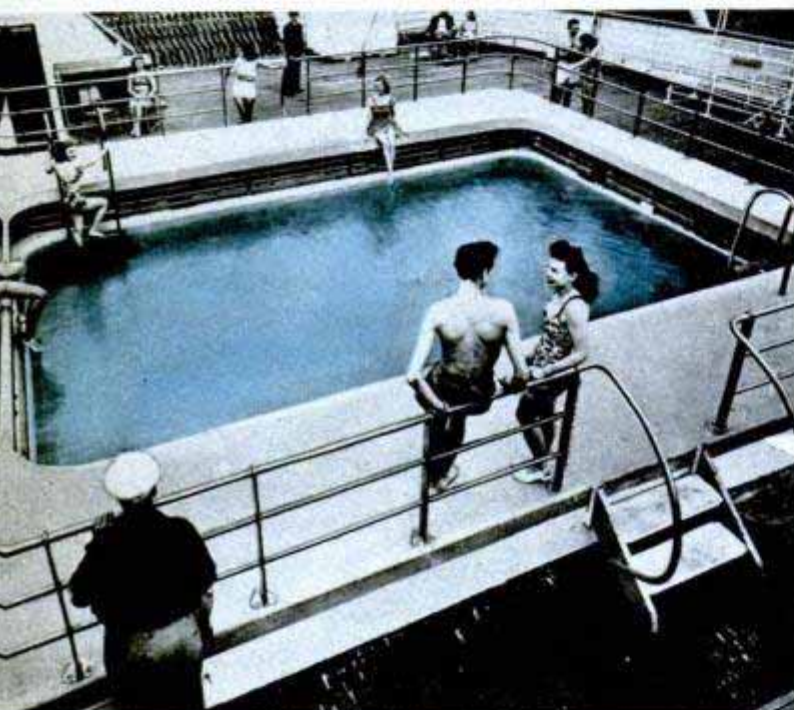

The ship has two swimming pools. Deep recess near the top (above) prevents splashing during stormy weather

Children love the merry-go-round (below) in the play-room. Thatched hut in rear is a junior-sized washroom



HOTEL TO THE ORIENT

By Thomas E. Stimson, Jr.

THE FINEST ships under any flag on any ocean!" Those were the specifications laid down for America's twin post-war ocean liners, the President Cleveland and the President Wilson, designed and built for the trans-Pacific trade.

Each is 610 feet long, weighs 23,000 tons, and can be driven at 21 knots by its 20,000-horsepower turbo-electric motors.

Flying the house flag of the American President Lines, the President Cleveland went into service late last year on the San Francisco-Honolulu-Manila-Hongkong-Shanghai-Yokohama run. The Wilson is scheduled to make its maiden voyage over the same circuit this month. The

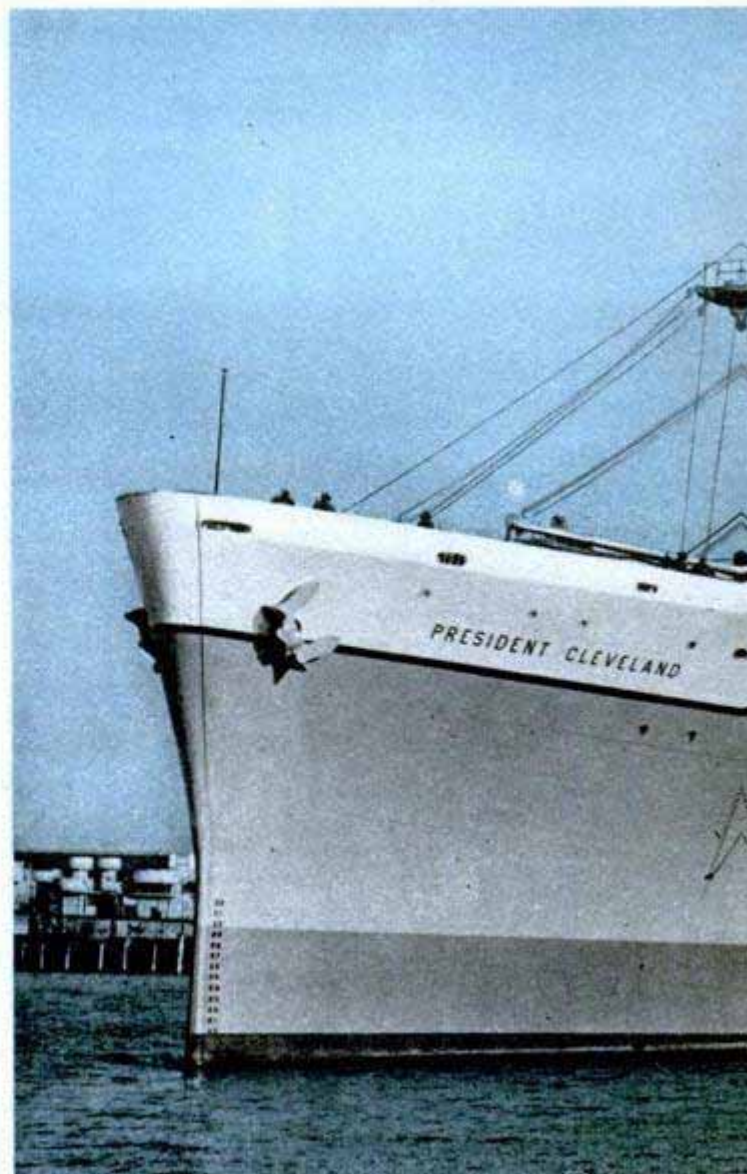

vessels are the largest ever built on the west coast and were constructed by Bethlehem-Alameda Shipyard in California.

Each is a combination of luxury passenger liner, express freighter, refrigerator ship and tanker. In addition to 550 passengers and 350 crew members, each can carry more than 600 tons of cargo refrigerated to 10 degrees below zero, more than 700 tons of tung, coconut, and other edible oils in special tanks, and nearly 5000 tons of general cargo.

Refrigerated cargo and general ship's stores are loaded on the vessel by a new type of overhead trolley that can be extended on retractable booms through an opening in the ship's side. Called the Siporter, the trolley can pick up as much as three long tons of stores from the pier alongside the ship, carry it inboard, lower it into a hold and return for another load in 2½ minutes. The usual deck booms and winches are used for loading and unloading the other holds.

The ship manufactures its internal weather, has two illuminated swimming pools, a passenger elevator, movies, radio-broadcast receivers and public-address systems, dial telephones and a long-range ship-to-shore radiophone. There is a marine veranda on the promenade deck, a



Signal-flag locker on the flying bridge is forward of the streamlined aluminum funnels. Below, powerful tugs ease the big liner into the main channel

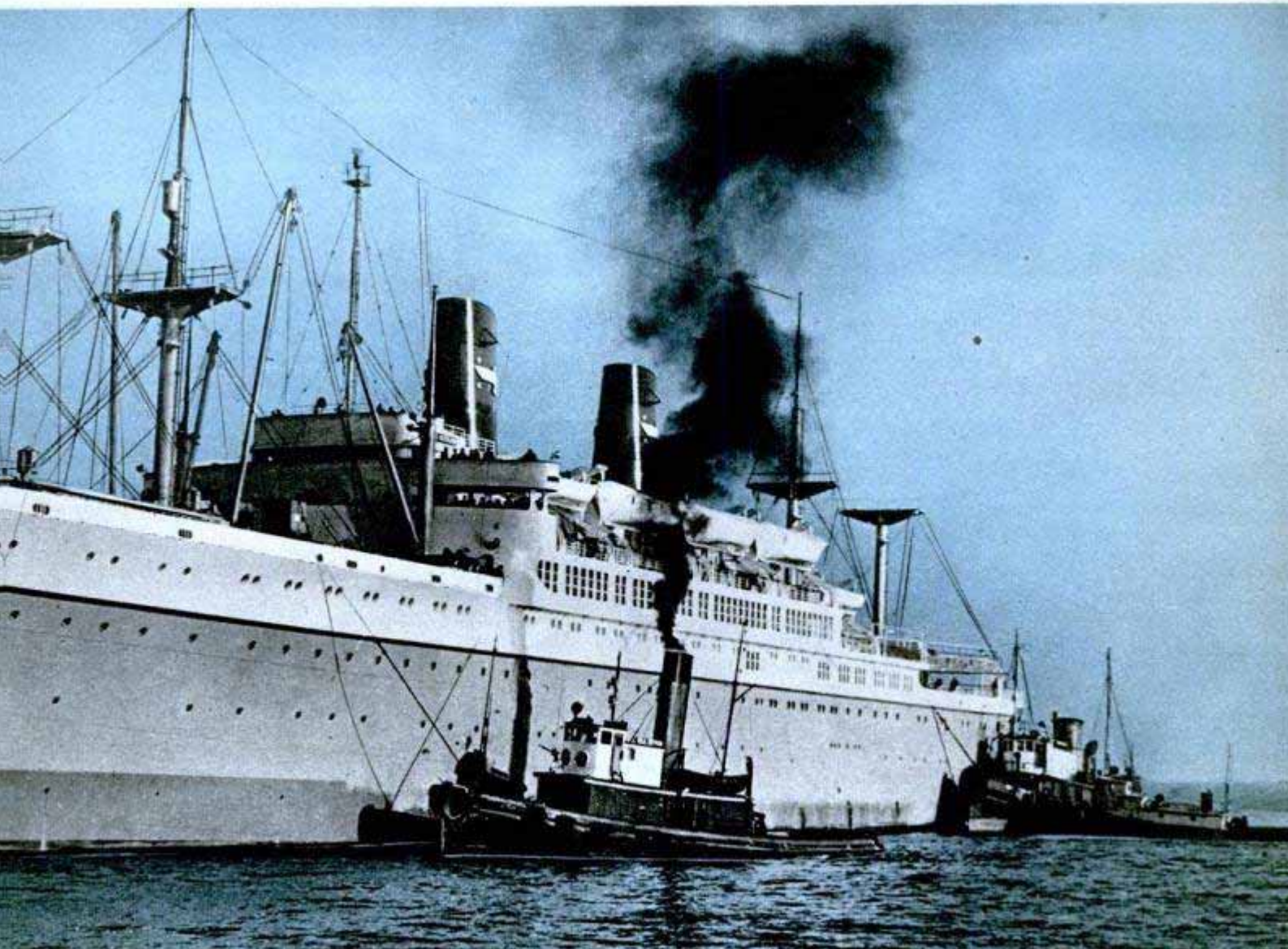



Alarm system sounds a warning in fire-control room (above) when automatic devices detect smoke or flame in any part of the ship

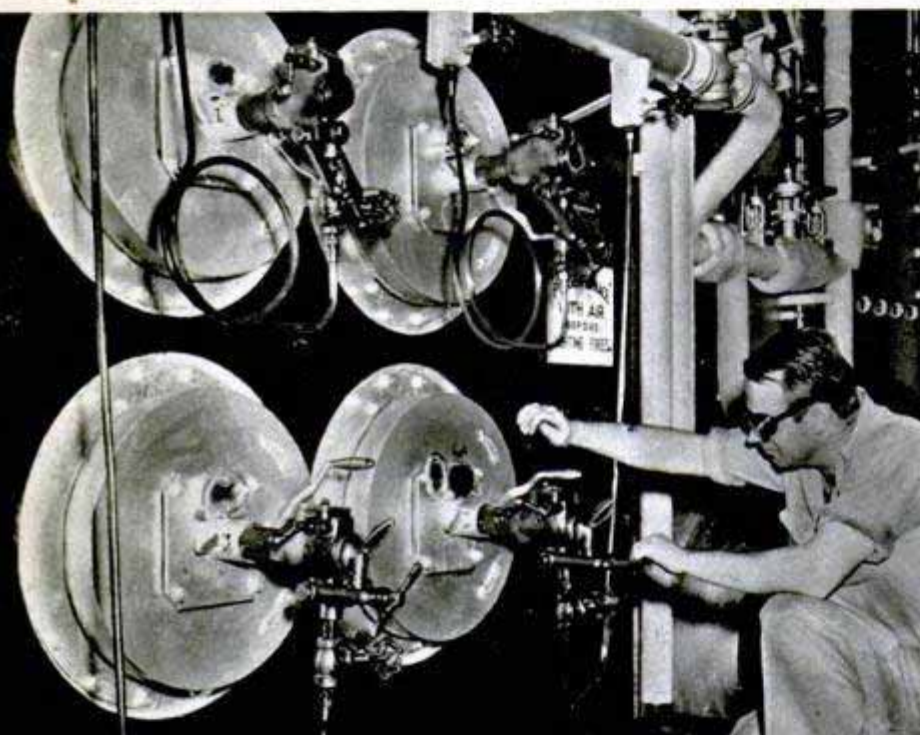

Safety-goggled fireman (above) inspects fuel-oil flame in one of the boilers by opening peep hole in fire door. Below, long-range radiophone on the bridge enables officers to talk to other ships or to shore stations. Officer at left turns on navigation lights

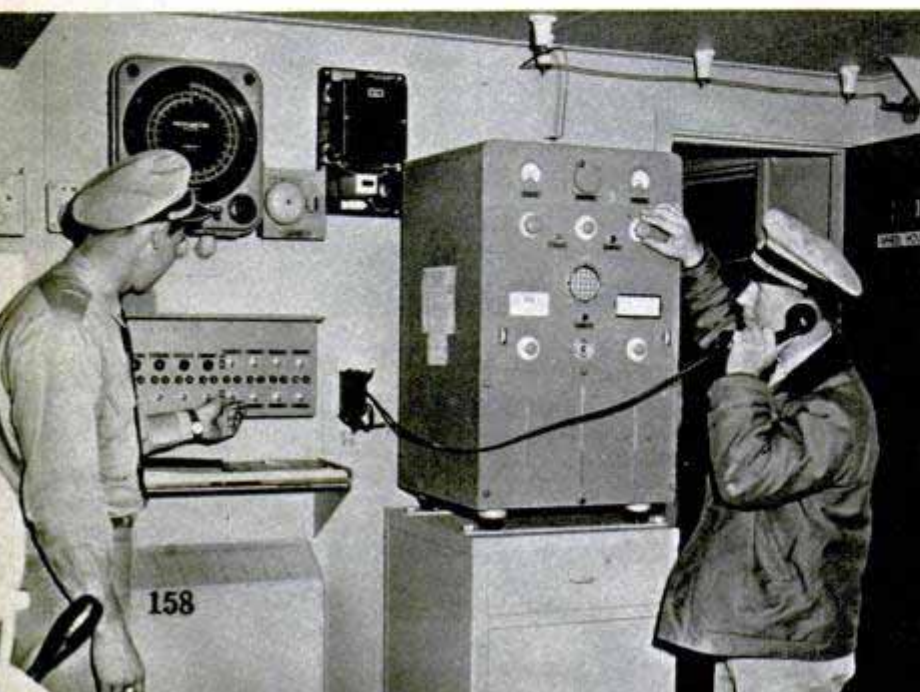

lounge and a circular dance floor. Most of the furniture in the public areas is made of aluminum, covered with attractive leather or plastic fabrics.

Adult passengers make use of a gymnasium, massage parlor and beauty parlor, while the children have a special playroom containing playhouses, a carousel and a miniature ship's bridge from which the ship may be "steered." Pets are kept in kennels that are steam heated in cold weather.

The ship has three main galleys and five pantries and 54 waiters are required for serving the first-class, tourist and third-class passengers and the officers and crew. Crew members have air-conditioned lounge rooms. Hospital facilities include a fully equipped operating room, dispensary and diet kitchen.

A radical departure from standard construction is that each ship from the boat deck up consists almost entirely of aluminum structural shapes and plates. Lifeboats, davits, funnels and the midship houses all are of riveted aluminum. The saving of some 75 tons of weight high in the ship contributes to stability.

Because they were designed to serve as potential wartime auxiliaries, both vessels incorporate certain novel safety features in addition to all the latest peacetime safety measures. The two engine rooms, for instance, are entirely separate and self-contained. Each has its own pair of high-pressure steam boilers, its own General Electric impulse reaction turbine and its own group of turbine-driven generators. The boilers are fed with preheated fuel oil and with air heated to 240 degrees, and are served by automatic combustion regulators that maintain the correct fuel-air ratio at all times.

Each engine normally powers one propeller, but either power plant may be connected to both propulsion motors in an emergency. Either engine can produce 80 percent of normal cruising speed when driving both propellers. Dynamic braking allows the ship to go from full speed ahead to full speed astern in much less time and distance



Left, speed and direction of movement of propellers are regulated at this main propulsion control board. Right, quartermaster operates hand steering gear as ship nears harbor. Officer (rear) watches radar screen

than is possible with most merchant ships.

The ship has 35 sliding steel doors that may be operated manually or by electricity from several control points to divide the vessel into 14 separate watertight compartments. In addition there are numerous electrically operated fire-screen doors to close passageways and divide the ship into fire zones, each of which has its own fire-fighting apparatus.

Fire detection equipment is so complete that the ship has a special fire alarm and control room adjacent to the bridge. In this headquarters a fire in virtually any part of the ship is detected at once by eye, ear or nose.

Alarm bells ring automatically, both on the bridge and in the fire-control room,

when any detection system "senses" fire. Electric thermostats in the passenger and crew areas operate an "automatic supervisory fire-alarm annunciator" in the fire-control room if they become overheated, flashing on a number to show the location of the trouble. Another continuous detection system uses electric eyes to examine the air that is pumped from 51 portions of the ship for traces of smoke. The air exhausts into the fire-control room where smoke is detected immediately by its odor. From the fire-control room the ship's watertight doors can be closed, the fire-screen doors operated and the ship's ventilation system shut down. In addition to the usual fire-fighting apparatus in many parts of the ship, special areas are protected by

Left, indexed signal board flashes a warning when any unit of the ship's machinery doesn't operate properly. Right, aluminum lifeboats can be lowered instantly by gravity davits. Two lifeboats have motors and radios

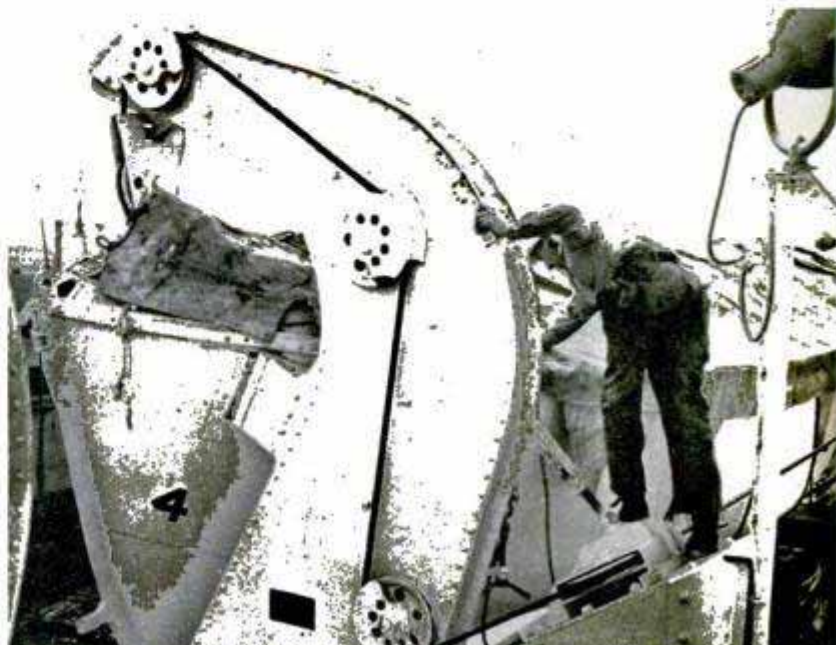

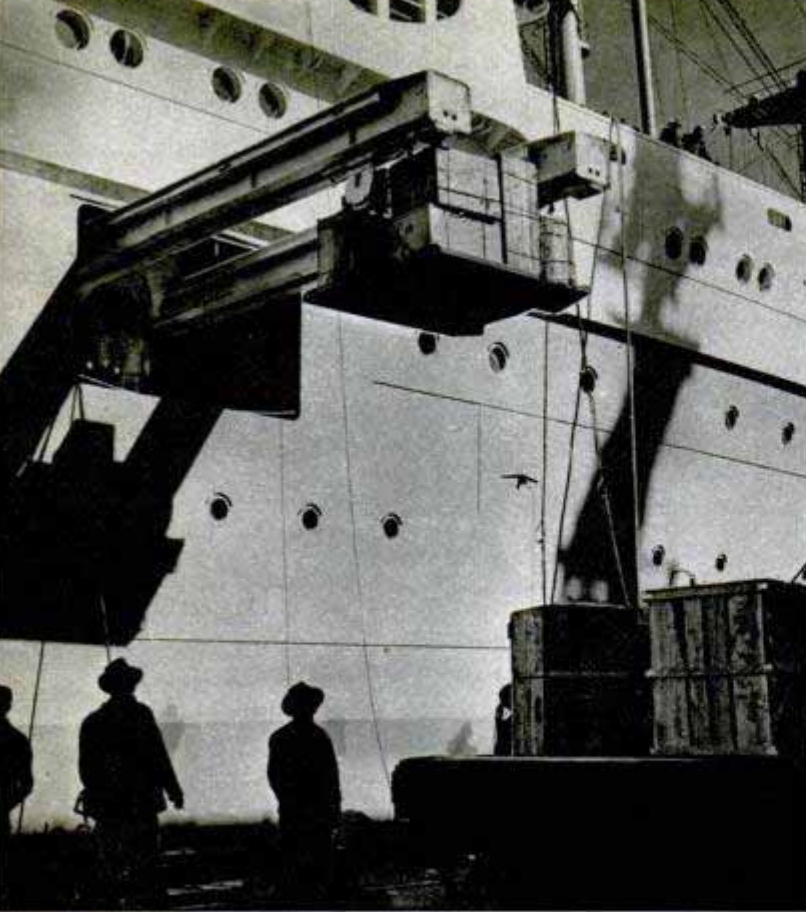

All the comforts of a luxurious hotel are found in the lounge. The clock is of special Chinese design

Left, called the Siporter, this loading device is used to lift cargo from dock and carry it inside to the hold eliminating the top deck booms and winches

built-in carbon-dioxide systems operated by remote control.

Fireproof construction is employed to a much greater extent than in prewar ships. Most partitions in the vessel's living spaces consist of two inches of a fireproof material such as glass wool with steel facings. Fire-resistant Vinyl-plastic deck coverings are used instead of rubber tile in most of the enclosed spaces and passageways. As a final precaution, three fire watchmen are on patrol all night long, no matter whether the ship is at sea or in port.

Naturally, the postwar ships are equipped with the latest types of navigating equipment. These include radar and

loran in addition to an echo depth sounder, radio direction finder and gyro-compass with eight repeater stations, plus several magnetic compasses in the wheelhouse and on the flying bridge. An automatic steering system employs electric telemotors that control the rudder pumps for manual as well as automatic steering. The main steering gear itself is of the hydro-electric double-ram type and can move the rudder from hard-over to hard-over (70 degrees) in less than 30 seconds when the ship is moving ahead at full speed and at full-load draft. The steering motors and their ram pumps can be controlled from any of five

(Continued to page 256)

Left, 48 electric eyes examine air throughout the ship. If smoke is present, a light flashes on this board. Right, master indicator board operates 38 steel doors that divide the ship into 14 watertight compartments

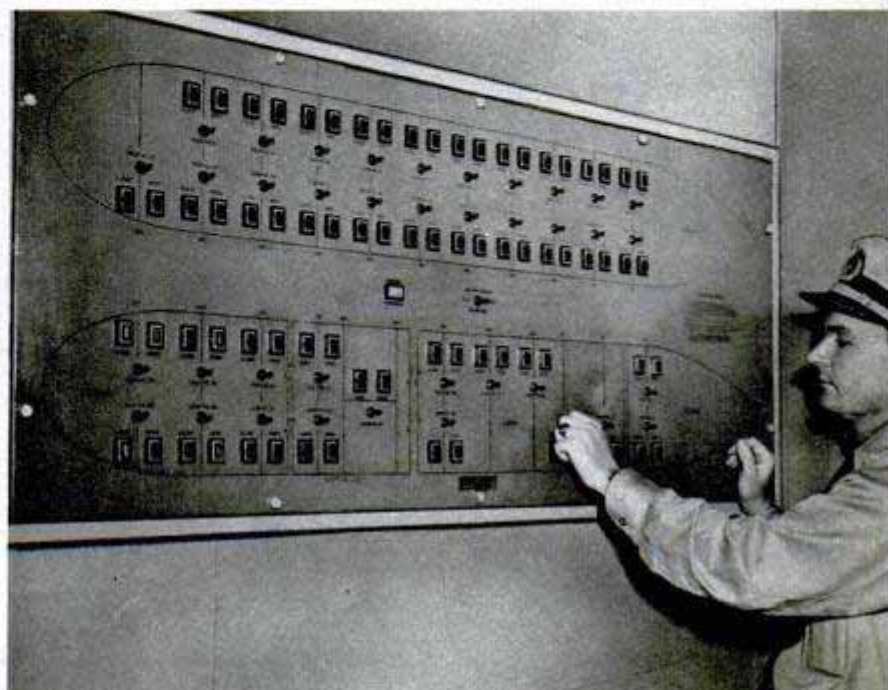

Electrical Giant Hauls Coal Trains

Designed for hauling trains heavily loaded with coal from the West Virginian mines over the Allegheny Mountains to Roanoke, Va., an all-electric locomotive weighing a million pounds was put into service recently. It develops 6800 horsepower, making it the most powerful locomotive of its type in the country. Four have been ordered by the Virginian Railway from General Electric.

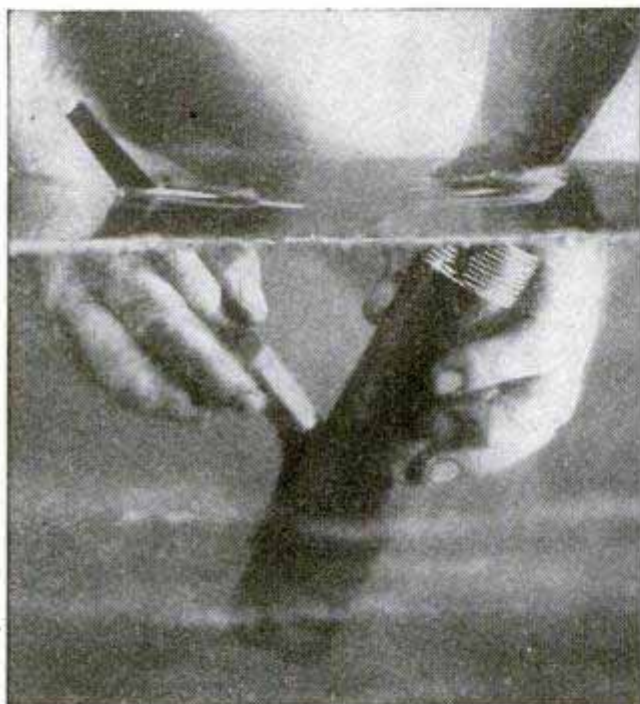

Underwater Paint

Preventing moisture penetration, a protective coating for concrete, masonry and steel can be applied on damp surfaces or even underwater. Composed of asphalts, plasticizing and adhesive compounds, the paint does not contain any tar. It does not impart any taste to drinking water, dairy products or other liquids and is not affected by diluted acids or alkalis.

Milk-Fed Vegetables

Even vegetables grow fat on a milk diet, according to experiments conducted at Montana State College. Yields of tomatoes and onions were markedly increased when buttermilk and skim milk were added to the soil either alone or in combination with commercial fertilizers. In addition, the soil was in better condition after the tests than before.

Curved Wires Aid Drawing

Almost all types of curves, even those in reverse, can be drawn accurately with a five-piece unit intended for draftsmen, designers, commercial artists and pattern-makers. It consists of four pre-formed wire curves and a 12-inch base that holds any one of them in place. They are used singly and inserted by snapping the looped ends over adjusting screws. Their shapes can be altered by adjusting one or both screws along slots.

☐ Since 1941, when there were only 121,220 acres of tree farms in the United States, the total has increased to 14,864,413 acres of which 9,360,388 are in the South.

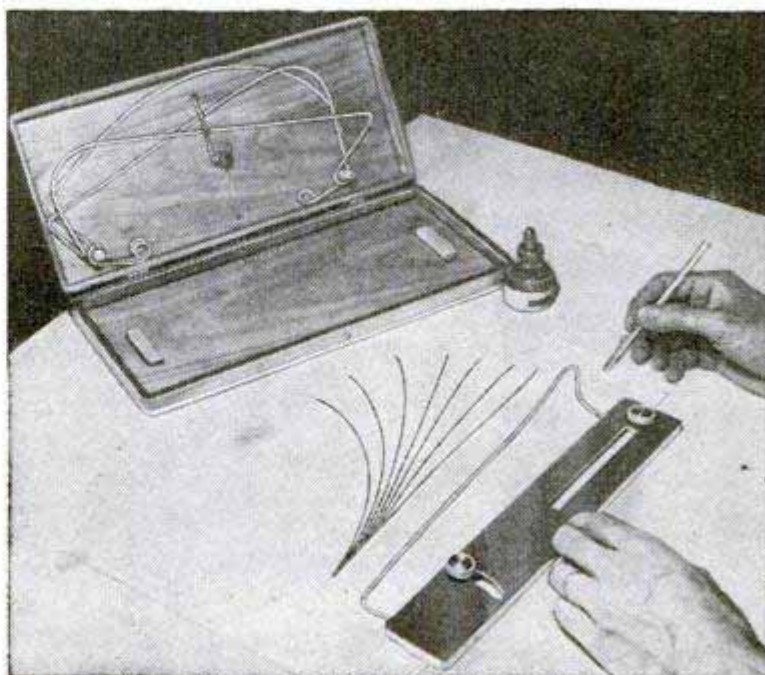



Press Reshapes Piano Hammers

Misshapen piano hammers are squeezed back into shape by a hand press similar to a pair of pliers. The press was invented by J. Kaye Booth, a Salt Lake City piano tuner. The inside surfaces of the press are shaped like a striking hammer. When squeezed around a hammer that has been bent, the press forces it back into the correct shape.

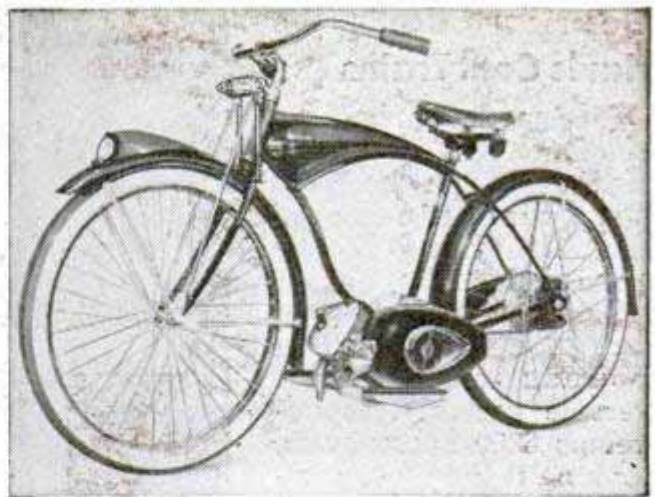

Bicycle Power Unit Replaces Pedal Crank

One pedal controls the throttle, clutch and brake on a bicycle power unit that attaches at the pedal-sprocket housing to provide a low center of gravity for safety and comfort. The power supply is built into a compact unit that is easily installed after removing the pedal crank. Rubber bushings absorb engine vibrations. The single control is operated by the right foot. When the toe is pressed down, the throttle opens and the clutch engages. Pressing down on the heel closes the throttle, throws out the clutch and applies the large drum brake in the rear hub. A heavy chain transmits power from the engine to the rear wheel. Speeds up to 45 miles per hour are possible and gas consumption is one gallon for 125 to 150 miles.

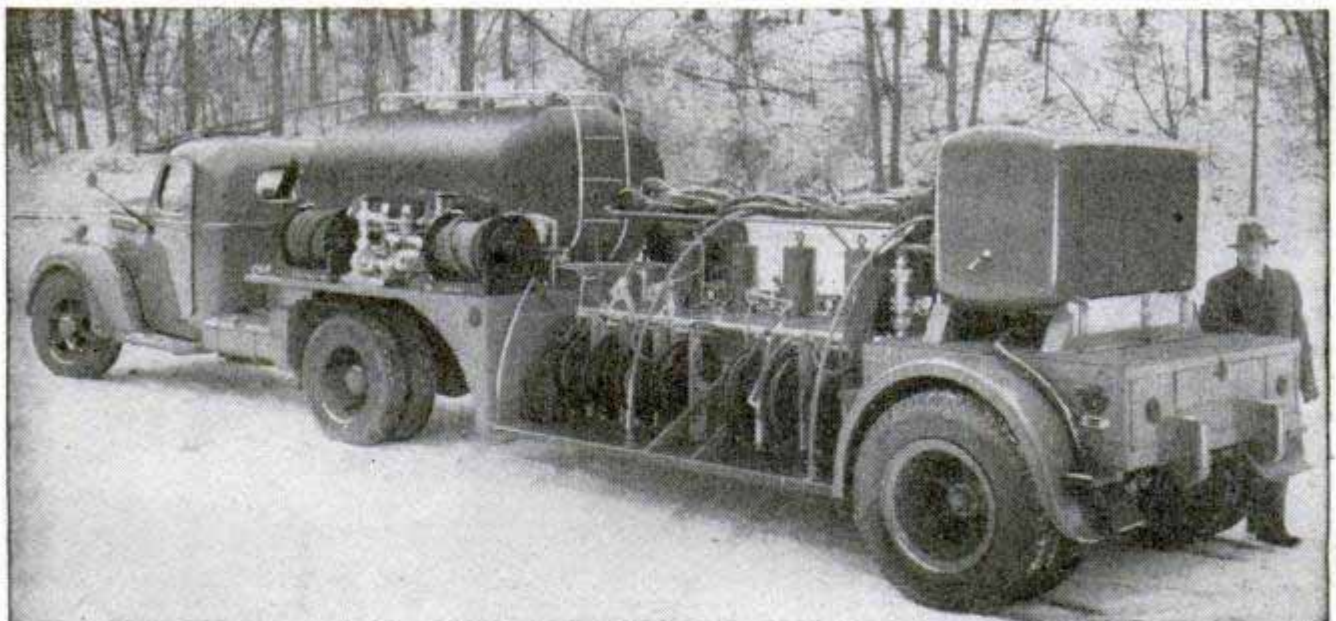

Mobile Service Station

Trucks on large construction jobs are serviced at the scene by a mobile service station with full facilities for maintenance. Mounted on a 21-foot trailer, the unit carries 700 gallons of gasoline and Diesel fuel,

200 gallons of oil and grease, 60 gallons of water, a supply of kerosene and a heavy-duty gasoline-driven air compressor. On each side of the assembly is a battery of nine hose reels for dispensing the materials. A crew of four can simultaneously service two trucks in 15 minutes.

FEUDAL CRAFTSMEN OF THE MOVIES

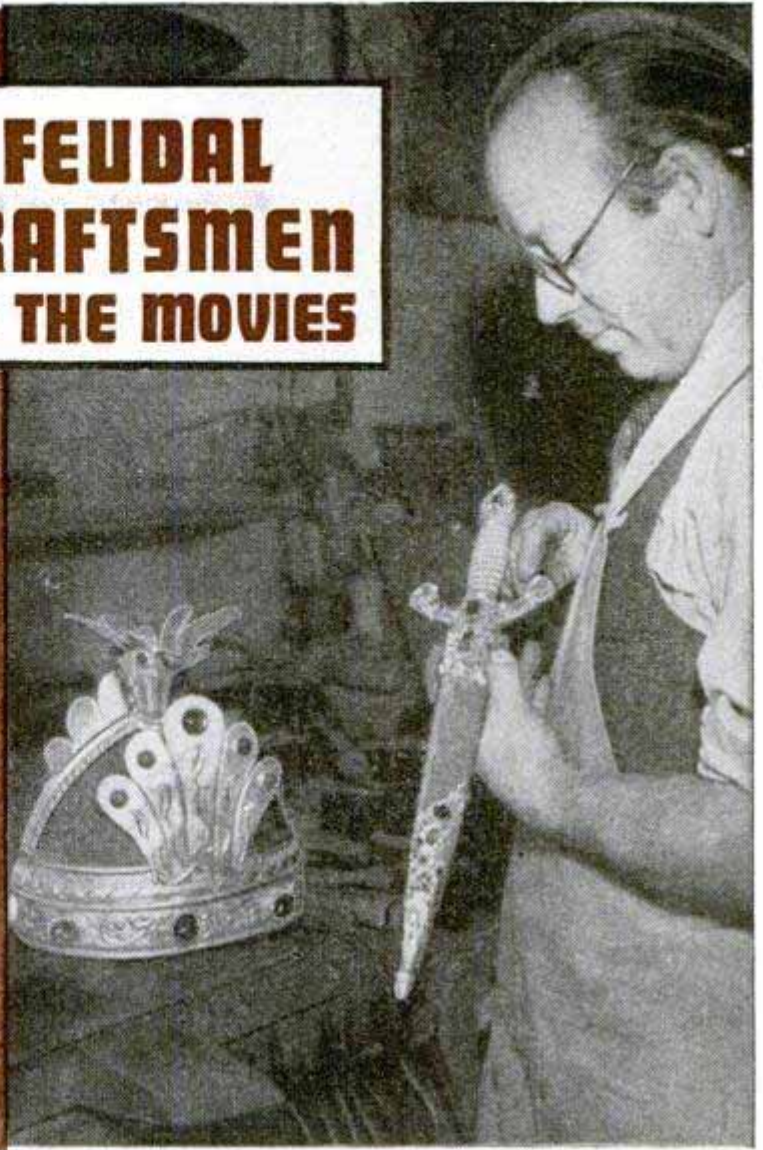
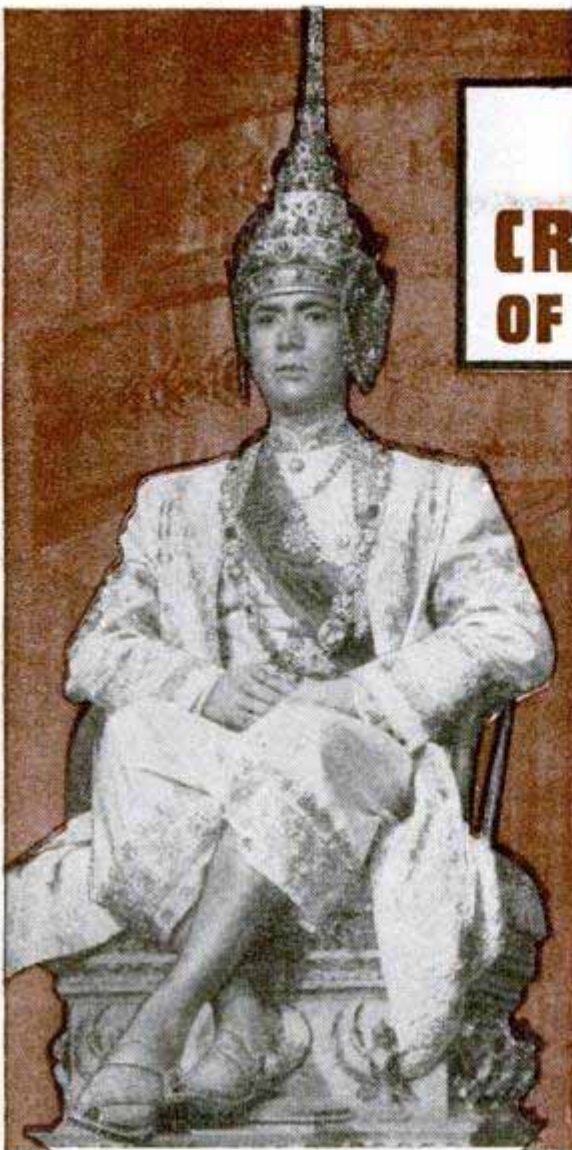

The gold and silver in the Hollywood reproduction of the Oriental headpiece (left) are real, but the stones are paste. Right, a skilled goldsmith works on a jeweled dagger and a royal crown for use in a recent film

THE MOVIE studios of Hollywood are modern counterparts of picturesque feudal baronages of the Middle Ages. Inside their walls artisans representing more than 80 crafts have revived many ancient skills.

Armorers are busy hammering out suits of linked mail, jousting lances, war shields and hooded visors. Bootmakers recreate thousands of pieces of footwear worn by man from the Stone Age to the present. These include prehistoric rawhide sandals, long-toed "Arabian Nights" crakows, the white leather boots of Hussar cavalry officers and bejeweled slippers of the court of France's Louis XIV.

Wax impressions of every known royal crown, scepter, jewel and decoration have been taken for moviedom's archives. Working directly from these molds, goldsmiths have reproduced the symbols of authority with uncanny fidelity. Although paste gems are, of course, used by the movie craftsmen, the bases of the replicas are made of solid gold and silver.

It's not enough that antique clocks and

By Mel Wharton

watches photographed on sets be genuine in appearance.

They must also run. This is called for when scripts require close-ups showing old pieces ticking off time. "Guildsmen" who repair these heirlooms have breathed new life into the all but obsolete craft of time-smithing.

What happens when a scene must show an Etruscan bronze plate? A dynastic Chinese metal teapot? The massive hinges of a medieval drawbridge? A Roman oil lamp? An ancient Grecian hand mirror or a Scottish claymore?

A drawing of the article is taken to a studio machine shop. There, usually working with the same metal as the original—wrought iron, bronze, pewter, copper or brass, although aluminum is becoming a favorite—the ancient piece lives again. But where once it took days to fashion certain items, the studio craftsmen using power lathes, hammers, drills, shapers and welding equipment turn out better work in minutes or hours.

Plying a trade that was old in Biblical

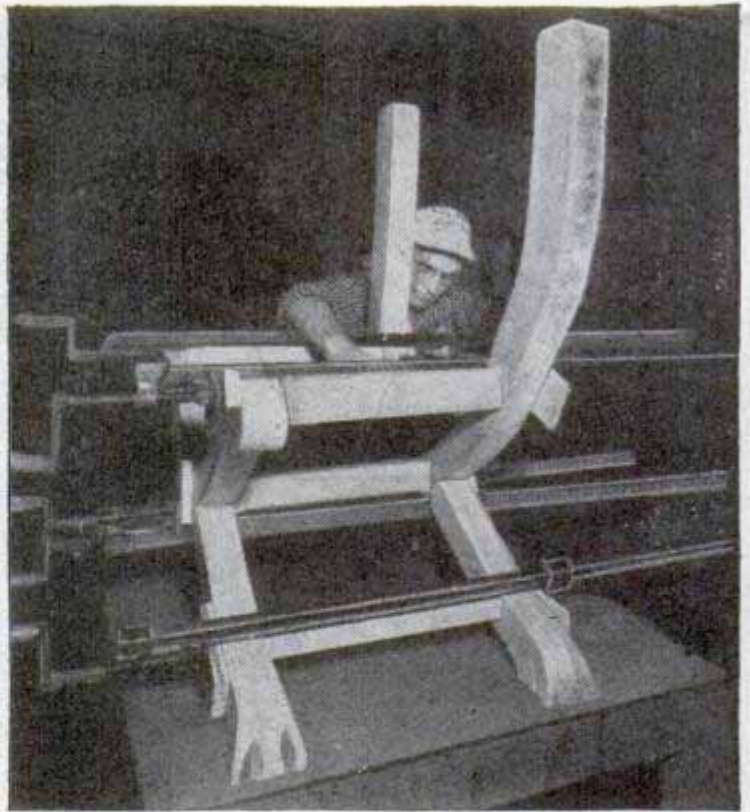

Left, not a museum, but a costume room in a studio. Right, a studio craftsman builds an "antique" throne prop

Coarse fabric worn by this actor was woven on the lot. His sword is studio made and the "stone" he's standing on is the product of plasterers

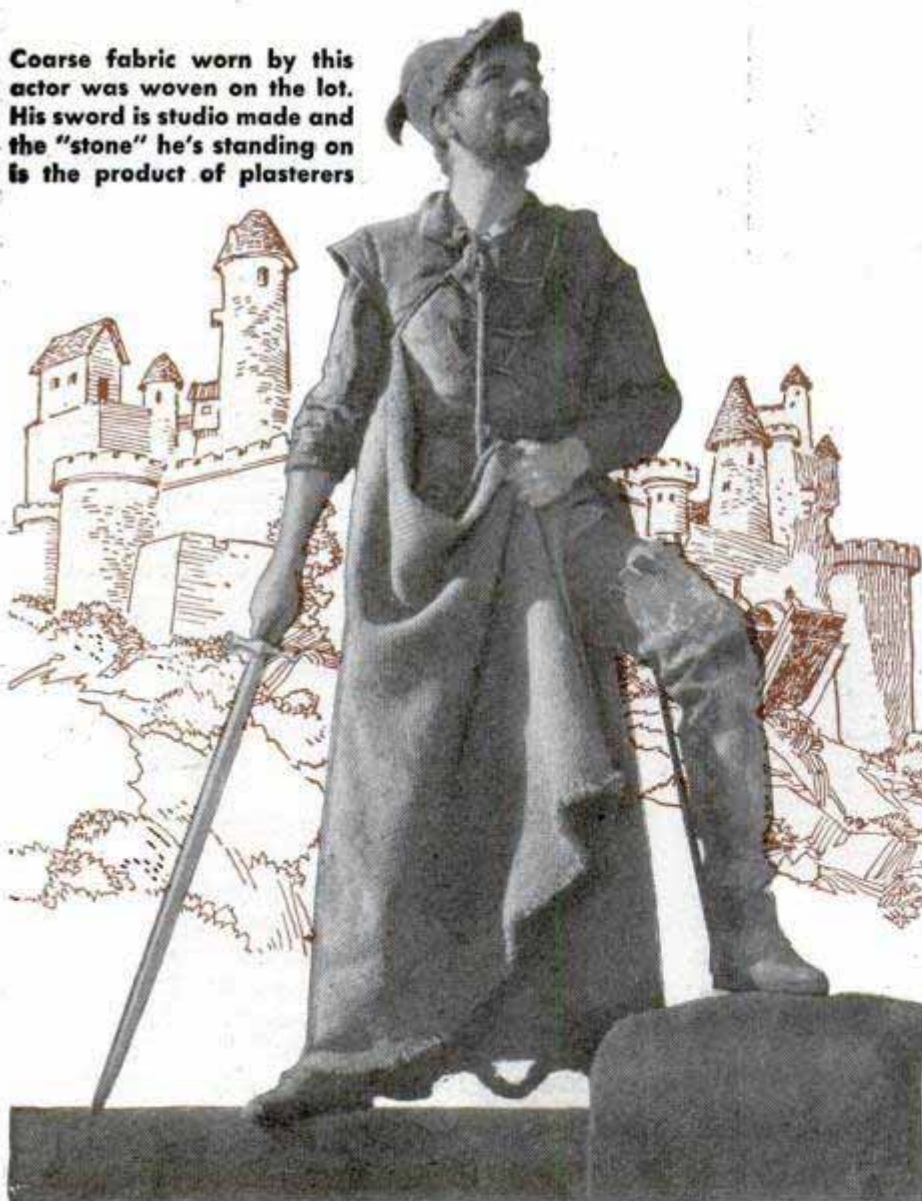

times, tile setters and terrazzo workers find no difficulty in translating the designs of any period into ornate walls, pavements and ceilings.

Several motion-picture lots have looms on which weavers turn out authentic copies of long-outmoded fabrics. Other craftsmen, using a technique which is centuries old, are reviving the all but defunct art of glass blowing. In the field of movie plaster work, some studios employ as many as 120 craftsmen. These skilled artisans can duplicate in plaster and color the carved frieze of a Greek temple, a bunch of bananas, a statue, an iron balustrade, a T-bone steak or the square face of London's Big Ben.

"In common with the great estates of feudal Europe, every big movie lot has enough of its own resources and talents to carry on independently," explained a producer. "There's no need to go outside for anything

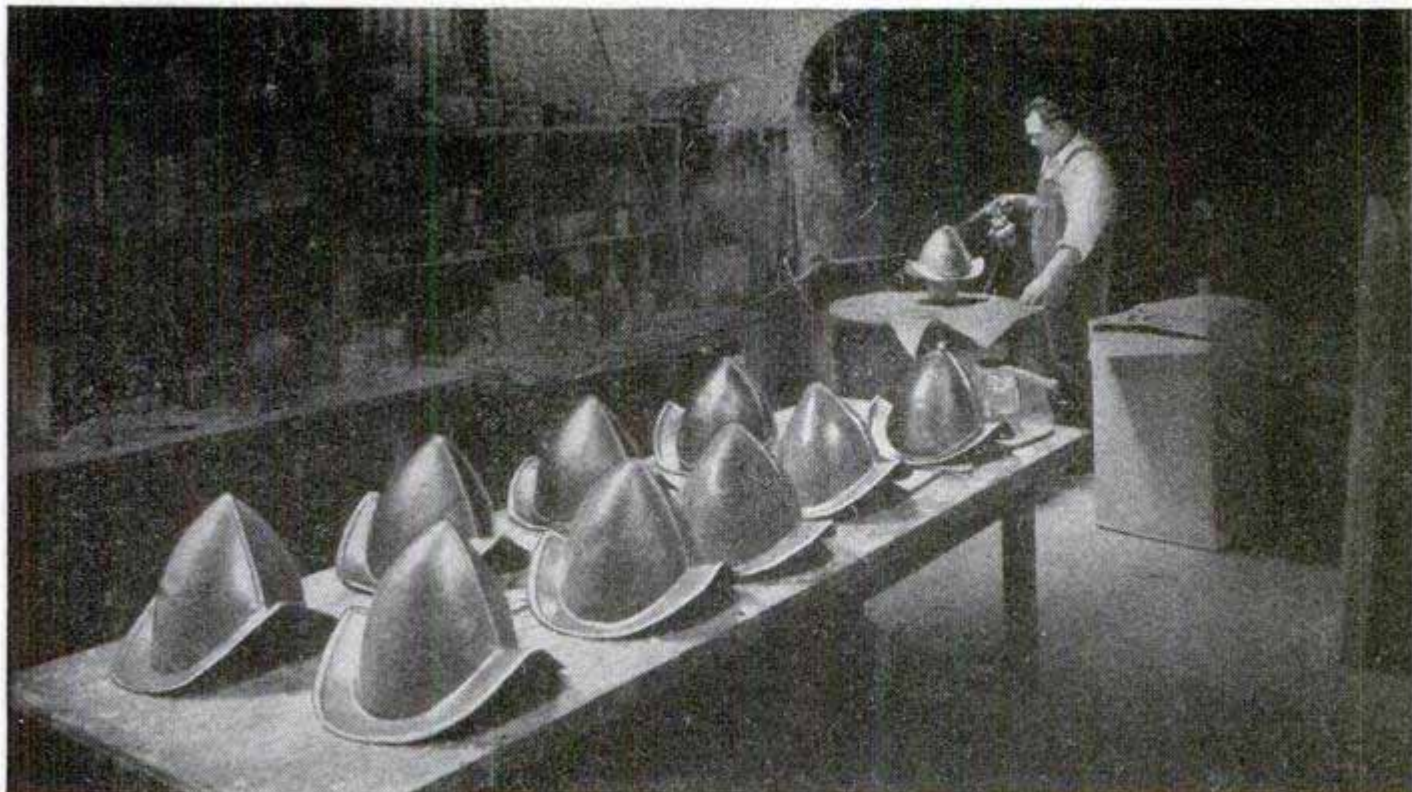

These cavalier helmets look like originals, but the craftsman of yore had no spray gun to speed his work

—not even a new dress, suit, hat or pair of shoes. There are tailors, dressmakers, hatters and cobblers, as well as barbers, beauticians, carpenters and painters.”

Hollywood's film baronages even have their own electric power plants standing by for use during interruptions in regular service. The plant at Warner Brothers can generate enough electricity to supply every industry, home and office in nearby Burbank, a city of 70,000 inhabitants. Sev-

eral studios have drilled artesian wells so they will be able to pump their own water when outside sources temporarily fail.

Next time you see a movie that features old Roman galleys and chariots remember that some 20th-century craftsmen, working with the latest type of power tools, built those galleys and chariots on a Hollywood lot. And very probably the modern versions are sturdier and more efficient than the originals were in their prime.

Movie plasterers are pouring "rocks" that will look like nature's own to the eyes of the movie audience



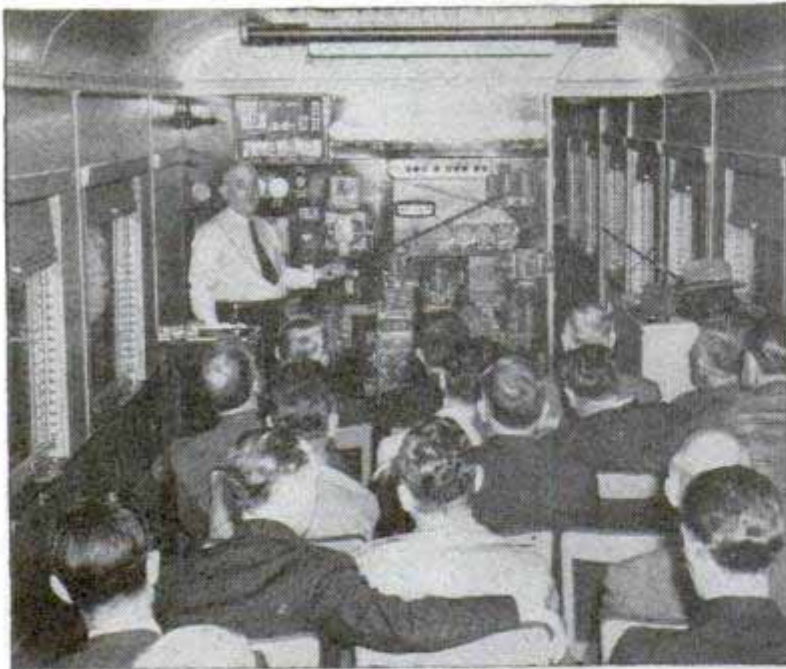

Traveling Classroom for Casey Jones

School travels to the students by means of a "traveling classroom" used by the Chicago and North Western Railway to instruct enginemen and mechanics. The classroom is a 70-foot all-steel car fitted with modern control equipment and training aids. The car's lecture room seats 35 employees. On the forward wall is a panel containing a battery of gauges and dials, which can be operated to demonstrate air-brake equipment. From a booth in the rear the instructor can project motion pictures or slides during his lecture. In another room of the car is a set of instruments which record time, distance, brake-cylinder pressure and brake-pipe pressure. Time-interval pens automatically mark this information on rolls of paper. The instruments record all the infor-



← Classroom's forward panel reproduces action of brakes. Above, instrument records all essential information about train. Below, instructor explains brakes



mation provided by a dynamometer car, the conventional test car, except drawbar pull. The car also has complete quarters for the instructor including a living room, bedroom, bath and kitchen. In eight months, more than 14,000 employees have been trained in the car.

All-Metal Shaper Fence for Drill Presses and Small Shapers

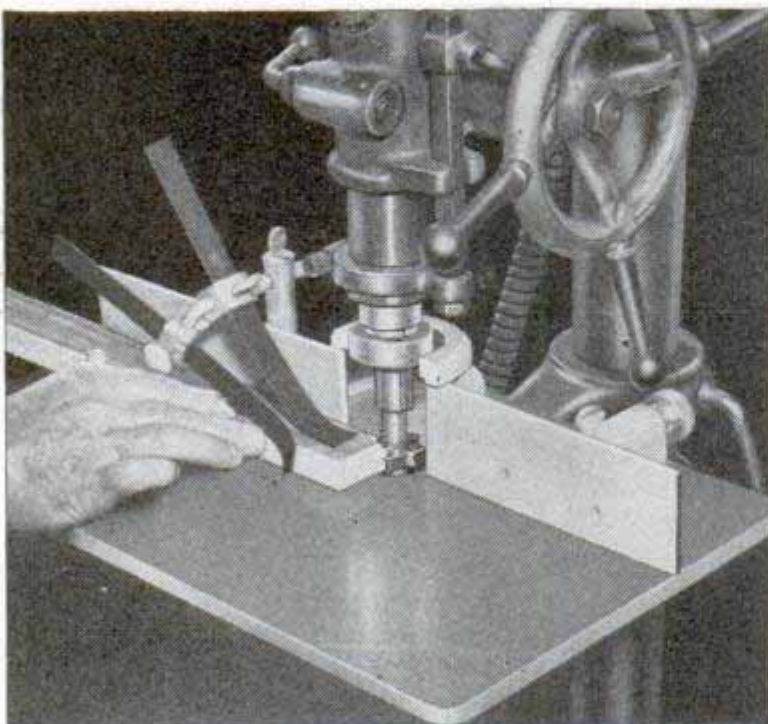

With guide plates of aluminum to eliminate warping, an all-metal shaper fence is designed to fit all standard drill presses and many small shapers. The right-hand face can be adjusted in and out by a knurled knob for variations in shaping and molding cuts. It accommodates various cutters up to 3½ inches in diameter. Two steel hold-down springs and anchor bolts are included.

You may wish to obtain additional information about the new products described each month in Popular Mechanics. If you want to know the name and address of the manufacturer or distributor, just write to Bureau of Information, Popular Mechanics Magazine, 200 East Ontario Street, Chicago 11, Ill.

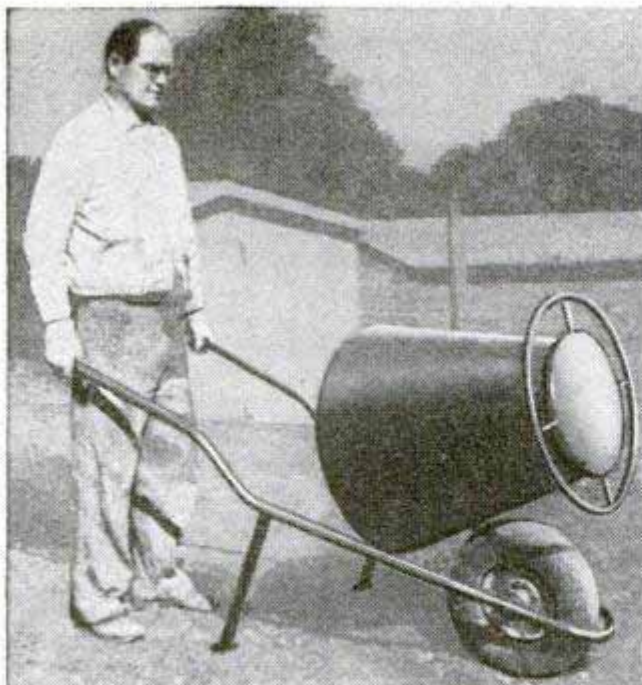

Wheelbarrow Has Mixing Hopper

For small construction jobs a wheelbarrow has a hopper in which cement can be mixed. The cone-shaped hopper is mounted on ball bearings and rotated by a handle on the lid. It is made of 16-gauge steel and has a capacity of $2\frac{1}{4}$ cubic feet. The wheelbarrow frame is made of steel tubing. A conventional body can be installed on the frame to move dirt or dry material.

"Okay Pass" Signal



Drivers will appreciate a light signal that tells when it is safe to pass the vehicle ahead. It is a lamp that attaches to the rear of buses, trucks or autos, on which the words "Okay Pass" appear when the driver presses a button.

Paperlike Insulation Defies Flame

Made of nearly pure asbestos and a mineral binder, a paperlike insulating material will not burn at any temperature. The material, developed by General Electric, is unaffected by most chemicals and can be processed in a modified papermaking machine in thicknesses less than the diameter of a human hair. The mineral binder in the material is clay. Superior to asbestos paper in thermal life and insulating properties, the material is made stronger by treating it with varnish.



Portable Drafting Kit Folds Like a Notebook

Convenient for draftsmen who work in the field, a portable drafting kit that folds like a large notebook is available in two sizes: $9\frac{7}{8}$ by $11\frac{7}{8}$ inches and $13\frac{3}{8}$ by $18\frac{7}{8}$ inches. Instead of the usual four drawing instruments, only two are necessary with the kit. One is an L-square that is squared on marginal straightedges. The second is a 45 by 60 by 75-degree triangle with the center cut in the shape of a quadrant to serve as a protractor. Thumbtacks are not needed in the kit as strong clips hold the paper in place.

Mirrors Form Sight for Golf Club

Two mirrors embedded in the head of a golf putter function as a sight in lining up strokes on the green. The upper mirror slants in the direction of the putt and the bottom mirror is parallel with the ground.



The golfer sights down the club until the hairline on the bottom mirror cuts directly across his eyes. He then pivots the putter until he can see the flag pin in the slanting mirror and center it on the sighting line. The head of his club then is in line for a perfect putt. Other sighting lines on each side of the center line of the slanting mirror permit aiming when the stroke must be off-center to allow for rolling ground.



America's Kingfish!

Top spot on our fish parade goes to the menhaden, a lowly shad relative that you won't find on the menu. But the 1946 catch yielded \$10,000,000 worth of oil, meal and dry scrap valuable to industry and the farmer. Annual take of 900 million menhaden represents 20 percent of the U. S. total fish catch. Based in North Carolina, a fleet of trawlers gets radio reports from airplane observers when fish are spotted. The boats speed to the scene to make their haul. The menhaden are cooked and oil extracted in coastal processing plants.

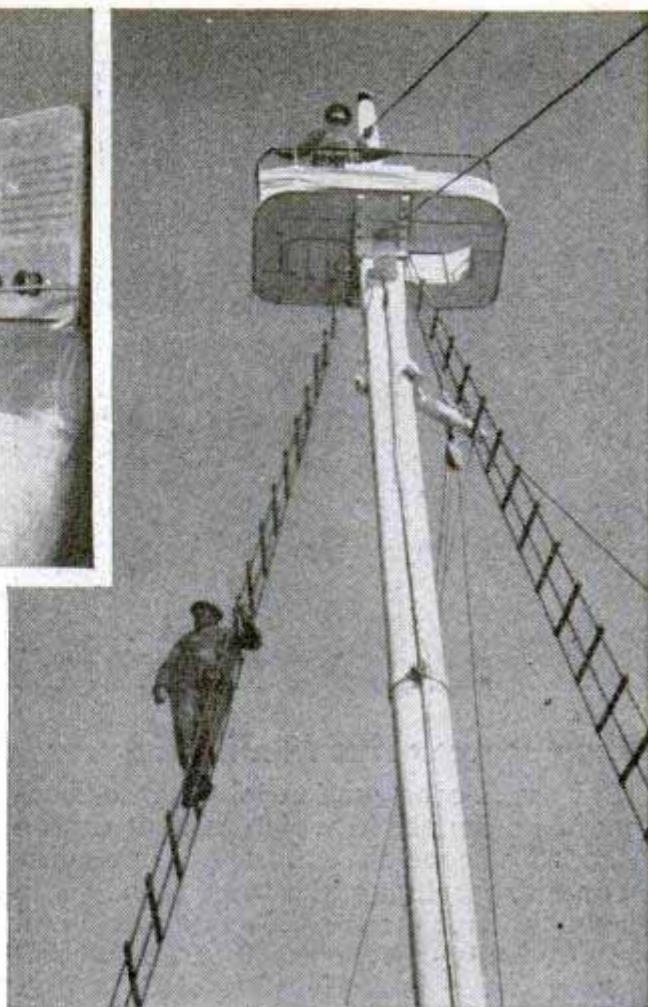

Top left, airplane spotter radios location of fish to fleet. Above, nearing the spot, lookouts watch for schools of menhaden. Below, unloading the catch

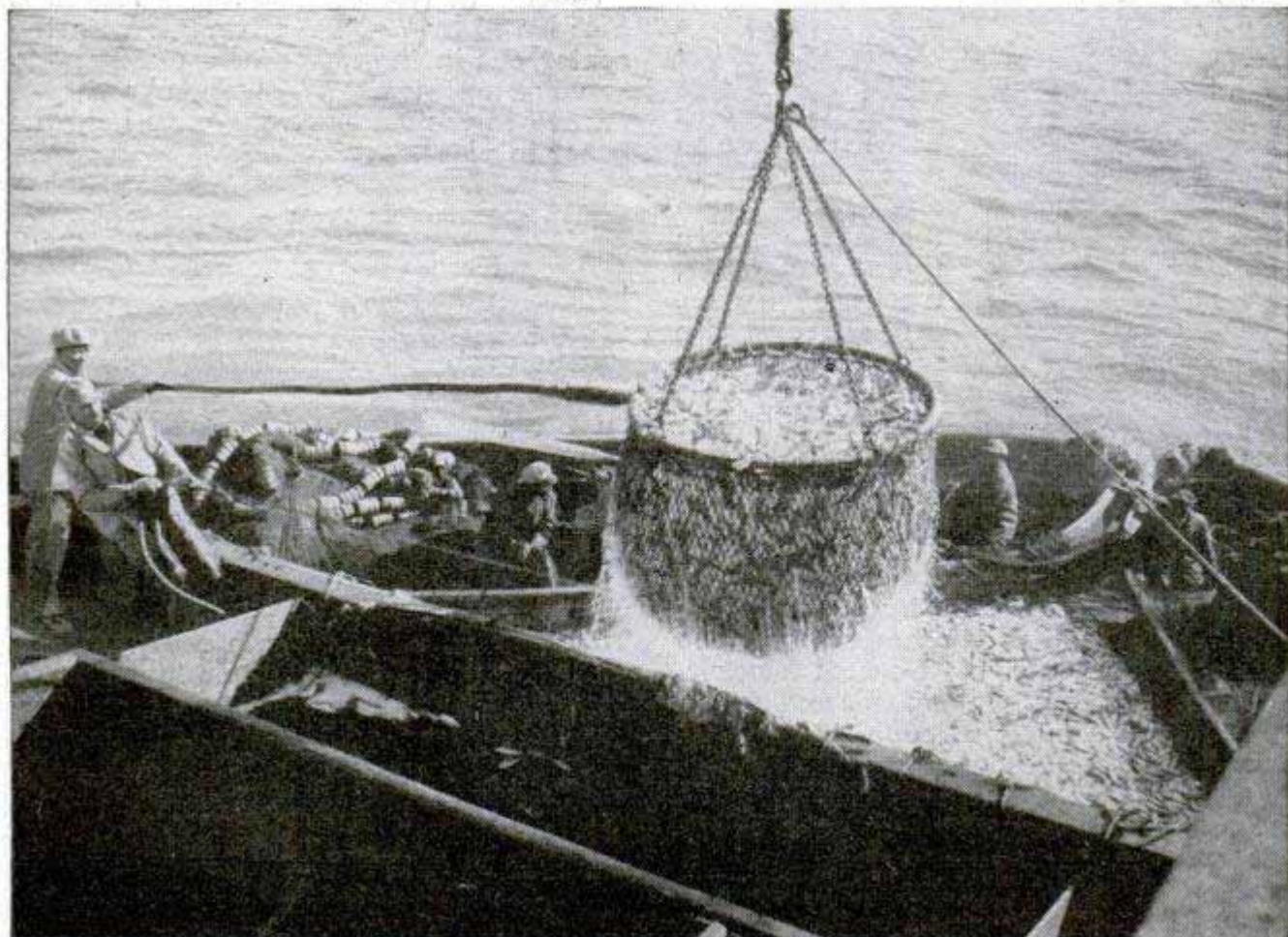

The CRAFTSMAN

★ This month we're top billing photo hobbyists with full instructions for building a 35-mm. slide projector. It has a lamp housing so designed that it can be built partly from plywood, which simplifies construction. Parts are all stock items readily obtainable. Turn to page 194.

★ Woodworking craftsmen will like the desk described on page 177, especially its "island" bases and simple, modern styling. The top and panels are made from plywood. False drawer forms a rigid base for a portable typewriter.

★ It's easier and cheaper to build an outdoor fireplace of poured concrete, and while you're doing the job, include an incinerator. Plans on page 170.

★ Rowing a canoe in the same way as you would a boat (see page 185) can be a lot of fun if you use a sliding seat and outrigger oarlocks.

SLIDE PROJECTOR

KNEEHOLE DESK

OUTDOOR FIREPLACE

ROWCANOE



OUTDOOR FIREPLACE of poured concrete

X286

By Hi Sibley

THE CLEAN LINES and massive appearance of this poured-concrete fireplace form an interesting center of attraction in the yard, and it will make possible many an outdoor feast on balmy summer days. The design includes an incinerator which is served by the same chimney as the barbecue grill, and a concrete smoke deflector prevents smoke from circulating from one firebox to the other. The wooden forms are easy to build and may be constructed from any kind of dry lumber. Forms should be oiled on the inside surface to prevent sticking to the concrete. Fig. 1 shows step-by-step construction of the forms, and the necessary dimensions are given in Fig. 3. The cutaway view, Fig. 2, indicates in perspective how the grates, chimney and deflector should appear.

Begin construction of the fireplace by digging the 4-in.-deep excavation for the slab foundation. After the concrete for the foundation has been poured and allowed to harden, use 9-in. boards to build up the sides of the main form to the bottom of the ashpit. At this time assemble the double form for the incinerator, placing iron bars for the grate so they will be embedded in the concrete. Note that the main-form cleats are triangular in shape and are nailed inside the corners, while on the incinerator they are located on the outside. Fill the main form and incinerator form up to the top of the 9-in. boards and allow the concrete to harden. Next, place the ashpit form in position, add boards to the main form until it is level with the top of the ashpit form, and pour

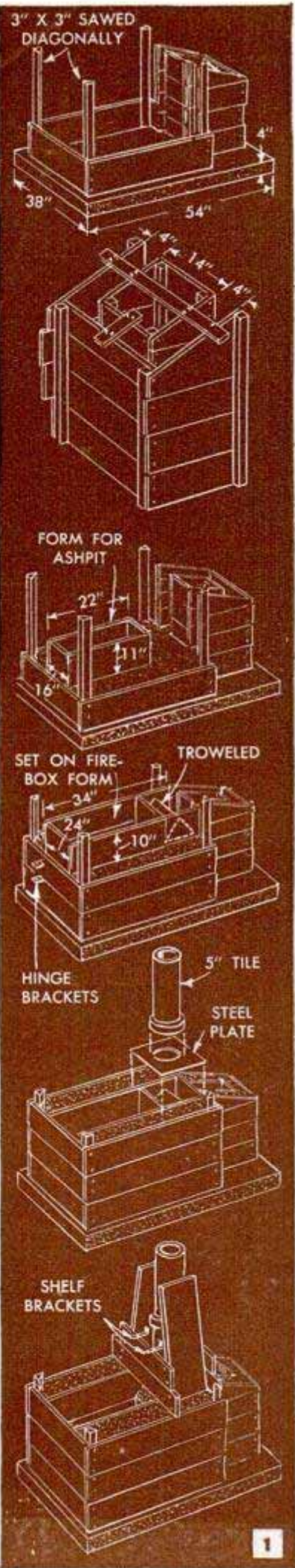

Screen Wire Stretched Firmly By Covering Two Frames at a Time

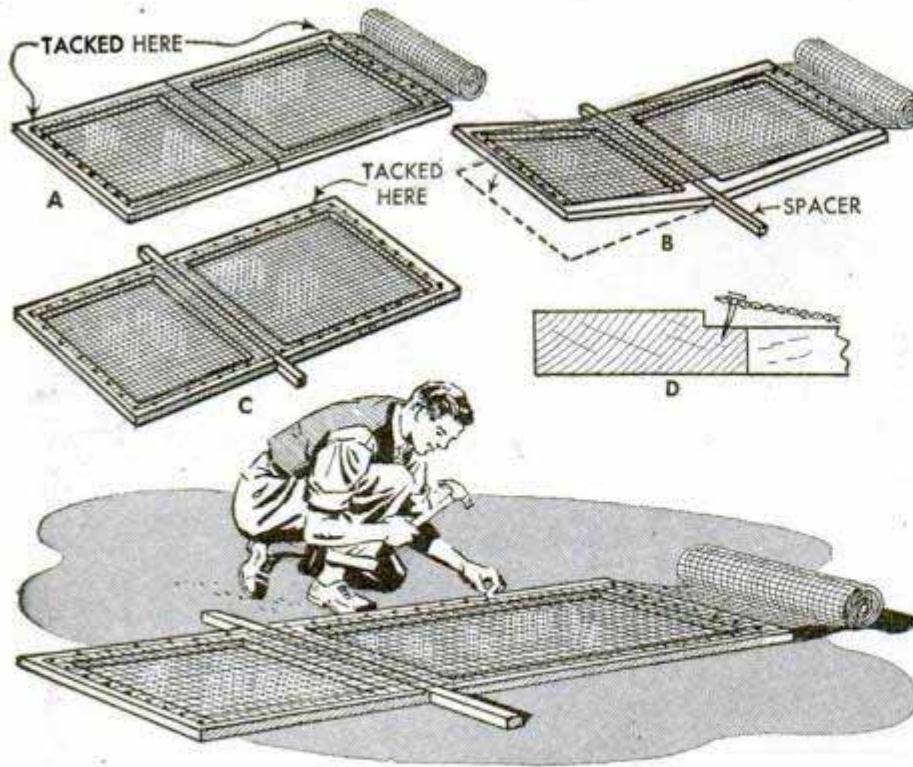

When renewing screen wire this spring, a taut, even screen can be had by covering two frames of the same width at one time. Start by laying the two frames end to end and tacking the screen wire to them as shown in A. Next, insert a wooden spacer between the frames, B, and force them flat to stretch the wire tightly. The wire is made taut crosswise by tacking one side of both frames, C, and applying tacks to the opposite side at an angle, D. Then tack the wire to the remaining sides of the frame and cut them apart.—A. W. France, Raritan, N. J.

Plaster-of-Paris Sanding Block Molded to Match Contour of Work

A quick, easy way to sand irregular-shaped molding is to use a sanding block of plaster of paris molded to the shape of the work. To form the block, cover an identically shaped piece of work or the work itself with a sheet of wax paper and carefully mold a thick block of plaster of paris on the wax paper to fit the contour. For small work, wood putty may be substituted for plaster of paris.



Removing Rusted Bolts From Car Springs

Recently when trying to remove the rear springs from my Chrysler, I found that the shackle bolt on the front spring hanger had rusted to the steel bushing. Penetrating oil would not free the bolt, nor would pounding with a heavy hammer. Not having a cutting torch at hand, I used a hacksaw to cut through the bolt at each side of the spring, and then knocked out the parts with a punch. As the bolt was not hardened, the hacksaw did the job.—D. W. Brentlinger, Richmond, Calif.

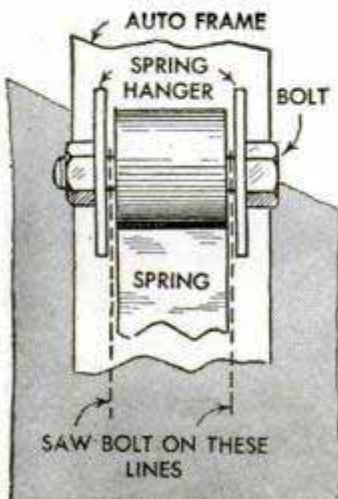

Shiplap Gives Bevel-Siding Effect

Shiplap will give the appearance of the more expensive bevel siding, if nailed to the studding in the manner shown. It is best to plane off the tongue from the bottom or starting board and also to use a furring strip under the base of this board to retain the bevel effect. Take care not to draw the lower nails too tightly or they may split the boards where they lap.—Herbert E. Fey, New Braunfels, Tex.

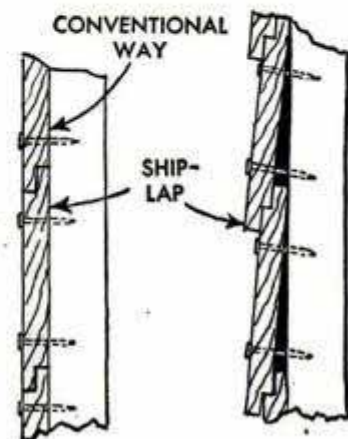

Four-Section Bin Stores Vegetables

Constructed of 1/4-in. plywood or hard-pressed board and mounted on a worktable or cabinet, this storage bin provides easy access to fresh vegetables and fruit in either the pantry or basement. It also may be modified to fit inside a cabinet in the kitchen. The bottom of the bin is sloped toward the front, permitting the vegetables to roll forward as the lower ones are removed. Note that a 1/4-in. opening is left along the lower edge of the back panel to allow ventilation. The bottom and sides of each section may be lined with sheet metal or oilcloth to facilitate cleaning. A standard storm-window sash will serve as a cover, or a suitable one may be made by building a frame from 1-in. stock and glazing with single-strength glass. A sash lift provides a handle for the cover.



Handy storage bin for fresh fruit and vegetables has glass-paned cover and compartments that slope toward front

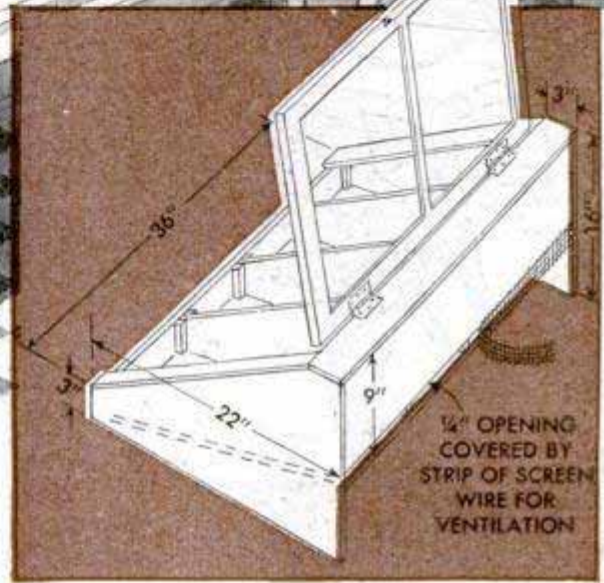

Self-Setting Garage-Door Prop

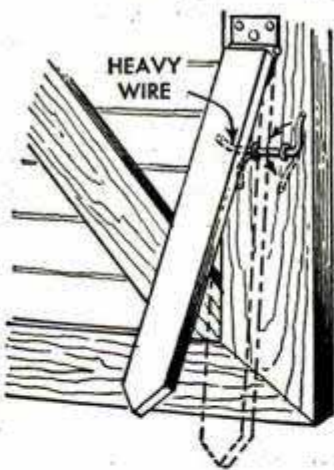

Here's a novel drag-type prop designed for swinging garage doors which automatically resets itself when the doors are closed. It is reset by giving the doors a slight jar when closing them. This causes the hinged prop to swing upward momentarily to allow a wire

trip lever to disengage the prop and permit it to drag when the doors are again swung open. To close the doors, the trip lever is set to hold the prop in a raised position. To install the prop, hinge a short wooden picket to the inside of each door so it extends about 2 in. below the bottom of the door when in the drag position. Then bend a trip lever from heavy-gauge wire and

fasten it to the door loosely with staples to hold the prop in such a position that it will clear the ground as the door is closed. The lever should be loose enough to drop down when the weight of the prop is removed from it momentarily as the door hits the frame. Be sure to attach the props several inches away from the outer edge of the doors.—Walter A. Humphrey, Reynoldsburg, Ohio.

Wire Hook on Oil Drum Holds Can for Filling

Filling a 5-gal. can from a fuel-oil drum is made easy if the can is held under the spigot by a wire coat hanger. Loop the hanger around the filler plug and form it to hold the can at the proper height.

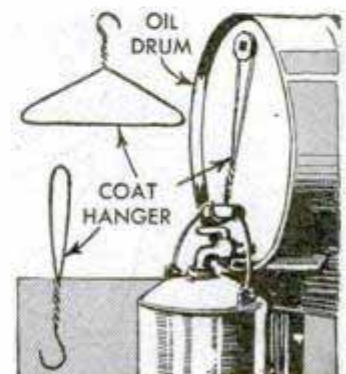

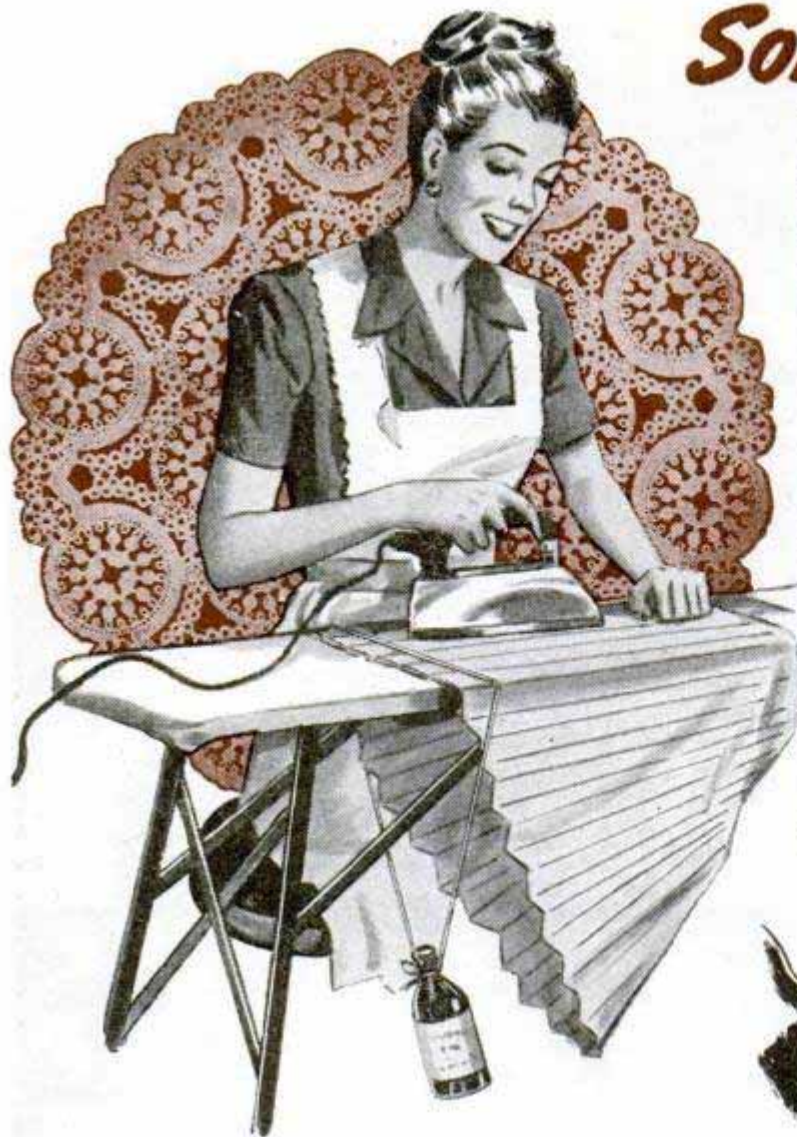

Pressing a pleated skirt is simplified by using a loop of string attached to a weighted object, such as a bottle, to hold the pleats flat. The pleats are pressed up to the string, and the string is removed before finishing. This is faster than pinning the pleats

Here's an idea that has been found effective in preventing tubular-metal furniture from marking linoleum. Just apply cellulose tape to each corner of the chair legs. Being transparent the tape is inconspicuous and is easy to renew when worn merely by peeling it off

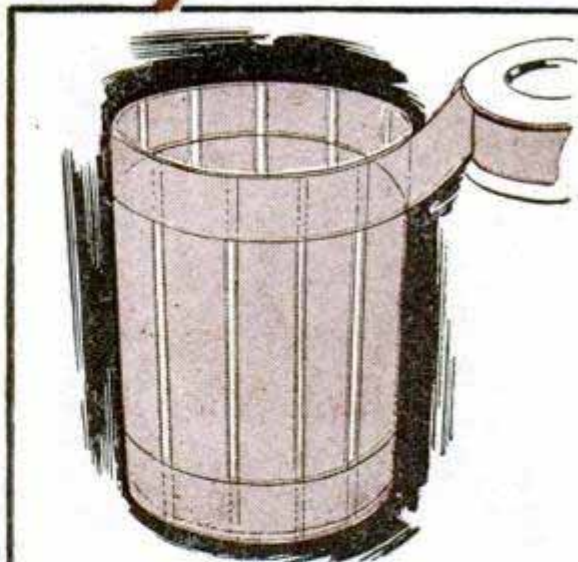

A drinking glass used by a small child who is apt to drop it can be rendered "shatterproof" by covering the outside and bottom with strips of cellulose tape



To remove a white ring caused by a beverage glass on a varnished surface, try rubbing the discoloration with cigarette ash moistened with water. Rub the ring gently with a piece of cleansing tissue and then finish with furniture polish. The ash acts like pumice

Scouring an oven encrusted with baking drippings is made easier if you first turn off the pilot lights and place a bowl of household ammonia in the oven and close the door. Fumes from the ammonia will loosen the charred drippings, making them easy to remove



PROBLEMS

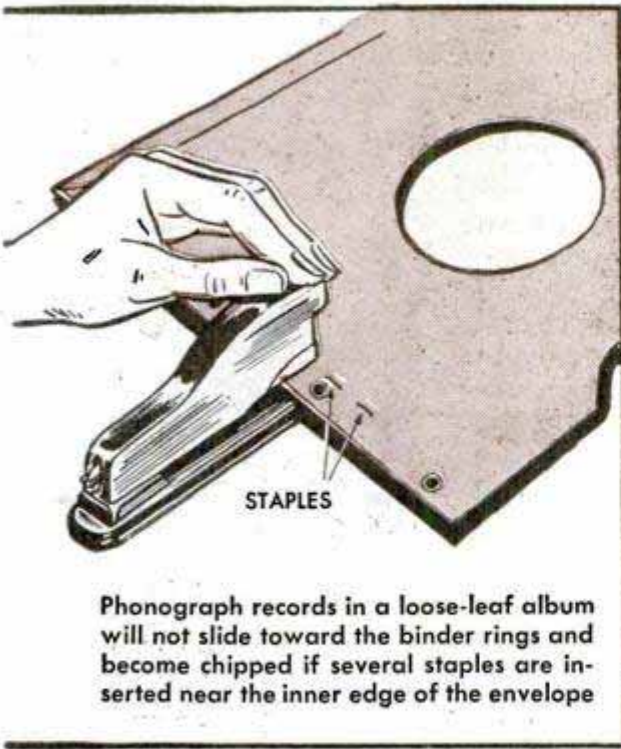

Phonograph records in a loose-leaf album will not slide toward the binder rings and become chipped if several staples are inserted near the inner edge of the envelope

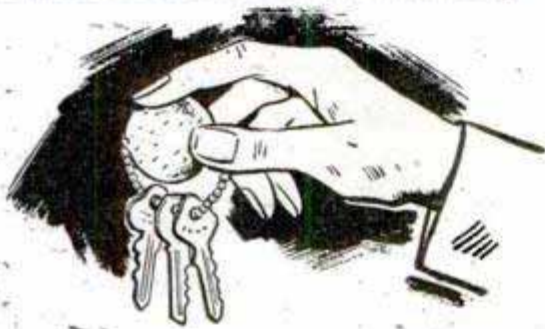
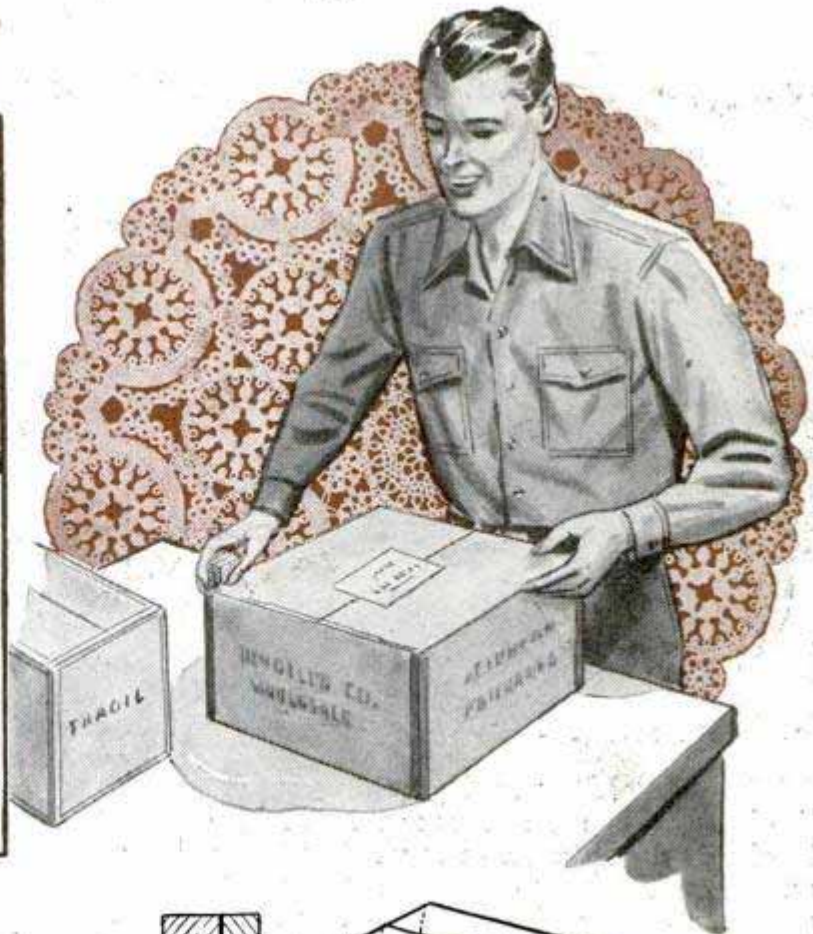

Household keys will be easy to find in a cluttered drawer if they are strung on a key chain threaded through a round cork fishline bobber. By painting the cork a bright color, it will stand out from other items in the drawer. A hot wire will burn a hole in cork

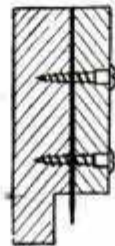

END VIEW

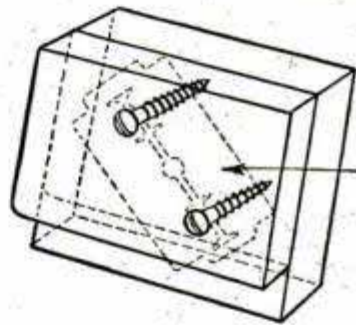

RAZOR BLADE

Sealed cardboard cartons received in the mail are easy to open with a simple razor-blade cutter. It consists of two wooden blocks, one being slightly larger than the other and rabbeted, between which a double-edge razor blade is clamped with two round-headed screws

When the steps of a stepladder become worn to the point where they are apt to split under normal weight, reinforce them with plywood. Use 1/2-in. plywood and cut it to the same shape as the step. Then attach to the top surface with glue and screws

Fumbling for the nail on which to hang a yardstick is not necessary if part of the lid from a baking-powder can is used as a cup to guide the end of the yardstick. Cut the lid in half and fasten it to the wall by driving a long casing nail through it at an angle

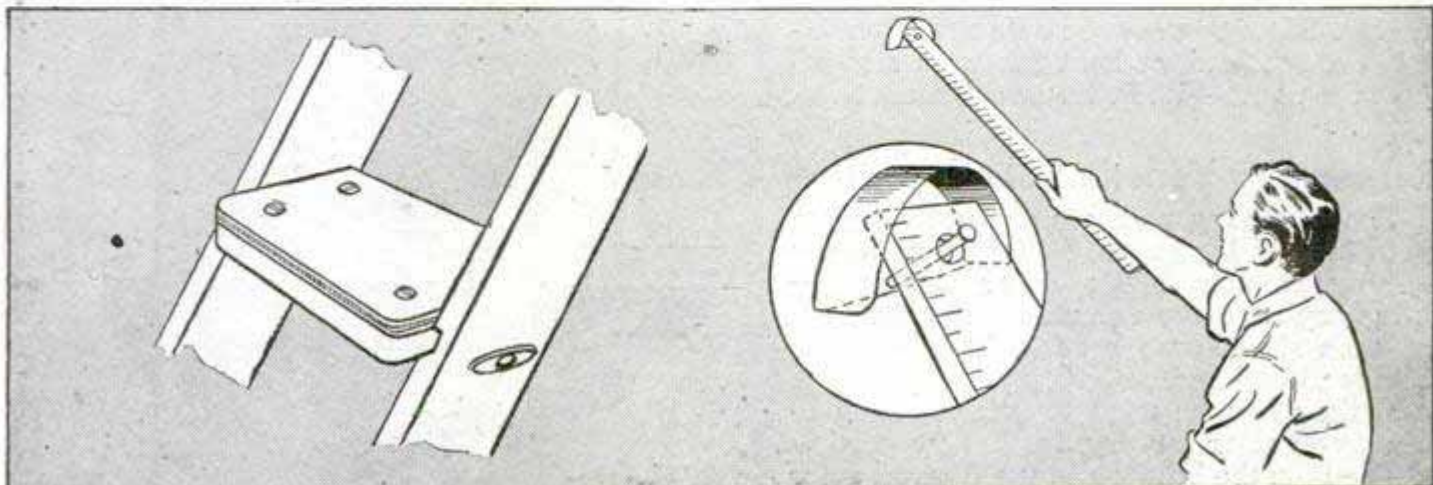

Meat Tenderizer Prepares Ground When Reseeding Lawn

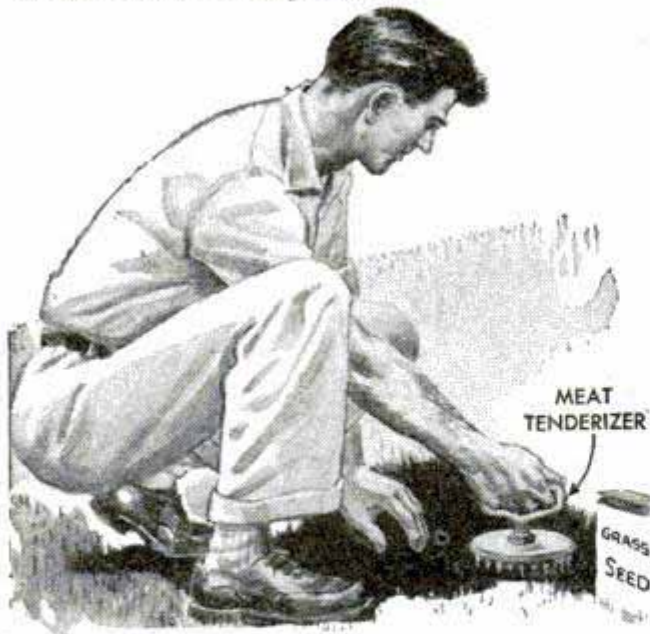

When reseeding and patching spots in the lawn where the grass is thin, difficulty is often encountered in loosening the soil without disturbing the grass. A household meat tenderizer of the type shown is ideal for this purpose. When pressed into the ground, the tenderizer loosens the soil and leaves small holes for the seed. At the same time, it does not uproot growing grass.

Harold E. Benson, Denver, Colo.

Garden-Hose Ring Supports Bushes



The spreading of small garden bushes may be prevented by supporting them with a ring made from garden hose. The ring is formed by inserting heavy-gauge wire and twisting the ends together. Three or four stakes are

used to support the ring at the desired height. Because the hose acts as an insulator, the sun cannot heat the wire and injure the plant.—W. P. Houser, Organ, N. M.

Renovating Venetian Blinds

The following pointers are useful when painting and repairing Venetian blinds having wooden slats: After taking the blinds apart, drive a small brad in the ends of each slat. These brads will enable the blinds to be handled easily while painting, and they can be used to attach string to hang the slats for drying. If new cord is needed for the blinds and the desired color

is not available, purchase white cord and dye it with a cold-water dye. In replacing the tape, select one that will not stretch and cause the slats to sag and hang unevenly.—Francis W. Henry, Pottsville, Pa.

Button on Safety Pin Protects Clothing

Clothing often will become caught in the coil of a safety pin and is apt to tear, in addition to making removal of the pin difficult. To prevent this, slip a button over the end of the pin. The button will act as a shield over the coil and protect the clothing material from possible damage. The button, of course, must be of a size that will permit the pin to close.—I. M. Fenn, Chicago.

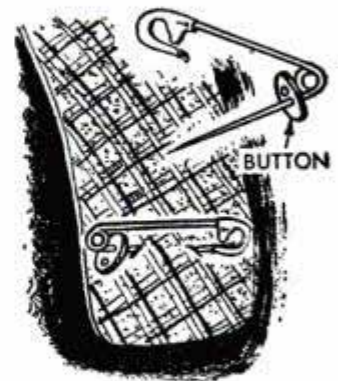

Chairs Form Improved Pen For Small Baby

Here's a stunt that is worth remembering when visiting friends, if you have a small baby and no playpen or high chair is available. Just take two dining-room, or other type chairs having stretchers, and place one upside down on the other as shown. Tie the legs together, place a pillow on the seat and you'll have a safe and comfortable enclosure in which to place the baby. The ends of the legs can be padded, if you wish, to avoid possible injury.



Furniture you can't find elsewhere

All-Purpose X218 KNEEHOLE DESK

HERE is the desk you've been waiting for—a big roomy one, good looking, with built-in typewriter slide, and designed to harmonize with both modern and traditional furniture. What's more, it is very easy to make. Ends, front and top are plywood, hardwood faced, which can be had in oak, birch, walnut, mahogany, etc. The rest of the desk is made of solid hardwood stock with inner shelves, partitions and other unexposed parts being made of soft and less expensive wood. Both end compartments of the desk are assembled as separate units. Cut out the three corner posts of each unit first.

By Willard Allphin

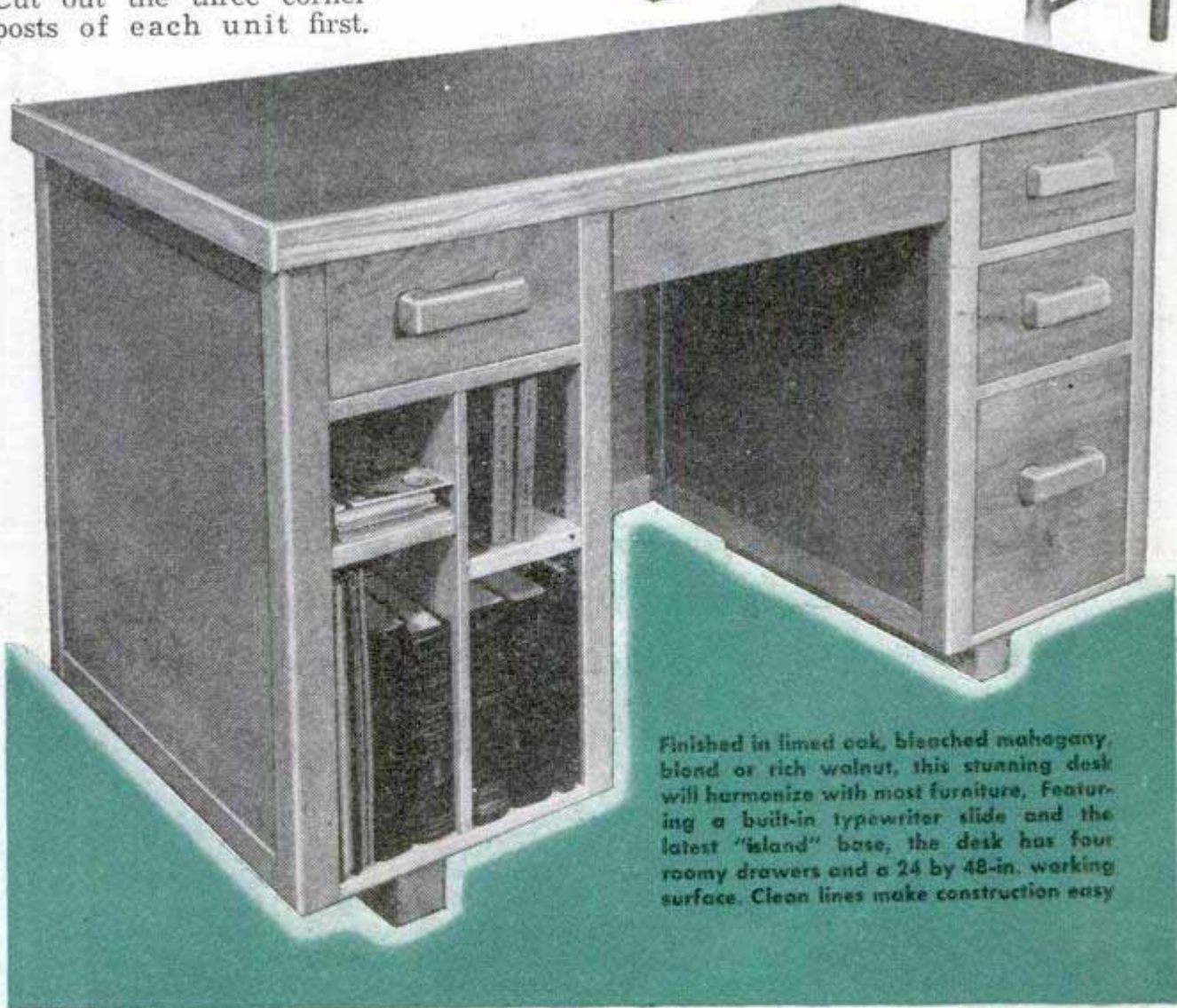
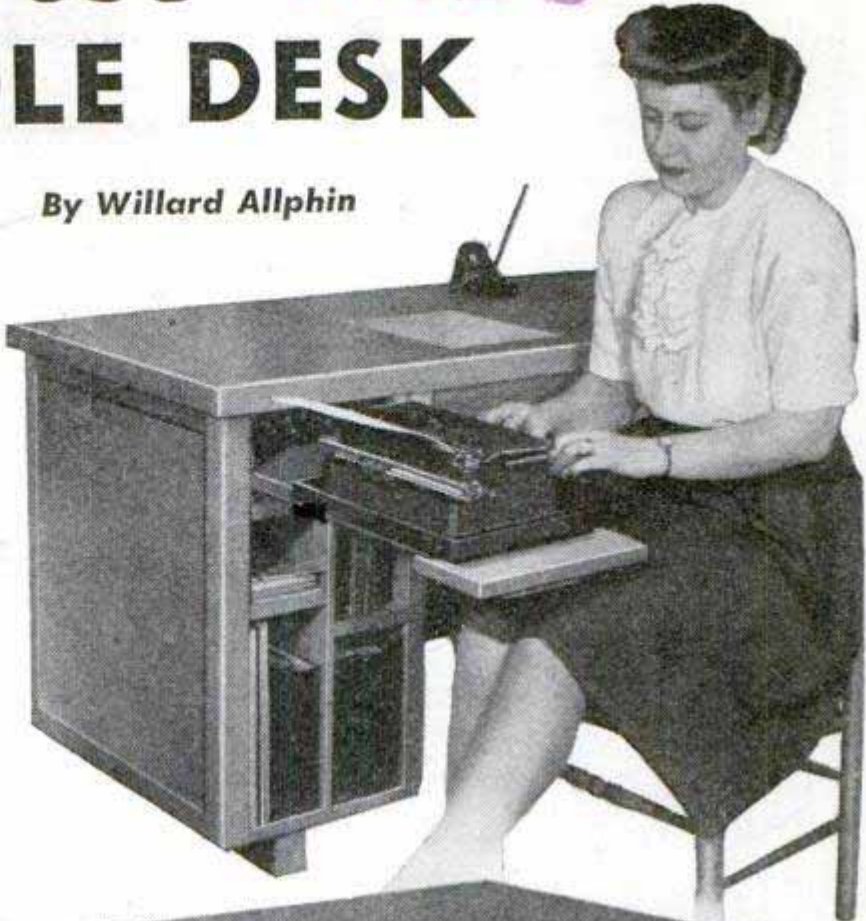

Finished in lined oak, bleached mahogany, blond or rich walnut, this stunning desk will harmonize with most furniture. Featuring a built-in typewriter slide and the latest "island" base, the desk has four roomy drawers and a 24 by 48-in. working surface. Clean lines make construction easy

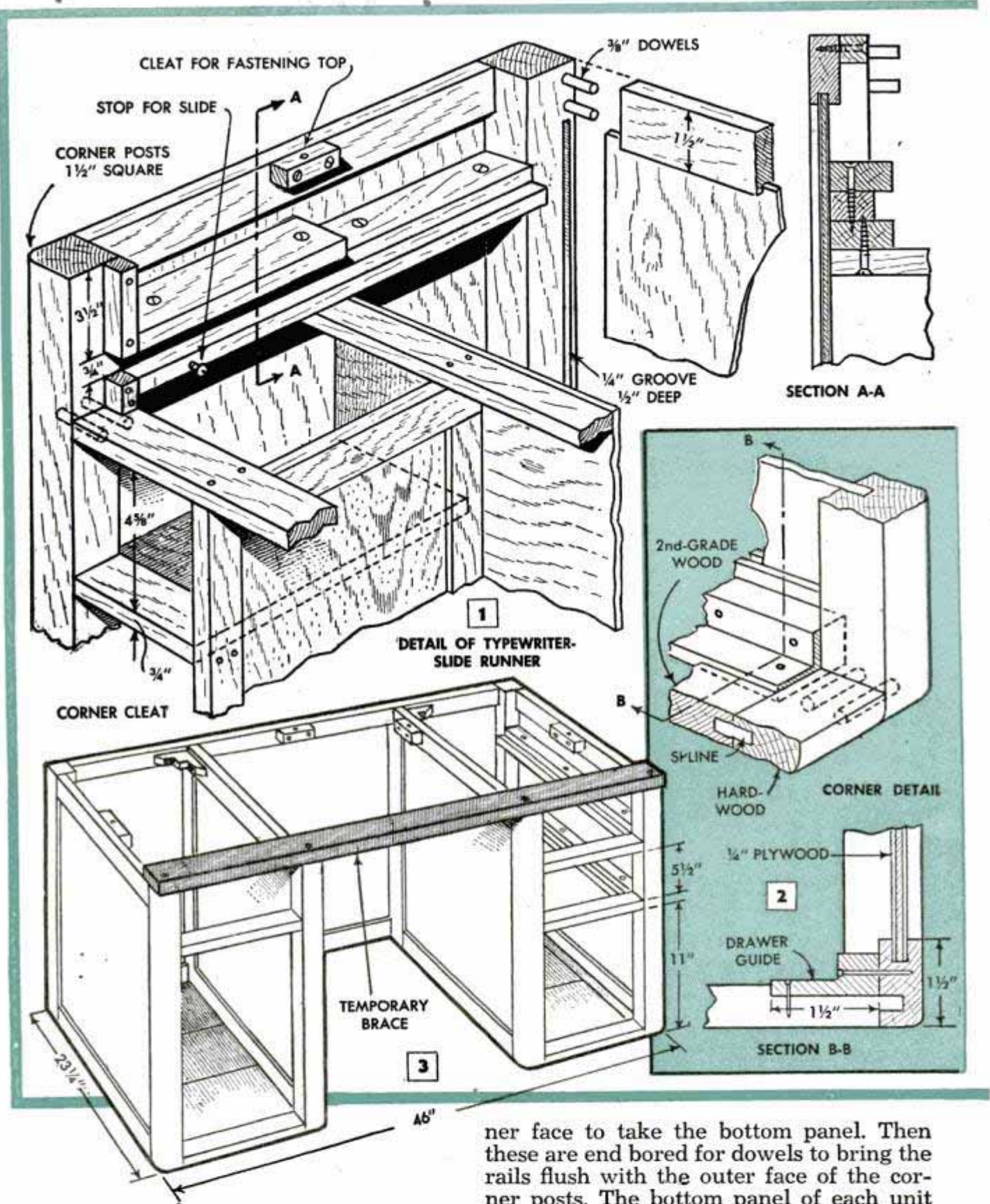

These are 1 1/2-in. square stock and are grooved lengthwise for 1/4-in. plywood. Note that the grooves are run 1/4 in. in from the outside edge and that they are stopped 1 in. from each end for dowel joints. The rear posts of each unit are grooved on one face only, whereas the others are grooved on two adjacent faces. All end rails are edge-grooved for the plywood panels, the lower ones also being grooved on the in-

ner face to take the bottom panel. Then these are end bored for dowels to bring the rails flush with the outer face of the corner posts. The bottom panel of each unit is made up of soft wood and the front edge is faced with a hardwood rail. The bottom panel of the right-hand unit differs from the other in that a shallow groove is run along each edge for an L-shaped drawer guide, as detailed in Fig. 2. The outer corners of all posts and the lower edge of all bottom rails are rounded 1/2 in. The panels of the kneehole are made the same size as the end panels, except that the edge which butts against the front panel is edged with

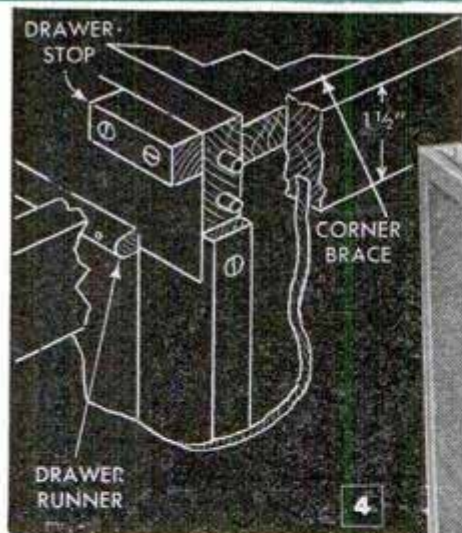

Detail above shows how knee-hole panels are notched and doweled to front panel. Note corner brace is screwed to inside

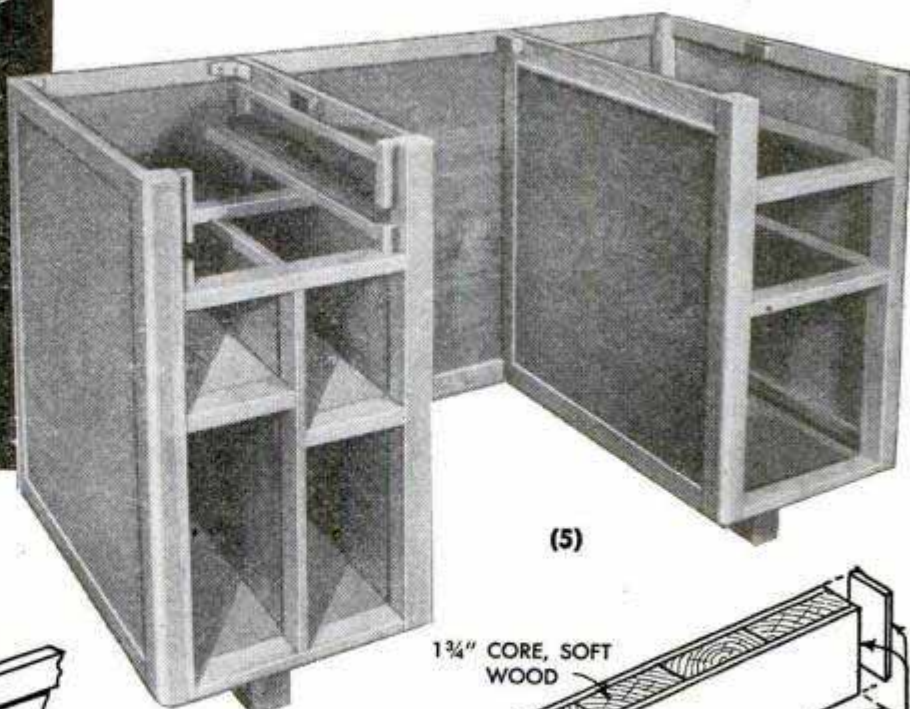

(5)

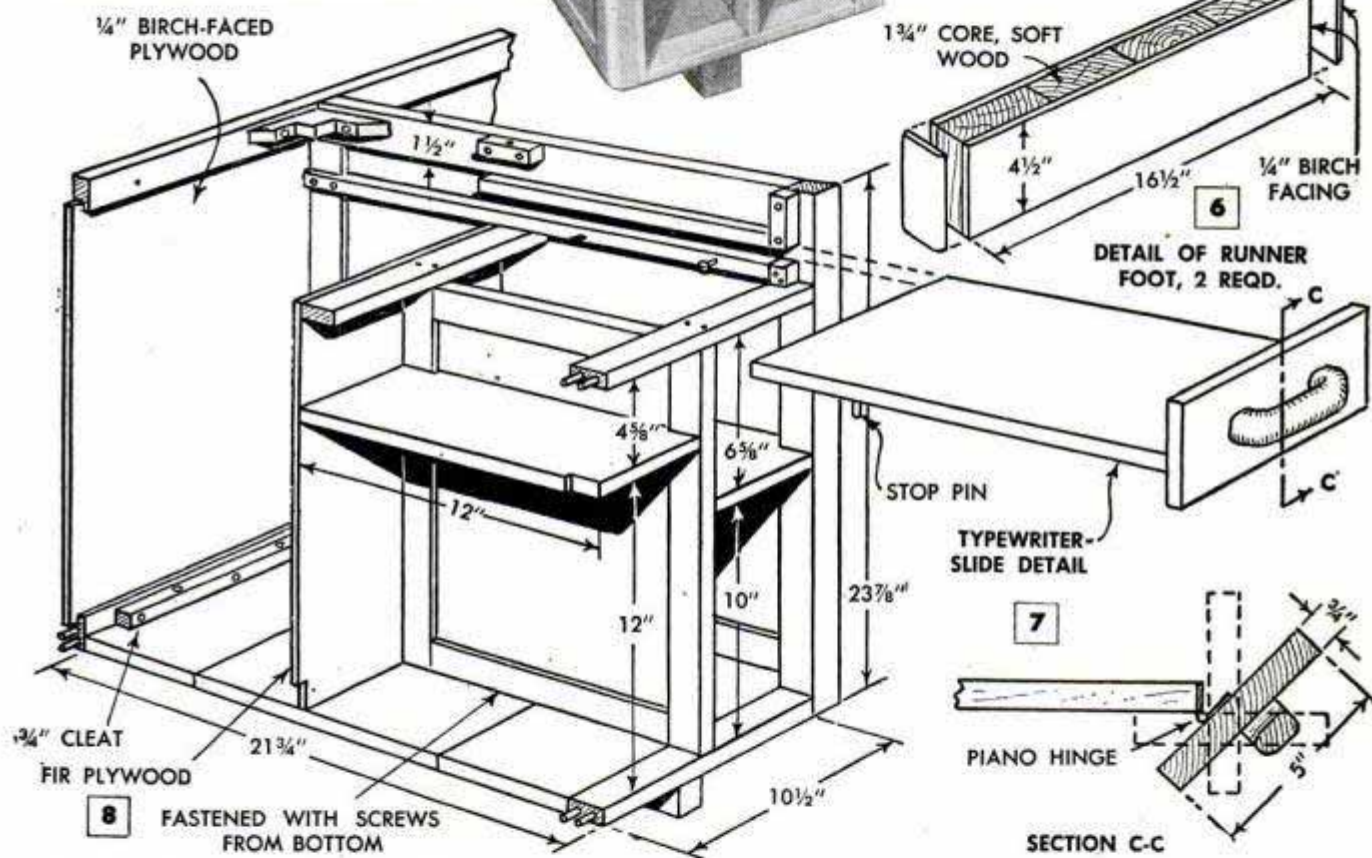

DETAIL OF RUNNER FOOT, 2 REQD.

STOP PIN
TYPEWRITER-SLIDE DETAIL

SECTION C-C

a $\frac{3}{4}$ -in. member notched to fit over the lower rail, Fig. 3. Fig. 4 shows how a notch is formed at the top, after which the piece is doweled to both rails at the top and bottom.

Start assembling the parts by gluing and clamping together the rear ends of the units. Follow this by gluing and clamping the outer end panels to them. When this is done, place a brace diagonally from post to post and nail temporarily to hold the assembly square while the glue is drying. Next, put in the dustproof bottom panels and then add the knee-hole panels. Finally, glue and clamp both assembled units to the

front plywood panel. In doing this, fit the dowel joints of the knee-hole panel first. When dry, spring out the corner posts to engage the dowels in the ends of the rails. Your desk should now look like Fig. 3. Note that a temporary wooden brace is placed across the two units to hold the assembly square.

Fig. 8 details the book compartments for the left-hand unit, and you'll notice that these do not extend the full depth of the unit. Here, the shelves are edge-faced with hardwood as before, the facing strips being fastened to the posts with screws driven from the underside and at an angle. Figs.

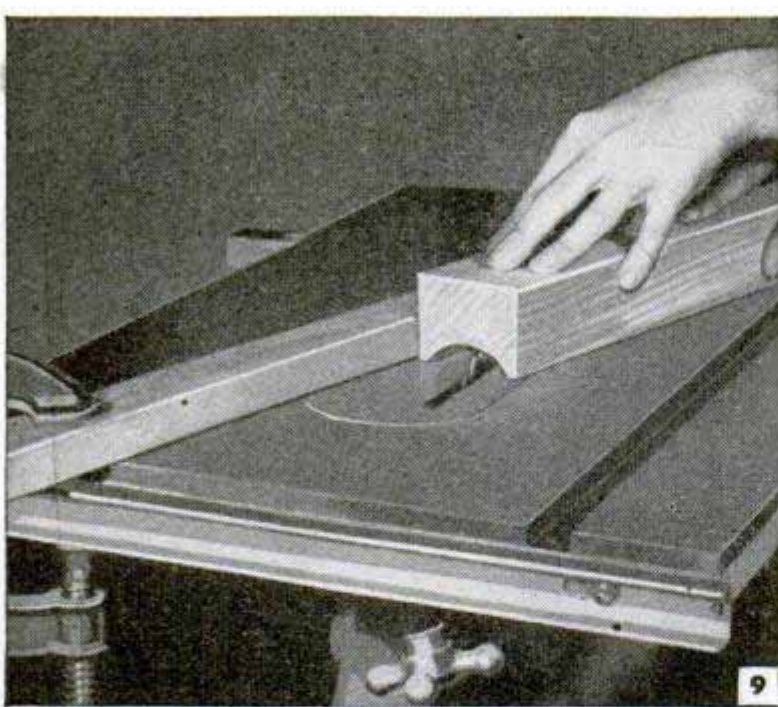

9

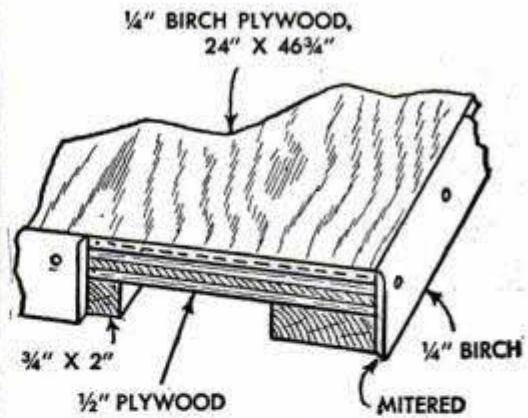

10 HOW TOP IS BUILT UP

Here is how the thickness of the top is obtained. Two thicknesses of plywood, plus $\frac{3}{4}$ by 2-in. battens, form core which is faced around the edge with $\frac{1}{4}$ -in. hardwood

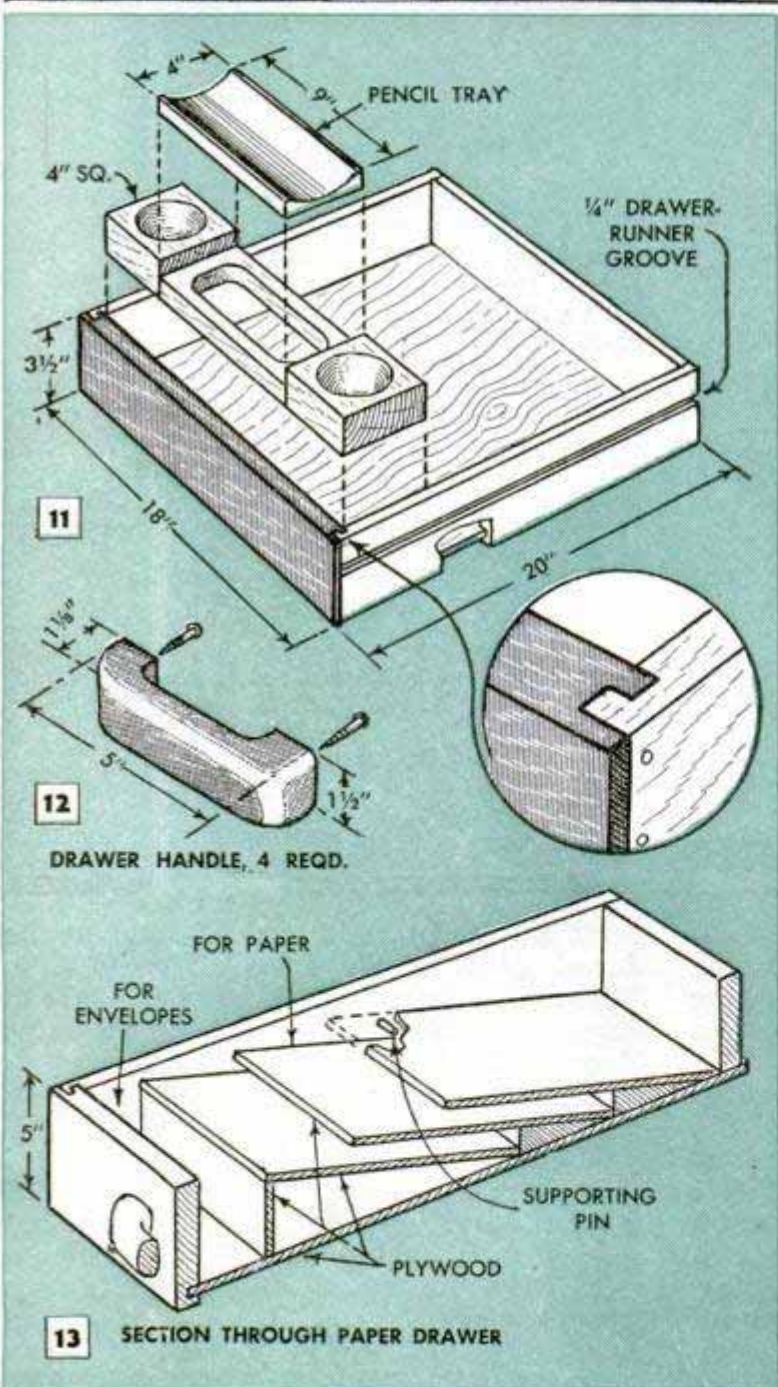

1 and 8 show how the guide is installed for the typewriter slide which folds up to represent a drawer when not in use. Section A-A shows how three strips placed on top of one another form a channel for the slide. Construction of this varies slightly when installing it on the opposite side, as shown in Fig. 8. Fig. 7 details the slide itself and how the front is hinged.

Next come the bases. These are of the popular "island" type and are built up as in Fig. 6. A core of softwood is faced with $\frac{1}{4}$ -in. hardwood and then counterbored holes are made through the core for attaching the base to the bottom and in the center of each unit. At this point the desk should look like Fig. 5. This brings you to the construction of the top, Fig. 10, which is built up of two panels of plywood, one being of $\frac{1}{2}$ -in. fir plywood, and the other $\frac{1}{4}$ -in. hardwood faced. These are glued together and backed with five $\frac{3}{4}$ by 2-in. strips, which run lengthwise to add thickness and provide a gluing surface for a $\frac{1}{4}$ -in. edging.

The drawers are detailed in Figs. 11, 12 and 13. The center drawer has no handle. Grooves cut in the side of the drawer, ride over runners which are bradded to the sides of the kneehole panels. Fig. 9 shows a method of cutting the pencil tray by repeatedly passing the work across a rotating saw blade at an angle.

HAMMERED COPPER BOWLS



By Dick Hutchinson

HAND-HAMMERED copper bowls, Fig. 1, provide beautiful ash trays and serving dishes. They are especially attractive when set in a wooden base such as red cedar. To hammer a copper disk into a bowl having the same top diameter as the disk, right-hand detail, Fig. 4, use a ball-peen hammer and an anvil, as in Fig. 2. Direct each hammer blow toward the edge of the disk, but be careful not to hit the extreme edge as this will expand the metal and increase the diameter of the finished bowl. Hammer the entire surface once, and then anneal the disk by heating it to a cherry red and plunging it in cold water. Continue hammering and annealing in this manner until the desired shape has been attained. The top may be curved inward by holding the bowl in the hand and tapping around the rim with the planishing end of the hammer. Trays and flat-bottomed bowls are formed on a hardwood block, hammering around the edge and in toward the center as shown in the left-hand detail, Fig. 4. To flare the rim, hammer it against the edge of the anvil, as in Fig. 3. When the bowl is completed, lacquer it to prevent tarnishing.

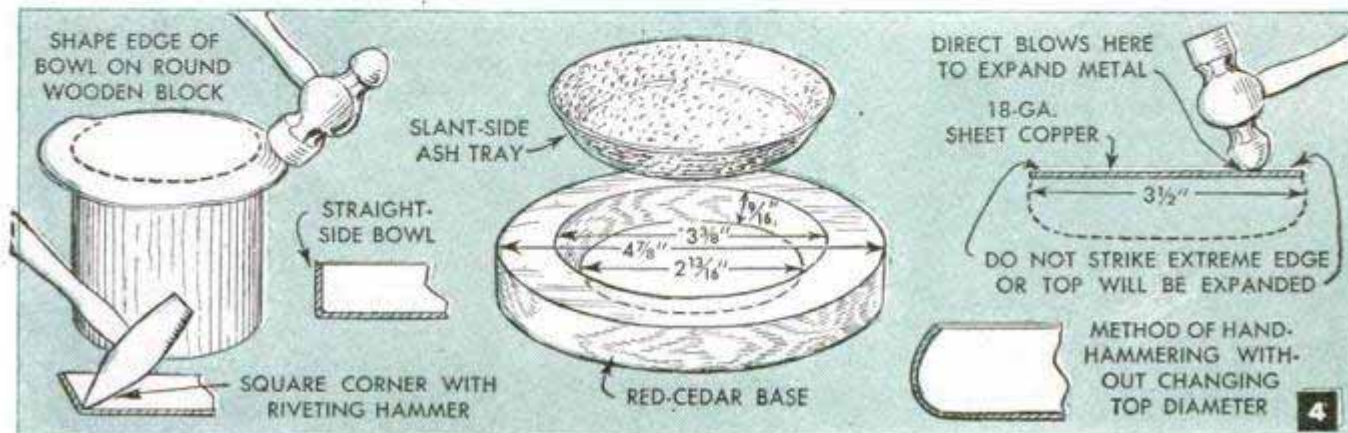
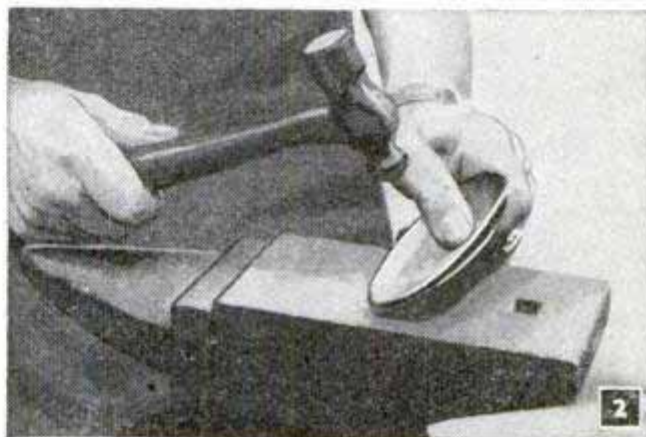

Multiple Lawn Sprinkler on Rollers Moved Without Damaging Sod

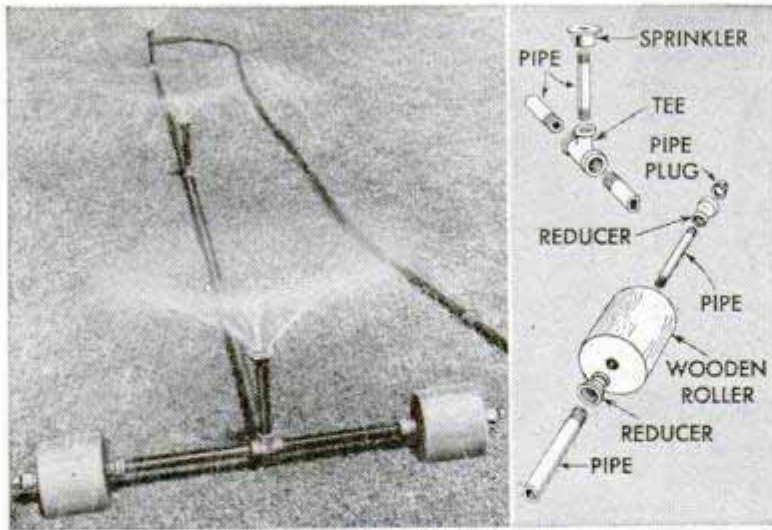

This multiple lawn sprinkler permits the watering of large areas at one time, and the wooden rollers allow it to be moved about without damage to the lawn. The unit is assembled from pieces of pipe and standard fittings, and the rollers are turned from wooden blocks. Outlets are spaced at intervals along the length of pipe so that the spray will cover the largest possible area. Any of the various types of stationary and rotary sprinkler heads or spray nozzles may be attached to the outlets. The rollers are held on the axles by pipe reducers and a pipe plug is inserted in the end of each outside reducer. Assemble all fittings with pipe compound.

Small Table Lamps Easily Modernized to Give Soft Indirect Light

Small table and boudoir lamps can be converted easily to the more modern hurricane lamps which give an indirect light, by fitting them with a glass shade taken from an old-type chandelier. If the lamp has a harp-type shade holder, this is discarded because, if a cloth shade is used in addition to the glass one, the cloth shade simply rests on the top of the latter. The glass shade is attached to the lamp socket in an inverted position, as shown, using a standard metal shade holder, which also can be taken from the chandelier. The socket on the lamp must be the type that has threads for screwing on the holder.



Typewriter Eraser Saves Fingers When Starting Small Brads

Tiny brads difficult to hold between the fingers can be driven easily when held in the edge of a typewriter eraser. Cut several slits about $\frac{1}{4}$ in. deep in the edge of the eraser to take the brads. When a brad is started, the eraser is pulled free and the brad is driven home, or a number of brads can be started and then driven all the way. If a brush-type eraser is used, the brush part will serve as a convenient handle. The bristles can be shortened, if you wish, to make a stiffer handle. Cut off about $\frac{1}{2}$ in. of the bristles.

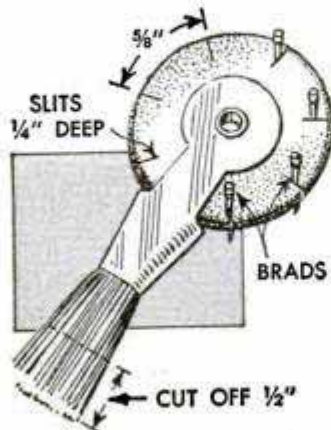

Locating Inner-Tube Leaks

By rolling up a portion of an inner tube and applying pressure with your foot as shown in the drawing, small leaks may be located even though a pump is not at hand to inflate the tube. If the leak is not located at the first attempt, try rolling up another section of the inner tube.

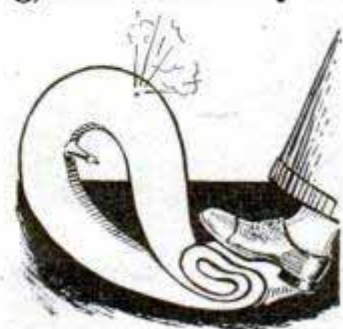

THREE-WHEEL GARDEN BARROW

By Hi Sibley

In this garden barrow a good part of the load is carried on the two front wheels, thereby allowing it to be dumped easily. When making turns, the single rear wheel is lifted clear of the ground. Build the body of $\frac{1}{2}$ -in. outdoor plywood, cutting the sides according to the squared drawing. The body is put together with galvanized screws, casein glue and cleats, the cleats being placed on the outside so that the inside of the body is smooth and easy to clean. A tie bar prevents the sides from spreading when hauling dirt, but wing nuts make it easy to remove the bar when the barrow is used to haul leaves or grass. The body is attached to a 2 by 6-in. wooden chassis with flat-headed screws, and flat-iron straps anchor the axles. Equip the axles with rubber-tired disk wheels.

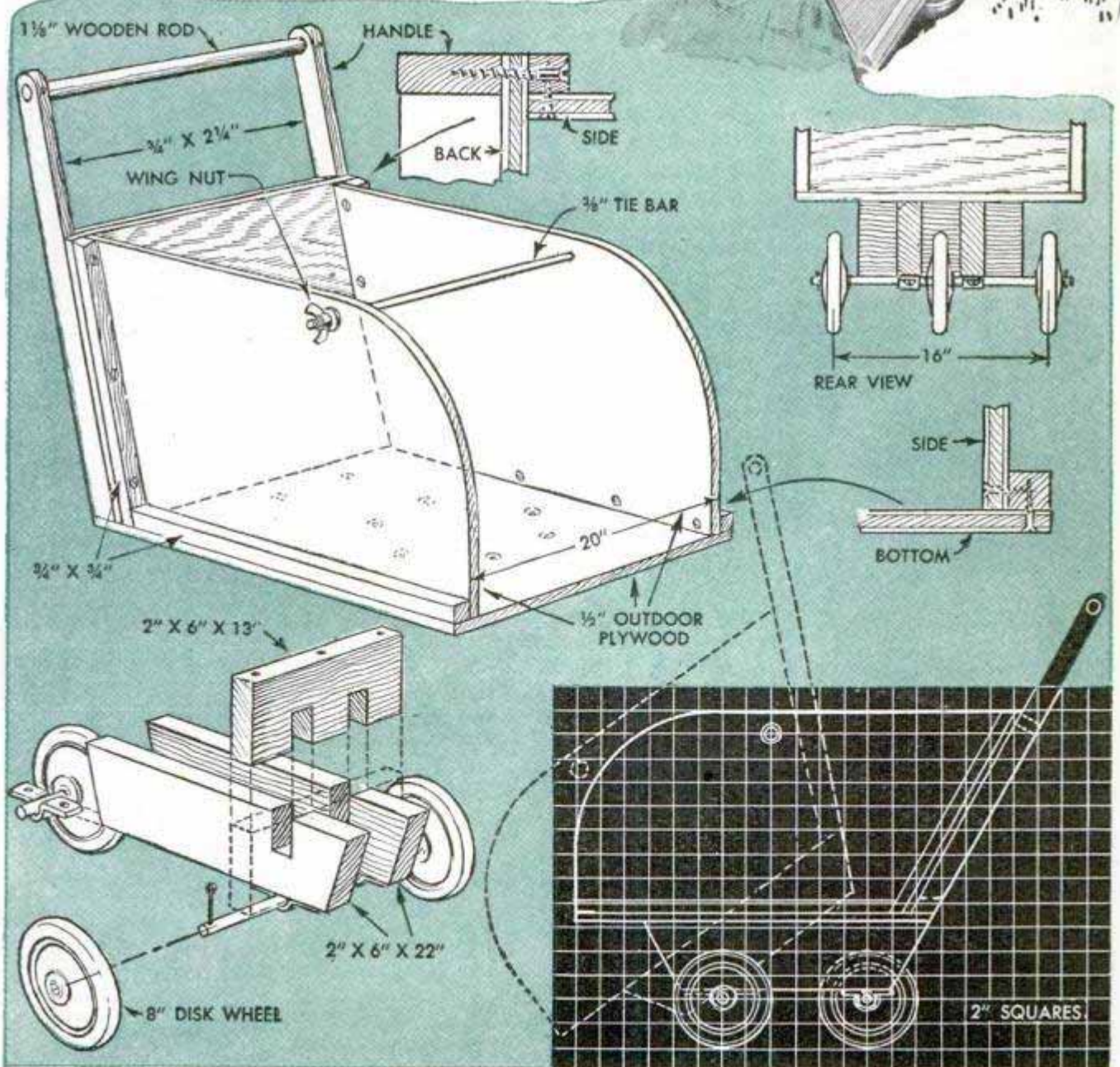

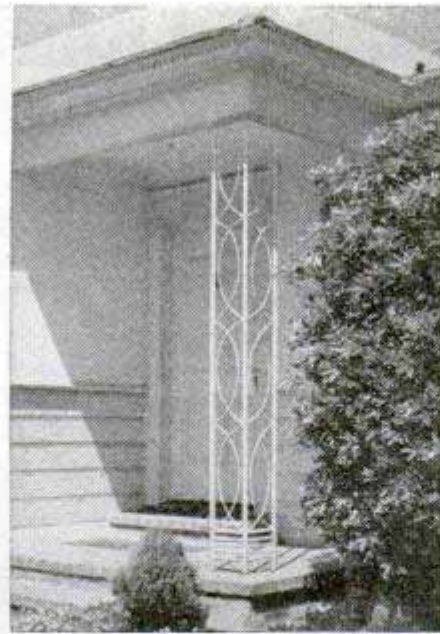

Modern Entryways Enliven Homes

To relieve severely plain architecture and add interesting detail to his front entry, one man built the wooden frame shown in the left-hand photo. He painted the wood a light tone and set brightly colored flower pots on the horizontal members. The right-hand photo pictures an entry column, made from lengths of pipe and galvanized wire, that simulates ornamental iron.

Wooden Strip Guides Large Work When Sawing Tapered Edge

It's no job at all to saw a tapered edge on a large sheet of plywood or other material if a wooden strip of uniform width is tacked temporarily to the stock to hold the line of taper parallel with the saw fence. To position the guide strip for a certain angle, mark the taper on the work, lower the saw blade all the way and place the work on the table. Then lay the strip on top of the work and against the fence so the line of the taper is parallel with the edge of the strip. When in this position, tack the strip to the work, remove from the saw and raise the blade to make the cut. The width of the guide strip is determined by the angle of taper. The greater the angle, the wider the strip must be, although a fairly narrow strip can be used by first sawing off the waste corner of the work 1 in. or so from the line of cut. The nails holding the strip should be driven into the waste part of the work. This stunt is especially useful in cutting plywood sheets, although it is helpful in cutting any stock where the size

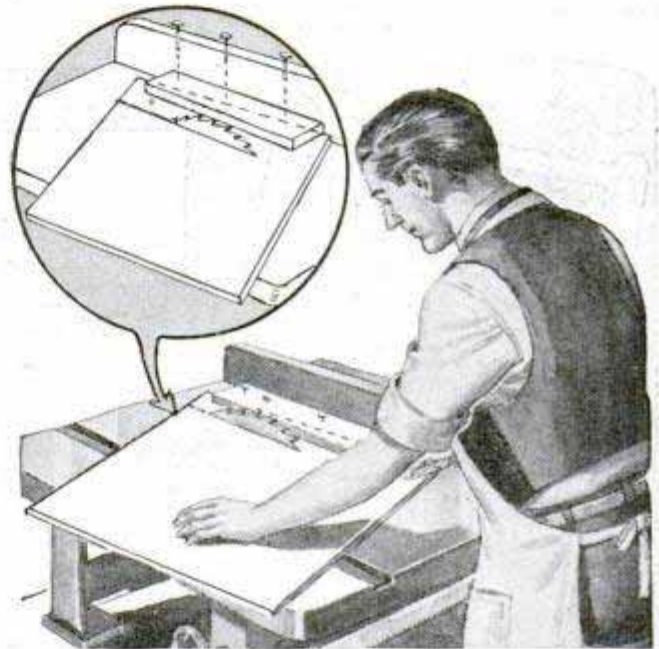

of the work is greater than the capacity of the crosscut guide.

Michael Ligocki, Gary, Ind.

Progress Made in Tracing Patterns Easily Seen by Using Colored Pencil

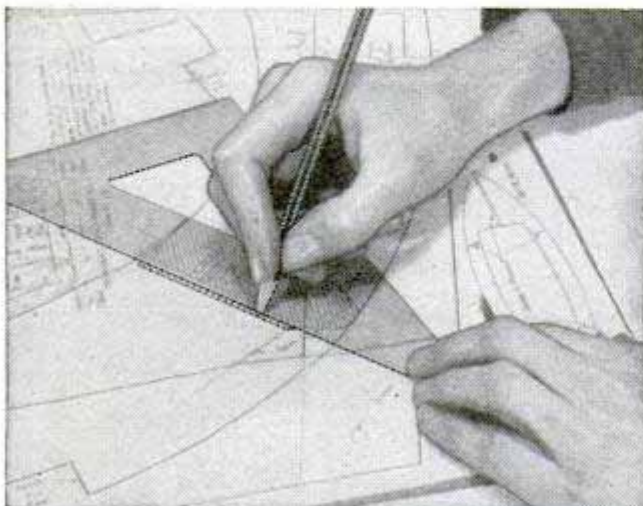

When transferring patterns to another sheet of paper or directly onto the work, it's an easy matter to tell just which lines have been traced if a hard-lead, colored pencil is used. This is especially helpful when tracing complicated patterns, and if they are to be traced several times, a different colored pencil is used each time.

Graphite Restores Fly Line

Powdered graphite will impart a hard, smooth surface to worn oil-processed fly line. Before rubbing-in the graphite, wash the line in lukewarm water and dry thoroughly. Do not use soap when washing.

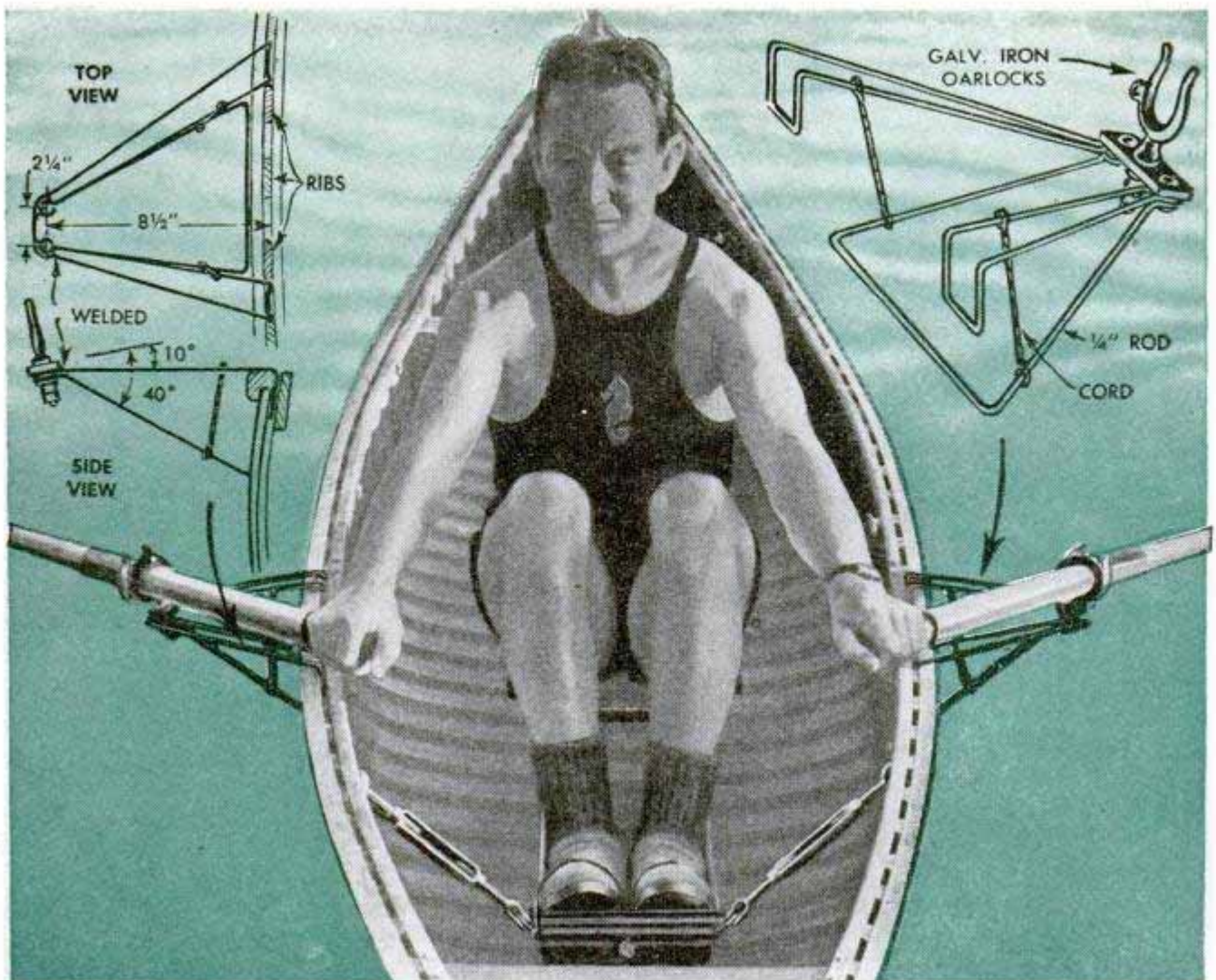

furniture casters. Foot plates and heel board are easy to make from $\frac{1}{2}$ -in. waterproof plywood. Toggles on the center partition turn down over one rib and prevent creeping of the seat frame while in use. The sliding seat may be flat but it is more comfortable if made from solid wood and shaped to saddle-seat form.

The axle keepers are designed to provide 3-in. travel for the axle, and the spacer plate which keeps the axles in parallel alignment can be made from aluminum. Sheet-metal clips bent around the axles and riveted to the plate hold the axles securely in place. To make the outriggers, you'll need about 20 ft. of $\frac{1}{4}$ -in. steel rod, one pair of size No. 1 galvanized malleable, U-type oarlocks and four $\frac{3}{16}$ -in. flat-headed stove bolts, with nuts and washers. The upper member of each outrigger spans three ribs, and the inner ends are bent to form hooks that fit snugly into the gunwale slots. One arm of each outrigger assembly is a little shorter than the other so that when in position they rake forward slightly and have a 10-deg. downward tilt at the outer end. The $8\frac{1}{2}$ -in. extension suggested is correct for the oars dimensioned. However, the extension may be increased somewhat if you prefer longer oars. The

lower, A-shaped brace for each outrigger bears against the outside of the canoe hull about 5 in. below the gunwale. Fishline bindings over dowel spacers keep the assembly rigid when in place.

Oars for use with the outrigger should be 6 ft. 8 in. long over-all, with the blade and loom dimensions closely approximating those shown. Working a pair of regular oars down to these dimensions is quite simple to do. The leather and button should be located as shown. Bend the horns of the oarlocks so that the oars will not slip out when in rowing position, and key the oarlocks to the outriggers to prevent loss of the oars.

Pad Altered for Outdoor Sketching

Nail polish applied across the loose ends of sketch-pad pages prevents them from being disturbed by wind when sketching outdoors. This will still permit removal of the pages.



Camp Stove From Ammunition Can

A compact, easy-to-carry camp stove for cooking and furnishing heat for a small tent or cabin can be made from two war-surplus items—a .30-cal. machine-gun ammunition box and a twin-burner alcohol sterilizer of the type used in field hospitals. Holes, $\frac{1}{2}$ in. in diameter, are drilled in one side of the can to form the top of the stove, and the alcohol burner, which gives off intense heat when ignited, is inserted in the can, as shown. The lid of the can is used as a draft control to regulate the amount of heat. When not in use, the ammunition can serves as a container for food.



Colored-Bead Telltale Indicates When Wall-Type Clock Needs Rewinding

A brightly colored bead attached to a length of thread fastened and wound around the key shaft on the mainspring of a wall clock, will serve as a reminder and show at a glance when the clock needs winding. To attach the thread and bead, let the clock run down, give the key one com-

plete turn and fasten the thread to the shaft with cellulose tape. Then make a mark on the door of the case even with the bead and rewind the spring. As the spring unwinds, the thread unwinds on the shaft, lowering the bead into view. When the bead reaches the mark, rewind the clock.

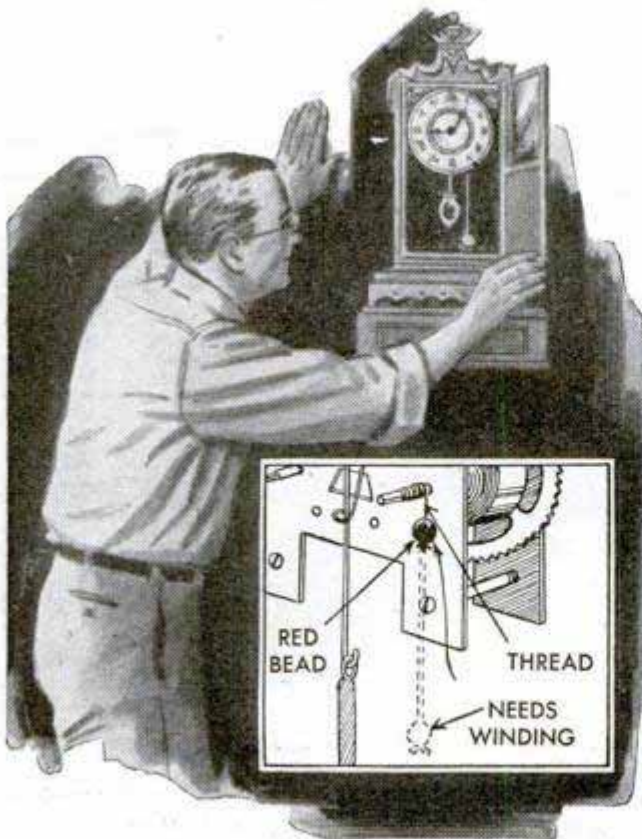

Handy Tray for Small Parts From Length of Gutter

Here's a small-parts tray that is excellent for holding tiny screws, brads, washers, etc. The rounded bottom of the gutter from which it is improvised makes it easy to remove items that are difficult to pick up with the fingers. Thin wooden partitions divide the tray into separate bins which can be labeled to indicate different sizes of brads or screws. Attach the tray to a wall with pieces of wire and screw hooks as shown, or nail it to the end of a bench.

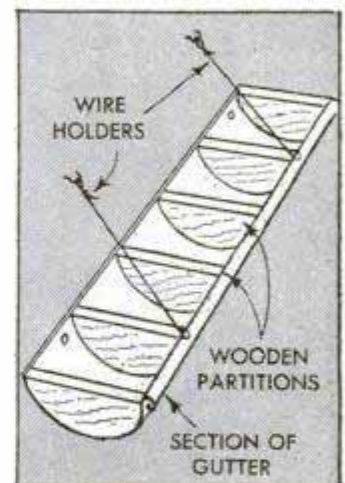

Domenick Bava, Detroit, Mich.

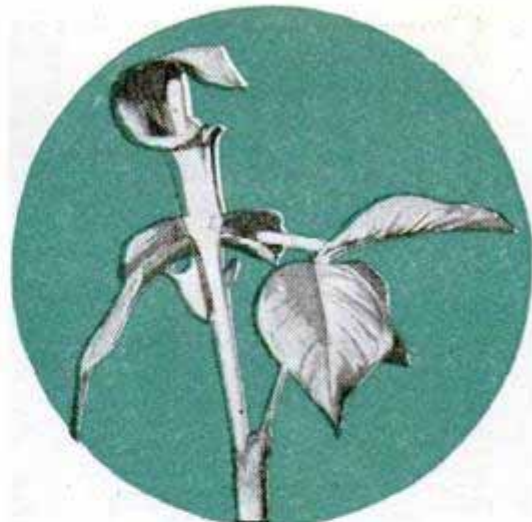
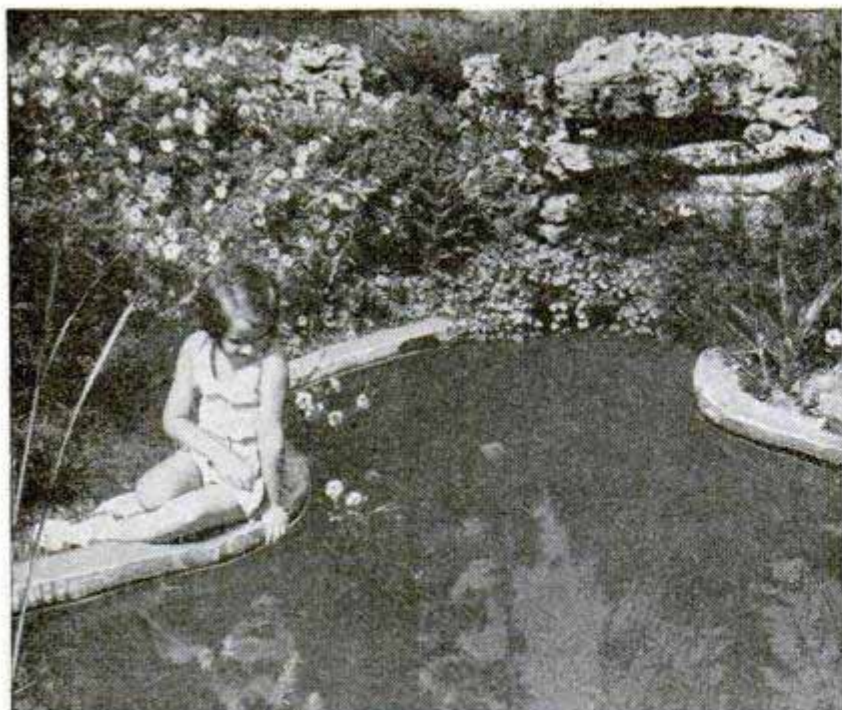

There's no need to go to the woodlands for wild-flower blooms. You can grow them easily in your own garden

WILD FLOWERS for 'TAME'

SELECTION of the varieties, environment and exposure, and the proper soils are the essential requirements for the propagation of wild flowers in a "tame" garden. If space is limited, a half dozen varieties selected for color, profusion and time of blooming, and growth habits will make a small garden of continuing interest and decorative value throughout the season. As a rule, different varieties of wild flowers cannot be crowded in with tame plants of differing habits of growth. Wild plants withstand transplanting unusually well under average conditions, and once established in the new location, even the smallest of them are vigorous growers. But they must have

room if they are to do their best. Plant in a separate bed, and space the plants in the row according to their height and spread at full growth. Some plants spread from a single root system. Others of perennial habit reach maximum growth each season. Still others grow in height and spread progressively from season to season, taking several years to reach the maximum. These growth characteristics should always be kept in mind when transplanting, otherwise crowding will result when the plants reach maturity.

Some flowering plants grow wild in areas of the deep woodlands where they are tree-shaded all day. Such plants will not thrive if trans-

By Paul Hadley



HIBISCUS (rose mallow): Grown as individual plant or in a pruned hedge. Has medium-large flowers, papery petals, blooms profusely

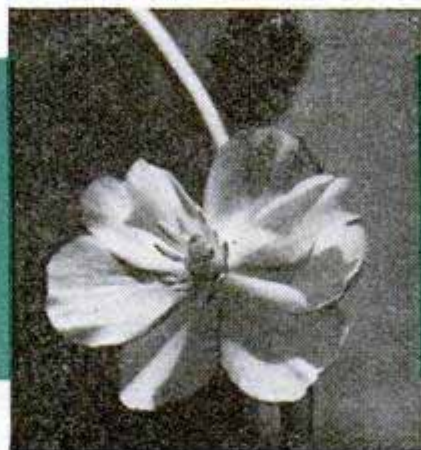

MAY APPLE (also called mandrake): May-flowering native perennial with shield-shaped leaves. Thrives in moist soil, south slopes



SPRING BEAUTY (claytonia): Another spring-flowering perennial. Dwarf plants 12 in. high. Thrives in damp, rich soil. Profuse bloom

planted to a garden plot in bright sunlight, or even in a plot that is partially shaded. They must have the full shade to which they are accustomed, but they should not be planted in the solid shadow cast by a building or wall. Likewise large and small plants that grow wild along the sides of damp, rocky ravines cannot be planted in open beds exposed to drying winds and sun. They will do well only in the protected, partially or wholly shaded areas of a rock garden, or on the north side of a sloping rock wall where proper soil and moisture conditions can be provided continuously. Other plants will be found growing in the wild state in more exposed locations where there is only broken or partial shade during the day from the trees or other plants. Still others thrive best in the open in drier soils



GARDENS

where they are fully exposed to the sun.

In digging up wild plants for transplanting it is important to disturb the root systems as little as possible. Where convenient to do so, the ideal method is to soak the area around the plant and then remove the plants and roots together with a large, unbroken ball of earth. In this way you get the root system practically intact. When transplanted in this manner, growth is interrupted very little, if any at all. Those with the shallow root systems such as violets, bluebells and others generally are found in the shaded areas of woodlands and are easy to remove. Others such as the jack-in-the-pulpit, lilies of certain varieties, may apple, etc. grow from bulbs and

deep root systems and are more difficult to remove without damage. Where possible, plants should be removed and transplanted during cloudy weather, or after a rain. Even then, precautions should be taken to prevent the roots and the soil about the root system from drying out. Most wild flowers can be transplanted in spring when the plants are in bloom as they are more easily found at that time. Certain varieties are difficult to recognize when not in bloom. As a rule, those that flower in the early spring are more easily moved than the varieties that bloom in the late summer. The late-blooming plants are mostly annuals which propagate from seed. The early bloomers are nearly all perennials.

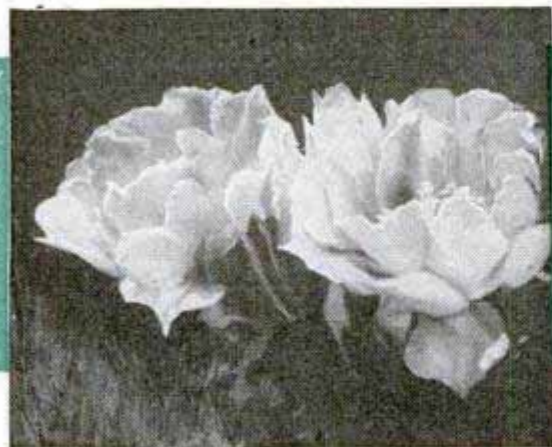

CACTUS (prickly-pear group): Quite widely distributed and a novel plant for wild gardens. Has large cup-shaped blossoms. Thrives best in the open in dry, sandy soils



HINTS TO HELP SOLVE FISHING PROBLEMS

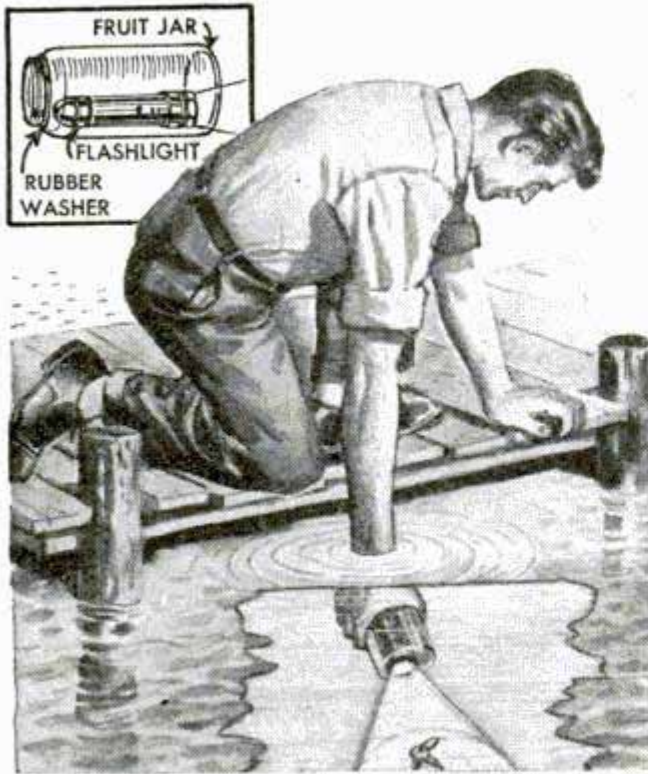

AN UNDERWATER FLASHLIGHT for locating key rings, fishing tackle and other objects dropped from a pier or boat in shallow water at night, can be made by sealing a small flashlight in a fruit jar fitted with a rubber ring. To do this, turn the light on and place it in the jar so that the beam is directed through the bottom. After making sure that the rubber lid washer is in good condition to prevent water from seeping into the jar, screw the lid on tightly. Then hold the jar under the water, and the flashlight should provide enough illumination to permit locating the item

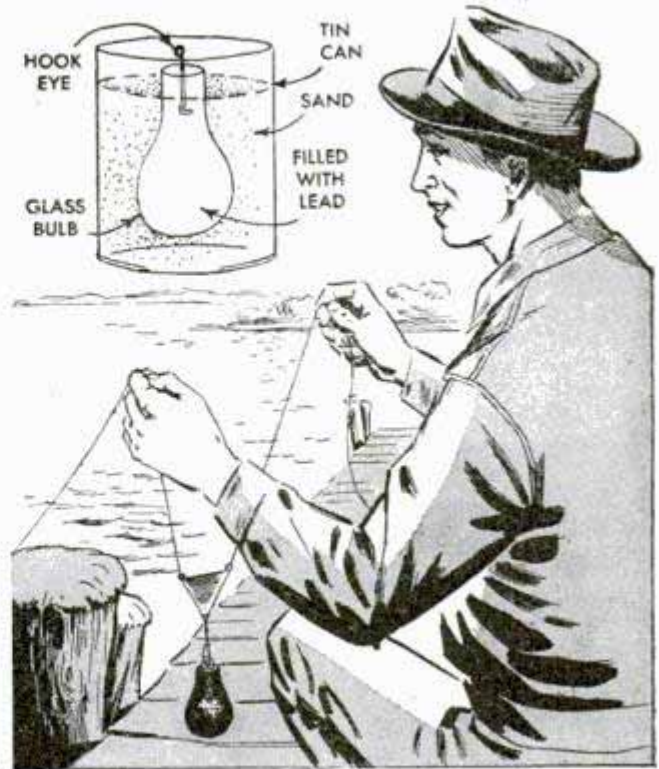

CASTING LEAD SINKERS of the type used for deep-water fishing may be done with an improvised mold made by embedding a burned-out lamp bulb in a can of sand. Dampen the sand and pack it around the inverted bulb, but let the sand dry before casting the sinker so that steam will not generate between the sand and the outside of the bulb. After the bulb is filled with molten lead, quickly suspend a hook eye in the lead and let cool. If many sinkers are to be cast, it is best to make a regular two-part sand mold, using the bulb as a master pattern

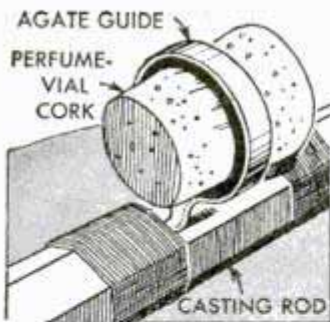

AGATE GUIDES on casting rods are protected from being cracked or broken when the rod is not in use by inserting a small cork of the size used in perfume vials in each guide. If the corks are too large, sand them until they fit snugly in the guides

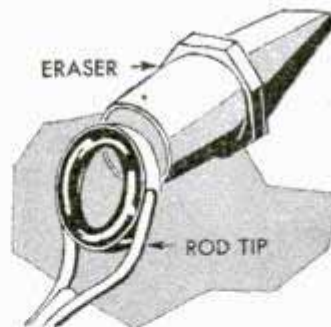

ROD-TIP BREAKAGE due to rough handling in transit will be reduced if a pencil-tip eraser is placed over the rod tip. The eraser should be a tight fit so that it will not slip off. The bulb from a medicine dropper also will serve the purpose

FISH LURE of bright, stainless-steel beads attracts perch, bass, bluegills and similar fish for one fisherman when other ways fail. Beads are about the size of BB shot and are held in place on the line by tying knots under each one. The first bead is fastened about 6 in. above the bait and several others are attached at 4-in. intervals

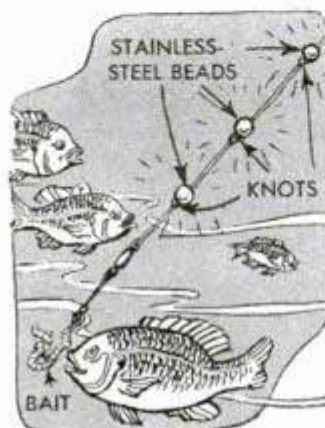

SPLIT SHOT eliminates tying and untying of knots when attaching lures or fishhooks to a line, permitting them to be exchanged quickly. The end of the line is fastened to the hook or lure as shown, and the shot is clinched with a pair of pliers. To separate the line and release the hook, just pry open the shot with knife-blade edge



CLOTHES HAMPER

THIS hamper was designed with the simplest possible construction in mind and it is as easy to build as a box. Design features are a novel floral pattern, made by boring holes of varying size in the front and sides, and a recessed panel effect obtained by finishing the edges and corners with half-round molding, detail A. If an enamel finish is desired use birch plywood, $\frac{1}{2}$ in. thick for the back and hinged top, and $\frac{1}{8}$ or $\frac{1}{4}$ in. thick for the front and sides. Cut the back and bottom panels to size and join with screws and glue. Then make the frame, using $\frac{1}{2}$ by $\frac{5}{8}$ -in. strips for the horizontal members and 1 by 1-in. strips for the corner uprights. Plane these latter members to a triangular shape as indicated in the sectional detail C, and assemble the frame members with nails and glue, or use screws. Next, cut the side and front panels to size and locate and bore the holes forming the floral design as shown on the squared pattern. Holes also are shown in the side panels and top, but these can be omitted if desired. Bore the large holes with an expansive bit. Then attach the panels to the frame using small brads and glue. True up all exposed edges by planing and sanding, then bevel the two front corners as in the sectional view C. Install the partition, using small triangular strips to hold it in place as in detail B. Sand the edges of the plywood top and hinge to the back panel. Finally attach the half-round moldings.



100 W. P.

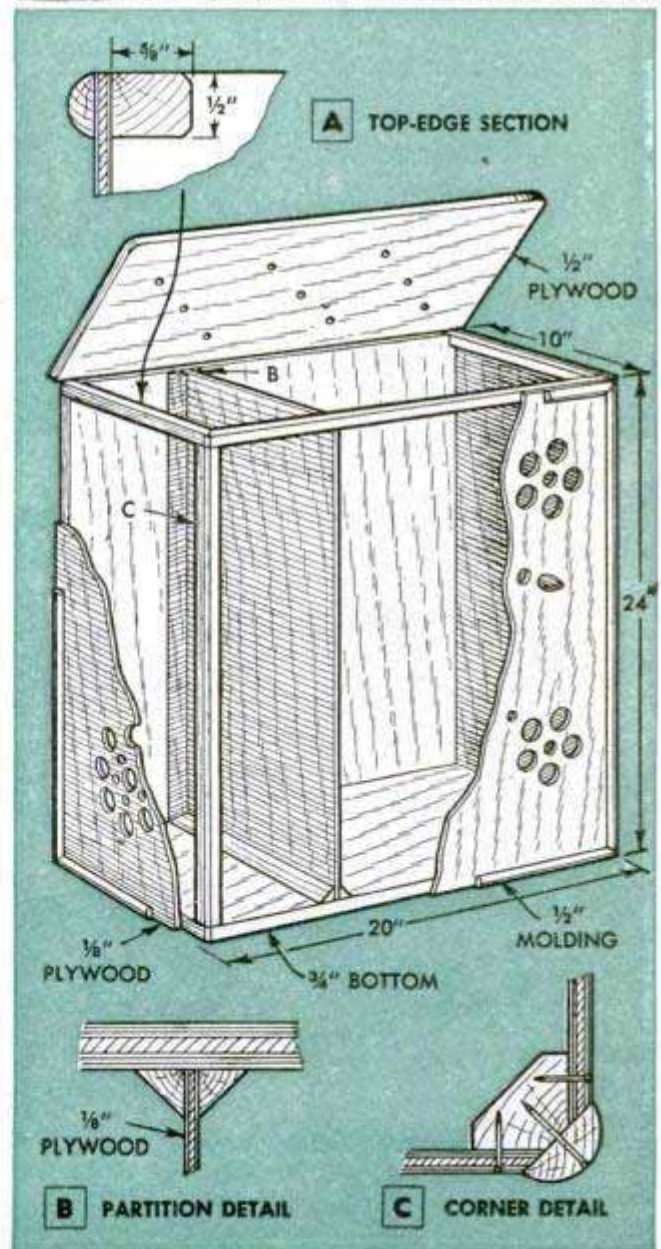
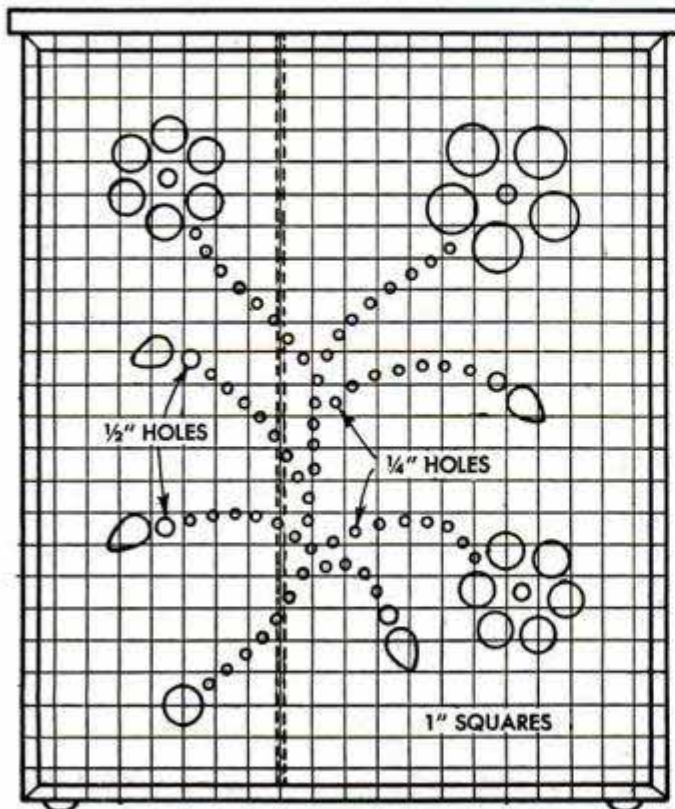

Channel Runway Aids Wheeling Bike Up or Down Steps

If a bicycle is stored in a basement or on a porch, this portable wooden runway will facilitate wheeling it up and down the steps. While the length of the runway, of course, should suit the particular stairway, the sectional dimensions given will accommodate most bicycles. Note that opposite sides of the runway are cut down at each end to clear the sprocket wheel and mud guard. If both ends are cut alike, it makes no difference which end is placed at the top of the stairs. In wheeling the bicycle up or down the runway, it is more convenient to hold it by the handlebars.

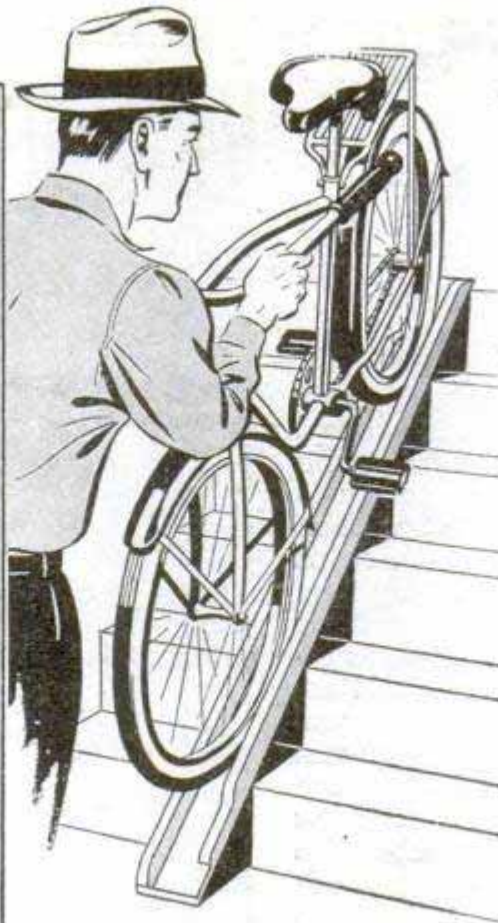
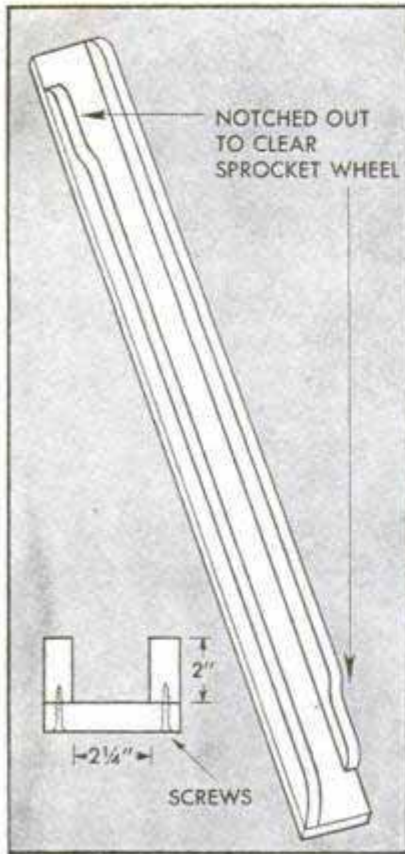

Quick-Change Attachment for Pin-End Blades Fits Scroll Saw Chuck

When making internal cuts in intricate scroll saw work, the bother of loosening the clamping screw in the upper blade chuck to release the blade is eliminated if the

chuck is fitted with this auxiliary attachment. It is designed for use with pin-end blades and is made from sheet metal, folded double. One end is spread apart to take the end of the blade and notched as shown. To release the blade from the attachment it is only necessary to pull down on the plunger to relieve tension and then unhook the blade. The pin in the lower end of the blade must be removed so that it can be clamped in the lower chuck in the regular manner. The teeth should point downward.

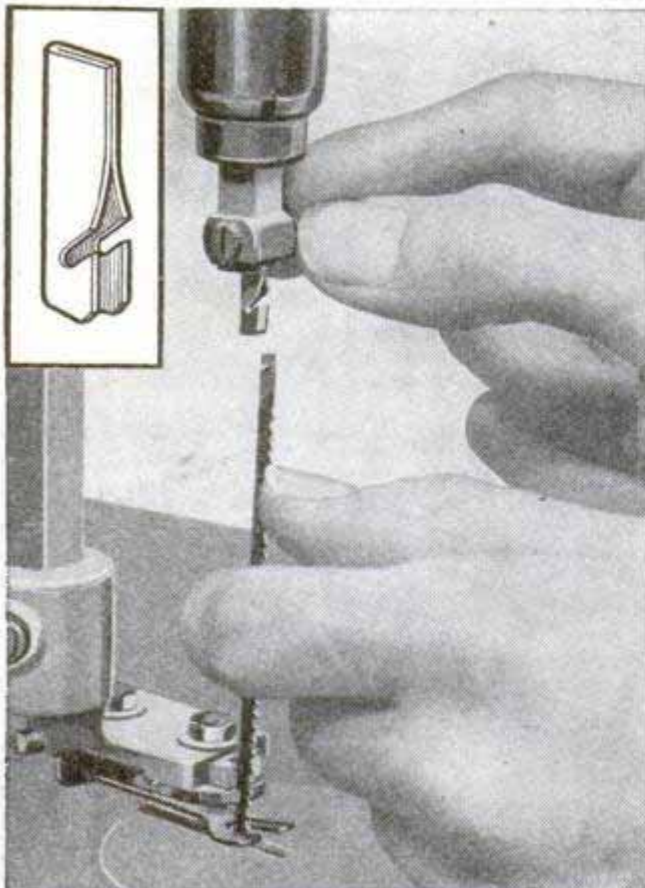

Copper Tubing Bent Without Kinking

Where it is necessary to make sharp bends in copper tubing to fit special requirements, one mechanic finds that a coil spring is more convenient to use than filling the tubing with sand to prevent it from kinking. A snug-fitting coil spring is pushed over the place to be bent, and after the bend is made it is readily slipped off.

G. E. Hendrickson, Argyle, Wis.

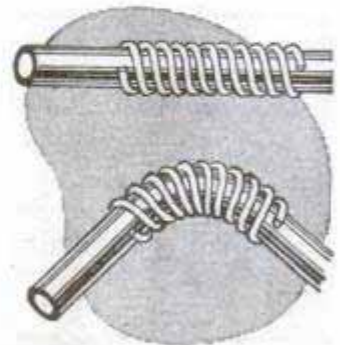

Garden Lounging Chair Has Barrel-Stave Seat

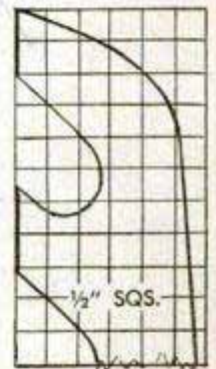
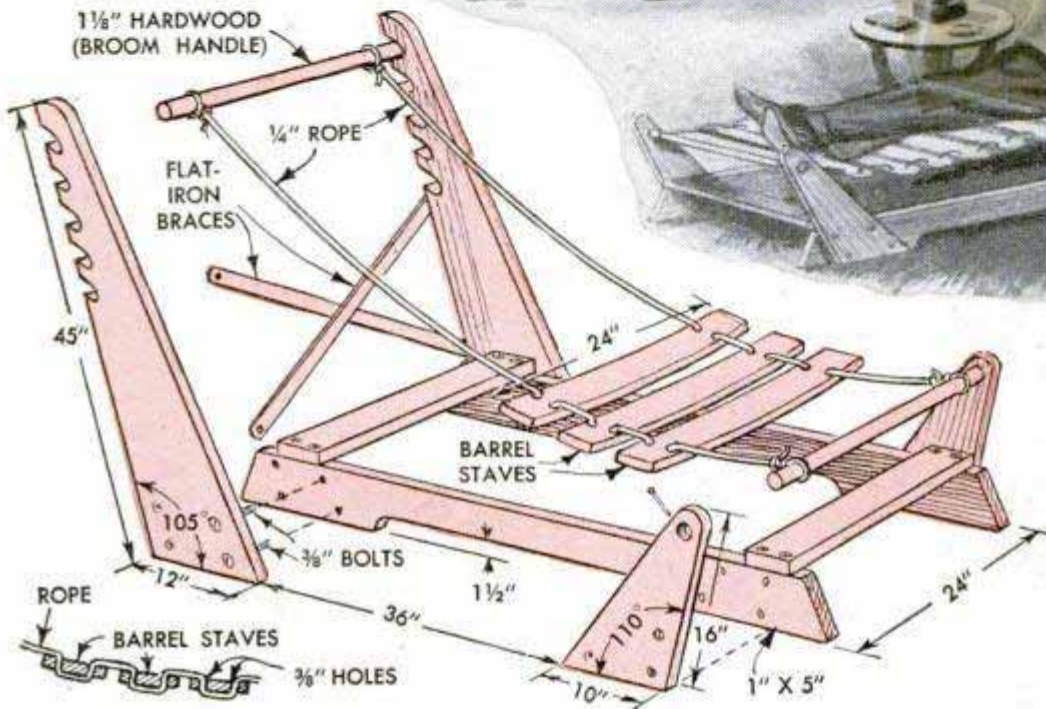
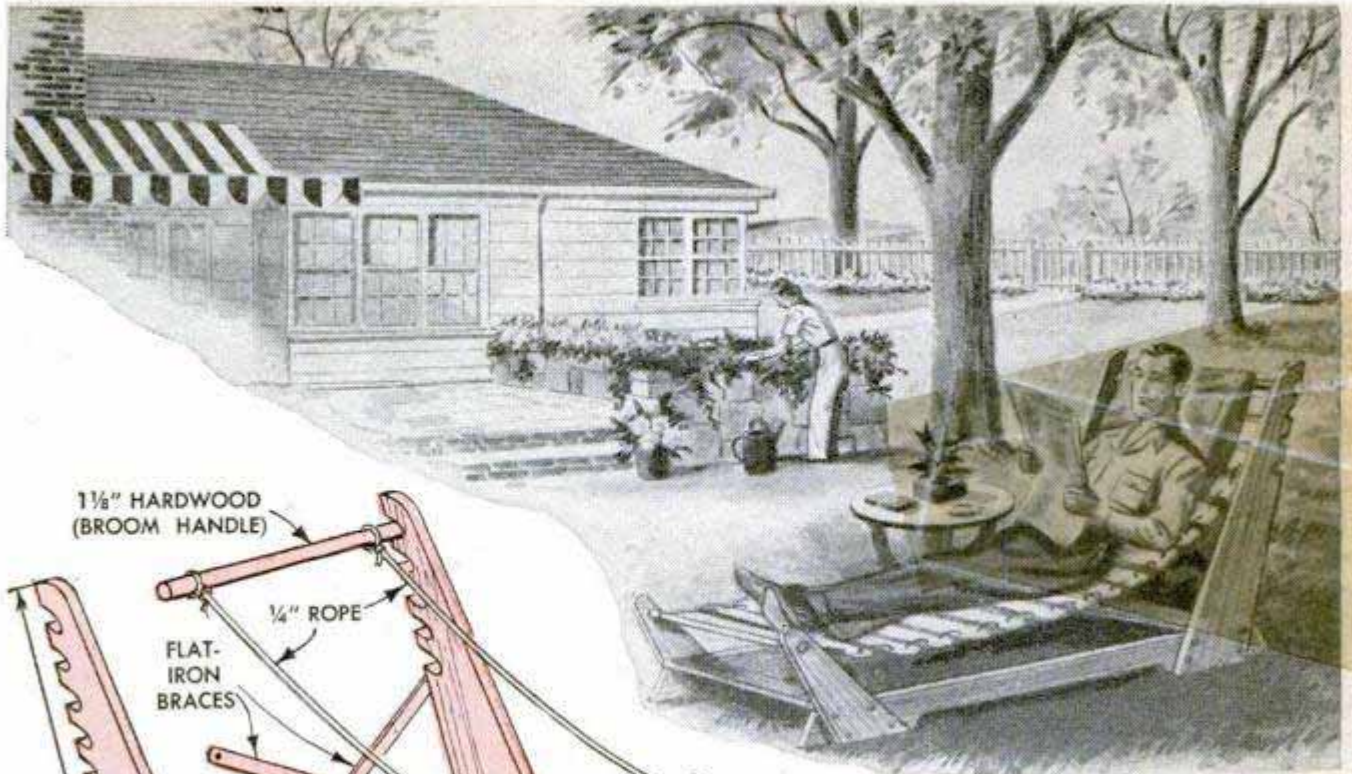

A good-looking lawn chair that's as comfortable as it is easy to build, is made by suspending a barrel-stave seat from a wooden frame. The notches in the back uprights permit the seat to be adjusted to suit the individual requirements of the user. The chair is constructed as shown in

the drawing, $\frac{3}{4}$ -in. pine or similar wood being suitable for the frame. The squared pattern will aid in cutting the notches accurately. After sawing the barrel staves to length, drill $\frac{3}{8}$ -in. holes near each end and string the staves about 1 in. apart on two lengths of $\frac{1}{4}$ -in. manila rope.

Ticking of Clock Soothes Small Puppy or Kitten During First Nights

If a young puppy or kitten is restless and whines or cries during the first few nights you have him home, try placing a small clock in the pet's sleeping box. The ticking of the clock will keep him company and prevent him from getting lonesome.

William Swallow, Brooklyn, N. Y.

When applying only one finish coat to interior walls, better coverage will be insured if the white undercoat is tinted with a little of the finish color. This will be especially helpful if the walls are to be finished in a delicate shade.



U.S. Pat. 2,164,171 Rep. also Rep. in Photo Kinks Book

35-MM. SLIDE PROJECTOR

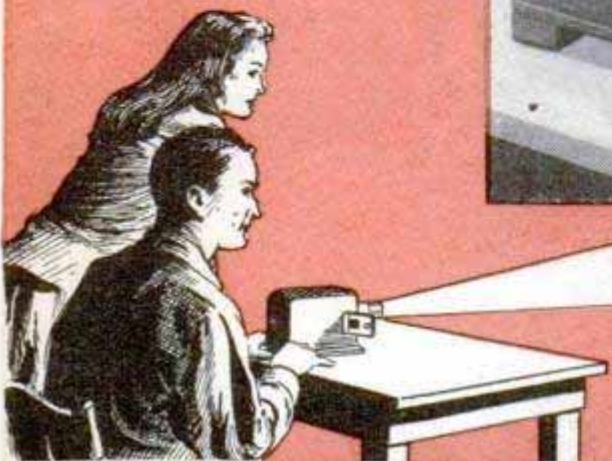
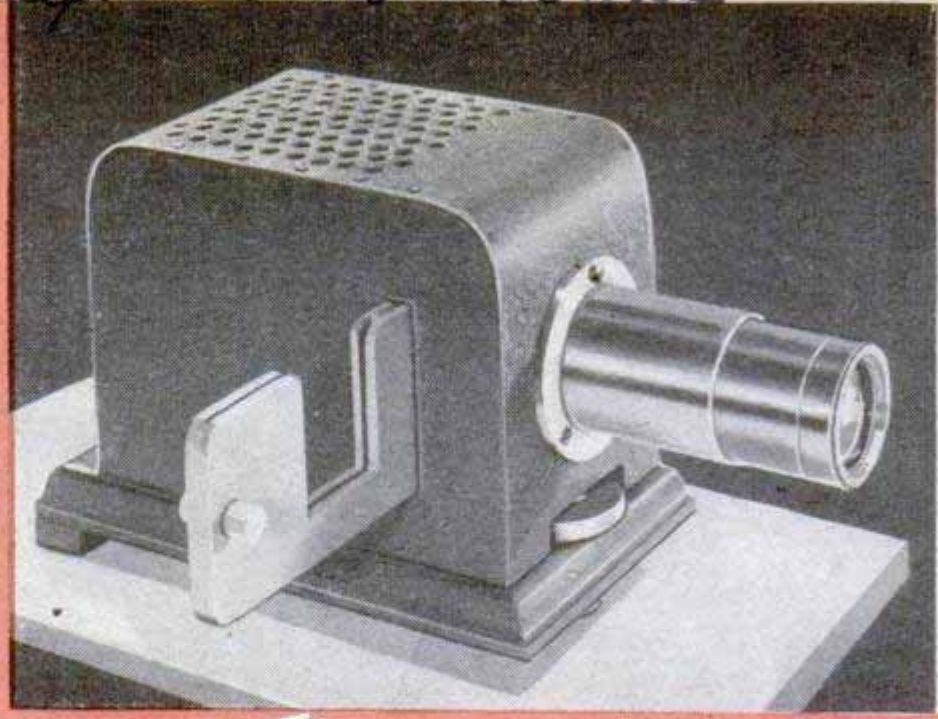

By Sam Brown

THIS SLIDE PROJECTOR can be built at a very reasonable cost and is an interesting job for the home craftsman. The unit takes a 2 by 2-in. cardboard ready-mount, which is the common mounting for both purchased slides and the transparencies you shoot with your own camera. Lenses suggested are stock items and can be obtained from optical supply dealers. Tests have shown that performance of the unit is excellent.

A full-size detail of the lens mounting is shown in Fig. 12, and this should be the first item made. Its construction can be varied to suit—a lot depends on just what you can pick up in the way of tubing. The lens mounting screws inside a piece of tubing which is a slide fit inside a second tube, and the latter is attached by means of a threaded ring to the outer case.

The condenser mount is detailed in Figs. 3 and 5. This is a split turning, made by turning down the part in the full round and then sawing in half about 1/8 in. beyond the center. Grooves for the condenser lenses must be measured carefully as the lenses should snap lightly in place, and once seated they should be fairly loose in the grooves.

Make the lamp-socket support by turning down a piece of brass to fit, Figs. 3 and 7. Next, cut the brass support arm and then sweat-solder the two parts together. Chuck the work in the lathe and bore the support arm to the same internal diameter as the socket support. Drill and tap for a

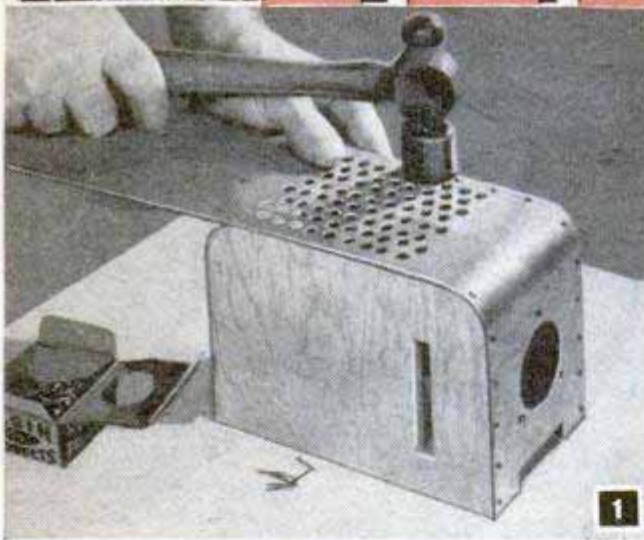

OUTER CASE IS SHEET METAL OVER PLYWOOD SIDES

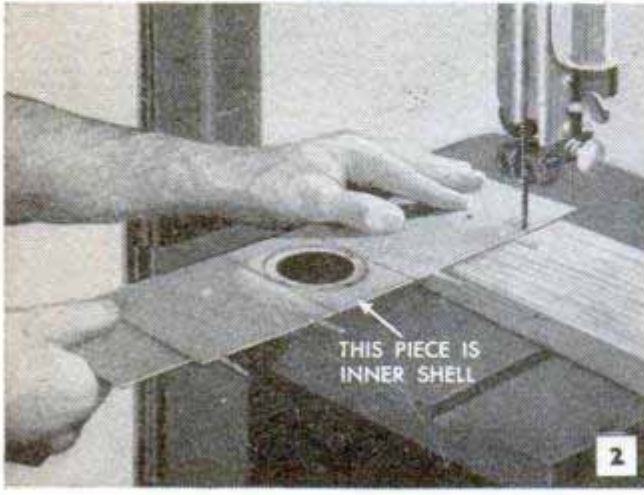

THIS PIECE IS INNER SHELL

SHEET-METAL PARTS ARE SAWED ON BANDSAW

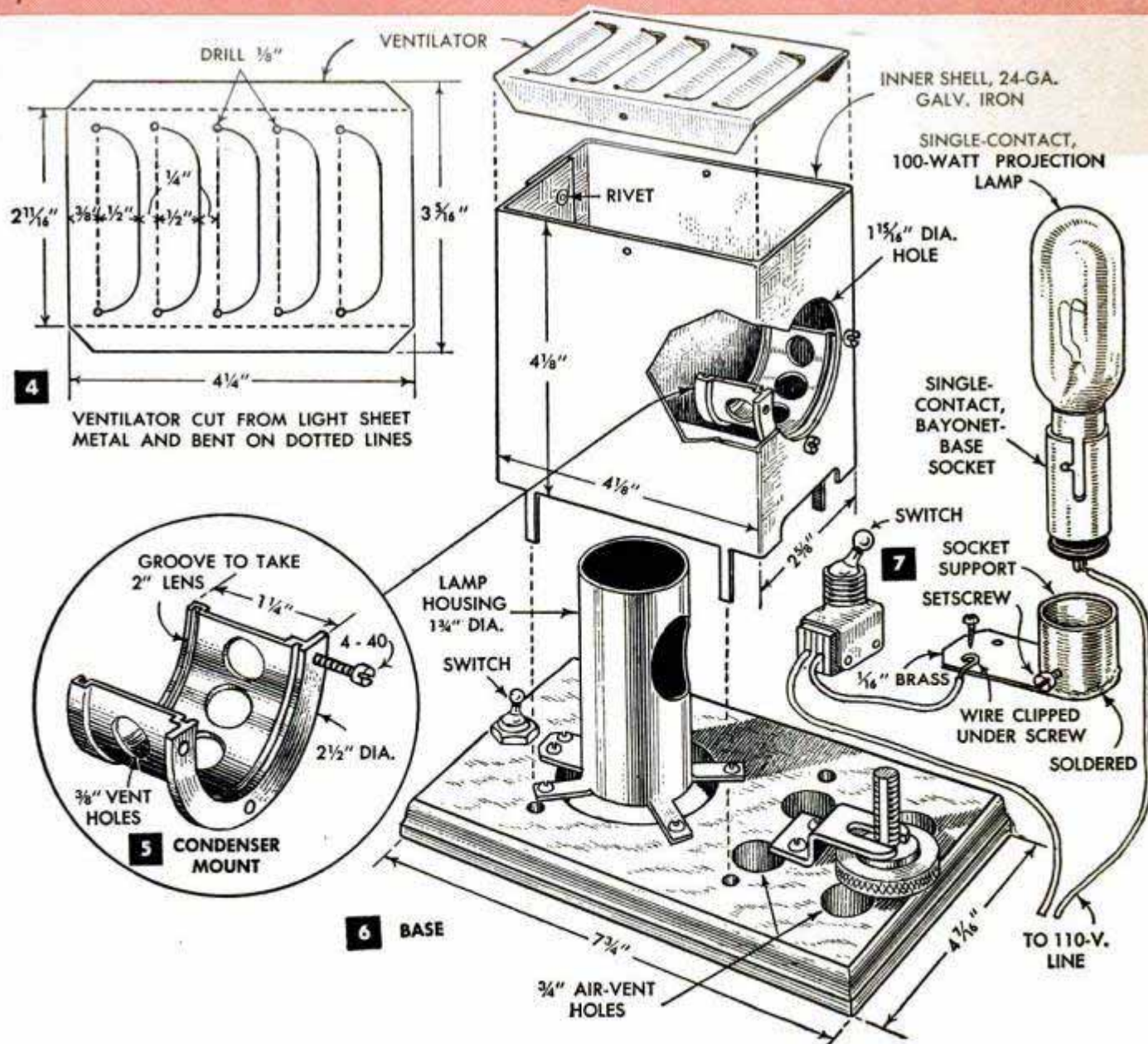
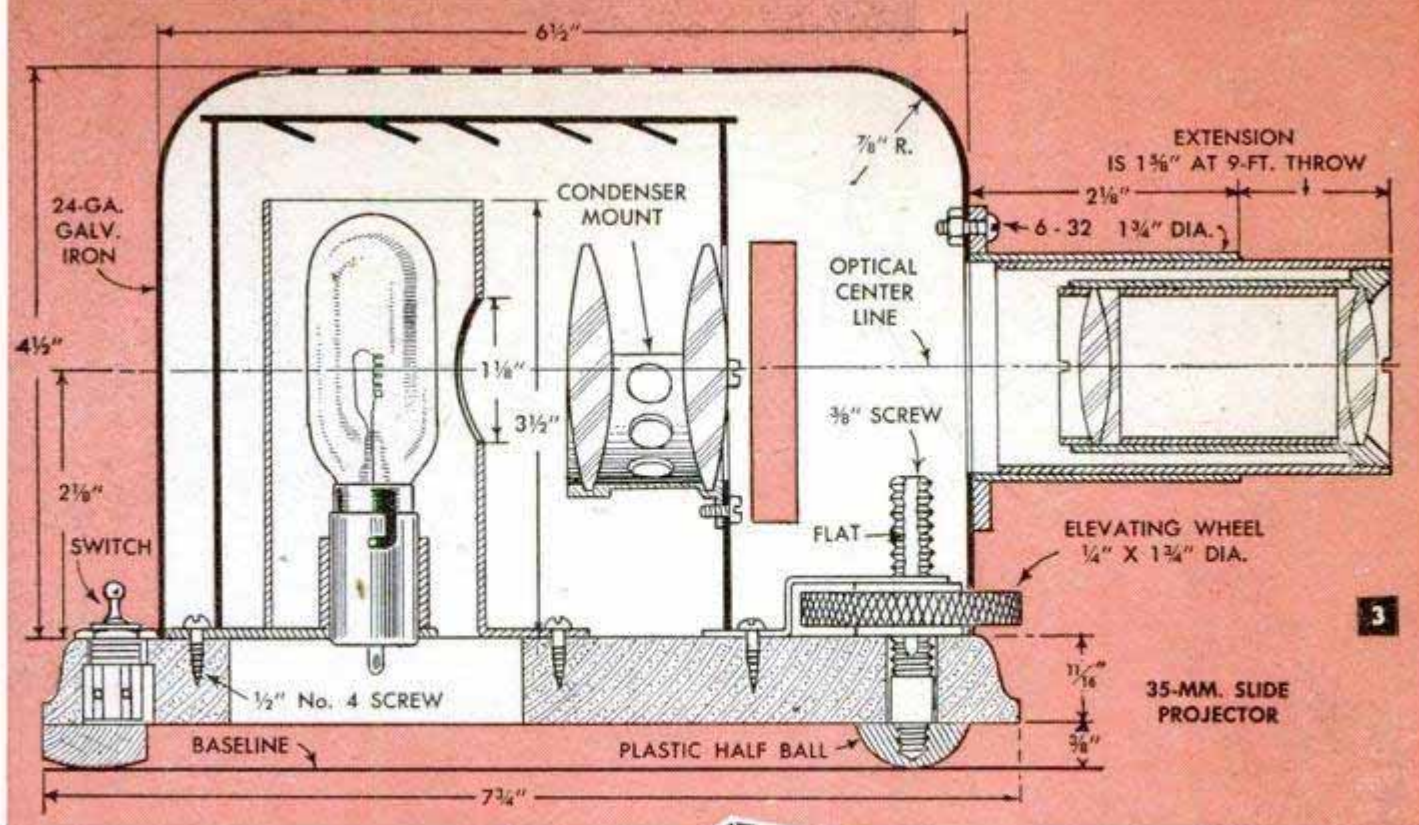

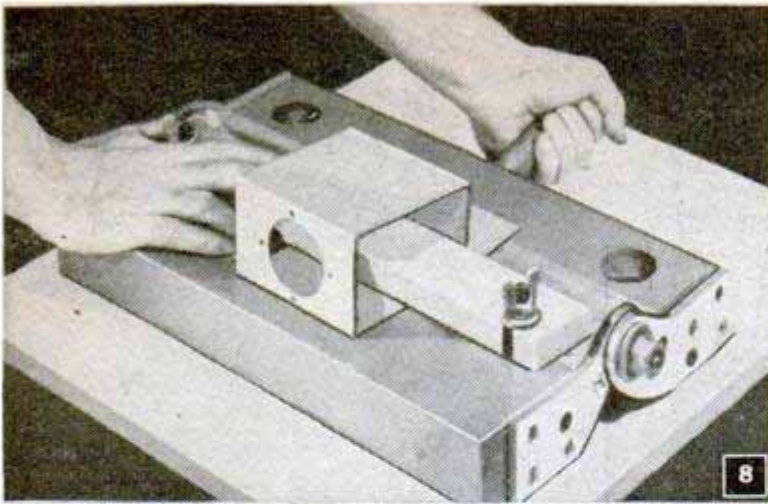

BENDING THE INNER SHELL WITH BENDING BRAKE

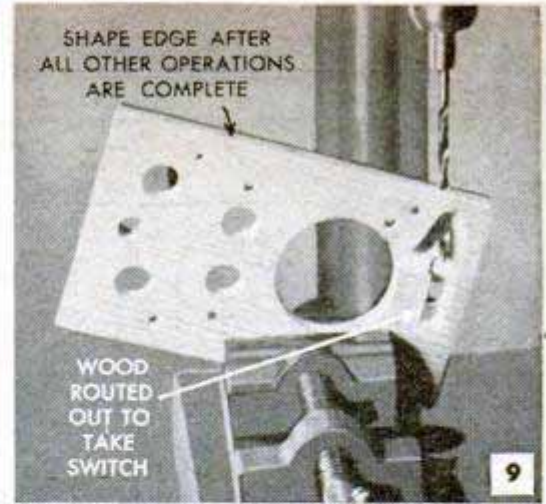

SHAPE EDGE AFTER ALL OTHER OPERATIONS ARE COMPLETE

WOOD ROUTED OUT TO TAKE SWITCH

DRILLING HOLE IN BASE FOR WIRE

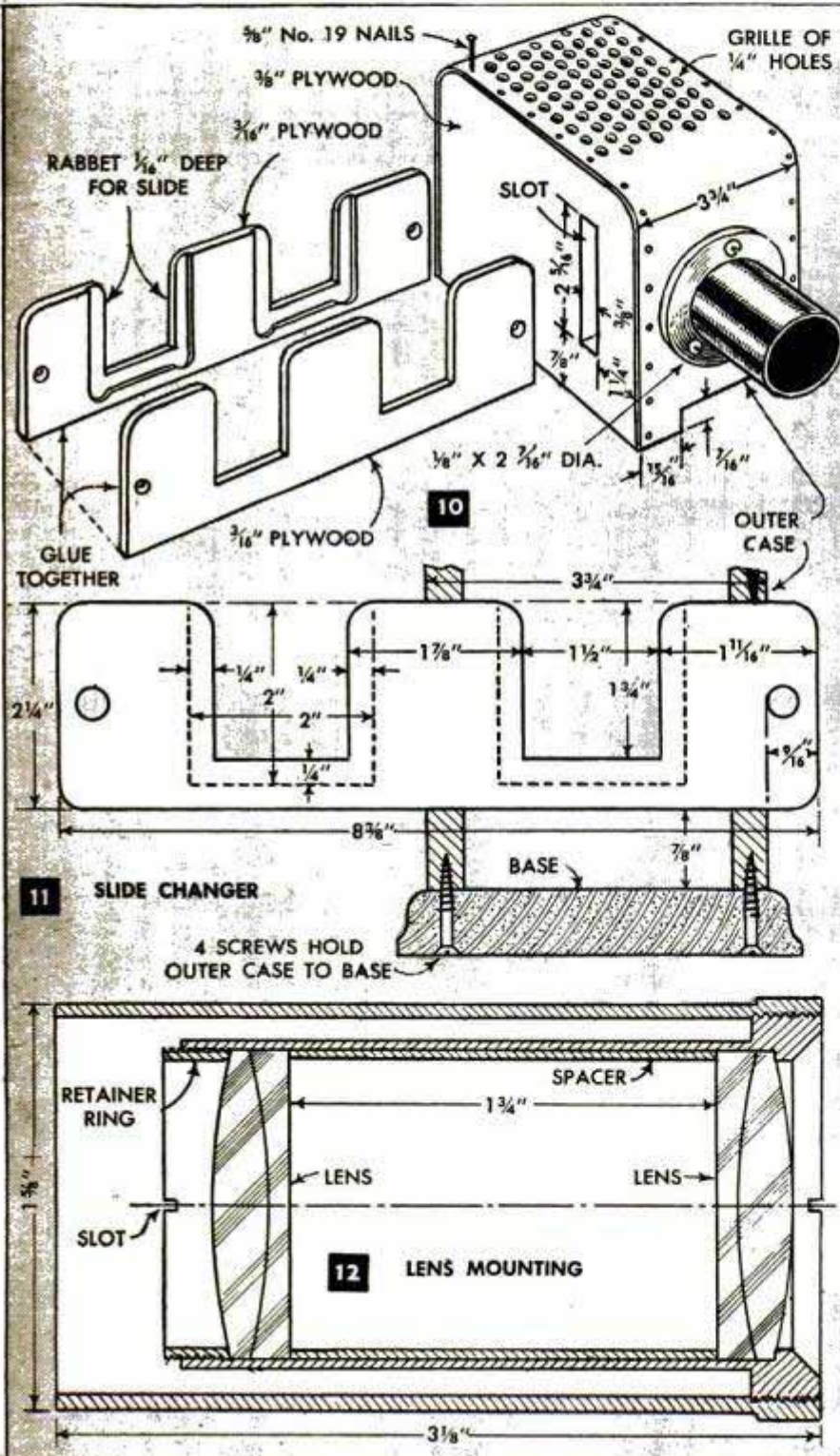

setscrew to hold the lamp socket in position.

The outer case, or housing, consists of 3/8-in.-plywood sides covered with galvanized sheet metal, Figs. 1, 2 and 3. If you like metalworking make an all-metal case. The wooden sides simplify the construction somewhat and are quite practical as they are well protected from lamp heat by the housing and inside shell. Tack the plywood sides together and saw out both parts in one operation, including the opening for the slide changer. Mount the lens on the case, and then make the slide changer, Figs. 10 and 11. Note that openings into the slots are rounded over before gluing so that the slides can be inserted easily. Wipe excess glue out of the slideways.

The base, Figs. 3 and 6, is wood. Note that one end of the lamp housing is split four ways to form lugs for attaching to the base. The inner shell, Figs. 3 and 6, is 24-gauge galvanized sheet metal. Since the inner shell carries the condenser mount and the combination ventilator and light trap, Fig. 4, it should be made accurately to stand square; cut it to size on the bandsaw, Fig. 2. Opening for the condens-

OPTICAL SYSTEM
SHOULD BE MADE UP OF OPTICS SHOWN, OR CLOSE SUBSTITUTES. CONDENSER SYSTEM IS CHECKED AS SHOWN IN PHOTO. DETAIL BELOW SHOWS HOW DOUBLE-CONTACT SOCKET CAN BE CHANGED FOR SINGLE-CONTACT LAMP

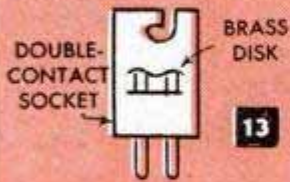

LAMP
100-WATT, SINGLE-CONTACT PROJECTION LAMP

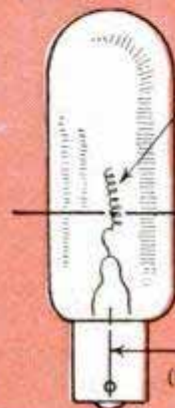

CONDENSERS
PLANO-CONVEX OR CROSSED CONVEX. 2" DIA. BY 3" FOCAL LENGTH. E.F.L. = 1 1/2".

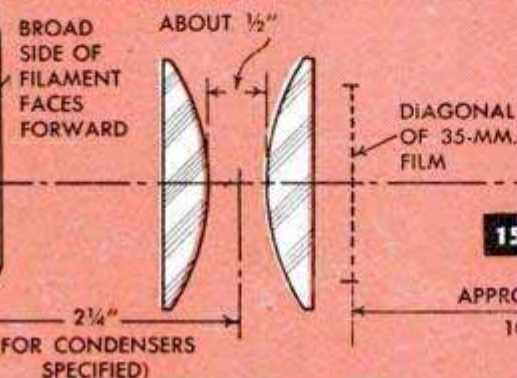

PROJECTION LENS
USE TWO ACHROMATS OR SINGLE PLANO-CONVEX LENSES. DIAMETER SHOULD BE 1 1/4" AND FOCAL LENGTH 6 3/4" (32 X 171MM.). LARGER DIAMETER LENSES CAN BE USED, UP TO ABOUT 1 1/2" AND F. L. CAN VARY BETWEEN 5 3/4" AND 7 1/2".

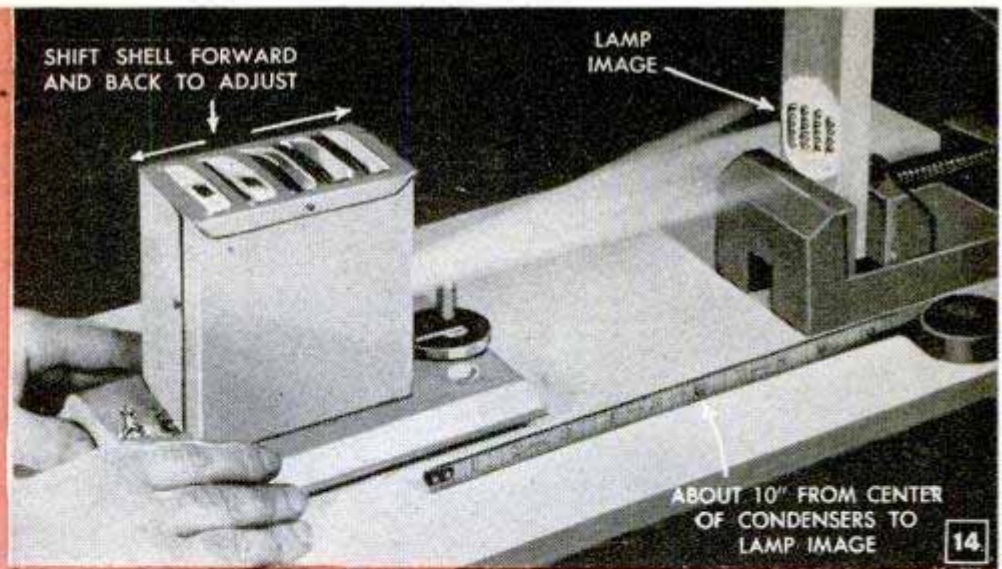
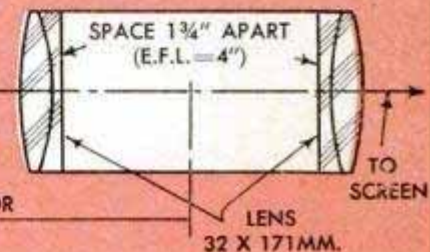

ers is cut on a jigsaw or with a holesaw. It is important that the 2 1/8-in. dimension from the top of the base to the optical center line be maintained in making all parts, Fig. 3. Fig. 8 shows the inside shell being bent on a sheet-metal brake, but of course this can be done in a vise, using wooden blocks to bend the corners square. Fig. 9 shows the base being drilled for wiring. Note that the bottom is routed out to take the toggle switch, Figs. 6 and 7.

The light unit for the projector is a 100-watt projection lamp of the single-contact type, and is fitted into a corresponding single-contact bayonet-base socket, Fig. 15. You can use a double-contact lamp and double-contact socket. However, the single-contact lamp is a standard item, but the single-contact socket is not standard. You can alter a double-contact socket, as in Fig. 13, by soldering a disk of brass over the contacts. Then use the double post as a single post and take the second wire from the screw holding the socket support, as in Fig. 7.

At this stage the unit should be tested. Make the setup in Fig. 14 and move the partly assembled projector forward and backward until the image of the lamp filament is sharply focused. Note that the

distance from the center of the condensers to the image should be about 10 in. Some adjustment is possible by moving the inside shell forward or backward. The 10-in. distance is specific for the lenses shown. If you use a larger-diameter lens, pick up the lamp image about 15 in. from the center of the condensers.

While the optical elements specified are standard, there are certain substitutions. Condensers must be at least 2 in. in diameter in order to cover the diagonal of the slide. Focal length of the condensers should be about 3 in.; two of these very nearly in contact have an equivalent focal length of one half the individual lenses. For the projector lens, two 32 by 171-mm. achromats are suggested. Spaced 1 3/4 in. apart, the equivalent focal length will be about 4 in., which is the right figure for average home use where the throw from the projector to the screen is 8 to 10 ft. Shorter focal-length lenses will give a larger image with a shorter throw while a longer focal length results in a smaller image and a longer throw.

The finish on the projector must withstand heat. Use a baking enamel, black inside and any color outside. Bake at low heat in the oven with the door open.

Match-Book Flap Is Resetting Target For Outdoor Use With Air Rifle



An excellent outdoor air-rifle target that will reset itself is nothing more than an empty match book tacked to the top of a convenient post. When the flap of the cover is bent vertically, it will have enough flexibility to return to that position after being hit. It is unlikely that the pellet will penetrate or tear the cover unless it is fired at close range. A thumbtack will serve to hold the book in place.

Outdoor "Sitting Room" in Tree Provides Restful Retreat

When it's too warm in the house, you can retire to this outdoor "sitting room" and relax in comfort. A tree with a large trunk and spreading branches near the ground should be selected. A platform about 12 ft. square provides ample space

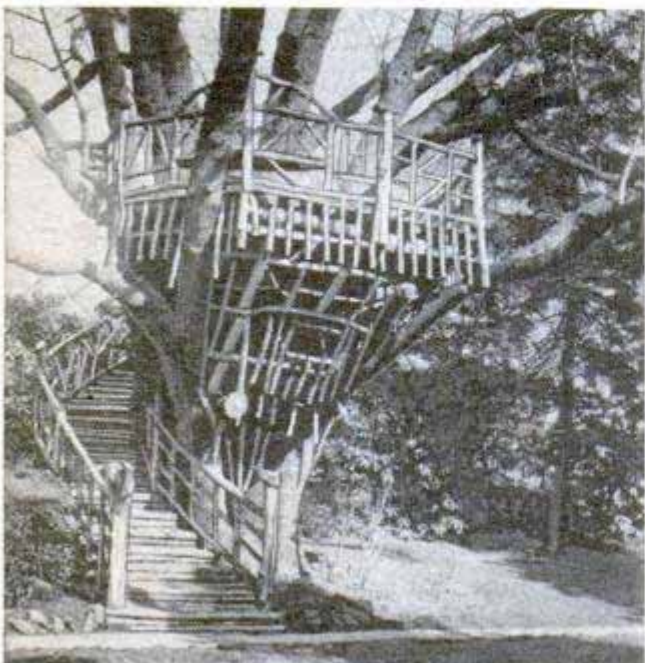

to build several rustic seats around a railing, and a stairway to the sitting room winds around the tree trunk. Because of its durability, redwood is especially suitable for this purpose.

Paul Hadley, Philadelphia, Pa.

Mounting Pads for Small Motors Cut From Fuller Balls

Soft-rubber pads for mounting small high-speed motors, eliminating rattles in automobiles and dampening vibration in other pieces of equipment, may be cut from an ordinary fuller ball. Such balls come in a number of sizes and are easily sliced into thin washers with a sharp knife or razor blade.

Richard Hanscom, Elmhurst, Ill.

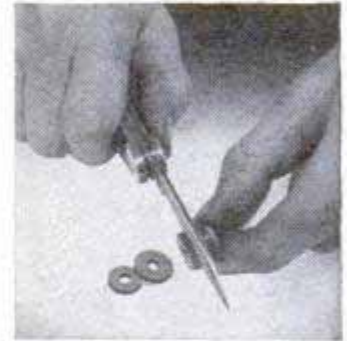

Grease Pencil Marks Glass When Cutting Freehand



Following a curved or other irregular line when cutting glass freehand is made easy if the pattern is drawn directly on the underside of the glass with a grease pencil.

There's no shifting of the line as when a line is drawn on a paper pattern and the glass placed on top of it. In following the guideline, watch it by looking directly over the cutter.

Purse Serves as Tool Bag

A lady's discarded purse, or a large tobacco pouch, preferably one with a zipper fastener, will serve as a handy tool kit for use in the home, car or on a bicycle. The

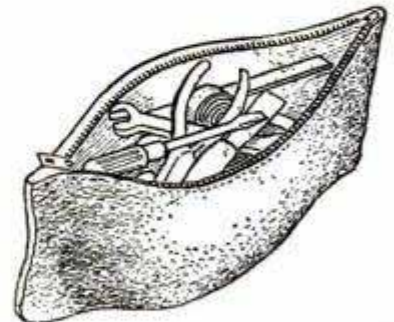

tools necessary for most minor repairs will fit neatly in a purse of average size. When used on a bicycle, it can be fastened to the frame or luggage rack with two leather straps.—Jo Ro Jung, New Orleans, La.

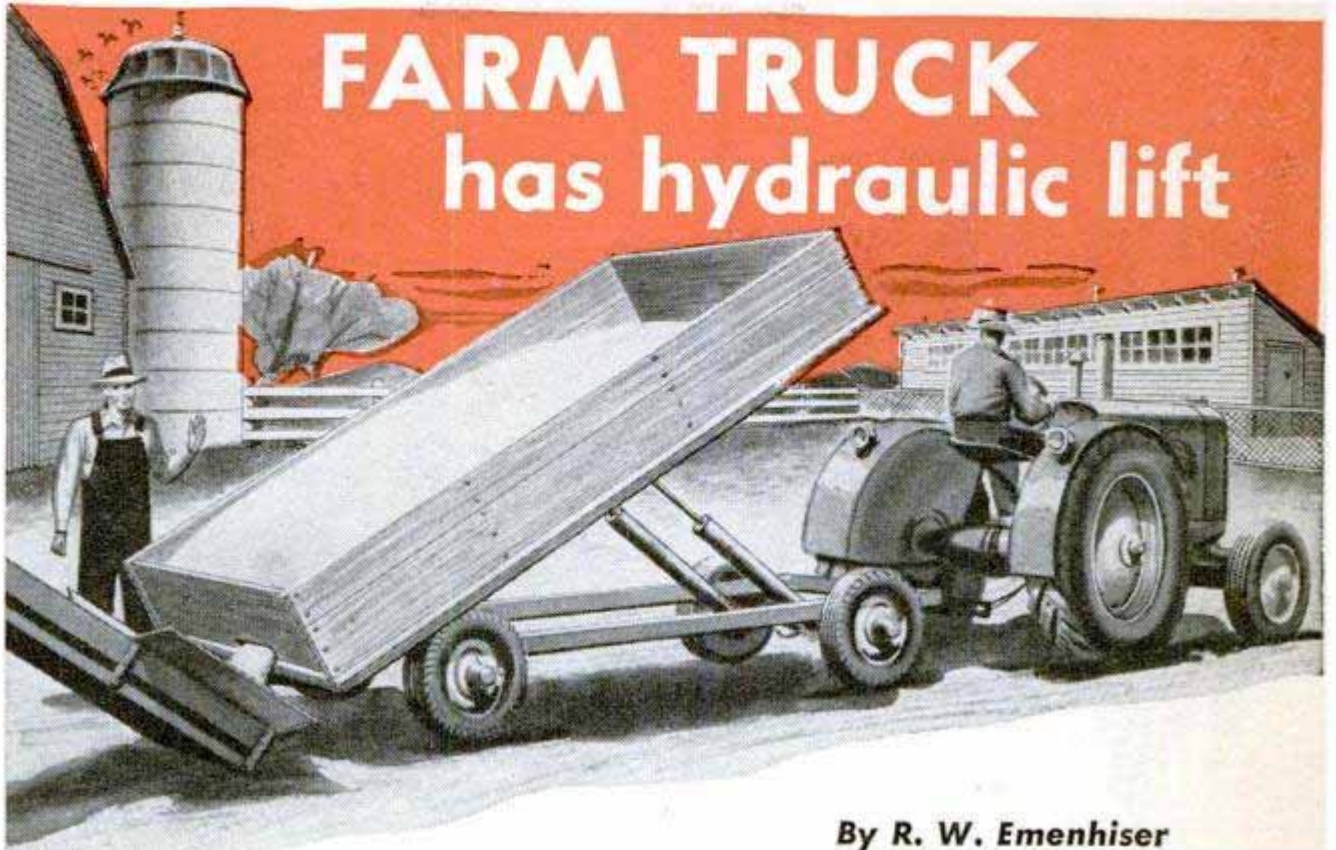

By R. W. Emenhiser

WHY SPEND TIME and hard labor to unload grain, cobs, sand or gravel from a tractor-drawn trailer truck with a hand scoop when it is so easy and inexpensive to put a hydraulic lift on the trailer to dump the load just where you want it? This type of lift gives positive control of the height and rate of lift, which is important when dumping grain into an elevator hopper or when spreading a load in a

grading, filling or field-leveling operation. All parts of the trailer truck pictured and detailed in Figs. 1 and 2 are stock items readily obtainable at nominal cost. Standard trailer-truck axles are used. Both the subframe, or truck frame, and the tilting frame are made from steel channels, and the necessary reinforcing gussets and other small parts of each assembly are cut from heavy sheet steel. The

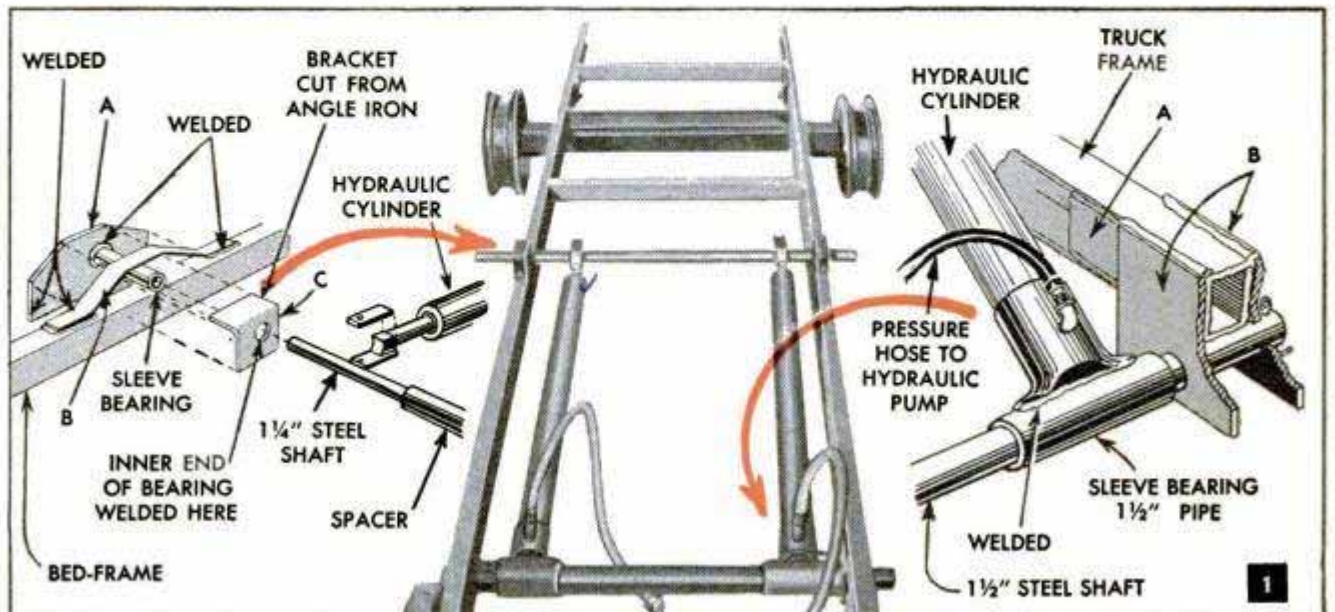

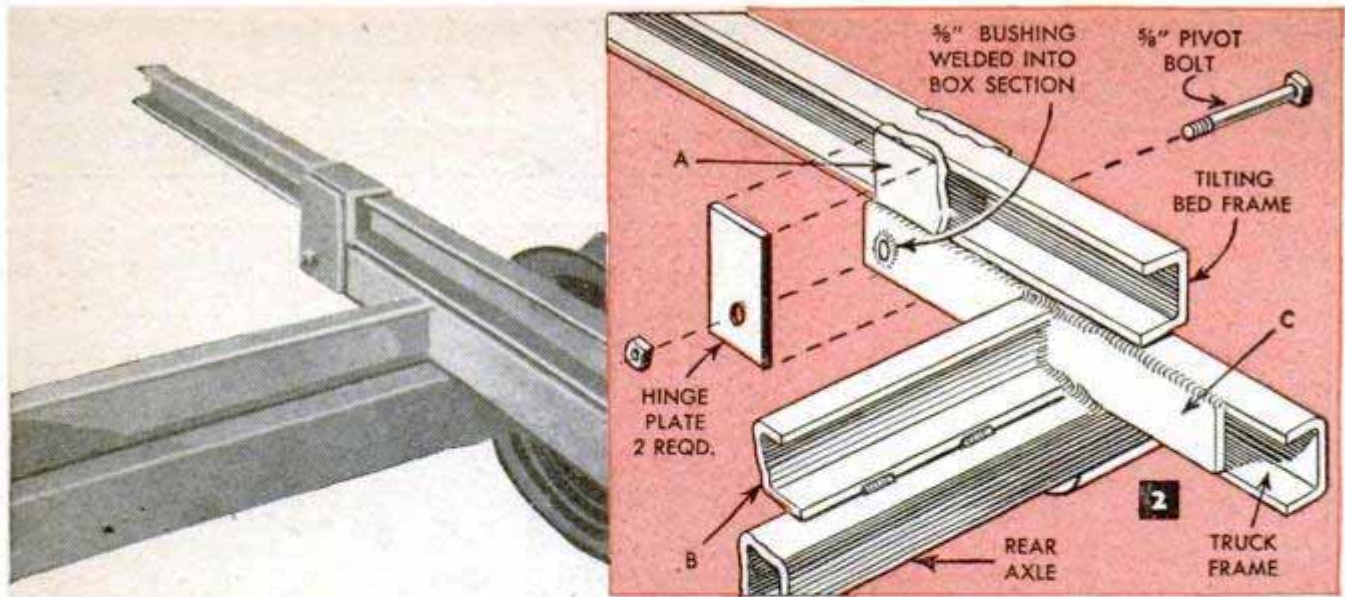

tilting bed frame pivots on the truck frame at a point just back of the rear axle, as shown in Fig. 2. The bed frame should be raised about 1 in. above the truck frame, or the truck frame cut at an angle of 45 deg., to allow the bed frame to tilt. In addition to the two channels on each side, this pivot assembly consists of the parts A, B and C welded in the positions indicated. Note from the detail that the truck-frame cross member, B, is welded to the box-section axle. Of course, the truck frame can be bolted to the front and rear axle if desired. Hydraulic cylinders are of the type used with tractor scoops, but any similar cylinders can be used. The lower ends of the cylinders pivot on a shaft mounted on the truck frame by means of the parts

A and B shown in the right-hand detail, Fig. 1. The hydraulic plungers bear against a shaft pivoting in sleeve bearings mounted on the tilting frame as in the left-hand detail, Fig. 1. The sheet-metal parts A, B and C are welded to the frame in the positions shown to form the bearings. In making up the truck frame, be sure that the front wheels have clearance for turning. Determine this before welding the box-section cross braces to stiffen the tilting frame as shown in Fig. 1. Use a pipe tee and hydraulic unions to connect the two lines from the hydraulic cylinders to a single line running to the hydraulic pump on the tractor. The bed is of usual construction, 7-ft. wide, supported on hardwood sills bolted to the tilting frame.

Race of Broken Pilot Bearing Removed Easily With Machine Bolt

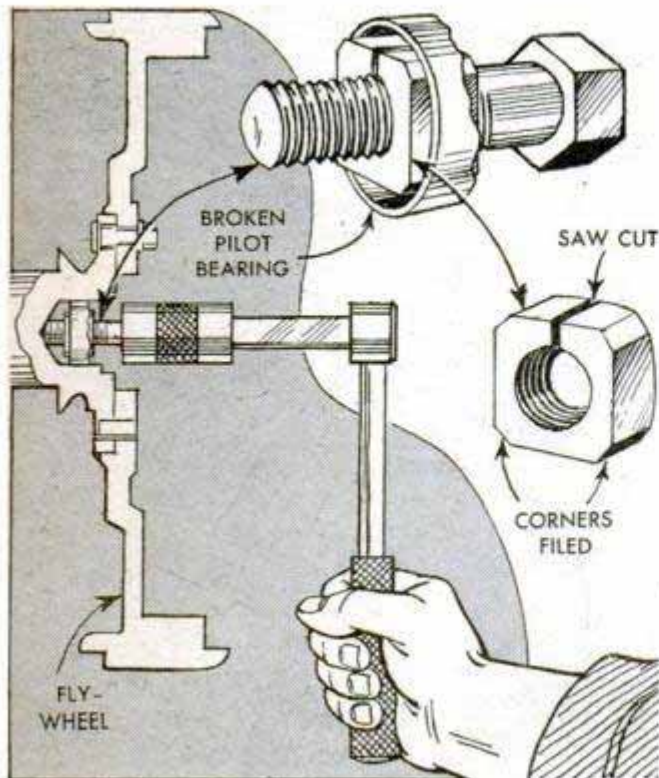

Faced with the problem of extracting the outer race of a broken pilot bearing in an auto-engine flywheel, I hit upon a simple way of removing it with a machine bolt. First, I selected a short bolt having a nut which measured slightly more from corner to corner than the inside diameter of the race. Then I slotted the edge of it, as shown, and squeezed the nut to close the slot. Next, I filed down each corner at a slight backward taper so that the nut just fitted inside the bearing race. After this, I expanded the nut in the race by opening the slot with a cold chisel and turned the bolt into the nut. When the end of the bolt made contact with the crankshaft, continued turning with a wrench forced out the race.—T. O. Carlsson, Chicago.

Flat belts and V-belts used on equipment in the shop, home or on the farm, may be cleaned safely and efficiently by using carbon tetrachloride. This liquid is non-inflammable and it will not injure the belt.

In addition to being well suited for moving heavy farm machinery on the road or from field to field, this trailer is especially handy for hauling fruit from orchard to packing house. Freshly picked fruit must be handled carefully by hand, whether it is sacked or packed in crates, and the wide trailer platform, underslung only a few inches above the ground, makes it easy to lift and stack the fruit for hauling. A multiple hitch consisting of two clevises welded to the drawbar, one directly above the other as in the inset photo, permits hitching the trailer to either a tractor or truck. By using a welded axle of channel iron, the width of the trailer can be built out to the maximum allowed on the highway.

This Low-Lift Platform Trailer Hitches to Your Tractor or Truck

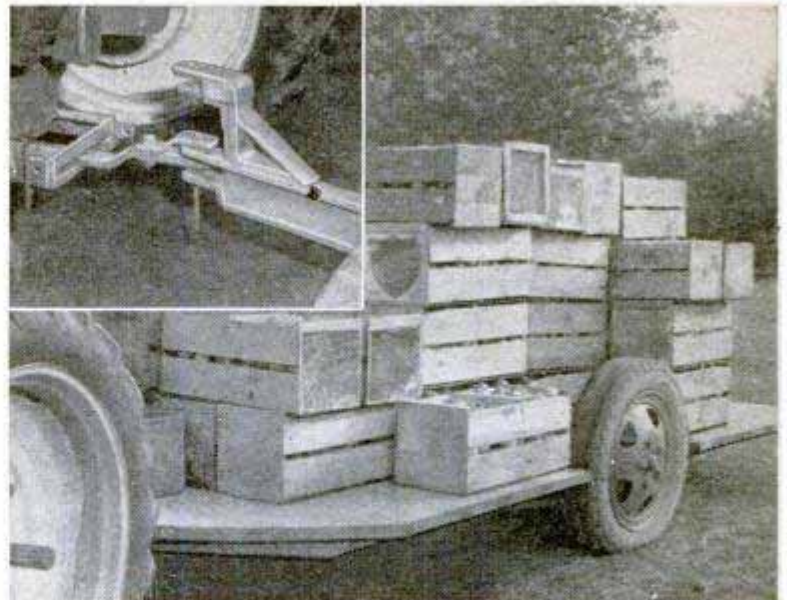

Red Core in Car-Battery Post Identifies Positive Terminal

After noticing that the negative and positive terminal markings on rental batteries soon became defaced and thereby confused customers who often installed the batteries themselves, one garage attendant permanently identified the positive post of the battery in the following manner: First, he drilled a $\frac{1}{4}$ -in. hole down through the center of the positive post, about $\frac{1}{2}$ in. deep. He was careful not to drill all the way through the post. Then he melted the lead drilling chips from the hole and colored them with a small amount of dry red lead. After this he poured the lead back in the hole in the post. This formed a permanent colored core that cannot be destroyed by the points of a tester or by repeated clamping of battery cables.

Roosts Divided Into Stalls Prevent Crowding

Nearly every poultryman has trouble at times with individual birds in his flock who crowd others from pole-type roosts. One poultryman has found that dividing the roosts in the manner shown helps prevent this trouble. Simply drill holes about 7 in. apart and insert 12 in. lengths of $\frac{1}{2}$ -in. dowel stock. The dowels will effectively keep the birds separated and provide each with an equal amount of roosting space.

When cutting a stencil on a typewriter, errors will be easy to locate if a piece of carbon paper is inserted between the stencil and its cardboard backing so that the copy will be reproduced on the cardboard.

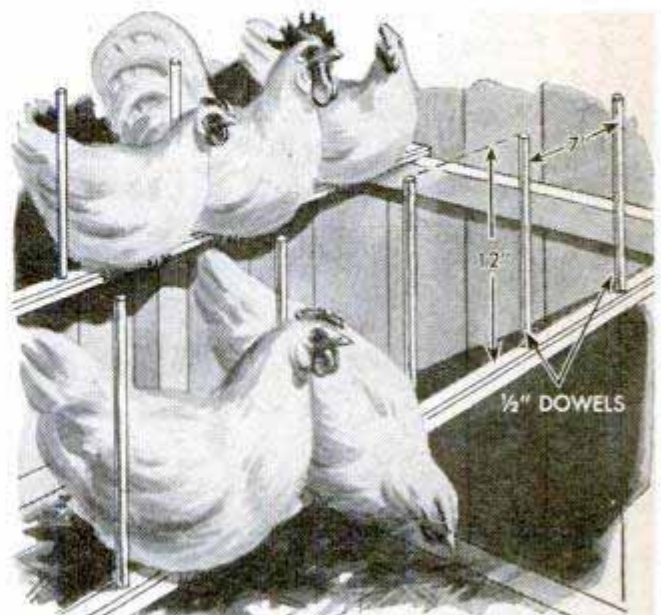

Broken Stud Bolts Removed By Two Simple Methods

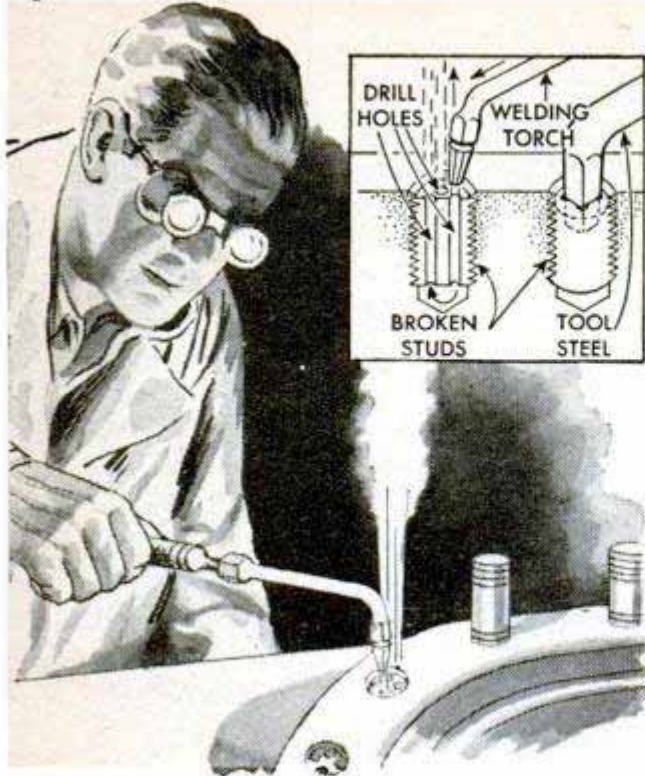

Here's a method which I have found very effective in extracting a broken stud bolt. First, drill four small holes lengthwise through the stud in a square pattern. Then direct the flame of an acetylene torch into one of the holes so that it will emerge from the others, as indicated in the left-hand detail. Heat the broken stud to a cherry red and let cool. The heating-and-cooling treatment will cause the stud to shrink slightly and make it easy to remove with slim-nose pliers.

Another method which works well when removing the broken part of a large stud is to drill a hole in the center of the stud and then drive the square and tapered end of a steel rod in the hole. The square corners of the rod will bite into the edges of the hole, and with the rod bent L-shape, the broken part can be backed out of the hole by merely swinging the tool.

L. D. Barner, Waco, Tex.

Jig Aids in Boring Small Bushings

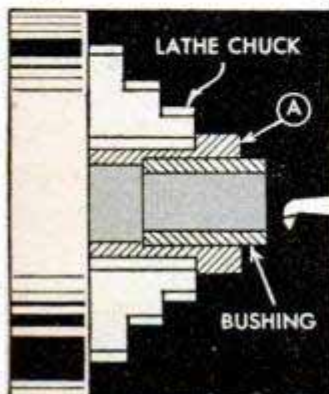

When it is necessary to enlarge the hole in a small bushing exactly concentric with the outside diameter, this boring jig will save time and afford greater accuracy than mounting the bushing directly

in the lathe chuck. Bore a hole in a short length of brass or soft-steel rod to a push fit over the bushing, detail A. If you wish, leave a small internal shoulder to back up the bushing, but be sure it will not interfere with pushing out the work. Then, insert the bushing in the sleeve to project a short distance and chuck the assembly. Light cuts with the boring bar at a fairly high speed will do an accurate job.

Drill and Tap for Cast Iron Combined in One Tool

Made from a 4-fluted high-speed tap, this combination tool permits drilling and tapping through cast iron in one operation. Grind off the threads about halfway up from the bottom of the tap and grind off two opposite flutes, forming cutting edges so this portion of the tap will serve as a drill. To use, chuck the tool in a drill press and bore through the work until the threads are reached. Then tap the hole by turning in the remaining half of the tool by hand. This tool has been used successfully on cast iron up to $\frac{1}{16}$ in. thick.

Charles N. Dyer, Kansas City, Mo.

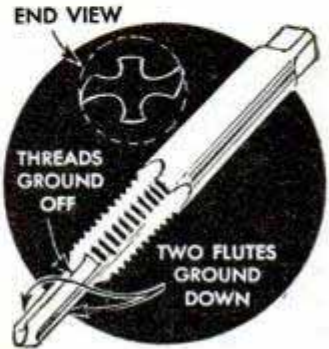

Spring-Action Latch on Farm Gate

Spring action provided by a hay-rake tooth closes the latch on this farm gate as soon as the handle is released. The latch is a heavy sliding member with a broomstick handle. One end of the tooth is attached to the latch and the other is fastened to a fixed cross member of the gate.

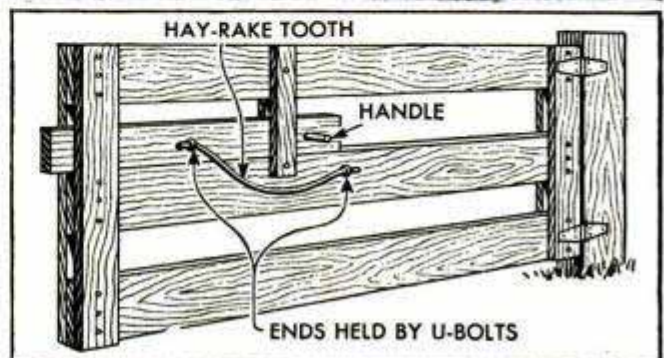

Electrician's Test Light Built From Stock Parts

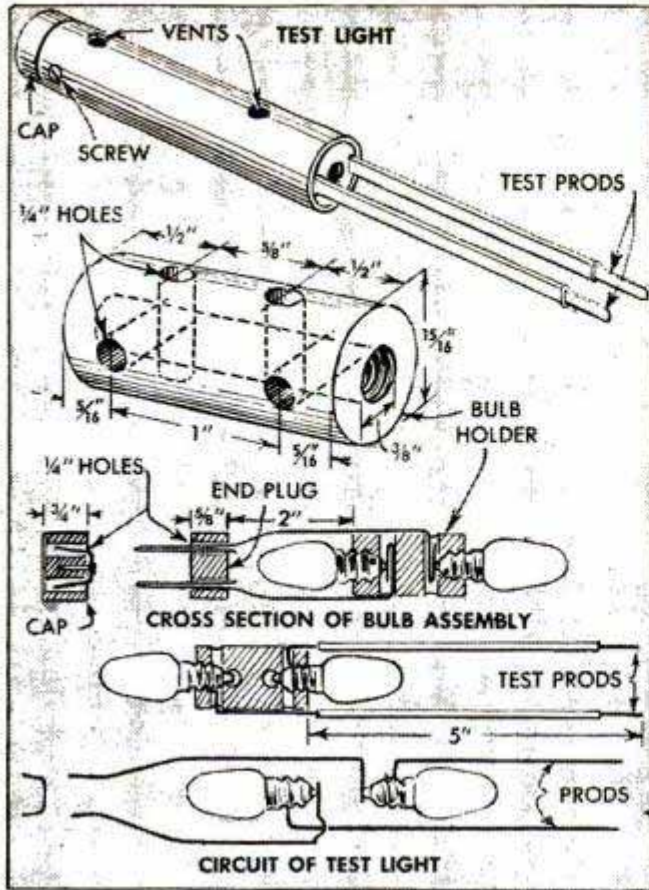

In addition to the regular flexible prods for locating defective fuses and open circuits, this test light has a novel and useful feature. A removable end cap allows the light to be plugged into a 110-volt outlet, either a wall receptacle or an extension cord, for testing fuses and locating grounds or open circuits in electrical equipment without danger of grounding the source of power. The housing is made from a length of fiber tubing and the bulb holder is a round piece of wood cut from a shade roller. Two 110-volt candelabra-base bulbs are used. With care these can be turned into the holes in the ends of the bulb holder to form their own threads. The end plug supporting the plug prongs and cap can be cut from the same wooden stock as the bulb holder. Contact strips for the whole assembly are made from $\frac{1}{2}$ -in. spring-brass strips, $\frac{1}{4}$ in. wide. After assembling and wiring the parts, the assembly is forced into the fiber holder. Slip the end plug over the plug prongs and close the opposite end of the holder with a fiber disk notched to provide openings for the test prods. The cap is fitted with a bent strip of metal held in place with a small brad, as shown in one of the sectional views. A disk of thin fiber is glued to the outer face of the cap to cover the small holes drilled in the cap to take the ends of the strip. When the cap is in place, the metal strip

closes the circuit between the two prongs so the unit may be used to locate defective fuses and open circuits in the usual manner. Removing the cap and plugging the tester into a receptacle on the end of an extension cord allows the user to test grounded motors and other equipment for open windings and circuits without danger of grounding the "live" side of the circuit, as one lamp is in each lead. With the prods touching, both lights will be on at half brilliancy. However, contact with a grounded circuit will cause one light to be extinguished while the other reaches full brilliancy.—T. W. Benson, Philadelphia, Pa.

Smooth-Working Pivoted Joint

If you wish to obtain a smooth-working pivoted joint when riveting two parts together, this may be accomplished merely by inserting a small piece of paper between the parts before riveting. After the joint is riveted, the paper is removed, allowing sufficient clearance for the parts to pivot freely.—F. Tashiro, Seattle, Wash.

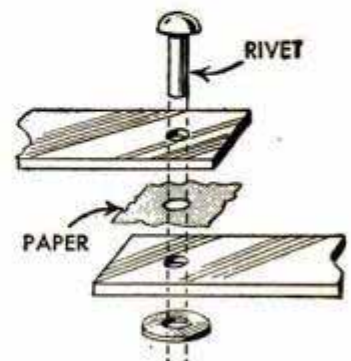

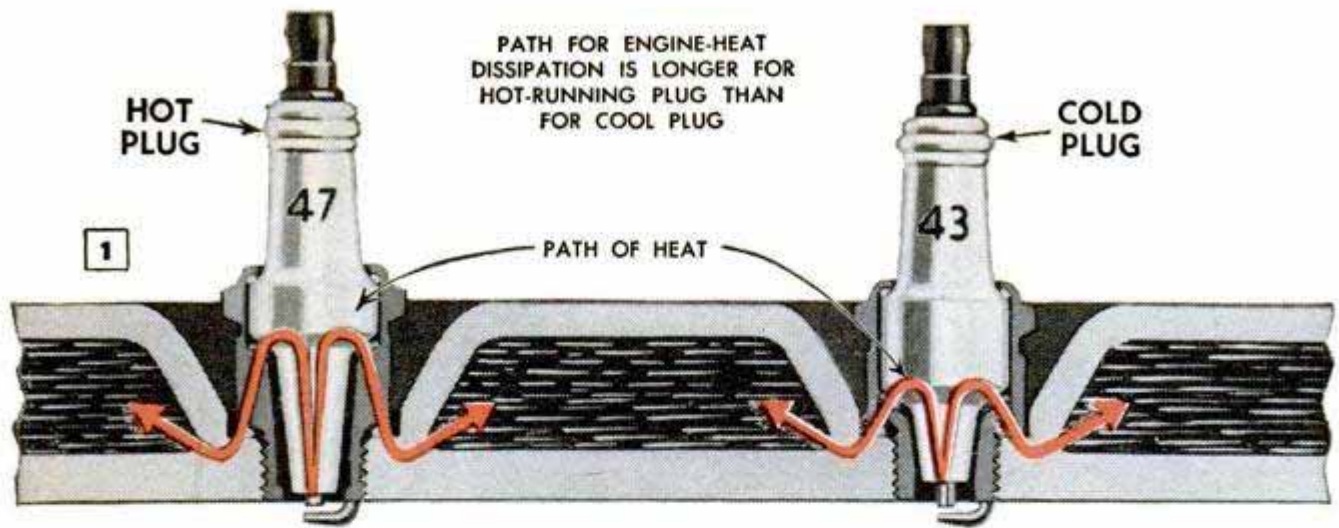

WATCH YOUR SPARK

REGULAR servicing procedure applies to the spark plugs, just as it does to all other parts of the car that require periodic attention. Plugs should not be removed, cleaned and adjusted by a haphazard schedule. This may often do more harm than good as frequent removal and reinstallation of plugs is ordinarily unnecessary and causes undue wear on the threads of both the plug and cylinder head. This is especially true when the car is new, unless, of course, faulty engine performance at some time during the first few thousand miles fouls the plugs. In older cars the plugs, and also the ignition system, require a careful check more often to keep these parts performing properly. Badly worn pistons, cylinders and rings accelerate wear on the plugs. On the average, plugs need a careful check every 3000 to 5000 miles, and should be replaced with new ones every 10,000 miles. They will run longer, of course, but with greatly reduced efficiency. At the regular checks of other parts of the car examine each plug to see that the exposed portion is clean

and dry, and that the plug wire snaps over the terminal firmly and with a clean connection, Fig. 10. Other parts of the ignition system should be inspected regularly to assure delivery of the normal high-tension current to the plugs.

The basic parts of a plug are shown in the cross-sectional drawing, Fig. 2. Inspection of these parts will tell a lot about how the plug is performing and what to do about correcting any trouble that may develop. The six photos below picture some of the common causes of plug failure.

A plug must run hot at low engine temperatures, and cold at high engine temperatures. The running temperature of the plug must be sufficient to burn off ordinary carbon deposits but not so high as to cause detonation, pre-ignition, fusing or blistering of the insulator, or rapid erosion of the points. To obtain the right plug temperature, use a plug of the correct "heat range." This is determined from the type of engine and the operating conditions. When buying a set of plugs, remember there are three "heat range" types—hot, normal

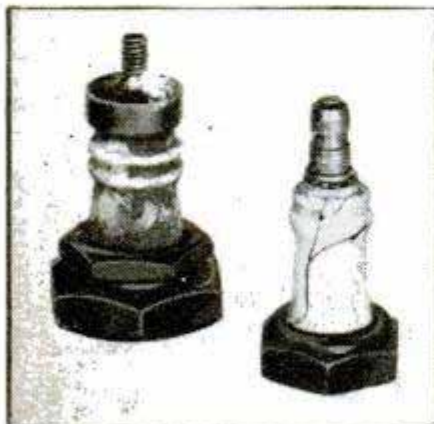

Cracked, dirty insulators affect engine performance, cause compression leaks, shorts, fuel waste



Plug has been running too cool. Shell, electrodes and insulator are fouled with hard carbon deposits

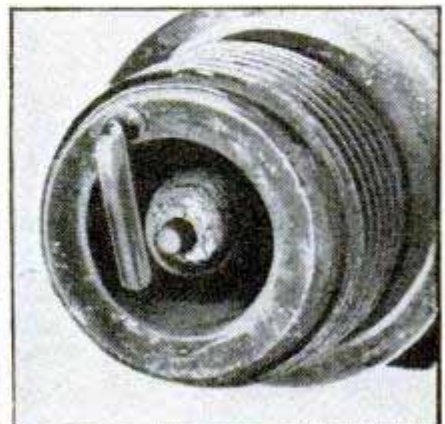

Insulator eroded by oxidation. Tends to short the plug, causing the engine to miss at high speeds

Clean plugs, properly chosen for heat range, give peak engine performance with very substantial savings in fuel and oil consumption and reduce costly repairs

By Phil Ruskin

PLUGS

and cold. The hot plugs, Fig. 1, have a long insulator with a correspondingly longer path for the dissipation of heat to the engine block. The insulator on the cold plug is short, heat is dissipated rapidly, and it operates much cooler. A plug operating at the correct temperature will have a soft, powdery deposit on the nose of the insulator—either a grayish tan or rusty brown in color. Wear of the points will be normal and confined to the faces of the spark gap. If point wear is rapid while the color of the insulator is normal, the gap may be incorrectly set or the fault may be in the wrong type of coil. It's well to keep in mind, too, that in old cylinder heads there is the possibility that water passages near the plug may be partially or wholly blocked with hard deposits, causing a hot spot in the head that may affect the plug. Plugs operating too hot will show

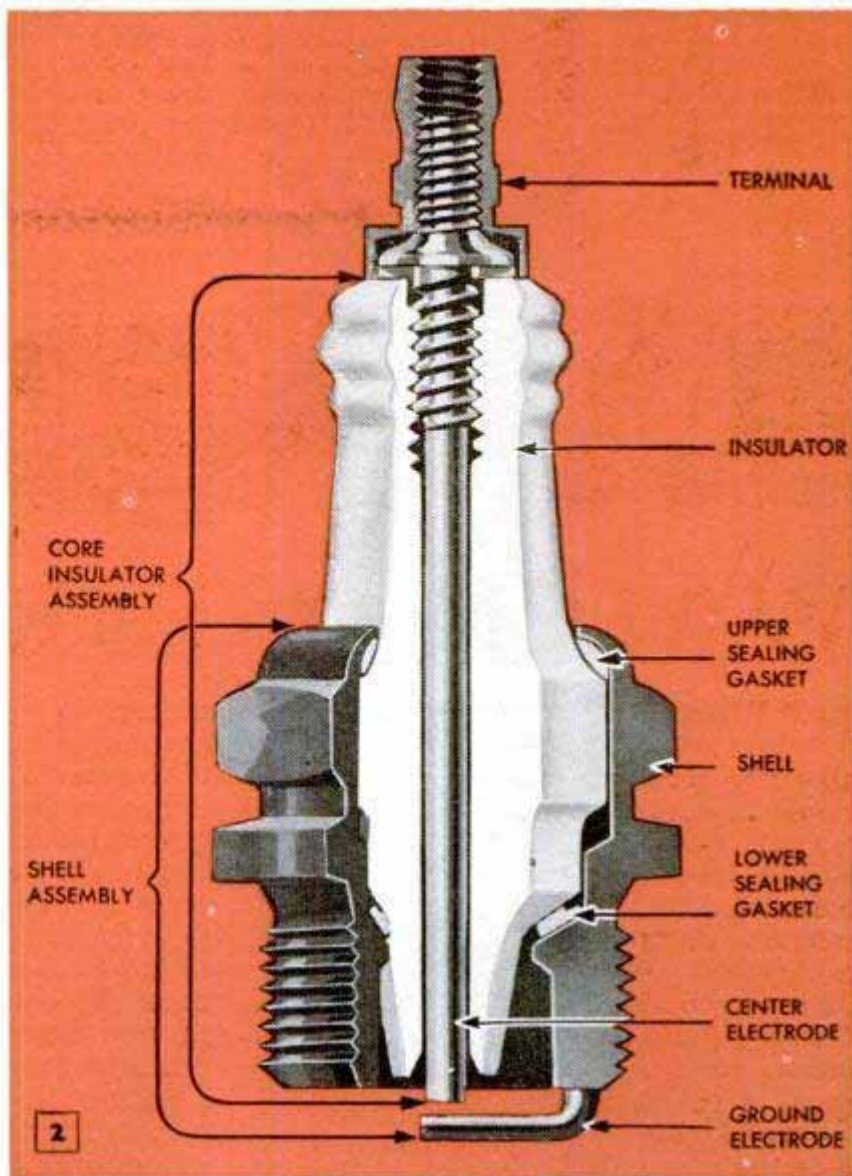

dark spots or blisters on the insulator nose. The points will be badly burned, in proportion to the length of time the hot condition has existed. Fused and glazed deposits on the insulator may "short" the current and cause misfiring.

Often a plug will be of the correct heat type for a particular engine and still run hot. In this case, the plug may not be tightened sufficiently, permitting hot gases to



This happens when a plug runs too hot. Undue wear of the electrodes shows in comparatively short time



According to reliable tests, plugs in this condition may waste as much as one gallon of fuel in ten



Insulator broken at the lower end may be due to hot operating conditions or careless installation



3
Clean the threads of the shell thoroughly. Carbon deposits here will retard dissipation of heat

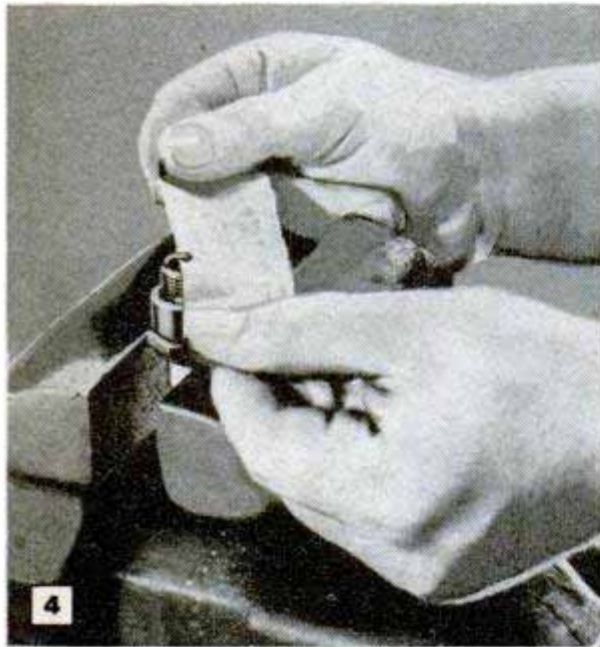

4
Shallow-pitted electrode points can be restored by the careful use of fine-grit abrasive or a file

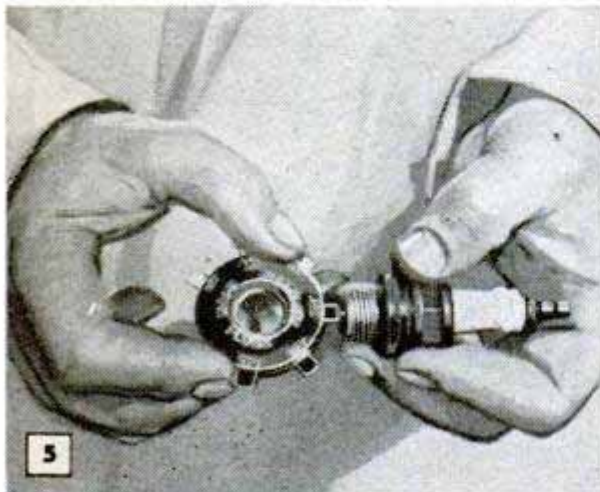

5
Use a round gauge to check the gap. Adjust to exact distance recommended by the manufacturer

escape and heat the plug in passing out. There may be gas leakage between the insulator and the electrode, or between the insulator and the shell. This condition can be detected by soot streaks on the outside portion of the insulator. A lean fuel mixture, wrong ignition timing, poorly seating valves and other faulty engine conditions, can cause plug overheating. Plugs running too cold will be sooty, gummy and possibly oily. Oil pumping from the crankcase, too rich a fuel mixture and long idling periods will cause this condition. Fuel fouling is indicated by a dull, black, fluffy deposit; oil fouling, by a shiny, black, hard deposit. In judging plugs for heat range, be sure normal operating conditions have existed for a time before making the inspection. Otherwise, one may get a false interpretation of the average plug needs of the engine.

Although servicing a spark plug looks simple enough, there is danger of permanent damage to the plug unless certain precautions are carefully followed. Use a socket wrench of the correct size to remove the plug—never use an end wrench or other makeshift wrench that is likely to burr the plug nut or slip off and break the insulator. Blow dirt out of the plug well before removing the plug to prevent it from falling into the cylinder. Condition of the gasket is important. Inspect it carefully each time the plug is removed. It may be the key to plug trouble or poor engine performance. If the gasket is flattened or badly scored, it may be the cause of a baffling compression leak as well as a hot plug. On the other hand, if the gasket is still rounded, it is probable that the plug has never been correctly tightened. This condition may also be the cause of a hot plug or a compression leak. If there are indications of soot and burning on the gasket, it was not tight enough to seal. The gasket serves the dual purpose of sealing engine compression and acting as a bridge for the dissipation of heat.

After removing and inspecting the plug and gasket, clean the shell threads, insulator and

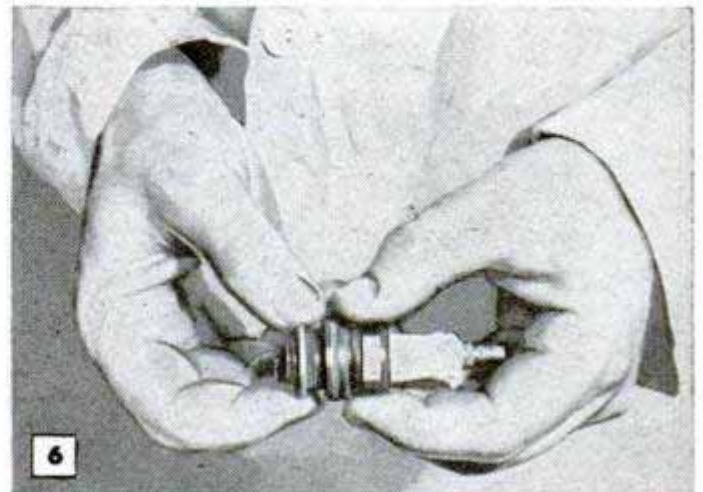

6
Before replacing a plug, turn a new gasket over the threads by hand. Make sure gasket is properly seated

points carefully as in Figs. 3 and 4. Or if desired, take the plugs to a service station equipped with a spark-plug cleaning machine. If the insulator is badly fused, cracked or blistered, the plug should be replaced. Plugs with badly corroded and worn points also should be replaced. Adjust points to the correct spacing by bending the side electrode, never the center one. Use a round gauge, Fig. 5, to check the gap setting recommended by the car manufacturer.

When installing the plug, always use a new gasket and turn it over the shell threads as in Fig. 6. Before screwing the plug into the cylinder head clean the gasket seat with a cloth as in Fig. 8. Turn the plug in by hand, making sure the thread is not crossed and the gasket is not cocked at an angle. Snug it up by hand also, then tighten with a socket wrench only one half to three quarters of a turn, Fig. 7. Wipe the insulator as in Fig. 9 and be sure to connect the correct wire to each terminal.

If plugs foul in a new engine, check for wrong lubricating oil in the gasoline for run-in purposes; carburetor adjustment out; improper choke adjustment; car driven too slowly during break-in period; distributor points incorrectly set; coil or condenser weak; plug gap set too close. If the engine misses at high speeds or under a heavy load, check these common causes: distributor points dirty, glazed or incorrectly set; weak coil or condenser; carburetion incorrect; valve-tappets out of adjustment; plug gap set too wide; overheated plugs, calling for cooler plug in the heat range, overheated plugs due to gasket leakage or other causes.

If the engine "rolls" when idling, check the carburetor adjustment; distributor points; coil; engine compression; valve-tappets; improper valve timing; sticking valves and the plug gap. When making any inspection with the plug removed, always check the gap.

Certain photos and details by courtesy of A.C. Spark Plug Div., General Motors Corporation; Champion Spark Plug Co., and The Electric Auto-Lite Co.



When removing or tightening plugs, use a socket wrench. Other wrenches may burr the hex section

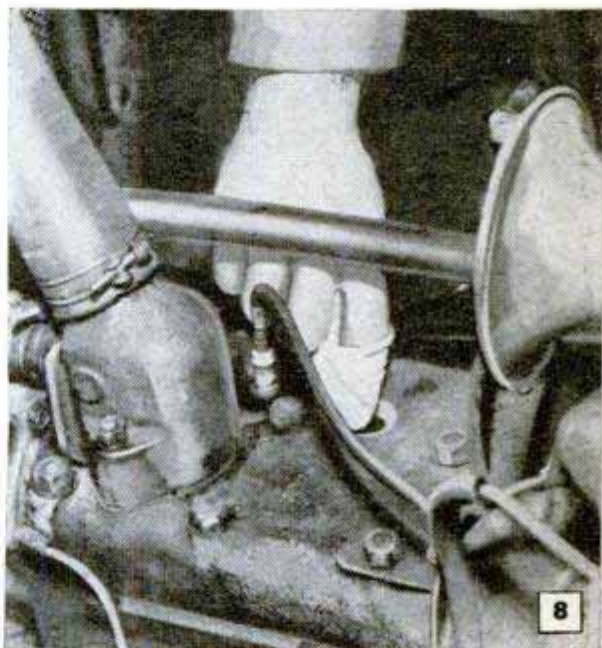

Wipe the gasket seat with a clean cloth before installing plug. Avoid pushing dirt into opening

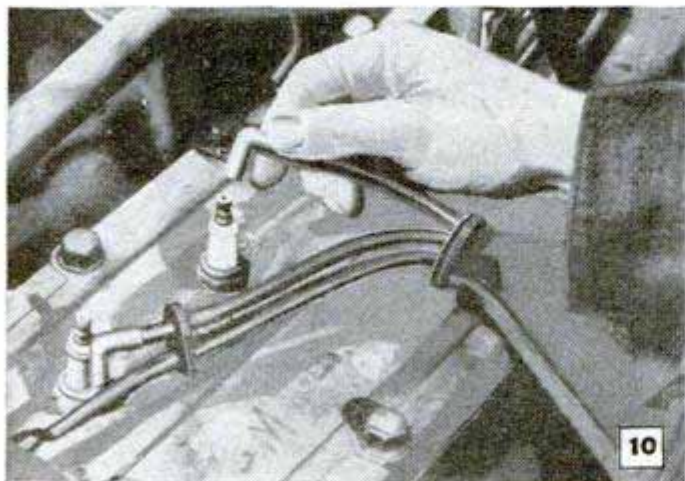

It's very important to attach the correct ignition wire to the terminal after cleaning and installing the plug

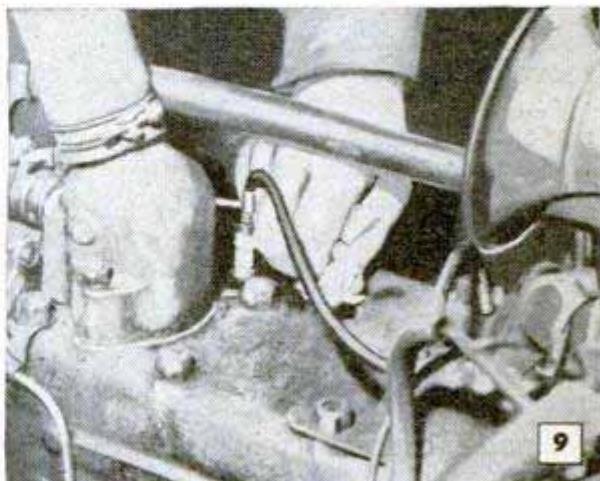

Clean the insulator after installing the plug to prevent shorts through caked dirt or hard grease

Lands on Facets of Mandrel Nut Prevent Punch From Slipping



Skinned knuckles resulting when using a hammer and punch to tighten or loosen a saw-mandrel nut that is too big to turn with a wrench, led one man to provide lands in the nut so that the punch would not slip off. The lands can be formed by milling a shallow notch or grinding a flat in opposite facets of the nut as shown.

Flat-Topped Sunshade for Hogs Moved by Small Tractor

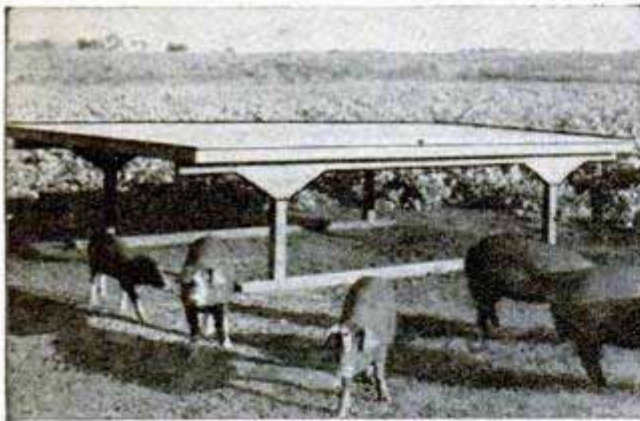

This sunshade is easy to build and it's moved about from range to range merely by hitching to a small tractor. The runners are made from 4 by 4-in. stock rounded at the ends, and are fastened to the vertical posts by pieces of flat iron bolted in place. The roof is made from rough boards covered with roll roofing or sheets of corrugated-metal roofing.

A. M. Wettach, Mt. Pleasant, Iowa.

Silicon-Carbide Dispenser

Small talcum-powder cans provide ideal dispensers for silicon carbide or similar abrasives. If several grades of the abrasive are used, label each can with the grit

size it contains. The holes in the top of most of these cans may be used to control the flow of the material.

Removing Corrugated Roofing In Usable Condition

If corrugated metal roofing or sheathing is to be removed from a building and used again, the nails can be pulled without damage to the roofing by using a short length of pipe as a fulcrum block as shown in the drawing. This method is especially helpful when dismantling shed-type buildings and salvaging the materials.

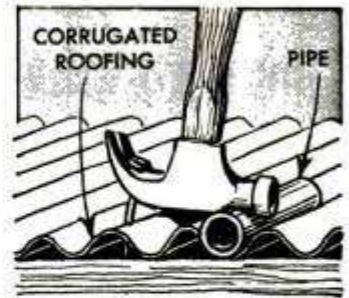

Bench Vise With Calibrated Jaw Speeds Small Cutoff Jobs

Measuring and cutting off short pieces of stock is speeded up by scribing an inch scale on the vise jaw, inserting the material to the required dimension, and sawing it flush with the end of the jaws. As this method is not intended for especially accurate work, divisions of $\frac{1}{4}$ in. will be found suitable for most jobs.

Ronald Eyrich, Milwaukee, Wis.

GRADUATED VISE JAW

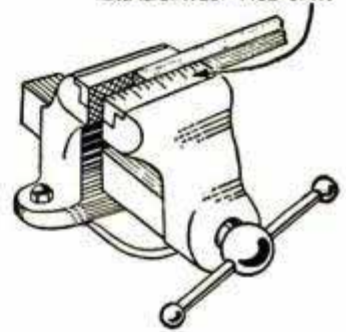

Slots Cut Through Steel Plate Aid Bending It

A piece of $\frac{1}{4}$ -in. steel plate can be bent in a vise with comparative ease and without the usual equipment, if it is first slotted along the bend line with a torch. Leave about $1\frac{1}{4}$ in. of material between each slot and at the ends. Should it be necessary to strengthen the plate after bending, fill the V-shaped channels formed by the slots with welding rod.

Earl R. Goddard, Denver, Colo.

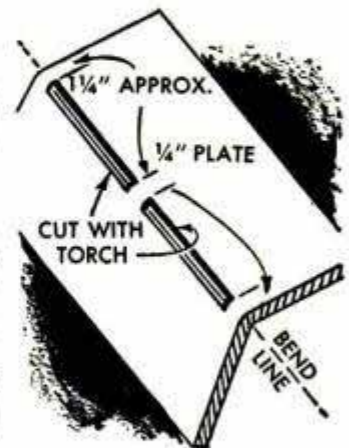

EDGE-LIGHTED SIGNS in plastic

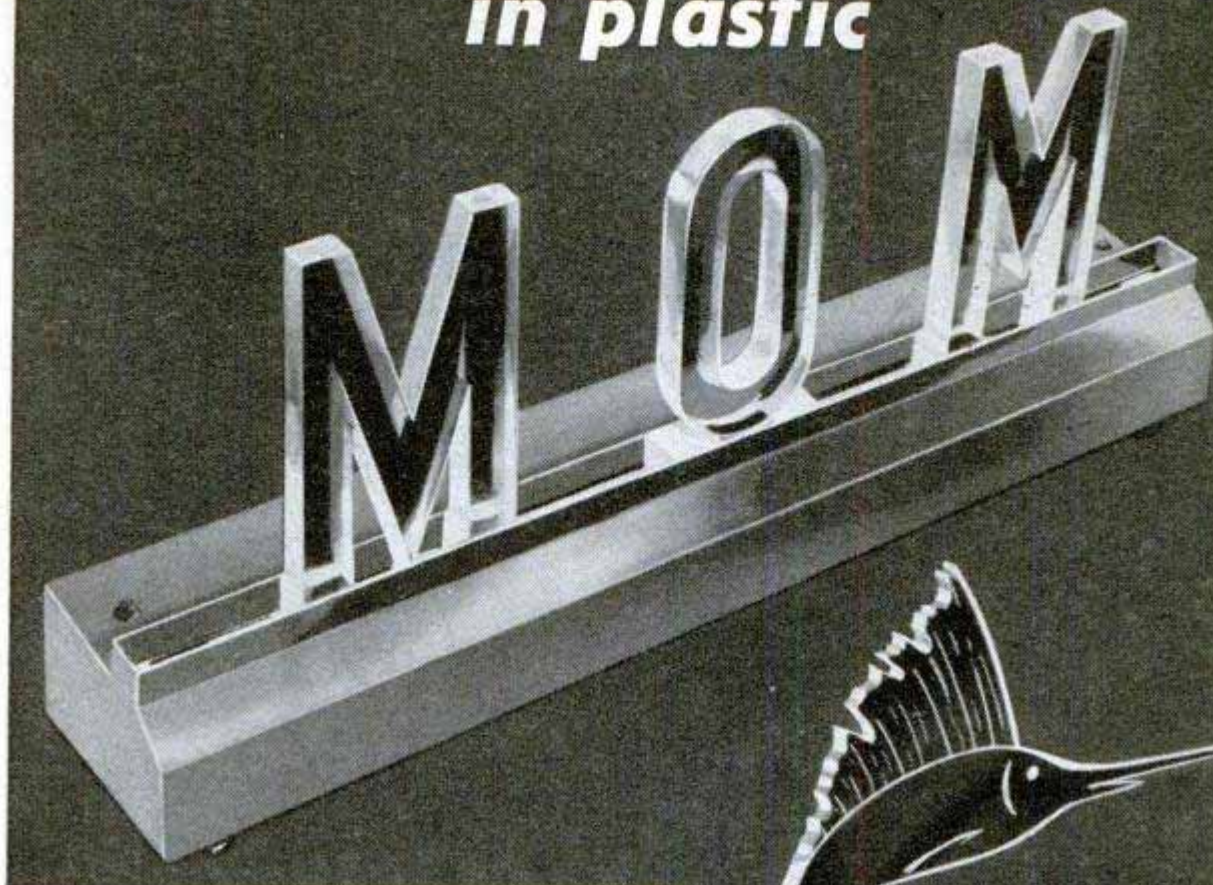

By John P. Arnold

UNUSUAL and striking effects in lettered signs and displays are obtained by skillful use of the light-transmission and deflection properties of transparent plastics. These are both light and strong, and are good electrical insulators. They are readily formed by heating and can be engraved, etched, stained and painted. Properly finished, these plastics possess qualities of light-transmission, dispersion, reflection and refraction equal to those of fine-quality optical glass, Figs. 1, 2 and 3.

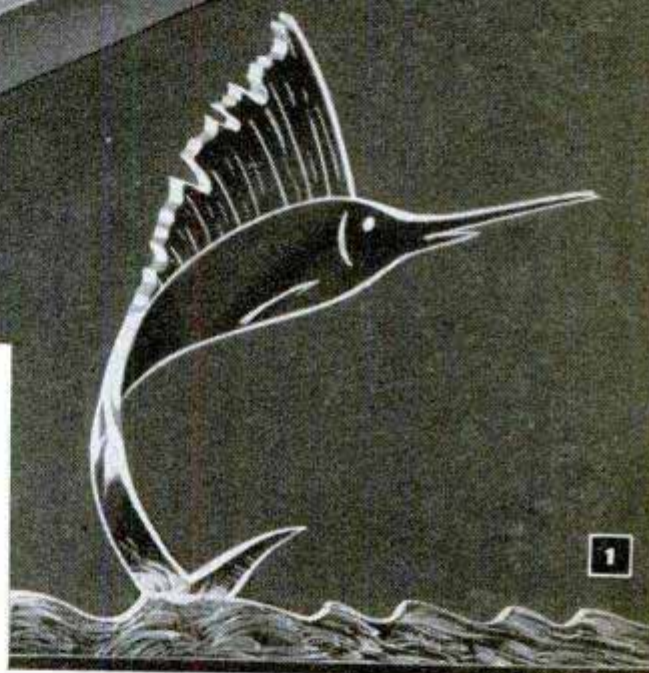

Rohm & Haas Co. photos

In the top sign a fluorescent bulb concealed in a slotted metal base gives the striking edge-lighting of the plastic block letters. In the lower design, light is "piped" through the curved body of the sailfish to the fin where it brilliantly outlines the edge

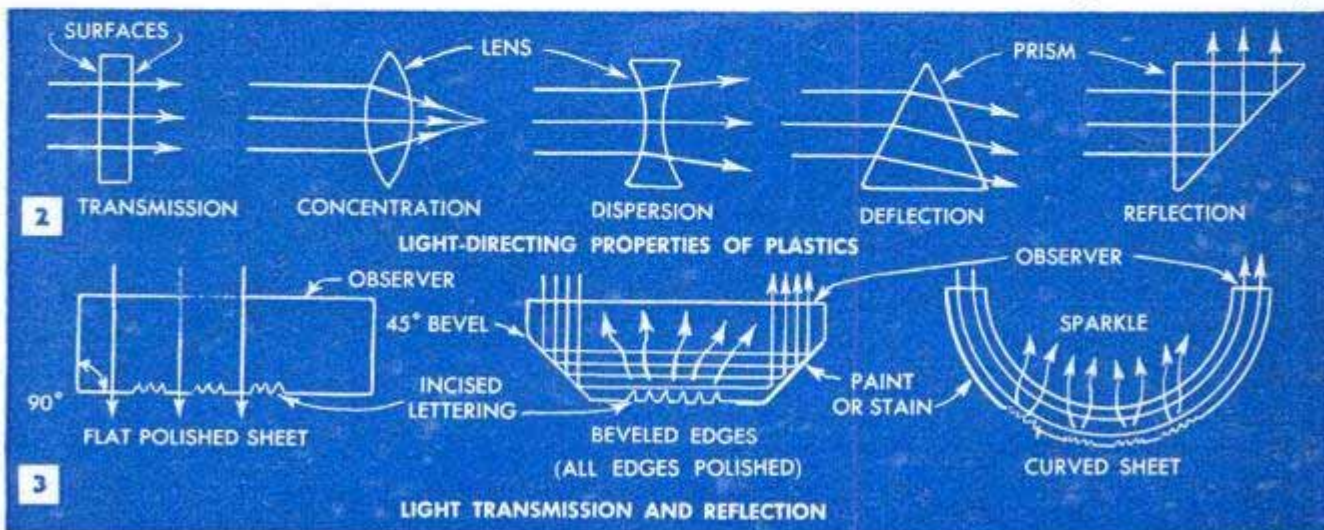

Marrix Shoes

YOUR FOOTWEAR



SCRIBED, OUTLINE LETTER



BLOCKED IN BY CROSSHATCHING



ROUTED TO AN EVEN DEPTH



PAINTED, GILDED, LUMINOUS PIGMENTS, ETC.



TRANSPARENT OVERLAY CEMENTED TO VENEERED BACKGROUND



FROSTED BY ETCHING OR SANDBLASTING



ENGRAVED OR CARVED



FORMED LETTERS INSERTED IN OPAQUE BACKGROUND AND LIGHTED FROM BACK

COLORED PLASTIC INLAID IN TRANSPARENT OR COLORED BACKGROUND

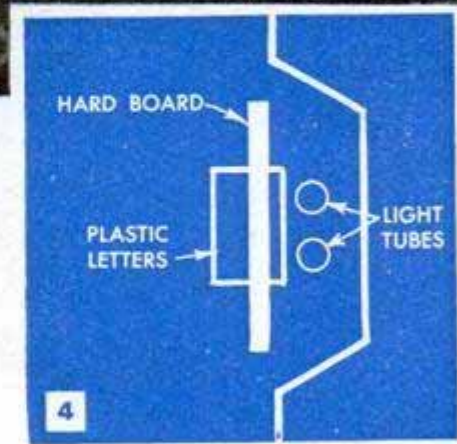

The effectiveness of edge-lighted script letters is brought out with the simple lighting installation shown in the detail above. The letters are inserted

For signs which are to be viewed either by diffused artificial light or daylight, the most useful effects are those which result from internal reflection within the plastic itself. If the sign is made from a transparent plastic having parallel faces and square polished edges, and the design, or lettering, is applied to the side away from the observer, practically all of the incident light is transmitted directly through the plastic itself. If the back edges are beveled or the piece is curved, light entering from the front or the edge will, by a series of internal reflections, make the sign appear to have a brightly luminous border. Applied or incised lettering will stand out with greater brilliancy. If the reverse surface is either stained or painted, the color also will be picked up and transmitted to the eye. Light-directing effects are limited by conditions which must be carefully observed in order that the incident light will be internally reflected. Light cannot be successfully "piped" around a curve having a radius less than three times the thickness of the material or through angles greater than 48 deg. from the vertical without most of the light escaping from the surfaces of the plastic, Fig. 9. Light also will escape wherever the polished surfaces are scratched, abraded or painted. Such applications or incisions will appear brightly illuminated.

Sharper effects are obtained by the edge-lighting method shown in Fig. 1, where the letters are illuminated by a

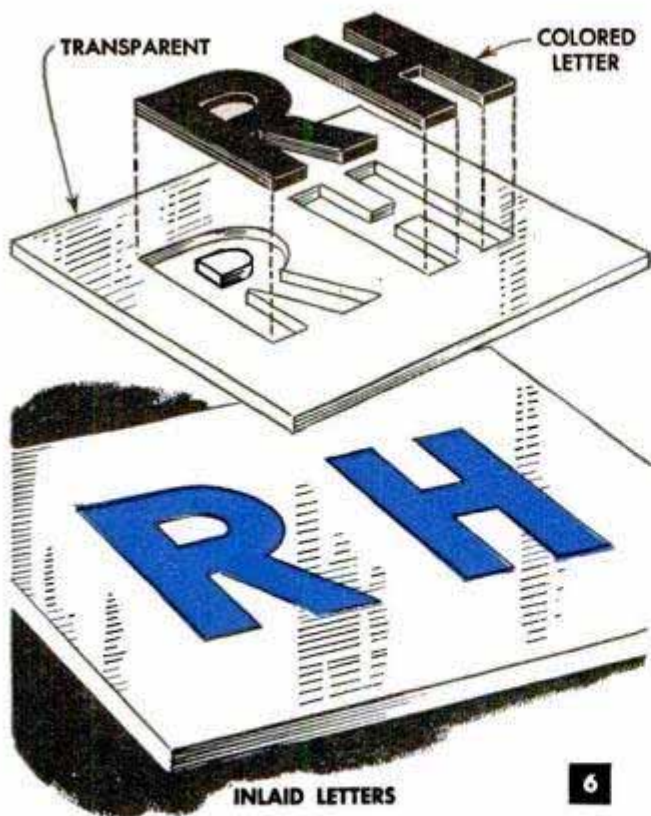

INLAID LETTERS

6

Block letters cut from colored plastic can be inlaid in transparent plastic or inserted in openings cut through. Hard board or sheet metal can also be used

fluorescent bulb concealed in a metal base which is slotted for the letters. Fluorescent lights are preferred to incandescent bulbs for small, unventilated signs as they radiate less heat and provide continuous light for illuminating the edges of thin plastic sheets.

Signs employing this edge-lighting effect should have the top edges of letters or designs painted white and the sides and bottoms highly polished. In Fig. 4 the plastic script letters are inserted in slots cut in the background to a depth equal to the thickness of the plastic. The edges of the slot preferably should be lined with black felt or other light-absorbing material.

As it is only necessary to interrupt the passage of light through the polished surfaces of the plastic to make lettering stand out, sign-makers employ methods of etching, engraving and abrading suggested in Fig. 5. Another simple method of inlaying letters of colored plastic is detailed in Fig. 6. Colored block letters also can be inlaid or inserted in hard board or sheet metal. The letters are laid out and jigsawed in the same manner as the design shown in Fig. 7. In Fig. 8 letters are painted directly on the reverse side of the transparent plastic by using a stencil. The top coat is applied first and this is followed by one or more ground coats. The process is the reverse of normal painting procedure. Incised lettering and carving also can be stained and the cavities filled with plaster.



7

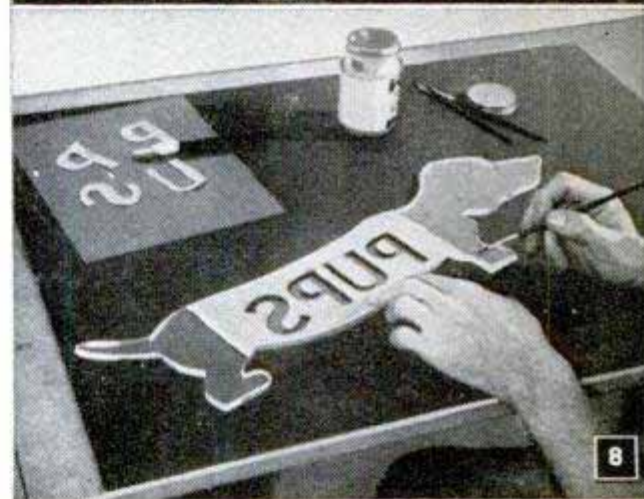

8

Using a simple stencil, block letters can be painted on the reverse side of a transparent panel or figure outline. Apply the top coat first, then ground coat

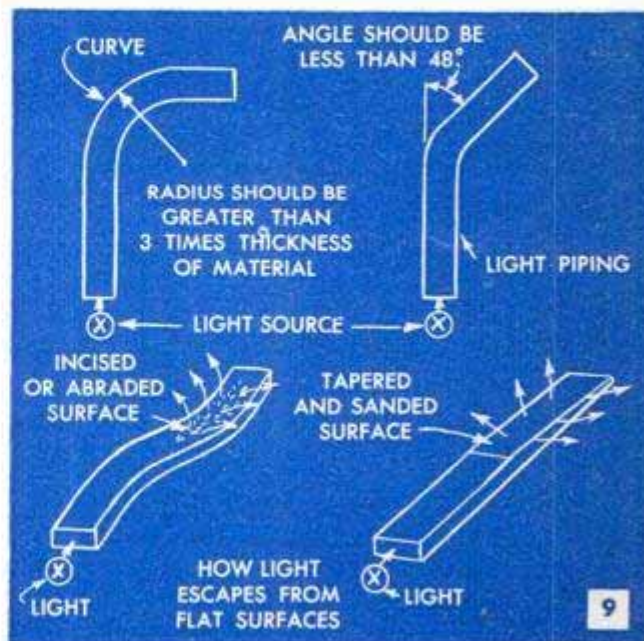

9

Driver to Set Steel Fence Posts Made of Shaft and Pipe

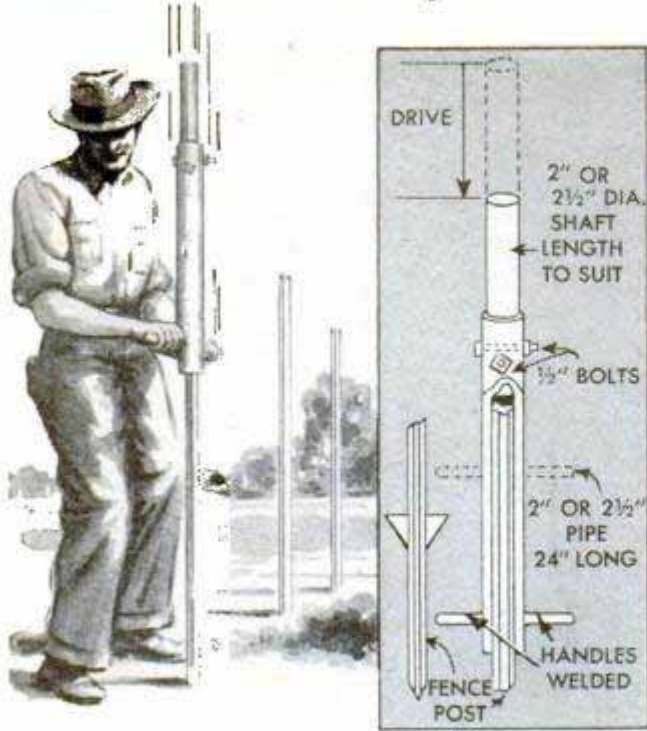

Constructed from a 24-in. length of 2 or 2½-in. pipe and a piece of steel shafting, this steel fence-post driver is fitted with handles that simplify operation and permit greater downward force to be exerted. Weld the handles to the pipe near the lower end and then fasten a steel shaft to the top of the pipe with crossed bolts. The length of the shaft, of course, will depend on the weight desired.

Clarence Klumb, Rockfield, Wis.

Eliminating Whistle in Car Louvers

A whistling noise sometimes heard in '41 Oldsmobile and Buick cars at speeds of 30 to 40 m.p.h., frequently is caused by air passing through the louvers at the sides of the grille. The noise may be stopped by fastening a piece of wire vertically inside the louvers so it will break the air stream. To determine if this is the cause of the noise, cover louvers with cloth and drive the car at the speed at which it occurs.

Hive Cover Held by Coil Spring



To keep the covers of his beehives from blowing off, one man devised this method of anchoring them with coil springs. A hole is bored in the side of the cover from the inside and a coil spring is fas-

tened in the hole with a nail. The spring is turned so that the outward end of the coil is pointed upward, permitting the cover to be placed over the super without trouble, but also furnishing enough friction to prevent the cover from blowing off in high winds. One or two of these on one side of the cover should serve the purpose.

Benj. Nielsen, Aurora, Nebr.

Stud-Upsetting Tool

Fastening steel dowels securely for use as studs or locating pins is done rapidly with this tool which upsets the metal around the dowel. Use tool steel to make it and drill a hole in the end for a close fit over the dowel. Chamfer the edge of the tool 10 deg. and harden the end.

In use, drive the dowel snugly in position, place the tool over the dowel and tap it sharply with a hammer.

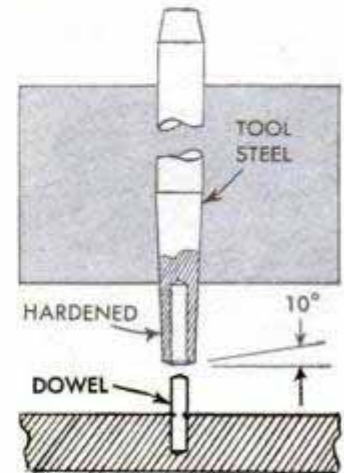

Sturdy Hinges for Floodgates

Frequently farmers and ranchers have trouble with the hinges on floodgates because they are too light for such heavy service. One farmer found that front-wheel axle spindles could be made to serve as sturdy hinges. The axle is cut down and drilled for bolts to attach it to the cross-beam, and the spindle is threaded and bolted to the gate by inserting in holes drilled through the edge of the frame.

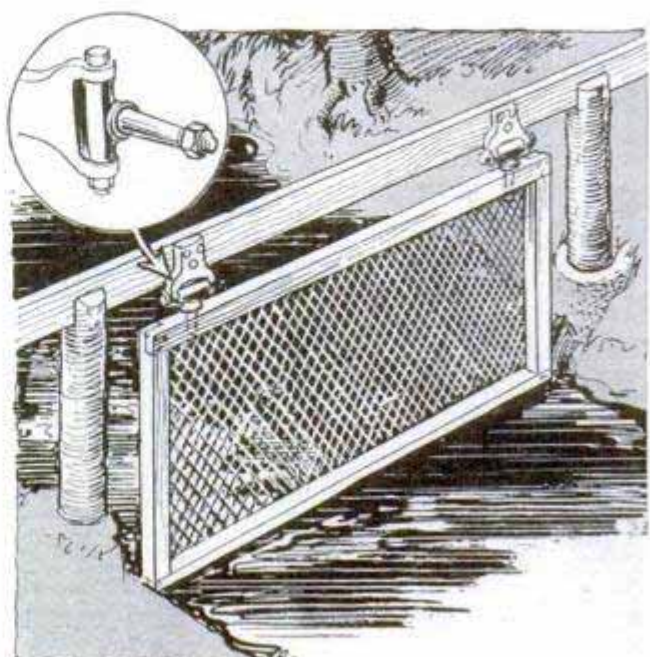

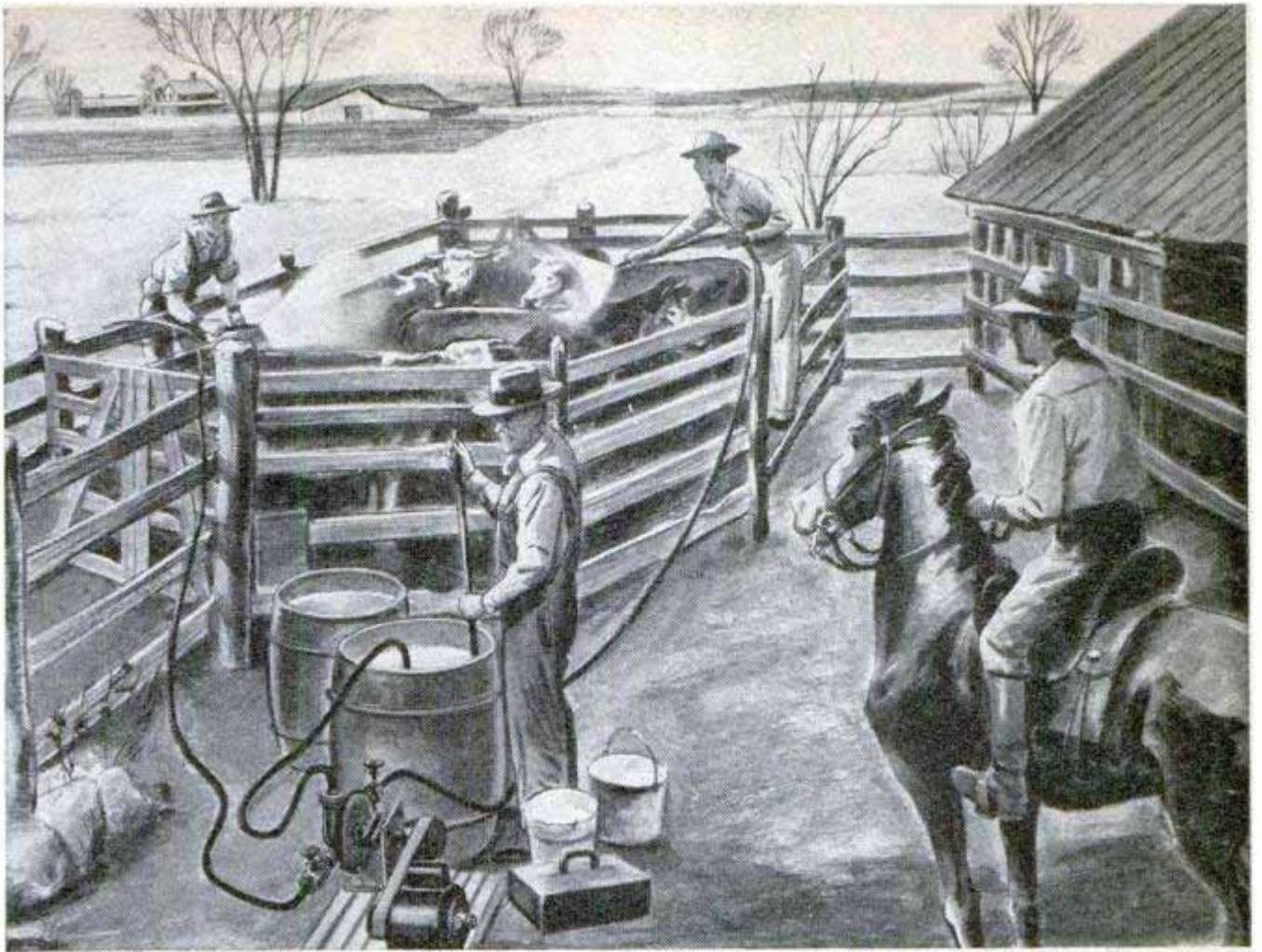

CATTLE SPRAYER IS POWER DRIVEN

RANGE cattlemen and dairymen will find this simple cattle sprayer easy to build from parts which are readily obtainable at a cost of about \$25, less the engine or electric motor. Some operators belt the sprayer directly to a tractor as shown in Fig. 1, while others drive it as in Fig. 2. Ordinary garden hose and nozzles will serve for handling the solutions commonly used to control such insect pests and parasites as lice, horn flies and ticks. To control horn flies and lice use a solution of 3½ lbs. of 50 percent wettable DDT powder mixed with 100 gal. of water. For control of ticks use a solution of 7 to 8 lbs. of 50 percent wettable DDT powder to each 100 gal. of water. Dissolve the powder in a small quantity of water, then add the full amount later.

C. A. Stone, Bastrop, Tex.

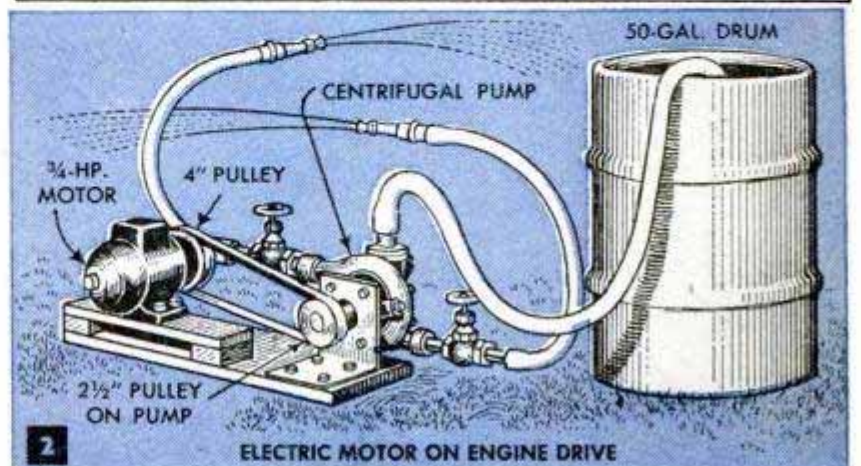
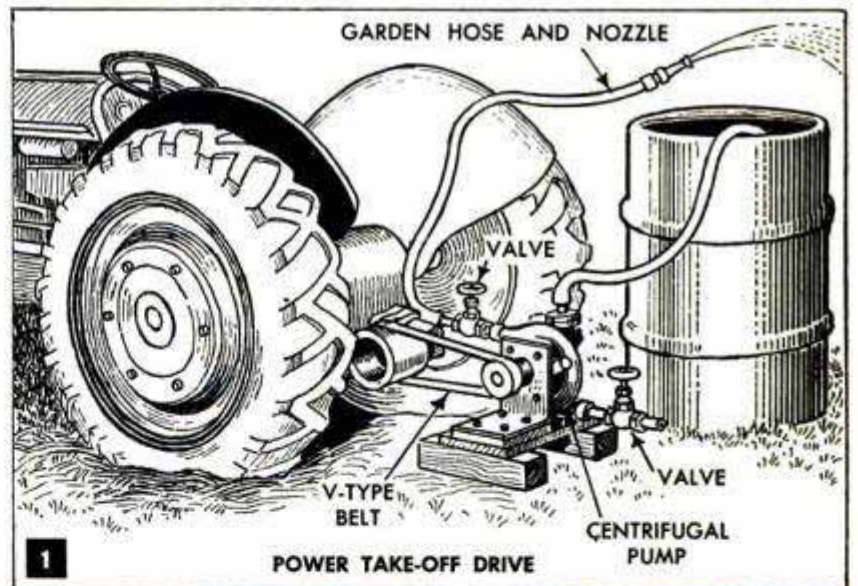

"SEA CRAFT" - a 25-ft.

WHEN the planking is completed and the seams below the L.W.L. have been calked, sand and give the planking a coat of flat white paint. The seams above the L.W.L. are filled later with a plastic seam sealer. When sanding, keep the machine constantly in motion to avoid sanding one area more than another, thus causing low spots.

The 1 by 3½-in. oak sheer clamps, shown in Figs. 31 and 38, extend from the transom to station 2. Note in Fig. 30 that one clamp is placed above the other at station 7 where the sheer line drops. When screwing the clamps to each rib, allow the top edges of the clamps to project above the hull sheer line slightly. These are later planed down to come flush with a 2-in. crown in the decks. The sheer clamps from station 1 to the bow stem are lapped and bolted to the long sheer clamps at station 1 and are fastened to the bow stem with a block.

At this time, decide what kind of an engine will be used in the boat. A marine engine is best. However, many automobile engines work well when converted to marine use. Kits are available for converting the engine

Part III

yourself, or a marine machinist can convert your engine by removing all gears except the reverse and high gears and installing a thrust bearing. A water pump to circulate cooling water also is necessary. Sea Craft's Chrysler engine, Fig. 29, was converted in this way. Note the extra oil sump welded to the bottom of the oil pan to permit the engine to be operated on an angle.

The engine-bed pieces, Fig. 33, are made of 2-in. oak and bolted to the engine stringers, Fig. 38, which extend from the transom to a 2 by 4-in. tie bar, which replaces the original tie bar on the frame of station 6. The engine stringers are placed approximately parallel with the keel apron, and are notched out and screwed to the lower transom beam and ribs. If placed 19 in. apart they will accommodate most engines. However, this dimension should be checked with the engine before installing them. The floor stringers, Figs. 33 and 38, are bolted to the outside of the engine stringers and are notched for the ribs to which they are screwed. The port stringer extends from station 3 to ⅝ in. forward of station 8; star-

By Edward Colby

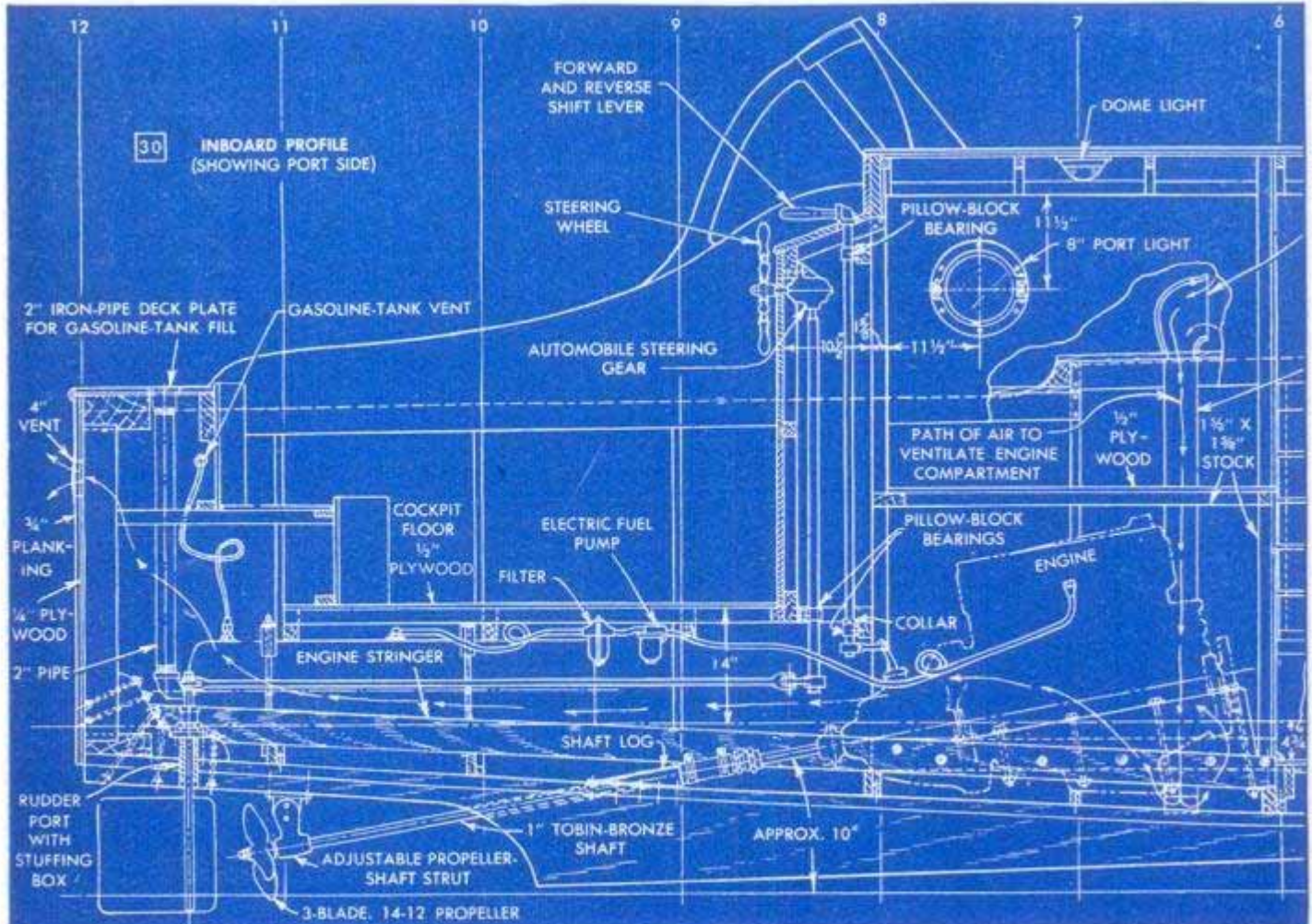

Cabin Cruiser

board stringer from station 3 to 11 $\frac{5}{8}$ in. aft of station 8.

Before determining the shape of engine-bed pieces and the location of the propeller-shaft hole, the exact position of the engine in the hull must be determined. This can be done best by making a full-size, cutout pattern of the engine profile on heavy paper. Carefully mark the location of the mounting brackets and center line of the crankshaft on the paper. Place the pattern on the full-size profile drawing between stations 6 and 8 and shift it around until the crankshaft center line is at an angle of 10 deg. or less with the L.W.L. Check the oil pan, flywheel and the transmission housing for clearance with the apron and ribs. When the engine pattern is in position, Fig. 30, fasten it down with tape and draw an extension of the crankshaft line across the keel and apron. Other parts, such as the rudder, propeller, shaft log, rudder post and propeller-shaft strut, shown in Figs. 30 and 33, should be on hand so they may be

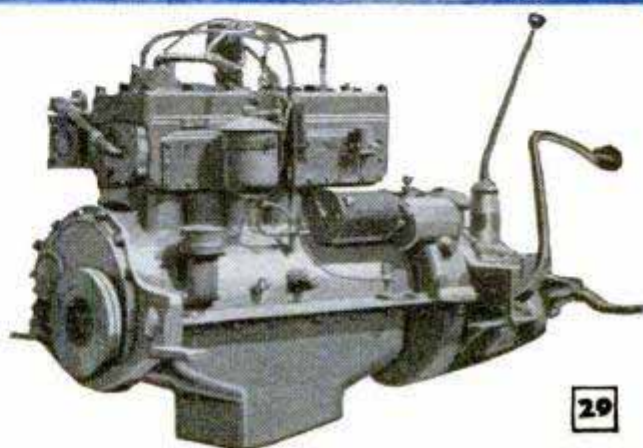
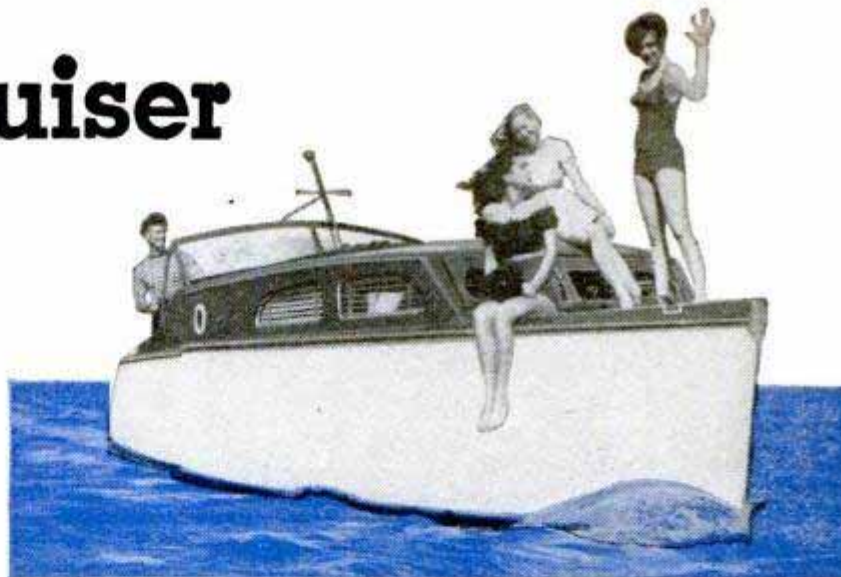

Auto engine converted to marine use gives dependable, low-cost power. Only high and reverse gears are used

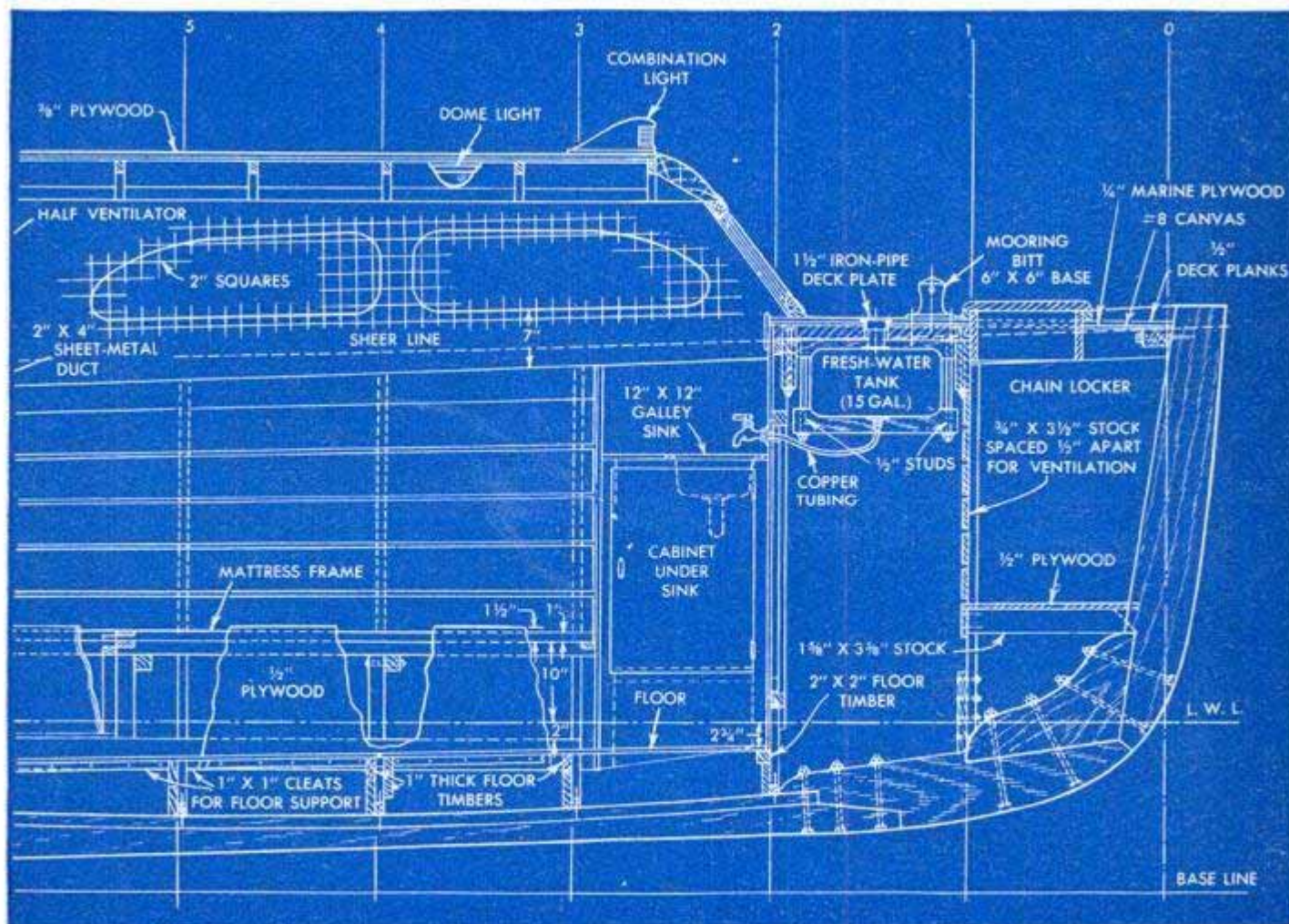

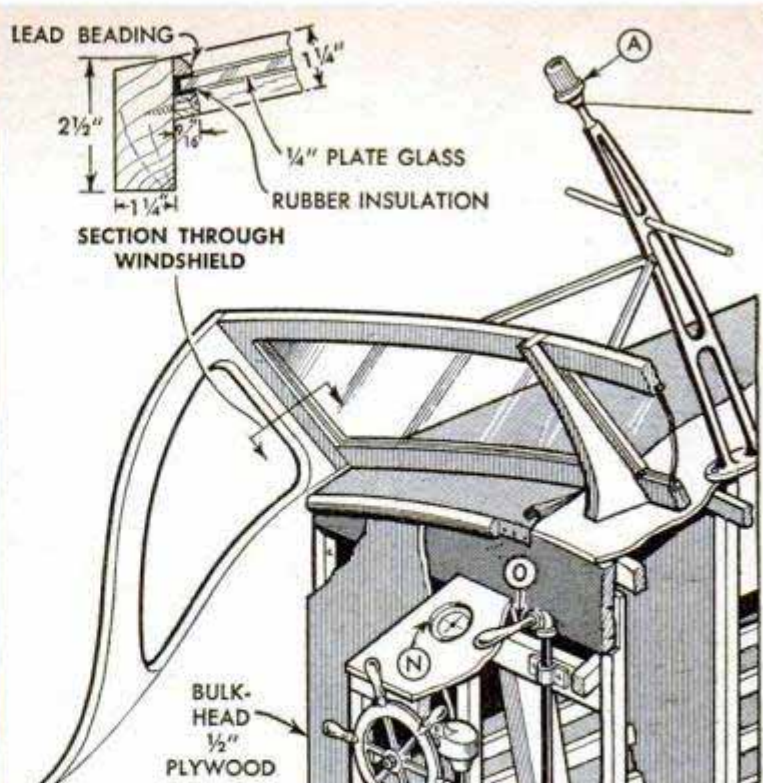
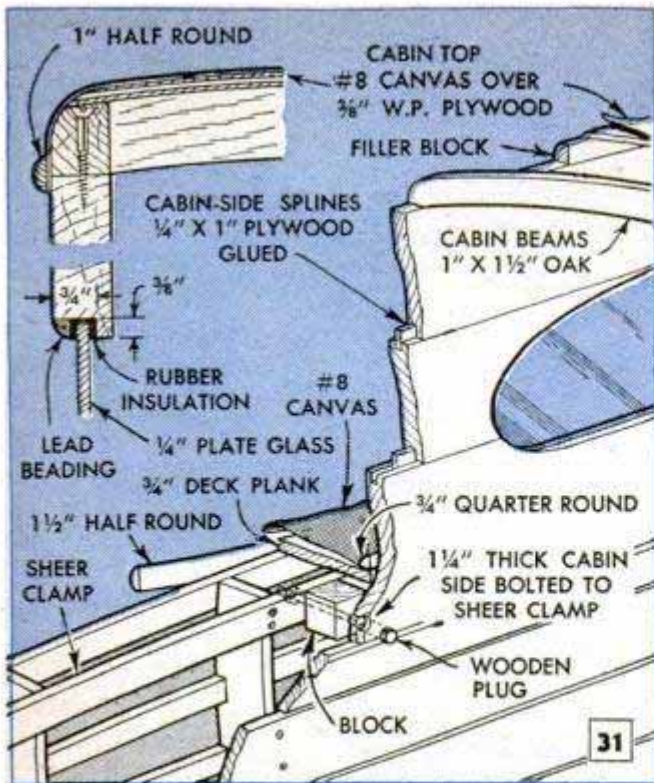

Drawings by Eldon Schiel

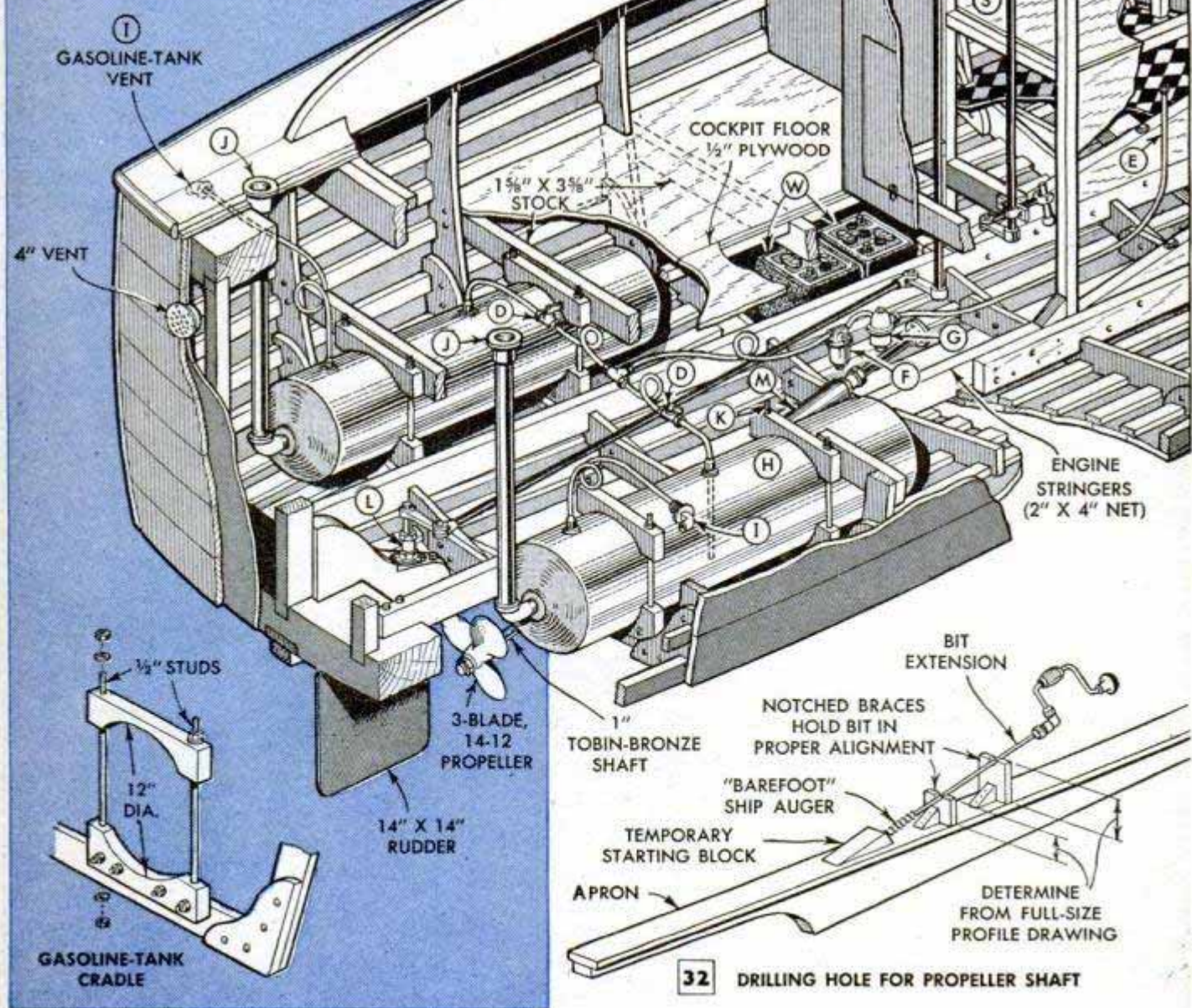

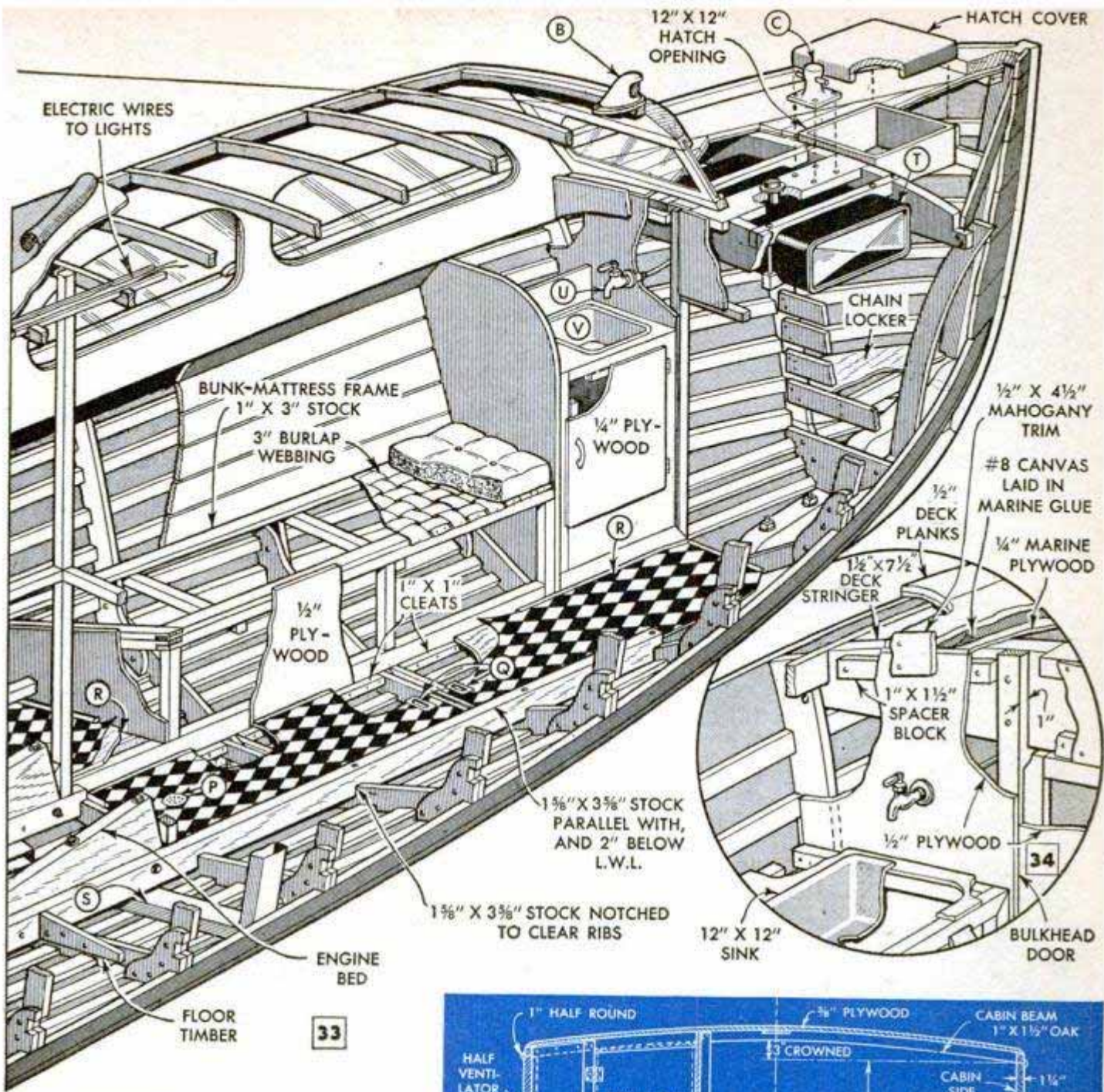

- A—MAST LIGHT
- B—COMBINATION LIGHT
- C—MOORING BITT (6" X 6" BASE)
- D—GASOLINE-LINE SHUTOFF VALVE
- E—COPPER TUBING (GASOLINE LINE)
- F—GASOLINE-LINE FILTER
- G—ELECTRIC FUEL PUMP
- H—24-GAL. GASOLINE TANK
- I—THROUGH-HULL, GASOLINE-TANK VENT
- J—PIPE DECK PLATE (For Filling Gasoline Tank)
- K—1/2" STUDS
- L—RUDDER PORT WITH STUFFING BOX
- M—PROPELLER-SHAFT LOG
- N—MARINE COMPASS
- O—FORWARD AND REVERSE SHIFT LEVER
- P—DRAIN PLATE
- Q—FLUSH-TYPE LIFTING HANDLE
- R—FLOOR (1/2" PLYWOOD COVERED WITH LINOLEUM)
- S—2" X 4" SHEET-METAL VENTILATING DUCT
- T—15-GAL. FRESH-WATER TANK
- U—FRESH-WATER FAUCET
- V—12" X 12" GALLEY SINK
- W—TWO 6-VOLT STORAGE BATTERIES

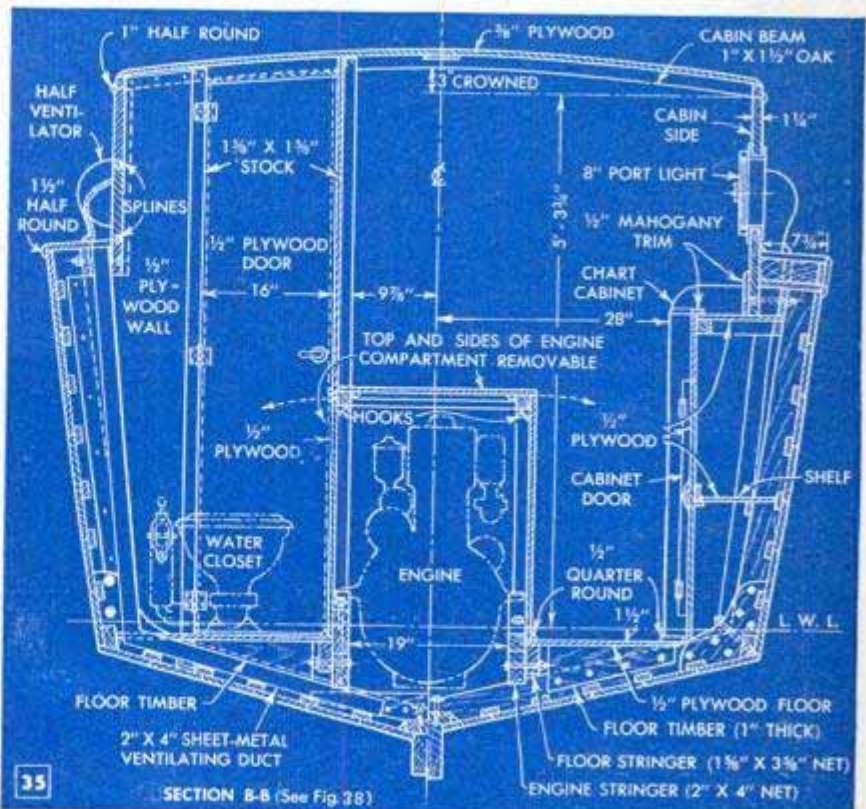



sketched in on the profile drawing to check for clearance.

A method of holding the bit at the correct angle when drilling the propeller-shaft hole is shown in Fig. 32. The braces and starting block should be sketched on the profile drawing and their exact location transferred to the hull. Since the propeller shaft is 1-in.-dia. Tobin bronze, the hole must be $1\frac{1}{4}$ in. It is started with a

regular wood bit because a "barefoot" ship auger has no lead screw. In the event the hole runs out slightly, a bar of iron heated red hot can be used to burn the hole in the proper direction.

Next, bolt the propeller-shaft strut to the keel, and drill a hole through the transom knee, apron and keel to take the rudder port. Locate the positions of the strut and port from the sketches made on the profile drawing. Assemble the shaft log to the apron temporarily with two wood screws and insert the propeller shaft. A flanged coupling is used to connect the shaft to the engine. The engine stub shaft and the propeller shaft will require some machining to take the flanged coupling. After setting the engine on its bed, it can be lined up with the shaft by bringing the faces of the coupling flanges together and gauging the distance between them at four places 90 deg. apart around their periphery with a mechanic's feeler gauge. The shaft log may have to be shifted somewhat and the engine raised or lowered to get them in proper alignment. If the installation makes it impossible to line up the engine and shaft, a universal joint and thrust bearing can be installed between the coupling and shaft log. After the boat has been in the water a while, the propeller shaft may start to "pound" due to dampness from the bilge swelling the engine bed and throwing the motor out of alignment. However, once the motor has been realigned it rarely requires further adjustment.

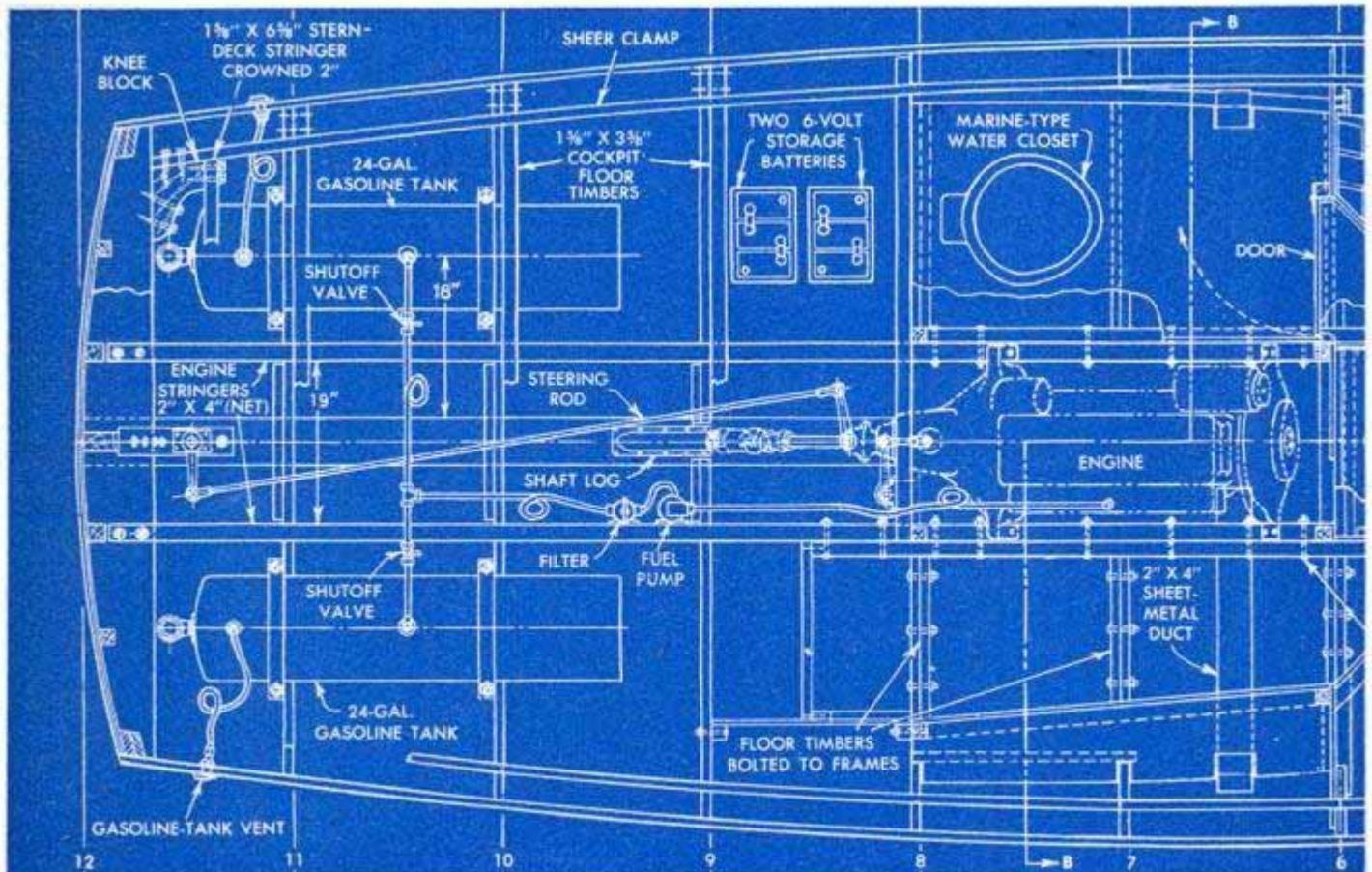

Although many boats do not have a clutch-control pedal, it will be found useful. If an automobile engine is used, it is a simple task to saw off the clutch pedal, install the necessary linkage and connect to a foot pedal extending out of the control box, Fig. 37. The gearshift lever also is sawed off and connected to the forward and reverse lever as in Figs. 30 and 38.

Water to cool the engine is piped from an intake scoop to the pump. The scoop is fitted in a hole drilled in the bottom of the hull. Engine exhaust gases are carried through a 2½-in. galvanized pipe from the engine manifold to a hole in the transom 2 in. above the L.W.L. Cooling water from the engine also runs out the exhaust pipe. Asbestos must be wrapped around the exhaust pipe between the manifold and the cooling-water-pipe connection. The water keeps the rest of the exhaust pipe cool.

Sea Craft has two 24-gal. round tanks supported by cradles. However, any type of marine gasoline tanks can be used provided they have the fill pipe connected to deck plates located on an open deck so there is no danger of gasoline being spilled into the bilge. The tanks also must be vented through the hull as indicated. Copper tubing, coiled to absorb vibration, carries the gasoline to the engine by means of an electric pump. The tank outlet is the type fitted to the top of the tank to minimize the possibility of leakage.

Air for engine and bilge ventilation is supplied by sheet-metal ducts between stations 6 and 7, Figs. 30 and 35. Circulation is maintained by two plate vents in the transom.

(To be continued)

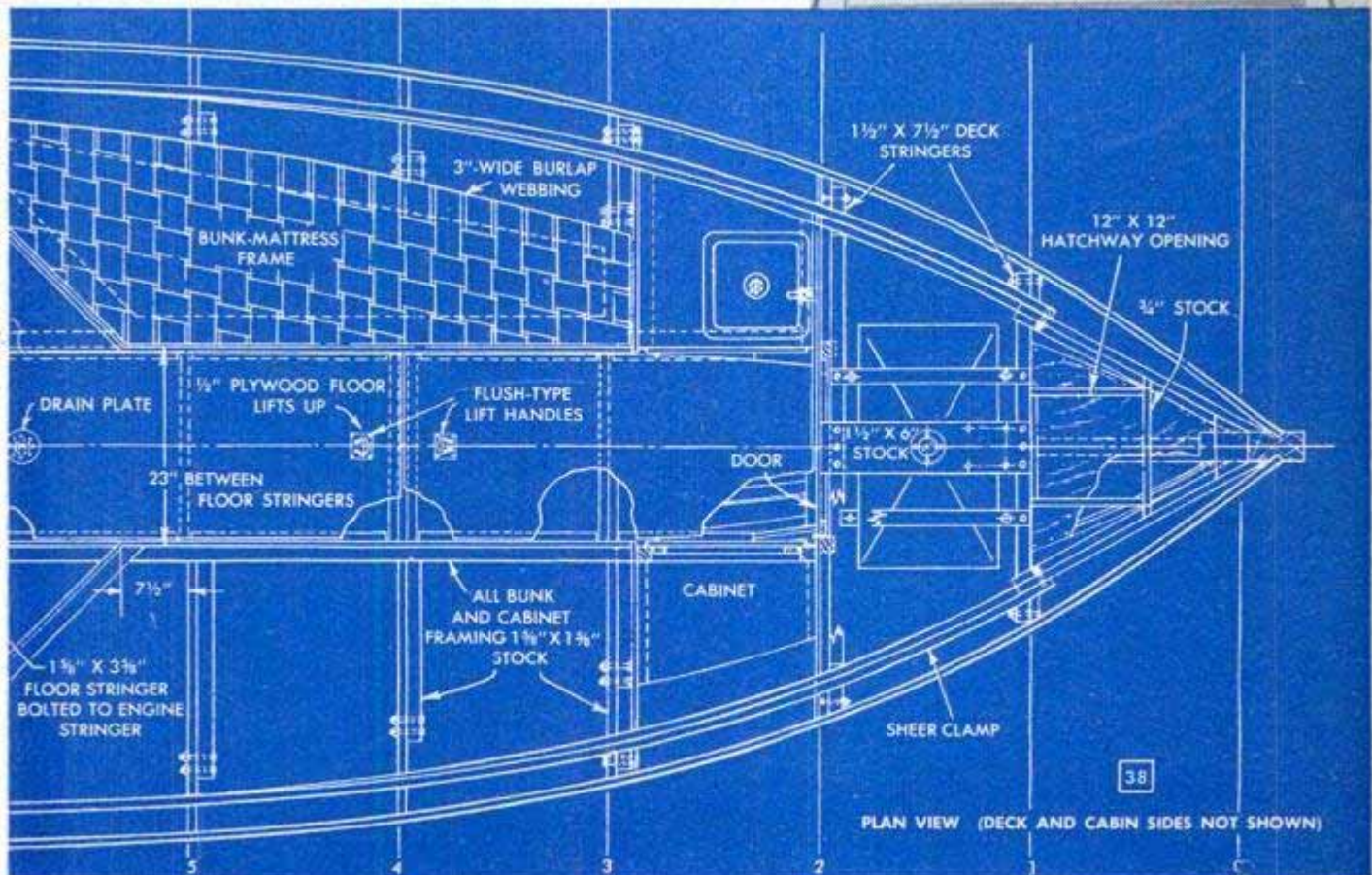
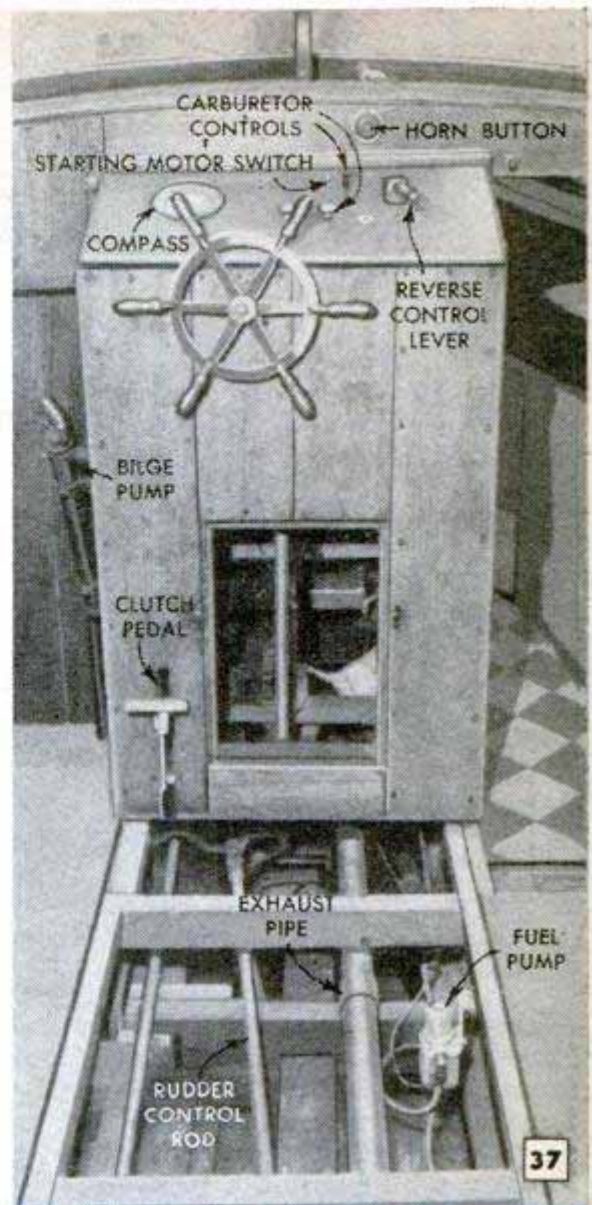

Hinged Poultry-Wire Frames Display Garden Tools

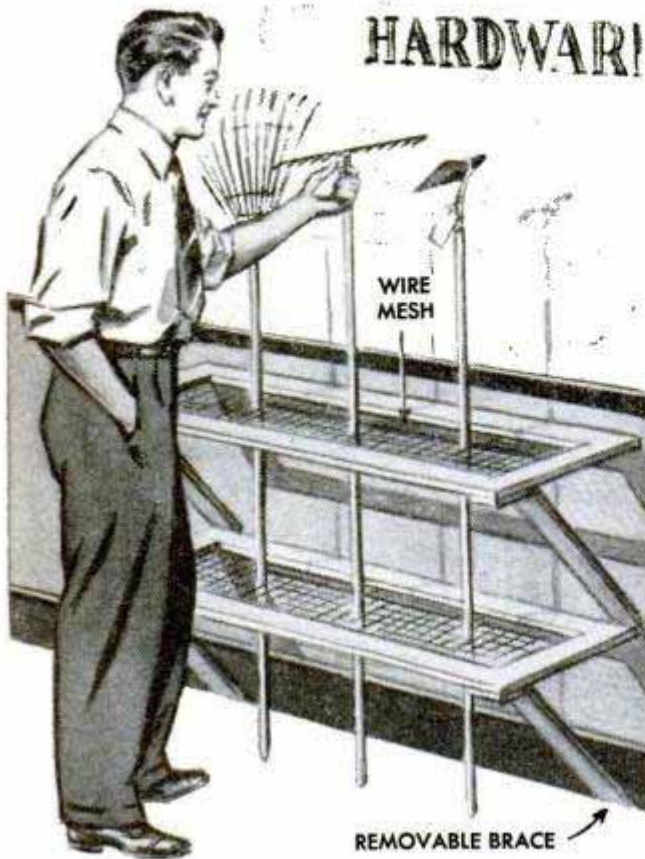

To display rakes, shovels and other long-handled farm and garden tools effectively, one hardware dealer constructed two wire-mesh frames to fit under the show window at the front of his store. Poultry wire holds the tools in a vertical position so they can be examined easily by prospective customers. The frames are hinged to fold downward and out of the way when not in use, and are held in the raised position by removable wooden braces as shown.—Opie Read, Jr., Chicago.

Hand Grinder Removes Small Taps Broken Below Work Surface

Very small taps which have broken below the surface of the work are easy to remove safely by grinding away the center of the tap with a brass or bronze rod containing an abrasive in the tip. The rod is chucked in a high-speed hand grinder. With the rod rotating in the grinder, file it down to a diameter slightly less than the root diameter of the tap. Next, drill a small hole lengthwise of

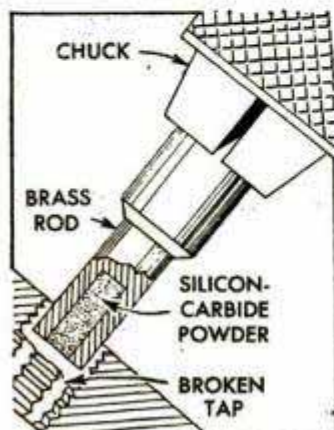

the rod and about 1/2 in. deep. Then fill the hole with valve-grinding compound or a mixture of silicon carbide and oil. The abrasive will feed down from the hole and grind away the center of the tap, after which the flutes can be picked out with an awl.—F. E. Averill, Jr., Santa Ysabel, Calif.

Suction Cup Lifts Corners Of Stacked Metal Sheets

If your job requires lifting pieces of sheet metal from a stack, you can make it easier by using a suction cup to lift the sheet momentarily, allowing you to grasp it with the other hand. I took an ordinary suction cup with a metal center, cut off the projecting end and then soldered the cup to a metal ring.—H. Horikawa, Seattle, Wash.

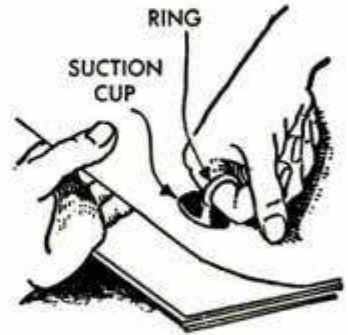

Oil-Soaked Burlap Tied to Rope Lubricates Hay Carriage

Because of its inaccessible location, keeping a hay carriage lubricated usually is a difficult job. However, by simply tying a piece of oil-soaked burlap to the hay rope, the pulleys of the carriage and hoist are oiled automatically as the rig is used. Use a piece of burlap large enough to be compressed slightly and deposit oil when it passes between the sheaves of the pulleys. Tie the burlap to the rope about 15 or 20 ft. from the carriage.

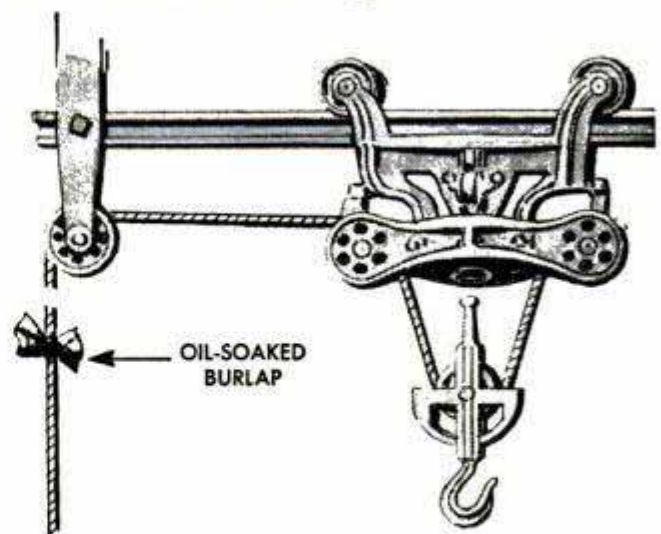

When a stationary thresher, irrigation pump or similar machine is operated on a windy day, the long tractor belt can be kept from whipping by setting up a snow fence windward of the belt and parallel with it to break the wind.



A GHOST IMAGE CAUSED BY REFLECTED SIGNALS



B ORIGINAL IMAGE AS MONITORED AT TV STATION

ELIMINATING TELEVISION "GHOSTS"

SHADOWS, or "ghosts" as they are commonly called, produce effects in the received television picture similar to that shown in photo A. These overlapping images occur when the transmitted-picture (video) signals strike objects which reflect secondary waves. The secondary signal, or signals, is picked up by the receiving antenna which is usually a single dipole, over different and longer paths at later time intervals, thus producing the ghosts which are out of register with the

primary direct signal. This effect is quite common in cities where tall buildings are numerous, as illustrated in Fig. 1.

High-frequency television-picture signals travel in straight lines, similar to light waves, until some object blocks their path.

An ideal receiving condition would exist where the antenna of the television-broadcasting station could be seen at the

(Continued to page 226)

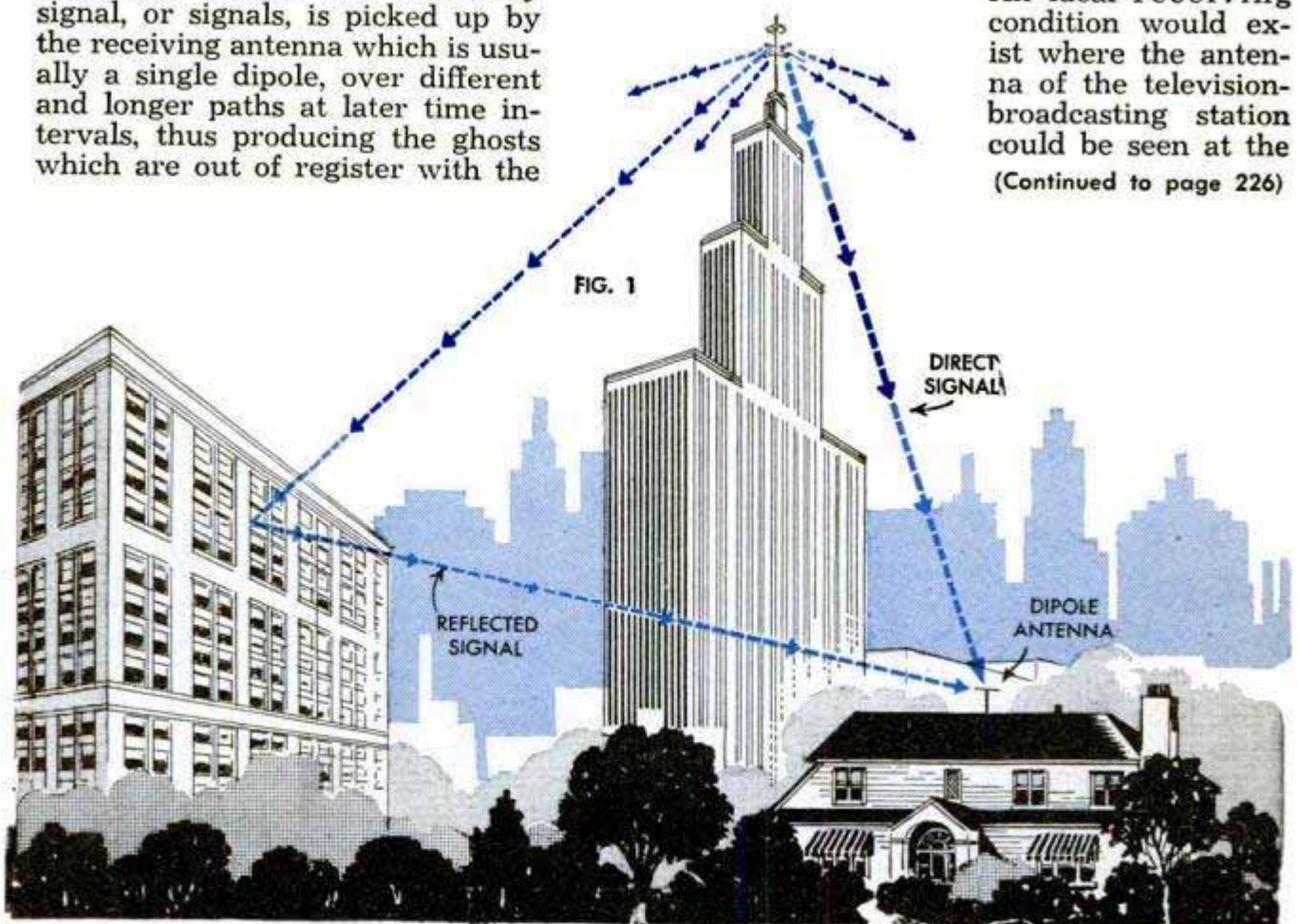

FOUR-TUBE SUPER BROADCAST TUNER

By Joseph Vanella

UNUSUALLY compact and highly efficient, this AM super tuner will provide the owner of any public-address system with a means for supplying "on the spot" radio music, news and public events at picnics, ball games, meetings or wherever PA systems are used. It also makes an ideal addition to sound installations of the type used in industrial plants for playing recordings for employees. It may be employed as a remote tuner for any radio receiver that is equipped with phono input jacks or with any of the audio amplifier units that have been described in past issues of this magazine.

The straightforward superheterodyne circuit consists of a converter stage employing a type 12SA7 tube in an electron-

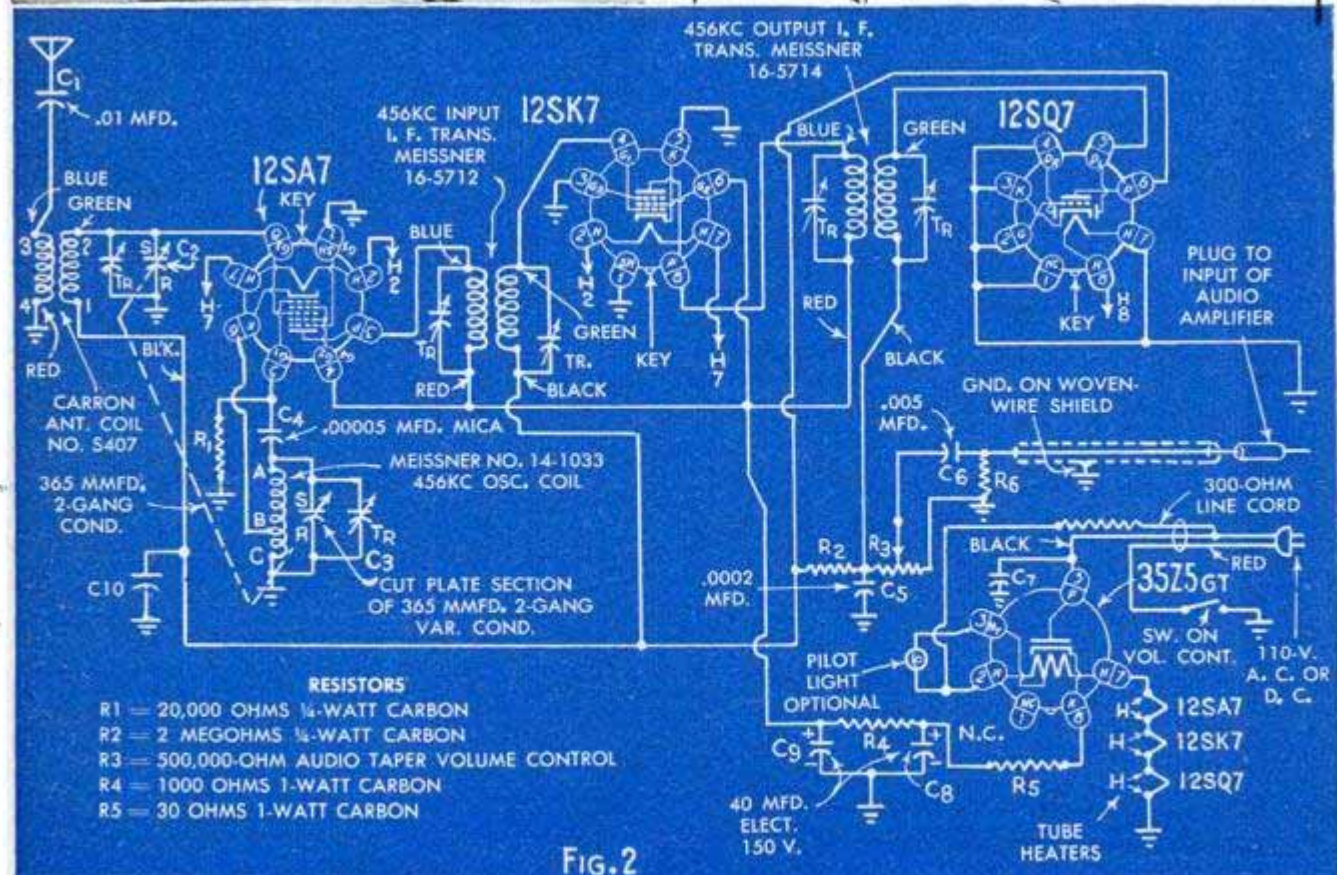
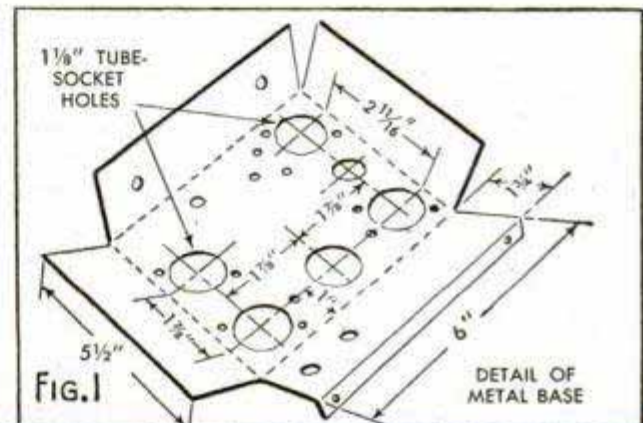
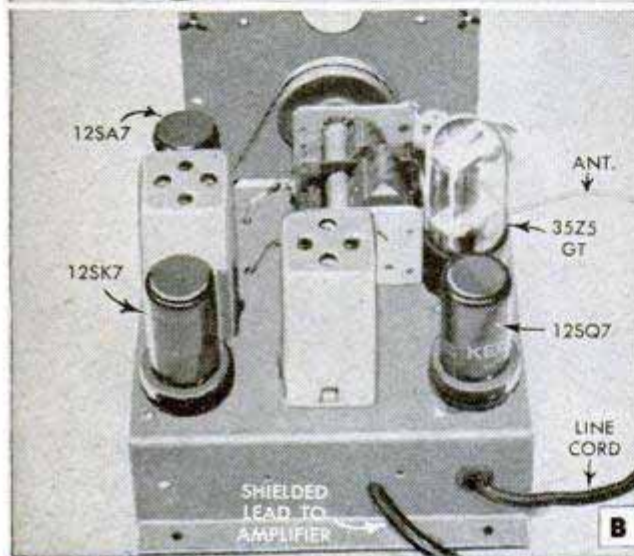
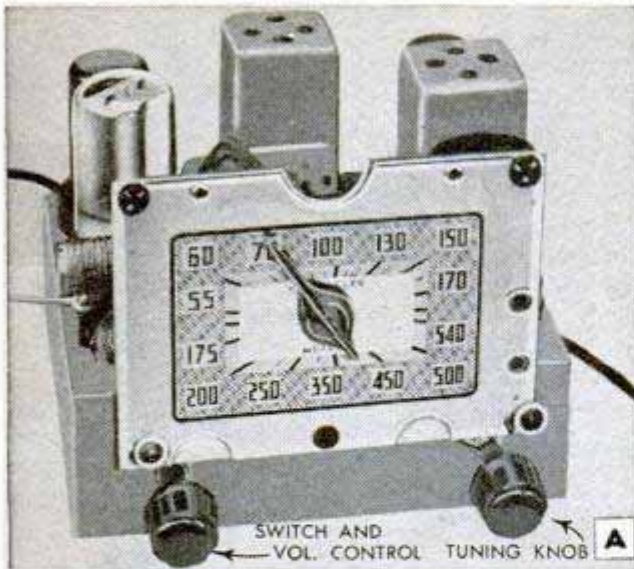

FOR USE WITH ANY AUDIO AMPLIFIER

coupled oscillator circuit. All parts are standard and available from any of the radio supply houses. The antenna coil is a Carron No. S407 and the intermediate frequency (I.F.) transformers and oscillator coil are all Meissner types well known to radio students and experimenters. The 2-gang 365 mmfd. variable condenser has a cut-plate section and trimmer condensers on each section. Photos A, B, C and D show various views of the completed unit and the parts should be arranged just as shown in order to facilitate wiring. The simple sheet-metal chassis base is detailed in Fig. 1. Note that the antenna coil, in photo C, is mounted above the base in a horizontal position by soldering its red ground terminal No. 4

(Continued to page 228)

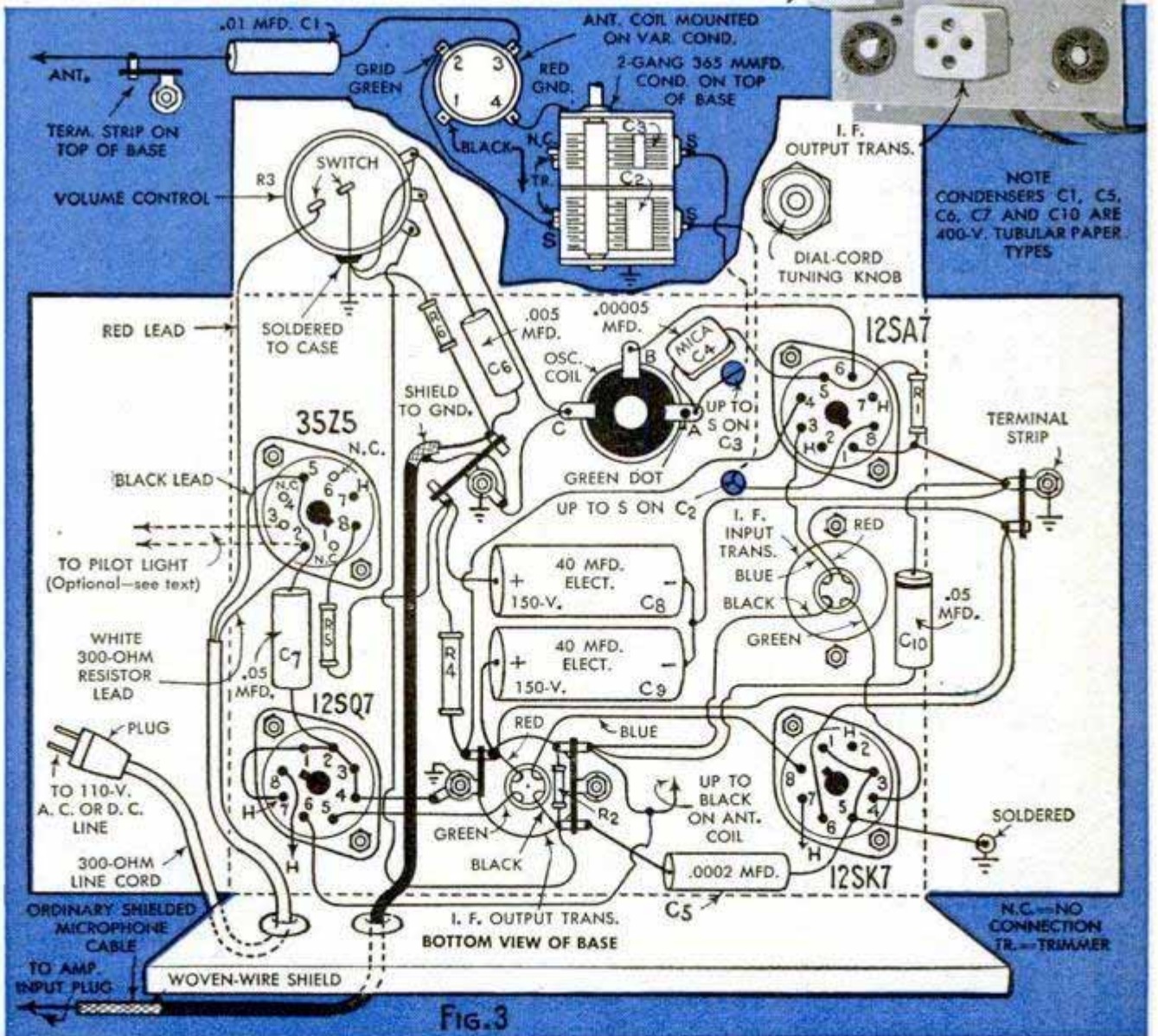

PRACTICAL RADIO SUGGESTIONS



A—When oscillation or hum cannot be traced to a defective part, try a temporary shielding plate between tubes as shown. If reception is improved, standard tube shields are indicated

B—To test for an open coil in a loudspeaker or speaker-output transformer, use a small flashlight battery with short leads soldered to each end. Check for click at plug prongs; if no sound is heard, test directly across speaker terminals

C—Compact tester for checking tiny hearing-aid batteries tests batteries under full operating-load for greater accuracy

D—An efficient ground clamp for use on rusty or corroded pipes may be improvised from an old C-clamp. The pointed screw bites into the pipe and provides a clean contact

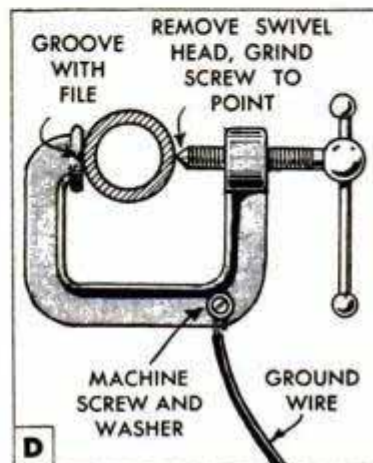
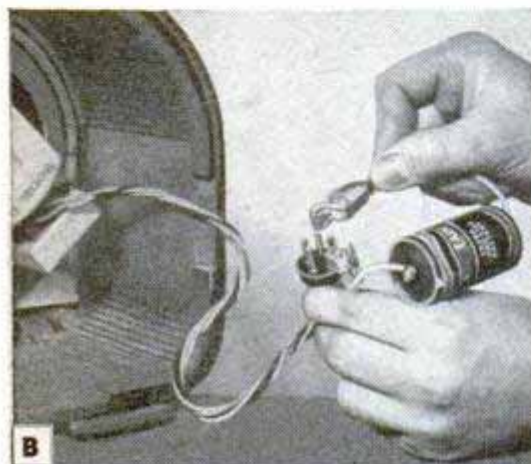

E—Master switch for car radio is mounted in glove compartment. The switch is connected in series with the wire leading to the regular radio switch. Being ahead of the set switch, it provides a master control when the glove compartment is locked during owner's absence

F—Emergency lightning arrester added to antenna switch furnishes protection in case the regular switch is not thrown to ground. Copper strips are mounted under the center and ground terminals; the gap may be reduced to about 1/16 in. if the capacity effects are not too great

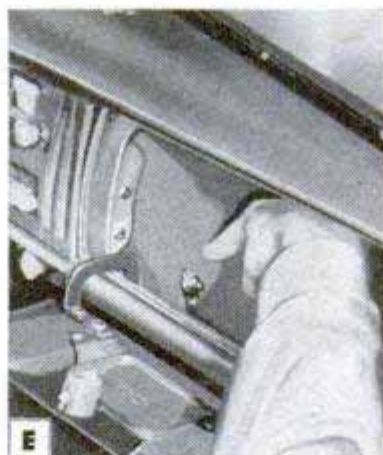

G—To solve problem of running antenna leads through glass in a 4 or 6-light sash remove one pane of glass and substitute a sheet of clear Lucite or Polystyrene, which insulates, and drills easily

H—Check voltage across defective condensers before installing new ones. If condenser is shorted it should be removed after checking polarity and the voltage tested across opened leads

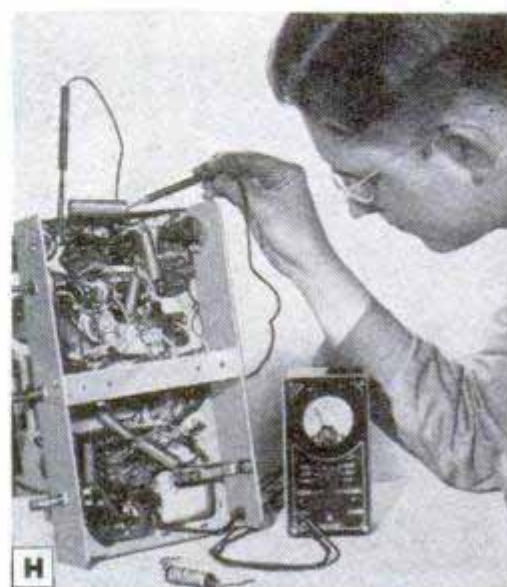
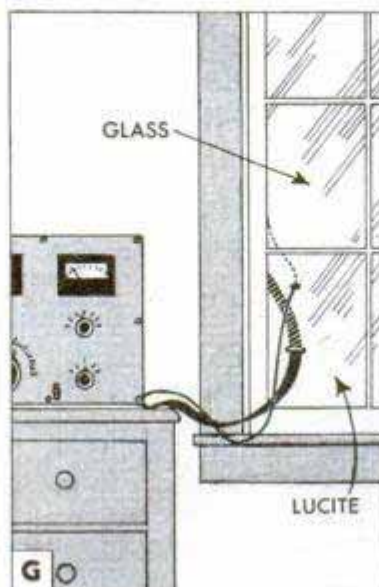
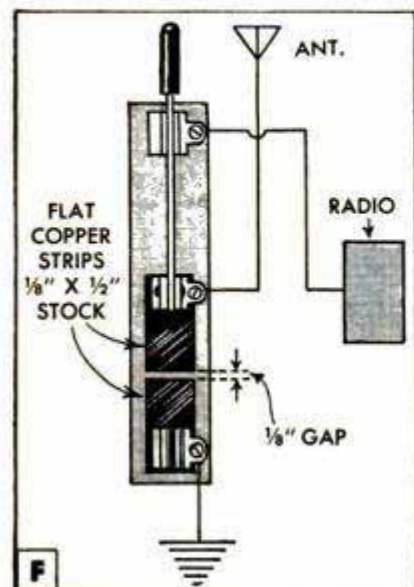

The NEW KODAK DUAFLEX CAMERA

Gets you off
to a flying start
in photography



... and it's only \$11.75—plus tax

Large Reflex View Finder

Shows big, brilliant image. You see what you're getting *before* you snap the shutter.

Big Print Size

Snapshots as big as with the most expensive reflex camera. Black-and-white prints $2\frac{1}{4} \times 2\frac{1}{4}$; Kodacolor Prints $2\frac{7}{8} \times 2\frac{7}{8}$ inches.

So Simple to Use

The Kodet lens is fixed-focus—no adjustments necessary. The shutter is ready-set—just press the button.

Pictures round the clock

Brilliant outdoor shots—and, with Kodak Duaflex Flashholder, indoors as well . . . day or night . . . in color or black-and-white.



Camera comes complete with protective shield

KODAK DUAFLEX FLASHHOLDER—\$2.50 (plus tax)—

is the only accessory needed for flash pictures. It quickly attaches to camera. Two studs and slide lock hold it in place. Electrical contacts built into camera and Flashholder give direct connection between battery and shutter mechanism.



KODAK CLOSE-UP ATTACHMENT 6A—\$1.20 (plus tax)—

slips over the taking lens . . . equips your Kodak Duaflex Camera for a new range of pictures . . . allows you to take head-and-shoulder shots, close-ups of flowers, etc. Focus with attachment is from 3 feet to $4\frac{1}{2}$ feet.



"Kodak" is a trade-mark

(Prices subject to change without notice)

Kodak

EASTMAN KODAK CO., ROCHESTER 4, N. Y.

Like good food?



Don't appear rude
Always carry
TUMS

- TUMS neutralize excess acid almost instantly—relieve gas and heartburn fast!
- TUMS contain no soda. No risk of overalkalizing—and no acid rebound.
- TUMS are like candy mints—easy to take. Nothing to mix or stir—no water needed!

Night and day, at home or away,
always carry 'TUMS'

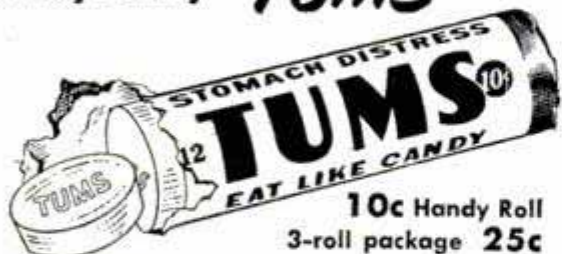

QUICK RELIEF FOR ACID INDIGESTION



TUMS ARE ANTACID — not a laxative. For a laxative, use mild, dependable, all-vegetable NR Tablets (Nature's Remedy). Get a 25c box today.

SAY YOU SAW IT IN POPULAR MECHANICS

Eliminating Television "Ghosts"

(Continued from page 221)

site of the receiving antenna. Fortunately, reception is fairly good even when the direct signal is partially obstructed by large reflecting surfaces. As the video signals are radiated in all directions from the transmitting-station antenna simultaneously, the receiving antenna must be highly directional or it will receive both the

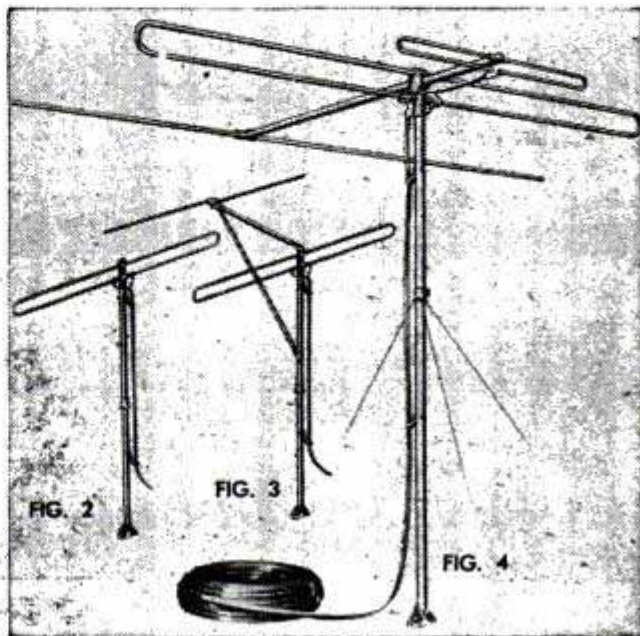

direct and multipath reflected signals. These undesired reflected ghost signals can be eliminated by directional antenna systems. The antenna installation is usually made by two men, one at the controls of the television receiver and the other on the roof, with the antenna temporarily installed but free to be turned in any direction until oriented for best results.

Various types of modern television receiving antennas are shown in Figs. 2, 3 and 4. The folded dipole, Fig. 2, is satisfactory under favorable receiving conditions, and is an improvement over the single dipole; Fig. 3 is a folded dipole with a reflector element and is designed for use in low signal areas. Fig. 3 is a new Amphenol television antenna array designed to give a unidirectional receiving pattern over both television bands, 174 to 216 mc. and 54 to 88 mc. It is claimed to eliminate ghosts caused by multipath signal pickup. Consisting of two broad-banded folded dipoles and a low-band reflector with a common transmission line, this unusual design permits the large folded dipole (for the 54 to 88-mc. band) to be used as a reflector for the small folded dipole, which is tuned to the 174 to 216-mc. band. The array is substantially unidirectional and maintains high front-to-back and front-to-side ratios.

How to adjust power tools accurately

● Yes, your modern power tools are marvels of speed and accuracy *if*—and it's a big IF—*you* are accurate in their use, if *you* make them do their best work. And that's where your flashlight comes in handy. Better keep it powered with "Eveready" batteries. Powerful, dependable, *they outlast all other brands.**



← Gauges for power tools are frequently in shadow where they are hard to read. That's where you need your flashlight to make adjustments with a fine degree of accuracy.



A clamp on the side of the table → will keep your "Eveready" flashlight handy, ready for use.



● Brighter light, longer life! That's what you want in a flashlight battery—that's what you get with "Eveready" brand batteries. Laboratory tests prove it. And the best "laboratory" of all—*your own flashlight*—proves it! That's why "Eveready" batteries *outsell* all other brands—because they *outlast* all other brands!*

**According to the "General-Purpose 4-Ohm Intermittent Test" devised by the American Standards Association, which most closely approximates average use.*

The registered trade-mark "Eveready" distinguishes products of
NATIONAL CARBON COMPANY, INC.
 30 East 42nd Street, New York 17, N. Y.
 Unit of Union Carbide and Carbon Corporation

Proof! . . . in the laboratory . . . in your own flashlight . . .

"EVEREADY" BATTERIES

OUTLAST ALL OTHER BRANDS!*

ANCO® RAIN-MASTER®

WINDSHIELD WIPER BLADES and ARMS

**Blade snaps on—Stays put
Can't fall off—Can't blow off**

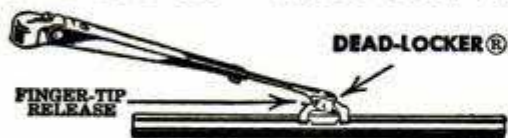

Don't Blame Your Gas-Pump Man!

Sure, he knows how dangerous it is for you to drive your car . . . in stormy weather . . . with dull old windshield wipers that *smear* and **SMEAR!**

He'll gladly put on for you—quickly—a pair of keen new ANCO RAIN-MASTER Blades—or Blades and Arms.

HE NEGLECTS YOU?

He has RAIN-MASTERS . . . But he forgets to remind you? Too busy?

After all it's *YOUR* car to protect. . . So, *YOU* ask *HIM* for RAIN-MASTERS next time you buy gas. . . Patented features. . . Original equipment on DeLuxe Models of high-grade cars . . . because RAIN-MASTERS *Clean quicker—Clean cleaner—Last longer.*

*Get yours—next time you buy gas.
May save you a costly smashup!*

Made by ANCO . . . makers of the new CLEAR-FLEX* Wiper Blade—the only Blade worth more than RAIN-MASTER. Costs more. Ask your good ANCO dealer to show you why.

*Trade Mark

Quality Protected Under Fair Trade Laws
ANCO Patented Products—Patents Make Jobs

THE ANDERSON COMPANY
Established 1918
GARY, INDIANA

Four-Tube Super Broadcast Tuner

(Continued from page 223)

directly to the frame of the variable condenser at front. This connection is indicated with a wire lead in Fig. 3. Antenna terminal No. 3 on this coil is marked with a blue dot; the green grid terminal No. 2 connects to the stator of C₂; the black No. 1 terminal lug is connected to a lead that will run

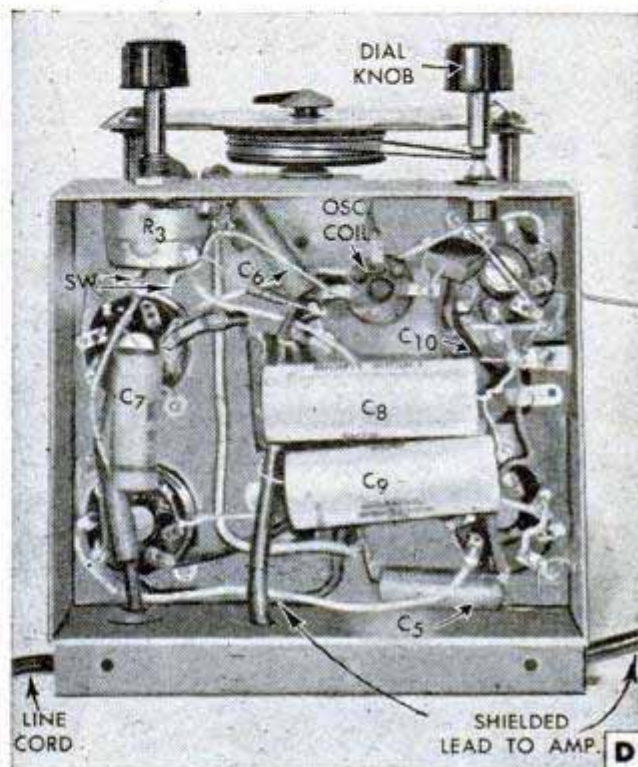

down through a hole in the chassis and is to be connected to the terminal strip on the underside of the base as indicated by the arrows. Fixed condenser C₁, which is in series with the antenna, connects to the blue coil terminal No. 3; it is mounted directly under the antenna coil.

A complete schematic circuit diagram appears in Fig. 2. The pictorial wiring diagram, Fig. 3, shows all parts in their relative positions and every wired connection

(Continued to page 232)



Model Builders Attention!

| | V | V-2 | V-3 |
|---------------|---------|---------|---------|
| Hex | 1/2" | 3/8" | 5/16" |
| Thread | 3/8"-24 | 1/4"-32 | 1/4"-32 |
| Thread Length | 7/32 | 7/32 | 5/32 |
| Weight, Grams | 8 | 3 1/2 | 2 1/2 |

Actual Size V-Plug
Champion Spark Plugs for model gas engines give the same dependable performance as regular Champions. Champion Ceramic insulation—Sillment sealed. Alloy needlepoint electrodes for easy starting. One piece construction.

CHAMPION

SPARK PLUG COMPANY • TOLEDO 1, OHIO

Dependable

CHAMPION

America's Favorite Spark Plug



Crisp-firing spark plugs are a primary factor in keeping your car's engine in good operating condition. They are truly vital in maintaining its performance, gas and oil economy, and dependability. It's Spring again, so have your spark plugs checked. If new ones are needed, insist on the spark plugs preferred and used by most motorists — dependable Champions.

Champion Spark Plug Company, Toledo 1, Ohio.



FOLLOW THE EXPERTS DEMAND NEW DEPENDABLE CHAMPIONS FOR YOUR CAR

Listen to CHAMPION ROLL CALL, Harry Wisner's fast sportscast every Friday night, over ABC network

At Last! THE POWER

SHOP SMITH

REG. TRADE MARK

\$159.50

Complete five-tool unit
with 1/2 H.P. ball
bearing motor \$195.50

BUILT RUGGED

with cast iron headstock and carriage. Centerless ground and polished steel ways. Heavily-ribbed aluminum table. Four life-long grease-sealed Fafnir ball bearings. Unit weighs over 200 pounds. Will last a lifetime.

SHOP SMITH AS A CIRCULAR SAW

Has maximum distance of 46" between saw blade and fence. Tilts to any angle—positive lock. New principle provides micro-adjustment of distance between fence and saw blade. Specifications: Saw Blade: 8" Dia. Depth of cut: 2 1/4". Table: 12 1/2" x 17"; with extension, 54" x 17".

Standard Equipment: 8" saw blade and arbor. Table extension. Mitre gauge. Rip fence. Saw guard.

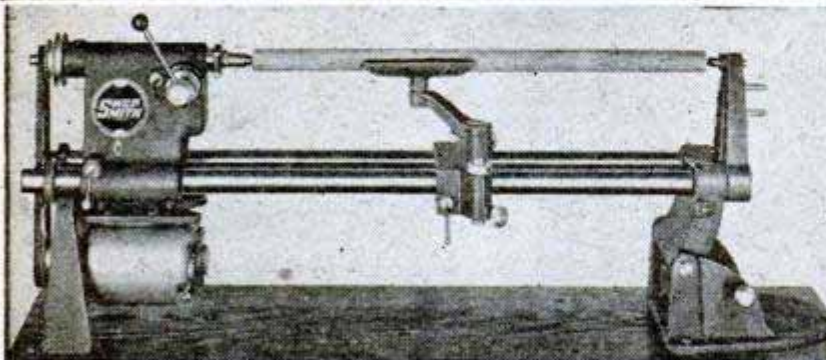

SHOP SMITH AS A LATHE

84" between centers. Swing: 15". Variable speeds. Quill Feed: 4 1/2".

Standard Equipment: Tool rest. Drive center. Dead center.

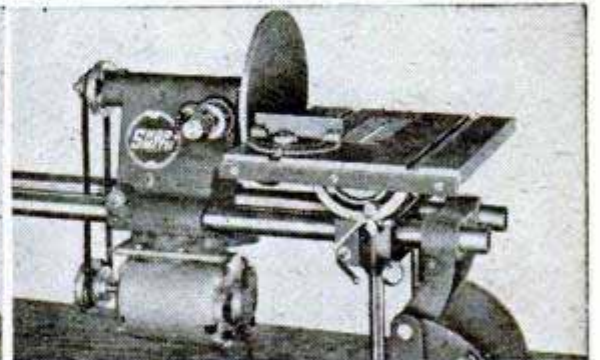

SHOP SMITH AS A DISC SANDER

Disc Diameter: 12". Table Dimensions: 14 1/2" x 17". Tilting Table.

Standard Equipment: 12" disc. Mitre gauge.

TOOL YOU'VE ALWAYS WANTED

CIRCULAR SAW • DRILL PRESS VERTICAL AND HORIZONTAL
WOOD LATHE • DISC SANDER

Five Sturdy Tools...each better than a single-purpose tool—engineered into one compact unit. Thousands already in use. Is rugged enough to last a lifetime. And priced so you can afford it

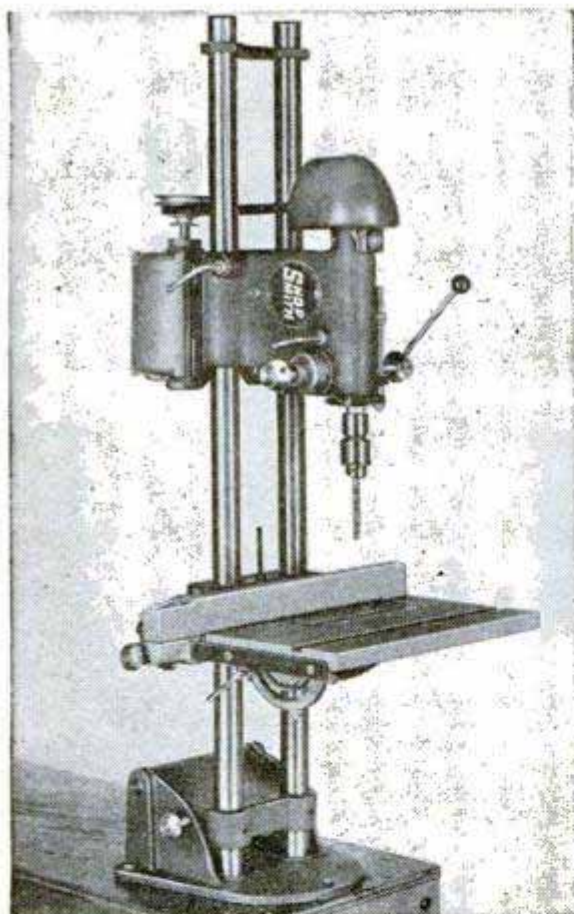

SHOP SMITH AS A VERTICAL DRILL PRESS

Capacity: Drills to center of 15" circle. Clearance: Table to chuck—27" max. Spindle: $\frac{3}{8}$ " Dia., 6 spline, hardened tip. Spindle Feed: $4\frac{1}{2}$ ". 4 grease-sealed Fafnir ball bearings. Variable speeds. Table: $14\frac{1}{2}$ " x 17".

Standard Equipment: $\frac{1}{2}$ " Jacobs key chuck. Fence.

SHOPSMITH—built for man-size work—is no toy. Compact (59" long by 21" wide by 18" high). Shopsmith weighs over 200 pounds. There's an 8" combination circular saw that cuts $2\frac{1}{4}$ " deep... big capacity lathe with 15" swing... accurate 12" disc sander... horizontal drill press with no limit to work length... vertical drill press with $\frac{1}{2}$ " capacity Jacobs key chuck. Shopsmith also excels as grinder, buffer, drum sander, router. And you can change from tool to tool in less than one minute!

Demand, of course, is ahead of production. But Shopsmith will soon be available to the thousands of craftsmen who have long demanded a compact, sturdy multi-purpose power tool. Your wait will be rewarded. Magna Engineering Corporation, 465 California St., San Francisco 4.

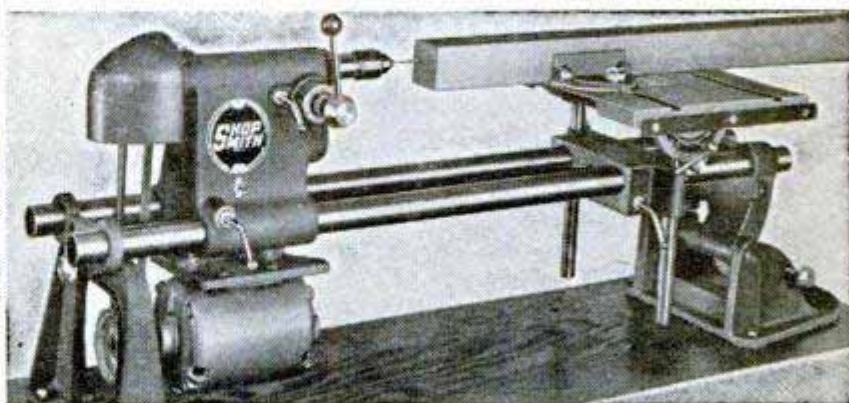

SHOP SMITH AS A HORIZONTAL DRILL PRESS

Only Shopsmith performs this highly useful function. No limit to length of work. Provides accurate method of drilling for doweling, etc.

Action

YOU'VE NEVER EXPERIENCED BEFORE IN A ROD



That's what experienced anglers say about the No. 411 South Bender. It has an action all its own that adds a new thrill to bait casting. Controlled flexibility produces a live suppleness that gives just the right whip for perfect, effortless casting.

No. 411 SOUTH BENDER ROD

The solid tip is machined from a new, high-strength metal alloy . . . and it weighs *only* 3½ ounces. Foolproof reel and tip locking device. Maroon trim. Length 4 feet, 11 inches \$15.

PERFECTORENO REEL

No thumbing—no backlashes. Makes casting easy and a real pleasure. \$10, \$11, and \$13.50.



LEVEL-WINDING ANTI-BACK-LASH REEL

A favorite with casters. Built for long, hard usage. Precision-built. \$5.60, \$8.50, \$9.50, \$11 and \$15.



BLACK-ORENO LINE

The bait casting line you can trust. Braided of nylon. \$1.25 to \$2.30 per 50 yard spool. Silk slightly higher.



No. 973 BASS-ORENO

Famous fish-getter. World's greatest bait \$1.10. Also 4 smaller sizes 65¢ to 95¢.



FREE! NEW '48 BOOK ON FISHING

"Fishing—What Tackle and When" shows South Bend and Oreno tackle. Color pictures of fishes. Fly and bait casting instructions. Every fisherman needs a copy. Write for your copy today. Sent FREE!

SOUTH BEND BAIT CO.
891 HIGH ST., SOUTH BEND 23, INDIANA



SOUTH BEND

A Name Famous in Fishing

in the unit. Mount all tube sockets with the keys in the positions shown in Fig. 3. The pilot light is optional and was not included in the model. However, it can be a No. 47 in a clip-type pilot-lamp socket which is easily mounted on the tuning dial. The ground connection on volume control R3 is soldered directly to its case as indicated in Fig. 3. The shielded lead to the audio amplifier may be 2 or 3 ft. long, and the shield must be grounded on the underside of the base to a soldering lug placed under the terminal-strip mounting screw as shown in Fig. 3.

A long and high outdoor antenna will give best results in locations remote from broadcasting stations. For local stations, a short indoor antenna will be satisfactory. To balance the tuner unit, connect the antenna and audio amplifier, and tune in a station at about 670 kc. The I.F. transformers are peaked at the factory and require very little adjusting. A slight adjustment of the trimmer condensers in the top of each unit is all that is necessary to bring in the station at maximum volume. With the unit still tuned to this station, adjust the trimmer on C3, which is the oscillator cut-plate section, to bring in the station at its proper dial reading. Now tune in a station at about 1400 kc. and adjust the trimmer on C2, which is the antenna-tuning condenser section, until the station is received with maximum volume. Detailed student material list R-366 is available from Popular Mechanics Radio and Electronics department upon receipt of ordinary letter postage.

Diving Mechanics

(Continued from page 149)

gear and methods against approved rigging standards.

A knowledge of cement and concrete work is essential also—not only for patching ships but for building foundations. Strength, water-tightness and ability to adhere to steel are principal requirements.

Concrete mixtures set in sea water in about 45 minutes, but do not reach maximum strength for three or four weeks. A diver, therefore, uses cement of high early strength and dumps a large amount into his mixture. For example, 1 part cement, 1½ parts sand, and 2 parts rock.

At times, a diver's life depends upon his skill with explosives. It may be necessary to cut through a stubborn piece of steel, sever a large timber or breach the side of a vessel. The newest explosive used in underwater work is blasting gelatin which

(Continued to page 238)

Exclusive Du Pont Formula Speeds Car Polishing

...GIVES A
BRILLIANT LUSTRE!



A small section of the surface of an average car magnified 20 times. The left side is shown still covered with Traffic Film. The right side has been cleaned with Du Pont NO. 7 POLISH.

DU PONT NO. 7 POLISH

Contains "stroke saving"
methyl cellulose



Car polishing doesn't have to take all day. You can do the job quickly and easily with NO. 7 POLISH. It is made by a patented, exclusive Du Pont formula . . . removes dirt and grime quickly, without tedious scrubbing. And it cleans up *fast*, leaving a dry, brilliant shine. Use NO. 7 POLISH as a short-cut to that "showroom shine"!



BETTER THINGS FOR BETTER LIVING
...THROUGH CHEMISTRY



Attention . . . NEW CAR OWNERS!

Here's a wax-polish made especially for new cars—and others whose finish is in first-class condition. It cleans and wax-polishes in one easy operation. Gives a brilliant lustre. Keeps cars looking new.



DU PONT SPEEDY WAX

May is National Nu-Enamel Month

Paint Your Automobile

Paint Your Entire Car With **NU-ENAMEL** For Only **\$3⁴⁵—**

Paint All Your Fenders For Only **\$1⁹⁵—**



ONE COAT COVERS
NU-ENAMEL
TRADE MARK REG. U. S. PAT. OFFICE
NO BRUSH MARKS

Ask Your **NU-ENAMEL** Dealer For This Instruction Folder

Contains the step-by-step story of how you can Paint-It-Yourself with Nu-Enamel and get a professional looking job.



"Paint-it-Yourself"

It's EASY! It's FUN!

Clinic



for Homemakers

As a service to our readers in solving the hundreds of problems pertaining to a home—inside or out—the editors of *Popular Mechanics* invite you to present your problems to The Clinic Editor for help and advice. Address your questions to The Clinic Editor, *Popular Mechanics Magazine*, 200 East Ontario Street, Chicago 11, Ill.

Condensation Reduces Efficiency of "Side-Arm" Water Heater

Q—The pipe that carries fumes from my thermostatically controlled side heater to the chimney is made from gutter downspout. When I use the heater, water runs out of the pipe about 2 ft. from the heater. Where does this water come from?

M. R.—Canton, Ohio.

A—Your trouble is caused by condensation. Combustion releases water vapor in considerable quantity. When the heater shuts off, the pipe cools more quickly than the moisture-laden air inside. This moisture condenses on the cooler inner surface of the pipe and runs out at the joints. One remedy is to shorten the vent pipe and reduce the natural draft through the burner. This can be done by installing a draft deflector on top of the burner unit.

Partitioning Kitchenette and Living Room

Q—My front door opens directly into the living room and there is no partition between the living room and kitchenette. What can I do to make a more pleasing arrangement?

H. B.—West New York City.

A—What you can do depends on the size of the room, that is, the amount of space you have available in which to make changes. Usually, where the outside door opens directly into the living room, there isn't much you can do about this particular situation without extensive remodeling which would involve changes to both the interior and exterior of the building. However, attractive interiors can be made by installing an open partition and counter between the two rooms. This gives only a partial separation, but it is sufficient to obtain a more pleasing arrangement of the furnishings of the two rooms.

Filler Turns White on Hardwood Floor

Q—I sanded my hardwood floors myself, then applied a light-oak wood filler and two coats of shellac. Now the filler has turned white. What can I do to remedy this?

W. D.—Overland, Mo.

A—We believe it is the shellac, rather than the filler that has turned white on your hardwood floor. There also could be other reasons, but we cannot say definitely without knowing more about the floor's history. At any rate, we believe that the best and probably the surest procedure would be to remove the shellac, taking care to get all of it off, and then apply a sealer. Allow this to dry a little longer than the prescribed time, then follow with a coat of floor varnish. This should give you a good finish.

(Continued to page 236)

NOT IN 100 YEARS

Will this screening ever rust, corrode or stain your house !

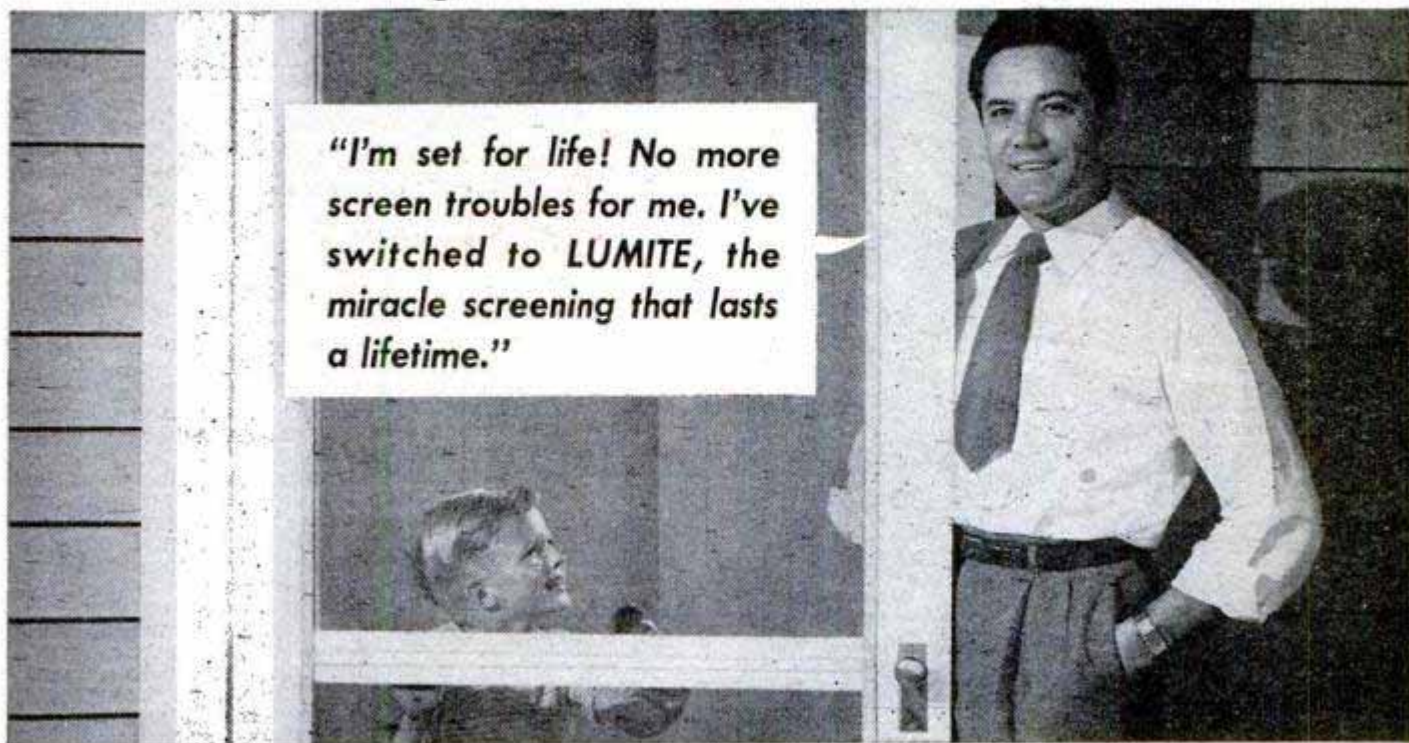

This spring get this amazing new screening that's sweeping the country

Incredible, but true, LUMITE screening will NEVER rust, NEVER corrode, NEVER stain your house! Laboratory tests . . . and actual use in homes throughout the country have proved that LUMITE will not change in any weather or climate!

Woven of saran's tough, resilient plastic fibres, LUMITE is virtually indestructible. It never needs painting . . . always stays

taut and firm . . . protects the beauty of your house. This amazing new kind of screen is in stock today at your Hardware, Lumber, or Building Supply Dealer. If you need screens for any part of your house this spring, be sure to order your supply of LUMITE now!

For further information and free sample

write Dept. 42, Lumite Division
Chicopee Manufacturing Corporation
47 Worth Street, New York 13, N. Y.

Rustproof!

Stainproof!

Never needs painting!

Lasts a lifetime!

*®



Screen once and for all with

LUMITE*

Woven of saran

**53¢ VARNISH
VALUE
FOR ONLY 25¢**



**TOUGH! HARD!
UNHARMED
BY LIQUIDS!**

★
**FINEST VARNISH
DEVOE EVER
MADE**

★
REPLACEMENT OR A REFUND OF MONEY
Guaranteed by
Good Housekeeping
IF NOT AS ADVERTISED THEREIN

DRIES IN 4 HOURS

(May vary from 3 to 6 hrs.
depending on conditions.)

Users from coast to coast
acclaim Devoe 87 Spar as the
postwar varnish miracle!

Devran*, the new resin created
in the Devoe Laboratories, makes
it the most damage-resistant var-
nish in generations!

USE TEST COUPON TODAY—This offer
gives you enough to finish a piece
of furniture or 20 sq. ft. of wood-
work, floor or linoleum! Mail cou-
pon direct to Devoe with 25¢ for
full ¼ pint of Devoe 87 Spar!

*Patent applied for

87 SPAR TEST COUPON

DEVOE & RAYNOLDS CO., INC., Dept. J-1
787 First Avenue
New York 17, N. Y.

Enclosed is 25¢ for a ¼-pint test sample of
Devoe 87 Spar Varnish (retail value 53¢)

Name.....

Address.....

City..... State.....

This offer expires June 1st

ANOTHER DEVOE PRODUCT

DEVOE & RAYNOLDS COMPANY, INC.

787 First Avenue, New York 17, N. Y.

Removing Linoleum From Concrete Floor

Q—My home has a concrete floor covered with roll roofing and linoleum cemented down. We would like to remove this covering and lay a hard-wood floor. Is this advisable and how should it be done?

V. F.—Kalkaska, Mich.

A—We doubt the advisability of attempting to remove a floor covering which has been installed as you describe. Although it can be done, with painstaking care, it is difficult to get up the covering intact. If your floor is dry the year 'round—and it should be with the treatment you describe—we see no reason why you cannot lay the new floor over the old one by anchoring wood furring strips to the concrete. However, floors laid on furring strips tend to develop squeaks and looseness due to the fact that the nails cannot be staggered.

Painting a Concrete Floor

Q—How can I paint a concrete floor, the surface of which seems to be poorly bonded so that I sweep up fine sand and dust constantly?

A. G.—Sullivan, Ind.

A—Your description of the concrete floor raises the question of the condition of the floor. If we correctly interpret your description of the way the floor "dusts" when swept, it seems rather doubtful if painting would remedy the trouble. In ordinary procedure a concrete floor is prepared for painting by thoroughly cleaning the surface then applying zinc sulphate, which acts as a neutralizer and prevents discoloration of the paint or enamel. This is followed by one or two coats of floor enamel as the job requires. However, if your floor is dusting badly, as it seems to be, it is a question whether the zinc-sulphate treatment plus the enamel coating would be sufficient to anchor the loose material on the surface. If this looseness is due to normal wear then the paint film is likely to be broken up. Another suggestion is to cover the floor with either asphalt or rubber tile. However, this would be practical only if the surface is reasonably smooth with no offsets due to cracks.

Cleaning Marble

Q—I have a slab of marble which apparently has been used for a long time. It is rough and stained. I tried pumice stone but this does not seem to remove the stain. What will clean the marble?

W. H.—Greenville, Tex.

A—Ordinarily, marble is cleaned readily with a mild solution of oxalic acid applied with a sponge or cloth swab. (Do not get the solution on your hands.) The marble must be washed immediately with quantities of clean water to remove all traces of the acid. After this treatment, you can at least partially restore luster by rubbing with precipitated chalk. Make a paste of chalk and water and rub with a soft pad—an old shoe polisher will do.

Bonding Sandpaper to Disk

Q—I have tried several adhesives—wood glue, rubber cement, etc.—for bonding sandpaper to a metal sanding disk. None of these seem to hold satisfactorily. What should I use for this purpose?

M. M.—Brockton, Mass.

A—A stick adhesive is most commonly used for bonding sandpaper to disks. This is readily available from dealers handling power tools and power-tool accessories.

How To Remedy "Hammering" in Water Pipes

Q—When I open and close water faucets in my home, there is an unusual pounding noise and the water pipes seem to vibrate. What is this and how can I correct it?

R. R.—Apopka, Fla.

A—This is known as water "hammer" and usually is due to air entrapped in the system. The simplest and generally the surest remedy is the installation of an air chamber. Just where to locate this is difficult to say offhand without examining the system, but usually it should be placed at the end of a long run of pipe. A common installation is to cut the pipe, install a tee and a piece of pipe varying in length from 1 to 4 ft. or more. The end of the pipe is closed with a cap to form an air chamber. This type of installation usually cures the trouble.

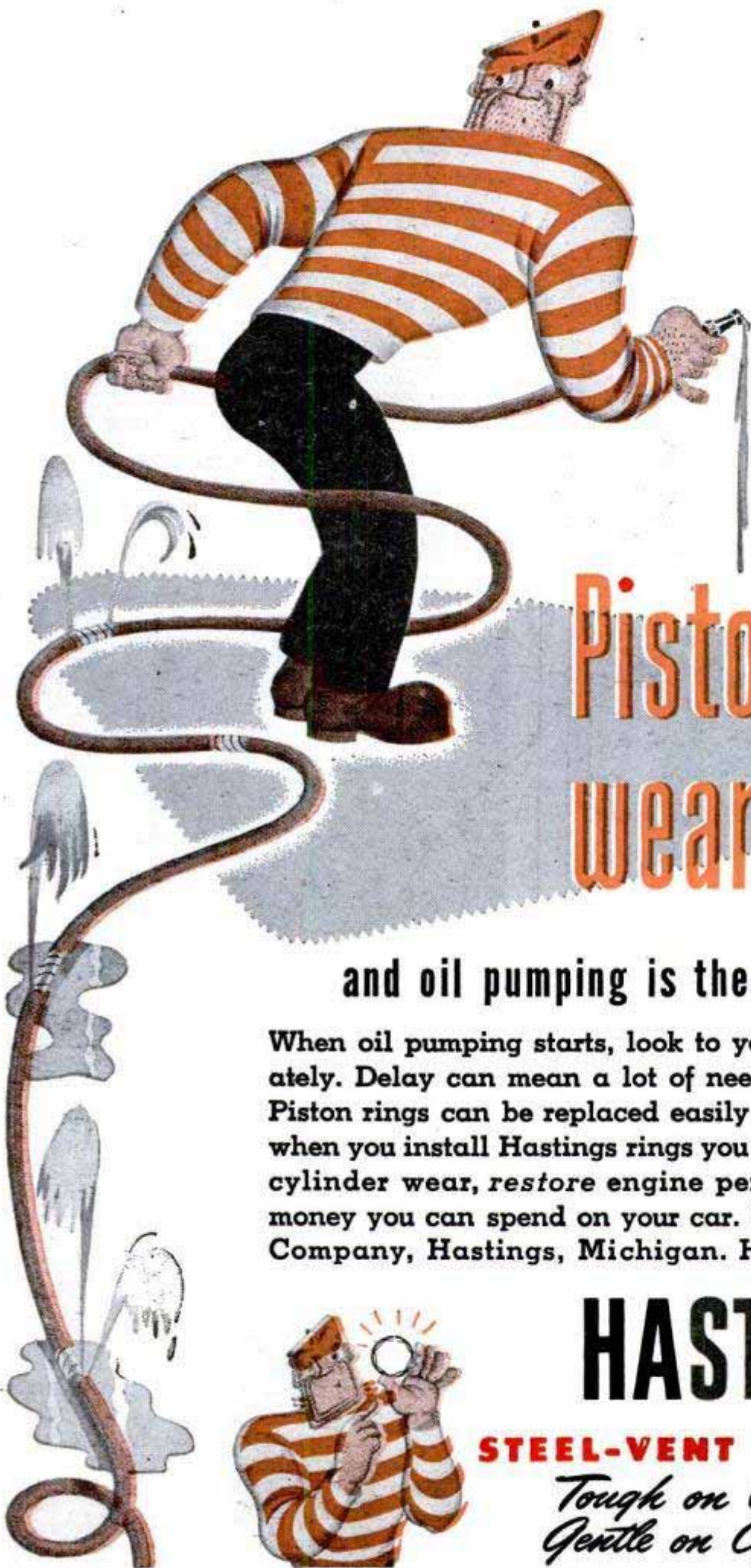

Piston Rings wear out, too

and oil pumping is the first symptom

When oil pumping starts, look to your piston rings immediately. Delay can mean a lot of needless grief and expense. Piston rings can be replaced easily and inexpensively. And when you install Hastings rings you *stop* oil pumping, *check* cylinder wear, *restore* engine performance. It's the best money you can spend on your car. Hastings Manufacturing Company, Hastings, Michigan. Hastings Ltd., Toronto.

HASTINGS

STEEL-VENT PISTON RINGS

*Tough on Oil Pumping
Gentle on Cylinder Walls*

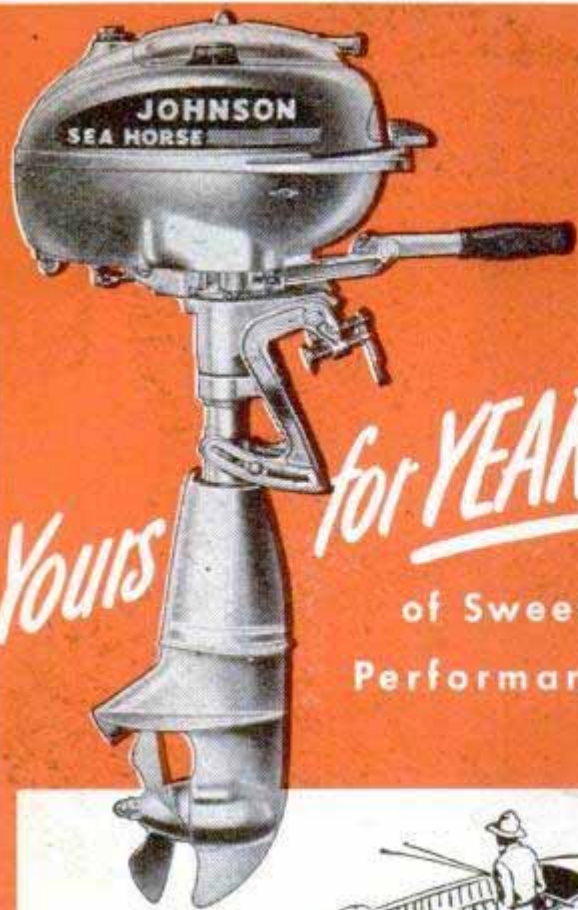

Yours for **YEARS**
of Sweet
Performance

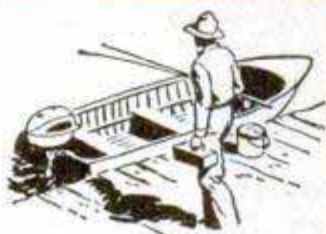

When you look for quality features in an outboard motor, look for them in the line where they were originated, developed, and perfected!

- | | |
|----------------------------|---|
| Perfected Alternate Firing | Ready-Pull Starter |
| Dual Carburetion | Die Cast Cylinder Block |
| Reverse | Anti-Cavitation Plate |
| Rotary Valve | these, and more, are Johnson developments |
| Shock Absorber Drive | |

JOHNSON
SEA-HORSES
for *DEPENDability*

FREE HANDY CHART

New! Illustrates and charts the 5 great Johnsons for '48. Sent free. Write... Look for the name of your Johnson dealer under "Outboard Motors" in your classified telephone book. JOHNSON MOTORS; 400 Pershing Rd., Waukegan, Illinois
Johnson Motors of Canada, Peterboro, Canada

the Navy calls Composition "C." When the superstructure of a sunken vessel is to be blown off, cratering charges are used. For cutting metal or wood, the explosive is kneaded into a manila rope and wrapped around the object to be cut.

There are two real dangers in underwater demolition jobs: undiscovered explosives in the ship, and a premature explosion while the diver is in the water.

Although most divers today are skilled underseas craftsmen, some of them branch out into unique businesses of their own.

An ex-Pfc from Oregon could hardly wait until he'd finished his course at diving school before heading back to the Rogue River. He figured that gold-bearing gravel could be taken out of the river with an air

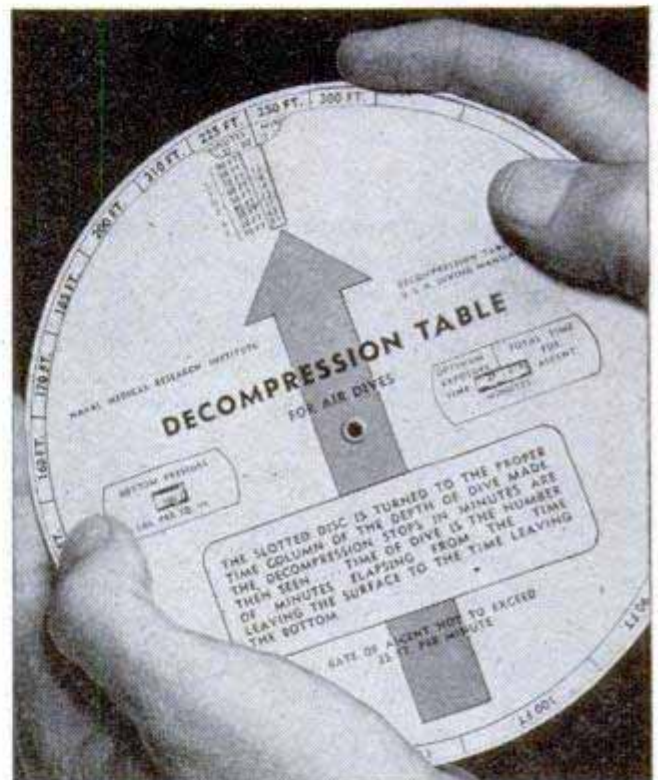

Decompression table shows how long deep-sea diver should remain on underwater "stages" to avoid bends

lift—in places too deep for the prospector and his cradle, too shallow for the dredges. When last heard from he was removing 15 to 18 tons of gold-bearing gravel a day which ran from \$3 to \$4 a ton.

A former Navy man from Pennsylvania also had a money-making idea. Picnickers and vacationists on the lakes of Pennsylvania, Ohio and New York were always dropping watches, binoculars, diamond rings, outboard motors and other objects into the water. Why not set up a regular route to these vacation spots—hitting each one about once a month? Six, eight or 10 persons who had lost something in the water would pay his day's wages.

(Continued to page 240)

HOOVER MOTORS

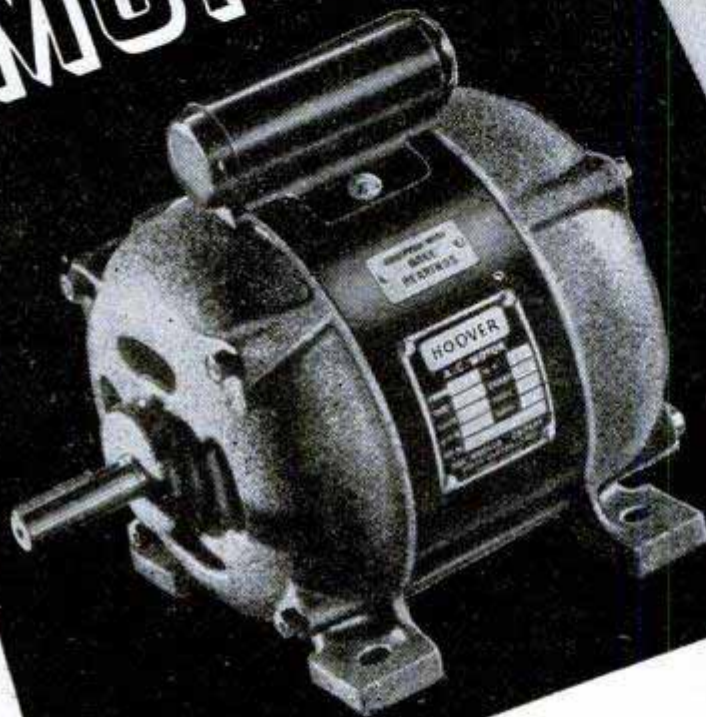

1/4 up to 1 horsepower

Yes, Hoover motors are built by the makers of the world-famous Hoover Cleaners.

This means every Hoover motor is backed by the same reliable skill that has built over seven million Hoover Cleaners.

No wonder a rugged Hoover motor will give you years of efficient, dependable service.

Put a Hoover motor to work—in your home, in your workshop or hobby shop. Watch how it speeds your job, saves your time.

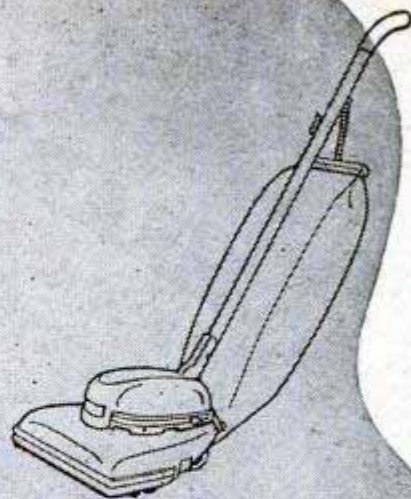

**A GREAT NAME . . .
A GREAT MOTOR**

HERE'S WHY YOU'LL LIKE HOOVER MOTORS

Induction run . . . single phase . . . 60 cycles . . . dual voltage —110/220 . . . 1725 R.P.M.

Capacitor start . . . more than 300% full load starting torque with minimum current flow.

No vibration or "shift" . . . integral feet, carefully machined to give solid mounting and quiet operation.

Low temperature . . . electrical and mechanical design for low-temperature operation. Ventilated open type. 40° C. Rise.

Laminated steel rotor . . . carefully ground and balanced for maximum efficiency.

Centrifugal starting switch . . . designed and built for years of trouble-free operation.

High-grade ball bearings . . . sealed against dust and grit, give smooth performance and long wear.

Rotation . . . clock or counterclockwise.

See your authorized Hoover motor dealer. If unable to locate, write

THE HOOVER COMPANY

Electric Motor Division, North Canton, Ohio • Hamilton, Ontario, Canada

THE FAITHFUL
HEART
OF YOUR FUEL
SYSTEM

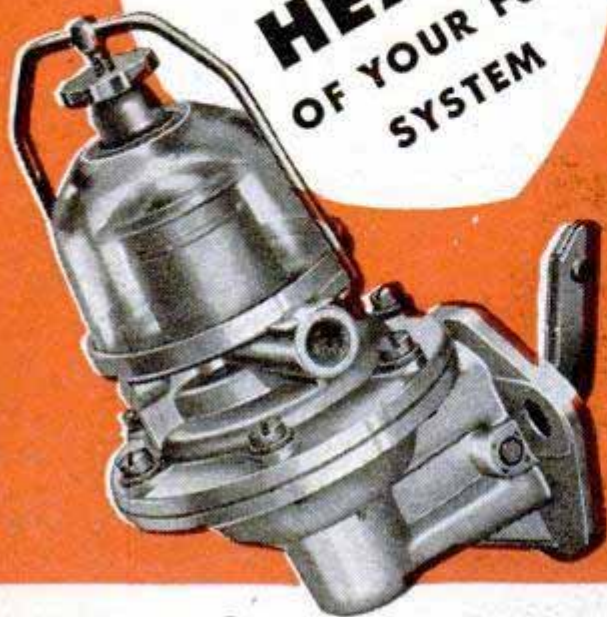

**OVER
30,000,000 IN USE
TODAY**

Pulsing steadily, nearly 100,000 times an hour, your AC Fuel Pump is the strong, reliable heart of your fuel system. It has given you long, faithful service because of its inbuilt quality and scientific design.

You can prolong that faithful service indefinitely, if you insist upon a new AC when you replace your present pump.

There is no satisfactory substitute for quality.



AC SPARK PLUG DIVISION • GENERAL MOTORS CORPORATION

A New Zealander, after completing diving school, remained in California to become a collector of agar, a sort of deep-sea alfalfa. Agar is finding a number of uses in the manufacture of confections, paint, cosmetics and pharmaceuticals. When the weather is good he collects three tons of agar every three days at \$85 a ton.

Two young men on the St. Marie's River in Idaho noticed that logs floating downstream in the spring and summer often rammed into mud banks and became stuck under water. "Let's learn to dive and get these things free," one of them suggested. Now they spend eight months of the year freeing logs, and their pay at \$15 per thousand board feet allows them to ski at Sun Valley the other four months.

So there's money to be made in the pro-

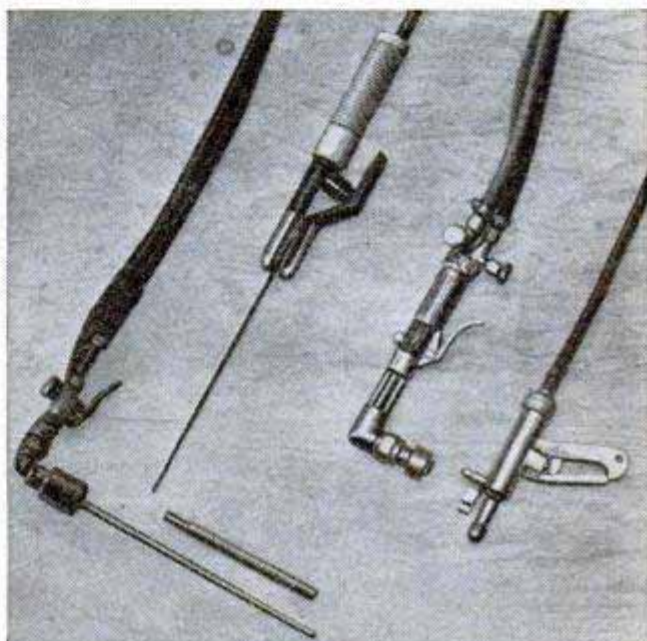

Essential tools for cutting and welding are, left to right, oxyelectric torch, electrode holder, oxyhydrogen torch and air-operated igniter for torch

profession of deep-sea diving — whether you want to be a skilled underwater craftsman or go into the diving business for yourself.

Consider what Lieutenant Cross says:

"Sonar and other underwater sound gear, developed by the Navy during the war, are going to make treasure hunting a lot easier from now on."

In addition to sunken treasures of the past centuries there are at least two new ones. In World War II the Army dumped \$8,500,000 worth of silver coins off Corregidor. Much of it has been recovered, but there is still a fortune lying in the mud. Another treasure, estimated at several million dollars, was dumped into the Black Sea by a central European government threatened by the Nazis.

"These and others await anyone who can dive for them," says Lieutenant Cross.

SAVE YOUR PRECIOUS EYESIGHT!

Soften that **GLARE...**
wear these genuine

U. S. ARMY AIR FORCE TYPE

SUN GLASSES



SPECIAL OFFER
WHILE
THEY LAST!



Regular \$15.00 Value

SUPER-SENSATIONALLY PRICED

at only **\$2.49** including convenient leather case
Men's and Women's sizes!

Imagine! These attractive, optically-correct sun glasses at such a bargain price! U.S. Gov't. approved for meeting all specifications for absorption of ultra-violet and infra-red rays.

DON'T BE A SUMMER AND WINTER SQUINTER!

Effectively protect your eyes from harsh glare of summer sun and winter snow. Wear these smartly-made, official Army type sun glasses for carefree, glare-free pleasure . . . the year 'round!

- Ground and polished 4 base lenses.
- Gold plated adjustable frames.
- Pearlloid sweatband and pads.
- Made to highest optical standards.
- Absolute satisfaction guaranteed or money cheerfully refunded.

LIFETIME GUARANTEE!

If at any time during the life of these sun glasses you return them to us for repairs, we will be glad to fix them for a nominal service charge of 50c.

AMERICAN HANDICRAFTERS, INC.

Division of S & B Surplus Sales Co.

2905 W. Madison St.

Chicago 12, Ill.

HURRY! FILL OUT AND MAIL THIS ORDER COUPON NOW!

AMERICAN HANDICRAFTERS, INC., Dept. P5
2905 W. Madison Street, Chicago 12, Ill.

Please send me _____ men's _____ women's SUN GLASSES.

- Send C.O.D.
 Enclosed find check or money order for \$2.49 pr. postpaid.

Name _____

Address _____

City & State _____

(Illinois residents add 2% ret. occ. tax)

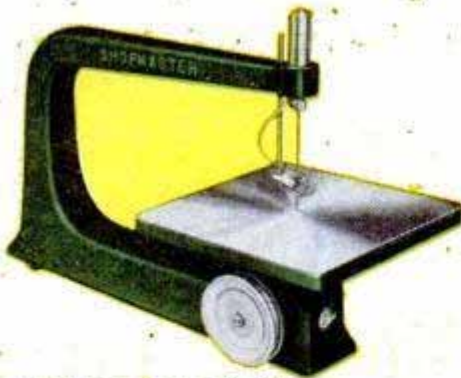

15" Tilting Table Jig Saw



A boat of your own will add to your fun this summer. You'll find one easy to build with Shopmaster Tools.



Travel in your own house trailer. Parts are now available and you can build one yourself with Shopmaster Tools.



Enhance the beauty of your home or lake cottage with trellises, garden furniture and other projects easily made with Shopmaster Tools.

Large projects or small, you can give them that professional touch which means beauty and long life, when you use Shopmaster Tools.

Shopmaster tools are built to meet the requirements of precision work, yet the controls and ease of operation makes them ideal for the beginner and home craftsman. They embody design and operational features found only in the best equipment. Handsome additions to your workshop, you'll find Shopmaster Tools most reasonably priced.

15" Tilting Table Jig Saw — new style blade support, blower, and with mechanism encased in oil.

6" Jointer-Planer — with sealed-for-life ball bearings and an exceptionally large table capacity.

12" Bench Type Drill Press — performs perfectly on drilling, routing, mortising and other jobs.

8" Tilting Table Bench Saw — with ball bearing arbor, accurate calibrations and many other features not ordinarily found on bench saws.

Adjustable Stands — two models designed to hold power tool and motor.

10" Wood Turning Lathe — exceptionally accurate to full 31 inch capacity.

12" Tilting Table Band Saw — with fully enclosed adjusting and operating mechanism, and dynamically balanced wheels.



12" Bench Type Drill Press

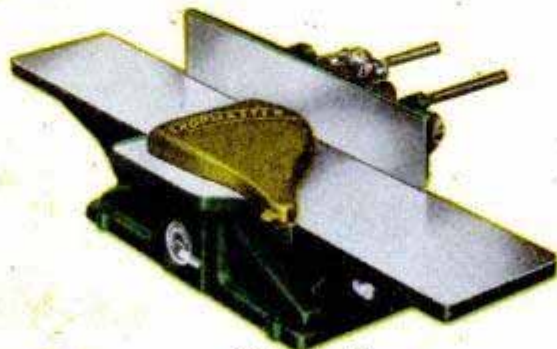

6" Jointer-Planer

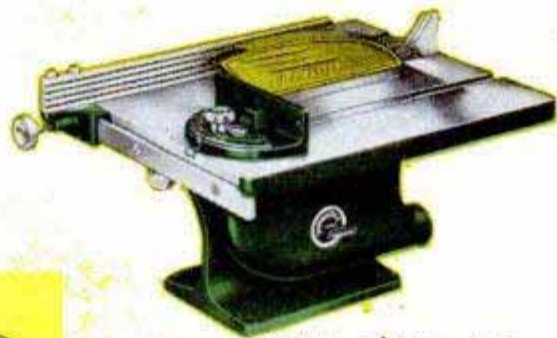

8" Tilting Table Bench Saw



Adjustable Stand

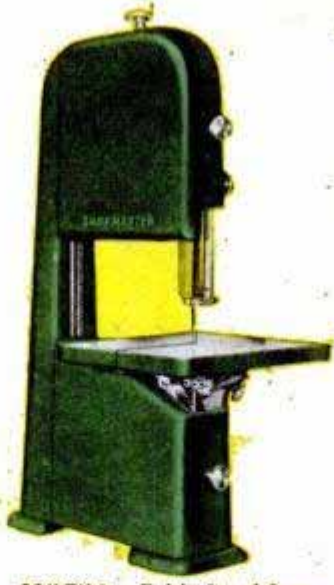

12" Tilting Table Band Saw



10" Wood Turning Lathe

SHOPMASTER, INC.
1214 Third St. S., Minneapolis 15, Minn.

Please send me information on Shopmaster Tools.

NAME _____

ADDRESS _____

CITY & STATE _____

SHOPMASTER, INC.
1214 Third St. S., Minneapolis 15, Minn.



fun thrills
excitement



when you own a

HARLEY-DAVIDSON

Like to roam? Does a winding road fascinate you with its alluring promise of something new around every bend? Do you enjoy country air, the fragrance of fields, meadows, woodlands? Do tumbling waterfalls, quiet lakes, broad rivers bring you back to them again and again? Then you'll like motorcycling, world's greatest sport! For it takes you places, out in the open, to scenic wonderlands, faraway cities, brings you the thrills of gypsy tours, race meets, hillclimbs, exciting vacations . . . makes every spare hour mean happier, healthier outdoor enjoyment. It's so easy to enjoy motorcycling, easier than you think to own a genuine Harley-Davidson. Why not get started now? See your dealer. Mail coupon today.

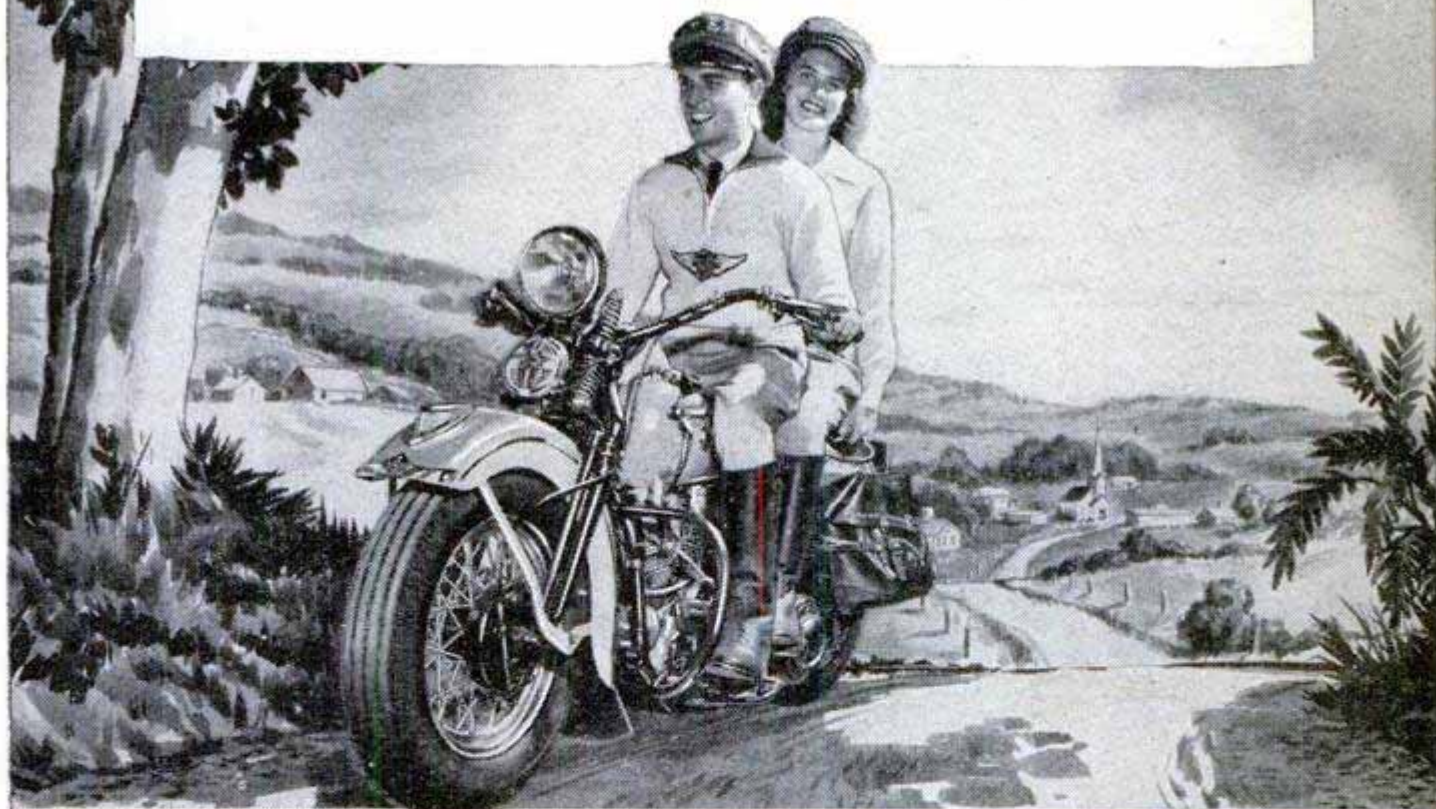

HARLEY-DAVIDSON MOTOR CO.
Dept. P, Milwaukee 1, Wis.

Send free copy of ENTHUSIAST magazine, filled with motorcycle action pictures and stories; also literature on 1948 models.

Name.....

Street or R.F.D.....

City..... Zone..... State.....

"Hope this won't make
you mad, Jerry..."



JERRY: What's on your mind, Uncle Pat? I can take it.

UNCLE PAT: Well, you'd better return that saw and get your money back—if you still can.

JERRY: What do you mean? What's the matter with this saw?

UNCLE PAT: It's one of those bargain counter orphans, Jerry. No brand name. No reputation. Nothing behind it to back it up. It'll let you down just as sure as you're born.

JERRY: Brand names aren't *that* important, are they?

UNCLE PAT: They are to *me*. I want *quality* when I buy tools. That's why I always do my buying at the hardware store, where they carry the best in every line. And believe me, I never put my money down till I see a brand name I can trust.

Your **HARDWARE DEALER** sells **QUALITY** tools
and hardware... Buy from HIM



POPULAR MECHANICS

Ingenious New Technical Methods

To Help You
Simplify Production

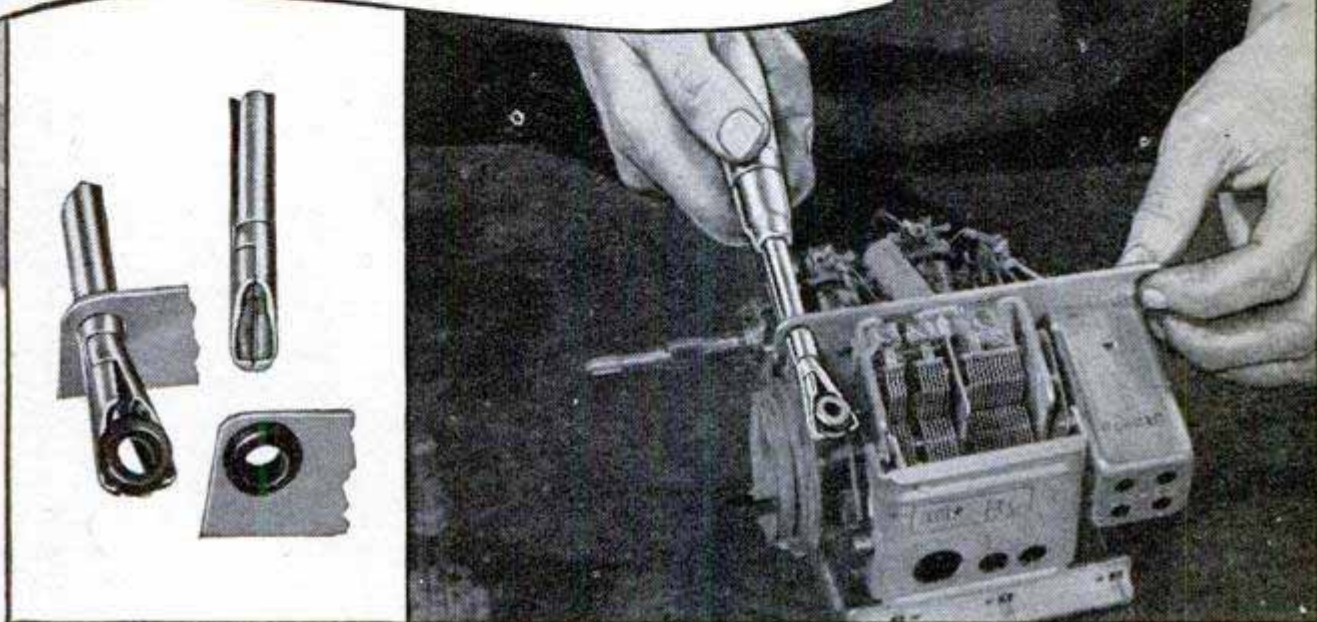

New Tool Inserts Rubber Grommets Quickly . . . Easily!

A new tool called a Grommet Inserter is shown above inserting a rubber grommet in a Sub-Chassis of a Zenith 7H820 Table Model Radio. The inset illustrates a close up view of the Grommet Inserter before and after the grommet has been inserted.

Anyone can insert grommets in an instant with the new Grommet Inserter. Saves time, labor, and assures perfect fit. No longer is it necessary to use the time-consuming, cumbersome method of insertion by hand. The new Grommet Inserter does it efficiently.

Simple as A-B-C. All you do is push the Grommet Inserter through the hole, open jaws, place grommet in jaws, and pull back—leaving grommet firmly in place, and perfectly fitted. Comes in four standard sizes: $\frac{1}{4}$ ", $\frac{5}{16}$ ", $\frac{3}{8}$ ", $\frac{7}{16}$ ". Can be furnished in any special sizes to order.

You can count on chewing gum, too, to help step up employee's on-the-job efficiency. Chewing gum helps relieve tension and thereby enables him to work quicker and easier while leaving hands free. That's why more and more plant owners are making Wrigley's Spearmint Gum available to everyone.

*Complete details may be obtained from
D. B. Rich Manufacturing Co., 6217 Melvina Avenue
Chicago 30, Illinois*



Grommet Inserter



AC-64

Doll Doctor

(Continued from page 154)

On the work areas are racks and drawers containing standard surgical and dental instruments plus some common workbench items and an assortment of special knives, pallets and hooks which Nash designed and made. The dental and medical instruments help lend an authentic atmosphere, but they are not primarily for show. Nash actually uses them in many of his doll-repair operations. A haemostat, for instance, makes an excellent clamp for holding the elastic cords used to string a doll's arms, legs, head and torso together. And there are a hundred uses for a surgeon's scalpel. A flexible-shaft outfit originally intended for a dental laboratory is handy for delicate carving on doll heads, hands and other parts. The patching material used to close a break in a head or body can, after drying, be smoothed quickly with a dental burr driven by the shaft.

Another room is used for making wigs and clothing and for painting and tinting doll heads and bodies. Wig-making is discouraged, but when a customer brings in hair and wants it made into a wig for a keepsake doll, there isn't much Mrs. Nash can do except comply. Usually a stock wig is used, made of material like mohair or horsehair—seldom of human hair.

Doc Nash now is looking for an old-fashioned dentist's gas outfit that he can install in his operating room for atmosphere. And he plans to convert the fifth room of his establishment into a six-bed ward for doll babies.

Nash claims to be one of the few doll-repair specialists who actually repair. That is, he makes a practice of rebuilding broken heads, arms and other parts whenever possible; only as a last resort does he replace the damaged parts with new or usable old ones. In this way, the customer feels that he or she is getting the original doll back. Sometimes a doll looks beyond hope—with the body completely disassembled, perhaps a considerable hole in the head, part of a foot missing and invariably one or more fingers no longer present.

The first thing Nash does is to clean up the body and remove the original finish. Then, using his own plastic repair materials, he mends breaks, fills holes and rebuilds missing parts. He spent some time with paint manufacturers in developing a satisfactory rapid-drying enamel for finishing doll bodies. He can produce either a shiny or an eggshell finish. The normal re-finishing requires one or two applications

(Continued to page 248)

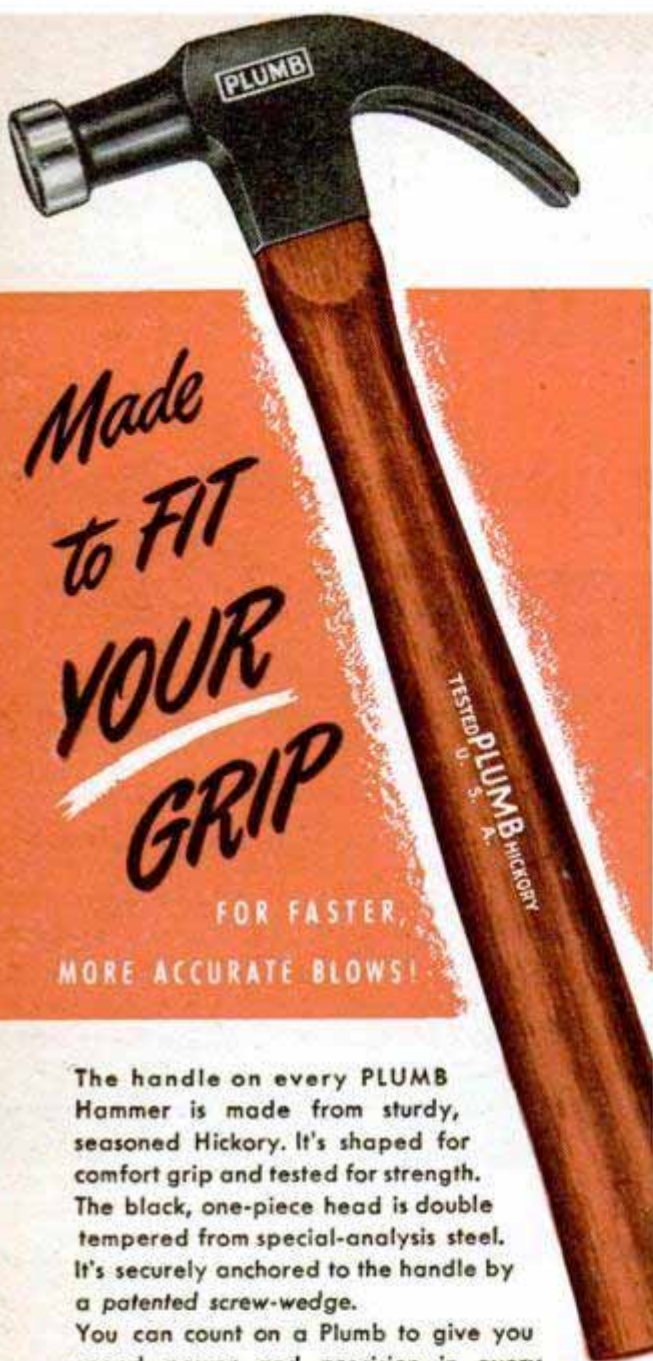

Made
to FIT
YOUR
GRIP

FOR FASTER,
MORE ACCURATE BLOWS!

The handle on every PLUMB Hammer is made from sturdy, seasoned Hickory. It's shaped for comfort grip and tested for strength. The black, one-piece head is double tempered from special-analysis steel. It's securely anchored to the handle by a patented screw-wedge. You can count on a Plumb to give you speed, power and precision in every blow. Yes, Plumb is a lifetime tool, built for permanence. Fayette R. Plumb, Inc., Philadelphia 37, Pa.

Quality Comes FIRST
PLUMB
is FIRST in Quality

The red handle with the black head—exclusively Plumb.

PLUMB

HAMMERS • HATCHETS • AXES • FILES

Mail this **FREE BOOKLET COUPON** Today

R. H. SHEPPARD CO., INC., 305 Philadelphia St.
Hanover, Pennsylvania
Please send me your FREE Sheppard Diesel Engine Booklet.

I am especially interested in (check one):

- Diesel Power Units
- Diesel Marine Auxiliaries
- Diesel Generators
- Diesel Marine Engines
- Dealer Franchise
- Equipment Manufacturers

Name.....
Address.....
City & Zone.....County.....State...

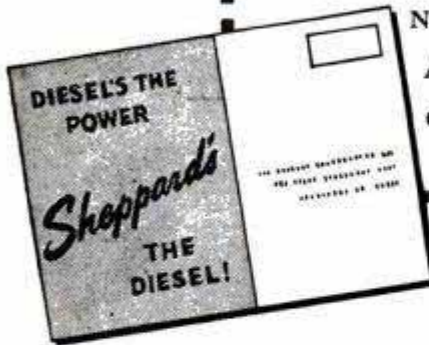

FREE Sheppard Diesel Engine Booklet

Find Out How These Amazing Small Diesel Engines Can Solve Your Power Problems

At last—here's safe, dependable, economical Diesel power for SMALL engine users! Sheppard Diesels will do any job a gasoline engine will do—at one-quarter the fuel cost—with less maintenance. Farmers, contractors, plant operators, coal mines, oil wells, hatcheries, air lines, railroads, boats and ships are all saving money—getting a better job done—with Sheppards! They're using them to drive cranes, pumps, compressors, mills, generators, conveyors, rollers, scrapers and other power-driven equipment. So find out how Sheppard can help you solve your power problems! Mail coupon today for FREE Sheppard booklet. No obligations!

These Sheppard Features Mean Ease of Operation!

PUSHBUTTON STARTING . . . in any weather. A child can start any Sheppard Diesel! Just press button; to stop—close throttle. Operates itself.

AMAZINGLY LOW FUEL COSTS! Uses only half as much fuel as gasoline engine, and fuel costs only half as much—less than 1/4 of operating cost of gas engine.

SIMPLE DESIGN FOR EASE OF MAINTENANCE! Only ONE moving part in the injector. No carburetor, no ignition system. Easily serviced.

DELIVERED COMPLETE, READY TO OPERATE! No extras to buy on any Sheppard Power Units. All the accessories are STANDARD EQUIPMENT.

SHEPPARD DIESEL CUTS ICE PLANT POWER COSTS 66 2/3%! Evergreen Fruit Farms, Warwick, N. Y., formerly operated its cold storage compressor from a tractor drive—now uses a Model 6A Sheppard Diesel, and saves 2/3 of former power costs—because Sheppard does more work with 1 gallon of fuel, at half the price, than the tractor did with two.

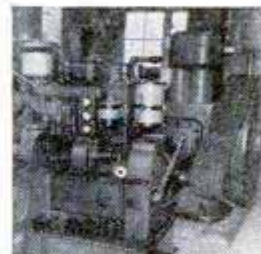

SHEPPARD DIESEL POWERS MACHINE SHOP FOR 3 1/2 YEARS WITHOUT OVERHAUL. Henry Riehl & Son of Philadelphia secure power for their entire machine shop from one Model 6 Sheppard Diesel, which was installed in June, 1941, and operated the shop 9 hours a day, 6 days a week, for 3 1/2 years before overhaul became necessary! Another example of Sheppard dependability.

Which of These SHEPPARD DIESELS Will Solve YOUR Power Problems?

SHEPPARD AIR-COOLED DIESEL (Model 14)—5.4 H. P., pushbutton starting. Delivered complete, ready to operate.



SHEPPARD POWER UNITS—3.5 to 100 H. P. Pushbutton starting. Delivered ready to operate, no extras to buy.

SHEPPARD GENERATING SETS—2 K. W. to 36 K. W., A.C. or D. C. Pushbutton starting. Optional automatic starting.



SHEPPARD MARINE ENGINES—3.5 to 100 H.P. Pushbutton starting, reduction gears, etc. are all standard equipment. No extras to buy.

SHEPPARD MARINE AUXILIARIES—Complete with fire, bilge or fish wash pump; compressor; generator. Other special equipment as required.



DIESEL'S THE POWER *Sheppard's* **THE DIESEL**



... Quick Easy Way to BIG PROFITS

Read What Others Are DOING!

"Enclosed you will find 56 orders representing 9 1/2 hours' work on Monday and Tuesday."
 "Enclosed are twelve orders secured after supper this p.m."

Housewives are Enthusiastic

Everyone that sees this outstanding Cell-U-Mop immediately wants one... That's the reason why our distributors are so successful... You also have the advantage of our other QUICK SELLING PRODUCTS that step up your Volume Sales and Profits.

Hands Never Touch the Water—Can be put in Boiling Water. Housewives Like It.

48" Long Handle

Sales QUICK, EASY Every Locality

SALES ARE EVERYWHERE... Sells quick to Taverns, Clubs, Hotels, Hospitals, Stores, Restaurants, Large and Small Buildings and the Homes... Scores can be sold on a single street... Note the Drain Bracket in the illustration... This squeezes out the water so thoroughly that HANDS NEVER TOUCH THE WATER... Makes no difference what you ever sold, you will like this proposition... Your name on a Post Card will bring you FREE PARTICULARS.

CELL-U-MOP CO., Dept. P-5 FREEPORT, Ill.

We Teach You How •

Gets down under and around for MOPPING, DUSTING or WASHING

DOES THE WORK OF 6 TOOLS IN 1

Get Choice Territory NOW!

Holds 20 times its weight in water.



32 DRAWER UNIT \$4.95
 64 DRAWER \$8.95

for home or shop

THE JIFFY CABINET

WITH LAMINATED FIBRE BOARD DRAWERS THE HANDY WAY TO KEEP SMALL PARTS, WASHERS, NAILS, SCREWS, NUTS, BOLTS AT HAND

DRAWER SIZE
 1 1/4" DEEP
 3" WIDE
 6" LONG

CABINET SIZE
 32 Drawer Unit
 6" DEEP
 12 3/4" WIDE
 15 1/4" HIGH
 Shipping Weight approx. 9 lbs.

64 Drawer Unit
 6" DEEP
 25 1/2" WIDE
 15 1/4" HIGH
 Shipping Weight approx. 18 lbs.

For small items, the low-cost Jiffy Cabinet, 32 or 64 drawer units that put office, shop, work bench, household and hobbyist needs at your fingertips. Metal flange drawer guides. Spot welded all metal cabinet with sturdy laminated drawers insures long time-saving service. Why fumble? With the Jiffy you know where it is. 32 drawer unit—\$4.95; 64 drawer unit—\$8.95. Send check or money order—No C.O.D.'s please. Ohio orders please add 3% Sales Tax. Shipping charges parcel post collect.

KAYTEE PRODUCTS
 Dept. M, Box 588 Canton, Ohio

Sand Casting — Forging — Heat Treating — Case Hardening BRONZE FOUNDRY



In your own workshop allows you to design and build your own GASOLINE ENGINES, STEAM ENGINES, STATUARY, ART OBJECTS, SPECIAL TOOLS, NEW INVENTIONS, ETC. You can also make forgings and case harden steel. Your shop is not complete without a FOUNDRYETTE. Three sizes are available capable of making bronze castings of 1 1/2, 3 and 6 pounds weight, aluminum, copper, brass, etc., \$22.50, \$29.50, \$42.00 f.o.b. Kansas City. Domestic gas supply and 110 volt AC or DC energy required for operation. Write for circular.

KANSAS CITY SPECIALTIES CO.
 Box 6022, Dept. P-4 Kansas City, Mo.

NONE BETTER! SUPER DRILL GRINDER



Sharpens round shank drills from 3/32" to 1-1/16" in diameter, up to 11" long. Grinds old drills like new in 4 different point angles, using hand or power grinding wheels. Money-back guarantee.

Price only \$2.95
 At Dealers or Postpaid
 CRANDALL MFG. CO. 1512 W. Slauson, Dept. FA-29, Los Angeles 44, Calif.

OWN A Printing Business

Cards, Tickets, Stationery, etc. Good profit in spare time. PRINT YOUR OWN greeting cards, movie titles, church work, etc. Save money. Easy rules supplied. Raised printing like engraving too. Have home shop. Sold direct from factory only. Send time for supply book, suggested outfits, all details and advice on your needs. No obligation. **KELSEY, INC. C-37, MERIDEN, CONN.**

PISTON TYPE COMPRESSOR EASY PROFIT IN PAINT SPRAYING



Paints walls, ceilings, screens, furniture and machinery faster, better. All complete as shown less motor. Carry anywhere. Fully guaranteed. Could be used with 1/4 H.P. motor or less. Price \$35.00 less motor F.O.B. Chicago. \$5.00 deposit balance C.O.D. or see your dealer. With motor \$55.00. **IDEAL AUTOMATIC PUMP CO., Dept. P.M. 8 Chicago 7, Ill.**

PACKAGED BOATS MARINE MART BOAT PATTERNS



Save 50%—build from our precision cut, plywood kits—preassembled frames—row, power, sail—dinghies—inboard and outboard runabouts—5 to 18 feet—finest design—full hardware—nothing else to buy—illustrated instructions—\$34.50 up—send 25c (coin) for literature.

BUFFALO 7-M, N. Y.

Order cut-to-shape patterns, blueprints, from Boat Pattern Catalog containing 60 world's best plywood designs—kayaks to cruisers—by outstanding specialists, MacGregor and Deed. Send \$1.00 for catalog plus Wm. Deed's booklet "Plywood Boats" (Pattern Catalog only, 25c coin).





THE TOUGHEST ALL-AROUND KNIFE IN THE WORLD!

Men, here's the world-famous Marine combat knife at tremendous saving. Brand new...with razor-keen 7" Parkerized rust-resistant blade....5" grooved leather handle....heavy leather sheath. Beautiful rugged knife unexcelled for a thousand outdoor and workshop uses. ORDER NOW AND SAVE! Send check, money order, cash. WE PAY POSTAGE!



Made by Ka-Bar and Camillus for the Marines

now \$2.00 just 3 for \$5 (f. o. b. Los Angeles)

SHERIDAN & SONS

855 S. LOS ANGELES ST., LOS ANGELES 14, CALIF.

AUTOMATIC RETOOTHER

Cuts new saw teeth in 50 seconds — any size 4 to 16 points. Old teeth fall off as chips. Easy to operate. A perfect job. Write today for details on GREATER PROFITS FOR SAW SHOPS.

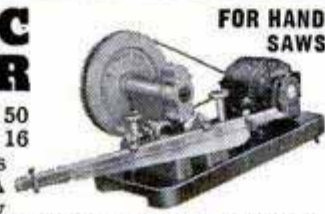

FOR HAND SAWS

BURR MFG. CO. 8933-Q Venice Blvd. Los Angeles 34, Calif.

BUILD YOUR POWER TOOLS

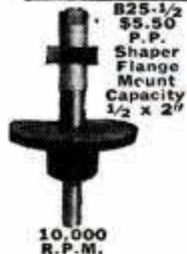

B25-1/2 \$5.50 P.P. Shaper Flange Mount Capacity 1/2 x 2"

WITH OUR GUARANTEED INDUSTRIAL POLY BALL BEARING ARBORS

New Departure Self Lubricating Bearings



10,000 R.P.M.

(No extra charge for left hand threads) C5-5/8 Pictured C4-1/2x12 1/2 spindle, housing 2x8 \$7.95 PP. C5-5/8x12 1/2 spindle, housing 2x8, \$8.25 PP. C6-3/4x12 1/2 spindle, housing 2 1/4x8, \$9.25 PP. D8-1x17 1/2 spindle, housing 2 3/4x11 \$17.00 PP. 1 INCH BETWEEN WASHER AND COLLAR

SHAPER ARBORS 3 inches between collars, C4-1/2 \$14.25, C5-5/8 \$14.25, C6-3/4 \$15.25, D8-1 \$23.00, B25-1/2x2" (pictured) \$5.50. SPECIAL SAW ARBOR LENGTHS for 1 1/2, 2, 3, 3 1/2, add \$1.50.

POLY PRODUCTS, 2032-A E. Walnut, Pasadena 8, Calif.



Opportunity UNLIMITED

Today hundreds of average American men and women are building a profitable business of their own with Tradio-ette, the coin radio functionally-designed for booth operation in taverns, restaurants, ice cream parlors, etc. Making money with Tradio-ette is about the simplest and most lucrative business you ever imagined. You need no experience and your educational background is of minor importance. You merely install the sets on a percentage basis in locations all around you and make periodic collections. Only a small investment is needed to get in on the ground floor. Opportunities for expansion are unlimited.

Send for complete information. Write: Dept. N-5.

TRADIO, Inc. ASBURY PARK NEW JERSEY

TACK WITH A GUN

It's Quick—It's Easy
It's
DUO-FAST

\$7.50
FACTORY PRICE



FOR YOUR HOME

NEAT — QUICK — PROFESSIONAL WORK

Making screens—insulating your home—reupholstering that old chair—tacking shelf paper—lining dresser drawers—tacking carpet and linoleum—attaching shade cloth to rollers—repairing furniture. Wherever tacks are used, DUO-FAST will do it better—quicker—neater.

FOR YOUR SHOP

INDUSTRY SAVES LABOR AND MONEY

Furniture mfrs.—carpenters—woodworking plants—shippers—sign makers—chain stores—home builders—display houses—luggage—screen wire—theatres—stock rooms—dept. stores—mechanics—mattress mfrs.—insulation—upholstering—automotive.

FOR YOUR SHIPPING

SIMPLIFIES WORK

Shipping tags
Waterproof lining

Protective padding
Lining box cars

It's DUO-FAST Wherever Tacks Are Used

DUO-FAST will do it Better—Quicker—Neater. It's lightning fast—just squeeze the handle—staples are driven rapidly, accurately and easily—even in close quarters.

The DUO-FAST Gun Tacker is operated with one hand, leaving the other hand free for holding work

RAPID LOADING — RAPID TACKING

140 staples per load in 2 different leg lengths 1/4" or 3/8"

5000 1/4" staples \$2.00

5000 3/8" staples \$2.25

Prices F.O.B. Chicago

Remit with order to save C.O.D. and postage charges

DUO-FAST makes many other tackers to fit your individual business. Write for information on Hammer tacker, Air tacker, Lip tacker and Narrow crown tacker.

Certain dealer territories open—write for full information.

FASTENER CORP. • 854 FLETCHER • CHICAGO, ILL.

FASTENER CORPORATION
854 Fletcher St.
Chicago 14, Ill.

Please send me the following:

- DUO-FAST Gun Tacker
- For medium gauge staples \$7.50
- DUO-FAST Gun Tacker
- For heavy gauge staples \$7.50
- C.O.D.
- Remittance Enclosed
- 5000 1/4" staples \$2.00
- 5000 3/8" staples \$2.25
- More information

Amount \$ _____
Remit with order to save C.O.D. and postage charges.

NAME _____
ADDRESS _____
CITY AND STATE _____

★ HERE'S ONE for your boat!

The right one! From the complete six-model Evinrude line, it's easy to choose the motor that gives you exactly what you'd like in power and performance. Three thrilling four-cylinder motors . . . smoothest on the water! A brilliant new "Sportwin" with dozens of exciting new features! Two models with the revolutionary FISHERMAN DRIVE — *weedless, shoal-riding, snag-proof* . . . a boon to fishermen! See your Evinrude dealer — look for his name under "Outboard Motors" in the yellow pages of your phone book. Catalog FREE — write EVINRUDE MOTORS, 5762 N. 27th St., Milwaukee 9, Wis.

SPORTWIN
28 thrilling new features — it's complete even to a fuel gauge!

SIX MODELS
the right motor for every boat — 1.5 to 33.4 certified horsepower.

WRITE FOR CATALOG!



of undercoater followed by one to three finish coats. Using the same waterproof pigments, he paints in new eyebrows and other features. For the pink cheeks that are characteristic of most dolls he uses ordinary lipstick, blending it into the painted surface with a cloth. The lipstick, if it wears off, can be restored by anyone.

Doll surgeons usually find it difficult to obtain replacement parts that match the originals. Nash simply steps into his shop and, with the aid of power equipment and hand tools, fashions a new hand, leg, or other required bit of anatomy.

By watching the procession of Nash's clients, an observer can gain a fairly accurate idea of the doll hobby in the United States. Some of his visitors are doll collectors. Some collectors specialize in old china heads. Others will accept any kind of doll as long as it is 30, 40 or maybe 100 years old. Still others collect character dolls. And there are collectors who are happy to possess any kind of doll, new or old, that is attractive or interesting.

But a large percentage of Nash's hospital patrons are persons who might be called one-doll devotees. Sentiment is often the basis for a doll-repair job. One day a woman, who obviously was close to 75 years old, came into the hospital with a French doll in her arms. She wanted to know whether it could be restored to its original freshness. Nash, after a diagnosis, assured her that it would not be a difficult case, and asked her how she came to have the doll. Years before, the woman and her husband had lost their 13-year-old daughter. Later the husband had bought the French bed doll. Still later the husband died, and the doll since has traveled extensively with the woman. The years of wear made a trip to the hospital advisable.

Another French doll, a fashion type about 75 years old, was brought to Nash by a man who was a leading attorney in an Ohio city. After the doll had been repaired and dressed in a new costume, the attorney took it to his office and placed it on his desk. To curious visitors he explains that the doll belonged to his grandmother. Did he need a better reason for giving the doll a throne of honor?

Nash says that many men are doll fanciers. The ones that Nash has encountered are more critical than women collectors, know exactly what they want, and when they find it they are not inclined to haggle over the cost.

As a doll grows older it may become one of the few of its kind in existence. A bisque or china head aged 50 years may be worth

(Continued to page 252)

For those who want something **EXTRA** in a Hearing Aid!



● Have you been waiting for a hearing aid that gives you the *extras* you require? *Extra* power, for example, to enable you to hear even a whisper. Or *extra-wide* tonal range, *extra* wearing convenience, *extra* economy.

Whatever your needs, you'll want to see Western Electric's two new all-in-one hearing aids. Each was designed by world-famed Bell Telephone Laboratories. Each incorporates special features found *only* in Western Electric instruments.

Ask for a free demonstration at your Western Electric Hearing Aid dealer's (address in Classified Telephone Directory). Or send coupon for free booklets.

Free!

MAIL THIS COUPON NOW

WESTERN ELECTRIC, Dept. 380-PM-5
195 Broadway, New York 7, N. Y.

Send me free booklet about two new *all-in-one* Western Electric Hearing Aids plus "Modern Science and Your Hearing."

Name _____

Address _____

City _____ Zone _____ State _____

Distributed in U. S. A. by Graybar Electric Co.; in Canada by Northern Electric Co. Ltd.; in other countries by Westrex Corp.

GRIND IT on Your Lathe

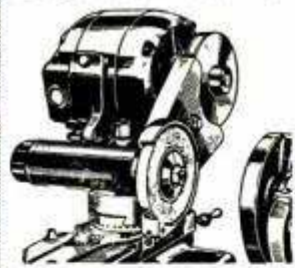

A powerful External Grinding Attachment for sharpening reamers and cutters, grinding hardened bushings, etc. Has precision ball bearing spindle with 4" x 1/2" grinding wheel. 5 sizes for South Bend Lathes — adaptable to others. Write for dimension sheet. Price with 1/4 h. p., 1 ph. motor, f.o.b. factory **\$49**

SOUTH BEND LATHE WORKS

455A E. Madison St.
South Bend 22, Ind.

SAY YOU SAW IT IN POPULAR MECHANICS

Get A SEAMAN ROTARY TILLER

Better Yields—Better Crops



Because this farm-size rotary tiller prepares seedbeds most ideally suited to your soil and crop conditions, it helps produce *higher yields* and *better quality* crops. Can be adjusted for fine pulverization, coarse or medium tillage . . . just the way you want it. Mixes fertilizer and humus into the GROWING AREA of seedbed; aerates soil; eliminates air pockets and hard plow soles; conserves moisture; promotes earlier and more complete germination of seed; helps to destroy many crop pests and certain varieties of fungus; provides effective weed control; reduces erosion . . . all with ONE machine!

SEAMAN ROTARY TILLERS are available in power take-off and motorized models 3 to 7 ft. tillage widths. See your Seaman dealer and write for complete information.

SEAMAN MOTORS, Inc. 364 N. 25th Street
Milwaukee 3, Wis.



THE NEW

MONARK Super Deluxe

ONE YEAR'S FIRE AND THEFT INSURANCE INCLUDED In Purchase Price

Dream bike of the century! Super streamlined "air flow" design with new "Air-Wing" head shield and dozens of other exciting new features. New mar proof and chip resistant finish. For sale by better dealers everywhere.

MONARK SILVER KING, INC.
6501 West Grand Avenue, Chicago 35, Illinois
Send Free Folder B-63 showing complete new Monark line in full color.

NAME _____

ADDRESS _____

CITY _____ STATE _____

EASIER TO OPERATE

Smith-Corona

PORTABLE TYPEWRITER



Has regulation keyboard same as on big office machines

Check these points!

FLOATING SHIFT, famous exclusive feature that makes typing easier, faster.
TOUCH SELECTOR, gives you 7 positive adjustments from *light* to *heavy*!
ALL AROUND FRAME, surrounds and protects mechanism. Smith-Coronas last longer.

AT YOUR DEALERS TODAY

Smith-Corona

PORTABLE TYPEWRITER

Be Your Own Boss



There's a great feeling to being in something for yourself, where all the profits go into your own pocket. American floor sanders make it possible for you to realize this ambition without special schooling or a big investment. Begin small and work up to as large an enterprise as you desire... It all depends on your ambition to get ahead.

Ask for "tell-all" booklet entitled "Opportunities in Floor Surfacing". Use coupon and enclose 25 cents in coin or stamps to cover handling.

AMERICAN FLOOR SURFACING MACHINE CO.

535 So. St. Clair St. • Toledo 3, Ohio

Gentlemen: Enclosed find 25c in stamps or coin for booklet "Opportunities in Floor Surfacing," telling me how I can start my own floor sanding business.

Name _____
 Street _____
 City _____ State _____



ASSEMBLE

King Midget



45 MILES AN HOUR

90 MILES A GALLON

New, low cost transportation. Practical. Safe. A pleasure to drive. Home assembly keeps cost low. Just bolt together our factory built units. Immediate delivery. Send 25c for detailed circular with 8x10 picture, 4-view drawings, price of all parts. Or send for actual Assembly Book with 42 photographs, blueprints, drawings, sketches AND above literature — all for \$1 (refunded first order).

MIDGET MOTORS MFG. CO., Athens, Ohio



NEW 30" SHEET METAL BRAKE

Forms angles, channels, vees, flanges, locks, zees, boxes. Handles 26 gage sheet steel, heavier gages of aluminum, copper, plastic, etc. Portable. Can be held in a bench vise, or bolted down. All steel construction. Wt. 40 lbs. \$24.50 Shipped exp. collect. ONLY

12" BRAKE. Cast iron and steel construction. For difficult bends. \$14.50 PP.

18" CURVE FORMER. Forms cylinders, round corners and cones in sheet metal and strap iron. Price, 10.00 PP.

VISE IRON BENDER. Forms rings, hooks, eyelets, etc. in 1/2" round or square: 1/4" up to 2" wide in bar iron. Price \$10.00 PP. For bending 3/4" pipe, \$2.00 extra.



SHEET METAL PLIERS, 2 1/2". Forms angles and channels, \$2.00. Sheet Metal and Wire Forming booklet, 50c.

VISE BRAKE MFG. CO., Dept. P5, 1318 So. 30th Ave., Omaha 5, Nebr.

U. S. GOVERNMENT SURPLUS

All Weather Hammocks

BRAND NEW

Cost Govt. \$30.00

\$5.95

Parcel Post & Handling Add 40c

Weatherproof Roof, Mosquito Netting with Zipper, Waterproof, Mildew Proof. Made of combination Synthetic Rubber-treated Poplin Duck Material, double reinforced bottom. FOLDS COMPACTLY.

I. GOLDBERG & CO.

429 MARKET ST.

PHILADELPHIA 6, PA.

Send for New Catalog P.M.

DIVING EQUIPMENT

New & Used Surplus Equipment for Deep and Shallow Water Use. **BARGE PROPULSION UNITS**, 115 h.p. Diesel and 141 h.p. M-8 Gas.

M & E MARINE SUPPLY CO.,

P. O. Box #601-Y, Camden, N. J.

SAY YOU SAW IT IN POPULAR MECHANICS

INBOARD MARINE ENGINE \$159.95

● Famous Clinton Angler air cooled boat engine—with forward, neutral and reverse.

Includes 34" shaft, shaft log, stern bearing, propeller and 6 ft throttle control. No extras to buy. Quickly installed. For boats up to 16 ft. 1md't delivery. Penny post card brings FREE LITERATURE.



CLINTON ENGINE CO.
 16351 E. Jefferson, Detroit 30, Mich.

POPULAR MECHANICS

U.S. NAVY 7X50

PRISM BINOCULARS WITH COATED OPTICS

Used but in
Excellent Condition

\$95.00

Complete with leather
carrying case and sling

Universal, 6x 30 Navy Prism Binoculars, used but in excellent condition, complete with leather \$42.50 case and sling straps.....

With Coated Optics, \$10 Extra.

WHEATSTONE BRIDGES

Portable. Used, in excellent condition. Manufactured by Thompson Lever Mfg. Co., Philadelphia. Value \$150.00..... **SPECIAL \$49.50**

Field Glass, 4X 40 Wollensak. Ideal for bird study. Brand New. **\$17.95**

Engineers All Metal Army Type Hand-Sighting

LEVELS

\$2.00 PRECISION
QUALITY



Send \$1.50 for 3rd Edition of Gun Digest with our complete catalog of new and used guns, etc. Our separate catalog 25c.

PUBLIC SPORT SHOPS

11 S. 16th St., Phila. 2, Pa.

No COD's

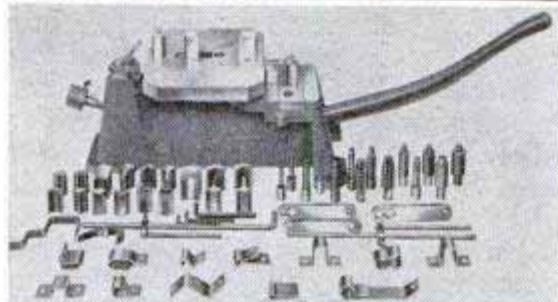

Make It On A "MULTIFORM" BENDER-CUTTER

BENDS — CUTS — PUNCHES
All Types Metal and Plastics

J. A. RICHARDS CO., Dept. 5M
KALAMAZOO 13F, MICH.

BURIED TREASURE, MINERALS AMAZING NEW GOLDAK LOCATORS

SENSATIONAL NEW MODEL!
ONLY 11 pounds weight! One hand operation! Money-Back Guarantee of Superiority. Write for full details.

THE GOLDAK CO.
1542 WEST GLENOAKS BLVD.
GLENDALE 1, CALIFORNIA

World's
largest
maker
of fine
locators.



PRECISION JEWELERS SCREW DRIVERS

Complete Set of 8 for Every "Hobbyist"



At last—a complete set of precision screw drivers to meet the needs of every model builder. Not a miniature but the same type set used by U. S. Navy for precision instruments and watches during the war. Brass knurled handles, hexagon heads, finest tempered steel blades. Sizes 2-9. Never before a set of this quality and precision at such a low price. Your money back if not satisfied. C.O.D. \$2.00 plus postage or send \$2.00 and we pay postage.

PINE WATCH CO., Rm. 40A, 29 Eldridge St., New York 2, N. Y.

Earn Big Money! ...Arc Welding

NEW HOBART
A.C. A.C. Welder
and Power unit

You can even
"Build Your Own"
gas drive portable
welder and SAVE
\$300⁰⁰ to \$500⁰⁰

Small Investment Starts You

in the profitable arc welding business. All you need is a low cost reconditioned auto engine, chassis and Hobart generator to "build your own" portable unit. Easy to build and saves you \$300 to \$500 over cost of factory built job. Send for FREE instruction book today and get started immediately on the "Big Pay" welding jobs!

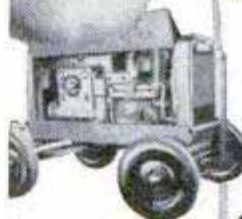

Gas Drive Portable

Simplified in Operation

and it's no trouble at all to learn to weld with the Hobart "Simplified" Arc Welder. Practice makes you perfect.

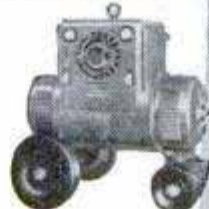

Hobart AC Arc Welders

are ideal for low cost shop operation and you'll want one later on for general shop use. Leaves your portable unit for "Big Pay" outside jobs.

Electric Drive Portable

Hobart School of Welding

can teach you arc welding in a short time at low cost. Individual instructions by expert instructors. Qualified under G.I. Bill of Rights. Check coupon.



20-200 A.C. Welder

Hobart Bros. Co., Box M-58, Troy, O.

"World's largest builder of Arc Welders"



• Yes, send me **free** instruction book on "How to Build Your Own Gas Drive Welder," and information and catalogs on the items I've checked.

- Gas Engine Drive A.C. Welder
 Electric Drive Welder Welding School

HOBART BROTHERS COMPANY, BOX M-58, TROY, OHIO

Name _____

Address _____

SAY YOU SAW IT IN POPULAR MECHANICS

Speed Sweep

THE BRUSH WITH
THE STEEL BACK



*Sweeps
cleaner, faster—
Outlasts ordinary
brushes 3 to 1!*

Mail Coupon Today

Milwaukee Dustless Brush Co.
530 N. 22nd St., Milwaukee 3, Wis.

Please send me complete information about
Speed Sweep brushes.

Name _____

Street Address _____

City, State _____

from \$5 to \$20. Complete dolls range upward in value with practically no ceiling; and the costume may represent more than half the doll's worth. A French fashion doll as big as a sizable child and dressed in gay silks and satins may carry a \$250 price tag.

A great many persons who bring in a doll to be repaired expect, for sentimental reasons, to keep it themselves or present it to a grown daughter or other member of the family. It is becoming fashionable to display dolls on mantels, dressers, beds, pianos, desks or in glass-doored cabinets. A small group of doll heads makes an interesting whatnot display.

"If you have a childhood doll, get it out of its trunk or box and have it repaired and dressed in new clothes," Nash suggests. "Many old dolls are valuable, and should be kept in good condition. Old bisque and china heads are getting scarce, and any damage to them, such as a chipped or broken edge should be repaired."

After Nash gives a talk to a women's club or other group, many members of the audience get out half-forgotten dolls and either try to fix them themselves or bring them to Doc Nash.

Amateurish doctoring, Nash says, can prove as disastrous to a doll as to a human. Even giving dolly a bath may lead to a lot of trouble. While many dolls can be cleaned merely by washing them with soap and water, others are allergic to such baths. Some doll makers form eyebrows and other facial details with paint that is not waterproof. Many dolls are ruined by owners who apply fingernail polish to the doll's hands and feet, or attempt to use such polish for tinting cheeks. If you color a doll's cheeks, use ordinary lipstick.

A dry-cleaning fluid such as carbon tetrachloride (which is fireproof) often can be used for cleaning soiled hair and hair ribbons, cloth bodies or body parts, and even entire dolls, provided there are no wax or rubber parts. The piece to be cleaned may be immersed in the solvent, gently swooshed about, and then hung up until all solvent odor disappears. Never use naphtha gasoline—it's too dangerous.

Whenever a doll, fully recuperated, leaves Doc Nash's hospital, he presents the owner with his combination business card and post-operational pill supply. This is a standard physician's pill envelope bearing the hospital's name and address and a prescription advising the administering of one pill a day. The pills? Little candy pellets. Nash originated his pill-envelope cards as an advertising stunt and a novelty for children; but he has found that they already have become collector's items.

ELECTRICITY *Anywhere*



for
HOMES
FARMS
SHOPS
BOATS
RADIO
USE

● Onan gasoline-engine-driven Electric Plants supply reliable, economical electric service for any use. Portable, stationary or standby models. Water or air-cooled, compact and rugged.

A.C.: 350 to 35,000 watts in all standard voltages and frequencies. D.C.: 600 to 10,000 watts. 115 and 230 volts. BATTERY CHARGERS: 500 to 3,500 watts; 6, 12, 24, 32 volts.

Write for folder

D. W. ONAN & SONS INC.
2541 Royalston Ave., Minneapolis 5, Minn.



Look
your best
... save
money, too

STROP YOUR
RAZOR AS A
BARBER DOES!



STROPS—CLEANS
WITHOUT
REMOVING BLADE

RAZOR, STROP
AND
5 VALET BLADES

\$1.25

SELF-SHARPENING . . . ONE PIECE

HOW TO EARN EXTRA PROFITS

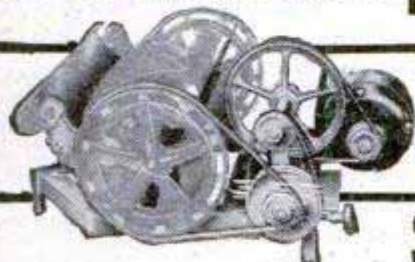

only
\$47.50
LESS MOTOR

"QUAD-CITY SHARPENER"

Get into profitable lawn mower sharpening at low cost with this highly successful machine. Order direct from QUAD-CITY PRODUCTS CO., Box 42, Rock Island, Ill.

CONVERT HAND MOWERS TO POWER MOWERS

Takes Less than 3 hours

Handy-Dandy Lawn Mower Kit fits any hand mower from the 16 to the 20 inch size. Kits furnished separately or with power units.

NOW AVAILABLE — Maytag, Power Products, Lauson Engines, and the Penn. Great American 12" Lawn Mower with sprocket mounted with all steel tubular handle.

DEALERS WANTED

LE CLAIRE MFG. CO., Le Claire, Iowa Write Dept. P.M. 45

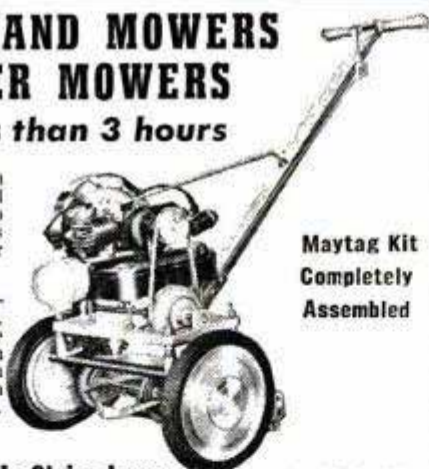

Maytag Kit
Completely
Assembled

WRITE FOR YOUR FREE COPY OF THE NEW KRW HYDRAULIC PRESS BOOK

Describes all manner of Production and Shop Work on KRW Hydraulic and Bench Type Arbor Presses. 32 pages illustrating the new KRW Hand-operated, Electric-operated and Air-operated Hydraulic Presses. Write for your copy today.



K. R. WILSON, DEPT. 17, 215 MAIN ST., BUFFALO 3, N. Y.
Builders of Shop Equipment for Ford Dealers Since 1916

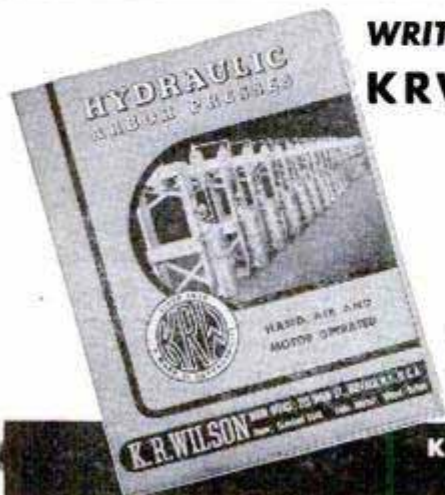

Patents
Applied
For

Triple Your Catch with a "KWIK-KATCH"

Here is the Sensational New Hook that really gets-em! Holds bait horizontal... the natural way for the fish to feed... You don't get just nibbles... **YOU GET FISH FAST.** The plate keeps the fish from swallowing the hook. When the fish takes the hook, the hook is released and the pull is straight from the fish to pole (as shown in illustration).



**CATCH THEM
the RIGHT WAY!**

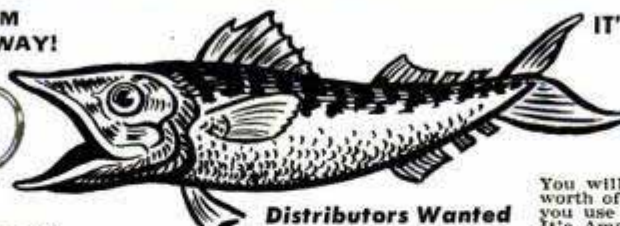

**IT'S NEW...IT'S MARVELOUS
..GET YOURS TODAY!**

**For Still Fishing with
Minnows, Worms or
Other Bait**

You will get more than a dollar's worth of fun and fish the first time you use the "KWIK-KATCH" It's Amazing! 2 for \$1 or 12 for \$5.00 Postpaid (in U.S.A.) 2 sizes, including the hooks.

Distributors Wanted

2 for \$1.00
12 for \$5.00 Postpaid

W. E. KAUTENBERG CO., Dept. PK-5, FREEPORT, ILL.



**SMART
NEW**



POWERBIKE

gets you there safely and economically

The motor is in the rear, mounted low to aid balance and handling. No grease to rub off on your legs, no hot fumes blowing in your face. 100 miles per gallon, 30 MPH.

1½ HP fan cooled engine, kick starter, automatic clutch, fits any man's or woman's balloon-tire bike. See your dealer or write direct.
TERRITORIES AVAILABLE.



SAGINAW PRODUCTS CORP. • SAGINAW, MICHIGAN

SAY YOU SAW IT IN POPULAR MECHANICS

Model Race Car SENSATION!



**HERE IT IS!
AMAZING
NEW
REUHL
BIG**

1948 IMPROVEMENTS

New Plastic body molded with Fiberglas

- new one-piece ball-bearing front drive
- new free-wheeling ball-bearing rear axle
- new rubber mountings
- new 2-to-1 bevel gears
- new line 1948 deluxe accessories

Standard for Cable
Adaptable for Rail.
Takes any engine

This super-streamlined high-speed beauty offers model race enthusiasts the last word in 1948 racer design. Length 17 inches. Height 5½ inches. Wheelbase 12½ inches. Tread 7½ inches. Complete Kit — all precision-built parts ready for assembly and operation (less engine) — \$24.95 Fully guaranteed.

If not available at your dealer, send \$24.95 for immediate shipment, postpaid Or C.O.D.—send \$3, and pay balance plus postage charges on delivery.

REUHL PRODUCTS, INC., 2611 Monroe St., Madison 5, Wis.

for AMAZING acceleration

DIXIE-WESTERN

DUAL INTAKE MANIFOLDS for V-8 FORDS AND MERCURYS

\$15.00 Gas Line and Throttle Kit \$2.50 extra

Chrome Plated Velocity Stocks — \$1.50 ea
By Test: Increased Acceleration by 26%
Increased Power and Speed by 11%

All DIXIE-WESTERN manifolds are brightly polished cast aluminum.

DIXIE-WESTERN MANIFOLD CO.
Box 364 • Los Angeles 43, California

Dealers Wanted

DUAL INTAKE MANIFOLDS

**DEEP
TONE**

DUAL MUFFLERS

**LONG
LIFE**

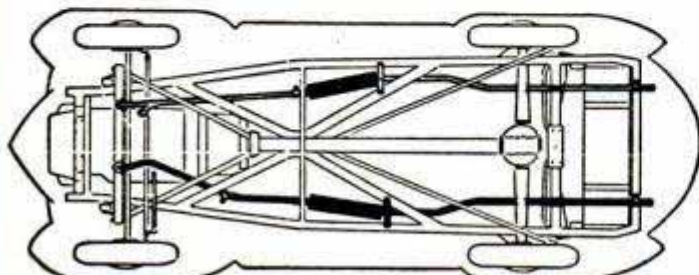

1935 TO 1948 — V-8 FORD AND MERCURY ONLY

- More Horse Power
- Blow-Out Proof
- Better Gas Mileage
- Straight Thru Mufflers

FORD & MERCURY DUAL SETS ...\$20.00

C.O.D. - F.O.B. Los Angeles Order by Year and Model
No Welding, Cutting, Drilling of Holes.

All Fixtures Furnished Rubber Insulated Clamps

| | | |
|---------------------------|-------------------------|--------|
| DEEP TONED | Ford, Chevrolet, Ply. . | \$4.86 |
| SINGLE MUFFLER | All others | \$5.50 |
| 2½" CHROME TAIL PIPE TIPS | | \$1.75 |

Advance Mufflers 6800 SO. VERMONT AVE. LOS ANGELES 44, CALIF.

Mows and Trims Lawns



In One Simple
Easy Operation
8 1/4 Lbs.

Save Time
and Labor with a

MONTAMOWER

New model. New type metal handle has special device to adjust cutting height. Drive shaft now mounted on free rolling, factory lubricated, sealed ball bearings. No tired backs or aching arms. 8 1/4 lbs. live precision made mechanism that first gathers, then cuts smoothly a clean 16" swath through grass, dandelions, spike grass, lawn weeds. No noise or clatter. As modern and efficient as your electric razor. Cuts right up to walls, fences, trees or posts; leaves no fringes to be trimmed by hand. Cutters self-sharpening. Built to last many years. Many thousands in use. Sold direct from factory for 26 years. Costs little. Write at once for trial on your own lawn "approval offer," guarantee information and literature.

MONTAMOWER DISTRIBUTING CO.

820 Keeler Bldg. GRAND RAPIDS 2, MICHIGAN

ELECTRIC SHEAR SHARPENER

Over 35,000 Sold - It Must Be Good!



Genuine Carborundum wheel ideal for shop or home use. Send remittance with order and shipment will be made at once, prepaid to your door, complete with electrical goods catalogue.

MOTOR
DRIVEN

\$9.75

complete
with vise

WILLIAM MARVY COMPANY

479 West St. Peter Street St. Paul 2, Minn.

**Thompson
BEATS
the World
on BOATS**



**Better Built
Lower Prices**



**Safe Boats With
Full Length Spray Rails**
Keep passengers perfectly dry—even at high speeds. Catalog also shows two new models of "Take-Along" Boats. Two big factories—save you freight.

CATALOG FREE
Write for your copy. State kind of boat in which you are interested.
THOMPSON BROS. BOAT MFG. CO. (151)
213 Ann St. PESHTIGO, WIS. (Write to either place) 113 Elm St. CORTLAND, N.Y.

Light Boat for Auto



PATENTED FILTER
WHIRLCLEANS

WHIRLCOOLS
Your Smoke

MEDICO
FILTERED
SMOKING

Frank Medico pipes have the replaceable filter that

- absorbs juices
- collects flakes and slugs
- reduces tongue bite



Not a hollow tube!

Only this patented filter has the 66 baffles that whirl smoke cleaner and cooler into your mouth. Replace when discolored.

Frank Medico V.F.Q. (Very Fine Quality)

Bowls of rich-grained beauty. Wide variety of shapes. With 10 filters. . . . **\$2**

Frank Medico Standard Quality, still . . . \$1

S. M. FRANK & CO., INC., NEW YORK 22

"I'LL TAKE THE WHITE ONE EVERY TIME!"



WYTEFACE
TRADE MARK
STEEL MEASURING TAPES



KEUFFEL & ESSER CO.

(Continued from page 160)

steering stations on the new luxury liner.

There are five electric engine-order telegraph transmitters and, in addition, a sound-powered telephone system connects the wheelhouse with both engine rooms, both motor rooms and the steering-gear room. A separate sound-powered system connects the wheelhouse with the fore-castle head, crow's nest, stern capstan and the after steering station.

Radio equipment is far more complex than in earlier ships and includes an automatic alarm that rings bells in the radio room, wheelhouse and radio-operator's cabin whenever the ship's call letters are picked up on the air. The main radio installation, in addition to radio navigation equipment, includes four telegraph transmitters and four receivers that cover all regular and emergency wave lengths, plus a broadcast and high-frequency receiver that can be plugged into the ship's loud-speaker system for spreading music and radio programs.

The ship has an automatic SOS transmitter and an SOS receiver that sounds an alarm when a distress call is received. Ship-to-shore conversations are carried on over a radiophone transceiver that has a range up to 1000 miles. By means of the marine radiophone exchanges, a passenger on the ship can be connected, when within radio range of an exchange, with any telephone number in the United States. Each motor lifeboat is equipped with radio telegraph equipment.

Each of the liners carries 10 lifeboats with more than sufficient space for the entire complement. These are lowered or hoisted by electric winches. Buoyancy apparatus that can be launched over the side or floated free is also provided, capable of supporting 25 percent of the personnel, and in addition 18 life buoys are on board as well as a life preserver for every person.

The President Cleveland and the President Wilson are the last of 10 hulls originally laid down as wartime troop transports. Eight of the ships, designated as the P-2 type, were built by Bethlehem-Alameda to carry 5000 troops apiece. Hulls 9 and 10 were redesigned into the present crack liners when it became apparent that they would not be finished before the war ended. Late this year two other P-2 vessels are to be withdrawn from interim service and completely converted for luxury travel, forming a quartet of magnificent liners that will connect the west coast with the Orient on a schedule of fortnightly sailings.

AMAZING *New* WAY TO PAINT-CUTS TIME 75%

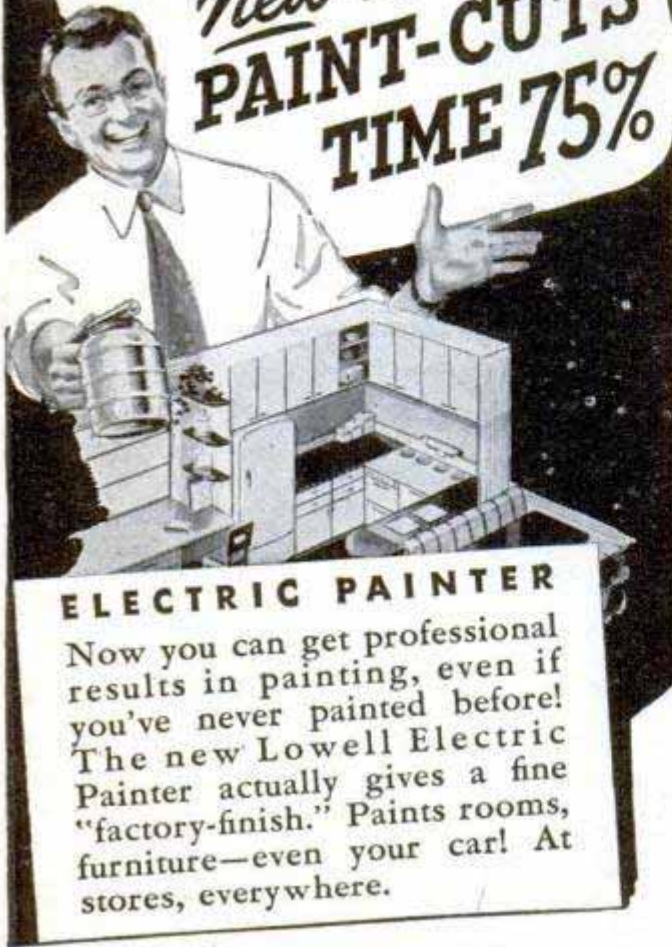

ELECTRIC PAINTER

Now you can get professional results in painting, even if you've never painted before! The new Lowell Electric Painter actually gives a fine "factory-finish." Paints rooms, furniture—even your car! At stores, everywhere.

PAINTS BEHIND RADIATORS!



Lowell Electric Painter actually atomizes paint. Covers area in a minute. Directional nozzle sprays paint straight ahead, up, down or sideways.

FURNITURE PAINTING EASY!

Use any kind of paint with the Lowell Electric Painter—enamel, flat paint, or varnish. Holds a quart. Easy to use. Small, efficient AC/DC motor. Weighs 8 lbs.



FASCINATING BOOKLET

Write for fascinating, new booklet: "40 Ways to Beautify Your Home." Send 10c to Lowell, Dept. 72, 589 East Illinois Street, Chicago 11, Illinois.

© 1947 LM. Co.
Guaranteed

"Thoro-Spray"*

Electric Painter
COMPLETE
No Extras To Buy

\$34⁹⁵

Slightly higher in western territories.



*T. M. REG. U. S. PAT. OFF.

LOWELL
Manufacturing Co.
World's Largest Manufacturer of
Sprayers and Dusters Exclusively

All cars have **TIRES**
but in the lowest-priced field only **PLYMOUTH**
has **SUPER-CUSHION TIRES** on **SAFETY-RIM WHEELS**

Bigger, softer-riding Super-Cushion Tires are standard equipment with Plymouth. They reduce chances of tire failure but if trouble occurs you have the added protection of Plymouth's new, wider Safety-Rim Wheels.

All cars have **SPRINGS**
but in the lowest-priced field only **PLYMOUTH**
has **AMOLA STEEL SPRINGS**

You draw extra dividends of continuing comfort with Plymouth's famous high-tensile Amola Steel Springs. They're tough for long life . . . soft-acting always for front and rear riding ease on all types of roads.

**It's easy to tell
where the Value is!**

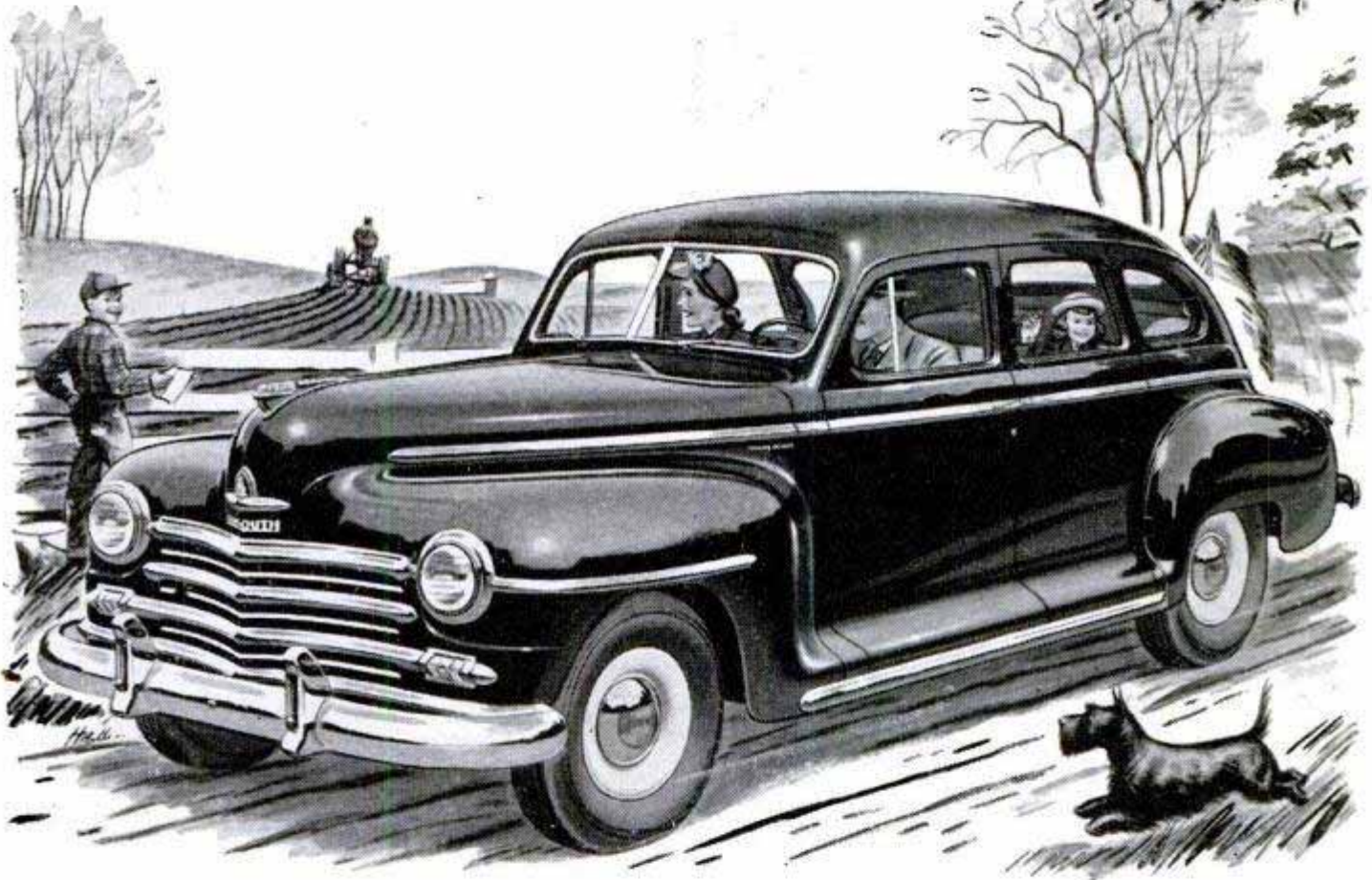

It's easy to tell that low-priced Plymouth leads the field in reduction of tire-failure hazards and increase of riding ease.

It's just as easy to tell that Plymouth stands out for all-around safety, comfort and top performance. A look at the Quality Chart at your Plymouth dealer's will show you that Plymouth has 20 of 21 features common to most high-priced cars.

You can make your own comparison and see for yourself that neither of the other leading low-priced cars has *half* as many of these features. Yes, it's easy to tell where the Value is in the lowest-priced field.

2ND INTERNATIONAL MODEL PLANE CONTEST

*Sponsored by Plymouth Motor Corporation
Subsidiary of Chrysler Corporation*

AUGUST 18 - 23 • DETROIT, MICHIGAN
Ask your Plymouth dealer for full information



If it's **VALUE** you want—
it's **PLYMOUTH** you want

**28,000 MILES
for \$200**



It's sensational! Smart Crosley station wagon seats 4 or carries 1/4 ton load; yet costs \$600 to \$700 less than any other station wagon and operates for about half as much. For instance:

Fred Langille, 167 N. 18th St., East Orange, N. J., reports he has driven his Crosley Car 28,000 miles; averaged 35 miles per gallon of gasoline. Total cost, \$200.



← **SEDAN:** Seats 4 in comfort, with ample luggage space.

PICKUP: Cuts → service, delivery costs.



← **PANEL DELIVERY:** Full 1/4-ton capacity.

Revolutionary 4-cylinder engine

CROSLLEY

a FINE car

For beautiful full color catalog, write: Crosley Motors, Inc., 2532-HL Spring Grove Ave., Cincinnati 14, Ohio

Stucco Spraying

Today's Outstanding Business Opportunity



Beauty and protection are sprayed on old and new buildings . . . exterior and interior surfaces . . . by COLORCRETE. It's a plastic, water-resistant material, spread evenly over surfaces and forced into cracks by air pressure. Fuses to masonry with enduring tenacity. Many textures. Range of 30 smart colors. Fully proven by 20 years of actual use under all conditions.

Big Earnings for Colorcretors

Colorcrete ties in with today's huge building program. Renews old buildings. Makes new construction more attractive and enduring. Large waiting market, because building owners get long lasting beauty and protective values at low price. Yet your selling price can be several times your basic cost. Machine is easy to operate. Moderate investment. Write or wire for complete information.

COLORCRETE INDUSTRIES, INC.
570 Ottawa Avenue Holland, Michigan

COLORCRETE

The SPEED SAW FILER

Saves You Time, Money

Now you can do expert saw filing at home. Lifetime tool makes precision filing easy for even the most inexperienced. Two simple adjustments make it fit any type hand saw. Keep your saws extra sharp and true-cutting with a Speed Saw Filer. Complete with file, ready to use. Money back guarantee! Cash with order, prepaid (C.O.D. postage extra.)

THE SPEED CO., Dept. PM
2025 N.E. Sandy, Portland 12, Ore.



ORDER NOW!



\$295

COMPLETE TRAILER

CHASSIS-AXLE
2 WHEEL ASSEMBLY

Only **\$52.50**

Shipped KD., F.O.B. Yonkers or send \$10 & bal. C.O.D.

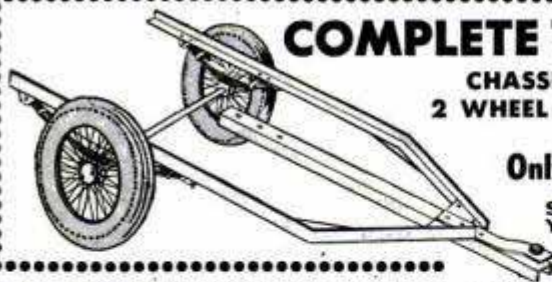

Never before offered at this low price. Tested to carry 1000 lbs.—built to take hardest usage . . .

COMPARE!—in construction—utility—value! You'll agree there's nothing like it.

YOU GET: Complete draw bar assembly, chassis of steel angle, 2 automobile type springs; 2 wheels with Timken roller bearings take standard 4.75 x 19 tires, 2 hub caps and grease rings . . . 91" Overall, 57" Tread. Less Tires, Tubes.

BEST BENCH VALUE ON MARKET

Solid, tough wood construction—**ALL STEEL LEGS.** Very large drawer, tool rack, shelf, 34 1/2" high, 59" x 23". **COMPLETE WITH ALL HARDWARE.** Shipped KD with easy instructions. **ONLY \$15.35 F.O.B., Yonkers.**

Send check, Money Order on all items. **SATISFACTION GUARANTEED.**

UNIVERSAL YONKERS CORP. (M-5) 137 Alexander St., Yonkers 2, N.Y.

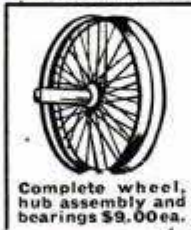

Complete wheel, hub assembly and bearings \$9.00 ea.



HEAVY CAST ALUMINUM BLOWER

Now **\$10.00**
Only

SINGLE EXHAUST BLOWER DELIVERS 100 CU. FT. AIR PER MINUTE. Ready to install yourself with any household tools. It's built for that. Housing is solid cast aluminum to last indefinitely. 110 V., 50-60 cycles. Cont. duty motor.



DOUBLE EXHAUST BLOWER

Same wonderful construction, performance, easy installation as the Single. Adaptable for any Blower need. **ONLY \$15.85.**

On Blowers, add 50c for handling. \$1 west of Mississippi.



UNIVERSAL COLUMN JACK with the overlapping pin that reinforces the telescopic joint . . . Raises, levels, supports sagging floors.

| | |
|----------------|--------|
| 3' 8" to 5' 7" | \$6.95 |
| 5' 7" to 8' 4" | 7.95 |
| 8' 4" to 37" | 4.95 |

MIKE

Designed especially for speech amateurs, P.A., recording . . . High impedance, output 54.2 db below 1v per bar. All chromium plated; rubber covered, shielded cable. 5' cord. Remove from base for hand use. We know it's so good, we sell it on 5 day, money back guarantee! Ship. wt. 2 lbs. Lists for \$10.75. **COST TO YOU \$4.95.**



KAYAKS
AQUA V-18
Easy to Build
OUTBOARDS ROWBOATS
25¢ COIN FOR ALL THREE
V-23 CRUISER
 Length 23 Ft.
 Beam 7 Ft., 10 In.
 Draft 14½ In.
 Sleeps Two. Open or With Cabin.

BOATS for Home Assembly
 KAYAKS, ROWBOATS, DINGHIES, INBOARDS, OUTBOARDS, RUNABOUTS
 Cut-To-Fit for Quick Assembly. Everything Complete plus Illustrated Instructions. No Experience Necessary. Simple as A. B. C.
 SEND 25¢ POSTAGE (COIN) TODAY FOR 3 MONEY SAVING ILLUS. CATALOGS Showing all '48 Models (marine plywood) & construction details.

AQUAMOBILE V-18
 Designed for Auto Engines. Open or with cab. Length 18 ft. Fast VEE Bottom Hull.

Established 1928 — Manufacturers **U-MAK-IT KITS**
KAYAK BOAT CO. 703 P-WHITTIER ST. NEW YORK 59, N. Y.

SAVE MONEY
 build your own
SMITH COMPRESSOR

Now, use the world-famous Smith Air Compressor to operate rock drills, paving breakers, spray guns, sandblasting, etc., at low cost! Just order the Smith Compressor Head and Accessories with complete instructions for assembling. All you need is a Ford Motor and shop facilities. Capacity 60 cu. ft.—ample power for most compressor jobs. Pressure up to 100 lbs. per square inch. Head equipped with high speed compressor valves; automatic unloading and idling.

WRITE **GORDON SMITH & CO., Inc.**
 TODAY! 410 College Street Bowling Green, Ky.

ELECTRIC WELDER
 AC or DC 110 Volts
 Pre-war type—All metal—No chemical—5 year written guarantee. Welds ¼" thick metal or money back. Repairs tanks, tools, fenders, machine parts, etc. Comes complete with rods, unit directions and eye shield.
\$6.45 COMPLETE
 On C.O.D. mailing charges extra.
ESSAY MFG. CO., INC., Dept. P. M., Quincy 69, Mass.

\$10-\$25 DAILY FOR LIVE SALESMEN
Cash Commission Advanced
 DEALER SALESMEN—Earn \$10 to \$25 daily. Easy \$1 deal all merchants need and want, you keep the dollar, and big repeat commissions. Free actual samples and kit offer. Write Quick!
FAST DOLLAR DEAL—YOU KEEP THE \$
STATES TRADING CO. 330 So. Wells St. Dept. 12, Chicago 6, Ill.

LAW
 STUDY AT HOME for Personal Success and LARGER EARNINGS. 39 years expert instruction—over 108,000 students enrolled. LL.B. Degree awarded. All text material furnished. Easy payment plan. Send for FREE BOOK—"Law and Executive Guidance."
AMERICAN EXTENSION SCHOOL OF LAW
 Dept. 89-PM, 646 N. Michigan Ave. Chicago 11, Ill.

DON'T YOU BELIEVE IT!
... THAT ANY OLD PISTON RING WILL DO



Some people think it doesn't matter what piston rings they use in their cars. But the truth is, there's a great difference between brands. And there are good reasons why Burd Piston Rings are better. Burd uses an individual pattern for each type of ring and each ring is individually cast from Burd's own electric furnaces. Further refinements are accomplished by accurate machining plus a careful "Graf-Flox" finishing treatment. These scientific methods are your guarantee that each type of Burd Piston Ring has just the right degree of hardness, flexibility, and tension for its specific use. Burd "Graf-Flox" Piston Rings stop fuel and oil losses . . . restore pep and power to your car. Mail coupon below for further facts.

BURD PISTON RING CO., ROCKFORD, ILL.

BURD
 AUTOMOTIVE PRODUCTS

Engineered for results

MAIL THIS COUPON FOR THESE FREE BOOKLETS
 BURD PISTON RING CO., DEPT. 118-E
 Rockford, Illinois
 I'd like copies of your "Servicemen's Handy Handbook" which tells how to keep my car in good working order, and the booklet "No Job For a Dub."
 Name.....
 Address.....
 City..... State.....

HANDY HAND BOOK
No Job for a Dub

You've never used a finer tool than this new drill



Hop right down to your favorite hardware store and take a good look at this brand new automatic drill . . . (it'll be prominently displayed). See if your fingers don't itch to hold it . . . heft it . . . put it to work. Note that *man-size* handle . . . feel how snugly it fits your grip. Sense that *balance*. See how easily and rapidly this drill works . . . how smoothly it's controlled.

Clean lines, slick design, bright nickel-plated shaft — a honey of a drill no craftsman can resist.
MILLERS FALLS CO.
Greenfield, Mass.

DIAL THE DRILL POINT YOU WANT

. . . and out of a hole in the handle drops any one of 8 points, $\frac{1}{16}$ " to $\frac{11}{64}$ "

MILLERS FALLS TOOLS 80th ANNIVERSARY
No. 100
AUTOMATIC DRILL
Complete with 8 drill points \$3.50 Slightly higher in the West

Millers Falls Tools



Celebrating 80 Years of Toolmaking

Stepping Up the Speedboats

(Continued from page 111)

edge. It was used both on Copperhead and Blue Blazes and a dozen other inboard and outboard craft that set 1947 speed records.

"We were forced to develop a prop to match the boats," Johnson says. "For the real strain comes when the boat gets to riding on struts alone. Then only one blade is hitting the water at a time. The other blade, in the air, acts as a flywheel doubling the strain on the submerged blade. This will cause it to bend, even though it is actually stronger than the shaft.

"The new propeller is sharp on the leading edge and thickens as it goes back, like a butcher knife. In fact, some of the racing boys call them 'cleavers.' Strength is increased without adding thickness to the leading edge.

"This design is possible because tests disclosed that water on the back side of the blade does not come down to a thin, trailing edge but goes straight back after passing over the widest part of the blade. Actually the new blade is not so thick in its thickest part as old-type propellers.

"As a second feature, the tip of the new blade has a smaller radius than that of the conventional blade. Our tests also showed that, both in commercial work and racing, it required less power to split the water with the new blade.

"An incidental but important third feature developed from the fact that the new design left extra surface at the hub. This permitted the drilling of two tap holes so the prop could be pulled off the shaft without damage with a simple pulling device which is inserted in the tap holes.

"Important in propeller development is the quest for stronger materials. Bronze, the perfect metal for commercial use, is too weak for props that turn faster than 7000 r.p.m. Right now," Johnson says, "we are using a semistainless steel that is twice as strong as bronze. When we can get more material we'll improve on this."

Such developments indicate that the peak of motorboat speed in each class is still in the future even with restrictions on hulls and motors. However, some restrictions are being lifted. The American Power Boat Association recently raised the motor restriction in Division I of the 225-cubic-inch hydroplane class to allow motors up to 255 cubic inches. To put this added power into the same hull which carried a 225-cubic-inch motor last year means the power will be enough to push an added gear step-up of 20 percent, says

(Continued to page 264)

More Sport for your money with

Marlin's **CLIP** **MAGAZINE** .22

IT's a whale of a value—this man-sized .22 repeater! A real Marlin, ready for instant action on vermin or small game. There's eight rapid-fire shots in the clip to get 'em, no matter how fast they run. You'll get the most sport for your money with a Marlin 80-DL!

Look over these specifications for big value at low cost!...

American Walnut buttstock, with fluted comb and semi-beavertail forearm.

Quick-release trigger; self-cocking action; side ejection; Off and On safety.

24" tapered blued steel barrel; Ballard type rifling; crowned muzzle.

8-shot clip magazine. Shoots .22 caliber short, long, long rifle cartridges—regular and high speed without adjustment.

Equipped with peep sight, hooded ramp front sight and sling strap swivels.

BOYS: Be a Ranger! Write Sportsmen's Service Bureau, 343 Lexington Ave., New York, for **FREE** booklet on marksmanship.



Marlin's 80-DL is a go-getter for small fur-bearing game—fox; squirrel; woodchuck; muskrat; mink.

A handy target rifle with its clip magazine, the 80-DL also takes care of marauding crows, hawks and rats.



Marlin 80-DL

8-shot Clip Magazine
.22 Cal. Repeating Rifle

Who said
good blades
have to be high priced?



\$22.90 Price slightly higher
west of the Rockies
and in Canada.

THE MARLIN FIREARMS CO., NEW HAVEN, CONN. • Fine Guns Since 1870

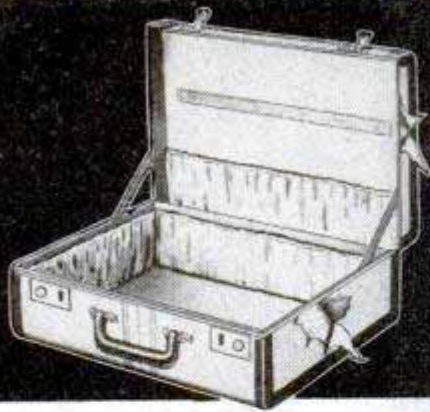

FIXES

LUGGAGE, FURNITURE,
DISHES, TOYS,
AND BOOKS

It's transparent, water-proof, flexible and durable. Get a tube today.

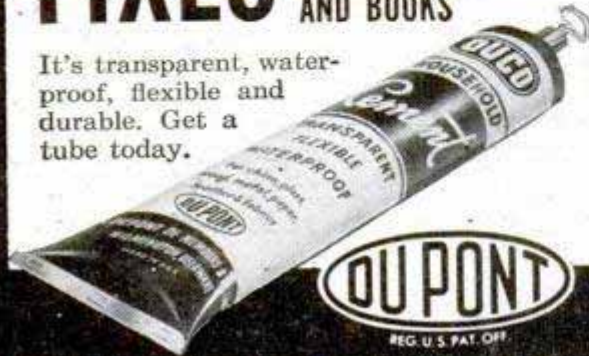

DUCO CEMENT

REG. U. S. PAT. OFF.

OWN YOUR OWN
Profitable Business

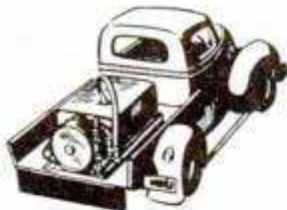

PROVIDE CUSTOM SPRAYING

Service in Your Area

A modest investment will start you in the business of supplying a custom spraying service to homes, estates, farms, dairies, factories, hotels, resorts. With John Bean high pressure sprayers you spray faster and better, at lowest cost. There is a big demand for custom spraying service. Profits are assured by fast work and low cost of materials.

KILLS WEEDS — SPRAY LIVESTOCK Eliminate Flies and Mosquitoes

Protect fruit and shade trees, rid gardens of pests, eliminate flies from homes, parks, factories, restaurants. Disinfect buildings, barns, etc. Good profits, low costs. Write for full information today.

JOHN BEAN

DIVISION OF FOOD MACHINERY CORPORATION
LANSING 4, MICHIGAN



STAR METAL BOATS



STAINLESS STEEL
& GALVANIZED BOATS

FOR ROUGH USE

STAR METAL BOATS lead in comfort, convenience, durability, and lightness. Always dry and ready . . . no upkeep. Smoother riding for oars or outboard, spray rails stamped in hull. New lifetime Stainless Steel models, easily carried, nearly puncture-proof. Air chambers. Reasonable prices. Write for folder.

WRITE FOR
Folder

STAR METAL BOAT CO. • GOSHEN, IND.

GIGANTIC SURPLUS SAVINGS

Brand New Delta Extra Heavy Duty NAVY LANTERN

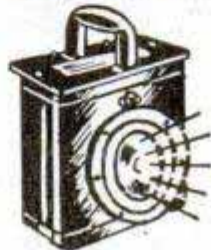

An unexcelled value for general utility. Rigid handle on top. Operates on two standard No. 6 dry cells. Red enamel finish. This lantern is vapor proof and gives more than 800 ft. spot beam. Type JR-IS. Special. less batteries . . .

\$4.95



FISH LURE and LIGHT

Uses one ordinary flashlight battery. A floating fish lure that brings 'em in. Also can be used as a regular flashlight. Brand new.

\$1.29

Prices FOB, Kansas City. Send 25c for handling and mailing.

ATLAS SALVAGE & EQUIPMENT CO.
229 SW. BLVD. KANSAS CITY, MO.



Work Table LAMP

Overall dimensions, 37 1/2", weight 1 lb. Has 4 flexible ball joints. 110 volt. Less bulb and plug. Real surplus bargain. Only.

\$2.95

REYNOLDS CIRCULAR SAW GRINDER



FOR
SAWS
5"-30"

FOR JOINTING
GUMMING • SHARPENING
ALL TYPES OF CIRCULAR SAWS

Write for Circular
REYNOLDS MACHINERY CO.
303 EDDY ST., PROVIDENCE 3, R. I.

WHEELS AT BARGAIN PRICES



- ... 4" wheel & tire, 5/16" sleeve bearing & hub cap 50.45 ea.
- ... 5" wheel 5/8" solid tire 5/16" shaft hole 0.65 ea.
- ... 6" wheel 5/8" solid tire 5/16" shaft hole 0.75 ea.
- ... 7" wheel 3/4" solid tire 3/4" shaft hole 0.85 ea.
- ... 8" wheel 1" solid tire 1/2" sleeve bearing 1.25 ea.
- ... 8x2" wheel, semi-pneumatic tire 7/16" ball bearing 2.50 ea.
- ... 10x1.75 wheel semi-pneumatic tire 7/16" or 1/2" ball bearing 3.25 ea.
- ... 12x1.75 wheel semi-pneumatic tire 1/2" bronze bearing 4.00 ea.
- ... 16x2.50 wheel semi-pneumatic 1/2" ball bearing 4.50 ea.
- ... 6x2" wheel 5/8" ball bearing, solid tires 3.95 ea.

BUILD YOUR OWN— Wagons — Scooters — Soap Box Racers — Welding Carts — Baby Pens — Etc. To order above wheels write number wheels wanted in space provided, tear out and mail this ad with check or money order and your name and address. If other sizes are wanted write for FREE LIST.

TRULSON MFG. CO., 811 E. 31 St., Dept. PM-14, Kansas City, Mo.

BUILD YOUR OWN

- DRIVEWAY
- PATIO
- WALK

**H&H CONCRETE
BLOCK MOLDS**

COMPLETE PLANS FOR ONLY \$1 DOUBLE PURPOSE

Send NOW for a complete set of fully illustrated and easy to understand working plans. Build your own block mold for only a few cents worth of lumber. All you need is found in your own basement or workshop. Mold a dozen blocks in as many minutes. The H&H block mold will make a curbed slab for a double ribbon drive way... turn it over and make a plain slab ideal to fill in the drive or for walks and patios. Five cents per square foot for concrete walk. Write today...

OR COMPLETE MOLD, SHIPPED POSTPAID \$12.00

H&H ENGINEERING CO. 1415 HICKORY AVE. FORT WAYNE, IND.



Gerstner TOOL CHESTS

Extra value and longer life built into genuine Gerstner chests for machinists and toolmakers. Free catalog.

GERSTNER TOOL CHESTS
448 Columbia St. Canton 7, Ohio

NOW YOU TOO CAN BUILD 15 RADIOS

COMPLETE KIT \$14.75

Absolutely No Knowledge of Radio Necessary

You Need NO Additional Parts

The **PROGRESSIVE RADIO KIT** is THE ONLY COMPLETE KIT. Contains everything you need. Instruction Book, Metal Chassis, Tubes, Condensers, Resistors and all Radio parts. The 36-Page Book written by Expert Radio Instructors teaches you to build radios in a Professional Manner. You start with a 1-tube receiver. Before you are done with this kit, you will have built 11 Receivers, 1 Public Address System and 3 Transmitters.

SPECIAL FREE OFFER!

Electrical and Radio Tester sent absolutely FREE with each Progressive Radio Kit. PLUS FREE membership in Progressive Radio Club. Entitles you to free expert advice and consultation service with licensed radio technicians.

Write for further information, or ORDER your KIT \$14.75

NOW! ONLY... Postage prepaid with check or money order (Postage not prepaid with C.O.D. orders)

PROGRESSIVE ELECTRONICS CO., Dept. PM-10
497 Union Avenue Brooklyn 11, N. Y.

Give Your Lawn that 'Golf-Green' Look with a

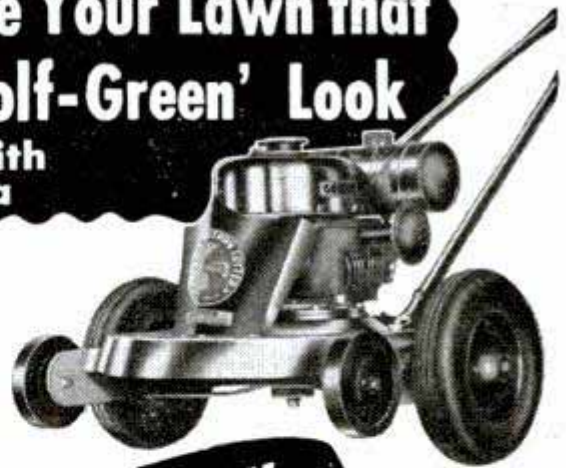

Goodall POWER MOWER

ENDS GRASS-CUTTING DRUDGERY You take it easy behind a GOODALL Rotary Power Mower... it cuts your lawn in 1/3rd time, cuts any height grass or tough weeds... cuts on any terrace or hillside... gets into hard-to-reach places easily.

NOTE: GOODALL is the original U.S. patent holder of direct vertical drive — at better dealers everywhere.

Cuts Grass Velvety Smooth in 1/2 time



EXTRA FEATURES

GOODALL is the one and only 4 CYCLE — VERTICAL CRANK-SHAFT — DIRECT DRIVE Rotary Cutter manufactured... successfully used by thousands from coast to coast.

Precision built for years of low cost service... Two wheel flexibility.

Many imitators... No successful duplications!

Write for Picture Folder and name of nearest dealer

Goodall MANUFACTURING CORPORATION
DEPT. PM, WARRENSBURG, MO.

Get that NEW-CAR FEEL again!
SEALED POWER PISTON RINGS
The only ring with the Full-Flow Spring!
SEALED POWER CORP., DEPT. G-3, MUSKOGON, MICH.

AMERICA'S FINEST BUMPER JACK

Here's an all-around hydraulic utility jack with hundreds of uses where easy lifting or pulling is required. Safest, quickest, easiest to use on any car built. Result of 15 years of advanced precision engineering. Extra long, heavy duty steel chain with forged steel grab hook picks up loads from 4" BELOW bottom of jack to 22" ABOVE. Base, handle socket, head and chain plate are all tough malleable iron castings. 17" hydraulic lift, 3000 lb. capacity. Order now at your dealer or send money order or check to

© 1948 American Hydraulics, Inc.



\$15.95
Complete with chain, hook and handle.

American Hydraulics, Inc.
SHEBOYGAN, WISCONSIN

American Hydraulics, Inc.

Sheboygan, Wisconsin

Enclosed find check or money order.

Please send.....American Bumper Jacks.

Name.....

Address.....

"Stop Pedaling, Pal...Get Wise to WHIZZER!"

Cover the town for a penny—with a WHIZZER Motor on your bike. Good-bye, pedal pushing—with 2½ rugged horsepower to take you everywhere. 125 miles to a gallon of gas! See your Whizzer Dealer Now!

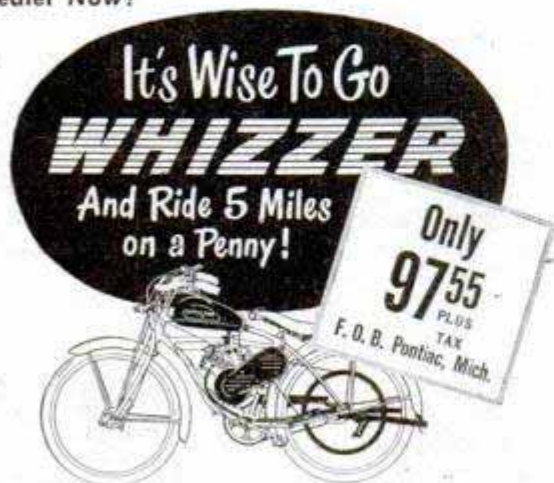

- ★ America's only proved 4-cycle bike motor!
- ★ Complete with all attachments!
- ★ Speeds up to 35 m.p.h.
- ★ Nation-wide network of 3,500 Whizzer Dealers!

Your Whizzer Dealer is as near as your telephone... or write Whizzer Motor Co., Pontiac, Mich.—world's largest bike motor builder.

X-acto*

HANDICRAFT KNIVES & TOOLS



Choice of experts in every art and craft field. A blade for every purpose—quickly interchangeable. Singly and in sets, 50¢ to \$50.00. (Slightly higher in Canada.)

Buy where you see this sign—
At hobby, hardware, gift and dept. stores.

X-acto Crescent Products Co., Inc., N.Y.
In Canada, Handicraft Tools, Ltd., Toronto

*Reg. U.S. Pat. Off.

Smith. This will add about 1000 r.p.m. to a propeller speed already nearing the five-figure bracket.

Judged from this and the "taking-off point" that some boats reached in 1947, the problem in 1948 and 1949 will be to push them up on the r.p.m. and hold them down to the water.

If the marine speedsters of 1948 ride on anything less than they did last year it will be air! That would put motorboat racing under the jurisdiction of the Civilian Aeronautics Administration. The American Power Boat Association wouldn't like that at all!

How Your Car Shifts for Itself

(Continued from page 106)

In the General Motors Hydra-Matic the foot clutch is eliminated entirely. The Hydra-Matic is more nearly full automatic than any of the designs just mentioned. Two sets of planetary gears (they are used in modern automatic overdrives and 30 years ago in Model-T Fords) are arranged in series—one in front of the other—making possible four forward speeds. A fluid coupling permits smooth engagement of engine power on starting and during shifts.

Shifts from one ratio to another are made by hydraulic controls, in accordance with car speed and accelerator-pedal position. Each speed is engaged by frictional pickup of gears under engine power. On standing starts, the transmission shifts 1-2-3-4 but the changes are so smooth that the average passenger is not aware of any difference in acceleration. Downshifts are normally 4-3-1, skipping second.

There is a low range for the drive-selector lever. In this low range, used chiefly for downhill braking, the transmission is restricted to first and second. No more power is provided in low range, as these same speeds also are used in high range.

The Hydra-Matic has been sold since before the war on Oldsmobiles and Cadillacs, and now also can be obtained in the 1948 Pontiacs.

The new Dynaflo transmission provides an automatically variable drive ratio without use of gear shifting. There is no clutch pedal—in this respect, the same as the Hydra-Matic.

Drive ratio is self-changed gradually by means of controlled oil flow in a hydraulic torque converter. The first of its kind ever used in an American passenger car, the Buick converter permits perfectly smooth acceleration without shifting gears. All normal driving is done without moving the

(Continued to page 268)

"LETTER PERFECT!"

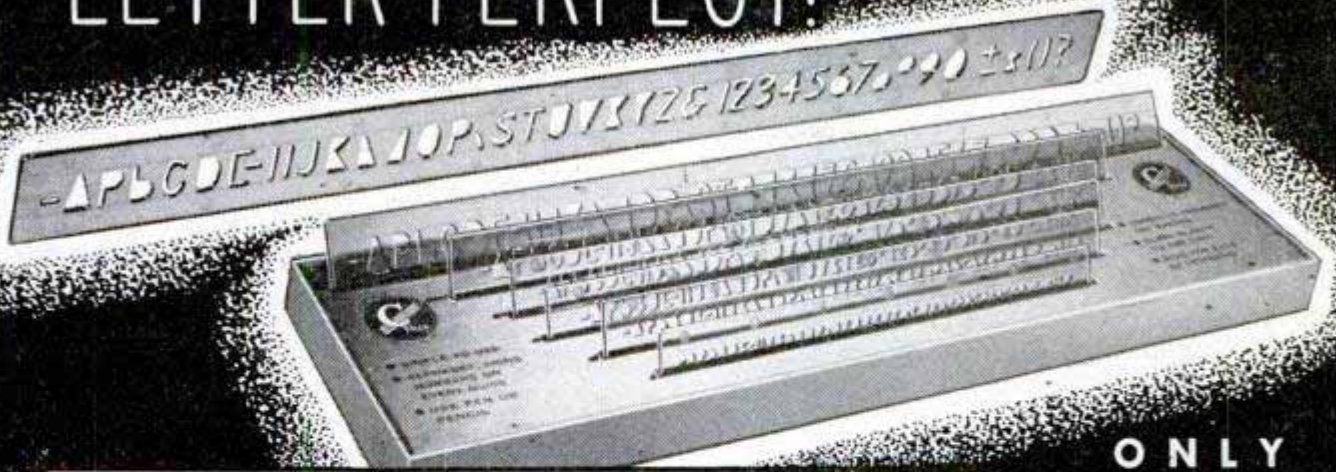

WITH THE New C-THRU LETTERING GUIDES

You too, can letter perfectly with the new C-Thru plastic LETTERING GUIDES. An amazing time saver for the expert draftsman, designer; or the home workshop "Hobbyist," at an unheard-of price. A complete set of six, different sized lettering guides, with many new improved features, at one-third the price of the ordinary, old fashioned type. Each C-Thru LETTERING GUIDE has a complete alphabet, numbers from 1 to 10 and commonly used symbols ON ONE GUIDE—no lost motion changing guides—makes old slow motion methods obsolete. These Durable, Practical, Beautifully designed guides are undercut to prevent smudging—beveled edges insure a perfect letter every time, using pen or pencil. You too, can dash off professional looking lettering and dimensions, like magic.

ONLY
\$9.00
 COMPLETE
 SET OF 6

LETTER SIZES
 1/8" 3/16" 1/4"
 5/16" 3/8" 1/2"



ARCHITECTS - DRAFTSMEN An indispensable aid to the professional Architect or Draftsman. Easy to use — Easy to own. You'll be proud of the neat, clean appearance of your drawings.



ARTISTS - STUDENTS C-Thru LETTERING GUIDES have hundreds of uses for Artists or Students. Charts, Posters, Layouts, Plans, Working Drawings, quickly professionally finished.

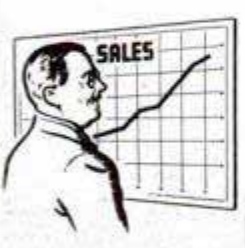

BUSINESS CHARTS Business offices will find C-Thru LETTERING GUIDES save time and money, over and over again. Business charts, Organization charts, and other projects, take on that professional look.

ENGINEERS - DESIGNERS A job well planned is half done. Drawings detailed with C-Thru LETTERING GUIDES, make sharp, easy-to-read blueprints. Saves time at the drawing board.



HOME WORKSHOP The home workshop is not complete without a set of C-Thru LETTERING GUIDES. If you draw your own plans, give them that expert touch with perfect lettering.



SIGN WRITING Clean neat signs and posters for stores, clubs, business offices, professional offices and hundreds of other uses. Anyone can letter expertly with C-Thru LETTERING GUIDES.



ASK FOR C-THRU LETTERING GUIDES AT YOUR STATIONERS, DRAWING SUPPLY STORE, OR WRITE

C-THRU *Ruler Company*
 HARTFORD, CONNECTICUT U. S. A.

RULERS · TRIANGLES · SLIDE RULES · CURVES · STENCILS · PROTRACTORS · T-SQUARES





"Fun To See Bass Hit JITTERBUG!"

Mike Citroek, Akron, Ohio, angler, says, "It's fun to see bass hit the Jitterbug. Its surface action is so tantalizing they hit it viciously." Mike is shown with his limit catch weighing 13 1/4 lbs. Beside these, he threw back five smaller bass all caught in 2 hours on the Jitterbug from nearby Mogadore Reservoir.



\$1.21
Choice of 7 Colors Write for catalog

FRED ARBOGAST & CO., INC.
1625 North St., Akron 3, Ohio



COOLANT PUMP

For metal working lathes and other machine tools. Consists of self-priming pump, tubing, reservoir, mounting tray, motor, switch, and wiring. Reservoir intake fitted with strainer. Write for dimension sheet. Price with 1/4 h.p., 1 ph. motor, f.o.b. factory

\$103

SOUTH BEND LATHE WORKS

455A E. Madison St.
South Bend 22, Ind.

HOLD-E-ZEE Automatic Grip

SCREWDRIVERS

... not only tools of finest quality, with chrome-vanadium blades, hand-ground bits, insulating, unbreakable handles ... but possessing the exclusive Gripper which holds, starts, and sets up screws in unhandy places. At leading dealers everywhere. Upson Bros., Inc., 86 Exchange St., Rochester, N.Y.



QUALITY UNSURPASSED • CONVENIENCE UNEQUALLED

RUST! RUST! RUST!

WHAT a headache! Here's the answer! A new liquid RUST REMOVER—quickly dissolves rust on iron or steel, tools, hardware, machinery, etc. NO RUBBING or hard work. Brush, swab, spray or dip. Put ON—let SET—wipe off—RUST GONE! On sale at all Sears Retail Stores in HARDWARE DEPTS. 50c and \$1.00 in Mid-West (slightly higher elsewhere.) Also available through our mail order catalog. Manual of rust control FREE.

SEARS, ROEBUCK and CO.

For further information, write ALLIED PRODUCTS COMPANY, Dept. E-1, 1133 Newport Ave., Chicago 13, Ill. Manufacturers of CorOdex.



CORODEX Liquid RUST REMOVER

PER QT. \$1

SEND FOR FREE CATALOGUE AND MANUAL

QUALITY

Aluminum Guard Easily Removed For Dadoing

TABLE
18" x 16"

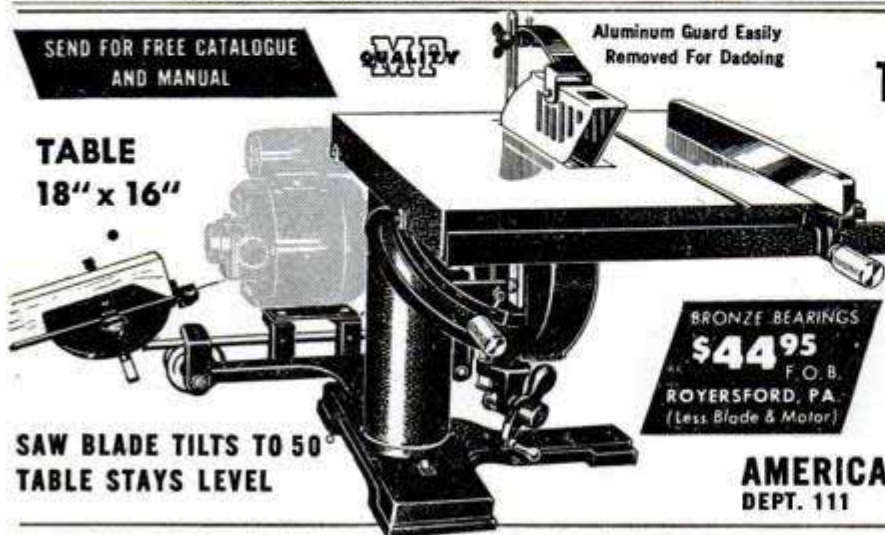

SAW BLADE TILTS TO 50°
TABLE STAYS LEVEL

BRONZE BEARINGS

\$44.95

F.O.B.
ROYERSFORD, PA.
(Less Blade & Motor)

NEW IMPROVED (88) TABLE MODEL TILT-ARBOR SAW

OIL IMPREGNATED BRONZE BEARINGS OR DOUBLE SHIELDED BALL BEARINGS, BOTH WITH THE PATENTED BALL BEARING TRANS-AXIAL MOTOR DRIVE

MODEL #2021X AS SHOWN WITH COMPLETE MITRE GAUGE. Precision etched scales show angles on mitre gauge and saw cradle. STEEL BAR RIP FENCE. ALUMINUM SAW INSERT AND GUARD. STEEL SPLITTER. BALL BEARING TRANS-AXIAL DRIVE 3/8" GROUND ARBOR. "COMPO" OIL IMPREGNATED BRONZE BEARINGS WITH OIL CHAMBER AND CUP, (OR, DOUBLE SHIELDED BALL BEARINGS, \$5 EXTRA). TABLE 18" x 16". BUILT IN SWITCH. Depth of Cut 2 5/16". Shipping Wt. 110 lbs. Requires 3/4 & 3/8 H.P. Motor.

(BALL BEARING FLOOR MODEL WITH 18" x 32" TABLE INCLUDING EXTENSION \$79.50)

AMERICAN MACHINE & TOOL CO., Inc.
DEPT. 111
ROYERSFORD, PA.

MASTER YOUR FARM JOBS!

With the New **3 in 1**
(PATENTS PENDING)



1 OTTAWA
"BUZZ-
MASTER"

2 "MO-MASTER"

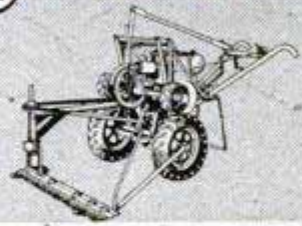

Available as an attachment to the famous Ottawa Buzz Master — or complete unit. Cuts 48" swath. Mows close to trees, under fences. One man mows 3 to 6 acres a day.

Clears Away Brush, Cuts Trees, Saws Logs, Tills the Soil, Mows, Digs Post Holes. Add Acres To Your Farm with the Ottawa BUZZ MASTER. Clears 1 to 3 acres a day. Propels itself as it cuts brush, saplings and other small vegetation. Has powerful 7 H. P. motor, two speeds, swivel axle, brakes for hillside sawing, adjustable saw shaft, other exclusive Ottawa features. Does many farm jobs; runs belt machinery. Belt Pulley furnished. Make money sawing wood, clearing land, etc., for neighbors.

Saws used on the BUZZ MASTER are manufactured in our own saw plant... made according to our own specifications and analysis, of finest quality nickel chrome steel obtainable.

Keep Profits Up, Costs Down... investigate this new work-saving, money-making Ottawa 3 in 1 outfit — the Buzz Master, the Mo-Master and the Post Hole Digger. Purchase any one of them and add the other two as attachments or GET ALL THREE NOW and have real year-round power equipment. Write today for FREE details, Low Factory Prices.

3 POST HOLE DIGGER

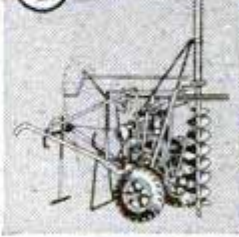

ROTARY TILLER ATTACHMENT



Increases crop yields. Tills 25" swath.

Adds greatly to work-saving, money-making ability of the Buzz Master. Double flight auger, "he-man" power. Can drill 3 ft. deep in 25 seconds. Furnished as attachment or complete unit.

OTTAWA MFG. COMPANY, 4-827 Birch St., Ottawa, Kansas

For FATHER'S DAY Give DAD a
Nimrod PIPELITER

DOWN-DRAFT **CHIMNEY-ACTION**

- WINDPROOF
- LIGHTWEIGHT
- LARGE FLAME

\$3.50 and up
AT YOUR DEALER

Unconditionally Guaranteed

YOUR CIRCLE SAW BLADE CAN CUT GROOVES LIKE THIS
Easily — Quickly — Accurately

Woodworkers! Here's My Advice:

\$4.95 SET
POSTPAID INCLUDING TAX

WAR SURPLUS BARGAIN FLASH EQUIPMENT KIT

FAMOUS "MODEL 1503" AIRCRAFT FLASH UNIT powerful high quality equipment made for U. S. Air Corps will be shipped brand new in original boxes.

POWER SUPPLY built into beautiful gray finished case, with all connectors, relay control, 2 condensers each 2000 Volts, 50 M.F.D. light output 110 Watt seconds, can be used with any 12 Watt battery as a professional studio flash equipment. Power pack alone is worth more than the price we are asking for the complete unit.

FOUR HIGH SPEED FLASH TUBES plastic sealed, unbreakable, 12 million peak lumens light output for more than 15,000 flashes.

WE INCLUDE aluminum reflectors, transformer, connectors, connecting cords, spare parts, diagram and instructions on how to convert the unit for 110 Volt A.C. Converting parts included.

IT IS THE BEST VALUE IN WAR SURPLUS MATERIAL. WHILE THEY LAST.

PRICE complete **\$68.00**

CINEX INC., Dept. M.P.
165 WEST 46th ST. NEW YORK 19, N. Y.

YES—THIS NEW INVENTION WILL FIT THE ARBOR OF ANY WOOD POWER CIRCLE SAW—AND WILL SAW ANY DESIRED GROOVE CLEANER, EASIER AND FASTER THAN ANY DADO HEAD ON THE MARKET TODAY... GRADUATED IN 32nds AND NUMBERED TO CUT ANY WIDTH GROOVE WITH YOUR SAW BLADE... MICRO-MATIC ADJUSTMENT MAKES POSSIBLE A CHANGE IN CUTTING ANGLE IN 15 SECONDS... WARREN DADO SAWING WASHERS CAN BE LEFT ON THE ARBOR OR QUICKLY REMOVED FOR CUT OFF SAWING.

ORDER YOUR SET OF FOUR WASHERS TODAY. TRY THEM FOR TEN DAYS. IF NOT SATISFIED, YOUR MONEY WILL BE REFUNDED.

Arbor 1/2 3/4
 Sizes 5/8
 Check
 Money Order
 Free Booklet

Gentlemen:— Please send _____ sets of sawing washers

Name _____
 Address _____
 City _____ State _____

ALL SETS SHIPPED POSTPAID

WARREN DADO SAWING WASHERS CO.
 P. O. BOX 98 NORTH END STATION
 DETROIT, MICHIGAN

ALWAYS READY
FOR ACTION!



KIEKHAEFER

MERCURY LIGHTNING

Full-Jeweled Power

(Ball and Roller Bearings Throughout)

Proved through OVER 10,000 HOURS
OF CONTINUOUS PERFORMANCE

The 10 hp. Mercury Lightning steps out, ready to deliver outstanding performance at top speeds . . . slowest trolling. Tested and proved, Full-Jeweled Power is a Kiekhaefer engineering triumph that reduces wear, gives Mercury parts an anti-friction ride on Ball and Roller Bearings . . . assures greater power — longer life. See the complete Mercury line at your dealer. Drive a Mercury and you'll learn why it's MATCHLESS in OUTBOARD EXCELLENCE.

KIEKHAEFER CORPORATION, Dept. N, Cedarburg, Wis., U.S.A.

Write for FREE Illustrated Brochure and name
of your nearest Mercury dealer.

NAME

ADDRESS

CITY STATE

drive-selector lever under the steering wheel. The action is reminiscent of old-time steam cars whose speed was controlled entirely by the throttle.

On starting the car the driver merely flicks the selector lever to D (meaning "Drive"). With engine idling the car does not move. As the accelerator pedal is depressed the engine speeds up, its power increases, greater push is transmitted to the rear wheels and the car moves off.

The converter produces the hydraulic equivalent of a mechanical-gear transmission. Unlike the geared arrangement with only three or four ratios, the converter provides a continuously variable set of drive ratios over its total range.

The complete Dynaflo transmission consists essentially of the torque converter (which looks something like a fluid coupling) in front of a hydraulically applied two-speed-and-reverse planetary transmission. Direct drive is used for most forward driving.

Production automatic transmissions now available provide a wide range, all the way from the standard shift to full automatic operation. Arranged by increasing order of "automaticity" (from the driver's standpoint) these transmissions are: (1) conventional, (2) conventional plus overdrive, (3) Chrysler and DeSoto Fluid Drive, (4) Hudson Drive Master, (5) General Motors Hydra-Matic, and (6) Buick Dynaflo.

"Automaticity" is a matter of personal preference. Some drivers, particularly women and beginners, like to be relieved of as much "machinery manipulating" as possible. To these people either the Hydra-Matic or Dynaflo is well suited. Other drivers prefer to retain more personal control of transmission action, and as a result favor the Drive Master or the Fluid Drive, or perhaps the standard transmission plus automatic overdrive.

Power loss in the transmission, unfortunately, seems to be closely related to degree of automaticity. That is, the more nearly automatic a transmission is, the greater its power loss appears to be. A standard transmission generally has the highest efficiency.

Power loss concerns the driver because of fuel economy. Automatic transmissions, by themselves, do not help gas mileage. (The automatic overdrive is a possible exception.) Most designs, however, permit other car changes which recapture some of the lost power and fuel economy.

The most popular method of recovering losses involves slowing down the engine,

(Continued to page 272)



RCA scientists—pioneers in radio-electronics—apply the “radio tube” to communications, science, industry, entertainment, and transportation.

This “magic lamp” makes Aladdin’s look lazy

You will remember the fabulous lamp—and how it served its master, Aladdin. Serving you, today, is a real “magic lamp” . . . the electron tube.

You are familiar with these tubes in your radio, Victrola radio-phonograph or television set . . . but that is only a small part of the work they do. Using radio tubes, RCA Laboratories have helped to develop many new and useful servants for man.

A partial list includes: all-electronic television, FM radio, portable radios, the electron microscope, radio-heat, radar, Shoran, Teleran, and countless special “tools” for science, communications and commerce.

The electron microscope magnifies bacteria more than 100,000 diameters to help fight disease, radar sees through fog and darkness, all-electronic television shows events taking place at a distance, radio-heat “glues” wood or plastics, Shoran locates points on the earth’s surface with unbe-

lievable accuracy, Teleran adds to the safety of air travel.

Advances in radio-electronics are a major objective at RCA Laboratories. Fully developed, they are part of the instruments bearing the name RCA, or RCA Victor.

When in Radio City, New York, be sure to see the radio, television and electronic wonders at RCA Exhibition Hall, 36 West 49th Street. Free admission. Radio Corporation of America, RCA Building, Radio City, N. Y. 20.



RADIO CORPORATION of AMERICA

- ★ Sharpen Tools ★ Remove Rust
- ★ Sand, Polish Furniture
- ★ Grind Welds ★ Burnish Metal

NO END to the Uses for these HANDY Kits!

You'll zip through light sanding, grinding and buffing jobs like magic with these versatile Accessory Kits! Mount them on a Home-Utility 1/4" Electric Drill (only \$18.95). Use them as portable tools or in a Horizontal Stand (\$3.35). Like all Home-Utility Electric Tools, they're quality-built by Black & Decker, famous maker of industrial tools for 37 years! Ask to see these Kits today at your hardware, electrical or implement dealer. They're real buys for homes, farms and hobby shops!

\$4.50 HOME-UTILITY Buffing and Polishing Kit

Contains 4" Wire Wheel Brush, 3" Grinding Wheel, 3" Cotton Buff, Compound and arbor for cleaning, grinding, buffing and polishing.



HOME-UTILITY Abrasive Kit \$4.50

Contains 4 assorted arbors and 15 abrasive bands and rolls for cleaning and sanding flat, curved and irregular surfaces.



ELECTRIC HOME-UTILITY TOOLS

Products of The Black & Decker Mfg. Co.
Dept. H-2M, Towson 4, Maryland

BUILD YOUR OWN TILTING TABLE SAW!

SAVE
\$50
OR MORE



WITH
GIL-BILT
PLANS—PARTS

- 21x27 in. table tilts full 45 degrees; 13 in. capacity in front of blade.
- 8 in. blade mounted to cut from 0 to full 2 1/2 inches.
- Self-aligning and calibrated rip fence and miter gauge.
- No machining, no welding, no blueprint reading.
- Sturdy wood, steel, and aluminum construction.
- Build easily with common hand tools.

GIL-BILT Step-by-Step Plans—Simplified perspective drawings, full size patterns; illustrated with 13 actual photographs. Post-**\$1.00** paid anywhere in the world.

GIL-BILT 5/8 in. Arbor—Machined spindle, two lubricated for life ball bearings, one piece cast aluminum housing, complete ready **\$6.95** to run. Uses blades with 1/2" hole.

GIL-BILT Special Metal Parts Kit—Includes Step-by-Step Plans, 5/8 in. ball bearing arbor, aluminum channel and bar, cast aluminum hand-wheels, steel hinges, V-pulley and all other metal parts **\$14.95** (less blade).

Same Kit with high quality 8 in. combination blade. **\$18.95**
(Prices include postage up to 600 miles)

GILLIOM POWER TOOLS P. O. Box 1-Z, Lambert Field
St. Louis 21, Missouri

Build Your Own ROTARY POWER LAWN MOWER & WEED CUTTER with the Wind-King MOWER SPINDLE & BLADE

\$18.75 FOB
Merrill,
Iowa



- Timken Bearing equipped
- Smooth operation at high speed
- Spindle unconditionally guaranteed
- 20-inch tool steel blade—easily sharpened
- Precision built with quality materials
- Designed for efficient, long-lasting lubrication

For further information, write to:

WIND-KING ELECTRIC MFG. CO.
Merrill, Iowa

Take a Deep Breath . . . and Your Tie Mysteriously Rises!
Lift Up a Drink . . . and Your Tie Comes Up Too . . .

WITH THE NEW FLIP-UP TIE!

Loads of laughs—just waiting for your order! It's the famous FLIP-UP TIE—funniest thing in town. You can make your tie pop up instantly, lie flat in a second—you control the speed. Startle your gang into howls of laughter next time they get together—get the FLIP-UP—it's the life of the party!

SATISFACTION GUARANTEED SPECIAL PRICE TO DEALERS

BERNARD FINE CO., Inc.

Dept. PMT-1
501 Sixth Avenue New York 11, N. Y.

\$1.98

complete
SEND NO MONEY

Rush your order today. Remit with your order and we pay postage or order C.O.D. plus postage.



TONGUE AND GROOVE - FLUTING - NOTCHING - INLAY - ANY JOINT

Aladdin's Tool

AND YOUR DRILL PRESS

Makes any cut wood-shaping tools costing up to \$300.00 can make—more too. Sturdily built, lasts a lifetime.

TWO MODELS—IMMEDIATE DELIVERY

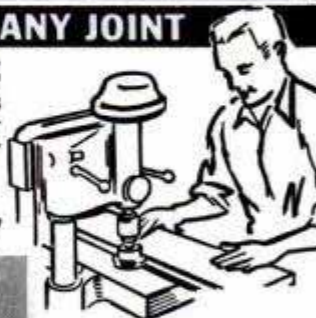

DELUXE MODEL

\$11.95 with bottom bearing as illustrated

REGULAR MODEL

without bottom bearing **\$7.95**



DeLuxe Model includes bottom bearing that anchors tool to bottom of press. Regular Model without bearing. Comes complete with adaptor and 6 blades making 12 standard cuts—balance blade—beautiful wood box. Over 100 different, practical cuts can be made with the 6 blades. See your dealer or send check or money order for delivery to your door. All other orders C.O.D. plus postage.

THE DESIGN COMPANY
2603 Warwick, Dept. M-20, Kansas City 8, Mo.

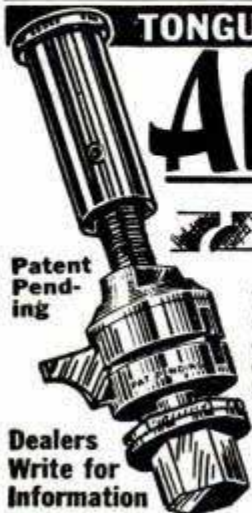

Patent Pending

Dealers Write for Information

GET MORE FROM YOUR HOBBY WITH A SPEED GRAPHIC!



Do you have a model train-set panorama you'd like to photograph? How about that sculpturing you do? Or model planes? Or ships? *Whatever* your hobby, you can make it more enjoyable by taking sparkling photos of your best work for your den... any other room in the house... or for showing your friends! Close-ups are a cinch! And the SPEED GRAPHIC is the *easy* way to get more from your hobby. It's the one camera you can count on for taking pictures under *any* circumstances, of *any* subject! See your dealer today! Or write for free booklet to Room 40, Graflex, Inc.

GET PRIZE-WINNING PICTURES WITH GRAFLEX

Rochester 8, N. Y.
Western Division Office, 3045 Wilshire Blvd.,
Los Angeles, Cal.

New...Self-Contained SPRAY GUN

No Hose! No Tanks! No Pumps!
No Motor!

It's true! A high-pressure spray gun as self-contained, as compact and portable, as a flashlight! Uses no current. Pressure comes from inexpensive CO2 cartridge. A cartridge sprays 10 to 20 oz. of liquid (depending on viscosity). Use gun for paints, liquid insecticides, oils, etc. For home, farm, workshop, garden, garage. Comes with 3 cartridges. Fully guaranteed. The Becker Spray Gun is shipped postpaid for only \$18.50; or send only \$2—we'll ship C.O.D., you pay postman balance plus postage. Extra cartridges, 10 for \$1, postpaid.



\$18.50

(With 3 cartridges)
POSTPAID

SULLIVAN-BECKER CO., Dept. 118-E, KENOSHA, WIS.



Working with a powerful Dumore is faster, easier—twice the fun!

—extra power, capacity, and flexibility for jobs in plastics, wood, and metal

A Dumore Duplex gives you: a full 1/14 HP motor for heavy jobs; extra-capacity chuck for 1/4", 1/8", 3/32" tool sizes; attachments to convert for bench, lathe, and flexible-shaft duty. See it at your dealers, or write for details today! The Dumore Co., Dept. E-51, Racine, Wis.



Tear out this coupon and mail today!

The Dumore Co., Dept. E-51, Racine, Wis.

- check Please send me complete information on the Duplex Grinder.
 Send me Deluxe Duplex Kit (27 accessories), \$27.50 enclosed.
 Send me Standard Duplex Kit (9 accessories), \$19.75 enclosed.
 Shipping charges C.O.D.

Name.....
 Address.....
 City..... (.....) State.....

H-14A

Now! Set of 7 STRIPING TOOL

Now you can paint 7 stripe widths on furniture, bikes, model planes, bulletins, wall board... make plain walls look like tile! Easier than using a pencil! Straight, curved, circular, even parallel stripes made expertly in any color! Regular price Type "M" Tool with tip for 1/16" stripe \$1.00. Extra tips 1/64", 1/32", 3/64", 1/16", 5/64", 3/32", 1/8"—75c each. Special offer: Tool with complete set of 7 tips \$5.00. (C.O.D. orders 25c extra.) WENDELL MFG. CO., 4234-B Lincoln Ave., Chicago 18, Ill.

A TOOL... NOT A BRUSH



WITH 7 TIPS
\$5 POST PAID

Dealers Write Today!

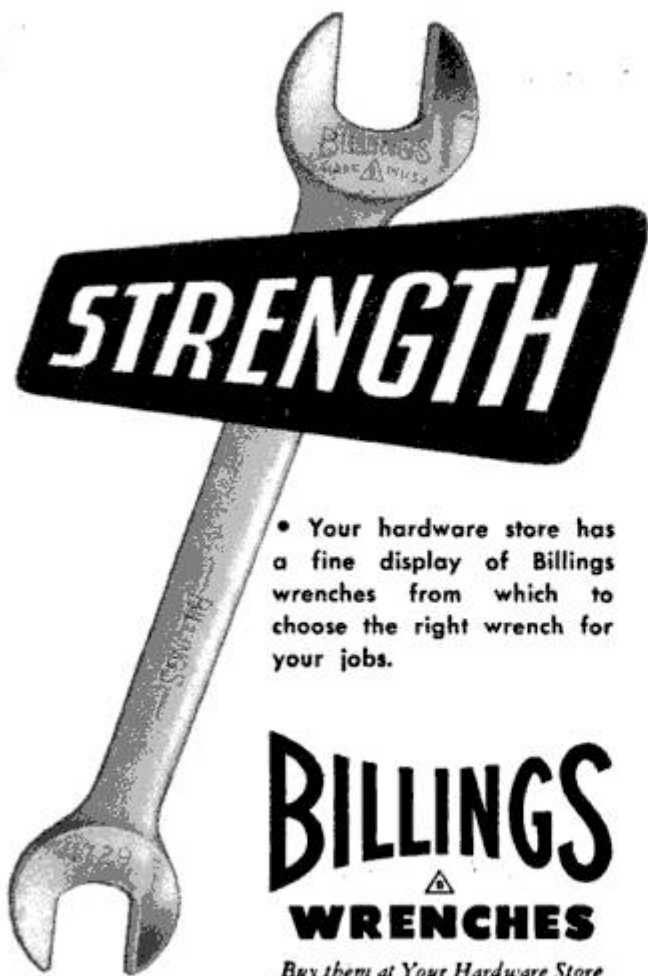

• Your hardware store has a fine display of Billings wrenches from which to choose the right wrench for your jobs.

BILLINGS WRENCHES

Buy them at Your Hardware Store

The Billings & Spencer Company, Hartford 1, Conn.

presenting the DART METRO-METER



gives you lens reading
pin-point measurements

Two years of market testing have proved that METRO-METER has all the advanced features you want in your steel rule.

- ↗ measures inside widths — no 2" added.
- ↗ tape numbered on both sides permits lens or direct reading.
- ↗ retractable scribe for desired marking.
- ↗ clear plastic lens plainly marked.
- ↗ polished stainless steel case with replaceable nickle plated steel tape.

If not available at your local hardware or gift store, send check or money order direct to

\$2.95
national price.

DART Manufacturing Co.

Mason, Michigan

so that it turns over fewer revolutions, and uses less gas, for each mile of travel. In a standard car this change reduces pickup and hill-climbing ability; but with an automatic transmission a lower gear immediately is available when more power is demanded.

In comparison with a standard car, improved fuel economy on open intercity highways will be obtained consistently with the more nearly full-automatic makes. The gain may be as much as two miles per gallon. For slow-speed traffic more gasoline probably will be used by these same automatic jobs. The reason is that more driving is done in the lower, less-efficient gears. Here the loss may be as much as two miles per gallon—a price paid for better performance and freedom from gear shifting.

The over-all effect on gas mileage, then, depends on how much the car is used in city traffic and how much on long trips. A heavy footed driver also is a big factor.

Automatic transmissions like the Chrysler and General Motors designs cost the car purchaser from \$150 to \$200 extra. The standard transmission and clutch which are replaced cost perhaps \$30 to \$50, making the total value \$180 to \$250. Based on the same relative manufacturing costs, an engine can be built for somewhere between \$120 and \$180.

Critics point out the inconsistency of a transmission, even though automatic, which costs more than an engine. Before automatic jobs become standard equipment, they say, a better cost balance should be obtained between transmission and engine. In the meantime, however, there are plenty of buyers apparently willing to pay \$200 extra for automatic shifting.

The engineers now do not know how to build a satisfactory low-cost automatic shifter. They do not yet agree what standardized kind of self-shifter is desirable for the average car buyer. In the process of answering these questions a wide variety of designs is being and will be offered to the motoring public. In the final analysis the buyer will determine what transmission the manufacturers will build, and how much it will cost.

Rubber Prop for Outboards

Rubber propellers for outboard motors bounce over driftwood and slide over weeds without fouling. Encasing a cast aluminum or bronze core, the rubber propeller is stiff enough to cut the water, yet will slip off most underwater obstacles without shearing the drive-shaft pin.

TENITE
an ideal
GUNSTOCK MATERIAL

BEAUTIFUL

DURABLE



TIME-TESTED



Beauty, durability, time-tested dependability! More of all three . . . *plus* more dollar for dollar gun value—when you buy a Stevens Tenite stocked model. You'll admire the fine checkering . . . full capped pistol grips . . . attractive paneling, fluting and lustrous, burlled finishes. TENITE stocks make it possible for you to have custom-built features and appearance on guns priced with the lowest.

But, "handsome is as handsome does" and Tenite stocks are durable and time-tested, too. They won't chip, split or crack . . . are moisture resistant and aren't affected by climatic temperature changes.

And remember—not only was Savage "First in the Field" with Tenite, but *only* Savage offers you guns with this beautiful, durable, service-proven stocking material. *Write for free catalog.*

Savage Arms Corporation, *Firearms Division*, Chicopee Falls, Mass.

THREE TENITE STOCKED VALUES



STEVENS MODEL 311—Double Barrel Hammerless Shotgun—12, 16, 20, .410 gauges. Rugged lock-up . . . positive extraction . . . fast hammer fall . . . polished, case hardened frame . . . forged steel, proof-tested barrels . . . matted sighting rib.



STEVENS MODEL 94—Single Barrel Shotgun—12, 16, 20, .410 gauges. Barrel—forged steel, hollow tapered, proof-tested, full choked. Action—two-way, top snap, low rebounding hammer . . . automatic ejector.

First in the Field



STEVENS MODEL 22-410—Over-and-Under .22 rifle and .410 shotgun in one streamlined, single trigger, lightweight gun. Over barrel shoots .22 long rifle cartridges (also, short or long) . . . under barrel, .410 shot shells—2½" or 3".



WORLD FAMOUS FOR DEPENDABILITY AND ACCURACY

WAR SURPLUS VALUES

Air Corps SUNGLASSES

New Air Corps Type. 24 Karat gold plated frame. 4 base optically ground lens. Pearlloid brow rest. Complete with case.



2.25

Jungle HAMMOCK

Brand New. Mosquito proof. rain-proof, mildew-proof nylon. Use as hammock or tent.

4.95

Full length zipper opening.



SLEEPING BAG

100% wool, mummy type. 30" zipper. Reissue—guaranteed like new. Complete with water repellent cover.

3.95



NAVY T-SHIRT

Brand New. First quality. Soft fine knit cotton. Sizes small, med., large.

3 for \$2



CANVAS BUCKET

New Army surplus collapsible canvas bucket. Heavy double wall construction. 8 qt. capacity.

49c



ARMY BLANKET

Guaranteed perfect condition—like new. No holes, tears, or repairs. 100% wool, full size, OD color.

3.88

ARMY PUP TENT

Army surplus. Full size. Used—guaranteed perfect condition. Complete with poles and pins.



3.95

GOOSENECK FLASHLIGHT

Brand New. Gov't. surplus. For mechanics, electricians, and home use. 12" extension adjustable to any angle. Water and shockproof. With extra bulb.



1.39

ORDER FROM THIS AD

FOOTLOCKER

New Army type metal footlocker with 2 drawbolt latches and center lock with key. Metal bumper corners. Removable tray. (This item shipped freight charges collect.)



9.95 (Plus 20% Fed. tax)

PYRAMIDAL TENT

Heavy canvas. Full size 16x16 feet. Used—guaranteed perfect condition. Ideal for covering machinery or haystack. No poles or pins. (This item shipped freight charges collect.)



34.50

Used Army FIELD JACKET

Completely renovated—guaranteed serviceable. Water repellent poplin. 100% wool flannel lining. Zipper button front. Sizes 34, 36, 38.



1.88

New Navy FIELD JACKET

Water repellent poplin with 100% wool flannel lining. Zipper and button front. Sizes 34, 36.

5.95

NAVY KNIFE

Brand New. Tempered steel 5 1/4 inch "Parkerized" blade. Laminated leather grip handle. Complete with sheath.



\$1

MILITARY TYPE WRIST WATCH

Brand New. Fully guaranteed 17 jewel movement. Luminous radium dial. Stainless steel back. Water-proof. anti-magnetic. Genuine pigskin leather strap.



21.95 Plus 10% Fed. tax

Send check or cash—Shipped prepaid unless otherwise noted. COD's sent postage collect.

NATIONAL JOBBING COMPANY
1703 No. 24th St. Omaha, Nebr.

Every MILE Saves You MONEY!

"PAY AS YOU RIDE"



GO Cushman MOTOR SCOOTER

75 MILES PER GALLON

Cushman Solo Model

Cushman Engines

For 47 years Cushman has produced high quality small air-cooled and water-cooled engines. These engines are available to original equipment manufacturers and other users. Write for details.

Enjoy America's new ride. The Cushman Motor Scooter travels 300 miles on a dollar's worth of gas. Operates for less than 1c per mile. Will carry 2 passengers. Has rugged 4 H.P. Cushman "Husky" engine, two-speed transmission, automatic clutch, balloon tires and knee-action springing for added comfort. Park anywhere. Gives you a "second car" at low cost.

5 Models. Finest selection. Cushman offers SOLO, SIDE-KAR, PACKAGE-KAR, STAKE-KAR, SPORT models.

FREE Write for Free Folders, name of your nearest dealer and details of the new, liberal Cushman TIME PAYMENT PLAN.

CUSHMAN MOTOR WORKS, INC., Dept. M-500, Lincoln, Nebr.

PALMGREN Rotary, Indexing, Milling TABLE

DUAL CROSS FEED and ROTARY FEED

Has 8" table, 360° movement and 4" cross feed travel. Adjusting wheels and dials graduated in degrees and thousands. Slotted for bolting to table. No. 83 Priced \$49.50. No. 82 without rotary feed \$39.75.

Write for Circular No. 10

CHICAGO TOOL and ENGINEERING CO.
8365 South Chicago Ave., Chicago 17, Ill.



REAL DIESEL ENGINE

For Model Planes, Boats and Race Cars

Now you can own and run a real miniature diesel engine that operates by the heat of compression. No coil, condenser, wires, or annoying ignition failures. Simply flip the prop or flywheel to start. It's the new DEEZIL—a .125 cu. in. displacement, 5 oz. engine that runs at 8000 RPM. Order today; only \$12.95 p.p., less tank. Every engine fully tested and guaranteed. DEEZILMIX 50c. Send for valuable free price list!

FUEL \$1.00; PROP 50c.

GOTHAM HOBBY CORP.

107 East 126th Street

New York 35, N. Y., Dept. "P"

NEW B-M POWER MOWERS

For Modern Lawn Care

Newest model self-drive, three-wheel, rotary blade mower. Equipped with quick-starting, dependable, trouble-free 1 1/2-2 h.p. Clinton engine. Light, Sturdy. Choose from three models of assembled mowers or Build-it-yourself kit of parts. Guaranteed.

B-M MOWER COMPANY
Box, 66-M Blue Mound, Kansas



FREE Literature

AT LOW FACTORY COST

E-Z THREAD QUICK CHANGE GEAR BOX

To fit SOUTH BEND 9", LOGAN 9" and 10", POW-KRAFT, CLAUSING and SHELDON LATHES. Will cut 78 threads. Aluminum casting with fourteen Torrington needle bearings, heat treated shafts and cut steel gears. Easily installed. Special 30 day offer. Send for literature.

MONGE MACHINE SHOP
NORTH CHICAGO, ILL.

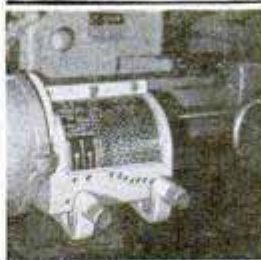

SAY YOU SAW IT IN POPULAR MECHANICS

AUTO ENGINE SPEED CONTROL GOVERNORS



In Montreal, 7546 Wiseman; in Skaneateles, N. Y., Horle Welding Supply.

Agents Wanted

CANDEE-SMITH GOVERNORS
2641 S. Hill St., Los Angeles 7, Calif.

All 7 of these low-cost **Homecraft**® Power Tools

a complete home shop of your own!

Only
\$218⁵⁰

(All prices without motors or lamp attachments)

Now! ... you can start that workshop you've dreamed about — or expand your present shop — *without spending a lot of money.*

Yes, you can have a real shop — filled with Homecraft Power Tools — for only \$218.50. These popular tools are designed just for people like you — hobbyists who use tools off and on, folks who want a lot of dependable service ... a lot of fun ... a lot of healthful relaxation!

Ask your Homecraft dealer to show you his complete display of Homecraft Power Tools.

See your Homecraft dealer now!



Homecraft Band Saw, No. 28-110 — Has 6½" capacity under guide and throat capacity of 9½". Fully-adjustable blade guides. Table tilts 45°..... **\$36⁹⁵**

Lamp Extra

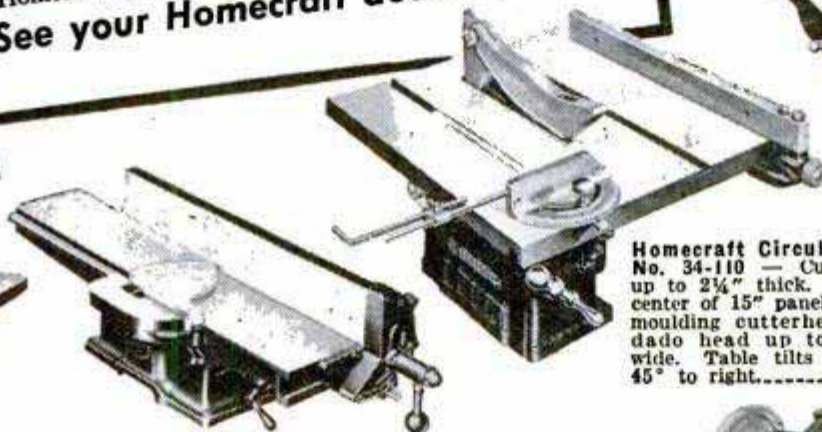

Homecraft Jointer, No. 37-110 Planes wood up to 4" wide. Cuts ¼"-deep rabbets. Has lubricated-for-life ball bearings. Fence tilts 45° to right and left..... **\$29⁹⁵**



Homecraft Lathe, No. 46-110 — Handles 36" of stock between centers. Swings 10" over bed. Spindle is carried on oil-impregnated bronze bearing. All thrust is absorbed by sealed-for-life ball bearings..... **\$34⁹⁵**



Homecraft Scroll Saw, No. 40-110 — Cuts up to 2" thick, to center of 32" panel. Has speed of 1275 cutting strokes per minute. Table tilts 45° right, 15° left..... **\$29⁹⁵**

Lamp and Motor Extra



Homecraft Grinder and Buffer — Can be driven from either bottom or rear. Has long-wearing bronze bearings..... **\$9⁸⁰**



Homecraft Drill Press, No. 11-120 — Four speeds from 700 r.p.m. to 4700 r.p.m. Has capacity up to ½" holes in cast iron. Oil-impregnated bronze bearings in quill. Ball-thrust bearing in spindle pulley..... **\$41⁹⁵**

Motor Extra

Homecraft Power Tools

are built by the makers of Delta-Milwaukee* Power and Machine Tools—the tools with a widespread reputation for safety, accuracy, and dependability, in factories and schools, as well as home shops. If your goal is a shop equipped with power tools that embody the most advanced principles of engineering, design, and construction, then insist on Delta-Milwaukee Power Tools.

*Trade Mark Reg. U. S. Pat. Off.



Free Catalog Sheets! Show all Homecraft Power Tools and accessories. Use coupon, to get your copies.

Tear out coupon and mail today!



DELTA MANUFACTURING DIVISION
Rockwell Manufacturing Company
681 E. Vienna Ave., Milwaukee 1, Wis.

Please send me free catalog sheets on Homecraft Power Tools and list of dealers in my area.

Name.....

Address.....

City..... (.....) State.....

HM-58

The New Improved
All-Purpose

DYNAMIC Super Charged ARC WELDER

Industrial Transformer Type

IT WELDS • IT BRAZES • IT SOLDERS

IDEAL FOR AUTO—HOME APPLIANCE AND FARM REPAIRS. This portable, industrial transformer type welder easily carried right to the job can be operated from any convenient properly wired 110 Volt 60 Cycle Line. Can also be supplied for 220 volt 60 cycle operation and other voltages and cycles at slight additional cost.

EASY-TO-OPERATE. If inexperienced you can easily learn to do a variety of high grade welding jobs by following the practical, simplified welding and operating instructions furnished. Once you see the DYNAMIC WELDER in operation you won't want to be without it. Its simplicity will amaze you. In a year the DYNAMIC only costs you about 7c a day. COMES COMPLETE READY TO OPERATE WITH HELMET, RODS, CABLES, HOLDER, OPERATING AND WELDING INSTRUCTIONS, ETC.

SAVES YOU VALUABLE TIME AND MONEY!

DESIGNED TO DO HIGH GRADE WELDING inexpensively—Maintenance Men, Farmers, Mechanics, Machine Shops, Foundries, Auto, General Repair and Job Welding Shops, all using the DYNAMIC find it so indispensable and useful that they can't afford to be without it. **WORKS ON IRON, STEEL, BRASS, BRONZE AND OTHER METALS.** Has 8 metallic and carbon arc heat stages. DOES WORK YOU WOULD THINK ONLY POSSIBLE WITH A LARGER, MORE EXPENSIVE MACHINE.

DYNAMIC WELDER CO., 15 EAST 23rd ST., G, CHICAGO 16, ILLINOIS

ONLY
\$2850
COMPLETE

Do Your Own Welding

Just a few repair jobs will pay for this machine. A practical and profitable machine tool for any workshop... Make money doing repair work for others.

Write Today for Particulars

GET DETAILS on our 10 day Trial Offer.

Member Chicago Association of Commerce.



SPECIAL GIFT OFFER! ELECTRIC ARC TORCH ATTACHMENT WORTH \$6.80

THIS TWIN CARBON TORCH illustrated below for use with the DYNAMIC is unsurpassed for brazing, soldering, pre-heating and cutting on iron, steel, brass, bronze and other metals. With it you can greatly increase the profitable uses of your welder. Comes complete with instructions, carbons & cables. Does work of an Oxy-Acetylene Torch.

MAIL COUPON FOR FREE DETAILS

10-DAY TRIAL OFFER

DYNAMIC WELDER CO.

15 EAST 23rd STREET, G, CHICAGO 16, ILL.

Send me FREE details of your ELECTRIC Arc Torch Gift Offer and Dynamic Welder 10-Day Trial Offer.

NAME _____

ADDRESS _____

CITY _____ Zone _____ STATE _____

Yours at No Extra Cost!

For a limited time only we are giving away a Twin Carbon Electric Arc Torch worth \$6.80 with every DYNAMIC WELDER. This valuable premium is yours at the single low price of welder alone if you act now.

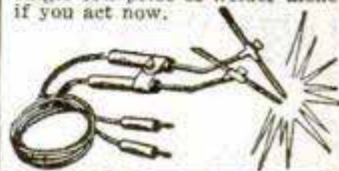

NOW you can PREVENT RUST and SCALE from forming in your AUTO RADIATOR

PROTECT your new car's cooling system from the start... end radiator rust-ups in your old car. Butler De-Scaler has been used with great success industrially for over ten years... proven in thousands of truck and bus fleets. Now available for car owners. Unconditionally guaranteed... for one year... will not interfere with Anti-freeze or stop leak. Easily installed... available at service stations, garages, and car dealers everywhere. If no dealer near you, write BUTLER ENGINEERING CO., 2622 Rousseau St., New Orleans 11, Louisiana.



KEEP WATER CRYSTAL CLEAR. Installed in radiator hose, Butler De-Scaler's Galvanic Cell Action prevents RUST and SCALE throughout the entire cooling system. Causes the removal of OLD RUST AND SCALE.



New Fair Trade List Price \$2.95
Butler De-Scalers are also available for use in boilers, home hot water systems, Diesels, etc.

BUTLER De-scaler

Government Surplus — 1,000 P.S.I.
Brand New

VICKERS

Hydraulic Pumps and Motors

Hundreds of Practical Uses. Build your own hydraulic presses, and other equipment.

\$15.00 each F.O.B. Detroit, Mich.

JAY-CEE SALES CO.

4554 Grand River Ave. Detroit 8, Mich.



DRAINS CELLARS, WASH TRAYS CIRCULATES OIL

Pumps 1800 GPH 300 gal. 30' high, use 1/8 to 1/2 HP **\$6.50** motor. Will not clog.

Postpaid if cash with order. (Add 50c for west of the Mississippi.)

Thousands in use since 1936

LABAWCO PUMPS, BELLE MEAD 7, N. J.



UTICA TOOLS FOR MORE TOOL MILEAGE



TOOL NO. 523-7"
General Purpose Gripping Pliers

UTICA DROP FORGE & TOOL CORPORATION
UTICA 4, NEW YORK

GROBAN'S SURPLUS BARGAINS!

BRAND NEW



AIR OR OIL HYDRAULICS

Use hydraulics on arbor presses, hydraulic presses, hay lifts, manure loaders, lift trucks—push or pull, tilt or turn, press or squeeze, open or close, lift or lower—and other hydraulic and industrial applications. Use with either air or oil . . . of finest precision workmanship.

1. Double action, 3" bore, 12" stroke. All steel hydraulic cylinder, will lift up to 12,000 lbs. (7000 lbs. in 3 seconds with Vickers Pump). \$78.00 value. Wt. 12 lbs. . . . \$19.50 postpaid
2. Double action, 1½" bore, 27" stroke. (Will lift 1760 lbs. in 2 seconds with Vickers Pump). Wt. 8 lbs. A \$55.00 hydraulic cylinder value for only \$12.95 postpaid
3. Double action, 2¾" bore, 8" stroke. (Will lift 4400 lbs. in one second with Vickers Pump). Will withstand 1500 P.S.I. against wall. A \$65.00 value, available now at \$14.50 postpaid.

BRAND NEW HYDRAULIC CONTROL VALVES

With built-in relief valve. Use them manually or automatically for single or double action cylinders. Inlet port 3/16", outlet port 3/8", cylinder port 3/4". Complete with ILLUSTRATED instruction sheet. 6"x3 1/2"x3 1/4". \$5.95 postpaid.



VICKERS MF6 HYDRAULIC PUMP OR MOTOR

Compact, powerful, rated 1,000 P.S.I., 507 cu. in. per revolution, 8 gal. per min. at 3750 r.p.m. Change rotation by reversing flow. Delivers up to 6 H.P. BRAND NEW. Wt. 4½ lbs. \$60.00 value for \$14.95 postpaid.



GRINDING WHEELS

Actually Worth \$50.00

A wonderful buy! 350 pieces incl. 35 ass't. Grinding and Cut-off wheels up to 10 inches diameter, 1/16 to 1¼" face, ¼ to 3 in. holes. Ass't. grits—all brand new—Made by Norton, Carborundum, Macklin, Bay State, etc. Also included are 100 slotted disc cloths; 100 paper discs; 10 pencil rolls; 20 abrasive strips; 2 felt bobs; 2 felt wheels; 1 4" rag buff; 3 honing stones; 10 abrasive sleeves; 10 mounted stones, ½ and ¼" shank; 2 mandrels; 2 rotary files, ½" shank; 50 abrasive discs; 2 72" abrasive belts; 5 9x11 abrasive sheets. Satisfaction Guaranteed. 350 Pieces—Ass't. sizes FOB Chicago—All for **\$6.95** Only.

VACUUM-AIR HYDRAULIC

GENERAL PURPOSE PUMP

Original Cost \$45.00
Now Only \$9.95
Prepaid in U.S.A.

BRAND NEW!

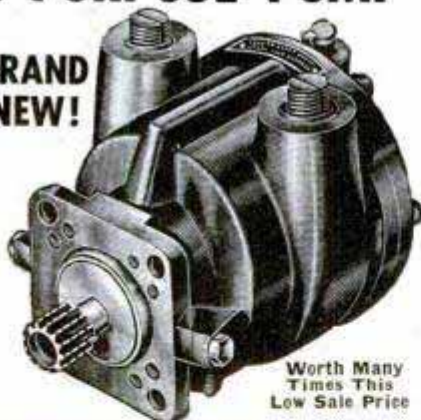

Worth Many Times This Low Sale Price

- Use them for
- SPRAYING MACHINES
- MILKING MACHINES
- COMPRESSORS
- VACUUM PUMPS
- HYDRAULIC SYSTEMS
- MANURE LOADERS
- PRESSES, etc.

Originally cost \$45.00. May be used as air or fluid pump—for pressure or vacuum. Standard ¾ inch pipe thread with interchangeable ports. Will pump 7½ gal. SAE 30 oil per minute at 300 RPM. Builds air pressure of 30 lbs. per sq. in. at 1000 RPM. Vacuum will draw 26 inches of mercury at 1750 RPM. Develops up to 120 lbs. per sq. inch of hydraulic pressure, which in conjunction with a 3 inch hydraulic cylinder will lift 800 lbs. minimum. Runs forward or reverse. Self aligning shaft. Die cast aluminum housing 6x4x4 inches. Has stainless alloy steel vanes and impeller. Made by Bendix Avia. Corp. Spline terminal for direct drive—readily replaced with a pulley. Recommend a ¼ H.P. or stronger electric motor. Rated capacity 1500 RPM with high overload factor. Special price for quantity users. Complete illustrated engineering report and instruction booklet FREE with every pump. Send check or money order today! Postpaid in U.S.A. **\$9.95**

CENTRIFUGAL PUMP

Belt Driven

Ready for use on any Liquid Pumping Need

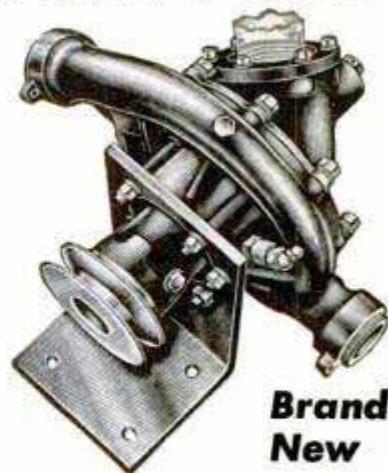

Brand New

- Use it for
- DRAINING BASEMENTS
- HOME WATER SYSTEMS
- IRRIGATION
- STOCK WATERING
- FIRE PROTECTION
- DRAINING PONDS, TANKS, etc.
- INDUSTRIAL PUMPING

A super value for all types of intermittent service in pumping large volumes of liquid in home, farm and industrial service. Ideal for home water systems, draining basements, fire protection, etc. On the farm for watering stock, draining ponds, sprinkling, etc. In shops and factories for all types of pumping service.

MOVE LARGE VOLUME QUICKLY

When operated at 1750 RPM, will pump 42 gallons per minute on a 23 foot head; at 3600 RPM on 52 foot head will pump 88 gallons per minute. May be run with electric motor, gas engine or power take-off on tractor.

COMPLETE ENGINEERING REPORTS AND OPERATING INSTRUCTIONS FREE WITH PUMP

Pump has cast aluminum housing—accurately machined bronze impeller vanes. Complete with mounting bracket and 3½" V belt pulley. Shaft rotates on sealed ball bearings with grease gun fitting. Has 1½" threaded intake flange, two 1 inch outlets. Use one or both, as necessary. Made for Packard Motor Car Co. for use in Rolls-Royce Merlin Aircraft engines.

Complete with Pulley and Mounting Bracket—Ready for Use

\$29.75

F. O. B. Chicago

GREATEST PUMP VALUE IN YEARS

Original cost approx. \$147.00. Sold F.O.B. Chicago. Shipping weight 23 lbs. You can't beat this value at anywhere near this price. Satisfaction guaranteed. Original Cost Approx. \$147.00.

U.S. SURPLUS BARGAIN

Polaroid Goggle Kit



Use them for all outdoor sports, beach, motoring, boating—anything.

Brand New! In original packing. Each with four interchangeable lenses. Shock Proof Frame. Shatterproof Lenses.

Heavy windproof sponge rubber ventilated frame with snap button lens retainers! Adj. elastic head band. Clear, red, green, amber, flexible, shatterproof lens, all instantly interchangeable, with carrying case. They won't last long at this price—it's smart to buy an extra. **\$1.00** Prepaid in U.S.A.



CLUTCH with UNIVERSAL JOINT

Used on midget auto racers, garden tractors, power lawn mowers, small boats and other power transmission applications. BRAND NEW. Formerly used on Amphibious Jeeps. Has steel shaft 3 ft. long, ¾" diameter and 5 inch pulley . . . with ball bearings in pulley can be used for power take off with winch and hoist. Worth a lot more, only **\$4.95** F.O.B. Chicago

GROBAN SUPPLY CO. DEPT. PM-5, 1507 S. MICHIGAN AVE., CHICAGO 5, ILL.

TOOL BARGAIN

Electric Hand

GRINDER ASSORTMENT
for cutting wood, metal or plastic.

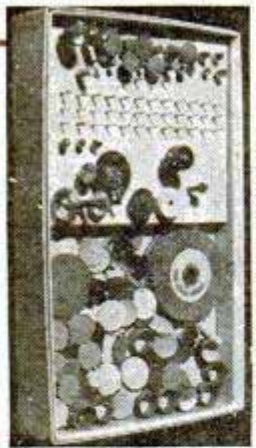

MASTER **\$9.75** A \$45 Value
KIT Only Postpaid

- 115 Grinding, Cutting and Polishing WHEELS PLUS 150 assorted tools most useful for Home or Shop.
- 2 Grinding Wheels 3" and 2" dia.
 - 2 Rotary Files, High Speed Steel.
 - 6 Rotary Cutters 1/8" Shank.
 - 3 Rotary Cutters 3/32" Shank.
 - 6 Mounted Grind. Wheels 1/2" Shank.
 - 6 Mounted Wheels 3/32" & 1/4" Shk.
 - 3 Rubber Wheels.
 - 4 Speed Drills 3/32" Shank.
 - 30 Rotary Cutting Burs 3/32" Shank.
 - 2 Mandrels 3/32" Shank.
 - 1 Mandrel 1/8" Shank.
 - 1 Screw Type Mandrel 3/32" Shank.
 - 3 Rotary Bristle Brushes 3/32" Shank
 - 1 Rotary Wire Brush 3/32" Shank.
 - 1 Circular Saw
 - 1 Mandrel for Circular Saw 1/8" Shank.
 - 2 Rubber Cylinders and Mandrel 3/32"
 - 10 Cut-off Discs up to 1" in dia.
 - 1 Rotary Drum Sander 1/8" Shank.
 - 15 Bands for Rotary Drum Sander.
 - 15 Rotary Felt Wheels 1" dia.

Compact container. Special rack for drills. Over 260 tools and items.

The right attachment for every job. **ORDER TODAY.** Send check or send \$2.00 deposit with C.O.D. order.

3-ROLL BARGAIN

1 1/2" — 100 and 400 Grit
2" — 100, 120, 150 Grit
3-50 YD. ROLLS
ABRASIVE CLOTH **\$5.95**
Now Only

Tremendous bargain in abrasive cloth rolls. **FOB Chicago**
Three 50 yd. aluminum oxide rolls of finest abrasive cloth from mfgs. like Minn. Mining Carburundum, Sandpaper Inc. A \$27.60 list value for only \$5.95. Specify widths and grit sizes. Send check or M.O. Or send on \$2.00 deposit and let bal. come C.O.D.

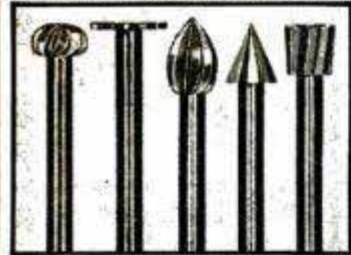

18 ROTARY CUTTERS
ASS'T. SIZES ON 1/8"
OR 3/32" SHANK

Will fit all electric hand grinders. Ideal for cutting wood, metal or plastic.

Reg. Value **NOW \$5.85**
\$13.50 ONLY post paid
\$2.00 Deposit on C.O.D. Orders

D. SCHUPACK 7331 Cottage Grove Ave. Dept. PM-5, Chicago 19, Ill.

UNCONDITIONALLY GUARANTEED

ALDOR

AUTOMATIC SPARK PLUGS

NON FOULING — AIR COOLED
THERMOSTATIC HEAT CONTROL

YOU GET

- INCREASED POWER
- SMOOTH PERFORMANCE
- INSTANT STARTING
- GREATER MILEAGE

For Cars, Trucks, Tractors, Marine Engines, Outboard Motors, Motorcycles, Buses, Farm Machinery and Lighting Plants

ALDOR AUTOMATIC SPARK PLUGS are the result of more than 40 years' experience in the manufacture of oil firing spark plugs

MILLIONS IN DAILY USE are giving the utmost in power and smooth performance to satisfied users

PRICE \$1.00 EACH—4 OR MORE .85 EACH
Mention Make and Year of Car—Order From

CENTRAL SALES
CORYDON, INDIANA

Orders Shipped Parcel Post Prepaid
Send Check, Money Order or C. O. D.



MOVE 800 CUBIC FEET AIR PER MINUTE!

With This Quiet, Sturdy, Constant Duty VENTILAIRE



VENTILATING FAN

Will remove stale Air, Odors, Fumes from room or space in home, store, office, shop, factory. Also useful for Drying, Cooling, Humidifying. Complete with cord and plug—attached—ready to plug in—easily installed.

\$11.50

10" Dia. Aluminum Blade • Sq. Steel Frame, 11"x11" • Constant Duty Ventilated Electric Motor • A.C., 110 V., 60 cyc., 1525 RPM • Shipping Wt. 6 lbs. Many others available in sizes from 7" to 42".

FULLY AUTOMATIC POWERFUL PISTON TYPE — VENTILAIRE — AIR COMPRESSOR

Reserve Tank • Pressure Regulator • With paint gun; 15 ft. hose. 1/4 h.p. capacitor motor, A.C., 110 volt, 60 cycle. Ready to plug in and operate. 1 1/2 cu. ft. air; 50 lbs. pressure max.

Ideal for Spray Painting • Tire Inflating • Insecticide Spraying • Beer Pump • Machinery Cleaning • Many other uses.

1/3 H.P. Size—2 1/2 cu. ft.—70 lbs. Max. Complete . \$95.00
1/2 H.P. Size—3 1/2 cu. ft.—90 lbs. Max. Complete . \$112.50
Other Sizes up to 5 H.P.

ELECTRIC TRADING CO., 313-315 Canal St., New York 13, N.Y.

Write for Catalogue "M" — Ventilating Fans, Exhaust Blowers, Mill Exhausters, Air-Compressors, Cellar Drainers, etc.



Do You Ride a Bike? Here's the Real

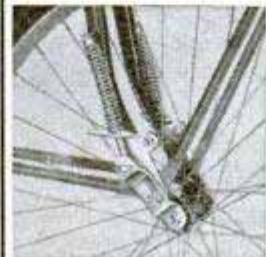

SHOCKMASTER for all Bicycles

- LEVELS ROUGH ROADS
- PREVENTS BROKEN SPOKES, WHEELS, FORKS
- MAKES RIDING SMOOTHER, SAFER
- EASY TO INSTALL

A Shockmaster and front wheel shock absorber. Ruggedly constructed of nickel plated steel and engineered for years of real service. It'll pay for itself in added pleasure, saves tires and eliminates many costly repair bills. 20,000 satisfied users. Order yours today. Only \$3.69 postpaid. No C.O.D.'s. Complete satisfaction or money back. Dealers Wanted.

H. M. GIBB and COMPANY

1304 PENOBSCOT BLDG. DEPT. A DETROIT 26, MICH.

Hey-Kids! And Grown-Ups, too! HERE'S the SENSATION OF THE AUTO AGE



THE AMAZING MYSTERY CAR

Want to keep your eyes guessing? Get the PUZZLE CAR—the laugh-mystery of the year! 'Round and 'round it goes—and why it turns, nobody knows. This is the little car with a mind of its own—put it on any surface—table top, carton top—and off it goes—and as soon as it reaches the edge, it turns to keep from falling off! Hitting a new high in hilarity and suspense, the PUZZLE CAR makes more fun than a barrel of monkeys—send for yours today! **SEND NO MONEY.** Rush your order today. Remit with order and we pay postage or order C.O.D. plus postage.

\$2.98

SATISFACTION GUARANTEED complete

BERNARD FINE CO. Inc. DEPT. PMCI
501 Sixth Avenue New York 11, N. Y.

SAY YOU SAW IT IN POPULAR MECHANICS

PLASTIC UTILITY BOX

TRANSPARENT

Ideal for Fishermen, Radio Mechanics, Jewelers, etc. Just the thing for small objects. 17 Compartments -- over all size 1 1/4" x 4 1/2" x 7 1/2". Regular \$1.95 value. Sent for only



Send for Free Catalog **\$1.00** Postpaid

NORTON BERGER • 117 MARKET STREET
PHILADELPHIA 6, PA.

POPULAR MECHANICS

For Outdoor Fun and Adventure . . . Ride a **Royal Enfield**

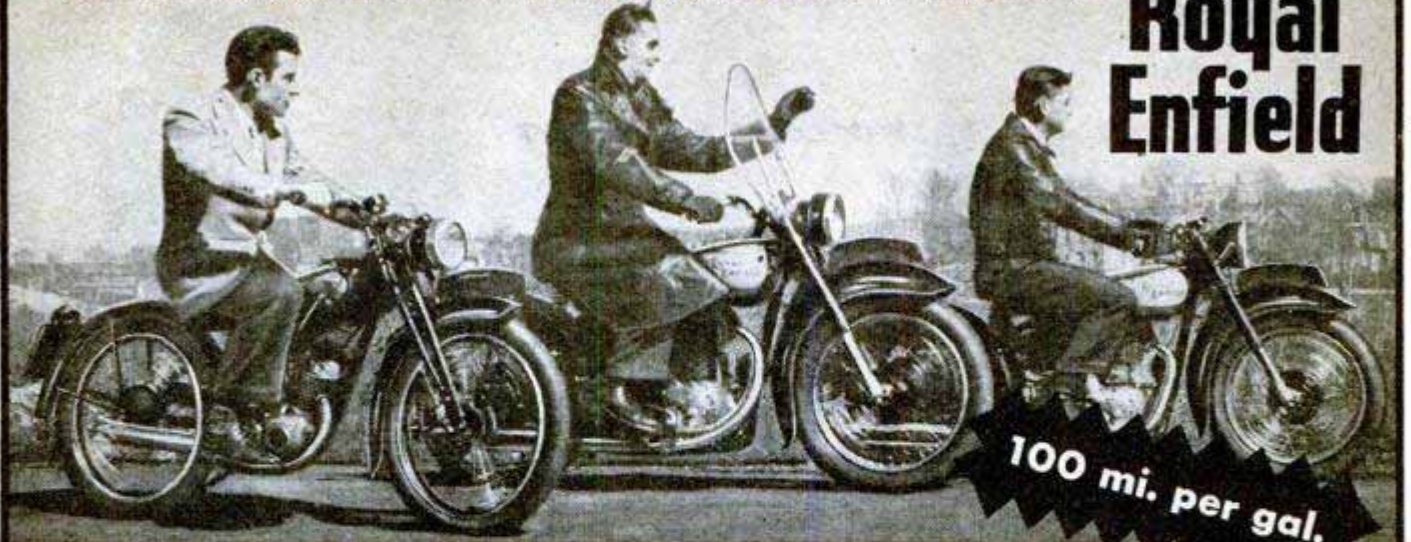

100 mi. per gal.

MODEL R. E.

MODEL G. 1

MODEL J. 2

THE WORLD'S MOST COMPLETE LINE OF MOTORCYCLES

Outdoor enthusiasts acclaim the new Royal Enfield Motorcycles. They are easy to ride whether you prefer the famous R. E. Lightweight or the Standard Models. Exclusive, precision-machined features assure dependable performance, outstanding riding comfort and economy of operation. For fun and adventure see your Royal Enfield dealer or write for folder "P" for complete details.

Dealer inquiries given prompt attention.

WHITEHALL DISTRIBUTORS, Inc.

1385 Commerce Avenue, New York 61, N. Y.

Model R. E. 125 c.c. Two-Stroke. Front fork with pressed steel blades; rubber suspension; needle, jet type carburetor, twist grip control.

Model G. 1 346 c.c. Overhead Valves. Push rods totally enclosed, automatically lubricated. AMAL carburetor, automotive type air cleaner. Cradle type frame; exclusive Telescope Front Fork and Neutral Finder.

Model J. 2 499 c.c. Overhead Valves. Push rods totally enclosed, automatically lubricated. High compression engine for top performance. AMAL carburetor, automotive type air cleaner. Cradle type frame; exclusive Telescope Front Fork and Neutral Finder. Two port exhaust system, chromed.



ALL-PURPOSE CUTTER YOU NEED!

Cuts holes, discs, grooves, beads—routs—rabbets in wood, plastic, even soft metal. "Wouldn't take \$100 for it," say users. No drill press or home workshop is complete without it.

\$1.00 with 3 Bits ONLY

Send check or money order to

SOUTHERN ENGINEERING & METAL PRODUCTS

21 N. E. 17th Terrace, Miami, Florida

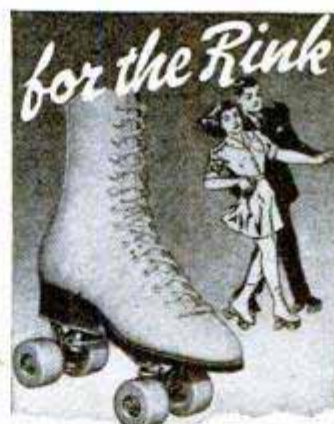

"CHICAGO" ROLLER SKATES

Forty years of leadership reflect the outstanding quality and performance of these beautiful "CHICAGO" Shoe Skates. Stars and Champions are made on "CHICAGOS." Be popular—get on the road to Stardom. Own a pair of the World's Finest Skates.

Consult your Rink Manager before you buy. Get the best and a perfect fit.

Choice of Champions

CHICAGO SCOUT FLYING Roller Skates

Boys and Girls all want "CHICAGO" Sidewalk Skates. The World's Greatest Roller Skates for youngsters or grown-ups. The Triple Tread, Ball Bearing Steel Wheels give more action—Speed and Longer Life. Demand "CHICAGOS" from your Dealer.



Send for **FREE** Booklet "How to Roller Skate." Enclose 10c for Skate Club pin. Value 25c.

For the Sidewalk



No. 101

CHICAGO ROLLER SKATE CO.

Leading Manufacturer of Rink Skates for Over 40 Years
4414 WEST LAKE STREET - CHICAGO 24, ILLINOIS

GIVES YOU 2 DRILLS IN 1



Converts any 1/4 inch Electric Drill to 1/2 inch capacity. Reduction gears reduce speed 5 to 1, the average speed of 1/2 inch Drill thereby increasing power.

Jobbers write Price **\$1.195** for proposition

M.O. or check with order

G. M. CO. MANUFACTURING, INC.

1308 43rd Avenue
Long Island City 1, New York

Keep Brushes like New

BEFORE

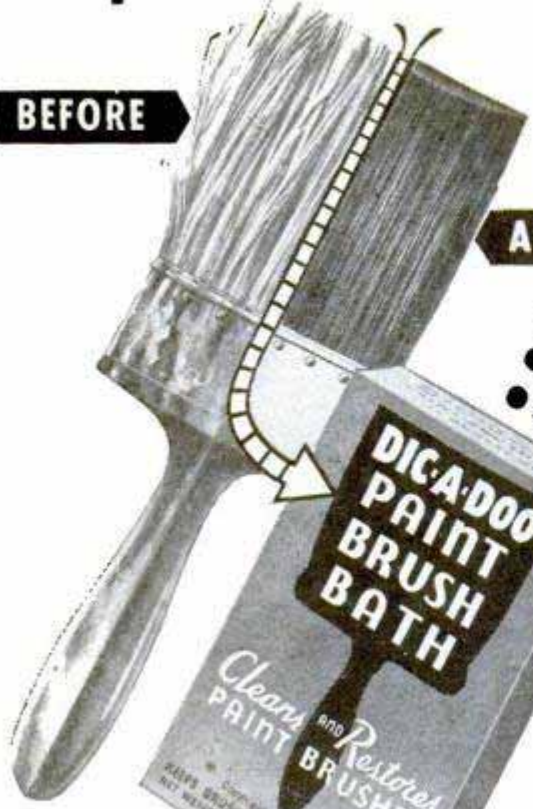

AFTER



DICA-DOO PAINT BRUSH BATH
Cleans and Restores PAINT BRUSHES

5c
10c
25c

At Paint, Hardware, Dept., and 5 & 10c Stores
Patent Cereals Co. Geneva, N. Y.

The New SIMPLE SIMON 12" BAND SAW ONLY \$49.99

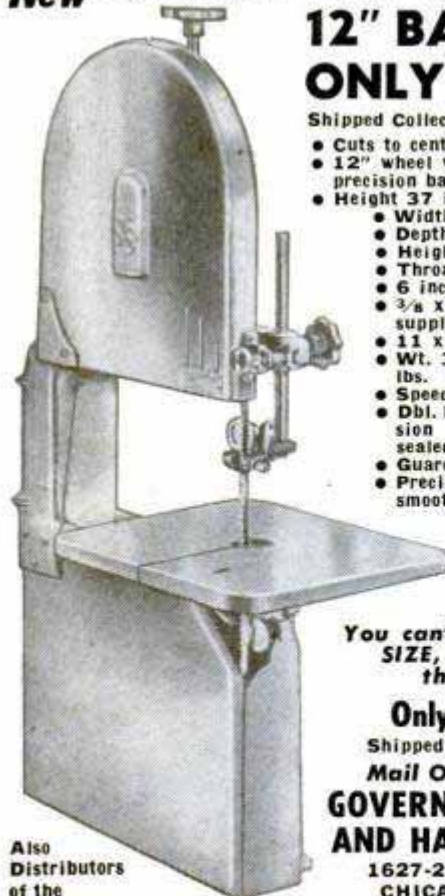

- Shipped Collect
- Cuts to center of 24" circle
 - 12" wheel with heavy rubber tire—precision balanced
 - Height 37 inches
 - Width 22½ inches
 - Depth 11 inches
 - Height of cut 6 inches
 - Throat 12 inches
 - 6 inch drive pulley included
 - ¾ x 80 inch long blade supplied
 - 11 x 13 inch table
 - Wt. 38 lbs. Shipping wt. 43 lbs.
 - Speed 600 R.P.M.
 - Dbl. BALL-BEARING suspension of each wheel, grease-sealed for life
 - Guard over blade for safety
 - Precision-balanced wheels for smooth operation
 - Cast, ribbed table tilts from 0° to 45°
 - Constructed of dural and aluminum—just wipe off to keep sparkling clean

You can't refuse this FULL SIZE, Quality Saw at this low price

Only \$49.99

Shipped Collect Chicago, Ill.

Mail Orders Payable to GOVERNMENT SURPLUS AND HARDWARE SALES

1627-29 N. DAMEN AVE. CHICAGO 47, ILLINOIS

Write For Circular and Prices.

Also Distributors of the Eagle Electric Drill Kits.

*Reg. Trade Mark



Assemble THIS FAMOUS, HAGERTY SEA SHELL* In a Few Hours

Make this light, tough, extremely stable, unsinkable boat in a few hours. Ideal for fishing, sailing, out-boarding. It weighs but 65 lbs. Easily transported. 8 ft. long, extra wide. It requires simple tools to assemble, everything else furnished. You save 75% cost of new boat. Earn money—make boats for others at a profit!

COMPLETE PARTS KIT, ONLY \$35.00

Includes: Assembly Jig and Full Scale Plans

Send ORDER or WRITE FOR LITERATURE To: PRITCHARDSONS' Dept. PM-2744 W. 37th Place CHICAGO 32, ILL.



The Modern PLASTIC for lasting Home Repairs

PERMANENTLY mends cracks or holes in wood, tile, stone or plaster. Sticks and stays put—Does not chip, shrink or fall out. Easy to use. Economical. Mold it, chisel it, polish or paint it. If unobtainable from your lumber, paint or hardware dealer, the big 4-lb. can will be sent you post-paid (in U.S.) for only \$1 Full money-back guarantee, order now.

DONALD DURHAM CO. Box 804-Q, Des Moines, Ia.



Ideal Gift for Mother — Wife — Sister

SEW WITH A SEW-LITE

MAKES SEWING A PLEASURE

Fits all type machines—chrome plated shade and socket with bracket, bulb and cord all assembled. Just attach and plug in. \$245 Post-Paid

110 V a-c-de complete with instructions

HOME SEWING MACHINE CO., 822 Fifth Ave., Brooklyn 32, N.Y.

FASTEST PLANER in the WORLD at this Low Price... \$195.00

BELSAW Multi-Duty Planer

Speed up production! Increase your profits! BELSAW power self-feeds at 24 feet per minute... The lowest-priced surfacer that will handle 12 x 6 in. stock. Planes green or dry sawed lumber into smooth, worked forms. Three high-speed steel knives make 42 cuts per inch. Multi-duty BELSAW takes inexpensive attachments for all planing mill operations—Jointing, Rabbeting, Grooving, Matching. BELSAW is the only 12 in. planer providing attachments for jointing and grinding its own knives. Start planning NOW for BIGGER VALUE and BETTER PERFORMANCE, with BELSAW. Write for FREE specifications, illustrations and low prices.



• LARGER CAPACITY • FASTER OUTPUT • KNIFE SHARPENING ATTACHMENT

BELSAW MACHINERY CO B-1016 Field Bldg., 315 Westport Rd., Kansas City, Mo.

Clean Clogged Drains Quick as a Flash!

WITHOUT Poisonous Caustics,
Dangerous Fumes — Use New

ZIP PRESSURE PLUNGER \$1.95

Now — HYDRAULIC WATER PRESSURE forces dirt, hardened grease, lint, etc. from clogged drains. Caustics work slowly — release dangerous fumes. ZIP PLUNGER pushes column of water into drain to force dirt out quickly. No fumes. No bad odors. Leaves drains sweet and clean. Saves plumbers bills, too! Pays for itself many times over. Send only \$1.95, and we pay delivery costs. Or we'll send C.O.D. for \$1.95 plus postage and C.O.D. charges. Sent on 10 days trial. Supply limited. Write for your ZIP PRESSURE PLUNGER now. Use for 10 days. If not delighted, return for full refund. (Mail order today — sure.)



Sent on 10 Days Trial

ZIP PRESSURE PLUNGER INC.

Dept. 17, 314 W. Chicago Ave.

Chicago 10, Ill.

Easy way to remove paint

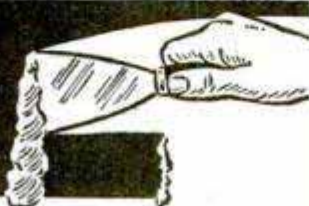

Write for
**WONDER-
PASTE
leaflet**

In refinishing furniture, woodwork, etc. all cracked or peeling portions of the old finish should be removed. It's easy with WONDER-PASTE REMOVER. Applied with an ordinary paint brush, this remarkable paste quickly softens up the toughest finish, whether paint, varnish, enamel, lacquer or shellac. Will not run, even on an upright surface. Turns the finish into a soft sludge that comes off easily at every stroke of the scraper. A long-time favorite of painters. Get Wonder-Paste at your paint or hardware store. Write for Wonder-Paste leaflet, and for advice on your particular removing problem.

Wilson-Imperial Co., 119 Chestnut Street, Newark 5, N. J.

MAGNETS OF ALL TYPES—10c UP
AMAZINGLY POWERFUL!!
5 oz. Alnico Magnet, lifts 10 lbs.
\$1.00. Our Leader, 15 oz. Magnet,
lifts 40 lbs. \$1.95. New alloy—will not
weaken! Useful for lifting valuables from tanks,
jakes, or rivers easily! 7 small magnets \$1.00 with
list of many shop and home uses. Satisfaction guaranteed.
R. EYRICH, 2566 N. 49TH ST., MILWAUKEE 10, WIS.

NYLON FISH LINE \$1.98
Approximately 1500 Feet
2 ply (25 pound test)—rubberized—water proof—long life.
Send cash, check or money order. We prepay postage.
ALLENDER & CO., Dept. 808, 2346 So. Dearborn St., Chicago
16, Ill.

SAY YOU SAW IT IN POPULAR MECHANICS

LET ME SEND
YOU THIS
AMAZING...



S. T. Christensen
President

ELECTRONIC KIT!



Get in on the Big Money NOW! It is not unusual for mechanically inclined men to make \$5.00 to \$6.00 an hour repairing electrical household appliances and factory machinery.

Lifetime Security can be yours in the fascinating, revolutionary, Electronic Repair Business. My Christy Electronic Kit checks and tests electrical equipment, current consumption, heat controls, shorts, motor winding, etc. and reveals where repairs are needed. My

Christy Course tells in simple, easy-to-understand language how to make each repair, how to build power tools, how to secure business, what to charge, where to get repair parts . . . in fact, everything is told.

**RUSH COUPON
TODAY!**

**GET FULL FACTS
.. BY WRITING NOW.**

Mr. S. T. Christensen, President
Christy Supply Co.
2835 N. Central Ave., Dept. D-5703
Chicago 34, Ill.

Mail me FREE without obligation complete illustrated information on how to get the Christy Electronic Kit and Christy Appliance Course.

Name.....Age.....

Address.....

City.....State.....

Speed Thrills! MINIATURE RACING with JET POWER and ENGINES



\$4.25
POSTPAID

Thimble Drome Racer

Power with Gas or Jet Engine.
Free Instructions with Each Car

New scale model of midget racer, the classiest thing you ever laid eyes on. Die Cast aluminum body, turned aluminum, rubber-tired wheels with treads. Chrome exhaust stacks. Wobble pump. Simulated leather seat and back.

Instrument panel and numbers. Equipped with bridge lugs for cable track racing. Car is 9 3/8" long, 4" high, weighs 18 oz. Can be powered with CO2 engine or most gas engines. Instructions accompany each car. Only \$3.95. Postage 30c additional.

GAD-JET RACER

All metal miniature racer, ultra streamline design. Aluminum, die cast, two-part body, aluminum wheels, rubber tires.

Completely finished, ready to go, with clip for jet cartridge racing, only \$1.50. Same, with OK CO2 engine and conversion kit for installing engine at home, \$6.95. Add 20c for postpaid delivery either model.

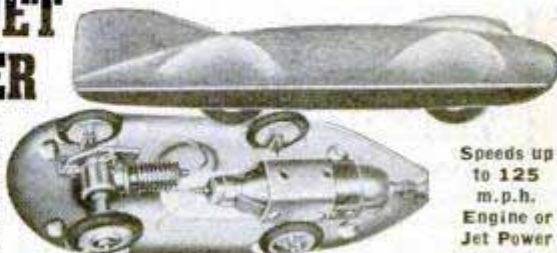

Speeds up
to 125
m. p. h.
Engine or
Jet Power

Rush Order to Address Below. If you prefer C.O.D. Delivery send \$1.00 deposit with order.

HOME SHOP PRODUCTS COMPANY, Dept. 15, 4821 Sheridan Road, Chicago

Portable Paint Sprayers

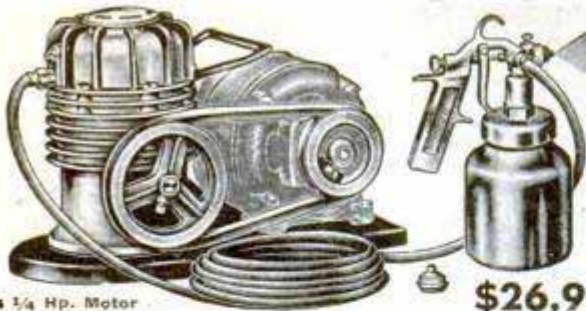

Uses 1/4 Hp. Motor

\$26.95

Complete as illustrated. less motor. Sprays all kind of paint, lacquer, varnish and etc. Oil-less ball bearing compressor. 2 cu. ft. air per minute. 15 to 50# pressure. Sprays paint 5 times faster than hand brushing.

No. 890—Outfit complete as shown, with "V" belt, motor pulley, 15 ft. high test air hose and No. 112 gun, but without motor. **\$26.95**

No. 444—Outfit, twin cyl. 4 cu. ft. production type gun. 15 ft. air hose, reg. and gauge. V belt and motor pulley. Complete less motor, **\$47.50**. Uses 1/2 Hp. motor.

Spray Guns—Low Pressure

Operate on 15 to 50# pressure

| | |
|---|--------|
| #115—1 qt. cup | \$4.95 |
| #112—1 qt. cup | 6.50 |
| #121—Production type | 7.95 |
| #125—External mix | 9.50 |
| Regulator & Gauge 0 to 160# | 4.95 |
| Air Filters | 1.85 |
| Air Hose—15 ft. | 1.75 |
| Air Hose—25 ft. | 2.75 |
| 3 Gal. Paint tanks, with hose, reg. and gauge | 24.95 |
| Less reg. and gauge | 17.95 |

HOME UTILITY BLACK & DECKER DRILLS—110 AC-DC—With Jacobs Hex Key Chuck—Pistol grip. 1/4". 2250 rpm. **\$18.95**

1/2" 375 rpm spade grip **\$35.95**

Sewing Machine Motor Kits—**\$16.95**

Bargain prices on motors, all sizes.

Woodworking Power Tools

SPECIAL—Paint sprayer outfit, complete with gun. Operates from any auto engine. **\$4.85**

WE STOCK NATIONALLY ADVERTISED MERCHANDISE ONLY. MONEY BACK GUARANTEE WITH EVERY ITEM SOLD.

Immediate delivery—check or M.O. with order shipped prepaid, cod's plus chgs.

INDIANA APPLIANCE CO.

20 East Sycamore Dept. PM548 Evansville, Ind.

NEW REVOLVING BINS for HOME WORKSHOPS

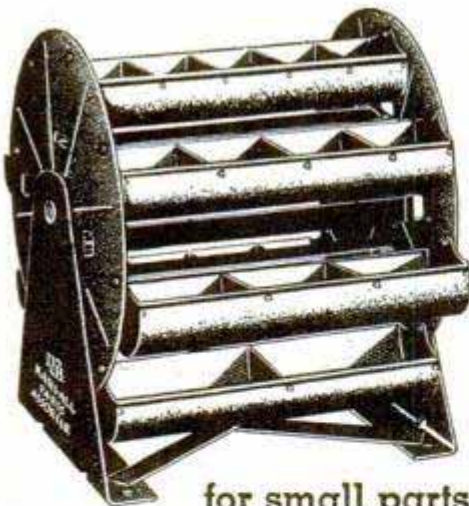

STANDARD MODEL:
10 1/2" x 10 1/2" x 12" — eight trays, 28 bins.

\$5.95
Prepaid in U.S.A.

JUMBO MODEL:
18 3/4" x 10 1/2" x 12" — eight trays, 56 bins.

\$8.95
Prepaid in U.S.A.

for small parts storage

The KARI-ALL PARTS ASSORTER

Keep nuts, bolts, screws, nails and other small parts always at your finger tips in the KARI-ALL. Rotates like a Ferris wheel. May be used on work bench or attached to wall or ceiling. Built to last a lifetime. Send check or money order—No C. O. D.

DIAGRAPH-BRADLEY INDUSTRIES, INC.

3745 Forest Park Blvd., St. Louis 8, Mo.

DEALERS WANTED

• Test ALL Home Outlets
• Find Open Circuits

STAR TEST-PLIERS

• Locate Blown Fuses
• Remove Fuses SAFELY

A must tool for electricians, maintenance men, home owners. Replaceable lamp inside Plier tests 110 to 250 Volts. Plier pulls fuses from 10 to 100 Amperes. Shockproof. Requires the use of only one hand. Can be obtained from General Electric or Westinghouse stores, or from local electric dealers.

Price \$2.75 without Leads, \$1.50 additional for Leads. Order TODAY. **STAR FUSE CO., 233 Canal St., New York 13, N. Y.**

FIND UNDERGROUND MINERALS and METALS with M-SCOPE

New sensational lightweight models, unsurpassed efficiency
Low prices. Time-payment plan. Write for free 16 page booklet.



FISHER RESEARCH LABORATORY, INC.
PALO ALTO CALIFORNIA

SAY YOU SAW IT IN POPULAR MECHANICS

ACE LATHE TOOL SET

Be permanently tooled-up for every operation on your Metal Cutting Lathe

The ACE Set is complete—there's nothing more to buy. Drop forged by the manufacturers of cutting tools used by 96 per cent of the plants and shops in industry they are correctly designed, are of special steel, are finely finished, are stronger—will last a lifetime. You can cut easier, faster and more accurately with ACE TOOLS. At your Hardware Store—

ARMSTRONG BROS. TOOL CO.
"The Tool Holder People"
5268 W. Armstrong Ave., Chicago 30, U.S.A.

1 Turning Tool, 2 Cutting Off Tools, Knurling Tool, Boring Tool, Threading Tool, High Speed Steel Cutters and Blades, and 2 Wrenches in Fitted Steel Case.

WAKE UP YOUR Scalp

BE FAIR TO YOUR HAIR Want better looking hair? Embarrassed by falling dandruff, itching scalp? Then try VITABRUSH, new electric driven scalp brush that gives your scalp a vigorous and invigorating "workout" in just three minutes of fun. Cleans scalp. Stimulates blood supply. Restful. Pleasant. Write today for complete information and satisfaction-guaranteed offer. Hershey Mfg. Co., 149 S. La Salle, Chicago 3.

WAR Surplus

AND OTHER Startling BARGAINS.



BRAND NEW
Khaki SUN TAN SHIRTS & PANTS

BRAND NEW! Pants made of 8 oz. and shirts of 6 oz. mercerized khaki suntan twill materials. Well tailored. Add 8c per garment postage.

SHIRTS **2.99** PANTS **3.79**
 14 to 17 29 to 42

SEND FOR FREE

SENSATIONAL VALUE!

24 K Gold Plated FRAME 4 BASE CURVE LENSES

Aviators' Style SUN GLASSES

Precision made. 24 K GOLD PLATED METAL FRAME. 4 base curve. Ophthalmic ground. Pearl sweatband. SHUTS OUT 98% OF THE ULTRA VIOLET RAY. We sold thousands at \$5.00. Add 12c postage and handling.

2.88

50 FT. HANK NYLON

59¢ PARACHUTE CORD

New. 3/8 inch diameter. Ideal for clothes lines and venetian blind and drapery cords. 550 lbs. tensile strength. Add 3c postage.

NAVY STYLE T-SHIRTS

Brand new. Sizes, small, medium and large. White only. Fine long staple combed cotton yarn. Add 3c per garment postage.

69¢

Greatest Watch Value in U.S.A!

17-JEWEL Military Style

Think of it! Here is a genuine 17-jewel wrist watch with a GUARANTEED SWISS MOVEMENT. WATER & DUST REPELLANT. SHOCKPROOF. ANTI-MAGNETIC. RADIUM DIAL and SWEEP SECOND HAND. Set in a genuine stainless steel case with a fine leather strap. Save at least \$15.00. If you don't think this the greatest value in the U.S., return it for refund.

19.95 PLUS 10% FED. TAX

U.S. NAVY WORK JACKETS

U.S. Navy Regulation
 First Quality
 Brand New
 Full Cut Size

Made of 8 oz. green herringbone twill. Tailored to Navy specifications. Ideal utility and work jackets. Add 10c per garment postage.

1.69

WAR Surplus CIRCULAR

OVER 150 OUTSTANDING WAR SURPLUS BARGAINS ---also many other special offers.

Surplus UNLINED NAVY FIELD JACKETS

BRAND NEW. Made of fine quality water-repellant poplin material. Unlined, full zipper front, 2 slash pockets. WORTH TWICE OUR PRICE. Add 10c postage.

3.99

Surplus DUST MASKS

Brand new. For paint or insect spraying. For millers and farmers. Perfect dust protection. Add 5c postage.

33¢

O.D. wool serge SHIRTS-PANTS

Used but in excellent condition, perfect. They have been designated for RE-ISSUE BY THE GOVT. Pure wool serge. Less than the price of the cheapest overall. Add 8c per garment for postage.

SHIRTS **2.69** PANTS **2.79**
 13 to 15 27 to 33

MAIL ORDERS

Please send remittance with order. Include postage. Order will be sent C.O.D. plus C.O.D. fee. Satisfaction or your money back.

Send today

SIoux FALLS SURPLUS STORE
 SIoux FALLS, S. D.

"YOU ARE UNDER ARREST!"

Help Bring Crooks to Justice Through Scientific **CRIME DETECTION!**

We have taught thousands this exciting, profitable, pleasant profession. Let us teach you in your own home. Learn Finger Printing, Firearms Identification, Police Photography, Secret Service Methods thoroughly, quickly, at small cost. Over 800 of all American Bureaus of Identification employ I. A. S. students or graduates. We can prepare you for this fascinating work, during spare time. Write today, stating age, for "Blue Book of Crime."

INSTITUTE OF APPLIED SCIENCE, 1920 Sunnyside Ave., Dept. 9355, Chicago 40, Ill.

UTILITY CABINET

36 Roomy Compartments
 4-7" Drawers with Removable Partitions

A Thousand Uses For

**HOBBYISTS
 MECHANICS
 DRAFTSMEN
 TECHNICIANS**

For home workshop, factory, laboratory, garage, outdoors, fishing and hunting. Made of heavy gauge aluminum. Strong airplane construction. Sag proof—Rust proof.

\$2.98 plus postage
 Shipping Weight 2 lbs., 8 ozs.

Cut out this coupon and send with money

NAME.....
 ADDRESS.....
 CITY..... STATE.....
 Enclosed find check or money order for \$2.98.
THE KNICKERBOCKER CO. ST. CLAIR, MICHIGAN

SAY YOU SAW IT IN POPULAR MECHANICS

We'll Start You Complete in this PRODUCTS BUSINESS And Help You Put It Over

The great building industry is your profitable market for masonry products. Low investment . . . high returns . . . wide-open opportunity to establish a lifetime business.

The biggest building years in the nation's history are just beginning. New construction, involving billions of dollars, means huge demands for block, drain tile, and other masonry products which YOU can manufacture locally, from local materials, with local labor for local consumption. Remember, MASONRY products are in mesh with today's building preference!

Use our modern machines and equipment to insure the finest quality products at pared-to-the-bone manufacturing costs. Sold direct from factory to you. Backed by 40 years of pioneering and manufacturing. Write for new catalog. Describes complete line of equipment with prices plainly marked. Tells how we help you in manufacturing and merchandising. Write TODAY.

CONCRETE EQUIPMENT COMPANY
 512 Ottawa Avenue
 Holland, Mich.

YOUR "STARS" Really SHINE



ON A
DA-LITE
(Reg. U. S. Pat. Off.)
SCREEN

DA-LITE CHALLENGER
The preferred tripod screen for homes, schools, industry. Quickest set-up. Instant "Slide-A-Matic" locking. Handsome, sturdy, octagon case. Lightest weight.

Da-Lite's multi-layer Pyroxylin-faced, Crystal-Beaded fabric makes all pictures—movies or slides—"come to life" with sparkling brilliance. Built right by pioneers who have led in screen improvements for 39 years. Priced below 10 years ago.

Write for new **FREE** book on Da-Lite Screens, (41 sizes); has projection data and size charts.

DA-LITE SCREEN CO., INC.
272½ N. Pulaski Rd., Chicago 39, Ill.



WORLD'S LARGEST SELLING SCREENS SINCE 1909

WALKIE-TALKIES!



Radio Telephone Sends And Receives Several Miles

This is the light weight battery-operated radio that was used so successfully by the Army. One knob tunes both transmitter and receiver. Sends and receives merely by pushing a button. Recommended for amateurs, explorers, police and Government services, etc. Shipped ready to operate, complete with tubes, telephone handset, telescoping antenna, and new batteries. Rebuilt by the Government and guaranteed. Price only \$45.00 each or \$90.00 per pair F. O. B. Chicago.

Extra Batteries (80 hours continuous service) \$4.75 each.

Parts and Accessories for Walkie Talkies

We maintain complete stocks of replacement parts, batteries, antennas, chassis, etc., for Army Walkie Talkies and Handie Talkies. Write for Special Listing No. 20.



320 N. La Salle St., Dept. P-5
Chicago 10, Illinois

SANDING WHEEL

CAST ALUMINUM
for all ½ in. shafts. 5½ in. diameter. Full 2 in. surface. A fast, smooth sander for—WOOD, PLASTIC OR SOLDER... Will not load up. Takes place of sanding belt.



FOR SHARPENING KNIVES... CHISELS... DRILLS

only **\$3.00** complete

Now keep kitchen knives... workshop tools really sharp.

Note—Emery cloth is inserted in slot and tightened with Allen Wrench.

order from **BRAINARD & Co**
Box 11
Moline..... Illinois



WATSON DOUBLE-ACTION HYDRAULIC TRAILER DOLLY
60 miles per hour SAFELY — all day

THE WATSON AUTOMATIC MACHINE CO.
Glendale, Calif. Mansfield, Ohio

4 WHEELER
(Illustrated)
\$175
Cap. 1200 lbs.

2 WHEELER
\$125
Cap. 600 lbs.

Genuine Snap-on Tools

Available Only Through Snap-on's Direct-To-User Tool Service

WRITE FOR INFORMATION
SNAP-ON TOOLS CORP. • Kenosha, Wisconsin

KEEPS YOU RIGHT

When You Could be Wrong



AUTOMOBILE COMPASS \$5.95
(ILLUMINATED)

Automobile Compass \$3.95
(STANDARD)

Boat Compass \$2.75
BY HULL

HULL MFG. CO., P. O. Box 246-D5, Warren, Ohio

Please Mention Popular Mechanics When Answering Ads

PRICES SLASHED! ALUMINUM PIPES

\$4.50 pipe for \$1.00. Imported briar bowl, hard rubber stem, air cooled aluminum shank. No filters required. Check or money order, we pay postage. C. O. D. orders filled on request. Write for **FREE** catalog of pipes and cigars.

\$1

SATISFACTION GUARANTEED OR YOUR MONEY BACK

Eddie THE CIGAR MAN
Dept. M-5, 1094 Bedford Ave., Brooklyn 5, N. Y.



New IMPROVED Electric MOTO-SAW

ONLY \$585
(with 3 Saw
Blades) Postpaid



SAFE AS A HAND SAW
JUST GUIDE IT!

More like magic than any tool you ever saw. Imagine an electric scroll saw only slightly heavier than a hand coping saw... a tool that takes no effort to run, no pressure to feed. Works at any angle — on big assembly jobs or on the tiniest piece you can hold in your fingers. Runs 7200 strokes a minute... so fast the blade seems to stand still. Sturdily built... only two moving parts... never needs oiling. Easily cuts intricate designs — so smooth it eliminates sanding. Novice or craftsman, a thrill awaits you when you get a Moto-Saw in your hand.



THOUSANDS OF SATISFIED USERS
U. S. Patent 2233862
Other Patents Pending.
Dremel Mfg. Co.
Dept. S-118-E
Racine, Wisconsin

No Limit to Length of Stock it Will Cut. Saws to Center of 19" Widths.

It's fast... cuts on an average of 1 ft. per minute up to 3/4" medium hard wood. Operates on 110-120 V. 50 or 60 cycle alternating current. If your dealer does not yet have Moto-Saw, send \$5.85... we'll pay postage. Or send \$1, pay postman balance plus postage. MONEY BACK if not delighted after 5 days' trial.

Save Fingers with Steel-Grip Finger Guards



Hundreds of factories are saving time and protecting workers with Steel-Grip Finger Guards. Used for handling rough, sharp articles, buffing, grinding, sanding, polishing, punch press work, many other jobs. Wear on fingers or thumb, front or back. Durable leather, elastic web back for snug, cool, comfortable fit. Easy on and off. One size fits all, men or women. Send 10c each for samples or trial order box of 50 at \$4.25 less 10%.

Catalog of Steel-Grip Safety Apparel free on request.

INDUSTRIAL GLOVES COMPANY
1400 Garfield Blvd., Danville, Ill.
(In Canada: Safety Supply Co., Toronto)



GARDEN TRACTORS

\$146.50

F.O.B. Ravenna

LATEST MODEL C SPEEDEX

1 1/2 Horsepower with cultivator 500-12 pneumatic tires, powered with Briggs and Stratton engine, and many other features. Deliveries being made now. Prices slightly higher West of Rockies.



P-248-33

WRITE FOR FREE BOOKLET

POND GARDEN TRACTOR

BOX 216

5821 First Ave., South

RAVENNA, OHIO

Seattle, Wash.

LIFETIME BRONZE ANCHOR FOR FISHING & HUNTING BOATS

Non-rusting, non-corrosive... single cast assembly... "nothing to come apart."

Weight: 9 lbs.
Arms: 9 1/2" (length)
Flukes: 2 3/8"
Over-all length: 17"
Swivel shank in 6 1/2"
self-cleaning housing. Will not foul ropes.

\$3.50
FOB
IMMEDIATE DELIVERY

CALDWELL & WARD BRASS CO.
SYRACUSE, NEW YORK

America's Best Auto Values BUY DIRECT! SAVE 50% to 75%

Adjustable ALL ALUMINUM SUN VISOR

Universal—will fit popular cars. NO HOLES TO DRILL. Simple to Install. WILL NOT RUST, TEAR, or WARP. Chrome plated fittings. Custom-built to contour of car. Relieves eye strain. Gives clearer vision in fog, rain or sleet. ALL ALUMINUM. Lasts for years. Prime finish. \$29.95 Value. Our low price saves you 50%..... **\$1345**

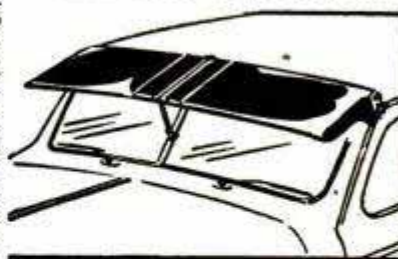

PLUG-A-LITE AUTO SERVICE LIGHT

Plugs into cigar lighter socket. Comes with shield reflector, hook and ground die. Toggled cord and bulb. Ready for instant use. You'll be glad you had one. \$2.00 VALUE! A real buy **\$1.19** at.....



SEALED BEAM CHROME SPOTLIGHT

Not ordinary spotlight but SEALED BEAM. Inner control pistol grip handle. Toggle switch. SEALED BEAM UNIT throws powerful long distance penetrating beam. Full rotation... All weather... Triple chrome plated. \$18.50 VALUE, Amazing **\$1045** Value—each.....

AUTO TOP CARRIER

HEAVY DUTY! Complete with 8 oversize rubber suction cups and straps. Ideal for carrying that extra load. Perfect for fisherman, tourists, salesmen, farmers, etc. Adjustable features—Will fit on any car. Complete, ready to use. \$12.00 VALUE! Unheard- **\$595** of Bargain at.....

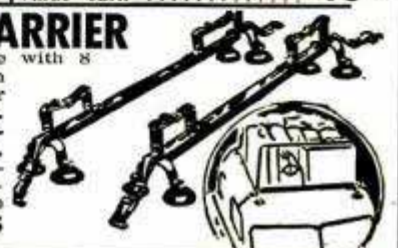

ALL Chrome SEALED BEAM FOG LIGHT

Never a value like this! 1948 model. Complete with insulated wire, switch and universal mounting. Streamlined shallow type to fit all late model cars. AMBER LENS to pierce fog. **\$395** IN PAIRS..... \$7.65 pair



GIANT ALL PURPOSE LOCKING JAW WRENCH

10 inch Size. Full Adjustable. Does the work of pliers, end wrench, pipe wrench, clamp, etc. With non-slipping VISE GRIP. **\$2.95 VALUE!** Very, **\$145** very special—Each.....



HYDRAULIC BUMPER JACK

Heavy duty! \$15.00 VALUE! So positive and simple to operate will raise the car with a few strokes of the handle. Has lifting range of 16", which is ample for any pass., car and **\$795** light truck. Complete with handle. Each

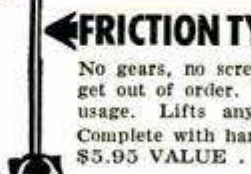

FRICITION TYPE BUMPER JACK

No gears, no screws, no valves, no ratchets to get out of order. Extra strong, built for hard usage. Lifts any pass., car or light truck. Complete with handle. **\$5.95 VALUE**..... **\$295**

WE ARE FACTORY DISTRIBUTORS. Our stock Guaranteed Brand New. (Not Surplus or Distressed.) Prices F.O.B. Chicago. 25% Cash with Order. Balance C.O.D. plus charges. Or Deduct 2% Discount if Full Remittance Accompanies Order. Illinois residents add 2% for state tax.

WANTED-SALESMEN FREE! Send name and address — we will mail latest bargain bulletins with money saving values!

SEL-LO DISTRIBUTORS

MAIL ORDER DIVISION
LOCK BOX 8191 CHICAGO, ILL.

SAY YOU SAW IT IN POPULAR MECHANICS

WHETHER YOU
FARM FOR FUN or
FARM FOR PROFIT

YOU'LL DO IT
QUICKER
AND
BETTER

WITH A

Bready GARDEN
TRACTOR

Part-time farmers can mechanize too—with the all-purpose, easy-handling BREADY GARDEN TRACTOR. For on small acreage, BREADY does *all* the work—makes gardening fun for the whole family! And on larger farms, BREADY is a *profitable auxiliary*. Low in cost, inexpensive to use, powerful 1½ H.P. motor, complete line of implements for year 'round use. *Write Today* for free folder.

THE BREADY TRACTOR & IMPLEMENT CO.
BOX NO. 230 SOLON, OHIO

CASH FOR
YOUR
SPARE
TIME

MACHINE SAW FILING PAYS UP TO \$2 or \$3 an hour. With a Foley Saw Filer you can file all hand saws, also band and cross-cut circular saws. It is easy to operate—simple adjustments—no eyestrain. Start AT HOME in basement or garage. Patented jointing principle evens up all irregular teeth and makes an old saw cut just like new.

Send Coupon for
FREE PLAN

No canvassing necessary—"I advertised in our local paper and got in 93 saws—I only work spare time at present" says M. L. T., Ohio. L. H. M., New York, writes: "I made about \$900 in spare time last year." You can get IMMEDIATE DELIVERY on a Foley Saw Filer. Send coupon today—no obligation.

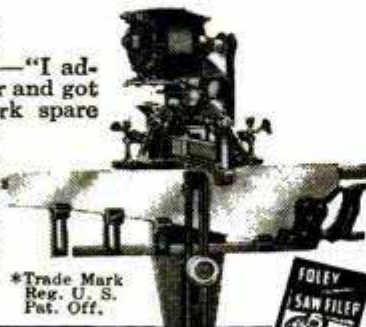

*Trade Mark
Reg. U. S.
Pat. Off.

FOLEY Automatic SAW FILER

FOLEY MANUFACTURING CO.
316-B Foley Bldg., Minneapolis 18, Minnesota
Send Free Plan on Saw Filing business, no obligation.

Name.....
Address.....

Famous BANNER
FIREWORKS

OH-BOY! Don't be disappointed. Get the best for your money. Famous Banner Fireworks have all the ZIP, BOOM, BANG you expect of fireworks. This year several new creations have been added. You'll thrill to every last piece in this Big Bargain Assortment.

BIG SPECIAL DEAL—ONLY \$4.95
Retail value \$11.25. Buzz Bombs—Star shells Block Busters—Zig-Zag Whistles—Flashlight Crackers—Sky Rockets—Roman Candles—Repeating Aerial Bombs, Sparklers and many others. Over 500 pieces in all. Rush order today. Supply limited. Send money order, bank draft or currency. No C. O. D.'s. Catalog FREE.

BANNER FIREWORKS MFG. CO., INC., DEPT. 141
446 Capistrano Toledo 12, Ohio



LOW PRICED
STEAM CLEANER

Jenz Super Chief

Portable—No moving parts—Cleans anything—Motors—Chassis—Machinery—Floors—Buildings—Remove wallpaper—Dairy & Creamery—Oil Rigs etc. Oil fired—Economical—fully tested and warranted. 75# Steam in less than 10 min. Model 70, Complete as illustrated. **\$276.50**

F.O.B. factory.
HI-PURE LABORATORIES
EVANSVILLE, IND.

NEWEST OTTAWA LOG SAW

SELF-PROPELLED — MOVES ANYWHERE on OWN POWER

World's fastest Log Saw. Powerful 6 H-P air-cooled motor. Attachments for sawing down trees, buzzing limbs, post hole digging and pulley for belt jobs. Big demand for wood, pulp, posts. Make big money sawing wood this easy way. Low factory-to-user prices. Nothing like it. FREE details.



OTTAWA MFG. CO., 7-827 Pine St., Ottawa, Kansas



Make **BIG MONEY . . . in** } Send for **FREE CATALOG**
WRITE NOW!
No obligation

Learn how YOU can start your own profitable Plastics business for just a few dollars. No experience necessary, we teach you how, furnish you with all supplies and Marketing Helps. This is your opportunity! **DON'T DELAY!**

COLONIAL PLASTICS CO., 216 S. 7th St., St. Louis, Mo. Dept. M2

Say You Saw It In
POPULAR MECHANICS

Dado any width with a DA-DALL

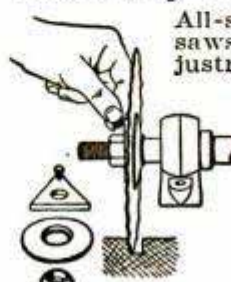

All-steel attachment for circular power saws; dados any width with one adjustment. Safe, easy to install and use.

STANDARD (for saws to 10" diam.)..... \$4.75

HEAVY DUTY (for saws over 10")..... \$8.75

(Specify arbor size when ordering.)

Money-back guarantee. Write for free pamphlet, or order now (no c.o.d.'s, please . . . California buyers, add sales tax).

• Dealer Inquiries
Invited.

PACIFIC COAST TOOL CO.
1711-A Webster St., Oakland 12, Calif.



SANDING FURNITURE



SANDING WOODWORK



REFINISHING CARS

THE BULL BUFFER
PAT. PEND.

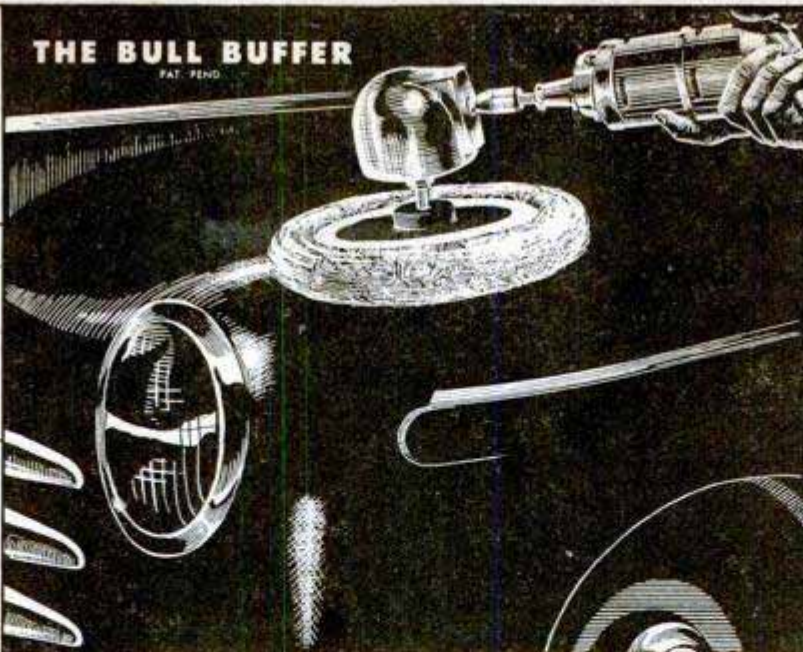

POLISHING CARS



POLISHING FLOORS



POLISHING FURNITURE

Pat. Pend.

The very first time you polish your car, sand your own floors, refinish furniture, this tool has more than paid for itself. And what a kick you'll get out of doing all the polishing and sanding jobs that used to cost lots of money! With the Bull Buffer, you can do beautiful, professional work—make your car, furniture, floors, woodwork gleam like new. You'll find no limit to the ways Bull Buffer will save time and money in your home and business.

- Used in
- HOMES**
- FARMS**
- FACTORIES**
- GARAGES**
- OFFICE BLDGS.**
- STORES**
- SHOPS**
- SERVICE STATIONS**
- CABINET SHOPS**
- METAL SHOPS**
- UPHOLSTERING SHOPS**

THE BULL BUFFER FITS ANY CHUCK ON AN ELECTRIC DRILL (OR FLEXIBLE SHAFT). Attach it quickly . . . polish and sand . . . then disconnect it and use your drill for any other purpose.

HIGHLY MANEUVERABLE, EASY TO OPERATE. Holding drill stationary, buffer can be turned in a

complete circle. Bull Buffer easily reaches all curved or flat surfaces. It's RUGGED — POWERFUL — BUILT TO LAST A LIFETIME. Sturdy aluminum casting houses self-lubricated bearings and steel gears that operate in a bath of oil. All materials and workmanship are guaranteed.

The sooner you order, the sooner you'll have this handy new tool in your hands. It's a real bargain—only \$9.95, complete with five-inch rubber disc, sheepskin bonnet, and 2 sanding discs. (Extra bonnets, \$1.25—extra medium and coarse sanding discs, 10c each.) If your dealer doesn't stock, send cash, check or money order for \$9.95, postage prepaid. C.O.D. plus postage. **\$9.95**

BERTRAM A. ENGINEERING COMPANY
3034 MAIN ST. KANSAS CITY, MO.
DEALERS WRITE FOR INFORMATION



MUFFLERS
STEELS and ALUMINUMS
with a motorboat tone

SINGLES, Chev., V-8, Plymouth, Steels \$5.50, Aluminum \$7.00. Chry., Olds., Buicks, etc., Steels \$7.50, Aluminum \$9.00. V-8 and MERCURY DUALS, Steel \$17.50, Aluminum \$21.00. Split Manifold Sets, Steels \$35.00, Aluminum \$45.00. Aluminum are guaranteed for life of your car.

SANDEE MUFFLER CO.
BOX 296 LA TIJ., LOS ANGELES 43, CALIF
2624 W. SLAUSON AVE., LOS ANGELES, CALIF.

BARGAINS UNLIMITED

Hundreds of money-saving values at today's lowest prices — for your every need.

FREE CATALOG

of Refrigeration, Radio, and Electrical Supplies.
Send for yours at once!

G. & E. Equipment Supply Co.
Ogden at Fulton Chicago 7, Ill.

ZIPSCOOT \$49.75

America's Outstanding Scooter Value!
This smart looking speedster is easily and quickly assembled from our factory finished kits. Uses standard gasoline motor. Speeds up to 30 miles per hour. 100 miles per gallon of gas. Send 25 cents for assembly information, drawings, and illustrations. Kits available for immediate shipment.



Zipscot Company, Toledo 6, Ohio



Get This
AMAZING MISENER **HOLE SAW**
Multi-cut



Cuts finished HOLES, WHEELS, DISKS, RINGS, GROOVES

One Tool Head Holds
11 SIZES OF BLADES
1, 1 1/4, 1 1/2, 1 3/4, 2, 2 1/4, 2 1/2, 2 3/4, 3, 3 1/4, 3 1/2 dia.
(3/4" Blade Depth)

Replacement blades at LOW COST

Perfectly cuts WOOD, METALS, PLASTICS and many other materials

—with electric drill or bit brace

—on drill presses and lathes

ONLY

\$17.50

Includes Tool Head and 11 sizes of blades

Specify whether for power or hand use

Send for Folder "THE HOLE STORY"

MISENER
Mfg. Co., Inc.

Walton St.
SYRACUSE 2, N. Y.

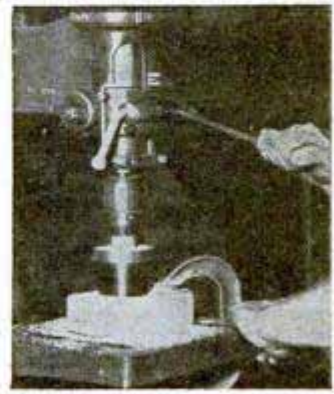

AUTOMOBILE OWNERS ATTENTION!

Auto Sluggish
Troubled with Carbon
Spark Plugs Foul and Burn
Ping in Your Motor
Valves Sticking
Cylinders Showing Wear
Want More Miles Per Gallon



USE



The Modern Motor Vitelizer

A Secret Formula Developed During the War

ONLY 1 OZ. NEEDED IN 10 GAL. OF GASOLINE

Ask Your Service Station Operator or
Write Us

LENZ TESTING LABORATORIES

ARMORY PLACE

LOUISVILLE 2, KY.

WAR SURPLUS AND OTHER BARGAINS

POWER DRIVEN ANTENNA REEL

1/4 HP, G. E. Motor—12-24 V. Removable 6" Reel. Cam worm gears, bevel gear. Solenoid clutch. In gear only when current on. Operates clockwise or counter clockwise. Ideal for power fish line, opening or closing doors, auxiliary power take-off. Can be used as buffing machine or for dozen of other uses. New. Weight 6 Lbs. \$4.50 each.



CLIPS: Rubber lined, aluminum, hundreds of uses in any shop. Assorted sizes, all new. 5 Doz. \$1. — 500 \$5.

SEND CHECK, MONEY ORDER or CASH

MICROMETER



Chrome plated, precision, engineered and carefully tooled to give long life ...

all new: 0-1" capacity, \$2.25.
1-2" capacity, \$3.50 Each.

HIGH SPEED DRILL BITS



Like new!
Original value over \$16.00.
25 assorted sizes & lengths \$2.50.

ROUTER BIT ground for BORING BAR: High speed steel, right hand, single flute, 1/2" bit, straight shank for 3/8" chucks. Ideal for every machine shop. Like new, original cost about \$10. 3 for \$2



25% DEPOSIT REQUIRED ON C.O.D. ORDERS

SCOOP!
We have been awarded 100,000 genuine briar pipes by Quarter-



master Corps. Assorted shapes and sizes. All popular makes. Set of 6, \$3.50



MICROSWITCH:
Type Z-2"x1"x1". Used open or closed. For automatic contact- ing-light, sound, model train systems, chimes, etc. New. 3 for \$1. Aluminum Spring Actuator to fit above Microswitch. 3 for \$1.

EMERSON 3 HP MOTOR:

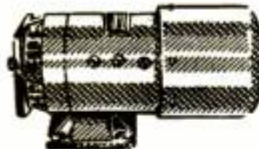

AAF Type D50. This motor can also be used as generator when driven by another motor. Ideal for portable welder, etc. 28 Volts, D.C. Compound, 3800 RPM, 115 AMP, windings glass insulated, blower cooled, shaft dimension 5/8". Weight 27 Lbs. New. \$13.95 each

ALL PRICES F.O.B. CULVER CITY, CALIF.

GOGGLES:



Designed for paratroopers. Great for motorcycling, speed boating, hot-rod driving, etc. (One polarized and one clear) All new 2 pair for \$1.00.

4 in 1 SCREWDRIVER:



3 smaller sizes fit into 6" overall size. Fine steel bits. Solid brass handles. All New. Each \$1.

TRANSFORMER: Jefferson Electric step up or step down transformer. Input, primary 110-117 Volts A.C. Output, from 5 Volts to 650 Volts. Suitable for use with war surplus gadgets, heater relays, radio test filaments, electric trains, house chimes, etc. Weight 10 Lbs. New. \$7.95 Each.



AIRBORNE SALES CO., INC. DEPT PM 5-B CULVER CITY, CALIF.

DUAL TAIL PIPE EXTENSION

Fits all cars — chrome plated
DEEP TONE
produced by 2 1/2 inch outlets \$2.95
Postage free on prepaid orders
DEALER INQUIRIES INVITED

LYONS PRODUCTS COMPANY
PAT. PEND.
2319 Ridgeley Drive, Dept. PM5, Los Angeles 16, Calif.

WOODWORKERS ... Get this!

CONSTANTINE MASTER MANUAL

Get the Most Fun From Your Hobby
Indispensable to woodworkers. Newest, biggest edition, more pages, more color, helpful how-to-do-it articles, pre-war and new items, more bargains. Send 25c today and we will include **FREE! FULL YRS. SUBSCRIPTION** to Chips and Chats, published bi-monthly. Keeps you up-to-date on everything in woodworking, offers big money-saving bargains. Send now.

ALBERT CONSTANTINE & SON, Inc.
791-A 135th Street, New York 54, N. Y.

TRAILER BUILDERS!

BUILD or BUY ... SPECIFY

- Torq-Less Axles
- Bull Dog Hitches and Parking Jacks, Safety-Engineered by HAMMER BLOW TOOL COMPANY

Dept. 122 Wausau, Wisconsin

Send for **FREE** Catalog

Write today for booklet on the new **FLEX-O-SHAFT** Tool Kit, illustrating this improved all-purpose power machine with the hand-piece that works as easily as a pencil. Motor with switch, foot-operated rheostat, and 66 accessories, all at a special low price. **FLEX-O-SHAFT SALES CO., Dept. C, Prairieview, Illinois.**

BUILDING CONSTRUCTION

with composition cement and cheap wood builds good 3-room house for \$250; barns low as \$50.00. 100 illustrations and 100 money and labor saving suggestions. Get this newly revised and enlarged, guaranteed book before you build. \$1.00, postpaid.

SHEET METAL COTTAGES and other buildings. Several new methods. Illustrated instructions, 50c.

FURNITURE OF COMPOSITION. Cement, sawdust, asbestos, etc., scrap wood, metal, etc. illus. 50c.

SHOP MACHINES FROM OLD AUTO PARTS: Over 60 described, 50c.

HOME MFG. ENTERPRISE. 50 home shop projects. illus., 50c.

Special: All five booklets described above, \$2.00 postpaid.

HOME INDUSTRIES, 1318 So. 30th Ave., Dept. P5, Omaha 5, Nebr.

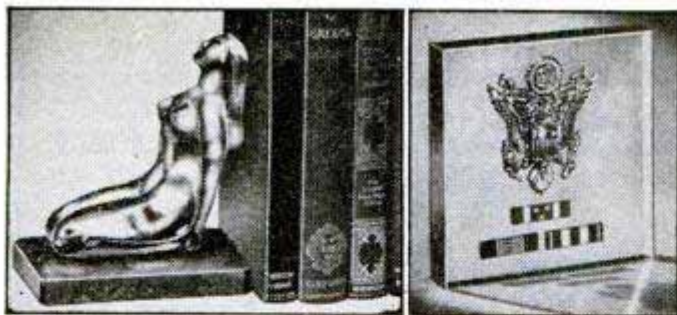

NEW LIQUID PLASTIC

Makes Fine Gifts, Novelties, Things to Sell

Have fun, make extra money, with CASTOLITE, crystal clear liquid plastic. Pours without heat, sets at low temperatures. Make book-ends, wall plaques, jewelry, tiles, figurines, coasters. Embed real flowers, butterflies, coins, medals. Preserve treasured photos.

CASTOLITE can be sawed, carved, turned, drilled. Can be mixed with CASTOLITE DIES for brilliant color effects. It's easy to do.

THE CASTOLITE CO., Dept. E-1 Box 211, Kenilworth, Ill.

You can have the thrill of making things the very first day. No tools are needed.

20-PROJECT CASTO-KIT \$3.50
(W. Coast, Can., Mex., \$3.75)

CASTO-KIT contains materials and instructions for making useful objects at once. Send check or M.O. for postpaid Kit today, or order C.O.D. For Manual alone, 25c. DEALERS—write for details.

FLUORESCENT FIXTURES EASY TO ASSEMBLE

"SAVE THREE WAYS"

- ON THE FIXTURE
- CUTS ELECTRIC BILL IN HALF
- BETTER, COOLER LIGHT

Only 5 simple parts with 20 Watt General Electric bulb. All materials highest quality Underwriters Laboratory Approved. Diagram simple and easy to follow.

\$3.85
Complete

Send Check or Money Order
Postage Prepaid

Also D. C. at 50c extra.

Other sizes and Kitchen units—sembled or unassembled—available. Write—stating requirements.
IDEAL FOR WORKSHOP KITCHEN,
BASEMENT, ATTICS AND GARAGES.

FLUORESCENT KIT PRODUCTS
161-163 PARK ROW NEW YORK 7, N. Y.



Rebuilt GENERATORS

Chevrolet—Ford—Plymouth
exchange price **\$6.95** guaranteed
F.O.B. Chi.
Generators rebuilt by factory-trained experts. Also hard-to-get parts for every car. STARTERS and TRANSMISSIONS at tremendous savings.

WORLD AUTO PARTS CO.
2200 N. Ashland Chicago 14, Ill.

ORDER from one of the nation's largest replacement dealers

BUILD YOUR OWN FAST FREEZER

PLANS \$1

It's easy to build this household appliance with LeJay Plans. Made from new or used parts. Save up to 75%. No expert knowledge needed. Plans show 5 sizes and are easy to follow. All details clearly explained. Enjoy making one of these freezers. Mail \$1 for set of plans and catalog. **LEJAY MFG. CO.,** 447 LeJay Bldg., Minneapolis 8, Minnesota

5 sizes
8 to 40 cu.ft.

DRAIN YOUR CELLAR, POOL, WASH TRAYS, ETC.

LABAWCO Type P Pump keeps garden pools fresh. Circulates oil or refrigerant, etc. DOES NOT CLOG! 1500 Gals. per hr. — 300 Gals. at 30'. Uses 1/2 to 1/2 H.P. motor.

PUMP ONLY \$6.50 POSTPAID

COMPLETE SELF-PRIMING UNIT (less motor): Pump, motor stand, special bracket, 18" flexible shaft, 14" length 1" suction hose, bolts, etc. **\$13.95** postpaid

Pump alone \$6.50.
Pump with complete self-priming unit . . . \$13.95
POSTPAID if cash with order. West of Mississippi, add 50c.

SEND ORDER TODAY

LABAWCO PUMPS
BELLE MEAD 4, N.J.

NEW INDUSTRIAL QUALITY Atlas TOOLS FOR YOUR HOME SHOP

NEW: 24" JIG SAW

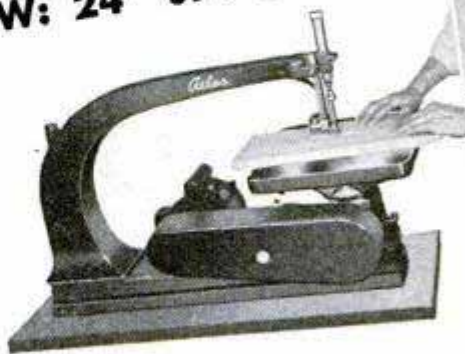

NEW: WOOD SHAPER

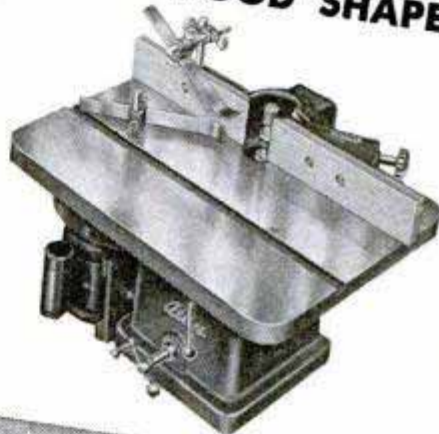

Now you can go ahead with your plans to equip your shop for real "professional" workmanship. These are the industrial quality tools every true craftsman has long been waiting for.

NEW 24" JIG SAW

A massive tool for the smoothest work on every jig saw operation in woods, plastics, light metals, composition materials. SKF ball bearings. 4 speeds. 14" x 14" table tilts right or left, swivels 90° for cutting long stock from side of saw. Overarm easily removed for cutting panels.

NEW WOOD SHAPER

A most valuable tool for cabinet making, custom furniture, storm sash, screens, etc. Has stationary spindle with 21" x 15" elevating table. Large cutter capacity. SKF ball bearings.

Ask your Atlas distributor or send for illustrated literature about these unusual new tools for fine quality workmanship.



ATLAS PRESS COMPANY

543 N. Pitcher St., Kalamazoo 13D, Mich.

EARN BIG MONEY
AND BE YOUR OWN BOSS
Sharpening Lawn Mowers

THE UNIVERSAL GRINDER

PUTS YOU INTO BUSINESS WITH SMALL INVESTMENT

Earn as much as \$400.00 a month in your basement or garage. Mr. Feiber of Ind., writes, "MY UNIVERSAL GRINDER is faster and more accurate than any other grinder. Its efficiency enabled me to sharpen 450 mowers in 4½ months. More than paid for itself the first month. Every customer satisfied." Mr. Hardy of Mississippi writes, "Received my Universal Grinder the first part of May and by August 18 had sharpened over 1000 mowers." Mr. Bacon of California writes, "The lawn mower business, with my Universal Grinder, has been a gold mine these last two years."

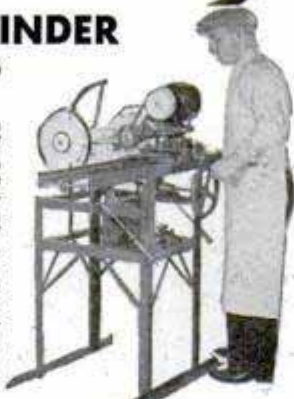

Only on the UNIVERSAL GRINDER can the inside face, the edge of the stationary blade, and the reel blades, be ground to proper clearance ALL IN ONE SET-UP WITHOUT REMOVING ANY BLADE FROM THE MOWER

Free Folder

Rogers Mfg. Co., Dept. M-58, Lindsey, Ohio

SEND TODAY FOR FULL DETAILS

ROGERS MFG. CO., Dept. M-58, Lindsey, Ohio
Please send me without obligation complete details about how I can earn BIG Money with the Universal Grinder.

Name _____

Address _____

City _____ Zone _____ State _____

SAY YOU SAW IT IN POPULAR MECHANICS

WAITING TO BE SHIPPED TO YOU

12,000 Lb. Capacity WINCHES \$125.00

NEW CADILLAC MOTORS With Hydramatic Transmission \$545.00

Rolls of ½" Width CABLE Complete With Chain And Grab Hook - 250 Ft. Roll \$27.50

SPECIAL . . . NEW JEEP POWER UNITS Complete \$388.00

NEW HALF-TRACKS \$1500.00 And Up

NEW 2000 GAL. TANKERS \$1275.00

25% Deposit On All Mail Orders Except Dealers

WILENSKY AUTO PARTS CO.

1226-28 WASHINGTON AVE. N. MINNEAPOLIS, MINN. AT. 4438

TOOL STEEL DRILL ROD **\$1.95** POSTPAID in Continental U.S. C.O.D.'S ACCEPTED

25 RODS **SAMPLER KIT** 25 SIZES

Ground and Polished to a Perfect Finish
1001 Uses for Craftsmen, Hobbyists, Mechanics, etc.

For Making Punches Chisels Engraving Tools Shafts, Etc. Free machining, easily worked, yet can be made file hard or hardened to spring temper. Hardening instructions included! **FREE** With Every Kit or first order 8" Steel comb, rule and depth gage with pocket clip and latest price list.

FLAT TOOL STEEL

The Precision ground flat tool steel with the satin-smooth finish. Simple to work, easy to harden, ready to use.

SHOP ASSORTMENT 5 dif. Pieces—1/32" to 1/8" thick 1/2" wide; 18" long. \$4.80

BOTH KITS — \$6.50
Complete ALUMINUM—BRASS—STAINLESS and TOOL STEEL Stocks Include 25c postage on orders under \$5.00.

BESSEMER STEEL COMPANY OF AMERICA, Dept. FC-17
1958 W. 59th St. Chicago 36, Illinois

\$10,000 a year is easy—SELL the charger that is safe FOR FAST BATTERY CHARGING

Model K \$149.50 F.O.B.

H-H PRODUCTS MFG. CO.
SUCCESSORS TO PLASTIFORM MFG. CO.
DEPT. PM 306 BOYD STREET • LOS ANGELES 13, CALIFORNIA

FAST CHARGER & COMPRESSOR
GUARANTEED not to harm batteries. Users all over the world say "Wouldn't be without it!" **SIMPLE—FAST and SAFE TON!**
Starts motors and inflates tires QUICKLY. Charges in 30-45 min. Model GKN gas powered for farm use. Model SN, charger only. Write direct to factory. VALUABLE TERRITORY OPEN FOR SPECIALTY SALESMEN AND DISTRIBUTORS. WRITE NOW. Manufactured and GUARANTEED by

MARCOT KEY MACHINES

| | |
|--|-----------------|
| MARCOT No. 8 KEY MACHINE, mounted on Cabinet | \$ 82.50 |
| Auto Code Book and Auto Depth Keys | 12.50 |
| 1,944 Popular Cylinder Key Blanks Set — Key File, Follow-Through Rods, Lock Picks, Bit Key Gauge, Thimble, Pins, Springs. | 10.50 |
| "Locksmith Trade Books": How to Open Locks without Keys or Picks; Secret of Locksmithing; How to Make Keys by the Impression Method; Master Key Systems. | 6.75 |
| TOTAL COST: | \$190.00 |

The \$77.75 cost of the Key Blanks would return to you \$486.00 or more. This would more than pay for your entire KEY MACHINE OUTFIT. IMMEDIATE DELIVERY—Motors available with Key Machine Orders. 1200 N. KEDZIE AVE. A. J. MARCOTTE CO. DEPT. PM, CHICAGO 51, ILL.

SKRU-KITS
20 Assortments—49c Each

Machine Screws, Wood Screws, Nuts, Washers, Cotter Pins, etc. Each assortment features one type fastener in wide variety of sizes and styles . . . Every fastener for your work. For workshops, garages, repair shops, hobbyists, mechanics. Stock up with several assortments at your favorite hardware counter. Look for STRONGHOLD!

Stronghold Screw Products Inc. 236B W. Hubbard St., Chicago 10, ILL.

COMPLETE OUTFIT TO DRILL THROUGH CHINA, GLASS, or POTTERY
\$7.00 — Postpaid. Guaranteed.
LANG LAMP COMPANY, Dept. PM
1245 BELLEVUE AVE. EAU CLAIRE, WISCONSIN

BETTER PERFORMANCE FOR OUTBOARD MOTORS

Enjoy more speed, smoother performance, greater carrying capacity by equipping your motor with the Michigan propeller recommended for your particular motor and type of boat used. Write for outboard catalog containing recommendation chart for all motors, old and new.

INBOARD: Our "AQUA-MASTER" is miles faster; smoother than conventional propellers. Investigate.

MICHIGAN WHEEL COMPANY
DEPT. P, GRAND RAPIDS 3, MICHIGAN

GARAGE HOME MECHANICS
Need A Motor Rebuilt?
LET JACOBY DO IT!



SAVE TIME, TROUBLE, MONEY

Let experts do the job! A. Jacoby & Sons, Inc. have been in business for over twenty-five years — operating a complete automotive machine shop specializing in rebuilding Ford and all other types of motors. We also maintain a complete stock of automotive parts and accessories. You can do your own motor overhauling and general repair;

all parts at a substantial discount.

Write for information and price, specifying job or repair you intend to do, giving year, make and model of vehicle.

A. JACOBY & SONS, Inc.
 8620 18th Avenue, Brooklyn 14, New York

PLYWOOD BOAT KITS
\$49.00

(Including Freight)



This **READY-CUT 12** ft. fishing boat can be assembled in 8 hrs. without forms or special tools. Kits are complete including all hardware, paint, and etc. Send for free folder.

TAFT MARINE WOODCRAFT

Dept. E, 636 39th Ave. N.E. Minneapolis 18, Minn.

LAWN ORNAMENT-NOVELTY PATTERNS

28 Lawn Ornament Patterns, 25c. Other patterns; 15-20" high; Dutch Girl, Dutch Boy, Pirate, Bull Terrier, Mexican Girl, Mexican Boy, Dwarf, Penguin, Flower Girl, 10c each. 25 Novelty Patterns, 30c. All 62 Full Size Patterns, \$1.00 Postpaid. Strother Pattern Service, Dept. A K-8, Box 383, Belington, W. Va.



TYPEWRITERS!

ALL MAKES — REBUILT LIKE NEW

For Business, School or Home Use

Write for Information

M & M TYPEWRITER CO.

84 W. Washington St. Chicago, Ill.

OTTAWA POST HOLE DIGGER

There is No Other Like It!

Patents Pending



Here's the tractor digger you have been waiting for. Quickly hitched to most any farm tractor with power take-off. Fastest power auger return—pull cord control. Heavy hi-speed two-flight auger—leaves hole clean. Castor wheels permit fast and accurate settings. Safety clutch prevents damage, eliminating shear pins. Strictly a one-man digger. All controls from driver's seat. Short-cut to labor problems where holes are needed. Trench digging attachment. Get up-to-the-minute facts by sending for descriptive matter and low factory-to-user prices.

New Low Prices

Serving farmers for 44 years.

OTTAWA MFG. CO., 6-827 Elm St., Ottawa, Kan.



Give Your Workshop FLEXIBILITY

DRUM SANDING of scroll work and many other curved surfaces is easier when you equip a flexible shaft with a tight-gripping **JACOBS HAND-TITE CHUCK**.

When you add a flexible shaft equipped with a **JACOBS CHUCK** to your power tool set-up, your workshop takes a big jump in versatility. Sanding, buffing, drilling, sawing and many other hand-held operations are possible when the tools are held tight and true in a **JACOBS HAND-TITE CHUCK**.

Get greater gripping power . . . Better accuracy . . . Longer life with Jacobs' New Rubber-Flex Collet Chucks.

Exclusive, bonded rubber-and-steel construction . . . no loose jaws . . . no springs . . . not harmed by oils or coolants. Real precision chucks at popular prices. See them at your local hardware dealer's.

IF IT'S A JACOBS . . . IT HOLDS



HEX-KEY CHUCK . . . fits drill press spindles — motor shafts — jack shafts. With Morse taper arbor, fits lathe headstock, tailstock. 4 models, capacities to 1/2"; fits 1/2" or 3/8" shafts.



HAND-TITE CHUCK . . . fits hand tools and power tools with threaded spindles . . . used on polishing heads, bench grinders, flexible shafts, etc. 3 sizes . . . capacities to 1/2". Models to fit 3/8"-24, 1/2"-20 and 1/2"-24 threaded spindles.

ONLY

Jacobs Chucks

Have The Rubber-Flex Collet Its Parallel Bite Holds True And Tight



The JACOBS MANUFACTURING COMPANY
 150 Jacobs Road, Hartford 2, Conn.

Please send me your new illustrated folder on the Jacobs Rubber-Flex Hex-Key and Hand-Tite Chucks.

NAME.....

STREET.....

CITY.....ZONE.....STATE.....

NONE BETTER AT ANY PRICE!

PAINT YOUR CAR WITH

KAR-WIPE

NEW AUTO ENAMEL SENSATION

WIPE IT ON!
NO SPRAYING!
NO BRUSHING!

GUARANTEED
2 FULL YEARS \$1.95



YOU CAN DO A FACTORY LIKE JOB

One Quart Covers Average Car With Two Gleaming Coats. A Glowing Professional Finish!

Not a streaky wax or polish. KAR-WIPE is the new miracle high lustre auto enamel that is so easy to use. Anyone can do a professional looking job quickly.

No Lap Marks
No Masking
No Streaks

Almost anyone can get high-gloss job that looks like a Professional finish. KAR-WIPE does the trick!

Easy to apply! No brush! No masking! Simply WIPE IT ON with the applicator that we give you FREE. Get a

factory-like finish that's GUARANTEED against chipping, cracking, peeling, fading when simple directions are followed. Dries dust free quickly. In newest colors.

SEND NO MONEY! Order one or more quarts today. Just mail postcard Pay postman plus C.O.D. upon delivery. Send remittance, save postage. SEND NO MONEY! ORDER Kar-Wipe TODAY! In Black, Grey, Firey Red, Brewster Green, Washington Blue, Maroon ... \$1.95 per qt.

KAR-WIPE CO., Dept. P5, 828 S. 18th St., St. Louis, Mo.

SAFE • EFFICIENT • SIMPLE KUT-RITE (Patented) LAWN MOWER SHARPENER

Keeps Mower Cutting Right. 3 Popular Sizes. Retail Prices: 14" - \$1.40; 16" - \$1.50; 18" - \$1.60. Replacement Emery Cloths, 50c each Plus Postage from Milwaukee, Wis. Weight 2 lbs. each.

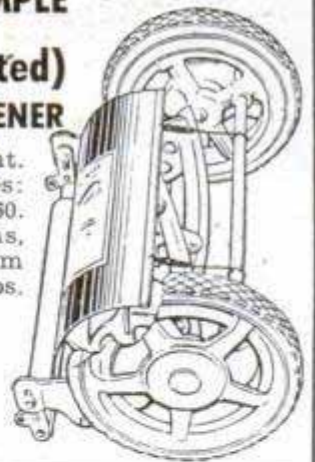

AGENTS WANTED —

Write for Details
ACCURATE SHARPENER
MFG. CO., DEPT. PM2
Milwaukee 12, Wisconsin

\$19.95



PORTABLE PHONOGRAPH

3 Tube Amplifier, Volume and Tone Controls, 5" Alnico P.M. Speaker, light weight crystal pickup, heavy duty motor, A.C. operation only. Handsome luggage type carrying case.

Kit form \$17.50 - Completely assembled \$19.95
Table Model Phonograph—same as above, but with Walnut finish cabinet.
Kit form \$16.50 Complete assembled \$18.50

PHONO AMPLIFIER KITS

3 Tube Phono Amplifier, Tone and Volume Controls
Kit form \$2.35 Wired and Tested \$2.85
3 Tubes for above 12Sk7, 50L6, 35Z5 \$1.75
5" Alnico Permanent Magnetic Speaker and Transformer \$1.95
Astatic or Shure Crystal
Pickup \$1.95
Self Starting Phono Motor \$3.25
V.M. Automatic Record
Changer \$16.95



WRITE FOR FREE CATALOG

25% deposit on C.O.D. orders

All prices F.O.B., N. Y.

Order From This Advertisement

RAYTONE ELECTRONIC CO. 25P Frankfort St. New York 7, N. Y.

CUBIC-INCHER CRYSTAL SET \$2.39

SIGNAL-POWERED
NO ELECTRICITY



Transparent plastic cabinet is 3/8" square by 3/4" deep. This tiny space contains a variable tuning condenser, coil, 1N34 Radar detector, by-pass condenser, and tip jacks. Set rests easily in the bowl of a teaspoon! Works anywhere — costs nothing to operate—never wears out—the nearest bed radio you ever had! With connecting leads, complete instructions, but no phone. \$2.39 postpaid. With single phone included, \$3.19 postpaid. CARING - BOX 1308 - CHICAGO 90, ILLINOIS



AUTOMATIC ACCELERATOR CONTROL

Push the pedal and it stays put until you move your foot left or push the brake. Pays for itself many times with the gas it saves by holding the pedal steady. Fits all pedals. Can be disengaged permanently, and reengaged again with your foot, in a second. It has been used successfully for five years. \$2.98 post paid or C.O.D.

Dealers and Salesmen Wanted

AUTOMATIC ACCELERATOR CONTROL, Inc.
MONROE, MICHIGAN

25 SANDING DISCS \$3.85

\$7.50 VALUE

(post paid)



Aluminum Oxide and Fibre Combination 7" x 3/8" in assorted grits—coarse, medium, fine. Made by Minnesota Mining, Carborundum, and Behr-Manning. Adapters for 1/2" arbor furnished free upon request.

Send cash, check, or money order to:

S & S JOBBING CO.

401 Plymouth Ave. N. Minneapolis, Minn.

WRITE TODAY! for any type of abrasive or grinding wheel at 50% off YOUR PURCHASE PRICE.

New BRUSH Electroplater

ESPECIALLY BUILT FOR MECHANICS, MODEL MAKERS HOME CRAFTSMEN



Easy to Plate GOLD, SILVER, NICKEL, COPPER, etc... For Pleasure and Profit!

If you have a workshop—at home or in business—you need this new Warner Electroplater. At the stroke of an electrified brush, you can electroplate models and projects—you can replate worn articles, faucets, tools, fixtures, silverware, etc. with a durable, sparkling coat of metal... Gold, Silver, Nickel, Copper, Cadmium, and after a bit of practice, even Chromium! Everything furnished—equipment complete, ready for use. By doing a bit of work for others, your machine can soon pay for itself. So make your shop complete by getting a Warner Electroplater right away. Send today for FREE PLATING SAMPLE and illustrated literature. ACT AT ONCE.

WARNER ELECTRIC CO., Inc., Dept. S-13
1512 Jarvis Ave., Chicago 26, Illinois

FREE Details & Sample!

WARNER ELECTRIC CO., Inc., 1512 Jarvis Ave., Chicago 26, Ill., Dept. S-13

Gentlemen: Send Free Sample and Details to:

Name _____
Address _____
City _____ State _____

SAY YOU SAW IT IN POPULAR MECHANICS

POCKET Alarm WATCH

GENUINE "HARMAN" ... FAMOUS
WATCH OF A THOUSAND USES

Sensational Value!

Hard-to-find precision pocket watch with alarm r-r-r-ing. Ideal for hobbyists, technicians, radio and traveling men. 7 Jewels. Chrome case. Luminous dial.

13⁵⁰

Plus 10%
Fed. Tax



MONEY BACK GUARANTEED if returned in 10 days. Send check or money order (add \$1.35 Fed. Tax) or shipped C. O. D.

ROWES JEWELERS, 660 Fifth Ave., New York 19, N. Y.

TOTE YOUR TOOLS IN THE NEW-HANDY Chuck box

Use it at home and in the shop

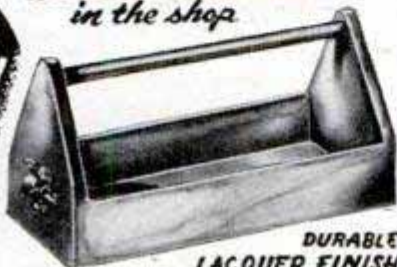

DURABLE LACQUER FINISH

KEEPS EVERYTHING HANDY — NO LOST TOOLS

Handiest gadget yet for tools — hobby supplies — cleaning implements — gardening tools, etc. It saves you time — prevents loss of tools. Rugged, all wood construction 7 x 15 1/2 x 9 inches. Durable lacquer finish — decorative decal ends. You'll want one for home and one for the shop. Immediate delivery. A wonderful gift for gardening friends. Send check or money order. Postpaid only.

\$2⁹⁵

ZEIGLER CORP. 77 W. WASHINGTON ST. DEPT. PM5 — CHICAGO 6, ILL.

E-Z MARK BUTT GAUGE

HANG THAT DOOR THE PROFESSIONAL WAY!

Makes a clean cut deeply etched profile. Remove chips. Repeat on jamb. Hang door!
• No adjustments. • Precision made.
• Used and approved by master mechanics.
• Comes in 3 1/2" and 4" (Std.) sizes.
ONLY \$1.75 ea. or \$3.50 a set at your hardware store. If dealer can't supply, send only \$1.00 with order and pay postman balance, plus postage C.O.D. In Canada \$3.75 (No C.O.D.)



COMES WITH LEATHERETTE CASE

E-Z MARK TOOLS

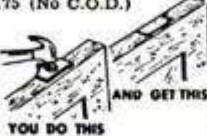

\$3⁵⁰

Set of 2

AND GET THIS YOU DO THIS

P.O. Box 8377, Los Angeles 16, Calif., Dept. P

Take a Schult FOR TRAVEL-LIVING



COMFORT and ECONOMY

● Here is outstanding VALUE! One modest investment, in a Schult, buys a complete, equipped home, ever ready to follow your car easily at regular driving speeds. Schult offers dozens of plus-values that cost you nothing, but add to your satisfaction. Ask your Schult dealer to show you 1948 models or write Schult Corporation, Dept. 3205, Elkhart, Indiana. In Canada: John Inglis Co., Ltd., Toronto.



FREE

Write today for book with full details of the new 1948 Schult models.



SCHULT Trailer Coaches

It's Here! AMERICA'S FINEST TILLAGE TOOL

New G-26 has wider cut, more power, plus all the other famous M-E features: No tine breakage — 4 cycle engines — handlebar controls — special clutch for self-powered turning — patented tine assembly. Everything about these M-E Rotary Garden Tillers makes garden work easier, quicker. Prepares perfect seed bed . . . guarantees 22% to 51% increase in crop yield.



Model G-26-010

- CUTS 26" SWATH
- 10 H.P. ONAN ENGINE (2 Cylinder, opposed)
- DUAL WHEELS

Pat. Applied for

Rotary Garden Tillers and Tractor Power Take-Off Units



ROTARY TILLERS

REBUILDS SOIL — NATURE'S WAY

Milwaukee Equipment Mfg. Co., So. Milwaukee, Wis., U. S. A.

Milwaukee Equipment Mfg. Co.
Dept. PM-5, So. Milwaukee, Wis.
Please send illustrated folder.

Name _____

Address _____

Carries the Same 90 DAY GUARANTEE As a New Motor Assy.

Our Finest Precision REBUILT

MOTOR BLOCK ASSEMBLIES

Sold Outright or Exchange

Rebuilt by skilled mechanics. Assembly has Rebores Block with New Pistons, Pins, Rings, Reground Crankshaft, all New Bearings. Guaranteed 90 Days. Allowance on Old Motor We ship at outright price. Send your motor prepaid, must be suitable for rebuilding. Send in notarized bill of sale showing title number if any. We refund difference when we receive your motor.

\$5.00 Crating Charge

BUICK Outright Exch.
34-47 8 cyl. \$199.00 \$160.00

CHEVROLET Outr. Exch.
29-47 6 cyl. 117.50 87.50

CHRYSLER Outright Exch.
35-47 8 cyl. 199.00 160.00

DODGE—3 1/4" bore
35-47 6 cyl. 144.00 109.00

FORD Outright Exch.
28-31 4 cyl. 119.00 87.00

32-34 V8 . 139.00 99.00
35-47 V8 . 149.00 99.00

HUDSON-TERRA. Outright Exch.
35-47 6 cyl. \$175.00 \$135.00

MERCURY Outright Exch.
39-47 V8 . 149.00 99.00

Oldsmobile Outright Exch.
37-47 6 cyl. 175.00 135.00

35-47 8 cyl. 199.00 160.00

PLYMOUTH Outr. Exch.
35-47 6 cyl. 139.00 109.00

PONTIAC Outright Exch.
37-47 6 cyl. 175.00 135.00

35-47 8 cyl. 199.00 160.00

Studebaker Outright Exch.
35-47 6 cyl. 175.00 135.00

35-47 8 cyl. 199.00 160.00

We Can Supply REBUILT ENGINES, TRANSMISSIONS, REAR ENDS, etc., for Cars and Trucks. Also JEEP ENGINES. Write for Prices!

POWER TAKE-OFF for JEEP ENGINE

Bolts to clutch housing on the Jeep engine. Has a spline shaft to engage with clutch and extending from rear is a keyed shaft on



which pulley can be mounted. Hand lever controls clutch. PFA-23J—Each \$37.50

NEW 5 Gal. CANS

FOR GAS, OIL OR WATER Vented for Safety. Self-locking Safety Cap Extra Heavy Construction Will Float When Full Size of can, 18" high, 6 1/4" thick, 13" wide. PA35U-60— Lots of 5, ea. 1.15 Lots of 50, ea. 1.05 Lots of 100, Each 98c



65 KW. 225 Volt D.C. DIESEL ELECTRIC GENERATING UNIT RECONDITIONED



Equipped with 6 cyl. DRXB Hercules DIESEL engine, 4 3/8" bore, 5 1/4" stroke, 120 H.P. at 2000 R.P.M. Complete with injector, pump, nozzles and electrical equipment. Generator attached to engine. Complete as shown. PG60R-193 Each \$1095.00

RADIATOR for above Unit... \$69.50

SEND 25% CASH WITH ORDER, BALANCE C.O.D.

J.C. WHITNEY & Co.

1917 Archer Ave. Chicago 16, Ill.

USE THE WIND TO CHARGE BATTERIES



6 VOLT WIND DRIVEN GENERATOR

Ideal for farm and camp lighting — for boats, motorcycles, autos, farm radios, etc. The wind driving the propeller operates the generator. Produces 6 volts, 12 amps— weighs only 8 1/2 lbs.

OPERATE WITH PROPELLER OR PULLEY May be used with propeller as illustrated—with homemade propeller or pulley. For farm lighting plants using batteries it may be run direct by windmill. Use pulley for autos, boats, etc. Fitted with brake to control charging. With 13 inch propeller as shown, each \$22.95. Generator only, less propeller \$14.95. Shp. wgt. approx. 12 lbs. F.O.B. Houston. Send check or money order. Immediate shipment.

AERO PARTS SUPPLY Dept. PM5, 8242 Travelair Blvd. Houston 17, Texas

K-R-O KILLS RATS

• Comes in POWDER and BIS-KIT form. Both contain *red squill*; are safer around farm animals and pets. POWDER, 75¢; BIS-KITS, 35¢ and \$1.00. If unavailable from your druggist or seedsman, order direct; adding 15¢ for mailing and handling. Money-back guarantee. *The K-R-O Company, Springfield, Ohio.*

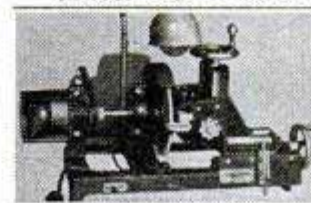

Start a NEW BUSINESS Or Add to Your Present Repair Business Sharpen Dull Pipe Wrenches Pipe Taps & Dies "Gum" Circular Saws Write for information.

Pat. applied for J. C. MOORE INDUSTRIES P.O. Drawer 276 FREDONIA, PA.

FURNACES FOR HOME AND SHOP



COAL—LP—GAS—OIL. Fittings, pipes and registers. Water heaters, Ranges and floor furnaces. COOLING, evaporative, water coil or refrigerated. BLOWERS with motors. Of interest to contractors and builders. DEALERS.

FREE BOOKLET PEERLESS SALES & SUPPLY 4318 Sheridan Lincoln 6, Nebr.

\$45 THAT'S TOO MUCH TO PAY FOR A HORN!

I didn't think so. For years I had been looking for an electric automobile horn that would blast like dynamite. Finally I came across this "Perko" Marine Horn, and does it put out! It's chrome on solid brass, nineteen inches long, and comes with a heavy duty switch and wire. Be sure to specify voltage when you send your check or money order to:

TOM McCANNA 620 Pelhamdale Ave., Pelham 65, New York

100 PRACTICAL USES Glider Model FLAME GUN

KILL WEEDS, crab grass, Canada thistle,—stalks, seeds and roots. Destroy brush, caterpillar nests, diseased trees, grasshoppers, chinch bugs, etc. Clear irrigation ditches, split rocks, burn tree stumps, Sterilize poultry houses, kennels, barns. Use as portable home forge. Melt ice, thaw pipes. Safe, inexpensive. Burns only 6% kerosene —94% Air! Thousands satisfied users. Write for FREE CATALOG.

HAUCK MFG. CO., 76 Tenth St., Brooklyn 15, N.Y.

AMAZING MYSTERY BUTTON

Startles Everybody. With this *Electronic Button* you can make your own Telephone — Amplifier—Detectophone. Attach this button to piece of cardboard—transmit conversation to another room. Music also transmitted to distant places. Most interesting electrical apparatus ever discovered. Enables you to perform hundreds of experiments. So tiny it can be concealed in dozens of places. A Pre-War Product. Electronic Button including 5000 word instruction booklet with 50 illustrated experiments. postpaid, only \$1.00

Electronic Products Company, Saint Charles 5, Ill.

GET INTO BUSINESS for YOURSELF

meet the demand for...

Metalized BABY SHOES

...in your own home in spare time



WE HELP YOU • STEP BY STEP!

- HOW TO START
- HOW TO BRING THE BUSINESS
- HOW TO METALIZE THE WARNER WAY
- HOW TO PYRAMID PROFITS

This is a lifetime opportunity! No matter what you're doing now, you can get set for the future while beating today's high cost of living. Our plan offers everything you need to know... a completely charted path to personal independence — with your home as your "factory."

This tested and proved plan is working right now. Backed by an old company, it's sent to you on a No-Risk Trial, Money-Back Guarantee!

The exclusive Warner Method applies an actual coat of pure metal, in genuine Gold, Silver or Bronze finish, "Eternalizing" Baby Shoes and other keepsakes forever. The de-

mand for these Metalized Keepsakes is big... and getting bigger every day. (More than a million dollars' worth last year.) In every way, it's a proved proposition. Proud parents everywhere buy on sight!



A NEVER ENDING MARKET

No matter where you live, small town or big city, there is a never ending, ready-to-buy market for "Eternalizing" Baby Shoes — more than 3,500,000 babies this year. This tested plan reaches out and brings in the business. Spare or Full Time, you can make money!

BE YOUR OWN BOSS

Get the facts on this new opportunity. Mail the coupon below... TODAY. We'll send you fully descriptive literature, on our No-Risk Trial and Positive Guarantee: "Money Back If You Say So."

Isn't This What You Are Looking For!

1. Steady Income
2. Permanent Future
3. Wide-open Market
4. No House to House
5. Plan Works for You
6. Backed by 25 Year Old Company
7. No-Risk Trial
8. Money-Back Guarantee

WARNER ELECTRIC COMPANY, Dept. 35
1512 JARVIS AVE. CHICAGO 26, ILLINOIS

SEND THIS COUPON NOW, FOR SURE!

WARNER ELECTRIC COMPANY, Dept. 35
1512 Jarvis Ave., Chicago 26, Illinois

Please send, without obligation, complete details about your No-Risk Trial, Money Back Plan for "Eternalizing Baby Shoes for Plus Profits."

NAME _____
ADDRESS _____
CITY _____ ZONE _____ STATE _____



OTTAWA "WORK-MASTER"

CUTS 40" SWATH

Most useful machine of its kind. Powerful 2-HP motor. It mows grass or weeds, tills soil and cultivates (see picture), moves snow, pumps water, runs grinder, etc. **TWO SPEEDS** and Free Wheeling. Nothing else like it. "WORK-MASTER" is much needed year 'round machine. Mows close to trees and under fences. Follows ground contour. One man mows 3 to 6 acres a day. Boy or woman operates easily. Designed for private homes, estate, etc. Sold direct to user. Free details with low prices. **OTTAWA MFG. CO., 3-827 Lawn Ave., Ottawa, Kansas**

\$2.95 **TORNADO GAS TORCH**
The Modern Way of Soldering

Ideal for hard and soft soldering. Will heat quickly; solder will flow freely and smoothly. No compressed air required. Self-adjusting. Safe. Economical. Can be used for annealing small parts and bending metal parts. Generates a heat of 1700° F. Simply connect to any illuminating gas jet with a rubber hose and operate. Tornado Torch No. 119 comes with three tips, (1/8", 1/4", 3/8" blast).

Tornado Gas Torch No. 119 — Complete with 2 tips, for Natural Gas or Bottled Gas; with 3 tips for Manufactured Gas. \$2.95 per set. See your dealer or order direct. Send check or money order — post paid.

Robco Corporation, 202 E. 44th Street, New York 17, N. Y.

What makes it so SMOOTH RUNNING?

How should a Plunger Type Deep Well Water System be designed and constructed to insure smooth, quiet operation — the elimination of binding stresses, friction and wear — over a long period of years? The scientific answer is found in the latest Myers Water System booklet showing cross-section views of Plunger and Ejecto Types in the complete Myers line of quality water systems. Mail the coupon.



Myers Plunger Type Deep Well Pump

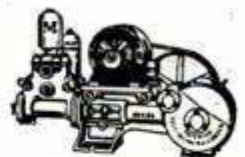

Myers Plunger Type Shallow Well Pump



Myers Ejecto — for shallow and deep wells



THE F. E. MYERS & BRO. CO.
Dept. K-166, Ashland, Ohio

Send me your free water system booklet.

NAME _____
TOWN _____ STATE _____
COUNTY _____

Today's Biggest Drill Value!

MAKES TOUGH JOBS EASY

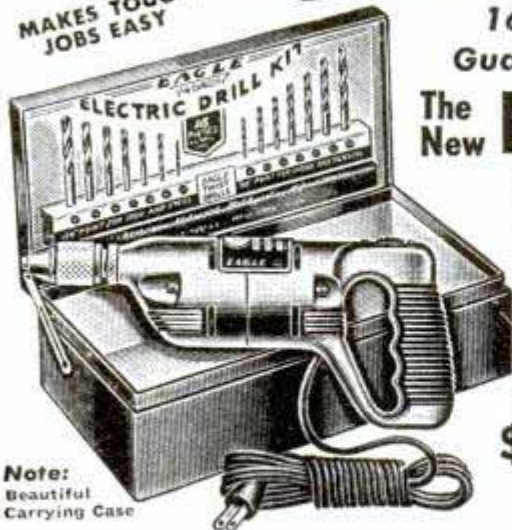

Note: Beautiful Carrying Case

16 Piece Guaranteed The New **EAGLE** Improved DRILL KIT

all for only **\$16.95** postpaid IN U.S. ONLY

KIT INCLUDES

- 1/4" Electric Drill with 110-120 Volt AC-DC Motor
- 7 Drills for Iron and Steel
- 7 Drills for Wood and Plastic
- 1 Compact Carrying Case

A "Once in a Lifetime" offer . . . a complete drill kit that makes work easier and more fun. Drills Iron, Steel, Wood and Plastic. Works wherever there is electricity. Tested and approved by Home Craftsmen, Hobbyists and Mechanics. A good "he-man" tool you'll be proud to own and happy to use. Sold only on our iron clad MONEY BACK guarantee and Factory Service Guarantee. Send today for your Complete Eagle Drill Kit . . . only \$16.95 . . . we pay postage.

OTHER DRILL VALUES. Black & Decker 1/4" Utility Drill only \$18.95. Speedway 1/2" Jacobs Chuck Drill only \$35.00.

Orders Payable To

PREHLER BROS. HARDWARE

1629 N. Damen Ave. Dept. P.M.5 Chicago 47, Ill.

WAR SURPLUS

TERRIFIC BARGAINS

NEW 1/2 H. P. ELECTRIC MOTOR, G.E. 27 V.D.C., RPM 4000, FOR INTERMITTENT OR CONTINUOUS DUTY, 3/8" SHAFT VARIABLE SPEED MOTOR. Can be adapted to 110 V.A.C. or R.E.A. line, by rearranging armature brush leads. **\$7.50**

Instructions incl. Ea. **\$10**

GENERATORS, new. Output 430 V.D.C., 86 Watts RPM 4350. NOW WHILE THEY LAST, EACH. **\$4.50**

DYNAMOTORS NEW, check list and order now, G.E. 485 KVA. Input 27 V.D.C. Output 115 V.A.C. Ea. **\$4.95**

DYN. new, Type D, Input 20 Amps. Output 350 MA at 1000 V.D.C. Mfg. by G.E. Ea. **\$2.50**

DYN. new, Input 27 V.D.C. 1.75 Amps. Output 285 V.D.C. .075 Amps. Ea. **\$2.75**

DYN. new, DY-22/ARC, .3V. Input 28 V.D.C. Output 210 V.D.C. Duty Cont. **\$2.95**

NEW CUNO OIL FILTER, aircraft type, keeps oil clean without cartridge replacement, for all AUTOS, TRUCKS and TRACTORS. Install at home in a few minutes. STOP CHANGING MOTOR OIL. **\$4.95**

Instructions included. Ea. **\$4.95**

SEXTANTS—Surplus Bargain Close-Outs

FAIRCHILD TYPE A-10, Army air force bubble sextant averaging type includes light system for night readings, slightly used but guaranteed perfect, wood case includes 2 Galilean telescopes. **\$750**

Ea. only (Fairchild Type A-10-A \$10.)

NEW FUEL PUMPS, general purpose Mfg. Chandler Hill, capacity 425 gal. per hr. at 2500 rpm, also Romeo Pump, capacity 1.7 gal. per minute at 1700 rpm. SAVE BIG MONEY, only **\$495**

FARM-AUTO SPOTLIGHT new, U. S. Navy portable pistol grip sealed beam 20 V., search, spot or Emergency light, featherweight, 3 extra filters, red, green and amber, incl. Ea. **\$295**

NEW NYLON CARGO LANDING NETS, mesh 2 1/4" x 2 1/4". Approx. 9 ft. by 9 ft., wt. 4 1/2 lbs. For fishing, hammocks, Farms **\$250** and Rugs. Ea. **\$98c** (\$5.00)

NEW SAFETY BELTS, made for U. S. Govt., 3 inch wide, reinforced with leather and buckles, wt. 4 lbs., adjustable, for (6 for jeeps, homes, industrial safety and farms. Ea. **\$5.00**)

SEND CHECK OR MONEY ORDER. NO C.O.D.'s. PRICES F.O.B. K. C. **GENERAL SALVAGE COMPANY** Dept. 5, 2920 E. 27th St. Kansas City, Mo.

Motors, fixtures, and appliances are quickly tested for open circuits, dangerous grounds or short circuits. Traces circuits in wiring, radios, airplanes and signal circuits.

STAR UNIVERSAL NO-LEAK TESTER

- FOR CONTINUITY testing on your bench or at the job. Simply plug into any outlet — no batteries needed.
- FOR LINE AND POWER testing, the plug is inserted into the insulated frame and circuits of 110-600 volts are positively tested.

PRICE \$2.50
If unable to obtain from jobber, add 10c postage

Send for free illustrated circular describing uses.

STAR FUSE CO., INC. 235 CANAL STREET NEW YORK 13, N. Y.

RE-STRING RACKETS AT HOME



EARN MONEY WITH THE WONDER VISE

It's pleasant, profitable work. No experience or skill required. Easy to learn. Full line of guaranteed Stringing Tools, Frames, Gut and Silk Strings. Every item high quality.

W. A. BICKEL & CO.
803 South Boulevard, Dept. A-62, Oak Park, Ill.

MACHINE STEEL

SMALL LOTS From stock — Cold Rolled Rounds, Squares, Hexagons, Flats for machining, welding carburizing. Also Polished and Ground Drill Rods. Write for free stock list and prices.

CHESTERFIELD STEEL SERVICE COMPANY
P. O. BOX 3058, CLEVELAND 17, OHIO

CANOE-CRUISE OUTFITS RENTED ON LAKE GEORGE

CAMP ON STATE OWNED ISLANDS, FREE.

Complete outfits rented — Canoe, tent, lantern, cots, dishes, axe, grate, etc. Send for folder "M."

\$30. per week for 2 persons

CRAIG-WALKER CO. Bolton Landing, N. Y.

TRAILER BUILDERS' SUPPLIES! TO BUILD, REPAIR OR MODERNIZE!

And save money. You must have our big Catalog. We are the largest and most complete trailer supply house in the States. Our new large 1948 catalog 10c; blue prints and building instructions, 25c.

NATIONAL TRAILER EQUIPMENT CO., 1007 N. Water St., Milwaukee 2, Wis.

Sun Glasses only **\$2.95** post paid No C. O. D.'s

For Men **For Women**

Aviation type lens; gold or rhodium plated frame. Mother of pearl sweat bar and nose pads; cable comfort temple. Four base curve ground lens.

Sensational design with up-sweep styled especially for the new look. Mother-of-pearl nose pads and paddle tip temple. Gold plated frame. Four base curve ground lens.

B & M SUPPLY Complete with Leathette case. Yes! your money back if not satisfied!
Dept. F 1010 Park Ave., Cranston, R. I.

A TOOLSHOP IN YOUR HAND



THERE'S ONLY ONE GENUINE HANDEE

First tool of its kind—today's finest. Smooth, steady power at your fingertips. Easy to handle. Make ship, plane and train models, bookends, costume jewelry. Grinds, drills, polishes, routs, carves, sands, saws, engraves on metal, wood, plastic, glass, leather, etc. 25,000 r.p.m. AC or DC. Wt. 12 oz. With 7 accessories \$20.50. In case with 40 accessories \$27.50. At stores or sent postpaid. A fine gift for a friend or yourself. CHICAGO WHEEL & MFG. CO., 1101 W. Monroe St., Dept. PM, Chicago 7, Ill. Free 52-page manual.

HANDEE TOOL OF 1001 USES

NU-WAY HEAVY DUTY CUTTING UNIT with Timken Roller Bearings

PRICE
\$16.50
WHY PAY MORE



Build your own rotary type lawn or weed cutter.

Take the hard work out of weed cutting. Build yourself an up-to-date weed and lawn mower with the Nu-Way heavy duty unit.

Write for Free Circular—We Supply Cutting Unit Complete
TRACTOR-LITE MFG. CO., Spirit Lake, Iowa

PROTECT YOUR LATHE

Covers for SOUTH BEND, ATLAS, LOGAN, CRAFTSMAN, etc. 9" and 10" lathes

Heavy Dust Tight Canvas Drill, Securely Stitched, Dark Blue, Tailored to Fit

Send \$7.69 and this ad. Cover will be sent Postpaid in U.S.A. Advise make of lathe, Length Overall, Back or Underneath Motor. Covers for Anything — Prices on Request.

The CRAMSON Co., P. O. Box 184, Hales Corners, Wis.



MIDGET EARPHONES



Ideal for crystal sets, hearing aids, wrist radios, "Handi-Talkies." One 'phone can be used for mike, other for speaker. Two sets can be used for 2-way communication up to 1 mile WITHOUT BATTERIES or ELECTRICITY. Lightest headset on market. Each 'phone weighs only 3/4 oz.; set weighs 6 oz. Instructions and extra set earplugs included.

BRAND NEW, 2 sets only..... **\$1.85**

SEND CHECK WITH ORDER. WE PAY POSTAGE

ELECTRONIC SUPPLIES 317-M EAST 2nd ST. TULSA, OKLAHOMA

22 Models

TO MEET THE NEEDS OF ALL SOFTBALL PLAYERS



To play better softball in 1948 be sure to use a genuine Louisville Slugger softball bat. H & B's "Softball Rules" for 1948 is ready at your dealers. See him for your copy or send 10c direct to us (stamps or coin) to cover mailing. Address Dept. P-31, Hillerich & Bradsby Company, Inc., Louisville 2, Kentucky.



get yours for '48

LOUISVILLE SLUGGER BATS for BASEBALL and SOFTBALL

STOP that LEAKING TOILET for good!

SIMPLE SIMON

SAVE \$\$\$\$
IN REPAIR BILLS
You can do this job yourself! Kit contains all material you'll need to replace old, worn, flush ball seat, easily, in 5 minutes.

UNIVERSAL RING KIT

To get your repair kit containing Simple Simon ring, a generous supply of sealing compound, and easy-to-follow directions, mail \$1 to Hardware Division,

ROCHESTER INSTRUMENT CORP.
Office 70 Penhurst St., Rochester 11, N. Y.



A Proven Product

Nationally Sold

All These Jobs With One Tool
SANDS • POLISHES

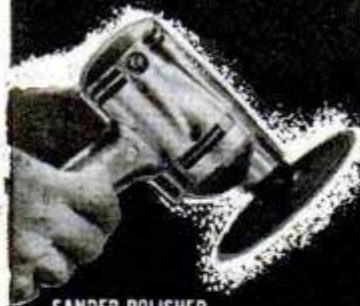

- DRILLS
- GRINDS
- BUFFS
- Mixes Paint
- Wire Brushes
- Steel Wools

SANDER-POLISHER
\$36.50

(F.O.B. Muskegon)
(Accessories listed above—\$28.90)
Sander-Polisher with accessories
\$65.40

Sanding and polishing—easy and fast with the Duo Portable Electric! Use it on wood, metal, plastics. Accessories quickly change it to a drill, grinder, buffer, mixer, brush or steel wooler—the most versatile tool you ever saw. Ideal for work on autos, furniture, boats, building, farms—for all types of refinishing and repair. Lightweight, powerful, rugged. Listed by Underwriters' Laboratories, Inc. AC or DC.

Get the Duo at your nearest hardware, paint, appliance store... or order direct with coupon below.

CLARKE SANDING MACHINE CO. — Muskegon, Mich.

Please ship Duo Portable Electric Machines Complete with all accessories \$65.40 Sander-Polisher (only) \$36.50
Ship C.O.D. plus shipping charges Postpaid. Money order enclosed Send information on individual accessories.

Name _____
Address _____
City _____ Zone _____ State _____

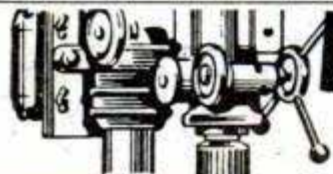

NEW!

HANDY, FLEXIBLE SHAFT

Converts Any Motor, Drill Press, Electric Drill, Electric Fan Into A Handy Rotary Tool

Attach ROTA-SHAFT in a Jiffy. Can Be Used for Grinding, Polishing, Sharpening, Cleaning, Engraving, Marking Tools, Carving, On Metal, Plastic, Wood, Glass.

Yes! Only \$2.95 and ROTA-SHAFT turns your old motor, drill press, electric drill or electric fan (10 inch or larger) with blades removed, into an efficient, versatile Flexible Shaft Tool for doing hundreds of grinding, polishing, sharpening jobs, especially in hard-to-get-at places. Attaches to motor shaft or in chuck. Convenient handpiece for ease of handling. Generous 40-inch overall length. Comes complete with buff and sanding disc ready to use in a drill press chuck. Order today.



ONLY \$2.95



SEND NO MONEY! Just mail order. Pay postman only \$2.95 plus postage on delivery, or send \$2.95 and we pay postage. Try 10 Days — if not delighted return for money-back.

If you order Rota-Shaft for use on motor add 35c for Special Coupling and State Shaft Diameter. **MAIL ORDER NOW!**

STRADER PRODUCTS CO., Dept. C-101
259 Strader Ave. Cincinnati 26, Ohio

Government Paid \$15,000 For Complete Unit... PORTABLE POWER PLANT

\$695 each
LOTS OF 3—\$650 each

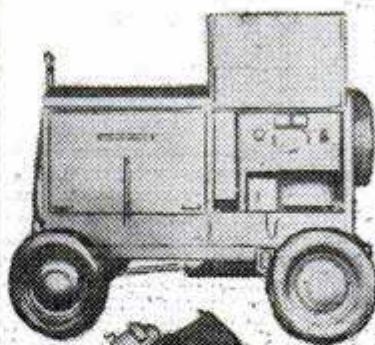

Same unit as converted to 300 AMP. ELECTRIC WELDER
\$895

HERCULES 6 cyl. gas engine. Model JXD 4x4 1/2. Self starter. Operating panel, complete ready for operation.

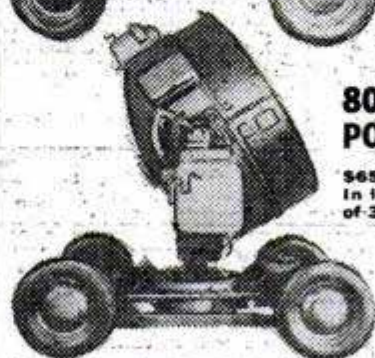

800 MILLION CANDLE POWER SEARCHLIGHTS

\$650 Ea. In lots of 3 **\$695 each**

Performs perfectly with Power Plant. Ideal for carnivals, outdoor games, advertising purposes, and hundreds of other uses.

(Send 25% with order, balance C.O.D.)

ALBERT H. MILLER LTD.

4545 W. Madison St. Dept. PM Chicago 24, Ill.

ONE-MAN SAWMILL LESS THAN \$200.00
Easy To Turn Trees Into Money

Makes lumber, ties, shingles, crates, etc., studding.

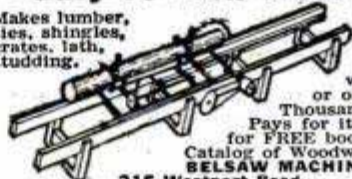

Belsaw Models

in 10 to 24 foot sawing lengths.

MECHANICAL FEED, accurate set works and positive dogs. Use tractor or old auto engine for low cost power. Thousands used for commercial sawing. Pays for itself quickly. Send post card today for FREE booklet, "How To Make Lumber" and Catalog of Woodworking Equipment.

BELSAW MACHINERY CO., 811-D Field Bldg.
315 Westport Road Kansas City 2, Mo.

NEW A. C. MOTORS

Popular make and brand new, 110 volts... 60 cycle... 1725 RPM... 1/2" shaft with sleeve-type bearing. Heavy, rigid base. Shipped direct from manufacturer. One year unconditional guarantee.

- 1/8 HP \$13.70
- 1/6 HP \$14.47
- 1/4 HP \$15.50
- 1/3 HP \$19.25

All prices F.O.B. N.Y.C. No C.O.D.'s; pay express charges on delivery.

DOMEX MAIL ORDER CO., Dept. M, 170 Broadway, N. Y. 7, N. Y.

KINKADE GARDEN TRACTOR
and Power Lawnmower

A Practical Power Plow and Cultivator for Gardeners, Suburbanites, Florists, Truckers, Nurserymen, Fruit Growers.

Easy Terms - Write Today

American Farm Machine Co.
1058 33rd Ave. S. E. Minneapolis, Minn.



TENTS

Small and large, new and used, Army surplus. Also canvas covers, hammocks, canvas cots, clothing, paints. Lowest prices. Free circular.

MORSAN SALES

10-15G 50th AVE., LONG ISLAND CITY 1, N. Y.

REPAIR CRACKED BLOCKS AND HEADS—

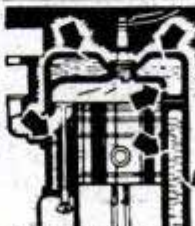

External and internal leaks in blocks, cylinders and valve ports quickly and easily with **LUSCO PLASTIC SEAL**.

90 day Service Guaranteed or your money back. Send money order or check for full pint—more than **\$3.00** sufficient for average repair. Postpaid

C. F. LUSK CO., 5924 BONNA AVE., CLEVELAND 3, OHIO

SAFE EASY TO USE HAND DRILL

FIST GRIP HANDLE AND ENCLOSED GEARS
MAKE DRILLING
SAFER - FASTER



**BENGAL
HAND
DRILL**

Only \$3.95

Hobbyists, homecraftsmen, mechanics, carpenters—here's most practical drill ever. Fist grip handle—marvel of modern functional design—gives you firm grip and perfect control. No wobble! No shimmy! Lightweight; Compact—fits any tool box. $\frac{1}{2}$ " capacity, rustproof steel chuck with hardened jaws. Balanced design prevents frequent breakage of drill bits. Made to last a lifetime! Order now! Send check or money order. Money back guarantee! Dept. EP-1

DEVUE & RAYNOLDS CO., Inc.
787 First Ave., N. Y. 17, N. Y.

TX-5 GEIGER COUNTER

for Locating
RADIOACTIVE MINERALS

The TX-5 is light weight, battery operated. Locates deposits of radioactives. Simply switch "on"—clicks in headphones indicate presence of radioactives. Extra sensitive, yet ruggedly built.

Each unit comes complete with headphones, probe, batteries and manual. For prospecting and mining operations. Write for details and price. Address Dept. PM



Geiger Counters
for every purpose...
*OIL PROSPECTING
*MINERAL LOCATION
*HOSPITAL WORK
*INDUSTRIAL USE

OMAHA SCIENTIFIC SUPPLY CORP., 3623 LAKE, OMAHA 4, NEBR.

Here's the Cutter

YOU'VE BEEN WAITING FOR...
Ace-Kutter \$11.95



ASBESTOS SIDING AND SHINGLE CUTTER

All Steel • 3" x 3 1/2" x 22" • Cuts, notches and punches all sizes of shingles cutting 3/16" ribbon • Complete instructions for application of Asbestos Siding furnished with each cutter • Write for FREE folder today.

TRI STATES BUILDING MATERIALS CO.
Dept. PM, 2037 E. Lancaster Fort Worth, Texas
Agents and dealers inquiries answered promptly

COLORED POTTERY MADE WITHOUT MOLDS!

Self-Hardening—No firing or kiln required. New chemical coloring methods. Beautiful solid colors, mottled, veined, rainbow hues. Big money making Bird Baths, Wishing Wells, Benches, Garden Furniture, Cemetery Products, Stucco-rock. Particulars Free!

RAPID POTTERY SERVICE • Box 170 • Edwardsville, Illinois

Raise Broilers in 7-8 Weeks



BROWER BATTERY BROODERS

Raise broilers and pullets with this three deck automatic electric heated 40-a-month broiler plant. Made of steel and aluminum... Price, \$40.95. Other batteries from \$15.95 up. All capacities... Write for free battery brooder and poultry supply catalog.
Brower Mfg. Co., Box 161, Quincy, Ill.

World's Largest Line of Poultry Supplies

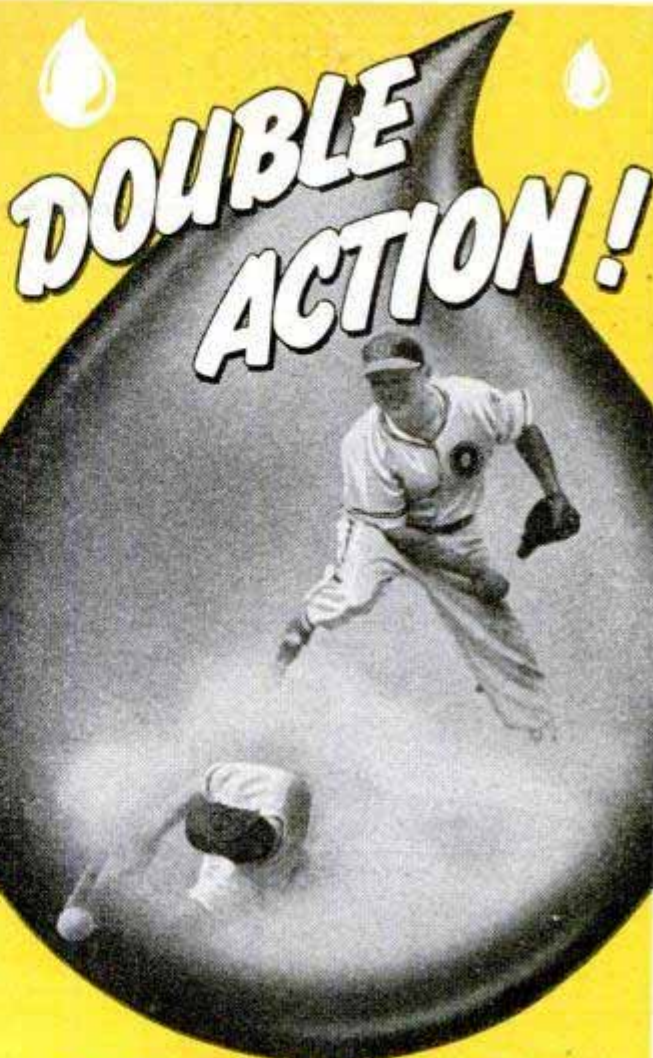

PENNZOIL

MOTOR OIL

FLOWS FAST-STAYS TOUGH!

Be safe with both instant, lasting engine protection from this double-action Pennsylvania motor oil...

Change for summer now!



Copyright, 1948,
The Pennzoil Co.

At this sign of better dealers, coast to coast

*Registered Trade Mark Member Penn. Grade Crude Oil Ass'n., Permit No. 2

Tough-film PENNZOIL* gives all engines
an extra margin of safety

MILL IT...ON YOUR LATHE!

PALMGREN

MILLING ATTACHMENT

3 SIZES

No. 250 Illustrated

2 1/2"
JAW
Only

24.75

CONVERT LATHE
IN 10 SECONDS

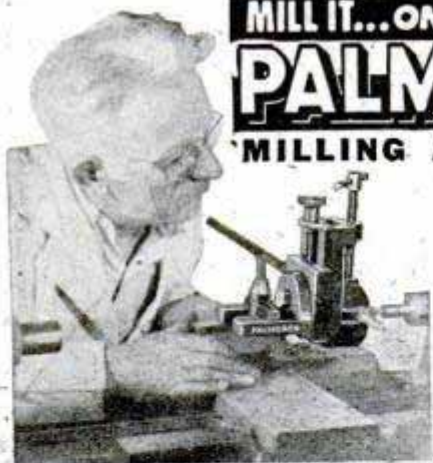

Now you can Mill, Slot, Grind, Groove, Square Shafts, Saw at Angles, Recess and many other important jobs. SAVE TIME and MONEY! Why send work out or use costly methods when a PALMGREN MILLING ATTACHMENT will solve your problem.

Precision built, it has accurate graduations for rotary angle adjustments, also graduated vertical feed screw. Fits South Bend, Atlas, Craftsman, Logan, Sheldon and all other lathes. Thousands now in use in small and large machine shops, repair shops, railroads, schools, home work shops, etc. ORDER SIZE NEEDED TODAY!—It will quickly pay for itself.

IMMEDIATE DELIVERY

| Nos. | Width Jaws | Depth Jaws | Jaws Open | Weight Pounds | Fits Tool Post | Price F.O.B. Factory |
|------|------------|------------|-----------|---------------|----------------|----------------------|
| 150 | 1 1/2" | 1" | 1 5/8" | 6 1/2 | 1" Dia. | \$18.75 |
| 250 | 2 1/2" | 1 7/16" | 2 1/2" | 11 | 1 1/4" Dia. | 24.75 |
| 400 | 4" | 1 1/2" | 4" | 25 | 2" Dia. | 39.75 |

Order From Your Dealer or Jobber: Write for Circular No. 351
Mfrs. of PALMGREN PRODUCTS Since 1915

CHICAGO TOOL and
ENGINEERING CO.

8365 South Chicago Ave.
Chicago 17, Ill.

JUST A FEW OPERATIONS YOU CAN DO ON YOUR LATHE!

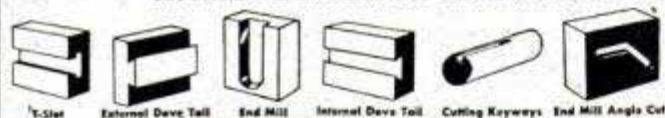

for COMFORT, ECONOMY
and LONG WEAR

Riegel WORK GLOVES



Ask for the Riegel Brand wherever work gloves are sold. Full descriptive literature sent free if requested on business letterhead.
Riegel Textile Corp.
342 Madison Ave.
New York 17, N. Y.

"THIS TRADE MARK IS YOUR GUARANTEE OF VALUE"

Hollywood WOLF WHISTLE



GIVE THE
WOLF CALL

CAR HORN

— imitate BARKING DOGS and make other weird noises. You, too, can become a Hollywood Wolf. Have lots of harmless fun. Install a Hollywood Wolf Whistle on your car. Beautiful Hammertone finish. Self lubricating bearings. Works off of the intake manifold. Simple to install in 15 minutes. Full instructions with every box. For cars, trucks, motorcycles, motor boats, outboard motors. Money back guarantee. If your dealer can't supply you, order today. Be the first to have this attention-getting horn. ONLY \$4.00 postpaid — Cash, Check, or Money Order. QUITE A DEAL. Sorry, no individual orders outside U.S.A.

YODER MFG. COMPANY

2403-A E. 103rd Street, Los Angeles 2, Calif.

DESCRIPTIVE
LITERATURE
ON
REQUEST

Save Money

KITS for
Amateurs
and
Experimenters

FREE

RADIO CATALOG AND SUPPLEMENT

Build it yourself.

Thousands of radio values in this big book — Radios and radio phonographs, F.M., P.A., Ham Xmitters, receivers, kits, thousands of parts — whatever the job calls for Lafayette has it. And every item priced way down, to save you money!

RADIOS
KITS
HAM
P. A.

Lafayette Radio

RADIO WIRE TELEVISION, INC.

100 Sixth Ave., N. Y. 13 • 542 E. Fordham Rd., Bronx 58
110 Federal St., Boston 10 • 24 Central Ave., Newark 2, N. J.

LAFAYETTE RADIO, Dept. LE-8
100 Sixth Ave., New York 13, N. Y.
Rush catalog #88 Flyer #C42

Name.....

Address.....

City..... Zone..... State.....

WOOD WORKERS

LUMBER — PLYWOOD AVAILABLE

Harold Hunt wants to send new No. 15 catalog. Over 148 pages of woodworking ideas. UNEQUALED BARGAINS in imported and American woods, supplies, hard-to-find hardware. Send only 15c to cover postage and handling.

CRAFTSMAN WOOD SERVICE CO.
2729 S. Mary St., Dept. A-93, Chicago 8, Ill.

only
15¢

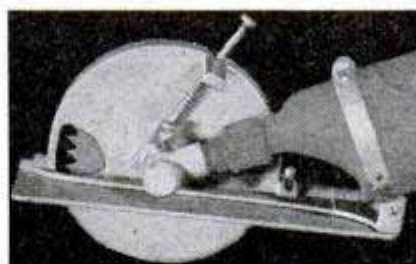

POWERDRILL CONVERSION

LITE-SAW converts most stand. 1/4" drillmotors to 6" circ. port. saw. Complete kit, ready to attach \$19.50 postpaid. ORDER NOW. Write for literature. DEALERS WANTED.

FUTURE PRODUCTS CO.
3625 N. Mississippi Ave.
Portland 12, Ore.

RACING CAR EQUIPMENT FOR ALL CARS

Engines, Racing Heads, Manifolds, Carburetors, Mufflers, etc. Speed Instructions and literature \$1.00—refunded first order.

LEE MOTORCRAFT CO.

1412 Great Northern Bldg.

Chicago, Ill.

BUILD THIS CONCRETE BLOCK MACHINE

Sell blocks; or build your home, garage, barn at 1/2 cost by making and laying your own blocks.

This simple machine which you can build yourself at a cost of about \$15 (excluding motor) will make a block in 30 seconds using only one form. 2 to 4 forms can be used on each vibrator.

Power driven concrete mixer plans also. Send dime for details and "How to Make and Lay Blocks."

U-BUILD-IT SERVICE
Dept. 3-A, 206 West Wilder Ave., Tampa 3, Fla.

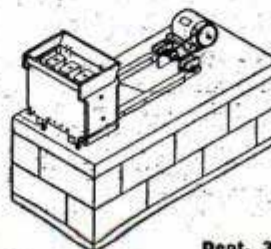

**POLISHES!
SANDS! GRINDS!
CURVED & FLAT**

**SURFACES - FASTER -
EASIER!** Works with any
1/4" Electric
Power Drill,
Flexible Shaft.

You Can Use It To:
Fix Bodies, Fenders;
Wax, Polish Cars, Floors, Linoleum;
Refinish Furniture, Wood, Metal
Surfaces; Smooth, Reduce Welds; etc.



Bends
To Take
Curved
Surfaces

On Flat Surface

On Curved Surface

NEW FLEX Sander - Polisher

Works with your electric drill, flexible shaft or chuck equipped motor. Speeds up all grinding, sanding and polishing jobs - fits any 1/4 inch chuck. Rubber face plate flexes into curves for fast, smooth, clean work. Outfit includes 6 1/2 inch rubber disc, with metal flange and shank, fibre backed sanding disc, and heavy sheep's wool polisher. Makes your drill the equal of any \$75.00 grinding or polishing outfit. Satisfaction guaranteed. **\$4.95**

Order today. Shipping wgt. 2 lbs. F.O.B. Chicago. Only

PREHLER PROVED PRODUCTS

Division Norbert Prehler & Co.

Dept. PM5, 1623-S Milwaukee Ave. Chicago 47, Ill.



Unbreakable
Amber
Hammer
Proof
Shock
Proof
TOOL STEEL
PRICED FROM 5c
TO \$1.00 EACH

Ask Your Hardware Store for
**FULLER'S
Unbreakable Amber Handle
SCREW DRIVERS**

America's most popular line of moderately-priced screw drivers! Wide range of sizes. FULLER TOOL CO., Inc. 911 Faile St. New York 59
America's largest makers of Amber-Handle Tools

make your own Gems 29.50

F.O.B.

All necessary lapidary equipment is furnished, including a super-charged diamond blade for sawing, and all wheels for grinding, shaping and polishing; also complete instructions. The complete equipment as shown, less motor and belt, for only \$29.50. f.o.b., Burlington, Wisconsin. Write today for information and literature.

B&I MANUFACTURING CO.

Dept. S Burlington, Wis.



HANDY TOOL

reconditions battered threads and makes quick repairs without dies. Repairs 1/4", 5/16", 3/8", 7/16", 1/2", 5/8", and 3/4" threads. SPECIFY U.S.S. or S.A.E. SATISFACTION GUARANTEED

ADVANCE SUPPLY CO.

3243 Joy Road Detroit 6, Mich.



ADVANCE
RE-THREADER

\$3.75

POSTAGE PAID

NEW G-E

exposure meter

the meter with a MEMORY
... and so easy to use!

PRESS button ... release ...
meter remembers light on scene.



SET ... just line up
Trident over pointer.
A flip of your finger
does it! (High and
low light range to fit
any scene.)

READ ... correct exposure
settings for better stills, movies,
color in only five seconds!

TYPE PR-1

\$32.50*

Ask your photo dealer about it.
General Electric, Schenectady 5, N.Y.
Famous Type DW-58 meter only \$19.95*

*In states where Fair Trade Contracts are in effect. Federal Tax included.

GENERAL ELECTRIC

606-23K

STANDARD GARDEN AND SMALL FARM TRACTORS

Plow Seed Cultivate Mow Hay and Lawns Powerful Gas Tractors for Small Farms, Gardeners, Florists, Nurseries, Fruit Growers, Poultrymen.
1 & 2 Cylinders
High Wheels. Rubber or Steel Tires. Walk or Ride.

Do Belt Work - **Free Catalog**

STANDARD ENGINE CO.
MINNEAPOLIS, MINN.
3221 Como Avenue

NEW YORK, N. Y.
617 West 26th Street



ASSEMBLE SAWHORSES FOR HOME OR SHOP THE EASY, CONVENIENT WAY

with DALTON Mechanical SAWHORSE BRACKETS

If you are a home owner, farmer, mechanic, merchant, or construction worker, you use sawhorses to do a variety of jobs. Why be inconvenienced by old-fashioned, or makeshift sawhorses when you can assemble a strong, professional-looking sawhorse in a jiffy with Dalton Sawhorse Brackets. Completely mechanical, this amazing bracket requires **NO NAILS, BOLTS, or SPECIAL CUTS** ... has a wing-nut locking device that converts five pieces of lumber into a useful sawhorse, **quickly, easily.** They're sturdily built of heavy gauge, rust-resistant metal. Available in sizes to fit 1x4's and 2x4's. Nothing like it anywhere. Use them for assembling sawhorses for tables, platforms, scaffolding, barricades, winches, seesaws, etc. Sawhorses can be dismantled for storing or transporting.

DALTON MANUFACTURING CO.

20 S. Central Ave.

St. Louis 5, Mo.



Locks rail securely. Can't slip or pull out.

Wing-nut adjustment. Puts pressure on legs and rail.

TWO SIZES

Immediate Delivery

Guaranteed to satisfy, or money refunded.

1" x 4" per pr. **\$2.60**

2" x 4" per pr. **\$3.00**

F.O.B. St. Louis, Mo. Send check or money order, or order C.O.D.

**NO Nails
NO Bolts
NO Special
Cuts**

Just insert lumber in leg and rail slots ... tighten wing-nut adjustment. Gives you a strong, solid sawhorse.

Hundreds of Uses for

**Home-Farm-Shop
Factory-Garage
Craftsmen
Store and others**

IF YOUR DEALER CANNOT SUPPLY YOU, ORDER DIRECT. Dealer inquiries invited.

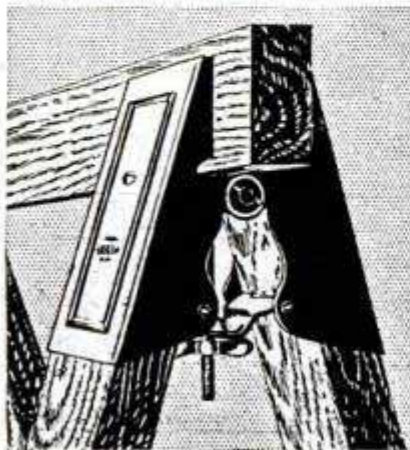

Operates from Auto Truck or Tractor Motor



Speedy Jr.

"For only \$4.85 I'm Painting the EASY Way!"

Now paint things in minutes instead of hours! Save money besides! Speedy Jr. needs no electric motor or compressor. Just fill cup—attach to spark plug opening—idle auto—and spray away! Gives that smooth factory-look to furniture, toys, handicraft, screens and auto touch-up. Inflates tires and sprays insecticides, too.

At hardware, auto supply, paint stores, complete with 18-ft. hose, only \$4.85.

Write Dept. 20 for Free Booklet—"How to Spray" and Catalog
W. R. BROWN CORP. 5720 Armitage Ave., Chicago 39
 Makers of famous "Speedy Sprayer"

Buy a CARLSON RULE and Save Money!

WITH 10-SECOND BLADE CHANGE



SAVE 50% BY GETTING AN EXTRA BLADE

With a Carlson Rule you can buy an extra blade for about 1/2 the cost of a new rule. When a blade is accidentally damaged or numerals become worn, you don't have to buy a new rule. Just get an extra blade and insert it without opening the case. Presto, in 10 seconds, a "new" rule for 1/2 the cost!

CARLSON & SULLIVAN, INC., Monrovia, Calif.

CARLSON STEEL TAPE RULES

AGENTS - DISTRIBUTORS

To sell the remarkable **PRECISE "400"** Adding Machine to stores, offices and individuals. Does work of \$100.00 machines. Stylus operated. Adds and subtracts automatically. 7 columns. *Lifetime Guarantee.* Sells for only \$19.95. You earn up to \$10.00 each.



WRITE FOR DETAILS!

E.C.A. MFG. CO., 2518 W. Montrose, Dept. M5, Chicago 18, Ill.

Weights under 5 lbs.
 Size 4 3/4" high, 4 1/2" x 7" base.

No other tool like it!

BURGESS vibro-tool

Writes on . . .

- Watches
- Glassware
- Tools
- Leather
- Plastics
- Costume Jewelry
- Pots and Pans
- Sporting Equipment



\$7.50

Engrave your name . . . etch letters or designs . . . place permanent identification marks on anything with this unique hand tool. Carves wood and linoleum, cuts cardboard and balsa, tools leather. Just plug in on any 110 volt AC line. No home shop is complete without a Burgess Vibro-Tool. See your dealer or write for information.



DELUXE KIT
 Vibro-Tool complete with 22 attachments in handsome, polished wood chest. . . . \$16.50

BURGESS Vibro-Tool Division
 LAKE ZURICH, ILLINOIS

INCREASE YOUR LATHE CAPACITY

Most versatile! Every home workshop needs the Porter Holder. Provides wide range of angles and settings—can get around "back" of work. Simplifies grinding of tool bits. Keep your tools sharp. Do better work easier. At your dealer or order direct. Introductory price \$2.65 postpaid.

HURON FACTORY SERVICE CO., Dept. 2
 505 Lafayette Bldg. Detroit 26, Mich.

RARE PUMP BUYS
 • FOR HOME, FARM, RANCH OR SHOP •

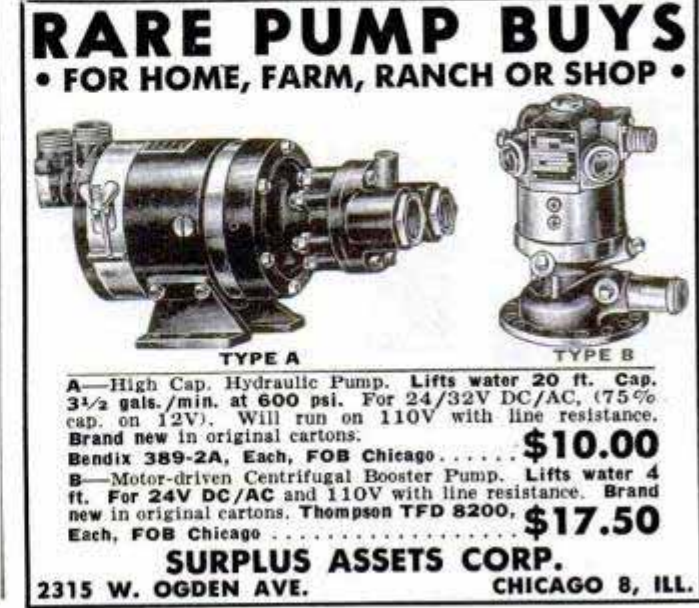

TYPE A
 A—High Cap. Hydraulic Pump. Lifts water 20 ft. Cap. 3 1/2 gals./min. at 600 psi. For 24/32V DC/AC. (75% cap. on 12V). Will run on 110V with line resistance. Brand new in original cartons. Bendix 389-2A, Each, FOB Chicago. . . . **\$10.00**

TYPE B
 B—Motor-driven Centrifugal Booster Pump. Lifts water 4 ft. For 24V DC/AC and 110V with line resistance. Brand new in original cartons. Thompson TFD 8200, Each, FOB Chicago. . . . **\$17.50**

SURPLUS ASSETS CORP.
 2315 W. OGDEN AVE. CHICAGO 8, ILL.

WORLD'S LOWEST PRICED ADDING MACHINE

VEST POCKET SIZE

IDEAL FOR BUSINESS OR PERSONAL USE

FREE TRIAL
ONLY \$2.95
TOTAL COST
SEND NO MONEY
FREE!!

Each Baby Calculator in Beautiful, rich-looking Leatherette case—at no extra cost.



Fits vest pocket or purse. Guaranteed accurate. Operated as easily, and as reliably, as machines costing many times as much. Not a toy. Precision made, very durable—guaranteed for life against defects in construction. You positively can't buy a calculator of equal quality for as little money. **ACCEPTED AS THE FINEST LOW PRICED CALCULATOR FOR OVER 35 YEARS!** Operates with a flick of your finger. Adds, subtracts, multiplies, divides—counts up to one billion. Pays for itself over and over in mistakes avoided, and time saved. **MAKES IDEAL GIFT.**

Sold on a positive money back guarantee. Send only \$2.95, Calculator sent postpaid, or send name and address and pay postman \$2.95 plus postage. **MONEY BACK IN 10 DAYS IF NOT DELIGHTED!** (If outside U. S., send \$3.50.) **AGENTS WANTED.**

CALCULATOR MACHINE CO., (Mrs.)
Dept. 202, P. O. Box 248, Glenview, Illinois

SAVE \$ MOTORS

Rewind motors — learn and earn in your spare time to start a business of your own repairing motors. Our accurate machine wound coils, material kit and motor repair supplies will start you in this profitable business.

PETERS ELECTRIC CO.

P. O. BOX 89 ROYAL OAK, MICHIGAN

BUILD HEAVY DUTY MACHINES



SAVE UP TO 90%— You can build, using our practical, easy-to-read plans, all kinds of machines, for home, farm or shop — scooters, portable sawmills, metal working machines, concrete machinery of all kinds, printing equipment, woodworking machines, midget autos, dish washers, farm equipment, freezers, tractors.

FREE

CATALOG HANDBOOK
183 SETS OF PLANS
VALUABLE INFORMATION

NICHOLS EQUIPMENT COMPANY
D-1010 PURVIS, MISS.

25 lbs. SURPLUS RADIO PARTS \$5.00

A gold mine of parts for repairmen, amateurs, and experimenters . . . sockets, condensers, resistors, transformers, coils, hardware, wire, etc. An outstanding bargain in usable parts! Send \$5.00 cash, check or M.O. today!
(Pay small express charges on receipt.)

ELECTRONIC DISTRIBUTORS, Inc. Dept. M5 620 W. Randolph St., Chicago 6, Ill.

PLATE WITHOUT ELECTRICITY! ... on any surface!

New discovery plates hard, non-corroding nickel alloy on any wood, leather, or metal surface (except chrome, zinc, or white metal). Wears like chrome. Thousands of home uses: door knobs, golf clubs, baby shoes, hobby parts, etc. No electricity, anodes, or fixtures—just add water. Kit contains everything needed for 5 full hours of plating. **MONEY-BACK GUARANTEE:** Use 10 days according to directions; if not completely satisfied, return for full refund.

MAIL THIS HANDY ORDER FORM

Metal Processing Co., Inc., P. O. Box 2814, Paterson, N. J.
Ship one standard LUSTRALOY PLATING KIT, prepaid. Check for \$12.50 enclosed.

Name _____
Address _____ (548)

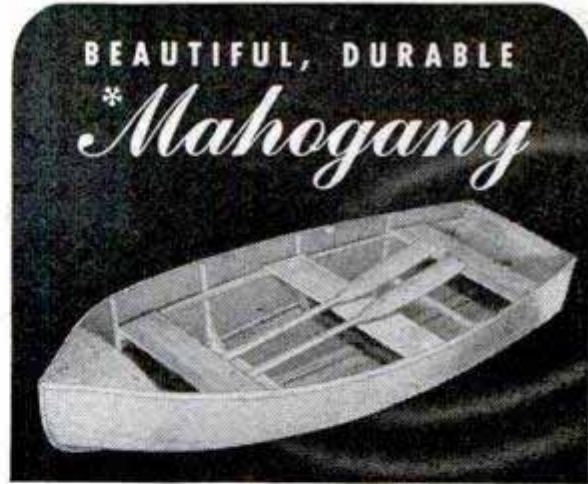

BEAUTIFUL, DURABLE

Mahogany

ASSEMBLE THIS 12' BOAT YOURSELF

All Mahogany—sturdy, and seaworthy. Same type materials used on P.T. boats. Hull 1/4" Mahogany, Marine plywood. Solid Mahogany ribs, seats, transom, keel, stem and floor boards. 108 lbs., 12 ft. long, 46" beam, 13" minimum free-board.

Kit includes: All mahogany parts, pre-cut, ready to assemble. Water-proof aircraft type glue. Brass screws, bronze oar locks, oars, marine varnish. Easy to follow instructions. No special tools or forms needed. ***Central American, African, or Philippine Mahogany.** **\$115**

Add sales tax if you live in Michigan, Ohio, or California.

\$115.00 enclosed—express free.
(\$120.00 West of Rockies.)

Send C.O.D. and Send Free Literature. I pay express.

Name..... Address.....

City..... State.....

HASKELITE MFG. CORP.
Dept. PM Grand Rapids 2, Mich.

Don't Risk Engine Overheating

Keep cooling systems
ALWAYS up to par
with regular

Warner care



Warner Liquid Solder (Non-Metallic)
• Deposits tiny fibers to repair leaks anywhere in the cooling system.

Warner Radiator Cleaner

• Thoroughly cleans cooling system of rust, oil muck and grease.

Warner Cooling System Protector

• Prevents rust, scale and corrosion.

No delays—just pour in and keep on driving.
Do it yourself, or ask your service man.



Warner-Patterson Co., 920 S. Michigan Ave., Chicago 5

REDUCE GARDENING AND MOWING TO TAKING A WALK

Just guide ROTO-ETTE. Thrill as it responds to do nearly all your irksome garden work. Makes deep-tilled, ready-to-plant seed beds. Furrows, hills, tills, cultivates, dusts. Cuts hay and weeds, mows lawns, saws wood, plows snow, hauls loads, powers sprayers and pumps. Cuts food costs; reduces work to play.



WRITE DEPT. N
ROTOTILLER, Inc., TROY, N. Y.

ROTO-ETTE
Reg. U. S. Pat. Off.
**THE ALL-PURPOSE
POWER GARDENER**

Worth an
EXTRA MAN
Anytime

Modernizing?
Remodeling? Use..
CHROMTRIM
"Trim-it-Yourself"
METAL MOULDINGS

HOME INTERIORS
Trim Ideas
with
CHROMTRIM
METAL MOULDINGS

You'll find hundreds of uses for this handy metal trim around your home. Kitchen, bathroom, stairs or attic can be streamlined in a jiffy. Chromtrim comes in convenient 6' lengths, 8 shapes, all ready to tack on.

Chromtrim is easy to cut - Economical to use - Bends simply to any shape.

Send 10¢ for "Trim Ideas" - 16 pages brimming with Chromtrim projects, ideas, and directions for use.

R. D. Werner Co., 291 Fifth Ave., N.Y. 16
Enclosed is 10¢ for CHROMTRIM "Trim Ideas" booklet PM-5.
Name _____
Address _____
City _____ Zone _____ State _____

R. D. WERNER CO., INC.
295 Fifth Avenue, New York 16, N. Y.

SAY YOU SAW IT IN POPULAR MECHANICS

Have you? OR APPLICATION!

We Have Complete Manufacturing, Engineering Development And Sales Facilities. We Are Interested On The Basis Of Outright Sale, Royalty Or Franchise For Manufacture And Sale.

Write Complete Details To—

DRAPER MOTORS CORPORATION
9680 Grinnell Ave., Detroit 13, Michigan

**NEW SOLID BRASS 7 FT. PORTABLE
RADIO ANTENNAS**

Real \$12 Value Now Only \$3.45 Postpaid
FOR HOMES, BOATS or AUTOS

JUST OUT! Gov't surplus used on Army tanks. These telescopic rustproof antenna have tremendous pickup eliminate dangerous wiring. Solid Brass throughout practically insuring **NOISE FREE RECEPTION.**

Exceptionally Rugged Sections compress into 1 ft. 3 in. Handy for Camping Trips, also Useful for Transmitting, FM & Television sets. Each antenna comes securely packed with mounting bracket. Easy to install anywhere.

QUANTITY LIMITED
ORDER TODAY. A real \$12 value for only \$3.45 Postpaid. Mail check or money order now or sent C.O.D. plus postage. Money back in 10 days if not satisfied.

RADIO HOSPITAL 442 East 86th St., Dept. A17
NEW YORK 28, N. Y.

BEARINGS Fafnir, S.K.F., N.D. & Torrington

| Bore | O.D. | Type | Price |
|--------|--------|--------|---------|
| .1875 | .6299 | Ball | 15c ea. |
| .1895 | .500 | Needle | 15c ea. |
| .2495 | .625 | Needle | 15c ea. |
| .250 | .750 | Ball | 22c ea. |
| 1" | 1 1/4" | Needle | 2Rc ea. |
| 1 3/4" | 3" | Ball | 90c ea. |

Minimum order 10 bearings. Add 10¢ for postage.

JAY-CEE SALES CO.
4554 Grand River Ave. Detroit 8, Mich.

GARDEN TRACTOR

3, 4, 5 H.P. On market nearly a quarter century. No belts. No chains. Warm driven. 2 clutches. Power turning. All tractors guaranteed. Full line of attachments. Buy direct from factory. Write Dept 105 for free catalogue.

RED E TRACTOR COMPANY RICHFIELD, WISCONSIN

**New 1948
PLASTICS SUPPLIES CATALOG**

Just off press. Full details on Plexiglas, Lucite, rods, sheets, tubes, Acetates, cements, dyes, buffs, molding sets, tools, carving kits, accessories. Everything in plastics. Gives prices, sizes, colors, etc. Price 10¢, stamps or coin, with ad for catalog.

PLASTICS MFG. & SUPPLY CORP.
DEPT. M-5 • 4707 EUCLID AVE. • CLEVELAND 3, OHIO

**Big Money for Workers
In Home or Shop**

Licensed Concrete Specialists wanted. No experience needed. Make *Colorglazed* concrete pottery without molds. New, low cost, patented method. Cemetery products, novelties, tiles, etc. Basement leaksealing. Other big pay projects. Booklet, details free. Men only.

NATIONAL POTTERIES COMPANY
415 Third Avenue, W., Grand Rapids, MINNESOTA

Manufacture for the Building Industry



Get in the Dunbrik-Dunstone business today and ride the tide of the biggest building cycle in history. It's the outstanding manufacturing opportunity in the building field, with broad market potentials and high income possibilities.

A Wide-Open Opportunity

Dunbrik (and Dunstone) is masonry at a new peak point of colorful beauty and modern design. Easy to make in local plants, using local material and local labor. Low costs means you can give more quality for less money—even undersell lumber. We supply all necessary equipment; back you with liberal cooperation. Write today for full information.

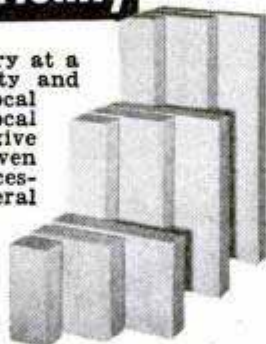

W. E. DUNN MFG. CO.
600 W. 24th STREET
HOLLAND, MICH.

DUNBRIK DUNSTONE

NO MORE BACK BREAKING MOWER PUSHING



Build a POWER LAWN MOWER yourself from your old HAND MOWER

We supply complete ATTACHMENT that needs no welding. Easy to install in less than an hour, fits any make or size of mower for Electric Motor or Gasoline Engine. COMPLETE ATTACHMENT ONLY \$27.80.

ENGINE:

OUR 1½-2 H.P. 4 Cycle Air Cooled with High and low Adjustable Jets Dependable Starting. Light weight, 30 lbs. ONLY \$62.15

Both the ATTACHMENT and the ENGINE are ABSOLUTELY GUARANTEED, you are getting the very best that money can buy at a price you can afford.

ATTACHMENT AND GASOLINE ENGINE ONLY \$89.95

Orders filled in seven days. Send Stamp for FREE FOLDERS.

ROYAL-OAK LAWN MOWER SHOP
Box 48 Royal-Oak, Mich.

PRECISION BUILT To Last A Lifetime

If you prefer:
Enclose \$10.00 deposit. I ship C.O.D. for balance.

CANVAS COVERS Waterproof tarpaulins, war surplus (Used), perfect condition. Originally made for tents. Approx. 5'x8'. Two buttoned together make approx. 80 sq. ft. Complete with buttons attached. Suitable for use as canvas dams, hay covers, truck covers, machinery and equipment covers, etc. Packed in bales 40 each, priced 40 covers, \$1.00 ea.; 15 covers, \$1.50 ea. Less than 15, \$1.75 ea. All FOB, Kansas City.

AMERICAN SUPPLY CO.

329 W. 5th Dept. P. M. Kansas City, Mo.

MARINE JET PROPULSION!

Sensational marine application of the jet principle. Powerful unit easily, inexpensively built at home and installed in any boat from our plans. Dependable, rugged, easily removed and replaced. Plans postpaid \$1.00.

MERCATOR PLANS, BOX 1271, MILWAUKEE 1, WIS.

MOTORS - PLANES - CARS - BOATS - MODELS

400 Pictures — 2,000 Model Items

A bible for wide-awake modelers. Model gas engines, planes, boats, cars, rubber-powered planes, jet models, accessories, etc., PLUS articles and stories on building and flying. Send only 10¢, stamps or coins. Also free catalog available.

SPECIAL: U-Control or Free Flight Flying Outfit, complete with motor, plane and over 30 needed accessories.

Only \$10 COMPLETE

1/6th h.p. Engines: Thor \$9.95; Genie \$6.95; Judco \$7.25

AMERICA'S HOBBY CENTER, INC. DEPT. B58 156 WEST 22 ST., N. Y. 11

RECAPTURE AGAIN... All Your Greatest Fishing Thrills!



A fisherman's dream come true—all a fine reel can be in quiet operation, instant response to your every cast, faultless performance. Truly custom-crafted with 9 better fishing features built in—THE FINEST REEL EVER MADE. This season, recapture again all your greatest fishing thrills—fish with the NEW PRESIDENT! At your sports store.

FREE TACKLE BOOK and Fishing Calendar. Tells how to bait and fly cast. Reels, Rods, Lines, Accessories. Write for yours—SHAKESPEARE COMPANY, Dept. 85, Kalamazoo 2, Michigan.

Shakespeare
FINE FISHING TACKLE HONOR BUILT for FIFTY YEARS

14,000 sanding strokes per min. with SAND-O-FLEX



—Compare this speed with hand sanding!

Quickly cleans and finishes intricate curves, contours on metals, wood, etc.

EACH SAND-O-FLEX sanding wheel contains 8 abrasive strips backed up by 8 separate brushes. When rotated at usual motor speed, you get 14,000 sanding strokes per minute!

Not only does SAND-O-FLEX finish faster—it gets in and around complicated forms. Brushes mold to the work shape and rapidly sand, de-burr, finish. Produces beautiful satin finishes on metal. Abrasive strips unreel when worn. Replacement cartridges in many grits available at low cost.

Use SAND-O-FLEX on your present tools—motor shaft, electric drill, flexible shaft, drill press, lathe, etc. SAND-O-FLEX has unlimited uses in home, farm and industrial workshops—3 sizes. See your dealer or write for free literature.

MERIT PRODUCTS, INC., 4373 Melrose Ave., Los Angeles 27, California

IT STAYS STUCK!

WITH ...

MULTI-PURPOSE AMBROID



If you want permanent results from an adhesive, you can't equal multi-purpose Ambroid liquid cement — for home workshop, household or factory. A quality leader for 37 years, ready-to-use Ambroid is waterproof, transparent, quick-drying, extra strong. Flexible, heat-and corrosion-resistant. For assembling, repairing or mending jobs, keep Ambroid handy. At your dealer's, or send 25¢ for big 2-oz. tube post-paid. Money back guarantee.

Also 50¢ 4-oz. tube. Pts., qts., gals., for industrial use.

2 OZ.
25c
TUBE



303 Franklin St., Boston 10, Mass.

Use it to save time and money when you mow, plow, cultivate, disc, harrow, or plow snow.



It's easy with a

PAGE the streamlined Garden Tractor

Mowing grass or weeds is only one of many jobs you do quickly at low cost with a new Page. New "big tractor" features. *Head-light and equipment light* for night work. New quick-change hitch. Balanced for easy handling. Direct drive, worm-gear transmission, using cut gears and ball bearings. No cheap belts or chains. Gears and clutches in dust-free case. Adjustable wheels. Individual wheel clutches make turning easy. 1½, 2, 3, and 4 H.P. Backed by 20 years' experience. Write for dealer's name and free catalog.

Page Dairy and Farm Equipment

1904 S. 81st Street P-5 Milwaukee 14, Wisconsin

AMATEUR BUILDERS! HOME OWNERS!

LOWEST PRICES NOW!

NEW ELECTRIC MOTORS



Long-hour duty for continuous operation without overheating. Resilient base, fully enclosed motors for hobby and home shop work, home appliances, fans, blowers, etc. Externally reversible direction of rotation. Diamond bored sleeve bearings.

1/6 H.P. Split Phase 115 Volt 60 Cycle 1725 RPM... only **\$10⁵⁵** ea. 1/4 H. P. Capacitor Start 115 V. 60 Cycle 1725 RPM... only **\$13⁶⁰** ea.

Satisfaction Guaranteed — Immediate Delivery — Send Check or Money Order. No COD's — FOB, Bedford, Ind.

UTILITY MOTOR DIVISION

Manufacturers—Bedford, Ind.



7x50 PRISM BINOCULARS

MILITARY SPECIFICATIONS BRAND NEW WITH LEATHER CASE

Coated **\$58**
Uncoated **\$48**

Plus 20% Tax

DESCRIPTIVE LITERATURE ON REQUEST

BROWSCOPE CO.

Dept. 5M 24 West 45 St. New York 19, N. Y.

STATION WAGON CABS

AND BODIES FOR ALL JEEPS—SMART MAPLE—OAK WOODS



Year around comfort for Jeep owners. Kiln dried hardwoods, safety glass. Finest hardware, varnishes, top materials. Full opening rear door, locks.

CABS **\$144.50** Plus Tax

FOB Cleveland, Complete, semi-assembled. Full bodies slightly higher. Send 25¢ with order, balance COD.

STATION WAGONS, INC. (PM) 6619 Euclid Avenue, Cleveland, O.

Build AIR-CONDITIONING UNIT

FOR YOUR HOME

We show you how. It's easy to build and a pleasure to use. An individual unit that fits your window and really cools the room. Up to 18° cooler than outside. Real Air-Conditioning, not just a fan. Different sizes to fit any room. No expert knowledge needed. Mail \$1 now for complete simplified PLANS and valuable Catalog.

LEJAY MANUFACTURING COMPANY 547 LeJay Building, Minneapolis 8, Minn.

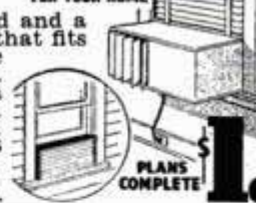

PLANS COMPLETE

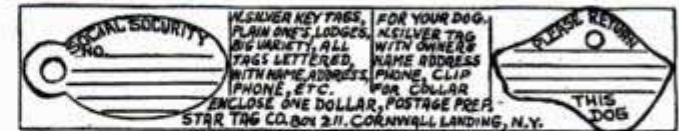

Say You Saw It in Popular Mechanics

MAKE THESE LEATHER and LEATHERETTE ITEMS LIKE NEW

With New Plastic LEATHER-NEW

Covers leather, leatherette and cloth and gives new finish and color — wears like leatherette. Easily applied with brush — quickly renews with liquid artificial leather. Write for FREE sample.

Own Your Own LEATHER-NEW Contracting Business — Big Profits Renew equipment for Bars, Restaurants, Hotels, etc. Profits possible up to \$125.00 on a single job... write for details.

FREE Sample of coated material— Write for it — No Obligation

LEATHER-NEW, 4723A1 Troost, Kans. City, Mo.

- Leather Covered Furniture
-
- Grille and Cafe Equipment
-
- Any Leather or Leatherette Item

NEW! Nothing else like it!
Thrilling, live 5-ft. action—
Yet only 21 in. long!

Trade Mark
Stubcaster
CASTING AND TROLLING ROD

Sensational coil spring gives full length rod action! • Shortened arc gives greater accuracy—maximum distance • Fits your tackle box—21" overall breaks to 14" • Reduces backlash! • Cast "close in" streams, overhand or underhand—no foliage interference • Cast 3 or 4 in a boat without tangling lines!
 • Brings fish right to net; fewer losses
 • U. S. Patents Pending!

\$5.95
 without reel

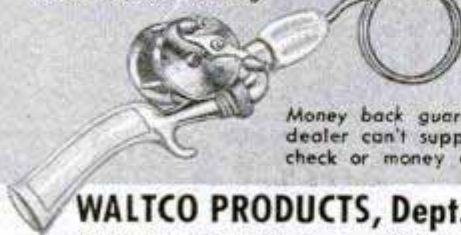

Money back guarantee! If dealer can't supply, send check or money order to

WALTCO PRODUCTS, Dept. 68-E
 2300 W. 49th Street • Chicago 9, Ill.



New Designs in
FRANZITE GRIPS

Modernize Your Gun! Improve Your Score!
 Most durable grips made. Positively unbreakable! For Colt, Smith & Wesson, Hi-Standard, Orgies, Luger & Mausers in a wide choice of beautiful designs in ivory, pearl, walnut, onyx, etc. Low prices. **FREE CATALOG.** Dealers Wanted.
SPORTS, INC. (Mfrs.) 5501 Broadway, Dept. P-5, Chicago 40, Ill.

NEW SANDER READY!
 Now ready for hobbyists, craftsmen, model makers, pattern makers, workshops! Mead's sensational new **BANDSANDER** quickly shapes, carves, sands and polishes **WOOD, METAL and PLASTIC PROJECTS!** Cuts fast and clean on **ENCLOSED EDGES**, intricate scrolls, curves. Tilting table. Saves hours of tiresome hand work. Does better job. Nothing else like it! Order yours now only **\$14.95 FOB Chicago.** Try it **5 Days**, then, if not perfectly satisfied, return it and we'll refund **\$14.95** your money promptly!
FREE! Or write for Free Circular describing, illustrating how this amazing new **BANDSANDER** invention saves time money, trouble. Write now—a post-card will do!
Mead Specialties Co., 4114 No. Knox Ave., Dept. 158, Chicago 41, Ill.

FLASH THAT VOLTAGE
 Turn that knob. Extinguish the neon glow. Instantly read voltage right off dial. **MINI-VOLT** measures 65 to 660 v. AC. Also DC. Tells whether AC or DC. Virtually burnout-proof. Guaranteed for 10,000 hours' operation. Bakelite case. 12" flexible test leads and test prods. A "must" in electrical and radio work. Only **\$2.50** postpaid!
INDUSTRIAL DEVICES, INC., EDGEWATER 1, N. J.

New CAR WASHER
 Designed to simplify that cleaning job! Just attach to any standard garden hose. For every purpose. Auto, Airplane, Trailers, Trucks, Porch Furniture, Windows, etc. Built for years of service. Money-back guarantee. For complete details write **\$1.95** Retail Price
JON HENRI CO.
 101 Neave Bldg., Dept. PM, Cincinnati 2, O.
 Agents Wanted



enjoy a pouchful
 of fresh tobacco

Rogers
 Air-tite*

the finest in
 tobacco pouches

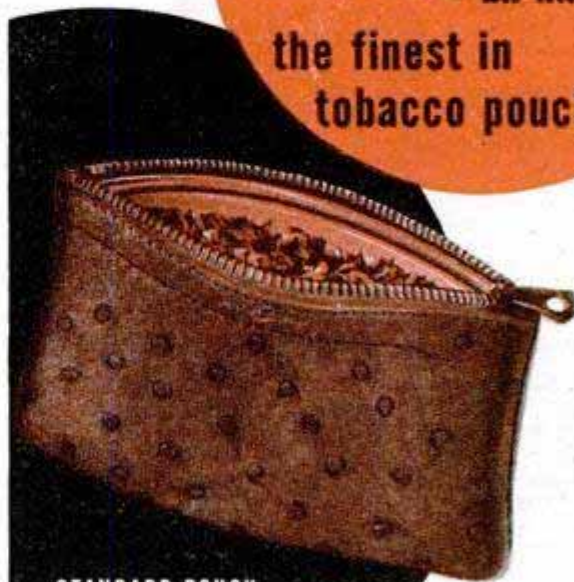

STANDARD POUCH
 Holds generous supply of tobacco. Choice of leathers. \$1.50 to \$15



COMBINATION POUCH
 Holds pipe as well as tobacco. Choice of leathers . . . \$2.50 to \$20
ROGERS RARITY PIPE \$5

The Rogers Air-tite* with its patented inner pouch of moulded, seamless rubber, protects freshness and flavor. Exquisitely made of fine leathers in a variety of models, by Rogers craftsmen. The largest-selling tobacco pouch made. At better shops everywhere.

Rogers imports, inc.

419 Fourth Avenue, New York 16, N. Y.
 manufacturers and importers of the finest smokers' accessories
 EXCLUSIVE U. S. DISTRIBUTOR, PETERSON'S PIPES, DUBLIN, LONDON
 Rogers Air-tite Pouches in Canada—G. T. Lanning Ltd., Toronto
 *TRADE MARK REGISTERED U. S. PAT. NO. 1,801,192. CAN. PAT. NO. 374,167

AMERICA'S BIGGEST WAGON VALUE!

Manufacturer's Close-out
You Save 35%!

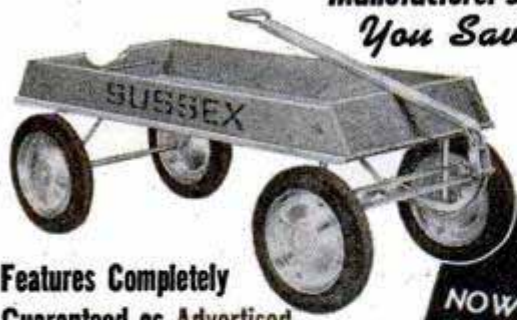

Features Completely
Guaranteed as Advertised

A once-in-a-lifetime buy! A wagon you will be proud to own! Actually sold for \$19.95 in retail stores!

Not a cheap tin wagon, but a real, strongly built wagon that supports 1/4 ton load. Body is extra-heavy gauge rustproof steel and solid oak.

Safe! Non-tilting — turns at a 90° radius without tipping. Patented hubless wheels do not injure shins or tear clothes.

HURRY—only 2500 of these wagons available. Freight cost is low! Send cash, money order or check. No C. O. D.'s, please. **ORDER NOW!**

WAS
\$19.95
RETAIL
NOW ONLY
\$12.95
You Pay Freight

Plus Features

1. Big 16"x 36" body
2. 10"x 1 3/4" Firestone demountable tires
3. Chrysler Oilite bronze bearings
4. Auto-type steering gear
5. Metal parts cadmium and nickel plated
6. Chromium plated channeled steel handle

MARKWARDT MANUFACTURING COMPANY
1937 WEST CANAL STREET • MILWAUKEE 3, WISCONSIN

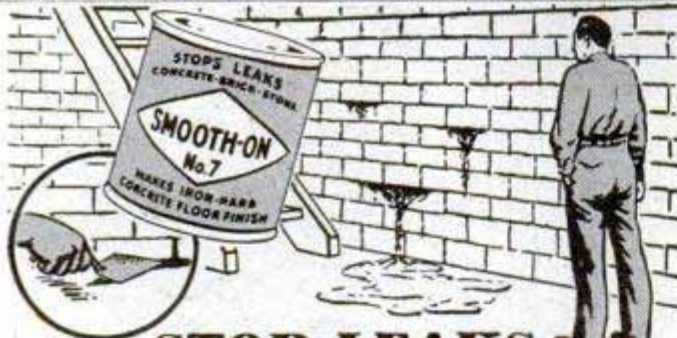

STOP LEAKS IN CELLAR WALLS

Do it with Smooth-On No. 7 Cement! Apply with trowel or stiff brush to leaky cracks, holes, porous spots, seams or other leaks in concrete, brick or stone walls and floors. The leaking will stop and Smooth-On will "stay put", for it expands slightly as it hardens. May be applied to wet or dry surfaces, indoors or outside. Use Smooth-On No. 7, too, to seal openings around pipes passing through walls. Buy Smooth-On No. 7 by name and number in 1-, 5-, 20- or 100-lb. size. If your hardware store hasn't it, write us.

FREE Leaflet and Handbook

We'll send you leaflet showing No. 7 uses, also the famous 40-page Smooth-On Repair Handbook describing other Smooth-On Cements and showing many helpful home repairs. 170 illustrations. Write today

SMOOTH-ON MFG. CO., Dept. 37E
570 Communipaw Ave., Jersey City 4, N. J.

Do it with
SMOOTH-ON
NO. 7 CEMENT



Golfers!
**ASSEMBLE GOLF-CART
YOURSELF...**
FOR ONLY

\$17.50

Assemble GOLF-CART in 15 minutes with ordinary household tools. Order direct from factory and save middleman's markups and extra labor costs. Never before has a golf club carrier of this quality been offered at this sensationally low price. Special aluminum-alloy construction—light but strong. Easy-rolling, ball-bearing wheels. Full cushion pneumatic tires. Folds for compact storage without pressure on clubs. Instantly adjustable for any size bag. Ample storage space for raincoats, etc. Unconditionally guaranteed one year against mechanical defects. Dealers Wanted.

SAVE
UP TO
\$1500

SHIPPED PREPAID FOR \$17.50
Complete in Carton (Add \$1 postage east of Mississippi)
SEND CHECK OR MONEY ORDER — NO C.O.D.'s

WESTERN GOLF-CART CO. 229 N. W. 10th Avenue
PORTLAND 9, OREGON

PIPE SMOKERS JUST THE THING FOR YOUR CAR

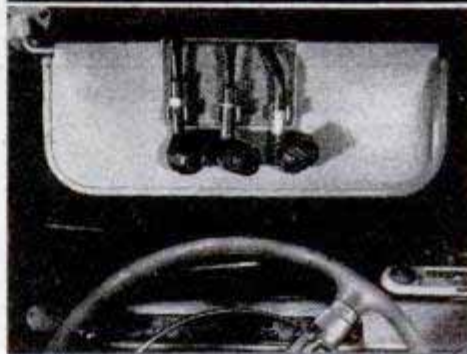

THE SUN VISOR
PIPE RACK
FITS ANY CAR
\$1.00 postpaid
anywhere

Holds all shapes and sizes. Pipes drain properly and are out of sight when not in use. Pipes held in place securely by new scientifically developed spring steel clips. Modern golden bronze hammer-tone finish. Neat, compact, attractive. Completely made of tempered steel and constructed to last a lifetime.

SEND \$1.00 TO

BERJ. MFG. CO. 3950 E. Olympic Blvd.
Los Angeles 23, Calif.

PRESTO! ANYONE CAN MASTER GLAZE



Car Owners! Meet Master Glaze—the sensationally different luster for new and used cars! Not a wax—not an oil polish—not a paint!—nothing that "smears" over the surface.

MASTER GLAZE is a unique discovery—a creamy liquid—quick and easy to apply! Gives a hard, glass-like surface. Even gasoline cannot dull it! Lasts six months to a year! Amazing luster—beautiful, sparkling clean and brilliant! Doesn't finger-mark—doesn't smear! A match box full glazes an entire car. Seals the pores—protects! **NOTHING LIKE IT!**

AGENTS
An unusual opportunity! Quick, flashy demonstrator. Big profits. Good territory. Write today!

FREE SAMPLE

Just send your name and address to.

MASTER GLAZE CO., 7720-657 W. Harwood Ave., Milwaukee, Wis.

Do both jobs

cleaning *polishing*

at once!

Car care made easy
with sensational
Liquid Polish

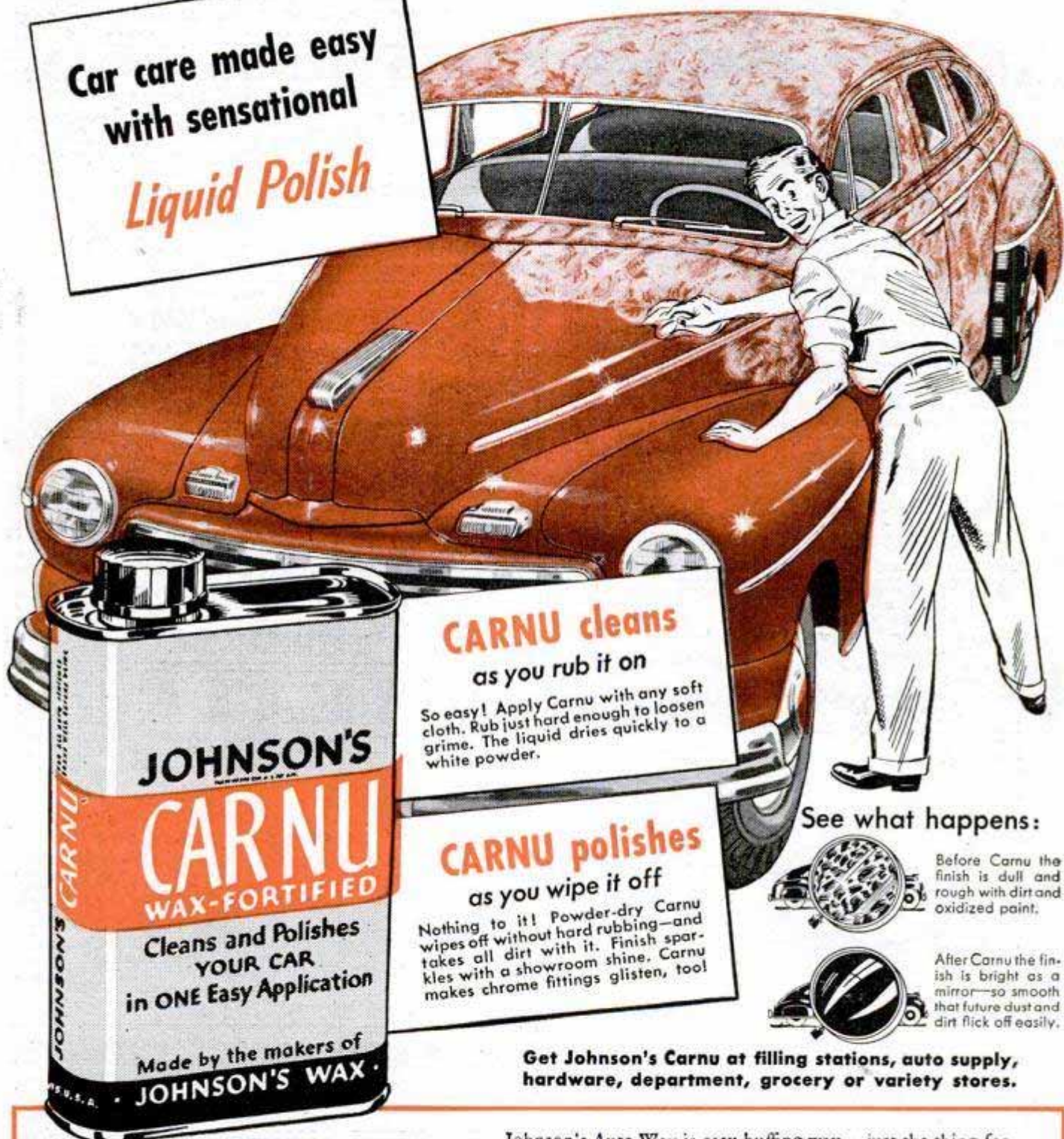

CARNU cleans
as you rub it on

So easy! Apply Carnu with any soft cloth. Rub just hard enough to loosen grime. The liquid dries quickly to a white powder.

CARNU polishes
as you wipe it off

Nothing to it! Powder-dry Carnu wipes off without hard rubbing—and takes all dirt with it. Finish sparkles with a showroom shine. Carnu makes chrome fittings glisten, too!

See what happens:



Before Carnu the finish is dull and rough with dirt and oxidized paint.



After Carnu the finish is bright as a mirror—so smooth that future dust and dirt flick off easily.

Get Johnson's Carnu at filling stations, auto supply, hardware, department, grocery or variety stores.

How to weatherproof a Carnu Polish

A tough, protective coat of Johnson's Auto Wax does all three:

1. Maintains the Carnu shine
2. Protects the finish in all weather
3. Helps preserve the color.

Johnson's Auto Wax is easy-buffing wax—just the thing for any home handy-man who wants to give his car a professional shine. And there's no better protective coating. Johnson's Auto Wax guards the finish against sun, heat and moisture. You'll find it easier, too, to keep your car clean and shining—dirt can't imbed itself in the smooth, hard waxed surface. Johnson's Auto Wax is sold wherever Carnu is sold. Try it!



"Carnu" and "Johnson's" are registered trademarks

© S. C. Johnson & Son, Inc., Racine, Wis., 1948

BUILD YOUR OWN 2500 WATT ELECTRIC LIGHT PLANT

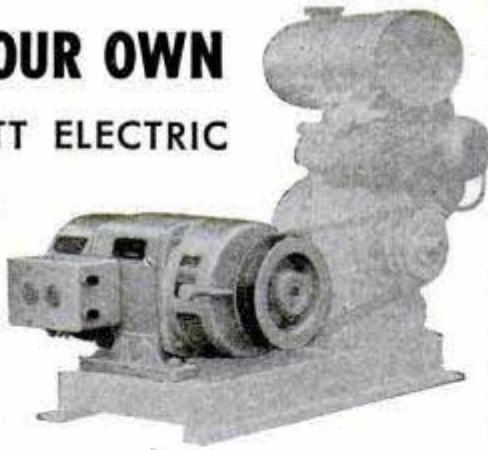

All you need is a standard electric generator, a small 6 H.P. gasoline engine, an angle iron base, 2 sheaves, and 2 v-belts. You can assemble the unit in your spare time far cheaper than any factory with high overhead expense.

Start out by buying the electric generator shown here. Costs \$125.00 (without sheave or belts), freight prepaid to your city. It is a Leland Alternator, 2.5 KVA, 120 volt, single phase, 60 cycle, alternating current. It must turn at 1800 r.p.m. Voltage is self regulating.

Produces enough current to burn 50 fifty watt bulbs, or 100 twenty-five watt bulbs. Just the size to start and operate a 3/4 H.P. electric motor. Current characteristics suitable for all standard electric appliances, and most electric motors.

Generators are available in this one size and type only, and complete instructions for constructing base and assembling are furnished. We ship the same day order is received if accompanied by bank draft or cashiers check. A slight delay on orders with personal checks.

HOPFER & COMPANY

3124 EAST 14TH STREET · OAKLAND, CALIFORNIA

PRESSURE QUEEN

FOUR CYLINDER
PORTABLE AIR COMPRESSOR
SPRAY PAINTING OUTFIT

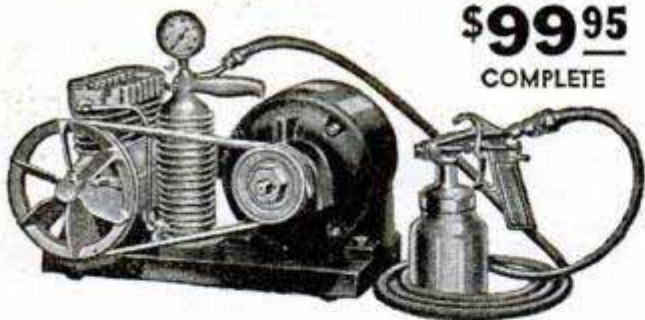

\$99⁹⁵
COMPLETE

COMPACT • RUGGED • POWERFUL

The ideal air supply for home and farm workshop, machine shop, garage, service station and contracting painter. Inflates tires; refinishes automobiles, trucks, implements and furniture. Paints buildings better, faster and at lower cost than brush work. Compressor has 4 cylinders, drop forged crankshaft, heat treated valves and pistons, bronze bearings, forced feed lubrication. 50-60 lbs. pressure without pulsation. Price includes compressor as shown, with air gauge, 15 ft. hose, spray gun and 3/8 h.p. motor; fully guaranteed. With 1/2 h.p. motor—\$109.95.

IF YOUR DEALER DOES NOT SELL
PRESSURE QUEEN WRITE DIRECT.

THE CAMPBELL-HAUSFELD CO.

1046 RAILROAD AVE. HARRISON, OHIO

Outstanding Surplus VALUES



CORNELIUS AIR COMPRESSOR

Brand new. 1/2 hp 27 volts DC-AC. 3 stage piston type. 1500 lbs. per sq. inch rated pressure. 20 AMP series wound motor. Equipped with fan for cooling. Approx. 2 cubic feet of air per minute, can be used direct from Delco system. Can be adapted to 110 AC with 27 volt transformer. Perfect for low-pressure paint spray guns, inflating tires, spraying trees, air horns, laboratory use, etc. Shipping weight, approx. 25 lbs. Cost Govt. over \$200.00. **\$17.95**
Our price only, FOB, K. C.

TRANSFORMERS: New. 27 volt, for use with compressor **\$14.95**
or other uses. Only, FOB K.C.

FLASHLIGHT INSPECTION LAMP ASSEMBLY

Water, Vapor and Shock Proof

NEW—Lights up "Hard-to-get-at" places. Fine for mechanics, electricians, radio repairmen, filling stations, home and other uses. Plastic 12" extension (6" flexible). Adjustable any angle. Govt. cost \$4.00. Our price.....



\$1.80
Ea.

ADD 10% FOR HANDLING AND SHIPPING.

National Surplus Sales Co. 1810 Charlotte
Kansas City 8, Mo.

NOW YOU CAN POLISH

"SIMONIZ" and WAX EASY

This exclusive patented way... saves 3/4 the time. Does a better job. 25c can enough for 4 cars. At your dealer or send 25c for can postpaid.

TIMEX PRODUCTS CO. ST. LOUIS, MO



A BETTER JOB EVERY TIME

CLEANS AND WAX POLISHES IN ONE EASY OPERATION!

Just Rub On, Let Dry, Wipe Off

Quick and easy. Do your car in less than an hour. Contains expensive, pure Carnauba wax, hardest wax known. Lasts up to 6 months.

RAIN-PROOF, SUN-PROOF, MUD-PROOF

In ready-to-use powder form. At your dealer or send \$1.50 for big 10-oz. can (enough for 4 cars) and get Timex Wax Polisher FREE. Limited offer! C.O.D. orders, plus postage.

A FEW TERRITORIES STILL OPEN FOR DISTRIBUTORS

TIMEX PRODUCTS CO. 5506 Virginia Ave. St. Louis, Mo.

HEATERS



Gasoline, burning 40,000 B.T.U., built by Stewart Warner for USAAF as cabin and engine heaters. Brand new and in original cases. Small modification makes ideal installation in trucks, buses, trailers, boats, small buildings, etc. No exposed flame. Crated shipping wt. — 40 lbs. A bargain at **\$28.50** ea. FOB Wash., D. C.

MICHEHL INDUSTRIES

ATLANTIC BLDG. WASHINGTON, D. C.

FULLSIZE, CUT-TO-SHAPE BOAT PATTERNS

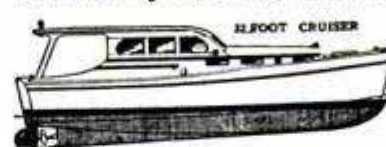

and specifications. Designed by Naval Architect. Cruisers, runabouts, sloops, outboards, sailing canoe, etc. Low prices. Send 10c (coin) for illustrated catalog. SPECIAL: Send \$1.00 for "HOW TO BUILD BOATS" book, postpaid.

Cleveland Boat Blueprint Co. Dept. 666, Cleveland 13, Ohio

Gun Camera Owners

Adapt your 16m.m. movie camera for close-ups. Unique mechanism provides conventional adjustment from 5 feet to infinity. Neat, easy to install. Send **\$2.95** for mechanism and instructions.

R. C. WOOD • 849 Birch Ave. • Hawthorne, Calif.

HOTTER GAS TORCH

100% PRIMARY AIR KELLER GAS TORCH **\$3.45**
Burns Regular House Gas (Natural Gas Only)—No Compressed Air, No Adjusting Needed—Develops 2100° F. POSTPAID

Guaranteed to silver solder, light brazes, solders, removes paint rapidly. Precision-engineered, 1500 B.T.U. per hour.

Order today C.O.D. from

KELLER GAS APPLIANCES

P. O. Box 261

Monrovia, California

Save 80% ASSEMBLE YOUR OWN ARC WELDER Only \$24.95



OWN A GENUINE INDUSTRIAL-TYPE HEAVY-DUTY WELDER
ALL PARTS READY-MADE - READY TO ASSEMBLE
WELDS ANY THICKNESS METAL

Why pay expensive assembling and shipping costs? The ATOMIC WELDER PARTS come packed in a compact box—YOU SAVE THE DIFFERENCE! EASY TO ASSEMBLE WITH SIMPLE, STEP-BY-STEP instructions, in a few hours. Also included are 10 easy lessons in Arc Welding. IDEAL HEAVY-DUTY WELDER for all-purpose arc welding. Safe, rugged, compact and EFFICIENT. WILL OPERATE FOR ONLY A FEW CENTS PER DAY. USES 1/4" ELECTRODES. Plugs into either 110 or 220 AC line. Can be used consistently on 30 amp. fuse. ALL PARTS DESIGNED TO GIVE LIFE-TIME SERVICE.

DO WELDING FOR PROFIT:

Increase YOUR earnings this easy way. The Atomic Arc Welder is designed by practical Welding Engineers to give you a quality Arc Welder at low cost. Complete step-by-step instructions furnished free. Shipping weight 60 lbs. — Immediate delivery.

- Satisfied Users From Coast to Coast Say:**
1. "Have bought two other welders — Atomic Welder is the only one that lives up to claims."
 2. "Did not heat up after four hours of constant use."
 3. "Welds any thickness of material."

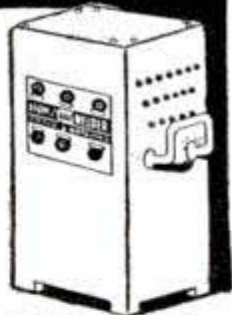

Buy Only NECESSARY PARTS
 60 lbs. OF PARTS INCLUDING SECONDARY AND SHUNT COILS WOUND COMPLETELY WITH DOUBLE GLASS COVERED ELECTROLITIC COPPER.

ORDER WITH CONFIDENCE!
 Try your ATOMIC WELDER FOR 30 days. If not satisfied, return as is. Your money will be refunded with no questions asked. What could be fairer than that?
IMMEDIATE DELIVERY — WRITE FOR BOOKLET P-17
ATOMIC WELDER COMPANY, 1038 So. 19th Street, Omaha, Nebr.

DEALERS WANTED
WRITE TODAY FOR LIBERAL DISCOUNTS.

NOW AVAILABLE

6 FOOT FOLDING RULE



Accurate 6-foot folding rule with sure-lock joints. Solid black calibrations on sturdy, satin-finish aluminum. Clear, distinct readings. 1/4-inch divisions with 1/8 divisions on first inch. Rust-proof rivets at all joints. Folds to 7-inch length. Sent postpaid on receipt of \$1.00. You take no risk. Satisfaction guaranteed. Money cheerfully refunded if rule is returned within 5 days. Order NOW.

\$1.00
 Postpaid

HESSE & CO. 77 W. WASHINGTON ST. CHICAGO 2, ILL.

\$13.50 Value for Only \$1.95

8000 ohm impedance Headphones, produced to Air and Signal Corps specs. Extremely sensitive, lightweight (only 9 oz.) With 5 1/2 ft. cord, plug, jack and ear cushions. BRAND NEW.
 No. 17A37
Spec., Per Pair... \$1.95 Plus 25c each for Postage.

FREE Catalog on Everything in Radio and Electronics.
Burstein-Applebee Co. 1012 McGee, Kansas City 6, Mo.

NEW STOP LIGHT

Auto FLASHER FOR FAST, SNAPPY DRIVERS
 Makes your Stoplight shout. Flashes 115 times a minute when footbrake is applied. Automatic. Approved by Safety Engineers. Used by Fire and Police Depts. If your dealer can't supply send check or M.O. for \$3.00. We pay postage. FREE booklet MONEY SAVING "Motoring Hints" with each order. Dealers and agents wanted.
MACCHI AND COMPANY, Dept. M58
 927 Larkin St., San Francisco 9, Calif.

PREHLER PROVED PRODUCTS

HOME CRAFTSMEN MECHANICS DRILL FASTER—EASIER—BETTER
 with this NEW CUMMINS 1/2" DRILL

SMOOTH PROFESSIONAL JOBS EVERY TIME!

You get a real thrill when you put this husky he-man tool to work on your toughest jobs. Drives twist drills for drilling up to 1/2" holes in steel—1 1/4" in wood—drives hole saws for holes 3/4" to 3 1/2" in wood, steel or composition—also drives sanders, buffers, etc. Saves hundreds of hours. Not a toy, even at this low price. PERPETUALLY GUARANTEED. Order yours today... only \$39.95... \$5.00 down, balance C.O.D. Shipping wt. 8 lbs.

CUMMINS 1/4" ELECTRIC DRILLS
 Strong speedy motor—streamline design—takes drills—sanders—buffers—wheels, etc. with shanks of 1/4" or less. PERPETUALLY GUARANTEED. With Jacobs Geared Chuck, only... \$20.95
TERMS: \$5.00 down, balance C.O.D. Shipping wt. 5 lbs.

Join the thousands of master mechanics and home craftsmen—men who know fine tools—by ordering your Cummins Drill today. IMMEDIATE DELIVERIES—EASY TERMS—Only \$5.00 down balance C.O.D.
 Send Check or Money Order to

PREHLER PROVED PRODUCTS - CHICAGO 47, ILLINOIS

DEALER INQUIRIES INVITED

PREHLER PROVED PRODUCTS
 Dept. P.M.17
 Div. Norbert Prehler & Company
 1623 Milwaukee Ave., Chicago 47, Ill.

Please send me the Cummins Drill I've checked on your Perpetual Guarantee Basis. I am enclosing _____ in _____
 Check _____ Money Order. I'll pay the balance C.O.D.

Cummins 1/2" Drill, Wt. 8 lbs. Cummins 1/4" Drill with Jacobs Geared Chuck, Wt. 5 lbs.

Name _____
 Address _____
 City _____ Zone _____ State _____

ONLY \$39.95
 \$5.00 down balance C.O.D. MAIL COUPON

GET MORE FUN for LESS MONEY with a CROSMAN!

ADJUSTABLE POWER without powder means you can shoot your Crosman indoors with safety and accuracy, without recoil, noise or odor. It means keen sport outdoors, too... target shooting, small game. Ammunition (Super-Pells) less than 1/3 cent a shot.

Crosman Silent RIFLE

... is available in single-shot or magazine types, .177 or .22 cal. A man's size, fine quality gun, with perfect balance, rifled barrel, rear peep and blade front sights. At sporting goods or hardware dealers, or write direct.

Crosman "Bullseye"

is a new .177 cal. single-shot target pistol with all Crosman "power without powder" advantages. Endorsed by experts... inexpensive to own and shoot—everyone can enjoy it. At your dealer's... or write direct.

CROSMAN ARMS CO., INC.
 3 HENRIETTA ST. • ROCHESTER 7, N. Y.

SAY YOU SAW IT IN POPULAR MECHANICS

SAVE BACK-BREAKING WORK!

**PLANT YOUR GARDEN
2 ROWS AT A TIME!**

with the
versatile

Garden-All
LAWN and GARDEN TRACTOR

Saves time...
assures uniformity
in seeding!

Adjustable
for rows
from
10" to 42"
apart

Write
for
Folder



Double Row Seeder
with Row Markers

Get a better job and avoid risk of sowing cracked or broken seed. Sow all kinds of seeds... from the smallest up to beans and corn. For small gardens—the Single Row Seeder; for larger gardens use two singles to make a Double Row Seeder. The exclusive Garden-All hitch allows seeders to follow contour of ground regardless of position of tractor.

Excellent Dealer Territories Open. Write for Details.

GARDEN-ALL TRACTOR, INC.
Dept. P, 100 W. UNION STREET, LIBERTY, INDIANA

**War and Factory
SURPLUS
TOOLS**

Superior Warranted
Spring Steel

**HAND
SAW**

Large 26"
Blade



\$1.00
ea.

Handy for every tool shop, work shop, experimenter... in the home, on the farm, in the factory... a wonderful surplus value worth many times this low price.

WOOD CHISELS

Set of 3 Great Neck

1/2" - 3/4" - 1"

\$1.00
set



Durable, convenient,
handy... A REAL BUY!

Write for FREE catalog featuring many surplus values. Enclose payment with orders plus 25c for handling and postage. Sorry—no C.O.D. orders accepted.

CITY SURPLUS OUTLETS - Dept. M
1518 E. 67th St. Chicago 37, Ill.

**STOP
CHANGING!
MOTOR OIL!**



End this needless waste and expense forever with **RECLAIMO** Today's Most Advanced Oil RE-REFINING Filter

Continuously cleans and RE-REFINES motor oil as you drive (by utilizing motor heat)—keeps oil in high grade lubricating quality at all times—reduces motor wear to a minimum! Proves conclusively that "Oil Does Not Wear Out Mechanically" as stated by U. S. Bureau of Standards, (Bulletin 86).

- "RECLAIMO"**
- REMOVES SOLIDS (by filtration)
 - REMOVES WATER (by distillation)
 - PREVENTS Excess Fuel Dilution
 - PREVENTS Acid and Sludge Formation
- MAINTAINS Stable Viscosity ELIMINATES All Oil Changes**
CAR • TRUCK • TRACTOR OWNERS!

You'll want to know more about Reclamo's Oil, Motor and Money-Saving Features. **FREE 40-PAGE BOOK "OIL FACTS"** gives you the complete "Reclamo" story plus details about our **New 90-Day No Risk-No Cost TRIAL OFFER!** WRITE for YOUR COPY TODAY!

NEW ADDED FEATURE!
Gas - Moisture Vapor Injector
Increases Mileage with Smoother Performance



RECLAIMO MFG. CO.

5083 ELSTON AVE., Dept. 76, CHICAGO 30, ILL.

BRIGGS-STRATTON ENGINES

1 1/2 HP. MODEL N - GOVT. SURPLUS

Special Low "as is" price **\$34.50**
Only.....

In good operating condition with 30 day written guarantee... **\$44.50**

Engines will develop almost 2 Hp. at 3600 RPM. Hurry don't wait, buy now while limited supply lasts. Suitable for lawn mowers, garden tractors, motor bicycles and scooters, midget cars, etc. Will power many kinds of machinery.

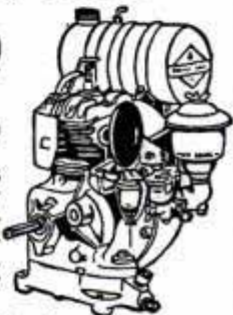

Write for Descriptive Circular

MIDWEST SURPLUS SALES CO. 2531 INDIANA KANSAS CITY, MO.

Spectacular New Plumbing Tool

INSTANTLY—THOROUGHLY
CLEANS CLOGGED DRAINS
in Kitchens, Toilets, Laundries
and Baths

SAVES TIME AND MONEY
Anyone can use it. **\$1.00**
Price, postpaid only....

AGENTS WANTED

N. N. NORRIS

209 Tenth Ave., New York 11, N. Y.



FIX SEWING MACHINES



BIG MONEY. Spare or full time. Open your own neighborhood shop. Thousands need repairs. Send for complete Service Manual—only \$1.08 postpaid. Money back guarantee.
SEWING MACHINE SERVICE CO., Hamilton 25-AA, Ohio

FISH POLE or SKI CARRIERS



A "must" for Sportamen! Genuine rubber suction cups for fenders or car top. Rigid, safe carrier for fish poles, skis, etc. \$1.50 per set delivered postpaid cash with order. No Stamps.

\$1.50 PER SET
THOMPSON ENGINEERING CO.
DEPT. 70 GRAND RAPIDS, MICH

IDEAL — For Lawnmower
Sharpening Profits

- PRECISION-BUILT
- GRINDS ALL MAKES OF LAWNMOWERS
- AUTOMATIC OPERATION
- NO EXPERIENCE REQUIRED
- MAKE UP TO \$200 PER WEEK

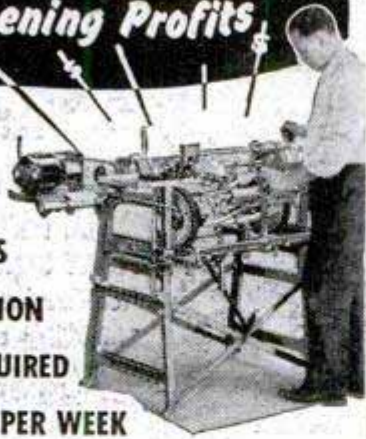

OPERATE in YOUR OWN GARAGE or BASEMENT

Ideal Lawnmower Sharpener sharpens blades easily, speedily, accurately. Grinds reel knives to fit the straight blade perfectly. Behind Ideal's strong, sturdy construction are nearly 50 years of engineering experience. Handles maximum width lawnmowers. Get ready for the lawnmower sharpening rush now.

Send for FREE Book

The FATE-ROOT-HEATH CO.

Dept. D-3, Plymouth, Ohio



"Factory" at your Fingertips

Saw blade tilts table stays flat

POWER KING 8" SAW

All your "construction" work — shelves, cabinets, furniture — can be built in a fraction of the time with this accurate Power King saw in your shop. Big 18" x 20" table, has 10 3/8" ahead of blade. Saw cuts 2 3/8" deep. Precision ball bearings assure long service. Rip fence locks at both ends, releases instantly for positioning or removal. It's America's outstanding table saw value. See it at your Power King dealers today, or send postcard for free literature.

NOW ONLY \$58⁷⁵



POWER KING TOOL CORP.
520 Cleveland Street
WARSAW, INDIANA
F.O.B. Warsaw less motor
Division of ATLAS PRESS COMPANY

New Way to Hear Better

Without Risking a Penny!



This is all you wear! \$75 Complete.

New Radionic **Zenith "75"**

THE HEARING AID THAT NEEDS NO "FITTING"

Send coupon below, receive this amazing hearing aid by mail—no "fitting" needed, no sales pressure.

So good it can be offered on this **MONEY-BACK TRIAL**

Wear your Zenith "75" at home, at work, anywhere. Compare its **QUALITY, PERFORMANCE, OPERATING ECONOMY** (less than 1c per hour battery cost) with that of **ANY** other hearing aid. If the Zenith "75" isn't better than you ever dreamed **ANY** hearing aid could be, return it within 10 days and get your money back in full.

Now—for the first time—you can judge for yourself how much a hearing aid can mean in your life! For the new Zenith "75" employs an advanced principle that eliminates need for "fitting." The correctness of this principle was recently confirmed by U.S. Government-sponsored research at Harvard University.

SAVES YOU OVER \$100, TOO! Because the new Zenith "75" comes to you by mail, it saves you embarrassing visits to salesrooms and annoying sales pressure. Also saves you over \$100 cash money. If its price had to include "fitting," middlemen's profits and high sales commissions, it would have to sell for \$195 instead of \$75. So do as tens of thousands have already done. Mail the coupon below—right now!

BY THE MAKERS OF THE WORLD-FAMOUS ZENITH RADIOS

Look only to your doctor for advice on your ears and hearing



MAIL THIS COUPON TODAY

Zenith Radio Corp. Hearing Aid Division, Dept. PM58
5801 Dickens Avenue, Chicago 39, Illinois

I enclose check or money order for \$75* for one Zenith "75" Hearing Aid. Unless I am completely satisfied and find the Zenith "75" superior to any other hearing aid, I may return it within ten days and get my money back in full.

*Plus tax of \$1.50 in Illinois or New York City; \$1.88 in California, except Los Angeles, \$2.25.

Please send me free descriptive literature.

Name.....

Address.....

City.....State.....



MOTO-TOOL ★ THE "POCKET-SIZE" MACHINE SHOP



A TESTED TOOL THAT PACKS YEARS OF PLEASURE

If you get a kick out of making things, you'll have fun with a Moto-Tool. It grinds, drills, routs, carves, polishes... does work better, faster... on practically any material. Moto-Tool is backed by 10 years of successful industrial service... also used by every branch of the Armed Forces. Compare Moto-Tool with other grinders and see for yourself why it's better.

- 10 Reasons Why Moto-Tool's a Better Buy**
- Oil-less, sealed bearings
 - Patented automatic chuck lock pin
 - Over-size armature shaft; hardened, ground, polished
 - 110 Volt, AC-DC motor
 - Sliding snap-type switch
 - Handy hanger hook; cord protector
 - Shock-proof bakelite housing
 - Dust-filtered air-cooling system
 - Dynamically balanced for vibrationless operation
 - Weights only 13 oz.

MONEY-BACK GUARANTEE:

Buy Dremel Moto-Tools from your dealer. If he cannot supply you, order direct from the factory on 10 day trial, money-back guarantee. Shipped postpaid for payment in full (send check or money order); or send only \$2, we will ship C.O.D. You pay postman balance plus postage. Catalog of Moto-Tools and Accessories FREE.

DREMEL MFG. CO.

Dept. 118-E • Racine, Wisconsin



APPROX. 27,000 R.P.M.

New DREMEL DRILL PRESS ONLY \$9.95

(Less Moto-Tool)

Here's a portable, precision drill press at an amazingly low price. Just the thing for creating costume jewelry, model making, wood carving, routing, etc. Utilizes Model No. 2 Moto-Tool, which can be raised or lowered, swung in any direction, or quickly removed for off-hand use. Drill Press stands 12" high. Base is 6 3/4" x 4". Weighs approximately 3 1/2 pounds.



PRE-WAR PRICES STILL PREVAIL

Moto-Tool Kit No. 2, with 23 accessories (high speed steel cutters, grinding wheels, polishing accessories) and heavy-duty professional Model 2 Moto-Tool in natural-finish, hardwood case. \$23.50 (Items purchased separately would cost about \$30.00; you save \$6.50.)
 Moto-Tool No. 2, with one emery point \$16.50
 Moto-Tool Kit No. 1, with 34 accessories and Model 1 Moto-Tool in wood case. \$17.50
 Model 1 Moto-Tool, with one emery wheel point \$9.85

Ball-Bearing SPEED WHEELS

Juvenile wheels, solid tire—No Bearings

- 7" wheels60c
- 6" wheels50c
- 4" wheels30c

- Semi-pneumatic tired wheels**
- 12 x 1.75"\$3.25
 - 10 x 1.75"\$2.75
 - 10 x 1.25"\$2.00
 - 8 x 2"\$2.00

Industrial wheels for heavy loads

- Semi-Pneumatic**
- 400 x 8, 2 ply tire and tube....\$12.50
 - 12 x 3.00", bolt hub, ea.....\$9.75
 - 10 x 2.75" Hollow Core.....\$6.75
 - 10 x 2.75" Single Tube.....\$7.25
 - 8 x 2.50"\$4.90
 - 6 x 2" lug base\$3.30
 - 6 x 2"\$2.80



DEALERS WANTED MANUFACTURERS INQUIRED

Free blueprints with all wheel orders. Send check with order. Shipments f.o.b. Akron.

JIM BROWN TOY COMPANY

1097 Home Ave. Akron 10, Ohio



\$5.00 PREPAID

New Invention 1 MINUTE TIRE TOOL

Make big money re-tiring cabs, tricycles, wagon wheels. Easy to operate. For shop or home. Guaranteed satisfaction. Send \$5. Tool shipped prepaid in U.S.A.—Canada.

O. P. DAVIS MANUFACTURING CO. Waterloo, Iowa

Patent App'd. For

WOODWORKERS

Use GESSO, a paint preparation used by craftsmen and decorators, to produce chalk white, ivory or antique finishes on raw wood furniture, bric-a-brac, frames, cigarette boxes, lamp bases, etc. Quart jar Gesso \$1.65 (instructions included). Add 25c to cover shipping costs. M. F. BERNER, 1121 Walton Ave., New York 52, N. Y.

| | | | | | |
|---|---|---|--|--|--|
| DOUBLE SIZE IMAGE VIEW FINDER OPTICALLY GROUND LENSES ASSURE BRIGHT IMAGE. PARALLAX MAY BE CORRECTED FOR CLOSEUPS. MADE FOR 1 3/8" and 1" LENSES. \$ 7.50 inc. tax | | GROVER 16MM GUN CAMERA ACCESSORIES | | PRECISION FOCUSING MOUNT ACCURATE FOOTAGE SCALE ENABLING SHARP PICTURES AS CLOSE AS 4 FEET FOR 1 3/8" LENS AND DOWN TO 10 FEET FOR THE 3" TELEPHOTO LENS. ALSO MADE FOR USE WITH BOTH LENSES AT SLIGHTLY HIGHER PRICE. SPECIFY LENS WHEN ORDERING. PRICE FOR MOUNT—\$2.85 LENS HOOD—85¢ | |
| BATTERY CARRIER 18 REGULAR FLASHLIGHT CELLS SUPPLY CORRECT OPERATING VOLTAGE FOR EITHER 12 OR 24 VOLT CAMERAS HAS CLIP FOR ATTACHING TO TROUSER BELT. \$3.00 | 16mm FILM 30 FOOT TROPIC-PACKED EASTMAN FILM MAGAZINES ONLY \$125 NO LIMIT !!! | CONVERTED G.S.A.P. CAMERAS COMPLETE WITH GROVER ACCESSORIES LISTED HERE— \$ 55.00 | | INSTRUCTION FOR THE CONVERSION OF THESE CAMERAS WILL BE SENT FREE OF CHARGE WITH YOUR ORDER. ALL OF OUR MERCHANDISE CARRIES A MONEY-BACK GUARANTEE | |

ASSOCIATED SURPLUS COMPANY. 10838 VENTURA BLVD., NO. HOLLYWOOD, CALIF.

Amazing New Invention "Drive It" NAIL DRIVER

• All Steel Construction •



• Saves Time, Effort and Temper •

For: **NAILS, BRADS, STAPLES, SCREWS, TACKS, etc.**

Every Carpenter or Home Mechanic appreciates the value of "Drive It" NAIL DRIVER for those hard to get at places to drive a nail or start a screw... you never miss a blow... on the head... EVERY TIME—and you never hit your finger... No wonder housewives like it... Overall length 10 inches (expands to 17 1/2 inches). Made to stand hard use... Simple, Easy and Quick to use... It belongs in every tool box.

IDEAL FOR THE HOME

HAMMER STAYS ON NAIL—STRONG BLOW RIGHT ON THE HEAD EVERY TIME

No swinging blow... No effort... A hit every time... Nail goes where you want it to go... without any damage to wood, furniture or wall... Something NEW.

for difficult or hard places

NO BRUISED FINGERS

Simply put the nail, screw or tack in the end of "Drive It" NAIL DRIVER and place it where you want it to go... Then drive it in the wood with easy blows... No damage to wood or your fingers.



... only **Postpaid \$1.19**

We ship C.O.D. plus postage...

MAIL YOUR ORDER TODAY

DRIVE IT-NAIL DRIVER, Dept. P-5, 4107 No. Meade Ave., Chicago 34, Ill.

WAR SURPLUS

CUT TO A BARE FRACTION OF REGULAR PRICES



NEW BOMB CABLE HOIST

Mighty handy for shop, garage or home. Can be used as winch. Hooks on wall, beam, tripod or trolley. Lifts or pulls 350 pounds. 20 ft. multistrand lifting cable and heavy chain ratchet. Each.....

\$889



BLOCK AND TACKLE

For lining fences, skinning and butchering. Die cast hooks, frame and wheels. 1/2 inch hemp rope. 288 inch length, each only

\$2.45



PARACHUTE HARNESS

SEAT PACK

Makes a swell swing for the youngsters. Complete with seat and back cushions, each only....

\$175

CHEST OR BACK PACK

Many feet of webbing, swell tow rope, many clamps and buckles, each

\$150



DIP TANK

Made of 1/4" galvanized sheet steel, strip welded for extra rigidity.

Heavy angle iron legs welded to frame. Drain and overflow pipe. For home, factory, farm or shop. Length 42", width 26", depth 22". Each.....

\$1795

Self Inflating Rubber LIFE RAFT

Sail, mast, rain canopy, repair kit, ball bucket, sea anchor, etc. For fishing, duck hunting, beach parties. Inflates when opened. These \$125.00 boats at Only.....



\$1795

AIRCRAFT BATTERY

12 v. - 45 amp. at 5 hr. rate - 10-5/32" x 113/4" x 8 1/2". For home power units as storage batteries. Shipped dry. W. # \$75.00. Now

\$1595

24 v. aircraft batteries, \$1950
17 amp. hr., only.....



PILOT CHUTES

Silk or nylon, spring steel frame—pops open like parachute. Swell toy, each



75c

HEATING ELEMENTS



For home made photo print dryers, chicken brooders, etc. Wiring diagram for use on 110 v., set of four.....

96c

RUBBER CEMENT



For cementing rubber, leather, paper and a thousand other household uses, pint.....

89c

4 oz. can only.....

24c

GOOSE NECK FLASHLIGHT

Flexible neck for workshop, car, garage. Brand new. With 2 bulbs (less batteries), ea. only.....

\$165

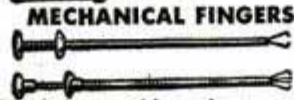

MECHANICAL FINGERS

Rigid for reaching places your fingers can't. Only.....

95c

Flexible for reaching things that drop or have to be set around corners. Only.....

\$105

MICARDA TUBING

Per Length
1" Solid black paper base, 36" lengths.....
1" Solid Red linen base 47" lengths.....
1" Hollow o.d., 3/4" i.d., 48" lengths red linen base.....
3/4" Hollow o.d., 1/2" i.d., 36" length red linen.....
5/8" Hollow o.d., 1/2" i.d., 36" length red paper.....

\$.95

1.79

1.39

.98

.79

For antennas, motors for windings coil winding cores, etc.



MOTOR GENERATOR



5 speeds - 5 drives. Very useful for pulleys. Input 18 volts and 4.5 amps. Output 450 volts 0.060 amps. Speeds from 4000 r.p.m. up. Each.....

\$695

SWITCH KIT



5-Toggle switches. Various types of single pole - single throw, double pole - double throw, flush mounting and hole mounting switches, all rated at 125 volt-5 amps. All five switches, new, per kit.....

\$124

SPRAY GUNS

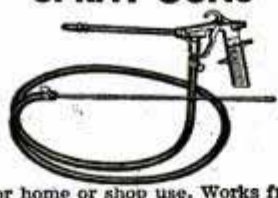

For home or shop use. Works from any can or bottle. New DeVilbiss type G. D. Z. series 510. Complete with hose, ea.....

\$525

Continuous PIANO HINGE

Length 72 inches, thickness .040"-width 1 1/4"

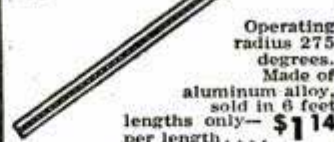

Operating radius 275 degrees. Made of aluminum alloy, sold in 6 feet lengths only - \$114 per length.....

GENERAL ALL PURPOSE PUMP

For all burners, spray machines, milking machines, compressors, vacuum pumps, hydraulic systems, manure loaders, pressers, etc. Original price \$45.00, your price, each, only.....



\$995

GENUINE TROPICAL SUN HELMETS



Light weight durable composition, covered with water repellent cloth. Adjustable chin strap. Adjustable sweat band. Sizes 6 3/8 to 7 3/8. Made to exacting specifications for our service men in the African campaign. For outdoor summer wear. A bargain! Each.....

\$195

WHEELS COMPLETE WITH TIRES AND TUBES

Brand new 5:00 x 4 wheel, bearings, tire and tube. Tire 6-ply, smooth tread, width inflated 4.8" overall height inflated 13.1". Wheel—split wheel, 5/8" axle hole, width at axle 2" - \$1450
Wheel—spilt wheel, 5/8" axle hole, width at axle 2" - \$1450
Complete tire, tube, wheel, bearings and axle stub, load cap. 29,000 pounds. Used, good condition, each..... \$9400
56" Wheel, Tire and Tube—16-ply. Height overall 56" width 19". Complete tire, tube, wheel, bearings and axle stub, load cap. 8,200 pounds. Used, good condition, each..... \$6250
38" Wheel, tire and tube—10-ply. Height overall 38" width 12 1/2". Complete tire, tube, wheel, bearings and axle stub—load cap. 3,500 pounds. Used, good condition, each..... \$4950
EXTRA—new 56" tire and tube..... \$4700
EXTRA—new 27" tire and tube..... \$1495
NEW 30 x 7 Tires 8-ply, Nylon and rayon cord, equal to 7:00 x 16, each..... \$1495

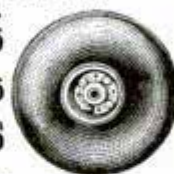

Arens Heavy Duty Flexible CONTROL CABLE

For autos, trucks, motor scooters or on controls beyond reach. Length 8 feet. 2 1/2" pull. Can be mounted through 3/8" hole and has brass knobs. Only

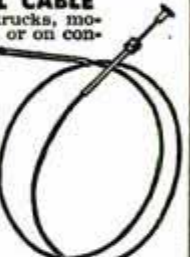

\$198

FOAMEX SPONGE RUBBER PADS

Oil and gasoline resistant. A thousand uses. Each only



Parachute Seat Cushions



For cars, fishing, baseball games, gardens, etc. Size 2" x 14" x 14"—olive drab. Used, excellent condition, each... \$75c

STAINLESS STEEL PRESSURE TANKS

Tapped with 1/4" pipe thread on both ends of the 500 cu. in., 1000 cu. in. and the 2100 cu. in. Smaller tanks, 1/4" pipe thread one end. For compressors, pneumatic units, hydraulic, liquids, or portable air storage for tires, etc. Tested to 500 pound pressure per sq. inch.



| Internal Volume | Capacity Under Pressure |
|-----------------|-------------------------|
| 104 cu. in. | 1.4 cu. ft. \$1.25 |
| 280 cu. in. | 3.8 cu. ft. \$2.00 |
| 500 cu. in. | 6.9 cu. ft. \$2.50 |
| 1000 cu. in. | 13.8 cu. ft. \$4.50 |
| 2100 cu. in. | 29.0 cu. ft. \$5.50 |

SEND 25% DEPOSIT ON C.O.D. ORDERS

SHIPPING CHARGES EXTRA
Rush Your Order Today! Satisfaction guaranteed or money refunded.

FREE! Write for Illustrated Circular

U. A. S. Corporation
Dept. PM1
5637 W. 63rd Pl. CHICAGO ILLINOIS

IT TOOK **TRIPPE**
TO PUT A *Spotlight*
WHERE IT BELONGS—
On the Roof of Your Car

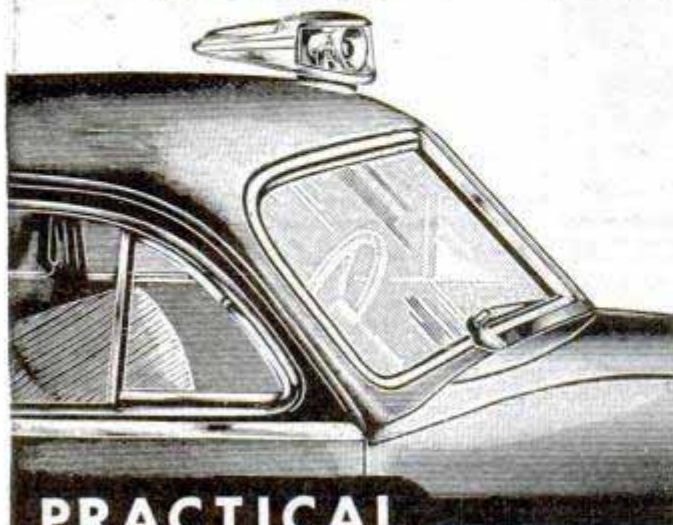

PRACTICAL

Mounted on the roof of your car in such a manner as to allow a sweep of 240° range of view (ahead, on both sides and to the rear) plus a 40° up and down movement. Inside control knob, directly connected with the lamp itself, is mounted close to the car roof within easy reach of the driver's right hand or the passenger's left hand.

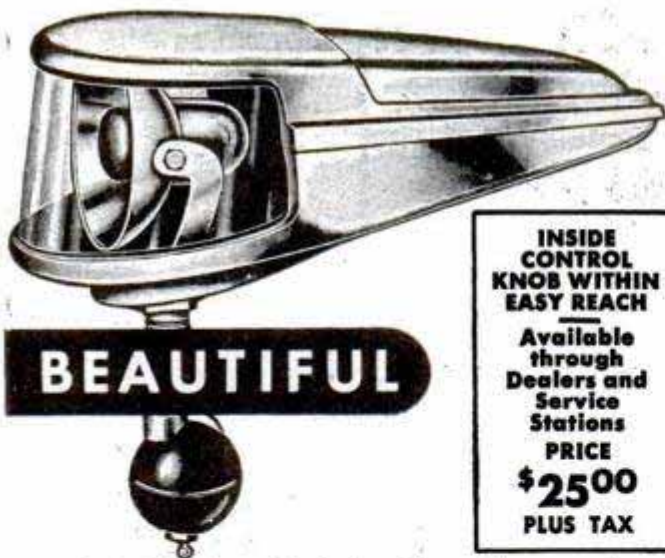

BEAUTIFUL

INSIDE CONTROL KNOB WITHIN EASY REACH

Available through Dealers and Service Stations

PRICE **\$25.00** PLUS TAX

Streamlined to blend in with modern car design, this highly chromed attractive unit adds distinctiveness to any car on which it is mounted.

Write for descriptive literature. Also we would appreciate having the name of your dealer or service station.

TRIPPE Manufacturing Co.
2610 W. 16TH STREET, CHICAGO 8, ILLINOIS

PROFITS AND SPEED

THE **MODERN**
LAWN MOWER
SHARPENER

PRICE **\$241.50**
LESS MOTOR

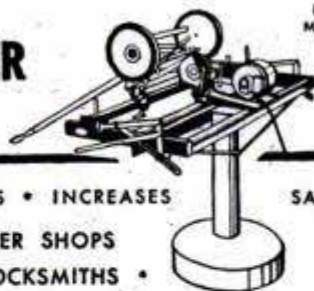

INCREASES PROFITS • INCREASES SALES!
FOR LAWN MOWER SHOPS
FITIT SHOPS • LOCKSMITHS •
HARDWARE STORES • GOLF COURSES • SCHOOLS
PARKS • PLAYGROUNDS • INSTITUTIONS •
CEMETERIES • AND ALERT INDIVIDUALS!

Sharpens All Reel Type Mowers • Hand, Power or Gang • 10 to 20 Minutes • No Dismantling • No Extra Attachments Needed

All reel type mowers, from 5-inch edgers to 36-inch power mowers, are quickly sharpened to extreme ends of both left and right twist reel blades. Handle, wheels, roller and motor remain in place when sharpening is in process. Bed knife is sharpened in same brackets that hold mower in grinding position. No extra attachments required. One lever puts mower or bed knife in grinding position. 100% steel construction. Grinding head rides on five ball bearing races. Small, compact, easy to operate. Sharpens wood chisels, joiner knives and planer blades without extra attachments.

ORDER NOW

Immediate Delivery

Skate Sharpener Attachment Available
Send For Free Bulletin No. 10B

MODERN MFG. CO. 160 N. FAIR OAKS AVE
PASADENA, CALIFORNIA

IMMEDIATE DELIVERY!

Complete as shown



\$24.95

F. O. B. ROYERSFORD, PA.



BENCH SAW

CUTS THROUGH 2 5/16"

UNCONDITIONALLY GUARANTEED ONE YEAR

Comes complete with Floating motor mount—miter gauge with adjustable stop—aluminum guard—soft aluminum insert—spring steel splitter—heavy gray iron fence—(no motor—no blade). Table 12" x 14". Tilts to 45°—Oilite bearings. Shipping Wt. 48 lbs.

AMERICAN MACHINE & TOOL CO. Inc.

DEPT. 100

ROYERSFORD, PA.

WRITE FOR FREE BOOKLET AND GUARANTEE BOND

SAY YOU SAW IT IN POPULAR MECHANICS

POPULAR MECHANICS

BARGAINS OF A LIFETIME!

Buy NOW at
Tremendous Savings!

SAVE \$100.00 ON NEW LIGHTING PLANT

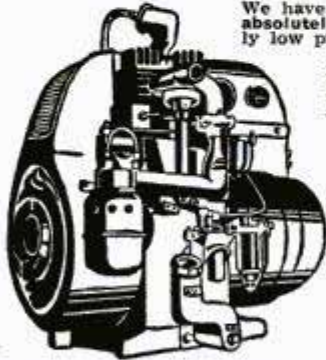

We have just obtained a limited quantity of absolutely new lighting plants at an amazing low price. You can share in our fortunate purchase by acting quickly. This is your buying opportunity of a lifetime. Remember, this equipment has never been used before. Act at once and save \$100.00.

1000 Watts—110 Volts AC—Manufactured by Onan and Sons. Generator 4 pole, self-excited, self-regulated, direct connection to the engine. Drip-proof, conservatively rated. Engine 1 cylinder, 4 cycle, air cooled, gasoline driven, magneto ignition, radio shielding. Manual Start. Brand New Units. Shipping weight 27 1/2 pounds. Factory Price \$295.00

Special Price **\$195.00**

PNEUMATIC AIR TOOLS

At a Saving of \$64.00 and Up!



RIVETER & CHIPPING HAMMER
Ingersoll-Rand AVC-11 with air control, push button throttle, takes up to 5/32 rivet. Like new. Weight 5 pounds. List Price \$73.00—Special Price..... **\$7.95**



RIVETER & CHIPPING HAMMER
Chicago pneumatic CP4 with air control, push button throttle, takes up to 3/16 rivet. Weight 6 lbs. List Price \$73.00—Special Price... **\$8.95**



CHICAGO PNEUMATIC ONE SHOT RIVET HAMMER
CP-204, Pistol grip with air control. Weight 5 lbs. List Price \$73.00—Special Price..... **\$9.75**



THOR PNEUMATIC ALLIGATOR Squeezer and Compression Riveter
Model PRS-10, Alligator jaws, or PRS-10, "C" Type Yoke. Weight 3 lbs. List Price \$39.00—Special Price..... **\$12.95**

Ideal fender and bumping hammers, and for riveting brake lining, concrete breaking and many other uses. Like new. At these unheard of low prices it pays to order a good supply.

MOTOR BARGAIN \$2.45



USE AS 6 VOLT GENERATOR—Generate your own power. Can be operated on your bicycle wheel. Furnishes sufficient power for two 6 volt bulbs. Resistor furnished free with each motor enables you to maintain constant voltage. Special Price \$2.45, or 4 for \$7.50, or 24 for \$36.00.

1/30 HP 24 volt DC motor 2450 R.P.M., .95 amps, 1/4" shaft size overall 3"x4", Weight 3 lbs. Also operates on 32 volts, only **\$2.45**

PRICES ARE F.O.B. CHICAGO. Immediate delivery. SOLD ON MONEY BACK GUARANTEE. Send check or money order today.

C & M EQUIPMENT CO.
1831 S. STATE STREET
DEPT. D5 CHICAGO 16, ILL.

PISTON TYPE AIR COMPRESSOR

Piston type, size 2 x 1 1/4, head in valves, bronze bearings, splash lubrication, "V" Belt drive, Intake muffler and cleaner. Capacity 2.8 c.f.m. at 100 lbs. continuous pressure or 150 lbs. Intermittent, with 1/2 HP motor. Can be used with 3/4 HP or 1 1/2 HP at lower speed. Weight 14 lbs. Operating instructions furnished.

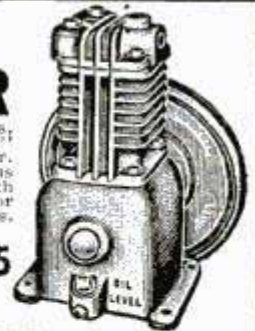

Immediate delivery. **\$17.95**
Price only



1/4" REDUCING VALVE & GAUGE

Oil resistant, pressure 0-to-200 lb. Reduced pressure 0-to-75 lb.; 3 outlets 1/4". Wt. 2 lbs. **\$5.75**



DASH POT CHECK VALVES

Prevent leakage after compressor stops. 1/4" Check Valve..... **\$2.50**
1/2" Check Valve..... **\$4.25**



AIR GAUGE

Standard air gauge, 1 1/2" diameter, 0-200 lb. pressure. **\$1.75**



POP TYPE VALVES

Has a close range of closing after pop-off pressure is reached. 1/4" pipe thread. Only..... **\$1.50**



AUTOMATIC PRESSURE SWITCH WITH UNLOADER

125-150 lb. pressure. Uses 1/4 to 5 H.P. unit. Only **\$8.95**

SPECIAL OFFER! SAVE 1/2 PORTABLE AIR COMPRESSOR SPRAY PAINTING OUTFIT



1/3 HP. GE MOTOR **\$49.50** COMPLETE LESS BASE

2.8 C.F.M. Displacement Compact Power Plus
Complete as shown, less base

Here is what you get: 1/3 HP. GE motor or equal, 110 volt, 60 cycle, 1 phase, 1750 RPM, with 6 ft. cord and plug; Compressor, 2 x 1 1/4 piston type; Spray gun with qt. cup, 2 nozzles, round-fan spray, air filter, 15 ft. hose and fittings; belt and pulley. All bolts necessary for mounting on base. We pass the big saving in labor on to you. All you have to do is mount on base as shown. Complete operating instructions furnished. Weight 50 lbs. **\$49.50**
Special Price.....

Flexible Shaft Unit



\$32.50 COMPLETE



HEAVY DUTY ELECTRIC MOTORS

1/3 H.P. General Electric Motor—110 volt—60 cycle—1750 RPM; 6 foot Stow or Mall heavy duty shaft, 3/8" core, ball bearing handle and arbor, 4" wire brush. Weight 32 pounds. **\$32.50**
Special Price...

Ball Bearing 110/220 volts—1 phase—60 cycle—1750 RPM—Continuous duty, 300% full load starting torque, outlet box, operates clockwise or counter-clockwise, carries one year guarantee against mechanical defects.
1/4 HP Wt. 30 lbs. **\$24.00**
1/2 HP Wt. 33 lbs. **\$28.00**
3/4 HP Wt. 26 lbs. **\$34.50**
1 HP Wt. 50 lbs. **\$44.00**
1 HP Wt. 80 lbs. **\$57.00**
These motors also furnished in 3450 R.P.M. at same price.

BALL BEARING STEEL WHEELS

Complete With Wheels, Tires & Bearings Made To Outwear Other Type Wheels

| SIZE | TIRE | BEARINGS | LOAD | ONE | TWO | FOUR |
|------------|-----------------------|-------------------|----------|---------|---------|---------|
| 12"x2 1/2" | Semi-Pneumatic | Ball 1/2" or 5/8" | 150 lbs. | \$ 5.50 | \$10.00 | \$18.00 |
| 12"x2 1/2" | Semi-Pneumatic | Ball 1/2" or 5/8" | 225 lbs. | \$ 6.00 | \$11.00 | \$20.00 |
| 12"x3" | Semi-Pneumatic | Bronze 3/4" | 340 lbs. | \$ 7.00 | \$13.50 | \$26.00 |
| 10"x1 3/4" | Semi-Pneumatic | Ball 1/2" or 5/8" | 125 lbs. | \$ 3.00 | \$ 5.50 | \$10.00 |
| 10"x2 1/2" | Semi-Pneumatic | Ball 5/8" | 250 lbs. | \$ 5.50 | \$10.00 | \$18.00 |
| 8"x1 7/8" | Solid | Ball 3/4" | 640 lbs. | \$ 8.00 | \$15.00 | \$29.00 |
| 6"x2" | Solid | Ball 1/2" | 340 lbs. | \$ 4.00 | \$ 7.50 | \$14.00 |
| | | Bronze 3/4" | | | | |
| 4.00"x8" | Pneumatic 16" O.D. | T.R. 1" | 700 lbs. | \$13.50 | \$26.00 | \$50.00 |
| 5.00"x8" | Pneumatic 16" O.D. | T.R. 3/4" | 700 lbs. | \$15.50 | \$30.00 | \$59.00 |

The above Pneumatic Wheels are Complete With Wheels, Bearings, Tires and Tubes . . . 4 Ply Tires for 3/4" and 1" Straight Axles. (Also 18", 21" and 23" High Speed Auto Type Wheels.)

SEND 10c FOR CIRCULAR: On Power Racers, Steering Wheel Assemblies, Auto Type Axles, Parts, Sulkies, Etc.

OSBORN WHEEL COMPANY, 115 So. Main St., Dept. P-5, Doylestown, Penn.



— NEW —

1948 Model Racers

MODEL "A" CHASSIS . . . Price \$39.75
with 10" Semi-Pneumatic Wheels.

MODEL "B" CHASSIS . . . Price \$56.00
(shown above) 12" Semi-Pneumatic Wheels.

MODEL "D" CHASSIS . . . Price \$139.50
with 5.00"x8" (16" dia.) Pneumatic Wheels.

Less Engines and Transmissions

Also sold Complete With 1 H.P. to 6.6 H.P. Gasoline Engines

25% DEPOSIT ON C.O.D. ORDERS

ORDER NOW

Add 10% for Prepaid Shipment in U.S.A.

MULTIPLE PURPOSE SUPERDRIVER

F-O-R-C-E by LEVERAGE!



The hardest jobs are easy with this entirely new driver. Tool for the Home and the Workshop. Die-Cast Aluminum Alloy Handles—Chrome Vanadium Steel Blades. Positively guaranteed against defects in original material and workmanship.

- Regular Screwdriver
- Leverage Screwdriver
- Light Hammer
- Pry Tool

Three sizes . . . please specify

- SD107—1/4" tip x 5" blade
- SD209—5/16" tip x 5 1/2" blade
- SD311—3/8" tip x 6" blade

Handles all identical

ORDER NOW! **\$1.00** ea.

2 for \$1.75 — 3 for \$2.50

JOBBERS WANTED — WRITE FOR DETAILS

MUELLER BROS. MFG. CO. 1701 N. Calhoun St. Box 839, Ft. Wayne 1, Ind.

TELESCOPING MEASURING TOOLS

Highly Precise Beautifully finished and fully guaranteed. The greatest advance in Telescoping Tool design in 25 years. The straight heads make for ease in squaring the tool with the hole or slot being measured and very definitely add to accuracy in making angle measurements.

The Plungers on all Tools are hardened and Precision Ground to very close limits.

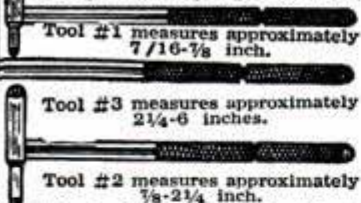

- Tool #1 measures approximately 7/16-3/8 inch.
- Tool #3 measures approximately 2 1/4-6 inches.
- Tool #2 measures approximately 7/8-2 1/4 inch.

Micrometer Accuracy Inside Measurements 7/16 inch to 6 inches ONLY

\$4.95 C.O.D. PLUS POSTAGE

Completely finished parts. SAVE \$10. Anyone can assemble in less than one hour. No tools of any kind needed.

ALCO SHOP • 2845 So. Delta St. • San Gabriel, Calif.

Say You Saw It in Popular Mechanics

MOTOR AND GENERATOR \$2.95 EA.



G.E. - 5D21NJ3A
Use as 1/2 Hp. 24/32 vdc. motor or 24/32 vdc. to 110 vac. 400 cycle converter. Complete instructions furnished. Excellent condition.

\$2.95 EA.

F.O.B. Everett

Write for free illustrated list. Satisfaction guaranteed or money back.

DICK ROSE—ERECO, 2912 HEWITT AVE., EVERETT 21, WASH.

Who Ever Heard of POWER TOOLS

Only \$7.00 Each?

5 large capacity power tools in one unit: lathe, drill press, circular saw, grinder and sander. Uses 1/4 h.p. motor. Complete, only \$34.95. Does same work as equipment costing up to 8 times more. Send \$17.50 (balance c.o.d.) on 10-day FREE trial, money-back guarantee. Or write us today for FREE illustrated literature.



HEAVY DUTY HOME WORKSHOP

COMPLETE **\$34.95**

ENRICK, INC., 1735 Clinton, Kalamazoo, Mich.

CAR BATTERY TESTER



Checks voltage of individual storage battery cells under operating conditions. Red, yellow, and green areas indicate satisfactory or unsatisfactory operation while under load, no load, or charging. Calibrated scale 0-3 volts. Will check flashlight or #6 dry cells. 2 3/4" square.

Stock No. MVD-25 \$2.00 postpaid
DUBIN ELECTRONICS CO., INC. Dept. PM-5
Box 68, Corona, N. Y.

ARMY SURPLUS A-C PLANTS

LECO ENGINEERING CO., Box 908-PM5, Lincoln, Nebr.

Nation's greatest bargains in 110-volt, 60-cycle, 2500 and 600-watt plants. Also plants without engines. FREE CATALOG!

NATIONALLY KNOWN QUALITY! FACTORY PRICES!

PAINT CLOSEOUTS

BEST BUYS IN AMERICA!

FINEST OILS AND PIGMENTS!

WHITE MILL ENDS

Top quality, for outside and inside. Will not yellow or peel; raw-material cost alone exceeds \$31 Glossy, tough, reliable. In 5-gal. drum. **\$1.95** gal.

OUTSIDE WHITE PAINT

Pure lead, zinc, titanium and linseed oil. Slightly off-white in can—will bleach white when applied. In 5 gal. drum... **\$2.95** Gal.

NAVY GRAY PAINT

Government surplus made from the finest formulation for the Navy. Can be applied to wood or steel, for years of service. In 5-gal. drum... **\$2.50** gal.

MAIL CHECK OR MONEY ORDER TODAY Satisfaction Guaranteed or your Money Back

SUPERIOR PAINT & VARNISH WORKS DEPT. P M 5

Manufacturers of Famous Superior 365 DDT BARN Coating

FACTORY SALES ROOM, 2260 ELSTON AVENUE, CHICAGO 14, ILLINOIS

SENSATIONAL GOV'T. SURPLUS BUY! LINSEED MIXING OIL

A perfect formula for a better, longer-lasting paint job! (84% pure linseed oil, 16% pure turpentine and dryer.) Picked as best to meet all tests of armed services for mixing exterior paints. Buy it NOW—does not spoil! SAVE at this really amazing low price! **\$2.60**

It's only... **\$2.60** Gal. Add 25c per gal. for handling and postage.

Write for FREE Illustrated Factory-to-You Price Catalog



ELECTRONIC KITS

For HOBBYISTS and EXPERIMENTERS



INTERPHONE 2-WAY CALL SYSTEM KIT



Shipping Wt. 5 lbs.
\$14.50

Ideal call and communication system for homes, offices, factories, stores, etc. Makes excellent electronic baby watcher, easy to assemble with every part supplied including simple instructions. Distance up to 1/5 mile. Operates from 110-V A.C. 3 tubes, one master and one remote speaker.

GN58 GENERATOR

Makes excellent home lighting plant, operated by wind propeller, waterfall, gas engine, or hand crank. Reduction gear allows full output at slow speed; supplies 6 volts at 2.45 amp., 425 volts at .115 amp. New. Add postage for 28 lbs. **\$7.95**



DYNAMOTORS



\$1.95
\$5.95
\$5.95

An electric motor operating a generator on same shaft—hundreds of uses—gives high voltage from storage battery.
Dynamotor C—Input 28 volts, output 220 volts at 60 MA. Add postage for 6 lbs.
Dynamotor A—Input 12 volts, output 1000 volts at 350 MA. Shipping weight, 72 lbs.
Dynamotor B—Input 6 or 12 volts, output 500 volts at 160 MA. Shipping weight, 30 lbs.

GENERAL ELECTRIC TRANSMITTER-RECEIVER FOUNDATION

A beautifully constructed tuner containing the best in variable condensers, coils, vernier dials, etc., at least \$30.00 worth of parts, complete with conversion instructions to transmitter and receiver. Add postage for 20 lbs. **\$2.49**



GENERAL ELECTRIC BC 645 TRANSCIEVER

10 times as powerful as a walkie talkie



\$14.95
2 for **\$27.00**

A brand new two-way communication set which cost the Army over \$400.00 and is ideal for two way communication between house and cars, office, service trucks, ambulances, boats, etc. Range up to 15 miles in the 450 to 500 Megacycle band. Operates in the new citizens band. Supplied complete with 15 tubes and conversion instructions to operate from 110 V A.C. Add postage for 25 pounds.

ACCESSORIES NEEDED

PE101C Dynamotor for 12 or 24 Volt storage battery operation \$3.95
110 V A.C. Power Supply to operate BC 645 from house current \$11.95
T-32 Table Microphone..... \$2.95
Microphone Transformer..... \$1.00
5" PM Speaker for BC 645 \$2.80

HEATHKIT 3-TUBE ALL-WAVE RADIO

110-volt AC operation

\$5.95

An ideal way to learn radio. This kit is complete ready to assemble, with tubes and all other parts. Operates from AC. Simple, clear detailed instructions make this a good radio training course. Covers regular broadcasts and short wave bands. Plug-in coils. Regenerative circuit. Operates loud speaker. Battery model for use where no AC house current is available. Add postage for 3 lbs.

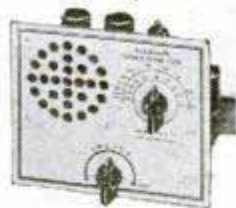

Heathkit Beginners' Radio 110-volt type \$5.95
Heathkit Beginners' Radio, battery type (2 tubes, no rectifiers) \$5.95
Headphones for either type HS 30 per set \$1.00
2 1/2" permanent magnet loudspeaker for either type \$1.95
Batteries, complete kit for battery type set \$3.25

MIDGET TRANSMITTER KIT

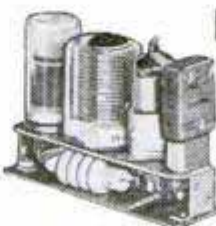

Complete kit to assemble a 1 Watt battery operated amateur 80 meter transmitter, including tube and crystal. Range up to 500 miles. Only accessories needed are sending key and batteries. Complete instructions supplied. Add postage for 2 lbs.

Key—add postage for 2 lbs. \$1.00
Batteries—add postage for 4 lbs. \$3.25

THE NEW 1948 HEATHKIT 5" OSCILLOSCOPE KIT

Complete kit to build a beautiful 5" oscilloscope. Ideal for studying and servicing television and FM radio. 6 tubes including 5BP1 cathode ray tube. 1500-volt power supply operates from 110-V 60 cy A.C. Has compensated vertical and horizontal amplifiers and 15 cy to 30 KC sweep generator. Detailed instructions make assembly easy. Shipping weight, 35 lbs. Nothing else to buy **\$39.50**



WRITE FOR LITERATURE ON HEATHKIT SERVICE INSTRUMENTS

MINIATURE HEADPHONES



\$1.00

Hearing aid type, comfortable, keeps out outside noise, one of the army's best types. Add postage for 2 lbs.

T32 TABLE MICROPHONE

One of the army's finest built by Kellogg. Ideal for public address, transmitters, etc.

Add postage for 5 lbs. **\$2.95**



G. E. CIRCUIT BREAKER



\$2.95

Protect your electrical equipment, eliminate fuses. 50 AMP 220 Volt rating. Add postage for 4 lbs.

MINIATURE MOTOR

24V.D.C. size 1 1/4" x 1" x 2". Add postage for 1 lb.

\$2.95



ORDER DIRECT FROM THIS AD
Include postage for weight shown. Print name and address. No orders under \$2.00



The **HEATH COMPANY**

DEPT. M . . BENTON HARBOR, MICH.

Which of these Amazing FLEXIBLE SHAFT TOOLS Do You Want?



Grinds, Polishes, Sharpens, Cleans, Mills, Carves, Engraves, Etches on Metal, Wood, Glass and Plastic

Now you can turn your old motor, drill press, or electric drill into a Flexible Shaft Tool. Amazing new Presto-flex, latest addition to the Foredom flexible shaft family. Simply attach to your electric drill, drill press or motor. Presto—a flexible shaft machine! Off again in a jiffy! Pencil size handpiece gives you finger-tip control. Gets into tight places you can't reach with any other tool. Handy 35" overall length. And—only \$5.95 complete! Order NOW. If you order Presto-flex for use on motor, specify motor shaft diameter and add 50c for motor coupling. (Available for 1/4", 5/16", 3/8", and 1/2" shafts.) No. 50 Accessory Set available \$1.50 extra. Order TODAY.

Foredom FLEXIBLE SHAFT MACHINE with PENCIL-SIZE Handpiece



Complete with Motor **\$19.95**

5 REASONS WHY FOREDOMS ARE TOPS:

1. Extra power and longer motor life because motor not dwarfed to fit hand.
2. Correct handpiece size for deft, sensitive, FINGER-TIP CONTROL.
3. No obstructed view of your work.
4. Freedom from gyroscopic action—hence better work.
5. Small handpiece size lets you get into hard-to-reach places.

Hundreds of Uses

Foredoms handle hundreds of tasks. Use them for pleasure or profit, for tinkering or expert craftsmanship. Their versatility is unlimited. Use them to grind, polish, mill, engrave, sharpen, slot, rout, saw, carve, clean, sand, etch, cut, etc. Ideal for internal carving of plastics, the astounding new craft. You can work on wood, glass, plastic and all metals with a Foredom. No. 25 Accessory Set (A truly versatile assortment) only \$5.50 extra.

OVER 60,000 FOREDOMS NOW IN USE

SEND NO MONEY

FOREDOM ELECTRIC CO., Dept. A-116 MAIL COUPON NOW!

27 Park Place, New York 7, N. Y.

Please send me FOREDOMS checked below on 10 day trial.

- PRESTO-FLEX Tool (\$5.95) Specify motor shaft diameter.
- Motor Coupling (50c) No. 50 piece accessory (\$1.50)
- FLEXIBLE SHAFT Machine No. 25 piece accessory (\$5.50)

Send C.O.D. plus postage. I will pay postman.

I enclose payment. Send postpaid.

(Money back either way if not delighted)

Name _____ Age _____

Address _____

City _____ Zone _____ State _____

SAY YOU SAW IT IN POPULAR MECHANICS

\$16.95

Complete



FLOCKING or SANDBLASTING GUN operates on small air compressor

The most Decorative Gun on market—101 uses. Home Craftsman, Hobbyist or Refinisher—Spray that velvet Suede Finish on your Radio Cabinet, Lamp bases, shades, Book ends, Statuettes, Jewelry boxes, Auto Dashboards. Make things Snagproof, Marproof. Ideal for Cushioning, Art or Sign Work, Print Goods. Sand Blasting Designs on glass for frosting glass or writing Names on Tools, Wood or Metal. Will remove paint or rust from Auto Bodies. This feature alone is worth \$16.95! Aluminum Alloy Casting, Brass Fittings, Chrome Molybdenum, Heat-Treated Sand Nozzle and Air-Jet. Shipped complete with flock ready to use, \$16.95. 3-Day money-Back-Guarantee. Money with order Post-Paid in U.S.A. California orders send 2 1/2% Sales Tax.

BLASTO SPRAY GUN MFG. Dept. PM-5, 7007 Haas Avenue Los Angeles 44, Calif.

.. I GUARANTEE TO WASH YOUR CAR in 10 MINUTES or less!



YES... Remove ALL Oil and Grease Film, Caked-on Mud, Sticky Road-scum... without soap!! no streaks!!

I am the Amazing **"WASH-MASTER"** The Scientific **REVOLVING** Water-Driven **BRUSH...**

So easy, safe, lightweight, a child can use it. Just screw the Wash-Master to your garden hose—water rushes thru tubular aluminum handle into hydro-turbine head causing center brush to whirl fast and loosen dirt, mud, grime which washes away instantly. Polishes as it cleans. Stationary outer brush gets into corners. No splash, no streaks, no scratching. Can't leak. 10 min. to perfectly wash car, trailer, truck without soap, sponge, or chamois. Ideal for washing windows, walls, floors in homes, stores, factories, offices; for outside surfaces of homes, buildings, etc. Can be screwed into length of Std. 3/4" pipe to reach high places. Users make money fast doing wash jobs for others. Available at automotive and hardware dealers—if not, send check or money order to

\$7.50 POST-PAID

MELVIN & SPERLING, Inc.
2100 PARK ST. SYRACUSE, N. Y.

WHEELS



Spotwelded Heavy Gauge Steel LOWER PRICES!

- 5"-3/4" solid tire, 3/8" bushing, ea.... 49c
- 8" with 1" solid tire—
- 1/2" OR 3/4" steel bearing, ea.... 99c
- with 7/16" bronze bearing, ea.... 99c
- with 7/16" KILIAN BALL B'R'GS, ea. 1.19
- with 1/2" KILIAN BALL B'R'GS, ea. 1.25
- 10" with 1/2" KILIAN BALL B'R'GS, and 1.75 semi-pneumatic tire, ea.... 2.29

ADD 10% to ALL prices for P.P.: 15% West of Miss. Send check or money order only. We guarantee satisfaction. Mail order NOW!

C. W. YOUNG MFG. CORP.
208 BURNET AVE. SYRACUSE, N. Y.

CASTING REEL



No Fancy Gadgets! Just a Well Built Conventional Level Wind Fishing Reel!

Highly plated brass construction. Smooth click. Adjustable tension. Capacity 100 yds. 25 lb. test line. Money back guarantee. Send check or money order.

Direct Factory Sales Make This Price Possible

\$3.95 POSTPAID

Mohawk Products Co., 235 SARGENT ST., HARTFORD, CONN.

HOOF MASTER Steel Cutting Shears

for bench or portable use, cuts flats up to 3/4" x 3 1/2", rods 7/16". Used by leading Mfrs., Home work shops, etc. Perfectly Machined; Guaranteed 1 Year. Save Money—order direct from this ad. ONLY \$49.50. Shipped promptly Frt. or Express Weight 35#. Circulars free.

2508 14 Ave. So. P. M. HOOF, Mfrg. Minneapolis 4, Minn.

PATENTS

TRADEMARKS

Patrick D. Beavers

REGISTERED PATENT ATTORNEY
929 COLUMBIAN BUILDING

416 5TH ST. N.W.

WASHINGTON 1, D. C.

THE **foster** LINE

TRADE MARK

POWER TOOLS



8" TILTING TABLE SAWS
44.95 to 75.00

9-12" LATHES
29.50 to 37.50



18" JIG SAWS
39.95

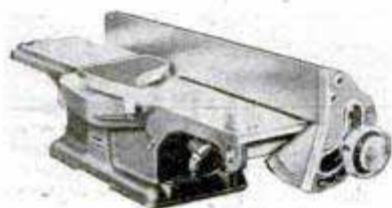

4" JOINTERS
39.95

**DOLLAR FOR DOLLAR
TOOL FOR TOOL**

THE **foster** LINE

LEADS THE FIELD



SPINDLE SHAPERS
29.95 to 99.50

Make your selection from this broad line. You'll find just the right Foster Power Tools to fill your needs.

Built to serve home, farm and industry Foster Power Tools have all the latest design and construction features.

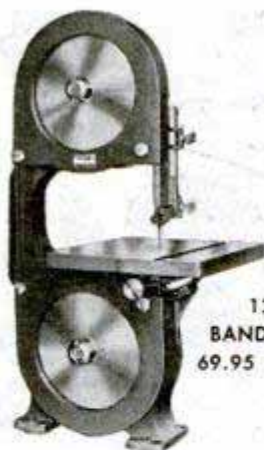

12-14"
BAND SAWS
69.95 to 84.50



12"
DRILL PRESSES
49.50

33 fine tools

FROM WHICH TO CHOOSE

- 10x2 3/4" THICKNESS PLANERS \$119.50
- 12 3/4x4" THICKNESS PLANERS 230.00
- 12" TILTING ARBOR SAWS 147.50
- 8" RADIAL ARM SAWS 119.50
- DRUM AND DISC SANDERS 29.95

- 12" WOOD TURNING CHISELS—set of 6 6.95
- 17" WOOD TURNING CHISELS—set of 8 12.50

CIRCULAR SAW BLADES — DADO HEADS
SHAPER HEADS AND KNIVES

FOR FREE CATALOG SHEETS
SEE YOUR DEALER OR WRITE DIRECT

SEE THEM NOW AT
YOUR FRIENDLY FOSTER DEALER

foster manufacturing co.

1 KINSEY AVE, BUFFALO 17, N. Y.

DRILLMASTER

Power Drill

with
Accessories

**DRILL
GRINDER
POLISHER**

Ideal for Particular Craftsman. Beautifully designed with aluminum die-cast body, 2 interchangeable chuck collets, cool running motor 3,000 R. P. M. 60 cycle, 110 V.-A. C., Cutler-Hammer slide switch, 6 ft. cord. - Steel saw, 3 bristle brushes, steel brush, felt and cloth polishing wheel, grinding wheel, emery discs and dressing stone.

only
\$7.95

SEND NO MONEY - FILL IN AND MAIL TODAY

MINOR MACHINE CORP.
45 North Division St., Buffalo, N. Y. DEPT. P. M.-1
Send Parcel Post, C. O. D. one Drill master Power Drill
and Accessory Kit at \$7.95.

Name _____

Address _____

Charges Paid if Money Accompanies Order

MINOR MACHINE CORP. 45 N. Division St. Buffalo, N. Y.

KESTER SOLDER MAKES METAL REPAIRS EASY



Use Kester Cored Solder for metal repairs as well as all metal craft hobbies. An outstanding product that will give you real soldering efficiency.

KESTER SOLDER COMPANY

4251 Wrightwood Avenue Chicago 39, Illinois

Factories also at Newark, New Jersey - Brantford, Canada

GENERATORS AND PUMPS

AT LOW SURPLUS PRICES

ALL BRAND NEW

AC Generators

5 KW (5000 Watt) **\$175.**

7.5 KW (7500 Watt) **\$225.**

60 Cycles
1800 RPM
Ball Bearing
Easily Connected to
7½ to 10 HP Power Source

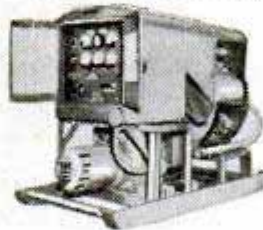

7.5 KVA (6 KW)

Gasoline Generator Sets
Wisconsin 20 HP
Self Contained
Panel Board & Tank
120 Volts AC
3 Phase 60 Cycles

LIST: **\$850.**

OUR PRICE: **\$450.**

Self Priming
Gas Engine
55 Gal. Per Minute
at 50 foot Head

2" MARLOW PUMP: \$110.



All prices F.O.B. Brooklyn
Terms: 25% with order, Remainder C.O.D.

BENJAMIN'S FOR MOTORS

2122 Mill Ave.

Brooklyn, N.Y.

Compare

The Features of these sturdy.

Aviation Type

SUN GLASSES

complete with handsome leatherette case

\$2.45

plus 15c postage and handling

What a scoop! The most superior sun glasses we've seen at this low price! Made to exacting optical specifications! They'll shut out 96% of harmful ultra-violet and infra-red rays. Give your eyes the best—send for these glasses today!

To insure prompt delivery, please send remittance with order. Full money-back guarantee—our reference, the Milwaukee County Bank.

VETS Surplus Sales

1414 W. FOREST HOME AVE.

MILWAUKEE 4, WIS.

VETS Surplus Sales

1414 W. Forest Home Ave., Milwaukee 4, Wis.

Enclosed is my money order for \$_____

Please send me _____ prs. Sun Glasses at \$2.45. I have included 15c postage for each pr.

Name _____

Address _____

City _____ Zone _____ State _____

**MAIL
THIS
COUPON**

Here At Last

A Complete Electrode Service for Better, Easier, Faster Welding

**P&H Shop Packs —
8 types of electrodes—fill every
shop welding need**



These industrial and commercial arc-welding jobs are easier to do and cost less when you use P&H Welding Electrodes:

- All types of industrial welding
- Sub-contracting work for large manufacturers
- Air conditioning
- Home heating
- Truck body building
- Trailer building
- Automotive repairs { blocks, fenders, frames
- Fuel-oil tanks
- Contractors' welding
- Bridge work
- Construction equipment repairs { excavators, tractors, graders, ditchers, etc.
- Kitchen equipment
- Cabinet work
- Fabricated housing
- Fabricated garages
- Cast iron repairs
- Maintenance work for industrial plants
- Ventilating systems
- Bicycle repairs
- Stainless steel bar equipment
- Ornamental iron work
- Fabricating equipment of your own design

Eight famous P&H industrial electrodes now conveniently packaged for automotive, general repair, job welding, and machine shops; foundries; schools; etc.

You save welding time and do better work, when you always have the right electrode for the job.

P&H Shop Packs consist of eight different packages of electrodes. Detailed instructions are printed on each individual package so that you can use the right electrode for every job.

Guesswork is eliminated. Welds are stronger, better looking. Welding time is greatly reduced.

And you can weld anything made of steel, alloy or stainless steel, sheet metal, cast iron. You can also put hard, protective, long-life surfaces on new parts, or build up worn parts better than new. P&H Shop Pack electrodes let you do a wider variety of work — at lower cost.

Attractive Price

The cost of all 8 Shop Packs, individually packaged and labeled for your convenience, is only \$11.75.

Simplifies Inventory

The use of individual packages means that you only have to reorder the types you need — at little cost. Maintaining a complete range is easy. You can always handle any job that comes up.

Can be used on any type of welder

It pays to use P&H packaged electrodes. No matter what make of welder you have, no matter whether you use AC or DC current, order P&H Shop Packs today from your nearby P&H distributor.

Reduces Welding Costs

Purchase P&H Shop Pack electrodes (\$11.75). Check their speed, quality, easy manipulation, and wide variety of uses. This 'small' investment paves the way to lower

welding costs. You will want to standardize on these efficient weld rods.

As a further aid to reducing costs, we suggest that you investigate the new P&H AC Arc Welder. This is the only welder with easy-to-use Dial-lectric control. It has no moving parts and needs no maintenance.

Connectible to 220 or 440 volt current, the P&H Dial-lectric machine requires only 2 1/4 feet of floor space. Built-in remote control; easy, quick-start arc; high-low welding range; elimination of arc blow; and the simple radio-like knob that provides complete welding range from 20 to 275 amps with a 1/4 turn — all these features make for better, faster welding.

Contact your nearby P&H distributor for complete details about America's most complete welding service, or mail the coupon below, clipped to your business letterhead.



Manufacturers of
America's Most Complete Welding Service

TEAR OUT COUPON, ATTACH TO YOUR BUSINESS LETTERHEAD, AND MAIL TODAY

HARNISCHFEGER CORPORATION
4673 W. National Avenue, Milwaukee 14, Wisconsin
Yes, I'm interested in Shop Packs, P&H's complete electrode service, and the new P&H AC Arc Welder with revolutionary Dial-lectric control. I would like information on the items that I have checked below:
 P&H AC Welders Send address of distributor
 P&H Shop Pack Electrodes Send representative
 Send Free Book, "Simplified Welding."

Name.....
Position..... Company.....
Address..... Home Business
City..... State.....

Announcing SHAPER and MOLDING Cutters FOR ALL MAKES OF DRILL PRESSES!



NO SET SCREWS TO LOOSEN!
BLADES AUTOMATICALLY ADJUSTED. CANNOT SLIP OR FLY OUT!



OTHER EXCLUSIVE FEATURES

Blades instantly replaceable—automatically drop into position—cannot loosen or fly out . . . quickly rehoned or re-ground. Variety of blade shapes for varied contours. Balanced, concentric, built for lifetime use. One locking nut only. Fits tapered, threaded, or 1/2" I.D. spindles. Specify type and size spindle.

\$9.00

Complete as illustrated with 3 sets of blades. Full Money-Back Guarantee



ALL-METAL SHAPER FENCE

For use with shaper and molding cutters, planers and drum sanders. Fits all drill presses and shapers. Complete—with tempered hold down springs. Fully rust proofed. A real buy.

\$7.95



2 1/2" DRUM SANDER

\$3.95

with 5 Sleeves



ROTARY WOOD PLANER

Most sensational, versatile drill press tool ever built. Planes, trues-up, tenons, panels, rabbits, grooves, beads, bevels, etc. An all purpose, lifetime tool. Complete.

\$7.50



4" ROTARY SANDER

Sands wood and plastic surfaces to agate smoothness. Available for hand drills, flexible shafts and drill presses. Two size arbors 1/4" or 1/2". Complete with 20 discs.

\$5.95

FULL 10 DAY MONEY-BACK GUARANTEE

FREE Workshop Catalog →

BARRON TOOL COMPANY, INC.
569 Architects Bldg.: Detroit 1, Mich.



BARRON PRECISION WORK SHOP TOOLS

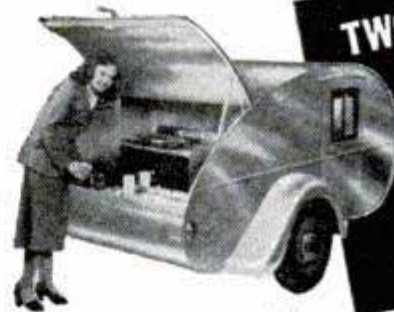

TWO DAYS' FUN SAVES \$200!

You've seen the CUB Sports Trailer on local lots for more than \$500. You've envied CUB owners who could afford the luxury of an all-metal trailer. Now you can have a CUB of your own—for \$279.50.

Here, for the first time, is a full-size trailer in construction kit form—at less than the cost of materials alone. Best of all, assembly is so simple that you can build the CUB with a crescent wrench and screw-driver—in less than two days.

Actually, the CUB is all but ready to roll when it leaves our factory. Aluminum panels are precision cut and guaranteed to fit, holes are all drilled, and every practical sub-assembly is completed by factory craftsmen. You simply tighten a few bolts—and hit the road with a streamlined sportster that pays for itself on one vacation.

The CUB is 12' 7" long, 6' wide, 5' high, sleeps two, adds only 75 pounds tongue-weight to your car, and includes galley, wheels, fenders—all essential parts except tires and tubes.

F.O.B. Los Angeles, price for full kit—\$279.50

(C.O.D. shipment will be made if at least \$50 deposit accompanies order)

Write for illustrated booklet . . . FREE

National Trailer Stores

Dept. 54, Box 2353, Terminal Annex,
Los Angeles 54, California

HELPFUL BOOKS

Send post card asking for FREE catalog

Popular Mechanics Press, 200 E. Ontario, Dept. 601, Chicago 11

INVENTORS

Whether an invention is patentable can be substantially determined by a search of the U. S. Patent records. Without obligation, write for information explaining the steps you should take to secure a patent.

JOHN N. RANDOLPH

Registered Patent Attorney

201 Columbian Building, Washington 1, D. C.

7 BIG SPECIAL BARGAINS at LOW PRICES

110 Volts D.C.

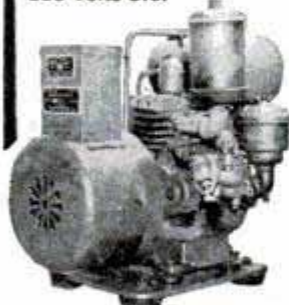

Made For the Government: All NEW . . . Never Used

BRIGGS & STRAYTON Portable Lighting Plant priced at a fraction of the original cost. Built to rigid Government requirements. Especially built for Field Use or for permanent installation in Cottage, Farm, Trailer, Boat, etc. Complete with 1 3/10 H.P. Gasoline Engine, Hand Starter, Rated 250 Watts will develop 500 Watts. With Spare Parts and Tools. Mounted on permanent base . . . Rubber cushioned . . . Ready for Immediate Use anywhere . . . At this LOW PRICE they won't last long . . . Better Hurry only \$129.50.

SPERRY S-1 BOMB SIGHT—Here is an unusual opportunity to get one of these MARVELOUS Precision Mechanical Instruments . . . Marvellous beyond description. Contains hundreds of parts usable in 1001 ways . . . Regular and Bevel Gears, Shafts, Approx. 100 Roller Bearings, Electrical Parts, Precision Lenses and Prisms, Countless Gears, Dials, Knobs, Switches, Polaroid Filter, Calibrated Dials for Air Speed, Drift Indicator and Illuminated Spirit Level, Gyroscope, etc. . . . Excellent for Inventors, Experimenters, Hobbyists. Schools use for Study Demonstration. Only \$49.50.

Cost U. S. Gov't \$4,500
OUR LOW PRICE

ONLY

\$49.50

F.O.B. Chicago

SPERRY S-1 Bomb Sight—Same As Above But Used.

ONLY \$29.50

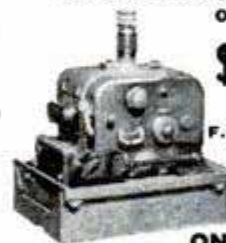

COMPLETE WITH POWER PLANT, Only \$129.50 F.O.B. Chicago

MOMENTARY SWITCH

Made by Cutler Hammer. Excellent for Photo Flash Gun, Testing Circuits, Microphones, etc. Only

\$1.25 ea. Postpaid



LENSATIC COMPASS (used)

With Sight Finder and Stop Button. In Case with Folding Cover. Perfect for travel.

Only \$1.59 ea.

Postpaid



PISTOL GRIP SWITCH (new)

Double Contact Switch. Trigger Action for ON and OFF. Complete with 6 ft. Insulated Lead Wires. Any circuit to 115 volts. Only \$1.19



ea. Postpaid

GENERAL ELECTRIC AIR COMPRESSOR

Catalog #T8252882 G1 . . . Rated Pressure 1000 pounds to square inch . . . Dual Cylinders . . . Shipping Weight 9 1/2 lbs.

Only \$9.95

ea. fob. Chicago



Paint Your Own Car in One Hour with the NEW AUTO ENAMEL

YOU WIPE ON Like Magic with only a POWDER PUFF

2 YEAR Guarantee LUSTR-WIPE

TRADE MARK

Dries in about one hour to smooth, mirror-like professional finish.

GUARANTEED FOR 2 YEARS not to crack, chip, peel or fade, if simple directions are followed. Lustr-Wipe is NOT a wax or a polish but a marvelous new Auto Enamel.



**NO Brushing
NO Spraying
NO Masking
NO Streaks**

Follow the simple instructions and LUSTR-WIPE will give your car that new FACTORY-LOOK. Dries dust-free in about an hour. Goes over any color, enamel or lacquer.

ONE QUART PAINTS YOUR ENTIRE CAR ANYONE CAN DO A BEAUTIFUL JOB

LUSTR-WIPE is the easy, speedy, economical, yet most successful way you've ever seen to PAINT YOUR OWN CAR. It's different-works almost like magic! All you need is ONE QUART of LUSTR-WIPE, the Miracle Auto Enamel, and the powder puff we send you AT NO EXTRA COST. Almost ANYONE, can do a magnificent job in about ONE SHORT HOUR. It seems unbelievable but true. JUST WIPE IT ON. No brush needed. No spray required. No masking of any kind. LUSTR-WIPE dries dust-free in about an hour. You'll be amazed—thrilled beyond words with the results! Your friends will think you spent \$75 to \$125 for a professional paint job. YOUR CAR WILL LOOK "LIKE NEW". Rush your order for a quart of LUSTR-WIPE TODAY.

This Price for Immediate Delivery

**SAVE by
Ordering
NOW!**

\$3.95
PER
QUART
Applicator
Furnished

ORDER ONE OR MORE
QUARTS TODAY

Send for free details of powerful money-making plan. Why wait? The weather is ideal for painting cars. **START NOW BY ORDERING ONE OR MORE QUARTS OF LUSTR-WIPE TODAY!**

SEND NO MONEY! ORDER LUSTR-WIPE TODAY!

| | |
|--|----------------|
| BLACK | \$3.95 per Qt. |
| GREY (Gunmetal-Dark or Air Wing-Light) | 3.95 per Qt. |
| GREEN (Brewster-Dark or Jewel-Light) | 3.95 per Qt. |
| BLUE (Washington-Dark or Monticello-Light) | 3.95 per Qt. |
| SUN BEIGE (Tan) | 3.95 per Qt. |
| RED or MAROON | 3.95 per Qt. |

Order one quart or more today! **SEND NO MONEY!** Mail penny postcard. Then pay postman for LUSTR-WIPE plus postal charges. Or, if you send money with order, WE pay postage. See your dealer or order direct.

MAIL COUPON TODAY! SEND NO MONEY!

AGENTS WANTED FOR NEW MONEY-MAKING BUSINESS! CAN MAKE GROSS PROFITS UP TO \$275.00 IN ONE WEEK.

Go into business for yourself selling LUSTR-WIPE in cans, or painting cars yourself or having others to do the work. Owners of old cars everywhere (who can't get new cars) are easy prospects. Send now for our MONEY-MAKING PLAN.

DISTRIBUTORS WANTED: A few wonderful territories now available. Write at once for our SPECIAL OFFER. LUSTR-WIPE CORP. 166 W. Washington St. Dept. 5, Chicago 2, Ill.

LUSTR-WIPE CORP. 166 W. Washington, Dept. 5, Chicago 2, Ill.

Please send me _____ quarts of LUSTR-WIPE AUTO ENAMEL at the special price of \$3.95 per quart.

COLOR _____

- Send Postpaid. Full Payment \$_____ enclosed.
 Send C.O.D. plus Postal charges.

NAME _____

ADDRESS _____

CITY _____ ZONE _____ STATE _____

- Send information regarding AGENT PLAN.
 Send information regarding DISTRIBUTORSHIP.

Champion of them All

m&e MODEL EP $\frac{1}{4}$ -20A PORTABLE SPRAY PAINTING OUTFIT



Complete \$68.20

AS SHOWN

WITH $\frac{1}{4}$ hp MOTOR

SHIPPING WEIGHT—COMPLETE OUTFIT—49 LBS.

Here's the outstanding Portable Spray Painting Outfit, ideal for Home, Garage, Schools, Factories, Workshops, etc. Refinishes cars, trucks, furniture, repair parts... Sprays paint, enamel, lacquer, varnish, insecticides, coatings, etc. Inflates tires. A real husky! Piston type, single cylinder, displacement 2.3 C.F.M. 50 lbs. air pressure. Mounted on sturdy steel base, rubber feet incl.

| | |
|--|---------|
| EP $\frac{1}{4}$ -20A Outfit Complete with $\frac{1}{4}$ H.P. Motor, Gun, and 12' Air Hose with Connections..... | \$68.20 |
| EP $\frac{1}{4}$ Outfit Less Gun, Hose..... | \$56.85 |
| EP $\frac{1}{4}$ Outfit Less Gun, Hose, Motor..... | \$44.80 |
| Model 20-A Gun Only with Qt. Metal Cup..... | \$ 9.25 |

Also available, $\frac{1}{2}$ H.P. outfit complete with 2 gallon capacity pressure tank and necessary accessories for larger painting jobs.

IMMEDIATE DELIVERY

IF YOUR DEALER CAN NOT SUPPLY YOU—WRITE DIRECT

Write for FREE information

TERMS: 25% with order—balance C.O.D. or Cash with order—prices F.O.B. Indianapolis

m&e MANUFACTURING COMPANY
2571 Winthrop Ave. INDIANAPOLIS 5, INDIANA



ESPEY Television Kit

Designed around modern circuits, and manufactured of the finest materials, this ESPEY Television Kit offers you the opportunity of building your own personal television set at unbelievably low cost. Kit is supplied complete (less tubes and cabinet) with all parts, punched and welded chassis, instruction book, etc. **\$69.50*** for only.....

Magnifier makes 20 sq. in. picture!

*Prices 5% higher West of Rockies

For full details, write to Dept. D

ESPEY MANUFACTURING COMPANY, INC.
528 EAST 72ND STREET - NEW YORK 21, N. Y.



\$1.00

2000 Scale M. P. H.

ALL METAL

Completely Carved Body.
Metal Wheels.
Bubble Canopy.
Decals.

JET SHOOTER 35c

Send 15¢ for Catalog

If your Dealer cannot supply you send 10% postage and order direct.

The Megow Corporation Philadelphia 22, Pa.

STOP FUEL PUMP TROUBLES

Amazing New Fuel Pump
GUARANTEED FOR THE LIFE OF CAR!

Stop fussing with faulty fuel pumps! Get a new AIRPRENE and we'll replace it FREE at the first sign of trouble! That's the amazing UNCONDITIONAL GUARANTEE of the AIRPRENE FUEL PUMP with the 100,000 MILE DIAPHRAGM. Models for most Fords, Chev., Ply., Dodge, DeSoto, Chry. and other cars (Single Action Pumps) \$5 at your dealer or garage — or send name, model and year of car to (Enclose \$5 check or M.O. and save postage and C.O.D. charges.)



airprene

AIRPRENE DIVISION M1 Murray Auto Specialty Co., Inc.
1228 South Olive Street • Los Angeles 15, California

THE ONLY SAW BLADE THAT CUTS IN ALL DIRECTIONS WITHOUT TURNING WORK OR SAW

TYLER Spiral SAW BLADES

Saws in any Direction for Most Intricate, Difficult Patterns.... Oil-tempered spring steel wire blade...outlasts other type blades

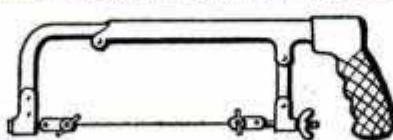
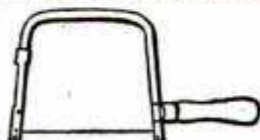
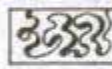

At Your NEAREST HARDWARE STORE Or order direct today... Prompt shipment Your money back if not delighted.

COPING SAW... Entirely new, better way of sawing... Only coping saw blade that cuts plastics... wood... metal... with absolutely clean, even edges. Won't tear. Now... anything you can draw... you can saw. 360° cutting blade. 1 coping saw frame. 5 spiral blades, complete... only \$1.00

REVOLUTIONARY SPIRAL HACKSAW BLADE... Cuts iron, steel, bronze, brass, aluminum, plastics... any direction. Only blade that cuts tubing without tearing or grabbing. For intricate internal work... before impossible. Fits any standard frame. Merely slip adapters over pins. Length 10". 2 blades and pair of adapters... a real buy... only 39¢

YOUR BLADES ARE THE ANSWER TO MY CUTTING PROBLEMS. SEND AT ONCE... SAWING IS BELIEVING

TYLER MFG. CO. — 938 Pico Blvd., Santa Monica, California, Dept. M5
Please Rush Send 1 coping saw frame Send 2 hacksaw blades and pair adapters (enclosed 39¢)
 Send BOTH — 1 coping saw frame 5 blades plus 2 hacksaw blades and pair adapters complete (enclosed \$1.39)

NAME _____
ADDRESS _____
CITY _____ STATE _____

TYLER MANUFACTURING CO. 938 PICO BOULEVARD SANTA MONICA, CALIF.

SAVE 85%

in WAR SURPLUS... SENSATIONAL VALUES
at 'GADGETEER'S HEAVEN'
IN MANY ITEMS WE HAVE THE WORLD'S LARGEST SUPPLY

MACKINAW
 Made of heavy water repellent poplin cover. Wool blanket lined. High length sleeve flap for adjustment. An ideal coat for the outdoor man, Truck Driver, Hunter, Farmer.
\$7.89 each

16 m.m. MOVIE CAMERA
 Standard Eastman magazine loaded. Battery Driven. Handy, no winding. Has F-3.5 lens. Cost Government \$235.00. Used but perfect. Only **\$24.95**
 Conversion diagram with each camera.

F-56 CAMERA
 20" focal length. telephoto lens with F-5.6 Bausch and Lomb lens. Complete with spare magazine, filter and film roll in trunk. A \$1000 Value Complete for **\$395.00**

WE'RE SCRAPIN' THE BARREL JUST A COUPLE HUNDRED LEFT
AIR CORPS FLEECE LINED JACKET
 D-1 TYPE
 These have been reconditioned, cleaned, and brushed. but they are kinda rough. We do not recommend them for dress wear. However, if you want a warm, rugged, full sheepskin felt, fleece lined collar, zippered front, leather jacket that has lots of outdoor wear left in it that you can't beat for value at this close-out price **\$7.95** ea.
 You'd better write in fast, before they are all gone. Ideal for Hunters, Farmers, Garage Mechanics, etc. Large Size Only

NEW DUST RESPIRATORS
 200,000 in 5 different types with adjustable hd. bands
 B1 Valve Type **29c** each
 in lots of \$0.25c ea. 100 or more, 19c ea.

MESS TRAY
 6 compartments, rustless, stainless steel. Barbecue, outdoor cooking, save dish-washing. Hospital, Restaurant, Home, or roughing. **83c** each #311

KEYSTONE F-8 CAMERA
 F-8, 15" focal length with F-5.6 telephoto lens. Hand operated, complete with carrying case **\$105.00**

Rubberized Nylon NEW Tarps, 7' x 11' **\$6.95**
 Rubberized Linen 7' x 11' **\$5.95**
 Only 3 lb. light weight yet waterproof. Ideal for outside car storage, etc.

FOR PNEUMONICOSIS—producing dusts, road dusts, mists, & chronic acid mist, produced in crushing, mining, road building, abrading, farming, drought, painting, spraying, etc. Ideal for Farm, Mill, Factory, Garage, Foundry.

COMPLETE NAVIGATION SET, 14 clothbound, 230 page volumes. Embracing tables & graphs from 0-4 degrees, thru 65-69 also American Air Almanac, 2 volumes Air Navigation Line of position manuals all issued by United States Navy
 1 Plastic Parallel Straight Edge.
 1 Weems Aircraft Plotter.
 1 Rude's hydrographic star identifier, screw driver and other tools.
 1 Controllable Diamond Navigation Divider Packed in Airplane Luggage Type, compartmentalized with extra roll insert celestial navigation suitcase A-6 30-12-12. Dim. 10 1/2" wide 8 1/2" deep 2 3/4" long & extra outside compartment **\$31.25**
 or packed in briefcase 16 1/2" long, 6" deep, 11" wide **\$29.25**

FLYING HELMET
 #407 Fleece-lined winter **\$1.59** ea.
 Ideal for cycle drivers, racers, sportsmen. Used, but in excellent condition.

SLEEPING BAG
 NEW! 100% wool. Mummy type. Heavy duty 30" zipper. \$1 extra Gov't. cost \$22.00 for used **\$4.95** #103
 water repellent cover

COMFO-RESPIRATOR
 dual-disc, Style BM-2101, with 10 extra filters, a \$3.50 value. **\$1.59** each

CANVAS HELMET
 #407 A—Summer weight **69c** ea.

BED TRAY-TABLE
 adjustable legs, removable tray stainless steel formed tray spreads 33" x 12" high is 17" x 23", on bed. Made of light weight metal. **\$4.49**

NEW TARPS - HEAVY CANVAS
 Mildew & Flame Resistant, Cheap Outside Storage. They are Really Moving at These Prices.
 5' x 7' **\$3.95**
 8 1/2' x 10' **\$8.50**
 9' x 16' **\$11.95**

WILSON CO. dual disc, type J-750 with 10 extra filters in appearance like BM-2101 **\$1.29** each

NEW OXYGEN MASK
 A-14 Demand type **\$3.50** ea.
 Slightly used but perfect **\$1.95** ea.
 Used but with make **\$2.50** ea.

MUKLUKS
 Knee height, double thickness, leather filled, water repellent body, leather foot with adjustable knee strap and instep lace, also 8" pocket on shank. You'll love 'em in the cold winter sports. **\$4.29** pr.

NEW 100% ALL WOOL BLANKET
 7 x 7 ft. Extra heavy. Also Double warmth. Fits Wood's Robe sleeping bag. **\$4.65** #414

PULMASON RESPIRATOR
 with Felt Filter. **79c** ea.

PERISCOPE M3 2 Power with small 3" telescope inside. Lenses in both scopes worth more **\$3.95** ea.

TANK TELESCOPE
 For Fun & Utility 3 Power **\$4.95** ea. #201 T M-3A1

'Twas Made for the Air Force THE BEST
Loose Leaf BINDER
 You ever saw a metal post, cylindrical locking heavy duty 2 1/8" telescoped hinged cover. End identification window. Ideal for price books, salesman catalogues, photo albums, students publications, Reference books, wear check books, etc. Will hold 500 sheets 8 1/2" x 11". A \$5.00 Value for Only **\$5.95** ea.
 30 Page Binder Bond
 Folders for 25 Extra.

AMERICAN OPTICAL CO. RESPIRATOR
 Style B-9100 small & compact especially suited to laboratory & hospital work. **59c** ea.

PILLOWS
 CURLED CHICKEN FEATHERS
 26" x 17" **99c** ea.
 Blue & white ticking. New, but still Renovated and Sterilized, in accordance with Laws of California.

NEW AIRCRAFT ALUMINUM BUCKET SEAT
 Use for boats, jeeps, tractor seats etc. 17" x 18" seat, 18" x 24" back. Rib reinforced. Adjustable height tube mounting. Wide, high back gives excellent support. Easily installed. Shipped in original carton. You'll appreciate the buy at **\$4.95**

HORSEHIDE WORK GLOVES
 ALL LEATHER GAUNTLET TYPE REINFORCED PALMS & FINGERS SEWING. LENGTH 12 1/2" - 13 1/2" **\$1.95** pr.
 ALL LEATHER WORK GLOVES. Length 10 1/2" - 11 1/2" **\$1.55** pr.
 Barbed wire, welding, all purpose work gloves.
 A Steal . . . Gov't. cost many, many times more.

MICARTA TUBE
 Ideal for insulation or bushing. Stock, 36" x 1/4" wall x 1" O. D. Original use was for trailing antenna - F 10. Use for towel rack, souvenir displays, shafting spacers, bearings, etc. **59c** ea. In original carton.

NEW HUNTING KNIFE #107
 6" chrome vanadium blade 4" handle, leather grip. In leather sheath. **\$5.98** Value For Only **\$1.69**

CUSHIONS
 New int. leather cushions, yellow pigskin color. Filled with kapok. Will float. Size - 22 1/2" x 17" x 1 1/2" thick. At fraction of Gov't. cost **\$2.95**

COMPASSES
 #151 Marching, lensite, with luminous dial **\$1.59**
 #152 Matchbox, both jewel & liquid floating dial **39c**
 #154 Wrist strap Compass **69c**

RADIO ANTENNA Reel
 Just the thing for tuning beam antenna. Powered by 1 1/2 A. P. 24 G. E. Motor. Removable 6" Neelimit Switch - Can Warm gears, Rev. at gear, Scleroid clutch. Motor engaged to gear reduction only when electrical contact made. Operates in either direction. Ideal for auxiliary power take-off, opening and closing doors, etc. **\$4.95**
 A TREMENDOUS VALUE

TEAR SHAPED PLEXI-DOME
 Overall length 21", width at widest point 11", at base 4", 6" deep. **\$1.39** ea.
 Also 200,000 lbs. of other plexiglass sizes and shape

RUBBER GLOVES
 Neo-Prene, Protective, Impermeable
 1000 Uses. Home Farm, Factory or Laboratory **79c**

STOP WATCH
 Elgin 15 Jewel Waltham Pocket style. Stopwatch crystal. Split seconds (1/10th). Waterproof. Stainless steel, coil suspension Case. NEW **\$12.95** #260

RADIO HEAD SET
 AN-BH-1 with Leather Sponge Rubber Pad - A Wonderful Buy **\$1.00**

NEW NAVIGATORS Magnetic Compass
 type B-12 size 7" dia x 4 1/2" deep Rubber lined - rotating verge range rings calibrated in 1 degree from 0-360° with 2 parallel grid wires for alignment with N & S line. South, declines. **\$17.95** ea.

RUBBER GLOVES
 Neo-Prene, Protective, Impermeable
 1000 Uses. Home Farm, Factory or Laboratory **79c**

ORDER DIRECT FROM THIS AD
 FREE - LARGE ILLUSTRATED CATALOGUE
 All sales final. Make remittances by money-order, bank draft or personal check. Purchase orders acceptable from D & B firms. All quotations F. O. B. Los Angeles. Send 1/2 deposit with C. O. D. orders. Also Complete Aircraft Supplies

BC 308-A NEW SIGNAL CORPS TUNING UNIT
 In heavy aluminum case with black crocodile finish 18" x 10" x 8". Velvet vernier knob, calibration 0-100, with locking assembly. Switch - 3 positions with knob. 4 1/2" diam. coil with three others inside, and movable induction tuning coil. WORTH MANY TIMES MORE **\$1.89** ea.

PALLEY SUPPLY CO. THE LARGEST FIRM OF ITS TYPE IN THE WORLD
 DEPT. P. M. 58 — 6321 SAN FERNANDO RD. GLENDALE 1, CALIFORNIA

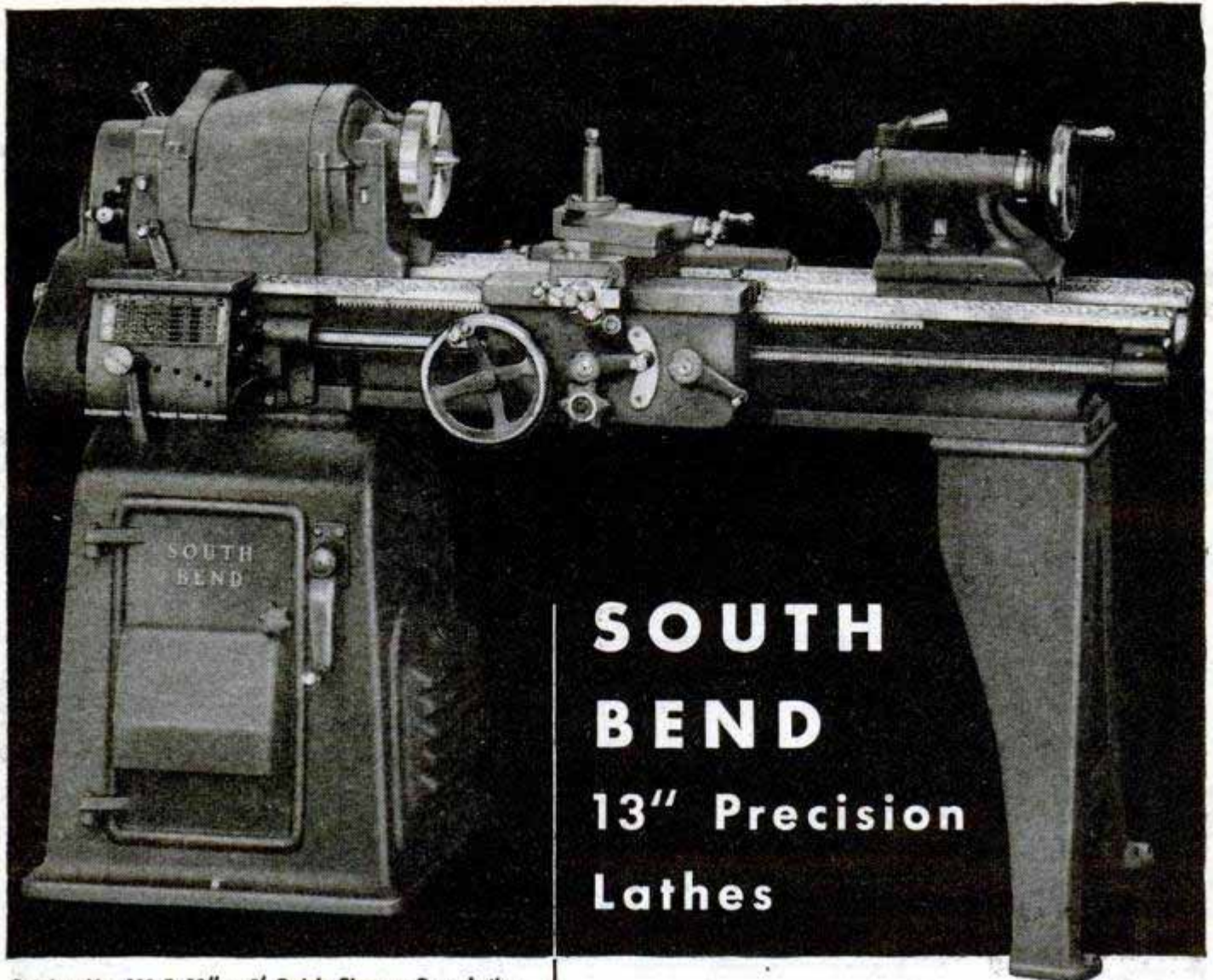

SOUTH BEND 13" Precision Lathes

Catalog No. 113-B 13" x 5' Quick Change Gear Lathe with 3 ph., 60 cycle, 220 v., A. C. motor and drum switch; f.o.b. factory **\$1153.50**

South Bend 13" Precision Lathes offer many advantages where close-tolerance machining is required. They are economical of power, accurate, fast, and versatile; and have capacity to handle chuck work up to 13" in diameter, and between-center jobs up to 8" x 52". Substantial savings in capital investment, floor space, and labor cost often result from their installation.

The Quick Change Gear model (illustrated above) is popular for production operations, maintenance, and service work. The Toolroom model has sufficient capacity to handle a large variety of toolroom work—its accuracy insures perfect results. Numerous tools and attachments are available for special jobs.

Other South Bend Lathes with 9" to 16" swings—\$145.00 and up. We also

SPECIFICATIONS

| | |
|---|--|
| SWINGS: | 13 $\frac{1}{8}$ " over bed and saddle wings; 8 $\frac{3}{4}$ " over saddle with chip guard removed. |
| BED LENGTHS | 4, 5, 6, and 7 feet |
| DISTANCE BETWEEN CENTERS | 16 to 52 inches |
| COLLET CAPACITY | 11/16 inch |
| SPINDLE BORE | 1 inch |
| SPINDLE SPEEDS: Eight | 34 to 875 r.p.m. |
| POWER LONGITUDINAL FEEDS: 48 R.H. or L.H., .0015" to .0841" | |
| POWER CROSS FEEDS: 48 | .0006" to .0312" |
| THREAD CUTTING: 48 R.H. or L.H. pitches | 4 to 224 per inch |
| CROSS SLIDE TRAVEL | 8 $\frac{1}{4}$ " |
| COMPOUND REST TOP ANGULAR FEED | 3 $\frac{1}{2}$ " |
| TAILSTOCK SPINDLE TRAVEL | 4 $\frac{1}{4}$ " |
| TAILSTOCK TOP SET-OVER | 15/16" |

| | |
|---|------------------|
| PRICE RANGE OF SOUTH BEND 13" PRECISION LATHES | |
| Quick Change Gear Lathes | \$1054 to \$1162 |
| Toolroom Lathes | \$1418 to \$1494 |
| <i>(Prices f.o.b. factory, less electrical equipment)</i> | |

manufacture Precision Turret Lathes with $\frac{1}{2}$ " and 1" collet capacities, and a 14" Drill Press in bench and floor models.

Immediate delivery. Time payment plan available. Write for catalog.



SOUTH BEND LATHE WORKS

Building Better Tools Since 1906 • 455 E. MADISON ST., SOUTH BEND 22, IND.

Printed by Popular Mechanics Company, Chicago, Ill., U. S. A.

SHAW "DU-ALL" and "PEPPY-PAL" TRACTORS

RIDING and WALKING MODELS—1½ to 12½ H.P.

Backed by
45 YEARS
OF MANUFACTURING
"KNOW-HOW"

**PROMPT
SHIPMENT**

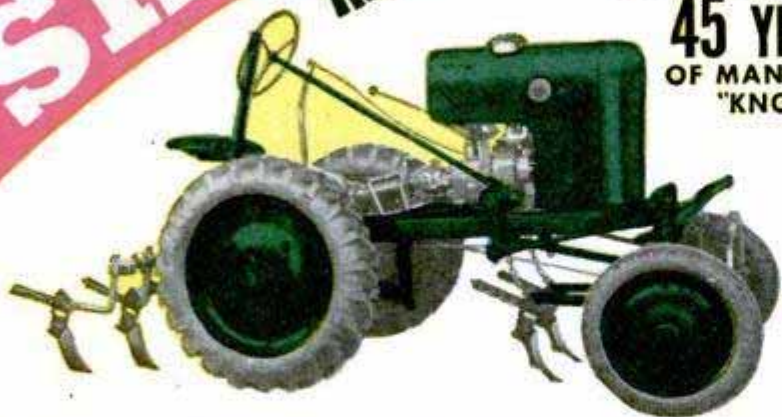

Dozens of Jobs Done Quickly and Easily

Do all kinds of hard jobs the easy way with Shaw Du-All or Peppy-Pal tractors . . . jobs that produce more food and feed, in less time with less work . . . at less cost. You can plow, cultivate, mow, harrow, disk, spray, grind, bulldoze, plow snow, saw wood and do many kinds of belt jobs, dig, haul, seed and scores of other jobs with these sturdy, powerful tractors.

Their extra-strength construction, precision engineering and efficient power utilization mean top performance on the most rugged job.

IDEAL FOR GARDENS, SMALL FARMS

Shaw walking and riding tractors are dependable, all-around economical workers . . . ideal for truck farms, gardens, orchards, nurseries, poultry farms, golf courses, estates, and cemeteries. They're always ready, always willing . . . a size to fit your needs. Hand or electric starter on riding models; 24 inch plant clearance.

Many outstanding features make Shaw tractors easy to operate — women and children enjoy running them. Equipment is easily attached with the "Jiffy Hitch," handles are adjustable. Models with variable speeds — forward and reverse. Also power turn.

SOON PAYS FOR ITSELF

Shaw tractors save so much time and labor and get so much work done, at such low cost, they pay for themselves quickly and many times over. Hundreds of operators use Shaw tractors to earn spare-time money.

CHEAP TO OPERATE

Just a few cents an hour will operate your Shaw tractor. They're strong, rugged, well-built . . . give you years of good service with very low maintenance expense. The initial cost is amazingly low . . . write today for full information and price lists.



HARROWS



MOW

**SAWS WOOD — Does
Many Kinds of Belt Jobs!**



ACT NOW!

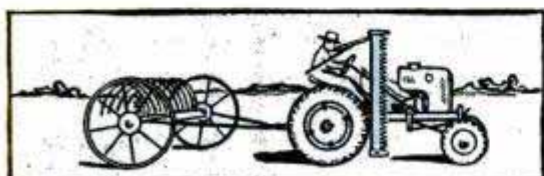

CUTTER BAR and HAY RAKE



WORKS WINTER and SUMMER

Shaw tractors are the result of more than 45 years' experience in building tractors and other farm equipment. They're built by men who have the "know-how" of both farming and mechanics. That's why every Shaw tractor carries a full year's guarantee protecting you against any defect in workmanship or material.

DEALER TERRITORIES OPEN

There are still some good, profitable territories open for aggressive retail dealers. Write for information.



PLOWS

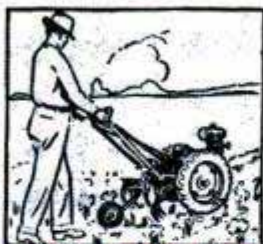

CULTIVATES

TOP QUALITY MATERIALS

Built almost entirely of steel, arc-welded and consisting of thoroughly field-tested parts, Shaw tractors are famous for their dependability, utility and low upkeep. You can buy them with complete confidence.

LOW FACTORY PRICES

A modern factory and streamlined production methods assure you substantial savings. Shaw Du-All and Peppy-Pal tractors are available through dealers or direct from the factory. Mail the coupon for full information and special price list.

**MAIL COUPON FOR
Send no money PRICE LIST AND FREE FOLDER**

SHAW MANUFACTURING CO.

4505 Front Street, Galesburg, Kansas or
668-G North 4th Street, Columbus, Ohio

Please send me Free Folder and price list.

Name _____

Address _____



**FREE
FOLDER
and Price List!
MAIL COUPON TODAY!**

WORLD'S ROUGHEST RIDE!

Motorcycle Hill-Climbing Champion **CLEM MURDAUGH** says:
"Experience is the Best Teacher in motorcycling—and in choosing a cigarette, too!"



* SLANT SHOOTING—MOTORCYCLE SLANG FOR HILL CLIMBING



THE TERRIFIC JOLTING OF MURDAUGH'S FIRST UPHILL RUN HAS LOOSENED THE HANDLEBAR STEM BOLT. HE MUST CALL ON ALL HIS EXPERIENCE—STEER WITH "BODY ENGLISH!"



EXPERIENCE IS THE BEST TEACHER—IN MOTORCYCLING—YES, AND IN CHOOSING A CIGARETTE, TOO. CLEM MURDAUGH SAYS, "THROUGH THE YEARS, I'VE TRIED ALL BRANDS. **CAMELS ARE THE CHOICE OF EXPERIENCE WITH ME!**"



YOUR "T-ZONE" WILL TELL YOU WHY!

T for Taste...
T for Throat...

That's your proving ground for any cigarette. See if Camels don't suit your "T-Zone" to a "T."



Motorcycle Champion **CLEM MURDAUGH** says:

CAMELS ARE THE CHOICE OF EXPERIENCE WITH ME! THEY'RE FULL FLAVORED, MILD, COOL SMOKING

Clem Murdaugh
 1946-1947 National Hill-Climbing Champion

According to a Nationwide survey:
MORE DOCTORS SMOKE CAMELS THAN ANY OTHER CIGARETTE

Three nationally known independent research organizations asked 113,597 doctors to name the cigarette they smoked. More doctors named Camel than any other brand.



More people are smoking **CAMELS** than ever before!