

ANC



# POPULAR MECHANICS

## MAGAZINE

WRITTEN SO YOU CAN UNDERSTAND IT

REGD. TRADE MARK GREAT BRITAIN NO. 40620



*Dave Thibault*

SEE "THE NEW CROP OF LIGHT CARS" PAGE 96



**NEW NEW NEW**

# AUTO-LITE

## *Resistor*

# SPARK PLUG

### *Here's what it is*

The many benefits which can be obtained through a wider than standard spark gap setting are well known to the automotive industry. Up to this time the rate of spark gap increase due to electrode erosion has been such that the desired wide setting has not been generally used. Auto-Lite, working with leading car and truck manufacturers, has Ignition Engineered a built-in 10,000 Ohm Resistor which reduces electrode erosion so that Auto-Lite Spark Plugs can now be given this wider gap setting desirable for improved operation and economy.

### *Here's what it does*

- PROMOTES SMOOTHER IDLING**, because the wider spark gaps help eliminate occasional missing.
- REDUCES MISFIRING** due to lean spots in carburetion.
- ASSISTS IN BURNING OF LEANER MIXTURES** for improved engine economy at idle and throughout the speed range.
- REDUCES RING AND CYLINDER WEAR** when lubrication is washed away by gasoline not burned as a result of occasional misses.
- INCREASES ELECTRODE LIFE** up to 200% and more.
- SUPPRESSES SPARK PLUG INTERFERENCE** with radio, radio-telephone, radar and television reception.\*

### **Advantages So Significant They Are Expected To Affect The Entire Industry**

A complete line of Auto-Lite Resistor Spark Plugs with the built-in Resistor will soon be available for original equipment and replacement on popular makes of cars, trucks and tractors. The regular line of ignition engineered Auto-Lite Spark Plugs, which has won such an enviable reputation for dependability of performance, will continue to be manufactured. Ask your favorite dealer.

**THE ELECTRIC AUTO-LITE COMPANY**  
Toronto 1, Ontario                      Toledo 1, Ohio

**NEW**

## **BUILT-IN RESISTOR**



Auto-Lite Ignition Engineers, working with leading automotive manufacturers, have developed the new Auto-Lite Resistor Spark Plug with this built-in resistor. As a result, improved operation and economy will be possible for the owners of cars, trucks and tractors everywhere.

\*Within 35 mv/m from 540 kc. to 150 mc. at 50 ft.



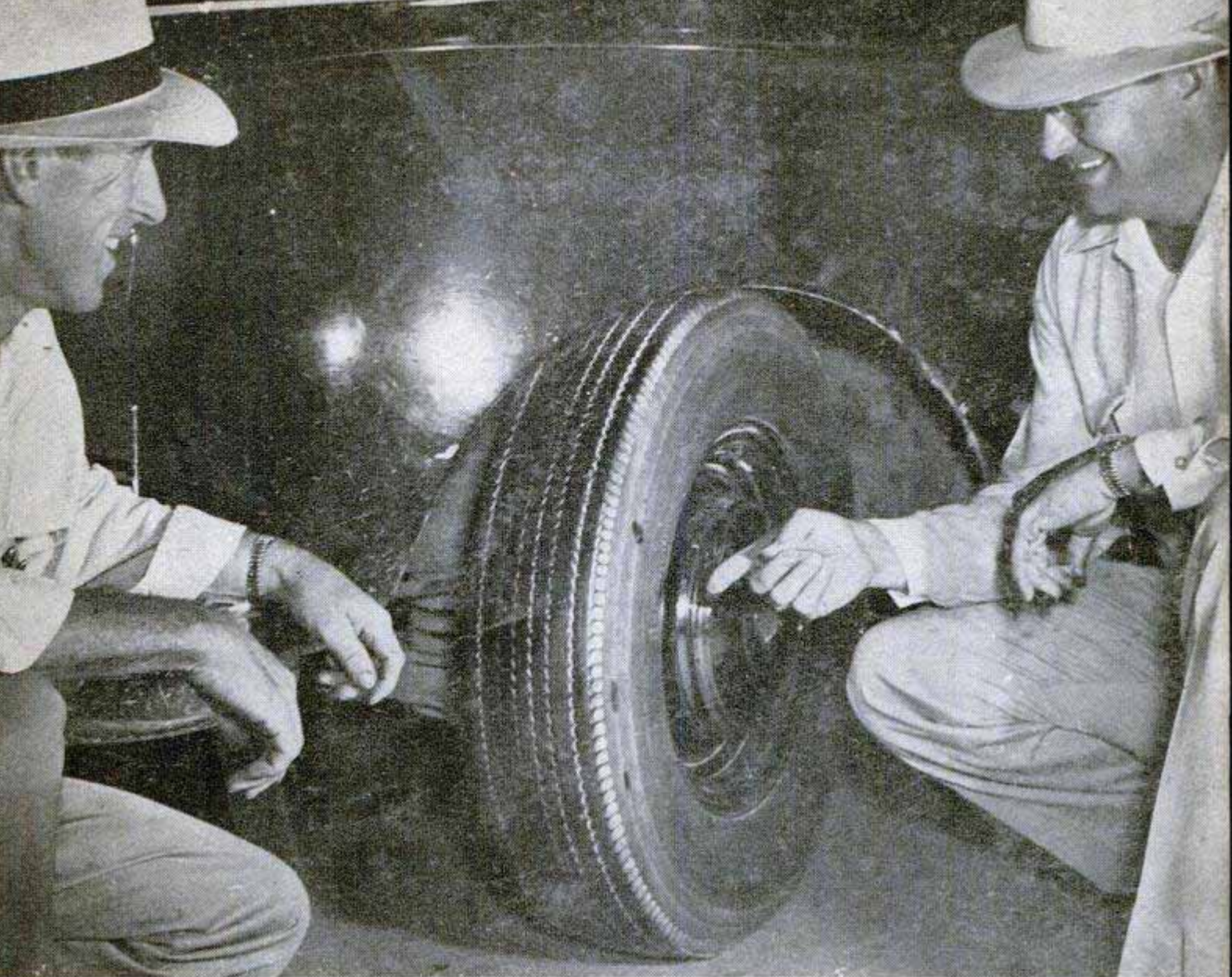

## Typical example: user's experience with B. F. Goodrich tires

THE smiling man on the right in the picture above is Curtis Corn of Roswell, New Mexico. He and a partner own the 201 Taxi Company and operate a fleet of 16 cabs over a 100-mile radius in New Mexico.

Mr. Corn says his B. F. Goodrich Silvertowns outwear any other tires he has ever owned—including prewar tires. Mr. Corn had a good chance to compare brands during the tire shortage when he used whatever tires he could get. B. F. Goodrich tires outperformed them all.

Here are two examples of B. F. Goodrich tire service from fleet records:

One pair of Silvertowns gave 49,896 miles of continuous, trouble-free service before being removed. And Mr. Corn adds that these casings still looked good for 2,000 *more* miles.

Another pair of B. F. Goodrich tires traveled 42,000 miles on one of the cabs before it was removed and durecapped. These tires are back in service now.

Mr. Corn's experience is typical. Hundreds of other enthusiastic B. F. Goodrich owners report outstanding mileages too. B. F. Goodrich tires go farther because tread wear is more uniform. This tread puts a bigger footprint on the road

and makes every inch of rubber take its fair share of the load. The tire body has more and stronger cords in it—and a double breaker strip for protection against shocks.

If you need tires, see your B. F. Goodrich dealer today. You'll be surprised what your old tires are worth on a trade-in. If you don't know the address, look under *Tires* in the yellow pages of your 'phone book. *The B. F. Goodrich Company, Akron, Ohio.*

**B.F. Goodrich**  
FIRST IN RUBBER



Dependable

# CHAMPION

America's Favorite Spark Plug

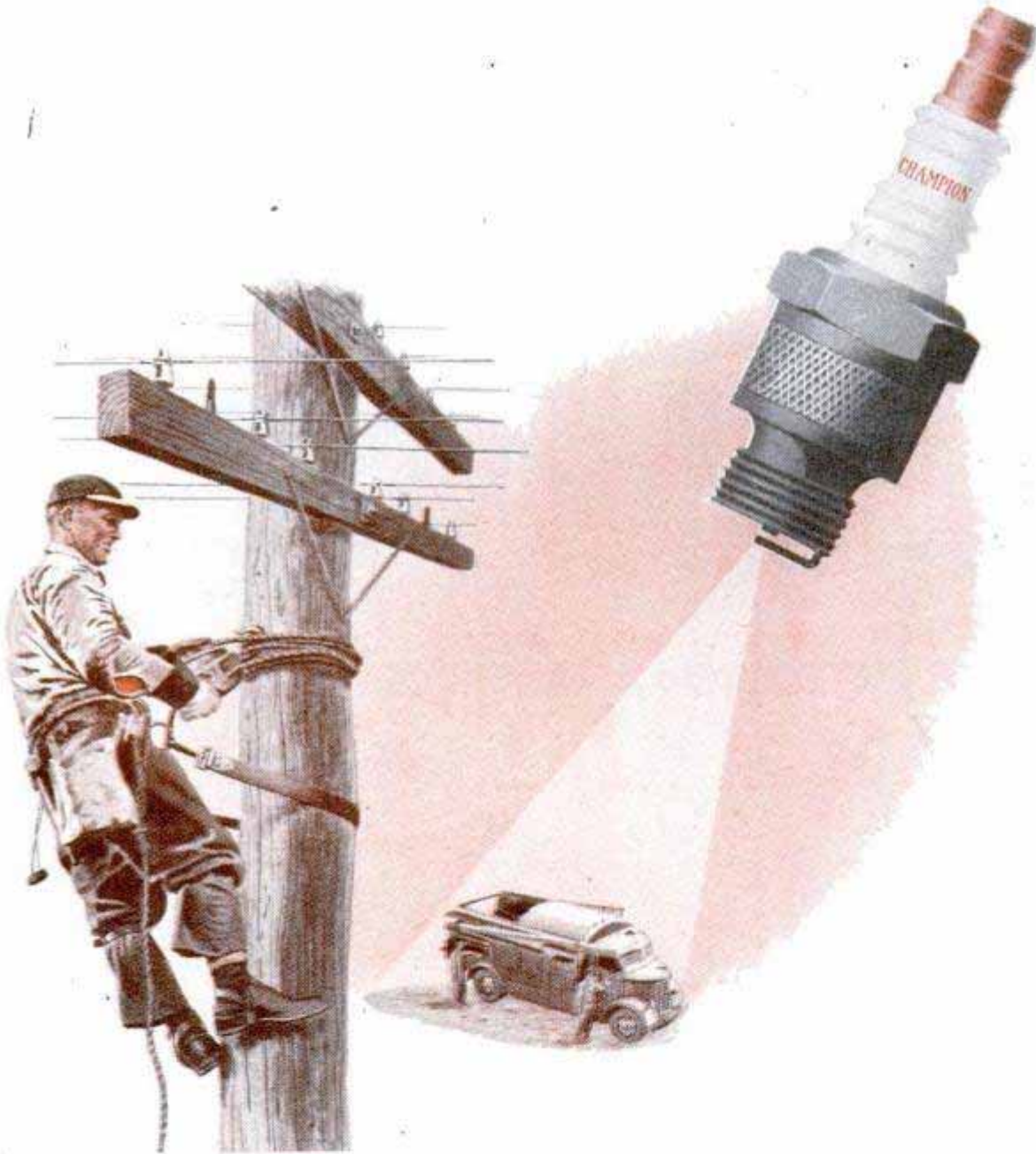

Utilities having a direct obligation to the public are exacting buyers of such vital equipment as spark plugs. Their fleets must have dependable ignition. Ex-

perts on spark plug performance and dependability, the majority specify dependable Champion Spark Plugs. Champion Spark Plug Company, Toledo 1, Ohio.

***FOLLOW THE EXPERTS—DEMAND NEW DEPENDABLE CHAMPIONS FOR YOUR CAR***

*Listen to the CHAMPION ROLL CALL . . . Harry Wismer's fast sportscast every Friday night, over the ABC network*



# Popular Mechanics Magazine

Registered in U. S. Patent Office and Canada

H. H. WINDSOR, Founder

H. H. WINDSOR, Jr., Editor and Publisher

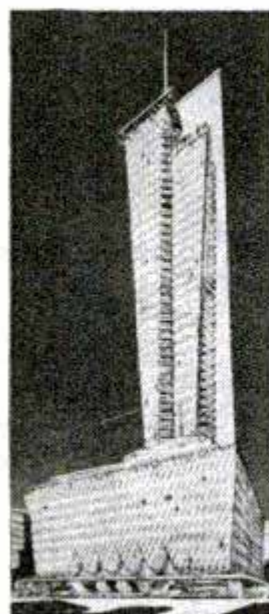

THIS hotel to be built of diamond-shaped colored glass panes was designed by Frank Lloyd Wright. It has overlapping stories which are self-cleaning. The shape of the novel structure of 47 stories may startle tourists in Dallas, Tex., when it is erected. The work of

Wright, America's most original and best known architect, is the subject of Cliff Hicks' feature on page 164. Hicks visited Wright at his Taliesin school near Spring Green, Wis., to learn about "Architecture From the Ground Up."

NEXT MONTH a feature on speedboats (they broke 14 world records last year in two days) contains the amazing prediction of a 10-percent increase in speed for the 1948 races. Another May feature delves into what is going on in farm building these days. Ever hear of steel barns and of "milk-ing parlors?" They partially explain why "The Old Red Barn Is Vanishing."

CRAFTSMAN features for May include constructional details for a modern flat-topped desk in "island base" design. One top drawer pulls out to form a base for a portable typewriter. Photo fans will find full instructions for building a 35-mm. slide projector with an unusual ventilating system. Shop Notes tells how to check the family auto before starting on that vacation trip.

ANY audio amplifier may be used with the four-tube super tuner described in the May Radio and Electronics section.

Volume 89 APRIL 1948 Number 4

Managing Editor.....Roderick M. Grant  
 Assistant Managing Editor.....Wayne Whittaker  
 Shop Notes and Crafts Editor.....James R. Ward  
 Radio and Electronics Editor.....Frank L. Brittin  
 Aviation Editor.....Aubrey O. Cookman, Jr.  
 Associate Editor.....Clifford B. Hicks  
 Eastern Editor.....Bill Reiche  
 Western Editor.....Thomas E. Stimson, Jr.  
 Art Director.....Frank Beatty

### Assistant Editors

Donald R. Brooks Arthur R. Railton

### Assistant Editors, Shop Notes and Crafts

W.Clyde Lammey Wayne C.Leckey Frank N.Stephany A.E.Youngquist

## In This Issue

We're Racing a Power Shortage	89
Here's the New Crop of Light Cars	96
He Built a Home of Sawdust-Concrete	106
Iceberg Hunt	114
What's New for Your Home	122
Guardians of the Rails	131
How Do Pigeons Navigate?	137
Setting the Stage for an "Ad"	148
A Ranger's Day is Never Done	156
Architecture From the Ground Up	164
Pulling the Fangs of War	170

## For the Craftsman

Cars Need Care	185
Beautify With Shrubs	192
Pan-Tilt Tripod Head	202
Ball-Bearing Centers	207
Finishing Floors	212
"Sea Craft"—Cabin Cruiser— Part II	219
Radio and Electronics	229
Clinic for Homemakers	242

Table of Contents continued on page 8

Published monthly by POPULAR MECHANICS COMPANY, 200 East Ontario Street, Chicago 11, Ill. H. H. Windsor, Jr., president; Paul H. Dunakin, vice president and general manager; D. F. Windsor, vice president and secretary-treasurer; William Harrison Petridge, vice president and assistant to the publisher; Clover L. Perkins, advertising manager; Alan M. Deyoe, circulation manager. Single copy in the United States and Canada, 25 cents; subscription rates in United States and possessions, Canada, Philippines and countries of the Pan-American Postal Union, 1 year, \$2.50; 2 years, \$4.50; 3 years, \$6.00. To all other countries add \$1.00 a year over United States prices for overseas postage. If you plan to move, notify us at least 30 days in advance so you will not miss an issue. Give both old and new addresses. Entered as Second Class Matter, September 15, 1903, at the Post Office at Chicago, Illinois, under Act of March 3, 1879. Entered as Second Class Matter at Post Office Dept., Canada. Copyright 1948 by Popular Mechanics Company, Copyright under International Copyright Union. Copyright in France. All rights reserved under Pan-American Copyright Union. Printed in the United States of America.



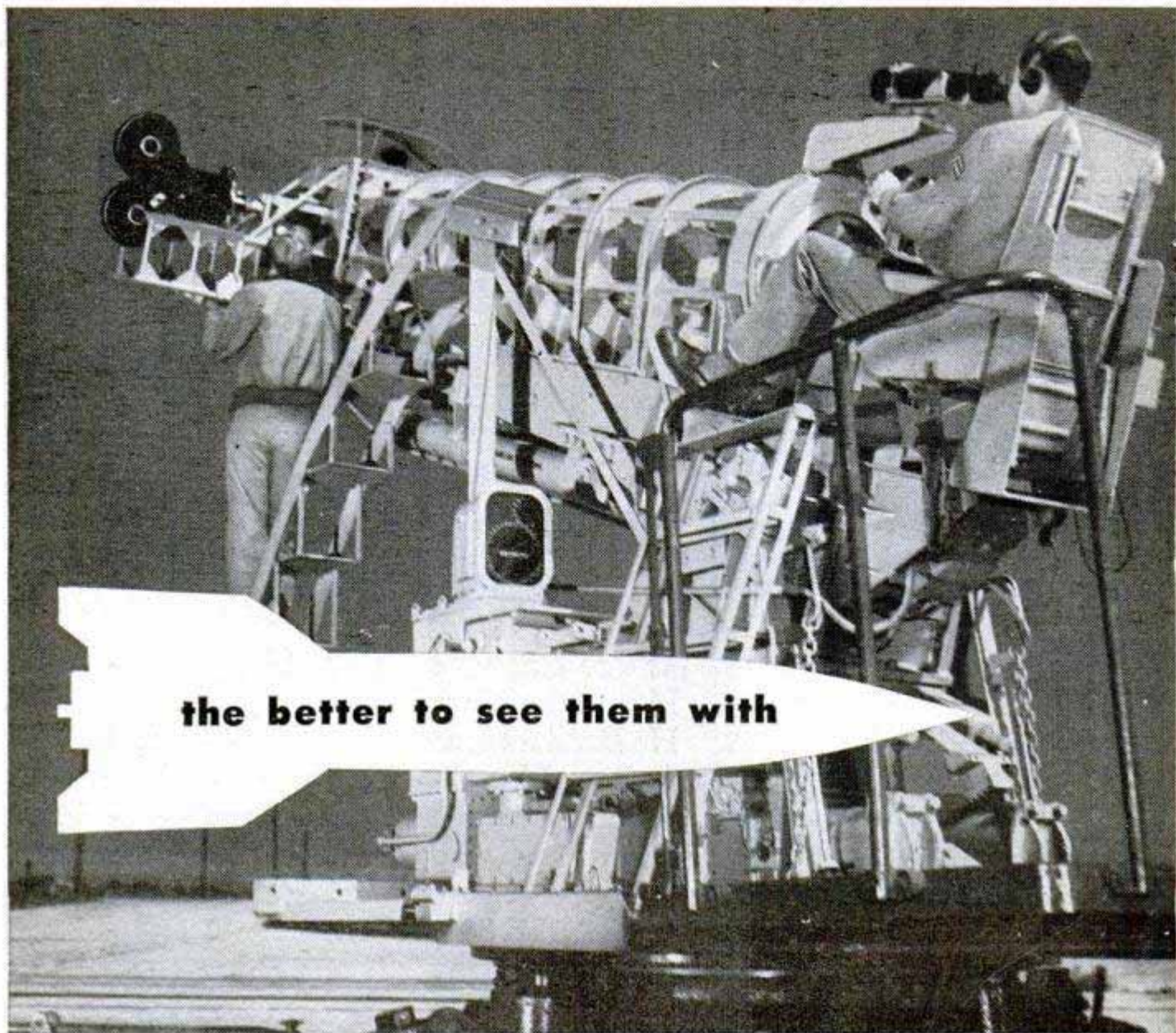

the better to see them with

This colossal 16-inch reflecting telescope was designed and built by the U. S. Army's Ordnance Department. Artillerymen and airmen will use it to study the flight of guided missiles whizzing along at 3000 miles an hour at altitudes of 100 miles or more.

The telescope, fixed to an antiaircraft gun mount, tracks three and four degrees per second in azimuth and elevation, respectively. A 35-mm. camera attachment records the image produced by the telescope, takes 15 exposures every second. Experts are thus able to check missile controls, collect aerodynamic information, and follow ejection of instruments attached to the missiles.

The reflecting telescope is another spectacular example of what the U. S.

Army is accomplishing in the fascinating realm of research and development. Thousands of projects, covering virtually every scientific field, are going forward daily at Army laboratories and proving grounds. If you want to be a member of an organization that is leading the way to great new things for the future, consider the U. S. Army. There are many new programs available specifically to young men interested in science. Your nearest U. S. Army and U. S. Air Force Recruiting Station will be glad to give you full details.

U. S. Army and U. S. Air Force Recruiting Service

CAREERS WITH A FUTURE

**U. S. Army and  
U. S. Air Force**

**APRIL 6  
IS ARMY DAY**

• Watch your local papers for announcement of nearby exhibits.



*Tests Prove*  
**STRENGTH and DURABILITY**  
*of*  
**CRESCENT\***  
**TOOLS**

There's much more strength in Crescent Tools than is actually needed for their efficient and enduring performance. For instance, no human being could possibly apply the strain to which the wrench in the photograph is being subjected. Yet, constant testing proves the ability of these wrenches to withstand great strains without failure.

This is but one of many tests which insure that all tools shipped out of the Crescent plant have more than ample ability to perform their intended tasks.

Whether you buy Crescent Tools for your own use or for resale—remember this fact: Every one is carefully made from selected raw materials, machined by precision methods, accurately hardened and tempered and nicely finished, ready to take its place in the work of the world and do its job well.

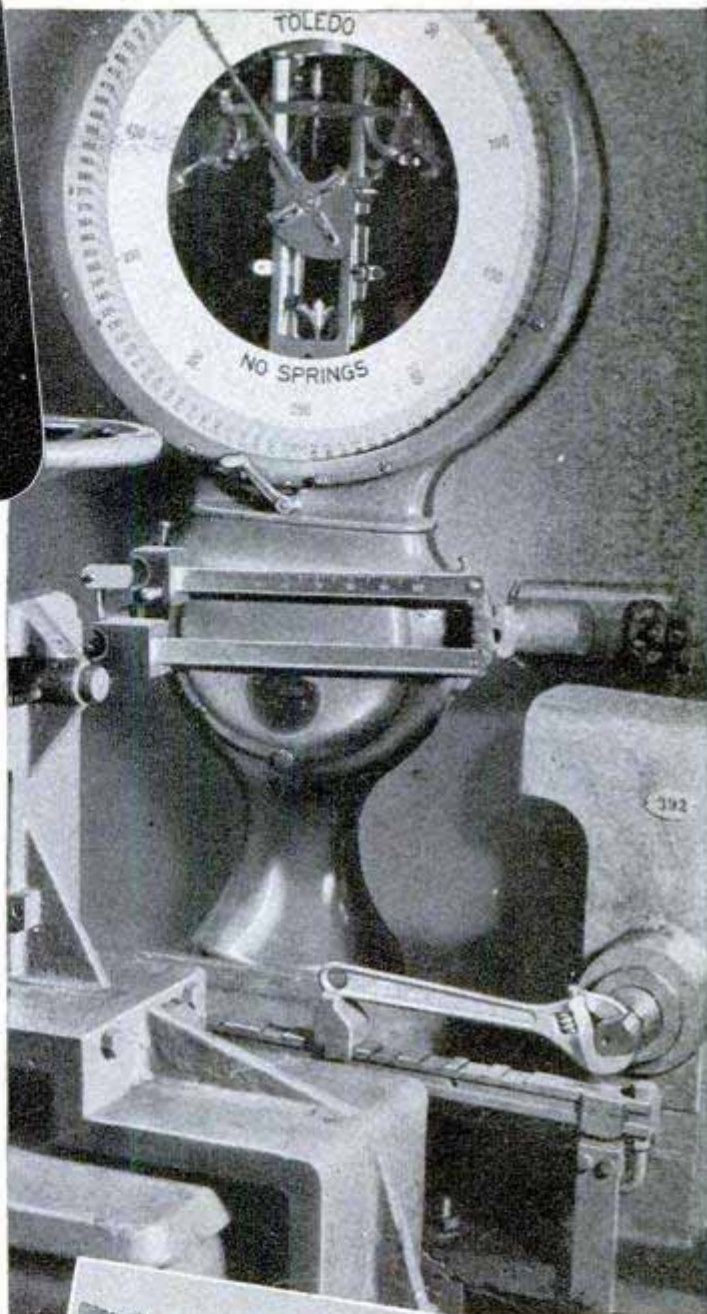

This shows how Crestoloy Pliers are individually tested for cutting ability before being boxed for shipment.

Crescent Screwdrivers are heat treated full length. This test determines their efficiency in that respect.

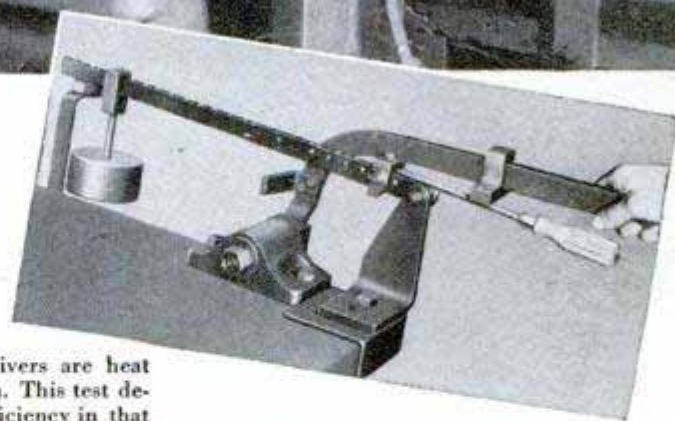

**\*CRESCENT TOOLS**  
*Give Wings to Work*

CRESCENT TOOL COMPANY, Jamestown, N. Y.

\*"CRESCENT" is our trade-mark registered in the United States and foreign countries for wrenches and other tools. "Crescent" tools are made only by Crescent Tool Company of Jamestown, N. Y., and are sold by leading distributors everywhere.







# INVENTORS



Learn how to protect your invention. The U. S. Patent Laws provide that any new and useful art, machine, article of manufacture, or composition of matter, or any new and useful improvement thereof, may be patented if the act of invention is involved. Therefore, every inventor with a valuable invention should take advantage of the Patent Laws and proceed for patent protection in order to safeguard his rights.

A patent gives the inventor the exclusive right to prevent others from making, using, or selling the invention claimed in the patent for a period of seventeen years.

The Patent Laws were enacted for the benefit of the inventor to give him protection for the features of his invention which are patentable. These features must be properly and concisely set forth and claimed in a formal application for patent, in order to comply with the requirements of the U. S. Patent Office. For that reason, the Patent Office advises the inventor, unless he is familiar with such matters, to engage a competent registered patent attorney or agent to represent him. We maintain a staff of registered patent attorneys ready to serve you in the handling of your patent matters.

A specially prepared booklet entitled "Patent Guide for the Inventor", containing detailed information with respect to patent protection and procedure, together with a "Record of Invention" form will be promptly forwarded to you without obligation upon request.

*Registered  
Patent  
Attorneys*

**CLARENCE A. O'BRIEN & HARVEY B. JACOBSON**  
Registered Patent Attorneys  
81-D District National Bldg., Washington 5, D. C.

Please send me copy of "Patent Guide for the Inventor" and also "Record of Invention" form. This request does not obligate me.

Name \_\_\_\_\_

Address \_\_\_\_\_

City \_\_\_\_\_ State \_\_\_\_\_

(Please write or print plainly.)

**CLARENCE A. O'BRIEN  
& HARVEY B. JACOBSON**

81-D District National Building + Washington 5, D. C.





To the man who wants to enjoy  
**an ACCOUNTANT'S CAREER**



**IF** you're that man, here's something that will interest you.

Not a magic formula—not a get-rich-quick scheme—but something more substantial, more practical.

Of course, you need something more than just the desire to be an accountant. You've got to pay the price—be willing to study earnestly, thoroughly.

Still, wouldn't it be worth your while to sacrifice some of your leisure in favor of interesting home study—over a comparatively brief period in your life? Always provided that the rewards were good—a salary of \$3,000 to \$10,000?

An accountant's duties are interesting, varied and of real worth to his employers. He has *standing!*

Do you feel that such things aren't for you? Well, don't be too sure. Very possibly they *can* be!

Why not, like so many before you, investigate LaSalle's modern Problem Method of training for an accountancy position?

Just suppose you were permitted to work in a large accounting house under the personal supervision of an expert accountant. Suppose, with his aid, you studied accounting principles and solved problems day by day—easy ones at first—then the more difficult ones. If you could do this—and if you could turn to him for advice as the problems became complex—soon you'd master them all.

That's the training you follow in principle under the LaSalle Problem Method.

You cover accountancy from the basic Principles right up through Accountancy Systems and Income Tax Procedure. Then you add C. P. A. Training and prepare for the C. P. A. examinations.

As you go along, you absorb the principles of Auditing, Cost Accounting, Business Law, Statistical Control, Organization, Management and Finance.

Your progress is as speedy as you care to make it—depending on your own eagerness to learn and the time you spend in study.

Will recognition come? The only answer, as you know, is that success *does* come to the man who is really *trained*. It's possible your employers will notice your improvement in a very few weeks or months. Indeed, many LaSalle graduates have paid for their training—with increased earnings—before they have completed it! For accountants, who are trained in organization and management, are the executives of the future.

### Write For This Free Book

For your own good, don't put off investigation of *all* the facts. Write for our free 48-page book, "Accountancy, The Profession That Pays." It'll prove that accountancy offers brilliant futures to those who aren't afraid of serious home study. Send us the coupon *now*.

Over 2600 Certified  
 Public Accountants among  
 LaSalle alumni

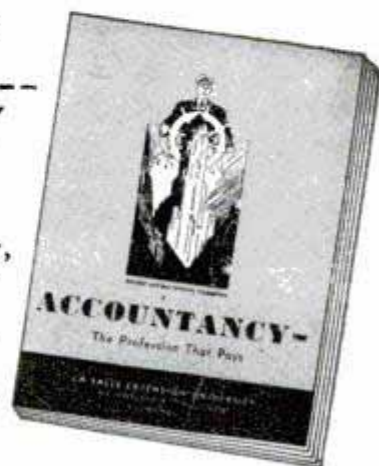

## LASALLE EXTENSION UNIVERSITY

### A CORRESPONDENCE INSTITUTION

417 South Dearborn Street, Dept. 464-H Chicago 5, Illinois

I want to be an accountant. Send me, without cost or obligation, the 48-page book, "Accountancy, The Profession That Pays," and full information about your accountancy training program.

Name.....

Address..... City.....

Position..... Age.....



# You're running on OIL with PYROIL

Pyroll in your gasoline and crankcase means your car is running smoothly on oil. Metal to metal contact in cylinders causes undue wear — dry cylinder surfaces corrode and rust. *Pyroll gives oil the property of clinging to metal surfaces.* It means ready lubrication the moment you step on your starter. It means a protective coating against rust when your car is not running. To add miles to your car — ask your gas station attendant to add Pyroll.

### PYROIL For Aircraft Engines

Use Aircraft Pyroll B for lubricating oil, Aircraft Pyroll A for gasoline.

### GIVEN!

An attractive PYROIL metal savings bank—takes coins up to 50c pieces—is yours for the asking—sent postage paid.

Manufactured and Guaranteed by Pyroll Company, 78 Pyroll Bldg., La Crosse, Wisconsin.

Canadian Distributors:  
Central Purchasing Agencies, Ltd.  
Toronto, Ontario, Canada



**PYROIL COMPANY**  
78 Pyroll Bldg., La Crosse, Wisconsin

I want my car to last and run properly. Please tell me more about Pyroll and how it can accomplish this for me.

Name

Address

City or Town  State



## TABLE OF CONTENTS (Continued)

### AUTOMOTIVE

Powerful wrecker lifts entire truck off street.....	110
Lock-on hub cap.....	113
Demountable battery.....	121
Homemade racer powered by battery.....	146
Gauge measures toe-in from outside of tires.....	147
Midget electric car.....	163

### AVIATION

Boatswain's chair aids C-99 mechanic.....	95
Self-driven berth simplifies seaplane moorings.....	102
Biggest ramjet faster than sound.....	105
Navy chute "blows top".....	127
Plywood air flivver homemade for \$500.....	127
Flying doctors.....	128
Designers of flying wings study secrets of "strato" glider.....	130
Flying trapezist rides helicopter.....	130
Look, no hands!.....	144
Combat glider carries 30 men.....	154
Midget autopilot.....	155
Fire-resistant plane paneling.....	162
Light two-place helicopter.....	163

### BOATS AND BOATING

Lightweight trailer holds seven canoes.....	102
Boat pilot faces forward with tiller under foredeck.....	111
"Package" engines on ocean ships may be attached outside hull.....	119
Danish sea-going ferry has landing-craft bow.....	143

### FARM

Bees turn out honey in six flavors, each appropriately colored.....	110
Conceal for cattle.....	111
Self-powered wheelbarrow.....	121
Portable fodder drier.....	154

### HOUSE AND HOME

Button-making kit.....	95
Reading lamp clips on book.....	103
Electric tape warms pipes.....	105
Plastic flooring similar to linoleum resists chemicals.....	113
Electric sharpener can't damage knife.....	120
Man-o-war becomes home-of-peace for Japanese family.....	136
Sandwich walls.....	142
Interlocking tiles.....	146
Unit system for home cuts building costs.....	147
Electric shoeshiner.....	152

### INDUSTRY

Shedding light on lighting.....	94
Atom clocker.....	95
Plastic "snow" for the movies made from foam blocks.....	103
Quick-freezing dried foods preserves natural flavor.....	111
Test machine "smokes" cigarettes.....	121
Electronic "brain" has photo memory.....	127
Scientists seek answer to what holds atoms together.....	135
Self-loading truck has built-in crane and trolley.....	136
Pigment made from sand reduces lead required in paint.....	141
Push-button telegram flashed to 143 offices.....	155
Coal-made plastic.....	176

### RECREATION

"Ref's" sleeve covers serve as signals.....	111
Livelier golf ball.....	113
Cameraman chases bowling ball to film close-up of a strike.....	135
Pinless bowling.....	153
Billiard-score indicators built into table rail.....	175

### TOOLS

Vibration of "reed" gauges motor speed.....	103
Saw replacement handle.....	119
Continuous casting with double furnace.....	120
Wide-belt cutter.....	152
Paint spreader for screens.....	152
Handle keeps paint off hands.....	162
"Machine shop" operated by tractor's power take-off.....	175
Powerful hand magnet.....	176

### MISCELLANEOUS

Life story in pictures.....	104
Metal fingers "pump" liquid through tube in waves.....	112
Electric blackboard.....	112
Vest-pocket humidior.....	119
Birds glow in dark.....	120
Chemical smoke may turn back radar in the future.....	120
Button snaps key out of case.....	121
Transplanting a giant Arizona cactus.....	126
Bucking turret tester imitates planes.....	141
Hypodermic spray replaces needle.....	146
Brief case serves as desk.....	152
Use high-frequency radio to take pheasant census.....	155
Garden tool cuts even furrows.....	162
Cruising telegraph office picks up messages by radio.....	169
Aluminum blocks for scale models.....	169
Venetians stroll on famed canals with "pneumatic" water skis.....	176

## Craftsman and Shop Notes Index

### AUTOMOTIVE

Electrical coupling for trailer made from sealed-beam sockets.....	204
Soft-nosed punch improvised from auto kingpin.....	216
Paper disk tags ignition wires when removed from distributor.....	228

### FARM

Kinks removed from wire fence with forked stick.....	210
Baling-wire knot is nonkinking.....	210
Stopping floor in farrowing house protects infant pigs.....	210
Old wagon wheel serves as shoe scraper.....	216

(Continued to page 10)



# THERE'S NO SECRET OF SUCCESS!

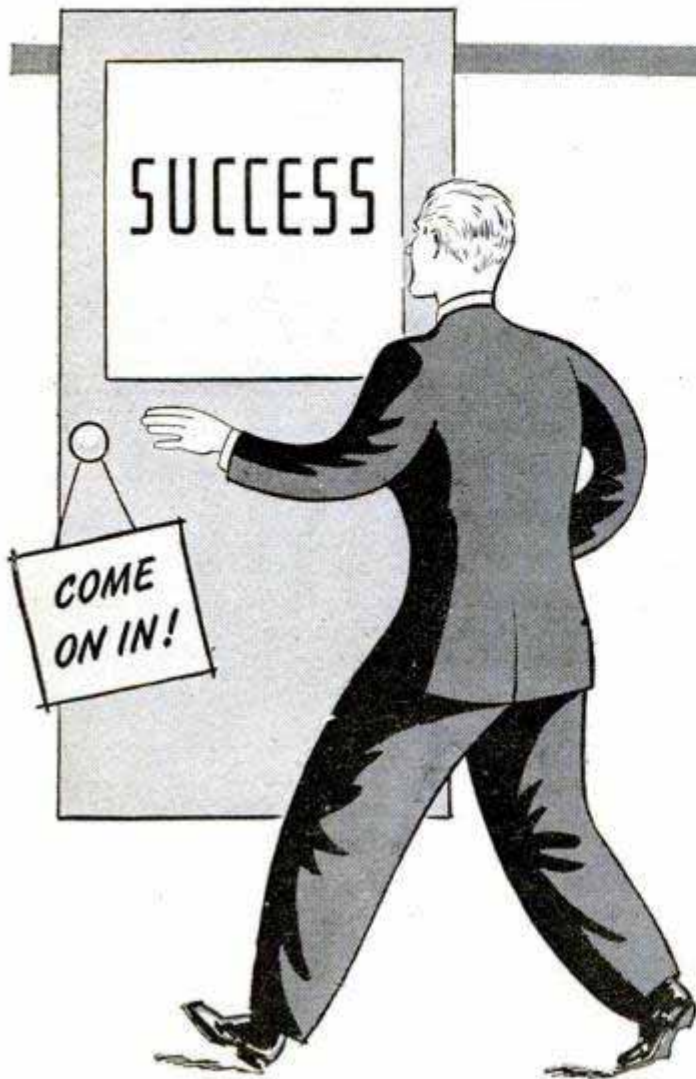

**T**HE FORMULA for success in industry and business is an open book—no secret about it at all. Promotion comes when you've *trained* yourself to handle bigger jobs, *prepared* for larger responsibilities.

Such training you'll find in a library of extremely literal books—and it's up to you to open them and keep on opening them until you've mastered their contents. You can do this in your spare time for these are the easy-to-understand texts of the International Correspondence Schools with the teacher, "built right in."

Covering more than 400 practical subjects, I. C. S. Courses have aided thousands of men and women to win better jobs and larger rewards in every business and industrial field. These thousands are the proof of the familiar saying, "Today's I. C. S. student is tomorrow's leader."

Mark and mail the coupon and you can be on the way to joining them. It brings you full information on the subject you're interested in. Act today—if you're serious about becoming a success!

## INTERNATIONAL CORRESPONDENCE SCHOOLS



BOX 5625-K, SCRANTON 9, PENNA.

Without cost or obligation, please send me full particulars about the course BEFORE which I have marked X:

- |                                                                                                                                                                                                                                                                                                                                                                                                                                                                                                                                                                                                                                                                                                                                                                                                                                                                                                                                                                                                                                                                                                                                                                                                                                                                                                                                                              |                                                                                                                                                                                                                                                                                                                                                                                                                                                                                                                                                                                                                                                                                                                                                                                                                                                                                                                                                                                                                                                                                                                                                                                                                                                                                                                                                  |                                                                                                                                                                                                                                                                                                                                                                                                                                                                                                                                                                                                                                                                                                                                                                                                                                                                                                                                                                                                                                                                                                                                                                                                                                                                                                                                                                                                         |                                                                                                                                                                                                                                                                                                                                                                                                                                                                                                                                                                                                                                                                                                                                                                                                                                                                                                                                                                                                                                                                                                                                                                                                                                                                                                                                                                                                                                                              |
|--------------------------------------------------------------------------------------------------------------------------------------------------------------------------------------------------------------------------------------------------------------------------------------------------------------------------------------------------------------------------------------------------------------------------------------------------------------------------------------------------------------------------------------------------------------------------------------------------------------------------------------------------------------------------------------------------------------------------------------------------------------------------------------------------------------------------------------------------------------------------------------------------------------------------------------------------------------------------------------------------------------------------------------------------------------------------------------------------------------------------------------------------------------------------------------------------------------------------------------------------------------------------------------------------------------------------------------------------------------|--------------------------------------------------------------------------------------------------------------------------------------------------------------------------------------------------------------------------------------------------------------------------------------------------------------------------------------------------------------------------------------------------------------------------------------------------------------------------------------------------------------------------------------------------------------------------------------------------------------------------------------------------------------------------------------------------------------------------------------------------------------------------------------------------------------------------------------------------------------------------------------------------------------------------------------------------------------------------------------------------------------------------------------------------------------------------------------------------------------------------------------------------------------------------------------------------------------------------------------------------------------------------------------------------------------------------------------------------|---------------------------------------------------------------------------------------------------------------------------------------------------------------------------------------------------------------------------------------------------------------------------------------------------------------------------------------------------------------------------------------------------------------------------------------------------------------------------------------------------------------------------------------------------------------------------------------------------------------------------------------------------------------------------------------------------------------------------------------------------------------------------------------------------------------------------------------------------------------------------------------------------------------------------------------------------------------------------------------------------------------------------------------------------------------------------------------------------------------------------------------------------------------------------------------------------------------------------------------------------------------------------------------------------------------------------------------------------------------------------------------------------------|--------------------------------------------------------------------------------------------------------------------------------------------------------------------------------------------------------------------------------------------------------------------------------------------------------------------------------------------------------------------------------------------------------------------------------------------------------------------------------------------------------------------------------------------------------------------------------------------------------------------------------------------------------------------------------------------------------------------------------------------------------------------------------------------------------------------------------------------------------------------------------------------------------------------------------------------------------------------------------------------------------------------------------------------------------------------------------------------------------------------------------------------------------------------------------------------------------------------------------------------------------------------------------------------------------------------------------------------------------------------------------------------------------------------------------------------------------------|
| <p><b>Air Conditioning and Plumbing Courses</b></p> <p><input type="checkbox"/> Air Conditioning<br/><input type="checkbox"/> Heating<br/><input type="checkbox"/> Refrigeration<br/><input type="checkbox"/> Plumbing<br/><input type="checkbox"/> Steam Fitting</p> <p><b>Chemistry Courses</b></p> <p><input type="checkbox"/> Chemical Engineering<br/><input type="checkbox"/> Chemistry, Analytical<br/><input type="checkbox"/> Chemistry, Industrial<br/><input type="checkbox"/> Chemistry, Mfg. Iron &amp; Steel<br/><input type="checkbox"/> Petroleum Refining<br/><input type="checkbox"/> Pulp and Paper Making<br/><input type="checkbox"/> Plastics</p> <p><b>Civil Engineering, Architectural and Mining Courses</b></p> <p><input type="checkbox"/> Architecture<br/><input type="checkbox"/> Architectural Drafting<br/><input type="checkbox"/> Bridge and Building Foreman<br/><input type="checkbox"/> Building Estimating<br/><input type="checkbox"/> Civil Engineering<br/><input type="checkbox"/> Coal Mining<br/><input type="checkbox"/> Contracting and Building<br/><input type="checkbox"/> Highway Engineering<br/><input type="checkbox"/> Lumber Dealer<br/><input type="checkbox"/> Reading Structural Blueprints<br/><input type="checkbox"/> Sanitary Engineering<br/><input type="checkbox"/> Structural Drafting</p> | <p><input type="checkbox"/> Structural Engineering<br/><input type="checkbox"/> Surveying and Mapping</p> <p><b>Communications Courses</b></p> <p><input type="checkbox"/> Electronics<br/><input type="checkbox"/> Practical Telephony<br/><input type="checkbox"/> Radio, General<br/><input type="checkbox"/> Radio Operating<br/><input type="checkbox"/> Radio Servicing<br/><input type="checkbox"/> Telegraph Engineering</p> <p><b>Electrical Courses</b></p> <p><input type="checkbox"/> Electrical Drafting<br/><input type="checkbox"/> Electrical Engineering<br/><input type="checkbox"/> Electric Light and Power<br/><input type="checkbox"/> Lighting Technician<br/><input type="checkbox"/> Practical Electrician</p> <p><b>Internal Combustion Engines Courses</b></p> <p><input type="checkbox"/> Auto Technician<br/><input type="checkbox"/> Diesel-Electric<br/><input type="checkbox"/> Diesel Engines<br/><input type="checkbox"/> Aviation<br/><input type="checkbox"/> Gas Engines</p> <p><b>Mechanical Courses</b></p> <p><input type="checkbox"/> Aeronautical Engineer's, Jr.<br/><input type="checkbox"/> Aircraft Drafting<br/><input type="checkbox"/> Flight Engineer<br/><input type="checkbox"/> Forging<br/><input type="checkbox"/> Foundry Work<br/><input type="checkbox"/> Heat Treatment of Metals</p> | <p><input type="checkbox"/> Industrial Engineering<br/><input type="checkbox"/> Industrial Metallurgy<br/><input type="checkbox"/> Machine Shop<br/><input type="checkbox"/> Mechanical Drafting<br/><input type="checkbox"/> Mechanical Engineering<br/><input type="checkbox"/> Mold-Loft Work<br/><input type="checkbox"/> Patternmaking—Wood, Metal<br/><input type="checkbox"/> Reading Shop Blueprints<br/><input type="checkbox"/> Sheet-Metal Drafting<br/><input type="checkbox"/> Sheet-Metal Worker<br/><input type="checkbox"/> Ship Drafting<br/><input type="checkbox"/> Ship Fitting<br/><input type="checkbox"/> Tool Designing<br/><input type="checkbox"/> Toolmaking<br/><input type="checkbox"/> Welding—Gas and Electric</p> <p><b>Railroad Courses</b></p> <p><input type="checkbox"/> Air Brake<br/><input type="checkbox"/> Diesel Locomotive<br/><input type="checkbox"/> Locomotive Engineer<br/><input type="checkbox"/> Locomotive Fireman<br/><input type="checkbox"/> Railroad Section Foreman<br/><input type="checkbox"/> Car Inspector</p> <p><b>Steam Engineering Courses</b></p> <p><input type="checkbox"/> Boilermaking<br/><input type="checkbox"/> Combustion Engineering<br/><input type="checkbox"/> Engine Running<br/><input type="checkbox"/> Marine Engineering<br/><input type="checkbox"/> Steam Electric<br/><input type="checkbox"/> Steam Engines</p> | <p><b>Textile Courses</b></p> <p><input type="checkbox"/> Cotton Manufacturing<br/><input type="checkbox"/> Rayon Weaving<br/><input type="checkbox"/> Textile Designing<br/><input type="checkbox"/> Woolen Manufacturing</p> <p><b>Business and Academic Courses</b></p> <p><input type="checkbox"/> Accounting<br/><input type="checkbox"/> Arithmetic<br/><input type="checkbox"/> Business Administration<br/><input type="checkbox"/> Business Correspondence<br/><input type="checkbox"/> Certified Public Accounting<br/><input type="checkbox"/> Commercial<br/><input type="checkbox"/> Commercial Art<br/><input type="checkbox"/> Cost Accounting<br/><input type="checkbox"/> Federal Tax<br/><input type="checkbox"/> First Year College<br/><input type="checkbox"/> Foremanship<br/><input type="checkbox"/> Good English<br/><input type="checkbox"/> Higher Mathematics<br/><input type="checkbox"/> Motor Traffic<br/><input type="checkbox"/> Salesmanship<br/><input type="checkbox"/> Sign Lettering<br/><input type="checkbox"/> Spanish<br/><input type="checkbox"/> Traffic Management</p> <p><input type="checkbox"/> Advertising<br/><input type="checkbox"/> Bookkeeping<br/><input type="checkbox"/> Bookkeeping<br/><input type="checkbox"/> French<br/><input type="checkbox"/> High School<br/><input type="checkbox"/> Postal Service<br/><input type="checkbox"/> Secretarial<br/><input type="checkbox"/> Stenography</p> |
|--------------------------------------------------------------------------------------------------------------------------------------------------------------------------------------------------------------------------------------------------------------------------------------------------------------------------------------------------------------------------------------------------------------------------------------------------------------------------------------------------------------------------------------------------------------------------------------------------------------------------------------------------------------------------------------------------------------------------------------------------------------------------------------------------------------------------------------------------------------------------------------------------------------------------------------------------------------------------------------------------------------------------------------------------------------------------------------------------------------------------------------------------------------------------------------------------------------------------------------------------------------------------------------------------------------------------------------------------------------|--------------------------------------------------------------------------------------------------------------------------------------------------------------------------------------------------------------------------------------------------------------------------------------------------------------------------------------------------------------------------------------------------------------------------------------------------------------------------------------------------------------------------------------------------------------------------------------------------------------------------------------------------------------------------------------------------------------------------------------------------------------------------------------------------------------------------------------------------------------------------------------------------------------------------------------------------------------------------------------------------------------------------------------------------------------------------------------------------------------------------------------------------------------------------------------------------------------------------------------------------------------------------------------------------------------------------------------------------|---------------------------------------------------------------------------------------------------------------------------------------------------------------------------------------------------------------------------------------------------------------------------------------------------------------------------------------------------------------------------------------------------------------------------------------------------------------------------------------------------------------------------------------------------------------------------------------------------------------------------------------------------------------------------------------------------------------------------------------------------------------------------------------------------------------------------------------------------------------------------------------------------------------------------------------------------------------------------------------------------------------------------------------------------------------------------------------------------------------------------------------------------------------------------------------------------------------------------------------------------------------------------------------------------------------------------------------------------------------------------------------------------------|--------------------------------------------------------------------------------------------------------------------------------------------------------------------------------------------------------------------------------------------------------------------------------------------------------------------------------------------------------------------------------------------------------------------------------------------------------------------------------------------------------------------------------------------------------------------------------------------------------------------------------------------------------------------------------------------------------------------------------------------------------------------------------------------------------------------------------------------------------------------------------------------------------------------------------------------------------------------------------------------------------------------------------------------------------------------------------------------------------------------------------------------------------------------------------------------------------------------------------------------------------------------------------------------------------------------------------------------------------------------------------------------------------------------------------------------------------------|

Name \_\_\_\_\_ Home Address \_\_\_\_\_

City \_\_\_\_\_ State \_\_\_\_\_

Age \_\_\_\_\_ Present Position \_\_\_\_\_ Working Hours \_\_\_\_\_ A.M. to \_\_\_\_\_ P.M.

Special tuition rates to members of the Armed Forces. Special discount to World War II Veterans.  
Canadian residents send coupon to International Correspondence Schools Canadian, Ltd., Montreal, Canada.



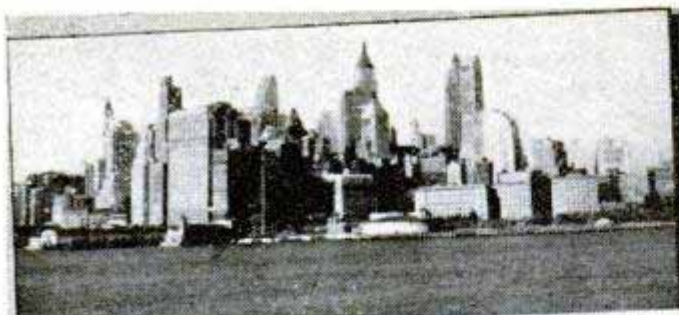

**LOWER MANHATTAN**—a sight that amazes the visitor and is ever a thrill to New Yorkers. This group of huge skyscrapers is the 20th Century wonder of the world, and a symbol of this country's progress.

## New York

...the city that belongs to everybody

...fabulous city of finance, fashion and fun, teeming with life, gleaming with greatness. To the visitor, New York is a maze of excitement and crowds—but to New Yorkers it is home, and enjoyment of all the good things New York has to offer. One of the most popular is...

## Beech-Nut Gum

It has the flavor you like



Beech-Nut  
**BEECHIES**  
—good too—  
Peppermint, Spearmint  
and Peppin.



**STATUE OF LIBERTY**—symbol of hope to all freedom loving people—its light must burn forever.



**FIFTH AVENUE**—looking South towards the Empire State Building tallest structure in the country.



**TIMES SQUARE**—the amusement center—everything from a flea circus to the Metropolitan Opera.

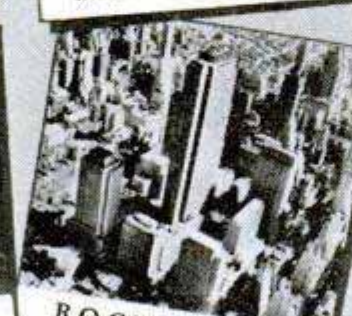

**ROCKEFELLER CENTER**—city within a city, mecca of visitors, radio headquarters.

(Continued from page 8)

Bottle feeder weans calves at an early age.....	217
Water level maintained in livestock tank with automatic control.....	217
Car axle provides gate hinges.....	218
Reversible feeding trough keeps one side free of ice and snow.....	224
Fence divides poultry pen to supply green food.....	224
Pipe-and-chain rigging employs tractor to stretch wire fencing.....	224
Tar paper protects binder canvas from damage by rodents.....	224
Wire-fencing "unloader" speeds removal of material from flat-bed truck.....	225
Metal guard protects trouser leg while stringing barbed wire.....	228

### HOUSE AND HOME

Furniture scratches touched up with brown pencil.....	180
Screw hook aids in cleaning gasoline-stove generator.....	180
Solving home problems.....	182
Improving wire coat hanger by adding spring clothespins.....	184
Playing cards used as stencils.....	184
Reverse kitchen-cabinet worktable to place worn edge at rear.....	184
Artificial flowers cleaned with corn meal.....	184
Repaint window sills frequently.....	189
Unusual hanging flower box made from auto tire.....	190
Removing wallboard from studding.....	191
Cotton string absorbs excess oil from sewing-machine head.....	200
Uses for toothbrush container.....	200
Tin can serves as soap dish.....	200
Tape makes drain plug fit tightly.....	206

### LAWN AND GARDEN

Wooden slats replace canvas seat of lawn chair.....	181
Half-lapped trellis cut quickly on table saw.....	189
Flagstone retaining wall around tree provides attractive fernery.....	189
Two distinctive gates for the informal garden.....	191
Clothesline used as height gauge in building scalloped-top fence.....	196
Small evergreens protected with poultry wire.....	204

### METALWORKING

Novelty hardware you can make.....	178
Sheet-metal guard shields worker when removing gauge glass.....	210
Power mixer for feed, seed or concrete.....	226

### OFFICE

Bottle holder has gluing surface.....	204
Heavy canvas cleans eraser.....	218
Thumbtacks fasten bulletins without perforating.....	228

### PHOTOGRAPHY

Retarding developer spoilage.....	201
Newspaper pads prevent sinking of tripod legs in soft ground.....	201
Low-altitude aerial photos taken from box kite.....	201

### RADIO AND ELECTRONICS

Sprayed and printed circuits.....	229
Tapped-coil crystal receiver and battery-operated amplifier.....	230
Radio-electronics today.....	232

### TOOLS

Saw vise for home workshop.....	180
Paintbrushes kept in readiness by sealing in ball of putty.....	180
Pipe mounted in wood lathe with aid of plug "center".....	190
Hinge forms razor-blade holder.....	190
Mandrel permits multiple turning of wooden toy wheels.....	200
Handy glue spreader.....	204
Craft quiz.....	205
Tweezers from cotter pin.....	206
Hole in hammer to start nails.....	206
Steel stress block rides holder in tool post to reduce bit chatter.....	209
Small ignition wrenches carried on shower-curtain ring.....	210
Grinding-wheel dresser rides lathe tailstock.....	211
Driving dog for faceplate work.....	211
Bushing puller makes gear changing easy.....	215
Index mark on compound slide shows maximum cross-feed limits.....	215
Pail of water steadies plumb bob when working in high wind.....	216
Zigzag rule is substitute for contour gauge.....	216
Outside caliper has scale.....	218
Offset center attachment permits taper turning.....	228

### TOYS AND NOVELTIES

Rubber-tired wheels for toys formed from can lids and hose.....	181
Animated monkey slides down pole to amuse small children.....	197
"Spatterprint" silhouettes have unusual finish.....	197
Children's glass-bottom boat has educational value.....	206

### WOODWORKING

Rafters erected singlehandedly with aid of wooden hook.....	196
Shoe eyelets serve as portholes for ship models.....	197
Matching joints cut with saw guide.....	225

### MISCELLANEOUS

Friction tape on oarlocks prevents slipping of oars.....	184
Abrasive-cloth dispenser.....	190
Generator-operated bicycle light stays bright.....	196
Signal mast displays yacht-club flags.....	198
Coils wound on film spools.....	200
Raising shallow dents in hard or soft wood.....	204
Bull-nose concrete blocks take place of square type.....	206
Dealer furnishes bulletin board as service to customers.....	216
Worker wears checkered cap to indicate deafness.....	218
Sticks made from solder scraps.....	218

**IMPORTANT NOTICE**—It is the intention of this magazine to provide its readers with information regarding the latest developments in the mechanical arts. We take no responsibility as to whether the disclosures contained in our articles are covered by patents and advise readers to investigate this subject before making, using, or selling any of the products, machines, or processes described in order to avoid possible liability for patent infringements.



## AUDELS REFRIGERATION & AIR CONDITIONING GUIDE.....\$4

New from Cover to Cover—1280 Pages, Fully Illus. Covering basic principles, servicing, operation & repair of household, commercial & industrial refrigeration & air conditioning. A gold mine of essential important facts for engineers, servicemen, users.

## AUDELS CARPENTERS & BUILDERS GUIDES—4 Vols. ....\$6

A practical illustrated trade assistant on modern construction for carpenters, joiners, builders, mechanics and all woodworkers. 4 vols., 1600 pages, 3700 Illustrations, flexible covers. Pocket size. Each volume sold separately \$1.50 a vol.

## AUDELS AUTOMOBILE GUIDE.....\$4

A practical quick ready reference book for auto mechanics, service men, operators & owners. Explains theory, construction & servicing of modern motor cars, trucks, buses & auto type Diesel engines. 1700 pages, fully illustrated, 55 chapters. Indexed. A standard book for mechanics. New fluid drive covered.

## AUDELS DIESEL ENGINE MANUAL..\$2

A practical, concise treatise with questions and answers on the theory, operation and maintenance of modern diesel engines including General Motors 2 cycle Diesel. 384 pages, fully illus., flexible binding, pocket size. All details plainly brought out, this book is of extreme value to engineers, operators & students.

## AUDELS WIRING DIAGRAMS.....\$1

210 Pages; Illustrated. Gives practical facts on wiring of electrical apparatus. It shows clearly how to wire apparatus for practically all fields of electricity. Each diagram is complete & self-explanatory. Highly Endorsed Pocket Companion.

## AUDELS PLUMBERS & STEAMFITTERS GUIDES—4 Vols. ....\$6

A Practical Trade Assistant & Ready Reference. Explains in plain language & by clear illustrations, diagrams, charts, graphs, pictures principles of modern plumbing practice including Marine Pipe Fitting and Air Conditioning. 4 Vols.—1670 Pages—3642 Diagrams. Pocket size. Each Vol. Sold Separately \$1.50 a Vol.

## AUDELS SHEETMETAL WORKERS HANDY BOOK.....\$1

Practical inside information. Fundamentals of Sheet Metal Work. 388 pages. Illustrated. 11 sections. Clearly written. Essential & important facts, figures, pointers in everyday language. Ref. Index.

## AUDELS SHEETMETAL PATTERN LAYOUTS.....\$4

Developed by Experts for Sheet Metal Workers, Layout Men & Mechanics. A Practical Encyclopedia in 10 Sections, size 7 x 10 x 2—1126 Pages—350 Layouts—1600 Illustrations, 1001 Key Facts. Fully indexed for ready reference in answering your layout problems. Covers all phases of sheet metal work including Pattern Cutting, Pattern Development & Shop Procedure.

## AUDELS ANSWERS ON BLUE PRINT READING.....\$2

For Mechanics & Builders. Covers all types of blue print reading including ship & airplane. 416 pages, fully illustrated.

## AUDELS NEW MACHINIST & TOOLMAKERS HANDY BOOK.....\$4

Covers modern machine shop practice in all its branches. 5 practical books in 1. New from cover to cover. Tells how to set up & operate lathes, screw and milling machines, shapers, drill presses and all other machine tools. 1600 pages, fully illustrated, 5 x 6 1/2 x 2. Indexed. 5 sections. 1—Modern Machine Shop Practice. 2—Blue Print Reading & How to Draw. 3—Calculations & Mathematics for Machinists. 4—Shop Physics. 5—How to Use the Slide Rule. 60 chapters. Easy to read and understand. A shop companion that answers your questions.

## AUDELS MATHEMATICS & CALCULATIONS FOR MECHANICS \$2

Mathematics for home study or reference. 700 pages, 550 illus. Practical mathematics from beginning. How to figure correctly. Easy, correct methods covering complete review. Illus. & Indexed.

## AUDELS HANDY BOOK OF PRACTICAL ELECTRICITY.....\$4

For maintenance engineers, electricians & all electrical workers. 1440 Pages, 2600 Illus. Covers important electrical information in handy form—including Marine Wiring, Radio Principles, Welding. Indexed. A Key to a practical understanding of electricity.

## AUDELS RADIOMANS GUIDE.....\$4

A key to the practical understanding of radio including Frequency Modulation, Television, etc., Aircraft & Marine Radio. For radio engineers, servicemen, amateurs, 914 Pages, 633 Illustrations & Diagrams. Photos. Review Questions & Answers, Reference Index. Authentic, clear, concise.

## AUDELS ELECTRONIC DEVICES.....\$2

Tells What You Want to Know About Electric Eye. Easily Understood. Covers photo-electric cells & their applications. Amplifiers, illumination, frequencies, voltage, photocell, tubes, Ohm's Law, wiring diagrams, etc.

## AUDELS WELDERS GUIDE.....\$1

A concise, practical text on operation & maintenance of all welding machines for all mechanics. Over 400 pages, illustrated. Covers all methods of electric and acetylene welding including airplane work.

AUDELS, Publishers, 49 W. 23 St., N. Y. 10

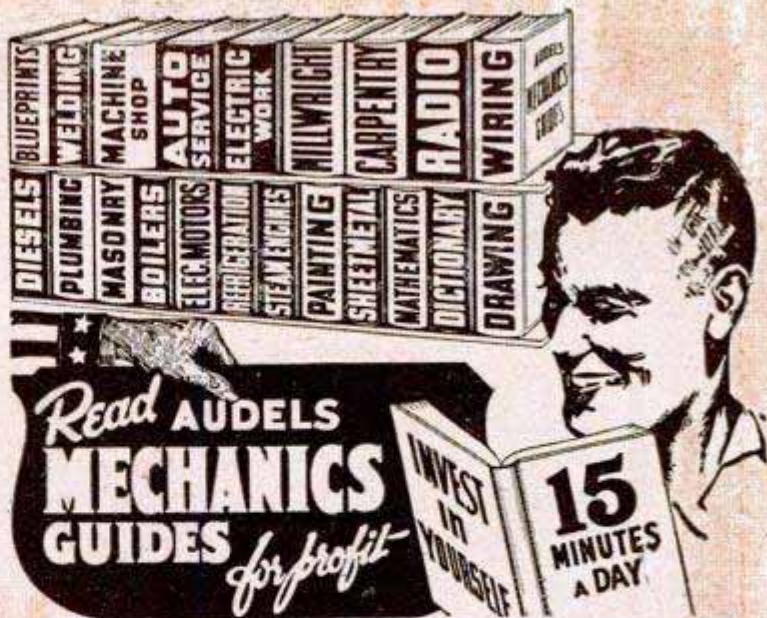

## AN AUDEL GUIDE IS A GOOD FRIEND!

Step Up Your Own Skill with the Practical Facts and Figures of Your Trade. Save time and money with right methods, short cuts, labor saving ideas. CHECK NOW! You can look over any Audel Guide in your home. Start the Easy Payments if satisfied.

# CUT HERE MAIL ORDER

THEO. AUDEL & CO., 49 W. 23 St., New York 10, N. Y.

Please mail me for 7 days' free examination the books marked (X) below. I agree to mail \$1 in 7 days on each book or set ordered, and to further mail \$1 a month on each book or set ordered until I have paid purchase price.

If I am not satisfied with Guides I will return them.

- |                                 |                                                        |       |      |
|---------------------------------|--------------------------------------------------------|-------|------|
| <input type="checkbox"/> Audels | ELECTRIC MOTOR GUIDE                                   | ..... | \$4. |
| <input type="checkbox"/> Audels | OIL BURNER GUIDE                                       | ..... | 1.   |
| <input type="checkbox"/> Audels | REFRIGERATION & Air Conditioning Guide                 | ..... | 4.   |
| <input type="checkbox"/> Audels | POWER PLANT ENGINEERS GUIDE                            | ..... | 4.   |
| <input type="checkbox"/> Audels | PUMPS, HYDRAULICS & AIR COMPRESSORS                    | ..... | 4.   |
| <input type="checkbox"/> Audels | WELDERS GUIDE                                          | ..... | 1.   |
| <input type="checkbox"/> Audels | BLUE PRINT READING                                     | ..... | 2.   |
| <input type="checkbox"/> Audels | SHEET METAL WORKERS Handy Book                         | ..... | 1.   |
| <input type="checkbox"/> Audels | SHEET METAL PATTERN LAYOUTS                            | ..... | 4.   |
| <input type="checkbox"/> Audels | AIRCRAFT WORKER                                        | ..... | 1.   |
| <input type="checkbox"/> Audels | MATHEMATICS and CALCULATIONS                           | ..... | 2.   |
| <input type="checkbox"/> Audels | MACHINISTS & TOOLMAKERS Handy Book                     | ..... | 4.   |
| <input type="checkbox"/> Audels | MECHANICAL Dictionary                                  | ..... | 4.   |
| <input type="checkbox"/> Audels | AUTOMOBILE GUIDE                                       | ..... | 4.   |
| <input type="checkbox"/> Audels | DIESEL ENGINE MANUAL                                   | ..... | 2.   |
| <input type="checkbox"/> Audels | MARINE ENGINEERS Handy Book                            | ..... | 4.   |
| <input type="checkbox"/> Audels | MECHANICAL DRAWING GUIDE                               | ..... | 1.   |
| <input type="checkbox"/> Rogers | MECHANICAL DRAWING and DESIGN                          | ..... | 2.   |
| <input type="checkbox"/> Audels | MILLWRIGHTS and Mechanics Guide                        | ..... | 4.   |
| <input type="checkbox"/> Audels | CARPENTERS and Builders Guides (4 vols.)               | ..... | 6.   |
| <input type="checkbox"/> Audels | PLUMBERS and Steamfitters Guides (4 vols.)             | ..... | 6.   |
| <input type="checkbox"/> Audels | MASONS and Builders Guides (4 vols.)                   | ..... | 6.   |
| <input type="checkbox"/> Master | PAINTER and DECORATOR                                  | ..... | 2.   |
| <input type="checkbox"/> Audels | GARDENERS & GROWERS GUIDES (4 vols.)                   | ..... | 6.   |
| <input type="checkbox"/> Audels | ENGINEERS & FIREMANS EXAMINATIONS                      | ..... | 1.   |
| <input type="checkbox"/> Audels | ENGINEERS and Mechanics Guides                         | ..... |      |
|                                 | Nos. 1, 2, 3, 4, 5, 6, 7 and 8 complete                | ..... | 12.  |
| <input type="checkbox"/> Audels | Answers on Practical ENGINEERING                       | ..... | 1.   |
| <input type="checkbox"/> Audels | ELECTRICIANS EXAMINATIONS                              | ..... | 1.   |
| <input type="checkbox"/> Audels | WIRING DIAGRAMS                                        | ..... | 1.   |
| <input type="checkbox"/> Audels | Handy Book of PRACTICAL ELECTRICITY                    | ..... | 4.   |
| <input type="checkbox"/> Audels | ELECTRICAL POWER CALCULATIONS                          | ..... | 2.   |
| <input type="checkbox"/> Audels | ELECTRONIC DEVICES                                     | ..... | 2.   |
| <input type="checkbox"/> Audels | ELECTRIC Dictionary                                    | ..... | 2.   |
| <input type="checkbox"/> Audels | RADIOMANS GUIDE                                        | ..... | 4.   |
| <input type="checkbox"/> Audels | NEW ELECTRIC LIBRARY at \$1.50 a Volume                | ..... |      |
|                                 | Vols. I, II, III, IV, V, VI, VII, VIII, IX, X, XI, XII | ..... |      |

Name \_\_\_\_\_

Address \_\_\_\_\_

Occupation \_\_\_\_\_

Employed by \_\_\_\_\_



# The Mystery of Numbers

0  
2  
4  
6  
8

Add any two numbers on the left; the sum is always an even number. Multiply any two even numbers; the result, again, is an even number. Axiom: even numbers always add or multiply to even numbers.

Add any two odd numbers; the sum is always an even number. However, in multiplication, odd numbers multiply with one another to produce only odd-numbered totals; likewise, adding any odd number to an even one will produce odd-numbered sums.

1  
3  
5  
7  
9

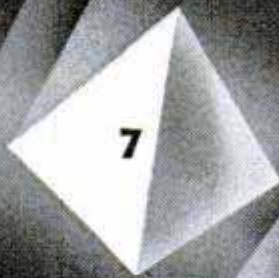

3

## WHAT DO THEY MEAN?

The value of numbers goes beyond their mere mathematical function. Therefore, man has devised various systems of numerology and symbolism, hoping thereby to be able to understand and control the affairs of his life. Why have most of these systems failed? Is there a true method—a practical one—for wresting from numbers their hidden power? By what essence do numbers relate to each other, and to other laws in nature?

## Write for FREE Book

In man, as well as in nature, there are geometrical laws—a harmonious relationship of his personal powers. Learn how to direct these laws of your being so as to attune with the mathematical unity of the universe. Let the Rosicrucians (NOT a religious organization), a world-wide brotherhood of learning, reveal to you the *hidden symbolism* of successful living. A FREE book, *The Mastery of Life*, explains how you may learn these secrets of self. Write for it today. Use the coupon below

Send this coupon today!

SCRIBE G. K. V.  
THE ROSICRUCIANS (AMORC)  
Rosicrucian Park, San Jose, California

Please send me the book, *The Mastery of Life*, which explains how I may learn to use my faculties and powers of mind. No representative will call.

Name \_\_\_\_\_  
Address \_\_\_\_\_  
City \_\_\_\_\_  
Zone Number \_\_\_\_\_ State \_\_\_\_\_

THE ROSICRUCIANS (AMORC)

ROSICRUCIAN PARK - - - SAN JOSE, CALIFORNIA



**I WILL SEND YOU  
BOTH FREE**

**NEW 64 PAGE BOOK**

64-page illustrated book describes many fascinating jobs Radio, Television, Electronics offer, shows big kits of Radio parts I send you, tells how I give you practical experience building real Radio circuits at home in spare time, how you make extra money fixing Radios while still learning; contains letters from many men I trained, telling what they are doing, earning, FREE. Mail Coupon below!

**SAMPLE RADIO LESSON**

I will also send you my Lesson, "Getting Acquainted With Receiver Servicing," FREE, to show you how practical it is to learn Radio at home in spare time. It's a valuable Lesson. Study it—keep it—use it—without obligation! Tells how "Superhet" Circuits work, gives hints on Receiver Servicing, Locating Defects, Repair of Loudspeaker, I.F. Transformer, etc. 31 illustrations. Mail Coupon below!

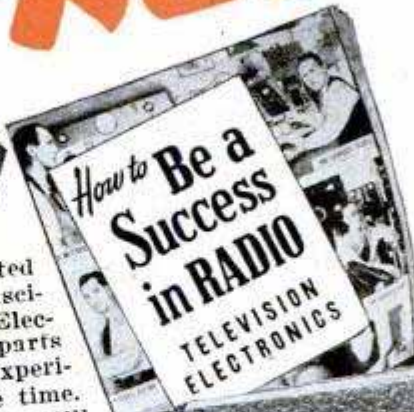

GETTING ACQUAINTED WITH  
RECEIVER SERVICING



**SEE FOR YOURSELF HOW I TRAIN YOU  
AT HOME TO BE A RADIO TECHNICIAN**

Do you want a good-pay job in the fast-growing Radio Industry — or your own Radio Shop? Mail the Coupon for a Sample Lesson and my 64-page book, "How to Be a Success in Radio — Television, Electronics," both FREE. See how I will train you at home—how you get practical Radio experience building, testing Radio circuits with BIG KITS OF PARTS I send!

**Many Beginners Soon Make Extra Money  
In Spare Time While Learning**

The day you enroll I start sending EXTRA MONEY manuals that show how to make EXTRA money fixing neighbors' Radios in spare time while still learning! It's probably easier to get started now than ever before, because the Radio Repair Business is booming. Trained Radio

Technicians also find profitable opportunities in Police, Aviation, Marine Radio, Broadcasting, Radio Manufacturing, Public Address work. Think of even greater opportunities as public demand for Television, FM and Electronic devices continues to grow! Send for FREE books now!

**Find Out What NRI Can Do For You**

Mail Coupon for Sample Lesson and my FREE 64-page book. Read the details about my Course; letters from men I trained; see how quickly, easily you can get started. No obligation! Just MAIL COUPON NOW in envelope or paste on penny postal. **J. E. Smith, President, Dept. 8DP, National Radio Institute, Pioneer Home Study Radio School, Washington 9, D. C.**

**I TRAINED THESE MEN**

AVERAGES BETTER THAN  
**\$3,000 A YEAR**

"I now have a shop and am doing fine. I average better than \$3,000 per year, and certainly give NRI much of the credit."—**RAYMOND F. DAVIS**, Ashburn, Georgia.



**MADE \$612 IN 12 MONTHS,  
SPARE TIME**

"Soon after I finished my experimental kits lessons, I tackled my first Radio service job. I made \$612 in past 12 months in spare time."—**J. W. CLARK**, Wilmington, N. C.



**VETERANS**

You can get this training right in your own home under G. I. Bill. Mail Coupon.

**Build Radio Circuits Like These With Kits I Send**



**Good for Both FREE**

**MR. J. E. SMITH, President, Dept. 8DP  
National Radio Institute, Washington 9, D. C.**

Mail me FREE, your sample lesson and 64-page book. (No salesman will call. Please write plainly.)

Name \_\_\_\_\_ Age \_\_\_\_\_

Address \_\_\_\_\_

City \_\_\_\_\_ Zone \_\_\_\_\_ State \_\_\_\_\_

**Approved for Training under GI Bill**



# IT'S FUN TO BE YOUR

and enjoy the home  
of your dreams!

with the aid of the

## COMPLETE HOME

Here's How This Book Will  
Save You Hundreds of Dollars

**T**HIS amazingly comprehensive volume shows you how to do yourself all of the jobs around the house that have long needed doing—and a lot more you've wished *could* be done. In simple, practical language and pictures it shows you not only how to make your own repairs on your Plumbing, Wiring, Electrical Appliances, Masonry, Plaster, Heating System, Furniture, etc, but also how to *make valuable improvements* in your home, from a new closet to a whole new roof—from a new floor to a whole new modern kitchen.

No longer need today's high labor costs keep you from having the kind of home you'll be proud of—attractive, smooth-running, free from hazards, and equipped with every comfort! This COMPLETE GUIDE makes even the most unfamiliar job easy to do—and *fun* to do! You not only save time and money, you also enjoy the thrill of watching your home acquire new luxury, comfort and value.

(Continued on opposite page)

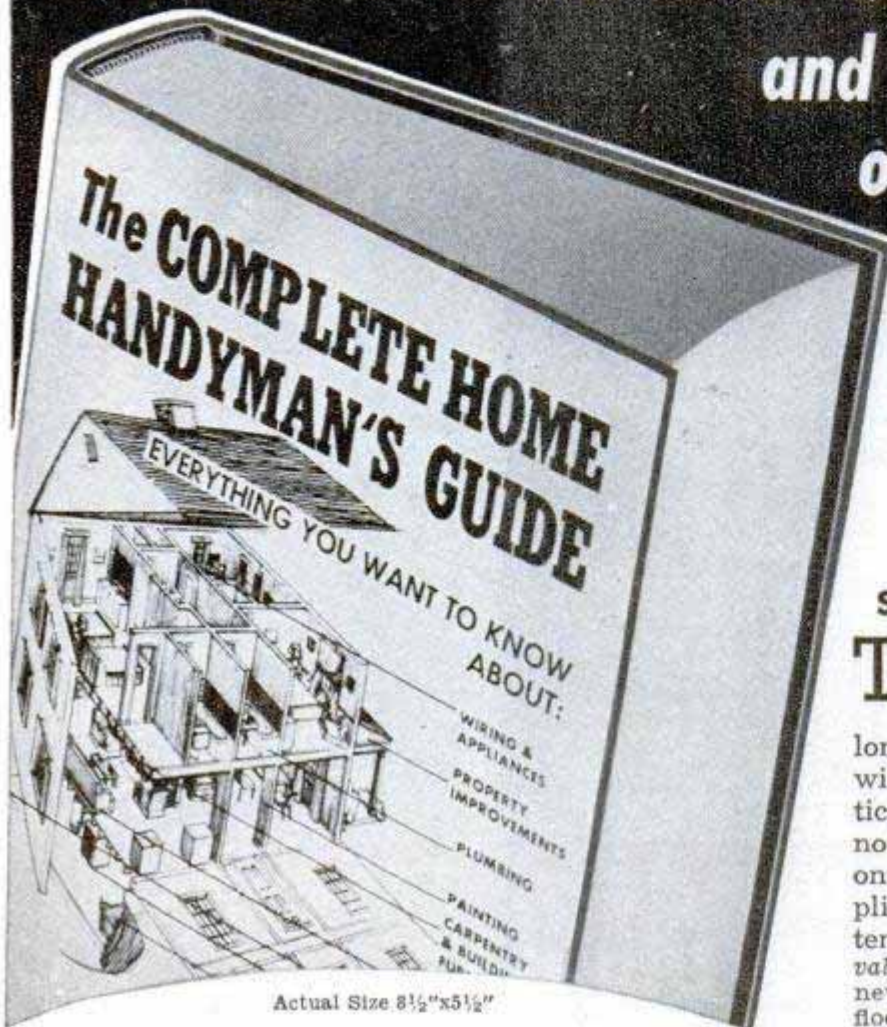

Actual Size 8½"x5½"

More than 1,000  
"How To Do It" Illustrations!  
300,000 Words! • 512 Pages

Here is Just a Partial List of the Hundreds of  
"How-To-Do-It" Articles in this One Book:

### HOUSE CONSTRUCTION AND MATERIALS

How to Build a Foundation  
Types of Girders and Sills  
Beams and Floor Joists  
Building Materials  
Types of Lumber  
Roofing Materials—  
Asphalt, Asbestos,  
Aluminum, Wood  
Shingles  
Concrete forms, mixing  
How to Make All Types  
of Tinsmith Repairs

### INTERIOR REPAIRS

Repairing Creaky Floors  
Repairing and Storing  
Screens  
Repairing Windows—sash  
cord, windowpanes;  
loosening stuck  
windows  
Linoleum-laying, patching  
Fixing Loose Tiles  
Mending China  
Metal Utensils  
Repairing Door Locks,  
Hinges  
Fire Fighting Equipment  
Basement into Game Room  
Building Partitions  
Laying Hardwood  
Flooring, etc.

### DECORATING

Wallpapering  
Cleaning Wallpaper  
Cleaning Painted Walls  
Repairing Plaster  
Scraping Floors  
Refinishing Floors  
Care of Carpets  
and Draperies

### PAINTS AND PAINTING

Types of Paint Brushes  
Types of Paint  
Varnishes, Enamels  
Lacquers, Shellac  
Calcimine  
Paint Thinners  
Mixing Paints  
Surface Preparation  
Removing Paint



(Above) A simple little trick like knotting the wire inside extension plugs can save you severe burns, blown-out fuses, and fire hazards. Protect your home and family with the advice in this book!

Painting a New Surface  
Porch Floors and Steps  
Painting Metal  
Preparing Plaster  
Fillers, Staining, etc.

### ELECTRICITY IN THE HOME

Approved Electrical  
Equipment  
Home Generators  
Fuse Boxes and Fuses  
Appliance and Extension  
Cords  
Replacing Fixture Sockets  
Electric Motors  
Home Signaling Systems  
Burglar Alarms, etc.

### HEATING THE HOUSE

Chimneys  
Coal Furnaces, Oil  
Burners  
Automatic Draft  
Regulators  
Thermostats  
Fuel Economy  
Warm Air Heating  
Systems  
Steam Heating Systems  
Cleaning, Adjusting  
Radiators  
Noise in Steam System  
Hot Water Heating System  
Repacking Leaky Valves  
Cleaning Boilers  
Cleaning the Furnace

How to Insulate Your  
House

How to Build and Install  
Storm Windows  
Efficient Weather  
Stripping, etc.

### PLUMBING

Water Supply  
Cause of Dirty Water  
Repairing Sewage System  
Cesspools, Septic Tanks  
Stopped Up Sewer Pipes  
Stopped Up Drains  
Chemical Drain Cleaners  
Plumbing Traps  
Noisy Plumbing  
Repairing Hot Water  
Tanks  
Thawing Frozen Pipes  
Water Softening  
Equipment  
Repairing Faucets, Flush  
Tanks, Leaky Pipes, etc.

### EXTERIOR REPAIRS

Waterproofing Damp  
Basements  
Waterproofing Masonry  
Walls  
Repairing Cracks in  
Foundation, Stucco  
Walls  
Repairing Brick Walls  
Repairing Leaky Roofs  
Caulking Seams  
Gutters and Downspouts  
Ridding the House of  
Termites, etc.

### YOUR GARDEN

Building Garden Paths  
Building Garden Pool  
Care and Use of Garden  
Tools  
Cold Frames  
Rustic Screens and Arches  
Building an Outdoor Fire-  
place  
Erecting Garage, Summer  
Guest House or Play  
House in Garden, etc.

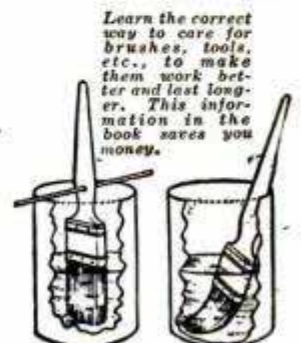

Learn the correct way to care for brushes, tools, etc., to make them work better and last longer. This information in the book saves you money.



# OWN HANDYMAN!

Here's Everything You Need to Know to Do Your Own Repairing, Beautifying, Modernizing, Converting! The A to Z of CARPENTRY, PLUMBING, PAINTING, DECORATING, WIRING AND APPLIANCES, MASONRY, FURNITURE REPAIR, HEATING SYSTEMS—all in one book!



## HANDYMAN'S GUIDE

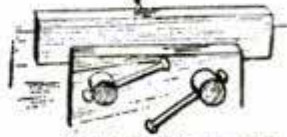

**Make a New Kitchen, Game Room or Bathroom! Build an Extra Apartment and Live Rent-Free!**

Here's 1,001 methods to help make your house more livable—and add hundreds, even thousands of dollars to its value. Need new closet space? Want to eliminate that dangerous draft in the baby's room? Redecorate sister's room? Build a garden walk? Lay a new linoleum floor? Get better winter heat for less money?

Want to convert your basement or attic into an extra apartment and give yourself a rent income that may well offset a good part or all of your taxes, mortgage payments and other expenses?

You can make these improvements yourself, at surprisingly little cost, with the help of *The Complete Home Handyman's Guide*.

**Easy Step-by-Step Instructions in Clear Pictures and Simple Text!**

This book assumes no mechanical knowledge or skill on your part. It starts from the very beginning, explaining how to select and use tools and materials. It gives you detailed information every step of the way, from repairing a lamp or iron to installing a complete wiring system; from repairing a chair-leg to rebuilding your upholstery; from buying a paintbrush to repainting the house inside and out. More than 1,000 ILLUSTRATIONS, accurately and explicitly drawn, make the complete instructions easy to follow. The book will repay its amazingly small cost many times over within a short time!

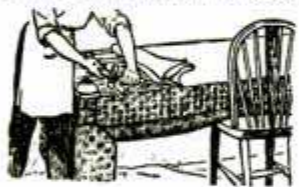

(Left) Furniture upholstery and repair is a fascinating and money-saving hobby when you follow the easy step-by-step instructions in this book.

### YOUR TOOL KIT

Equipping Your Workshop  
Selecting the Right Tools  
Correct Use of Tools  
Care of Tools  
How to Sharpen Tools  
Sandpapers, Glues, etc.  
Soldering Equipment and Technique

### FURNITURE CARE AND REPAIR

Upholstery of Chairs, Sofas, etc.  
Replacing Worn Springs  
Strengthening Frame  
Furniture Upkeep, Cleaning, Removing Water Stains, Marks, Scratches, etc.  
Loose Joints  
Broken Chairs  
Polishes and Polishing  
Staining, etc.



It's Easy to Do Your Own Window Screening and Save High Costs!

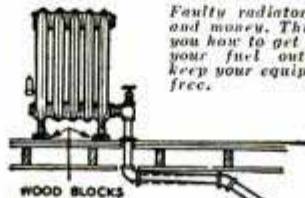

WOOD BLOCKS

Faulty radiators waste heat and money. This book shows you how to get more heat for your fuel outlay, how to keep your equipment trouble-free.

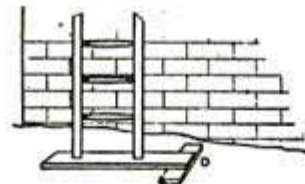
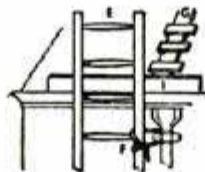

Avoid hazards. This illustration shows how to secure a ladder when you make roof repairs. Complete instructions for repairing walls, foundations, gutters, shingles, etc.

How to equip a workshop, how to use all types of tools, how to use sandpaper and glues—all are fully covered in this "show-me-how" volume.

**Yours for a Week's Free Trial!**

THINK of getting in this one big 512-page volume all the practical information you need to do a good professional-looking job of repairing or improving any part of your home—from cellar to chimney-top! Think of getting all this—not for the \$18.00 or \$24.00 you would expect to pay for 6 or 8 books covering all these fields—but for the miracle price of only \$3.95! But don't take our word for this big value. Just mail the coupon below. When book arrives, test it a full week FREE at our risk and expense! If you don't agree it's the best money-saving buy ever, return it without further obligation. If you keep it, pay the small price in small monthly installments. But act at once. Quantity is limited. Wm. H. Wise & Co., Inc., 50 W. 47th St., New York 19, N. Y. Copyright 1948 by Wm. H. Wise & Co., Inc.

### MAIL THIS FREE-TRIAL COUPON!

Wm. H. Wise & Co., Inc., 50 West 47th Street, New York 19, N. Y.

Without obligation to me, rush me immediately, for Free Examination, a copy of the big new 512-page "COMPLETE HOME HANDYMAN'S GUIDE," bound in sturdy rich Novelex and profusely illustrated with more than 1,000 "How-to-do-it" pictures. After a full week's free trial, I will either return the book promptly and owe you nothing, or I will keep it and remit only \$1 monthly until the amazingly low price of only \$3.95 plus a few cents postage is paid.

Check here for De Luxe Edition at only \$1 extra.

SAVE CHARGES on 3 LB. SHIPMENT. Send only \$3.95 with this coupon and we will stand all shipping charges. Same return and refund privilege. (\$4.95 for De Luxe.)

MR. \_\_\_\_\_  
MRS. \_\_\_\_\_  
MISS \_\_\_\_\_

(Print Plainly in Block Letters)

ADDRESS \_\_\_\_\_

CITY AND ZONE NO. \_\_\_\_\_

STATE \_\_\_\_\_

COMPANION VOLUME. Initial here to reserve "PRACTICAL AND TECHNICAL ENCYCLOPEDIA"—ready in a few months—to be shipped you for FREE trial. 640 pages, over 1,000 pictures, thousands of subjects. Covers Autos; Mechanical, Electrical, and Aeronautical Engineering; Building, Plumbing, Metallurgy, Chemistry, Printing, Sheet Metal and Foundry Work, Radio, and Television, etc. Only \$4.95 plus postage. Same easy terms.

DO NOT WRITE IN BOXES

153

564





**I Put You to Work with Your Hands to LEARN RADIO!  
You Build Receivers! You Make Typical Defects Occur  
and Make Tests to Prove the Theory!**

**YOU GET  
8 BIG KITS OF RADIO  
PARTS & EQUIPMENT  
including  
2-BAND SUPER  
RECEIVER!  
and 16 RANGE METER  
FOR TESTING**

F. L. SPRAYBERRY, PRESIDENT of the SPRAYBERRY ACADEMY OF RADIO. This is the man who directs your study. His years of experience and Radio "know-how" assure you of the finest in-home Radio Training!

# LEARN RADIO to MAKE MONEY!

**LOW COST TRAINING — EASY PAYMENT PLAN!**

**You Learn at Home How to  
Build and Test Dozens and  
Dozens of Circuits — Simple  
and Complex!**

**YOU DO  
OVER 175  
INSTRUCTIVE  
EXPERIMENTS**



**YOU BUILD  
ALL THESE TESTERS  
..... AND MORE!**



I give you a fine, moving-coil type Meter Instrument on Jewel Bearings — with parts for a complete Analyzer Circuit Continuity Tester. You learn how to check and correct Receiver

defects with professional speed and accuracy.

You'll get valuable experience and practice building this Signal Generator and multi-purpose Tester. Makes a breeze out of fixing Radios and you don't have to spend money on ready-made Equipment.

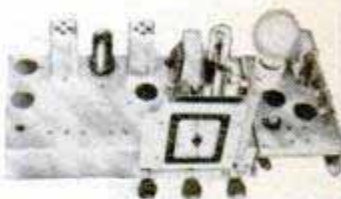
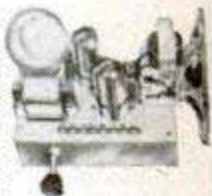

Soldering, wiring, connecting Radio parts . . . building circuits with your own hands — you can't beat this method of learning. When you construct this Rectifier and Filter, Resistor and Condenser Tester, etc., you get a really practical slant on Radio that leads to a money-making future.



Set has Long and Short Wave Tuning. All Sprayberry Equip. is yours for KEEPS.

## SPRAYBERRY HOME TRAINING is PLANNED to MAKE MONEY for you FAST!

I train you with regular professional Radio Equipment. I tell you exactly what to do . . . how to do it. You handle Radio Parts, see them operate, learn what they're for. With the fine Kits I supply, you learn how to build Radio Circuits, construct your own Test Equipment. I'll show you how to cause typical Radio defects so you can watch and see how they act. You learn the latest methods for trouble-shooting and repair. All this adds up to

the finest kind of "bench" experience. And you get it right in your own home. In no time at all, you'll be ready for a business of your own or a good job in Radio, FM, Television, Radar, Industrial Electronics, etc. Now's the time to get started!



## VETERANS!

**Approved for  
G. I. Training  
Under Public  
Laws 16 and 346**

**SEND FOR MY  
VALUABLE  
FREE BOOKS!**

"How To Read Radio Diagrams and Symbols"  
A wonderfully complete new book, which explains in simple English how to read and understand any Radio Set Diagram. Includes translation of all Radio symbols. Send for this volume at once! It's free! With it I'll send you another Big Free Book, describing in detail my Radio Electronic Training!

### SPRAYBERRY ACADEMY OF RADIO

F. L. Sprayberry, President  
1048 Sprayberry Building, Pueblo, Colorado

Please rush my FREE copies of "How to MAKE MONEY in RADIO, ELECTRONICS and TELEVISION" and "How to READ RADIO DIAGRAMS and SYMBOLS."

Name \_\_\_\_\_ Age \_\_\_\_\_

Address \_\_\_\_\_

City \_\_\_\_\_ State \_\_\_\_\_

Check here if a veteran.

(Mail in envelope or paste on penny postcard)



# INVENTORS

## Patent Laws Encourage The Development of Inventions

The Rules of Practice of the U. S. Patent Office advise—unless an inventor is familiar with such matters—that he employ a competent registered attorney or registered agent, as the value of patents depends largely upon the skillful preparation of the specifications and claims.

The firm of McMorrow, Berman and Davidson is registered to practice before the U. S. Patent Office. Additionally, it maintains a staff of attorneys able to readily understand inventors' disclosures, to advise concerning patentability, and to prepare appropriate specifications and claims for filing with the Patent Office.

If an inventor believes he has an invention, a search of the most pertinent prior U. S. patents should be made and a report obtained relative to its patentability. Where such report indicates that the invention appears patentable, in order to secure protection, diligence should be exercised in making application for a patent.

## McMORROW, BERMAN & DAVIDSON

*Registered Patent Attorneys*

PATENTS • TRADE MARKS • COPYRIGHTS

135-G VICTOR BUILDING, WASHINGTON 1, D. C.

### McMORROW, BERMAN & DAVIDSON

*Registered Patent Attorneys*

135-G Victor Building, Washington 1, D. C.

Send me further particulars as to patent protection and procedure and "Invention Record" form at once. I understand that this request does not obligate me.

Name \_\_\_\_\_

Address \_\_\_\_\_

City \_\_\_\_\_ State \_\_\_\_\_

(WRITE OR PRINT NAME CLEARLY)



# Will You Let Me PROVE I Can Make YOU a New Man?

LET ME START SHOWING RESULTS FOR YOU

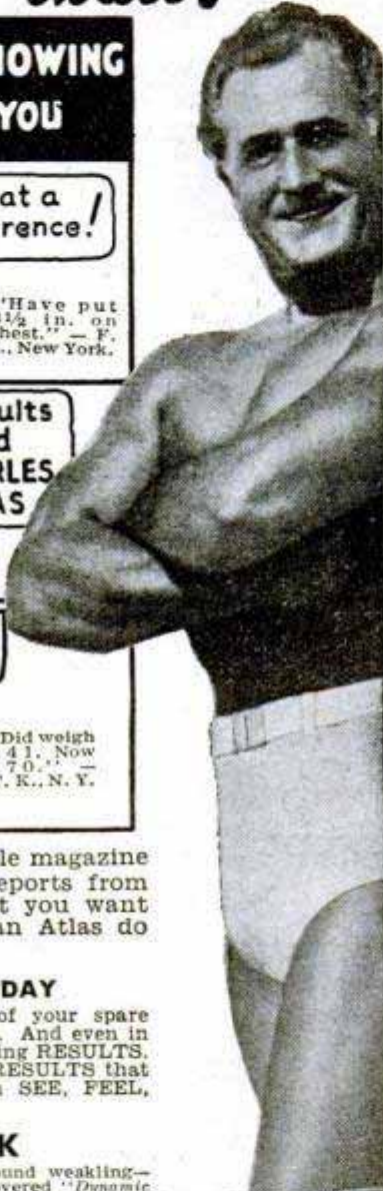

I COULD fill this whole magazine with enthusiastic reports from OTHERS. But what you want to know is—"What can Atlas do for ME?"

### 15 MINUTES A DAY

Just give me 15 minutes of your spare time daily. That's all I ask. And even in that short time I'll start giving RESULTS. And it will be the kind of RESULTS that you (and anyone else) can SEE, FEEL, MEASURE with a tape.

### FREE BOOK

I myself was once a 97-pound weakling—sickly, half-alive. Then I discovered "Dynamic Tension." And I won the title, "The World's Most Perfectly Developed Man!" "Dynamic Tension" has done so much for other fellows that I simply ask you to let me prove that it can make a New Man of YOU—that it can start new inches of power pushing out your chest—build up your shoulders to champion huskiness—put new, hard, firm muscles on your biceps—make those stomach muscles of yours hard ridges!

Why not risk a postage stamp? Send coupon for my 48-page illustrated FREE BOOK AT ONCE! Address me personally; Charles Atlas, Dept. 8D, 115 East 23rd Street, New York 10, N. Y.



**CHARLES ATLAS, Dept. 8D,  
115 East 23rd Street, New York 10, N. Y.**

I want the proof that your system of "Dynamic Tension" will help make a New Man of me—give me a healthy, husky body and big muscle development. Send me your free book, "Everlasting Health and Strength."

Name \_\_\_\_\_ Age \_\_\_\_\_  
(Please print or write plainly)

Address \_\_\_\_\_

City \_\_\_\_\_ State \_\_\_\_\_

## ARREST HIM, OFFICER! I'LL HAVE COMPLETE FACTS ON THE OTHER FELLOW TONIGHT!



Operator No. 38 is on the job... FOLLOW HIM through all the excitement of his chase after the automobile thieves. Write NOW for

### FREE Confidential Reports

**No. 38 Made to His Chief!**  
It may open your eyes to the great opportunity for YOU as a well paid Finger Print Expert. The kind of work you'd like, Excitement! Thrills! A REGULAR MONTHLY salary. REWARD MONEY. Over 800 of all Identification Bureaus in U. S.

employ I. A. S. students or graduates! Write for Free Reports, Finger Print Book, low prices. Easy Terms Offer.

Literature will be sent only to persons stating their age.

**INSTITUTE OF APPLIED SCIENCE**  
1920 Sunnyside Ave., Dept. 1354, Chicago 40, Illinois

## LEARN MONEY-MAKING CARTOONING

**IN SPARE TIME—by Easy PICTURE CHART METHOD!** Teaches originality—the big need today. Same Simplified Method that has helped train creators of "Steve Canyon," "Winnie Winkle," "Out Our Way," "Secret Agent X-9," "The Neighbors," "Reck'lar Fellers," "Strange As it Seems," and many other successful strip, sport, and editorial cartoonists. Earn while you learn. Don't wonder whether you have talent—rush name, address and 10c for Picture Chart (to test your ability), samples of successful students' work, and full details. Please state age.



**LONDON SCHOOL OF CARTOONING**  
4804 Cleve. Transit Bldg., Cleveland 14, Ohio



## Bar Bells

Buy Direct From Factory

\$8<sup>95</sup>  
up

Write for free booklet and price list

INDEPENDENT IRON WORKS  
2416 East 23rd Street, Dept. B  
Los Angeles 11, Calif.

## WANTED DISTRICT PURCHASING AGENTS

No experience or money required. Exceptional opportunity for those who want to establish themselves in a steady, year 'round, well paying business.

For details: Write

**PURCHASING MANAGER, DEPT. C**  
2719 LAWRENCE AVE. CHICAGO 25, ILL.

## Master Watchmaking

The life-long profitable trade of thousands as taught by the Swezey System.

"FAMED THE WORLD OVER"

**CHICAGO SCHOOL OF WATCHMAKING**  
Founded in 1908 by Thomas B. Swezey  
1608 N. Milwaukee Ave., Dept. 148 Chicago 47, Ill.

## LAW

STUDY AT HOME for PERSONAL SUCCESS and LARGER EARNINGS. 39 years expert instruction—over 108,000 students enrolled. LL.B. Degree awarded. All texts furnished. Easy payments. Send for FREE BOOK.

**AMERICAN EXTENSION SCHOOL OF LAW**  
Dept. 88-M, 646 N. Michigan Ave., Chicago 11, Ill.

## LEARN MEAT CUTTING



Through actual practice. Profitable Meat Cutting and Successful Meat Merchandising taught easily, quickly. LEARN BY DOING at Toledo in just six short weeks under actual market conditions. For beginners or men with experience. All subjects taught thoroughly and completely. Diploma. Job help. Get store of own. People must eat. School in operation nearly 25 years. Approved for GI training. Send today for FREE literature. No obligation.

**NATIONAL SCHOOL OF MEAT CUTTING, Dept. U-92, Toledo 4, Ohio**



# RADIO SERVICING

Learn More! Earn More! with I.C.S. Shop-Method Training

Here's a brand-new training course geared to the big money-making opportunities in RADIO. It's complete, thorough, extremely practical. You learn by the Shop-Method; actually working with high-grade radio parts and tools provided with the course. Step-by-step, you build up a sound working-knowledge that helps prepare you for the big rewards ahead. The coupon brings full information. Mail it TODAY.

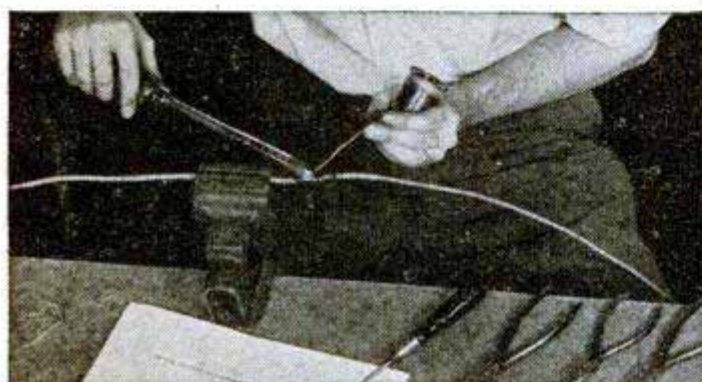
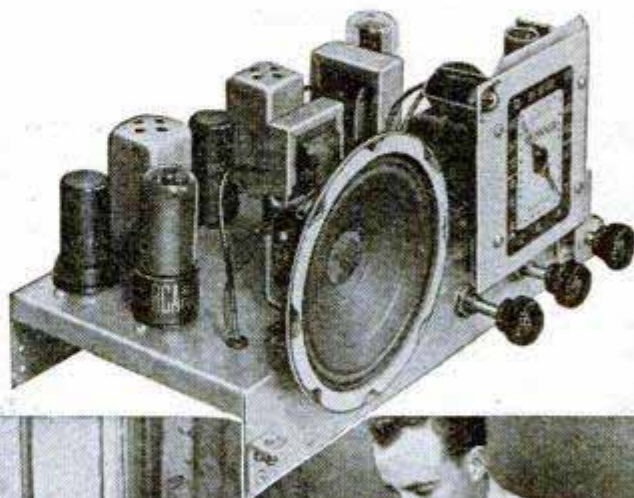

Learning to handle tools is an important part of I.C.S. training. You get valuable instruction plus a complete set of top-quality tools.



Training equipment includes kit for building a modern, 6-tube, two-band receiver. You learn about each part—how it works, what it does.

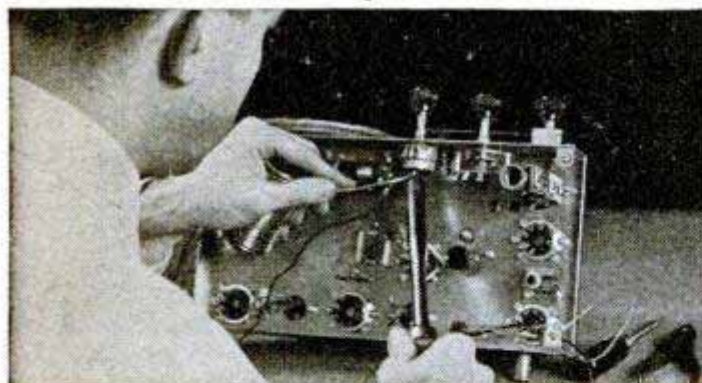

Illustrated training sheets show how to assemble and wire the set. Every step is clearly explained, easy to follow. You learn by doing!

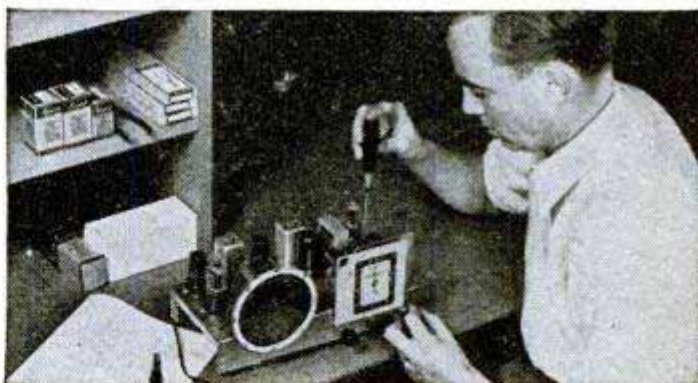

When your receiver is completed, you check it, analyze it, run tests like those used in modern shops. You're ready to make your training pay!



INTERNATIONAL CORRESPONDENCE SCHOOLS, Box 5626-K, Scranton 9, Pa.

Without cost or obligation please send me full information on the courses before which I have marked X.

- |                                                                    |                                                  |
|--------------------------------------------------------------------|--------------------------------------------------|
| <input type="checkbox"/> RADIO SERVICING (with training equipment) |                                                  |
| <input type="checkbox"/> Radio, General                            | <input type="checkbox"/> Electrical Engineering  |
| <input type="checkbox"/> Radio, Operating                          | <input type="checkbox"/> Lighting Technician     |
| <input type="checkbox"/> Electronics                               | <input type="checkbox"/> Practical Electrician   |
| <input type="checkbox"/> Practical Telephony                       | <input type="checkbox"/> Business Administration |
| <input type="checkbox"/> Telegraph Engineering                     | <input type="checkbox"/> Salesmanship            |

Name \_\_\_\_\_  
 Address \_\_\_\_\_  
 City \_\_\_\_\_ State \_\_\_\_\_  
 Age \_\_\_\_\_ Occupation \_\_\_\_\_ Working Hours \_\_\_\_\_ A.M. to \_\_\_\_\_ P.M.



# PATENT PROTECTION *for* INVENTORS

## A PATENT IS A VALUABLE RIGHT

On the basis of a constitutional provision Congress has established a system under which inventors may secure the exclusive right to prevent the unauthorized use, manufacture and sale of their inventions for periods of seventeen years. The inventor secures this protection by obtaining a patent from the United States Patent Office.

**THE UNITED STATES PATENT OFFICE RECOMMENDS** in its Rules of Practice that "an applicant is advised, unless familiar with such matters to employ a competent registered patent attorney or registered patent agent, as the value of patents depends largely upon the skillful preparation of the specifications and claims."

**WE RECOMMEND** that you authorize us to conduct a search through the U. S. Patents pertinent to your invention and submit a report setting forth our opinion regarding its patentability.

**Victor J. Evans & Co.** has a staff of experienced registered patent attorneys, available to represent inventors in the preparation and prosecution of their cases before the Patent Office. Detailed information and the steps to be taken in obtaining patent protection will be furnished upon request.

### FORM BELOW FOR MAILING CONVENIENCE

. . . . VICTOR J.  
**EVANS & CO.** . . . .  
*Merlin M. Evans*  
 REGISTERED PATENT ATTORNEY  
 330-D MERLIN BUILDING, WASHINGTON 6, D. C.

• Please forward to me detailed information regarding procedure to obtain Patent Protection, together with your convenient "Evidence of Invention" form.

• Name.....

• Address.....

• City and State.....

. . . . .  
**PATENTS . . . TRADEMARKS . . . COPYRIGHTS**



These Men are Learning

# ELECTRICITY

ON REAL EQUIPMENT

in the GREAT SHOPS of COYNE



**Why Spend Years Preparing for a Good Job?  
Train Quickly at COYNE—Be Making Real  
Money While Others are Still Puttering Along!**



B. W. COOKE

Yes, you can get ready for Good Pay—a Big Future in ELECTRICITY—by coming to COYNE in Chicago to train on actual equipment! Here you work on real motors, armatures, switchboards—do actual wiring and trouble-shooting—get the "all-around" training you need.

**Not a "Home-Study" Course**

We do not teach by mail. All training is given in our Great Shops, plus necessary theory. Expert instructors guide you. No advanced education or previous experience needed.

**EARN WHILE LEARNING**

If you need part-time work to help out with living expenses while at Coyne, we'll help you get it. Don't be held back by lack of money.

**COYNE ELECTRICAL AND RADIO SCHOOL**

B. W. COOKE, Pres.

500 S. Paulina St., Dept. 48-72, Chicago 12

This modern fireproof building is occupied entirely by COYNE. Located in Chicago, the Electrical Center of the World.

FOUNDED 1899



**Electrical Refrigeration Included**

Added training now included in great new field of Electric Refrigeration—Industrial Electronics also included. Both mean added opportunities.

**GI Approved—Finance Plan for Non-Vets**

COYNE is authorized to train men under the G.I. Bill. Non-veterans may enroll now, pay most of tuition after graduation. Whatever your problem, COYNE can help you! Mail the coupon now.

**GET THE FACTS!**

BIG FREE BOOK tells all about your future in Electricity and how you can get ready quickly at COYNE. Dozens of pictures. Rush coupon today!

**PREPARE FOR PERMANENT JOBS LIKE THESE**

- Light and Power Wiring
  - Power Plant Work
  - Armature Winding
  - Substation Operator
  - Maintenance Electrician
  - Electrical Testing
  - Signal Maintenance
  - Industrial Electronics
  - Electric Refrigeration
  - and many others
- Our Employment Bureau for graduates gives FREE Lifetime Job Service.

**FREE BOOK**



B. W. COOKE, Pres.  
COYNE ELECTRICAL  
AND RADIO SCHOOL, Dept. 48-72  
500 S. Paulina St., Chicago, 12, Ill.

Send me your big FREE BOOK on ELECTRICITY and tell all about your training offer. This does not obligate me in any way and no salesman will call on me.

NAME.....  
ADDRESS.....  
CITY.....STATE.....

**MAIL NOW**





## BE A CLERK all my life? NOT ME!!

Of course you say you won't.

But you may be unless you do something about it.

Hoping and wishing won't get you a better job and more money.

You must prepare for that step ahead—be ready to make promotion come.

We have helped thousands of ambitious men and women get ahead in the business world—perhaps we can help you.

At least you should investigate. It may be the turning point in your life to a better job and more money. So send the coupon without delay. Check the field of your choice and we'll send you without obligation the requirements and opportunities in that field.

### LASALLE Extension University A Correspondence Institution

417 S. Dearborn St., Dept. 464-R Chicago 5, Ill.

I want to know whether you can help me get ahead in the field I have checked below. Send me your free 48-page booklet and full information about your home-study training in that field.

- |                                                        |                                                |
|--------------------------------------------------------|------------------------------------------------|
| <input type="checkbox"/> Accounting                    | <input type="checkbox"/> Business English      |
| <input type="checkbox"/> Bookkeeping                   | <input type="checkbox"/> Effective Speaking    |
| <input type="checkbox"/> C.P.A. Coaching               | <input type="checkbox"/> Industrial Management |
| <input type="checkbox"/> Law: LL.B. degree             | <input type="checkbox"/> Business Management   |
| <input type="checkbox"/> Salesmanship                  | <input type="checkbox"/> Business Management   |
| <input type="checkbox"/> Stenotypy (Machine Shorthand) | <input type="checkbox"/> Traffic Management    |
|                                                        | <input type="checkbox"/> Foremanship           |

Name.....Age.....

Position.....

Address.....

City.....Zone.....State.....

## Be a PILOT!

Get

THOROUGH INDIVIDUAL INSTRUCTION

It will pay you well to learn aviation "from the ground up," at an old established flying school where expert instructors, personal attention and an aggressive, thorough program can prepare you for an aviation career in the shortest possible time.

GOVERNMENT APPROVED CAA APPROVED

Students from all over the nation and many parts of the world are getting their private, commercial, instrument and multi-engine ratings NOW! at the Gotschalk School. Veterans' tuition paid by the Government under G.I. Bill. To others, there are opportunities for work to cover living expenses or tuition. Write today.

**GOTSCHALK**

School of Aeronautics

ADRIAN, 1, MICHIGAN

APPROVED FOR VETERANS UNDER G.I. BILL



## CHEMISTRY

LEARN AT HOME...Chemical knowledge is essential for thousands of good jobs in industry, business, science. IPC enables you to master practical chemistry. It's the ONLY home study chemistry course which enables you to learn by performing actual experiments—using chemicals and apparatus supplied with the course—in addition to your IPC textbook studies. Compares with recognized college courses in General Chemistry. Write today for free descriptive booklet.

INSTITUTE OF PRACTICAL CHEMISTRY  
5 PROSPECT AVENUE, HAGERSTOWN, MD.

### SHOE REPAIR OFFERS BIG INCOME

LEARN IN 12 WEEKS TIME

In 12 weeks time you can own your own shop or earn big income as skilled shoe repairman. Growing demand everywhere at top wages for men who know how. We teach you quickly by actually working on shoes and modern machines. Costs nothing under G.I. Bill of Rights. We help you get big pay job or start your own shop in 12 short weeks. School open to all from 18 to 60 years of age. FREE BIG 16 PAGE BOOK explains everything. Send for your copy today.

MODERN SHOE REBUILDING SCHOOL

Established 1927

2937 Belmont Ave., Chicago, Ill. RUSH POSTCARD TODAY

PROFESSIONAL TRAINING IN A MINIMUM OF TIME

## RADIO ENGINEERING

An Accredited Technical Institute; preparing high school graduates for technical careers. CREI graduates are in demand—in every branch of radio. Classes start every Monday. Comprehensive courses in Radio-Electronics Engineering. Broadcast and Television Engineering or Servicing; 2,100 hours classroom and laboratory study.

Write for FREE booklet, "Radio Engineering as a Career."

CAPITOL RADIO ENGINEERING INSTITUTE

Dept. P-4, 16th & Park Road, N.W., Washington 10, D. C.

## LOOK

### for Rupture Help

Try a Brooks Patented Air Cushion appliance. This marvelous invention for most forms of reducible rupture is GUARANTEED to bring YOU heavenly comfort and security—day and night—at work and at play—or it costs you NOTHING! Thousands happy. Light, neat-fitting. No hard pads or springs. For men, women, and children. Durable, cheap. Sent on trial to prove it. Not sold in stores. Beware of imitations. Write for Free Book on Rupture, no-risk trial order plan, and Proof of Results. Ready for you NOW!

Brooks Company, Dept. 1613, Marshall, Mich.





# WHICH OF THESE *Opportunities* INTERESTS *You* MOST?

Accounting Air Conditioning Architecture & Building Automotive Engineering Aviation—Practical Aviation Drafting & Design Better Foremanship Bookkeeping Business Management	Contracting Diesel Engineering Drafting & Design Electrical Engineering Electricity—Practical Electronics, Industrial High School Courses Machine Shop Operations Mechanical Engineering	Plastics Engineering Plumbing—Practical Private Secretary Radio Operating & Servicing Railway Training Refrigeration Sheet Metal Pattern Drafting Shop Management Tool Making
-----------------------------------------------------------------------------------------------------------------------------------------------------------------------------------------------------	------------------------------------------------------------------------------------------------------------------------------------------------------------------------------------------------------------------	-------------------------------------------------------------------------------------------------------------------------------------------------------------------------------------------------------

**THINK! LOOK FORWARD!**

**Business is making big, new plans**

**Men and Women are preparing for the future**

**WHAT ARE YOU DOING ABOUT YOUR TOMORROWS?**

● *Today*, choose the job you want—and prepare for it. Or if you are already engaged in the work you like best, start training *now* for quicker promotion. Acquire the knowledge that will help you to get ahead faster, make more money and have greater security.

Invest part of your spare time in more rapid progress. Start training now, in spare time in your own home. Be ready to grasp your opportunity and step out ahead of those who lack the ability you have attained.

American School, founded in 1897 as an educational institution *not for profit*, can help you to reach your goal just as it has helped others during the past fifty-one years. Give serious thought to the list above. Pick one or more subjects that interest you. Then check the coupon at right, add your name and address and mail it at once. The school will send you details on its training plan and outline of study prepared by specialists. There is no charge, no obligation, so send the coupon immediately.

**PRACTICAL, EFFECTIVE HOME - STUDY TRAINING SINCE 1897**  
**Take This First Easy Step**

**CHECK, CLIP AND MAIL COUPON NOW**

**AMERICAN SCHOOL, Dept. G445, Drexel at 58th, Chicago 37, Ill.**  
*Without obligation. Please send FREE and postpaid, bulletin and details of the Subject checked.*

- |                                                    |                                                |                                                                |
|----------------------------------------------------|------------------------------------------------|----------------------------------------------------------------|
| <input type="checkbox"/> PLASTICS ENG'R            | <input type="checkbox"/> Accounting            | <input type="checkbox"/> Drafting and Design for Men and Women |
| <input type="checkbox"/> Refrigeration             | <input type="checkbox"/> Electrical Engr.      | <input type="checkbox"/> Radio                                 |
| <input type="checkbox"/> Architecture and Building | <input type="checkbox"/> Electricity-Pract.    | <input type="checkbox"/> High School                           |
| <input type="checkbox"/> Contracting               | <input type="checkbox"/> Electronics, Industr. | <input type="checkbox"/> Air Conditioning                      |
| <input type="checkbox"/> Practical Plumbing        | <input type="checkbox"/> Bookkeeping           | <input type="checkbox"/> Mechanical Eng.                       |
| <input type="checkbox"/> Automotive Engineering    | <input type="checkbox"/> Private Secretary     | <input type="checkbox"/> Shop Management                       |
| <input type="checkbox"/> Aviation Drafting         | <input type="checkbox"/> Diesel Engineering    | <input type="checkbox"/> Tool Making                           |
| <input type="checkbox"/> Aviation                  | <input type="checkbox"/> Sheet Metal           | <input type="checkbox"/> Better Foremanship                    |
| <input type="checkbox"/> Business Mgmt             | <input type="checkbox"/> Pattern Drafting      | <input type="checkbox"/> Machine Shop Operations               |
| <input type="checkbox"/> Railway Training          |                                                |                                                                |

Name..... Occupation.....  
 Address..... Age.....  
 City..... State.....

**AMERICAN SCHOOL**  
 Dept. G445, Drexel at 58th Street, Chicago 37





**EARNED \$400 THE FIRST YEAR**

"Last year I made around \$400, and it was the first year I really started to write. Your course is the best way to get expert instruction in professional writing." — T. Edward Karlsson, 224 East 79 Street, New York, N. Y.

**To People Who Want to Write  
BUT CAN'T GET STARTED**

**DO YOU** have that constant urge to write but the fear that a beginner hasn't a chance? Here is what the former editor of Liberty said:—

"There is more room for newcomers in writing than ever before. Some of the greatest of writing men and women have passed from the scene in recent years. Who will take their places? Fame, riches and the happiness of achievement await the new men and women of power."

**A Chance to Test Yourself — FREE**

The Newspaper Institute of America offers a free Writing Aptitude Test. Its object is to discover more men and women who can add to their income by fiction and article writing. The Writing Aptitude Test is a simple but expert analysis of your latent ability, your powers of imagination, logic, etc. Those who pass this test are qualified to take the famous N.I.A. course based on the practical New York Copy Desk Method which teaches you to write by writing. You work at home, in leisure time, constantly guided by experienced writers. Soon you acquire the coveted "professional" touch. Then you're ready to market your stories, articles and news items.

**Mail the Coupon Now**

Taking the Writing Aptitude Test requires but a few minutes and costs nothing. So mail the coupon now. Take the first steps toward the most enjoyable and profitable occupation—writing for publication! Newspaper Institute of America, One Park Ave., New York 16, N. Y. (Founded 1925.)

**VETERANS: Course approved for Veterans' Training.**

**FREE** Newspaper Institute of America  
One Park Avenue, New York 16, N. Y.

Send me, without cost or obligation, your Writing Aptitude Test and further information about writing for profit as promised in Popular Mechanics, April.

Miss \_\_\_\_\_  
Mrs. \_\_\_\_\_  
Mr. \_\_\_\_\_

Address \_\_\_\_\_

Check here if you are eligible under the G. I. Bill of Rights. (All correspondence confidential. No salesman will call on you. 72-D-788)

Copyright 1948 Newspaper Institute of America



**YOU CAN LEARN TO  
BE AN  
ARTIST**

Start **DRAWING**  
At Home in Your  
**SPARE TIME!**

**Draw for Money! Trained Artists are capable of earning \$60, \$75 and more a WEEK!**

Your future is in your own hands. Prepare yourself now in **COMMERCIAL ART, DESIGNING and CARTOONING**—all in **ONE** complete home study course. No previous art experience necessary — we teach you step-by-step for a fascinating hobby and a profitable career. For 34 years WSA graduates have been "making good"—**WHY NOT YOU? FREE BOOK.** "Art for Pleasure & Profit" fully describes course, service and commercial opportunities. **TWO ART OUTFITS** included with training. Mail coupon today.

**(VETERANS! Course approved under G. I. Bill.)**

**FREE BOOK gives details!**

**WASHINGTON SCHOOL OF ART,**  
Studio 124M, 1115 15th St., N. W., Washington 5, D. C.

NAME \_\_\_\_\_ AGE \_\_\_\_\_

Address \_\_\_\_\_

City \_\_\_\_\_ Zone ( ) State \_\_\_\_\_

I am entitled to training under the G. I. Bill.



Poultry is providing many trained men and women with a good, comfortable living, either part or full time. You, too, can enjoy country life, home-grown food, increased income, if you have the specialized knowledge that is so important.

For 27 years our Home Study Course has been helping thousands to greater success. Proper knowledge and "Know How" mean extra income from the start. Don't delay—write today for prospectus describing courses, methods, opportunities, service.

**NATIONAL POULTRY INSTITUTE**  
DEPT. 50 — ADAMS CENTER, N. Y.

**Be A MASTER PLUMBER**

**Earn \$15 To \$50 A Day**

**DON'T ENVY THE PLUMBER — BE ONE**

Every skilled workman will tell you that Plumbers have the best of it. **WINTER** and **SUMMER** the Plumber is busy at top wages. No skilled Plumber is ever out of a job—compare his opportunities with any trade, plus the opportunities of having your own shop.

We teach you Plumbing with **TOOLS** (not books) under Licensed Master **PLUMBERS** in one of the finest equipped schools in America. We make you a Plumber, every branch is taught thoroughly—Lead Work—Blueprint for plan reading—all other tricks.

**LEARN IN 30 WEEKS WITHOUT PREVIOUS EXPERIENCE**

If you like to work with tools you owe it to yourself to investigate. No need to ever work as an apprentice. Get free bulletin. Write now! **G.I. APPROVED.** Our 24th year.

**UNIVERSAL PLUMBING SCHOOL**  
815 HOLMES STREET KANSAS CITY, MO.

**ENGINEERING DEGREE IN 27 MONTHS**

**INDIANA TECHNICAL COLLEGE**

Aeronautical, Chemical, Civil, Electrical, Mechanical, and Radio Engineering (inc. television). Drafting, 1-yr. Gov't approved for G.I.'s. Low rate. Earn board. Large industrial center. Students from 48 states, 18 countries. Demand for graduates. Enter June, September, December, March. Catalog.

548 E. Washington Blvd., Ft. Wayne 2, Ind.

**INVENTING**

**—FOR PROFIT!** If you have an inventive turn of mind, write for free 28-page booklet explaining how the Institute of American Inventors is helping inventors pre-test the profit possibilities of proposed devices to fill today's unprecedented demand for useful new inventions.

**INSTITUTE of AMERICAN INVENTORS**  
Dept. 4, 1926 Eye St., NW, Washington 6, D. C.

**Photography**  
for   
**PLEASURE or PROFIT**



Learn at home. Spare time. Practical basic training. Long-established school. Many have earned while learning. Send coupon below for free booklet, "Opportunities in Modern Photography" and full particulars.

**AMERICAN SCHOOL OF PHOTOGRAPHY**  
1315 Michigan Avenue Dept. 1354 Chicago 5, Illinois

Send booklet, "Opportunities in Modern Photography," full particulars and requirements. No salesman will call.

Name \_\_\_\_\_ Age \_\_\_\_\_

Address \_\_\_\_\_

City \_\_\_\_\_ Zone \_\_\_\_\_ State \_\_\_\_\_





ABOVE: TELEVISION offers YOU one of today's thrilling, newer fields with possibilities for a bright and promising future. The above scene shows some of the modern equipment at D.T.I. used in preparing men for TELEVISION.

# Television

- RADIO
- Industrial ELECTRONICS

## Get FREE Facts About YOUR Future in These Fields

SEE HOW YOU MAY MAKE REAL MONEY, HAVE A GOOD JOB, OR A BUSINESS OF YOUR OWN . . .

Mail the coupon below and you will receive, absolutely FREE, facts showing how you may get started toward a good job or a business of your own in RADIO or ELECTRONICS. See how readily you may begin to realize your life-long ambition for a REAL FUTURE. See how you may make your start toward a field that also includes such interesting branches as F-M Radio, Broadcast Radio, Aviation Radio, 2-Way Train Radio, Police-Cab-Truck Radio, Sound Recording.

**NO ADVANCED EDUCATION,  
NO EXPERIENCE NECESSARY**

Our Chicago Laboratory and Home Training have been designed to prepare you and to get you started in Radio and Electronics — whether or not you have a higher education or previous experience. Don't delay . . . mail the coupon below today!



With our HOME TRAINING you receive actual radio parts from which you make 133 experiments and build 7 radio receivers . . . plus loose-leaf lessons with fold-out diagrams . . . plus HOME MOVIES to help you learn easier, faster.



One of today's most promising fields is INDUSTRIAL ELECTRONICS. D.T.I. can prepare you for this field — either at home or in our modern Chicago laboratories. See HOW you may get started toward this fascinating work now. Fill in — mail the coupon below today!

## 2 TRAINING PLANS—TAKE YOUR CHOICE

1. You may come to our modern, Chicago laboratories, where you train with the aid of capable instructors and some of the finest Radio-Electronic equipment. We will find comfortable living quarters for you
2. Or, if you prefer, you may STUDY AT HOME — using modern, commercial-type radio equipment, well illustrated lessons and HOME MOVIES. You can do this in your SPARE TIME, without interfering with your present job.

## VALUABLE EMPLOYMENT SERVICE

When you complete either training, our effective Employment Service goes to work for you, to help you get started toward a real future in Radio-Electronics. Don't delay!

## MAIL THIS OPPORTUNITY COUPON NOW.

Mr. E. B. DeVRY, President  
DeForest's Training, Inc.  
2533 N. Ashland Ave., Dept. PM-E4  
Chicago 14, Illinois

**ACCEPTED FOR G.I.  
TRAINING**

Please show me how I may get started toward a good job or a business of my own in Radio-Electronics.

Name \_\_\_\_\_ Age \_\_\_\_\_

Address \_\_\_\_\_ Apt. \_\_\_\_\_

City \_\_\_\_\_ Zone \_\_\_\_\_ State \_\_\_\_\_

If under 16, check here for special information.  If a discharged Veteran of World War II, check here.

**DeForest's Training, Inc.**  
CHICAGO, ILLINOIS

Associated with the DeVry Corporation  
Builders of Electronic & Movie Equipment



# PRACTICAL AUTO INFORMATION

Keeps Cars Rolling by Making Repairs and Adjustments Easy!

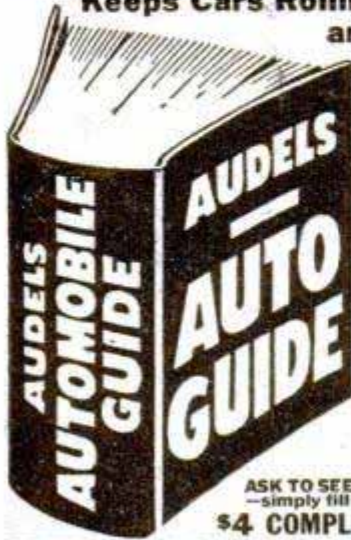

**AUDELS AUTO GUIDE**  
For Every Mechanic, Driver, Owner and Repair Shop.

Sent on 7 Days Approval Shows How to Tune Up—Keep Brakes Safe—Batteries Powerful—Tire Mileage Up—Save Gas—Lubricate Correctly.

**ANSWERS YOUR QUESTIONS** Contains all you need to know about 1—Construction, 2—Operation, 3—Service, 4—Repair of Modern Motor Cars, Trucks, Buses & Diesel Engines in every detail.

**NEW FLUID DRIVE TREATED** Easy to understand—1540 Pages, 1540 Illustrations. Gives definite directions on How to handle service jobs.

ASK TO SEE IT—Get this information for yourself—simply fill in and mail coupon today.

**\$4 COMPLETE • PAY ONLY \$1 A MO.**

**AUDEL, Publishers, 49 West 23rd St., New York**  
Mail AUDELS AUTOMOBILE GUIDE (\$4) for free examination. If O. K., I will send you \$1 in 7 days; then remit \$1 monthly until \$4 is paid. Otherwise, I will return book promptly.

Name \_\_\_\_\_  
Address \_\_\_\_\_  
Occupation \_\_\_\_\_  
Reference \_\_\_\_\_ PM

# AVIATION Career

## MAXIMUM TRAINING IN MINIMUM TIME

CAL-AERO TECH TRAINING will add dollars to your pay check all the rest of your life. Specializing in AERONAUTICAL ENGINEERING and MASTER AVIATION MECHANICS since 1929, Cal-Aero Tech training is carefully designed for just one thing—TO MAKE MORE MONEY FOR YOU. An alumni of over 6000 successful graduates proves our career training is unsurpassed.

**VETERANS**—Write us about Aviation Training, as provided under "G.I. Bill of Rights."



**CAL-AERO TECHNICAL INSTITUTE**  
MAJOR C. C. MOSLEY PRES. SINCE 1929  
FORMERLY CURTISS-WRIGHT TECHNICAL INSTITUTE  
GRAND CENTRAL AIR TERMINAL  
GLENDALE 1, CALIFORNIA  
LOS ANGELES COUNTY

### MAIL THIS COUPON TODAY!

Cal-Aero Technical Institute, Grand Central Airport, Glendale 1, California  
Please send full information on Aviation Training FREE—without obligation. Dept. 1 PM-4

Name \_\_\_\_\_ Birth Date \_\_\_\_\_  
Street \_\_\_\_\_  
City \_\_\_\_\_ State \_\_\_\_\_



## FUN!

### MAKE THIS Squirrel Lamp

Yes sir, out of a real squirrel! Also make ash-trays, book-ends, etc., using rabbits, frogs, etc. **LEARN AT HOME TO MOUNT BIRDS, ANIMALS & FISH;** tan skins and make rugs. Decorate your room. **It's FUN! BIG profits in spare time!** Free book tells how.

**FREE BOOK!** Write TODAY for beautiful free book telling how to learn this fine hobby. Book is free. Contains many fine pictures. **STATE YOUR AGE.**

N. W. SCHOOL OF TAXIDERMISTS, Dept. 3374, Omaha, Nebr.

The American Institute of Specialized Watch Repair  
276-276 East Building GRAND RAPIDS 6, MICHIGAN

A Fully Accredited School

You can learn this highly fascinating and profitable trade through this Institute, either at home by correspondence... or at the resident school. **Earn While You Learn**



Write for Free Circular

## Learn WATCH REPAIRING

## "How to Make Money With Simple Cartoons"

A book everyone who likes to draw should have. It is free; no obligations. Simply address  
**CARTOONISTS' EXCHANGE**  
Dept. 94-D Pleasant Hill, Ohio



## CORRESPONDENCE COURSES IN RADIO and ELECTRICAL ENGINEERING

Tuition \$25

**ELECTRICAL ENGINEERING.** Get good grasp of wide electrical field. Modern. Very understandable. Theory made easy.  
**RADIO ENGINEERING.** Extra fine course in radio, public address, photo-electric work. Trains you to be super-service man, real vacuum tube technician. Tuition ONLY \$25, either course. Deferred payment plan. Servicemen needed badly.  
**FREE** Write for free copies of school catalogs, student magazines, etc.  
**LINCOLN ENGINEERING SCHOOL, Box 931-P112, Lincoln, Nebr.**

SAW YOU SAW IT IN POPULAR MECHANICS

THOUSANDS OF SUFFERERS USE  
**BREATH-EASY**  
FOR  
**ASTHMA**  
CARRY IT WITH YOU  
USE IT ANYWHERE  
*Sold on Money-Back Guarantee*

Write To Dept. PM  
**BREATH-EASY DISTRIBUTORS, INC.**  
65 CEDAR STREET  
SEATTLE 1 WASHINGTON



# I will teach you... ELECTRICAL APPLIANCE REPAIRING

**LEARN IN  
YOUR OWN HOME BY  
BUILDING, TESTING, REPAIRING**

• Learn this fascinating, big money-making business. Repair all kinds of electrical appliances. Millions now in daily use will eventually require repair. Thousands of new appliances sold daily in all parts of the country! These unlimited prospects mean you will always have places to do profitable jobs. If you are mechanically inclined (can hold and use tools), you can qualify for this big steady-paying field. It is not at all unusual for appliance repairmen to charge on the basis of \$5.00 to \$6.00 an hour! **WE TEACH YOU EVERYTHING!** What trouble to look for, how to detect it, and how to quickly repair the appliance! Our course is written in simple, easy-to-understand language, is profusely illustrated with photographs and drawings and shows you each and every step! Also shows you how to build the power tools you need. **FREE** advisory service is yours for **LIFE!** Should intricate technical problems arise or the need for a special repair part, simply call on us! We teach you how to solicit business and how to keep it coming to you! Not a theory course but a practical, honest-to-goodness course written by and used by repairmen the country over. Price of course is so low the repairs on your own appliances should pay for it many times over.



**S. T. CHRISTENSEN**  
President & Founder

## New Electronic Kit Does All!

**AND BEST OF ALL I'LL SEND IT TO YOU**

• Knowing how valuable Practical Shop Training Experience is, particularly in the Electrical Field, I will send to you the **CHRISTY ELECTRONIC KIT**. It will be sent to you completely unassembled, together with detailed instructions on how to assemble this portable all-purpose, electric trouble finder! Read the partial list of its multiple uses listed below and realize how valuable and helpful such a kit will be to you! Every part is sent to you including the lightweight case, precision meter, jacks, etc., etc., even down to the very last screw! In addition to the practical electrical experience just assembling this kit will provide, we also include complete instructions as to the many, many ways this delicate instrument can be used by you. It took us years of academic training and years of hard work to obtain the knowledge this kit will give you. The combination of our Course and Electronic Kit will go a long way towards **ASSURING YOUR SUCCESS.**



### MODEL 390 TESTS

- Current Consumption
- Heat Controls
- Electrical Circuits
- Motor Windings
- Shorts
- Refrigerators, Radios
- Irons, Fans
- Washing Machines
- Motors
- House Wiring, etc.

**RUSH COUPON NOW!**

**CHRISTY SUPPLY CO.**  
2835 N. Central Ave., Dept. D-5603  
Chicago 34, Illinois

Please send me free illustrated literature about America's Fastest Growing Industry — **ELECTRICAL APPLIANCE REPAIRING.**

Name \_\_\_\_\_

Address \_\_\_\_\_

City \_\_\_\_\_ State \_\_\_\_\_





# AUTO BOOKS ON APPROVAL



**SEND NO MONEY.** Just mail the coupon for a complete set of 4 Big, Thick Auto Books. 20th Edition. Over 2700 Pages! Whether you are a mechanic or helper, expert or apprentice, auto owner or driver, take immediate advantage of this **FREE EXAMINATION OFFER.**

### MAKE GOOD MONEY NOW HOLD A PERMANENT JOB

America wants its automobiles kept in good repair. Men with "know how" are in demand, at big pay. These books will help you get and hold an important job, or give you a chance to go into business for yourself now or later. Any man who half tries to improve himself can learn auto servicing and repairing by this quick reference method. Use the **JIFFY INDEX** to find easily understood answer to any auto problem. These wonder books prepared by eleven of America's great automobile engineers. Many hundreds of valuable illustrations. Send the coupon **TODAY.**

**A year's consulting privileges with our engineers now given with these books without extra charge.**  
*Vocational Publishers Since 1898*

### CAN YOU FIX IT?

These wonder books tell step by step **HOW** to make difficult repairs and adjustments, how to keep a car at maximum efficiency, including latest improvements in car design and operation. Engine troubles and how to correct them well covered. **4 BIG, THICK VOLUMES** Over 2700 pages, 2000 illustrations, wiring diagrams, etc., including Diesel engines. Beautiful modernistic, washable cloth binding.

**AMERICAN TECHNICAL SOCIETY, Dept. A419**  
 Drexel Ave. at 58th St., Chicago 37, Ill.

I would like to examine your 4-Volume Set of Auto Books. I will pay the delivery charges only, but if I choose I may return them express collect. If after 10 days' use I prefer to keep them, I will send you \$2 and pay the balance at the rate of only \$3 a month until \$24.80 has been paid. Include consulting service as offered above.

Name \_\_\_\_\_  
 Address \_\_\_\_\_  
 City \_\_\_\_\_ State \_\_\_\_\_  
 Please attach letter stating age, occupation, employer's name and address and name and address of at least one business man as reference. Men in service, also please give home address.

# PLUMBERS & STEAM FITTERS



**AUDELS PLUMBERS & STEAM FITTERS GUIDES.** This valuable set explains in practical concise language the principles, advances and shortcuts of the trade—based on good practice. Includes careful detailed instructions on how to figure & calculate various jobs. A quick reference; saving time & money. A complete Trade course.

Over 1,670 Pages—  
 3,642 Trade Illustrations

### PRACTICAL TRADE INFORMATION ON:

Soldering, tinning, Joint wiping, bending, beating Pipe—Iron—steel, threading. Mathematics, tables, physics. Materials—Iron, steel, copper, brass, lead, tin, antimony; etc. Sheet metal—galvanized—plate. Sanitation, syphonage, tanks. Drainage, sewage, purification. Fixtures—bath—kitchen. Pipe fittings, soil pipe, tools. Laying out work. Roughing. Screwed fittings, flanges, joints. Pipe bending, examples. Elbows. Heating, ventilation, air conditioning, refrigeration. Water supply, mains, wells, tanks. Gas-fittings. Sheet metal work, problems, methods. Brazing, heating, lead burning. Welding, various welds, methods. Blacksmithing, forges, tools. Copper Tubing, Marine Pipe Fitting & Oil Burners. **HIGHLY ENDORSED—ASK TO SEE THEM. TO GET THIS ASSISTANCE FOR YOURSELF, FILL IN AND**

### MAIL ORDER

**AUDEL, Publishers, 49 W. 23rd St., New York 10, N. Y.**  
 Mail Audels Plumbers' Guides, 4 vols. on 7 days' free trial. If O. K. I will remit \$1 in 7 days and \$1 monthly until \$6 is paid. Otherwise I will return them. No obligation unless I am satisfied.

**4 \$6** Name \_\_\_\_\_  
**VOLS. 6** Address \_\_\_\_\_  
**COMPLETE** Occupation \_\_\_\_\_  
**PAY ONLY** Employed by \_\_\_\_\_  
**\$1 A MO.** \_\_\_\_\_ PM

# Have an OFFICE of YOUR OWN!

**LEARN NEW PROFITABLE PROFESSION**  
 At Home in 60 Days, Men & Women, 18 to 70!

Earnings of men and women in this profession run as high as \$5,000-\$15,000 yearly. Others make good money in spare time. Little money needed to start. A business where your earnings begin sooner. Easy to learn. No selling or goods to buy. No experience necessary. A depression-proof business. A course of action to guide you step by step as you earn. All 53 lessons sent at once to use as operating manuals. Easy terms. Diploma. Money-back agreement. Write for **FREE BULLETIN.**

Be Your Own Boss and the Boss of Others. Be Respected. Meet Interesting People.



**FRANKLIN CREDIT SCHOOL**  
 Dept. 75-D ROANOKE 7, VIRGINIA

**BY MAIL in Easy Lessons**

# LEARN TO WRITE

*a Good Hand!*

### FOR BUSINESS AND SOCIAL SUCCESS!

Easy to improve your handwriting at home quickly with my new instruction books just off the press. Master all the secrets of better penmanship. Simple and easy, fully illustrated, highly endorsed. Begin today. Write for:  New Free Book, "How to Become a Good Penman," or check books wanted, \$1.00 each.  Business Writing  Artistic Flourishing  Card Writing  Engraving Alphabets  Bird and Design Flourishing  Complete Set \$4.50  Enclose 10c for your name beautifully written and special penpoint for shaded writing. S. A. Ziller, President, **TAMBLYN SCHOOL OF PENMANSHIP** 441 Ridge Bldg. In Business Over 52 Years Kansas City, Mo., U.S.A.

# LEARN WATCH REPAIRING



**AT HOME.** By our modern and original system of instruction you can learn every part of the **WATCH REPAIRING TRADE AT HOME.** Prepare yourself for a well-paying position or start in business after completing our course of instruction. Good watch repairers are in demand and generally earn very good salaries. For particulars apply to the **Wisconsin School of Watch Repairing** 759 North Milwaukee St., Milwaukee 2, Wis.

# THERE'S MONEY IN CARTOONS!

**RAYE BURNS** will teach you **HOW TO CREATE ORIGINAL CARTOONS** at home that you may **SELL!** Course contains 26 lessons and over 600 illustrations. All for **Only... \$2.85**

Send name and address for free details.  
**RAYE BURNS SCHOOL, Dept. M, Box 3583, CLEVELAND, OHIO**

**GREATEST MOVIE EVER MADE**  
**ATOMIC FURY**  
 Bikini atom bomb tests in thrilling Kodachrome  
 8mm., 50 ft., \$6.50  
 16mm., 100 ft., \$13.00 (Silent)  
 83 Subject Catalog - 10c  
 ORDER DIRECT FROM  
 World In Color Productions, Elmira, N. Y.

**The HAMSTER MANUAL**  
  
 By Albert F. Marsh

**READ THE HAMSTER MANUAL**  
 The most complete guide book on the successful breeding and raising of Syrian Golden Hamsters. Tells all about this new, fast growing, profitable and interesting hobby industry. Reveals all the secrets of the largest breeder of these delightfully profitable pets and laboratory animals. 34 Chapters

chuck-full of information gleaned from actual experience as a breeder. Twenty Pages of illustrations. A few subjects are: history, housing, three methods of breeding, easy to get feeds, sexing, fertility vitamins, handling, educational, scientific projects, crating, profits and selling, where to buy and how to sell hamsters. Sent postpaid for \$1.00.  
**Albert F. Marsh, 1522 Basil St., Mobile, Alabama**





# Learn BUILDING

AT HOME • All Blue Print Building Plans, Specifications, Lessons Furnished

## FIND OUT ABOUT TRAINING AND OPPORTUNITIES FOR YOU IN BUILDING

Established in 1904, Chicago Technical College offers you thorough, practical training in Building, by home-study. Mail coupon for free information. See what this Course has done for others, what it can do for you. Read what Chicago Tech graduates say about their work, earnings, success. Learn the rewards awaiting you as a trained builder — and how quickly, easily you can get started. Simply MAIL COUPON TODAY in an envelope or paste on a penny postcard.



Earn more money as a building tradesman. Prepare for advancement and increased pay as a building foreman, superintendent, inspector, estimator, material buyer or salesman. Train to be a building contractor, have your own money-making business in this busy, prosperous building field.

More than 19 million new homes needed in U. S., say experts. New building now at rate of one million homes a year, plus 200,000 commercial buildings, plus expanding farm building construction.

Mail coupon today. FREE book tells how you learn Building Construction — How to Read Blue Prints, and Estimate Building Costs — at home in your spare time. Learn modern construction methods and materials, how to lay out work and direct all building operations. This is the training needed for rapid advancement to higher-paid jobs, or your own successful building business.

**CHICAGO TECHNICAL COLLEGE**  
D-152, Tech Building, 2000 South Michigan Ave.  
Chicago 16, Illinois

## MAIL COUPON NOW

**CHICAGO TECHNICAL COLLEGE**  
D-152, Tech Bldg., 2000 So. Michigan Ave.  
Chicago 16, Illinois

Mail me FREE building Lesson with information about big opportunities in BUILDING and how I can train at home.

Name \_\_\_\_\_ Age \_\_\_\_\_

Address \_\_\_\_\_

City \_\_\_\_\_ Zone \_\_\_\_\_ State \_\_\_\_\_

## SALESMEN 40 AND OVER BREAK INCOME RECORDS!

Here's an unusual Big Income Opportunity for ambitious men in a field where advancing years are an ADVANTAGE instead of a handicap. Save thousands of dollars for building owners in your area—make thousands of dollars for yourself. Time proven and public accepted line of building maintenance materials quickly and dramatically demonstrated — sold amazingly fast. Thirty of our leading salesmen averaged \$8,738.85 earnings last year—that record is being smashed now! No house-to-house canvassing. Powerful demonstration and sales equipment furnished. Personal sales coaching helps good men get started earning bigger money right away.

Write TODAY, asking for details. Tell us about yourself. Personal interview arranged.  
**HYDROTEX INDUSTRIES**  
Dept. PM-4, Wilson Bldg., Dallas 1, Texas

## HI-SPEED EQUIPMENT

High Compression Heads—Dual Manifolds  
Dual Air Cleaners For V8's

Use these simple conversions to increase horsepower, speed acceleration, and increase top speed of your car. Write today for prices and full information.

SANDEE MUFFLER CO. 7523 S. Western Ave. Los Angeles, Calif.

V-8  
DUALS  
& SINGLES



DEALERS WANTED

**MUFFLERS**  
**STEELS and ALUMINUMS**  
with a motorboat tone  
SINGLES, Chev., V-8, Plymouth, Steels \$5.50, Aluminum \$7.00. Chry., Olds., Buicks, etc., Steels \$7.50, Aluminum \$9.00. V-8 and MERCURY DUALS, Steel \$17.50, Aluminum \$21.00. Split Manifold Sets, Steels \$35.00, Aluminum \$45.00. Aluminums are guaranteed for life of your car.

**SANDEE MUFFLER CO.**  
BOX 296 LA TIJ., LOS ANGELES 43, CALIF.  
2624 W. SLAUSON AVE., LOS ANGELES, CALIF.

# New BRUSH Electroplater

ESPECIALLY BUILT FOR MECHANICS, MODEL MAKERS HOME CRAFTSMEN



## Easy to Plate GOLD, SILVER, NICKEL, COPPER, etc... For Pleasure and Profit!

If you have a workshop—at home or in business—you need this new Warner Electroplater. At the stroke of an electrified brush, you can electroplate models and projects—you can replate worn articles, faucets, tools, fixtures, silverware, etc. with a durable, sparkling coat of metal... Gold, Silver, Nickel, Copper, Cadmium, and after a bit of practice, even Chromium! Everything furnished—equipment complete, ready for use. By doing a bit of work for others, your machine can soon pay for itself. So make your shop complete by getting a Warner Electroplater right away. Send today for FREE PLATING SAMPLE and illustrated literature. ACT AT ONCE.

**WARNER ELECTRIC CO., Inc.**, Dept. S-12  
1512 Jarvis Ave., Chicago 26, Illinois

## FREE Details & Sample!

WARNER ELECTRIC CO., Inc., 1512 Jarvis Ave., Chicago 26, Ill., Dept. S-12  
Gentlemen: Send Free Sample and Details to:

Name \_\_\_\_\_

Address \_\_\_\_\_

City \_\_\_\_\_ State \_\_\_\_\_



# MASONS



**& BUILDERS GUIDES**

Inside Trade Information for Bricklayers, Cement Workers, Plasterers, Tile & Stone Setters.

Covering:—**BRICK LAYING** tools, materials, bonding mortars,

designs, setting Frames, Foundations, Arches, Chimneys and Repairing old brick work. **GLASS BRICK and TILE SETTING**, hollow tile, walls, roofing. Placing re-inforced work, stucco, waterproofing, Plastering in all its branches, wall board. Stone Masonry, Mosaic and Steel Construction. **INCLUDING CONCRETE MIXING—CONCRETE BLOCK CONSTRUCTION**

**1100 Pages, 2067 illustrations, Handy Size. HIGHLY ENDORSED. ASK TO SEE THEM! TO GET THIS ASSISTANCE FOR YOURSELF FILL IN AND**

**MAIL ORDER**

**AUDEL, Publishers, 49 W. 23rd St., New York 10, N. Y.** Mail Audels Masons and Builders Guides, 4 vols. on 7 days' free trial. If O.K. I will remit \$1 in 7 days and \$1 monthly until \$6 is paid. Otherwise I will return them. No obligation unless I am satisfied.

Name \_\_\_\_\_  
 Address \_\_\_\_\_  
 Occupation \_\_\_\_\_  
 Employed by \_\_\_\_\_ PM

## Learn this Profitable Profession



**IN 90 DAYS AT HOME**

## Money-Making Career Open to Men and Women, 18 to 50

Hundreds of men and women between 18 and 50 make \$10 to \$20 in a single day giving scientific Swedish Massage and Hydro-Therapy treatments. There is big demand from doctors, hospitals, sanatoriums and clubs. Graduates earn large full time incomes from these or in private practice in their own offices. Others make good money from home treatments given in spare time. Learn this interesting, money-making profession in your own home, through our home study course. Same instructors as in our nationally known resident school. You can win independence and prepare for future security by qualifying for your Diploma. Course can be completed in 3 to 4 months. Many earn while they learn. Begin your training at once.



### Anatomy Charts & Booklet FREE

Enroll now and we will include, at no extra cost, many needed supplies. Fit yourself to help meet growing demand for Scientific Swedish Massage. Send the coupon at once for complete details. Anatomy Charts and 32-Page Illustrated Booklet, FREE, postpaid.

**THE COLLEGE OF SWEDISH MESSAGE**  
 Dept. 864D, 100 East Ohio St., Chicago 11, Illinois  
 Please send me FREE and postpaid, Anatomy Charts, 32-page Booklet and complete details on Home Training.

Name \_\_\_\_\_  
 Address \_\_\_\_\_  
 City \_\_\_\_\_ State \_\_\_\_\_

## BE A GOVERNMENT LICENSED AIRPLANE AND ENGINE MECHANIC

Train Now at **LINCOLN**



**EARN BIG PAY IN AVIATION**

Our new enlarged school now offers these courses: **MASTER AVIATION MECHANICS**, CAA Approved 1 Yr. Airplane & Engine Mechanics Course. **REFRESHER AIRPLANE & ENGINE MECHANICS**. Designed for veterans with aviation mechanics experience. Either course is available to veterans under the G. I. Bill of Rights. Write today for complete information.

**LINCOLN AVIATION INSTITUTE**

UNION AIR TERMINAL DEPT. P-4 LINCOLN, NEBRASKA

## LAW FREE BOOK



Write today for FREE 48-page book, "THE LAW-TRAINED MAN," which shows how to learn law easily in spare time at home through the Blackstone course prepared by 60 well-known law authorities. We furnish all material including 18-volume Modern American Law library. Many successful attorneys among our graduates. LL.B. degree. Moderate cost; easy terms; Money-Back Agreement.

**BLACKSTONE COLLEGE OF LAW**  
 225 N. Michigan Ave., Dept. 54, Chicago 1, Ill.

A Correspondence Institution Founded in 1890

## DO YOU LOVE HORSES?

ARE YOU INTERESTED IN HORSE TRAINING AND MANAGEMENT?

SUBSCRIBE FOR The "EXPERT HORSEMAN"

**2 YEARS \$7.00**



FREE BOOK—You will also receive a booklet that tells how you can learn to break colts, gait show horses, train rodeo, stock, and race horses, break bad habits, handle any horse and train circus trick horses.

SEND \$1.00 TODAY

**ANIMAL LOVERS ASSOCIATION**  
 Box No. KA111, TARZANA, CALIFORNIA

## ARTISTS MAKE MONEY

Do you like to draw? Send name, address, age and occupation for FREE ART TEST, to find out your ability.

**ART INSTRUCTION, Inc.**

4138 ART INSTRUCTION BLDG., MINNEAPOLIS 15, MINN.

## STAMMER?

This new 128-page book, "Stammering, Its Cause and Correction," describes the Bogue Unit Method for scientific correction of stammering and stuttering—successful for 47 years. Benj. N. Bogue, Dept. 4824, Circle Tower, Indianapolis 4, Ind.



## APTITUDE TESTS

discover the kind of work or studies best for your success! You get a personal report—a guide for life—more happiness—more prosperity. For men, women, boys and girls. Write for complete facts.

**VOCATIONAL COUNSELING INSTITUTE**  
 956 Maccabees Bldg., Detroit 2, Michigan

## RUPTURED?

Get Relief This Proven Way

Why try to worry along with trusses that gouge your flesh—press heavily on hips and spine—enlarge opening—fail to hold rupture? You need the Cluthe. No leg-straps or cutting belts. Automatic adjustable pad holds at real opening—follows every body movement with instant increased support in case of strain. Cannot slip whether at work or play. Light. Waterproof. Can be worn in bath. Send for amazing FREE book, "Advice To Ruptured," and details of liberal truthful 60-day trial offer. Also endorsements from grateful users in your neighborhood. Write: **CLUTHE SONS, Dept. 31, Bloomfield, New Jersey**



# AMERICA'S GREATEST ELECTRICAL SCHOOL OFFERS YOU

**MORE EQUIPMENT!**

**MORE SPACE!**

**MORE TRAINING!**



OVER

**1000**

PIECES of ACTUAL ELECTRICAL EQUIPMENT to WORK ON!

## Learn **ELECTRICITY**

It's Easy - "LEARN-BY-SEEING" MOVIES  
It's Fast - "LEARN-BY-DOING" METHODS

and its THOROUGH! . . . There is no other place—no other way to get the same all-around training you get at M.T.I. NOT A HOME STUDY COURSE! . . . You get actual "hands-on-equipment" training in great MODERN SHOPS in Detroit. No previous experience necessary. Learn HOUSE WIRING, A.C., D.C. MOTORS, ARMATURE WINDING, POWER PLANT WORK, etc. New classes start every few weeks. Part time work available. Living arrangements made.

**NO COST TO VETERANS** Train at Gov't expense. Receive \$65 to \$90 month while learning. Coupon brings details.

**MICHIGAN TECHNICAL INSTITUTE**  
Department PM-4, 2281 West Fort Street, Detroit 16, Michigan

In  
**NATION'S  
LARGEST  
EXCLUSIVE  
ELECTRICAL  
SCHOOL**



**MAIL TODAY  
FOR QUICK  
ACTION!**

MICHIGAN TECHNICAL INSTITUTE, Dept. PM-4  
2281 W. Fort St., Detroit 16, Michigan

- MAKE MORE \$\$\$**
- Send me catalog and complete information.  
 I am a GI. Send special information.  
 Married.  Single

NAME \_\_\_\_\_

ADDRESS \_\_\_\_\_

CITY \_\_\_\_\_

ZONE \_\_\_\_\_ STATE \_\_\_\_\_

## BE A REAL ESTATE BROKER

**PAYS BIG!** EASY TO LEARN—Start and run your own business quickly. Many graduates report making up to \$1000 a month. Course of study covers Sales, Property Management, Appraising, Loans, Mortgages and hundreds of related subjects. Course offered in home study or residential classrooms.

**FREE** Big new illustrated catalog from this nationally known school. Send Post Card Today. G. I. Approved.

**WEAVER SCHOOL OF REAL ESTATE**  
Dept. PM-1, 15 E. Pershing Road Kansas City, Mo.



## LEARN } ACCOUNTING SALESMANSHIP SECRETARIAL WORK

### Assure Your Future Now!

Hill's, one of America's outstanding Business Schools, offers you the opportunity to enter one of the three fields acknowledged to hold substantial earnings and a secure future. Our FREE book, "Through Hill's to Success," tells how and where the best positions are found and how you can qualify for them by study at home or in our resident school. We have thousands of successful graduates and maintain nationwide employment service. G. I. Approved.

**FREE  
WRITE  
TODAY**

### USE THIS HANDY COUPON

**HILL'S EXTENSION SCHOOL** Dept. PM-4  
AND BUSINESS UNIVERSITY,  
619 W. Main St., Oklahoma City 2, Okla.  
Please send me your Free book, "Through Hill's to Success."

NAME \_\_\_\_\_

ADDRESS \_\_\_\_\_

CITY \_\_\_\_\_ STATE \_\_\_\_\_

## Do you want

→ .. to go to College?

→ .. or to enter a Profession?

(Such as Accounting, Architecture, Nursing, Dentistry; Teaching, Social Work, Osteopathy, Beauty Culture, Optometry, Embalming, Chiropody, Law, Medicine, etc.)

→ .. or get an Office Position?

To get anywhere, you practically **MUST** finish High School **FIRST**. You can complete our simplified High School Course in SPARE time at home, as FAST as your time and abilities permit. Equivalent to resident school work—prepares you for college, pre-professional examinations, business, industry. Standard texts furnished. Diploma. Credit for H. S. subjects already completed. Single subjects if desired. Low tuition, easy terms. American School, Chicago, est. 1897—endorsed by educators. Finish your high school education NOW. Write TODAY!

## High School Course at Home

Many Finish in 2 Years

American School, Dept. H445, Drexel Ave. at 58th St., Chicago 37, Ill.  
Gentlemen: Send me FREE information covering special training in subjects checked below. No obligation on my part.

- |                                                      |                                                              |
|------------------------------------------------------|--------------------------------------------------------------|
| <input type="checkbox"/> High School Course          | <input type="checkbox"/> Diesel Engineering                  |
| <input type="checkbox"/> Architecture and Building   | <input type="checkbox"/> Drafting and Design for Men & Women |
| <input type="checkbox"/> Automotive Engineering      | <input type="checkbox"/> Plastics                            |
| <input type="checkbox"/> Business Management         | <input type="checkbox"/> Private Secretary                   |
| <input type="checkbox"/> Electrical Engineering      | <input type="checkbox"/> Mechanical Engineering              |
| <input type="checkbox"/> Elec. and Gas Refrigeration | <input type="checkbox"/> Aviation                            |
| <input type="checkbox"/> Air Conditioning            | <input type="checkbox"/> Salesmanship                        |
| <input type="checkbox"/> Railway Training            | <input type="checkbox"/> Radio                               |
| <input type="checkbox"/> Electronics, Industrial     |                                                              |

Name.....

Address.....



# FREE

get it now

## ALLIED'S NEW 1948 RADIO CATALOG!

172 Value-Packed Pages



EVERYTHING IN RADIO AT LOWEST PRICES



TELEVISION AND NEW HOME RADIOS



SERVICE SUPPLIES BUILDERS' SUPPLIES



AMATEUR GEAR



SOUND SYSTEMS

### Radio's Great Buying Guide

Send today for your FREE copy of Radio's Leading Catalog! It's the preferred Buying Guide for Servicemen, Dealers, Engineers, Soundmen, Amateurs, Builders and Experimenters. Shows everything you want in Radio and Electronic equipment—all the newest releases—complete, highest quality stocks at low, low prices that save you money on every purchase!

### World's Largest Stocks!

You'll find everything in the new 172-page ALLIED Catalog—television receivers, latest home radios and radio-phonos, Ham receivers and station equipment, test instruments, public address equipment, new builders' kits, thousands of parts, tubes, tools, radio books, diagrams. Get the speedy, reliable service and expert help you want from ALLIED—Radio's Largest Supply House! Be sure to send today for your FREE copy of ALLIED'S new 1948 Buying Guide!

## ALLIED RADIO

ALLIED RADIO CORP.  
833 W. Jackson Blvd., Dept. 5-D-8  
Chicago 7, Illinois

Rush FREE 1948 ALLIED Catalog

Name.....

Address.....

City..... Zone..... State.....



## PROTECT YOUR HOME

with these **MODERN** Low Cost **FIRE EXTINGUISHERS**



A little foresight now may save LIVES and property later! Equip your home, your garage, your boat with AUTOFYRSTOP, the modern fire extinguisher and alarm that is setting new efficiency records. Write for free literature:

**KILLS FIRE BY ITSELF**

**AUTOFYRSTOP CO.** Dept. PM-448  
2035 Washington Av., Philadelphia 46, Pa.

**MONEY MAKING OPPORTUNITY** We have openings for high grade salesmen in choice territories. Write for Plan.

## TRIM YOUR OWN

**TRIM HAIR AT HOME—SAVE BARBER BILLS**  
Trims hair as it combs! Easy! Quick! Keeps men's, women's, children's hair trim, neat, freshly-cut looking all the time! Trims, tapers, thins out uneven hair. Use like ordinary comb. Safe. Simple. No experience required. Fine for legs, underarms! *Sells Like Wild!*



**SAMPLES for AGENTS**  
Sample offer sent immediately to all who send name at once. Penny postal will do. **SEND NO MONEY.** Just your name. **KRISTEE CO.**  
683 BAR ST., AKRON, OHIO



## TRI-STATE COLLEGE

B. S. Degree in 27 months in Civil, Electrical, Mechanical, Chemical, Aeronautical, Radio Engineering; Bus. Admin., Acc't and Sec. Science. Graduates successful. 64th year. Enter June, Sept., Jan., March. Catalog. 448 College Ave., Angola, Ind.

## Become a Doctor of PSYCHOLOGY

Win the degree of Ph.D. Teach the secret of contentment, happiness. Solve mental worries. Experience the revelation of truth. Chartered college. Individual help. Write for FREE book. **COLLEGE OF UNIVERSAL TRUTH.** 5153-B North Clark St., Chicago.

## OLD GOLD JEWELRY WANTED

Dental gold teeth, plates and bridges with metal attached. Any broken pieces of gold jewelry. Immediate payment and free mailing container to you or your friends upon request. **LOWES, DEPT PM** Holland Bldg., St. Louis 1, Mo.

## CARTOONING

**HAVE FUN! MAKE MONEY!** Cash in on your sense of humor **AT HOME—BY MAIL.** No experience needed to start. Write today for **FREE TRIAL LESSON** and full particulars. **MOON Gag Cartoon School, Dept. M, Fall Creek, Wis.**

**RAISE RABBITS, HAMSTERS**  
**FOR FUR and BREEDING PURPOSES**  
Big Demand - Steady Income - From a Growing and **PROFITABLE INDUSTRY**

**START A PAYING BUSINESS TODAY**  
Small space required, a ready market, descriptive folder and magazine 10¢. Book - **RAISING SMALL STOCK** and Magazine 25¢. All the above and magazine (Monthly) for one year \$1.00  
**Small Stock Farmer, Pearl River, 4 N. Y. HAMSTERS**

## Say You Saw It in POPULAR MECHANICS

**MONEY MEN ALL FREE**  
**DATA**

THE PLASTEX Industry needs manufacturers on small scale and for big production of Lamp and Clock Stands, Art Goods and Novelities in Plastex and Marble Imitation. Experience unnecessary. 1/2c material makes regular 10c store sellers. Rubber moulds furnished for speed production. Small investment brings good returns. Big chain store orders now being placed. Ambitious men have chance for real prosperity. Our Free booklet will interest and benefit you.  
**PLASTEX INDUSTRIES, Dept. A**  
3400 Third Ave. New York 56, N. Y.



ENJOY the **HAPPINESS**  
of owning  
**YOUR OWN BUSINESS**



**H. T. ARMSTRONG**  
General Manager

Learn

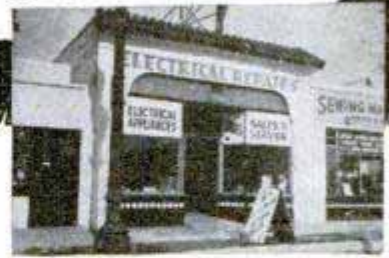

# ELECTRIC APPLIANCE

I'll Train You  
**AT HOME**  
in your spare time



## YOU LEARN

how to repair electrical appliances such as washing machines, vacuum cleaners, ranges, lamps, irons, motors, etc.—HOUSE WIRING and also

## REFRIGERATION

which we now include at no extra cost. Our lessons are understandable and easy to grasp.

Send for  
**FREE BOOKLET**  
and complete details

NO  
SALESMEN  
WILL CALL

## NEW BOOK

**"HOW TO START YOUR OWN BUSINESS"**

Sent if you act promptly

This valuable book covers locating your shop, contains drawings of how to build and wire work-benches, where and how to advertise, what to charge, how to hire solicitors, etc. Sent without charge to students who enroll promptly.

## REPAIRING & SERVICING

This is an **ELECTRICAL WORLD!** Every home is a customer for the man who knows how to service electric appliances. It's a wide-open, expanding field for men of all ages who are handy with tools . . . who seek the independence, happiness and rewards that come to the man who owns his own business. Our practical, thorough course teaches you this interesting well-paid business **AT HOME**—during your spare time. A grade school education is all you need. Without obligation, I'd like to send you our new booklet telling about our method of instruction—about today's money-making possibilities in this field—and why I believe this business offers you the depression-proof security, happiness and opportunity you seek.

## EARN WHILE LEARNING

Pay For Your Course With Part Time Work

You can actually start making money before your course is finished. With your first set of lessons, I show you easy jobs that can be done in your spare time, at home. Remember—**ONE GOOD REPAIR JOB** will pay for your entire training. You can also start this business **AT HOME**, in your garage or basement, with the tools I send you, also in your **SPARE TIME**, if you like. Or, you can take a well-paid job . . . as there's always a big demand for trained men.

I Send  
You a  
**BIG KIT**  
of Refrigerator  
and Appliance  
**TOOLS**  
AT NO EXTRA  
COST

## A Business That Gets Better Every Year!

Every year, more and more new electrical appliances are being developed. Hundreds of thousands of new homes being built . . . and others wired for electricity for the first time—through gigantic government electrification projects. Thus, this business gets better every year. And, when you own your own business, **YOU** get the profits when times are booming. If depression comes, you can't lose your job. It usually **IMPROVES** the service and repair business. Let's talk it over by mail!

## MAIL COUPON TODAY!

H. T. ARMSTRONG, General Manager,  
**PACIFIC TRAINING SCHOOL, Dept. P-84**  
7217 So. Broadway, Los Angeles 3, Calif.

Dear Sirs: Please send me, without obligation, your **FREE BOOKLET**, "Today's Big Opportunity, Appliance Servicing" and full details.

Name \_\_\_\_\_

Address \_\_\_\_\_

City \_\_\_\_\_ State \_\_\_\_\_



# HOW TO Fight! Wrestle! Jiu-Jitsu!

**FREE**



## Plus Weight Lifting! Strong Man Stunts!

Be prepared to protect your family, friends, yourself in any emergency! Be admired! George F. Jowett, Champion of Champions, gives you free his "SMASHING CHAMPION SECRETS." Contains many "HOW-TO-DO-IT" pictures that quickly and simply show you how to powerfully deliver a knockout, how to break any hold, how to overpower any opponent plus weight lifting and strong man stunts! Inside professional "Tricks of the Trade" proved successful by police, armed forces, fighters, wrestlers, etc. Free for a limited time with this sensational offer!

You Need He-Man Fitness to Handle Any Tough Situation!



**NOW!** All 5 Famous Jowett Courses  
IN 1 COMPLETE MUSCLE BUILDING VOLUME!

FOR ONLY **25c**

Let Me Prove I Can Make You—

# COMMANDO-TOUGH OR IT WON'T COST YOU A CENT!

says *George F. Jowett* WORLD'S GREATEST BODY BUILDER

## Give Me 10 Minutes a Day Learn My Time Tested Secrets of Strength

I'll teach you the "Progressive Power Method" that rebuilt me from a physical wreck condemned to die at 15, to the holder of more strength records than any other living athlete or teacher! Has proven it builds the strongest, handsomest men in the world. Let me prove on a money back basis—that no matter how flabby or puny you are I can add inches to your arms, broaden your shoulders, give you a man-sized chest, powerful legs and a rock-like back—in fact power pack your whole body so quickly it will amaze you—right in your own home! I'll bring to life new power in you inside and out, until YOU are satisfied you are the man you want to be.

### PROVE IT TO YOURSELF IN ONE NIGHT

Send only 25c for my 5 easy-to-follow, picture-packed courses now in 1 complete volume, "How to Become a Muscular He-Man." Try it for one night! Experience the thrilling strength that surges through your muscles.

### 10 DAY TRIAL!

Think of it—all five of these famous courses now in one picture-packed volume for only 25c. If you're not delighted with this famous muscle-building guide—if you don't actually FEEL results within ONE WEEK, send it back and your money will be promptly refunded! Photo Book of Famous Strong Men!

**FREE!**

Photos that inspire you to might and muscle. Free with order.

I am making a drive for thousands of new friends fast—REGARDLESS OF COST!  
**SO GET NOW MY 5 Muscle Building Courses**  
(Valued at \$5 each)

All in 1 Great Complete Volume  
Packed With How-To-Do-It Pictures!

Now this "get-acquainted," extremely low price of only 25c is your chance to build a body you'll be proud of! Follow Jowett's easy method of muscle building NOW!

For Only **25c**

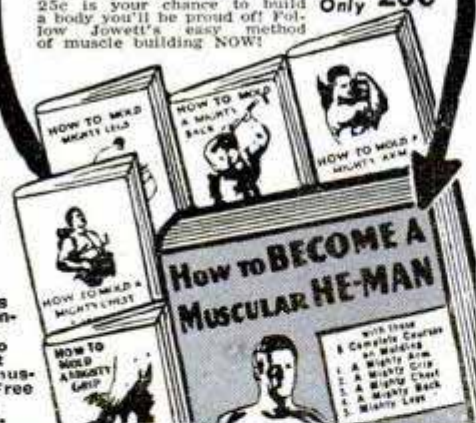

## How to BECOME A MUSCULAR HE-MAN

### 2 FREE GIFTS!

Jowett Institute of Physical Culture Dept. PM-84  
230 Fifth Avenue, New York 1, N. Y.

George F. Jowett: Please send by return mail, post-free **FREE** "Smashing Champion Secrets" and **FREE** Jowett's Photo Book of Strong Men, along with all 5 Muscle Building Courses. 1. Molding a Mighty Chest. 2. Molding a Mighty Arm. 3. Molding a Mighty Grip. 4. Molding a Mighty Back. 5. Molding Mighty Legs—Now all in One Volume "How to Become a Muscular He-Man." Enclosed find 25c. NO C.O.D.'s.

George F. Jowett  
Champion of Champions

NAME \_\_\_\_\_ AGE \_\_\_\_\_  
(Please Print Plainly, Include Zone Number)

ADDRESS \_\_\_\_\_

**GLOWS in the DARK** **FREE Sample!**

Be the first to sell luminous house numbers, light switch plates, wall protectors, pull cords. Also luminous pictures, statues, decals, and a host of religious, nursery and other objects that glow in the dark. Get into this new and growing industry. Enormous demand... no competition... sensational demonstration... big profits. Represent a large manufacturer, established over 34 years. Write today for liberal money-making offer and free sample to show how they glow in the dark.

**MADISON MILLS, 303 Fourth Ave. Dept. D-4, NEW YORK 10, N. Y.**

## EXPERT PHOTOGRAPHY MADE EASY

LEARN PHOTOGRAPHY NOW

—for both sound, secure future and immediate opportunities. Ever-increasing demand for trained men and women. Excellent earnings. Resident or home study. Write for full details.

NEW YORK INSTITUTE OF PHOTOGRAPHY

Dept. 49, 10 West 33rd Street New York 1, New York

## IMPROVE YOUR PENMANSHIP

Write Like This

Complete OUTLINE FREE!

YOUR penmanship can be improved in 3 hours or corrected to your satisfaction in 10 hours' practice with my DEFINITE HAND CONTROLS. New way!

WRITE OZMENT 34-S ST. LOUIS, MISSOURI

## DON'T DELAY DRAFTING

Start QUICK in

Guaranteed Home Training Until You Get a GOOD PAY JOB

Ample Supplies & Tools Furnished

More Pay, Better Job, Pleasant Working Conditions. Start now to invest in a successful, profitable future. Thousands of new positions. **ACTIVE JOB PLACEMENT.** Write today for facts and **FREE** information

WEST COAST ENGINEERING  
Box 2303, Terminal Annex  
Los Angeles 54, California DEPT. 221

FREE BOOK



## RAISE HAMSTERS

The new wonder animals from Syria. Often called Toy Bears. Delightful pets. Everyone wants them. Laboratories need thousands. Clean, odorless. Raise anywhere. A profitable and interesting hobby or business. We furnish breeding stock with manual of instructions.

Write today for free illustrated literature.

GULF HAMSTERY, 1536 BASIL, MOBILE, ALA.

## LEARN WATCH and CLOCK REPAIRING

Start training now for a better paying job or your own profitable business. Qualified Watch Makers are in demand... Unlimited opportunities. Intensive practical training by experienced watch makers. Approved for Veterans. Write for full details. Indicate if Veteran.

**SCIENTIFIC SCHOOL OF WATCH MAKING, Dept. PM-4**  
3923 San Fernando Road Glendale 4, Calif.

## Say you saw it in POPULAR MECHANICS

## LAW

STUDY AT HOME for PERSONAL SUCCESS and LARGER EARNINGS. 39 years expert instruction—over 108,000 students enrolled. LL.B. Degree awarded. All texts furnished. Easy payments. Send for **FREE** BOOK.

**AMERICAN EXTENSION SCHOOL OF LAW**  
Dept. 83-M, 646 N. Michigan Ave., Chicago 11, Ill.

## FIBRE ARMS AND LEGS!

Light, correctly fitted, strong and comfortable. Natural appearance. Braces for all deformities. Scientific design. Fair Terms.

**BUCHSTEIN-MEDCALF**  
223 S. 6th St., Minneapolis, Minn.







INDUSTRY-RECOGNIZED

# HOME TRAINING IN PLASTICS

## PLASTICS INSTITUTE CURRICULUM Embraces Comprehensive Coverage of Following Subjects

Introduction to Plastics  
Origin and Role of the Plastics Industry  
Formation of Phenolic Plastics, Part I  
Formation of Phenolic Plastics, Part II  
Laminated Phenolic Resin  
Urea and Melamine Resins  
Cellulose Acetate  
Acrylic and Polyacrylate Resins  
Polyvinyl Resin  
Characteristics of Plastics  
Miscellaneous

Optical Properties of Plastics  
Molding of Plastics—Preparatory Measures  
Compression and Transfer Molding  
Compression Molding and

air pressure  
Molds  
Injection  
Plastics Parts—Part I  
Plastics Parts—Part II  
Laminates  
Materials  
Veneering  
Plastics—Part I  
Plastics—Part II  
Materials  
Farm Products and  
By-Products  
Uses of Plastics.



### YOU CAN LEARN PLASTICS AT HOME

Plastics Institute's famous home-study course, like the Resident Courses at Plastics Institute in Los Angeles, was developed under guidance of industry leaders. Many leading companies in the Plastics industry have endorsed this training. No wasted time or padded lessons. You learn quickly, easily, the many interesting phases of Plastics—molding, laminating, fabricating, the correct methods of using and applying plastic materials, etc. Find out about the tremendous growth of this great industry and the future in it for trained men.

**YOU MAKE THINGS—**  
Home Study students get practical kit materials. You make handsome, useful articles. You form, dye, decorate, cast and laminate various types of plastics. You get experience designing and developing your own ideas.

**START YOUR TRAINING NOW.** Prepare for a career in Plastics. Either study at home or come to Plastics Institute's resident school in Los Angeles. Check coupon.

APPROVED FOR VETERANS

## PLASTICS INDUSTRIES TECHNICAL INSTITUTE

Member of Society of the Plastics Industry, National Council of Technical Schools and National Home Study Council, Washington, D.C.

NEW YORK—122 East 42nd St. • CHICAGO—3810 N. Broadway  
LOS ANGELES—1601 South Western Ave.

### MAIL COUPON FOR FREE LITERATURE

Plastics Industries Technical Institute  
1601 S. Western Ave., Los Angeles 6, Calif. PM-48  
Gentlemen: Please send me literature and information on your  
Home Training Course  Resident School Course

Name \_\_\_\_\_ Age \_\_\_\_\_  
Street \_\_\_\_\_ Zone \_\_\_\_\_  
City \_\_\_\_\_ State \_\_\_\_\_  
Veteran \_\_\_\_\_ Non-Veteran \_\_\_\_\_  
Previous Education \_\_\_\_\_





## Make this YOUR DESIGN for SECURITY and SUCCESS

The aeronautical engineer designs aircraft for specific performance. YOU can design *your career, your future*, for security and success. Choose the field that is young, with years of growth and tremendous size ahead. *That's Aviation.* Choose a profession vital to that field—*Aeronautical Engineering or Aviation Maintenance.*

In either of these two *key divisions* of Aviation your future is *designed* for interesting duties, good earnings from the start, rapid advancement, earlier independence and security, gratifying personal achievement.

### Train at Northrop

This design for your career in Aviation is a *practical design...* for you are trained by a division of the company that developed the Flying Wings and other famous aircraft... an organization that is itself a major employer of engineers and mechanics, and knows *how* and *what* you must learn.



In only 2 years (less time, with advanced standing) you can complete the *Northrop Aeronautical Engineering course...* a technical institute curriculum accredited by the Engineers' Council for Professional Development. The *Aircraft & Engine Mechanics course* (approved by Civil Aeronautics Administration) requires only 1 year. Get complete information on the broad opportunities open to you with Northrop training—send coupon now.

APPROVED FOR VETERANS

## NORTHROP

*Aeronautical Institute*

Division of Northrop Aircraft, Inc.

1527 East Broadway

Hawthorne, Los Angeles County  
California

Please send me the Institute catalog and complete information, including starting dates of classes. I am interested in  Aeronautical Engineering

Aircraft and Aircraft Engine Mechanics (A&E)

Name

Address

Age

City

Zone

State

Check one:  Veteran

In Service

Civilian

# STUDY AT HOME

With An Educational Institution

Men with specialized training win higher positions, insure larger earnings, and are bigger successes in business and public life. Opportunities NOW greater than ever before. Send for our Catalog.

## ARTS and SCIENCES

Courses in Philosophy; Education; Letters; Public Health; Medical Jurisprudence; Psychology; Sociology; Physics; Chemistry; Plastics; Geology; Political Science; Theology; Business and Commerce; Accounting; Mathematics; Statistics; Agriculture.

## ENGINEERING

Courses in Electrical, Civil, Mechanical, Drafting, Architectural, Steam, Aeronautical, Radio, Structural, Mining, Industrial, Petroleum, Marine, Chemical, Diesel, Automobile, Refrigeration, and Air Conditioning Engineering.

## LAW

Complete Professional Law Course includes 18 Hornbook Series college grade textbooks. Courses also in Commercial Law, Patent Law and Medical Jurisprudence.

McKinley-Roosevelt Incorporated, 4610-K, Sheridan Rd., Chicago 40, Ill.



**Learn to Write**  
Good Penmanship makes favorable impressions and helps you win success. Poor penmanship contributes to failure. It makes no difference how poor you now write, you can quickly and easily learn *Business Writing*, and you can learn *Shaded Writing* also right in your own home during spare time by my *Simplified Method*, without cost of going away to school. Easy Lessons, Diploma.  
**BEGIN NOW!** Write for my FREE BOOK, "How to Become an Expert Penman," which contains valuable information and many specimens of penmanship that show what others have learned by taking my Courses. If you enclose 10c, I will send you one of my Favorite Penpoints suitable for plain or shaded writing, and your name with a beautiful flourished bird written on a card. Write TODAY.  
**T. M. TEVIS, BOX 25K, CHILLICOTHE, MO.**

## REFRIGERATION and AIR CONDITIONING

REFRIGERATION TRAINING Since 1927



MECHANICAL units everywhere need servicing. Soon new units will require installation service. You can be ready with reliable pay-knowledge of this big income field. Unique home study-plus actual practice plan prepares you to enter servicing or installing field or get into business of your own. Great opportunities now and later. Get facts FREE. Write today!

**UTILITIES ENGINEERING INSTITUTE**  
Dept. 148, 2525 Sheffield Ave., Chicago 14, Ill.

## PROTECT ALL HOME DELIVERIES!

Install a theft proof milk and package receiver in your present or future home. Any handy man can do it. Protects deliveries from weather, animals and theft when you are not home. High quality—practical—very inexpensive. Offers complete protection. Write today for FREE illustrated literature.

**CLAUSEN SALES CO., Northport, Michigan**



## MAKE JEWELRY AND NOVELTIES AT HOME!

Work right on your kitchen table! No tools or experience necessary. Learn—earn within a week. Complete home instruction course, beautifully photographed, shows how to make 115 different designs of earrings, pins, sprays, brooches, hair ornaments, bracelets, candy dishes, ash trays, wall plaques, etc. Illustrates also 55 kinds of Sea Shells and Fish Scales often used. Explains fully home methods of dyeing, pearlizing, gilding and glow-in-the-dark processes. Lists hundreds of raw materials with wholesale prices. Complete course only \$1. Beginner's Kit, \$3 (\$3.50 in Canada), postpaid.

**HOUSE OF GIFTS, Box 4550-PM2, Coral Gables, Fla.**



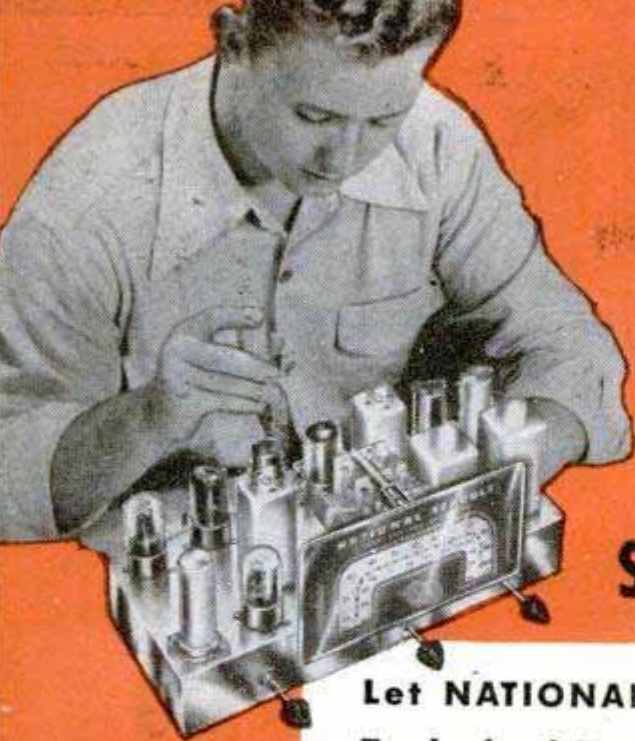

# Learn RADIO TELEVISION, ELECTRONICS *by* SHOP METHOD HOME TRAINING

Let NATIONAL SCHOOLS, of Los Angeles, a practical Technical Resident Trade School for over 40 years, train you for today's unlimited opportunities in Radio

You receive all parts, including tubes, for building this fine, modern Superheterodyne Receiver. This and other valuable standard equipment becomes your property.

these two **FREE** books will tell you how



## Good Jobs Await the Trained Radio Technician

You are needed in the great, modern Radio, Television and Electronics industry! Trained Radio technicians are in constant and growing demand at excellent pay—in Broadcasting, Communications, Television, Radar, Research Laboratories, Home Radio Service, etc. National Schools Master Shop Method Home Study Course, with newly added lessons and equipment, can train you in your spare time, right in your own home, for these exciting opportunities. Our method has been proved by the remarkable success of National Schools-trained men all over the world.

## You Learn by Building Equipment with Standard Radio Parts We Send You

Your National Schools Course includes not only basic theory, but practical training as well—you learn by doing. We send you complete standard equipment of professional quality for building various experimental and test units. You advance step by step until you are able to build the modern superheterodyne receiver shown above, which is yours to keep and enjoy. You perform more than 100 experiments—build many types of circuits, signal generator, low power radio transmitter, audio oscillator, and other units. The Free Books shown above tell you more about it—send for them today!



## NOW! NEW PROFESSIONAL MULTITESTER INCLUDED



This versatile testing instrument is portable and complete with test leads, batteries and tubes. Simple to operate, accurate and dependable. You will be able to quickly locate trouble and adjust the most delicate circuits. You can use the Multitester at home or on service calls. It is designed to measure AC and DC volts, current, resistance and decibels. You will be proud to own and use this valuable professional instrument.

GET THE DETAILS—SEND THE COUPON

## LESSONS AND INSTRUCTION MATERIAL ARE UP-TO-DATE, PRACTICAL, INTERESTING

National Schools Master Shop Method Home Training gives you basic and advanced instruction in all phases of Radio, Television and Electronics. Each lesson is made easy to understand by numerous illustrations and diagrams. All instruction material has been developed and tested in our own shops and laboratories, under the supervision of our own engineers and instructors. A free sample lesson is yours upon request—use the coupon below.

Here's Just a Few of the Interesting Facts you Learn with the **FREE MANUAL**

1. Routine for diagnosing Radio Troubles.
2. Preliminary inspection of Receivers.
3. How to Test and Measure Voltages.
4. How to Test Speaker in Audio Stages.
5. How to Trace the Circuit and Prepare Skeleton Diagram.
6. Complete Reference Table for Quickly Locating Receiver Troubles.



## VETERANS

If you are a veteran, qualified for training under the G.I. Bill, check the coupon for a Special Bulletin.

G. I. APPROVED

## NATIONAL SCHOOLS

LOS ANGELES 37, CALIFORNIA EST. 1903



### MAIL OPPORTUNITY COUPON FOR QUICK ACTION

National Schools, Dept. PM-4  
4000 South Figueroa Street  
Los Angeles 37, California

(Mail in envelope or paste on penny postcard.)

Mail me FREE the books mentioned in your ad including a sample lesson of your course. I understand no salesman will call on me.

NAME \_\_\_\_\_ AGE \_\_\_\_\_

ADDRESS \_\_\_\_\_

CITY \_\_\_\_\_ ZONE \_\_\_\_\_ STATE \_\_\_\_\_

Check here if veteran of World War II



# AUDELS Carpenters and Builders Guides 4 vols. \$6

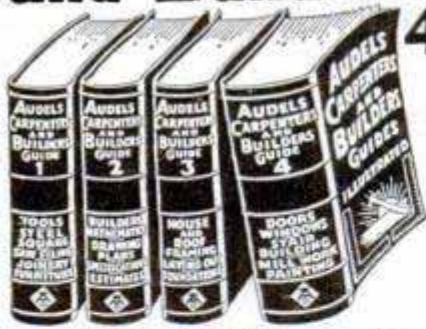

**Inside Trade Information** for Carpenters, Builders, Joiners, Building Mechanics and all Woodworkers. These Guides give you the short-cut instructions that you want—including new methods, ideas, solutions, plans, systems and money saving suggestions. An easy progressive course for the apprentice and student. A practical daily helper and Quick Reference for the master worker. Carpenters everywhere are using these Guides as a Helping Hand to Easier Work, Better Work and Better Pay. To get this assistance for yourself, simply fill in and mail the **FREE COUPON** below.

## Inside Trade Information On:

How to use the steel square—How to file and set saws—How to build furniture—How to use a mitre box—How to use the chalk line—How to use rules and scales—How to make joints—Carpenters arithmetic—Solving mensuration problems—Estimating strength of timbers—How to set girders and sills—How to frame houses and roofs—How to estimate costs—How to build houses, barns, garages, bungalows, etc.—How to read and draw plans—Drawing up specifications—How to excavate—How to use settings 12, 13 and 17 on the steel square—How to build hoists and scaffolds—skylights—How to build stairs—How to put on interior trim—How to hang doors—How to lay floors—How to paint



**AUDEL, Publishers, 49 W. 23rd St., New York 10, N. Y.**  
Mail Audels Carpenters and Builders Guides, 4 vols., on 7 days free trial. If OK I will remit \$1 in 7 days and \$1 monthly until \$6 is paid. Otherwise I will return them. No obligation unless I am satisfied.

Name \_\_\_\_\_  
Address \_\_\_\_\_  
Occupation \_\_\_\_\_  
Employed by \_\_\_\_\_ PM

## ELECTRICIANS! RADIO MEN!

Earn More Money!

Get this new  
**GIANT SIZE**

**ELECTRICAL and RADIO TROUBLE SHOOTING MANUAL**  
GUARANTEED BY COYNE

Yours Free for 7 Days

**NEEDED** by Electrical and Radio Workers, beginners, old timers! Nothing else like it. Saves time, helps boost your pay.

**4 GREAT BOOKS IN ONE!**  
1. New Step-by-Step Trouble Shooting Course. 2. 500 Shop Prints. 3. Electrical-Radio Dictionary. 4. Spare Time Jobs.

**FREE!** 1 year Technical Counsel by mail from COYNE staff, on trouble-shooting problems.

**SEND NO MONEY!** Just send coupon and you'll get the Trouble Shooting Manual for 7 days Free Trial. You owe nothing if Manual is returned in 7 days. To keep it, in 7 days send only \$6.95 cash price or \$7.50 at \$3 down and \$3 a month. Act now—**SEND COUPON TODAY!**

INCLUDES OVER  
**500**  
Large Size  
Electrical and Radio  
Shop Prints

Educational Book Publishing Division  
COYNE ELECTRICAL SCHOOL, Dept. 48-R5, 500 S. Paulina St., Chicago 12, Ill.

O. K., send me, postpaid, Coyne's Electrical & Radio Trouble Shooting Manual for 7 days Free Trial per your offer.

NAME \_\_\_\_\_ Age \_\_\_\_\_  
ADDRESS \_\_\_\_\_  
CITY \_\_\_\_\_ Zone \_\_\_\_\_ STATE \_\_\_\_\_

**FREE TRIAL COUPON**



**LOOK TALLER INSTANTLY!**

**WEAR HITE-BUILDERS IN YOUR OWN SHOES**



Want more respect? ... more opportunities? Then increase your height **INSTANTLY** with Davis Hite-Builders. Slip them inside your own shoes. Invisible ... comfortable ... easy to wear. Made to last for years. Amazingly low-priced!

**SEND NO MONEY**

Rush name, address, and shoe size today. Pay postman only \$1.95 plus few cents postage for your pair of Hite-Builders, mailed in plain package. If not delighted with immediate result, just return them and we'll refund your money at once. Or send \$1.95 now and save postage. Same guarantee ... of course. Order today, look **TALLER** next week!

**DAVIS MFG. CO.**  
DEPT. J-338, LOVELAND, OHIO

Only  
**\$1.95**  
A PAIR

## REFRIGERATION

**AIR CONDITIONING**—Trained men paid well to service, install, maintain, repair, rebuild household and commercial refrigerators. Opportunity for full time, spare time earnings. Train at home or in our shops. Approved for Veterans. (Non-Veterans inquire about our Low Payment Plan and Pay After Graduation Plan.) Send for **FREE BOOKLET AND FULL INFORMATION**. No obligation.

**COMMERCIAL TRADES INSTITUTE, Dept. A2-4**  
1400 W. Greenleaf Chicago 26, Illinois

## DEVELOP RUGGED STRENGTH!



**Strong Men's Club of America offers FREE Membership!**

Send for your personal membership card and Strength Secrets. No dues! No obligations! Many valuable privileges! Send name, address, age, on penny postcard.

**JOE BONOMO** Strong Men's Club of America  
Director (Dept. PM4B) 1841 Broadway, N. Y. 23, N. Y.

## HOW TO CUT RAFTERS

New vest pocket book gives lengths, side cuts, plumb cuts, deductions. For all rafters for any building from one inch to forty feet wide. Gives numbers to cut on square. Also degrees for same cuts for Radial Saws. All standard pitches from 1/4 to 5/8. Just open book to pitch page and there are your lengths, side cuts, etc. Anyone who knows what a jack rafter is can frame a roof if he has this great book. Price one dollar, (\$1.25 in Canada). **Builders' Topics, Dept. 5, Lock Box 828, Seattle, Washington.** CARPENTERS, PLUMBERS, PLASTERERS, ELECTRICIANS, ETC. subscribe for Builders' Topics, the monthly magazine for **HE-MAN CONSTRUCTION WORKERS**. Only \$1.00 per year, (In Canada—\$1.25). Sample copies 25c.

## Now CHEAP OIL BURNER FOR HEATING AND COOKING STOVES-FURNACES

**HEAT YOUR HOME, COOK YOUR MEALS WITH CHEAP FURNACE OIL**

**NO MORE SHOVELING COAL OR ASHES.** Sensational Fuelizer Starter Vaporizing System turns Cheap No. 1 Furnace Oil, also Range, Heater, Tractor Distillate, Kerosene and like oils into oil heat—one of the quickest, hottest fires known. **LIFETIME GUARANTEE. \$1.00 Bonus Offer for Testing.** We will let you try it in your own

stove or furnace for one month. Get yours for introducing. Big profits **QUICK**. Be first. Send in your name today for details and cash in on the tremendous demand for this Amazing Invention.

**NORTHWEST MFG. CO., 608-D, Mitchell, S. Dak.**





# GET INTO DRAFTING

The Draftsman Plays a most Important Part in INDUSTRY

## DRAWING OUTFIT INCLUDED with Drafting courses

All the tools you need including folding drawing table. With them you can put your ideas on paper quickly and with accuracy. With training you are all set to master Drafting in months, — not years — at home.

### Learn in Spare Time—At Home!

(or at the College in Chicago)

A few hours of pleasant home study every week — that's all. With Chicago Tech's help, you train yourself step by step. This tested method — developed over 44 years of C.T.C. progress — prepares men for good positions in industry.



## CHICAGO TECHNICAL COLLEGE

D-211 Tech Building, 2000 South Michigan Ave.  
Chicago 16, Illinois

## MAIL COUPON NOW

Chicago Technical College  
D-211 Tech Bldg., 2000 So. Michigan Ave.  
Chicago 16, Illinois

Mail me FREE Drafting Lesson with information about big opportunities in DRAFTING and how I can train at home.

- Architectural Drafting       Electrical Drafting  
 Machine Drafting         Structural Drafting  
 Builders' Course

Name \_\_\_\_\_ Age \_\_\_\_\_

Address \_\_\_\_\_

City \_\_\_\_\_ Zone \_\_\_\_\_ State \_\_\_\_\_

## INCREASE YOUR INCOME — Learn LANDSCAPE GARDENING My 3 Way Plan Shows You How To EARN MORE MONEY

### 1. Start Your Own Business!

Thousands of opportunities now open for Landscape Gardeners. My course shows how you may cash in on this tremendous field and start your own successful business without capital.

### 2. Earn Extra Money in Spare Time!

Many students take my course to earn extra money in spare time. My book tells how you, too, may be able to increase your earnings with a few hours of pleasant, profitable work. Special "Earn While You Learn" lessons included in course.

### 3. Get a Better Job!

My Consultation and Placement service help qualify you for healthful and pleasant jobs in nursery industry, large estates, parks, playgrounds, airports, golf courses, etc.



Hundreds of thousands of new homes are being built, and many more older homes need the professional advice and services of Landscape Gardeners. No previous training or special education is needed to learn this profitable, healthful profession. Course is written in easily understood language. Hundreds of inspirational pictures carry you step by step through practical and professional landscaping. Actual landscape work is part of the course so that you gain actual experience. **FREE BOOK** — write today for copy of "How to Learn Landscape Gardening for Pleasure or Profit" and see how easily and quickly you may get started on a new, successful career. **AIR MAIL REACHES ME OVERNIGHT.**



NORMAN A. MORRIS  
Landscape Architect

APPROVED FOR VETERANS

### NATIONAL LANDSCAPE INSTITUTE

310 S. Robertson Blvd., Dept. P-4, Los Angeles 36, Calif.

## TRAVEL - for 'UNCLE SAM'

### ARE YOU JOB-SATISFIED? GET A U. S. JOB

Many Government Jobs to Be Filled

Postoffice Clerks—Mail Carriers—Stenographers—Typists.  
Statistical Clerks—Storekeeper—Gaugers, etc. 32 Page Civil Service Book—FREE.

**MEN — WOMEN**  
**Veterans Get Preference**  
Mail Coupon immediately—today sure.

AS HIGH AS \$3,021  
FIRST  
YEAR



### COUPON

FRANKLIN INST., Dept. A85, Rochester 4, N. Y.

Gentlemen: Rush to me without charge, 32 page book with list of U. S. Government big paid positions. Advise me also regarding salaries, hours, work, vacation, etc. Tell me how to qualify for a position.

Name \_\_\_\_\_

Address \_\_\_\_\_ Vet? \_\_\_\_\_



# 8 BIG BUILDING BOOKS

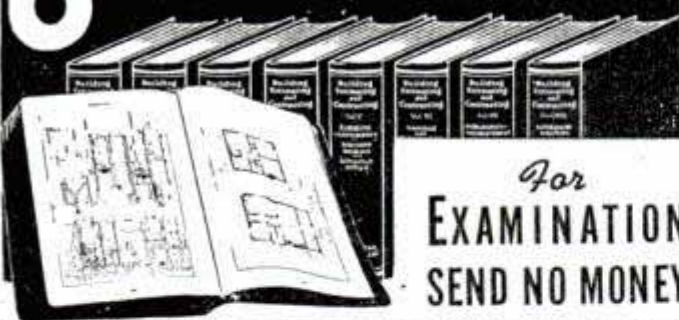

For  
**EXAMINATION**  
SEND NO MONEY

Learn to draw plans, estimate, be a live-wire builder, do remodeling, take contracting jobs. These 8 practical, profusely illustrated books cover subjects that will help you to get more work and make more money. Architectural design and drawing, estimating, steel square, roof framing, construction, painting and decorating, heating, air-conditioning, concrete forms and many other subjects are included.

## BETTER JOBS — BETTER PAY

The postwar building boom is in full swing and trained men are needed. Big opportunities are always for MEN WHO KNOW HOW. These books supply quick, easily understood training and handy, permanent reference information that helps solve building problems.

## UP-TO-DATE EDITION

These books are the most up-to-date and complete we have ever published on these many subjects.

## Coupon Brings Eight Big Books for Examination

AMERICAN TECHNICAL SOCIETY Vocational Publishers since 1898  
Dept. G419 Drexel at 58th Street Chicago 37, Ill.

You may ship me the Up-to-Date edition of your eight big books, "Building, Estimating and Contracting," without any obligation to buy. I will pay the delivery charges only, and if fully satisfied in ten days, I will send you \$2.00, and after that only \$3.00 a month, until the total price of only \$34.80 is paid. I am not obligated in any way unless I keep the books.

Name \_\_\_\_\_

Address \_\_\_\_\_

City \_\_\_\_\_ State \_\_\_\_\_

Please attach a letter stating your age, occupation, employer's name and address, and name and address of at least one business man as a reference. Men in service, also please give home address.

# ELECTRICIANS

Get this Great Book

# FREE

For Merely Examining  
Coyne's NEW Pay Raising

Book of 150  
Shop Prints.  
Wiring  
Diagrams.  
Full Size  
8 1/4 x 11"



## 8 Volume Set APPLIED ELECTRICITY

Here's a brand new set of electrical books to give you the "know how" on all branches of electricity from appliance repairing to D.C. and A.C. equipment, electrical refrigeration, Industrial Electronics, etc. 3,400 subjects, 11,500 facts, latest methods explained in easy to follow instructions. To prove how valuable and practical this set can be to you, I'll give you a FREE copy of my book "150 Shop Prints and How to Read Them" just for looking over this set. Written by the Coyne Staff and backed by 47 years' experience, this set has helped many ambitious electrical workers to bigger pay and added opportunity.

**OFFER LIMITED • ACT NOW!** If you act promptly, I'll send you the 8 volume set Applied Practical Electricity for 7 days FREE examination... together with the 150 Shop Print Book. Look the set over 7 days. If you like it send either \$22.75 cash or \$3.00 after 7 days and \$3.00 per month until \$24 is paid. If you don't want the set, return it and YOU OWE NOTHING. In either event you keep the 150 Shop Print Book absolutely FREE.

Coupon below is just a request to see the books free and to get my gift book for doing it. ACT—Send coupon Today!

Technical Book Div. COYNE ELECTRICAL SCHOOL  
500 S. Paulina St., Dept. 48-R6, Chicago 12, Ill.

**FREE BOOK**  
Coupon



B. W. Cooke, Director COYNE ELECTRICAL & RADIO SCHOOL  
500 S. Paulina St., Dept. 48-R6, Chicago 12, Ill.

O. K. send me, postpaid, Coyne's new 8 volume, "Applied Practical Electricity" for 7 Days FREE TRIAL per your offer. Also send, absolutely FREE, the book of 150 Shop Prints as a gift.

Name \_\_\_\_\_ Age \_\_\_\_\_

Address \_\_\_\_\_

Town \_\_\_\_\_ Zone \_\_\_\_\_ State \_\_\_\_\_

# WANTED MAN WITH CAR



No Time Like  
Now to Get In  
McNess Business

It's no trick to make good money when you use your car as a McNess "Store on Wheels." Farmers buy everything they can from McNess Men because McNess Products are tops in quality, represent extra values. Attractive business-getting prizes and premiums; also money-saving deals to customers make selling McNess daily necessities a snap.

## We Supply Capital—Start Now!

There's no better work anywhere. Pays well, permanent, need no experience to start, and we supply capital to help you get started quick. You begin making money first day. Write at once for McNess Dealer Book. It's FREE. Tells all — no obligation. (1)

THE McNESS CO., 578 Adams St., Freeport, Ill.

Use Your  
CAR  
to Raise  
Your  
PAY

## DEVELOP RUGGED STRENGTH!



Strong Men's Club of America  
offers FREE Membership!

Send for your personal membership card and Strength Secrets. No dues! No obligations! Many valuable privileges! Send name, address, age, on penny postcard.

JOE BONOMO Strong Men's Club of America  
Director (Dept. PM4A) 1841 Broadway, N. Y. 23, N. Y.

# INVENTIONS

## WANTED AT ONCE

Patented or unpatented inventions, all types needed by manufacturers. Write for free booklet "MARKETING YOUR INVENTION" and Protective Disclosure Form. We have a tremendous list of firms who may pay cash or royalties for good inventions. For full particulars, write today.

NATIONAL INVENTION SERVICE  
1404 Mitchell Street, Dept. 5 Oakland 1, Calif.

## LEARN MOVIE THEATRE MANAGEMENT

The Motion Picture Theatre Business offers big opportunities for trained men. Get into a fascinating field with a promising future. Train at home in spare time. Free Catalog. Established 20 years.

THEATRE SCHOOL, 370 Washington St., Elmira, New York

How to Become Good Penman  
Free Book tells all  
For a Profit \$5000 Get your copy now  
The Tarnham School of Penmanship P-441 Ridge Building, Kansas City, Mo., U.S.A.

## TALK-SING thru your own radio with RADIO MICROPHONE

Be the life of the party. Put on your own broadcasts at home. Talk-Sing make announcements from any room. Wonderful voice practice. Microphone easily attached to any radio. Follow enclosed instructions. SEND NO MONEY—pay postman \$2.25 plus postage. Send Money Order or check and save postage.

EMPIRE RADIO & TELEVISION CO. (Dept. M1) 1521 Bedford Ave. Brooklyn 16, N. Y.

## MAKE MONEY—WITH CHIN-CHINS

No experience needed. Start with pure-bred CHIN-CHIN Chinchilla rabbits—a few females and a male—you'll soon have at small cost, a large, profitable herd. FREE INSTRUCTIONS. BIG DEMAND for breeding and laboratory stock, meat, and world's most beautiful rabbit fur. DEALERS. CUT OFF FROM IMPORTED RABBIT PELTS BY WORLD FAMINE. NEED CHIN-CHIN FURS NOW AND FOR YEARS TO COME! Write today for free, illustrated catalog.



WILLOW BROOK FARM • R-36 SELLERSVILLE, PA.



**Famous BANNER**  
**FIREWORKS**

**OH-BOY!** Don't be disappointed. Get the best for your money. Famous Banner Fireworks have all the ZIP, BOOM, BANG you expect of fireworks. This year several new creations have been added. You'll thrill to every last piece in this **BIG BARGAIN ASSORTMENT**.

**BIG SPECIAL DEAL—Only \$4.95**  
 Retail value over \$10.00. Cannon Salutes—Sky-screamers—Whistling Devils—Battle in the Clouds—Sky Rockets—10 ball Roman Candles—Chinese Firecrackers—Sparklers and many others. Over 200 pieces in all. Rush order today. Supply limited. Send money order bank draft or currency. No C.O.D.'s. Catalog **FREE**.

**BANNER FIREWORKS MFG. CO., INC., DEPT. 140**  
 446 Capistrano Toledo 12, Ohio

**NEW YORK SCHOOL of MECHANICAL DENTISTRY**

SINCE 1920—The outstanding Training Center for all phases of Dental Laboratory Technology. Licensed by New York and New Jersey States. Approved for Veterans P.L. 346 and P.L. 16. Visitors Welcome. Ask for Free Bulletin "P."

**NEW YORK SCHOOL OF MECHANICAL DENTISTRY**  
 America's Oldest School of Dental Technology  
 133 Washington St. NEWARK 2, NEW JERSEY  
 Also: 125 W. 31 Street NEW YORK 1, N. Y.  
 Immediate Enrollment — Day and Evening

**LEARN MEAT CUTTING**

through actual practice. Profitable Meat Cutting and Successful Meat Merchandising taught easily, quickly. **LEARN BY DOING** at Toledo in just six short weeks under actual market conditions. For beginners or men with experience. All subjects taught thoroughly and completely. Diploma. Job help. Get store of own. People must eat. School in operation nearly 25 years. Approved for GI training. Send today for **FREE literature**. No obligation.

**NATIONAL SCHOOL OF MEAT CUTTING, Dept. 50, Toledo 4, Ohio**

**A BUSINESS OF YOUR OWN**

Use simple home-made equipment. Make **HOLLYWOOD STYLE** cement pottery, birdbaths, benches, mantels, coffee tables, miniature castles. Also rustic garden walks, steps, stucco-rock walls, imitation marble. Chemical coloring, formulas & instructions. 10c brings pictures, sample, details.

**HOLLYWOOD CEMENTCRAFT**  
 8529 Wonderland Ave., Hollywood 46, Calif.

**CANVAS COVERS** Waterproof tarpaulins, war surplus (Used), perfect condition. Originally made for tents. Approx. 5'x8'. Two buttoned together make approx. 80 sq. ft. Complete with buttons attached. Suitable for use as canvas dams, hay covers, truck covers, machinery and equipment covers, etc. Packed in bales 40 each. priced 40 covers, \$1.00 ea.; 15 covers, \$1.50 ea. Less than 15, \$1.75 ea. All FOB, Kansas City.

**AMERICAN SUPPLY CO.**  
 329 W. 5th Dept. P. M. Kansas City, Mo.

**Big Money for Workers In Home or Shop**

Licensed Concrete Specialists wanted. No experience needed. Make **Colorglazed** concrete pottery without molds. New, low cost, patented method. Cemetery products, novelties, tiles, etc. Basement leaksealing. Other big pay projects. Booklet, details free. Men only.

**NATIONAL POTTERIES COMPANY**  
 415 Third Avenue, W., Grand Rapids, Minnesota

**ACE Hollywood Experts WILL TRAIN YOU AT HOME... NOW YOU CAN MAKE GOOD IN**

**RADIO**

**TELEVISION ELECTRONICS**  
 Through Practical Experiments With

**10 BIG KITS R.T.A. Gives you!**

**You Do Scores of Practical Experiments**

Illustrated above are only a few of the many job-exercises you do, through RTA's "shop-type" home training method. You build a TRF Receiver, a High-Frequency Converter, a 8-tube AC-DC Superhet Receiver, plus dozens of other interesting jobs.

These jobs give you actual **SHOP EXPERIENCE** necessary to your success.

**YOU WORK ON REAL EQUIPMENT**

**Opportunities Wide Open**  
 400 MILLION new radio and television sets will be built within ten years. 72 MILLION dollars are being spent **RIGHT NOW** for radio repairs alone! When you are trained by RTA's Hollywood Experts, you too can qualify for big, interesting **GOOD-PAYING** technicians jobs, or **YOUR OWN** profitable radio-television repair business.

**Extra Cash in Spare Time**  
 RTA's Hollywood Experts show you how to earn welcome **EXTRA CASH**, while you learn. In fact, like many RTA students, you may actually get **MORE** spare time work than you can handle.

**25 Years of Success**  
 RTA's long years of experience assure you quickest progress. If you are at all mechanically inclined, RTA can teach **YOU** to **MAKE GOOD** in Radio-Television.

**SO GET THE FACTS! SEND FOR FREE 30-PAGE BOOK TODAY!**

**APPROVED FOR VETERANS**

**RADIO TRAINING ASSOC. OF AMERICA, DEPT. PMD**  
 5620 Hollywood Blvd., Hollywood 28, Calif.

Send **FREE BOOK** showing how to make good in Radio-Television through training by Hollywood experts.

NAME \_\_\_\_\_ AGE \_\_\_\_\_  
 ADDRESS \_\_\_\_\_  
 CITY \_\_\_\_\_ ZONE \_\_\_\_\_ STATE \_\_\_\_\_

Check box if **VETERAN of World War II**



**NEW SERIES 16 IMPROVED NO-DRIFT FM in the Sensational 1948 MIDWEST RADIOS.**



5 WAVE BANDS

Separate Chassis Like the Powerful Series 16 AM-FM Above, or Beautiful Radio-Phono Consoles Available

**The SYMPHONY GRAND RADIO-PHONOGRAPH AM-FM CONSOLE**



A truly magnificent instrument that offers new, improved No-Drift FM, 5 Wave Bands, Automatic Intermix Record Changer that handles both 10" and 12" records, 14 1/2" Panasonic Speaker, and exclusive Midwest Tri-Magnadyne Coil System and Color-Ray Tone Selection. Luxurious Cabinets. Other Console and Table Models with Series 16, 12, and 8 Chassis.

EASY TERMS 30 DAYS TRIAL

SEND FOR FREE CATALOG BUY DIRECT FROM FACTORY AND SAVE FILL IN COUPON AND MAIL TODAY OR JUST SEND YOUR NAME AND ADDRESS ON 1c POSTCARD

MIDWEST RADIO CORPORATION Dept. 25-W, 909 Broadway, Cincinnati 2, Ohio

Please send me your new FREE 1948 Catalog.

NAME .....  
STREET.....  
CITY.....ZONE.....STATE.....

**AIR RIFLES BENJAMIN AIR PISTOLS**  
PIONEERS - LEADERS

SEND FOR FREE FOLDER OF LATEST MODELS TODAY If you want a REAL GUN for PRACTICAL USE inside or outdoors get a SAFE - CLEAN - ECONOMICAL - BENJAMIN with Adjustable Power and Amazing Accuracy. For BEST RESULTS use BENJAMIN H-C PELLETS. WRITE AT ONCE. BENJAMIN AIR RIFLE CO., 812 MARION ST., ST. LOUIS 4, MO.

**22 Big Money-Makers in a Single Line! Amazing New Fluorescent Lights with Circular Tubes**



MAXILUME COMPANY

**FREE Sales Outfit** Don't send a penny. Sample Outfit is FREE. Rush name on penny post card for money-making facts about sensational new "CIRCLINE" Fluorescents. Latest scientific development gives you 22 new type circular tube fixtures for kitchens, dinettes, halls, and play rooms. Also Floor and Table lamp for living rooms and pin-ups for shaving and vanity tables. Sells on sight to homes, restaurants, stores, offices. No other fluorescents like CIRCLINE. Salesmen who order samples quickly reorder in large quantities. All fixtures complete with tubes. No waiting. Also immediate delivery on all standard type Fluorescent Fixtures. This is too good to miss. Big, quick profits waiting. Rush name on postcard today for FREE Sales Outfit.



NEW MAXILUME PIN-UP MIRROR LIGHT

125 W. HUBBARD • DEPT. 84 • CHICAGO 10, ILLINOIS

**SAVE ON Surplus Bargains PERFECT ALL WOOL OLIVE DRAB SLEEPING BAG**

Handy for fishing trips, hunting, camping, boating, just roughing it or use as auto robe and many other purposes. Warmth of 2 blankets; zipper slide fastener; tiestrap on bottom; approx. Gov't cost \$12.00. Our Price each..... \$2.39

**PUP TENTS** Perfect—2 man size for scouting, Camping, etc. Without Pole..... \$2.95

**NEW GOGGLES** Set comes complete. Kit with 1 extra interchangeable shatterproof, flexible, cellulose acetate lens. Green and white colors. A rubber flexible goggle frame. Back adjustment head strap. Cost Gov't approx. \$4.50. Ea..... 98c

**SUN GLASSES**—Air Corps Type, Nothing Finer..... \$3.49

**PYRAMIDAL TENTS**—16'x10', 8 man tent. Reconditioned, perfect. Of heavy duck. Complete with tie ropes. Cost Govt. over \$100.00 Our Sale Price..... \$24.95

**WALL TENT**—9'x9', reconditioned, perfect..... \$19.75

**MARKSMEN PIPES**—Smoker's Preference, \$5.00 retailer. Our price..... \$3.49

**NEW PARACHUTES** (Green Rayon) Approx. 36 sq. ft. Cloth good for making into ties, handkerchiefs, lining, etc. Complete with canister, wght, approx. 10 lbs..... \$2.95

Add 10% for Mailing — No COD — Send check or M.O.

**AMERICAN SUPPLY CO.,** Dept. P. M., 329 W. 5th St. Kansas City, Mo.

**BUILD HEAVY DUTY MACHINES**

SAVE UP TO 90%— You can build, using our practical, easy-to-read plans, all kinds of machines, for home, farm or shop — scooters, portable sawmills, metal working machines, concrete machinery of all kinds, printing equipment, woodworking machines, midget autos, dish washers, farm equipment, freezers, tractors.

**FREE CATALOG HANDBOOK 183 SETS OF PLANS VALUABLE INFORMATION**

**NICHOLS EQUIPMENT COMPANY** DEPT. D-910 PURVIS, MISS.

**SPATTER CRAFT**

Learn for fun and profit! Produce color effects on wood, cloth, or paper impossible any other way. Sunfast, wash-proof, too. Kit has GUN; 5 BOTTLES OF COLORED INK; STENCIL PAPER; many PATTERNS and DESIGNS; and 22-page TEXTBOOK in full color. Just \$2.50 postpaid.

**CRAFT CATALOG FREE** with order. (If W. Va. add 5c Sales Tax)

**DWINNELL CRAFT SHOP,** Dept. P-84, Elm Grove, Wheeling, W. Va.

**ANALYZE Handwriting**

Uncrowded, fascinating field. Gratifying earnings reported by graduates in Employment, Credit, Social Service, Police and Entertainment fields. Others have developed profitable private practice, full or spare time, as Personal Problem and Vocational Counselors. Send for 3000 word TEST LESSON and Grapho Analyst FREE.

A.I.G.A. Inc. Wilhoit Bldg., Dept. 120 Springfield, Mo.

**SAY YOU SAW IT IN POPULAR MECHANICS**

**Learn BAKING At Home**

Baking is one of America's high industries in wages. Nearly depression-proof. Thorough basic home course lays sound foundation. If you have aptitude, write for FREE BOOKLET, "Opportunities in Commercial Baking."

**National Baking School,** 1315 Mich. Ave., Dept. 1354, Chicago 5



THESE 5 TRADES ASSURE YOU

# HIGH PAY • Future Security

- **PLUMBING** Every phase of plumbing: Pipe-Cutting and Threading, Lead-Wiping, Rough-in Projects on Installations, Completed Installations of entire plumbing systems, Blueprint reading, Estimating.
- **DRAFTING** College-level courses in General Machine and Architectural Drafting, with fundamentals in Drafting Mathematics—all under graduate engineers.
- **SHOE REPAIRING** From simplest repairs on boots and shoes to the finest details of reconditioning and rebuilding, under expert craftsmen.
- **ELECTRICAL** Technical and shop training include Basic Electricity, Residential Wiring, Industrial Wiring, General Testing and Trouble Shooting, and Appliance Repair.
- **AUTOMOTIVE & TRACTOR** Applied training on latest model automobiles and tractors, including engine overhaul, transmission and differentials, carburetion, generator and ignition systems, engine tune up, Hydramatic and Vacumatic Transmissions, and general service.

## Choose One of these 5 Essential Trades

Our complete courses of thorough training prepare you to go right into the field as a Qualified Tradesman at High Pay in only 34 weeks (39 in Shoe Repair). All courses under especially trained instructors with practical experience. 6 Hour Classes 5 Days a Week. Our Employment Department helps you.

**VETERANS** "Approved for veterans' training by the State Department of Education under Public Law 346."  
"Approved for veterans' training by the Veterans' Administration under Law 16."

Send Coupon for Free Information Now

*"There's Always a Demand for the Man who KNOWS!"*

### CHOOSE ONE OF THESE 5 LEADING TRADES

Get Out of that Rut... Be a Skilled Tradesman! Have a Lifetime Career... Own Your Own Business and Be Secure in Your Old Age.

**NOW** while Enrollment is still open, send for FREE information.

THE 5 DIVISIONS OF

## NATIONAL TRADE SCHOOL

2610 Grand Ave., Kansas City 8, Mo.

- \_\_\_ ● Plumbing
- \_\_\_ ● Drafting
- \_\_\_ ● Shoe Repairing
- \_\_\_ ● Electrical
- \_\_\_ ● Automotive & Tractor

NAME \_\_\_\_\_

ADDRESS \_\_\_\_\_

CITY \_\_\_\_\_

STATE \_\_\_\_\_

VETERAN \_\_\_\_\_

OCCUPATION \_\_\_\_\_

**SOUTH BEND**

## LATHE CENTERS and DRILL PADS



Description	No. 2 Taper	No. 3 Taper
L—SCREW CENTER.....	\$3.00	\$3.25
G—DRILL PAD.....	2.50	2.75
H—CROTCH CENTER.....	2.50	3.25
J—HOLLOW CENTER, 60°..	2.00	2.75
I—60° CENTER.....	2.25	3.00
P—CARBIDE TIPPED CENTER	4.50	8.00
Q—HALF CENTER.....	2.25	3.00
N—CUP CENTER.....	2.00	2.75
M—SPUR CENTER.....	3.00	3.25

**SOUTH BEND LATHE WORKS** 455A E. Madison St. South Bend 22, Ind.

## Operate Your Own Business!

18 YEARS OF PROVEN SUCCESS



## Clean and Mothproof Rugs and Upholstery

- Nationally Advertised Services
- Big Profits
- Repeat and Voluntary Orders
- No Experience Needed

If you are dependable, honest and willing to work, send today for details on how to become financially independent in a profitable, growing business of your own. Choose an

open territory anywhere in United States, Canada or foreign countries. Services rendered in homes, offices, clubs or public buildings.

**DURACLEAN** cleans by absorption. **NO SCRUBBING.** No soaking or shrinkage. This modern safe cleaning process uses mild solvents. Dirt, grease and many unsightly spots vanish as if by magic. Wool fibers come to life... matted pile rises... colors revive. Upholstery and floor coverings last longer.

**DURAPROOF** is another year 'round service. Not only kills moths and carpet beetles but makes materials resistant to both. Protects furnishings, clothing and auto interiors. Guards against mildew, too. **DURAPROOF**, to our knowledge, is the only moth proof service backed by a National MONEY BACK, 4 YEAR WARRANTY.

Leading furniture and department stores recommend **DURACLEAN Dealer's** service. Almost every building in your territory houses a potential customer needing one or both these Nationally Advertised services. Even auto dealers buy your service to revive upholstery in used cars.

Easy to learn. No shop needed. Operate from your own home. We furnish enough material to return your **TOTAL** investment. Gross profits up to \$15 and \$20 a day on **EACH** of your service men.

Start full or part time. Territories are limited! Write immediately for **FREE** Booklet explaining details. Easy terms.

**Duraclean Co.** 16-4 Ct. DEERFIELD, ILL.

## Hollywood WOLF WHISTLE



GIVE THE WOLF CALL

CAR HORN

— imitate BARKING DOGS and make other weird noises. You, too, can become a Hollywood Wolf. Have lots of harmless fun. Install a Hollywood Wolf Whistle on your car. Beautiful Hammertone finish. Self lubricating bearings. Works off of the intake manifold. Simple to install in 15 minutes. Full instructions with every box. For cars, trucks, motorcycles, motor boats, outboard motors. Money back guarantee. If your dealer can't supply you, order today. Be the first to have this attention-getting horn. **ONLY \$4.00** postpaid — Cash, Check, or Money Order. **QUITE A DEAL.**

**YODER MFG. COMPANY**

2403-A E. 103rd Street, Los Angeles 2, Calif.

DESCRIPTIVE LITERATURE ON REQUEST





YOU  
can  
acquire

## LAW NIGHTS AT HOME! L. L. B. DEGREE

LaSalle's famous Law Library—used as reference in many Law libraries and Law offices—has enabled thousands to master Law surprisingly fast, in spare hours at home, for business and professional advancement.

These 14 remarkable volumes, compiled by leading professors and lawyers, cover the whole basic field of Law in condensed, orderly, simplified manner.

You advance rapidly with this great library, plus special lectures furnished. We guide you step-by-step with personalized Problem Method of instruction . . . you learn by doing—handling legal problems—not by memorizing rules.

Send for two FREE 48-page booklets, "Law Training for Leadership," and "Evidence," answering questions about Law and its value to you, and telling how LaSalle Law graduates are winning rapid advancement in business and public life. Mail coupon below. No obligation.

### LA SALLE EXTENSION UNIVERSITY A Correspondence Institution

417 S. Dearborn St. Dept. 464-L Chicago 5, ILL.

Send me your two FREE booklets described above, without obligation.

Name \_\_\_\_\_ Age \_\_\_\_\_

Street \_\_\_\_\_

City, Zone & State \_\_\_\_\_



*Why Pay More?*

**FREE TUBE**  
With Each Order

EVERY TIRE GUARANTEED  
98% NON SKID, ORIGINAL TREAD  
TRIPLE INSPECTED DEMONSTRATORS

Positively Not Re-caps!

600-16 ..	6.42	700-15 ..	8.42
650-15 ..	7.12	700-16 ..	8.82
650-16 ..	7.42	750-16 ..	9.42
900-16 ..	\$7.52	900-20	\$17.52
650-20	9.52	1000-20	17.52
700-20	12.52	1100-20	17.52
750-20 (8)	12.52	32x6 (8)	12.52
750-20 (10)	13.52	32x6 (10)	13.52
825-20	16.52	34x7 (10)	13.52
7.50-20 MILITARY B PLY \$17.52			

1/2 million tires shipped to satisfied customers. Trial will convince you. Mail Orders Rushed on Receipt of Check or Money Order.

**STANDARD**  
834 N. Broad St. Phila. 30, Pa.

Made to U. S. Army Specifications!

16-JEWEL

# ELGIN

\$19.95



Sturdy 16-Jewel ELGIN men's wrist watches. Water-repellent. Sweep second hand. Stainless Steel back. Unbreakable crystal. QUALITY! American made. Fully reconditioned with ONE YEAR GUARANTEE! Made for the U. S. Army Air Corps. They HAD to be good. SEND NO MONEY. Simply pay postman \$19.95 plus 10% tax and postage on delivery. Cash orders sent postpaid. Limited supply. UNITED PRODUCTS CO., 7941 S. Halsted St., Dept. RES-609, Chicago 20, Ill.

**AUTO  
BODY &  
FENDER  
REBUILDING**

Tired of Working for the Other Fellow?

**Be Your Own Boss**

A Big Field for Your Future

Body & Fender Rebuilding is one of the best paid branches of the automobile industry. Go into business for yourself or prepare for good job opportunities. Train at home or in our big shops. Approved for Veterans. (Non-Veterans inquire about our Low Payment Plan and Pay After Graduation Plan.) Send for FREE Booklet and full information. No obligation.

COMMERCIAL TRADES INSTITUTE, Dept. F 2-4

1400 W. Greenleaf Avenue, Chicago 26, Ill.

## MAKE THESE LEATHER and LEATHERETTE ITEMS LIKE NEW

With New Plastic LEATHER-NEW

Covers leather, leatherette and cloth and gives new finish and color—wears like leatherette. Easily applied with brush—quickly renews with liquid artificial leather. Write for FREE sample.

**Own Your Own LEATHER-NEW  
Contracting Business — Big Profits**

Renew equipment for Bars, Restaurants, Hotels, etc. Profits possible up to \$125.00 on a single job . . . write for details.

**FREE** Sample of coated material—  
Write for it—No Obligation

LEATHER-NEW, 4723A1 Troost, Kans. City, Mo.

Leather Covered  
Furniture

Grille and Cafe  
Equipment

Any Leather  
or Leatherette  
Item



## COMBAT JUDO

Fiercest fighting technique known. Learn trick knock-outs, police tactics, and the art of Defense and Attack. Expert instructions in THREE volumes with 200 photographs and illustrations. Complete...only \$2.25

VARIETY HOUSE

Box 46-BA Wall St. Sta., New York 5, N. Y.



## BIG MONEY FOR YOU!

Just Telling Property Owners About  
**ZONE HEAVY-DUTY ROOF COATING**  
Sensational product cuts essential building repair cost up to 75%. Amazing demonstration gets orders in a hurry. Only six average orders a week can pay you well over \$100.00! Complete FREE selling outfit includes everything you need to make big money right from the start. If 30 or over, this may be the opportunity of your life. Tell about yourself. Write, Jack Canning, Vice Pres. ZONE Company P. O. BOX 789, DEPT. D-12 FORT WORTH 1, TEXAS

## NEW! LOW COST! RESPIRATOR

Wear when sanding, grinding, paint spraying, sweeping, dusting, furnace cleaning, etc. Handy as a pair of glasses. Just keep mouth closed and breathe through nose is all you do to operate. Protects against nuisance dusts, lint, coal, cement, grain dust, hay fever pollen. Has 9 sq. in. filter. For EYE protection against paint spray, dusts, gases, fumes, smoke, order our Fog-Proof Rubber GOGGLES . . . \$2.00 p.p.

JERRY BRYANT, Dept. PM  
519 N. Michigan Ave. Chicago 11, Ill.



Order Today \$1.00  
POST PAID



# BUILD YOUR CAREER on a Solid Foundation Through PRACTICAL TECHNICAL TRAINING

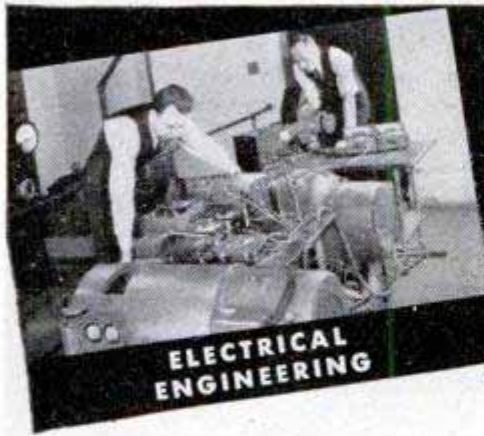

**ELECTRICAL ENGINEERING**



**ELECTRONICS**



**REFRIGERATION AND AIR CONDITIONING**

## SPECIALIZE In 6 Months to 3 Years

Since 1903 — the Milwaukee School of Engineering has trained men for substantial careers in technical fields. More than 35,000 former students now in industries the world over attest the career-building value of the school through its comprehensive, practical technical courses. Now 1,538 students are enrolled from 48 states and 13 overseas countries — training under the supervision of its faculty of 72 specialists — and utilizing the institute's exceptional facilities in buildings, classrooms, laboratories and shops with their full complement of modern technical equipment. World-wide Alumni Counselor Committee offers career guidance to prospective students.

### COURSES

You can build your career step by step through our time-tested CONCENTRIC SYSTEM. Each 6-month course is complete in itself, yet prepares you for advanced courses. Continue your training as long as circumstances permit — until you reach your occupational goal.

#### SERVICE—6 to 12 months

- Electricity
- Welding
- Refrigeration
- Heating

#### TECHNICIAN—1 to 2 years

- Electricity
- Radio
- Electronics
- Refrigeration, Heating and Air Conditioning

#### PROFESSIONAL—3 years

- Electrical Engineering Bachelor of Science Degree Major in Machinery or Electronics

### Write for "Career Building" And Interesting PHOTO STORY

Purposeful men who wish to specialize in one of the technical fields listed at the left, are invited to write for catalog "Career Building" and "Photo Story." You will find the "Photo Story" most interesting, as these booklets are illustrated with views of electrical, radio and electronics laboratories; refrigeration and heating "labs"; and drafting halls. They also describe the experiments and work done by students during various phases of training in technical and engineering fields.

**4 Terms per year—starting in January, April, July, September. PLAN NOW to ENTER the NEXT TERM**

MILWAUKEE  
**SCHOOL of ENGINEERING**  
A Technical Institute · Founded 1903

MILWAUKEE SCHOOL OF ENGINEERING  
Dept. PM-448, North Broadway and East State, Milwaukee, Wis.  
Without cost or obligation, send me catalog — "Career Building" and "Photo Story", also more details on course in.....

Name..... Age.....  
Address.....  
City..... State.....



# Learn Radio Now!

SERVICING — TELEVISION — ELECTRONICS  
FREQUENCY MODULATION — RADAR



## IN THE SOUTHWEST'S LEADING RADIO SCHOOL

For over 26 years The Tyler Commercial College has pioneered in the field of radio. Its courses are designed to provide a broad foundation for careers in this technical field. This residence school provides complete shop and laboratory facilities plus experienced, qualified instructors.

### 26 Years of Leadership in Radio

Modern Radio Servicing and Complete General Radio are offered. Frequency Modulation, Electronics, Radar, and Television are covered. Each student builds and tests his own receiver, voltmeter, oscillator and other actual radio apparatus. Preparation for an FCC license is a feature of the Complete General Radio Course.

### VETERANS

Here's an opportunity to prepare for a life-time vocation. Take advantage of the educational policy of the "G. I. Bill of Rights". We are approved by the Veterans Administration and have qualified hundreds of veterans in the field of Radio.

### FREE BOOKLET AND CATALOG

Write for these two beautiful booklets. One our complete catalog and the other, "A Priceless Heritage", a pictorial preview of Tyler Commercial College.

WRITE TODAY

**THE TYLER COMMERCIAL COLLEGE**  
College Avenue, Tyler, Texas

I am interested in your radio school.  
Please send me your two free booklets.

Name \_\_\_\_\_  
Street \_\_\_\_\_  
City & State \_\_\_\_\_

# BE YOUR OWN BOSS! LEARN ELECTROPLATING HIGHLY PAID FIELD



UNCROWDED interesting business. Part or full time. Common school education sufficient Chromium, Nickel, Silver, Gold, etc., money making trade secrets Learn at home in spare time. Send postcard today for **FREE** electroplating idea booklet.

**PLATER HYDE**  
432 F Street Room 520  
San Diego 1, California

## Learn about Earning Opportunities in THE BUILDING TRADES

**FREE**—Important Information Telling How to Get Started. Do you want to be on the inside in the building boom — where big money is made? This is your chance now. **HOME TRAINING** prepares you for these big opportunities. Course recognized by Building Industry. (Approved for Veterans.) Write today — no obligation.



**HOME BUILDERS TRAINING INSTITUTE**, Dept. D2-4  
7050 N. Glenwood Ave. Chicago 26, Ill.

## New Designs in FRANZITE GRIPS

**Modernize Your Gun! Improve Your Score!**  
Most durable grips made. Positively unbreakable! For Colt, Smith & Wesson, Hi-Standard, Ortgies, Luger & Mausers in a wide choice of beautiful designs in Ivory, pearl, walnut, onyx, etc. Low prices. **FREE CATALOG**. Dealers Wanted.  
**SPORTS, INC. (Mfrs.) 5501 Broadway, Dept. P-4, Chicago 40, Ill.**

## YOUR NAME OR MONOGRAM

**MATCH BOOKS** 50 for \$1  
Your name or initials on match books that reflect your good taste. As a business card, they remind your clients of you many times. Sent postpaid. No COD's.  
**Dept. PM, CALVERT MONOGRAM COMPANY**  
2208 Eutaw Place, Baltimore 17, Maryland  
**AGENTS WANTED**—write for details about our complete line of monogram items.



## KINKADE GARDEN TRACTOR

and Power Lawnmower  
A Practical Power Plow and Cultivator for Gardeners, Suburbanites, Florists, Truckers, Nurserymen, Fruit Growers.  
**Easy Terms - Write Today**  
**American Farm Machine Co.**  
1058 33rd Ave. S. E. Minneapolis, Minn.



SAY YOU SAW IT IN POPULAR MECHANICS

**FENDER SKIRTS . . . . . \$17.20 PER PAIR**



For Ford, Chev., Merc., Plym., DeSoto, Chry., Dodge, Kaiser-Frazer and Buick. Beautify your car — bring out the flowing lines inherent designed there. Sparkling beauty you'll like. Constructed of heavy gauge body steel, finished in prime, perfect fit.

**SANDEE MUFFLER CO**  
Box 296, La Tijera Sta.,  
Los Angeles 43, Calif.  
Gentlemen, Please send me one set of Sandee Fender Skirts to fit my \_\_\_\_\_ (year and make of car)  
 Check for \$17.20 enclosed  
 Ship C.O.D.



# Now YOU-TOO-Can Be a "WHIZ" on ANY AUTO REPAIR JOB!



"Motor's Manual paid for itself on the first 2 jobs, and saved me valuable time by eliminating guess work."—W. SCHROP, Ohio



"Instructions so clear, have no trouble learning anything about any car. Now working as mechanic in big plant."—SAM. ORDONEZ, Cal.



"Fixed motor another mechanic had worked on half a day. With your Manual, I did it in 30 minutes!"—C. AUBERRY, Tenn.



"So complete, easy to understand—have done jobs with Manual I would not have attempted without it."—C. L. VAN-ERSTROM, Mich.

**MoToR's AUTO REPAIR MANUAL Is Showing Thousands of Men How to Handle ANY Job on ANY Car—Faster and Easier! Now Let It Go To Work For YOU!**

## FREE-7 Day Offer

HERE'S the book YOU need to "Whiz through" every auto repair job—including those "ornery," extra-hard ones that give other mechanics such a "headache"!

THOUSANDS of men like the four above are letting MoToR's AUTO REPAIR MANUAL help them "lick" even the toughest repair problems—in LESS TIME, with LESS work and MORE profits than ever before!

### Complete "How-To-Do-It"

Now let these 200,000 factory-correct instructions and facts, 1700 "how-to-do-it" pictures, 200 "quick-check" charts and tables, go to work for YOU! With them you

can repair anything from carburetor to rear end, Ford to Cadillac, shaky '35 model to shining '48—quickly, easily, right!

Just look up make, model, job in quick index; then let official instructions, "boiled down" from 150 auto manufacturers' factory shop manuals, show you how, step-by-step! Sturdy binding, 8½ x 11 inches, over 700 pages.

### SEND NO MONEY

Find out for yourself how this book can pay for itself first few days you use it. Try it FREE 7 days! Just mail coupon. Pay postman nothing. Put Manual to actual test. Then, if not entirely satisfied with it, return book in 7 days, pay nothing. Mail coupon today! MoToR Book Dept., Desk 1D, 572 Madison Ave., New York 22, New York.

### Every Job on Every Car Built Since 1935!

Nearly 200,000 service and repair facts on:  
American Bantam • Auburn • Austin • Buick • Cadillac • Chevrolet • Chrysler • Cord • Crosley • DeSoto • Dodge • Ford • Frazer • Graham • Hudson • Hupmobile • Kaiser • Lafayette • LaSalle • Lincoln • Lincoln Zephyr • Mercury • Nash • Oldsmobile • Packard • Pierce Arrow • Plymouth • Pontiac • Reo • Studebaker • Terraplane • Willys.

700 big pages; including 70 pages of carburetor text, charts, illustrations covering all models. Over 200 charts, tables: Tune-up Chart; Valve Measurements; Torque Wrench Reading; Starting Motor; Engine Clearances; Generator; Body Service; Dash Gauges; Brake Specifications; Front End Measurements, etc., Engines; Electric, Fuel,

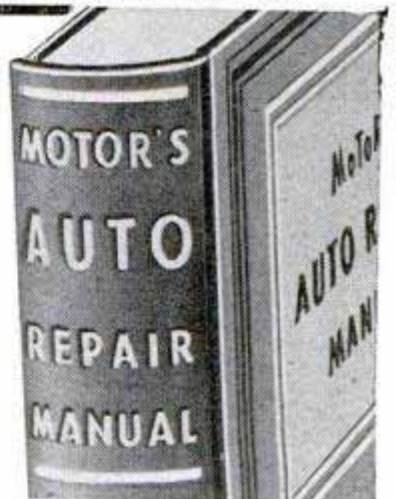

Cooling, Lubricating Systems; Transmissions; Universals; Front Ends; Wheels; Rear Ends, etc.

**MoToR** Published by MoToR, The Leading Automotive Business Magazine. MoToR's manuals assure high standards of repair work.

### Same FREE 7-Day Offer Applies on MoToR's Truck Repair Manual

For mechanics, truck specialists, service stations, fleet owners. Covers EVERY job on EVERY truck made since 1933! 1403 pictures, 952 pages, 300,000 facts. Used by Armed Forces. Warranted to contain every essential fact you need to know. Strong binding size 8½ x 11.

Covers all types Gasoline Engines; Diesels and Hesselmans. Fuel Sys-

tems, Governors, Lubrication Systems, Ignition Systems, Starters, Generators, Clutches, Transmissions, Axles, Torque Dividers, Transfer Cases, Brakes, Steering, etc., etc.

Also services buses, farm and industrial tractors, contractor, and road building equipment, stationary power machinery, etc. (on all parts described in Manual.)

Offered on same FREE 7-Day examination as Auto Repair Manual. Check box in coupon at right.

### MAIL COUPON NOW FOR 7-DAY FREE TRIAL

MoToR Book Dept., Desk 1D, 572 Madison Ave., N. Y. 22  
Rush to me at once: (Check box opposite book you want)

- MoToR's AUTO REPAIR MANUAL. If O.K. I will remit \$1 in 7 days; (plus 35c delivery charge), then \$2 monthly for 2 months, and a final payment of 95c a month later. (Foreign price, remit \$8 cash with order).
- MoToR's TRUCK REPAIR MANUAL. (Desc. "bed at left.) If O.K. I will remit \$2 in 7 days, and \$2 monthly for 3 months, plus 35c delivery charge with final payment. Otherwise I will return book postpaid in 7 days. (Foreign price, remit \$10 cash with order.)

Print Name.....Age.....

Print Address.....

City..... Zone No. (if any).....

State..... Occupation.....

Check box and SAVE 35c delivery charge by enclosing WITH COUPON entire payment of \$5.95 for Auto Repair Manual (or \$8.00 for Truck Repair Manual). Same 7-day return-refund privilege applies.



# Learn RADIO -TELEVISION



## in the GREAT SHOPS OF COYNE

Get ready for a better job, bigger pay NOW in Radio. Cash in with "All-around" knowledge of Radio—Television. Train on actual equipment. You learn easily at COYNE because it's real shop training. Thousands of graduates in Industry.

### Not a "Home-Study" Course!

You get actual shop work on full-size equipment plus necessary theory. Whether you had previous experience or not makes no difference at Coyne.

### Easy To Start Own Shop

Right along with our course, we include special training on how to operate your own Radio Shop.

### GI Approved—Finance Plan for Non-Vets EARN WHILE LEARNING

If you need part-time work to help out with living expenses while at Coyne we'll help you get it. Don't be held back by lack of money. Free employment service to graduates.

### SEND FOR FREE BOOK

Get the facts! BIG FREE BOOK tells about your future in Radio and Television and how you can prepare at Coyne. Dozens of pictures. No obligation—no salesman will call.

Established 1899

### MAIL COUPON TODAY!

B.W. COOKE, President  
COYNE Electrical and Radio School  
500 S. Paulina St., Dept. 48-3H, Chicago 12, Ill.

Please send me your Big Free Radio and Television Book and all the facts.

NAME.....

STREET.....

CITY..... STATE.....

### COYNE

Gives You All-Around Radio Training

RADIO MFG.  
TELEVISION  
FREQUENCY MODULATION (FM)  
RADIO SERVICE (Your own shop)  
SOUND SYSTEMS



## RACE 'EM FOR FUN

GENUINE PHOTOGRAPHS  
TAKEN AT THE TRACKS

YOU DEVELOP THEM

PLAY THE RACES



THE NATIONAL PASTIME

### 20 REAL RACES IN EACH PACK!

Be FIRST with this racy, racetrack novelty! Pack contains 20 actual Photos of real races—but here's the trick: They're PLAIN until you use the magic paper included. INSTANTLY, a winning horse appears! Place bets on back of cards. You'll GO for these!! Only \$1 prepaid—3 Packs, \$2.50. (Write for wholesale prices).

DEPT. PM2 STAR SPECIALTY CO. BUTLER, PENNA.

## NEW EASY WAY TO MAKE MONEY @ HOME

Your cost only 5c

You get \$5.00.

Full or spare time.

It's easy to Bronze Baby Shoes. Business still in infancy. Get in on ground floor and skim cream of profit from rich and never-ending market. No experience needed. Learn in one week. Income up to \$1,000 a month full time—\$50 to \$75 weekly in spare time. We furnish complete kit and full instructions. Simple as A B C to become an expert.

FREE FACTS. Write today. Don't send a penny. Just name and address in letter or post card. Be the first in your territory to reap rewards waiting. Costs only 5c to bronze shoes. Sell for \$5.00! This is too good to miss. Get facts today. Write to

KIKTAVI COMPANY

Dept. 21, 8620 So. Ruthelen Los Angeles 44, California



## NOW! YOU OR ANYONE CAN HAVE HOT WATER QUICK!

NEW PORTABLE  
POCKET-SIZE WATER HEATER

Costs only \$2.95

### BOILS WATER SUPER-FAST

Merely place a BOIL-QWIK Portable Electric Water Heater in a receptacle containing water. Plug in the nearest socket... Eureka! In a few minutes HOT WATER. Heats a sufficient quantity for bathing, washing dishes, and clothes, shaving, cleaning cream separators, pails, etc., the speed depending on quantity. No fires to build, hot water to carry, or running up and down stairs. Economical! Handy! Inexpensive! Complete directions accompanies each heater. SEND NO MONEY! Just your name and address. When your heater arrives pay postman only \$2.95 plus C.O.D. and postal charges. Satisfaction GUARANTEED or return within 10 days for refund of full purchase price.

THE ZEVEK CORPORATION, Dept. 49-D  
25 East Lake Street, Chicago 1, Illinois





### HOME BARS 25 DESIGNS

HOME BARS for genial hosts. Fun to make and use. 25 designs... built-in, portable bars; celtarettes, only \$1.00. Send currency or check today. Money-back guarantee.

DEPT. P-112  
7241 Madison Kansas City 5, Mo.

## RUPTURE SUFFERERS GET RELIEF



Get comfortable, safe relief with scientific support Soft, sanitary material gives natural support with real comfort to active wearers. Satisfaction guaranteed. For free literature write:

WEB TRUSS CO.

Dept. M-8, Hagerstown, Md.



GET INTO

# DIESEL

AND

**STOP** worrying about the future. **LOOK** at these students and **LISTEN** to what graduates of the Hemphill Diesel Schools have to say:

*"From the training that I received at Hemphill Diesel School I secured a civil service position."* — Alexander C. Hanson

*"I am senior partner in 'Canadian Marine Service.' We have offices in Halifax, N.S., Brielle, N.J. and the main office and yard in Miami."* — J. R. Hicks



*"I have found that the experience I got at the school has proved very helpful at all times. After five months I was promoted to Third Assistant Engineer."* — John Henry

*"I wish to thank you for the education I received which so enormously helped me attain my Marine Engineers License."*

— Arne Maki

*... responsible for my securing a position as mechanic with the Triboro Coach Corp."* — Joseph M. Kelly

Similar opportunities are open to you. Prepare for them now by getting your Diesel training the famous "Hemphill way." You can learn at home during spare time or get practical training at schools listed below. Mail the coupon for free booklet which describes many types of Diesel engines and applications and the tremendous growth of this great industry.

## HEMPHILL Diesel Schools

*Approved for Veterans*

America's Original Exclusive Diesel training institution. Resident schools located in following cities.

New York, 31-28 Queens Blvd., Long Island 1, N. Y.

Memphis, 311 South Main St., Memphis 3, Tenn.

Los Angeles, 1601 S. Western, Los Angeles 6, Calif.

**--- MAIL COUPON TODAY ---**

HEMPHILL DIESEL SCHOOLS - Dept. PM-48  
1601 S. Western Ave., Los Angeles 6, Calif.  
Please send me free booklet. I am interested in Home Study  Resident training in New York  Memphis  Los Angeles

Name.....Age.....

Street.....

City.....State.....

Veteran.....Non-veteran.....

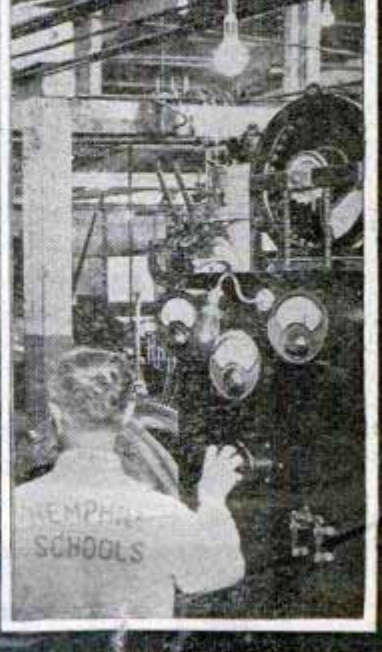



# Learn A Trade NOW! PRACTICAL SHOP TRAINING!

## In Our Chicago Shops

- |                                           |                                              |
|-------------------------------------------|----------------------------------------------|
| <input type="checkbox"/> AUTO MECHANICS   | <input type="checkbox"/> WELDING—ARC and GAS |
| <input type="checkbox"/> DIESEL MECHANICS | <input type="checkbox"/> MACHINIST           |
| <input type="checkbox"/> REFRIGERATION    | <input type="checkbox"/> PIANO TUNING        |

One of America's Leading Practical Schools  
7 Floors of Fully Equipped Shops  
Over 45,000 Graduates  
Expert Individual Instruction  
Learn by Doing—Low Living Expense  
Established 1902—Day and Evening Classes  
Above Approved For G. I.'s and Civilians

- BODY-FENDER

## Also the following Home Study Courses

- |                                  |                                        |                                 |
|----------------------------------|----------------------------------------|---------------------------------|
| <input type="checkbox"/> PLASTIC | <input type="checkbox"/> REFRIGERATION | <input type="checkbox"/> DIESEL |
|----------------------------------|----------------------------------------|---------------------------------|

— CALL IN PERSON OR MAIL THIS AD TO —

## GREER SHOP TRAINING

(Dept. PM-248) 460 South State St., Chicago 5, Ill.

Please send without obligation free information regarding trade checked above. (Specify whether you are a Veteran  or Civilian )

Name \_\_\_\_\_ Age \_\_\_\_\_

Address \_\_\_\_\_

City \_\_\_\_\_ State \_\_\_\_\_

# INVENTORS

When you are satisfied that you have invented a matter of value—write me, without obligation, for full information as to what steps you should take to secure a Patent or Trademark.

The usual first step is to have a search of the prior U. S. Patents conducted, so that I can report to you on the question of Patentability.

## PATRICK D. BEAVERS

(Formerly RANDOLPH & BEAVERS)

Registered Patent Attorney

934 Columbian Building Washington 1, D. C.

**PATRICK D. BEAVERS, Registered Patent Atty.**  
934 Columbian Bldg., Washington 1, D. C.

Please send me full information on how to secure Patent Protection.

Name \_\_\_\_\_

Street \_\_\_\_\_

City \_\_\_\_\_ State \_\_\_\_\_

## Famous BAILEY DIESEL SCHOOLS Now Accepting CIVILIAN STUDENTS!

Bailey has a national reputation for "finest training methods." Bailey teaches you fundamentals, plus the practical application of theory in plenty of actual shop work. Bailey is approved by industry. Bailey graduates get the jobs!

Civilian men and boys over 17 who are ambitious to get ahead will act now. Send for FREE catalog. No salesman will call.

## BAILEY TECHNICAL SCHOOLS

1655 So. Grand Blvd., St. Louis, Mo.



## 48 PLANS

\$100

48 complete plans of toys, ash trays, garden ornaments, Dutch boys and girls, what-not shelves, and many other interesting projects. Finest selection available. Novel method allows you to make finished project any size desired. PLUS FREE De-Luxe Plan of corner shelves. Send only \$1 to

Jackson, Dept. 3D-5440 N. Shoreland Ave., Milwaukee 13, Wis.

## Get Ready for Big Opportunities!

*Engineer Dobe*

### TOOLS AND EQUIPMENT SENT WHEN YOU START

Get a better job with more pay and pleasant working conditions. Get into Drafting — where all products start. I will train you at home — give you experience — on the same kind of jobs you will do with the best paying firms. I furnish instruments and all equipment when you start. Write today for vital facts and FREE book. Give age.

ENGINEER DOBE • Div. 14 • Libertyville, Ill.

I Will Train You at Home  
Until You Get a

## GOOD PAY JOB in DRAFTING

# PATENTS

## AND TRADE MARKS

### C. A. SNOW & CO.

REGISTERED PATENT ATTORNEYS

WRITE FOR INFORMATION TO

428 SNOW BUILDING, WASHINGTON 1, D. C.

# PATENTS

*"Proof of Invention"*  
Folder mailed without obligation.

## E. E. VROOMAN, Registered Patent Atty.

871 Woodward Building, Washington 5, D. C.

# INVENTORS

If you wish to protect your invention, you should take steps to protect it by a U. S. Patent. Write me for "Record of Invention" Form.

## CARL MILLER

### REGISTERED PATENT ATTORNEY

Woolworth Bldg., 35th Floor, Dept. 48A, New York City  
Please send me "Record of Invention" form.

NAME \_\_\_\_\_

ADDRESS \_\_\_\_\_



# DO ANY JOB EASIER MAKE MORE MONEY

Used by Army, Navy, Other Government  
Depts., 200 Schools and Industrial Firms.

Mail Coupon

**FREE TRIAL** in Your Home.  
Send No Money!  
We Ship C.O.D. in U. S.  
and Will Refund Money  
if Not Satisfied.



# Get Ready for BIGGER OPPORTUNITIES and BEST PAYING JOBS

Do it now! Get the better pay that goes to men with specialized knowledge. Get into one of these big opportunity fields. Big money and many other advantages await you if you prepare now. Here is the help you need—EASY—QUICK—AT LOW COST. Thousands of men have already used these famous books. Beginners and experienced men alike have doubled and tripled their earnings with this help. You too, can now get the special knowledge you need for top pay, better jobs, or a business of your own. This is your **GOLDEN OPPORTUNITY**.

## AIR CONDITIONING

Big air conditioning boom interrupted by war now bigger than ever and alive with new opportunities! Get this non-technical book by international authority and be ready for your share of millions to be spent. Covers whole field. 450 pages. Illustrated. \$4.00.



## MODERN WELDING PRACTICE

Newest book on all types of welding and heat treatment of metals. Written by recognized specialists in training men for production jobs. **Practical and Non-Technical.**

430 Pages  
277 illus.  
Practical and Non-Technical

Covers everything you need to know. Prepare for best pay jobs now. Price \$4.00.

## SHEET METAL LAYOUT

Makes sheet metal layout work so simple that anyone can learn. Get this new instructor and get into the easiest, cleanest and best paying part of all sheet metal work. 143 jobs worked out in drawings and carefully explained. Gives standard for all sheet metal fittings. \$3.50.

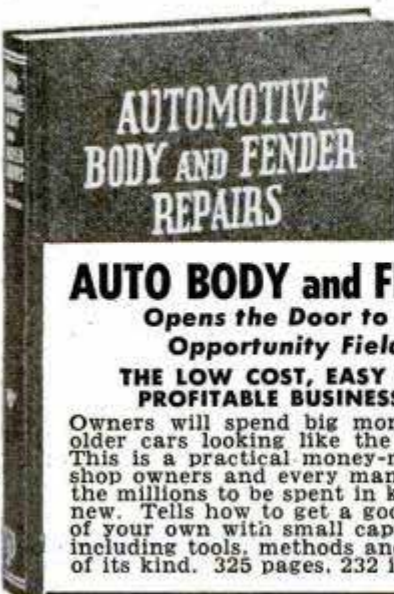

## AUTO BODY and FENDER REPAIR

Opens the Door to One of the Big Opportunity Fields of the Day

**THE LOW COST, EASY WAY TO A GOOD PROFITABLE BUSINESS OF YOUR OWN**

Owners will spend big money to keep their good older cars looking like the new ones coming out. This is a practical money-making guide, ideal for shop owners and every man who wants a share of the millions to be spent in keeping old cars looking new. Tells how to get a good job or start business of your own with small capital. Covers everything including tools, methods and materials. Only book of its kind. 325 pages. 232 illustrations. \$3.50.

## HOUSE WIRING LATEST EDITION

Get this sixth edition of this standard and practical electrical wiring book. It gives complete practical instruction on every phase of house wiring in one handy volume. Goes further than most books on subject. Hand-book style. Gives National Electric Code, 400 pages, 669 illustrations. Electrical work will reach a new high with millions of new homes to be built. Get started now. \$3.00.

## DYKE'S FAMOUS CARBURETOR BOOK

This famous book has been the standard guide in the best paying auto work for a generation. It has helped thousands of men make money. New edition covers engine tune-up, compression, ignition, carburetion, fuel pump valves, etc. Use this book to specialize in this big field. 244 pages. 549 illustrations. \$3.50.

## Modern Gas and Electric REFRIGERATION

New Printing—Almost 1000 Pages,  
408 Pictures, 17 Diagrams in Colors

The Book of the Hour

Thousands of Refrigerators need repairs! Owners will pay big for competent service. Get this non-technical guide to all types of refrigerators and get your share of this new profit. Get a job or start your own service business. This book will help you make money anywhere. Price \$5.00.

Make Big Money  
Keeping Old Cars  
Looking New. Get  
This Book Today!

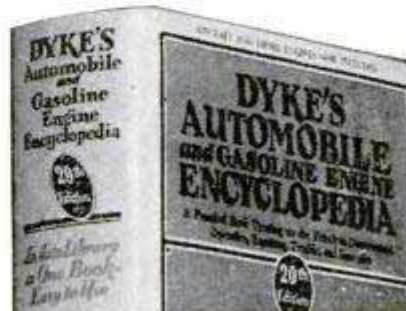

**BIG 20th EDITION**  
Leading Auto Book for Over 36 Years

## World's Greatest AUTO BOOK

New Material on Transmissions, Trucks, Tractors, Diesels, Aircraft and Auto Engines

Now with millions of cars needing repairs and thousands of men needed to do the work, you need the famous DYKE Auto Book more than ever before. This big 20th Edition covers all principles, construction, repair, adjustments, testing, troubles and remedies of all cars. Over a half million copies of 20 editions of Dyke's have been sold. Gives specifications of old and newer cars. World's biggest book value. \$7.00. This big book, a complete auto library in one volume, has 1483 pages—4600 illustrations and diagrams—weighs 6 lbs.—equal to 4 ordinary books.

## BAILEY'S HANDBOOK For Engineers and Firemen

World famous handbook of universal questions and answers for Stationary, Marine and DIESEL engineers and firemen. Prepares for any license examination. This is the one book that men should have if they want to reach the top in installation, maintenance and operation of Diesel and steam plants. Pocket size, \$2.00.

**Goodheart-Willcox Co., Inc.**  
2099 S. Michigan Ave., Dept. 14, Chicago 16, Ill.

**SEND NO MONEY! Mail Coupon**

**GOODHEART-WILLCOX CO.,**  
2099 S. Michigan Ave., Dept. 14, Chicago 16, Ill.

Send books checked, C.O.D. I will pay postman, plus few cents charges. If not satisfactory I will return books in 5 days and you will refund money paid. (Outside U.S. or possessions remit with order.)

- |                                                                        |                                                            |
|------------------------------------------------------------------------|------------------------------------------------------------|
| <input type="checkbox"/> Gas & Electric Refrigeration . . . . . \$5.00 | <input type="checkbox"/> Air Conditioning . . . . . \$4.00 |
| <input type="checkbox"/> Dyke's Auto Book . . . . . \$7.00             | <input type="checkbox"/> Engineers Handbook . . . \$2.00   |
| <input type="checkbox"/> Dyke's Carburetor Book . \$3.50               | <input type="checkbox"/> Body and Fender Repair . \$3.50   |
| <input type="checkbox"/> Modern Welding . . . . . \$4.00               | <input type="checkbox"/> Shop Math. (2 vols.) . . . \$3.00 |
| <input type="checkbox"/> Airplane Welding . . . . . \$3.50             | <input type="checkbox"/> House Wiring . . . . . \$3.00     |
| <input type="checkbox"/> Sheet Metal Layout . . . \$3.50               | <input type="checkbox"/> A.C. Power Wiring . . . \$4.00    |
|                                                                        | <input type="checkbox"/> D.C. Power Wiring . . . \$4.00    |

If remittance accompanies order we will pay all postage charges under same return privilege.

Name \_\_\_\_\_  
Address \_\_\_\_\_  
City \_\_\_\_\_ State \_\_\_\_\_



# The Handy-Sized Merriam-Webster

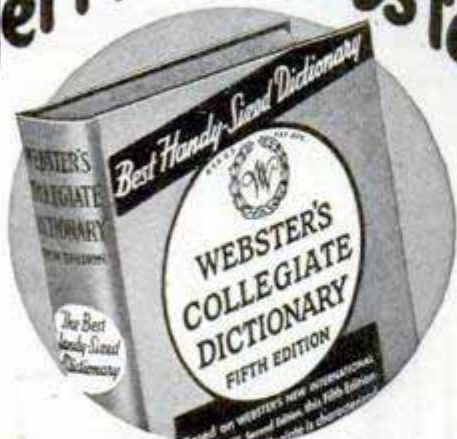

**WEBSTER'S COLLEGIATE** is the most dependable handy dictionary for home and office because it is a compact abridgment of the famous *Webster's New International Dictionary, Second Edition*—"The Supreme Authority." Defines all the words most commonly used. 1,300 pages; 110,000 entries, \$5 to \$10, depending on binding. Ask your bookdealer.

G. & C. MERRIAM CO., SPRINGFIELD 2, MASS.

Buy Give-a-Book Certificates at Your Bookseller



## WANT A GOVERNMENT JOB?

**START as high as \$3,021 Year**  
Prepare NOW For Next Examinations

### VETERANS GET SPECIAL PREFERENCE

Many Early Appointments Expected  
City Mail Carriers  
City Postoffice Clerks  
Ass't Statistical Clerks  
Stenographers-Typists  
Storekeeper—Gaugers, Etc.

32-Page Civil Service Book  
**FREE**

Mail Coupon today—**SURE**



COUPON

### FRANKLIN INSTITUTE

Dept. A86  
Rochester 4, N. Y.

Rush to me, entirely free of charge, 32 page book with: (1) A full description of U. S. Government jobs; (2) A list of U. S. Government jobs; (3) Tell me how to qualify for a job.

Name \_\_\_\_\_

Address \_\_\_\_\_

Vet? \_\_\_\_\_

HERE'S

*Fun*

AT YOUR FINGERTIPS

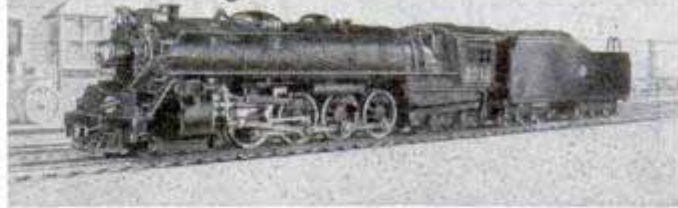

Now EVERYONE can enjoy

## RAILROADING IN MINIATURE!

Build true reproductions of famous trains that are actual working models! Our "00" Gauge kits are especially scaled for home use where layout space and time are limited. Yet these kits are as accurate in detail as our larger model, the "0" Gauge. Kits contain every part needed to build the model with only common tools. Made of fine materials, rugged, realistic . . . Scale-Craft Model Railroading kits provide a challenging, thrilling hobby. The Scale-Craft Catalogue and Data Book fully describes layouts, types of kits and model railroad practice, with room to add supplemental information, and costs only 25c U. S. coin postpaid.

Send stamp TODAY for your How to Begin folder. Address Dept. M-4



**SCALE-CRAFT & CO.** 1731 N. HIGHLAND AVE. HOLLYWOOD 28, CALIF.

# MAKE \$ MORE MONEY

Applying or Selling

## CORKSTONE

A General Purpose Magnesium Oxychloride Flooring

### THE MODERN PLASTIC FLOORING

**EASY TO APPLY**  
Here's your opportunity to get into business for yourself applying or selling Corkstone, the economical, top-grade plastic flooring. Plenty of profit Act without delay!



### Dealers & Agents Wanted

WRITE FOR DETAILS

### LASTING PRODUCTS COMPANY

Franklinton Road Plant,

Baltimore 23, Md.



**WORLD'S  
BEST  
WANT AD  
MEDIUM**

# CLASSIFIED Advertisements



Advertisements in this section 75 cents per word, each insertion, minimum 10 words, payable in advance  
To be inserted under proper classification, copy must be in our office the 22nd of the  
second month preceding date of issue

F. W. Johnson, Manager, Classified Advertising  
Popular Mechanics Magazine, 200 East Ontario Street, Chicago 11, Illinois

**1204**

**CLASSIFIED  
ADVERTISEMENTS**

**1204**

**OPPORTUNITIES  
FOR YOU**

## AUTOMOBILES, MIDGET CARS

**"VAPO-STEAMATIC"** Water injection. Thousands using this famous automatic system. Easily assembled (for less than \$1.00). Saves gasoline. Engineering triumph—up to 33 miles per gallon! Burns 15% water! Reduces wear. Greatly increases horsepower! Speed! Prevents knocking, overheating. Eliminates carbon. Smoother performance! Copyrighted "Installation Handbook." Also "Injectors"—tractors, lightplanes, trucks, motorcycles. Including "Mileage Secrets"—gas savers, economizers! Carburetion! Power methods! Tricks! Illustrations! Lists! \$1.98. Newhouse Industries, 5941-B1 Hereford, Los Angeles 22.

**BRITISH Cars.** New, unique book illustrates, describes 34 British postwar cars, all makes, models, 67 beautiful photographs. A real catalog. Just out. \$2.00, deluxe edition \$3.00 postpaid. Clymer, Dept. A-PW, 2125 W. Pico, Los Angeles 6, Calif.

**"STREAMLINED Roadster"**—Speedy two passenger automobile! Beautiful! Practical! Sporty! Unbelievably easy construction from scrap parts; small motor! Instruction kit plus handbook showing midgets. "Motor-ette," racer blueprints, photographs. \$1.98. Alquist Engineering, Milford 7, Pennsylvania.

**RACE Driver History.** Complete information every driver competing Indianapolis "500," 1911 to present. 313 drivers performance records every year alphabetically arranged. \$1.50 postpaid. Clymer, Dept. A-RD, 2125 W. Pico, Los Angeles 6, Calif.

**"SPEED And Power"** handbook—Very latest methods! Construct your own superchargers, water injectors, compression heads, fuel saving devices—easily, practically without cost. Get racing speed, acceleration, dynamic power increases from any automobile! Build stock conversions! Fast roadsters! Hotrods. Ingenious formulas! Speed secrets! Fuels. Lubricants. Get "Economy Information"—tuning techniques! Ignition! Carburetion! Mileage tricks. Literature! Illustrations! Including "Restyling Ideas"—streamlining. Model revising! Customizing! Sport changes. Accessories! Parts lists! Drawings! \$1.98 complete. Newhouse Industries, 5941-B1 Hereford, Los Angeles 22.

**"CUSTOM Styling"** manual—Easily make car look Hollywoodized, custom, ultra-beautiful by quick inexpensive methods! 100 photographs, instructions on customizing, restyling, streamlining—new and old cars. Also model, sport, conversions; accessories; mufflers; engine "soup up" specifications! \$2. Alquist Engineering, Milford 7, Pennsylvania.

**CLYMERTONE.** Twin muffler sets, beautiful sound, complete with necessary welded pipes, E-Z installation. Ford V-8, \$20.00. Chevrolet set with split manifolds, \$37.50. Specify car model. Clymer, Dept. A-44, 2125 W. Pico, Los Angeles 6, Calif.

**HIGH Compression heads.** V-8. More speed, acceleration, power. Offenhausser or Edelbrock \$75.00 complete set. Dual manifolds complete with throttle kit, fuel lines. Edelbrock \$49.00, Offenhausser \$55.00. Give make, model V-8. Catalog 10c. Clymer, Dept. A-43, 2125 W. Pico, Los Angeles 6, Calif.

**PROFESSIONAL Midget racer, motor-scooter, midget roadster, midget motorcycle.** Plans, specifications contained in illustrated handbook. 25c. Directory bargain priced used motors, motorscooters, servicycles, etc., included free! Midwest, 3839 Drummond, Toledo, Ohio.

**DUALTONE** Chrystaline packed, California mufflers, single or twin for all automobiles. Carburetor velocity stacks. Compression cylinder heads. Dual manifolds. Large double or single chromed tailpipe extensions. Chromed station wagon stacks. Fender skirts. Request catalogue. Openings for established dealers. Dualtone Mufflers, 2636C India Street, San Diego 1, California.

**"SPEED & Mileage"** Manual—Obtain greater speed, mileage, racing performance from any automobile! Shows "simplified speed tuning." Mileage secrets. "Soup-up" tips! Instructions on building speed equipment, economizers, mufflers, "water injectors," manifolds, superchargers, fuels, heads, "hotrods," fast conversions, engines! Also "Hollywood customizing" information, photographs, parts lists! \$1.98. Alquist Engineering, Milford 7, Pennsylvania.

**CALIFORNIA** Speed equipment, doll 'em-up accessories, dual, single, mufflers, skirts. Save freight from California. Midwest warehouse. 25c for catalog. Von Esser's, 2840 No. Kedzie, Chicago 18, Ill.

**KAISER-FRAZER.** Floyd Clymer's new book (no connection with Kaiser) gives uncensored, impartial report 3000-mile test including Pikes Peak, Kansas City-Denver record runs, economy test. Part by part equipment analysis. Good, bad comments, no punches pulled. \$1.50 postpaid. Clymer, Dept. A-41, 2125 W. Pico, Los Angeles 6, Calif.

**FROM** Speedway to roadway! Track-proved hi-speed heads and manifolds now available for your passenger car! No special tools needed! Increase horsepower 25%! Astounding getaway! Free illustrated catalog. Speedsport, 5747AA Waveland, Chicago 34.

**ELECTRIC** Power kit for midget car consisting of war surplus hydraulic transmission, electric motor, and fittings. Delta Sales, P.O. Box 968, Shreveport, Louisiana.

**GERMAN** Photos—Opel rocket racer. Auto Union. \$1.00 each. Webb, 1730 Langston Ave., Atlanta, Ga.

**NO. 4** Clymer Historical Scrapbook. Entirely new, different. 224 pages, advertisements, photographs 250 early automobiles, motorcycles. \$1.50, deluxe edition \$2.50 postpaid. Clymer, Dept. A-48, 2125 W. Pico, Los Angeles 6, Calif.

**ENGLISH** Magazines: yearly rates. Autocar weekly \$7.50. Automobile Engineer monthly \$8.00. Commercial Motor weekly \$7.00. Motor weekly \$7.00. Motor Sport monthly \$3.50. The International News Company, 131 Varick St., New York 13, N. Y.

**SEE** Our ad under motorscooters for midget car bargains. Midget Motors Directory, Athens, Ohio.

**INTERCHANGEABLE** Parts book. New book tells every automobile part that interchanges with others. Same parts many times vary 100% in price. This book enables garages, mechanics, dealers, owners to buy under cheapest listing. Tremendous savings for users. \$15.50 postpaid. Clymer, Dept. A-1P, 2125 W. Pico, Los Angeles 6, Calif.

**BUILD** Your midget race car. Get in the racing game, win big money. Send today for complete set of plans \$2.00. Leon's, Dept. 15, 215 Carl Bldg., Independence, Mo.

**BRITISH** Sports cars. New book. 96 makes described. Fine illustrations, specifications. \$2.00, deluxe edition \$3.00 postpaid. Clymer, Dept. A-47, 2125 W. Pico, Los Angeles 6, Calif.

**FORD** Racing manifolds. The famous Columbia Ford racing manifolds, increased speed and efficiency for 60'-85' Fords and Mercurys. Now only \$32.50 for 85' Fords and Mercurys. \$27.50 for 60' Fords. Write for free circular. P. O. Box 2372, Portland, Oregon.

**SAVE** Gas. Use water injection, get 5 miles more per gallon. More power and pickup. Easy to install. Send \$6.00 for yours today. Water Injector, 6126 Harlandale Station, San Antonio, Texas.

**DON'T** Buy any car until you read "Buyer's Manual"! Fully copyrighted charts, instructions, etc., expose dealers' secrets. \$1.00 postpaid. Groben, 21A Lansing, Auburn, New York.

**GREASE** Car yourself. Illustrated conversion system. \$2. Rodd, Trona, California.

**1948 SUPERIGNITIONER.** Atomic starting, pep, mileage. \$5.50. EG Mfg. Co., New York 55.

**HOT-ROD** Enthusiasts. Get a reflecting license plate emblem. Replica of hot rod in red, yellow, or blue. \$1.00 ea. postpaid. Speed Specialties, Box 5983, Dept. A, Indianapolis, Ind.

**FORD-MERCURY** Owners 1941-1947, operate your dome lights from both front doors. \$2.50. Free literature. Danby Manufacturing Company, Portland, Michigan.

**GREATLY** Increase gas mileage! Latest copyrighted "Economy Tuneup" tells how. No gadgets. Proven, simple facts. \$1.00. Huff Engineering, 10230 San Carlos, South Gate, Calif.

**SPEED** Equipment. Marine and automotive. We have only the best, made by leading southern California manufacturers including—Edelbrock, Meyers, Weiland, Winfield, Jahns, Offenhausser, etc. Complete line of high compression heads, dual manifolds, racing pistons, camshafts, dual ignitions, etc. Send 25c for illustrated catalog. So-Cal Speed Shop, 1104 S. Victory, Burbank, California.

**FORD** And Mercury owners. Attention! Give your car that knee-action ride. Restore arch to flat springs. Eliminate sideways. Free literature. Supertone Mufflers, 2470 E. Slauson, Huntington Park 3, Calif.

**R & R** Mfg. Co., Robert M. Roof, Anderson, Ind., Auto and Marine Division. Complete line of speed and power equipment for hydroplanes, race cars, and midgets. Motor rebuilding instructions and price list \$1.00.

**BUILD** Speedy midget track racer from castoff parts! Plans, specifications, construction information, \$1.00. Motor Supply, Box CS-1682, Toledo, Ohio.

**CUSTOMIZE** Your automobile! Revised, enlarged book, latest restyling, complete, sharp. 50 photographs! \$1 pp. Post Publications, Box 723-SE, Arcadia, California.

**AUTOMOBILE** Racing book, fifth edition, well illustrated. Instructions on building bodies, frames, engines. Ford A and B conversions. Plans. AAA rules, specifications. Roadster racing. Indianapolis cars. \$1.00 postpaid. \$1.30 C.O.D. Ray Kuns, Dept. 47, Madisonville, Cincinnati 27, Ohio.

**HOT-ROD** Manual, fast Fords, photos, instructions. \$1.50. Airmailed \$1.75. Racing parts list 25c. Hollywood Hot-Rod, Los Feliz, Box 9626P, Hollywood 27, California.



**AUTOMOBILE Racing, Sixth Edition.** 100 illustrations. Working drawings with building instructions for Ford-60 midget, California roadster, Offenhauser racer. Details on racer parts. Sample entrance blank. World's record 158.5 m.p.h. rear engine four-wheel drive car. Interesting information for fans, drivers, mechanics. \$2.00 postpaid; \$2.25 c.o.d. Ray Kuns, Department 63, Cincinnati 27, Ohio.

**CUSTOM-CAR Photograph album.** Fascinating automobile style classics. Coachcraft, Summers, independents, photo-packed! \$1 pp. Post Publications, Box 723-AE, Arcadia, California.

**MAKE Your Ford fast!** Complete details, photographs. How to construct 120 m.p.h. Hotrod. \$1 postpaid. California Bill, Box L-1, Eaglerock, Los Angeles 41, Calif.

**USED-CAR Buyer's Handbook.** Save dollars, grief. Photographs, dealers' tricks, complete tests. \$1 pp. Post Publications, Box 723-TE, Arcadia, California.

**INSTALL V-8 engine in your Model A** for extreme acceleration, more top speed, smoother performance. Complete details, photographs. \$1 postpaid. A-V-8, Box L-1, Eaglerock, Los Angeles 41, Calif.

**MAKE Your Model "A" do 100 m.p.h.** Lightning acceleration, breath-taking top speed. Complete details, photographs. \$1 postpaid. Four Barrel, Box L-1, Eaglerock, Los Angeles 41, Calif.

#### AUTO SUPPLIES AND EQUIPMENT

**FREE Trial in your car:** Order Gane Air Flow Needle today: \$1.50 postpaid. Ten day money back guarantee, if not satisfied. For all cars, trucks, tractors; state make of car, truck, tractor; make of carburetor. Advanced Automotive Products, 563-2 Lake Road, Webster, N.Y.

**CAR-BED.** Make it yourself. Inexpensive. Fits any 2 or 4 door sedan. Plans \$2.00, easy to follow. Martins, Box 297, Upper Darby, Penna.

**GRILLES** For all cars; 1940 Plymouth shells. Wagner Grille Co., Route 2, Bernville, Penna.

**BURN Water in your car.** Costs less than gas. More power, cleaner motor. Mail card for data on \$17.50 Octa-Gane Water Injecting Carburetor. Advanced Automotive Products, 563-2 Lake Road, Webster, N.Y.

**BATTERY Cement.** "Fixes cracked batteries." Saves money! Batteryman, Grand Junction, Colorado.

**"POWERIZER" Water Injector;** increases speed, acceleration, mileage to 30%. Easily assemble yourself for few cents! Sensational performance! Reduces wear, knock, oil pumping! "Installation Manual" includes "hop-up" tips. \$1. Almqvist Engineering, Milford 7, Pennsylvania.

**MENDALL Metal** permanently repairs cracked motor blocks, heads, scored cylinder walls, water jackets, radiators, porous welds, inside leaks, etc. Blow torch only tool needed. Positive guarantee. Special limited offer, send \$1.00 now for full bar, prepaid, with instructions. 4 A Products, Department 11, Littleton, Colorado.

**"NEW-LOOK."** Makes cars look new. Free sample. Walker, Box 394, Union, N.J.

**NIGHT-DRIVING Bugaboo ended.** Amazing new Nite-Lite driving eye-glasses stop blinding headlight glare of oncoming cars. See everything more clearly. Colors look bright and natural. Issued to police of many states and cities. Fulvex lenses with gold-plated frames—\$8.50. C.O.D., check or money order. Orders shipped postpaid anywhere in United States. Nite-Lite Sales Company, Dept. 1, 315 North Seventh Street, St. Louis, Mo.

**WANTED—Stoddard-Dayton automobile** and literature. L. R. Lohr, 1401 Ridge, Evanston, Ill.

**READY-MADE Convertible tops.** Easily installed. Reasonable prices. Free literature. Rio Top Company, 1370 Roanoke, Newport News 4, Virginia.

**WELDING Bodies,** repairing fenders pays good profits. Easy with Hobart a.c. welder. Catalog free. Write Hobart Welders, Box M-482, Troy, Ohio.

**WELDERS** For all requirements. Free catalog. Write Hobartweld, Box M-483, Troy, Ohio.

**VAPOR Injection** for cars. Faster get-away, improved climbing. Wartime development eliminates knock, carbon. Installs 10 minutes. \$3.98 plus postage. Radar Products, 140-27 169th St., Jamaica 5, N.Y., Dept. FM1.

**AUTOMOBILE Grilles—New.** Buy from authorized factory distributor. Write immediately for our low prices. Grove Auto Supply, 4854 Cottage Grove, Chicago.

**AUTOMOBILE Shatterproof glass!** Rubber mats! Shock absorbers! Direct factory savings. Write requirements. Immediate quotations. Cooper's, 3135 Lawrence, Chicago 25.

**BRUSHLESS Auto enamel.** \$3.75, postpaid. Very best, guaranteed. Distributors wanted. Cover-Nu, 1911-N, Lubbock, Texas.

**DRIVERS** That smoke—Avoid dangerous cigarette fumbling. "Pres a life" automatically hands you a lighted, ready to smoke cigarette; easily clamped to steering column; compact yet holds 23 cigarettes; complete only \$6.95 prepaid or c.o.d. plus postage. Literature 10c. Robert Theis, Rydal, Pennsylvania.

**AGENTS—Make big profits** selling sheepskin wash mitts for washing cars, polishing, dusting. Write for sample. K. W. Fur Creations Co., Northampton, Penna.

**MOTORISTS** Save gasoline by Vacuumating overrich mixtures. Fits all cars. For free particulars write Vacuumatic, Dept. 1316, Wauwatosa, Wis.

**TIRE X — Instant tire inflator** and fire extinguisher. Handy, compact 2½ pound steel cylinder contains carbon dioxide gas under 800 pounds pressure. Will inflate three or more tires. Put out fires. \$4.95. Breakstone & Co., 2155 W. Harrison, Chicago 12.

**NEW 30 Ampere heavy duty generator** and voltage regulator only \$15.50. With a sealed beam light conversion kit for all cars, tractors and trucks only \$19.50. Generator and starter parts and armatures at 40% off list prices. Mail deposit and model information to Generator Service Co., 7059 Indiana Ave., Chicago 37, Illinois.

**GASOLINE Saving vacuum supercharger** \$12.50. Self addressed stamped envelope for pamphlet. McDowell, 2000 NE. Union, Portland 12, Ore.

**AUTO Parts, New or rebuilt.** Prompt shipment. Write requirements. Save money, buy direct. Factory Warehouse, Mechanics Auto Parts, 3807-PM North Ashland Ave., Chicago 13.

**AUTO Parts** for all cars, transmissions, motors, differentials, fenders, carburetors. Security Auto Parts, 1923-PM Grace, Chicago 13.

**GRILLES** For all cars. Meyers Auto Parts, 820 Dryades, New Orleans, La.

**NEW And used automobile and truck parts.** Lowest prices. Complete stock. Prompt reply. Babbitt Auto Parts, 2833 W. Chicago Ave., Chicago 22.

**PLATING Outfits** for auto parts. Connect to a battery. No tanks used. Free particulars and proofs. Gunmetal Co., Ave. J, Decatur, Ill.

**CAR Trouble?** Million new used parts. Describe needs. Automotive, 2928A North Western, Chicago 18.

**PROTECT Automobile tires** against flats. Avoid accidents. Save lives. The Tiresignal does it. Every automobile needs them. Five for \$2.00. Tiresignal, Dept. A, P.O. Box 1667, Los Angeles 28, California.

**SPRAY Paint** your automobile. Complete professional instructions, \$1.00. 155 Tasso, Palo Alto, California.

#### AUTO TRAILERS

**DESIGN** And build trailers up to 30 ft. Circular illustrating 10 designs, 20c. Craftsmann Books, Box 1153-TP, Milwaukee 1, Wisconsin.

**TRAILER Plan booklet—House, sport,** etc. with complete parts, accessory catalogue and book, "Trailer Building" \$1.00. Marine Mart, Buffalo 7b, N.Y.

**BUILD Your own trailer!** Save money! Have every feature you want! Plans for house, sport, camp and utility trailers. Catalog describing 9 models 10c. 15c in Canada and overseas. Jim Dandy, Box 125-A, Wausau, Wisconsin.

#### MOTORCYCLES, BICYCLES, MOTORSCOOTERS AND SUPPLIES

**MOTORCYCLE News,** monthly. Yearly subscription \$1.00. Latest worldwide information. Motorcycle News, 5424-A Sawyer, Chicago 25.

**BOYS.** Bicycle repair manual, "Illustrated." \$1.00. Klausner Cycles, Shelbyville, Illinois.

**FREE!** Illustrated folder custom motorcycle accessories. New seat covers, bright colors, molded cushions, \$6.75. Leather jackets, \$36.95. Chrome muffler-loudspeaker, \$15. Pacific Cycles, Dept. A5, 1208 Pine, Seattle, Washington.

**ASSEMBLE Sensational, clutch operated, motorscooter speedster yourself!** We furnish factory finished kits ready to bolt together. Rockbottom prices. Fork \$4.95, etc.! Complete plans, literature, 25c. Zipscoot, 3839 Drummond, Toledo, Ohio.

**MOTORIZED Your bike.** Easy, simple method. No welding, no cutting. Complete diagrams, instructions, pictures, all for \$1. Dunakin Shops, 819 Golf Lane, Wheaton, Ill.

**CUSTER Car \$25, Ner-A-Car \$35,** other midget cars as low as \$12; motorscooters \$10 up; Briggs Stratton engines \$3 up; motorbike conversion \$5; Whizzers \$30 up. Over 5000 tires \$1 up. Mailorder only. Send 25c for Big War-Bargain catalogue No. 24, just out, listing the above and almost 400 other bargains in new and used motors, motorscooters, midget racers, parts, plans, etc. (35c by First Class Mail). Midget Motors Directory, Athens, Ohio.

**PLAT Rate repair manual** for Harley-Davidsons. Gives flat rate charge for every operation. Every dealer, owner, mechanic needs this new book. \$2.00 postpaid. Clymer, Dept. A-FR, 2125 W. Pico, Los Angeles 6, Calif.

**MOTOR Scooters, bicycle engines.** 120 miles gallon. Dime for catalog. Clymer, Dept. A-45, 2125 W. Pico, Los Angeles 6, Calif.

**NEW 1948 Whizzer bike motor** now direct express prepaid \$97.55. Installed in Schwinn heavy duty spring fork bike \$164.50. \$20.00 with order, balance c.o.d. Lakeland Sporting Goods, Fort Atkinson, Wis.

**SCHWINN Bicycles.** All sizes. Wholesale. Retail. Send dime for list. Century Cycle, 3447 Lawrence, Chicago 25, Ill.

**BICYCLE Supplies,** wholesale, retail. List. 10c. Universal, 4713 Virginia, St. Louis, Missouri.

**CHROME Plating** on all motorcycle parts. Doll up your bike. Free literature. Master Silverplaters, 2033 Caniff, Detroit 12, Michigan.

**MOTORCYCLE Cams** ground for speed and power. Write Harold Schaller, Box 31, Turlock, Calif.

**MIDGET Automobile \$15,** Cushman motorscooter \$20, Indian motorcycle \$30, tires 75c. Send 25c for Spring catalog #940 listing sensational bargains in motorscooters, Servicycles, midget cars, used motors, parts. Associated, Box CS-1764, Toledo, Ohio.

**HARLEY-DAVIDSON Supplies,** parts, accessories, oil service, tires all sizes, repaired 45" motors. Send \$2.25 for Army Motorcycle Manual, 10c for bulletin. Knuth's (Harley-Davidson Dealers), 2491 Fondulac, Milwaukee, Wis.

**MIDGET Racer \$40,** Cushman motorscooter \$15, motorbike outfit \$15, Harley-Davidson motorcycle \$35. Send 25c for new catalog #12 listing amazing bargains in motorscooters, motorbikes, midget cars, motors, parts. Gail, 538 Erie, Toledo, Ohio.

**HARLEY-DAVIDSON Parts,** accessories, batteries, and tires. 24 hour service. Authorized factory dealer. Philadelphia Harley-Davidson Company, 857 North Broad Street, Philadelphia 23, Penna.

**WHEELS! Build wagons, scooters, mowers,** trailers, wheelbarrows, grocery carts, baby carts, play pens, baby carriages. 4" to 16". Free list. Trulsen Mfg. Co., 811 E. 31, Kansas City, Mo.

**TIRES And industrial wheels,** suitable for scooters, wheelbarrows, farm equipment, etc. All sizes. Bicycles and accessories. Largest assortment in America. Send dime for list. Cycle Transport Company, 1241 So. Michigan Ave., Chicago 5, Illinois.

**SCHWINN Bicycles,** new and slightly used. Send dime for pictures. Atlas, 3002 Broadway, Chicago 14, Illinois.

**MOTORCYCLISTS Chromium accessories.** New and reconditioned motors. Complete stock Indian parts. Expert motor rebuilding. Indian Motorcycle Sales, Kansas City 1, Missouri.

**BICYCLES, Tricycles,** parts, accessories. Send 10c for bulletin. Propp's, 2202 Fondulac, Milwaukee, Wis.

#### AVIATION

**COMMERCIAL And Private Pilot Rating** (Zweng). Authentic examinations included \$3.00; Mechanics Rating (Zweng) \$3.00; Flight Engineer \$4.00; Airport Operation \$4.50; Fairchild sextants (surplus) \$12.50. (Free folder.) Pan American Navigation Service, 12021-C Ventura Blvd., North Hollywood, Calif.

**BUILD Lightplane.** Licenseable. Blueprints, manuals. Circular illustrating designs, motors, 20c. Craftsmann Books, Box 1153, Milwaukee, Wisconsin.



**PROPELLERS**—2 And 3 blade, for snow-ice sleds, boats. Catalog. Standard Aero-craft, Box 387, Ft. Worth, Texas.

**JET Propulsion experiments.** New design. Drive bicycle. Circular on plans. Rush name. Maupin, Tipp City 8, O. 10.

**GROUNDING Aircraft engines**—Suitable for boats, water-planes, snow-planes, educational purposes, etc. Reasonable. Aero-Traders, Adams, Massachusetts.

**GIANT Kites.** Only \$20. Fraction government's cost. 10x14 ft. double tier. This monster tows cars, skiers, skaters, canoes. Lifts light persons, antennas, advertising, cameras. Pleasure. Profit. Great-Northern Mart, North Adams, Mass.

**VETERANS:** Flight training under the G. I. Bill. Tuition paid. Private, commercial, flight instruction, instrument and multi-engine ratings. Opportunities to work for living expenses or tuition, if not a veteran. Write Gottschalk School of Aeronautics, Adrian, Mich.

### ELECTRICAL SUPPLIES

**VACUUM Cleaner dustproof cloth dust-bags** \$2.00 postpaid. Every vacuum part. Vacuum Service, 1671-3rd Ave., New York City.

**ELECTRIC Pencil**—Writes, engraves all metals. Ideal for marking tools, etc. 110 volts. \$2.95 or 2 for \$5.00 postpaid. (C.O.D.s plus postage.) Battery model \$1.00. Reb Industries, Dept. 265-DD, Elmhurst, Ill.

**AUTOMATIC Pop-up toasters**—\$19.95, \$22.00, postpaid 48 states. Moneyback guarantee. Mailorder Electric, 713 South Dearborn, Chicago.

**LAMPS**—All parts to build or repair. Catalog 10c. Gyro Lamps, 5416P Clark, Chicago 40.

**ELECTRIC Pencil:** Engraves all metals. \$1.00 postpaid. Beyer Mfg., 229-H Dixon, Uniontown, Penna.

**CORNELIUS Air compressors.** Brand new, 27 volts d.c., 20 amps. \$15.00 each, \$5.00 deposit with order. War Surplus Sales, Shawnee, Oklahoma.

**FREE Catalog motors, welders, welding supplies, generators, fencers, electric mowers, freezers, other electrical items.** LeJay Company, Minneapolis, Minn.

**LELAND Electric generators, 2.5 KVA, 120 volt, 60 cycle single phase with radio filter.** Turn at 1800 rpm, producing 2500 watts. \$125.00 freight prepaid. Hopfer & Company, 3124 East 14th Street, Oakland, California.

**LAMPS**—Build own originals, parts wholesale any amounts. Catalogue 10c. Brown Lamp Co., Box 501 Wellston, St. Louis 12, Mo.

**PERMANENT Energy**—Alnico magnets, new source of concentrated power. Unlimited practical applications. Special bargain this month, 4 useful pieces \$1.00 postpaid. Free list. Engineered Products, Dept. MM, Sandusky, Ohio.

**RECTIFIER:** Maximum amps. 20. 0-45 v. d.c. For low amperage surplus, charging batteries, electroplating, etc. \$3.50 postpaid. BP Products, Box 247, Flint, Michigan.

**FRACTIONAL Motors.** New, surplus, dustproof, ballbearing, 110v 60c 1/40 hp. 3-phase. Operates on single phase with capacitor. \$10.00. Nelson, 3620 Agnes, Corpus Christi, Texas.

**LAMP Sockets, mogul sockets, three way switches, tumbler switches, receptacles, cord sets, electrical repair parts, lamp parts, etc.** Catalog 10c. Gearon Company, 6405 North Oakley, Chicago.

**TATTOOING Machines, outfits.** Free catalogue. Jensen, 120 West 83rd Street, Los Angeles 3.

**ALNICO Magnets.** free list. Terry Sales Company, 3726 South Detroit Avenue, Toledo 9, Ohio.

**BOOKS**—All Kinds—Homecraft, Radio, Plastics, Boat Building, Photography, Model Building. Catalog free. Popular Mechanics Press, 200 E. Ontario St., Chicago 11, Ill.

### WELDING, SOLDERING, PLATING

**AMAZING 6-12 Volt d.c. carbon soldering iron.** \$2.00 postpaid. Address Electro Specialties, Box 813, Westport, Conn.

**LEARN At home, increase your earnings.** Complete instructions and formulas \$1. Taylor, 53 Woodland Ave., Clementon, N. J.

**OWN Mirror shop.** Resilver mirrors. Glass sign making. Electroplating. John Sprinkle, V55, Marion, Indiana.

**NEW Airplane tires, tubes, wheels, bearings, spindles.** For harvesters, implements, lowbeds. Free pictures. World's largest stock. Airplane Tire Company, Dept. 3, Box 89, Merced 3, California.

**WELDING Shop operators, four machines you can build and sell in your shop.** Plans \$1.00. W. Randle, 625 Gerard, Santa Rosa, Calif.

**A.C. Welders, 110 v. welds 1/2" steel.** \$29. Morris Welding Service, 1850A State, Schenectady 4, N. Y.

**"BUILD-UR-OWN"** Portable arc welder. Save \$350. Easy with Hobart generator plus auto engine. Free instruction book. Write Hobart Welders, Box M-484, Troy, Ohio.

**WELDERS** For all requirements. Free catalog. Write Hobartweid, Box M-485, Troy, Ohio.

**WELDERS!**—New portable Champion special transformer welder; 110/120 volts, a.c. 8 heat stages. Welds, brazes, solders, cuts all metals. Complete with electrode holder, helmet, rods, carbons, fluxes, cables. Also special flame weld torch. Easy to use. Full directions. Splendid for shop, farm and home repairs. Guaranteed. Only \$27.50. Money back guarantee. Also resistor model, now \$14.95. Magic Welder Co., 239 MP Canal St., New York, N. Y.

**BUY Direct from factory.** Welding outfit \$48.36. Soldering outfits \$7.76 to \$10.16 complete prepaid. Box 331, Hamilton, Ohio.

**30 AMP. Selenium plating rectifiers with Powerstat control, \$85.00.** Lead lined tanks, geared motors for agitation. Complete line of bronzed baby shoe mounts. Hollywood Bronze Supply, 1770 N. Vermont, Hollywood 27, Calif.

**PREHEAT Guns and generators.** Preheating for welding, annealing. Gun complete \$39.50, burns natural gas. Generator \$59.50, uses gasoline. Write Goodwin Mfg. Co., Crab Orchard, Ky.

### MACHINERY, TOOLS, SUPPLIES

**FOOT Switch**—Operates any 110 volt motor, power tool or device, large or small. Guaranteed. \$3.95 or 2 for \$6.50 postpaid. (C.O.D.s plus postage.) Reb Industries, Dept. 265-DH, Elmhurst, Illinois.

**PORTABLE Shop fans.** Something different. Dealers wanted. Betco, 619 North Broadway, Oklahoma City, Oklahoma.

**BUZZARD Cyanide gas furnace** \$75.00. Colborne 3 speed polishing head, 20 round collets, motor \$200.00. Ajax, Fairview, Erie County, Penna.

**DRILL Press** \$18.75. Standard size. Free information. Marantette Industries, Columbia Falls, Montana.

**GAUGES.** New in water-proof packages. U.S. Gauge Companies combination 30" vacuum to 30# pressure and straight 60# pressure. 3 1/2" dial. Bottom connection. Limited supply. While they last \$3.95 each. No c.o.d. Industrial Machinery Parts, 6423 Chocolate Bayou Road, Houston, Texas.

**SET OF 9 spring steel screwdrivers, 1/2x 2 to 5/16x8 blades.** Gunsmiths and mechanics. Prepaid \$4.50. E. C. Grace, Elk Rapids, Mich.

**POWER Tools.** Build your own with Lewis Castings. Save up to 80%! Complete castings, materials and blueprints supplied for 23 woodworking and metalworking tools. Free catalog. Write today. Lewis Machine Tool Co., 3217 Union Pacific Avenue, Dept. M, Los Angeles 23, Calif.

**AIR Compressors,** for service stations, garages, shops and paint spraying. Attractive dealer offer. Betco, 619 North Broadway, Oklahoma City, Oklahoma.

**COMPLETE New GI kit of 134 mechanics tools.** \$100.00. List on request. E. C. Grace, Elk Rapids, Mich.

**NEW Atlas 9" screw cutting lathe,** on cabinet. Taper attachment. Center grinder. 20 collets. Universal and Jacobs chucks. Tools, motor. All new \$800.00. Ajax Expander Co., Fairview, Erie County, Penna.

**BAND Saw**—Bench type for home workshop, ideal for hobbyists. Cuts wood, metal, plastic, leather, etc. Special \$14.95. Factory to you. Lowest priced band saw on market. Thousands in use. Free circular. Woodcraft Tools Inc., 147 E. Lake St., Minneapolis, Minn.

**\$25 AND Up paid for Singer sewing machine heads,** mail serial number to Box 8, Station P, Brooklyn 12, N. Y.

**CHUCKS.** Independent, Universal, threaded 1 1/2"-8 for South Bend, Atlas, Logan, Clausing, Craftsman lathes. Also other chucks to 16". Top value. Free literature. Westcott Chuck Co., 3600 Walnut, Oneida, N. Y.

**COMPLETE Tools, dies, jigs,** for manufacture of tricycle, available one-fourth original cost. Metalcraft Toy, Paul Brown Bldg., St. Louis, Mo.

**MODERATELY Priced!** Immediate delivery! Nationally known portable electric sander. Woodworking power tools. Shaper, bandsaw, etc. Paint sprayers, Armand grinder. For schools, home workshops, cabinet-makers, farmers, garages, repair shops, others. Postcard brings free illustrated bulletin. H. Saltzman Co., Dept. M, 118-14 83rd Ave., Kew Gardens 15, N. Y.

**"BUILD-UR-OWN"** Combination a.c. welder and a.c. power plant. Welding, plus power to run tools, lights, motors. Portable. Save \$350. Easy with Hobart generator plus auto engine. Free instruction book. Write Hobartweid, Box M-486, Troy, Ohio.

**0-1/2" CAPACITY Drill chuck and adapter,** fits your Sunbeam Mixmaster. \$2.95. O. Nahser, 248 San Gabriel Court, Sierra Madre, Calif.

**WAR Surplus in small tools for machine shop.** Send 15c for bulletin. Travers Tool Co., Dept. P, 5 Court Square, Long Island City 1, N. Y.

**HARDWARE, Tools, pattern supplies,** brass, steel, drill rod. GE electric motors, 1/2 h.p., \$17.75. Catalog 5c. Terek, 6304 Patterson, Chicago 34.

**SCISSOR Repairing supplies.** Free list. Overland Saw Service, Independence, Iowa.

**NEW High-speed drill sets.** No. 1 to No. 60, \$10.50 set. 1/16" to 1/2", \$14.75 set. Will ship c.o.d. promptly. Metal plated stand 25c each with any order. Midwest Surplus Tool & Supply, 174 N. Clinton St., Chicago 6.

**HOME Workshop bench belt sander.** Plans \$1.00. Fred Young, Sandy Spring, Md.

**BUILD Your own streamlined drill chuck.** Newly designed chuck gives amazingly rapid and accurate drilling in smaller sizes to #60. Complete plans and instructions, with supplement on converting your present chucks, 50c postpaid. Write, J. McMenamin, Clementon, N. J.

**SPECIAL Sale**—Power tools. Saw, jointer, lathe, jig-saw, sander, shaper—complete with line, shafting, belts and pulley, all for \$39.50! 1/4 hp. motors \$14.95 (motors sold only with above). Send \$10.00—balance c.o.d. Skarie, Inc., 707 N. Howard St., Baltimore, Md.

**DRILL Grinder for twist drills,** \$2.95. See ad on page 266.

**WAR Surplus special:** Big 50 lb. box popular size bolts, nuts, washers, screws, clamps, etc. \$6.85. War Surplus Co., Box 910, New Brunswick, N. J.

**GRINDERS, Drills, vises, clamps, punches, taps, dies, tool boxes, micrometers, indicators.** Catalog 10c, refunded. Precision Tool Service, Dept. M, 55 E. Washington, Chicago 2, Illinois.

**LATHE Boring and threading done fast and accurate with America's newest low priced bar holder.** Free literature. Miles Products, 2532 Wabash, Chicago 16, Ill.

**HOME Lathe owners**—Build your own attachments. Send for picture, sample of work and list of blueprints. Cut gears, ratchets, etc. Make neat screws easy way. The Home Shop, 415 Raymond Ave., Glendale 1, Calif.

**V-BLOCKS At low prices,** new type with clamps, rust-proof, home or factory. Write Miles Products, 2532 Wabash, Chicago 16.

**SHEBEL Saw filer.** Files all saws. Circular. A. P. Shebel, 730 B. So. 2nd St., Milwaukee 4, Wis.

**CONCRETE Block machines** \$39.50 up. Catalog free. Concrete Machine Company, 5466 Gravois, St. Louis 16, Missouri.

**DRILL Grinder**—Grinds drills to factory accuracy. Calipers with direct reading scales. Circle cutters. New Tool grinder. Lowest prices. Free literature. Factory, 811-B East 31st, Kansas City 3, Mo.

### ENGINES, MOTORS, DYNAMOS

**MOTOR Repair men,** get our bulletins on stator winding tester and a.c. motor winder. Motor Industries, Quincy, Illinois.

**MOTORS!** 1/2 H.P. D.C. converted to A.C. All new. High speed 110 volt, 25 or 60 cycle, ball bearing motors. Actual value about \$75.00. Now \$15.00 each or 3 for \$40.00. With forward and reverse switch \$19.50, 3 for \$50.00. Countless uses for home mechanics. Can be used in any position. Order today! Immediate delivery! No c.o.d. orders. "Amazing Bachman's," 27 Herman Street, Rochester 5, New York.

**WELDING Generator, 150 ampere,** \$47.50. 1/2 horse 1725 r.p.m. a.c. motor, \$24.50. Butler, 1885 Milwaukee, Chicago.



**BARGAINS** in war surplus hydraulic transmissions, switches, motors, geared speed reducers, aviation instruments, etc. Delta Sales, P.O. Box 968, Shreveport, Louisiana.

**NEW** Single phase motors—1/6 hp. 1725 RPM J. & Heintz, \$11.75; 1/4 hp. 1725 RPM J. & Heintz, \$13.50; 1/2 hp. 1725 RPM J. & Heintz capacitor, \$14.80; 3/4 hp. G. E. 1725 RPM, \$14.55. These motors are not war surplus; all are new in original manufacturer's cartons. 20% on mail orders, motor inquiries solicited. Jersey State Equipment Company, 180 Mulberry St., Newark 2, New Jersey.

**NEW** A.K. Wisconsin air cooled engines. 3 to 4 h.p. complete, \$85 f.o.b. R. H. Kuehne Hardware, 136 Northampton St., Buffalo 8, N. Y.

**DEALERS**—Sell electric motors, gas engines, light plants, generators. Wholesale catalog, 10c. CMCO, 3546 Fullerton, Chicago.

**ENGINES**—3/4 H.P. and up; 4 cycle, for industrial, power-mowers and scooters. Nationwide Motors, 650 Sunrise Highway, Rockville Centre, N. Y.

**NEW** Two speed 110v. a.c. or d.c. ball bearing geared head motors. Develops approximately 1/4 and 1 h.p. at 400 and 500 r.p.m. Suggested uses: Heavy duty drill, power lawn mower, cylinder hones, hoists, etc. \$25.00 each. Ball bearing three to one right angle drives for above motor \$7.50 each. Motor and right angle drive together \$30.00. Limited quantity. Send check or money order, no c.o.d. Prices f.o.b. Machine Design Co., Dunedin, Florida.

**RANGER** Engine-Aircraft—All new in original case. 570 h.p., 12 cyl. V type air-cooled. Engine Spec. No. 177. Complete with spark plugs. Original government cost over \$12,000.00 each. Special offer \$200. Crated weight 1200 lbs. No c.o.d. Write for complete description. "Amazing Bachman's," 23 Herman Street, Rochester 5, N. Y.

**INVALUABLE** Collection of diagrams and instructions for motor winders. Jednak, 107 Island Ave., McKeesRocks, Penna.

**WINDING** Data, listing 225 motors, single and three phase, \$1.00. Motor Data Co., Box 7631, Kansas City 3, Mo.

### BOATS, OUTBOARD MOTORS

**OUTBOARD** Motor parts, New-used, all makes. New pistons (standard, oversize). Cylinders rebored. Outboard Motor Mart, 309 Atlantic Ave., Boston 10, Mass.

**P-38** Belly tank speed boat. Complete plans, instructions \$1.00. Twintank Boat Company, 1032 62nd Street, Oakland, California.

**MARINE** Supply catalog. Thousands of deliverable items; illustrated and priced. Send 75c. Arthur Gershel, 51 Chambers St., New York City.

**BOATING**, Learn at home. Seamanship and Piloting. Cruise scientifically. Prepare for a job on the water. Fairway School, Box 811, Old Greenwich, Conn.

**BOAT** Building plans: Runabouts, cruisers, sail boats. Wood, plywood, and welded steel construction. Illustrated book, "Modern Designs For Boats And Yachts" \$1.00. John B. Clark, Yacht Designer, 329 Kenmore Drive, Bay Village, Ohio.

**SURPLUS** New marine reverse gears, suitable for any engines from 10 to 100 h.p. Arthur Gershel, 51 Chambers St., New York City.

**BUILD** Your own boat by the Welch system. knock-down kits. No experience necessary. Save 2/3 cost rowboats to cruisers. Illustrated catalog 25c. Midwest Boat Company, Menomonee Falls, Wisconsin.

**ROWBOAT**, Stadium, seats. Metal, cushioned. New \$5.00. Used, three \$5.00. Edford, 541 S. Dearborn, Chicago 5.

**NEW** 1948 Neptune outboard motors at wholesale prices. 1.7-3.3-5-7 and 10 h.p. Write for list. Le Jay electric outboard motors, regular price \$56.95, now \$36.90. Check or money order. Lakeland Sporting Goods, Fort Atkinson, Wis.

**SAILS**, Canvas, all widths. Wingdope, marine hardware, paints. Canoe equipment. Alan Clarke, 96 Chambers, New York City 7.

**ATTENTION** Sportsmen! Assemble kayak from easy-construction kit. Complete! Nothing additional needed. Play-yacks, Dedham, Mass.

**MARINE** Catalogue—15,000 deliverable items; pictured \$1.00. Marine Mart, Buffalo 7b, N. Y.

**CATALOG**; Sixty best designs, full size patterns, blue prints — outboard, sail, power; with book "Boat Building" \$1.00. Marine Mart, Buffalo 7b, N. Y.

**PACKAGED** Boats—Complete moulded and sheet plywood kits; \$39.50 up. All sizes. Literature 25c. Marine Mart, Buffalo 7b, N. Y.

**OUTBOARD** Motors—Good values, used motors. Also used parts for most makes and models. Crandall-Hicks Co., 911 Commonwealth, Boston, Mass.

**P-38** BELLY Tanks, new, steel, 10 ft. 2 in. 165 gallon \$9.95. Anzio Boat Co., Box 89H, Merced, Calif.

**BARGAIN** \$20. Make your own boat now with readymade streamlined laminated one piece hull as developed for Navy. Light, sturdy, leakproof. Anyone can convert into dinghy, outboard scooter, cartopier, other craft. 9'x4' Write Warwood, 480 Lexington, New York 17.

**BELLY** Tanks—75 gallon, new, steel. 6 ft. 4 in. \$7.50. Anzio Boat Co., Box 89H, Merced, Calif.

**NEW**, Used, rebuilt marine motors. Marine conversions, fittings. Free catalog. Stokes Marine Supply, Dept. 24, Coldwater, Michigan.

**BOATS** And all about them. How to select, build, repair and operate. For 40 years the leading practical boating magazine. Half price trial subscription. 12 issues for \$1.00. Motor Boat, 62 Gold Street, New York 7.

**BOAT** Designers are highly paid professionals. Complete course by mail. Catalog. Westlawn, Montville, N. J.

### ATHLETIC EQUIPMENT, BODY BUILDING COURSES

**BARBELLS**, Exercise equipment. Courses. Free booklet. Good Barbell Co., Reading, Penna.

### SPORTING GOODS, GUNS, FISHING TACKLE, ARCHERY, TRAPPING

**SHOTGUNS**, Rifles, handarms, ammunition, rods, reels. List 10c. Rudolph's, Atchison, Kansas.

**DEVICE** Rushes fishworms to surface. E. E. Jones, Slater, Mo.

**FIREARMS** — Ammunition; complete list 25c. Satisfaction. Frank Farish, Vicksburg, Miss.

**RAISE** Easily thousands fishworms in 1948 with "Starter," full instructions, \$1.25 prepaid. Caldwell's, Barwick, Georgia.

**TROUT** Flies, assortment of six. Send 25c in coin. M. Pflueger, 6410 Arsenal St., St. Louis 9, Mo.

**SUPERB** Quality 48" casting rod, guaranteed unbreakable. \$5.25. Write Ken Smith, Postoria, Ohio.

**AVAILABLE**. Savage high power rifles. Model 99. 300 caliber. \$88.80 postpaid. Pulver's Sporting Goods, Hudson, N. Y.

**TENNIS** Players—Nylon strings \$1.75. Stringing equipment \$1.50. Instructions. \$25.00 day spare time. Shipment C.O.D. Matco, Box 267, Lexington, Kentucky.

**HORSESHOE** Pitching agents wanted. Make money, full or spare time, your favorite sport. Equipment furnished, easy to organize local clubs, run prize contests, take orders. Details free. Murray-Haines, 33 E. 112th, Chicago 28, Illinois.

**EDWARDS** Attachments double power of scopes. Finest glareproof 1 1/4" hard coated, sliding lens. Improves target and varmint shooting. Install yourself. Write for information. Edward's Sights, Union City 2, Indiana.

**AMMUNITION**, 75 Sizes in stock. Dime for list. Central Sports, Delphos 5, Ohio.

**SKI-TOWS**, Portable, auto-powered, 500 ft. long. Pulls you both ways. Up, level or downhill. Set up in 20 minutes. Only \$125. Send card for particulars. Great-Northern Mart, North Adams, Mass.

**FISHERMEN**—Handmade split bamboo (tonkin) rods, any type or to your specifications. Rod building supplies. Free literature. Aaron G. West, 4144 Marion Street, La Mesa, California.

**BOOKS** On gunsmithing. Catalog 10c. W. Joseph O'Connor, Baker, Oregon.

**FLY** Tiers: One of the leading commercial manufacturers of flies offers you the same materials he uses. Buy only what you need. Save money. Free catalog. Bennett Millard Fishing Tackle, Inc., 130 Washington, Binghamton 10, N. Y.

**5000** BARGAINS, Firearms, binoculars, war relics. Catalog 40c. Smith Firearms, Runnemed, New Jersey.

### FIELD GLASSES, TELESCOPES, MICROSCOPES, MAGNIFIERS

**7x50MM**. Prism binoculars. Zeiss design. New, save 75%. Sacrifice, \$49.50 plus tax. DuMaurier Co., 304 State, Elmira, N. Y.

**POWERFUL** Astronomical telescopes easily made. Perfect lenses and instructions. 100 power \$2.50. 100 and 200 power \$3.50. 100, 200 and 400 power \$5.50. Clear vision and full power guaranteed. Instructions alone 10c. Suffolk Science Service, Manorville, N. Y.

**BINOCULARS**, Telescopes, watches. Buy, sell, trade. Paul Schweer, Donnellson, Iowa.

**GOVERNMENT** Surplus — Telescopes, binoculars, lenses, prisms. Send stamp for "bargain" list. Hobbyist lens set—magnifiers, reducing lenses, positives, negatives, 10 piece set, \$1.00. H. Jaegers, 123-26 Rockaway Boulevard, South Ozone Park 20, New York.

**ASTRONOMICAL** Telescope lens kit. 100X—200X—400X—powers \$3.00. Microscope lens kit. 100X—200X—400X—800X \$2.00. Plans included. Pfeiffer Optical Co., PM-4, Sunbury, Penna.

**VARIABLE** Density filter for binoculars assures comfortable viewing under all conditions \$1.50. Ross, Section B, 68 West Broadway, New York.

**TELESCOPE**: Newly designed 2 1/2" 100x. Mokey design. Free literature. Janan Instrument Company, Box 89, Plainfield, N. J.

**TELESCOPES**, Binoculars, microscopes, big bargain catalog free. Brownscope Company, 24 West 45th Street, New York.

**REFLECTING** Telescopes, complete. 3 1/2" diameter, equatorially mounted. View planets, stars. \$19.75. Write Sky-scope Company, 475-P 5th Ave., New York.

### DOGS, PETS, BIRDS, RABBITS

**RAISE** Rabbits profitably. Big future. Read weekly bulletin on markets, trends, legislation, new ideas, extra profits. Sample free. Rabbit Federation, 200 Burrell Building, San Jose, Calif.

**\$250.00** MONTHLY Raising angora rabbits. Particulars free. White's Rabbitry, Newark, Ohio.

**\$3000** YEARLY Raising Angora rabbits. Markets furnished. Particulars free. Vaughn's Rabbitry, Otley, Iowa.

**RAISE** Guinea pigs. Make money at home. Big demand. Booklet free. Taylor, Box 426A, Hapeville, Georgia.

**SEE** "Golden Hamster" ad on page 34, and "Hamster Manual" ad on page 28. Each ad shows picture of Hamster.

**PROFITABLE** Industries. Raise rabbits, cavies, etc. See our display advertisement on page 32. Small Stock Farmer.

**MONEYMAKING** Opportunity raising Giant Chinchilla Rabbits. Waters Rabbit Farm, Glennville, Georgia.

**ANGORAS**, Giant Chinchillas. Heavy-producing prize winners. Literature free. Grinsteeds, Edwardsville, Illinois.

**\$2000** PER Year raising Angora rabbits. We buy your output. Contract particulars free. Wilsons, 1065 Shryer, St. Paul & Minn.

**NEW** Reptile catalogue 10c. Biological hobby catalogue 10c. Current reptile bulletin 5c. Quivira Specialties, Topeka, Kansas.

**NEW** Zealand red rabbits, registered, pedigree, Free circular. Daniel McIlraith, Montezuma, Iowa.

**REGISTERED** Chinchilla Giants—Whites. Breeders supplied, pay with youngsters. Literature, 25c. Booklet, beginners greatest opportunity free start plan, hutch plans, \$1.00. (Refundable.) Behrens Farms, Pearl River 4, New York.

**\$50.00** WEEKLY Raising Angoras for us. Free literature. Angoraville, 1215-34th Northeast, Cedar Rapids, Iowa.

**GUARANTEED** Chin-Chin Giant Chinchilla rabbits. Greatest amount of delicious meat. Largest, finest, most valuable furs. Tremendous demand for breeding stock. We buy youngsters, contact world's largest breeder. Willow Brook Farm, R15, Sellersville, Penna.

### SEEDS, NURSERY AND GARDEN SUPPLIES

**LATHAM** Red raspberry plants 8c each. Strawberries, June bearers 100 — \$1.70. Everbearers 100 — \$2.20. Henry Kiewiet, Route 4, Kalamazoo 84, Michigan.

**GINSENG**. Goldenseal. Dozen seed bearing plants, \$1.50. Hundred seed, \$1.50. Thousand, \$5.00. Complete instructions included. F. M. Collins, Viola, Iowa.



SOILLESS Gardening. Complete illustrated book \$1.00. Send card for details. Malcolm Tabor, Park Hills, Huntington, W. Va.

## FARMS, FARM LANDS, REAL ESTATE

EXCELLENT Lake front lots \$400.00. \$10.00 down, \$10.00 monthly. R. W. Stewart, Inverness, Florida.

SPRING Farm catalog—Free! New 136-page Green Book, just out! Don't be without it: write today! Over 2800 super-duper bargains, 34 states, coast to coast. Strout Realty, 255-P 4th Ave., New York 10, N. Y. 20 W. 9th St., Kansas City 6, Mo. 453 S. Spring, Los Angeles 13, Calif.

IT'S Spring again in the exciting pages of United's new free spring catalog of up-to-the-minute bargains just off press! Farms, ranches, groves, tourist courts, business opportunities, summer homes, water frontage, mountain and valley properties. Over 100 pages with complete descriptions, many photographs, from northern dairy country, famous Ozarks, to glamorous California, many states. Write for free copy today. United Farm Agency, 1408-PM Consumers Bldg., Chicago 4, Ill.

WEST'S Latest catalogue: Over 1000 farm and business bargains. 180 representatives, 16 states. Free. Write West's Farm Agency, HE-15, Pittsburgh 17, Penna.

FREE Fertile lands obtainable in Latin-America, yielding four annual crops. Homesteads, large plantations, 25,000 acre ranches obtainable free. Make your fortune growing sugarcane, tobacco, cereals, bananas, coffee, fruits, timber, cattle, sheep. Send 25c for illustrated booklet "100,000 Square Miles Free!" Valles, 395-TM Broadway, New York 13.

HOMESITES \$450—Convenient payments. California's finest garden section. On Morro Bay's scenic shores. Wonderful fishing, hunting, boating, bathing. Fertile soil, softest water, temperate climate, congenial community. Free literature. Richard Otto, Department M, San Luis Obispo, California.

\$5.00 MONTHLY Buys 40 acres near town; price \$200.00. Free list. Box 425-P, Carthage, Mo.

CANADIAN Tax sale lands for two dollars an acre and up. Small monthly payments. Farms, timber, hunting and fishing camps, minerals. Limited number of properties. Write at once for free catalogue. Tax Sale Service, Room 613, 72 Queen St. W., Toronto 1, Canada.

GOVERNMENT Lands \$2.00 acre up. Information all states twenty-five cents. National Tax Service, 834-A Majestic Bldg., Detroit.

GOOD Farms—Ranches. Washington, Minnesota, Montana, Idaho, Oregon, North Dakota. Dependable crops, favorable climate. Write for literature. Lists describing typical farm opportunities. Specify which state. J. W. Haw, 119 Northern Pacific Ry., St. Paul 1, Minn.

OZARK Lands for all purposes. Actual river frontages, 5 acres \$90.00 and upwards. Free list and literature. Hubbard, 424-I Minnesota Ave., Kansas City 4, Kansas.

FARMS, Ranches. All kinds, sizes. Choice of location, climate, production. Information on irrigation projects Columbia and Missouri River Basins. Resorts, summer homes. Milwaukee Railroad territory: Washington, Idaho, Montana, Dakotas, Wisconsin, Upper Michigan, Central corn belt. Free folders, price lists. L. H. Robbins, 604 Union Station, Chicago 6, Illinois.

## FARM MACHINERY AND SUPPLIES

FREE—Big 1948 new and used tractor parts catalog. Satisfaction guaranteed. Write Irving's Tractor Lug Company, Fargo, North Dakota.

## POULTRY, FARM SUPPLIES

CHICKENS Actually raised in ten weeks for profitable sales. Complete instructions one dollar. Floyd Bratcher, 827½ North Flores, San Antonio 1, Texas.

RAISE Fryers new easy way. One-man home plant earns \$500 monthly. Booklet free. Poultry Guild, 1046-A So. Olive, Los Angeles 15, California.

KNOW How to raise poultry for profit. Read Northeastern Poultryman. Every issue packed with helpful hints and practical suggestions. Latest articles on breeding, feeding and management. Subscribe now. 1 year 65c. 2 years one dollar. Foreign subscriptions \$1.00 a year. Northeastern Poultryman, Dept. P.M., 376 Boylston St., Boston 16, Mass.

RAISE Turkeys the new way. Write for free information explaining how to make up to \$3000.00 in your own backyard. Address National Turkey Institute, Dept. 3, Columbus, Kansas.

BABY Chicks, champion mated, 25 varieties, 6 hybrids, licensed inspected, blood-tested. Rush postal, large colored book free, low prices. Berry's Farm, Route 12, Clarinda, Iowa.

## PROFITABLE OCCUPATIONS

\$5000 YEARLY Raising honeybees. Anyone, anywhere. Our complete, detailed book shows you how. \$1.00. Galson Beehives, Ramsey 11, New Jersey.

LEARN To build architectural scale models. A well paying, interesting, and dignified profession. Any normal high school boy or girl will qualify. Send for literature and particulars. Elliott Hollywood Studios, Box 57, Hollywood 2, Florida.

OWN Mirror shop. Resilver mirrors. Glass sign making. Electroplating. John Sprinkle V50, Marion, Indiana.

MAKE Extra cash! Receive moneymaking propositions. Easy money. Free literature. Sackett, 92A, Waring Ave., Mansfield, Ohio.

LOCKSMITHING Secrets—Key fitting, lock opening, repairing, prices to charge, supply sources. Illustrated book only \$1.00. Wechsler Supply, 7 W. 36, New York City.

OPERATE Profitable home business. Guaranteed plans free. McClure, 323-PM N. Main, El Dorado, Kansas.

BE Independent—\$1500 starts theatre circuit. Legg, 5629 Lake, Chicago 44.

START Your own business on our capital. Always your own boss. Hundreds average \$6,000 to \$25,000 annual sales year after year. We supply stocks, equipment on credit, 200 home necessities. Selling experience unnecessary to start. Wonderful opportunity to own pleasant, profitable business backed by world-wide industry. Write Rawleigh's, Dept. D-U-PPM, Freeport, Ill.

CAKE Decorating (for beginners). Teaches wedding, celebration cakes, ornaments, plastic icing, etc. Instructions, 100 diagrams, \$2. Mail Sales, Lakemba, N.S.W., Australia.

PERMANENTLY Stops chimney creosote—down draft. Profitable. WIG, Abington, Mass.

DOLL Hospital instruction \$4.75. Big profit. Box 124, Station C, Grand Rapids, Michigan.

GUNNERS Training table. New—the greatest value offered yet. Ideal for clubs, shooting galleries, automatic checking, counting, burglar alarms. Can be operated as a very profitable business. Comes complete with 7 a.c. 110 volt motors, sensitive electric eye, powerful amplifier, rotating mechanism, maple top table, etc. All parts can be used individually. Worth the investment for parts and mechanism alone. Limited time, \$300. "Amazing Bachman's," 25 Herman Street, Rochester 5, N. Y.

AMAZING New industry now developing. Earthworm culture in basement or garage offers wide possibilities for handsome profits. Send dime for full details. Leyden Earthworm Breeders, P.O. Box 186, Franklin Park, Ill.

MAKE Flexible molds! Few cents each! Cast plaques, novelties, bookends! Free sample! H. Tooker, Hamilton 9, Ohio.

MUSHROOMS Grown. Boxes, Barrels. Instruction 50c, spawn \$1.00. Gordon's, 553 William, Winnipeg, Manitoba.

EXTRA Money? Free details. Trable, 1018½ Elm Street, Dallas, Texas.

EARTHWORMS—For soil building, and better composting. Write for free booklet. Coolville Earthworm Farm, Coolville, Ohio.

START Lamp factory. Profitable, fascinating, easy to learn. Illustrated course teaches you. General instructions, wholesale catalog \$1.00. Gearon Company, 6405 North Oakley, Chicago.

MAKE Beautiful mirrors from inexpensive window glass. No special equipment required. Details free. Tes-Co, Box 189-MP, Wilkes-Barre, Penna.

TYPISTS—Profitable business at home. Complete copyrighted information, 50c. Gaunt, 3521A Broadway, Chicago 13, Ill.

"FROG-RAISING"—New book teaches everything! Marlboro, 1035 Marlborough, Detroit 15, Michigan.

"MOST Everybody likes candy." Learn to manufacture in a professional manner. (Our 38th year). Ragsdale Candies, #107, East Orange, N. J.

NO Selling, operate vendors, amazing profits, details free. Silver-King, 622 Diversey, Chicago 14, Ill.

FOREIGN Employment? Brief directory, companies with foreign projects of branches \$1 or c.o.d. Foreign Service Institute, Box 3934, Miami 24, Fla.

"ALASKA" The last frontier offers unlimited opportunities. \$1 brings official government map and copyrighted report with listing of firms: Fishing, construction, mining, aviation, homestead lands, prospecting business. Alaska Opportunist, P.O. Box 883, Hollywood 28, Calif.

PERMA-FLEX Molds, made from B. F. Goodrich Company's Koroseal flexible molding compound. Stock or custom built molds. Send 25c for catalog and sample mold. The Perma-Flex Mold Company, Columbus 15, Ohio.

PROFITABLE Business in making and building with interlocking blocks. Delaware Industries, Dept. 10, Muncie, Indiana.

INTERESTED In Latin American and foreign employment? \$1 brings copyrighted Foreign Service Directory listing firms with interests in construction, oil, mining, aviation, manufacturing by personnel expert. Hot list of companies hiring. Global Reports, P.O. Box 883, Hollywood 28, Calif.

WOULD You pay 3%—first \$350 made? Color-illustrated book "505 Odd, Successful Enterprises" free! Some offer occasional "day off." Work home. Expect something odd! Pacific, Oceanside, Calif.

\$40.00 WEEKLY Made growing mushrooms, fresh, dried. Dominion patent 331583. Free spawn. North American, 169P Yonge, Toronto, Canada.

## BOOKS, PERIODICALS, PICTURES, POSTCARDS

FREE Particulars for book bargains. Rosenthal, 200 Ross, Brooklyn 11, N. Y.

WE Can supply you with almost any book. (magazine subscription). House of Kilroy, (Booksellers), Box 772, Detroit 33, Mich.

BOOKS. College text and reference. New and used, bought and sold. Founded 1902. Free catalog. Long's College Book Co., Columbus 1, Ohio.

TRADE Magazines—Business, vocational, diversion. Choose current copies from more than 1000 publications available through our easy-to-get-acquainted plan. All fields. Price list free. Commercial Engraving Publishing Co., 34C North Ritter, Indianapolis 19, Indiana.

TEN Old dated magazines, \$1.00. Lora Whitehead, 606 So. Washington, Bloomington, Ind.

"PADDY The Cope," \$2.50. Also free catalog, interesting books. A. Faller Company, 201 Dewey Street, Newark 8, New Jersey.

BOOK Bargains, free information. Wood, 921-P So. Jackson, Tulsa, Oklahoma.

BOOKHUNTERS! All subjects. Send wants! Jaher Book Service, 620-P East 178 Street, New York 57.

BE Your own long range weather forecaster. New scientific method, 50c. W. C. Ewert, 4411 Greenview Ave., Chicago 40, Illinois.

BOOKFINDERS! (Scarce, out-of-print, unusual books.) Quickly supplied. Send wants. Clifton Company, Box 1377pm, Beverly Hills, Calif.

SELF-EXPLAINING Bible: Illustrated circular free. Box 446-P, Minneapolis, Minn.

BIG Sparetime profits taking magazine subscriptions. Complete supplies, confidential catalog free. Cassell Publishers Service, Westfield, New Jersey.

## GAMES, ENTERTAINMENT

BE The life of the party! Wear electric Bow Tie. Complete tie, bulbs, battery, all for only \$1.50. No c.o.d.s. Electric Bow Tie Co., 306 Bowery, New York 12, N. Y.

## MAGIC TRICKS, PUZZLES, JOKER NOVELTIES

SVENGALIS Trick decks \$1.00. Everyone, free trick. Stivers, 40 Salem, Medford 55, Mass.

COIN And ring trick. Mystifies, amuses. 35c. Descriptive literature of fun and magical items with gift trick included. Powell's, P.O. Box 2155 B, Potomac Station, Alexandria, Virginia.



**BUZZING**, Vibrating handshaker. Fun. 50c. "Marean," 2200 Gordon, Hopewell, Virginia.

**REMARKABLY** Inexpensive pocket tricks! Catalogue, 5c. Postways, Box 5325-C, Philadelphia 42.

**ENTERTAINING**—Fresh egg stands on end. \$1.00 sends instructions. A. Millici, 143 St. Felix St., Brooklyn 17, N. Y.

**TRICKY** Magic matchbox. It turns around, it stands, it opens. Confuses, amuses everyone, easy to do. Free to you if you send 25c for big illustrated catalog of 425 magic tricks. Magician, 2463-C, Kensington Ave., Philadelphia 25, Penna.

"BE A real magician." Write for free literature. F. L. Dupont, Arnold 24, Penna.

**FREE** Pack trick cards with catalog 25c. 12 Churchlane, Philadelphia.

**ASTOUND** Everybody. Hollywood Tie-Popper raises any tie automatically. Used by magicians. Satisfaction guaranteed. \$1 postpaid. Craig Magic, 1956 Franklin Circle, Hollywood, Calif.

**BEST** Pocket, parlor, stage tricks. Illustrated catalogue 10c. DeLux Magic Studio, 739 Poydras, New Orleans 12, La.

**80 MAGIC** And party stunts. Book explains magic, party games, and stunts. 64 illustrated pages. Remit \$1.00. "Billwin," Box 1077, Joliet, Illinois.

**LARGE** Illustrated catalog, circulars, listings, special offers, etc., 10c. Send 10c now to—Newton's, Dept. A-4, Bonham, Texas.

**MAGICIANS'** Headquarters. 400-page professional catalogue, pocket, parlor, stage tricks. World's finest magic. Send \$1.00 for catalogue (refunded first \$5.00 order). Kanter's, M-1311 Walnut, Philadelphia 7, Penna.

**MAGIC** Has vast opportunities. Illustrated catalogue 25c. Hall Magic Co., 345 John R. Detroit 26, Michigan.

**ASTOUNDING** The country, Dice-o-mat \$1. Road, 629 Drexel Bldg., Philadelphia 6, Penna.

**LARGE** 160 Page catalog, just published, 35c. We have supplied the best tricks to beginners and professionals for 38 years. Chicago Magic Company, 2300 No. Mason Avenue, Chicago 39.

**PERFORM** Magic over telephone. Amazing. Complete. Guaranteed. \$1.00. Half & Half, Box 29P, New York City 24.

**LARGE** Catalogue of the best magic for professionals and amateurs. Send 25c. Mazda Magic Co., 1135 Westgate Ave., Oak Park, Ill.

"**VENTRILLO**," Professional voice-throwing instrument and illustrated catalog 25c. POB-971, Philadelphia.

**LEARN** Magic, ventriloquism, mind-reading. Write for particulars. Quackenbus, Big Flats, N. Y.

**200 ELECTRIC** Stunts, 110 volts, \$1. Kutting Sons, Campbell, Calif.

**BIG** Magic magazine, trick and price lists—25c. Lloyd M. Jones, 4064 39th Avenue, Oakland 2, California.

**BE A** magician. Large professional magic catalog of latest tricks, 25c. Ireland, C-109 North Dearborn, Chicago 2.

**VENTRILLOQUISM** Taught. 3c stamp bring particulars. Smith, 801 Bigelow, Peoria 5, Ill.

**VANISHING** Half dollar trick and catalog 25c. Sterling Magic Co., Royal Oak, Mich.

**SNEEZING**, Itching powders, eighteen other tricks, free with joker's catalog 25c. 2404-N Fifteenth, Philadelphia.

**WORLD'S** Largest professional magic shop, keeps you in touch with latest tricks. To receive mailings, send 35c for new catalog. Holden's, M220 West 42nd St., New York.

**MAGIC** Tricks, puzzles, books, cards, punch boards. Catalog 10c. Specialty, Box 671, St. Louis 1, Mo.

**500 TRICKS**. Send only 10c for Douglas' famous 112-page catalog 500 tricks. New magic for amateur, professional. America's fastest service for 25 years. Douglas Magician, Dept. 1, Dallas, Texas.

**PROFESSIONAL** Catalog, 112 pages, 25c. Williams, 900 Plymouth, Ellwood City, Penna.

**DOLLAR** Magic set free with gigantic catalog 25c. Mysto, 4462 Germantown, Philadelphia.

**BOOKS**—All Kinds—Homecraft, Radio, Plastics, Boat Building, Photography, Model Building. Catalog free. Popular Mechanics Press, 200 E. Ontario St., Chicago 11, Ill.

## COINS, TOKENS, CURRENCY

**OLD** Money wanted. Will pay fifty dollars for nickel of 1913 with Liberty head (no buffalo). We pay cash premiums for all rare coins. Send 4c for large coin folder. May mean much profit to you. Numismatic Co., Dept. 20, Fort Worth, Texas.

**SOUTH** Africa, Rhodesia coins. Set \$3.00. McDonald, 30 Rosetta Street, Regents Park, Johannesburg, Africa.

**2 BOOKS**, Total 302 pages, handsomely illustrated; U. S. coins 1852 to present; prices paid by collectors and dealers—the 2 books for \$2.00 (send money order; not stamps). Hobby Helpers, Dept. G, Box 665, Washington 4, D. C.

**FREE!** Scarce foreign coin given to serious collectors requesting approval selections. Worldwide Coins, 400-M 37th, Union City, N. J.

**LAST** Large \$1.00 bill, new, \$2.50. 12 wooden nickels, \$1.00. 3-legged Buffalo nickel, \$1.25. Whitman silver dollar folders, all others, any 4, \$1.00. Handbook 75c. Our large retail catalogue 15c. Bebee Coin Company, 1180 East 63rd, Chicago 37, Ill.

**COLLECT** Coins! Start right, avoid costly mistakes. \$3 brings complete instructions, modern numismatists' kit, and big surprise coin packet. Satisfaction guaranteed. Kirkham's, Glens Falls, New York.

**25 COINS** And bills, 25c. Oddehon, Box 482, St. Louis, Mo.

**FOR** Sale: 1893 Columbian World's Fair half dollar, 75c; U. S. 2-cent pieces or 3-cent pieces, 25c each; 50 assorted Indian head cents, \$1.25; large 50 page U.S. coin catalog, listing thousands of coins for sale at reasonable prices, 25c; Giant 72 page foreign copper-silver-gold catalog listing over 10,000 coins for sale, 25c. Ben's Coin Company, 72 West Washington, Chicago 2, Illinois.

**UNUSUAL** Worldwide collection twelve different foreign coins and bills only 25c. Webb, Box 473, San Bruno, Calif.

**50 WORLD** Coins \$1.00. Harry Elsholz, Box 9014, Pittsburgh 24, Penna.

**FREE!** Foreign coin, banknote and coin collectors illustrated catalog to approval service applicants. Send 3c postage. Tatham Coinco, Springfield-125, Mass.

**GET** Profit and pleasure in collecting old coins. Send 10c for 56 page illustrated coin catalog. You'll be delighted with it. Send for it now. B. Max Mehl, 370 Mehl Bldg., Fort Worth, Texas. Largest rare coin establishment in U. S. Established 48 years.

**BARGAINS!** Rare collection contains United States large cent before 1848, flying eagle cent, white Indian cent, 2c piece, 3c silver, 3c nickel, half dime, shield nickel, liberty seated dime, Civil War cent, fractional currency note, confederate bill, foreign coin, foreign bill and our complete buying, selling catalogue, all for \$3.00. Catalogue alone, 25c. 25 dates Indian cents \$1.00. 50c before 1840-\$1.00. Pilgrim or Lexington 50c-\$1.25, half cent before 1810-75c, large cents 1826 to 1856-35c each, colonial coin before 1790-\$1.00, \$100.00 confederate bill \$1.00, 1780 foreign silver dollar \$1.00. Worthy Coin Corporation, 152-D Washington, Boston, Mass.

**COMMEMORATIVE** 1/2, Oregon, Texas, Kentucky, Cleveland, Long Island, \$2.00 ea. Illustrated catalogue 25c. Norman Shultz, Salt Lake 9, Utah.

**COINS** Wanted, will pay up to \$2000 for certain coins, send 25c for catalogue. Burton's, 111 So. Third, Columbus, Ohio.

## OLD STAMPS WANTED

**I WILL** Pay \$100.00 each for 1924 1c green Franklin stamps, rotary perforated eleven (up to \$1,000.00 each unused). Send 10c today for large illustrated folders showing amazing prices paid for old stamps and coins. Vernon Baker, PM-84, Elyria, Ohio.

## STAMP COLLECTING

**111 DIFFERENT**, At least 40 countries, only 5c with six-ways-better approvals. Frank P. Nagel, 674 Franklin, Denver 3, Colo.

**FREE** Monthly illustrated bulletin showing recent issues. Penny approvals on request. Reed Company, Box 980, Chicago 90, Illinois.

**FREE** Monthly "Colonial Collector" describes all British Empire new issues. Glen D. Wilson, Box 1499, Tampa 1, Florida.

**FREE!** Latest style perforation gauge. Mounblow, 740 Hegney, Bronx 56, New York.

**DEALERS** (Also part time) send for free samples, printed philatelic forms. These, 9320 San Juan Ave., South Gate, Calif.

**FREE**—101 World wide. Drop a card requesting approvals from Samson, 3526 Kipp Street, Philadelphia 34, Penna.

**SIXTY** Different stamps fifteen cents. 1c approvals. Morgan Service Co., Mabelvale, Ark.

**GET** That new look. Collect new issues. Outstanding purchase dividend plan. Falls Stamp and Coin Shop, Box 2078Q, Akron 11, Ohio.

**FREE!** Complete Denmark ship set. Approvals. Sanders, 6126-N Carpenter, North Hollywood, Calif.

**15 DIFFERENT** U. S. over 40 years, 10c. Special with bargain U. S. approvals. Bill Portney, 1806P E. 22 St., Brooklyn 29, N. Y.

**WORLDWIDE** Packet 50 stamps 5c with approvals. Carlins Approval Service, Box 307, Fresno, Calif.

**FREE**, Irish commemorative collection, including rebellion issue with approvals. Raymax, 123-Z William St., New York City 7.

**FREE!** Mint British Colonies from Solomon Islands, Caymans, Grenada, Dominica, Turks Caicos. Absolutely free to new approval applicants. Viking, 130-Z Clinton St., Brooklyn 2, N. Y.

**FREE** 7-Mint British colonies with approvals. Brooten, 6805 NE. 23, Portland 11, Oregon.

**25 MINT** Hitler stamps \$1.00. Zaporowski, 4360 Edgemont, Philadelphia, Penna.

**AMAZING** Bargain 25 different Vatican stamps, illustrated lists, only 10c. Approvals. Wilhelm, 14646 58th Road, Flushing, N. Y.

**FLAG** Stamp free with U. S. approvals. Wenigman, 929 Oakdale, Chicago.

**BETTER** Approvals for less. Tower, 7910 S.E. Cooper, Portland 6, Oregon.

**POSITIVELY** Greatest free offer—Latest Scott's International \$6.00 stamp album—covering entire world, contains 36,000 illustrated descriptive spaces; Scott's 1948 standard \$7.00 catalogues "Philately's Encyclopedia"—absolutely free to applicants for foreign approvals becoming customers. Plymouth Specialty Company, Dept. A9, Bell, California.

**VICTORY** Packet free—Includes stamps from Tanganyika, British Cayman Islands, animal, scarce babyhead, Coronation, early Victorian, airmail, map stamps. Including big illustrated catalogue. Send 5c for postage. Gray Stamp Company, Dept. PM, Toronto, Canada.

"**CONFEDERATE** States." Twelve different unused 10c, approval applicants only. "Stamps," Box 87, Albany 1, New York.

**STAMPS** 100 Years old. Every collector should have at least a few stamps nearly 100 years old. Although hard to get, we offer a wonderful selection of ten old 19th century foreign stamps and also the blue re-issue of the 100 year old first U. S. stamp, the famous 5c Franklin. All for only 10c. Kindly state whether approvals shall consist of U. S. or foreign stamps or both. Globus Stamp Company, 268 Fourth Avenue, Dept. 212, New York 10, N. Y.

**50 DIFFERENT** Hungary stamps and our price list, one silver dime. Stamp-sales, Box 1649P, Oakland 4, California.

**U. S. Price** list free. Slikes, 1831 E. Allegheny, Philadelphia 34, Penna.

**APRIL** Only! High catalogue mint-commemorative collection only 3c. Approvals. Sunlite, 29 Lincoln Road, Brooklyn 25, New York.

**SUPERB** Non-hinged approvals! Quarter's worth stamps, your choice, free, each dollar's worth purchased. Write Phipps, 10993-P Wellworth, Los Angeles 24, Calif.

**FREE**—10 Japan war stamps. Approvals. Schroeder, 636 Charles, St. Paul 4, Minn.

**POPULAR** U. S. stamps, popular prices; premiums. Jarr, Box 217-b Madison Sq., New York 10.

**COLLECTION** Builder approvals. Henry Jay Service, 15 Park Row, New York 7, N. Y.

**FREE** Desirable airmails, commemoratives, pictorials. Seven countries. Approvals enclosed. Green and Company, Norwood 12, Ohio.

**15 DIFFERENT** San Marino stamps absolutely free to sincere approval applicants. All mints; never hinged. Includes the famous propaganda stamps and other beautiful pictorials. Send 5c to cover postage. Mercury Stamp Service, Bell Gardens, California.



GREENLAND, Ascension, Haiti, etc., 70 stamps from 35 countries 3c with world approvals. Carl Peterson, 2187 East 27th South, Salt Lake City 6, Utah.

YIPPEE! Free, 25c worth from first U. S. selection. Village Stamps, 90-39P 214th St., Queens Village 8, N. Y.

ROOSEVELT, Churchill, Stalin, Hitler, Vatican stamps free to approval applicants. Tamiamp Stamps, Box 2188, Miami 13, Fla.

ROOSEVELT, Honduras airmail, mint; only 5c to approval applicants. GeeKay, 13 Overlea Ave., Baltimore 6, Md.

FREE—Beautifully illustrated monthly price lists of mint complete sets. Send for your copy now. Roger Rijfkoegel, Box 14 General P.O., New York 1.

CANADA Collection, from 1870 to date. 80 face different, including many pictorial, 25c only with approvals. Fields, 1939 E. 85th, Cleveland 6, Ohio.

FREE! San Marino airmail set, mint. Approvals. Standard, Box 1616, Miami Beach 39, Florida.

20c RETAIL Packet only 3c, approvals. Lee, Box 1455, Greenwich, Connecticut.

1000 MIXED U. S. old and new—25c; 2 lb. \$1.25. Weatherby, Medina, Ohio.

LIBERIAN Triangulars, 10c with approvals. Vargo Stamps, 6044 South Fairfield, Chicago 29, Illinois.

BRITISH Colonials—50 different 25c, B.C. approvals. Midland Stamps, Box 83, Victoria Harbour, Ontario, Canada.

GOOD U. S. approvals, used or mint. Panther Stamps, Dorchester Center 24, Mass.

CANADA Peace set 10c with attractive approvals. Rheume, 8949 Routhier, Montreal 12, Canada.

5 DIFFERENT United States \$5.00 stamps 10c to approval applicants. Mohawk, Box 524, Albany, New York.

FREE! Complete Balkan aviation set with approvals. Beaman, Elliston, Virginia.

\$10.00 FOR \$1.00. Box full excellent quality stamps valued Scott's over \$10.00 and illustrated album. Everything \$1.00. Super bargain. Worth much more. Satisfaction guaranteed. Longacre Shop, 108 West 42nd, New York City 18.

FREE! Tiny Chinese "midget" war set. Approvals. Seminole, Elliston, Virginia.

75 UNSORTED Newfoundland 25c. Real value. Mayfair, Regal Rd., Toronto 10, Canada.

FIRST Day covers on approval. Knobel, 1918 SW 12 Street, Miami 35, Florida.

FREE—\$25.00 Stamp collector outfit—Finest, most complete outfit ever offered; Large Scott album, valuable collection of 1050 different stamps, airmails, odd-shapes, hi-values, "Stamp Finder," watermark, magnifier, perf-gauge, tongs and hinges. Actually over \$25.00 value absolutely free when regular customer. Mail application now for foreign approvals. Bargain Stamp Service, Dept. "D," Santa Ana, California.

SELECTED Copies—Mint set U. S. flags, singles, only 80c. Approvals. Quinn, 570, Madison 1, Wis.

GENUINE "Goya nude" set complete, 35c. Approvals. Royal Stamp Company, Tamaqua, Penna.

ELEGANT Offer! Includes Norfolk, Brunei, Kedah, Nigeria, Cook, etc. 10c to approval applicants. Val Stamps, 16 Powell, Evansville 9, Indiana.

TRIANGLES, Diamonds, octagons, midgets! Roosevelts, Hitlers! \$500.00 stamps! Stamp magazine. Everything 5c! Approvals. Thrifty Stamps, Silver Spring, Maryland.

DOUBLE Bargain—Fine used, Washington Bicentennial and Army-Navy sets. Both, only 20c. Approvals. Quinn, 570, Madison 1, Wis.

STAMP Magazine, copy free! "Stamp Post," Station A, Pasadena, Calif.

51 DIFFERENT Belgium beauties, used, unused, pictorials, parcel post. Catalogs way over \$1.00, only 5c if you request approvals. L. Frazer, Box 4600, Portland 2, Oregon.

200 WORLD Wide 27c. Pacific, P.O. Box 5704, Los Angeles, Calif.

TERRIFIC! Globe girdling packet from fifty countries 10c. Approvals accompany. AAA Stamp Company, Arcade Building, Saint Louis, Missouri.

ABSOLUTELY Free! 25 different valuable mint Chinese new issues with approvals. Barton, Box 321, Elizabeth, N. J.

FREE: Twenty different foreign commemorative stamps to new approval applicants. Modern Stamp Service, Box 12, Wakefield Station, N.Y.

PRINCE Edward Island #6, over 80 years old! Scarce! Only 20c to adults requesting approvals. Star Stamps, 11 East 15th Street, Jamestown, New York.

10 ALL Different Iraq only 5c to applicants for approvals containing airmails, commemoratives, and pictorials. Jeffery Stamp Co., 9726 So. Chappel, Chicago 17, Illinois.

\$1 STAMP, 100 Different U. S., 25c. Approvals. Miller, Box 600-A, Palo Alto, California.

1880-1899 SCARCITIES: Egyptian, U. S., Persian, Cuban, others; plus 25 different Br. India 10c. (Approvals.) Gerhardt, 2804 Rio Grande, Austin, Texas.

BIG Money in stamps. Buy at low cost. Sell at big profit. New book "How to Sell Stamps by Mail" reveals startling stamp secrets. Write: Donald Kelly, 9544 Whitcomb, Detroit 27, Michigan.

77 DIFFERENT United States. Many commemoratives included. 17c to approval applicants. Standard, 3817 Sackett, Cleveland 9, Ohio.

STAMP Remover 25c. Free with approvals. L. White, Box 922, Pittsfield 3, Mass.

25 ALL Different stamps 10c. Tunis, Wakeman Ave., Newark 4, New Jersey.

WORLDWIDE, Fifty different, free. Additional fifty, up to 1,000 different, 10c per fifty. Approvals included. Jack Duda, Streator 3B, Illinois.

MIXTURES, Worldwide, 1,500, \$1.00. Missions Outlet, Reverend Marshall, Paterson 1, New Jersey.

FRENCH Colonies, 50 different only 25c. Approvals sent if requested. Floyd Frederick, 513½ Green Street, Lancaster, Penna.

UNITED States stamps on approval. Bargain prices. Metropolitan, 140-B Nassau, New York 7.

MINT Hitler heads, 18, Scott's #506-523 for only 25c. Blocks of four \$1.00. Reich Stamp Co., 4647 Kenmore, Chicago 40, Ill. Dept. M16.

200 DIFFERENT Stamps—Cataloging up to 15c each, only 3c to approval applicants! Littleton Stampco, Littleton 42, N. H.

MAP Stamps, 15 different plus world's smallest triangle, scarce, only 5c with approvals. R. George, Box 2774, Phoenix, Arizona.

YOU'LL Like our American and British Colonial approvals. Write now. Chesapeake Stamps, 748 Overbrook, Baltimore 12, Maryland.

25 UNUSED Stamps. Pictorials, airmail, triangle, etc., only 3c with approvals. Paul Bauer, 31 Wilshire, Lancaster, N. Y.

FREE U. S. price list. Postage 3c. Mark Hanna, 335-5th Avenue, Pittsburgh 22, Penna.

WOW! \$10.00 Worth of fun. Only 10c! What a treasure hunt! Big package 500 foreign stamps from foreign missions, other sources. Includes stamps from Africa, South America, Free French, Somali, Palestine, etc. Includes airmails, commemoratives and stamps worth up to 50c. This offer sent for 10c to approval applicants only. Jamestown Stamp Co., Dept. 22, Jamestown, N. Y.

GRAND Value packet, 5 sets, free with approvals. Stoll Stamp Service, 2631 Burnett, Louisville 10, Kentucky.

FREE Catalog U. S. mint sheets. Kenda, 82 New Jersey Avenue, Brooklyn 7, New York.

CIPEX Sheet, commemorating 100th anniversary 1847 issue with 30 different U. S. containing early issues, commemorative, airmail, envelope, revenue. Catalog value exceeds 65c; all for 10c to approval applicants only. Curhan Stamp, Gloucester, Mass.

COLLECTORS Outfit, album, hinges, gauge, detector, 50 different stamps, 2 mint sets. All 10c, approvals. Cornett, 228 West 25th, New York 1.

START Your own stamp business. Write for free circular. Donald Shepard, Box 5139, Chicago 80, Ill.

ILLUSTRATED Stamp Magazine, 26 weeks 25c. Stamp Journal, Kalamazoo, Michigan.

CHOICE Of 35c worth of stamps from our first U. S. selection free to applicants enclosing 3c postage. Large selection to choose from. Act now! S. C. Engel & Co., 38 Park Row, New York.

200 DIFFERENT, including Roosevelt triangle, 5c to approval applicants. H. Avalon Stamp Co., Springfield, Mass.

WORLD'S Largest stamp (7½x14 inches). A real curiosity! Retail for 50c, only 3c to approval applicants. Tatham Stamp Co., Springfield 30, Mass.

FREE—The Stamp Finder. Big new edition—32 pages profusely illustrated. Identifies all difficult stamps immediately. Given free with 319 different stamp from Vatican City, Palestine, Cyprus, San Marino, etc. All sent to approval applicants for only 10c. Price lists. Garcelon Stamp Company, Box 800, Calais, Maine.

GENERAL Collection, breaking up. Approvals. Lion, 200 W. 81 Street, New York 24.

PENNY Approvals, that satisfy. Neil Gronberg, Box 5441-P, Philadelphia 43, Penna.

DANDY United States approvals. Write immediately. Sullivan, Endicott Building, St. Paul, Minnesota.

NICARAGUA "Tin Pan Alley" diamond, Ecuador showing George Washington, and American flag in natural colors. Fezzan, Trieste, "American Army" stamp, first U. S. commemorative, \$100.00 Shanghai, Corsica, Anzac, Antique, others. All 5c. Approvals. Capital Stamp Co., Dept. 2, Little Rock, Ark.

50 DIFFERENT United States 10c. No approvals. Seidenberg, Cassopolis, Mich.

GIANT Bicolored royal visits, Malta pictorials, gorgeous Guianas, Goose airmail, Scandinavian packet and illustrated stamp publication, 10 cents with approvals. Crown Stamps, Box 331, Toronto, Canada.

SUPER Value penny approvals. None higher. Arthur Terreson, Box 479, Bellmore, N. Y.

300 DIFFERENT Given free with approvals. Postage 3c. Windsor Stamps, 1435 East 67th Place, Chicago 37.

FREE—Famous Americans set, plus Flag Set, plus the National Parks Set, plus the Presidential Set to the \$5. A total of 90 stamps absolutely free to customers for our unsurpassed U. S. or foreign selections. Send 3c postage for 15 of the above mentioned stamps and full particulars. Triboro Stamp Company, 145 Nassau St., Dept. 112, New York.

CANADA—75 Diff. 25c. Approvals, Lists. Victoria Stamp Co., London 4, Canada.

FREE! Triangle Roosevelt, Vatican, Ethiopia, Hitler heads. With approvals. Florida Stamp Company, Box 807, Miami 5, Fla.

FREE! 100 Worldwide different stamps to approval buyers. Big U.S. and illustrated bargain lists sent with approvals. Bookman, Maplewood, N. J.

128-PAGE United States catalog—1000 illustrations, 10c. Harris & Co., 202 Transit Bldg., Boston.

50 DIFFERENT Stamps, triangle, airmails, etc., 5c with approvals. Carlton's, 10243 Silverton, Tujunga, California.

BRITISH, Spanish and French Colonies. Vatican, Hitler heads, and airmail packet, free with approvals. Pan-American Stampco, Box 145, New York 33, N. Y.

STAMP Collections wanted. Complete collections, duplicate lots, surplus stock, mint and used. Prefer trade for printing or other items, buy outright if priced right. What have you, what's wanted? Vanroy Shirk, Lebanon, Penna.

U. S. Price list. Send postage. State Stamp Service, 1225 Park Building, Pittsburgh 22, Penna.

DEALERS—Wholesale list. Postage 3c. Frank, 5031 Queensberry, Baltimore 15, Md.

ZOWIE-E! A barrel of fun for only a dime. 500 United States stamps—absolutely unpicked and unsorted—just as received from church missions. Many varieties, including large commemoratives, airmails, high denominations up to \$5.00! Stampdom's biggest package of fun—and you might find something really valuable! Price only 10c to serious approval service applicants. Money back if not delighted. Illustrated bargain lists with each order. Mystic Stamp Company, Dept. 80, Camden, New York.

U. S. Price list. Send postage. Stanley Gibbons, 38-P Park Row, New York.

FREE! Crystal-mount samples! Har-risco; 202 Transit Bldg., Boston.

UNITED States approvals complete coverage, fine quality, attractive prices. Seminole Stamps, Box 1138-P, Coral Gables, Florida.

WHOOPIE! Wow! 25c worth of U. S. stamps free! No obligations! Write M & N Co., 742A Sheffield Ave., Brooklyn 7, N. Y.

ANTIQUES, RELICS, INDIAN GOODS, CURIOS

SWORDS, Rapiers, daggers, pistols, armor. Illustrated catalog 50c. Robert Abels, 860-A Lexington Ave., New York.



## HOBBIES AND COLLECTIONS

THE Magazine all hobbyists, collectors, need. Twelve issues, \$1. Everyday Hobbies. Box 104PM, Highland Station, Los Angeles 42, California.

**BASEBALL** Picture fans! 54 exclusive 7"x10" sensational picture cards of top major league stars, now only \$3.00 postpaid. Many others in stock for your selection. Sports Exchange, Box 2497, W.S. Sta., Youngstown 9, Ohio.

**MEDALS**, Foreign campaign bars, samples, catalogue, 25c. Insigniacrafts, 236 28th Avenue N.W., Calgary, Canada.

**SCRAP** Leather, large sizes, assorted colors, 5 lb. \$3.95. Enterprise, Sheboygan, Wisconsin.

**NEW**—15 Different match covers 10c. Box 202, Rochester 1, N. Y.

**WORLDWIDE** Hobby magazine, twelve issues \$1.00; sample 10c. Klings', Blue Island, Illinois.

**WANTED** Old cigarette cards. Write Charles Bray, East Bangor, Penna.

**UNUSED** Match book covers, 100 all different \$1.00. Free catalog. Charles Edelman, 1311C East 84, Cleveland 3, Ohio.

**INVENTING** Can be an interesting and profitable hobby. Write for complete particulars. Institute of American Inventors, Dept. 40-E, 1926-Eye St. N. W., Washington 6, D. C.

## PRECIOUS STONES, MINERALS

**PETRIFIED** Woods. Rare, beautifully grained. 12 cubic inches, \$2.00. Flossie Lee, Mountain View 1, Oklahoma.

**"GENUINE"** Deep red Arizona rubies (garnets). Send quarter for packet. Mineral Specimen Company, Box 2651, Phoenix, Arizona.

**ZIRCONS**, Diamond like sparkle, ready to set. 2 samples \$1.00. 5 samples \$2.00. Others. Imhusex, P.M., Box 232, White Plains, N. Y. Agents wanted.

**METAL** Detectors. The very latest circuit. Free literature. Hedden Metal Detectors, 538 N. Homewood Ave., Pittsburgh 8, Penna.

## CAMERAS, PHOTO SUPPLIES

**200X TELEPHOTO** Camera easily made. Trifling cost. Telephoto lens and instructions \$3.00 postpaid. Instructions alone 10c. Suffolk Science Service, Manorville, N. Y.

**AUTOFOCUS** Enlarger, easy to build, no figuring, simple construction. Illustrated instructions \$1.00. Photolab, Rohnerville, Calif.

**SENSATIONAL!** Photo greetings in color! Sample, catalog 10c. F. H. Frey, LaCrosse 1, Wis.

**STILL** Cameras, movie cameras, projectors. Standard makes, bargain prices. Free list. 35mm. reloads 40c. Church Studio, Enterprise 3, Ore.

**REVOLUTIONARY** Contact photo printer. Ten contrasts same paper. Write for literature. Campus Camera Shop, 1083 Broxton, Los Angeles 24, Calif.

**BUILD** Your own enlarger. Takes negatives up to 4"x5". Detailed plans one dollar. Emby Co., Birmingham 5, Michigan.

**OIL** Coloring photographs can be a fascinating hobby or profitable sideline for those with artistic talent. Learn at home. Easy simplified method. Send for free booklet. National Photo Coloring School, 1315 Michigan, Dept. 3432, Chicago 5, Ill.

**BASS** Says! At the sign of the old "Horse Trader," 37th year. Thousands of satisfied customers everywhere! Finest brands including Kodak, Bell & Howell, Argus, Zeiss, Leitz, etc. Satisfaction always guaranteed, or your money back! Bass buys 'em, sells 'em, trades 'em. Write or wire, Bass Camera Company, Dept. AG, 179 W. Madison St., Chicago 2.

**PHOTOGRAPHY** For pleasure or profit. Learn at home. Practical basic training. Long established school. Write for booklet. American School of Photography, 1315 Michigan, Dept. 3432, Chicago 5.

## PHOTO FINISHING

**CUSTOM** Says! We pay air mail (over-seas) for GI's and civilians. Your pictures back four days Guam, five days, Tokyo. Custom Photo, "your nearest postal port." See our offers below.

**YOUR** Photo enlarged 8x10. 50c. Robert Renshaw, Jr., P.O. Box 478, Chester, Penna.

**NEW** Process developing and printing. 8 exposure rolls 35c. Mayfair Photo Service, Box 261K, Toledo, Ohio.

**8 BILLFOLD** Size black and white copies from your favorite portrait \$1.00. Jean Anne Jacob, 125 N. 4th Ave., Morton, Illinois.

**CUSTOM** Says! Eight hour service. Standard rolls 30c, 12 exposures 40c, 16 exposures 60c. Deckled (regular) or jumbo reprints, 4c each. Custom Photo, Box 567, San Francisco 1.

**PHOTOS**, Documents, etc. photocopied to wallet size and permanently sealed in plastic. Details free. Madfis Specialty, 175A Tremont St., Boston 11, Mass.

**ENLARGEMENTS** In album form developed and printed in one continuous story-telling arrangement. Any 8 exposure roll reproduced this novel, loose-leaf way for only 30c. Reprints 4c each. Extra prompt service! Clip this ad for free mailers. Larga-Pic, Box Z2, Brookline, Mass.

**PHOTO** Copying. Mail picture and only one dollar, we will make negative and proof. Kino Service, 2042 South Eight Street, Milwaukee 4, Wisconsin.

**EVERY** Picture an enlargement! New electronic developments give you bigger and better enlargements at the same low prices. Any 8 exposure roll developed and printed enlarge size, only 30c; reprints 4c each. Fast, accurate service guaranteed. Send for free mailers today! Enlarge Photo Service, Box 791-D, Boston 2, Mass.

**CUSTOM** Says! One buck! 36 jumbo prints from 35mm.—I'll reload your cartridge, fresh panchromatic film, half a buck.

**"BETTER** Photo finishing." Jumbo prints 40c a roll. Reprints 3c. Best by test, 35mm. positives \$1.50 strip, 36 ex. Seal-tone Photo, Box 468, Seal-Beach, Calif.

**PHOTO** Novelties, greetings, puzzles, jokes, games. Fun galore! Sample, catalog 10c. F. H. Frey, LaCrosse 1, Wis.

**ENLARGEMENTS** From your negatives. 5x7, 10c; 8x10, 25c. National Film Service, Box 950, Canton 1, Ohio.

**CUSTOM** Says! Send us your work and our work sends you. Custom Photo, Box 567, San Francisco 1.

**8 HOUR** Service, eight exposures 30c; 12 exposures 35c; 16 exposures 50c; 36 exposures \$1.00. Reprints jumbo or deckled regular 3c. Send for free mailers. Quality Photo, Box 468, San Francisco, California.

**FASTEST** Service. Finest jumbo size enlarged prints. Roll of eight 30c. Over eight 50c. Reprints 4c. Dick's Photo, Louisville, Ky.

**FOUR** 8x10" Professional enlargements, \$1.00. Send negatives. Enlargemart, 535 Lemaster, Memphis, Tenn.

**BEAUTIFUL** Enlargement from each picture on roll 25c. Cut Rate Photos, Dept. B4, Janesville, Wis.

**TWO** Beautiful prints from each picture on roll 25c. Twenty-seven years of satisfied customers. Quick service. Lens Photos, Dept. J4, Janesville, Wis.

**ENLARGEMENTS**, 5x7 15c, 8x10 25c. Glossy or dull. Oil colored, 50c extra. Negatives made 50c. Roll film developed and printed, 25c. L & R, P.O. Box 1476, Milwaukee Wis.

**PROFESSIONAL** 8x10 Enlargement 50c. Three, \$1.00. Rush negative. Mosher Studios, Vineyard Haven, Mass.

**8 BEAUTIFUL** Double size pictures and roll developed 30c. 8 hour service. Free mailers. Pacific Photo Service, Box 666, San Francisco, Calif.

**TEN** Photographic enlargements of typical Mexico, \$1.00. Apartado 2807, Mexico City.

**ROLL** Developed, 8 prints and two enlargements 25c. Trial offer. Young Photo Service, 405-C, Albany 2, N. Y.

**PHOTOGRAPHY** For pleasure or profit. Learn at home. Practical basic training. Long established school. Write for booklet. American School of Photography, 1315 Michigan, Dept. 3451, Chicago 5.

**8 PRINTS** All enlarged to nearly postcard size from your roll or negatives 25c; 16-50c. (Trial offer). Willard Studios, Box 3535A, Cleveland, Ohio.

**16 DECKLEDGE** Prints from any standard 8 exposure roll 25c. Quick service. Professional work. Skrudland, Lake Geneva, Wis.

**FREE** Price list on quality developing, printing, enlarging. Write for it today. Bryan's Photo Shop, Dept. M, Panama City, Florida.

## MOTION PICTURES AND SOUND EQUIPMENT

**SEND** 10c For 8mm., 16mm., catalogue. Sterling's, 679 Northampton, Easton, Pennsylvania.

**35MM.** Sound features, shorts, cheap. Reisinger, 2909 Whitney, Baltimore 15, Maryland.

**16MM.** Sound western features. Money-making roadshow attractions. Top stars. New prints. Low prices. Write! Grand, 2506M-52nd, Kenosha, Wisconsin.

**SURPLUS** Laboratory supplies. 8mm.-16mm. silent; sound recording. Lists free. Fischer Photographic Laboratories, 1731 North Mobile, Chicago 39, Illinois.

**BARGAINS** In used 16mm. sound films. Cartoons, sports, musicals, features. Big list for stamp. Blackhawk Films, Davenport, Iowa.

**MAKE** Beautiful titles yourself. Beginners' illustrated booklet worth a dollar, send 25c. Descriptive folder if requested. Westwood Company, 635 Victoria Street, San Francisco, California.

**FREE** Movie list. Superior Film Service, Box 713, Troy, N. Y.

**SEND** Name for particulars and membership in Film Exchange Bureau. Your old films exchanged for new subjects. Screen Supply Service, 514 Main St., Cincinnati 2, Ohio.

**MOVIE** Fans 100' 16mm. \$2.25, three rolls \$6.00. Magazine films \$1.95. Titles 15c. Ambassador, 479-A Quincy Street, Brooklyn 21, N. Y.

**MOVIE** Film at tremendous savings! Kodak Super X, Gov't stock, tested, guaranteed! 16 mm. 100 ft., \$2.95; 50 ft. magazine, \$2.50; double 8 mm. 25 ft., \$1.65. Super XX, 50c add'l each roll. Free processing. Fast service. Photo Surplus Sales, Box J-9, 12 Duane St., New York City.

**SPECIAL** 16MM. assortment: sound tracks, negatives, prints, color. Educational; entertaining. \$1.00 postpaid. Film Associates, Dayton 9, Ohio.

**MOVIE** Film processing—Finest automatic machine processing 8mm., 16mm. 48 hour service. Also duplicating, editing, titling, other lab services. Send for list of prices. Fotoshop, Inc., Room 121, 18 E. 42nd St., New York City.

**35 MM., 16 MM.,** silent, sound films, projectors. Lists dime. John Logue, Carnegie, Penna.

**MOVIE** Cameras! New Lektro Junior 16mm. electric, magazine-load F3.5 anastigmat lens, battery, cord. Complete, ready-to-operate only \$59.50. Money back guarantee. Free literature. Panchromatic magazine film for this camera \$2.50, free processing. Army-Navy GSAP, original condition, value \$200, new \$32.50, used \$19.50. Other Panchromatic film—25 ft. double 8mm. \$1.65; 100 ft. 16mm. \$2.95; includes processing. Fotoshop, Room 95, 18 E. 42nd St., New York City.

**GIANT** Film offerings, 5c. American Films, 6711 Sunset, Hollywood, Calif.

**16MM.** Sound projector complete with case \$139.50. H. E. Tyndale, 2965 The Mall, Los Angeles 23, Calif.

**LEARN** Professional motion picture technique at home. Approved for veteran training under G.I. Bill. Free catalog. Motion Picture Institute, Birmingham 4, Mich.

**BARGAINS!** Free films-equipment catalog! Towers, 935 North 40th, Philadelphia 4.

**35MM.** Silent-sound films, supplies. Bedner, 5300 So. Talman, Chicago.

**FREE**, Catalog, movies; sample films, 10c. Goodwill Company, Jackson, Tennessee.

**GUARANTEED** Fresh anti-halo outdoor movie film! Weston 12! Daylight loading! Processing free! Three spools double 8 mm. \$3.45! Six single 8 mm. for Univex, \$4.60! Postpaid! Catalog. Eso-S, 47th Holly, Kansas City 2, Missouri.

**FINEST** Movie screens, inexpensive, make them yourself. Free literature. Snow White Screen Company, Danville, Illinois.

**BARGAINS** In 16mm. sound projectors, films, reels, splicers. Harris, 303 West 42nd Street, New York 18.

**SURPLUS** 16mm. Eastman Super X on 50' cores, 50c postpaid! 12 rolls \$5.00! Outdated but tested and guaranteed! 100' camera spools 25c postpaid! Processing, 75c. Filmmcraft, 47th Holly, Kansas City 2, Missouri.

**HOLLYWOOD** Films. Color sample, \$1.00 (refunded). Catalogs, 10c (refunded). Stone, Lunenburg 2, Mass.

**I BUY**, Exchange, swap movie films. Rental catalogue 25c Harvey Iris, Box 539, Brockton, Mass.



**RARE 8-16MM.** Silent-sound films. International, 2120 Strauss, Brooklyn, N.Y.  
**PROCESS** Your own movie film. Literature. Duro Products, 1519 Eggert, Eggertsville 21, N. Y.

**SILENT** To sound—Convert your silent 16mm. projector into sound with our guaranteed sound conversion equipment. Fits any silent 16mm. projector. Includes: Sound head kit (easily assembled); radio film adapter (plays sound through your radio) and complete instructions. Total price \$48.95. Send check or money order to Apex Video Co., 12209P Branford St., Roscoe, Calif.

**EXCLUSIVE** Home movies. Select films. Write for free lists. Home Pix, 1674 Broadway, New York 19, N. Y.

**ARMY** Surplus 50' 16mm. magazine Super X Weston 50 films, \$1.00. Processing 75c. Guaranteed. Filmcraft, 828 West 39th, Kansas City 2, Missouri.

**WE BUY.** Sell, rent, exchange home movies. Details for dime. Midland, Box 429, Oak Park 4, Ill.

**LEARN** Movie projection, management. Free catalog. Theatre Institute, Elmira, N. Y.

**8-16MM.** Silent-sound films. Complete rental library. All latest subjects. Free catalogue, (sample film 10c). Garden Film, 317 West 50th, New York 19.

**BASS** Says! 37 years of leadership means satisfaction to you! Finest equipment, 8 and 16 mm., sound cameras, sound projectors. Bass buys 'em, sells 'em, trades 'em. Satisfaction always guaranteed, or your money back! Bass Camera Company, Dept. A, 179 W. Madison St., Chicago 2.

**BEAUTIFUL** Kodachrome slide and lists 25c. Slide Supply Service, 3111 West Tuscarawas, Canton, Ohio.

## MUSIC AND MUSICAL INSTRUMENTS

**HOHNER** Harmonicas, marine band, chromatics, all kinds. Guitars, trumpets, accordions, marimbas, vibraphones, saxophones, Radios, Tonettes, Batons. Everything musical. Hawes Music Store, Portland, Maine.

**DUO-FLEX** Reeds, for clarinets and saxophones. Eliminate your reed troubles. Circular free. Duo-Flex Reeds, 1204 First Ave., Evansville, Ind.

**SONGWRITERS** Attention! The amazing demand for phonograph records, accelerated by countless juke-boxes, warrants your immediate investigation. We are offering new writers the rare opportunity of having celebrated "hit" composer furnish music on reduced percentage basis for any likely poems received this month. The Petrillo ban does not affect us. Recola Records, Hollywood 28, Calif.

**MUSIC** Printing \$5-100. Composing, arranging, publishing. Auto-Litho, Jensen, Fla.

**SONGWRITERS.** To get anyplace your song should have a beautiful professional piano arrangement by the arranger of "Open the Door, Richard." We send you twelve copies expertly and beautifully arranged for \$25. Satisfaction guaranteed. Send manuscript and money order to Songwriters Arranging Service, 6406 Sunset Blvd., Hollywood, Calif.

**PHONOGRAPH** Records 20c. Catalogue. Paramount, MP-313 East Market, Wilkes-Barre, Penna.

**LEARN** Piano playing quickly. New speed method. Very simple. Public schools approve. Literature free. Speed Method, 435 Abiso, San Antonio 5, Texas.

**CHURCH** Organist 35 years composes music, prints music. Reginald Belcher, 14 Harrison Street, Morristown, New Jersey.

**1948 ACCORDIONS** — Wholesale. Free catalog. American Accordion Center, 39 So. Kedzie, Chicago.

**SONGWRITERS:** Honest outstanding music writing offer. Len-Tex Studios, Leonard 2, Texas.

**AMPLIFY** Your accordion with our new mike \$22.50. Sounds like organ. Installed in minute. Use any amplifier. Amplifier and mike \$72.50. Write Del Principe, 307 So. Wabash Ave., Chicago.

**ACCORDIONS**—Guitars, trumpets and all musical instruments, new and used. Direct from national distributors, cash and terms. Save money. Del Principe, 307 So. Wabash Ave., Chicago.

**BE Independent.** tune pianos, music unnecessary. Practical Piano Tuning shows you how. \$2.00 postpaid. Chord-Slide Co., P3122 Lawrence Drive, Corpus Christi, Texas.

**POEMS** Set to music. Experienced composer. Free folder. Moquin, 5333 La Cresta Ct., Hollywood, Calif.

**SONGWRITERS!** Ethical composing offer. Hibbeier, C5, 2157 N. Avers, Chicago.

**ACCORDIONS.** Streamline, wholesale. Request circular, Metro Accordion, 44 North Albany, Chicago.

**MUSIC** Arranged. Songs printed. Frank Wildt, Music Publisher, Lancaster, Penna.

**SONGWRITERS**—Protect your songs. Get the facts first. Free booklet, attractive offer. Song Service, 331-C West 46th, New York.

**POEMS** Wanted for musical setting. Send poems for free examination. Five Star Music Masters, 630 Beacon Bldg., Boston, Mass.

**POEMS** Wanted for musical setting! Send poem for immediate consideration. Hamann Service, 614 Manhattan Building, Milwaukee, Wisconsin.

**POEMS** Wanted to be set to music. Free examination. Send poems. McNeil, Master of Music, 510-PM S. Alexandria, Los Angeles, California.

**SONGWRITERS:** Send poems for free examination and outstanding offer. United Music Service, 150, Salem, Indiana.

**WRITE** Songs. Big money and reputation. Write for information. J. Gordon Pub Co., 201 N. Hoyne Ave., Chicago.

## RADIOS, SUPPLIES, INSTRUCTION

**BIG** Bargains in radio parts, tubes, electronic equipment! Bantam 1-watter 24c; crystal oscillator unit \$2.95; miniature tube pin straightener 27c; permeability tuner \$1.24; T-17 microphone 49c; Daco tube tester \$29.50; FM transmitter (APN-1) \$34.50; HS-30 headset 36c. All brand-new, unused. All guaranteed. Rush order today! Send 25¢ deposit, balance c.o.d. Minimum order \$2.50! Write for free bargain bulletins. Mid-America, Dept. CD-10, 2412 S. Michigan Ave., Chicago 16, Ill.

**SOUND-POWERED** Batteryless telephone, \$5.00 pair. Miles, 812 Broadway, New York.

**BUILD** "Loudest" crystal radio. Instructions, very loud crystal, 25c. Amorse, Route Four, Richmond, Virginia.

**BUILD** Marvelous, tiny, concealed, 21 ounce, 4 tube superheterodyne. Astonishes radio engineers. Plans, photographs, \$2.00. World famous pocket radio plans, \$1.00. United Manufacturing Associates, 3605 Canyon Ridge, Fort Worth 3, Texas.

**BARGAINS**—Complete crystal kit with headphone, aerial, illustrated instructions, only \$2.95. Free list. Radios, phonographs, supplies. Al's Radio Service, Sioux City 7, Iowa.

**TELEVISION:** Telecraft distributes Transvision kits exclusively. Build your own television receiver. Complete simple instructions. Buy from headquarters. Servicemen, dealers, write for wholesale price list. Telecraft Corp., 2 W. 15 St., New York City.

**ALUMINUM** Parabolic reflectors for experiments in radar, television, etc. List free. Torngren, 100 Skilton, Somerville 45, Mass.

**POSTWAR** Aerial eliminator-signal booster for your radio. Complete with instructions. \$1.98 postpaid. Eatons, Box 471-E, Lorain, Utah.

**RADIOS.** Record players, tubes, parts. Send for free bargain list. Hallmark, 594A Communipaw, Jersey City 4, New Jersey.

**MAKE** Selective distance getting crystal radios. Also one tube radios. Improved designs. Instructions and crystal 25c. Radio Leader, La Verne 4, Calif.

**SACRIFICING** All new stock of our radio laboratory parts. Save 75%. Write for free list. Wesco, 1618 Greenleaf, Chicago, Ill.

**24 PAGE** Plans "18 Long Distance Crystal Sets," catalog, "Radiobuilder"—all 25c. Laboratories, Eye-c, San Carlos, California.

**LEARN** Elements of radio at home. Ideal course for beginners. \$15.00. Write Waca Radio School, 1421 Sixth St., S.E., Minneapolis 14, Minn.

**EXPERIMENTERS**—All wave radio kits. Free circular. Artlin Company, Knickerbocker Station, Box 25, New York 2.

**RADIO** Controlled garage door opener—works from button in car. Complete plans \$1.00. Radio, Box 3236, Birmingham, Alabama.

**FIX** Any radio. Amazing new instrument locates radio troubles double quick. Simple instructions show you how. Thousands in use. Write today for 24-page booklet, "The Inside Story." Feller Engineering Co., 945 George St., Dept. PM, Chicago 5, Illinois.

**26 YEARS** Experience radio repairing at your fingertips. I've repaired 45,000 radios. Have perfected simple system you can follow step by step. No calculations or formulas. Total price \$2.00 postpaid or c.o.d. Moneyback guarantee. Ross Radio, 14615-M Grandriver, Detroit 27, Michigan.

**MAKE** Simple, tubeless, batteryless, distance-getting crystal radios. Crystal and illustrated instructions 25c postpaid. Allen, 427-P, Clinton, Missouri.

**RADIO** Technician and radio service courses. Training for federal licenses. American Radio Institute, 101 W. 63 St., New York City. Approved under G. I. Bill of Rights.

## BUSINESS OPPORTUNITIES

**QUICK** Money. "Repairing car batteries." At home! Easy too! Batteryman, Grand Junction, Colorado.

**GET** It for them wholesale. Be community buyer nationally advertised merchandise; radios, refrigerators, washers, sweepers, typewriters, etc. Savings to 50%. This pleasant easy work can earn \$5,000 year. Details free. Cox, 14 Church, Saugus, Mass.

**DOLLARS** in your own business at home. Literature free. Frank Webster, Box 1972A, Hollywood, Calif.

**COMPLETE** Mail order business. Write Joseph Vassar, 312 Harden Street, S.E., Atlanta, Ga.

**RUBBER** Molds. Illustrated list free. Oman, 642-P Broadway, St. Paul 1, Minn.

**MAKE** Profits in mail order business. Astounding plans describing method sent free. Jimton Service, Lock Box 1373K, Mobile 8, Ala.

**WANTED** Unused U. S. postage stamps, small discount. Advance Stamp Company, 24 East 23rd Street, New York.

**WINDSHIELD** Wiper rebuilding brings big profits. Free particulars. H & H Products, Box 430, East Akron 5, Ohio.

**GOODYEAR**—Has natural Malaya 75% heavy brushing rubber for molds. Trial half pint, 50c. Write for full particulars. Goodyear, Lake Geneva, Wis.

**BE Independent**—Operate America's lowest price penny vending machine. Big profits. Immediate shipments. Write for bulletin and prices. Fielding Mfg. Co., Desk (448), Jackson, Mich.

**OPERATE** Your own employment agency. Get into this good paying business. Complete operational plan, sample forms. Postpaid only \$3.00. Jack Seliars, Box 822, Coos Bay, Oregon.

**VARIETY** Store business, large profits. I tell you how to start, \$1.00. Fred Carpenter, Hamlin, Texas.

**MECHANICALLY** Inclined? Resurface butcher blocks. Lifetime business. Roy Crawford, Keyport, New Jersey.

**MAKE** And sell candy professionally, inexpensive to start, information free. Box 670, Kissimmee, Florida.

**MAKE** Big money! You can clear 25 to 50 dollars a day in your own popcorn-candy business. Start now! Write for free literature and prices. All electric candy floss machines, popcorn kettles, candy pullers, other big money makers. Concession Supply Company, 3906 Secor Road, Toledo, Ohio.

**FOR** An extremely profitable lifetime business operate a collection agency; credit bureau. Easily learned. Free folder. Cole & Associates, Syracuse 2, N. Y.

**SILVER** Plating, new way. Big profits. Fairchild Company, Mt. Vernon, Ohio.

**OPERATE** Vending machines. Small capital. Long profits. Write T. O. Thomas Co., 1572 Jefferson, Paducah, Ky.

**OWN** Mirror shop. Resilver mirrors. Glass sign making. Electroplating. John Sprinkle, V60, Marion, Indiana.

**PLASTIC** Tablecloth covers, curtains, drapes, baby pants, bowl covers and other plastic articles selling like wildfire! Make big money now! Free details. Write Plastics, Dept. 58-D, 206 N. Fourth, St. Louis, Mo.

**YOUR** Own plastic business at home. Learn to produce costume jewelry, novelties. Use flexible molds, liquid plastic—marble. Write for free book. American Trades, Box 89-A-5, Cincinnati 29, Ohio.

**MOLD** Makers. Genuine natural latex for rubber molds, only two coats needed for thick mold. Reproduce statuary, plaques. Inexpensive. Write Major Chemical Co., 131A Inman Street, Cambridge 39, Mass.



**WALL Plaques, figurine, rubber molds.** Emerson, 142 Bay 14, Brooklyn 14, N. Y.

**EARN Good income in mail order business.** Proven methods. Small capital. Details free. Mosley Business Service, Box 3528, Shreveport, La.

**SAWDUST.** Turn it into cash. Six methods. Instructions 25c. Charles, 12-BD, Norwood, Ohio.

**GOLDEN Opportunity "How to Establish and Operate a Successful Mail Order Business."** Free information. Palmer Publications, 4219-A Southwest Marigold, Portland 1, Oregon.

**HOME Workers** wanted to hand-spin Angora wool. Either sex. House of Angora, Springfield, Illinois.

**NEW And unusual product.** Big profits. Repeats. Spare or full time. Details free. R. A. Scheuerer, 1821 Menahan St., Brooklyn 27, New York.

**SAVE!** Half million articles wholesale. Directory 10c. Publishers, Olinger, Va.

**CASH In.** 68 page book, over 40,000 words. 25c. Money-making business secrets. Mail order plans galore. Mail Order Sales, 7905 Birchdale Ave., Chicago 35, Ill.

**BUILD Your own trailer—midget house, utility.** Complete details 25c. Popular Mechanics Press, (C-43), 200 E. Ontario, Chicago.

**A BUSINESS Of your own!** Beautifully bound book, practical plans for over 75 small businesses, compiled by qualified economic analysts. Over 300 fact-filled pages. Cost only \$3.00 with 5-day money back guarantee, if not completely satisfied. Bickford Co., 528-A White Building, Buffalo 2, N. Y.

**FASCINATING Mailorder plans,** legitimate big-profit schemes. Warren, Freedland 1A, Mich.

**OPERATE Profitable mail order business.** Excellent opportunity. Particulars free. Write Reid, 400 Norwood St., Lynchburg, Va.

**SENSATIONAL New roller skate item.** Sells on sight! Field barely scratched. Make big money now! Send \$1.00 for sample and full details. Write today. Pro-Tek-Toe Skate Stop Co., Dept. M-1, 5166-68 Easton Ave., St. Louis, Mo.

**MAKE Big earnings.** Operate an S-I-P Mobile Paint Store as our franchised representative. Make your car earn money for you. No experience or capital required. We train you and get you started right. Full time and part time positions now open. A clean, interesting, healthy and profitable business. Write Standard Industrial Products, Inc., Dept. S-1, Evansville 4, Indiana.

**MANUFACTURE At home your own line of fluorescent bed lamps and desk lamps to be sold to stores.** Complete parts, instructions, diagrams, etc., available. Write E. C. A. Mfg. Co., 2520 W. Montrose, Chicago, Ill.

**RUBBER Moulds** made to order. Send us your models. We will make you perfect moulds. Guaranteed, priced reasonable. Estimates given on request. Star Plastex Co., Butler, Wis.

**METALIZE Baby shoes** for pleasant profits. Write Enterprise, Box 189-MP, Wilkes-Barre, Penna.

**FIFTY Tested mail order plans** for profitable, fascinating home-operation. Full particulars free. Reiss, 3017-S Ocean Parkway, Brooklyn 24, N. Y.

**WANT Independence, regular income?** If prompt, \$5 buys publisher's plan, especially adapted for your community, now netting me over \$60 weekly, sparetime. Hardy Hoover, 40 North Hemlock, Ventura, California.

**OWN Your business.** Everybody chews ball gum. Machines low as \$11.00 new or \$7.50 reconditioned. Best ball gum \$10.00 case 3500 balls. Less in larger quantities. T. O. Thomas Co., 1572 Jefferson, Paducah, Ky.

**AGENT Or exclusive distributor** for cigarette lighter mfg. MacGregor, Tahoe Valley 16, Calif.

**BARGAIN.** \$4.50 Value for \$2.00. Mail order dealers and beginners, free information. V. Jensen, Box 199, Bingen, Wash.

**ONYX And plastic mountings** for bronzed baby shoes, also hardening solution. Box 2095, Wichita, Kansas. (Wholesale.)

**OWN—Operate ball gum, nut, cigarette vending machines.** Amazing profits, no selling. Write for free details. Cameo Vending, Dept. P, 432 West 42nd, New York.

**WANT Pleasant outdoor work** in a business of your own? Good profits selling over 200 widely advertised Rawleigh home/farm necessities. Pays better than most occupations. Hundreds in business 5 to 20 years or more! Products-equipment on credit. No experience needed to start—we teach you how. Write today for full particulars. Rawleigh's, Dept. D-145-PPM, Freeport, Ill.

**METALLIZE Baby shoes.** Excellent profits. New system assures success. Free details. Treasures Forever, 89 Henry Ave., Lynn, Mass.

**PLASTACAST—Intermix,** hardens casting plaster "tenfold." Sample 2 pounds 25c. Standard Products, 1416-EN Fletcher, Chicago.

**BE Wealthy.** Get business self-starters. Own self-paying homes. Midco, 67 S. Harris, Columbus 4, Ohio.

**AT Home — Your own manufacturing business;** making popular \$1.00 novelties. Cost you 3c to 15c. Everything supplied. Write So-Lo Works, Dept. D-600, Loveland, Ohio.

**HOMEWORKERS—\$50.00, \$100.00 Weekly!** Manufacture wood plastic gifts, plaques, novelties. Material, molds, instructions furnished. (Sample mold-kit) complete with production mold, scottie model, big list supplies \$1.00 postpaid. Standard Art Products, 1416-E Fletcher, Chicago.

**IDEAL Business stamping metal key protectors, social security plates.** Information upon request. General Products, 11 No. Pearl (M), Albany, N. Y.

**BELTS! Make 'm and make money.** No tools! Sample 50c. Artnic Leather, 411 Joseph Ave., Rochester 5, N. Y.

**FREE.** 64 Page mail order magazine. Wiggins, Box 207, Lincoln Park 25, Mich.

**WATCHES, Wholesale.** Rebuilt Elgins, Walthams, Bulovas, etc., \$9.75 up; new and used diamond, railroad, 21J wrist. Catalogue free. Brookings, B-1975, Little Rock, Ark.

**"HOW To Build Your Own Mail Order Business."** Idea book for beginners, mail dealers. Quarter. Satisfaction guaranteed. R. Edmonson, 1327 Miller Reed, Atlanta, Ga.

**BABY Shoes preserved.** Formulas, instructions \$1.00. Supplies and bases. Novelty Bronzing, Box 56, Hyde Park 36, Mass.

**BRONZING Baby shoes** is big business. Start your own business for exactly \$3.95. Particulars free. "Metalsealed," Box 2095, Wichita, Kansas.

**GINSENG Big money crop,** easily raised, sparetime, details free. Hobnob Products, Dept. A1, 406 Market St., St. Louis 2, Mo.

**"DO It With Sea Shells."** Profitable easy home work, lesson free. C. Werts, Sharp Park, California.

**START A lost key service** in your community. Brand new. Big home money maker; spare time. Beautiful plastic tag and chain, contains 3 color social security plate; registered serial number; advertising space. Every merchant can use your service. Send 25c for sample and plan. American Specialty Sales, Box 108, Chicago 90.

**LIQUID Marble—Make in any color.** Soundproof plastic flooring. Flexible molds. Cast novelties, plaques, statuary. Big money—your own business. Catalog free. Write—Bing Products, 88-A45 Broad Street, Boston 10, Mass.

**EXCLUSIVE Distributorship** stainless steel whipped cream dispenser. Sold to soda fountains, drug stores and restaurants. Makes 4 pints of whipped cream instantly from one pint of light cream. Operates from refillable gas cylinder. Constant repeat sales of gas assures steady income. Breakstone & Co., 2155 W. Harrison, Chicago 12.

**DRAFTSMEN — Use your professional skill** to earn you extra money. Complete details \$1. J. J. Mills, 126 Lexington Ave., New York City.

**GET Plenty of mail steadily,** samples, catalogs, seedbooks, masses of real bargains and opportunities. Every day a big mail day, when your name is listed in our big mail column. Only \$1.00 for 6 months. Martin's Service, Box 295P, Bassett, Va.

**MAKE—Sell new amazing auto paint** you simply wipe on. Complete formula \$1.00. Ideal Service, Park Ridge 8, Ill.

**HANDY Men—Make quick, easy profits** repairing leaking water faucets with Economy renewable seat tools. Build valuable sales and service business in your spare time. Territories open, literature free. See our display ad this issue. Economy, 3122 N. California, Chicago 18.

**PROFITABLE Mail business.** Instructions \$1.00. Details free. Wisuri, 10 Railroad, Maynard, Mass.

**NEW Liquid plastic.** Earns money for you at home. Make plastic containers for the drug and cosmetic trade. Terrific demand. You make them, we sell them. You can earn a minimum of \$50.00 per week at home. No machinery or experience required. We supply raw materials and instructions; or you can come to our laboratories and receive personal instruction and contract. Write for full details. Travaco Laboratories, P.O. Box 1883, Boston 5, Mass.

**START Your own business!** Big money manufacturing novelties, plaques, statuary. Free catalog. Write Bing Products, 88-A4R Broad Street, Boston 10, Mass.

**AMAZING Ways to make money** at home. Great opportunity. Details free. Ramljak, 2339 W. Charleston St., Chicago 47, Ill.

**SUCCESS, Independence,** 12 new products a year. \$2 brings membership, details, first product. "Pamrod," 11th and Lehigh, Philadelphia 33, Penna.

**BE A used car dealer.** Tested plan \$1. or details. Smith, 17A Rockland, Yonkers, N. Y.

**START Home business making** statuettes, plaques, artificial marble flooring, liquid marble, flexible molds, metallizing baby shoes. Amazing profits. Folder free. Creative, 236-L, Winnetka, Illinois.

**SIGNS Made easily.** Instructions and ten sets modern alphabets, numerals, patterns. Sizes up to eight inches. All for \$1.00. Co-operative Business, 7 West Madison, Chicago 2.

**COLOR Concrete with chemicals.** Formulas, instruction. Sample 10c. Hollywood Cementcraft, 8527-A Wonderland, Hollywood 46, Calif.

**FORTIFY The future—Start own business,** home or office; no peddling, little or no investment. Collection describes 137 money plans. Full particulars free. Wilson, Box 3272, Chouteau Sta., St. Louis 10, Missouri.

**START Home manufacturing business** making Cleaning Compounds, Soaps, Insecticides, Cosmetics, Polishes, Food Flavors. No machinery. Literature free. Kemix, Park Ridge, Ill.

**CAPITAL Raising made easy;** millions available; send for Financing Your Business; large 250 page volume; complete details, only \$2.00. Seminole Publishing Company, Room 9, 317 W. Forsyth St., Jacksonville, Florida.

**MAKE Flexible molds!** Few cents each! Cast plaques, novelties, bookends! Free samples! H. Tooker, Hamilton 44, Ohio.

**EXTRA Money? Free details.** Trable, 1018 1/2 Elm Street, Dallas, Texas.

**OPPORTUNITY Knocks,** big demand. Different. Easily sold. Belmont, Garrett, Indiana.

**RUBBER Molds,** slightly used, \$1.00 each, big selection. Guaranteed Malaya liquid rubber, \$1.25 pint, \$3.00 quart, \$6.95 gallon with instructions and list of confidential trade secrets for mold makers free. Southern Service, Box 3303-A, Jacksonville, Fla.

**RUBBER Molds,** natural liquid rubber, flock filler (for making sectional molds), statuary plasters, felt finishes for novelties. Catalog and "Plastercraft" course free. Blue Rapids Supply, Blue Rapids, Kansas.

**MAKE Money spare time.** Write for details. American Letter, New Market 3, N. J.

**ELECTROPLATING!** Want a money making trade or profitable business of your own? Learn from nationally recognized authority. It's easy when I show you how! Free particulars. Joseph A. Kushner, Metal Finishing Consultant, Stroudsburg 43, Pennsylvania.

**POPCORN Machines.** Potato chip outfits. Long Eakins Company, 4860 Hi Street, Springfield 99, Ohio.

**INVENTIONS Protected** in 30 days. Patents for sale. Patent News, 12M, Washington, D. C.

**MAIL Order business,** start at home. Ideas, plans, many practical formulas. Details free. Kasdorf, 273 Bridge St., Brooklyn N. Y.

**OPERATE Profitable mail order business.** Splendid opportunity. For details write V. M. McKinley, 76 Ave. "A," Battle Creek, Mich.

**READ "Advance"—The voice of mail order.** Offers money-making opportunities, sources of supply, personal guidance, etc. Issued monthly. Sample copy 25c. Yearly subscription \$2.00. American Mail Trade Association, 313 East 21st Street, Suite 450, New York 10, N. Y.



**ELECTRICALLY Inclined men.** Amazing illustrated literature free, proving \$100-\$250 weekly possible installing, maintaining fluorescent lighting. Rebuild fixtures for excellent profits. Make beautiful lights for 50c each and less. Free sample materials. Write Willis Fluorescent Service, 101 York Street, Brooklyn 1, New York, Dept. C.

**446 FROM** Square foot plywood. Jigsaw necessary. Write, Woodarts, X-38, Bridgewater, Mass.

**OPERATE** Profitable mail order business. Write Walter Service, 4159-A East 112th, Cleveland 5, Ohio.

**BE A** tax consultant. Bookkeepers, etc. qualify quickly. Details free. Smith, 17 Rockland, Yonkers 5, N. Y.

**"HOW To Build Your Own Mail Order Business."** Idea book for beginners, mail dealers. Quarter postpaid. Satisfaction guaranteed. Edgar Gilchrist, 623-M, Massachusetts Ave., N. E., Washington 2, D. C.

**1021 MONEYMAKING Ideas!** Free details. Newway Institute, Box 5463-M, Chicago 80.

**HANDYMEN—**Earn money home operating Community "Fix-It" Shop. Write Stafford, 708 Rawlings, Carbondale, Ill.

**RAISE** Earthworms. Instructions \$1.00. Huffman's Worm Ranch, R.R., Rives Junction, Michigan.

**RE-NEW** Leather and leatherette—Make cloth into imitation leather with plastic discovery called Leather-New. Opportunity to make real profits taking care of sales resulting from national advertising. Write for free sample of Leather-New covered material and complete deal. 4723A Troost, Kansas City, Missouri.

**MAKE** Perfume. Complete outfit \$7.50. Information free. Walter Lawson, 21 Joiner, Saint Augustine, Florida.

**OPERATE** Home business that may mean the road to independence. Write Sunray, 4756-A N. Bernard, Chicago 25, Illinois.

**MEN** And women wanted to place self-selling coin machines in stores, hotels, filling stations, etc. New machine earns up to \$6.00 weekly—costs only \$10.50. We furnish supplies and machines for nuts, gum, candy, stamps, scales and amusements. Free details of tested selling plan. Write Dept. P, Parkway Machine Corp., 623 W. North Ave., Baltimore 17, Md.

**FREE** Literature describing many moneymaking plans. Verner, 108 Delaware, Oakmont 11, Penna.

**A FACTORY** in your home garage! Mfg. and sales rights, mechanics' waterless hand cleaner. \$500-\$800 monthly. No special equipment necessary. Western Aircraft Mfg., Dept. D, Los Angeles 6, Calif.

**DISTRIBUTORS** Wanted everywhere. Large profits. Details, catalog 25c. Re-Bilt, Manitowoc, Wis.

**LEARN** Piano tuning, repairing, at home. Tremendous field! Piano parts, tools furnished. Established 1935. Empire School of Piano Tuning, 606-B East University Ave., Champaign, Ill.

**RECAST** Old batteries into new. Latest achievements. Battery Laboratories, Minneapolis.

**MEN-WOMEN.** "Most everybody likes candy." Learn to manufacture professionally at home. (Our 38th year.) Ragsdale Candies, Dept. 4, East Orange, N. J.

**MAKE** Money casting new 1948 metal toys and novelties. Latest scale model autos, original ashtrays, savings banks, water pistols, etc. Enormous wholesale and chain store demand keeps manufacturers busy. Spare or full time. No experience or special place necessary. Write for details and illustrations of patterns needed. Metal Cast Products Co., Dept. A, 1696 Boston Road, New York 60, N. Y.

**LEARN** To publicize yourself for increased income in your business or profession. Details free. Publicity Systems, Box 322, Jacksonville, Illinois.

**MAIL** Order businesses bought, sold, brokered. Write for free bulletin of exclusive opportunities. Turnipseed, Inc., Box 681, St. Louis, Mo.

**START** Home plaster novelty business. Amazing course tells how. Literature free. Kemo-Courses, 4862 Catalpa, Chicago 30, Ill.

**LIQUID** Marble—Colorful, glossy! Mold, brush, spray. Plastic ivory, flexible molds, composition floors. Particulars free. Marbleizing Service, Edwardsville, Illinois.

**NATURAL** Molding Latex. Extra thick. Free sample. W. Wooley, 115-A Donald, Peoria, Ill.

**COLORGLAZED** Concrete pottery made without molds. Patented method. Cemetery products, novelties, tiles. Basement leak-sealing. Money-making projects. Booklet, details free. Men only. National Potteries Company, Grand Rapids, Minnesota.

**MAKE** Rubber stamps. Metalize baby shoes, silver mirrors, make plaster novelties. Catalogue of "20 Ideas" free. Universal, Box 1076-A, Peoria, Ill.

**START** Mailorder bookshop—Everything furnished. 25c brings booklet, samples, exciting ideas. General Publications, Ossining, N. Y.

**MAKE** Liquid marble, flexible mosaics, statuary, art goods, novelties, artificial marble flooring. Literature free. Kemico, Park Ridge 50, Ill.

**LIQUID** Rubber for making flexible molds. Cast novelties. Sample bottle 25c. Free literature. Chaney, 1130 E. 16th St., Jacksonville 6, Fla.

**BIG** Money in vending machines. Smallest capital start brings immediate profits that build permanent profitable business. Starting instructions free. Becker Vendors, 105-A Dewey, Brillion, Wis.

**START** Your own electroplating business, highly paid, uncrowded field. Learn at home in spare time. Send postcard for free electroplating booklet and proof. Plater-Hyde, Room 521, 432 "F" Street, San Diego 1, California.

**METALLIZING** Baby shoes makes you money! Learn this simple, profitable, low investment business from nationally recognized authority. Get professional results with professional "know-how"! Free particulars. Joseph B. Kushner, Metal Finishing Engineer, Stroudsburg 23, Penna.

**RUBACREAM!** Natural rubber latex! Makes molds quicker! Thicker! Free sample convinces! Castcraft Studios, 509-P Fifth Avenue, New York 17.

**TWO** Amazing new typing opportunities. Earn up to several dollars hour, right at home. New, exclusive, different. Write Schroder, 221 E. Bush, Covington, Ky.

**BRONZED** Baby shoe mountings and supplies. All metal bronze bookends, picture frames, ash trays, etc. Onyx ash trays, desk sets, plaques. Hardening solution. 30 amp. plating rectifiers with powerstat control, \$85.00. Geared motors for agitation, \$15.00. Lead lined tanks. Write for list. Hollywood Bronze Supply, 1770 N. Vermont, Hollywood 27, Calif.

**ELITE** Collection contains 137 practical money-making plans; local and mail order. New edition. Particulars free. Elite Co., 220 Grand St., New York 13.

**SELL** By mail!—Books and novelties! 35 different items! Large profits! Catalog free! Ellico, 432 N. Wells, Chicago 10.

**OPERATE** Profitable home business selling merchandise by mail. Fast sellers. Large profits. Powell Service, 5713 Euclid, Cleveland 3, Ohio.

**COPUBLISH** Leading m.o. paper. Latest copy Mail Sale Advertiser and proposition, commemorative stamp. Vanroy Shirk, Lebanon, Penna.

**HOW** And where to obtain capital. Fully explained. Particulars free. Star Service, Wapakoneta, Ohio.

**SPECIALTY** Manufacturing, the big money business that can be operated anywhere, start on a very small capital; we supply dependable formulas and complete instructions; get interesting free booklet, "Moneymaking Opportunities in Specialty Manufacturing." Howard Robinson, Ph.G., 1300-A South Ohio Street, Sedalia, Mo.

**\$25 WEEKLY** Working two hours daily. No canvassing. No manufacturing. Lycke, Box 2471, Cleveland 12, Ohio.

**137 WAYS** To make money, in home or office, business of your own. Full particulars free. Elite Co., 220 Grand St., New York 13.

**BRUSH** Plating outfits connect to a battery. No tanks necessary. Good paying business at home plating autoparts, bathroom fixtures, bicycles, reflectors, silvering mirrors. No shop or experience required. Outfits furnished. Free booklet. Gunmetal Co., Ave. H, Decatur, Ill.

**GET** It for them wholesale. Be community buyer nationally-known merchandise; radios, refrigerators, washers, sweepers, typewriters, etc. Savings up to 50%. This pleasant, easy work can earn up to \$5000 year. Get details today. Kraft, Aurora 8, Missouri.

**WOULD** You pay 3%—first \$350 made? Color-illustrated book "505 Odd, Successful Enterprises" free! Some offer occasional "day off." Work home. Expect something odd! Pacific, Oceanside, Calif.

**MAILING** Postcards selling repeat merchandise is profitable. Everything supplied. Details free. Gordan Publishers, Box 23, Pawtucket, R. I.

**CO-PUBLISH** And advertise in The Central Mail Advertiser. Sample copy for stamp. Low rates. Large circulation. Bagby Printing Co., Georgetown, Ohio.

**WHITE** Liquid rubber for making flexible molds! Quick drying! Safe! For home, classroom, or industry! Quart \$2.00. Gallon \$5.95. Full instructions! Beginner's booklet on molding and plaster casting 25c. Free with order! Plastercraft Supply Company, 1406 East 43rd Street, Cleveland 3, Ohio.

**MAIL** Order opportunities. Full or spare time. Hundreds of chances. No charge. Postal brings copy. Blackstone Press, Somerville, New Jersey.

**MACHINES** Available for making new designs of interlocking concrete building blocks. Delaware Industries, Dept. 11, Muncie, Indiana.

**LEARN** Direct advertising, letter shop business. Free booklet. Armstrong, 7219 Broadway, Los Angeles 3.

## MONEYMAKING OPPORTUNITIES

**SELLS** Like mad! Show it once—smacko! It's grabbed! No sales talk. Costs \$5. Brings \$5. Just one of those inexplicable successes. Inquire Stampico, 8837 Quincy, Detroit 4, Mich.

**CONVERT** Burnt out light bulbs into fire extinguishers. Every home a prospect at your own price. Full instructions \$1.00. Details free. Fred A. Lewis, Box 104-A Kensington Station, Brooklyn, New York.

**MECHANICALLY** Inclined? Resurface butcher blocks. Lifetime business. Roy Crawford, Keyport, New Jersey.

**EARN** Up to \$520 month part or full time keeping books for small firms. Simplified system. Write Tax-Saver System, Dept. J, Ft. Worth, Texas.

**SEWING** Machine repairmen make big money lifetime. Start neighborhood shop. Complete repair manual, covering all makes, \$1.98 postpaid. Money back guarantee. Sewmachine Serviceman, Hamilton 9-M, Ohio.

**SURE** Profits statulizing baby shoes. Free details. Schauder's, Dept. F, Shawano, Wis.

**PROFITABLE** Home business. Serigraph printing. Information, samples free. Joseph Bolger, 148 Concord, River Edge, New Jersey.

**FREE** Literature describing fifty proven successful, home-operated mail order plans. Reiss, 3017-D Ocean Parkway, Brooklyn 24, N. Y.

**INSTRUCTIONS:** How to make rubber stamps, luminous paints, money from sawdust, resilver mirrors, raise earthworms. 25c each. All five \$1.00. Davies, Box 1087-PM, Kingston, Penna.

**WHETHER** You're first contemplating or presently in a mail order business. You must read "How to Build Your Own Mail Order Business." A guide to sound profitable mail merchandising. Only 25c pre-paid. Satisfaction guaranteed or money refunded. Biga Mailway Sales, 4903 W. Cullom Ave., Chicago 41, Illinois.

**REPAIR** Leaking faucets easily with our repairing kit. Write for details. Great Lakes Metal Specialty Mfg. Co., 1450 North Ave., Chicago 22, Ill.

**LOOK** Here! Wanted—Men to start in business on our capital. Sell some 200 farm-home products. Thousands our dealers now make quick sales, big profits. For particulars write Rawleigh's, Dept. D-192-PPM, Freeport, Ill.

**MAKE** Money, paint wall plaques. We furnish plaques small cost. Big demand. Marbleite, Ames Station Box 53, Omaha, Nebraska.

**DOLLARS** For spare time. Send postcard. Free details. Hasco, 119 Ravine, Matawan, New Jersey.

**EARN** Up to \$2,000 year, inventing simple items. Special cash markets. Hendrickson, Argyle 7, Wisconsin.

**I MADE** \$1000.00 from 1000 tomatoes using my unique methods. Detailed instructions, \$1.00 (refundable). Alfred Dinsmore, Marlborough, Mass.

**BIGGEST** 25c Value ever offered! Three big issues "Opportunities Preferred," greatest business building magazine published; plus big, dollar idea "reference directory" book—\$1.75 value, only 25c! Hurry! Coates, Publisher, 88-P, Dorchester, Mass.

**MAKE** Money re-working slightly imperfect beautiful hand carved Chinese chests I import from China. Both camphorwoods and teakwoods. Sell to friends, furniture stores, oriental shops. Wide profit possible. Write for illustrated free folder. Money back guarantee you are satisfied. Chinese Chests, Room 310, 420 Market Street, San Francisco 11, Calif.



**START Home mail business!** Takes only few dollars. No experience—good earnings. "How" folder, free! Shutt, Box 269-B, Newcastle, Indiana.

**MONTHLY List of 100 brand new products and manufacturers.** For mail order, agents, opportunists. Free copy of business plans bulletin with every order. 4 months \$1, 2 months 50c, 1 month 25c. Successful Ventures, 1311 Widener Bldg., Philadelphia, Penna.

**ANALYZE Handwriting for profit!** Complete outfit \$1.00. Graphologists, POB-971, Philadelphia.

**TECHNICAL Bulletin listing 24 opportunities.** Free. Public Educational Service, 493 Irving, Bridgeton 2, N. J.

**\$100-\$200 WEEKLY.** No selling schemes or manufacturing. Charge \$80 up each job takes 8 hours. H. Imlach Co., 2102 India St., San Diego, Calif.

**MAKE Amazing profits, mailorder business.** The best plan I've seen in 20 years. 25c (silver). Different. Satisfaction guaranteed. Campbell Service, Millwood, Ky.

**THOUSANDS Articles wholesale.** "Supply Source Directory" 10c. Ideal Service, Park Ridge 40, Illinois.

**EXTRA Money? Free details.** Trable, 1018 1/2 Elm Street, Dallas, Texas.

**MAIL—Beginners.** Look before you leap in 1948! Get big information guide to financial independence. Truly the greatest opportunity of the year! Send 15c to cover costs. Leese, 4718 North Laverne, Chicago 30, Ill.

**METALLIZE Baby shoes.** Further information—3c stamp. Metal Crafts, Box 125-R5, Tampa 4, Florida.

**UNPAINTED Plaster ornaments.** Beautiful designs, easily decorated with water colors or oil paints. Profit or hobby. Illustrated list free. Distributors of new Loxite, a Firestone product, for molds. Midwest Novelty Mfgs., 108A Cedar, Anaconda, Montana.

**WHOLESALE Anything imaginable.** New guaranteed list 25c. Refundable. L. L. L. Novelty, Box 2188, Waterloo, Iowa.

**RESILVER Mirrors at home.** Formula 25c. Ideal Service, Park Ridge 6, Illinois.

**EARN Money at home!** Thousands do "Home Worker Magazine" tells how. Sample, 25c. Sizemore, Box 7, 4917 Kostner, Chicago 30, Ill.

**WIN Contest money.** General Contest Magazine gives hundreds of tips. Lists current contests and rules. Sample 25c. General Contests, 1609 1/2 East 5th, Duluth, Minn.

**WOULD You pay 3%—first \$350 made?** Color-illustrated book "505 Odd Successful Enterprises" free! Proven! Work at home, office. Expect something odd! Pacific, Oceanide, Calif.

**\$246.50 MAKING Unusual secret device** without skill, machinery, from former war material costing \$1.50! Simple, baffling invention, unbelievably profitable! Illustrated proofs free. Rolls Enterprises, 115-D West 16th, New York 11.

**FORTIFY The future!** Start own business; home, office. Booklet describing "Collection of 137 Tested Plans" free. Elite Co., 220-A Grand St., New York 13.

**PUBLISH Your own magazine.** Handmade 52 page format, well edited, illustrated. Cost low as \$1.00 month. Brings you prestige, profits. 25c brings sample, details. National, Ord. Nebr.

### FORMULAS, PLANS, ETC.

**21 POPCORN, Candy apple, etc. formulas.** All money-makers. \$1.00. We can supply equipment. Concession Supply Co., Dept. "A," Box 133 Sta. "B," Toledo, O.

**FORTUNES In formulas.** Ten thousand trade secrets, recipes, processes. 900 pages. Only \$3.00 postpaid. Natco Supply, Dept. PM, 1090 West 43rd, Norfolk 8, Va.

**MANUFACTURE Cleaners, soaps, polishes, flavors, cosmetics.** Literature free. Kemico, Park Ridge 16, Illinois.

**10,000 FORMULAS And trade secrets.** Free literature: Stillman, 555 Kingston Ave., Brooklyn 3, N. Y.

**REAL Manufacturing formulas.** Lists free. Cummings, Chemist, Gordon Ave., Syracuse 4, N. Y.

### PLASTICS

**INTERNAL Carved swans, bluebirds, goldfish, butterflies, etc., pins, \$1.50.** Rose or daisy costume jewelry sets, \$1.50 less findings. Also gifts and novelties. Crystal Floral Novelty Co., Somerville, New Jersey.

**MOLDS Made to order.** Send us your models by insured parcel post. Models returned unharmed. Work guaranteed. Literature 25c. Apex Art Plastics, 2126 Marconi, St. Louis, Missouri.

**PLASTIC Carvers drills 75c ea.** Supply catalogue free. Procliv, Box 618, Seattle 11, Wash.

**PLASTIC Injection machine, Plexiglas, jewelry findings, self designing paints, chrome initials, internal carving drills, kits.** Catalog. G. Baker Company, River Edge, New Jersey.

**LUCITE, Plexiglas, Masked sheets.** All sizes. Cost square foot (12"x12") 1/16" 90c; 1/8" \$1.16; 3/16" \$1.43; 1/4" \$1.68; 5/16" \$2.09. Include 10% postage. Lucite kit \$3.00. Almac Plastics Inc., 230 Fifth Ave., New York 1, N. Y.

**PLEXIGLAS, Clear, masked.** Prices per square foot. 1/16"—\$1.00, 3/32"—\$1.15, 1/8"—\$1.25, 3/16"—\$1.50, 1/4"—\$1.80, 3/8"—\$2.60, 1/2"—\$3.40, plus 10% postage; all colors 10% additional. Rethel Plastic Co., 15 Walnut St., Steelton, Penna.

**BARGAINS In plastics.** Lucite, Plexiglas, Catalin. Many colors and sizes. Details free. George Plastics, 6938A George St., Chicago 34, Ill.

**PLEXIGLAS, 6 Pieces, red, black, white, green, yellow, blue.** Instructions, cameos, supplies to make set two tone costume jewelry. \$1.00. Bradlee, P.O. Box 142, Buffalo 5, N. Y.

**PLASTICS Trade secrets.** Write for free information. Enclose 25c if you would like plastics samples. Plastics Research, Box 346, Alhambra, Calif.

**RENEW Leather and leatherette—Make cloth into imitation leather with plastic discovery called Leather-New.** Opportunity to make real profits taking care of sales resulting from national advertising. Write for free sample of Leather-New covered material and complete deal. 4723B Troost, Kansas City, Missouri.

**PLEXIGLAS—Masked sheets, 12"x12".** 1/16"—\$1.00, 1/8"—\$1.25, 3/16"—\$1.55, 1/4"—\$1.85, include 10% postage. Internal carvings. Drills, dyes, Luminous powders, rods, tubes, cements, jewelry findings. Free catalogue. Craft Plastics, Somerville, N. J.

**PLASTICS—Sheets, rods, tubes, all colors; dyes, supplies; findings.** Illustrated fabricating manual, prices, 10c. Lucite sample, 35c. Gem-O'-Lite, Box 686F, North Hollywood, Calif.

**PLASTIC—Sheets, rods, tubes, etc.** Free list. Plastic Supply Co., 2618 St. Louis Ave., St. Louis 6, Mo.

### CHEMISTRY

**LEARN Chemistry at home, from the house of Winn.** Home of supplies for student chemists. New idea chemical and apparatus outfits for home experimenting. Semi-professional microscopes and accessories. Send 10c for retail catalogue. Established 1931. John H. Winn, Dept. 504, 124 West 23 Street, New York 11, N. Y.

**LABORATORY Supplies, chemicals, glassware, etc., low prices.** Large catalog 15c. Microscopic stain catalogue 20c. Both for 25c. National Scientific Company, Established 1908, 2204 W. North Ave., Chicago 47, Ill.

**CHEMICAL Laboratory, used; equipment, chemicals, glassware, books, etc.** Sacrifice price. Lacy Boyer, Woodstock, Va.

**CHEMICALS And apparatus for industrial, analytical and private laboratories.** Complete supply service for correspondence school students. Send 10c for catalog. Dept. M-43, Biological Supply Co., 1176 Mt. Hope Ave., Rochester 7, New York.

**FREE Catalog: Chemistry, mineralogy, physics, biology.** Tracey Laboratories, Evanston, Illinois.

**CHEMICALS—LAB. Supplies.** New catalog 10c. Mel-Gio Chemical Co., 258 Fourth Avenue, Brooklyn 15, N. Y.

**APPARATUS, Chemicals, ounce quantities, catalog 10c.** Fleischer's Laboratories, Everett 49, Mass.

**HANDBOOK For chemical experimenters.** Illustrated, hundreds of experiments, 50c. Experiment booklet 15c. Supply catalog 5c. Reading Scientific Company, Reading, Penna.

### HELP WANTED

**RELIABLE Man with car wanted to call on farmers.** Wonderful opportunity now. \$15-\$20 in a day. No experience or capital required. Permanent. Write today. McNeess Co., Dept. 78, Freeport, Ill.

**BOYS Wanted.** Over \$50 week! Sell name plates for front doors. Write National, 214-U Summer, Boston, Mass.

### AGENTS WANTED

**AMAZING Discovery.** Miracle glaze puts brilliant glass-like surface on cars. Free sample, information. Big profits. Miracle Glaze Company, 9714 S. Austin Ave., Oak Lawn, Illinois.

**DO You want \$25? Show lovely all-occasion greeting cards, stationery, gift wrappings, to friends, neighbors, co-workers.** \$25 profit on 50 \$1 boxes. Free literature shows beginner easy way to make money. Approval samples. Torres Company, 5A St. Francis Place, Brooklyn 16, N. Y.

**100% PROFIT, No investment, handle quality Photostamps.** Amazing glossy photographs, gummed stamp form. Business year round. Free samples, particulars. American Photo Stamp Co., 103 East 125th St., Dept. PM4, New York 35.

**90c PROFIT Each \$1 sale!** Sell real mothproofing solution. Employ agents. Experience unnecessary; we tell you how. Kinford, Wayne 3, Penna.

**SELLS At sight, Stainless steel carving sets \$21 doz.** Samples available. 125 other fast sellers. Manufacturers, 264-5th Ave., New York.

**WHOLESALE! Balloons, novelties, watches, jewelry, premium goods.** Collins Co., Forsyth, Georgia.

**DOUBLE Duty shopping bag.** Zips open. Instantly changes from small to large size. Lightning seller. Samples sent on trial. Kristee, 121, Akron, Ohio.

**POCKET Pal: Replaces pocket knives.** New, safe, beautiful! Always razor-sharp. 50c seller. 231% profit. \$15.00 or more daily. Agents, salesmen, distributors. Sample 10c. Nelson Mfg. Co., 222 W. Kellogg, St. Paul 2, Minn.

**AMAZING Sales.** Giant profits. With new electric flasher sign direct from manufacturer. Send for catalog. Pricing Press, Dept. P-2, 124 White St., New York, N. Y.

**AGENTS Wanted for Tiresignal.** Fast selling device. Eliminates flat tires on automobiles. Sample \$1.00. Tiresignal, Dept. A, P.O. Box 1667, Los Angeles 26, California.

**FARMERS! Make more money.** Your own boss. Outside work. Steady year-round. 200 farm-home necessities. No experience necessary. We train and help you. For details write Rawleigh's, Dept. D-242-PPM, Freeport, Ill.

**CREW Managers, wagon jobbers, agents!** Established manufacturer can supply you with top quality floor waxes and polishes all sizes from pint to drum. Write Windsor Wax Co., Inc., Dept. PM-2, Hoboken, N. J.

**AT Last! Something new and sensational in everyday cards.** New gorgeous satin and velvet designs. Get orders fast. Big profits. Imprinted stationery. 14 assortments for year round occasions. Retail 60c to \$1. Get samples on approval. Puro Co., 2801 Locust, Dept. 840-D, St. Louis 3, Mo.

**A Dress yours with every 3 you order for yourself and family.** Amazing new bonus plan. Everything free. Harford Frocks, Dept. L-9128, Cincinnati, Ohio.

**SPRING Months offer money making opportunities.** Easy sales. Unlimited market in your community. Our helps build business. Write for free wholesale catalog today! McGregor Magazine Agency, Dept. 12, Mount Morris, Illinois.

**EARN Extra money selling greeting cards.** Free details. Pascale Card Service, Irvington 11, N. J.

**AMAZING Offer—\$25 is yours for selling fifty \$1.00 boxes of entirely different, new deluxe all-occasion cards.** Each box sells for \$1.60, your profit 50c. It costs nothing to try. Write today for samples. Cheerful Card Co., Dept. 297, White Plains, N. Y.

**\$1 STARTS You in business.** Sell deluxe ties, 100% wool interlining. Costs you only \$7 per dozen, you make \$5.00 dozen. Send \$1.00 for special introductory offer two deluxe ties. Catalog complete line free. Philip's Neckwear, 20 West 22nd St., Dept. K-22, New York 10.

**SELL Gold embossed monogram stationery.** Sample free. Dunbars, Sanford, Florida.

**PAST Selling line greeting cards.** All-occasion sample box on approval. Big personalized line stationery, matches, playing cards, coasters, napkins and guest towels. Free stationery samples. Senrab Co., 212E W. Washington St., Syracuse, N. Y.

**NEW Company requires agents throughout country.** Send \$1.50 for sample. Refunded if not interested. Kahree Co., 97 Joline Ave., Staten Island 7, N. Y.



**FREE Nylons** given if Kendex hosiery runs or snags! Mere words could not possibly express the almost unbelievable opportunity you now have to make money taking orders for the world's only complete line of women's beautiful hosiery actually guaranteed against everything! Free replacements made regardless whether cause is use or abuse. Not sold in stores. Here is sales dynamite that will blast your earnings to the sky. Even if you never sold a thing in your life, three magic words "Guaranteed Against Everything" are enough to make women eagerly buy. Complete line includes sheer and service nylons, rayons etc. in different lengths. You need no money or experience. Simply write orders. We deliver and collect. Liberal advance cash earnings plus huge cash bonus. Write orders spare or full time; exclusively or as a side line. Everything you need to start making money furnished free and prepaid. Just send name and address on postcard for your free outfit. No obligation. Write Dept. 126, Kendex Co., Babylon, N. Y.

**SILVER** Cleaning, plating, polishing, liquid (NuSilver). Apply with cloth. Renew silverplated ware, articles, pieces. Silverplates brass, copper, bronze. Female, male, agents wanted, part or full time. NuProcess Products, Aurora, Ill.

**CAPITALIZE** Now on housewives' fear of prowlers, housebreakers, petty thieves. Sell automatic open window lock that locks window in any position, prevents further opening of either sash. Dealer-agents wanted, so send \$1 retail price for sample or \$6 for dozen today. No c.o.d.s. Burbridge Mfg. Co., Dept. PM4, Kenosha, Wis.

**PROFITS** To 100% selling everyday greeting card box assortments. Birthday, convalescent, wrappings, stationery, etc. Details and assortment on approval. Glorian, Dept. 22, 515 East 45th Street, Brooklyn 3, N. Y.

**EARN \$200** Weekly installing new amazing "Styron" plastic wall tile in homes, offices. Easily applied. Tile your own kitchen, bathroom, too. Instructions, everything furnished. Literature free. U. S. Tile Co., 30 W. Washington St., Chicago 2, Ill.

**AGENTS** Sweet smelling perfume novelties sell on sight. Gorgeous samples. Free particulars. Mission, 2328R West Pico, Los Angeles 6, Calif.

**SELL "Baskets"**—The patented folding work basket. Card brings details. Lewis W. Martin, 665 S. Ann St., Lancaster, Penna.

**NEW!** Big profits taking orders for our fine picture enlargements on beautiful hardwood sparkling plastic front plaques. Customers everywhere! Gotham Products, Box 5427, Philadelphia 43, Penna.

**SELL** Ultra blue stock signs to stores, 1000 slogans, comedy, general, religious. 7x11, cost 6c, sells 35c. Make money. Sample free. Lowy, 8 West Broadway, Dept. 373, New York City 7.

**AMAZING** Daily profits, big repeat business selling famous top-quality, lowest priced men's hosiery, full or part-time. Experience, investment unnecessary. Free selling outfit. Coltsos, 242-J4 Purchase, Boston 10, Mass.

**START** Your own business on our capital. Always your own boss. Hundreds average \$6,000 to \$25,000 annual sales year after year. We supply stocks, equipment on credit. 200 home necessities. Selling experience unnecessary to start. Wonderful opportunity to own pleasant, profitable business backed by world-wide industry. Write Rawleigh's, Dept. D-U1-PPM, Freeport, Ill.

**BIG Profit!** New helicopter flies indoors, outdoors! 14" rotors, rubber motor. \$4.20 doz. Refundable, \$1.00 two samples. Heliotoy Co., FDR8, Dallas 11, Tex.

**BIG Profits** selling beautiful imprinted stationery, greeting cards, etc. Free samples. The Ed-Brite Co., 435 North Terrace Ave., Mount Vernon, New York, Dept. 15.

**FACTORY** Agents-dealers. Gas mower (Maytag), \$99.50. Photos free. Rotacut, M-2004, Excelsior Springs, Mo.

**UNLIMITED** Commissions taking orders. Colorful pocket perfume atomizers. Prospects everywhere. Dynamic Sales, Box 3552M, Cleveland 18, Ohio.

**SELL** Process embossed business stationery. Samples free. Sperry's, Williamsport 10, Penna.

**SELL** Royal blue stock signs to stores. 17 sample signs \$1.00, postpaid, sell 35c. Make money fast. All-Art, 179 N. Wells, Chicago 6, Ill.

**EARN \$5.00** With every ten \$1.00 boxes of everyday cards you sell. Also personalized stationery, note paper and wrappings. Send for samples today. Howard P. Ellis, Dept. PM-5, Pitman, N. J.

**AGENTS** Make big profits selling sensational new diapers which require no folding. Every new mother a prospect. Rush name for free sample. Fred Dexter and Staff, 234 West 17th, Houston 8, Texas.

**DEALERS—Distributors:** Exclusive territory open. Cash in on steady sale with new art cleaner. Self-wringing, self-cleaning sponge rubber mop; scrub, wipe, dust, wax floors, wash walls. No franchise fee. You buy merchandise, make sales, and you profit on every dollar you invest in stock. Artmoore Co., Dept. P-48, Milwaukee 12, Wis.

**MONEY** Every day. Take orders for our lifetime photo-plaque, they sell on sight. Made from any photo, snapshot or negative. Send for free details. Quaker Photo-Plaque Co., 914 Walnut Street, Philadelphia 7, Penna.

**AMAZING** New window cleaner concentrate. Works fast. 300% profit. Whirlwind seller. Sample for stamp. Edwards Products Co., Box 653, Davenport, Iowa.

**DEALERSHIPS.** Sweetline No-Rub Refinish, revolutionary cleaner-polisher. Instantly cleans, renews, preserves, leaving high gloss finish on hard surfaces without rubbing. A one-time-over principle. Dries immediately. For factories, stores, hotels, banks, theatres, restaurants, lobbies, bars, etc. Repeat sales. Utilized by army, now available generally. H. C. Sweet Co., 3727 Fenkell, Detroit, Michigan.

**AGENTS**—To sell our sensational Adjust-Kwik light to body shops, garages, etc. Hosrent, 10830 Grand Ave., Melrose Park, Illinois.

**EARN \$25 A day** and more selling nationally advertised aluminumware, silverware, pressure cookers and jewelry. It is simple, let us show you how to make big profits with no investment. Write Continental Products, Dept. B4, 30 Ormsbee Avenue, Providence, R. I.

**QUICK** Cash. Salesmen, make \$10.00 to \$15.00 daily with only six shoe sales. Good future, liberal bonus. Invest nothing; experience unnecessary. Over 60 styles. Geo. Merritt Shoe, M2, Brockton, Mass.

**DISTRIBUTOR** Salesmen wanted to wholesale guaranteed Reflex Spark Plugs as a sideline to dealers, garages, service stations, fleet owners. Big profit. Repeat orders. Exclusive territory. The Reflex Spark Plug Co., 10902 Madison Ave., Cleveland 2, Ohio.

**MAKE** Money at home like I do! Write immediately. Duffy, Covington, Ky.

**UP** To 122% profit! "Mad-Nets," \$1.00 novelty magnets. Free bulletin. Frederick, 4 South, Stamford, Conn.

**MAKE** Big initial commissions and steady repeat money selling Pronto Stencil Duplicators and Pronto Photocopy Equipment. Write for free sales kit, indicating interest in one or both lines. Pronto, Inc., 515 Dempster, Evanston, Ill.

**AGENTS, Distributors**—Personal name plates for homes, office. Big profits. Al Peterson Associates, Box 822, Providence 1, R. I.

**\$3 FIRE** Extinguisher; quick sales, wholesale or direct; liberal profits. "Fire-Killer," 109 N. Franklin, Syracuse 1, N. Y.

**BIG** Money selling tooth powder. Write today. James Walker, 633 Plymouth Ct., Chicago, Ill., Dept. 1.

**FREE** Sample! Big profit opportunity with amazing glow-in-the-dark house numbers, switch plates, pictures, decals, religious articles. Represent large manufacturer, Madison Mills, 303 Fourth Avenue, New York, N. Y.

**MAKE** More money selling personal initialed individualized belts, buckles, cap badges, tie holders. 2000 emblems to choose. Big profits, whole or part time. Write today special outfit offer. Hookfast Specialties, Box 1425, Dept. 6, Providence, R. I.

**FREE** Water and our concentrates, makes flavors, lotions, shampoos, 72 products, labels, bottles furnished. Qualco, E-20030 Russell, Detroit.

**INFORMATION**—Wholesale supply sources. Money-making plans. Increase your income! Write Reynard Service, Smithfield 3, Ohio.

**AGENTS**—Big line including food products. Fast selling premium and bargain deals. Low prices. Send card for big outfit offer with gift. Ho-Ro-Co, 2725 Dodier, St. Louis 7, Mo.

**100% PROFIT** With new electric gas lighter, eliminates matches. Pilot. Write Optical Research Products, Fairview, N. J.

**EXCELLENT** Sideline for printing and advertising salesmen. Decalomania name plates in small quantities. Great demand. Also, make money with our line of automobile initials and sign letters. Free samples. "Ralco" XL-Roxbury, Boston 19, Mass.

**MAGIC** Cleaner and laundry soap deal. Hotter than a firecracker. Big profits. Sample free. Bestco, 5007 Irving Park, Chicago.

**137 COMPLETE** Plans for starting own business: local—mail order. Particulars free. Elite Co., 220 Grand St., New York 13.

**AGENTS**—300% Profit selling genuine gold window letters; stores and offices. Free samples. Metallic Letter Co., 438-B North Clark, Chicago.

**GOLD** Lacquered window sign letters. Large sizes penny each. New foils. Absolutely beautiful. Free samples. Atlas, 544 W. 79th, Chicago 20.

## HIGH-GRADE SALESMEN

**SALESMEN** Will clean up this year selling our electric fans and sump pumps. Write Universal Fan Co., Peru, Indiana.

**BALLOONS,** Balls, rubber dolls; fireworks; battery powered toy automobiles. Profits plenty. Ellswood Distributors, LaJunta, Colorado.

**SELL** Over 1100 items—Electric flasher signs, adding machines, tags, tape, all printed necessities, pencils, restaurant supplies, and many others. Free sales portfolio. No experience necessary. David Lionel Press, 312-Z So. Hamilton Ave., Chicago 12, Ill.

**EARN \$25 A day** and more selling nationally advertised aluminumware, silverware, pressure cookers and jewelry. It is simple, let us show you how to make big profits with no investment. Write Continental Products, Dept. B, 30 Ormsbee Avenue, Providence, R. I.

**PHOTO-SALESMEN**—Agents. Sell beautiful hand colored plastic enlargements. Collect deposit, we deliver. Profitable sideline. Send card, for free sample kit. Novel Portrait, 3343 North Ave., Chicago, Illinois.

**REPRESENTATIVE**—Selling high quality nylon hosiery and lingerie to stores. Excellent sideline for traveler now contacting general and department stores. Dept. 1, Rosalee Hosiery Co., 386 Main Ave., Clifton, N. J.

**BUILD** Steady, large, reliable advertising specialty business. Lowest prices, largest profits on key cases, electric flasher signs, book matches and hundreds of others. Free sales portfolio. Willens and Company, 2130-Y Gladys Ave., Chicago 12, Ill.

**START** Your own business on our capital. Always your own boss. Hundreds average \$6,000 to \$25,000 annual sales year after year. We supply stocks, equipment on credit. 200 home necessities. Selling experience unnecessary to start. Wonderful opportunity to own pleasant, profitable business backed by world-wide industry. Write Rawleigh's, Dept. D-U-PPM, Freeport, Ill.

**SALESMEN:** Big money showing building owners sensational product; cuts essential repair cost up to 75%. Six average orders weekly pay you over \$190.00. Age: 30 or over. Get money-making facts. Write, Zone Co., Dept. D-6, Box 789, Ft. Worth 1, Texas.

**ADVERTISING** Book matches—Cash in on political campaigns; sell union label matches. Cuts for all businesses, political parties. Free powerhouse selling kit, low prices, protection guaranteed on repeat orders. Cash commissions. Superior Match Co., Dept. M48, 7530 Greenwood, Chicago.

**AMAZING** New zipper shoe sells on sight. Big cash profits for salesmen. Leads line 200 splendid styles. Territory open. Get free sample outfit. Write Consolidated, Dept. S-49, Chippewa Falls, Wis.

**SELL** Delicious candies, nuts, gum. Immediate delivery. Write Casterline, 2031-PF Sunnyside, Chicago 25, Illinois.

**SALESMEN.** Here's a natural. New patented tool multiplies man's strength 31 times. Sell retailers. Needed by autoists, farmers, lumbermen, builders, transporters, garagemen, public works. Immediate deliveries from our U. S. plant. Write or wire for attractive proposition. Palcosee Co., Ltd., Cornwall, Ont., Canada.

**SALESMEN.** Earn \$100.00 weekly, selling only six pair shoes daily. Commission and bonus. Wide variety for men, women, children. No investment. Experience unnecessary. Tanners Shoes, 231, Boston, Mass.

**CALENDARS**—Printing—Complete line, book matches, metal novelties, advertising specialties. Experience unnecessary. Big commissions advanced. Free samples. Rob-Ren Studio, 625-A Jackson, Chicago 6.



**EARN** Money selling multi color tinsel religious mottoes. Size 8x10 — \$1.00 for sample of 15. Lamey Motto, Versailles, Ohio.

**AMAZING** Daily profits, steady repeat business selling famous Colt shoes direct. Exclusive features make selling easy. Experience unnecessary. Patented Footograph assures accurate fitting. Free selling outfit. Colt Shoes, 601-J4 Atlantic, Boston 10, Mass.

**WANT** Pleasant outdoor work in a business of your own? Good profits selling over 200 widely advertised Rawleigh home/farm necessities. Pays better than most occupations. Hundreds in business 5 to 20 years or more! Products—equipment on credit. No experience needed to start—we teach you how. Write today for full particulars. Rawleigh's, Dept. D-145A-PPM, Freeport, Ill.

**AUTOMATIC** Fire extinguishers. Red Ball Co., Box 1552, Salt Lake City, Utah.

**\$240.49 IN** One week—Unusual? Not at all! Just look at one week's earnings of these representatives. WWS \$290.99, JMH \$229.75, RJR \$262.47, VJM \$275.95, JEA \$240.49, RWF \$231.21. Direct mail campaign brings hot leads right into your home. Remarkable product does part of 10 men's work; a "natural" during these labor problem days. Has perfect sales story; sells year round. As modern as radar! Special demonstrator offer. We extend credit, deliver and collect. No capital required; no experience necessary. You make big profit on first sale and full credit on repeat business. Every business, store, factory, etc. are prospects. Write John Porter, 2433 Indiana, Dept. 306, Chicago 16.

**AGGRESSIVE** Salesmen. To keep stores supplied with self-selling 5c and 10c counter-card products. Nationally advertised throughout the year in leading magazines and more than 2300 newspapers. Biggest profits, full time or sideline. Write today. World's Products, Dept. 10-B, Spencer, Ind.

**AMAZING** Discovery. Master Glaze puts brilliant glass-like surface on cars. Free sample, information. Big commissions. Master Glaze, Dept. 647, 7720 Harwood, Milwaukee, Wis.

**BIG** Profits daily taking every family's magazine subscriptions. Give unlimited choice of valuable books free. Publishers. 323-5 Hammond, Cincinnati 2, Ohio.

**WE** Manufacture paradichlorobenzene moth blocks. Other chemical products. Guaranteed money makers. Banner, 85 Ludlow, New York 2, N. Y.

**CASH** Profit—Big earnings; selling personalized buckles, belts, cap-badges, tie clasps, 2000 emblems, caps, shirts, ties. Write, Hook-Fast Products, Dept. A, Columbus 6, Ohio.

**WAGON** Salesmen—Fast moving carded goods and 10c line. Long profits. Free facts. Peerless, 2720 Dodier, St. Louis 7, Mo.

**BIG** Cash profits daily taking orders: uniforms, shirts, ties, personal initialed individualized buckles, belts, cap badges, tie holders, 2,000 emblems. Repeats. Write today. Special outfit offer. Hook-Fast Company, Box 480-PM, Roanoke, Virginia.

**JOBS** Open in selling! Send name, address for free copy Opportunity Magazine, listing hundreds of companies who need men now, full or spare time. Experience not essential. Opportunity, 28 E. Jackson, Dept. 17, Chicago 4, Ill.

**BIG** Money taking orders. Shirts, ties, sox, pants, jackets, sweaters, shoes, uniforms, etc. Sales equipment free. Experience unnecessary. Nimrod, 4922-AN Lincoln, Chicago.

**SELL** Calendars—Every business a prospect. Also wholesale to printers: calendars, sheet pictures, Fleming Calendar Co., 6540 Cottage Grove, Chicago 37.

## EDUCATIONAL AND INSTRUCTION

**WANT** U. S. Gov't job? Big starting pay. Security. Men-women. Vets get preference. Qualify now for next examinations. Sample lessons—Details free. Apply Franklin Institute, Dept. A24, Rochester, N. Y.

**SAY** Goodbye to job hunting. Get a life-time government civil service job. Men-women. Write for free booklet: "How to Get a Government Civil Service Job." Lincoln Institute, Dept. P-2, 7951 Yates Ave., Chicago 17, Ill.

**NOW** You can have an office. Learn credit-collection business by new home study course. Many earn up to \$5000-\$15,000 annually. Free bulletin. Franklin Credit School, Dept. 202D, Roanoke 7, Va.

**"HOW To Break and Train Horses"**—A book every farmer and horseman should have. It is free, no obligation. Simply address Beery School of Horsemanship, Dept. 1104, Pleasant Hill, Ohio.

**GRADUATE** Work in all subjects. Degrees available in one year. Resident and extension classes. Golden State University, Hollywood, Calif.

**BOOKKEEPERS!** Increase your earnings! Operate your own simplified "dollar-a-week" bookkeeping and tax service. Full or spare time. Details free. No obligation. Ellis, Box 16-D, Cedar Grove, North Carolina.

**3800 LATEST** Used correspondence courses. Catalog 50c. EG, Elmsford, N. Y.

**WELDING**—A profitable trade. Demand for trained men. Learn quickly at best equipped school in U. S. G. I. approved. Catalog free. Write Hobart Welding School, Box M-487, Troy, Ohio.

**DENTAL** Technician training. Easy home study in spare time. Dental Crafts and Sciences, P.O. Box 1321, Palo Alto, Calif.

**COURSES** In jewelry instruction: watchmaking, engraving, jewelry repairing. G.I. approved. Two fine schools—Pittsburgh, Pa., and Warren, Ohio. Write for free illustrated catalog. Immediate enrollment. Veteran housing available. Low rates. A. W. Thacker Academy for Jewelers, 423 Federal Street, Pittsburgh 12, Penna.

**SHORTHAND.** Learn in 20 days. \$1.00. Gaer, 1212 Lincoln Place, Brooklyn 13, N. Y.

**VALUABLE** Information on your memory, famous feats of memory; super-memory; free. Write today. Thor Books, CM-4, Box 1210, Chicago.

**USED** Correspondence courses and educational books, bought, sold, rented. Catalog free. Educational Exchange, Summer-ville, Georgia.

**MATHEMATIC** Tutoring. Specify wants. Math Tutor, Box 1214-A, Indianapolis 6, Indiana.

**USED** Correspondence courses and books bought, sold, rented and exchanged. Catalog free. Lee Mountain, Pisgah, Alabama.

**LINGUAPHONE** Makes languages easy. At home learn to speak Spanish, Portuguese, Italian, French, German, Russian, by quick, easy Linguaphone Conversational Method. Save time, work, money. Linguaphone correspondence courses are available to veterans under G.I. bill of rights. Send for free book. State if G.I. Linguaphone Institute, 83 RCA Bldg., New York 20, N. Y.

**LEARN** Air conditioning at home. Big demand for trained men. Enormous profit opportunities. Write Nelson, Box 8-C, Warner Robins, Ga.

**INVESTIGATOR** Training. Phillips Secret Service, 1917B North Kenneth, Chicago 39, Illinois.

**NEW** Writers needed. Want to cash editors' checks? If you can read, we can teach you how to write for pay. Earn as you learn. First lesson free on request. No obligation. Send postcard today. Comfort Writer's Service, 200 S. 7th St., Dept. 11, St. Louis 2, Mo.

**LEARN** Photo-engraving at home or in oldest, largest school in America. Work for newspaper or establish own profitable business. New Tasope' Photo-Engraving equipment available soon. Write for information. Veterans ask about G.I. training. The Aurora School of Photo-Engraving, Tasope' Bldg., Aurora, Mo.

**HOME** Study course, drugless therapy. Free literature. Institute of Drugless Therapy, Tama, Iowa.

**MEDICAL** Laboratory technicians in great demand. We train you in your spare time, in your own home. You can practice while studying. Write for free catalogue. Imperial Technical Institute, Box 973-E, Austin, Texas.

**SECRET** Investigation. Experience unnecessary. Investigators particulars free. George Wagner, M 125 West 86th, New York.

**LITTLE** Library of Useful Information. 112 different books. Catalog free. Popular Mechanics Press, 200 E. Ontario St., Chicago 11, Ill.

## PLAYS, STORIES, MANUSCRIPTS

**I WANT** New writers to cash hundreds of checks for \$1 to \$100, offered each month. The easiest way to write for pay. No previous experience necessary. Send for free details. No obligation. Saunders M. Cummings, 467-M Independence Bldg., Colorado Springs, Colo.

## BUSINESS SERVICE

**"WORLD'S** Most famous beach," letters remailed from vacationland, 25c, three, 50c. Also special services. Marion L. Gowan, P.O. Box 2165, Daytona Beach, Florida.

**MAIL** Forwarded, remailed, each letter 25c. Monthly \$2.00. Confidential. Bond, P.O. Box 246, Tacoma 9, Wash.

## SPECIAL SERVICES

**PARENTS:** Your baby's shoes beautifully metallized. Satisfaction guaranteed. Beautiful circular folder, information, 25c. C. Buchanan, Dept. 2, 16 Lisie Ave., Binghamton, N. Y.

**MAIL** Forwarded. Confidential. 25c each letter. Clarence Buchanan, Dept. #2, 16 Lisie Ave., Binghamton, N. Y.

**SPECIAL** Supply source information on anything made in United States \$2.00. Money refunded if can't supply. Business Service, 1101 Kings Highway, Shreveport, Louisiana.

**TEXAS** Remail service. Letters and post cards forwarded 25c ea., 3 for 50c. Martin, 922 Schley, San Antonio 3, Texas.

**SUCCESSFUL** Development of your ideas and patents by former technical advisor U. S. Army Air Forces. W. H. Hollister, 143 So. Euclid Ave., Oak Park, Illinois.

**POSTMARK** Your letters, "Washington, D.C." 25c each or complete (receiving, reforwarding) service, \$3.00 monthly. "Hawkins," 1300 Taylor-m.

**MFG.-WHOLESALE** Sources. Most any item. "Service," 1332D Findlay, New York 56.

## CARTOONING, COMMERCIAL ART, SHOWCARD WRITING, SIGN PAINTING

**ARTISTS,** Layout men, draftsmen, send 10c for circular showing complete line of tools. Artist & Display Supply Co., Room 8, 89 Westminster Rd., Rochester, N. Y.

**"HOW To Make Money With Simple Cartoons"**—a book everyone who likes to draw should have. It is free; no obligation. Simply address Cartoonists' Exchange, Dept. 94C, Pleasant Hill, Ohio.

**LEARN** Showcard writing at home in spare time. Free information. Sherwood Publishing Company, Irvington, 11-Q, N. J.

**CARTOON** Course—Earn big money. 22 easy lessons. Nearly 200 sketches. 50c coin. Snack-Pack Co., Box 412, Indianapolis, Ind.

**EARN** Money evenings, copying and duplicating comic cartoons for advertisers. Adservice, Argyle 1-B, Wisconsin.

**CUSTOM** Sign patterns, designs; any type. Free estimate. Wescraft, P.O. Box 398, Red Wing, Minn.

**GET** The facts on cartooning. Read Pen and Brush Newsletter, professional cartoonists' trade journal. Avoid beginners' mistakes. Sell more. 6 issues \$1. Sample 25c stamps. P.O. Box 189-B, Jackson Heights, N. Y.

**LEARN** Cardwriting. Free details. O'Rourke, P.O. Box 710, Alhambra, California.

**TEST** Free to prospective art students. American, Box 8066, Dallas 5, Texas.

**MAKE** Up to \$100 weekly cartooning, illustrating, designing and lettering at home. No experience necessary. Big, new, simplified method shows you how. Rush name for free trial offer. National Artists Bureau, Box 4248-M, Dallas 8, Texas.

**9 ALPHABET** 3 Numeral pattern sets and catalog. \$1.00. Sign Letter Distributors, P.O. Box 101, Mineola, N. Y.

**CHALK** Talks. Laugh producing program. \$1.00. Catalog 10c. Balda The Cartoonist, Oshkosh, Wisconsin.

## ADVERTISING AGENCIES, LETTER WRITERS, FOR ADVERTISERS

**ADVERTISE:** 24 Words, 40 newspapers \$3.50. Lists free. Advertising Bureau, 229-C Dixon, Uniontown, Penna.

**BUSINESS** Building sales literature written by direct mail specialist. Sales letters as low as \$3.00. Stamp brings complete price-list. Paul Wallace, Box 143, Sheboygan 5, Wis.

**FREE** Advertising rate guide. Paramount Advertising, Box 694, Baltimore 3, Maryland.



**FREE:** Want an advertising rate bulletin covering the southern states. Alabama Advertising Agency, Exchange Building, Birmingham 3, Alabama.

**ADVERTISING** Art, ideas, layout, copy. Offset. Ads, leaflets, folders, postcards. Fischer, 711 South Boulevard, New York 55, New York.

**ADVERTISING** Sensation! Reach 2,100,000 families, \$32.90 inch. Display, classified, ratebook (newspapers, magazines, mailing lists), advertising assistance, free. Chicago Advertising Agency, 20-PM West Jackson, Chicago 4.

**ADVERTISERS!** Reach nearly 18,000,000 readers. 25 Sunday national key newspapers, 18 words, \$47.75. "Terrific pullers." 20 popular newspapers, \$9.75. "Free booklet." Special—One inch display 2-821,198 circulation, \$42.00. Newmark's Advertising Agency, (Established 1893) 217-7th Ave., New York 11.

**ADS** Placed in out of town newspapers and magazines. Low rates. Catalogue free. Ideas that pay. Baker Advertising Agency, Successors Ankrum Agency, 189 W. Madison, Chicago 2.

**MAILING** Lists, certified, productive, inexpensive, \$5.00 1000. Homeworkers, agents, buyers, etc. Write Dixie Service, King, N. C.

**24 WORDS** in 64 weeklies \$4.96. H. J. Darnell, 730 Hays, Jackson, Tenn.

**LEARN** Direct advertising, letter shop business. Free booklet. Armstrong, 7219 Broadway, Los Angeles 3.

### TYPEWRITERS, DUPLICATORS, OFFICE DEVICES

**DUPLICATORS** \$9.95 up. (New.) Immediate delivery. "Free circular." Rucker, 2836-PM Slevin, Louisville 12, Ky.

**"PRINTOMATIC"** Selffeeding post card stencil printing duplicators \$9.50 up. Office size duplicators. Speedoprints, Hilcos, Excellographs \$33.41 up. Literature free. Pittsburgh Typewriter Supply, 336-WK Fourth Avenue, Pittsburgh 22, Penna.

**RECONDITIONED** Typewriters, mimeograph, multigraph printing devices, appliances, supplies. Catalog. Dixiegraph Service, King, N. Carolina.

### RUBBER STAMPS AND OFFICE SUPPLIES

**3 LINES** 50c. Cushioned, indexed, 500 printed noteheads \$2.85, postpaid. Iden Charles, Wauwatosa, Wis.

**NAME** Plates—Desk. Your name engraved on 2 1/2"x6" clear plastic \$1.25 postpaid. Hummel Manufacturing Corporation, Hopewell, Virginia.

**RUBBER** Stamps. Send for catalog. Excello, Box 500, Shreveport, Louisiana.

**RUBBER** Stamps. Illustrated literature free. Lee-Vall Press, Dept. 7-A, Box 1242, Indianapolis 6, Indiana.

**2 LINES** 35c. 3 Lines 50c. Newman, Box 284, Fort Collins, Colo.

### PRINTING, MULTIGRAPHING, MIMEOGRAPHING, GUMMED LABELS

**MAKE** Your own labels! Samples free. Bukley, 2539 Devon, Chicago 45.

**100 8 1/2x11** HAMMERMILL Letterheads and envelopes \$1.98. Herbert Hudson, 261 Woonasquatucket, Centredale, R. I.

**100 BUSINESS** Cards 75c. printed, prepaid. W. Davis, 935 Maxwell, Chicago 8.

**500 6 3/4** ENVELOPES, Printed, \$3.00 postpaid, c.o.d.'s accepted. Dickerson Printing Co., Gas City, Indiana.

**1,000 BUSINESS** Cards \$2.95; 1,000 6 3/4 white envelopes \$5.50. Crowe, Boelus, Neb.

**CUTS** Made, art work. Free estimates. Webb, 2708 Ross, Dallas, Texas.

**MIMEOGRAPHING** Specialists — Any copy. Reasonable. Mailers Service, Box 606-A, Chicago 90, Ill.

**FREE** Estimate on your printing. Send copy. Samples. Wood, 9 Arapahoe, West Hartford, Conn.

**LETTERHEADS**, Envelopes, 100 for \$1.00. Samples free. Walter Narlock, 1215 S. Van Buren, Bay City, Mich.

**1000 EMBOSSED** Business cards, \$3.95. Ortiz, 700 West 180 Street, New York.

**1000 BUSINESS** Cards (embossed) \$2.95 postpaid. Zephyr Printing, Box 312, Venice, Calif.

**LETTERHEADS**, Envelopes, circulars, booklets, cards, ruled forms, other quality printing lowest prices. Small, large quantities. Journal Printing Co., Newark, Ark.

**PERSONAL** Stationery: 200 sheets and 100 envelopes exquisite bond paper each with your name and address, \$2.00. Brookside Press, 146 Mount Joy Place, New Rochelle, N. Y.

**5000 6 3/4** ENVELOPES Printed \$2.75 per thousand, price list free. Michel, Box 76F, New York 16.

**QUALITY** Printing: business, personal stationery. State requirements. Samples. Mero Products, 100 Morrison, Punksawtawney, Penna.

**MIMEOGRAPHING**—Any copy, reasonable. Free samples! Topical Emprise, 1527 Highland, Louisville 4, Kentucky.

**500 3/4x2 1/4** FOUR Line gummed stickers 35c; red border 50c. Moritz Printery, Saginaw, Mich.

**1000 BUSINESS** Cards, \$2.50, prepaid. Samples free. Reliable Print Shop, 905 E. Jefferson, Louisville 6, Ky.

**SEND** 10c Now, for our 48 page 1948 price list—refunded first order. McCall Press, 1326 South 27th, Omaha, Nebraska.

**BETTER** Grade printing reasonable. Estimates on anything. Economic Press, Leonia, N. J.

**QUALITY** Printing—Reasonable prices. Fast service on catalogs, folders, publications. Write for prices. Bagby Printing Co., Georgetown, Ohio.

**MIMEOGRAPHING**—Letters, pricelists, formulas, instructions. Lowest prices. Lem's Letter Shop, 5710 Stanton, Detroit 8.

**LEARN** Direct advertising, letter shop business. Free booklet. Armstrong, 7219 Broadway, Los Angeles 3.

### PRINTING OUTFITS AND SUPPLIES

**BARGAINS** Equipment, supplies, paper, catalog 10c. Customprint, Box 211, Springfield, Missouri.

**SEND** \$1.00 For retractable, replaceable blade make-read/ knife. Printer, Room 10, 89 Westminster Road, Rochester, N.Y.

**BARGAINS**—Type, supplies. Send stamp. Garza, 8 Walden, Cambridge 40, Mass.

**1948 PRINTERS** Supply catalog 10c. Refunded with \$1.00 order. Brighton Printers Supply, 4234-M South Mozart, Chicago 32, Illinois.

**(9x13) JOBBER**, Motor, 2 speeds, counter, inker, \$350.00. Mapco, Mendota, Ill.

**SAVE** Money! Build own inexpensive, workable printing press with easy to follow instructions. Details free. Otanco, Box 114E, Akron 5, Ohio.

**PRINTING** Presses, type, supplies. Lists 3c. Turnbaugh Service, Loysville, Penna.

**PRINTING** Presses, type, supplies. Send dime for complete illustrated printer's supply book, details and press samples. Kelsey, Inc., A-11, Meriden, Connecticut.

**INEXPENSIVE** Home-made printing press. Details free. Novelty Shop, Downs-ville, Louisiana.

**MAKE** Your own printing cuts. Newly invented plexiplat process. Plexiservice, Argyle 1, Wisconsin.

### PATENT ATTORNEYS

**INVENTORS**—Patent Laws encourage the development of inventions. The Rules of Practice of the U. S. Patent Office advises; unless an inventor is familiar with such matters; that he employ a competent registered attorney or registered agent, as the value of patents depends largely upon the skillful preparation of the specifications and claims. Write for further particulars as to patent protection and procedure and "Invention Record" form at once. No obligation. Mc Morrow, Berman & Davidson, Registered Patent Attorneys, 134-A Victor Building, Washington 1, D. C.

**PATENTS**—Trade marks. Irving L. McCathran, 315 McLachlen Bldg., Washington 1, D. C. Registered Patent Attorney.

**INVENTORS:** Learn how to protect your invention. The United States Patent Office advises the inventor, unless familiar with such matters, to engage a competent registered patent attorney or agent to represent him. We maintain a staff of registered patent attorneys ready to serve you in the handling of your patent matters. Special booklet "Patent Guide for the Inventor" containing detailed information concerning patent procedure with "Record of Invention" form will be forwarded upon request, without obligation. Clarence A. O'Brien & Harvey Jacobson, Registered Patent Attorneys, 81B-D District National Building, Washington, D. C.

**C. A. SNOW & Co.**—M-427, Snow Building, Washington 1, D. C. Registered Patent Attorneys. Write for information.

**PATENT** Protection—The U. S. Patent Office recommends—"an applicant is advised, unless familiar with such matters, to employ a competent registered Patent Attorney or registered Patent Agent, as the value of patents depends largely upon the skillful preparation of the specification and claims." Preliminary steps to take to obtain patent protection will be sent upon request. Victor J. Evans & Co., 331-D Merlin Building, Washington 6, D. C.

**INVENTORS.** For "Record of Invention" form, contact Carl Miller, Registered Patent Attorney, Woolworth Building, New York.

**INVENTORS:** Without obligation, write for information explaining the steps you should take to secure a patent. John N. Randolph, Registered Patent Attorney, 203 Columbian Bldg., Washington 1, D. C.

**INVENTORS:** When you are satisfied that you have invented something of value write me, without obligation, for information as to what steps you should take to secure patents or trademarks. Write Patrick D. Beavers (Formerly Randolph & Beavers) Registered Patent Atty., 935 Columbian Bldg., Washington 1, D. C.

**PATENT** Practice before U. S. Patent Office. Validity and Infringement investigations and opinions. Booklet and form "Evidence of Conception" forwarded upon request. Lancaster, Allwine & Rommel, Registered Patent Attorneys, Suite 411, 815-15th Street, N.W., Washington 5, D. C.

**"INVENTOR'S** Guide" free on request. Frank Ledermann, Registered Patent Attorney, 154 Nassau St., New York 7, N. Y.

**PATENTS.** "Proof of Invention" folder mailed without obligation. E. E. Vrooman, Registered Patent Attorney, 871 Woodward Building, Washington 5, D. C.

**INVENTORS:** Write for free brochure "Evidence of Invention." Labiner, World Building, New York 7.

### FOR INVENTORS

**INVENTORS**—Patent Laws encourage the development of inventions. The Rules of Practice of the U. S. Patent Office advises—unless an inventor is familiar with such matters—that he employ a competent registered attorney or registered agent, as the value of patents depends largely upon the skillful preparation of the specifications and claims. Write for further particulars as to patent protection and procedure and "Invention Record" form at once. No obligation. Mc Morrow, Berman & Davidson, Registered Patent Attorneys, 1349 Victor Building, Washington 1, D. C.

**SAVE** Your ideas! Drawings of your inventions can be an important step toward future wealth. Our drawing and designing service is absolutely confidential and low in cost. Free estimates. Write today! Machine Design Service, 416 Madison Avenue, Rahway, New Jersey.

**INVENTORS:** Learn how to protect your invention. The United States Patent Office advises the inventor, unless familiar with such matters, to engage a competent registered patent attorney or agent to represent him. We maintain a staff of registered patent attorneys ready to serve you in the handling of your patent matters. Special booklet "Patent Guide for the Inventor" containing detailed information concerning patent procedure with "Record of Invention" form will be forwarded upon request, without obligation. Clarence A. O'Brien & Harvey Jacobson, Registered Patent Attorneys, 81A-D District National Building, Washington, D.C.

**FREE** Pamphlet "P" will tell you how we have helped others develop their ideas into worthwhile patented inventions ready for market. Elo Development Co., 29-28 41st Ave., Long Island City, N. Y.

**PATENT** Protection—The U. S. Patent Office recommends—"an applicant is advised, unless familiar with such matters, to employ a competent registered Patent Attorney or registered Patent Agent, as the value of patents depends largely upon the skillful preparation of the specification and claims." Preliminary steps to take to obtain patent protection will be sent upon request. Victor J. Evans & Co., 332-D Merlin Building, Washington 6, D. C.

**INVENTORS:** Reliable patent searches \$6.00. Reports back in five days. All sketches returned. "Invention Record" and "Certificate of Search" forms free. Write Raymond L. Smith, Patent Searcher, 410-M Bond Building, Washington 5, D. C. (Formerly with U. S. Patent Office.)



**CASH** For your idea. 280 manufacturers need inventions, patented or unpatented. List free. Invention Bureau, 208 Clinton, Oak Park, Illinois.

**FREE** Service. U.S. Industrial Research Committee, 23 Nelson Ave., Staten Island 8, N. Y.

**INVENTORS:** If you have an invention for sale, patented or unpatented, write Institute of American Inventors, Dept. 40A, 1926 Eye St. N.W., Washington 6, D. C.

**INVENTORS:** Without obligation, write for information explaining the steps you should take to secure a patent on your invention. John N. Randolph, Registered Patent Attorney, 202 Columbian Bldg., Washington 1, D. C.

**INVENTORS:** The usual first step is to have a search of the U. S. Patents conducted, so I can report on patentability. Write, without obligation, Patrick D. Beavers (Formerly Randolph & Beavers), Registered Patent Atty., 936 Columbian Bldg., Washington 1, D. C.

**I SELL** Patents. Established in 1900. Charles A. Scott, 773PM Garson Ave., Rochester, N. Y.

**FREE.** Two months on trial. Patent News, Washington, D. C. 12.

**"INVENTOR'S Guide"** free on request. Frank Ledermann, Registered Patent Attorney, 154 Nassau St., New York 7, N. Y.

**PATENTED.** Unpatented inventions promoted. M. Joyce Humphries, 1424 Land-tite, Philadelphia 10, Penna.

### INVENTIONS WANTED

**CASH** For your idea. 280 manufacturers need inventions, patented or unpatented. List free. Invention Bureau, 208 Clinton, Oak Park, Illinois.

**INVENTIONS** Wanted. Patented or pending only. Inventors' Exchange-B, Hartford 1, Conn.

**INVENTORS!** Have you good, patentable ideas? Write Patent Agent Metzler, 11 W. 42nd, New York.

**HIGHEST** Royalties—cash. Free literature. Universal Marketing Co., 126 Lexington Ave., New York 16, N. Y.

**MANUFACTURERS** Want patented or patent pending inventions! Write, Universal Guaranty Company, Lakewood, New York.

**INVENTORS:** Hundreds of manufacturers have requested our assistance in locating marketable new products. Complete information, free. Institute of American Inventors, Dept. 40-D, 1926-Eye St. N.W., Washington 6, D. C.

**SMALL** Inventions wanted by manufacturers. I'll help you sell your invention. Write for circular, Stanley Hull, 7829 Euclid, Cleveland, Ohio.

**PATENTED.** Unpatented inventions wanted. We have tremendous lists of manufacturers who may pay cash royalties. Descriptive booklet free. National Invention Service, 1404-T Mitchell St., Oakland 1, Calif.

### PATENTS FOR SALE

**PENDING.** Electric singing bird clock. Easily manufactured. Large market. Davis & Son, Bellfontaine, Ohio.

**NEW** Kind of wrench. Simple, practical. Michael Gryniuck, 2671 San Marino St., Los Angeles 6, Calif.

**PATENT** For sale outright. Small electrical household article. More than twelve uses. Labor-saver. Every woman prospective buyer. Address Box 1274, Detroit 31, Michigan.

**INVENTORS:** Test the commercial value of your patented or unpatented inventions, quickly and inexpensively. Write for free information. Institute of American Inventors, Dept. 40-B, 1926-Eye St. N.W., Washington 6, D. C.

### MANUFACTURING

**PRECISION** Dies, machine. New inventions. Baum's Metal Specialties, Kansas City, Mo.

**EXPERIMENTAL** Work, models, small lot manufacturing. Halfer Eng. Co., 5238 W. Chicago Ave., Chicago, Ill.

**PATENT** Models, experimental devices. Designed, constructed. Nelson Mfg., Woodburn, Oregon.

**SMALL** Lot production wanted. Aluminum castings; stampings; screw machine; plastics. J and M Company, Burlington, Kentucky.

**MODELS**—Small lot manufacturing. Metals, plastics, etc. Milburn, Burlington, Kentucky.

### MODELS, MODEL SUPPLIES

**ONE** Request brings list of Lionel or American Flyer available equipment monthly. 25c brings scale catalog with refund coupon. Tri-Lor's, State Road, North Dartmouth, Mass.

**HOBBYIST'S** Catalogs! Controlog-engine powered, line control model planes, 100 kit photos, construction, flying instructions 10c. Send large self-addressed stamped envelope for free folder featuring famous English Twin Trix 3-rail trains, 164 page ship model kit-fittings catalog 35c. Booklog—hundreds of model, hobby, craft books 10c. Send coin, stamps. Polk's Hobbies, "World's Leading Hobby House," 314(PM4) Fifth Avenue, New York 1.

**LIONEL** Train sets, accessories available. Lists furnished. Roundhouse, Box 273, Newark 3, New Jersey.

**FREE!** Big train folder, packed with new Lionel cars, sets and accessories. Madison Hardware Co., 103 East 23rd, New York 10.

**MINIATURE** Steam locomotives, 1/4", 1/2", 3/4" scales. Castings, parts, rail, steam fittings! Thorough drawings with instructions. Catalog 25c. Little Engines, Wilmington, Cal.

**CHRIS** Craft—Harco, Owens genuine model boat kits. Literature 10c. Trimcraft, 312 East Wisconsin, Milwaukee 2, Wis.

**MINIJET** Engine kit now \$9.95 pp. U.S.A. Assemble real pulse-jet at home. Send m.o. today. No c.o.d.'s. Minijet Motors Sales Company, Box 406, Pasadena, California.

**AUTHENTIC** Working model Dutch mill kits \$1.50 postpaid. Martin's Model Industries, 977 Howard Street, San Francisco, Calif.

**SHIP** Model supplies, kits. Complete line of yacht and speedboat fittings. Catalog 25c. Welcher, 203 South Seventh Street, Fulton, New York.

**MODEL** Railroads exclusively—Complete stock scale; Lionel, American Flyer. Send for catalog, 15c, state gauge. Eric Fuchs, 28 Brattle Street, Boston 8, Mass.

**RAILWAY** Models, complete informative catalog HO and O gauge. 132 pages, 50c. Walthers, 247 Erie, Milwaukee, Wisconsin.

**SHIP** Models, copper sails, Blinker light house, book ends. Construction sets. Catalogue 25 cents. Trade Wind Models, Box 171B, Lakewood, N. J.

**BRASS** Gears and model supplies for the inventors. Send 10c for catalog. Pierce Model Works, Tinley Park, Ill.

**POWER** Models—Steam and gasoline engines, steam traction engine, metals, tools. Catalog 35c. Chas. Cole, Ventura, Calif.

**LANDLOCKED** Sailors! Here's a beautiful, richly illustrated, fully descriptive catalogue of famous model ships—whalers, slavers, corvettes, etc., authentic in every detail. Send for it today. Only 25c. Halesite Yacht Service, Inc., Halesite, Huntington, N. Y.

**FUN** Building models—Airplanes, trains, ships. Everything furnished. Giant catalog 10c. Ben's Hobby Shop, 72 West Washington, Chicago 2, Illinois.

**SHIP** Models and yacht supplies complete. Large 64 page catalogue 30c. Bill Wild's, 510 East 11 St., New York City 9.

**SHIP** and Yacht model fittings; blueprints. Send 25c for illustrated catalog No. 20—listing hundreds of items. A. J. Fisher, 1002-1 Etowah Ave., Royal Oak, Mich.

### HOME CRAFTSMEN

**CRAFTSMEN'S** Deals—Exotic veneers, turning squares, blocks. Cabinet lumber, plywood, hardware. Sedio Company, P. O. Box 7161, New Orleans, La.

**LEATHERCRAFT:** Free! Two billfold designs with latest illustrated price list. Inclose 10c for handling charges. Leather Specialties Shop, Dept. M, 358 East Broadway, Long Beach 2, California.

**LEATHERCRAFTERS**—Just out! 1948 edition—The Leatherworkers' bible! Completely illustrated catalogue and textbook. Instructions, descriptions, and actual leather samples. Guaranteed to exceed any expectation or your money refunded. \$1.00 postpaid. Artercraft Leather, 271 12th St., Dept. PM-5, Oakland 7, California.

**PATTERNS**—40 Pictures of new jigsaw projects. Illustrated folder 10c. Joannes Patterns, P. O. Box 141, Omaha 7, Nebr.

**RHINESTONES,** Moonstones, pearls, ear-wires. Free literature. Herber, 1360-A Hicks, New York 67.

**MASONITE** Mill ends 10# \$1.00 plus postage. Carl Signs, Wooster, Ohio.

**LEATHERCRAFTERS!** 10 Different lacing methods 10c. Buckley, 2539 Devon, Chicago 45.

**OREGON** Myrtlewood turning squares for sale. M. Weaver, 3923 S.E. Tibbetts, Portland 2, Oregon.

**CATALOG:** Many kinds full size patterns, craft books—booklets, decals, tools, picture frame mouldings, etc. Hundreds articles superbly illustrated. 25c, refunded first order. (No stamps please.) Wo-Met Shop, Ashburn, Georgia.

**LEATHERCRAFT.** Try Tandy Leather, Tulsa 1, Oklahoma, for supplies. Catalog free upon request.

**LEATHER-CRAFTERS:** Free 1947 catalog showing easily completed projects, full line of tools, hides and accessories. Ester Leather Co., 145 St. Paul St., Rochester 4, N. Y.

**DO** Your own professional felt flock finishing. Complete kit includes flock, undercoat, thinner, spray gun and instructions. \$9.25 post paid. Write for free color card and circular. Berott-Ross, Dept. 4A, 411 N. Foothill Road, Beverly Hills, Calif.

**MYRTLEWOOD.** Beautiful, mysterious. Grows only on Pacific coast and Holy Land. Samples and pamphlet \$1.00. Runyan Mfg., 2606 N. Williams, Portland 12, Ore.

**LAWN** Chairs, toys, novelties, garden figures, furniture etc. 62 popular plans for \$1.00. Mastercraft 4M, 7041 Olcott, Chicago 31, Illinois.

**LEATHERCRAFT!** Complete stocks of leathers, tools, supplies. Immediate shipment. Free catalog. Kit Kraft, 3203 W. Washington Blvd., Los Angeles 16, California.

**COPPER** And brass materials. Complete line for craftsmen and workshops. Catalog A free. Groundmaster Company, Boulder, Colorado.

**TIDY** Tot clothes rack. \$3.00 brings kit containing 10 parts, assembly diagram and decals. Thombert, Newton, Iowa.

**NEW** Velvet flock finish. 10-color trial kit, instructions and decorative patterns \$1.00. V-Sparks, 1145 Queen Anne, Los Angeles 6.

**MACI-CHEM** Your tools or jewelry; for identification or decoration. \$1.00 brings liberal supply or write F. L. Dupont, Arnold 27, Penna.

**METAL** Craft! Brass, copper, instruction books, supplies. Immediate shipment. Free catalog. Kit Kraft, 3203 W. Washington Blvd., Los Angeles 16, California.

**BANDSAW** Blades repaired 40c. New blades to 8 feet, 80c to \$1.30. Cushman Company, Frankfort, New York.

**BUILD** Fully-rigged ship in bottle. Big money full or spare time. Fascinating hobby. Blue prints and instructions \$1.00. Mariner, Box 2095, Wichita, Kansas.

**BOOMERANGS**—Profitable hobby! Exciting sport! Materials, instructions, \$1.00. American Boomerang Exchange, 1229 South Avers, Chicago 23, Ill.

**SHELL** Jewelry, Findings, Hobby Lobby, Box 486, Sta. A, St. Petersburg, Fla.

**LEATHERCRAFTERS:** Belt kits, projects, leather, supplies. Free catalog. Art Leather, 411 Joseph Ave., Rochester 5, N.Y.

**SHELLS.** Three dozen imported perfect specimens, catseyes, cowries, and nine other varieties. Sufficient for set earrings, dinner ring, brooch, bracelet, and necklace. Nothing like them in the U.S. Money refunded if not satisfied. Send five dollars to Eric Lee, Box 245, P.O. San Anselmo, Calif.

**SOUTHERN** Woods: Texas ebony, mesquite, Brazil, catsclaw, Guayacan, Huisache, many others. Working supply, \$1.00 each prepaid; sample, dime each; details, stamp. StarCraft 1, Edinburg, Texas.

**LEATHERCRAFT**—Tools, dies. Made to order. Belt tapers, billfolds, key cases. Louis Jones, 1405 Throckmorton, Ft. Worth, Texas.

**ROCKET** Rocker, children's delight, atomic end tables, etc. 16 sensational plans \$1.50 postpaid. Modern Plans, Deerwood, Minn.

**LEATHERCRAFT** Designs — Handbags \$1.00, billfolds \$1.00, belts \$1.00. All three \$2.50. Lampkin Artercrafts, Box 641-M, Culver City, Calif.

**BRAD-DRIVING** Device increases profits, saves time, easily made. Write. Reed Brothers, Thomaston, Maine.

**\$46.00 FROM** Square foot plywood. Jigsaw necessary. Write. Woodarts, H-38, Bridgewater, Mass.



**SPECIAL 77 Full sized patterns.** Lawn ornaments, toys and novelties \$1.00. Modern Woodcraft, Saginaw, Michigan.

**DRILLS.** Cutters, stones, and accessories. Dental drills 3/32" shaft, ideal for internal carving, cutting wood, metal. Assorted sizes, shapes, four dozen \$2.25. One dozen assorted mounted stones \$2.25. Diamond stones for sale. Postpaid in U.S. Schrader Instrument Company, East Main, Independence, Iowa.

**FREE Folder—"Amazing New Service."** Materials furnished to build projects featured in this magazine. Project Headquarters, 1756A Henderson, Chicago 13, Ill.

**MAKE Your own jewelry!** Findings in metal and plastics; earwires, pinbacks, cameos, stones, beads, clasps, sprays, combs, hairbars, plastic and metal chains. Hobby Art Corp., Dept. 7, P.O.B. 276, New York 18, N. Y.

**SHELLS.** Plastics, findings. Beginner's kit \$3.00. Free catalog. Stelle's, 230 Randall Avenue, Trenton 10, New Jersey.

**35 PATTERNS** Toy furniture, action toys, etc. \$1.00. Continental Homecrafters, 907 Birch, Eau Claire 3, Wisconsin.

**FAST Selling.** Good profits making lawn chairs, furniture, toys. Illustrated folders of popular items. 25c. Refundable. Summercraft Studio, Dept. KN, 42 Vernon St., Newton 58, Mass.

**SHELL Jewelry supplies.** Wholesale only. McFarland Plastic Co., Sarasota, Fla.

**LEATHER.** Retail, mail orders, catalog, tools, lacing, supplies. National Handicraft Co., 30 Frankfort St., New York City 7.

**PLASTIC Jewelry supplies.** Free catalog. J & M Novelties, Box 464P, Griffith, Indiana.

**SPECIAL Offer:** 80 full size toy, novelty, and lawn ornament patterns only \$1.00. Lynds, Medway, Mass.

**CERAMIC Jewelry supplies,** bar pins, ear screws, for ceramic and woodworkers; also glass and seashell assemblers. Free catalog. Philadelphia Badge Co., Dept. B-1, 1007 Filbert St., Philadelphia, Penna.

**SHELLS.** Plastics, findings. Lowest prices. Free catalog. Frances Jones, Box 251, Sarasota, Fla.

**SWISS Music units** from manufacturer's agent. \$2.75. Assorted tunes. Helax Company, 233 West 72 Street, New York 23.

### MAKE IT YOURSELF

**BUILD Your own concrete block machine.** Motor vibrator or hand in 2 days for \$10 (exclusive of motor). Write Clyde Lee, Dept. A, Mountain View, Okla.

**BUILD Your own tilting table bench saw.** Plans and instructions \$1.00. Metal parts available. Write for descriptive circular. William H. Crandall Company, 1009 Fruitvale Ave., Oakland 1, California.

**BUILD Better tilting table circular saw.** Details 10c, refundable. Ward Manufacturing Co., Walsenburg, Colo.

**BUILT-IN Kitchen cabinets.** \$1.00 brings detailed plans and specifications showing construction methods. Will fit any kitchen. Thombert Co., Box 447, Newton, Iowa.

**GRANDFATHER Clock plans.** \$1. Simple, shop-tested, thousands built, with pictured prices fine Westminster weight movements. Kuempel Chime Clocks, Minneapolis 16, Minn.

**CONCRETE Block mold,** 4x8x16 block, \$6.70. Circular free. Lehnert, Norwood, N. J.

**PLAYHOUSES** And doghouses, scientifically designed. Plans and material list for 4 sizes of either, \$1.00 postpaid. Miller & Wutkee, 254-A Conant Hotel, Omaha, Nebr.

**HOT Water free—**From sunlight. System efficient any locality year round. Standard materials—easily built—low cost—facts free. Solar Water Co., Box 175, Dept. M, Coral Gables, Florida.

**ZEOLITE Water softener.** Original plans for building your own, \$1. Materials available from us. Lake Region, Box 2732-P, Minneapolis 7, Minnesota.

**BUILD Your own home,** scaled drawings and plans like blueprints for 5 homes \$1.00. A. Piccirilli, Box 549, Sharpsville, Pennsylvania.

**ATTENTION.** Your lingerie, hosiery, finest silks, curtains, drapes, your best woolens, all can be washed in your own machine without harm to cloth or fiber contents, in half time now required. No dry cleaning. Complete plans \$1.00. Write Gustav Lavrenz, 113 Main St., Campbellsport, Wis.

**BUILD Concrete mixer** from auto parts and sheet metal. Plans \$1.00. W. J. Latvala, R. 2, Box 147, Chassell, Michigan.

**MAKE Plastic wallets.** Everything furnished. Details free. Lakeshore Supply, 534 Surf St., Chicago 14, Ill.

**"CONCRETE Block homes."** 32-page booklet; drawings, instructions on how to build. \$1.00. H. C. Lightfoot, Civil Engineer, Richboro 1, Penna.

**MAKE Your own paint and varnish finishes—yourself!** Easy-quick-economical! Send \$1.00 for famous handbook and large trial size of working material. Make enamels, waterproofing and rustproofing compounds, concrete paints, marine, furniture, bartop varnishes, etc. Periseal Company, 25 West 45th Street, New York 19.

### WATCHES, OLD GOLD, JEWELRY

**ANY Old broken jewelry.** Highest prices. Cash mailed same day. Mail gold teeth, watches, rings, diamonds, spectacles or anything. Reliability guaranteed. If dissatisfied, articles returned. Free information and surprise gift for new customers. Great American Buying Co., 2227 Calumet, Dept. P-1, Chicago.

**WATCH Repairing.** Send your Bulova watch to us. We specialize in one make, so you get a better price. Cleaning \$2.50. Over 45,000 satisfied customers. Gilbert Jeweler, 1820 East High St., Springfield, Ohio.

**EXPERT Watch repairing** by hand-capped people whose livelihood and livelihood is watchmaking. Rapid service. Guaranteed work. Genuine factory parts for American and Swiss movements, stop-watches, chronographs. Cases and bracelets refinished free. Send insured mail for prompt estimate. Bonded Watch Repair Co., Dept. 20, 219 W. Chicago Ave., Chicago 10, Ill.

**WATCHES.** Wholesale. Rebuilt Elgins, Walthams, Bulovas, etc. \$9.75 up; new and used diamond, railroad, 21J wrist. Catalogue free. Brookins, 1975-B, Little Rock, Ark.

**JOBGING Stones** for rings, earrings, costume jewelry, etc., assorted sizes and colors. \$3.00 per 100. Morrison's Jewelry, Flanagan, Ill.

**WATCH And Clockmakers Handbook—**Britten \$5.79. Most complete on the subject. Free catalog. Engineer's Book Service, 19 W. 44th St., New York City 18.

**PRECIOUS, Semiprecious stones,** plastic-metal findings, list 10c refundable with first order. Pickwick Findings, Box 780-L, Stamford, Conn.

**JEWELRY Findings,** lowest prices. George Sassen, 154 Nassau Street, New York 7.

**CASH For old, broken jewelry.** Highest prices paid immediately. Mail gold teeth, watches, rings, silverware, diamonds, spectacles. Satisfaction guaranteed. Information free. Rose Smelting Co., 29-A East Madison, Chicago.

**GEMS, Precious and semi-precious,** all genuine, from world wide sources. Deal direct, no overhead, save money. Catalog 10c. Hill Co., Route 7, Salem, Oregon.

### PLANS AND BLUEPRINTS

**BUILD Your own home.** Working blue prints at fraction of usual cost. Comply with F.H.A. and G.I. regulations. Send \$1.00 for book showing 59 distinctive, economical small homes. Griffin-Patterson Company, Box 1190, Glendale, California.

**SENSATIONAL, Easy way** to make own lawn furniture, household furniture, etc. Full size patterns with simple instructions save time and labor making beautiful, finished furniture. Wonderful hobby or business. Individually styled—make under own name. Send for full particulars with free lawn furniture circular or general catalogue of all furniture. Craftsman Design Service, 823-M Eckart St., Fort Wayne 5, Ind.

### TOBACCO, SMOKERS' SUPPLIES

**REJECTS \$5.00 Pipes** 65c. Briar blocks, bits. Literature free. Carvapipe, 2829-H Dixie, Hamilton, Ohio.

**CIGARETTES—**Popular brands \$1.45 per carton delivered postpaid. Minimum 3 cartons. Check or money order. Service Sales, Dept. X, Box 3146, University City 5, Missouri.

### SURVEYING INSTRUMENTS

**GUARANTEED Factory rebuilt** transits and levels, sale, or rent, with purchase option. We will repair, trade or buy old instruments. Write for list M-48. Warren-Knight Co. (Manufacturers of Surveying Instruments), 136 North 12th St., Philadelphia 7, Penna.

### FOR SALE OR EXCHANGE

**WILL Swap photographs** of Mexico, with photographic amateurs. Dandini, Dolores 8-1, Mexico City.

### FOR THE HOME

**WRITE Jiffy-Till,** La Mesa, Calif. for folder on "paddle wheel" garden tractor. Featured in February issue, Popular Mechanics.

**SCALES—**Household (25 lb.) \$6.95. Baby weighing scales, \$9.95. Ideal for gifts. Immediate delivery. Cameo, 432 West 42d St., New York.

**IT'S New!** Insulating, weather-proof door-step milk bottle box. Keeps milk cool, clean in summer, helps keep it from freezing in winter. 2 qt. size \$2.00; 4 qt. \$2.50; 6 qt. \$3.00. Send check, cash or money order, for prepaid shipment. Better Box Co., 98 Central St., Ansonia, Conn.

**INGENIOUS Ever-Level picture hanger.** Keeps pictures straight under any condition. 15 cents per set, post paid. Stevens Manufacturing Co., Box 673, Morristown, N. J.

### FOR SALE — MISCELLANEOUS

**DIRECT From mill to you.** Raw extra large Virginia peanuts, shelled, 30 cents per pound; unshelled 18 cents per pound. Check or money order. Keel Peanut Company, Greenville, North Carolina.

**ARMY Tents, covers, clothing, hammocks, paints.** Jarashow, 10-15G 50th Avenue, Long Island City 1, N. Y.

**HULL Automobile compass,** value \$4.95, brand new, \$2.50. Prisms for 6x30 or 8x30 binoculars, brand new, \$1.50 each. Offset prisms to be attached to 7x50 B. & L. binoculars, gives double the field of the ordinary 7x50 binocular. Cost \$98.00, special \$25.00. Green sunshades for binoculars, size 6x30 and 7x50, snap on type, value \$7.50, special \$1.25 per pair. Forward money order. No c.o.d. shipments. Send coin \$1.50 for Third Annual Edition of Gun Digest together with our complete catalog of new and used guns, ammunition, rifles, binoculars and powder flasks. Our separate catalog 25c. Public Sport Shops, 11 S. 16th Street, Philadelphia, Penna.

**BROOM Handles** in large quantities, and building material. Box 117, Helsingborg, Sweden.

**KNIVES—**Automatic, pen, pocket, hunting, fishing. Large selection, lowest prices. Free catalogue. Knifemaster, 1441 Prospect Place, Brooklyn, N. Y.

**50,000 SURPLUS Bargains** in stock! War surplus, factory surplus, overstocks. Write for free illustrated list! The Allender Co., 1966 E. Forest, Detroit 7, Mich.

**SURPLUS Items:** 1/3 h.p. 115 v. drip-proof, reversible, rubber mounted type PH Westinghouse motors with 3/8" shaft, \$27.50. 1/6 h.p. pipe type, powerful blowers by G-E, \$12.50. Insulated transformers for 115 primary, 8-9 volt output at 4-8 amperes, \$1.50. 4 1/2 to 33 1/2 volts output at 2-5 amperes, \$3. 11 taps from 11 to 60 volts output at 7-10 amperes \$6. American hammered standard piston rings for 1941 through 1947 Dodge and Plymouth cars, retails \$13.60, factory sealed \$5 set. #1 battery cables, 50 to 75% discount. 3" 24 v. a.c.-d.c. Edwards bells \$2. Magnet wire, other items. Strickland Electric Co., Columbus 11, Ohio.

**WAR Surplus—**Other bargains, new. Collapsible cups 15c; navy lights, red or clear 29c; gas masks, huck towels, work caps, waist belts, khaki, blue, white, fatigue caps, 39c each; leggings 59c; axe and sheath 98c; pistol belts 69c; white \$1.39; utility boxes 98c; Dietz lanterns \$1.89; flashlights 89c; line rope 50 ft. 50c; trench shovel and cover 98c; hunting knife and sheath \$1.49 to \$1.98; tire pumps 98c; knee rubber boots \$4.50; combat boots \$7.25; Navy T-shirts 59c; work shoes \$5.75-\$6.75. Sweat shirts \$1.69; Dungarees sizes to 34, \$2.15. Used Army goods, good condition; canteens 50c; cups 29c; covers 15c; mess-kits 39c; musette bags 79c; garrison caps 50c; pup tents \$2.95; blankets (all wool) \$3.75. Shipped railway express or parcel post. Include sufficient postage. Any overage will be refunded. Money back guaranteed. Imperial Outlet Co., 529 Nostrand Ave., Brooklyn 16, N. Y.

**ARMY Surplus,** new and used merchandise; for workers, farmers, sportsmen, etc. "House of a thousand bargains." Send for free catalogue No. D. Fair Deal Bargain House, Box 141, Knickerbocker Station, New York 2, N. Y.



GET \$1.25 Guaranteed fire extinguishers: Scheall, Box 225X, Duluth, Minnesota.

### WANTED—MISCELLANEOUS

**MANUFACTURERS, Jobbers, publishers:** I am looking for something that will increase my mail-order sales. Send me information on what you have to offer. Box B, Colfax, California.

**QUICKSILVER (Mercury)** urgently needed! Immediate payment. Wholesale Terminal, Norwood, Massachusetts.

### PERSONAL

**"BIG Mails,"** moneymaking offers, magazines, samples, catalogs. Listing 10c. Bentz, Jr., Chatawa 3, Mississippi.

**MEMORY Gems** by Wilson, enjoyable. Instructive. E. S. Shimer, 302 Broadway, Milton, Penna.

**BUSINESS Building sales literature** written by direct mail specialist. Sales letters as low as \$3.00. Stamp brings complete price-list. Paul Wallace, Box 143, Sheboygan 5, Wis.

**"BROOKLYN"** Remail service. Mystify your friends. 3 postcards 25c. You address, return. I remail free. Letters forwarded 25c. Box 8, Station P, Brooklyn 12, N. Y.

**MEXICAN Mailing address.** Letters received, forwarded 25c. Photographic postcards 15c. Remailed free. Remit stamps. Tillotson, Apdo. 1405, Guadalajara, Jal., Mexico.

**BEAUTIFULLY Engraved—Your name, initials,** on polished plastic name plates, purse pulls, buttons, etc. Full information free. 'K' of Hollywood, 1315 Colorado, Los Angeles 41.

**HOW You can find out!** Information discreetly developed, any matter, person, problem, anywhere. Personal-business assignments, representations, undertaken. Nation-wide. Officially licensed, bonded service established 1922. Reasonable. Confidential. William Herman, 170 Broadway, New York.

**WIN Thousands of dollars in cash!** Healy's Prize Winner tells where, how. Sample, dime. 332A East 52, Seattle 5, Wash.

**SAN Antonio, Texas, Box 2037.** 5 postcards \$1.00. Letters remailed 25c. Western style belt and watch band, \$2.50, \$5.00. Area map with complete data 50c.

**MORE And better hair for you.** All about latest secrets, discoveries. Write immediately. Bruns, 3307-D Fremont, Madison 4, Wis.

**LOSING Hair?** Have dandruff? Write for free, confidential booklet on care of scalp and hair. Eugene Burt, 1926 State Blvd., Kansas City, Kansas.

**WE Mail, receive, forward, letters.** 25c. Apartado 2807, Mexico City.

**MEXICAN Law.** General practice attorney, 1203 Arizona Street, El Paso, Texas.

**GLOBAL Picture postcard supply;** unusual novelties; worldwide letter remailing service. Free particulars. Travelpost, Box 1436, Brawley, California.

**SWAP! Trade! Anything, everything.** Free information. "Swappers" Gazette-PM, Louisville 12, Kentucky.

**HAIR Falling? Dandruff?** Write Trichologist, 137 Lewis St., Phillipsburg, N. J.

**RUPTURED?** Positive comfort, no understraps, no steel, no elastic. Write Smith Manufacturing Company, Preston, Ontario.

### MISCELLANEOUS

**DANCING?** No need for embarrassment on the dance floor. Write for free booklet concerning easy picture method as taught by Engstrom Dance Guide. Engstrom Dance Studios, PM1, Box 358, Grand Island, Nebr.

**TROPICAL Sea shell brooch—Earring** set. 200 shells used. Beautiful colors. \$1.98. Grey's, Box 484a, Melbourne, Florida.

**WILL Mail six postcards** beautiful tropical scenes to your friends make them believe you traveling foreign countries. Give names, addresses and name you wish sign. Send \$2.00 U. S. money order. Arthur Carroll, Puerto Barrios, Guatemala, Central America.

**RECEIVE Free samples, magazines, catalogues, money-making opportunities!** Mails galore! Your name in all our "Sure-fire" mailing directories two years, \$1.00. Nine months, 50c; three months, 25c. Stanford, 6220-M 16th, Philadelphia 41, Penna.

**NAMEPLATE Hand-cast, hand-buffed** brass with highlighted  $\frac{1}{2}$ " letters. Introductory price \$1.00 postpaid; print plainly initials and name wanted. Details for agents and dealers. Nam-plates, 3220 State St., Salem, Oregon.

**MEN! Large size shoes, large size sox!** We specialize large sizes 10 to 16, widths AA-EEE, Oxfords, hipops, work shoes. Guaranteed extra quality. Free catalog. Kingsize, 469, Brockton, Mass.

**PANNING Gold—Two instruction books** 25c. Old Prospector, B102, Dutch Flat, Calif.

**ABACUS.** Add with the abacus, world's oldest calculator. Now improved. Adds, subtracts, multiplies, divides quick as a flash. Illustrated instructions show how. Send for free lesson and details. Loy's Chinese Calculator, Dept. 84M, 1317 R.I. Ave., N.E., Washington 18, D.C. Agents wanted.

**WANTED 1000 Foot sufferers** to test Kindschi Foot Balancers at our risk. Rush name for free trial offer. Kindschi Foot Appliances, Dept. A6, 321 W. Jefferson, Dallas 8, Texas.

**ZIP-FIX Fixes zippers.** Puts slider on track. Complete with instructions, \$1.00. Donald Eakin, Route 1, Harrisville, Penna.

**NATIONALLY Advertised cameras, cosmetics, jewelry, etc.** Send for free catalogue. Dale Leland Co., 143 Federal, Dept. P4, Boston, Mass.

**CALIFORNIA Redwood novelties, novel** "tree key chain" 40c stamps or coin postpaid. Novelty list free. Gifford's, 1230 William, San Jose 12, California.

**REPAIRED Like new—Expansion watch bands, bracelets, \$1.25; Ronson, Evans, Thorens cigarette lighters, \$1.75.** Standard Repairers, 1545 East 55th, Cleveland, Ohio.

**"DUX" Removes rust!** Simply dissolve in water and immerse or sponge rusted article. Actually wipe rust off! Safe, clean working. No rubbing with abrasives. For shop or household. Quart size, 35c. Gallon, \$1, postpaid. Baldwin Company, Box 552, Church Station, New York 8, N. Y.

**BERMUDA Grass destroyed** by nature, no digging, no chemicals. New method clears garden of this pest. Guaranteed instructions one dollar. The Plan Service, Box 451, Douglas, Arizona.

**QUALITY Highly buffed, solid stainless steel knives, forks and spoons.** Rust-proof, tarnishproof. No polishing necessary. Send postcard for free folder. Kolk Mfg. Co., 363-A Old Falls Blvd., North Tonawanda, N. Y.

**WATCHES—How to take care of them.** Send 10c for information. Thousands of satisfied customers. Poynter's, 310 Thirteenth Street, Richmond, Calif.

**DE-ODO-BAC:** An amazing new versatile disinfectant which also destroys odors of garbage pails, cages, kennels, urinals, cellars, shoes, etc. Kills germs. Introductory offer; send \$1 for enough to make one gallon. Distributors solicited. Formulas, Box 410, Bloomington, Indiana.

**MEXICO.** Your personal questions about Mexico, answered. Assignments, \$1.00. "Ahorá," Apartado 2807, Mexico City.

**BOOKFINDERS!** (Scarce, out-of-print, unusual books) Quickly supplied. Send wants. Clifton Company, Box 1377 pmm, Beverly Hills, Calif.

**TREASURE Finders!** Goldak's new 11 pound lightweight, gold, silver and mineral locator, money-back guaranteed superior any other device. Free information. The Goldak Co., 1542 West Glenoaks Blvd., Glendale 1, Calif.

**MEXICAN Jumping beans.** Wholesale, July crop. Mexican Products Co., 126 N. Main, Tulsa 3, Oklahoma.

**INQUIRE Now** about our Home Plan Service for 24'x26' and 24'x30' one floor, two bed-room homes. Write today for particulars. Columbia Small Home Plan Service, Dept. 10, 1570 Hawthorne Park, Columbus 3, Ohio.

**"RECEIVE Mail,"** Moneymaking offers, opportunities, catalogs. Name listed 10c. Ideal Service, 100 Park Ridge, Ill.

**TWELVE Alnicov magnets, 100 experiments, \$3.00.** Experiments, 25c. Disc magnet, \$1.00. Eljay, Box 891, Newark 1, N. J.

**M-SCOPE Metal, mineral locators** sensational new electronic lightweight models, immediate shipment. Fisher Research Laboratory, Inc., manufactures some of the finest metal locators for the U. S. Army. Built for Arctic, Tropic use. Unsurpassed efficiency, low prices. Time-payment plan available. Send for free 16-page illustrated booklet. Fisher Research Laboratory, Inc., Palo Alto, Calif.

**TATTOOING Outfits, supplies.** Illustrated list free. Zeis, 728 Lesley, Rockford, Illinois.

**70 BIBLE Lessons, 25c.** Bulletin, Box 87, Cathedral Station, New York 25.

**BECOME A Christian.** Free explanatory letters. Millard Hart, Rockland, Maine.

**END Your travel worries and cares—**"Home of a Thousand Addresses." Build it yourself. It features complete house-keeping facilities and will sleep four comfortably. Inside dimensions are 7' 6" x 17' x 6' 4". Any car will tow it. All-steel chassis and rugged framework permit it to roll along safely on the roughest roads. Send \$1.50 for complete set of blueprints and material lists. Popular Mechanics, Room 604, 200 E. Ontario St., Chicago 11, Ill.

## How To Make Liquid Marble

### And BIG PROFITS In Your Own Business

Amazing Liquid Synthetic Marble can be made at home without machinery. Needs no heat or pressure. Can be poured into molds for casting expensive novelties. Liquid Synthetic Marble can be made in any color. It is even more beautiful than genuine marble because of its highly glazed finish. Costs far less. **FLEXIBLE MOLDS:** Make your own Flexible Molds. Cast novelties, statuary, desk sets, book-ends, etc. out of Liquid Marble, plaster and many other molding compositions. A large sized mold costs but a few cents. Hundreds of casts can be taken from a single mold. **UNLIMITED MARKET:** You will find steady year-round demand in your own community. No selling problem. We supply names of buyers for your finished products. Let BING PRODUCTS show you how to start with a small investment and build a permanent, independent, profitable business! Write now for FREE CATALOG!

**BING PRODUCTS: Dept. A-29 88 BROAD STREET BOSTON 10, MASS.**

## AMERICAN JIU JITSU TRICKS

### ★ COMMANDO FIGHTING ★

Learn American Jiu Jitsu. Be a winner in clean or dirty fighting where it means do or die. Four no man, club, knife or gun. A complete course by the world's most famous Jiu Jitsu instructor. He has personally taught many in the U. S. Army, Navy, Marine, National Guard, Coast Guard, R.O.T.C., Customs, Immigration Border Patrol, peace officers, civilians, men and women throughout the United States and Canada. **Book No. 1. A Course on**

**36 SECRET KNOCK OUT BLOWS and DEATH BLOWS 25c**  
ABOVE the WAIST WITHOUT the USE OF FISTS

Just a jab with tip of fingers or strike with edge of hand and numerous nerve pressure points. 62 photographic illustrations.  
**Book No. 2. A course on a series of Game Along Holds** that will enable you to subdue and hold any man with ease. With 45 illustrations, 50c  
**Book No. 3. A Course of slaking down the Gunman,** shows how you can approach and disarm armed persons so that they can't disarm you, regardless of how much they know of any jiu jitsu methods, 51 illustrations, 50c  
**Book No. 4. All the latest in disarming persons** with guns, knives or clubs; defense against any kind of foul attack. Also how to do dirty fighting, where it means your life. 108 pages, 181 illustrations, \$1.00. You can have the complete set for only \$2.00 postpaid, or sent C. O. D. plus postage in U.S.A. only. Send the four books on these latest methods of hand-to-hand fighting to a fighting man today.

**THE ALLIED ARMED FORCES EMPLOY MY METHODS**

**S. J. JORGENSEN, 1111-P Virginia St., Seattle, Wash.**



Please Mention Popular Mechanics When Answering Ads



# EVEN IF YOU DON'T KNOW A NOTE OF MUSIC NOW...

## You Can Learn Your Favorite Instrument This Easy A-B-C Way

No special talent, no previous musical training needed. This remarkable U. S. School home-study method is so successful because you learn to play by playing real tunes by note, right from the very start.

Once you start a U. S. School Course you look forward to the time you spend on your lessons. No tiresome exercises. No long-



winded explanations. Instead of hard work, learning to play becomes a happy pastime. You begin with simple melodies. As you improve, you take up more advanced tunes. Sooner than you ever dared hope you're thrilled to find yourself playing many popular numbers by note. And no matter which instrument you take up, the cost is only a few pennies a day.

If you honestly want to learn music, to be invited everywhere, and get lots more fun out of life, send in the coupon below for our FREE 36-page Booklet and Print and Picture Sample. They give full details. (Instruments supplied when needed, cash or credit.) U. S. School of Music, 74 Brunswick Bldg., New York 10, N. Y. (50th Successful Year)



## FREE PRINT AND PICTURE SAMPLE

U. S. School of Music, 74 Brunswick Bldg., New York 10, N. Y.

Please send me free booklet and Print and Picture Sample. I would like to play instrument checked below.

Piano	Saxophone	Modern Elementary
Guitar	Trumpet, Cornet	Harmony
Violin	Reed Organ	Clarinet
Piano Accordion	Tenor Banjo	Other Instrument

Name \_\_\_\_\_ (PLEASE PRINT)  
 Street \_\_\_\_\_  
 City \_\_\_\_\_ State \_\_\_\_\_

### CODE-RECEIVING-SPEED

Learn to send and receive Radio Code with greater speed. Stop nervous tension. Have confidence. Be proficient. Same system used by radiotelegraph specialists. Thousands of operators needed. Rush name for FREE book.

**CANDLER SYSTEM CO.**  
 Dept. 5-D, Box 928, Denver 1, Colo., U. S. A.

### LOCKSMITHING AND KEY MAKING

COMPLETE UP-TO-DATE COURSE... Practical modern training for self-instruction. How to work on locks, de-code, make masterkeys, repair, install, service, etc., etc. For carpenter, fix-it shop, service station operator, hardware dealer, gunsmith, mechanic, home-owner. 53 easy illustrated lessons. Full price only \$3.95, postpaid — or C.O.D. plus postage. Satisfaction guaranteed or refund. Address below.

### Thrilling Work COLORING PHOTOS

Fascinating vocation learned at home by those with aptitude. Thrilling pastime. National method brings out life-like colors. Free booklet.

**NATIONAL PHOTO COLORING SCHOOL**  
 1315 S. Michigan, Dept. 1354, Chicago 5

### WATCH AND CLOCK REPAIRING

LEARN at HOME in Your Spare Time. Prepare for a happy future of prosperity and security—and get a good job NOW. A fascinating, thorough self-instruction training in American and Swiss watches, clocks. Special section on alarm clock repairs. Fast-growing field. Complete, \$4.95 postpaid—or C.O.D. plus postage. Satisfaction guaranteed! **NELSON-HALL CO.**, Dept. D-02, 1139 S. Wabash Ave., Chicago 5, Ill.



# Prepare NOW! —FOR JOB SECURITY —AND BIG MONEY IN ELECTRICAL REPAIR

FREE TRIAL  
EASY TERMS

**NOW**—this minute—you can take the first step toward a high-pay position in electrical repair and maintenance... a fast-growing field that's crying for men—trained men to fill top-notch jobs! Right now hundreds of men are getting the solid background needed to advance quickly in electrical repair work from this up-to-date library. You can too — **IF YOU ACT PROMPTLY.**

Don't delay — take advantage of this free-trial offer

MAIL THIS COUPON TODAY

McGraw-Hill Book Co., Inc., 330 W. 42d St., New York 18, N. Y.  
 Send me for ten days' free examination the Electrical Maintenance and Repair Library. If satisfactory I will send you only \$2.50 in 10 days and \$3.00 monthly until the price of \$17.50 is paid. If not wanted I will return books postpaid.

Name \_\_\_\_\_  
 Home Address \_\_\_\_\_  
 City and State \_\_\_\_\_  
 Company \_\_\_\_\_  
 Position \_\_\_\_\_

PM-4-48



## THE LIBRARY OF ELECTRICAL MAINTENANCE AND REPAIR

5 VOLS., 1826 PAGES,  
1724 ILLUSTRATIONS

### HERE'S WHAT YOU GET:

—The "know-how" to tackle any wiring or motor job big or small — practical, easy-to-understand information on how to install, inspect, and repair all types of motors, generators, starters, transformers, regulators, etc. — how to diagnose troubles quickly — how to figure new windings. Gives you step-by-step procedure for every wiring and repair job you may run up against. One book is full of trouble-shooting charts to show you symptoms, causes, specific remedies, etc. A gold-mine of electrical knowledge—Send for free-trial set today.



# WAR SURPLUS OPTICAL BARGAINS

ASSEMBLE YOUR OWN BINOCULARS!

Save More Than 1/2 Regular Cost



## GOVERNMENT'S 7X50 BINOCULARS

Complete Optics, new and ready for assembly. We supply full instructions. Limit—1 Set of Metal Parts and 1 Set of Optics to a customer.

**METAL PARTS**—Set includes all Metal Parts—completely finished—for assembly of 7 X 50 Binoculars. No machining required. Bodies have been factory hinged and covered. A sturdy Binocular Carrying Case is optional with each set of Metal Parts.

Stock # 842-H ..... \$39.40

Postpaid, plus \$4.80 for Case—Total.....\$44.20

**OPTICS**—Set includes all Lenses and Prisms you need for assembling 7 X 50 Binoculars. These are in excellent condition—perfect or near-perfect—and have new low reflection coating.

Stock # 5102-H ..... \$25.00 Postpaid

**NOTICE!** If you buy both Binocular Optics and Binocular Metal Parts, add 20% Federal Excise Tax to above prices.

## ARMY'S 6x30 BINOCULARS

**COMPLETE OPTICS & METAL PARTS**—Model M-13A1, 6 X 30 Binoculars. (Waterproof Model). Everything you need—ready for assembly. When finished will look like a regular factory job costing \$102. to \$120. The Optics are new, in perfect or near-perfect condition. Have new low reflection coating. Metal Parts are new and perfect, all completely finished. No machining required. Bodies factory hinged and covered. Complete assembly instructions included.

Stock # 830-H ..... \$40.00 Postpaid plus \$8.00 tax—Total—\$48.00

## TERRIFIC BARGAIN—BUBBLE SEXTANT

These Army Air Forces Bubble Sextants cost the Govt. about \$125 each. A real bargain at our price of \$12.50! Included with Bubble Sextant shipment is wooden Carrying Case, 5 spare waxed paper discs, flashlight with rheostat for night use (uses ordinary flashlight cells—not furnished) aux. 2-power Galilean Telescope, Allen wrench, 1 spare marking point. Wartime used. **BUT COMPLETELY REPAIRED, COLLIMATED AND PUT IN GOOD WORKING ORDER.** If not satisfied that Sextant is exactly as represented, return within 10 days and money will be refunded. Full directions for use accompany each shipment.

Stock # 924-H ..... \$12.50 Postpaid

Same SEXTANT as above, but **BRAND NEW** and with Automatic Electric Averaging Device and Illuminated Averaging Disc for nighttime use. Govt. cost \$217. Your brand new we have re-checked Bubble and Collimation and **GUARANTEE** perfect working order. Stock # 933-H ..... \$22.50 Postpaid

## 8 POWER ELBOW TELESCOPE

Gov't Cost \$200.00! Our Price \$17.50!

Big 2" diameter objective. All lenses Achromatic. Amici prism erects the image. 4 built-in filters—clear, amber, neutral and red. New to slightly used condition but all guaranteed for perfect working order. Weight 5 lbs. Can be carried but a trifle bulky.

Stock # 943-H ..... \$17.50 Postpaid

## \$200.00 DRIFT METER FOR \$5.60

These were used for determination of drift and true air speed. You can adapt to other uses or take apart to get 2 mounted Achromatic Lenses,—Mirrors—Field Lens—Pantograph—Engraved Scales—Sponge Rubber Discs—metal parts and other components. Instrument weighs 4 lbs.

Stock # 942-H.....\$5.60 Postpaid



**6 POWER GALILEAN TELESCOPE**—(Commercial Surplus) 28mm dia. Achromatic Objective Lens. Sturdily constructed of Aluminum. 7" long, extends to 9". Complete with carrying case.

Stock # 941-H ..... \$3.00 Postpaid

We have literally millions of war surplus lenses and prisms for sale at bargain prices ranging 10c and up. Write for Catalog "H"—Sent Free!

Order by Stock No. Satisfaction Guaranteed

# EDMUND SALVAGE COMPANY

P. O. AUDUBON, NEW JERSEY

# MAKE UP TO \$5<sup>00</sup> AN HOUR In Your Own YEAR ROUND Business!

ONLY A FEW  
DOLLARS  
PUTS YOU IN  
BUSINESS!

Many Clearing as High as \$20 to \$30 a Day **NET** Renewing Rugs, Carpets, Upholstery. New Method Now Used for Auto Upholstery. Write for Facts About Quick, Easy Way to Get Started

Here is the chance you've been looking for to step into a pleasant, dignified, big-pay business of your own that offers you a steady, year 'round income. Start on "a shoe-string," full or spare time, right from your own home. Equal opportunities for men and women, young or old, in small towns or big cities. No experience needed. Many making big money with new American System just cleaning auto upholstery. Easy to learn. We send you complete instructions and quick-cleaning supplies so you can start making money the very first day! Quick method cleans upholstery, rugs and carpets like new without taking off floor! Tremendous demand in homes, apartments, hotels, stores, office and public buildings. Steady repeat business. Territories going fast. Write today for full **FREE** facts. No cost or obligation. Rush letter or postcard now to **AMERICLEAN CO., Inc.; Dept. G-16; 211 North 7 St.; St. Louis 1, Mo.**

WRITE  
FOR FREE  
DETAILS  
NOW!

## ROOSEVELT AVIATION SCHOOL

HANGAR 37 MINEOLA, L. I., N. Y.

Qualify for Airplane or Engine Mechanic's license in 24 weeks (both in 48 wks.). Every CAA-approved maintenance station must have a licensed mechanic. GI-approved. Begin April 26, May 24, June 21.

ELMER WHEELER shows you

## HOW TO SELL YOURSELF TO OTHERS

A noted sales expert shows you the tried and tested way to success and happiness. From "Don't Make 'em Drink—Make 'em Thirsty", to the "Secret Ingredient" of your personality, this 320-page book is packed with pertinent advice on selling that most precious commodity—**you**. Be a success—send this with your name and address and \$3.50 for your copy to **PRENTICE-HALL, Inc., 70 5th Ave., N. Y. 11, Dept. 30.**

**TRAIN**

# Your VOICE!

Results **GUARANTEED**

We build, strengthen the vocal organs—not with singing lessons—but by sound, scientifically correct silent and vocal exercises and absolutely guarantee complete satisfaction with results. Write for Voice Book, **FREE**. Sent to no one under 17 years old unless signed by parent. Perfect Voice Studios, Studio 1354, Kimball Half Bldg., Chicago 4, Ill.

## ELECTRICIANS' SCHOOL

HOUSE AND COMMERCIAL WIRING • MOTOR REPAIR  
AND REWINDING • ELECTRIC REFRIGERATION

Approved for Veterans Training

## PENNSYLVANIA INSTITUTE SCHOOL OF ELECTRICITY

42nd and SPRUCE STS.

PHILADELPHIA 4, PENNA.

## HONEY BEES

Fascinating - Profitable - Inexpensive



Little care required. Increases fruit yield. Catalog free or send \$2.50 for 12 month subscription to our monthly magazine

**GLEANINGS IN BEE CULTURE**

and 106 page beginners' book

**STARTING RIGHT WITH BEES**

The A. I. Root Co., Dept. 4801, Medina, Ohio



# \$200 GROSS IN MY FIRST WEEK!



Some Make More, Some Less... Start This Business for **YOUR OWN**

Would YOU like to own a permanent, year-round business in which it is possible to take in as much as \$200 gross the first week, as did L. A. Eagles? R. E. Traynor says, "I made \$62 gross in one day." R. R. Newlin reports, "I have averaged \$173 gross per week." Others report gross from \$100 per week to \$12,000 per year.

Surely YOU will want to investigate a golden opportunity like that. You need not have any special skill or experience, but if you are ambitious, honest and courteous, we will help you to start and succeed in YOUR OWN money-making business where net profits are high.

### No Shop Necessary

Our Electric Rug Washer cleans rugs and carpets like new right on the customer's floor. This quick, thorough and highly efficient method removes dirt and grime, thus restoring the natural, fresh beauty of floor coverings. Anyone can run it. Rugs and carpets are not harmed.

There are hundreds of possible customers in YOUR vicinity. Most of them have several rugs needing regular cleaning. To get a quick start,

## FREE BOOK! MAIL COUPON

VON SCHRADER MFG. CO.  
A41, Racine, Wis.

Send at once (no obligation) your FREE booklet containing information about your Electric Rug Washer and how I can own my own permanent, profitable business.

Name \_\_\_\_\_

Address \_\_\_\_\_

City \_\_\_\_\_ (Zone) \_\_\_\_\_ State \_\_\_\_\_

shampoo a few rugs or carpets. These customers tell their friends and soon you should have an independent, prosperous business, and you should be able to keep it growing. Send the coupon RIGHT NOW for booklet that explains everything.

### Every Machine Guaranteed and Easy to Own

You take no risk. These wonderful, fully guaranteed machines have been used and endorsed by largest hotels, railroads—also used by U. S. Government. Many individuals have built up successful businesses that made big profits. Mail the coupon TODAY and we will send complete information, including how to start and succeed in YOUR business without a large investment. Don't delay your BIG opportunity. Send the coupon AT ONCE.



MAIL COUPON TO

**VON SCHRADER MFG. CO., A41, RACINE, WIS.**

## LEARN TO DRAW The Human Figure

Figure drawing from life is easy with the "ACTION LINE" method—the most simplified of all methods. Start drawing at once, following amazing step by step directions. You'll thrill at the ease with which you can learn. Rush order today. Send only \$1.00 for 24 page, 9 x 14 inch portfolio, "Figure Drawing from Life"—Action Line Method. Money back if not satisfied.



Only \$1

FREDERICK J. DRAKE & COMPANY

600 West Van Buren St., Dept. 14

Chicago 7, Ill.

SAY YOU SAW IT IN POPULAR MECHANICS

## LEARN CARPENTRY AND MASONRY

Write for FREE Catalog

Train in Big Shops. G. I. Approved

MIDWEST SCHOOL OF BUILDING TRADES, Dept. A-14

411 N. Center St.

Bloomington, Ill.

## LEARN EXPORT



Buy and sell world-wide without capital. Travel abroad if desired. Export men and women in demand. Your own business—profits unlimited. Salaried jobs—up to more than \$10,000 a year. Practical, low cost WORLD TRADE COURSE teaches you quickly at home in spare time. No previous special experience or schooling needed. World Trade Certificate awarded. Write today for FREE DETAILS. No obligation. Please state age. Air-mail reaches us overnight. THE MELLINGER CO., Exporters-Importers, 1422-G Westwood, Los Angeles 24, Calif.

# VETERANS Learn WATCHMAKING

## A Lifetime Career

No Age, nor Physical Limitations

YOUR OPPORTUNITY

To Lift Yourself from a Futureless Job



Approved G. I. Training

## LEARN WATCHMAKING

and earn from the start, higher than average pay... easy hours... ideal working conditions... be prepared to establish your own business.

WATCH REPAIRING — JEWELRY — ENGRAVING  
Always in Demand

Requests for our Graduates from Everywhere. Permanent positions (no layoffs) \$75.00—\$100 per week for trained men. Write today for latest FREE Catalog.

## KANSAS CITY SCHOOL OF WATCHMAKING

America's Most Progressive Horological School

617-621 Wyandotte St.

Kansas City 6, Mo.



Less than

# 50¢

A week buys as much as

# \$1746

of Old Line Legal Reserve  
**LIFE INSURANCE**

**YOU ACTUALLY PAY**

only \*\$2.00 a month at all ages for the amounts shown below.

\*THIS IS HALF THE PERMANENT RATE WHICH TAKES EFFECT THE 6TH YEAR.

AT AGE	FOR MONTHLY PREMIUM OF	YOU GET A POLICY FOR
20	\$2.00	\$1746.
25	2.00	1582.
30	2.00	1408.
35	2.00	1250.
40	2.00	1086.

Proportionate amounts at all other ages, 15-55. Mail coupon now for full facts and amounts at your age.

Here is a unique plan that lets you budget your Life Insurance like rent. The rate is the same no matter what your age! The amounts vary but, even at 40 you can get \$1086 of this Solid, Old Line, Legal Reserve Life Insurance protection! And not only that—but your policy will be

**FULLY PAID-UP IN 30 YEARS**

with no more premiums to pay, yet your

insurance continues in force the rest of your life.

**POSTAL LIFE** operating under the rigid New York State Insurance laws has sold Life Insurance by mail and over the counter for 43 years and has satisfied policyholders everywhere. Over \$14,000,000 in assets! More than \$60,000,000 paid out in benefits!

Postal Policies are participating! Mail Coupon today!

**Get the FACTS by mail!**

Postal Life Insurance Company  
511 Fifth Avenue, Dept. D—792  
New York 17, N. Y.

Mail me complete information about your new "\$2.00-per-month", 30-payment Modified 5 Whole Life Policy at my age.

NAME .....

OCCUPATION .....

DATE OF BIRTH .....

ADDRESS .....

Include Postal Zone, if any.

**MAKE BIG MONEY IN FEW DOLLARS STARTS YOUR OWN PROFITABLE BUSINESS! LIQUID SYNTHETIC MARBLE**

Here are 3 amazing, new opportunities to get into your own highly-profitable, dignified business—without previous experience—regardless of your age or sex. 1. **LIQUID Synthetic MARBLE**—Easy to make and install beautiful synthetic Marble Slabs—pouring from liquid state. Big Demand for kitchen and bathroom walls, etc. 2. **FIBRE-TITE FLOORING**—Easy to make and install—in any color or color combination. Many years wear. Dustproof. Soundproof. Verminproof. 3. **FLEXIBLE MOLDS**—for Plaster Casting. \$1.00 in raw materials makes up to \$25 worth finished products. F. B., Iowa, writes: "Am on job that will net me \$150 for 4 days work." Get FREE details. No obligation. Write today!

**Write For FREE DETAILS NOW!**

**COMPOSITION PRODUCTS CO.**

5853 Delmar Blvd. Dept. 41 St. Louis 12, Mo.

**LEARN WATCH REPAIRING**

**AT HOME, WITH OUR NEW KIT**

THERE'S BIG MONEY and a SECURE FUTURE for YOU in this field even if you're just a beginner. Our **PRACTICAL SELF-TRAINING KIT** is all you need to start. Contains **QUALITY TOOLS**: (Tweezer, Loupe, and set of 6 special screw drivers) and **COMPLETE BOOK** on Modern Watch Repairing. Book is fully illustrated, easy to understand, shows every step in re-pair, adjustment and use of tools. Only \$5.95 Post (If C.O.D., plus charges.) Money Back Guarantee. If ordered separately: book \$3.25; set of tools, \$3.25.

**MODERN TECHNICAL BOOK & TOOL CO.**  
Dept. MMC, 55 W. 42nd Street, New York 18, N. Y.

**NEW ALL-INCLUSIVE TOOL, MATERIAL CATALOG**  
For Watch-clockmakers, Jewelers, Handicrafters. Complete SETS for STUDENTS. Over 450 ILLUSTRATIONS and IDENTIFICATION CHART. NEW REDUCED PRICES. All books in these fields.

SEND 25c—FREE with above order

**MAGIC LIQUID MAKES PHOTOS APPEAR**

Amazing discovery permits you to print pictures from any of your snapshot negatives on wood, cloth, leather or paper. Like magic your pictures will show on ties, handkerchiefs, purses, cards, and letterheads. Takes only a few minutes in broad daylight. Won't rub off or harm negative. An attractive set with enough material for over 100 pictures. **ORDER TODAY.** Send \$1.00 postpaid. C. O. D. pay postman a few cents more in addition. (Foreign \$1.50 money order only.)

**STYLE-ARTS, Inc., Dept. PM-15, 2427 Cortland, Chicago 47, Ill.**

**LEARN TO PLAY AN ACCORDION "THE PAGANI WAY" WRITE FOR DESCRIPTIVE CIRCULAR**

**O. PAGANI & BRO., INC.** 289 Bleecker Street New York 14, N. Y. Dept. P

**Balance 4"x9" Base. With either \$7.00 Metric or Avoirdupois Weights ..**

Catalog with 3000 Illustrations of laboratory apparatus, and over 10,000 prices sent for \$1.00.

**LABORATORY MATERIALS CO.**  
7321 Vincennes Ave. Chicago 21, Ill.

**FREE MRS. BERRY'S POULTRY BOOK**

**BABY CHICKS or STARTED.** Champion-Mated, Licensed-Inspected, B.V.D. TESTED, 52 BREEDS, 6 HYBRIDS, Sexed or straight, Mature fowls, Hatching Eggs and Remedies. **LOW PRICES.** The ORIGINAL Berry's Farm—over 50 years' service. **LARGE BEAUTIFUL BOOK FREE.** Stamps appreciated.

**BERRY POULTRY FARM, Bx. 25, CLARINDA, IOWA**

**BRUSH PLATING OUTFITS**

for re-plating articles in the home and shop. No tanks necessary. Free particulars.

**GUNMETAL CO., AVE. M, DECATUR, ILLINOIS**

**SAGENTS 300% Profit SIGN LETTERS**

For Store Fronts and Office Windows. Anyone can put them on. Free Samples. Liberal Offer to General Agents.

**METALLIC LETTER CO., 430 N. Clark, Chicago 10**



# LEARN TO USE THE SLIDE RULE

The Easy, Quick Way to Better Jobs—  
Bigger Pay — for All Who Use Figures

Get this new revised and simplified edition of the "Slide Rule and How to Use It." Thousands of older editions sold at much higher price. Now—a more simplified book at a lower price and a genuine Mannheim type Slide Rule included at no extra cost. Do all kinds of figure work. Stop wasted time. Stop pencil errors. Learn quickly to multiply, divide, extract roots, find ratios and percentages, squares, areas of circles, radii, volume, etc. Do it in a flash and learn now with this book and slide rule combination.

# FREE SLIDE RULE

10 in. SLIDE RULE and  
Famous Book Both for Only

Revised and Simplified  
Step by Step Method

**\$2.98**

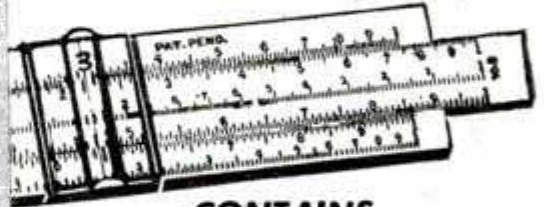
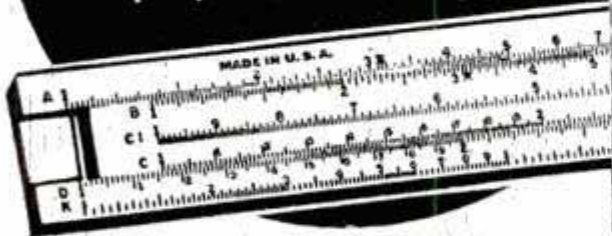

### CONTAINS

Complete Slide Rule instruction, Five Place Logarithm Tables, Trigonometric Functions and a valuable Review of Mathematics from Arithmetic to Calculus.

Nothing Mysterious — Learn in a Few  
Hours to Do Many Calculations

No other book like it. Contains complete instructions and work sheets that make the slide rule simple as A.B.C. Complete answers to check yourself on every problem. It can easily be worth hundreds of dollars to you in promotions, better pay, saving time and error. It's a book for students, mechanics, business men—

everyone should learn to use the slide rule, now that it is so easy. You'll be amazed at the problems you can solve in just a few hours. Mail the coupon now. Book and slide rule will be sent at once. Use them for 5 days, then if you are not satisfied in every way, return them and your money will be refunded without delay. Use the coupon. Mail now.

AUSTIN PUBLISHING CO., Dept. 14, 165 N. Pine Ave., Chicago 44, Ill.

Mail Coupon Money Back if Not Satisfied

AUSTIN PUBLISHING CO., Dept. 14  
165 N. Pine Ave., Chicago 44, Ill.

Send me "The Slide Rule and How to Use It" and 10" Mannheim type Slide Rule. Total cost for both \$2.98. I understand you will refund amount paid if I return them in 5 days.

Remittance enclosed  
Send Postpaid

Send C.O.D. Postage  
and charges extra

Name \_\_\_\_\_

Address \_\_\_\_\_

City \_\_\_\_\_

State \_\_\_\_\_



## AMAZING BURGLAR ALARM GUARANTEED TO STOP THIEVES

FOR CARS • HOMES • FARM BUILDINGS

A South Dakota manufacturer has discovered an easy way to protect cars, homes, farm buildings from Burglars, sneak and chicken thieves. The manufacturer is so sold on his sensational DEVIL DOG Burglar Alarm that he is willing to let you try it for ten days and will offer you \$1.00 for testing it. New sales plan promises big money to hustlers. Be first to get your DEVIL DOG Burglar Alarm for introducing in your territory. CASH-IN on the tremendous demand this device will create. Shipped prepaid from factory on ten year guarantee. Rush name and address for details to

NORTHWEST ELECTRIC CO., Dept. D-303, Pukwana, S. Dak.

# BLISS Electrical Training

Intensive 32 weeks residence course in fundamentals of industrial electrical engineering, including radio and electronics. Extensive laboratory, shop work, drafting. Prepares for electrical technician and engineering aides in communications, power, manufacturing, business machines, sales, service. 54th year. Classes begin July 26, Nov. 22. Catalog. 7630 TAKOMA AVENUE, WASHINGTON 12, D. C.

LEARN AT HOME A PROFITABLE, LIFETIME TRADE

Many Start Own Business While Learning!

Learn SCREEN PROCESS, the modern machineless method of printing. Uncrowded, profitable field where trained men are always in demand. 2 BIG KITS OF SUPPLIES we send start many of our students making money even before finishing home

study course. Many we have trained now have own successful businesses or spare time earnings. Write today for FREE BOOK giving full details. You owe it to yourself to find out about this profitable field NOW.

CALIFORNIA SCHOOL OF SCREEN PROCESS • 3740 Overland Boulevard, Dept. M48, Los Angeles 34

FREE BOOK



APPROVED  
FOR  
VETERANS





## Graduate Sells to Big Magazines

"Since studying the Palmer course, I've been able to sell to The Post, American, Coronet, Esquire, Liberty. It's the finest course anywhere."—Keith Monroe, Santa Monica, Calif.

# How to Write

Free Lesson Shows How You Learn to Write Short Stories, Mysteries, Articles, for Extra Part-Time Income or Full-Time Career

## Big New Opportunities Now

Renewed interest in technical, mechanical subjects offers big new opportunities to writers who are trained to make dry facts interesting and exciting. Editors agree: the demand for new writers is great, and you don't have to be a genius to make money. Many Palmer beginners earn while learning, selling short stories and articles which bring in small but welcome checks of \$25, \$50, \$100 and more. Such material may be turned out quickly once you acquire the technique. And now it's easier to learn than you may imagine, through Palmer's unique method of training for ALL fields of writing: Fiction, Article, Radio. Endorsed by famous authors: Rupert Hughes, Ruth Comfort Mitchell, Katharine Newlin Burt, Gertrude Atherton.

## You Learn By Writing

You get practical writing assignments to do at home. Your work is *individually* handled by professional writers. Study fast or slow. Save time and effort. To find out how you too may make money writing, send for free illustrated book with free sample lesson and typical assignment. Palmer Institute of Authorship, Since 1917, Desk T-48, 1680 N. Sycamore, Hollywood, Calif. Send today.

### VETERANS

This course approved for veteran's training.

## FREE LESSON

Palmer Institute of Authorship, Desk T-48  
1680 N. Sycamore Hollywood 28, Calif.

Please send me free sample lesson and illustrated book explaining how your training helps new writers get started. This is confidential. No salesman will call.

Mr. \_\_\_\_\_  
Mrs. \_\_\_\_\_  
Miss \_\_\_\_\_  
Address \_\_\_\_\_  
City \_\_\_\_\_ Zone \_\_\_\_\_ State \_\_\_\_\_  
 Check here if eligible under the G. I. Bill.

### Say You Saw It In POPULAR MECHANICS

# BE A SUPERVISOR



Franklin Technical Institute  
Helps Young People Get Ahead

• The door to well-paid supervisory jobs in industry is wide open—to the man or woman with specialized technical training. 50,000 graduates of this Boston school have gone out to good jobs in engineering and technical fields.

Practical courses in industrial electricity and electronics, industrial chemistry, mechanical and machine design, structural and architectural design, automotive service and management, electric wiring and maintenance. Also preparatory course. Approved for veterans. 40th year.

FRANKLIN TECHNICAL INSTITUTE  
43 Berkeley St. Boston, Mass.  
Please send free information on all courses.

Name \_\_\_\_\_ Age \_\_\_\_\_  
Address \_\_\_\_\_  
City \_\_\_\_\_ State \_\_\_\_\_

## THIS IS THE BUSINESS YOU DREAM ABOUT

QUICK STEADY PROFITS

# CORADIO

The Coin Operated Radio

IT'S the new, fast-growing, depression-proof business. Coin operated radios are

placed in hotels, tourist courts, clubs, hospitals, etc. on a commission basis—play 1 or 2 hours for 25c and produce immediate profits. The best coin operated radio is CORADIO

## ACT NOW

Start your own lifetime business, full or part time. Send For Free Catalogue And Complete Information.

WRITE TODAY Dept. P. M.



# CORADIO

COIN OPERATED RADIO

108 W. 31st St. N. Y. 1. N. Y. WISCONSIN 7-5902

## ELECTRO TECH SET #1

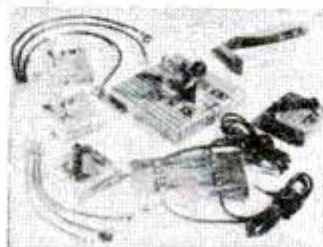

Entirely Safe!  
No 110 Volt AC  
Uses New Snap Leads!  
No Soldering

Sensational new practical Set for learning the fundamentals of electricity. Fifteen experiments—learn how to connect batteries—series-parallel circuits—how light bulbs work—how simple switches and three way switches work—how a motor works (supplied in kit form—you build it too!)—reversal and speed control

of motors—how 3 heats are obtained with hotplate—9 with electric stove—short circuits, etc. This Set is designed so these same parts may be supplemented by our later Electro Tech Sets to build crystal receivers, code practice oscillators, 1, 2 and 3 tube radios and amplifiers. List price of Electro Tech Set #1 is \$12.50 less batteries (uses two inexpensive #6 dry cells), but a few are being offered at special mail order introductory price of ONLY \$7.95 POSTPAID FOR CHECK OR MONEY ORDER. COD orders extra.

RAFFERTY LIMITED PRODUCTION CO. DEPT. D-1, BOX 353 PITTSBURGH 30, PA.



## A PENNY POSTCARD MAY

### CHANGE YOUR FUTURE . . .

Get full information on the coin-operated vending machine industry. Start with a few machines and build to a wonderful future. We'll give you complete advantage of our "know-how."

Send For Free Booklet Today—No Routes Sold!

## PIONEER VENDING SERVICE

Address all mail to Dept. PM  
461 SACKMAN ST. • BROOKLYN 12, N. Y.

## MAKE BIG MONEY IN REAL ESTATE

Be your own boss! Some report they make as high as \$1000 a month. Simplified home study course in Real Estate covers Selling, Listings, Appraisals, Loans, Mortgages, all essentials. A SHORT CUT TO PERMANENT PROSPERITY it quickly qualifies you for big earnings. START NOW! Send postcard for prospectus and complete information. DO IT TODAY!

PHOENIX REALTY MART-EDUCATIONAL DIVISION  
Dept. AB, 923 No. Fourth St., Phoenix, Ariz.



## NOW Make Your Own RUBBER MOLDS MAKE MONEY AT HOME!

Make your own RUBBER MOLDS at home! NO EXPERIENCE NEEDED—start small, GROW BIG! Cast thousands of perfect figurines, ash trays, book ends, plaques, etc. X. L. RUBBER, Pts. \$2.00; Qts. \$3.00; Gallons \$8.95—Models and enough rubber for 3 molds \$1.00—Foreign \$1.50 — FREE FACTS SENT!

PLASTIC ARTS STUDIO • Route 2 • Dept. 3 • Muncie, Ind.

## Profit with LARSON Leathercraft

Make as gifts—or to sell—practical leather items. Complete stock of leathers, tools and accessories. No experience necessary. Instructions with materials. Send ten cents for new catalog of 101 money-making ideas.

J. C. LARSON COMPANY  
824 S. Tripp Ave. Chicago 24, Illinois

POPULAR MECHANICS



# PRACTICAL TECHNICAL TRAINING FOR YOU in REFRIGERATION, HEATING and AIR CONDITIONING

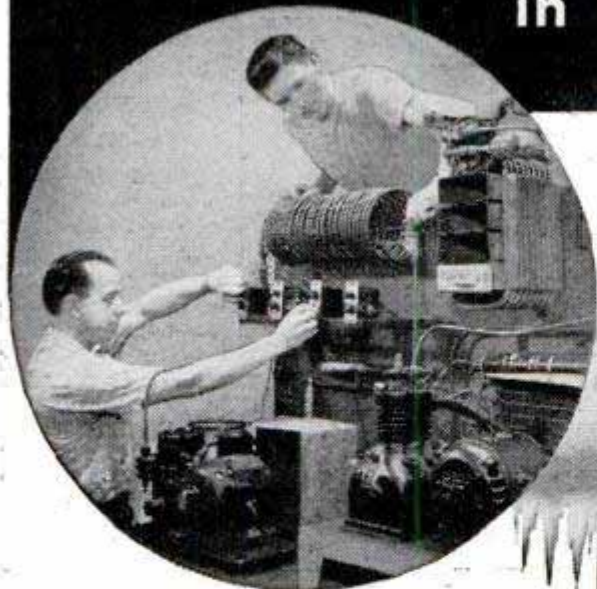

## A Field of Boundless OPPORTUNITIES

Trained Men are in great demand to meet urgent requirements for Refrigeration, Heating, Ventilating, Cooling, and Air Conditioning in domestic, commercial, industrial and processing fields of applications. Train now for a substantial career in industry — or a business of your own. Our practical technical courses fit you to become a Refrigeration Serviceman in 6 months; Refrigeration and Heating Serviceman in 12 months; Refrigeration, Heating, and Air Conditioning Technician in 2 years. Four terms per year—January, April, July, September. Start your training at beginning of any term. Write for free "PHOTO STORY" with 49 action photos of students fitting themselves for responsible positions — just as you can do!

**SPECIALIZE**  
In 6 Months to 2 Years

## MILWAUKEE SCHOOL of ENGINEERING

A Technical Institute • Founded 1903

Write for FREE  
PHOTO STORY

### MILWAUKEE SCHOOL OF ENGINEERING

Dept. PM-448R, North Broadway, Milwaukee 1, Wis.

Without cost or obligation, send me your new 44-page "PHOTO STORY."  
I'm interested in course on.....

Name.....Age.....

Address.....

City.....State.....

## NU-STONE HOMES



BY THE BUILDING BOOM—Other building compositions of Cement, Sawdust, Asbestos, Paper, Earth, etc. Home-made Forms make blocks, panels, TILE IN COLORS. Wallboard. Particulars Free.

RAPID MARBLEIZING SERVICE, Dept. 10-H Edwardsville, Illinois

New Building Material! Re-surface old homes; build new ones. Colorful, Beautiful! Looks like real stone—molded on-the-job. PROFIT

### WHAT'S THE BEST BUY IN HOME MOVIES?

See Universal Camera Corporation's advertisement in Popular Mechanics for May.

### "EVEREADY" Flashlight Batteries OUTLAST ALL OTHER BRANDS!\*

\*According to the "General-Purpose 4-Ohm Intermittent Test" of the American Standards Association.

## WATCH FORD IN '48

## RUST! RUST! RUST!

WHAT a headache! Here's the answer! A new liquid RUST REMOVER—quickly dissolves rust on iron or steel, tools, hardware, machinery, etc. NO RUBBING or hard work. Brush, swab, spray or dip. Put ON—let SET—wipe off—RUST GONE! On sale at all Sears Retail Stores in HARDWARE DEPTS. 50c and \$1.00 in Mid-West (slightly higher elsewhere.) Also available through our mail order catalog. Manual of rust control FREE.

SEARS, ROEBUCK and CO.

For further information, write ALLIED PRODUCTS COMPANY, Dept. D-1, 1133 Newport Ave., Chicago 13, Ill. Manufacturers of CorOdex.



**CORODEX** Liquid RUST REMOVER \$1 PER QT.

SAY YOU SAW IT IN POPULAR MECHANICS

## LOWEST PRICE IN HISTORY! Sensationally New WELDRITE Electric Welding-Cutting Torch

Plugs into any convenient AC-DC Socket  
WELDS - BRAZES - CUTS - MELTS - SOLDERS - HEAT TREATS

The WELDRITE Torch—tested and proven by countless commercial and amateur users, is now offered direct to you at the amazingly low price of only \$12.00. No Gas—No Gauges—No Spark Lighter needed. Always ready for immediate use—Just plug WELDRITE into any 110 AC or DC outlet. Uses standard welding and brazing materials available at all welding supply stores. WELDRITE furnished complete with Converter Unit, Single Holder with attached Alligator clip, for Welding metal up to 3/16" thickness, using up to 3/32" rod, and Double Holder with Carbon-Tipped Dual Copper Electrodes for Cutting, Brazing, Heat Treating,

Soldering, etc. Supply of welding materials included free.

Ideal for home workshop. Invaluable for body and fender shops, garages, repair and machine shops, manufacturers, etc.

SEND NO MONEY. Order your WELDRITE Electric Welding-Cutting Torch today. Pay postman \$12 plus postage charges (wt. 4 lbs.) or send \$12 and we pay postage. Either way, if not satisfied, return WELDRITE in 5 days, and money will be refunded. California orders please add sales tax.

CALIFORNIA TECHNICAL PRODUCTS COMPANY  
8510 Warner Drive • Culver City, California • Dept. A-4

NOW ONLY  
**\$12**  
FULLY GUARANTEED

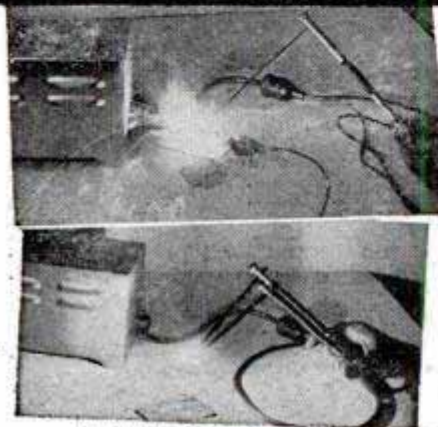



# NOW! EXTRAORDINARY New GOV'T RELEASE!

Shoots A High Pressure Stream Of 30 Feet!

ALL PURPOSE STIRRUP  
**PUMP**  
ONLY **\$149**  
EACH



The Tool of 100 Uses!

Just the thing for

- FIRE FIGHTING. A very handy tool to have in your workshop in case of fire.
- Spraying Garden
- Washing Cars
- Bailing Boats and Basements

Finest quality all purpose pump on the market! Never before offered at this ridiculously low price. There are dozens of uses for this versatile sprayer. Approximate height 27" overall. Complete with 10 feet of flexible hose, ready for assembly. SEND NO MONEY: Simply send name and address and number of pumps desired and we will promptly mail your order C.O.D. plus 25c for postage. If you prefer send \$1.49 plus 25c for postage with order and save C.O.D. charges.

**S & B SURPLUS SALES CO., Dept. PM-30**  
3244 West Roosevelt Rd Chicago 12, Ill.

Say You Saw It in  
**POPULAR MECHANICS**

THE GREATEST  
THING

IN  
PLASTICS!

# PLASTICAST



**PLASTICAST** is a liquid plastic: can be poured into ANY kind of mold or container. Hardens in a few minutes into a transparent solid, clear-as-glass, tough-as-steel plastic! No tools or machinery required. Ideal for imbedding flowers, butterflies, photos, souvenirs, and for making beautifully brilliant jewelry, gems, displays, fishing lures, magnifiers, lenses, knick-knacks and novelties. Easily cast into sheets, rods or blocks, ANY shape, ANY color. **EVERYTHING FURNISHED**, including 4 molds, for making over 200 attractive articles! Start manufacturing beautiful and useful plastics today—no other equipment required. C.O.D. orders accepted with \$1.00 deposit.

**COMPLETE MASTER OUTFIT \$3.50**

Postpaid U.S.A. and Canada only

**MULTIPLY MOLD COMPOUND** . . . simply pour over models to form solid, flexible rubber molds in which ANY material may easily be cast! Nothing else like it. Good for thousands of castings! Never wears out or spoils . . . may be remelted into new molds over and over again! Easily handles difficult shapes and undercuts. **Pound can, only \$2.00.**

**FREE** A very attractive and useful novelty made of one of our products given absolutely free with every one of our catalogs! Catalog lists many new materials for making **MOLDS and CASTINGS** with Liquid Plastics, Liquid Ivory, Liquid Marble, Wax, Latex, Metal, Castwood, Plaster, etc.; also many molds listed. Price of catalog only 10c coin or stamps.

**PLASTICAST CO., (Dept. C)**

5961 Madison St. (Send order to nearest address)  
Chicago 44, Illinois

P. O. Box 987  
Palo Alto, Calif.

YOU CAN **MAKE \$50 A DAY!**



Be  
**INDEPENDENT**  
in your own  
business  
with our  
**15**  
Trade Secrets

**START** your own business in your spare time with our 15 private manufacturing processes—like **REMOVE-ALL** Paint Remover.

We tell you **ALL!** How to **MAKE**. Where to **BUY** simple inexpensive materials. How to Package, Promote, **SELL**.

**Lose no time! Write for details!**

**CHEMICAL RESEARCH CO.**

214 West 42nd St. New York 18, N. Y.

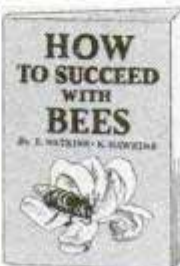

## BEE RAISING PAYS BIG PROFITS

Get **HOW TO SUCCEED WITH BEES**, written by two outstanding experts, which gives more than 190 successful plans to produce big crops of honey. Join the ranks of spare time moneymakers and send for this guaranteed 96-page book today. Tells all about queens, equipment, summer, winter and spring management, swarming, increasing colonies, how to produce section honey and extracted honey, etc. 19th edition, fully revised, only \$1.00.

**POPULAR MECHANICS PRESS**  
200 E. Ontario St. Chicago 11, Ill.

SAY YOU SAW IT IN POPULAR MECHANICS



## New WHAT TO MAKE out now!

Every home craftsman and home workshop should have a copy of this wonderful collection of articles from the "CRAFTSMAN" Department of Popular Mechanics. Bigger and better than ever before, it has 240 pages and over 450 illustrations telling how to make hundreds of useful and unusual projects. Bound in its new soil-proof, Lamcote cover. What To Make is on sale at your News Dealer for \$1.00. We can supply only the cloth editions of What To Make—9 Vols. at \$1.75 each or \$14.00 for the set.

**POPULAR MECHANICS PRESS**  
200 E. Ontario Street Chicago 11, Illinois

**\$9.95** Takes  
All Three  
Big Bargains

**1. AUDIO AMPLIFIER** Undreamed of value. Uses 6V6's. Has 4 microphone inputs brought to jacks at rear panel. Various output impedances available at rear panel connections. Steel case with chrome handles. 9" long x 9" high x 6" deep. Tubes included. New in original carton. Shipping weight 15 lbs. **SUPER SPECIAL—\$4.95** while supply lasts.

**2. RADIO HEADSETS** Latest supersensitive type with rubber earpieces. Every pair guaranteed perfect. \$.50 per pair **OR 3 PAIRS FOR \$1.00.**

**3. HOME WORKSHOP at BARGAIN PRICE** Accurate and precise 2 speed guaranteed hobby lathe, the essential machine for the home workshop. Sturdy enough for light production work or factory standby service. Supplied with 56" of belting for connecting to any available electric motor or power take-off, such as on a jeep or tractor. Also included in this unbelievable offer are such accessories as a 1/2" drill chuck with specially hardened tool steel jaws, a 4" electric furnace high speed grinding wheel, a cotton buffing wheel with a large supply of buffing compound and a 4" steel wire scratch brush. Your cost \$6.00. Sole export agent. Distributor inquiries invited.

**BUFFALO RADIO SUPPLY**

219-221 Genesee St., Dept. 4-M

Buffalo, N. Y.



# NOW RAYON CAN GLAMORIZE ANY SURFACE OR ARTICLE BY PROFESSIONAL FLOCK FINISHING!

IT'S HERE FOR ONLY \$7.95

FLOK-KRAFT is the proven method by which YOU can spray that velvety, plush surface you are familiar with on phono turntables, book-ends, car dashes, etc. Now YOU can do a beautiful job on any surface or object for less than 3c sq. ft. with RAYON FLOCK.

FLOK-KRAFT KIT \$7.95 ppd.

### EARN BIG MONEY

Complete Kit includes two beautiful colors of flock, Undercoat/match, reducer, brush, SPRAY GUN, and easy instructions, your FLOK-KRAFT KIT postpaid. Or order C.O.D. and START FLOCKING!

Get in this fascinating new business NOW, while you have a head start! Send for FREE Illus. Folder and details of Powerful Money-Making Plan. But why wait? Start NOW by ordering your FLOK-KRAFT KIT today.

COAST INDUSTRIES, Dept. 23M, 1509 W. Manchester, Los Angeles 44

## MAKE GOOD MONEY

LEARN OIL BURNER INSTALLATION AND SERVICE at one of America's finest institutions. Our 12 week course qualifies you to be an expert oil burner service man. No previous experience necessary! We teach you with tools and actual working machinery. Approved for G.I. training. Write today for Booklet S.

AIR CONDITIONING & REFRIGERATION INSTITUTE  
110-112-114 N. Paca St. Baltimore 1, Md.

AMERICA'S LEADING OIL BURNER INSTALLATION AND SERVICE SCHOOL

## BRASS JAW CAPS

For Bench Vises. A necessity for every home work shop, garage, factory, for fine finish work. Will not mar threads or finishes. Ideal for metals, plastic or wood. Manufactured by Reed Vise Company. Fits up to 4 1/2" jaws. Regular price \$2.60. Sale price..... \$1.59 per pair

## UTILITY LAMP

Cup type, swivels to any direction. Ideal for all kinds power tools; such as lathes, drill presses, power and home sewing machines, hundreds other uses. Complete with 15 watt bulb for 110 volt AC-DC. Only..... \$1.29

Add 10% for Handling and Mailing. Write for 1948 Circular.

MIDWEST BUY ANYTHING CO. 1520 LOCUST ST. KANSAS CITY, MO.

**RADIO ENGINEERING.** Broadcasting, Television, FM, Servicing, Electronics, Aviation, Marine & Police Radio taught thoroughly. Engineering course equivalent to 3 years' college radio work. Approved Veteran Training. Catalog free. VALPARAISO TECHNICAL INSTITUTE, Dept. D, Valparaiso, Ind.

## LIQUID MARBLE and PIASTONE FLOORS

Mold, Brush, Trowel, Spray It! MOLD Novelties, Statuary, Art Goods in Flexible Plastic Molds; 5c material makes \$1 seller. Make Marbleized floors, Tile Walls. Colorful, glossy, amazing! Easily learned; start in garage or basement. Particulars free. MARBLEIZING SERVICE, Dept. 10-F, Edwardsville, Ill.

**SIGNS EASILY AND EXPERTLY PAINTED WITH LETTER PATTERNS AND SHOWCARDS** MANY SIZES & STYLES WRITE FOR FOLDER! JOHN F. RAHN 1820-31 N. Central Ave. CHICAGO 51, ILL.

Say You Saw It in POPULAR MECHANICS

### New 1948 SHOP NOTES Now Ready!

Bigger and better than ever—240 pages crammed full with the best articles that have appeared in Popular Mechanics during the past year. Invaluable for the mechanic, painter, carpenter, auto-worker, electrician, welder, farmer, plumber and home craftsman; in fact for every man who uses tools. Attractively bound in the new soil-proof Lamco cover, it is on sale at your News Dealer for \$1.00 or obtainable from

POPULAR MECHANICS PRESS

200 E. Ontario Street Chicago 11, Illinois



# These Trades Pay HIGH EARNINGS!

AUTO BODY & FENDER WORK  
REFRIGERATION  
AIR CONDITIONING



DIESEL

These fast-moving mechanical trades offer many fine, big-paying jobs in big cities and small towns. As a result, there is a steady demand for qualified men... men with training, to grow with these industries... perhaps have businesses of their own.

UEI training is available to mechanically inclined men between the ages of 17 and 60. You can get thorough, practical instruction in your spare time while you keep your job. This is followed by actual 'shop practice' with modern, costly equipment. Experienced instructors teach you in easy-to-understand lessons—by methods that have produced so many successful graduates.

UEI residence courses, too, offer the same careful training using the same costly equipment for the shop work... in day and evening classes.

Don't delay another day. Act NOW! Send in the coupon below for FREE facts on the UEI training and opportunities in the big paying trade you prefer. Don't wait... Write at once!

## U.E.I. TRAINING OPPORTUNITIES



Practical shop training follows preliminary spare time course... includes welding, metal work, and auto painting.

Complete training from fundamentals to installation and repair service of all commercial and domestic types.

From basic principles to actual practice of installing and maintaining home and industrial equipment.

Men who know Diesel teach engine operation, fuel systems, auxiliary equipment, repairs and maintenance on all types of Diesel installations. (Founded 1927)

UTILITIES ENGINEERING INSTITUTE DEPT. 148-C CHICAGO 14, ILL.



## MAIL COUPON FOR FREE FACTS

UTILITIES ENGINEERING INSTITUTE, Dept: 148-C 2525 Sheffield Ave., Chicago 14, Ill.

Please RUSH me FREE facts about UEI training and opportunities in the field checked below.

- Auto Body and Fender Work  Air Conditioning  
 Refrigeration  Diesel

Name \_\_\_\_\_ Age \_\_\_\_\_

Address \_\_\_\_\_

City \_\_\_\_\_ Zone or County \_\_\_\_\_ State \_\_\_\_\_

Check here for special information if you are under 17.



# Learn RADIO

This book will start you on the way to an interesting, good-paying career **EVERYTHING IN RADIO AND ELECTRONICS IN ONE BOOK!**

OVER 1000 PAGES

All the expert knowledge at your fingertips . . . quick to find . . . easy to read in the

## RADIO DATA BOOK

This new radio bible will be your lifelong tool. You will use it every day for every operation in radio and electronics. The RADIO DATA BOOK provides complete information on any radio subject . . . in clear-cut, easy-to-understand, completely illustrated style. It is a complete course in radio for the beginner . . . it is packed with money-making knowledge for the professional . . . and it is a complete reference for the master. Advance sale, only 10,000 available—to make sure you get your copy of the RADIO DATA BOOK send in your order now!

12 sections . . . over 1000 pages . . . completely illustrated

Section 1. THE 150 BASIC CIRCUITS IN RADIO.

Section 2. COMPLETE TEST EQUIPMENT DATA.

Section 3. TESTING, MEASURING AND ALIGNMENT.

Section 4. ALL ABOUT ANTENNAS.

Section 5. SOUND SYSTEMS, RECORDING.

Section 6. RECORDING.

Section 7. COMPLETE TUBE MANUAL.

Section 8. CHARTS, GRAPHS AND CURVES.

Section 9. CODES, SYMBOLS AND STANDARDS.

Section 10. 50 TESTED CIRCUITS DESIGNED FOR OPTIMUM PERFORMANCE.

Section 11. DICTIONARY OF RADIO AND ELECTRONIC TERMS.

Section 12. RADIO BOOK BIBLIOGRAPHY.

Handsomely bound in red and gold.

12 complete books in one, only \$5.00 — less than 42c per book!

**SATISFACTION GUARANTEED — OR YOUR MONEY BACK!**

**BOLAND & BOYCE, INC. PUBLISHERS**

PM-2

460 Bloomfield Ave., Montclair, N. J.

Send me the RADIO DATA BOOK. Enclosed is \$5.00.

NAME \_\_\_\_\_

ADDRESS \_\_\_\_\_

CITY \_\_\_\_\_

ZONE \_\_\_\_\_

STATE \_\_\_\_\_

**BOLAND & BOYCE INC., PUBLISHERS**

Learn . . . . .

# WATCH REPAIRING



From The Largest Approved School Of Its Kind

## HOME TRAINING WITH TOOLS

With FREE WATCH Included AS Part of Your Course

Earn As You Learn In Your Spare Time For a Big Pay Future

The demand for skilled Watch Makers is increasing with the step-up in the manufacture of watches because more and more watches need repairing. Now is the time to prepare yourself in the fascinating art of Watch Repairing with the aid of our HOME TRAINING SPARE TIME COURSE WITH ACTUAL TOOLS. No loss from your present work! No previous mechanical experience needed! Our Earn-As-You-Learn-Plan helps you to pay for your course, like student C. Fuller of Texas: "I have repaired 63 watches and have more than paid for Course."

**WRITE TODAY**—for free, interesting facts and low cost Enrollment Plan.

## ILLINOIS SCHOOL of WATCH REPAIRING

2870BN Elston Ave.

Chicago 18, Ill.

NONE BETTER AT ANY PRICE!

PAINT YOUR CAR WITH

# KAR-WIPE

NEW AUTO ENAMEL SENSATION

WIPE IT ON!

NO SPRAYING!

NO BRUSHING!

No Lap Marks

No Masking

No Streaks

GUARANTEED

2 FULL YEARS \$1.95



YOU CAN DO A FACTORY LIKE JOB

One Quart Covers Average Car With Two Gleaming Coats. A Glowing Professional Finish!

Not a streaky wax or polish. KAR-WIPE is the new miracle high lustre auto enamel that is so easy to use. Anyone can do a professional looking job quickly.

Almost anyone can get high-gloss job that looks like a Professional finish. KAR-WIPE does the trick!

Easy to apply! No brush! No masking! Simply WIPE IT ON with the applicator that we give you FREE. Get a factory-like finish that's GUARANTEED

against chipping, cracking, peeling, fading when simple directions are followed. Dries dust free quickly. In newest colors,

SEND NO MONEY! Order one or more quarts today. Just mail postcard. Pay postman plus C.O.D. upon delivery. Send remittance, save postage.

SEND NO MONEY! ORDER Kar-Wipe TODAY! In Black, Grey, Firey Red, Brewster Green, Washington Blue, Maroon . . . \$1.95 per qt.

KAR-WIPE CO., Dept. P4, 828 S. 18th St., St. Louis, Mo.

## "I saved \$150.00 BY INSTALLING MY OWN DELTA OIL BURNER"

"Yes, sir! I saved \$150.00 when I installed my Delta Automatic Oil Burner myself in a few hours. I shopped around but couldn't get a burner installed for less than \$350.00. The work was easy because of the Delta Photo-Installation Manual . . ."



MADE BY THE WORLD'S LARGEST MANUFACTURER OF OIL BURNERS

Now you can enjoy fully automatic heat in your home by installing it yourself simply and quickly with a few tools. You can save at least \$150.00 in your spare time! The Delta Automatic Oil Burner comes completely assembled along with everything necessary for the complete installation by you for the low price of only \$195.00. Includes the famous copyrighted DELTA PHOTO-INSTALLATION MANUAL showing step-by-step photographs of an actual installation.

PAY AS LITTLE AS \$6.26 A MONTH! And—you need not pay a single penny to get the Delta Automatic Oil Burner because a simple deferred payment plan is available. Just send the coupon below for full information and free brochure in color describing how you can install and enjoy fully automatic heat in your home with the Delta Automatic Oil Burner, Delta Automatic Floor Furnace, and other Delta Heating products. Mail coupon today!

PASTE COUPON ON PENNY POSTCARD

DELTA HEATING CORPORATION  
85-07 Northern Blvd., Jackson Heights, New York City  
Please send FREE Color Brochure and full information about DELTA Heating Products.

NAME \_\_\_\_\_

ADDRESS \_\_\_\_\_  
(Please Print Clearly)

CITY \_\_\_\_\_

PM-A



Get This Fascinating New Popular Mechanics Book

# WHAT to MAKE for Children



175 Things  
Dad and Mother  
can Make for  
Young Folks  
at Home!

This is a book by the authors of Popular Mechanics. It will show you how to make, at little or no cost, many of the things so dear to the hearts of younger children—things that money won't buy, such as playroom and nursery toys and trappings, dolls and dollhouses, gymnasium equipment, things to ride on, toys that "work" and go.

**A BOOK FOR THE ENTIRE FAMILY**  
Mother and Dad and Big Sister and Brother can save many dollars and have worlds of fun too, making all these things for the little tots. Only discarded materials or inexpensive new materials are needed, with WHAT TO MAKE FOR CHILDREN as a guide.

### SIMPLIFIED INSTRUCTIONS — ANYONE CAN FOLLOW

The book contains 175 different projects with detailed "how-to-do-it" instructions, dimensions and more than 250 sketches, drawings, plans and photographs covering every detail of construction.

Order WHAT TO MAKE FOR CHILDREN today. Mail coupon below for immediate delivery. Money back if not satisfied.

175 PROJECTS  
250 ILLUSTRATIONS

Action Toys—Dolls—Pull

Toys—Play Houses—

Games



Swings—Furniture—

Sleds—Playground Equip-  
ment—Desks—Sandboxes



Wagons—Coasters—

Merry-go-round—Animals

Cribs—Dozens of Others



Popular Mechanics Press, Dept. 660  
200 East Ontario St., Chicago 11, Ill.

Send at once \_\_\_\_\_ copies of WHAT TO MAKE FOR CHILDREN at \$2.00 each. Remittance enclosed. I understand I may return the book in 5 days if not satisfactory and you will refund my money.

Name \_\_\_\_\_

Address \_\_\_\_\_

City \_\_\_\_\_ State \_\_\_\_\_

SAY YOU SAW IT IN POPULAR MECHANICS

APRIL 1948

## WAR SURPLUS BARGAINS

Get in on these great bargains. Because they're war surplus, you buy them at a fraction of original cost. Stock up on your needs while these low prices are in effect.

### UTILITY HYDRAULIC PUMP

Item 1—Brand new Permo gear type aircraft pump. At 1750 RPM exerts 1000 PSI hydraulic pressure and pumps over 2 gallons per minute. Has 3/8 inch intake and outlet ports. Standard threads. Has 5/8 inch shaft for pulley or other coupling. Run with electric motor, gas or engine or power take-off. Original cost over \$100.00. Part 1P203UB. Actual weight 3 lbs. 14 oz. Shp. wgt. 6 lbs. Original overseas packing. Use for any pumping job. Guaranteed brand in U.S. Each only **\$10.00**

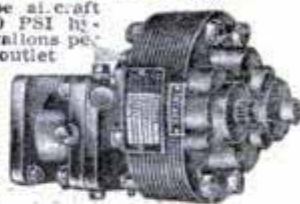

### ALL PURPOSE GENERATOR



Item 2—Brand new Aviation type generator, ideal for use on boats, trucks, light and power plants, welders, water wheels etc. Rated 24 volts, 25 amps at 2500 RPM. Has 7/8 inch shaft. Measures 10 x 5 inches overall. Highest quality aviation design. Actual weight 23 1/2 lbs. Shipping wgt. **\$17.50** new. Two for \$30.00. Each

### SERVO ACTUATING UNIT

Item 3—A combination hydraulic and electrical actuating unit that includes a 1/10th horsepower (6000 RPM) 24 volt motor. May be adapted to many uses such as operating garage doors, gates, etc. All units are brand new and guaranteed perfect. Shipping weight approximately 27 lbs. Each **\$4.95**



### AMPLIFIER RACK



Item 4—Sperry A-5 Auto Pilot assembly. Includes a great array of valuable electronic parts such as a 2 1/4 inch 0-120 AC volt meter, 3 1/4 inch, 350-450 frequency meter, plus relays, capacitors, resistors, condensers, plugs, switches, etc. Measures 14 x 10 x 12 inches. Approximate shipping weight 30 lbs. The meters alone are worth more than the price quoted for the complete assembly. Each only **\$5.95**

### POWER AMPLIFIER

Item 5—A 4 tube power amplifier (not audio) that contains a compact assembly of condensers, transformers, switches, resistors, sockets, terminal strips, chassis and panel. A real value for the radio and electronic experimenter. Shipping weight approximately 5 lbs. Each only **\$1.45**

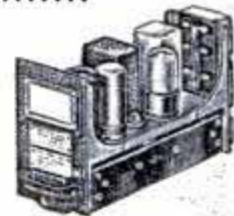

### CONTROL UNIT AND PANEL

Item 6—Made by Sperry. Designed to provide electronic control for the various units of the auto pilot. Measures 7 1/2 x 8 x 4 1/2 inches. Includes 6 toggle switches, 2 three-way switches, 3 dials, indicators, plugs, resistors, etc. Parts alone are worth many times this low price. Shp. wgt. 8 lbs. Each **\$3.95**



### AIR FORCE DRIFT METER



Item 7—Type B-3. Overall length 47 inches, tube length 27 inches. Used in navigation of bombers. Includes valuable electric lenses, prisms, electric gyro, etc.

Original cost hundreds of dollars. Used, but in good condition. Shp. wgt. approx. 50 lbs. Each **\$9.95** only.

### HOME AND SHOP BARGAIN ASSORTMENTS

Item 8—Full 10 lb. ass't. aircraft hardware, mixed screws, rivets, nuts, bolts, washers. All new! Shp. wgt. 12 lbs. **\$2.00**

Item 9—150 or more aluminum clamps in ass't. sizes to 1 1/2 inch. All new and perfect. Shp. wgt. 5 lbs. **\$2.00**

Item 10—Ass't. of 20 aircraft bearings, mixed sizes and types; all under 1 1/2 inch O.D. All new. Worth much more. **\$2.00** Only

Item 11—Full 10 lb. experimenter's ass't. mixed radio, electric and electronic parts— odds and ends — many valuable parts. Shp. wgt. 12 lbs. **\$2.00**

Item 12—Ass't. of 8 aircraft pulleys (micarta sheaves) with fine bearings. Mixed sizes. A find for inventors, experimenters, etc. Shp. wgt. 2 lbs. **\$2.00**

Send stamp for FREE CATALOG. All prices F.O.B. Houston. Mail orders promptly filled. Send check or money order.

**AERO INSTRUMENT COMPANY, Dept. PM 4**  
MUNICIPAL AIRPORT HOUSTON, TEXAS



# WAR

## Surplus

also other

### STARTLING VALUES

#### MAIL ORDERS

Please send remittance with order. Include postage. If desired, order will be sent C. O. D. plus C. O. D. fee. SATISFACTION OR YOUR MONEY BACK.

## SENSATIONAL VALUE!



### Aviators' style SUN GLASSES

Precision made. 24 K. GOLD PLATED METAL FRAME. 4 base curve. Ophthalmic ground. SHUTS OUT 96% OF THE ULTRA VIOLET RAY. We sold thousands at \$6.00. Add 12c postage and handling.

# 288



### Surplus DUST MASKS

# 33

Brand new. Ideal for paint or insecticide spraying. Practical for miners and farmers. Gives perfect dust protection. Add 5c postage.

### Genuine NYLON

### PARACHUTE CORDS

New. 3/16 inch diameter. Ideal for clotheslines and ventilation blinds and drapery cords. 550 lb. tensile strength. Add 3c postage.

PER HANK

# 59

### PARACHUTE CORDS

New. 3/16 inch diameter. Ideal for clotheslines and ventilation blinds and drapery cords. 550 lb. tensile strength. Add 3c postage.



### GREATEST WATCH VALUE In the U.S.!

### 17 JEWEL Military Style

# 19<sup>95</sup>

### Plus 10% Fed. Tax

Brand new. THIS SPECIAL PRICE FOR 30 DAYS ONLY. GUARANTEED fine quality 17 jewel Swiss movement. WATER RESISTANT; SHOCKPROOF; ANTI-MAGNETIC; SWEEP SECOND HAND; RADIUM DIAL; STAINLESS STEEL CASE. Comes complete with fine leather strap. If you don't think this is the greatest value in America you may return the watch for refund. PLEASE ADD \$2.00 Fed. Tax.

### O. D. WOOL SHIRTS PANTS

Used but in excellent condition, perfect. They have been designated for REISSUE BY THE GOVT. Pure wool serge. Less than the price of the cheapest overall. Add 8c per garment for postage.

### PANTS Sizes 28-33 2.95 SHIRTS 13-15 2.69

### NAVY STYLE T SHIRTS

Brand New: Sizes small, medium and large. White only. Fine long staple combed cotton yarn. Add 3c per garment postage.



### FREE SURPLUS Circular

Send for

OVER 150 GOVT SURPLUS ITEMS at TREMENDOUS SAVINGS.

### SIoux FALLS SURPLUS STORE SIoux FALLS, S. DAK.

SAY YOU SAW IT IN POPULAR MECHANICS

## HIGH TEST LUMINOUS POWDERS

### For Dusting, Painting and Mixing to Suit Your Requirements

We can furnish you with unadulterated, non toxic chemicals that really glow in the dark. Be recognized for your craftsmanship and make unlimited profits by useful applications — safety aids, toys-games, novelties, displays, advertising, premiums, decoration, radio, automotive, aviation, etc. Listing of various pigments and wide range of colors free with your special trial order for only \$1.00 prepaid.

### GLOWELL ENGINEERING CO.

475 FIFTH AVENUE

NEW YORK 17, N. Y.

# ARMY BALLOONS and KITES

## FOR RADIO ANTENNAS, WEATHER OBSERVATION, AERIAL PHOTOGRAPHY or JUST PLAIN FUN



Originally made to take up emergency radio antennas, these balloons and kites are beautifully made of the finest materials.

The balloons inflate to approximately 4 feet in diameter and have a lifting capacity of 3 to 5 lbs. They are made of extra heavy rubber and come sealed in metal cans. Each balloon has its own hydrogen generator which works when simply put in water.

The box kite is scientifically designed. Its strong aluminum frame folds up like an umbrella so the kite can be stored in a small space.



A complete kit consisting of 2 Balloons, 2 Generators, 1 Box Kite, all packed in a tubular canvas bag. Is priced at only \$9.95. (Cost the Government \$75.00.) Send your check (or M.O.) for \$9.95 and we will promptly ship your Balloon-Kite Kit via express. Quantity limited.

## WELLS SALES, INC.

320 N. La Salle St., Dept. P-4  
Chicago 10, Illinois

### SAVES TIME... SAVES WORK

### DOES A THOROUGH JOB!

### See Garden-All before buying!

# Garden-All

LAWN and GARDEN TRACTOR

Instant Tool Attachment!

Exclusive Depth Control!

A Tool For Every Need!



Write for Folder

Spike  
Tooth  
Harrow

Garden-All gives you everything you need for a complete job in efficient gardening. Attachments include Plow, Disc, Spike Tooth Harrow, Cultipacker, Seeder (for single or double row planting) and Cultivator. Also Sickle Bar, Lawn Mower, Utility Scraper and Dump Trailer. And you can attach or detach any one of them in less than a minute. No wonder so many owners say *there's nothing at all like Garden-All!*

## GARDEN-ALL TRACTOR, INC.

Dept. P, 100 W. UNION STREET, LIBERTY, INDIANA



**WIN \$2500<sup>00</sup> CASH! \$5,000 CASH PRIZES IN ALL**

**READ FULL DETAILS in COLUMN AT RIGHT BELOW**

# Paint Your Car for ONLY \$3<sup>95</sup>

ONE QUART DOES ENTIRE JOB  
2 FULL COATS

**WITH WYPE** TRADE MARK REG.

**NO SPRAYING · NO MASKING · NO BRUSHING**



ANYONE CAN DO BEAUTIFUL JOB

**Dries Dust Free One Hour · No Streaks or Lapmarks**

**AMAZING NEW BRUSHLESS AUTO ENAMEL**  
**You JUST WIPE ON**  
**with a POWDER PUFF**  
instead of Brushing or Spraying

**Get Beautiful Mirror Like Finish That Looks Like Spray Job!**

At last! Practically anyone can now paint his car with WYPE! No previous car-painting experience necessary. You get a beautiful high-gloss job that gives you an expensive finish such as is sprayed on by Professional Auto Painters—at a fraction of regular cost! With WYPE you need **NO BRUSH, NO SPRAY, NO MASKING!** Just **WIPE ON** with Powder Puff—which we furnish at no extra charge. You get a brilliant, glossy finish that is truly "factory-like." No streaks. No lap-marks. Guaranteed for **TWO** years not to crack, peel, chip or fade, if simple directions are followed. Takes about an hour to apply. Dries dust-free in an hour. WYPE comes in eight most popular shades including those on newest model cars. Goes over any other color, lacquer or enamel.

**MOST POPULAR COLORS**

Black	Brewster (dark)	Green
Maroon	Jewel (light)	Green
Red	Washington (dark)	Blue
Gray	Monticello (light)	Blue

**\$3<sup>95</sup> Per Quart**

**SEE YOUR DEALER or ORDER DIRECT**  
**SEND NO MONEY · Get WYPE Today!**

If your dealer can't supply you, just send us a postcard. We'll ship C.O.D. Just pay mailman for Wype, plus postal charges. Or send remittance with order and WE pay postage.

**You're SURE You Are SAFE when You Paint with WYPE**  
**HERE'S WHY!**

**TESTED BY U. S. Testing Co., Inc.**

**Leading Scientific Testing Laboratory**

Report No. 87496  
Jan. 5, 1948

and found to conform to the claims and guarantee of the Wype Corporation.

No higher or more rigid standards are set by any Testing Laboratory. United States Testing Company conducts scientific tests for the world's foremost organizations and is accepted as a leading authority on such tests.

**For Your Protection**  
With cars so expensive, it's a satisfaction to find ONE product you can TRUST to renew and protect the beauty of your car—especially when it's so easy to do!

**2-YEAR GUARANTEE**  
We Guarantee WYPE against cracking, peeling, fading or chipping for two years after application, if applied according to directions furnished. Your money cheerfully refunded if WYPE does not live up to this Guarantee.

COPYRIGHT 1948, WYPE CORP



**APPLY in ONE HOUR — DRIES to GLISTENING PROFESSIONAL FINISH**

WYPE is a new Miracle Enamel for Autos. It is NOT a wax or polish but a hard high lustre ENAMEL finish! With WYPE, ANYONE can do a beautiful job! Order a quart to paint your car or to get started in this BIG-MONEY Business!

**NO STREAKS OR LAPMARKS LOOKS LIKE SPRAY JOB**

**ANYONE MAY WIN**

Yes, YOU may win \$2500 in cash by writing the best letter telling your experience with Wype; how easily and quickly Wype can be applied, what a beautiful job it does; how it compares to a professional spray job.

**Just 3 Easy Steps**

1. Write a letter on the subject: "My Experience with Wype."
2. Enclose with this letter any one of the following—not all—just one:
  - Either the sales check or receipt you got when purchasing Wype, or the powder puff you used to paint your car, or a reasonable facsimile of the Wype can. Send only one of the above with your letter, not all three. (When you order direct, we send official entry blank—our dealers also have blanks.)
3. Mail to Wype Corporation, 2214 Dolman St., St. Louis 4, Mo.

**\$5,000 CASH PRIZES!**

1st Prize...\$2,500 Cash!  
2nd Prize...\$500 Cash!  
3rd Prize...\$250 Cash!

Five Prizes—Each \$50 in Cash!

One Hundred Prizes, Each Ten Dollars Cash!

One Hundred Prizes, Each Five Dollars Cash!

Total Cash Prize List, Five Thousand Dollars Altogether!

Two Hundred & Eight Prizes—Two Hundred and Eight Chances to Win!

**HURRY! Act Now!**

Your letter can be any length. The letters considered best by the judges get the cash prizes! Decision of judges on all points final. Duplicate awards in case of ties. No entries returned.

All entries must be postmarked before Midnight, June 30, 1948, and received before July 14, 1948.

**Some of the FAMOUS DEPARTMENT STORES that Sell WYPE**

- |                                              |                                                                                                                                                                                                                                                                                                                                            |                                                                                                                                                                                                                                                                                   |                                                                                                                                                                                                                                                                                                                                                                                |
|----------------------------------------------|--------------------------------------------------------------------------------------------------------------------------------------------------------------------------------------------------------------------------------------------------------------------------------------------------------------------------------------------|-----------------------------------------------------------------------------------------------------------------------------------------------------------------------------------------------------------------------------------------------------------------------------------|--------------------------------------------------------------------------------------------------------------------------------------------------------------------------------------------------------------------------------------------------------------------------------------------------------------------------------------------------------------------------------|
| <b>VISIT OR PHONE THE STORE IN YOUR CITY</b> | Akron: M. O'Neil Co.<br>Baltimore: May Co.<br>Baton Rouge, La.: D. G. Rosenfield Co.<br>Chicago: Goldblatt's 15 Department Stores (Goldblatt's Department Stores, also, at Joliet, Ill., Hammond, Ind., Gary, Ind., South Bend, Ind.)<br>Cincinnati: Fair Store Co.<br>Cleveland: May Co.<br>Dallas: Sanger Bros., Inc.<br>Denver: May Co. | Ft. Wayne: Wolf-Dessauer Co.<br>Ft. Worth: W. C. Stripling Co.<br>Kansas City, Mo.: Jones Store Co.<br>Los Angeles: May Co.<br>Louisville: Kaufman-Straus Co.<br>Memphis: B. Lowenstein & Bros.<br>Milwaukee: Ed. Schuster & Co., Inc.<br>Montgomery, Ala.: Montgomery Fair Store | New Orleans: Maison Blanche Co.<br>Philadelphia: Lit Brothers<br>Richmond, Va.: Miller & Rhoads, Inc.<br>St. Louis: Famous-Barr Co.<br>St. Paul, Minn.: The Golden Rule<br>San Antonio: Joske's of Texas<br>San Diego: Whitney's<br>Toledo: Lion Dry Goods Co.<br>Youngstown, O.: Strauss-Hirshberg Co., and many other leading merchants. Phone or visit your favorite today! |
|----------------------------------------------|--------------------------------------------------------------------------------------------------------------------------------------------------------------------------------------------------------------------------------------------------------------------------------------------------------------------------------------------|-----------------------------------------------------------------------------------------------------------------------------------------------------------------------------------------------------------------------------------------------------------------------------------|--------------------------------------------------------------------------------------------------------------------------------------------------------------------------------------------------------------------------------------------------------------------------------------------------------------------------------------------------------------------------------|

**WYPE CORP. Dept. 16-D 2214 DOLMAN ST. ST. LOUIS 4, MO.**



# Sensational Values!

## AIR CORPS TYPE Service Precision Watches

### CHRONOGRAPH

SWISS MOVEMENT — INCABLOC

**\$29.95**

Exact Type as Used by Armed Forces



10% Fed. Tax plus 25c postage and insurance

#### ATTENTION!

Fliers, Photographers, Yachtsmen, Fishermen, Hunters, Seafarers, Doctors, Engineers, etc.

#### Check These Features!

- 17 JEWELS
- STOP WATCH
- 30 MINUTE DIAL
- 60 SECOND DIAL
- 2 PUSH BUTTONS
- TELEMETER
- SWEEP SECOND HAND
- RADIUM DIAL AND HANDS

Satisfaction guaranteed or your money back.

### 17 JEWEL WRIST WATCH

SWISS MOVEMENT — INCABLOC

A REGULAR \$50.00 VALUE!

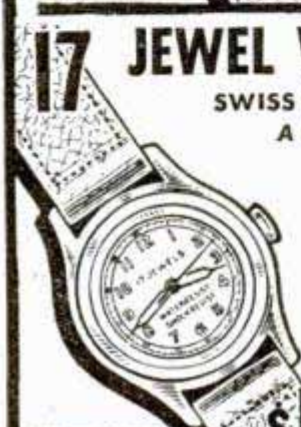

- WATERPROOF
- SHOCKPROOF
- SWEEP SECOND HAND
- RADIUM DIAL AND HANDS
- STAINLESS STEEL BACK
- LEATHER STRAP

Brand New . . . Complete satisfaction guaranteed or your money refunded.

**\$19.95**

Add 10% Fed. Tax plus 25c postage and insurance

DON'T MISS THIS BUY!

#### FREE

Send for free illustrated catalog. Has many marvelous WAR SURPLUS BARGAINS.

### ALLIED SALES CO.

DEPT. PA-88 CLAY STREET - SAN FRANCISCO 11, CALIFORNIA  
Send check or money order. Sorry no C.O.D.s.

### FLOYD CLYMER'S unbiased book

#### "INDEPENDENT TEST REPORT ON KAISER-FRAZER CARS"

Read what 3000 owners now think of their K-F cars. Expert, part-by-part analysis. 100 photos. Tells all. 3000-mile test run, Pike's Peak closed car record, gas mileage. Thousands are buying. Order now, \$1.50 postpaid. \$2.50 deluxe ed. Cash, money-order, or specify C. O. D. Money-back guarantee. Clymer, Publisher, Dept. PM-4 2125 W. Pico, Los Angeles 6, Calif.



## AMAZING SAVINGS JUST OUT OF PAWN!

### GENUINE HIGH QUALITY DIAMONDS

UNREDEEMED DIAMOND PLEDGES DIRECT TO YOU! SAVE UP TO 50%!

Full cut genuine diamonds, expertly reset in beautiful modern mountings of 14 Kt. Yellow or White Gold, ladies' or men's, priced at a small fraction of retail value. Over 100,000 satisfied customers. Iron-clad guarantee. Wear your diamond 7 days. Your money refunded immediately if not delighted. Order from this ad.

Also write us for FREE illustrated catalog of other Unredeemed Diamond Pledges from \$5.00 to \$5000. Small deposit holds any diamond until wanted. Write us today. Bank Reference on request, or your own bank.

1/5 ct. (\$125 Value)  
**\$49.00**  
Tax included.

BERMAN'S COLLATERAL LOAN BANK  
Dept. P-8, 636-38 W. Balto. St. Baltimore-1, Md.

**BIG PAY TRADE**

## AIR CONDITIONING REFRIGERATION

Learn at one of America's finest institutions, under expert, experienced instructors

ACRI will train you for a profitable career in air conditioning and refrigeration. Homes, restaurants, offices, industrial plants, etc., will require air conditioning installations and maintenance. Get in on the ground floor—this is the trade of the future—WITH A FUTURE FOR YOU. If you are a veteran, the government pays you while training—pays your entire school tuition—and buys your tools. Non veterans may arrange easy, weekly or monthly payments. Train at ACRI for your future. Write today for FREE catalogue M. ACRI, 110-112-114 N. Paca St., Baltimore 1, Md.

#### AT HOME COURSE

ACRI also teaches you air conditioning and refrigeration at home. Outstanding opportunities await young men in this great field. Start by training at home—finish in the modern shops of ACRI, where experienced instructors teach you on working machinery. Act now—write today for catalogue P.

#### AIR CONDITIONING & REFRIGERATION INSTITUTE

110-112-114 N. Paca St. Baltimore 1, Md.



### COMB-A-TRIM The New Quick Trimmer

Something New! Trim your hair without any experience. It's easy! The excess hair comes off smoothly and easily by just pulling trimmer through hair like an ordinary comb. Also removes hair from legs—armpits. Save on haircut bills. . . . Trim your own hair or the whole family's. Send 59c and your Comb-A-Trim will be sent at once.

**SPECIAL OFFER** Send \$1.00 for 2 Comb-A-Trim and save 18c. **2 for \$1** 5 Extra Blades (Year's Supply) **25c**

COMB-A-TRIM CO., 1734 Carew Tower, Dept. R-26, Cincinnati, O.

SAY YOU SAW IT IN POPULAR MECHANICS



## BUY A STONE

MARK LOVED ONES GRAVES  
Special prices. Freight paid. Erected. Write for our BIG FREE Book.  
U. S. MARBLE & GRANITE CO., ONECO, 19, FLORIDA

## WHAT TO MAKE SERIES

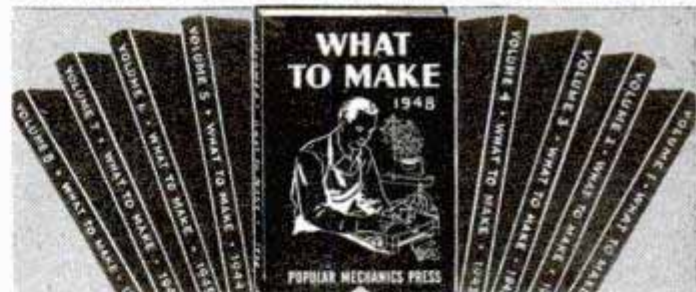

Send for your copy of the new 1948 clothbound edition now! Keep your set up to date. This is the 9th in this famous series of Home Workshop and Hobby Guides. If you do not have the earlier volumes you are missing a wonderful source of inspiration for making fascinating things at home. Every book is different . . . contains material not in the other volumes.

POPULAR MECHANICS  
1948  
EDITION

Partial contents: Birdhouses, sideboards, benches, furniture, book ends, chairs, toys, games, photo equipment, Dutch windmill, leathercraft, bookbinding, ship and yacht models, recaning chairs, fruit baskets, hobbled hamper, garden furniture, log cabins, porch furniture, tables, hostess trays, footstools, desks, lamps, fireplace screens, bookcases, wall cabinets.

### PACKED WITH FUN AND PROFIT FOR EVERY HOME CRAFTSMAN

Nine big books . . . 1900 pages, 4000 pictures \$1.75 a volume . . . \$14.00 for set of nine

POPULAR MECHANICS PRESS, 200 E. Ontario St., Chicago 11, Ill.

Please send What To Make books as checked below. I will pay postman price and few cents postage. It is understood my money will be refunded if I'm not satisfied.

What To Make Vol. 9 . . . \$1.75  
What To Make Library (9 vols.) . . . \$14.00  
Postage paid if remittance accompanies order.  
Outside U.S.A. 15% additional.

Name \_\_\_\_\_  
Street and No. \_\_\_\_\_  
City \_\_\_\_\_ Zone \_\_\_\_\_ State \_\_\_\_\_



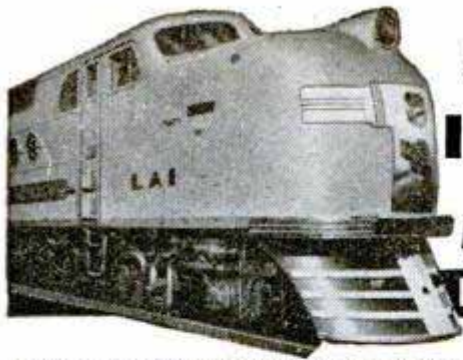

# GET INTO DIESEL NOW!

Let this Great School qualify You!

LEARN AT HOME IN YOUR SPARE TIME

With National Schools' tested and proved Master Shop Method of Home Training, you can become a qualified Diesel and Automotive technician equipped to step right into a good paying job. One of America's great trade schools, established in 1905, stands behind your training!

## National Schools-trained Diesel and Automotive Technicians Are Welcome Everywhere

Our files are filled with facts of National Schools-trained men who have reached success in their chosen field because of the thorough, practical and up-to-date instruction we gave them.

Diesel is becoming more and more important in transportation, industry and agriculture all over the world. Trained men who really know Carburetion, Ignition, Fuel-Injection, Motor Tune-up, etc., are in constant demand to fill interesting, good pay jobs. Opportunity is here now for you!

## Every Word and Picture in Your Home Study Course Comes Out of the Great National Schools Training Shops

Behind all National Schools training is our permanent faculty of experienced instructors and engineers who will teach you about Diesel-electric, Internal Combustion Engines, including Diesel, Gasoline and Butane Types, High-octane fuels, Automotive Drive Systems, etc. National Schools instructors are daily teaching resident students in our modern, fully equipped Shops and Classrooms, using the same instruction methods and lessons you study at home in your spare time. These instructors know how to guide your home study!

TODAY'S GREAT OPPORTUNITIES IN DIESEL, AUTOMOTIVE AND ALLIED MECHANICS



G. I. APPROVED

## NATIONAL SCHOOLS

LOS ANGELES 37, CALIFORNIA EST. 1905



### MAIL OPPORTUNITY COUPON FOR QUICK ACTION

National Schools, Dept. PMD-4

4000 South Figueroa Street  
Los Angeles 37, California

(Mail in envelope or paste on penny postcard)

Mail me FREE the book, YOUR FUTURE IN DIESEL, together with the Sample Lesson. I understand I may keep and use the information with no obligation.

Name \_\_\_\_\_ Age \_\_\_\_\_

Address \_\_\_\_\_

City \_\_\_\_\_ Zone \_\_\_\_\_ State \_\_\_\_\_

Check here if Veteran of World War II

## Imported 15 JEWEL HEAVY DUTY Wrist WATCH



Handsome... Rugged... A watch designed to meet the demands of men who want accuracy and durability in a timepiece.

Note these outstanding features:

- DUSTPROOF CHROME CASE
- GENUINE CALFSKIN STRAP
- RADIUM DIAL AND HANDS
- UNBREAKABLE CRYSTAL

Regular \$24.95 value!

ONLY \$13.88 INCL. FED. TAX

GUARANTEED!

Order Direct from DRAKE!  
Mail check, money order or pay C.O.D.

The DRAKE Company, Dept. PM 26

1380 MILWAUKEE AVE.

CHICAGO, ILLINOIS

## Earn BIG PAY Now!

thousands of ambitious men helped

FREE EMPLOYMENT SERVICE  
LEARN THESE TRADES IN THE BIG ALLIED SHOPS

• BIG SHOP TRAINING •

- Choose one of these 6 LEADING TRADES
- Machinist Trade
  - Tool & Die Making
  - Tool & Die Machine Designing
  - Mechanical Drafting
  - Tool Engineering
  - Industrial Product Illustration

Largest School of its Kind in the World

FREE! BIG METAL TRADES ILLUSTRATED BOOK

APPROVED FOR VETERANS  
WRITE TODAY: A 1c Postcard will do.

ALLIED SCHOOL OF MECHANICAL TRADES  
1338-1340-1342 So. Michigan Ave. — Est. 1928  
424 Allied Bldg. CHICAGO 5, ILL.

The New Improved All-Purpose

## DYNAMIC Super Charged ARC WELDER

Industrial Transformer Type

IT WELDS • IT BRAZES • IT SOLDERS

IDEAL FOR AUTO—HOME APPLIANCE AND FARM REPAIRS. This portable, industrial transformer type welder easily carried right to the job can be operated from any convenient properly wired 110 Volt 60 Cycle Line. Can also be supplied for 220 volt 60 cycle operation and other voltages and cycles at slight additional cost.

EASY-TO-OPERATE. If inexperienced you can easily learn to do a variety of high grade welding jobs by following the practical, simplified Welding and Operating Instructions furnished. Once you see the DYNAMIC WELDER in operation you won't want to be without it. Its simplicity will amaze you. In a year the DYNAMIC only costs you about 7c a day. Comes complete ready to operate with helmet, rods, cables, holder, operating and welding instructions, etc.

SAVES YOU VALUABLE TIME AND MONEY!

DESIGNED TO DO HIGH GRADE WELDING inexpensively—Maintenance Men, Farmers, Mechanics, Machine Shops, Foundries, Auto, General Repair and Job Welding Shops, all using the DYNAMIC find it so indispensable and useful that they can not afford to be without it. Works on Iron, Steel, Brass, Bronze and Other Metals. Has 8 metallic and carbon arc heat stages. Does work you would think only possible with a larger, more expensive machine.

ONLY \$2850 COMPLETE

DO YOUR OWN WELDING

Just a few repair jobs will pay for this machine. A practical and profitable machine tool for any workshop. Make money doing repair work for others.

Write for Particulars Get Details on our 10 day Trial Offer Member Chicago Association of Commerce.



DYNAMIC WELDER CO., 15 East 23rd Street, F, CHICAGO 16, ILL.



It's MORE FOOD for LESS MONEY

Send

# CARE

Food Packages Abroad... \$10.

INSURED · GUARANTEED DELIVERY  
DUTY FREE · RATION FREE  
NON-PROFIT · GOVERNMENT APPROVED



### CONTENTS:

- 1 lb. Braised Beef
- 2-8 oz. tins of Liver Pâté
- 2-8 oz. tins of Corned Beef Loaf
- 2 lb. Shortening
- 1 lb. Chocolate
- 2-8 oz. tins of Cocoa
- 2 lb. Whole Milk Powder
- 8 oz. Egg Powder
- 1 lb. Apricots
- 1 lb. Raisins
- 7 lb. Flour
- 2 lb. Sugar
- 1 lb. Coffee (For Britain 1/2 lb. tea)
- 2-3 oz. Bars of Soap
- 1/4 oz. Yeast

The entire cost of this advertisement has been donated.

**CARE** Cooperative for American Remittances to Europe, Inc., 50 Broad Street, New York 4, N. Y.

CARE Food Packages may be sent to: Austria, Belgium, Bulgaria, Czechoslovakia, Eire (Ireland), Finland, France, Germany (American, British and French Zones and all of Berlin), Great Britain, Greece, Hungary, Italy, Netherlands, Poland

Your Name and Address:

\_\_\_\_\_  
 \_\_\_\_\_  
 \_\_\_\_\_  
 \_\_\_\_\_  
 \_\_\_\_\_  
 \_\_\_\_\_  
 \_\_\_\_\_

(City and State)

Prompt Delivery Depends on Clear, Correct Address.  
**PLEASE PRINT**

Enclosed is ten dollars for each CARE package

To Be Delivered To:  Check  Money order

\_\_\_\_\_  
 \_\_\_\_\_  
 \_\_\_\_\_  
 \_\_\_\_\_

(Name)

(Street and Number)

(Town and Country)

A RECEIPT, SIGNED BY THE BENEFICIARY YOU NAME, WILL BE RETURNED TO YOU.

(signature of sender) (Date)



### OXYGEN TANK



Loaded with aviator's breathing type oxygen at 1800 pounds pressure. Tank measures 13 1/2 x 5 1/2 inches with rounded ends. Tank is of solid metal fitted with brass release valve at top. Brand new! Loaded—ready for all types of emergency use. Shp. wgt. 13 pounds. A real value! Stock No. 390—Each, only \$3.50

### MESS KITS

Regulation two-piece Army Mess Kits with folding handle. Used, but perfect. Weight 2 lbs. Ea. 69c

### CANTEENS

Reg. U. S. issue canteens. Plastic screw top chained to body. Slightly used but perfect. Wgt. 1 lb. 117—Metal 118—Plastic—Ea. 69c

**CANTEEN CUPS**  
All metal. Folding handle. Wgt. 1 lb. No. A120—Each... 25c

**CANTEEN COVERS**  
Heavy canvas. Button fastener. New No. 530—Each... 69c  
Used No. 119—Each... 35c

### WIRE CUTTER

Heavy duty type with compound leverage. Cuts up to 1/4 inch wire. Extended upper jaw acts as feeder to cutting edges. Insulated handles. Ideal for farm fence work and shop use. Shp. wgt. 2 lbs. Stock No. 392—Each \$1.95

**HEAVY DUTY RUBBER GLOVES**  
BRAND NEW

Extra heavy—extra long. Brand new, high quality gum rubber for softness and ease in use. Designed for heavy duty industrial service—protection in handling chemicals, acids, etc. A real bargain at this low price. Stock No. 295—Per Pair, Only... 79c

### AMMUNITION BOX

Used for 50mm ammunition. Heavy, all metal design with latching top and folding handle. Provides safe, fire-proof storage for valuables, etc. Measures 12x 6x7 1/2 inches. Used but in new condition. Shp. Wgt. 8 lbs. No. 338—Each... 79c

### SUN GLASSES

**ARMY AIR CORPS TYPE**  
Brand new!

Ideal for driving, sun glare, sports and work. 2 1/2 carat gold plate frames with Pyralin aviator bar—adjustable nose bands. Large aviation type lenses. Case included. Shp. wgt. 1 lb. No. 238—Per Pair... \$2.95

### DECORATIVE CHROME STRIPS

For your car, boat, furniture, etc. Highly polished chrome finished strips with clinched edges for flush mounting to any surface. The 3 pound kit provides approx. 15 pieces in lengths from 6 inches to 3 feet and average 3/4 inches wide. Wgt. 4 lbs. No. R224... \$2.00

# WAR SURPLUS AND HUNDREDS OF OTHER BARGAINS

### POPULAR RECORD ASSORTMENT



No. A300—25 Records. All Dance. Wgt. 14 lbs. .... \$4.88

Fifty records of modern dance, race, blues and hillbilly selections. No two alike. Famous name bands and artists included. Used in juke boxes, but guar. perfect. Shipped exp. collect only—no exchanges or refunds. Wgt. 28 lbs. No. A303—50 records ..... \$9.64

No. A301—25 Records. Hillbilly, Race and Blues. Wgt. 14 lbs. Set... \$4.88

No. 302—25 Records. All Hillbilly numbers. Wgt. 14 lbs. Set... \$4.88

### STIRRUP PUMP

Works with any pail or bucket. Shoots a high pressure stream up to 30 feet. Use it for spraying garden and trees, for whitewashing, fire fighting, drainage, etc. Complete with 10 foot flexible hose. All brand new. Regular \$3.80 value. No. 244—Each... \$1.49



### 15 JEWEL STOP WATCH U. S. AIR CORPS SURPLUS

Genuine Elgin 15 Jewel movement. Ideal for split second timing in racing, sports, time study, etc. Full sweep split second hand graduated in 1/10th seconds. Stem wind, start, stop and reset. Used but guaranteed perfect. A splendid value. Shp. wgt. 1 lb. No. 200—Each... \$9.95



### 27 LENSES, ALL NEW, PERFECT.

For experimental work in optics. Consists of 27 precision ground and polished prisms and lens elements in assorted diameters and focal lengths. Big variety positive, negatives, etc. Actual value over \$100.00. A519—27 PIECES... \$7.95



### MCCLELLAN SADDLE



Brand new! Top grade cowhide, 12 inch seat. Halr girth. Has straps for blanket roll and knapsack. Gun boot and sabre loops. A real buy for any horseman. Worth much more. Shipping weight 15 lbs. Stock No. A145. Each... \$16.95

### BAYONET BLADE

Fine forged steel. Ground but not polished. May be made into throwing or hunting knife or spear. Blade 6 3/4 x 7/8 inches, 1 1/4 inches overall. Will take and hold a fine edge. Shp. wt. 1 lb. No. 664-R—Each... 49c

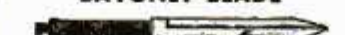

### RUBBER OVERBOARD SUIT

Here is a buy! Fits over your regular clothes and shoes. Can be cut apart for waist high waders, hip high or knee high boots, also arm length rubber gloves. Heavy gum rubber over fabric. Fine for those who work in the water, commercial fishermen, sewer diggers, etc. Use it as is or cut it up for waders. All brand new! Wgt. 14 lbs. Each... \$4.95  
No. 183, Each... \$4.95  
Please include 75c for postage.



### ARMY TENTS—16x16 Ft.

A value you can't beat. Big 16x16 ft. pyramid tent with 4 foot drop wall. Used but in excellent condition. Poles not included. Fine for camping out, carnivals, etc. Worth twice this money. Shp. wgt. 100 lbs. Stock No. 521—\$35.00  
Each only...



### 7 LB. EXPERIMENTER PARTS ASSORT. KIT



A "gold mine" for the radio serviceman. Hundreds of valuable radio parts, new radar and electronic parts and sub-assemblies. coils, resistors, trimming condensers—worth many times this low price. \$1.79  
A130R—7 lbs. .... \$1.79

### AVIATOR'S OXYGEN OUTFITS

Ball out type. Consists of all metal tank, release valve, gauge and breather hose, all enclosed in khaki colored cloth bag. These tanks are loaded with oxygen at 1800 pressure. Ideal for use as reserve oxygen supply for all types of emergency use. Shipping weight 4 pounds. All brand new. Stock No. 391—Each... \$4.95



### SATCHEL POUCH

Heavy canvas pouch. Ideal for toting lunches, shopping, books, etc. Has 11x12 inch pocket. Brand new, guaranteed perfect. Has oversize flap with single strap fastener. A113—EACH \$1.69



### FLEXIBLE NECK FLASH LIGHT

Ideal trouble shooter's flash light. Flexible neck lets you direct light around corners and inaccessible spots. Brand new! Plastic case with BX type neck. Uses 2 standard flash light batteries (less batteries). Shp. wgt. 2 lbs. No. 205—Each... \$1.39



### Officers Watch Compass

Brand new gov't. surplus. Army-Navy model. Single jewel mounted needle. Silver colored dial. A splendid value. Shp. wgt. 1 lb. A174—Each... 98c



### HIGH PRESSURE SHATTERPROOF TANKS

**TYPE D2**  
A high pressure shatterproof tank of 500 cubic inch capacity— for 50 pound pressure or 6.9 cubic feet. All metal—measures 8 1/2 x 2 1/2 inches. Threaded plug end vents. Shp. wgt. 6 lbs. No. 388—\$2.45  
Each



**TYPE F1**  
A high pressure shatterproof tank of 1000 cubic inch capacity— for 50 pound pressure or 13.8 cubic feet. All metal—measures 9 1/2 x 17 inches. Threaded plug end vents. Shp. wgt. 11 1/2 lbs. No. 389—\$3.75  
Each

### WILLARD 1 1/2 VOLT STORAGE BATTERY



A rechargeable, wet plate battery good for years of service. Brand new. Battery is shipped dry but fully charged—any battery station will add acid. Use singly or in multiples for radio sets, bell circuits, alarm systems, etc. Measures 5 1/4 x 4 x 3 inches. Ball floats indicate proper level for filling. Shp. wgt. 4 lbs. Stock No. 297—Each Only... \$2.95

### ORDER DIRECT FROM THIS AD

Values galore! Hundreds of hard-to-find items for home, shop and outdoors. Make remittances by money-order, bank draft or personal check. Send 25% deposit on C.O.D. orders. No C.O.D.'s on orders for less than \$5.00. Include sufficient postage on parcel-post orders—any overage will be promptly refunded. All quotations F.O.B. Chicago. Used items and materials are guaranteed serviceable and as described. Your money back if not more than satisfied.

**BIG ILLUSTRATED CATALOG FREE**  
Dept. PM4  
**STARK'S**  
509 So. State St.  
CHICAGO 5, ILL.



He's on the right track  
he's got **P.A.\***

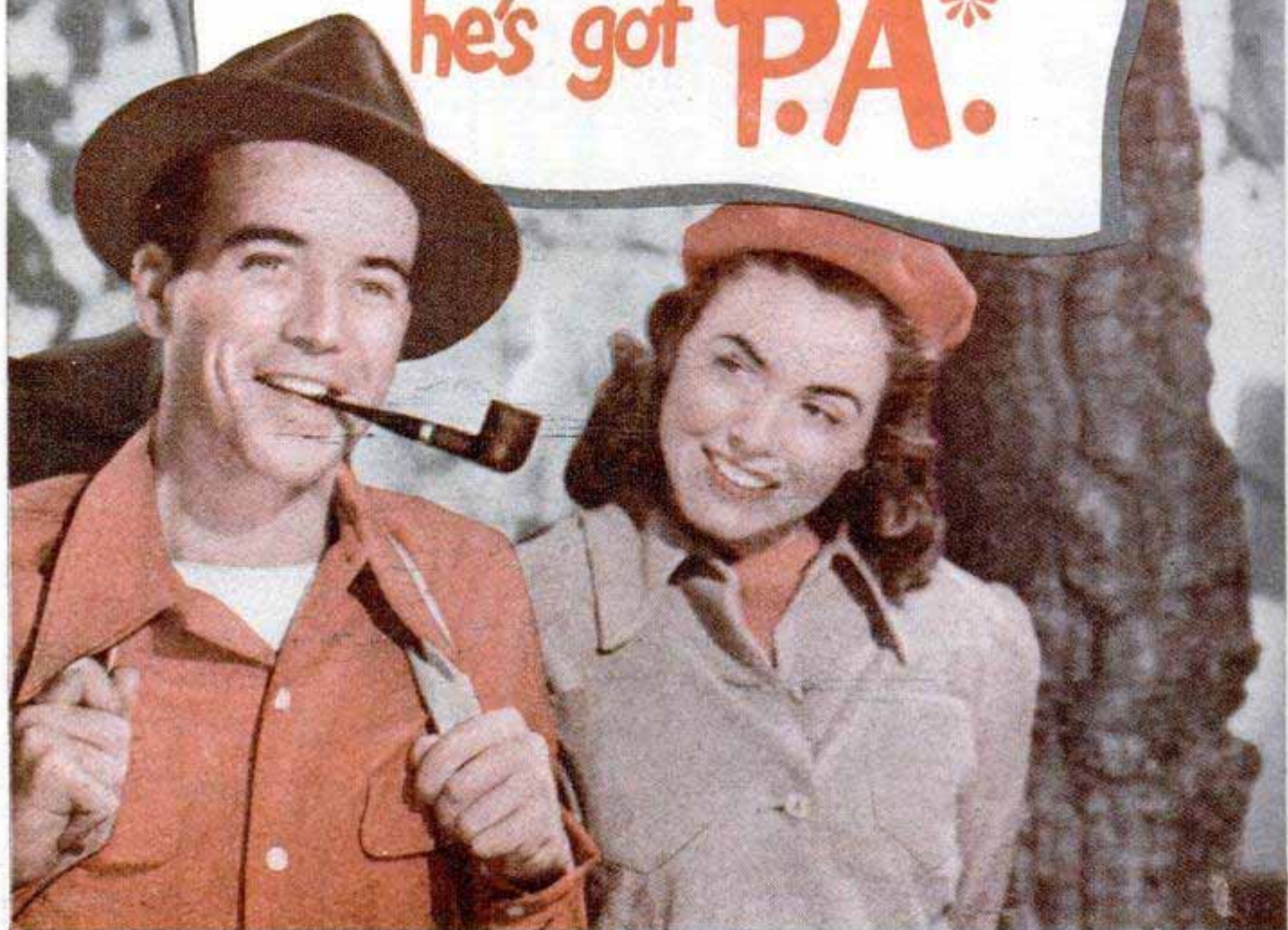

**P.A.\*** means **Pipe Appeal**

—And Pipe Appeal puts you on the right track with the ladies! With Prince Albert, you're sure of smoking joy and comfort, too!

means **Prince Albert**

FOR THE MAKING OF A GREAT CIGARETTE, YOU CAN'T BEAT P.A.! IT'S CRIMP CUT—ROLLS UP FAST AND EASY!



● Long known as the National Joy Smoke, Prince Albert is America's largest-selling smoking tobacco. Try it —and you'll see why! P.A. is rich tasting, mild, easy on the tongue. That choice tobacco is specially treated to insure against tongue bite. Get Prince Albert—in the red tin—at your dealer's.

**The National Joy Smoke**



R. J. Reynolds Tobacco Co.  
Winston-Salem, N. C.



# WE'RE RACING A POWER SHORTAGE

By Bill Reiche

**A**MERICA'S electric power systems, which kept the nation in high gear through 3½ years of unparalleled war production, might now reasonably assume peacetime should bring a breathing spell.

There should be time now to replace over-age equipment and generally to catch up with the parade of expansion and development which had been interrupted by World War II. Experts representing both private enterprise and government stated after VJ day that power demands would ease off and would not approach the national capacity of about 50 million kilowatts for several years.

Last November the Federal Power Commission pointed out how wrong the estimates had been:

"When war production in 1944 was keyed to its highest pitch, the demand for power reached 39.4 million kilowatts. Today it has reached 46 million kilowatts, a 17-percent increase over the wartime high."

It was simply not reasonable to assume that any peacetime activity could embarrass the industry which had kept our mammoth economy "juiced up" through the most demanding war in history. And a classic job it had done. Yankee ingenuity and audacity enabled the power men to squeeze every last kilowatt from a groaning system.

Every old turbine and generator set in the country capable of turning out a few kilowatts was put back into service. The old water wheels at Niagara Falls, long since retired, were restored to service to aid Buffalo's booming war industries.

Steam plants were loaded above their

Top, symbol of the nation's race to provide power is this lofty tower for new 220,000-volt transmission line

← Brush of fine wires detects leaks in gas-filled electric lines. Current grounds on the pipe at break

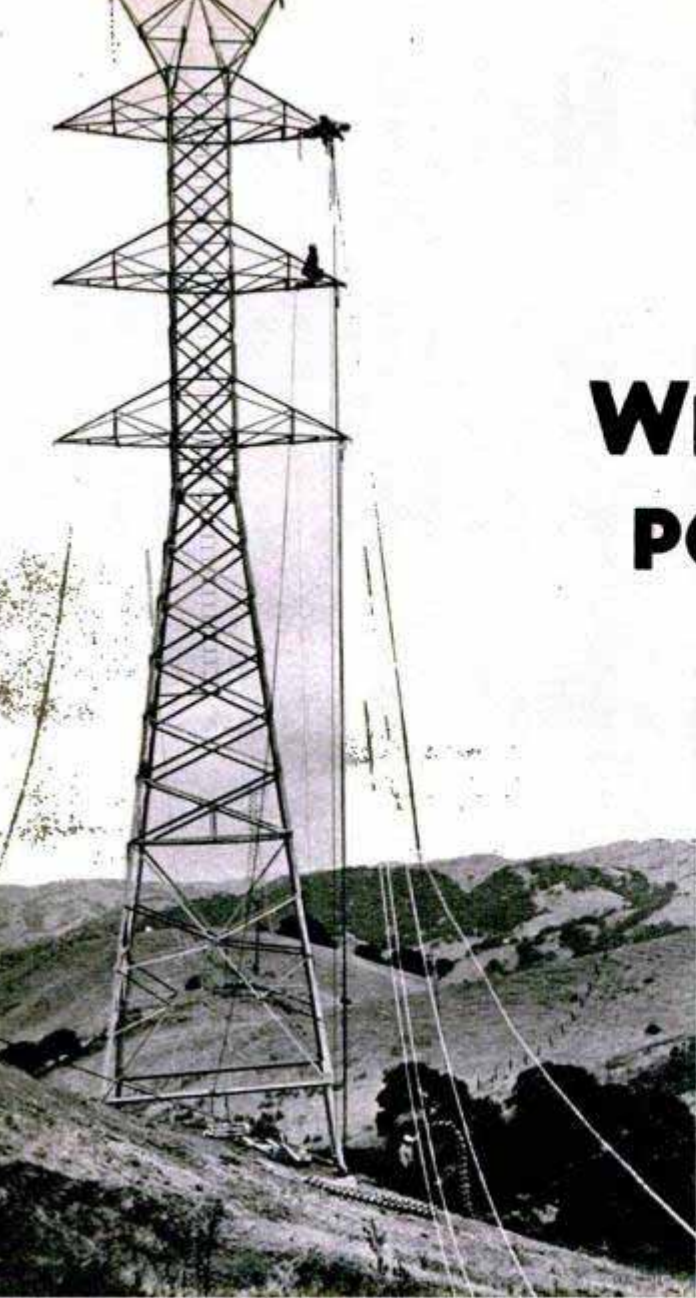

Pacific Gas and Electric Company photos

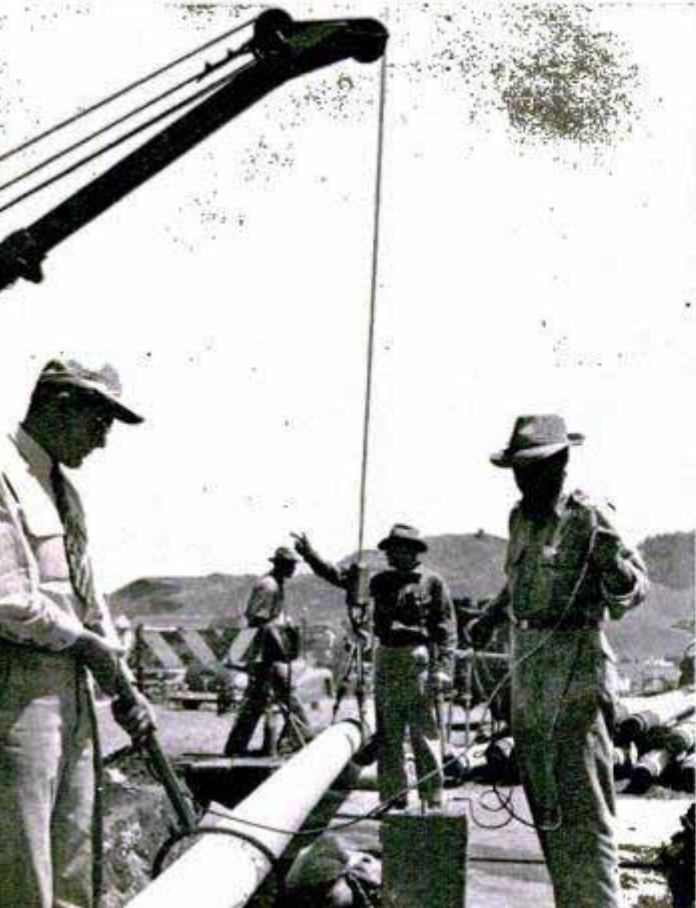



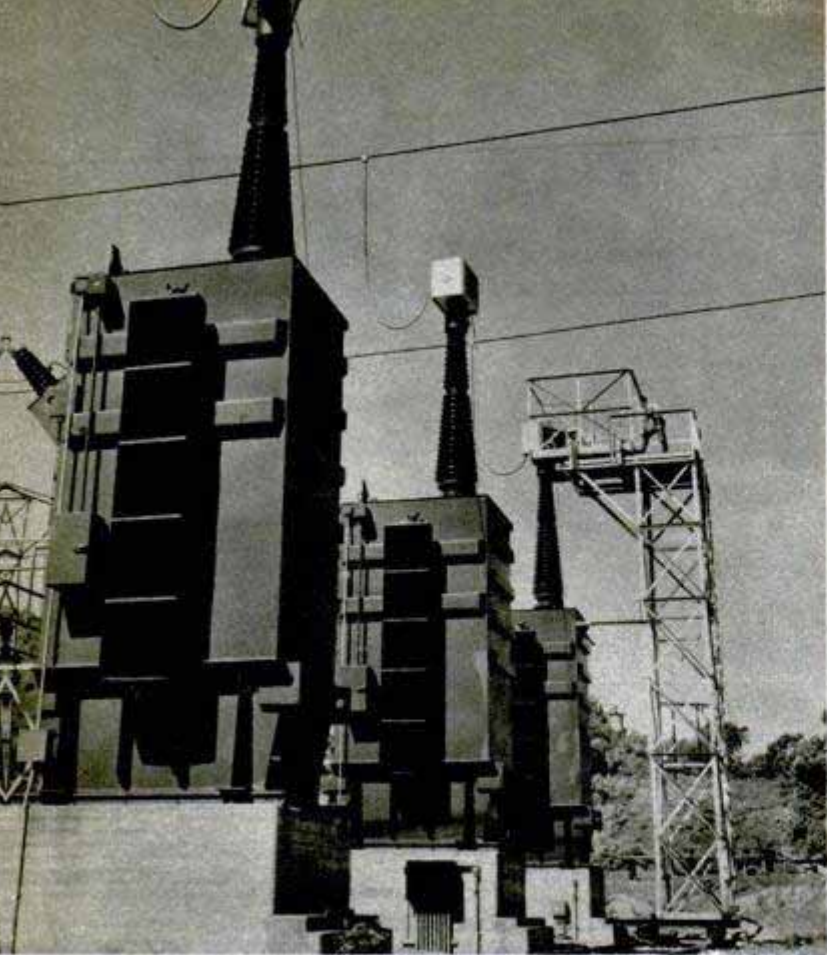

Westinghouse photos

At test station near Brilliant, Ohio, engineers use maze of new equipment shown below in effort to send greater blocks of power than ever attempted. Above, giant transformers will release 500,000-volt current. Above right, meters automatically record results. Right, arrester provides zigzag path for lightning

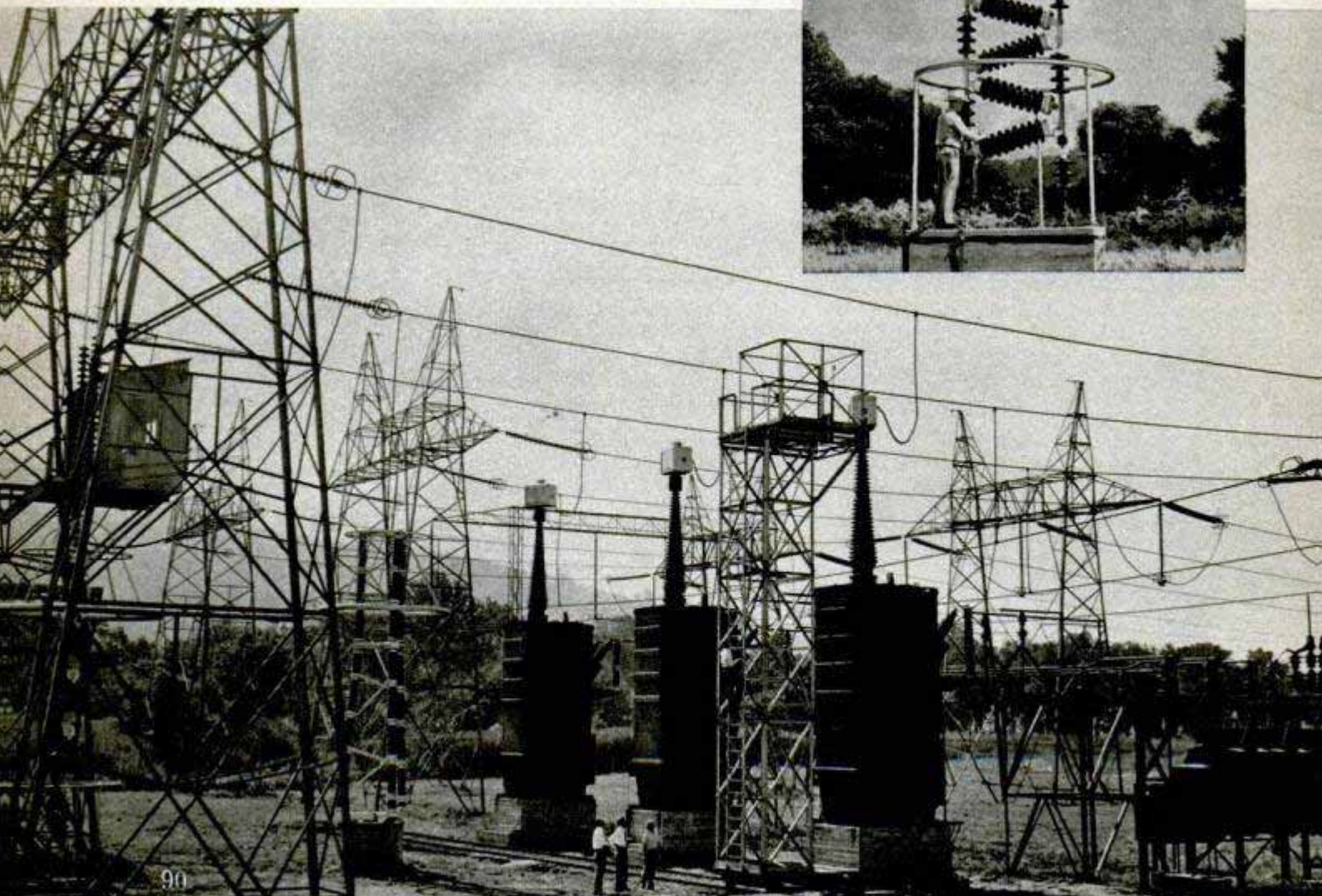
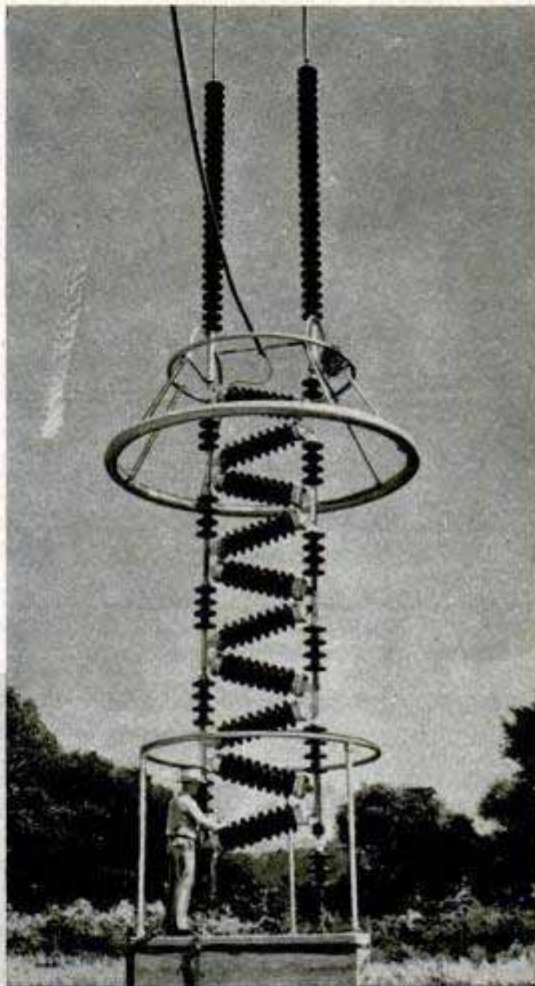



rated capacity until every normal 100-kilowatt capacity became 125 kilowatts. Insulation deteriorated at an abnormally rapid rate with the increased heat; transformer banks with a capacity of 50,000 kilovolt amperes were made to handle 60,000 and got so hot they had to be sprayed with water from hoses. Overloading such as this could, in two years, cut the life of equipment by 10 years.

The industry also made extensive use of a device designed to prevent the putting of all the electrical "eggs" in one basket—the power pool. Such pools are the joining, by inter-connections, of two or more adjacent systems for the purpose of transferring surplus power from one to the other. They are particularly useful in times of emergency or when one of the systems depends heavily on hydro-power and may encounter difficulties owing to drought.

One of the largest power pools of the war years was formed in 1941 when the combination of a shortage of rainfall in the Tennessee Valley and rising power demands caused a serious shortage in Tennessee, Alabama and Georgia. Assistance was received from Virginia, the Carolinas, Pennsylvania, Illinois and other North Central States, Kentucky, Florida and the Southwest via Arkansas. As much as 42 million kilowatt hours a week—enough to light 420 million 100-watt lamps



Big as a house, each 144,000-hp. generator at Grand Coulee turns water power into electricity. Boulder switching yard (below) is striking symbol of power

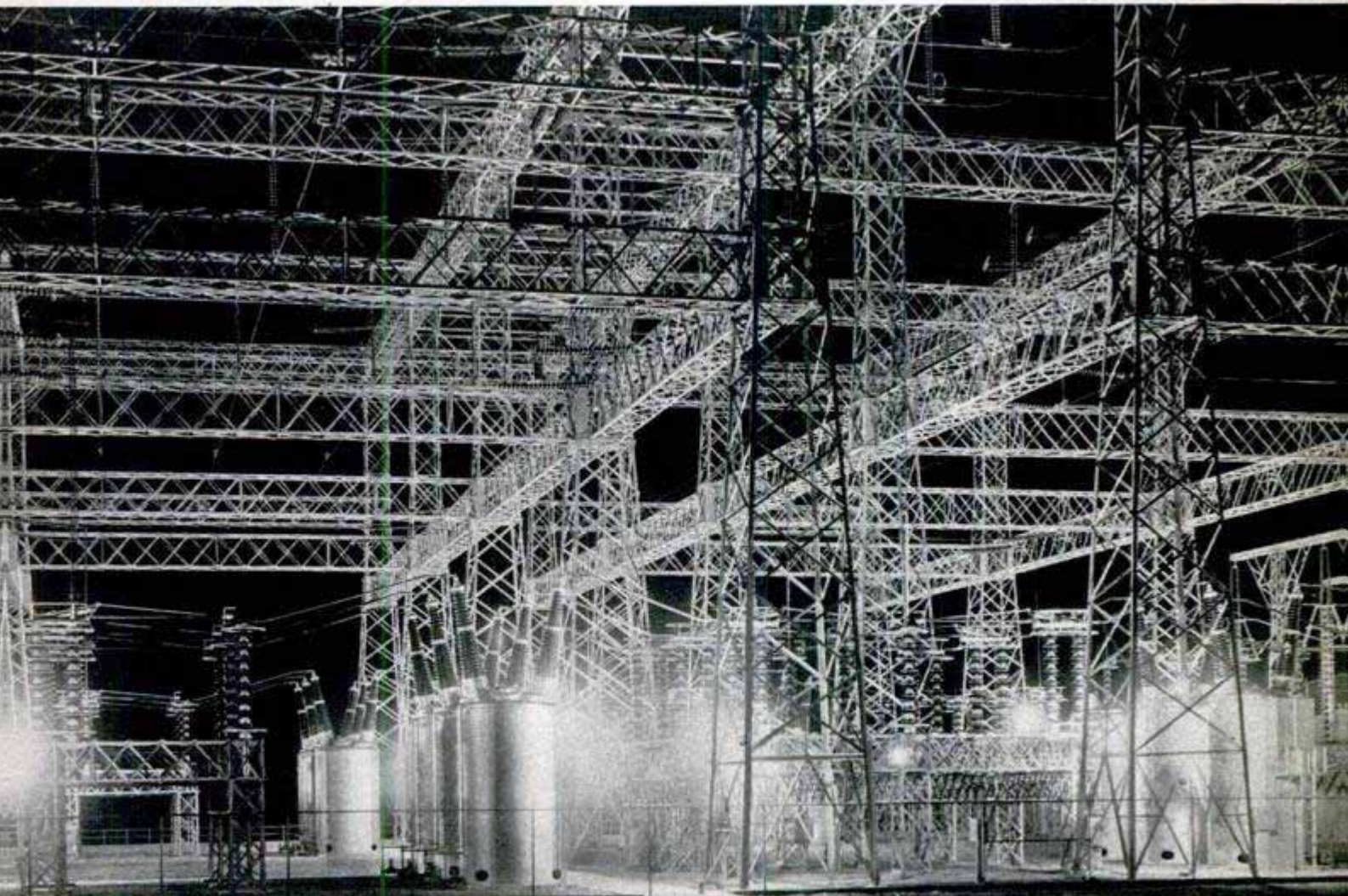



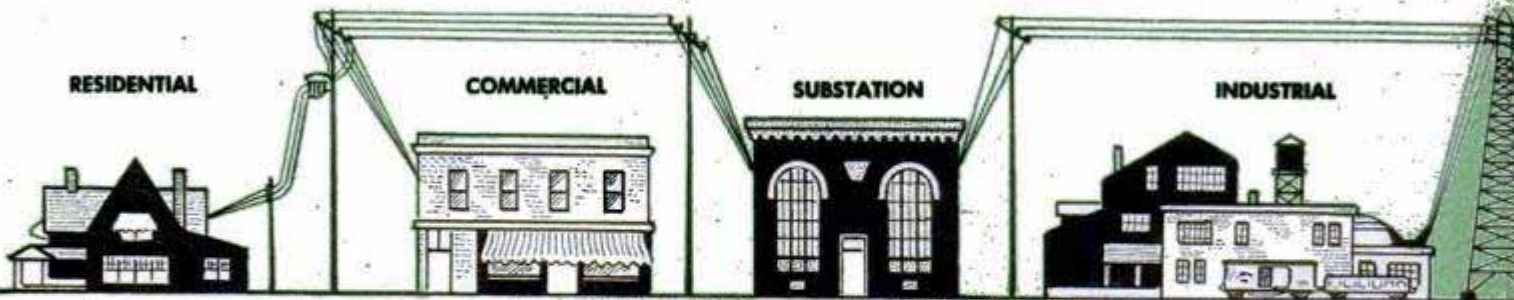

**CHARTS SHOWING HOW U. S. ELECTRIC-POWER DEMAND HAS OVERTAKEN SUPPLY 1939 - 1947**

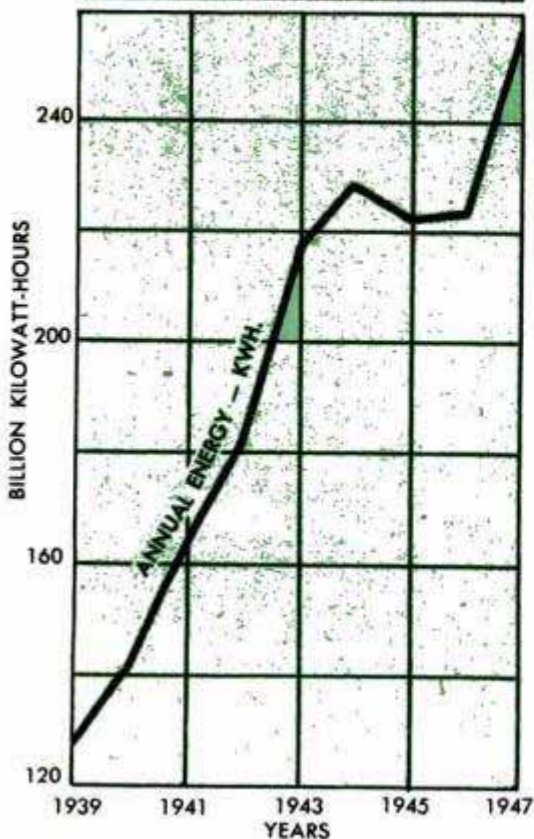
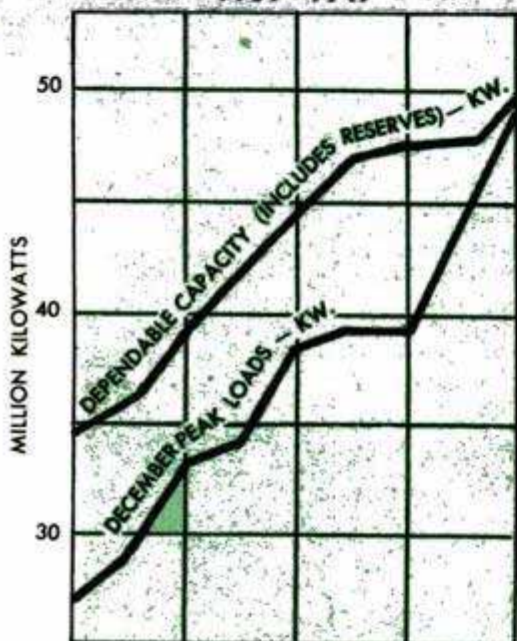

for one hour—were brought into the distressed area. Power pools were used almost constantly during the emergency in many parts of the country. “Longest” of these was the Southwest Pool, which extended from Texas, through Louisiana, Arkansas, Oklahoma and Kansas, into Nebraska. In this pool, reserves were often as far as 500 miles from where they were needed and the power was shuttled from system to system.

Before going on with the 1948 power picture, it might be well to outline briefly how electricity is generated and transmitted to home and industry.

The two primary sources of electrical energy are fuel

← Top chart shows how peak loads are pushing dangerously close to capacity. Line on bottom graph shows increase in the power output

↓ Gleaming generator boosts power supply in western Pennsylvania

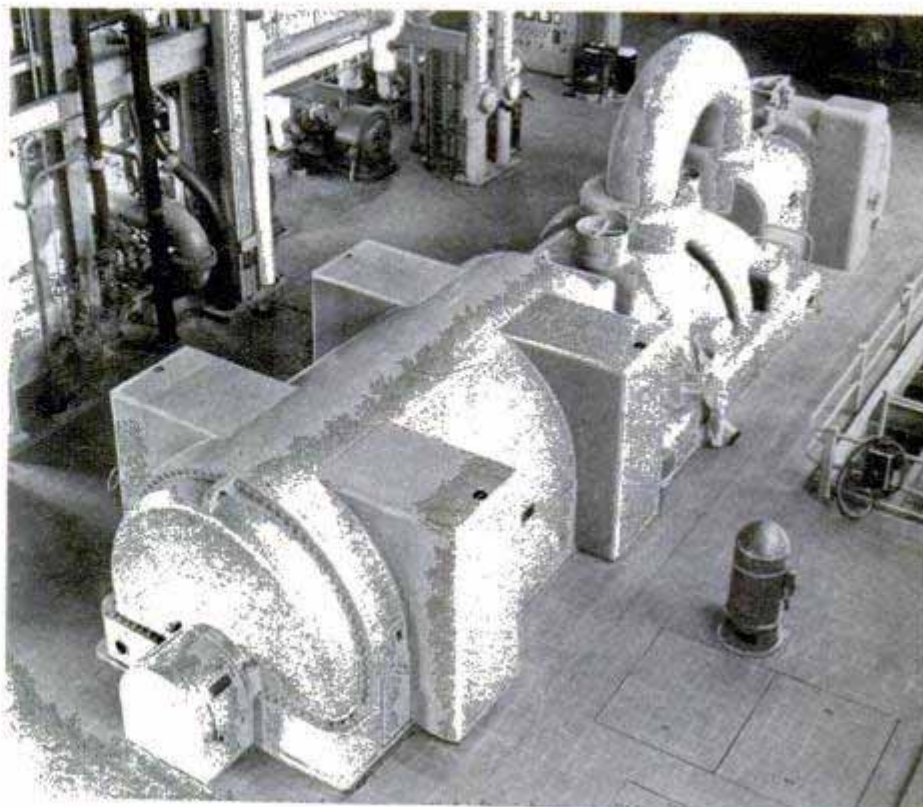



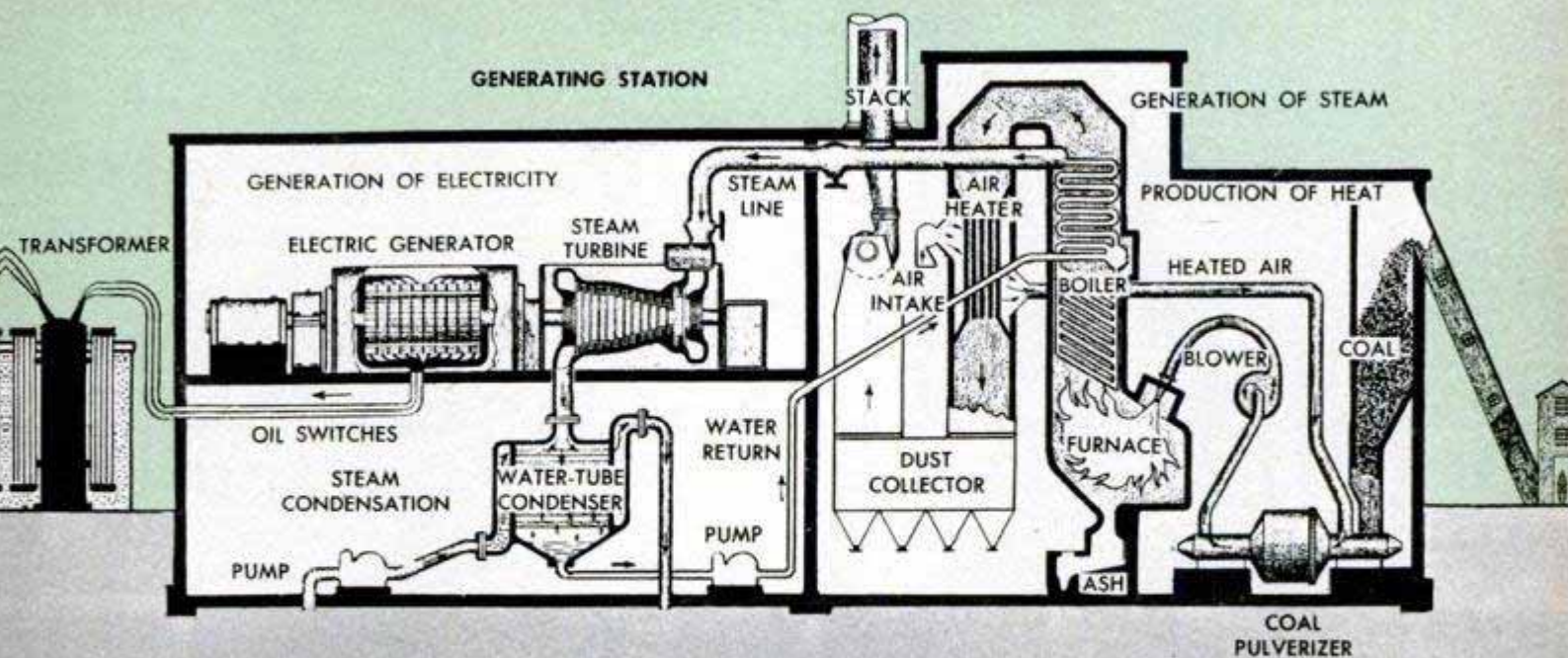

Diagram shows how a modern city is supplied with power. Coal which enters at right comes out as electricity

and water. About 65 percent of the nation's power comes from fuel, 35 percent from water. In the former category, roughly 77 percent was coal, 10 percent fuel oil and 13 percent natural gas during the first 10 months of 1947.

The fuel is burned beneath hundreds of tubes containing water, which is thus converted to steam. The steam is collected in a drum atop the boiler and is discharged through nozzles into the turbine, an en-

closed device resembling a windmill except that its blades are motivated by steam rather than air. The steam passes several sets of blades and proceeds to a condenser, where it is converted back to water and returned to the boiler. Through a common shaft the turbine drives the generator, which, in simplest terms, consists of a large electric magnet rotating inside a coil of heavy copper conductors.

(Continued to page 264)

Master control board at Chattanooga registers all power produced by TVA—some 14,000,000,000 kwh a year  
TVA photo

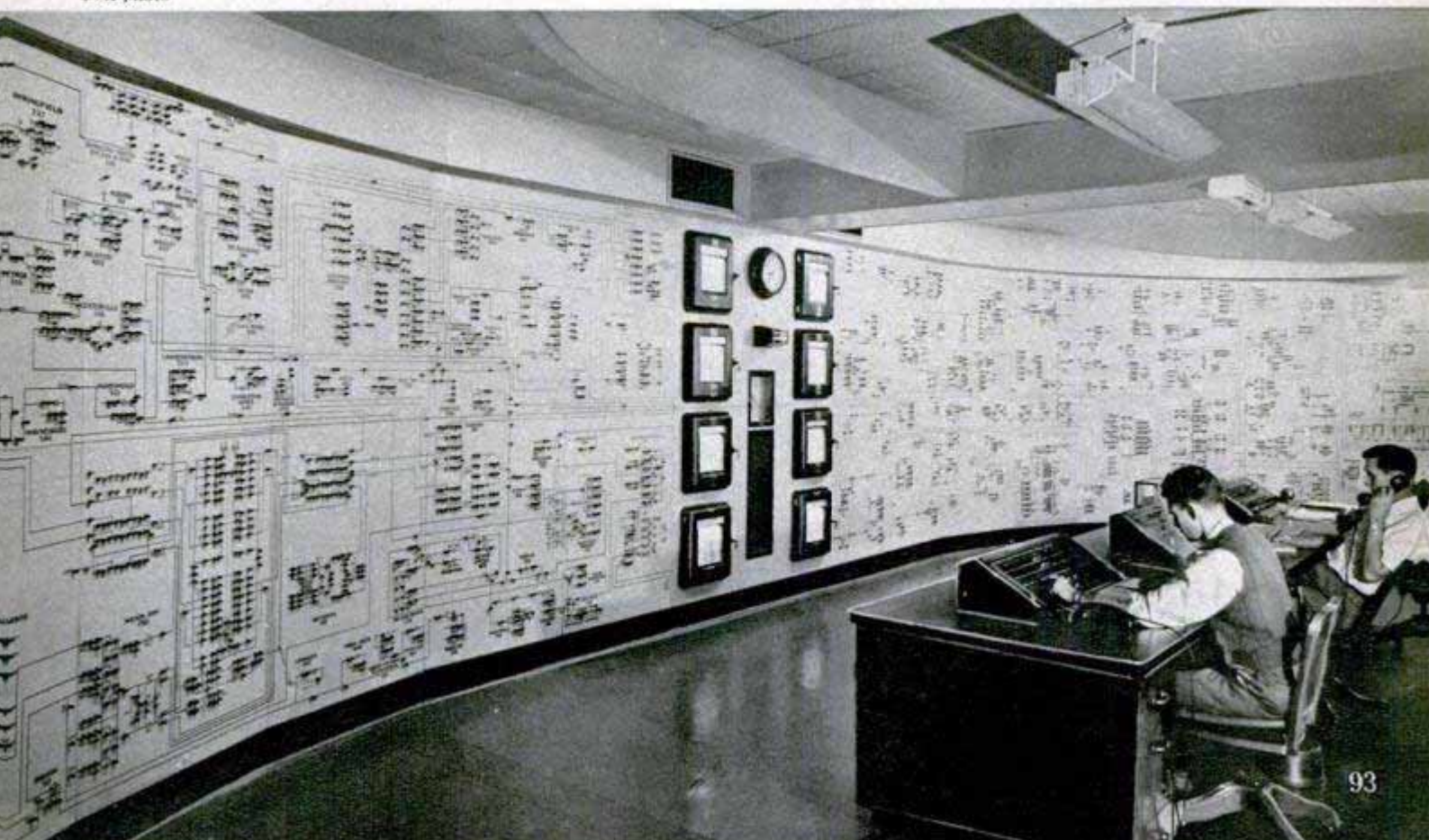





Street lights have to operate during all kinds of weather. A new model is tested for waterproofing under roof-top shower

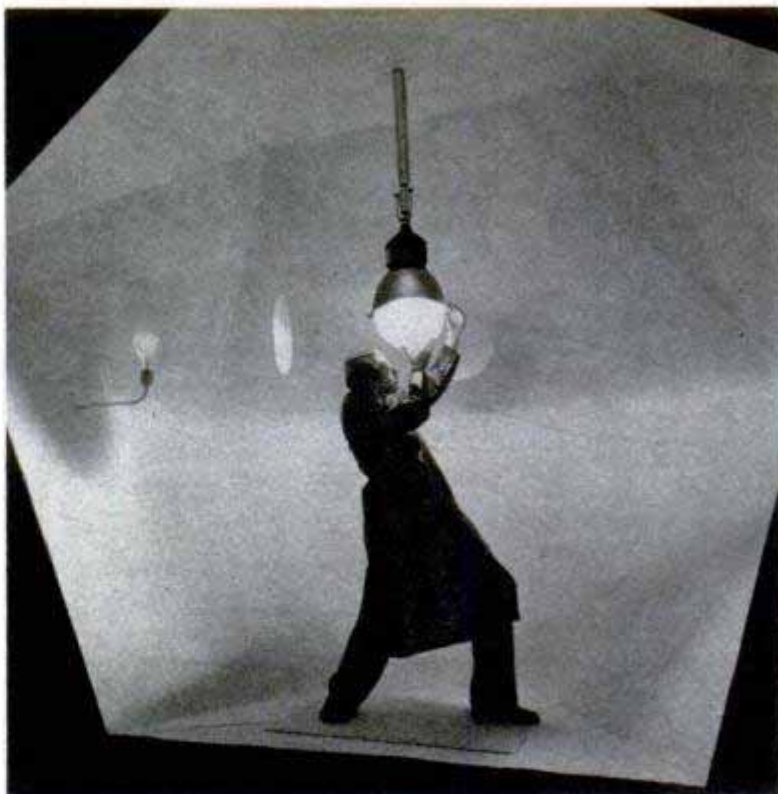

## SHEDDING LIGHT ON LIGHTING

There's an untraveled, dead-end street in Cleveland that's one of the world's "Great White Ways." It is a street-lighting testing ground used by Westinghouse engineers. The miniature Times Square is only one branch of the laboratory. Inside tests are conducted in a building that has black walls, ceilings, floors and furniture to prevent light reflection. One exception is a shiny, white-walled room (above) that opens into two halves like a walnut shell. The walls consist of 20 flat sides giving it the name of "icosahedron." Its white interior provides perfect light reflection, according to the engineers. A small photocell on one wall measures light output of new designs.



Light intensity of new street lamps is tested (above) by means of big mirror shown at left. The mirror is moved around in a giant circle to reflect the light from the football-shaped lamp at right. The reflected light is measured with a photoelectric cell located about 25 feet away. An engineer controls the position of the mirror which enables him to make many readings without moving the light

Irregular-shaped "umbrella" attached to street-lighting unit is a plastic model of the way light beams from the lamp are reflected. Most rays are directed along the street providing maximum illumination of the pavement. This means fewer accidents for pedestrians and motorists





## Boatswain's Chair Aids C-99 Mechanic

To inspect and maintain the 57-foot-high tail of the Air Force's giant C-99, the builders borrowed a trick from seafaring men. They knew hydraulic stands couldn't be raised that high and few fields would have stands tall enough. Ingenious engineers at Consolidated-Vultee rigged up a boatswain's chair on the end of a block and tackle, hoisting it into place with a pulley built into the fin for that purpose. It will be a permanent part of the plane's inspection and maintenance facilities.

## Atom Clocker

Speeds of atomic particles can be clocked to one thousandth of a millionth of a second with a new electronic "stop watch." It also counts the particles and determines their energy in nuclear reactions. Developed at Yale University, the instrument is a combination of conventional vacuum tubes and standard electrical equipment. Its operation is based on

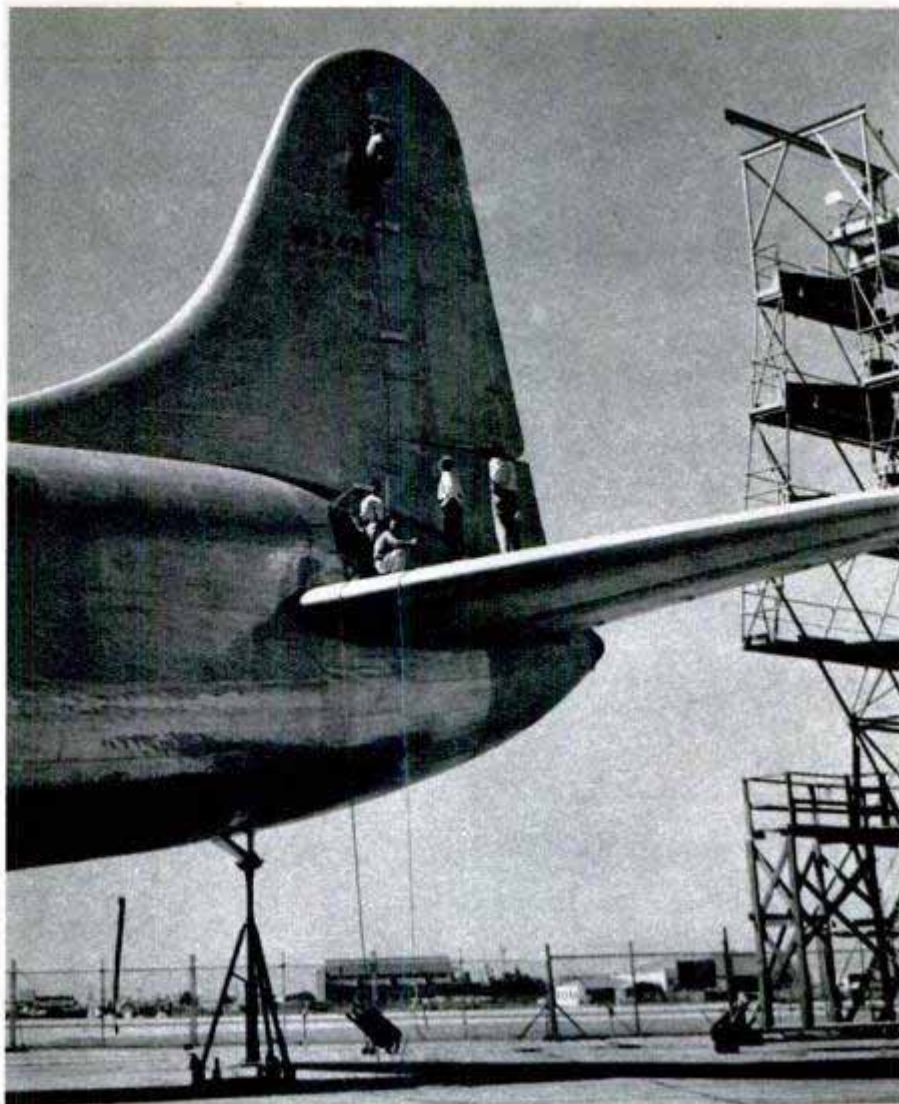

Consolidated-Vultee Aircraft photo

synchronizing electrical counters that detect a pulse in the circuit. The timing is done by measuring the delay inserted in the circuit to synchronize the counters.

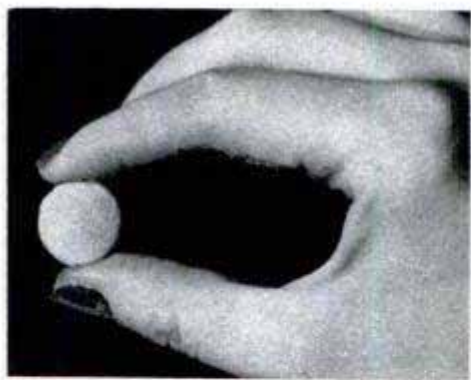

## Button Maker

Buttons can be fabric-covered to match clothing with a kit that contains the button parts and necessary tools. A circle is cut from the desired fabric and placed in a holding tool together with the two metal parts of the button. Another tool is inserted and struck with a hammer to fold the excess fabric between the halves of the button and crimp the metal edges, forming a neat, covered button. The buttons require no special care and may be laundered. Parts for 12 buttons are provided in the kit, and refill packages are available.



# Here's the new crop of light cars



By Wayne Whittaker

**T**HIS is one automobile story that could be told without once mentioning the magic Motor City of Detroit. It is the story of a "minor league" revolt against the conservative full-size product that has made Detroit famous.

Some of the "leaders" of this revolution have such un-Detroit attributes as rear engines, three wheels, two cylinders, the ability to travel 50 miles on a gallon of

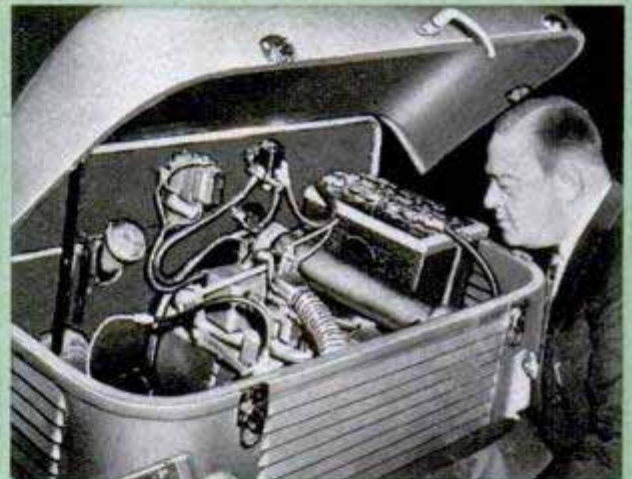

There's plenty of room for packages (top) under hood of Towne Shopper. It has 2-cyl. rear engine. Car goes 50 miles on gallon of gas

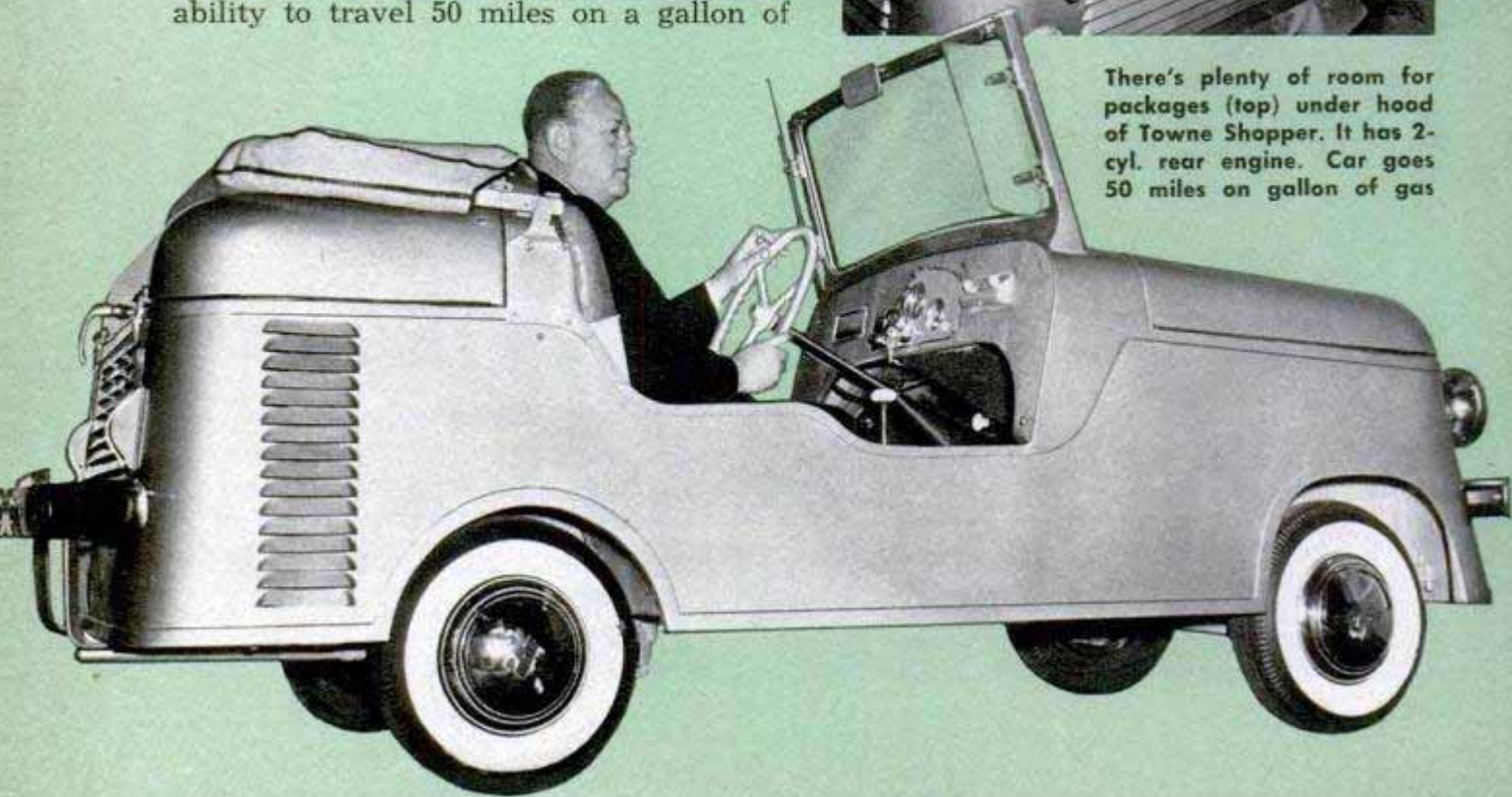



gasoline, and the starvation weight for at least one of only 600 pounds!

Let the curtain go up on a drama that may make U. S. automotive history. Take a bow, Cincinnati and Toledo, Ohio; San Diego, Van Nuys and Los Angeles, Calif.; Huntsville, Ala., and Buffalo, N. Y.

What's all the shouting about? Answer: A new crop of lightweight cars that will be pouring from assembly lines this year from coast to coast. Two veteran manufacturers of these cars (Crosley and Willys-Overland) are in production and at least five other newcomers to the field expect to be in mass production by the end of the summer. The Crosley output for 1947 (19,684 cars) and Jeep station wagon last year (33,307) are only drops in the bucket to the 400,000 small cars which optimistic manufacturers hope to build in 1948. Willys-Overland alone has production plans for 240,000 Jeeps. Some manufacturers predict that the figure for 1948 may be doubled next year, including cars built for export.

These light-car manufacturers are betting many millions of dollars that their plans will succeed. Bringing out a new car, however small, runs into figures that would

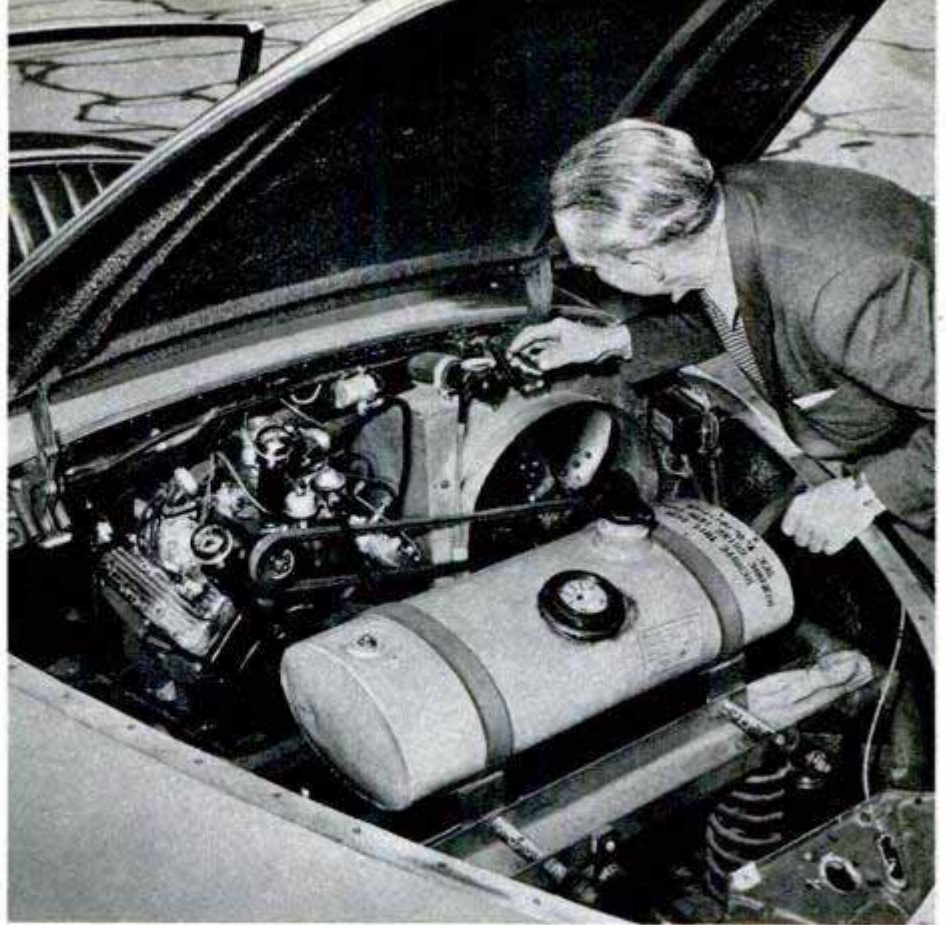

Radiator of the streamlined rear-engine Rocket is mounted alongside engine

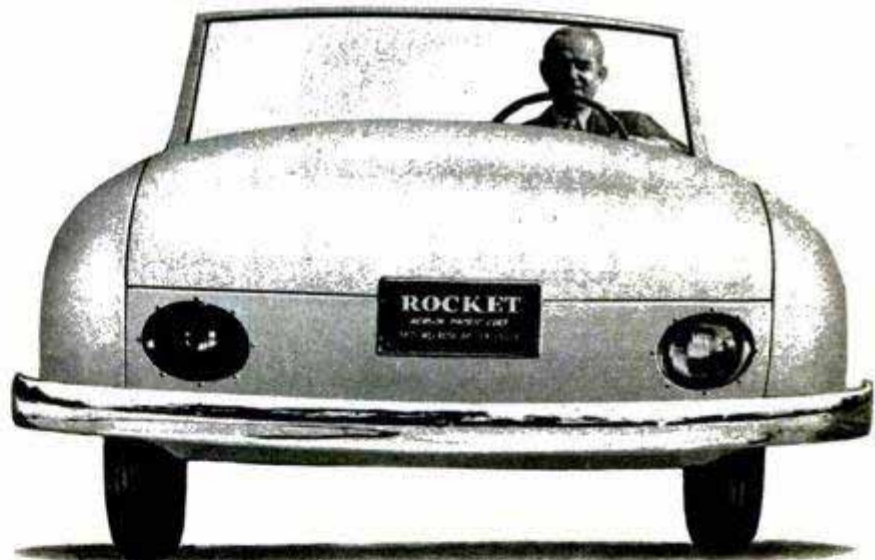

Top of Rocket's windshield is only 4 feet 4 inches above road. Below, note the padded instrument panel

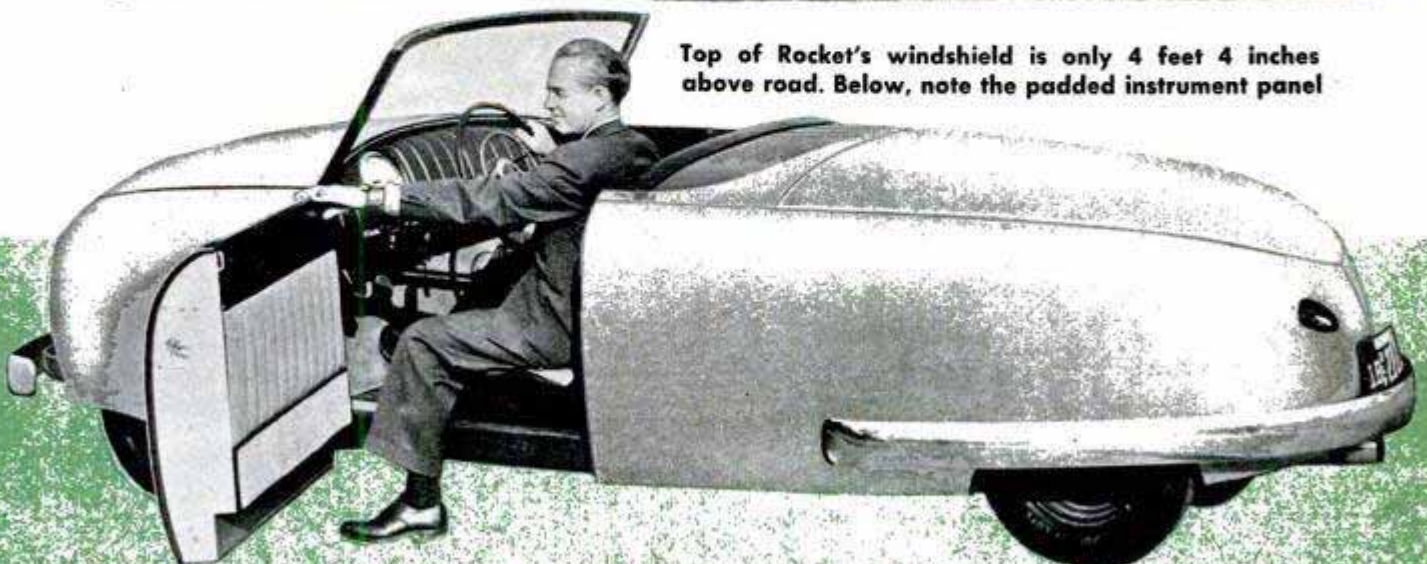





Crosley convertible is one of six '48 Crosley models

stagger any small-time operator. The little Towne Shopper, for instance, which will be built to sell for \$595, occupies a San Diego factory containing \$500,000 worth of tools and dies. The maker of another small car estimates his costs of getting into mass production at around \$15,000,000.

Light-car manufacturers are well aware of a long-time prejudice against small "foreign looking" cars on the part of the U. S. public; also the fact that Americans in general are supposed to like everything big. The manufacturers expect to beat down this prejudice — or



Powel Crosley, Jr., displays a new model sports utility car. Ideal for hunting or fishing trip, it holds two passengers and can carry 500 pounds of baggage. Below, another newcomer is smart all-steel Crosley station wagon with ample room for four passengers

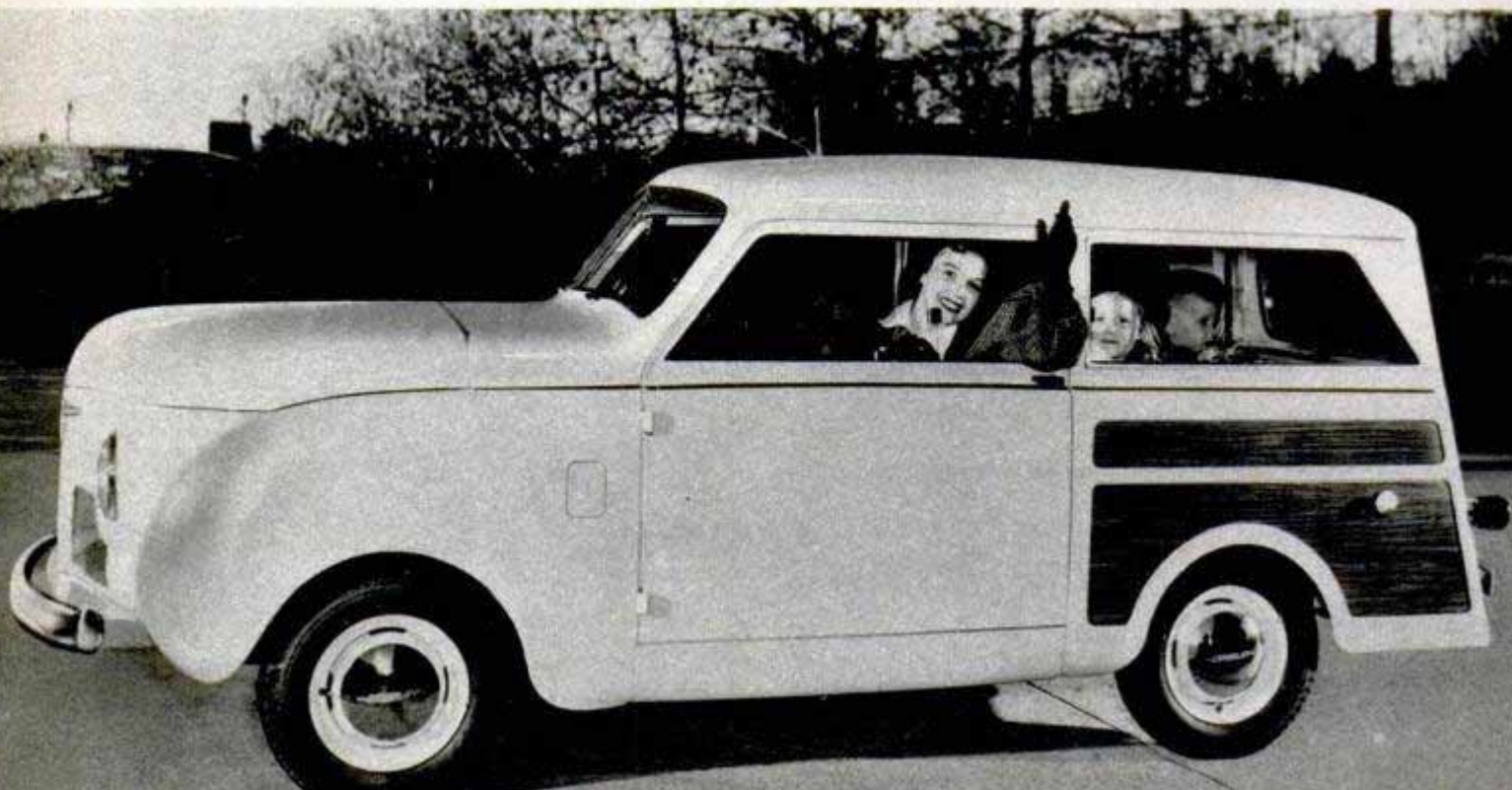



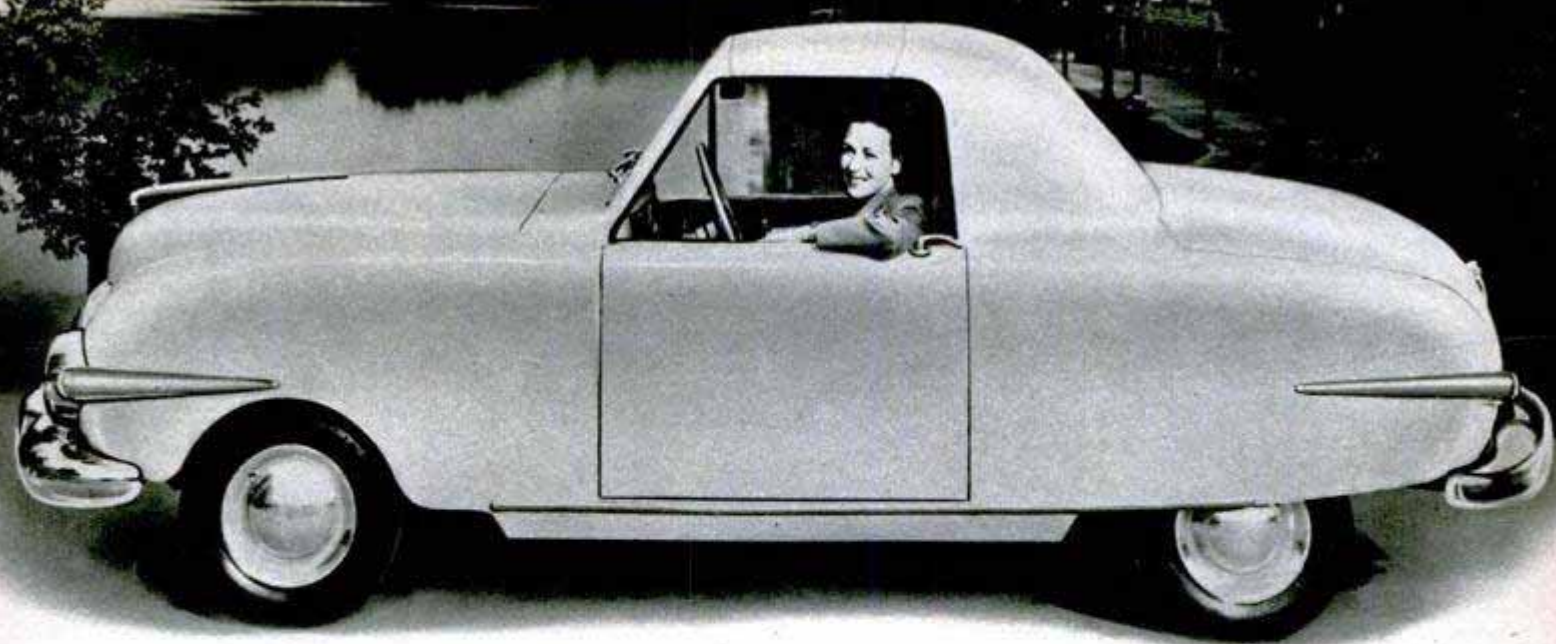

Playboy convertible coupe features an all-steel disappearing top; the 51-inch seat holds three passengers

habit—with low prices, excellent mechanical performance, beauty of exterior and interior design, variety of models, comfort, maneuverability and economy of operation. In the past, they say, there was little choice in the type of light car a man could buy. Soon he will be able to take his pick from sedans, racy-looking sports cars, coupes, convertibles and sturdy station wagons such as the new Keller and the Crosley. Both of these station wagons will be built to sell for many hundreds of dollars less than standard cars of this type.

Rising costs of rent, food and gasoline are other major factors in the manufacturers' thinking. When a light-car owner tells his neighbor that he has just returned from a 1700-mile business trip with car expenses

totaling \$11, it inspires the neighbor to do some serious thinking—and comparing. (The trip referred to was made in a Crosley through Kentucky and Arkansas.)

Crosley Motors at Cincinnati is offering six 1948 models which consist of station wagon, sports utility, panel delivery, sedan, convertible and pickup truck. All are powered by the 59-pound Crosley Cobra four-cylinder engine of 26.5 horsepower. Top speed of the Crosley is about 60 miles an hour and gasoline consumption ranges from 36 to 50 miles per gallon, depending on speed and load.

The new Crosley station wagon is of all-steel construction and will accommodate four passengers or two passengers plus ¼ ton of baggage or other cargo. It is

### COMPARATIVE SMALL-CAR CHART

	CROSLY*	DAVIS	JEEP* (Station Sedan)	KELLER* (Chief Convert.)	PLAYBOY	ROCKET	TOWNE SHOPPER
Engine	Valve-in-head, 4 cyl. 26.5 hp.	4 cyl. 60 hp. Hercules	6 cyl. 70 hp.	4 cyl. 25 hp. L-head	4 cyl. 40 hp. L-head Continental	4 cyl. 65 hp. or 6 cyl. 95 hp.	2 cyl. 10.6 hp.
Wheelbase	80 in.	108 in.	104 in.	92 in.	90 in.	106 in.	63 in.
Over-All Length	145 in.	180 in.	175 in.	160 in.	156 in.	161 in.	116 in.
Weight	1150 lbs.	1385 lbs.	2968 lbs.	1800 lbs.	1900 lbs.	2000 lbs.	600 lbs.
Top Speed	60 plus	116 m.p.h.	70 plus	60 plus	70 m.p.h.	75 with 4 cyl.; 95 with 6 cyl.	50 m.p.h.
Gasoline Consumption	36-50 m.p.g.	30-50 m.p.g.	25-30 m.p.g.	35.6 m.p.g.	30-35 m.p.g.	30 m.p.g. with 4 cyl.; 25 m.p.g. with 6 cyl.	45-50 m.p.g.
Tires	4.5x12	5.50x15	6.00x15	6.00x12	6.00x12	6.40x15	4.00x8
Price (F.O.B.)	\$799-\$929	\$995	\$1865	\$848	\$985	About \$1500	\$595

\*Specifications for only one model of Jeep and Keller are used in chart. Crosley figures are uniform for all models except price as is noted.



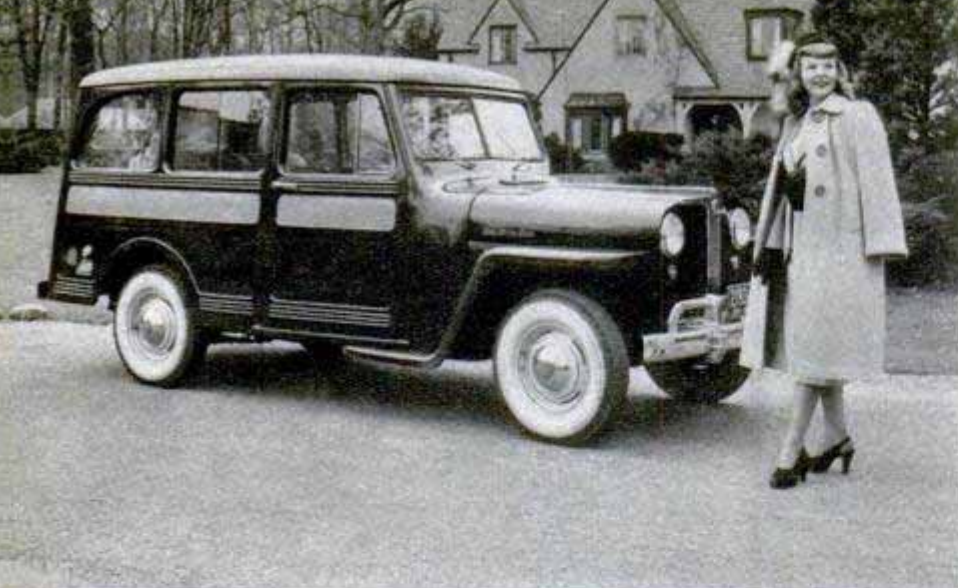

**First Jeep with a six-cylinder engine is this deluxe station sedan; it has the interior finish of a conventional passenger car**

designed for family use, business or farm hauling. The Crosley sports utility car, lowest priced in the line (\$799 F.O.B. Marion, Ind.) is a sporty two-passenger job handy for hunting, fishing and recreational trips. With its fabric top in place, the sports car has the same interior dimensions as the station wagon and provides about 45 cubic feet of space for 500 pounds of cargo. It can be converted into a four-passenger auto with the addition of a double rear seat. Another Crosley newcomer is the panel-type delivery truck designed for dry cleaners, grocers, druggists and other types of business where the merchandise handled is neither bulky nor excessively heavy. Sides and top of the two-door panel truck are of 20-gauge steel.

The Crosley company has big production plans for 1948 with a goal of 3000 cars and trucks a month. The number of dealers (now 700) is expected to be doubled by summer.

The Davis Motorcar Company in Van Nuys, Calif., has been exhibiting pilot models of its three-wheeled car in various cities about the country. This four-cylinder 60-horsepower car weighs 1385 pounds and travels 35 to 50 miles on a gallon of gasoline at speeds up to 116 miles an hour, according to the inventor, Gary Davis. This single-seat, teardrop-shaped car is 72 inches wide and seats four persons. Its Hercules engine is the only part not produced in southern California.

Initial production plans call for 50 cars a day and the company has hopes of boosting this figure to 1000 daily!

Willys-Overland at Toledo, Ohio, is hitting its stride this year with seven Jeep models in production, including a \$3500 fire engine, and an eighth model (sports phaeton) due to roll from its assembly lines next month. Some of the new Jeeps, particularly the station sedan, are a far cry from the old GI work horse. The station sedan (see comparative chart) and delivery car are moving out of the light-car class with weights only slightly under those of standard cars. However, wheelbase and over-all length are considerably less.

The Jeep station sedan has a new six-cylinder 70-horsepower engine which is

**Production on this Jeepster sports phaeton will begin next month; its paint job will be fire-engine red**

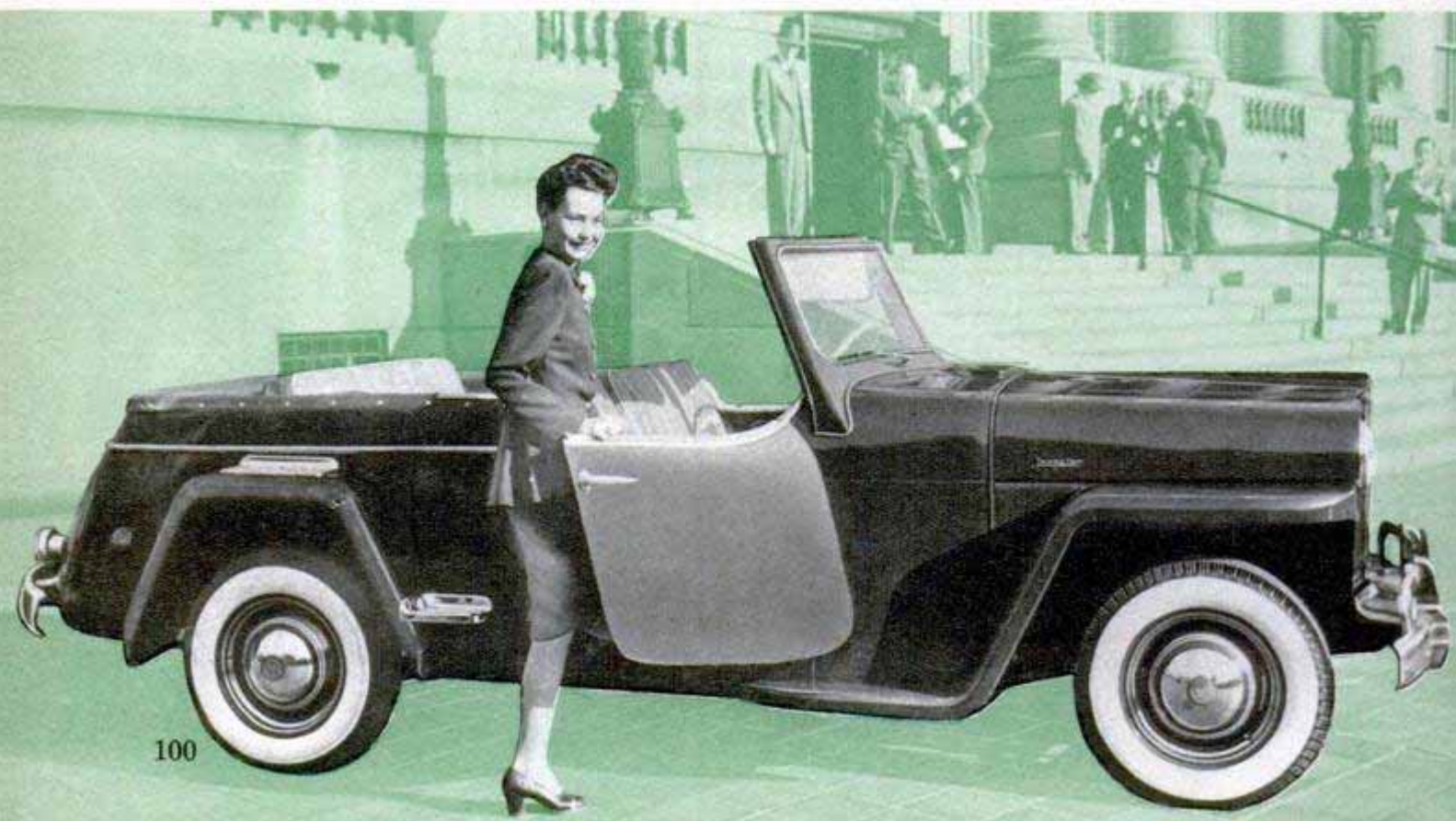



George Keller, light-car manufacturer, sits at wheel of a Keller Super Chief convertible. In this model a buyer is given a choice of front or rear engine; chassis is shown below with rear engine. Each wheel is independently suspended with rubber torsion springs; brakes are hydraulic

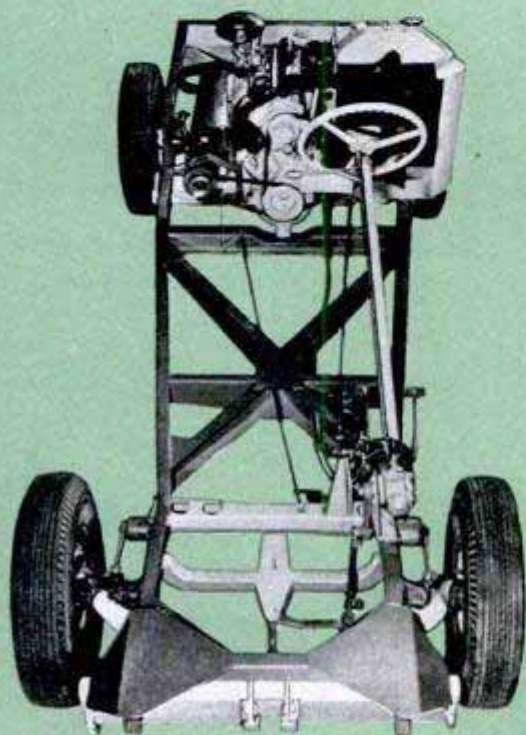

faster and more powerful than the regular 4-cylinder engine in the other models. The engine is L-head type with a 3-inch bore, a 3½-inch stroke and a displacement of 148.5 cubic inches.

Keller Motors at Huntsville, Ala., is getting into production at a converted wartime plant with a smart station wagon which will be followed later in the season with a convertible model. The Keller has an unusually substantial appearance for a lightweight car and has some outstanding mechanical features. All four wheels are independently suspended with rubber torsion springs; brakes of a standard design are fully hydraulic, and the 4-cylinder 25-horsepower engine can be placed either front or rear in the convertible. George D.

(Continued to page 256)

Gary Davis drives his new three-wheel teardrop-shaped Davis car 35 to 50 miles on gallon of gasoline

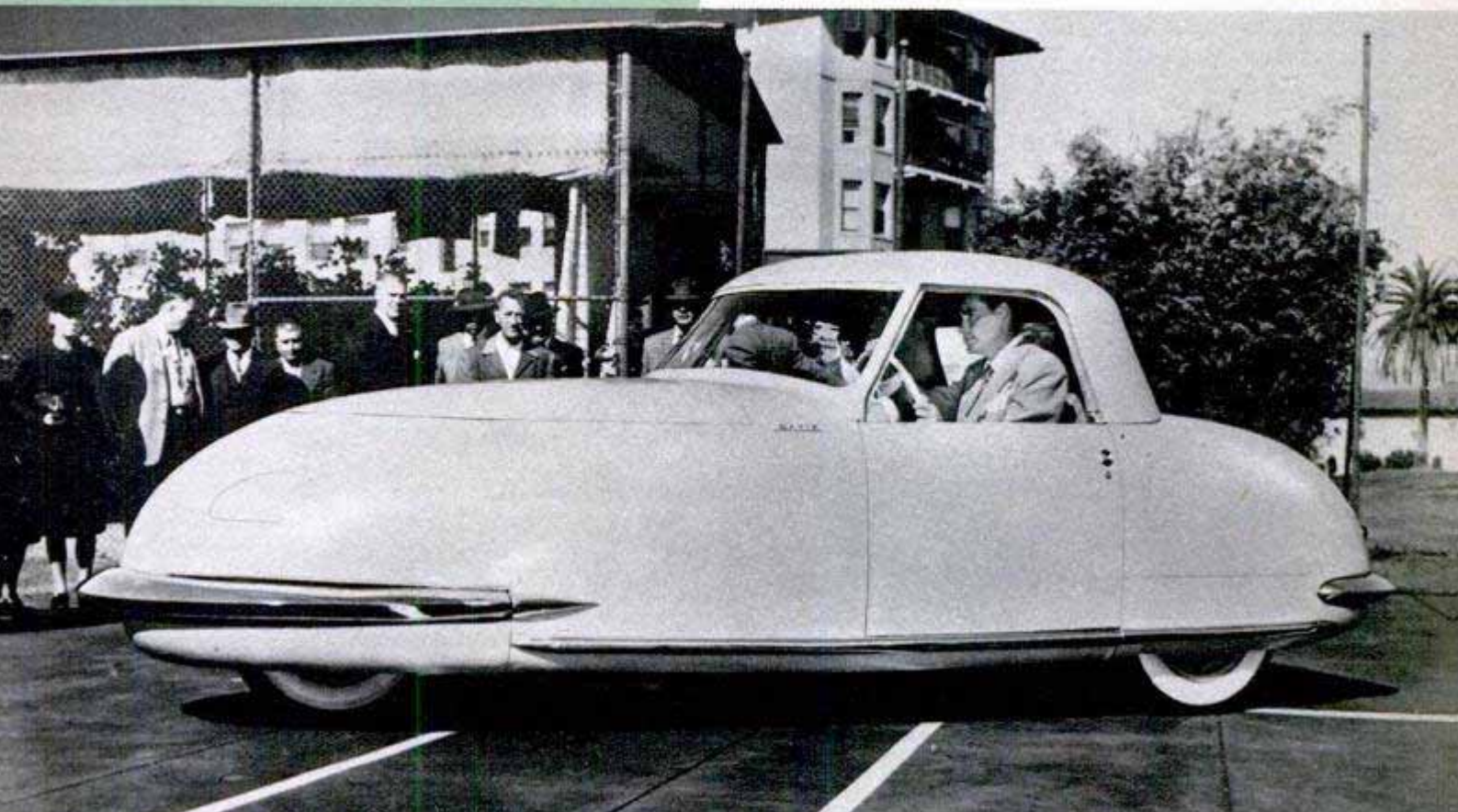





U. S. Navy photos

## Self-Driven Berth Simplifies Seaplane Moorings

Mooring of flying boats is simplified by the Navy's new self-propelled floating seaplane berth. Even in the roughest seas, where maneuvering is a problem, it can be guided to the plane's side along a 600-foot submerged cable. Entry is further aided by water jets from six fire nozzles, pushing the craft from one side of the slip to the other. The berth is built of pontoons, with sides 125 feet long, spaced 17½ feet apart

at the narrowest point. They are joined below surface by horizontal and vertical trusses. Rows of partially inflated airplane tires on the slip's sides prevent damage to the plane in mooring. There are three propulsion units, one to pivot the slip and the other two to move it forward or back along the cable. It can be lowered and raised by pumping water in or out of the pontoon sections.



## Lightweight Trailer Holds Seven Canoes

Having to transport seven canoes many miles to a fishing camp in the woods, one sportsman built a special automobile trailer that would complete the move in one trip. Built of airplane tubing welded to form seven separate compartments, each designed to hold a canoe securely, the trailer is mounted on a pair of old automobile wheels. Lightweight, the loaded trailer is pulled along rough trails easily. Total cost of the unit was less than \$100.





### Plastic "Snow" for the Movies Made From Foam Blocks

"Snow," made in a machine resembling a large-scale meat grinder, keeps Hollywood ready for winter scenes on even the hottest days. The make-believe storm material is ground-up plastic foam block, a



Blocks of plastic foam are put through the grinder above to make snow for sets under hot studio lights

war surplus material used for buoyancy in aircraft and as insulation. The chaff photographs exactly like snow and can be made to simulate any kind of snow action. Gypsum and raw corn flakes were formerly used almost exclusively.



### Vibration of "Reed" Gauges Motor Speed

Matching motor vibrations with those of an adjustable steel "reed" measures the speed of a motor in revolutions per minute. A pocket-sized instrument, consisting of a spring-steel reed and a scale graduated in r.p.m. gives the motor speed without any connection to the revolving shaft. The instrument is held against the motor and the vibration frequency of the reed is varied by a thumb wheel until it matches that of the motor. The scale gives the motor's r.p.m.

### Reading Lamp Clips on Book

Weighing less than six ounces, a plastic reading lamp has a built-in clip that holds it to the cover of a book for direct, soft illumination that won't disturb others. The hooded shade directs the light on the pages only. A push-button switch glows in the dark.





# LIFE STORY IN PICTURES

**R**ECORDING the life story of an insect in pictures is the photographic hobby of George A. Smith, supervising principal of a Quarryville, Pa., school. Four photographs are enough to tell the story because most insects pass through four distinct stages in their life cycle.

They start out as tiny eggs almost invisible to the eye. These eggs hatch crawling larvae. Then, after a period of feasting, the larvae settle down to the pupa stage in which they spin a cocoon and remain motionless for days. Finally, they emerge from the cocoon ready for adult careers.

Insect photography requires some special equipment. The camera should have an extra long extension bellows or a supplementary lens to bring the tiny insects up to recognizable size. A sturdy tripod is necessary to insure sharp negatives. The slightest jar means fuzzy pictures in close-up work. Photoflood or flash bulbs provide the light needed to permit stopping down the lens for depth of focus.

By watching the insect carefully during its life cycle, Smith is able to record the complete picture-biography in the four photographs. How does he keep his models still during the exposures? That's easy, he says. Insects are inactive and helpless when passing from one stage to another—so that's the time he goes to work and snaps his pictures.

↓ After eating, the larva forms a cocoon from which it emerges after 16 days as an adult lacewing fly

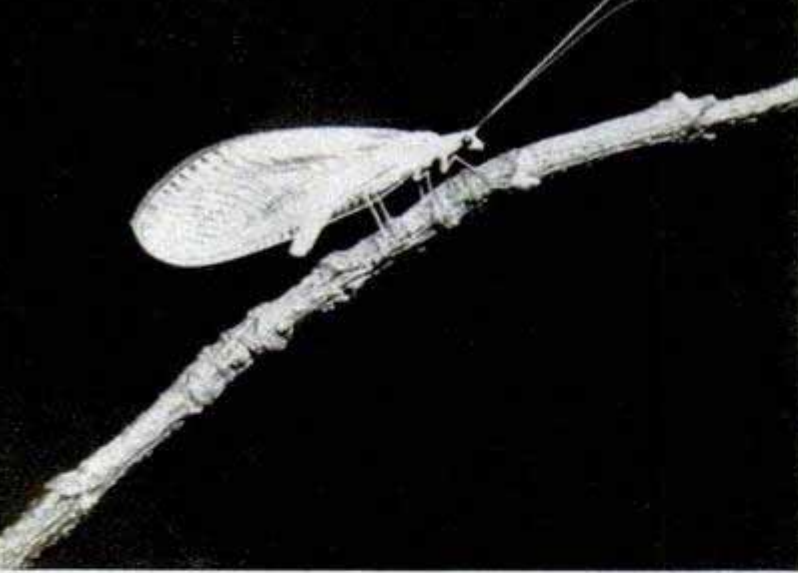

Still too weak to fly, this adult lacewing fly was photographed just after it emerged from its cocoon

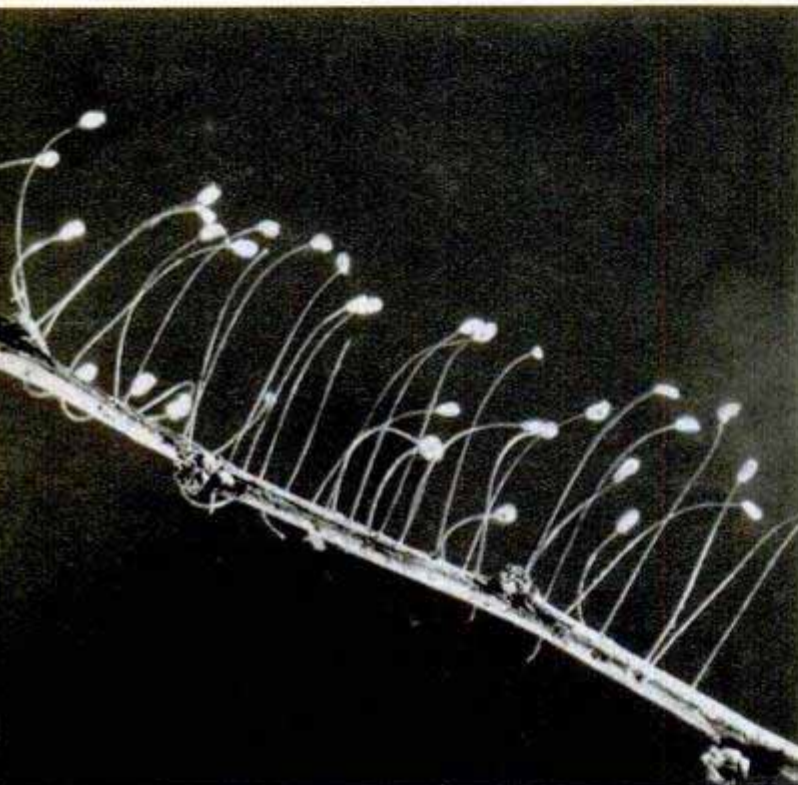

↑ Eggs of the lacewing fly are laid on stiff stalks to prevent hatching larvae from eating other eggs

↓ Once hatched, the larva leaves its stalk and goes looking for food. Here it feeds on tiny plant lice





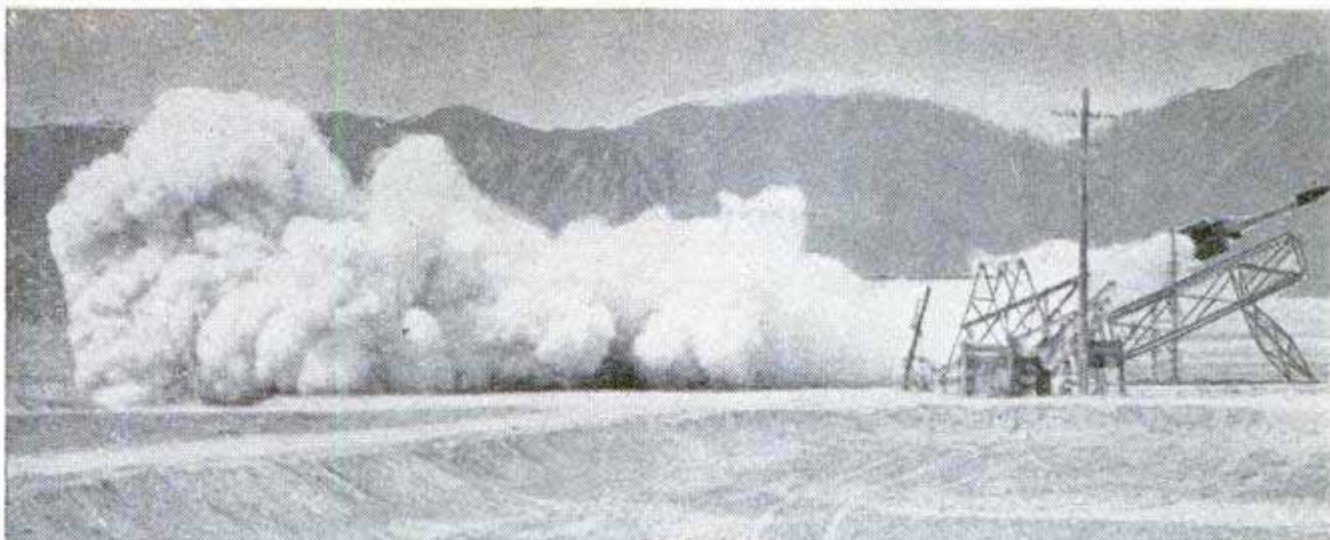

U. S. Navy photos

World's largest supersonic ramjet leaves cradle at Navy testing base in a huge cloud of dust. It develops more power than a four-engine plane

## Biggest Ramjet Faster Than Sound

About 25 times the pound-for-pound power of the best aircraft piston engines has been attained by the largest ramjet engine ever flown. Navy officials said it reached a speed "far into the supersonic range" in an initial flight at the Inyokern, Calif., naval-ordnance testing center. A duct open at both ends and with no moving parts, the "flying stovepipe" was developed by Johns Hopkins and associated universities and companies as a propulsion unit for the guided-missile program. Before it can operate efficiently, the engine has to be boosted to

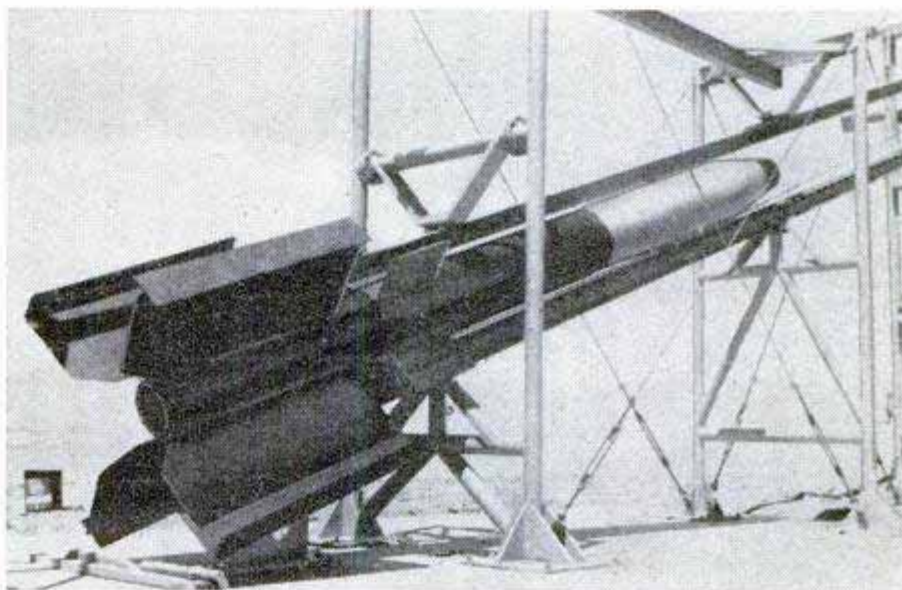

supersonic speed by a rocket booster unit, which then drops away, leaving the ramjet to continue under its own power.

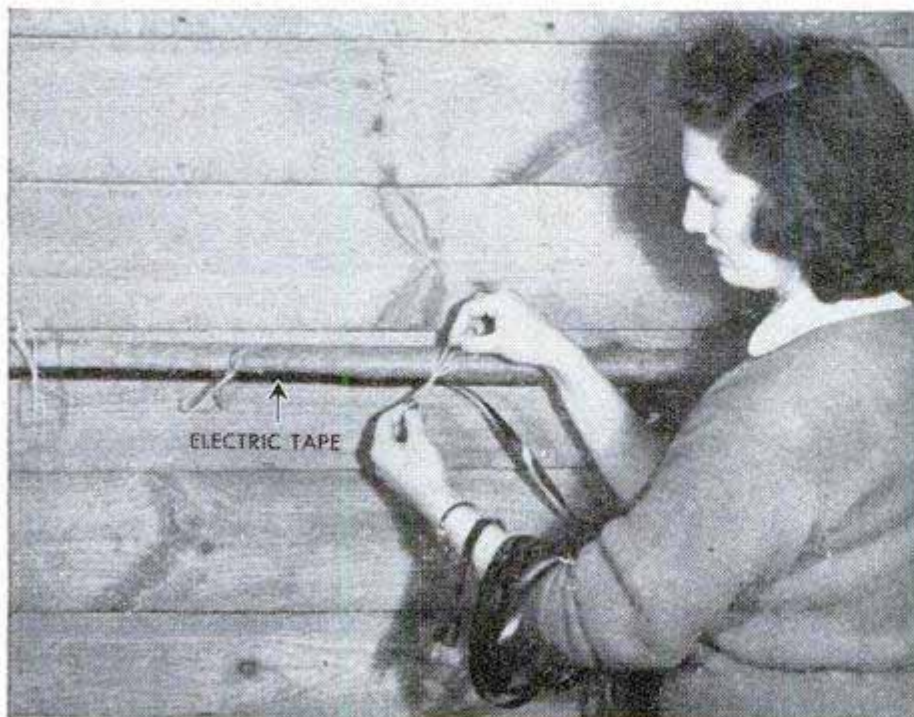

## Electric Tape Warms Pipes

Water pipes won't freeze at low temperatures when protected by an electric heating tape that can be used with or without an automatic thermostat. Available in 20 and 40-foot lengths, the tape is  $\frac{1}{2}$  inch wide and will prevent freezing in temperatures down to four degrees above zero, without insulation. With insulation, the freezing point is lowered considerably. The tape is tied to the pipe and plugged into a household outlet.



By O. A. Fitzgerald



ANYONE experiencing a revival of the old desire to use sawdust and shavings in place of sand and gravel to get a lighter and cheaper concrete should get acquainted with the tiny diatom—nature's wonder plant—and how Walt Friberg used it to cut costs in his new home at Moscow, Idaho.

Walls, floors and roof of the house are made of this sawdust-and-shavings concrete. By teaming up wood waste and diatomaceous earth, every cubic inch of which contains millions of nature's microscopic wonder plants, Friberg cut in two the cost of these parts of his house and got superior insulation.

When he returned to the Agricultural Engineering faculty of the University of Idaho, Friberg, a veteran of the Army Engineers, found himself house-hunting.

He saw sawdust and shavings being burned as waste by mills in his locality. Building a house out of wood waste was an old, old dream, he realized. Most engineers long ago gave up hope of getting a satisfactory wood-waste concrete. When the mix was lean, to take advantage of the cheap wood waste, the

## He built a home of sawdust-

Top, casting slabs for inside walls. Weighing a third as much as ordinary concrete, sawdust mix is easily pushed up ramp (below)

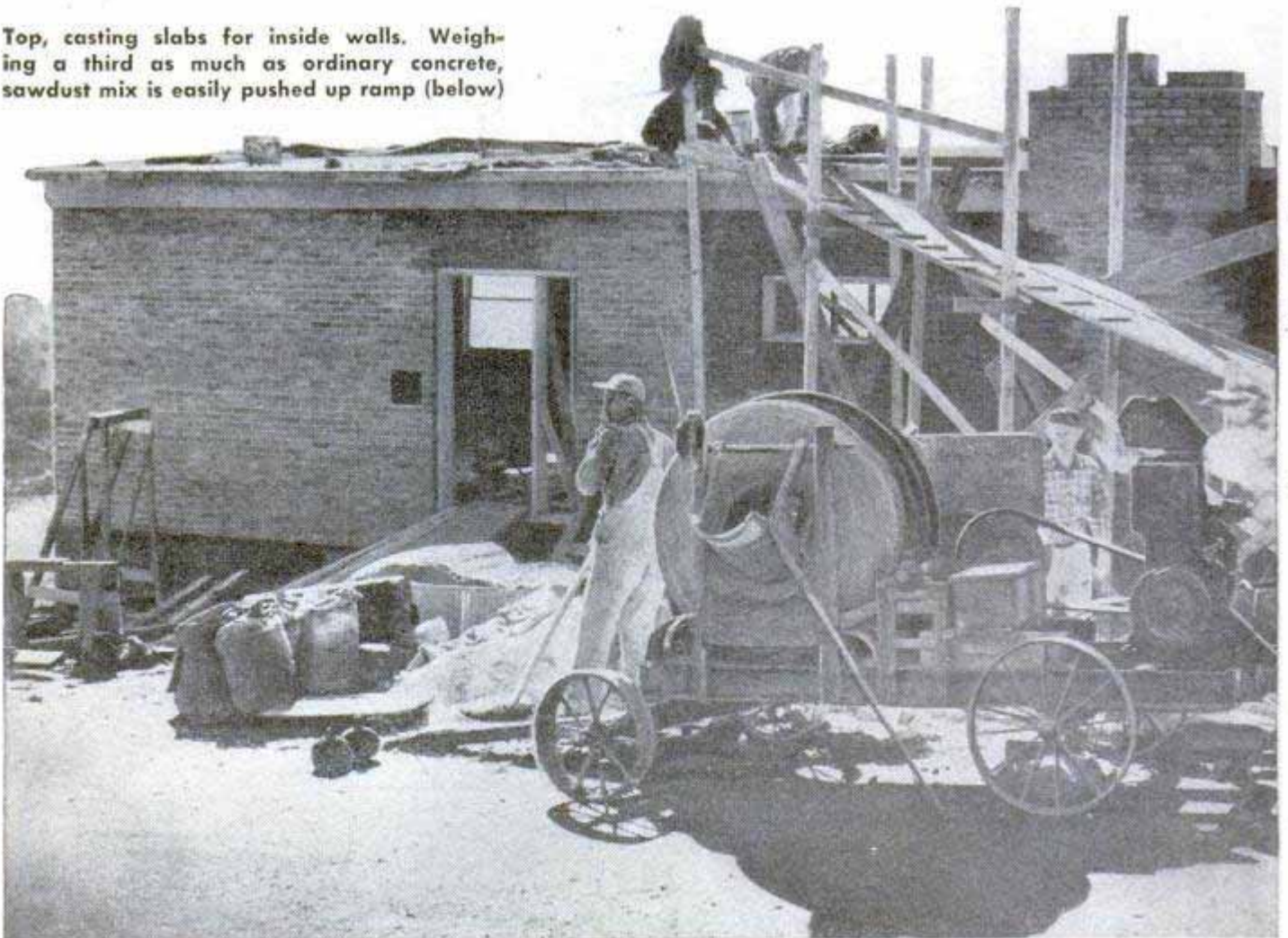



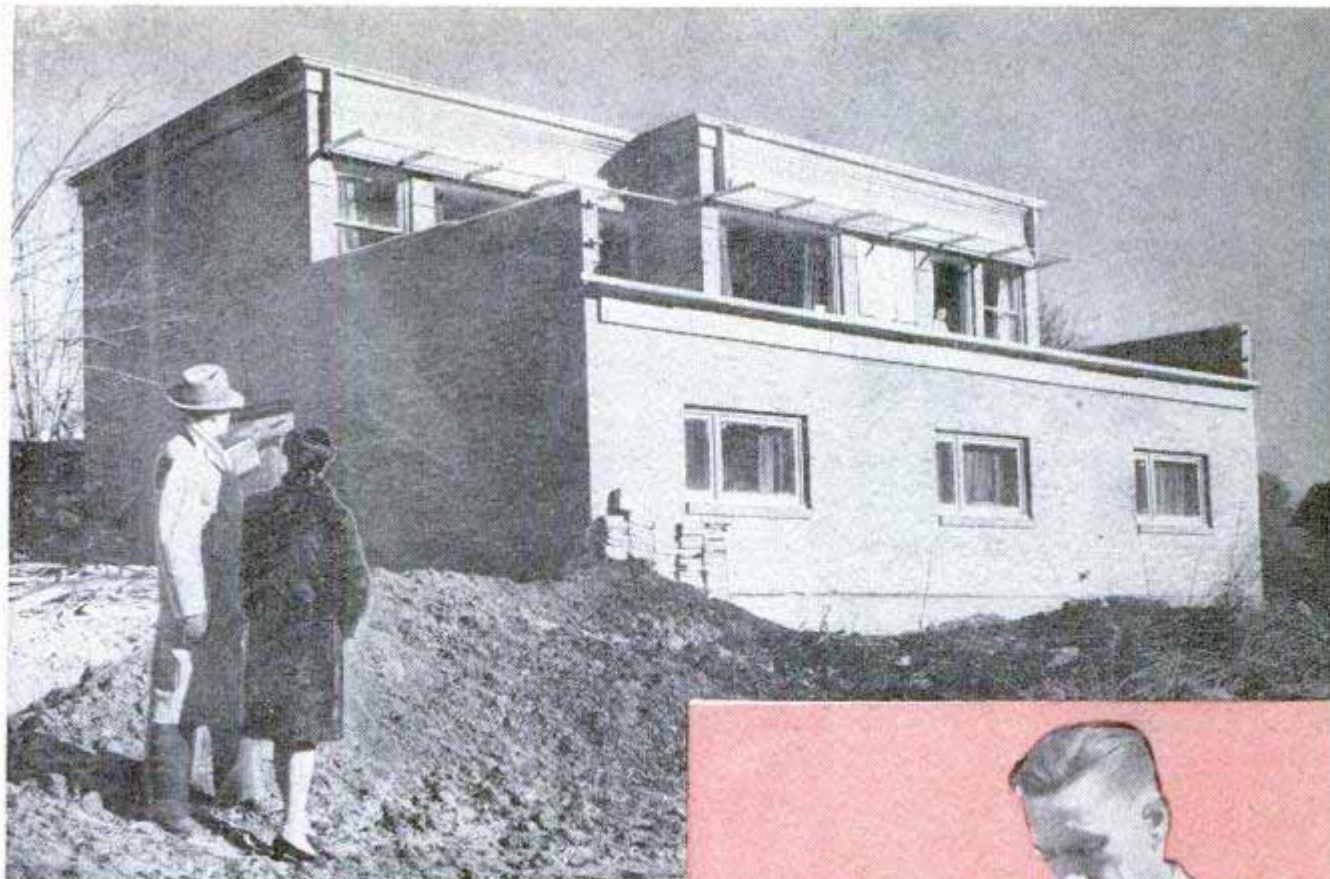

## concrete

The Fribergs (above) look over the rear of their new home. It was designed to conform to the slope of the hill. Right, some blocks were cemented in pairs to provide full wall thickness

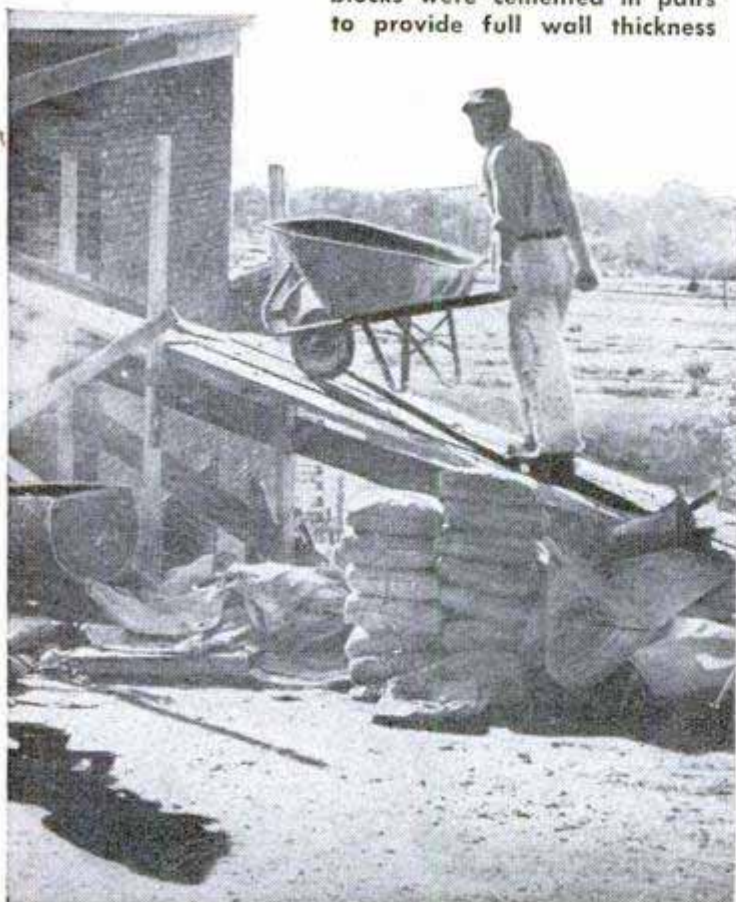
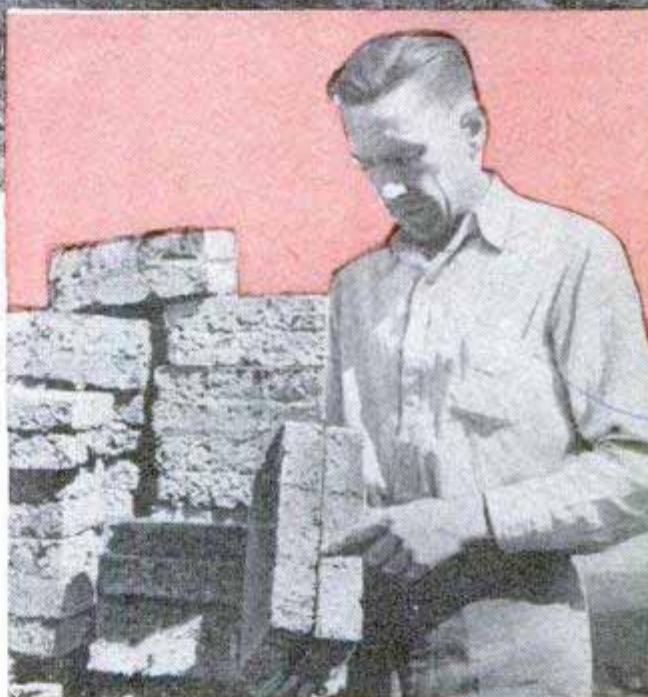

resulting concrete was not strong and would burn almost as rapidly as wood. When the mix was rich enough to be fireproof, the extra cement used wiped out much of the savings over sand and gravel and also destroyed much of the insulating value of the wood.

But during the war Friberg had learned something about the diatom that gave him courage to reopen the old question. Diatomaceous earth was used in industry as an insulator and fireproof. He had seen how the magic material, added to the concrete mix in building giant reclamation dams in California, had greatly increased its workability. Perhaps diatomaceous earth would solve the sawdust-concrete problem. That hunch paid off and the diatom is in the building spotlight today.

Deposits of the diatom are widely distributed in the United States. Some of the



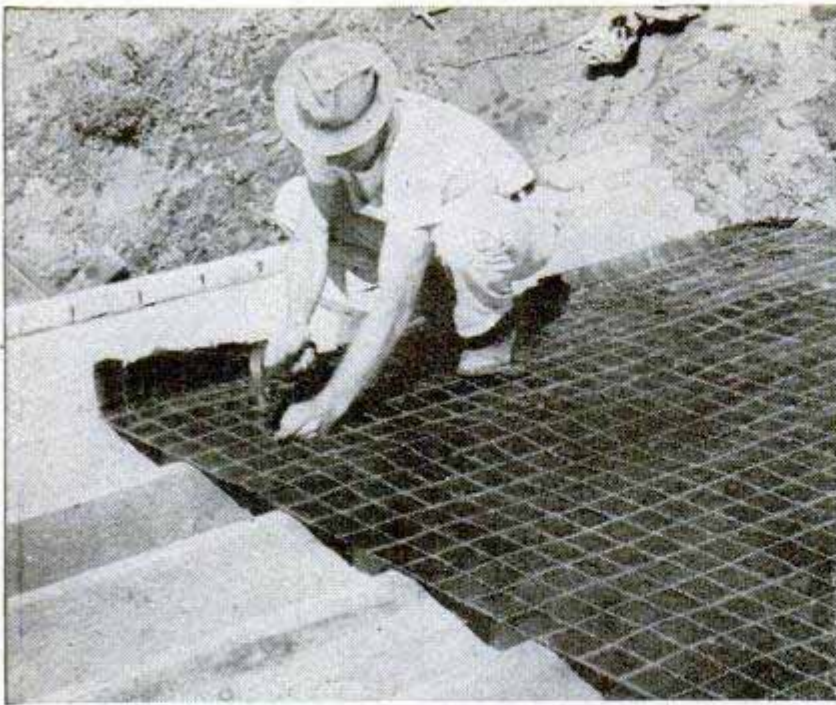

Reinforced wire mesh is nailed on joists before the floor is poured

largest deposits are in Oregon, California, Nevada and Washington. Because of its strategic value during the war there was an intensive search for new deposits. Many were found. While most of the new ones are too small or not of sufficient purity for manufacturing use, they are suitable for sawdust-and-shavings concrete.

In grandfather's day the diatom was just an interesting little plant to look at through a microscope. School-teachers impressed their pupils with the wonders of nature by holding up a small pinch of diatomaceous earth and telling them it contained thousands upon thousands of tiny shells.

Within the last decade, however, the diatom has vaulted to a

top place in industry. It is used in toothpaste, silver polish and nail polish; in purifying filters in sugar factories; as insulators in high-tension motors and electrical equipment, and as fillers in paint. Diatomaceous earth has over a hundred industrial uses, mostly in the chemical, food and pharmaceutical fields.

Friberg found that when a small part of the cement was replaced by some diatomaceous earth and a little common clay added, a low-cost, high-insulating, fire-resistant, lightweight concrete resulted. The cost, about half that of regular concrete, varies with localities, depending on the availability of wood waste and the distance from a deposit of diatomaceous earth.

Friberg's concrete cannot carry heavy loads. But since one inch of it has the insulating value of 12 to 14 inches of ordinary concrete, it is excellent for floors and walls where high insulation is desired and the load can be carried by a veneer of bricks or boards. Sawdust-concrete can be sawed, drilled and nailed just like wood and is amazingly fire-resistant.



Sawdust-concrete, though of coarse texture, spreads very easily. Here, workmen cover reinforced wire mesh with a thick coat of the mixture to form the solid floor slab





Here is the mix he used: 1 part of cement, 1 part of diatomaceous earth, 3 parts of sawdust, 3 parts of shavings and 1 part of clay—all volume measurements. Since sawdust-concrete has a higher absorption rate than straight concrete, Friberg added 1 part of clay to the mix.

First the clay is put into the concrete mixer. If it is lumpy, the clay should be soaked overnight before using. Next the diatomite is dumped in, then the cement. After these have been thoroughly mixed, the sawdust and shavings are added.

In his house, Friberg used mill-run sawdust that had aged about a year. In his experimenting, he found that new sawdust is not desirable. Neither is sawdust that has stood so long it is white. One year's aging, he says, is about right. With the shavings, age is not important. He used them green, aged a year, and older. They all worked well.

A mixture of pine, larch and fir sawdust and shavings was used in the house. Being run-of-the-mill, there was bark in the waste. Friberg found no objections to this, but he did discover that cedar and hardwood waste are not satisfactory.

No special equipment is necessary to put the diatom to work in home building. Friberg cast blocks and bricks in commercial

(Continued to page 280)



↑ Double-thickness blocks are laid inside the brick siding. The brick supports the main load of the building. The interior wall is given a plaster coat later

↓ Workmen say the sawdust-mix concrete handles much easier than normal mix. Here, they smooth out one-piece slab on the roof

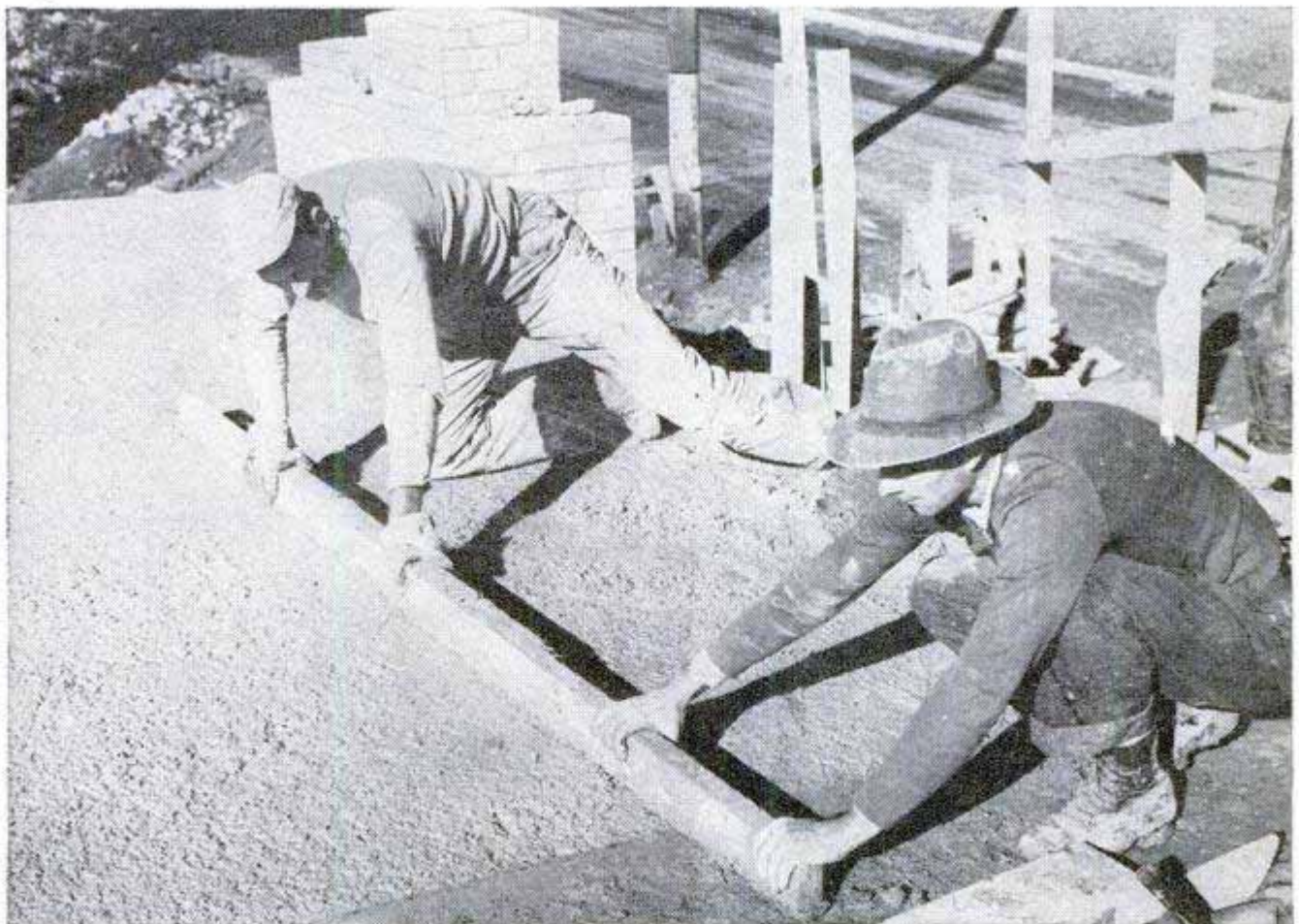



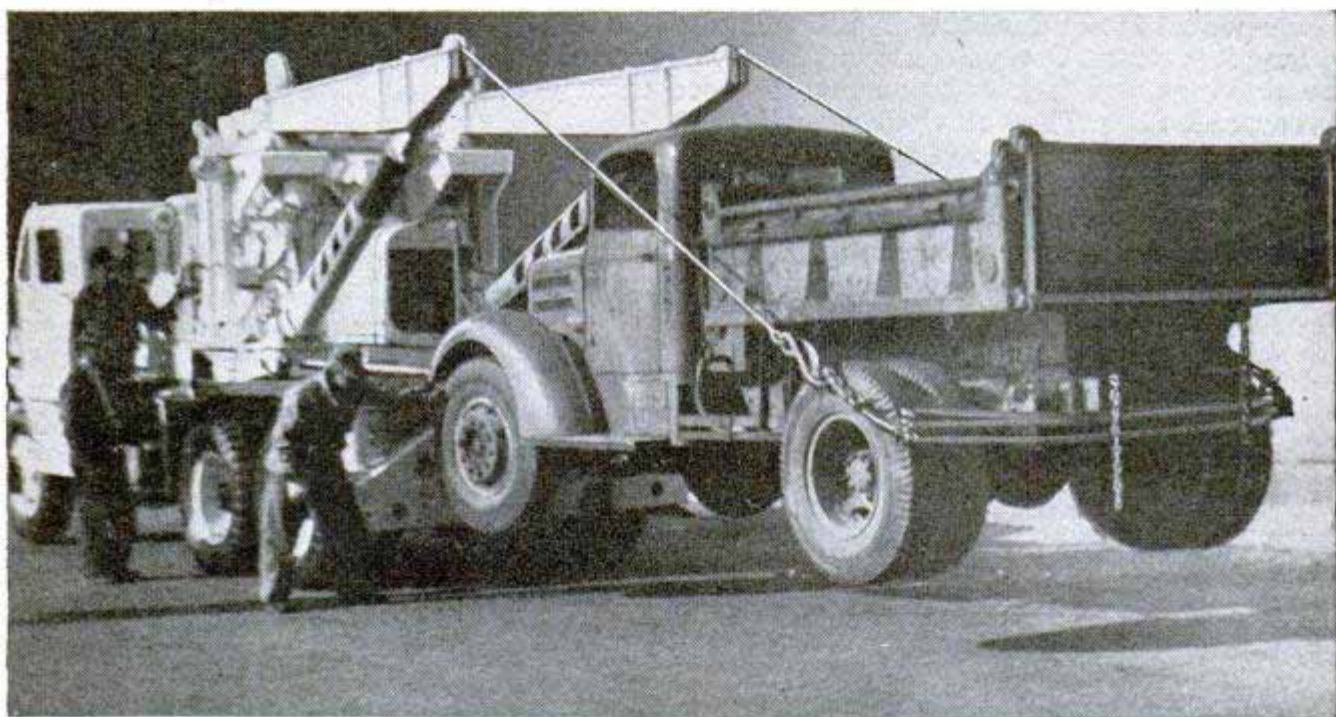
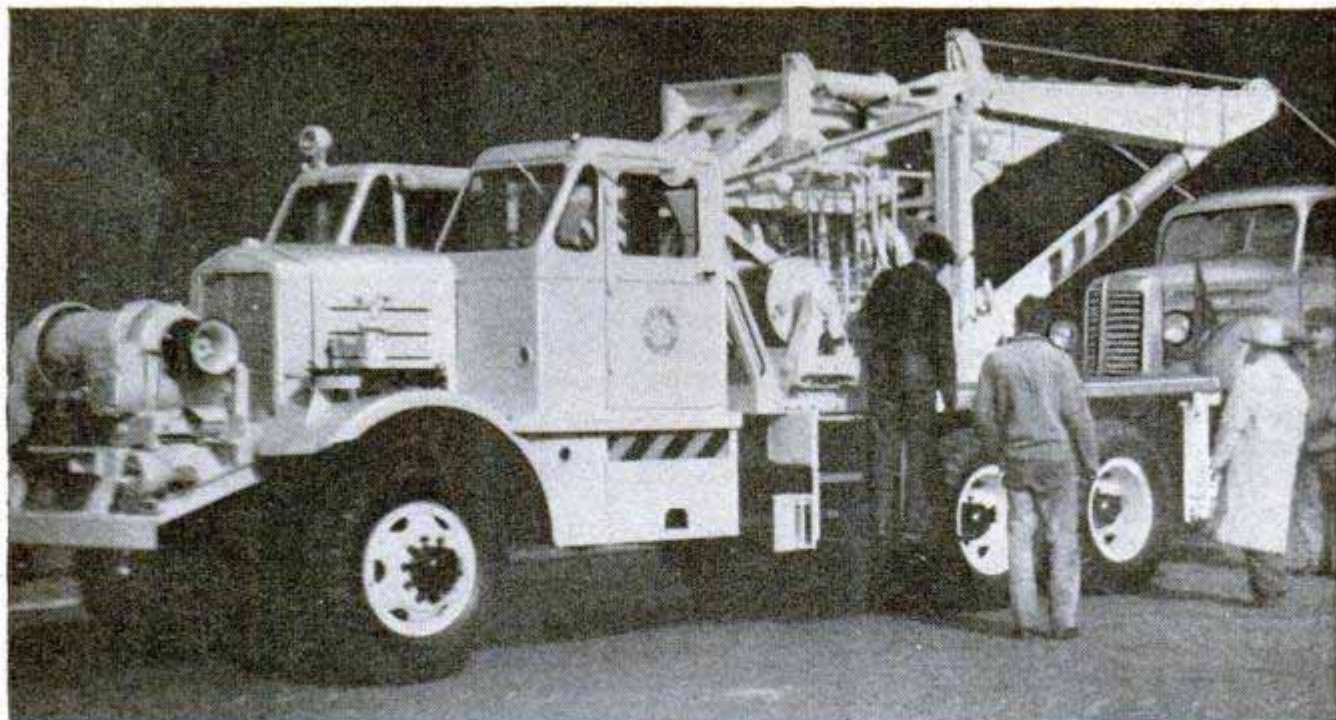

## Powerful Wrecker Lifts Entire Truck Off Street

In Cincinnati, a city-owned wrecker clears almost any type of vehicle off the streets in case of breakdown. The 20-ton wrecker was designed by employees of the municipal garage and is capable of lifting or moving loaded trucks, streetcars and jackknifed trailers. Cables from two lift-

ing booms on the truck can be fastened to the rear end of the broken-down vehicle so that the entire vehicle can be lifted. Two cabs are mounted on the wrecker, one for driving and the other for the operation of the booms. The wrecker also is used for pulling down weakened walls at fires.

## Bees Turn Out Honey in Six Flavors, Each Appropriately Colored

Green-colored honey with the tang of mint leaves? That's just one of the six flavors of honey, each of them appropriately colored, produced at the Corning, Calif., apiary of E. C. Close. The beekeeper has applied for a patent on his process to produce flavored and colored honeys.

Through this process he manufactures honey in strawberry, pineapple, chocolate, lemon, maple and mint flavors. Close keeps his bees in electrically heated hives. He tricks the bees into turning out flavored honey by flavoring and coloring the syrup and pollen which he feeds them.



## Boat Pilot Faces Forward With Tiller Under Foredeck

Owners of small motor boats in the Puget Sound region use a simple tiller mounted under the foredeck for steering. This allows them to sit forward in the boat instead of at the stern, providing better balance. The wooden tiller is pivoted at the front end and may be swung to the left or right to steer the boat. Rudder lines from the tiller are carried aft through pulleys attached along the gunwales inside the hull.



## Coffee for Cattle

Waste pulp from coffee beans is a good substitute for corn in the feeding of cattle, according to technicians of the United States and El Salvador. Tests with the coffee pulp prove that pound for pound it is the equal of corn in milk production. The discovery may be important to the economy of coffee-producing countries, where the fleshy covering of the coffee bean is a waste product that presents a disposal problem. Tests show that the digestibility of dried coffee pulp is about the same as that of corn, although it is less

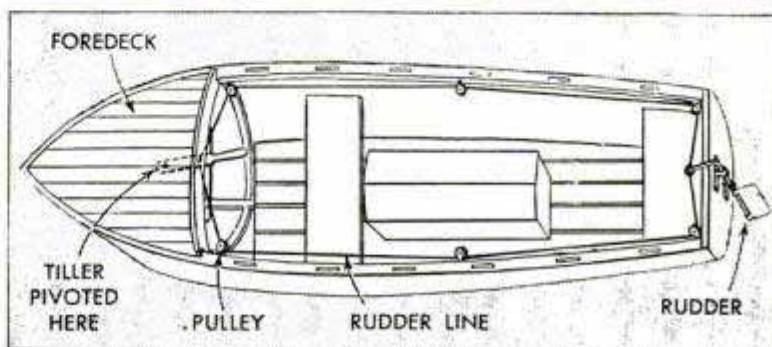

palatable. The pulp is mixed with dried banana leaves or molasses to make it more appealing to the cow. Additional tests are planned, using the pulp as poultry feed.

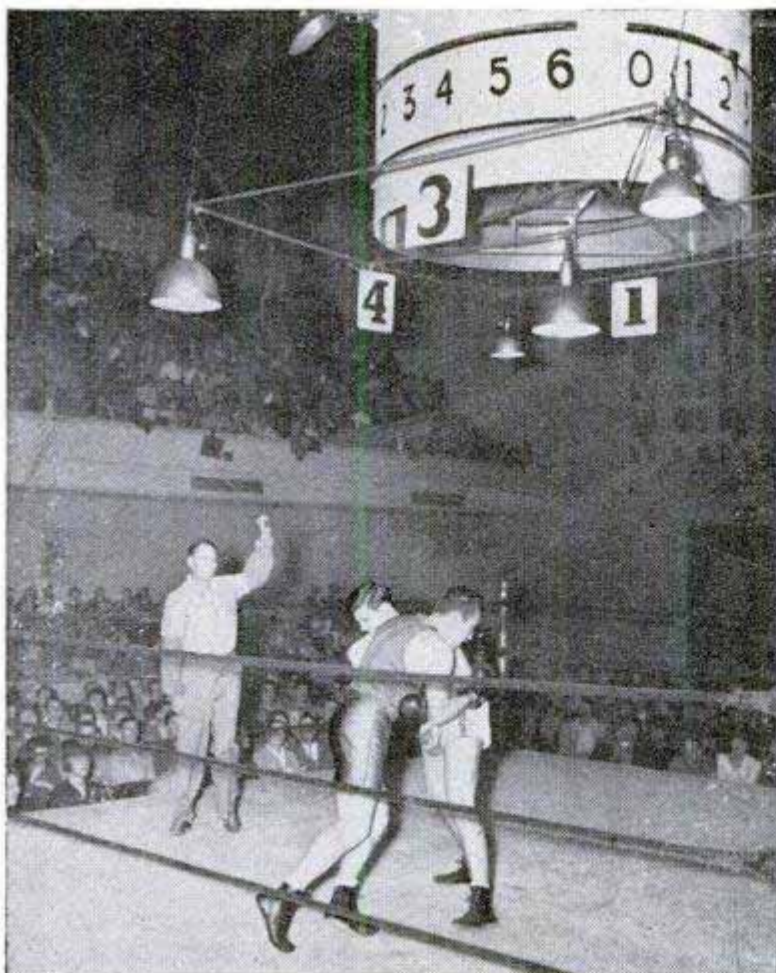

## "Ref's" Sleeve Covers Serve as Signals

Since aggressiveness is an important factor in deciding fight winners, a San Jose, Calif., boxing promoter offers a way to keep fans informed while the bouts are in progress. The referee wears specially colored sleeve covers and raises a corresponding arm when one or the other of the boxers is on the aggressive. A huge timer above the ring records the time of each boxer's aggressiveness.

## Quick-Freezing Dried Foods Preserves Natural Flavor

Fruits and vegetables are preserved through a new technique called dehydrofreezing. The process combines the advantages of dehydration with those of quick freezing, removing much of the moisture before the food is frozen to reduce weight and bulk. This creates a saving in packaging, storage and transportation. Food value is virtually undamaged.





## ELECTRIC BLACKBOARD

Instructors can present their material visually with the aid of an electric blackboard, which projects the actual process of writing or drawing upon a large screen. The instructor sits at a desk facing the audience. Any transparency in the form of a photograph, kodachrome, drawing, sketch, map or business form can be slipped into the machine's frame beneath a continuous sheet of transparent material

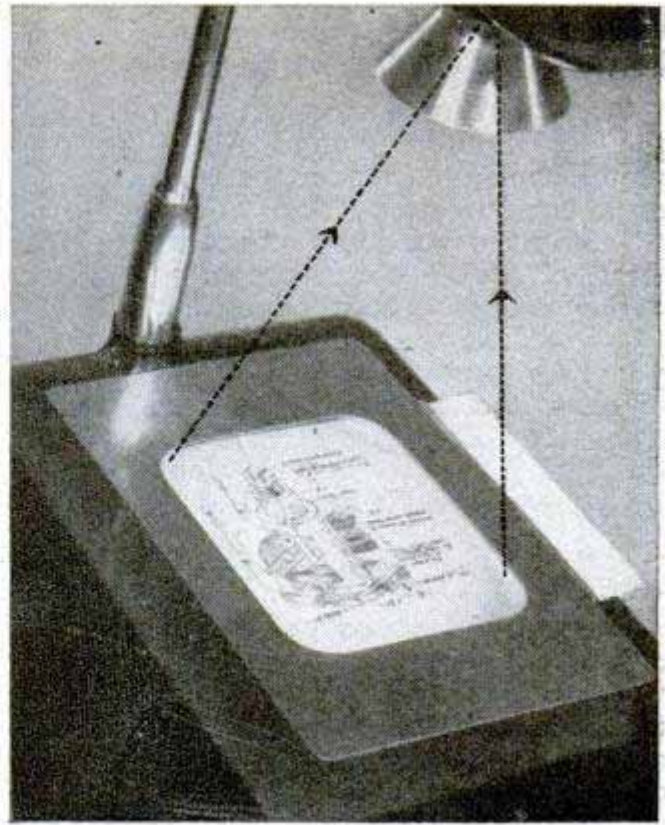

Left, when operator draws, lines appear on screen. Above, lens picks up the transparency for projection

that provides a writing surface. Light is projected upward through the transparency to an overhead lens, which focuses the image on a mirror. From there it is reflected to the overhead screen. The instructor may write on the 8 by 10-inch transparent surface of the lower projection case with a grease pencil and the lines will appear on the screen. The projector with screen and tripod weighs 30 pounds.

## Metal Fingers "Pump" Liquid Through Tube in Waves

Without touching the material being pumped, an unusual pumping device moves liquid or gas through flexible tub-

ing in a wavelike manner. The tubing is inserted in the machine and metal fingers press against it in rapid succession forcing

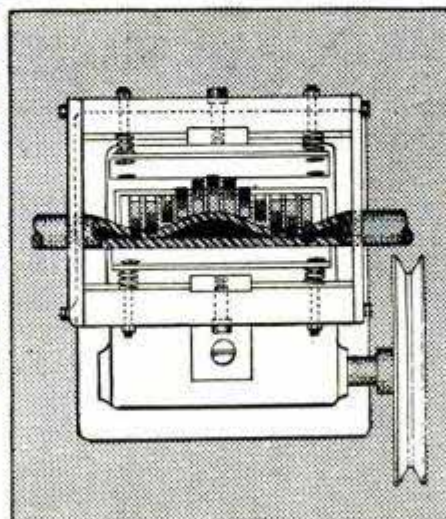
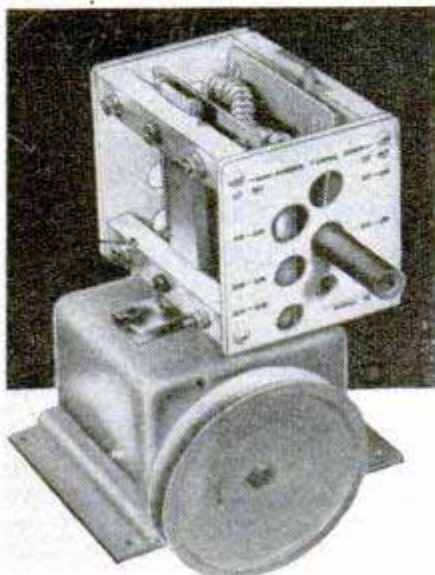

Left, rubber tube that carries liquid runs through the pumping device. Right, "fingers" pinch tube in rapid succession forcing liquid forward

ing the material through with a pulsing motion. As it is forced along, additional material enters the tubing to be moved forward in the next pulsation. Because there are no valves, pistons or metal parts in contact with the material, the device can be used for pumping corrosive liquids and gases, and liquids containing solids without damage to the machine or separation of the materials. The volume pumped is varied by changing the size of the tubing used or by using more tubes.



## Livelier Golf Ball

Golfers are promised improved distance this summer from a silicone-center ball wound by a new method. Derived from sand, the "bouncing putty" has more resilience than anything previously used. The center is the size of a large pea. It will be wrapped with about 30 yards of rubber thread by an electronic winder that insures uniform tension in the manufacture of all balls. The winder consists of a photoelectric tube wired to a system of relays and amplifiers. A narrow beam of light shines through a lens onto the tube. In its path is the golf-ball thread, vibrating like the string of a violin. When the vibrating thread crosses the beam it sends light impulses to the phototube, which is adjusted to take them at a preset, uniform frequency. When they come too fast or too slowly, an electronic brake puts more or less pressure on the thread, bringing it back into "tune." The checking and adjusting automatically take place in a fraction of a second.



United States Rubber Co. photo

## Plastic Flooring Similar to Linoleum Resists Chemicals

Floor covering similar to linoleum is made of plastic and requires no waxing. Produced in roll form six feet wide, it is more flexible than linoleum, nonporous and resistant to chemical action. The material is Vinylite plastic, laminated to a felt back with the design running through

the entire thickness of the plastic. It is laid in the same manner as linoleum. A wall covering made of plastic, which also resists chemical action, is available in the same colors and patterns as the floor covering. It can be bent at sharp angles without showing surface cracks.



## Lock-On Hub Cap

Automobile hub caps that lock in place cannot be stolen, and protect the wheel from theft. A decorative emblem conceals the lock. When this is removed, the key can be inserted and the hub cap taken off. The cap, made of stainless steel, can be installed with a tire wrench without altering the wheel. The accessory is available for three makes of cars, and production of other models is planned.

If you would like additional information concerning products described in this issue, including names and addresses of manufacturers, just write to the Bureau of Information, Popular Mechanics, 200 E. Ontario St., Chicago 11

*Letter answered left no return*



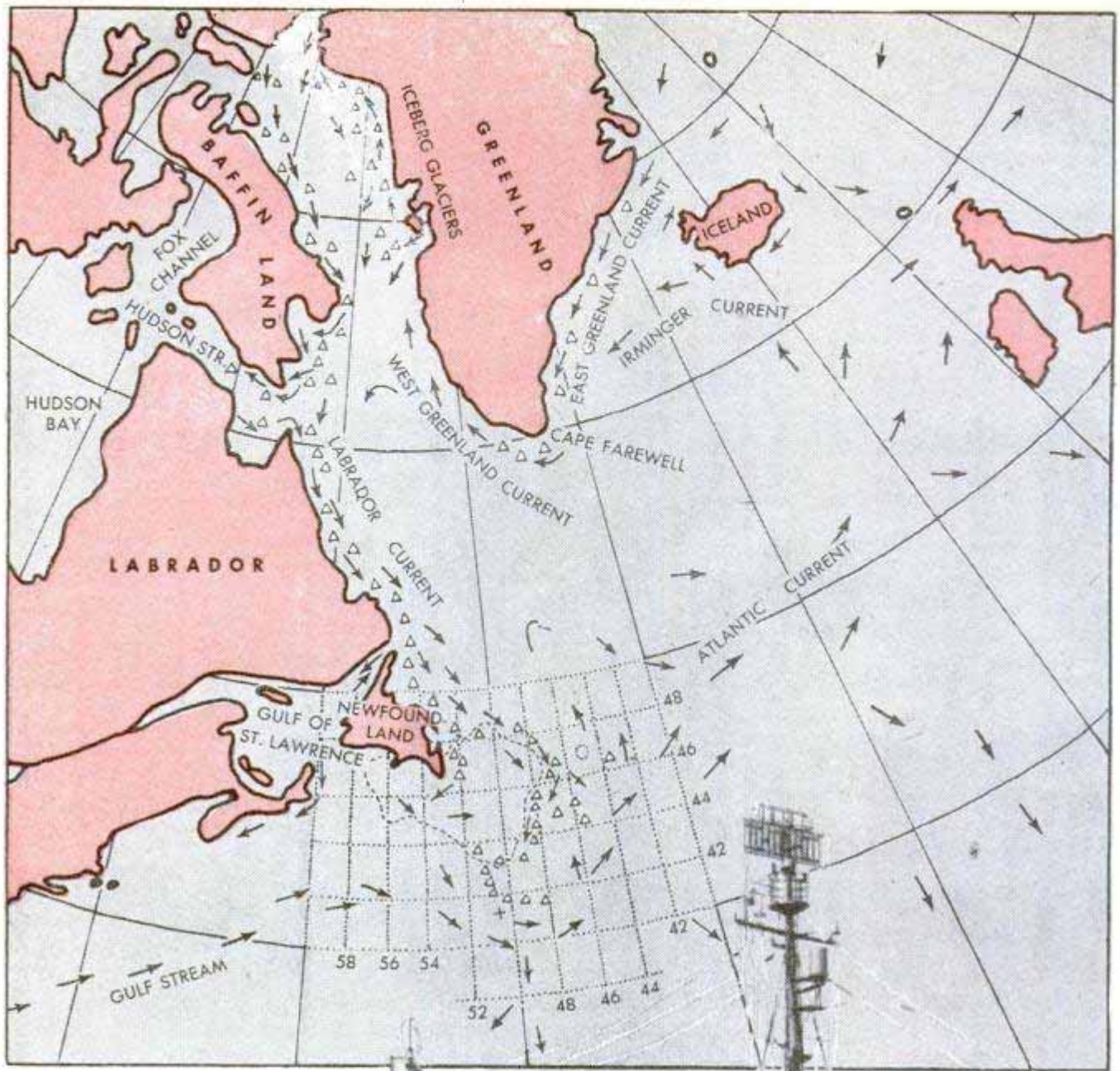
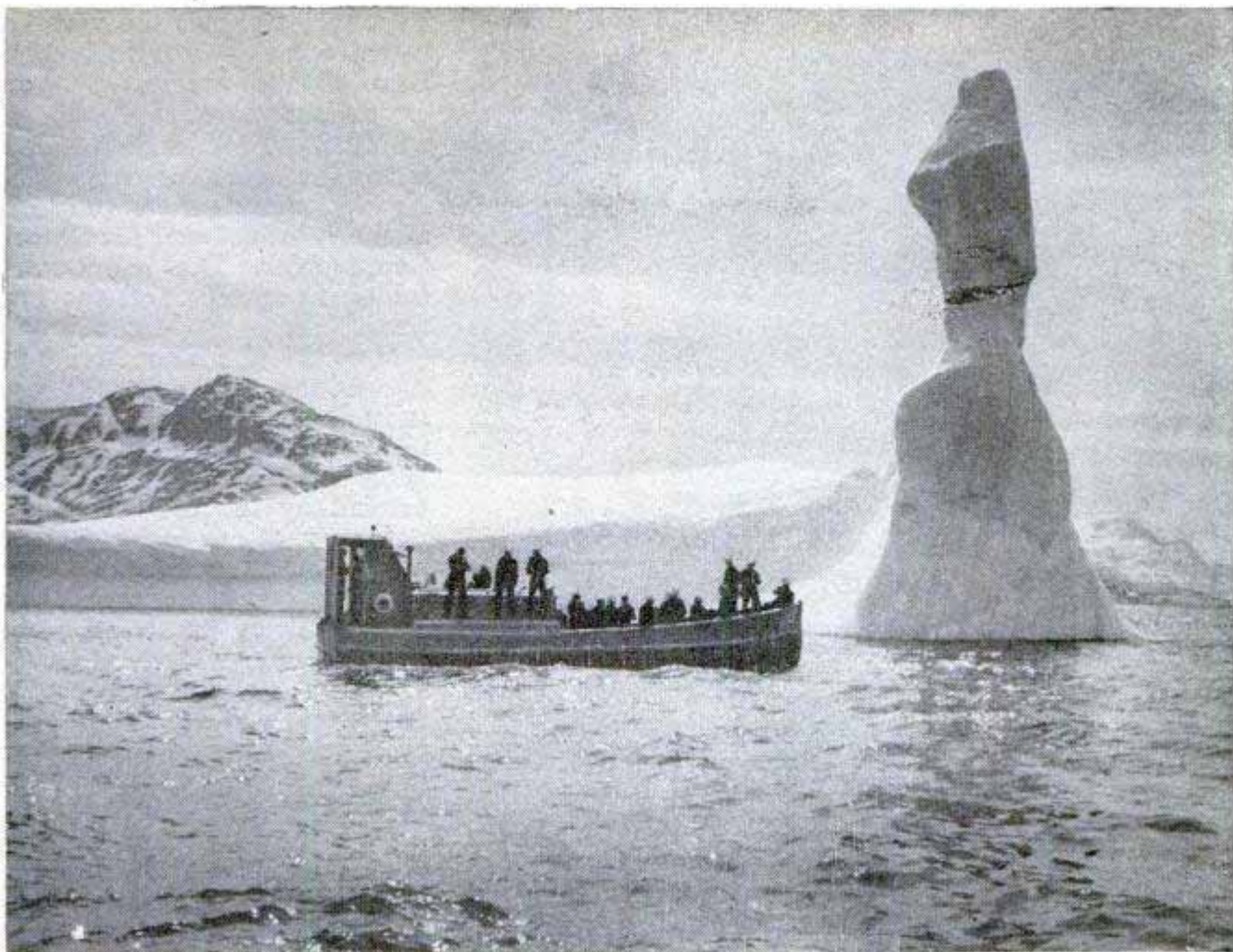

Chart shows currents which propel icebergs from Greenland into the shipping paths. Below, Coast Guard cutter Mendota has cruising range of 10,805 miles at 11 knots. Its motor is turbine-electric







Coast Guard photos

Eroded by wind and sea, this iceberg off Greenland coast has odd shape. Coast Guard takes a close look

# ICEBERG HUNT

By Comdr. G. H. Bowerman, USCG  
*Commanding Officer,  
 Coast Guard Cutter Mendota*

**T**HIS is the story of the U. S. Coast Guard cutter Mendota and her 11 officers and 108 men who sail on the International Ice Patrol. Our job is to round up maverick icebergs that menace shipping in the North Atlantic.

After the disaster of the Titanic in 1912, 14 maritime nations organized the International Ice Patrol and entrusted its operation to the Coast Guard. Regularly from 1914 to 1941 its vessels patrolled the shipping lanes. Not a single life was lost in an iceberg collision during those 27 years. When World War II came, the Coast Guard abandoned the patrol. Then on March 20, 1943, a merchant vessel struck an iceberg in the fog and there was heavy loss of life. On March 27, 1945, several ships in convoy were damaged when two of them rammed a huge berg.

These tragedies were proof enough of the patrol's value and it was promptly resumed in the spring of 1946. Coast Guard vessels now patrol an area east of Newfoundland as large as the state of Pennsylvania each year from March to July.





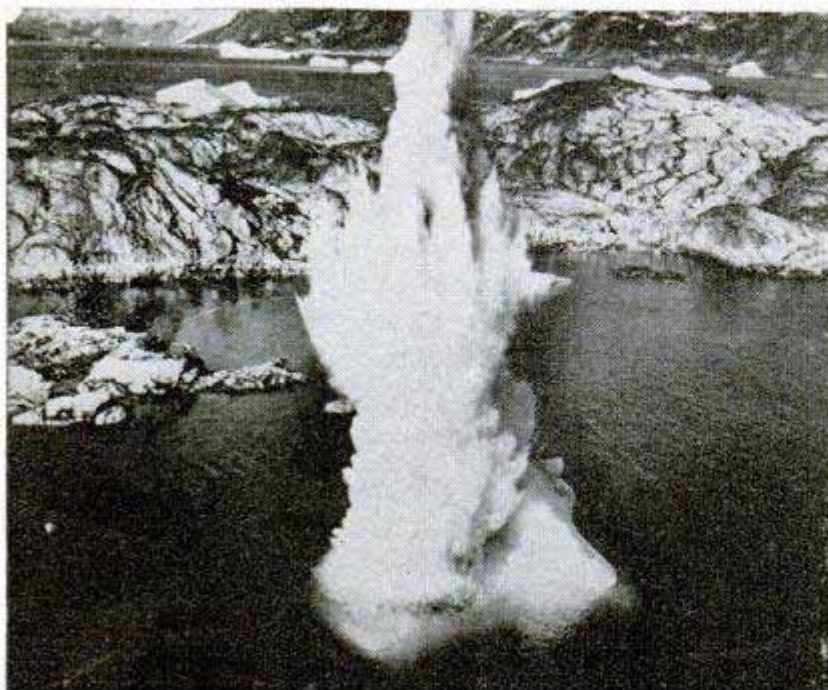
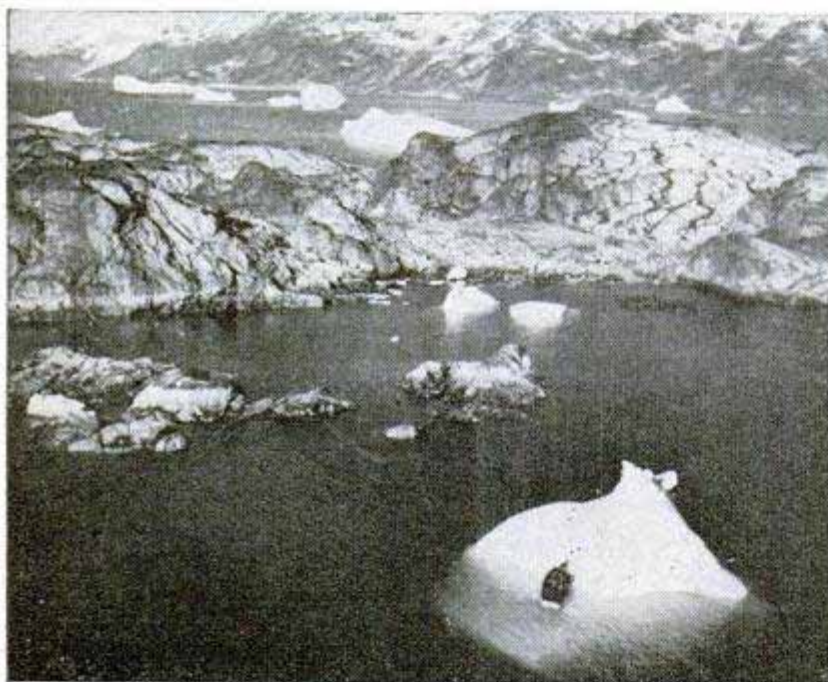
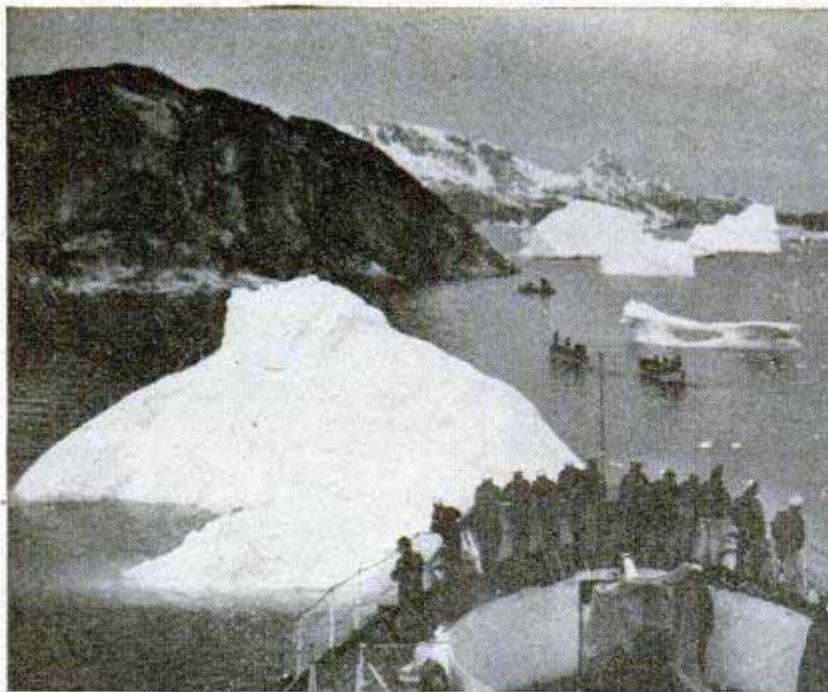

Through it passes the world's heaviest sea-borne traffic. Here is the account of our cruise last year:

**May 14**—The Mendota sailed from the port of Argentia, Newfoundland—headquarters of the International Ice Patrol Commander. The snow was falling in squalls and the fog was thick.

**May 15**—As the Mendota cruised toward its search area, latitude 44 degrees north, officers and men who had never been on ice patrol before were briefed by the old-timers.

Just what are icebergs? Ice masses, often as long as a city block and weighing thousands of tons. They break off from glaciers along Greenland's western coast and drift south. An average of 428 drift down each year, ranging from a low of eight or ten in 1924 to a high of 1350 in 1929.

How fast do they travel? About 10 miles a day on the average. Some have been known to drift 30 or 40 miles a day for a week. Ocean currents move icebergs. Wind influence is negligible. About 85 percent of the berg is below the water.

Most of the bergs found in the North Atlantic are in the area off the Grand Banks near Newfoundland.

**May 16**—A radio message from the SS Lucy Stone, out of San Francisco, requested medical aid for a seaman with a badly infected finger. The two vessels altered courses and effected a rendezvous about 5 p.m. One of the Mendota's boats transferred the injured man and when brought aboard he responded to penicillin treatment.

**May 31**—Iceberg seasons have a cycle of seven years and this year was the lightest in the cycle. The Mendota patrolled for more than two weeks without sighting a single berg. On this date, how-

Top, Cutter Storis is trapped by icebergs in Greenland waters. Middle, a small boat lands blasting party on berg. Bottom, explosives throw up a 200-foot fountain and clear a path



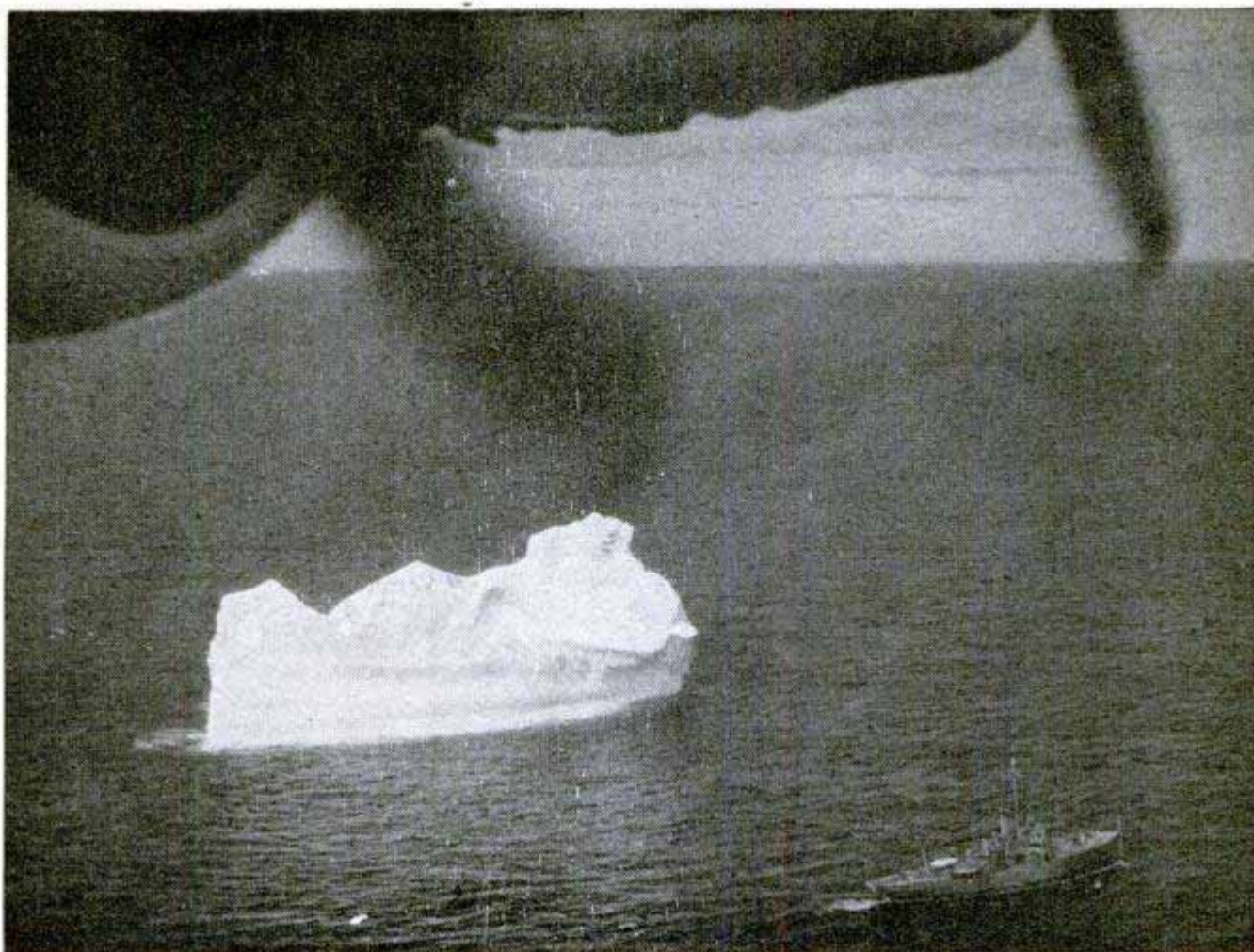

**Beneath motors of B-24 patrol plane, a Coast Guard cutter circles an immense iceberg in the North Atlantic. Teamwork between aircraft and ships of the International Ice Patrol speeds charting of iceberg movements**

ever, the first one was spotted at 6:41 p.m.

Word spread quickly throughout the ship and all hands who could leave their stations found a place topside. From a distance it appeared to be a white line on the horizon. As the cutter approached, delicate blues and greens of hard glacial ice could be seen. In size and shape it resembled an aircraft carrier. It was flat on top with vertical clifflike sides rising 30 feet above the water. Its length was estimated at 750 feet and its width 200 feet. Around it were growlers and bits of recently undermined ice. Veterans of the patrol estimated its "depth" at about 210 feet.

Information on the berg's position and size was radioed to Argentinia. Soon this information crackled through the air from the powerful Argentinia radio sta-

tion to all ships in the North Atlantic. The Mendota then settled down to drift with the berg for 24 hours to measure its speed and direction.

**June 1**—The Mendota spotted its second berg. This one, instead of being flat and square, was canted on one side and its

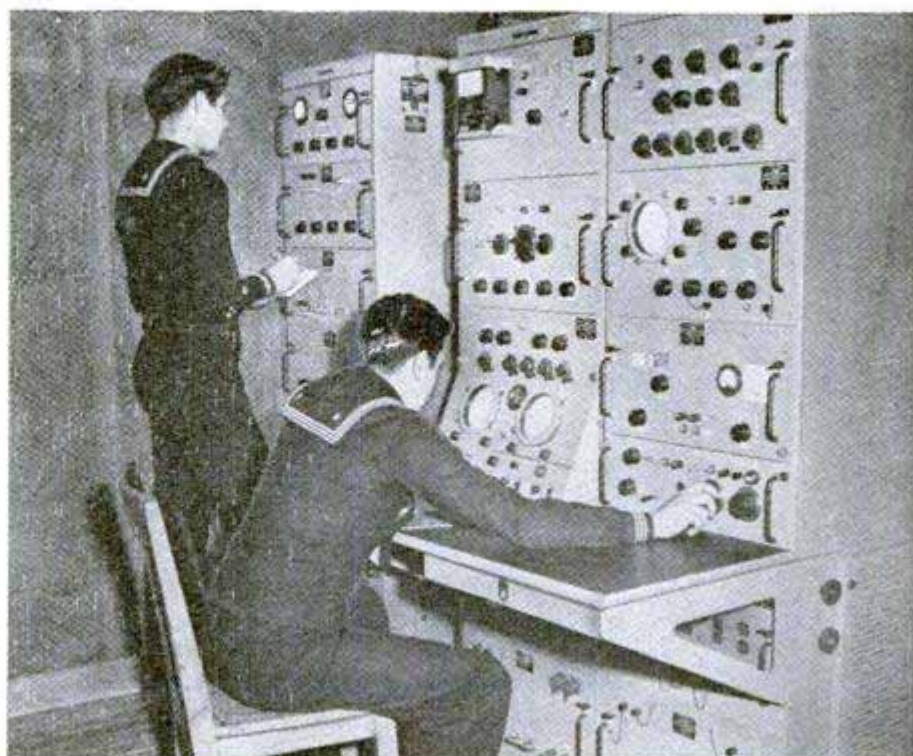

**Plotting position of icebergs at a new loran timing station**



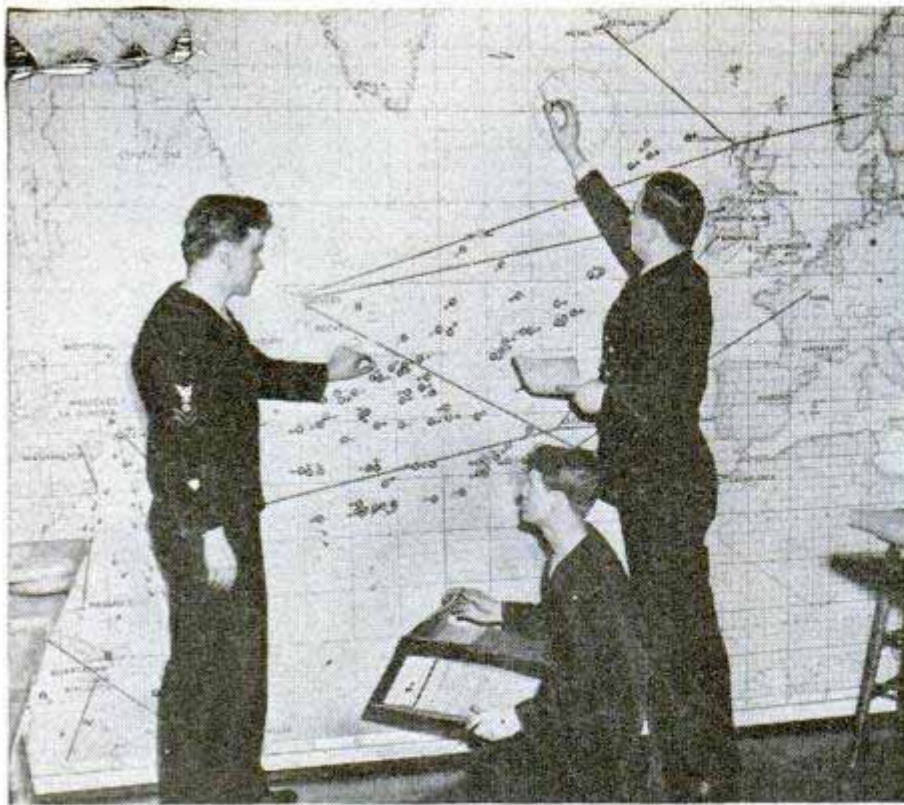

Iceberg and ship positions are all plotted on this board at headquarters

peak rose 70 feet into the air. As it melted, it gave off a cracking sound and huge pieces of ice sloughed off into the sea.

Radar and loran are now being used to insure better detection and location of icebergs. However, a vigilant patrol by cutters and planes is essential.

Both radar and loran are most useful in

Twice on this date four-motored Coast-Guard manned B-24s have roared overhead and pilots have dipped their huge wings in greeting. These patrol planes are based at Argentia and represent another refinement in the search for icebergs that are drifting in shipping lanes.

(Continued to page 284)

This is the Ice Patrol's version of spring plowing as a cutter heads into crust of a North Atlantic ice pack



foggy weather. Large and medium-sized bergs are picked out easily on the radar scope. Some night experiments have also been made with underwater sound gear and bergs 2000 feet away have been located.

This ship is a single-screw, turbine-electric vessel, 254 feet long with a 43-foot beam. It has a cruising range of 10,850 nautical miles at 11 knots or 5750 nautical miles at 17 knots.

**June 10**—The Mendota was ordered to search for a large berg drifting in shipping lanes 1300 miles due east of New York City. This elusive berg, nicknamed Dumbo, was reported by the SS Esso Glasgow to be 50 feet high and 200 feet long.



## "Package" Engines on Ocean Ships May Be Attached Outside Hull

Ocean-going ships may have their engines mounted in streamlined gondolas attached outside the hull instead of in the hold, according to William Costa of San Diego, Calif. Costa has invented a system of "packaged power" in which marine engines are complete units that can be attached to the hull. He has built a model of a liner to be powered by four 1200-horsepower Diesel engines affixed in tandem to a 165-foot hull. Twin grooves that run the length of the vessel will stabilize the craft at speeds in excess of 30 knots by creating a vacuum along the bottom of the hull. Advantages of the power system include a greater payload capacity when engines are removed from the hold, greater adaptability and ease of maintenance, according to Costa. A faulty engine could be removed and an entire new unit installed within 24 hours.

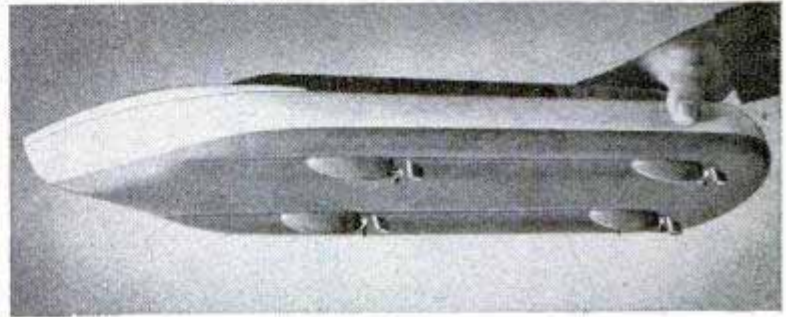

Top, Costa built model of liner to show streamlined design. Right, "package" engines in gondolas will be attached to hull

## Saw Replacement Handle

Replacement handles that fit any conventional saw can be installed by drilling only one hole in the blade. A key fastens to the hole and slips into the handle. A single screw is threaded into this key to hold the blade rigid. The wedging action of the rear edge of the saw blade against the handle prevents any play. Some saws must be cut at the proper angle to fit into the slot.

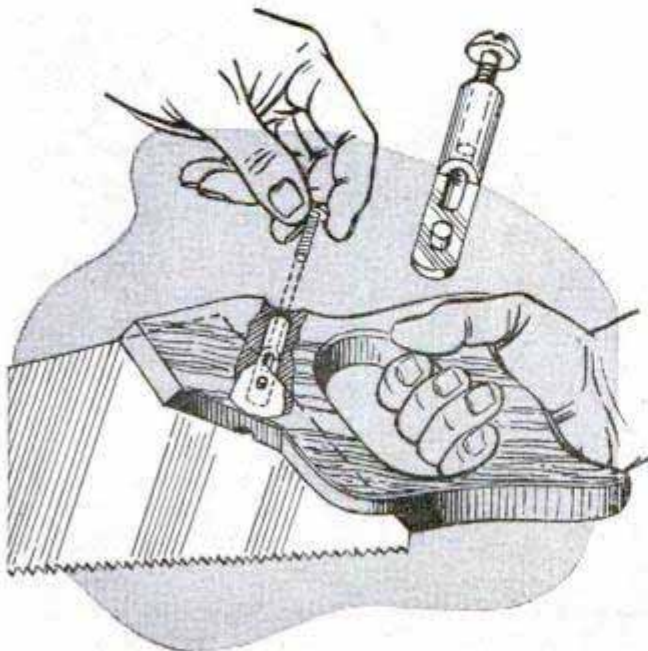

## Vest-Pocket Humidor

Two days' supply of pipe tobacco keeps fresh in a flask-type humidor curved to fit small pockets without excess bulging. A spout with a flip-up cover facilitates pipe filling. Made of two-tone rigid plastic, it is 2½ inches wide and 3¾ inches high. To service the humidor unit built into the top section, the felt insert is removed and dipped in water, then squeezed out and replaced.

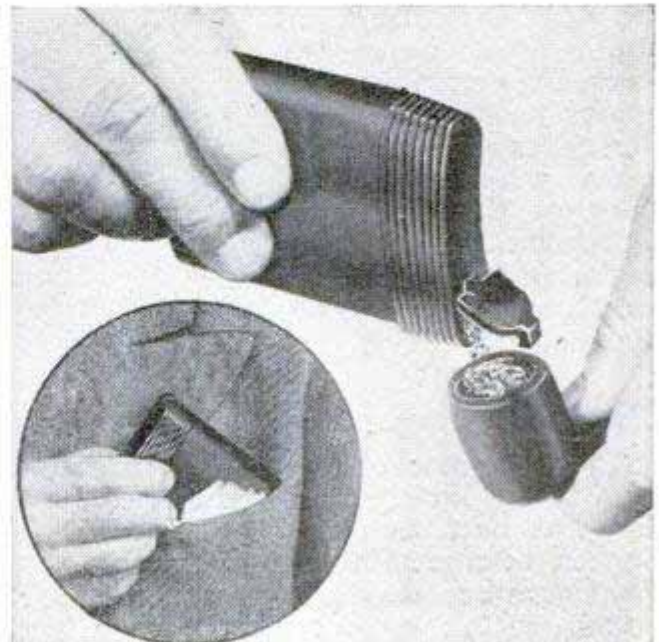



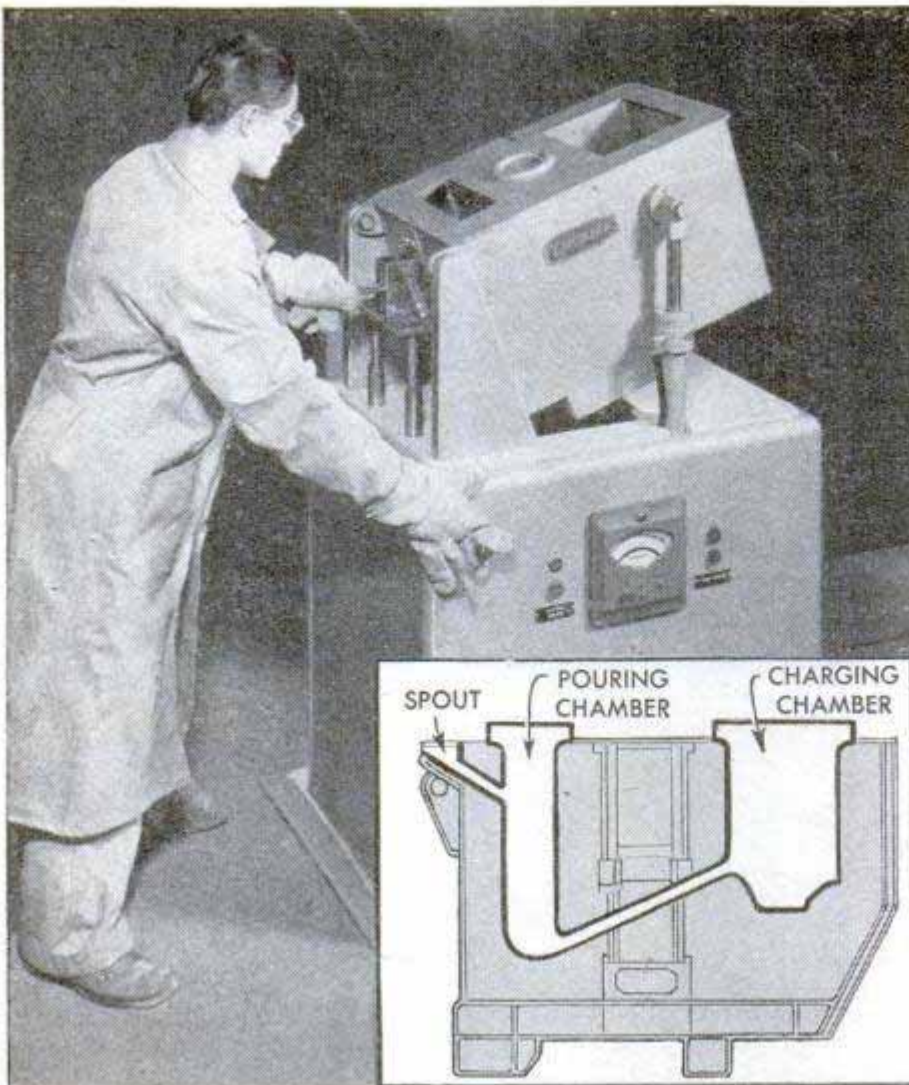

## Continuous Casting With Double Furnace

Molten metal is always ready to pour with a two-chamber melting furnace that raises and lowers hydraulically. Cold metal added to the charging chamber does not affect the temperature of the pouring metal, thus pouring can be continuous. In addition, impurities in the metal remain in the charging chamber so that metal poured from the second chamber is always clean.

## Birds Glow in Dark

Some birds glow in the dark with a phosphorescent light, just like certain fish and other sea life. Dr. W. L. McAtee of the U. S. Fish and Wildlife Service thinks the light comes from luminous bacteria or fungi eaten by birds, like the barn owl, or attached to their tissues.

## Electric Sharpener Can't Damage Knife

Too much pressure automatically stops a motor-driven electric knife sharpener and prevents blade gouging. Only the edge of the blade is sharpened. If more than the edge is held against the wheel, the motor stops. Two stainless-steel guides position the cutting edges against the abrasive wheel and both sides of the blade are sharpened at the same angle. A pressure panel switch starts and stops the motor.

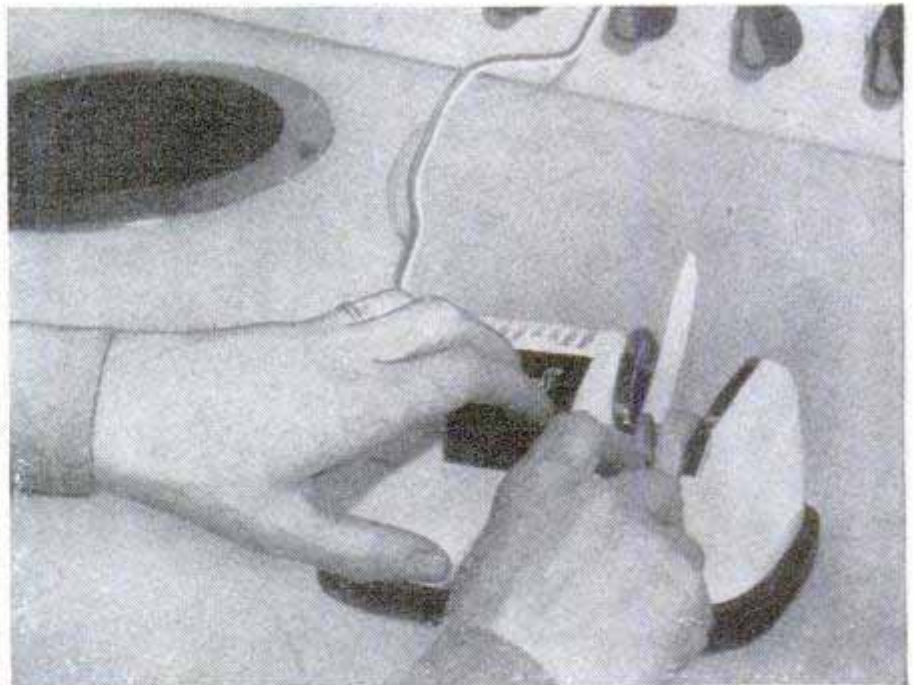

## Chemical Smoke May Turn Back Radar in the Future

Chemical smoke that can stop radio waves, thus limiting the usefulness of radar, has been predicted by Col. M. E. Barker, commandant of the U. S. Chemical Corps School. He suggests that radar beams, which have made concealing

smokes relatively useless, may be turned back by a special smoke. Such smoke would be effective against gun-laying by radar and as protection against guided missiles. He also forecasts poison gases made more deadly by radioactive particles.





Bell Aircraft Corp. photo

### Self-Powered Wheelbarrow

Taking the backache out of pushing a wheelbarrow, a motorized version has a capacity of 1000 pounds and can climb a 20-percent grade with a full load. The three-wheeled machine has a three-horsepower air-cooled engine that runs for eight hours on three gallons of fuel. Transmission, clutch and gears are completely enclosed and no belts or chains are used. Weighing about 400 pounds, it turns in its own length and is narrow enough to go through ordinary doors. The 10-cubic-foot bucket can be replaced with a platform deck. A snowplow attachment is also available.

### Button Snaps Key Out of Case

Keys loaded into a new key case are easily distinguished and ready for use when a button is pressed. The case, made of Tenite plastic, holds two keys, which can be loaded with the notches facing in the direction most convenient for handling. Pushing one of the buttons ejects the key. When the button is released the key snaps back into the case. The keys are identified by different button surfaces.

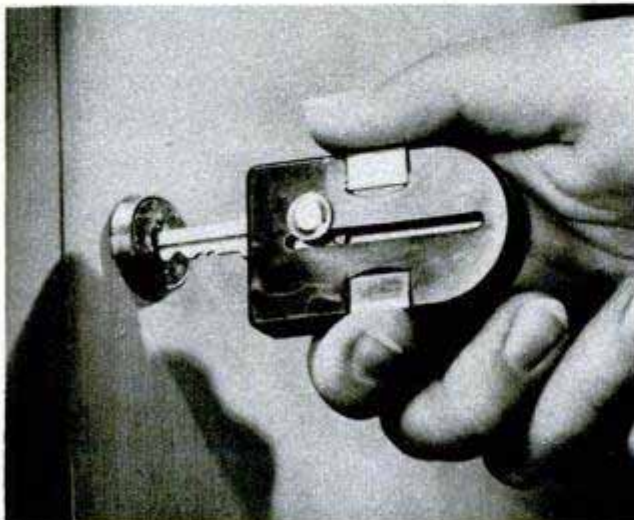

### Test Machine "Smokes" Cigarettes

Cigarettes can be "smoked" with regular puffs by a machine developed to measure combustion and to determine what unburned residue is left in automobile exhausts. The device's lungs suck in as much air in one breath as the average smoker does from his cigarette, and takes the same time doing it. When it exhales, a filter tape intercepts the "exhaust" and retains the solid content. The machine was built by petroleum engineers in the research laboratories of the Cities Service Company.

### Demountable Battery

In 15 minutes a new demountable battery can be taken apart, repaired and re-assembled, using only a pair of pliers. The plates are suspended from the cell covers, avoiding damage from shock and vibration that often occurs when plates rest on the bottom of the battery.

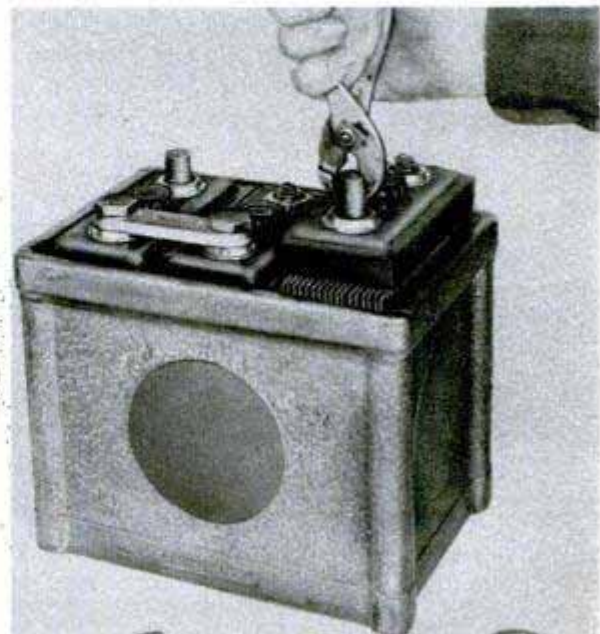

APRIL 1948  
George E. Cross



# WHAT'S NEW *For Your Home*

Sources of supply for these products may be obtained from Bureau of Information, Popular Mechanics Magazine



**MAGNESIUM CHAIRS FOLD** for easy storage but when opened they don't have that collapsible look. Thick upholstery provides beauty and comfort and die-cast construction gives them strength

**RANGE HAS A PRESSURE COOKER** that fits into heating element which can be raised for top-of-range cooking when the cooker is not being used. The electric range has automatic time controls

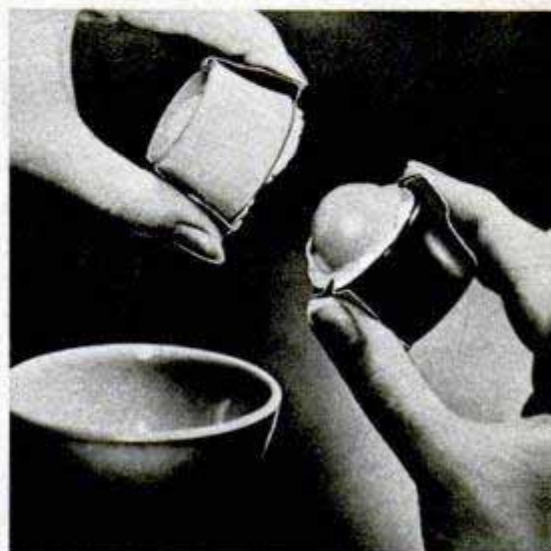

**EGG CRACKERS** made of Tenite plastic prevent burned fingers. One half holds the egg; other removes the top

**SHELF SUPPORTS** with snap-on clips are adjustable to any height. Hammer is only tool needed for installation

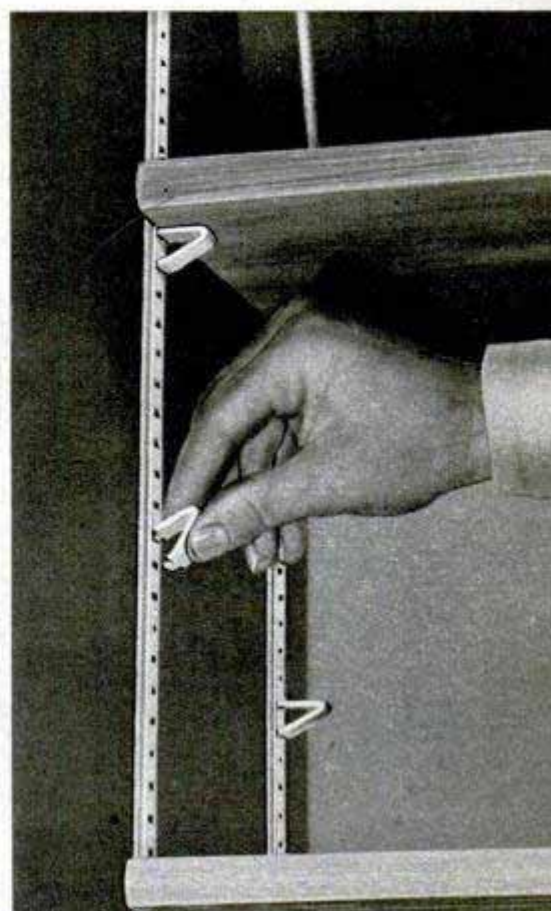





**BED HAS PADDED ARMRESTS** built into headboard for comfort while reading or eating in bed. The center section of headboard tilts forward to support the back. When not in use, the armrests fold out of the way

**CORN BUTTERER** ends the problem of chasing the butter around a hot ear of corn. Held inside the curved "spoon" the butter is spread evenly over the ear without any waste or mess

**TAPERED DRAWER** in dining table keeps silverware in convenient place and eliminates knee-cracking by diners. Narrow along its front edge, the drawer doesn't interfere with leg room, but does have ample space for silverware

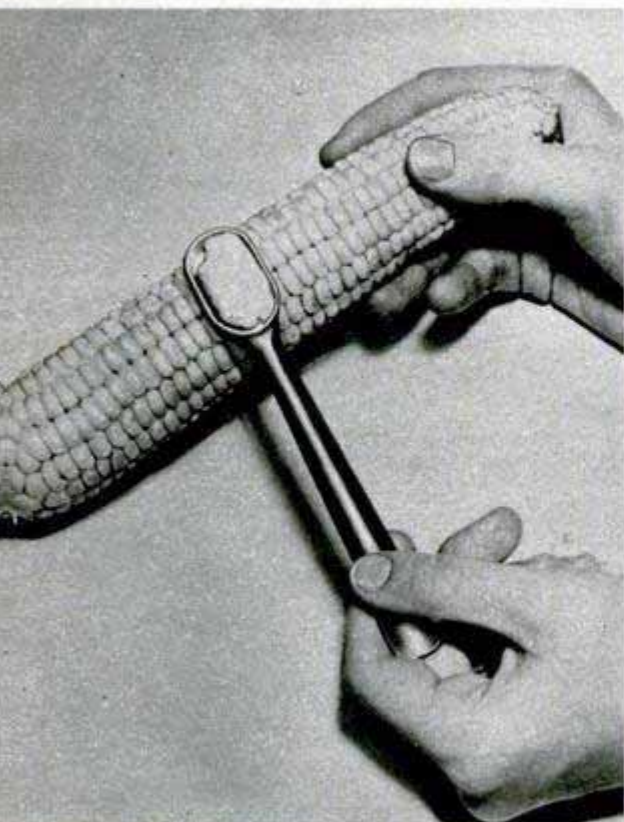



# WHAT'S NEW *For Your Home*

Continued from preceding page



**FLEXIBLE TABLEWARE** of unbreakable plastic can be squeezed to form a convenient spout for pouring

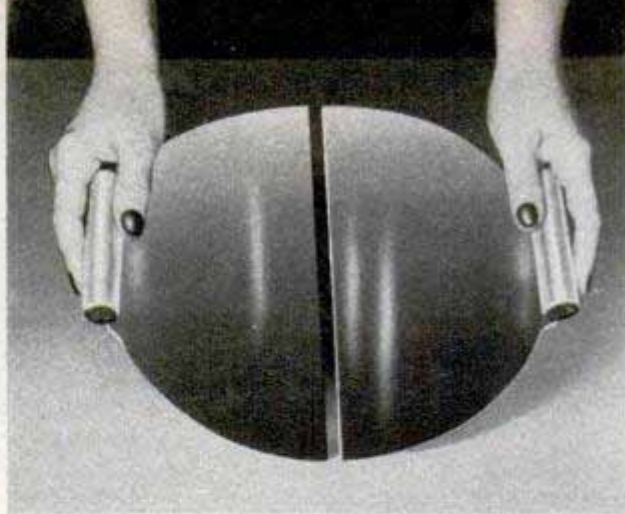
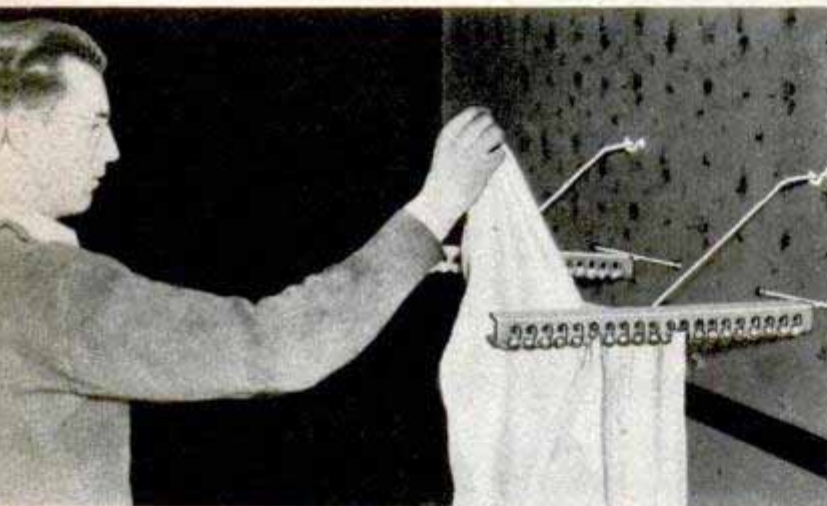

↑ **PASTRY LIFTERS** slip under thin-rolled dough for transferring it to pie plate without tearing

← **CLOTHES RACK** needs no cross rods. Pressure between marbles in the arms holds clothes securely

**BABY CHAIR-TABLE** (below left) has wide surface; slide under top fills opening for use as a table

↓ **STAND-UP TRIMMER** can be adjusted to cut at various heights. Large wheel makes it roll easily

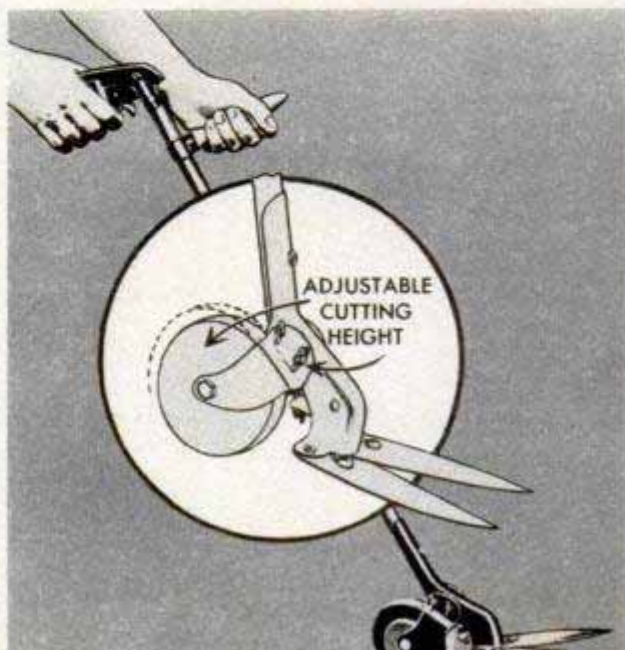



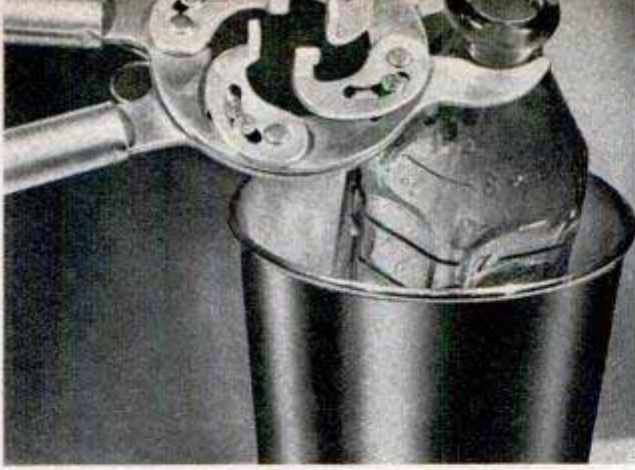

↑ **GERM-FREE NURSING BOTTLES** result when this tool is used. Hands never touch the nipple or bottle

**EGG POACHING** is foolproof with four-egg poacher (right) that cooks eggs in water below boiling point

↓ **INSULATED JUG** has electric element that boils water and keeps it hot for use on the dining table



↑ **SKIRT HANGER** never slips as clothing is held between two nonskid rollers of colorfast plastic

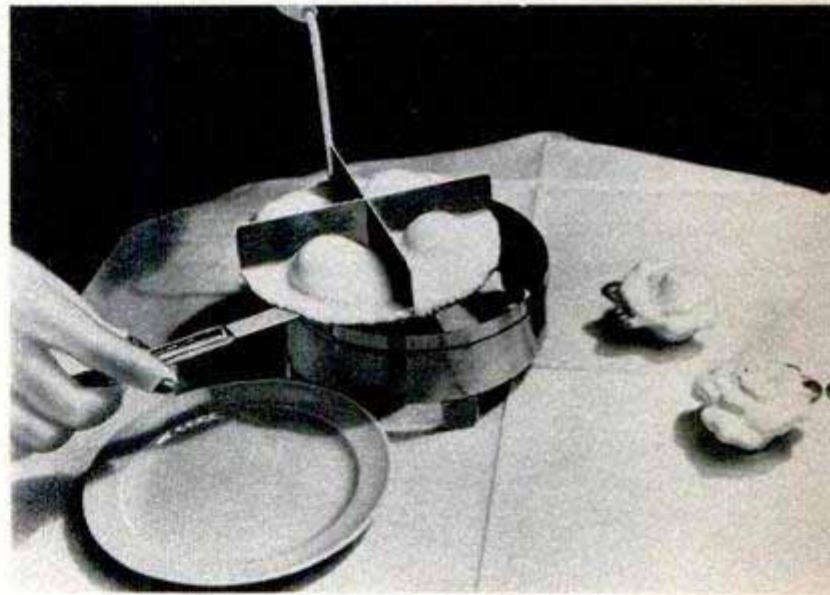



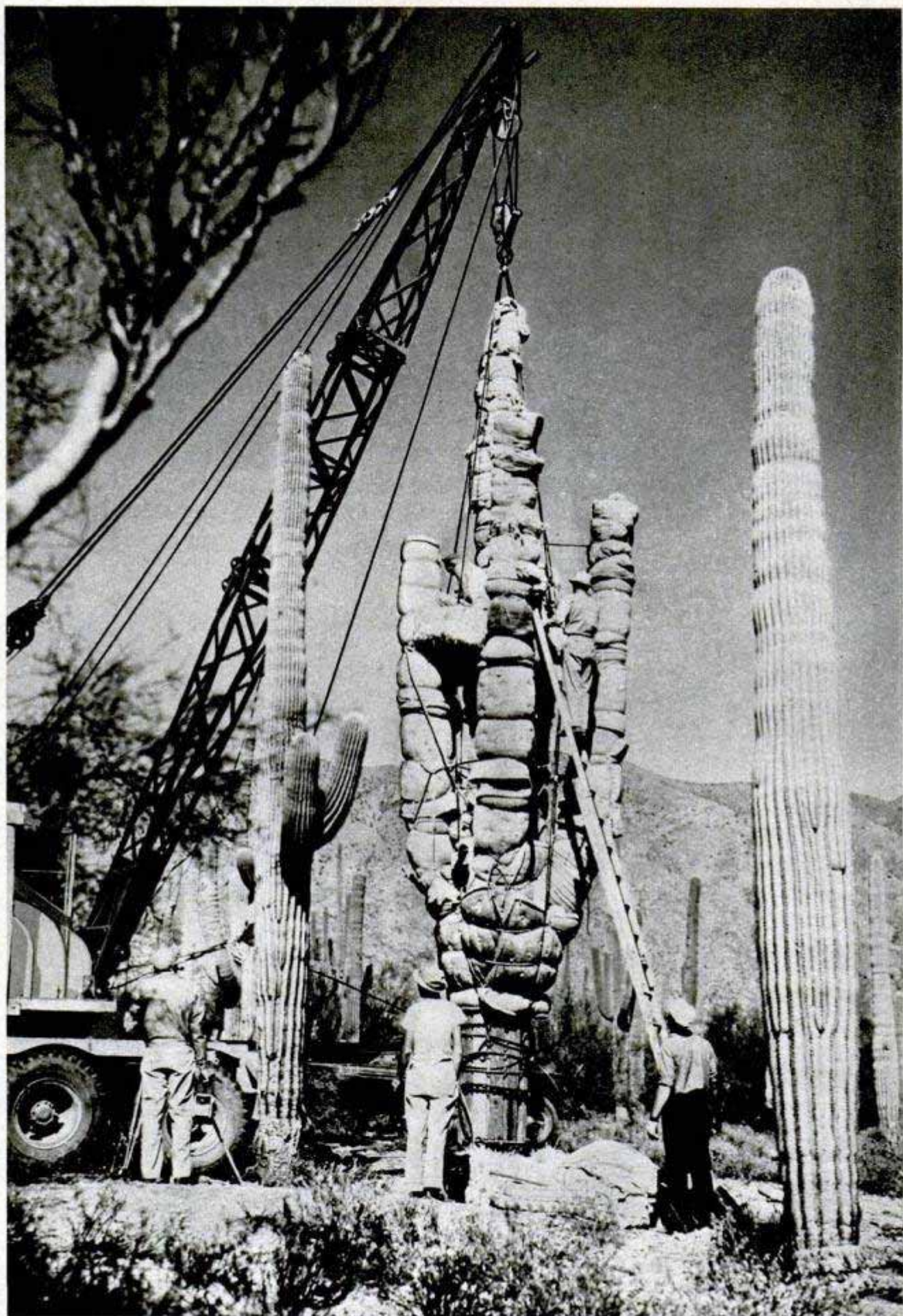

**FORTY-THREE OLD MATTRESSES** and six bales of hay padded a giant Arizona cactus while it was being transplanted from its mountain-slope home of three centuries to a private estate. A Saguaro, largest and least common of all American cacti, it is 38 feet tall and has five arms. The large white blossom is Arizona's state flower. For the unique move, the cactus was lifted and held upright by a 20-ton crane on a truck. Chains tightened with log boomers and a steel plate that secured the base helped prevent swaying on the desert roads



## Electronic "Brain" Has Photo Memory

With its really photographic memory, the Navy's electronic "brain" will memorize mathematical data at a rate of a thousand 12-digit numbers every second. Numbers from the calculator are converted to dark and light rectangles by a cathode-ray tube. A special movie camera, operating at tremendous speed, photographs these rectangles as they flash on the tube. The numbers can be fed back into the calculator for further computation by projecting the developed film onto photoelectric cells that translate the rectangles into numerical values. Eastman Kodak, where the photo-memory device was developed, plans to

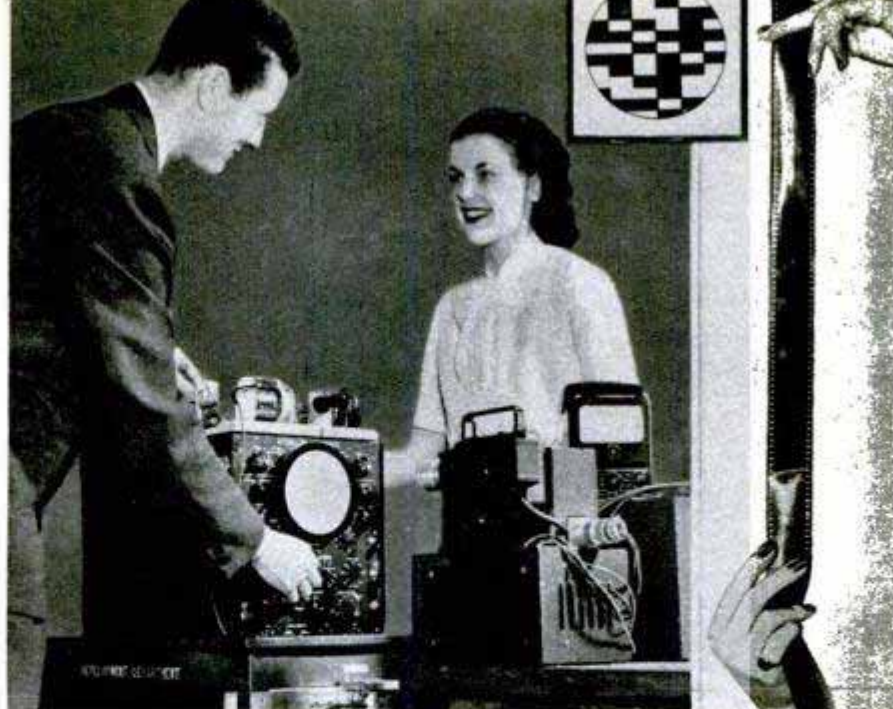

Numbers flash on circular scope at left as black and white rectangles (see insert) are recorded on film (right) by special movie camera (center)

build an auxiliary unit that will convert the recorded information into tables of numbers for study by mathematicians.

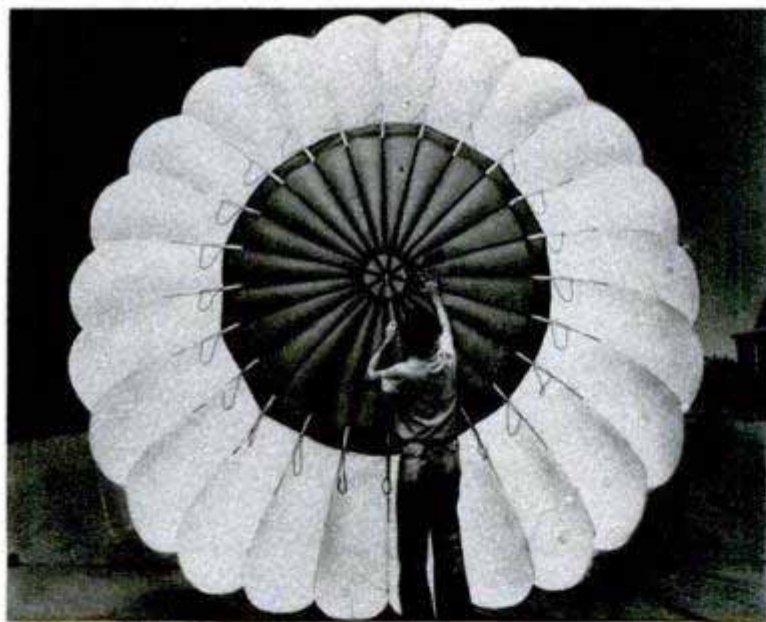

U. S. Navy photo

## Plywood Air Flivver. Homemade for \$500

With \$500 and 850 hours of his spare time, Edward O. Effenheim of Milwaukee was able to build a vest-pocket plane with a 143-mile-an-hour top speed. The plywood flying flivver's wingspan is 15 feet and it is 13 feet 6 inches long. Effenheim, a student pilot and a licensed aircraft mechanic, expects his craft to have a 400-mile range.



## Navy Chute "Blows Top"

For 500-mile-an-hour bail-outs, the Navy has a new parachute that "blows its top" during the initial heavy stress. Immediately after bail-out, a six-foot-wide "cap" extends on elastic cords, spilling the air out the top. The cap is drawn back as the chute slows down, spillage is reduced and the rate of descent is gradually decreased. Using dummy bombs to simulate bodies, it has been drop-tested at speeds twice as great as those present types will withstand. The designer is a veteran parachute rigger at the Navy's Lakehurst, N. J., base.





## FLYING DOCTORS

Radio plea for help sends a flying doctor on house call a hundred miles away

**I**N THE "Never-Never" land of northern Australia — the rugged territory where neighbors live a hundred miles apart — doctors are on 24-hour duty. A message by radio from one of the transmitters in the lonely outback homes sends the medics by plane on a call hundreds of miles away.

These are Australia's flying doctors. They provide a mantle of medical attention for the 2,000,000 square miles of sparsely settled country. No spot in Australia is more than 300 miles from a flying doctor. Recently a five-year-old boy was saved

after a 400-mile flight and an operation performed by lamplight.

Seven towns provide bases for the Australian Aerial Medical Services — the organization's official name. Doctors covering the Queensland area alone wing their way over 60,000 miles a year.

The idea of blanket medical coverage for the Never-Never land was conceived by the Rev. Dr. John Flynn, who once patrolled the "inland" with medicine in his camel pack. He started the organization with a nursing home at Oodnadatta.

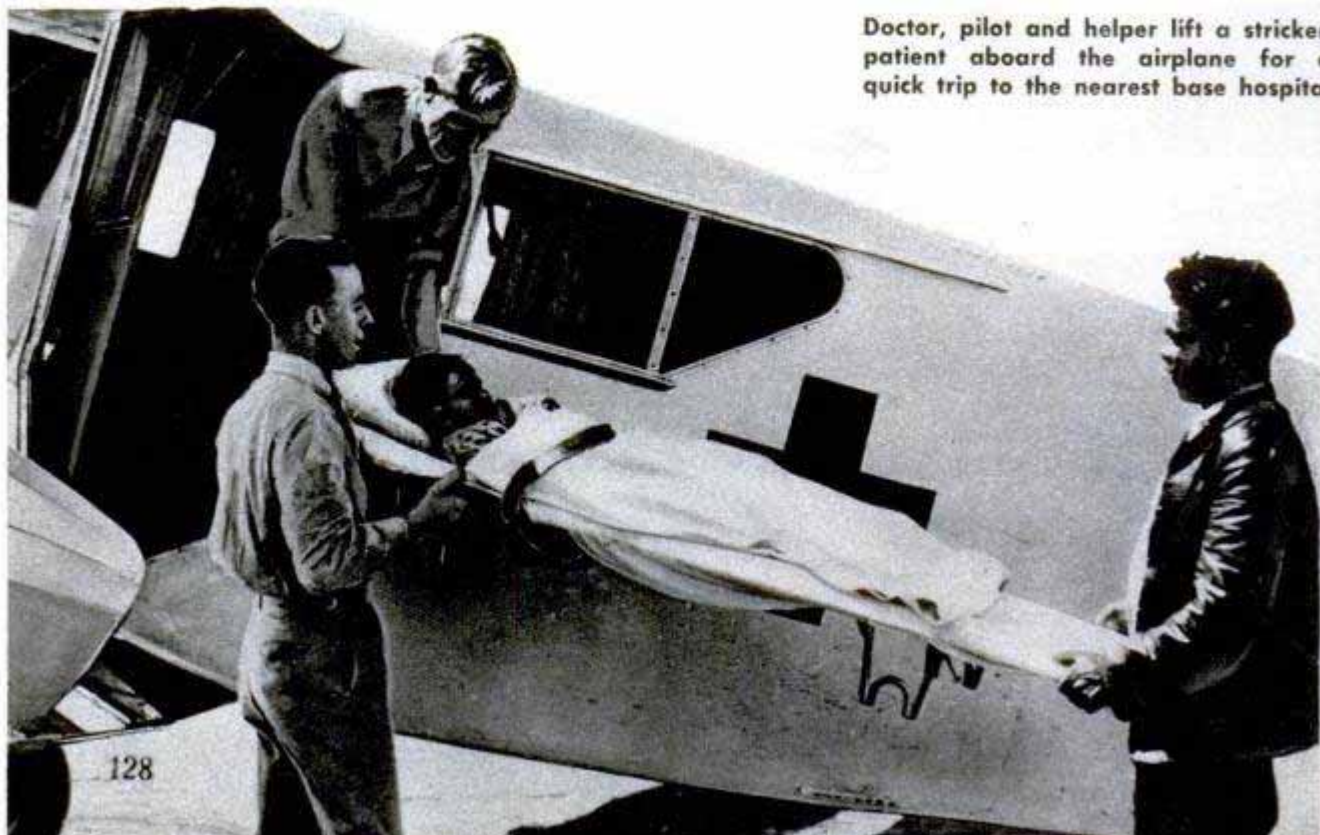

Doctor, pilot and helper lift a stricken patient aboard the airplane for a quick trip to the nearest base hospital



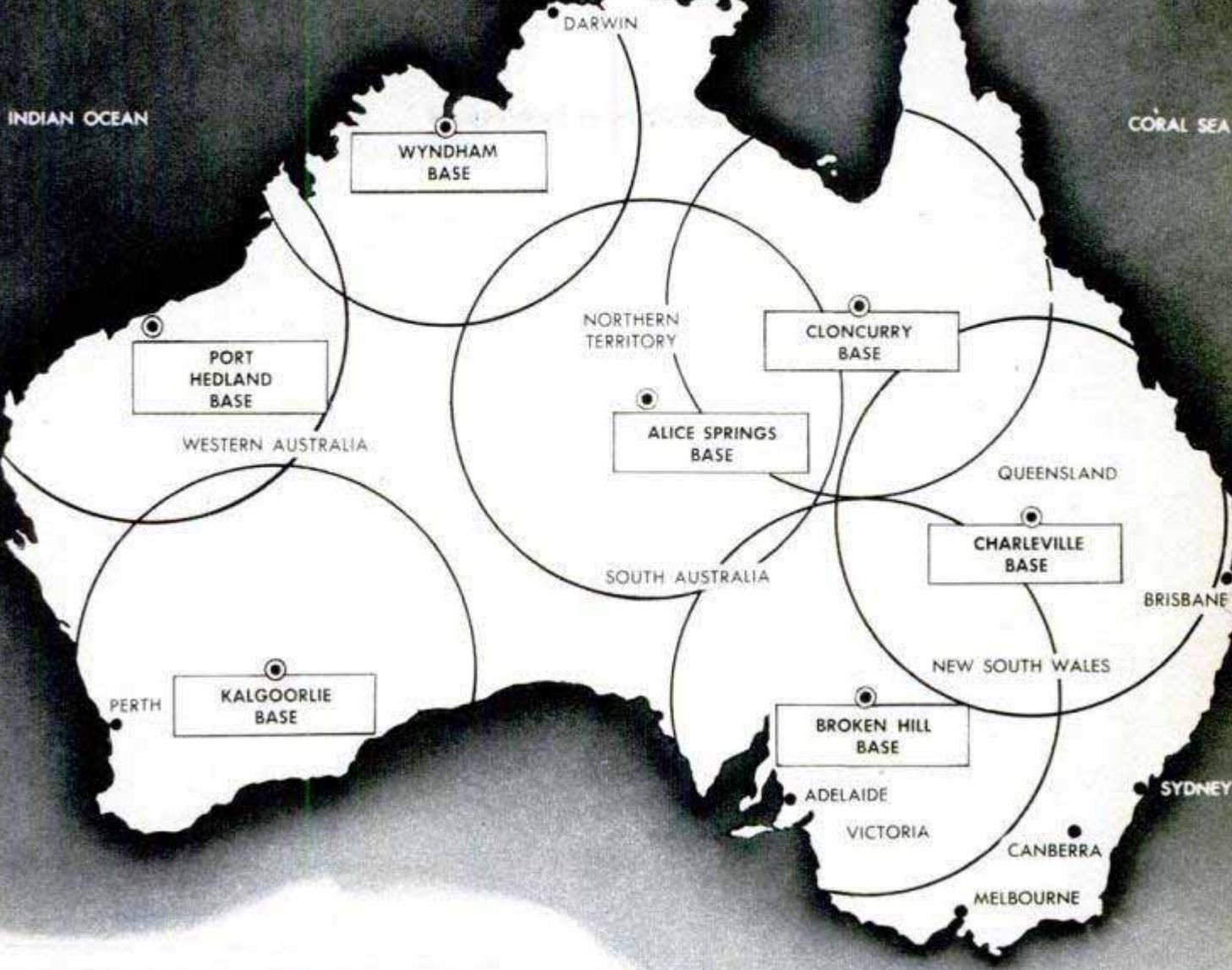

But a trek by camel or horse takes time and emergency treatments can't wait. Flynn saw that only aircraft could cover the interior fast enough. He decided that flying doctors operating from medical bases offered a solution.

Communication was another stumbling block. The type of radio set Flynn needed had not been developed at that time, so he built a portable set so simple that any member of the household could operate it.

The 250 sets scattered across the interior today are more than links with the flying doctors. They have become the telephones of the outback settlers, and the postmaster-general has registered the sets to transmit telegrams to any part of the world.

Lonely housewives use the wireless to talk to their neighbors a hundred miles away. On-the-air time has been allocated for what are called "over the fence" chats so womenfolk can exchange gossip daily.

But essentially the network is for medical service. Relatives of a sick person call the hospital and the doctor gives instructions. If it's an emergency he hops in the plane for a call a hundred miles away.



Doctor and nurse land as near the patient as possible, then wade floodwaters carrying medical kits  
↓ Radio operator listens for the outback stations

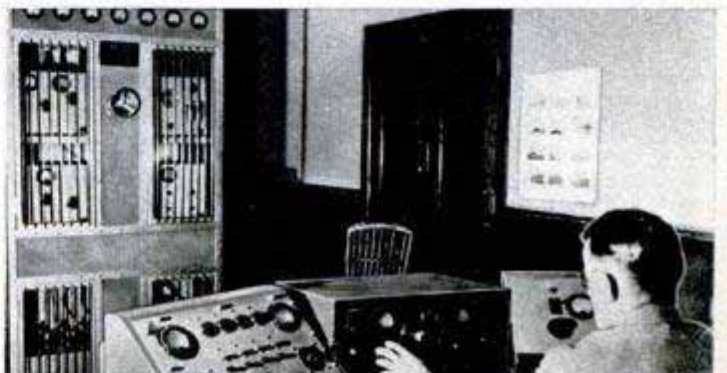



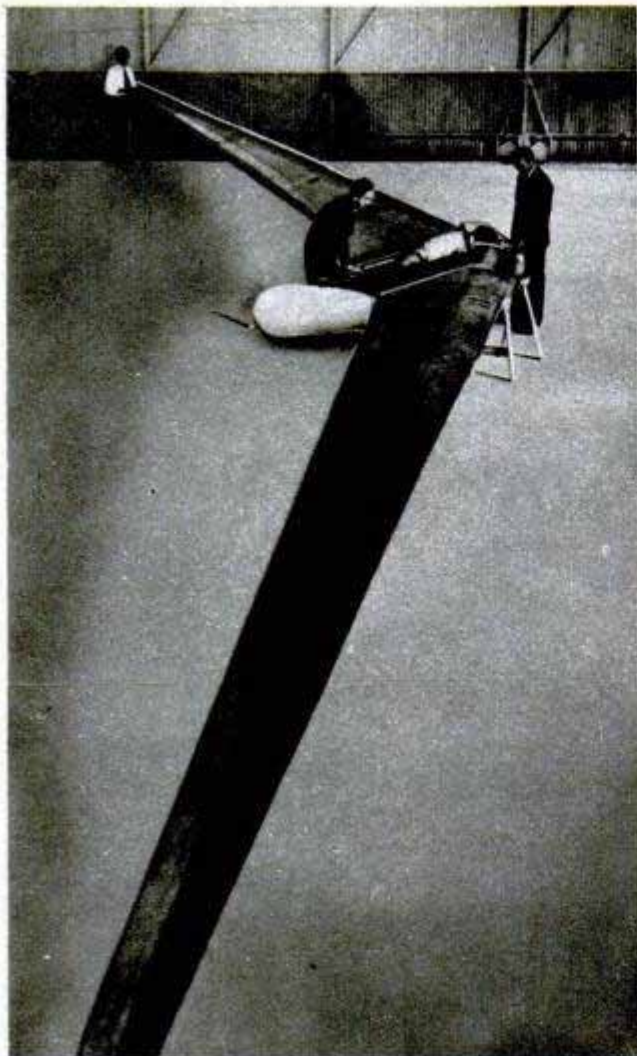

### Designers of Flying Wings Study Secrets of "Strato" Glider

Called the "nearest thing to a bird ever built," the Horten 6 German glider has a 78-foot wing. It holds the world's altitude record of 39,000 feet for engineless craft. The pilot crouches under a plastic bubble and controls the glider with a conventional wheel and tiny toe-rudder pedals. One device simultaneously releases the pilot's safety belt and jettisons the metal hatch cover for emergency bail-out. The craft is being studied by Northrop aircraft engineers at Hawthorne, Calif., for possible design improvements on current-type flying-wing aircraft, like the giant B-35.

### Flying Trapeze Artist Rides Helicopter

Even the "daring young man on the flying trapeze" would have to take a back seat for Marilyn Rich, a 24-year-old circus performer. From trapeze equipment wired beneath the landing gear of a helicopter, she does full body spins while dangling by one arm from the end of a rope. Miss Rich's mark of 402 consecutive turns is a world's record for this specialty.

You may wish to obtain additional information about new products described each month in Popular Mechanics. If you want to know the name and address of the manufacturer, just write Bureau of Information, Popular Mechanics, 200 E. Ontario St., Chicago 11. Your letter will be answered promptly

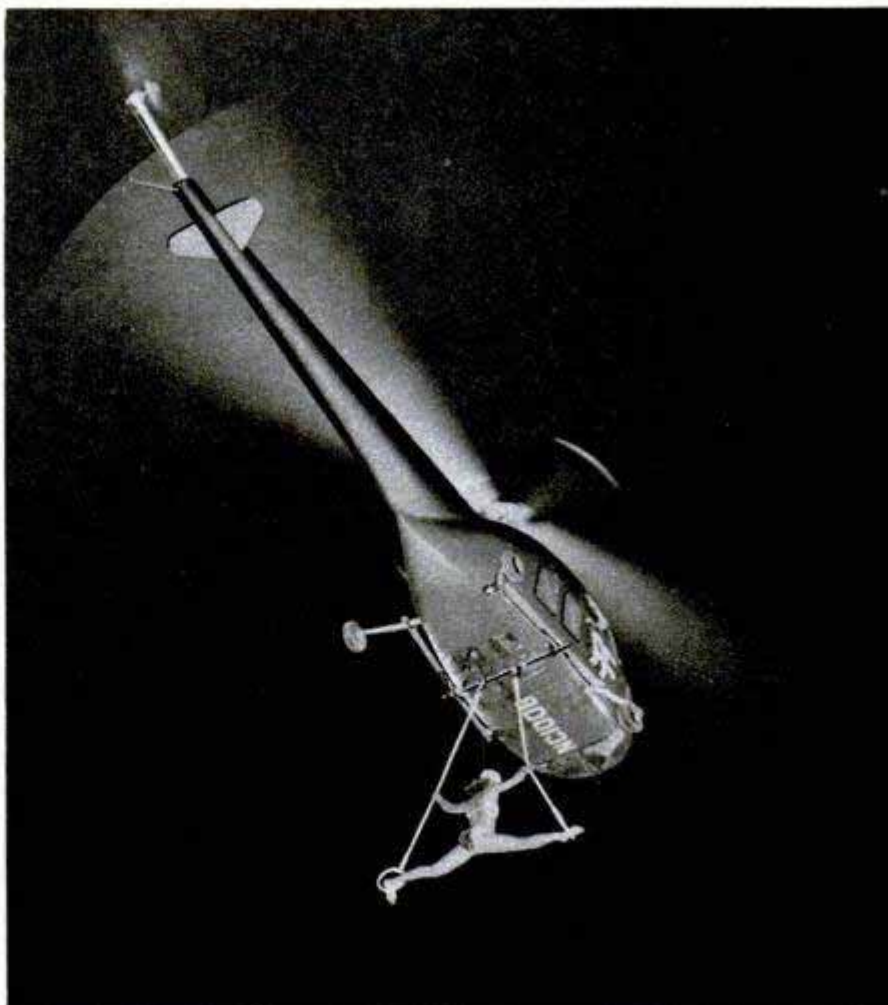



# GUARDIANS of the RAILS

**I**F JESSE JAMES had started his crime career as a train robber in 1948 instead of 1867 the chances are it would have been nipped in the bud. An alarm would have gone out from alert railroad police to marshal a network of local and state patrolmen and Mr. James soon would have been on his way to the cooler instead of a 15-year career of crime.

Railroad special agents—the policemen of the iron roads—may not be as picturesque as they were in the six-shooter era, but they are far more lethal. Rail-riding travelers are little aware of the invisible protection provided by this unpublicized branch of railroading. The majority of railroad police, like the G-men they emulate, are in plain clothes. They make use of every modern means of crime prevention and detection from the lie detector to spectrographic analysis.

Delbert L. Wood, chief special

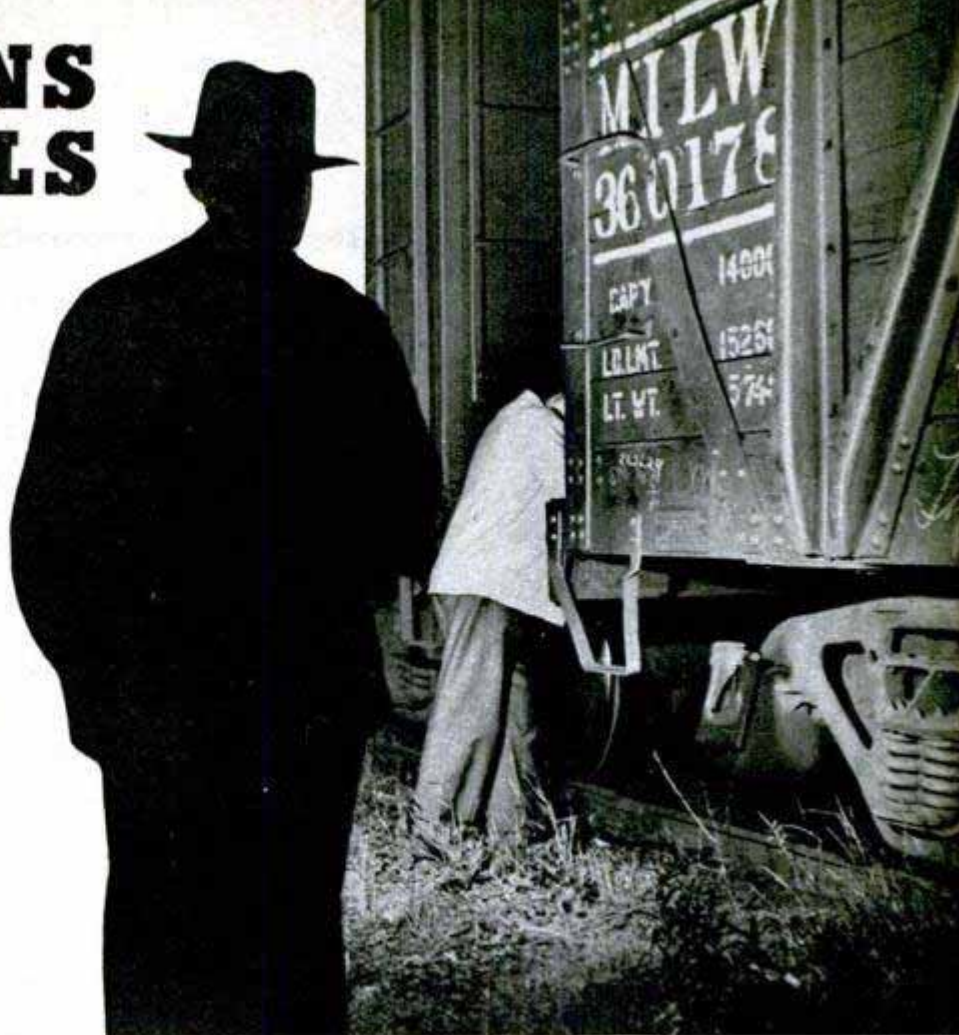

Here's how Illinois Central detective spots prowlers (often escaped convicts) around freight cars in the yards at night. Below, plain-clothes man (arrow) looks for station pickpockets







Lt. C. J. Buttimer of the Illinois Central police placing seal on freight-car door. This seal consists of a loop made of a metal strip and must be broken to open door. If cargo is particularly valuable, latch (above) is "hog tied." Flat nail is pushed through the slot and one end twisted into curly pigtail effect

agent of the Illinois Central Railroad and a former G-man, recently initiated a system which has gained him national renown for training these guardians of the rails. As chairman of the education committee of the Chicago Railway Special Agents and Police Association, he organized a training course of 10 sessions conducted by the Federal Bureau of Investigation, state, county and city police departments. The G-men stole the show with an array of talent and systems for detection that had

the most hard-boiled coppers jotting down notes like schoolboys.

The criminals who receive the undivided attention of the railroad police are: train wreckers, robbers, burglars, pickpockets, and the hybrid and garden varieties of confidence men.

FBI agents have plenty of firsthand information on hunting down train wreckers. This crime is a federal offense if a train is engaged in interstate or foreign commerce.

In the case of a train wreck, the investi-

Railroad police rush to wreck scenes like this one to obtain clues before they are all destroyed by onlookers





gative work is divided into an immediate and necessarily hurried search of the scene for clues, a terrain search of the vicinity and a neighborhood investigation. Train wreckers are no different from other criminals in one respect, says the FBI—they are sure to leave clues at the crime scene.

Some months ago after a wreck in the East, local and railroad police were baffled and called in the FBI. One clue at the scene was obvious enough—a 185-pound iron casting from a mine car. A terrain search had revealed that the casting had lain along the right-of-way for some time



Lt. J. C. Buttmer takes stroll in the Illinois Central's big Markham Yards near Harvey, Ill., to check a few freight-car seals to see if his inspectors are on their toes. Inspectors can spot a tampered seal 20 feet away

and probably had not been dragged there for the purpose of wrecking a freight. The police concluded, logically enough, that a strong man had moved the casting onto the rails. This belief made the case unusual because a great majority of train wrecks are caused by juvenile criminals.

As the wreck had occurred in an out-of-the-way community where strangers are a novelty, it seemed likely that the criminal was a local adult male. A thorough investigation proved this premise to be wrong. At this point, the FBI launched an exhaustive neighborhood investigation. Every person in the vicinity was questioned not only about his own comings and goings, but about everything he or she had seen and heard during a period going back to several weeks before the wreck. Finally, one old lady recalled having seen a strange boy skating along a creek which ran near the railroad track about two weeks before the wreck. If the FBI investigator had dis-

missed this clue as being of no value (due to the weight of the casting) the case might never have been solved.

They found that the strange boy, who lived in a nearby town, had been visiting his grandparents, and established his identity. He was a husky lad about 13 years old who had a good reputation in his community. The investigators also discovered that he had returned to visit his grandparents the day of the wreck. When confronted by the FBI he not only confessed but demonstrated how he had dragged the heavy casting onto the rails.

Here are a few tricks in modern sleuthing passed along to the railroad police by the G-men:

In looking for clues don't overlook anything as insignificant as a cigarette butt, a hair or a torn piece of any type of clothing—particularly if it is cloth that may have been laundered. Most laundries in the U. S. put an invisible mark on clothing





Lt. William Bangert inspects riddled carton of expensive perfume. Packages like this are held by police while order is traced. Below, freight under guard

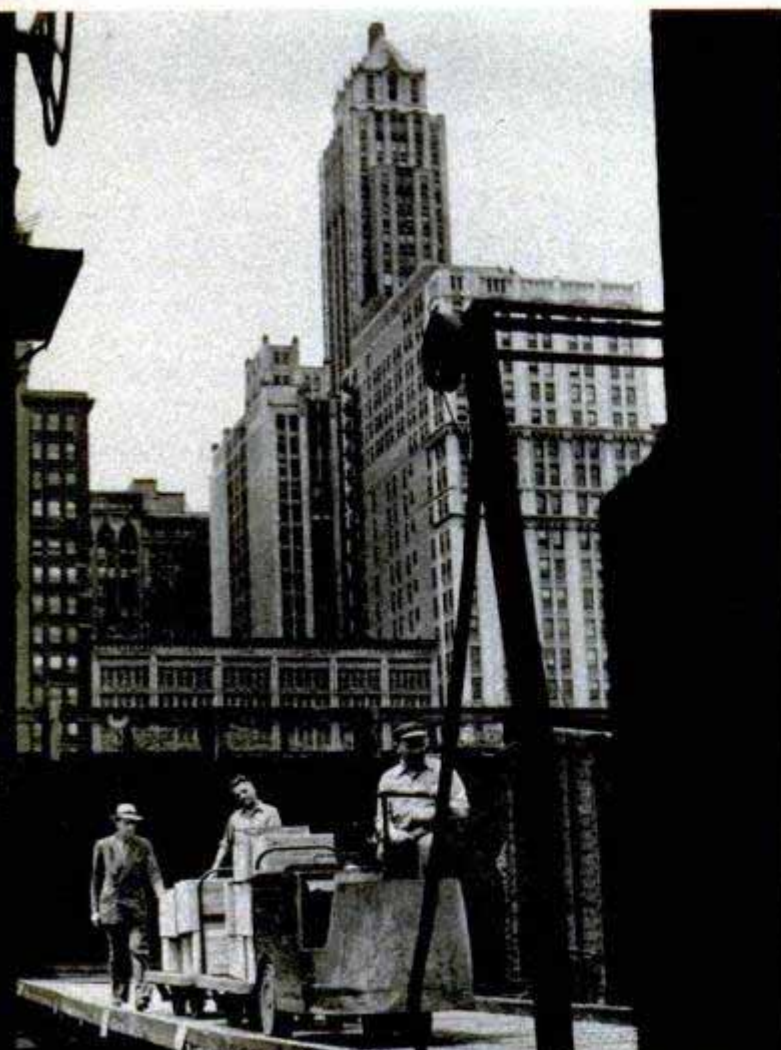

which passes through their plants. These marks, visible only under ultraviolet light, are registered with the FBI. A cigarette butt may not "put the finger" on a criminal but can be helpful in eliminating suspects. The saliva, if any, on the butt can be typed just as human blood is typed. Hair has racial classifications.

Any cutting of signal wires or air hose done with a sharp instrument, such as a pair of nippers, provides a valuable clue. No sharp tool, whether chisel, knife, plane, nippers, or even a razor, is so finely ground that it doesn't leave some jagged and distinctive marks. Microscopic examination of a cut can be matched with the tool that made the cut to provide indisputable evidence. Also when a wire is cut, microscopic particles of the wire are left on the tool that did the job. Spectrographic analysis reveals the exact metallic composition of the wire and the loose particles.

Ordinary dirt found near the scene of a crime also can be an important clue. In making a terrain search investigators are on the alert for particles of dirt unlike those of the immediate area. A piece of dirt from a criminal's heel or from the tread of a tire has helped solve many crimes.

The obvious clues, such as fingerprints, footprints and bloodstains are never to be overlooked. The railroad police have at their disposal the great fingerprint files of the FBI in Washington.

A footprint found in the dirt can be preserved, as every policeman knows, with a plaster-of-paris mixture. But what if the footprint is found in the snow? The FBI merely dusts the print with talcum powder or flour before pouring in the plaster of paris. Results are excellent.

Fast-working boxcar thieves occasionally gash a finger and leave bloodstains. How can you tell whether a stain which may be any color is blood? A few drops of a solution composed of equal parts of benzidine and hydrogen peroxide will cause the stain to turn blue or bluish purple if it is blood.

At the training session for railroad police in Chicago, FBI instructors stressed the importance of terrain search. Every inch of ground around a crime scene should be surveyed. Wooded areas, places with heavy undergrowth, creeks or gullies present a problem. This is often the type of terrain in which a train wreck occurs. A careful search of such an area can be made with a team of four or five men and several balls of twine. First, some sort of boundary line such as a fence or creek is decided upon. Working within arm's reach of each other the men start out walking abreast. The man walking farthest from the boundary

(Continued to page 248)



## What Holds Atoms Together? Scientists Seek Answer

What mysterious force keeps the core of matter from exploding like an atomic bomb? According to electrical theory, the nucleus should explode rather than stick together, as it is made of positively charged protons and neutral particles called neutrons. Since like charges repel, protons could be expected to blast one another out of the nucleus, according to Westinghouse scientists who recently launched an extensive research campaign on the subject. Actually, the protons stick together with tremendous tenacity, and it is this binding force that technicians are attempting to analyze and measure. The principal tool of the research program is the Westinghouse 47-foot-high atom smasher, which fires "atomic bullets" at a target with great accuracy, permitting scientists to measure the force required to break atoms. The atom smasher was tested for its newest assign-

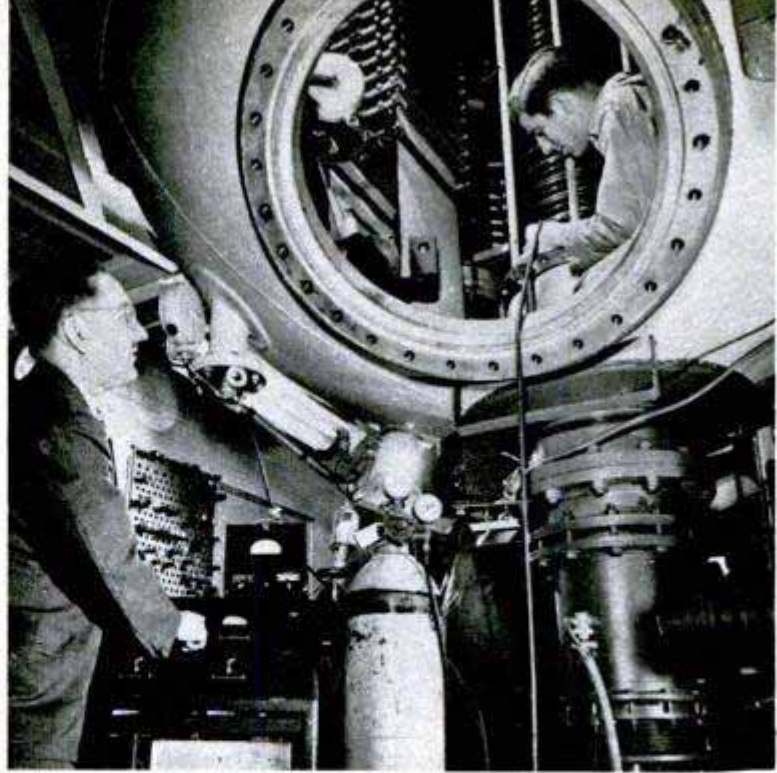

Scientists check atom smasher with detector that finds a leak so tiny it would take 3000 years to deflate an automobile tire

ment by spraying helium along every inch of surface joint. Leaks in the system were detected by an electronic "sniffer."

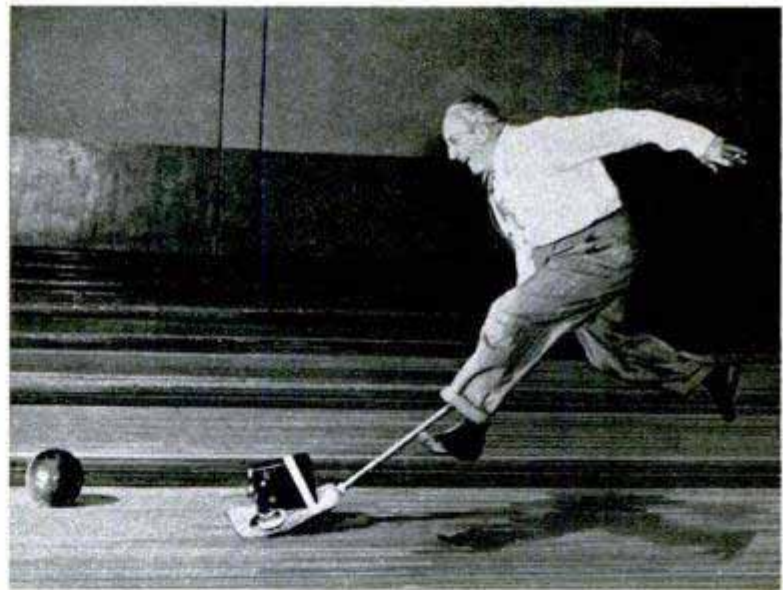

## Cameraman Chases Bowling Ball To Film Close-Up of a Strike

When cameraman Norman Alley filmed a bowling ball in action he provided more action than the ball. Fastening his movie camera to a broom, he removed his shoes and chased the ball down the alley pushing the broom a foot or so behind it. The resulting film shows the ball from start to finish of a perfect-strike roll.

Top left; Alley gets away fast after the ball. Top right, at full speed one Alley flies over the other alley. Right, the camera films the perfect strike







## Man-of-War Becomes Home-of-Peace for Japanese Family

Beating swords into plowshares is given a novel twist by a Japanese laborer at the Hiroshima shipyards. He converted part of the former battleship Ise into a comfortable

home for his family. Formerly the officers' quarters, the superstructure is mounted on a rock base. The admiral's stateroom serves as the family bedroom.

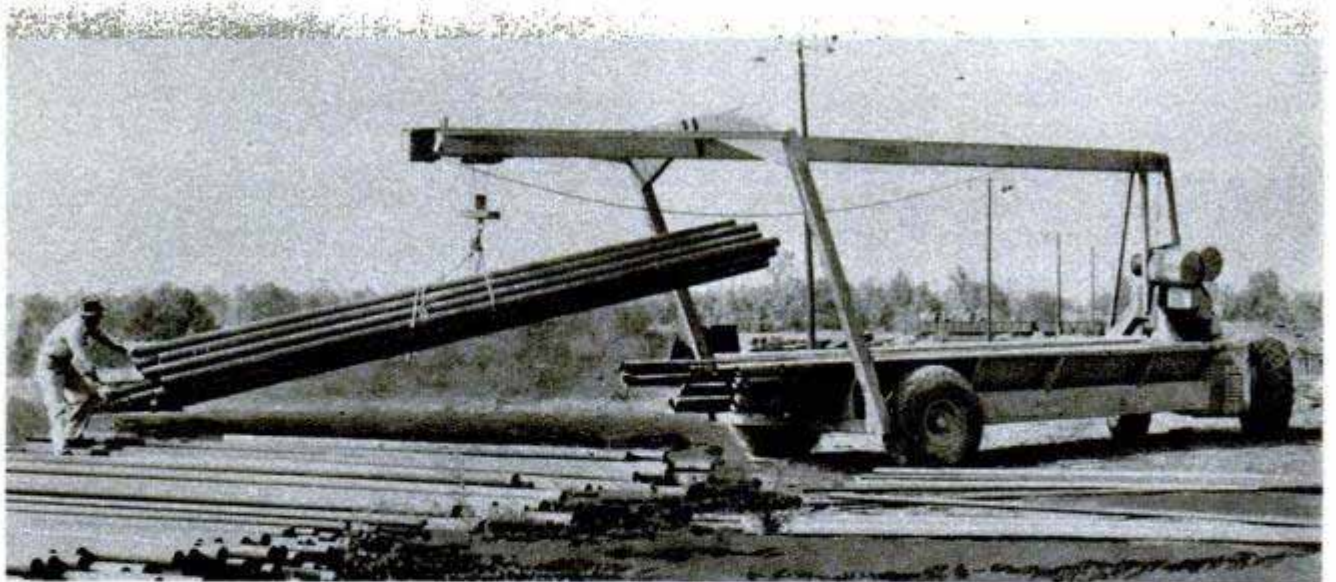

## Self-Loading Truck Has Built-In Crane and Trolley

With a built-in crane and trolley a new truck can load and unload almost any type of material. The vehicle, mounted on large rubber tires, has a loading capacity of 100 tons and can move down the highway or across rough terrain. Powered by a Diesel engine, the truck has a differential that

supplies the most power to the wheel that has the firmest footing. When equipped with the crane and trolley the vehicle can be used to load and unload heavy pipe or logs or other cumbersome material. The two-wheel prime mover permits 90-degree turns for increased maneuverability.





Pennsylvania State College photo

Dr. Henry L. Yeagley releases bird to test theory that earth's rotation and magnetism guide it

## HOW DO PIGEONS NAVIGATE?

By Clifford B. Hicks

**H**OW DO homing pigeons find their way home? A Pennsylvania State College scientist has come up with a fascinating answer to the pigeon puzzle, one of the two popular mysteries that have baffled six-year-olds and scientists for centuries. The other—how bats fly in total darkness—was answered a few years ago when scientists discovered the bats' built-in radar system.

Now, Dr. Henry L. Yeagley has probed the pigeon riddle and discovered a possible answer to the bird's navigating ability.

Pigeons often fly amazing distances over unfamiliar terrain to find home sweet home. Probably the record flight was one from Alaska to California in which the bird plugged along for 3000 miles to find its nest. Pigeon races of 1000 miles are not uncommon.

**Homing pigeons are bewildered by Dr. Henry L. Yeagley. He can make them flutter in circles or fly straight away from home, thereby giving an answer to the puzzle of the homing instinct**

According to Dr. Yeagley, pigeons can navigate because they are sensitive to two influences. A built-in "instrument" enables them to sense the effect of flying through the earth's magnetic field. And they also are able to sense latitude as though the earth were a grid-work map below them.

Sound impossible? Listen to Dr. Yeagley build his case.

In simple terms, the theory states that pigeons grow accustomed to the "feel" of these two effects at their home point, and can follow these guiding influences to their home when released some distance away.

In 1941, Dr. Yeagley's 15-year-old son brought home a pair of carrier pigeons. The scientist was fascinated by the birds and decided to



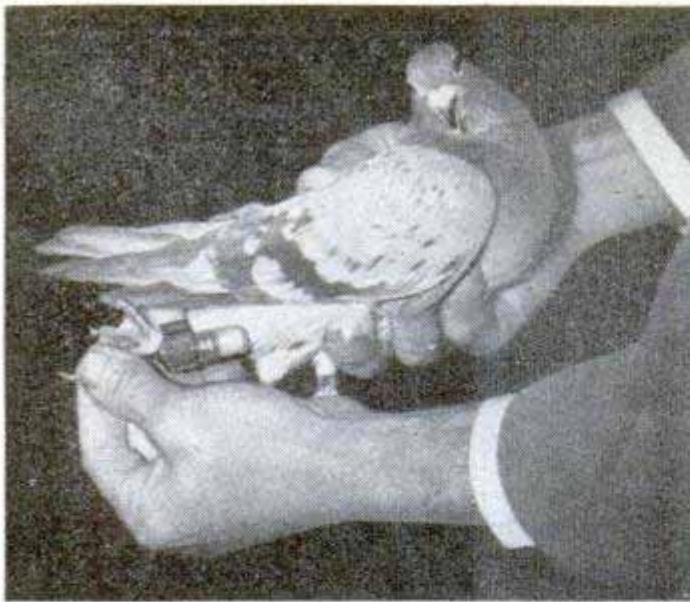

Pigeons carry message containers in the experiments. At right are shown the instructions to finder of bird

seek a solution to the old pigeon puzzle.

By a process of elimination he theorized that pigeons react to the earth's magnetism. How could he test this magnetic sense? A friend trained 20 birds for him to use in his first experiment. To 10 of these the scientist attached small magnets. The other 10 he equipped with copper plates, identical to the magnets in shape and weight. When the birds were released, eight of the 10 with the plain copper plates returned home during the first two days. Only one of the 10 with magnets on both wings ever came home and he was a weary bird when he settled down on the loft the fourth day.

The wing magnets, says Dr. Yeagley, had

set up conflicting magnetic fields which confused the birds. This proved that pigeons can sense magnetic attraction in much the same way that a blindfolded man in a room, cold at one end and warm at the other, can easily walk toward the warmer end by sensing the change in temperature. But this ability alone would not account for the pigeon's homing ability, as a bird could fly around the world on a line where the strength of the magnetic field was identical to that at its home loft.

Whereupon Dr. Yeagley theorized that pigeons also can sense latitude. In this field, a ready-made explanation awaited him. The missing element could be the Coriolis force, an effect created by the spin

Note how the same lines of magnetic force and latitude intersect at State College, Pa., and Kearney, Neb. Because these two influences guide the birds, Dr. Yeagley's Pennsylvania pigeons fly "home" to Nebraska

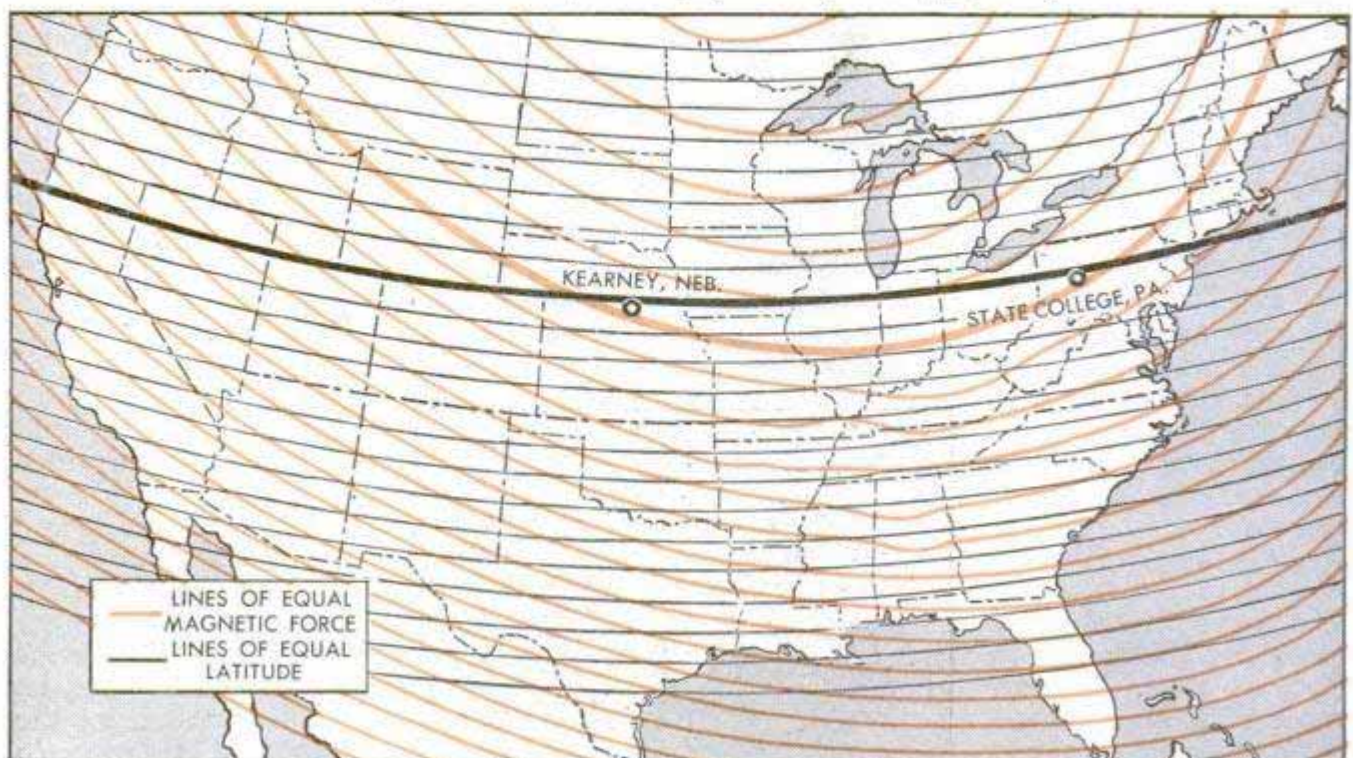



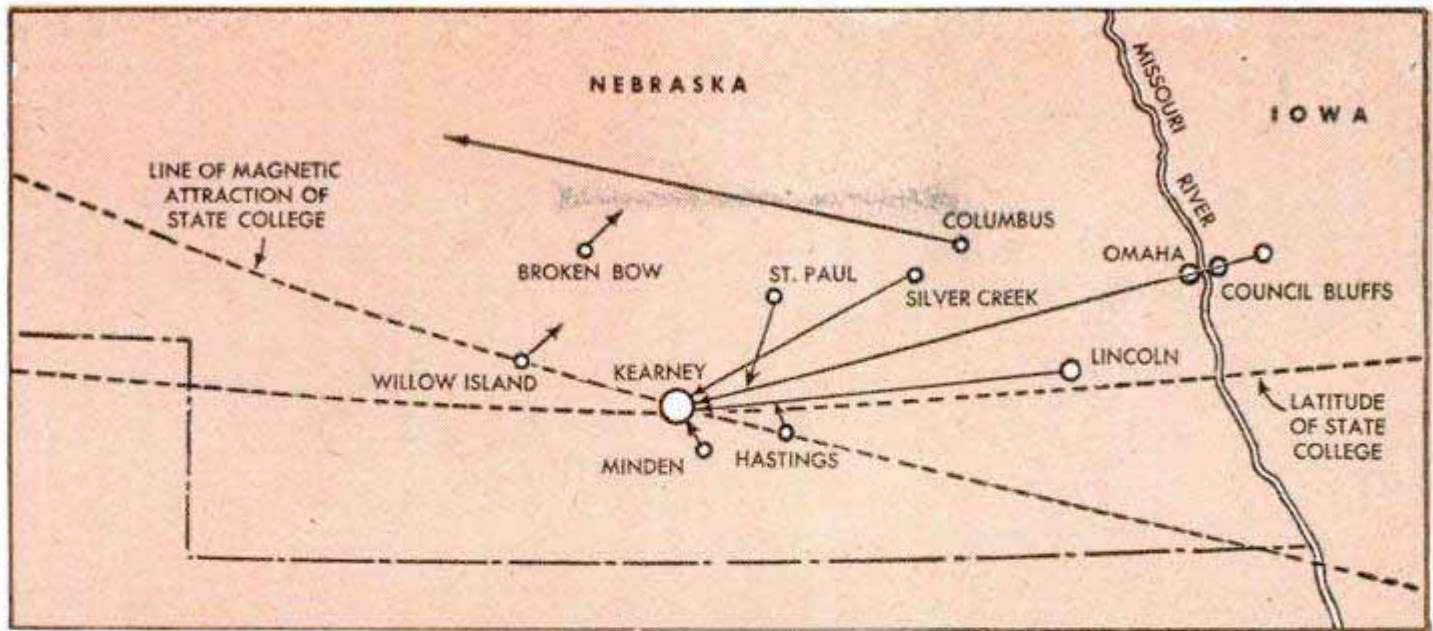

of the earth. It's this force that turns whirlpools of water in a counter-clockwise direction in the Northern Hemisphere, clockwise in the Southern Hemisphere. The force is constant along any line of latitude, and its effect is exerted on any body moving above the earth.

If a bird could detect this force, Dr. Yeagley reasoned, why couldn't it fly directly to a line of latitude where the force was the same as that at its home? And why couldn't it pin-point its home by flying to a spot where both the magnetic and Coriolis effects were familiar, in much the same way that two intersecting lines determine the location of a point on a map?

Dr. Yeagley took a look at a government map showing lines of magnetic-field intensity and lines of latitude. He found that any line of magnetic force which crosses a latitude line always intersects it again. After locating the lines that intersect near the loft at State College, Pa., he traced them westward and found that they intersect again, and at about the same angle, near Kearney, Neb. Dr. Yeagley reasoned that, according to his theory, a pigeon trained to fly to State College would fly to Kearney instead, if released nearer the latter point.

A few other odd facts about homing pigeons turned up in his research. He determined that pigeons "navigate" by natural know-how over long distances, but "pilot" the last 10 or 20 miles to their loft by recognizing familiar sights. And he found that pigeons have an internal "speedometer" in order to check their land speed. About this time the Army Signal Corps became interested and subsidi-



Arrows on map represent pigeon flights during Nebraska experiments. Note how most of them converge on Kearney. Below is pigeon that flew 185 miles west from Iowa, directly away from home to find its loft in Nebraska field

dized Dr. Yeagley's work. With the help of Maj. Otto Meyer and Dr. P. F. English of the Pennsylvania Wildlife Research Unit, he undertook his first major experiment.

The scientist trained 100 pigeons to home to State College. Their loft was designed with a conspicuous steeple and painted a bright yellow. When all was ready he shipped the birds west. At the same time he moved the loft to a "conjugate point" 10 miles north of Kearney. A conjugate point is a spot where the magnetic field and latitude are the same as the training point. He released the birds at varying distances from Kearney.

Dr. Yeagley believed that there was little chance a bird would go to the displaced



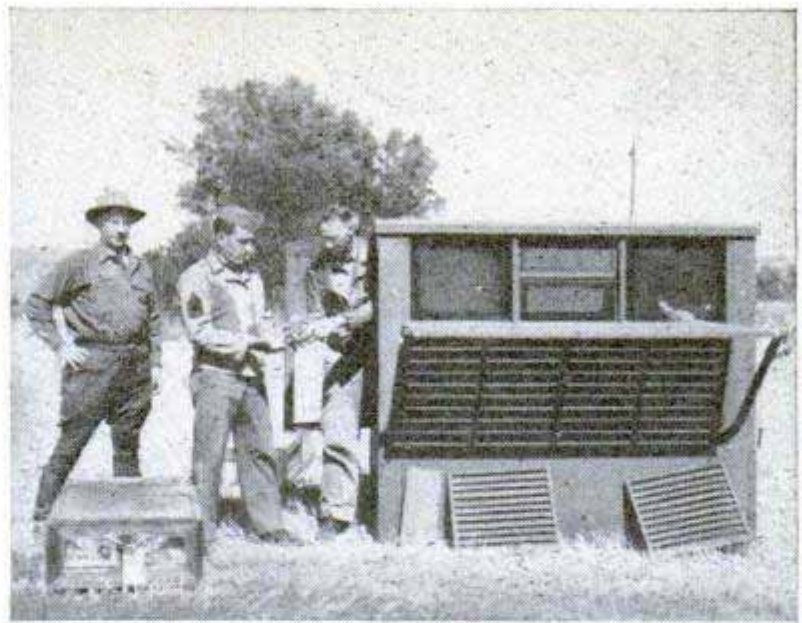

Magnets fastened to wings confuse the bird, proving that pigeons can sense magnetic attraction. At right is a standard Signal Corps loft, used during the war after the Army became interested in the experiments

loft, as there were no familiar terrain features to enable it to pilot the last 20 miles. He wanted only to find out whether the birds would fly toward State College or toward the location of their displaced loft in Nebraska.

The results were amazing. Eight flights of birds were released. Six of those flights were in the direction of the new loft site and terminated within 10 miles of the loft. Three of the six ended very close to the loft. And one pigeon released in Iowa flew 185 miles straight west, directly away from State College, and found and entered its

tiny loft in a Nebraska grainfield 1000 miles from its original home.

In another experiment a pigeon fancier at Cozad, Neb., trained 12 pigeons to return to their loft at his home. They then were shipped east and released singly at Berkeley Springs, Va. They were found along a flight line in the proper direction toward the conjugate point in Pennsylvania and within 10 miles of the same latitude line that passes through Cozad. If the terrain had been familiar they could have piloted home in a breeze.

(Continued to page 246)

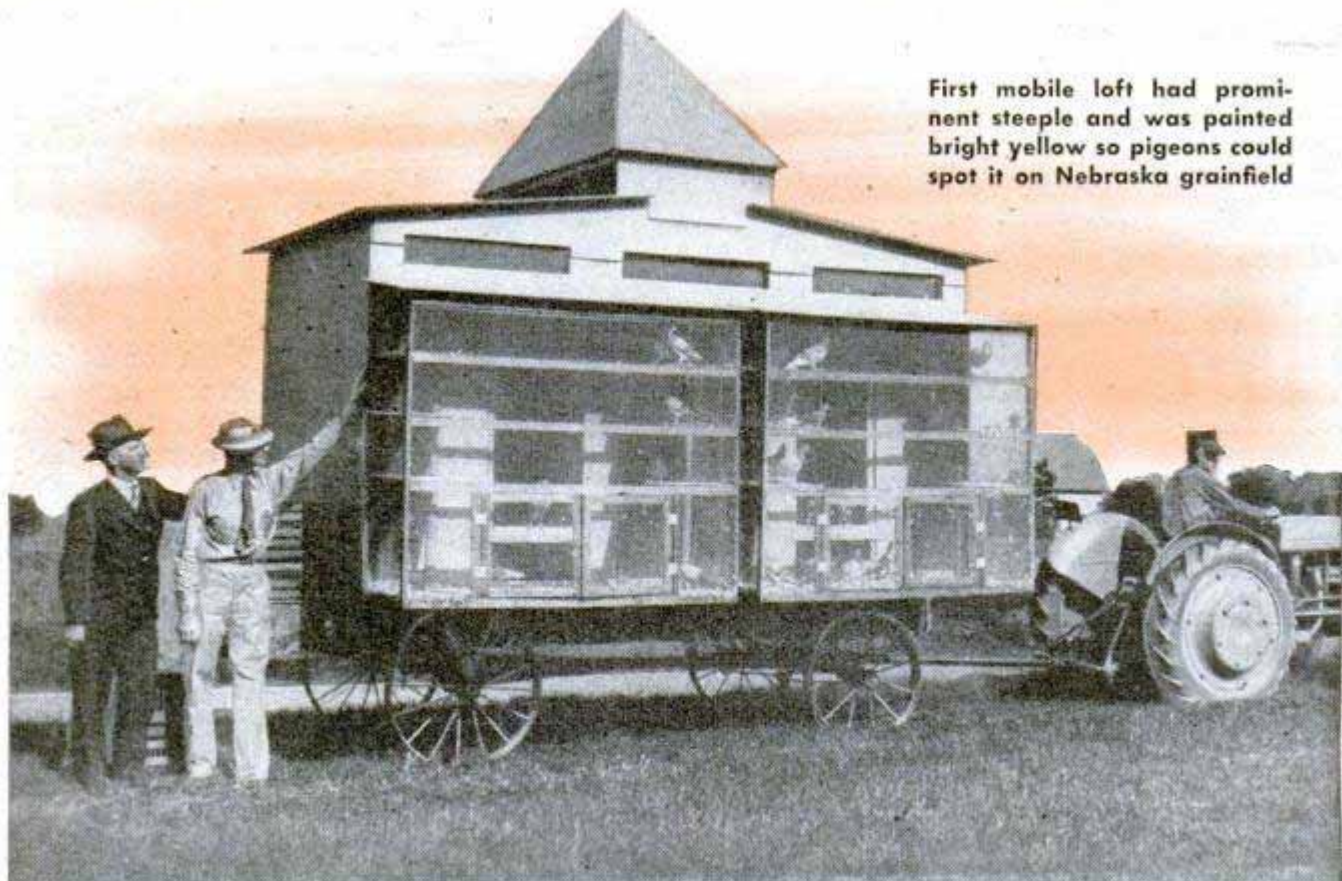

First mobile loft had prominent steeple and was painted bright yellow so pigeons could spot it on Nebraska grainfield



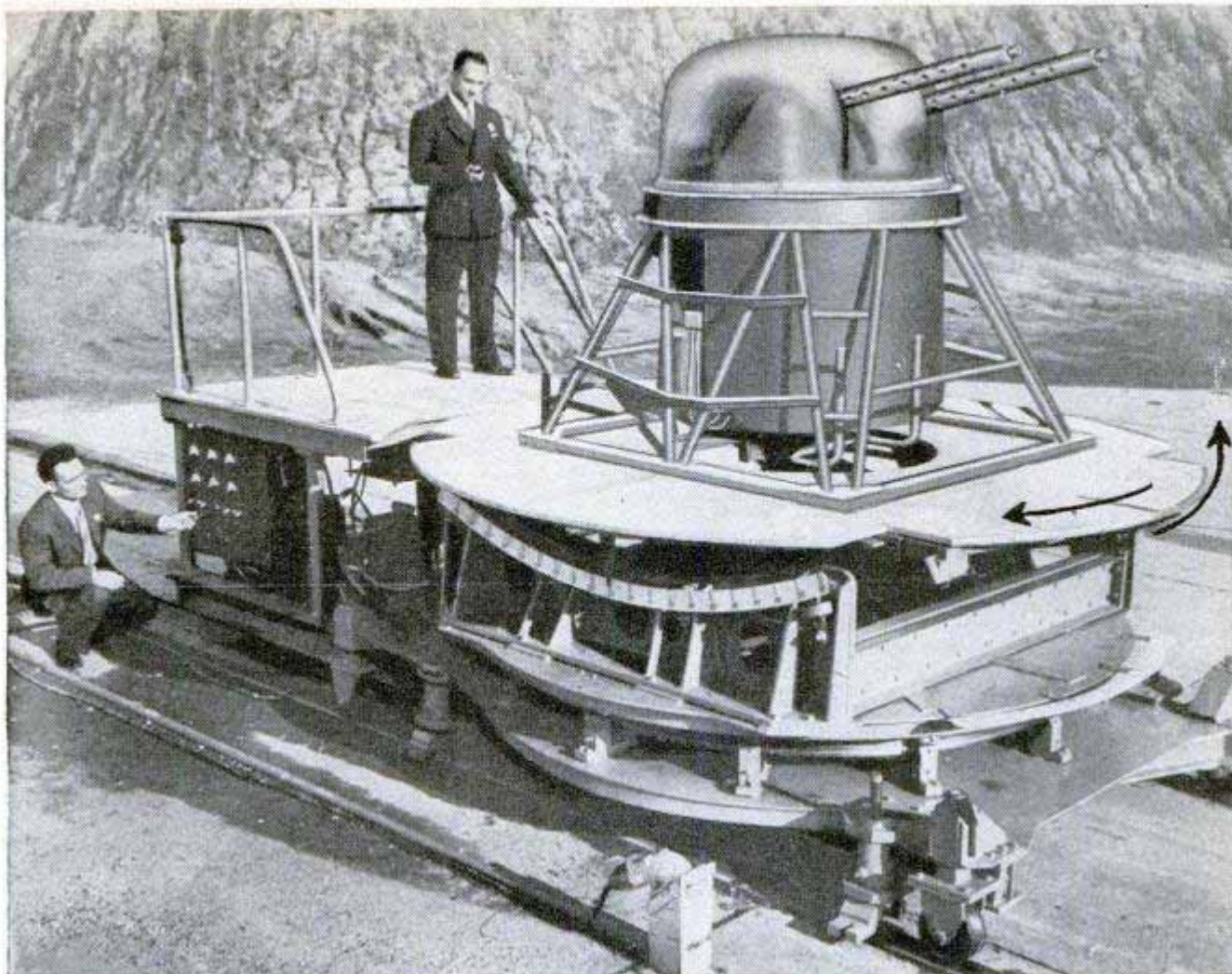

Martin Aircraft Company photos

## Bucking Turret Tester Imitates Planes

Gun turrets for Navy planes will be tested on earthbound Scorsby units that simulate all the motions of maneuvering aircraft. Scorsby was the name of a destroyer famed for its excessive rolling. The units consist of two electrically operated moving platforms. One can be elevated in either direction at speeds up to 20 degrees a second and the other rotated at the same speed. Operated simultaneously they can simulate any type motion of a plane in flight.

Two moving platforms are the key to the operation of Scorsby units. One can rotate in either direction at 20 degrees a second, while the other, resting on it, can raise or lower guns at same speed, simulating maneuvers

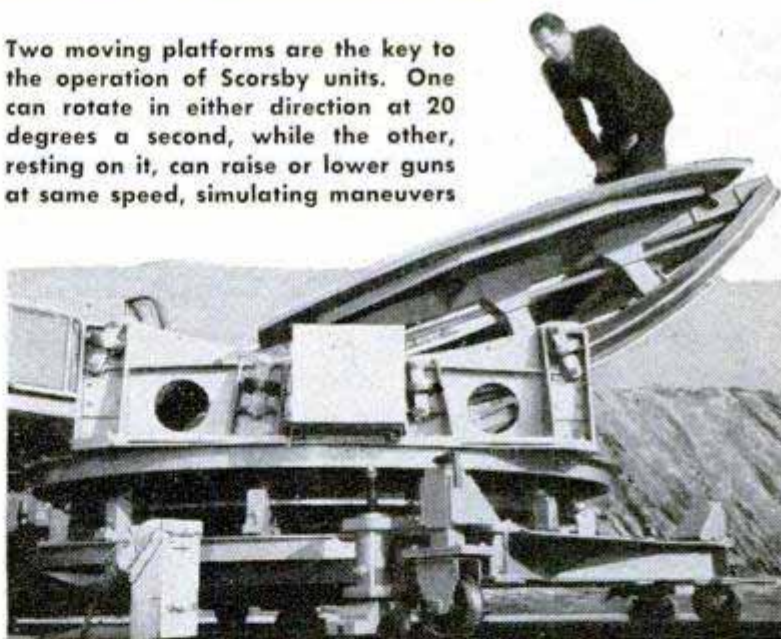

## Pigment Made From Sand Reduces Lead Required in Paint

Three times as much paint can be made from the same amount of lead when a new pigment is used, according to F. J. Williams and A. R. Pitrot of the National Lead Company. Exhaustive tests have shown that the new pigment is equal in performance to lead pigments now used, despite the small amount of lead required. The pigment is produced by grinding silica

sand to extremely small particles. Lead oxide then is added with a small amount of sulphuric acid, converting part of the lead oxide to lead sulphate. The mixture is dried and heated in a furnace to produce a pigment with particles having a thin coating of lead silicate and lead sulphate. Because only the surface of the particle fortifies paint, a saving in lead is possible.



# SANDWICH WALLS

Sandwich wall panels with cores made of corrugated paper are being tested by the U. S. Forest Products Laboratory for possible use as a building material. An experimental structure has been built with the panels to study the resistance of such construction to weather and climate. The panels are made by gluing a cover of thin, strong material on either side of a thick, light material such as corrugated paper. This "sandwich" construction gives the panel surprising stiffness and strength. In addition, the core is a honeycomb which provides excellent insulation. The cover can be made of metal, plywood or veneer and the panels can be joined without a framework. They can be factory made and finished for either exterior or interior walls. Under test in the structure at the Forest Products Laboratory are panels faced with aluminum, plywood and veneer. Such facings are fastened to the core material with modern glues that make a joint stronger than the material itself. These panels are exposed to all kinds of weather in tests to check their resistance under extreme conditions. The panels originally were developed for wartime use in high-speed aircraft.

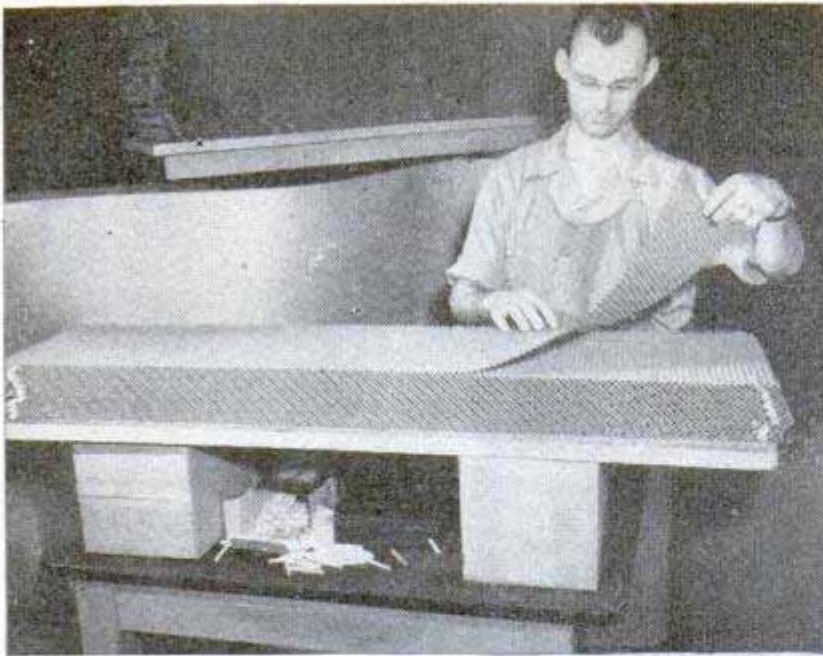

Sheets of corrugated paper are stacked to form a honeycomb core

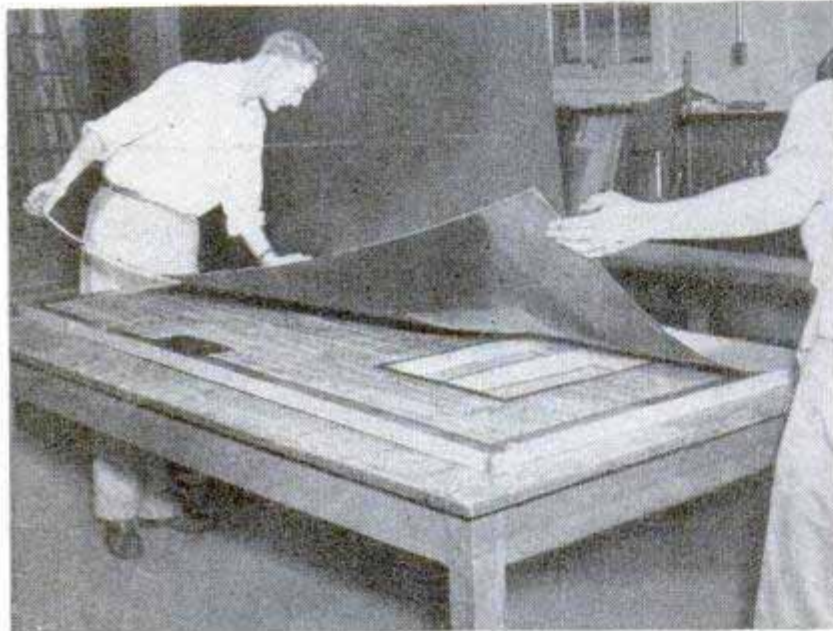

↑ Aluminum facing is glued on each side of the core to form a panel

↓ Panels are installed in test building to check weather resistance

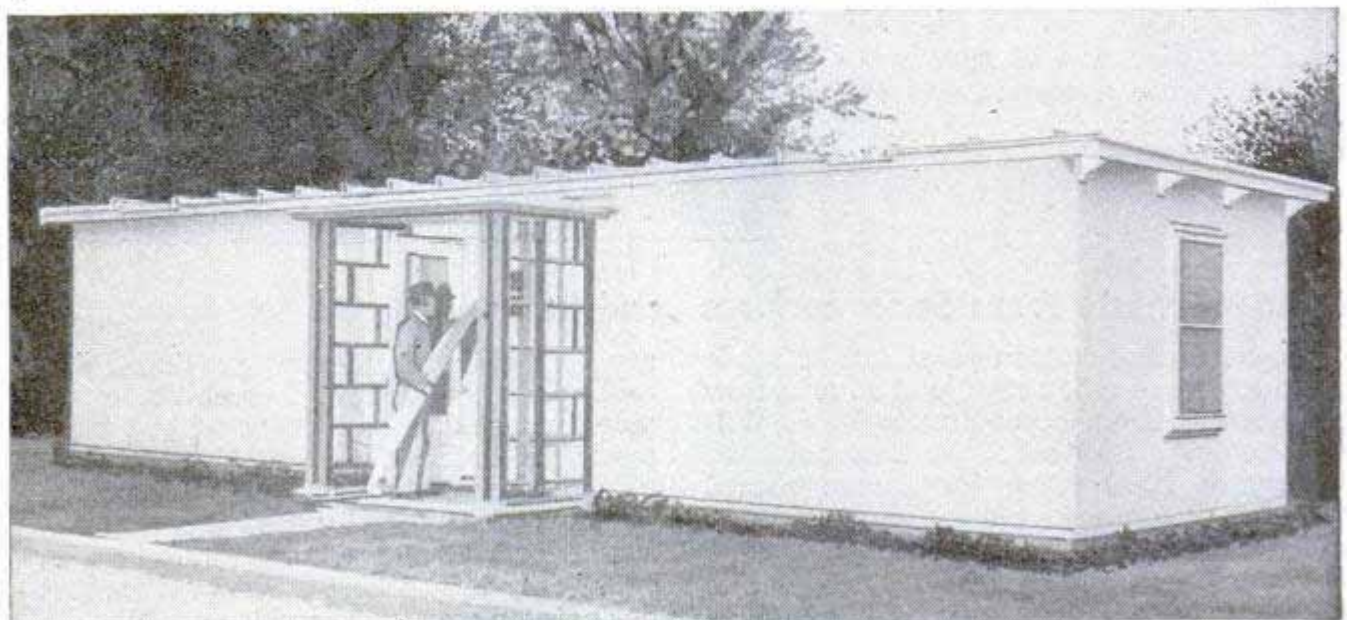



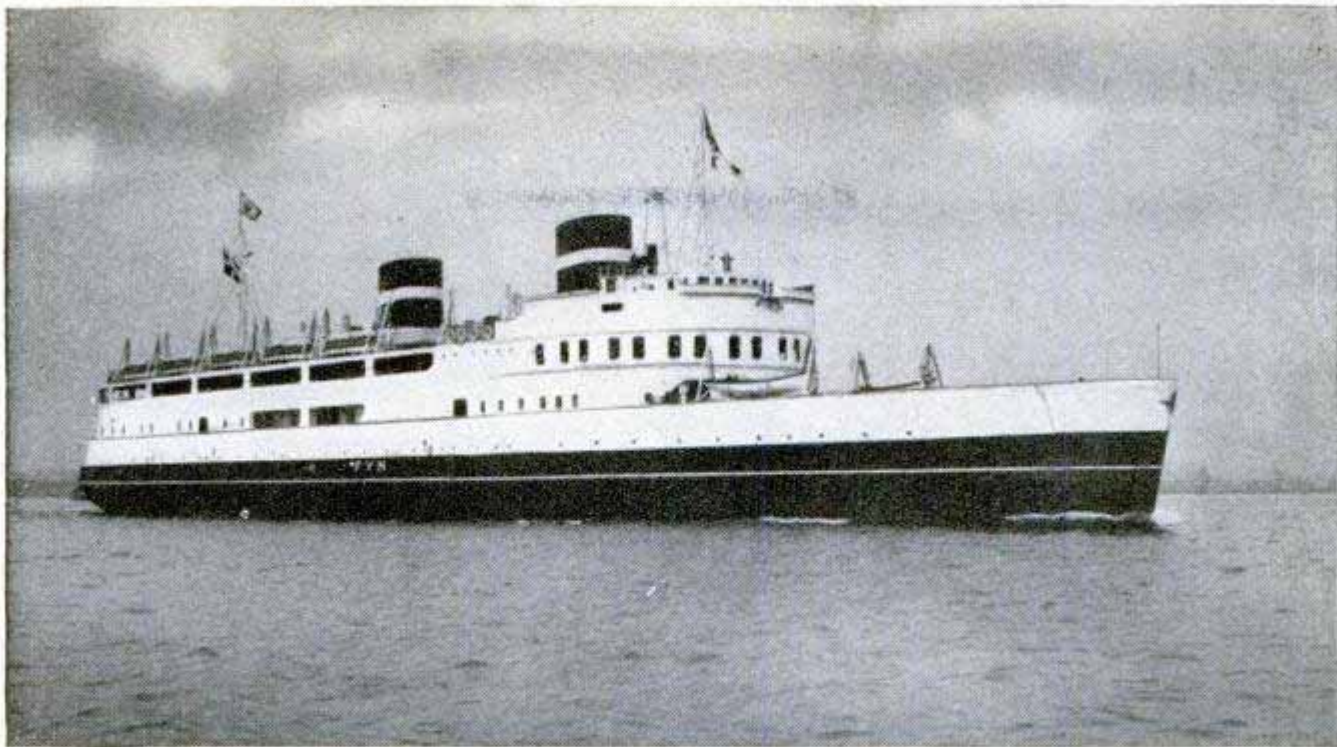

The hinged bow, so closely fitted that the joint cannot be seen, gives the ferry a streamlined appearance

## Danish Sea-Going Ferry Has Landing-Craft Bow

With a streamlined bow that opens like those on wartime landing craft, a sea-going Danish ferry can carry 30 railway cars and 1500 passengers at a time. Rounded deck houses and raked masts and funnels give the ferry a modern appearance in sharp contrast to conventional boats of its type. The wheelhouse and foremast are of aluminum to eliminate magnetic dis-

turbances to navigational instruments. A radar tower above the chart room is high enough to provide an unobstructed "view" in all directions. With two rudders, one at each end of the vessel, the ship can be maneuvered easily in crowded harbors. Powered by two Diesel motors with a maximum indicated horsepower of 5450, the 353-foot ferry cruises at 16.5 knots.

Taller than the funnels, the plastic-domed radar mast has an unobstructed "view" in all directions

In unloading, the bow is raised by air pressure to permit freight trains and trucks to roll off easily

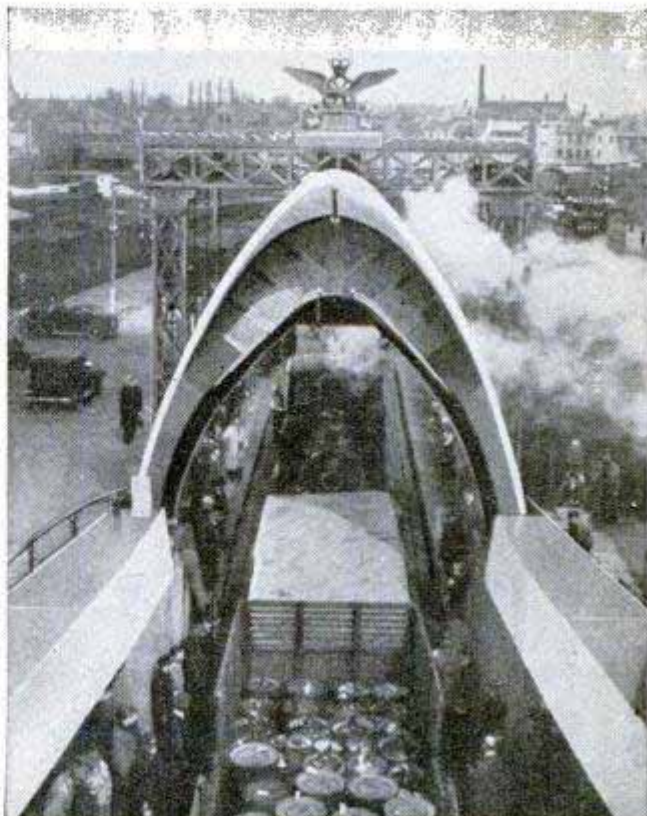
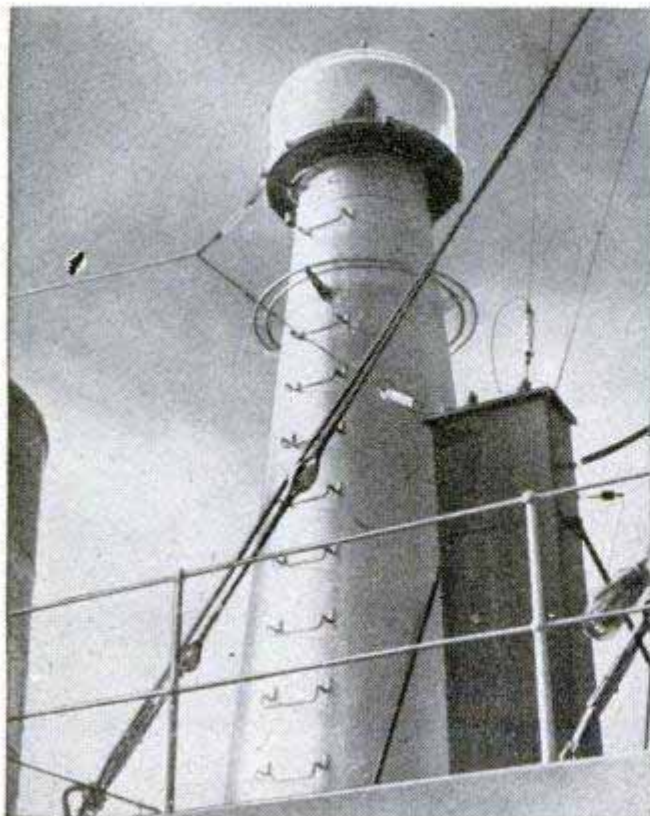





## LOOK, NO HANDS!

**L**EARNING to fly a helicopter is easy with a new control system that responds to fingertip pressures and allows hands-off flight in any attitude. A major objection to helicopters has been that two hands were needed to maintain control.

In a demonstration, the pilot sped around a 30-acre course at about 80 miles an hour and brought the craft to a full stop with both hands off the controls. Only a light touch of the control column is needed to correct for wind gusts while hovering. A man with no helicopter experience took off, hovered and landed after eight minutes of ground instruction.

Developed by United Helicopters, Inc., Palo Alto, Calif., the system has two small servo airfoils mounted at right angles to the main rotor blades and attached to the control stick by a scissor linkage. There is no direct connection between the airfoils and the rotor blades. The entire rotor head is mounted on a universal joint.

The servo airfoils are inclined the way the pilot pushes his control stick. This causes the entire rotor head and its blades to tilt so that the helicopter moves in the desired direction. Spring loading of the control stick makes it movable with less than a pound of pressure. Instead of sev-

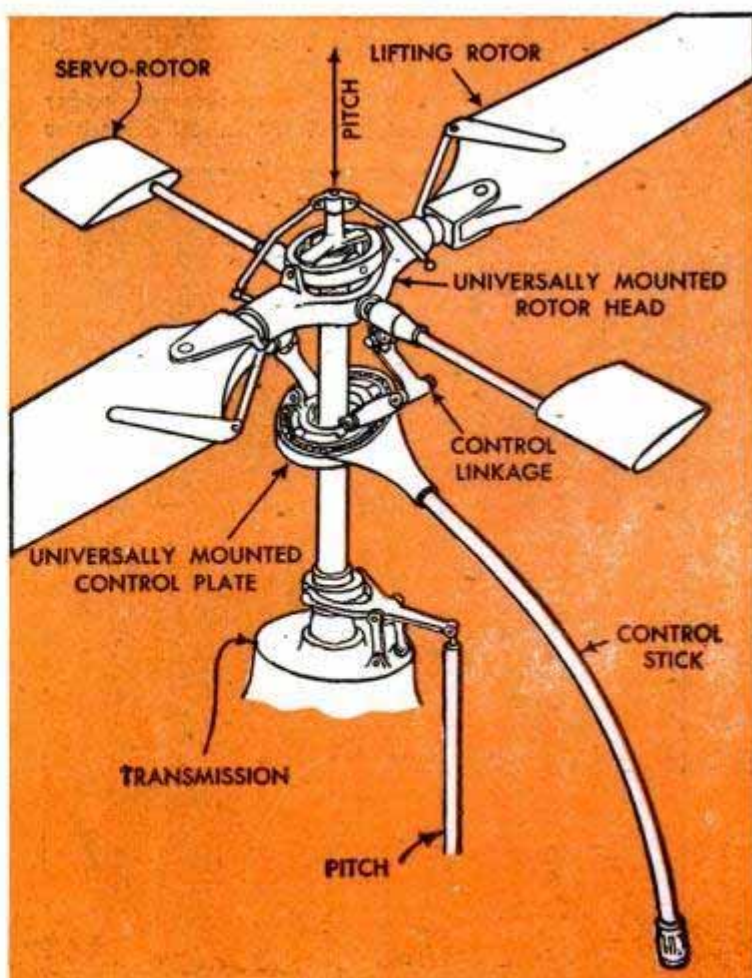



eral hundred moving parts that comprise other control methods, the system has but seven.

The airfoils return to neutral when pressure on the control stick is released and the craft comes to a stop in the air. The self-dampening effect of the airfoils eliminates any tendency toward oscillation. Trim tabs can be adjusted and locked to keep a desired speed and altitude for flying hands-off.

The system opens up possibilities of much larger blades than are now practical. It is adaptable to all types of rotary-wing craft and has been initially incorporated in the company's three-place Hiller 360 helicopter. It has two main rotor blades, 34 feet in diameter, and two 5½-foot blades in the anti-torque rotor at its tail. The craft carries an unusually large load, equal to more than a third of its 2100-pound gross weight, including fuel and oil.



First helicopter using the simplified control system is Hiller's 360 model, above. Less than a pound of pressure on the control stick guides the craft. Below, close-up of the rotor head. In contrast to the several hundred moving parts of other systems, this method involves only seven

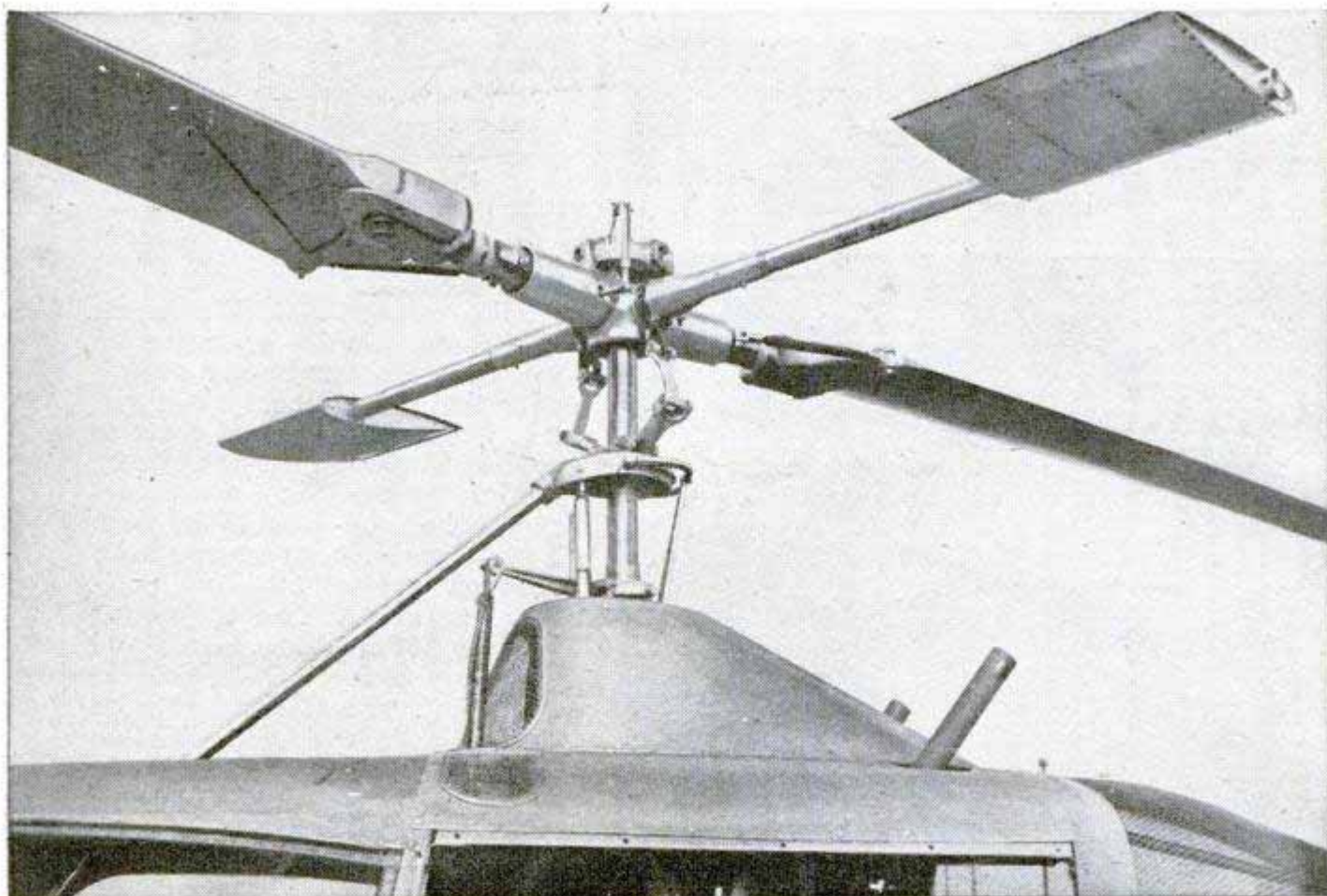



DETROIT 13, MICH.



## Homemade Racer Powered by Battery

Surplus plane parts and an old Mercedes starter motor were used in making a battery-driven midget car for Bobby Brown of Pasadena, Calif. It can travel 2½ hours at a top speed of 10 miles an hour before the 6-volt auto battery needs charging. The differential was part of a B-17's flap control and the steering unit was made from the dive-flap actuator of a P-38. His father, who built the car during his spare time in 2½ months, is adding a racing-car body.

MANUFACTURED BY R. P. SCHERER CORP. 9425 GAINNELL AVE.

## Hypodermic Spray Replaces Needle

Hypodermic injections are given painlessly with a high-pressure spray device that looks like a flashlight. No needle is used. Instead the instrument is merely held against the skin. Medication is forced through the skin in a fine spray when a spring-loaded plunger is released, driving the stopper into the Metapule capsule. The injection takes three seconds.

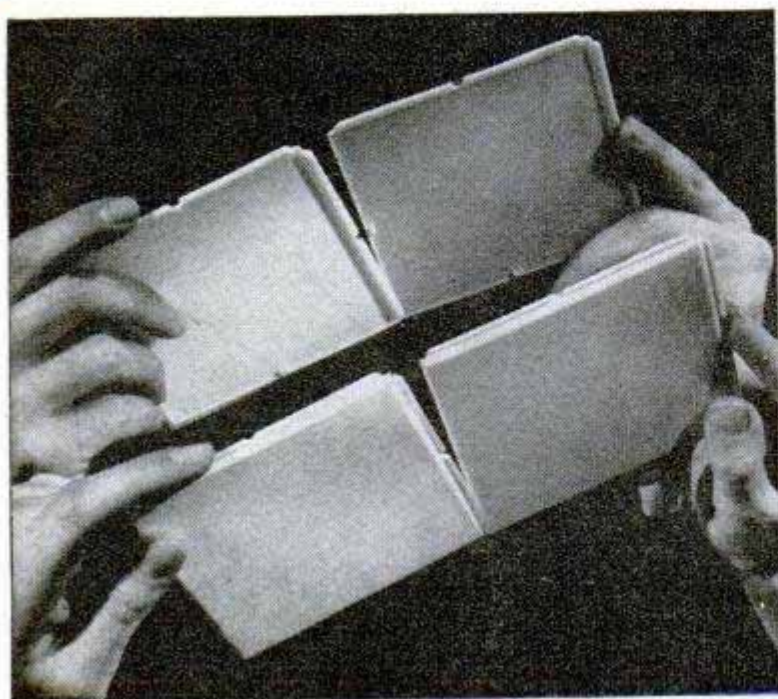
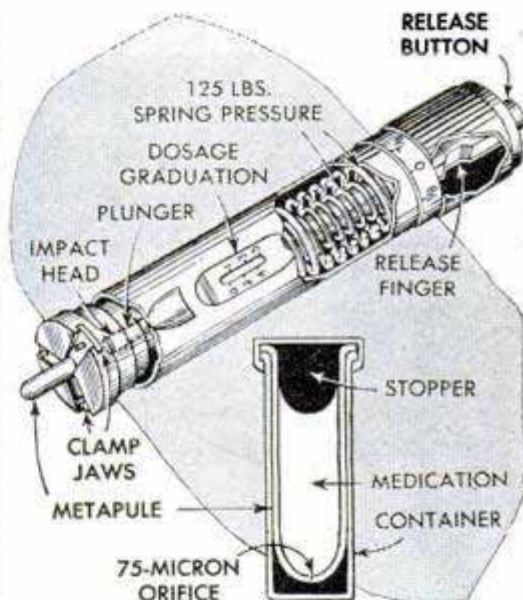

## Interlocking Tiles

Tile squares that can be installed on kitchen or bathroom walls have a tongue-and-groove edge that makes them self-aligning. No molded cement seam is required between the squares, as the interlocking edges are waterproof when cemented to the wall. Two edges of each square have grooved projections and positioning slots. The adjacent squares fit into the grooves and a tongue locks in the slot for alignment. The tile is cemented to the wall with an adhesive paste. The squares are available in several colors, either plain or marbelized. They are nonabsorbent and can be washed.



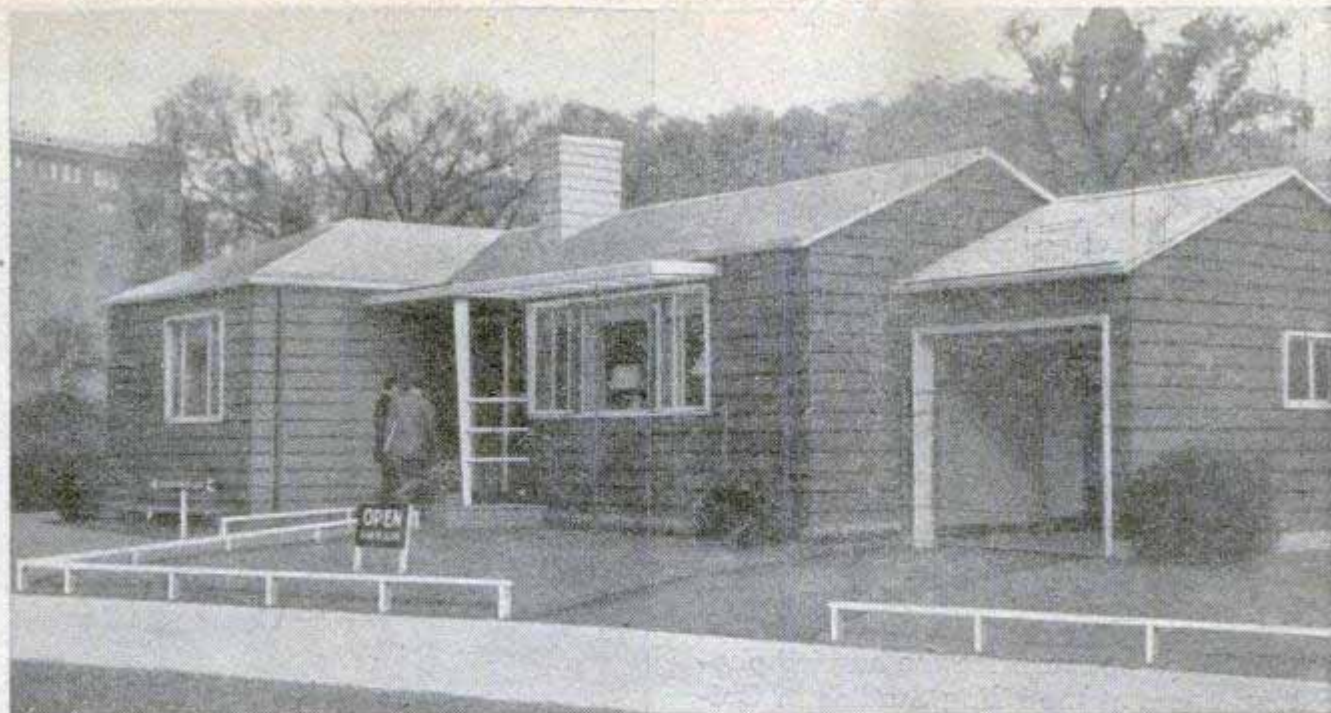

## Unit System for Home Cuts Building Costs

All dimensions of a small home built for exhibition in Washington, D. C., are multiples of four inches, a method that saves time in construction and prevents waste of materials by eliminating many problems of trimming to fit. Called "modular coordination," the method uses a four-inch "module" as a pattern for all materials in the house. Much of the material can be pre-cut to fit the four-inch pattern. The exhibition house has four rooms and is made of plywood on a standard frame. The plywood is covered with building paper and wood siding.

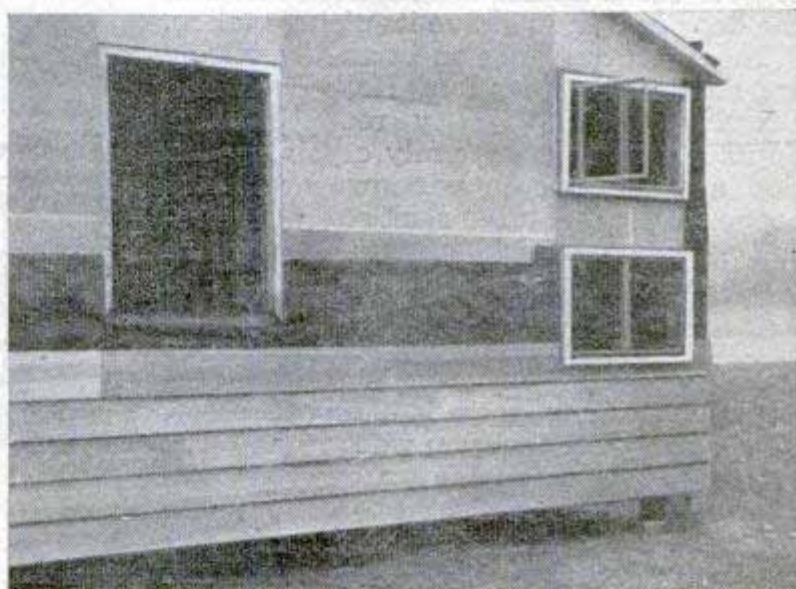

Top view shows finished home with all dimensions in multiples of four inches, saving time and cost in trimming materials. Above, wood siding is installed over a shell made of plywood.

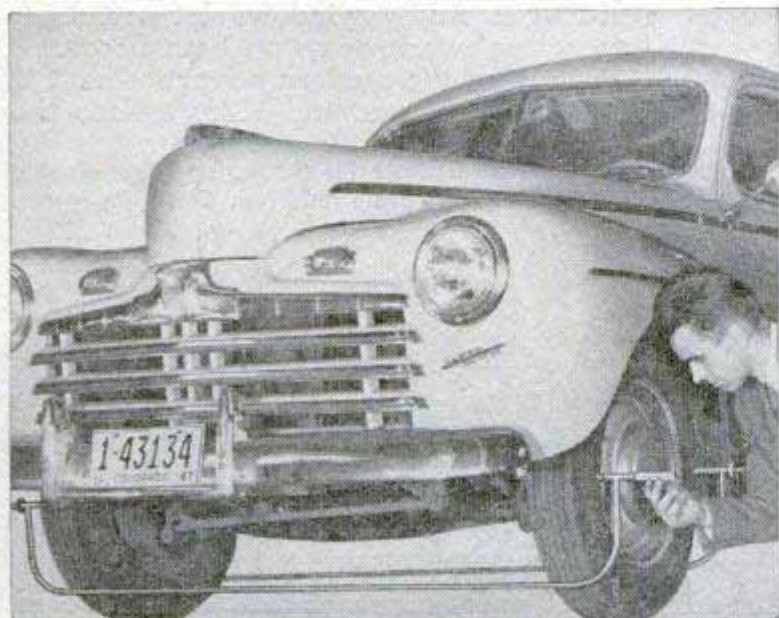

## Gauge Measures Toe-In From Outside of Tires

Measuring toe-in of the front wheels from the outside walls of the tires, a new gauge eliminates the need of crawling under the car. The gauge has a micrometer-type scale and built-in spirit level that make accurate positioning simple. According to the manufacturer, the average operator can measure toe-in on any car or truck in less than two minutes.

☐ Radiant-heating pipes warm stretches of highway in Belmont, Mass., and Klamath Falls, Ore., to guard against ice formation.



# Setting the Stage for an "Ad"

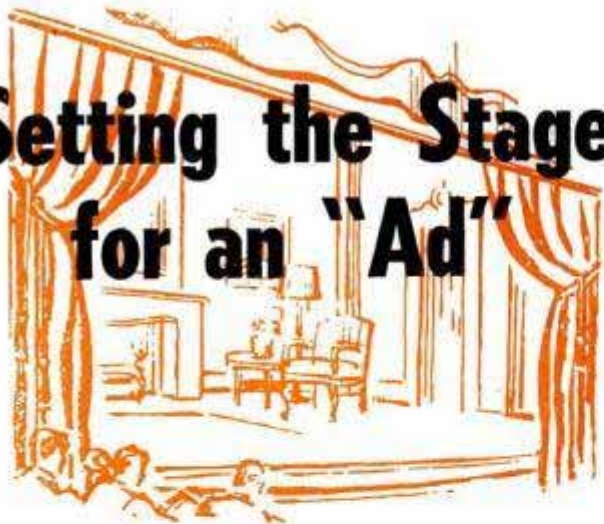

By Arthur R. Railton

**I**T WOULD not surprise the harried photographers at the Kling Studios in Chicago to see a Diesel-drawn train stroll in the door one day to have its picture taken.

The work that goes on in an advertising art studio is a blend of Hollywood and Broadway on a slightly reduced scale. Southern beaches suddenly crystallize inside a studio whose windows are being peppered by a Chicago sleet storm; the resulting advertisement makes men yearn for the right kind of swimming trunks and a Florida vacation.

Then minutes later the prop men are tearing down the make-believe beach and a luxurious living room is taking its place. It is so complete that you want to step into the room and relax for an evening in a cavernous lounge chair, pick your favorite magazine from the table, play symphony or swing on the record-changer and tap your cigarette ashes into the ash tray.

But the realism lasts only a few minutes. Once the photographers have recorded the carefully laid scene, the room is rapidly dismantled and filed away. All this to convince you of the merits of a particular brand of furniture or carpeting.

Paintings, advertising layouts, billboards and photographs are produced



speedily but only after hours of careful planning in a modern advertising studio and Kling's is among the newest. According to Lee R. Blevins, a partner in the firm, it is the first building of its kind specially designed for commercial art work. Outside and inside, its clean, straight lines are both functional and beautiful. Along two sides, full-length studio windows let soft light into artists' workrooms on both floors.

Producing the modern advertisement is a complicated task and Kling's does the

**Full-length windows along two sides of the Kling Studios admit natural light for the artists. Overhanging corners at both entrances provide unloading space for automobiles well protected from Chicago's storms**





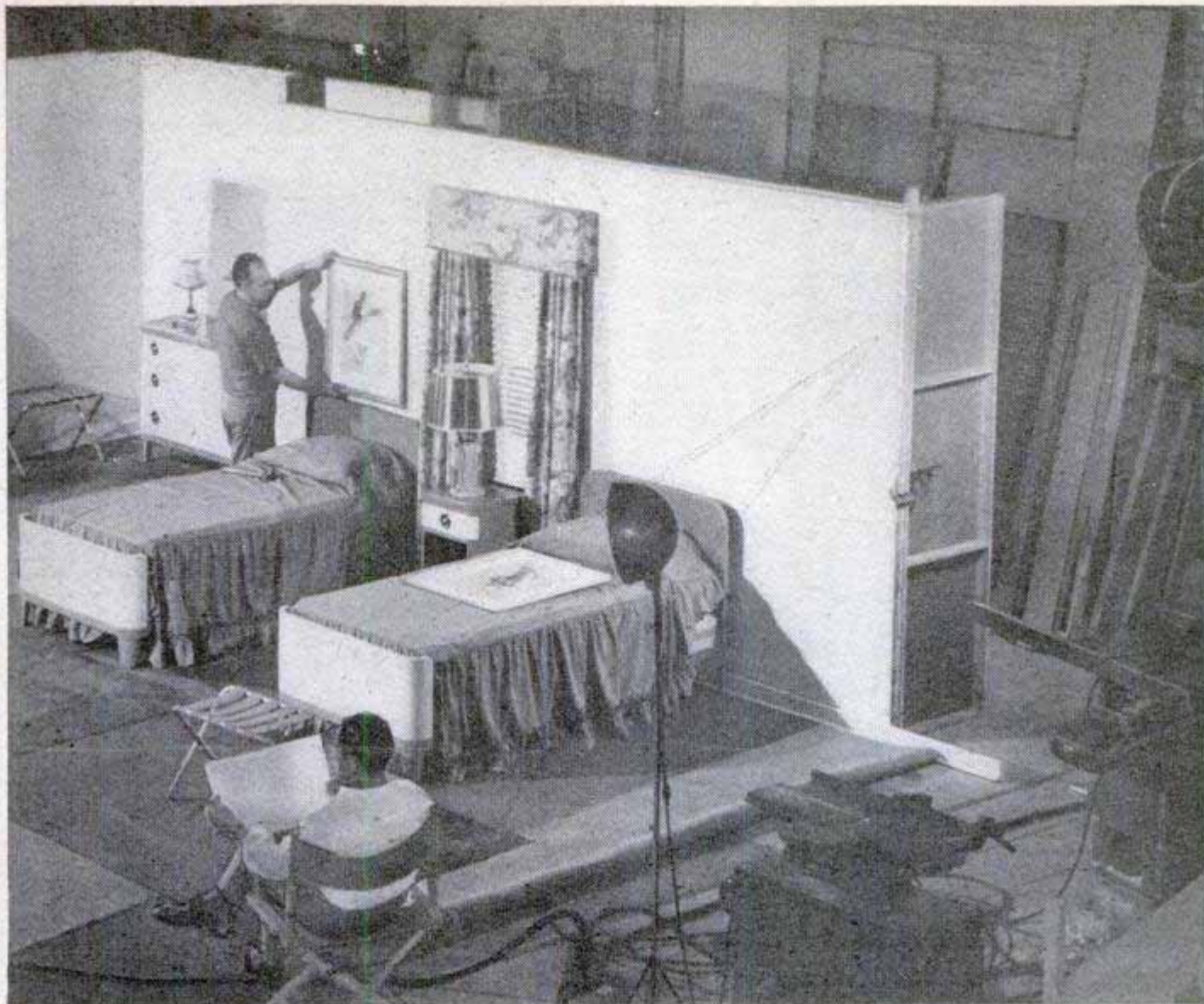

Prop men complete a set for a furniture advertisement as the art director (seated) checks the layout. Portion of woodworking shop shows at extreme right

For high-angle shots a 20-foot stepladder is used →

Modern lines of the reception room and its ramp to the second floor are beautiful and practical

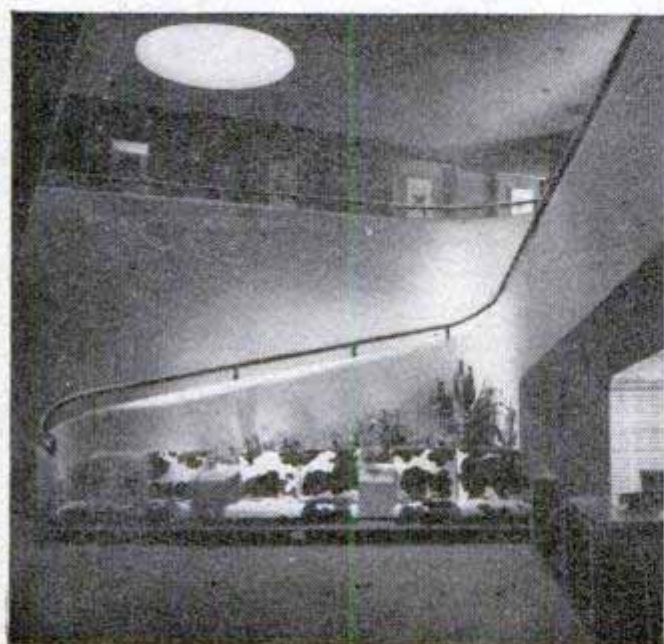



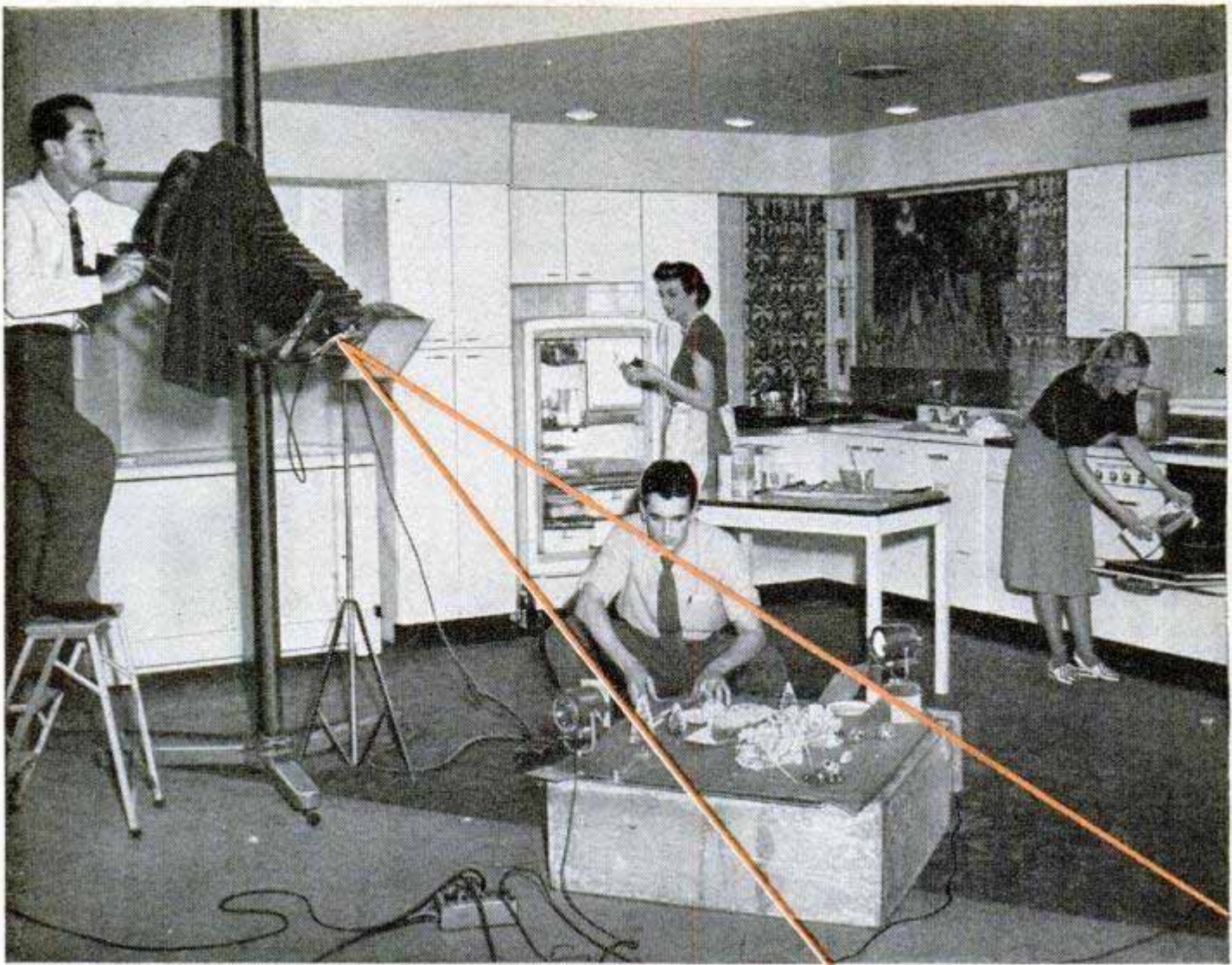

It's only a few steps from the oven to the photograph in the modern kitchen used in preparing food for an advertising photo. Photographers "pose" a hot coffee cake before taking the picture shown on the next page

complete job from the rough layout to the finished photograph. Nearly 200 highly specialized men and women, varying in occupations from carpenters to expert color photographers and artists, combine their talents to produce many of the advertising photographs you see in *Popular Mechanics* and other national magazines.

Sets for these advertisements go up and down so fast that the studio changes its appearance almost hourly. Ready-made walls are stacked around the studio like books in a library. Doors and window frames of different shapes and sizes lean against the walls. A woodworking shop fills one corner of the building and, in a matter of minutes, the carpenters turn out necessary props with modern power tools.

When an advertisement calls for a luxurious bedroom, the prop men roll up three walls, doorframes and doors, windows and frames, clamp them together with heavy C-clamps and the room has taken shape.

Then the painters move in (using water-mix paint that is easily washed off when the job is finished), draperies are hung, pictures placed on the walls and the room

is ready for rugs and furniture. By the end of the day, the room has been photographed, the advertiser's furniture removed and the walls taken down. There is no evidence of the room's existence except as captured on the color film of the camera.

The carpenters work in a hobbyist's dream shop. Power tools, mounted on caster trucks, are rolled from set to set to speed preparation for the photographs. Lumber of various sizes is stacked behind the workshop and, on short notice, the woodworkers produce anything from a built-in bookcase to the observation platform of a streamliner.

After the set is taken down, the lumber is stored for use in the next photograph. One day a board might be part of a modern bathroom and the next day, repainted, it becomes a corner of a bombed-out building in Europe.

Prop girls and stylists have one of the most interesting and probably the most nerve-wracking jobs in the studio. They're sent out to track down any items necessary to furnish the set to perfection.

For example, one advertiser wanted to



include a photograph of an old-fashioned kitchen in his layout. One item he required was an early model washing machine. The prop girls prowled for days through Chicago's second-hand stores. After a long search, they finally unearthed one in the attic of a private home. But it looked too old! In the advertisement it had to look like a new machine right from the factory. The mechanics went to work and in a few days it was ready to pose for its picture—gleaming under fresh varnish as bright as the day it left the store.

On the other end of the time scale are items that have to be brand new. When a flour miller wants a color photograph of hot rolls right out of the oven, that's the way they are photographed—right out of the oven. In Kling's own kitchen, adjacent to the studio, the food is prepared by expert home economists. The kitchen is as streamlined as the rest of the building and is complete with shining appliances that would make the average housewife sigh with envy.

Whether it's a batch of crisp cookies or

Here's the coffeecake as it looks in the advertisement. Taken from the oven seconds before it was photographed, the cake looks (and is) good enough to eat

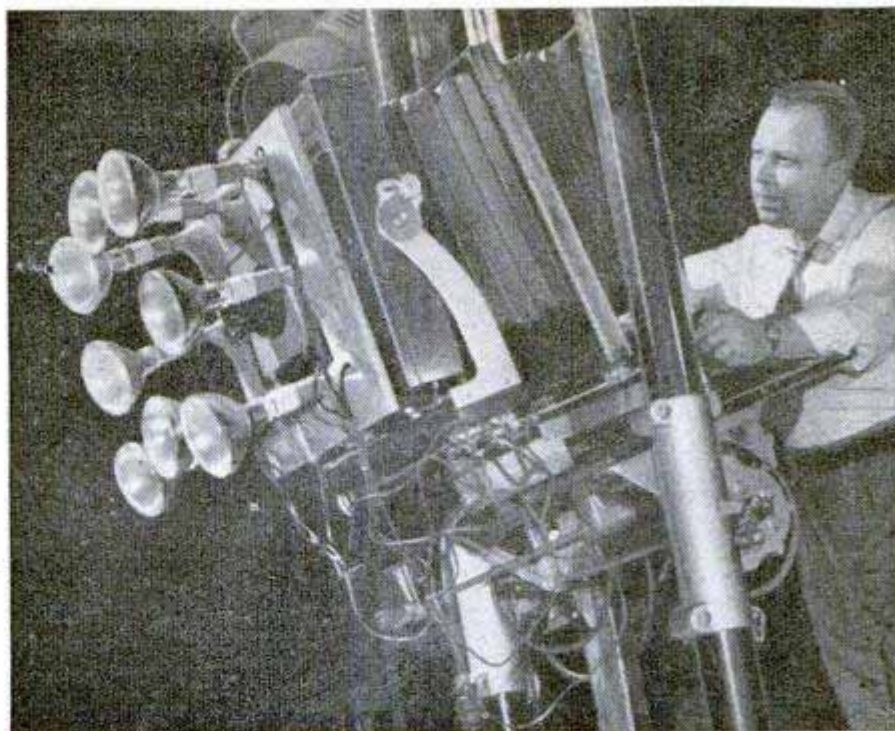
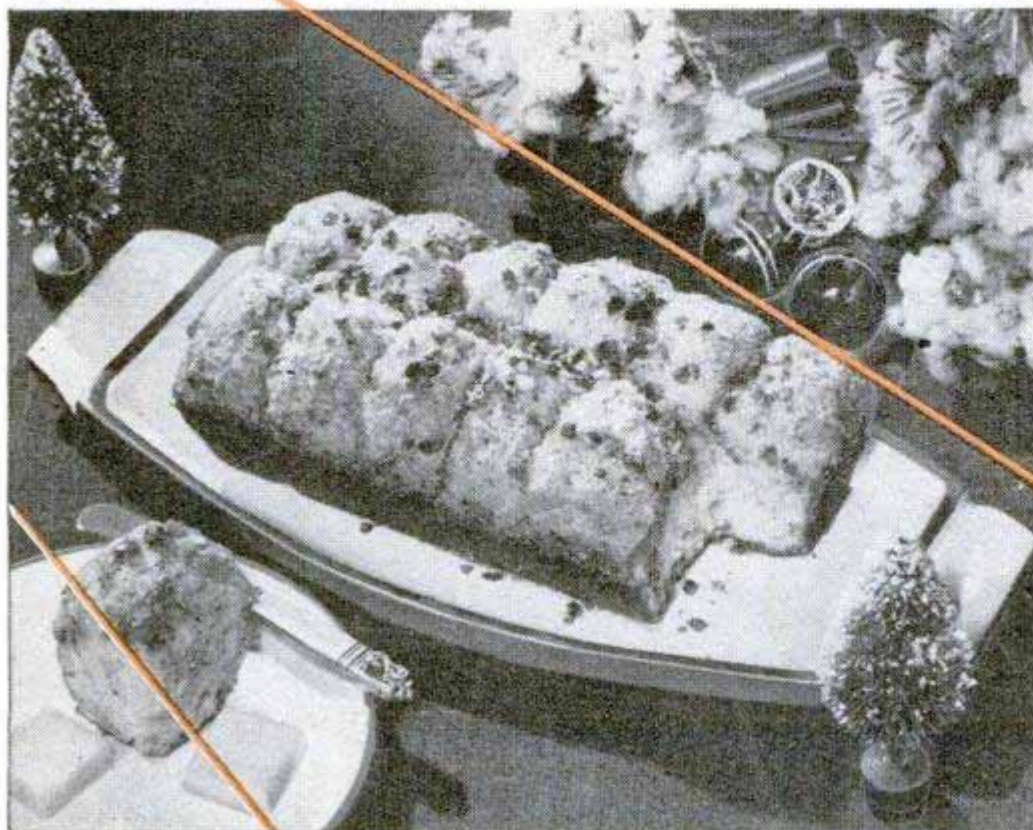

No simple box camera, this huge studio camera, mounted on a heavy stand, is equipped with a battery of floodlights for shadowless lighting

a complete turkey dinner, Kling's expert cooks whip it up easily in the streamlined kitchen. Still steaming, the food is placed under bright lights and photographed.

Such intensive preparation is necessary so the photographers can capture in life-like color the exact nature of the advertised product. Expert color photographers spend hours setting up the products, checking light reflections and shadows, making the composition artistically perfect and, most important, showing off the items to best advantage.

Ten darkrooms, along an inside corridor, are used for developing and printing the pictures. As soon as the shutter clicks, the photographer's helper rushes into the developing room with a test negative to make sure everything is perfect before the final color shots are taken.

Today, the trend is to color and a great many of the thousands of shots taken at Kling's are in full, natural color. This requires more exact lighting and exposure and more complex processing, but at

(Continued to page 234)





### Electric Shoeshiner

There's no excuse for dull shoes if you have an electric shoeshiner that buffs up a bright polish in seconds. Powered by a  $\frac{1}{20}$ -horsepower motor, the shiner has a circular chamois that can be removed for cleaning. Because of its low power, there is no danger to children in the whirling buffer. To shine shoes you apply polish with an attached dauber, hold your shoe lightly against the chamois and the motor does the rest.

### Wide-Belt Cutter

Belts up to 60 inches wide are cut quickly and without jagged edges by a combination cutter and guide. The V-shaped steel blade will cut belting up to  $1\frac{1}{8}$  inches thick. Each pass of the tool cuts  $\frac{1}{8}$  inch and adjustment of a thumbscrew lowers the blade for deeper cutting. The base is held stationary by nails or C-clamps.

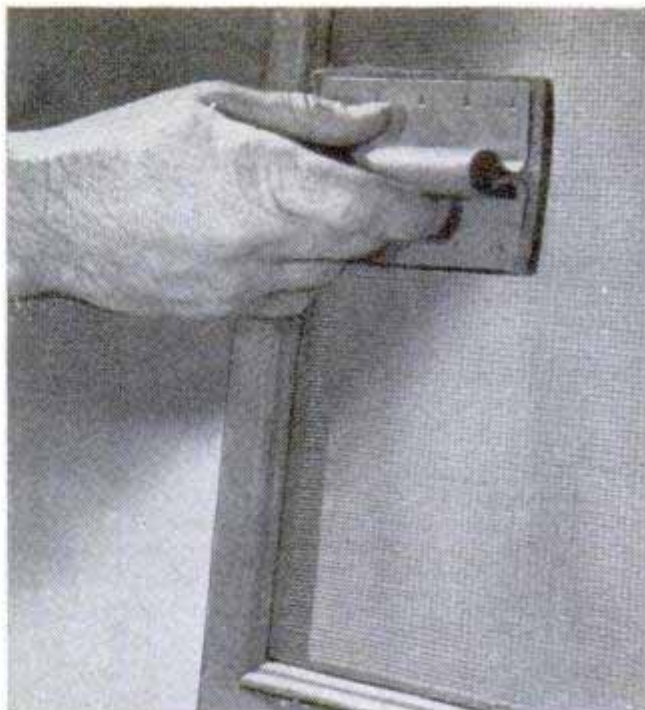
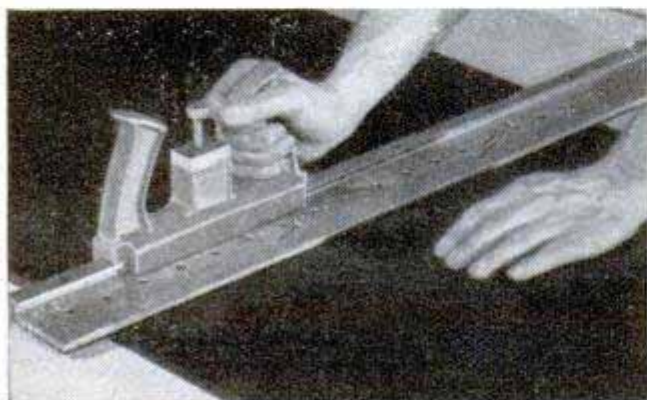

### Paint Spreader for Screens

Consisting of thousands of hairs set in a slightly convex composition base, an applicator spreads paint on screens much faster than a brush. Equipped with a metal grip to fit the hand, it also serves for cleaning screens.

### Brief Case Serves as Desk

Busy executives can carry their desks with them when they have a leather traveling case with a warp-proof divider for use in letter writing. The top half of the case holds a partitioned brief case that can be removed and carried separately. The compact case can be held on the lap comfortably when used as a desk.





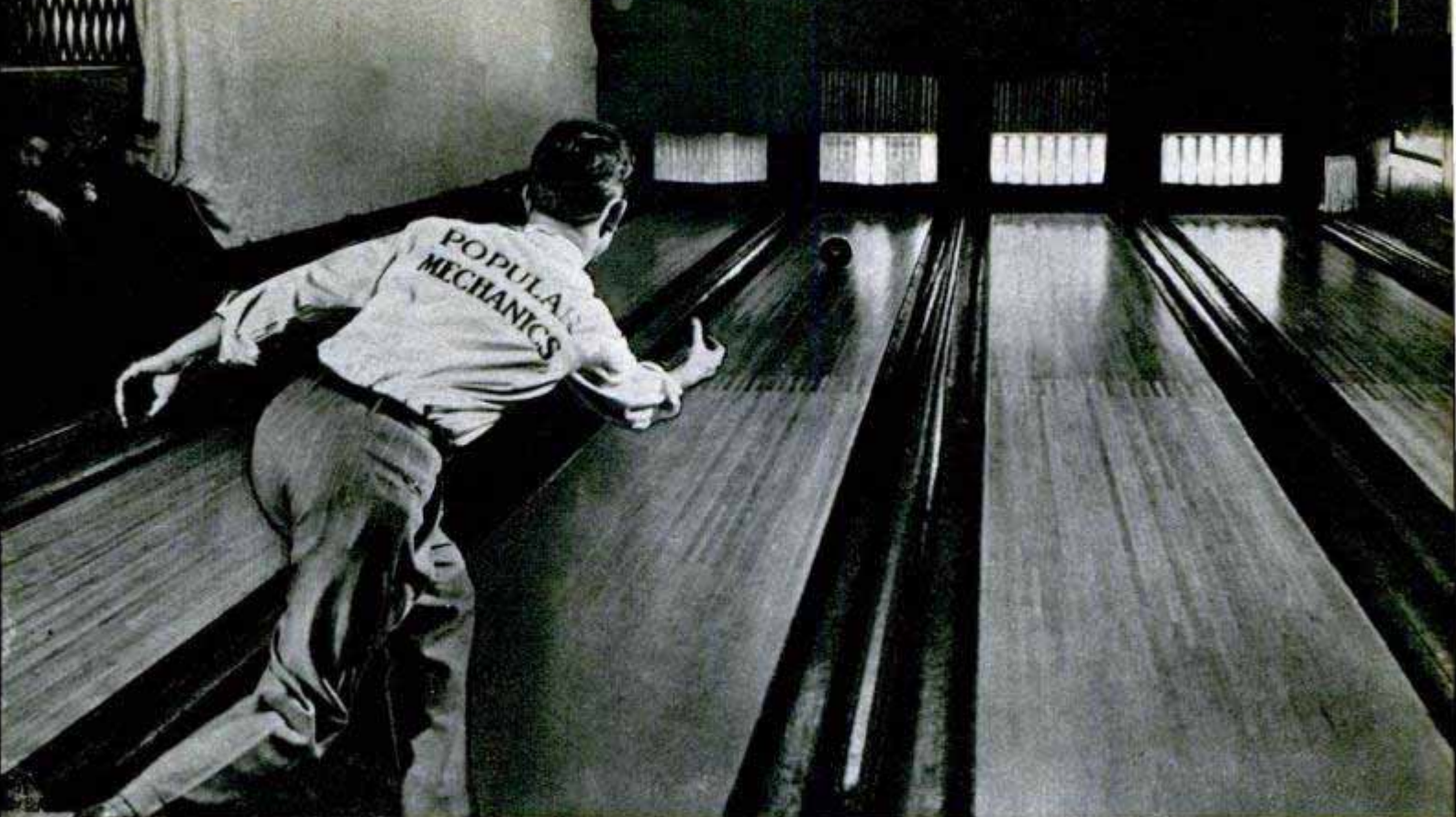

## PINLESS BOWLING

NEITHER pins nor pin boys figure in the full-size bowling game devised by Henry Leavitt of Ogden, Utah. Bowlers roll at a lighted target showing regulation-size pins in the usual positions, but suspended about a foot above the alley. The ball brushes against rollers wired to the pin lights as it speeds beneath the target. Depending on which combination of rollers the ball contacts, lights indicating the corresponding pins turn off. As nearly as possible, the electronically controlled machine is set to respond as pins do when the ball reaches specific points. Hits against either side of the head pin, for example, switch off all the lights to indicate a strike. After the ball thuds against the backstop, it is automatically hoisted to the return rail and sent on its way back to the user. Leavitt was inspired to build the machine by Louis P. Petersen, a Chicago bowling-alley operator plagued by the shortage of human pin setters. Synchronized with the machine will be sound equipment that reproduces bowling-alley noises, like the clatter of falling pins and the shouts of pin boys. The sounds will vary with the number of pins "hit." Later models of the machine will be coin-operated.

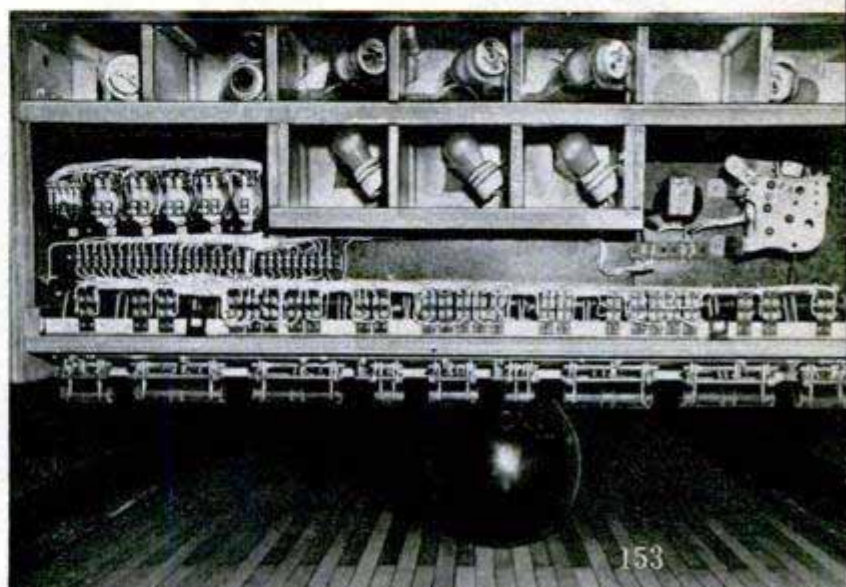
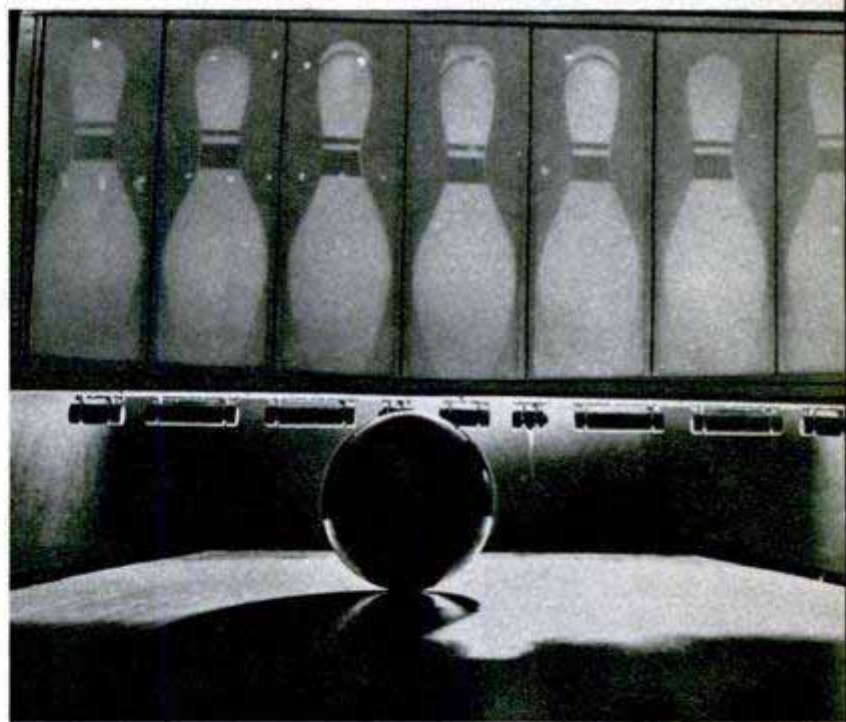

Top, bowler testing skill against Leavitt's pinless, boyless machine. Middle, ball brushing against rollers controlling lights for a 1-2 or "Brooklyn" strike. Bottom, same hit shown from rear of target. Bulbs illuminating 10 pin images are at the top





## Combat Glider Carries 30 Men

Surer landing control and a steel tube fuselage are two major features of the U. S. Air Force's newest combat glider, the XCG-18A Avitruac. The all-metal craft can carry 8000 pounds of cargo, 30 fully equipped troops or 24 litter patients. Landing accidents are minimized by use of a tricycle landing gear, providing safer ground control than was possible in wartime models. An extremely thin wing decreases drag so much that the glider has been towed aloft by a P-47 fighter in test flights. A rear cargo ramp leads into the hold, which is 24 feet long, 6 feet high and about 8 feet wide, facilitating movement

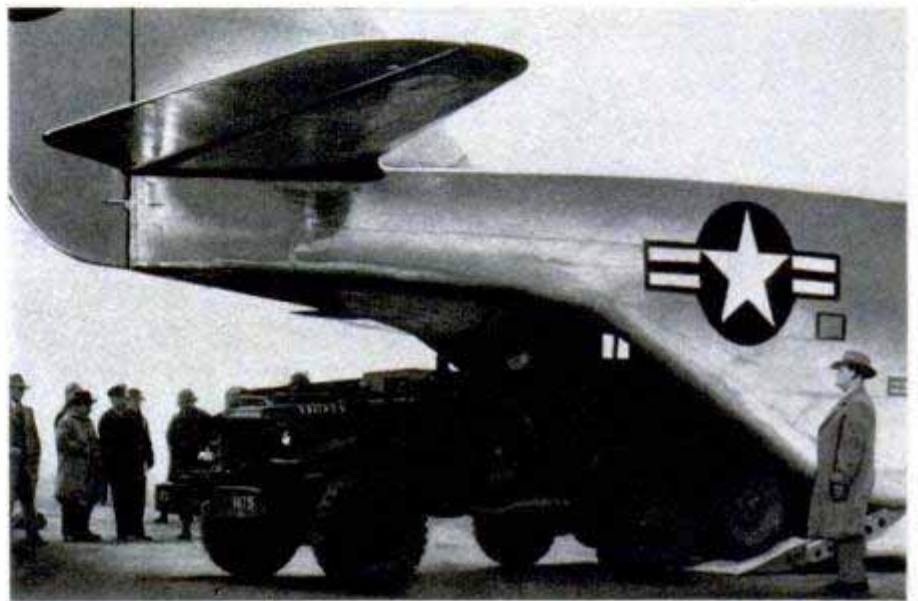

Chase Aircraft Co. photo

of bulky freight. There is a direct communication system between the glider and its tow plane. Its wingspan and length are 86 and 53 feet. The builder is designing a powered version for transport use.

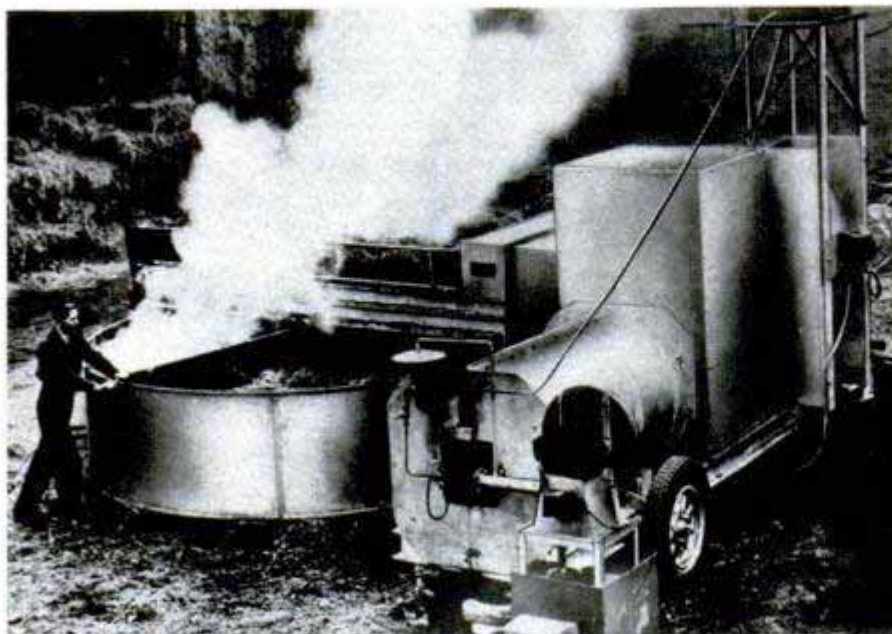

## Fodder Drier

Grass is prepared for fodder by a mobile drying plant designed in England. The drier permits owners of small farms to process fodder on a cooperative basis. The plant can be erected within two hours. Diesel oil is burned to supply the heat and one tractor powers the plant. The grass is loaded on a turntable that revolves to expose the entire load to the burners. The plant, prepared for moving, makes a 34-foot "train."



## Push-Button Telegram Flashed to 143 Offices

Pressing one button flashes telegrams with vital flight information simultaneously to 143 United Air Lines offices throughout the United States. Each message is typed only once, at the point of origin, and the distribution pattern selected on a master push-button switching panel. After a start button is depressed, the message is automatically fed to designated receivers over the 15,000-mile network as quickly as the circuits are free. The feature was specially engineered by Western Union for the world's most extensive telegraph and private telephone system, handling more than 2,500,000 messages monthly.

## Use High-Frequency Radio To Take Pheasant Census

Relying on the male cock pheasant's habit of crowing only once in two minutes and loudly enough to be heard two miles, the North Dakota Game and Fish Department has evolved a new method for counting. Biologists in autos, with high-frequency radio receivers which pick up only the crows of pheasants, start the census 20 minutes before sunrise. Traveling for 1½ hours, they stop every two miles to record

the number of calls heard during a two-minute period. The tours are made during April, May and June. Results from the surveys are used in determining whether to open the season in various counties and in setting the bag limit.



## Midget Autopilot

Three gyros spinning 12,000 times a minute are the "brains" of a midget automatic pilot that reacts in  $\frac{1}{10}$  second. The 35-pound pilot isn't much larger than a box camera and is about half the ordinary size. Unlike other types, it is not affected by loop-the-loops, barrel rolls or great bursts of speed and may be used with radio control for pilotless planes and guided missiles. The gyros are "locked" to the plane during flight and follow it during all maneuvers without any possibility of tumbling. To dive or climb, the knob of the midget box is moved in or out; for turns, it is rotated right or left. In level flight, the pilot can sit back and relax while the plane flies itself. Although still in the experimental stage, it may be used for light commercial and private planes, as well as military craft.

Westinghouse photo





Light stretcher dolly, above, designed at Yosemite to carry sick or injured. Loaded, it can easily be lifted over rocks and depressions by two men, where six were formerly required



Above, rangers using keyed horizon photos, made from lookout tower reporting, to determine actual location of fire. Below, carrying gasoline-operated pumping unit, hose and a two-way radio to scene of blaze. Water is drawn from closest source



**R**ANGER STATION?" asked the voice on the telephone. "There's a bear over here running around with its head stuck in a big milk can! Come and do something at once!"

The Yosemite Park ranger who hurried over really did find a bear with its head in a can, only by then the animal was on the verge of collapse from lack of air.

First the ranger shot a hole in the can, so the bear could breathe, and then the animal was roped and led over to a nearby machine shop. There a mechanic cut the can open. Unharmed, the bear appeared to shrug its shoulders and shambled off into the brush.

The bears that frequent a number of our national parks do no harm, as long as they are left alone, but vacationists who attempt to feed or tease them are occasionally badly clawed or bitten. Sometimes

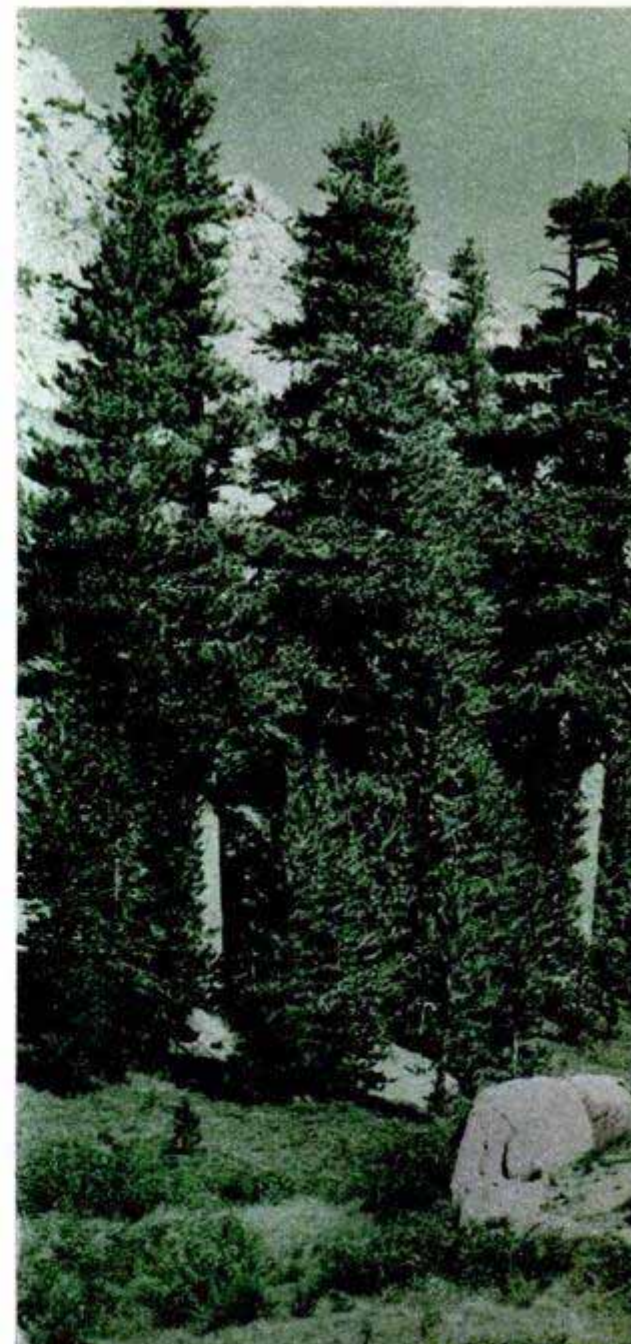



a bear makes a nuisance of himself by hanging around a camp in search of food. When this happens at Yosemite, the rangers haul out their mobile bear trap, a length of corrugated steel culvert pipe mounted on wheels. At-

tracted by food inside, the bear enters the trap and a steel door slams down behind him. Then the rangers tow the trap far out into the woods and release the animal.

Protecting the public from the bears and the bears from the public are among the incidental jobs that keep rangers of the National Park Service busy. Every summer millions of Americans, soft from city living, take their vacations in the national parks that are located in the most scenic, and rugged, parts of the country. Inevitably a number of them get lost, fall

**Uncle Sam's caretakers  
run a 24-hour service in  
protecting people from  
animals, and vice versa**

off horses or down mountain sides, slip on glaciers, tumble into streams and lakes, or even, in the midst of the wilderness, have automobile accidents.

Three hundred permanent rangers administer our 28 national

parks and 85 national monuments. During the tourist season this staff is augmented by 500 temporary rangers who are given short, intensive training courses. College students and school teachers often serve as temporary rangers.

Briefly, their job is to protect the vacationists from harm and at the same time preserve the natural features, wildlife and property of the park from damage or molestation. This breaks down into dozens of duties, ranging from directing traffic to planting fish and from trail building to

**With a pack animal hauling their food, three rangers patrol trails just under timber line in the Yosemite high country. There are 300 of these highly trained woodsmen on full-time duty in the National Park Service**  
National Park Service photo by Ralph H. Anderson

# A Ranger's Day is Never Done

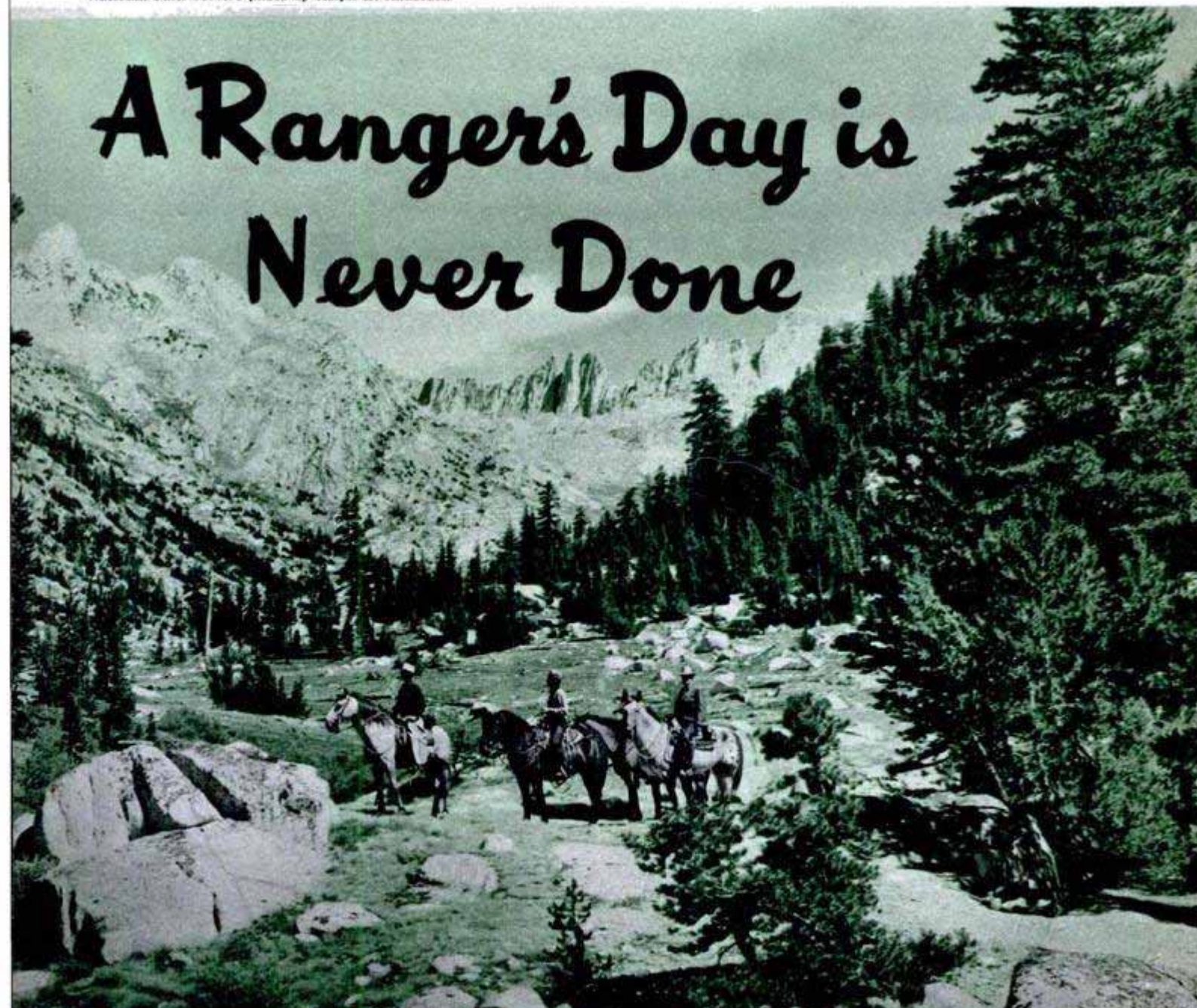



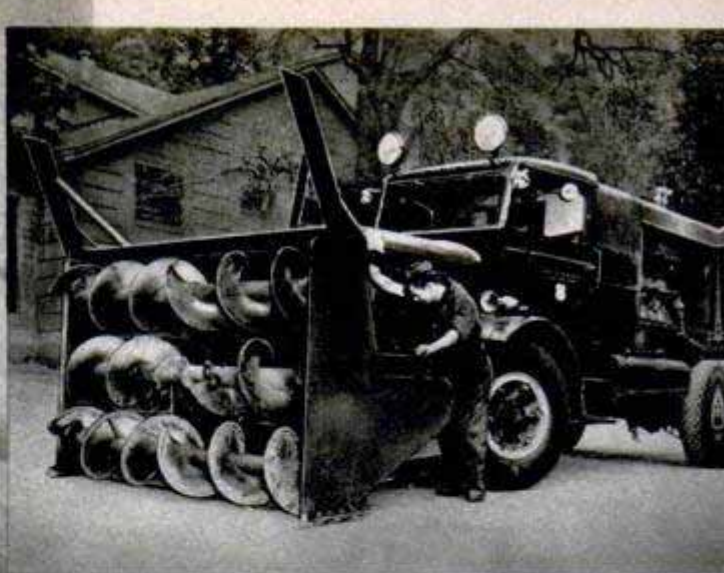

Close-up of the plow shown at left. It clears way for a growing army of skiers

National Park Service photos  
Above, digging out at Lassen Volcanic National Park, where roads are sometimes buried 30 feet deep in snowdrifts. Below, the oddly shaped hummocks on this Yosemite glacier are caused by reflection of the sun's rays from sides of the water channels

forest-insect control. The rangers supervise the camp grounds, pack in supplies to lookout stations, take an annual game census, and give illustrated talks and campfire lectures. They patrol the trails, organize search and rescue parties, and fight forest fires. Depending on its location, a park may have up to 150 forest fires a year, most of which are caused by lightning and each of which must be put out as soon as possible.





At any of the larger and more heavily visited parks the rangers can expect that several people will be killed by accident or drowning each season in spite of all the safety precautions that are taken. They can anticipate an average of one cliff rescue per year and four or five organized man-hunts. They can expect that 125 or so vacationists will need first aid for sprains or broken bones. At each of the parks the rangers maintain an emergency headquarters at which all sorts of rescue gear is stored and kept ready for immediate use.

Chief Park Ranger Oscar Sebergren of Yosemite, for instance, has an emergency storeroom in which are kept diving helmets, life rings, ropes and irons for mountain climbing, stretchers, blankets, flashlights and spare batteries, and emergency rations. Complete camping outfits made up into back packs stand ready to be picked up in a hurry. Walkie-talkie radios, portable power pumps, and fire-fighting equipment are kept serviced and ready to go. Recently added to the emergency equipment is a trail buggy developed at Yosemite on which one or two men may transport an injured person across rough ground or along trails in comfort.

The trail buggy consists of a light two-wheeled cart that weighs only a few pounds and a wire stretcher that fits on top. In the past an injured person often had to be transported on horseback or by a hand-held stretcher that was tiring and awkward to use.

Years ago the national parks entertained very few winter visitors. Now, with the

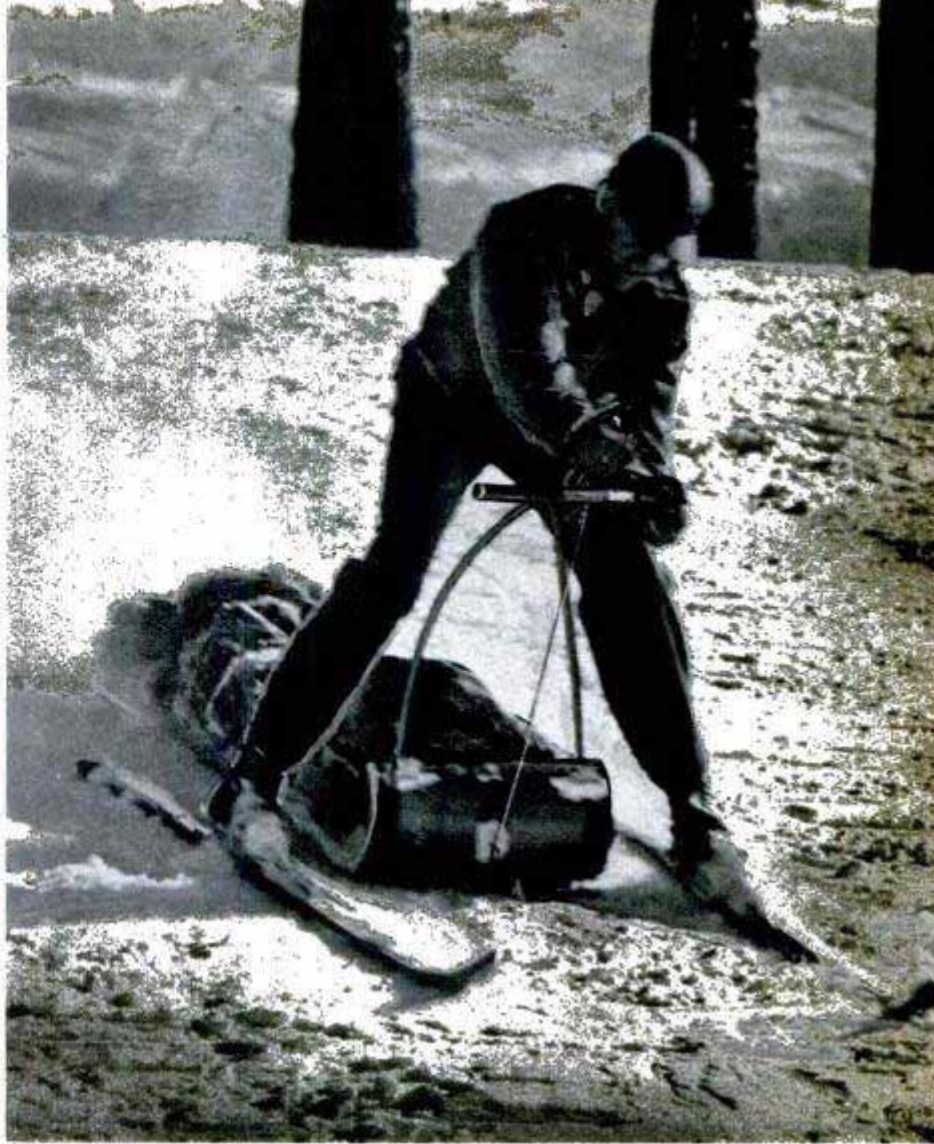

Snow flies from the rear of rescue toboggan as a ranger pulls the brake handle (see sketch below). He uses his skis to steer

increasing popularity of snow sports a number of the parks are busy most of the year around. Highways into the ski regions are kept open in answer to the demand. Ski accidents are bound to occur, and the rangers and park mechanics have devised some ingenious rescue equipment.

A toboggan makes a good vehicle for carrying an injured skier downhill to a

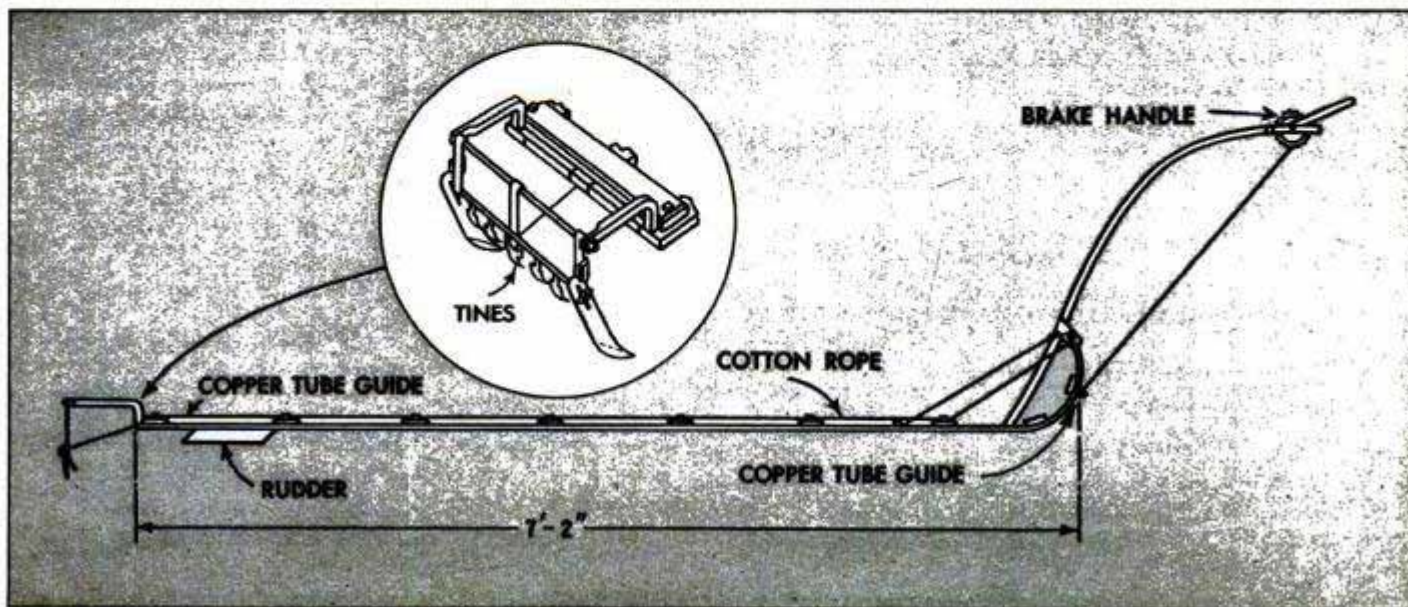





Seining trout from dammed stream, for use as spawning stock in fish hatchery, is another ranger responsibility

first-aid station or ambulance, but as many as six men with ropes used to be needed for guiding the sled. Now one ranger can do the same job, using a rescue toboggan that was developed at Yosemite. The improved sled has a V-frame in front that rises up to form a handle. To the handle is attached a ratchet that is connected to a rake-type snow brake at the rear of the sled. A ranger simply straddles the handle and holds onto it while sliding downhill, using his own skis for steering. He brakes to slow speed, or stops completely by turning the ratchet handle with one hand.

Once the alertness of a ranger at Mount Rainier National Park saved the lives of two skiers buried under a snow slide. Making his way along a trail, the ranger noticed that a number of ski tracks came to an end at a point where a fresh slide covered the trail. Since no fresh tracks were visible on the other side of the slide, the ranger went for help at once.

The rescue party probed the slide area with 12-foot lengths of aluminum tubing and shortly an object was located at a depth of eight feet. Digging down, the rangers uncovered an unconscious skier. They revived him as rapidly as possible and learned that there were two other people in the group, both of whom had been behind him. With this information the rangers were able to locate the other two, one of whom was still alive. The men had been buried for four hours.

Ranger Ben Miller of Glacier National Park was caught by a snow slide while on

lonely winter patrol and carried 200 feet down the side of a mountain. He was buried in snow that was compacted almost as solidly as ice, yet a day later he managed to escape. One of the things that saved him was that he could reach up with his arms and open up a breathing hole, another was that he kept his wits with him all through his imprisonment.

His back pack was wedged in the snow so firmly that he could hardly move and his snowshoes had twisted so that he couldn't release his feet. It took Miller 24 hours of slow, patient clawing with his hands to get his pack off his back. Inside the pack was his hand ax and with this he hacked away enough snow from around his legs to release them from the snowshoes. He got loose with only a few sprains and frostbites and made his way home.

Behind the scenes at any busy national park is an organization comparable to that of a small city. All sorts of facilities and services must be available for its visitors. The result is that there are thousands of summer jobs for young men and women of around college age at such scenic spots as Yellowstone, Yosemite and the Grand Teton. The summer employees work in hotels and gas stations and devote their free time to mountain climbing, fishing and all the other activities of the out of doors.

Some of them are employed by the National Park Service itself, but most of the jobs are with the private companies that operate the resorts in the parks. At Yosemite, for instance, the Yosemite Park and



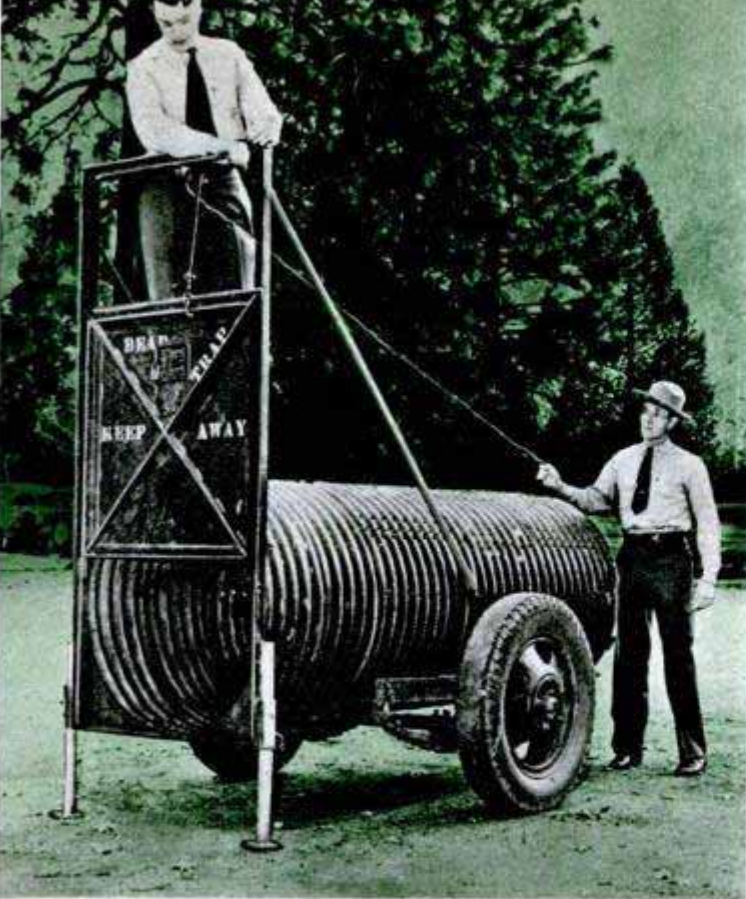

Setting trigger of a mobile bear trap. Steel panel slams down after animal moves in to take food bait

Curry Company is the licensee in charge of the hotels, restaurants, warehouses, laundries, barber shops, stores, bus transportation and a variety of other facilities.

Beginning in May, or as soon as accepted applicants finish their school terms, the Yosemite concessioner employs about 1000 extra people for the summer season. Some of the jobs require previous experience, others can be handled with a minimum amount of training.

Warehouse workers earn a dollar an hour, dishwashers get \$140 a month plus meals, waitresses average \$10 a day plus meals, and other jobs are paid on appropriate scales. The employees receive reduced rates for meals and laundry service and they pay less than half a dollar per day for dormitory tents. They put in a 48-hour week and contract to work all through the season to Labor Day or later.

Yellowstone employs twice as many people as does Yosemite. Other parks that draw fewer visitors employ only a few score or a few hundred extra people during the summer. To learn more about summer job opportunities you should address a letter to the superintendent of the park you have in mind and ask the name of the principal concessioner. You can then send a letter to the concessioner company, describe your capabilities and background, and ask about the chances of employment. Policies vary with the different companies, although all are receptive to school and college students.



Bears are curious, too. A park machine-shop worker finally had to saw away milk can into which this one stuck his head. Bullet hole at the bottom was put in to give him air. Below, rangers on a patrol

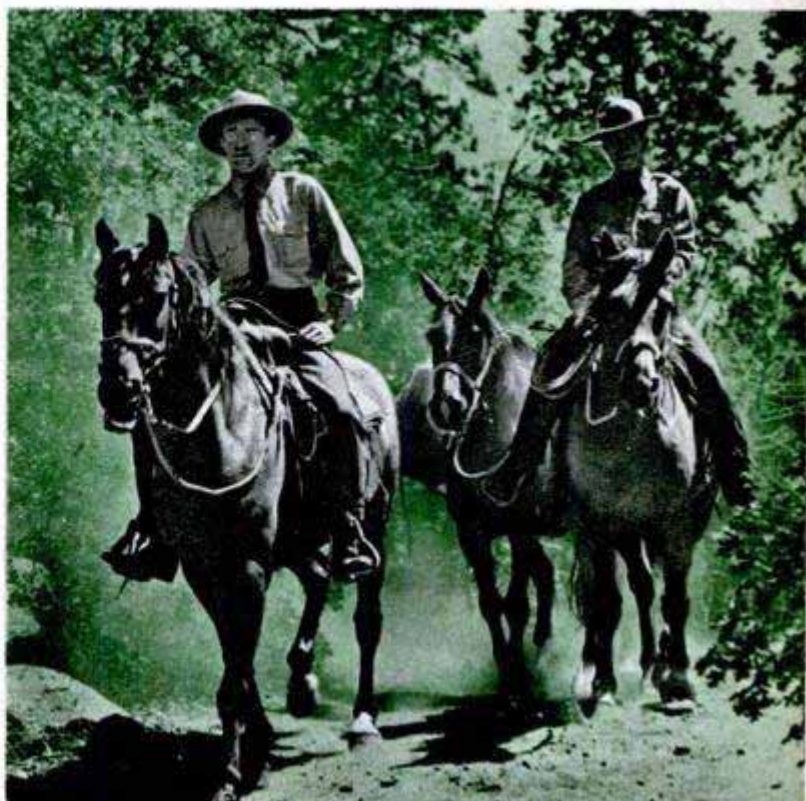





Du Pont Company photo

### Fire-Resistant Plane Paneling

Paneling that protects human flesh within one inch of a 2200-degree flame has been developed for airplanes. Called Pyroply, the  $\frac{1}{4}$ -inch-thick panels consist of cellulose-acetate plastic sandwiched between very thin sheets of carbon steel. On exposure to heat, the plastic forms parchmentlike layers that act as a barrier. The panels weigh less than a pound per square foot, yet are strong enough to support a large man.

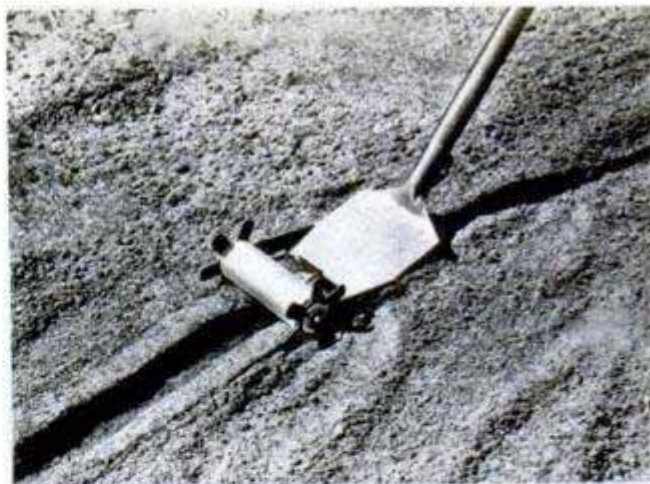

### Garden Tool Cuts Even Furrows

Furrows of uniform depth are cut and covered by a garden tool that assures even planting. The tool, which has a four-foot handle, is pulled along the surface of the ground. The cutting plate between the blade and the roller can be adjusted to make a furrow of the desired depth. After the furrow is cut and the seed planted, the tool is turned over and pulled back along the same path to roll the soil smooth.

### Handle Keeps Paint Off Hands

Cans of paint can be held by a removable handle to avoid coating the hands. The handle also serves as a brush holder and scraper, and the tip can be used to open the paint can. Three projections hold the handle in place, two under the inner rim and one on the outside of the can. When not in use, the brush can be rested on the scraper blade so that excess paint on the rim of the can does not coat the brush handle. The blade provides a convenient surface for wiping paint out of the bristles.

Information, including manufacturers' and distributors' names and addresses, concerning products described in this issue may be obtained by writing to Bureau of Information, Popular Mechanics Magazine, 200 East Ontario Street, Chicago 11





### Midget Electric Car

Scooting down the streets of Tokyo is a midget electric car that was invented by a former Kamikaze pilot who never had the

opportunity to take a fatal dive. A 30-volt battery provides power and the little vehicle can hit 25 to 30 miles an hour for six hours without recharging the battery. The car sells for about \$2400.



### Light Two-Place Helicopter

Exceptionally light weight and stability feature the twin-rotored JOV-3 helicopter being built in Philadelphia. The craft weighs only 1200 pounds, seats two tandem-

fashion and is driven by a small 100-horsepower engine. Its inventor claims it can make turns and land within a space its own size. Each rotor has three blades and is 18½ feet in diameter. The JOV-3 cruises 73 miles an hour and has a 138-mile range.



Frank Lloyd Wright, the noted architect, teaches students at his Wisconsin hillside school to design, model and build in a native American pattern

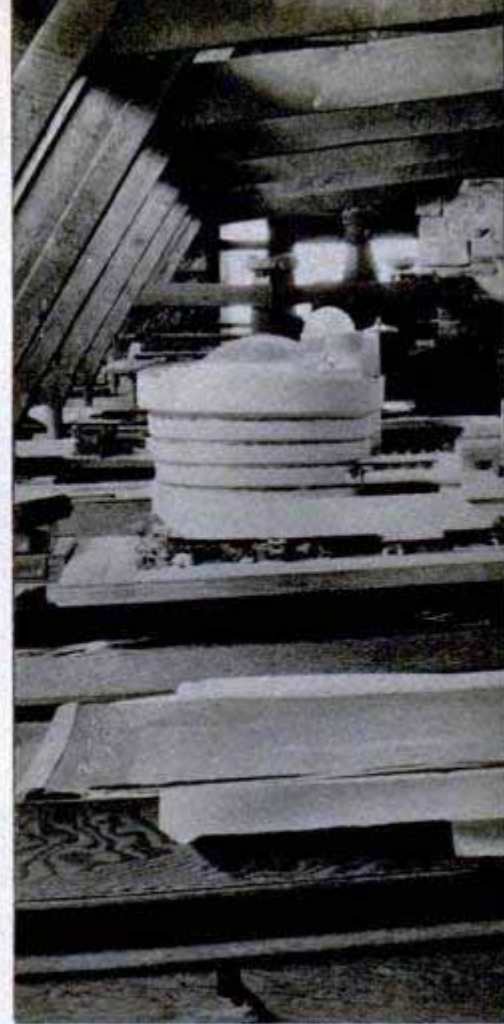
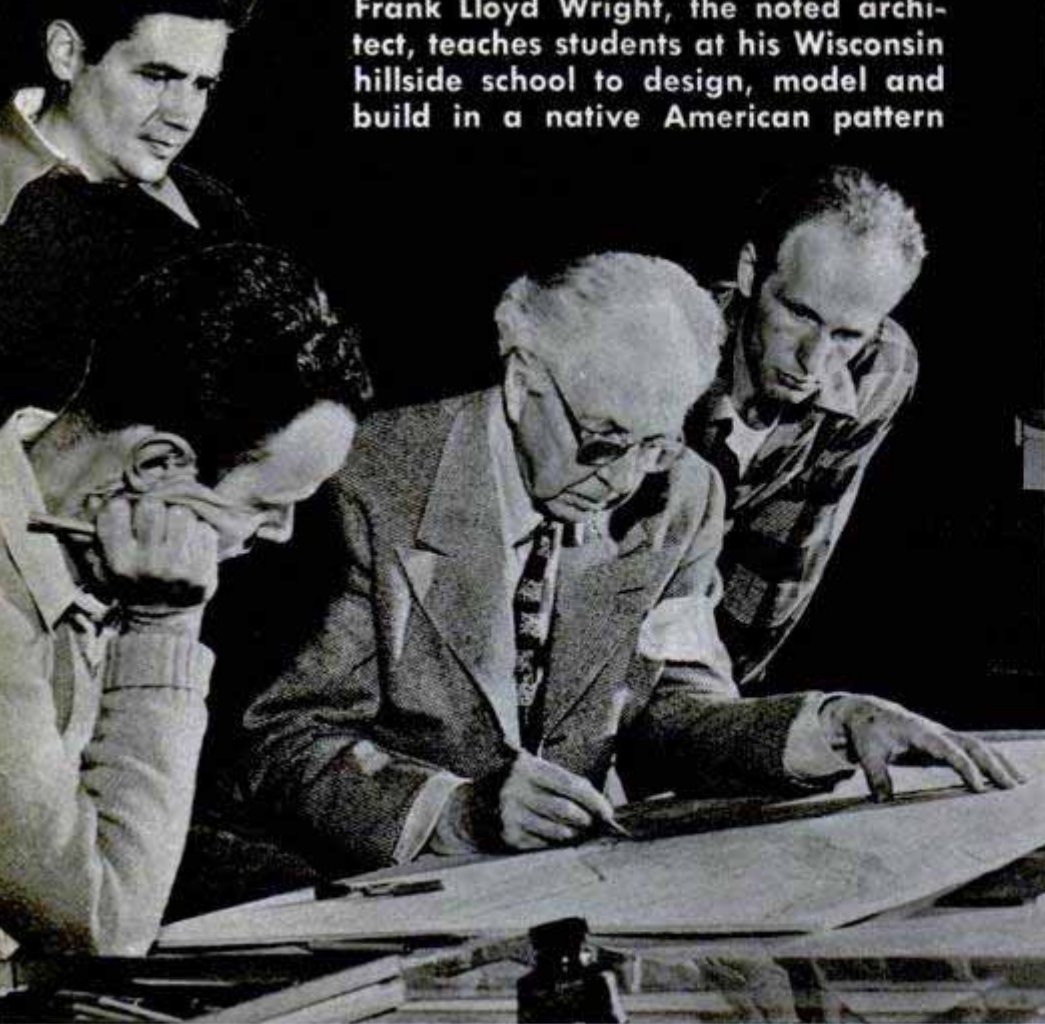

## Architecture From the Ground Up

By Clifford B. Hicks

**F**RANK LLOYD WRIGHT believes that an architect is more than a designer. An architect is a builder to whom tools and materials should be old friends. To prove his idea, Wright not only is building world-famous structures but is building good architects.

At Taliesin, the noted architect's estate near Spring Green, Wis., Wright is the faculty of a unique school for architects. The 55 students in his school this year made their way to Taliesin from 15 different countries to learn his techniques.

Wright is the forthright exponent of a native American architecture. Homes, he says, should blend into the surrounding countryside—should be "wedded to the ground." His estate at Taliesin is an outstanding example of this technique. Taliesin is a Welsh word meaning "Shining

Apprentice touches up model of an unusual home with circular pool. Water will splash over edge in a cylindrical waterfall

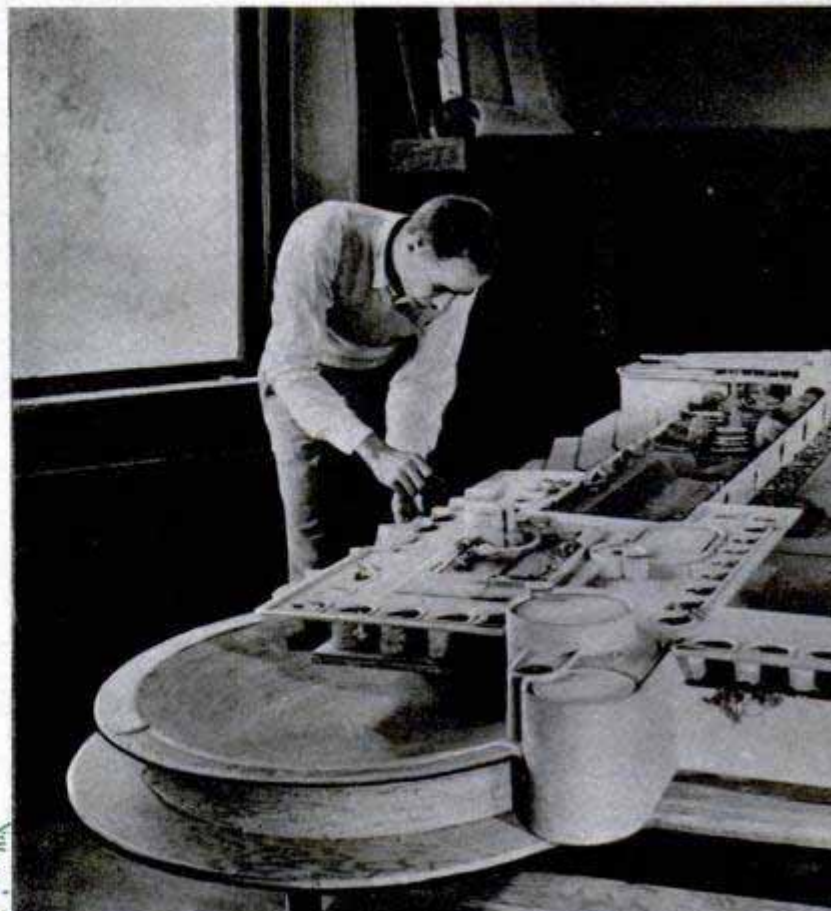



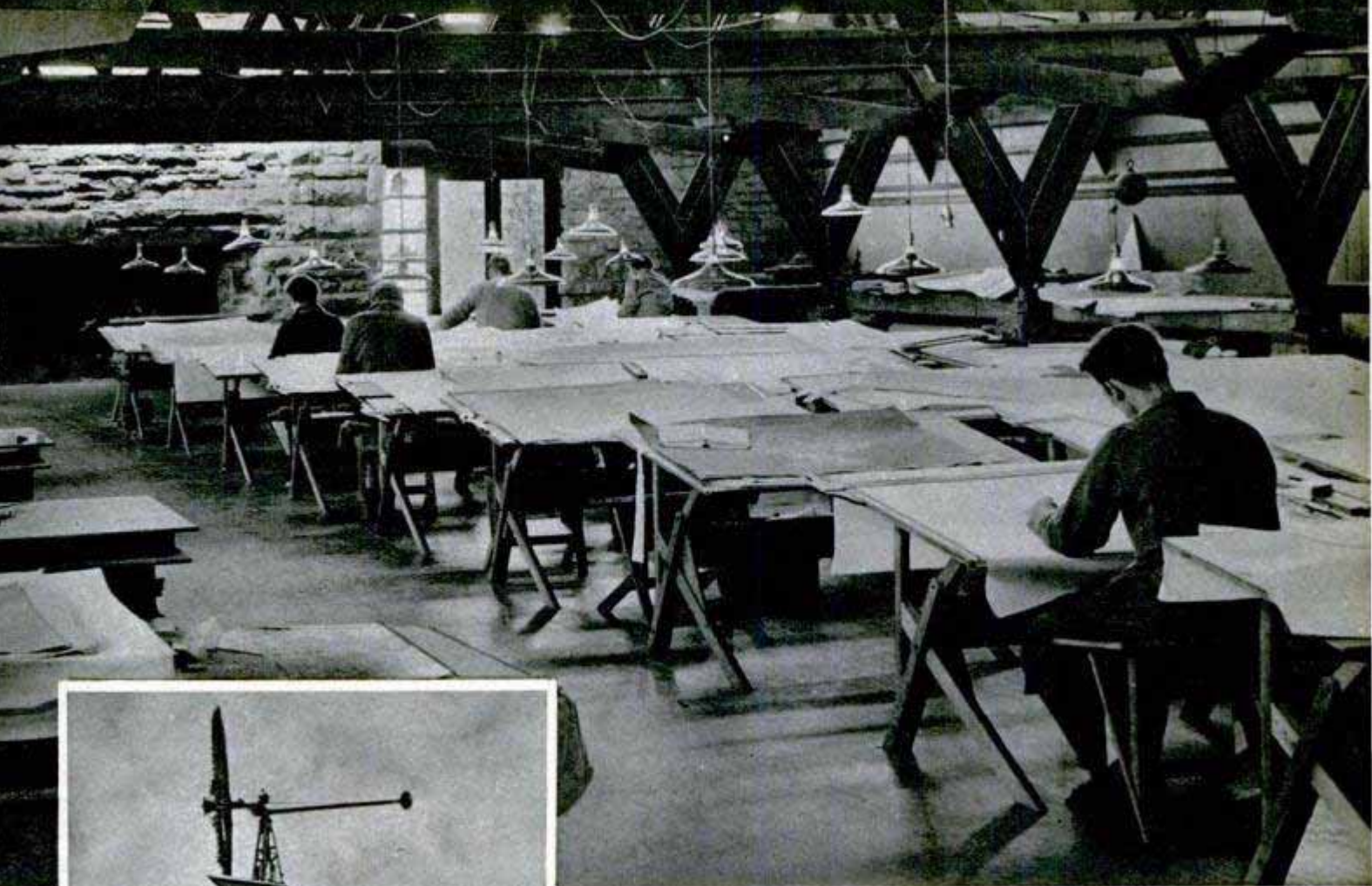

Students work in the vast drafting room they designed. Left, windmill tower which Wright built 50 years ago overlooks the school. Neighbors said it wouldn't weather the first storm

Brow." On a ridge overlooking the Wisconsin River stands Wright's home, a building that seems to grow out of the ground. The home and two older buildings in the valley below house the Taliesin Fellowship, the school which Wright hopes will turn out a generation of architects who are builders, not merely designers.

Standing like a symbol high on a hill overlooking the school is one of Wright's first architectural projects—a wooden windmill tower which neighbors said would topple in the first storm. It has lasted 50 years.

The school has no faculty other than Wright, no curriculum and no hourly courses. Wright believes that students "learn by doing." His apprentices learn architecture by working with Wright on his projects. They may remain at the school 10 days or 10 years, and when they leave they are given a letter of recommendation instead of a diploma, if their work has been satisfactory. Usually such a letter signed by Wright assures them of a good job or clients of their own.

Students feel that they are working under the guidance of the master architect. In the 50 years that Wright has been an architect of stature he has designed 500-odd homes and buildings, many of them so revolutionary that they have set a new style in architecture. His ideas are best expressed in his homes, which he designs "from the inside

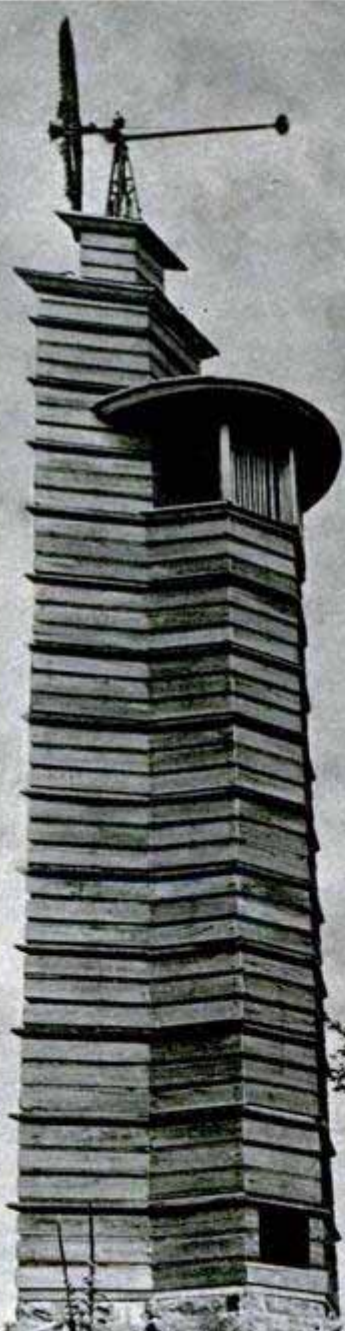





Daughter watches as mother-student weaves tapestry. Weaving is but one of the arts taught at Taliesin



Apprentices lay stone for new wing of school building. Wright believes students should "learn by doing" From workshop come famous models of Wright's buildings. Apprentices even carve each "stone" from wood

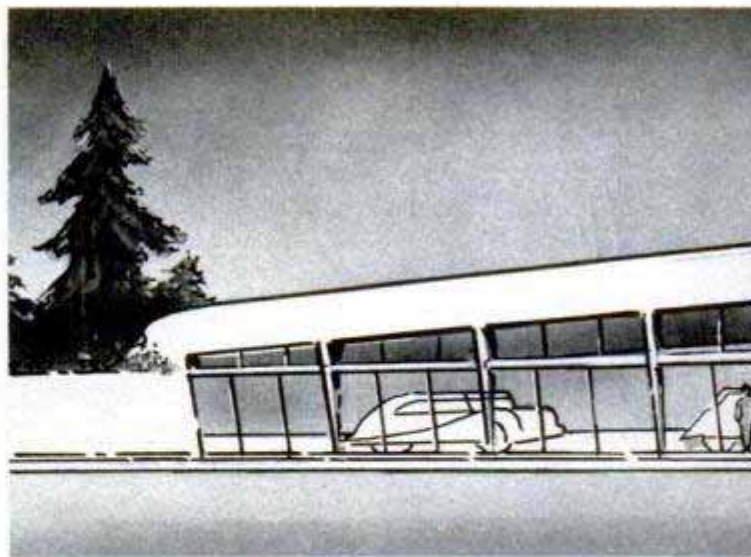
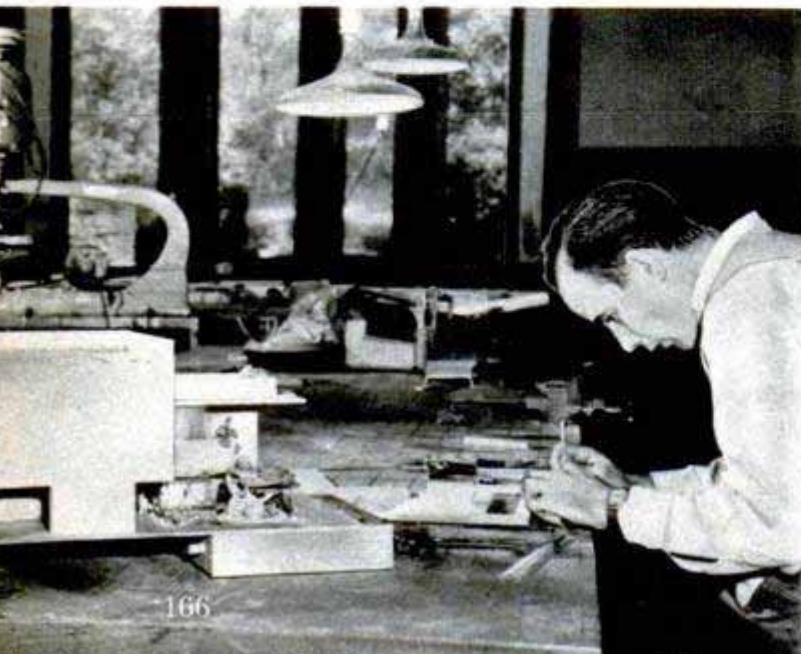

out." Most of his houses are spacious and low-slung with broad roofs, big fireplaces and long horizontal lines. They usually are built of materials that will blend into the landscape, so that they seem a part of the setting. In his large city buildings, for which he is more famous, his idea is to tailor the structure to its purpose instead of designing a beautiful exterior and then splitting the inside into cubicles. The outside lines flow around the pattern set in the interior. The resulting buildings usually have such simplicity that they are startling.

One example is the research building now under construction for the makers of Johnson's Wax in Racine, Wis. The structure will be 15 stories high with circular walls of tubular glass. Alternating with the main floors will be circular floors inside the walls. The entire building will be supported by a circular masonry stem extending 50 feet into the ground. According to Wright, the building will be flooded with light and will house the research offices in natural relationship flowing downward.

These are among the many ideas that apprentices at his school are absorbing. The Taliesin Fellowship was founded in 1932 to include the young draftsmen who were working with Wright on his projects. A few of the original apprentices work with him today, serving as advisers for other students. Others have made brilliant careers in architecture. The Foundation has grown slowly through the years and taken on an international flavor with the addition of students from foreign countries. Today apprentices from Japan and Palestine are working with T-square and triangle beside young men from China and Egypt. Among the other countries represented are Norway, Ceylon, India and England.

Because the 79-year-old architect believes that a man cannot design a good building unless he knows the nature of the materials from which it will be built.



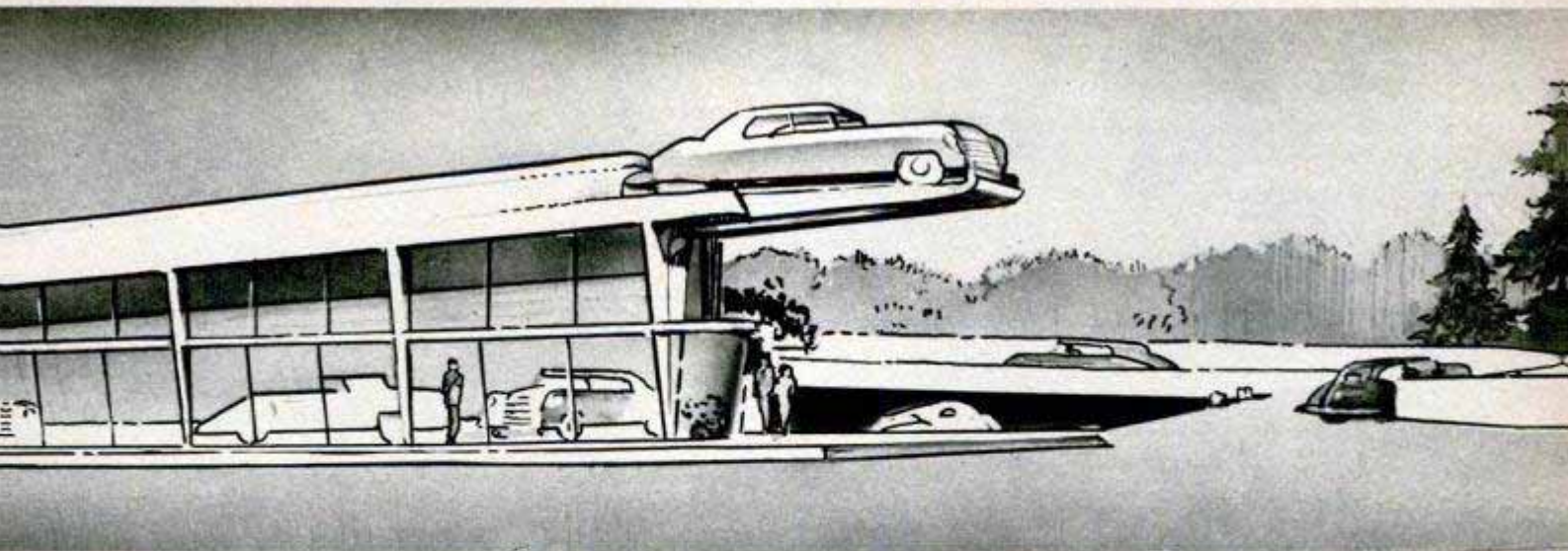

Among Wright's latest designs is garage-salesroom to be built in Detroit. Real car will be exhibited on ramp

Wright insists that his apprentices build with their own hands. All the buildings of the school have been built or rebuilt by the apprentices. Under the guidance of old Welsh stonemasons, the apprentices chip stone, select faces, patiently fit walls together and bind them with mortar.

The young men cut lumber for their buildings from the native growth around Taliesin, supervise the milling of it, and erect it themselves. After years of such patient work, according to Wright, students and materials will work together as a team in building new structures.

Brand new building materials are under study at Taliesin, too. Metal and plastics are receiving attention, and there are big triangular glass panes lying about the

buildings. They will form the walls of the 47-story glass hotel which Wright has designed to be built in Dallas. Most of the panes will be insulated with glass fiber, and colorful bundles of the wool-like material are strewn about Wright's personal studio.

The hotel design is revolutionary in itself. The structure will be built of glass, magnesium and stainless steel and will be stronger than reinforced concrete, according to Wright. Every room will be an outside room reached by interior sun galleries. Each row of glass panes will project slightly at the top and slant inward toward the bottom, giving the effect of overlapping stories. Wright says the walls will be self-cleaning and impervious to hail because of the inward slant.

Students translated Wright's ideas of ideal community into model complete with "acre of ground for each home"







**Old buildings at Taliesin were redesigned by apprentices. Then they did back-breaking stonework themselves**

Apprentices start designing and drafting the day they enter the Fellowship. Whenever a man is assigned a room, he rebuilds it according to his own tastes and requirements. The resulting arrangements are unique. The apprentice actually must live with his own design, and the mistakes he makes he never forgets. You can't forget a mistake that greets you every day.

Several hours are set aside each afternoon for work on the projects Wright has undertaken. This is essentially a drafting job, as Wright himself works out the idea of the building and draws a floor plan and elevation, whether it's a five-room home or a 50-story hotel. But the apprentice

takes over the job of making detailed drawings of the building, and here he expresses his own originality, both in conception and drawing. Wright describes his apprentices as "the fingers of my hands." The final drawings of some of the buildings are so well done that they are considered works of art and have been exhibited throughout the country. A few have been done by men with no drafting experience before they came to Taliesin. In fact, a majority of Wright's students have had no previous training in architecture.

In the now-famous workshop of the Fellowship the apprentices carry through another phase of their training, patiently fashioning scale models of the buildings Wright has planned. By the time the students have drawn detailed plans, pored over them for months and built models to exact scale, they are just as familiar with

(Continued to page 256)

**Research tower for wax company at Racine, Wis., is now under construction. Other buildings in this drawing already have been erected. Inside each glassed-in story of tower will be an intermediate circular floor**

S. C. Johnson & Co. photo

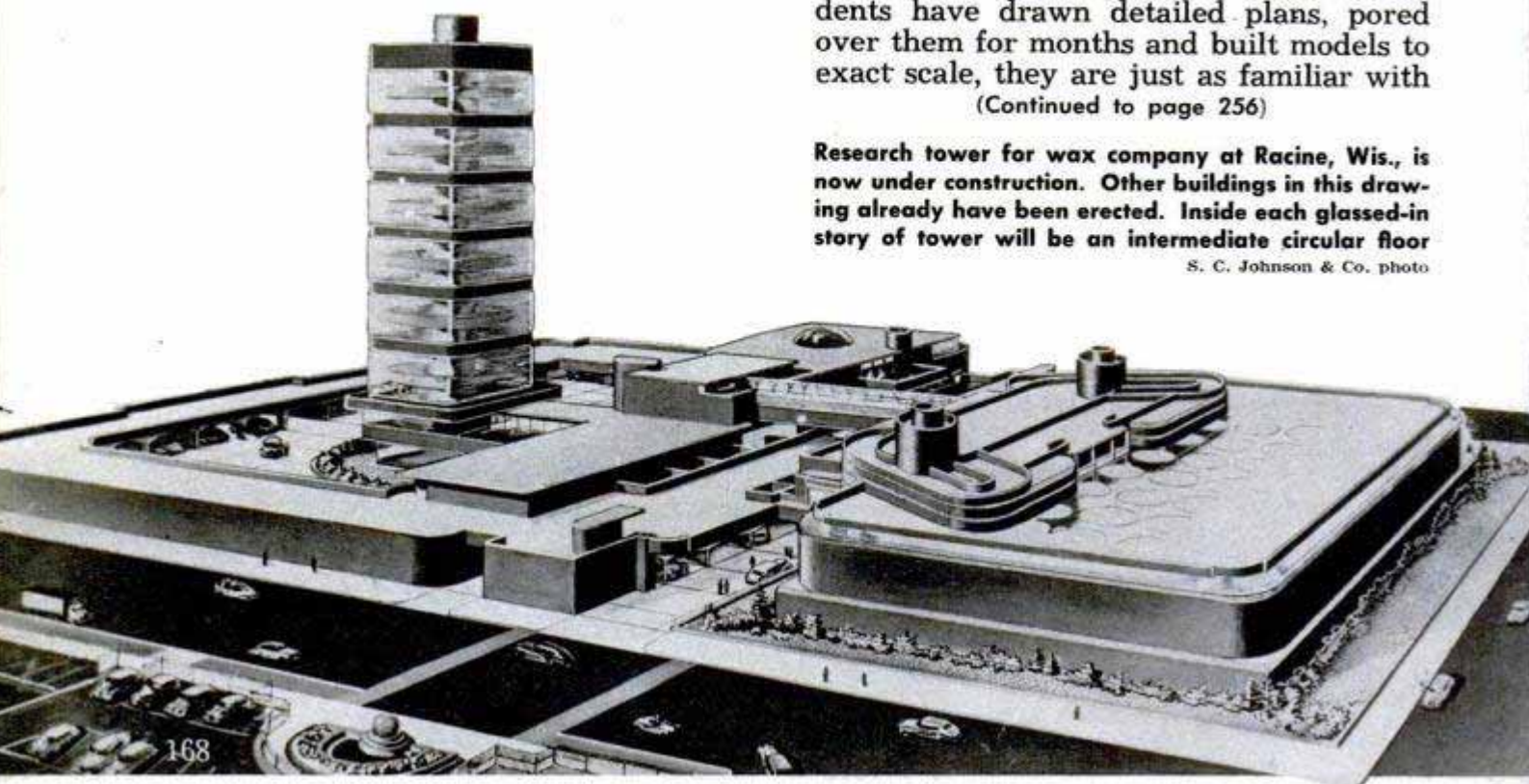





### Cruising Telegraph Office Picks Up Messages by Radio

Telegrams are received and delivered by a telegraph office on wheels—a car equipped with machines for recording radio messages. Recently tested in Baltimore, the car cruised through an assigned residential district, offering speedy delivery of messages picked up over its ultra-short-wave radio system. Telegrams addressed to residents in the area were

received at the central Baltimore office and then broadcast to the car. Inside the car a recorder picked up the messages and printed a facsimile. The driver merely made the delivery at the address on the telegram. Replies and telegrams that he picked up were transmitted by radio to the Western Union office where they were flashed to the proper destination.

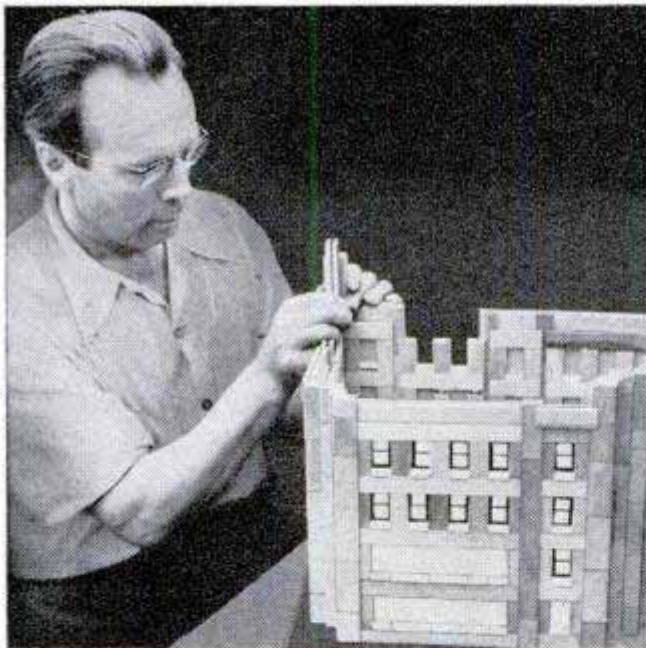

### Aluminum Blocks for Scale Models

Scale models of buildings ranging from a tiny cottage to a model of the Empire State Building can be built with interlocking building blocks made of aluminum. Designed to permit reproduction on a scale of  $\frac{1}{4}$  inch to the foot, the blocks are available in 19 colors. Only five shapes of blocks are needed and they can be used over and over. In the model of the Empire State Building, 16,000 blocks were used, 4700 of them being used as windows.

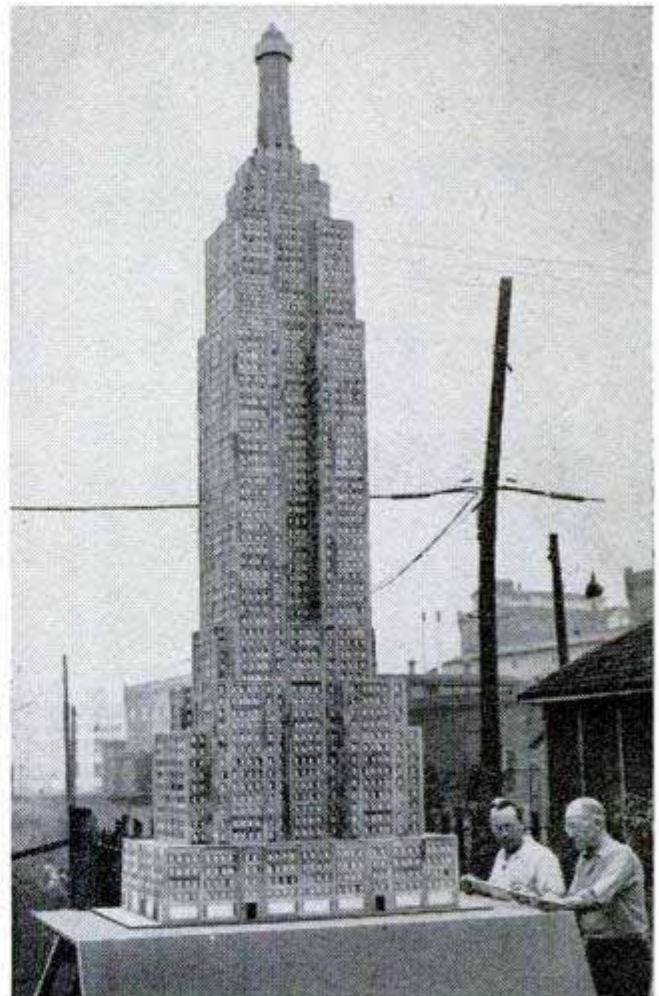

Towering above its builders, this realistic model of the Empire State Building contains 16,000 blocks





After making it safe by de-fusing, Army engineers recover an unexploded Japanese bomb on a Pacific island

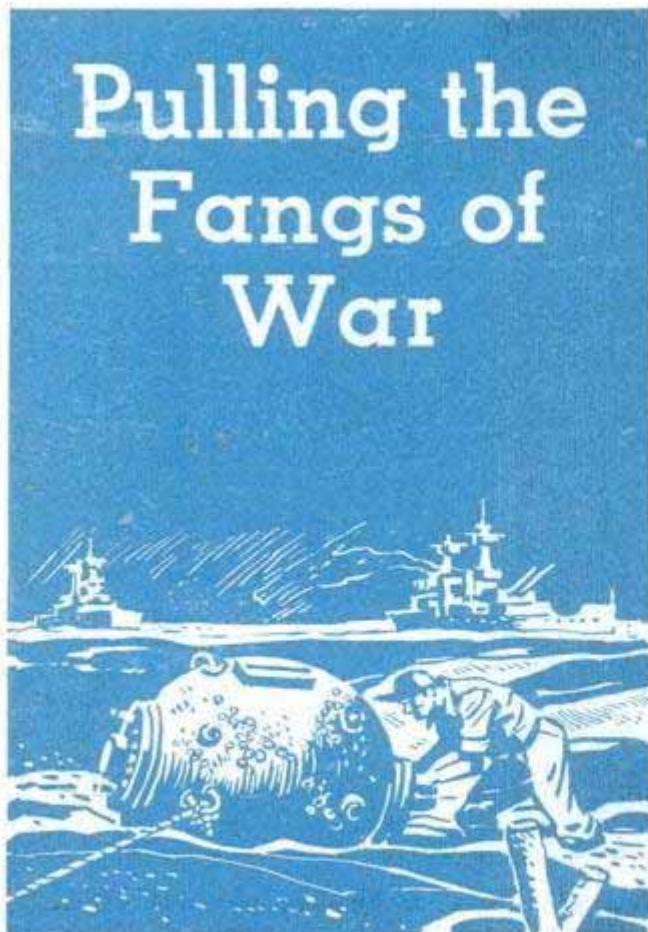

**By Andrew Hamilton**

**I**N THE DIM LIGHT of dawn, fisherman Jose Gonzales couldn't see the wicked-looking Japanese horned mine that floated in front of his tiny boat as he left Manila Bay. He never knew what blew his boat to kindling wood—he never knew because he was killed instantly.

Death also came suddenly to an 11-year-old boy in Kansas as he played with a bazooka shell. "Hey, look, I'm a bazooka gunner," he shouted to two playmates as he slammed the projectile on the sidewalk. It exploded with a blinding flash killing him instantly and injuring his playmates so severely they died in the hospital.

A Sunday picnic on a Normandy beach was almost fatal to an entire French family of four. They stepped on a live land mine hidden in the sand. The explosion sent all four to the hospital.

People are still being killed and injured by World War II ammunition. It took almost 15 years to sweep the water and clear the battlefields of Europe after World War I; it may take even longer to pull the fangs of World War II.

Here in the United States we are lucky



that no battles were fought on our soil. But even here death lurks in war souvenirs, occasional mines that drift onto our beaches, and in areas that were used as bomb, artillery and infantry-training grounds.

At the Naval Ordnance Disposal Unit at Indian Head, Md., officers who have had wartime experience in this work are given further training in the latest methods of bomb disposal. They are carefully schooled in identifying, handling and disposing of U. S. ammunition as well as all known foreign makes including rockets, torpedoes, booby traps, depth charges, land and sea mines, projectiles, bombs and demolition charges.

These Navy-trained "bomb busters" have answered several hundred calls for help ranging from de-fusing a souvenir mortar shell to cleaning up 1900 rounds of live ammunition scattered by the explosion of the destroyer USS Solar at the Naval Ammunition Depot, Earle, N. J.

Coastguardsmen on Nantucket Island, Mass., found two spherical mines that had washed up on the beach approximately five miles apart. A guard was posted on each mine and the information relayed to Washington. An ordnance disposal unit arrived by plane the next day and de-fused the mines.

At the Gulf Shipbuilding Co., Chickasaw, Ala., a fused bomb

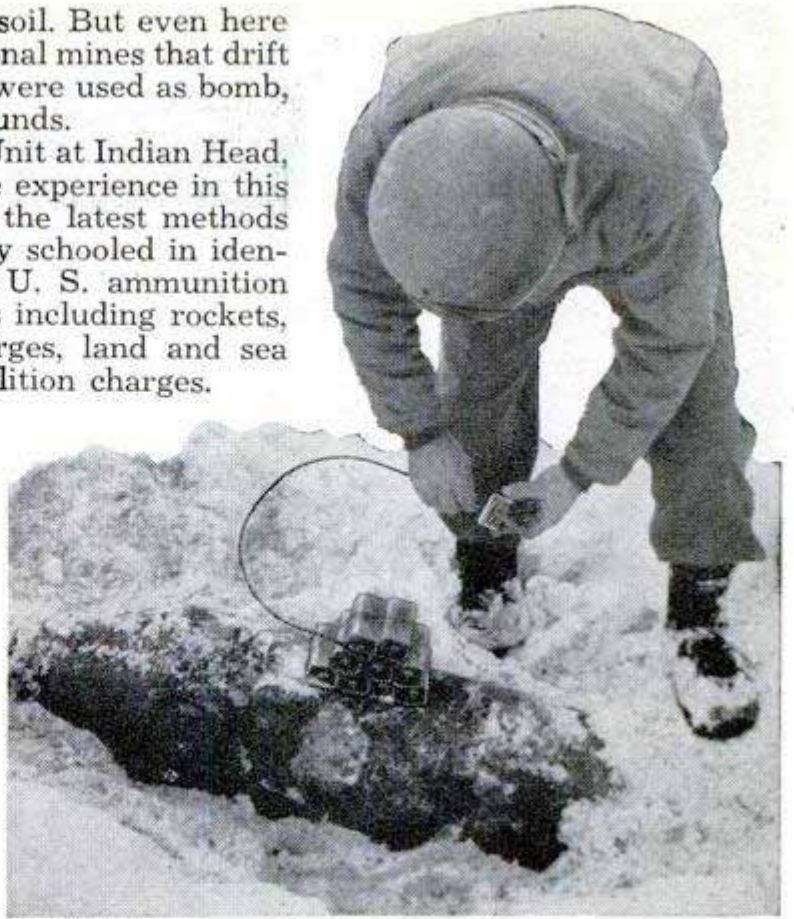

In open country bombs are often exploded where they are found. Above, soldier places five half-pound blocks of TNT on a dud bomb. He holds a safety time fuse in his hands. Below, here's what happened when the bomb shown above was detonated







This barnacled mine drifted ashore. Navy officer removes its arming pin



Above, huge signs such as this one on a California desert warn travelers that the fangs of war are still dangerous in the U.S. Below, the "Snake," a long trough pushed by a tank, contains explosives that blow up mines in the area. The football-like object in the foreground guides it over bumps

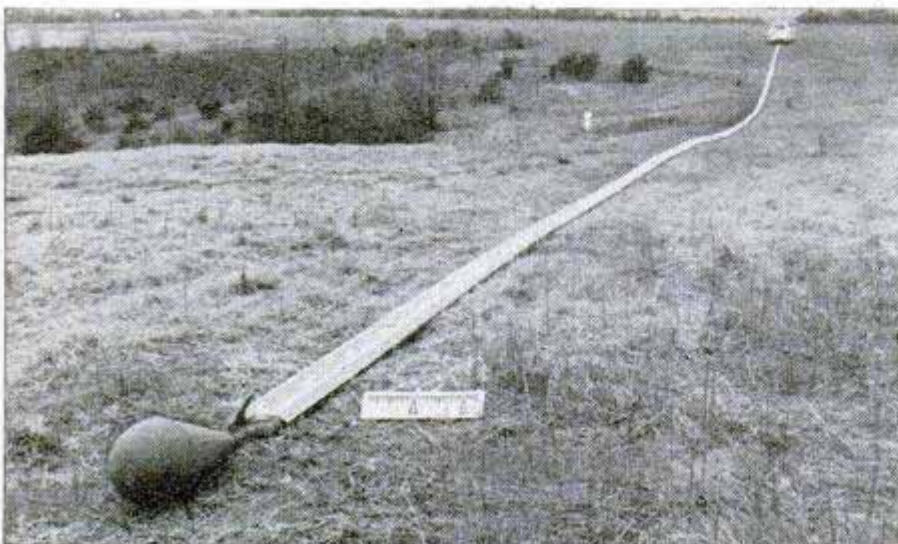

was found in the hold of the decommissioned escort carrier, *Stalker*. A wire to Washington brought one of the Navy's top bomb busters to the scene. He removed the fuse and directed the removal of the death-dealing object, a 500-pound British bomb.

The next few years will bring more, not fewer, calls for the Navy demolition experts as time and weather working on mine moorings set more of them adrift. American and British mines are comparatively easy to disarm because their mechanisms are well known. Japanese and German mines often provide the additional hazards of booby traps.

At the close of World War II, the U. S. Army's Corp of Engineers organized six Bomb and Shell Disposal Teams, each consisting of one officer and eight enlisted men. They scoured millions of acres of Army training areas in the United States ridding them of rockets, grenades, mortar shells and bombs that had failed to explode when fired. Although nearly 10,000,000 acres have been returned to public use, danger areas still exist.

The Southwestern Proving Ground at Hope, Ark., was built by the Army to test ammunition ranging from hand grenades to 2000-pound blockbusters. When the war ended duds were so thick there that you could hardly walk without stepping on them. The demolition teams went to work searching the area, flagging suspicious bombs and shells, blowing them up. In six weeks more than 300,000 potential death traps were destroyed.

Although accidents in



the United States have never approached the number in Europe, the increase has been alarming. Farmers, children and souvenir hunters frequently ignore signs posted by the Army in danger areas. Sometimes this has fatal results.

A more difficult phase of demolition work concerns the sites of munition plants. TNT, one of the most enduring chemical compounds, is not soluble. The process of manufacture, involving washes, contaminates the soil with explosives to an unknown depth. Sewer pipes have been found to contain as much as 18 inches of sudden death deposited by the wash water. Explosives have even infiltrated and permeated concrete.

Mechanical ingenuity has aided the bomb busters. The "Snake," for example, was the Army's clever device for clearing mine fields during hostilities. Pushed by a light or medium tank, the Snake consists of a 400-foot aluminum extension, 14 inches wide and 5 inches high. This long, flexible trough, filled with 4480 pounds of high explosive, was exploded by machine-gun fire. The detonation fired all mines within several yards and allowed tanks to roll through safely.

The Navy developed a 78-layer suit of pure Nylon worn by officers and men of the bomb-disposal squads. Hands are protected by heavy Nylon gloves and the face is shielded by a shatter-proof-glass mask.

In Europe and the Far East, other nations are conducting a systematic campaign to free their fields and the sea of lurking death.

One disposal squadron of the British Army's



Steaming main charge out of a Japanese 500-pound high-explosive bomb



Above, 78-layer suit of pure Nylon protects this Navy bomb buster from any possible explosion as he disarms fuses. The mask he wears has a window of shatterproof glass. Below, rockets that failed to go off during a naval barrage of a Pacific-island beach are piled up and prepared for detonation







Above, Italian youth inspects two Nazi demolition bombs that failed to explode when bridge across river was blown up. New bridge is shown at right. Below, soldier prepares to unscrew the nose fuse of a bomb that the disposal crew has uncovered



Royal Engineers recently dug up the largest unexploded bomb found in England. Weighing 4000 pounds, the German bomb, called a "Satan," was buried 57 feet in the earth. The engineers dug a shaft 12 feet square down to the bomb, removed the fuse and hoisted the Satan out safely. Today it stands alongside the door to the squadron's mess hall looking dangerous but actually harmless now that it has been de-fused.

In Germany, former Nazi explosives experts are clearing the fields and roads of land mines, booby traps, unexploded bombs and shells. In the Rhineland the danger is especially great. During the war, for example, engineers of the 65th Infantry Division destroyed between 3000 and 4000 mines in a quarter-mile stretch.

Along the invasion coast of France all manner of devilish devices of Hitler's Atlantic Wall are being cleaned out. As Nazi troops retreated across the fields of Normandy, they left a thick sprinkling of underground land mines to slow the advance of the Allies. French livestock has helped the

(Continued to page 240)



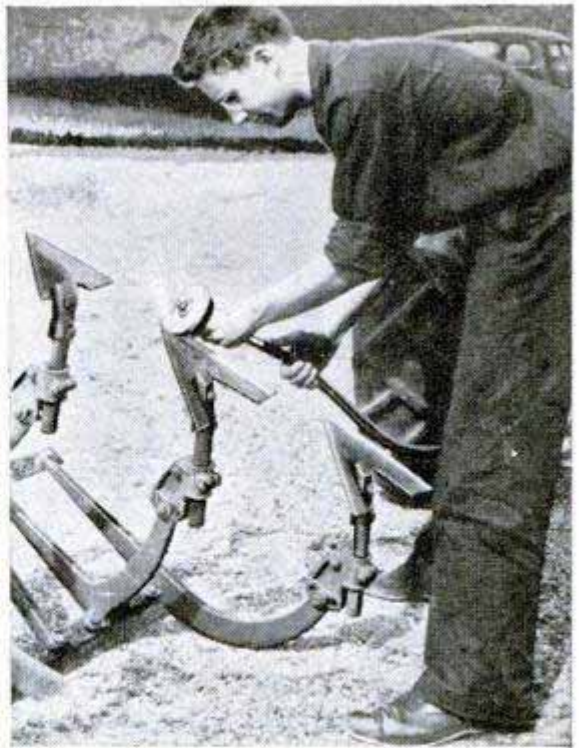
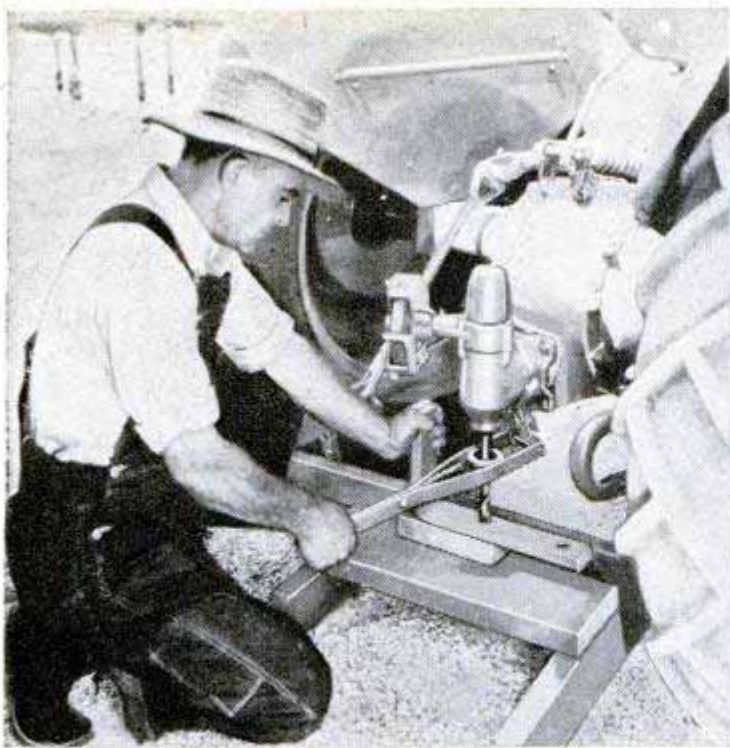

### "Machine Shop" Operated by Tractor's Power Take-Off

Repairs to farm equipment can be made in the field with a "machine shop" that operates from a tractor's power take-off. The repair tools consist of a grinder, drill press, high-speed drills and a flexible shaft that takes many standard attachments. The

tools are mounted on the splined shaft of the take-off and permit sharpening or repairing equipment on the site without a trip to the tool shop. By using the flexible shaft, the farmer can sharpen implements without disassembling them.

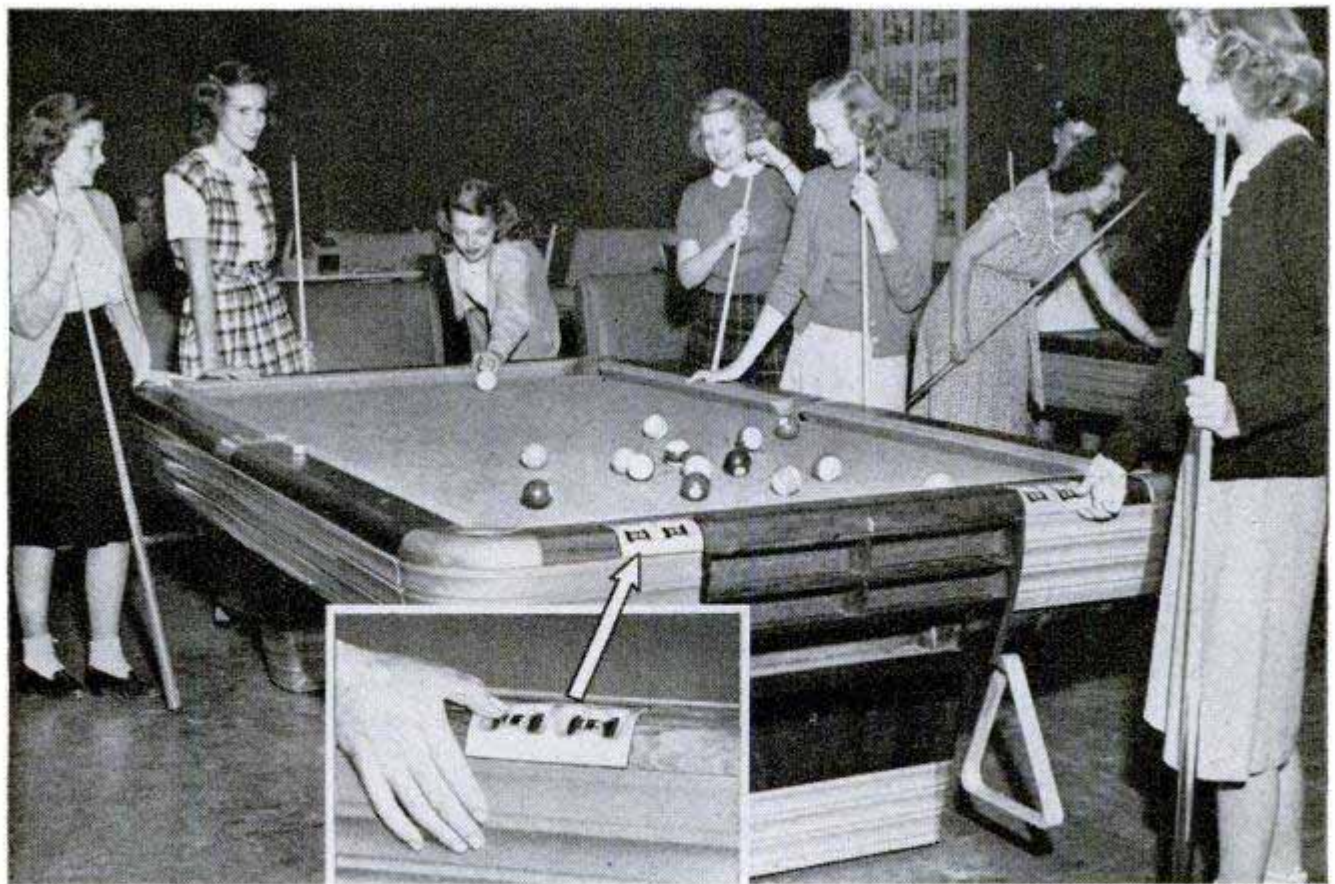

Brunswick-Balke-Collender Co. photo

**BILLIARD SCORE INDICATORS** built into the outer edge of the table rail are replacing overhead string counters reminiscent of the game's gas-light era. The new counters are located near the corners and are turned by knurled knobs. It was one of the improvements first introduced at the Cue & Cushion recreation parlor in Springfield, Ill., where a campaign is underway to popularize the game with the younger crowd



## Venetians Stroll on Famed Canals With "Pneumatic" Water Skis



There's no miracle in the way residents of Venice walk on water. A Venetian barber has invented a pair of water skis that can be worn like shoes, enabling residents to walk on the waters of the city's famous canals. The skis are about the same size as snow skis but have an air chamber to give them buoyancy. Pedestrians keep their balance with the aid of poles.

### Coal-Made Plastic

Under high pressure, bituminous coal becomes plastic and can be molded into many shapes. Powdered coal is used and its temperature raised to about 345 degrees Centigrade. Best molding pressures are between 4500 and 6700 pounds per square inch. The product is glossy black and similar to glass in texture. It is used for manufacturing electrical insulators and storage containers for chemicals that are corrosive.

### Powerful Hand Magnet

Powered by two permanent magnets, a load-releasing magnetic separator and handler lifts up to 15 pounds of iron or steel. When a finger lever is raised, the magnetic force is cut off and the load is released. No wires or batteries are needed as permanent magnets are used. The manufacturer states that the separator will not lose its strength no matter how long it is used. It is especially useful in handling nuts, bolts and nails, and in separating ferrous from nonferrous materials.

Information, including manufacturers' names and addresses, concerning products described in this issue may be obtained by writing to Bureau of Information, Popular Mechanics Magazine, 200 East Ontario Street, Chicago 11, Illinois

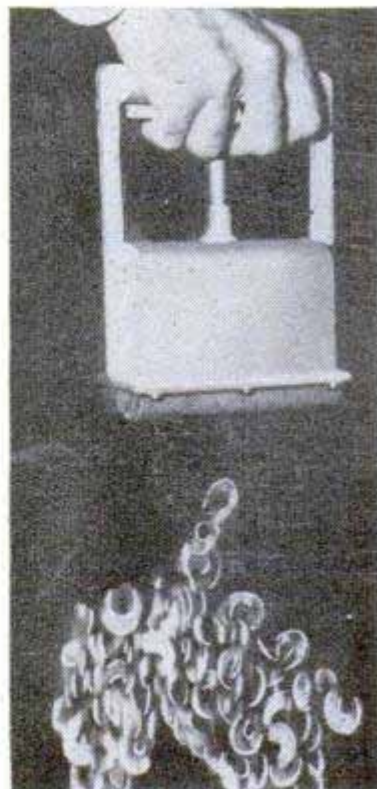
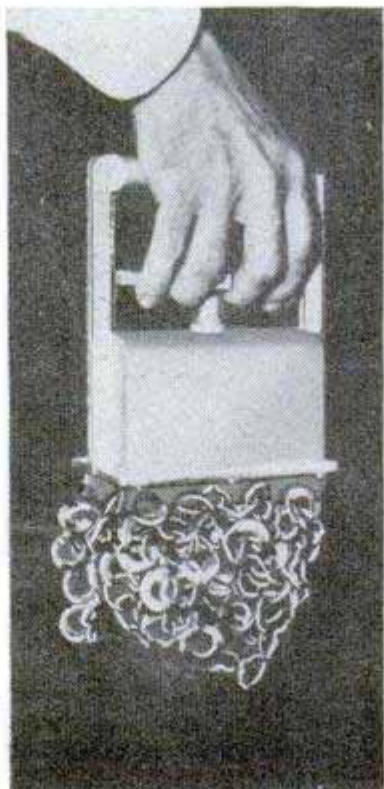





FINISHING  
HARDWOOD  
FLOORS

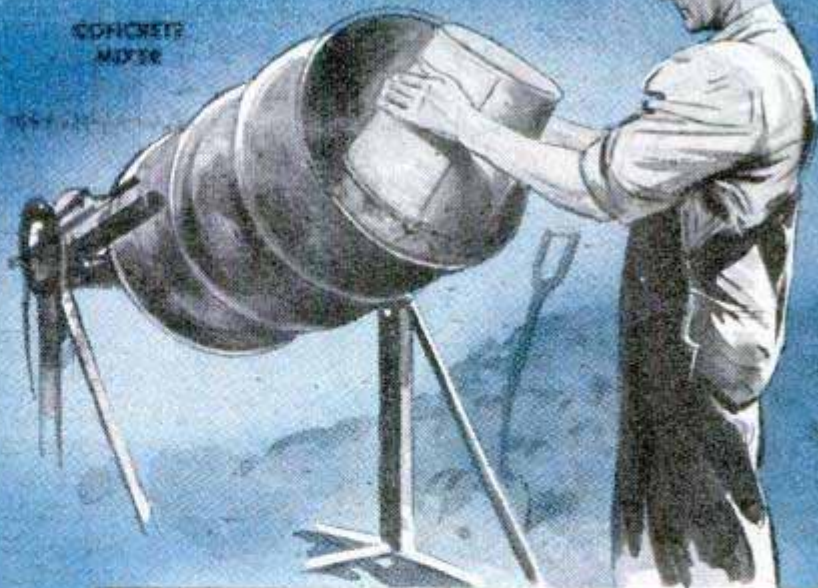

CONCRETE  
MIXER

## The CRAFTSMAN

★ Spring is the best time to re-do your hardwood floors. Temperature is right for proper drying of finishing materials and you can have windows open while you work. Helpful instructions for finishing old and new floors are given on page 212.

★ A concrete-feed-seed mixer, made from an oil drum and discarded auto parts as in details, page 226, actually handles these materials efficiently.

★ Nowadays a tilting tripod head is a must item in every photo fan's kit. The one described on page 202 has a new feature you'll like.

★ Among important things to be considered before making a landscape planting are age of the shrubs at planting time, and size and height at full growth. Read the story on page 192 for helpful pointers.

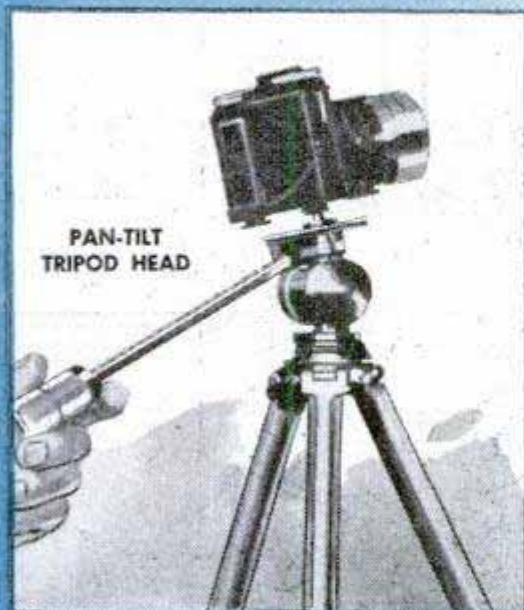

PAN-TILT  
TRIPOD HEAD

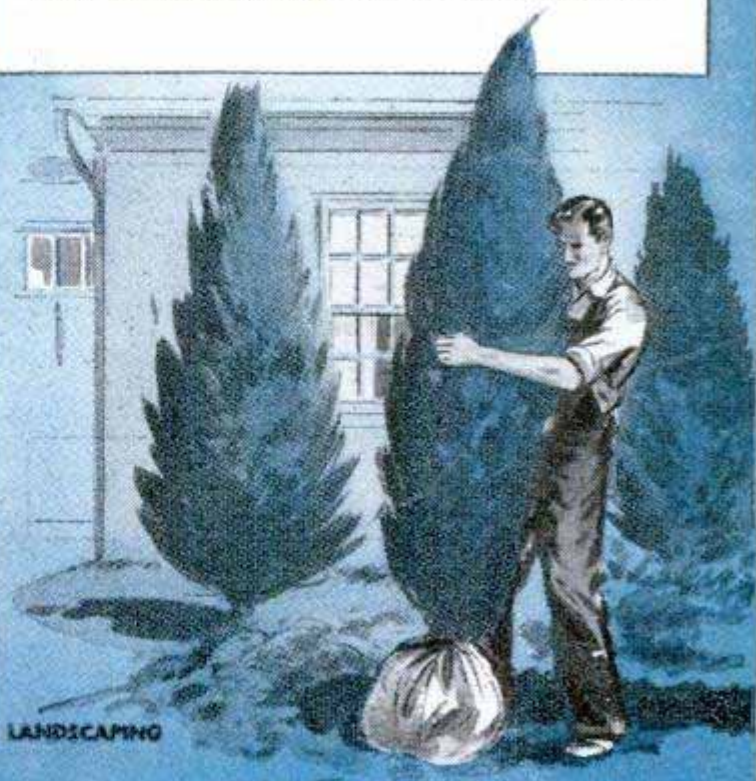

LANDSCAPING



# NOVELTY HARDWARE

*You Can Make*

By Dick Hutchinson

**S**PECIAL hand-wrought hardware of polished copper or brass will add an attractive and personal touch to your craftwork. Such hardware, a few pieces of which are pictured and listed at the left, is difficult or impossible to purchase, but it can be made for practically nothing from scraps of soft sheet metal. Also, in making it yourself, the hardware can be designed expressly to suit the particular project.

The two examples given on these pages, the photo album and the glove box, show what can be done in combining metal and wood. The photo album incorporates hinges designed to simulate heavy strap hinges which are applied to a cover that is scored vertically to represent the individual boards of a door. The glove box, made in the form of a book, is bound with strap hinges and has a hasp to match the metal fittings sometimes used on a heavily bound volume. Soft sheet copper or brass, 22 or 24-ga., are the best materials to use as they can be cut easily

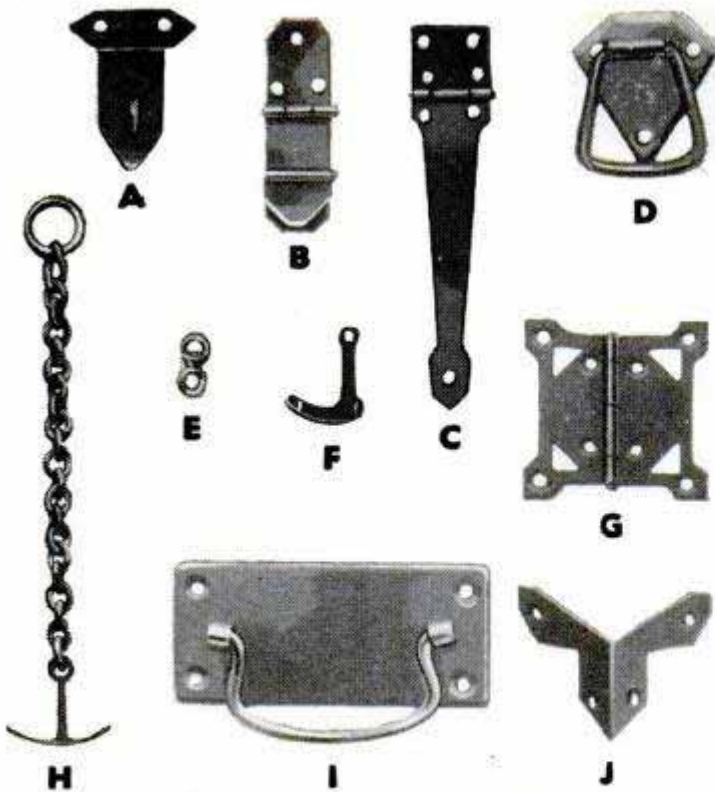

- A—Hasp
- B—Double-action catch
- C—Half-strap hinge
- D—Chest handle
- E—Swivel
- F—Hook
- G—Pierced hinge
- H—Chain and anchor
- I—Drawer pull
- J—Corner brace

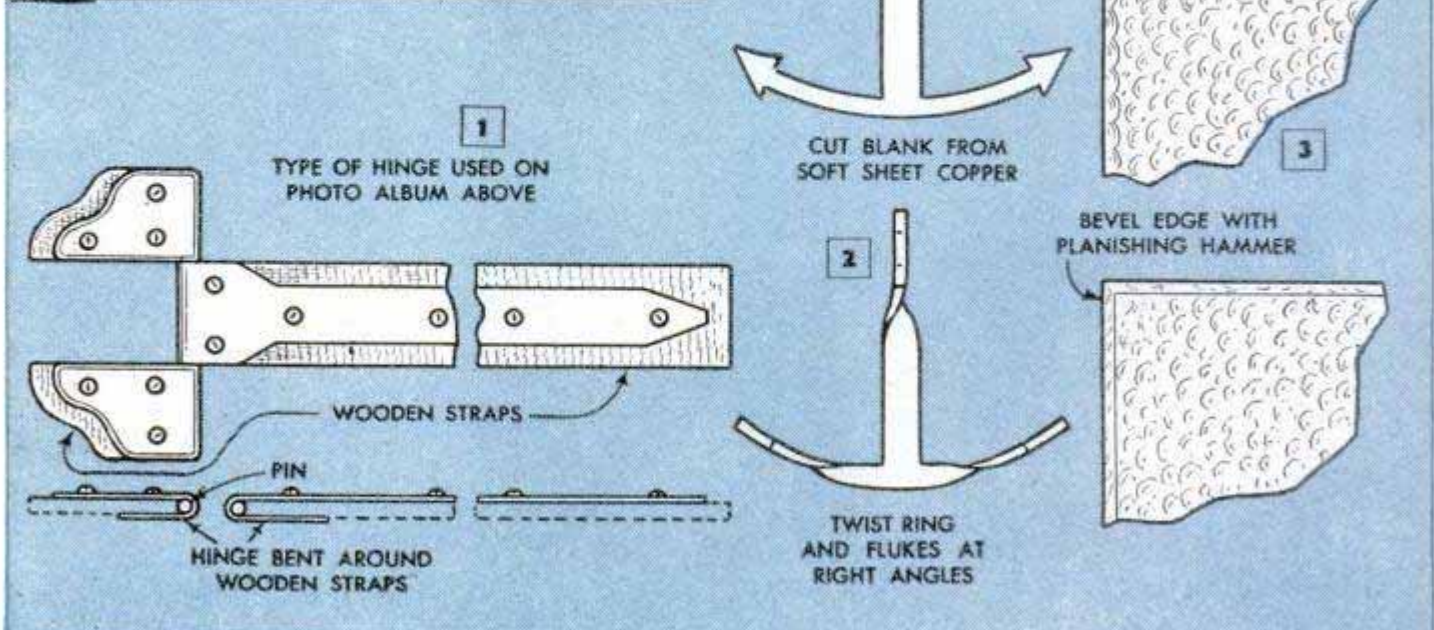
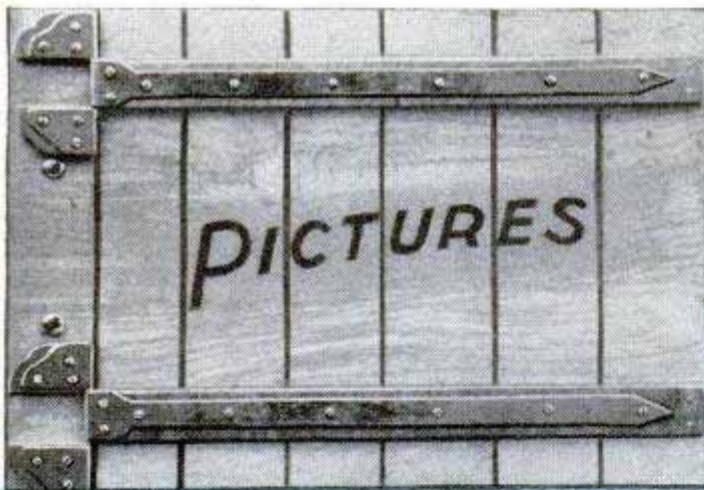



even with a pair of old scissors. Figs. 1 to 9, inclusive, give suggestions for making several simple pieces of special hardware. Fig. 1 details the strap hinge for the photo album. Note how the barrel of the hinge is formed by bending the ends of the metal around a nail and inserting the ends under the wooden straps. The anchor, Fig. 2, can be used purely as a decorative overlay, or it may be twisted as suggested, then attached to the end of a chain and used on a nautical project. The barrel joints of hinges and hasps, Fig. 6, are formed by cutting tabs on the ends of the parts and crimping them around a nail with pliers. The flat hook shown in Fig. 7 has a finger grip to facilitate engaging it in a flat staple. The flat hook shown in Fig. 7 has a finger grip to facilitate engaging it in a flat staple.

Outside corner braces of polished or hammered copper add both strength and ornamentation to fancy wooden boxes, Fig. 3. An attractive finish for these as well as the other metal fittings is produced by hammering the surface lightly with the round nose of a ball-peen hammer. Edges of the metal are beveled by tapping lightly with a planishing hammer, after which the surface is polished with steel wool and coated with clear lacquer.

Figs. 4 and 5 show an easy way of forming the links for a decorative chain. Copper wire is wound around an iron rod of the proper size and then formed into links by sawing lengthwise through the wire winding. The links are assembled into a chain by interlacing them and squeezing the ends together. Such chain is suitable for ship-model fittings or other purposes where it is not subject to strain.

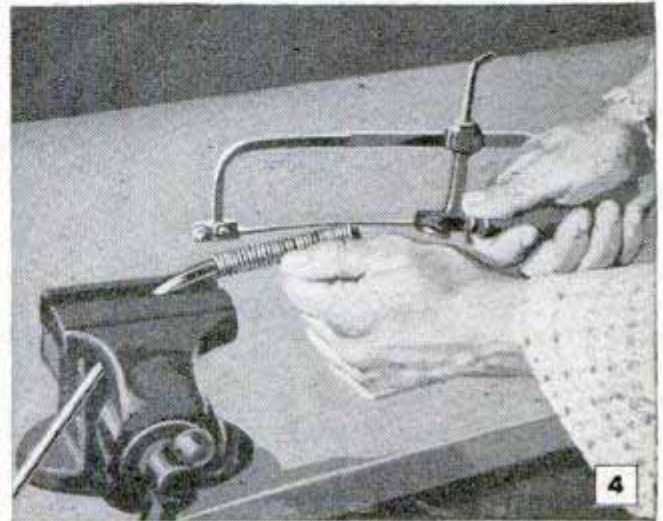

After winding copper wire around rod of proper size, the wire winding is cut lengthwise to form links

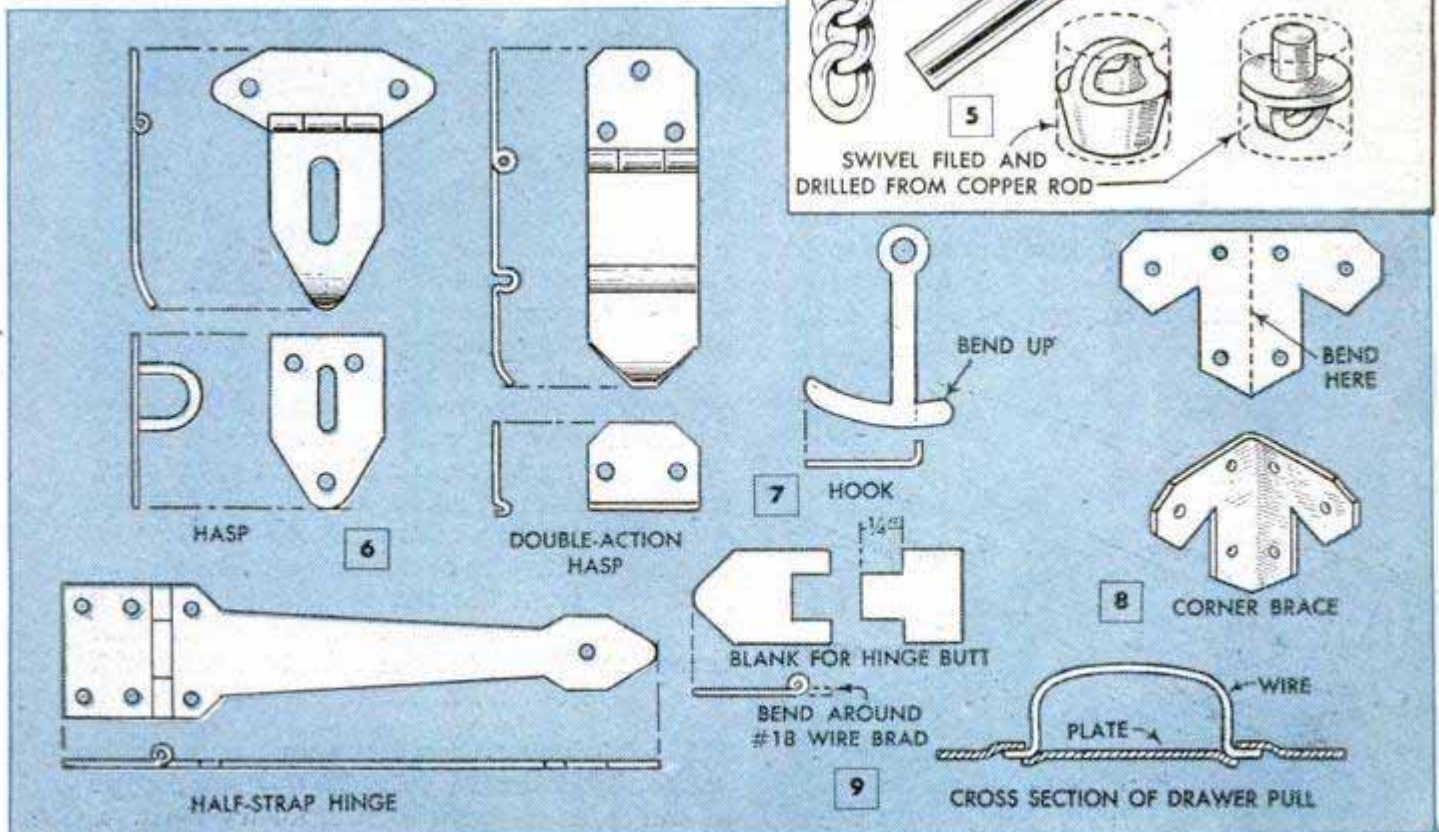
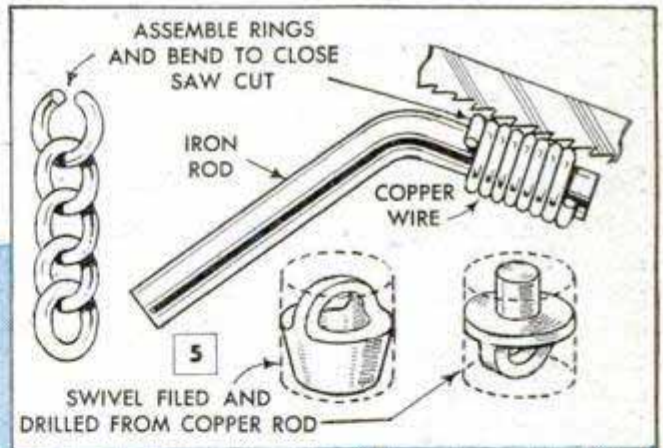



## Furniture Scratches Touched Up With Brown Pencil

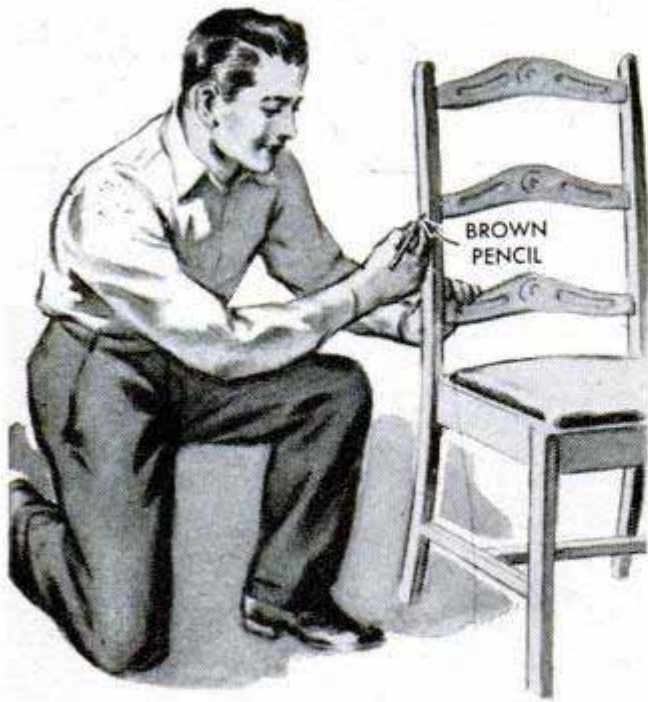

To cover scratches in furniture or interior trim that you do not wish to refinish, use a pencil with a brown crayon lead. This makes an inconspicuous repair and, if the pencil mark is covered with furniture wax or polish, the scratch will be difficult to detect. After filling the scratch, rub it with the tip of your finger to blend the color. Keep a fine point on the pencil lead for filling very small scratches.

## Saw Vise for Home Workshop

For the craftsman who has an occasional saw-filing job, this vise, or holder, is simple to make and economical in cost. The only materials required are a few odds and ends of scrap wood. Dimensions are omitted because they are determined by the size of handsaws that are to be sharpened. Construction details and method of assembly are indicated in the drawing. A C-clamp is used to fasten the holder to a workbench and then wedges are inserted

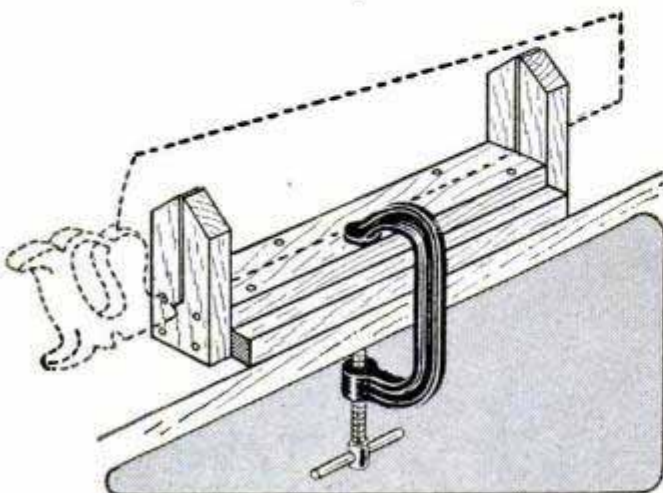

in the slotted endpieces to clamp the blade firmly. Be sure to use hardwood for the endpieces to prevent splitting when wedging. When sharpening a saw, support it with the hand placed close to the point where you are filing to prevent the blade from whipping.

Victor Lamoy, Upper Jay, N. Y.

## Paintbrush Kept in Readiness By Sealing in Ball of Putty

When a small paintbrush is laid aside to be used subsequently to apply the same color of paint, one painter does away with the necessity of having to clean the brush each time. He merely wipes off the excess paint and rolls the bristle end of the brush in a ball of soft putty. The putty keeps the bristles moist and ready for use by forming an airtight seal around them.

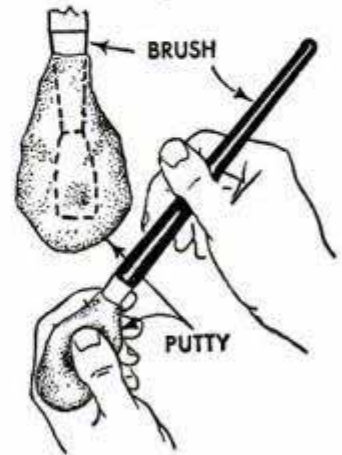

G. E. Hendrickson, Argyle, Wis.

## Screw Hook Aids in Cleaning Gasoline-Stove Generator

The generators or generating tubes on some gasoline cooking ranges are "packed" with a small coil spring, which aids in vaporizing the gasoline fuel before it enters the stove burner. After varying periods of use, depending on the quality of fuel, the spring becomes clogged with carbon and must be cleaned or replaced. However, removing the spring is difficult without the proper tools. While trying to repair his own generator, one man found that he could pull out the spring by using a screw hook as indicated. The hook must be of a diameter just slightly larger than the inside diameter of the spring so that when it is screwed in, the threads will engage the coils of the spring.

Lester M. Diehl, Pittsfield, Mass.

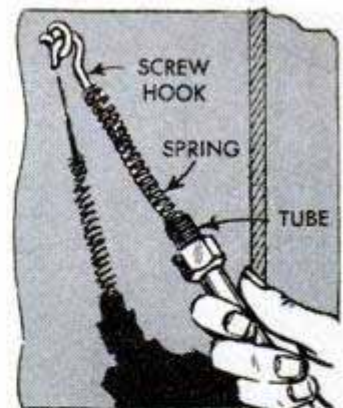

¶ If a stairway to a basement or attic is without handrails, stretch a strong rope at the sides to serve as temporary rails.



# Wooden Slats Replace Canvas Seat of Lawn Chair

If the canvas seats on your lawn chairs are threadbare or torn, replace them with a durable slat seat like this one. In addition to having an attractive appearance, it will withstand plenty of punishment from the elements, and unlike a canvas seat, you can use it immediately after a rain by wiping it dry. To make this slat-type seat, get two lengths of fairly heavy rope long enough to permit sufficient curvature for comfort, and then cut a number of wooden slats to the same length as the width of the canvas. Fasten the slats to the rope about 1 in. apart with a small metal clip near each end. A screw, set flush in the face side of the slat opposite the clip and turned into the rope, keeps the slat from slipping. Of course, you can paint the slats either before or after mounting them on the ropes. However, painting them before assembling likely will result in a better looking job. Regardless of the paint requirements for the rest of the chair, give the slats at least two coats of a good outdoor paint. After the paint dries, attach the seat to the chair by looping the ends of the rope over the

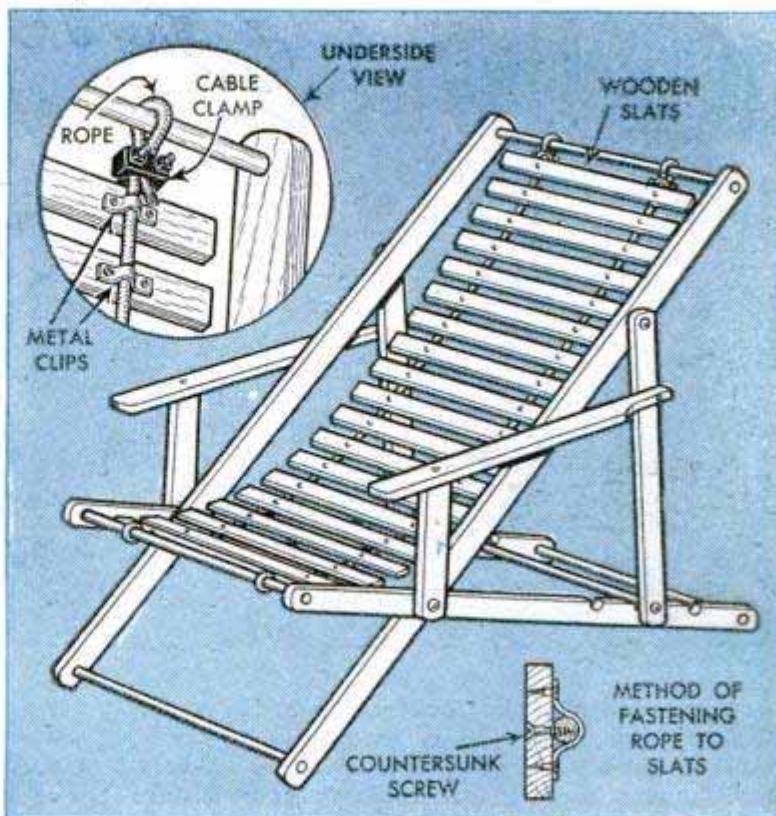

crosspieces of the frame and fastening them with cable clamps. Another method of doing this, which permits easy removal, is to tie the ends of the ropes to S-hooks and hook them over the crosspieces.

Walter Stolt, Cleveland, Ohio.

# Rubber-Tired Wheels for Toys Formed From Can Lids and Hose

Sturdy wheels for small coaster wagons, doll buggies, scooters, etc., can be made by using compression-type can lids for wheel disks and garden hose for tires. First, shape a hardwood hub for each wheel as shown in the left-hand detail, and then dish the can lids to match the curvature of the hub. Drill a hole through the wooden

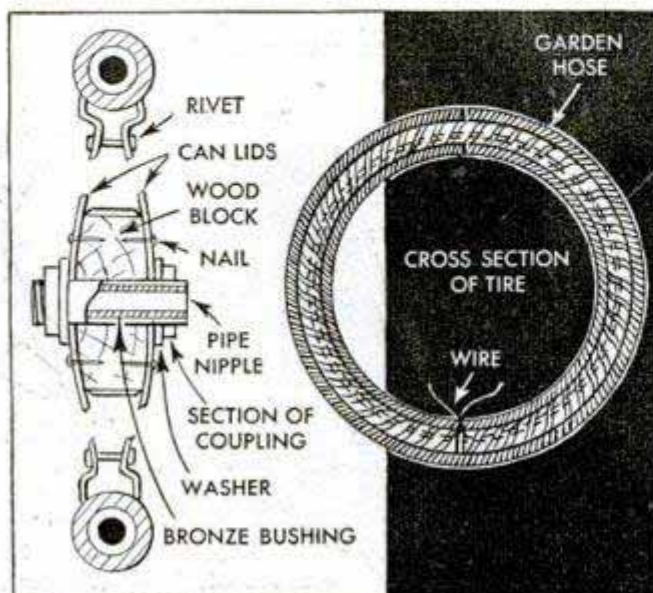

hub for the bearing assembly, which consists of a bronze bushing pressed into a pipe nipple. The latter is held in place by washers and short lengths of pipe coupling that serve as nuts for the threaded ends of the nipple. The can lids, when placed back to back, form a tire rim. The tire is made from a length of garden hose reinforced with a core of armored electrical cable. Cut the cable a little shorter than the length of hose required and pull out the wires. Next, drill a 1/4-in. hole through one wall of the hose at a point one half its length. Insert a long tie wire through the cable, letting it extend about 2 ft. from each end, and pass one end of the wire through the hole in the hose. After this, push the end of the cable into the same end of the hose until it meets the hole in the hose. Do the same with the other end of the wire and cable, inserting both in the opposite end of the hose. Finally, when the ends of the hose meet, pull the tie wires taut and twist them. Mount the tire between the can lids before they are nailed to the hub and riveted as shown.—Ernest F. Lind, Buchans, Newfoundland.



# Solving Home

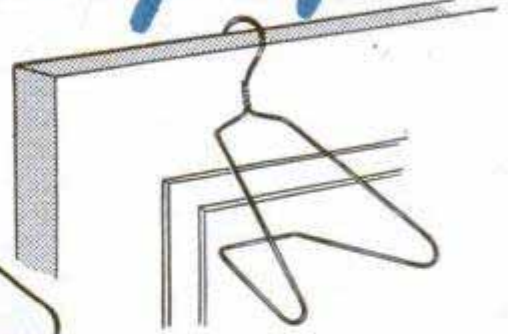

A light wire coat hanger, bent as shown and hooked over the top of a door, provides a handy rack for drying hose, gloves and other small items occasionally washed and dried over night. Use a hanger that is painted to prevent rust stains

As a precaution against accidentally taking poison liquids internally by picking up the wrong bottle, seal the cap with adhesive tape. The tape will forestall hurried doses before realizing your mistake

Removing drapes from shallow cornices is made more convenient if the facing board of the cornice is hinged. This is especially helpful when there isn't room to reach underneath to lift out the drapery rod

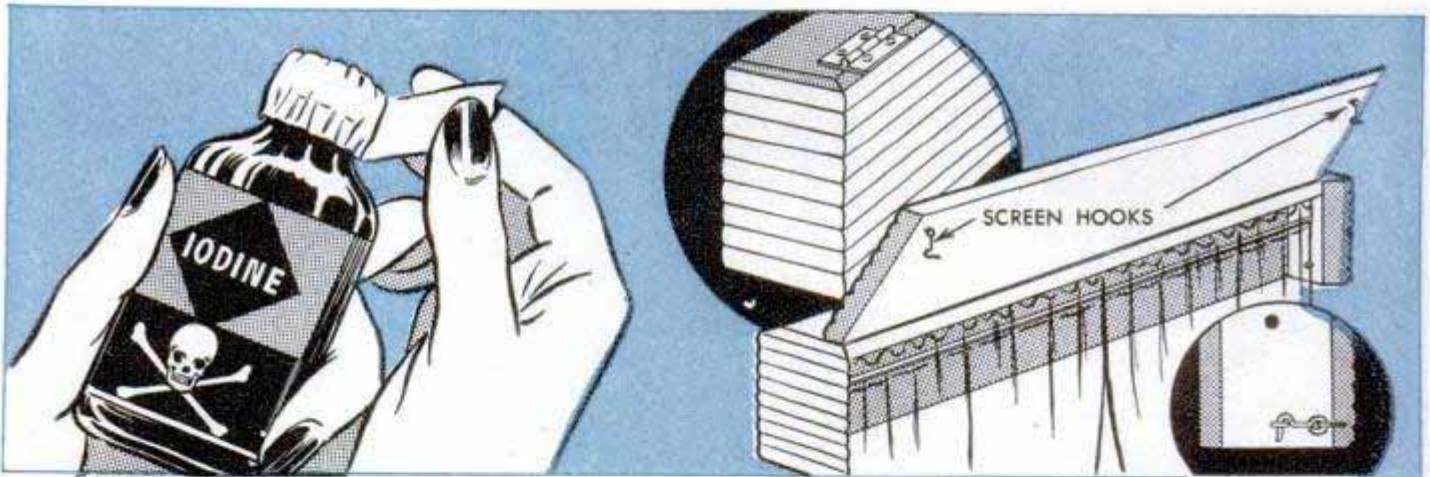

Two paper plates, one of them cut in half and laced to the other with colored cord, form an attractive holder for bills and recipes. A decal or picture clipped from a magazine will add a decorative touch

If the snap fasteners on the inside of ladies' gashes are rough, causing snags and runs in sheer hose, coat the rough parts and surrounding lining with several applications of clear fingernail polish





# Problems

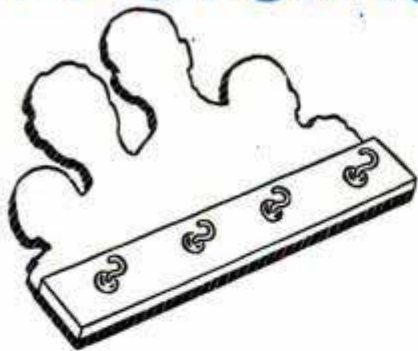

This toothbrush holder, attached to a cutout family photo, features a novel way of identifying the brush of each member. Glue the photo to a piece of  $\frac{1}{4}$ -in. plywood and outline with a jigsaw. Then glue a wooden crossbar to the bottom of the cutout as shown and screw a hook under each figure in photo. Apply a coat of clear shellac to finish the holder



Clean milk cartons cut in half serve as excellent containers for holding small amounts of paint or varnish. The straight side of the carton affords a better wiping edge for the brush than the rim of a can

Fires caused by dumping the contents of ash trays into a wastebasket are avoided by hanging a small tin can inside the basket to hold the ashes. The can is supported by a wire hook soldered to the side

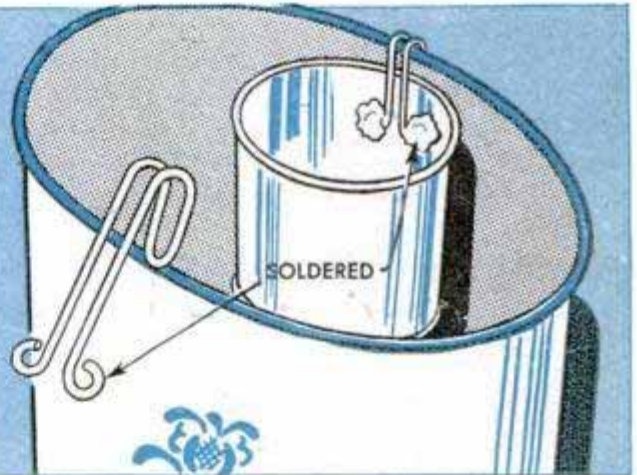

Split ends of a bird-cage perch can be repaired by slipping pencil-tip erasers over them. Notch the heads of the erasers to hold the perch securely in place and to permit easy removal from the bird cage

The noise of a whirlpool in the sink drain is eliminated by inserting a length of brass wire through holes in the strainer, bending the ends as shown. In some cases, two lengths of wire may be required

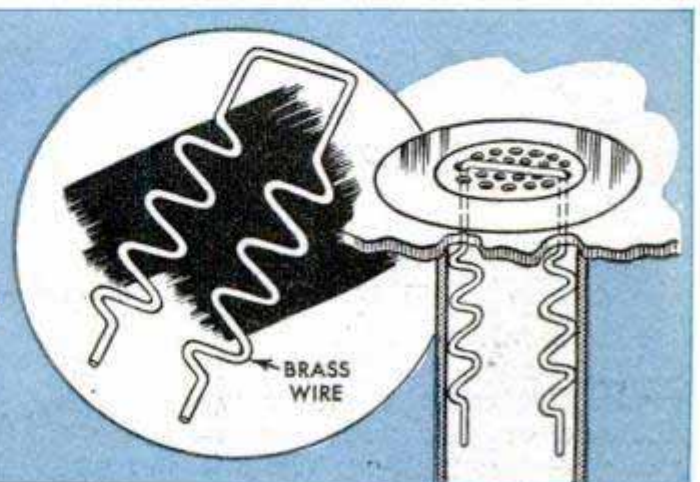
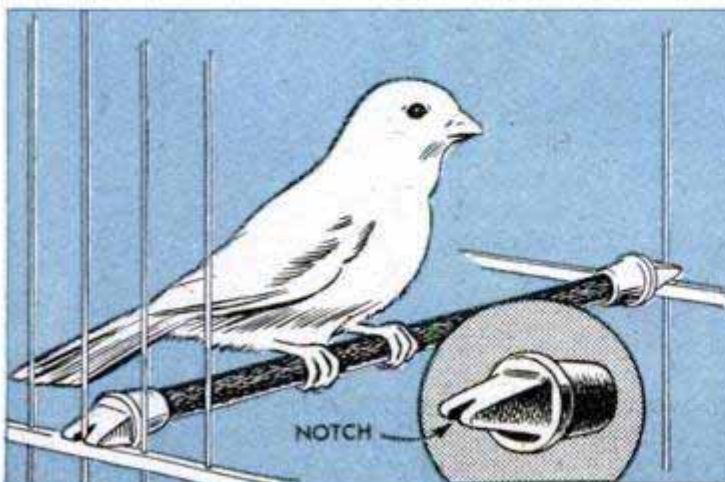



## Improving Wire Coat Hanger By Adding Spring Clothespins

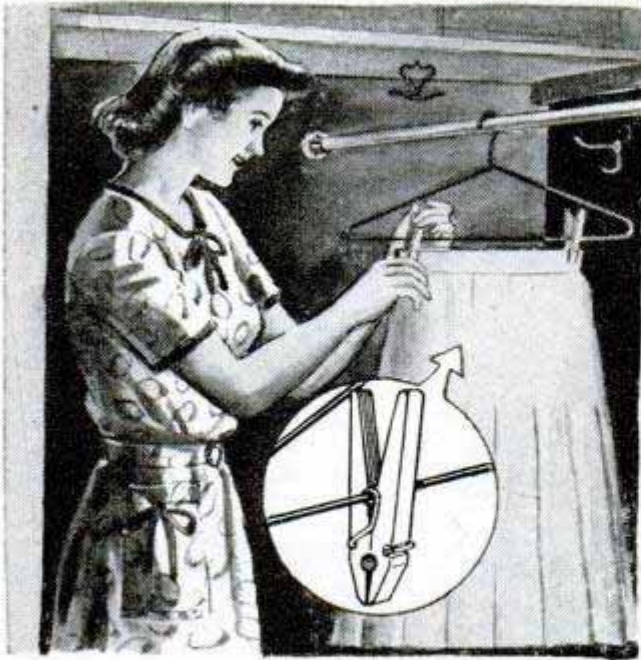

Creases and wrinkles in skirts and slacks, usually resulting from hanging such items over a wire coat hanger, can be avoided by slipping a couple of spring clothespins over the hanger and using them to hang the garments by the top or cuff. To attach the clothespins to the hanger, untwist the wire hanger where it is formed into a hook, insert it through the spring of the clothespin and retwist.

David B. Clapp, Livingston, N. J.

## Playing Cards Used as Stencils

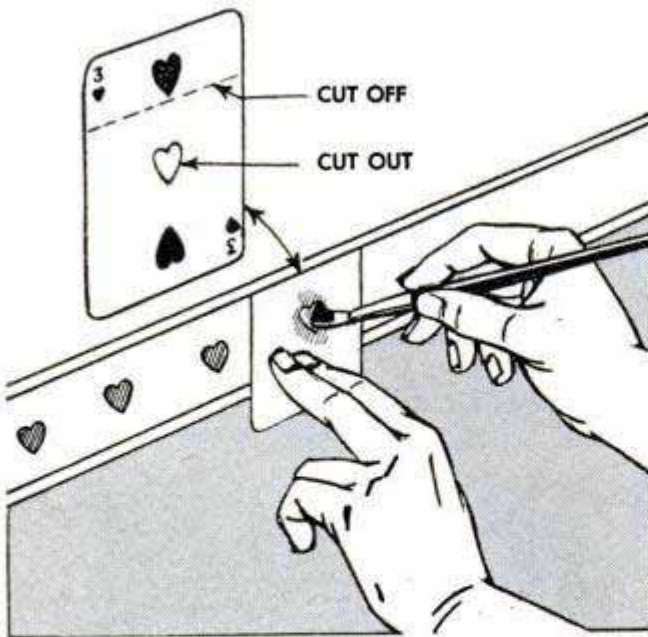

Painting an attractive border around the chair rail in a kitchen or bathroom is easy if you use stencils made from playing cards. Cut out the center heart, spade, diamond or club with a sharp knife or razor blade and then trim the top edge

so it can be lined up with the top of the rail to serve as a height gauge. Variety in design is secured by alternating the cards and choosing contrasting colors. To avoid smearing the paint, use old linen-finished cards and replace them whenever necessary.—Don Brooks, Chicago.

## Friction Tape on Oarlocks Prevents Slipping of Oars

To help keep the oars from tipping or sliding out of position when using a socket-type oarlock, a spiral wrapping of ordinary friction tape will provide a nonslip surface. Wrap the oarlocks with three layers of tape and bind the ends of the tape with cord, as shown, to prevent unwrapping.—Albert M. Lindner, Jr., Cold Spring, N. Y.

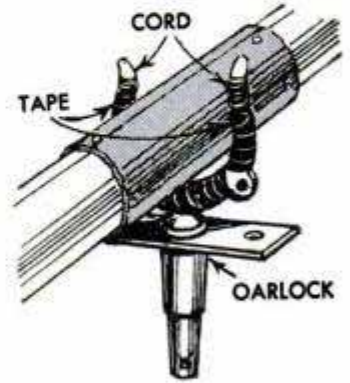

## Reverse Kitchen-Cabinet Worktable To Place Worn Edge at Rear

One of the first places to show wear on the worktable of a kitchen cabinet is usually along the front edge. When this happens, examine the underframing of the table top to determine whether it can be reversed. This part on some cabinets is simply held with wood screws which can be removed easily, and the top placed end for end to bring the marred edge at the rear where it is less noticeable. This will keep the cabinet looking its best.

L. C. Barkley, Glendale, Calif.

## Artificial Flowers Cleaned With Corn Meal

Dusting a bouquet of artificial flowers is easy if you use a paper bag large enough to hold the bouquet, and fill it to a depth of about 1 inch with corn meal. Insert the flowers as shown, grasp the bag and stems and shake gently. Then remove the flowers from the bag and shake off the clinging particles of the cleaner.

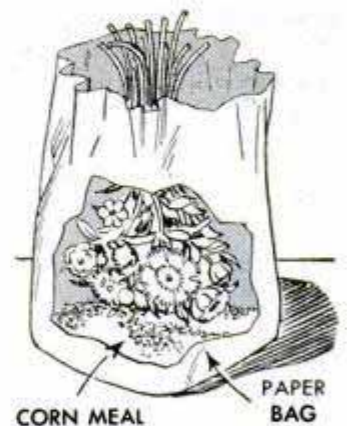

Opie Read, Jr., Chicago.



# CARS NEED CARE



Costly repairs due to engine overheating can be avoided by thoroughly cleaning and flushing cooling system periodically

**By Phil Ruskin**

**K**EEPING your car on the road does not call for a continuous process of tinkering with the mechanical parts. Instead it's regular periodic attention to simple details that keeps a car going year after year. Many vital mechanical parts never really wear out. They deteriorate simply because of neglect and inattention to a regular servicing schedule. The cooling system is a good example. With proper care, it will last as long as the car, but if it is not serviced regularly, it can be a constant source of trouble. Figs. 1 and 3 show why it is necessary to do a thorough job of flushing out the system periodically and why the hose should be carefully checked on schedule. Even though you use soft water or a rust inhibitor each time the cooling solution is changed, considerable debris collects in the cooling spaces of the engine block. This should be cleaned out at least twice a year with a flushing gun as in Fig. 2. Reverse flush the radiator at the same time to remove loose rust and other particles that may collect in the top tank, Fig. 1. Hard scale on the tubes and in the engine block can be removed only with special cleaners which dissolve these deposits. Follow the manufacturer's directions when using any of these preparations.

Another important check easily made periodically by the car owner, is that pictured in Fig. 5. The instruction book that

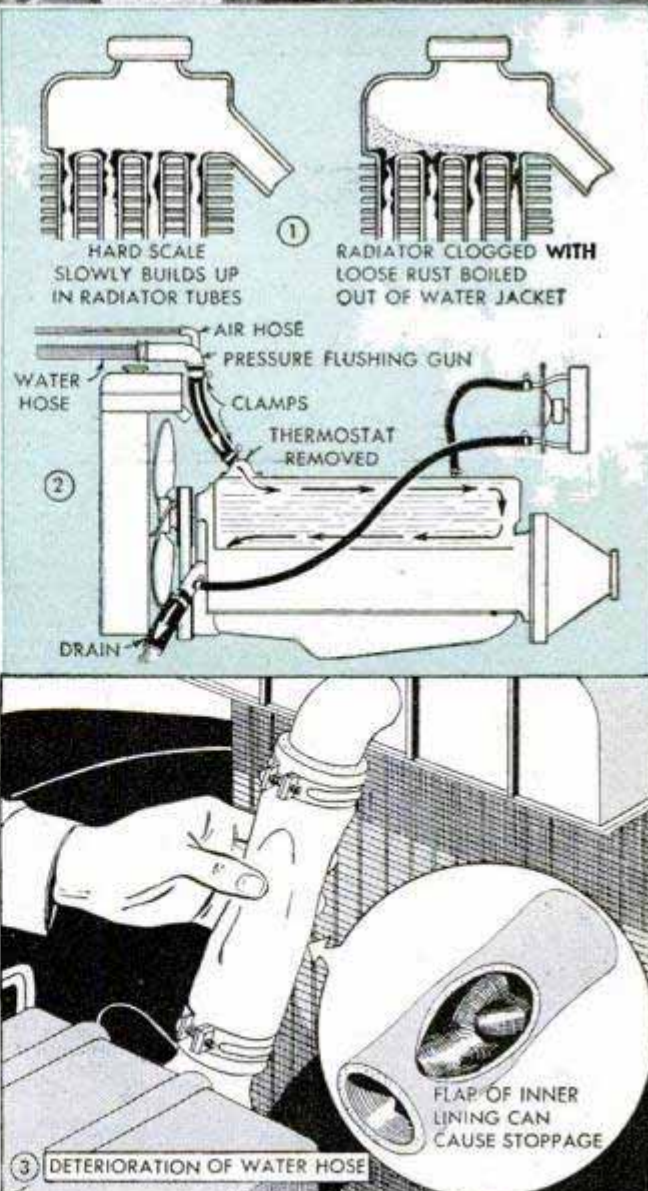



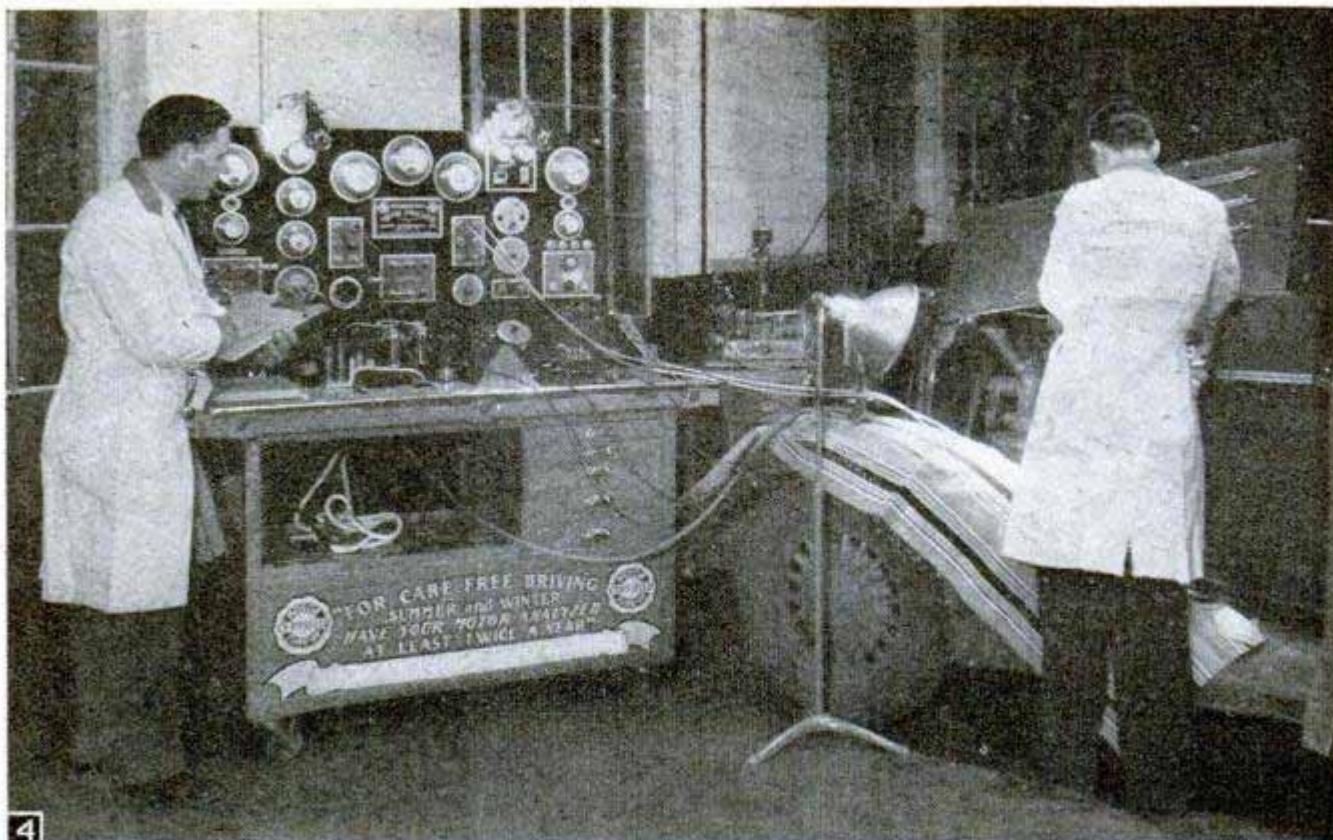

**4** An accurate check with scientific motor-testing equipment takes the guesswork out of tuning up an engine

comes with the car usually specifies a fan-belt deflection, or slack, ranging from  $\frac{1}{2}$  to  $\frac{3}{4}$  in. Measure this with a ruler and straightedge as shown and adjust to the specified tension. When you put on a new fan belt it is particularly important to check this adjustment often, as a new belt will slacken with use.

Periodic instrument checks at your local garage, Fig. 4, will disclose any faults developing in the fuel and ignition systems, which then can be remedied easily

before they create serious trouble. When the engine gets sluggish, lacks pick-up or runs roughly, its poor performance usually indicates that either the fuel or ignition system, or possibly both, are at fault. Other probable causes should not be overlooked, however. Faulty valves or a clogged cooling system can cause somewhat similar symptoms. If sluggish engine performance indicates poor compression, first thought usually is given the piston rings and the condition of the pistons and

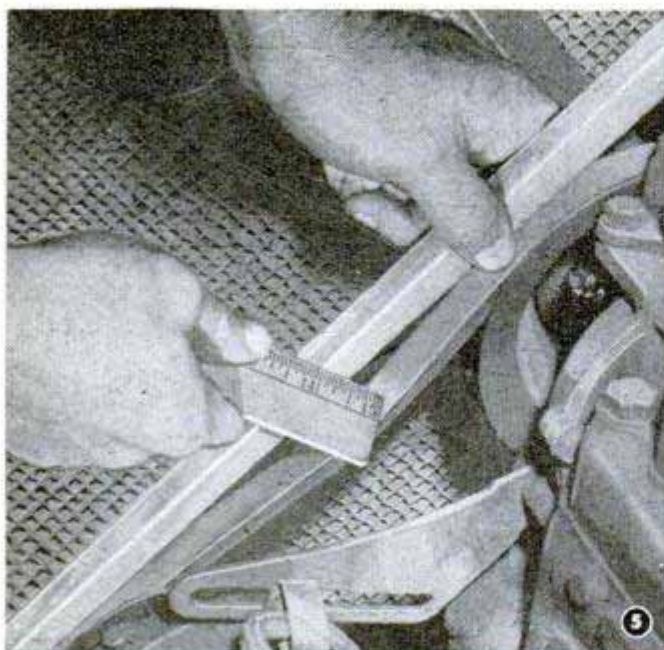

**5** A fan belt that's too tight will squeal and wear rapidly. Adjust to produce about  $\frac{1}{2}$  to  $\frac{3}{4}$ -in. slack

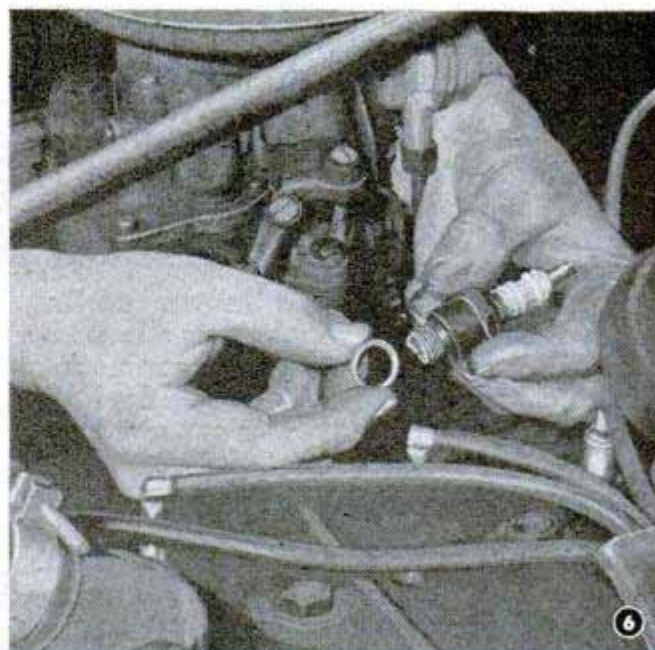

**6** Engine compression can be improved by replacing worn gaskets when plugs are removed for cleaning



cylinders. However, there is another possible cause, not at all common, but it should be kept in mind and always checked before dismantling the engine. In older cars, where spark plugs have been removed several times for cleaning and checking the spacing of the points, the copper plug gaskets, Fig. 6, are frequently flattened or roughened so that they no longer provide a tight seal. This can cause a slight compression leak which is difficult to detect. Several leaky plug gaskets, even if each leak is only very slight, can materially affect engine performance. A good insurance against trouble from this source is taking care to tighten the plugs uniformly after removal, but avoid drawing them too tight. Before screwing the plug in, see that there is no grit or other hard substance on the gasket. The spark gap should be adjusted to the setting specified by the manufacturer. The slow burning away of the bendable point reduces its diameter and changes the gap correspondingly. Because of this, the spark gap in each plug should be checked regularly. Use a feeler gauge or a spark-plug tool made especially for the purpose. Keep close check on the ignition wires in an older car, Fig. 8. The insulation usually breaks first at the



Keep the water level in your battery about  $\frac{3}{8}$  in. above the top of the plates and use only pure distilled water. Do not overfill

bends and where the wires pass close to the engine block. When small cracks show at these points the wires should be replaced. If this is not done, current may leak to the block and "short" a plug.

With regular care a battery will last for at least two years, more often longer. Watch for corrosion around the terminals, on the clamp end of the ground strap and



Ignition wires should be examined periodically to see that there are no bare or frayed spots

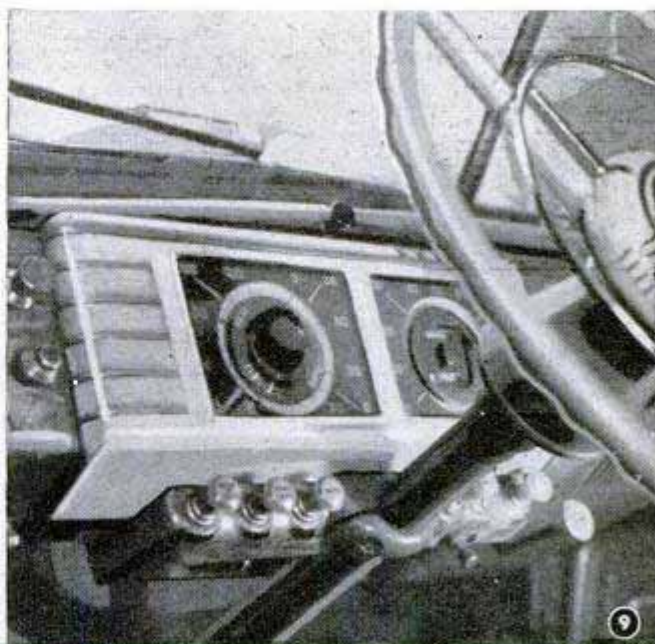

Keep all the instrument-panel gauges and switches in good working condition for safety and economy



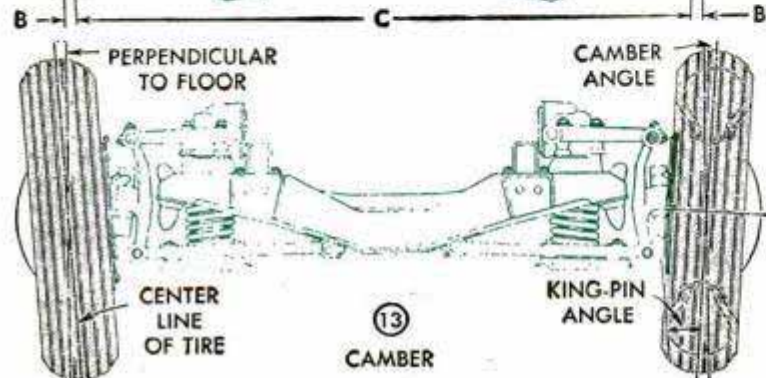
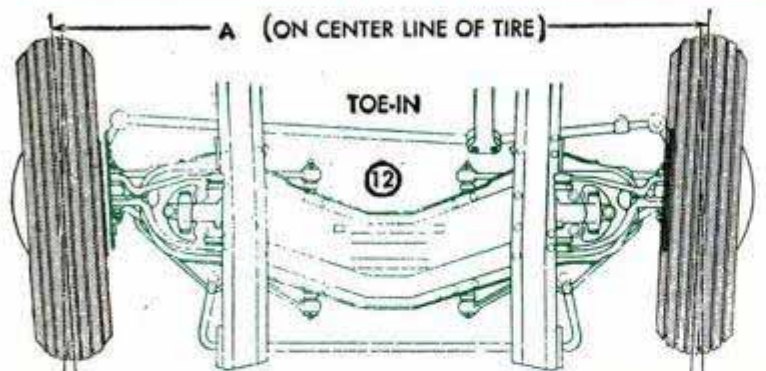
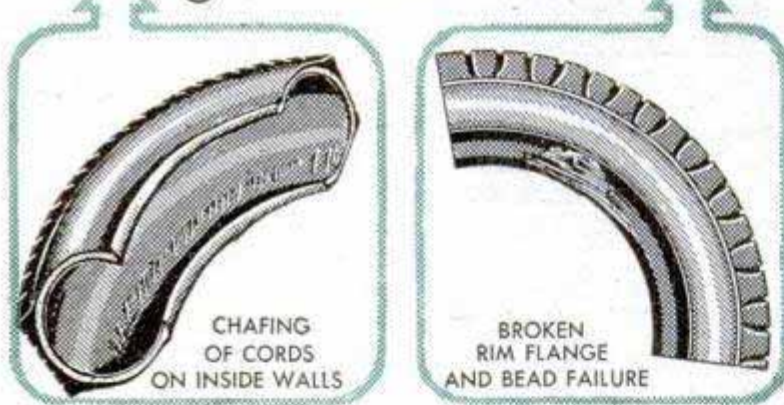
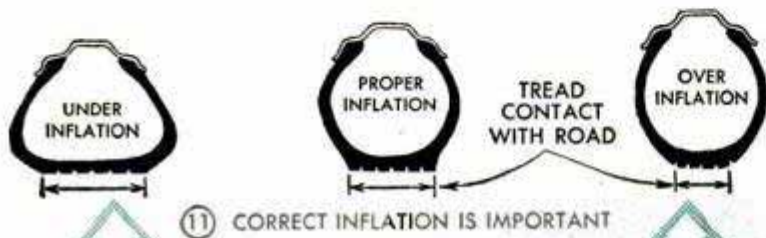
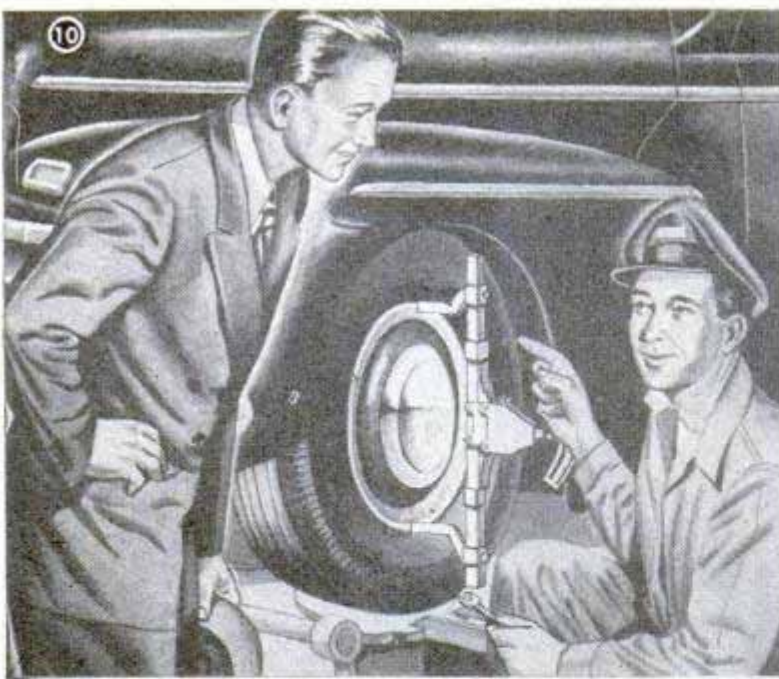

on the cradle. Wash this off with a moderately strong soda water, rinse with clear water and wipe dry. Then coat all the affected parts with petroleum jelly. Be sure that the battery is supported firmly in the cradle so that it cannot shift. Looseness of the lead clamps on the terminals or a faulty connection of the ground strap to the engine block or car frame may cause hard starting and perhaps engine failure on the road. Keep the battery solution at the correct level by adding distilled water at regular intervals, Fig. 7. Don't add water during cold weather without driving the car immediately. If the car stands idle the fresh water may freeze and crack the battery case. On older cars not fitted with voltage regulators the charging rate should be watched carefully. Adjust the rate so that the battery is kept fully charged at all times. Check occasionally with a hydrometer. Keep all gauges and switches on the instrument panel, Fig. 9, in good working order, particularly the ammeter and oil-pressure gauge.

If you hit a bad bump or nudge a high curb too hard with one wheel while parking, it's a good idea to have the wheel alignment checked immediately. The alignment check should always include toe-in, camber and caster of the front wheels, Figs. 10, 12, 13 and 14. Toe-in slightly out, too little camber or incorrect caster angle can cause undue wear on the tires and hard steering. When adjusting any of these wheel angles, follow the recommendations of the car manufacturer. Under or over inflation can cut up tires quickly even when driving is done at moderate speeds on good roads. Fig. 11 shows why, and how.

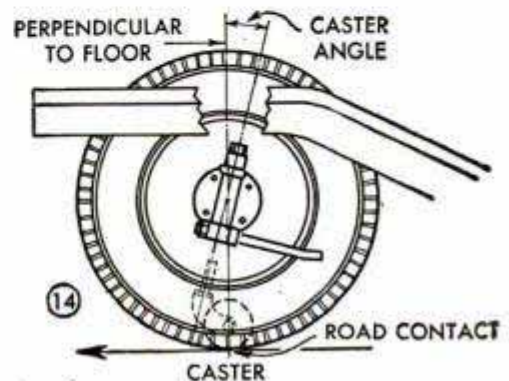



# Half-Lapped Trellis Cut Quickly on Table Saw

An attractive trellis of the type shown in the photo is easy to build with half-lapped joints if this miter-guide jig is used to space the notches uniformly. The notches preferably are made with a dado saw, but they also can be cut with an ordinary saw blade. The notches, of course, must be the same width as the thickness of the stock and as deep as one half its width. Standard lattice stock is used for the grillwork of the trellis which, when assembled, is framed with 1 by 2-inch pieces. First, notch a short length of stock and drive a nail into it as indicated, distance A being equal to the distance the notches are to be spaced. Then screw this strip to the miter guide on the saw table. To cut the notches with a dado saw, make the first one near the end of the strip, and using the jig with the nail as a stop pin, proceed to cut each succeeding notch. Approximately the same method is used with a saw blade, except that the notches are made by holding one side of the preceding notch against the nail and making repeated cuts until the other side of the notch contacts the nail. By adjusting the miter guide, angle cuts also can be made in this way to obtain a diamond-shaped pattern. After notching the strips, cut them to length and assemble the trellis with brads in the usual manner by driving them through the center of the half-lapped joints. Before nailing each joint, apply white lead to the meeting faces

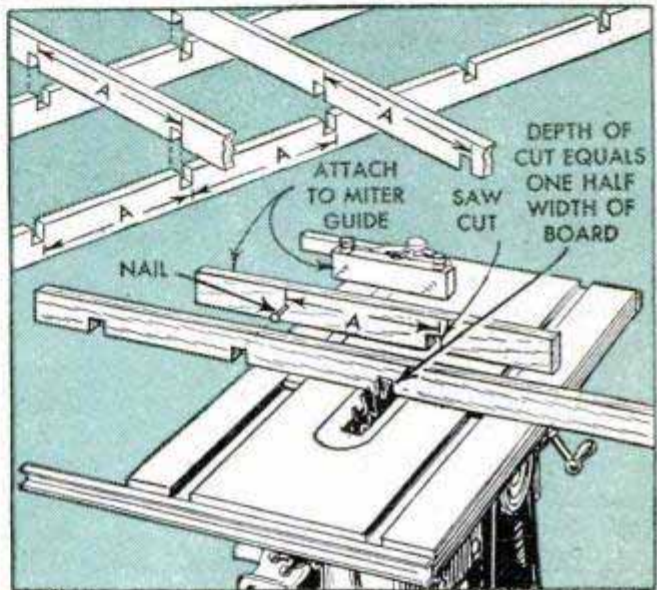
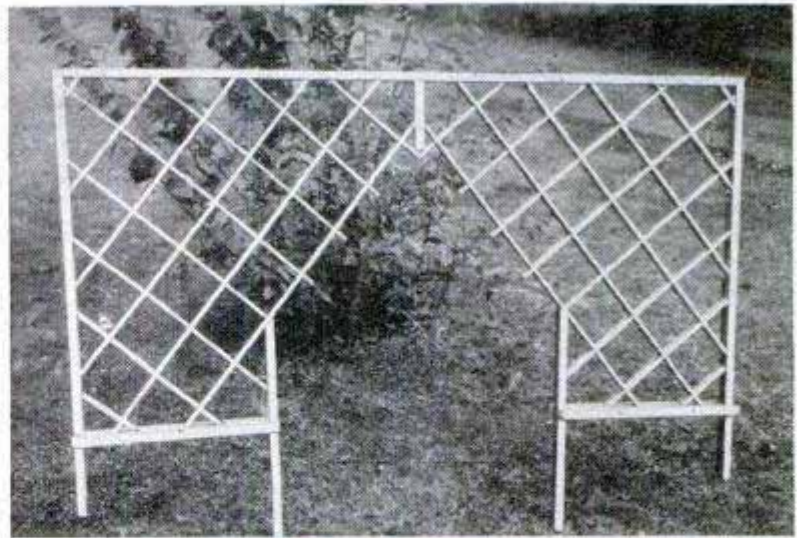

to prevent dry rot. The trellis is supported by two center stakes, the ends of which are preserved by dipping in creosote.

*W.T.M. Concrete*

## Flagstone Retaining Wall Around Tree Provides Attractive Fernery

This unusual and beautiful outdoor fernery is made from flagstones which encircle the trunk of a tree to form a retain-

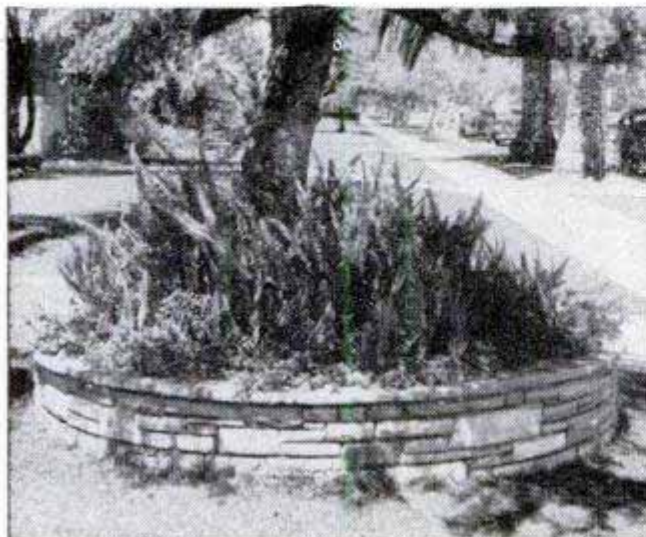

ing wall for ferns or other rock-garden plants. Build a low wall similar to the one shown in the photo, allowing the coping course on top of the wall to project a few inches. If you wish, mix a little lampblack with the mortar so that the black mortar joints will contrast with the light-colored stone. Then fill the area inside the wall with a suitable soil and plant ferns well in the background near the tree. To add variety, place small, brightly colored foliage plants around the ferns along the inner edge of the coping.—Bob Hurst, Chicago.

## Repaint Window Sills Frequently

Outside window sills absorb more punishment from the weather than any other part of the house. To preserve them, paint them at least every other year even though the rest of the house is not to be painted.



## Pipe Mounted in Wood Lathe With Aid of Plug "Centers"

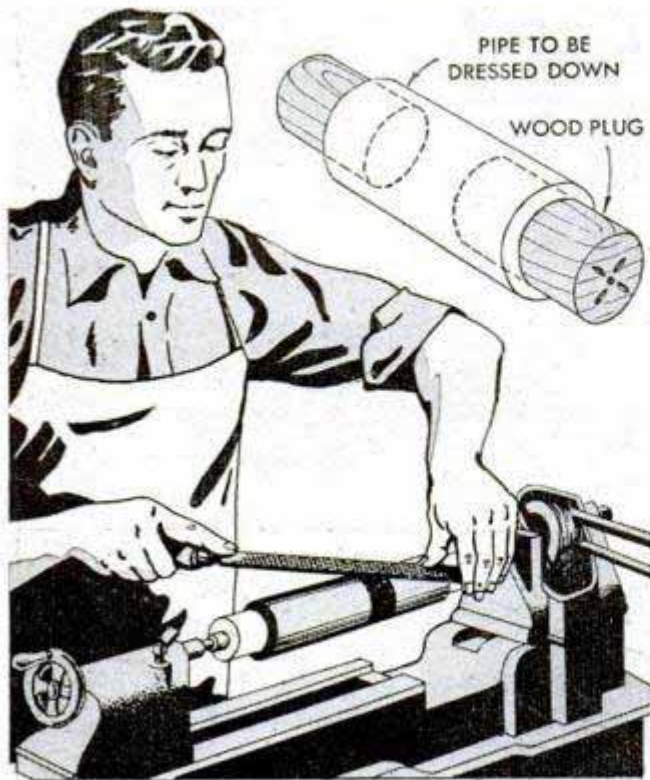

Not having a metal-turning lathe to turn down a length of pipe for a sliding fit through a pipe tee, one man did the job on his wood lathe with a file. First, turn a 6-in. length of hardwood to a diameter slightly greater than the inside diameter of the pipe. Check to see that it is a tight fit in the pipe, and cut it in half to form two 3-in. plugs. Tap a plug securely into each end of the pipe, leaving about  $\frac{1}{2}$  in. of the plug projecting. Center the unit in the lathe and see that the spur and tailstock center enter the indentations made when the plugs were turned. With the lathe running at a speed of approximately 1200 r.p.m., rough-file the pipe to size with a double-cut flat file and then finish the surface with emery cloth. When the job is completed, the tight-fitting plugs are removed from the pipe by clamping them between the jaws of a machinist's vise and turning the pipe.

C. R. Schlegel, Jenkintown, Pa.

## Hinge Forms Razor-Blade Holder



When using a double-edged razor blade to rip seams, scrape paint or cut paper, a holder to protect the fingers can be improvised by clamping the blade between the leaves of a

small butt hinge. Select a hinge that will cover the top edge of the blade completely, and fasten the latter with two small stove bolts inserted through the slot in the blade.—Ronald Eyrych, Milwaukee, Wis.

## Abrasive-Cloth Dispenser

Strips of roll-type abrasive tape are easy to tear off if the roll is mounted in this simple dispenser. Bend a piece of heavy wire to the shape of a wide staple and sharpen both ends so they can be driven into a wall to hold the roll as

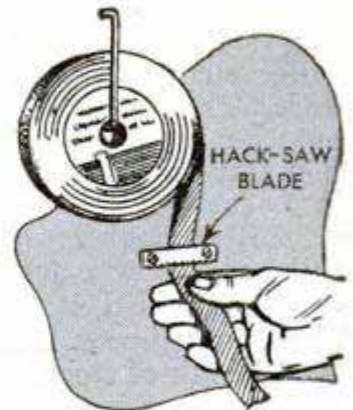

shown. Make the staple large enough to allow a full roll to rotate freely. A short piece of hacksaw blade is screwed to the wall to serve as a tearing edge. Thread the cloth under the blade with the grit side toward the wall so that grit will not clog the teeth of the blade when tearing.

Benj. Nielsen, Aurora, Nebr.

## Unusual Hanging Flower Box Made From Auto Tire

With a section of auto-tire casing, two metal rings and some wire, it is easy to make this novel flower box. When the box is fastened to a porch column, vines and flowers trailing over a grille produce an unusual floral effect. Fasten the two supporting rings to the tire with wires through holes punched in the bead. Wire the rings together at the top and solder a grillwork between them, forming it in an attractive design. Finish with enamel.

Wm. M. Maddox, Jackson, Ga.

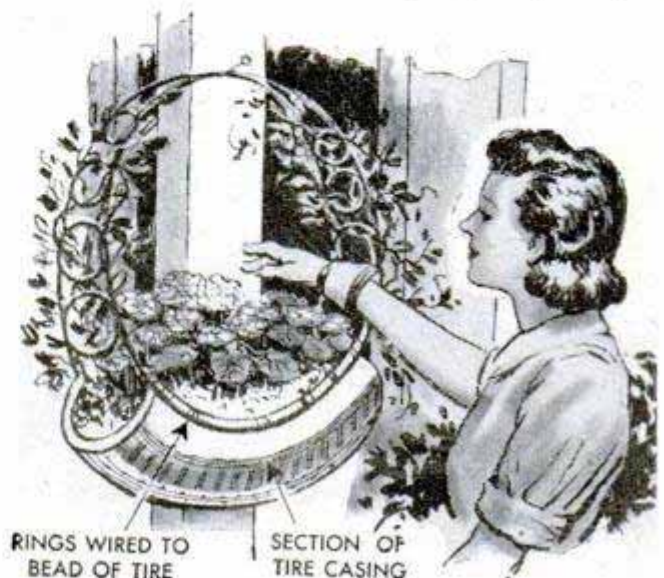



# Two Distinctive Gates for the Informal Garden

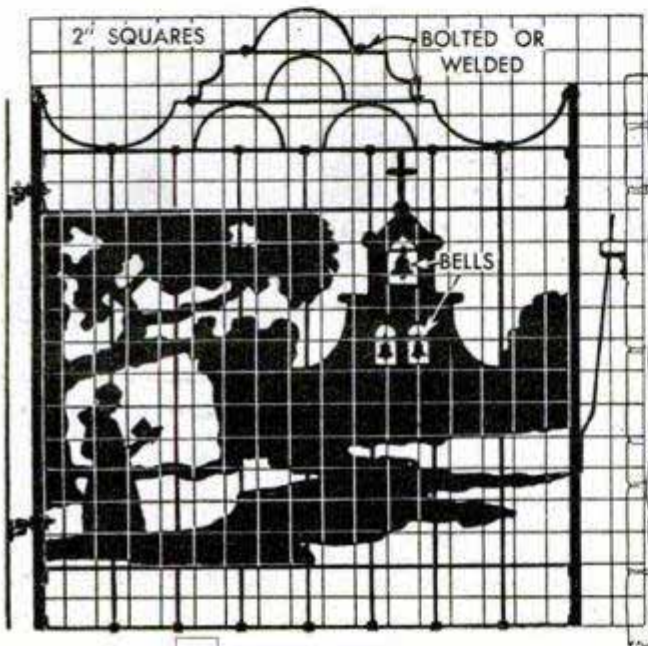
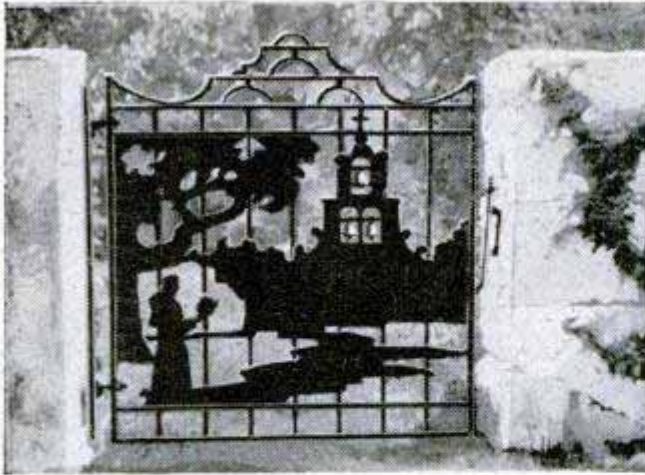

1 MISSION GATE

Here are two unusual and interesting gates for a garden entrance or pathway to the house. The mission gate, Fig. 1, with its tinkling bells, and the ranch-type gate paneled with horseshoes, will impart a western atmosphere to your grounds. The mission gate is constructed of two  $\frac{3}{4}$ -in. iron bars used as end posts, to which are bolted four crosspieces made from  $\frac{3}{16}$ -in. flat iron. The seven vertical members are  $\frac{3}{8}$ -in. iron rods, threaded at both ends and fastened to the top and bottom pieces with two nuts. Form the ornamental ironwork at the top of the gate from the same material as the four crosspieces and bolt it to the end posts. The gate is pivoted on eyebolts and is fitted with a spring-type latch. Make a full-sized paper pattern for the silhouette and tape it to a piece of 26 or 28-ga. sheet metal. Then cut out the metal silhouette by using a small cold chisel and anvil. Mount the bells in position rigidly so they will ring only when the gate is moved, and solder the silhouette to the gate. After assembling, paint the gate with

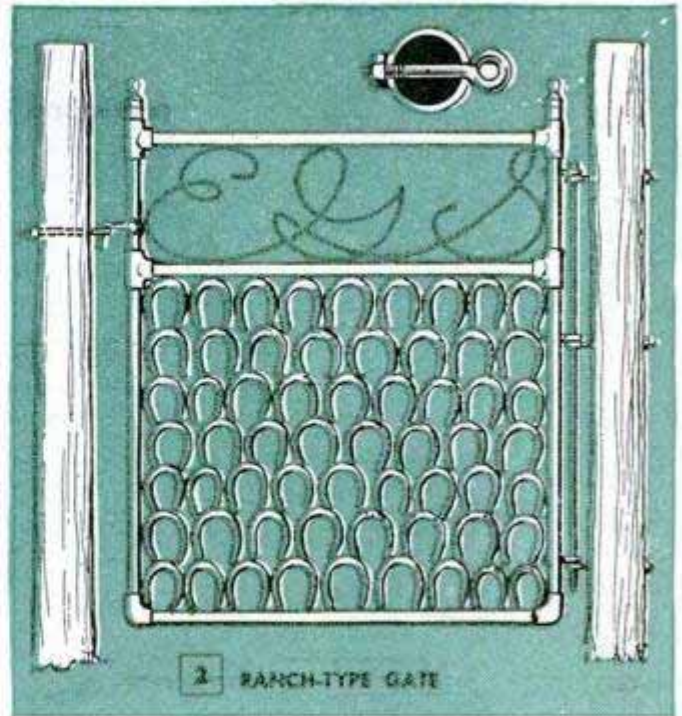

2 RANCH-TYPE GATE

red lead and then finish a dull black to contrast with brass or silver bells.

Construct the ranch-type gate, Fig. 2, from 1-in. pipe, using tees and elbows where indicated. Over-all dimensions are determined by the size of horseshoes used, which are either welded together or merely wired to poultry fencing stretched over the opening. Add a personal touch to the gate by forming "rope" initials from a single length of soft-iron wire and welding or wiring them to the upper opening of the gate. In keeping with the western theme, suspend the gate between two bark-covered posts. A  $\frac{3}{8}$ -in. iron rod inserted through eyebolts in the edge of the frame and in one of the supporting posts, forms the hinge. Add a nut to the top of the rod to prevent it from sliding through the eyes, and cap the open tees with pipe plugs.—R. W. Madden, Palatine, Ill.

## Removing Wallboard From Studding

Wallboard or insulating sheathing may be removed from studding without damage to the board by removing the nailheads with a drill slightly larger than the shank of the nail. After drilling through just the head of the nail as shown, drive the rest of the nail all the way into the stud with a pin punch.





# Beautify with

By  
Paul Hadley

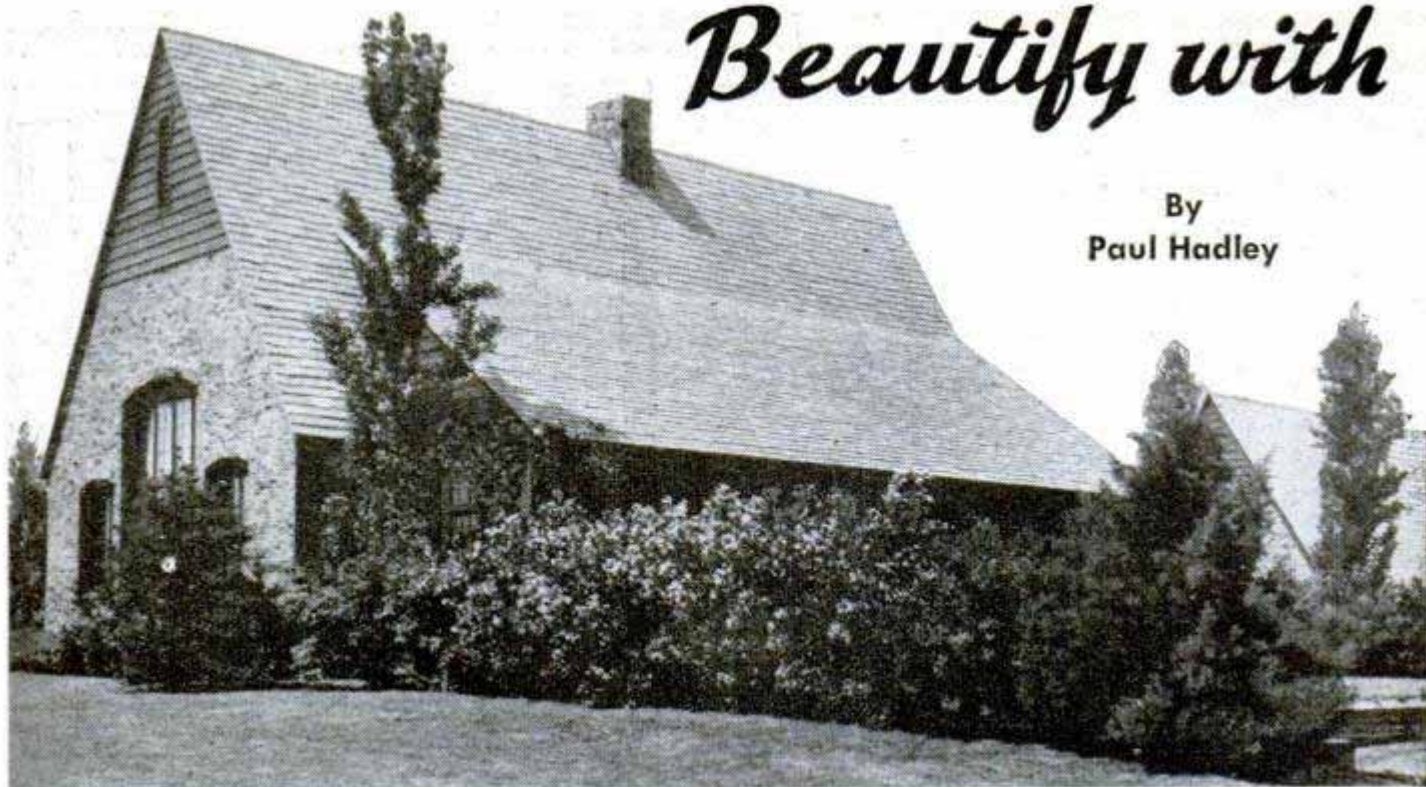

**P**LANNED SHRUBBERY plantings not only add materially to the value of any home, large or small, but they give it that natural appearance so difficult to achieve in any other way. Hardy flowering shrubs, climbing vines, evergreens and small ornamental trees now are available from nursery stocks for almost any exposure and type of architectural design, either old or new. These classify mainly as the deciduous shrubs and ornamental trees, which shed their foliage at the end of the growing season, and the evergreens, which retain their foliage and continue growth at varying rates throughout the whole year. Both of these classifications are subdivided into a great number of varieties. In making a selection for a given location, keep in mind the exposure, type of soil, appearance, and especially the spread and height of the

trees and shrubs when they have attained maximum growth. In some locations and for certain specific purposes, the relative rates of growth of a group of shrubs must be considered in the planning. Most of the extremely hardy shrubs grow very slowly, taking years to attain maximum height or spread. Others grow rapidly, taking only two or three seasons to reach tree size from a single nursery "whip." Certain varieties of slow growers have been designed by nature to withstand very severe cold without harm and without any additional protection. Some thrive in exposed positions in thin soils, while other more tender plants require sheltered locations and moist soils rich in plant foods. This wide variety gives you a choice of plants with size, color of foliage and bloom, and growth habits suitable for almost any plan,

**In corner plantings, left, low-growing shrubs with thick foliage ordinarily are planted in the foreground. Right, formal plantings require regular seasonal care. Trimming must be done repeatedly as growth progresses**

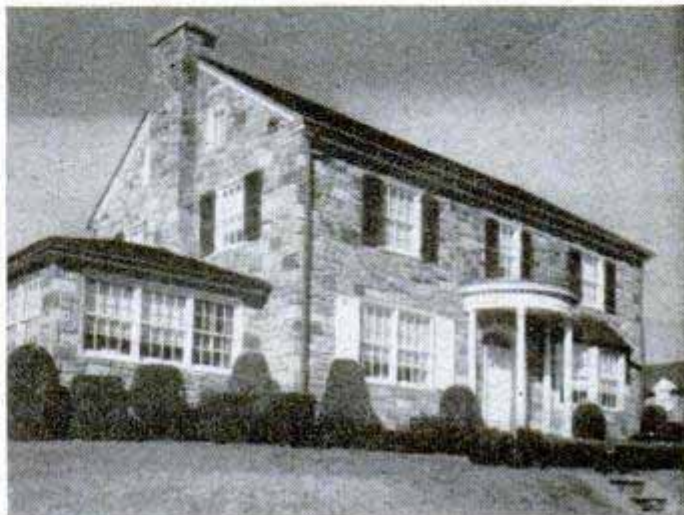



# SHRUBS

location and climatic conditions.

Corner plantings, using both tall, conical shrubs and the low-growing types, which spread a thick foliage only a few inches above the ground, are especially effective around small homes. Plan views of such plantings are shown in the keyed drawings. Usually, tall-growing shrubs are planted in the background and the lower varieties in the foreground in those arrangements where close grouping is necessary. Where shrubbery borders a walk, driveway or a terrace stairway, those bordering the stairway should be of the low-growing



Here a planting of alternate shrubs of different heights and varieties is especially effective in screening a large entryway

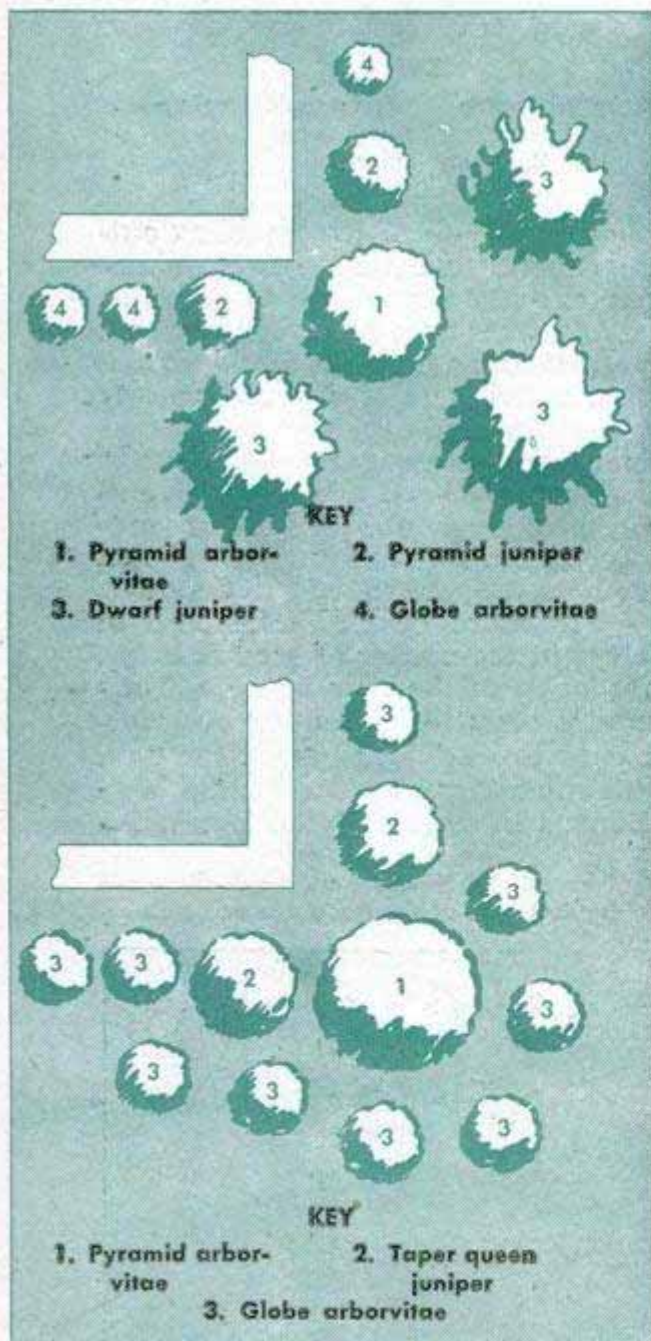

Above and below, two examples of plantings of evergreens and deciduous shrubs arranged to achieve the more rambling outline found in nature. As you can see, both are effective

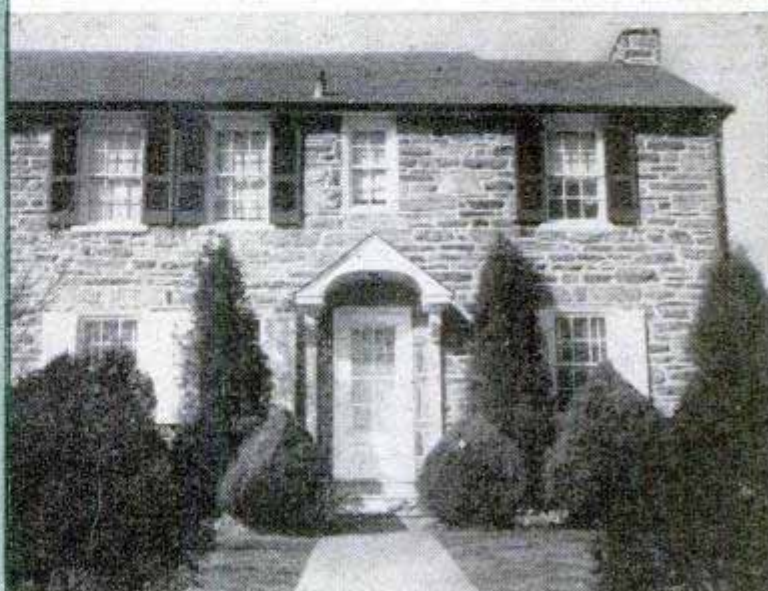



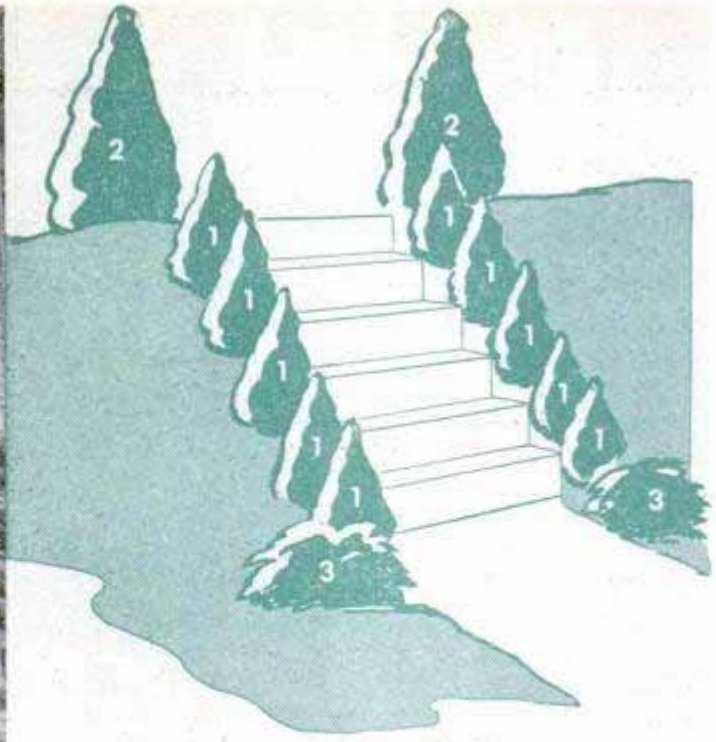

**KEY**

- 1. Globe arborvitae
- 2. Pyramidal arborvitae
- 3. Dwarf junipers

Large trees growing alone are always attractive features of landscaping on large or small lots

varieties, all specimens being of equal age at the time of planting. Where the stairway leads from a lower to a higher level of the garden or lawn and not directly into the house, the lower-level terminal planting usually is a low, spreading evergreen, the spreading junipers being especially suitable. At the top of such an arrangement the stairway row planting may properly terminate in a single taller specimen on each side. When making any closely grouped planting requiring the use of duplicate specimens, be sure that the duplicates are of the same age.

Border plantings, on the other hand, should not achieve the more geometric symmetry required near a building. In-

stead they should show the rambling outline often found in natural surroundings. The one exception, perhaps, is a hedge which also serves as a boundary between two properties. Here the planting should consist of individuals of a single variety of the same size and age.

Often, on both large and small grounds, a single large specimen growing above in the open, best serves the purpose of landscape decoration. Two examples are shown in the photos. Such solitary individuals usually will more or less take care of themselves in the matter of growth habit, after rerooting in the new location. They will require very little training or pruning. It pays to buy balled stock for both individual plantings and also for the larger specimens in a group planting. When

When making a landscape plan, number the duplicate shrubs of a given variety. Where there are duplicates in a single group or in adjacent groups, it's quite important that the duplicates be of the same age and training

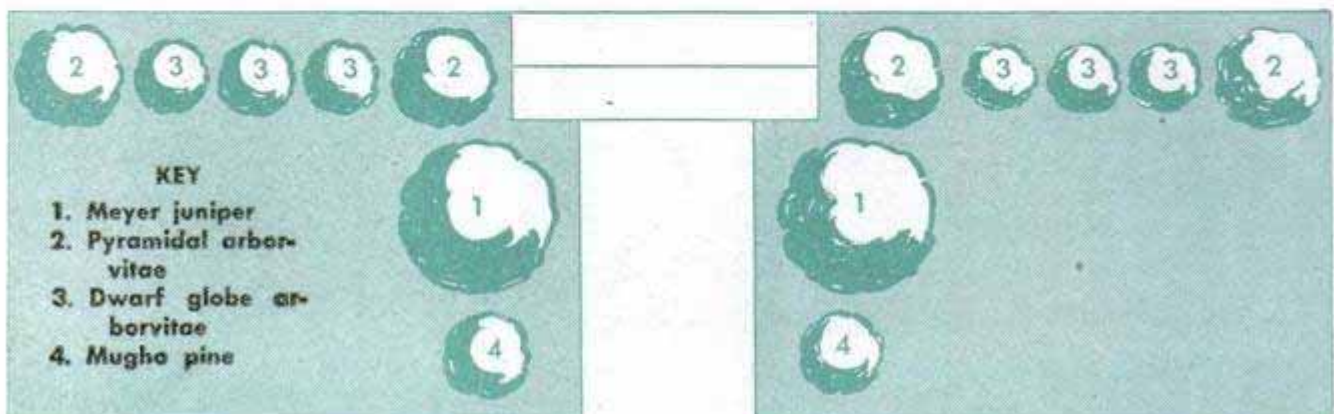



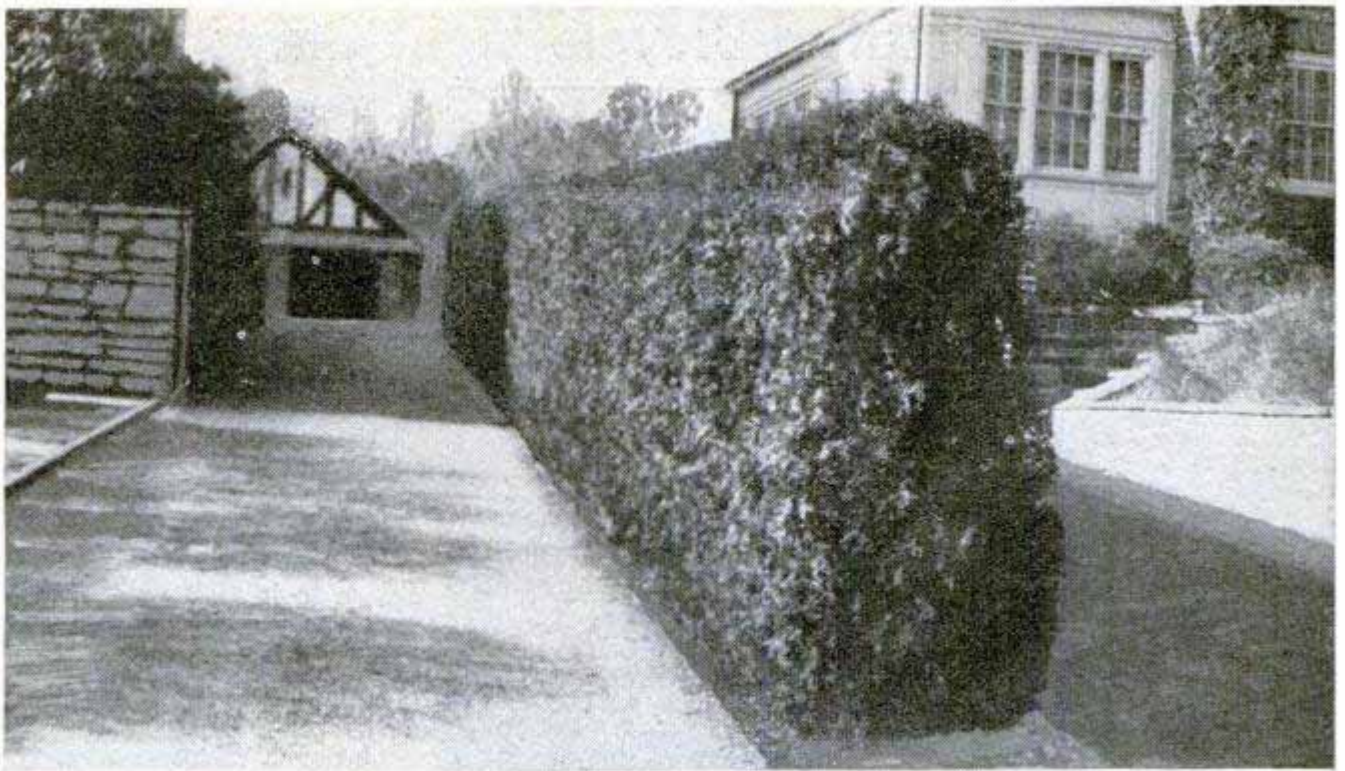

Such a planting as this ornamental hedge calls for a single variety of plants of the same age, all planted at the same time

planting balled stock buy from a reputable nurseryman and follow his instructions to the letter. Uninterrupted growth is practically certain with this procedure. Balled evergreens should be at least 3 years old. The 5-year specimens of most varieties of evergreens cost more but these have had the benefit of two or three years training in the nursery.

Smaller specimens dug from the nursery row are supplied with open-root systems packed in damp moss. These should be handled with the greatest care after unpacking to prevent the roots from drying out before the shrubs can be planted in a permanent location. If there are a number of shrubs such as a single lot of one variety for a long hedgerow, all those which cannot be planted immediately after unpacking should be "heeled" into moist soil. To do this dig a V-shaped trench in the garden and lay the shrubs side by side against one side of the trench with the roots at the bottom. Cover the roots and trunks some distance above the ground line with soil and pack it lightly. Soak the trench thoroughly. When you remove the shrubs from the trench, or the original packing, place the roots in a pail or tub filled with water.

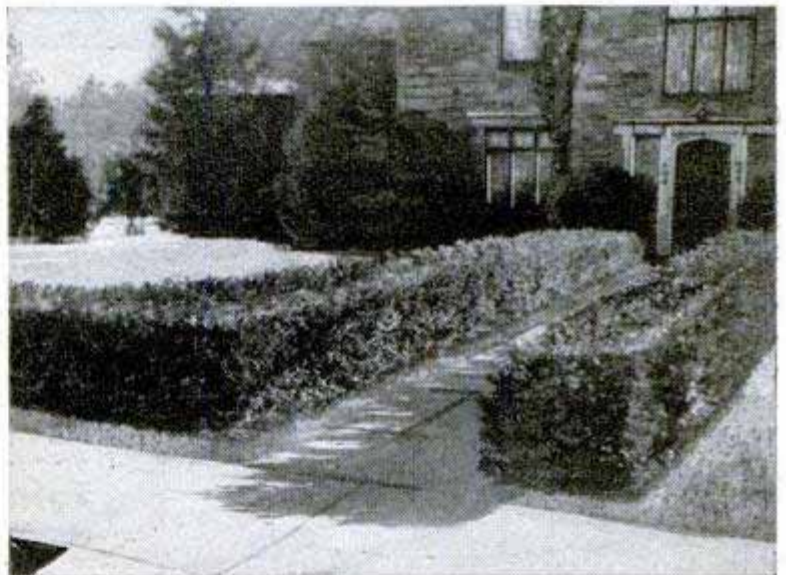

Above, the precise lines of this border hedge guide the caller directly to the building entrance. A well-kept hedge like this is an asset to any property. Below, here again the decorative value of a large single specimen is demonstrated. Many low-growing varieties attain maximum size only when planted alone





# Generator-Operated Bicycle Light Stays Bright

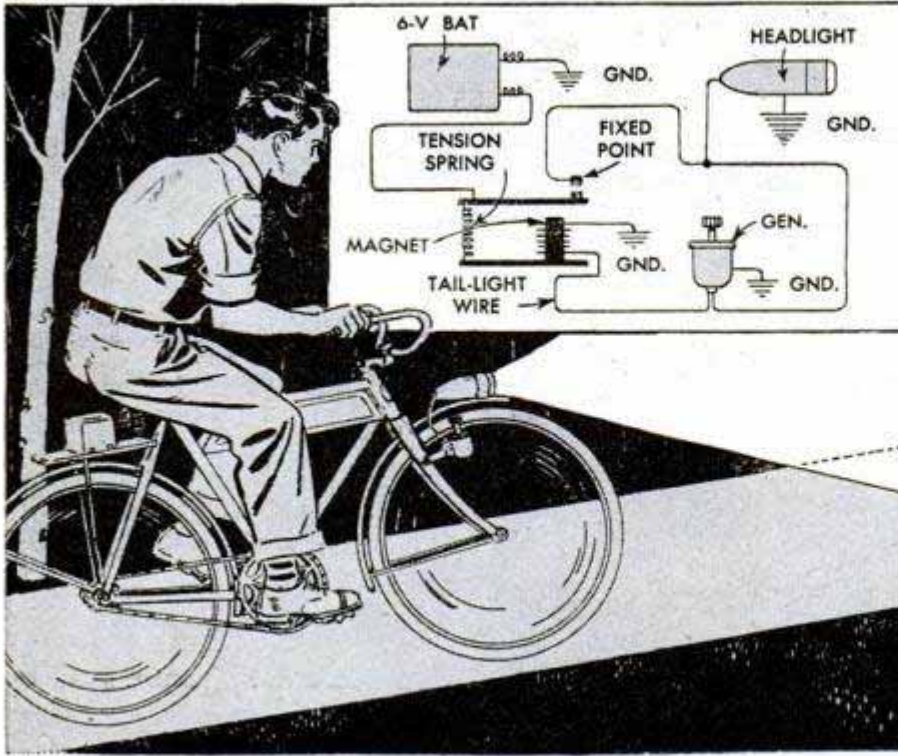

Generator-operated bicycle headlights will remain at constant brilliance when the bicycle is stopped, or slowed down to climb a hill, if a 6-volt dry battery and an automotive-type relay are wired into the circuit as shown. The relay cuts in the battery when the generator current drops. The points of the relay will have to be reversed, and when doing this be sure to insulate the fixed point from the relay case. Also, make certain that the armature and battery-lead connection is insulated from the relay tension spring.—Luther E. Brown, Spangler, Pa.

## Clothesline Used as Height Gauge in Building Scalloped-Top Fence

To simplify the job of marking and nailing the pickets to the crossrails of a scalloped-top fence, one man suspended a length of rope between the two end pickets of each section and used its natural curve as a guide. He first set the end pickets for height by holding a straightedge and level across the top and then drove a nail in the top end of each picket for at-

taching the rope. The rope not only served as a guide for marking the pickets for length, but was used to line up the tops of the pickets as each one was nailed to the fence rail. The same depth of scallop is maintained for each section by setting all end pickets an equal distance apart and using the same length of rope between the pickets.—Sven E. Siemen, Harvard, Mass.

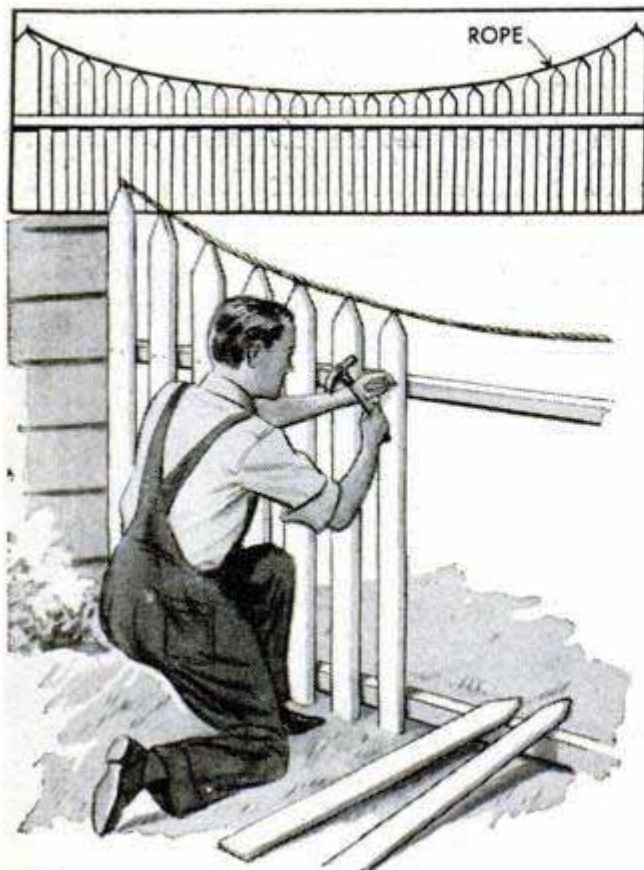

## Rafters Erected Singlehandedly With Aid of Wooden Hook

Normally, raising and nailing rafters is a job for two men, one to hold the rafter at the ridge and another to hold it at the plate. However, the job can be done easily by one man if this simple wooden hook is used. It is clamped temporarily to the rafter to permit hook-

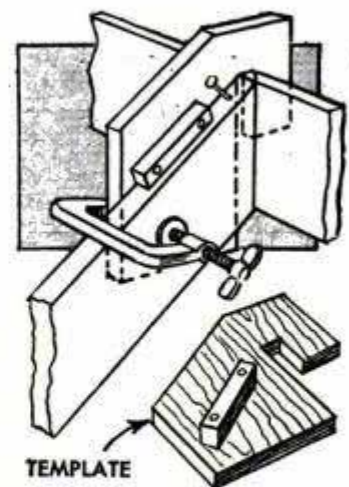

ing the plank over the ridge board. Cut the hook from plywood and notch it to suit the thickness of the ridge board. The cleat, which automatically aligns the hook on the rafter, is located to correspond with the roof pitch. The hook also can be used to mark the rafter plumb cut.



# "Spatterprint" Silhouettes Have Unusual Finish

If you are looking for something unique in the way of decoration for wall prints, album covers, bridge tallies, etc., then try "spatterprint" silhouettes. They are simple to make and require few materials. A cigar box with the top and bottom removed, some screen wire, thumbtacks and a toothbrush are all that are needed. To make the frame, tack the screen over the top opening of the box. Then select a pattern for the silhouette. This can be a pressed leaf, a design cut from a magazine or any other suitable subject. Lay this on a piece of heavy paper and place the frame over it. Dip the toothbrush in poster paint or liquid shoe polish and, after shaking off the surplus, rub the brush across the screen until the desired depth of color is obtained. Let dry before removing pattern.

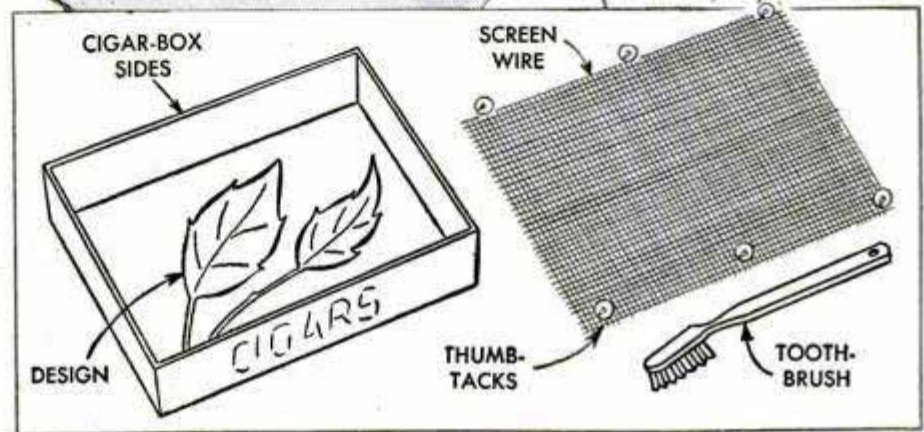

## Animated Monkey Slides Down Pole to Amuse Small Children

Watching the monkey literally "jump" down the pole will amuse youngsters by the hour. The toy is made from a  $\frac{1}{4}$ -in. dowel, a length of stiff wire and a wooden

cutout of a monkey. A portion of wire is formed into a coil spring by winding it around a  $\frac{5}{16}$ -in. metal rod. Wound over a form of this size, the spring will be a loose fit on the dowel. The cutout is attached to the projecting end of the wire, and a wooden block serves as a base to support the pole vertically. To operate the toy, place the coiled end of the spring supporting the monkey over the top of the pole, give the monkey's head a flip to set up a vibration and he will slide down the pole in a very realistic manner.



## Shoe Eyelets Serve as Portholes For Ship Models

Neat portholes for ship models are made easily by using shoe eyelets. Drill holes for a snug fit in the side of the ship and drive in the eyelets. Place a small block of soft wood over the eyelet when driving it to avoid damage. Use a metallic-type paint to finish each porthole.—Harry E. Vandryes, Jr., Kingston, Jamaica, B. W. I.



# STRICTLY

By W. Mack Angas

This 55-ft. signal mast provides for the correct display of flags ashore by yacht clubs, boat clubs and other nautical organizations. The national ensign is flown from the peak of the gaff and all lesser flags from the masthead and yard. Although it is common practice to fly the yacht ensign from the gaff, as shown in the photo, this is not strictly correct procedure.

For the lower mast, a 12 by 12-in. seasoned Douglas-fir timber, 40 ft. long is required. Or, you can use a 40-ft. pole having a minimum diameter at the butt of 14 in. Note that the upper part of the mast is square and has a 6-in. tenon which carries the cap. If a round pole is used, the lower 8 ft. should be shaped 11½ in. square with an adz. The round, tapered portion of the pole is then worked down to the diameters specified. The mast support is built up of two 6 by 16-in. timbers, 14 ft. long. After the pieces are cut to size they are clamped to the butt of the mast for boring bolt holes through both the butt and the timbers in alignment. The timbers and spacer blocks should be pressure treated with a wood preservative to protect them against dry rot and termite attack. The topmast, gaff and yard are Doug-

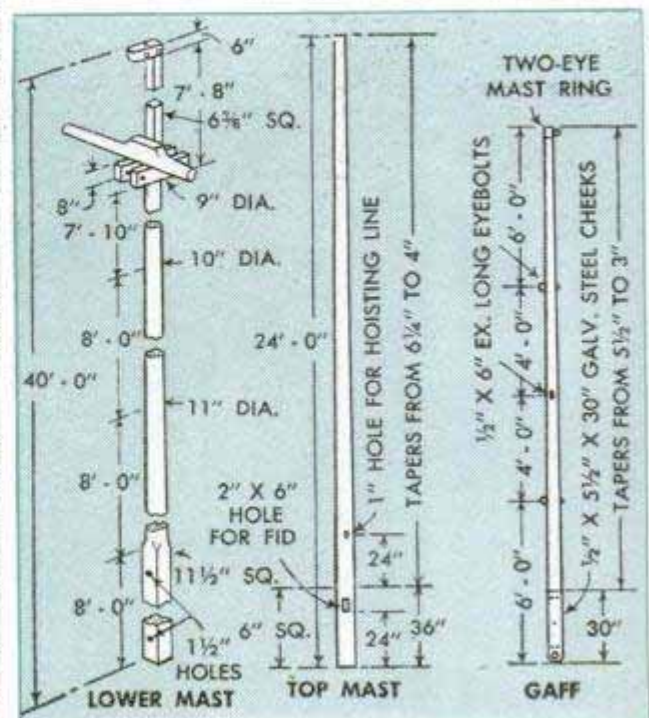







## Mandrel Permits Multiple Turning Of Wooden Toy Wheels

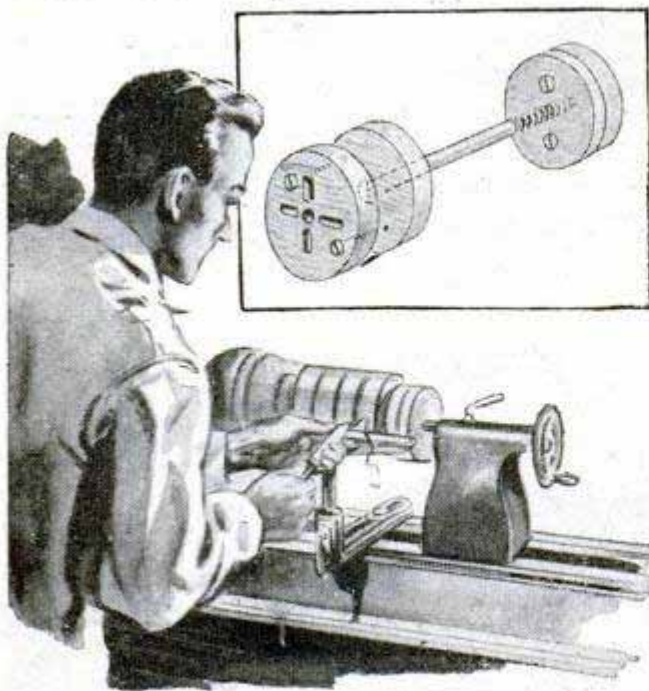

When duplicate wooden wheels are needed, such as those for toys, they can be turned four or more at a time by mounting them on this improvised lathe mandrel. The mandrel consists of four disks, three being of wood and the other of metal, and a machine bolt. The bolt should be the same size as the axle of the toy and of a length that will make the distance between the jaws of the mandrel slightly greater than the combined thickness of the four pieces of work. The head of the bolt is held between two wooden disks, one of which is drilled through the center and countersunk for the bolt head, and the other screwed to it as shown. The metal disk,  $\frac{1}{8}$  in. thick, is drilled and tapped for the threaded end of the bolt and, in turn, is screwed to a wooden disk. Drill a hole half-way through the wooden disk for the end of the bolt. Finally, mount the mandrel between centers and true up the jaws. In use, the work is drilled to fit the bolt, then roughly cut to size and mounted and tightened on the bolt by turning up the jaw on the end of the bolt. The whole assembly is replaced in the lathe, using the original spur and tail center marks.

## Coils Wound on Film Spools

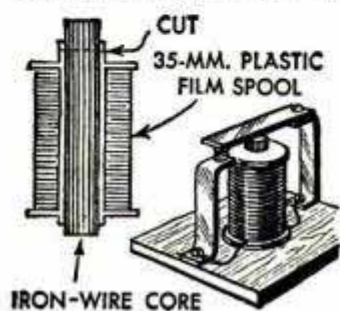

If you wish to make a small electromagnet for a relay, the plastic spool from a 35-mm.-film cartridge provides an excellent form. Drill out the thin

web in the end of the spool, insert short lengths of soft-iron wire for the core, and cut off the top end as shown. Then, drill a hole in a wooden base to hold the electromagnet in place. These plastic spools also are suitable forms for winding radio coils and resistors.—Henry Zave, Chicago.

## Cotton String Absorbs Excess Oil From Sewing-Machine Head

To prevent oil from spotting material after a sewing-machine head has been lubricated, tie a short length of cotton string tightly above the needle bar, as shown in the drawing. The string will absorb the excess oil and prevent it from seeping down to the cloth. Check the string occasionally and, when it appears to be saturated with oil, replace it.

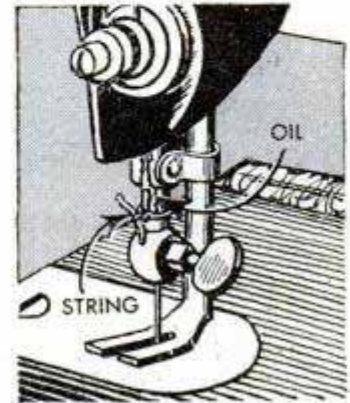

## Uses for Toothbrush Containers

Instead of discarding plastic toothbrush containers, put them to use either as decoration or for utility. For example, if decorated with decals and fastened to the molding or walls with cellulose tape, they make attractive bud vases. In the nursery they are useful containers for swabs. They also serve as a protective cover for scissors, and in the kitchen they can be used to protect the blades of sharp knives.—Edward B. Tunstead, Minneapolis, Minn.

## Tin Can Serves as Soap Dish

For use in the shop or basement where appearance is not too important, a handy soap dish is made from an ordinary tin can. Obtain a fruit-juice can from which the top has not been

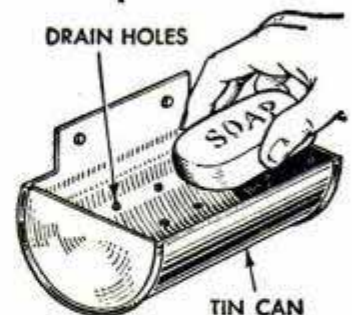

removed, and cut it in half lengthwise, leaving a tab on one side as shown. Dull the sharp edges of the metal with a file, and then drill or punch several drain holes in the can and holes in the tab to fasten it to the wall. If you prefer, leave off the tab and punch holes through the ends of the can to suspend it with wire between two faucets.—A. E. Fenn, Chicago.



# Low-Altitude Aerial Photos Taken From Box Kite

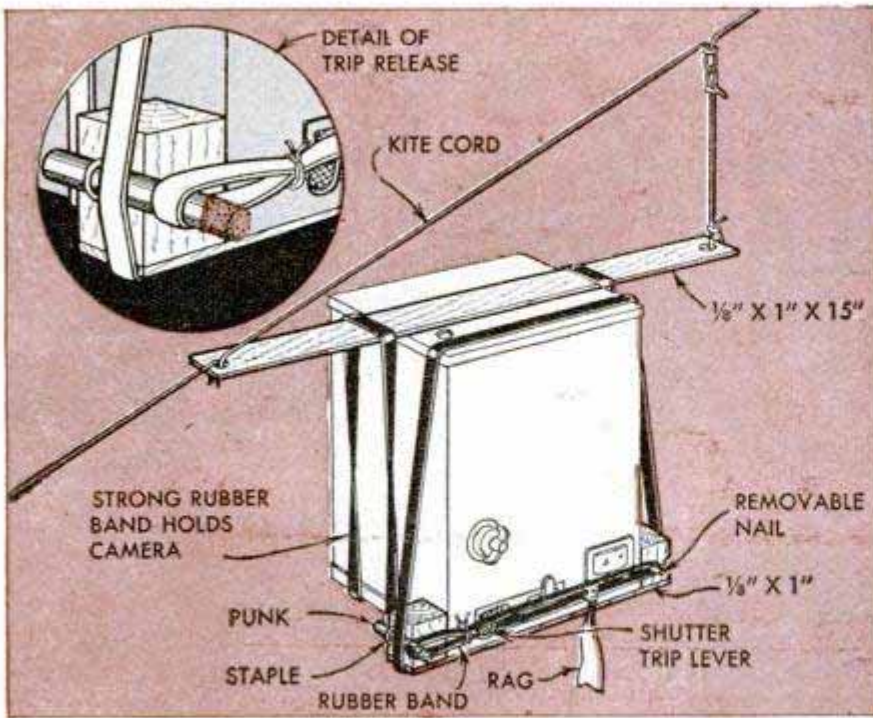

Here's a novel way to take clear aerial photos of homes in your neighborhood with the lowest possible investment in practical aerial photo equipment. Any kite capable of lifting an ordinary box camera in light to medium winds, will do. An automatic shutter-release mechanism consisting of two small wooden blocks, two rubber bands and a piece of punk of the kind used to ignite fireworks, is attached to the camera. Then the assembly is fastened to the kite cord as indicated. Note that a cord is knotted around the rubber band just behind the shutter trip lever and also that a small piece of white rag is attached to this band. In taking the picture, you ignite the punk and send up the kite with camera attached. As soon as the punk has burned sufficiently, it releases the rubber band, which trips the shutter and falls clear, the telltale cloth indicating when the shutter has been released. Remember there is some danger of fire when shrubs and grass are dry.

C. L. Meehan, Lakeview, Ont., Can.

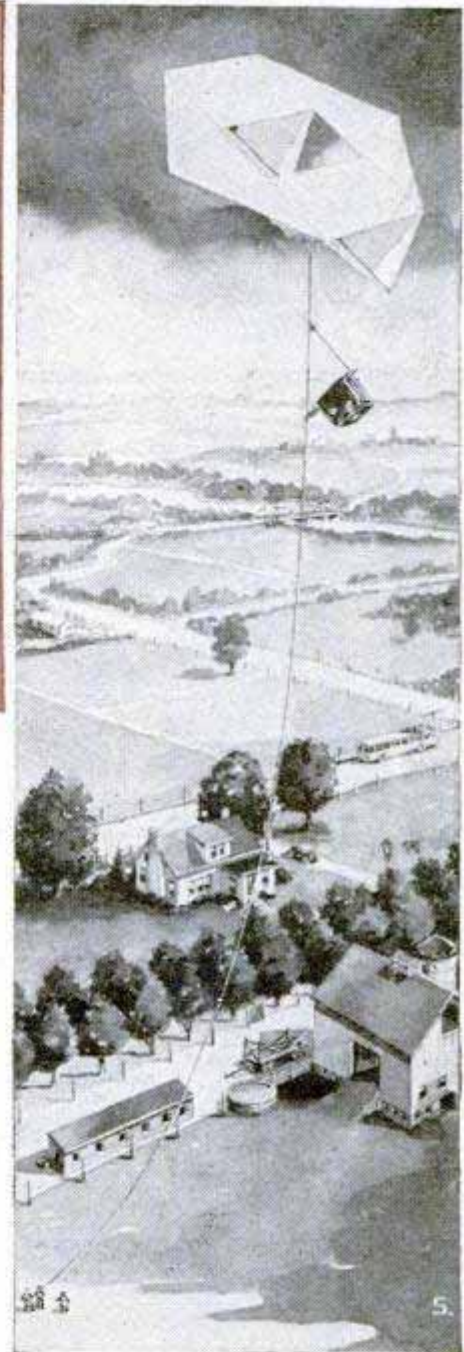

## Newspaper Pads Prevent Sinking of Tripod Legs in Soft Ground

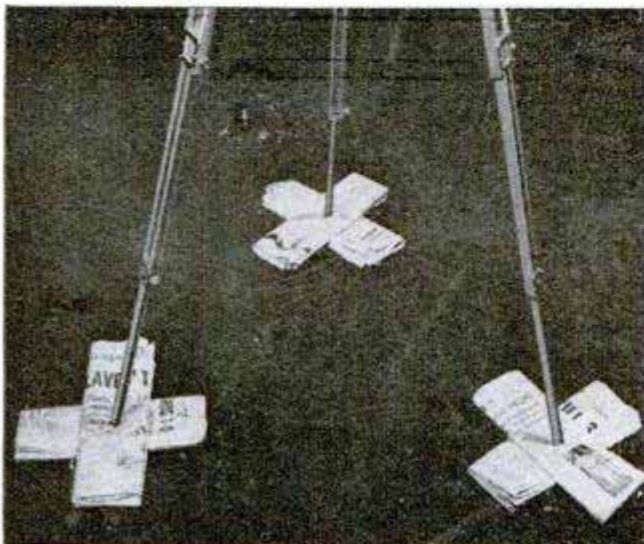

When shooting outdoor pictures, the legs of a tripod can be kept from sinking into soft ground by supporting them on pads of folded newspapers. Fold the papers flat as shown, and place them crisscross under each leg.

Frank P. Fritz, Cicero, Ill.

## Retarding Developer Spoilage

A partially filled bottle of developing solution will oxidize (turn brown) more quickly than a full bottle because there is more air space above the level of the solution. To retard oxidation, pour the developer from a large bottle to a small one that will be filled completely.



# PAN-TILT

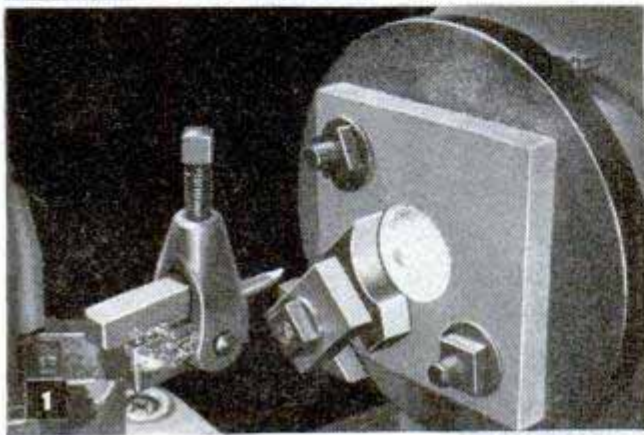

With this setup, machining the arc on the saddle block is easy. Block is backed with 1/2-in. plywood

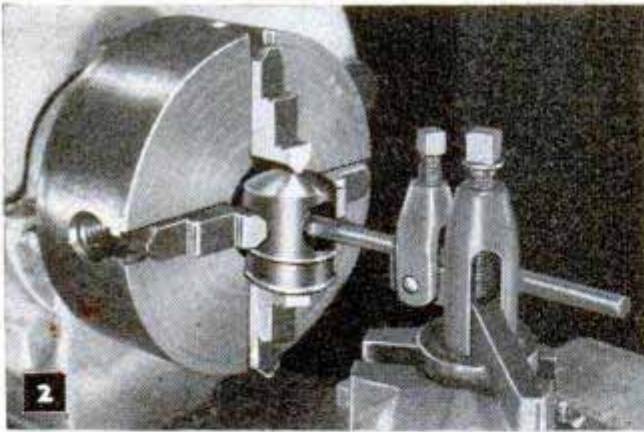

Hole in the pivot bar is bored .002 in. undersize to assure a snug fit on the main pivot after slotting

**Q**UICK and positive locking of both tilt and "pan" adjustments with a single action is possible with this tripod top. It is sturdy enough to support large view cameras, is adaptable to all standard tripods, and the smooth pan action makes it especially desirable for use with movie cameras. No castings are required.

The main pivot, Fig. 3, is turned from 1 1/2-in. cold-rolled steel. A 1/8-in. retaining groove turned in the body receives the tip of the locating setscrew that holds the pivot bar in place. The top of the column is slightly chamfered and a hole is drilled in the bottom and tapped 1/4-20 to permit mounting on standard tripods. Cold-rolled steel, 1 1/2 in. in dia., also is used for the pivot bar which has a 1/32-in. step cut 1/16 in. from the end for the clamping strap. The shoulder formed by this step keeps the tilting head in place when it is loosened for moving. The 7/8-in. transverse hole is bored in the lathe, Fig. 2. The diameter of this hole should be about .002 under that of the main pivot to assure the proper fit after slotting the bar. After boring, slot this part with a hacksaw as indicated in Fig. 3, and drill and tap for the locating setscrew. Note that the threaded end of this screw is turned down to 1/8 in. in diameter.

The tilting head consists of a saddle block and a brass binding strap that rides

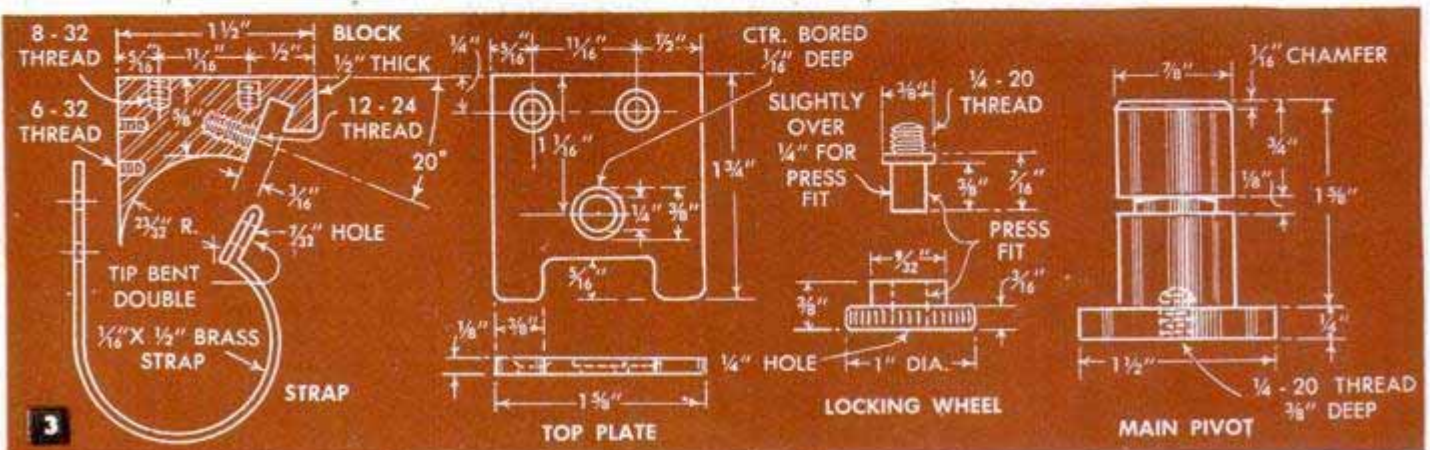



# TRIPOD HEAD

This tripod head is sturdy enough to support a large view camera. A single locking device controls both pan and tilting movements without any other adjustment

By Henry and Richard Hanscom

in the crossbar step and serves as a clamp. The block is machined from  $\frac{1}{2}$ -in. brass, the arc being cut on the same radius as that of the  $\frac{1}{2}$ -in.-wide step cut on the crossbar. Fig. 1 shows the setup for cutting the arc. After the arc has been cut, the block is grooved as in Fig. 3 to take the bent end of the binding strap. The shouldered end of the locking handle, Fig. 3, passes through the strap and turns into a threaded hole drilled and tapped in the saddle at a 20-deg. angle. Two 6-32 fillister-head machine screws, turning into holes drilled and tapped into the back face of the saddle block, hold the flat end of the binding strap. The locking handle, which is threaded to fit the 12-24 tapped hole, is used to hold the strap in position while it is bent to shape. Holes are marked while the strap is held tightly in position and then are drilled and tapped for short screws. The handle is in "release" position to allow for proper tightening of the strap.

A brass top plate is fastened to the saddle block with two flat-headed cap screws. Note that the plate is counterbored for the flanged spindle of the locking wheel, Figs. 3 and 4, and that the spindle is machined for a press fit in the wheel hub. Glue a piece of felt to the top of the plate. Although a machine finish is attractive, some builders may wish to grind and polish exposed parts of the unit. The handle, pivot bar and the main pivot can be ground smooth in the lathe and then polished on a buffing wheel. Flat surfaces are polished by rubbing on a piece of crocus cloth tacked to a flat block of wood.

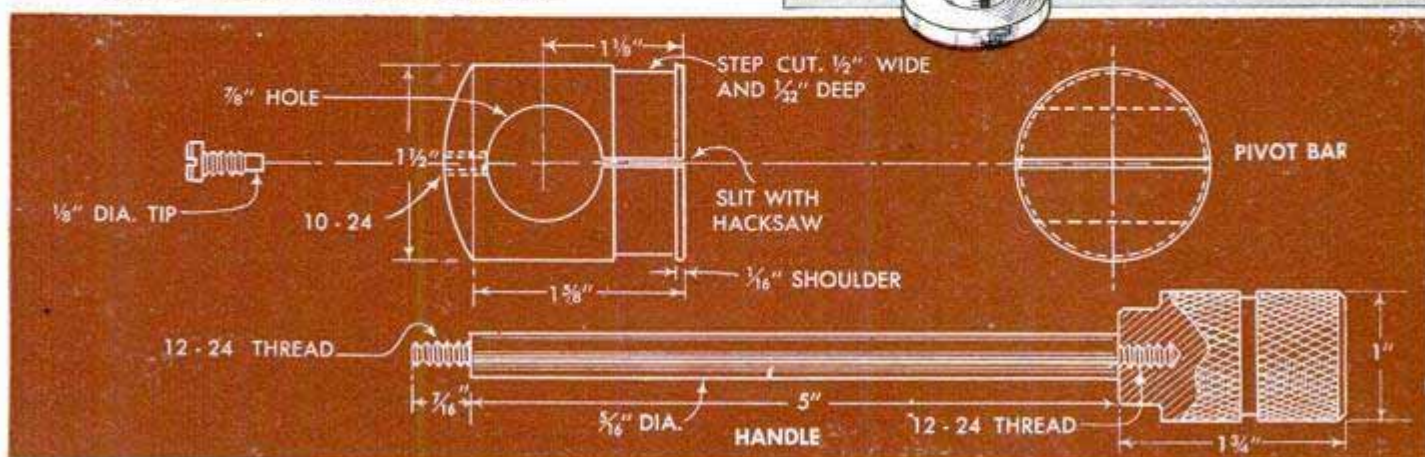
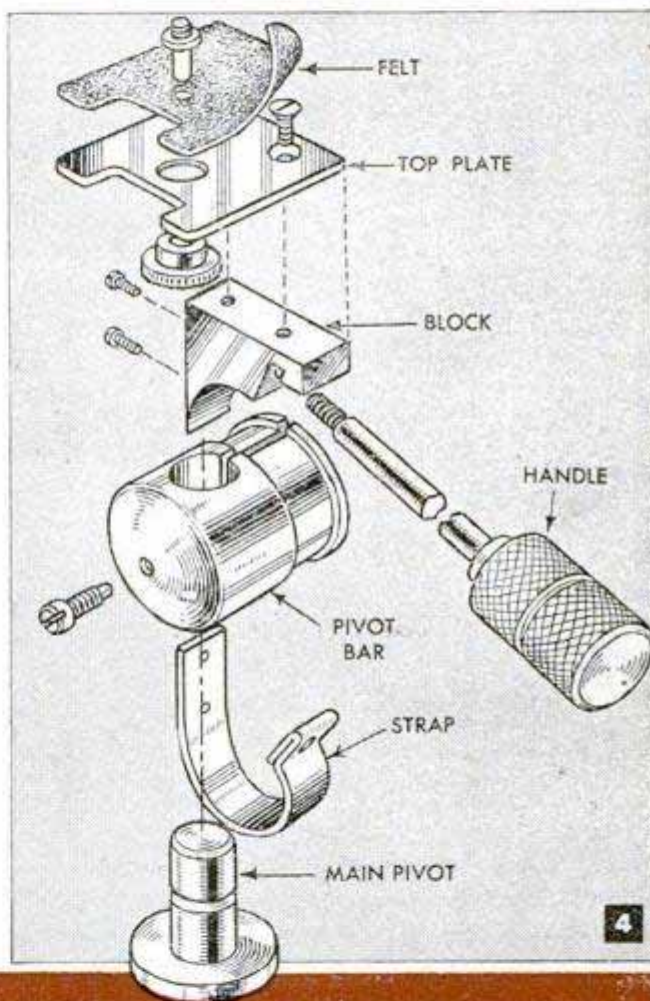



## Small Evergreens Protected With Poultry Wire

POULTRY WIRE

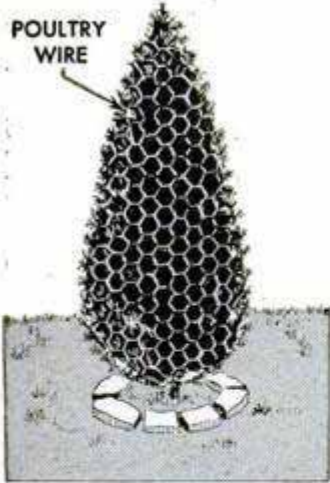

Shrubs and small evergreens will keep their shape and be protected from storm damage if they are wrapped with poultry wire. Use the large-size mesh so that the shrub will continue to grow unhampered.—Duke D'Ambra, Lawrence, Kans.

## Raising Shallow Dents In Hard or Soft Wood

Hammer marks and other shallow dents in unfinished wood, such as furniture or woodwork can be raised flush with the surface by a simple heat treatment. Place a few drops of denatured alcohol in the dent, A, ignite, B, and let burn. The combination of heat and moisture will cause the wood fibers to swell and rise to the level



of the surrounding surface. The spot then is sanded lightly, C, to remove any slight scorch that may result. This is effective only on very shallow dents and cannot be expected to raise deep depressions. Another method of raising

a dent is to cover it with a dampened cloth pad and steam the wood by applying a hot soldering iron or household iron to the cloth. This treatment also will raise the grain of the surrounding wood and it will be necessary to sand down the raised grain. To remove a dent in a surface already finished, the varnish or paint, naturally, must be scraped from the dent and adjacent area.

R. E. Murray, Fremont, Ohio.

## Handy Glue Spreader



Desiring a fast way of spreading glue on narrow boards which I was laminating, I found that a piece of clock spring

made an excellent tool for the purpose. The spring was formed into a loop and the ends inserted in the end of a dowel handle. In using the tool, I poured the glue inside the loop and then moved it slowly over the work, lifting the tool slightly to leave a film of glue. A hacksaw blade can be used in this same way, the serrated edge allowing the glue to level uniformly.

Kenneth Murray, Colon, Mich.

## Bottle Holder Has Gluing Surface

In offices or homes where mucilage is used, a glue-bottle holder can be made from a cigar box or similar container. Bore a hole in the lid of the box to permit the bottle top and brush handle to project.

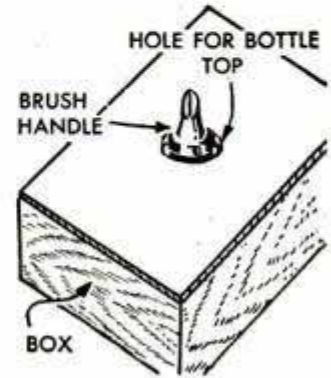

Then place the glue bottle in the box and close the lid over it as shown. In addition to catching the drippings from the brush, the lid will serve as a place where gluing can be done without danger of smearing the desk or table top.—I. M. Fenn, Chicago.

## Electrical Coupling for Trailer Made From Sealed-Beam Sockets

To operate the taillight and stop light on his trailer simultaneously with those on his car, one motorist devised a convenient coupling from two sealed-beam headlight sockets. Three prongs are soldered into the slots of one of the sockets to make a plug, and its leads are spliced into the various parts of the trailer circuit as indicated.

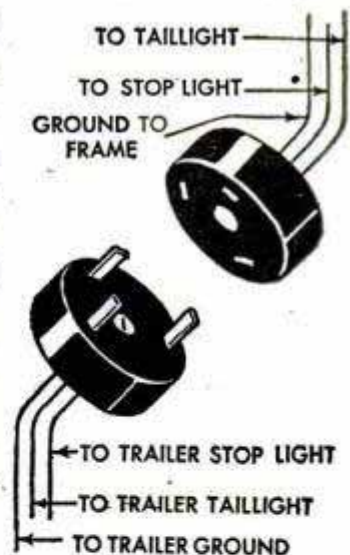

Then, the other socket is fastened under the rear of the car with two of its leads connected into the taillight and stop-light circuits and the third lead grounded to the frame. The wires of the plug should be long enough to enable it to reach the socket, and both plug and socket should be marked plainly so that the wires leading to corresponding parts of the trailer and car circuits will be connected.

C. Buxton, Chicago.



# CRAFT QUIZ



1. This bandsaw job is—  
 (a) Rabbeting (c) Chamfering  
 (b) Resawing (d) Spiling

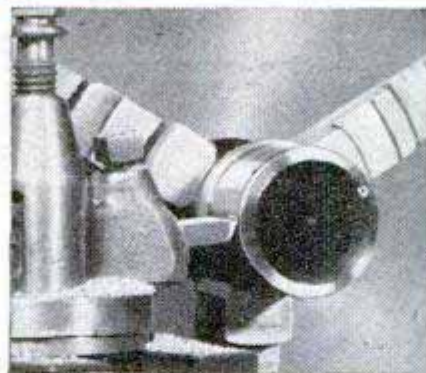

2. Metal being turned is—  
 (a) Brass (c) Mild steel  
 (b) Aluminum (d) Stainless steel



3. He is painting the—  
 (a) R.F.D. (c) LL2  
 (b) L.W.L. (d) Buttock

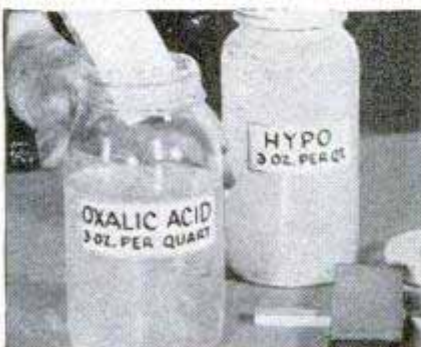

4. With this you do—  
 (a) Staining (c) Filling  
 (b) Sealing (d) Bleaching



5. Big faceplate job is turned—  
 (a) All aboard (c) Inboard  
 (b) Outboard (d) Between centers



6. Sparks show this metal is—  
 (a) Aluminum (c) Copper  
 (b) Brass (d) Steel

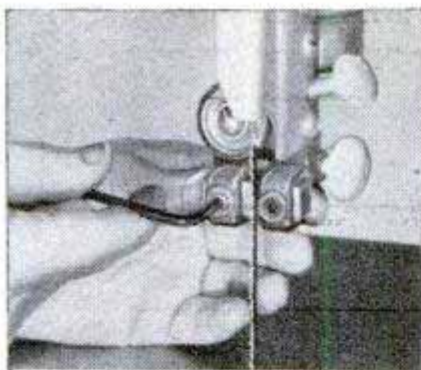

7. He is adjusting the—  
 (a) Blade support (c) Roller guides  
 (b) Pin guides (d) Side relief

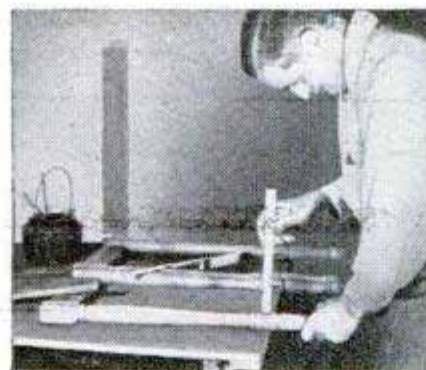

8. He is putting glue in the—  
 (a) Mortise (c) Groove  
 (b) Tenon (d) Rail

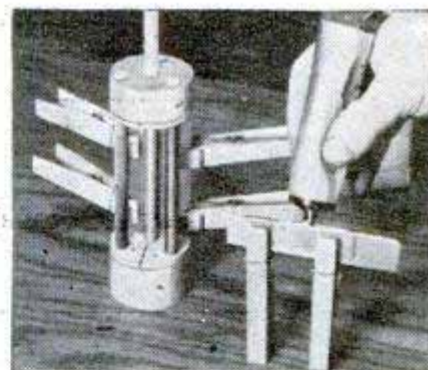

9. His hobby is—  
 (a) Archery (c) Photography  
 (b) Boats (d) Gem cutting

ANSWERS: 1—b; 2—a (other metals mentioned require positive back rake); 3—b (load water line); 4—d (oxalic acid is a mild bleach for wood); 5—b (on outboard end of headstock spindle); 6—d (others do not spark); 7—b; 8—a; 9—a (gadget shown is a feathering jig); 10—b; 11—a



10. Yes, it writes on glass:  
 (a) Silicon carbide (c) Tungsten  
 (b) Tungsten carbide (d) Tantalum



11. Getting ready to do—  
 (a) Tumbling (c) Knurling  
 (b) Sandblasting (d) Curling



## Children's Glass-Bottom Boat Has Educational Value

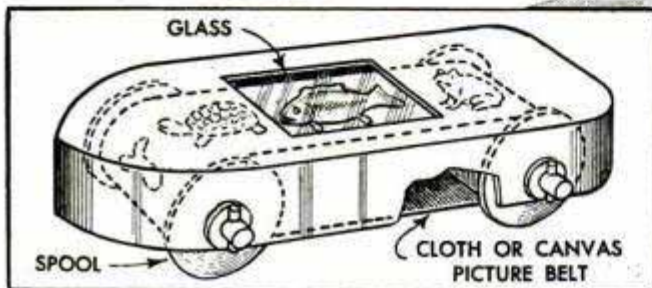

Made from sheet metal cut and soldered to the shape of a boat, this novel toy will fascinate children and help teach them to identify various forms of marine life. Thread spools serve as wheels for the boat and also as reels for an endless cloth or canvas belt on which pictures of fish, frogs, turtles, etc. are pasted. A glass viewer is mounted in the center of the deck to enable the children to watch the pictures pass by as the boat is pushed along. Dowel axles pinned crosswise against washers hold the spools in place.

Ralph L. Ralston, Jackson, Mich.

## Tweezers From Cotter Pin

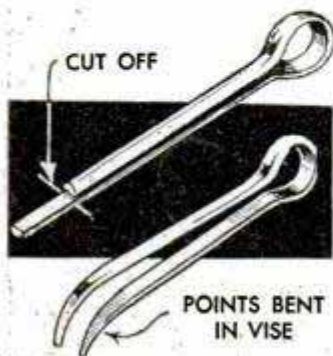

Cut off one leg of the cotter pin slightly so that when bent both legs will be the same length. Grind each one to a point and bend

If tweezers are needed for a particular job and none are obtainable, you can make a pair from a large-size cotter pin of the type used on heavy machinery. These are available 3 in. or more in length.

the ends as shown by clamping them together in a vise. Then force them far enough apart to obtain a spring action.

John Krill, North Lima, Ohio.

## W.T.M. Concrete Bull-Nose Concrete Blocks Take Place of Square Type

Should you run short of square-type concrete blocks or desire to make use of extra bull-nose blocks, the latter may be used at the corners of a building. Merely turn the rear side of the block to the outside and chip off the adjoining block to fit around the curved portion, as shown in the sketch. When the job is done in this manner, both the interior and exterior of the corners will appear square.

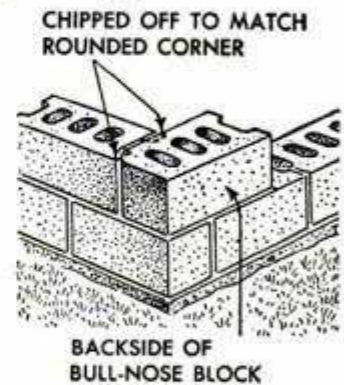

Michael Ligocki, Gary, Ind.

## Tape Makes Drain Plug Fit Tightly

A slow leak caused by a loose-fitting drain plug in a laundry tub or wash basin can be stopped by using friction tape or waterproof adhesive tape. Wrap a few turns around the tapered part of the plug so that it is a tight fit in the drain. When wrapping the tape, have it flush with the top of the plug and trim excess width off the bottom to make a neat repair.

Chas. F. Cretien, San Diego, Calif.

## Hole in Hammer to Start Nails

When it is necessary to hold both the stock and a nail in position somewhere overhead, or when starting a finishing nail in a spot that is hard to reach, the problem can be solved by using an old hammer that has a hole drilled in

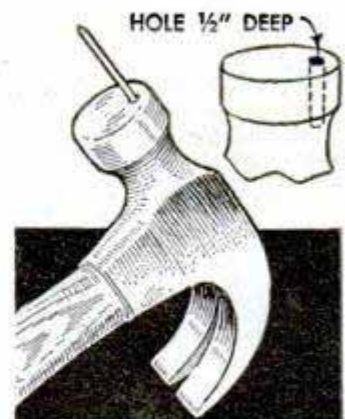

the head to hold the nail. Drill the hole near the edge of the face so it will not interfere with hammering, and make it large enough to accommodate a nail of the largest diameter commonly used. To use, merely insert the nail in the hole, tap it lightly until it grips the wood, and then finish hammering in the normal manner.



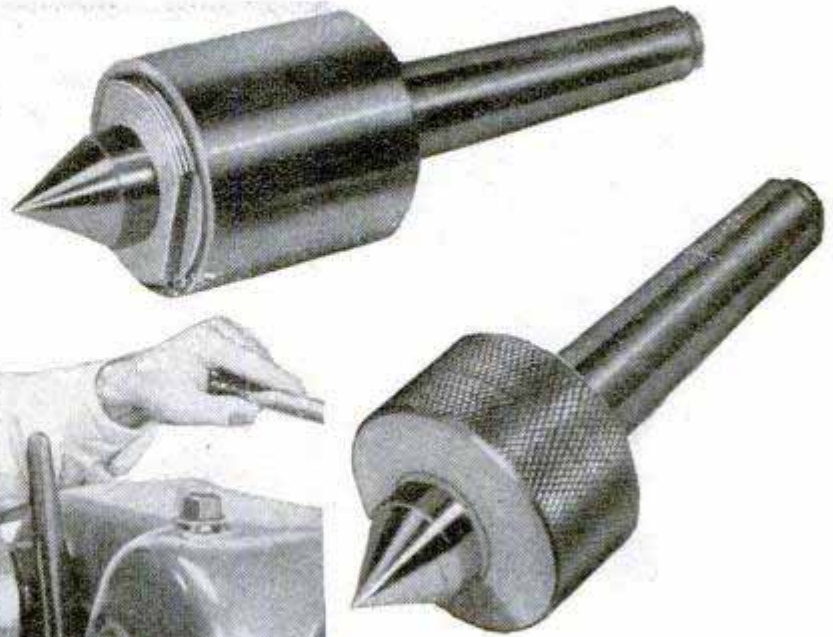

By Sam Brown

## BALL-BEARING CENTERS

**B**ECAUSE a ball-bearing center decreases the work load and eliminates oiling, it is a practical lathe accessory. The two types described here will handle any ordinary job that requires a tail center. Bearings must be the angular-contact type specified, as the finished center cannot be made rigid enough to withstand extremely heavy cuts when an ordinary, radial-type bearing is used.

Fig. 2 shows construction of style No. 1. The center point and housing are turned in one piece from a length of 1 $\frac{3}{4}$ -in. cold-rolled steel. First turn the housing to the outside diameter and then knurl. With the same chucking, bore the inside of the housing, Fig. 3.

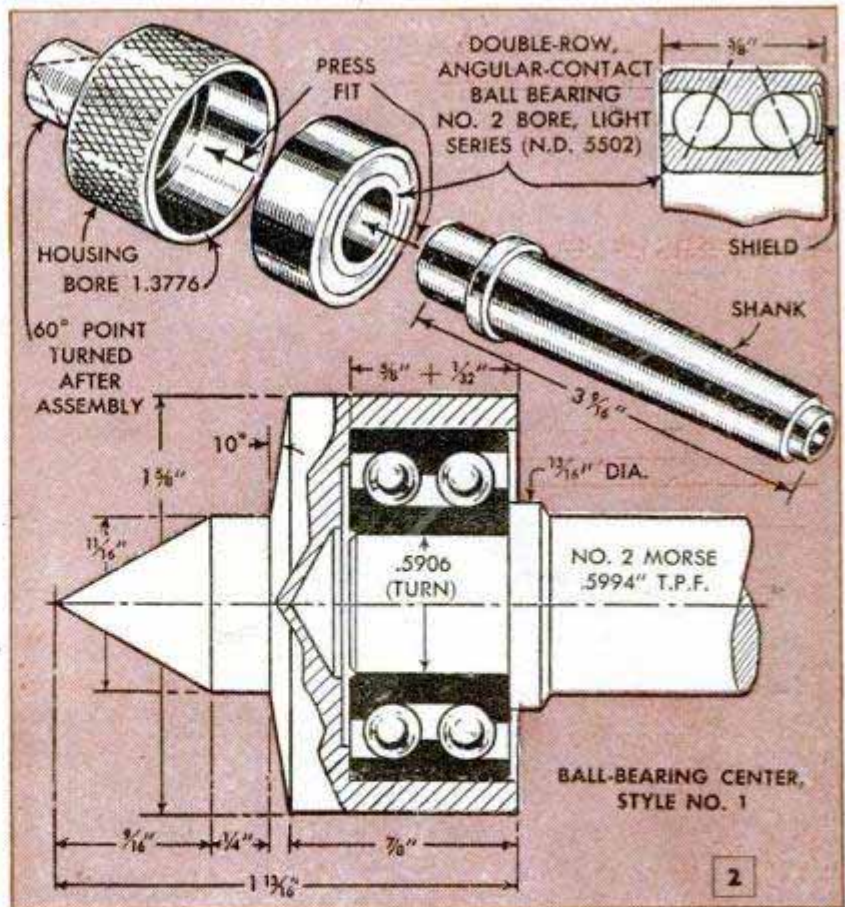

Of the two types given, the center detailed above is the easier to make. Although nonadjustable, it is as rigid as the adjustable one. Both types provide interesting projects in precision lathe work.



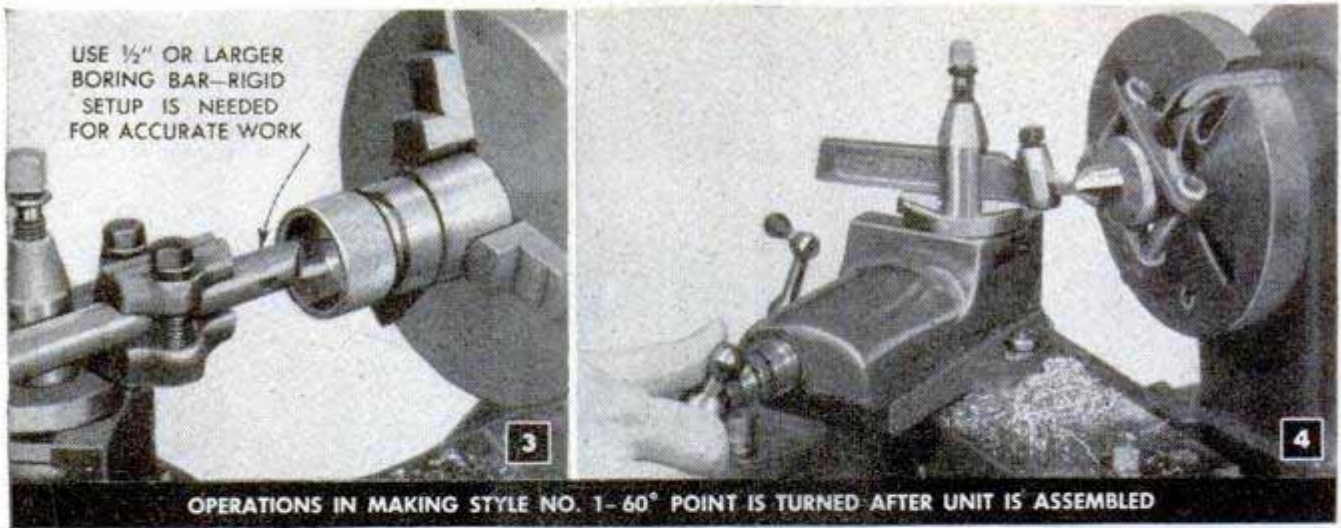

Boring requires precision work, so use the largest boring bar you have and make the final cuts with a feed of .002 in. per revolution. If you have had no experience with fitting ball bearings, it is worthwhile to turn a plug gauge .0004 in. less than the diameter of the bearing. When the gauge is a snug slide-fit inside the bored hole, you will know that the bearing will be a press-fit. Then rough-turn the center point. The shank can be turned with a taper attachment or by offsetting the tail center. However, it is possible to purchase Morse No. 2 shanks ready-ground. Fig. 4 shows how the 60-deg. point is finish-turned after assembly, using the compound slide.

Style No. 2 makes use of two single-row, angular-contact bearings of No. 2

bore, but No. 16 separable-magneto bearings, which also are the angular-contact type, are equally good. The general construction of the center is shown in Fig. 5. It will be noted that this center has a take-up nut for preloading, whereas the double-row bearing used for style No. 1 is factory preloaded. Start by turning the Morse-taper shank and housing from one piece of 1 3/4-in. cold-rolled steel, Fig. 1. Test it for fit in the tailstock spindle at an early stage by chalking the work and noting where the chalk rubs off. After the shank is turned, it is mounted in the headstock spindle for boring the housing, Fig. 6. Run in a light relief cut before threading it for the take-up nut. The bearings for this center should be a snug fit in the housing. Fig. 7 shows

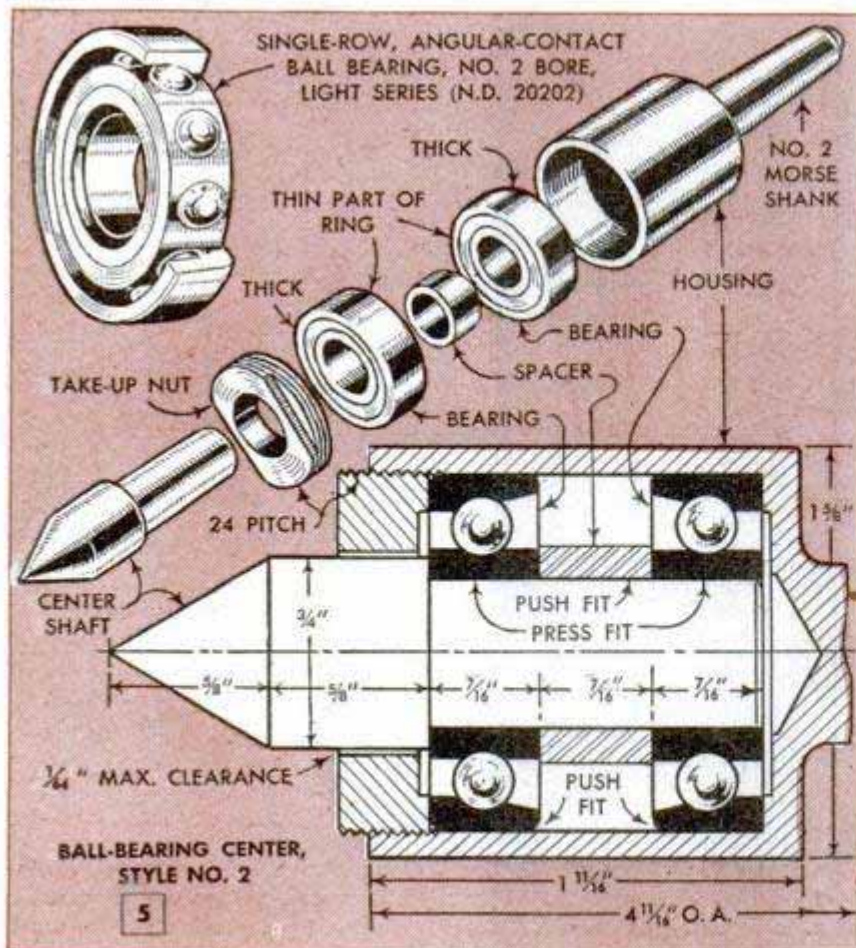

STYLE NO. 2—BORING THE HOUSING

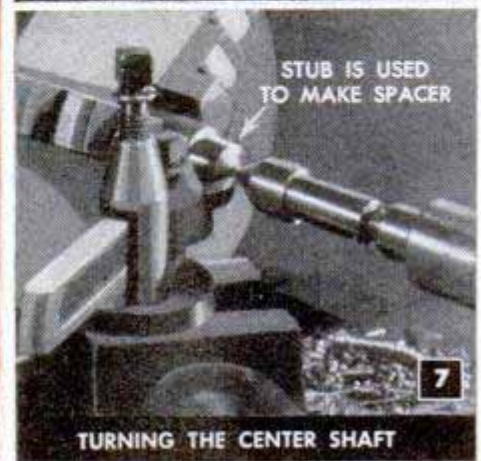

TURNING THE CENTER SHAFT



## BALL-BEARING DATA

	BEARING BORE	SHAFT SIZE PRESS FIT	BEARING DIAMETER	HOUSING SIZE PRESS FIT	HOUSING SIZE PUSH FIT
NO. 2 BORE LIGHT SERIES	.5903 min. .5906 max.	.5905 min. .5908 max.	1.3775 min. 1.3780 max.	1.3771 min. 1.3776 max.	1.377 min. 1.3782 max.
SIZE 16 MAGNETO	.6296 min. .6299 max.	.6298 min. .6301 max.	1.4961 min. 1.4966 max.	— —	1.4963 min. 1.4968 max.

the center shaft being turned. The 60-deg. point is rough-turned at this stage and finish-turned when the unit is completed, Fig. 10. The center is locked in place by turning the takeup nut. Fig. 9 pictures the assembly. A short section of  $\frac{1}{2}$ -in. pipe, faced at one end, makes a good driving tool for a bearing having a No. 2 bore. If the bearings are heated by placing them on a 60-watt lamp for about  $\frac{1}{2}$  hr., they will expand slightly and slide on the shaft easily. Heating the housing in the same way also will simplify assembly. Use a soft-grease packing in assembling both units. Except for the knurled surface, all parts of the centers can be given a high polish while they are chucked by using fine emery cloth dipped in oil and holding it against the work.

In making either style of center use utmost care in boring the housing and turning the center shaft. The table, Fig. 8, gives the minimum and maximum size of manufactured bearings, and the minimum and maximum diameters of work for press and push fits. It will be noted that tolerances must be held to a .0002 or .0003-in. limit. Ten-thousandths can be measured with an ordinary micrometer by dividing the small divisions by eye. Each small division, of course, represents .001 in.

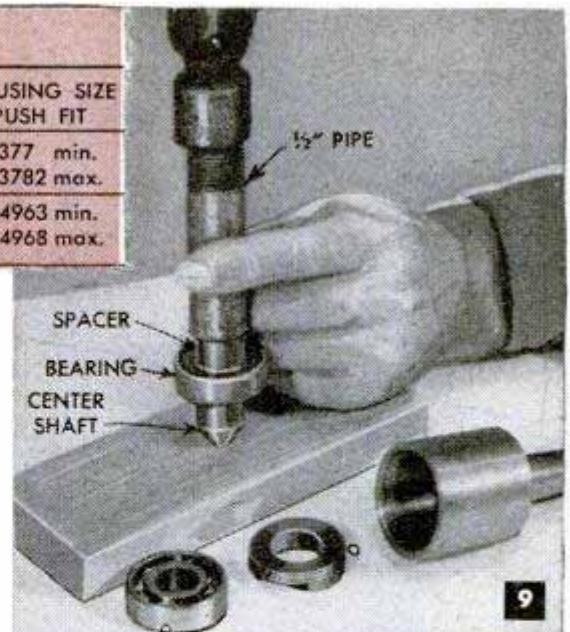
DRIVE BEARINGS ON SHAFT WITH  $\frac{1}{2}$ " PIPE

60° CENTER IS TRUED AFTER ASSEMBLY

## Steel Stress Block Rides Holder in Tool Post to Reduce Bit Chatter

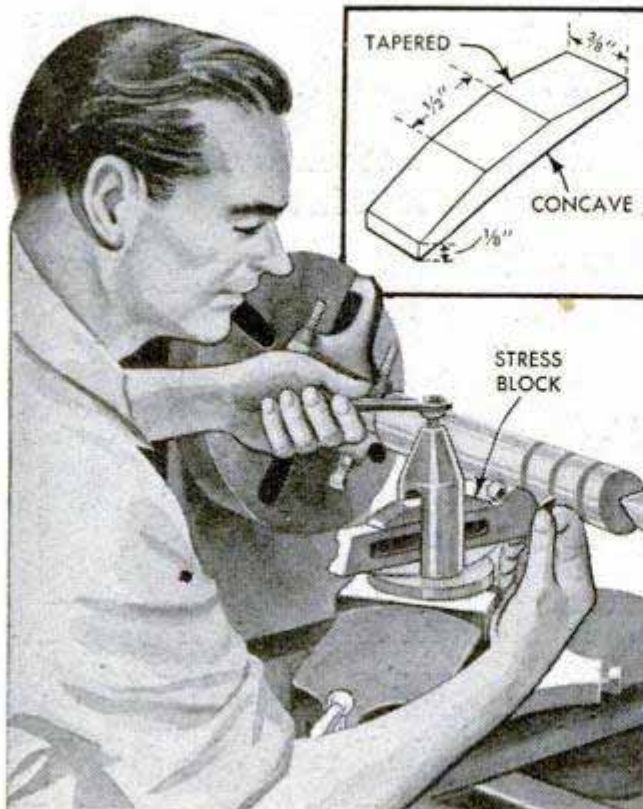

Precision lathe work such as finish-turning, boring and thread cutting to close limits makes it necessary to clamp the tool holder rigidly in the tool post to avoid chattering. In most cases, merely tightening the clamping bolt will not prevent this, because pressure from the bolt is centered only on a small area of the tool holder. However, this trouble can be corrected by using a stress block between the holder and the end of the clamping bolt to exert pressure over a greater area and consequently lock the holder rigidly in position. Naturally, the dimensions of the block must fit the tool post at hand; the dimensions given being for a 9-in. lathe. Make the block from tool steel and, after grinding it to the shape shown, harden it by heating to a cherry red and quenching immediately in oil. Note that the bottom of the block is slightly concave to provide a "spring" action which exerts pressure when clamped to prevent shifting due to vibration. The flat surface on the top of the block should fit the clamping bolt.



## Kinks Removed From Wire Fence With Forked Stick



One man can take the kinks out of woven-wire fence that has been crushed by snowdrifts or trampled by cattle if this method is used. Select a forked stick that is about 8 or 10 in. longer than the height of the fence and set the top strand in the crotch. Holding the stick in a vertical position, place a foot on the lower strand and use both hands to pull up on the top strand.

## Sheet-Metal Guard Shields Worker When Removing Gauge Glass

Danger of steam burns when closing shutoff valves on a gauge glass before removing it, or when working around connections from which live steam may escape, is lessened if this sheet-metal guard is used. It is made by bending a rectangular piece of sheet metal to form a right

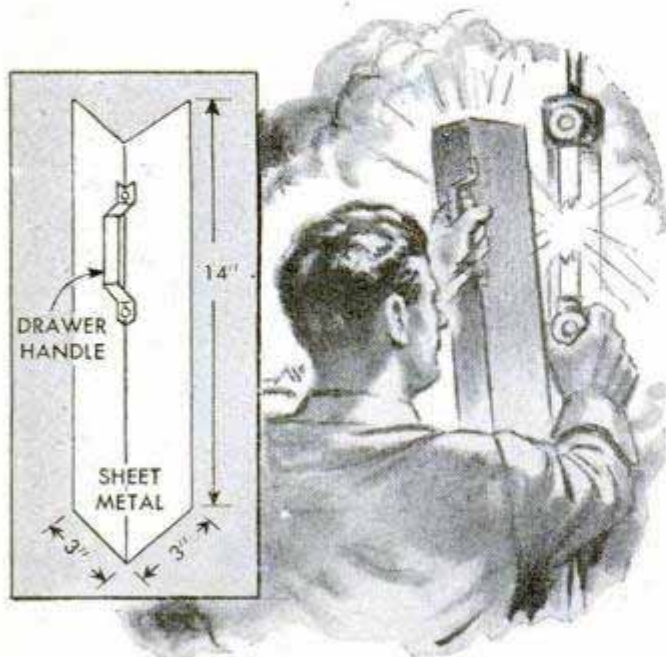

angle and attaching a drawer handle. Make the unit according to the dimensions given, or even larger, to afford ample protection. Wrap the handle with cord or other insulating material to protect the hand.

## Baling-Wire Knot is Nonkinking

Many farmers who bale hay for home use follow a method of tying knots in baling wires which later eliminates straightening kinks in the wires if they are to be used again. As shown in the drawing, the knot is made by inserting the tie end through the loop, but instead of bringing it back on itself as in regular practice, the end is simply given one turn over the loop end.

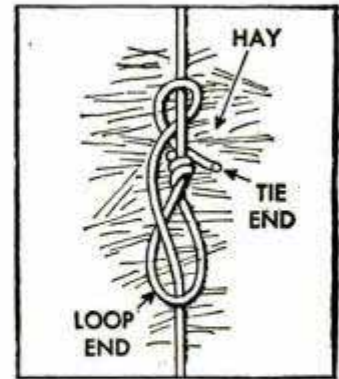

## Sloping Floor in Farrowing House Protects Infant Pigs

Because the foundation of a farrowing house settled, causing the floor to slope, a method was discovered to prevent a sow lying upon and crushing young pigs. It was found that the sow always preferred to lie with her back toward the high side of the floor. Newly farrowed pigs do not move about much during the first few days of life and, due to the sloping floor, they cannot climb and get into a position where they might be crushed. Experiment has shown that a floor slope of about 1½ in. to 1 ft. works well. The floor of any portable house can be slanted by blocking.

## Small Ignition Wrenches Carried On Shower-Curtain Ring

Sets of small combination wrenches for ignition work are carried easily on a shower-curtain ring attached to your trouser belt. If you prefer not to carry them in this manner, the ring may be hung on a nail within easy reach of the workbench or kept in a toolbox. A snap or key chain will serve the same purpose. Such a holder also is handy for carrying a small assortment of washers or nuts.

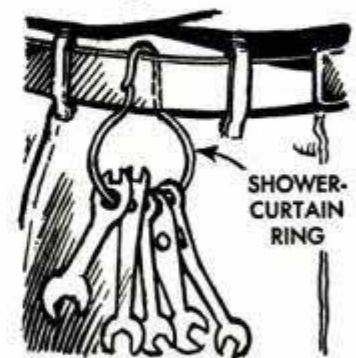

Charles H. Hardy, Los Angeles, Calif.



# Grinding-Wheel Dresser Rides Lathe Tailstock

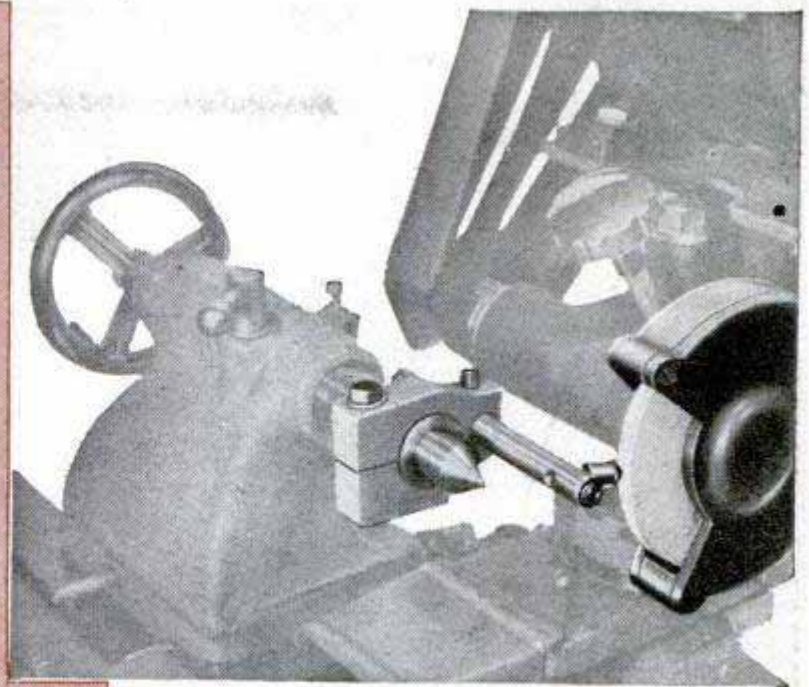
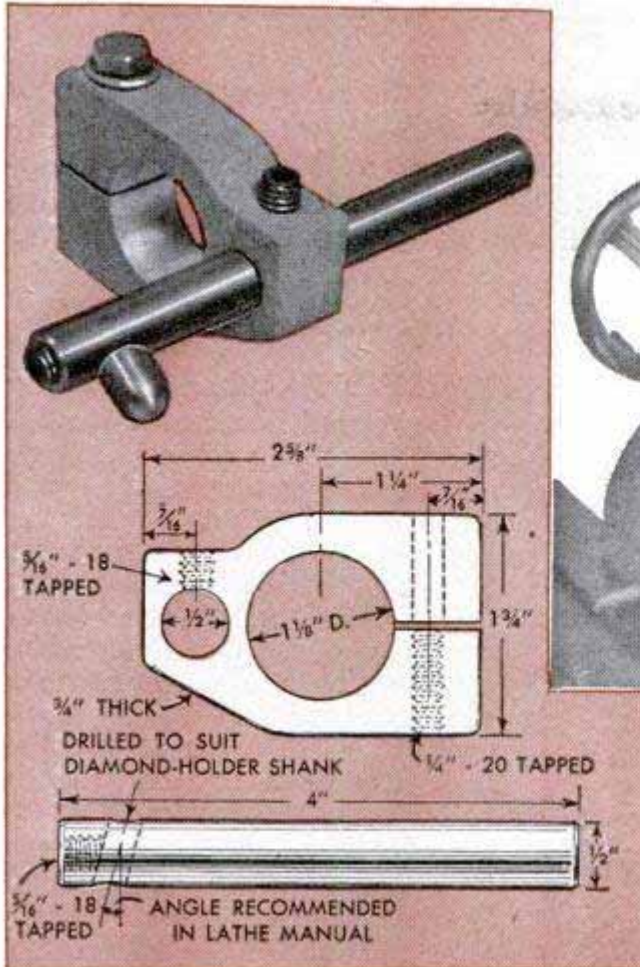

spindle, the lathe shown requiring a 1 1/8-in. hole. Then a slot is made in from the edge to meet the hole. This permits take-up on the holder when clamping it to the spindle with a cap screw. Note that the slotted end is counterbored for the screw with a clearance hole in the upper half and a tap hole in the lower.

Designed to clamp on the tailstock spindle and support a diamond-tipped grinding-wheel dresser, this handy lathe attachment is especially useful in truing wheels on a tool-post grinder. Mounted in this manner, the dresser can be left undisturbed in any set position to maintain the same wheel-to-work angle each time the wheel requires dressing.

The extension arm is 1/2-in.-dia. cold-rolled steel and is locked in the holder with a socket-headed setscrew. The angle of the hole which is drilled crosswise through the arm to receive the shank containing the diamond tip, can be 15 to 30 deg. This is not critical, although the type of diamond tip used determines the amount of angle necessary to permit rotating the tip to expose a new cutting edge when the diamond wears. The end of the arm is drilled and tapped for a socket-headed setscrew which locks the shank of the diamond tip in place. In use, the wheel is moved past the diamond dresser.

The attachment consists of a simple clamp-type holder which can be a casting or machined from 3/4-in. steel or brass plate. In either case, the holder is chucked and lathe-bored to fit over the tailstock

## Driving Dog for Faceplate Work

To simplify and speed the operation of mounting and driving duplicate work on a lathe faceplate, I made this simple driver to replace the regular faceplate dog. It is bolted to the faceplate and has two adjustable jaws to accommodate both round and square stock of various sizes. Once adjusted to suit the work at hand, the driver permits subsequent pieces of work to be chucked rapidly merely by inserting between the jaws and clamping with a lock screw. The jaws are of square cold-rolled steel, V-notched, drilled and tapped for two cap screws and the locking screw.

Francis McCartin, Schenectady, N. Y.

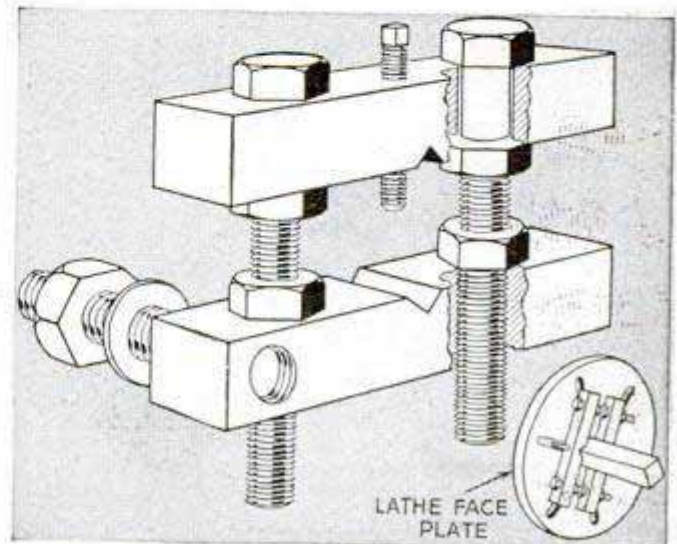



# FINISHING

Although floor finishing on old or new work is one of the simplest wood-finishing jobs, the process calls for careful attention to details. Here are ways of making old floors new, and new floors better

*By Charles H. Leach*

**F**INISHING either old or new hardwood floors requires the same procedure except that on an old floor you sometimes add one more step, that of removing the old finish. Some finishers take off the old varnish first with a paint and varnish remover. This will save time when sanding floors which have been varnished several coats. However, in most cases where the floor has been finished in the usual way, removal of the varnish before sanding is not necessary. The first step on either old or new floors is to smooth and fill the bare wood. On new floors this should be done before the floor has been walked on or exposed too long to changes of temperature and humidity. Dust, which settles and becomes embedded in the open grain of the wood by the action of moisture darkens the surface.

**Sanding:** On both new and old floors the edges of the boards will be slightly raised, due to shrinkage and also the clearance in the joints. This wavy surface



With an edger like this one you can sand the floor clear to the baseboard. Machines of this type are available at most hardware stores on a rental basis

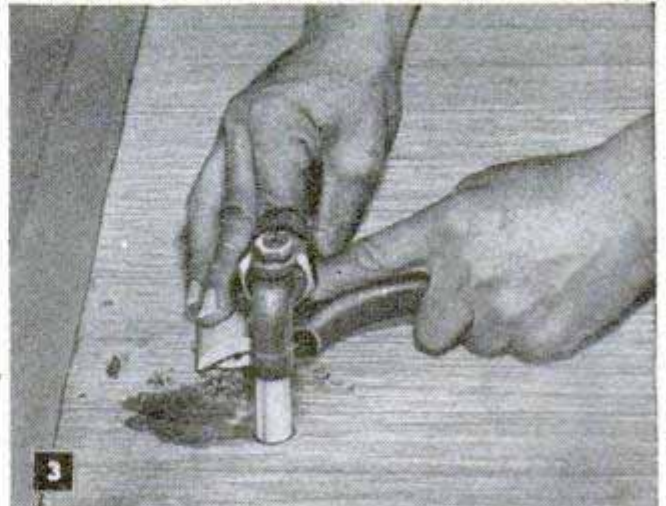

On nearly every floor there will be some spots you cannot reach with the sander, near drain pipes and in corners. Finish such places by hand with a scraper



# FLOORS

can be noted by passing the palm of your hand over the floor. Although these raised places can be removed with a hand scraper as was the regular practice in older methods, a much faster way is to go over the floor with a sanding machine.

There are several types of sanding machines available on a rental basis and you will need two of them. The drum-type machine, Fig. 1, is used for preparing the open area of the floor to within 2 or 3 in. of the baseboards, while the disk-type edger, Fig. 2, is designed to finish this remaining strip. It is best to remove the shoe mold before using this machine. If there are radiators in the room, these also should be taken out. Remove the finish from an old floor with a coarse abrasive on the sanding drum. Then use a medium grit for smoothing out the scratches left by the first abrasive and finally finish with a fine-grit abrasive. On a new floor in good condition, the coarse sanding is not necessary.

In the operation of these machines, it is essential to keep them in motion while the abrasive is in contact with the floor. Otherwise the abrasive will dig in. Speed of movement over the floor is not as important as uniformity. When operating the drum-type machine keep it in motion and raise the drum from the floor when you reach the baseboard. Roughing (first sanding) can be done in any direction, with the grain or across the grain. Most floor finishers run the machine at an angle of 45 deg. for the first sanding, as shown in Fig. 1. The rough sanding removes the old finish and evens up the individual floor boards. When finishing with the medium and fine abrasives, sanding is always done with the grain. Use coarse, medium and fine disks on the edger also, so that you get the same uniformity of finish all the way to the baseboards.

**Scraping:** There are always some spots you cannot reach even with both sanding machines, such as around radiator pipes, sink drains, and a small area in each corner of the room that the shoe mold will not cover. Here the old finish must be removed and the wood smoothed with a hand scraper, Fig. 3. Care must be taken when scraping around water pipes, as the wood is nearly always discolored. It's important to remove all this discoloration as otherwise it will show up with greater emphasis when the floor is finished.

**Dusting:** When the floor has been thoroughly sanded and scraped, dust off all window stools and frames, all doorframes,



The filler should be reduced with turpentine to a light, creamy consistency. Stir thoroughly to dissolve all lumps, and stir the mixture occasionally while using



Some finishers apply the filler with the grain as shown; others insist that it is better to apply it across the grain, as this method promotes greater absorption



Filler should always be rubbed in across the grain with a coarse cloth. Double the cloth several times to make a soft pad which will pick up excess material



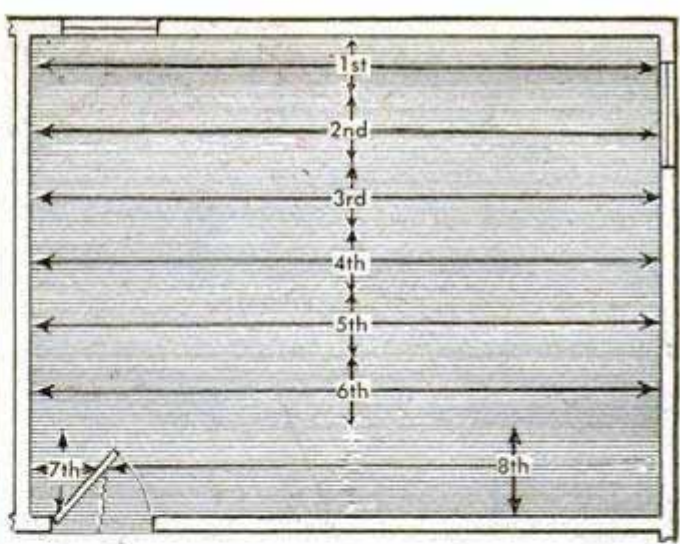

Above and left, apply sealers and varnish with long strokes, using a wide, well-filled brush. Begin in the corner farthest from the door and apply a strip about 2 ft. wide all the way across the room. Finish to the door with successive varnished strips of equal width

doors and baseboards. Use a painter's tack rag for this as it picks up dust without scattering it about. Dust the floor thoroughly with the same cloth. Frequent dusting while the finishing process is going on is important. If light dust accumulates in the room air movement may dislodge it. Floating dust particles always settle on the freshly varnished surface, and cause flecking and spotting of the finish.

**Filling:** All porous woods must be filled. Some finishers prefer to apply a light oil stain before filling, to give the floor an even color tone. Others mix the stain with the filler. On a new floor this latter method is faster and gives good results, but on either old or new work, the former method generally is considered the best practice. In either case, a small quantity of stain is added to the filler, Fig. 4, to prevent it from lightening the natural color of the wood after application. Filler should be applied with a brush, in the direction of the grain, as in Fig. 5, and then rubbed crosswise of the grain with burlap or other coarse cloth, as in Fig. 6. Continue rubbing until the filler begins to set or flatten, which it will do after a few minutes. Keep the excess material wiped off as you go along. A few drops of turpentine on the cloth will help to remove excess filler that sticks tightly in spots. After applying, allow the filler to dry for 24 to 36 hours. Then go over the floor with fine steel wool, rubbing at an angle with the grain, to remove all traces of filler that have hardened on the surface.

**Varnishing:** Although not necessary, it's best to first cover your shoes with cloth boot socks before you step on the floor. A smudge from a rubber heel is difficult to remove. Next, apply a floor sealer with a

wide brush. Start in a corner and work a strip from one side of the room to the other, Fig. 7, laying on the material with a full brush and with the grain of the wood. After allowing this coat to dry in a temperature of 68 to 70 deg., smooth with fine steel wool and dust thoroughly. Follow with one coat of high-grade floor varnish. Flow on the varnish coat with a full brush, covering narrow strips successively, as in the detail at the right of Fig. 7. Finish up at the door. Allow this coat to dry for a longer period than the first, and then smooth again with fine steel wool. If, after drying, the floor shows a dull spot here and there where the wood grain has taken up the finish, you will need to apply a third coat. Usually, however, one coat of sealer and one of varnish are ample on a well-filled floor.

**Waxing:** Wax protects against scratches because it provides a "slip" surface. Grit, shoe nails, toys or other sharp objects tend to slide over a waxed surface without gouging or scratching. However, a rubbed and polished wax coating is slippery and rugs placed on such a floor may be the cause of injury to someone from falling. Avoid this danger by using a "self-polishing" wax which gives a pleasing gloss without being slippery.

Don't wax the floor immediately after the varnish is dry. Allow at least two weeks, although more time is better. If a paste wax is used, apply it to the sealed floor in thin applications with a cloth pad. Two light coats of wax are easier to polish than one heavy coat. Like sanding machines, wax-polishing machines are available on a rental basis. Some polish with a rotating brush, others with a cloth belt.



# Bushing Puller Makes Gear Changing Easy

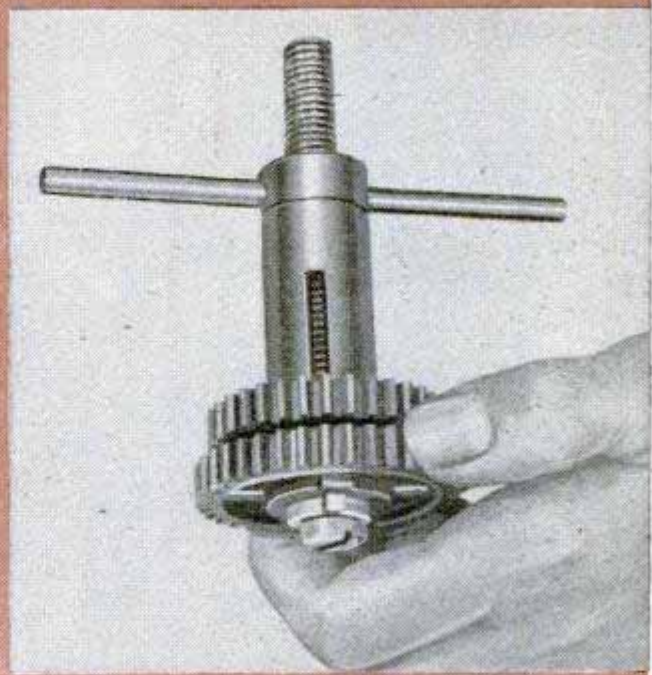
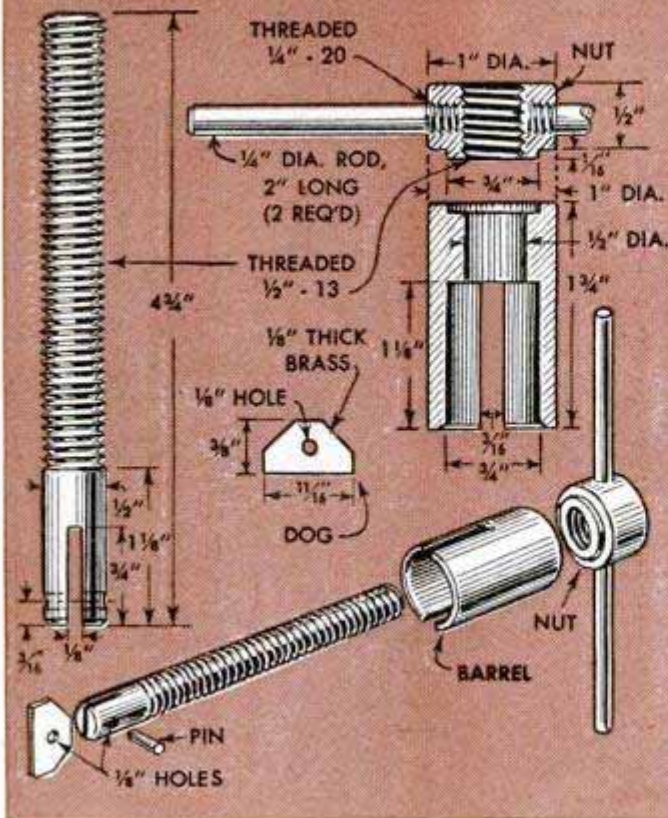

By altering dimensions, this bushing puller can be made up for a wide range of sizes. It gives a straight pull that does not damage the work

On some change-gear lathes it is necessary to pull the bushings of individual gears when making setups for various carriage speeds and for thread cutting. To speed up this job and also to avoid any danger of damaging the parts, make the handy bushing puller, detailed above. It is dimensioned for lathe-gear bushings having a  $\frac{3}{4}$ -in. outside diameter and a  $\frac{1}{2}$ -in. bore. By altering dimensions of the barrel and the threaded puller rod, the tool can be made to fit bushings of other sizes and types. The barrel is turned from cold-rolled steel. The rod must be slightly smaller in diameter than the bore of the bushing and the barrel must be bored

slightly larger than the outside diameter of the bushing. Slots in the barrel allow keys on the lathe-gear bushings to pass, but for straight sleeve bushings the slots are not needed. The rod is turned from  $\frac{1}{2}$ -in. steel shafting and threaded with a  $\frac{1}{2}$ -13 thread. The unthreaded end is slotted to receive a brass dog pivoted on a pin to allow it to pass through the bushing. Brass or bronze is used for the nut, which is turned with a  $\frac{1}{16}$ -in. shoulder to seat in a counterbore as shown. To use the puller, the nut is turned back on the rod, and the rod, with the dog in the folded position, is passed through the bushing. Then turn the dog to engage the end of the bushing.

## Index Mark on Compound Slide Shows Maximum Cross-Feed Limits

Accidentally backing a compound slide off the feed screw on a metal-turning lathe will not happen if a white index mark is painted on the saddle and the bottom slide of the rest to show the operator the maximum length of the thread. Run the cross-feed out to the limits of the thread before marking. This makes it easy to prevent running out the saddle too far by merely watching the marks and stopping when the two are aligned. This idea is especially helpful when a beginner is unfamiliar with the compound slide. If you wish, the index marks can be made by applying narrow strips of adhesive tape instead of paint to the saddle and bottom slide.





## Practical Steel Foot Scraper Utilizes Old Wagon Wheel



There's good use to be had from that old steel wagon wheel rusting away behind the barn. Place it near the porch steps or by the rear entrance, give it a coat of paint and you'll have an excellent foot scraper. A stake through the hub will anchor it.

## Dealer Furnishes Bulletin Board As Service to Customers

As an added service to his customers, one feed-and-seed dealer mounted a bulletin board in his store to be used by people in the community to post "For Sale" or "Wanted" items. The service is free and has a double purpose in that it brings people into the store and builds up good will among potential customers. Users of the board take care of removal of the signs when they are no longer needed.

LeRoy Lincoln, Minneapolis, Minn.

## Soft-Nosed Punch Improvised From Auto Kingpin

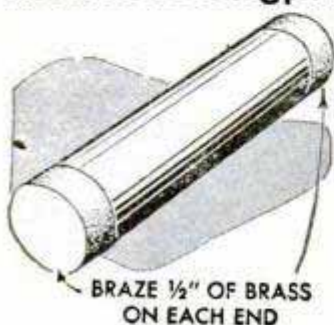

Needing a soft-nosed punch or drift to drive a threaded axle, I made one from an auto kingpin. Being made from hardened steel, the kingpin will withstand ham-

mering, and by building up a 1/2-in. thickness of brass brazing rod on each end of the pin, I obtained a soft head that would not damage the work. Where a punch of greater length is needed, two or more kingpins can be brazed end-to-end, after first chamfering the abutting ends.

John A. Stankiewicz, Louisville, Ky.

## Pail of Water Steadies Plumb Bob When Working in High Wind

If you are working in a high wind, a plumb bob and line will remain fairly steady when the bob is immersed in a pail of water. If a pail is not available, shelter the plumb bob and string from the direct action

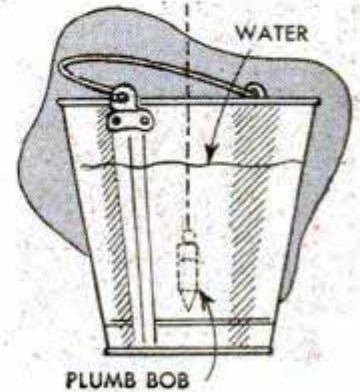

of the wind by standing a wide board on the windward side or by blocking the wind with your body.

Charles Lothardt, Baltimore, Md.

## Zigzag Rule Is Substitute For Contour Gauge

When wiring my garage recently, I found that a carpenter's folding rule of the zigzag type was just the thing to determine the shape to bend the conduit. After adjusting the folding sections of the rule to conform to the wall, I used it as a contour gauge and bent the conduit accordingly. The same idea can be used to determine the amount of offset in a water pipe.—E. W. Moses, Jr., Blacksburg, Va.

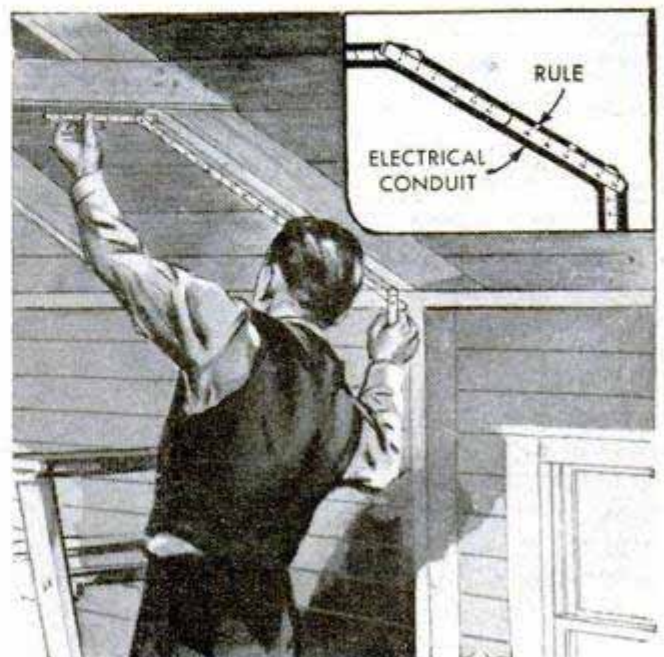



# Bottle Feeder Weans Calves at an Early Age

Farmers and dairymen will find this calf weaner a real timesaver. A simple bottle rack, designed to hold either six or twelve ½-gal. bottles, is mounted on the feed-trough side of a row of specially made stanchions, Figs. 1 and 2. When the nursing calves have finished, the bottles are removed from the rack, which then can be lifted off the feed trough. Stanchions are graduated in size from 4 to 5½ in. Baby calves start in the smaller stanchions and are moved to the larger sizes as they grow. In this way calves can be weaned from milk to dry feed in a much shorter time. As shown in Fig. 2, the feed trough is fitted with metal partitions, which are attached to the stanchion frames with bolts.



Above, calf nursing from ½-gal. bottle in same position as it would from mother. Below, front view of stanchions with bottle rack in place. Note partitions

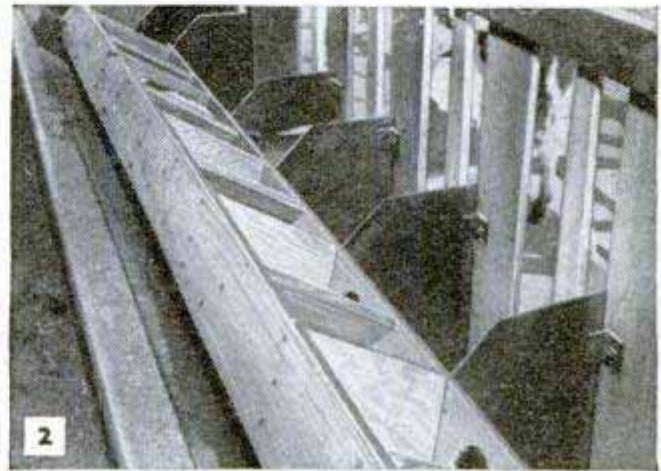
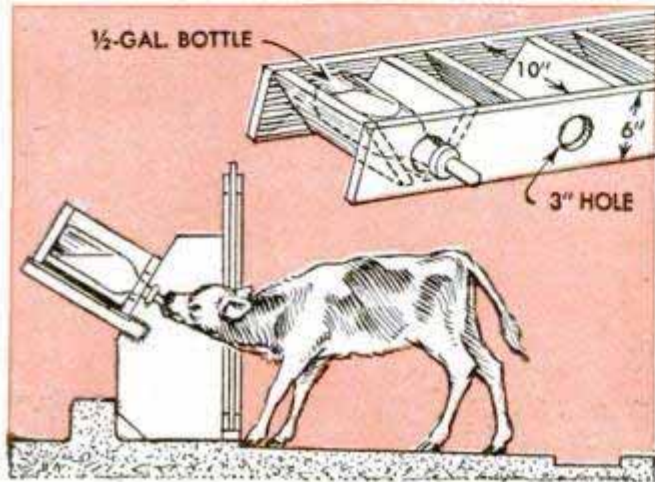

## Water Level Maintained in Livestock Tank With Automatic Control

Although use of a float-and-lever mechanism to control flow of water is not new, here's an application of the idea that will automatically keep a watering tank filled

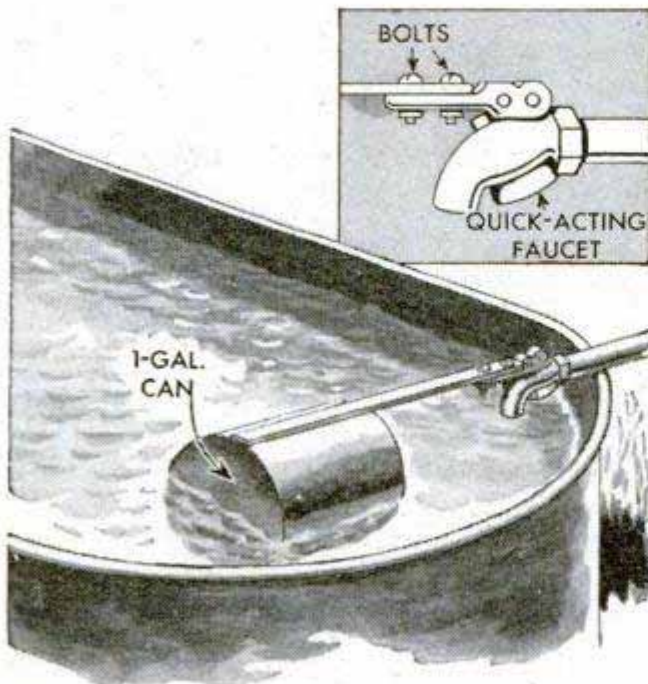

at a constant level and save many a trip to the tank to turn the faucet on and off. Principal parts of the mechanism are: A 1-gal. can, flat-iron lever and a quick-acting faucet of the type that opens when the handle is depressed. Seal the can so that it does not leak and solder it to one end of the lever. Then bolt the other end to the faucet handle and test for operation. It may be necessary to shorten or lengthen the lever somewhat to secure proper balance so the weight of the can will open the faucet as the water level drops. After the unit is assembled and operating satisfactorily, paint it to prevent rusting. Although not shown, a guard bolted to the tank, covering the float and faucet, will protect it from damage by livestock.

Herbert E. Fey, New Braunfels, Tex.

☐ Shorten the center tine of a three-tine pitchfork to about 7 in., leaving the outside tines 1 in. longer, dull the points slightly by grinding them round and you will be able to handle bundles of cornstalks almost as easily as bundles of grain.



## Worker Wears Checkered Cap To Indicate Deafness



In one shop, workers who have defective hearing wear special checkered caps. These serve as a warning to crane operators, truck drivers, etc., that a sound audible to most people cannot be heard by a worker wearing the cap. Other shop hands warn the hard-of-hearing person of the approach of cranes and trucks. Often it is possible to assign such a worker to a part of the shop where the traffic is not heavy.

## Heavy Canvas Cleans Eraser

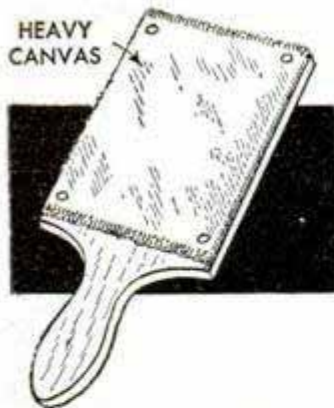

While cleaning the pencil smudges from a large drawing after inking, one draftsman found that he could clean his eraser thoroughly by rubbing it on a piece of heavy canvas. Obtain a small piece of canvas and mount it on a paddle board. This will hold the canvas taut and make it easy to locate when needed. If you wish, drill a hole in the handle to permit hanging.

Francis A. Moore, Rochester, N. Y.

## Sticks Made From Solder Scraps

Neat solder sticks can be made from scraps of solder by using a sheet of corrugated cardboard for molds. Each corrugation serves as a "mold" or tube for an

individual stick. After the sheet has been cut so there are enough molds of the proper length, seal one end of each corrugation with putty and form a V-shaped trough at the other end for pouring the metal. This is done by spreading the flat part of the sheet and making a putty dam at each end. Pour the metal and, after it has cooled, remove the cardboard.

M. R. Thornburg, Whittier, Calif.

## Car Axle Provides Gate Hinges

The front axle from an old car will make a strong and serviceable pair of hinges for a heavy farm gate. Cut the axle in half and drill three holes in each of the halves to bolt them firmly to the gate uprights. Either large washers or a piece of flat iron drilled with registering holes should be placed on the opposite side of the uprights to serve as a bearing plate for the nuts. Then, bore holes through the post to take the wheel spindles and fasten them in place rigidly with wheel nuts and washers.

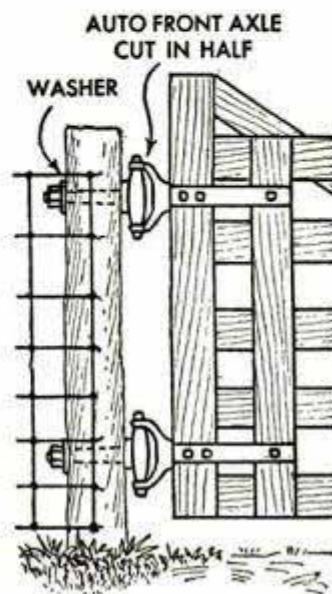

## Outside Caliper Has Scale

With this outside caliper, the thickness of the walls of pipe and tubing may be measured several inches from the end, and the measurement noted while the caliper is still in position. A scale which gives a direct reading from the measuring points is mounted at the opposite end of the caliper. Distances from the pivot point to scale A, and the measuring points, B, must be exactly equal, as the slightest variation will give an inaccurate reading on the scale. The scale should read zero when the measuring points are in the closed position.

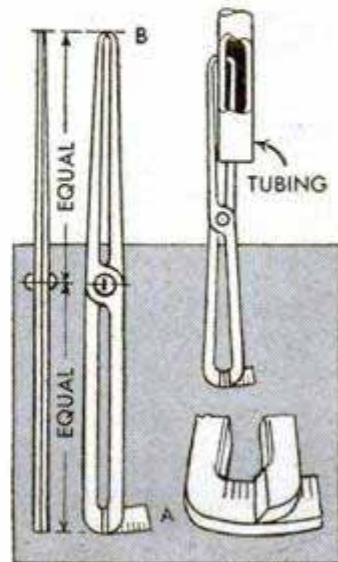



# "SEA CRAFT"

## α 25-ft. Cabin Cruiser

### Part II

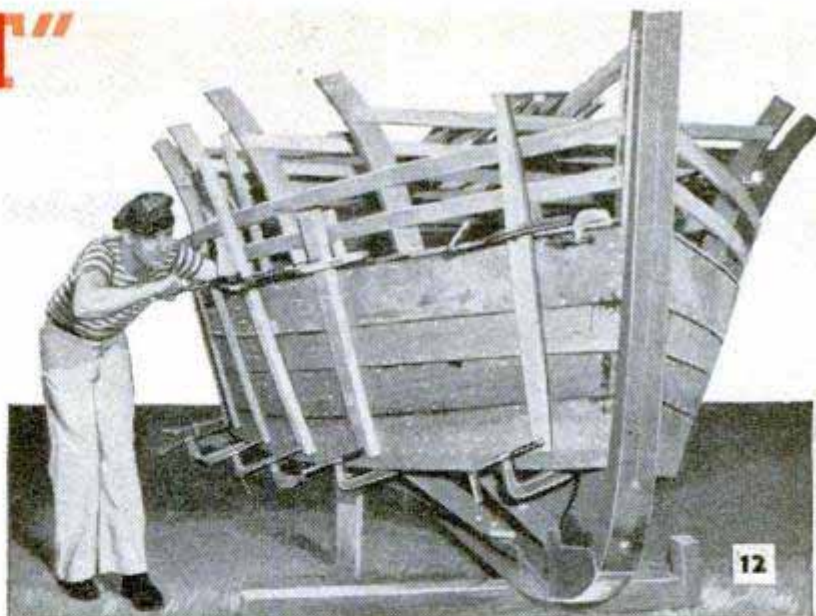

WHEN the keel, apron and bow-stem parts have been bolted together as described in Part I, a suitable erection site must be selected. As a boat of this size, in most cases, requires being built outdoors on uneven ground, blocking is necessary to support the bottom of the keel at the correct angle in relation to the base line. A leveled chalk line stretched between two stakes to correspond to the base line of the profile drawing, will serve as a starting point from which to measure heights of the blocks. The exact heights can be determined by taking measurements from the base line to the bottom of the keel on the full-size profile drawing. Two wedges driven between the keel and a block, Fig. 19, give close adjustment. The bow stem also must be lined up perpendicular athwartships. This can be done with a plumb line fastened to the top of the bow stem, as in Fig. 28.

By Edward Colby

The transom is made as shown in Figs. 15 and 16. The aft edges of the top and bottom timbers have a convex curve of 12-ft. radius as in the plan view of Part I. The top timber is crowned 2 in. and the bottom timber is notched for the apron, and tapered  $\frac{1}{8}$  in. from keel to chine on the lower surface. When assembled, the transom is bolted to the keel with a knee block, as indicated in the lower left-hand detail of Fig. 16, and then braced to hold it in position. It must be perpendicular to the base line and exactly centered on the keel.

Before assembling the rib frames on the keel, refer to the profile view, Fig. 4, of Part I. Note that the No. 6 frame straddles the station line and that frames 1 to 5 inclusive are forward of the station lines, whereas frames 7 to 12 inclusive are aft of the station lines. This refers only to the thickness of the rib and does not apply to

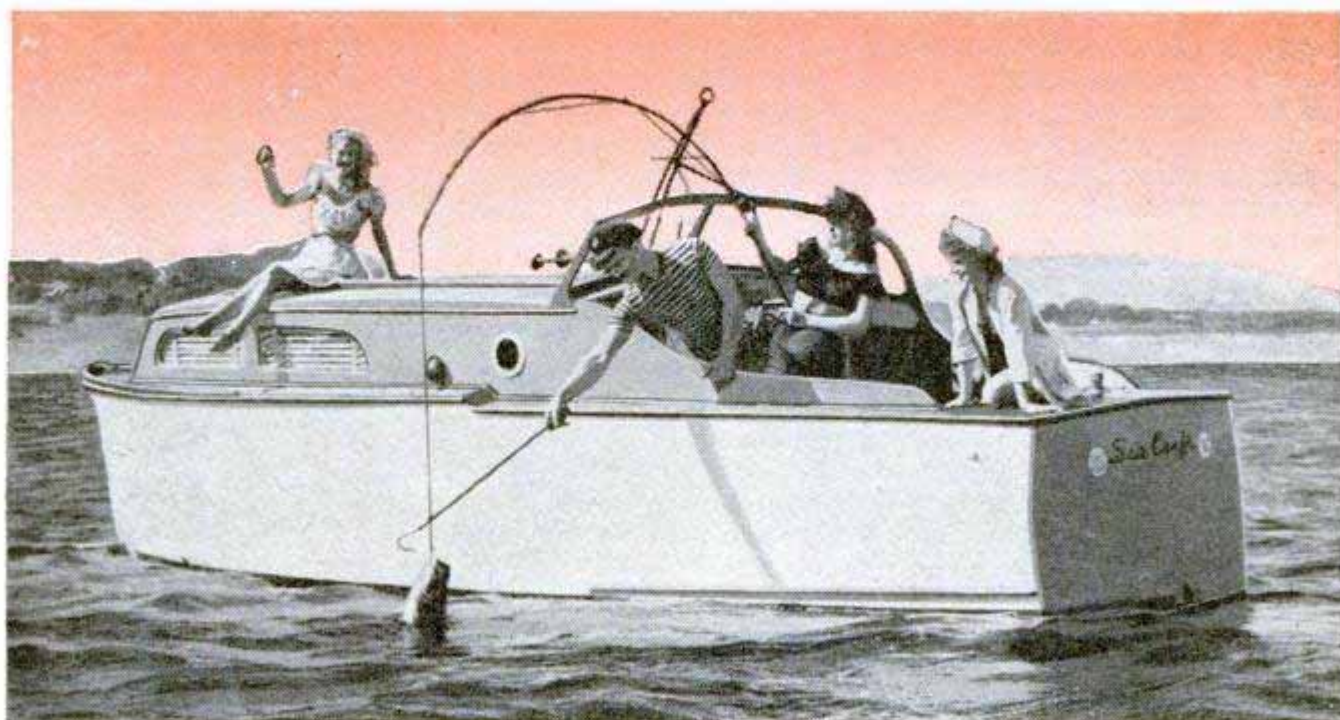



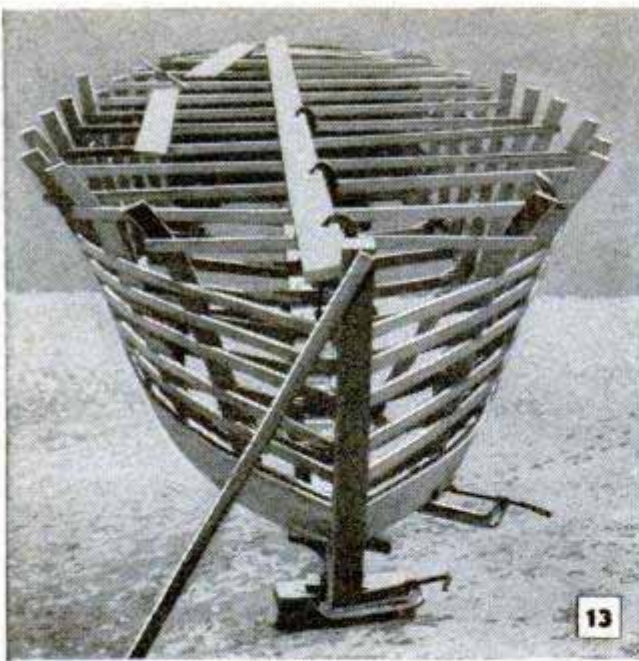

13

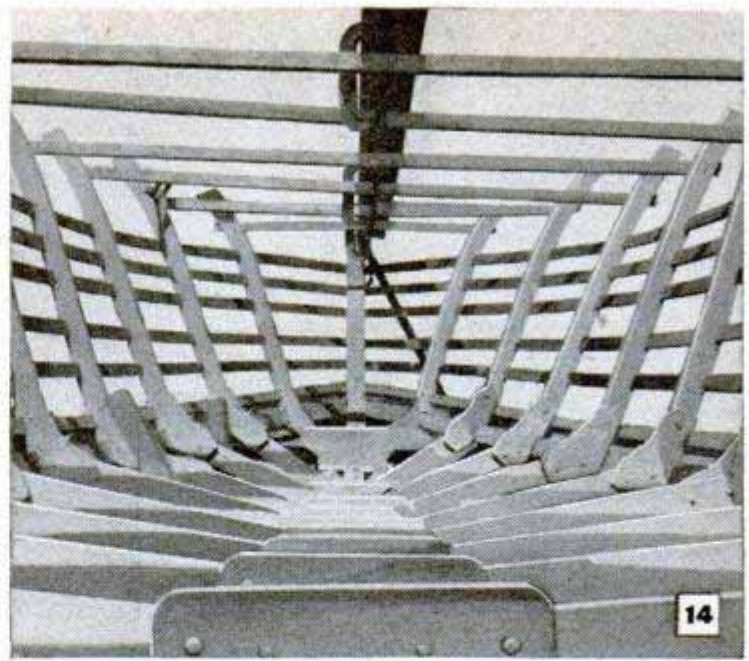

14

the thickness of the tie bar. To start assembling, first mark each station line on the apron. Then draw a second line representing the thickness of the rib and set up the frames between the two lines. Use galvanized lag bolts to fasten the frames to the apron, Fig. 17. A chalk line from the center of the keel to the center of the transom, Fig. 16, is used to line up the frames with the centerlines marked on the temporary tie bars on each frame. The frames also must be at right angles to the keel athwartships and should be well braced.

The chine, which is vertical-grained oak, is fitted to the frames in one piece from bow to stern. To determine the position on the bow stem where the chine notch should be cut, clamp the chine in the rib notches and bend it over to the bow stem. The chine notch on the other side of the bow stem should be exactly opposite this point. Before fastening them permanently, be sure none of the station frames has been sprung out of position. A board clamped across the tie bars as in Figs. 13 and 14, will help keep the frames aligned.

Screw the chines to the bow stem and transom with 1½-in. No. 9 galvanized screws and bolt them to each rib gusset as in Fig. 17. Sea Craft is planked with ¾-in. Philippine mahogany, but other woods such as white cedar or vertical-grained Douglas fir may be used. Be sure that all lumber is boat stock and keep in mind that it must be wider than the final width of the planks. In some cases, a 10-in. piece will make only a 6-in. plank. There is no set width for the finished planking. However, planking of uniform widths will give the best appearance. The battens are ¾ by 2-in. and of the same material as the planking. They are notched into the ribs and may be spliced over a rib. When laying out

A plank, extending full length of boat and clamped to temporary tie bars, as shown in upper left photo, will help keep frames in proper alignment when installing the battens and planks. Photo above shows interior of the assembled frames looking forward

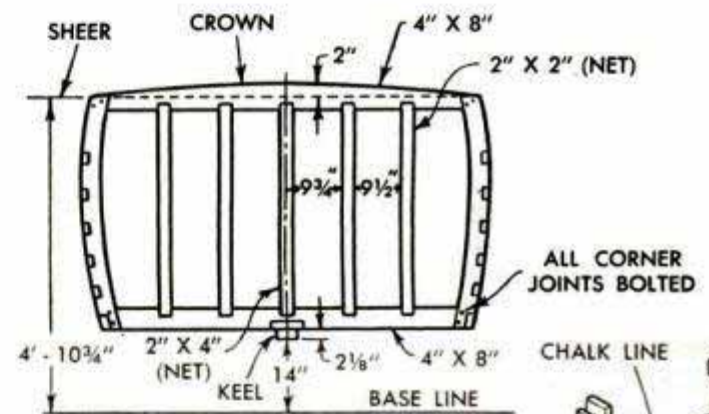

15 TRANSOM

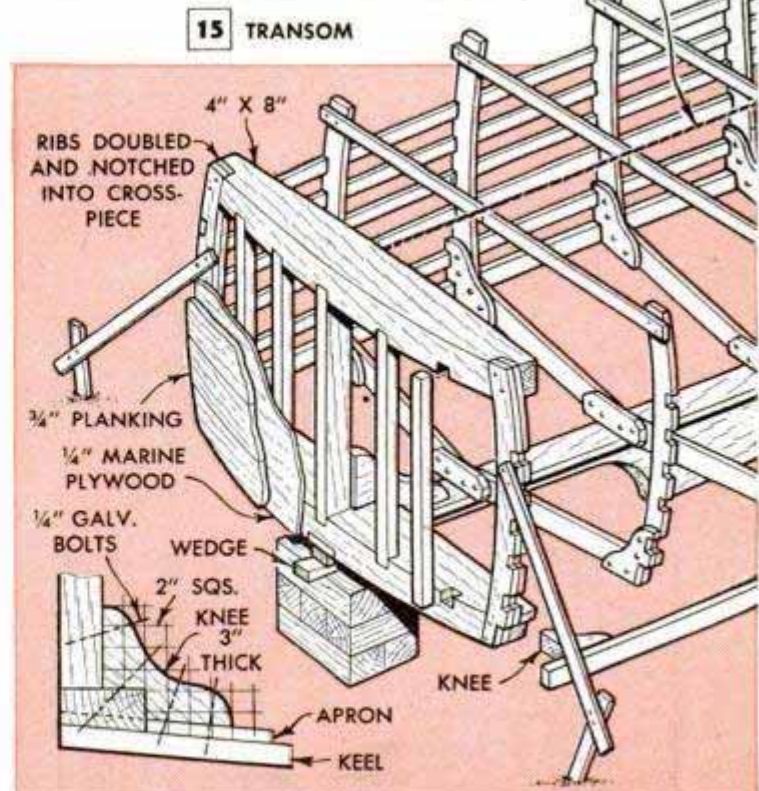



the batten notches, measure upward from the bottom of the chine so that the center-to-center distance between the battens will equal the width of the planks. In this way, the seams between the planks will be directly over the centers of the battens as in Fig. 21. The battens are notched into the bow stem the same as the chines so the planking will fit snugly into a rabbet cut in the bow stem, Fig. 18. Notches are cut at intervals between the rabbet and bearding lines and checked for correct depth and angle with a fid, which is a small block the same thickness as the planking, Fig. 18. Then the waste is removed between these notches to form a continuous rabbet. When installing the battens alternate them from port to starboard side to equalize the strain on the frames.

As the side planks lap over the transom planking, the transom must be planked first. Cover the transom frame with  $\frac{1}{4}$ -in. marine plywood and fasten with flat-headed screws, countersunk. Then screw  $\frac{3}{4}$ -in.

mahogany planking over the plywood, counterboring the screw holes to take wooden plugs as in Fig. 21. For a neat appearance, run the grain of the plugs the same way as the grain of the planking. When planking the sides, start at the chine and alternate from side to side, being sure that the plank ends fit correctly into the bow-stem rabbet. Clamp the plank in place at the bow stem and mark for cutting. Then remove, cut and reclamp for further fitting. Repeat until you have a good joint. It will be necessary to steam the forward ends of all planks to prevent breakage. To avoid marring the wood when clamping the planks, use a strip of wood between the clamp and plank as in Figs. 12 and 20. Work from the bow toward the stern, keeping the bottom edge of the plank even with the bottom edge of the chine. When in place, mark the inside surface of the plank along the top edge of the first batten. Then remove the plank and draw another line 1 in. in toward the

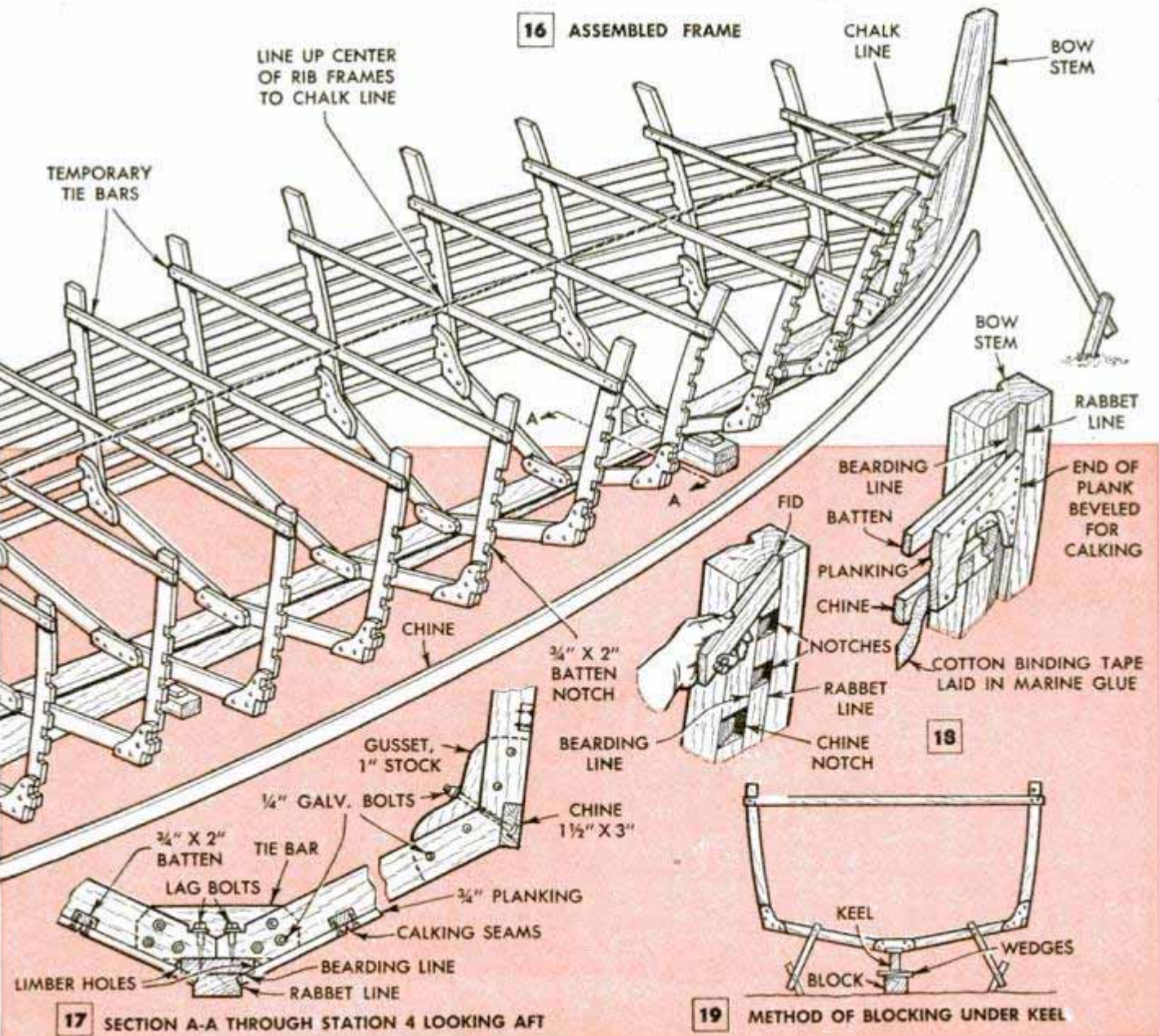

17 SECTION A-A THROUGH STATION 4 LOOKING AFT

19 METHOD OF BLOCKING UNDER KEEL



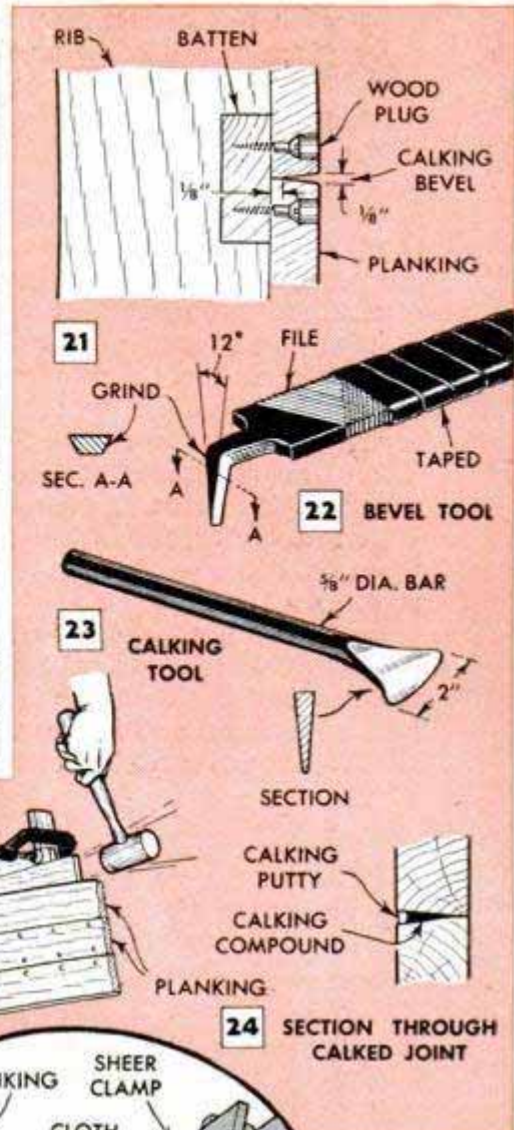
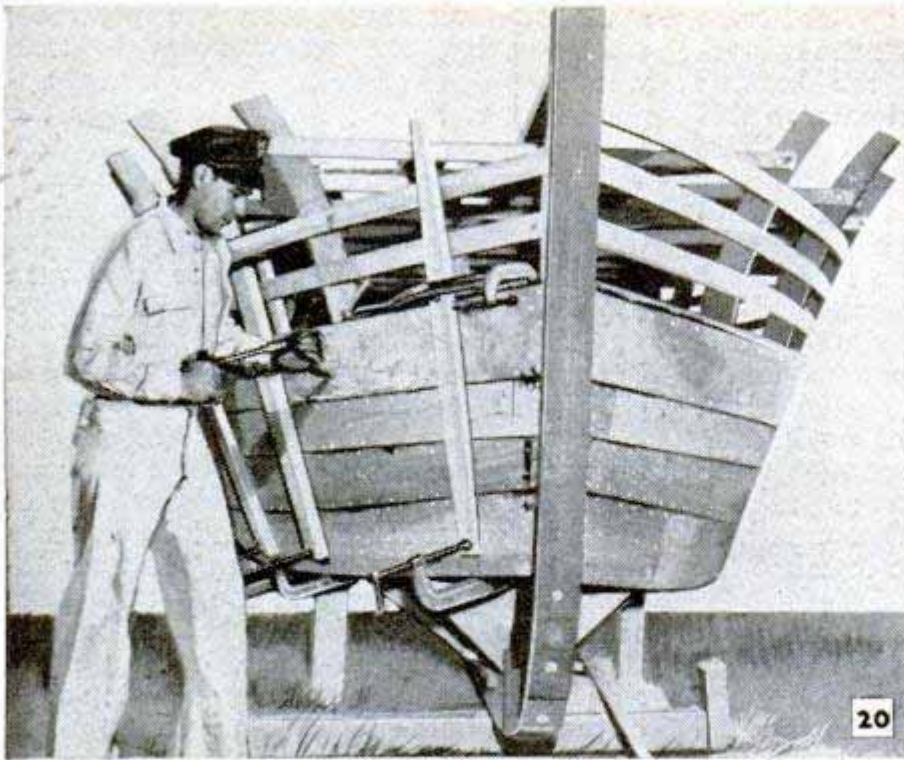

chine edge. This is the cutting line which will bring the edge of the plank over the center of the batten. A slight bevel for calking, as in Fig. 21, should be planed along the edge. Before attaching the plank permanently, coat the chine and lower half of the first batten with marine glue. Apply muslin or cotton binding tape and more glue. Then clamp the plank firmly in place and fasten with  $1\frac{1}{4}$ -in. No. 8 flat-headed galvanized screws at the battens and  $1\frac{1}{2}$ -in. screws at the bow stem. Stagger all screws so they do not run in the same grain and place about 1 in. apart at the bow stem and 3 in. apart along the battens and ribs. Counterbore all screw holes for wooden plugs to be added later.

Planks can be spliced between the ribs amidships where the bend is not severe. A butt block, shown in the inset of Fig. 26, is used to join the ends of the planks. Use muslin and plenty of glue between the block and planks. Splices in adjacent planks should be staggered as in Fig. 26. Binding tape is not needed in seams above the L. W. L. Fig. 25 shows how the edges of the planks are drawn tightly together with wedge blocks.

Turn the boat over after all the side planks, except the sheer plank, are in place. This is left off to prevent it from being damaged. The bow-stem rabbet must be continued along the entire length of the keel, and the apron must be beveled flush with the bottom edge of the ribs. At this time, be sure the notches that serve as limber holes have been cut in the ribs on each side of the apron, Fig. 17. Also be sure the stopwaters are in place. These are  $\frac{1}{2}$ -in. softwood dowels dipped in paint and

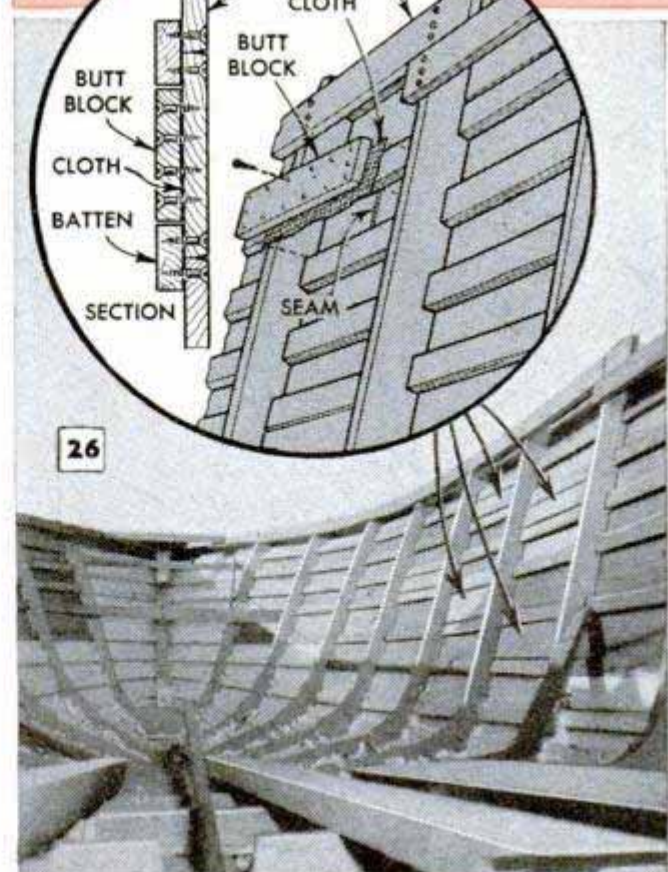

Planks are butted together between ribs and joined with a butt block. Adjacent splices are staggered



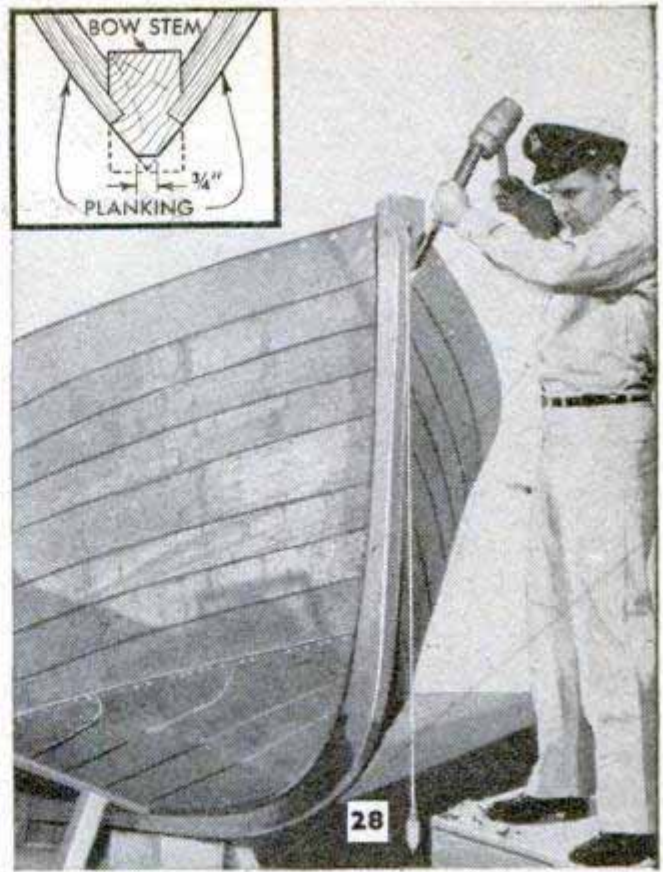

driven into holes drilled through the keel athwartships between the rabbet and bearding lines at four places as in Figs. 4 and 9 of Part I.

The bottom edge of the chine and chine plank must be planed flush with the bottoms of the ribs. Test with a small square as detailed in Fig. 27. The bottom planks, especially forward, require considerable fitting and cutting to bring them to exact shape. A cardboard template for the forward end of each plank will simplify this fitting job. Fig. 27 shows the unusual contours the bottom planks assume at the forward end. It is best to install the bottom battens as the planking proceeds. Binding tape laid in marine glue is used on all bottom planks. Install the planks adjacent to the keel first, and then work toward the chine.

When this much of the planking is completed, wooden plugs dipped in marine glue are driven into the counterbored screw holes and cut off flush with the surface. The plugs can be purchased and should be of the same material as the planking. The bottom of the keel is planed flat to approximately the position of the second station. From this point forward the keel takes a slight bevel, which tapers to a sharp bevel at the bow stem, Fig. 28. Sand, calk and paint the bottom before turning the hull upright. Although a power belt sander is preferred, a disk sander may be used if care is taken not to gouge the planking. To clean out the plank joints for calking, bend and grind the tang of a

file as shown in Fig. 22. Cotton marine calking is driven into the seams with the calking tool shown in Fig. 23. Use plenty of calking along the keel seams. However, one strip between planks is usually enough because room must be left for the calking putty, which is applied with a knife over the calking cotton. The putty is slightly indented below the surface as in Fig. 24. To prevent the bottom from drying out, give it a coat of copper bottom paint. The hull is quite heavy now so probably you will need more help to turn it over. As the boat will remain in this position until it is finished, level the L. W. L. and securely block the hull in position.

Next, install the top or sheer planks. Carefully fit the bottom edge of the planks and clamp in position on the hull. Transfer the sheer-line marks on the ribs to the sheer planks and cut them slightly oversize at the sheer lines to allow for planing later. When the sheer planking is in place, plug the screw holes and calk the seams. Then sand the transom smooth, fill with a mahogany-colored wood filler and follow with two coats of marine varnish. The inside of the hull is painted with a mixture of white lead and linseed oil.

The best way to bevel the edge of the bow stem is with a wide wood chisel as shown in Fig. 28. Although there is enough stock to bring the stem to a sharp edge, most boatbuilders prefer a flat edge about  $\frac{3}{4}$  in. wide which is faced with a half-round metal strip.

(To be continued)



# Fence Divides Poultry Pen to Supply Green Food

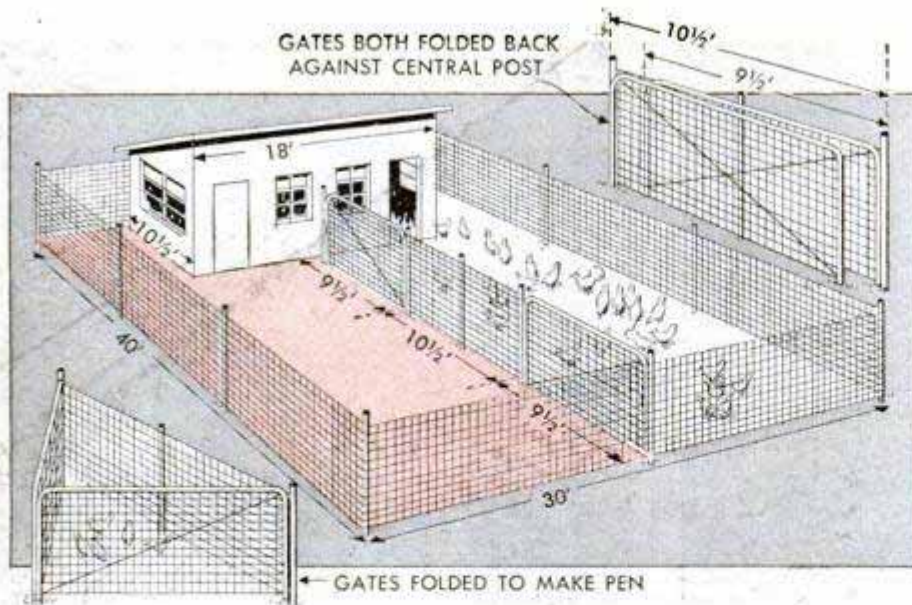

Keeping a flock penned alternately on one side of a divided yard while feed is growing in the other, assures the chickens fresh "greens" all through the summer months. Note that the gates of the fence also fold to form a small culling pen. By using dimensions proportionate to those given in the drawing for the gate section, a similar fence may be built in a yard of almost any size.—D. Jay Rhoades, Omaha, Nebr.

## Reversible Feeding Trough Keeps One Side Free of Ice and Snow

You can solve the annoying problem of ice and snow accumulating in the feed trough during the winter time, by building this reversible one that merely is turned over when the top side is not usable. Unless the weather is extremely cold, the ice usually will melt from the underside leaving it ready for use at the next feeding. Build the trough with a double-V bottom as shown, using one board wide enough to extend from corner to corner diagonally and two narrower boards nailed in place to form a V-shape on each side.

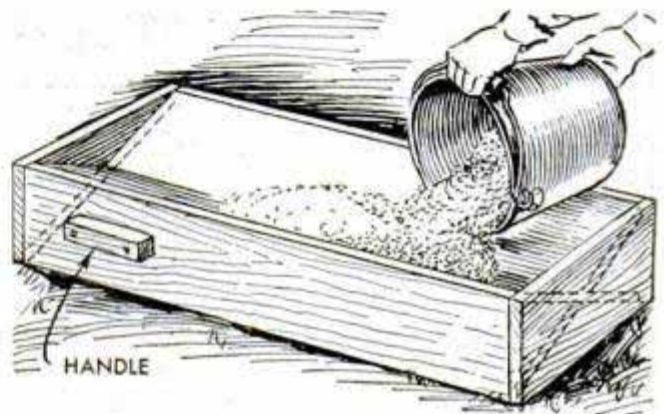

## Pipe-and-Chain Rigging Employs Tractor to Stretch Wire Fencing

Having to erect a woven-wire fence recently without help, I was able to do the job quickly and easily by putting the tractor to work to do the stretching. This was done by first twisting the ends of the fencing around a length of pipe and resting it on a board. Then I hooked a strong chain into the ends of the pipe and attached a

steel tow cable to it in the manner shown. With the tractor facing the fence, I backed it away slowly until the wire was taut, and set the brakes. Then all I had to do was drive the staples. Note that the removable post supporting the tow cable must be about half the height of the fence to produce an even pull at both top and bottom of the fencing.

L. A. Potts, Panama City, Fla.

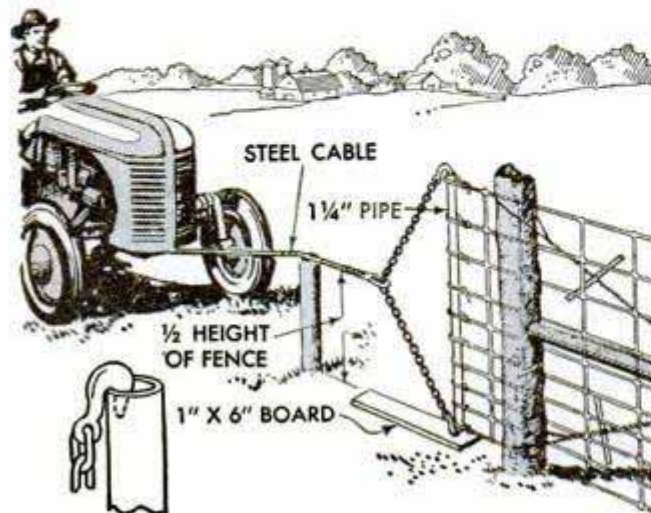

## Tar Paper Protects Binder Canvas From Damage by Rodents

An effective way to keep rats and mice from damaging binder canvas in storage is to wrap it in a strip of tar paper. Use a strip longer and wider than the canvas and roll it as shown.





## Matching Joints Cut With Saw Guide

For a shop with limited woodworking facilities, this circular-saw guide or jig will aid in making open-end, mortise-and-tenon corner joints for boxes, chests and similar types of containers requiring matching corners. Although the dimensions of the guide will vary according to the size of box being made and the particular saw being used, the ones given are suitable for most work. The base is a  $\frac{1}{4}$ -in. plywood panel, 12 by 24 in. long and the crosspiece is a 2 by 4-in. board, 24 in. long. The crosspiece is screwed lengthwise to the panel, as indicated by the photographs, and two guide strips that slide in the saw-table grooves are fastened to the underside of the base. These strips should be about 18 in. long. The gauge strip, which fits into the corner formed by the crosspiece and the base, is the only other piece required, and its size and position are determined by the requirements of the job at hand. For example, assuming that you wish to make a box with  $\frac{3}{8}$ -in. mortise-and-tenon corner joints, set the dado head for a  $\frac{3}{8}$ -in. cut and saw through the crosspiece and base for a distance of 5 in.

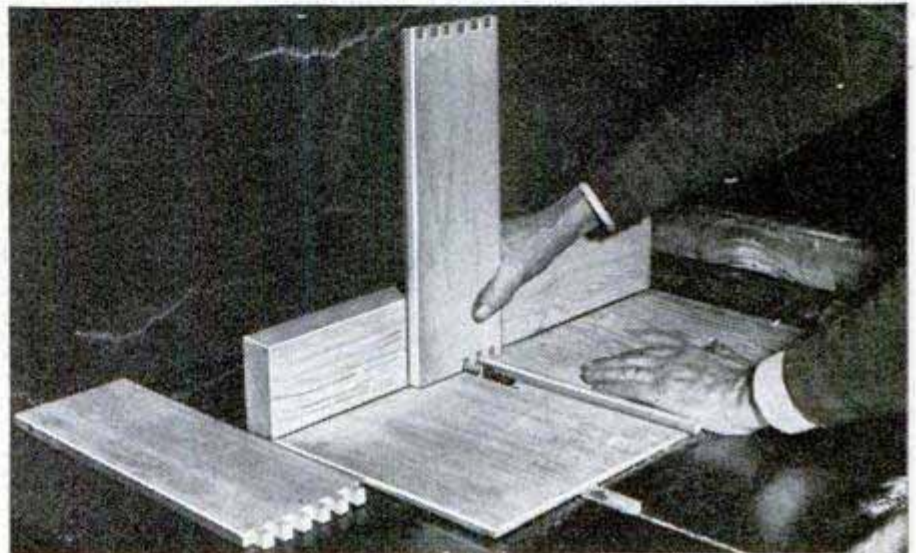
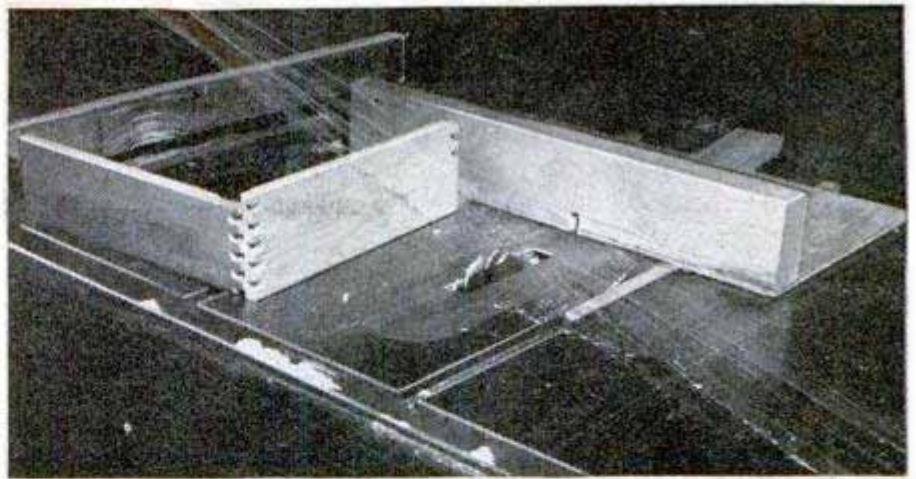

Trim the gauge strip to a width of  $\frac{3}{8}$  in. and fasten it exactly its own width from the right side of, and parallel with, the cut in the base. Then, to start the cuts on end pieces, hold them against the strip. Side pieces are started  $\frac{3}{8}$  in.—the width of a mortise or notch—to the left of the gauge strip. As each notch is cut, place it over the strip to cut the next one.

Wm. B. Swindells, Baltimore, Md.

## Wire-Fencing "Unloader" Speeds Removal of Material From Flat-Bed Truck

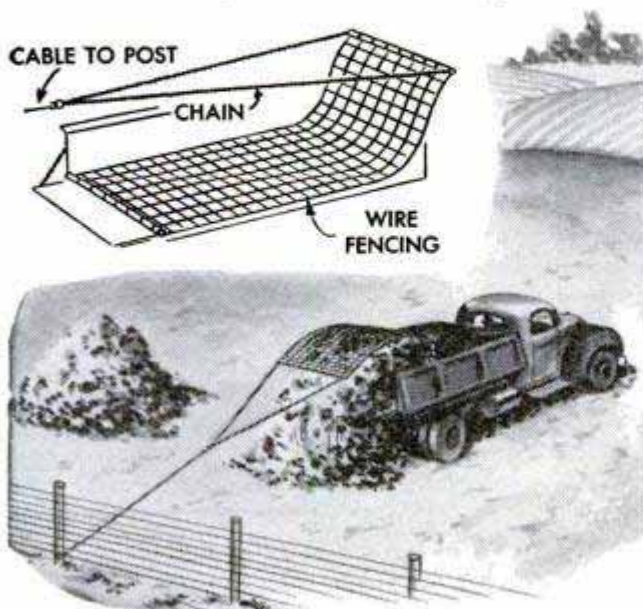

Removing a load by hand from a flat-bed truck is slow and laborious work, but with this wire-fencing and chain arrangement, corn fodder, stovewood and other materials that will not slip through the mesh can be unloaded in short order. For finer materials, use a fine-mesh screen. The detail shows how the fencing is placed on the bed of the truck with one end fastened near the tail gate and the free end reinforced with a spreader made from a length of 2-in. pipe to which chains and a cable are attached. Load the truck in the ordinary manner, putting the load on top of the fencing. To unload, tie the cable to a post and drive the truck forward slowly, being careful not to tear the fencing from the tail gate. Carry a stake to anchor the cable in case a post is not near.



# POWER MIXER for FEED, SEED

By Edward R. Lucas

Used car parts and a 55-gal. oil drum are the principal units of this motor-driven mixer, which is used for mixing concrete, dry and moist feeds, and for dusting seed grains for fungus diseases

BUILT with metal runners cut from an old car frame, this electrically driven, self-contained mixer is easily moved to the work. It will handle almost any dry or moist material, such as finely ground feeds, cement aggregate and small grains which are to be dusted for fungus diseases. A triple-speed reduction through a two-stage V-belt drive, plus a pinion and gear, means that the machine requires only a 1/4-hp. electric motor to handle the heaviest loads.

Fig. 1 pictures this multiple drive while Fig. 2 details the complete construction. A section of an old car frame and a number of chassis parts (rods, braces and the like) are welded together to make the frame for the machine. Next, pieces of channel iron are welded to the bottom of the oil drum to make a square base for a brake drum. Two Model-A Ford starter gears, placed side by side with the teeth of the gears in exact register, are welded to the brake drum. A front-wheel hub as-

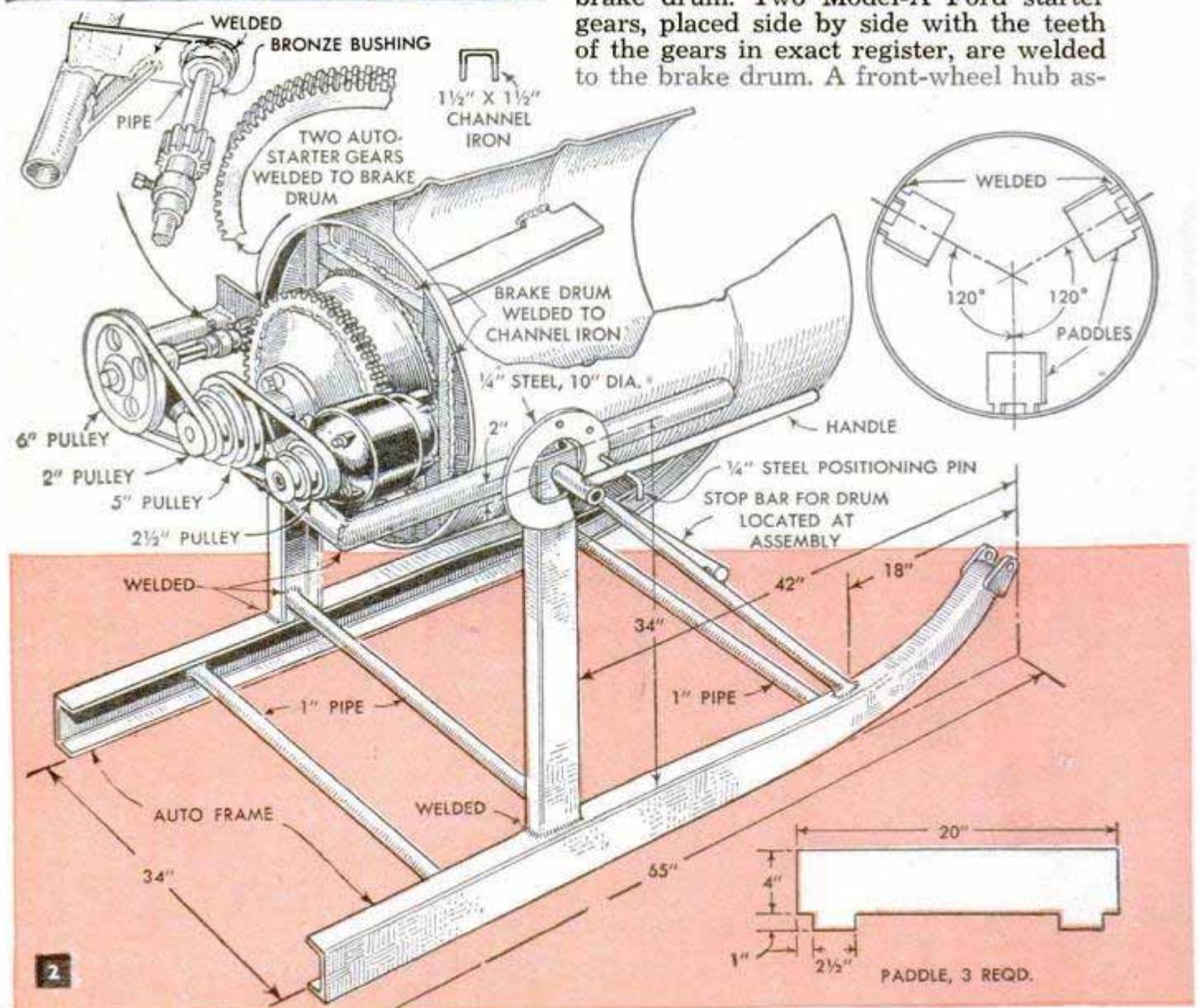
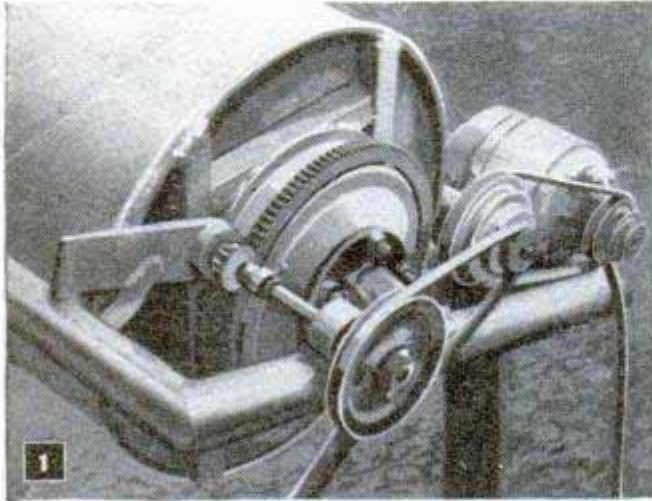



# or CONCRETE

sembly is bolted to the brake drum, which then is tack-welded to the channel-iron base.

To make the U-shaped frame which supports the oil drum, cut three lengths of 2-in. pipe, mitering the ends and welding together as shown in Figs. 2 and 3. Next, short lengths of pipe are welded to opposite sides of the U-frame to serve as axles on which the oil drum pivots. Note that when the machine is assembled, as in Fig. 3, one axle extends through the channel-iron frame member so that a 3/4-in.-pipe handle can be welded to it. A pin passing through a hole drilled in the handle enters holes drilled in a steel disk and holds the mixing drum in several positions from horizontal to vertical. Weld the end of the wheel spindle to the base member of the U-frame, so that the oil drum is centered in the frame. This arrangement allows the oil drum to turn freely on the roller-bearing wheel hub independent of other support.

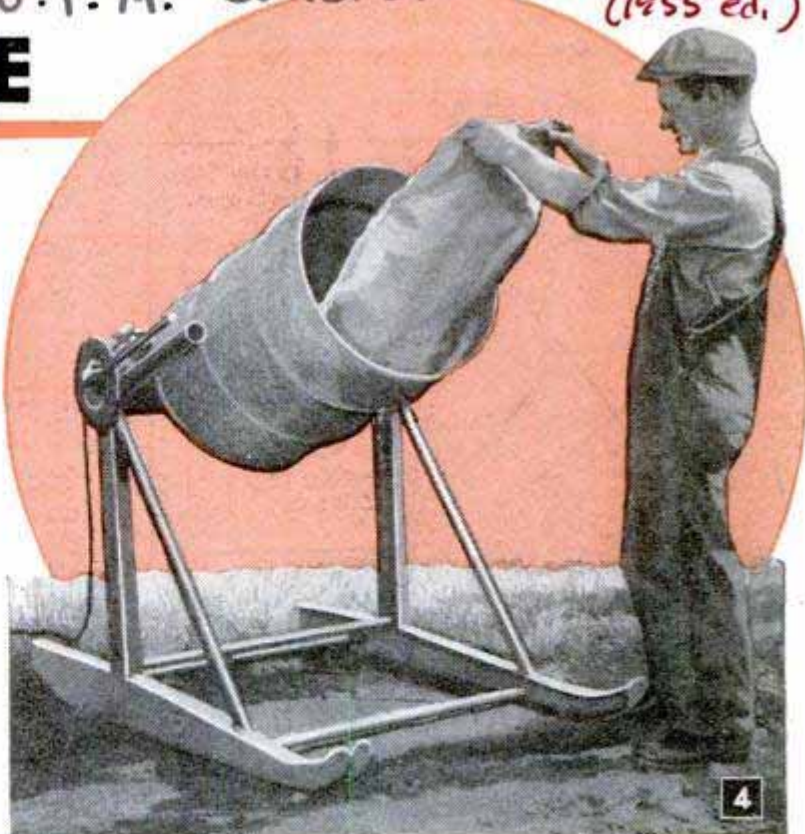

Three paddles are welded inside the drum 120 deg. apart. These are of 1/4-in. sheet steel cut to the dimensions given in the lower right-hand detail, Fig. 2, and are placed at the approximate angle indicated in Fig. 3. The upper left-hand detail in Fig. 2 shows the assembly of the pinion shaft. The pinion drive gear is fixed to the shaft by welding it to the end of a pipe nipple which in turn is locked on the shaft with a setscrew. The outer bushing or ball bearing is also in a housing which is welded to the U-frame, and a collar against this bearing holds the shaft in place. The 1/4-hp. motor is bolted to an L-shaped base welded in one corner of the U-frame, as indicated by dotted lines in Fig. 3. A short length of pipe into which two bronze bushings are forced, provides a bearing for the jackshaft. The pipe is welded to a flat-iron arm, which is welded to the U-frame. Step V-pulleys on the motor and jackshaft permit a range of speeds. Finally, a stop bar for the oil drum is welded to the angle braces of the supporting frame. The bar should stop the drum at a point just slightly below the horizontal position.

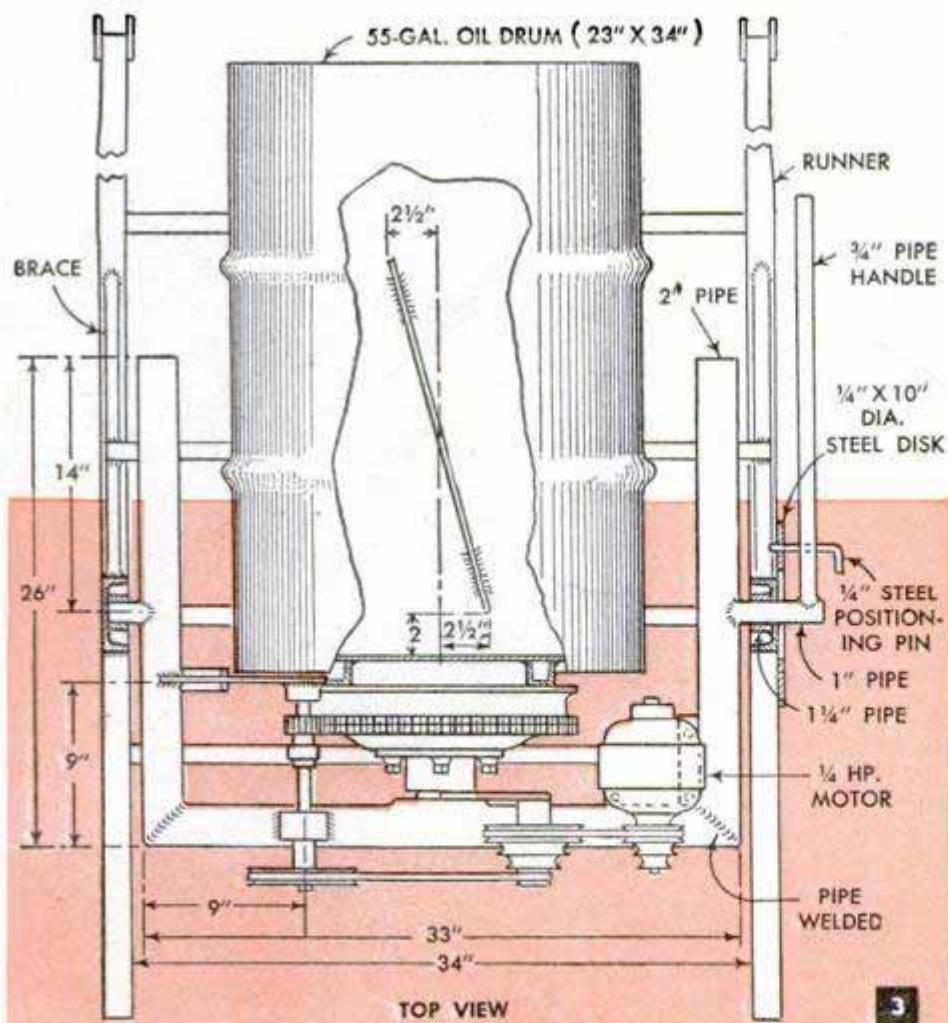



## Offset Centering Attachment Permits Taper Turning

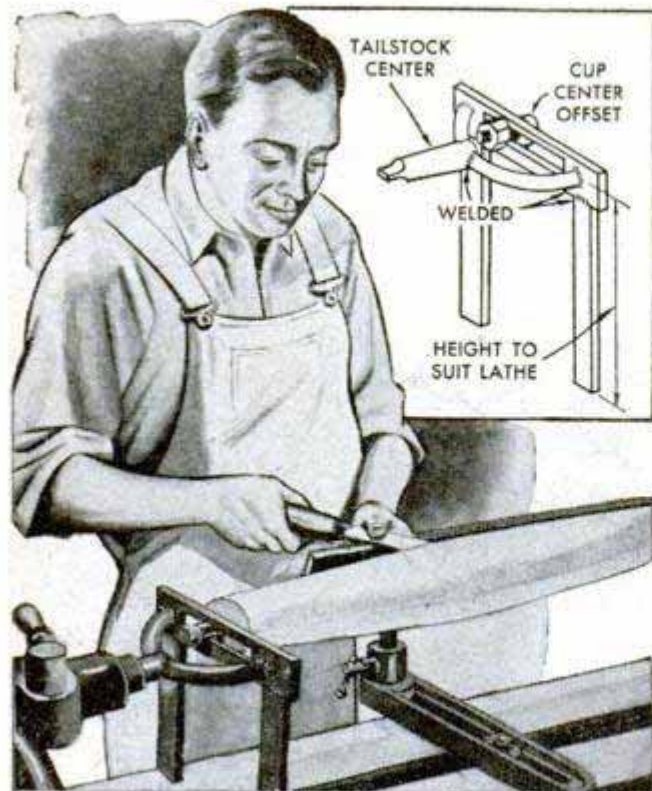

If the tailstock of your wood-turning lathe cannot be shifted laterally to permit taper turning, this auxiliary attachment provides an adjustable tail center. It fits in place of the regular tailstock center and has a movable center which can be offset to suit the taper desired. To make it, cut off the cup end of an extra Morse-taper center and weld it to a short length of threaded rod or a section of bolt. Next, weld the tapered part of the severed center to a U-shaped rod as shown in the detail. Then cut a slot in a piece of flat iron for the movable center and weld it to the U-shaped rod. Finally, weld two flat-iron legs to the assembly to rest on the lathe bed and support the centering attachment laterally in a horizontal position.

James McDonald, Johnsonburg, Pa.

## Paper Disk Tags Ignition Wires When Removed From Distributor

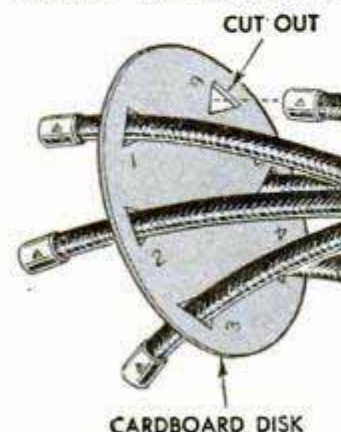

Unless ignition wires are numbered, it is very important when removing them from the distributor that they be tagged. Otherwise, you stand a good chance of fouling the firing order of the engine by forgetting where

each wire goes when replacing it. To avoid this, one mechanic used a cardboard disk to tag the wires. Holes were made in it and numbered as shown, and as each wire was removed from the distributor, it was inserted in the corresponding hole in the disk. Held in this manner, there was no way of getting the wires mixed up.

Gene Holce, Seattle, Wash.

## Thumbtacks Fasten Bulletins Without Perforating

By bending one side of the heads of thumbtacks with a pair of pliers as shown, they may be used to hold papers securely to bulletin boards without perforating them. Used in this way, the tacks need only be pried up slightly to remove the bulletins.

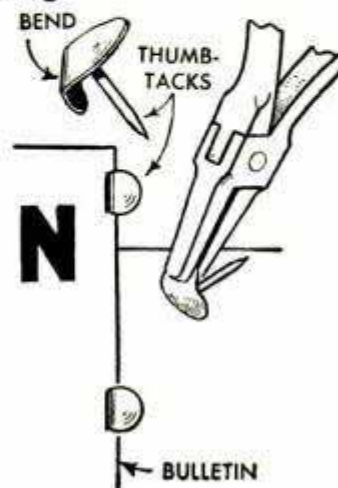

## Metal Guard Protects Trouser Leg While Stringing Barbed Wire

A rectangular piece of galvanized iron bent to the curvature of your hip and thigh and extending from the waist to below the knee makes a good guard when stringing barbed wire. Holes are drilled in the top corners of the metal so that a cord can be passed through them and around the waist to hold the guard in place. Small stove bolts are spaced along the length of the guard to hold the wire at different heights. Holes may be drilled at the end of the guard to tie it to your leg.

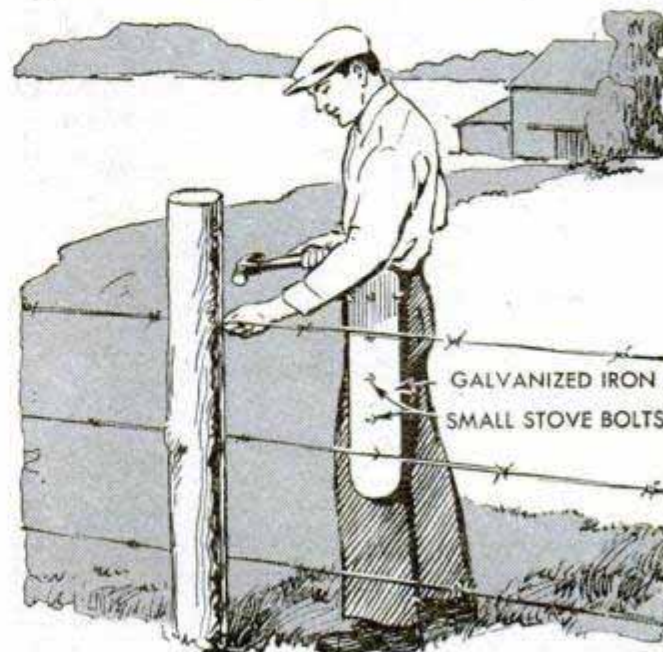





## SPRAYED AND PRINTED CIRCUITS

**R**EALLY "wireless" radio receivers and hearing aids have been made possible by the technique first developed by the Bureau of Standards to solve a space problem in the successful proximity fuse of World War II. This process, which employs paths of silver, or silver oxides, to replace conventional bulky wiring, has undergone many refinements which are now employed in commercial applications. These methods reduce the assembly time and eliminate possible errors in wiring.

The spraying method illustrated in photos A and B is employed by Spraywire Laboratories Inc., Minneapolis, Minn. A circuit stencil is applied to a dielectric material such as a plastic, or ceramic, panel which is to provide the chassis of the receiver; a sandblasting process is then used to form grooves in the panel which are later filled with metal. Tube sockets, condensers, etc., are mounted on top of the panel prior to the blasting and metallizing, and their contacts are sprayed into permanent connection with the conductors. The tiny hearing aid shown in photos C and D, designed by Allen-Howe Electronics Corp., Peabody, Mass., employs a "printed" circuit, 3-stage high-gain audio amplifier on a ceramic plate smaller than a calling card. Sub-miniature tubes fit into clips on the opposite side of the panel. A long-life A-battery and a 22½-volt B-battery are all contained in the case.

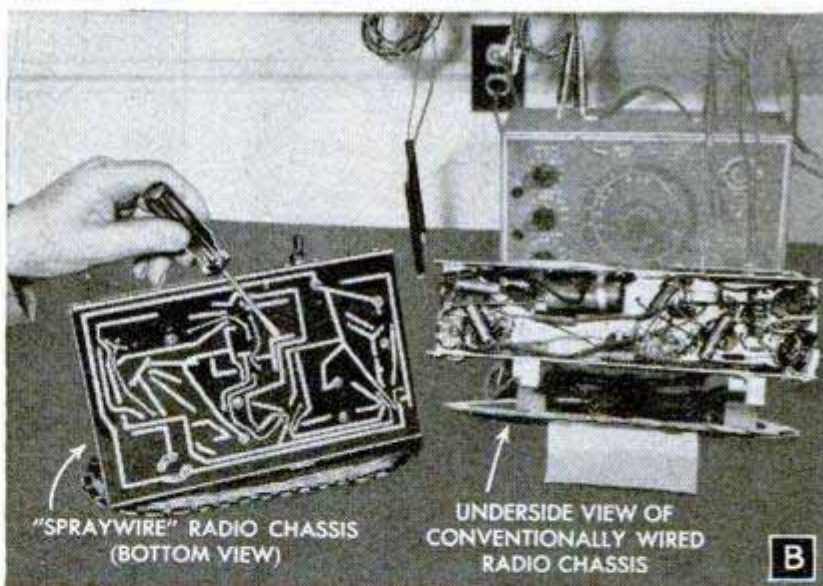
**A**

"SPRAYWIRE" RADIO CHASSIS  
(BOTTOM VIEW)

UNDERSIDE VIEW OF  
CONVENTIONALLY WIRED  
RADIO CHASSIS

**B****C**

"SOLO-PAK"  
HEARING AID

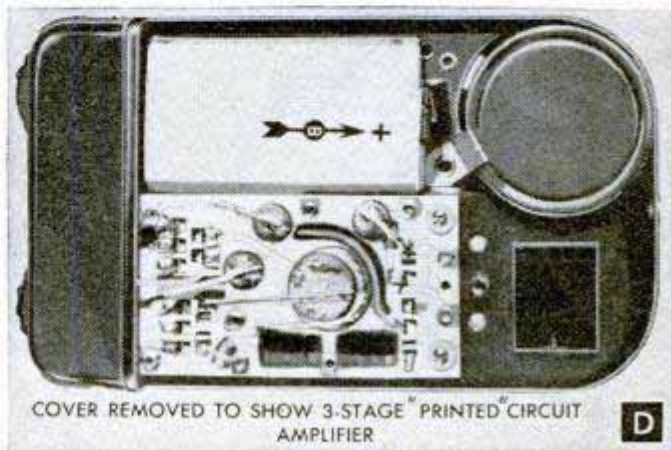

COVER REMOVED TO SHOW 3-STAGE  
PRINTED CIRCUIT  
AMPLIFIER

**D**



# TAPPED-COIL CRYSTAL RECEIVER AND



SINCE a crystal set is the simplest form of radio receiver, it is the logical starting point for the student or junior experimenter. Unlike other types of receivers a crystal set uses no batteries or power-line supply, therefore the sound that emerges from the headphones is derived entirely from radio energy picked up by the antenna. It is apparent then that a good antenna and ground are particularly necessary for satisfactory crystal-set performance. Time is always well spent in putting up a long, high, antenna and in making a good low-resistance ground connection to a cold-water pipe. The crystal set must also be efficient so that the small amount of signal power collected by the antenna will not be wasted and the set must be as selective as possible in order to separate stations.

The tapped-coil crystal receiver illustrated in photos A and B employs adjustable loading in a simple tuning arrangement that is very effective when used with a good sensitive pair of headphones. A schematic circuit diagram and the coil-winding details appear in Fig. 1; pictorial wiring diagram in Fig. 2 shows all connections clearly.

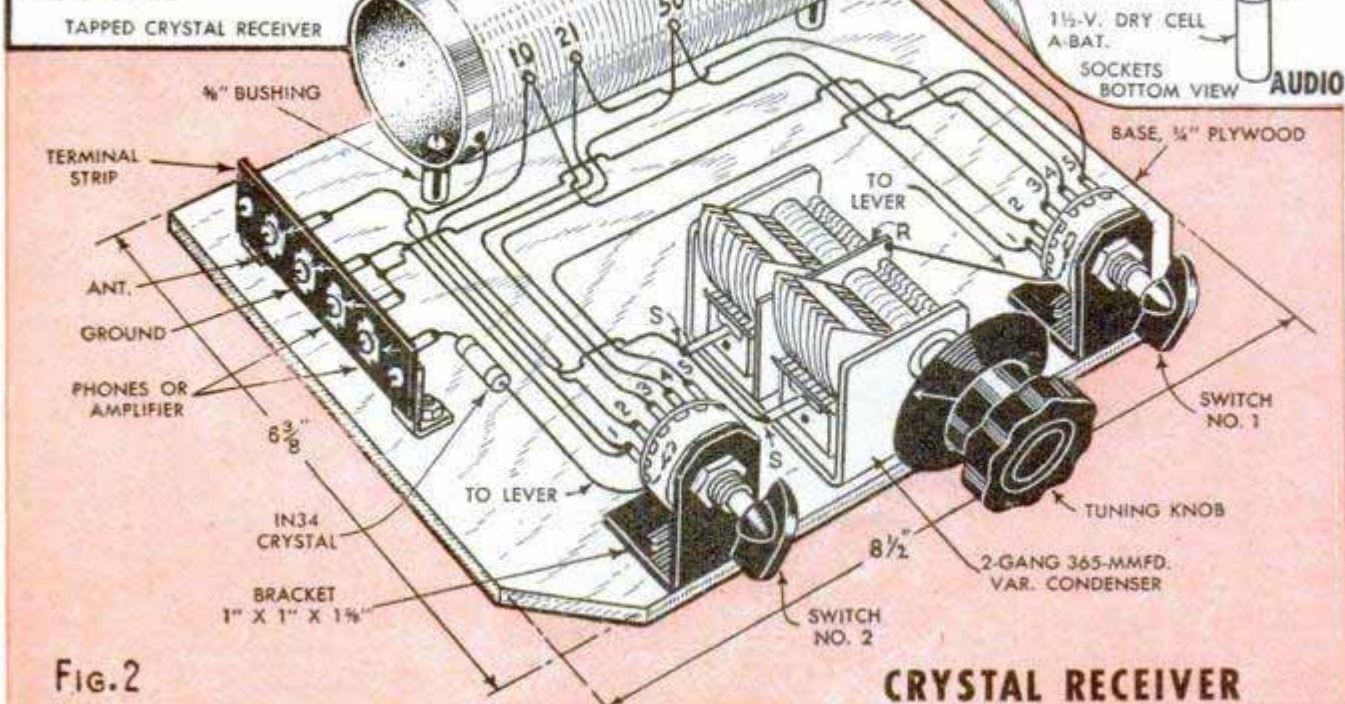
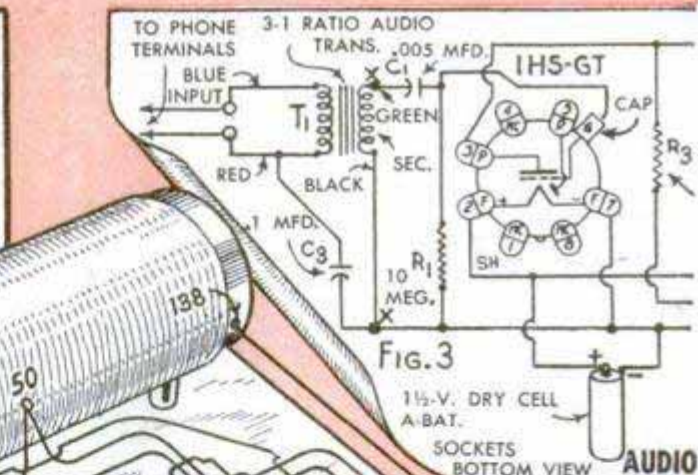
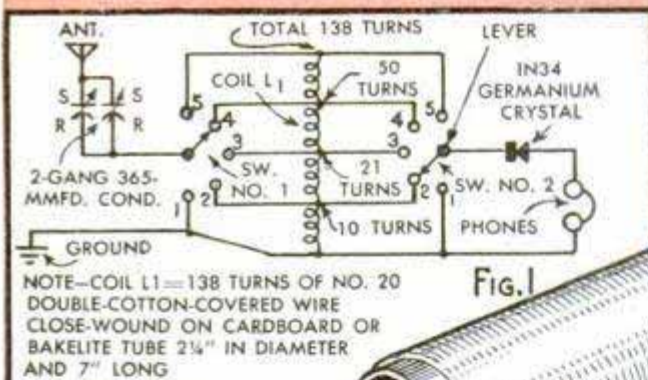
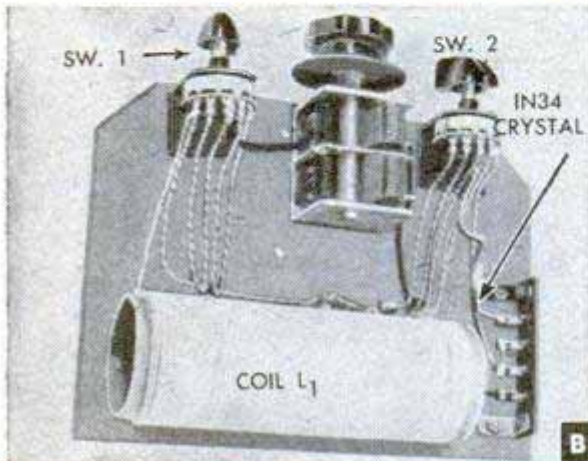

Fig. 2

CRYSTAL RECEIVER



# BATTERY-OPERATED AMPLIFIER

The 2-gang variable-condenser stator plates (S), are connected in parallel; the rotor plates (R) are common with the frame. Therefore, the single connection to the condenser frame is all that is necessary. This lead goes to the lever of switch No. 1; the lever of switch No. 2 is connected to one side of the 1N34 germanium crystal. These switches are single-pole, five-position Mallory No. 3115J type, and are mounted on standard angle brackets. Coil L1 is mounted on small bushings; Fahnestock clips may be substituted for the 4-screw terminal strip if desired. When winding the coil, place a toothpick or matchstick under the turns which are to be tapped; this aids in the removal of the insulation where the leads are to be soldered

(Continued to page 236)

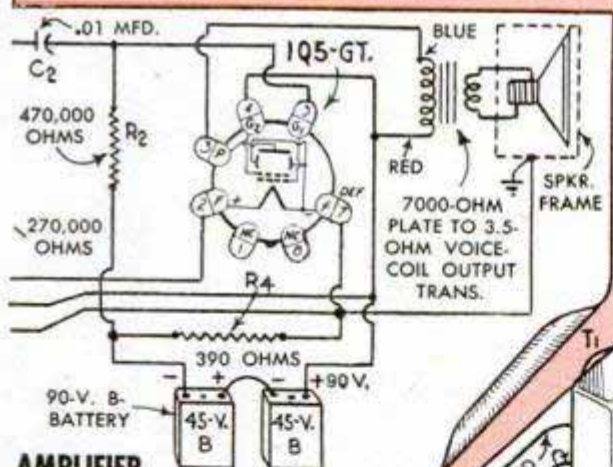
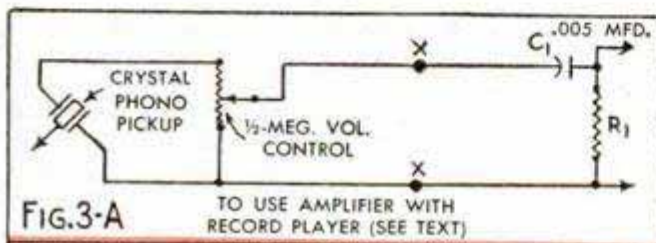
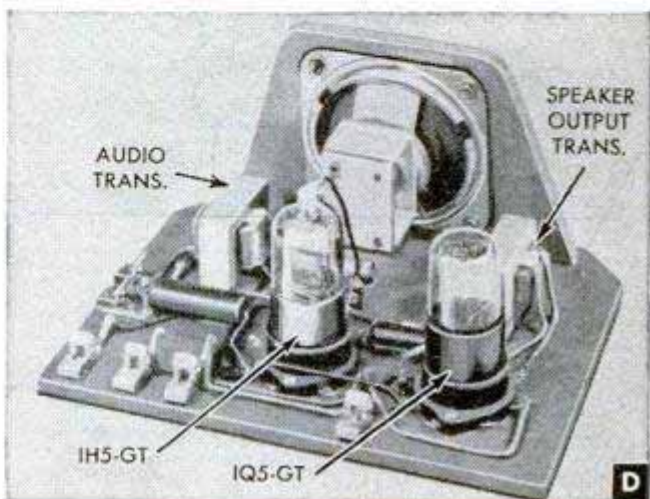

AMPLIFIER

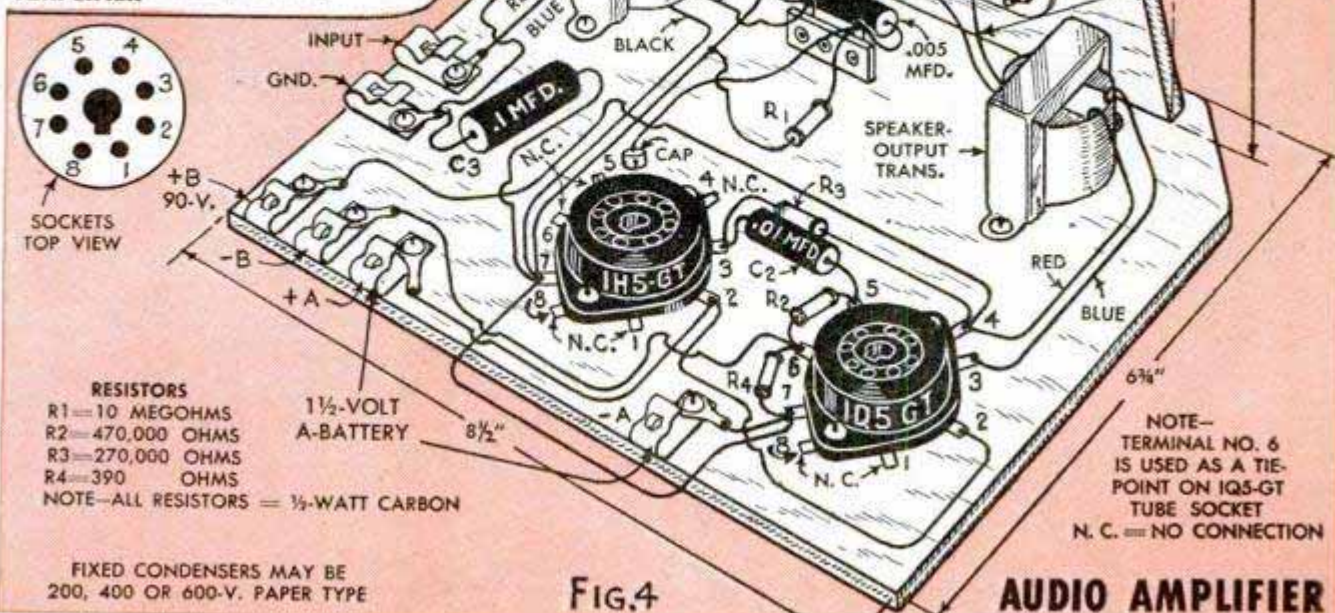
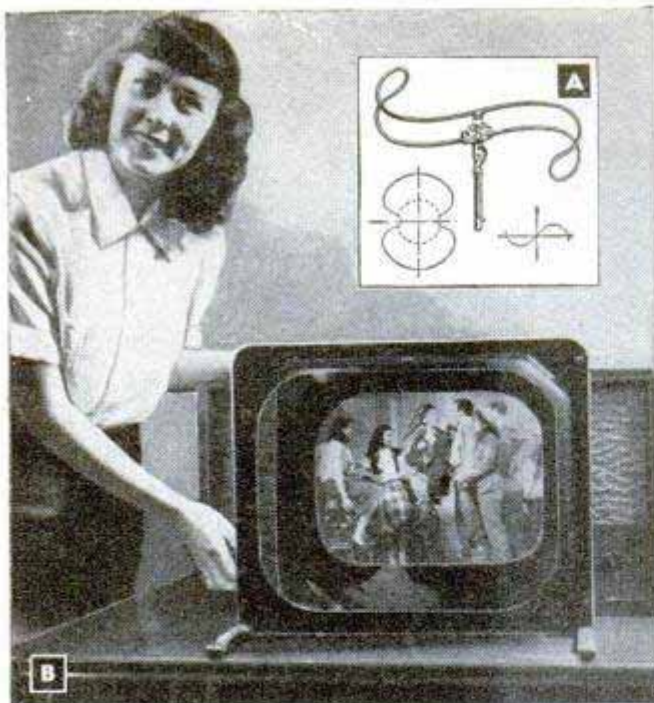

FIG. 4

AUDIO AMPLIFIER



# RADIO-ELECTRONICS TODAY



(A) Nondirectional "S" dipole antenna for television and FM receives stations at various points in any locality. Field pattern indicates intercepted signal strength around the compass.

(B) Television-picture magnifier enlarges 7 or 10-in. received images to approximately the size produced by a 15-in. picture tube. Magnifier is a hollow plastic lens filled with a clear oil.

(C) Five-deck chassis construction and a 12-in. direct-view swivel screen, which can be focused in any direction, are features of this TV receiver.

(D) Portable camera-radio includes a battery-operated superheterodyne receiver, and a camera which employs a standard roll film, thus providing both radio programs and candid camera shots.

(E) Matching television console, radio-phonograph combination and record cabinet are available in units which may be purchased separately and matched at any time. The television section retails for about \$300; it offers a 10-in. screen and employs a 28-tube circuit. FM is included in the radio-phono section.

(F) Lightweight wire recorder eliminates complicated handling of wire by utilizing a simple plug-in cartridge. It is housed in a streamlined black plastic cabinet with a disappearing carrying handle. The instrument weighs less than 25 pounds with cartridge and microphone. It operates from any 110-volt a.c. power source and includes a 3-watt high-gain audio amplifier for playback.

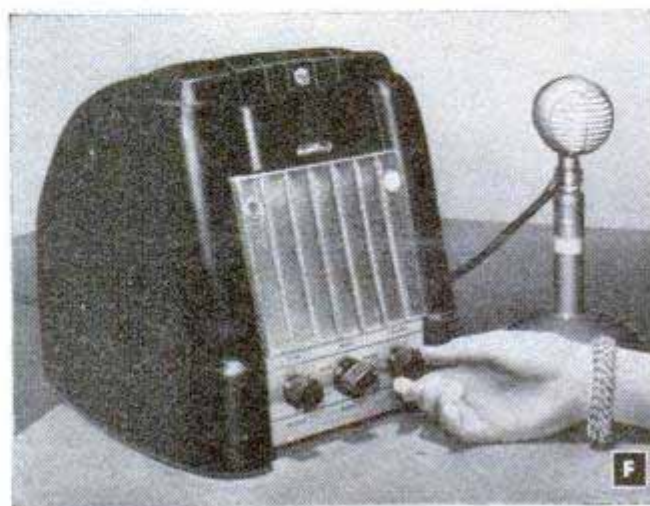
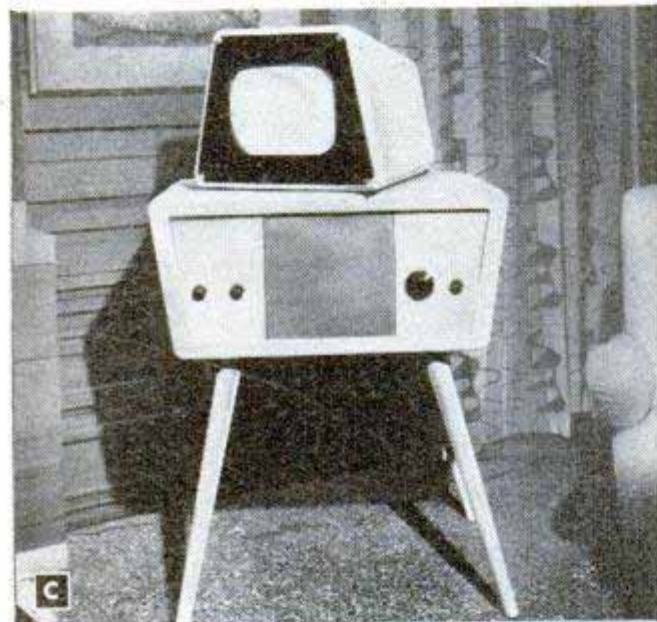



# What's your choice of these

## Marlin .22's?

Marlin Model 39-A—25-shot Lever Action Repeating Rifle. \$50.45\*



Marlin Model 81-DL—25-shot Tubular Magazine Repeating Rifle. \$26.95\*



Marlin Model 80-DL—8-shot Clip Magazine Repeating Rifle. \$22.90\*

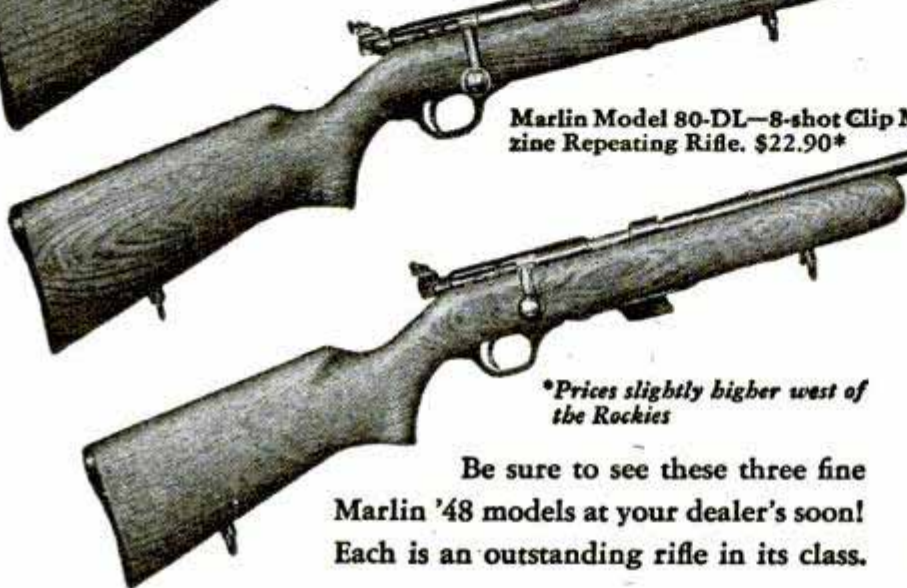

*\*Prices slightly higher west of the Rockies*

Be sure to see these three fine Marlin '48 models at your dealer's soon! Each is an outstanding rifle in its class.

● Here you have three great rifles for small game and all around sport. Marlin's 39-A is the only lever action .22 repeater made...a favorite in hunting circles the world over since 1892. As a practical weapon for vermin and small game, the 81-DL is a wise selection. It carries a full day's ammunition, and its light weight is a great asset in the field. The loaded clip of the 80-DL provides extra shots for fast-running game ...and allows use as a single loader for target work. All three are rugged, man-sized Marlins, famous for accuracy and dependability. All shoot .22 short, long and long rifle cartridges—regular or high speed—without adjustment. Whichever you choose, you'll buy years and years of trouble-free sport!

*American Black Walnut Stocks & Forends Standard on All Models*



Often called the "world's best all around .22," Marlin's 39-A is a light rifle of remarkable accuracy and versatility. Only lever action .22 made. Extra fast for snap and exhibition shooting.



A full day's hunting is provided by the large 25-shot capacity of the Marlin 81-DL. Removable bolt assembly; Off and On safety... a fine "learning gun."

## Marlin .22 Rifles

*Outstanding for accuracy, dependability, long life*



12 for 25¢ • Single or double edge

THE MARLIN FIREARMS CO., NEW HAVEN, CONN. • Fine Guns Since 1870



# Speed Sweep

THE BRUSH WITH  
THE STEEL BACK

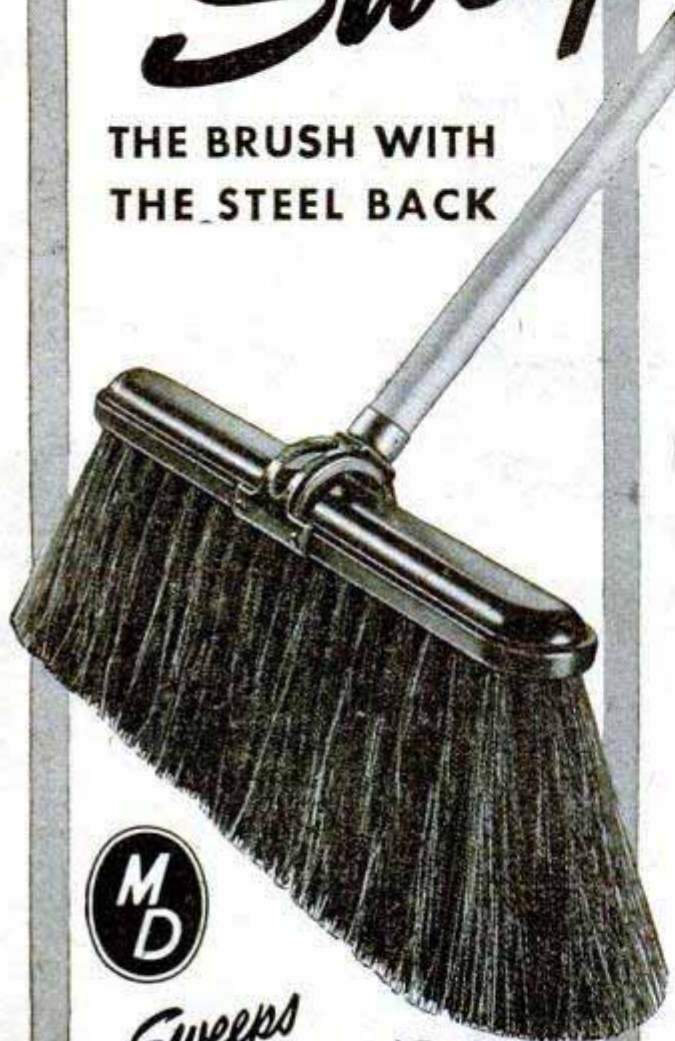

*Sweeps  
cleaner, faster -  
Outlasts ordinary  
brushes 3 to 1!*

Mail Coupon Today

Milwaukee Dustless Brush Co.  
530 N. 22nd St., Milwaukee 3, Wis.

Please send me complete information about  
Speed Sweep brushes.

Name \_\_\_\_\_

Street Address \_\_\_\_\_

City, State \_\_\_\_\_

## Setting the Stage for an "Ad"

(Continued from page 151)

Kling's it's all part of the daily routine.

Another phase of the complex business of the modern studio is counter and window-display design and production. A separate department plans the cardboard units (called "point-of-sales" material in the trade) that you see on store counters and in windows throughout the nation.

These displays are designed to fold flat for shipment and are easy to assemble so that Mr. Jones, the corner druggist, can put them together without special tools and complicated instructions. And, of course, they must have eye appeal and sturdiness, and must sell the product.

Another Kling activity is producing movie shorts. Most of the work here is in the field of industrial movies, promotional films and film slides. A complete recording studio and projection room designed with perfect acoustics are in another corner of the building. Frequently, the movie cameramen go out on location and when they do, the caravan of vehicles looks like something from Hollywood.

Photographing the thousands of items in big mail-order house catalogues is another phase of Kling's work. Every item is photographed in exactly the proper perspective and size to make the page attractive and at the same time to avoid waste of valuable catalogue space.

Items such as linoleum, rugs, draperies or any product in which design must be shown are cut into small sample strips and pasted on a gigantic wallboard "page." The page is made to exact proportions and when photographed the items are shown precisely as they appear in the catalogue.

Kling's has had some unusual orders, such as the time an observation platform of a streamlined train was built for an advertiser, but the most unusual, perhaps, was the picture that required a gigantic transcontinental bus for a prop.

The giant bus, gleaming in shiny metal, was driven into the studio through the large prop-entrance doors in the rear. Lights were set up and models posed so that the completed picture looked like a scene in a busy metropolitan bus depot.

That was the largest single prop ever used in a Kling photo, but, as Blevins says, you can't be sure what complex problem tomorrow will bring.

"One of these days," he said, "I expect a client to ask us to photograph a trans-Atlantic plane here in the studio. Don't ask me how we'll do it, but when the time comes, we'll find a way."



IF YOUR HAM RIG ACTS  
LIKE THIS... IT'S TIME TO  
HUNT 'BUGS' AND...



IF YOUR CAR FEELS LIKE THIS...  
IT'S TIME FOR MARFAK  
CHASSIS LUBRICATION

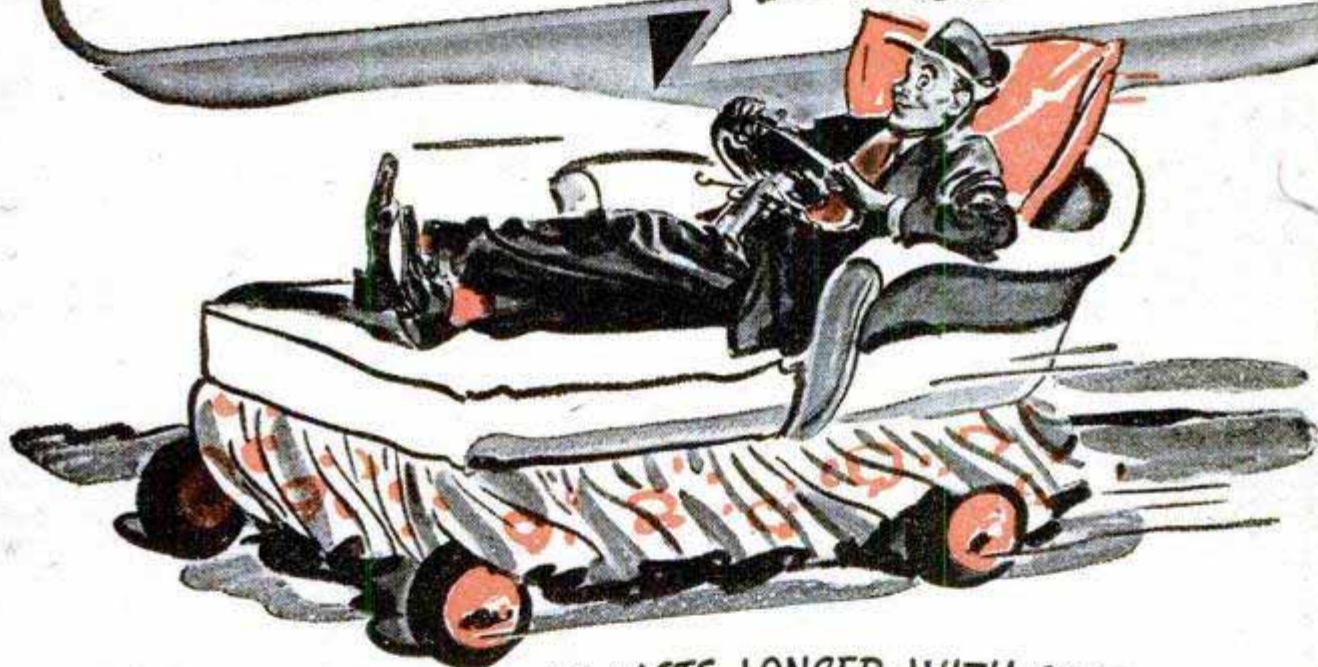

**THAT CUSHIONY FEELING LASTS LONGER WITH MARFAK!**

When you get a lubrication job, get a *good* one. Ordinary grease peters out after a couple of hundred miles. But *Marfak* Chassis Lubrication lasts 1,000 miles and more. *Marfak* takes road shocks with ease, clings to wear points and bearings. And notice that long-lasting "cushiony" riding ease! That's *proof* that *Marfak* is on the job. Applied by chart, never by chance. Ask your Texaco Dealer, the best friend your car ever had, for *Marfak* Lubrication.



**THE TEXAS COMPANY**  
**TEXACO DEALERS IN ALL 48 STATES**

Tune In: TEXACO STAR THEATER presents the TONY MARTIN show featuring ALAN YOUNG every Wednesday night. See newspaper for time and station.



not just  
one strong  
point but . . .

**STRONGER  
AT ALL POINTS**



STANLEY No. 923  
BIT BRACE

Look at the Stanley 923 Bit Brace in a workman's tool box. It's probably taken years of hard work, rough use . . . and got little care. Yet it's still a fine tool . . . accurate, smooth working. Steel clad hardwood head turns freely on ball bearings and bronze bushings. Chuck assembly locked in place with perforated nut, cotter pin and slotted screw end. Heavy duty, all steel box ratchet. Universal jaw takes round and tapered shanks, all sizes of auger bits and twist drills up to 1/2". More tool for your money.

**COUPON brings you  
Two books for your shop shelf**

One is FREE! The other, the latest edition of a famous textbook for the home workshop, cloth-bound, fully illustrated, just \$1.00.

THE TOOL BOX OF THE WORLD

**STANLEY**

Reg. U.S. Pat. Off.

**HARDWARE · HAND TOOLS · ELECTRIC TOOLS**

Stanley Tools, 148 Elm St.  
New Britain, Conn.

Please send by return mail:

- FREE booklet: "The Joy of Accomplishment."  
 188-page book: "How to Work with Tools and Wood." \$1.00 enclosed.

(In Canada: Send order to Stanley Tool Co. of Canada, Ltd., Roxton Pond, Quebec.)

Name .....

Address .....

City ..... State .....

## Tapped-Coil Crystal Receiver

(Continued from page 231)

for switch points at 10, 21 and 50 turns.

Whenever the builder wishes to discard the headphones and use a small loudspeaker with this crystal set, which he will probably want to do at an early date, the 2-tube amplifier shown in photos C, D, E and F, and detailed in Figs. 3, 3-A and Fig. 4 will meet every requirement. Furthermore this highly efficient little battery-operated audio amplifier will make a

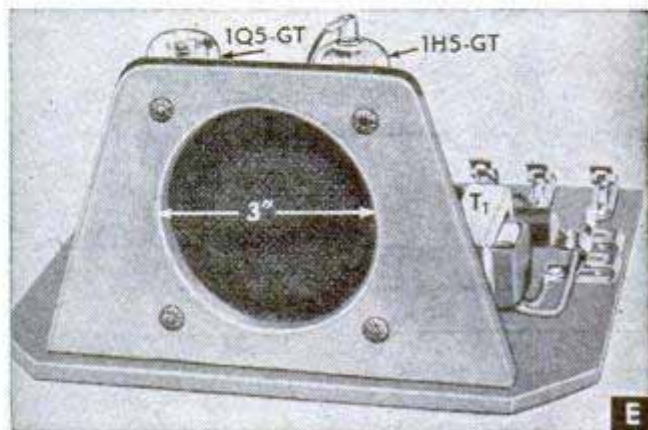

handy unit for the experimenter as it is suitable for a number of other uses. It can be employed with any one or two-tube student set and it makes an ideal amplifier for use with any record player. The volume, with this crystal receiver, is ample for the ordinary room and the quality on local broadcasting stations is surprisingly good. Both units are mounted "bread-board" fashion on 1/4-in. plywood, and the speaker baffle is made of the same material. Any d.c. voltage present in the headphone circuit to which this amplifier may

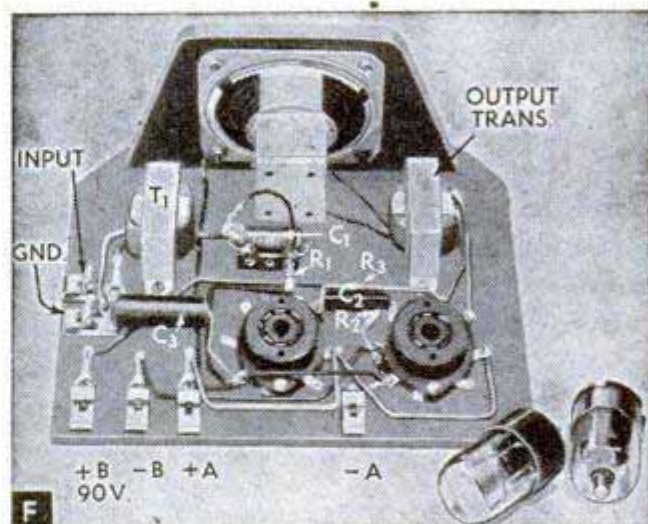

be connected, is isolated from the amplifier circuit by fixed condenser C3. When connecting the units together, the grounded terminal on the crystal set connects to

(Continued to page 240)



*No rust  
for the  
wary!*



*Clean rust out of your radiator with*  
**DU PONT Cooling System CLEANSER**

Drain out your anti-freeze, and clean out winter's accumulation of scum, scale, and rust. Neglect now may mean trouble and costly repairs later. Just pour a can of DU PONT COOLING SYSTEM CLEANSER into your radiator, run the engine 30 minutes or more, and drain. It dissolves rust—cleans thoroughly—improves engine performance. It's safe, sure, and easy to use.



*Keep out rust with*

**DU PONT Acid and Rust INHIBITOR**

After cleaning out the radiator, you can keep it free from rust all season by pouring in a can of DU PONT ACID AND RUST INHIBITOR. It prevents rust forming, and keeps out acid, too.



*Avoid radiator leaks with*

**DU PONT Cooling System SEALER**

Stop leaks quickly and securely—and make the cooling system LEAKPROOF—by pouring in DU PONT COOLING SYSTEM SEALER. It will not clog the radiator.

**DU PONT**  
REG. U.S. PAT. OFF.

BETTER THINGS FOR BETTER LIVING  
... THROUGH CHEMISTRY



# "Dave ought to know better than that"



**AL:** Yeah, I wouldn't take that set of drills if they gave it to me.

**PHIL:** Just junk—that's all they are. And Dave's bragging about the bargain he got.

**AL:** You'd think he'd know by this time that you can't save money buying "no-name" tools.

**PHIL:** Sure, it's plain as day that when a well-known manufacturer puts his name on tools, those tools have got to be good. And when you buy tools *without* known brand names, you're just throwing money

away.

**AL:** Well, I guess we all have to learn it the hard way.

**PHIL:** Yeah. I made some bad buys before I got wise. Now I stay away from bargain counters and do all my tool buying at the hardware store.

**AL:** Same here—and the first thing I look for is the brand name.

**Your HARDWARE DEALER sells QUALITY tools  
and hardware... Buy from HIM**



## POPULAR MECHANICS



# *Any time is time for fun* with a **HARLEY-DAVIDSON**

You've got the "greenlight" to good times, when you own a Harley-Davidson. Fun is around every corner, happiness along every highway in the world's greatest sport — motorcycling! Alone or with gay companions, there's no end to enjoyment. Within easy reach whenever you want to go are gypsy tours, hillclimbs, race meets, sightseeing trips, exciting vacations, all beckoning to new pleasures and adventures. Owning a Harley-Davidson is easier than you think. See your dealer today.

## **HARLEY-DAVIDSON MOTORCYCLES**

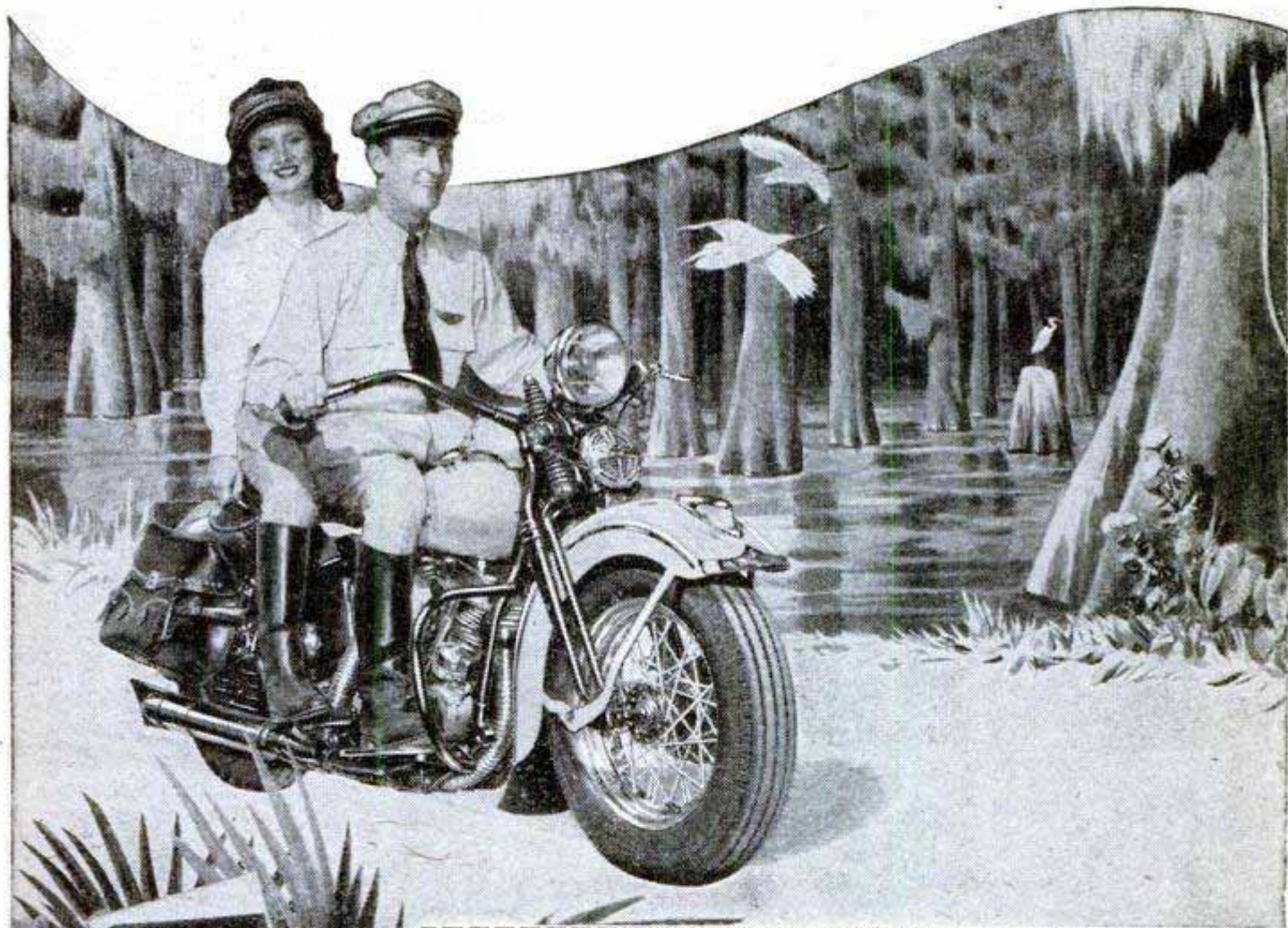

HARLEY-DAVIDSON MOTOR CO., Dept. P. Milwaukee 1, Wis.

Send free copy of ENTHUSIAST magazine, filled with motorcycle action pictures and stories; also literature on 1948 models.

Name.....

Street or R.F.D.....

City.....Zone.....State.....



# Repair Storm Windows

## and Screens with

# PLASTIC WOOD

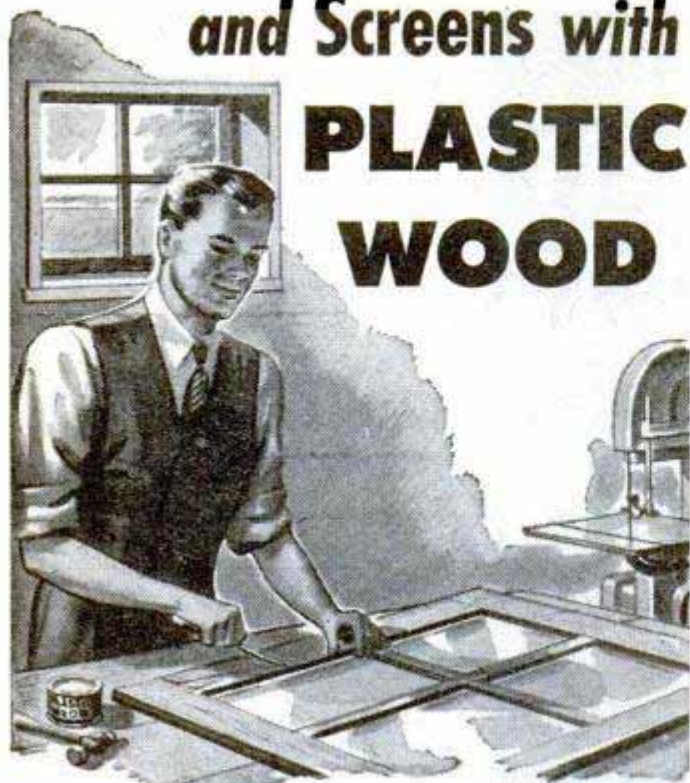

When making new screens, or replacing old rusted screen, apply thin layer of PLASTIC WOOD around frame after tacking down screen. This gives greater strength to the frame. PLASTIC WOOD can be easily shaped to match broken molding. Valuable in replacing rotted wood in storm windows.

... dozens of other uses

#### FOR FILLING ...

- Cracks in floors
- Countersunk screws
- Chipped furniture
- Nail and screw holes

#### FOR REPAIRING ...

- Loose tiles
- Loose casters
- Broken balusters
- Broken furniture

- PLASTIC WOOD SOLVENT is indispensable to the home workshop hobbyist for controlling the consistency of Plastic Wood and removing dried Plastic Wood from hands and tools.

T.M. Reg. U. S. Pat. Off.

At all Hardware,  
Paint and 10c Stores

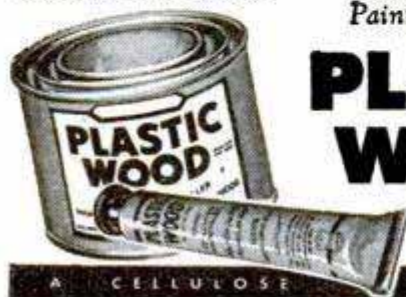

# PLASTIC WOOD

Tube or Can

A CELLULOSE FIBRE FILLER

the red lead terminal on the amplifier and the other phone terminal on the crystal set connects to the blue input terminal clip on the amplifier; the antenna and external ground leads remain the same. The frame of the speaker must be connected to the common ground on the No. 7 lug on the 1H5-GT tube socket in order to prevent oscillation. A 390-ohm resistor in the negative-B lead provides approximately 4 volts of bias for the 1Q5-GT beam-power output tube. Two 45-volt B-batteries and one 1½-volt dry cell A-battery provide power. No on-off switch was used in order to keep cost at a minimum. The amplifier is merely turned on and off by disconnecting the positive A-battery lead. A s.p.s.t. toggle switch may be inserted in the positive A-battery lead if desired. To use the amplifier with a record player, disconnect the audio transformer at X and X in Fig. 3, and substitute the phono-pickup circuit Fig. 3-A using X and X as input terminals. Connect the lever of the volume control to C1 at the terminal strip on the amplifier; one end of the volume control goes to ground on the No. 7 terminal of the 1H5-GT tube socket. Leave condenser C3 in the ground lead. The phono pickup leads are then connected across the outside terminals of the volume control. If the volume control works backward reverse the outside connections. If your record player has a shielded pickup lead, the shield connects to ground. If the pickup is provided with red and black leads, the black goes to ground. Detailed student material list R-365 covering both units is available from Popular Mechanics Radio and Electronics department upon receipt of ordinary letter postage.

## Pulling the Fangs of War

(Continued from page 174)

trained disposal crews. Wandering in the fields, they often step on mines and explode them. Because a cow represents a small fortune, the French farmers are especially cooperative in the work of removing bombs and mines.

Approximately 1900 minesweepers of European countries are clearing the waterways of that continent. The task will not be finished for several years. There were 493,000 mines laid between 1939 and 1945 and many of them were dropped by planes and therefore not charted. In spite of precautions taken and warnings issued, about 150 merchant vessels, fishing boats and pleasure craft have been sunk by mines in European waters since war ended.

(Continued to page 246)



# Logan

**ACCURACY IN A  
9-INCH SWING**

**Plus Logan speed,  
ruggedness and  
versatility at \$159.50**

• This lathe will produce precision results on any job you give it, and it retains its accuracy through years of use. Bed ways precision ground to within .0005" of parallelism. Ball bearing spindle needs no bearing adjustment from 30 to 1450 rpm. In brief, it is a LOGAN Lathe built in a compact 9-inch size. See it at your Logan dealer's, or write for information.

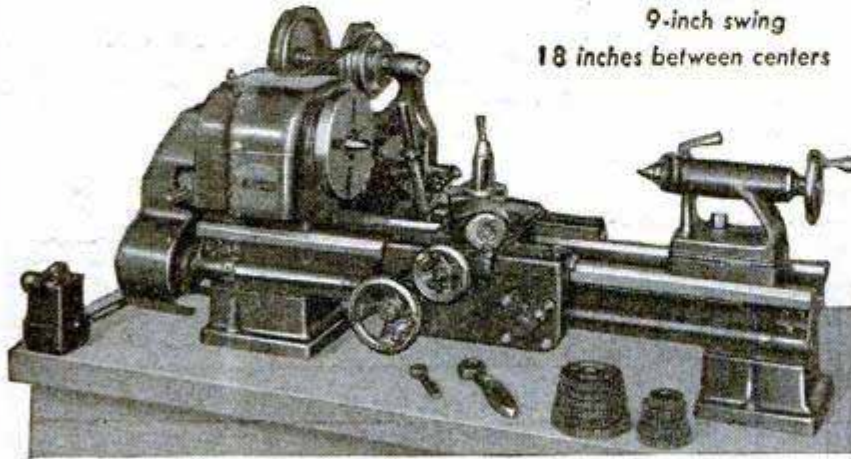

9-inch swing  
18 inches between centers

**DISTRICT  
OFFICES**

Woolworth Bldg.,  
New York 7, N. Y.  
CO 7-8024

550 W. Washington Blvd.  
Chicago 6, Illinois  
Central 1246

1672 Mission Street  
San Francisco, Calif.  
Underhill 5682

700 Commerce St.  
Dallas 2, Texas  
Central 4075

**LOGAN ENGINEERING CO.,**

Dept. BB-4  
CHICAGO 30, ILLINOIS

**Build Your Own  
ROTARY POWER  
LAWN MOWER  
& WEED CUTTER  
with the Wind-King  
MOWER SPINDLE  
& BLADE**

**\$1875** FOB  
Merrill,  
Iowa



- Timken Bearing equipped
- Smooth operation at high speed
- Spindle unconditionally guaranteed
- 20-inch tool steel blade — easily sharpened
- Precision built with quality materials
- Designed for efficient, long-lasting lubrication

For further information, write to:

**WIND-KING ELECTRIC MFG. CO.**  
Merrill, Iowa

**REMOVE PAINT  
WITH WONDER-PASTE**



In refinishing furniture, woodwork, etc. all cracked or peeling portions of the old finish should be removed. It's easy with WONDER-PASTE REMOVER. Applied with an ordinary paint brush, this remarkable paste quickly softens up the toughest finish, whether paint, varnish, enamel, lacquer or shellac. Will not run, even on an upright surface. Turns the finish into a soft sludge that comes off easily at every stroke of the scraper. A long-time favorite of painters. Get Wonder-Paste at your paint or hardware store. Write for Wonder-Paste leaflet, and for advice on your particular removing problem.



Wilson-Imperial Co., 119 Chestnut Street, Newark 5, N. J.

# Surplus CAMERAS



Buy direct — avoid higher prices. Millions of dollars worth of aerial cameras and accessories are now available to the public at government established prices. May be used as is, modified, or lens, shutters, motors, and other components obtained for use. W.A.A. prices are often less than value of lens alone!

WRITE US TODAY FOR

*Complete Listing Catalog*  
AND PRICES!

**ABRAMS INSTRUMENT CORP.**

Acting as Agent for  
**WAR ASSETS ADMINISTRATION**  
606 E. SHIAWASSEE ST., LANSING, MICH.



**paint at 1...  
use by 2!**

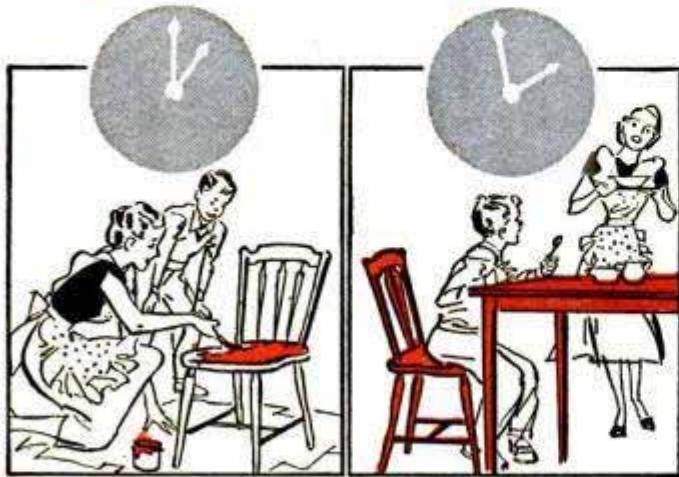

Easy to apply. Flows on smoothly. Low cost!

Dries dust-free in 17 min. Little does a lot!

**WONDERFUL NEW  
Stop Watch Enamel  
DRIES IN 57 MINUTES\***

- FOR FURNITURE IN CONSTANT USE!
- FOR MODELS!
- FOR TOILET SEATS!
- FOR TOYS!
- FOR HANDICRAFTS!



**STOP WATCH ENAMEL** is available at Hardware, Paint and Variety stores in 14 decorator colors: Robin Blue, Royal Blue, Java Brown, Canary Yellow, Foam Green, Jade Green, Forest Green, Pilgrim Gray, Rich Cream, Imperial Red, Orange, Ivory, White and Black.

If your dealer cannot supply you, send \$1.50, plus 25¢ to cover shipping, for 1 qt. of **STOP WATCH ENAMEL**. Indicate color wanted.

**THOMAS C. DUNHAM, INC.**  
Long Island City, New York, Founded 1852

\*Average drying time

**Clinic**



**for Homemakers**

As a service to our readers in solving the hundreds of problems pertaining to a home—inside or out—the editors of *Popular Mechanics* invite you to present your problems to The Clinic Editor for help and advice. Address your questions to The Clinic Editor, *Popular Mechanics Magazine*, 200 East Ontario Street, Chicago 11, Ill.

**Oil-Soaked Floor Joist Stains Ceiling**

**Q**—Oil leaking from a can soaked a second-floor joist in one of the rooms of my home. This stained the paper on the ceiling. What can I do to stop this?  
C. B.—Alpena, Mich.

**A**—If you can get at this oil-soaked floor joist easily, coating it with asphaltum likely would remedy the trouble. However, if you mean that the oil has penetrated through a plastered ceiling, then it would be necessary to remove all the affected plaster and replaster the area.

**Chimney Stains Brick Wall**

**Q**—Recently I purchased an old house built of brick. Chimneys at each end are built into the solid brick walls. Following the line of the flues a dark, brownish stain appears on the outside of the walls. I want to paint the house with a white masonry paint, but am afraid this stain will show through. What should I do to prevent this?  
A. W.—Lancaster, Pa.

**A**—You are correct in assuming that the stain will "bleed" through the masonry paint. If the bricks are still in good shape, the remedy is quite simple. Clean off all loose material with a wire brush and point up any open joints with mortar. Then apply white asphaltum to the stained area and also cover a foot or so of the wall on either side.

**How to Prevent Sink-Drain Clogging**

**Q**—How can I keep a sink drain clean without using an auger every two or three weeks?  
J. Z.—St. Louis, Mo.

**A**—First clean it thoroughly with the auger, removing all possible debris. Then, at regular intervals, from 10 days to two weeks, flush the drain with a good commercial cleaner. Follow directions on the can. If this is done regularly and correctly, you should have no further trouble.

**Moisture Condenses on Cold Walls**

**Q**—We have a concrete-brick house and when we turn on the gas heater the windows and walls get very wet and water drips to the floor. What can I do to keep the house drier?  
W. D.—Santa Monica, Calif.

**A**—If you are using an unvented gas heater—a common type—that is the source of your trouble, as one of the products of the combustion of highly concentrated fuel is water vapor. This condenses on the walls which are several degrees colder than the air in the room. Apparently, the only remedy for the trouble is to vent the gas heater either to a chimney or to the outside of the building in some other way.

(Continued to page 244)



# NOW\_a New Kind of Screening

rustproof! stainproof! never needs painting! lasts a lifetime!



*"Believe me, this Lumite screening is amazing. I'll never have to think of screens again."*

## Don't fuss with screens anymore! Replace old screens with Lumite!

Millions of homeowners have been amazed at this revolutionary plastic window screening. And no wonder it's sweeping the country! Just think of having screens that will *never rust, never rot, never corrode*. Imagine screens you never have to paint or scrub clean—that never stain the sills or sidewalls of your house. Yes, here's an amazing new kind of screening (woven of SARAN) that's been tested the world over—and proved virtually indestructible! If it's time to rescreen, don't wait, order LUMITE at your Hardware, Lumber, or Building Supply Dealer's today!

**For further information and free sample**

write Dept. 32, Lumite Division

Chicopee Manufacturing Corporation, 47 Worth St., N. Y. 13, N. Y.



### STAINPROOF!

Guaranteed never to "bleed" or "run"—never to stain the sills and sidewalls of your house. LUMITE keeps its glistening fresh beauty always.



### RUSTPROOF!

Absolutely cannot rust or corrode in any climate. Completely unaffected by hot or cold weather, water, sun, smoke, acid fumes, or salt spray.



### NEVER NEEDS PAINTING!

Requires no protective coating. Any dust or dirt that collects on a LUMITE screen can be wiped off in seconds with a damp cloth.



### LASTS A LIFETIME!

LUMITE is unbelievably strong—has greater impact strength than any other type screening by actual test. Lasts as long as your house.

\*®

Screen once and for all with

# LUMITE\*





**53¢ VARNISH  
VALUE  
FOR ONLY 25¢**



**TOUGH! HARD!  
UNHARMED  
BY LIQUIDS!**

**★  
FINEST VARNISH  
DEVOE EVER  
MADE**

**REPLACEMENT OR A REFINE OF MONEY  
★  
Guaranteed by  
Good Housekeeping  
IF NOT AS ADVERTISED THEREIN**

**DRIES IN 4 HOURS**

(May vary from 3 to 6 hrs. depending on conditions.)

Users from coast to coast acclaim Devoe 87 Spar as the postwar varnish miracle!

Devran\*, the new resin created in the Devoe Laboratories, makes it the most damage-resistant varnish in generations!

**USE TEST COUPON TODAY**—This offer gives you enough to finish a piece of furniture or 20 sq. ft. of woodwork, floor or linoleum! Mail coupon direct to Devoe with 25¢ for full ¼ pint of Devoe 87 Spar!

\*Patent applied for

**87 SPAR TEST COUPON**

DEVOE & RAYNOLDS Co., Inc., Dept. J-1  
787 First Avenue  
New York 17, N. Y.

Enclosed is 25¢ for a ¼-pint test sample of Devoe 87 Spar Varnish (retail value 53¢)

Name.....

Address.....

City..... State.....

This offer expires May 1st

ANOTHER DEVOE PRODUCT

**DEVOE & RAYNOLDS COMPANY, INC.**

787 First Avenue, New York 17, N. Y.

**Moisture Condenses in Oil-Heater Vent Pipe**

**Q**—I have an oil-burning space heater in the hallway. There are 19 lengths of 4-in. vent pipe in all, 8 in the hallway and 11 in the kitchen. The pipe drips water constantly onto the kitchen floor. What causes this and how can I prevent it?

R. L.—Montreal, Que., Can.

**A**—Your trouble is caused by condensation of moisture in long, horizontal runs of stove pipe. This is due to the fact that one of the products of combustion of fuel oil is water vapor. Where possible, one remedy that usually succeeds is increasing the rise of the pipes, which correspondingly increases the velocity of the flue gases and helps to prevent the condensation of moisture in such quantities as you describe.

**Basement Rain Pipe Thickly Coated with Frost**

**Q**—How can I prevent frost on the masonry walls where a rain pipe enters my basement? On cold days the pipe and the wall all around the pipe are thickly coated with frost.

A. R.—Winnipeg, Man., Can.

**A**—According to the sketch you enclosed, cold air coming down the pipe causes moisture to condense on and about the downspout at the point where it enters the basement. Temporarily, you could coat the pipe and adjacent area with a special paint made for the purpose of preventing condensation on water pipes in basements. This, we think, would at least minimize your trouble. However, it does seem that the only permanent remedy is to remove the pipe from the basement, making the installation somewhere outside the building.

**Refinishing Painted Furniture**

**Q**—I have a white-enameled kitchen set of maple. Can I take off the enamel, then stain a reddish color and finish with varnish?

M. K.—Providence, R. I.

**A**—We doubt the advisability of attempting to stain furniture after paint or enamel has been removed by ordinary methods. It can be done with fair success on work where it is possible to remove all the old finish from the wood. Otherwise, the new finish is likely to be patchy. The reason is that the liquid vehicle in paints and enamel's penetrates the wood unequally, that is, deeper on those areas where the grain is oblique. Unless you can remove all the original finish from such areas, the stain will not "take" uniformly. A wood bleach, in strong solution, will help but still does not entirely eliminate the problem of getting a uniform color in the new stain finish. However, there are several quite simple processes for finishing over the enamel, provided, of course, it is in good condition. To do this, you apply a ground coat first and then wipe with a cloth while wet to give a wood-grain effect. When you get the desired graining, the ground coat is allowed to dry thoroughly. This is followed with varnish alone, or shellac and wax. This will not equal the natural wood grain brought out by a skillfully applied stain finish, but we have seen some very attractive work done on painted furniture by using this method.

**Making Stove From Oil Drum**

**Q**—I have tried to make stoves from 50-gal. oil drums by cutting holes in various parts of the drum. The stove always smokes. How can I prevent this?

D. S.—Brooklyn, N. Y.

**A**—One method is to install a welded grate to raise the fuel bed above the bottom. Holes should be drilled about two inches or so below the grate.

**Leak in Kerosene Line**

**Q**—I have a kerosene heater which is fed from a tank through copper tubing. Kerosene leaks from two joints. If I cut the tubing to make a new connection it will be too short. Is there a way to stop the leaks without cutting the tubing?

W. S.—Brooklyn, N. Y.

**A**—White-lead paste applied to the threads usually will stop leaks of this kind. Time must be allowed for the lead paste to set. Lacking the lead paste, plumbers' pipe-joint compound would probably do as well.



# How one application of sensational liquid-type car polish does two jobs!

**1** As you apply Carnu, it **CLEANS!**  
So easy—just apply Carnu with a soft cloth. Rub only hard enough to loosen grime. The liquid dries quickly to a white powder.

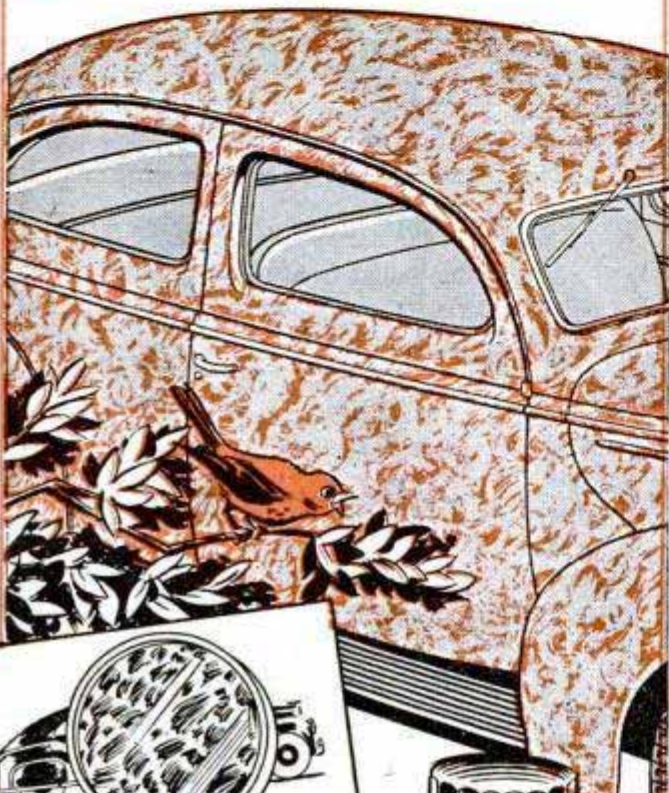

**BEFORE CARNU** The finish is dull and rough with dirt and oxidized paint.



**AFTER CARNU** The finish is bright as a mirror—so smooth that future dust and dirt flick off easily.



Pull up a chair—they're on the air!  
Fibber McGee and Molly  
Tuesday Nights—NBC

**2** As you wipe Carnu off, it **POLISHES!**  
Nothing to it! Powder-dry Carnu wipes off without hard rubbing—and takes dirt with it. Finish sparkles with a showroom shine. Carnu also polishes chrome fittings.

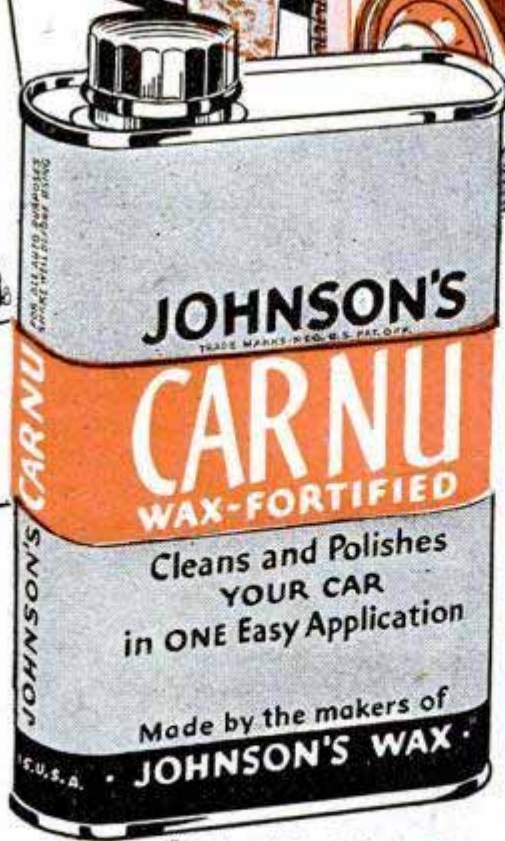
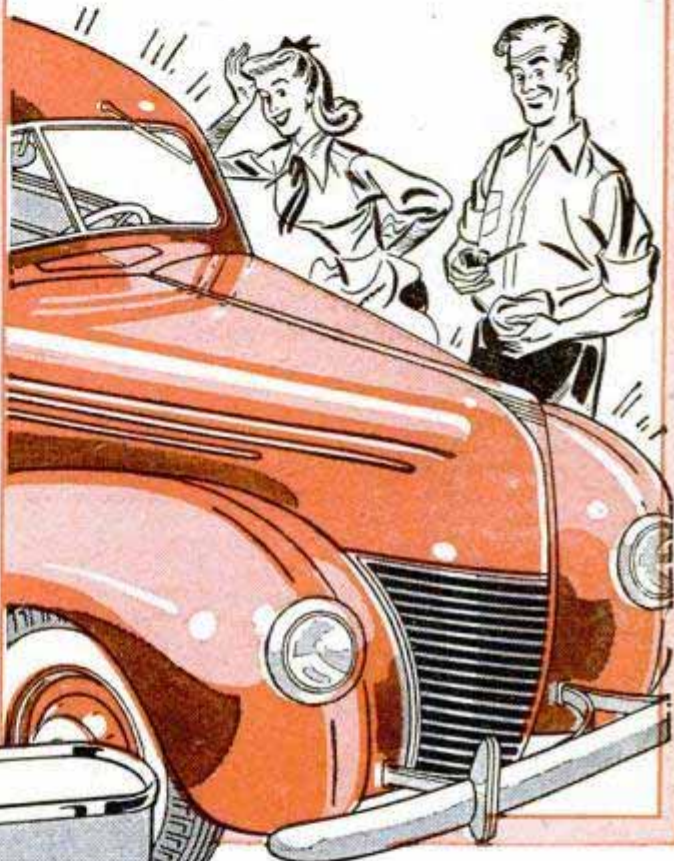

Get Johnson's Carnu\* at filling stations, auto supply, hardware, department, grocery or variety stores.

## For Extra Protection... Johnson's Auto Wax



This easy-buffing wax is just the thing for any home handy-man who wants to give his car a professional finish. There's no better protective coating than Johnson's Auto Wax. It guards the finish against sun, heat, moisture. Easier, too, to keep your car clean and shining—dirt can't imbed itself in the smooth, hard, waxed surface. Johnson's Auto Wax is sold wherever Carnu is sold. Try it!

\*Trademark Reg. U. S. Pat. Off.

© S. C. Johnson & Son, Inc., Racine, Wisconsin, 1948



**ALL YOURS  
FOR YEARS  
in a Johnson**



Perfected Alternate  
Firing

Dual Carburetion

Reverse

Ready-Pull Starter

Positive Primer

Synchro-Control

Co-Pilot

Salt Water Protec-  
tive Treatment

Rubber Rotor Pump

Weedless Propeller

Stainless Steel Pro-  
peller Shaft

Grease Seals

Big Grease Capacity

Big Gas Capacity

Automatic Oiling

Hardened Steel  
Gears

Rubber Flow Shock  
Absorber



**Yours for YEARS**  
OF SWEET  
PERFORMANCE

#### FREE HANDY CHART

New! Illustrates and charts the 5 great Johnsons for '48. Sent free. Write! Look for the name of your Johnson dealer under "Outboard Motors" in your classified phone book. See him!

JOHNSON MOTORS  
400 Pershing Rd., Waukegan, Ill.  
Johnson Motors of Canada  
Peterboro, Canada

**JOHNSON**  
SEA-HORSES  
for *DEPENDABILITY*

Under the direction of U. S. officers, several hundred Japanese ships are sweeping the waters of Japan and the Philippines. Bomb-disposal crews are de-fusing unexploded bombs dropped on Tokyo, Yokohama, Osaka and other large cities by the B-29s. Still another group is removing from an inland sea naval base 15,000 tons of mustard gas and other poisonous chemicals, putting them in 100-gallon rustproof cans and dumping them into the sea.

It will be a happy day for the world when no more hidden pockets of death lie in the fields, forests and waterways. Until these fangs of war are pulled, there will be no security for many peoples of the world.

## How Do Pigeons Navigate?

(Continued from page 140)

What would happen if pigeons were released between their home and the conjugate point? This interesting question came up and Dr. Yeagley trained 50 birds to home at State College for a new experiment. He released them in pairs every 50 miles on a line between State College and Kearney. The results are significant. Those released east of the halfway mark flew almost in a straight line for State College and the other half flew directly away from State College toward Kearney.

Dr. Yeagley then attempted to disprove the theory that homing pigeons always return to their loft because of some mysterious ability, inherited from their forebears, to sense the direction and distance they are being carried, even though they are drugged or asleep. Three hundred untrained pigeons from homes in Texas, Missouri and New Jersey were released in the region of Hamlet, Neb. According to this popular theory, the birds should have been able to pilot their way back along the railroad tracks to their various homes. Actually, the birds scattered across the country, some making long flights and others short ones. This seems to explode the theory that pigeons have an inherited instinct that does not need to be developed.

Dr. Yeagley does not claim to have fitted together all the pieces of the pigeon puzzle. For example, he doesn't know what organ of the pigeon's body is the navigating instrument that senses magnetic effects and Coriolis force. One of many possibilities is the pecten, a moundlike structure in the pigeon's eye which has no known function. Dr. Yeagley also suggests that other birds may have this homing ability to a greater extent than the pigeon

(Continued to page 248)





# OTHER PROTECTION FOR YOUR DOORWAYS

— ADDS BEAUTY AND VALUE TO YOUR HOME!

Now, at low cost, you can dress your home and protect doorways with a beautifully designed awning. Available to install by anyone. All-aluminum construction. Permanently rust-free. Effectively protects your roof.

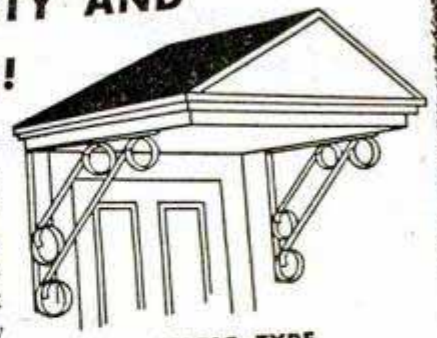

### GABLE TYPE

48 inches wide, 32 inches deep, 57 inches tall. Furnished complete with 2 ornamental columns. Ready to install.

COMPLETE



"Thanks a Million,  
American..."



—a possible partial solution to the mystery of migration—but he has not yet been able to prove or disprove this belief.

Another pigeon peculiarity is the use of radio and radar waves on their homing ability. When in the presence of powerful radio waves, pigeons are seen to flutter helplessly, without any sense of direction. This has been reported to have been observed in released pigeons. The birds were broadcast from a plane flying over the





# ALL-WEATHER PROTECTION FOR YOUR DOORWAYS

— ADDS BEAUTY AND VALUE TO YOUR HOME!

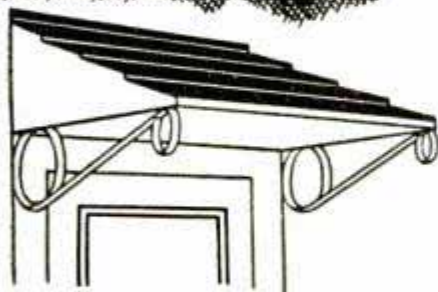

### SLANT TYPE

48 inches wide, 32 inches deep, 9 inches tall. Furnished complete with 2 ornamental brackets ready to install.

**ONLY \$18.95 COMPLETE**

*Write for descriptive folder and dealer in your locality*

Now, at low cost, you can dress up your home and protect doorways with a beautifully designed canopy. Simple to install by anyone in 20 minutes. All-aluminum construction — permanently rust and rot proof — attractively finished in white with green roof. You'll be delighted over the smart styling and extra value appearance these canopies will add to your home. Your satisfaction is guaranteed.

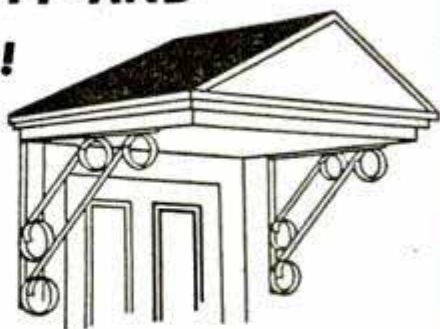

### GABLE TYPE

48 inches wide, 32 inches deep, 17 inches tall. Furnished complete with 2 ornamental brackets, ready to install.

**ONLY \$29.50 COMPLETE**

## All-Aluminum DOORWAY CANOPIES

TEL-O-POST COMPANY • 140 Ash St., Akron 8, O.



I'M RIDING FOR A FALL, UNLESS I HURRY WITH THIS WELDWOOD GLUE

When you want to fix things fast... remember Weldwood Glue. It's quick to mix... easy to use... tremendously strong... stain-free... rot-proof... and permanent. At hardware stores, lumber yards, chain stores.



## WELDWOOD PLASTIC RESIN WATERPROOF GLUE

United States Plywood Corporation, New York 18, N. Y.

### NOW—For the First Time a SCREW-STEM FILTER PIPE for \$1

Royalton <sup>®</sup>  
**FILTERWELL**  
With *Ajustomatic* Stem

Patented

AJUSTOMATIC STEM NEVER LOCKS OUT OF LINE →

FILTER ABSORBS TARS & JUICES →

IMPORTED BRIAR

Never before a screwstem pipe with all these features: patented free-turning self-aligning *Ajustomatic* stem—an easy-to-replace Filter—choice of smart styles in fine imported briar — and a low, low price making it the best buy in pipe history!

**\$1**

At Better Stores . . .

HENRY LEONARD & THOMAS, INC. OZONE PARK 17, N. Y.



# "Thanks a Million, American..."

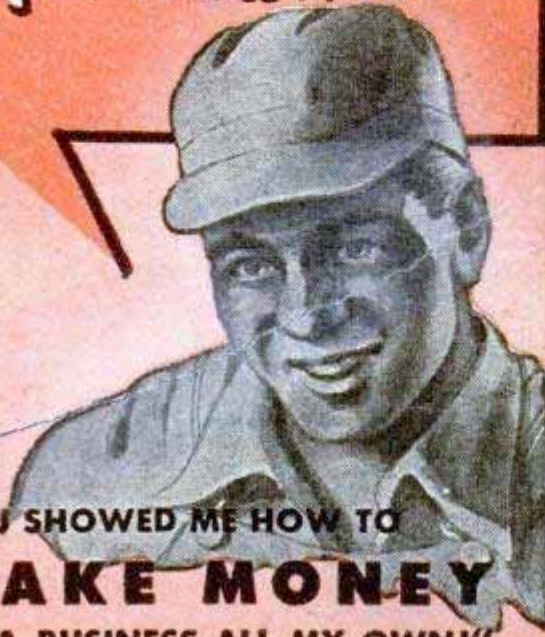

**"YOU SHOWED ME HOW TO  
MAKE MONEY  
IN A BUSINESS ALL MY OWN!"**

Now—you, too, can be your own boss and step into big profits in the building industry as a floor surfacing contractor! Make \$35 to \$50 a day—that's what

hundreds of men everywhere are earning in floor surfacing work today with an American Floor Sander! Easy to operate—no big overhead—no large investment—no special schooling. Prospects everywhere—sand new and old floors. Start now and get ahead! Send coupon for money-making booklet.

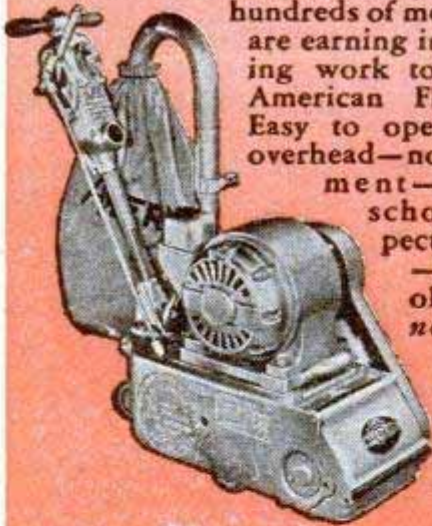

## AMERICAN

FLOOR MACHINES

The American Floor Surfacing Machine Co.  
535 So. St. Clair St., Toledo 3, Ohio

Enclosed find 25c in stamps or coin for booklet "Opportunities in Floor Surfacing", telling me how I can start my own floor sanding business.

Name.....  
Street.....  
City..... State.....



—a possible partial solution to the mystery of migration—but he has not yet been able to prove or disprove this belief.

Another pigeon peculiarity is the effect of radio and radar waves on the birds' homing ability. When in the vicinity of powerful radio waves, pigeons have been seen to flutter helplessly in circles with no sense of direction. In one experiment reported to Dr. Yeagley, a pigeon fancier released 20 well-trained birds beneath a broadcasting tower. Most of the pigeons flew around the tower for an hour or more, a few crash-dived in the vicinity and not one bird ever returned to its loft.

Dr. Yeagley plans to conduct experiments seeking an answer to this phenomenon soon, and to determine the effect of violent sunspots, which also seem to impair the ability to home. He will use relatively rare white homers which can be spotted easily and followed by plane.

The scientist suggests that some animals may have the same ability as homing pigeons. He also says it's possible that some of the sickness experienced by high-speed pilots may be caused by movement through magnetic fields rather than just the accelerations resulting from turns at these speeds.

## Guardians of the Rails

(Continued from page 134)

line unrolls the twine as they advance. This serves as the boundary for the return trip across the field while another ball of twine is being unrolled by the outside man as the next marker.

Guarding millions of dollars worth of valuable freight is one of the less dramatic but more important functions of the railroad police. A single large freight yard may handle from three to five million dollars worth of cargo in one day. Freight thieves work in organized gangs with both "inside" and "outside" operators. Small items, such as watches, perfumes, playing cards, pocket radios, jewelry and clothing are smuggled out on their persons. Larger loot, typewriters, cartons of cigarettes, cigars, gum, table radios or bales of costly cloth are "planted" in some hiding place where they can be smuggled out later. The plain-clothes men who frequent the yards are on the alert for these "plants." Many items in transit are under guard from the time they arrive at the freight house until they are re-sorted and sent on their way. The trained police can spot a tampered package at a glance. These packages are immediately taken to the cooper's office

(Continued to page 252)





# QUALITY **MP** TABLE MODEL TILT-ARBOR SAWS

OIL IMPREGNATED BRONZE BEARINGS OR DOUBLE SHIELDED BALL BEARINGS, BOTH WITH THE PATENTED BALL BEARING TRANS-AXIAL MOTOR DRIVE

TABLE 18" x 16"

Double Shielded Ball Bearings \$5 Extra

Aluminum Guard Easily Removed for Dadoing

**BRONZE BEARING**  
**\$44.95** F.O.B.  
 ROYERSFORD, PA.  
 (Less Blade & Motor)

IMMEDIATE DELIVERY

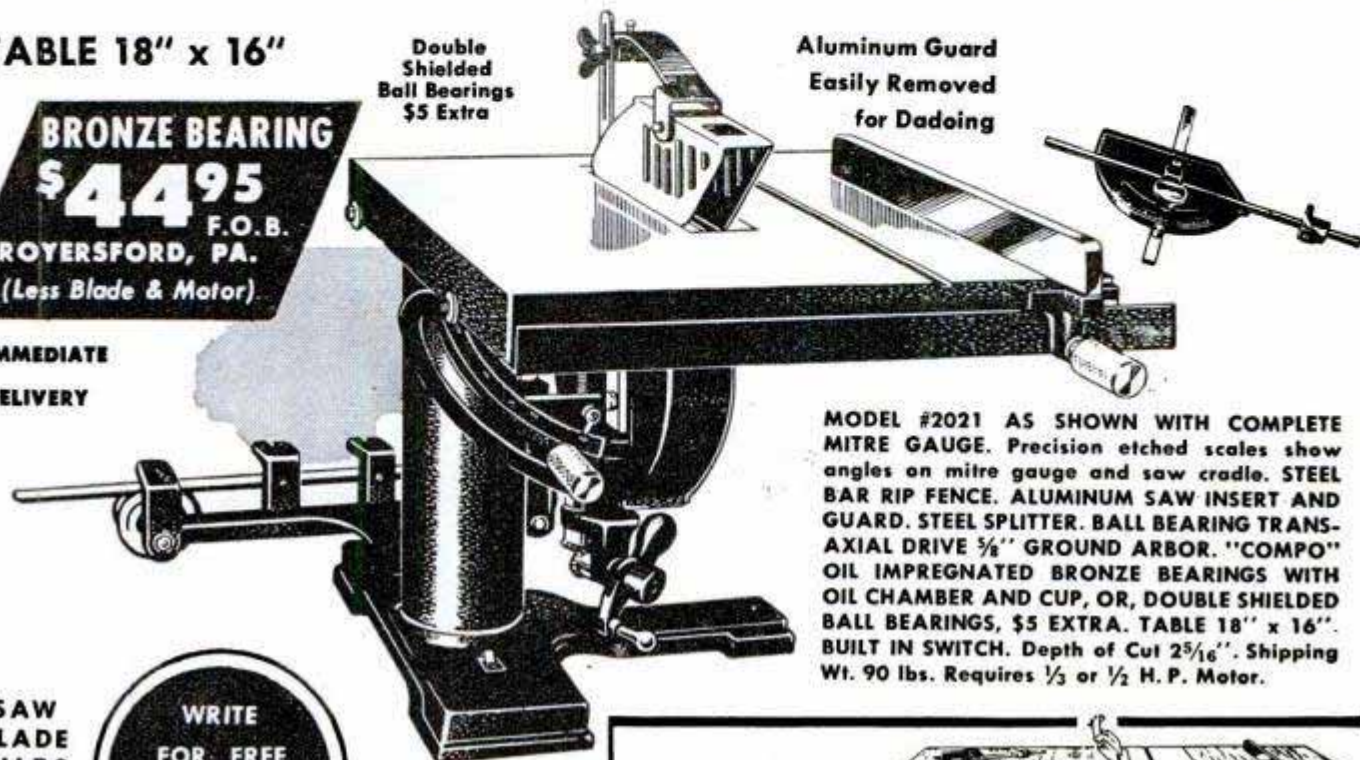

MODEL #201 AS SHOWN WITH COMPLETE MITRE GAUGE. Precision etched scales show angles on mitre gauge and saw cradle. STEEL BAR RIP FENCE. ALUMINUM SAW INSERT AND GUARD. STEEL SPLITTER. BALL BEARING TRANS-AXIAL DRIVE  $\frac{3}{8}$ " GROUND ARBOR. "COMPO" OIL IMPREGNATED BRONZE BEARINGS WITH OIL CHAMBER AND CUP, OR, DOUBLE SHIELDED BALL BEARINGS, \$5 EXTRA. TABLE 18" x 16". BUILT IN SWITCH. Depth of Cut  $2\frac{5}{16}$ ". Shipping Wt. 90 lbs. Requires  $\frac{1}{3}$  or  $\frac{1}{2}$  H. P. Motor.

SAW BLADE TILTS

WRITE FOR FREE ILLUSTRATED FOLDER

TABLE STAYS LEVEL

**FLOOR MODEL**

Model #201 With 2 Extensions Makes Table 18" x 48"



TABLES PRE-DRILLED FOR EXTENSIONS

EXTENSION MAKES TABLE 18" x 32"

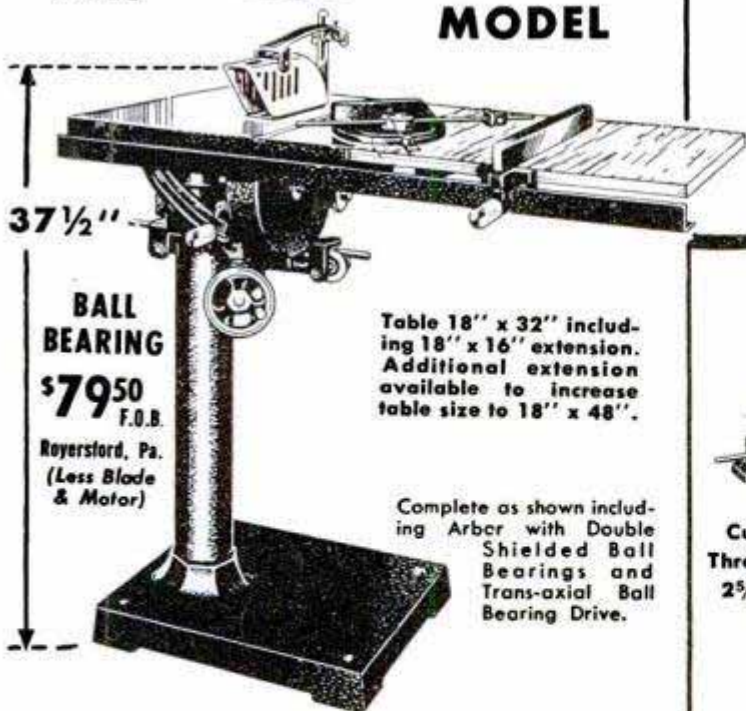

BALL BEARING \$79.50 F.O.B.

Royersford, Pa. (Less Blade & Motor)

Table 18" x 32" including 18" x 16" extension. Additional extension available to increase table size to 18" x 48".

Complete as shown including Arbor with Double Shielded Ball Bearings and Trans-axial Ball Bearing Drive.

**8" TILT TABLE BENCH SAW**

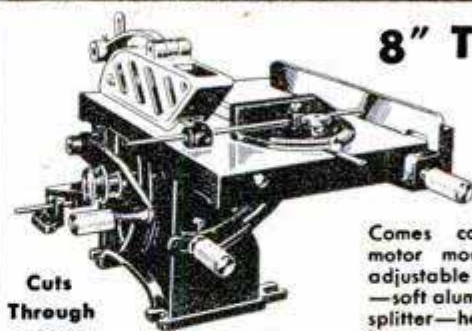

Cuts Through  $2\frac{5}{16}$ "

**\$24.95** F.O.B. ROYERSFORD, PA.

Comes complete with Floating motor mount—mitre gauge with adjustable stop—aluminum guard—soft aluminum insert—spring steel splitter—heavy gray iron fence—(no motor—no blade). Table 12" x 14" Tilts to 45°—Oilite bearings. Shipping Wt. 50 lbs.

COMPLETE AS SHOWN

MARCUS • POLLAK

**AMERICAN MACHINE & TOOL CO. INC.**

DEPT. 20 ROYERSFORD, PA.

MACHINE BUILDERS AND IRON FOUNDERS FOR OVER A QUARTER OF A CENTURY



**CASH IN ON THE BUILDING BOOM!**

**MAKE BUILDING BLOCKS**

**RIGHT IN YOUR OWN BACKYARD**

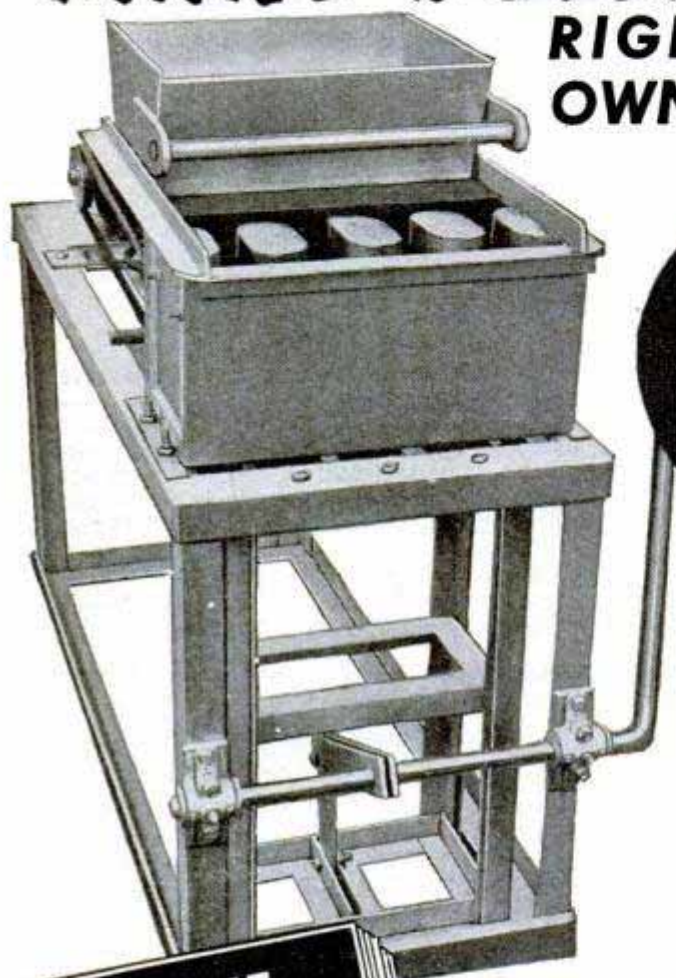

**AMAZING GENERAL BLOCK MACHINE**  
 CAPACITY 1000 BLOCKS PER DAY  
 Only **\$199** LESS MOTOR  
 F.O.B. PHILA. 6, PA.

**CINDER AND CEMENT BLOCKS IN BIG DEMAND . . . SELL ALL YOU PRODUCE TO CONTRACTORS, BUILDERS, SUPPLY YARDS AT 15c TO 25c EACH. EASY TO START A PROFITABLE BUSINESS.**

General Block Machine can be operated indoors or out, in space 10 feet by 15 feet. Rugged construction. Vibrator shaft mounted in self-aligning sealed roller ball bearings. Very simple to run. Powered by 1/2 H.P. electric motor, or can be rigged for gasoline engine. Produces up to 1000 8x8x16 Blocks in 8-hour day—superior 3-core type, meeting all Building Code requirements. Can produce 8x8x16, 4x8x16, 8x8x8, chimney corner and cesspool Blocks. Ingredients for Blocks—cinders, cement, sand—readily obtainable anywhere in U.S. Full operating instructions and complete mixing formulas with each General Machine. Immediate delivery anywhere in U.S. Mail Coupon at once for further details, sent Free, without obligation.

**TERRITORIES OPEN—DEALER INQUIRIES INVITED**

**SAVE MONEY BUILD THAT DREAM HOME**  
 of Beautiful CONCRETE BLOCK  
 Only \$1 prepaid

Wonderful Booklet Written and Illustrated by Our Staff of Experts

Shows you how to save 1/3 to 1/2 by doing the easy work yourself.

Mail coupon at once with \$1.

**1/2 BAG CONCRETE MIXER**  
 ONLY **\$299** COMPLETE

Powered with Briggs & Stratton 2.08 H.P. Air-Cooled Gas Engine. Rugged construction, simple design, mixes concrete, mortar, fertilizer, feed. Fully Portable. Good-year pneumatic tires, roller bearing wheels, steel bowl, wheels into hard to get places. Just fuel, crank and start mixing. Instructions and parts list included. Immediate delivery.

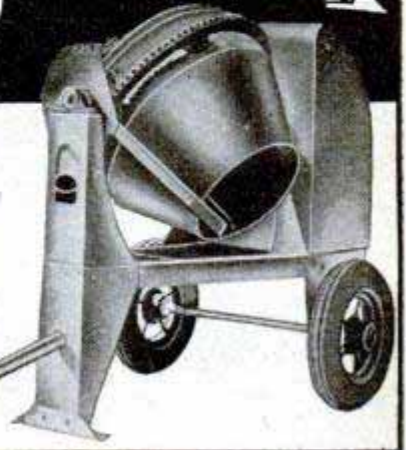

**GENERAL ENGINES CO.**

(Eastern Division)

Drexel Building, Dept. P, Philadelphia 6, Penna.

- Rush FREE Literature on General Block Machine
- Rush FREE Literature, 1/2 Bag Concrete Mixer
- Enclosed find \$1. For Your Wonderful Booklet "HOW TO BUILD YOUR OWN CONCRETE BLOCK HOME"

Name.....  
 Address.....  
 City.....Zone.....State.....



# K-R-O KILLS RATS

• Comes in POWDER and BIS-KIT form. Both contain *red squill*; are safer around farm animals and pets. POWDER, 75¢; BIS-KITS, 35¢ and \$1.00. If unavailable from your druggist or seedsman, order direct; adding 15¢ for mailing and handling. Money-back guarantee. *The K-R-O Company, Springfield, Ohio.*

**SOUTH BEND**

## NEW SURFACE PLATE, V-BLOCKS, ANGLE PLATE

**SURFACE PLATE** for checking, laying out, etc. Precision ground to .001". 12" x 17" x 3", top 3/4" thick. \$37.50

**V-BLOCKS** for holding cylindrical parts. Precision ground. 1-15/16" x 2-15/16" x 2-1/4". Cap. 1/4" to 2". Per matched pair.. \$32.00

**ANGLE PLATE.** Precision ground. 3-1/4" x 3-1/4" x 4-1/4" \$20.00

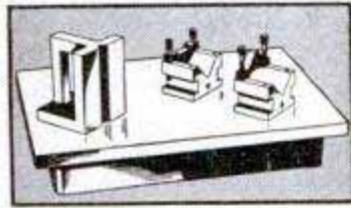

**SOUTH BEND LATHE WORKS** 455A E. Madison St. South Bend 22, Ind.

# MACHINE STEEL

**SMALL LOTS** From stock — Cold Rolled Rounds, Squares, Hexagons, Flats for machining, welding carburizing. Also Polished and Ground Drill Rods. Write for free stock list and prices.

**CHESTERFIELD STEEL SERVICE COMPANY**  
P. O. BOX 3058, CLEVELAND 17, OHIO

## NEWEST OTTAWA LOG SAW

**SELF-PROPELLED — MOVES ANYWHERE on OWN POWER**

World's fastest Log Saw. Powerful 6 H-P air-cooled motor. Attachments for sawing down trees, buzzing limbs, post hole digging and pulley for belt jobs. Big demand for wood, pulp, posts. Make big money sawing wood this easy way. Low factory-to-user prices. Nothing like it. **FREE** details.

**OTTAWA MFG. CO., 7-827 Pine St., Ottawa, Kansas**



## GARDEN TRACTOR

3, 4, 5 H. P. On market nearly a quarter century. No belts. No chains. Worm driven. 2 clutches. Power turning. All tractors guaranteed. Full line of attachments. Buy direct from factory. Write Dept. 104 for free catalogue.



**RED E TRACTOR COMPANY RICHFIELD, WISCONSIN**

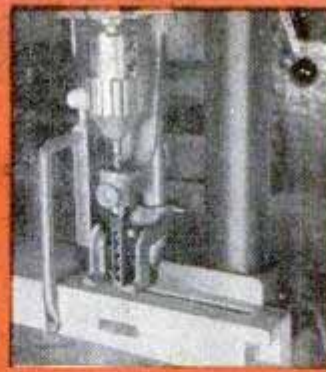

## TEACH YOUR DRILL PRESS THIS TRICK

Mortising on the drill press... results in fast accurate work with a skilled "custom" look about it. It's easy when you have a hollow chisel and mortising attachment, held true and tight with a JACOBS HEX-KEY CHUCK.



Your drill press can do many extra jobs when you outfit it with a tight-gripping JACOBS CHUCK. Mortising on the drill press is just one example of how your home workshop equipment multiplies in value when you enlist the aid of JACOBS CHUCKS.

Get greater gripping power... Better accuracy... Longer life with Jacobs' New Rubber-Flex Collet Chucks — Designed particularly for home workshop use.

Exclusive, bonded rubber-and-steel construction... no loose jaws.. no springs... not harmed by oils or coolants. Real precision chucks at popular prices. **SEE THEM AT YOUR LOCAL HARDWARE DEALER'S.**

## IF IT'S A JACOBS... IT HOLDS



**HEX-KEY CHUCK**... fits 1/2" or 3/8" drill press spindles—motor shafts—jack shafts. With Morse taper arbor, fits lathe headstock, tailstock. 4 models, capacities to 1/2"



**HAND-TITE CHUCK**... fits all hand tools and power tools with threaded spindles... used on polishing heads, bench grinders, flexible shafts, etc. 3 sizes... capacities to 1/2". Models to fit 3/8-24, 1/2-20 and 1/2-24 threaded spindles.

ONLY

**JACOBS CHUCKS**

Have The Rubber-Flex Collet Its Parallel Bite Holds True And Tight



**The JACOBS MANUFACTURING COMPANY**  
150 Jacobs Road, Hartford 2, Conn.

Please send me your new illustrated folder on the Jacobs Rubber-Flex Hex-Key and Hand-Tite Chucks.

NAME.....

STREET.....

CITY.....ZONE....STATE.....



# AMAZING New WAY TO PAINT-CUTS TIME 75%



## ELECTRIC PAINTER

Now you can get professional results in painting, even if you've never painted before! The new Lowell Electric Painter actually gives a fine "factory-finish." Paints rooms, furniture—even your car! At stores, everywhere.



### PAINTS BEHIND RADIATORS!

Lowell Electric Painter actually atomizes paint. Covers area in a minute. Directional nozzle sprays paint straight ahead, up, down or sideways.

### FURNITURE PAINTING EASY!

Use any kind of paint with the Lowell Electric Painter—enamel, flat paint, or varnish. Holds a quart. Easy to use. Small, efficient AC/DC motor. Weighs 8 lbs.



### FASCINATING BOOKLET

Write for fascinating, new booklet: "40 Ways to Beautify Your Home." Send 10c to Lowell, Dept. 72, 589 East Illinois Street, Chicago 11, Illinois.

© 1947 LM. Co.  
Guaranteed



"Thoro-Spray"™

Electric Painter  
COMPLETE  
No Extras To Buy

**\$34.95**

Slightly higher in western territories.



\*T. M. REG. U. S. PAT. OFF.

**LOWELL**  
Manufacturing Co.  
World's Largest Manufacturer of  
Sprayers and Dusters Exclusively

where they are opened, the contents counted, losses recorded and the manufacturer notified.

Any person who travels by rail has some time or other brushed elbows with a plain-clothes man in the station. There are usually at least one or two of these officers on duty, on the alert for pickpockets, confidence men and other criminals who prey on travelers.

The police say pickpockets are easy to spot. They work in pairs and both men buy tickets for a short trip. Then they wait for a "tip" which is a large crowd of travelers lined up to get on a train. The pickpockets look over the tip and select their victim, possibly a well-dressed man who had made the mistake of feeling his wallet several times to make sure it was there. Then the pickpockets move in, one in front of the victim and one behind him. When the line starts to move the front man drops something or creates some delay which causes the victim to stop. The pickpocket behind bumps into him sharply and the victim's wallet is lifted.

During the war years the railroad police did an outstanding job in protecting the lives of troops in transit, in guarding ammunition trains, and in delivering suspicious characters to the FBI. One of the latter was found in the Chicago yards of the Illinois Central taking photographs of the tracks and posing as a model-railroad enthusiast. His films, however, were all of the big Stevens Hotel which overlooked the yards and was serving as an Army headquarters. This is just one of scores of similar incidents all over the country.

Taking another leaf from the pages of the FBI, the railroad police today are stressing crime prevention as well as detection. Even "knights of the road," otherwise known as bums or drifters, are handled with care. In some cases in the old days they were handled roughly, thus making lifelong enemies for the road and potential train wreckers. Now the bums are frequently handed over to proper legal authorities for punishment.

In the near future the special agents who ride the trains hope to make radio hookups with local and state police. This would expedite the handling of any disturbance of a criminal nature that might occur en route.

Jesse James wouldn't have a chance today.

Ⓞ With a voltage estimated in the millions and a current equal to that flowing into 300,000 homes, a tremendous lightning bolt that struck a Pittsburgh skyscraper recently is believed to be the most powerful ever recorded.



# Performance!\*

Boat Length	Boat Weight	Boat Load	1-12		1-20	
			Trolling Speed	Top Speed	Trolling Speed	Top Speed
12 ft.	115 lbs.	One	1.01 mph	12.5 mph	1.06 mph	20.7 mph
13 ft.	165 lbs.	One	.83 mph	12.1 mph	1.18 mph	18.8 mph
14 ft.	190 lbs.	One	.97 mph	10.9 mph	1.03 mph	16.2 mph

\* Tests conducted by an independent laboratory. Speeds are up-wind, down-wind averages.



## Two Great New Motors

# Scott-Atwater 1-12 AND 1-20

### A New Experience in Outboard Motoring

What do you want in an outboard motor? Sensational performance? Faithful reliability? Simplicity of operation? You'll find extra measure of all of these in the new 1948 Scott-Atwater Motors! Plus luxurious styling and real Scotch value.

Your dealer will gladly demonstrate Scott-Atwater's superb performance and all-weather, botherfree reliability. See the new porous metal filter (exclusive) that keeps even water out of the fuel system. Scott-Atwater's new high-pressure water pump (exclusive) permits slowest trolling for hours on end without over-heating, and super-ignition keeps spark plugs clean all season long, just as the super-sealed lower gears require attention but twice a year. Truly, Scott-Atwater gives you the kind of reliability you'd expect only in a fine motor car.

Scott-Atwater's performance is amazing! And its "A B C" simplicity of operation and distinguished styling impress you immediately. Best of all, you get more O B C Certified horsepower per dollar. Write Dept. PM48 for literature.

One mph trolling  
Twelve mph top speed

One mph trolling  
Twenty mph top speed

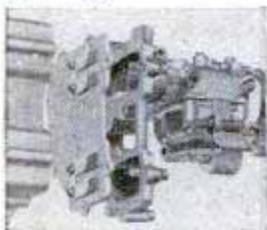

**Multiple Feather Intake Valves**  
—Give phenomenal idling and top speeds by automatically changing timing to admit optimum charge at all speeds (not possible with other types of valves) . . . flood-proof for easy starting, and wear-proof.

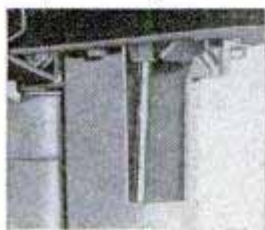

**Full-Expansion Exhaust**— plus the jet-silenced cut-out. Reduces back pressure to an absolute minimum . . . a major contribution to Scott-Atwater's remarkable high speed . . . slow trolling . . . and easy starting.

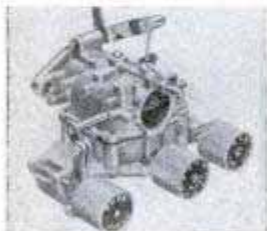

**Concentric Bowl Carburetor**— With automobile type dual jets gives correct mixture at any speed, even tilted to 50°.

**New Type Magneto**— Shoots hotspark for one-pull starting, clean-plug trolling.



**High Pressure Water Pump**— Oscillating rotor type located on drive shaft operates 60% faster giving positive circulation at slowest trolling. New synthetic rubber out-wears metal. Patent pending.

Scott-Atwater 1-12  
Deluxe Single with  
Auto. Recoil  
Starter, 3.6 h.p.  
(OBC Certified @  
4,000 rpm).

Also available,  
Scott-Atwater 1-20  
Deluxe Alternate  
Firing Twin,  
7 1/2 h.p. (OBC  
Certified @ 4,200  
rpm).

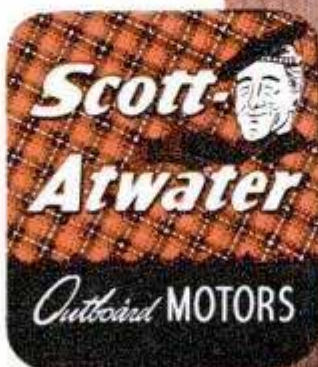

© 1948 Scott-Atwater  
Manufacturing Co., Inc.  
Minneapolis 13, Minn.

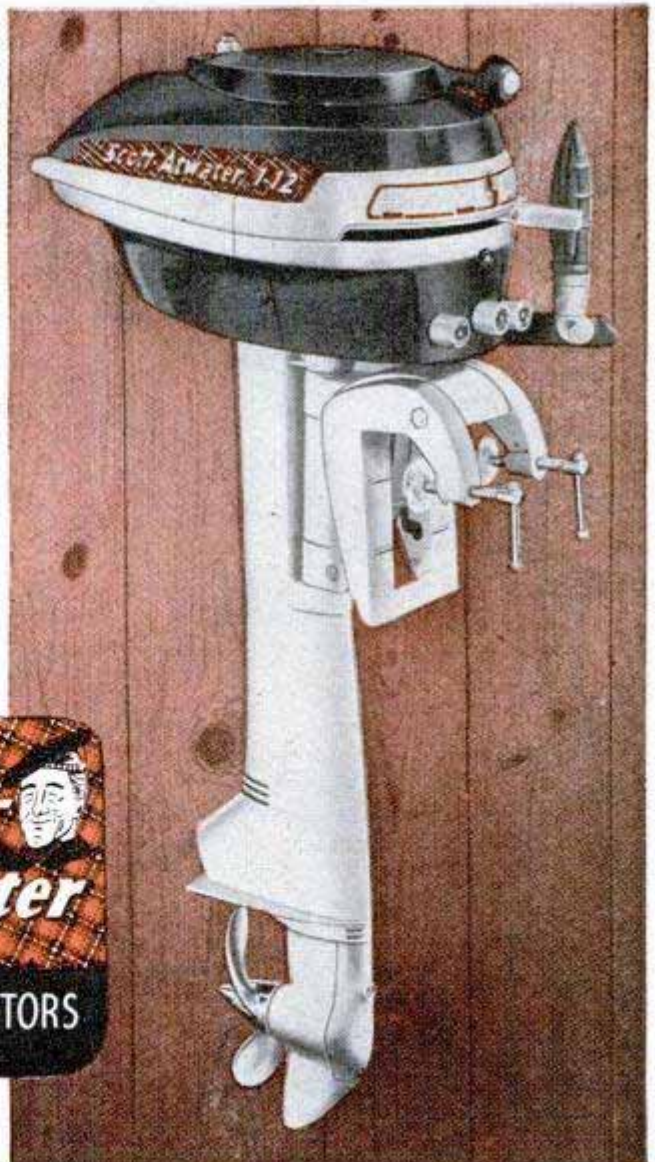



F & S PRIZE WINNER

# Wonderlure



New **BABY FLYROD**, 1/4 oz., \$1.10.  
Ready **APRIL 1**.

## HAVE YOU SENT IN A NAME?

Send a catchy name in at once for the **BABY FLYROD LURE**—looks just like its **DADDY**—the Wonderlure above. Then write 25 words giving reasons for name. Send in as many names as you care to. Be sure to attach a Makinen Box Top to each entry.

\$1.25  
8 colors  
Wt. 1/2 oz.

## WIN CHEVROLET or \$500 CASH 2000 Other Valuable PRIZES

Get lucky — Why not try. Other prizes are Karriall Trailer—Television Set—Canoe—Johnson Sea Horse—Radios—Rods—Reels—Camp Stoves. Etc. Open to all, boys, girls, men and women. Contest closes Sept. 30, 1948.

**GET FACTS TODAY!** Don't Delay. Circular describes all prizes, rules, etc. Stop at your dealer or write us. Thousands of chances to WIN with names or photos.

**IF DEALER CAN'T SUPPLY**, send us his name check or money order and we'll ship lures postpaid. The more names you send in, the more chances you have to WIN. Give color of lures wanted: **RED HEAD—FROG—PERCH—ORANGE—RED SPOT—YELLOW RED SPOT—MOUSE—BLACKIE**. Don't Delay! Enter Contest Today!

## MAKINEN TACKLE CO.

Contest Editor, Dept. PM4, Kaleva, Mich.

F & S PRIZE WINNER



**WADDLE BUG** Surface Killer 5/8 oz. \$1.10  
8-Colors



**HOLI-COMET-Diver** 5/8 oz. \$1.10  
8-Colors



**FLUTED MAKIDEVL** Weedless Spoon 1/2 oz. 85c  
8-Colors



# MENDS

**DISHES, TOYS, ETC.**

It's clear, water-proof, flexible, durable.



# DUCO CEMENT

REG. U. S. PAT. OFF.

## Every Driver Needs...



**HANDE-FEED**

**Finger-Tip Gas Control**

only  
**\$4.95**

Postpaid  
Complete

**DRIVE RELAXED!** . . . install **HANDE-FEED** on your car and **MINIMIZE DRIVING FATIGUE!** Installed in about 15 minutes on most cars. Connects directly to carburetor. **RELIEVES AND RELAXES THE FOOT.** Minimizes back-roll on up-hill starts. Simply lift lever to increase engine speed, when released engine idles. Pivots for use with right or left hand. Does not interfere with gear shift or steering. Chrome finish. Complete instructions with every unit. **\$4.95** postpaid. Send check or money order, or sent C.O.D. plus postage.

TRANS-CONTINENTAL IND., Dept. PM-2, 818 Olive, St. Louis 1, Mo.

## STAY HOME AND MAKE MONEY!

—Men! Women! Get into profitable, uncrowded profession you can operate from your home or small office after short home training course. No capital required. No goods to buy. No age limit. Others earn \$50.00 to \$100.00 per week making famous Stephenson corrective foot devices to order. Foot sufferers everywhere pay gladly for relief. Send today for **FREE BOOKLET**.

**STEPHENSON METHOD**, Established 1894, 12-28 S. Market St., Boston, Mass.

## BUILD THIS CONCRETE BLOCK MACHINE

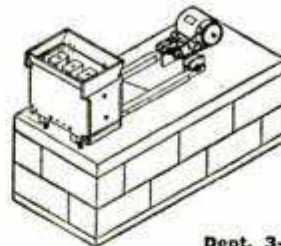

Sell blocks; or build your home, garage, barn at 1/2 cost by making and laying your own blocks.

This simple machine which you can build yourself at a cost of about \$15 (excluding motor) will make a block in 30 seconds using only one form. 2 to 4 forms can be used on each vibrator.

Power driven concrete mixer plans also. Send dime for details and "How to Make and Lay Blocks."

### U-BUILD-IT SERVICE

Dept. 3-A, 206 West Wilder Ave., Tampa 3, Fla.

## WRITE FOR YOUR FREE COPY OF THE NEW KRW HYDRAULIC PRESS BOOK

Describes all manner of Production and Shop Work on KRW Hydraulic and Bench Type Arbor Presses. 32 pages illustrating the new KRW Hand-operated, Electric-operated and Air-operated Hydraulic Presses.

Write for your copy today.

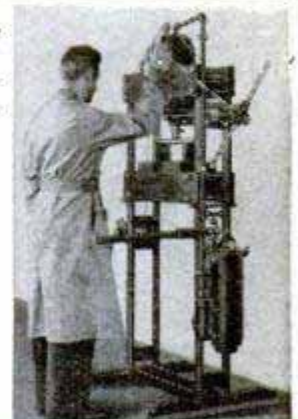

**K. R. WILSON, DEPT. 17, 215 MAIN ST., BUFFALO 3, N. Y.**

Builders of Shop Equipment for Ford Dealers Since 1916



# U.S. NAVY 7X50 PRISM BINOCULARS WITH COATED OPTICS



Used but in Excellent Condition

## \$95

Complete with leather carrying case and sling

Universal, 6x 30 Navy Prism Binoculars, used but in excellent condition, complete with leather case and sling straps. . . . . **\$42.50**

With Coated Optics, \$10 Extra.

Field Glass, 4X 40 Wollensak. Ideal for bird study. Brand New. . . . . **\$17.95**

Engineers All Metal Army Type Hand-Sighting

## LEVELS

### \$2.00

PRECISION QUALITY



Send \$1.50 for 3rd Edition of Gun Digest with our complete catalog of new and used guns, etc. Our separate catalog 25c.

**PUBLIC SPORT SHOPS**

11 S. 16th St., Phila. 2, Pa.

No COD's

## NEW 30" SHEET METAL BRAKE



Forms angles, channels, vees, flanges, locks, zees, boxes. Handles 26 gage sheet steel, heavier gages of aluminum, copper, plastic, etc. Portable. Can be held in a bench vise, or bolted down. All steel construction. Wt. 40 lbs. **\$24.50** Shipped exp. collect. ONLY



**12" BRAKE.** Cast iron and steel construction. Price, \$14.50 PP.

**18" CURVE FORMER.** Forms cylinders, round corners and cones in sheet metal and strap iron. Price, 10.00 PP.

**VISE IRON BENDER.** Forms rings, hooks, eyelets, etc. in 1/2" round or square: 1/4" up to 2" wide in bar iron. Price \$10.00 PP. For bending 3/4" pipe, \$2.00 extra.



**SHEET METAL PLIERS.** 21 1/2". Forms angles, channels, etc. \$2.00 pp. All items guaranteed.

**WISE BRAKE MFG. CO., Dept. P4, 1318 So. 30th Ave., Omaha 5, Nebr.**

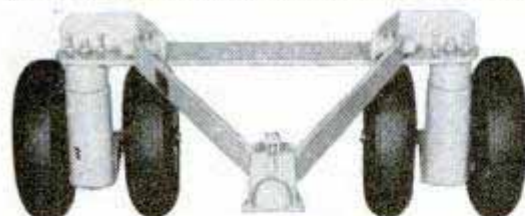

**4 WHEELER (Illustrated)**

**\$175**

**2 WHEELER \$125**

**WATSON DOUBLE-ACTION HYDRAULIC TRAILER DOLLY**

60 miles per hour SAFELY - all day

**THE WATSON AUTOMATIC MACHINE CO.**

Glendale, Calif.

Mansfield, Ohio

## AIR COMPRESSORS

Model 2-V-S-4-V-A Bendix-Westinghouse 4 cu. ft.

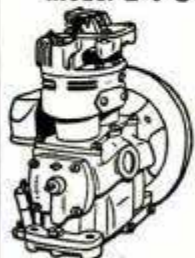

Govt. Surplus, 2 cylinder Bus and Truck Type. Ball bearing crank shaft. Pressure feed oil system. Positively one of the finest and most accurately built air compressors on the market.

Original Cost Over \$140.00

In good operating condition with 30 day written guarantee, . . . . . **\$3450** Special Low "as is" price . . . . . **\$2950**

Accessories available for compressors, air regulators, safety valves, air gauges, control governor, misc. fittings, hose, paint guns. Write for Prices and Catalogue

**MIDWEST SURPLUS SALES CO. 1520 LOCUST ST. KANSAS CITY, MO.**

*"Paint-it-Yourself"*

# \$345

## PAINTS YOUR ENTIRE CAR WITH

ONE COAT COVERS

# NU-ENAMEL

TRADE MARK REG. U. S. PAT. OFFICE

NO BRUSH MARKS

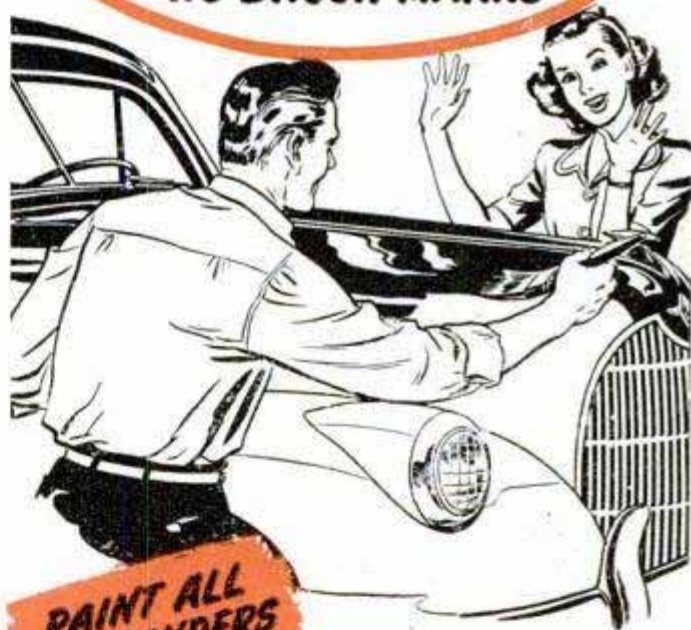

**PAINT ALL YOUR FENDERS FOR ONLY \$1.95**

ASK YOUR **NU-ENAMEL** DEALER FOR THIS INSTRUCTION FOLDER



Contains the step-by-step story of how you can Paint-It-Yourself with Nu-Enamel and get a professional looking job.

**It's EASY! - It's FUN!**



# Listen, pal-

## HERE'S A FISHIN' FOURSOME THAT'S TOPS!



The No. 411 South Bender rod—the No. 750 Perfectoreno reel—a Black-Oreno nylon line—a world-famous Bass-Oreno lure... Man, there's matched tackle that's tops. It's quality-built for perfect casting and the finest of fishin' fun.

### No. 411 SOUTH BENDER ROD

"Action you've never experienced before in a rod," anglers say. It adds a new thrill to bait casting. Controlled flexibility produces a live suppleness that gives just the right whip for perfect, effortless casting. Length 4' 11" .. \$15

### No. 750 PERFECTORENO REEL

*No Thumbing—No Backlashes*

Makes casting easy, effortless and a real pleasure. Precision-built. Level winding. Chrome-plated frame .. \$10 Others priced at . . . \$11 and \$13.50

### No. 973 BASS-ORENO

*Famous Fish-Getter*

World's greatest—and most imitated—bait. Darting, diving action that gets results. Six finishes, \$1.10 each. Also available in 4 other sizes .. 65c to 90c

### BLACK-ORENO LINE

*The Line You Can Trust*

World-famed bait casting line braided of nylon. Smooth finish, long-lasting quality. Easy casting. Waterproofed. 12 to 35 pound test. \$1.35 to \$2.50 per 50 yard spool.

### FREE! NEW '48 BOOK ON FISHING

"Fishing—What Tackle and When" shows South Bend and Oreno Tackle. Color pictures of fishes. Fly and bait casting instructions. Every fisherman needs a copy. Write for it today. FREE!

SOUTH BEND BAIT CO., 891 HIGH ST., SOUTH BEND 23, IND.



# SOUTH BEND

*A Name  
Famous in  
Fishing*

## Architecture From the Ground Up

(Continued from page 168)

the structure as though they had lived in it.

The workshop is equipped with power tools, but most of the model work is fine craftsmanship by hand. Many of Wright's buildings call for stonework, and each stone is represented in the finished model by a tiny piece of carved wood.

To live at Taliesin is to live creative architecture from the ground up. Changes in the terrain of the estate are planned and executed by the students. Landscaping to the apprentice has become the art of preserving the natural beauty of an area instead of creating a new setting as a backdrop for a building of foreign design. Steam fitting and carpentry aren't taught—they're learned by doing the job.

Each winter the entire school moves to Arizona to take up residence at Taliesin West, the desert estate built by apprentices. This sprawling building is as rugged as the Arizona wasteland, jutting out of the ground like the huge rock slabs that surround it. It was started from packing boxes and canvas in 1938 and is still expanding.

Life at Taliesin, either in Wisconsin or Arizona, is a cooperative enterprise to maintain the school. Students tend the garden, prepare and serve the food, wash their clothes, study and work together.

Wright also develops the talents of his students in some of the arts allied to architecture. For example, the few women students and the wives of the men work at looms weaving many of the fabrics that decorate the buildings. Furniture is designed as an integral part of each building.

By encouraging his students to express themselves naturally in their work, Wright hopes to train a new generation of architects, men who can build structures that seem a part of the earth itself.

## Here's the New Crop of Light Cars

(Continued from page 101)

Keller, president of the company, and a veteran of the automotive business, points out that the motorist will find on his cars the usual refinements such as steering-wheel shift lever, electric gasoline gauge, heat indicator, sealed-beam headlights, toe dimmer switch, clutch-pedal starter and adjustable seat.

Playboy Motor Car Corporation at Buffalo, N. Y., is offering a three-passenger convertible coupe and plans to build only one model. An outstanding feature of this car is an all-steel disappearing top which

(Continued to page 260)





# SEALED POWER PISTON RINGS



**FRANCHISED  
DEALER**



**EXPERT  
ENGINE SERVICE**

**GET THAT "NEW CAR FEEL" AGAIN!**  
SEE YOUR SEALED POWER  
FRANCHISED DEALER!



© 1948, Sealed Power Corp.

**G**ET the same thrill from your old engine that it gave you when new—when it seemed to have wings! On some auto repair shop near you is this thermometer sign—the sign of your Sealed Power Franchised Dealer. Let him put new life in that old engine and save you a lot of money on gas and oil.

He has a set of Sealed Power Piston Rings specifically engineered to do the best possible job in your engine, whatever the make, model, or cylinder wear condition. When he gets through installing these rings, you'll thrill to that "new car feel" again.

Your Sealed Power Franchised Dealer uses

Sealed Power Piston Rings because they are the best piston rings made, the choice of engine builders for 37 years. Sealed Power Ring Sets include the famous MD-50 Steel Oil Ring—THE ONLY RING WITH THE FULL FLOW SPRING.

Send a postal for illustrated, informative new booklet on 7 ways to save oil. It's free and may save you real money. Sealed Power Corporation, Dept. G4, Muskegon, Michigan. In Canada: Stratford, Ontario.

Your Sealed Power Franchised Dealer also handles Sealed Power Pistons, Cylinder Sleeves, Valves, Water Pumps and Chassis Parts.

**Sealed Power**  
PISTON RINGS

BEST IN NEW CARS!

BEST IN OLD CARS!



# BALL BEARING STEEL WHEELS

Complete With Wheels, Tires & Bearings Made To Outwear Other Type Wheels

SIZE	TIRE	BEARINGS	LOAD	ONE	TWO	FOUR
12"x2 1/2"	Semi-Pneumatic	Ball 1/2" or 5/8"	150 lbs.	\$ 5.50	\$10.00	\$18.00
12"x3"	Semi-Pneumatic	Ball 1/2"				
		Bronze 3/4"	340 lbs.	\$ 7.00	\$13.50	\$26.00
10"x1 3/4"	Semi-Pneumatic	Ball 1/2" or 5/8"	125 lbs.	\$ 3.00	\$ 5.50	\$10.00
10"x2 1/2"	Semi-Pneumatic	Ball 5/8"	250 lbs.	\$ 5.50	\$10.00	\$18.00
8"x1 7/8"	Solid	Ball 3/4"	640 lbs.	\$ 8.00	\$15.00	\$29.00
6"x2"	Solid	Ball 1/2"				
		Bronze 3/4"	340 lbs.	\$ 4.00	\$ 7.50	\$14.00
4.00"x8"	Pneumatic	T.R. 1"	700 lbs.	\$13.50	\$26.00	\$50.00
5.00"x8"	Pneumatic	T.R. 3/4"	700 lbs.	\$15.50	\$30.00	\$59.00

The above Pneumatic Wheels are Complete With Wheels, Bearings, Tires and Tubes . . . 4 Ply Tires for 3/4" and 1" Straight Axles. (Also 18", 21" and 23" High Speed Auto Type Wheels.)

SEND 10c FOR CIRCULAR: On Power Racers, Steering Wheel Assemblies, Auto Type Axles, Parts, Sulkies, Etc.

OSBORN WHEEL COMPANY, 115 So. Main St., Dept. P-4, Doylestown, Penn.



- NEW -

## 1948 Model Racers

MODEL "A" CHASSIS . . . Price \$39.75 with 10" Semi-Pneumatic Wheels.

MODEL "B" CHASSIS . . . Price \$56.00 (shown above) 12" Semi-Pneumatic Wheels.

MODEL "C" CHASSIS . . . Price \$103.00 with 16" Pneumatic Wheels.

Less Engines and Transmissions

Also sold Complete With 1 H.P. to 6.6 H.P. Gasoline Engines

25% DEPOSIT ON C.O.D. ORDERS

**ORDER NOW**

Add 10% for Prepaid Shipment in U.S.A.

## Do a Better Job WITH ONE OF THESE EMPIRE LEVELS

Smallest, most handy and accurate Level made. "Cigar-shaped"—no sharp corners to tear pocket. Aluminum stock. Only 3 oz. wt. 9" long. Has Level, Plumb, 45° Vials. No. 26 . . . \$2.00

### EMPIRE TORPEDO LEVEL



### ALUMINUM LEVEL — No. 151

Cast and Machined, a Beautiful Tool, with Patented, Removable Level and Vial.

With 2 Plumb, 2 Levels, 2 — 45° Vials. 18" . . . \$6.00

24" . . . \$6.50 28" . . . \$7.00

Order EMPIRE LEVELS from your local dealer. Write direct for literature.

## EMPIRE LEVEL MFG. CO.

BOX 97, DEPT. P-251, MILWAUKEE 13, WISCONSIN

## PROTECT YOUR LATHE

Covers for SOUTH BEND, ATLAS, LOGAN, CRAFTSMAN, etc. 9" and 10" lathes



Heavy Dust Tight Canvas Drill, Securely Stitched, Dark Blue, Tailored to Fit

Send \$7.69 and this ad, Cover will be sent Postpaid in U.S.A. Advise make of Lathe, Length Overall, Back or Underneath Motor. Covers for Anything — Prices on Request.

The CRAMSON Co., P. O. Box 184, Hales Corners, Wis.

## ELECTRIC MOTORS

### NEW HEAVY DUTY MOTORS

Nationally known makes. Guaranteed capacitor type, ball bearing heavy duty motors, 110/220 volts, 60 Cycle AC Single Phase. 1725 RPM

1/4 HP	Wt. 30 lbs.	\$24.00
1/2 HP	Wt. 36 lbs.	\$34.50
3/4 HP	Wt. 50 lbs.	\$44.00
1 HP	Wt. 80 lbs.	\$57.00

These motors also furnished in 3450 R.P.M. at same price. Prices are F.O.B. Chicago. Immediate delivery. **SOLD ON MONEY BACK GUARANTEE.** Send check or money order today.

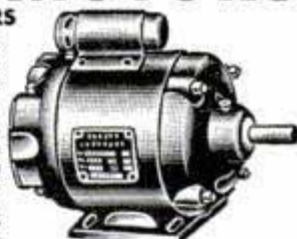

DEALERS — WRITE . . . 1831 S. State St. Dept. D-4, Chicago 16, Ill. C & M EQUIPMENT COMPANY



## ... Quick Easy Way to BIG PROFITS

### Read What Others Are DOING!

"Enclosed you will find 56 orders representing 9 1/2 hours' work on Monday and Tuesday."

"Enclosed are twelve orders secured after supper this p.m."

### Housewives are Enthusiastic

Everyone that sees this outstanding Cell-U-Mop immediately wants one . . . That's the reason why our distributors are so successful . . . You also have the advantage of our other QUICK SELLING PRODUCTS that step up your Volume Sales and Profits.

Hands Never Touch the Water—Can be put in Boiling Water. Housewives Like It.

48" Long Handle

### Sales QUICK, EASY Every Locality

SALES ARE EVERYWHERE . . . Sells quick to Taverns, Clubs, Hotels, Hospitals, Stores, Restaurants, Large and Small Buildings and the Homes . . . Scores can be sold on a single street . . . Note the Drain Bracket in the illustration . . . This squeezes out the water so thoroughly that HANDS NEVER TOUCH THE WATER . . . Makes no difference what you ever sold, you will like this proposition . . . Your name on a Post Card will bring you FREE PARTICULARS.

CELL-U-MOP CO., Dept. P-4 FREEPORT, Ill.

### • We Teach You How •

Gets down under and around for MOPPING, DUSTING or WASHING

DOES THE WORK OF 6 TOOLS IN 1

Get Choice Territory NOW!

Holds 20 times its weight in water.







# MOTO-TOOL

## THE "POCKET-SIZE" MACHINE SHOP

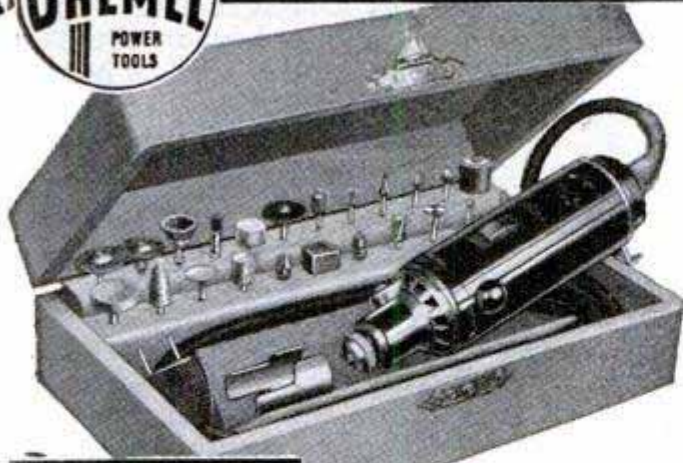

### A SHOP-TESTED TOOL

Moto-Tool is backed by over 10 years of industrial use . . . packs extra years of pleasure . . . yet, due to increased production, pre-war prices still prevail!

About 27,000 R.P.M.  
Cuts Cleaner . . .  
Saves Cutters



### LOOK FOR THESE MOTO-TOOL FEATURES

Approximately 27,000 R.P.M. plus dynamically balanced armature provides vibrationless finger-tip control. Moto-Tool has oil-less, sealed bearings • Patented automatic chuck lock pin • Over-size armature shaft, hardened, ground, polished • 110 Volt, AC-DC motor • Sliding snap-type switch • Cord protector • Shock-proof bakelite housing • Dust-filtered air-cooling system • Weighs only 13 oz.

**HERE'S BIG VALUE!**  
MODEL No. 1  
**MOTO-TOOL KIT**  
Only \$17.50

This popular Kit contains the smaller, lighter (Model 1) Moto-Tool and 34 accessories in attractive, lacquer-finish wood box. It's the biggest bargain in the field.

### MOTO-TOOL KIT No. 2

With 23 Accessories (HIGH SPEED STEEL Cutters, Grinding Wheels, Polishing Accessories)

Only \$23.50

### New DREMEL DRILL PRESS

Only \$9.95  
(Less Moto-Tool)

Here's a light, portable precision drill press at an amazingly low price. Just the thing for creating costume jewelry, model making, wood carving, routing, etc. Utilizes Model No. 2 Moto-Tool, which can be raised or lowered, swung in any direction or quickly removed in a few seconds for off-hand use. Drill Press stands 12" high. Base is 6 3/4" x 4". Weighs approximately 3 1/2 pounds.

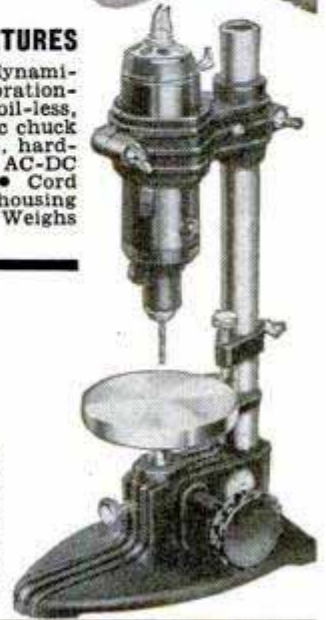

**MONEY-BACK GUARANTEE:** Buy Dremel Moto-Tool from your dealer. If he cannot supply you, order direct on 10 day trial, money-back guarantee. Shipped postpaid for payment in full (send check or money order); or send only \$2, we will ship C.O.D. You pay postman balance plus postage.

DREMEL MANUFACTURING COMPANY • DEPT. 118-D • RACINE, WIS.

## Dexter UNIVERSAL LATHE CHUCKS

IMMEDIATE DELIVERY. Shipped postpaid from stock same day order received. Precision accuracy and construction assure you complete satisfaction.



Size	Fits Spindle	Price (Postpaid)	Note:
2"	1/2"-20	\$16.00	5" chuck also to fit following spindles: 3/4" x 16 1" x 10 1" x 12 1" x 14 1" x 16 1 1/8" x 7
3"	1/2"-20	17.00	
4"	1"-8	21.00	
5"	1 1/2"-8	25.50	
6"	1 1/2"-8	33.00	

## THE LEAVITT MACHINE COMPANY ORANGE, MASSACHUSETTS

### UTILITY CABINET

36 Roomy Compartments  
4-7" Drawers with Removable Partitions

A Thousand Uses For

HOBBYISTS  
MECHANICS  
DRAFTSMEN  
TECHNICIANS

For home workshop, factory, laboratory, garage, outdoors, fishing and hunting.  
Made of heavy gauge aluminum.  
Strong airplane construction.  
Sag proof—Rust proof.



\$2.98  
plus postage

Shipping Weight 2 lbs., 8 ozs.

Cut out this coupon and send with money

NAME.....  
ADDRESS.....  
CITY.....STATE.....

Enclosed find check or money order for \$2.98.  
**THE KNICKERBOCKER CO. ST. CLAIR, MICHIGAN**

## DON'T HIT IT...TAP IT!

Now! You can have the right hammer for every job!



### ALL-PURPOSE HAMMERS

Here's the handiest trio in your workshop! No handyman, hobbyist or mechanic can afford to be without this set of precision-made all hardened steel ball pein hammers. An amazing value—all 3 at better hardware stores—only 87c.

If your dealer cannot supply you, sent postage paid on receipt of \$1.00. Or sent C.O.D. postage and charges collect.

SET OF 3  
only 87c

- THREE HANDY SIZES
- ALL HARDENED STEEL
- RUST PROOF PLATING
- FINELY BALANCED

Dealer Inquiries Invited

## C & L SCREW MACHINE PRODUCTS CO.

Dept. A, 1651 W. Van Buren St., Chicago 12, Ill.



**FREE!**



**SEND FOR  
ALLIED'S  
NEW RADIO  
CATALOG**

**172 PAGES OF  
BIG VALUES!**

## Everything in Radio at Lowest Prices

Get ALLIED'S new Catalog—biggest and most complete in Radio! Tremendous values in new Television receivers, home radios, latest Amateur receivers and station equipment, new builders' Kits, Sound Systems. Thousands of parts, tubes, test instruments, tools, books and diagrams—the world's largest stocks—all at money-saving low prices! Send for your FREE ALLIED Catalog today.

### HERE'S A TYPICAL ALLIED VALUE!



### A Quality Electric Drill Kit at a Big Savings

A wonderfully handy tool for light-duty, intermittent service in every shop. This sturdy 1/4" drill comes complete with 14 popular size drills for wood, plastics, iron and steel. Dependable AC-DC motor operates efficiently at 1100 rpm. Has

self-lubricating oilite bearings; heavy chuck; built-in on-off switch and 7 foot cord and plug. Entire unit is balanced for easy, non-tiring work even in close quarters. For 115 volts AC-DC. An outstanding value. 46-027 (FOB Chicago)

**ONLY  
\$15<sup>95</sup>**

### GET THESE VALUABLE ALLIED RADIO BOOKS!



- Radio Formulas & Data No. 37-752.....10c
- Dictionary of Radio Terms No. 37-751...15c
- Radio Circuit Handbook No. 37-753....25c
- Radio Builders' Handbook No. 37-750...15c
- Simplified Radio Servicing No. 37-755...10c
- Radio Data Handbook No. 37-754.....25c
- ALL 6 BOOKS above No. 37-799.....\$1.00
- Parallel Resistance and Series Capacitance Calculator, No. 37-960...25c
- R-F Resonance and Coil Winding Calculator, No. 37-955.....25c

## ALLIED RADIO

**ALLIED RADIO CORP.**  
833 W. Jackson Blvd., Dept. 5-DD-8  
Chicago 7, Illinois

- Send FREE New ALLIED Catalog  
 Send Drill Kit No. 46-027  
 Send 6 Books No. 37-799  
 Send Calculator No. .... } \$.....enclosed

Name.....

Address.....

City.....Zone....State.....

can be raised or lowered without getting out of the car. The 40-horsepower Continental engine is in the front and most of the parts are standard. The car is designed for sports use or as a second car. Pilot models have been produced by machine-shop operation, but company officials hope for a production rate of 100,000 cars a year when they get their converted aircraft-engine plant into full swing.

Another good-looking sports car, known as the Rocket, is scheduled for production this year by the Hewson Pacific Corporation at Los Angeles. The car is a three-passenger single-seater and the buyer will have a choice of a four or six-cylinder rear engine. Design of the car is modern with no reverse curves, grilles, handles or protrusions. The "skin" is formed in 10 sections of aluminum sheet attached to hydraulically formed dural extrusions. Other features are a curved windshield of safety glass set in rubber, padded instrument board with all instruments grouped in a circular cluster in front of the driver, and an automatic transmission with hydraulic torque converter. Three tops for the car will be optional: a detachable metal top, a convertible fabric top, or a clear-plastic top for winter driving.

The International Motor Car Company at San Diego expects to be in production sometime this month with a two-cylinder two-seater called the Towne Shopper. This interesting new lightweight (600 lbs.) measures 116 inches over-all, has an engine mounted in the rear and is designed to sell for \$595. The usual engine space in front is converted into a package compartment. A unique engine feature is a fly-wheel that contains a generator and starter mounted in one unit, a fuel pump, and a pressure lubricating system. Aluminum construction is used almost entirely in the car aside from axles, bearings, springs, bumpers and steering column. Production is planned at the rate of 100 units a day.

Another light car—but still on the drawing boards—is the Kurtis-Kar which is being planned by Kurtis-Kraft of Glendale, Calif., builders of midget and Indianapolis race-car chassis and bodies. This auto is a three-passenger sports car with steel frame, aluminum skin and magnesium wheels. It will have a 96-inch wheelbase and a six-cylinder 80-horsepower engine in the front. The Kurtis-Kar will weigh 1500 pounds. The price will be in the \$2000 bracket, but customers who desire may purchase a complete set of knock-down parts and assemble the car themselves! The parts will be sold for about \$1000.

(Continued to page 264)



# Snap-on

## Armature

### Reconditioning Tool

#### does both

1

TURNS DOWN  
ARMATURE

2

UNDERCUTS  
THE MICA

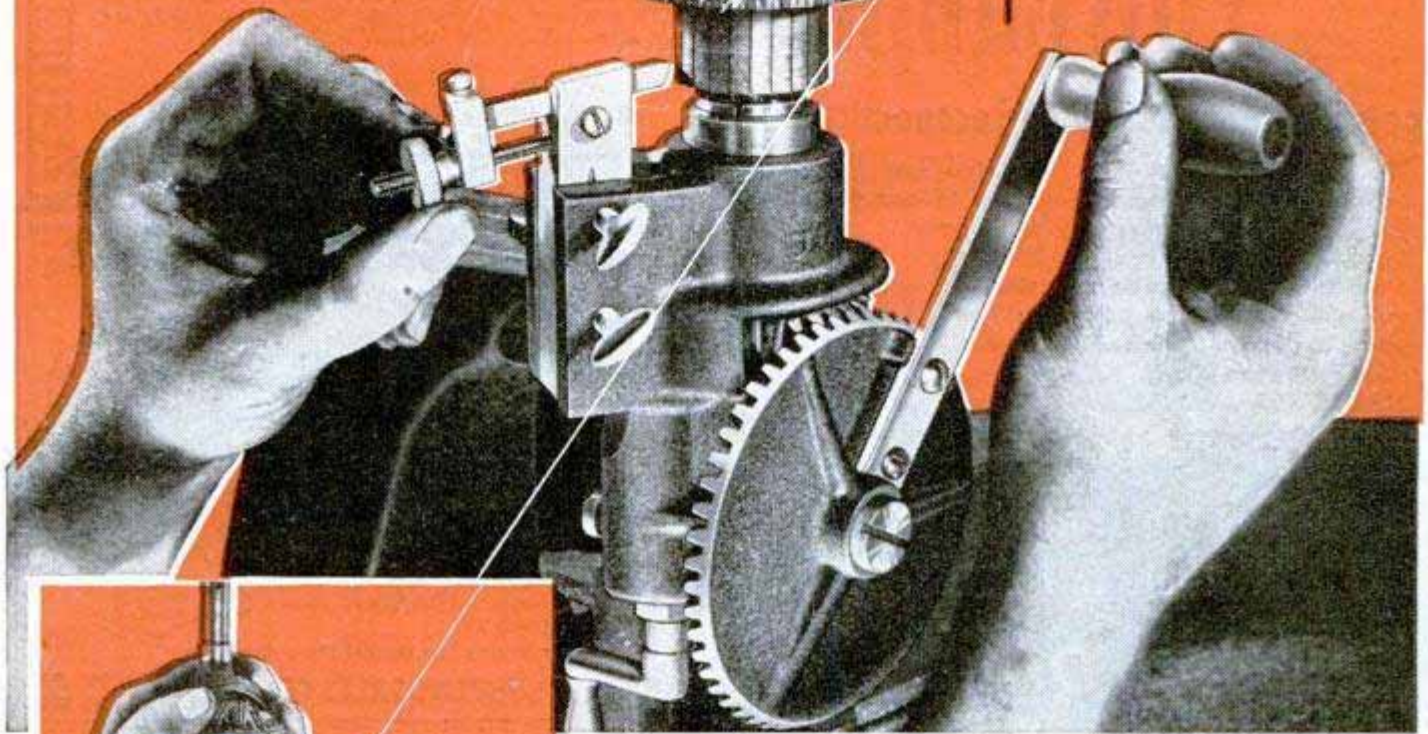

From start to finish, Snap-on Armature Reconditioning Tools are engineered to do an accurate turning and undercutting job. This unit requires no motor . . . no special centerless chuck. Simply lock it in a vise, insert armature shaft, and it's set to do an exact job, quickly, and with important savings in time and in capital investment, because it's faster to use than an ordinary lathe. The depth of the cut can be controlled to the finest shaving . . . the downward lead is fully automatic.

Undercutting the mica is just as simple . . . and when you finish the job by touching up the commutator with fine sand paper, the operation is completed to the entire satisfaction of even the most critical.

Ask the Snap-on man for full details.

## Snap-on Tools

THE CHOICE OF BETTER MECHANICS



SNAP-ON TOOLS CORPORATION

8062-D 28th AVENUE • KENOSHA, WISCONSIN

International Division: Kenosha, Wisconsin, U. S. A.



**SMART  
NEW**



# POWERBIKE

**gets you there safely and economically**

The motor is in the rear, mounted low to aid balance and handling. No grease to rub off on your legs, no hot fumes blowing in your face. 100 miles per gallon, 30 MPH. 1½ HP fan cooled engine, kick starter, automatic clutch, fits any man's or woman's balloon-tire bike. See your dealer or write direct.  
**TERRITORIES AVAILABLE.**



**SAGINAW PRODUCTS CORP. • SAGINAW, MICHIGAN**

**Proved by Big Truck Fleets—  
Now Available to Motorists!**

## Scientific Discovery Ends Auto Radiator Rust-Ups!

Installed in radiator hose, Butler De-Scaler's galvanic cell action dissolves scale and rust throughout cooling system—keeps water crystal clear, mineral free.



At last—modern science ends your auto cooling system troubles caused by rust and scale! The amazing Butler De-Scaler, used in industrial boilers for over ten years and successfully proved in thousands of trucks and buses from coast to coast, is now available to car owners. De-Scaler's silver-plated coil and Butler-metal core, installed in radiator hose, produce a galvanic cell action that dissolves existing scale, prevents further formation—thereby prevents rust-ups, boiling over, pump and thermostat troubles due to scale. Guaranteed for 1 year or 25,000 miles. Does not interfere with anti-freeze or stop-leak. At service stations, garages and car dealers. \$4.95 Fair Trade List Price. Butler Engineering Co., 2622 Rousseau Street, New Orleans 11, La.



## BUTLER De-Scaler

Butler De-Scalers are available for use in home hot water systems, boilers, Diesel engines, etc.



# DUNTILE

## More Local Plants are Badly Needed

Amazing demand for DUNTILE—World's Most Beautiful Roof—opens up new manufacturing opportunities for men of modest capital, backed by vision and aggressiveness. Ties in with the great building industry, now starting its biggest period in history. Duntile is masonry—strong, safe, enduring. Smart design, in choice of many select colors. Has pride-appeal to every home owner. Definitely economical. With these advantages it has unlimited market possibilities. Manufacturing is easy; we supply all equipment. Excellent profits—100%-125% mark-up on basic costs. Write immediately for Prospectus Y.C.B. Get into this business NOW!

**W. E. DUNN MFG. CO.**

619 W. 23rd Street, Holland, Michigan

**MANUFACTURING OPPORTUNITY**

## AN OUTSTANDING MANUFACTURING OPPORTUNITY

### BRIGGS-STRATTON ENGINES

1½ HP. MODEL N — GOVT. SURPLUS

Special Low  
"as is" price

**\$34<sup>50</sup>**

Only.....

In good operating condition with 30 day written guarantee..... **\$44<sup>50</sup>**

Engines will develop almost 2 Hp. at 3600 RPM. Hurry don't wait, buy now while limited supply lasts. Suitable for lawn mowers, garden tractors, motor bicycles and scooters, midget cars, etc. Will power many kinds of machinery.



Write for Descriptive Circular

**MIDWEST SURPLUS SALES CO. 1520 LOCUST ST. KANSAS CITY, MO.**

SAY YOU SAW IT IN POPULAR MECHANICS

### Burn-Rite Wood Burning Detachable Pen

Approved By Underwriters

Only one of its kind. Write for complete list of casting and wood burning sets.

**\$1.50**  
EACH  
POSTPAID

**RAPAPORT BROS. INC.**

Dept. PM4, 1830 S. Washtenaw Avenue

Chicago, Illinois

## New MILLING ATTACHMENT



Sizes for 8" to 16" metal lathes

**BUILD IT YOURSELF** from our sets of semi-machined castings and save \$\$. Can be finished on your lathe alone. Complete working drawings and step-by-step instructions furnished with castings.

Mill keyways, slots, splines, dovetails. Flutes in reamers, taps, hobs, and special cutters: produce spur, bevel, mitre and worm gears, ratchets and racks; mill flat surfaces, square shafts, mill hexes, spot face, drill spaced holes, bore, etc. on your lathe with this precision attachment. It has a T-slotted table, a vise which swivels for angular milling, a gear cutting fixture and dividing centers.

**FREE!** Illustrated folder and price list. Includes milling cutters, keyway cutters, drill rod, slitting saws and many hard to get shop items. Mention your lathe. Write today.

**HURON MACHINE AND TOOL CO. YALE 4, MICHIGAN**





SANDING FURNITURE

# THE BULL BUFFER

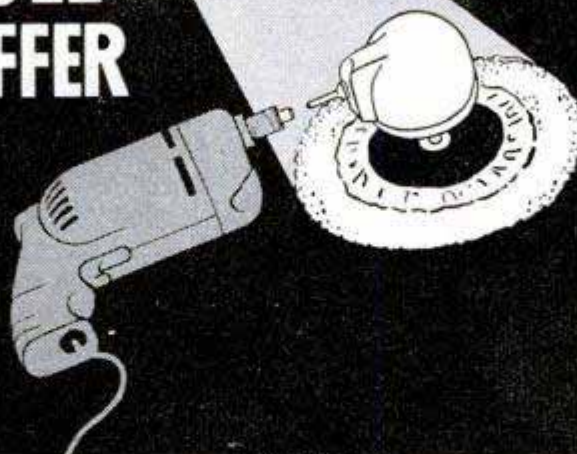

POLISHING CARS



SANDING WOODWORK



POLISHING FLOORS



REFINISHING CARS



POLISHING FURNITURE

- For the
- HOME**
- FARM**
- FACTORY**
- GARAGE**
- OFFICE BLDG.**
- STORE**
- SHOP**
- SERVICE STATION**
- CABINET SHOP**
- METAL SHOP**
- UPHOLSTERING SHOP**

The very first time you polish your car, sand your own floors, refinish furniture, this tool has more than paid for itself. And what a kick you'll get out of doing all the polishing and sanding jobs that used to cost lots of money! With the Bull Buffer, you can do beautiful, professional work—make your car, furniture, floors, woodwork gleam like new. You'll find no limit to the ways Bull Buffer will save time and money in your home and business.

THE BULL BUFFER FITS ANY CHUCK ON AN ELECTRIC DRILL (OR FLEXIBLE SHAFT). Attach it quickly . . . polish and sand . . . then disconnect it and use your drill for any other purpose.

**BERTRAM ENGINEERING COMPANY**  
3034 MAIN ST. KANSAS CITY, MO.

**DEALERS WRITE FOR INFORMATION**

**HIGHLY MANEUVERABLE, EASY TO OPERATE.** Holding drill stationary, buffer can be turned in a complete circle. It's **RUGGED — POWERFUL — BUILT TO LAST A LIFETIME.** Sturdy aluminum casting houses self-lubricated bearings and steel gears that operate in a bath of oil. All materials and workmanship are guaranteed.

The sooner you order, the sooner you'll have this handy new tool in your hands. It's a real bargain—only \$9.95, complete with five-inch rubber disc, sheepskin bonnet, and 2 sanding discs. If your dealer doesn't stock, send cash, check or money order for \$9.95, postage prepaid. **\$9.95** C.O.D. plus postage.



IF you stop, look and listen, we can show you how to build a business of your own NOW with Tradio, the radio functionally-designed for coin operation in hotels, tourist camps, restaurants, taverns, etc. in your community. Hundreds of men and women are entering this new depression-proof business daily. It's a natural for big earnings and a steady income. Tradio has pioneered in this flourishing post-war industry. Only a small investment is needed to get in on the ground floor.

WRITE Dept. N-4 for complete information and free illustrated brochure.

**TRADIO, Inc.** ASBURY PARK NEW JERSEY

## NEW SOLID BRASS 7 FT. PORTABLE RADIO ANTENNAS

Real \$12 Value Now Only \$3.45 Postpaid FOR HOMES, BOATS or AUTOS

**JUST OUT!** Gov't surplus used on Army tanks. These telescopic rustproof antenna have tremendous pickup eliminate dangerous wiring. Solid Brass throughout practically insuring **NOISE FREE RECEPTION.**

Each antenna comes securely packed with mounting bracket. Easy to install anywhere.

**QUANTITY LIMITED**

ORDER TODAY. A real \$12 value for only \$3.45 Postpaid. Mail check or money order now or sent C.O.D. plus postage. Money back in 10 days if not satisfied.

**RADIO HOSPITAL** 422 East 86th St., Dept. A16 NEW YORK 28, N. Y.

## World's Most Complete Hand Tool!



**NEW VISE-GRIP WRENCH**

Now Even More Useful, More Powerful!

New Involute Jaw Curve fits anything, any shape. Provides increased tooth contact on all work. Knurled Jaw Tips hold to the very tip. Thin Nose reaches into tight places. Powerful Wire Cutter easily cuts wire and small bolts. Locks to work with Ton Grip. Easy to open. Adjusts to ratchet action. Fine alloy steel. Nickel plated. 2 sizes — 7" and 10" — with or without cutter. **SEE YOUR DEALER!** With cutter—7", \$2.25; 10", \$2.50. Without cutter—7", \$1.85; 10", \$2.25. Get yours now. **PETERSEN MFG. CO. • Dept. M4 • DeWitt, Nebr.**



# Every Car Needs

## SIMONIZ!

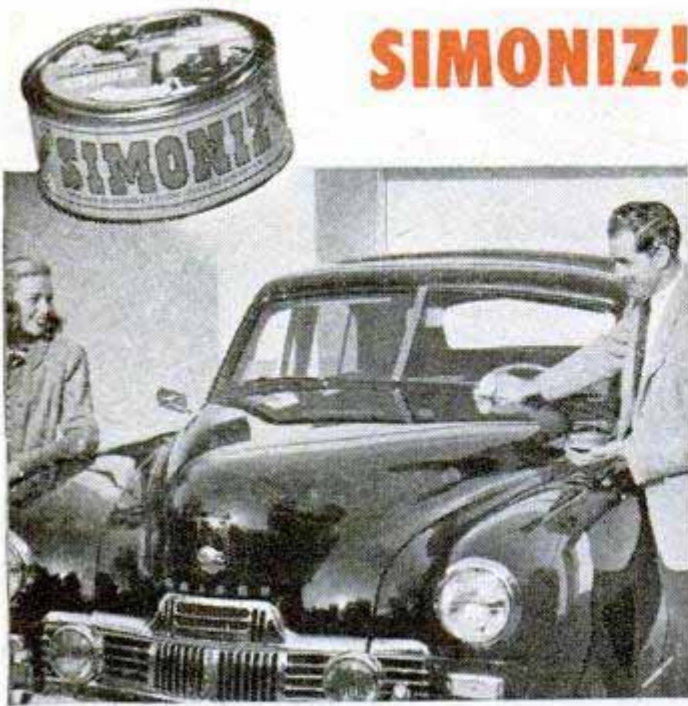

Only SIMONIZ gives your car such long lasting beauty and protection . . . so why try a substitute?

Simoniz "builds up" your car's beauty—makes the finish brighter with each application—keeps colors from fading—protects against damage by grit and airborne chemicals. It's easy to use Simoniz—just follow the simple directions. Get Simoniz for your car today!

**Liquid Simoniz Kleener** is wonderful for cleaning quickly new cars or finishes in average condition. **Paste Simoniz Kleener** works miracles in restoring the luster to dull cars. Then apply Simoniz to make that restored beauty last years longer.

THE SIMONIZ CO., CHICAGO 16, ILL.



Motorists Wise Use

# SIMONIZ

TRADE MARK REG.

KEEPS ALL CARS NEW LOOKING

Also available to American buyers of small cars this year are four new models of the British Austin.

Will the so-called boom of the light-car manufacturers go down in history as a fad following World War II, or is it here to stay? This is what Powel Crosley, Jr., leading figure of the industry, has to say:

"The lightweight car is the result of years of study as to how to put automotive transportation back into the hands of budget-conscious American families. The small car has long been popular abroad, where gasoline always has been expensive. Its low initial cost, economical upkeep and maneuverability in the narrow streets of ancient cities account for that. In voluminous correspondence from owners of our cars in every walk of life we learn that they favor the small car because (1) the first cost is reasonable; (2) upkeep is inexpensive and budgetable; (3) maneuverability is simple and energy-saving; (4) general utility features make such a car highly serviceable; and (5) the price permits low-cost financing and a rate of payment within the means of any income group.

"The flow of mail from doctors, lawyers, tradesmen, housewives, new drivers, veterans and satisfied customers from coast to coast is steady, unsolicited and extremely gratifying. We feel it is worth all we have done to put economical automobiles within reach of average American families who must eat, live and travel on a modest income. Besides this vast field, the lightweight car will always find acceptance where people can afford a second car. The factors cited here, and a long view of the nation's economy have convinced me that the future of the light car is assured."

## We're Racing a Power Shortage

(Continued from page 93)

In a hydro system the mechanical power would be derived from a shaft connected to the water wheels instead of to a turbine.

We now have 60-cycle alternating current at 11,000 volts pressure, suitable for transmission over short distances. For longer distances it will be increased to 66,000—or even higher voltage—by means of a transformer. In essence, a transformer consists of an inverted iron U, submerged in oil for insulation and to reduce heat, with the incoming and outgoing legs wrapped with copper wire. To raise the voltage six times, there are six times as many turns around the outgoing side as around the incoming side.

A large industrial customer may take

(Continued to page 268)



# ELECTRIFY

Your Sewing Machine With a

## "SEWING MACHINE MOTOR KIT"

The IDEAL GIFT for Mother... Wife... Sister!

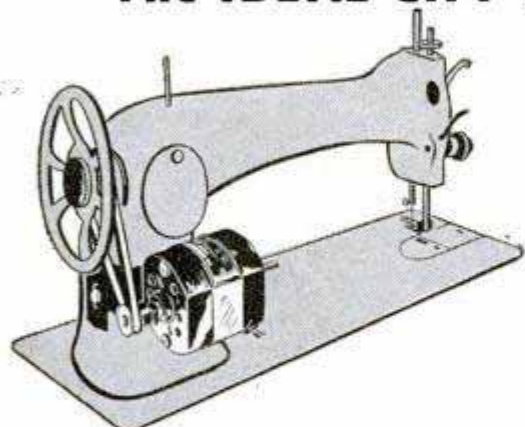

**\$17.75**  
COMPLETE

ADJUSTABLE FOR USE WITH ANY TYPE OF SEWING MACHINE

**ANYBODY CAN INSTALL IT!**

Takes but a few seconds

COMPLETE SET CONSISTS OF:

(A) MOTOR & BRACKET—Universal AC or DC, 60 cycle, 115 Volts. (B) BELT—Long Wearing Rubber Belt. (C) PULLEY—Single Grooved Steel Hubbed Pulley. (D) BRACKET—New and Improved. (E) FOOT CONTROL—7 Step Rheostat. (F) CORD SET—Extension Cord fitted with plug and socket. (G) Installation Instruction Sheet.

**SPECIAL NOTE:** This 1/20-H.P. motor with double end shaft and rheostat can be used in all hobby workshops for flexible shaft attachments, grinding, drilling etc.

Special Offering to DEALERS!

MAIL THIS COUPON

Dept. PM-5

BROWNELL DISTRIBUTORS, INC.

308 Canal St., New York 13, N. Y.

Please rush \_\_\_\_\_ motor kits at \$17.75 each (postage prepaid) in:

money order or  check  
 send C.O.D.—and I'll pay postman \$17.75 plus C.O.D. fees.

Name \_\_\_\_\_

Address \_\_\_\_\_

City \_\_\_\_\_

Zone \_\_\_\_\_ State \_\_\_\_\_

## Harley-Davidson Motors

Brand NEW (not used) 1/2 Price!

For '37 to '48 Motorcycles. Or boats, power plants, saws, midget cars.

Worth \$265. Complete with new carburetor, new generator, new sprockets. Never uncrated. Positively guaranteed new in perfect condition. Government surplus. These are not rebuilt but BRAND NEW regular Harleys. Side valve. L head. 30 HP (N.A.C.C. 6-05). Worth more than our price for new parts! \$122.25 crated. FOB Okla. City. Weight packed 220 pounds. Remit \$25. bal. C.O.D. Shipped immediately. Few left. Guaranteed as advertised or money refunded. You have seen our ads for years.

FEDERAL IDENTIFICATION CO.

1910 Classen Blvd.

Oklahoma City, Okla.

## AMERICA'S BIGGEST WAGON VALUE!

Manufacturer's Close-out  
You Save 35%!



Features Completely Guaranteed as Advertised

WAS \$19.95  
RETAIL  
NOW ONLY \$12.95  
You Pay Freight

A once-in-a-lifetime buy! A wagon you will be proud to own! Actually sold for \$19.95 in retail stores!

Not a cheap tin wagon, but a real, strongly built wagon that supports 1/4 ton load. Body is extra-heavy gauge rustproof steel and solid oak.

Safe! Non-tilting — turns at a 90° radius without tipping. Patented hubless wheels do not injure shins or tear clothes.

HURRY—only 2500 of these wagons available. Freight cost is low! Send cash, money order or check. No C.O.D.'s, please. ORDER NOW!

### Plus Features

1. Big 16"x 36" body
2. 10"x 1 3/4" Firestone demountable tires
3. Chrysler Oilite bronze bearings
4. Auto-type steering gear
5. Metal parts cadmium and nickel plated
6. Chromium plated channeled steel handle

MARKWARDT MANUFACTURING COMPANY  
1937 WEST CANAL STREET • MILWAUKEE 3, WISCONSIN

## Harley-Davidson Motors

Brand NEW (not used) 1/2 Price!

For '37 to '48 Motorcycles. Or boats, power plants, saws, midget cars.

Worth \$265. Complete with new carburetor, new generator, new sprockets. Never uncrated. Positively guaranteed new in perfect condition. Government surplus. These are not rebuilt but BRAND NEW regular Harleys. Side valve. L head. 30 HP (N.A.C.C. 6-05). Worth more than our price for new parts! \$122.25 crated. FOB Okla. City. Weight packed 220 pounds. Remit \$25. bal. C.O.D. Shipped immediately. Few left. Guaranteed as advertised or money refunded. You have seen our ads for years.

FEDERAL IDENTIFICATION CO.

1910 Classen Blvd.

Oklahoma City, Okla.

## The SPEED SAW FILER

Saves You Time, Money

Now you can do expert saw filing at home. Lifetime tool makes precision filing easy for even the most inexperienced. Two simple adjustments make it fit any type hand saw. Keep your saws extra sharp and true-cutting with a Speed Saw Filer. Complete with file, ready to use. Money back guarantee. Cash with order, prepaid. (C.O.D. postage extra.)

THE SPEED CO., Dept. PM  
2025 N.E. Sandy, Portland 12, Ore.

Now FILE YOUR OWN SAWS

ORDER NOW!

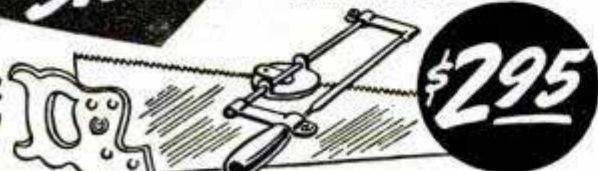

\$2.95



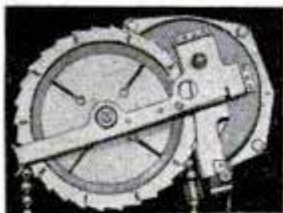

## SURPLUS SPUR GEAR HAND HOIST

LIFTS, as a hoist . . . or pulls, as a winch. Hundreds of uses for this converted bomb hoist. Made by famous manufacturer for Uncle Sam . . . Brand new, unused. Easily lifts or pulls up to 350 pounds. 20 ft. of multi-strand wire rope can be fed out of any one of three drum housing openings. Rig it up yourself on wall, beam, tripod or trolley, wherever you want to lift or pull heavy or bulky loads, such as boats, outboards, stock . . . anything too heavy to handle. Free illustrated "How To Use It" suggestions.

LIMITED QUANTITY  
at never-again price of:

**\$9.95**

Postpaid in U.S.A.

IRELAND & VICE P. O. Box 146-A, Auburn, N. Y.

## Mows and Trims Lawns



In One Simple  
Easy Operation  
8 1/4 Lbs.



Save Time  
and Labor with a

## MONTAMOWER

New model. New type metal handle has special device to adjust cutting height. Drive shaft now mounted on free rolling, factory lubricated, sealed ball bearings. No tired backs or aching arms. 8 1/4 lbs. live precision made mechanism that first gathers, then cuts smoothly a clean 16" swath through grass, dandelions, spike grass, lawn weeds. No noise or clatter. As modern and efficient as your electric razor. Cuts right up to walls, fences, trees or posts; leaves no fringes to be trimmed by hand. Cutters self-sharpening. Built to last many years. Many thousands in use. Sold direct from factory for 26 years. Costs little. Write at once for trial on your own lawn "approval offer," guarantee information and literature.

### MONTAMOWER DISTRIBUTING CO.

820 Keeler Bldg.

GRAND RAPIDS 2, MICHIGAN

## NONE BETTER! SUPER DRILL GRINDER



Sharpens round shank drills from 3/32" to 1-1/16" in diameter, up to 11" long. Grinds old drills like new in 4 different point angles, using hand or power grinding wheels. Money-back guarantee.

Price only \$2.95

At Dealers or Postpaid

CRANDALL MFG. CO. 1512 W. Slauson, Dept. FA-28, Los Angeles 44, Calif.

Everything you want for outdoor  
pleasure when you ride a . . .



# Royal Enfield

## FAMOUS ENGLISH LIGHTWEIGHT MOTORCYCLE RUNS 100 MILES ON A GALLON OF GAS

Up and go—with the rugged new Royal Enfield popular Model R.E. Style, safety, flexibility, 125 c.c. 2-stroke, single cylinder engine, 3-speed gears; 45 m.p.h. Write today for folder "P", for complete details. Also 350 c.c. and 500 c.c. models are immediately available.

Dealer inquiries given prompt attention.

**WHITEHALL DISTRIBUTORS, Inc.**

1385 Commerce Avenue, New York 61, N. Y.

Make your own **Gems** **29.50**  
F.O.B.

All necessary lapidary equipment is furnished, including a super-charged diamond blade for sawing, and all wheels for grinding, shaping and polishing; also complete instructions. The complete equipment as shown, less motor and belt, for only \$29.50. f.o.b., Burlington, Wisconsin. Write today for information and literature.

**B&I MANUFACTURING CO.**  
Dept. S Burlington, Wis.

**PISTON TYPE COMPRESSOR**

**EASY PROFIT IN PAINT SPRAYING**

Paints walls, ceilings, screens, furniture and machinery faster, better. All complete as shown less motor. Carry anywhere. Fully guaranteed. Could be used with 1/4 H.P. motor or less. Price \$35.00 less motor F.O.B. Chicago. \$5.00 deposit balance C.O.D. or see your dealer. With motor \$55.00.

**IDEAL AUTOMATIC PUMP CO., Dept. P.M. 8**  
801 W. Washington Blvd. Chicago 7, Ill.

**Glider Model FLAME GUN**  
with 100 PRACTICAL USES!

KILL WEEDS, crab grass, Canada thistle, stalks, seeds and roots. Destroy brush, caterpillar nests, diseased trees, grasshoppers, chinch bugs, etc. Clear irrigation ditches, split rocks, burn tree stumps.

Sterilize poultry houses, kennels, barns. Use as portable home forge. Melt ice, thaw pipes. Safe, inexpensive. Burns only 6% kerosene—94% air! Thousands of satisfied users. Write for **FREE CATALOG**.

**7 MODELS from \$22 up**

**HAUCK MFG. CO., 75 Tenth St., Brooklyn 15, N. Y.**



**WAR SURPLUS**

# BIG BARGAIN ABRASIVE CLOTH ASSORTMENT

\$10.00 Value... **\$1.98**  
NOW ONLY

Big bargain package of abrasive cloth! Contains 10 rolls (average length 73") from 1" to 4 1/4" wide. Grits range from #40 to #600. Each roll is different width and grit. Every roll top quality from such makers as Carborundum Co., Minnesota Mining & Mfg., and Behr-Manning. Assortment easily worth over \$10.00! Perfect for handymen, mechanics and home craftsmen. Supply limited—order today!

**SEND NO MONEY!** Just send your name and address. When assortment arrives pay postman \$1.98 plus a few cents postage or send cash and we pay postage. Inspect for 10 days. If not delighted return for full refund.

**R. ALLENDER & CO.** Dept. SW, 1966 E. Forest Detroit 7, Mich.

*for AMAZING acceleration*

## DIXIE-WESTERN DUAL INTAKE MANIFOLDS for V-8 FORDS AND MERCURYS

**\$15.00** Gas Line and Throttle Kit \$2.50 extra

Chrome Plated Velocity Stocks — \$1.50 ea.  
By Test: Increased Acceleration by 26%  
Increased Power and Speed by 11%

All DIXIE-WESTERN manifolds are brightly polished cast aluminum.

**DIXIE-WESTERN MANIFOLD CO.**  
Box 264 • Los Angeles 43, California

Dealers Wanted

## V-8 DUALS & SINGLES

### MUFFLERS

**STEELS and ALUMINUMS with a motorboat tone**

SINGLES, Chev., V-8, Plymouth, Steels \$5.50, Aluminum \$7.00. Chry., Olds., Buicks, etc., Steels \$7.50, Aluminum \$9.00. V-8 and MERCURY DUALS, Steel \$17.50, Aluminum \$21.00. Split Manifold Sets, Steels \$35.00, Aluminum \$45.00. Aluminum are guaranteed for life of your car.

**SANDEE MUFFLER CO.**  
BOX 296 LA TIJ., LOS ANGELES 43, CALIF  
2624 W. SLAUSON AVE., LOS ANGELES, CALIF.

## MARCOT KEY MACHINES

MARCOT No. 8 KEY MACHINE, mounted on Cabinet ..... \$ 82.50  
Auto Code Book and Auto Depth Keys ..... 12.50  
1,944 Popular Cylinder Key Blanks ..... 77.75  
Set — Key File, Follow-Through Rods, Lock Picks, Bit Key Gauge, Thimble, Pins, Springs... 10.50  
"Locksmith Trade Books": ..... 6.75

How to Open Locks without Keys or Picks: Secret of Locksmithing; How to Make Keys by the Impression Method; Master Key Systems. **TOTAL COST, \$190.00**

The \$77.75 cost of the Key Blanks would return to you \$486.00 or mo. o. This would more than pay for your entire KEY MACHINE OUTFIT. IMMEDIATE DELIVERY—Motors available with Key Machine Orders.

**A. J. MARCOTTE CO. DEPT. PM, CHICAGO 51, ILL.**

## DIE-LESS DUPLICATING

Many small parts can be formed without dies, to duplicated accuracy of .001" with DI-ACRO Precision Machines. — Benders, Brakes, Shears. Save die expense and time delay. Ideal for experimental and research work, making samples, models, etc., as well as regular production runs. Write for descriptive literature.

**O'Neil-Irwin Mfg. Company**  
341 8th Ave. Lake City, Minnesota

**SHEAR**  
**BENDER**  
**BRAKE**

# Hobart

helps you **SUCCEED**

## in ARC WELDING





The HOBART "Build Your Own" (Generator Only)

**A Big Pay Business**—and it's all yours! It's so easy to start your own job welding shop and reap the big dividends that Hobart Arc Welders bring you. There's plenty of arc welding repair and construction work everywhere, customers even bring it to you.

**HOBART Jr. Electric 150 Ampere Welder**



The HOBART A. C. Welder for single phase lines



**Hobarts Weld Better**—that's because of exclusive operation features that save you time and money. The exact welding heat is easy to get, for Hobart lets you select from 1000 volt-amp combinations. Hobart's Remote Control saves valuable time by allowing you to adjust welding heat at the work. Hobarts last longer because they're built better!

**"Build Your Own"**—and save hundreds of dollars! Make your own gas drive portable arc welder using the Hobart "Build Your Own," a reconditioned motor and chassis. Free booklet gives complete instructions.

**Send the Coupon**—for complete details on the Hobart Arc Welder you desire—there's no obligation.

**HOBART BROTHERS COMPANY**  
BOX M-48, TROY, OHIO. "One of the World's Largest Builders of Arc Welders"



# HOBART

**Free!** Arc Welder's Vest Pocket Guide contains tables, equations, charts, etc.

HOBART BROS. CO., BOX M-48, Troy, Ohio

Send me the Free Book, and also information on items I've checked below:

Electric Drive     A. C. Welder  
 "Build Your Own"     Welding School

NAME \_\_\_\_\_  
ADDRESS \_\_\_\_\_



TRY THIS AMAZING NEW  
**ANCO® CLEAR-FLEX**  
Trade Mark  
**WINDSHIELD WIPER BLADE**

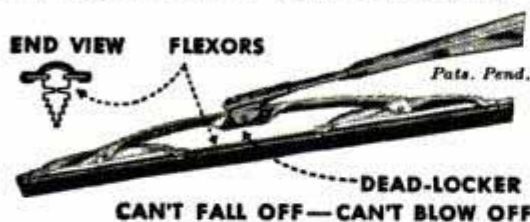

**FLEXES TO CLEAR THE LOW SPOTS**

Know CLEAR-FLEX . . . the first Wiper Blade to conform fully to all windshield surface irregularities. Even wipes uniformly all types of curved windshields. Keeps clear those annoying hard-to-reach low spots common to all FLAT windshield glass. Clears quickly blinding road muck . . . slapped against your windshield from sloppy pavements . . . by passing cars. CLEAR-FLEX already has engineering approval for original equipment on coming models of high-grade cars.

**THRILL WITH CLEAR-FLEX AS OUR "GUEST"**

Deposit with your dealer only the regular retail price. Use CLEAR-FLEX through the next storm. Then IF you are willing, dealer is authorized to remove CLEAR-FLEX and refund all your money.

**ANCO DEAD-LOCKER®**



**WIPER ARM**

ANCO Arm fits quickly any wiper shaft. Suits any good wiper motor. Holds Blade true . . . at correct pressure. If not now on your car, ask serviceman to install a PAIR quickly for you. More than 250,000 good gas stations and service stores sell ANCO BETTER Blades and Arms.

Made by the makers of long-famous ANCO RAIN-MASTER® Blades and Arms . . . original equipment for years on DeLuxe models of high-grade cars. Your dealer knows ANCO.

**Get yours next time you buy gas.  
 May save you a costly smashup.**

**Quality Protected Under Fair Trade Laws  
 ANCO Patented Products—Patents Make Jobs**

**THE ANDERSON COMPANY**  
 Established 1918  
 GARY, INDIANA

power off the line at this high voltage or after it has been reduced to 22,000 at a transmission substation, by reversing the process which increased it. It is subsequently reduced to 4000 volts and is finally knocked down to 115/230 before entering a home or store.

We have seen that the power demand is 17 percent higher than the wartime peak, but when one attempts to translate this situation into concrete terms of "power shortage" or "no power shortage" he finds himself in the middle of an argument.

On the one hand we have the Edison Electric Institute, whose members include practically all the large privately operated utilities producing 70 to 75 percent of the power generated in the nation. It announced at the end of last year that "telegraphic reports from power systems throughout the nation show that the greatest electric power demand in history was successfully met by the electric light and power industry this December, the period of greatest use of electricity. This accomplishment confutes 'dope stories' of an impending power famine, current last summer and fall, and the recent 'power shortage' report of REA Administrator Claude Wickard."

Mr. Wickard, as head of the Rural Electrification Administration, is vitally interested in available power, since his agency loans money to cooperative groups to install distribution systems and bring the blessings of alternating current to those who haven't enjoyed it.

The EEI declares that the power industry got through the month of December—crucial because of less daylight, Christmas shopping and peak industrial production—with a reserve capacity of five percent and concludes that there is no shortage.

"The power people have tended to minimize the shortage right along," Mr. Wickard states. "And, in addition to this, they seem to be unaware of how rapidly America wants to grow. Reserve capacities of five and eight percent may mean that no one will have his service cut off—if we're lucky—but it does mean that we all have our heads pressed against the ceiling, that we lack the capacity to serve new industries and meet the increased demands of residential users."

Critics of the power industry have one adherent in the person of the president of a southern utility, who recently declared, "There is a very serious shortage of electric power and energy all over the United States."

While it is unquestionably true that few

(Continued to page 272)



## The CLINTON Gas Engine

2 H.P.—\$59.50

3 H.P.—\$74.75



● Complete, compact, dependable, 4 cycle, single cylinder, air cooled gasoline engines—by world's largest producer of 2 H.P. gas engines. Ideal for power tools, saws, farm machinery, pumps, boats, bikes, etc. A penny postcard brings you full information. Immediate Delivery

**SPECIAL MODELS:** Kick starter • Thrust bearing type  
Gear reduction • Marine type

**FREE:** Literature describing all uses. Write today.

**CLINTON ENGINE CO.**

16351 E. Jefferson

Detroit 30, Mich.

## EVER NEED THIS ?

Maybe tonight's the night you'll need a good electric lantern. Here it is! Has dozens of uses, indoors and out. Shoots 800 foot beam. Light "stays put" at any angle you set. Buy at hdwe., sport, or electrical stores.



\$2.98  
less  
bat.  
(6-volt)

## Delta REDDYLite

DELTA ELECTRIC CO., MARION, INDIANA



**NEW  
FREE  
FISHING  
TACKLE  
Catalog**

**GATEWAY SPORTING GOODS CO.**

319 MAIN STREET

KANSAS CITY 6, MO.

SAY YOU SAW IT IN POPULAR MECHANICS

**5,000,000 FEET OF LUMBER  
@ \$35 per M. B. M.**

One man did it. You can too, with a BELSAW All-Purpose Sawmill. Replace or repair farm buildings with your own well-finished, low-cost lumber. Portable BELSAW goes to the trees, brings back ALL the lumber for ALL your buildings... boards, joists, lath, shingles.

811-B BELSAW MACHINERY CO.  
315 Westport Road, Kansas City, Missouri

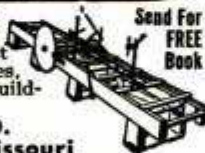

Send For  
**FREE  
Book**

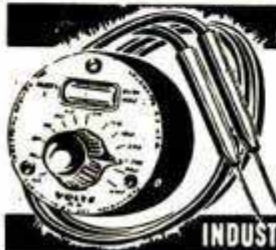

## FLASH THAT VOLTAGE

Turn that knob. Extinguish the neon glow. Instantly read voltage right off dial. MINI-VOLT measures 65 to 660 v. AC. Also DC. Tells whether AC or DC. Virtually burnout-proof. Guaranteed for 10,000 hours' operation. Bakelite case. 12" flexible test leads and test prods. A "must" in electrical and radio work. Only \$2.50 postpaid!

INDUSTRIAL DEVICES, INC., EDGEWATER 1, N. J.

## If you love fine tools, we dare you to look at this drill

YOU CAN'T GO to your hardware store, see this new Millers Falls tool, heft it, grip its smooth, warm handle, spin its drive gear . . . and come away without wanting it for your own!

This is the new Millers Falls No. 104 Hand Drill . . . and if you know Millers Falls Company at all, you know it *must* be right. We don't take tools lightly. A new tool has to be *right* — in performance, in durability, in value — or it has no place in our line.

This new tool *is* right. Long planned and released now to celebrate the company's eighty years of toolmaking, it's the finest hand drill we've ever made.

See it — if you dare — at your hardware store. Millers Falls Company, Greenfield, Mass.



80th ANNIVERSARY  
1/4" HAND DRILL  
NO. 104  
Complete with 8 drill points  
**\$5.00**  
Slightly higher in the West

NO MERE DIE-CAST GEARS but machine-cut; cast iron drive gear meshes smoothly with steel pinion to deliver trouble-free performance year after year.

EASY-GRIP HANDLE of tough, durable plastic. Contains 8 drill points; long enough to hold standard twist drills.

**Millers  
Falls  
Tools**

"OILITE" SPINDLE BEARING with ball thrust.

NEW TRUE-RUNNING 1/4" CHUCK; 3 hardened jaws.



Celebrating 80 Years of Toolmaking



**WITH MOLLY YOU CAN FASTEN ANYTHING**  
and do it quickly, neatly and safely. MOLLY will hold fixtures securely to floors, ceilings or any hollow wall construction... Simple to install, all you need is a screw driver. Sold by leading hardware stores everywhere.

Write for Free Descriptive Folder

**MOLLY**  
SCREW ANCHORS

**MOLLY CORP.**  
522 COURT STREET  
READING, PA.

**PRESSURE QUEEN**  
FOUR CYLINDER  
PORTABLE AIR COMPRESSOR  
SPRAY PAINTING OUTFIT

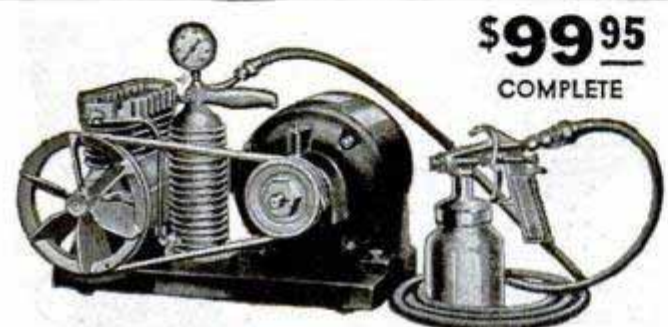

**\$99.95**  
COMPLETE

**COMPACT • RUGGED • POWERFUL**

The ideal air supply for home and farm workshop, machine shop, garage, service station and contracting painter. Inflates tires; refinishes automobiles, trucks, implements and furniture. Paints buildings better, faster and at lower cost than brush work. Compressor has 4 cylinders, drop forged crankshaft, heat treated valves and pistons, bronze bearings, forced feed lubrication. 50-60 lbs. pressure without pulsation. Price includes compressor as shown, with air gauge, 15 ft. hose, spray gun and 1/2 h.p. motor; fully guaranteed. With 3/4 h.p. motor—\$109.95.

IF YOUR DEALER DOES NOT SELL  
PRESSURE QUEEN WRITE DIRECT.

**THE CAMPBELL-HAUSFELD CO.**  
1046 RAILROAD AVE. HARRISON, OHIO

**\$2.95** **TORNADO**  
GAS TORCH

**The Modern Way of Soldering**

Ideal for hard and soft soldering. Will heat quickly; solder will flow freely and smoothly. No compressed air required. Self-adjusting. Safe. Economical. Can be used for annealing small parts and bending metal parts. Generates a heat of 1700° F. Simply connect to any illuminating gas jet with a rubber hose and operate. Tornado Torch No. 119 comes with three tips, (1/8", 1/4", 3/8" blast).

Tornado Gas Torch No. 119—Complete with 2 tips, for Natural Gas or Bottled Gas; with 3 tips for Manufactured Gas. \$2.95 per set. See your dealer or order direct. Send check or money order—post paid.

Robco Corporation, 202 E. 44th Street, New York 17, N. Y.

**It's EASY!**  
**ECONOMICAL!**

**Build Your Own Trailer with NATIONAL'S Simplified Plans**

Beat the housing shortage with a full-size house on wheels or add new pleasure to your vacations and week-ends with a sleek sport trailer. Step-by-step instructions and complete bill of materials with every plan. *Three different models.*

- NATIONAL MODEL 27:** A 27-ft. luxury liner with 3 rooms, lavatory, sleeping space for six. Plans . . . . . **\$1.00**
- NATIONAL MODEL 28:** A 20-ft. cabin trailer that's good-looking and sturdy, with beds for four. Plans . . . . . **\$1.00**
- NATIONAL CAMPER:** The sport trailer you've wanted for hunting, fishing, vacations. Sleeps two. Plans . . . . . **.50**

**ORDER ALL THREE—AND GET ONE FREE**  
Complete set \$2.00

Big parts catalog **FREE!**  
FREE with any order!

**NATIONAL TRAILER STORES**  
Dept. 51 • Box 2353 Terminal Annex • Los Angeles 54, Calif.

**TONGUE AND GROOVE - FLUTING - NOTCHING - INLAY - ANY JOINT**

**Aladdin's Tool**



Patent Pending

Dealers Write for Information

**AND YOUR DRILL PRESS**

Makes any cut wood-shaping tools costing up to \$300.00 can make—more too. Sturdily built, lasts a lifetime.

**TWO MODELS—IMMEDIATE DELIVERY**

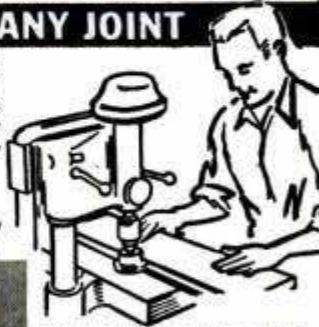

DeLux Model includes bottom bearing that anchors tool to bottom of press. Regular Model without bearing. Comes complete with adaptor and 6 blades making 12 standard cuts—balance blade—beautiful wood box. Over 100 different, practical cuts can be made with the 6 blades. See your dealer or send check or money order for delivery to your door. All other orders C.O.D. plus postage.

**THE DESIGN COMPANY**  
2603 Warwick, Dept. A19, Kansas City 8, Mo.



**DELUXE MODEL**  
**\$11.95** with bottom bearing as illustrated

**REGULAR MODEL**  
without bottom bearing .. **\$7.95**



## CONVERT HAND MOWERS TO POWER MOWERS

Takes Less than 3 hours

The Handy-Dandy Lawn Mower Kit fits any hand mower from the 16 to the 20 inch size. Complete with all necessary parts. Kits can be purchased separately or complete with power units.

DEALERS WANTED

LE CLAIRE MFG. CO., Le Claire, Iowa

Mfgs. of the Handy-Dandy Aluminum Clothes Pole

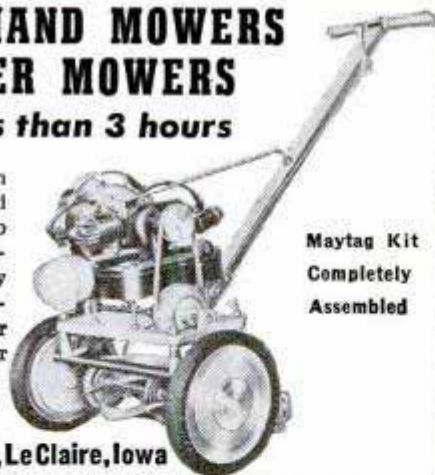

Maytag Kit  
Completely  
Assembled

## LIFETIME BRONZE ANCHOR

FOR FISHING & HUNTING BOATS

Non-rusting, non-corrosive . . . single cast assembly . . . "nothing to come apart."

Weight: 9 lbs.  
Arms: 9½" (length)  
Flukes: 2¾"  
Over-all length: 17"  
Swivel shank in 6½"  
self-cleaning housing. Will not foul ropes.

**\$3.50**  
FOB  
IMMEDIATE  
DELIVERY

**CALDWELL & WARD BRASS CO.**  
SYRACUSE, NEW YORK

## Thompson BEATS the World on BOATS



Better Built  
Lower Prices



Safe Boats With  
Full Length Spray Rails  
Keep passengers perfectly  
dry—even at high speeds.  
Catalog also shows two new  
models of "Take-Along"  
Boats. Two big factories—  
save you freight.

Write for your copy. State kind of  
boat in which you are interested.

**THOMPSON BROS. BOAT MFG. CO.** (151)  
213 Ann St. (Write to either place)  
PESHIGO, WIS. 113 Elm St. CORTLAND, N.Y.

## Build AIR-CONDITIONING UNIT

FOR YOUR HOME

We show you how. It's easy to build and a pleasure to use. An individual unit that fits your window and really cools the room. Up to 18° cooler than outside. Sleepless nights vanish with a cool bedroom. Real Air-Conditioning, not just a fan. Different sizes to fit any room. No expert knowledge needed. Mail \$1 now for complete simplified PLANS and valuable Catalog.

**LEJAY MANUFACTURING COMPANY**  
547 LeJay Building, Minneapolis 8, Minn.



PLANS  
COMPLETE



## HUNTING KNIFE

MADE FOR U. S. MARINE CORPS  
USED BY HUNTERS — FISHERMEN — CAMPERS  
7½" Single Edge Blade — 12" Overall Length  
Dressed Leather Handle Saddle Leather Sheath

A \$4.00 Value — Send \$1.25

No C.O.D. We Pay Postage

**ZIMM'S SURPLUS STORE**  
2310-A Broadway, Oakland 12, Calif.

APRIL 1948



in  
Basic  
Improvements



Now, AC introduces, for automotive service, insulators made of the *patented* wide Heat Range aluminum oxide material, which was used exclusively in aircraft plugs for American planes during World War II. AC has consistently been *first* in basic spark plug improvements—pioneering such revolutionary advancements as the one-piece plug—the welded side electrode—the unglazed insulator tip—the complete Heat Range of plugs in every thread size—and *now* the patented aluminum oxide insulator.

That's why AC Spark Plugs are tops in performance—why you should choose them for utmost reliability.

AC SPARK PLUG DIVISION • GENERAL MOTORS CORPORATION

SAY YOU SAW IT IN POPULAR MECHANICS





**IT'S BACK!**—the Handy File which won the favor of tens of thousands of users before the war temporarily halted its manufacture. Now again craftsmen and home owners can enjoy the convenience and economy of its features, which include two kinds of cutting surfaces:

**Single cut** teeth on one side, for sharpening edged tools and smooth finishing in general. **Double cut** teeth on the other side, for fast stock removal.

In addition, the Handy File has one cutting and one "safe" uncut edge. Flat, orange-colored handle makes the Handy File easy to carry (no bulge—slips conveniently into hip or leg pocket). Also has convenient hang-up hole.

The Handy File (in either Nicholson or Black Diamond brand) is virtually two files in one. Get it at your hardware dealer's. Each Handy File is cellophane wrapped, to bring it to you fresh and free from rust.



**NICHOLSON FILE CO.**  
22 Acorn St.  
Providence 1, R. I.



(In Canada, Port Hope, Ont.)

**NICHOLSON**  
**FILES** FOR EVERY PURPOSE

home users had to go to bed in the dark or that there has been little real industrial dislocation, there are enough recorded instances to indicate that all is not well:

In Maine, customers of one utility were divided into three groups and each group received power only one hour out of every three. A farm bureau, the potato growers association and 12 chambers of commerce declared that the power shortage "wreaked such havoc and cost the county so much money that (the utility) rates should be reduced rather than increased."

Two Florida plants producing phosphate were forced to curtail operations because they were deprived of power. This, however, was interruptible power, bought at a low rate with the understanding that it might be cut off at the utility's discretion.

Residents of Minneapolis and persons living between La Crosse, Wis., and Sioux Falls, S. D., were asked to cut their use of power between the hours of 4 and 6 p.m.

In many states consumers were asked to reduce over-all consumption and particularly at peak hours; the use of electric hot-water heaters was discouraged; industry was asked to voluntarily shift heavy loads to off-peak hours. Many systems reduced voltage at peak hours to spread out the supply of power.

National demand is at its present high level because of heavy production of all types of goods, a high national income which permits the individual to use all the current he wants and to buy appliances which increase the load.

Consumption, prewar, increased about 10 percent a year; since 1945 every year has more than doubled the 1939 figure. In 1947 the average family used 1400 kilowatt hours, as compared to the prewar average of 950. In one week last December, we used more than 5.3 billion kilowatt hours; in the same week of 1940 we used only three billion.

That the power industry is trying to keep abreast and forge ahead of this demand is quite clear. Its current construction program calls for installation of 15 million kilowatts of capacity in the five years from 1947 to 1952 at a total cost of from five to six billion dollars. The magnitude of this program can be appreciated by pointing out that this represents 37 percent as much installed capacity as the industry achieved in the previous 65 years. This year utility companies expect to install enough equipment not only to keep up with the increased demand but to exceed it by two million kilowatts. This would add a little slack to the reserves.

(Continued to page 276)



# Revolutionary New

# Dumore Carvit

makes you a skilled wood-carver in 20 minutes!



Here's a fascinating new hobby—complete in one tool. The unbelievable perfection of your first carving amazes your friends! Experienced craftsmen use the Carvit to give their woodworking projects

that professional touch.

With the Carvit, you make beautiful replicas of inexpensive objects you can find in any dime store or gift shop—in mahogany, walnut, and other fine woods.

**You're an expert at once — with a Carvit!**

Here's how the easy-to-use Carvit works: You clamp a model to the table below the tracer, and a wood block below the cutter. Then you switch on the motor and guide the tracer over the raised contours of your model. The cutter moves with the tracer to carve an exact duplicate of the model. With an index

attachment, you can carve objects in the round—statuettes, busts, etc.

Carving with the Carvit is fascinating fun for everyone. The Carvit is the ideal gift for your sweetheart, husband, or son! See this exciting new tool at your local hardware store today — or mail us the coupon below!

Satisfaction guaranteed or your money back in 10 days!

No skill or training needed to do work like this



Carve useful ornaments for the home — distinctive gifts for friends — fine carvings that sell!

**Tear out coupon and mail today!**

The Dumore Company, Dept. D-51 Racine, Wisconsin

- Please send complete information on the Carvit.
- Please send one Carvit. \$48.50 enclosed.
- Please send one Carvit with index attachment. \$58.25 enclosed. Shipping charges C.O.D.

Name.....

Address.....

City..... State.....

H-5

**SOUTH BEND**

## LATHE COLLETS

Precision Steel and Brass Collets for use in any make of lathe or other machine that they will fit.

### SPECIFICATIONS

Collet No.	Thread Dia. In.	Thread Length In.	Th's Per In.	Body Dia. In.	Collet Length In.	Head Dia. In.	Head Taper Deg.
3	.650	3/4	26	.6495	2-11/16	.852	12
2	.855	13/16	20	.8595	3-5/16	1.095	15
5	1.250	3/4	20	1.2495	3-9/32	1.452	10
4	.950	13/16	20	.9495	3	1.150	10

	No. 3	No. 2	No. 5	No. 4
STEEL COLLET	\$3.75	\$4.00	\$4.75	\$4.25
BRASS COLLET	2.00	2.25	2.50	2.35

**SOUTH BEND LATHE WORKS** 455A E. Madison St. South Bend 22, Ind.

# RA-TOX

WOOD SPLINT Ventilating SHADES

for INDUSTRIAL WINDOWS

RA-TOX wood-splint Shades provide protection from direct sun-rays and reflections; they produce a soft, restful illumination that protects your employees from "Eye Strain" and "Glare Fatigue."

RA-TOX Shades are good looking, easy to roll up or down quickly, adjust to changing daylight conditions. Made to your measurements, of basswood splints interwoven with special strong seine-twine . . . heavy duty cord-lock holds shade at any height. Sturdy installation brackets. Up to 15 or 20 year service with ordinary care.

Write for latest Folder.

**HOUGH SHADE CORP.**

(Industrial Division)

1107 Jackson St., Janesville, Wis.

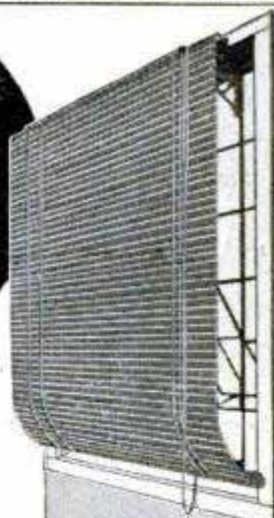

**LIGHT WITHOUT GLARE!**  
**AIR WITHOUT DRAFT!**

Made in sizes and types to fit every style of industrial window either steel or wood sash. A nation-wide shading service. There is a RA-TOX representative in your area.

"The gun that looks and feels like a Luger"



**HY-SCORE**

**World's Most Powerful AIR PISTOL**

ACCURATE! FAST! HARD-HITTING . . . Expensively made piston-type pistol for use by experts. No pumping. 30½ oz. 10¼" long. Cal .177 or .22. \$19.85 for set including Hy-Score Pellets and darts\*. Extra ammunition per box of 500 rounds. \$1.49 for cal .177, \$1.88 for cal .22.

\*When available.

If your dealer cannot supply, write for free booklet, Dept. PM4  
**HY-SCORE ARMS CORP., BROOKLYN 1, N. Y.**

Use HY-SCORE Pellets for best air pistol shooting.



YOU GET THE "HORSE LAUGH" WHEN

PERFORMANCE  
GOES UP  
IN SMOKE

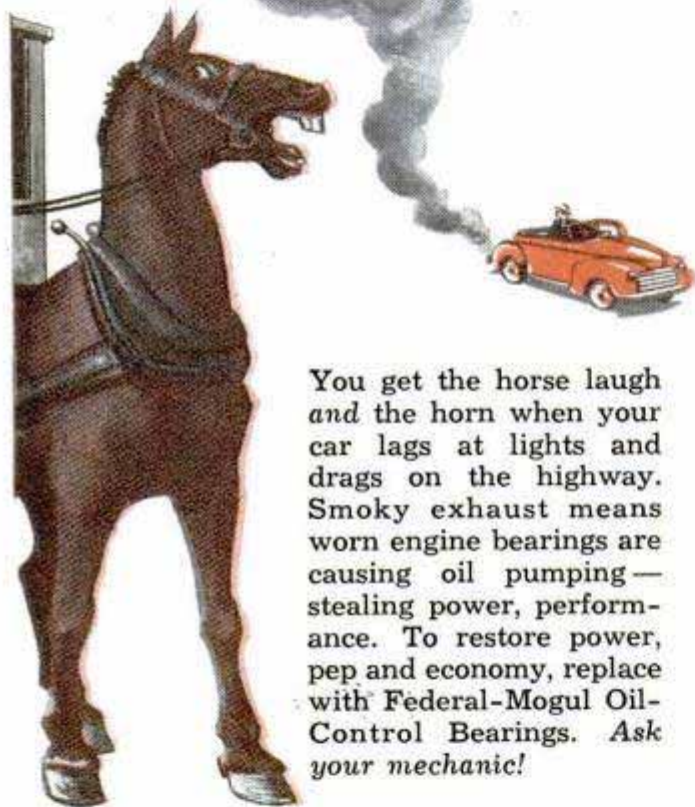

You get the horse laugh and the horn when your car lags at lights and drags on the highway. Smoky exhaust means worn engine bearings are causing oil pumping—stealing power, performance. To restore power, pep and economy, replace with Federal-Mogul Oil-Control Bearings. Ask your mechanic!

FEDERAL-MOGUL SERVICE  
DIVISION OF FEDERAL-MOGUL CORPORATION  
COLDWATER, MICHIGAN

Replace in Sets with Genuine

**FEDERAL-MOGUL**

Oil-Control Bearings  
in your car



FEDERAL  
Mogul

**STEEL  
TUBING  
KIT**



\$2.50  
POSTPAID IN U.S.A.

**For Home Craftsmen**  
NOW YOU CAN MAKE, REPAIR  
LAMPS BUSHINGS HANDLES  
JEWELRY NOZZLES SPRAYERS  
TOOLS SHAFTS TOYS  
HUNDREDS OF OTHER USES

12" Lengths Longer lengths on request.	8 Sizes 3/8" to 1 1/4" O.D. Graduated in 1/8"
----------------------------------------------	-----------------------------------------------------

Precision-made, electric-welded tubing, 18-gauge, low-carbon, cold rolled steel. Free machining, bends, forms, rolls, beads, plates easily. Protected against rust.

SEND CASH OR MONEY ORDER  
TOWERS CORPORATION, Dept. A-1  
404 Public Square Bldg. • Cleveland 13, O.

USE THE  
WIND TO  
CHARGE  
BATTERIES



**6 VOLT WIND DRIVEN  
GENERATOR**

Ideal for farm and camp lighting — for boats, motorcycles, autos, farm radios, etc. The wind driving the propeller operates the generator. Produces 6 volts, 12 amps—weighs only 8 1/2 lbs.

OPERATE WITH PROPELLER OR PULLEY

May be used with 13 inch propeller as illustrated—with homemade propeller or pulley. For farm lighting plants using batteries it may be run direct by windmill. Use pulley for autos, boats, etc. Fitted with break to control charging rate. With 13 inch propeller as shown, each \$22.95. Generator only, less propeller \$14.95. Shp. wgt. approx. 12 lbs. F.O.B. Houston. Send check or money order. Immediate shipment.

AERO PARTS SUPPLY Dept. PM4, 8242 Travelair Blvd.  
Houston 17, Texas

**AUTO ENGINE SPEED CONTROL  
GOVERNORS**



In Montreal, 7546 Wise-  
man; in Skaneateles, N. Y.,  
Horle Welding Supply.

Agents Wanted

CANDEE-SMITH GOVERNORS  
2641 S. Mill St., Los Angeles 7, Calif.

**FISH POLE or SKI  
CARRIERS**



A "must" for Sportsmen! Genuine rubber suction cups for fenders or car top. Rigid, safe carrier for fish poles, skis, etc. \$1.50 per set delivered post-paid cash with order. No Stamps.

\$1.50 PER SET THOMPSON ENGINEERING CO.  
DEPT. 70 GRAND RAPIDS, MICH.

**Air Corps Type SUN GLASSES**



Brand New. Protect your eyes in style with this attractive sun glass. Ground and polished processed lenses. Approved by the Government Bureau of Standards. These glasses absorb over 96% of the ultra-violet and infra-red rays. 24 K gold plated frames with pearl Sweat Bar. Comes in individual case. \$3.45

Also available in ladies styles:

SEND CHECK OR MONEY ORDER. IMMEDIATE DELIVERY.  
B-G SALES CO. 714B DELAWARE ST.  
KANSAS CITY, MO.

SAY YOU SAW IT IN POPULAR MECHANICS

**PALMGREN Rotary, Indexing,  
Milling TABLE**

DUAL CROSS FEED and ROTARY FEED

Has 8" table, 360° movement and 4" cross feed travel. Adjusting wheels and dials graduated in degrees and thousands. Slotted for bolting to table. No. 83 Priced \$49.50. No. 82 without rotary feed \$39.75.

Write for Circular No. 10

CHICAGO TOOL and ENGINEERING CO.  
8365 South Chicago Ave., Chicago 17, Ill.



No. 83



Electrically Welded Endless

# Paramount

**BAND  
SAW  
BLADES**



Made in widths from 1/8" to 1-3/4"

Make your band saw do more work for you. The proper width of blade will extend the scope of this important machine. Burrill's Paramount Blades are made from tough Nickel Alloy Steel properly tempered. Teeth accurately set and filed, and all saws carefully straightened. Send order and check today. Delivery will be made as promptly as conditions permit, from a few days to a week or two. You can obtain these saws at the following prices:

1/4"-3/16"-1/4"-3/8" wide, 5'6" long.....\$1.04 each  
 1/2"-3/16"-1/4"-3/8" wide, 6'6" long.....\$1.16 each  
 3/4"-3/16"-1/4"-3/8" wide, 7'6" long.....\$1.27 each

Other sizes at proportional prices

**NO C.O.D. SHIPMENTS ACCEPTED**

State Make of Machine

Your satisfaction is guaranteed

**BURRILL SAW & TOOL WORKS**

407 E. Main St., Ilion, N.Y.

# For smoother shaves and more of 'em

STROP YOUR RAZOR AS A BARBER DOES!



**use**

RAZOR, STROP AND 5 VALET BLADES

**\$1.25**



STROPS—CLEANS WITHOUT REMOVING BLADE

SELF-SHARPENING... ONE PIECE



## NEW! BETTER!

**AIR-COOLED CARBURETOR INTAKE STACK!** FOR 2 1/2" CARBURETORS

Soup-up performance! Increase Mileage! Low Price, only **\$2.00**

(Includes Postage)

Send Cash, Check, Money Order to:

**MERCURY TOOL & DIE COMPANY**

5977 Washington Blvd. Culver City, Calif.



## NEW B-M POWER MOWERS

For Modern Lawn Care

Newest model self-drive, three-wheel, rotary blade mower. Equipped with quick-starting, dependable, trouble-free 1 1/2-2 h.p. Clinton engine. Light. Sturdy. Choose from three models of assembled mowers or Build-it-yourself kit of parts. Guaranteed.

At LOW FACTORY COST

**B-M MOWER COMPANY**

Box, 66-M Blue Mound, Kansas

SAY YOU SAW IT IN POPULAR MECHANICS

**MAGNETS** OF ALL TYPES—10c UP  
 AMAZINGLY POWERFUL!!  
 5 oz. Alnico Magnet, lifts 10 lbs. \$1.00. Our Leader, 15 oz. Magnet, lifts 40 lbs. \$1.95. New alloy—will not weaken! Useful for lifting valuables from tanks, lakes, or rivers easily! 7 small magnets \$1.00 with list of many shop and home uses. Satisfaction guaranteed.  
 R. EYRICH, 2566 N. 49TH ST., MILWAUKEE 10, WIS.

## JET The Sensational NEW Combination ROLLER-ICE SKATES

**FASTER—SMOOTHER—EASIER SKATING**

Skating Clubs are Enthusiastic Users...

YOU will like the NEW "JET" Roller Skate... Study the THREE-IN-LINE-ROLLERS... Goes over cracks and irregular surfaces with a new smoothness... The "JET" Skate is the ONLY SKATE WITH BRAKES to STOP QUICK.

Another feature: you can quickly change to Ice Skates by replacing the rollers with the "JET" Ice Skate Attachment... A new experience awaits you in Roller Skating... Get a pair TODAY... Three Sizes: Large, Small, and Medium for CHILDREN and ADULTS... In ordering simply GIVE SIZE OF SHOE.

Local Agents Wanted... RUSH ORDER

AFCO PRODUCTS, INC., 4547 No. Clark St., Dept. P-4, CHICAGO 40, ILL.

## ICE SKATERS ROLLER SKATES

50% Lighter Than Ordinary Skates

Streamlined



PAT. NO. 2113862

The Ideal Gift

Be First In Your Locality

Only **\$4.95** A PAIR

Postpaid in U.S.A. Ice Skate Attachment \$2.25 Extra

3 Ball Bearing Wheels in line gives MORE SPEED with LESS EFFORT...

Note the BRAKE! to STOP QUICK simply RAISE THE TOE

We Ship C. O. D. Plus Postage

Mail Your Order Direct To Factory



# CASH

FOR YOUR SPARE TIME

**MACHINE  
SAW FILING  
PAYS UP TO  
\$2 or \$3 an Hour**

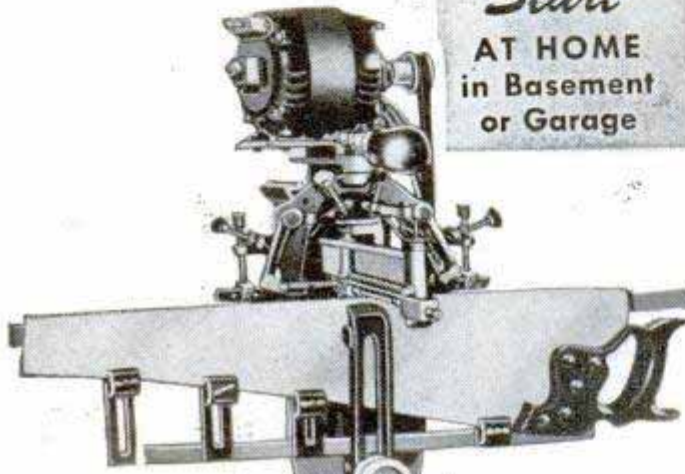

**Filed Over 5,000 Saws**

"I have used your Foley Automatic Saw Filer for over eight years and find it very satisfactory. To this date I have filed over 5,000 saws." A.G.W., Mass.

**Made \$900 in Spare Time**

"I did very well last year with my Foley equipment, about 950 saws and 240 lawnmowers, in my spare time. About \$900 for the." L. H. M., New York.

**MAKE OLD SAWS CUT LIKE NEW**

"The first saw I sharpened came out 100%. I have been filing saws for 15 years by hand, and my Foley Filer showed me that I didn't know a thing about filing saws"—writes C.E.P., Penn. H.S.W., Iowa says—"Didn't think there were so many saws in my whole territory. I am working all day and late at night trying to keep ahead of the rush."

With a Foley Saw Filer you can file all hand saws, also band and cross-cut circular saws. It is easy to operate—simple adjustments—no eyestrain. Patented jointing principle evens up all irregular teeth and makes an old saw cut just like new.

**FREE PLAN SHOWS HOW TO START**

No canvassing necessary—"I advertised in our local paper and got in 93 saws—I only work spare time at present" says M.L.T., Ohio. You can get IMMEDIATE DELIVERY on a Foley Saw Filer. Send coupon today—no obligation.

**FOR A STEADY REPEAT CASH BUSINESS GET A**



**FOLEY Automatic SAW FILER**

FOLEY MFG. CO., 416-8 Foley Bldg., Minneapolis 18, Minn.  
Send Free Plan on Saw Filing business, no obligation.

Name.....

Address.....

The electrical manufacturing industry, loaded with orders right after war's end, has met the challenge head-on and is now producing steam and hydro facilities at a rate never before contemplated and the leading companies in the field are said to be capable of turning out 4½ million kilowatts of capacity a year.

Westinghouse hit its stride last July and has since been turning out steam-turbine generating equipment at double the previous highest rate and expects to continue this pace through 1950. Switchgear and distribution transformers are running off its lines twice as fast as in 1941.

General Electric, the world's largest producer, expects to deliver 9½ million kilowatts of steam-turbine capacity in the next four years and one million kilowatts of hydro capacity in the next two years. In 1947 GE turned out 50 percent more steam turbines than in 1940, both in numbers and capacity.

Nor is the industry resting on its oars as far as developing new techniques to increase efficiency is concerned.

Transmission of electricity under the heaviest pressure in history—500,000 volts—is being conducted experimentally at Brilliant, Ohio, in an effort to learn techniques which will permit sending more electricity farther and more economically than has ever been accomplished. Success in these experiments will mean that greater interchange of power between systems will permit a reduction in the number of generators inter-connected systems must keep in reserve, and will provide greater operating economies than are possible at present.

This outdoor laboratory includes three test lines, two of which are 1½ miles long and the third 800 feet. Power received from a nearby station of the Ohio Power Company is raised by three giant transformers from 264,500 volts to a maximum of 500,000 volts in 24 steps. Until these tests were inaugurated, the highest voltage at which electricity had been transmitted in this country was 287,000 volts, on the 265-mile line from Hoover Dam to Los Angeles. However, in Sweden pressures of 345,000 volts have been successfully handled.

One of the major problems to be solved is that of corona, which is the loss of power from the lines or conductors into the air when the power is under heavy pressure. The obvious solution—using extremely large transmission cables—would make the line too heavy to withstand wind and ice loading and would boost the cost of such an installation to a prohibitive point.

(Continued to page 280)



\* Reg. Trade Mark



# Assemble

THIS FAMOUS, HAGERTY

## SEA SHELL\*

In a Few Hours

Make this light, tough, extremely stable, unsinkable boat in a few hours. Ideal for fishing, sailing, out-boarding. It weighs but 65 lbs. Easily transported. 8 ft. long, extra wide. It requires simple tools to assemble, everything else furnished. You save 75% cost of new boat. Earn money—make boats for others at a profit!

COMPLETE PARTS KIT, ONLY

### \$35<sup>00</sup>

Includes Assembly Jig and Full Scale Plans

Send ORDER or WRITE FOR LITERATURE To:

**PRITCHARDSONS'**  
Dept. PM-2744 W. 37th Place CHICAGO 32, ILL.

## SAVE MONEY

build your own

### SMITH COMPRESSOR



Now, use the world-famous Smith Air Compressor to operate rock drills, paving breakers, spray guns, sandblasting, etc., at low cost! Just order the Smith Compressor Head and Accessories with complete instructions for assembling. All you need is a Ford Motor and shop facilities. Capacity 60 cu. ft.—ample power for most compressor jobs. Pressure up to 100 lbs. per square inch. Head equipped with high speed compressor valves; automatic unloading and idling.

WRITE **GORDON SMITH & CO., Inc.**  
TODAY! 410 College Street Bowling Green, Ky.



**MOTOR ARBOR AND COMBINATION V-PULLEY**  
1/2" right .65c 1/2" left .75c  
5/8 & 3/4 R & left. . . . . \$1.00  
Add 10c postage each. U.S.A. Trade disc.  
**B. DOWICK, Dept. P**  
584 Communipaw Ave., Jersey City, N. J.

## THIS MOTOR

1/30 HP 24 volt DC motor  
2450 R.P.M. .95 amps 1/4" shaft size overall 3" x 4".  
Weight 3 lbs. Also operates on 32 volts . . . . . only

### \$245



**USE AS 6 VOLT GENERATOR**—Generate your own power. Can be operated on your bicycle wheel. Furnishes sufficient power for two 6 volt bulbs. Resistor furnished free with each motor enables you to maintain constant voltage. Special Price \$2.45, or 4 for \$7.50, or 24 for \$36.00.

## REVERSIBLE THOR

218RY Screw Driver and nut setter 750 RPM. Like new. List \$93.00. Special price \$22.50. Wt. 4 lbs.

### \$22<sup>50</sup>



**INGERSOLL-RAND**  
Riveter and Chipping Hammer  
Model AVC-11, like new. Takes up to 5/32" rivet. \$73.00 list. Special price \$8.75. Wt. 5 lbs.  
Prices are F.O.B. Chicago. Immediate delivery. **SOLD ON MONEY BACK GUARANTEE.** Send check or money order today.  
**DEALERS — WRITE . . .**

### \$8.75



**C & M EQUIPMENT COMPANY** 1831 S. State St., Dept. D-4, Chicago 16, Ill.

enjoy a pouchful of fresh tobacco

# Rogers

Air-tite\*

the finest in tobacco pouches

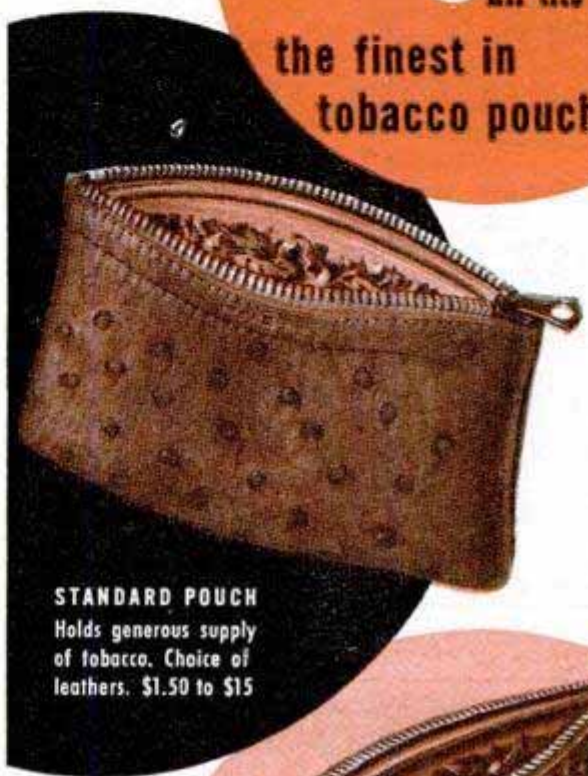

**STANDARD POUCH**  
Holds generous supply of tobacco. Choice of leathers. \$1.50 to \$15



**COMBINATION POUCH**  
Holds pipe as well as tobacco. Choice of leathers . . . \$2.50 to \$20  
**ROGERS RARITY PIPE \$5**

The Rogers Air-tite\* with its patented inner pouch of moulded, seamless rubber, protects freshness and flavor. Exquisitely made of fine leathers in a variety of models, by Rogers craftsmen. The largest-selling tobacco pouch made. At better shops everywhere.

**Rogers imports, inc.**  
419 Fourth Avenue, New York 16, N. Y.  
manufacturers and importers of the finest smokers' accessories  
**EXCLUSIVE U. S. DISTRIBUTOR, PETERSON'S PIPES, DUBLIN, LONDON**  
Rogers Air-tite Pouches in Canada—G. T. Lanning Ltd., Toronto  
\*TRADE MARK REGISTERED U. S. PAT. NO. 1,801,192. CAN. PAT. NO. 374,167



# No other tool like it!

## BURGESS vibro-tool

Writes on . . .

Watches  
Glassware  
Tools  
Leather  
Plastics

Costume Jewelry  
Pots and Pans  
Sporting Equipment



\$7.50

Engrave your name . . . etch letters or designs . . . place permanent identification marks on anything with this unique hand tool. Carves wood and linoleum, cuts cardboard and balsa, tools leather. Just plug in on any 110 volt AC line. No home shop is complete without a Burgess Vibro-Tool. See your dealer or write for information.



**DELUXE KIT**  
Vibro-Tool complete with 22 attachments in handsome, polished wood chest. . . . \$16.50

**BURGESS Vibro-Tool Division**

LAKE ZURICH, ILLINOIS

## DEATH AHEAD BRAKE FLUID LEAKING!

... SAYS THE *Shur Brake Gauge*



1 Leak develops in line—and

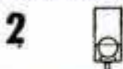

2 Trips float in Shur-Brake Gauge, then



3 Flashes red light signal on dash to warn you

● 600 accidents a day involve faulty brakes! Watch your brake fluid! Install *Shur-Brake Gauge* . . . be forewarned of accident when fluid pressure drops. Comes complete, ready to install yourself in 20 minutes . . . under the hood for easy service-

ing. Specify year, make and model of car or truck when ordering.

**\$3.95**

postpaid anywhere in U.S.

Used by thousands of motorists, truck fleets, and cabs.



\$3.00 LIST

2 FOR \$1.98

Safety when changing tires. Will not skid. Fits any Tire. Easy to use. Reg. \$3.00 list. 2 for \$1.98 postpaid anywhere in U.S.

*Shur Brake Gauge Co.*

3320 E. 41 St., Minneapolis 6, Minn.  
Dealers write for information



## IT STAYS STUCK! WITH . . . MULTI-PURPOSE AMBROID

If you want permanent results from an adhesive, you can't equal multi-purpose Ambroid liquid cement — for home workshop, household or factory. A quality leader for 37 years, ready-to-use Ambroid is waterproof, transparent, quick-drying, extra strong. Flexible, heat-and corrosion-resistant. For assembling, repairing or mending jobs, keep Ambroid handy. At your dealer's, or send 25¢ for big 2-oz. tube postpaid. Money back guarantee.

Also 50¢ 4-oz. tube. Pts., qts., gals., for industrial use.



303 Franklin St., Boston 10, Mass.



## NOW YOU CAN POLISH "SIMONIZ" and WAXEASY

This exclusive patented way . . . saves 3/5 the time. Does a better job. 25c can enough for 4 cars. At your dealer or send 25c for can postpaid.

TIMEX PRODUCTS CO. ST. LOUIS, MO



## A BETTER JOB EVERY TIME

CLEANS AND WAX POLISHES IN ONE EASY OPERATION!

Just Rub On, Let Dry, Wipe Off

Quick and easy. Do your car in less than an hour. Contains expensive, pure Carnauba wax, hardest wax known. Lasts up to 6 months.

**RAIN-PROOF, SUN-PROOF, MUD-PROOF**

In ready-to-use powder form. At your dealer or send \$1.50 for big 10-oz. can (enough for 4 cars) and get Timex Wax Polisher FREE. Limited offer! C.O.D. orders, plus postage.

A FEW TERRITORIES STILL OPEN FOR DISTRIBUTORS

TIMEX PRODUCTS CO. 5506 Virginia Ave. St. Louis, Mo.

# METALS

sold in small quantities for the home workshop. Steel, Brass, Copper, Aluminum, etc. In Bars, Shapes, Tubes and Sheets. Write for free price list.

CASHMETALS CO., 2720 California Ave., Pittsburgh 12, Pa.

## SPECIAL OFFER

**Personal Initials in Solid Bronze**

Beautiful polished bronze initials personalize home-craft items — fireplace sets, cigarette boxes, doors; many other uses. Easy to apply to metal, wood, leather or plastics. Order your initials today.

2 Sets Polished Bronze Initials, total 6 letters, 3/4" high, (\$1.50 regular price): Special offer, \$1 postpaid.

Send \$1.00 for 2 sets — money back guarantee.

H. W. KNIGHT & SON, INC., 43 Lane St., Seneca Falls, N. Y.

SAY YOU SAW IT IN POPULAR MECHANICS



## LAWN ORNAMENT-NOVELTY PATTERNS

28 Lawn Ornament Patterns, 25¢. Other patterns: 15-20" high; Dutch Girl, Dutch Boy, Pirate, Bull Terrier, Mexican Girl, Mexican Boy, Dwarf, Penguin, Flower Girl, 10¢ each. 25 Novelty Patterns, 30¢. All 62 Full Size Patterns, \$1.00 Postpaid. Strother Pattern Service, Dept. AH-8, Box 383, Belington, W. Va.

# "PLASTICS"

Work in a fascinating and profitable hobby. Just out—our latest fabricating manual. Tells you how to work with Plastics. Our new Catalogue provides all needed materials: Plexiglas—Lucite—Tenite—Catalin—Acetate—all in sheets, rods, and tubes. Complete line of cements, dyes, accessories and supplies. Send 20¢ today for Fabricating Manual and Catalog. We apply this amount on initial order.

**HOUSE OF PLASTICS**

8648 Linwood Avenue P. M. Dept. Detroit 6, Michigan



# ASSEMBLE THIS DESK... SAVE \$30.00

Here's the most unusual furniture value yet! Your chance to own this beautiful, sturdy Colonial kneehole desk at a saving of 40% of its retail price. This new low price is possible because you assemble and finish the desk in your own home. No workshop needed... just a hammer and screwdriver and you're in for some real fun — and a real saving of \$30.00

## COMPLETELY READY-TO-ASSEMBLE

Made by one of the largest manufacturers of desks, the ASSEMBLY desk comes to you completely ready to assemble in an evening's time — with all parts, materials and simple-to-follow instructions included, all wood sanded smooth and cut to exact size for precision construction.

## DESIGNED FOR BEAUTY AND LASTING SERVICE

Imagine an attractive kneehole desk which combines today's graceful lines with the proud Colonial style of the past. The ASSEMBLY desk stands a full 30 inches high and has a beautifully-grained 22x42-inch solid birch top. Finest quality hardwoods are used throughout to give maximum durability and beauty. All wood is aged and kiln dried to meet our exacting requirements. Every piece is specially treated in our factory to prevent warping regardless of climate. You may paint or stain and varnish to suit your taste. When ordering, specify your choice of stain.

## MANY HIGHER-PRICED FEATURES

There are eight (8) roomy lip drawers, including one double-size drawer for filing. Drawer channels are coated with penetration wax to insure free sliding. For sturdiness and ease of construction, we have dovetailed the drawer ends — a feature usually found only in more expensive furniture. Drawer interiors are completely finished, sanded smooth and require only shellac.

## AMAZINGLY EASY TO ASSEMBLE

When your desk parts arrive you'll be pleasantly surprised. There are only 16 basic types of pieces — each one cut to exact size. Every piece is marked so that our directions are easy to follow. Holes are drilled to simplify correct and permanent assembly. We supply all necessary hardware and materials.

## NO SPECIAL TOOLS NEEDED

Your ASSEMBLY desk comes completely ready-to-assemble in just one enjoyable evening's time. You need no special workshop or tools... just follow our simple directions. Whether you buy it for your home... for your son to bring back to college... or decide to assemble and sell ASSEMBLY desks at handsome profits... you'll be glad that you took advantage of this outstanding offer. Simply send check or money order to ASSEMBLY Furniture Co., Dept. P-1, Somerville, Mass. Money refunded upon return of Kit if you are not satisfied on inspection.

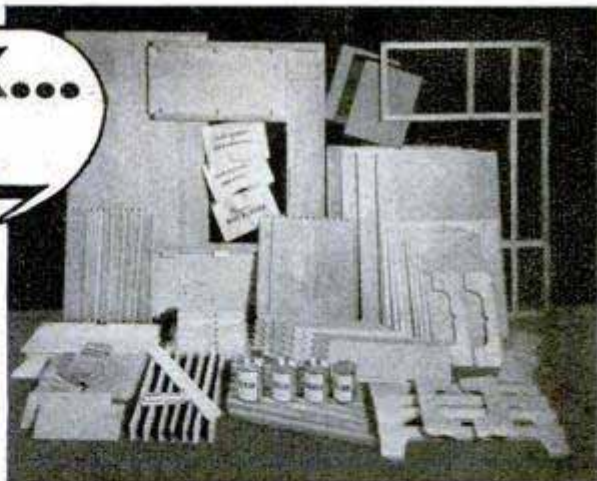

FREE. For further information, write today to ASSEMBLY Furniture Co., Dept. P-1, Somerville, Mass., for our FREE descriptive folder.

ASSEMBLY FURNITURE CO., Dept. P-1, Somerville 43, Mass.

I enclose \$44.45 check (or money order) for the ASSEMBLY desk.

Check stain  maple  mahogany  walnut

NAME .....

ADDRESS .....

**ASSEMBLY FURNITURE CO.** \$44.<sup>45</sup>  
DEPARTMENT P-1  
SOMERVILLE • MASS. F.O.B. BOSTON

## FOG LENS

Convert full power of your headlights to fog lights. Each amber colored plastic lens has 3 rubber suction cups. Attach over headlight glass. Use both up and down beam. Approved! Guaranteed! Directions! Supply limited. COD. plus charges.

**\$2<sup>95</sup>**  
PER PAIR  
POSTPAID

HART SALES SERVICE, 105 LATROBE, GRAFTON, W. VA.  
(Dealers Write for Wholesale Prices)



## FIX SEWING MACHINES

BIG MONEY. Spare or full time. Open your own neighborhood shop. Thousands need repairs. Send for complete Repair Manual—only \$1.98 postpaid. Money back guarantee.

SEWING MACHINE SERVICE CO., Hamilton 25-M, Ohio

## BUILD YOUR OWN POWER LAWN MOWER

## WHY BREAK YOUR BACK MOWING FIELD OR LAWN?

WRITE FOR  
FREE  
LITERATURE  
The Rite-Way  
Mower  
Attachment  
Ball Bearing



## SAVE MONEY SAVE TIME

Now anyone can save time and effort mowing field or lawn by building their own whirl type power mower. Build according to your own ideas and needs at small cost. Cut close to fences, walks, buildings, etc. Build in short time with parts and instructions we furnish. Save hours of time and back breaking labor. Write today for FREE information.

IT'S FUN TO BUILD

T & H MFG. CO., Dept. MP-14  
811 E. 31, Kan. City 3, Mo.



## Foredom PRESTO-FLEX

←YOUR MOTOR

**NOW! For Only \$5<sup>95</sup> You  
can have an Amazing New  
FLEXIBLE SHAFT TOOL**

with PENCIL-SIZE HANDPIECE

**Grinds, Polishes, Sharpens, Cleans, Mills, Carves,  
Engraves, Etches on Metal, Wood, Glass, and Plastic**

Now you can turn your old motor, drill press, or electric drill into a Flexible Shaft Tool. Amazing new Presto-flex, latest addition to the Foredom flexible shaft family. Simply attach to your electric drill, drill press or motor. Presto—a flexible shaft machine! Off again in a jiffy! Pencil size handpiece gives you finger-tip control. Gets into tight places you can't reach with any other tool. Handy 35" overall length. And—only \$5.95 complete! Order NOW.

—SEND NO MONEY—

Just send your name and address. We will rush your Presto-flex COD. Pay postman \$5.95 plus postage or send \$5.95 now and WE pay postage. Money back if not delighted! If you order Presto-flex for use on motor, specify motor shaft diameter and add 50c for motor coupling. (Available for 1/4", 5/16", 3/8" and 1/2" shafts.) 50 piece accessory set available \$1.50 extra. Order TODAY from

**FOREDOM ELECTRIC CO., Dept. 115**  
27 PARK PLACE NEW YORK 7, N. Y.

SAY YOU SAW IT IN POPULAR MECHANICS



# "At Home" Comfort



*on the trail*

**Ta-pat-co**

## SLEEPING BAGS

You'll *really rest* in a warm, comfortable, Ta-pat-co Sleeping Bag. There's a variety of styles—lined with your choice of Wool, Kapok, or Down. And they're all high in quality, high in comfort. Many extras like heavy-duty zippers, special foot space, make Ta-pat-co your best buy. See them at your favorite sporting goods or department store.

**The AMERICAN PAD & TEXTILE CO.**  
GREENFIELD, OHIO DEPT. 14  
CANADIAN BRANCH: CHATHAM, ONTARIO



Ta-pat-co Sports Shirts are handsome, long-wearing, comfortable. Made of finest materials in many patterns and colors. Be sure to look for the Ta-pat-co label!

Write for free full-color Folder.



The experiments are being conducted by companies in the system of the American Gas & Electricity Company with the cooperation of equipment companies.

No new major sources of power for generation show immediate promise of breaking into the coal, oil, gas and water team. The use of atomic power for the commercial production of electricity seems as far away as it did a year ago. The controlling factor commercially will be cost—or the relative price of heat from uranium or plutonium and from coal. Where transportation is a factor, the atom would have the advantage, since a plane could fly in atomic fuel equal to shiploads of coal.

The gas turbine may well be the next major development in the field, but it is not yet a serious rival to the steam turbine. Allis-Chalmers is studying plans for gas-turbine units which would have a full-load capacity of 20,000 kilowatts.

The "broadcasting" of wireless power like radio waves makes interesting dinner-table conversation, but is hooted down by electrical engineers. They compare it to feeding a baby by squirting milk from across the room with a hose. You may get some into the baby, but you'll waste a great deal of milk.

We squeaked through this last winter with a five-percent margin of capacity, according to the EEI, which states that the average reserve this year should be eight percent. More than 5,200,000 kilowatts of capacity should be delivered this year, which should widen the gap somewhat. But, come what may, it looks like another tough December ahead.

## Sawdust-Concrete Home

(Continued from page 109)

precasting machinery. He also cast small and large slabs using simple forms like those used in building adobe houses. Because the concrete is so light, he poured the floors and roof of his house in one slab.

To test the sawdust-concrete, Friberg cast slabs 32 by 48 inches square and 1 inch thick. Close to the edge of these slabs he drove 8-penny nails and drilled rows of holes with a power drill. There was no splitting. Then he sawed off strips an inch wide with a power saw. With a power sander he produced a smooth surface that could be painted. He tested the slab for insulating value and found it equal to a foot or more of concrete.

Friberg believes that a 3½ by 32 by 48-inch slab, which can be precast and cured during spare time, will be useful in farm

(Continued to page 284)

# ARC WELDING

**FOR PROFIT OR PLEASURE**

**EASY TO OPERATE - EASY TO ASSEMBLE**

**OWN THIS GENUINE INDUSTRIAL-TYPE HEAVY DUTY WELDER**

Ideal for all-purpose welding. **SAFE, RUGGED, COMPACT and EFFICIENT. WILL OPERATE FOR ONLY A FEW CENTS PER DAY.**

Plugs into 110 or 220 AC line. Can be used consistently on 30 amp. fuse. **ALL PARTS DESIGNED TO GIVE LIFETIME SERVICE.** Why pay expensive assembling and shipping costs? **ATOMIC WELDER PARTS** come in a compact box—**YOU SAVE THE DIFFERENCE! ORDER WITH CONFIDENCE!**

Try your **ATOMIC WELDER** for 30 days. If not satisfied, return as is. Your money will be refunded with no questions asked. **IMMEDIATE DELIVERY—WRITE FOR FULLY ILLUSTRATED BOOKLET P-16**

**60 LBS. READY MADE PARTS**  
Only **\$24.95**



**ATOMIC WELDER CO.**  
1038 So. 19th St., OMAHA, NEBR.

Sold on 30 Day Money-Back Guarantee.



*Real*  
**FIRE PROTECTION!**

**WAR SURPLUS BARGAIN  
NEW—UNUSED  
FIRE EXTINGUISHERS**

- Approved by Underwriters.
- 1 Gal. Capacity . . . Ready to use.
- Anyone can operate them.
- Carbon tetrachloride is non-conductor—will not freeze.
- Stored Pressure Type Shoots 40 foot stream.
- Height 23". Dia. 5".
- Complete with wall bracket.

**IDEAL FOR: Home, Office,  
Garage, Boats, Workshop, Summer Cabins, etc.**

Lists for approx. \$80.00

*Our Price*

**\$14<sup>95</sup>**

Send check with order.

F.O.B. Ill. Ordnance Depot, Marion, Ill.

**ACME EQUIPMENT CO. INC.**

126 S. Clinton Street

Chicago 6, Illinois

**NEW KITS  
only \$7<sup>00</sup> JET  
RACERS**



**MIDJET**



**MONO-JET**

**Get started in the new sport craze. Enjoy the fun of jet racing. Build these snappy racing models in one evening.**



**TERRA-JET**



**HOT SHOT**

apolls Type, \$1.00; Midjet, Midjet type, \$1.00; Terra-Jet, deluxe, \$1.25; Hot Shot, original Jet racer, 85c; Aqua-Jet (not illustrated) Jet Speedboat, 85c. **SPECIAL: All five kits \$4.50.** All prices include postage. Rush order to

**MONOGRAM MODELS** Dept. 14, 2329 S. Michigan Ave. Chicago 16, Ill.

**TYPEWRITERS!**

**ALL MAKES — REBUILT LIKE NEW**  
For Business School, Business or Home Use



Write for Information

**M & M TYPEWRITER CO.**

84 W. Washington St. Chicago, Ill.

**OTTAWA SELF-PROPELLED  
BUZZ MASTER**



**7 H-P  
MOTOR**

**New Improved OTTAWA Buzz Master.** Two speeds for brush cutting and road travel. Clears land of brush, saplings and large trees. Goes anywhere on its own power. Hills no obstacle. Most useful saw ever built—pulley for belt work. Reclaim waste land this easy way. Make big money doing custom work. Endorsed by Conservation experts. Post Hole Digger attachment available. Digs a post hole in 25 seconds. Send for **FREE** details today.  
**OTTAWA MFG. CO., 4-827 Walnut St., Ottawa, Kansas**



**It's Tune-up Time  
for Your Car!**

It's time to clean up winter's sludge and gum—step up your engine's performance—with Casite!

And it's high time you gave your engine Casite's extra protection too! Casite cuts engine wear because it improves lubrication—gets oil around quickly and into the tight spots. Casite guarantees Better Motor Performance or Double-Your-Money-Back, no matter what kind of motor oil is used.

Get a Casite tune-up today—from your garage, service station or car dealer. The Casite Corporation, Hastings, Michigan and the Casite Division, Hastings Ltd., Toronto.

75¢ a pint

95¢ in Canada

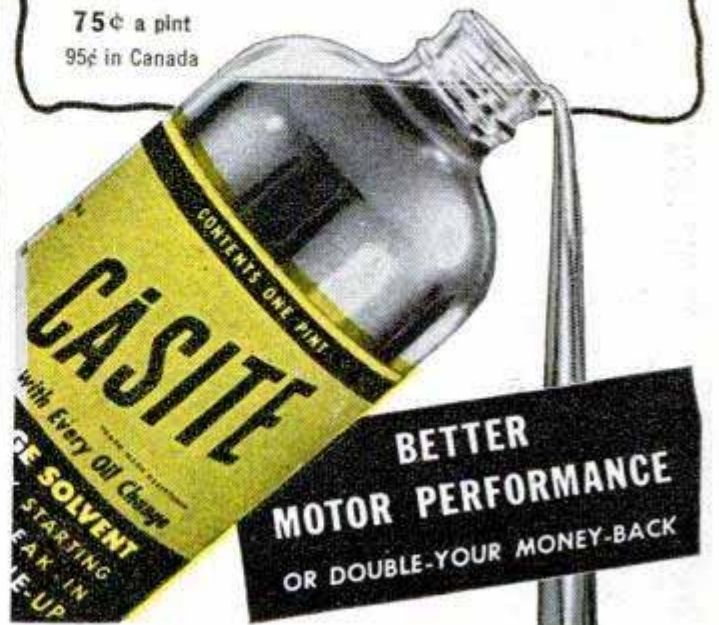

**BETTER  
MOTOR PERFORMANCE  
OR DOUBLE-YOUR MONEY-BACK**



**DRILL FOR RAWLPLUGS\* or other Masonry Anchors****NEW**

WITH YOUR  
1/4 IN. ELECTRIC DRILL  
AND THE

**DRIL-HAMER\***

Especially fitted to use RAWLDRILLS\* Nos. 6 to 14, and 5/16 in. to 5/8 in. Easily adapted to operate any tool where hammering is required: Sealing, Riveting, Czulking, Gouging, Chiseling, etc.  
\*Reg. U. S. Pat. Off.

(Agents' inquiries invited. Attractive set-up.)

From your Dealer or send check or money order to

**DRIL-HAMER Co.** Box 158 Planetarium Sta. New York 24, N. Y.

SIZE  
6 1/2" x 1 1/8"

**\$9.50**

P.P. in U.S.A.

No C.O.D.

SAVE LABOR

DO A BETTER JOB WITH A DRIL-HAMER

SAVE TIME

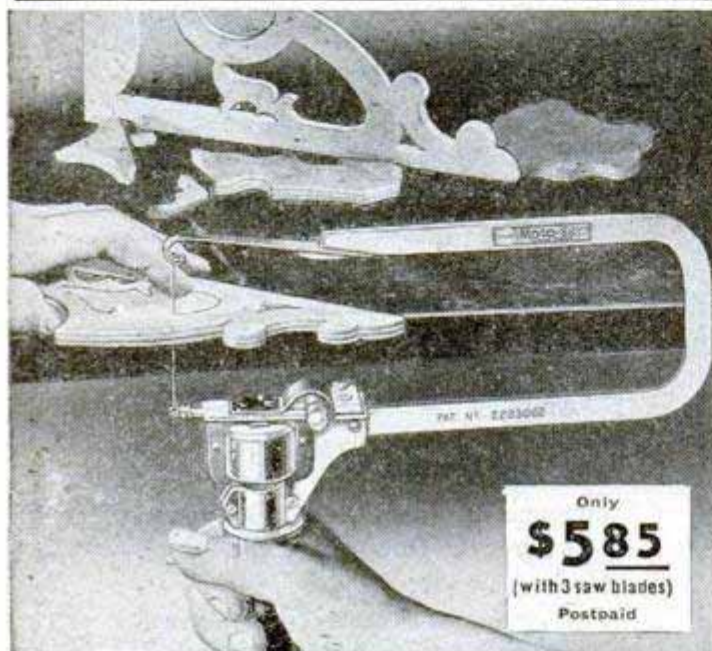

Only  
**\$5.85**  
(with 3 saw blades)  
Postpaid



## MOTO-SAW

THE AMAZING ELECTRIC  
SCROLL SAW

Boys from 8 to 80 (and girls, too) have fun with a Moto-Saw . . . it works more like magic than any tool you ever saw! It takes no effort to run, no perceptible pressure to feed. Runs 7,200 strokes a minute . . . easily cuts intricate scroll designs in medium hard wood up to 3/4" thick. Blade holder faces blade 4 ways . . . permits you to saw sideways as well as forward and backward. No limit to length of stock it will cut . . . saws to center of 19" widths. **Moto-Saw is as safe as a hand saw . . . has only two moving parts . . . never needs oiling. Uses 110-120 V. 50 or 60 cycle A.C. (only). Thousands of satisfied users.**

**MONEY-BACK GUARANTEE:** If your dealer does not yet have Moto-Saw, send only \$5.85 . . . we'll pay postage. Or send \$1. and pay postman balance plus postage. Money back if not delighted after 5 days' trial.

**DREMEL MFG. CO., DEPT. S-118-D, RACINE, WIS.****SPOTLIGHTS 6 Volt \$2.95****5 Lights in One**

Furnished with 4 emergency snap-on lenses. Red, Amber, Green, Blue. Equipped with standard 6 volt seal beam bulb. Pistol grip trigger switch with directional swivel base—built-in toggle and pistol trigger switch . . . . . **4.95**

Ideal for police—fire depts., State patrol, taxi cabs, ambulances, tow trucks, farm tractors, implements, boats, contractors machinery, hunters, fishermen, campers. Other uses.

Write for descriptive circular • No COD • Prices FOB, Kansas City

**MIDWEST BUY ANYTHING CO.**

1520 Locust St.

Kansas City, Mo.

Men's Fully Guaranteed **NEW \$13.95**  
**15-JEWEL WRIST WATCH** PLUS TAX

ORIGINALLY sold up to \$55  
Sacrificed because they're post-war surplus

**LOOK AT THESE FEATURES:**

Luminous dial . . . sweep second hand . . . waterproof . . . shockproof . . . anti-magnetic . . . imported Swiss precision movement and case. You get them now for a small fraction of original prices. Don't delay! Order now . . . while they last. Send only \$1 down payment with order. Pay balance to postman on arrival, plus postage. Or we pay postage if you enclose \$13.95 plus \$1.39 Fed. Tax.

Receive Reg. \$2 expansion band FREE with prepaid order. Money back in 5 days if not delighted. Order now.



**MARYLAND DISTRIBUTORS, Dept. 54**  
501 E. Baltimore St. Baltimore 2, Md.

## CARBURETOR TOO RICH

MAKES MOTORIST TOO POOR



Car owners who are wasting money and not getting proper gas mileage due to over-rich mixtures will be pleased to learn how to save gasoline by VACU-MATING over-rich mixtures. VACU-MATIC fits all cars, trucks and tractors. It is automatic and operates on the supercharge principle. Easily installed in a few minutes.

**SALESMEN WANTED!** Big Profits!

Send name, address on penny postcard for free particulars and how to get yours for introducing.

VACU-MATIC CO., 7617-1314 W. State St., WAUWATOSA, WIS.

**BASS**  
IS BEST  
WEEJUNS  
LEISURE  
COMFORT



**BASS**  
IS BEST  
QUAIL  
HUNTERS  
FIELD and STREAM



**BASS**  
IS BEST  
SKI BOOTS  
EXTRA  
CONTROL



**BASS IS BEST**  
SPORTCASINS  
GOOD GOLF STRATEGY



**G. H. BASS & CO.**  
60 MAIN STREET  
WILTON, MAINE



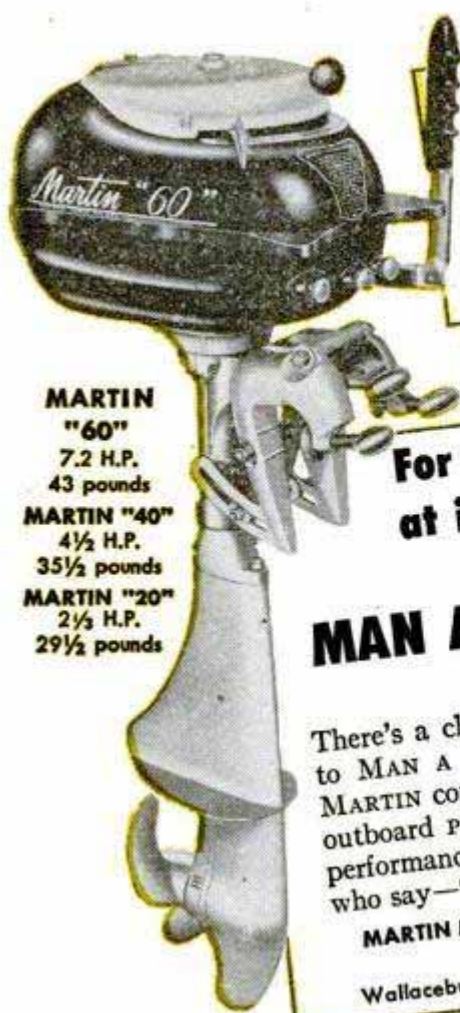

**MARTIN**  
**"60"**  
 7.2 H.P.  
 43 pounds  
**MARTIN "40"**  
 4½ H.P.  
 35½ pounds  
**MARTIN "20"**  
 2½ H.P.  
 29½ pounds

**MAN A MARTIN** for thrilling top speed performance. MARTIN's exclusive patented, mechanically-controlled poppet valves set a new standard of performance in outboard motors.

**MAN A MARTIN** for smooth, unbelievably slow trolling speeds. MARTIN's sputter-free operation at slow speeds adds to fishing pleasure.

**MAN A MARTIN** for more family pleasure on the water. MARTIN has the features for all around easy handling by any member of the family.

**For outboard motoring at its best . . .**

# MAN A Martin

There's a choice of three great outboard motors, when you decide to MAN A MARTIN, and enjoy outboard motoring at its best. A MARTIN combines all the finest features you would expect in a great outboard PLUS exclusive features which have enabled it to set new performance records. Take a tip from America's keenest sportsmen, who say—"for tops in outboarding . . . Man a Martin!"

**MARTIN MOTORS, Eau Claire, Wis.,** Division National Pressure Cooker Company  
 Canadian Sales by: **MARTIN MOTORS,**  
 Wallaceburg, Ontario, Division National Pressure Cooker Company (Canada) Ltd.

**The NEW Standard of Performance!**

**Do You Ride a Bike? Here's the Real**



## SHOCKMASTER for all Bicycles

- LEVELS ROUGH ROADS
- PREVENTS BROKEN SPOKES, WHEELS, FORKS
- MAKES RIDING SMOOTHER, SAFER
- EASY TO INSTALL

A Shockmaster and front wheel shock absorber. Ruggedly constructed of nickel plated steel and engineered for years of real service. It'll pay for itself in added pleasure, saves tires and eliminates many costly repair bills. 20,000 satisfied users. Order yours today. Only \$3.69 postpaid. No C.O.D.'s. Complete satisfaction or money back. Dealers Wanted.

**H. M. GIBB and COMPANY**  
 1304 PENOBSCOT BLDG. DEPT. A DETROIT 26, MICH.

## PLATE WITHOUT ELECTRICITY! . . . on any surface!

New discovery plates hard, non-corroding nickel alloy on any wood, leather, or metal surface (except chrome, zinc, or white metal). Wears like chrome. Thousands of home uses: door knobs, golf clubs, baby shoes, hobby parts, etc. No electricity, anodes, or fixtures—just add water. Kit contains everything needed for 5 full hours of plating. **MONEY-BACK GUARANTEE:** Use 10 days according to directions; if not completely satisfied, return for full refund.

**MAIL THIS HANDY ORDER FORM**

Metal Processing Co., Inc., P. O. Box 2814, Paterson, N. J.  
 Ship one standard LUSTRALOY PLATING KIT, prepaid. Check for \$12.50 enclosed.

Name \_\_\_\_\_  
 Address \_\_\_\_\_ (448)

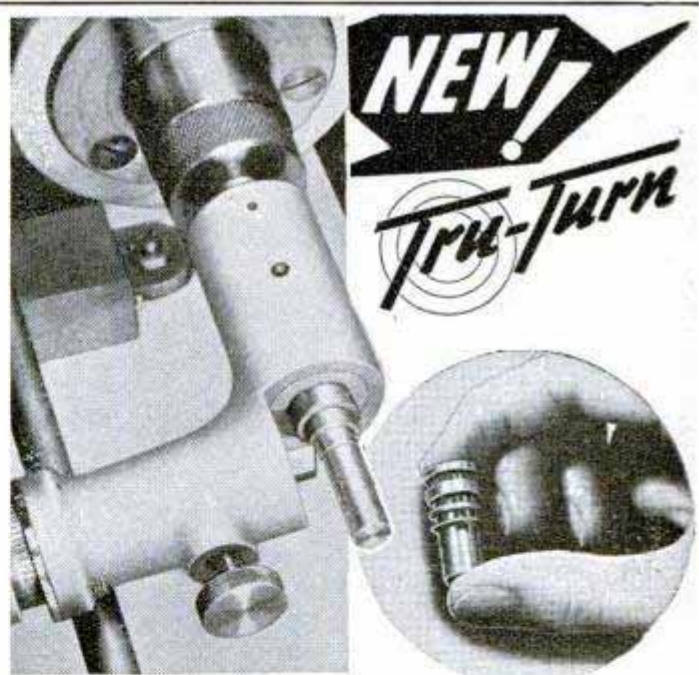

**NEW!**  
**TRU-TURN**

It is now possible for home craftsmen . . . and garage-men, gunsmiths, and repairmen . . . to turn and cutoff metal without buying an expensive lathe. This new tool converts woodturning lathes, drill presses and grinder stands into precision metal lathes. TRU-TURN has a built-in micrometer . . . turns and cuts-off steel, brass, aluminum.

**TRU-TURN TOOL** — Two guide bushings; and bits for steel, brass and aluminum . . . only \$11.75

**FACE-PLATE WORK-DRIVING CHUCK**—For converting woodworking lathes. Chuck plus three adapter bushings . . . only \$4.50

Add 25c to each item for C.O.D. orders. Send money order or checks for prepaid shipment within U.S.A. Illustrated folder free.

**MILLHOLLAND SCREW PRODUCTS CORPORATION**  
 134 West 13th Street, Indianapolis 2, Indiana



# EASIER SANDING 10 Times Faster!



## HOME Craftsmen!

Why wear your skin down to the bone with hand-sanding drudgery? This sturdy, light Belt Sander turns out smooth, expert sanding in minutes—instead of hours.

On wood, metal, stone or plastics . . . on flat, straight or curved surfaces, this time-tested Porter-Cable Sander gives you a beautiful, professional finish. Does refinishing, clean-up work. Smooths glued joints. Hollows out. Removes paint and varnish. Gives final finish.

Powerful motor speeds 2" x 21" abrasive belt at 600 surface feet per minute. Over-all size 4" x 12" x 6". Weighs only 12 lbs. Operates in any position.

Model A-3 — 3/4 hp — \$99.50

Model A-2  
**\$57.00**

## For Heavier Sanding in Less Time

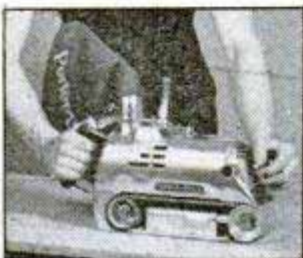

### BB-10 Sander

Size and speed suits it to production sanding and planing. Easy to handle in continuous work. Perfect balance . . . Instant belt change . . . Dust-free operation. Excellent for wood shop, maintenance jobs, and many industrial uses. Extra powerful 1

HP motor. Abrasive belt is 3" x 27". Speed: 1475 s.f.p.m. Overall size 5" x 18" x 9 1/4" . . . Weighs only 36 lbs.

**COSTS ONLY \$148.00**

Pays for itself in a few weeks.

## New Abrasive-Belt BENCH GRINDER

Unit can be attached to bench motor. In any shop—on production lines—or in the home—this abrasive belt-type Handy Grinder increases production 200% over ordinary wheel grinder. Deburrs, chamfers, bevels, knocks off corners, etc. Eliminates wheel loading, wheel dressing, wheel digging. Grinds on contact wheel, formed contour wheel, platen or free belt. Easily adjusted to any position within 90° arc.

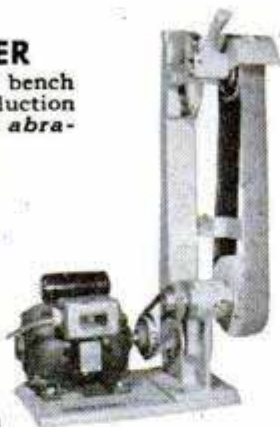

**COSTS ONLY \$39.50**

## See These Time-Saving Tools

At leading hardware stores, mill and building supply houses. Meanwhile, write us for further information on the many uses of these tools, carrying lifetime guarantee. We'll also send you the name of your nearest dealer.

**PORTER-CABLE Machine Co.**  
2050-4 N. Salina St. Syracuse 8, N. Y.

buildings. This size will span two studs or floor joists or can be sawed to fit between studs. Northwest farmers already are showing interest in its use for dairy barns and poultry houses where the need is great for a low-cost material that has high insulating value.

Someday a method of waterproofing the concrete may be found. Until then Friberg recommends that it be used indoors only. It has another limitation also. With a load strength only one quarter to one third that of ordinary concrete, it can't be used in sidewalks or driveways or for floors and walls that carry heavy loads.

But even if these limitations are never completely overcome, Friberg sees a tremendous field for the tiny diatom and the sawdust and shavings piles. His living-room floor, for example, is a solid block of the low-cost material. Carpet and linoleum are fastened directly to it. The roof also is a solid block, covered with roofing paper and pulverized pumice stone. In the walls of his house the main load is carried by a layer of regular concrete bricks. Double-thickness sawdust-concrete bricks provide the insulation.

Since diatomaceous earth deposits were investigated during the war, state departments of geology and schools of mines have information on their locations. So, if the prospective builder can locate a convenient pile of pine, larch or fir sawdust and shavings and it isn't too far from a deposit of diatomaceous earth, Friberg has found a way for him to bring them together to produce a new type of low-cost building material.

## Iceberg Hunt

(Continued from page 118)

**June 11**—The Mendota put into the Argentinia Naval Operating Base to refuel and replenish provisions. The ever-welcome mailbags came aboard. Officers and crew got a few hours shore leave to get the kinks out of sea legs.

The Mendota was ordered to take bathythermograph observations in the Labrador current and to cruise along the west coast of Greenland and into Davis Strait and Baffin Bay. It is here that icebergs are born. Several thousand shear off each year from the 100 or more glaciers along Greenland's west coast. They spend the first winter near Melville Bay, the second in the vicinity of Cape Dyer and drift into shipping lanes the next spring and summer.

Data on currents, icebergs, pack ice and weather conditions would be useful next

(Continued to page 288)



# Don't Risk Engine Overheating

Keep cooling systems ALWAYS up to par with regular **Warner** care



**Warner Liquid Solder (Non-Metallic)**  
• Deposits tiny fibers to repair leaks anywhere in the cooling system.

**Warner Radiator Cleaner**  
• Thoroughly cleans cooling system of rust, oil muck and grease.

**Warner Cooling System Protector**  
• Prevents rust, scale and corrosion.

No delays—just pour in and keep on driving. Do it yourself, or ask your service man.



Warner-Patterson Co., 920 S. Michigan Ave., Chicago 5



## 16 PLANS for easy-to-build CALIFORNIA STYLE BARBECUE FURNITURE

**Make Your Yard A Living Room!**  
Almost anyone can use these simplified plans. Save money by building professional looking, smartly designed Barbecue Furniture. Or start a spare-time business for extra profits. Send check or money order now. Price only \$2.00!

**GUARD & GUARD**

1274 NAGLEE AVE. • SAN JOSE, CALIF.

## TRAILER BUILDERS!

**BUILD or BUY... SPECIFY**

• Torq-Less Axles • Bull Dog Hitches and Parking Jacks, Safety-Engineered by **HAMMER BLOW TOOL COMPANY** Dept. 121 Wausau, Wisconsin

Send for FREE Catalog

## POWER Your Lawnmower

Convert Your Mower to a Power Mower. Use old auto generator and car battery or gas engine. Plan also shows how to make an electric rotary-blade mower from easy-to-get materials. Complete plans and catalog, 35c.

**LEJAY MFG. CO.**  
847 LeJay Bldg., Minneapolis 8, Minn.

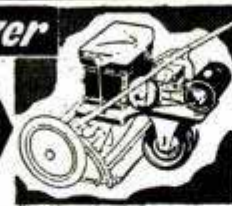

## USEFUL SURPLUS BARGAINS FISH LURE and LIGHT



Uses one ordinary flashlight battery. A floating fish lure that brings 'em in. Also can be used as a regular flashlight. Brand new..... **\$1.29**

**A to Z Steel Letter**

**PUNCH SETS**  
1/4" — \$6.50  
3/8" — \$7.95  
1/16" — \$1.95



## New Precision Bit MICROMETERS

Chrome finished, nationally known makes. Give a lifetime of accurate detailed service. Individually boxed.

1" Central ..... \$3.50    4" Central ..... \$6.25  
1" Lufkin ..... \$4.25    2" Reed ..... \$5.25  
6" Stocumb ..... \$7.50

Prices FOB, Kansas City. Send 25c for handling and mailing.

**ATLAS SALVAGE & EQUIPMENT CO.**  
229 SW. BLVD. KANSAS CITY, MO.



## FOR FAST, ACCURATE WORKMANSHIP

GREENLEE 22 is a name it will pay you well to remember whenever you buy Auger Bits. For it assures you sharp cutting edges, accurate sizing, bright, high finish, and that smooth, easy action so necessary in fine craftsmanship. You can be certain, too, that every GREENLEE 22 Solid-Center Auger Bit is "factory sharp" when it reaches you. For each is "Plastic-Sealed" with a special protective coating to keep it in perfect condition for you. To buy top quality, buy GREENLEE.



TOOLS FOR CRAFTSMEN

## GREENLEE



## SPECIAL OFFER... ONLY 10¢ FOR HANDY WOODWORKING CALCULATOR

Quick solutions to countless woodworking problems. Just set dial: convert linear feet to board feet; compare characteristics and workability of various woods. Also shows bit



sizes; nail specifications; tool sharpening hints; etc. Heavily varnished cardboard, 6" diameter. Send 10c to Greenlee Tool Co., 2104 Columbia Avenue, Rockford, Illinois, U. S. A.



# WAR SURPLUS AND OTHER BARGAINS

## POWER DRIVEN ANTENNA REEL

1/2 HP, G. E. Motor—12-24 V. Removable 6" Reel. Cam worm gears, bevel gear. Solenoid clutch. 1/2 gear only when current on. Operates clockwise or counter clockwise. Ideal for power fish line, opening or closing doors, auxiliary power take-off. Can be used as buffing machine or for dozen of other uses. New. Weight 6 Lbs. \$4.50 each.

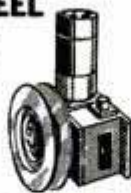

## MICROMETER

Chrome plated, precision engineered and carefully tooled to give long life

All new. 0.1" capacity, \$2.25. 1-2" capacity, \$3.50 Each.

SEND CHECK, MONEY ORDER or CASH



## SHIP'S BELL:

U. S. Navy Surplus. Solid Brass with smooth polished finish. 5" Diameter. Great for Patios, Doorways, in Dens, Ranches, etc. Matching solid brass wall bracket included. Weight 3 1/4 Lbs. All New. \$5.95 Each.



## GEAR PUMP

For circulating liquids... oil or water. Will operate on 1/10 H.P. Pumps 3 gals. per minute at 1700 R.P.M. Hardened steel gears, bronze bushings, aluminum housing. 2" diameter, 3 1/4" long. Wgt. 2 lbs. New... \$3.50 each.

## 4 in 1 SCREWDRIVER: 3 smaller screwdrivers

fit compactly into hollow barrel of largest screwdriver. Sizes... 6", 3", 1 1/2", and 1" overall. Fine steel bits. Solid brass knurled handles for non-slip grip. Large enough for standard screws, small enough for watches. Will handle all sewing machine screws. A handy all-purpose tool for kitchen, garage, or workshop. All New... \$1.00 per set.



25% DEPOSIT REQUIRED ON C.O.D. ORDERS

## SCOOP!

We have been awarded 100,000 genuine briar pipes by Quartermaster Corps. Assorted shapes and sizes. All popular makes. Set of 6, \$3.50



## FISHING AND HUNTING KNIFE

Hollow ground 6" blade of bright finish, high quality, tempered steel. Non-slip cowhide handle, with hand finished metal guard and butt. Stitched and riveted genuine leather sheath. It's a knife you'll be proud of! All New... \$1.50 Each.



CLIPS: Rubber lined, aluminum, hundreds of uses in any shop. Assorted sizes, all new. 5 Doz. \$1. — 500 \$5.

ALL PRICES F.O.B. CULVER CITY, CALIF.



## BLOWER COOLER or HEATER:

For trailers, autos, offices, darkrooms, homes. DUMORE Motor, 1/6 cont. HP, Amperage 7.5, RPM 6400, 24 Volts. May also be used as dryer. Simple installation, radiator type, copper coils. Transformer advertised in this ad will operate this unit from house current. Weight 13 Lbs. New, \$15.00

## EMERSON 3 HP MOTOR:

AAF Type D50. This motor can also be used as generator when driven by another motor. Ideal for portable welder, etc. 28 Volts, D.C. Compound, 3800 RPM, 115 AMP, windings glass insulated, blower cooled,

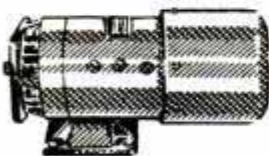

shaft dimension 5/8". Weight 27 Lbs. New. \$13.95 each

AIRBORNE SALES CO., INC. DEPT. PM 4-8 CULVER CITY, CALIF.

## STOPS LEAKS PERMANENTLY

Cut your fixture replacement, water and fuel bills with Economy Renewable Seats. Make economical, permanent repairs quickly and easily with the Junior Kit (illus.). Repair bathroom, kitchen and laundry fixtures. Everything you need included in steel box. This is a natural for the "Fixit" shops—get extra income from making permanent repairs on your customers' faucets.

Senior Master Kit also available—repairs faucets and valves up to 1" pipe. At Better Jobbers and Hardware Stores

See our ad under BUSINESS OPPORTUNITIES

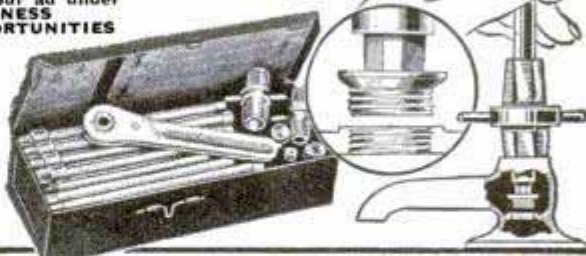

## ECONOMY VALVE SEAT CO.

3122 N. California Ave. Chicago 18, Ill.

## 27 VOLT AC/DC SERIES MOTORS



BRAND NEW \$2.95 each BOTH FOR \$4.95



FUEL PUMP MOTOR 1/10 HP 2000 RPM Free Illustrated List Satisfaction Guaranteed or Your Money Back. DICK ROSE—ERECO, 2912 Hewitt Ave., Everett 21, Wash. Windshield Wiper Motor 1/6 HP 5000-10,000 RPM

## WOODWORKERS... Get this!

CONSTANTINE MASTER MANUAL Get the Most Fun From Your Hobby Indispensable to woodworkers. Newest, biggest edition, more pages, more color, helpful how-to-do-it articles, pre-war and new items, more bargains. Send 25c today and we will include FREE! FULL YRS. SUBSCRIPTION to Chips and Chats, published bi-monthly. Keeps you up-to-date on everything in woodworking, offers big money-saving bargains. Send now.

ALBERT CONSTANTINE & SON, Inc. 791-S, 135th Street, New York 54, N. Y.



## BUILD AN ARC WELDER FROM OLD GENERATOR

For Light or Heavy Work. 75-200 amps. No previous experience needed. Complete PLANS and valuable Catalog 35c. LEJAY MANUFACTURING CO. 1347 LeJay Bldg., Minneapolis 8, Minn.



SAY YOU SAW IT IN POPULAR MECHANICS

## BEFORE YOU BUY

## ANY TRACTOR-



SEE THE POWERFUL 5-HP GRAVELY—the world's finest, yet most moderately priced Garden Tractor... Complete line of exclusively designed power tools for every Garden, Lawn and Field Job.

WRITE FOR FREE CATALOG

## GRAVELY TRACTOR-MOWER

FIELD - TESTED FOR 25 YEARS

GRAVELY MOTOR PLOW & CULTIVATOR CO. Box 463 Dunbar, W. Va.



- ★ WRIST WATCH
- ★ STOP WATCH
- ★ TELEMETER
- ★ TACHOMETER

**Phenomenal Value!**  
**17 JEWEL • 2 PUSH BUTTON**  
**CHRONOGRAPH**

ONLY \$ **29.75** PLUS 10% TAX



**INCABLOC SHOCK RESISTANT FEATURE**  
 • Sweep Second Hand  
 • Radium Dial • Anti-Magnetic • Unbreakable Crystal. (formerly \$71.50)  
**IDEAL FOR**  
 • Physicians • Engineers  
 • Radio Men • Sportsmen  
 • Photographers • Aviators

**OUR GUARANTEE**  
**MONEY BACK** IN 10 DAYS

If not satisfied for any reason

**ADLEW JEWELERS**

117 W. 42nd St., N. Y. C. 18

Mail Orders Promptly Filled • Shipped C.O.D. or send check or money order.

Address mail-orders to:  
 ADLEW JEWELERS (Dept. PM-3),  
 152 West 42nd St., N.Y.C. 18

Also available in 18-k Gold Case. \$64.50 (plus 10% tax), formerly \$125.

**NOW YOU TOO CAN BUILD 15 RADIOS**

Absolutely No Knowledge of Radio Necessary

You Need NO Additional Parts

The **PROGRESSIVE RADIO KIT**

is THE ONLY COMPLETE KIT. Contains everything you need. Instruction Book, Metal Chassis, Tubes, Condensers, Resistors and all Radio parts. The 36-Page Book written by Expert Radio Instructor teaches you to build radios in a Professional Manner. You start with a 1-tube receiver. Before you are done with this kit, you will have built 11 Receivers, 1 Public Address System and 3 Transmitters.

**SPECIAL FREE OFFER!**

Electrical and Radio Tester sent absolutely FREE with each Progressive Radio Kit. PLUS FREE membership in Progressive Radio Club. Entitles you to free expert advice and consultation service with licensed radio technicians.

Write for further information, or ORDER your KIT \$14.75

NOW! ONLY Postage prepaid with check or money order

(Postage not prepaid with C.O.D. orders)

**PROGRESSIVE ELECTRONICS CO., Dept. PM-9**

22 Havemeyer Street

Brooklyn 11, N. Y.



**BUILD YOUR POWER TOOLS**

WITH OUR GUARANTEED INDUSTRIAL POLY BALL BEARING ARBORS

New Departure Self Lubricating Bearings

10,000 R.P.M.



(No extra charge for left hand threads)  
 C4—1/2x12 1/2 spindle, housing 2x8 \$7.95 PP.  
 C5—5/8x12 1/2 spindle, housing 2x8, 58.25 PP.  
 C6—3/4x12 1/2 spindle, housing 2 1/4x8, 59.25 PP.  
 D8—1x17 1/2 spindle, housing 2 3/4x11 \$17.00 PP.  
 1 INCH BETWEEN WASHER AND COLLAR  
 SHAPER ARBORS 3 inches between collars. C4-1 1/2 \$14.25, C5-5/8 \$14.25, C6-3/4 \$15.25, D8-1 \$23.00, B25—1 1/2x2" cap. flange mount \$5.50.  
 SPECIAL SAW ARBOR LENGTHS for 1/2, 5/8, 3/4, add \$1.50.  
 PILLOW BLOCKS—Ball Bearing, 1/2 \$3.50, 5/8 \$3.50, 3/4 \$4.25.

**POLY PRODUCTS, 2032-A E. Walnut, Pasadena 8, Calif.**

SAY YOU SAW IT IN POPULAR MECHANICS



\$1.98

For Laughs **DAFFY DILLY**  
 For Fun The Wonder Drinking Clown

The Greatest Acrobat of All Time

Complete with stand. No springs, no gadgets, no wires, not mechanical. Sensational "Daffy Dilly" somersaults through the air into a glass of water. It's "eye-stounding." Young and old go wild over him. A wonderful gift. Send no money. Start laughing at the antics of Daffy Dilly today. Pay postman \$1.98 plus postage and C.O.D. charges when delivered or send \$2.00 and we pay postage. Special Price to Dealers

**BERNARD FINE CO. INC.**  
 501 6th Ave., Dept. PM11, New York 11, N. Y.



every mile's **More Fun**

with an

**Evinrude "4"**

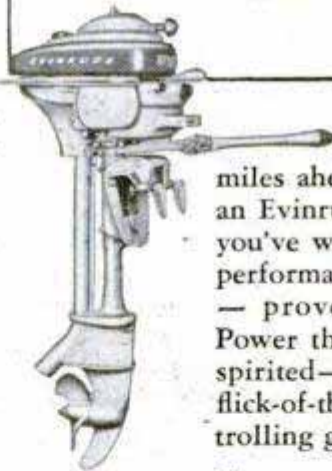

New thrills for all the miles ahead — they're yours with an Evinrude "Four". Everything you've wanted in deluxe outboard performance is here — perfected — proved — and eager to go! Power that's superbly smooth and spirited — famed starting ease — and flick-of-the-throttle flexibility from trolling glide to surging top speed!

There are three great "Fours" to choose from in Evinrude's complete line of 6 models. See your Evinrude Dealer — look for his name in the yellow pages of your phone book.

**Send For FREE Catalog**

Write today for full-color catalog of the complete Evinrude line. Address, EVINRUDE MOTORS, 5740 N. 27th St., Milwaukee 9, Wisconsin.



In Canada: Evinrude Motors, Peterboro, Ontario

**EVINRUDE**

FIRST IN OUTBOARDS • 39th YEAR





**...FIT  
BETTER  
LAST  
LONGER**

**YOUR  
HARDWARE  
STORE**

displays many styles and sizes - Get the sizes you need - have them ready for use.

**ALWAYS  
RIGHT FOR THE JOB!**

Billings have everything you look for in quality wrenches — balance, strength, lightness and feel. Easy on you . . . Tough on the job . . . Write for our new catalog of Wrenches and Wrench Sets. Ask for FF-48-2

**BILLINGS  
WRENCHES**



Buy them at Your Hardware Store  
THE BILLINGS & SPENCER CO. HARTFORD 1, CONN.

**WHY**

**Thousands Acclaim  
Western Electric's  
New Hearing Aids**



Model 65



Super 66

● Magnificent performance, economy, dependability, and compactness are responsible for the popularity of Western Electric's new all-in-one hearing aids. They're designed by the world-famous Bell Telephone Laboratories.

Investigate these wonderful new instruments *yourself*. Find out why they bring new hearing satisfaction to *anyone* who can be helped by a hearing aid. Your Western Electric Hearing Aids dealer will be glad to give you a demonstration. (Address in your Classified Telephone Directory.) Or send coupon now for free illustrated booklets.

**FREE! MAIL THIS COUPON TODAY**

**WESTERN ELECTRIC Dept. 380-PM4  
195 Broadway, New York 7, N. Y.**

Send me the illustrated booklet about two new *all-in-one* Western Electric Hearing Aids. Include my free copy of "Modern Science and Your Hearing."

Name \_\_\_\_\_

Address \_\_\_\_\_

City \_\_\_\_\_ Zone \_\_\_\_\_ State \_\_\_\_\_

year in predicting the number of icebergs likely to venture across shipping lanes.

Nine hours after putting in Argentina, the Mendota was on her way again.

**June 13**—About 175 miles northeast of Newfoundland a berg was spotted approximately in the center of the Labrador current. A cold and rough night was spent drifting with the ice mass to chart its course. The crew tried (unsuccessfully) to plant a wood-and-tinfoil target on the berg so that radar tracking would be easier.

**June 15**—The Mendota's bathythermograph winch was in use day and night, three times an hour. The deep-sea thermometer, which resembles a baby torpedo, was lowered every five miles approximately 900 feet and hauled back with the cold, scientific facts to be recorded.

This bathythermograph "cross section," taken directly across the axis of the cold Labrador current, when analyzed by oceanographers will have peculiar importance in revealing the mood and intent of the Labrador stream.

**June 17**—In the Strait of Belle Isle, the Mendota's radar picked out a few small bergs grounded near shore.

**June 18**—With the bathythermograph work nearly completed and the weather fair again, the skipper allowed all hands to try their luck at fishing. In this latitude full daylight lasts from 3:30 a.m. to 11 p.m.

**June 25**—The Mendota cruised south again and searched in a dense fog for a berg reported drifting 200 miles southeast of Newfoundland.

**July 5**—The only thing of interest sighted during the past several days of blanket-ing fog has been numerous dead sea gulls and thousands of feathers on the sea.

**July 6**—The Mendota has discovered the long-lost berg after receiving a report of its position from the SS William Wheelwright. The stray mass had drifted around the Grand Banks and considerably farther west than computations had allowed for. Since its discovery, the Mendota has drifted with the berg, warned ships, and watched it calve and melt down to a fair-sized growler.

Dynamite, other explosives and gunfire have been used to break up icebergs, but this technique has not been successful. Bergs are too large and their bulk too well concealed below the surface.

**July 7**—The Mendota arrived in Argentina after being relieved of its duties by the Coast Guard cutter Spencer. Thousands of cargo and passenger ships had crossed North Atlantic shipping lanes in safety—thanks to the ships and men of the Coast Guard on International Ice Patrol.



# BUILD YOUR OWN TILTING TABLE SAW!



WITH **SAVE \$50 OR MORE**  
**GIL-BILT**  
**PLANS - PARTS**

- 21x27 in. table tilts full 45 degrees; 13 in. capacity in front of blade.
- 8 in. blade mounted to cut from 0 to full 2 1/2 inches.
- Self-aligning and calibrated rip fence and miter gauge.
- No machining, no welding, no blueprint reading.
- Sturdy wood, steel, and aluminum construction.
- Build easily with common hand tools.

**GIL-BILT Step-by-Step Plans**—Simplified perspective drawings, full size patterns; illustrated with 15 actual photographs. Post-**\$1.00** paid anywhere in the world.

**GIL-BILT 5/8 in. Arbor**—Machined spindle, two lubricated for life ball bearings, one piece cast aluminum housing, complete ready **\$6.95** to run. Uses blades with 1/2" hole.

**GIL-BILT Special Metal Parts Kit**—Includes Step-by-Step Plans, 5/8 in. ball bearing arbor, aluminum channel and bar, cast aluminum hand-wheels, steel hinges, V-pulley and all other metal parts **\$14.95** (less blade).

Same Kit with high quality 8 in. combination blade.....**\$18.95**  
(Prices include postage up to 600 miles)

**GILLIOM POWER TOOLS** P. O. Box 1-Z, Lambert Field  
St. Louis 21, Missouri

## WAR SURPLUS

### NAVY KNIFE

BRAND NEW. Navy surplus. 5 1/4 inch tempered steel "Parkerized" blade. Laminated leather handle. Complete with sheath ..... **98¢**



### SUN GLASSES

AIR CORPS TYPE. Brand new. 24 karat gold plated frames. 4 base optically ground lens. Pearlloid brow rest. **1.99**

### NATIONAL JOBBING CO.

1703 No. 24 Dept. P Omaha, Nebr.

Just clip ad, check items desired. Send check, money order, or cash—postage prepaid. C.O.D.'s—postage collect.

ORDER BY MAIL

## PLYWOOD BOAT KITS

**\$49.00**

(Including Freight)



This **READY-CUT 12**

ft. fishing boat can be assembled in 8 hrs. without forms or special tools. Kits are complete including all hardware, paint, and etc. Send for free folder.

### TAFT MARINE WOODCRAFT

Dept. E, 636 39th Ave. N.E. Minneapolis 18, Minn.

Write today for booklet on the new **FLEX-O-SHAFT** Tool Kit, illustrating this improved all-purpose power machine with the hand-piece that works as easily as a pencil. Motor with switch, foot-operated rheostat, and 66 accessories, all at a special low price. **FLEX-O-SHAFT SALES CO.**, Dept. C, Prairieview, Illinois.

## MAKE FUNNY MONEY!

**100% MORE PROFIT**

### COMIC Greeting Cards

—Like You Have Never Seen Before! Rip-Roaring, happy, laugh wallops for All-Occasions. Nothing like them ever published! Hilarious Boxed Assorts. Sell on Sight! Write **FREE** samples, details.

**NOVO PRODUCTS** Dept. K-1  
1757 N. Pk., Chicago, Ill.



TIME TO

# CHANGE OVER!

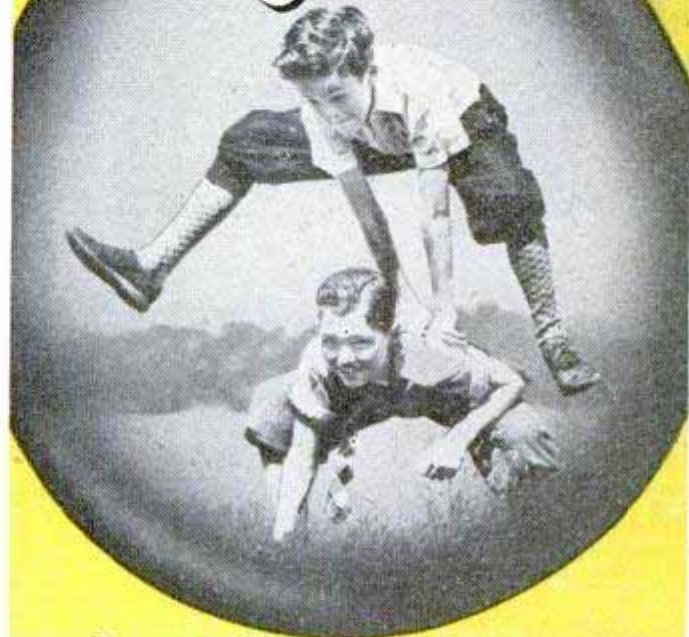

For Summer Safety,

**DOUBLE ACTION**

# PENNZOIL MOTOR OIL

**FLOWS FAST-STAYS TOUGH!**

Safe warm-weather driving calls for *instant, lasting* lubrication... Get them both with double-action Pennzoil. Change for summer now!



Copyright, 1948, The Pennzoil Co.

At this sign of better dealers, coast to coast

\*Registered Trade Mark

Member Penn. Grade Crude Oil Ass'n., Permit No. 2

Tough-film **PENNZOIL\*** gives all engines an extra margin of safety





## "CHICAGO" ROLLER SKATES

Forty years of leadership reflect the outstanding quality and performance of these beautiful "CHICAGO" Shoe Skates. Stars and Champions are made on "CHICAGOS." Be popular—get on the road to Stardom. Own a pair of the World's Finest Skates.

Consult your Rink Manager before you buy. Get the best and a perfect fit.

## Choice of Champions

### CHICAGO SCOUT FLYING Roller Skates

Boys and Girls all want "CHICAGO" Sidewalk Skates. The World's Greatest Roller Skates for youngsters or grown-ups. The Triple Tread, Ball Bearing Steel Wheels give more action—Speed and Longer Life. Demand "CHICAGOS" from your Dealer.



Send for FREE Booklet "How to Roller Skate." Enclose 10c for Skate Club pin. Value 25c.



## CHICAGO ROLLER SKATE CO.

Leading Manufacturer of Rink Skates for Over 40 Years  
4414 WEST LAKE STREET • CHICAGO 24, ILLINOIS

## BUILD YOUR OWN

2500 WATT ELECTRIC

## LIGHT PLANT

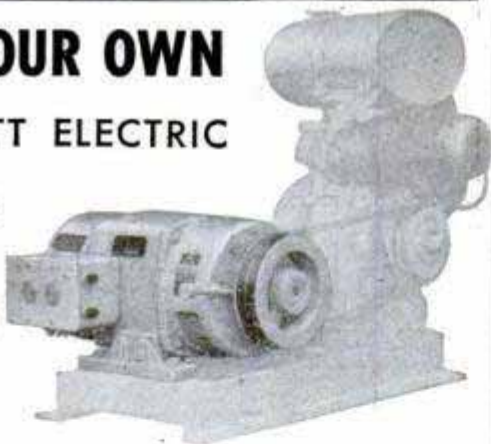

All you need is a standard electric generator, a small 6 H.P. gasoline engine, an angle iron base, 2 sheaves, and 2 v-belts. You can assemble the unit in your spare time far cheaper than any factory with high overhead expense.

Start out by buying the electric generator shown here. Costs \$125.00 (without sheave or belts), freight prepaid to your city. It is a Leland Alternator, 2.5 KVA, 120 volt, single phase, 60 cycle, alternating current. It must turn at 1800 r.p.m. Voltage is self regulating.

Produces enough current to burn 50 fifty watt bulbs, or 100 twenty-five watt bulbs. Just the size to start and operate a 3/4 H.P. electric motor. Current characteristics suitable for all standard electric appliances, and most electric motors.

Generators are available in this one size and type only, and complete instructions for constructing base and assembling are furnished. We ship the same day order is received if accompanied by bank draft or cashiers check. A slight delay on orders with personal checks.

## HOPFER & COMPANY

3124 EAST 14TH STREET • OAKLAND, CALIFORNIA

## Make Your Car or Truck A PORTABLE POWER PLANT This Easy, Economical Way!

ASPEN DRIVE-ALL gives power when you want it . . . where you want it! Just line up with rear wheel, drive on to unit, and you're set for work! No jacking up or demounting! Use the rugged DRIVE-ALL for all belt-driven operations requiring up to ten h.p.!

LOW-COST  
ACCESSORIES—  
Generator; Grinder  
Centrifugal Pump.

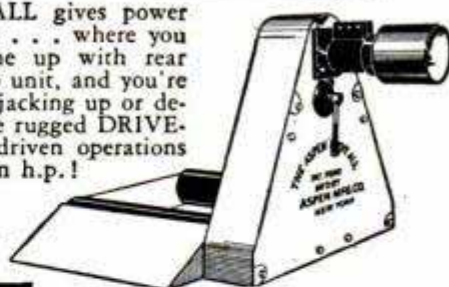

## Aspen DRIVE-ALL

FREE! Write today for illustrated folder and full information to: Aspen Mfg. Co., Inc., 1612-J Webster Avenue, Bronx 57, N. Y.

GOVERNMENT SURPLUS

BRAND NEW

## VICKERS HYDRAULIC PUMPS

Constant Displacement, Piston Type 1000 PSI

Hundreds of Practical Uses

BUILD YOUR OWN HYDRAULIC PRESS, ELECTRIC EYE DOOR OPENER, ETC.

\$15.00 F.O.B. DETROIT, MICH.

BENJAMIN SALES CO.

8774 Linwood Dept. M Detroit 6, Michigan



## BUILD YOUR OWN ENLARGER

Enjoy Photography's most fascinating hobby at a fraction of usual cost. With simple step-by-step instructions and diagrams plus a screwdriver and pliers you assemble your own Enlarger and Save! Get all features of more expensive Enlargers—precision machined aluminum alloy castings, 90° tilt for wall projection of prints, spherical aluminum lamphouse, helical rack and pinion focusing with extra large knobs, unconditional guarantee.

Write Today for Free Illustrated Folder

CALIFORNIA TECHNICAL PRODUCTS CO.

8510 Warner Drive, Dept. M-4, Culver City, Calif.



## LEARN TO MAKE TRICK PICTURES

### THE HOLLYWOOD WAY NO DARK ROOM NEEDED

Print your own, trick photos, snapshots, greeting cards. Complete Photo Printing Kit. NOTHING ELSE TO BUY. Printing Frame, Fixer Salts, Paper, Trick Negatives and simple instructions.

FREE—while they last—Amazing Magic Propeller with each direct order. All for \$2.00, postpaid. No C.O.D.

LEONARD M. POOLE CO., DEPT. PM-4  
7614 Santa Monica Boulevard • Hollywood



## WORLD'S BEST RADIO BUY

World Radio Laboratories Inc. offers another FIRST in seasonal radio buys. For bedroom, kitchen or den. The ideal gift for graduations, birthdays, etc.

### EXTRA POWER—TONE—BEAUTY

Gleaming ivory plastic cabinet—modernized 4 tube AC or DC circuit. Operates on ordinary house current. Clear tone—equipped with Hank antenna. FREE TRIAL OFFER. If not completely satisfied after 10 days trial, return and money will be refunded. Send check, money order, or say C.O.D. Weights approximately 8 lbs.—shipped anywhere in U. S. postage collect. We reserve the right to limit quantity.

WORLD RADIO LABORATORIES INC.  
P. O. Box 511 Dept. K Co. Shells, Iowa

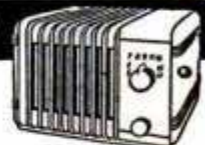

Order Today \$9.95  
POSTAGE COLLECT

SAY YOU SAW IT IN POPULAR MECHANICS

## Complete plans for converting 36' L. C. V. P.

Into 42' \$25,000 cruiser, only \$25. Send 50 cents for preliminary data.

LOCKHAVEN MARINA  
3030 Commodore Way, Seattle 99, Wash.



## WOOD WORKERS

LUMBER—PLYWOOD AVAILABLE  
Harold Hunt wants to send new No. 15 catalog. Over 148 pages of woodworking ideas. UNEQUALED BARGAINS in imported and American woods, supplies, hard-to-find hardware. Send only 15c to cover postage and handling.  
CRAFTSMAN WOOD SERVICE CO.  
2720 S. Mary St., Dept. A-92, Chicago 6, Ill.



only 15¢



# WORLD'S LOWEST PRICED ADDING MACHINE

VEST POCKET SIZE

IDEAL FOR BUSINESS OR PERSONAL USE

FREE TRIAL  
ONLY \$2.95

TOTAL COST  
SEND NO MONEY  
FREE!!

Each Baby Calculator in Beautiful, rich-looking Leatherette case—at no extra cost.



Fits vest pocket or purse. Guaranteed accurate. Operated as easily, and as reliable, as machines costing many times as much. Not a toy. Precision made, very durable—guaranteed for life against defects in construction. You positively can't buy a calculator of equal quality for as little money. **ACCEPTED AS THE FINEST LOW PRICED CALCULATOR FOR OVER 35 YEARS!** Operates with a flick of your finger. Adds, subtracts, multiplies, divides—counts up to one billion. Pays for itself over and over in mistakes avoided, and time saved. **MAKES IDEAL GIFT.**

Sold on a positive money back guarantee. Send only \$2.95. Calculator sent postpaid, or send name and address and pay postman \$2.95 plus postage. **MONEY BACK IN 10 DAYS IF NOT DELIGHTED!** (If outside U. S., send \$3.50.) **AGENTS WANTED.**

**CALCULATOR MACHINE CO., (Mfrs.)**  
Dept. 201, P. O. Box 248, Glenview, Illinois

**\$1.00**  
POSTPAID

**SPECIAL OFFER!** Famous, patented, lock-stitch sewing awl complete with needles, waxed thread, direction folder. Hundred uses—sewing, repairing leather goods, canvas, belting, old or new harness, saddles, gun cases. Satisfaction guaranteed, or money back. Send currency, check, or money order, no stamps, please. **Yates Mfg. Co., 611-H Main St., Lake Geneva, Wis.**

**A AND N SUPPLY CO.**

Thousands of Bargains in Military, Outdoor & Sport Goods for Hunter, Farmer, Scout. Send 10c for NEW 32-page catalog, just issued, returned with first order.

**A and N SUPPLY CO.**  
4720 Lester St. Richmond 15, Va.

APPROXIMATELY 1500 FEET  
**NYLON FISHING LINE**

2 ply—Strong (25 pound breaking strength)—rubberized—waterproof—long life. Send remittance to — **\$1.98**

**ALLENDER & CO.** Postpaid (in U.S.A.)  
2346 So. Dearborn St., Chicago 16, Ill.

**FREE Project Sheets!**

Three sets of plans for making attractive end tables, sewing chests, etc., at home. Simplified so beginners can follow. **FREE** with purchase of full size jar famous Rogers "Gorilla Grip" Glue for only 10c. This powerful glue makes furniture, toys, etc., last a lifetime.

Offer good only until June 1, 1948. Send 10c TODAY to Rogers Insignia & Glue Co., Gloucester, Mass.

**ROGERS**  
the best LIQUID FISH GLUE  
GLOUCESTER, MASS.

## DON'T YOU BELIEVE IT! ... THAT PISTON RINGS ARE ALL ALIKE

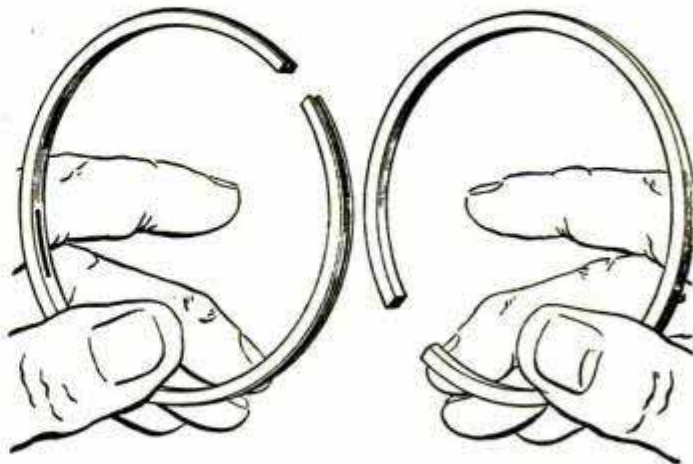

● Some people think one make of piston ring is as good as another. But don't be fooled just because piston rings all seem to look alike. Burd "Graf-Flox" Piston Rings, made of electric furnace iron, are unrivaled in meeting the demands of increasingly high speeds and high compression in modern engines . . . even excessively worn cylinders can't stop their efficiency. With flexibility to follow worn cylinder walls faster, Burd "Graf-Flox" treated Piston Rings help correct piston slap . . . restore lost power . . . stop fuel and oil waste . . . bring quiet, smooth, new-car performance to your automobile. The coupon will bring you more information in two **FREE** booklets.



**BURD**  
AUTOMOTIVE PRODUCTS

*"Engineered for results"*

MAIL THIS COUPON FOR THESE FREE BOOKLETS  
BURD PISTON RING CO., DEPT. 118-D  
Rockford, Illinois

I'd like copies of your "Servicemen's Handy Handbook" which tells how to keep my car in good working order, and the booklet "No Job For a Dub."

Name.....  
Address.....  
City..... State.....



# Handy Electric Drill Saves Time 3 Ways



**HOME-UTILITY**  
1/4" Electric Drill  
**\$18.95**

## 1 FOR PORTABLE DRILLING—

Drills bolt holes, lead holes in metal, wood, plastics. Saves you time, turns out better work in homes, on farms, in workshops.



**HOME-UTILITY**  
1/4" Horizontal Stand  
**\$3.35**

**2 FOR GRINDING, SANDING,** buffing, polishing—Helps you sharpen cutlery and tools, remove rust, sand hobby shop items, etc. Frees both hands for applying work.



**HOME-UTILITY**  
1/4" Vertical Bench Stand  
**\$11.45**

**3 FOR DRILL PRESS WORK—**Quickly converts the Drill into a convenient drill press with a smooth feed for bench work. Drill is slipped into both Stands, or removed, in a few seconds.

Versatile Home-Utility Drills and Stands—including the 1/2" Drill (only \$35.95)—are quality-built by **BLACK & DECKER**, famous maker of industrial tools for 37 years! Order Home-Utility Tools from your hardware, electrical or implement dealer.

# ELECTRIC HOME-UTILITY TOOLS

Products of **THE BLACK & DECKER MFG. CO.**, Dept. H-2, Towson 4, Maryland

# SPEEDY VISE



**EVERY WOODWORKER NEEDS ONE...**

Holds Any Thickness from 0" to 2"



Just the thing for Contractors — Pattern Makers — Cabinet Makers and Home Work Shop. Rugged design — made of cast aluminum alloy. Easily installed on the bench or use on the floor for door and sash work. Send \$1.50 today for yours, or see your dealer.

**SPRUNGER BROS., Inc.**  
143 Main St. Topeka, Ind.

**POSITIVE GRIP QUICK ACTION**

**\$1.50 Each**  
Prepaid

Satisfaction Guaranteed

## STRONGHOLD SKRU-KITS

**20 Assortments—49c Each**

Machine Screws, Wood Screws, Nuts, Washers, Cotter Pins, etc. Each assortment features one type fastener in wide variety of sizes and styles... Every fastener for your work. For workshops, garages, repair shops, hobbyists, mechanics. Stock up with several assortments at your favorite hardware counter. Look for **STRONGHOLD!**

**Stronghold Screw Products Inc. 236B W. Hubbard St., Chicago 10, Ill.**

## PILOTS' JACKETS

(Left) **NEW AIR-CORPS SURPLUS, B-15** Style. Green poplin. Warm alpaca wool pile lining. Genuine Mouton fur collar. 4 Pockets. 36-46... **\$15.50**

(Right) **A-2 Style.** Brown leather, sturdy rayon lining. Zipper front. Sizes 34-46... **\$17.95**

**NAVY N-4 JACKET:** Water repellent green poplin. All wool flannel lining. Zipper front. Sizes 34-36... **\$5.50**

Write for **FREE** Illus. List Army Surplus. Orders sent postpaid except C.O.D.

Satisfaction or Money Back  
**CONSUMERS CLOTHING CO., Box P, 26 Greene St., New York 13, N. Y.**

## HOOF MASTER Steel Cutting Shears

for bench or portable use, cuts flats up to 1/4" x 3 1/4", rods 7/16". Used by leading Mfgs., Home work shops, etc. Perfectly Machined: Guaranteed 1 Year. Save Money—order direct from this ad. **ONLY \$49.50.**

**P. M. HOOF, Mfg.** Minneapolis 4, Minn.  
2508 14 Ave. So.

## HERE'S CLOTHING YOU WANT

Ever have trouble getting the Trousers, Shirts, and Jackets you want for work, sports and knocking around, at the price you wish to pay? Write for our **FREE CIRCULAR, No. 6.**

**ADDISON UNIFORM CO. • Dept. PM • CAMBRIDGE, OHIO**

## Gerstner TOOL CHESTS

Always popular with good Machinists and Tool-makers because of durable construction. Free catalog.

**GERSTNER TOOL CHESTS**  
448 Columbia St. Dayton 7, Ohio

SAY YOU SAW IT IN POPULAR MECHANICS

# 5 BIG SPECIAL BARGAINS at LOW PRICES



**Made For the Government: All NEW... Never Used**

**BRIGGS & STRATTON** Portable Lighting Plant priced at a fraction of the original cost. Built to rigid Government requirements. Especially built for Field Use or for permanent installation in Cottage, Farm, Trailer, Boat, etc. Complete with 1 3/10 H.P. Gasoline Engine, Hand Starter. Rated 250 Watts will develop 500 Watts. With Spare Parts and Tools. Mounted on permanent base... Rubber cushioned... Ready for Immediate Use anywhere... At this **LOW PRICE** they won't last long... Better Hurry only **\$129.50.**

Cost U. S. Gov't \$4,500  
**OUR LOW PRICE**  
ONLY **\$49.50**

**SPERRY S-1 Bomb Sight—**Here is an unusual opportunity to get one of these MARVELOUS Precision Mechanical Instruments... Marvellous beyond description. Contains hundreds of parts usable in 1001 ways... Regular and Bevel Gears, Shafts, Approx. 100 Roller Bearings, Electrical Parts, Precision Lenses and Prisms, Countless Gears, Dials, Knobs, Switches, Polaroid Filter, Calibrated Dials for Air Speed, Drift Indicator and Illuminated Spirit Level, Gyroscope, etc... Excellent for Inventors, Experimenters, Hobbyists, Schools use for Study Demonstration. Only **\$49.50.**

Same As Above But Used.  
**ONLY \$29.50**

**COMPLETE WITH POWER PLANT. ONLY \$129.50**

**DEALERS:**  
Write For Quantity Prices...

**A-8-B... OXYGEN MASKS:**  
Made of Genuine Rubber With Sponge Filters  
**ONLY \$2.75 ea.**

**General Electric AIR COMPRESSORS**  
Catalog # T825282 G1... Rated Pressure 1000 pounds to square inch... Dual Cylinders... Shipping Weight 9 1/2 lbs.  
**ONLY \$9.95 ea.**

**ACE SURPLUS SALES CO., INC., 1449 West 69th St., Dept. P-4, Chicago 36, Ill.**





**New Walking Aid**  
 is safe, lightweight  
 and convenient

The modern improvement over the conventional type crutch is this new Anchor Walking Aid. A real help for invalids and recuperating persons. Sturdy... Adjustable... Lightweight Construction. Used by hospitals throughout the U. S. Write today.

**Anchor Mfg. Co.**  
 12 W. Water St., Piqua, O.

**\$9.95**  
 (CASH WITH ORDER)

**MAKE YOUR OWN DISC SANDER**



Mount this 8" cast aluminum sanding disc on any 1/2", 5/8" or 3/4" spindle. Sturdy ribbed design. Order direct — \$2.00 postpaid. Threaded bore 25¢ extra. Abrasive paper discs, 8" — 1 doz. asst. grits \$1.25.

1734 Clinton Street  
**EMRICK INC. KALAMAZOO, MICH.**  
 WRITE FOR FREE TOOL LIST.

Get genuine full-color  
**KODACHROME PRINTS**  
 and look for the name stamped on the back  
 Order through your Kodak dealer  
**EASTMAN KODAK CO., Rochester 4, N. Y.**

**SAVE \$ MOTORS**

Rewind motors — learn and earn in your spare time to start a business of your own repairing motors. Our accurate machine wound coils, material kit and motor repair supplies will start you in this profitable business.

**PETERS ELECTRIC CO.**  
 P. O. BOX 89 ROYAL OAK, MICHIGAN

**BEARINGS**

Bore	O.D.	Type	Price, each
.250	.750	Ball	\$0.15
.1575	.6299	Ball	.15
.1895	.500	Needle	.15
.1895	.625	Needle	.15
.2495	.625	Needle	.15
1"	1 1/4"	Needle	.15
1 1/4"	3"	Ball	1.25

All Brand New—Minimum order 10 bearings.  
**BENJAMIN SALES CO.**  
 8774 Linwood Ave. Dept. M Detroit 6, Mich.

Fafnir,  
 N. D.,  
 S. K. F.,  
 Torrington,  
 Schatz &  
 Norma



**RID YOUR DOG OF WORMS**  
 USE  
**PARKE-DAVIS NEMA WORM CAPSULES**

**KEEP YOUR DOG FRISKY!**

Dependable, easy to give, scientifically prepared and low in cost, NEMA Worm Capsules effectively remove large round worms and hookworms in dogs and cats.  
 FREE! Send for illustrated, helpful worm booklet.  
**PARKE, DAVIS & CO., DETROIT 32, MICH.**  
 DRUG STORES SELL PARKE-DAVIS PRODUCTS  
 APRIL 1948



**MERCURY**

\* BALL AND ROLLER BEARINGS throughout

**IN SPEED IN STAMINA**

**KIEKHAEFER MERCURY LIGHTNING**

Tremendous power under control. Top speeds, or slowest trolling — your Mercury responds instantly to the throttle. Full-Jeweled Power\* proved through thousands of hours of operating performance provides the "guts" for seasons of the toughest outboard operation... gives MERCURY parts an anti-friction ride on ball and roller bearings... See the full MERCURY line at your dealer. There's a model for every outboarding need.

Write for FREE Illustrated Brochure and name of your nearest MERCURY dealer

**KIEKHAEFER CORPORATION**  
 Cedarburg, Wis., U. S. A.

NAME \_\_\_\_\_

ADDRESS \_\_\_\_\_

CITY \_\_\_\_\_ STATE \_\_\_\_\_

**CLIP AND MAIL TODAY**



Another GREAT NECK First!

ALL NEW!

REVOLUTIONARY  
MAXIMUM-GRIP  
PLASTIC HANDLE  
SCREW DRIVER,<sup>2</sup>

★ Unbreakable!  
★ Twistproof!  
★ Modern Design!

Blade lengths from 4" to 10"



GREAT NECK—leader in tool design—offers the new, handsome maximum-grip screw driver you've been waiting for! Richly colored unbreakable plastic handle is slip-proof, non-explosive, non-absorbent to grease or oils. Entire blade is of specially hardened and oil tempered quality alloy tool steel, highly mirror-polished. Bit is precision-ground to exact size. Blade is deeply embedded and twistproof. Here is a beautiful engineered tool to give good service for many years!

THE QUALITY TOOL FOR CRAFTSMEN, MECHANICS, HOBBYISTS—EVERYONE!

ASK FOR GREAT NECK TOOLS BY NAME

NOW AT HARDWARE COUNTERS

GREAT NECK SAW MFRS., INC. • MINEOLA, N. Y.

World's easiest welding with this NEW 180 AMP. LINCOLN

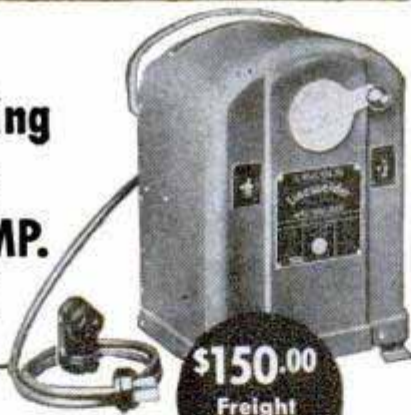

\$150.00  
Freight Prepaid

Lincoln Electric announces a new 180 amp. AC arc welder . . . the "Lincwelder." This welder has the same exclusive features as larger Lincoln industrial AC welders, yet it sells at the lowest price of any arc welder of its size.

Its "Arc Booster" makes welded repairs easier and broadens your opportunities for greater income with arc welding. Welds broken parts. Hard-faces worn parts. Builds new equipment of all kinds. Range 20 to 180 amperes with "dial tuning" control. No plugs to shift. See the new "Lincwelder" 180 AC at your nearest Weldealer. Try it yourself . . . or write for details in Bulletin 370.

THE LINCOLN ELECTRIC COMPANY  
Dept. 331 • Cleveland 1, Ohio  
Largest Manufacturer of Arc Welding Equipment in the World

Low-Priced GARDEN TILLER

Makes It Easy to Work 5 to 20 Acres of Common Crops



The Mulsifier Soil Tiller! A great time and labor saver! Prepares the soil for planting in a single operation. Pulverizes the soil as fine as if it were plowed, disced and harrowed. Spreads fertilizer as it tills. Ideal also for cultivating. Has adequate power for all workable soils. Travels at speeds up to 2 1/2 miles per hour. Easy to operate; nothing to do but guide it. Any teenage boy or girl can do it. Sells at a fraction of the price of a tractor. Send postcard for circular.

MULSIFIER CORPORATION

381 MIDLAND, DETROIT 3, MICH.

\* Trade Mark Reg. U. S. Pat. Off.

Free CIRCULAR

Mulsifier ROTARY SOIL TILLER



Ideal Gift for Mother — Wife — Sister

SEW WITH A

SEW-LITE

MAKES SEWING A PLEASURE

Fits all type machines—chrome plated shank and socket with bracket, bulb

and cord all assembled. Just attach and plug in. \$245 Post-110 V ac-de complete with instructions. . . . . \$245 Post-paid.

HOME SEWING MACHINE CO., 822 Fifth Ave., Brooklyn 32, N. Y.

CUBIC-INCHER CRYSTAL SET \$239  
SIGNAL-POWERED NO ELECTRICITY



Transparent plastic cabinet is 7/8" square by 3/4" deep. This tiny space contains a variable tuning condenser, coil, 1N34 Rarar detector, by-pass condenser, and tip jacks. Set rests easily in the bowl of a teaspoon! Works anywhere—costs nothing to operate—never wears out—the nearest bed radio you ever had! With connecting leads, complete instructions, but no phone, \$2.39 post-paid. With single phone included, \$3.19 post-paid.

CARING • BOX 1308 • CHICAGO 90, ILLINOIS

ANGORA RABBITS



Valuable ANGORA WOOL (high priced) — shear regularly; steady cash income! Plenty markets. Luxurious 2-tone CHINCHILLA Furs! Finest pedigreed stock. Guaranteed. Easily raised anywhere. Illustrated literature free.

GRINSTEAD'S FARM

Dept. 60-R

GIANT CHINCHILLA WHITE GIANTS

World's most profitable rabbit!



Edwardsville, Illinois

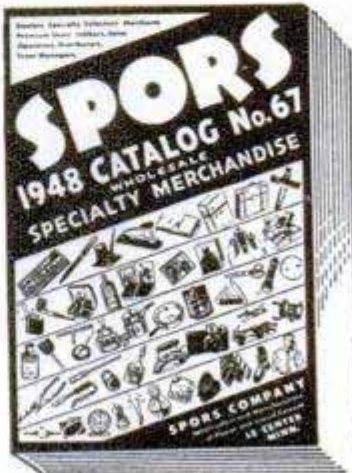

SPORS CO.

2-48 Dodge

6000 SMASH HITS—  
IN 324 PAGE  
Wholesale Book

Dealers, agents, salesmen and jobbers, you will find this book bulging with Tested Money Makers. Latest catalog shows average price reductions about 21% on many items. A guarantee of satisfaction stands back of every purchase you make from us. 25c brings you this latest 1948 wholesale catalog of Tested Sellers. You may take credit for the 25c on your first order. In that way the Book will not cost you any money. Get your copy now, before supply is depleted.

Le Center, Minn.



# PRESTO! - ANYONE CAN MASTER GLAZE

LEAVES HARD GLASS-LIKE FINISH  
EASY TO APPLY  
PROTECTS THE SURFACE  
NO SMEAR OR STREAKS AS WITH WAX  
LASTS SIX MONTHS TO A YEAR

SEALS THE PORES OF THE SURFACE  
WILL NOT FINGER-MARK  
NO OILY FILM AS WITH POLISH  
SAVES YOU MONEY

Car Owners! Meet Master Glaze—the sensationally different luster for new and used cars! Not a wax—not an oil polish—not a paint!—nothing that “smears” over the surface.

**MASTER GLAZE** is a unique discovery—a creamy liquid—quick and easy to apply! Gives a hard, glass-like surface. Even gasoline cannot dull it! Lasts six months to a year! Amazing luster—beautiful, sparkling clean and brilliant! Doesn't finger-mark—doesn't smear! A match box full glazes an entire car. Seals the pores—protects! **NOTHING LIKE IT!**

**AGENTS**  
An unusual opportunity! Quick, flashy demonstrator. Big profits. Good territory. Write today!

**FREE SAMPLE**  
Just send your name and address to  
**MASTER GLAZE CO., 7720-650 W. Harwood Ave., Milwaukee, Wis.**

**12 lbs. SURPLUS RADIO PARTS \$2.00**

A gold mine of parts for repairmen, amateurs, and experimenters . . . sockets, condensers, resistors, transformers, coils, hardware, wire, etc. An outstanding bargain in usable parts! Send \$2.00 cash, check or M.O. today!  
(Pay small express charges on receipt.)

**ELECTRONIC DISTRIBUTORS, Inc.** Dept. MA 620 W. Randolph St., Chicago 6, Ill.

## You Can Afford A Sprunger

PRECISION-BUILT 14" BAND SAW

America's finest for production work or home workshop. 14" x 14" table tilts to 45° on double trunnions. One-piece frame. Ball-bearing throughout. Cuts to center of 28" circle, up to 6½" depth. 42" high. Price, including 94" blade. . . . . **\$89.95**

See your dealer, or write . . .  
**SPRUNGER BROS., Inc.**  
145 MAIN ST. TOPEKA, IND.  
Dealer inquiries invited

## MIDGET SOCKET SET

1/4" DRIVE

**ONLY \$3.95**

Here's a real value! This top-quality 15 piece midget socket set is ideal for work in cramped quarters. All parts precision-tooled from quality, tempered steel. Compare this amazing value. Get your order in today—the supply is limited. **MONEY BACK GUARANTEE.**

**CONTAINS:**  
8 sockets . . . 3/16" to 7/16".  
4 double open-end wrenches 9/32" to 1/4".  
1 plastic handle socket holder  
1 sliding T handle.  
1 pr. midget pliers.

**HERE'S MY ORDER:**  
 Enclose \$3.95. Ship midget socket set, postpaid.  
 Ship Midget Socket Set COD; will pay postman \$3.95 plus postage and COD charges.

Name \_\_\_\_\_  
Address \_\_\_\_\_  
**W. R. MULLEN & CO., 20 N. WACKER DRIVE, CHICAGO 6, ILL.**

# A TOOLSHOP IN YOUR HAND!

- GRIND • DRILL • ROUT
- POLISH • ENGRAVE
- CUT • SAND • SAW, etc.

Make Things From Wood—Plastics—Metals—Glass—Linoleum—Leather—Alloys—Horn—Stone—Bone, etc.

**\*HANDEE TOOL OF 1001 USES**

**THE FIRST TOOL OF ITS KIND AND TODAY'S FINEST**  
Smooth, steady power at your fingertips! Perform precision operations not possible with any other portable tool! With a Handee you can turn out professional looking projects for pleasure or profit—ship, plane and train models, delicate, internally carved costume jewelry, wood carvings, puppets, initialed tumblers, etc. AC or DC. 25,000 r.p.m. Wt. 12 oz.

## GET A GOOD START GET THE HANDEE KIT

**HANDEE** Tool and 40 most popular accessories packed in compact steel carrying case. You'll be amazed at what you can accomplish! Complete, \$27.50. Handee only, with 7 accessories \$20.50.

**FOR YOURSELF OR A FRIEND... THE GIFT OF A LIFETIME!**

## NEW PLASTIC-CRAFT KIT

For internal carving. Contains special plastic cutters, buffers, sanding discs, buffing compounds, dyes, cement, a liberal supply of clear plastics, and instructions. At stores or postpaid . . . . . **\$6.95**

\*Reg. U. S. Pat. Off.

Get a Handee at stores everywhere. If they can't supply you we'll send it postpaid. Satisfaction guaranteed! Ask for free 52-page Manual

**CHICAGO WHEEL & MFG. CO.**  
1101 W. Monroe St., Dept. PM, Chicago 7, Ill.

Send  Handee Kit  Handee Tool  Plastic-Craft Kit  C.O.D.  
 Remittance enclosed  Send Manual

Name \_\_\_\_\_  
Address \_\_\_\_\_



# WOOD-MITES 3 HANDY WOOD TOOLS

THAT DO A MIGHTY BIG JOB

★ MIDGET CARPENTER PLANE

★ MIDGET SPOKE SHAVER

★ MIDGET END SHAVER

Guaranteed  
\$3 VALUE  
NOW  
Only

**\$1.98**  
Complete Set  
OF 3

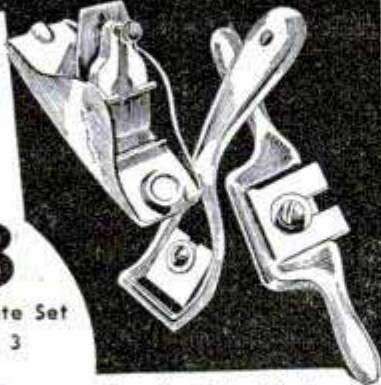

Ideal For Every Home—for "sticking" doors, windows, drawers; for rough edges on furniture; for every household planing purpose.

For All Who Work on Wood—Cabinet Makers, Craftsmen, Hobbyists, Small Shops, Model Builders. Solid Aluminum—Steel Cutting Blades—in box.

**SEND NO MONEY - MAIL TODAY**

TODDWARE PRODUCTS Dept. P. M.-1

68 E. Utica St., Buffalo 8, N. Y.

Send C. O. D. one set of 3 woodmites for only \$1.98

Name \_\_\_\_\_

Address \_\_\_\_\_

**SHIPPING CHARGES PAID IF MONEY ACCOMPANIES ORDER**

## YOUR CIRCLE SAW BLADE CAN CUT GROOVES LIKE THIS

Easily — Quickly — Accurately



YES—THIS NEW INVENTION WILL FIT THE ARBOR OF ANY WOOD POWER CIRCLE SAW—AND WILL SAW ANY DESIRED GROOVE CLEANER, EASIER AND FASTER THAN ANY DADO HEAD ON THE MARKET TODAY... GRADUATED IN 32nds AND NUMBERED TO CUT ANY WIDTH GROOVE WITH YOUR SAW BLADE... MICRO-MATIC ADJUSTMENT MAKES POSSIBLE A CHANGE IN CUTTING ANGLE IN 15 SECONDS... WARREN DADO SAWING WASHERS CAN BE LEFT ON THE ARBOR OR QUICKLY REMOVED FOR CUT OFF SAWING.

... ORDER YOUR SET OF FOUR WASHERS TODAY, TRY THEM FOR TEN DAYS, IF NOT SATISFIED, YOUR MONEY WILL BE REFUNDED.

Arbor  1/2  3/4  
 Sizes  5/8  
 Check  
 Money Order  
 Free Booklet

Gentlemen:— Please send \_\_\_\_\_ sets of sawing washers

Name \_\_\_\_\_  
 Address \_\_\_\_\_  
 City \_\_\_\_\_ State \_\_\_\_\_

ALL SETS SHIPPED POSTPAID

**WARREN DADO SAWING WASHERS CO.**  
 P. O. BOX 98 NORTH END STATION  
 DETROIT, MICHIGAN

"the gun that looks and feels like a Luger"

## HY-SCORE

World's Most Powerful  
AIR PISTOL

22 or 177 cal. Post Paid . . . . . \$19.85  
 Crossman powerful repeater air rifle . . . \$22.50  
 Crossman single shot rifle or pistol . . . \$19.80  
 H & R "922" 22 cal. 9 shot revolver  
 4 or 6 in. . . . . \$24.75  
 Hi-Standard 22 cal. automatic pistol 4 1/2 or 6 in. . . . . \$49.50  
 S & W 38 ctl. Mil. and Police revolver . . . . . \$56.50  
 S & W K-22 Masterpiece 22 cal. revolver . . . . . \$65.00

Send for list of real bargains in fishing tackle, guns, ammunition, outboard motors, bike motors, etc.

SEND CHECK OR MONEY ORDER - NO C.O.D.

**LAKELAND SPORTING GOODS**  
 FORT ATKINSON, WIS.

Personalize

YOUR POSSESSIONS  
WITH  
YOUR NAME  
DECAL  
TRANSFERS



Permanent—easy to apply—identify your golf equipment, guns, radio, cameras, archery sets, tools, etc. Send your name, city and state with \$3.00 for 36 of these large, personalized transfers in gold letters on black background. Send an additional \$1.00 if street address is to be added. Sorry, no C.O.D's. Dealers wanted—Immediate Deliveries.

**BING DECALS INC.** 16162 WOODWARD  
 DETROIT 3, MICH.

WAR SURPLUS!

## HIGH SPEED DRILL BITS

LIKE NEW! Original value over \$16.00. 25 assorted sizes and lengths. **\$2.50**

Send check, money order or cash. Shipped F. O. B. Culver City. Weight 1 lb.

**AIRBORNE SALES CO. INC.** CULVER CITY, CALIF.

SAY YOU SAW IT IN POPULAR MECHANICS

## AMAZING MYSTERY BUTTON

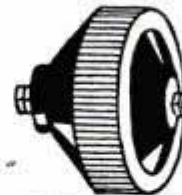

Startles Everybody. With this Electronic Button you can make your own Telephone Amplifier—Detectaphone. Attach this button to piece of cardboard—transmit conversation to another room. Music also transmitted to distant places. Most interesting electrical apparatus ever discovered. Enables you to perform hundreds of experiments. So tiny it can be concealed in dozens of places. A Pre-War Product. Electronic Button including 5000 word instruction booklet with 50 illustrated experiments. postpaid. only. **\$1.00**

**MICROSCOPES SUPPLIES ACCESSORIES & SCIENTIFIC INSTRUMENTS**  
 BEL SPENCER NEW USED LEITZ ZEISS  
 BOUGHT SOLD EXCHANGED REPAIRED  
 Send for FREE LIST  
**NATIONAL SCIENTIFIC INSTRUMENT CO.** 119 CHAMBERS ST NY7  
 MEDICAL INDUSTRIAL AMATEUR

## WOO-WEE AUTO HORN



Reproduces "Wolf Whistle" better than any siren. Screeches, barks, whistles, imitates siren, moves any "road hog" off the highway in "double quick plus." Attract more attention than by driving a yellow Cadillac. Operates from manifold. Installed on any car in 15 minutes. Sturdily constructed. Cleverest novelty since the use of the auto. Be the first user in your neighborhood. Absolute money back guarantee. 6 dollars each. Order today. Ohio orders add 3% tax. Write for free literature on our Chrome Air Horns. **THE PROTECTUROID COMPANY** - Dept. 101 4033 Windsor Road - Youngstown 7, Ohio



**GENERAL ELECTRIC  
BC 645  
TRANSCEIVER**

**TWO-WAY COMMUNICATION  
For EVERYBODY !!**

**10 times as powerful as a walkie talkie**



**\$14.95 for \$27.**

A brand new two-way communication set which cost the Army over \$400.00 and is ideal for two way communication between house and cars, office, service trucks, ambulances, boats, etc. Range up to 15 miles in the 450 to 500 Megacycle band. Operates in the new citizens band. Supplied complete with 15 tubes and conversion instructions to operate from 110 V A.C. Add postage for 25 pounds.

**ACCESSORIES NEEDED**

- PE101C Dynamotor for 12 or 24 Volt storage battery operation .....\$3.95
- 110 V A.C. Power Supply to operate BC 645 from house current .....\$11.95
- T-32 Table Microphone.....\$2.95
- Microphone Transformer.....\$1.00
- 5" PM Speaker for BC 645 \$2.80

**GN58 GENERATOR**

Makes excellent home lighting plant, operated by wind propeller, waterfall, gas engine, or hand crank. Reduction gear allows full output at slow speed; supplies 6 volts at 2.45 amp., 425 volts at .115 amp. New. Add postage for 28 lbs. **\$7.95**



**DYNAMOTORS**



- An electric motor operating a generator on same shaft—hundreds of uses—gives high voltage from storage battery.
- Dynamotor C—Input 28 volts, output 220 volts at 60 MA. Add postage for 6 lbs. **\$1.95**
- Dynamotor A—Input 12 volts, output 1000 volts at 350 MA. Shipping weight, 72 lbs. **\$5.95**
- Dynamotor B—Input 6 or 12 volts, output 500 volts at 160 MA. Shipping weight, 30 lbs. **\$5.95**

**BRAND NEW ARMY AIR FORCE ASTROGRAPHS With Case**

New B29 navigation instrument which can easily be used to make a good contact printer, strip map holder, etc. The plywood case 14 1/2"x11"x10" high is perfect as a tool kit, camera, projector case or for building a portable phonograph, picnic kit, make up case, etc., has leather handle reinforced covers, 8 covered compartments in bottom. Cost Gov't \$125.00. Add postage for 20 lbs. **Only \$3.95**



**G.E. BC375 TUNING UNIT**



A beautifully constructed tuner containing the best in variable condensers, coils, vernier dials, etc., at least \$30.00 worth of parts, complete with conversion instructions to transmitter and receiver. Add postage for 20 lbs. **\$2.49**

**HEATHKIT 3-TUBE ALL-WAVE RADIO**

110-volt AC-DC operation

**\$5.95**

An ideal way to learn radio. This kit is complete ready to assemble, with tubes and all other parts. Operates from AC or DC. Simple, clear detailed instructions make this a good radio training course. Covers regular broadcasts and short wave bands. Plug-in coils. Regenerative circuit. Operates loud speaker. Battery model for use where no AC house current is available. Add postage for 3 lbs.

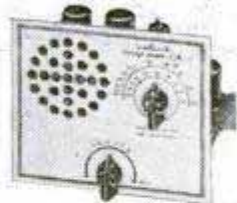

- Heathkit Beginners' Radio 110-volt type .....\$5.95
- Heathkit Beginners' Radio, battery type (2 tubes, no rectifiers).....\$5.95
- Headphones for either type HS 30 per set.....\$1.00
- 2 1/2" permanent magnet loudspeaker for either type.....\$1.05
- Batteries, complete kit for battery type set.....\$3.25

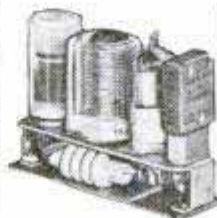

**MIDGET TRANSMITTER KIT**

Complete kit to assemble a 1 Watt battery operated amateur 80 meter transmitter, including tube and crystal. Range up to 500 miles. Only accessories needed are sending key and batteries. Complete instructions supplied. Add postage for 2 lbs.

**\$3.95**

- Key—add postage for 2 lbs.....\$1.00
- Batteries—add postage for 4 lbs. ....\$3.25

**THE NEW 1948 HEATHKIT 5" OSCILLOSCOPE KIT**

Complete kit to build a beautiful 5" oscilloscope. Ideal for studying and servicing television and FM radio. 6 tubes including 5BP1 cathode ray tube. 1500-volt power supply operates from 110-V 60 cy A.C. Has compensated vertical and horizontal amplifiers and 15 cy to 30 KC sweep generator. Detailed instructions make assembly easy. Shipping weight, 35 lbs. Nothing else to buy **\$39.50**



**MINIATURE HEADPHONES**

**\$1.00** Hearing aid type, comfortable, keeps out outside noise, one of the army's best types. Add postage for 2 lbs.



**T32 TABLE MICROPHONE**

One of the army's finest built by Kellogg. Ideal for public address, transmitters, etc. Add postage for 5 lbs. **\$2.95**



**G. E. CIRCUIT BREAKER**

**\$2.95** Protect your electrical equipment, eliminate fuses. 50 AMP 220 Volt rating. Add postage for 4 lbs.

**THROAT MICROPHONE**

Used by army in noisy applications in aircraft, tanks, etc. Many interesting home uses. Add postage for 1 lb. **\$1.00**



**No Orders Under \$2.00**  
Add postage for weight shown. Write for Flyers listing hundreds of other electronic bargains



**The HEATH COMPANY**

**DEPT. M . . BENTON HARBOR, MICH.**







# ATTENTION FARMERS!

Now is the Time to Get a SEAMAN ROTARY TILLER for Your Spring Work

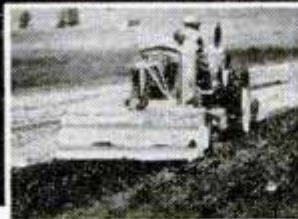

Speeds up tillage; makes better seedbed; use for finishing seedbed prepared with conventional equipment or for complete seedbed preparation with this ONE machine. Provides ideal tillage control — fine pulverization, coarse, or medium to suit soil and crop conditions. Promotes higher yields . . . holds more moisture, longer; mixes fertilizer and green manure into GROWING AREA of seedbed; hastens germination; aerates seedbed; helps control weeds, grubs and many other crop pests; reduces wind and water erosion; makes plants more drought-resistant. Available in complete range of sizes from 3 ft. to 7 ft. tillage widths, power take-off and motorized (gas or diesel) models. See Your Seaman Tiller dealer and write for complete descriptive literature.



SEAMAN MOTORS, Inc. 364 N. 25th Street Milwaukee 3, Wis.

## Shoes HURT?

### RELIEVE CORNS AND BUNIONS!

Take the painful pinch out of your shoes with this guaranteed Shoe Stretcher! Just slip wooden form into shoe and turn handle to stretch leather as desired. Attachable metal plugs give added stretch over corns or bunions. Practical, well-made, easy to use. Complete satisfaction or your money back. State shoe size, whether for man's or woman's shoe. Mail check or money order today!



### C & K COMPANY

32 COSTAKIS ST. MANCHESTER, N. H.

New Precision Built Commercial

## Wood Shaper and Matcher

Now Within The Reach Of Every Home Workshop



Make corner matched joints, panelling, butting, routing, notching, inlay, tongue and groove and joints. Designed for commercial use, now simplified design and mass production brings it within the reach of every one. Just attach in chuck of drill press and it's ready to use. Write for complete FREE information.

Write for FREE Information T & H Mfg. Co. 811 East 31 St. Dept. SP-3, Kans. City, Mo.

## Save Time and Money with this Press

Ten-ton press, ideal for all kinds of pressing, separating, straightening, and bending jobs. Ample capacity for home shops. Easily adjustable table takes work up to 18 inches wide and 11½ inches high. Roller-bearing ram for long life. Send for free bulletin showing press and wide variety of accessories.

UT-10A Press f. o. b. factory \$31.00



## DAKE ENGINE COMPANY

624 Seventh Street, Grand Haven, Michigan

## "More Time— More FUN"



Says Ben C. Robinson, noted outdoorsman and outing editor, with a

# Coleman

## Folding CAMP STOVE



"I do my cooking with a Coleman Camp Stove and light up the camp with my Coleman Lantern," says Mr. Robinson. "The good old days of the campfire are mighty fine to think about . . . but the smoked pots and pans, the smudged food and the cut and burned fingers have for me, at least, gone into the limbo of past events."

### NOW—COOK WITH GAS ANYWHERE

Take a tip from famous outdoorsmen who make outdoor life their business — and have more time for fun with a Coleman Folding Camp Stove. Cooks like a city-gas stove—lights instantly. Folds up, carries like a suitcase. Folding High Stand (extra) holds stove at convenient height. Ask your Hardware or Sporting Goods Dealer for a demonstration.



Easy to Carry

## FISH LATER—

Have More LUCK with a Coleman Floodlight Lantern

Coleman Floodlight Lantern gives you more time for fun—better luck! Lights up 100-ft. area. Safe—a 105-mile gale can't put it out. Ask to see it demonstrated.



THE COLEMAN COMPANY, INC. Dept. 232PM, Wichita 1, Kansas  
Gentlemen: Please send, without obligation, FREE illustrated folders on Coleman Camp Stoves and Floodlight Lanterns.

FREE FOLDER!

NAME \_\_\_\_\_

ADDRESS \_\_\_\_\_

Help Prevent Forest Fires — COOK SAFELY



# Keep Brushes like New

**BEFORE**



**AFTER**

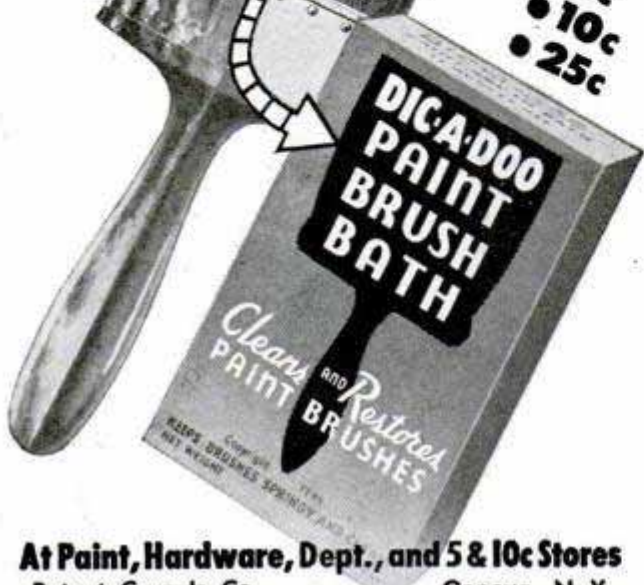

**DICA-DOO PAINT BRUSH BATH**

Clean and Restores PAINT BRUSHES

5c  
10c  
25c

At Paint, Hardware, Dept., and 5 & 10c Stores  
Patent Cereals Co. Geneva, N. Y.

SAY YOU SAW IT IN POPULAR MECHANICS

## NEW — Army Surplus

# ELECTRIC MOTORS

24 Volt . . . . AC-DC., Ball Bearing

1/6th H.P. 6350 R.P.M.

1/10th H.P. 3600 R.P.M.

1/11th H.P. 3600 R.P.M.

1/12th H.P. 6000 R.P.M.

1/20th H.P. 3900 R.P.M.

3 1/2 H.P. 24 V. D. C. ONLY

**ORDER TODAY YOUR CHOICE \$295 EACH**

**RADIO CENTER**  
2530 E. DAVISON  
DETROIT 12, MICH.

All prices F.O.B. Detroit. Send cash or money order. No C.O.D.'s—Orders shipped by railway express.

## HOW TO EARN EXTRA PROFITS

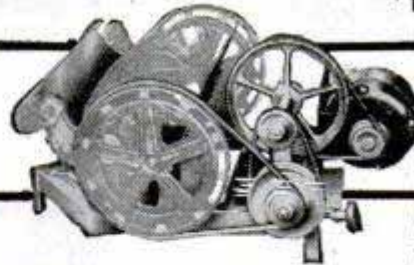

only  
**\$47.50**  
LESS MOTOR

for this popular

## "QUAD-CITY SHARPENER"

Get into profitable lawn mower sharpening at low cost with this highly successful machine. Order direct from QUAD-CITY PRODUCTS CO., Box 42, Rock Island, Ill.

LET BAKONTROL GIVE NEW, PROFITABLE USES TO YOUR

# WATER POWER



BAKONTROL gives automatic starting—fast acting governing—automatic stopping—of any hydro plant. Bakontrol boards water, gives amazing convenience. Pays for itself. Lock up your power house and leave it for weeks, while it continues to deliver power automatically. Tell your friend with water power of this ad. Send now for free 12 page booklet B-1. Bakontrol Mfg. Co. 4867-C HAMILTON DETROIT 1, MICH.

**Print Your Own**

Cards, stationery, circulars, tags, labels, photo and movie titles, advertising, etc. Save money. **Print for Others, Good Profit!** easy rules sent. Raised Printing like Engraving, too. Send dime for press samples, supply book, all details and advice on your needs. No obligation. **KELSEY INC., B-37, Meriden, Conn.**

**MR. FIX-IT SAVE MONEY!** *adhere* **IT YOURSELF**

use **perma-bond plastic adhesive**

1001 uses in home, garage, workshop. Waterproof. Flexible. Strong. Never brittle. Fast Drying. Easy to Apply. Order Direct. Quart \$2.25 — Pint \$1.50 — 4 oz. 60c

Hundreds of new uses discovered every day. Keep a supply on hand for unexpected emergencies.

**TUCKER HOME-BUILDING PRODUCTS**  
101 Park Ave., New York 17, Dept. PM-1

**BUILD YOUR OWN TRAILER**

Complete Assembly ONLY \$67.30 Inc. Axle, Springs, 2 Wheels with tires, fenders, draw bar and hitch

**WITH NEW FACTORY-BUILT PARTS**

**Parts and Assemblies**

Axle Assembly—tubular steel, with Timken bearings, hubs, wheel bolts, nuts, dust caps	\$13.30
Axle Assembly—complete with steel disc wheels, 6.00x16 4-ply tires	47.25
Spring Assembly—with brackets, U bolt and grease fittings	5.65
Disc Wheels—for 6.00 or 6.50 by 16 tires	ea. 4.25
Heavy Fenders	ea. 2.10
Draw Bar	ea. 2.45
Hitch	ea. 2.10

(F.O.B. Milwaukee)

**ORDER NOW! IMMEDIATE DELIVERY**  
10% with order, balance C.O.D.

**MILWAUKEE TRAILER MFG. CO.**  
622 N. WATER ST., DEPT. M, MILWAUKEE, WIS.



**STRIPE WITH PAINT EASY AS USING A PENCIL**

# PAINTERS' STRIPING TOOL

NOW you can do your own expert striping on furniture, bikes, model planes, bulletins, autos, toys, signs, linoleum, wall board . . . make plain walls look like tile! It's easy to paint straight, curved, circular, even parallel lines with any color. Handiest paint tool in your workshop! Type "M" Master Painters' Striping Tool complete with tip for 1/16" stripe, \$1.00. Extra tips 1/64", 1/32", 3/64", 1/16", 5/64", 3/32", 1/8" - 75c each. Tool with complete set of 7 tips \$5.00. (C.O.D. orders 25c extra.) WENDELL MFG. CO., 4234 - B Lincoln Ave., Chicago 18, Ill.

**A TOOL . . . NOT A BRUSH**

Dealers Write Today!



**\$1.00 POST PAID**

## DRAIN YOUR CELLAR, POOL, WASH TRAYS, ETC.

LABAWCO Type P Pump keeps garden pools fresh. Circulates oil or refrigerant, etc. **DOES NOT CLOG!** 1500 Gals. per hr. - 300 Gals. at 30'. Uses 1/4 to 1/2 H.P. motor.

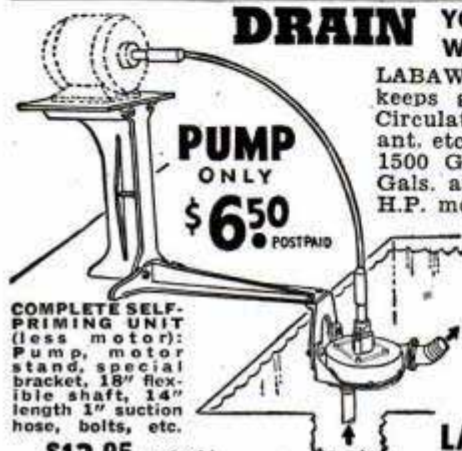

**PUMP ONLY \$6.50 POSTPAID**

COMPLETE SELF-PRIMING UNIT (less motor): Pump, motor stand, special bracket, 18" flexible shaft, 14" length 1" suction hose, bolts, etc.

**\$13.95 postpaid**

Pump alone \$6.50. Pump with complete self-priming unit . . . \$13.95

POSTPAID if cash with order. West of Mississippi, add 50c.

**SEND ORDER TODAY**

**LABAWCO PUMPS BELLE MEAD 4, N.J.**

## SPARE TIRE INFLATER

Don't get caught with a flat spare! Install Curtis Spare Tire Inflator in five minutes. Check and fill spare tire without opening trunk or moving luggage. Fits all cars. Also use for filling air horn supply tanks. Large bright chrome cap dresses up car. Only \$2.00 postpaid. Ohio residents add 6c state sales tax. No C.O.D.'s, please.

**CURTIS AUTOMOTIVE DEVICES, INC.**  
8 Norwood Ave., Dayton 7, Ohio

**\$2.00**

Postpaid

## STANDARD GARDEN AND SMALL FARM TRACTORS

**Plow Seed Cultivate Mow Hay and Lawns**

Powerful Gas Tractors for Small Farms, Gardeners, Florists, Nurseries, Fruit Growers, Poultrymen.

**1 & 2 Cylinders**

High Wheels. Rubber or Steel Tires. Walk or Ride.

Do Belt Work - Free Catalog

**STANDARD ENGINE CO.**  
MINNEAPOLIS, MINN.  
3221 Como Avenue

NEW YORK, N. Y.  
617 West 26th Street



## ACE

LATHE TOOL SET

**Be permanently tooled-up for every operation on your Metal Cutting Lathe**

The ACE Set is complete—there's nothing more to buy. Drop forged by the manufacturers of cutting tools used by 98 per cent of the plants and shops in industry they are correctly designed, are of special steel, are finely finished, are stronger—will last a lifetime. You can cut easier, faster and more accurately with ACE TOOLS.

At your Hardware Store—

**ARMSTRONG BROS. TOOL CO.**

"The Tool Holder People"  
5268 W. Armstrong Ave., Chicago 30, U.S.A.



3 Turning Tools, 2 Cutting Tools, 2 Clipping Tools, 2 Knurling Tools, 2 Boring Tools, 2 Threading Tools, 2 High Speed Steel Cutters and Blades, and 2 Wrenches in Fitted Steel Case.

## For the Amateur and Professional Woodworker



15" TILTING TABLE JIG SAW

*Your*  
**SHOPMASTER SHOP**

12" DRILL PRESS

8" BENCH SAW

6" JOINTER-PLANER

10" WOOD LATHE

Your own home workshop equipped with Shopmaster tools will give you countless hours of relaxation and enjoyment. Shopmaster tools are designed and built for the professional craftsman, but are priced well within the reach of the amateur workman. Equip your shop with these tools now.

For complete information see your local dealer or write:



12" BAND SAW

## SHOPMASTER INC.

1214 THIRD ST. SO., MINNEAPOLIS 4, MINN.

SAY YOU SAW IT IN POPULAR MECHANICS



Carries the Same  
90 DAY  
GUARANTEE  
As a New  
Motor Assy.

## Our Finest Precision REBUILT MOTOR BLOCK ASSEMBLIES



\$5.00  
Crating  
Charge

### Sold Outright or Exchange

Rebuilt by skilled mechanics. Assembly has Reborn Block with New Pistons, Pins, Rings, Reground Crankshaft, all New Bearings. Guaranteed 90 Days. Allowance on Old Motor We ship at outright price. Send your motor prepaid, must be suitable for rebuilding. Send in notarized bill of sale showing title number if any. We refund difference when we receive your motor.

<b>BUICK</b>	Outright	Exch.
34-47 8 cyl.	\$199.00	\$160.00
<b>CHEVROLET</b>	Outr.	Exch.
29-47 6 cyl.	117.50	87.50
<b>CHRYSLER</b>	Outright	Exch.
35-47 8 cyl.	199.00	160.00
<b>DODGE</b> —3 1/4" bore		
35-47 6 cyl.	144.00	109.00
<b>FORD</b>	Outright	Exch.
28-31 4 cyl.	119.00	87.00
32-34 V8	139.00	99.00
35-47 V8	149.00	99.00

<b>HUDSON-TERRA</b>	Outright	Exch.
35-47 6 cyl.	\$175.00	\$135.00
<b>MERCURY</b>	Outright	Exch.
39-47 V8	149.00	99.00
<b>Oldsmobile</b>	Outright	Exch.
37-47 6 cyl.	175.00	135.00
35-47 8 cyl.	199.00	160.00
<b>PLYMOUTH</b>	Outr.	Exch.
35-47 6 cyl.	139.00	109.00
<b>PONTIAC</b>	Outright	Exch.
37-47 6 cyl.	175.00	135.00
35-47 8 cyl.	199.00	160.00
<b>Studebaker</b>	Outright	Exch.
35-47 6 cyl.	175.00	135.00
35-47 8 cyl.	199.00	160.00

We Can Supply REBUILT ENGINES, TRANSMISSIONS, REAR ENDS, etc., for Cars and Trucks. Also JEEP ENGINES. Write for Prices!

### POWER TAKE-OFF for JEEP ENGINE

Bolts to clutch housing on the Jeep engine. Has a spline shaft to engage with clutch and extending from rear is a keyed shaft on



which pulley can be mounted. Hand lever controls clutch.  
PF4N-23J—  
Each.....

\$37.50

### NEW 5 Gal. CANS

FOR GAS, OIL OR WATER Vented for Safety. Self-locking Safety Cap Extra Heavy Construction Will Float When Full Size of can, 18" high, 6 1/4" thick, 13" wide. PA35U-60— Lots of 5, ea. 1.15 Lots of 50, ea. 1.05 Lots of 100, Each 98c



SEND 25% CASH WITH ORDER, BALANCE C.O.D.

## J.C. WHITNEY & Co.

1917 Archer Ave. Chicago 16, Ill.

## Now a "10-FOOTER" with Standard Size Blade

in a Standard Size Case

A TOP QUALITY, inside-measuring rule with sturdy etched steel blade and standard size case with triple-chrome plated finish. Also made in 6 and 8 ft. lengths and metric measures.

Carlson & Sullivan, Inc.  
MONROVIA, CALIF.

SOLD BY LEADING HARDWARE STORES



CHANGE BLADE IN 10 SECONDS

Without opening the case

## CARLSON STEEL TAPE RULES

## Does Your Chevy Shift-Lever Rattle or Slip Out?

You can easily and quickly have it corrected by your dealer or you can do it yourself. Just get



## HOVE Genuine SHIFT-TITE Self Adjusting SWIVELS

Anyone can install them. Does the job permanently Takes a load off your mind because the condition may be dangerous Insures positive stay in gear shifting. It's inexpensive.

ASK YOUR CAR DEALER OR GARAGE

If they don't carry them—send \$1.50 per pair and we will mail them to you with instructions, postpaid. Don't wait—Be safe—tomorrow may be too late All models from 1940.

## HOVE ENGINEERING CO.

1108 SO. 6TH ST. • MINNEAPOLIS, MINN.

## PRICES SLASHED! ALUMINUM PIPES

\$4.50 pipe for \$1.00.

Imported briar bowl, hard rubber stem, air cooled aluminum shank. No filters required. Check or money order, we pay postage. C. O. D. orders filled on request. Write for FREE catalog of pipes and cigars.

SATISFACTION GUARANTEED OR YOUR MONEY BACK

Eddie THE CIGAR MAN

Dept. M-4, 1094 Bedford Ave., Brooklyn 5, N. Y.



## TT GAUGE Table Top MODEL RAILROAD!



LOCOMOTIVES \$12.50 to \$28.50  
FREIGHT & PASGR. CARS \$1.50 to \$5.50

Imagine a roaring locomotive in the palm of your hand . . . cars not much bigger than this ad . . . all exact scale models that operate electrically on 15/32" track. You can have a whole layout on a card table or desk. Equipment easy to build from kits, or may be obtained ready-to-run, including freight and passenger cars, steam and diesel engines, track etc. See your Hobby Dealer or send dime for illustrated circular and price lists.

H.P. PRODUCTS CO., Hartford City, Indiana

## HIGH SPEED DRILLS—TREMENDOUS SAVING

Assortment of 15 new High Speed Center Drills, fractional and numbered to 1/4", \$1.00 Postpaid.

GROOVED PULLEYS, Assortment of 4 Micarta Ball Bearing Sheave Aircraft Pulleys. Sizes 1", 2" and 2 1/2", \$1.00 Postpaid, Cash or check.

CONNER SALES CO., 917 S. Main, Ft. Worth, Texas

## BUILD ARC WELDER PLANS 35c

We Show You How to build this new powerful welder without rewinding. For light or heavy work. Uses coils taken from old auto generators. Works on 110 or 220 volts A. C. Has 20 different heats. Send 35c for complete PLANS and valuable Catalog. Write today.

LEJAY MFG. CO., 3347 LeJay Bldg., Minneapolis 8, Minn.



## Build YOUR OWN BOAT



Complete parts cut to exact size—ready to assemble. Marine water-proof plywood, hardwood frame; rustproof oarlocks. Ideal for car top carry. Also models with laminated airplane spruce frames; mahogany decked outboard motor, high speed runabouts. Build now for personal use or sale at attractive profit. Exclusive franchise to local builders. Send 10 cents (one dime) for illustrated literature today.

\$39.50  
and up

OZARKA

702 WASHINGTON AVE.  
WOODSTOCK, ILL.





# "YANKEE" VISES

*hold work through every step  
without a misstep*

Any job locked in a "Yankee" Vise, is correctly positioned for every operation . . . hand or machine. Lifts on and off swivel base at bench. Machined accurately . . . top, bottom, sides and front end . . . V-grooved block for rounds. Four sizes, with and without swivel base . . . 1 1/2", 2", 2 3/4" and 4" jaw widths. At your dealer's.



Write for  
"Yankee"  
Tool Book

**NORTH BROS. MFG. CO.**  
Philadelphia 33, Pa.

YANKEE TOOLS NOW A PART OF  
**STANLEY**  
THE TOOL BOX OF THE WORLD

GOVERNMENT SURPLUS BRAND NEW

## PESCO AIRCRAFT ELECTRIC MOTOR PUMPS

Complete with 1/4 HP Electric Motor  
Self Contained Explosion-Proof

Ideal for pumping Gasoline, Oils, Water, Liquids,  
Farms, Cottages, Basements, Laboratories, Boats.  
24 Volt Ac. or Dc. can be converted to other  
Voltage.

\$15.00 FOB Detroit, Mich.

**BENJAMIN SALES COMPANY**

8774 LINWOOD

DEPT. M

DETROIT 6, MICHIGAN



Start a NEW BUSINESS

## Sharpen Dull Pipe Wrenches

Or Add to Your Present  
Repair Business

Write for information.

**J. C. MOORE INDUSTRIES** P. O. Drawer 276  
FREDONIA, PA.



## DRILL-INDEX

A compact container for indexing and filing twist drills. Eliminates search. Made entirely of steel in ten sizes. See your dealer or write to

**HUOT MANUFACTURING CO.**  
555 No. Wheeler St. Paul 4, Minn.

Say You Saw It in  
**POPULAR MECHANICS**

## U. S. SURPLUS CLOTHING BARGAINS

For Men and Women: SAVE 1/2 on WORK CLOTHES, DRESSES,  
SHIRTS, PANTS, SHOES, ETC. Free Catalogue.

**NEW YORK CLOTHING CO.** DEPT. PM, 2079 SECOND AVE.,  
NEW YORK 29, N. Y.

## PRECISION JEWELERS SCREW DRIVERS

Complete Set of 8 for Every "Hobbyist"



At last—a complete set of precision screw drivers to meet the needs of every model builder. Not a miniature but the same type set used by U. S. Navy for precision instruments and watches during the war. Brass knurled handles, hexagon heads, finest tempered steel blades. Sizes 2-9. Never before a set of this quality and precision at such a low price. Your money back if not satisfied. C.O.D. \$2.00 plus postage or send \$2.00 and we pay postage.

**PINE WATCH CO., Rm. 40A, 29 Eldridge St., New York 2, N. Y.**



## JET PERFORMANCE FOR YOUR CAR!

**NO LONGER A MILITARY SECRET**  
During the war, simply by water injection, up to 600 additional horsepower was gained by U. S. fighter planes. Water injection also helped the P-80 Jet Plane bring back to the United States the world's speed record of 623.8 M.P.H., June 20, 1947. Now, you can have a Gazda OCTANATOR, giving you—

**GREATER ACCELERATION**  
(20% to 30% horsepower increase)

**SMOOTHER PERFORMANCE**  
(Eliminates destructive knocking)

**AMAZING ECONOMY**  
(15% to 20% more miles to the gallon)

## Gazda OCTANATOR

Patented throughout the world

For Cars,  
Trucks, Tractors

The Gazda OCTANATOR is easily installed in place of your present air filter.



- 1. MORE HORSEPOWER**  
Greater acceleration for overtaking.
- 2. REMOVES CARBON**  
Cleans pistons, piston rings, cylinder heads, valves, spark plugs.
- 3. NO MORE KNOCKING**  
Smoother performance.
- 4. LESS GEAR SHIFTING**  
More miles to the gallon.
- 5. BETTER AIR CLEANING**  
Wet-type air cleaner.
- 6. BETTER CARBURETION**  
Internal cooling.
- 7. EASY STARTING**  
Spark plugs always clean.
- 8. NO EXTRA WATER TANK**  
Fed by radiator—no hand operated; no moving parts.

**OPERATES FULLY AUTOMATICALLY - NO WATER TANK - NO ELECTRICITY**

- Standard equipment in many State and City police cars.
- Thousands of enthusiastic users.

Ask your dealer for the FREE Octanator Blue Booklet or mail this coupon today.

American Octanator Corporation  
Industrial Trust Building  
Providence, R. I. PM  
Please send me FREE Octanator Blue Booklet.  
Name \_\_\_\_\_  
Street and No. \_\_\_\_\_  
City \_\_\_\_\_ State \_\_\_\_\_

IT'S A *Gazda* PRODUCT



# DEAF NOW HEAR



with  
**WORLD'S  
Smallest  
HEARING  
AID**

**JUST  
OUT!**

**NEW 1948  
MODEL**

## With The Amazing "MAGIC SILVER CIRCUIT"

● Sensational tiny size—so small the entire unit can slip into the watch pocket of a man's trousers—yet, with a special receiver so powerful, it transmits 2 to 6 times more sound intensity than any other aids! Midget size made possible at last by great war-discovered secret—"The Magic Silver Circuit!" Try it, and you'll agree... there's no finer hearing aid!

**MAIL COUPON FOR FREE BOOK**



**BELTONE HEARING AID CO., Dept. PM-4  
1450 W. 19th Street, Chicago 8, Illinois**

Please send me, without cost or obligation, the new FREE Booklet of facts about DEAFNESS and How to Overcome It.

Name \_\_\_\_\_ Age \_\_\_\_\_

Address \_\_\_\_\_

Town \_\_\_\_\_ State \_\_\_\_\_

**IMPORTANT!** Please check hearing loss  
 Right Ear  Left Ear

The New 1948

**Beltone** MONO-PAC  
HEARING AID

MAIL  
COUPON  
TODAY

**Cushman**  
MOTOR SCOOTER  
A Real  
"EXTRA HAND"

GREAT FOR  
FARM HAULING



"The Cushman is our handiest farm helper... on the go all the time." That's what farmers everywhere are saying. Cushman is the newest in streamlined farm power. Operates for one-fifth the cost of running a truck, tractor, or station wagon. Rugged, too, has 4 H. P. Cushman "Husky" Engine, Automatic Clutch, Knee Action, 3-Wheel Brakes. Dealers Everywhere.

**FREE** Write for free folders, name of your nearest Cushman dealer and Free Demonstration Ride coupon.

**CUSHMAN MOTOR WORKS, INC., Dept. M-400, Lincoln, Nebr.**

### CUSHMAN ENGINES

For 47 years Cushman has produced high quality small air-cooled and water-cooled engines. These engines are available to original equipment manufacturers and other users. Write for details.

ASSEMBLE

King Midget



45 MILES AN HOUR

90 MILES A GALLON

Practical, safe, low cost Highway Runabout, with all the snap and looks of the finest midget track racers. Home assembly keeps cost low. Just bolt together from our factory built parts. Immediate delivery. Send 25c for complete circular with large picture, 4-view drawings, price of all parts. Or send \$1, (refunded first order) for this plus 24-page assembly book with 42 photographs and drawings, blueprints, etc.

**MIDGET MOTORS MFG. CO. Athens, Ohio**

Sand Casting — Forging — Heat Treating — Case Hardening

## BRONZE FOUNDRY



In your own workshop allows you to design and build your own GASOLINE ENGINES, STEAM ENGINES, STATUARY, ART OBJECTS, SPECIAL TOOLS, NEW INVENTIONS, ETC. You can also make forgings and case harden steel. Your shop is not complete without a FOUNDRYETTE. Three sizes are available capable of making bronze castings of 1½, 3 and 6 pounds weight, aluminum copper, brass, etc., \$22.50, \$29.50, \$42.00 f.o.b. Kansas City. Domestic gas supply and 110 volt AC or DC energy required for operation. Write for circular.

**KANSAS CITY SPECIALTIES CO.**

Box 6022, Dept. P-3

Kansas City, Mo.

**FLASHLIGHT INSPECTION LAMP ASSEMBLY**  
NEW—Govt. Surplus. Lights up the "Hard-to-get-at" places. Fine for mechanics, electricians, radio repairmen, filling station attendants, in the home, and many other uses. Plastic 12" extension (6" stiff and 6" flexible). Adjustable to any angle. Originally priced over \$4.00. Our price Postpaid... **\$1.80 Ea.**

Write for descriptive list of other Surplus Items  
**National Surplus Sales Co.** 1810 Charlotte Kansas City 8, Mo.

## RE-STRING RACKETS AT HOME

● EARN MONEY ●  
WITH THE WONDER VISE



It's pleasant, profitable work. No experience or skill required. Easy to learn. Full line of guaranteed Stringing Tools, Frames, Gut and Silk Strings. Every item high quality.

FREE Write for our 1948 Catalog and Instruction Sheet.

**W. A. BICKEL & CO.**

803 South Boulevard, Dept. A-61, Oak Park, Ill.

SAY YOU SAW IT IN POPULAR MECHANICS

## GARDEN TRACTORS

**\$146.50**  
F.O.B. Ravenna

**LATEST MODEL C  
SPEEDEX**



1½ Horsepower with cultivator 500-12 pneumatic tires, powered with Briggs and Stratton engine, and many other features. Deliveries being made now. Prices slightly higher West of Rockies.

P-248-33

WRITE FOR FREE BOOKLET

## POND GARDEN TRACTOR

BOX 216  
5821 First Ave., South

RAVENNA, OHIO  
Seattle, Wash.



**NEW! Nothing else like it!**  
**Thrilling, live 5-ft. action—**  
**Yet only 21 in. long!**

# Stubcaster

**CASTING AND TROLLING ROD**

Sensational coil spring gives full length rod action! • Shortened arc gives greater accuracy—maximum distance • Fits your tackle box—21" overall breaks to 14" • Reduces backlash! • Cast "close in" streams, overhand or underhand—no foliage interference • Cast 3 or 4 in a boat without tangling lines!  
 • Brings fish right to net; fewer losses  
 • U. S. Patents Pending!

**\$5.95**  
 without reel

Money back guarantee! If dealer can't supply, send check or money order to

**WALTCO PRODUCTS, Dept. 68-D**  
 2300 W. 49th Street • Chicago 9, Ill.

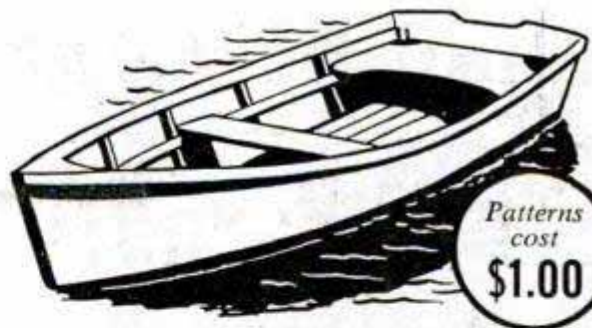

## BUILD YOUR OWN BOAT

**With EASI-BILD\* Pattern Method!**

**Easy... Inexpensive... Better!** You can build this 11½ ft. boat yourself. Just trace pattern on wood; saw, and assemble. Step-by-step directions, assembly illustrations, plus *Cascophen*, Casco's new completely durable, waterproof glue, make it easy.

Get pattern and *free* illustrated folder at your hardware store or send coupon below to:

\*Trade-Mark © 1948, East-Bild Pattern Co.

Casco Pattern Dept. PM-48,  
 P.O. Box 215, Pleasantville, N. Y.

- Enclosed is \$1.00 for Utility Boat Pattern #85.  
 Send **FREE** folder illustrating 100 patterns.

Name \_\_\_\_\_  
 Address \_\_\_\_\_  
 City \_\_\_\_\_ Zone \_\_\_\_\_ State \_\_\_\_\_

### Choose the right glue for the job!



Boats, outdoor furniture, sports equipment—joints that must withstand outdoor exposure—*Cascophen* (Resorcin Resin Glue). The first completely durable glue available to homecraftsmen.



For furniture, toys, heavy-duty home repairs—strong, stainfree, moldproof, highly water-resistant *Cascamite* (Urea Resin Glue). Mixes quickly with cold water!



For models, photo prints, labeling—general home, school, or office gluing, use the new, clean, white, fast-setting *Cascorez* (Polyvinyl Resin Glue). Liquid, ready to use!

**FOR FREE GLUING CHART WRITE:**

Casein Company of America, Dept. PM-48,  
*Makers of Casco Glue*  
 350 Madison Ave., New York 17, N. Y.  
 Please send me *free* Gluing Chart which gives full details in choosing the right glue for the job.

Name \_\_\_\_\_  
 Address \_\_\_\_\_  
 City \_\_\_\_\_ Zone \_\_\_\_\_ State \_\_\_\_\_

### NOW! YOU CAN HAVE YOUR OWN ELECTRO-PLATING Business

Plate **GOLD - SILVER - CHROMIUM, etc.**  
*It's Profitable - Simple - Pleasant*

Do as hundreds of successful men are now doing—start your own business! You can plate on metals and non-metals with the **VARI-PLATER**. Your cost is low, profits are **BIG!** Don't let this money-making opportunity go by!

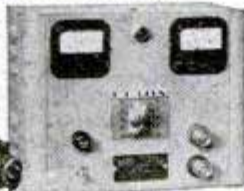

**FREE!** Write now for descriptive information and complete price list!

The **VARI-PLATER**—**\$55.00**  
 110 V. A.C., complete

**LEWIS ELECTRICAL MFG. CO.** 1266-A Gun Hill Rd.  
 New York 67, N. Y.

### New 1948 PLASTICS SUPPLIES CATALOG

Just off press. Full details on Plexiglas, Lucite, rods, sheets, tubes, Acetates, cements, dyes, buffs, molding sets, tools, carving kits, accessories. Everything in plastics. Gives prices, sizes, colors, etc. Price 10c, stamps or coin, with ad for catalog.

**PLASTICS MFG. & SUPPLY CORP.**

DEPT. M-4 • 4707 EUCLID AVE. • CLEVELAND 3, OHIO

### NU-WAY HEAVY DUTY CUTTING UNIT with Timken Roller Bearings

PRICE  
**\$16.50**  
 WHY PAY MORE



Build your own rotary type lawn or weed cutter.

Take the hard work out of weed cutting. Build yourself an up-to-date weed and lawn mower with the Nu-Way heavy duty unit.

Write for Free Circular—We Supply Cutting Unit Complete  
**TRACTOR-LITE MFG. CO., Spirit Lake, Iowa**



# BRAND NEW 7x50

Coated Lenses

## U. S. NAVY

PRISM

## BINOCULARS



COMPLETE WITH CARRYING CASE AND STRAPS, PLUS 20% FEDERAL EXCISE TAX

PRICE  
**\$95**  
POSTPAID

**SPOTTING SCOPE or MONOCULAR lens sets.** Consists of Achromatic Objective, 2 Prisms, Eye and Field Lens and diagram, all lenses are cemented. Buy 2 sets to construct a High Power Binocular.  
6 Power Set..... ea. \$5.00    11 Power Set..... ea. \$6.00  
8 Power Set..... ea. \$5.25    13 Power Set..... ea. 7.75  
27 Power Set..... ea. \$11.85

**ACHROMATIC TELESCOPE OBJECTIVE 3"** (76m/m) dia., 15" (381m/m) F.L. Magnesium-Fluoride Coated and Cemented. Mounted in aluminum cell O.D. 3 5/8". Postpaid ea. \$20.00

**ACHROMATIC TELESCOPE OBJECTIVE 1 7/8"** (48m/m) dia., 23 5/8" (600m/m) focal length, unmounted. Postpaid ea. \$9.75

**5 POWER TANK ARTILLERY TELESCOPE (M-71)** Brand New with Coated Optics. Completely assembled. Gov't Cost \$345.00. Postpaid ea. \$29.50

**WIDE ANGLE EYEPIECE 3** Perfect Coated Achromatic Lenses mounted in a Focusing Cell, 2" clear aperture, 1 1/2" E.F.L. Gov't Cost \$125.00. Postpaid ea. \$9.50

**F 1.9 ANASTIGMAT LENS SYSTEM** mounted, ideal for 35m/m Projector F.L. 91.44m/m, use also as Enlarging or Photographic Lens, etc. Postpaid ea. \$3.00

**KODACHROME PROJECTOR LENS SET** for 35m/m slides, includes Lenses, Heat Absorbing Glass and instructions. Postpaid ea. \$1.95

**LENSES, PRISMS, "WE HAVE THEM" PRICED FROM 25c UP. SEND STAMP FOR "BARGAIN LIST" OF WAR SURPLUS OPTICAL ITEMS.**

**A. JAEGER'S**

123-26P ROCKAWAY BLVD. SO. OZONE PARK 20, N. Y.



"I THREW AWAY MY OLD TOOL BOX  
When I saw this New  
**MASTER** Deluxe Model"

The Finest Tool Box Ever Made

Length 16"  
Width 7"  
Depth 7"



No. T-5016

Adjust the removable partitions in both big trays for your own arrangements of nuts, bolts, screws, pliers, or fishing tackle. Both trays are 1 3/4" deep; the top tray has cork lining. Sturdy, long-life service, heavy sheet-steel construction, continuous piano hinge, deep-drawn streamlined cover, quality chromium plated hardware. Corners are nicely rounded and the exterior is finished in latest gray wrinkle enamel, contrasting smartly with the deep green trays and interior. There's real carrying comfort in the easy-grip leather handle! It's the finest box in our 20 years of box-making. Only \$7.75 prepaid to you (\$7.85 south and west; \$7.95 Pacific Coast). At your dealer . . . or send check or money order. Master Metal Products, Inc., 277 Chicago St., Buffalo 4, N. Y.

# Manufacture for the Building Industry



Get in the Dunbrik-Dunstone business today and ride the tide of the biggest building cycle in history. It's the outstanding manufacturing opportunity in the building field, with broad market potentials and high income possibilities.

## A Wide-Open Opportunity

Dunbrik (and Dunstone) is masonry at a new peak point of colorful beauty and modern design. Easy to make in local plants, using local material and local labor. Low costs means you can give more quality for less money — even undersell lumber. We supply all necessary equipment; back you with liberal cooperation. Write today for full information.

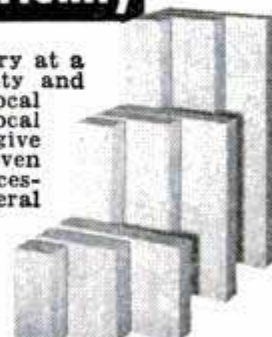

**W. E. DUNN MFG. CO.**  
600 W. 24th STREET  
HOLLAND, MICH.

# DUNBRIK DUNSTONE

## LOW PRICED STEAM CLEANER

Jenz Super Chief



Portable—No moving parts—Cleans anything — Motors — Chassis — Machinery — Floors — Buildings — Remove wallpaper — Dairy & Creamery — Oil Rigs etc. Oil fired — Economical—fully tested and warranted. 75# Steam in less than 10 min. Model 70. Complete as illustrated..... **\$276.50**

F.O.B. factory.  
**HI-PURE LABORATORIES**  
EVANSVILLE, IND.

## \$13.50 Value for Only \$1.95

8000 ohm impedance Headphones, produced to Air and Signal Corps specs. Extremely sensitive, lightweight (only 9 oz.) With 5 1/2 ft. cord, plug, jack and ear cushions. **BRAND NEW.**

No. 17A37 Plus 25c each  
Spec., Per Pair... **\$1.95** for Postage.

FREE Catalog on Everything in Radio and Electronics.



Burstein-Applebee Co. 1012 McGee, Kansas City 6, Mo.

SAY YOU SAW IT IN POPULAR MECHANICS

# DELCO MOTORS

1/75 H.P. Delco Motor—For cooling, ventilating and heating purposes. All are factory tested and guaranteed. Quiet operation. Triple rubber mountings. Horseshoe stand. 110 V. A.C., 60 Cy., 1000 C.F.M. 6 blade fan 7 1/2" — stand 6 1/4", 4 1/2" wide. Complete as shown. Shpg. Wt. 5 lbs.



No. 7014 Suction Type

No. 9272 Blower Type—Each..... **\$5.25**  
Lots of 10—Each...\$4.90    Lots of 50—Each...\$4.75  
Plus postage

## Super Charger Pump



Heavy duty super charger rotary pump designed to efficiently pump water, oil, gasoline, etc. Also used as a vacuum pump. Includes lovejoy coupling for 3/8" shaft. 1" outlet on top, 1" outlet on bottom. Size of pump 7 1/2" W. x 5" D. x 7" H. Compact and sturdy. Will pump approx. 30 gals. per minute at high speed. Four mounting holes in base. Can be used with 1/4, 3/8, or 1/2 H. P. motors. Shpg. Wt. 19 lbs. List \$48.00. **\$15.95**

No. 8536—Each.....

Send check or money order today plus postage.

**FREE CATALOG**—Send for new G. & E. APPLIANCE & PARTS CATALOG

Dept. P. M. 4

**G & E Equipment Supply Co.** OGDEN AVE. AT FULTON  
CHICAGO 7, ILLINOIS





Easy and  
Cheap to  
Operate

SAVE TIME, WORK, MONEY!

**SHAW**  
"DU-ALL"

and "PEPPY PAL" TRACTORS

**PLOW**



**CULTIVATE**



**MOW**

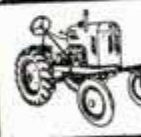

**RIDE**

**SHAW**  
MFG. CO.

These rugged walking or riding tractors ideal for farm, truck garden, orchard, poultry farm. They operate on a few cents an hour. A child can handle them.

**DO DOZENS OF JOBS**

The Shaw Du-All or Peppy-Pal does many jobs quickly and easily. Plows, cultivates, harrows, disks, bulldozes, sprays, hauls, grinds, and saws wood.

**BUILT FOR RUGGED WORK**

Sturdy, extra-strength construction means low upkeep, long life. Full year's guarantee.

**LOW FACTORY PRICES**

Buy direct or through your dealer! Almost anyone who owns a garden can afford a Shaw Du-All or Peppy Pal. Mass production holds prices down—quality up.

**RIDING TRACTORS**

4 models, from 5 to 12½ H. P., 58 in. wheel-base, 36 in. wide, 24 in. plant clearance. Hand or electric starter. Improved steering device, brakes enclosed in differential housing shaft. Heavier frame and bearings. Standard hitch for trailers and wagons. Plow, harrow, cultivator, cutter bar, snow plow, bulldozer available.

**FREE**—Illustrated folders giving complete details and price lists—write today!

4504 Front St., Galesburg, Kan.  
668-G North 4th St., Columbus, O.

**BUILDING CONSTRUCTION**



with composition cement and cheap wood builds good 3-room house for \$250; barns low as \$50.00. 100 illustrations and 100 money and labor saving suggestions. Get this newly revised and enlarged, guaranteed book before you build. \$1.00, postpaid. **SHEET METAL COTTAGES** and other buildings. Several new methods. Illustrated instructions, 50c. **FURNITURE OF COMPOSITION.** Cement, sawdust, asbestos, scrapwood, metal, etc. Ills., 50c.

**SHOP MACHINES FROM OLD AUTO PARTS:** Over 60 described, 50c. **HOME MFG. ENTERPRISE.** 50 home shop projects. Ills., 50c. Special: All five booklets described above, \$2.00 postpaid.

**HOME INDUSTRIES,** 1318 So. 30th Ave., Dept. P4, Omaha 5, Nebr.

**NEW CASTING REEL**

**Guarantees No Backlash!**

Unique new Lord Surfing Casting Reel positively guarantees against backlash through brand new patented features. You save enough in line alone during the season to pay for this amazing new reel. Elimination of birdsnests means more happy, profitable hours of fishing. Tested Lord Reels sold by mail only. Special introductory offer if you reply now. Send for free literature, today!

**LORD TACKLE CO.,** 212 Grove St., Waltham 54, Mass.



**BUILD YOUR OWN ZEOLITE WATER SOFTENER**

You can do it inexpensively with only a wrench and a little spare time. Same Zeolite process as used by other leading water softeners. Send \$1 for easy-to-follow directions and list of materials. (Materials available locally or from us.) Your money back if not satisfied.

**LAKE REGION MFG. CO.**

4184-A Xenwood Ave. Minneapolis 16, Minn.

**MAKE UP TO \$600 AN HOUR**

**DO RUG WEAVING AT HOME!**

Start a **STEADY** business of your own... **EARN BIG PROFITS** — with the **NEW DEEN ALL WEAVE LOOM** you can turn out six yards of beautiful designs every hour.

**IDEAL FOR HANDICAPPED PEOPLE.** Veterans and people unable to be active can operate this **NEW WEAVING MACHINE.** It is simple to operate.

**A SMALL INVESTMENT GETS YOU STARTED.** Original investment can be returned in thirty days. The All-Weave Loom has a capacity of forty to fifty yards a day.

**DON'T DELAY — DEMAND FOR RUGS** is greatest in history. Start your own rug weaving business **NOW!**

**WRITE FOR FREE BOOKLET** DEPT PM-100 THE GIBSON CO. 418 So. 17th St. OMAHA 2, NEBR. MAKERS OF DEEN LOOMS—FAMOUS SINCE 1895



**STOP LEAKS**  
In Concrete, Brick or Stone  
**WALLS and FLOORS**



Apply Smooth-On No. 7 Iron Cement to cracks, holes, seams and porous spots, using a trowel or stiff brush. The surface to which you apply it may be either wet or dry. In

about 24 hours Smooth-On will have set hard, sealing the leaks. It will stay in place, because it expands slightly as it sets.

Use Smooth-On No. 7 also to line cisterns, swimming pools, troughs, fountains, septic tanks, etc. Use it to seal openings where piping passes through walls.

Buy Smooth-On No. 7 in 1-, 5-, 25-lb. or larger size at your hardware store; if they haven't it, write us.

**FREE REPAIR HANDBOOK**

40 pages. 170 illustrations. Clear, simple directions for stopping leaks, sealing cracks, tightening loose parts in household equipment and autos. Every home needs this useful repair guide. Just mail the coupon for YOUR free copy.



-----**Sign and Send NOW**-----

**SMOOTH-ON MFG. CO.,** Dept. 37D,  
570 Communipaw Ave., Jersey City 4, N. J.  
Please send me a Smooth-On Handbook and Folder on #7.

Name \_\_\_\_\_

Address \_\_\_\_\_

4-48 \_\_\_\_\_

Do it with **SMOOTH-ON**  
**NO. 7 IRON CEMENT**





**You Can Make Up to \$5.00 Per Hour with the IDEAL**

There are hundreds of lawnmowers in your neighborhood that will need sharpening at least once or twice each season. You can build up a profitable business with the Ideal Lawnmower Sharpener, and earn up to \$5.00 an hour while doing it.

You need no experience to operate the Ideal Lawnmower Sharpener. Just place the lawnmower in the Ideal, make a few simple adjustments, and in a few minutes you have a smooth-running, perfect-cutting lawnmower. The Ideal is not a "make-shift" sharpener, it has 45 years of engineering design behind it, . . . is sturdily built, and grinds both straight blade and reel knives to a precision-cutting edge. Write today and learn what the Ideal Lawnmower Sharpener can do for you.

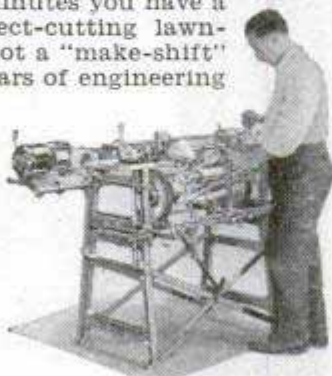

**DON'T DELAY**

**Send For FREE Book**

**The FATE-ROOT-HEATH CO.**

DEPT. D-3. PLYMOUTH, OHIO



32 DRAWER UNIT  
**\$4.95**

64 DRAWER \$8.95

*for home or shop*

**THE JIFFY all metal CABINET**

WITH LAMINATED FIBRE BOARD DRAWERS

THE HANDY WAY TO KEEP SMALL PARTS, WASHERS, NAILS, SCREWS, NUTS, BOLTS AT HAND

**DRAWER SIZE**

1 1/2" DEEP  
3" WIDE  
6" LONG

**CABINET SIZE**

32 Drawer Unit  
6" DEEP  
12 3/4" WIDE  
15 1/2" HIGH

Shipping Weight approx. 9 lbs.

64 Drawer Unit

6" DEEP  
25 1/2" WIDE  
15 1/2" HIGH

Shipping Weight approx. 18 lbs.

For small items, the low-cost Jiffy Cabinet, 32 or 64 drawer units that put office, shop, work bench, household and hobbyist needs at your fingertips. Metal flange drawer guides. Spot welded all metal cabinet with sturdy laminated drawers insures long time-saving service. Why fumble? With the Jiffy you know where it is. 32 drawer unit—\$4.95; 64 drawer unit—\$8.95. Send check or money order—No C.O.D.'s please. Ohio orders please add 3% Sales Tax. Shipping charges collect.

**KAYTEE PRODUCTS**

Dept. M, Box 588 Canton, Ohio

**ARMY FIELD Telephones**



**JOB-PROVED**

for most practical 2-way communication, indoors or out. Hundreds of uses. Compact . . . rugged . . . portable. Performance equals present-day commercial telephones . . . up to 17 miles!

Anyone can install. Just hook up terminals to any two-strand wire, or single wire and ground; several phones on same line if desired. Operates on standard flashlight batteries—no external power required. Every phone guaranteed. Two phones comprise a set—order as many as you need. Each phone complete with hand generator and self-contained ringer.

**NEW**—Leather case \$16.25 ea. Canvas case \$15.00 ea.  
**New or Reconditioned**—with cases soiled, etc. Performance equals new telephones. . . . \$10.75 ea.  
**New Field Phone Handsets** . . . . ea. \$3.75 postpd.  
**Genuine 2-strand W-110 Army Field Wire**. New. 500 ft. \$3.50; 1000 ft. \$6.50; 1/2-mile reel \$10.50; 1-mile reel \$16.00.

Write for Free Folder on Telephones

All Prices FOB Sacramento. No COD. In California, add 2 1/2% for sales tax.

Shipping weights: Phones—12 lbs. ea.; Wire—500 ft., 14 lbs.; 1,000 ft., 28 lbs.; 1/2 mile, 85 lbs.; 1 mile, 164 lbs.

**SEND CHECK OR MONEY ORDER LORIS SALES**

P. O. BOX 1896, DEPT. B, SACRAMENTO, CALIF.

**ONE-MAN SAWMILL LESS THAN \$200.00**  
**Easy To Turn Trees Into Money**

Makes lumber, ties, shingles, crates, 1st, studding.



**Belsaw Models**

in 10 to 24 foot sawing lengths.

**MECHANICAL FEED**, accurate set works and positive dogs. Use tractor or old auto engine for low cost power.

Thousands used for commercial sawing. Pays for itself quickly. Send post card today for FREE booklet, "How To Make Lumber" and Catalog of Woodworking Equipment.

**BELSAW MACHINERY CO.**, 811-C Field Bldg., 315 Westport Road Kansas City 2, Mo.

PATENTS

TRADEMARKS

*Patrick D. Beavers*

REGISTERED PATENT ATTORNEY

929 COLUMBIAN BUILDING

416 5TH ST. N.W.

WASHINGTON 1, D. C.

**DUAL TAIL PIPE EXTENSION**

Fits all cars — chrome plated

**DEEP TONE**

produced by 2 1/2 inch outlets

Postage free on prepaid orders

DEALER INQUIRIES INVITED

**\$2.95**



PAT. PEND.

**LYONS PRODUCTS COMPANY**

2319 Ridgeley Drive, Dept. PM4, Los Angeles 16, Calif.

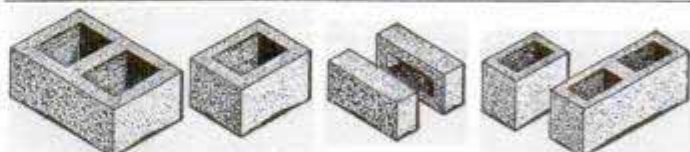

**Make Concrete Blocks and Bricks**

New superior method makes square, true, easy-to-lay units which will pass any building code. Small investment, high production, big profits. One \$30.00 machine will make four 5"x8"x12" blocks per minute. Pays for itself in a few days. Sell blocks or save 2/3 building cost by making and laying your own.

POST CARD BRINGS FREE FOLDER

**Economy Manufacturing Company**  
**Dept. P Stone Mountain, Georgia**



## AIR COMPRESSOR AT A BARGAIN

Piston type, size 2 x 1 3/4, head in valves, bronze bearings, splash lubrication, "V" Belt drive, intake muffler and cleaner. Capacity 2.8 c.f.m. at 100 lbs. continuous pressure or 150 lbs. intermittent, with 1/2 HP motor. Can be used with 1/4 HP or 1/8 HP at lower speed. Weight 14 lbs. Operating instructions furnished.

Immediate delivery. **\$17.95**  
Price only

### AUTOMATIC PRESSURE SWITCH WITH UNLOADER



125 to 150 lb. Pressure. Use with 1/4 to 5 HP Unit.

Only **\$8.95**

- 1/4" air check valve... \$2.50
- 1/2" air check valve... 4.25
- 2 1/2" air gauge, 160 lb. 1.75
- 1/4" safety valve, 125 lb. .... 1.50

Prices are F.O.B. Chicago. Immediate delivery. **SOLD ON MONEY BACK GUARANTEE.** Send check or money order today.

DEALERS - WRITE...  
**C & M EQUIPMENT COMPANY**

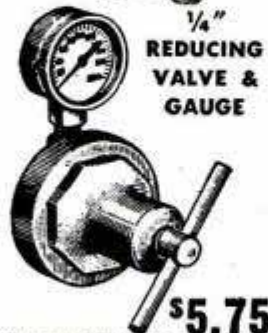
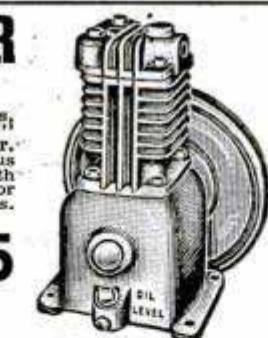

1/4" REDUCING VALVE & GAUGE

**\$5.75**

Oil resistant, pressure 0-to-200 lb. Reduced pressure 0-to-75 lb.; 3 outlets 1/4". Wt. 2 lbs.

1831 S. State St., Dept. D-4, Chicago 16, Ill.

## Ball-Bearing SPEED WHEELS



Juvenile wheels, solid tire—No Bearings

- 7" wheels ..... 60c
- 6" wheels ..... 50c
- 4" wheels ..... 30c

Semi-pneumatic tired wheels

- 12 x 1.75" ..... \$3.25
- 10 x 1.75" ..... \$2.75
- 10 x 1.25" ..... \$2.00
- 8 x 2" ..... \$2.00

Industrial wheels for heavy loads

- 400 x 8, 2 ply tire and tube .... \$12.50
- 12 x 3.00", bolt hub, ea. .... \$9.75
- 10 x 2.75" Hollow Core ..... \$6.75
- 10 x 2.75" Single Tube ..... \$7.25
- 8 x 2.50" ..... \$4.90
- 6 x 2" lug base ..... \$3.30
- 6 x 2" ..... \$2.80

DEALERS WANTED  
MANUFACTURERS  
INQUIRIES INVITED

Free blueprints with all wheel orders.

Send check with order. Shipments f.o.b. Akron.

## JIM BROWN TOY COMPANY

1097 Home Ave.

Akron 10, Ohio

## NO WOODWORKING SHOP COMPLETE Without the

### Electric WONDER PEN



Costs so little, yet enables you to put magiclike professional finishing touches, borders, decorations, etc. on whatever you make. Six interchangeable points for etching (woodburning), embossing, cutting, shading, hole cutting. Simply plug in and use. Guaranteed. Pays for itself the first time used. Complete professional kit in wood chest. Only \$2.25, postpaid.

AMERICAN T. & F. CO., 6130 N. Clark St., Dept. 148, Chicago 26, Ill.



BE FAIR  
TO YOUR  
Hair

**WAKE UP YOUR SCALP** Want better looking hair? Embarrassed by falling dandruff, itching scalp? Then try VITABRUSH, new electric driven scalp brush that gives your scalp a vigorous and invigorating "workout" in just three minutes of fun. Cleans scalp. Stimulates blood supply. Restful. Pleasant. Write today for complete information and satisfaction-guaranteed offer. Hershey Mfg. Co., 3767 Field Bldg., Chicago 3.

1947  
National  
League  
Batting  
Champion

Harry Walker

1947  
American  
League  
Batting  
Champion

Ted Williams

## THE Signatures OF THE CHAMPIONS

ARE FOUND ONLY ON THE BAT OF THE Champions

The 1948 edition of H & B's Famous Slugger Year Book is ready now. Get your copy from your Louisville Slugger dealer or send 5c direct to us (stamps or coin) to cover mailing. Address Dept. P-31, Hillerich & Bradsby, Inc., Louisville 2, Ky.

# LOUISVILLE SLUGGER BATS

**SAVE \$5** Genuine Quality Dress Trousers

## GABARDINE

\$6<sup>95</sup> PR.

\$11.95 VALUE! Order by mail and SAVE! Firmly woven virgin wool and fine-spun rayon. Twill weave resists wrinkles. Holds crease, gives amazing wear. Expert fashion tailored for perfect fit. Zipper front. Roomy pockets, bar-tacked for double strength. Blue, Tan, Sand, Lt. Brown, Dk. Brown, Blue-Gray. WAIST SIZES: 28-36 pleated—38-44 plain. SEND NO MONEY Send name, waist size, color. Pay postman only \$6.95 plus C.O.D. Or, send money and save C.O.D. Money-Back Guarantee!

LINCOLN TAILORS

Dept. PM-4  
Lincoln, Nebr.



# Portable Paint Sprayers

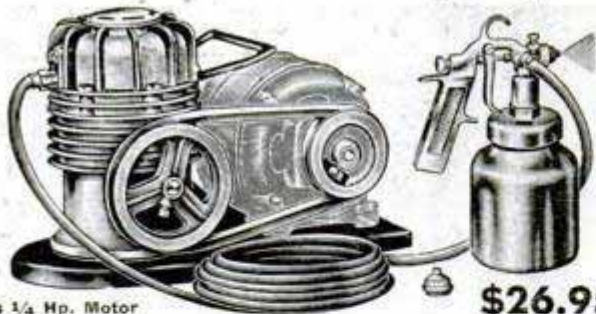

Uses 1/4 Hp. Motor

**\$26.95**

Complete as illustrated, less motor. Sprays all kind of paint, lacquer, varnish and etc. Oil-less ball bearing compressor. 2 cu. ft. air per minute. 15 to 50# pressure. Sprays paint 5 times faster than hand brushing.

**No. 890**—Outfit complete as shown, with "V" belt, motor pulley, 15 ft. high test air hose and No. 112 gun, but without motor. **\$26.95**

### Spray Guns—Low Pressure

Operate on 15 to 50# pressure  
 #115—1 pt. cup ..... **\$4.95**  
 #112—1 qt. cup ..... **6.50**  
 #121—Production type .. **7.95**  
 #125—External mix ..... **9.50**  
 Regulator & Gauge 0 to 160# **4.95**  
 Air Filters ..... **1.85**  
 Air Hose—15 ft. .... **1.75**  
 Air Hose—25 ft. .... **2.75**  
 3 Gal. Paint tanks, with hose, reg. and gauge ..... **24.95**  
 Less reg. and gauge. .... **17.50**

**No. 444**—Outfit, twin cyl. 4 cu. ft. production type gun. 15 ft. air hose, reg. and gauge. V belt and motor pulley. Complete less motor. **\$47.50**. Uses 1/2 Hp. motor.

**HOME UTILITY BLACK & DECKER DRILLS**—110 AC-DC—With Jacobs Hex Key Chuck—Pistol grip, 1/4", 2250 rpm. **\$18.95**  
 1/2" 375 rpm spade grip **\$35.95**

Bargain prices on motors, all sizes.

**SPECIAL**—Auto engine paint sprayer complete with gun ..... **\$4.85**

WE STOCK NATIONALLY ADVERTISED MERCHANDISE ONLY. MONEY BACK GUARANTEE WITH EVERY ITEM SOLD.

Immediate delivery — check or M.O. shipped prepaid, cod's plus chgs.

## INDIANA APPLIANCE CO.

20 East Sycamore Dept. PM448 Evansville, Ind.

# MASTER CRAFTSMEN use these finest fillers!



- SAVES TIME
- SMOOTH TEXTURE
- EASIER TO WORK
- SHRINKS ONLY 1%
- STAYS IN

FOR a perfect surfacing job on wood, metal or plastic—use the expert's choice—Duratite. Easy to use—faster—shrinkage is so slight, it fills completely in just one application—stays in! 7 wood colors. Ask your dealer or send for large tube.

### WEBB PRODUCTS COMPANY

228 S. G. St., San Bernardino, Calif.

Enclosed find 25c, send large tube Duratite Wood Dough.

Name \_\_\_\_\_

Address \_\_\_\_\_

City \_\_\_\_\_ State \_\_\_\_\_



# TOOL STEEL DRILL ROD

**\$1.95** POSTPAID in Continental U.S. C.O.D.'S ACCEPTED

25 RODS **SAMPLER KIT** 25 SIZES

Ground and Polished to a Perfect Finish

1001 Uses for Craftsmen, Hobbyists, Mechanics, etc.

For Making Punches, Chisels, Engraving Tools, Shafts, Etc. Free machining, easily worked, yet can be made file hard or hardened to spring temper. Hardening instructions included!

**FREE**

With Every Kit or first order 6" Steel comb, rule and depth gage with pocket clip and latest price list.

### FLAT TOOL STEEL

The Precision ground flat tool steel with the satin-smooth finish. Simple to work, easy to harden, ready to use.

SHOP ASSORTMENT ..... **\$4.80**  
 5 dif. Pieces—1 3/32" to 1 7/8" thick 1 1/2" wide; 18" long.

**BOTH KITS — \$6.50**

Complete ALUMINUM—BRASS—STAINLESS and TOOL STEEL Stocks Include 25c postage on orders under \$5.00.

**BESSEMER STEEL COMPANY OF AMERICA, Dept. FC-16**  
 1958 W. 59th St. Chicago 36, Illinois

# OTTAWA POST HOLE DIGGER

THERE IS NO OTHER LIKE IT!

The digger you have been waiting for. Quick hitch to any tractor with power take-off. Fastest power auger return. Hi-speed two flight auger. Strictly one-man machine. Write today for up-to-the-minute digger facts and low prices.



**OTTAWA MFG. CO., 5-827 Elm St., Ottawa, Kan.**



NOW WILL YOU ADMIT YOU COULD USE A HULL AUTOMOBILE COMPASS TO MAKE SURE OF THE RIGHT TURNS?

Beaconlite illuminated. **\$5.95**;  
 Streamline. **\$3.95**. At your dealer's. Write for illustrated literature.



**HULL MFG. CO., P. O. Box 246-D4, Warren, Ohio**

# ACCURATE TARGET SHOOTING

Indoor or Out

AT LOWEST COST

**Boone AIR TARGET PISTOL \$3.95**

including 150 standard BBs.

9 3/4 in. long. Solid aluminum grip and body; rustless steel barrel. Postpaid if prepaid, or send \$1, with \$2.95 plus postage COD.

**PRECISION SPORTS PRODUCTS, Parma 2, Mich.**



# INVENTORS

Whether an invention is patentable can be substantially determined by a search of the U. S. Patent records. Without obligation, write for information explaining the steps you should take to secure a patent.

## JOHN N. RANDOLPH

Registered Patent Attorney

201 Columbian Building, Washington 1, D. C.

# RACING CAR EQUIPMENT FOR ALL CARS

Engines, Racing Heads, Manifolds, Carburetors, Mufflers, etc. Speed Instructions and literature \$1.00—refunded first order.

**LEE MOTORCRAFT CO.**

1412 Great Northern Bldg.

Chicago, Ill.

SAY YOU SAW IT IN POPULAR MECHANICS

# BURIED TREASURE, MINERALS AMAZING NEW GOLDAK LOCATORS

**SENSATIONAL NEW MODEL!** ONLY 11 pounds weight! One hand operation! Money-Back Guarantee of Superiority. Write for full details.

## THE GOLDAK CO.

1542 WEST GLENOAKS BLVD. GLENDALE 1, CALIFORNIA

World's largest maker of fine locators.





**KAYAKS**  
**AQUA V-18**  
*Easy to Build*  
**OUTBOARDS ROWBOATS**  
**25¢ COIN FOR ALL THREE**  
**V-23 CRUISER**  
 Length 23 Ft.  
 Beam 7 Ft., 10 In.  
 Draft 14½ In.  
 Sleeps Two. Open or With Cabin.



**AQUAMOBILE V-18**  
 Designed for Auto Engines. Open or with cab. Length 18 ft. Fast VEE Bottom Hull.

Established 1928 — Manufacturers **U-MAK-IT KITS**  
**KAYAK BOAT CO.** 703 P. WHITTIER ST. NEW YORK 59, N. Y.

**BARGAIN IN WIRE!**  
 1,320 feet of spiral four telephone cable, 4 conductor stranded all-copper (approx. #17 AWG), rubber covered, about 1/2-inch diameter overall; 193 lbs. wt.  
 Ideal for light power, sound systems and telephone purposes.  
 Surplus, used, excellent. FOB Louisville, Ky.: \$25.00 each reel; 12 or more, \$20; 100 or more \$17.50.

**ELECTRONIC SERVICE COMPANY**  
 431 West Jefferson Louisville 2, Kentucky

\$17.50 for 1/4 mile.

**SWISS MUSICAL UNITS**

Ready to install in your own musical box. Choice of Waltz, Operatic, or Classical Selections.

**\$3.75 EACH**  
 Postpaid if cash with order. Literature on request.

**A. & R. MUSIC BOX CO.**  
 5828 Third Ave., N.Y.C. 16

(Agents Wanted)

**BUILD YOUR OWN FAST FREEZER** PLANS \$1

It's easy to build this household appliance with LeJay Plans. Made from new or used parts. Save up to 75%. No expert knowledge needed. Plans show 5 sizes and are easy to follow. All details clearly explained. Enjoy making one of these freezers. Mail \$1 for set of plans and catalog. **LEJAY MFG. CO.**, 447 LeJay Bldg., Minneapolis 8, Minnesota



5 sizes 8 to 40 cu.ft.



**"JITTERBUG— the greatest bass getter"**  
 "Fred Arbogast Co.: I can't resist showing these bass I caught on your Frog Jitterbug. It took just two hours. In the string are one 6-pounder and two 5-pounders. Smallest was 3½ pounds. Later I caught 29 large-mouth bass in two weeks' time — all on the same Jitterbug. They weighed 84¾ lbs. Jitterbug is the greatest bass getter on the market — a bait I shall never be without."  
 — John D. Sullivan, Tow, Texas.



Frog Jitterbug \$1.21 ea.  
 Choice of 6 colors. At your dealers. Write for Interesting, Free Catalog.  
**FRED ARBOGAST & CO., INC.**  
 1624 North St., Akron 3, Ohio

**DEEP TONE** **DUAL MUFFLERS** **LONG LIFE**

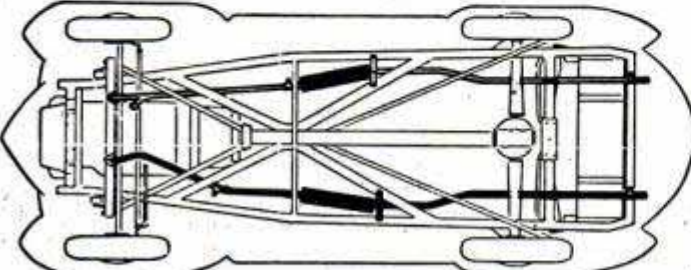

● More Horse Power ● Blow - Out Proof  
 ● Better Gas Mileage ● Straight Thru Mufflers

**FORD & MERCURY DUAL SETS ...\$20.00**  
 C.O.D. - F.O.B. Los Angeles Order by Year and Model  
 No Welding, Cutting, Drilling of Holes.  
 All Fixtures Furnished Rubber Insulated Clamps

DEEP TONED Ford, Chevrolet, Ply. \$4.86  
 SINGLE MUFFLER All others \$5.50  
 2½" CHROME TAIL PIPE TIPS \$1.75

**Advance Mufflers** 6800 SO. VERMONT AVE. LOS ANGELES 44, CALIF.

1935 TO 1947—V-8 FORD AND MERCURY ONLY



"MASTER Streamline gives me quick, accurate measurements"



Says Mr. Larry Klohs

36 Van Wort Ave., White Plains, N. Y.

"Streamline proves indispensable for the many measurements I make on the job and in my home workshop"

Mr. Klohs, a master carpenter, knows the value of a dependable, accurate measuring instrument. He chooses Streamline for its superior features, attractive appearance, and sturdy design. Graduations on both sides of blade, lever brake for holding reading, inside-outside measure.

You can own the Streamline, outstanding in its class, by asking for it at your hardware dealer, or by using the coupon.



Master Rule Mfg. Co., Inc., Dept. PM-4  
201 Main Street, White Plains, N. Y.

Gentlemen:  
I enclose  \$2.00 for the 6 ft. Streamline.  
I enclose  \$2.50 for the 8 ft. Streamline.

Name.....  
Address.....  
City.....State.....

## FOREDOM FLEXIBLE SHAFT MACHINE

only \$19.95

with PENCIL SIZE HANDPIECE for Finger-Tip Control

Works effortlessly and with marvelous ease. Tens of thousands of users attest to its innate superiority over other small grinders. Affords you vastly more satisfaction and fun.

### 5 REASONS WHY FOREDOMS ARE TOPS IN THE FIELD:

1. Extra power and longer motor life because motor not dwarfed to fit hand. 2. Correct handpiece size for deft, sensitive, finger-tip control. 3. No obstructed view of your work. 4. Freedom from gyroscopic action—hence better work. 5. Small handpiece size lets you get into hard-to-reach places.

### Hundreds of Uses

Foredoms handle hundreds of tasks. Use them for pleasure or profit, for tinkering or expert craftsmanship. Their versatility is unlimited. Use them to grind, polish, mill, engrave, sharpen, slot, rout, saw, carve, clean, sand, etch, cut, etc. Ideal for internal carving of plastics, the astounding new craft. You can work on wood, glass, plastics and all metals with a Foredom.

### OVER 60,000 FOREDOMS NOW IN USE

The power grinder you'll eventually buy if you want true operating ease and results which genuinely satisfy. Foredom's quarter century experience in building fine tools for home and industry is your assurance of superior performance.

Order your Foredom today, direct on 10-day trial. Send check or M.O. for \$19.95 (price not increased since OPA) and we send postpaid in U. S. or send \$2.00 and you pay postman balance plus postage. 50-piece accessory set \$1.50 extra. Catalog on request.

FOREDOM ELECTRIC COMPANY, Dept. F-115  
27 Park Place New York 7, N. Y.

NOW—Dado any width with a SINGLE adjustment!



For arbors 1/2" to 1 1/8". Specify size wanted.

DA-DALL all-steel dado attachment adjusts to any desired width with single, convenient screw. Positive, safe. Balanced; can leave on arbor at all times. Simple, easy to install. Makes clean dados with your present saw blade in plywood, hard woods. Permits fast ripping with crosscut blade! Standard duty for saws up to 10" diameter, \$4.75; Heavy Duty (mang. bronze) for saws over 10" diameter, \$8.75. Money back guarantee. Order today (send check or money order; no c.o.d.'s please) or write for free pamphlet. (California buyers, add 2 1/2% sales tax.) Dealer inquiries invited.

### PACIFIC COAST TOOL CO.

1711-A Webster Street • Oakland 12, California



### POWERDRILL CONVERSION

LITE-SAW converts most stand. 1/4" drillmotors to 6" circ. port. saw. Complete kit, ready to attach \$19.50 postpaid. ORDER NOW. Write for literature. DEALERS WANTED:

FUTURE PRODUCTS CO.  
3625 N. Mississippi Ave.  
Portland 11, Ore.



### AMAZING BENCH KNIFE CUTS ANYTHING

My famous handmade Buck knife has a blade that's tempered by a secret process to last a lifetime. The edge is ground to razor sharpness—cuts anything. Handiest tool on your work bench. Ideal for small game. Send check or money order. Satisfaction guaranteed or your money back. \$5 postpaid.

H. H. BUCK & SON  
1272 Morena Blvd., San Diego, Calif.

### Even Cuts Bolts With Out Hurting Blade

3 1/4" blade, 7" overall. Finest lucite handle in black, red, blue or green. Rugged saddle leather sheath included.

### COMMON SENSE..

proved thousands upon thousands of times!

### ALL-VEGETABLE LAXATIVE



● In NR (Nature's Remedy) Tablets, there are no chemicals, no minerals, no phenol derivatives. NR Tablets are different—act different. Purely vegetable—a combination of 10 vegetable ingredients formulated over 50 years ago. Uncoated or candy coated, their action is dependable, thorough, yet gentle, as millions of NR's have proved. Get a 25¢ box. Use as directed.

Nature's Remedy  
NR TO-NIGHT TOMORROW ALRIGHT



QUICK RELIEF FOR ACID INDIGESTION



# New

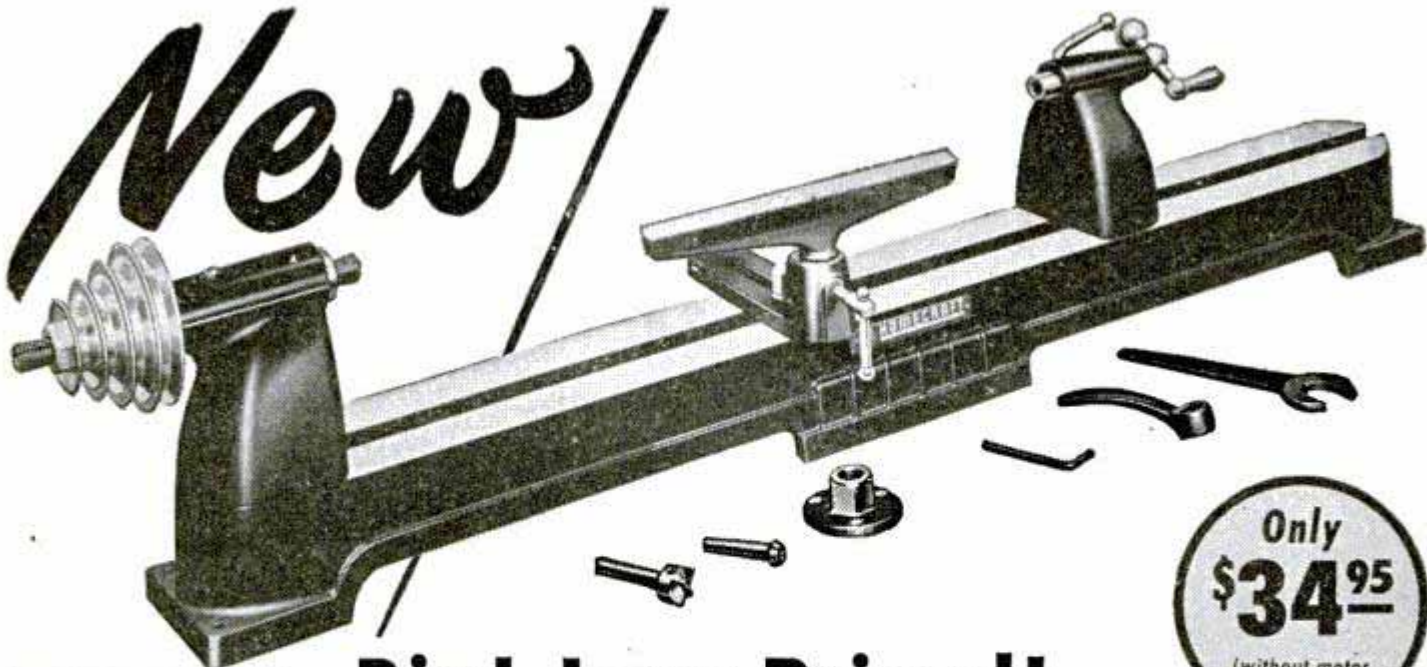

Only  
**\$34<sup>95</sup>**  
 (without motor  
 or pulley)

## Big! Low-Priced! HOMECRAFT® 10-inch Lathe

No. 46-110

Designed specifically to satisfy hobby-shop requirements, this lathe is a real value for the money!

You find many uses for this low-priced No. 46-110 Homecraft 10-inch Lathe — turning wood, light metals, and plastics. It handles 36 inches of stock between centers; swings 10 inches over the bed.

It is heavy, rigid, smooth-running. With this versatile tool, you get more pleasure in making furniture, lamps, toys, games, novelties, and other interesting objects.

### A Tool You're Proud to Own!

The Homecraft 10-inch Lathe is a really good, popular-priced tool that is exactly suited to your home woodworking needs.

It's as fine a lathe as can possibly be built for the money! Look at some of the features that are included:

- Built-in indexing mechanism in headstock has double row of holes — 8 holes and 60 holes — for maximum number of divisions. Index pin engages either row.
- Spindle is carried on oil-impregnated bronze bearings which provide long, trouble-free service and smooth operation.

- $\frac{3}{8}$ " hole in spindle permits repetition work and use of long-rod stock.
- All thrust is absorbed by a sealed-for-life ball bearing.
- Head and tailstock use No. 1 Morse taper accessories.
- Nose of spindle is right-hand threaded for chucks, face plates, etc. Outboard end is left-hand threaded for large turnings and face-plate work.
- Carefully-ground ways, front and back, provide sturdy base for locking headstock, tailstock, tool support base, and accessories.

### See It At Your Dealer!

Ask your Homecraft dealer to show you this new No. 46-110 lathe, and his complete display of Homecraft Power Tools that range in price from \$29.95 to \$41.95.

Visit your Homecraft dealer now!

**HOMECRAFT®  
 POWER TOOLS**

General Sales Office • Chicago 2, Ill.

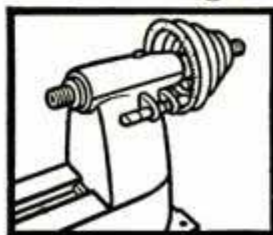

Husky headstock drives from either bottom or rear. Machined for No. 1 Morse taper. Indexing mechanism is built in.

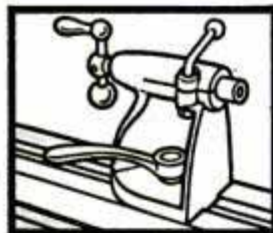

Substantial tailstock locks to bed with convenient hand lever. Centers are self-ejecting — machined for No. 1 Morse taper.

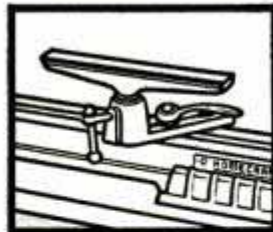

Above: Tool support locks quickly and firmly to groundways of lathe bed. Provides secure support for tool rest.

Below: Cast-iron bed is heavily ribbed, to prevent any warping or "give".

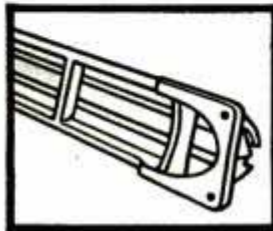

## HOMECRAFT POWER TOOLS

are built by the makers of Delta-Milwaukee\* Power and Machine Tools — the tools with a widespread reputation for safety, accuracy, and dependability, in factories and schools, as well as home shops.

If your goal is a shop equipped with power tools that embody the most advanced principles of engineering, design, and construction, then be sure to insist on reliable Delta-Milwaukee Power Tools.

Descriptive Literature! Shows all Homecraft Power Tools and accessories. Sent to you free. Use coupon, for your copy.



**Tear out coupon and mail today!**



DELTA MANUFACTURING DIVISION  
 Rockwell Manufacturing Company  
 681D E. Vienna Ave., Milwaukee 1, Wis.  
 Please send descriptive literature  
 on Homecraft Power Tools.

Name.....  
 Address.....  
 City..... (.....) State.....

HM-57

\*Trade Mark Reg. U. S. Pat. Off.



LOOKIT! HARD-TO-GET ITEMS -- AT EASY-TO-PAY PRICES!

# SUPER SAVINGS! WAR AND OTHER SURPLUS!

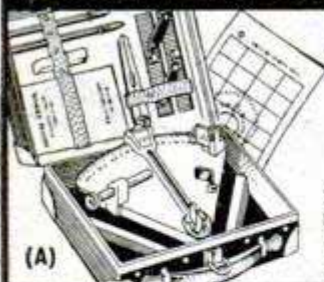

**U.S. Maritime  
LIFEBOAT  
SEXTANT  
\$14.95**

Plastic sextant, caliper, parallel triangulator, plotting charts, instructions, pencils, eraser—all in sturdy fibre case!



**(B) Guaranteed  
15-JEWEL  
WATCHES  
\$15**

Fed. tax included  
Luminous dial. Waterproof. Stainless steel case. Sweep second hand. Swiss movement. Choice of black, white, pink dial. Steel stretch band included.



**(C) AAF Type Sun Glasses  
\$2.50**

Scientifically ground & polished. True green. Plastic nose piece, sweat bar. Case included.

**AEROSOL BOMBS  
(D) \$1.00**

Sprays 1000 cu. ft. in 4 seconds. Non-inflammable; non-toxic. Full 16 oz.

**(E) Army #3  
SASH TOOL BRUSH  
50¢**  
Painter's pal! 10 inches long. Selected pure bristles. Polished wood handle.



**100% Wool Navy Blue  
TURTLENECK  
SWEATERS  
\$3.50**

Closely knit for snug fit! Sizes 34 to 44. A wealth of warmth, wear and style!



**(G) NAVY  
GOB HATS  
2 for \$1.00**

Swell for school and camp! Choice of gray or white heavy drill. Small, medium large.



**ARMY  
CARTS  
19.95**

Ideal for farms, gardens, industrial use. Steel reinforced. Back drops for unloading. Legs fold flat under handles. Comes knocked down—assembles easily!

Length 91 in. Wheel diameter 48 in. Wgt. 225 lbs. F.O.B. Williamsport, Pa.

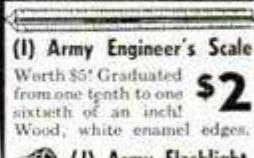

**(I) Army Engineer's Scale  
\$2**

Worth \$5! Graduated from one tenth to one sixteenth of an inch! Wood, white enamel edges.



**Adjustable  
ELECTRIC  
LAMP  
\$2.00**

For drafting, work bench, home study. Heavy metal tubing 4-way swivel. 14-in. reach. Heavy-duty clamp. 10 ft. of heavy cord.

## STAR SURPLUS SPECIALS FOR CAMPERS!

## ORDER DIRECT FROM THIS AD!

Send check or money order. No C.O.D. orders. Orders must total \$1 or more. For orders outside U.S. and possessions, add 25% for special packaging. Order items by key letter. Specify size and color where necessary.

On items B,C,E,G,I,J,L,Q, add 10¢ postage east of Mississippi River, 20¢ west of Miss. On items D,F,N,O,R, add 20¢ east; 40¢ west. On items A,K,M,P, add 50¢ east; \$1 west.

**BALTIMORE LUMBER  
Company  
War Surplus Division Dept. M  
418 N. HOWARD ST., BALTIMORE 1, MD.**

**Army Watch Compass  
Highly polished brass snap-open case. Radium-painted needle for night use!  
\$1**



**(P) ARMY  
PUP TENTS  
\$3.95**

Comes in 2 halves. Poles included! Plenty of room for 2 campers! Buy two, put 'em together, and sleep 4! As good as new!

**SLEEPING BAGS — \$15**

Army officer's type! Kapok-filled. New OD poplin. 6 1/2 ft. long, 106-in. zipper.



**(M) OFFICER'S CANVAS BEDROLL & RECON. ALL-WOOL ARMY BLANKET... BOTH FOR \$7.50**  
Bought separately, \$4 each

**(N) NEW NAVY MESS TRAYS...\$1**  
**(O) USED NAVY MESS TRAYS...50¢**  
Stainless steel; 6 compartments

**(Q) NAVY 7-INCH HUNTING KNIFE  
\$1**  
For hunters, fishermen! Worth \$6! Tempered steel, gunmetal finish. Leather sheath free!



# ELECTRICITY FOR ANY JOB, ANYWHERE!

- LIGHT & POWER for**
- Homes
  - Shops
  - Farms
  - Cabins
  - Boats
  - Industry



**Many Models and Sizes**  
Enjoy modern conveniences... profit by using time and labor-saving electrical equipment. Gasoline and diesel-powered models. Air or water cooled. Shipped complete. Low-cost, easy to install.  
**Stationary, Portable, Standby**  
A.C. Models: 350 to 35,000 watts.  
D.C. Models: 600 to 15,000 watts.  
Battery Chargers: 500 to 6,000 watts.  
**D. W. ONAN & SONS INC.**  
2540 Royalston Ave. • Minneapolis 5, Minn.

Model 103BH-1R  
1500 watts A.C.

Write for Folder



**ELECTRIC PLANTS**

## BE SMART! BE THRIFTY!

Put a rugged WHIZZER Motor on your bike—your own personal power transportation for pennies a day. 125 miles on a gallon! 2 1/2 horsepower, 4-cycle auto-type engine!



**ONLY \$97.55** PLUS TAX  
F.O.B. Pontiac, Michigan  
★ Precision engineered for long life.  
★ Complete with all necessary attachments.  
★ 3,500 Whizzer Dealers, at your service.



Your Whizzer Dealer is as near as your telephone... or write Whizzer Motor Co., Pontiac, Mich.—world's largest bike motor builder.



# New Revolution in Hearing Aids

The new Zenith "75" comes to you by mail! No "fitting," no sales pressure. Hear better or your money back in full!

Single Unit  
\$75 Complete

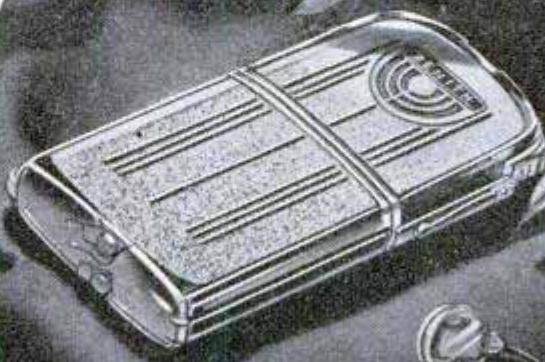

NEW *Zenith "75"*  
THE HEARING AID THAT NEEDS NO "FITTING"



**A**T LAST—your opportunity to discover how much a hearing aid can mean in your life... without embarrassment or inconvenience, without exposing yourself to high pressure salesmen, without risking a penny!

All made possible by this improved *kind* of hearing aid that needs no "fitting." Because it employs Zenith's "Full-Range Audio" principle, designed to amplify the *full range* of sounds covered by the instrument. Thus you, yourself, can instantly select the particular range that enables you to hear best in different surroundings—with Zenith's Fingertip Control! The correctness of this principle was recently confirmed in U.S. Government-sponsored research at Harvard University.

## Revolutionary Money-Back Trial

Because the Zenith "75" needs no "fitting"—is so advanced in performance—it is the *only* hearing aid that comes to you by mail with this sensational guarantee:

Wear it at home, at work, at movies, anywhere. **COMPARE ITS QUALITY, PERFORMANCE, OPERATING ECONOMY** (less than 1¢ per hour battery cost) with that of **ANY** other hearing aid. If the Zenith "75" does not excel on **ALL** counts... if it isn't better than you

ever dreamed **ANY** hearing aid could be... return it within ten days of receipt and get your \$75 back in full!

And because it comes to you by mail, the Zenith "75" also saves you over \$100! If its price had to include "fitting," middlemen's profits and high sales commissions, this top quality hearing aid would have to sell for \$195, instead of \$75. So do as tens of thousands have already done. Order your Zenith "75" and find new happiness, new zest for living. You owe it to your family, friends and business associates. Use the convenient coupon below.

BY THE MAKERS OF THE WORLD-FAMOUS ZENITH RADIOS

Look only to your doctor for advice on your ears and hearing



-----MAIL THIS COUPON TODAY-----

Zenith Radio Corp., Hearing Aid Division, Dept. PM-48  
5801 Dickens Avenue, Chicago 39, Illinois

I enclose check or money order for \$75\* for one Zenith "75" Hearing Aid. If I am not completely delighted, I may return it within ten days after receipt and get my money back in full.

\*PLUS TAX OF \$1.50 FOR RESIDENTS OF ILLINOIS OR NEW YORK CITY; \$1.88 FOR RESIDENTS OF CALIFORNIA, EXCEPT LOS ANGELES, \$2.25.

Please send me free descriptive literature about the new Zenith "75."

Name \_\_\_\_\_

Address \_\_\_\_\_

City \_\_\_\_\_ State \_\_\_\_\_



You Can't Catch Fish *Untangling*  
BIRDS' NESTS



EVERY CAST BACKLASH-FREE  
with *Shakespeare's* WONDEREEL

CASTING SKILL'S BUILT IN Shakespeare's amazing WONDEREEL. No backlashes to spoil your fishing fun. No untangling birds' nests. Only Wondereel gives you this great fishing advantage. The reason is an exclusive, light-weight spool and patented, spin-controlling bearings. After 5 minutes practice, even beginners get long, accurate casts. Get Wondereel at any sports store.

FREE TACKLE BOOK and pocket fishing calendar. Reels, Rods, Lines, Accessories, Fishing Tips. Mail coupon.



Shakespeare Company  
Dept. 84, Kalamazoo 2, Michigan  
Send me your Free Tackle Book and Pocket Fishing Calendar.

Name .....  
(Please write address and zone no. below)



Here's the Outstanding  
Value in Target  
Pistols

The Crosman

"Bullseye" Adjustable  
"power without

powder" for accuracy with safety indoors and out! No noise, no recoil, no odor, no cleaning! Perfect balance! Rifled barrel! Fine gunsmithing! Low cost! THAT'S what you get in this new .177 cal. single-shot pistol of regulation target type and weight. Shoots Crosman Super-Pells at 1/4 cent per shot. No wonder they say no other pistol provides so much fun at such small cost. At your sporting goods or hardware dealer's . . . or write direct.

Crosman *Silent* RIFLE



. . . most amazing gun ever invented for target shooting indoors or out and for small game! Adjustable "power without powder" . . . no noise, recoil, odor or cleaning. Rifled barrel. Shoots low-cost Super-Pells. .177 or .22 cal. single-shot or magazine models. At your dealer's . . . or write direct.

**CROSMAN ARMS CO., INC.**  
3 HENRIETTA ST. • ROCHESTER 7, N. Y.

**STOP  
CHANGING!  
MOTOR OIL!**



End this needless waste and expense forever with **RECLAIMO** Today's Most Advanced Oil RE-REFINING Filter

Continuously cleans and RE-REFINES motor oil as you drive (by utilizing motor heat)—keeps oil in high grade lubricating quality at all times—reduces motor wear to a minimum! Proves conclusively that "Oil Does Not Wear Out Mechanically" as stated by U. S. Bureau of Standards, (Bulletin 86).

- "RECLAIMO"
- REMOVES SOLIDS (by filtration)
  - REMOVES WATER (by distillation)
  - PREVENTS Excess Fuel Dilution
  - PREVENTS Acid and Sludge Formation

MAINTAINS Stable Viscosity ELIMINATES All Oil Changes  
CAR • TRUCK • TRACTOR OWNERS!

You'll want to know more about Reclamo's Oil, Motor and Money-Saving Features. FREE 40-PAGE BOOK "OIL FACTS" gives you the complete "Reclamo" story plus details about our New 90-Day No Risk-No Cost TRIAL OFFER! WRITE for YOUR COPY TODAY!

**NEW ADDED FEATURE!**  
Gas - Moisture Vapor Injector  
Increases Mileage with Smoother Performance



**RECLAIMO MFG. CO.**

5083 ELSTON AVE., Dept. 73, CHICAGO 30, ILL.

Take the Drudgery Out of Sanding!



A NEW, sensational tool for wood- and plastic-workers! Just chuck this portable sander to electric drill or flexible shaft! Cast aluminum case; all gear drive. Guaranteed! At Dealers or direct—\$25.85. Write for free folder!

**EQUIPMENT — TOOLS — SUPPLIES**  
Electric tools—Aluminum—Plastic—Bearings—Steel—Hundreds of other items, Catalog 1046—15c.

METPLAS SUPPLY CO., 1420 S. 16th Ave., Maywood, Ill.

**FOREIGN CAR PHOTOS**

Beautiful selection of current foreign car photos, 8x10 inches, including Rolls-Royce, Bentley, "M.G.," Jaguar, Austin, Triumph, Daimler, "A.C.," Lancia, Cisitalia, Isotta Fraschini, Delahaye, Simca, Citroen, Bugatti, Maserati, etc.

In sets of six, all different.

Price only five dollars per set.

**JOSEPH NEIDLINGER**

Importer of Rolls-Royce, Bentley, "M.G.," Austin, Lea Francis and other foreign cars.

7300 STONY ISLAND AVENUE  
CHICAGO 49, ILL.

**MULTIPLE PURPOSE SUPERDRIVER**

**F-O-R-C-E by LEVERAGE!**



The hardest jobs are easy with this entirely new driver. Tool for the Home and the Workshop. Die-Cast Aluminum Alloy Handles—Chrome Vanadium Steel Blades. Positively guaranteed against defects in original material and workmanship.

- Regular Screwdriver
- Leverage Screwdriver
- Light Hammer
- Pry Tool

Three sizes . . . please specify

- SD107—1/4" tip x 5" blade
- SD209—5/16" tip x 5 1/2" blade
- SD311—3/8" tip x 6" blade

Handles all identical

**ORDER NOW! \$1.00 ca.**

2 for \$1.75 — 3 for \$2.50

**MUELLER BROS. MFG. CO.** 1701 N. Calhoun St. Box 839, Ft. Wayne 1, Ind.

POPULAR MECHANICS



Do You Want— Thrills! Action! Terrific Speed?

# Get Into MINIATURE RACING

Get into this thrilling new sport. **THE NATION'S NUMBER ONE CRAZE**  
Race miniature autos — indoors or out. A fascinating hobby for young and old. Terrific speeds with real jet propulsion, gas and carbon dioxide engines. Here is everything you need for a barrel of fun — complete racing autos, kits, power units, engines, jet cartridges. Order from this page.



Here's Everything for FUN with **JET POWER** and **GAS ENGINE RACING**



## Famous THIMBLE DROME RACER

Completely Finished Race Car

New scale model of midget racer, the classiest thing you ever laid eyes on. Die cast aluminum body, turned aluminum rubber-tired wheels with treads. Chrome exhaust stacks. Wobble pump. Simulated leather seat and back. Instrument panel and numoers. Equipped with bridle lugs for cable track racing. Car is 9 3/8" long, 4" high, weighs 18 oz. Can be powered with transmission units and engines listed below. Only \$3.95. Postage 30c additional.

Only \$3.95

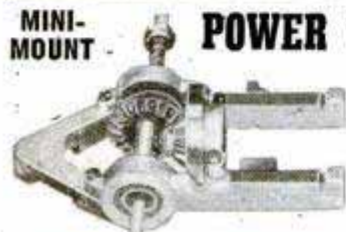

## MINI-MOUNT POWER TRANSMISSION UNITS for Thimble Drome Racers

Easy to install. Mini-Mount transmission unit for use with all class A, most class B engines, including the gas engines listed below. Die cast frame, ball bearings, steel axles with speed lock nuts, fly wheel and hardened bevel gears—universal type for flange or radial mount. If you have engine, give shaft diameter. Complete as shown, \$9.45. With ring gear only, \$7.45. Pinion gears \$2.00. All prices postpaid.

**CO2 ENGINE MOUNT** Conversion kit for OK-CO2 (Jet Cartridge) engine, for powering the Thimble Drome Racer. Easily installed. Racing bridle and control handle included. (Not illustrated) \$2.00. Postpaid.

## GAD-JET RACER

JET OR ENGINE POWER

All metal miniature racer, ultra streamline design. Aluminum, die cast, two-part body, aluminum wheels, rubber tires. Completely finished, ready to go, with clip for jet cartridge racing, \$1.50. Same, with CO2 engine and conversion kit for installing engine at home, \$6.95. Complete, with engine installed, bridle racing wire and suction cup center post, \$9.95. Kit, for jet power racing, car not painted, can be assembled in a few minutes, \$1.00. Add 20c for delivery.

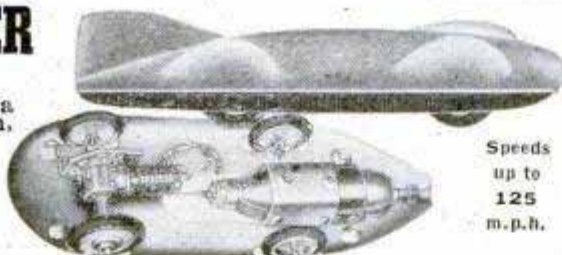

Speeds up to 125 m.p.h.

## MIDJET



## MONO-JET



## Monogram JET RACERS

Two new kits in this famous line. Can be built complete in one evening. Bodies shaped and bored for jet cartridge, rubber wheels, steel axles. Mono-Jet, Indianapolis type racer, Midjet, Midget type racer. Each \$1.00, postpaid.

## COX 302 SPECIAL

Midget type all metal racer with free wheeling, spring motor. Slightly smaller than Thimble Drome. Can be converted for CO2 engine power. \$2.95. Delivery 25c additional.

## JET TUBES

For Jet Power



Standard CO2 (Carbon Dioxide) cartridges for jet propulsion and use with CO2 engine. Packed 10 to package. Postpaid \$1.15.



## JET GUNS

For Starting Jet Propelled Racers

Trigger action. Fits over end of jet cartridge with racer in starting position. Trigger release pierces cartridge, producing jet power stream and starts racer on its way. All metal. 85c postpaid.

## GAS ENGINES FOR RACE CARS

Arden .099 Plain Earing	\$12.50
Arden .099 Ball Bearing	15.50
Arden .199 Ball Bearing	18.50
Forster 29	14.85
Cobra 45	12.50
Ohsson 23	9.95
Drone Diesel	14.95
Mohawk Chief	8.95
McCoy Sportsman, Jr. Glo Plug	14.95
McCoy 29	19.50

All Less Coil and Condenser

A selection from our large stock. We recommend any of these engines to power the Thimble Drome Racer.

## CO2 ENGINE

(Carbon Dioxide)



For engine power in Thimble Drome and Gad-Jet, other racers, airplanes, etc. Complete with automatic jet tube discharge assembly. \$4.95. Postpaid.

## HOW TO ORDER

Mail order to address below. Enclose remittance, including delivery charges, in check, postal or express money order, or currency if you prefer. On C.O.D. orders up to \$5.00, enclose \$1.00 deposit. Up to \$10.00, \$2.00 deposit. Over \$10.00, \$5.00 deposit. Balance to be paid on delivery. If interested in other items not listed here be sure to write us.

# HOME-SHOP PRODUCTS CO.

Everything for the Hobbyist and Home Craftsman

4821 Sheridan Road  
DEPT. 14. Chicago 40



# 7x50 BINOCULARS



with **COATED OPTICS**

**\$ 58**

Weight 36 oz.  
Height 7 in.

Also Available with **\$ 48**  
Uncoated Optics

These magnificent 7x50 prism binoculars have the brilliant luminosity, precise clarity, and wide, undistorted field of view obtainable only with a large glass having hard coated lenses and prisms. Because 7x50 glasses give the highest performance obtainable they are now the official choice of the Army, Navy and Marine Corps. Why be satisfied with a smaller glass when you can now have a brand new coated 7x50 at 1/3 of the usual price. Lifetime construction. Lightweight aluminum body. Ultra-precise optics that prompt users to remark, "The finest glass I have ever looked through." Sold with a guarantee of complete satisfaction or money refunded. Fine carrying case and straps included. Price, only \$58 plus 20% Federal tax. We pay the shipping cost. Immediate delivery. Supply limited so don't delay.

## BROWNSCOPE CO.

Dept. 4M, 24 West 45th St.

New York 19, N. Y.

**Time & Date AT A GLANCE**

**BELL GUARANTEED CALENDAR WATCH**

Tells time, name of day and date. Day name changes automatically.

No. MP 383 — 17 jewels, water-shock resistant, anti-magnetic, radium dial and hands. ALL STAINLESS STEEL CASE..... **\$55.00**

**OTHER SPORT WATCHES WATER-SHOCK RESISTANT**

Precision tested, 17 jewels, anti-magnetic, radium dial and hands, unbreakable crystal, sweep second hand. No. MP 197—Stainless Steel Back..... **\$29.75**

No. MP 945—ALL STAINLESS STEEL CASE **\$37.50**  
Other fine watches from \$12.65 Tax Incl.

**ORDER BY MAIL:** Send check, money order or pay C.O.D. THESE LOW PRICES INCLUDE FED. TAX & POSTAGE. Write for FREE Booklet "MP".

**Repair Service**

All types and makes of quality watches repaired expertly and promptly. Free estimate on request.

**BELL WATCH COMPANY, INC.**

Time and Life Bldg., Rockefeller Center, New York 20, N. Y.

## GOVT. SURPLUS TRUCK PARTS AND EQUIPMENT

Military Type. We have for immediate delivery genuine parts for all makes and models. 4x2—4x4—6x4 and 6x6. All models from 1/4 ton to 20 ton. All Makes: Jeeps, Fords, Chevrolet, GMC, Studebaker, Reo, Auto Car, Federal, Diamond T, Brockway, Bierderman, Macks, Oshkosh, Dodge, White and Sterling.

### • DIESEL ENGINE ASSEMBLY.

Mfgd. by Hercules Motors Corp., complete units less starter and Generator. Engines are new and have openings sealed for storage. On skids for shipment (as illustrated). Ideal for power plant units or truck installation. Specifications: 6 cyl., 5 1/2" bore with 6" stroke, 893 cu. inch displacement and a compression ratio of 14.6, Formula H.P. NACO 74.9, Max. torque 895 — 1175 RPM. Max. RPM 1600. Has a 12 V. electrical system and a solid injection fuel system with American Bosch injector transfer pump and governor. Equipped with Purolator type D21-10 fuel filter, two air Mase model 557 OBN air filters and three Fram No. 5266 oil filters, and a Delco model 1118061 stop control solenoid switch. Shipping weight 3,000 lbs.

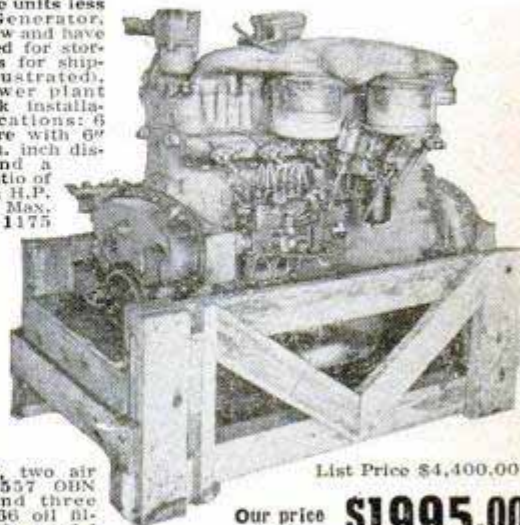

List Price \$4,400.00.

Our price only **\$1995.00**

**ELECTRIC STARTER UNIT** for above engine, net only **\$75.00**. Complete Fan Assembly for the above engine, net only **\$40.00**.

Prices Quoted are Net, FOB, Kansas City, Mo.

Firms not rated, 25% deposit required. Balance COD, Export Business invited.

**AMERICAN AUTO PARTS CO., Inc.**  
1830 Locust Kansas City, Mo.

## Now for EVERY WORK SHOP! NEW INVENTION Electroplates by BRUSH



**Easy to Plate CHROMIUM GOLD, SILVER, NICKEL, COPPER**

... For Pleasure and Profit!

If you have a workshop—at home or in business—you need this new Warner Electroplater. At the stroke of an electrified brush, you can electroplate models and projects—you can replate worn articles, faucets, tools, fixtures, silverware, etc. with a durable, sparkling coat of metal... Gold, Silver, Chromium, Nickel, Copper or Cadmium. Method is easy, simple, quick. Everything furnished—equipment complete, ready for use. By doing a bit of work for others, your machine can pay for itself within a week. So make your shop complete by getting a Warner Electroplater right away. Send today for FREE SAMPLE and illustrated literature. ACT AT ONCE! Mail Coupon.

**WARNER ELECTRIC CO., DEPT. 5-9**  
1512 Jarvis Avenue, Chicago 26, Ill.

### FREE Details & Sample!

**WARNER ELECTRIC CO., 1512 Jarvis Avenue, Chicago 26, Dept. 5-9**  
Gentlemen: Send Free Sample and Details to:

Name \_\_\_\_\_  
Address \_\_\_\_\_  
City \_\_\_\_\_ State \_\_\_\_\_



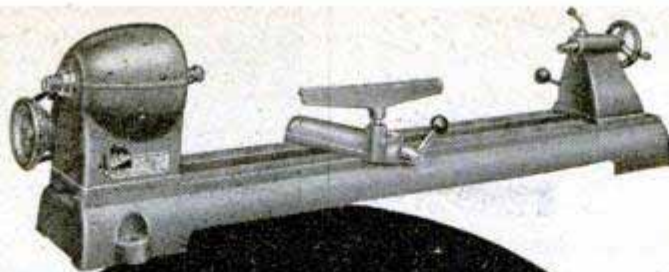

★ New Atlas  
12" WOOD LATHE

★ New Atlas  
8" and 10"  
TABLE SAWS



★ New Atlas  
WOOD SHAPER

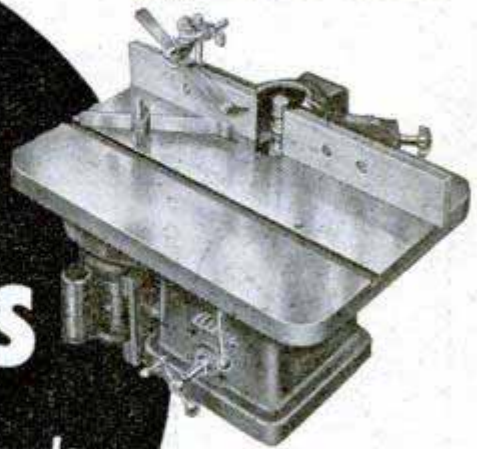

# 6 MORE New Atlas TOOLS

Built to Industrial Standards  
For New Perfection  
in Your Shop

★ New Atlas  
24" JIG SAW



★ New Atlas  
BELT and  
DISC SANDER



## AVAILABLE NOW!



New Atlas 10"  
Floor Saw. Every  
feature you want  
for fine workman-  
ship. Heavy-duty.  
Extra-large table.  
Unique rip fence.  
Easy-operating  
controls.  
PRICE \$179.50

*New*  
ATLAS 12 $\frac{3}{4}$ "  
BENCH DRILL, \$59.00  
ATLAS 15"  
BENCH DRILL, \$69.00  
ATLAS 15"  
FLOOR DRILL, \$79.00

See them today at your  
Atlas dealers.

All prices, less motors, F.O.B.  
Kalamazoo, subject to change without notice.



★ THEY'RE COMING YOUR WAY...  
6 brand-new Atlas woodworking tools . . .  
precision-built throughout . . . for the finest  
work you've ever produced in your shop!  
These are the kind of tools the real craftsmen  
in America have long been waiting for . . .  
built to exacting industrial standards . . . with  
every latest feature for accuracy, easy opera-  
tion, and long service life. They'll make your  
shop the best-equipped, most practical in your  
neighborhood. Keep in touch with your Atlas  
distributor—he'll have them to  
show you soon!



SEND FOR FREE CATALOG

ATLAS PRESS COMPANY

443 N. Pitcher St., Kalamazoo 13D, Mich.

Kindly send latest literature on Atlas woodworking  
tools to:

NAME \_\_\_\_\_

ADDRESS \_\_\_\_\_

CITY, STATE \_\_\_\_\_



*Now! You can install*  
**DUAL WHEELS!**

On your Trailer, Pick-up Truck, Farm Wagon or Jeep  
**IN LESS THAN TEN MINUTES**

Only **\$28<sup>50</sup>**

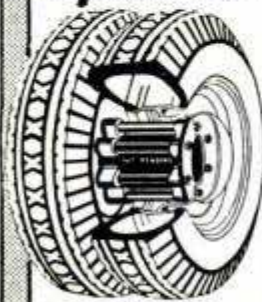

Complete Set of Castings and Extension Bolts for 2 Wheels Install with a rim-wrench—easier than changing a tire. New patent Du-All Adapters eliminate entirely the expense of changing to truck-type wheels and hub; no need to change the entire rear axle. Do the job at a fraction of the old cost.

Du-All Adapters are scientifically designed so that load is transferred from outer wheel by the casting direct to the hub. Increase traction and increase tire life with Du-All Adapters. Trailers can carry up to 50% more with Du-All. **GUARANTEED SATISFACTION OR MONEY BACK.**

**ATTENTION: JEEP OWNERS**

Now you can convert your wheel tread to standard 58" width. Avoid trouble with ruts on unpaved roads or driveways with these completely new Jeep wide tread adapters. Set of 4 castings and 20 extension bolts, for all 4 wheels, can be installed or removed in 15 minutes. Safe. Sturdy. Simple to install. Only \$36.00, complete set.

**G. I. MILITARY TRUCK PARTS**

Every part for every G.I. type vehicle from jeep to 20-ton prime mover 6x6. Sensational savings . . . from 40% to 80% below list.

**COMPLETE STOCK OF PARTS FOR STANDARD CONVENTIONAL CARS AND TRUCKS**

New—used—re-built. Truck operators, dealers, garagemen, learn about amazing low prices.

**DEALERS: SEND FOR FREE CATALOG**



834 North 7th Street, Minneapolis 11, Minnesota

- Please send me . . . . .  FORD  CHEV  DODGE-PLYM  
 INTNLT (1/2 ton, 37 47)  JEEP Dual Wheel Converters at \$28.50 each set. (Ship. Wt. 33 lbs.)  
 FORD ('36-39 Psgr. & Lt. Comcl.) Dual Wheel Converters. Also fits 3/4 ton '38-42 at \$32.50 each set (Ship. Wt. 70 lbs.)  
 JEEP Standard Tread Adapters . . . . \$36 for 4 wheel set.  
 WF111N 16" Drop Center Wheels for Model T . . . \$5.95 ea.  
 WP400N 16" Drop Center Wheels for all others, \$5.95 ea.

Name . . . . .  
 Address . . . . .  
 City . . . . . State . . . . .  
 Northwestern Auto Parts Co., 834 N. 7th St., Mpls. 11, Minn.

**DEALERS: Sell DUAL WHEELS. Many fine territories open.**

*Install your own*

**PRIVATE Telephone System**

With these self-contained magneto ringing phones.



Price, complete with handset and battery

**\$12.95** EACH F.O.B. DAYTON, O.

Stock No. B-588M

- No external power required. Operates on a standard radio "C" battery. Easy to install - requires only two wires or one wire and ground. Two or more units can be used on the same line.
- You'll find them useful on the farm, on construction projects, in the factory, on broadcast remotes, in your business and wherever you need communication. Good up to 50 miles.
- These telephones are not toys. They are Army surplus - slightly used, checked and inspected. Guaranteed to be in excellent condition. Dimensions: 5 1/2" x 6 1/2" x 9 1/2". Shipping weight 16 lb.

SEND CHECK OR MONEY ORDER.

**SREPCO**

STANDARD RADIO & ELECTRONIC PRODUCTS CO.  
 135 E. SECOND ST. DAYTON 2, OHIO.

**LOOK!**



WAR SURPLUS

**FIELD JACKETS**

*Ideal for*  
 Farmers • Lumbermen  
 Truck Drivers • Laborers  
 and for  
 Plain and Fancy Loafing

ONLY  
**\$1.98**  
 EACH

**Nothing like it has ever been offered at this low price!**

This full-zipper front, bi-swing back, fine poplin Army FIELD JACKET is the favorite of G.I.s all over the world. Although used EVERY jacket is guaranteed to be in perfect condition. Sizes 34 to 40. Send name, address and size and on delivery pay postman \$1.98 plus C.O.D. charges. Add 15c for postage. Or send \$1.98 plus 15c for postage with your order and save C.O.D. charges. Order yours today!

**S & B SURPLUS SALES CO., Dept. PM-28**  
 3244 W. Roosevelt Rd. Chicago 12, Ill.

**SAY YOU SAW IT IN POPULAR MECHANICS**

**POPULAR MECHANICS**



# Now Available...

## Amazing New P&H AC Arc Welder with Dial-lectric Control



**Makes sound welds easier, faster, and at lower cost**

*These industrial and commercial arc-welding jobs are easier to do and cost less when you use a P&H Dial-lectric AC Arc Welder:*

- All types of industrial welding
- Sub-contracting work for large manufacturers
- Air conditioning
- Home heating
- Truck body building
- Trailer building
- Automotive repairs { blocks, fenders, frames }
- Fuel-oil tanks
- Contractors' welding
- Bridge work
- Construction equipment repairs { excavators, tractors, graders, ditchers, etc. }
- Kitchen equipment
- Cabinet work
- Fabricated housing
- Fabricated garages
- Cast iron repairs for foundries
- Maintenance work for industrial plants
- Ventilating systems
- Bicycle repairs
- Stainless steel bar equipment
- Ornamental iron work
- Fabricating equipment of your own design

Built for heavy industrial use, with welding service range from 20-275 amps. Also ideal for automotive, general repair, job welding, and machine shops; foundries; schools; etc.

**The only welder with easy-to-use Dial-lectric Control**

Anyone can quickly learn to use the new P&H Dial-lectric welder. There is only one control — the dial is clearly marked and a ¼ turn of the radio-like knob covers the entire welding range. There are no plug-ins to make, no wheels or levers to crank or adjust — welding is just plain easy with a P&H Dial-lectric machine. A clearly illustrated, easily understood welding manual is supplied with each machine so that beginners can learn to weld in an extremely short time. Old hands may pick up some new tricks, too.

**No maintenance is needed**

Dial-lectric control eliminates all moving parts. That is why P&H AC Welders require no attention or maintenance — why operating costs are lower — why so many industrial users are switching to this new welder. Also, NEMA rating assures you of long life and dependable operation.

**You produce sounder, better-looking welds in a shorter time**

The P&H remote control feature permits proper heat selection at the job. You waste no time or energy walking back and forth to the machine to make adjustments. There is no temptation to skip — remote control lets you use the right heat. Welds are sound and better looking. Work is done faster. Additional features that make for better, faster welding are: Easy quick-start arc. High-low welding range. Elimination of arc blow.

**Requires only 2¼ feet of floor space**

You can put a Dial-lectric welder most any place — it is connectible for 220 or 440 volts. Despite its weight of 307 lbs., it is remarkably compact. The Dial-lectric is easy to move around, too — it's mounted on wheels, you handle it just like a hand truck.

**A complete electrode service is provided by convenient P&H Shop Packs**

P&H Shop Packs contain eight different packages of electrodes. Detailed instructions are printed on each individual package so that you can use the right electrode for every

job. Guesswork is eliminated. Welds are stronger, better-looking. You can weld anything made of steel, alloy or stainless steel, sheet metal, cast iron. You can put hard, protective, long-life coatings on new parts, or build up worn parts better than new. The cost of all 8 types, individually packaged and labeled for your convenience, is only \$11.75.

It pays to use P&H electrodes. No matter what make of welder you have, order a P&H shop pack today from your nearby P&H distributor.

**Reduce welding costs in your plant or business**

If you are connected with, or are interested in welding, use your influence to bring in a P&H Dial-lectric AC Welder. A comparison of its performance with that of other units quickly shows that a Dial-lectric improves the quality of the welds, speeds the work, and reduces costs.

A P&H Dial-lectric AC arc welder can be purchased for as little as \$209.75. Also get P&H Shop Pack electrodes (\$11.75). You will want to standardize on these weld rods after you have checked their speed, quality, easy manipulation, and great variety of uses. Contact your nearby P&H distributor, or send in coupon below, clipped to your business letterhead.



Manufacturers of America's Most Complete Welding Service

**TEAR OUT COUPON, ATTACH TO YOUR BUSINESS LETTERHEAD, AND MAIL TODAY**

**HARNISCHFEGER CORPORATION**  
4673 W. National Avenue, Milwaukee 14, Wisconsin

Yes, I'm interested in the new P&H AC Arc Welder with revolutionary Dial-lectric control, and money-saving P&H electrodes. I would like information on the items that I have checked below.

- P&H AC Welders
- Send address of distributor
- P&H "Shop Pack" Electrodes
- Send representative
- Send Free Book, "Simplified Welding"

Name.....  
 Position..... Company.....  
 Address.....  Home  Business  
 City..... (.....) State.....



# Give Your Lawn that 'Golf-Green' Look

with a

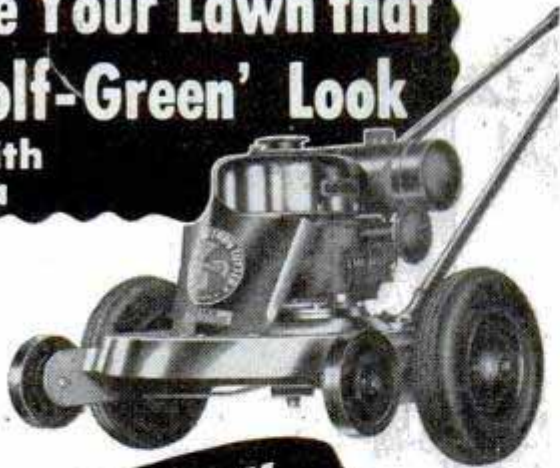

**Goodall**  
POWER MOWER

**ENDS GRASS-CUTTING DRUDGERY** You take it easy behind a GOODALL Rotary Power Mower...it cuts your lawn in 1/3rd time, cuts any height grass or tough weeds...cuts on any terrace or hillside... gets into hard-to-reach places easily.

**NOTE:** GOODALL is the original U.S. patent holder of direct vertical drive — at better dealers everywhere.

Cuts Grass Velvety Smooth in 1/2 time



### EXTRA FEATURES

GOODALL is the one and only 4 CYCLE — VERTICAL CRANK-SHAFT — DIRECT DRIVE Rotary Cutter manufactured...successfully used by thousands from coast to coast.

Precision built for years of low cost service... Two wheel flexibility.

Many imitators... No successful duplications!

Write for Picture Folder and name of nearest dealer

**Goodall** MANUFACTURING CORPORATION  
DEPT. PM, WARRENSBURG, MO.

## Handy Mail Order List

### Little Library of Useful INFORMATION

5 for \$1.00  
12 for \$2.00  
25¢ Each

Here at amazingly low cost is the practical help and information you have always wanted. Articles in previous issues of Popular Mechanics have been classified according to subject and are now available in these handy reprint booklets.

- How to Use Measuring Tools—Micrometers, Calipers, etc.—106.
- Power Driven Saws—74.
- Drill Presses, Grinders, Etc.—79.
- Wood, Metal Turning—Lathes—81.
- Filing Machine, Hacksaw, Cutoff Wheel, Shaper—82.
- Lathe Tools You Can Make—101.
- Workbenches—Tool Cabinets—47.
- Spray Painting—94.
- From Pattern to Casting—91.
- Tool and Saw Sharpening—92.
- Sharpening Drills, Wood Bits—90.
- Successful Wood Turning—32.
- How to Read Blueprint—71.
- Metal Turning Lathe Kinks—99.
- Operating a Metal Lathe—100.
- Heat Treating, Hardening—102.
- Working With Glass—103.
- Servicing Elec. Motors—75.
- Electromagnets & Solenoids—44.
- Transformer Construction—41.
- The Boy Electrician—43.
- Soldering and Brazing—17.
- Arc and Spot Welders—5.
- Electroplating With Nickel, Chromium, Cadmium, Etc.—86.
- Plating Leather, Wood, etc.—87.
- Lower Your Fuel Costs—31.
- Curing Leaky Basements—45.
- Fitting Home Game Room—55.
- Indoor & Outdoor Fireplaces—88.
- Backyard Gardening—39.
- Lawn and Garden Novelties—72.
- Trellises, Pergolas, Fences—76.
- Lawn and Garden Furniture—77.
- Playground Equipment—73.
- Concrete Garden Furniture—6.
- Making Serving Trays—53.
- Sanders—80.
- House Wiring—89.
- Treasure Finders—13.
- Hanging Wallpaper—38.
- Built-in Fixtures—78.
- Bird Houses—7.
- Magazine Racks—49.
- Clock Cases—50.
- Book Ends—52.
- Small Tables—54.
- Smoking Stands—56.
- Desks—58.
- Book Cases—59.
- Action Toys—66.
- High Flying Kites—67.
- Telescopes—20.
- Metal Craft—28.

- Knots and Ropework—105.
- Working With Plastics—61.
- Simple Home Improvements—104.
- Ridding Home of Insect Pests—107.
- Children's Room Furniture—51.
- Jigsawed Novelties—57.
- Doll House & Doll Furniture—60.
- 25 Shelves You Can Make—64.
- Novelties Turned on Lathe—62.
- Inlay Pictures—Veneering—63.
- Wood, Soap Carving—65.
- Windmills & Weathervanes—68.
- Lamps from Wood, Metal—69.
- Rustic Furniture—18.
- Wood Finishing—49.
- Boats—14 ft. Outboard—2.
- Boats—14 ft. Sail Dinghy—26.
- Boats—21 ft. Sloop—46.
- Rowboats, Small Dinghy—83.
- Small Sail Boats—84.
- Two Outboard Runabouts—85.
- Build Own Canoe, Kayak—30.
- Build Class-E Ice Yacht—22.
- Auto Kinks, Shortcuts—10.
- Sniding Trailers—27.
- Motor-Driven Midget Cars—34.
- Stop Auto Elect. Troubles—95.
- Photo Printers and Dryers—25.
- Photo Darkroom Equipment—56.
- Trick and Table Top Photos—97.
- Cosmetic Formulas—12.
- Poultry Houses—108.
- Guns and Decoys—109.
- Re-Silvering Mirrors—70.
- Chemical Experiments—93.
- Log Cabins, Tourist Houses—14.
- Trapping Small Animals—33.
- Farm and Garden Tractors—8.
- Building Extra Attic Rooms—23.
- Attractive Basement Rooms—24.
- Small Looms—37.
- Gem Cutting—42.
- Photo Enlargers—1.
- Photo Kinks—98.
- Cleaning Formulas—11.
- Taxidermy—9.
- Mag. 29.
- Training Dogs—35.
- Small Furnaces—36.

Check Titles Wanted, Clip, Mail with Remittance to

POPULAR MECHANICS PRESS, Dept. 635, 200 E. Ontario, Chicago 11

## REAL DIESEL ENGINE

For Model Planes, Boats and Race Cars



Now you can own and run a real miniature diesel engine that operates by the beat of compression. No coil, condenser, wires, or annoying ignition failures. Simply flip the prop or flywheel to start. It's the new DEEZIL—a 125 cu. in. displacement, 5 oz. engine that runs at 8000 RPM. Order today; only \$12.95 p.p., less tank. Every engine fully tested and guaranteed. DEEZILMIX

FUEL \$1.00; PROP 50c. Send for valuable free price list!  
GOTHAM HOBBY CORP.  
107 East 126th Street New York 35, N. Y., Dept. "P"

SAY YOU SAW IT IN POPULAR MECHANICS

## COMPLETE TRAILER

CHASSIS-AXLE  
2 WHEEL ASSEMBLY

Only \$52.50

Shipped KD., F.O.B. Yonkers or send \$10 & bal. C.O.D.

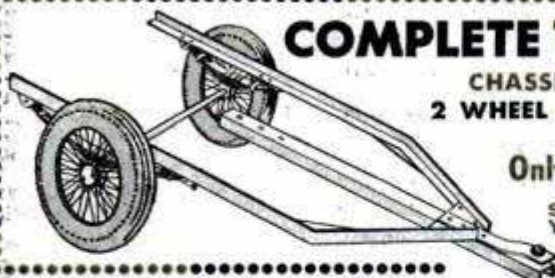

Never before offered at this low price. Tested to carry 1000 lbs.—built to take hardest usage...

**COMPARE!**—in construction—utility—value! You'll agree there's nothing like it.

**YOU GET:** Complete draw bar assembly, chassis of steel angle, 2 automobile type springs; 2 wheels with Timken roller bearings take standard 4.75 x 19 tires, 2 hub caps and grease rings... 91" Overall, 57" Tread. Less Tires, Tubes.

### BEST BENCH VALUE ON MARKET

Solid, tough wood construction—ALL STEEL LEGS. Very large drawer, tool rack, shelf, 34 1/2" high, 59" x 23". COMPLETE WITH ALL HARDWARE... Shipped KD with easy instructions. ONLY \$15.35 F.O.B., Yonkers.

Send check, Money Order on all items. SATISFACTION GUARANTEED.

UNIVERSAL YONKERS CORP. (M-4) 137 Alexander St., Yonkers 2, N.Y.



Complete wheel, hub assembly and bearings \$9.00 ea.



## HEAVY CAST ALUMINUM BLOWER

Now Only \$10.00

SINGLE EXHAUST BLOWER DELIVERS 100 CU. FT. AIR PER MINUTE. Ready to install yourself with any household tools. It's built for that. Housing is solid cast aluminum to last indefinitely. 110 V., 50-60 cycles. Cont. duty motor.

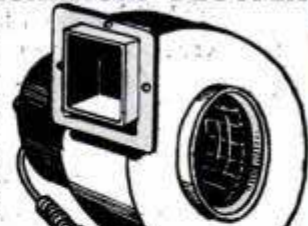

### DOUBLE EXHAUST BLOWER

Same wonderful construction, performance, easy installation as the Single. Adaptable for any Blower need. ONLY \$15.85. On Blowers, west of Mississippi, add \$1 for mailing, handling.

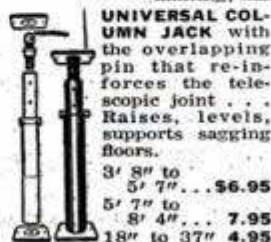

**UNIVERSAL COLUMN JACK** with the overlapping pin that reinforces the telescopic joint... Raises, levels, supports sagging floors.  
3' 8" to 5' 7" ... \$6.95  
5' 7" to 8' 4" ... 7.95  
8' 4" to 37" 4.95

**MIKE** Designed especially for speech P.A., amateurs, recording... High impedance, output 54.2 db below 1v per bar. All chromium plated; rubber covered, shielded cable, 8' cord. Remove from base for hand use. We know it's so good, we sell it on 5 day, money back guarantee! Ship. wt. 2 lbs. Lists for \$10.75. Cost to You \$4.95.





## JOIN OUR FAMILY OF HOME MONEY-MAKERS!

Show this Sparkling 9-piece ALUMINUM SET to Your Friends and Neighbors  
**YOU MAKE \$3.00 ON EVERY SALE!**

Complete Set Sells for Under \$10 and Includes Sensational 5-in-1 Combination Cooker Pictured

Make full-time money in your spare time. No sales experience necessary. This gorgeous aluminum set sells on sight! Has everything the modern housewife wants: 9 gleaming aluminum pieces including the sensational 5-in-1 Combination Cooker. Complete set sells for under \$10...

**You Pocket \$3 Immediately on Every Sale!**

You simply take the orders, collect your commission, we do the rest. Be first in your community to offer this guaranteed 'Regal' Aluminum Set. What's more, this gives you a chance to buy your own set—at agent's wholesale prices.

**WRITE TODAY!** Send no money. Your complete sales kit will be sent free by return mail. Send your name and address NOW to:  
**I. B. URY CO., DEPT. 12, 222 4th AVE. NEW YORK 3**



**TERRIFIC VALUE**  
Set includes 5-in-1 Cooker pictured above PLUS 1- 2- and 3-quart sauce pans, a super 9-in. frying pan and a big sparkling, 6-quart covered pot.

## LARGE PICTURE TELEVISION



You too can build your own giant screen television receiver. Easy step by step directions. You use only a screwdriver and soldering iron. Important parts furnished already wired and laboratory tuned. 20,000 people have already assembled these superb receivers.

Write for Details!  
**TELECRAFT Corp.**  
96 FIFTH AVE., N.Y.C.  
SERVICEMEN! SEND FOR SPECIAL LIST!

## STOP LOSING YOUR HUB CAPS



Why take chances losing Hub Caps that are expensive and practically irreplaceable today? Now you can safeguard them with

### New! SECURITY HUB CAP GUARDS

A simple, tested device which eliminates the loss of hub caps while driving or loss thru theft. Takes but a few minutes to attach it yourself or by serviceman. Made of stainless steel, rustproof. Send \$1.00 for set of 5 wheels—complete with instructions. Satisfaction guaranteed—order today.

**SECURITY MFG. CO. 144 WEST 27 ST., (DEPT. PM4) N. Y. 1, N. Y.**

**AGENTS DISTRIBUTORS**  
Make big money selling Garages, Service Stations, Dealers, Exclusive territories now being assigned. Write Today.



**HIGH-SKILLED HELP ON Spring "CONSTRUCTION"**

## New POWER KING 8" TILT/ARBOR SAW

### SPEEDS YOUR WORK ON:

Furniture, Cabinets, Cupboards, Shelves, Toys, Equipment, Etc.

Watch how much faster you do finer work with a new Power King saw as your "helper"! Gives you 10 times the speed of tedious hand sawing. Cuts accurately every time.

The new Power King 8" saw has a 18" x 20" precision-ground table—with 10 1/8" ahead of blade for wide boards. Cuts 2 5/8" deep. Blade tilts—table stays flat—for safe angle sawing. Precision ball bearings. Unique table-length rip fence locks at both ends.

Get into real "production" on things for your home this Spring with this fast, accurate, ruggedly built saw. Send for free literature and name of nearest dealer.

### POWER KING TOOL CORP.

420 Cleveland St., Warsaw, Ind. Division of Atlas Press Co.

EASI-BILD PATTERNS are sold by Power King dealers. Send for pictures of scores of practical projects.



### OTHER POWER KING SAWS



12" BAND SAW



18" JIG SAW



Now YOU CAN GET THIS  
Genuine Precision  
**MULTI-TOOL**  
At a **BIG** Saving!



A Whole  
Shopful  
of Tools  
in One

**ONLY**  
**\$17.50**

For The Complete  
**36-PIECE SET**  
Chest Included

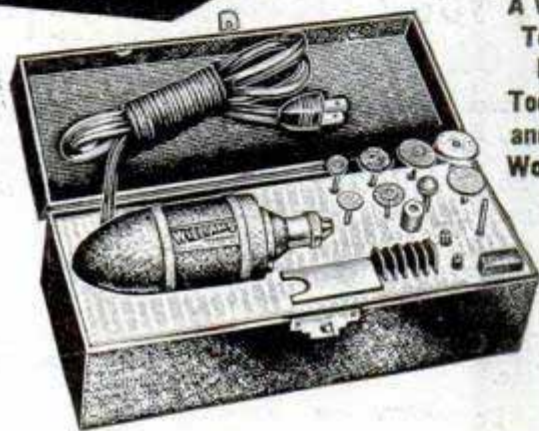

A Valuable  
Tool For  
Every  
Tool Room  
and Home  
Work Shop

"Multi-Tool" is truly today's outstanding power tool buy! It offers more value, greater efficiency, better performance . . . at an **AMAZINGLY LOW PRICE!** Recognized by expert tool men as a high quality, precision-made electric hand tool. Has a rugged, powerful motor; internal ventilator; sealed-in bearings; sure-grip chuck; finger-tip switch; and many other superb features. With it you can do grinding, finishing, burnishing, sanding, buffing, drilling, etching, routing and dozens of other jobs. Works perfectly on wood, metal, glass, stone, bakelite, ivory, china, plastics, linoleum, leather, rubber and other materials. Vibrationless, quiet, simple to use. Weighs 15 oz.

**Comes Complete . . . Ready to Operate**

Complete 36-piece outfit includes: genuine Williams Precision Multi-Tool Power Unit with 8 ft. approved cord and plug, 3 mounted grinding stones, 3 bristle brushes, 6 cut-off wheels, 1 muslin buff, 1 felt wheel, 1 rubber wheel, 1 roughing stone, 10 abrasive discs, 4 mandrels, 2 collets (1/8" and 3/32"), 2 wrenches, all contained in a handsome, durable chest. Operates on 110 volt AC or DC. Higher voltages can be supplied.

**TRY IT, TEST IT, FOR 10 DAYS**

**Send No Money—Just Mail Coupon**

We believe this tool to be the finest value for the money on the market today. We invite you to test it in your own shop. Try it for 10 days, then if you aren't completely satisfied, return it and your complete purchase price will be immediately refunded, no questions, no obligation. Take advantage of this trial offer, mail coupon NOW!

**CHICAGO PRECISION MACHINE CO., Dept. PM-448**  
920 S. Michigan Ave., Chicago 5, Illinois  
(Member: Chicago Chamber of Commerce)

Please send one complete Multi-Tool outfit. I will pay post-man \$17.50 plus postage and C.O.D., subject to return within 10 days for refund if not satisfied.

Name \_\_\_\_\_

Address \_\_\_\_\_

City \_\_\_\_\_ State \_\_\_\_\_

For those who put  
quality first!

**Darra-James**

TILTING  
ARBOR **SAW**

Blade and  
motor tilt  
to 45°...

Depth of  
cut 2 5/8"...

Steel base...

8-INCH

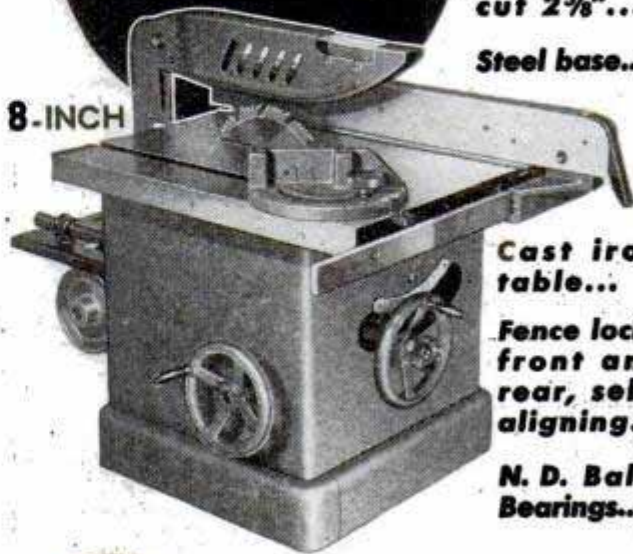

Cast iron  
table...

Fence locks  
front and  
rear, self-  
aligning...

N. D. Ball  
Bearings...

Full Details On Request!



**Toolkraft** CORP.  
WATERBURY 086, CONN.

**NEW SANDER READY!**

Now ready for hobbyists, craftsmen, model makers, pattern makers, workshops! Mead's sensational new **BAND SANDER** quickly shapes, carves, sands and polishes **WOOD, METAL** and **PLASTIC PROJECTS!** Cuts fast and clean on **ENCLOSED EDGES**, intricate scrolls, curves. Tilting table. Saves hours of tiresome hand work. Does better job. Nothing else like it! Order yours now only \$14.95 E.O.M. Chicago. Try it 5 Days, then, if not perfectly satisfied, return it and we'll refund \$14.95 your money promptly!

**FREE!** Or write for Free Circular describing, illustrating how this amazing new **BAND SANDER** invention saves time, money, trouble. Write now—a post-card will do!

Mead Specialties Co., 4114 No. Knox Ave., Dept. 148, Chicago 41, Ill.



**SENSATION ON WHEELS**



**the "SIDEWALK SAILER"**

**HERE'S HOW TO SAIL WITHOUT WATER!**

The **SIDEWALK SAILER** skims along over any land surface with even the lightest breeze. Sturdily built for seasons of fun, metal body is 12" x 10", with 32" mast, rubber wheels, vinyl plastic sail in rainbow fleet colors. Completely demountable for easy carrying.

**SEND NO MONEY.** Rush your Satisfaction Guaranteed order today. Remit with order and we pay postage or order C.O.D. plus postage. **Only \$2.98 complete**

**BERNARD FINE CO. Inc.** DEPT. S-M-2  
501 Sixth Avenue New York 11, N. Y.

**LAW**

**STUDY AT HOME FOR PERSONAL SUCCESS and LARGER EARNINGS.** 39 years expert instruction—over 108,000 students enrolled. LL.B. Degree awarded. All texts furnished. Easy payments. Send for **FREE BOOK.**

**AMERICAN EXTENSION SCHOOL OF LAW**  
Dept. 88-M, 646 N. Michigan Ave., Chicago 11, Ill.

**SAY YOU SAW IT IN POPULAR MECHANICS**

**WAR SURPLUS**

Lathes, Milling Machines, Drill Presses, Sawing equipment, Motors and thousands of miscellaneous items. Also information on Helicopters, Sleeper Trailers, Garden Tractors, Power Lawn Mowers, Welders, Jet Impulsion for Cars and Tractors etc. Rush name for free literature. **THE WAYNE ENGINEERING CO., DEPT. 1138, GREENVILLE, OHIO**



# Free

## NEW COMPLETE 160-PAGE *Concord* RADIO CATALOG

23 pgs. Radio & Television Sets • 62 pgs. Radio Parts • 18 pgs. Sound Amplifiers & Accessories • 23 pgs. Ham Gear • 9 pgs. Electronic Test Equipment

Mail coupon below now for FREE copy of this great, new Concord Catalog—a vast, complete selection of everything in Radio, Television, and Test Equipment. Thousands of items . . . new, latest 1948 prices. See the new LOWER prices on finest-quality RADIO SETS, PHONO-RADIOS, RECORD CHANGERS, RECORD PLAYERS, RECORDERS—wire and disc, PORTABLES, AMPLIFIERS, COMPLETE SOUND SYSTEMS, TESTERS. Latest listings of all well-known, standard, dependable lines of radio parts and equipment. 4,212,014 SATISFIED CUSTOMERS CANNOT BE WRONG! For more than a quarter-century at CONCORD the customer has been the Most Important Person in the world. This established reputation for Customer Satisfaction is the reason Radio Men (the Experts Who Know) keep coming back to CONCORD for every radio and electronic need. At CONCORD, YOU MUST BE COMPLETELY SATISFIED or your money will be cheerfully refunded.

# CONCORD

## RADIO CORPORATION

CHICAGO 7      ATLANTA 3  
101 W. Jackson Blvd.      765 Peachtree St.  
Downtown Chicago Branch, 229 W. Madison  
Atlanta Radio Corp.



### MAIL THIS COUPON NOW!

CONCORD RADIO CORPORATION, Dept. 104  
901 W. Jackson Blvd., Chicago, 7, Ill.

Yes, rush FREE COPY of the comprehensive new Concord Radio Catalog. (Please Print)

Name.....  
Address.....  
City & Zone..... State.....

# Berkroy..

# Metal Shear

For straight line cutting,  
slitting, and trimming.

## \$19.75

With Clamping Head,  
for cutting inside and  
outside circles (A)  
extra.

## \$7.50

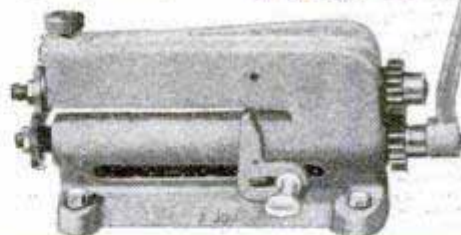
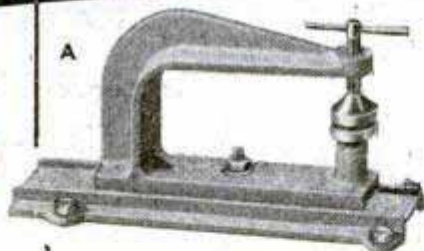

A handy professional type tool that easily cuts 20 gauge sheet steel and heavier gauges in softer metals. Cutters are adjustable for various gauges. Ideal for straight cutting, slitting and trimming. Adjustable arm controls width of strip up to 6". With clamping head will cut circles up to 12" in diameter. Rigid gray iron frame, heavily ribbed and completely machined. Can be bolted to bench. Shear has 1 1/4" Hardened and Tempered Cutters.

12" SLIP-ROLL  
For forming cylinders, scrolls and  
reverse curves, heavily constructed.

## \$27.50

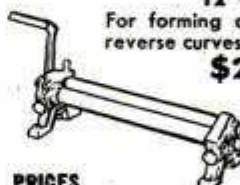

FREE FOLDER  
Contains Complete  
Specifications and  
Prices on Berkroy  
Metal Tools.

12" BRAKE

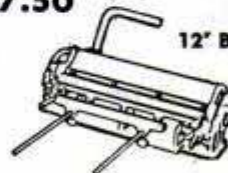

Forms flanges,  
boxes, tabs.  
Adjustable arm  
positions work  
for repeat  
operations. Works  
sheet steel up to 20 gauge. Heavier  
gauges in softer metals.  
Completely machined.. **\$43.95**

PRICES  
F. O. B.  
FACTORY

Other Berkroy Metal Working Tools  
Nibbler, less motor..... **\$49.50**  
Hand Punch..... **\$27.50**

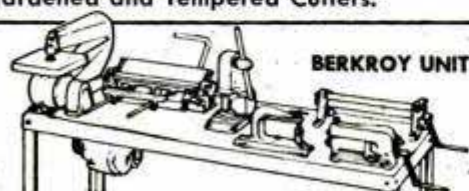

BERKROY UNIT

Five basic metal working tools mounted on metal bench:  
Nibbler, 12" Brake, 12" Shear with Clamping Head  
Accessory, 12" Slip-Roll and Hand Punch. Ideal for  
schools, shops, inventors and experi-  
mental work..... **\$217.50**

## BERKROY PRODUCTS, INC.

Dept. B, 336 Magnolia Street, Oakland 7, California

DISTRICT  
OFFICES

Woolworth Bldg.  
New York 7, N. Y.  
CO 7-8024

550 W. Washington Blvd.  
Chicago 6, Illinois  
Central 1246

1672 Mission Street  
San Francisco, Calif.  
Underhill 6682

700 Commerce St.  
Dallas 2, Texas  
Central 4075



# HERE'S THE NEW SAFER JIG SAW for YOU!



World's Safest Saw

Complete with Cord 3 Blades

**No Motor Needed...Just Plug In! Portable! Safe! Cuts Clean, Smooth...Needs No Sanding!**

Join the thousands of satisfied *Syncro Jig Saw* owners getting real pleasure, profit and relaxation using this amazing wonder tool! Think of the fun you can have making wall lamps, magazine racks, picture frames, games, many other articles for profit and pleasure. *Easy to use!* Just plug into any 50 or 60 cycle AC 110-130 volt outlet. Portable. Use anywhere... kitchen, basement, garage, attic. Ideal for apartments! *Syncro's* self-contained power unit needs no oiling—clean! Leaves no grease stains on table tops—no sawdust cloud. It's the perfect, safer educational tool for adults and younger children! Teach Junior to make fancy cut-outs, model planes, bookends, toys. Girls will love to make plastic monogram pins, jewelry, model furniture for doll houses. This amazing *Syncro* jig saw cuts wood, leather, plastic, 1/16" brass, aluminum, zinc, other thin metals, *all with the same blade.* It will follow the most intricate design, on that fancy what-not or cabinet you want to make, with perfect accuracy and ease. *Syncro's* safety stroke feature makes it the world's safest saw! Designed especially for you and your family. Low price. Mail coupon below for complete information without obligation!

**WHY SYNGRO IS THE SAFEST:**

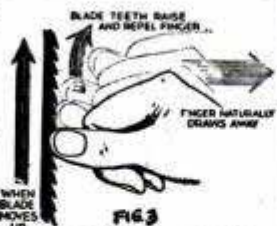

**Write for FREE CIRCULAR And Details of our 10 DAY TRIAL**

Mail coupon now for FREE circular containing complete *Syncro* information and details on our liberal money-back 10 DAY TRIAL OFFER. Paste coupon on penny post-card or mail in envelope today!

**Dealers Write!**

**FREE INFORMATION COUPON!**

**SYNGRO SAW CORPORATION, Dept. A-48**  
Rochester, Michigan  
(Export Address: 120 Wall St., N. Y. City)

Gentlemen: Rush me, without obligations, free, complete details of *Syncro* Saw, your 10 Day Trial Offer, amazing low saw price.

NAME \_\_\_\_\_

ST. & No. \_\_\_\_\_

CITY \_\_\_\_\_ ZONE No. \_\_\_\_\_ STATE \_\_\_\_\_

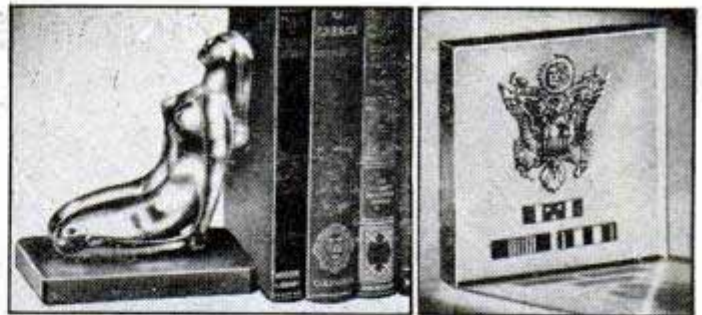

## NEW LIQUID PLASTIC Makes Fine Gifts, Novelties, Things to Sell

Have fun, make extra money, with **CASTOLITE**, crystal clear liquid plastic. Pours without heat, sets at low temperatures. Make bookends, wall plaques, jewelry, tiles, figurines, coasters. Embed real flowers, butterflies, coins, medals. Preserve treasured photos. **CASTOLITE** can be sawed, carved, turned, drilled. Can be mixed with **CASTOLITE DIES** for brilliant color effects. It's easy to do.

You can have the thrill of making things the very first day. No tools are needed.

**20-PROJECT CASTO-KIT \$3.50**  
(W. Coast, Can., Mex., \$3.75)

**CASTO-KIT** contains materials and instructions for making useful objects at once. Send check or M.O. for postpaid Kit today, or order C.O.D. For Manual alone, 25c. **DEALERS**—write for details.

**THE CASTOLITE CO., Dept. D-1 Box 211, Kenilworth, Ill.**

## COMPLETE OUTFIT TO DRILL THROUGH CHINA, GLASS, or POTTERY

**\$1.00 — Postpaid. Guaranteed.**

**LANG LAMP COMPANY, Dept. PM**  
1245 BELLEVUE AVE. EAU CLAIRE, WISCONSIN

## MULTI-COLORED FIREWORKS

**Dazzling!!! SPECTACULAR!!!**

**DEALERS AND JOBBERS Write For Direct FACTORY Prices.**

**ERNIE'S ENTERPRISES DEPT. PM-1, 725 PINE ST., ST. LOUIS 1, MO.**

THIS BOOK SHOWS HOW TO DO IT

## STEEL SQUARE POCKET BOOK

*Completely Revised*

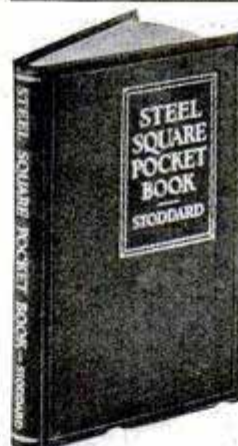

This concise and handy little book illustrates and describes the best methods of using the carpenter's steel square in laying out all kinds of carpentry work. It is easy to understand as a picture of the square laying directly on the work shows exactly how the various cuts are made. Its compact and handy size makes it convenient to carry in the pocket for quick reference.

Price \$1.25 Postpaid

**POPULAR MECHANICS PRESS**  
DEPT. 627 200 E. ONTARIO, CHICAGO 11, ILL.



- Row Boat—12 Foot
- Dinghy—8 Foot
- Dinghy—14 Foot Sailing
- Training Ship—6 Foot
- Sea Sled—9 Foot
- Outboard—12 Foot
- Cruiser—18 Foot
- Bicycle Boat—Kayak
- Row Boat—Sectional
- Dinghy—Sailing
- Canoe—16 Foot
- Sailing—12 Foot
- Outboard—12 Foot
- Outboard—Runabout
- Pontoons Ice Yacht

**FOR PLEASURE OR PROFIT DESCRIBES 17 LOW COST BOATS**  
Get this outstanding book and build a boat at home for your own use or to sell at a profit. You can do it. Just the boat you've always wanted—power, sail or row boat—17 different kinds and sizes.

Order **BUILD A BOAT** on postal card and pay only \$1.50 plus postage on delivery. Return in 5 days if not pleased and get money back. Or send \$1.50 with order and we'll pay postage. (Outside U. S: \$1.70 with order.) Order today.

**POPULAR MECHANICS PRESS**  
Dept. 598, 200 E. Ontario, Chicago 11





# MILL IT... ON YOUR LATHE!

## PALMGREN

MILLING ATTACHMENT

**3 SIZES**

No. 250 Illustrated

2 1/2"

JAW

Only

**\$24.75**

CONVERT LATHE  
IN 10 SECONDS

Now you can Mill, Slot, Grind, Groove, Square Shafts, Saw at Angles, Recess and many other important jobs. **SAVE TIME and MONEY!** Why send work out or use costly methods when a PALMGREN MILLING ATTACHMENT will solve your problem.

Precision built, it has accurate graduations for rotary angle adjustments, also graduated vertical feed screw. Fits South Bend, Atlas, Craftsman, Logan, Sheldon and all other lathes. Thousands now in use in small and large machine shops, repair shops, railroads, schools, home work shops, etc. **ORDER SIZE NEEDED TODAY!**—it will quickly pay for itself.

IMMEDIATE DELIVERY

Nos.	Width Jaws	Depth Jaws	Jaws Open	Weight Pounds	Fits Tool Post	Price F.O.B. Factory
150	1 1/2"	1"	1 5/8"	6 1/2	1" Dia.	\$18.75
250	2 1/2"	1 7/16"	2 1/2"	11	1 1/2" Dia.	24.75
400	4"	1 1/2"	4"	25	2" Dia.	39.75

Order From Your Dealer or Jobber: Write for Circular No. 351

Mrs. of PALMGREN PRODUCTS

Since 1915

8365 South Chicago Ave.  
Chicago 17, Ill.

**CHICAGO TOOL and  
ENGINEERING CO.**

JUST A FEW OPERATIONS YOU CAN DO ON YOUR LATHE!

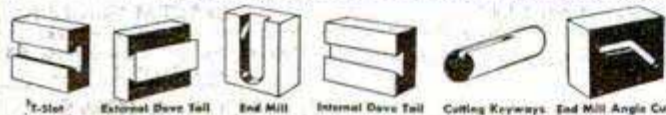

## AMAZING—FLIES UP WHEN YOU PULL THE STRING.

# HELICOPTER

Jet model. Aluminum, with 12-tooth plastic rotor. Only \$1.69 complete. Send \$1 with name and address. Pay postman's balance of 69c plus postage. **ORDER TODAY.**  
ROBERT SALES CO., Dept. E  
727 Hennepin Ave. Minneapolis, Minn.

## SPECIAL OFFER! SAVE 1/2

### PORTABLE AIR COMPRESSOR SPRAY PAINTING OUTFIT

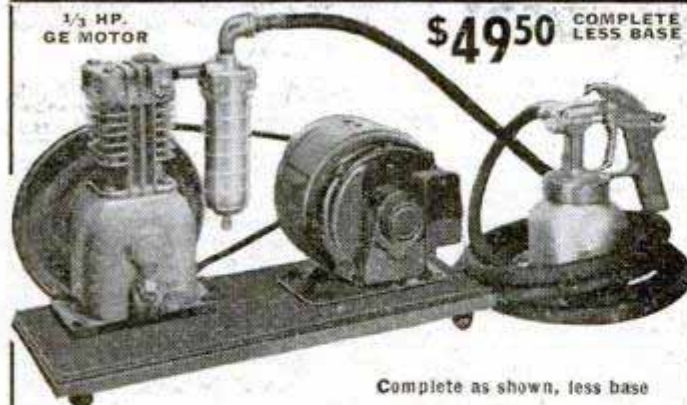

Complete as shown, less base

**2.8 C.F.M. DISPLACEMENT COMPACT POWER PLUS**

Here is what you get: 1/2 HP. GE motor or equal, 110 volt, 60 cycle, 1 phase, 1750 RPM, with 6 ft. cord and plug; Compressor, 2 x 1 3/4 piston type; Spray gun with qt. cup, 2 nozzles, round-fan spray, air filter, 15 ft. hose and fittings; belt and pulley. All bolts necessary for mounting on base. We pass the big saving in labor on to you. All you have to do is mount on base as shown. Complete operating instructions furnished. Weight 50 lbs.

**Special Price \$49.50**

SOLD ON MONEY BACK GUARANTEE. Prices F.O.B. Chicago. Immediate delivery. Send check or money order today. Dealers write.  
**C & M EQUIPMENT COMPANY**  
1831 S. State St.  
Chicago 16, Ill., Dept. D-4

# TACK WITH A GUN

*It's Quick—It's Easy*

*It's*

**DUO-FAST**

**\$7.50**  
FACTORY  
PRICE



**FOR YOUR HOME**

**NEAT — QUICK —  
PROFESSIONAL WORK**

Making screens—insulating your home—reupholstering that old chair—tacking shelf paper—lining dresser drawers—tacking carpet and linoleum—attaching shade cloth to rollers—repairing furniture. Wherever tacks are used, DUO-FAST will do it better—quicker—neater.

**FOR YOUR SHOP**

**INDUSTRY SAVES  
LABOR AND MONEY**

Furniture mfrs.—carpenters—woodworking plants—shippers—sign makers—chain stores—home builders—display houses—luggage—screen wire—theatres—stock rooms—dept. stores—mechanics—mattress mfrs.—insulation—upholstering—automotive.

**FOR YOUR SHIPPING**

**SIMPLIFIES  
WORK**

Shipping tags  
Waterproof lining

Protective padding  
Lining box cars

**It's DUO-FAST Wherever Tacks Are Used**

DUO-FAST will do it Better—Quicker—Neater. It's lightning fast—just squeeze the handle—staples are driven rapidly, accurately and easily—even in close quarters.

The DUO-FAST Gun Tacker is operated with one hand, leaving the other hand free for holding work

**RAPID LOADING — RAPID TACKING**

140 staples per load in 2 different leg lengths 1/4" or 3/8"

**5000 1/4" staples \$2.00**

**5000 3/8" staples \$2.25**

Prices F.O.B. Chicago

Remit with order to save C.O.D. and postage charges

DUO-FAST makes many other tackers to fit your individual business. Write for information on Hammer tacker, Air tacker, Lip tacker and Narrow crown tacker.

Certain dealer territories open—write for full information.

**FASTENER CORP. • 854 FLETCHER • CHICAGO, ILL.**

**FASTENER CORPORATION**

854 Fletcher St.

Chicago 14, Ill.

Please send me the following:

- |                                                                              |                                                   |
|------------------------------------------------------------------------------|---------------------------------------------------|
| <input type="checkbox"/> DUO-FAST Gun Tacker                                 | <input type="checkbox"/> 5000 1/4" staples \$2.00 |
| <input type="checkbox"/> For medium gauge staples \$7.50                     | <input type="checkbox"/> 5000 3/8" staples \$2.25 |
| <input type="checkbox"/> DUO-FAST Gun Tacker                                 | <input type="checkbox"/> More information         |
| <input type="checkbox"/> For heavy gauge staples \$7.50                      |                                                   |
| <input type="checkbox"/> C.O.D. <input type="checkbox"/> Remittance Enclosed | Amount \$ _____                                   |

Remit with order to save C.O.D. and postage charges.

NAME \_\_\_\_\_

ADDRESS \_\_\_\_\_

CITY AND STATE \_\_\_\_\_



**50 MILES  
PER GALLON**



Smart! Practical. Seats 4—or hauls a ¼ ton load. Costs \$600 to \$700 less than any other station wagon—operates for about half as much. Here's the experience of one Crosley Car owner: Francis Gettridge, 338 Columbia Ave., Atlas, Pa., has driven his Crosley 2,053 miles, averaging 50 miles gallon. Total cost was \$12.00.



← **SEDAN:** Seats 4 plus ample luggage space.



**PICKUP:** Cuts → service, delivery costs.



← **PANEL DELIVERY:** Full ¼-ton capacity.

Revolutionary 4-cylinder engine

**CROSLLEY**

a FINE car

For beautiful full-color catalog, write: Crosley Motors, Inc., 2532-HK Spring Grove Ave., Cincinnati 14, Ohio

**For Better, Faster Soldering**



SPECIAL REST Prevents Scorching

**AMAZING NEW  
GUN-GRIP  
ELECTRIC**

**SOLDERING IRON**  
WITH 3 SPECIAL-PURPOSE TIPS THAT REACH IN ALMOST ANYWHERE!

Now, lick any kind of soldering job, easily, quickly, certainly. Use heavy tip for heavy duty work. Use light tip for radios and wiring jobs. Use angle tips to reach out-of-the-way spots. And set the iron down anywhere—the special rest prevents scorching. This GUN-GRIP iron is amazingly easy to handle, enables you to do your best work. Has long-life element. U.L. Approved, 3000 cycle, 6-ft. cord, 75 watts, 110-120 volts, AC-DC, 9 1/2" long. The perfect soldering tool, and a terrific value. Order yours **Bargain \$4.95** at only

TODAY! Send check or send \$2.00 deposit with C.O.D. order. If not satisfied return in 5 days for money back. postpaid in U.S.

**D. SCHUPACK** Dept. PM-4S, 7331 Cottage Grove Ave., Chicago 19, Ill.

**REYNOLDS CIRCULAR SAW GRINDER**

FOR SAWS 5"-30"



FOR JOINTING  
**GUMMING • SHARPENING**  
ALL TYPES OF CIRCULAR SAWS  
Write for Circular

**REYNOLDS MACHINERY CO.**  
303 EDDY ST., PROVIDENCE 3, R. I.

**TOOL BARGAIN**  
Electric Hand Grinder Assortment

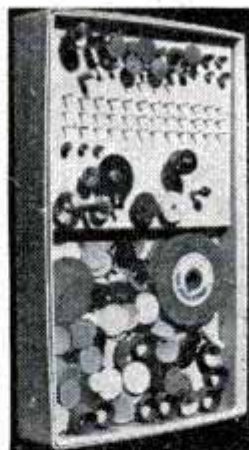

Now Only **\$9.75** A \$45 Value  
**MASTER KIT** POSTPAID IN U.S.A.

- 115 Grinding, Cutting and Polishing **WHEELS** PLUS 150 assorted tools most useful for Home or Shop.
- 2 Grinding Wheels 3" and 2" dia.
  - 2 Rotary Files, High Speed Steel.
  - 6 Rotary Cutters 1/4" Shank.
  - 3 Rotary Cutters 3/32" Shank.
  - 6 Mounted Grind. Wheels 1/4" Shank.
  - 6 Mounted Grind. Wheels 3/32" & 1/4" Sk.
  - 3 Rubber Wheels.
  - 4 Speed Drills 3/32" Shank.
  - 30 Rotary Cutting Burs 3/32" Shank.
  - 2 Mandrels 3/32" Shank.
  - 1 Mandrel 1/4" Shank.
  - 1 Screw Type Mandrel 3/32" Shank.
  - 3 Rotary Bristle Brushes 3/32" Shank.
  - 1 Rotary Wire Brush 3/32" Shank.
  - 1 Circular Saw
  - 1 Mandrel for Circular Saw 1/4" Shank.
  - 2 Rubber Cylinders and Mandrel 3/32" Sk.
  - 10 Cut-off Discs up to 1" in dia.
  - 1 Rotary Drum Sander 1/4" Shank.
  - 15 Bands for Rotary Drum Sander.
  - 15 Rotary Felt Wheels 1" dia.

• The right attachment for every job.  
**ORDER TODAY.** Send check or send \$2.00 deposit with C.O.D. order.

Compact container. Special rack for drills. Over 260 tools and items.

**D. SCHUPACK, 7331 Cottage Grove Ave., Dept. PM-4, Chicago 19, Ill.**

**NEW  
ARMY  
SURPLUS  
SHELL  
CASE**

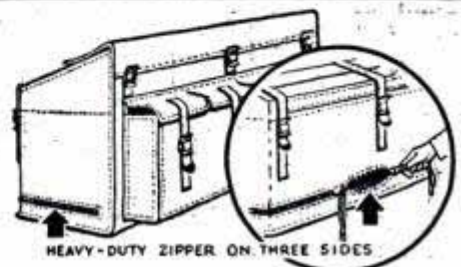

HEAVY-DUTY ZIPPER ON THREE SIDES

Ideal for camper, trappers, hunters, and picknickers. Made of extra heavy waterproof canvas. 30" x 13" x 17" deep with cover, pockets, and rugged heavy-duty zipper on three sides.

Plenty of room to carry your equipment on your vacation. More convenient than a trunk for storage. Easily attached to your automobile or truck. Get one of these sturdy, useful cases now for only.....

**\$4.00**

Postage paid anywhere in U.S.A.

**MACHINERY & EQUIPMENT EXCHANGE, Inc.**

3420 WEST FORT STREET

DETROIT 16, MICHIGAN

Now! Everyone can afford a **SPRUNGER BENCH SAW**



Own the best—for production or craft use. 8" blade. Rips, crosscuts, bevels, miters, dados. Big, accurate miter gauge. Easy-working handy controls. 16" x 20" rust-proof table tilts 45°. Ball bearing throughout. **68<sup>50</sup>**

Dealer inquiries invited. See your dealer, or write...  
**SPRUNGER BROS., INC., 140 Main St., TOPEKA, IND.**

**3-ROLL BARGAIN**

1 1/2" — 100 and 400 Grit  
2" — 100, 120, 150 Grit  
**3-50 YD. ROLLS**  
ABRASIVE CLOTH  
Now Only **\$5.95**

Tremendous bargain in abrasive cloth rolls. Three 50 yd. aluminum oxide rolls of finest abrasive cloth from mfgs. like Minn. Mining, Carborundum, Sandpaper Inc. A \$27.60 list value for only \$5.95. Specify widths and grit sizes. Send check or M.O. Or send on \$2.00 deposit and let bal. come C.O.D.

**D. SCHUPACK**  
Dept. PM-4R  
7331 Cottage Grove Ave.  
Chicago 19, Ill.

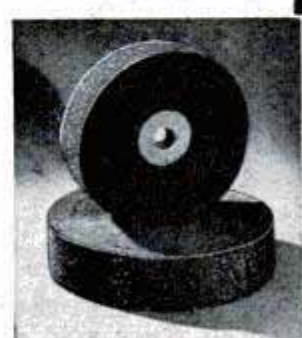

**GUARANTEE:** Our abrasives guaranteed to be top quality. Return for money back IN FULL if not satisfied.



**EARN BIG MONEY**  
**AND BE YOUR OWN BOSS**  
*Sharpening Lawn Mowers*

**THE UNIVERSAL GRINDER**  
**PUTS YOU INTO BUSINESS**  
**WITH SMALL INVESTMENT**

Earn as much as \$400.00 a month in your basement or garage. Mr. Felber of Ind., writes, "MY UNIVERSAL GRINDER is faster and more accurate than any other grinder. Its efficiency enabled me to sharpen 450 mowers in 4½ months. More than paid for itself the first month. Every customer satisfied." Mr. Hardy of Mississippi writes, "Received my Universal Grinder the first part of May and by August 18 had sharpened over 1000 mowers." Mr. Bacon of California writes, "The lawn mower business, with my Universal Grinder, has been a gold mine these last two years."



Only on the UNIVERSAL GRINDER can the inside face, the edge of the stationary blade, and the reel blades, be ground to proper clearance ALL IN ONE SET-UP WITHOUT REMOVING ANY BLADE FROM THE MOWER  
 Free Folder

Rogers Mfg. Co., Dept. M-48, Lindsey, Ohio

**SEND TODAY FOR FULL DETAILS**

ROGERS MFG. CO., Dept. M-48, Lindsey, Ohio  
 Please send me without obligation complete details about how I can earn BIG Money with the Universal Grinder.

Name \_\_\_\_\_  
 Address \_\_\_\_\_  
 City \_\_\_\_\_ Zone \_\_\_\_\_ State \_\_\_\_\_

**TOTE YOUR TOOLS IN THE NEW-HANDY Chuck box**

*Use it at home and in the shop*

**DURABLE LACQUER FINISH**

**KEEPS EVERYTHING HANDY — NO LOST TOOLS**

Handiest gadget yet for tools — hobby supplies — cleaning implements — gardening tools, etc. It saves you time — prevents loss of tools. Rugged, all wood construction 7 x 15½ x 9 inches. Durable lacquer finish — decorative decal ends. You'll want one for home and one for the shop. Immediate delivery. A wonderful gift for gardening friends. Send check or money order. Postpaid only.

**\$2.95**

ZEIGLER CORP. 77 W. WASHINGTON ST. DEPT. PM4 — CHICAGO 6, ILL.

**E-Z THREAD QUICK CHANGE GEAR BOX**

To fit SOUTH BEND 9", LOGAN 9" and 10", POWR-KRAFT, CLAUSING and SHIELDON LATHES. Will cut 78 threads. Aluminum casting with fourteen Torrington needle bearings, heat treated shafts and cut steel gears. Easily installed. Special 30 day offer. Send for literature.

**MONGE MACHINE SHOP**  
 NORTH CHICAGO, ILL.

**New CAR WASHER**

Designed to simplify that cleaning job! Just attach to any standard garden hose. For every purpose. Auto. Airplane. Trailers. Trucks. Porch Furniture. Windows, etc. Built for years of service. Money-back guarantee. For complete details write

**\$1.95** Retail Price

**JON HENRI CO.**  
 101 Neave Bldg., Dept. PM, Cincinnati 2, O.  
 Agents Wanted

**SOLVE Your Transportation Problems . . .**



with the new  
**MARMAN**  
**TWIN**

**THE ONLY BIKE MOTOR WITH EXTRA TWIN CYLINDER POWER**

Ride to work, school, shopping, anywhere — easily, inexpensively. No parking problems, no prohibitive maintenance costs. Saves your car... faster and cheaper than a bus or streetcar... loads of fun for everyone.

**SUPERIOR DESIGN AND PERFORMANCE**

With the Marman Twin you'll have faster getaway, easy hill climbing, effortless cruising speed of 35 MPH, because the Marman Twin has 3¼ H.P. . . more than 25% greater than any other bike motor.

You'll get over 100 miles per gallon . . . greater efficiency and horsepower per pound and per dollar from the 2-cycle, horizontally opposed engine.

Smoother, faster acceleration . . . easy idling at stops . . . no pedalling because of the automotive type, multiple plate dry disc clutch.

**LOW MAINTENANCE COST** With only 5 moving parts in the motor, upkeep is kept to a minimum. No valves or tappets to wear or renew. The clutch replaces the traditional belt slipping arrangement and saves wear and tear.

**TOP STYLING** Chrome plated gas tank, tool compartment, muffler and pipes, to harmonize with any color bike. Makes a bike look like an expensive motorcycle.

Easily installed on any man's balloon tire bike. Money back guarantee.

**Factory price \$129.50 plus tax**

**IF NO LOCAL DEALER... USE THIS COUPON**



P. O. Box 89, Inglewood, Calif., Dept. P.M.

**MARMAN PRODUCTS COMPANY, INC.**  
 P. O. Box 89, Inglewood, California ★ Dept. P.M.

Send me one Marman Twin Motor with complete installation instructions. I enclose \$135.98 ( ) check or ( ) money order which includes \$6.48 Federal Excise tax.

Send me further information and descriptive literature only.

Name \_\_\_\_\_

Address \_\_\_\_\_

City \_\_\_\_\_ State \_\_\_\_\_

**Dealers and distributors write for information. Many desirable territories open.**



For Good Living...  
Carefree Travel...



## A SCHULT IS "TOPS" IN VALUE!

● Your modest investment buys more in a Schult . . . dozens of plus-values that cost you nothing but ADD to comfort, privacy, livability and convenience. A Schult is a dependable, quality product, backed by more than a decade of experience and research. Let your Schult dealer show you the new 1948 models. Or write SCHULT CORPORATION, Dept. 3204 Elkhart, Indiana. In Canada: John Inglis Co., Ltd., Toronto.



★ ★  
You'll have to spend some time in a SCHULT to appreciate the living comfort it offers.

**Free** Write today for book on trailer coach living showing latest, comfortable 1948 Schult models.



**SCHULT** Trailer Coaches

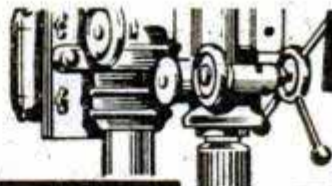

**NEW!**

## HANDY, FLEXIBLE SHAFT

Converts Any Motor, Drill Press, Electric Drill, Electric Fan Into A Handy Rotary Tool

Attach ROTA-SHAFT in a Jiffy. Can Be Used for Grinding, Polishing, Sharpening, Cleaning, Engraving, Marking Tools, Carving, On Metal, Plastic, Wood, Glass.

Yes! Only \$2.95 and ROTA-SHAFT turns your old motor, drill press, electric drill or electric fan (10 inch or larger) with blades removed, into an efficient, versatile Flexible Shaft Tool for doing hundreds of grinding, polishing, sharpening jobs, especially in hard-to-get-at places. Attaches to motor shaft or in chuck. Convenient handpiece for ease of handling. Generous 40-inch overall length. Comes complete with buff and sanding disc ready to use in a drill press chuck. Order today.

OLD FAN MOTOR



YOUR ELECTRIC MOTOR



VACUUM CLEANER MOTOR



**SEND NO MONEY!** Just mail order. Pay postman only \$2.95 plus postage on delivery, or send \$2.95 and we pay postage. Try 10 Days — if not delighted return for money-back.

If you order Rota-Shaft for use on motor add 35¢ for Special Coupling and State Shaft Diameter. **MAIL ORDER NOW!**

**STRADER PRODUCTS CO., Dept. B-101**  
259 Strader Ave. Cincinnati 26, Ohio

## HANDY TOOL

reconditions battered threads and makes quick repairs without dies. Repairs 1/4", 5/16", 3/8", 7/16", 1/2", 5/8", and 3/4" threads.

SPECIFY U.S.S. or S.A.E.  
**SATISFACTION GUARANTEED**  
**ADVANCE SUPPLY CO.**

3243 Joy Road, Dept. PM, Detroit 6, Mich.



ADVANCE RE-THREADER  
**\$3.75**  
POSTAGE PAID

## AUTOMATIC ACCELERATOR CONTROL

Push the pedal and it stays put until you move your foot left or push the brake. Pays for itself many times with the gas it saves by holding the pedal steady. Fits all pedals. Can be disengaged permanently, and reengaged again with your foot, in a second. It has been used successfully for five years. \$2.98 post paid or C.O.D.

Dealers and Salesmen Wanted

**AUTOMATIC ACCELERATOR CONTROL, Inc.**  
MONROE, MICHIGAN



# DINA-MITE

A BRAND-NEW, POWERFULLY EXCITING, CIGARETTE PACKAGE SIZE, ULTRA MIDGET RADIO!

### "DINA-MITE" FEATURES

- Over 1,000 Mile Range
- New Powerful Tiny Electronic Tube
- Dynamic Dina-Coil Tuning
- Brand-New Radical Circuit Design
- Amazing Selectivity
- Clear as a Bell Tone
- Portable for Campers, Hikers, Etc.
- Powered by New Midget Batteries
- Picture Diagram for Radio Beginners

Years ahead of its day . . . NEW . . . SENSATIONAL . . . "DINA-MITE" was designed for everyone who delights in a practical, ultra tiny radio. "DINA-MITE" IS SOLD DIRECT FROM LABORATORY TO YOU! We believe "DINA-MITE" to be the MOST POWERFUL MIDGET RADIO EVER DESIGNED!

"DINA-MITE" IS MOST COMPLETE AND INCLUDES A BRILLIANT RED CRACKLE FINISHED CHASSIS, AMPHENOL SOCKETS, POLYSTYRENE DINA-COIL, NEW MIDGET RESISTORS AND CONDENSERS AND ALL PARTS PRECISION FINISHED . . . Complete Set, Including Midget Tube, Ready to Wire . . . ONLY \$4.99 Postpaid. Or send \$1.00 Bal. C.O.D. Extra Electronic Tube \$1.90 Postpaid.

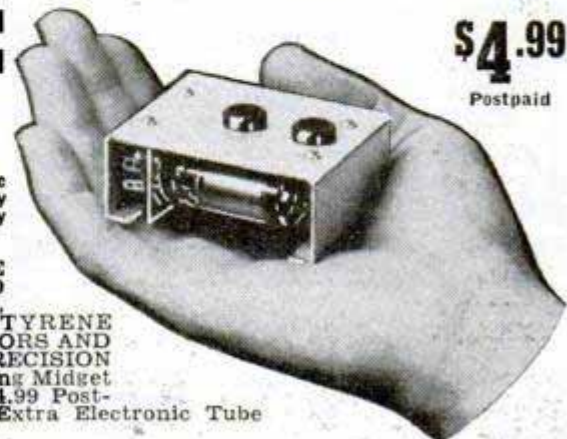

**\$4.99**  
Postpaid

**ELECTRONIC RESEARCH, 1216 Park Row Building, New York City 7**



**BRAND NEW**



**HYDRAULICS**

Use hydraulics on arbor presses, hydraulic presses, hay lifts, manure loaders, lift trucks—push or pull, tilt or turn, press or squeeze, open or close, lift or lower—and other hydraulic and industrial applications. Use with either air or oil . . . finest precision workmanship.

1. Double action, 3" bore, 12" stroke, all steel hydraulic cylinder, will lift up to 12,000 lbs. (7,000 lbs. in 3 seconds with Vickers Pump.) . . . \$78.00 value . . . \$19.50 postpaid. Weight 12 lbs.
2. Double action, 1 1/2" bore, 27" stroke. (Will lift 1760 lbs. in 2 seconds with Vickers Pump.) A \$55 hydraulic cylinder value for only \$12.95 postpaid. Wt. 8 lbs.
3. Double action, 1 3/4" bore, 10" stroke. (Will lift 2400 lbs. in 1 second with Vickers Pump.) A \$25 value, available now at \$8.95 postpaid.

**VICKERS MODEL MF6 HYDRAULIC PUMP**

Compact, powerful, rated 1,000 P.S.I., .507 cu. in. per revolution, 8 gal. per min. at 3750 r.p.m. Brand new, wt. 4 1/2 lbs. \$60 value for \$14.95 postpaid.

**U. S. SURPLUS BARGAIN POLAROID GOGGLE KIT**



Brand New! In original packing. Each with four interchangeable lenses. SHOCK PROOF FRAME — SHATTERPROOF LENSES. Use them for all outdoors sports, beach, motoring, boating—anything. Heavy windproof sponge rubber ventilated frame with snap button lens retainers! Adj. elastic head band. Clear, red, green, amber flexible, shatterproof lenses, all instantly interchangeable, with carrying case. They won't last long at this price—it's smart to buy an extra . . . . . **\$1.00**



**CLUTCH WITH UNIVERSAL JOINT**

Brand new. Formerly used on amphibious Jeeps. Has shaft 3 ft. long and 5 inch pulley . . . with ball bearings in pulley, can be used for power take-off with winch and hoist. **only \$4.95**

Worth a lot more!

**VACUUM-AIR HYDRAULIC GENERAL PURPOSE PUMP**

**BRAND NEW!**

Original Cost \$45.00  
Now Only \$9.95  
Prepaid in U.S.A.

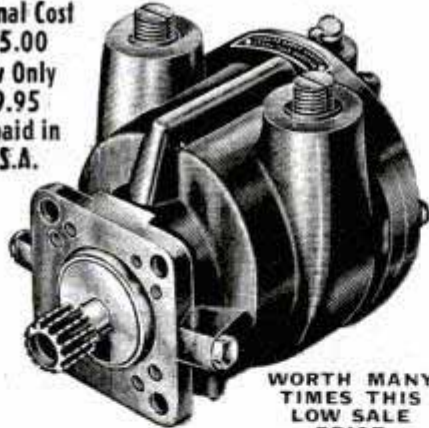

**WORTH MANY TIMES THIS LOW SALE PRICE**

Originally cost \$45.00. May be used as air or fluid pump—for pressure or vacuum. Standard 3/8 inch pipe thread with interchangeable ports. Will pump 7 1/2 gal. SAE 30 oil per minute at 300 RPM. Buflids air pressure of 30 lbs. per sq. in. at 1000 RPM. Vacuum will draw 26 inches of mercury at 1750 RPM. Develops up to 120 lbs. per sq. inch of hydraulic pressure, which in conjunction with a 3 inch hydraulic cylinder will lift 840 lbs. minimum. Runs forward or reverse. Self aligning shaft. Die cast aluminum housing 6x4x4 inches. Has stainless alloy steel vanes and impeller. Made by Bendis Avia, Corp. Spline terminal for direct drive—readily replaced with a pulley. Recommend a 1/4 H.P. or stronger electric motor. Rated capacity 1500 RPM with high overload factor. Special price for quantity users. Complete illustrated engineering report and instruction booklet FREE with every pump. Send check or money order today! Postpaid in U.S.A. **\$9.95**

- Use Them for
- OIL BURNERS**
- SPRAYING MACHINES**
- MILKING MACHINES**
- COMPRESSORS**
- VACUUM PUMPS**
- HYDRAULIC SYSTEMS**
- MANURE LOADERS**
- PRESSES, etc.**

**CENTRIFUGAL PUMP**

**BELT DRIVEN BRAND NEW!**  
**READY FOR USE ON ANY LIQUID PUMPING NEED**

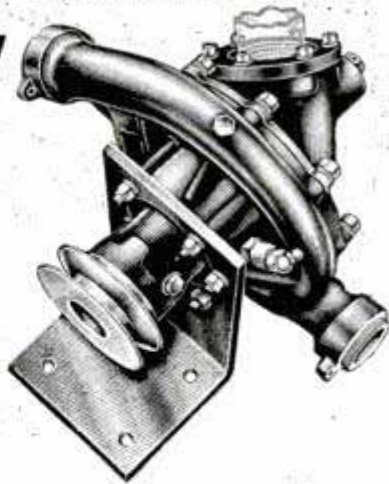

- Use it For
- DRAINING BASEMENTS**
- HOME WATER SYSTEMS**
- IRRIGATION**
- STOCK WATERING**
- FIRE PROTECTION**
- DRAINING PONDS, TANKS, etc.**
- INDUSTRIAL PUMPING**

A super value for all types of intermittent service in pumping large volumes of liquid in home, farm and industrial service. Ideal for home water systems, draining basements, fire protection, etc. On the farm for watering stock, draining ponds, sprinkling, etc. In shops and factories for all types of pumping service.

**MOVE LARGE VOLUME QUICKLY**  
When operated at 1750 RPM will pump 42 gallons per minute on a 23 foot head; at 3600 RPM on 52 foot head will pump 88 gallons per minute. May be run with electric motor, gas engine or power take-off on tractor.

**COMPLETE ENGINEERING REPORTS AND OPERATING INSTRUCTIONS FREE WITH PUMP**

Pump has cast aluminum housing—accurately machined bronze impeller vanes. Complete with mounting bracket and 3 1/2" V belt pulley. Shaft rotates on sealed ball bearings with grease gun fittings. Has 1 1/2" threaded intake flange, two 1 inch outlets. Use one or both, as necessary. Made for Packard Motor Car Co. for use in Rolls-Royce Merlin Aircraft engines.

**GREATEST PUMP VALUE IN YEARS**  
Original cost approx. \$147.00. Sold F.O.B. Chicago. Shipping weight 23 lbs. You can't beat this value at anywhere near this price. Satisfaction guaranteed. **Original Cost Approx. \$147.00.**

**COMPLETE WITH PULLEY AND MOUNTING BRACKET — READY FOR USE**

**\$29.75**  
F.O.B. Chicago

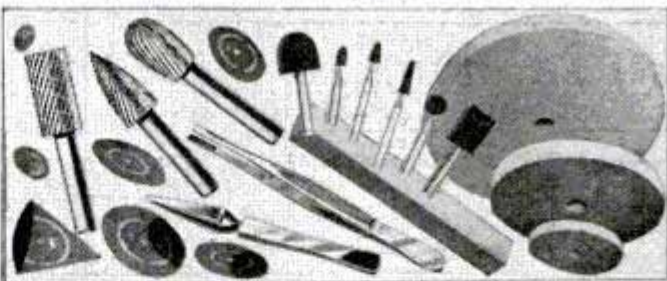

**GRINDING WHEELS**

Worth \$50.00!

A wonderful buy! 350 pieces incl. 35 ass't. Grinding and Cut-off wheels up to 10 inches diameter. 1/16 to 1 1/4" face, 1/8 to 3 in. holes. Ass't grits—all brand new—Made by Norton, Carborundum, Macklin, Bay State, etc. Also included are 100 slotted disc cloths; 100 paper discs; 10 pencil rolls; 20 abrasive strips; 2 felt bobs; 2 felt wheels; 1 4" rag buff; 3 honing stones; 10 abrasive sleeves; 10 mounted stones, 1/4 and 3/4 shank; 2 mandrels; 2 rotary files, 1/2 shank; 50 abrasive discs; 2 7/2" abrasive belts; 5 9x11 abrasive sheets.

**SATISFACTION GUARANTEED. 350 PIECES \$6.95**  
—Ass't sizes.  
FOB Chicago — ALL FOR ONLY . . . . .



**HI-PRESSURE TANK**

**SURPLUS SPECIAL!**  
NEW, 11 1/4"x2". ICC3A 1800—P.S.I. Can be filled with CO2 and used as tire inflator or fire extinguisher. Also as pulsating tanks, storage tanks. Wheel control brass valve. **COST THE GOVERNMENT \$9.80. NOW ONLY \$1.95**



The meter with a MEMORY

THE NEW

**G-E**

**Exposure Meter**

**Type PR-1**



Only G-E gives you  
all these advantages . . .

- Easy to use—gives correct camera settings in 5 seconds for better movies, stills, color
- Extra help for tricky scenes
- Precision built
- Automatic shift for bright light or dim
- Sturdy, lightweight, vest-pocket size
- At photo dealers everywhere. General Electric Company, Schenectady 5, N. Y. **\$32.50\***

ALSO famous Type DW-58 meter . . .  
a big value at **\$19.95\***

\*In states where Fair Trade Contracts are in effect; includes Federal Tax.



**GENERAL ELECTRIC**

WINFLOW  
"LOOK IT'S NEW"

Noiseless Fan Blades. More air than ever. Now all air units can be quiet. More efficient. Build a fan, change blades on your own. All sizes — 1001 uses. PATENTED.  
WINFLOW NOISELESS FAN BLADE CO.  
1972 S. Division Ave. Grand Rapids 7, Michigan

# SURPLUS BARGAINS



The Mart brings you the greatest money-saving values ever offered. A great array of war surplus items—practically all brand new—some slightly used but guaranteed perfect—at a fraction of their Gov't. acquisition cost. Thousands of items you've been waiting for, built to stiff Gov't. regulations. Watch for the Mart's amazing values.

## INDUSTRIAL GOGGLES



You get real eye protection with these Industrial Protective Goggles made by Wilson, Kimball, American Optical. Frame is ventilated for added wearer comfort. Lenses are clear for easy visibility and are truly shatterproof. Weighs 4 oz. Assures eye safety while grinding, buffing, etc. Real eye protection at **\$129** only.

## FRACTIONAL H.P. MOTOR



Ideal for use on all types of mechanical displays wherever small power is required. Made by Oster. Shaft terminal has helical cut gear; readily and easily replaced by a pulley. New. Operates on door bell or chime transformer, AC-DC 12 or 24 V. Approximately 1/25th H.P. Use one to make your own hand grinder, other power tools. Weighs 13 oz. A value **\$298** at only.

## WOBBLE HAND PUMP

General Utility Pump  
For Water and Other Liquids



Drain basements, tanks, pools, etc. Fill stock tanks or use for fire protection and irrigation. Finest aircraft design. Each stroke of the handle sends forth a powerful spurt of liquid. Pumps 425 gal. per hour at 60 strokes per minute with 3 ft. lift and 6 ft. head. Has 1 inch intake and outlet ports with standard pipe thread. Use hose or pipe. Made by Aero-Corry. Brand new! Fully guaranteed. Wgt. 6 lbs., 11 oz. Quantity is limited. **\$1995** Hurry! A buy at only.

## PISTOL GRIP SWITCH



Gives you trigger action for "ons" and "offs." Complete with rubber covered lead wire and plug. Made of enduring plastic. Adjustable tape for hand fastening. New. Use on any circuit up to 115 volts. Made by Cutler-Hammer. Hundreds of uses. Weighs 12 ounces. A real buy **\$119** at only.

## TOGGLE SWITCHES



Seven assorted toggle switches, all panel mounting types. All different. SP-ST, DP-ST, DP-ST. Brand new. Just the thing for your home made equipment, models, inventions, radio, electronic and other electrical equipment. Complete assortment. Weighs 11 oz. A bar **\$169** gain at only.

ORDER THIS EASY WAY Print your name, address, list of items. Enclose check, money order, bank draft. Add sufficient postage if shipment is parcel post. Excess postage immediately returned. On C.O.D.'s, include 25% deposit. Items are guaranteed as described. If not completely satisfied, after ten days, return goods and your money quickly refunded. Order your needs today.

**THE MART**

DEPT. M-48  
11 East Harrison Street  
Chicago 5, Illinois

**LAW**

STUDY AT HOME FOR PERSONAL SUCCESS and LARGER EARNINGS. 39 years expert instruction—over 108,000 students enrolled. J.L.B. Degree awarded. All texts furnished. Easy payments. Send for FREE BOOK.

AMERICAN EXTENSION SCHOOL OF LAW  
Dept. 88-M, 646 N. Michigan Ave., Chicago 11, Ill.

# AMERICA'S FINEST BUMPER JACK

Here's an all-around hydraulic utility jack with hundreds of uses where easy lifting or pulling is required. Safest, quickest, easiest to use on any car built. Result of 15 years of advanced precision engineering. Extra long, heavy duty steel chain with forged steel grab hook picks up loads from 4" BELOW bottom of jack to 22" ABOVE. Base, handle socket, head and chain plate are all tough malleable iron castings. 17" hydraulic lift, 3000 lb. capacity. Order now at your dealer or send money order or check to

**\$1595**  
Complete with chain, hook and handle.

© 1948 American Hydraulics, Inc.

*American Hydraulics, Inc.*

SHEBOYGAN, WISCONSIN

**American Hydraulics, Inc.**  
Sheboygan, Wisconsin  
Enclosed find check or money order.  
Please send.....American Bumper Jacks.  
Name.....  
Address.....



# Paint Your Own Car in One Hour with the NEW AUTO ENAMEL

## YOU WIPE ON Like Magic with only a POWDER PUFF

2 YEAR  
Guarantee

# LUSTR-WIPE

TRADE MARK

Dries in about one hour to smooth, mirror-like professional finish.

**GUARANTEED FOR 2 YEARS** not to crack, chip, peel or fade, if simple directions are followed. Lustr-Wipe is NOT a wax or a polish but a marvelous new Auto Enamel.



**NO Brushing  
NO Spraying  
NO Masking  
NO Streaks**

Follow the simple instructions and LUSTR-WIPE will give your car that new FACTORY-LOOK. Dries dust-free in about an hour. Goes over any color, enamel or lacquer.

### ONE QUART PAINTS YOUR ENTIRE CAR ANYONE CAN DO A BEAUTIFUL JOB

LUSTR-WIPE is the easy, speedy, economical, yet most successful way you've ever seen to PAINT YOUR OWN CAR. It's different-works almost like magic! All you need is ONE QUART of LUSTR-WIPE, the Miracle Auto Enamel, and the powder puff we send you AT NO EXTRA COST. Almost ANYONE can do a magnificent job in about ONE SHORT HOUR. It seems unbelievable but true. JUST WIPE IT ON. No brush needed. No spray required. No masking of any kind. LUSTR-WIPE dries dust-free in about an hour. You'll be amazed—thrilled beyond words with the results! Your friends will think you spent \$75 to \$125 for a professional paint job. YOUR CAR WILL LOOK "LIKE NEW". Rush your order for a quart of LUSTR-WIPE TODAY.

This Price for Immediate Delivery

**SAVE by  
Ordering  
NOW!**

**\$3.95**  
PER  
QUART  
Applicator  
Furnished

ORDER ONE OR MORE  
QUARTS TODAY

#### SEND NO MONEY! ORDER LUSTR-WIPE TODAY!

BLACK	\$3.95 per Qt.
GREY (Gunmetal-Dark or Air Wing-Light)	3.95 per Qt.
GREEN (Brewster-Dark or Jewel-Light)	3.95 per Qt.
BLUE (Washington-Dark or Monticello-Light)	3.95 per Qt.
SUN BEIGE (Tan)	3.95 per Qt.
RED or MAROON	3.95 per Qt.

Order one quart or more today! SEND NO MONEY! Mail penny postcard. Then pay postman for LUSTR-WIPE plus postal charges. Or, if you send money with order, WE pay postage. See your dealer or order direct.

Send for free details of powerful money-making plan. Why wait? The weather is ideal for painting cars. START NOW BY ORDERING ONE OR MORE QUARTS OF LUSTR-WIPE TODAY!

#### MAIL COUPON TODAY! SEND NO MONEY!

**AGENTS WANTED FOR NEW MONEY-MAKING BUSINESS!** CAN MAKE GROSS PROFITS UP TO \$275.00 IN ONE WEEK.

Go into business for yourself selling LUSTR-WIPE in cans, or painting cars yourself or having others to do the work. Owners of old cars everywhere (who can't get new cars) are easy prospects. Send now for our MONEY-MAKING PLAN.

**DISTRIBUTORS WANTED:** A few wonderful territories now available. Write at once for our SPECIAL OFFER. LUSTR-WIPE CORP. 166 W. Washington St. Dept. 4, Chicago 2, Ill.

LUSTR-WIPE CORP. 166 W. Washington, Dept. 4, Chicago 2, Ill.

Please send me \_\_\_\_\_ quarts of LUSTR-WIPE AUTO ENAMEL at the special price of \$3.95 per quart.

COLOR \_\_\_\_\_

Send Postpaid. Full Payment \$ \_\_\_\_\_ enclosed.  
 Send C.O.D. plus Postal charges.

NAME \_\_\_\_\_

ADDRESS \_\_\_\_\_

CITY \_\_\_\_\_ ZONE \_\_\_\_\_ STATE \_\_\_\_\_

Send information regarding AGENT PLAN.

Send information regarding DISTRIBUTORSHIP.



# Announcing SHAPER and MOLDING Cutters FOR ALL MAKES OF DRILL PRESSES!



**NO SET SCREWS TO LOOSEN! BLADES AUTOMATICALLY ADJUSTED. CANNOT SLIP OR FLY OUT!**

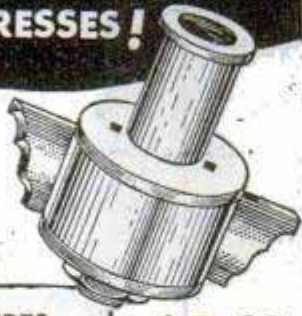

### OTHER EXCLUSIVE FEATURES

Blades instantly replaceable—automatically drop into position—cannot loosen or fly out . . . quickly re honed or re-ground. Variety of blade shapes for varied contours. Balanced, concentric, built for lifetime use. One locking nut only. Fits tapered, threaded, or 1/2" I.D. spindles. Specify type and size spindle.

**\$9.00**

Complete as illustrated with 3 sets of blades. Full Money-Back Guarantee



**\$7.95**

**ALL-METAL SHAPER FENCE**  
For use with shaper and molding cutters, planers and drum sanders. Fits all drill presses and shapers. Complete—with tempered hold down springs. Fully rust proofed. A real buy.



**2 1/2" DRUM SANDER**  
**\$3.95**  
with 5 Steeves



**ROTARY WOOD PLANER**  
Most sensational, versatile drill press tool ever built. Planes, trues-up, tenons, panels, rabbets, grooves, beads, bevels, etc. An all purpose, lifetime tool. Complete.

**\$7.50**



**4" ROTARY SANDER**  
Sands wood and plastic surfaces to agate smoothness. Available for hand drills, flexible shafts and drill presses. Two size arbors 1/4" or 1/2". Complete with 20 discs. **\$5.95**

**FULL 10 DAY MONEY-BACK GUARANTEE**  
**FREE Workshop Catalog** →  
**BARRON TOOL COMPANY, INC.**  
269 Architects Bldg.: Detroit 1, Mich.



## BARRON PRECISION WORK SHOP TOOLS

SAY YOU SAW IT IN POPULAR MECHANICS



**\$16.95**

Complete

### FLOCKING or SANDBLASTING GUN operates on small air compressor

The most Decorative Gun on market—101 uses. Home Craftman, Hobbyist or Refinisher—Spray that velvet Suede Finish on your Radio Cabinet, Lamp bases, shades, Book ends, Statuettes, Jewelry boxes, Auto Dashboards. Make things Snagproof, Marproof. Ideal for Cushioning, Art or Sign Work, Print Goods, Sand Blasting Designs on Tools, Wood or Metal. Will remove paint or rust from Auto Bodies. This feature alone is worth \$16.95! Aluminum Alloy Casting, Brass Fittings, Chrome Molybdenum, Heat-Treated Sand Nozzle and Air-Jet, Shipped complete with flock ready to use, \$16.95. 5-Day money-Back-Guarantee. Money with order Post-Paid in U.S.A. California orders send 2 1/2% Sales Tax.

**BLASTO SPRAY GUN MFG.** Dept. PM-4, 7007 Haas Avenue Los Angeles 44, Calif.

## NEW Auto FLASHER



### For Fast, Snappy Drivers

Makes your Stop Light Shout. Flashes 115 times a minute. Fully automatic when brake is applied. Approved by leading Safety Engineers. **INSTANT ACTING.** If your dealer can't supply you, send check or M.O. for \$3.00. We pay postage. Dealers and Agents desired.

Patented. **MACCHI and COMPANY** Simple to install. 927 Larkin St., Dept. M, San Francisco 9, Calif.

## FILM RENTAL LIBRARY

**One of World's Largest**  
8-16mm SOUND-SILENT  
Victor 40B Projector with Screen **\$214.95**  
Cameras — Projectors — Supplies  
**MOGULL'S** 68 W. 48 St. New York 19, N. Y.

SAY YOU SAW IT IN POPULAR MECHANICS



### makes False Teeth TIGHT

Makes loose dental plates fit snugly and comfortably. **LASTS for MONTHS!**

Simply squeeze on dental plate and put it in your mouth. Harious and becomes part of plate. Money-back guarantee.  
**FREE** Generous package of Dental Plate Cleanser with each order. Send \$1.00 or mailed parcel post collect.  
**Fit-Rite Co., 1557 Milwaukee Ave.**  
Dept. 4-PM, Chicago, Ill.



**THE AMAZING NEW LIGHTNING Adding Machine**  
For stores, homes, offices. Simple as dialing a phone. **ONLY \$12.95** NO C.O.D.  
**FULLER'S OFFICE MACHINES, 1340 N. Ashland, Chicago 22, Ill.**

**DYNAMOTORS!!** BRAND NEW with Fillers \$1.29; 3 for \$3.50. Input: 14 or 28 V.; Output: 235 V., 90 MA. (Specify Input Desired.) 50% Dep. — Bal. C.O.D.  
Write for **FREE Electronic Catalog.**  
**UNITED SURPLUS MATERIALS, 3313 Ogden Av., Chicago 23, Ill.**



## MOTORS \$4.95 F. O. B. N. Y. C.

**110 V. AC HEAVY DUTY CONSTRUCTION**  
Fractional H. P. Ball Bearing, Brand New. 3800 RPM. Ideal for Power Tools, Models, Fans. 100 other uses. Value \$15.00. In lots of 10 or more \$3.95 each.



**MANUEL KLEIN** 74 CORTLANDT ST. NEW YORK 7, N. Y.

25% Deposit on All Orders Bal. C. O. D.

## COMPRESSED AIR INSTANTLY, Anywhere!!

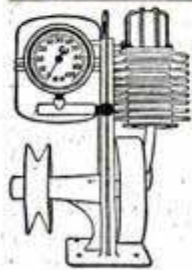

Portable Air Compressor and storage tank. Ruggedly built of best materials using lifetime lubricated ball-bearing on connecting rod and oil impregnated main bearing on shaft. Unusual design forever eliminates valve trouble, the most common fault in air compressors. **PATENTED** unique air intake system increases efficiency tremendously over other compressors so that air output is much greater than that from larger compressors powered by heavier motors. Will deliver approximately 3500 cu. inches of air per minute at maintained pressure of 30 lbs., or will inflate a 90 lb. truck tire in less than one minute. Comes complete with 100 lb.

gauge, although finger-tip adjustment allows setting of output pressure at any value, which will automatically be maintained. Works from any 1/4 H.P. motor. Useful for spraying paints or lacquers, disinfectants, insecticides, annealing or brazing with natural gas, inflating tires, etc. Price \$14.50 postage prepaid anywhere in the U. S. Efficient, completely adjustable syphon type spray gun complete with 12 ft. of 100 lb. tested hose available for only \$7.75 with pint container, also prepaid. 25% required on all C.O.D. orders. Send for free catalogs of radio parts and surplus items.

**BUFFALO RADIO SUPPLY, 219-221 GENESEE ST., DEPT. 4-M, BUFFALO, N. Y.**



**UP TO**  
**SAVE 85%**

**in WAR SURPLUS...SENSATIONAL VALUES**  
at "GADGETEER'S HEAVEN"  
IN MANY ITEMS WE HAVE  
THE WORLD'S LARGEST SUPPLY

**NEW HYDRAULIC CYLINDERS, VALVES, PUMPS, FITTINGS, HOSE & TANKS**  
51 sizes & types.  
World's Largest Supply  
1001 Labor Saving Adaptations for pulling, pushing, lifting operations. Finest precision workmanship and materials. Liquid and air operation, developing terrific power.  
**20,000 Available WRITE FOR CATALOGUE PRICED TO SELL AT 15% GOVT. COST.**

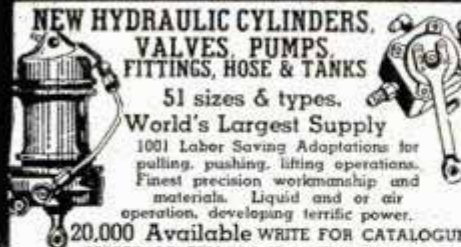

**WINCH HOIST**  
now equipped with mounting frame, handle, cable, etc. complete. Thousands of Satisfied Users! Hundreds have written, telling us it's the most wonderful tool in the world!  
Capacity 2500 lbs. 20-1 ratio  
Bronze Worm Gear  
Ideal for Garages, Truck loading, Machine Shop, Boat Builders, etc. \$14.99 ea.



**Pneumatic RIVET GUNS**  
Pistol & Goose-neck Type  
101 Uses. Chipping, Breaking cement and auto body work.  
Chicago Pneumatic, Cleco, Ingersoll Rand  
E3, E2, 3X, 2X, OY  
\$55 Value  
**\$8.95**  
PNEUMATIC #180 Value #186  
ALLIGATOR SQUEEZER **\$15.95**



**PUMPS**  
HYDRAULIC, VACUUM, AIR  
For every purpose at 15% of Value.  
**F-1 Hydraulic Pumps Type**  
Positive displacement gear type.  
Capacity: 1 gal. per min. at 1500 R. P. M. at 1500 P. S. I.  
Operating speed: 3750 R. P. M. Intermittent maximum 4500 R. P. M.  
M. Rotation: either direction with slight adjustments.  
**#9.49**  
**P-4 VICKERS**  
Positive displacement piston pump type.  
Capacity: 6 gal. per min. at 3500 R. P. M. at 1500 P. S. I.  
Operating Speed: 3750 R. P. M. Intermittent maximum 4500 R. P. M.  
Rotation to right only.  
**\$14.49**  
**PV-1**  
May be used as air or fuel pump for pressure or vacuum.  
Will pump 7 1/2 quils. oil at 300 R. P. M. Builds air pressure 20 lbs. per sq. in. at 1000 R.P.M.  
Vacuum draws 28 in. at mercury at 1750 R. P. M.  
**\$9.49**



**Here's a Real "Lite Special"**  
Farm, Auto, New U. S. Navy Portable Pistol Grip, Sealed Beam, 12v. 24v. Search Spot, or Emergency Light - featherweight Light - leatherweight Gov. \$35.00 our price  
**\$2.95**  
3 Extra fillers - Red, Green & Amber  
93c Set  
Extra Seal Beam  
95c ea.  
**AIRFORCE GUNSIGHT**  
#102 **\$1.95**  
#102 contains triple Lens. #103A NSA non-glass variable density Lens, plus other Lens. Valuable for Photo work \$2.55  
Lens in these sights are worth many times the entire cost of these items.



**Electric GYRO PILOT** Assembly Part 2 solenoids for reverse and forward motor control. 2 solenoids throw clutch to engage drive. With brake assembly. Can be used as boat rudder control, converted for lathe tapping and slow speed motor tool.  
Wt. 29 lbs. Finest precision workmanship.  
Cost Gov't. Thousands!  
**Your Cost \$8.95**



**AIR DRILLS** Pistol  
**CLECO ARO** #196  
**INGERSOLL-RAND** #196  
**CHICAGO** Pistol or Straight  
**PNEUMATIC** Angle Drill #15.00  
1/4" JCB Chuck



**New Electric Motors**  
#500 new 1/2 H.P. 27 Volt D. C. 24 Volt A. C. This motor can be readily adapted to 110 A. C. by the simple method of rearranging armature brush leads. We furnish free diagram of instructions with each order.  
A Sensational Value @ **\$5.95**  
1/8 H. P. 24 Volt D. C. Motor, Series Wound, New, #501. **\$3.95 ea.**  
#502 - 2 H.P. 24 V D.C. M. used, **\$8.95**



**#516 BATTERIES**  
NEW! FULL STRENGTH FOR PORTABLE RADIOS, SIGNAL LAMPS, BOATS, ELECTRIC TRAINS, ETC.  
#516 9 Volt 8 1/2" x 6" x 4 in. 3 run 24 or 27 Volt motor. 79c  
These batteries are especially suited to portable radios.  
#517 6 1/2" x 1 1/2" Volt Battery 69c  
#515 90 & 1 1/2 Volt 69c



**JEEP CANS**  
5 gal. gas or oil, self-locking screw cup type 18" x 6 1/2" x 13" Wide **\$1.19 ea.**  
non-leaking  
In lots of 5 **\$1.09 ea.**  
25 or more **\$1.05 ea.**  
Self locking, flexible screw spouts with brass filter at end. 1" I. D. x 16" lg. **39c**



**NEW FLEXIBLE GOOSENECK LAMP**  
110 V. A. C. 13 ft. wire with socket, switch and plug. In mounting bracket suitable for home or workshop.  
Wire alone worth our price of **99c** each.



**PEXTO SIDE CUTTING PLIERS**  
Revised head. Top load. Size 9 1/2". Cut wire, solder with alloyed steel. Ideal for home, electrical, or shop use. A \$2.50 value for **\$1.95**



**VALUABLE GEARS BARGAINS!**  
8 to 1 ratio, spindle drive #110 \$2.98  
6 to 1 with screw shaft #111 \$4.98  
85 to 1 (can be used for radio, antenna, etc.) #112 **\$3.95**  
#G-11 10-1 gear ratio **\$3.95**  
2 to 1 ratio 90° right angle #113  
10 tooth bevel steel boxed gear **\$4.95**  
113a 6 to 1 ratio 90° right angle **\$4.95**



**DC GENERATOR 140 AMP** #G-1  
Direct Current Generator, especially suited for adaptation to homemade welding unit.  
A last moving item at **\$15.95**



**NEW PRESSURE TANKS**  
Stainless steel - Shatter proof. Rustless. 10,000 available in 4 different sizes. 1001 uses.  
G-1 12 1/2" x 24 inches - 2100 Cu. in. capacity **\$4.75**  
D-2 8 1/2" x 24 in. - 500 Cu. in. capacity **\$2.49**  
F-1 - 10" x 18" 1000 Cu. in. Capacity **\$3.95**  
F-2 6 x 45 in. - 1000 Cu. in. capacity **\$3.95**  
14 cu. in. ft.  
Perfect portable air tank to carry in car or trailer. Ideal for painting, cooking, spraying, etc.



**All Purpose HAMMER**  
As a hammer combination for wood & metal work. 3 1/2 lbs. 14 1/2" hardwood handle, hard steel cutting edge. **69c**  
Compound Action METAL SNIPS  
Hard steel blades. Expansion spring. Locking device. Right Hand and Left Hand **\$2.59**



Flexible Gear Shafts With End Drives  
115 30" **69c ea.**  
115a 60" **99c ea.**  
Radio tuning shafts that can be used as flex gear drives #115a 12 ft. 1/2" nut -15 tooth internal spline **\$1.95**  
#115b 25 ft. 3/8" nut 12 tooth with internal spline **\$3.95**  
#115a



**Radio ANTENNA Reel**  
Just the thing for tuning beam antenna.  
Powered by 1 1/2 p. 24v. G. E. Motor. Removable 47' Reel-unit switch - Can Worn gears, Bevel gear, Solenoid clutch.  
Motor exposed to gear reduction only when electrical contact made. Operates in either direction. Ideal for auxiliary power take-off, opening and closing doors, etc.  
**A TREMENDOUS VALUE \$4.95**



**FIRE EXTINGUISHER** Eddie Lux Co. Type. Balls to 15 lb. w/wood shatterproof heavy case 20" x 4". Trigger controlled with hose, fully recharged, 478 Type.  
#601 value #301A **\$11.75**  
2 LB. CO2 TYPE **\$8.75**  
10 lb. Chod. CO2 with Horn **\$24.50**  
15 lb. Chod. CO2 with horn. **\$27.50**  
#605 Value **\$27.50**  
indispensable for small or large planes, trucks, auto, home, factories.



**BEARING MIX**  
Needle, ball and roller bearings in excellent assortment. Sizes from 1/2" to 2".  
#170 Introducing this treasure chest assortment of 15 Bearings at **\$2.95**



**HOBBYISTS!**  
An Unequaled Value!  
**GADGET MIX**  
Rivets, spacers, Clamps, bolts, nuts, Radio parts, gears, etc.  
A gold mine #108 5 lbs. **\$1.19**



**CLAMPS**  
Adel Aluminum, rubber lined. Mixed. #121 4 dozen **89c**  
#120 Aero-Seal, Rust Resistant. Slotted with screw gear top. 1/2" to 3".  
Regular 27c now **10c**



**HIGH PRESSURE OXYGEN BOTTLE**  
New. Will hold up to 3,000 lbs. PSI, with CO2 used as tire inflator or fire extinguisher, with oxygen for sick room or deep-water diving, etc. Completely equipped with brass valve, 36" hose, dial gauge, & canvas bag **\$1.95 ea.**

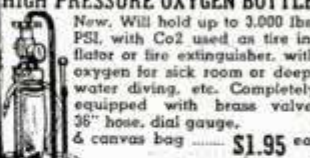

**SPRING MIX**  
Torsion, compression and tension springs. Assorted sizes. #206  
2 lbs. **89c**  
A treasure chest for emergency!



**PLASTIC PARALLEL STRAIGHT EDGE**  
with knobs & rubber pads for non-slipage on each section. A must for navigators, mechanics, draftsmen, Engineers...  
You've never seen 'em at **97c ea.**



**AIRCRAFT CABLE**  
Alloyed steel, rust resistant, 3/16" dia. 21 ft. long, with turnbuckle ends. **99c**  
On reels in any length  
3/32 4c Ft. 3/16 6c Ft.  
1/8 4 1/2c Ft. 5/32 8c Ft.  
5/32 9c Ft.

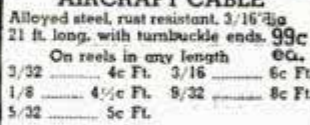

**RUBBER GOODS**  
NEOPRENE SHEET NUMBER

Thick-ness	Width	Approx. Price per sq. yd.
#323 .015"	1/64 36"	.50
#325 .020"	1/64 36"	.75
#326 .037"	1/32 36"	1.00
#327 .064"	1/16 36"	1.75
#328 .175"	3/16 42"	6.00



**ORDER DIRECT FROM THIS AD** All sales final. Make remittances by money-order, bank draft or personal check. Purchase orders acceptable from D & B firms. All quotations F. O. B. Los Angeles.  
FREE - LARGE ILLUSTRATED CATALOGUE Send 1/2 deposit with C. O. D. orders. Also Complete Aircraft Supplies.

**PALLEY SUPPLY CO. THE LARGEST FIRM OF ITS TYPE IN THE WORLD** DEPT. P. M. 48 - 6321 SAN FERNANDO RD. GLENDALE 1, CALIFORNIA



# SOUTH BEND 9" PRECISION LATHES

## \$14500 AND UP

f. o. b. factory, less electrical equipment and bench.

*You can buy a South Bend 9" Lathe on time payments.*

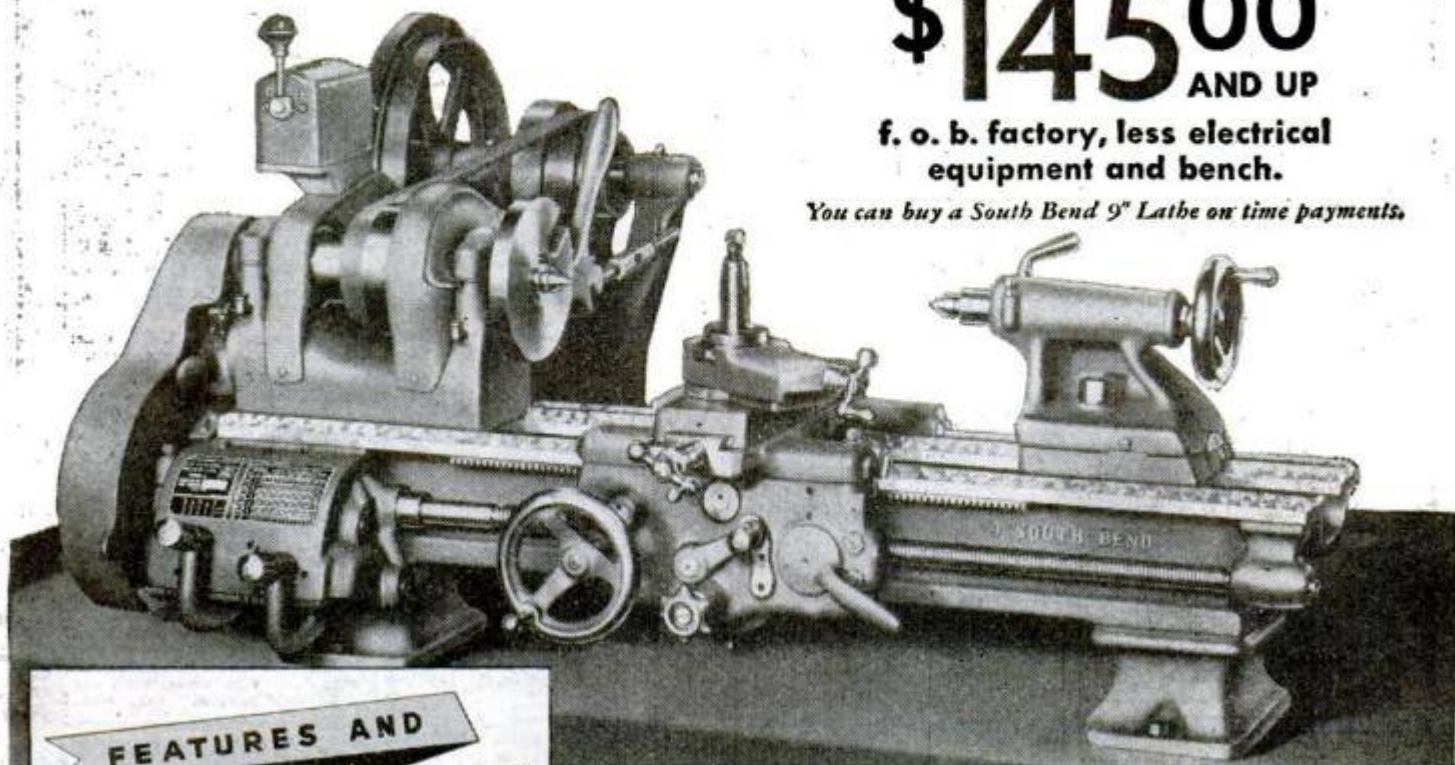

9" x 3' South Bend Model A Bench Lathe — \$270.00

### FEATURES AND SPECIFICATIONS

**SWINGS**—9 1/4" over bed and saddle wings  
5 1/2" over saddle cross slide

**BED LENGTHS**—3, 3 1/2, 4 and 4 1/2 feet

**DISTANCE BETWEEN CENTERS**—16 to 34 inches

**SPINDLE SPEEDS**—  
*depending on type of drive equipment*

Six—41 to 658 r. p. m.

Twelve—41 to 1270 r. p. m.

Sixteen—46 to 1176 r. p. m.

**POWER LONGITUDINAL FEEDS**—  
Model A Lathes—48, .0015" to .0853"  
Model B Lathes—26, .0021" to .0155"  
Model C Lathes—14, .0021" to .0156"

**POWER CROSS FEEDS**—  
Model A Lathes—48, .0004" to .0252"  
Model B Lathes—23, .001" to .0046"  
Model C Lathes—manual operation

**THREAD CUTTING RANGE**—  
Model A Lathe—48 pitches,  
4 to 224 per inch  
Models B and C Lathes—45 pitches,  
4 to 160 per inch

**MAXIMUM COLLET CAPACITY**—1/2 inch

**QUICK CHANGE GEAR BOX**—Model A Lathes

**PLAIN CHANGE GEARS**—Models B and C Lathes

The quality that is built into South Bend 9-inch Precision Lathes enables them to produce quality work with efficiency under all conditions. Regardless of the type of machining—between-centers, collet, fixture, or chucking—close tolerances can be maintained and a maximum volume of fine work produced with a minimum of effort. Write for Catalog 9-J which fully describes and illustrates all South Bend 9" Precision Lathes and attachments. Larger sizes with 10", 13", 14 1/2", and 16" swings are also shown.

**PROMPT DELIVERY**—See your South Bend Lathe distributor today—immediate delivery from his stock or early delivery from factory.

**PRICES**—Starting at \$145.00, f. o. b. factory, South Bend Lathes now represent a greater value per dollar of cost than ever before. Average price increase over prewar level less than 15 per cent.

**TIME PAYMENT**—South Bend Precision Lathes, tools, and attachments are available on Factory Time Payment terms. 25% down payment, twelve months to pay balance. Moderate finance charges.

### SPEED PRODUCTION WITH THESE ATTACHMENTS

TAPER ATTACHMENT  
MILLING ATTACHMENT  
COLLET ATTACHMENTS  
HANDLEVER BED TURRET  
DOUBLE TOOL CROSS SLIDE

CENTER REST  
SQUARE TURRET  
CARRIAGE STOPS  
FOLLOWER REST  
ELECTRIC GRINDER

BUILDING BETTER LATHES SINCE 1906

## SOUTH BEND LATHE WORKS



455 EAST MADISON STREET  
SOUTH BEND 22, INDIANA

Printed by Popular Mechanics Company, Chicago, Ill., U. S. A.



*Used on  
more new cars  
-sold by more  
dealers!*



replace with a  
**DELCO**  
BATTERY

DELCO-REMY WHEREVER WHEELS TURN OR PROPELLERS SPIN



IT TAKES EXPERIENCE TO SKIM THE SURF AT

*40 miles an hour on one foot!*

...and Champion  
**NANCE STILLEY**  
agrees that  
in water skiing—and  
in cigarettes too...

**"EXPERIENCE  
IS THE BEST  
TEACHER!"**



In twisting slaloms  
... in tricky jumps  
... this petite young  
Cypress Gardens  
aquamaid is in a  
class by herself.

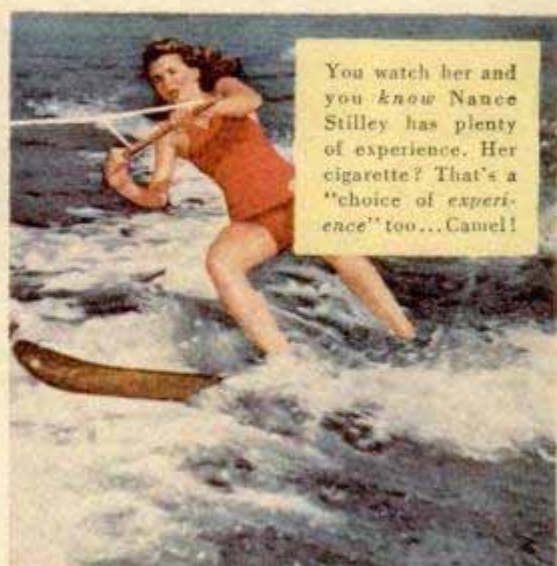

You watch her and  
you *know* Nance  
Stilley has plenty  
of experience. Her  
cigarette? That's a  
"choice of experi-  
ence" too... Camel!



I NOTICE MORE  
AND MORE PEOPLE  
SMOKING CAMELS.  
THEY'RE GREAT!

I LEARNED  
BY EXPERIENCE...  
BY COMPARING...  
THAT CAMELS SUIT  
MY 'T-ZONE'  
BEST!



THE "T-ZONE"  
T for Taste...  
T for Throat...

your final  
proving ground  
for any  
cigarette

R. J. Reynolds Tobacco Co., Winston-Salem, N. C.

Let your  -Zone tell you why

**More people are smoking  
Camels than ever before!**

● Now that people can get all the cigarettes they want... any brand... more people are smoking Camels than ever before.

Why? The answer is in your "T-Zone" (T for Taste and T for Throat). Let your taste... your throat... tell you why, with smokers who have tried and compared, Camels are the "choice of experience"!

*CHOICE OF EXPERIENCE!*



According to a  
Nationwide survey:

**MORE DOCTORS  
SMOKE CAMELS  
THAN ANY OTHER  
CIGARETTE**

When 113,597 doctors were asked by three independent research organizations to name the cigarette they smoked, more doctors named Camel than any other brand!