

ANC



POPULAR MECHANICS

MAGAZINE

WRITTEN SO YOU CAN UNDERSTAND IT

REG. TRADE MARK GREAT BRITAIN NO. 40426

REG. U.S. PAT. OFF.

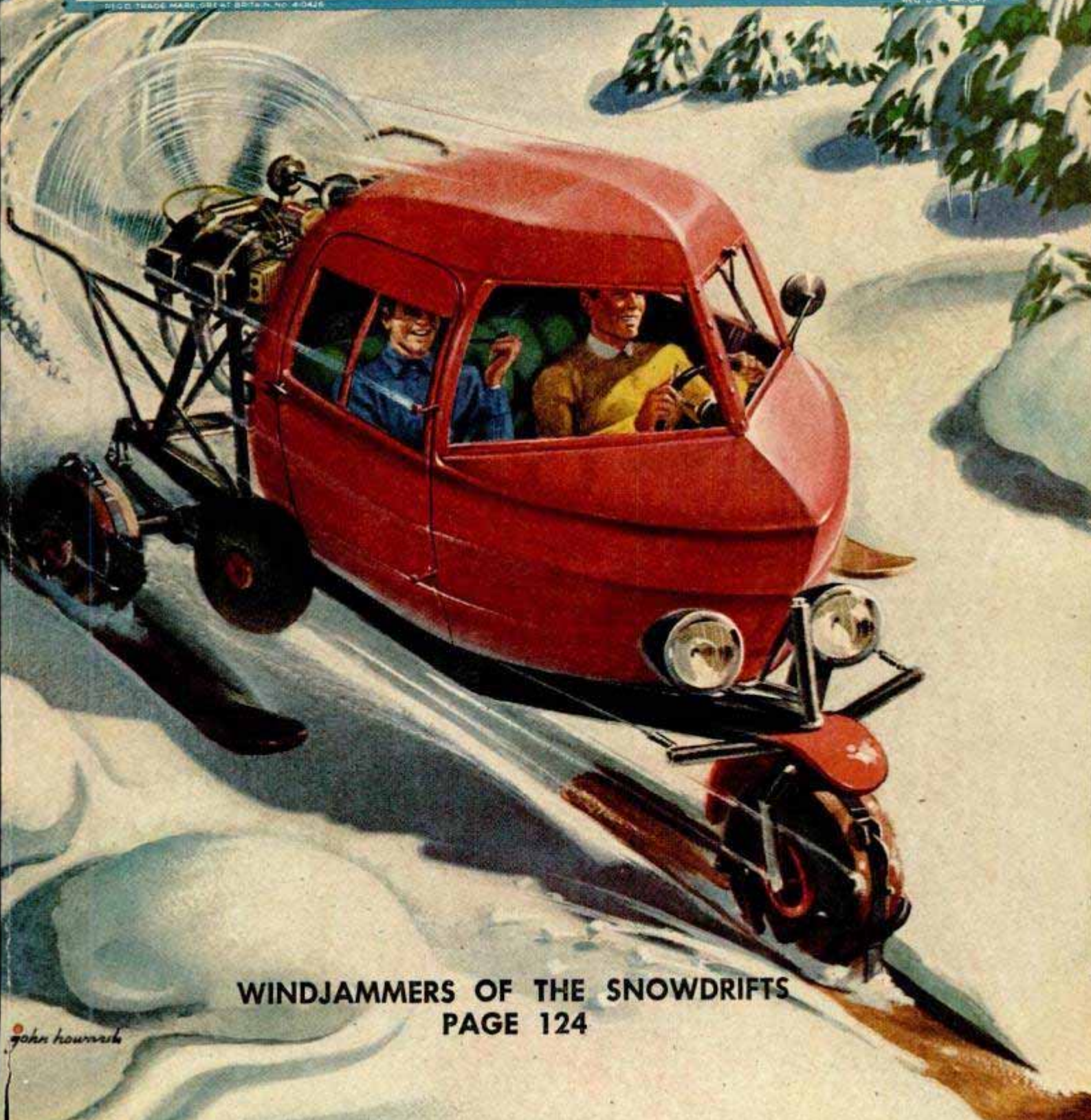

WINDJAMMERS OF THE SNOWDRIFTS
PAGE 124

John Hounsch

Dependable

CHAMPION

America's Favorite Spark Plug



In rendering invaluable service to all America, the trucking industry must keep detailed records of operating and maintenance costs. That's why fleet operators are qualified experts on spark plugs. It is extremely significant that the majority of leading fleets everywhere prefer and use dependable Champion Spark Plugs.



FOLLOW THE EXPERTS

DEMAND NEW DEPENDABLE CHAMPIONS FOR YOUR CAR

Listen to the CHAMPION ROLL CALL . . . Harry Wismer's fast sportscast every Friday night, over the ABC network

Research Keeps
B.F. Goodrich
FIRST IN RUBBER



Typical example: user's experience with B. F. Goodrich tires

THIS PICTURE shows Frank H. Neely of Columbus, Tennessee, pointing out how much tread is still left on a B. F. Goodrich tire, one of a pair, that he says has traveled over 30,000 miles on his Chevrolet coupe. Mr. Neely writes that these tires "look to be good for as many more miles before replacing". And he should know what he's talking about, because he has two other B. F. Goodrich tires on the same car that he says are still running at more than 58,000 miles.

We don't claim you'll often

get 58,000 or 60,000 miles on any tire. That sort of mileage depends on a lot of things. Proper inflation, for instance. Keeping wheels in line and balanced right. Shifting tires from wheel to wheel to even up on wear.

But here's what we do claim, and we can back it up with photographs and statements such as Mr. Neely's: B. F. Goodrich tires not only outwear others; they *do* outwear prewar tires.

From shoulder to shoulder the tread is wider and flatter. Weight and wear are distributed more

evenly over a greater area. The tougher tire body has a double shock-absorbing breaker strip.

This is a good time to buy tires. Why not get a set of four new sharp treads for winter driving? Turn your old tires in for a good allowance. If you don't know your B. F. Goodrich dealer's name look under "tires" in the yellow section of your telephone book. *The B. F. Goodrich Company, Akron, Ohio.*

B.F. Goodrich
FIRST IN RUBBER

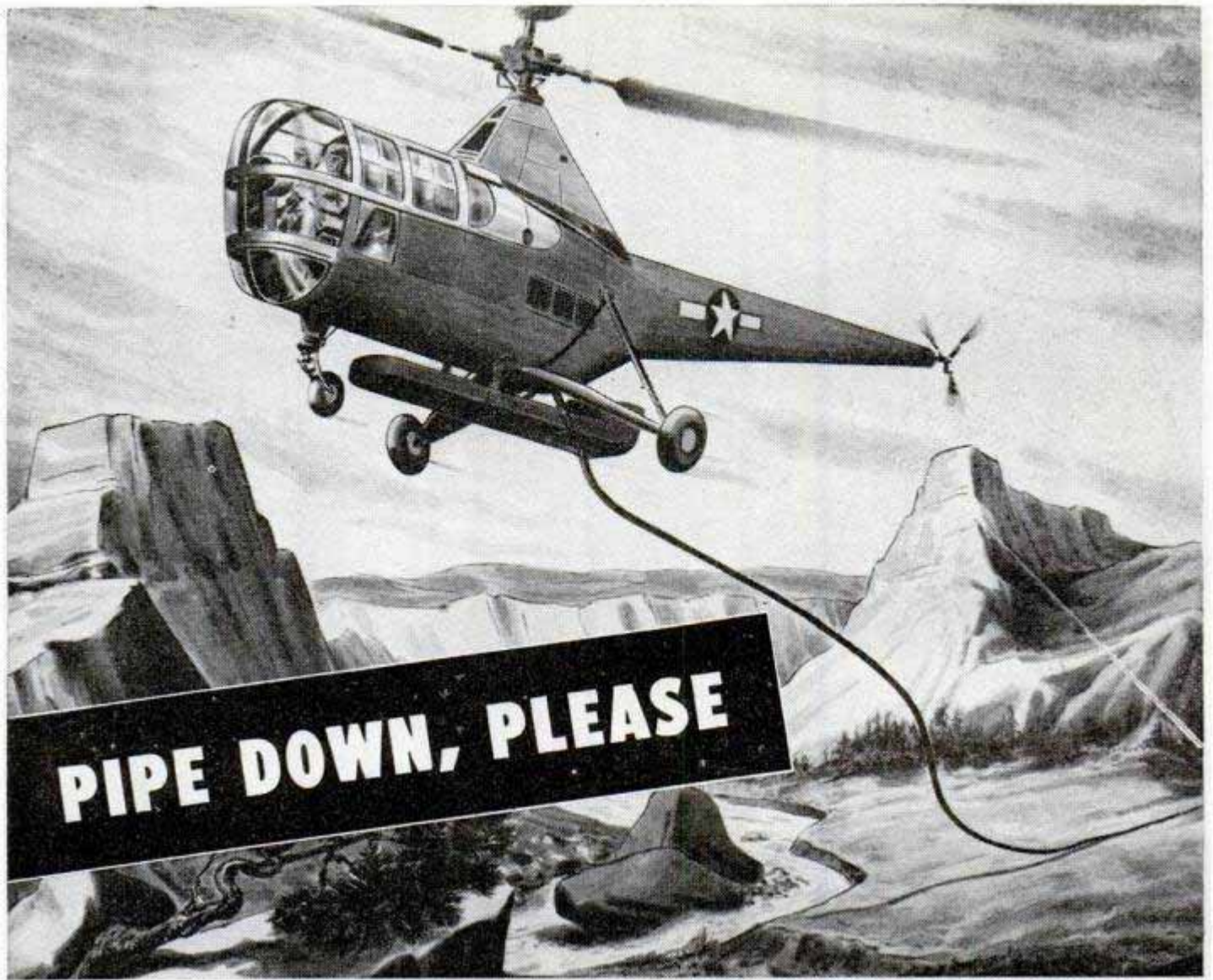

This "egg-beater" is laying a continuous pipeline of reinforced hose. An anchor is dropped, then the helicopter moves on and the line is paid out astern. Or sections of metal pipe are dropped where men on the ground can assemble them.

Credit the Army Engineers for this pipe-dream-come-true. Since the helicopter can go anywhere a man afoot can go—and some places where he can't—you don't have to build costly roads for heavy ground equipment. Savings in time and money add up.

CAREERS WITH A FUTURE
U. S. Army and
U. S. Air Force

All through the peacetime Regular Army you'll find scientific advances like this being tested and perfected. If you've imagination and want to get ahead, here is your opportunity. Enlist for 3 years and you may choose your branch of the Service. If you're a high school graduate you can pick the precise training you want *before* you enlist.

There's good pay while learning, too. Food, clothing, shelter, medical care—cost you nothing. There's the chance to travel and almost unlimited educational opportunity. Get the details at your nearest U. S. Army and U. S. Air Force Recruiting Station.

U. S. Army and U. S. Air Force Recruiting Service



**YOUR ARMY AND AIR FORCE SERVE THE NATION
AND MANKIND IN WAR AND PEACE**

Popular Mechanics Magazine

Registered in U. S. Patent Office and Canada

H. H. WINDSOR, Founder

H. H. WINDSOR, Jr., Editor and Publisher

Next Month



HOW-TO-BUILD-IT plans for this smart cabin cruiser have been adapted for "back yard" builders by Assistant Editor Arthur Youngquist from a naval architect's drawings. The original model was constructed just before the war with materials which cost \$1500. It has a galley, can be built to sleep two or four persons and makes 15 knots. The boat was used as an "Admiral's barge" by the Coast Guard during the war. This ambitious boatbuilding project starts in the March issue and will intrigue both the hammer-and-saw and armchair builders.

OTHER Craftsman features will tell the fine points of laying a hardwood floor and how to build a sickle-bar mower which snug-gles right up to a fence post.

AERONAUTICAL engineers are testing planes that can climb 100,000 feet. At this height gasoline boils and the temperature may be 70 below zero. One odd problem is to keep the crew from roasting. A March feature tells how "They Blaze The Trail Into Space." A story about Alaska, "Bigger Than Texas," is a companion piece to the Hawaii feature in this issue.

RADIO students and experimenters will find an efficient up-to-date two-band 5-tube super in the 1948 "Little Giant" a.c. set in the Radio and Electronics pages.

Volume 89 FEBRUARY 1948 Number 2

Managing Editor.....Roderick M. Grant
Assistant Managing Editor.....Wayne Whittaker
Shop Notes and Crafts Editor.....James R. Ward
Radio and Electronics Editor.....Frank L. Brittin
Aviation Editor.....Aubrey O. Cookman, Jr.
Associate Editor.....Clifford B. Hicks
Eastern Editor.....Bill Reiche
Western Editor.....Thomas E. Stimson, Jr.
Art Director.....Frank Beatty

Assistant Editors

Donald R. Brooks

Arthur R. Railton

Assistant Editors, Shop Notes and Crafts

W.Clyde Lammey Wayne C.Leckey Frank N.Stephany A.E.Youngquist

In This Issue

Industrial Revolution in the Desert	89
Pacific Sweet Spot	96
The Burned-Nose Club	107
Uncle Sam's Jungle Playground	118
Windjammers of the Snowdrifts	124
Cut a Figure on Ice	130
Hunting Big Fish Under the Ice	148
Jeep Posse	156
Hand-Carved Circus	160
Testing Ground for Grass	164
Has the Propeller a Future?	171

For the Craftsman

Child's Folding Table and Chairs	178
Plunder Chests	190
Baskets From Rustic Materials	201
Table-Top Studio for Nature Photos	208
Turn It With Carbide Tools	213
Installing Car Springs	218
Strong Cabinet Joints With Dowels	224
Radio and Electronics	229

Table of Contents Continued on Page 8

Published monthly by POPULAR MECHANICS COMPANY, 200 East Ontario Street, Chicago 11, Ill. H. H. Windsor, Jr., president; Paul H. Dunakin, vice president and general manager; D. F. Windsor, vice president and secretary-treasurer; William Harrison Fetridge, vice president and assistant to the publisher; Clover L. Perkins, advertising manager; Alan M. Deyoe, circulation manager. Single copy in the United States and Canada, 25 cents; subscription rates in United States and possessions, Canada, Philippines and countries of the Pan-American Postal Union, 1 year, \$2.50; 2 years, \$4.50; 3 years, \$6.00. To all other countries add \$1.00 a year over United States prices for overseas postage. If you plan to move, notify us at least 30 days in advance so you will not miss an issue. Give both old and new addresses. Entered as Second Class Matter, September 15, 1903, at the Post Office at Chicago, Illinois, under Act of March 3, 1879. Entered as Second Class Matter at Post Office Dept., Canada. Copyright 1948 by Popular Mechanics Company. Copyright under International Copyright Union. Copyright in France. All rights reserved under Pan-American Copyright Union. Printed in the United States of America.

Good Design means Better Performance for CRESCENT TOOLS



Tough jobs such as this are simplified with the use of efficiently designed Crescent Tools.

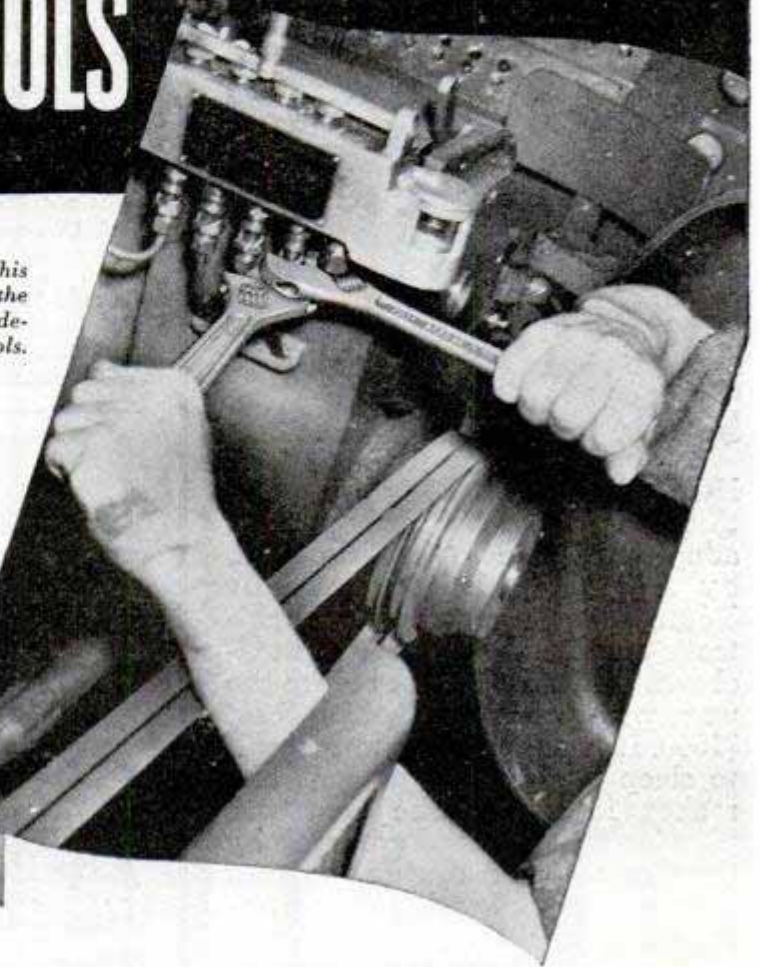

● Good design...extremely important in the tools you use...is the basis of *better performance on any job*. Good design not only gives greater functional efficiency in operation, but also contributes to the reduction of worker fatigue often encountered in the use of unwieldy, hard-to-handle equipment.

Crescent Tools are designed and

manufactured to incorporate *all* the elements desirable in a specific tool type...ease of adjustment, smooth-working action, comfortable grip, proper balance *and* strength enough to use with confidence. Crescent's tool design experts consider all these points in creating and maintaining a line of tools worthy of the name "Crescent".

CRESCENT TOOL COMPANY, Jamestown, N. Y.

CRESCENT TOOLS

Give Wings to Work



*"CRESCENT" is our trade-mark registered in the United States and foreign countries for wrenches and other tools. "Crescent" tools are made only by Crescent Tool Company of Jamestown, N. Y., and are sold by leading distributors everywhere.

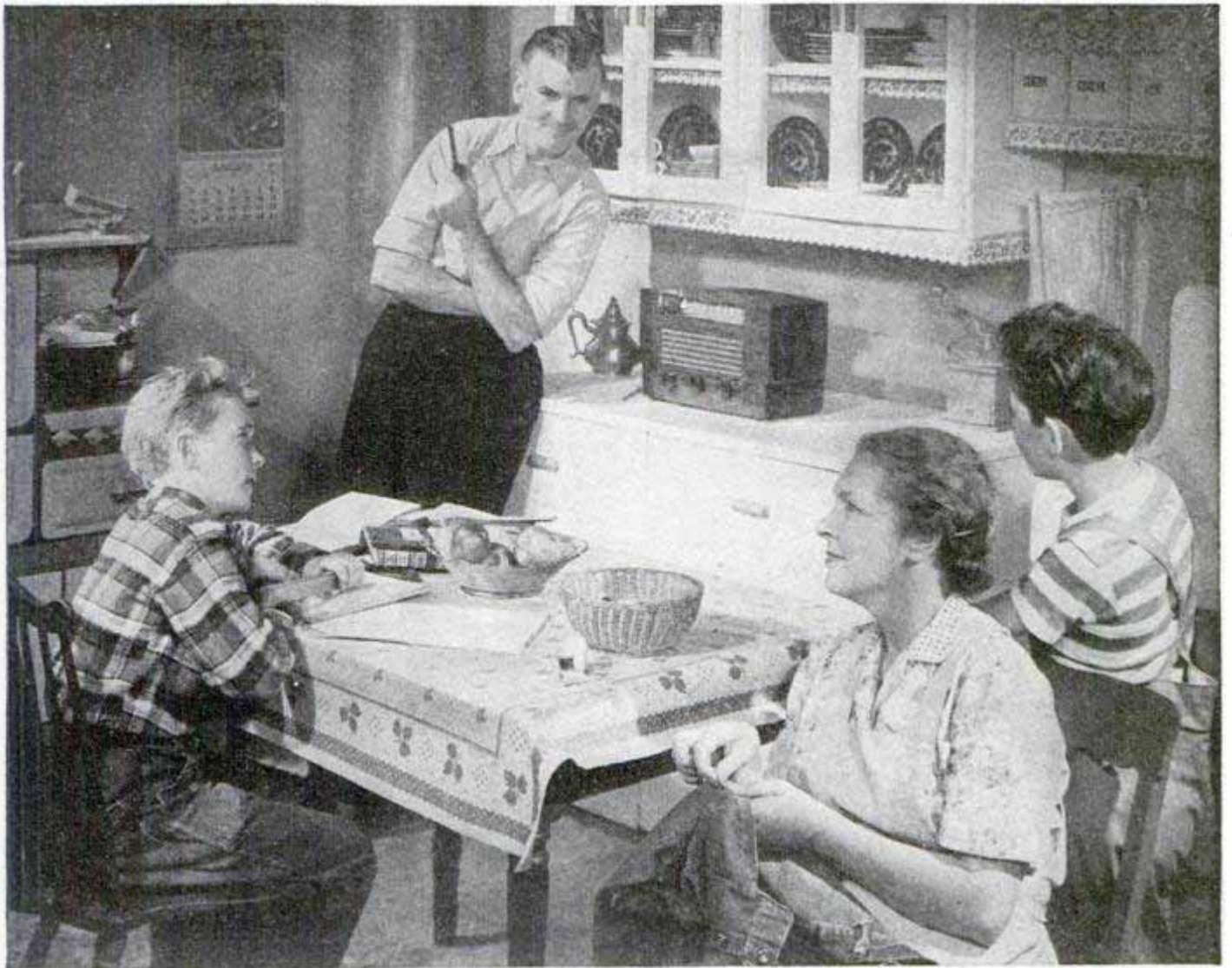

"Our American concept of radio is that it is of the people and for the people."

Freedom to LISTEN - Freedom to LOOK

As the world grows smaller, the question of international communications and world understanding grows larger. The most important phase of this problem is *Freedom to Listen* and *Freedom to Look*—for all peoples of the world.

Radio, by its very nature, is a medium of mass communication; it is a carrier of intelligence. It delivers ideas with an impact that is powerful . . . Its essence is freedom—liberty of thought and of speech.

Radio should make a prisoner of no man and it should make no man its slave. No one should be forced

to listen and no one compelled to refrain from listening. Always and everywhere, it should be the prerogative of every listener to turn his receiver on or off, of his own free will.

The principle of *Freedom to Listen* should be established for all peoples without restriction or fear. This is as important as *Freedom of Speech* and *Freedom of the Press*.

Television is on the way and moving steadily forward. Television fires the imagination, and the day is foreseen when we shall look around the earth from city to city, and nation to nation, as easily as we

now listen to global broadcasts. Therefore, *Freedom to Look* is as important as *Freedom to Listen*, for the combination of these will be the radio of the future.

The "Voice of Peace" must speak around this planet and be heard by all people everywhere, no matter what their race, or creed, or political philosophies.*

David Sarnoff

President and Chairman of the Board,
Radio Corporation of America.

*Excerpts from an address before the U. S.
National Commission for UNESCO.



RADIO CORPORATION of AMERICA

FREEDOM IS EVERYBODY'S BUSINESS

This One



YSNJ-16G-QQ7Z

FEBRUARY 1948



BEYOND EARTH

What Strange Cosmic Power Influences Humans ?

BY WHAT RIGHT does man presume that he is the chosen being of the universe and that the earth alone shapes his existence? In the infinite spaces above, tenanted by vast and magnificent worlds, are Cosmic forces which influence the life of every mortal. As iron filings respond to the attraction of a magnet, so too, your acts are the result of an impelling influence upon your will. Just as the unseen Cosmic rays give the earth form and substance, so too, from the infinite reaches, an invisible subtle energy affects the thought processes of every human. Life itself bows to this strange universal force—why, then, should YOU not understand and COMMAND IT? You are like a pendulum either to be swung forward to happiness and the fulfillment of your dreams, or backward into discouragement and disillusionment. Why remain poised in a state of anxiety, uncertainty, and anticipation? Learn to draw to yourself these Cosmic forces which will give your mind the creative impetus that will assure the end in life you seek.

For You — A Gift Copy of the Sealed Book

Not for the curious nor the skeptical, but for the modern man and woman the Rosicrucians, a progressive movement of thinking persons, offer a free, Sealed Book, telling how you may acquire the truth about these phenomenal Cosmic powers little understood today and which make for freedom and attainment in life. THIS IS THE DAY AND AGE OF MASTERY. Throw off the age-old custom of—"let life be as it may"—and learn to *create it as you wish it*.

The ROSICRUCIANS
(AMORC)
SAN JOSE. CALIFORNIA

USE THIS GIFT COUPON

Scribe C. Y. K. The Rosicrucians (AMORC)
Rosicrucian Park, San Jose, California.

Please send me without obligation the free, Sealed Book, which tells how I may obtain the unusual facts about the Cosmic forces which affect my life.

NAME.....

ADDRESS.....

CITY..... STATE.....

◆ The Rosicrucians are NOT a Religious Organization ◆



6

KEYS TO OPPORTUNITY for Men and Women

They have helped over a million toward their ambition... **THEY CAN HELP YOU!**

The great barrier to realizing ambition is the question "HOW?"

For the past 39 years more than a million ambitious men and women have found the "HOW" to greater success in business in one of the free 48-page books illustrated above.

These books are more than catalogues—they give you the facts about the field of your choice, tell you of the opportunities in that field, its demands, and how our training fits you for the field. They'll answer questions that may have bothered you.

We have perfected Home-Study Training—made it interesting and practical through the problem method. You train under specialists, men who have achieved success in their chosen field—you study principles and solve problems without any loss of time, pay or interference with your present job.

Our training is tried and proven—and what you study at home you can use on the job right away. Perhaps right in your own company there is a great opportunity to advance—to get an executive job with the prestige and money that go with such advancement.

The way to success is not magic. It requires study, and you will have to be willing to work earnestly—thoroughly.

But wouldn't it be worth your while to trade some of your leisure over a comparatively brief period for a bigger job and more money?

Why not be somebody in the business world—why be satisfied to go through life in a small job at small pay when the way to success is clearly marked. The years are going by very fast—and it's high time you did something concrete about your future.

The coupon below will bring you complete information about the field of your choice. **SEND IT TODAY.** Don't delay—it can be the turning point in your career to a better job and more money.

LASALLE Extension University
a Correspondence Institution
 Dept. 264-R Chicago 5, Ill.

I want to better my position—make more money. Send me your free booklet on the field I have checked below.

<input type="checkbox"/> Higher Accountancy	<input type="checkbox"/> Traffic Management
<input type="checkbox"/> Industrial Management	<input type="checkbox"/> Foremanship
<input type="checkbox"/> Executive Management	<input type="checkbox"/> Law LL. B. Degree

Name..... Age.....

Present Position.....

Address.....

City, Zone and State.....

the "PYROIL Habit" is good for your car...



Millions of car owners have developed the constructive habit of saying "Add Pyroil" to their gas station attendants. And when they add Pyroil, they add mileage to their cars. Pyroil gives all the property of adhering to metal surfaces — it prevents "battery drain" slow starts — it prevents excessive dry start wear and corrosion.

Introduce your car to the comfort of Pyroil. Ask your gas station attendant.

Pyroil for Aircraft Engines

Use Aircraft Pyroil B for lubricating oil, Aircraft Pyroil A for gasoline.

Manufactured and Guaranteed by Pyroil Company, 76 Pyroil Bldg., La Crosse, Wisconsin.

Canadian Distributors:
Central Purchasing Agencies, Ltd., Toronto, Ontario, Canada

PYROIL COMPANY

76 Pyroil Bldg., La Crosse, Wisconsin

I want my car to last and run properly. Please tell me more about Pyroil and how it can accomplish this for me.

Name _____

Address _____

City or Town _____ State _____



TABLE OF CONTENTS (Continued)

AUTOMOTIVE	
Carrying sack holds sand for slippery roads.....	106
Tire mounter rolls tires onto the rim.....	106
Spring-operated pump eliminates bubbles in brake fluid.....	106
Roof-top spotlight controlled from inside the car.....	106
Frameless trailer is light and strong.....	112
Auto-engine heater burns charcoal.....	116
Control holds accelerator pedal.....	117
Trailer hitch fits in trunk to place weight over axle.....	121
British station wagon runs at low cost on electricity.....	135
Extra wiper arm clears windshield.....	155
Emergency gasoline can has attached hose.....	170
Filter keeps auto radiators clean.....	170
Automatic tow bar allows use of brakes.....	170
BOATS AND BOATING	
Inflated rowboat weighs 62 pounds.....	121
Eight-foot plywood boat is built from precut kit.....	135
Ocean-going canoe.....	142
Loading a barge? Sink her first.....	159
ELECTRICAL	
Radioactive gold aids cancer war.....	95
"Chicken-brooder" television antenna.....	103
Electric slippers soothe feet.....	113
Loudspeaker for dictating machines.....	136
Midget generator produces 12,000 volts.....	137
Enclosed ultraviolet germ killer protects eyes from harmful rays.....	159
FARM	
Midget crawl-type tractor has engine in rear.....	95
Tractor-drawn scoop digs sacks "spuds".....	102
Potatoes "toasted" to speed harvest.....	102
Pigs fatten more quickly when drug is used to retard gland action.....	103
Boom spray covers wide strip.....	128
Guard on posthole digger pushes fence out of way.....	129
Fuel-saving tractor has engine in rear.....	137
Onion "mickey finns" potent weed killers.....	143
Paddlewheel on light tractor churns soil.....	146
HOUSE AND HOME	
Adhesive "welds" carpet padding.....	117
Air-cooling system provides hot water.....	129
What's new for your home.....	138
Moving? Your house can go with you.....	143
Electric roaster for weiners cooks six in 90 seconds.....	155
Spray cleans paint on exterior walls.....	176
INDUSTRY	
Plastic gas pipes.....	94
Ladder-like hoist lifts 500 pounds.....	95
"Laundry" scrubs locomotives.....	102
Pothole dam.....	114
Moving a giant.....	122
Glass "popcorn" lightens plaster.....	127
Two farm wagons carry moving stage.....	143
Avalanche "lab".....	144
Flames "burn" snow leaving road clear and dry.....	147
Percolator-style boiler.....	147
Rail-to-ship cargo system cuts loading time.....	152
Precut cabin logs held by wood key.....	153
Industrial uses for bark.....	154
Over-the-shoulder sprayer lightens painter's load.....	163
Gravel tamper levels rail ties.....	169
OUTDOOR RECREATION	
Walkie-talkie weighing 11 ounces for workers and sportsmen.....	94
Pocket-size skate sharpener handy for use at the rink.....	113
Trigger "safe" locks out accidents.....	146
PHOTOGRAPHY	
Camera that took the pictures used to make enlargements.....	127
Magnifier aids focusing of ground-glass camera.....	129
Airport floodlamps light slide projector.....	142
TOOLS	
Swing saw has depth adjustment.....	94
"Miss Hush" winner gets dream workshop.....	116
Pocket-size tool kit.....	128
Disks renew worn valve seats.....	136
Rubber block speeds sanding.....	146
Hand truck eases lifting.....	152
TOYS AND NOVELTIES	
Wind-blown cedar forms lamp bases.....	103
Junior can "drive" now.....	113
Model steamer tows boat.....	121
Coiled wire springs form tires.....	127
Youth "flies" giant plane with homemade controls.....	153
Model-T modelmaker.....	175
MISCELLANEOUS	
"Rabbits" chase atoms.....	104
Test your science I. Q.....	105
Flashing lights aid piano students.....	113
Huskies in Alaska pull cart mounted on two oil drums.....	117
Baby bottle warmer for trains.....	128
"Toe gauge" records blood pressure.....	128
Foot massaged by rubber ball.....	136
Plastic bag keeps brush soft.....	136
Kindling house built from firewood.....	142
Geography made easy.....	154
Huge bomber gets eight "legs" to distribute weight better.....	154
Movies use canoes as aquatic tripod.....	155
Flying automobile uses two engines.....	159
Dummy foods make displays attractive and long-lasting.....	163
Grain harvester "mines" lead.....	169
Hillside elevator.....	175
Going to town.....	176
Craftsman and Shop Notes Index	
AUTOMOTIVE	
Marks on wheel indicate balance.....	200
Container for crankcase oil.....	212
Grease drum kept in garbage can.....	217

(Continued to page 10)

Arthur Godfrey says:

"I.C.S. made the impossible—easy!"

YOU'VE often heard Arthur Godfrey, famed "Huck Finn of Radio," now winning new renown with his coast-to-coast "Talent Scouts" and other CBS programs. But this is the first time you've heard the star on the subject of I. C. S.:

"I had to quit high school before the end of my second year. Later in life, at the U. S. Naval Materiel School at Bellevue, D. C., I had to master a working knowledge of math, all the way from simple decimals and fractions through trigonometry, in the first six weeks or be dropped from the course. So I took an I. C. S. Course and finished at the head of the class! I. C. S. made the impossible—easy!"

As usual, the former Navy radio operator and present Lt. Commander in the U. S. Naval Reserve knows what he's talking about. As an I. C. S. graduate, Mr. Godfrey is in the best of all positions to tell you about the educational system that's served so long as talent scout for American industry.

Study his statement. Then mark your interest on the coupon and mail it today for full information on what I. C. S. can do for you!



INTERNATIONAL CORRESPONDENCE SCHOOLS



BOX 5621-K, SCRANTON 9, PENNA.

Without cost or obligation, please send me full particulars about the course BEFORE which I have marked X:

- | | | | |
|--|---|---|---|
| <p>Air Conditioning and Plumbing Courses</p> <input type="checkbox"/> Air Conditioning
<input type="checkbox"/> Heating
<input type="checkbox"/> Refrigeration
<input type="checkbox"/> Plumbing
<input type="checkbox"/> Steam Fitting <p>Chemistry Courses</p> <input type="checkbox"/> Chemical Engineering
<input type="checkbox"/> Chemistry, Analytical
<input type="checkbox"/> Chemistry, Industrial
<input type="checkbox"/> Chemistry, Mfg. Iron & Steel
<input type="checkbox"/> Petroleum Refining
<input type="checkbox"/> Plastics
<input type="checkbox"/> Pulp and Paper Making <p>Civil Engineering, Architectural and Mining Courses</p> <input type="checkbox"/> Architecture
<input type="checkbox"/> Architectural Drafting
<input type="checkbox"/> Bridge and Building Foreman
<input type="checkbox"/> Building Estimating
<input type="checkbox"/> Civil Engineering
<input type="checkbox"/> Coal Mining
<input type="checkbox"/> Contracting and Building
<input type="checkbox"/> Highway Engineering
<input type="checkbox"/> Lumber Dealer
<input type="checkbox"/> Reading Structural Blueprints
<input type="checkbox"/> Sanitary Engineering
<input type="checkbox"/> Structural Drafting | <p><input type="checkbox"/> Structural Engineering
 <input type="checkbox"/> Surveying and Mapping</p> <p>Communications Courses</p> <input type="checkbox"/> Electronics
<input type="checkbox"/> Practical Telephony
<input type="checkbox"/> Radio, General
<input type="checkbox"/> Radio Operating
<input type="checkbox"/> Radio Servicing
<input type="checkbox"/> Telegraph Engineering <p>Electrical Courses</p> <input type="checkbox"/> Electrical Drafting
<input type="checkbox"/> Electrical Engineering
<input type="checkbox"/> Electric Light and Power
<input type="checkbox"/> Lighting Technician
<input type="checkbox"/> Practical Electrician <p>Internal Combustion Engines Courses</p> <input type="checkbox"/> Auto Technician
<input type="checkbox"/> Diesel-Electric
<input type="checkbox"/> Diesel Engines
<input type="checkbox"/> Gas Engines
<input type="checkbox"/> Aviation <p>Mechanical Courses</p> <input type="checkbox"/> Aeronautical Engineer's, Jr.
<input type="checkbox"/> Aircraft Drafting
<input type="checkbox"/> Flight Engineer
<input type="checkbox"/> Forging
<input type="checkbox"/> Foundry Work
<input type="checkbox"/> Heat Treatment of Metals | <p><input type="checkbox"/> Industrial Engineering
 <input type="checkbox"/> Industrial Metallurgy
 <input type="checkbox"/> Machine Shop
 <input type="checkbox"/> Mechanical Drafting
 <input type="checkbox"/> Mechanical Engineering
 <input type="checkbox"/> Mold-Loft Work
 <input type="checkbox"/> Patternmaking—Wood, Metal
 <input type="checkbox"/> Reading Shop Blueprints
 <input type="checkbox"/> Sheet-Metal Drafting
 <input type="checkbox"/> Sheet-Metal Worker
 <input type="checkbox"/> Ship Drafting
 <input type="checkbox"/> Ship Fitting
 <input type="checkbox"/> Tool Designing
 <input type="checkbox"/> Toolmaking
 <input type="checkbox"/> Welding—Gas and Electric</p> <p>Railroad Courses</p> <input type="checkbox"/> Air Brake
<input type="checkbox"/> Diesel Locomotive
<input type="checkbox"/> Locomotive Engineer
<input type="checkbox"/> Locomotive Fireman
<input type="checkbox"/> Railroad Section Foreman
<input type="checkbox"/> Car Inspector <p>Steam Engineering Courses</p> <input type="checkbox"/> Boilermaking
<input type="checkbox"/> Combustion Engineering
<input type="checkbox"/> Engine Running
<input type="checkbox"/> Marine Engineering
<input type="checkbox"/> Steam Electric
<input type="checkbox"/> Steam Engines | <p>Textile Courses</p> <input type="checkbox"/> Cotton Manufacturing
<input type="checkbox"/> Rayon Weaving
<input type="checkbox"/> Textile Designing
<input type="checkbox"/> Woolen Manufacturing <p>Business and Academic Courses</p> <input type="checkbox"/> Accounting
<input type="checkbox"/> Advertising
<input type="checkbox"/> Arithmetic
<input type="checkbox"/> Bookkeeping
<input type="checkbox"/> Business Administration
<input type="checkbox"/> Business Correspondence
<input type="checkbox"/> Certified Public Accounting
<input type="checkbox"/> Commercial Art
<input type="checkbox"/> Commercial
<input type="checkbox"/> Cost Accounting
<input type="checkbox"/> Federal Tax
<input type="checkbox"/> First Year College
<input type="checkbox"/> Foremanship
<input type="checkbox"/> Good English
<input type="checkbox"/> Higher Mathematics
<input type="checkbox"/> Motor Traffic
<input type="checkbox"/> Salesmanship
<input type="checkbox"/> Sign Lettering
<input type="checkbox"/> Spanish
<input type="checkbox"/> Traffic Management |
|--|---|---|---|

Name _____ Home Address _____
 City _____ State _____
 Age _____ Present Position _____ Working Hours _____ A.M. to _____ P.M.

Special tuition rates to members of the Armed Forces. Special discount to World War II Veterans.
 Canadian residents send coupon to International Correspondence Schools Canadian, Ltd., Montreal, Canada.

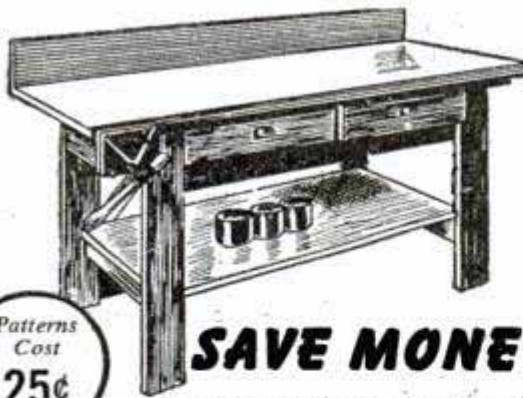

SAVE MONEY— make it with EASI-BILD* Full-Size Patterns!

Save at least 1/2 cost of this quality workbench. Trace the full-size pattern on wood: saw, assemble.

Use *CASCOPHEN Resin Glue*, recommended by Easi-Bild, for durable, waterproof, moldproof bonds, even in damp basements.

Over 100 patterns for furniture, toys, gifts, buildings, and home needs: Get workbench plans at nearest hardware store or send coupon below and 25¢ to:

CASCO Pattern Dep't. PM-28, P.O. Box 215,
Pleasantville, N. Y.

Please send me plans for Workbench, Project No. 15.

Name _____

Address _____

City _____ Zone _____ State _____

Choose the right glue for the job!



Boats, Outdoor Furniture, Sports Equipment—joints that must withstand outdoor exposure—*CASCOPHEN* (Resorcin Resin Glue). The first completely durable glue available to homecraftsmen.



For Furniture, Toys, Heavy-duty Home Repairs—strong, stainfree, moldproof, highly water-resistant *CASCAMITE* (Urea Resin Glue). Mixes quickly with cold water!



For Models, Photo Prints, Labeling—general home, school, or office gluing, use the new, clean, white, fast-setting *CASCOREZ* (Polyvinyl Resin Glue). Liquid, ready to use!

FOR FREE GLUING CHART WRITE:

Casein Company of America, Dep't. PM-28,
350 Madison Ave., New York 17, N. Y.

Please send me *free* Gluing Chart which gives full details in choosing the right glue for this job.

Name _____

Address _____

City _____ Zone _____ State _____

CASEIN COMPANY OF AMERICA
Makers of Casco Glues • ©1948, Easi-Bild Pattern Co.

(Continued from page 8)

Time switch extinguishes light after backing from garage.....	217
Tire-casing headrest on creeper contains wiping cloths.....	220
Match book checks spark plugs.....	220
Fitting head gasket to save wear.....	220
Bulletin posted at filling station gives motorists weather forecast.....	223

ELECTRICAL

How to saw holes for outlet boxes without cracking plaster.....	184
Prongs of electric plug shielded with a large cork.....	184
Snap-action switch on soldering-iron stand regulates heat automatically.....	193
Tape wrapped around dry cells protects flashlight case.....	198
Recessed ceiling light for playroom made from auto headlight.....	199

HOUSE AND HOME

Monk's cloth reclaims table top.....	180
Spring catch holds drawer closed.....	181
Home intercommunication system utilizes garden hose.....	181
Solving home problems.....	182
Cloth basted by using tape.....	184
Shoe buffer used to apply wax.....	186
Door latch is easily forced to rescue child locked in bathroom.....	193
Holder suspends paintbrushes in cleaning solution.....	196
Making bottles shatterproof.....	196
How to clean furniture hardware.....	198
Garments held on clothesline by crossing hangers.....	198
Plates keep grease off burners.....	200
Cellulose tape holds shelf paper.....	206
Wallpaper blister pasted down.....	212
Indicator that has rotating disk shows amount of milk needed.....	212

METALWORKING

Flower holder for use in cemetery made from tin can.....	181
Making extension clamp.....	184
Silent butler takes the "brush-off".....	185
Pencil substitutes as depth gauge.....	186
File can be made nonclogging by rubbing teeth with chalk.....	193
Spring restores oilcan action.....	196
Miniature spur center is handy for turning small work.....	196
Hollow rivets set with C-clamp.....	198
Drill vise takes place of nontilling table.....	216
Alcohol torch made from scrap parts.....	222

PHOTOGRAPHY

Collapsible reflector for outdoor photographs.....	207
Table-top studio for nature photos.....	208
Reflecting view finder on camera an aid when focusing.....	210
Storage rack for photo bulbs.....	210
Molding cup used as light diffuser.....	210
Labeling chemical-solution bottles.....	210
Positive identification of print tongs.....	210

RADIO AND ELECTRONICS

Eight-tube high-fidelity FM tuner and special-purpose amplifiers.....	229
Low-cost three-tube a.c. progressive receiver—Set No. 2.....	230
Radio data service for all postwar receivers.....	232

TOOLS

Splicing tool from paper clip.....	184
Inner-tube band around oilstone retains lubricant.....	200
Roofing-nail cap spots position of plumb bob.....	200
Sectional holder for small drills carried in pocket.....	206
Craft quiz.....	211
Pick to clean small oilholes.....	212
Gradometer made from protractor.....	216
Shadow screen for copying speeds painting signs.....	216
Ball stop for vise handle speeds clamping.....	220
Drill-press clamps.....	221
Nonfriction spinning tool.....	222
Adjustable jig positions chisel for grinding in drill press.....	222
Adjustable fence for drill press.....	223
Pressure gauge on heating boiler easy to read with magnifier.....	223
Depth stop for engine-lathe chuck made from tallstock center.....	228

TOYS AND NOVELTIES

Personalized lamp for child's playroom made from discarded alphabet blocks.....	188
Tire coating identifies toys.....	196
Children's home "movie" shows comic strips.....	199
Vest-pocket phone directory made from match pad.....	212

WOODWORKING

Wood-lathe collet chuck holds faceplate turnings.....	181
Duplicate parts are mass-produced with this faceplate sand-er-chuck.....	188
Lawn house numbers.....	189
Sports shelter.....	197
Dutch cradle.....	205
Marking jig locates centers on round or square stock.....	206
Sawing cove molding.....	206
Hand holes cut quickly with dado saw.....	207

MISCELLANEOUS

Law of physics is demonstrated by "diving" medicine dropper.....	180
Novel clothespin flashlight frees hands for work.....	186
Acid burns holes in clock spring.....	186
Greenhouse suggestions.....	187
Match-book guard for razor blades.....	193
Eight repair kinks for bicycles.....	194
Grip of paper clips improved by rubber coating.....	196
Caster-fitted luggage is pushed like a wheelbarrow.....	198
Repairing broken clock spring.....	200
Short pencil leads salvaged to use in compass.....	216
Demountable lugs fit rubber-tired garden tractors.....	217
Coffee-can rack holds harness.....	220

IMPORTANT NOTICE—It is the intention of this magazine to provide its readers with information regarding the latest developments in the mechanical arts. We take no responsibility as to whether the disclosures contained in our articles are covered by patents and advise readers to investigate this subject before making, using, or selling any of the products, machines, or processes described in order to avoid possible liability for patent infringements.

AUDELS REFRIGERATION & AIR CONDITIONING GUIDE.....\$4

New from Cover to Cover—1280 Pages, Fully Illus. Covering basic principles, servicing, operation & repair of household, commercial & industrial refrigeration & air conditioning. A gold mine of essential important facts for engineers, servicemen, users.

AUDELS CARPENTERS & BUILDERS GUIDES—4 Vols.\$6

A practical illustrated trade assistant on modern construction for carpenters, joiners, builders, mechanics and all woodworkers. 4 vols., 1600 pages, 3700 illustrations, flexible covers. Pocket size. Each volume sold separately \$1.50 a vol.

AUDELS AUTOMOBILE GUIDE.....\$4

A practical quick ready reference book for auto mechanics, service men, operators & owners. Explains theory, construction & servicing of modern motor cars, trucks, buses & auto type Diesel engines. 1700 pages, fully illustrated. 55 chapters. Indexed. A standard book for mechanics. New fluid drive covered.

AUDELS DIESEL ENGINE MANUAL..\$2

A practical, concise treatise with questions and answers on the theory, operation and maintenance of modern diesel engines including General Motors 2 cycle Diesel. 384 pages, fully illus., flexible binding, pocket size. All details plainly brought out, this book is of extreme value to engineers, operators & students.

AUDELS WIRING DIAGRAMS.....\$1

210 Pages, Illustrated. Gives practical facts on wiring of electrical apparatus. It shows clearly how to wire apparatus for practically all fields of electricity. Each diagram is complete & self-explanatory. Highly Endorsed Pocket Companion.

AUDELS PLUMBERS & STEAMFITTERS GUIDES—4 Vols.\$6

A Practical Trade Assistant & Ready Reference. Explains in plain language & by clear illustrations, diagrams, charts, graphs, pictures principles of modern plumbing practice including Marine Pipe Fitting and Air Conditioning. 4 Vols.—1670 Pages—3642 Diagrams. Pocket size. Each Vol. Sold Separately \$1.50 a Vol.

AUDELS SHEETMETAL WORKERS HANDY BOOK.....\$1

Practical inside information. Fundamentals of Sheet Metal Work. 388 pages. Illustrated. 11 sections. Clearly written. Essential & important facts, figures, pointers in everyday language. Ref. Index.

AUDELS SHEETMETAL PATTERN LAYOUTS.....\$4

Developed by Experts for Sheet Metal Workers, Layout Men & Mechanics. A Practical Encyclopedia in 10 Sections, size 7 x 10 x 2—1125 Pages—350 Layouts—1600 Illustrations. 1001 Key Facts. Fully indexed for ready reference in answering your layout problems. Covers all phases of sheet metal work including Pattern Cutting, Pattern Development & Shop Procedure.

AUDELS ANSWERS ON BLUE PRINT READING.....\$2

For Mechanics & Builders. Covers all types of blue print reading including ship & airplanes. 416 pages, fully illustrated.

AUDELS NEW MACHINIST & TOOLMAKERS HANDY BOOK.....\$4

Covers modern machine shop practice in all its branches. 5 practical books in 1. New from cover to cover. Tells how to set up & operate lathes, screw and milling machines, shapers, drill presses and all other machine tools. 1600 pages, fully illustrated, 5 x 6 1/2 x 2. Indexed. 5 sections. 1—Modern Machine Shop Practice. 2—Blue Print Reading & How to Draw. 3—Calculations & Mathematics for Machinists. 4—Shop Physics. 5—How to Use the Slide Rule. 60 chapters. Easy to read and understand. A shop companion that answers your questions.

AUDELS MATHEMATICS & CALCULATIONS FOR MECHANICS \$2

Mathematics for home study or reference. 700 pages, 550 illus. Practical mathematics from beginning. How to figure correctly. Easy, correct methods covering complete review. Illus. & Indexed.

AUDELS HANDY BOOK OF PRACTICAL ELECTRICITY.....\$4

For maintenance engineers, electricians & all electrical workers. 1440 Pages, 2600 Illus. Covers important electrical information in handy form—including Marine Wiring, Radio Principles, Welding. Indexed. A Key to a practical understanding of electricity.

AUDELS RADIOMANS GUIDE.....\$4

A key to the practical understanding of radio including Frequency Modulation, Television, etc., Aircraft & Marine Radio. For radio engineers, servicemen, amateurs. 914 Pages, 633 Illustrations & Diagrams. Photos. Review Questions & Answers, Reference Index. Authentic, clear, concise.

AUDELS ELECTRONIC DEVICES.....\$2

Tells What You Want to Know About Electric Eye. Easily Understood. Covers photo-electric cells & their applications. Amplifiers, illumination, frequencies, voltage, photocell, tubes, Ohm's Law, wiring diagrams, etc.

AUDELS WELDERS GUIDE.....\$1

A concise, practical text on operation & maintenance of all welding machines for all mechanics. Over 400 pages, illustrated. Covers all methods of electric and acetylene welding including airplane work.

AUDEL, Publishers, 49 W. 23 St., N. Y. 10

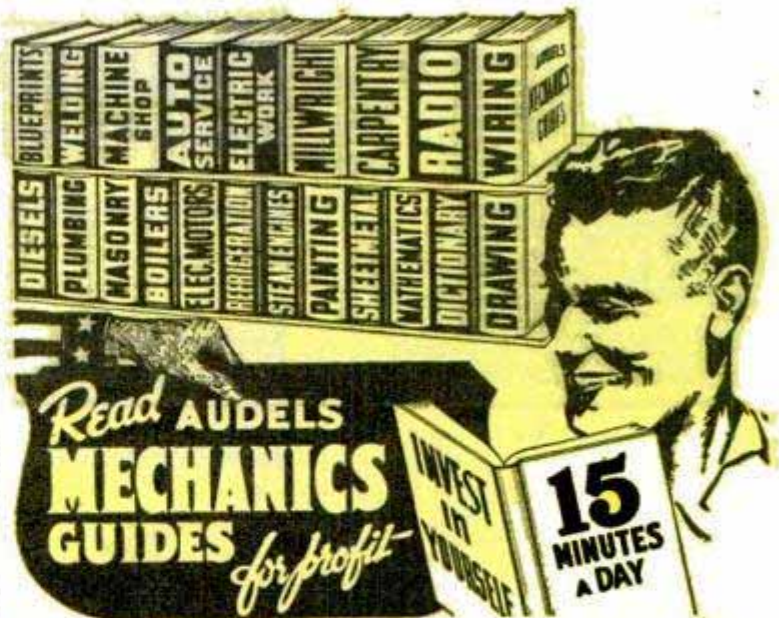

AN AUDEL GUIDE IS A GOOD FRIEND!

Step Up Your Own Skill with the Practical Facts and Figures of Your Trade. Save time and money with right methods, short cuts, labor saving ideas. CHECK NOW! You can look over any Audel Guide in your home. Start the Easy Payments if satisfied.

CUT HERE MAIL ORDER

THEO. AUDEL & CO., 49 W. 23 St., New York 10, N. Y.

Please mail me for 7 days' free examination the books marked (X) below. I agree to mail \$1 in 7 days on each book or set ordered, and to further mail \$1 a month on each book or set ordered until I have paid purchase price.

If I am not satisfied with Guides I will return them.

- Audels **ELECTRIC MOTOR GUIDE** \$4.
- Audels **OIL BURNER GUIDE** 1.
- Audels **REFRIGERATION & Air Conditioning Guide** 4.
- Audels **POWER PLANT ENGINEERS GUIDE** 4.
- Audels **PUMPS, HYDRAULICS & AIR COMPRESSORS** 4.
- Audels **WELDERS GUIDE** 1.
- Audels **BLUE PRINT READING** 2.
- Audels **SHEET METAL WORKERS Handy Book** 1.
- Audels **SHEET METAL PATTERN LAYOUTS** 4.
- Audels **AIRCRAFT WORKER** 1.
- Audels **MATHEMATICS AND CALCULATIONS** 2.
- Audels **MACHINISTS & TOOLMAKERS Handy Book** 4.
- Audels **MECHANICAL Dictionary** 4.
- Audels **AUTOMOBILE GUIDE** 4.
- Audels **DIESEL ENGINE MANUAL** 2.
- Audels **MARINE ENGINEERS Handy Book** 4.
- Audels **MECHANICAL DRAWING GUIDE** 1.
- Rogers **MECHANICAL DRAWING and DESIGN** 2.
- Audels **MILLWRIGHTS and Mechanics Guide** 4.
- Audels **CARPENTERS and Builders Guides (4 vols.)** 6.
- Audels **PLUMBERS and Steamfitters Guides (4 vols.)** 6.
- Audels **MASONS and Builders Guides (4 vols.)** 6.
- Master **PAINTER and DECORATOR** 2.
- Audels **GARDENERS & GROWERS GUIDES (4 vols.)** 6.
- Audels **ENGINEERS & FIREMANS EXAMINATIONS** 1.
- Audels **ENGINEERS and Mechanics Guides**
- Nos. 1, 2, 3, 4, 5, 6, 7 and 8 complete 12.
- Audels **Answers on Practical ENGINEERING** 1.
- Audels **ELECTRICIANS EXAMINATIONS** 1.
- Audels **WIRING DIAGRAMS** 1.
- Audels **Handy Book of PRACTICAL ELECTRICITY** 4.
- Audels **ELECTRICAL POWER CALCULATIONS** 2.
- Audels **ELECTRONIC DEVICES** 2.
- Audels **ELECTRIC Dictionary** 2.
- Audels **RADIOMANS GUIDE** 4.
- Audels **NEW ELECTRIC LIBRARY at \$1.50 a Volume**
- Vols. I, II, III, IV, V, VI, VII, VIII, IX, X, XI, XII

Name _____
 Address _____
 Occupation _____
 Employed by _____ PM

I Will
Show You
How to

Learn RADIO

You Build This Modern Superheterodyne Receiver

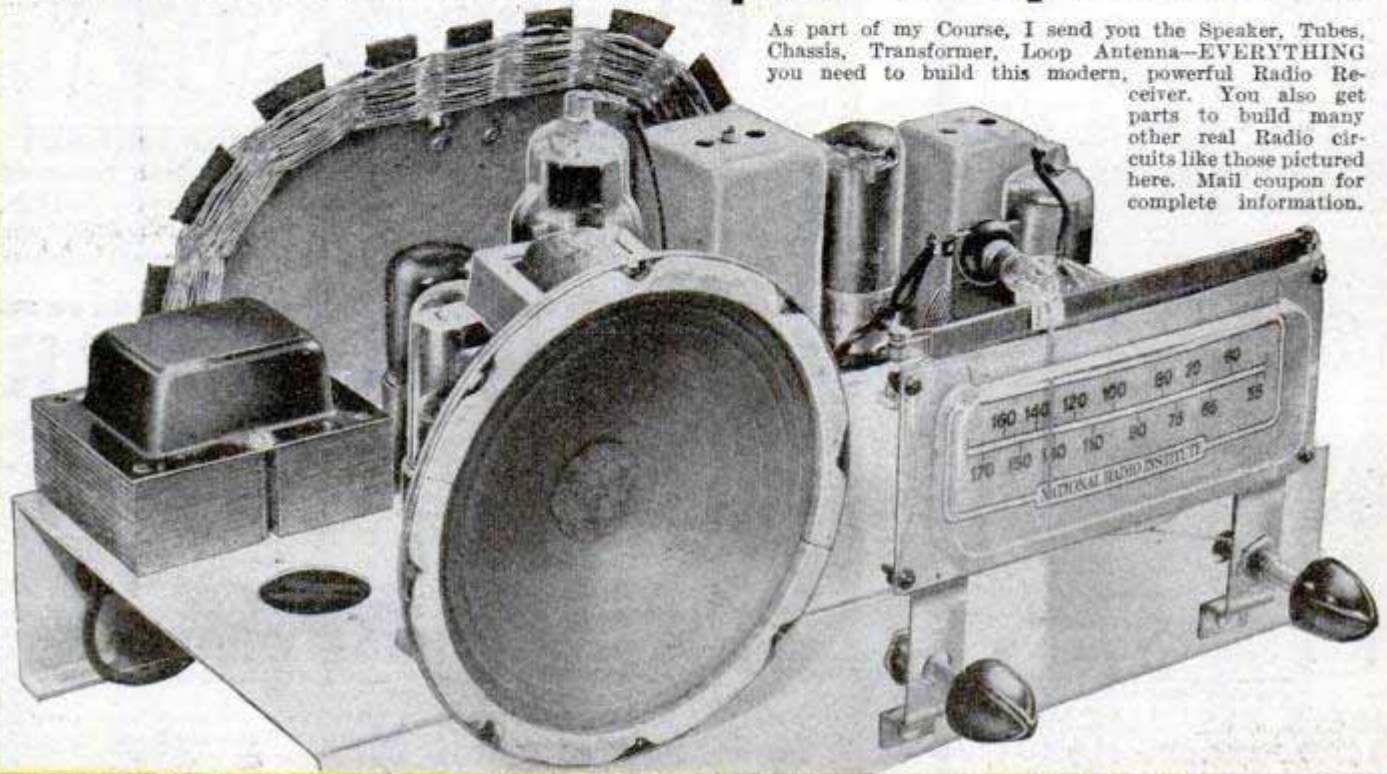

As part of my Course, I send you the Speaker, Tubes, Chassis, Transformer, Loop Antenna—EVERYTHING you need to build this modern, powerful Radio Receiver. You also get parts to build many other real Radio circuits like those pictured here. Mail coupon for complete information.

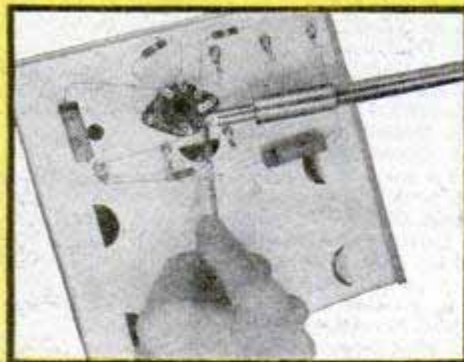

You build this Radio Circuit early in Course with Soldering Equipment and Radio parts I send; practice mounting, connecting, soldering Radio parts.

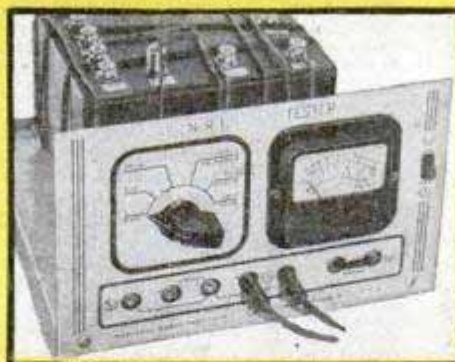

You practice Radio Servicing with this Tester built from parts I send. Also use it to help earn EXTRA MONEY fixing neighbors' Radios.

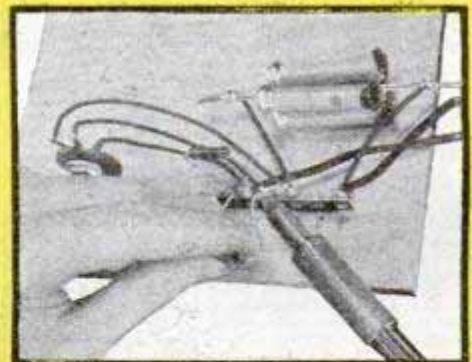

You practice "FM" Servicing on this Frequency Modulation (FM) Signal Generator, built with parts I supply; learn by repairing circuit defects.

MEN I TRAIN AT HOME GET GOOD JOBS LIKE THESE

Made \$1500 While Learning

"By the time I finished my NRI training I had made \$1500. When I started the Course I did not know a resistor from a condenser. I have bought my home. My income from Radio work, etc., is about \$3,000 a year." — WILLIAM THOMAS, Baldwin, Mississippi.



Assistant to Chief Engineer at Station WHJB

"Have been employed for the past two years as assistant to the chief engineer at Radio Station WHJB. Know nothing about radio when I enrolled for the NRI Course." — CECIL J. GIUNIPERO, Greenburg, Pennsylvania.



Knew Nothing About Radio

"I knew nothing about Radio when I enrolled. At present I am doing spare time work. I have more than paid for my Course and I have about \$200 worth of equipment which has paid for itself." — RAYMOND HOLT CAMP, Vandalia, Illinois.



Full Time Job Before Finishing Course

"After completing about two-thirds of my Course I entered a Radio Repair shop. Later I branched out for myself and opened a shop in my own home. I am much pleased with the work I had during my first year of business." — A. N. AYERS, Washington, District of Columbia.



by Practicing in Spare Time

**I Send You
Big Kits
of Radio Parts**

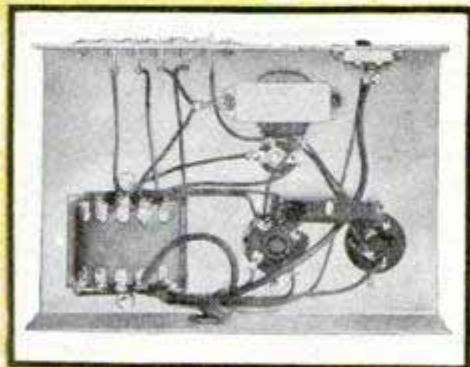

You build this Vacuum Tube Power Pack, make changes which give you experience, learn how to locate and correct power pack troubles.

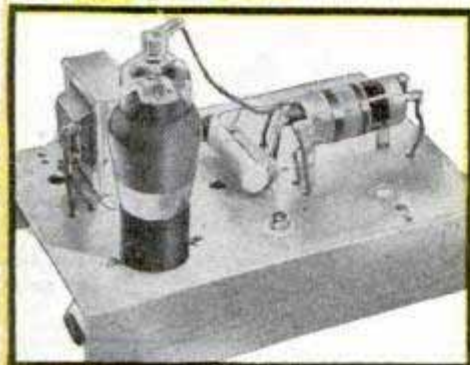

You build this A. M. Signal Generator which provides amplitude-modulated signals for many tests and experiments, gives you practical experience.

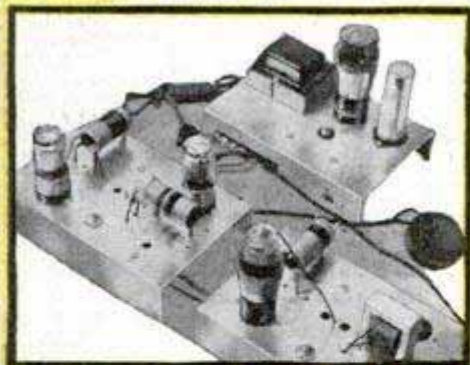

You practice signal tracing on this complete Superheterodyne Circuit you build with parts I send you, use it to conduct many tests and experiments.

**SAMPLE LESSON
FREE**

Gives hints on Receiver servicing, locating defects, repair of Loudspeaker, I. F. Transformer, Gang Turner, Condenser, etc. Mail coupon.

My Radio Course Includes
**TELEVISION • ELECTRONICS
FREQUENCY MODULATION**

KNOW RADIO *Win Success* I Will Train You at Home

Do you want a good-pay job in Radio—or your own money-making Radio Shop? Mail Coupon for a FREE Sample Lesson and my FREE 64-page book, "How to Be a Success in RADIO—Television, Electronics." See how N.R.I. gives you practical Radio experience at home—building, testing, repairing Radios with BIG KITS OF PARTS I send!

VETERANS

You Can Get
This Training
Under
G. I. Bill.
Mail Coupon.

**Many Beginners Soon Make Good
Extra Money in Spare Time
While Learning**

The day you enroll I start sending EXTRA MONEY manuals. You LEARN Radio principles from my easy-to-grasp, illustrated lessons—PRACTICE what you learn with parts I send—USE your knowledge to make EXTRA money fixing neighbors' Radios in spare time while still learning! From here it's a short step to your own full-time Radio Shop or a good Radio job!

**Future for Trained Men Is Bright in
Radio, Television, Electronics**

It's probably easier to get started in Radio now than ever before because the Radio Repair business is booming. Trained Radio Technicians also find profitable opportunities in Police, Aviation, Marine, Radio, Broadcasting, Radio Manufacturing, Public Address work. Think of even GREATER opportunities

as public demand for Television, FM and Electronic devices continues to grow. Send for free books now!

Find Out What N.R.I. Can Do for You

Mail Coupon for Sample Lesson and my 64-page book. Read the details about my course. Read letters from men I trained, telling what they are doing, earning. See how quickly, easily, you can get started. No obligation! Just MAIL COUPON NOW in an envelope or paste it on a penny postal. J. E. SMITH, President, Dept. 8BP, National Radio Institute, Pioneer Home Study Radio School, Washington 9, D. C.

Good for Both—FREE

Mr. J. E. SMITH, President, Dept. 8BP,
National Radio Institute,
Washington 9, D. C.

Mail me FREE, without obligation, Sample Lesson and my 64-page book about how to win success in Radio—and Television, Electronics. (No salesman will call. Please write plainly.)

Age _____

Name _____

Address _____

City _____ Zone _____ State _____

Approved for Training under GI Bill

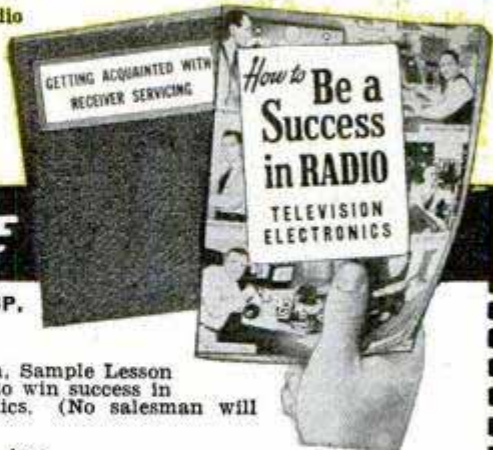

for
Engineers
Inventors
Machinists

A Book That
Shows You

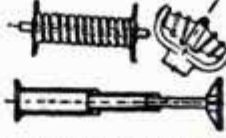
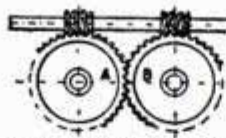

3000 ILLUSTRATIONS and DESIGNS OF MECHANICAL MOVEMENTS, DEVICES, CONTRIVANCES & DETAILS!

Every conceivable kind of mechanical motion and work is briefly explained and illustrated in this unusually helpful book. As far as known, the only work in existence which aims to provide side by side suggested sketches of the various methods in use for accomplishing any particular mechanical movement or work, in a form easily referred to. Every engineer, inventor or mechanic finds the need of devising, simplifying or improving some mechanical process or method. In doing this he has to rely on memory or experience. Here is a reference book of nearly 3000 MEANS AND METHODS for producing any kind of movement or work, classified and arranged for easy reference! SUCH AS: Accumulators, Anti-friction, Ball and Socket, Bearings, Blowings, Brakes, Cams, Chain Gear, Chopping,

Chucks, Circular Motions, Clutches, Conveying, Cranes, Cranks, Cutting Doors, Drilling, Eccentrics, Engines, Expanding, Filtering, Gears, Governors, Grips, Grinds, Heating, Hinges, Hydraulics, Indicators, Journals, Levers, Links, Lowerings, Lubricators, Measuring and Weighing, Mixing, Nozzles, Parallel Motions, Pipes, Pivots, Power Propulsion, Raising, Hatchets, Rotary Engines, Safety Appliances, Shafting, Signals, Slides, Sounds, Speed, Spindles, Springs, Starting, Striking, Swivel Tanks, Traps, Turbines, Valves, Water Wheels, Winding, Wipers, etc. If you work with machinery of any kind, you need this ENGINEERS' SKETCH BOOK by Thomas W. Barber—355 pages, durably printed and bound in cloth. Price.....\$2.98

Secrets
of
Furniture
Wonder
Working



PAINTING PATTERNS for HOME DECORATORS

By RUTH WYETH SPEARS

This book clears up the mysteries of the fabulous price tags on the painted accessories you have admired in smart shops. Follow these directions and you yourself can transform attic cast-offs, secondhand shop bargains, and family hand-me-downs into real decorative treasures for your home. Here are actual-size tracing patterns for dozens of designs. Here are directions for altering old furniture and making new, for preparing surfaces, for mixing 60 shades and tones of color from 5 tubes of paint, for achieving soft antique finishes or modern moisture and heat-resistant surfaces. With these easy-to-follow techniques you can make brush-stroke flowers and borders, or stencil quaint geometric

designs, you can do lettering like an expert, and work on any material—tin, glass, metal, wood, or fabric. Why not stop wishing and start working? With Ruth Wyeth Spears' guidance you can decorate kitchen cupboard doors, do a matched set of nursery furniture, transform a golden oak bureau into a modern foyer piece, paint a handsome pair of pottery lamps, decorate mirrors, picture frames, highball glasses, magazine racks, a silk or muslin bedspread, a luncheon set or card table covers. With paint and a gold stencil you can even make your own "antiques." And you don't have to go to an art school to learn how. Just read this book! Price.....\$3.50

For
Hobbyists,
Craftsmen,
Artists...
in Wood,
Leather,
Metal, etc.

A HANDBOOK OF DESIGNS—And How To Use Them

By GORDON DeLEMONS



118 big pages, giving you large, fully-detailed drawings of every imaginable sort of design, provide a quick solution to every problem in decoration for the craftsman—whether professional artist or fun-seeking hobbyist. Packed with fascinating design-ideas for every kind of work: Metal-Tooling, Stenciling, Leathercraft, Pottery, Wood Carving, Block Printing, Embroidery, etc.—and each design has been carefully selected to fit the use for which it is suggested—thus, the border for a metal tray will differ from the border for a button or belt-buckle. In addition to giving you hundreds of big, workable designs like: Leaf Motifs, Flowers, Animals, Birds, Boats, Nursery Designs, Rosette Designs, Abstract

Motifs (Geometric Patterns), Monograms, Alphabets, Designs for Holidays, etc.—there is page after page of invaluable information on how to Tool Your Design onto your work; How to Color Your Design; How to Work With Color; Step-by-Step Directions on How to Do Stenciling (from cutting to coloring); How to Adapt a Design and How to Enlarge Designs in the Easiest Way; What Designs to Use for Textiles, and How to Apply Them; and much more. There are tips, aids, and suggestions for every art and craft: 9 x 12 inches. Tables of 2, 3, and 4-color combinations

ONLY \$2.50

CREATING JEWELRY—For Fun and Profit

By ANDREW DRAGUNAS

Here is a complete how-to book on the craft of handmade jewelry. Designed for the beginner and carrying through to advanced techniques, it provides step-by-step instruction in jewelry design from the simple to the finely wrought. Describes explicitly the processes of soldering, pickling, coloring, cutting and bending sheet metal, and modeling. The tools you need and how to handle them, supplemented with 50 diagrams which graphically illustrate the methods outlined in the text. No special workshop required—the few tools are inexpensive. The use of all types of metal is treated: silver, gold, wire, aluminum, etc. Because of its broad scope and thorough text and illustrations this book will provide a firm foundation upon which an individual creative style may be established. As demonstrated by the many photographic plates and illustrations, the products of the craft can make it both a gratifying personal skill and a PROFITABLE HOBBY.....\$3.00

PRINCIPLES OF WOODWORKING

By HERMAN HJORTH

Principles of Woodworking, was designed and written to aid the "home woodworkers" as well as teachers and students of the many phases of woodworking. Read the Partial Contents and see how fully every one of your woodworking questions can be answered: A Complete Chapter on HAND TOOLS, listing 91 different tools, also MACHINE TOOLS, listing 36 different tools, all of these illustrated, described and explained. Special Chapters: Planing and Squaring to Dimensions; Joints, Gluing and Clamping; Metal Fastenings; Wood Turning; Wood Finishing; also, a series of Wood Projects, the construction of which are carefully analyzed and described. Even a History of Wood and Woodworking Tools is included, to give the woodworker a better background and understanding. Each subject above listed is complete in every detail. You get specific instructions for specific tools, woods, methods, etc. Every point of information is expertly illustrated, and diagrammed where necessary. 445 Pages, Illustrated and Indexed for Reference. Cloth Bound.....\$3.50

WOOD FINISHING AND PAINTING MADE EASY

By RALPH G. WARING

In an effort to meet the needs of the homecraftsman, home-owner, designer, finisher and educator, Mr. Waring, wood expert and chemist has put forth this book. This helpful book answers every possible question encountered in the selection and application of suitable finishes to wood and metalwork, concisely and with absolute accuracy, introducing the most recent techniques and demonstrating the use of the most modern equipment. This book begins with a discussion of cabinet woods with the preparation of cabinetwork for finishing. It then presents the problem of selecting and using stains and finishing materials; the application of intermediary coats of finish, fillers, putty; fast-drying finishes, both lacquers and enamels; selection, use and care of sprayguns and other paint-shop equipment; the application of special finishes to wood and metal, furniture, toys, and boats; the use of bronze powders and metallic paints. Here is a veritable encyclopedia in 19 chapters of indispensable information, with more than 100 photographs and sketches, clearly and completely illustrating the work; also photographs of the various woods. Beautifully Bound, Illustrated, 209 Pages, Glossary, Index.....\$3.50

BUILDING A LOG CABIN

By BEN HUNT

Answering the three most important questions involved in BUILDING A LOG CABIN ("Can I do it alone? What materials do I need? and What is the best and easiest way to get my cabin built?") this book was written by a famous outdoor-craftsman, to show you exactly the way it would be done by any veteran woodsman. Emphasizing the simple and practical steps, here is detailed information concerning the fundamentals of drainage, construction, finishing and repair. The clear, easy-to-follow, step-by-step text, is aided by numerous diagrams and drawings which show each step in the preparation and building of your cabin—and by many large photographs picturing the cabin in various stages of completion. Giving you the "inside track" on hundreds of little tricks in planning and building, the book includes sections on: The Cabin and the Site—Logs and Other Materials—Tools—Foundations—Fireplaces—Walls, Roofs, Windows, Doors, Shutters, Floors, Stairs, Ceilings, Partitions—Additions—Porches—Fixtures—Fireplace Equipment—Lighting—Heating—and an extremely valuable chapter giving explicit instructions on the Reconditioning of Old Cabins. Including explanations on the building of Outdoor Fireplaces, this invaluable book will guide you carefully and successfully in the BUILDING of a LOG CABIN that will assure satisfaction with maximum of ease in construction. 7 1/4 x 10 inches. (Published in 1947).....\$2.75

HOW TO ORDER: Fill out the convenient coupon, check the order. If you send payment with order we pay all delivery charges —If C.O.D., plus few cents postage.

MONEY BACK GUARANTEE: All books full library size, beautifully printed and hard cover bound. If, for any reason, not completely satisfied return books and get money back at once.

HOBBY BOOK MART 120 Greenwich St., Dept. PM-2
New York 6, N. Y.

HOBBY BOOK MART, Dept. PM-2
120 Greenwich St., New York 6, N. Y.

Please send me the book or books I have checked below. If not satisfied, I can return for full refund.

<input type="checkbox"/> Engineer's Sketch Book \$2.98	<input type="checkbox"/> Building a Log Cabin \$2.75
<input type="checkbox"/> Painting Patterns for Home Decorators 3.50	<input type="checkbox"/> Wood Finishing and Painting Made Easy 3.50
<input type="checkbox"/> A Handbook of Designs and How to Use Them 2.50	<input type="checkbox"/> Principles of Woodworking 3.50
<input type="checkbox"/> Creating Jewelry for Fun and Profit 3.00	

I enclose \$_____ in full payment. Send books postpaid.
 Send C.O.D. for \$_____ plus postage.

NAME _____
ADDRESS _____
CITY & ZONE _____ STATE _____



INVENTORS



Learn how to protect your invention. The U. S. Patent Laws provide that any new and useful art, machine, article of manufacture, or composition of matter, or any new and useful improvement thereof, may be patented if the act of invention is involved. Therefore, every inventor with a valuable invention should take advantage of the Patent Laws and proceed for patent protection in order to safeguard his rights.

A patent gives the inventor the exclusive right to prevent others from making, using, or selling the invention claimed in the patent for a period of seventeen years.

The Patent Laws were enacted for the benefit of the inventor to give him protection for the features of his invention which are patentable. These features must be properly and concisely set forth and claimed in a formal application for patent, in order to comply with the requirements of the U. S. Patent Office. For that reason, the Patent Office advises the inventor, unless he is familiar with such matters, to engage a competent registered patent attorney or agent to represent him. We maintain a staff of registered patent attorneys ready to serve you in the handling of your patent matters.

A specially prepared booklet entitled "Patent Guide for the Inventor", containing detailed information with respect to patent protection and procedure, together with a "Record of Invention" form will be promptly forwarded to you without obligation upon request.

**Registered
Patent
Attorneys**

CLARENCE A. O'BRIEN & HARVEY B. JACOBSON
Registered Patent Attorneys
81-B District National Bldg., Washington 5, D. C.

Please send me copy of "Patent Guide for the Inventor" and also "Record of Invention" form. This request does not obligate me.

Name _____

Address _____

City _____ State _____

(Please write or print plainly.)

**CLARENCE A. O'BRIEN
& HARVEY B. JACOBSON**

81-B District National Building + Washington 5, D. C.

I'll Send You 8 Big Kits of Training Equipment
including

TWO-BAND 6 TUBE SUPER RECEIVER
AND 16 RANGE METER SET-UP
for Testing

Learn Fast... Earn Fast
HOME TRAINING
Planned For Your Needs
You Build All These
TESTERS... and MORE!

I give you a fine, moving-coil type Motor Instrument on Jewel Bearings—with parts for a complete Analyzer Circuit Continuity Tester. You learn how to check and correct Receiver defects with professional speed and accuracy.

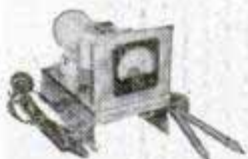

Practice Does It!

Soldering, wiring, connecting Radio Parts... building circuits with your own hands—you can't beat this method of learning. When you construct this Receiver and Filter Resistor and Condenser Tester, etc., you get a really practical slant on Radio that leads to a money-making future.

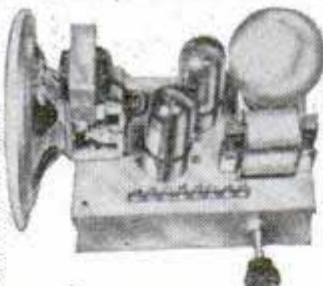

Building this Signal Generator and multi-purpose Tester will give you the kind of valuable experience and practice that is so important as a foundation for making good money in Radio. It makes a breeze out of fixing Radios, and you don't have to spend money on ready-made Equipment.

VETERANS:

Approved for G.I. Training under
Public Laws 16 and 346



PRACTICE WITH YOUR OWN HANDS!
Mind training through hand practice, that's the only way to LEARN and REMEMBER Radio. It's the most successful of Home Training methods.



OVER 175 PRACTICAL EXPERIMENTS
You'll find out how to build countless Radio Circuits. You'll learn a new, fast way to test Radio Sets without mfg. Equipment.

LOW COST HOME RADIO TRAINING!
Easy Monthly Payments!

My perfected Radio Training prepares you to start your own Radio Service Shop—or to land a big pay Radio job. With my help you get neighborhood Radio jobs while learning—for extra cash and rich experience. I train you RIGHT—by putting you to work with your hands in your own home during spare hours. You get 8 big kits of real professional Radio Parts and Equipment—and use them to build, test and trouble-shoot a powerful 6 tube superhet receiver, a 16 range test meter set-up and over 175 fascinating, instructive Radio experiments. My Training is down-to-earth, really PRACTICAL—it's the Training you need

to make money in Radio. Theory is cut to the bone—you don't need any previous schooling or experience. Sprayberry Training starts you out at the very beginning of Radio—the lessons are completely illustrated, simply written and easy to understand.

Get the facts about Sprayberry Training NOW. Find out what it can do for you—prepare for amazing opportunities in Radio Servicing, Television, FM, Radar and Industrial Electronics. Fill out and mail coupon for my two big Books—FREE. No obligation—and no salesman will call. Mail coupon TODAY!

MAIL COUPON FOR THESE 2 BOOKS!



"How to Read Radio Diagrams and Symbols" and "How to Make Money in Radio, Electronics and Television." Immense, practical value to you — and they're yours FREE!

F. L. Sprayberry, Pres.,
SPRAYBERRY ACADEMY OF RADIO,
1028 Sprayberry Bldg., Pueblo, Colo.

Please rush my FREE copies of "HOW TO MAKE MONEY IN RADIO, ELECTRONICS AND TELEVISION" and "HOW TO READ RADIO DIAGRAMS AND SYMBOLS."

Name _____ Age _____

Address _____

City _____ State _____

Check here if a Veteran
(Mail in envelope or paste on penny postcard)

INVENTORS

Patent Laws Encourage The Development of Inventions

The Rules of Practice of the U. S. Patent Office advise—unless an inventor is familiar with such matters—that he employ a competent registered attorney or registered agent, as the value of patents depends largely upon the skillful preparation of the specifications and claims.

The firm of McMorrow, Berman and Davidson is registered to practice before the U. S. Patent Office. Additionally, it maintains a staff of attorneys able to readily understand inventors' disclosures, to advise concerning patentability, and to prepare appropriate specifications and claims for filing with the Patent Office.

If an inventor believes he has an invention, a search of the most pertinent prior U. S. patents should be made and a report obtained relative to its patentability. Where such report indicates that the invention appears patentable, in order to secure protection, diligence should be exercised in making application for a patent.

McMORROW, BERMAN & DAVIDSON

Registered Patent Attorneys

135-E VICTOR BUILDING, WASHINGTON 1, D. C.

McMORROW, BERMAN & DAVIDSON

Registered Patent Attorneys

135-E Victor Building, Washington 1, D. C.

Send me further particulars as to patent protection and procedure and "Invention Record" form at once. I understand that this request does not obligate me.

Name _____

Address _____

City _____ State _____

(WRITE OR PRINT NAME CLEARLY)

⑤



Start as high as \$3,021 a Year (Veterans Get Special Preference)

Get Ready Now for Next Examinations

Railway Postal Clerks

Railway Postal Clerks get \$2,300 the first year of regular employment, being paid on the first and fifteenth of each month. (\$95.84 each pay day.) Their pay is automatically increased yearly to \$3,400 and \$3,600 in large organizations. Advance may be had to Chief Clerk at \$5,400 a year. Veterans only.

3 Days On — 3 Days Off — Full Pay

Railway Postal Clerks on long runs usually work 3 days and have 3 days off duty or in the same proportion. During this off duty their pay continues just as though they were working. They travel on a pass when on business. When they grow old, they are retired with a pension.

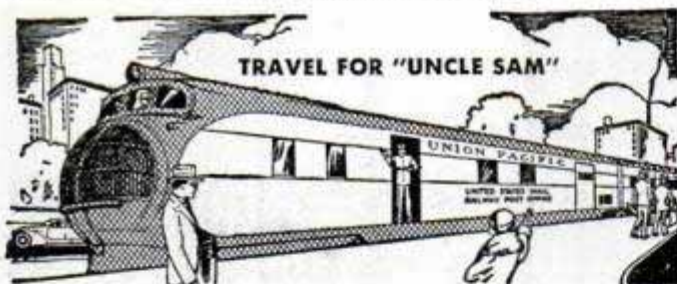

City Mail Carriers, Post Office Clerks

Clerks and Carriers now get \$2,100 the first year of regular employment and automatically increase \$100 a year to \$3,100. Open to Men — Women 18 to 50.

Many Other Positions

Many other positions are obtainable. Rural Carriers—Stenographers—Typists—Patrol Inspectors—Assistant Statistical Clerks—etc. Those wishing these positions should qualify at once.

Get Free List of Positions

Fill out the following coupon. Tear it off and mail it today — NOW, at once.

This investment can result in your getting a big-paid government job.

FRANKLIN INSTITUTE, Dept. T86, Rochester 4, N.Y.

Rush to me, entirely free of charge (1) a full description of U. S. Government Jobs; (2) Free copy of illustrated 32-page book, "How to Get a U. S. Government Job" with (3) List of U. S. Government Jobs; (4) Tell me how to qualify for one of these jobs.

Name _____

Address _____ Veteran? _____

Use This Coupon Before You Mislaid It.
Write or Print Plainly.

SUCCEED IN THE POULTRY BUSINESS!



Poultry is providing many trained men and women with a good, comfortable living, either part or full time. You, too, can enjoy country life, home-grown food, increased income, if you have the specialized knowledge that is so important.

For 27 years our Home Study Course has been helping thousands to greater success. Proper knowledge and "Know How" mean extra income from the start. Don't delay—write today for prospectus describing courses, methods, opportunities, service.

NATIONAL POULTRY INSTITUTE
DEPT. 50 — ADAMS CENTER, N. Y.

LEARN MONEY-MAKING CARTOONING

IN SPARE TIME — by Easy PICTURE

CHART METHOD! Teaches originality —

the big need today. Same Simplified Method that has helped train creators of "Steve Canyon," "Winnie Winkle," "Out Our Way," "Secret Agent X-9," "The Neighbors," "Reg'lar Fellers," "Strange As It Seems," and many other successful strip, sport, and editorial cartoonists. Earn while you learn. Don't wonder whether you have talent—rush name, address and 10c for Picture Chart (to test your ability), samples of successful students' work, and full details. Please state age.

LONDON SCHOOL OF CARTOONING

4802 Cleveland Transit Bldg.
Cleveland 14, Ohio



HORSE MASTERY!

A FINE HOBBY — A GREAT VOCATION!

"The EXPERT HORSEMAN"



FREE BOOK — Tells how You can learn to:
BREAK COLTS, GAIT SHOW HORSES, TRAIN
RODEO, STOCK and RACE HORSES, BREAK BAD HABITS,
HANDLE ANY HORSE, TRAIN CIRCUS TRICK HORSES. WRITE TODAY!

ANIMAL LOVERS ASSOCIATION
BOX KA-111 TARZANA, CALIFORNIA

SUBSCRIBE TODAY 50¢
One Year

ANALYZE HANDWRITING

Illustrated Lesson and Grapho Analyst **FREE**

shows you how to make money at home, full or spare time. Opportunities everywhere. **FREE** Analysis Offer for immediate answer. Must be over 21.
A.I.G.A. Inc., Wilhoit Bldg., Dept. 120-M, Springfield, Mo.



LEARN TO PLAY AN

ACCORDION

"THE PAGANI WAY"

WRITE FOR DESCRIPTIVE CIRCULAR

O. PAGANI & BRO., INC. 289 Bleecker Street
New York 14, N. Y. Dept. P



MOTION PICTURE

INSTRUCTION
LEARN AT HOME

Professional instruction in Hollywood. Business, Free Lance, and Educational film technique. Personal supervision by authorities. For career or hobby, write today for **FREE CATALOG**.

MOTION PICTURE INSTITUTE • BIRMINGHAM 14, MICHIGAN
APPROVED FOR VETERANS UNDER G.I. BILL

MONEY MEN ALL DATA FREE

THE PLASTEX Industry needs manufacturers on small scale and for big production of Lamp and Clock Stands, Art Goods and Novelties in Plastex and Marble imitation. Experience unnecessary. 1/2c material makes regular 10c store sellers. Rubber moulds furnished for speed production. Small investment brings good returns. Big chain store orders now being placed. Ambitious men have chance for real prosperity. Our Free booklet will interest and benefit you.

PLASTEX INDUSTRIES, Dept. A
3408 Third Ave. New York 56, N. Y.



"Why, he knows all about me!"

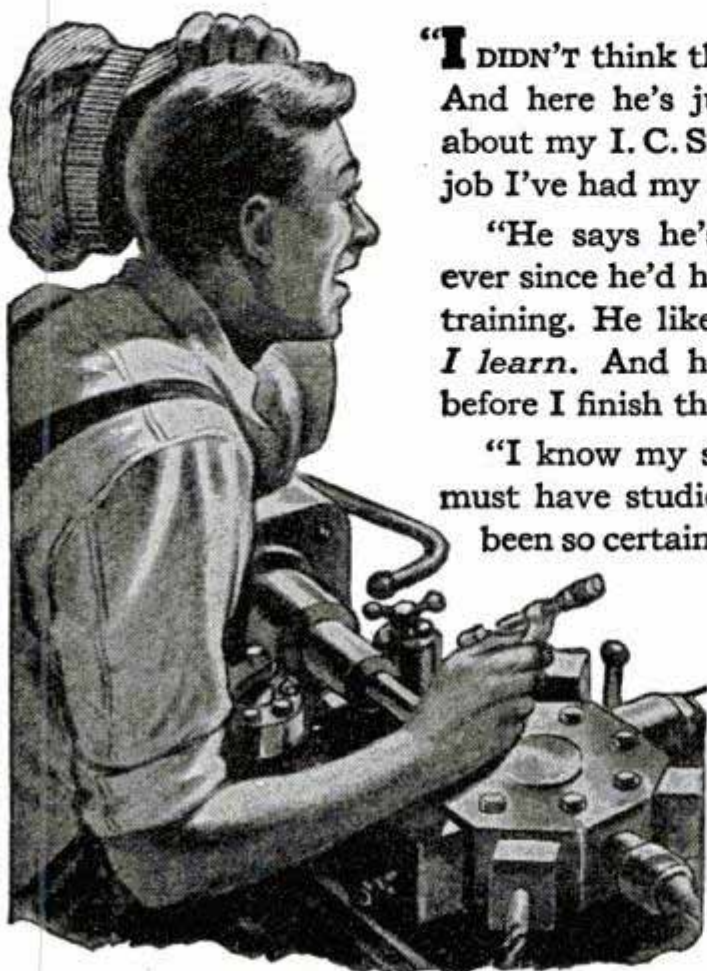

"I DIDN'T think the boss knew my name. And here he's just stopped by to talk about my I. C. S. Course and the bigger job I've had my eye on.

"He says he's had *his* eye on me ever since he'd heard I was getting that training. He likes the idea of my applying what I learn as *I* learn. And he says there'll be good news for me even before I finish the course.

"I know my studies showed in my work. But I guess he must have studied with I. C. S. himself or he couldn't have been so certain about just where I was getting my training."



Quite possibly the boss *is* an I. C. S. graduate. Thousands of employers are. Whether he is or isn't, however, he knows about your studies. I. C. S. regularly reports student progress to superiors. Letters of employer appreciation for this service are a regular part of our mail. So are student and graduate letters telling us of advancements—600 a month on an average. There *must* be a connection. Mail the coupon for full information.

INTERNATIONAL CORRESPONDENCE SCHOOLS



BOX 5622-K, SCRANTON 9, PENNA.

Without cost or obligation, please send me full particulars about the course BEFORE which I have marked X:

- | | | | |
|---|---|--|---|
| <p>Air Conditioning and Plumbing Courses</p> <p><input type="checkbox"/> Air Conditioning <input type="checkbox"/> Plumbing</p> <p><input type="checkbox"/> Heating <input type="checkbox"/> Steam Fitting</p> <p><input type="checkbox"/> Refrigeration <input type="checkbox"/> Steam Fitting</p> <p>Chemistry Courses</p> <p><input type="checkbox"/> Chemical Engineering</p> <p><input type="checkbox"/> Chemistry, Analytical</p> <p><input type="checkbox"/> Chemistry, Industrial</p> <p><input type="checkbox"/> Chemistry, Mfg. Iron & Steel</p> <p><input type="checkbox"/> Petroleum Refining <input type="checkbox"/> Plastics</p> <p><input type="checkbox"/> Pulp and Paper Making</p> <p>Civil Engineering, Architectural and Mining Courses</p> <p><input type="checkbox"/> Architecture</p> <p><input type="checkbox"/> Architectural Drafting</p> <p><input type="checkbox"/> Bridge and Building Foreman</p> <p><input type="checkbox"/> Building Estimating</p> <p><input type="checkbox"/> Civil Engineering</p> <p><input type="checkbox"/> Coal Mining</p> <p><input type="checkbox"/> Contracting and Building</p> <p><input type="checkbox"/> Highway Engineering</p> <p><input type="checkbox"/> Lumber Dealer</p> <p><input type="checkbox"/> Reading Structural Blueprints</p> <p><input type="checkbox"/> Sanitary Engineering</p> <p><input type="checkbox"/> Structural Drafting</p> | <p><input type="checkbox"/> Structural Engineering</p> <p><input type="checkbox"/> Surveying and Mapping</p> <p>Communications Courses</p> <p><input type="checkbox"/> Electronics</p> <p><input type="checkbox"/> Practical Telephony</p> <p><input type="checkbox"/> Radio, General</p> <p><input type="checkbox"/> Radio Operating</p> <p><input type="checkbox"/> Radio Servicing</p> <p><input type="checkbox"/> Telegraph Engineering</p> <p>Electrical Courses</p> <p><input type="checkbox"/> Electrical Drafting</p> <p><input type="checkbox"/> Electrical Engineering</p> <p><input type="checkbox"/> Electric Light and Power</p> <p><input type="checkbox"/> Lighting Technician</p> <p><input type="checkbox"/> Practical Electrician</p> <p>Internal Combustion Engines Courses</p> <p><input type="checkbox"/> Auto Technician <input type="checkbox"/> Aviation</p> <p><input type="checkbox"/> Diesel-Electric</p> <p><input type="checkbox"/> Diesel Engines <input type="checkbox"/> Gas Engines</p> <p>Mechanical Courses</p> <p><input type="checkbox"/> Aeronautical Engineer's, Jr.</p> <p><input type="checkbox"/> Aircraft Drafting</p> <p><input type="checkbox"/> Flight Engineer</p> <p><input type="checkbox"/> Forging <input type="checkbox"/> Foundry Work</p> <p><input type="checkbox"/> Heat Treatment of Metals</p> | <p><input type="checkbox"/> Industrial Engineering</p> <p><input type="checkbox"/> Industrial Metallurgy</p> <p><input type="checkbox"/> Machine Shop</p> <p><input type="checkbox"/> Mechanical Drafting</p> <p><input type="checkbox"/> Mechanical Engineering</p> <p><input type="checkbox"/> Mold-Loft Work</p> <p><input type="checkbox"/> Patterning—Wood, Metal</p> <p><input type="checkbox"/> Reading Shop Blueprints</p> <p><input type="checkbox"/> Sheet-Metal Drafting</p> <p><input type="checkbox"/> Sheet-Metal Worker</p> <p><input type="checkbox"/> Ship Drafting <input type="checkbox"/> Ship Fitting</p> <p><input type="checkbox"/> Tool Designing</p> <p><input type="checkbox"/> Toolmaking</p> <p><input type="checkbox"/> Welding—Gas and Electric</p> <p>Railroad Courses</p> <p><input type="checkbox"/> Air Brake <input type="checkbox"/> Car Inspector</p> <p><input type="checkbox"/> Diesel Locomotive</p> <p><input type="checkbox"/> Locomotive Engineer</p> <p><input type="checkbox"/> Locomotive Fireman</p> <p><input type="checkbox"/> Railroad Section Foreman</p> <p>Steam Engineering Courses</p> <p><input type="checkbox"/> Boilermaking</p> <p><input type="checkbox"/> Combustion Engineering</p> <p><input type="checkbox"/> Engine Running</p> <p><input type="checkbox"/> Marine Engineering</p> <p><input type="checkbox"/> Steam Electric <input type="checkbox"/> Steam Engines</p> | <p>Textile Courses</p> <p><input type="checkbox"/> Cotton Manufacturing</p> <p><input type="checkbox"/> Rayon Weaving</p> <p><input type="checkbox"/> Textile Designing</p> <p><input type="checkbox"/> Woolen Manufacturing</p> <p>Business and Academic Courses</p> <p><input type="checkbox"/> Accounting <input type="checkbox"/> Advertising</p> <p><input type="checkbox"/> Arithmetic <input type="checkbox"/> Bookkeeping</p> <p><input type="checkbox"/> Business Administration</p> <p><input type="checkbox"/> Business Correspondence</p> <p><input type="checkbox"/> Certified Public Accounting</p> <p><input type="checkbox"/> Commercial</p> <p><input type="checkbox"/> Commercial Art</p> <p><input type="checkbox"/> Cost Accounting</p> <p><input type="checkbox"/> Federal Tax</p> <p><input type="checkbox"/> First Year College</p> <p><input type="checkbox"/> Foremanship <input type="checkbox"/> French</p> <p><input type="checkbox"/> Good English <input type="checkbox"/> High School</p> <p><input type="checkbox"/> Higher Mathematics</p> <p><input type="checkbox"/> Motor Traffic <input type="checkbox"/> Postal Service</p> <p><input type="checkbox"/> Salesmanship <input type="checkbox"/> Secretarial</p> <p><input type="checkbox"/> Sign Lettering</p> <p><input type="checkbox"/> Spanish <input type="checkbox"/> Stenography</p> <p><input type="checkbox"/> Traffic Management</p> |
|---|---|--|---|

Name _____ Home Address _____

City _____ State _____

Age _____ Present Position _____ Working Hours _____ A.M. to _____ P.M.

Special tuition rates to members of the Armed Forces. Special discount to World War II Veterans.
Canadian residents send coupon to International Correspondence Schools Canadian, Ltd., Montreal, Canada.

A D V I C E

for the I N V E N T O R

The United States Patent Office advises the inventor, unless he is familiar with such matters, to employ a competent registered patent attorney or agent as the value of patents depends largely upon the skillful preparation of the specification and claims.

PRELIMINARY STEPS *toward* PATENT PROTECTION

The Evidence of Invention form mentioned below is offered as a convenience to the inventor in making his disclosure of invention.

The inventor should date and sign his disclosure and have it witnessed by two or more persons who are capable of understanding his invention. The disclosure should then be mailed to the registered patent attorney or agent whom he selects to assist him. The dis-

closure should be accompanied by a letter authorizing the patent attorney or agent to conduct a preliminary search in the Patent Office among previously granted U. S. patents for similar types of invention. The patent attorney or agent then prepares a report of the probable patentability of the invention and recommends the further course the inventor should take, provided the report indicates possible patentability.

Victor J. Evans & Co. . . . has a staff of experienced, registered patent attorneys available to assist inventors in the preparation and prosecution of their cases before the Patent Office. The coupon below is suggested as a convenience to the inventor in starting action on his invention.

• • • • VICTOR J. EVANS & CO. • • • •
Merlin M. Evans
 REGISTERED PATENT ATTORNEY
 330-B MERLIN BUILDING, WASHINGTON 6, D. C.

Please send detailed patent information together with convenient "Evidence of Invention" form.

Name.....
 Address.....
 City and State.....

• • • • •

Learn RADIO

in a Few Weeks

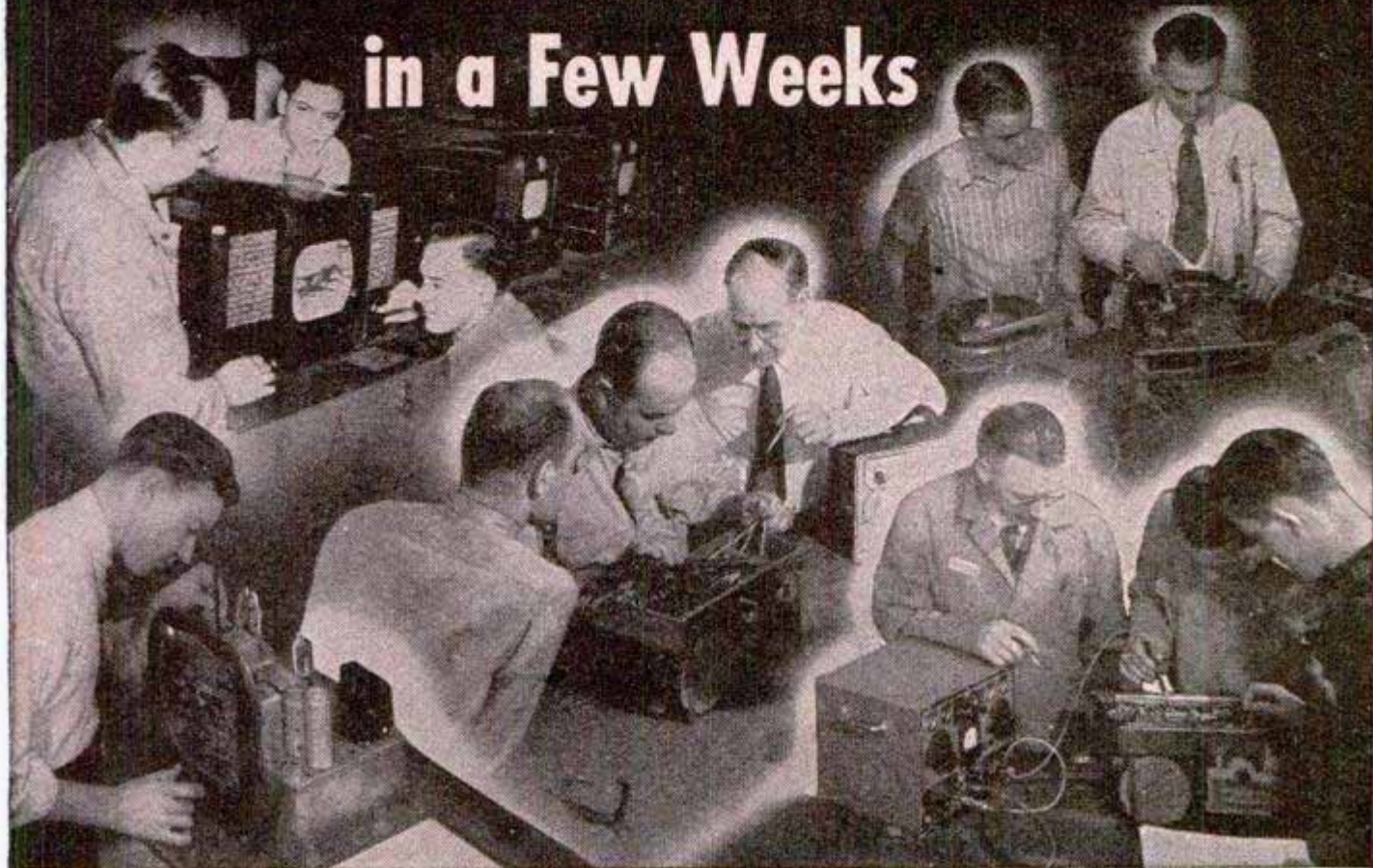

In the GREAT SHOPS of COYNE

NOT A "HOME-STUDY" COURSE!



B. W. Cooke

Men, here's the quick, easy way to learn Radio—with practical training in the Great Shops of COYNE. All training given on full-size equipment under friendly, helpful instructors, plus necessary theory. We do not teach by mail. At Coyne you learn Radio Set-building and Trouble-shooting, Public Address and Sound Systems, Television, Electronics, how to start your own shop. Prepare NOW for better jobs, bigger pay. Mail coupon today!

At Coyne you learn Radio Set-building and Trouble-shooting, Public Address and Sound Systems, Television, Electronics, how to start your own shop. Prepare NOW for better jobs, bigger pay. Mail coupon today!

ATTENTION, NON-VETERANS!

Don't let lack of money hold you back. Our Student Finance Plan has helped thousands. Pay most of tuition after you graduate. We also help you get part-time work while here, if you wish. Lifetime Job Service FREE to Coyne-trained men.

INCLUDED!

Added training in Electric Refrigeration Now Included with Radio Course.



VETERANS!

COYNE is authorized to train men who qualify under the G. I. Bill. Coupon brings special G. I. Bulletin.

SEND NOW FOR BIG FREE BOOK

Dozens of actual photos taken in the Great Shops of Coyne—also vital facts about YOUR opportunities in Radio-Electronics and Television. Coyne gives you ALL-AROUND Training, to prepare for many branches of the vast Radio field. Send for this book today. No obligation, and no salesman will call on you. Rush the coupon—new class starting soon!



Founded 1899

B. W. COOKE, President, Radio Division

COYNE ELECTRICAL SCHOOL
500 S. PAULINA ST. Dept. 28-3H CHICAGO 12

FREE BOOK COUPON

B. W. COOKE, President
COYNE ELECTRICAL SCHOOL, Radio Division
500 S. Paulina St., Dept. 28-3H, Chicago 12, Ill.

I want to build a REAL FUTURE for myself. Send your big FREE BOOK on RADIO, also details of Student Finance Plan and Lifetime Employment Service. This does not obligate me in any way, and no salesman will call.

NAME.....

ADDRESS.....

CITY.....STATE.....

...MAIL THIS TODAY!

Learn this Profitable Profession



IN 90 DAYS AT HOME

Money-Making Career Open to Men and Women, 18 to 50

Hundreds of men and women between 18 and 50 make \$10 to \$20 in a single day giving scientific Swedish Massage and Hydro-Therapy treatments. There is big demand from doctors, hospitals, sanatoriums and clubs. Graduates earn large full time incomes from these or in private practice in their own offices. Others make good money from home treatments given in spare time. Learn this interesting, money-making profession in your own home, through our home study course. Same instructors as in our nationally known resident school. You can win independence and prepare for future security by qualifying for your Diploma. Course can be completed in 3 to 4 months. Many earn while they learn. Begin your training at once.



Anatomy Charts & Booklet FREE

Enroll now and we will include, at no extra cost, many needed supplies. Fit yourself to help meet growing demand for Scientific Swedish Massage. Send the coupon at once for complete details. Anatomy Charts and 32-Page Illustrated Booklet, FREE, postpaid.

THE COLLEGE OF SWEDISH MASSAGE

Dept. 864B, 100 East Ohio St., Chicago 11, Illinois

Please send me FREE and postpaid, Anatomy Charts, 32-page Booklet and complete details on Home Training.

Name _____
 Address _____
 City _____ State _____

AVIATION Career

MAXIMUM TRAINING IN MINIMUM TIME

CAL-AERO TECH TRAINING will add dollars to your pay check all the rest of your life. Specializing in AERONAUTICAL ENGINEERING and MASTER AVIATION MECHANICS since 1929, Cal-Aero Tech training is carefully designed for just one thing—TO MAKE MORE MONEY FOR YOU. An alumni of over 6000 successful graduates proves our career training is unsurpassed.

VETERANS —Write us about Aviation Training, as provided under "G.I. Bill of Rights."



CAL-AERO TECHNICAL INSTITUTE
 MAJOR C. C. MOSELEY PRES. SINCE 1929
 FORMERLY CURTIS WRIGHT TECHNICAL INSTITUTE

GRAND CENTRAL AIR TERMINAL
 GLENDALE 1, CALIFORNIA
 LOS ANGELES COUNTY

MAIL THIS COUPON TODAY!

Cal-Aero Technical Institute, Grand Central Airport, Glendale 1, California
 Please send full information on Aviation Training FREE—without obligation. Dept. PM-2

Name _____ Birth Date _____
 Street _____
 City _____ State _____

Do You Make These Mistakes in English?

MANY persons say "between you and I" instead of "between you and me"—or use "who" for "whom"—or don't know whether to spell certain words with one or two "c's" or "m's" or "r's," or with "ie" or "ei," etc. Every time you speak or write you show what you are. Mistakes in English reveal lack of education, refinement. Lack of language power prevents you from presenting your thoughts in the strongest way. Real command of English will help you reach ANY goal. Stop making mistakes in spelling, punctuation, pronunciation, grammar. Increase your vocabulary.



Sherwin Cody

WONDERFUL INVENTION

Only 15 minutes a day with Sherwin Cody's new invention—and you can actually SEE your English improve. It teaches by HABIT—makes it easier to do the RIGHT way. Wonderful self-correcting lessons.

FREE BOOK ON ENGLISH Lack of language power may be costing you friendships, income, every year. See what Mr. Cody can do for you; it costs nothing to find out. Write this very minute for free book, "How You Can Master Good English in 15 Minutes a Day." It will prove a revelation. WRITE NOW, SHERWIN CODY SCHOOL OF ENGLISH, 52 B & O Bldg., Rochester 4, N. Y.



Good penmanship makes favorable impressions and helps you win success. Poor penmanship contributes to failure. It makes no difference how poor you now write, you can quickly and easily learn Business Writing, and you can learn Shaded Writing also right in your own home during spare time by my Simplified Method, without cost of going away to school. Easy Lessons. Diploma.

BEGIN NOW! Write for my FREE BOOK, "How to Become an Expert Penman," which contains valuable information and many specimens of penmanship that show what others have learned by taking my Courses. If you enclose 10c, I will send you one of my Favorite Penpoints suitable for plain or shaded writing, and your name with a beautiful flourished bird written on a card. Write TODAY.
T. M. TEVIS, BOX 25K, CHILLICOTHE, MO.

LAW STUDY AT HOME FOR PERSONAL SUCCESS and LARGER EARNINGS. 39 years expert instruction—over 108,000 students enrolled. LL.B. Degree awarded. All texts furnished. Easy payments. Send for FREE BOOK. G. I. approved. **AMERICAN EXTENSION SCHOOL OF LAW** Dept. 86-M, 646 N. Michigan Ave., Chicago 11, Ill.

CORRESPONDENCE COURSES IN RADIO and ELECTRICAL ENGINEERING Tuition \$25
ELECTRICAL ENGINEERING. Get good grasp of wide electrical field. Modern. Very understandable. Theory made easy.
RADIO ENGINEERING. Extra fine course in radio, public address, photo-electric work. Trains you to be super-service man; real vacuum tube technician. Tuition ONLY \$25, either course. Deferred payment plan. Servicemen needed badly.
FREE LINCOLN ENGINEERING SCHOOL, Box 931-P110, Lincoln, Nebr.

SAY YOU SAW IT IN POPULAR MECHANICS

THOUSANDS OF SUFFERERS USE

BREATHEASY

FOR

ASTHMA

CARRY IT WITH YOU
 USE IT ANYWHERE

Sold on Money-Back Guarantee

Write To Dept. PM
BREATHEASY DISTRIBUTORS, INC.
 65 CEDAR STREET
 SEATTLE 1 WASHINGTON

WHICH OF THESE *Opportunities* INTERESTS *You* MOST?

Accounting
Air Conditioning
Architecture & Building
Automotive Engineering
Aviation—Practical
Aviation Drafting & Design
Better Foremanship
Bookkeeping
Business Management

Contracting
Diesel Engineering
Drafting & Design
Electrical Engineering
Electricity—Practical
Electronics, Industrial
High School Courses
Machine Shop Operations
Mechanical Engineering

Plastics Engineering
Plumbing—Practical
Private Secretary
Radio Operating & Servicing
Railway Training
Refrigeration
Sheet Metal Pattern Drafting
Shop Management
Tool Making

THINK! LOOK FORWARD!

Business is making big, new plans

Men and Women are preparing for the future

WHAT ARE YOU DOING ABOUT YOUR TOMORROWS?

● *Today*, choose the job you want—and prepare for it. Or if you are already engaged in the work you like best, start training *now* for quicker promotion. Acquire the knowledge that will help you to get ahead faster, make more money and have greater security.

Invest part of your spare time in more rapid progress. Start training now, in spare time in your own home. Be ready to grasp your opportunity and step out ahead of those who lack the ability you have attained.

American School, founded in 1897 as an educational institution *not for profit*, can help you to reach your goal just as it has helped others during the past fifty-one years. Give serious thought to the list above. Pick one or more subjects that interest you. Then check the coupon at right, add your name and address and mail it at once. The school will send you details on its training plan and outline of study prepared by specialists. There is no charge, no obligation, so send the coupon immediately.

PRACTICAL, EFFECTIVE HOME - STUDY TRAINING SINCE 1897

Take This First Easy Step

CHECK, CLIP AND MAIL COUPON NOW

AMERICAN SCHOOL, Dept. G-245, Drexel at 58th, Chicago 37, Ill.
Without obligation, Please send FREE and postpaid, bulletin and details of the Subject checked.

- | | | |
|--|---|--|
| <input type="checkbox"/> PLASTICS ENG'R | <input type="checkbox"/> Accounting | <input type="checkbox"/> Drafting and Design for Men and Women |
| <input type="checkbox"/> Refrigeration | <input type="checkbox"/> Electrical Engr. | <input type="checkbox"/> Radio |
| <input type="checkbox"/> Architecture and Building | <input type="checkbox"/> Electricity-Pract. | <input type="checkbox"/> High School |
| <input type="checkbox"/> Contracting | <input type="checkbox"/> Electronics, Industr. | <input type="checkbox"/> Air Conditioning |
| <input type="checkbox"/> Practical Plumbing | <input type="checkbox"/> Bookkeeping | <input type="checkbox"/> Mechanical Eng. |
| <input type="checkbox"/> Automotive Engineering | <input type="checkbox"/> Private Secretary | <input type="checkbox"/> Shop Management |
| <input type="checkbox"/> Aviation Drafting | <input type="checkbox"/> Diesel Engineering | <input type="checkbox"/> Tool Making |
| <input type="checkbox"/> Aviation | <input type="checkbox"/> Sheet Metal Pattern Drafting | <input type="checkbox"/> Better Foremanship |
| <input type="checkbox"/> Business Mgmt | | <input type="checkbox"/> Machine Shop Operations |
| <input type="checkbox"/> Railway Training | | |

Name..... Occupation.....

Address..... Age.....

City.....State.....

AMERICAN SCHOOL

Dept. G-245, Drexel at 58th Street, Chicago 37

OIL BURNER

INFORMATION IN A HANDY FORM

JUST OUT!



A POCKET COMPANION THAT ANSWERS YOUR QUESTIONS!

AUDELS OIL BURNER GUIDE

- A new practical, concise treatise, 384 pages-31 Chapters - 321 Diagrams and Illustrations - covering Domestic and Industrial Oil Burners.

New from Cover to Cover, for mechanics interested in Oil Burners. Gives practical inside working knowledge of theory, construction, installation, operation, testing, servicing and repair of all types of oil burners. Includes electrical hook-ups and wiring diagrams of automatic control systems.

PRICE \$1 POSTPAID

Get this information for yourself. Mail coupon today. No obligation unless satisfied.

ASK TO SEE IT

AUDEL, Publishers, 49 W. 23rd St., New York 10, N.Y.

Please mail AUDELS OIL BURNER GUIDE (Price \$1). If satisfactory, I will remit \$1 on its safe arrival, otherwise I will return the book.

Name _____

Address _____

Occupation _____

Employed by _____ PM

8 BIG BUILDING BOOKS

For EXAMINATION SEND NO MONEY

Learn to draw plans, estimate, be a live-wire builder, do remodeling, take contracting jobs. These 8 practical, profusely illustrated books cover subjects that will help you to get more work and make more money. Architectural design and drawing, estimating, steel square, roof framing, construction, painting and decorating, heating, air-conditioning, concrete forms and many other subjects are included.

BETTER JOBS - BETTER PAY UP-TO-DATE EDITION

The postwar building boom is in full swing and trained men are needed. Big opportunities are always for MEN WHO KNOW HOW. These books supply quick, easily understood training and handy, permanent reference information that helps solve building problems.

Coupon Brings Eight Big Books for Examination

AMERICAN TECHNICAL SOCIETY Vocational Publishers since 1898
Dept. G219 Drexel at 58th Street Chicago 37, Ill.

You may ship me the Up-to-Date edition of your eight big books, "Building, Estimating and Contracting," without any obligation to buy. I will pay the delivery charges only, and if fully satisfied in ten days, I will send you \$2.00, and after that only \$3.00 a month, until the total price of only \$34.80 is paid. I am not obligated in any way unless I keep the books.

Name _____

Address _____

City _____ State _____

Please attach a letter stating your age, occupation, employer's name and address, and name and address of at least one business man as a reference. Men in service, also please give home address.

LEARN AT HOME TO MOUNT BIRDS



Animals, Heads, Fishes, Pets; to TAN. Be a Taxidermist. Profit and FUN.

Hunters, save your valuable TROPHIES. Mount ducks, squirrels, everything. Learn to TAN for leather and furs. Wonderful HOBBY Have a HOME MUSEUM. BIG PROFITS mounting for others. INVESTIGATE NOW.

FREE BOOK With 100 fine game pictures. NOW absolutely FREE. Write TODAY.

Send Postal TODAY for FREE BOOK. State AGE. N. W. SCHOOL OF TAXIDERMY, Dept. 9372, Omaha, Neb.



WANTED

DISTRICT PURCHASING AGENTS

No experience or money required. Exceptional opportunity for those who want to establish themselves in a steady, year 'round, well paying business.

For details: Write

PURCHASING MANAGER, DEPT. C

2719 LAWRENCE AVE.

CHICAGO 25, ILL.

SHOE REPAIR OFFERS BIG INCOME

LEARN IN 12 WEEKS TIME

In 12 weeks time you can own your own shop or earn big income as skilled shoe repairman. Growing demand everywhere at top wages for men who know how. We teach you quickly by actually working on shoes and modern machines. Costs nothing under G.I. Bill of Rights. We help you get big pay job or start your own shop in 12 short weeks. School open to all from 18 to 60 years of age. FREE BIG 16 PAGE BOOK explains everything. Send for your copy today.

MODERN SHOE REBUILDING SCHOOL

Established 1927

2937 Belmont Ave., Chicago, Ill. RUSH POSTCARD TODAY

LEARN TO WRITE

a Good Hand!

FOR BUSINESS AND SOCIAL SUCCESS!

Easy to improve your handwriting at home quickly with my new instruction books just off the press. Master all the secrets of better penmanship. Simple and easy, fully illustrated, highly endorsed. Begin today. Write for: New Free Book, "How to Become a Good Penman," or check books wanted, \$1.00 each. Business Writing Artistic Writing Card Writing Engraving Alphabets Bird and Design Flourishing Complete Set \$4.50 Enclose 10c for your name beautifully written and special penpoint for shaded writing. S. A. Ziller, President, TAMBLYN SCHOOL OF PENMANSHIP 441 Ridge Bldg. In Business Over 52 Years Kansas City, Mo., U.S.A.



Bar Bells

Buy Direct From Factory

Write for free booklet **\$8.95** up

and price list

INDEPENDENT IRON WORKS
2416 East 23rd Street, Dept. B
Los Angeles 11, Calif.



MAGIC TRICKS

It's FUN to do MAGIC

Amaze - mystify - entertain. Be Popular. You, too, can enjoy this fascinating hobby which has swept America. Only 10c brings you our famous Catalog of 500 TRICKS, profusely illustrated, containing all the latest in easy-to-do magic for pocket, parlor, stage. Join in the fun! Send 10c today. Douglas Magicland, Dept. C, Dallas 1, Texas

GET THIS FINE SUIT NO MONEY TO PAY!

BIG CASH EARNINGS, TOO!

Big news! This fine tailored suit yours without paying one cent - and big cash earnings, too! It's easy! Just take a few orders. Earn up to \$10 in a day and get your own suit as extra bonus. Dozens of rich new fabrics, superbly tailored in latest styles, at low prices produce orders on sight. Money-back guarantee.

FREE SAMPLES! Write today giving name, address, age, samples and details of amazing new BONUS SUIT and money-making plan - All Sent Free! No experience. SEND NO MONEY! W. Z. GIBSON, Inc. 500 S. Throop, Dept. 8-516, Chicago 7, Ill.



E. B. De Vry, President
DeForest's Training, Inc.

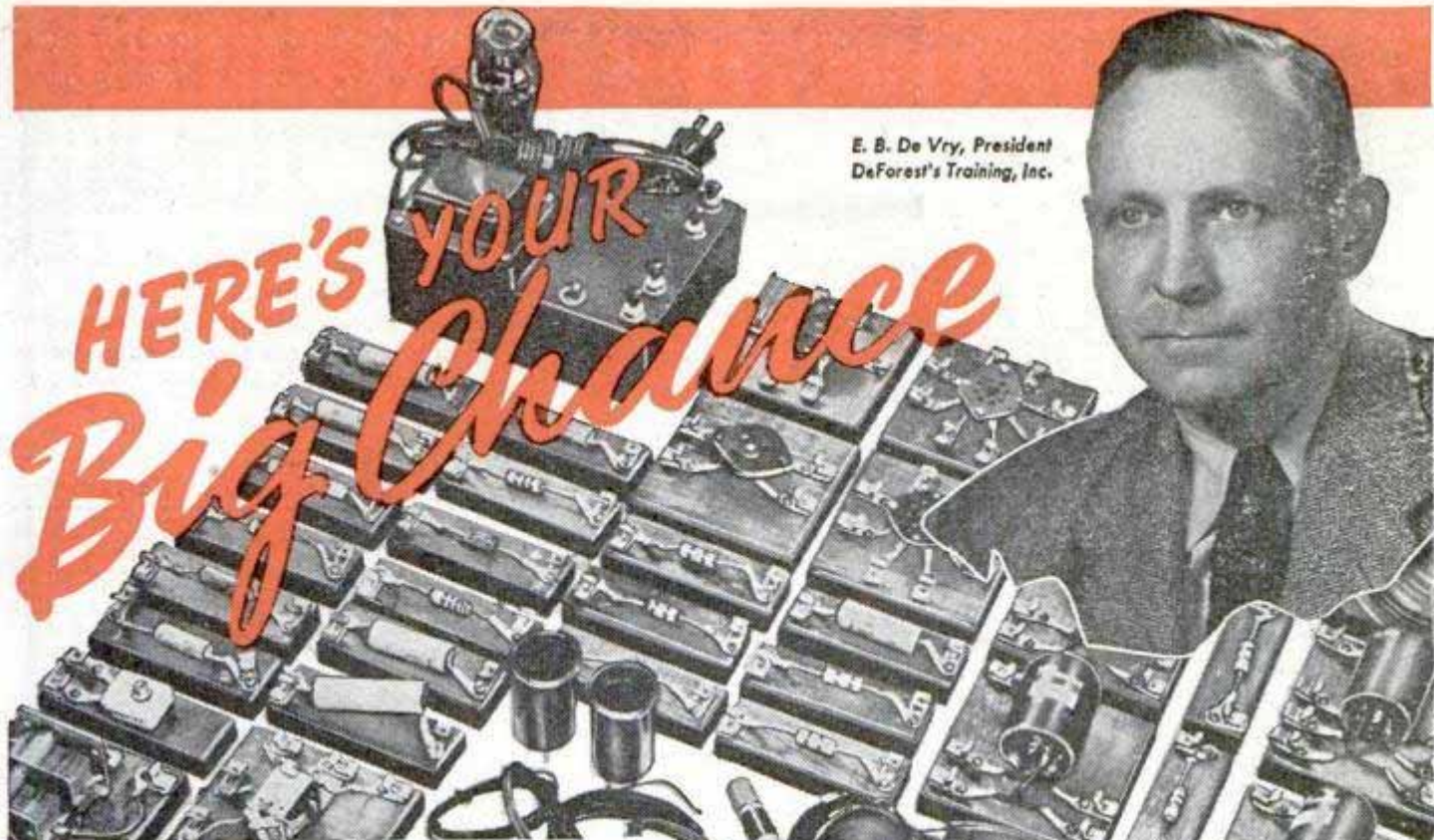

HERE'S YOUR
Big Chance

Profit Through Training in **RADIO-ELECTRONICS**

Prepare at HOME or in our CHICAGO LABORATORY to get REAL MONEY, a BETTER JOB, or a BUSINESS OF YOUR OWN

Our business is helping men . . . and young men . . . get into a well-paying future in the highly profitable fields of RADIO-ELECTRONICS. During the past sixteen years we have trained many men who desired better jobs or businesses of their own. We can effectively provide you with this same opportunity either in our new, modern Chicago laboratories or in the privacy of your own home.

TAKE YOUR CHOICE

If you choose to come to Chicago, we shall find comfortable living quarters for you. If you train at home, we shall send you modern, practical equipment. In either of these two methods, you will have the supervision of some of the finest instructors in the country. Fill in coupon below and we shall send you, absolutely FREE, full information about our program of building men for better opportunities in RADIO-ELECTRONICS. DeForest's Training, Inc. also includes instruction in FM Radio, Television and Industrial Electronics.

If you prefer to remain at home, you receive eight (8) big kits of radio parts and assemblies from which you can work out dozens of fascinating radio circuits to gain practical experience in your own home. In addition, you receive a 16 mm. motion picture projector and 12 information-packed reels of film which help you learn faster . . . easier. You also get modern looseleaf lessons with handy fold-out diagrams.

EMPLOYMENT SERVICE

When you complete your training our effective Employment Service helps you get started toward a real future. Mail coupon below today . . . do not delay.

VETERANS

Both our (1) Chicago Laboratory and (2) Home Study training are accepted under the "G. I. Law." If you qualify, the Government will pay cost of either training you select.

MAIL THIS OPPORTUNITY COUPON NOW!

Mr. E. B. De Vry, President
DeForest's Training, Inc.
2533 N. Ashland Ave., Dept. PM-2
Chicago 14, Illinois

Please show me how I may get started toward a good job or a business of my own in Radio-Electronics.

Name.....Age.....

Address.....Apt.....

City.....Zone.....State.....

If under 16, check here
for special information.

If a discharged Veteran of World War II
check here.

DeForest's Training, Inc.

CHICAGO
ILLINOIS

Associated with the DeVRY Corporation
Builders of Movie & Electronic Equipment

Amazing "Magic Keyboard"
MAKES YOU PLAY PIANO
 IN AS LITTLE AS 15 MINUTES
FREE TRIAL PROVES IT!

PATENT PENDING

I've created a new piano teaching device and system that makes you play so easy it's amazing! My new Magic Keyboard fits right on your piano and shows you simple as ABC how to play waltzes, hymns, marches, western songs and dance numbers. You play on sight and this offer proves it!

SEND NO MONEY—KEYBOARD COSTS NOTHING

Just send me your name and address and I'll send you my new Magic Keyboard entirely without extra charge with full instructions showing you how to play 3 songs . . . "Home On The Range," "Oh Susannah" and "Long, Long Ago." On arrival you deposit thru postman only \$1.49 (50c per song) plus c.o.d. postage. My Magic Keyboard picks out all chords, right hand and left hand, entirely without conventional music notes of any kind. No exercises, no scales, no books . . . no reading page after page of puzzling instructions. Play these three songs instantly to your delight and satisfaction. Convince yourself my new method does teach you to play piano and play it well. Be satisfied beyond all doubt. PLAY or you needn't pay because if I don't teach you to play 3 songs, return the songs in 10 days . . . I'll refund your \$1.49 in full and you can keep the keyboard for your trouble! That's how sure I am I can teach you piano with my Magic Keyboard System. Additional songs available month to month as you progress. Send me your name and address today.

DAVE SUTTLE PIANO TEACHER, Dept. 49-B
 230 East Ohio Street Chicago 11, Illinois

LEARN ACCOUNTING SALESMANSHIP SECRETARIAL WORK

Assure Your Future Now!

Hill's, one of America's outstanding Business Schools, offers you the opportunity to enter one of the three fields acknowledged to hold substantial earnings and a secure future. Our FREE book, "Through Hill's to Success," tells how and where the best positions are found and how you can qualify for them by study at home or in our resident school. We have thousands of successful graduates and maintain nationwide employment service. G. I. Approved.

FREE WRITE TODAY

USE THIS HANDY COUPON

HILL'S EXTENSION SCHOOL AND BUSINESS UNIVERSITY, 619 W. Main St., Oklahoma City 2, Okla.
 Please send me your Free book, "Through Hill's to Success."
 NAME _____
 ADDRESS _____
 CITY _____ STATE _____

BE YOUR OWN BOSS!
LEARN ELECTROPLATING
 HIGHLY PAID FIELD

UNCROWDED, interesting business. Part or full time. Common school education sufficient. Chromium, Nickel, Silver, Gold, etc., money making trade secrets. Learn at home in spare time. Send postcard today for FREE electroplating idea booklet.

PLATER HYDE
 432 F Street Room 520
 San Diego 1, California

LAW FREE BOOK

Write today for FREE 48-page book, "THE LAW-TRAINED MAN," which shows how to learn law easily in spare time at home through the Blackstone course prepared by 60 well-known law authorities. We furnish all material including 18-volume Modern American Law library. Many successful attorneys among our graduates. LL.B. degree. Moderate cost; easy terms; Money-Back Agreement.

BLACKSTONE COLLEGE OF LAW
 225 N. Michigan Ave., Dept. 52, Chicago 1, Ill.
 A Correspondence Institution Founded in 1890

LEARN LANDSCAPING

Profitable career—absorbing hobby for men and women! Thorough home-study course in landscaping, garden design. 45 lessons beautifully printed and illustrated. Learn in spare time 8-12 months. Hundreds of successful graduates all over the world. 32nd year. Write for Free Catalog.

AMERICAN LANDSCAPE SCHOOL
 6480 Grand Ave., Des Moines 12, Ia.

"How to Make Money With Simple Cartoons"

A book everyone who likes to draw should have. It is free; no obligations. Simply address
CARTOONISTS' EXCHANGE
 Dept. 92D Pleasant Hill, Ohio

Master Watchmaking.

The life-long profitable trade of thousands as taught by the Sweazey System.
 "FAMED THE WORLD OVER"
CHICAGO SCHOOL OF WATCHMAKING
 Founded in 1908 by Thomas B. Sweazey
 1608 N. Milwaukee Ave., Dept. 128 Chicago 47, Ill.

SIGN MEN EARN WELL

Tremendous demand always for glass and electrical sign men. Post war expansion assures growing need for more sign men. Only small investment required to start own business. Write today for full FREE particulars. **SIGN SERVICE**, 5944 Newark, Dept. S-501, Chicago 31, Ill.

NEW HELP FOR RUPTURE

Is the amazing Treatise which explains simple, inexpensive, easy, proven way for curbing your rupture, right at home. This proven way has helped many rupture sufferers quickly. So don't let your rupture get worse. **PRICE ONLY 3.00 POSTPAID.** Mailed to you in plain, sealed package.

BRADNER PUBLISHING CO. (Established 1933)
 Dept. H-2, Dixon, Ill.

PRACTICAL TECHNICAL TRAINING



ELECTRICAL ENGINEERING

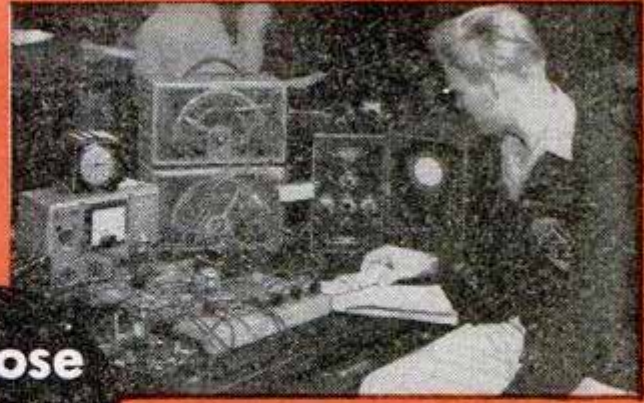

RADIO AND ELECTRONICS

**Choose
Your
Career**

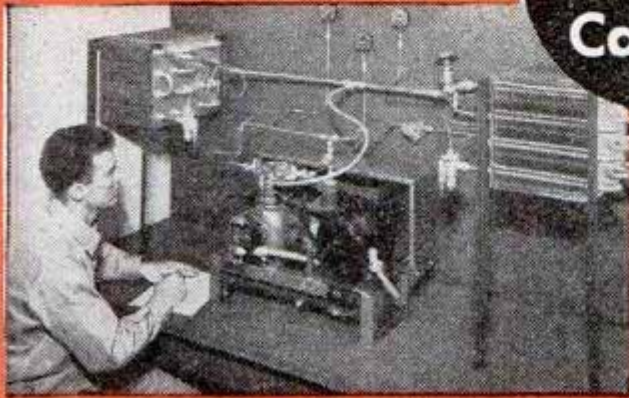

REFRIGERATION & AIR CONDITIONING



GAS AND ARC WELDING

CONCENTRIC CURRICULUM



Our time-tested CONCENTRIC SYSTEM enables you to build your career step by step. Each 6-month course is complete in itself. Stay as long as circumstances permit — until you reach your desired occupational objective.

COURSES

SERVICE . . . 6 to 12 Months

Practical Electricity
Practical Welding
Refrigeration Service
Heating Service

TECHNICIAN . . . 1 to 2 Years

Electro Technician
Radio Technician
Electronics Technician
Refrigeration, Heating, and
Air Conditioning Technician

PROFESSIONAL . . . 3 Years

Electrical Engineering
Bachelor of Science Degree — Major
in Machinery or Electronics

★ SPECIALIZE in 6 months to 3 years

Of utmost importance to anyone considering a technical school, is that school's history, facilities, faculty, and record of successful alumni. The Milwaukee School of Engineering was founded 44 years ago to train men for specific and substantial careers in industry. More than 35,000 former students in industries the world over attest the school's career-building value through its exceptional facilities in laboratories, class rooms, faculty of 72 specialists, and its comprehensive technical courses. 1,538 students now enrolled from 48 states and 13 overseas countries. World-wide alumni counselor committee. Terms start April, July, September. SEND COUPON TODAY!

MILWAUKEE
SCHOOL of ENGINEERING
A Technical Institute

Milwaukee School of Engineering,
Dept. PM-248, N. Broadway and E. State, Milwaukee, Wis.

Without obligation, send me free booklet "Career Building" and more details on course in _____

Name _____ Age _____

Address _____

City _____ State _____



AUTO BOOKS ON APPROVAL



SEND NO MONEY. Just mail the coupon for a complete set of 4 Big, Thick Auto Books. 20th Edition. Over 2700 Pages! Whether you are a mechanic or helper, expert or apprentice, auto owner or driver, take immediate advantage of this **FREE EXAMINATION OFFER.**

MAKE GOOD MONEY NOW HOLD A PERMANENT JOB

America wants its automobiles kept in good repair. Men with "know how" are in demand, at big pay. These books will help you get and hold an important job, or give you a chance to go into business for yourself now or later. Any man who half tries to improve himself can learn auto servicing and repairing by this quick reference method. Use the **JIFFY INDEX** to find easily understood answer to any auto problem. These wonder books prepared by eleven of America's great automobile engineers. Many hundreds of valuable illustrations. Send the coupon **TODAY.**

A year's consulting privileges with our engineers now given with these books without extra charge.
Vocational Publishers Since 1898

CAN YOU FIX IT?

These wonder books tell step by step **HOW** to make difficult repairs and adjustments, how to keep a car at maximum efficiency, including latest improvements in car design and operation. Engine troubles and how to correct them well covered.

4 BIG, THICK VOLUMES Over 2700 pages, 2000 illustrations, wiring diagrams, etc., including Diesel engines. Beautiful modernistic, washable cloth binding.

AMERICAN TECHNICAL SOCIETY, Dept. A219
Drexel Ave. at 58th St., Chicago 37, Ill.

I would like to examine your 4-Volume Set of Auto Books. I will pay the delivery charges only, but if I choose I may return them express collect. If after 10 days' use I prefer to keep them, I will send you \$2 and pay the balance at the rate of only \$3 a month until \$24.80 has been paid. Include consulting service as offered above.

Name _____
Address _____

City _____ State _____

Please attach letter stating age, occupation, employer's name and address and name and address of at least one business man as reference. Men in service, also please give home address.

AUDELS ELECTRIC MOTOR GUIDE

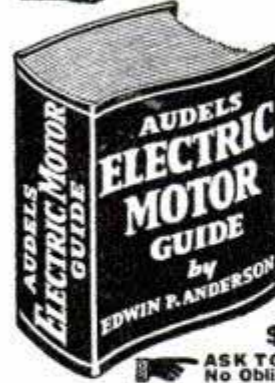

1000 PAGES OF PRACTICAL MOTOR INFORMATION

JUST OUT! Audels Electric Motor Guide covering the construction, hook-ups, control, maintenance and trouble shooting of all types of motors including armature winding. Explains entire subject in every detail. 31 Chapters, 617 Illustrations and Diagrams. A Handy Guide Fully Indexed for Electricians and all Electrical Workers.

\$4 COMPLETE • PAY \$1 A MO.

ASK TO SEE IT!—Get This Information for Yourself No Obligation Unless Satisfied.

MAIL ORDER

AUDEL, Publishers, 49 W. 23rd St., New York 10, N. Y. MAIL AUDELS ELECTRIC MOTOR GUIDE for free examination. If O. K. I will send you \$1 in 7 days; then remit \$1 monthly until price of \$4 is paid. Otherwise, I will return it.

Name _____
Address _____
Occupation _____
Employed by _____ **PM**

Learn to SPEAK SPANISH FRENCH GERMAN ITALIAN

Famous Cortina Method Makes It EASY



Count Cortina

BIG OPPORTUNITIES Await Americans who speak SPANISH. Learn as a child learns—"by listening" to these new CORTINA recordings. The CORTINAPHONE METHOD, famous for 65 years, teaches you to speak SPANISH as a NATIVE speaks! Right at home, relaxed and at ease.



Listen to this Record!

SENT ON 5 DAYS' APPROVAL

Write today for our amazing free book, "The Cortina Short-Cut." State language interested in.

CORTINA ACADEMY
DEPT. 642, 105 WEST 40TH ST.
NEW YORK 18, N. Y.

FREE BOOK

Learn LANDSCAPE GARDENING!

A thorough, constructive, interesting home-training, covering your regional conditions, for those who wish to become **LANDSCAPERS, DESIGNERS, GARDENERS, etc.,** for profit or pleasure. Write today for **FREE INFORMATION**, without obligation. **APPROVED FOR VETERANS.**

NATIONAL LANDSCAPE INSTITUTE
Dept. P-2, 310 So. Robertson, Los Angeles 36, California

NEW YORK SCHOOL OF MECHANICAL DENTISTRY

America's OLDEST School of Dental Technology

Complete training: Plate, Bridgework, Casting, Porcelain, Plastics.

Licensed by N. Y. and N. J. States
Vets: Approved P.L. 346 and 18
Ask for Free Bulletin "P"

NEW YORK SCHOOL OF MECHANICAL DENTISTRY
138 Washington St. NEWARK 2, N. J.
Also: 125 W. 31 St. NEW YORK 1, N. Y.
Immediate Enrollment—Day and Eve.

Thrilling Work COLORING PHOTOS

Fascinating vocation learned at home by those with aptitude. Thrilling pastime. National method brings out life-like colors. Free booklet.

NATIONAL PHOTO COLORING SCHOOL
1315 S. Michigan, Dept. 1352, Chicago 5

BUY A STONE

MARK LOVED ONES GRAVES
Special prices. Freight paid. Erected. Write for our BIG FREE Book.

U. S. MARBLE & GRANITE CO., ONECO, 19, FLORIDA

INVENTING

—FOR PROFIT! If you have an inventive turn of mind, write for free 28-page booklet explaining how the Institute of American Inventors is helping inventors pre-test the profit possibilities of proposed devices to fill today's unprecedented demand for useful new inventions.

INSTITUTE of AMERICAN INVENTORS
Dept. 4, 1926 Eye St., NW, Washington 6, D. C.

RUPTURED?

Get Relief This Proven Way

Why try to worry along with trusses that gouge your flesh—press heavily on hips and spine—enlarge opening—fail to hold rupture? You need the Cluthe. No leg-straps or cutting belts. Automatic adjustable pad holds at real opening—follows every body movement with instant increased support in case of strain. Cannot slip whether at work or play. Light. Waterproof. Can be worn in bath. Send for amazing **FREE** book, "Advice To Ruptured," and details of liberal truthful 60-day trial offer. Also endorsements from grateful users in your neighborhood. Write: **CLUTHE SONS, Dept. 31, Bloomfield, New Jersey**

These Men are Learning

ELECTRICITY

in a FEW SHORT WEEKS

in the GREAT SHOPS of COYNE



**Why Spend Years Preparing for a Good Job?
Train Quickly at COYNE—Be Making Real
Money While Others are Still Puttering Along!**



B. W. COOKE

Yes, you can get ready for Good Pay—a Big Future in ELECTRICITY—by coming to COYNE in Chicago for just a few short weeks! Here you work on real motors, armatures, switchboards—do actual wiring and trouble-shooting—get the "all-around" training you need.

Not a "Home-Study" Course

We do not teach by mail. All training is given in our Great Shops, plus necessary theory. Expert instructors guide you. No advanced education or previous experience needed.

EARN WHILE LEARNING

If you need part-time work to help out with living expenses while at Coyne, we'll help you get it. Don't be held back by lack of money.

COYNE **B. W. COOKE, Pres.**
ELECTRICAL AND RADIO SCHOOL

500 S. Paulina St., Dept. 28-72, Chicago 12



This modern fireproof building is occupied entirely by COYNE. Located in Chicago, the Electrical Center of the World.

FOUNDED 1899

Electrical Refrigeration Included

Added training now included in great new field of Electric Refrigeration—Industrial Electronics also included. Both mean added opportunities.

GI Approved—Finance Plan for Non-Vets

COYNE is authorized to train men under the G.I. Bill. Non-veterans may enroll now, pay most of tuition after graduation. Whatever your problem, COYNE can help you! Mail the coupon now.

GET THE FACTS!

BIG FREE BOOK tells all about your future in Electricity and how you can get ready in a few short weeks at COYNE. Dozens of pictures. Rush coupon today!

**PREPARE FOR PERMANENT
JOBS LIKE THESE**

- Light and Power Wiring
 - Power Plant Work
 - Armature Winding
 - Substation Operator
 - Maintenance Electrician
 - Electrical Testing
 - Signal Maintenance
 - Industrial Electronics
 - Electric Refrigeration
 - and many others
- Our Employment Bureau for graduates gives FREE Lifetime Job Service.

**FREE
BOOK**



B. W. COOKE, Pres.
COYNE ELECTRICAL
AND RADIO SCHOOL, Dept. 28-72
500 S. Paulina St., Chicago, 12, Ill.

Send me your big FREE BOOK on ELECTRICITY and tell all about your training offer. This does not obligate me in any way and no salesman will call on me.

NAME.....
ADDRESS.....
CITY.....STATE.....



AUDELS Carpenters and Builders Guides 4 vols. \$6



Inside Trade Information for Carpenters, Builders, Joiners, Building Mechanics and all Woodworkers. These Guides give you the short-cut instructions that you want—including new methods, ideas, solutions, plans, systems and money saving suggestions. An easy progressive course for the apprentice and student. A practical daily helper and Quick Reference for the master worker. Carpenters everywhere are using these Guides as a Helping Hand to Easier Work, Better Work and Better Pay. To get this assistance for yourself, simply fill in and mail the FREE COUPON below.

Inside Trade Information On:

How to use the steel square—How to file and set saws—How to build furniture—How to use a mitre box—How to use the chalk line—How to use rules and scales—How to make joints—Carpenters arithmetic—Solving mensuration problems—Estimating strength of timbers—How to set girders and sills—How to frame houses and roofs—How to estimate costs—How to build houses, barns, garages, bungalows, etc.—How to read and draw plans—Drawing up specifications—How to excavate—How to use settings 12, 13 and 17 on the steel square—How to build hoists and scaffolds—skylights—How to build stairs—How to put on interior trim—How to hang doors—How to lath—lay floors—How to paint



AUDEL, Publishers, 49 W. 23rd St., New York 10, N. Y.
Mail Audels Carpenters and Builders Guides, 4 vols., on 7 days free trial. If OK I will remit \$1 in 7 days and \$1 monthly until \$6 is paid. Otherwise I will return them. No obligation unless I am satisfied.

Name _____

Address _____

Occupation _____

Employed by _____ P.M.

Learn WATCH REPAIRING

From An Approved School
The Largest of Its Kind



EARN WHILE LEARNING

Spare Time Home Training Prepares You For Big Pay

FREE WATCH working tools and watch included as part of our Watch Repairing Course

The demand for skilled watch repairers—men and women—is increasing with the step-up in the manufacture of watches. Now is the time to prepare yourself in this fascinating profession with the aid of our highly practical HOME TRAINING COURSE—in your spare time at home. Start your own business or accept a big pay position.

WRITE TODAY FOR FREE DETAILS

Earn while you learn with an "approved" school. Get the facts—then judge.

ILLINOIS SCHOOL OF WATCH REPAIRING
2870-AR Elston Ave. Chicago 18, Illinois

SEND FOR THIS

FREE!

Make money with horses. Every farmer, every lover of horseflesh should have a copy of this booklet. If you want to know how to break, train and make money with horses, write today for full information FREE, together with my special offer of a course in Animal Breeding. If you are interested in Galting and Riding the saddle horse check here. Do it today—now. You'll never regret it.

BEERY SCHOOL OF HORSEMANSHIP
Dept. 1102 Pleasant Hill, Ohio

HOW to BREAK and TRAIN HORSES

Be A MASTER PLUMBER

Earn \$15 To \$50 A Day

DON'T ENVY THE PLUMBER — BE ONE

Every skilled workman will tell you that Plumbers have the best of it. WINTER and SUMMER the Plumber is busy at top wages. No skilled Plumber is ever out of a job—compare his opportunities with any trade, plus the opportunities of having your own shop.

We teach you Plumbing with TOOLS (not books) under Licensed Master PLUMBERS in one of the finest equipped schools in America. We make you a Plumber, every branch is taught thoroughly—Lead Work—Blueprint for plan reading—all other tricks.

LEARN IN 30 WEEKS WITHOUT PREVIOUS EXPERIENCE

If you like to work with tools you owe it to yourself to investigate. No need to ever work as an apprentice. Get free bulletin. Write now! G.I. APPROVED. Our 24th year.

UNIVERSAL PLUMBING SCHOOL

815 HOLMES STREET KANSAS CITY, MO.

ANALYZE Handwriting

Uncrowded, fascinating field. Gratifying earnings reported by graduates in Employment, Credit, Social Service, Police and Entertainment fields. Others have developed profitable private practice, full or spare time, as Personal Problem and Vocational Counselors. Send for 3000 word TEST LESSON and Grapho Analyst FREE.



A. I. G. A. Inc.

Wilhoit Bldg., Dept. 120 Springfield, Mo.

THERE'S MONEY IN CARTOONS!

RAYE BURNS will teach you HOW to CREATE ORIGINAL CARTOONS at home that you may SELL! Course contains 26 lessons and over 600 illustrations. All for Only...

\$2.85

Send name and address for free details.

RAYE BURNS SCHOOL, Dept. M, Box 3583, CLEVELAND, OHIO

Learn BAKING At Home

Baking is one of America's high industries in wages. Nearly depression-proof. Thorough basic home course lays sound foundation. If you have aptitude, write for FREE BOOKLET, "Opportunities in Commercial Baking." National Baking School, 1315 Mich. Ave., Dept. 1352, Chicago 5



MAKE MONEY! RAISE CHIN-CHINS

PURE-BRED CHINCHILLA RABBITS

NO EXPERIENCE REQUIRED. Costs little to start. Just a few minutes daily and a few feet of backyard space. Several females and one male starts a large herd which can furnish you an income for years. WE SUPPLY ALL INSTRUCTIONS FREE! Tremendous demand for breeding stock, delicious meat and world's most beautiful rabbit fur. Dealers, cut off from imported rabbit pelts, need thousands of these luxurious Chin-Chin furs now. Write today for free, illustrated booklet. The profit possibilities in this fascinating business will amaze you! Satisfaction guaranteed.

WILLOW BROOK FARM R-36 SELLERSVILLE, PA.
WORLD'S LARGEST BREEDER OF CHINCHILLA RABBITS.

ACE Hollywood Experts will TRAIN
YOU AT HOME to MAKE GOOD in

RADIO

TELEVISION- ELECTRONICS

through practical
EXPERIMENTS
with

10 BIG KITS of RADIO PARTS R.T.A. GIVES YOU!



YOU WILL DO
SCORES OF
PRACTICAL JOBS
AND
EXPERIMENTS

The 10 BIG KITS
RTA GIVES you en-
able you to do many
practical jobs. Il-
lustrated above are
only a few of the
many job-exercises
you do. You build
a TRF Receiver, a
High-Frequency
Converter, a com-
plete, powerful 6
Tube AC-DC
Superheterodyne
receiver, and per-
form more than a
hundred other fas-
cinating and valu-
able experiments.
These jobs you do
give you ACTUAL
SHOP EXPERIENCE
so vitally neces-
sary to future
success. Thus RTA
methods assure
you BALANCED
TRAINING—Theory
PLUS Real Experi-
ence.

TEAR-OUT
COUPON
AND MAIL
TODAY

MASTER HOLLYWOOD TECHNICIANS Guide You

It was no accident that RTA — RADIO TRAINING ASSOCIATION OF AMERICA — chose HOLLYWOOD as their headquarters. Hollywood has long been recognized as the very heart of America's Broadcasting, Television, Radio and Sound industries. Thus, RTA is right "on-the-spot" where new technical improvements are introduced, and is in the best possible position to bring students ACTUAL METHODS and TECHNIQUES developed BY the RADIO-TELEVISION industry, leading to real money-making opportunities!

OPPORTUNITIES NOW WIDE OPEN for Properly Trained Men

Latest reports estimate 400 MILLION new radio and television sets will be built in the next ten years... and more than 72 million dollars is being spent RIGHT NOW just for radio repairs ALONE! When you are

thoroughly trained by RTA's Hollywood Experts—who have their fingers on the pulse of the Radio-Television industry—you can imagine what un-dreamed of opportunities await you in Your Own Radio Sales & Service Business, Television, Aviation, FM, Manufacturing and Communications, etc.

EARN EXTRA MONEY while learning AT HOME

Under RTA's amazingly easy, practical home-training plan there is no need for you to quit your present job. You study in SPARE TIME ONLY and RTA's Hollywood Experts show you how to earn WELCOME EXTRA CASH, even BEFORE FINISHING YOUR TRAINING! In fact, when friends and neighbors know you are studying Radio-Television you may—like many RTA students—actually get MORE REPAIR WORK THAN YOU CAN HANDLE.

25 Year Success Record

Backed by more than 25 years of experience in the home

training field, RTA's practical "learn by doing" methods assure you quick, step-by-step progress. So begin preparing for your future in Radio-Television NOW, while the time is ripe. If you are at all mechanically inclined, and have a grammar school education, RTA can teach you how to MAKE GOOD as a Radio-Television technician.

R. T. A. GRADUATES SAY:

- ★ Thanks to R.T.A. I started my own radio store... am making 220 percent more than when I enrolled.—W. E. Thon, Chicago.
- ★ Truly thankful for the day I enrolled for R.T.A. Course - it fitted me splendidly for my present position.—N. R. Hoffman, Radio Station WCOD, Harrisburg.
- ★... R.T.A. sure opened my eyes to big money... thanks for all you have done for me.—Ernest Lancolt, Cleveland.

APPROVED for VETERANS

RADIO TRAINING ASSOC. OF AMERICA, DEPT. PMB
5620 Hollywood Blvd., Hollywood 28, Calif.

Send FREE BOOK showing how to make good in Radio-Television through training by Hollywood experts.

NAME _____ AGE _____

ADDRESS _____

CITY _____ ZONE _____ STATE _____

Check box if VETERAN of World War II

GET FACTS! SEND FOR FREE BOOK!

telling all about RTA's streamlined home-training plan, developed by technicians in the heart of the booming Radio-Television field. Fill out the coupon TODAY and your FREE BOOK, entitled "How To Make Good In Radio-Television" will go out to you AT ONCE! No Obligation. RTA APPROVED FOR VETERANS.



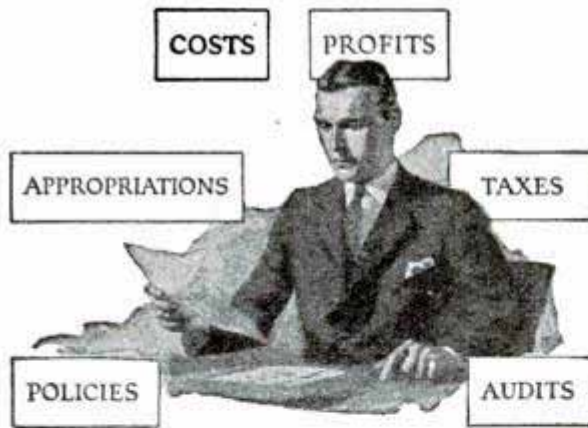

Become an Expert Accountant

The Profession That Pays

The demand for skilled accountants—men who really know their business—is increasing. National and state legislation is requiring of business—both big and small—much more in matters relating to Auditing, Cost Accounting, Business Law, Organization, Management, Finance. Men who prove their qualifications in this important field are promoted to responsible executive positions—given an opportunity to earn real salaries. The range is from \$3,000 to \$10,000 a year, even to higher income figures.

Send for Free Book—
"Accountancy, the Profession That Pays"

Why let the other fellow walk away with the better job, when thru home-study you can equip yourself for a splendid future in this profitable profession?

Knowledge of bookkeeping unnecessary. We train you from ground up, or according to your individual needs. Low cost; easy terms.

Send for free 48-page book describing the LaSalle accountancy training and the opportunities in this highly profitable field.

If you have the urge, the will to increase your income, mail the coupon NOW.

LASALLE EXTENSION UNIVERSITY

A CORRESPONDENCE INSTITUTION

Dept. 264-H, 417 S. Dearborn St., Chicago 5, Ill.

Please send my copy of "Accountancy, the Profession That Pays," without obligation.

Higher Accountancy
Other LaSalle Opportunities:

- If interested in the fields below, check and mail now.
- Business Management
 - Business Correspondence
 - Expert Bookkeeping
 - C. P. A. Coaching
 - Sales Training
 - Law—LL.B. Degree
 - Business English
 - Effective Speaking

Name.....
 Street.....
 City, Zone & State.....

Photography

for 



PLEASURE or PROFIT

Learn at home. Spare time. Practical basic training. Long-established school. Many have earned while learning. Send coupon below for free booklet, "Opportunities in Modern Photography" and full particulars.

AMERICAN SCHOOL OF PHOTOGRAPHY
 1315 Michigan Avenue Dept. 1352 Chicago 5, Illinois
 Send booklet, "Opportunities in Modern Photography," full particulars and requirements. No salesman will call.

Name..... Age.....
 Address.....
 City..... Zone..... State.....

THIS FREE BOOK

Tells how we can teach you QUICKLY & EASILY

TO MOUNT BIRDS AND ANIMALS

GAME HEADS, FISH

Send at once for this fascinating free book which tells how you can learn to be a taxidermy artist. Save and preserve your beautiful hunting trophies. Decorate your den. A grand hobby for sportsmen, hunters, anglers—both men and boys! **DOUBLE your fun from hunting and fishing.** We teach you this marvelous art right in your own home, by mail, in your spare time. Also, we teach you to make strong, useful GENUINE LEATHER from hides. **Act RIGHT NOW.**

SEND TODAY! Rush a letter or penny postcard for the beautifully illustrated 68-page FREE BOOK. Full of fascinating game pictures. Learn about this old reliable school for outdoorsmen. 43 years in business. More than 400,000 students. No cost or obligation for the book. **BE SURE TO STATE YOUR AGE!**

NORTHWESTERN SCHOOL OF TAXIDERMISTRY
 3372 Elwood Building - OMAHA 2, NEBRASKA

MAKE YOUR OWN LEATHER

HOW TO CUT RAFTERS

New vest pocket book gives lengths, size cuts, plumb cuts, deductions. For all rafters for any building from one inch to forty feet wide. Gives numbers to cut on square. Also degrees for same cuts for Radial Saws. All standard pitches from 1/8 to 5/8. Just open book to pitch page and there are your lengths, side cuts, etc. Anyone who knows what a jack rafter is can frame a roof if he has this great book. Price one dollar pre-paid. BUILDERS' TOPICS, Dept. M, Lock Box 828, Seattle, Washington. CARPENTERS, PLUMBERS, PLASTERERS, ELECTRICIANS, ETC. subscribe for Builders' Topics, the monthly magazine for HE-MAN CONSTRUCTION WORKERS. Only \$1.00 per year. Sample copies 25c.

ARTISTS MAKE MONEY

Do you like to draw? Send name, address, age and occupation for FREE ART TEST, to find out your ability.

ART INSTRUCTION, Inc.
 2148 ART INSTRUCTION BLDG., MINNEAPOLIS 15, MINN.

APTITUDE TESTS

discover the kind of work or studies best for your success! You get a personal report—a guide for life—more happiness—more prosperity. For men, women, boys and girls. Write for complete facts.

VOCATIONAL COUNSELING INSTITUTE
 956 Macabees Bldg., Detroit 2, Michigan

Please Mention Popular Mechanics When Answering Ads

Is Your Rupture HERE?

Why continue to suffer with an uncomfortable truss if we can help you? Relief GUARANTEED or it costs you nothing. Send for the facts about my perfected truss invention—the Brooks Appliance for reducible rupture—with the patented AIR-CUSHION support that works silently with Nature to give protection. Thousands bought by doctors.

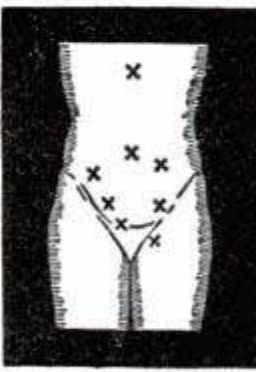

Sent on Trial—Made-to-measure, individual fitting for man, woman or child. Low-priced, sanitary, durable. No obnoxious springs or hard pads; no metal girdle to rust. Light weight, neat and comfortable. Not sold through stores or agents—beware of imitations. Write today for full information sent free in plain sealed envelope.

BROOKS APPLIANCE CO. 161 State St. Marshall, Mich.

**ENJOY the HAPPINESS
of owning
YOUR OWN BUSINESS**



H. T. ARMSTRONG
General Manager



Learn

ELECTRIC APPLIANCE

REPAIRING & SERVICING

**I'll Train You
AT HOME
in your spare time**



YOU LEARN

how to repair electrical appliances such as washing machines, vacuum cleaners, ranges, lamps, irons, motors, etc.—HOUSE WIRING and also

REFRIGERATION

which we now include at no extra cost. Our lessons are understandable and easy to grasp.

This is an ELECTRICAL WORLD! Every home is a customer for the man who knows how to service electric appliances. It's a wide-open, expanding field for men of all ages who are handy with tools . . . who seek the independence, happiness and rewards that come to the man who owns his own business. Our practical, thorough course teaches you this interesting well-paid business AT HOME—during your spare time. A grade school education is all you need. Without obligation, I'd like to send you our new booklet telling about our method of instruction—about today's money-making possibilities in this field—and why I believe this business offers you the depression-proof security, happiness and opportunity you seek.

EARN WHILE LEARNING

Pay For Your Course With Part Time Work

You can actually start making money before your course is finished. With your first set of lessons, I show you easy jobs that can be done in your spare time, at home. Remember—ONE GOOD REPAIR JOB will pay for your entire training. You can also start this business AT HOME, in your garage or basement, with the tools I send you, also in your SPARE TIME, if you like. Or, you can take a well-paid job . . . as there's always a big demand for trained men.

I Send You a
BIG KIT
of Refrigerator
and Appliance
TOOLS
AT NO EXTRA
COST

A Business That Gets Better Every Year!

Every year, more and more new electrical appliances are being developed. Hundreds of thousands of new homes being built . . . and others wired for electricity for the first time—through gigantic government electrification projects. Thus, this business gets better every year. And, when you own your own business, YOU get the profits when times are booming. If depression comes, you can't lose your job. It usually IMPROVES the service and repair business. Let's talk it over by mail!

MAIL COUPON TODAY!

**Send for
FREE
BOOKLET
and complete
details**

**NO
SALESMEN
WILL CALL**



NEW BOOK

**"HOW TO START YOUR
OWN BUSINESS"**

Sent if you act promptly

This valuable book covers locating your shop, contains drawings of how to build and wire work-benches, where and how to advertise, what to charge, how to hire solicitors, etc. Sent without charge to students who enroll promptly.

**H. T. ARMSTRONG, General Manager,
PACIFIC TRAINING SCHOOL, Dept. P-82
7217 So. Broadway, Los Angeles 3, Calif.**

Dear Sirs: Please send me, without obligation, your FREE BOOKLET, "Today's Big Opportunity, Appliance Servicing" and full details.

Name _____

Address _____

City _____ State _____

How to Make YOUR Body Bring You

FAME

Instead of SHAME!

Will You Let Me Prove I Can Make You a New Man?

I KNOW what it means to have a body that people pity! I was once a skinny, 97-lb. weakling—such a poor specimen that I was constantly self-conscious, embarrassed. But later I discovered the secret that turned me into the holder of the title, "The World's Most Perfectly Developed Man." I'd like to prove that the same system can make a NEW MAN of YOU!

Charles Atlas

This is an actual snapshot taken at the beach.

7 DAY TRIAL OFFER

I don't say I can do all this for you in 7 days. But I DO want to prove I can show you enough results in even THAT short time to convince you that my system of "Dynamic Tension" will give you the kind of body you have always longed to have!

Do you want powerful shoulders—a fine, deep chest—biceps like iron—arms and legs rippling with strength—a stomach ridged with sinewy muscle—a build to be proud of? Then let me prove that "Dynamic Tension" is what you need.

FREE BOOK It costs only a stamp—or a postcard—to mail coupon below. I'll send my new, free book, "Everlasting Health and Strength." It tells about my "Dynamic Tension" method; shows, from actual photos, how I have developed my pupils—explains about my 7 DAY TRIAL OFFER. Charles Atlas, Dept. 8B, 115 East 23rd St., New York, N. Y.



Mail Coupon Now for FREE Book

CHARLES ATLAS, Dept. 8B
115 East 23rd Street, New York, N. Y.

I want the proof that "DYNAMIC TENSION" will help make a new man of me—give me a healthy, husky body and big muscle development. Send me your free book, "Everlasting Health and Strength."

Name _____ Age _____
(Please print or write plainly)
Address _____
City _____ State _____

HOW TO DO WONDERS ON AN ACRE!

MY WIFE and I would like to send you our book showing how we turned "a little land into a lot of living." Tells how to do wonders with a garden, fruits, berries, poultry, livestock, etc.—all on small scale—in spare time! Many new devices, scientific methods. Special house plans and layouts for small acreages. (Perhaps you saw the articles about our place in The Reader's Digest or The Saturday Evening Post.) It's a whole wonderful NEW SCIENCE of living—a healthier, happier, more independent life! If you'd like to make the very most of the garden, farm or country home you now have—or hope to have some day—send only \$1 for this book about our "HAVE-MORE" PLAN right now! 255 illustrations, 43 fascinating chapters. We pay postage. I'll gladly return your dollar if you're not more than pleased. Ed Robinson, Box 2702, Noroton, Connecticut.

"A little land - a lot of Living"

ONLY \$1.00!

HI-SPEED EQUIPMENT

High Compression Heads—Dual Manifolds
Dual Air Cleaners For V8's
Use these simple conversions to increase horsepower, speed acceleration, and increase top speed of your car. Write today for prices and full information.
SANDEE MUFFLER CO. 7523 S. Western Ave. Los Angeles, Calif.

V-8
DUALS
& SINGLES



DEALERS WANTED

MUFFLERS
STEELS and ALUMINUMS with a motorboat tone

SINGLES, Chev., V-8, Plymouth, Steels \$5.50, Aluminum \$7.00. Chry., Olds., Buicks, etc., Steels \$7.50, Aluminum \$9.00. V-8 and MERCURY DUALS, Steel \$17.50, Aluminum \$21.00. Split Manifold Sets, Steels \$35.00; Aluminum \$45.00. Aluminum are guaranteed for life of your car.

SANDEE MUFFLER CO.
BOX 296 LA TIJ., LOS ANGELES 43, CALIF
2624 W. SLAUSON AVE., LOS ANGELES, CALIF.

TURN YOUR LONGHAND INTO

SHORTHAND in 6 Weeks at Home

Famous Speedwriting system. No signs or symbols; no machines; uses ABC's. Easy to learn; easy to write and transcribe. Fast preparation for a job. Surprisingly low cost, 100,000 taught by mail. Used in leading offices and Civil Service. Write for free booklet.

SPEEDWRITING, Dept. 1502-8, 55 W. 42 St., New York 18



LEARN MEAT CUTTING

through actual practice. Profitable Meat Cutting and Successful Meat Merchandising taught easily, quickly. LEARN BY DOING at Toledo in just six short weeks under actual market conditions. For beginners or men with experience. All subjects taught thoroughly and completely. Diploma. Job help. Get store of own. People must eat. School in operation nearly 25 years. Approved for GI training. Send today for FREE literature. No obligation.

NATIONAL SCHOOL OF MEAT CUTTING, Dept. 38, Toledo 4, Ohio

IMPROVE YOUR PENMANSHIP

Write Like This

YOUR penmanship can be improved in 3 hours or corrected to your satisfaction in 10 hours' practice with my DEFINITE HAND CONTROLS. New way!

WRITE OZMENT 34-S ST. LOUIS, MISSOURI

Complete OUTLINE FREE!

LEARN MOVIE PROJECTION THEATRE MANAGEMENT

The Motion Picture Theatre Business offers big opportunities for trained men. Get into a fascinating field with a promising future. Train at home in spare time. Free Catalog. Established 20 years.

THEATRE SCHOOL, 370 Washington St., Elmira, New York



You receive all parts, including tubes, for building this fine, modern Superheterodyne Receiver. This and other valuable standard equipment becomes your property.

Learn RADIO TELEVISION, ELECTRONICS by SHOP METHOD HOME TRAINING

Let NATIONAL SCHOOLS, of Los Angeles, a practical Technical Resident Trade School for over 40 years, train you for today's unlimited opportunities in Radio

these two **FREE** books will tell you how

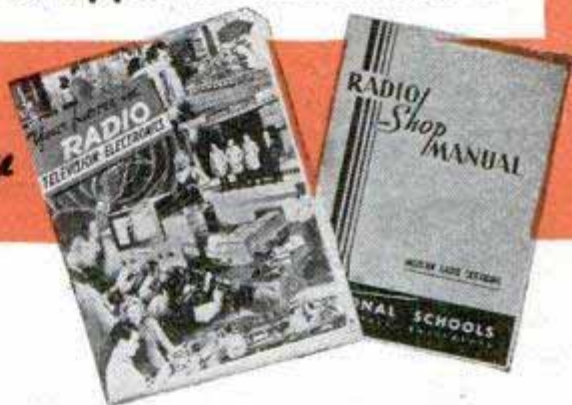

Good Jobs Await the Trained Radio Technician

You are needed in the great, modern Radio, Television and Electronics industry! Trained Radio technicians are in constant and growing demand at excellent pay—in Broadcasting, Communications, Television, Radar, Research Laboratories, Home Radio Service, etc. National Schools Master Shop Method Home Study Course, with newly added lessons and equipment, can train you in your spare time, right in your own home, for these exciting opportunities. Our method has been proved by the remarkable success of National Schools-trained men all over the world.

You Learn by Building Equipment with Standard Radio Parts We Send You

Your National Schools Course includes not only basic theory, but practical training as well—you learn by doing. We send you complete standard equipment of professional quality for building various experimental and test units. You advance step by step until you are able to build the modern superheterodyne receiver shown above, which is yours to keep and enjoy. You perform more than 100 experiments—build many types of circuits, signal generator, low power radio transmitter, audio oscillator, and other units. The Free Books shown above tell you more about it—send for them today!



NOW! NEW PROFESSIONAL MULTITESTER INCLUDED



This versatile testing instrument is portable and complete with test leads, batteries and tubes. Simple to operate, accurate and dependable. You will be able to quickly locate trouble and adjust the most delicate circuits. You can use the Multitester at home or on service calls. It is designed to measure AC and DC volts, current, resistance and decibels. You will be proud to own and use this valuable professional instrument.

GET THE DETAILS—SEND THE COUPON

LESSONS AND INSTRUCTION MATERIAL ARE UP-TO-DATE, PRACTICAL, INTERESTING

National Schools Master Shop Method Home Training gives you basic and advanced instruction in all phases of Radio, Television and Electronics. Each lesson is made easy to understand by numerous illustrations and diagrams. All instruction material has been developed and tested in our own shops and laboratories, under the supervision of our own engineers and instructors. A free sample lesson is yours upon request—use the coupon below.

Here's Just a Few of the Interesting Facts you Learn with the **FREE MANUAL**

1. Routine for diagnosing Radio Troubles.
2. Preliminary inspection of Receivers.
3. How to Test and Measure Voltages.
4. How to Test Speaker in Audio Stages.
5. How to Trace the Circuit and Prepare Skeleton Diagram.
6. Complete Reference Table for Quickly Locating Receiver Troubles.



VETERANS

If you are a veteran, qualified for training under the G.I. Bill, check the coupon for a Special Bulletin.

G. I. APPROVED

NATIONAL SCHOOLS

LOS ANGELES 37, CALIFORNIA EST. 1905



MAIL OPPORTUNITY COUPON FOR QUICK ACTION

National Schools, Dept. PM-2
4000 South Figueroa Street
Los Angeles 37, California

(Mail in envelope or paste on penny postcard.)

Mail me FREE the books mentioned in your ad including a sample lesson of your course. I understand no salesman will call on me.

NAME _____ AGE _____

ADDRESS _____

CITY _____ ZONE _____ STATE _____

Check here if veteran of World War II

Less than

50¢

A week buys as much as

\$1746.

of Old Line Legal Reserve

LIFE INSURANCE

YOU ACTUALLY PAY

only *\$2.00 a month at all ages for the amounts shown below.

*THIS IS HALF THE PERMANENT RATE WHICH TAKES EFFECT THE 6TH YEAR.

AT AGE	FOR MONTHLY PREMIUM OF	YOU GET A POLICY FOR
20	\$2.00	\$1746.
25	2.00	1582.
30	2.00	1408.
35	2.00	1250.
40	2.00	1086.

Proportionate amounts at all other ages, 15-55. Mail coupon now for full facts and amounts at your age.

Here is a unique plan that lets you budget your Life Insurance like rent. The rate is the same no matter what your age! The amounts vary but, even at 40 you can get \$1086 of this Solid, Old Line, Legal Reserve Life Insurance protection!

And not only that—but your policy will be

FULLY PAID-UP IN 30 YEARS

with no more premiums to pay, yet your

insurance continues in force the rest of your life. **POSTAL LIFE** operating under the rigid New York State Insurance laws has sold Life Insurance by mail and over the counter for 43 years and has satisfied policyholders everywhere. Over \$14,000,000 in assets! More than \$60,000,000 paid out in benefits!

Postal Policies are participating! Mail Coupon today!

Get the FACTS by mail!

Postal Life Insurance Company
511 Fifth Avenue, Dept. D-762
New York 17, N. Y.

Mail me complete information about your new "\$2.00-per-month", 30-payment Modified 5 Whole Life Policy at my age.

NAME

OCCUPATION

DATE OF BIRTH

ADDRESS

Include Postal Zone, if any.



*Amazing New Books
Reveal Secrets of Success*

AT HOME WITH ARTISTIC PENWORK—Copyrighted Now you can be at home with Artistic Penmanship for fun and Profit. These new authoritative books just off the press give you most modern, streamlined methods for perfecting your skill as a penman. Written by S. A. Ziller, President, Tamblin School of Penmanship. Acclaimed by leading authorities as the finest books on penmanship ever written.

Order Today—\$1.00 Each
These books are sensationally new and different. Each covers its subject fully and completely. You can select one or more—or get the whole series of five at the special introductory price of only \$4.50. Money on set of books deducted in full from tuition on signing up for professional course of school instruction.

- BOOK 1 *Business Writing* Write legibly—Be Recognized because of Your Writing
- BOOK 2 *Artistic Writing* Earn Money—Amaze Your Friends.
- BOOK 3 *Card Writing* For Fun and Profit, Write cards, invitations.
- BOOK 4 *Engrossing Alphabets* Letter diplomas, complete Alphabets Given.
- BOOK 5 *Bird and Design Flourishing* A good outlet for your artistic interest. Fascinating designs, birds, quills.

Complete Set of All Five Books—Special introductory offer. Prepaid, \$4.50. Money Back Guarantee. **FREE BOOK**—How to become a good penman. Tells how others learned in spare time. Imitate the professional, avoid mistakes, earn extra money—be a popular friend. Enclose 10c for a penpoint suitable for shaded writing and your name beautifully written. Write today, check the squares—attach to your name and address, enclose remittance, and send to **Stephen A. Ziller, Pres., The Tamblin School of Penmanship** C-441 Ridge Bldg., Kansas City, Mo., U.S.A. In business over 52 years

TRAIN

Your VOICE!

Results GUARANTEED

We build, strengthen the vocal organs—not with singing lessons—but by sound, scientifically correct silent and vocal exercises and absolutely guarantee complete satisfaction with results. Write for Voice Book, FREE. Sent to no one under 17 years old unless signed by parent. Perfect Voice Studios, Studio 1352, Kimball Hall Bldg., Chicago 4, Ill.

ENGINEERING DEGREE IN 27 MONTHS

INDIANA TECHNICAL COLLEGE

Aeronautical, Chemical, Civil, Electrical, Mechanical, and Radio Engineering (inc. television), Drafting, 1-yr. Gov't approved for G.I.'s. Low rate. Earn board. Large industrial center. Students from 48 states, 18 countries. Demand for graduates. Enter March, June, Sept., Dec. Catalog. 528 E. Washington Blvd., Ft. Wayne 2, Ind.

SENDING-RECEIVING SPEED

CODE

Learn to send and receive Radio Code with greater speed. Stop nervous tension. Have confidence. Be proficient. Same system used by radiotelegraph specialists. Thousands of operators needed. Rush name for FREE Book. **CANDLER SYSTEM CO.** Dept. 5-B, Box 928, Denver 1, Colo., U. S. A.

BE A Real Estate BROKER

PAYS BIG!

A profitable lifetime career in one of America's finest professions. Many make fortunes selling real estate. Send \$2 for our Real Estate Manual. Satisfaction guaranteed. Literature free. **AMERICAN BUSINESS BUILDERS**, Box 2983, Houston 1, Texas

CLEANS WINDOWS WITHOUT WATER

NEW CHEMICAL MITT

Sensational! DRY Window Cleaner! Uses no water, no messy liquids. Chemically Treated. Simply glide over windows; leaves glass sparkling clear. No heating water, no heavy buckets to carry, no rags, powders, sponges, cham- ois. No mess or moss. No red chapped hands. Dust, dirt, grime, fog disappear like magic. Wonderful for auto windows, windshield!

SAMPLES FOR AGENTS Sample offer sent immediately to all who send name at once. A penny postal will do. **SEND NO MONEY—just your name.** KRISTEE CO., 681 Bar Street, AKRON, OHIO.

THOUSANDS NOW PLAY who never thought they could!



Takes Third Course

"The piano course is the third course with your school. Over 20 years ago I took saxophone and clarinet. Since then I've played a lot of dance jobs."

*E. A., Lake View, Iowa



Wouldn't Take \$1000 for Course

The lessons are so simple that anyone can understand them. I have learned to play by note in a little more than a month. I wouldn't take a thousand dollars for my course.

*S. E. A., Kansas City, Mo.



Shares Course With Sister

The teaching is so interesting and the pieces so beautiful I couldn't ask for anything better. I recommend your course highly. My sister shares it with me and feels the same way.

*D. E. G., Wausau, Wis.



Finding New Joy

I am finding a new joy that I never experienced before, for I have always wanted to play, but had given up hope until I heard of your course.

*C. S., Lucien, Okla.



Fun to Learn

"Your lessons are everything you said they would be. Never before have I seen such an easy way to learn music. It's easy, encouraging and fun. I thank you with all my heart for introducing me to your wonderful course."

*G. M., Berlin, N. H.

*Actual pupils' names on request. Pictures by professional models.

You, too, can play any instrument By this EASY A-B-C Method

YOU think it's difficult to learn music? That's what thousands of others have thought! Just like you, they long to play some instrument—the piano, violin, guitar, saxophone or other favorites. But they denied themselves the pleasure—because they thought it took months and years of tedious study to learn.

Learn in Spare Time at Home

And then they made an amazing discovery! They learned about a wonderful way to learn music at home—without a private teacher—without tedious study—and in a surprisingly short time. They wrote to the U. S. School of Music for the facts about this remarkable short-cut method. And the facts opened their eyes! They were amazed to find how easy it was to learn.

The result? Over 850,000 men and women have studied music at home this simple, A-B-C way. Now, all over the world, enthusiastic music-lovers are enjoying the thrilling satisfaction of creating their own music. They have found the key to good time, popularity and profit.

Costs Only Few Cents a Day

And that's what you can do, right now. Get the proof that you, too, can learn to play your favorite instrument—quickly, easily, in spare

time at home for only a few cents a day. Never mind if you have no musical knowledge, training or talent. Just read the fascinating booklet and Print and Picture sample that fully explain all about the famous U. S. School method. If interested tear out the coupon now, before you turn the page. U. S. School of Music, 72 Brunswick Bldg., New York 10, N. Y. Largest school of its kind in the world. (50th year)

FREE!

Print and Picture
Sample



NOTICE

Please don't confuse our method with any systems claiming to teach "without music" or "by ear." We teach you easily and quickly to play real music, any music, by standard notes . . . not by any trick or number system.

U. S. SCHOOL OF MUSIC.

72 Brunswick Bldg., New York 10, N. Y.

I am interested in music study, particularly in the instrument checked below. Please send me your free illustrated booklet "How to Learn Music at Home," and your free Print and Picture Sample. (Instrument supplied when needed, cash or credit.)

Piano	Saxophone	Clarinet	Practical
Guitar	Trumpet, Cornet	Trombone	Finger
Hawaiian	Reed Organ	Flute	Control
Guitar	Tenor Banjo	Modern	Piccolo
Violin	Ukulele	Elementary	Mandolin
Piano Accordion		Harmony	

Name _____ Have you Instrument? _____
(Please print)

Address _____

City _____ State _____

NOTE: If you are under 16 years of age, parent must sign coupon.

SAVE 2c — STICK COUPON ON PENNY POSTCARD

NOW!
ALL 5 FAMOUS JOWETT COURSES--1 COMPLETE MUSCLE BUILDING VOLUME!
FOR ONLY 25¢
AND MY PHOTO BOOK OF FAMOUS STRONG MEN! FREE!

LET ME PROVE I can make YOU

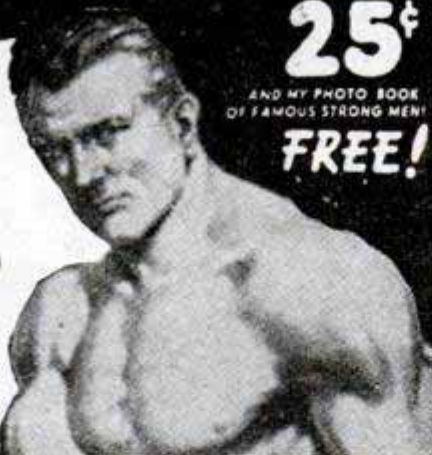

COMMANDO-TOUGH OR IT WON'T COST YOU A CENT!

says *George F. Jowett* WORLD'S GREATEST BODY BUILDER

GIVE ME 10 MINUTES A DAY LEARN MY TIME TESTED SECRETS OF STRENGTH

I'll teach you the "Progressive Power Method" through which I rebuilt myself from a physical wreck the doctors condemned to die at 15, to the holder of more strength records than any other living athlete or teacher! "Progressive Power" has proven its ability to build the strongest, handsomest men in the world. And I stand ready to show you on a money back basis -- that no matter how flabby or puny you are I can do the same for you right in your own home. Let me prove I can add inches to your arms, broaden your shoulders, give you a man-sized chest, powerful legs and a Rock-like back--in fact, power pack your whole body so quickly it will amaze you! Through my proven secrets I bring to life new power in you inside and out, until YOU are fully satisfied you are the man you want to be.

PROVE IT TO YOURSELF IN ONE NIGHT

Send only 25c for my 5 easy-to-follow, picture-packed courses now in 1 complete volume "How to Become a Muscular He-Man." Try it for one night! Experience the thrilling strength that surges through your muscles.

10 DAY TRIAL!

Think of it--all five of these famous courses are now in one picture-packed volume for only 25c. If you're not delighted with this famous muscle-building guide -- if you don't actually FEEL results within ONE WEEK, send it back and your money will be promptly refunded!

Photo Book Of Famous Strong Men!

I am making a drive for thousands of new friends fast--REGARDLESS OF COST!
SO GET NOW MY 5 Muscle Building COURSES
 (Valued at \$5 each)
All in 1 Great Complete Volume Packed With How-To-Do-It Pictures!
 Now, this "get-acquainted," extremely low price of only 25c is your chance to build a body you'll be proud of! Follow Jowett's easy method of muscle building NOW!
For Only 25c



FREE!



Photos that inspire you to might and muscle. Free with order.

FREE GIFT COUPON!

Jowett Institute of Physical Culture
 230 Fifth Avenue, New York 1, N. Y. Dept. PM-82

George F. Jowett:--Please send by return mail, prepaid, **FREE** Jowett's Photo Book of Strong Men, along with all 5 Muscle Building Courses. 1. Molding a Mighty Chest. 2. Molding a Mighty Arm. 3. Molding a Mighty Grip. 4. Molding a Mighty Back. 5. Molding Mighty Legs--Now all in One Volume "How to Become a Muscular He-Man." Enclosed find 25c. NO C.O.D.'S.

George F. Jowett
 Champion of Champions

NAME _____ AGE _____
 (Please Print Plainly, Include Zone Number)

ADDRESS _____

Have an OFFICE of YOUR OWN!

LEARN NEW PROFITABLE PROFESSION At Home in 60 Days, Men & Women, 18 to 70!

Be Your Own Boss and the Boss of Others. Be Respected. Meet Interesting People.



Earnings of men and women in this profession run as high as \$5,000-\$15,000 yearly. Others make good money in spare time. Little money needed to start. A business where your earnings begin sooner. Easy to learn. No selling or goods to buy. No experience necessary. A depression-proof business. A course of action to guide you step by step as you earn. All 53 lessons sent at once to use as operating manuals. Easy terms. Diploma. Money-back agreement. Write for **FREE BULLETIN**.
FRANKLIN CREDIT SCHOOL
 Dept. 75-B ROANOKE 7, VIRGINIA

BY MAIL in Easy Lessons

Enjoy WORLD'S MOST FASCINATING HOBBY! SEND FOR FULLY ILLUSTRATED BOOK TODAY!



GET THE FACTS on model railroading! Learn how easily you can enjoy the favorite hobby of thousands of mechanics, business and professional men. Endlessly fascinating... scale model railroads look, perform like real thing! **BOOK SHOWS HOW** to get started. Leading authority gives easy steps in complete 32-page beginner's manual. Profusely illustrated with photos, diagrams. Send 10c, coin or stamps, today! Address

MODEL RAILROADER MAGAZINE
 Dept. 1514, Milwaukee 3, Wis.

LEARN WATCH REPAIRING



AT HOME. By our modern and original system of instruction you can learn every part of the **WATCH REPAIRING TRADE AT HOME.** Prepare yourself for a well-paying position or start in business after completing our course of instruction. Good watch repairers are in demand and generally earn very good salaries. For particulars apply to the **Wisconsin School of Watch Repairing** 759 North Milwaukee St., Milwaukee 2, Wis.



WHY WEAR DIAMONDS

When dazzling Zircons from the mines of the far-away mystic East are so effective and inexpensive! Thrilling beauty, stand acid, true backs, flashing brilliance! Exquisite gold mountings. See before you buy. Write for **FREE** catalog.

National Zircon Company
 Dept. 21-N
 Wheeling, W. Va. **Catalog FREE!**

FENCING World's Finest Sport Exciting Fun--Harmless



Just Out! Two 3 ft. Spring Steel Folds with Safety Rubber Buttons. Complete Quilt 2 foils (swords) with hand guards and Free Instruction Book Now Only \$1.98 Postpaid. A healthful and clean sport, makes you Strong and Alert. Instruction Book teaches Quickly--Easily. Mail check or Money Order for \$1.98 Today. Add 28c for Foreign Postage.

LEE PRODUCTS CO., 1613-F First Ave., New York 28, N. Y.

AN ASTONISHING MEMORY

Wonderful new memorizing tricks. Pass examinations, give shows, make stunning public speeches, remember anything. Your success in life depends on your memory. . . . only \$1
CARILLON BOOKS, Dept. G, 1216 Park Row Bldg., New York 7, N. Y.

SAY YOU SAW IT IN POPULAR MECHANICS

DETECTIVES!!!

Study **SCIENTIFIC Criminology** at Home. Be an Investigator. Send for **FREE BOOKLET.** Write Dept.-N

PACIFIC SCHOOLS, INC.

601 S. VERMONT AVE. LOS ANGELES 5, CALIF.

Name _____
 Address _____



AUTOMOTIVE & TRACTOR

Covers all phases of mechanical training, tune-up, service, general trouble shooting, and repair. Includes latest types of cars, motors, and equipment for thirty-four weeks of work projects.



ELECTRICITY Basic principles, magnetism, current electricity, residential and industrial wiring, appliance repair. 34 Weeks.



SHOE REPAIR From simplest repairs on boots and shoes to the finest details of reconditioning and rebuilding under expert craftsmen. 39 Weeks.

PLUMBING

From pipe cutting, threading, and lead work to home and industrial installations, every step is worked out in our most modern shops. 34 Weeks.

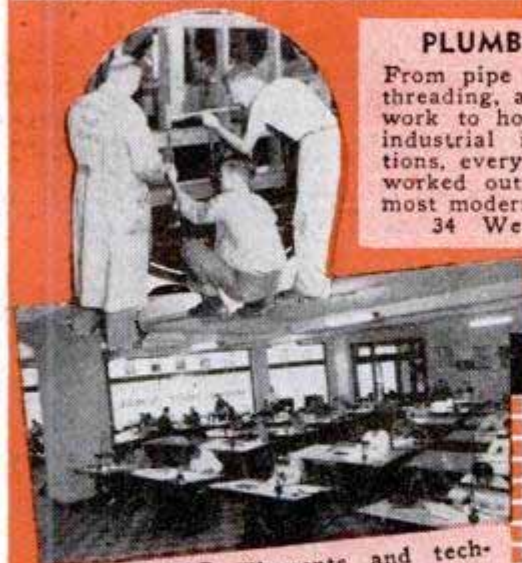

DRAFTING Elements and technique, drafting geometry, construction plans and specifications, auxiliary elevations, every phase. 32 Weeks.

**ALWAYS A JOB . . .
ALWAYS SECURITY . . . ALWAYS TOP PAY . . .
because—**

There's ALWAYS a Demand for the Man Who KNOWS—

Be Sure of Your Future!

MASTER A TRADE in the NATIONAL TRADE SCHOOL KANSAS CITY, MISSOURI

**Choose 1 of these 5 Important Trades
and Learn it the RIGHT way—**

- In the most modern shop—with every facility and the latest scientific equipment.
- Under the instruction of Technicians with years of actual experience in the Trade.
- With both theoretical training and practical application.

You will be equipped to handle the most difficult job—or go into business for yourself. You will ALWAYS be able to earn a good living. You need NEVER have to be "laid off" or retired . . . for—

These 5 Trades are Lifetime Trades

They are Essential to All Living—Boom—Depression—or Normal Times . . . and You'll be Happy in them, because you'll know you're Efficient in a real service. Classes 6 Hours daily—5 days a week—well ventilated classroom and shop . . . every convenience.

VETERANS We are fully approved for Veterans' Training. You owe it to yourself to get complete information regarding our schools before you make a decision. We challenge comparison.

Enroll with NATIONAL TRADE SCHOOL and be prepared for a money-making career all of your life. Take advantage of the advice of our counsellors.

Write For Full Details **WRITE TODAY**

National Trade School, Dept. A, 2610 Grand, Kansas City 8, Mo.

Without obligation to me please send full information on the courses checked:

____ Automotive and Tractor Technician ____ Drafting
____ Plumbing ____ Electricity ____ Shoe Repairing

Name _____ Age _____

Address _____

City _____ State _____

Veteran? _____



Put your future
in your own hands

BE AN ARTIST

Here's the Amazing
Way We Teach You
Step-by-Step to Draw
At Home in Spare Time

Draw for money. Prepare yourself now for a fascinating, pleasant and profitable Art career. COMMERCIAL ART, DESIGNING, CARTOONING—all in one complete home study course. No previous art experience necessary. We teach you step-by-step and prepare you for good jobs in advertising, newspaper and magazine publishing, department stores, printing, engraving, or in art studios where you can become your own boss. For 34 years our graduates have been "making good"—WHY NOT YOU?

Trained Artists Are Capable of Earning
\$50 - \$60 - \$75 and MORE a WEEK

Write for FREE BOOK, "Art for Pleasure & Profit"—tells about our course, instruction service, material furnished, what our graduates say, and commercial opportunities for you. TWO ART OUTFITS and other features included with training. Veterans! Course "G.I." Approved

FREE BOOK gives details!

Washington School of Art, Studio 122M
1115—15th St., N.W., Washington 5, D. C.

Please send me full information and your Free Book, "Art for Pleasure and Profit."

Name _____ AGE _____

Street _____

City _____ Zone _____ State _____

I am entitled to training under the GI Bill

22 Big Money-Makers in a Single Line! Amazing New Fluorescent Lights with *Circular Tubes*

THE
HOMELITER



FREE Sales
Outfit

Don't send a penny. Sample Outfit is FREE. Rush name on penny post card for money-making facts about sensational new "CIRCLINE" Fluorescents. Latest scientific development gives you 22 new type circular tube fixtures for kitchens, dinettes, halls, and play rooms. Also Floor and Table lamp for living rooms and pin-ups for shaving and vanity tables. Sells on sight to homes, restaurants, stores, offices. No other fluorescents like CIRCLINE. Salesmen who order samples quickly reorder in large quantities. All fixtures complete with tubes. No waiting. Also immediate delivery on all standard type Fluorescent Fixtures. This is too good to miss. Big, quick profits waiting. Rush name on postcard today for FREE Sales Outfit.



NEW MAXILUME
PIN-UP
MIRROR LIGHT

MAXILUME COMPANY • 125 W. HUBBARD • DEPT. 82 • CHICAGO 10, ILLINOIS

CONFIDENTIAL LOAN SERVICE

Borrow \$50 to \$300⁰⁰

Need money? No matter where you live you can borrow BY MAIL \$50.00 to \$300.00 this easy quick confidential way.

BY MAIL

IT IS EASY TO
BORROW
BY MAIL!

Completely confidential and private
CONVENIENT MONTHLY PAYMENTS

NO ENDORSERS NEEDED
EMPLOYED MEN and women of good character can solve their money problems quickly and in privacy with loans MADE BY MAIL. No endorsers or co-signers. We do not contact employers, friends or relatives. Convenient monthly payments. Send us your name and address and we will mail application blank and complete details FREE in plain envelope. There is no obligation.

NATIONAL LOAN PLAN, INC.
521 Temple Court Bldg., Dept. B-107, Denver 2, Colorado

REFRIGERATION and AIR CONDITIONING

REFRIGERATION
TRAINING
Since 1927



MECHANICAL units everywhere need servicing. Soon new units will require installation service. You can be ready with reliable pay-knowledge of this big income field. Unique home study-plus actual practice plan prepares you to enter servicing or installing field or get into business of your own. Great opportunities now and later. Get facts FREE. Write today!

UTILITIES ENGINEERING INSTITUTE
Dept. 128, 2525 Sheffield Ave., Chicago 14, Ill.

DEVELOP RUGGED STRENGTH!



Strong Men's Club of America offers FREE Membership!

Send for your personal membership card and Strength Secrets. No dues! No obligations! Many valuable privileges! Send name, address, age, on penny postcard.

JOE BONOMO Strong Men's Club of America
Director (Dept. PM2) 1841 Broadway, N. Y. 23, N. Y.



Save Costly Redecorating!
AMAZING INVENTION. Banishes old-style housecleaning mess and muck. No tags—no sticky "dough"—no red, swollen hands. No more dangerous stepladders. Literally erases dirt like magic from walls, ceilings, window shades, upholstered furniture, etc. Endadrunder! SAVES REDECORATING!

SAMPLES FOR AGENTS Sample offer sent immediately to all who send name at once. A penny postal will do. SEND NO MONEY—just your name, KRISTEE CO., 679 Bar Street, AKRON, OHIO.

Now

YOU CAN HAVE IMPROVED No-DRIFT FM
in the Sensational New 1948
MIDWEST RADIOS

NEW SERIES
16*
SUPER DE LUXE
AM-FM
CHASSIS

Here is the finest radio Midwest has ever produced in its 28 years of manufacturing—a world-ranging, 5-band radio with improved Midwest No-Drift FM . . . plus Standard Broadcast and 3 short wave bands, Television Audio Switch-over, and Color-Ray Tone Selection. The Series 16* Super De Luxe Chassis is a powerful, magnificently-toned radio that challenges comparison for performance, sensitivity, selectivity, and advanced engineering features. Supplied with satin stripe copper finish panel—ready to mount in your present cabinet. Send today for the FREE 1948 Midwest Radio Catalog. Buy your radio direct from the manufacturer on Easy Terms and 30 Days Trial and SAVE!



14½"
PANASONIC
SPEAKER

5
WAVE
BANDS

*Series 16
 CHASSIS USES ALL THESE
 LATEST TYPE TUBES,
 RECTIFIER AND TUNING INDICATOR

30 DAYS TRIAL **LOW FACTORY-TO-YOU PRICES** **EASY TERMS**

A COMPLETE LINE OF FINE RADIOS AND RADIO-PHONOGRAPHS . . . Available in Separate Chassis Like the Powerful Series 16* AM-FM Model above, or in beautiful Radio-Phonograph Consoles like this:

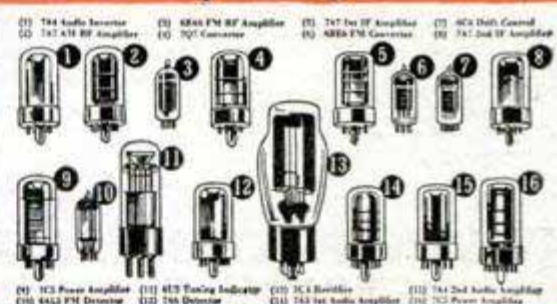

Scores of NEW Features such as the Exclusive MIDWEST TRI-MAGNADYNE COIL SYSTEM and COLOR-RAY TONE SELECTION



SYMPHONY GRAND AM-FM RADIO-PHONOGRAPH CONSOLE
 with NEW Intermix AUTOMATIC RECORD CHANGER

Our Finest! A superbly beautiful musical instrument . . . a masterpiece of furniture design and radio engineering that offers the sensational Midwest NO-DRIFT FM, Automatic Intermix Record-Changer, Exclusive Color-Ray Tone Selection, World-ranging 5-Band Reception, Television Audio Switch-Over, and many more new and exclusive features.

Rush for Free Catalog!
 FILL IN COUPON AND MAIL TODAY OR JUST SEND YOUR NAME AND ADDRESS ON 1c POSTCARD

MIDWEST RADIO CORP.
 Dept. 25-T, 909 Broadway
 Cincinnati 2, Ohio

Gentlemen: Please send me your new FREE catalog and details of your liberal 30 Days Trial.

Name _____
 Address _____
 City _____ Zone _____ State _____

MIDWEST RADIO CORP.
 Dept. 25-T • 909 BROADWAY • CINCINNATI 2, OHIO

DIESEL

IS GOING
PLACES
ARE YOU?



Look around—you will see Diesel Power in action all about you! In tractors, trucks, buses, trains, boats, power and lighting plants, farm and road equipment. Diesel's the Field of the Future! Low cost dependable power—new uses are constantly developing—and every Diesel engine increases the need for Diesel-trained men!

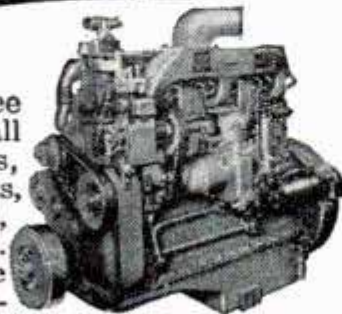

ON LAND



ON WATER



IN INDUSTRY



LEARN DIESEL AT HOME IN SPARE TIME!

If you are over 17, under 60, and mechanically inclined, you can get thorough Diesel instruction right at home. With U.E.I. balanced training, you learn fundamentals first, through home study. Practical, easy-to-understand lessons explain DIESEL operation . . . fuel systems . . . how to make repairs . . . auxiliary equipment, etc.

ACTUAL SHOP PRACTICE



START AT HOME
FINISH IN OUR SHOP

Then, you finish your training on actual engines in our Shop. You work on costly equipment under expert Diesel men who know latest techniques. On graduation, you get job-placement assistance. U.E.I. has 20 years of successful experience in fitting thousands for employment in new opportunity fields.

GET THE FACTS It costs you nothing to get full information on Diesel opportunities and how they can apply to you! **FULL FACTS SUPPLIED FREE.** Simply mail the coupon below now!

UTILITIES ENGINEERING INSTITUTE DIESEL DIVISION

FOUNDED
1927



MAIL THIS COUPON TODAY!

UTILITIES ENGINEERING INSTITUTE, Diesel Division, Dept. 128D
2521 SHEFFIELD AVE., CHICAGO 14, ILLINOIS

Please send me FREE FACTS about U.E.I. Training Opportunities. I am interested in:

- DIESEL REFRIGERATION WELDING
 AUTO BODY & FENDER REPAIR AIR CONDITIONING

NAME _____

ADDRESS _____

CITY _____ ZONE or COUNTY _____ STATE _____

Check here for special information if you are under 17.

STUDY AT HOME

With An Educational Institution

Men with specialized training win higher positions, insure larger earnings, and are bigger successes in business and public life. Opportunities NOW greater than ever before. Send for our Catalog.

ARTS and SCIENCES

Courses in Philosophy; Education; Letters; Public Health; Medical Jurisprudence; Psychology; Sociology; Physics; Chemistry; Plastics; Geology; Political Science; Theology; Business and Commerce; Accounting; Mathematics; Statistics; Agriculture.

ENGINEERING

Courses in Electrical, Civil, Mechanical, Drafting, Architectural, Steam, Aeronautical, Radio, Structural, Mining, Industrial, Petroleum, Marine, Chemical, Diesel, Automobile, Refrigeration, and Air Conditioning Engineering.

LAW

Complete Professional Law Course includes 18 Hornbook Series college grade textbooks. Courses also in Commercial Law, Patent Law and Medical Jurisprudence.

McKinley-Roosevelt Incorporated, 4610-K, Sheridan Rd., Chicago 40, Ill.

BOYS-IT'S FREE!

Exciting, new book tells about
"ATOMIC ENERGY"
and "THE WONDERS OF CHEMISTRY"

Also shows how to amaze friends with Chemcraft magic and do many exciting home experiments. Free. Send today!

THE PORTER CHEMICAL CO., 11 Prospect Ave., Hagerstown, Md.



BE A REAL ESTATE BROKER PAYS BIG!

EASY TO LEARN—Start and run your own business quickly! Many graduates report making up to \$1000 a month. Course of study covers Sales, Property Management, Appraising, Loans, Mortgages and hundreds of related subjects. Course offered in home study or residential classrooms.

FREE Big new illustrated catalog from this nationally known school. Send Post Card Today. G. I. Approved.

WEAVER SCHOOL OF REAL ESTATE
Dept. KA-3, 15 E. Pershing Road Kansas City, Mo.



INVENTIONS WANTED AT ONCE

Patented or unpatented inventions, all types needed by manufacturers. Write for free booklet "MARKETING YOUR INVENTION" and Protective Disclosure Form. We have a tremendous list of firms who may pay cash or royalties for good inventions. For full particulars, write today.

NATIONAL INVENTION SERVICE
1404 Mitchell Street, Dept. 5 Oakland 1, Calif.

SAY YOU SAW IT IN POPULAR MECHANICS

CASTING IS Profitable

You can easily make EXTRA MONEY casting Bookends, Statues, etc. Complete "Cast-Kit" contains everything needed: 1 Qt. best Latex; 5 lbs. Marblite Casting Clay; 3 Modelers; Scraping Knife, and Full instructions. Only \$4.50 postpaid (or COD, plus fee). Valuable 40-page Craft Catalog FREE. (W. Va. Orders add 9c Sales Tax.)
DWINNELL CRAFT SHOP, Dept. P82, Elm Grove, Wheeling, W. Va.

Raise GOLDEN HAMSTERS

The new wonder animals from Syria. Look like Toy Red Bears. Delightful pets. Everybody wants them. Thousands needed by laboratories. Make money, get started now. Write for illustrated literature, or send \$5 for a pair of hamsters and literature.
GULF HAMSTERY, 1536 BASIL ST., MOBILE 17, ALA.



FIBRE ARMS AND LEGS!

Light, correctly fitted, strong and comfortable. Natural appearance. Braces for all deformities. Scientific design. Fair Terms.
BUCHSTEIN-MEDCALF 223 S. 6th St., Minneapolis, Minn.





Learn BUILDING

AT HOME • All Blue Print Building Plans, Specifications, Lessons Furnished

FIND OUT ABOUT TRAINING AND OPPORTUNITIES FOR YOU IN BUILDING

Established in 1904, Chicago Technical College offers you thorough, practical training in Building, by home-study. Mail coupon for free information. See what this Course has done for others, what it can do for you. Read what Chicago Tech graduates say about their work, earnings, success. Learn the rewards awaiting you as a trained builder — and how quickly, easily you can get started. Simply MAIL COUPON TODAY in an envelope or paste on a penny postcard.



Earn more money as a building tradesman. Prepare for advancement and increased pay as a building foreman, superintendent, inspector, estimator, material buyer or salesman. Train to be a building contractor, have your own money-making business in this busy, prosperous building field.

More than 19 million new homes needed in U. S., say experts. New building now at rate of one million homes a year, plus 200,000 commercial buildings, plus expanding farm building construction.

Mail coupon today. FREE book tells how you learn Building Construction — How to Read Blue Prints, and Estimate Building Costs — at home in your spare time. Learn modern construction methods and materials, how to lay out work and direct all building operations. This is the training needed for rapid advancement to higher-paid jobs, or your own successful building business.

CHICAGO TECHNICAL COLLEGE
8-152, Tech Building, 2000 South Michigan Ave.
Chicago 16, Illinois

MAIL COUPON NOW

CHICAGO TECHNICAL COLLEGE
8-152, Tech Bldg., 2000 So. Michigan Ave.
Chicago 16, Illinois

Mail me FREE building Lesson and information about big opportunities in BUILDING and how I can train at home.

Name _____ Age _____

Address _____

City _____ Zone _____ State _____

MEET TODAY'S OPPORTUNITIES! GET STARTED QUICK in

Tools and Working Outfit Furnished

NOTHING FOR YOU TO BUY

Immediately when you start, I will furnish you with a complete set of drawing instruments, adjustable drafting table and other equipment you will need. Nothing for you to buy. You start right out doing professional type drafting with real professional equipment.



Real Professional Type Instruments

DRAFTING

I Will Train You at Home Until You Get a GOOD PAY JOB!



Engineer Dobe

Act Now! Get ready for a better job, advancement, more pay and security. Drafting is the field of big opportunities, and now bigger than ever before. Thousands of draftsmen and designers must come first—before any kind of production can begin. Get into Drafting.

You Get Experience As You Learn

I will train you at home in your spare time, and give you actual experience on actual work—the same kind of jobs you will do for the best paying firms. You will be trained until you are competent, experienced, and are actually holding a position that will bring advancement and pay raises as deserved.

Recommended for Job When You Are Ready

A careful record of your progress and experience will be kept. These I will give as a reference to employers when you become competent. Lack of previous experience or higher education won't hold you back.

ACT NOW!

Mail the coupon for all details and illustrated book. No obligation. No salesman will call. Give your age to insure reply.

Mail Coupon to ENGINEER DOBE, Libertyville, Ill.

Engineer Dobe, Div. 12, Libertyville, Ill.
Send me the Vital Facts on Drafting and Industrial Designing, your FREE BOOK and advertised list of positions for Draftsmen and Designers wanted.

Name _____ Age _____

Address _____

City _____ Zone _____ State _____



HOW TO Fight! Wrestle! Jiu-Jitsu!

FREE

Plus Weight Lifting! Strong Man Stunts!

Be prepared to protect your family, friends, yourself in any emergency! Be admired! George F. Jowett, Champion of Champions, gives you free his "SMASHING CHAMPION SECRETS." Contains many "HOW-TO-DO-IT" pictures that quickly and simply show you how to powerfully deliver a knockout, how to break any hold, how to overpower any opponent plus weight lifting and strong man stunts! Inside professional "Tricks of the Trade" proved successful by police, armed forces, fighters, wrestlers, etc. Free for a limited time with this sensational offer!

You Need He Man Fitness to Handle Any Tough Situation!



NOW! All 5 Famous Jowett Courses
IN 1 COMPLETE MUSCLE BUILDING VOLUME!

FOR ONLY **25c**

Let Me Prove I Can Make You—

COMMANDO-TOUGH OR IT WON'T COST YOU A CENT!

says *George F. Jowett* WORLD'S GREATEST BODY BUILDER

Give Me 10 Minutes a Day

Learn My Time Tested Secrets of Strength

I'll teach you the "Progressive Power Method" that rebuilt me from a physical wreck condemned to die at 15, to the holder of more strength records than any other living athlete or teacher! Has proven it builds the strongest, handsomest men in the world. Let me prove on a money back basis—that no matter how flabby or puny you are that I can add inches to your arms, broaden your shoulders, give you a man-sized chest, powerful legs and a rock-like back—in fact power pack your whole body so quickly it will amaze you—right in your own home! It's time to life new power in you inside and out, until YOU are satisfied you are the man you want to be.

PROVE IT TO YOURSELF IN ONE NIGHT

Send only 25c for my 5 easy-to-follow, picture-packed courses now in 1 complete volume, "How to Become a Muscular He-Man." Try it for one night! Experience the thrilling strength that surges through your muscles.

10 DAY TRIAL!

Think of it—all five of these famous courses now in one picture-packed volume for only 25c. If you're not delighted with this famous muscle-building guide—if you don't actually FEEL results within ONE WEEK, send it back and your money will be promptly refunded!

Photo Book of Famous Strong Men!

I am making a drive for thousands of new friends fast—REGARDLESS OF COST!
SO GET NOW MY 5 Muscle COURSES
(Valued at \$5 each)

All in 1 Great Complete Volume Packed With How-To-Do-It Pictures!

Now, this "get-acquainted," extremely low price of only 25c is your chance to build a body you'll be proud of! For **Only 25c** low Jowett's easy method of muscle building NOW!

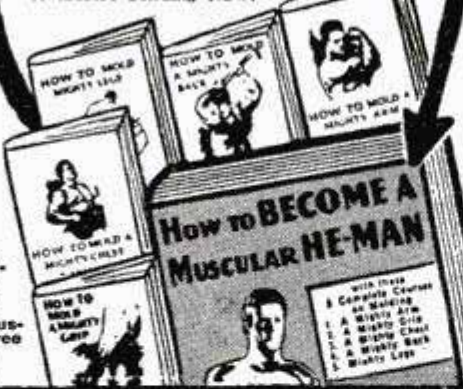

FREE!

Photos that inspire you to might and muscle. Free with order.

2 FREE GIFTS!

Jowett Institute of Physical Culture Dept. PM-82A
230 Fifth Avenue, New York 1, N. Y.

George F. Jowett: Please send by return mail, post-paid, **FREE** "Smashing Champion Secrets" and **FREE** Jowett's Photo Book of Strong Men, along with all 5 Muscle Building Courses. 1. Molding a Mighty Chest. 2. Molding a Mighty Arm. 3. Molding a Mighty Grip. 4. Molding a Mighty Back. 5. Molding Mighty Legs—Now all in One Volume "How to Become a Muscular He-Man." Enclosed and 25c. NO C.O.D.'s.

George F. Jowett
Champion of Champions

NAME _____ AGE _____
(Please Print Plainly, Include Zone Number)

ADDRESS _____

Be a PILOT!

Get

THOROUGH INDIVIDUAL INSTRUCTION

It will pay you well to learn aviation "from the ground up," at an old established flying school where expert instructors, personal attention and an aggressive, thorough program can prepare you for an aviation career in the shortest possible time.

GOVERNMENT APPROVED CAA APPROVED

Students from all over the nation and many parts of the world are getting their private, commercial, instrument and multi-engine ratings NOW! at the Gottschalk School. Veterans' tuition paid by the Government under G.I. Bill. To others, there are opportunities for work to cover living expenses or tuition. Write today.

GOTSCHALK

School of Aeronautics
ADRIAN, I, MICHIGAN

APPROVED FOR VETERANS UNDER G.I. BILL



LEARN EXPORT

Buy and sell world-wide without capital. Travel abroad if desired. Export men and women in demand. Your own business — profits unlimited. Salaried jobs — up to more than \$10,000 a year. Practical, low cost **WORLD TRADE COURSE** teaches you quickly at home in spare time. No previous special experience or schooling needed. World Trade Certificate awarded. Write today for **FREE DETAILS**. No obligation. Please state age. Air-mail reaches us overnight. **THE MELLINGER CO., Exporters-Importers,** 1416-L Westwood, Los Angeles 24, Calif.



TALK-SING thru your own radio with **RADIO MICROPHONE**

Be the life of the party. Put on your own broadcasts at home. Talk-Sing make announcements from any room. Wonderful voice practice. Microphone easily attached to any radio. Follow enclosed instructions. **SEND NO MONEY**—pay postman \$1.95 plus postage. Send Money Order or check and save postage.



EMPIRE RADIO & TELEVISION CO. (Dept. R2) 1521 Bedford Ave. Brooklyn 16, N. Y.



CARTOONING

HAVE FUN! MAKE MONEY! Cash in on your sense of humor **AT HOME—BY MAIL**. No experience needed to start. Write today for **FREE TRIAL LESSON** and full particulars. **Moon Gag Cartoon School, Dept. M, Fall Creek, Wis.**

Become a Doctor of PSYCHOLOGY

Win the degree of Ps.D. Teach the secret of contentment, happiness. Solve mental worries. Experience the revelation of truth. Chartered college. Individual help. Write for **FREE** book. **COLLEGE OF UNIVERSAL TRUTH, 5153-B North Clark St., Chicago.**

LEARN WATCH and CLOCK REPAIRING

Start training now for a better paying job or your own profitable business. Qualified Watch Makers are in demand... Unlimited opportunities. Intensive practical training by experienced watch makers. Veteran operated. Write for full details. Specify if veteran.

SCIENTIFIC SCHOOL OF WATCH MAKING, Dept. PM-2
3923 San Fernando Road Glendale 4, Calif.

ONE-MAN SAWMILL LESS THAN \$200.00

Easy To Turn Trees Into Money

Makes lumber, ties, shingles, crates, lath, studding.

Belsaw Models in 10 to 24 foot sawing lengths. **MECHANICAL FEED**, accurate set works and positive dogs. Use tractor or old auto engine for low cost power. Thousands used for commercial sawing. Pays for itself quickly. Send post card today for **FREE** booklet, "How To Make Lumber" and Catalog of Woodworking Equipment. **BELSAW MACHINERY CO., 28112 Field Bldg. 315 Westport Road Kansas City 2, Mo.**



**\$200 GROSS IN MY
FIRST WEEK!**



**Some Make More, Some
Less . . . Start This Busi-
ness for YOUR OWN**

Would YOU like to own a permanent, year-round business in which it is possible to take in as much as \$200 gross the first week, as did L. A. Eagles? R. E. Traynor says, "I made \$62 gross in one day." R. R. Newlin reports, "I have averaged \$173 gross per week." Others report gross from \$100 per week to \$12,000 per year.

Surely YOU will want to investigate a golden opportunity like that. You need not have any special skill or experience, but if you are ambitious, honest and courteous, we will help you to start and succeed in YOUR OWN money-making business where net profits are high.

No Shop Necessary

Our Electric Rug Washer cleans rugs and carpets like new right on the customer's floor. This quick, thorough and highly efficient method removes dirt and grime, thus restoring the natural, fresh beauty of floor coverings. Any can run it. Rugs and carpets are not harmed.

There are hundreds of possible customers in YOUR vicinity. Most of them have several rugs needing regular cleaning. To get a quick start,

shampoo a few rugs or carpets. These customers tell their friends and soon you should have an independent, prosperous business, and you should be able to keep it growing. Send the coupon RIGHT NOW for booklet that explains everything.

**Every Machine Guaranteed
and Easy to Own**

You take no risk. These wonderful, fully guaranteed machines have been used and endorsed by largest hotels, railroads—also used by U. S. Government. Many individuals have built up successful businesses that made big profits. Mail the coupon TODAY and we will send complete information, including how to start and succeed in YOUR business without a large investment. Don't delay your BIG opportunity. Send the coupon AT ONCE.



FREE BOOK! MAIL COUPON

VON SCHRADER MFG. CO.
A281, Racine, Wis.

Send at once (no obligation) your FREE booklet containing information about your Electric Rug Washer and how I can own my own permanent, profitable business.

Name _____

Address _____

City _____ (Zone) _____ State _____

MAIL COUPON TO

VON SCHRADER MFG. CO., A281, RACINE, WIS.

PROTECT YOUR HOME

with these **MODERN**
Low Cost **FIRE**
EXTINGUISHERS



A little foresight now may save LIVES and property later! Equip your home, your garage, your boat with AUTOFYRSTOP, the modern fire extinguisher and alarm that is setting new efficiency records. Write for free literature:

AUTOFYRSTOP CO. Dept. PM-248
2035 Washington Av., Philadelphia 46, Pa.

**KILLS
FIRE
BY ITSELF**

**MONEY MAKING
OPPORTUNITY**

We have openings for high grade salesmen in choice territories. Write for Plan.

**BE A GOVERNMENT LICENSED
AIRPLANE AND ENGINE MECHANIC
Train Now at LINCOLN**



**EARN BIG PAY IN
AVIATION**

Our new enlarged school now offers these courses: **MASTER AVIATION MECHANICS**, CAA Approved 1 Yr. Airplane & Engine Mechanics Course. **REFRESHER AIRPLANE & ENGINE MECHANICS**. Designed for veterans with aviation mechanics experience. Either course is available to veterans under the G. I. Bill of Rights. Write today for complete information.

LINCOLN AVIATION INSTITUTE

UNION AIR TERMINAL DEPT. P-2 LINCOLN, NEBRASKA

ELECTRICAL TRAINING

For Men of Ambition and Limited Time - Train for Successful Careers in Electricity

BLISS

Intensive 32 weeks residence course in fundamentals of industrial electrical engineering, including radio and electronics. Extensive laboratory practice in electrical measurements; testing power equipment; circuit tracing; wiring techniques; radio and industrial electronics; use of machine tools; motor construction; drafting. A basic training meeting industry's requirements for engineering

aides, laboratory assistants; operating, production and maintenance technicians; customer engineers; draftsmen. Graduates hold responsible technical and executive positions.

Modern buildings, dormitories, dining hall, campus. Moderate cost. 54th year. Classes begin March 22; July 26. For catalog write 7626 Takoma Avenue, Washington 12, D. C.

ELECTRICAL SCHOOL
A TECHNICAL INSTITUTE





**PAINT!
DECORATE!
IMPROVE!**
Your **HOME**
**SAVE OVER ONE HALF
DO IT YOURSELF**

Thousands of These Famous Books
in Use — Order on Coupon!

Here is the practical, low-cost help you need to save money on your own home upkeep and renewal. Makes all jobs easy. Professional painters, decorators—these books will keep you up-to-date. Select the help you need and circle book numbers in coupon. Money back if not satisfied.

House Painting Methods. Brush and Spray Gun. 400 pages, 150 illustrations and color chart. **\$2.50.** Book No. 1.

Wood Finishing. Plain and Decorative. Methods, tools and materials. 360 pages. illus. **\$2.50.** Book No. 2.

Paper Hanging. Practical Instruction. For professionals and handy men. 200 pages. illus. **\$2.00.** Book No. 3.

Interior Wall Decoration. All new and standard treatments. 491 pages. illus. **\$3.50.** Book No. 4.

Cyclopedia of Painting and Decorating. Covers every branch A to Z. 350 pages. illus. **\$3.50.** Book No. 5.

Spray Painting. Best book, covering all methods and materials. 125 pages. illus. **\$1.50.** Book No. 6.

Mail Coupon NOW FOR QUICK DELIVERY

Frederick J. Drake & Co., Dept. 12 1 2 3 4 5 6
600 W. Van Buren St., Chicago 7, Ill. (Circle Number)

Send me the books checked. If not satisfied I will return them in 5 days and money will be refunded.

Check or Money Order enclosed \$_____ Send books postpaid.
 Send C.O.D. Plus postage.

Name _____

Address _____

City _____ State _____

Drake's Books are Sold by Leading Booksellers

the letters pour in..

Everyday they come in from everywhere—telling us the success stories of New York Institute of Photography Home Study graduates. N. Y. I. Home Study Instruction is the perfect short-cut to a happier tomorrow for you. You, too, can study at home in your spare time without taking a moment from your present job. Even if you have had no previous experience the beautifully illustrated, easy-to-read and easy-to-understand lessons will start you on the way to professional perfection.

The N. Y. I. Home Study Course has been carefully prepared for us by leading photographic experts. YOU PROFIT BY OUR THIRTY-EIGHT YEARS OF TEACHING EXPERIENCE.

Men and women, too, tell us that they made enough money in photography, while learning, to pay for the cost of the course. There are dozens of ways you can "cash in" on your photographic knowledge. You do not have to have expensive equipment. The photographer with "know how" can make better pictures with a box camera than an untrained amateur with the finest equipment in the world.

FREE! Write today for our big colorful free book showing EVERY phase of photography—glamour, action, color-photography, theatrical shots, news.

Resident Training is Available Under the G. I. Bill.
LEADERSHIP SINCE 1910.

New York Institute of Photography

Dept. 49, 10 West 33rd Street, New York 1, N. Y.

New York Institute of Photography
Dept. 49, 10 West 33 Street
New York 1, New York

Please send me your beautiful four-color catalog illustrating all the different phases of photography and describing the N.Y.I. Home Study Course.

**38th
YEAR**

Name _____ (Please Print)

Address _____

City _____ Zone _____ State _____

**SCREEN PROCESS PRINTING
LEARN AND EARN AT HOME!**

WITHOUT PREVIOUS ART EXPERIENCE

1. LEARN BY DOING **3 WAY** Home Study Course Shows How To

2. ANYONE CAN LEARN
3. UNCROWDED FIELD
4. NO MACHINERY
5. IN GREAT DEMAND
6. A BUSINESS OF YOUR OWN

2 BIG KITS are yours at no additional cost. Complete in every detail. Every item needed to complete the course included.



CALIFORNIA SCHOOL OF SCREEN PROCESS
3740 OVERLAND BLVD., DEPT. 2126 LOS ANGELES 34, CALIF.

VETS: APPROVED UNDER G. I. BILL



WRITE FOR FREE BOOK NOW!

INVENTORS

Whether an invention is patentable can be substantially determined by a search of the U. S. Patent records. Without obligation, write for information explaining the steps you should take to secure a patent.

JOHN N. RANDOLPH

Registered Patent Attorney

201 Columbian Building Washington 1, D. C.

FLOYD CLYMER'S unbiased book

"INDEPENDENT TEST REPORT ON KAISER-FRAZER CARS"



Read what 3000 owners now think of their K-F cars. Expert, part-by-part analysis. 100 photos. Tells all. 3000-mile test run, Pike's Peak closed car record, gas mileage. Thousands are buying. Order now. \$1.50 postpaid. \$2.50 deluxe ed. Cash, money-order, or specify C. O. D. Money-back guarantee. Clymer, Publisher, Dept. PM2 2125 W. Pico, Los Angeles 6, Calif.

LEARN TRIG QUICKLY - EASILY

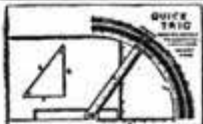

WITH QUICK TRIG, by competitive tests, it was found that QUICK TRIG gave answers faster to one with a slight knowledge of trig than to an expert on trig with a slide rule. Let it solve your trig problems. You need no previous training. Entirely automatic. Easy instructions included FREE. We mail C.O.D. plus postage or send \$1.00, the full price, and we will mail postpaid.

REED MFG. CO. 11350-P BURBANK BLVD. N. HOLLYWOOD, CALIF.

CANVAS COVERS Waterproof tarpaulins, war surplus (Used), perfect condition. Originally made for tents. Approx. 5'x8'. Two buttoned together make approx. 80 sq. ft. Complete with buttons attached. Suitable for use as canvas dams, hay covers, truck covers, machinery and equipment covers, etc. Packed in bales 40 each, priced 40 covers, \$1.00 ea.; 15 covers, \$1.50 ea. Less than 15, \$1.75 ea. All FOB, Kansas City.

AMERICAN SUPPLY CO. 329 W. 5th Dept. P. M. Kansas City, Mo.

Be an Investigator!

Our course in scientific crime detection may be studied in the quiet of your own home. Investigation training course written and supervised by former U. S. Government Investigator. Write today for full particulars and free booklet. No obligation whatever. **PACIFIC SCHOOLS, INC.**

601 S. VERMONT AVE., DEPT. M-3 LOS ANGELES 5, CALIFORNIA

SAY YOU SAW IT IN POPULAR MECHANICS



AJAX LIGHT BRAHMAS

Egg contest and show winners. **GIGANTIC SIZE.** Quick growing. Heavy layers. Exceptional CAPONS. Illinois U. S. Approved Tested. Thousands hatching weekly year around at **LOW PRICES.** Catalog **FREE.** Write **TODAY.** **AJAX HATCHERY, Box 434 QUINCY, ILLINOIS**



MRS. BERRY'S POULTRY BOOK

FREE **BABY CHICKS** or **STARTED.** Champion-Mated, Licensed-Inspected, B.W.D. TESTED. **52 BREEDS, 6 HYBRIDS.** Sexed or straight. Mature fowls, Hatching Eggs and Remedies. **LOW PRICES.** The **ORIGINAL** Berry's Farm—over 50 years' service. **LARGE BEAUTIFUL BOOK FREE.** Stamps appreciated. **BERRY POULTRY FARM, Bx. 29, CLARINDA, IOWA**

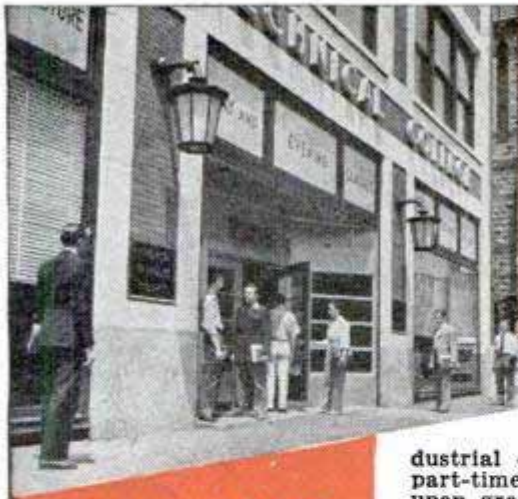

Learn ENGINEERING DRAFTING...BUILDING in Chicago, Industrial Hub

Approved for G.I. Training Time-Saving Courses Day & Evening Classes

Get your training at Chicago Tech in the Nation's industrial center. Chicago provides unequalled opportunities for part-time employment while training and for permanent positions upon graduation. Many other cultural and recreational advantages described in Catalog. — sent Free!

Chicago Tech, founded 43 years ago, has trained thousands of men now occupying important places in industry the world over. Training combines theory and practice in 1 year, 2 year, and 3 year (Degree) courses. Saving in time means earlier graduation. — and consequently earlier employment.

Terms start January, April, July and October. Get information now to arrange for early admission and accommodations.

**CHICAGO
TECHNICAL COLLEGE**
B-82 Tech Bldg.
2000 So. Michigan Ave.
Chicago 16, Ill.

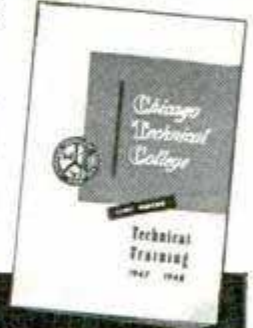

MAIL COUPON TODAY

CHICAGO TECHNICAL COLLEGE
B-82 Tech Bldg., 2000 So. Michigan Ave.
Chicago 16, Ill.

Please send me without obligation free booklet on Time-Saving Technical Training.

Name _____ Age _____

Address _____

City _____ Zone _____ State _____

**1 YEAR • 2 YEAR
3 YEAR COURSES**
**BUILDING
DRAFTING
ENGINEERING
AIR CONDITIONING
REFRIGERATION
ELECTRICITY
RADIO**



START AS HIGH AS \$3,021.00 YEAR MEN — WOMEN —

*Over 20,000 appointments
being made each month*

**VETERANS GET SPECIAL EXAM
PREFERENCE**

**Get Ready at once in your own home
for Examinations**

Mail Coupon today — SURE

Franklin Institute

Dept. T85, Rochester 4, N. Y.

Rush to me, entirely free of charge (1) a full description of U. S. Government Jobs; (2) Free copy of illustrated 32-page book, "How to Get a U. S. Government Job"; (3) list of U. S. Government Jobs; (4) Tell me how to qualify for one of these jobs.

Name _____

Address _____ Age _____

Use This Coupon Before You Mislaid It.
Write or Print Plainly.

VALUABLE COUPON

A NEW WORLD OF OPPORTUNITY
FOR YOU

Mechanical Engineering and Industrial Design

There is a vast new world of opportunity for the man with imagination and mechanical aptitude. It is combined in the modern, fascinating field of Industrial Design and the long established field of Mechanical Engineering. It is a world of new ideas and new products demanded urgently by industry, business, and the public. Rich rewards await the man who adds design practice and engineering knowledge to his own creative ability and originality. Never before has the demand for this type of trained man been so great, throughout all industry.

Learn in 2 years

Now you can prepare for this field in only 2 years. Intensive, practical training is given by the same methods already proved outstandingly successful in Northrop Institute's 2-year Aeronautical Engineering course. A thorough mastery of engineering techniques is combined with abundant practice in actual Product Design.

Train at Northrop

... birthplace of the famous Flying Wing and other outstanding design and engineering achievements. Here you receive your training in the midst of a teeming center of important research and development work. Here is training that is constantly kept in step with engineering progress. Here you gain the advantages of training guided by prominent engineers and designers. For complete details on your opportunities, with Northrop training, send the coupon.



APPROVED FOR
VETERANS

NORTHROP

Technical and Aeronautical
INSTITUTE

Division of Northrop Aircraft, Inc.
1527 East Broadway
Hawthorne, Los Angeles County
California

Please send me the Institute catalog and complete information, including starting dates of classes. I am interested in

- Mechanical Engineering Aeronautical Engineering
 Aircraft and Aircraft Engine Mechanics (A&E)

Name _____

Address _____

Age _____

City _____

Zone _____

State _____

Check one: Veteran In Service Civilian M-2

MAKE UP TO \$5.00 AN HOUR
In Your Own YEAR ROUND Business!

ONLY A FEW
DOLLARS
PUTS YOU IN
BUSINESS!

Many Clearing as High as \$20 to \$30 a Day NET Renewing Rugs, Carpets, Upholstery. New Method Now Used for Auto Upholstery. Write for Facts About Quick, Easy Way to Get Started

Here is the chance you've been looking for to step into a pleasant, dignified, big-pay business of your own that offers you a steady, year 'round income. Start on "a shoe-string," full or spare time, right from your own home. Equal opportunities for men and women, young or old, in small towns or big cities. No experience needed. Many making big money with new Americlean System just cleaning auto upholstery. Easy to learn. We send you complete instructions and quick-cleaning supplies so you can start making money the very first day! Quick method cleans upholstery, rugs and carpets like new without taking off floor! Tremendous demand in homes, apartments, hotels, stores, office and public buildings. Steady repeat business. Territories going fast. Write today for full FREE facts. No cost or obligation. Rush letter or postcard now to AMERICLEAN CO., Inc.; Dept. G-14; 211 North 7 St.; St. Louis 1, Mo.

WRITE
FOR FREE
DETAILS
NOW!

Get Into PLASTICS

Make Big Money As
Novelty Manufacturer!

Free Book on Plastics tells you how to start your own business. Answers your "Plastic" questions. Read about Flexible Molds, Artificial Liquid Marble and other profitable products.



Act Now! Get started while the field is not crowded. Write Today!

FREE BOOKLET

BING PRODUCTS

Dept. A-27
88 Broad Street
Boston 10, Mass.



ITALIAN ACCORDIONS

Hand Made. Very Best. Lowest Prices. Buy Direct from Factory Representative and Save Money. Send Name and Address for FREE catalog.

ITALIAN ACCORDION MFG. CO.
7600 Cottage Grove Ave., Dept. PM-2, Chicago 19, Ill.

LEARN TO MAKE TRICK PICTURES

THE HOLLYWOOD WAY
NO DARK ROOM NEEDED



Print your own, trick photos, snapshots, greeting cards. Complete Photo Printing Kit. NOTHING ELSE TO BUY. Printing Frame, Fixer Salts, Paper, Trick Negatives and simple instructions.

FREE—while they last—Amazing Magic Propeller with each direct order. All for \$2.00, postpaid. No C.O.D. Free Circular.
LEONARD M. POOLE CO. DEPT. PM-2
7614 Santa Monica Boulevard - Hollywood

SAY YOU SAW IT IN POPULAR MECHANICS

OLD GOLD JEWELRY WANTED

Dental gold teeth, plates and bridges with metal attached. Any broken pieces of gold jewelry. Immediate payment and free mailing container to you or your friends upon request.
LOWES, DEPT PM Holland Bldg., St. Louis 1, Mo.



Big Profit AUSTRA-WHITES

Sensational MONEY MAKING HYBRID. Customers report broilers 8 weeks, laying 4 1-2 mos. Disease resistant. Hardy Layers. 50,000 chicks weekly. Started pullets. Profit Sharing Plan. FREE Book. Write today.
BERRY BROS. FARMS, Box 592, ATCHISON, KANS.



AJAX AUSTRALORPS

SENSATIONAL WORLD CHAMPION LAYERS. Mature fast. Excellent roasters—capons. Massive size. Illinois U. S. Approved-Tested. Guaranteed chicks. Low prices. PROFIT SHARING PLAN. Catalog FREE. Write TODAY.
AJAX HATCHERY, Box 432 QUINCY, ILLINOIS

DO ANY JOB.. EASIER.. QUICKER
MAKE MORE MONEY *in the*
BIG OPPORTUNITY
FIELDS

Here's the Help You Need
For Best Paying Jobs
Right NOW!

FREE TRIAL
IN YOUR OWN HOME

Used by Army, Navy, Other Government
Depts., 200 Schools and Industrial Firms.

SEND NO MONEY
 Select the Books
 YOU Need Now!
 We Ship C.O.D.
 Anywhere in U. S.
 and Will Refund
 Amount Paid if
 Not Satisfactory.

Do it now! Get the better pay that goes to men with specialized knowledge. Get into one of these big opportunity fields. Big money and many other advantages await you if you prepare now. Here is the help you need—EASY—QUICK—AT LOW COST. Thousands of men have already used these famous books. Beginners and experienced men alike have doubled and tripled their earnings with this help. You too, can now get the special knowledge you need for top pay, better jobs, or a business of your own. This is your GOLDEN OPPORTUNITY.

AIR CONDITIONING

Big air conditioning boom interrupted by war now bigger than ever and alive with new opportunities! Get this non-technical book by international authority and be ready for your share of millions to be spent. Covers whole field. 450 pages. Illustrated. \$4.00.

MODERN WELDING PRACTICE

Newest book on all types of welding and heat treatment of metals. Written by recognized specialists in training men for production jobs. Practical and Non-Technical.

430 Pages
 277 illus.
 Practical and Non-Technical

Covers everything you need to know. Prepare for best pay jobs now. Price \$4.00.

SHEET METAL LAYOUT

Makes sheet metal layout work so simple that anyone can learn. Get this new instructor and get into the easiest, cleanest and best paying part of all sheet metal work. 143 jobs worked out in drawings and carefully explained. Gives standard for all sheet metal fittings. \$3.50.

HOUSE WIRING
LATEST EDITION

Get this sixth edition of this standard and practical electrical wiring book. It gives complete practical instruction on every phase of house wiring in one handy volume. Goes further than most books on subject. Hand-book style. Gives National Electric Code. 400 pages, 669 illustrations. Electrical work will reach a new high with millions of new homes to be built. Get started now. \$3.00.

DYKE'S FAMOUS CARBURETOR BOOK

This famous book has been the standard guide in the best paying auto work for a generation. It has helped thousands of men make money. New edition covers engine tune-up, compression, ignition, carburetion, fuel pump valves, etc. Use this book to specialize in this big field. 244 pages, 549 illustrations. \$3.50.

AUTO BODY and FENDER REPAIR



Owners will spend big money to keep their good older cars looking like the new ones coming out. This is a practical money-making guide, ideal for shop owners and every man who wants a share of the millions to be spent in keeping old cars looking new. Tells how to get a good job or start business of your own with small capital. 325 pages, 232 illustrations. \$3.50.

15 Million Refrigerators
Need Service and Repairs

REFRIGERATION—Book of the Hour!
Biggest Opportunity in Many Years!

NEW PRINTING—ALMOST 1000 PAGES

408 Pictures—17 Diagrams in Colors Makes All Refrigerator Service Maintenance, Repairs Simple as A. B. C.

Thousands of Refrigerators need repairs! Owners will pay big for competent service which will be needed more and more. Get MODERN GAS AND ELECTRIC REFRIGERATION, the non-technical guide to all types of refrigerators and get your share of this new profit. Get a job or start your own service business. This book will help you make money anywhere. Price \$5.00.

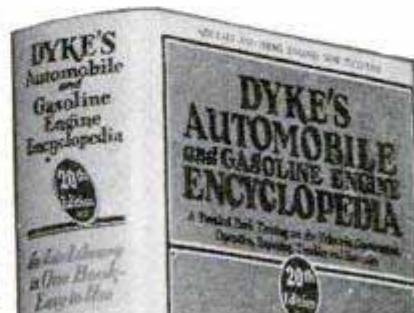

BIG 20th
EDITION
Leading Auto Book for Over 36 Years

World's Greatest AUTO BOOK

New Material on Transmissions, Trucks, Tractors, Diesels, Aircraft and Auto Engines

Now with millions of cars needing repairs and thousands of men needed to do the work, you need the famous DYKE Auto Book more than ever before. This big 20th Edition covers all principles, construction, repair, adjustments, testing, troubles and remedies of all cars. Over a half million copies of 20 editions of Dyke's have been sold. Gives specifications of old and newer cars. World's biggest book value. \$7.00. This big book, a complete auto library in one volume, has 1483 pages—4600 illustrations and diagrams—weighs 6 lbs.—equal to 4 ordinary books.

BAILEY'S HANDBOOK
For Engineers and Firemen

World famous handbook of universal questions and answers for Stationary, Marine and DIESEL engineers and firemen. Prepares for any license examination. This is the one book that men should have if they want to reach the top in installation, maintenance and operation of Diesel and steam plants. Pocket size, \$2.00.

Goodheart-Willcox Co., Inc.
 2009 S. Michigan Ave., Dept. 12, Chicago 16, Ill.

SEND NO MONEY! Mail Coupon

GOODHEART-WILLCOX CO.,
 2009 S. Michigan Ave., Dept. 12, Chicago 16, Ill.

Send books checked, C.O.D. I will pay postman, plus few cents charges. If not satisfactory I will return books in 5 days and you will refund money paid. (Outside U.S. or possessions remit with order.)

- | | |
|--|--|
| <input type="checkbox"/> Gas & Electric Refrigeration \$5.00 | <input type="checkbox"/> Air Conditioning \$4.00 |
| <input type="checkbox"/> Dyke's Auto Book \$7.00 | <input type="checkbox"/> Engineers Handbook . . . \$2.00 |
| <input type="checkbox"/> Dyke's Carburetor Book . \$3.50 | <input type="checkbox"/> Body and Fender Repair . \$3.50 |
| <input type="checkbox"/> Modern Welding \$4.00 | <input type="checkbox"/> Shop Math. (2 vols.) . . . \$3.00 |
| <input type="checkbox"/> Airplane Welding \$3.50 | <input type="checkbox"/> House Wiring \$3.00 |
| <input type="checkbox"/> Sheet Metal Layout \$3.50 | <input type="checkbox"/> A.C. Power Wiring \$4.00 |
| | <input type="checkbox"/> D.C. Power Wiring \$4.00 |

If remittance accompanies order we will pay all postage charges under same return privilege.

Name _____
 Address _____
 City _____ State _____

We'll establish you in Your Own Business and help finance you!

Ever said to yourself, "I don't like the idea of working for others. Someday I'd like to have my own business, and be my own boss." . . . Here, then, is an opportunity made-to-order for you. We are NOW enlarging this 17 YEAR OLD, Nationwide chain of individually-owned Certified Service business. If you are dependable, honest and willing to work, we invite you to mail coupon below for details on how to become financially independent in a profitable, lifetime

business of your own. We will establish you in your own business and arrange finance terms to help get you started. You use the proven successful methods of long established DURACLEAN Dealers. Here is truly a sound, steady, lifetime business. Dealerships grow from REPEAT and VOLUNTARY orders. Your gross profits (above materials and labor) are up to \$20 for a day's service on EACH of your service men. It's easy to learn . . . quickly established.

17 Years
of
PROVEN
SUCCESS



Foamovator becomes carrying case

You Become an Expert in cleaning and protecting Rugs and Upholstery!

DURACLEAN cleans by absorption. An aerated foam, created by the patented electric Foamovator, restores the natural lubrication of wool and other animal fibers in rugs and upholstery. Dirt, grease and many unsightly spots vanish as if by magic. Fabrics and floor coverings are cleaned with a new consideration for their life and beauty.

Cleaning is done right in the home! Fabrics dry in just a few hours. No inconvenience for customers. Rug pile again stands erect and even. Furnishings are left clean, fresh and enlivened.

Fabrics last longer because this modern, safe cleaning process avoids the use of strong soaps and harmful solvents that so often damage dyes or fabrics. . . . No machine scrubbing! This eliminates unnecessary wear on pile and the breaking of fibers.



DURAPROOF is another year 'round service rendered right in the home, office or institution—without removing furnishings. It protects carpets, upholstery, furs, clothing, piano felts and auto interiors against damage by moths, carpet beetles or mildew. The U. S.

Government says, "Moths are present in practically every household. . . . No section of the country seems free from such infestations." **DURAPROOF** not only kills moths and carpet beetles . . . it makes materials non-eatable to both and also protects against mildew. To our knowledge, **DURAPROOF** is the only mothproof service backed by a National MONEY BACK, 4 YEAR WARRANTY.

Easy To Learn • No Overhead Expense

Start Full or Part Time

No experience necessary! Some dealers establish shops or an office . . . others operate from their own homes. At the start you may want to render service yourself. Service may be rendered in homes, offices, hotels, theaters or institutions. Auto dealers buy your **DURACLEAN** Service to revive upholstery in used cars. Foamovator converts to easy carrying case. Almost every building in your territory houses a potential customer needing one or both services.

Repeat and Voluntary Orders

Demonstrations win new customers. Men with **DURACLEAN** Dealerships find **REPEAT** and **VOLUNTARY** orders become a major source of income. Customers are not merely satisfied—many are enthused with results and tell their friends and neighbors. Furniture and department stores and interior decorators turn over rug and upholstery cleaning and mothproofing to **DURACLEAN** Dealers. We show you 18 ways to get new customers.

Two-Way Profit

You enjoy big profits on both materials and labor—after paying service men and salesmen. These are year 'round services for which there is always a constant need. You have National prestige and the cooperation of a National 17 YEAR OLD organization interested in your services. The rapidly growing need for Certified Service makes **TODAY** the ideal time to become the owner of a **DURACLEAN** Certified Service business.

Dealer Comments:

- R. Kimbrough: "Finished First White House of Confederacy and am to **DURACLEAN** Governor's Mansion."
O. D. Heffelbower: "People who have seen the work have expressed amazement."
E. Schalchlin: "Have on hand 5 orders totaling over \$500.00 . . . obtained from recommendations of customers."

EASY TERMS!

A moderate payment establishes your own business. Easy terms permit you to pay balance from your sales. We furnish electric machines, folders, store cards, introduction slips, sales portfolio, demonstrators and enough material to return your **TOTAL** investment. You can have your business operating in a very few days. Mail coupon today! No obligation.

Copyright 1947 by

DURACLEAN CO. 16-2ct Street
Deerfield, Ill.

FREE Booklet

Our first letter and 16 page illustrated booklet will explain everything—the two modern, urgently needed services, waiting market, how business grows, your large profit, easy terms and **PROTECTED** territory.

Send Coupon TODAY!

"OWN a Business" Coupon

Duraclean Co.
Division of HOME SERVICE CO.
16-2ct Street, Deerfield, Illinois

With no obligation to me, send booklet and letter giving full details. Tell me how I may OWN a growing business of my own built upon satisfied customers.

Name _____ Age _____

Address _____

City _____ State _____

**WORLD'S
BEST
WANT AD
MEDIUM**

CLASSIFIED Advertisements



Advertisements in this section 75 cents per word, each insertion, minimum 10 words, payable in advance
To be inserted under proper classification, copy must be in our office the 22nd of the
second month preceding date of issue

F. W. Johnson, Manager, Classified Advertising
Popular Mechanics Magazine, 200 East Ontario Street, Chicago 11, Illinois

1224 CLASSIFIED ADVERTISEMENTS 1224 OPPORTUNITIES FOR YOU

AUTOMOBILES, MIDGET CARS

R & R Mfg. Co., Robert M. Roof, Anderson, Ind., Auto and Marine Division. Complete line of speed and power equipment for hydroplanes, race cars, and midgets. Motor rebuilding instructions and price list \$1.00

AUTO Racing magazine subscriptions. Pacific Speedway News, \$6.00 yearly. National Speed Sport, \$4.00. Illustrated Speedway News, \$4.00. All give complete data midget, big car race results. Sample copy each 50c. Specify publication wanted. Clymer, Dept. A-22, 2125 W. Pico, Los Angeles 6, Calif.

CALIFORNIA Mufflers, speed equipment, doll-up accessories, chrome twin motorcycle pipes. Save freight cost from California. Von Esser's, 2840 No. Kedzie, Chicago 18, Illinois.

REX MAY'S Racer \$3.00. Kun's Auto Racing Book 6th edition just out \$2.00 postpaid. Clymer, Dept. A-29, 2125 W. Pico, Los Angeles 6, Calif.

"SPEED And Mileage Manual - The Original!" Obtain greater speed, mileage, racing performance from any automobile! Large illustrated book gives easiest methods! Simplified speed tuning! Racing secrets! Gas saving tips! Instructions on building speed equipment, economizers, duals, mufflers, heads, superchargers, jet, water injection, fuels, fast conversions, engines, "hot rods." Also, streamlining—customizing—suggestions, photographs! Parts lists! \$1.98. Almqvist Engineering, Box 660-T, Brooklyn 1.

NO. 4 Clymer Historical Scrapbook. Entirely new, different. 224 pages, advertisements, photographs 250 early automobiles, motorcycles. \$1.50, deluxe edition \$2.50 postpaid. Clymer, Dept. A-28, 2125 W. Pico, Los Angeles 6, Calif.

DRIVE A new King Midget, world's lowest priced automobile. We supply all parts ready to bolt together. 45 miles per hour, 90 miles per gallon. Beautiful racer-roadster body. Full accessories, including ski adapters for snow and ice. 24-page assembly book, drawings, photos, blueprints plus detailed illustrated circular \$1 (refunded first order). Circular only 25c. Midget Motors, Athens, Ohio.

BRITISH Cars. New, unique book illustrates, describes 34 British postwar cars, all makes, models. 67 beautiful photographs. A real catalog. Just out. \$2.00, deluxe edition \$3.00 postpaid. Clymer, Dept. A-PW, 2125 W. Pico, Los Angeles 6, Calif.

"VAPO-STEAMATIC"—Water injection. Easily constructed (for less than \$1.00). Finest automatic "moist-humidity" system. Engineering triumph—gets up to 33 miles per gallon! Reduces wear, sludge. Tremendously increases horsepower. Acceleration! Eliminates ping, carbon, overheating. Smoother engine. Copyrighted, fully illustrated "Installation-Handbook," including additional "injection-conversions" covering tractors, airplanes, motorcycles. \$1.00. Newhouse Industries, 5941-B Hereford, Los Angeles 22.

BRITISH Sports cars. New book. 96 makes described. Fine illustrations, specifications. \$2.00, deluxe edition \$3.00 postpaid. Clymer, Dept. A-27, 2125 W. Pico, Los Angeles 6, Calif.

1948 SUPERIGNITIONER Atomic starting, pep, mileage, \$5.50. 13 improvements \$1.00. EG Mfg. Co., New York 55.

STOP Watches. 15 Jewel Elgins. \$9.95. Write for free brochure. Propar Distributors, Box 275A, San Antonio, Tex.

RACING Equipment and doll up accessories. Hi-compression heads, dual intake manifolds, fender skirts, spotlights, dual mufflers for Ford and Mercury, single mufflers for all cars, chrome station wagon stacks, air horns, racing cam shafts. Everything to make your car fast. Everything to make your car sharp. Write today. Bill J. Jones, 2300 S.W. 29th, Oklahoma City, Okla.

INTERCHANGEABLE Parts book. New book tells every automobile part that interchanges with others. Same parts many times vary 100% in price. This book enables garages, mechanics, dealers, owners to buy under cheapest listing. Tremendous savings for users. \$15.50 postpaid. Clymer, Dept. A-IP, 2125 W. Pico, Los Angeles 6, Calif.

"1948" CUSTOM Styling Manual. Easily make car look Hollywoodized, custombuilt, ultra-beautiful! Latest customizing, restyling, streamlining methods simplified for all cars. 100 photographs, illustrations, instructions—also, model changes, accessories, mufflers, engine "hop-up" specifications! \$2. Almqvist Engineering, Box 660-T, Brooklyn 1.

BRITISH Motor industry. A review 1896 to 1946. 176 photographs, charts, drawings. Names, addresses all British manufacturers. Contains everything pertaining to British auto industry. Old and new cars shown. 52 large pages. \$1.50 postpaid. Clymer, Dept. A-BM, 2125 W. Pico, Los Angeles 6, Calif.

BUILD Speedy midget track racer from castoff parts! Plans, specifications, construction information, \$1.00. Motor Supply, Box CS-1632, Toledo, Ohio.

HIGH Compression heads. V-8. More speed, acceleration, power. Offenhauser or Edlebrock \$75.00 complete set. Dual manifolds complete with throttle kit, fuel lines. Edlebrock \$49.00, Offenhauser \$55.00. Give make, model V-8, Catalog 10c. Clymer, Dept. A-23, 2125 W. Pico, Los Angeles 6, Calif.

MODERNIZE Your car with push-button controlled parking brake! Illustrated instructions \$1. Chas. Gates, 303 Ross, Pecos, Texas.

KAISER-FRAZER. Floyd Clymer's new book (no connection with Kaiser) gives uncensored, impartial report 3000-mile test including Pike's Peak, Kansas City-Denver record runs, economy test. Part by part equipment analysis. Good, bad comments, no punches pulled. \$1.50 postpaid. Clymer, Dept. A-21, 2125 W. Pico, Los Angeles 6, Calif.

BUILD Your own plastic automobile body. Repair your present automobile doors, fenders, body with laminated plastics. Details \$1.00. Refundable. Rawley Engineering, 2712 N. 37th St., Milwaukee 10, Wis.

AUTO Repair manuals, by Victor Page. Complete non-technical data all mechanical features, operation, repair. Ford V-8 cars, trucks, 823 pages, 369 illustrations. \$3.50 postpaid. Chevrolet six and truck, 896 pages, 363 illustrations. \$3.50 postpaid. Clymer, Dept. FC-1, 2125 W. Pico, Los Angeles 6, Calif.

FROM Speedway to roadway! Track-proved hi-speed heads and manifolds now available for passenger cars! No special tools needed! Increase horsepower 25%! Astounding getaway! Free illustrated catalog. Speedsport, 5747H Waveland, Chicago 34.

BUILD Automatic clutch, scooters, midget autos, tractors, shop machines. Catalog free. Nichols Equipment Co., Dept. 711, Purvis, Miss.

RACE Driver History. Complete information every driver competing Indianapolis "500." 1911 to present. 313 drivers performance records every year alphabetically arranged. \$1.50 postpaid. Clymer, Dept. A-RD, 2125 W. Pico, Los Angeles 6, Calif.

12 1/2"x4 1/2" AIRPLANE Tire, tube, wheel. Others. Department Two B, Post Office Box 89, Merced, California.

HOT-ROD Manual, fast Fords, photos, instructions, \$1.50. Airmailed \$1.75. Racing parts list 25c. Hollywood Hot-Rod, Los Feliz, Box 9626P, Hollywood 27, California.

DUALTONE Chrystaline packed, California mufflers, single or twin for all automobiles. Carburetor velocity stacks. Compression cylinder heads. Dual manifolds. Large double or single chromed tailpipe extensions. Chromed station wagon stacks. Fender skirts. Request catalogue. Dualtone Mufflers, 2636C India Street, San Diego 1, California.

1947 INDIANAPOLIS Race History. Enlarged, 56 pages, 125 photographs, charts, complete details cars, drivers, specifications. \$1.00 postpaid. 320-page Indianapolis history book 1909 to now \$3.50, deluxe edition \$5.00 postpaid. Clymer, Dept. A-20, 2125 W. Pico, Los Angeles 6, Calif.

AUTOMOBILE Racing, Sixth Edition, 100 illustrations. Working drawings with building instructions for Ford-60 midget, California roadster, Offenhauser racer. Details on racer parts. Sample entrance blank. World's record 158.5 m.p.h. rear engine four-wheel drive car. Interesting information for fans, drivers, mechanics. \$2.00 postpaid; \$2.25 c.o.d. Ray Kuns, Department 63, Cincinnati 27, Ohio.

CUSTOMIZE Your automobile! Revised, enlarged book, latest restyling, complete, sharp. 50 photographs! \$1 pp. Post Publications, Box 723-SE, Arcadia, California.

CHROME Air horns—For all makes of automobiles. Send for free literature. Protected Company, 4033A Windsor #1, Youngstown 7, Ohio.

CUSTOM-CAR Photograph album. Fascinating automobile style classics. Coachcraft, Summers, independents, photo-packed! \$1 pp. Post Publications, Box 723-AE, Arcadia, California.

MAKE Your Ford fast! Complete details, photographs. How to construct 120 m.p.h. Hotrod. \$1 postpaid. California Bill, Box L-1, Eaglerock, Los Angeles 41, Calif.

AUTOMOBILE Racing book, fifth edition, well illustrated. Instructions on building bodies, frames, engines. Ford A and B conversions. Plans, AAA rules, specifications. Roadster racing, Indianapolis cars. \$1.00 postpaid, \$1.30 C.O.D. Ray Kuns, Dept. 47, Madisonville, Cincinnati 27, Ohio.

CLYMERTONE, Twin muffler sets, beautiful sound, complete with necessary welded pipes, E-Z installation. Ford V-8, \$20.00. Chevrolet set with split manifolds, \$37.50. Specify car model. Clymer, Dept. A-24, 2125 W. Pico, Los Angeles 6, Calif.

USED-CAR Buyer's Handbook. Save dollars, grief. Photographs, dealers' tricks, complete tests. \$1 pp. Post Publications, Box 723-TE, Arcadia, California.

PROFESSIONAL Midget racer, motor-scooter, midget roadster, and midget motorcycle. Plans, specifications for all four contained in illustrated handbook, 25c. Big list bargain priced used motors, motorscooters, servicycles, etc., included free! Midwest, 3839 Drummond, Toledo, Ohio.

INSTALL V-8 engine in your Model A for extreme acceleration, more top speed, smoother performance. Complete details, photographs. \$1 postpaid. A-V-8, Box L-1, Eaglerock, Los Angeles 41, Calif.

MAKE Your Model "A" do 100 m.p.h. Lightning acceleration, breath-taking top speed. Complete details, photographs. \$1 postpaid. Four Barrel, Box L-1, Eaglerock, Los Angeles 41, Calif.

AUTO SUPPLIES AND EQUIPMENT

HEAT Booster. Raises temperature of water entering your hot water heater. Aluminum casting bolts to exhaust manifold. Cuts down warm-up time, increases heat, solves problem for sluggish heaters. Specify make and model. Russell Machine Co., 416 Scribner, Grand Rapids, Mich.

JEEP Plans. Station wagon body \$1.00. Diesel conversion water injection \$1.00. Illustrated circular 20c. Craftsman Books, Box 1153, Milwaukee 1, Wis.

SPEED And Power Handbook—Construct own superchargers, water injectors, compression heads, fuel saving devices! Get racing speed, acceleration, dynamic power increases from any car. Mileage tips! Speed secrets, ignition tuning! Hot-rods! Carburetion tricks. Fuels! Including "Restyling Ideas"—Streamlining, model re-vamping! Customizing. Accessories! \$1.98. Newhouse Industries, 5941-B Hereford, Los Angeles 22.

BATTERY Men—We have plates, cell groups, parts and tools. Battery Parts Distributor Co., 1311 Widener Bldg., Chestnut and Broad Sts., Philadelphia, Penna.

CONVERTIBLE Owners—Get that "New Look." Put one of our easily-installed ready-made tops on your convertible. Directions and all necessary trim included. Choice of tan or black first quality material. State car make and model. One price—\$39.50. Rio Top Company, 1370 Roanoke Ave., Newport News 1, Virginia.

OIL Pumping motors—Brought back to normal without ring job. Send address on postcard for free details. Mullner Co., Box 3102, St. Paul 1, Minn.

"SPEED" Handbook—Shows how to easily speed up stock automobiles! Simplified "tuning" includes instructions on building speed equipment, fast conversions, engines, "hot-rods," superchargers, mufflers, heads, fuel formulas, water injection. Racers, midgets, boat, roadsters—Racing secrets, data, photographs, parts lists, etc! \$2.00. Almquist Engineering, Box 660-T, Brooklyn 1.

AUTOMOBILE Glass! Rubber mats! Shock absorbers! Lowest quotations. Special! Ford, Chevrolet, 1933-47, rubber jute backed mats: \$3.75. Cooper's 3135 Lawrence, Chicago 25.

WELDING Bodies, repairing fenders pays good profits. Easy with Hobart A. C. Welders. Catalog free. Write Hobart Welders, Box M-282, Troy, Ohio.

GASOLINE Saving vacuum supercharger \$12.50. Self addressed stamped envelope for pamphlet. McDowell, 2000 NE. Union, Portland 12, Ore.

STOP Automatic choke trouble with Redex hand choke adapters. \$3.00. Details. Redex Co., 1301 Ridgeway, Rochester 13, New York.

AUTO Parts. New or rebuilt. Prompt shipment. Write requirements. Save money, buy direct. Factory Warehouse, Mechanics Auto Parts, 3807-PM North Ashland Ave., Chicago 13.

SENSATIONAL Seat covers. Jobber's discounts. Mono, 6545 Santa Monica Blvd., Hollywood, Calif.

AUTO Parts for all cars, transmissions, motors, differentials, fenders, carburetors. Security Auto Parts, 1923-PM Grace, Chicago 13.

EASY Starting at 30 below with Hove Spark Plug extensions. Keep plugs dry. Six cylinder set \$2.00, 8 cylinder \$2.50 prepaid. Specify make and model car. Hove Engineering Company, Minneapolis 4, Minnesota.

BURN Water in your car. Costs less than gas. More power. Cleaner motor. Mail card for data on \$17.50 Octa-Gane Water Injecting Carburetor. Advanced Automotive Products, 563-2 Lake Road, Webster, N. Y.

GRILLES For all cars. Meyers Auto Parts, 820 Dryades, New Orleans, La.

NEW And used automobile and truck parts. Lowest prices. Complete stock. Prompt reply. Babbitt Auto Parts, 2833 W. Chicago Ave., Chicago 22.

PLATING Outfits for auto parts. Connect to a battery. No tanks used. Free particulars and proofs. Gunmetal Co., Ave. J. Decatur, Ill.

AUTO TRAILERS

TRAILER Plan booklet—House, sport, etc. with complete parts, accessory catalogue and book, "Trailer Building" \$1.00. Marine Mart, Buffalo 7b, N. Y.

COMPLETE Foundation for trailer. Chassis frames, Tor-Q-Les axle, spring-wheel assemblies, hitches, tires, tubes. Order complete unit or specify items. Request literature. General Trailer Company, 412 South Barstow St., Eau Claire, Wisconsin.

AIRPLANE Tires 6, 8 ply. Department BE, Post Office Box 89, Merced, California.

STREAMLINER Trailer. 17 ft. plans manual \$1.00. Circulars. Illustrated trailers to 27 ft. 20c. Craftsman Books, Box 1153, Milwaukee 1, Wis.

TRAILERCOACHES—Learn about all types; sports, living or travel. Approximately 100 pages monthly; magazine tells all. Special rate, \$1 the year in U. S., \$1.50 to Canada, \$2.00 foreign. Trail-R-News, Box 431-A, Glendale, California.

BUILD Your own trailer! Save money! Have every feature you want! Plans for house, sport, camp and utility trailers. Catalog describing 9 models 10c. 15c in Canada and overseas. Jim Dandy, Box 125-A, Wausau, Wisconsin.

MOTORCYCLES, BICYCLES, MOTOR-SCOOTERS AND SUPPLIES

NEW! Motorcycle seat covers, bright colors, molded cushions, \$6.75. Chrome seat springs, fit British machines, pair \$6.75. Finest leather jackets, \$36.95. Free folder! Pacific Cycles, Dept. A3, 1208 Pine, Seattle, Washington.

INDIAN And Harley parts catalog 15c. Pistons, motor parts, batteries, tires, chrome accessories. Bootz, 622 East Grand, Des Moines 9, Iowa.

SCHWINN Bicycles. All sizes. Send dime for list. Century Cycle, 3447 Lawrence, Chicago 25, Illinois.

AUTO-PED Motorscooter \$10; midget racer less motor \$14; midget track racer, new motor \$65; Indian '45 motorcycle \$45; Indian Chief \$40; Harley single engine \$4; Whizzers \$30 up; 4500 small tires \$1 up. Mailorder only. Plenty brand new and surplus gasoline engines, motorscooters, midget cars. Send 25c for Big War-Bargain Catalogue Number 23, just out, listing the above and over 400 other bargains in motors, motorscooters, midget racers, parts, plans, etc. (35c by first class mail.) Midget Motors Directory, Athens, Ohio.

T. T. Racing. New exciting, accurate book of world famous English road racing history. Just printed. \$3.00 postpaid. See our advertisements under autos. Clymer, Dept. TT-1, 2125 W. Pico, Los Angeles 6, Calif.

MIDGET Automobile \$15, Cushman motorscooter \$20, Indian motorcycle \$30, tires 75c. Send 25c for Spring catalog #940 listing sensational bargains in motorscooters, Servicycles, midget cars, used motors, parts. Associated, Box CS-1764, Toledo, Ohio.

MOTORCYCLE Pistons and parts, new, used. Harley, Indian, Henderson, Super-X. List 10c. Ballak, 811 N. 9th, St. Louis 1, Mo.

MOTOR Scooters, bicycle engines. 120 miles gallon. Dime for catalog. Clymer, Dept. A-25, 2125 W. Pico, Los Angeles 6, Calif.

RACE Cars, Whizzer motorbikes, motorcycles, scooters. Parts for "hot rods." 25c in coin. Behnke's, 5721 Leland, Chicago 30, Illinois.

MIDGET Racer \$40, Cushman motorscooter \$15, motorbike outfit \$15, Harley-Davidson motorcycle \$35. Send 25c for new catalog #12 listing amazing bargains in motorscooters, motorbikes, midget cars, motors, parts. Gall, 538 Erie, Toledo, Ohio.

FLAT Rate Repair Manual for Harley-Davidson. Gives flat rate charge for every operation. Every dealer, owner, mechanic needs this new book. \$2.00 postpaid. Clymer, Dept. A-PR, 2125 W. Pico, Los Angeles 6, Calif.

EXPERT Rebuilding of racing and stock motorcycle engines. Largest stock of parts and accessories in middle west. Write for details. Bernardi Cycle Co., 1214 Jackson Blvd., Chicago 7, Illinois.

HARLEY-DAVIDSON Supplies, parts, accessories, oil service, tires all sizes, repaired 45" motors. Send \$2.25 for Army Motorcycle Manual, 10c for bulletin. Knuth's (Harley-Davidson Dealers), 2491 Fondulac, Milwaukee, Wis.

MOTORCYCLE News, monthly. Yearly subscription \$1.00. Latest worldwide information. Motorcycle News, 5424-A Sawyer, Chicago 25.

CHROME Plating on all motorcycle parts. Doll up your bike. Free literature. Master Silverplaters, 2031 Caniff Ave., Detroit, Michigan.

BICYCLE Supplies, wholesale, retail. List, 10c. Universal, 4713 Virginia, St. Louis, Mo.

HARLEY-DAVIDSON Parts, accessories, batteries, and tires. 24 hour service. Authorized factory dealer. Philadelphia Harley-Davidson Company, 857 North Broad Street, Philadelphia 23, Penna.

WHEELS! Build wagons, scooters, mowers, trailers, wheelbarrows, grocery carts, baby carts, play pens, baby carriages. 4" to 16". Free list. Truelsen Mfg. Co., 811 E. 31, Kansas City, Mo.

TIRES And industrial wheels, suitable for scooters, wheelbarrows, farm equipment, etc. All sizes. Bicycles and accessories. Largest assortment in America. Send dime for list. Cycle Transport Company, 1241 So. Michigan Ave., Chicago 5, Illinois.

BUILD America's lowest priced motor-scooter speedster! Complete plans, specifications, \$1.00. Big list bargain priced used motors, etc., included free! Motor Supply, Box 1682-CS, Toledo, Ohio.

LARGE Stock Indian parts. Expert motor rebuilding. New and rebuilt Chief motorcycle, motors only. Indian Motorcycle Sales, Kansas City 1, Mo.

AVIATION

PROPELLERS For sleds, air-boats, Cat-planes. Lowest prices. Box 2256, Fort Worth, Texas.

AVIATION "Quiz System" famous "Sweng" books with authentic "Multiple Choice Examinations" include: Flight instructor \$3.00; private and commercial (two books in one) \$3.00; A & E mechanic \$3.00; flight engineer \$4.00; Our "war surplus" releases include: Airforce Fairchild sextants \$12.50; Bausch-Lomb \$29.75; aerial cameras \$175.00; Elgin stop watches \$7.50; Astro Compasses (good) \$8.75, new \$12.50. (Free folder.) Pan American Navigation Service, 12021-C Ventura Blvd., N. Hollywood, Calif.

LIGHT Plane blueprints, manuals. Circular illustrates designs, motors, 20c. Craftsman Books, Box 1153, Milwaukee 1, Wisconsin.

PROPELLERS For sleds, air-boats. Catalog 10c. Banks-Maxwell, R.F.D. 7, Ft. Worth.

"JETS" How they work, latest planes and engines, manufacturers, how to get into this new exciting field. \$1.00 p.p. Engineering, P.O. Box 195, Lexington Park, Maryland.

JET Propulsion experiments. New design. Drive bicycle. Circular on plans. Rush name. Maupin, Tipp City 6, Ohio.

AIRPLANE Hydraulic pump, (gear), 1000 psi, new, \$9.95, Relay, \$1.00, 3 for \$2.00. Micro switch, \$1.00, 3 for \$2.00. Toggle switch, 3 for \$1.00; 7 for \$2.00. Throat microphone, \$1.00, 3 for \$2.00. Radio headphones, \$1.50 (rubber earcups), 3 for \$3.00. Manifold pressure gages, \$4.95. Airspeeds, \$4.95. Aero Instrument Company, Municipal Airport, Houston, Texas.

PROPELLERS—2 And 3 blade for snow-ice sleds, boats. Catalog. Standard Aero-craft, Box 387, Ft. Worth, Texas.

VETERANS: Flight training under the G. I. Bill. Tuition paid. Private, commercial, flight instruction, instrument and multi-engine ratings. Opportunities to work for living expenses or tuition, if not a veteran. Write Gottschalk School of Aeronautics, Adrian, Mich.

GET Into aviation! Train now at this Lincoln Aviation Institute for responsible position with an airline, aircraft factory or private airport operator. Good jobs open! Big money paid! We assist graduates in locating positions. Write today for information to Registrar, Lincoln Aviation Institute, Union Air Terminal, Lincoln, Nebraska.

GIANT Glider kites. Double, 14x10 ft. Lifts 100 lbs., tows car, etc. Cost government \$108. Yours for \$20. Satisfaction guaranteed. Great Northern Mart, North Adams, Mass.

BATTERIES, GENERATORS

BATTERIES (Aircraft) metal cases and covers. New 24 volt, 17 amp. hr. convertible to 12 volt, 34 amp. Weight 52 lbs. \$7.95. New 24 volt, 11 amp. hr. convertible to 12 volt, 22 amp. Weight 34 lbs. \$6.95. Original value \$75.00 each. Non-spillable vents. Terminal box attached. Shipped dry. Wonderful bargain. Supply limited. Send check or money order. Silver Creek Precision Corporation, Silver Creek, N. Y.

ELECTRICAL SUPPLIES, EQUIPMENT

LAMPS—If you build or repair and have trouble finding parts—your search is ended! We carry practically every part necessary. Harps, finials, vase caps, etc. Illustrated catalog 10c. Gyro Lamps, 5416P Clark, Chicago 40.

BURGLAR Alarms and parts. Installation instruction free. Marchewicz Electric, 418 Pokagon, South Bend 17, Ind.

TATTOOING Machines, outfits. Free catalogue. Jensen, 120 West 83rd Street, Los Angeles 3.

ELECTRIC Pencil—Writes, engraves all metals. No transformer or batteries to buy. Complete 110 volts \$2.95. Reb Industries, Dept. 265-DE, Elmhurst, Ill.

SIGNALLING Light—New. Gov't surplus. An exceptional value for boats, construction work, scouting, etc. Powerful light with three filters and case, at a fraction of cost. Operates on 27 volts or 110 volts with transformer. While they last \$7.95; three for \$20. "Amazing Bachman's," 25 Herman Street, Rochester 5, N. Y.

SELSYN Motors—For remote control. Bendix, 115 volts 60 cycles; powerful. Pair \$9.75, shipped express collect. 8" retractable airplane landing lights, motor driven, 250 watts, 24 volts, \$3.95 each. Burgess, Box 168, Ferguson, Mo.

BUILD Your own or electrify old clocks for fun and profit. Genuine self-starting Synchron movement complete with hands. \$4.95 prepaid. Scott Industries, Dept. P, Box 373, Coral Gables 34, Florida.

ELECTROPLATING Has a thousand and one uses when working with electrical supplies and equipment. Warner Electroplaters permit you to easily plate chromium, gold, silver, nickel, copper, etc. Plating equals costly commercial jobs. Pay for your electroplater in a short time by plating for others at a profit. Write today for free sample and literature. Warner Electric Co., Dept. ES-2, 1512 Jarvis Avenue, Chicago 26, Ill.

LAMP Parts, electrical repair parts, wiring supplies. New wholesale catalog 10c. Gearon Company, 6405 North Oakley, Chicago.

SAVE Money. Electrify your sewing machine. Complete kit \$19.95. Send money order. Radio Mail Order, 4613 188 Street, Flushing, New York.

25 USED D. C. 110 and 32 volt motors, 1/8 to 2 H. P. Edward Hindahl, Mason City, Illinois.

UNUSUAL Gov't surplus item—Airplane lights. New. Ideal for boats, for path clearance, signal or flashing. Excellent for road trucks, busses, construction night work, has powerful beam. Operates on 27 volts or 110 volts with transformer, complete with powerful motor to rotate beam. A value of a lifetime! Two complete units to a set. Now! \$19.50 set; three for \$50. "Amazing Bachman's," 25 Herman Street, Rochester 5, New York.

SENSATIONAL Photo electric relay. Operates household motors, appliances with interruption flash light beam. Kids can make it with simple picture diagrams. 25c each. Sandoz and Son, 46 Elmwood Ave., Dayton, Ohio.

AMAZING Communication unit! Remote controlled to send messages house to barn, to shop, etc. Communicate with dad working in the garage or junior in the attic. Contains two identical set-ups with buzzers, lights, remote control transformers and dial with codes. Operates on regular house current, ready to operate, simple to connect. Unlimited uses. Only \$14.95; three sets for \$40. "Amazing Bachman's," 25 Herman Street, Rochester 5, N. Y.

FREE Catalog—Motors, welders, welding supplies, generators, fencers, electric mowers, freezers, other electrical items. LeJay Company, Minneapolis, Minn.

ALNICO Magnets, free list. Terry Sales Company, 3726 South Detroit Avenue, Toledo 9, Ohio.

ELECTRIC Pencil: Engraves all metals. \$1.00 postpaid. Beyer Mfg., 229-H Dixon Uniontown, Penna.

BUILD Your own lamps. Save half. Free photos. Buddy Products, Dept. 30, 1123 Belmont, Chicago, Ill.

VOLTAGE Regulators. Autolite, silver contacts and large radio filter. Like new condition. Original cost \$140.90. Price \$5.95 prepaid. Also new Delco Remy regulators. Platinum contacts. \$8.95 prepaid. Both 24 volt, 50 amp. State Ignition, 2521 Indiana, Chicago 16, Ill.

BOOKS—All Kinds—Homecraft, Radio, Plastics, Boat Building, Photography, Model Building. Catalog free. Popular Mechanics Press, 200 E. Ontario St., Chicago 11, Ill.

WELDING, SOLDERING, PLATING

WELDERS!—New portable Champion special transformer welder; 110/220 volts, a.c. 8 heat stages. Welds, brazes, solders, cuts all metals. Complete with electrode holder, helmet, rods, carbons, fluxes, cables. Also special flame weld torch. Easy to use. Full directions. Splendid for shop, farm and home repairs. Guaranteed. Only \$27.50. Money back guarantee. Also resistor model, now \$14.95. Magic Welder Co., 239 MP Canal St., New York, N. Y.

BUY Direct from factory. Welding outfit \$48.36. Soldering outfits \$7.76 to \$10.16 complete prepaid. Box 331, Hamilton, Ohio.

AIRPLANE Wheels complete assembly with tires as used on plane. Department One B, Post Office Box 89, Merced, California.

ELECTROPLATING Has a thousand and one uses. Warner Electroplaters permit you to easily plate chromium, gold, silver, nickel, copper, etc. Plating equals costly commercial jobs. Pay for your electroplater in a short time by plating for others at a profit. Write today for free sample and literature. Warner Electric Co., Dept. WS-2, 1512 Jarvis Avenue, Chicago 26, Ill.

ELECTRIC Welder also pencil—Make yourself for \$1.00. Information free. "International," 6347 Parnell, 33, Chicago 21, Illinois.

SILICON Steel strips 30"x2"-5". E. Noyes, 32328 Brush, Royal Oak, R5, Mich.

NEW D.C. welders (air craft lighting generators)—War surplus; only \$47.50! Original cost \$250.00. Includes new rheostat, used cable, used Duro electrode holder, used scalling hammer, blue print to build resistor coil. Model R. 2, manufactured by Jack & Heintz, 30 volts, 300 amp. d.c., shipping weight 68 lbs. Size 16"x7". New Westinghouse P. 1 generators, d.c. 200 amp, 28 1/2 volts, cost \$150.00, price \$25 each. Immediate shipment. Check with order. Greer, 460-A South State Street, Chicago.

"BUILD-UR-OWN" Portable arc welder. Save \$300. Easy with Hobart generator plus auto engine. Free instruction book. Write Hobart Welders, Box M-283, Troy, Ohio.

WELDING Supplies—Electric and gas. 1/16" rod 15c doz., 3/32" 25c doz., 1/8" 30c doz., Carbons 1/4" 15c ea., 3/8" 25c ea. Welders gauntlet gloves \$1.95 pr. 110 volt welder complete \$17.85. New govt. surplus helmets with 3 lenses, \$3.85 ea. Gas welding outfit, complete \$57.00. Complete stock welders clothing, Sweeney, 7241 S. Halsted, Chicago 21, Ill.

A.C. Welders, 110 v. welds 1/2" steel. \$29. Morris Welding Service, 1850A State St., Schenectady 4, N. Y.

OXY-ACETYLENE Welding outfit including: Full oxygen and acetylene cylinders, \$72.95 complete, f.o.b. Cleveland, Ohio. New, supply limited. Check or deposit with order, balance c.o.d. Cylinders can be refilled anywhere. Ideal for hobbyists, garages, repair shops, etc., includes supply of rod. The Burdett Oxy-Weld Equip. Co., 3399 Lakeside Avenue, Cleveland 14, Ohio.

OXY-ACETYLENE Welding and cutting outfit complete with cylinders and carrying case. Designed especially for hobby-shops, small repair shops, refrigeration and electrical service men. You own the cylinders. Free literature. A-A Welding Supply Co., C9228 S. Ada St., Chicago 20, Ill.

30 AMP. Selenium plating rectifiers with Powerstat control, \$85.00. Lead lined tanks, geared motors for agitation. Complete line of bronzed baby shoe mounts. Hollywood Bronze Supply, 1770 N. Vermont, Hollywood 27, Calif.

MACHINERY, TOOLS AND SUPPLIES

WAR Surplus special: Big 50 lb. box popular size bolts, nuts, washers, screws, clamps, etc. \$6.85. War Surplus Co., Box 910, New Brunswick, N. J.

GEARS For inventors, experimenters, model makers, schools, work shops, laboratories, etc. Government surplus made of brass, bronze, dural steel and stainless steel. 12 matched pairs; 24 gears, bevel, spur and ratchet. List price \$12.00, our price \$2.50. 25 matched pairs; 50 gears, includes larger gears, also sets of worm gears. List price \$30.00, our price \$5.00. Limited quantity. Order now. Write for our bulletins on ball bearings, rectifiers, relays, selsyns, horns and government surplus materials MET Exchange, 323 Canal Street, New York.

SANDING Belt—Make your own. Inst. 40-220 grit; garnet or aloxide. 25 ft. 4" \$1.98, 6" \$2.50. Modern Products, 3919 S. S. St., Erie, Penna.

MACHINE Tool castings for woodworking and metalworking tools. Machine them yourself, save up to 80%. Catalog describing 23 Lewis tools and projects sent for 10c. Lewis Machine Tool Co., 3217 Union Pacific Avenue, Dept. M, Los Angeles 23, California.

SALVAGE Tools, high speed steel drills, bits, cutters. List with sample drills 15c. J. Dickey, Newfield, New York.

100 ASSORTED Scissor screws \$6.50. Scissor screw wrench \$2.50. Overland Saw Service, Independence, Iowa.

BEECO—The machine that sharpens lawnmowers like new. 4148 Cornwall, Berkley, Michigan.

TAPS, Dies, tools and supplies. Buy direct by mail. Free catalog. King Tap & Tool Co., North Attleboro, Mass.

REVOLUTIONARY Power tool saws or files with hand drill. Distributors wanted. Dongerson, Georgetown, Colorado.

HI-SPEED Drills, 25 piece assortment, number and fractional sizes to 1/4" \$2.00, to 3/8" \$3.00, to 1/2" \$5.00. H.S. tap assortment 10 for \$3.50, all sizes 1/4" thru 1/2". Decimal chart with orders. Lampke Surplus Tools, 11607 Linwood, Detroit 6, Mich.

HARDWARE, Tools, taps, dies, drills, pattern supplies, castings, electrical equipment, brass, steel, drill rod. Catalog 5c. Terek, 6304 Patterson, Chicago 34.

ANYONE Can sharpen saws using the Teeho-Tool! New 25c model. Write, Teeho, 316 North 2, Maywood, Illinois.

FOOT Switch—Operates all power tools. Guaranteed. \$3.95, or two for \$6.49. Reb Industries, Dept. 265-DC, Elmhurst, Illinois.

AIR Compressors. Dealers wanted to introduce the new Betco line for service stations, garages, shops and paint spraying. For particulars, write Betco, 619 North Broadway, Oklahoma City, Oklahoma.

BALL Bearings one-fourth list price. Free list. Burgess, Box 168, Ferguson, Mo.

MODELMAKER'S Miller—\$49.50. Screw-cutting lathes. Bulletin 10c. Machinery, Newfane 2, Vermont.

SURPLUS: Vickers hydraulic speed transmission—provides smooth stepless speed change from zero to maximum output r.p.m. in either direction without reversing input. Readily adaptable for hoists, lathes, presses, etc. Special \$28.75. Delta Sales, 738 Kirby, Shreveport, Louisiana.

QUICK-CHANGE Gear box for South Bend, Logan, Powerkraft, Clausing and Sheldon. Aluminum castings, needle bearings throughout, heat-treated shafts and steel gears. Will cut 48 different threads. Variable power feeds. Easily installed. Guaranteed. \$62.50. Monge Machine Shop, North Chicago, Illinois.

ELECTROPLATING Has a thousand and one uses when working with machinery, tools and supplies. Warner Electroplaters permit you to easily plate chromium, gold, silver, nickel, copper, etc. Plating equals costly commercial jobs. Pay for your electroplater in a short time by plating for others at a profit. Write today for free sample and literature. Warner Electric Co., Dept. MT-2, 1512 Jarvis Avenue, Chicago 26, Ill.

MODERATELY Priced. Available now. Portable electric sander, woodworking power tools, shaper, bandsaw, etc. Paint sprayers, Armand grinder for schools, home work-shops, cabinet-makers, farmers, garages, repair shops, others. Postcard brings free bulletin. H. Saltzman Co., 118-14 83rd Ave., Kew Gardens 15, N. Y. Dept. S.

DRILL Grinder for twist drills \$2.95. See ad on page 266.

SHEBEL Saw filer. Files all saws. Circular. A. P. Shebel, 730 B. So. 2nd St., Milwaukee 4, Wis.

HOME Lathe owners—Build your own attachments. Send for photograph, sample of work and list of blueprints. Cut gears, ratchets, etc. Make neat screws easy way. The Home Shop, 415 Raymond Ave., Glendale 1, Calif.

MACHINE Shops, garages, machinists, home craftsmen, hobbyists. Get our prices on tools, supplies. Catalogue 10c. Refunded. Precision Tool Service, Dept. M, 55 E. Washington, Chicago 2, Illinois.

FOR Sale—Keyway machine, use in electric drills, real machine tool, cuts 1/8 to 3/4 inch keyway. Seventy five dollars postpaid. Distributors wanted. Holt Equipment, Independence, Oregon.

DRILLS—Taps reconditioned, up to seventy-five percent off list. Send for free circular just published. Perry Screw and Bolt Corporation, 4250 Grand-River, Detroit 8, Michigan.

MECHANICS. Machinists, hobbyists—Amazing dual-drive assembly, geared 7 to 1 reduction, is driven by powerful 1/5 h.p. a.c. or d.c. motor, operates on 6-27, or 110 volts with transformer. Simple standard attachments convert this amazing unit into a dual, hand or table drill, polisher, buffer, router, sander, countless other uses. May be used as individual drill, sander, etc., by detaching flexible drive shaft. Complete with step down transformer, worth half the investment; which can also be used to convert nearly all aircraft motors to regular house current. \$300.00 value! While they last, \$19.50. No c.o.d. "Amazing Bachman's," 23 Herman St., Rochester 5, N. Y.

FOR Sale—Anvil, ideal for garage work or hobby shop, weight 22 pounds, six dollars postpaid. Holt Equipment, Independence, Oregon.

"WAR Surplus" bargains! All new! Flexible drive cables! Three sizes, 10"; 25"; 72". Over \$5.00 value. Combination offer of all three sizes, \$1.75. Precision built right angle drives. Complete with flexible drive cables. Only \$3.50. Magnet wire 1/2 lb. coils No. 22, 10 rolls for \$3. 27 volt geared head (120 r.p.m.) motor \$30.00 value; all new; special \$2.95. Bushings and spacers, all new, aluminum and steel. 25 variety assortment. Special! Minimum 5 pounds \$4.75. Bolt and screw assortment; over 50 varieties. Special! 5 pound \$4.75. Rivet assortment, copper, steel, aluminum, over 250 varieties. Extra special! 5 pound minimum \$4.75. Micro switches; new; 6 variety assortment. \$15.00 value, only \$4.75. Order today! No c.o.d. "Amazing Bachman's," 23 Herman Street, Rochester 5, N. Y.

CONCRETE Block machines \$39.50 up. Catalog free. Concrete Machine Company, 5466 Gravois, St. Louis 16, Missouri.

DRILL Grinder—Grinds drills to factory accuracy. Calipers with direct reading scales. Circle cutters. New Tool grinder. Lowest prices. Free literature. Factory, 811-B East 31st, Kansas City 3, Mo.

ENGINES, MOTORS, DYNAMOS

MOTORS. Electric, new, guaranteed, 1/4 h.p., 1725 r.p.m., 115 volt, 60 cycle, a.c. split phase \$18.75; capacitor \$22.75. Prices f.o.b. St. Louis, Missouri. Shipment c.o.d. or 5% discount if payment accompanies order. The Delton Company, P.O. Box 668, St. Louis 1, Missouri.

MOTORS. New d.c. electric motors, approx. 1/6 h.p.; speed 10,000 r.p.m. Equipped with gear reduction head and two 3" diameter sprockets. Speed at sprockets 135 r.p.m. Battery operation 6 to 27 volts, intermittent duty. Weight 5 lbs. Operates a.c. with step-down transformer. Unlimited uses. Original cost \$49.00. Closeout \$4.95. Limited quantity. Send check or money order. Silver Creek Precision Corp., Silver Creek, N. Y.

1/4 H.P. New capacitor motors 110 v.; 1725 r.p.m. \$18.75; 1/2 h.p. heavy duty ball bearing \$32.50. Stern Elec., 441 N. LaSalle St., Chicago 10, Ill.

INVALUABLE Collection of diagrams and instructions for motor winders. Jednak, 107 Island Ave., McKeesRocks, Penna.

ENGINE Sale. New Briggs-Stratton air-cooled engines, 2 1/4 h.p. \$82.00, 3 1/2 h.p. \$99.00. Prepaid. American Warehouse, Pueblo, Colorado.

GAS Drive arc welders. "Build your own." Portable, goes everywhere after profitable jobs. Free instruction book. Write Hobart Welders, Box M-284, Troy, Ohio.

1/4 H.P. Split phase, 110 volt, 1750 r.p.m., alternating current washing machine or general purpose motors, \$19.50 each. 1/2 h.p. per capacitor 110-220 volts, 1750 r.p.m., alternating current, heavy duty, for all purposes, \$32.00 each. Workshop Motors Company, Box 47, Berwyn, Illinois.

MOTORS! 1/2 H.P. D.C. converted to A.C. All new. High speed 110 volt, 25 or 60 cycle, ball bearing motors. Actual value about \$75.00. Now \$15.00 each or 3 for \$40.00. Countless uses for home mechanics. Can be used in any position. Order today! Immediate delivery! No c.o.d. orders. "Amazing Bachman's," 27 Herman Street, Rochester 5, New York.

WELDING Generator, 150 ampere, \$47.50. Other bargains. Butler, 1885 Milwaukee, Chicago.

SELSYNS—All new! Transformers, GE Model 2J1G1, 57.5-57.5V 400 cy.; generators, GE Model 2J1F1, 115-57.5V 400 cy. With gears. Sensational offer! \$1.50 each. Quantity lots \$15 dozen. Order now! No c.o.d. "Amazing Bachman's," 23 Herman Street, Rochester 5, N. Y.

MOTOR Repair men, get our bulletins on stator winding tester and a.c. motor winder. Motor Industries, Quincy, Illinois.

RANGER Engine-Aircraft—All new in original case, 570 h.p., 12 cyl., V type. Engine Spec. No. 177. Complete with spark plugs. Original government cost over \$12,000.00 each. Special offer \$200. Crated weight 1200 lbs. No c.o.d. Write for complete description. "Amazing Bachman's," 23 Herman Street, Rochester 5, N. Y.

AMPLIDYNE Motor - generators. All packed—new! GESAM 31N9A. Output 60 v.d.c. input 27 v.d.c. 530 watts. Original cost \$120.00. Now! \$7.95 each. Three for \$20. Order today! No c.o.d. "Amazing Bachman's," 23 Herman Street, Rochester 5, N. Y.

WINDING Data, listing 225 motors, single and three phase, \$1.00. Motor Data Co., Box 7631, Kansas City 3, Mo.

DYNAMOTORS. All new! 400-cycle, GE5D21N3A. 27 v.d.c. to 100 v.a.c. 485 watts. Sensational offer! \$8.00 each. Three for \$20. Order today! No COD. "Amazing Bachman's," 23 Herman St., Dept. PM, Rochester 5, N. Y.

BOATS, OUTBOARD MOTORS, ETC.

MARINE Power—Easily convert any Jeep or Ford motor (domestic or foreign) with Convo parts and kits. Complete catalog 25c (coin). Osco Motors Corporation, 2020B East Orleans Street, Philadelphia 34, Penna.

PACKAGED Boats—Complete moulded and sheet plywood kits; \$39.50 up. All sizes. Literature 25c. Marine Mart, Buffalo 7b, N. Y.

BUILD Your own boat by the Welch system, knock down kits. No experience necessary. Save 2/3 cost. Rowboats to cruisers. Send 25c for illustrated catalog. Midwest Boat Company, Menomonee Falls, Wisconsin.

\$35 SEA Shell pre-fabricated 8' plywood rowboat. Free illustrated folder. Hagerty Company, 2 Apple Tree Lane, Cohasset, Massachusetts.

BOAT Building plans: Runabouts, cruisers, sail boats. Wood and plywood construction. Illustrated book, "Modern Designs For Boats And Yachts," \$1.00. John B. Clark, Yacht Designer, 329 Kenmore Drive, Bay Village, Ohio.

MARINE Catalogue—15,000 deliverable items; pictured \$1.00. Marine Mart, Buffalo 7b, N. Y.

P-38 BELL Y Tanks, new, steel, 10 ft. 2 in. 165 gallon \$9.95. Anzio Boat Co., Box 89H, Merced, Calif.

P-38 BELL Y Tank speed boat. Complete plans, instructions \$1.00. Twintank Boat Company, 1032 62nd Street, Oakland, California.

OUTBOARD Motor parts. New-used, all makes. New pistons (standard, oversize). Cylinders rebored. Outboard Motor Mart, 309 Atlantic Ave., Boston 10, Mass.

FOR Sale—Boat loading winch for trailer, holds 75 feet, 1/4 inch cable, ten dollars postpaid. Holt Equipment, Independence, Oregon.

BARGAIN \$20. Make your own boat now with reynoldam streamlined laminated one piece hull as developed for Navy. Light, sturdy, leakproof. Anyone can convert into dinghy, outboard scooter, cartopper, other craft, 9'x4'. Write Warwood, 480 Lexington, New York 17.

SIXTY Best designs, full size patterns, blue prints—outboard, sail, power; with book "Boat Building" \$1.00. Marine Mart, Buffalo 7b, N. Y.

OUTBOARD Motors—Good values, used motors. Also used parts for most makes and models. Crandall-Hicks Co., 911 Commonwealth, Boston, Mass.

BELL Y Tanks—75 gallon, new, steel 6 ft. 4 in. \$7.50. Anzio Boat Co., Box 89H, Merced, Calif.

TWENTY Plywood boat plans \$1.00. 6 to 20 feet, sail, power. The Rudder, 15 Murray Street, New York.

NEW. Used, rebuilt marine motors. Marine conversions, fittings. Free catalog. Stokes Marine Supply, Dept. 24, Coldwater, Michigan.

ALL Copper water jacketed exhaust manifolds for marine conversions of automobile and aviation engines and marine engine replacements; any make, model or age. Joseph Van Blerck & Son, 391 Woodcleft Ave., Freeport, N. Y.

BOATS And all about them. How to select, build, repair and operate. For 40 years the leading practical boating magazine. Half price trial subscription. 12 issues for \$1.00. Motor Boat, 62 Gold Street, New York 7.

BOAT Designers are highly paid professionals. Complete course by mail. Catalog. Westlawn, Montville, N. J.

ATHLETIC EQUIPMENT, BODY BUILDING COURSES

NAT Berents popular body building course. Handy pocket edition. Complete. Only \$1.00 postpaid. Nat Berent, 1090 W. 43rd, Norfolk 8, Va.

BUILD Own body building home gym set! Save \$60! Gain weight, strength, trim waistline. Barbell plans, \$1.00. Cross Co., (C-1), Kenosha, Wisconsin.

DEADLY Judo—Fiercest fighting technique. Trick knockouts. (200 photographs—plus illustrations). Expert instructions. Three volumes. Complete \$2.25. Variety House, Box 46-BZ, Wall Station, New York 5.

BARBELLS! 95 Pound set \$9.80; extra plates 9c pound. Send for free course and catalog. Bur Barbell Co., Lyndhurst, N. J.

BARBELLS \$11.00 up. Stamp for folders. Jackson International Barbells, Springfield, N. J.

SPORTING GOODS, GUNS, FISHING TACKLE, ARCHERY, TRAPPING

SKI-TOWS. Portable, auto-powered, 500 ft. long. Pulls you both ways. Up, level or downhill. Set up in 20 minutes. Only \$125. Send card for particulars. Great-Northern Mart, North Adams, Mass.

AUTOMATIC Lure—Positively weedless. Greatest invention in ages. Nothing like it. Circular free. Babcock Reel Co., Oak Harbor, Ohio.

FISHING Canes: Dealer quantities; jobber quantities. Ferrules, clamps, guides, tops, rod blanks, seats, reels, nylon line, steel rod \$2.75. Jointed cane \$2.75. Jointed aluminum rod, combination five, seven, nine foot rod, three foot case, nylon-wrapped guides, reel lock, finest quality, \$6.95. Fish sacks, plugging kits, scale-gaffs, creels, many others from your dealer or Bob Pace, Combs, Ark.

FLAT Sinkers mold. Price \$1.00 postpaid. Circular free. Langholz Machine Works, Oak Harbor, Ohio.

SEND 10c For list 100 used guns. Frayseth's, Willmar, Minnesota.

FIREARMS—Ammunition, complete list 25c. Frank Farish, Vicksburg, Mississippi. U. S. A.

LUMINOUS Worms—Best fish catchers you ever used or money refunded. 24 inches only \$1.00 postpaid. Porko, 7105P Glenwood, Chicago 26.

SHOTGUNS. Rifles, handarms, ammunition, rods, reels. List 10c. Rudolph's, Atchison, Kansas.

AMMUNITION For sale. 9mm. Parabellum \$9.50 per 100, 25 Automatic \$6.00 per 100, 32 Automatic \$7.00 per 100. Peerless Machine Co., Dept. PM, 220 W. 42nd St., New York City.

FREE Catalog of raw materials to build your own bow and arrows. Fisher-Smith Co., 708 E. Mulberry, Bryan, Ohio.

FISHERMEN—Handmade split bamboo (tonkin) rods, any type or to your specifications. Rod building supplies. Free literature. Aaron G. West, 4144 Marion Street, La Mesa, California.

FLY Tiers: One of the leading commercial manufacturers of flies offers you the same materials he uses. Buy only what you need. Save money. Free catalog. Bennett Millard Fishing Tackle, Inc., 130 Washington, Binghamton 17, N. Y.

TENNIS Players—Improve your game, save your racket. Fawcett Products, 3808 Strandhill Rd., Cleveland, Ohio.

CATFISHERMEN!—40 Page handi-book of America's best catfish bait recipes, secrets, tips, tricks. \$1.00. Guaranteed. Curly Sharp, Marquette, Iowa.

START Business yourself. Send for list of spinner blades, shafts, beads, rudders and parts for constructing lures that will catch fish. Spinner Specialties, Inc., Lewiston, Idaho.

BOOKS On gunsmithing. Catalog 10c. W. Joseph O'Connor, Baker, Oregon.

SHOOT For fun, shoot to kill. Make a powerful, accurate, "folding crossbow pistol." Complete plans \$1.00. Louis P. Loutrel, Box 266P, Jamaica 1, N. Y.

5000 BARGAINS. Firearms, binoculars, war relics. Catalog 40c. Smith Firearms, Runnemed, New Jersey.

FIELD GLASSES, TELESCOPES, MICROSCOPES, MAGNIFIERS

ASTRONOMICAL Telescopes, binoculars, microscopes; bought, sold, repaired. Books. Lists 10c. Rasmussen-Reece, Amsterdam, N. Y.

POWERFUL Astronomical telescopes easily made. Perfect lenses and instructions. 100 power \$3.00. 100 and 200 power \$4.00. 100, 200 and 400 power \$6.00. Clear vision and full power guaranteed. Instructions alone 10c. Suffolk Science Service, Manorville, N. Y.

ARMY-NAVY Surplus. Telescopes, binoculars, lenses, prisms, etc. Send 3c stamp for "bargain" list H2. A. Jaegers, 123-26 Rockaway Boulevard, South Ozone Park 20, N. Y.

PORRO Prisms for 6x30, 7x50 binoculars. 50c each. Ross, C-68 West Broadway, New York, N. Y.

TELESCOPES, Binoculars, microscopes, big bargain catalog free. Brownscope Company, 24 West 45th Street, New York.

REFLECTING Telescopes, complete. 3½" diameter, equatorially mounted. View planets, stars. \$19.75. Write Sky-scope Company, 475-P 5th Ave., New York.

BINOCULARS, Telescopes, watches. Buy, sell, trade. Paul Schweer, Donnellson, Iowa.

VARIABLE Density. Polaroid filter device. 2½" diameter, \$2.35. Glass only, 2 for \$2.00. Ross, C-68 West Broadway, New York, N. Y.

TAXIDERMISTRY

FINEST Glass eyes; taxidermy supplies. Catalog free. Elwood Company, Department 234, Omaha 2, Nebr.

DOGS, PETS, BIRDS, RABBITS

BEAUTIFUL Pure white police puppies. Ansonia Kennels, Mose, N. Dak.

BEAUTIFUL, Useful Collie-Shepherd pups. \$14. Paul Schultetus, New Liberty, Illinois.

RAISE Guinea pigs. Make money at home. Big demand. Booklet free. Taylor, Box 426A, Hapeville, Georgia.

ZOOLOGICAL And pet animals for sale. Illustrated catalogue, literature. 25c. Trails End Zoo-5, St. Stephen, S. C.

\$50.00 WEEKLY Raising Angoras for us. Free literature. Angoraville, 1215-34th Northeast, Cedar Rapids, Iowa.

RAISE Hamsters. Free literature. Write postcard. Hamster Farms, 1713½ 9th Street, Wichita Falls, Texas.

RAISE Rabbits, market provided. Breeding stock furnished on production pay plan. Literature 25c. with hutch plans \$1. Hansen's Rabbit Institute, 1347 Miller Avenue, Salt Lake City 6, Utah.

\$250.00 MONTHLY Raising angora rabbits. Particulars free. White's Rabbitry, Newark, Ohio.

SPIN Angora wool into yarn. We buy, sell yarn, plucked wool, spinners. House of Angora, Springfield, Illinois.

PROFITABLE Industries. Raise rabbits, cavies, etc. See our display advertisement on page 266. Small Stock Farmer.

GUARANTEED Chin-Chin Giant Chinchilla rabbits. Greatest amount of delicious meat. Largest, finest, most valuable furs. Tremendous demand for breeding stock. We buy youngsters. Contact world's largest breeder, Willow Brook Farm, R15, Sellersville, Penna.

RACCOONS, Minks, skunks, foxes. Bred females. Baby skunks, Catalog 25c. Shady Fur Farm, Springfield, Minnesota.

MONEYMAKING Opportunity raising Giant Chinchilla Rabbits. Waters Rabbit Farm, Glennville, Georgia.

ANGORAS, Giant Chinchillas. Heavy-producing prize winners. Literature free. Grinsteads, Edwardsville, Illinois.

INCREASE Your income by raising domestic rabbits. Small space needed. Ready market for delicious meat, fur and wool. Largest magazine in the industry tells you how. \$1.50 per year. Sample 15 cents. No stamps. Small Stock Magazine, Lamoni 50, Iowa.

SUPERIOR Chinchilla giants—Other varieties. Breeding stock supplied credit terms. Beautiful picturesque catalogue. Complete instructions, 25c. Behrens Farms, Pearl River 4, New York.

RAISE Hamsters. New wonder animals from Syria. Delightful pets. Laboratories need thousands. Profitable. Free information. Hamstery, 1519 Basil, Mobile, Ala.

\$2000 PER Year raising Angora rabbits. We buy your output. Contract particulars free. Wilsons, 1065 Shryer, St. Paul 8, Minn.

SEEDS AND NURSERY STOCK

DESERT Mystery plant, Selaginella lepidophylla, can go years without water yet becomes green few minutes after being placed in bowl of water. 50c each or 3 for \$1.00 postpaid. National Service Company, Box 202C, Houston 1, Texas.

FARMS, FARM LAND, REAL ESTATE

GOVERNMENT Lands \$2.00 acre up. Information all states twenty-five cents. National Tax Service, 834-A Majestic Bldg., Detroit.

HITCH Your future to a farm! Security unlimited may await you on any one of the hundreds of bargains described in United's exciting big new spring catalog. Farms, ranches, orchards, tourist courts, country homes, resorts, retirement havens, covering mid-west to west coast. Here's your invitation to independence—write for your free copy today! United Farm Agency, 1408-PM Consumers Bldg., Chicago 4, Ill.

SIX Room house, \$2800 complete. Build now. Move in three months. Not prefabricated. Free illustrated literature. Box 3844, Los Angeles 54, California.

CANADA—For literature and information re—farming, ranching and fruit lands, write H. S. Williams, Department of Immigration & Colonization, Canadian Pacific Railway, Vancouver, B. C.

"100,000 SQUARE Miles Free!" Interesting illustrated booklet describing fertile South-American lands obtainable free, 25c. Valles, 395-TM Broadway, New York 13.

WEST'S Latest catalogue: Over 1000 farm and business bargains, 180 representatives, 16 states. Free. Write West's Farm Agency, HE-13, Pittsburgh 17, Penna.

OZARK Magazine, Eureka Springs 3, Arkansas. For Homeseekers, tourists. Year, \$1.50.

PALM Springs area, California, sacrificing 2 bedroom desert home. Healthy, sunny climate year-round. Magnificent mountain view, \$7,500. Worth double. Malnick, 6912 Hollywood Boulevard, Hollywood, California.

GOOD Farms—Ranches. Washington, Minnesota, Montana, Idaho, Oregon, North Dakota. Dependable crops, favorable climate. Write for literature, lists describing typical farm opportunities. Specify which state. J. W. Haw, 119 Northern Pacific Ry., St. Paul 1, Minn.

OZARK Lands for all purposes. Actual river frontages. 5 acres \$90.00 and upwards. Free list and literature. Hubbard, 424-I Minnesota Ave., Kansas City 4, Kansas.

\$5.00 MONTHLY Buys 40 acres near town; price \$200.00. Free list. Box 425-P, Carthage, Mo.

FARMS, Ranches. All kinds, sizes. Choice of location, climate, production. Information on irrigation projects Columbia and Missouri River Basins. Resorts, summer homes. Milwaukee Railroad territory: Washington, Idaho, Montana, Dakotas, Wisconsin, Upper Michigan, Central corn belt. Free folders, price lists. L. H. Robbins, 604 Union Station, Chicago 6, Illinois.

STROUT'S Big farm catalog—mailed free. Describes over 2800 outstanding bargains. Coast to coast. Time-money saver. Write today. Strout Realty, 255-P 4th Ave., New York 10, N.Y.; 20 W. 9th St., Kansas City 6, Mo.; 453 S. Spring, Los Angeles 13, Calif.

HOMESITES \$450—Convenient payments. California's finest garden section. On Morro Bay's scenic shores. Wonderful fishing, hunting, boating, bathing. Fertile soil, softest water, temperate climate, congenial community. Free literature. Richard Otto, Department M, San Luis Obispo, California.

POULTRY, FARM SUPPLIES

MONEY-MAKING Experimental farm poultry raising helps only \$1.00 for 24 months. Sixty months, \$2.00. Early start increases profits. Order now! Poultry Tribune, Dept. S, Mount Morris, Ill.

RAISE Turkeys for profit! Learn how others succeed with America's only all-turkey magazine. Experimental farm helps. Mail \$1.00 for six big issues today! Turkey World, Dept. 20, Mount Morris, Ill.

WHITE Guineas—Chicks, eggs, stock. Catalogue free. Goshen Poultry Farm, Goshen, Indiana.

SAVE Up to 3c a chick. Get Colonial's early order cut prices on 200-336 egg pedigree sired chicks. Purebreds, cross-breeds, as hatched or sexed. Catalog free. Colonial Poultry Farms, Box 703, Pleasant Hill, Mo.

SUPERIOR Best chicks with 200 to 336 egg bloodlines. Leghorns, Rocks, Reds, Hampshires, Wyandottes, Orpingtons, Austral-Whites and Legorcas, as hatched or sexed. Low prices save you \$1 to \$3 per 100. Old, reliable, established 1919. Big free catalog. Superior Hatchery, Windsor, Missouri.

BABY Chicks, champion mated. 25 varieties, 6 hybrids, licensed inspected, blood-tested. Rush postal, large colored book free, low prices. Berry's Farm, Route 12, Clarinda, Iowa.

SUCCEED In the poultry business. You, too, can enjoy country life, home grown food, increased income, if you have specialized knowledge. For 27 years our home study course has helped thousands obtain that knowledge. Write today for prospectus describing courses, methods, opportunities, service. National Poultry Institute, Dept. 50-C, Adams Center, N. Y.

RAISE Fryers new easy way. One-man home plant earns \$500 monthly. Booklet free. Poultry Guild, 1046-A So. Olive, Los Angeles 15, California.

RAISE Turkeys the new way. Write for free information explaining how to make up to \$3000.00 in your own backyard. Address National Turkey Institute, Dept. 3, Columbus, Kansas.

KNOW How to raise poultry for profit. Read Northeastern Poultryman. Every issue packed with helpful hints and practical suggestions. Latest articles on breeding, feeding and management. Subscribe now. 1 year 65c. 2 years one dollar, foreign subscriptions \$1.00 a year. Northeastern Poultryman, Dept. P.M., 376 Boylston St., Boston 16, Mass.

PROFITABLE OCCUPATIONS

OPERATE Profitable mail order business. Splendid opportunity. For details write name, address. W. T. Adams, 1526 So. Kedzie Ave., Chicago 23, Ill.

OPERATE Profitable mail order business. Splendid opportunity. For details write E. McQuaig, 3653 Hollingsworth St., Jacksonville 5, Fla.

"FROG-RAISING"—New book teaches everything! Marlboro, 1035 Marlborough, Detroit 15, Michigan.

MECHANICALLY Inclined men—Own and operate general appliance repair shop. Complete, illustrated course shows you how. Welding, refrigeration, motor repair, how to get business, etc., all phases covered. Free literature. Christy Supply, Dept. 478, 2835 N. Central Ave., Chicago.

MAGAZINE Agents attention! Looking for prompt service, co-operation, consideration? Write Cassell Publishers Service, Westfield, New Jersey.

"MOST Everybody likes candy." Learn to manufacture in a professional manner. (Our 38th year). Ragsdale Candies, #107, East Orange, N. J.

NO Selling, operate vendors, amazing profits. details free. Silver-King, 622 Diversey, Chicago 14, Ill.

EXTRA Money? Free details. Trable, 1018½ Elm, Dallas, Texas.

YOU Can make real money raising Golden Hamsters, the new amazing tiny animal. Food costs less than 10c month per animal. Breeds in 16 days! Easily raised in basement, attic, garage, barn, or shed. Write for convincing details. Hudson Hamstery, R.F.D. #1, Newfoundland, N. J.

FOREIGN Employment? Brief directory, companies with foreign projects or branches \$1 or c.o.d. Foreign Service Institute, Box 3934, Miami 24, Fla.

START Lamp factory. Profitable, fascinating, easy to learn. Illustrated course teaches you. General instructions, wholesale catalog \$1.00. Gearon Company, 6405 North Oakley, Chicago.

POLISHERS Make good money! Always needed! Learn professional techniques, easily, inexpensively! Free details. Joseph B. Kushner, Metal Finishing Consultant, Stroudsburg 23, Pennsylvania.

RAISE Worms—"Secrets of Fishing Worm Farming" \$1.00. Unlike anything ever printed. Whitgate, Locke 10, N. Y.

PROFITABLE Business in making and building with interlocking blocks. Delaware Industries, Dept. 10, Muncie, Indiana.

"ALASKA" The last frontier offers unlimited opportunities. \$1 brings official government map and copyrighted report with listing of firms; Fishing, construction, mining, aviation, homestead lands, prospecting business. Alaska Opportunist, P.O. Box 883, Hollywood 28, Calif.

LOCKSMITHING Secrets. Key fitting, lock opening, repairing, prices to charge, supply sources. Illustrated book only \$1.00. Wechsler Supply, 7 W. 36, New York City.

PERMA-FLEX Molds, made from B. F. Goodrich Company's Koroseal flexible molding compound. Stock or custom built molds. Send 25c for catalog and sample mold. The Perma-Flex Mold Company, Columbus 15, Ohio.

INTERESTED In Latin American and foreign employment? \$1 brings copyrighted Foreign Service Directory listing firms with interests in construction, oil, mining, aviation, manufacturing by personnel expert. Hot list of companies hiring. Global Reports, P.O. Box 883, Hollywood 28, Calif.

ELECTROPLATING Has a thousand and one uses. Make good money in spare or full time. Warner Electroplaters permit you to easily plate chromium, gold, silver, nickel, copper, etc. Plating equals costly commercial jobs. Pay for your electroplater in a short time by plating for others at a profit. Write today for free sample and literature. Warner Electric Co., Dept. PO-2, 1512 Jarvis Avenue, Chicago 26, Ill.

WOULD You pay 3%—first \$350 made? Color-illustrated book "505 Odd, Successful Enterprises" free! Some offer occasional "day off." Work home. Expect something odd! Pacific, Oceanside, Calif.

HOW To set up and run a mirror shop! Resilver mirrors. For price write, John Sprinkle V50, Mariqon, Indiana.

MUSHROOMS Grown. Boxes. Barrels. Illustrated instructions 50c. Spawn \$1.00. Gordons, 553 William, Winnipeg, Manitoba.

TYPEWRITER Repairmen urgently needed. Earn \$40 to \$50 weekly spare time. Our easy to learn home study course teaches how to repair typewriters. Write for free information. Houston Typewriter Repair Service, P.O. Box 5357A, Houston 12, Texas.

ELECTRIC Clocks are every where you go, buildings, homes, parking lots, factories, Repairs increasing. Our easy to learn course with pictures and drawings teach you how to repair these clocks. Electronic Supply Co., P.O. Box 2350A, Houston 1, Texas.

\$40.00 WEEKLY Made growing mushrooms, fresh, dried. Dominion patent 331583. Free spawn. North American, 169P Yonge, Toronto, Canada.

BOOKS, PERIODICALS, PICTURES, POSTCARDS

BOOKFINDERS! (Scarce, out-of-print, unusual books.) Quickly supplied. Send wants, Clifton Company, Box 1377pm, Beverly Hills, Calif.

POSTCARDS—View, advertising. Ideal Press, P.O.B. 169, (Sta. B.), Brooklyn, N. Y.

WHAT Every Mason wants. We have Masonic books for Blue Lodge, Chapter, Commandery, Scottish Rite and Shrine. Our rituals are used the world over. Send for free catalog of books and rituals for Masons, Odd Fellows, Knight of Columbus, etc. Ezra A. Cook, Publisher, P.O. Box 796-PP, Chicago 90, Ill.

AMAZE Your friends. New Radio Quiz book. Over 1000 unusual questions and answers, \$1.00. Press, 804 Anderson Bldg., Ft. Worth, Texas.

U. S. Plane pictures in color. Eight pictures, 8"x10", to one set 50c. Three sets \$1.10 postpaid. Maule, 1007 13th St., Niagara Falls, N. Y.

CHINA, India, Burma war pictures. Send \$1.00 for 12 enlargements. Col. C. M. Davis, Box 284, Rockport, Texas.

1000 DIFFERENT Pocket books. Catalog 5c. Gordon's, 2613 Crenshaw, Los Angeles 16.

BOOKS: On mail order, self-help, business and technical. Our catalog free. Patricola, 210 Fifth Ave., New York 10, N. Y.

MAGAZINES—Business, vocational, diversion. Current single copies. All fields. Free price list. Commercial Engraving Publishing Co., 34C North Ritter, Indianapolis 19, Indiana.

PICTURE Stories from the Bible. Designed to provide religious background for children. 232 pages. Illustrated in color. \$1.00. Austin Specialties, 818 Waller, Chicago 51, Ill.

BOOKS. Hard-to-find. Out-of-print. Genealogy experts. Banker Book Co., Dept. B, 13518 Contour Dr., Sherman Oaks, Calif.

WE Can supply you with almost any book, magazine subscription. House of Kilroy (Booksellers), Box 772, Detroit 33, Mich.

VIEWS of the hereafter. For copy of the remarkable book by Emanuel Swedenborg "Heaven and Its Wonders and Hell," send 5c to cover mailing. Swedenborg Foundation, Room 1649, 51 East 42nd St., New York 17, N. Y.

BIG Sparetime profits taking magazine subscriptions. Complete supplies, confidential catalog free. Cassell Publishers Service, Westfield, New Jersey.

SELF-EXPLAINING Bible: Illustrated circular free. Box 446-P, Minneapolis, Minn.

BOOKS Found free! All subjects. Send wants! Jaher Book Service, 620-P East 178 Street, New York 57.

GAMES AND ENTERTAINMENT

UNUSUAL Fun! Sybil, the fortune telling doll, draws visitors like ants to picnics. \$2.00 makes you a proud owner. Mysticraft, 2525 29th St., Santa Monica, Calif.

MAGIC TRICKS, PUZZLES, JOKER NOVELTIES

MAGICIANS' Headquarters. 400-page professional catalogue, pocket, parlor, stage tricks. World's finest magic. Send \$1.00 for catalogue (refunded first \$5.00 order). Kanter's, M-1311 Walnut, Philadelphia 7, Penna.

MAGIC Tricks 10c. Lists free. "Marean," 2200 Gordon, Hopewell, Virginia.

REMARKABLY Inexpensive pocket tricks. Catalogue, 5c. Postways, Box 5325-A, Philadelphia 42.

MASTER Cigarette vanisher—Will fool even your wife! 25c, including catalogue. Scheetz's, Sellersville, Penna.

LARGE Catalogue of the best magic for professionals and amateurs. Send 25c. Mazda Magic Co., 1135 Westgate Ave., Oak Park, Ill.

MAGIC, Novelties and puzzles. Free card trick. Stivers, 40 Salem, Medford, Mass.

COIN And ring trick! Mystifies, amuses! 35c with descriptive list of fun and magical items. Free gift for promptness. Powell's, P.O. Box 2155A, Potomac Station, Alexandria, Virginia.

GUARANTEED Magic tricks! Catalogue 10c. Newton Magic Company, Department A3, Bonham, Texas.

MAGIC Monthly. Year 25c. Sample and 1948 magic catalogue free. Magic Shop, Minneapolis 2, Minn.

DOLLAR Magic set free with mammoth catalog 25c. Mysto, 4462 Germantown, Philadelphia.

SNEEZING, Itching powders, 18 other tricks, free with joker's catalog 25c. Factory, 2404-N Fifteenth, Philadelphia.

PENNY That nails to floors, bars, 25c (Wholesale). Scheetz's, Sellersville, Penna.

MAGICIAN'S Pin, ghost illusion. Houdini escapes, giant catalog. Everything complete 35c. Magic Wand-M, 9 W. Colorado, Pasadena, Calif.

FASCINATE With amazement! Become magician! 1/2 pound circulars. Nelmar, 2820 North Lawndale, Chicago.

LEARN Magic, ventriloquism, mind-reading. Write for particulars. Quackenbus, Big Flats, N. Y.

TRICKY Magic matchbox. It turns around, it stands, it opens. Confuses, amuses everyone, easy to do. Free to you if you send 25c for big illustrated catalog of 425 magic tricks. Magician, 2463-C, Kensington Ave., Philadelphia, 25, Penna.

"VENTRILLO" Professional voice-throwing instrument and catalog 25c. Box 971-PM, Philadelphia.

500 TRICKS. Send only 10c for Douglas' famous 112-page catalog 500 tricks. New magic for amateur, professional. America's fastest service for 25 years. Douglas Magicland, Dept. 1, Dallas, Texas.

PROFESSIONAL Catalog. 112 pages. 25c. Williams, 900 Plymouth, Ellwood City, Penna.

200 ELECTRIC Stunts. 110 volts. \$1. Kutting Sons, Campbell, Calif.

BIG Magic magazine, trick and price lists—25c. Lloyd M. Jones, 4064 39th Avenue, Oakland 2, California.

BE A magician. Large professional magic catalog of latest tricks, 25c. Ireland, C-109 North Dearborn, Chicago 2.

VENTRILLOQUISM Taught. 3c stamp bring particulars. Smith, 801 Bigelow, Peoria 5, Ill.

VANISHING Half dollar trick and catalog 25c. Sterling Magic Co., Royal Oak, Mich.

WORLD'S Largest professional magic shop, keeps you in touch with latest tricks. To receive mailings, send 35c for new catalog. Holden's, M220 West 42nd St., New York.

MAGIC Tricks, puzzles, books, cards, punch boards. Catalog 10c. Specialty, Box 671, St. Louis 1, Mo.

COINS, TOKENS, CURRENCY

FOR Sale: 1893 Columbian World's Fair half dollar, 75c; U. S. 2-cent pieces or 3-cent pieces, 25c each; 50 assorted Indian head cents, \$1.25; large 50 page U.S. coin catalog, listing thousands of coins for sale at reasonable prices, 25c; Giant 72 page foreign copper-silver-gold catalog listing over 10,000 coins for sale, 25c. Ben's Coin Company, 72 West Washington, Chicago 2, Illinois.

UNUSUAL Worldwide collection twelve different foreign coins and bills only 25c. Webb, Box 473, San Bruno, Calif.

OLD Money wanted. Do you know that coin collectors pay up to \$100.00 for certain U. S. cents? And high premiums for all rare coins? We buy all kinds. Send 4c for large coin folder. May mean much profit to you. Numismatic Co., Dept. 20, Fort Worth, Texas.

10 DIFFERENT Coins 25c. 25 different bills 25c. Oddehon, Box 482, St. Louis, Mo.

U. S. Coins, lowest prices. Send stamp for lists. Hutchinson, 3463 "I" Street, Philadelphia 34, Penna.

20 DIFFERENT Fine coins, 50c. Bischoff, Box 2201, Kansas City, Mo.

WHITMAN Folders—Any four \$1.00. Twelve wooden nickels \$1.00. Large retail catalogue 15c. Bebee Coin Company, 1180 East 63rd, Chicago 37, Illinois.

"U. S. Rare Coin Value Guide" 30c—Send money order (not stamps). Descriptive price list free. We sell the best literature, mounting boards and coin albums, and other coin accessories available. Hobby Helpers, Dept. P, Box 665, Washington 4, D. C.

50 WORLD Coins \$1.00. Harry Elsholz, Box 9014, Pittsburgh 24, Penna.

FREE! Foreign coin, banknote and coin collectors illustrated catalog to approval service applicants. Send 3c postage. Tatham Coinco, Springfield-125, Mass.

SPECIAL Offer—80 different foreign coins; ancient coin 2,000 years old, 5 Indian cents, U. S. eagle cent, 2c piece and 5 foreign paper bills. The lot \$5.00. Pappas, 356 Wadsworth Ave., New York 33, N. Y.

GET Profit and pleasure in collecting old coins. Send 10c for 56 page illustrated coin catalog. You'll be delighted with it. Send for it now. B. Max Mehl, 370 Mehl Bldg., Fort Worth, Texas. Largest rare coin establishment in U. S. Established 48 years.

BARGAINS! Rare collection contains United States large cent before 1848, flying eagle cent, white Indian cent, 2c piece, 3c silver, 3c nickel, half dime, shield nickel, liberty seated dime, Civil War cent, fractional currency note, confederate bill, foreign coin, foreign bill and our complete buying, selling catalogue, all for \$3.00. Catalogue alone, 25c. 25 dates Indian cents \$1.00. 50c before 1840-\$1.00. Pilgrim or Lexington 50c-\$1.25. half cent before 1810-75c, large cents 1826 to 1856-35c each, colonial coin before 1790-\$1.00, \$100.00 confederate bill \$1.00, 1780 foreign silver dollar \$1.00. Worthy Coin Corporation, 152-D Washington, Boston, Mass.

COMMEMORATIVE 1/2, Oregon, Texas, Kentucky, Cleveland, Long Island, \$2.00 ea. Illustrated catalogue 25c. Norman Shultz, Salt Lake 9, Utah.

COINS Wanted, will pay up to \$2000 for certain coins, send 25c for catalogue. Burton's, 111 So. Third, Columbus, Ohio.

OLD STAMPS WANTED

I WILL Pay \$100.00 each for 1924 1c green Franklin stamps, rotary perforated eleven (up to \$1,000.00 each unused). Send 10c today for large illustrated folders showing amazing prices paid for old stamps and coins. Vernon Baker, PM-82, Elyria, Ohio.

STAMP COLLECTING

START Your own stamp business. Write for free circular. Donald Shepard, Box 5139, Chicago 80, Ill.

ABSOLUTELY Free! 25 different valuable mint Chinese new issues with approvals. Barton, Box 321, Elizabeth, N. J.

FREE—\$25.00 Stamp collector outfit—Finest, most complete outfit ever offered: Large Scott album, valuable collection of 1050 different stamps, airmails, odd-shapes, hi-values, "Stamp Finder," watermark, magnifier, perf-gauge, tongs and hinges. Actually over \$25.00 value absolutely free when regular customer. Mail application now for foreign approvals. Bargain Stamp Service, Dept. "D," Santa Ana, California.

INVESTIGATE Interesting, valuable, and attractive first day covers. Historic cover, giant price lists and full information only one time to approval applicants. Knobel, 1918 SW 12 Street, Miami 35, Florida.

ILLUSTRATED Stamp Magazine, 26 weeks 25c. Stamp Journal, Kalamazoo, Michigan.

25c WORTH Free from our first selection to sincere applicants for our used U. S. approvals. Village Stamp Co., 90-39 214th St., Queens Village 8, N. Y.

POPULAR Stamps: Philippines new Peso stamp, Nyassaland native, Hungary set, Hitler stamp, Honduras Roosevelt, plus 75 other good stamps, only 5c to approval applicants. Moulblow, 740 Hegney, Bronx 56.

VICTORY Packet free—Includes stamps from Tanganyika, British Cayman Islands, animal, scarce babyhead, Coronation, early Victorian, airmail, map stamps. Including big illustrated catalogue. Send 5c for postage. Gray Stamp Company, Dept. PM, Toronto, Canada.

CHOICE Of 35c worth of stamps from our first U. S. selection free to applicants enclosing 3c postage. Large selection to choose from. Act now! S. C. Engel & Co., 38 Park Row, New York.

FREE! Chile's \$1.00, \$2.00, \$5.00 pictorials, China's \$27.00 airmail, and two British colonies colorful sets. Approvals accompany. "PG," 195 Park, Lewiston, Maine.

POSITIVELY Greatest free offer—Latest Scott's International \$6.00 stamp album—covering entire world, contains 35,000 illustrated descriptive spaces; Scott's 1948 standard \$7.00 catalogues "Philately's Encyclopedia"—absolutely free to applicants for foreign approvals becoming customers. Plymouth Specialty Company, Dept. A9, Bell, California.

APPROVALS. Discount, and gift. Write to Russell, 519 Crystal, Findlay, Ohio.

REALLY Good penny approvals. Just try them! Stockers, Groton, Mass.

50 DIFFERENT French stamps and our price list, one silver dime. Stamp sales, Box 1649P, Oakland 4, California.

GERMAN Approvals including war semipostals. Stamping Grounds, Whiting Road, East Hartford, Conn.

200 DIFFERENT. Including Roosevelt triangle, 5c to approval applicants. H. Avalon Stamp Co., Springfield, Mass.

WORLD'S Largest stamp (7 1/2 x 14 inches). A real curiosity! Retail for 50c, only 3c to approval applicants. Tatham Stamp Co., Springfield 30, Mass.

UNITED States bargain. It sounds unbelievable, but it's true! 50 different United States stamps ranging in age as far back as over 60 years and in face value as high as one dollar. Only postage, commemorative, and air mails included. Nothing else. Extra 2 Jap occupation of Philippines, all for only 10c to approval applicants. Please state whether approvals shall consist of U. S. or foreign stamps or both. Globus Stamp Company, 268 Fourth Avenue, New York 10, N. Y. Dept. 211.

35 DIFFERENT Greece or 100 different world, 10c. approvals 1/2c up. Kingman, Highbridge Box 42, New York 52.

FREE! Mint British Colonies from Solomon Islands, Caymans, Grenada, Dominica, Turks Caicos. Absolutely free to new approval applicants. Viking, 130-Z Clinton St., Brooklyn, N. Y.

MAP Stamps, 15 different plus world's smallest triangle, scarce, only 5c with approvals. R. George, Box 2774, Phoenix, Arizona.

FREE Costa Rica triangle set. Approvals. Herman, 539C East 54th, Brooklyn 3, N. Y.

FRANCE Collection, 120 different, with pictorials, commemoratives, semipostals, 25c only with approvals. Fields, 1929 E. 85, Cleveland 6, Ohio.

BRAZIL Diamond shaped set, 10c with approvals. Vargo Stamps, 6044 South Fairfield, Chicago 29, Illinois.

1000 U. S. A. — Over 100 varieties including 50 different commemoratives \$1.00 postpaid. R. Lehr Somerton, Philadelphia, Penna.

GERMANY. "Nazi Army Issue"; ships, planes, rockets (13) free to approval applicants. William Deems, Ravenswood, W. Va.

HITLER! Eighteen German stamps picturing Hitler. Only 15c with approvals. Write today, while the supply lasts. Jack Dudak, Streator 2B, Illinois.

STAMPS Wanted by thousands of our readers. Your ad in this space will bring you some nice orders. One advertiser sold 150,000 stamps. Write for positive proof. F. W. Johnson, Classified Advertising Manager, Room 301, 200 East Ontario St., Chicago 11.

SEND \$1.00 For 51 different Cuban stamps. Juan Posada, Box 477, Havana, Cuba.

GUARANTEE To amaze you with my excellent penny approvals. Wilson, 1766-32nd Ave., San Francisco 22, California.

POLISH Corps in Italy mint set 10c to approval applicants. Third Stamp Co., 101 3rd Ave., Newark, New Jersey.

STAMP Magazine, copy free! "Stamp Post," Station A, Pasadena, Calif.

FREE! 25 different stamps — Russia, Manchukuo, Vatican, etc. Sent approval applicants enclosing 3c postage. Standard, Box 1616, Miami Beach, Florida.

GOOD U. S. approvals. Rock bottom prices. Panthers Prompt Stamp Service, Dorchester Center, Mass.

FREE — The Stamp Finder. Big new edition — 32 pages profusely illustrated. Identifies all difficult stamps immediately. Given free with 319 different stamp from Vatican City, Palestine, Cyprus, San Marino, etc. All sent to approval applicants for only 10c. Price lists. Garcelon Stamp Company, Box 800, Calais, Maine.

TOPS. Tops in value, priced to please. United States approvals. Jarr, Box 217-F, Madison Square, New York 10.

GENERAL Collection, breaking up. Approvals. Lion, 200 W. 81 Street, New York 24.

HITLER Bohemia-Moravia, twenty diff. 10c with approvals. Edward Swider, Cedar Lake, Ind.

MINT Hitler heads, 18, Scott's #506-523 for only 25c. Blocks of four \$1.00. Reich Stamp Co., 4647 Kenmore, Chicago 40, Ill., Dept. M16.

TRIANGLES! Diamonds! Midgets! Roosevelt! Hitlers! U. S. \$2.00, \$5.00! Sensational packet! Stamp magazine! Everything, 6c with approvals! Thrifty Stamps, Silver Spring, Maryland.

FREE Desirable airmails, commemoratives, pictorials. Seven countries. Approvals enclosed. Green and Company, Norwood 12, Ohio.

FREE Monthly illustrated bulletin of new recent issues. Penny approvals on request. Reed Company, Box 980, Chicago 90, Ill.

1000 MIXED U. S. old and new—25c; 2 lb. \$1.25. Weatherby, Medina, Ohio.

50 SOUTH. Central America; 20c. Northeast, Box 6618, Kansas City, Mo.

TERRIFIC! Globe girdling packet from fifty countries 10c. approvals accompany. AAA Stamp Company, Arcade Building, Saint Louis, Missouri.

\$10,000 USED Stamp free. A real stamp bargain. The new \$10,000 Chinese stamp sent absolutely free with our packet of 100 different stamps, for 10c to approval applicants. Allison Stamp Co., 49 W. 44th, New York 18.

TRIANGLES! Triangles! Triangles! 25 different only \$1.00 to approval applicants. Floyd Frederick, 513 1/2 Green Street, Lancaster, Penna.

WONDERFUL Surprise packet, 10c with approvals. Green, Box 107 Scobey, Brookings, S. D.

"CONFEDERATE States." Twelve different unused 10c. approval applicants only. "Stamps," Box 87, Albany 1, New York.

SEND For our better U. S. approvals today. Box 488A, Minneapolis.

1000 WORLD Wide 63c; 200, 27c. Pacific, P.O. Box 5704, Los Angeles, Calif.

FREE! 25 Different Switzerland, with swell approvals. Eric Kardell, 1175-M Clay, San Francisco 8, California.

NEW Somali Coast, issued October 1947. Six beautiful mint pictorials 7c to approval applicants. GeeKay, 13 Overlea Ave., Baltimore 6, Md.

PENNY Approvals, that satisfy. Neil Gronberg, Box 5441-P, Philadelphia 43, Penna.

FREE! Complete Balkan aviation set with approvals. Beaman, Elliston, Virginia.

FREE! Tiny Chinese "midget" war set. Approvals. Seminole, Elliston, Virginia.

55 DIFF. U. S. 3c to foreign approval applicants. Ehlert, 2456 Monroe, Kansas City, Missouri.

BIG Collector's outfit 10c. Miniature stamp album, twenty stamps from twenty foreign countries including scarce triangle, Roosevelt, packet of stamp hinges, and millimeter scale. All for 10c to serious approval applicants. Detroit Postage Stamp Company, Detroit 23, Michigan.

FREE: 55 Stamps, 55 countries; approvals. I. Tesmer, 17 West Green, Dunkirk, N. Y.

HISTORICAL Collection! Cavalry Charge! (Bulgaria) — Flaming Sword! (Ireland) — Big She-Wolf! (Italy) — Fort! (Dominican Republic) — Field Marshal! (New Zealand) — Pitcairn Mutiny Island! — Commemoratives! Pictorials! Only 3c. Approvals. Star Stamp Company, 11 East 15 Street, Jamestown, New York.

SCARCE United States stamps nearly 100 years old; Roosevelt set complete; \$5.00, \$10.00 stamps; Army, Navy, Marines, Coast Guard, Columbian Exposition commemoratives; 19th century revenues. Everything 5c to buyers U. S. approvals. Metropolitan, 140-B Nassau, New York City 7.

DANDY United States approvals. Write immediately. Sullivan, Endicott Building, St. Paul, Minnesota.

NICARAGUA "Tin Pan Alley" diamond, Ecuador showing George Washington, and American flag in natural colors. Fezzan, Trieste, "American Army" stamp, first U. S. commemorative, \$100.00 Shanghai, Corsica, Anzac, Antique, others. All 5c. Approvals. Capital Stamp Co., Dept. 2, Little Rock, Ark.

FREE. Fascinating airmail collection, including obsolete Liberian issue, with approvals. Raymax, 123-Z William St., New York City 7.

BOLIVIA. National anthem set, Ethiopia Red Cross, Roosevelt triangle, France coat of arms, fourteen beauties, only 10c with approvals. Huffman, Box 331, Miami 3, Fla.

OLD Scarce U. S. seconds on approval. Slightly defective. Specially priced. Hernefield, 551 Clinton, Newark 8, N. J.

U. S. Price list free. Sikes, 1831 E. Allegheny, Philadelphia 34, Penna.

3 DIFFERENT United States \$5.00 stamps and large illustrated catalog 10c to approval applicants. Tatham Stamp, Springfield-125, Mass.

HITLER Heads cataloguing \$1.05. 25c with approvals. Miller, Box 600-A, Palo Alto, California.

50 DIFFERENT United States 10c. No approvals. Seidenberg, Cassopolis, Mich.

GIANT Bicolored royal visits, Malta pictorials, gorgeous Gulanas, Goose airmail, Scandinavian packet and illustrated stamp publication, 10 cents with approvals. Crown Stamps, Box 331, Toronto, Canada.

6000 STAMPS Collected by British Hospitals, weighs 2 lbs. \$1.00. Canadian 1 lb. (2500) 95c. Netherlands 1 lb. (3000) \$1.50. British Colonials (1000) \$3.00. Gigantic lists free. Price & Co., London, Ontario, Canada.

SUPER Value penny approvals. None higher. Arthur Terreson, Box 479, Bellmore, N. Y.

GIVEN Free—Roosevelt-Churchill, Hitler-Mussolini with approvals. Imperial, Box 1491, Tampa, Florida.

WORLDWIDE Packet 50 Stamps 5c with approvals. Carlin's Approval Service, 1832 Thomas, Fresno, Calif.

300 DIFFERENT Given free with approvals. Postage 3c. Windsor Stamps, 1435 East 67th Place, Chicago 37.

FREE—Famous Americans set, plus Flag Set, plus the National Parks Set, plus the Presidential Set to the \$5. A total of 90 stamps absolutely free to customers for our unsurpassed U. S. or foreign selections. Send 3c postage for 15 of the above mentioned stamps and full particulars. Triboro Stamp Company, 145 Nassau St., Dept. 112, New York.

WOW! \$10.00 Worth of fun. Only 10c! What a treasure hunt! Big package 500 foreign stamps from foreign missions, other sources. Includes stamps from Africa, South America, Free French, Cape Juby, Palestine, etc. Includes airmails, commemoratives and stamps worth up to 50c. This offer sent for 10c to approval applicants only. Jamestown Stamp Co., Dept. 22, Jamestown, N. Y.

\$1.00, \$2.00, \$5.00 U. S., Roosevelt, Hitler, airmails, free with approvals. Tami-ami Stamps, Box 2188, Miami 13, Florida.

CANADA—75 Diff. 25c. Approvals, Lists. Victoria Stamp Co., London 4, Canada.

FREE! Triangle Roosevelt, Vatican, Ethiopia, Hitler heads. With approvals. Florida Stamp Company, Box 807, Miami 5, Fla.

SPECIAL! 40 Different Scandinavian, 5c. Approvals, Lee Stampco, Box 156M, Forest Hills, New York.

FREE! 100 Worldwide different stamps to approval buyers. Big U.S. and illustrated bargain lists sent with approvals. Bookman, Maplewood, N. J.

FLAG Stamp free with U. S. approvals. Wenigman, 929 Oakdale, Chicago.

75 DIFFERENT Countries, 75 stamps, 10c to approval applicants. Rae Stamps, 14 Stratford Rd., Buffalo 16, N. Y.

200 DIFFERENT Stamps cataloging up to 50c each; only 3c to approval applicants! Littleton Stamp Co., Littleton 42, N. H.

WORLDWIDE, Different 200, 25c; 500, 60c; 1000, \$1.50; 2000, \$4.25. Beacon Sales, Maynard 2, Mass.

FREE! Crystal-mount samples! Har-risco; 202 Transit Bldg., Boston.

UNITED States approvals complete coverage, fine quality, attractive prices. Seminoe Stamps, Box 1138-P, Coral Gables, Florida.

WHOOPIE! Wow! 25c worth of U. S. stamps free! No obligations! Write M & N Co., 742A Sheffield Ave., Brooklyn 7, N. Y.

55 DIFFERENT United States, 5c. Approvals. Utechs, 1143-C North Keeler, Chicago 51.

128-PAGE United States catalog—1000 illustrations, 10c. Harris & Co. 202 Transit Bldg., Boston.

50 DIFFERENT Stamps, triangle, air-mails, etc., 5c with approvals. Carlton's, 10243 Silverton, Tujunga, California.

BRITISH, Spanish and French Colonies. Vatican, Hitler heads, and airmail packet, free with approvals. Pan-American Stamp-co, Box 145, New York 33, N. Y.

STAMP Collections wanted. Complete collections, duplicate lots, surplus stock, mint and used. Prefer trade for printing or other items, buy outright if priced right. What have you, what's wanted? Vanroy Shirk, Lebanon, Penna.

U. S. Price list. Send postage. State Stamp Service, 1225 Park Building, Pittsburgh 22, Penna.

DEALERS—Wholesale list. Postage 3c. Frank, 5031 Queensberry, Baltimore 15, Md.

ZOWIE-E! A barrel of fun for only a dime. 500 United States stamps—absolutely unpicked and unsorted—just as received from church missions. Many varieties, including large commemoratives, airmails, high denominations up to \$5.00! Stamp-dom's biggest package of fun—and you might find something really valuable! Price only 10c to serious approval service applicants. Money back if not delighted. Illustrated bargain lists with each order. Mystic Stamp Company, Dept. 80, Camden, New York.

U. S. Price list. Send postage. Stanley Gibbons, 38-P Park Row, New York.

ANTIQUES, RELICS, INDIAN GOODS, CURIOS

SOUTH American Vicuna's fur coverlet \$65, giant fish sword \$5. Fossil wood, Indian necklace, South Pacific shell collection, natural saltpeter mineral, each \$1. Commemoratives 4c. Illustrated catalog 25c. Ovale, Lynch 1451, Iquique, Chile, South America.

SEND \$1 For book listing 1202 Currier and Ives prints and their values. I also buy prints. Earl Romey, Bluffton, Indiana.

SWORDS, Rapiers, daggers, pistols, armor. Illustrated catalog 50c. Robert Abels, 860-A Lexington Ave., New York.

HOBBIES AND COLLECTIONS

COPUBLISH Hobby magazine. Samples, details, 25c. 1326 South 27th, Omaha 5, Nebraska.

COLLECTORS, Craftsmen! Read "Hobbyists" Magazine, 3 months 25c. Hobbyists, 19A South Third, St. Louis 2.

WANTED Old cigarette cards. Write Charles Bray, East Bangor, Penna.

UNUSED Match book covers. 100 all different \$1.00. Free catalog. Charles Edelman, 1311C East 84, Cleveland 3, Ohio.

FOREIGN Campaign ribbon packet, and illustrated book \$1.00. Insigniacrafts, 236 28th Avenue N.W., Calgary, Canada.

KLONDIKE! For hobby jewelry makers! Novelty jewelry findings swept from tables of large manufacturers—parts for bracelets, pins, earrings, etc.—unfinished chains, rings, pins, stones, clips, beads—many other items. 1 lb. bags—\$3.00 sample bag—\$2.00 per bag in 5 bag lots. Prepaid only. Mdse. Distributing Co., 19 E. 16 St., New York 3, Dept. P.S.

INVENTING Can be an interesting and profitable hobby. Write for complete particulars. Institute of American Inventors, Dept. 40-E, 1926-Eye St. N. W., Washington 6, D. C.

PRECIOUS STONES, MINERALS

BEAUTIFUL Arizona agates with flowers, moss, trees, scenic; all colors. \$1.00 brings samples and listings. Arizona Agate Mines, Cave Creek, Arizona.

GENEROUS Assortment slabbed diamond cut gem material one dollar. M&O Gem House, Box 259, Mesilla Park, N. M.

ZIRCONS, Mined in Siam, 2 samples diamond-cut and polished \$1.00, 5 samples \$2.00. Imhusex PM, Box 232, White Plains, N. Y.

"LUCKY" Lodestones, highly magnetic natural magnets. Perform many extremely interesting experiments. Two large specimens only 50c postpaid. National Scientific Company, 2204 W. North Ave., Chicago 47, Ill.

CATSEYES—South Sea Island gems; excellent for jewelry, rings, bracelets, necklaces, ear rings, watchfobs, etc. Very ornamental. Check or money order, all sizes one dollar. Keau Fine Arts, 6100 Forest St., Gary, Indiana.

MINERAL Specimens, rough gems. Sapphire 10c. List free. Mission Mart, 818 Fort Stockton Drive, San Diego 3, Calif.

PETRIFIED Wood, rare, beautifully grained. 12 cubic inches \$2. Flossie Lee, Mountain View, Okla.

METAL Detectors. The very latest circuit. Free literature. Hedden Metal Detectors, 538 N. Homewood Ave., Pittsburgh 8, Penna.

CAMERAS AND PHOTO SUPPLIES

KODABROMIDE Enlarging paper, 4 1/4 x 8 2 1/2 feet rolls, enough for almost 2,000 4x5 enlargements. Single weight. Actual tests prove its worth. Fully guaranteed. Reduces printing costs to a fraction of a cent apiece. Value over \$30.00, our price \$2.25 postpaid in U.S.A. Delta Photo Supply, 690-M Third Avenue, New York 17, N. Y.

SOUND Projectors: Used 16mm., standard brands, from \$195.00. New and used cameras, enlargers and all types of film and equipment. Famous for low prices. Home movies our specialty. Write for catalog. Garaman's, 3808-C Eastern Avenue, Baltimore 24, Maryland.

ARGUS, Revere, Ampro, Bolex, Leicas, etc. available—savings. Write, wire Charles Wolfe, 167 Canal St., New York 13, N. Y.

MAKE Photostats on your enlarger, silvered prisms, instructions, \$2.00 complete. Wolf, 1261 Union St., Brooklyn 25, N. Y.

FO-DATA Technical bulletins by McKay tell how to make and use photo equipment. Limited offer. "Supplementary lenses" and "filters" both only one dollar. Chameleon Press, Eustis, Florida.

WARPLANE Photo Slides, 2X2, mixed types. 25 for \$1.95; 100; \$4.95; 500; \$17.95; 1000, \$29.95. Our selection. Postpaid. Aero Parts Supply, Municipal Airport, Houston, Texas.

GIVEN: Beautifully "framed" picture from any negative. Ideal for dresser or desk. Simply send your choice negative and 10c to cover postage and handling. Limit—one. Photo Service, Des Plaines, Illinois.

ANSCO Color 35mm. film Tungsten, 20 exposure cartridges. Includes processing by Anso. Fully guaranteed. Regular price \$2.82. Our price \$1.35 each—12 for \$15.50. Delta Photo Supply, 690-M Third Avenue, New York 17, N. Y.

PRINT Photos from negatives without darkroom. Automatic machine \$4.95. Mail \$1.00, balance c.o.d. or send for free folder. Craftex Products, 6751 Clyde Ave., Chicago 49, Illinois.

CHILD Photography specialists earn plenty. Amazingly helpful guide sheets condense instructions from famous experts. \$1.00. Guide-Pix, 147P Fourth Ave., New York 3, N. Y.

PINHOLE Camera designed for roll film. Feature for undistorted tall views. Plans \$1.00. Box 41, Fenton, Mich.

PICTURES Never before possible! 35mm. Tri-X film, Weston speed 200 daylight, 160 Tungsten. Guaranteed. 400' rolls \$6.75 postpaid. Delta Photo Supply, 690-M Third Avenue, New York 17, N. Y.

PROJECTOR Slides, 2x2, assortment of fifty airplane views, \$2.95. 125 slides, \$4.95. 300 slides, \$9.95. Postpaid. Aero Parts Supply, Municipal Airport, Houston, Tex.

8MM. Kodak Super XX Kodak Reversible, includes Kodak processing. 100' rolls, suitable for 16mm. cameras or Bolex H8. Short dated but fully guaranteed. \$4.95 each, \$50.00 per dozen. Delta Photo Supply, 690-M Third Avenue, New York 17, N. Y.

35MM. Film, 100' rolls, DuPont Superior #2, from surplus, outdated but guaranteed. Load your own cartridges for less than 10c each! 98c each roll, Delta Photo Supply, 690-M Third Avenue, New York 17, N. Y.

MAIL Your broken eyeglasses to Cordeau Wholesale Opticians, 87 Nassau Street, New York City, for fast service at low cost.

TWINLENZ Viewer for any size single picture transparency in a 2" by 2" mount. Vivid 3 dimensional effect. Free information. Byron McCall, Prescott, Arizona.

RUBBER Gloves, impermeable, acid resistant. Save your hands. Safe for all solutions. Brand new. Worth much more. Special price—\$1.69 per pair postpaid. Delta Photo Supply, 690-M Third Avenue, New York 17, N. Y.

AMATEUR Photographers—Photographic equipment for sale listed free in introductory issue. The Camera Directory, 234 E. Elm St., Olney, Ill.

200 POWER Telephoto camera easily made. Trifling cost. Free details. Suffolk Science Service, Manorsville, N. Y.

OIL Coloring photographs wonderful hobby. Free details. Home study course. Goynes, Lock Drawer 1784-1, Orange, Texas.

OIL Coloring photographs can be a fascinating hobby or profitable sideline for those with artistic talent. Learn at home. Easy simplified method. Send for free booklet. National Photo Coloring School, 1315 Michigan, Dept. 3432, Chicago 5, Ill.

PHOTOGRAPHY For pleasure or profit. Learn at home. Practical basic training. Long established school. Write for booklet. American School of Photography, 1315 Michigan, Dept. 3432, Chicago 5.

PHOTO Printer kit \$1.00. Spada Enterprises, 10 Lexington, Wethersfield 9, Conn.

CAMERAS, Enlargers, projectors. Lowest prices. Free catalog. Cavalier Camera, 1822 Center, Pittsburgh 19, Penna.

BASS Says! At the sign of the old "Horse Trader," 37th year. Thousands of satisfied customers everywhere! Finest brands including Kodak, Bell & Howell, Argus, Zeiss, Leitz, etc. Satisfaction always guaranteed, or your money back! Bass buys 'em, sells 'em, trades 'em. Write or wire. Bass Camera Company, Dept. AG, 179 W. Madison St., Chicago 2.

KODAK 35mm. Plus X. Original factory tropical packing, frame numbered 36 exposure cartridges. Fully guaranteed. Regular price \$1.10. Our special price 50c each—12 for \$5.50. Delta Photo Supply, 690-M Third Avenue, New York 17, N. Y.

PHOTO FINISHING

8 HOUR Service. Your 8 exposure roll printed jumbo or regular size. 25c; 12 exposures, 35c; 16 exposures, 50c; 36 exposures, \$1.00. Reprints, jumbo or regular, 3c. Regular prints deckled. Fine grain developing. Send for free mailers. Quality Photo Service, Box 468, San Francisco 1, Calif.

ROLL Developed, 8 prints and two enlargements 25c. Trial offer. Young Photo Service, 405-C, Albany 2, N. Y.

FINEST Enlargements. Four 4x6s 25c. Three 5x7s 25c. One 8x10 25c. Roll developed 2 sets prints 25c. Filmshop, Sweetwater, Texas.

GIVEN: Beautifully "framed" picture from any negative. Ideal for dresser or desk. Simply send your choice negative and 10c to cover postage and handling. Limit—one. Free Framed Photos, Des Plaines, Illinois.

PHOTOGRAPHY For pleasure or profit. Learn at home. Practical basic training. Long established school. Write for booklet. American School of Photography, 1315 Michigan, Dept. 3451, Chicago 5.

8 PRINTS All enlarged to nearly post-card size from your roll or negatives 25c; 16-50c. (Trial offer). Willard Studios, Box 3535A, Cleveland, Ohio.

FINEST Quality. Fastest service guaranteed. Roll developed and 16 Velox prints, 25c. Reprints 2c. 100 \$1.50. Dick's Photos, Louisville, Ky.

"BETTER Photo finishing." Jumbo prints 40c a roll. Reprints 3c. Best by test. Fast service. Sealtone Photo, Box 468, Seal Beach, Calif.

16 DECKLEDGE Prints from any standard 8 exposure roll 25c. Quick service. Professional work. Skrudland, Lake Geneva, Wis.

FREE Price list on quality developing, printing, enlarging. Write for it today. Bryan's Photo Shop, Dept. M, Panama City, Florida.

2 BEAUTIFUL Hi-Gloss prints each good negative and enlarging coupon with each 6 or 8 exposure roll developed 28c. Owlphoto Co., Weatherford, Oklahoma.

MOTION PICTURES AND SOUND EQUIPMENT

16MM. Films, projectors, sound, silent. Lists free. Osborn Films, Lebanon, Ohio.

35MM. Silent, sound films. Bedner, 5300 So. Talman, Chicago.

16MM. Sound. Shirley Temple, Baby Burlesks, Buster Keaton comedies, many others, dealers prices. Jubilee, 723 7th Ave., New York.

SENSATIONAL Savings! Movies. Cameras. Projectors. Towers, 935 North 40th, Philadelphia 4.

"MISS America, 1947" 8mm., 50 ft., \$2.00. 16mm., 100 ft., \$4.00. Catalog including miniature reproduced scenes from 71 exciting subjects, 25c. World In Color Productions, Elmira, N. Y.

THRILLING 8-16mm. movies. Catalog free. Fine Arts Productions, Box 2084, San Antonio 6, Tex.

HOLLYWOOD Films. Color sample, \$1.00 (refunded). Catalogs, 10c (refunded). Stone, Lunenburg 2, Mass.

FILM—Free processing 100 ft. 16mm. Weston 12 \$3.25. Weston 24 \$4.90. Weston 64 \$4.95, 25 ft. double 8mm. Weston 12 \$1.50, Weston 24 \$1.89, Weston 64 \$1.99. Free circulars. Fromader Genera, Davenport 4, Iowa.

16MM. Movies, Rental, sale, sound, silent. Equipment on time payment our specialty. Send for free catalog, stating your needs in first letter. Institutional Cinema Service, Inc., Dept. PM, 1560 Broadway, New York 19, N. Y.

BARGAINS In used 16mm. sound films. Complete subjects for as little as \$2.95 per reel. Big list for stamp. Blackhawk Films, Davenport, Iowa.

"LET'S Write a Song." new one reel sound now available in 16mm., 25c. 35mm. prints available. Dealer's discounts, \$39.95 streamlined projectors reduced to \$29.95. Oriole Films, Box 942, Baltimore 3, Maryland.

500 WATT 8mm. projector \$49.50. Others available. Selco, Danvers, Massachusetts.

"THE World's Greatest Passion Play." State projector. Rent or purchase. Write Hemenway Film, 33-F Melrose St., Boston 16, Mass.

MAGAZINE 16mm. 50' E.K. Super X panchromatic. Guaranteed. Processing included, \$1.99. Other values, free lists. Fischer Photo, 1731 N. Mobile, Chicago 39, Illinois.

MOVIE Film processing—Finest automatic machine processing, 8mm., 16mm. 48 hour service. Also duplicating, editing, titling, other lab services. Send for list of prices. Fotoshop, Inc., Room 103, 18 E. 42nd St., New York City.

RARE 8-16MM. Silent-sound films. International, 2120 Strauss, Brooklyn, N.Y.

SEND 10c for catalogue of movie cameras, movie projectors, films, etc. Sterling's, 679 Northampton, Easton, Pennsylvania.

I BUY, Exchange, swap movie films. Rental catalogue 25c. Harvey Iris, Box 539, Brockton, Mass.

DISTRIBUTORS Wanted. Make big money selling our new sensational movies. Send for sample today 16mm. Snd. \$10.00. 16mm. Sil. \$7.50, 8mm. \$2.50, and receive free our wholesale price list. Standard Pictures Corporation, Dept. A, Universal City, Calif.

MOVIE Cameras! New Lektro Junior 16mm. electric, magazine-load F3.5 anastigmat lens, battery, cord. Complete, ready-to-operate only \$59.50. Money back guarantee. Free literature. Panchromatic magazine film for this camera \$2.50, free processing. Army-Navy GSAP, original condition, value \$200, new \$32.50, used \$19.50. Other Panchromatic film—25 ft. double 8mm. \$1.65; 100 ft. 16mm. \$2.95; includes processing. Fotoshop, Room 79, 18 E. 42nd St., New York City.

PROCESS Your own movie film. Literature. Duro Products, 1519 Eggert, Eggertsville 21, N. Y.

SILENT To sound—Convert your silent 16mm. projector into sound with our guaranteed sound conversion equipment. Fits any silent 16mm. projector. Includes: Sound head kit (easily assembled); radio film adapter (plays sound through your radio) and complete instructions. Total price \$48.95. Send check or money order to Apex Video Co., 12209P Branford St., Roscoe, Calif.

SOUND. Silent movie film, 8mm. cartoons, 16mm. comedies, 35mm. shorts. Simpson, 155 High, Dayton, Ohio.

MOVIE Film at tremendous savings! Kodak Super X, Gov't stock, tested, guaranteed! 16 mm. 100 ft., \$2.95; 50 ft. magazine, \$2.50; double 8 mm. 25 ft., \$1.65. Super XX, 50c add'l each roll. Free processing. Fast service. Photo Surplus Sales, Box J-7, 12 Duane St., New York City.

EXCLUSIVE Home movies. Select films. Write for free lists. Home Pix, 1674 Broadway, New York 19, N. Y.

ARMY Surplus 50' 16mm. magazine Super X Weston 50 films, \$1.00. Processing 75c. Guaranteed. Filmcraft, 828 West 39th, Kansas City 2, Missouri.

GUARANTEED Fresh anti-halo outdoor movie film! Weston 16! Daylight loading! Processing free! Three spools double 8mm. \$4.50! 100 ft. 16mm. spool, \$4.50! Postpaid! Catalog, ESO-S, 828-B West 39th, Kansas City 2, Missouri.

SPECIAL! Free subscription offer! Amateur Screen Photography, 3021A Narragansett, Chicago 34.

WE BUY, Sell, rent, exchange home movies. Details for dime. Midland, Box 429, Oak Park 4, Ill.

LEARN Movie projection, management. Free catalog. Theatre Institute, Elmira, N. Y.

8-16MM. Silent-sound films. Complete rental library. All latest subjects. Free catalogue, (sample film 10c). Garden Film, 317 West 50th, New York 19.

BASS Says! 37 years of leadership means satisfaction to you! Finest equipment, 8 and 16 mm., sound cameras, sound projectors. Bass buys 'em, sells 'em, trades 'em. Satisfaction always guaranteed, or your money back! Bass Camera Company, Dept. A, 179 W. Madison St., Chicago 2.

BEAUTIFUL Kodachrome slide and lists 25c. Slide Supply Service, 3111 West Tuscarawas, Canton, Ohio.

MUSIC AND MUSICAL INSTRUMENTS

SONGWRITERS Attention! The amazing demand for phonograph records, accelerated by countless juke-boxes, warrants your immediate investigation. We are offering new writers the rare opportunity of having celebrated "hit" composer furnish music on reduced percentage basis for any likely poems received this month. The Petrillo ban does not affect us. Recola Records, Hollywood 28, Calif.

BE Independent, tune pianos, music unnecessary. Practical Piano Tuning shows you how, \$2.00 postpaid. Chord-Slide Co., P3122 Lawrence Drive, Corpus Christi, Texas.

POEMS Set to music. Experienced composer. Free folder. Moquin, 5333 La Cresta Ct., Hollywood, Calif.

PHONOGRAPH Records 20c. Catalogue. Paramount, MM-313 East Market, Wilkes-Barre, Penna.

PHONOGRAPH Records. Latest hits. Popular and hillbilly. Shipped anywhere. Standard prices. Order your favorites now. Free catalog on request. Mallorc, Dept. 14, 570 N. Gay, Baltimore 2, Md.

RECORDS. New 550 page Victor catalogue 35c. Wack, 3131 West North, Milwaukee 3, Wisconsin.

NEW Italian accordions, all sizes. Whole sale prices. Free catalog. American Accordion Center, 39 So. Kedzie Ave., Chicago 12, Illinois.

BAND Instrument repair service. Equipped to service all trumpets, trombones, cornets, saxophones, French horns, etc. Exceptional facilities for removing dents, plating, and improving tones. Ship instrument for free estimate without obligation. Music Department, Master Silverplaters, 2031 Caniff, Detroit 12, Michigan.

"SONGWRITERS"—Broadway arrangers will compose your melodies commercially. Submit poems. Free examination. Gardner's Music Service, 1650 M Broadway, New York 19.

PIANO; Beginners play popular music at sight. Just dial any song with Dial-A-Chord. Revolutionary self-teaching method, \$7.00. Nelson Studios, 9304 Edmunds, 102, Cleveland 6, Ohio.

GENUINE Hohner harmonicas. Marine band \$2.95, chromatic models, \$9.00, 12.50, 17.50. Sixteen hole Chromatica \$25.00. All new. Prompt service. Request price list of twenty different Hohner models. St. Johns Music Store, Winnipeg, Canada.

SONGWRITERS. Have your songs recorded. Music or lyrics written for uncompleted songs. Information, Dixon, 634 Common, New Orleans, La.

RECORDS 23c each. Recently taken off coin phonographs. New one side. Many excellent both sides. Write for list. Ockel Music Shop, 6267 Natural Bridge, St. Louis, Mo.

DUO-FLEX Reeds, for clarinets and saxophones. Eliminate your reed troubles. Circular free. Duo-Flex Reeds, 1204 First Ave., Evansville, Ind.

MUSICAL Instruments, 5 day trial. Free bargain list. Meyer's 454-A Michigan, Detroit 26, Michigan.

SONGWRITERS! Ethical composing offer. Hibbeler, Co, 2157 N. Avers, Chicago.

GUITAR Beginners: New automatic chord-changer eliminates "fumbling." Home study course teaches quickly. Also popular music supplies. Sell to schools, churches, friends, etc. Guitar Headquarters, Box 886, Ventura, California.

ACCORDIONS, Streamline, wholesale. Request circular. Metro Accordion, 44 North Albany, Chicago.

MUSIC Arranged. Songs printed. Frank Wildt, Music Publisher, Lancaster, Penna.

SONGWRITERS—Protect your songs. Get the facts first. Free booklet, attractive offer. Song Service, 331-C West 46th, New York.

POEMS Wanted for musical setting. Send poems for free examination. Five Star Music Masters, 630 Beacon Bldg., Boston, Mass.

BRAND New records. Distributor's surplus. Columbia and other major labels. \$3.50 per dozen, \$25.00 per 100. Indicate hillbilly, race, or popular selections. P.O.B. Cleveland, Record Rack, 7909 St. Clair Ave., Cleveland, Ohio.

AMPLIFY Your accordion with our new Del Principe pickup, \$22.50. Install it yourself in one minute. Makes any accordion sound like an organ. Works with any amplifier. Special Del Principe amplifier and pickup only \$72.50. Write for details. Del Principe, 307 So. Wabash Ave., Chicago.

POEMS Wanted for musical setting! Send poem for immediate consideration. Hamann Service, 614 Manhattan Building, Milwaukee, Wisconsin.

POEMS Wanted to be set to music. Free examination. Send poems. McNeil, Master of Music, 510-PM S. Alexandria, Los Angeles, California.

SONGWRITERS: Send poems for free examination and outstanding offer. United Music Service, 150, Salem, Indiana.

WRITE Songs. Big money and reputation. Write for information. J. Gordon Pub Co., 201 N. Hoyne Ave., Chicago.

RADIOS, SUPPLIES, INSTRUCTION

RADIO And television catalog—free! Money saving prices on radios, hard-to-get parts, record changers, wire and disc recorders, amplifier systems, tubes, books, amateur and test equipment. Write today! Radionic Equipment Co., Dept. 202, 170 Nassau Street, New York 7, N. Y.

BUILD "Loudest" crystal radio. Instructions, very loud crystal; 25c. Make "antentuner"—Increases volume; instructions; 20c. Amorose, Route Four, Richmond, Virginia.

BEGINNERS Educational radio kits. Free literature. Artlin, Knickerbocker Station, Box 25, New York 2.

ELECTRONIC Phototube kit complete with detailed instructions. Assemble automatic door openers, counters, alarms, scientific experiments, for home and business. \$9.95 prepaid check, money order. C.O.D. Gelbrook Products, Dept. 21, 9508 Queens Blvd., Rego Park, N. Y.

SENSATIONAL Radio parts bargains! Every item listed only 19c! Heavy porcelain insulators, 8" long; Steatite 826, 829B, 832 sockets; Steatite acorn tube sockets; pointed steel ground stake 16" long; 1K, 2K, 5K, 10K, 50K volume controls; 225 and 450 ohm field coils; hermetically sealed interstage audio transformer, 2 to 1 primary-secondary ratio; 1619 tubes. Every item listed only 19c each! Hurry with your order. Send 25¢ deposit, balance c.o.d. Minimum order \$1.90. Get on our big-bargain mailing list. Mid-America, Dept. CB-10, 2412 S. Michigan Ave., Chicago, Illinois.

24 PAGE Plans "18 Long Distance Crystal Sets." Catalog. "Radiobuilder"—all 25c. Laboratories, Eye-c, San Carlos, California.

SAVE 47%—Order your 1948 professional steel case, long range radio receiver direct from factory. Box 150, Manchester, N. H.

WE Are authorized wholesale distributors of Transvision kits. Free alignment on old bands—engineering service on all kits free when purchased from us. Servicemen, write for literature. Telecraft Corp., 2 W. 15 St., New York City.

PHOTO Electric relay kit including tubes, relay, sensitivity control, simple assembly \$4.95. Radio Development & Sales Co., 382 State St., Brooklyn 2.

EXPERIMENTERS: Make home communicating systems. Perfect T-30 throat microphones 40c; four for \$1.25. ANB-H-1 headphones \$1.00; two for \$1.90. Combination offer: four microphones, two headphones \$2.80 postpaid. Supply limited, order immediately. Stamp brings bargain list. Bardanal Engineering Company, Inc., 1222 West Washington Blvd., Whittier, Calif.

SUPERHETERODYNE Radio kit complete with all necessary parts, instructions and soldering iron so anyone can build a high quality set. Box 150, Manchester, N. H.

FIX Any radio. Amazing new instrument locates radio troubles double quick. Simple instructions show you how. Thousands in use. Write today for 24-page booklet, "The Inside Story." Feiler Engineering Co., 945 George St., Dept. PM, Chicago 5, Illinois.

MAKE Selective distance getting crystal radios. Also one tube radios. Improved designs. Complete instructions and crystal 25c. Radio Leader, La Verne 4, Calif.

26 YEARS Experience radio repairing at your fingertips. I've repaired 45,000 radios. Have perfected simple system you can follow step by step. No calculations or formulas. Total price \$2.00 postpaid or c.o.d. Moneyback guarantee. Ross Radio, 14615-A Grandriver, Detroit 27, Michigan.

MAKE Simple, tubeless, batteryless, distance-getting crystal radios. Crystal and illustrated instructions 25c postpaid. Allen, 427-P, Clinton, Missouri.

U. S. SIGNAL Corps featherweight ear-phones \$1.00. Radio service men and experimenters send stamp for our giant radio catalogue. Save dollars. United Radio Co., (100-V) Newark 1, N. J.

RADIO Technician and radio service courses. Training for federal licenses. American Radio Institute, 101 W. 63 St., New York City. Approved under G. I. Bill of Rights.

BUSINESS OPPORTUNITIES

I WANT To buy a profitable mail order business. Write Paul Harris, 228 Franklin Avenue, Norfolk, Virginia.

PLASTICS—Business of the future! Factory representative offers you hottest tested items. Are you buying right? Lifetime Plastic Co., 2814 Broadway, Oakland 11, Calif.

LEARN Big money principle of mail order business. Famous advertising expert "lets cat out of bag." His outstanding "key" booklet 25c. Particulars free. Rizer, Box 1364P, Glendale, California.

HANDYMEN—Earn money home operating Community "Fix-It" Shop. Write Stafford, 708 Rawlings, Carbondale, Ill.

START Home manufacturing business making Cleaning Compounds, Soaps, Insecticides, Cosmetics, Polishes, Food Flavors. No machinery. Literature free. Kemix, Park Ridge, Ill.

EARN Up to \$480 month part or full time keeping books for small firms. Simplified system. Write Tax-Saver System, Dept. W. Ft. Worth, Texas.

INCORPORATE Your business, free details. Tax Research Bureau, Inc., Delaware Trust Building, Wilmington, Delaware.

RAISE Earthworms. Instructions \$1.00. Huffman's Worm Ranch, R.R., Rives Junction, Michigan.

\$5 COMMISSION On booked distant moving jobs you recommend. United, 243 West 60th Street, New York, N. Y.

WATCHES Re-conditioned. Men's only. \$3.50 up. Send for price list. Satisfaction guaranteed. Veteran Watch Repair, 4400 Turner St., Lansing, Mich.

RE-NEW Leather and leatherette—Make cloth into imitation leather with plastic discovery called Leather-New. Opportunity to make real profits taking care of sales resulting from national advertising. Write for free sample of Leather-New covered material and complete deal. 4723A Troost, Kansas City, Missouri.

PLASTIC Tablecloth covers, curtains, drapes, baby pants, bowl covers and other plastic articles selling like wildfire! Make big money now! Free details. Write Plastics, Dept. 58-B, 206 N. Fourth, St. Louis, Mo.

MAKE Perfume. Complete outfit \$7.50. Information free. Walter Lawson, 21 Joiner, Saint Augustine, Florida.

OPERATE America's most popular low priced precision penny vending machine. Big profits. Be independent. Write for bulletin and prices. Stock shipments. Fielding Mfg. Co., Desk 248-PM, Jackson, Michigan.

MECHANICALLY Inclined men — Own and operate general appliance repair shop. Complete, illustrated course shows you how. Welding, refrigeration, motor repair, how to get business, etc., all phases covered. Free literature. Christy Supply, Dept. T-179, 2835 N. Central Ave., Chicago.

YOUR Own plastic business at home. Produce costume jewelry, novelties, statuettes, liquid plastics, liquid marble. Flexible molds. Write for free book. American Trades, Box 89-A-3, Cincinnati 29, Ohio.

START A business of your own cleaning drains without digging. Can earn from \$300 to \$500 monthly clear profit. Requires only \$400 investment which can be financed on monthly basis. A good sideline. Advertising helps and promotional material furnished. Write today for full details. No obligation. Ohio Tool & Engineering Co., Dept. M, Springfield, Ohio.

DISTRIBUTORS. All territories, new simplified bookkeeping and tax system. Many salable features, \$16.25 profit each sale. Repeats. Money maker. Opportunities. Exclusive franchise. National Accounting Service, Box M-2, Lynbrook, New York.

LEARN Mailorder business. Amazing opportunities. Literature free. Forest Sales Co., R60 West, Rupert, W. Va.

TREMENDOUS Profits mailing literature. Boundless mailorder opportunities. Generalprint, East Orange, N. J.

FREE Mail order tips. Griffin, 756 Broadway, Everett 49, Mass.

READ "Advance"—The Voice of Mail Order. Offers money-making opportunities, sources of supply, personal guidance, etc. Issued monthly. Sample copy 25c. Yearly subscription \$2.00. Advance Mail Trade Associates, 303 Fourth Ave., Suite 404, New York 10, N. Y.

FOR An extremely profitable lifetime business operate a collection agency-credit bureau. Easily learned. Free folder. Cole & Associates, Syracuse 2, N. Y.

PLASTER Paris gets hard as stone. Just mix in "ROC," amazing new chemical—air bubbles come to surface, disappear. Finished casts hard, ring like a bell. Enough for 2,000 casts only \$1.00 postpaid. Money back guarantee. So-Lo Works, Dept. C-200, Levelland, Ohio.

FREE Details for a business of your own. Any location. Acme Service, Box 268C, Rome, New York.

SAVE—Million articles wholesale. Directory 10c. Lawson, Box 1302-P2, Detroit 31.

MASTER New fascinating business quickly. Investment negligible. Unlimited possibilities. Write, Leslie Gaddis, Manager, Box 1251, Louisville 1, Ky.

WORK For yourself at home. Free details. Martin Company, 56 Thoma, Maywood, New Jersey.

50 GIGANTIC Profit producing plans for mail order operation. Guides you to a profitable business of your own. Free details. Metro Service, 1922 Milwaukee, Chicago 47, Ill.

OPERATE Home business that may mean the road to independence. Write Sunray, 4756-A N. Bernard, Chicago 25, Illinois.

EARN Money at home by mail. Information free. Goodrich, Edgewood Terrace, Longmeadow, Mass.

300% PROFIT Selling repeat items mail, local. Dade Products, Box 1720H, Cleveland, Ohio.

\$6000 YEARLY Possible; operating own local and national chain-office. Cities 5000 population up. Details free, Hunt, Box 308, Burlingame, Calif.

PRESERVE Baby shoes. Bronze, gold, silver. Instructions \$1.00. Johnson, 2611 Harriet, Minneapolis 8, Minnesota.

MEN And women wanted to place self-selling coin machines in stores, hotels, filling stations, etc. New machine earns up to \$6.00 weekly—costs only \$10.50. We furnish supplies and machines for nuts, gum, candy, stamps, scales and amusements. Free details of tested selling plan. Write Dept. P, Parkway Machine Corp., 622 W. North Ave., Baltimore 17, Md.

MAKE Big money now! New money making opportunity. Start small, grow big. Grow fast. Free details. Write today. Colonial Plastics Co., Dept. M., 6003 Thekia Ave., St. Louis, Mo.

HAVE A business of your own in home or garage, bronzing baby shoes. Details free. Ray-O-Lite Service, Box 491, Winnsboro, La.

MEN-Women; start candy kitchen at home. Big profit. Free booklet. Thompson Co., Baldwin, Michigan.

PROFITABLE Plans, ideas \$1.00. Details. Spada, 10 Lexington, Wethersfield 9, Conn.

SEA-SHELLS, Plastics, metal findings, free catalog. "Secors," 238 Bradenton Beach, Florida.

GET It for them wholesale. Be community buyer nationally-advertised merchandise; radios, refrigerators, washers, sweepers, typewriters, etc. Savings to 50%. This pleasant easy work can earn to \$5000 year. Details free. Cox, 14 Church, Saugus, Mass.

WINDSHIELD Wiper rebuilding brings big profits. Free particulars. H & H Products, Box 430, East Akron 5, Ohio.

\$5000 YEARLY Raising honey bees. Complete course \$1.00. The Beehive, Ramsey, New Jersey.

A PROFITABLE Business and hobby. Amazing Liquid Ivory, Liquid Glass. The most marvelous synthetics ever developed. Hard to tell from expensive genuine. Easy to start. Experience unnecessary. Immediate profits. Write for valuable free information. Empire Trades, Dept. MC2, Box 1340, St. Louis, Mo.

MAIL Order or book dealers. Attractive 6x9, 32 page illustrated catalogue on book paper, your imprint. Fast selling books, 40% to 70% profit. Catalogue and full particulars 10c. Thor's Book and Publishing Service, 404 West Ninth Street, Los Angeles 15, California.

EASTER Memorial Lycopodium wreath factory course. Bouquet sample with silvered decoratives 25c. Lycopodium Foundation, St. Paul 8, Minn.

OWN A mail-order paper products business. Sell envelopes, tags, bags, boxes—wholesale. Tremendous demand. Steady profits. Omaha Envelope Service, Dept. 240, 4721 California, Omaha 3, Nebraska.

START Real estate business. America's finest profession spare time. Details free. Educational Book Co., 2907 Berwick Ave., Baltimore 14, Md.

PERFUME. Make it yourself. Profitable spare time home business for men and women. Free information tells how. Write "International," 6347 Parnell-X, Chicago 21, Illinois.

NEW Mail order course sent on approval. Free details. Sams, 3009 Fifteenth, Ensley 8, Alabama.

LEARN Auctioneering by mail. Sample lesson free. Nelson Auction School, Renville, Minnesota.

MAILORDER Opportunities, everything furnished, free details. Shooke, R-10, Charlotte, N. C.

NEW System. Buy at lowest prices. Subscribe to Buyers Telegram. Weekly. Circular on plans. Rush name. Maupin, Tipp City 20, Ohio.

RAISE Fishworms; breeders \$10, thousand. Literature, stamp. Stoner's, Chattanooga 4, Tenn.

ONYX And plastic bases for bronzed baby shoes. 15 styles, also hardening solution. Wholesale. Box 2095, Wichita, Kansas.

MOLD Plastics, compositions, plasters. Simplified methods. Profits tremendous. Investment small. Instructive literature free. Plastics Digest, 2917B Michigan, Kansas City 3, Mo.

INCREASE Your income by mail. Learn how from successful dealer. Details and premium plan 10c. Mosley, Box 3528, Shreveport, La.

IDEAL Business stamping metal key protectors, social security plates. Information upon request. General Products, 11 No. Pearl (M), Albany, N. Y.

FREE Literature describing many moneymaking plans. Verner, 108 Delaware, Oakmont 11, Penna.

RIGHT Way to sell by mail! Hand-book. (priced 50c), free, with other "pointers." Write Phipps, Dept. C, 10993 Wellworth, Los Angeles 24, Calif.

BUYERS Wanted for plaster novelties and religious statuary. Painted, unpainted. Retail, wholesale. Write today for free information. Bing Products, 88-A4K Broad, Boston 10, Mass.

MAIL Order item, 85% profit. Write Revco, 5034-A Pernod, St. Louis 9, Mo.

HEAVY Duty latex for moulds, 95c pint, \$1.50 qt. Guaranteed. Vallance Art Products, 1873 E. 70, Cleveland 3, Ohio.

FREE! 64 Page mail order magazine. Wiggins, 1158 Mill, Lincoln Park 25, Michigan.

LITTLE Library of Useful Information. 112-different books. Catalog free. Popu'at Mechanics Press, 200 E. Ontario St., Chicago 11, Ill.

HOME Workers wanted to hand-spin Angora wool. Either sex. House of Angora, Springfield, Illinois.

BABY Shoes preserved. Formulas, instructions \$1.00. Supplies and bases. Novelty Bronzing, Box 56, Hyde Park 36, Mass.

PROFITABLE Home sparetime business, making wallets, belts, other fast-selling leather novelties. Simple to make. Tools not necessary. Amazing opportunity. Send for free catalog. Gold Leathercraft, 632 Desplaines, Forest Park, Ill.

GOODYEAR—Has Malaya liquid rubber for mold making. Quart \$3.00; gal. \$10.50, trial pint \$1.50. Write for full particulars. Goodyear, Lake Geneva, Wis.

START Profitable mail order business. Run ads, forward orders. Keep big cash commissions. Free details. McKittrick Publications, Mt. Vernon 4, Illinois.

STORM Windows (combination screen and glass) interchangeable from inside home. Make them yourself. We furnish the mouldings knocked down. Send glass size and over-all measurement of your windows. Write Weather-Rex, 155 Genesee Street, Buffalo, New York, for prices and description.

MAKE Strange plastic—1c pound. Makes durable floors, walls, etc. Build for half. Bays Laboratory, Oklahoma City 9.

SAWDUST. Turn it into cash. Six methods. Instructions 25c. Charles, 12-BA, Norwood, Ohio.

INVESTIGATE Mail order or home business. 140 new ideas. Write Marshall, Box 655, Centralia 13, Washington.

MILLIONS Made in mail order business. Mail 10c coin for further information and plan worth 25c. Rinson Mail Service, Box 244, Owatonna, Minnesota.

PENNY Vending machines, four compartment. Start small, grow big. Dinger-son, Georgetown, Colorado.

BE A tax consultant. Bookkeepers, etc. Qualify quickly. Details free. Smith, 17 Rockland, Yonkers 5, N. Y.

LET Us help you to independence, with our monthly "New Products Bulletin" listing 100 newest products, copy \$1.00, "Twenty Tested Advertisements," \$2.00, brand new book, "From Nothing to Independence" with 49 successful selling helpers; \$2.00, \$4.50 buys the three handy money making tools. Details free, satisfaction guaranteed. Educational Book Co., 2907 Berwick Ave., Baltimore 14, Maryland.

STOP Looking further. New combination two-way mail order business. Free information. United Mail Order Bureau, 1310 N. Wells, Chicago 10, Ill.

MAIL Order men, salesmen. Free folder, new profitable fast seller. Flinson, Box 433-B, Kansas City, Mo.

INCOME From leisure hours—Small investment in coin operated radios you place in cabins, tourist camps, hotels, clubs, YMCA's and hospitals brings steady returns. Box 150, Manchester, N. H.

RUBBER Mold makers: Make your liquid rubber go 100% further without affecting the quality, also simple chemical for hardening plaster. Cut shellac cost into half: This service offered by "Liquitex Makers" for 25c with free rubber sample and mold making instructions. Southern Service, Box 3303-A, Jacksonville, Fla.

UP To \$5,000 a year operating one-man home manufacturing business. Splendid opportunity. Previous experience unnecessary. Descriptive survey free. Write today, Roth Associates, Box 356, Appleton, Wisconsin.

INCREASE Your income—With mammoth collection, trade secrets, formulas, processes. Details free. Home Service, 124-N Austin, Wichita-Falls, Texas.

NEW Modern method to make more money. Invest less than \$10 in brand new profitable business. Free details. Mutual Service, 1310 N. Wells, Chicago 10, Ill.

ELECTROPLATING Has a thousand and one uses. Make good money in spare or full time. Warner Electroplaters permit you to easily plate chromium, gold, silver, nickel, copper, etc. Plating equals costly commercial jobs. Pay for your electroplater in a short time by plating for others at a profit. Write today for free sample and literature. Warner Electric Co., Dept. OB-2, 1512 Jarvis Avenue, Chicago 26, Ill.

A FACTORY in your home garage! Mfg. and sales rights, mechanics' waterless hand cleaner. \$500-\$800 monthly. No special equipment necessary. Western Aircraft Mfg., Dept. D, Los Angeles 6, Calif.

DISTRIBUTORS Wanted everywhere. Large profits. Details, catalog 25c. Re-Bilt, Manitowoc, Wis.

EXCLUSIVE Distributor. Plasticized beauty-protection for auto finishes. Used like polish. Must fin. own stock. Plasticize, 2254 N.W. 62nd St., Miami, Fla.

AT Home—Your own manufacturing business; making popular \$1.00 novelties. Cost you 3c to 15c. Everything supplied. Write, So-Lo Works, Dept. C-600, Loveland, Ohio.

LEARN Piano tuning, repairing, at home. Tremendous field! Piano parts, tools furnished. Established 1935. Empire School of Piano Tuning, 606-B East University Ave., Champaign, Ill.

RECAST Old batteries into new. Latest achievements. Battery Laboratories, Minneapolis.

PARATOL Supreme "706" Molder—A newly developed compound. The toughest rubber ever made for molding purposes. Supreme molds, precision reproductions, double strength. For the operator who wants the finest. There is no substitute. Direct to consumer prices: \$1.90 per quart, 1 gal. cans \$6.20, 5 gal. cans \$5.60 per gal. Paratol 705 standard grade still available prices as before: \$1.60 per quart, 1 gal. cans \$4.90, 5 gal. cans \$4.45 per gal. On request 4 oz. samples at 25c to cover mail handling. Be sure specify grade. No shipments outside U. S. A. Testworth Laboratories, Inc., 407 S. Dearborn, Chicago 5, Ill. Manufacturers of rubber coating and adhesive compounds.

MEN-WOMEN. "Most everybody likes candy." Learn to manufacture professionally at home. (Our 38th year.) Ragsdale Candies, Dept. 4, East Orange, N. J.

MAKE Money casting new 1948 metal toys and novelties. Latest scale model autos, original ashtrays, savings banks, water pistols, etc. Enormous wholesale and chain store demand keeps manufacturers busy. Spare or full time. No experience or special place necessary. Write for details and illustrations of patterns needed. Metal Cast Products Co., Dept. A, 1696 Boston Road, New York 60, N. Y.

LEARN To publicize yourself for increased income in your business or profession. Details free. Publicity Systems, Box 322, Jacksonville, Illinois.

YOUR Own business at home. Write, Werner Lindquist, 1210E 3rd Avenue, Rockford, Ill.

MAIL Profits opportunity! New fast selling books, "Leaders," complete line attractive "imprints." Get associate's mail sales rights. Rush quarter for sample "leader," plan. Publishers Associates, 1005 F Belmar, New Jersey.

BOOKS Wanted bulletin, sample copy, 25c. Fortunes in back number magazines. Details 10c. \$10,000 per year in junk. Details 10c. Jos. J. O'Brocta, Mountain Home, Ark.

MAIL Order businesses bought, sold, brokered. Write for free bulletin of exclusive opportunities. Turnipseed, Inc., Box 681, St. Louis, Mo.

BABY Shoes, we metallize hundreds and will teach you how. Easily learned in quick time. No experience needed. Schoettle, Friendship, Ohio.

START Profitable mail business at home. Unusual opportunity. Literature free. William Hawkins, Box 45, North Hartland, Vermont.

METALLIZE Baby shoes. Excellent profits. New system assures success. Free details. Treasures Forever, 89 Henry Ave., Lynn, Mass.

START Home plaster novelty business. Amazing course tells how. Literature free. Kemo-Courses, 4862 Catalpa, Chicago 30, Ill.

LIQUID Marble—Colorful, glossy! Mold, brush, spray. Plastic ivory, flexible molds, composition floors. Particulars free. Marbleizing Service, Edwardsville, Illinois.

MAKE Rubber stamps. Metallize baby shoes, silver mirrors, make plaster novelties. Catalogue of "20 Ideas" free. Universal, Box 1076-A, Peoria, Ill.

OPERATE Profitable mail order business. Write Walter Service, 4159 East 112th, Cleveland 5, Ohio.

SPECIAL Rubber for making molds. Literature and sample free. Universal, Box 1076-A, Peoria, Ill.

INVENTIONS Protected in 30 days. Patents for sale. Patent News, 12, Washington, D. C.

MACHINES Available for making new designs of interlocking concrete building blocks. Delaware Industries, Dept. 11, Muncie, Indiana.

NATURAL Molding Latex. Extra thick. Free sample. W. Wooley, 115-A Donald, Peoria, Ill.

SEX No barrier to success in this uncrowded mail business. Money maker for men and women. Hardinger, Tinley Park 1, Illinois.

DOLLARS To you at home. Write for details. W. A. Jones, Box 395, Upper Darby, Penna.

"PLASTIC Balloons"—New amazing novelty. Easily made. Large profit. Complete formula \$1.00. Ideal Service, Park Ridge 5, Ill.

START Mailorder bookshop—Everything furnished, 25c brings booklet, samples, exciting ideas. General Publications, Ossining, N. Y.

COLORGLAZED Concrete pottery made without molds. Patented method. Cemetery products, novelties, tiles. Basement leak-sealing. Money-making projects. Booklet, details free. Men only. National Potteries Company, Grand Rapids, Minnesota.

MAKE Liquid marble, flexible molds, statuary, art goods, novelties, artificial marble flooring. Literature free. Kemico, Park Ridge 50, Ill.

LIQUID Rubber for making flexible molds. Cast novelties. Sample bottle 25c. Free literature. Chaney, 1130 E. 16th St., Jacksonville 6, Fla.

LEARN The mail order business, \$1.00. Harold's Service, 145 S. Bannock St., Denver, Colorado.

BIG Money in vending machines. Smallest capital start brings immediate profits that build permanent profitable business. Starting instructions free. Becker Vendors, 105-A Dewey, Brillion, Wis.

START Your own electroplating business, highly paid, uncrowded field. Learn at home in spare time. Send postcard for free electroplating booklet and proof. Plater-Hyde, Room 521, 432 "F" Street, San Diego 1, California.

METALLIZING Baby shoes makes you money! Learn this simple, profitable, low investment business from nationally recognized authority. Get professional results with professional "know-how"! Free particulars. Joseph B. Kushner, Metal Finishing Engineer, Stroudsburg 23, Penna.

GET Hundreds money making deals, business ideas, plans and manufacturing. Amazing folio free. Austin Mail Service, 5538 Lexington, Chicago, Illinois.

RUBACREAM! Natural rubber latex! Makes molds quicker! Thicker! Free sample convinces! Castcraft Studios, 509-P Fifth Avenue, New York 17.

TWO Amazing new typing opportunities. Earn up to several dollars hour, right at home. New, exclusive, different. Write Schroder, 221 E. Bush, Covington, Ky.

BELTS! Make'm and make money. No tools! Sample 50c. Artistic Leather, 411 Joseph Ave., Rochester 5, N. Y.

CONVERT Hand mowers to power mowers. Sell the handy-dandy lawn mower conversion kits. Easily installed on any make mower in 3 hours. Used with any small gasoline or electric motor (Maytag, Power Products engines) in stock. Quick delivery. Kits can be purchased with or without engines. Fits 16 to 20 inch mower. Dealers wanted. Write for details. Le Claire Manufacturing Co., Le Claire, Iowa.

\$46 FROM Square foot plywood. Jigsaw necessary. Write, Woodarts, X-38, Bridge-water, Mass.

RUBBER Molds, liquid rubber, statuary plaster, kits for beginners. Complete "Plastercraft" course free on request. Blue Rapids Supply, Blue Rapids, Kansas.

DO It with sea shells. Beautiful jewelry, novelties. Big profit spare time. Free lesson. Werts (P.), 1429 56th Avenue, Oakland 3, Calif.

AGENT Or exclusive distributor for cigarette lighter mfg. MacGregor, Tahoe Valley 16, Calif.

START Home business making statuettes, plaques, artificial marble flooring, liquid marble, flexible molds, metallizing baby shoes. Amazing profits. Folder free. Creative, 236-L, Winnetka, Illinois.

FELLOW Workers, no bosses. National opportunity to become independent with business of your own. Details free. P. Padney, 307 York St., Jersey City 2, N. J.

BRONZED Baby shoe mountings and supplies. All metal bronze bookends, picture frames, ash trays, etc. Onyx ash trays, desk sets, plaques. Hardening solution. 30 amp. plating rectifiers with powerstat control. \$85.00. Geared motors for agitation. \$15.00. Lead lined tanks. Write for list. Hollywood Bronze Supply, 1770 N. Vermont, Hollywood 27, Calif.

POPCORN Machines. Potato chip outfits. Long Eakins Co., 4760 Hi St., Springfield, Ohio.

UP To \$1500 yearly selling by mail in spare time interest you? New ideas and plans every month. Details free. Idea of Month Club, Box 118-A, Baltimore 18, Md.

WHITE Liquid rubber for making flexible molds! Quick drying! Safe! For home, classroom, or industry! Quart \$2.00. Gallon \$5.95. Full instructions! Beginner's booklet on molding and plaster casting 25c. Free with order! Plastercraft Supply Company, 1406 East 43rd Street, Cleveland 3, Ohio.

WOULD You pay 3%—first \$350 made? Color-illustrated book "505 Odd, Successful Enterprises" free! Some offer occasional "day off." Work home. Expect something odd! Pacific, Oceanside, Calif.

GET It for them wholesale. Be community buyer nationally-known merchandise; radios, refrigerators, washers, sweepers, typewriters, etc. Savings up to 50%. This pleasant, easy work can earn up to \$5000 year. Get details today. Kraft, Aurora 8, Missouri.

MAILING Postcards selling repeat merchandise is profitable. Everything supplied. Details free. Gordon Publishers, Box 23, Pawtucket, R. I.

CO-PUBLISH And advertise in The Central Mail Advertiser. Sample copy for stamp. Low rates. Large circulation. Bagby Printing Co., Georgetown, Ohio.

HOW To set up and run a mirror shop! Resilver mirrors. For price write—John Sprinkle V60, Marion, Indiana.

MAIL Order opportunities. Full or spare time. Hundreds of chances. No charge. Postal brings copy. Blackstone Press, Somerville, New Jersey.

GREAT Opportunities and profits in mail order business at home. Free literature. F. Webster, Box 1972C, Hollywood, Calif.

ELITE Collection contains 137 practical money-making plans; local and mail order. New edition. Particulars free. Elite Co., 220 Grand St., New York 13.

QUICK Money! "Repairing car batteries." At home! Easy too! Write, Batteryman, Grand Junction 5, Colorado.

SELL By mail!—Books and novelties! 35 different items! Large profits! Catalog free! Elco, 422 N. Wells, Chicago 10.

OPERATE Profitable home business selling merchandise by mail. Fast sellers. Large profits. Powell Service, 5713 Euclid, Cleveland 3, Ohio.

COPUBLISH Leading m.o. paper. Latest copy Mail Sale Advertiser and proposition, commemorative stamp. Vanroy Shirk, Lebanon, Penna.

START A clock shop. Fascinating, easily learned profitable business requiring little capital. We teach you how to repair all kinds of clocks. Information free. Houston Clock Shop, P.O. Box 5086A, Houston 12, Texas.

HOW And where to obtain capital. Fully explained. Particulars free. Star Service, Wapakoneta, Ohio.

SPECIALTY Manufacturing, the big money business that can be operated anywhere, start on a very small capital; we supply dependable formulas and complete instructions; get interesting free booklet, "Money-making Opportunities in Specialty Manufacturing." Howard Robinson, Ph.G., 1300-A South Ohio Street, Sedalia, Mo.

\$25 WEEKLY Working two hours daily. No canvassing. No manufacturing. Lycke, Box 2471, Cleveland 12, Ohio.

137 WAYS To make money, in home or office, business of your own. Full particulars free. Elite Co., 220 Grand St., New York 13.

BRUSH Plating outfits connect to a battery. No tanks necessary. Good paying business at home plating autoparts, bathroom fixtures, bicycles, reflectors, silvering mirrors. No shop or experience required. Outfits furnished. Free booklet. Gunmetal Co., Ave. H. Decatur, Ill.

MONEYMAKING OPPORTUNITIES

METALLIZE Baby shoes. Further information—3c stamp. Metal Crafts, Box 125-R5, Tampa 4, Florida.

WHOLESALE Catalog. (illustrated, 10c). Bargains galore. Stafford, Box 5211, Indianapolis 1, Indiana.

MAKE—Sell new amazing auto paint you simply wipe on. Complete formula \$1.00. Ideal Service, Park Ridge 8, Ill.

EARN Up to \$520 month part or full time keeping books for small firms. Simplified system. Write Tax-Saver System, Dept. A. Ft. Worth, Texas.

WHOLESALE Shellcraft supplies catalog free; kits will make 28 pieces shell jewelry, \$4.50 postpaid. Sun Shell Supply, Box 2549-M, Sarasota, Florida.

SEWING Machine repairs make big money lifetime. Start neighborhood shop. Complete repair manual, covering all makes, \$1.98 postpaid. Money back guarantee. Sewing Machine Serviceman, Hamilton 9-K, Ohio.

SPARETIME Homework moneymaking opportunities free! Buckeye Lake Publishers, Buckeye Lake 1, Ohio.

INVESTIGATE Specialty manufacturing, for large profits with small capital. Bemcroft, 15 Park Row, New York 7, N. Y.

MONEY In raising mink, spare time. Big demand. Choice mink breeding stock for sale. Free literature. Genesee Mountain Fox and Mink Farms, 860 Metropolitan Bldg., Denver, Colorado.

WANT A good job? Or better one at higher pay? I'll tell you how to get amazing results quickly. Nothing else like it. Sampson Company, Box 388, Oklahoma City, Oklahoma.

INVESTIGATE This amazing life-time opportunity. Earn \$5000-\$10,000 yearly installing, maintaining and rebuilding fluorescent equipment. Make beautiful lights (complete with tubes) for 50c each and less. Free sample materials. For amazing illustrated details, write, Willis Fluorescent Service, 101 York Street, Brooklyn 1, New York, Dept. C.

SELLS Like mad! Show it once—bang! It's grabbed! No sales talk. Costs \$2. Brings \$5. Everybody's a prospect. Sell 10 per hour. Send for illustrated literature. Stampico, 8837 Quincy, Detroit 4, Mich.

500 MANUFACTURER Wholesaler sources \$1.00. (Agents wanted). Dancer, Mansfield, Ohio.

MAKE Money by making reflective signs. We furnish scotchlite material. Can be read day or night. Send \$1.00 for sample and instructions. Day-N-Nite Signs, 238 So. Pacific, Glendale, Calif.

EARN And learn, at home. Excellent opportunity. Details free. Gunn, 504 32 Street, Oakland 9, California.

UNPAINTED Plaster ornaments: Beautiful designs, easily decorated with water colors or oil paints. Profit or hobby. Illustrated list free. Distributors of new Loxite, a Firestone product, for molds. Midwest Novelty Mfgs., 108A Cedar, Anaconda, Montana.

START Profitable business. Manufacture Plastex novelties. Bava, 3655 E. Canfield, Detroit 7, Michigan.

BIG Money. Dry cleaning business. We wholesale. Any 3 garments \$1.00. Mail clothes insured. We reship 2nd day collect. Park Cleaners, 881 Park Ave., San Jose 11, Calif.

MAKE Money. Paint and decorate wall plaques, and book ends. Big demand, good profits. We furnish you the plaques at small cost. Write Marblite, Ames Station, Box 53, Omaha, Nebraska.

PUBLISH Amusement Guide. Profitable local business. Details free. Ward Associates (J2C), Greendale, Wis.

EARN Money. Make piano music boxes. Irv Meyers, 126 Lexington Ave., New York 16, N. Y.

INCREASE Your earnings! Local business opportunities; mail order information; wholesale supply sources; valuable money-making tips; information. Free details, rush name! Wilkin Company, Hillsboro, Ohio.

WANT More money, independence, happier living? New money-making catalog, lists hundreds of mail order business plans, ideas, to point the way. Just 10c brings your copy. Hurry! Silvercrest Publications, 3040-I West North Avenue, Chicago 47, Illinois.

MAKE Perfume. Profitable home business. Men, women write "International," 6347 Parnell, 35, Chicago 21, Illinois.

START Your own business! Big money manufacturing novelties, plaques, statuary. Free catalog. Write Bing Products, 88-A4H Broad Street, Boston 10, Mass.

START A home business in spare time. Make extra money. Experience not essential. Literature free. Patco Service Company, 4512 Willowbrook Avenue, Hollywood 27, California.

ELECTROPLATING Has a thousand and one uses. Make good money in spare or full time. Warner Electroplaters permit you to easily plate chromium, gold, silver, nickel, copper, etc. Plating equals costly commercial jobs. Pay for your electroplater in a short time by plating for others at a profit. Write today for free sample and literature. Warner Electric Co., Dept. MO-2, 1512 Jarvis Avenue, Chicago 26, Ill.

\$400 MONTHLY Possible by mail. Small investment, free details. R & M Mailing Service, 203 First Avenue, Carbon Cliff, Ill.

THOUSANDS Articles wholesale. "Supply Source Directory" 10c. Ideal Service, Park Ridge 40, Illinois.

EXTRA Money? Free details. Trable, 1018 1/2 Elm, Dallas, Texas.

MAKE Big money. Build your own lamps and sell. Free photos, Buddy Products, Dept. 25, 1123 Belmont, Chicago, Ill.

START Your own mail order business. Free literature. Schmalz, Box 335, Mar Vista, California.

WHOLESALE Anything imaginable. New guaranteed list 25c. Refundable. La-salle Novelties, Box 2188, Waterloo, Iowa.

MONEY Making opportunities. Exclusive supply sources. Benefits, etc. 25c. Satisfaction or money back. Evergreen Enterprises, Darrington, Washington.

RESILVER Mirrors at home. Formula 25c. Ideal Service, Park Ridge 6, Illinois.

BEAT Competition—Cash in with newest products. New Products Bulletin Service brings monthly advance notice of 100 newest items. Be first. Copy \$1.00. Details free. H. Heberlein, 17-A Prospect Street, Elizabeth 4, N. J.

EARN Money at home! Thousands do! "Home Worker Magazine" tells how. Sample, 25c. Sizemore, Box 7, 4917 Kostner, Chicago 30, Ill.

EARN Money evenings, copying and duplicating comic cartoons for advertisers. Adservice, Argyle 1, Wisconsin.

OPPORTUNITIES In mailorder. Sample magazine 10c. Adam Palmer, Blacklick, Penna.

WIN Contest money. General Contest Magazine gives hundreds of tips. Lists current contests and rules. Sample 25c. General Contests, 1609 1/2 East 5th, Duluth, Minn.

BIG Profits. Sensationally new. Every home, office, store prospective buyers. No competition. Exclusive dealerships. Sherwood Products, Erie, Penna.

WOULD You pay 3%—first \$350 made? Color-illustrated book "505 Odd Successful Enterprises" free! Proven! Work at home, office. Expect something odd! Pacific, Oceanside, Calif.

THERE'S Big money in junk," and repairing batteries. Write, Batteryman, Grand Junction 5, Colorado.

\$246.50 MAKING Unusual secret device without skill, machinery, from former war material costing \$1.50! Simple, baffling invention, unbelievably profitable! Illustrated proofs free. Rolls Enterprises, 115-D West 16th, New York 11.

FORTIFY The future! Start own business; home, office. Booklet describing "Collection of 137 Tested Plans" free. Elite Co., 220-A Grand St., New York 13.

PUBLISH Your own magazine. Hand-some 52 page format, well edited, illustrated. Cost low as \$1.00 month. Brings you prestige, profits. 25c brings sample, details. National, Ord. Nebr.

FORMULAS, PLANS, ETC.

10 COMPLETE Profitable formulas 50c. Hall, 2732 E. Baltimore, Baltimore 24, Md.

FORMULA To hold false teeth. Pure, simple, effective ingredients. 25c. O. Ward, North Branch, Michigan.

MANUFACTURE Cleaners, soaps, polishes, flavors, cosmetics. Literature free. Kemico, Park Ridge 18, Illinois.

10,000 FORMULAS And trade secrets. Free literature. Stillman, 555 Kingston Ave., Brooklyn 3, N. Y.

REAL Manufacturing formulas. Lists free. Cummings, Chemist, Gordon Ave., Syracuse 4, N. Y.

PLASTICS

PLASTICS Trade secrets. Write for free information. Enclose 25c if you would like plastics samples. Plastics Research, Box 346, Alhambra, Calif.

RENEW Leather and leatherette—Make cloth into imitation leather with plastic discovery called Leather-New. Opportunity to make real profits taking care of sales resulting from national advertising. Write for free sample of Leather-New covered material and complete deal. 4723B Troost, Kansas City, Missouri.

LUCITE. Plexiglas, masked sheets. All sizes. Cost square foot (12"x12") 1/16" 85c; 1/8" \$1.10; 3/16" \$1.30; 1/4" \$1.60; 5/16" \$1.96. Lucite rod, tubing. Include 10% postage. Almac Plastics, 230 Fifth Avenue, New York 1, N. Y.

10 ENTIRELY New ideas, plastic projects, \$1.00. Designers Group, Box 363, Pleasantville, New Jersey.

LUCITE—Rods, tubing, sheets, fabricators. Catalog dime. Book "General Plastics," \$1.50. Mid-West Plastic, 1717 No. 66, Omaha 4, Nebr.

PLEXIGLAS—Masked sheets, 12"x12", 1/16"-\$1.00, 1/8"-\$1.25, 3/16"-\$1.55, 1/4"-\$1.85, include 10% postage. Internal carvings. Drills, dyes. Luminous powders, rods, tubes, cements, jewelry findings. Free catalogue. Craft Plastics, Somerville, N. J.

SAMPLER—Contains casting plastic, mold material, instructions, color, everything to mold several small, saleable articles. \$1. Circular free. Artcrafters, 2917 Michigan, Kansas City, Mo.

VALUABLE Publication "How and Where to Sell Your Molded Plastic and Plaster Casts Profitably," only \$1.00. Postal brings free details. Banks, 6635-16S, Ave., Kenosha, Wis.

INTERNAL Carving Lucite, 4x4x1/2". Bulletins, 50c. Technicraft, 1156 Commonwealth, Boston 34, Mass.

PLASTIC Injection machines, Plexiglas, dyes, jewelry findings, kits, etc. Free catalog. G. Baker Company, River Edge, New Jersey.

FABROS Pre-fabricated plastic kits and supplies. Sample kit 50c. Catalog free. Fabros, Box 156 Station F-1, Buffalo 12, New York.

FORMALIN For lustrous color-castings. Free literature. Complete line plastics casting supplies. Sample kit \$3.00 f.o.b. Formalin, Romeo, Michigan.

INTERNAL Carved swans, bluebirds, goldfish, butterflies, etc; pins, \$1.50, 2 1/2 x 2 1/2 paperweights, \$2.50; roses, costume jewelry sets, \$1.50 less findings; 2x2x2 paperweights, \$2.00. Crystal Floral Novelty Co., Somerville, New Jersey.

WHEELS With spokes, lucite, up to 6 in. diameter. Free specifications and price list. Hudgens Plastic, Norcross, Georgia.

PLASTICS—Sheets, rods, tubes, all colors; dyes, supplies; findings. Illustrated fabricating manual, prices, 10c. Lucite sample, 35c. Gem-O'-Lite, Box 686F, North Hollywood, Calif.

PLASTIC—Sheets, rods, tubes, etc. Free list. Plastic Supply Co., 2618 St. Louis Ave., St. Louis 6, Mo.

BOOKS—All Kinds—Homecraft, Radio, Plastics, Boat Building, Photography, Model Building. Catalog free. Popular Mechanics Press, 200 E. Ontario St., Chicago 11, Ill.

CHEMISTRY

LEARN Chemistry at home, from the house of Winn. Home of supplies for student chemists. New idea chemical and apparatus outfits for home experimenting. Semi-professional microscopes and accessories. Send 10c for retail catalogue. Established 1931. John H. Winn, Dept. 502, 124 West 23 Street, New York 11, N. Y.

CHEMICALS And apparatus for industrial, analytical and private laboratories. Complete supply service for correspondence school students. Send 10c for catalog. Dept. M-43, Biological Supply Co., 1176 Mt. Hope Ave., Rochester 7, New York.

FREE Catalog: Chemistry, mineralogy, physics, biology. Tracey Laboratories, Evanston, Illinois.

LABORATORY Supplies, chemicals, glassware, etc., low prices. Large catalog 15c. Microscopic stain catalogue 20c. Both for 25c. National Scientific Company, Established 1908, 2204 W. North Ave., Chicago 47, Ill.

CHEMICALS—LAB. Supplies. New catalog 10c. Mel-Glo Chemical Co., 258 Fourth Avenue, Brooklyn 15, N. Y.

APPARATUS, Chemicals, ounce quantities, catalog 10c. Fleischer's Laboratories, Everett 49, Mass.

NEW Laboratory supply catalog of chemicals and apparatus, contains over 5000 items with illustrations, 212 pages. Send 50c. Standard Science Supply Co., 1232 No. Paulina Street, Chicago 22, Ill.

HANDBOOK For chemical experimenters, illustrated, hundreds of experiments, 50c. Experiment booklet 15c. Supply catalog 5c. Reading Scientific Company, Reading, Penna.

HELP WANTED

BOYS Wanted. Over \$50 week! Sell name plates for front doors. Write National, 214-M Summer, Boston, Mass.

SEND For free gift offer. Sell excitingly different, taste-thrilling, Creole Candy, 2910-MP, Maurepas, New Orleans 19, Louisiana.

AGENTS WANTED

90c PROFIT Each \$1 sale! Sell real mothproofing solution. Employ agents. Experience unnecessary—we tell you how. Kinford, Wayne 3, Penna.

FREE! Big box actual full size packages foods, groceries, home needs, sent f.o.b. factory. Try them at home and show friends. World beating money making opportunity. Write Zanol, Richmond St., Dept. 6089B, Cincinnati 3, Ohio.

FARMERS! Make more money. Your own boss. Outside work. Steady year-round. 200 farm-home necessities. No experience necessary. We train and help you. For details write Rawleigh's, Dept. B-242-PPM, Freeport, Ill.

AGENTS, Distributors—Personal name plates for homes, office. Big profits. Al Peterson Associates, Box 822, Providence 1, R. I.

\$70.00 A Week extra making and selling dial tire pressure indicator for cars. Very simple and easy to make for \$1.50. Every garage and auto supply house a customer. Our manual shows how, \$1.00. Tire Pressure Indicator, Box 6126, Harlandale Station, San Antonio, Texas.

WOMEN Buy elbow pads to sew on menfolk's sweaters. Profitable agents proposition. Kann Manufacturing, Box 486 Northwestern Station, Detroit 4, Mich.

BUILD, Enjoy own local shoe business. Sell amazing, new patented Miracle Cushion shoes. Complete line, entire family. No investment, experience unnecessary. Free samples to producers. Free outfit. Paragon Shoes, 729 Columbus, Boston.

EARN Money quickly, easily, pleasantly, showing greeting cards, stationery, wrappings. No experience needed. Up to 100% profit. Send today for everyday assortment on approval. Free personal stationery folder. Thomas Terry Studios, 200 Union Avenue, Westfield, Mass.

EVERYDAY Cards. Earn \$5.00 with every ten \$1.00 assortments you sell. Also wrappings and note paper. Unusual quality. Send for samples today. Howard P. Ellis, Dept. PM-3, Pitman, N. J.

MAKE Money fast showing exquisite greeting cards—Birthday, Valentine, Easter, wrappings, notes, stationery. Full-spore time. Amazing profits, bonus. Special offers. Opportunity for organizations. Free stationery samples. Feature \$1.00 all occasion assortment on approval. Write today. Hedenkamp, Dept. F-42, 343 Broadway, New York 13.

AMAZING Offer—\$25 is yours for selling fifty \$1.00 boxes of entirely different, new deluxe all-occasion cards. Each box sells for \$1.00, your profit 50c. It costs nothing to try. Write today for samples. Cheerful Card Co., Dept. 242, White Plains, N. Y.

EASY! Fascinating! Profits to 100%. Bonus. 31 new greeting card boxes 30c up. 5c and 10c individual cards, stationery. Request free name imprinted and floral stationery samples, free 32-page catalog and \$1.00 all occasion assortment on approval. Special offers. New England Art Publishers, North Abington 79, Mass.

\$1 STARTS You in business. Sell deluxe ties, 100% wool interlining. Costs you only \$7 per dozen, you make \$5.00 dozen. Send \$1.00 for special introductory offer two deluxe ties. Catalog complete line free. Phillip's Neckwear, 20 West 22nd St., Dept. K-20, New York 10.

SILVER Cleaning, plating, polishing liquid (NuSilver). Apply with cloth. Renew silverplated ware, articles, pieces. Silverplates brass, copper, bronze. Female, male, selling representatives wanted. Part, full, time. NuProcess Products, Aurora, Illinois.

FREE Sample Nifty shirt down holder. Send dime for jobbers prices, details. Nifty, Box 812, Oakland, Calif.

MAKE Extra money handling magazine orders in your community! Build your own business. Helps furnished. Big demand. Wholesale catalog sent free! Write today. McGregor Magazine Agency, Dept. 12, Mount Morris, Illinois.

EARN Big money fast! Sell finest-quality advertising work uniforms to garages, factories, filling stations, etc. Free selling kit. Topps, Dept. PM-248, Rochester, Ind.

EARN Big money. 21 Sunshine everyday cards for \$1 with beautiful floral lined envelopes. Sensational value. Take orders galore. Costs 50c. Sells \$1. Also 1948 Sunshine notes, birthday, monogram stationery 50 for \$1. Gift wraps. Samples on approval. Write today. Sunshine Art, 115 Fulton St., Dept. PM-2, New York City.

A DRESS Yours with every 3 you order for yourself and family. Amazing new bonus plan. Everything free. Harford Frocks, Dept. J-9128, Cincinnati, Ohio.

AT Last! Something new and sensational in everyday cards. New gorgeous satin and velour designs. Get orders fast. Big profits. Imprinted stationery, 14 assortments for year 'round occasions, retail 60c to \$1. Get samples on approval. Puro Co., 2801 Locust, Dept. 840-B, St. Louis 3, Mo.

ABSOLUTELY Free! Big package actual sample fabrics and style presentation of dresses, lingerie, hosiery, etc. Take orders. Commissions big. Send no money. Melville Co., Dept. 4569, Cincinnati 3, Ohio.

CALL On friends with greeting card assortments, birthday, get-well, others. Floral stationery. Gift wrappings. Big profits. Experience unnecessary. Samples on approval. Wallace Brown, 225 Fifth Ave., Dept. B-4, New York 10.

SELL Ultra blue stock signs to stores, 1000 slogans, comedy, general, religious. 7x11, cost 6c, sells 35c. Make money. Sample free. Lowy, 8 West Broadway, Dept. 362, New York City 7.

MEDICATED Candy breath deodorant, selling to taverns, drug stores, etc. New, profitable repeater. Chex, 2910 N. 16th St., Philadelphia 32, Penna.

ECUADOREAN Native handwork brings fantastic profit. Precious sample collection \$1. Novelties immediately saleable. Moneyback guarantee. Estrella, Box 537, Quito, Ecuador.

\$3 FIRE Extinguisher; quick sales, wholesale or direct; liberal profits. "Fire-Killer," 109 N. Franklin, Syracuse 1, N. Y.

SENSATIONAL News! Our magnificent picture enlargements on lifetime plastic hardwood plaques sell on sight! Take orders for big profits. Gotham Products, Dept. A, Box 5427, Philadelphia 43, Penna.

NEW "Sponge" wall cleaner. Erases dirt like magic. Wallpaper, painted walls, ceilings. Saves redecorating. Lightning seller. Samples sent on trial. Kristee 118, Akron, Ohio.

MAGAZINE And bookmen can increase their income by selling my lawn book. 100% profit. Agents copy 50 cents. Leslie Kerr, 3825-A Tenth Street N.W., Washington 11, D. C.

AGENTS—Call on garages, filling stations with \$24.50 quality wheel balancer. Competing models to \$2,000. Virgin market. Five minute demonstration means sales. \$10 cash commission. Twenty sales possible daily. Exclusive territory. Write B & B Mfg. Co., Box 816, Sioux City, Iowa.

BIG Money selling tooth powder. Write today. James Walker, 633 Plymouth Ct., Chicago, Ill. Dept. 1.

\$2 FIRE Extinguishers. 200% profit. Sample \$1 postpaid. Lorrac Products, Albany 1, N. Y.

UNLIMITED Commissions taking orders—Colorful pocket perfume atomizers. Prospects everywhere. Dynamic Sales, Box 3552P, Cleveland 18, Ohio.

DEMONSTRATE Vanishing cigarette trick. Working sample, 25c. Schetz's, Sellersville, Penna.

QUICK Extra cash. Sell value plus greeting cards. New 1948 line. 30 boxes retailing 60c to \$1.00 each. "Flower-of-month" and initial stationery. First name imprinted remembrance notes. Profits to 100%. Extra bonus. Special offers. Write today for feature all-occasion samples on approval and free name imprinted, floral stationery sample portfolios. Elmira Greeting Card Co., M-44, Elmira, N. Y.

NEW, Fascinating novelty. Unusual sales plans. "Mad-Nets"—magnets that float, walk, jump. Attractive \$1.00 package. Details free. Frederick, Rm. 10, 4 South St., Stamford, Conn.

FLASH: "Gold finished lapel cross"; fast 35c seller. Introductory dozen \$1.00. Sell, remit 50c. Valuable sample 20c with interesting moneymaking literature free. John Walter, 39 Bath, Ballston Spa, N. Y.

WIDE Awake young men earn big money in spare time. Travel for greater profits. Tried and proven. Immediate profits, unlimited territory. Send \$1.00, no more, for amazing plan. Davidson & Company, 1377 Euclid Avenue, NE, Atlanta, Georgia.

AUTOMATIC Cigarette lighter, 98c. Electric alarm clock, \$3.69. Samples c.o.d. United Watch Company, Saint Cloud, Minnesota.

EXCITING Details, shows "how" you make big profits with our fast-selling new lines! Plastic tablecloths, aprons; personalized, cotton pillow cases, many other sales-appealing items, novelties! Write for big discount price list, "Special Deals." Hurry! Royalty, Box 748-A, Passaic, N. J.

MAKE Money at home like I do! Write immediately. Duffy (4), Covington, Ky.

SELL Sweet smelling perfume beads, earrings, combs for quick sales. Low wholesale. Mission, 2328-P West Pico, Los Angeles 6, Calif.

RAINBOW Balloons, rubber balls, cute balloon dolls, squawkers, fireworks. Merchants profit plenty. Sample gross balloons \$3.50. Ellwood Distributors, La-Junta, Colorado.

MAKE Perfume, profitable home business. Men, women write, "International," 6347 Parnell, 35, Chicago 21, Illinois.

AGENTS—Stop! Never buy plastic aprons, tablecloths, etc., until you get our new low prices. They're amazing. Riddell Sales Co., 1313-P East 62nd Street, Chicago 37.

MAKE Extra profits on each call. We tell you how with new patented 3-in-1 screw-driver. Every direct seller should carry. Write today. Johnson Equipment Co., PM-248, 1940 E. Sixth, Cleveland, O.

PAINT, White house paint, for wagon jobbers and auctioneers, 95c gallon 5's, \$1.00 gallon 1's. Minimum 50 gallons, f.o.b. Kansas City. Surplus black enamel, nationally advertised brands, acidproof, 75c gallon. Mail money order for immediate shipment. No correspondence. Trading Post, 2032 Burlington, North Kansas City, Mo.

FREE Sample! Big profit opportunity with amazing glow-in-the-dark house numbers, switch plates, pictures, decals, religious articles. Represent large manufacturer. Madison Mills, 303 Fourth Avenue, New York, N. Y.

LARGE Variety general and essential merchandise 50c to \$3 sellers. Manufacturers, 264 5th Ave., New York.

STEADY Large earnings; real staple, rubber hose; sell jobber, wholesaler, consumer, industry, automotive; no territory restrictions, no investment. Advertised line, generous, protective deal, full or part time. Ace Hose & Rubber Co., 769 Van Buren St., Chicago 7, Ill.

BE First! Get free details. Earn big money at home. Spare time. Easy, pleasant, exciting. Unlimited. 1930 Adoline, Fresno, California.

100% PROFIT. No investment, handle quality Fotostamps. Amazing glossy photographs, gummed stamp form. Business year round. Free samples, particulars, American Foto Stamp Co., 103 East 125th St., Dept. PM1, New York 35.

BIG Profit. Quick sales. Automatic adding machine sells for \$21.50. Your profit \$10.00. Write for selling plan. Allied, 2518 W. Montrose, Dept. M, Chicago 18, Ill.

STARTLING, Sensational combination fluorescent desk lamp and photo frame. Easy seller. Big profit. E.C.A., 2518 W. Montrose, Dept. M, Chicago 18, Ill.

SCHOOL Seniors: Sell classmates superb Craftcards for super profits. Write Craftcards, Box 235(AK), Pittsburgh 30, Pennsylvania.

MAKE More money selling personal initialed individualized belts, buckles, cap badges, tie holders, 2000 emblems to choose. Big profits, whole or part time. Write today special outfit offer. Hookfast Specialties, Box 1425, Dept. 6, Providence, R. I.

DISTRIBUTORS Wanted for unusual household products. Levine's, 15-X Boulevard Station, New York 59, N. Y.

FREE Water and our concentrates, makes flavors, lotions, shampoos. 72 products, labels, bottles furnished. Qualco, E-20030 Russell, Detroit.

AGENTS. Sell finest food products direct to homes. Successfully sold for 25 years. Big profits. Powerful combination sale plans make sales easy. Permanent repeat business. Samples furnished. Live territories open to distributors. Mother Hubbard Products Co., 4139 Grand, Dept. P.M., Chicago.

INFORMATION—Wholesale supply sources. Moneymaking plans. Increase your income! Write Reynard Service, Smithfield 3, Ohio.

QUICK Sure money. Selling Annie Blain favors. New Brunswick, New Jersey.

SCHOOL Seniors—Earn 40% commission selling classmates America's most beautiful graduation name cards. Largest selection. Outsell all others. Send for free sample kit. Printcraft, 1425 E. Elm St., Scranton 5, Penna.

SCHOOL Seniors! Your postal will bring our wonder, Kwick-Sell Cardalog of popular graduation name cards. Biggest profits! Only firm giving free souvenir chest and card case. Don't miss out! Hurry that postal! Craftcards, Box 235(L), Pittsburgh 30, Pennsylvania.

AGENTS—Big line including food products. Fast selling premium and bargain deals. Low prices. Send card for big outfit offer with gift. Ho-Ro-Co, 2725 Dodier, St. Louis 7, Mo.

100% PROFIT With new electric gas lighter, eliminates matches, pilot. Write Optical Research Products, Fairview, N. J.

EXCELLENT Sideline for printing and advertising salesmen. Decalomania name plates in small quantities. Great demand. Also, make money with our line of automobile initials and sign letters. Free samples. "Ralco" XL-Roxbury, Boston 19, Mass.

AGENTS: Stamping names on pocket-key protectors. Sample check with your name, address, 25c. Stamping outfits. Emblem checks, check-fobs, name plates. Hart Mfg. Co., 303 Degraw St., Brooklyn, N. Y.

MAGIC Cleaner and laundry soap deal. Hotter than a firecracker. Big profits. Sample free. Bestco, 5007 Irving Park, Chicago.

137 COMPLETE Plans for starting own business: local—mail order. Particulars free. Elite Co., 220 Grand St., New York 13.

AGENTS—300% Profit selling genuine gold window letters; stores and offices. Free samples. Metallic Letter Co., 438-B North Clark, Chicago.

GOLD Lacquered window sign letters. Large sizes penny each. New foils. Absolutely beautiful. Free samples. Atlas, 544 W. 79th, Chicago 20.

HIGH-GRADE SALESMEN

SALESMEN: Big money showing building owners sensational product; cuts essential repair cost up to 75%. Six average orders weekly pay you over \$190.00. Age: 30 or over. Get money-making facts. Write, Zone Co., Dept. B-6, Box 789, Ft. Worth 1, Texas.

START Your own business on our capital. Always your own boss. Hundreds average \$6,000 to \$25,000 annual sales year after year. We supply stocks, equipment on credit. 200 home necessities. Selling experience unnecessary to start. Wonderful opportunity to own pleasant, profitable business backed by world-wide industry. Write Rawleigh's, Dept. B-U-PPM, Freeport, Ill.

AMAZING New zipper shoe sells on sight. Big cash profits for salesmen. Leads line 200 splendid styles. Territory open. Get free sample outfit. Write Consolidated, Dept. S-47, Chippewa Falls, Wis.

SALESMEN. Earn \$100.00 weekly, selling only six pair shoes daily. Commission and bonus. Wide variety for men, women, children. No investment. Experience unnecessary. Tanners Shoes, 208, Boston, Mass.

SALESMEN. Here's a natural. New patented tool multiplies man's strength 31 times. Sell retailers. Needed by autoists, farmers, lumbermen, builders, transporters, garagemen, public works. Immediate deliveries from our U. S. plant. Write or wire for attractive proposition. Palcoseel Co., Ltd., Cornwall, Ont., Canada.

ADVERTISING Book matches—Cash in on political campaigns. Sell union label matches. Cuts for all businesses and political parties. Free powerhouse selling kit. Low prices. Protection guaranteed on repeat orders. Cash commissions. Superior Match Co., Dept. M28, 7530 Greenwood, Chicago.

MEN Wanted at once. Full or part time. Just send name, address for free copy of Specialty Salesman Magazine giving hundreds of immediate openings with reliable firms. Sales experience unnecessary as we also send free 42 page book telling how. Specialty Salesman Magazine, Dept. PM-12, 307 N. Michigan, Chicago 1.

SELL Delicious candies, nuts, gum. Immediate delivery. Write Casterline, 2031-PD Sunnyside, Chicago 25, Illinois.

BUILD Steady, large, reliable advertising specialty business. Lowest prices, largest profits on key cases, electric flasher signs, book matches and hundreds of others. Free sales portfolio. Willens and Company, 2130-R Gladys Ave., Chicago 12, Ill.

SELL Over 1100 items—Electric flasher signs, adding machines, tags, tape, all printed necessities, pencils, restaurant supplies, and many others. Free sales portfolio. No experience necessary. David Lionel Press, 312-T So. Hamilton Ave., Chicago 12, Ill.

OPERATE Wholesale candy business. Sell stores. Samples, information \$2.00. Sally Dee Candies, Newport, R. I.

SELL Calendars—Every business a prospect. Also wholesale to printers; calendars, sheet pictures. Fleming Calendar Co., 6540 Cottage Grove, Chicago 37.

FACTORY Salesmen—Sell Charles Chester nationally known cushion shoes direct. Complete line for entire family. Full time or sideline. Full time men earn up to \$20 per day in commission. Big repeats. Samples and equipment free to producers. Chas. Chester Shoe Co., 2002 Chester Bldg., Brockton, Mass.

50% TO 65% Profits. Far superior automatic fire extinguishers. Free sales kit. Freight paid. Red Ball Co., Box 1552, Salt Lake City.

ADVERTISING Book matches—World's largest direct selling manufacturer of advertising book matches offers opportunity for profitable year 'round selling; every business a prospect; no experience needed to start; men or women; full, part time; Factory service. Low prices for high quality; repeats; sales kit furnished. Match Corp. of America, 3433-43 West 48th Place, Dept. E-15, Chicago.

SALESMEN Making \$100 weekly selling automotive hardware, industrial accounts. Grimebuster mechanics waterless handcleaner. Build permanent repeat business. Write Schaffner's, Dept. PM-2, Pittsburgh 2, Penna.

SALESMEN Wanted. To sell finest quality cast aluminum ware. Write Box 337, New Washington, Ohio.

FACTORY Representatives. Hardware-electrical. Leads furnished. Farm Products Co., M-2002, Excelsior Springs, Mo.

AGGRESSIVE Salesmen. To keep stores supplied with self-selling 5c and 10c counter-card products. Nationally advertised throughout the year in leading magazines and more than 2300 newspapers. Biggest profits, full time or sideline. Write today. World's Products, Dept. 10-Z, Spencer, Ind.

POCKET Pal: Replaces pocket knives. New. Safe. Beautiful. Always razor sharp. 50c seller. 231% profit. \$15.00 or more daily. Agents, salesmen, distributors. Samples 10c. Nelson Mfg. Co., 222 W. Kellogg, St. Paul 2, Minn.

\$221.90 IN One week—Unusual? Not at all! Just look at one week's earnings of these representatives. SWB \$247.84, JRS \$252.80, HMT \$242.75, HC \$252.93, MET \$319.38, OP \$442.40. Direct mail campaign brings hot leads right into your home. Remarkable product does part of 10 men's work—a "natural" during these labor problem days. Has perfect sales story—sells year 'round. As modern as radar! Free equipment offer! We extend credit, deliver and collect. No capital required—no experience necessary. You make big profit on first sale and full credit on repeat business. Every business, store, home, factory, etc. are prospects. Write John Porter, 2433 Indiana, Dept. 304, Chicago 16, Ill.

NEW Magic menu paper, copies without carbon, used from coast to coast. Large profits for restaurant salesmen. Systematic Company, Houston 1, Texas.

LONG Needed invention. Proved success. Powerful demonstration. Every home, factory, store, office a prospect. Low price, long profit. Exclusive. Fine outfit furnished. No deposit. Get facts quick. Write 392 R. C. Building, Red Comet, Inc., Littleton, Colorado.

CASH Profit—Big earnings; selling personalized-buckles, belts, cap-badges, tie clasps, 2000 emblems, caps, shirts, ties. Write, Hook-Fast Products, Dept. A, Columbus 6, Ohio.

PHOTO-SALESMEN—Agents. Sell beautiful hand colored plastic enlargements. Collect deposit, we deliver. Profitable sideline. Send card, for free sample kit. Novel Portrait, 3343 North Ave., Chicago, Ill.

WAGON Salesmen—Fast moving carded goods and 10c line. Long profits. Free facts. Peerless, 2720 Dodier, St. Louis 7, Mo.

BIG Cash profits daily taking orders: uniforms, shirts, ties, personal initialed individualized buckles, belts, cap badges, tie holders, 2,000 emblems. Repeats. Write today. Special outfit offer. Hook-Fast Company, Box 480-PM, Roanoke, Virginia.

JOBS Open in selling! Send name, address for free copy Opportunity Magazine, listing hundreds of companies who need men now, full or spare time. Experience not essential. Opportunity, 28 E. Jackson, Dept. 17, Chicago 4, Ill.

BIG Money taking orders. Shirts, ties, Sox, pants, jackets, sweaters, shoes, uniforms, etc. Sales equipment free. Experience unnecessary. Nimrod, 4922-AN Lincoln, Chicago.

BE The Popular Mechanics representative in your neighborhood and earn big profits in your spare time. Write Popular Mechanics Magazine, Room 408, 200 E. Ontario St., Chicago 11.

EDUCATIONAL AND INSTRUCTION

LINGUAPHONE Makes languages easy. At home learn to speak Spanish, Portuguese, Italian, French, German, Russian, by quick, easy Linguaphone Conversational Method. Save time, work, money. Linguaphone correspondence courses are available to veterans under G.I. bill of rights. Send for free book. State if G.I. Linguaphone Institute, 83 RCA Bldg., New York, 20, N. Y.

WHY Don't you write? Writing short stories, articles, etc., will enable you to earn extra money. In your spare time we teach you to write the way newspaper men learn—by writing. Free "Writing Aptitude Test" tells whether you possess the fundamental qualities essential to successful writing. Veterans! This course approved for veterans training. Write today: Newspaper Institute of America, Suite 5728-B, One Park Ave., New York 16, N. Y.

1948 GOVERNMENT Jobs! Start as high as \$58.09 week. Men; women. Vets get preference. Prepare now for next examinations. Particulars free. Write today. Franklin Institute, Dept. 724, Rochester 4, N. Y.

SUCCESSFUL Men are good at figures. Add, divide, subtract, multiply easily and with lightning-like rapidity—and always be right! Make your associates envious; astound your boss. Increase your efficiency. Become a "quick-at-figures" top-flight executive. Write for free literature: Adograf, P-1209 South Garfield Ave., Alhambra, California.

STAMMERING Corrected. Booklet gives full information. Write: William Dennison, 643-A Jarvis St., Toronto, Ont.

NOW You can have an office. Learn credit-collection business by new home study course. Many earn up to \$5000-\$15,000 annually. Free bulletin. Franklin Credit School, Dept. 202B, Roanoke 7, Va.

MAKE Up to \$30-\$40 week as a trained practical nurse! Learn quickly at home. Booklet free. Chicago School of Nursing, Dept. M-2, Chicago.

JOIN The Salesman's Club. Training—placement. Box 1805, Portland 11, Oregon.

DEPEND Yourself masterfully. Use amazing secret guerrilla tricks of self-defense. Easy, sure, effective. Free literature. Inspiration House, 3108 Hillside Road, Harrisburg, Penna.

WANTED. International and other good used correspondence courses and books. Write for catalogue and quotations. Baker, 5509 B Winthrop, Chicago 40.

ANALYZE Handwriting for profit! Complete outfit \$1.00. 4462-R Germantown, Philadelphia.

BOOKKEEPERS! Increase your earnings! Operate your own simplified "Dollar-A-Week" bookkeeping and tax service. Full or spare time. Details free. No obligation. Ellis, Box 207-F, Cedar Grove, North Carolina.

WELDING—Electric, gas trade training pays at GI approved welding school. Catalog free. Write Hobart Welding School, Box M-285, Troy, Ohio.

LEARN Air conditioning at home. Big demand for trained men. Enormous profit opportunities. Write Nelson, Box 8-C, Warner Robins, Ga.

WAKE Up! Investigate your overlooked resources—unsuspected opportunities. New home study course solves mental worries, develops confidence, increases income. Details free (expect something revolutionary). Jay Dalton, Psychologist, Box 824, Los Angeles 53.

FOOT Correction! Extension. Degree. National School of Foot Correction, Juneau 1, Alaska.

3800 CORRESPONDENCE Courses cat. 50c personal course barbells. EG, Elmsford, N. Y.

STUDY And win. Send \$2 for your copy. John V. Jewett, 19 Craftsland Road, Chestnut Hill 67, Mass.

AMAZE With Supermemory. Step up your brains and income. Get facts free. Write CM2, Thor Books, Box 1210, Chicago

INVESTIGATOR Training. Phillips Secret Service, 1917B North Kenneth, Chicago 39, Illinois.

NEW Writers needed. Want to cash editors' checks? If you can read, we can teach you how to write for pay. Earn as you learn. First lesson free on request. No obligation. Send postcard today. Comfort Writer's Service, 200 S. 7th St., Dept. 11, St. Louis 2, Mo.

EXPERT Bookkeeping, easily learned. 15 lesson course \$5, introductory lesson 35c. Bernard Buchalter, 1280 Ocean Ave., Brooklyn 30, N. Y.

LEARN Photo-engraving at home or in oldest, largest school in America. Work for newspaper or establish own profitable business. New Tasope' Photo-Engraving equipment available soon. Write for information. Veterans ask about G.I. training. The Aurora School of Photo-Engraving, Tasope' Bldg., Aurora, Mo.

BECOME Sanitation supervisor. Seven easy lessons. Certificate, profits, promotion. Institute, 2385-A Edgewater, Los Angeles 26.

HOME Study course, drugless therapy. Free literature. Institute of Drugless Therapy, Tama, Iowa.

MEDICAL Laboratory technicians in great demand. We train you in your spare time, in your own home. You can practice while studying. Write for free catalogue. Imperial Technical Institute, Box 973-E, Austin, Texas.

USED Educational books on all subjects sold, rented, also bought and exchanged. Moneyback guarantee. Write today for free catalog and details. Lee Mountain, Pisgah, Alabama.

SECRET Investigation. Experience unnecessary. Investigators particulars free. George Wagner, M 125 West 86th, New York.

PLAYS, STORIES, MANUSCRIPTS

PROFITABLE Book publication on even the limited sale of your book is possible. Details in our free copy of "A Decade of Publishing." Dept. K, Exposition Press, One Spruce Street, New York 7, N. Y.

I WANT New writers to cash hundreds of checks for \$1 to \$100, offered each month. The easiest way to write for pay. No previous experience necessary. Send for free details. No obligation. Saunders M. Cummings, 467-M Independence Bldg., Colorado Springs, Colo.

EVERY Help for all writers. Low cost. National Writers Club, 1837 Champa, Denver 2, Colo.

BUSINESS SERVICE

SWITZERLAND; Watches, anything. Factory prices. Catalog free. Post Sach 954, Solothurn, Switzerland.

SPECIAL SERVICES

SPEECHES Written for all occasions. Smith, 5635 Nicollet, Minneapolis, Minn.

FORWARDING. Prompt service, letter 25c, monthly \$2.00. Also special services performed. Arlestors, Box 256, New York 30, N. Y.

POSTMARK Your mail. "Washington, D. C.!" Letters mailed here, 25c each. Complete (receiving, re-forwarding) service, \$3.00 monthly. "Hawkins," 1300 Taylor-k N. W.

IF You have a new product to market, use my Sales Promotion Plan to make big money. Details free. Wellington J. Smith, Direct Advertising Service, 9611 Clifton Blvd., Cleveland 2, Ohio.

MANUFACTURERS Increase your markets! Find new uses for your present products, new products and waste products. Chemical, biological, electrical, mechanical and textiles. Sample or description with all technical information available with check for \$1.00 will bring you an appraisal by experts. Applications Research, Newtown, Penna.

MFG.—Wholesale sources. Most any item. "Service," 1332 D Findlay, New York City 56.

MAIL Forwarded from New York. 10c letter. United, 118 Lincoln Avenue, Brooklyn 8.

LETTERS Remailed 25c, three 50c. H. N. Johnson, Desk B, Box 85, Jacksonville 1, Fla.

CARTOONING, COMMERCIAL ART, SHOWCARD WRITING, SIGN PAINTING

FAMOUS \$75 Lockwood art course now only \$5 postpaid. Other smashing art bargains. Catalog 10c. Art Book Shop, Arnold 5, Mo.

LEARN Showcard writing at home in spare time. Fascinating, profitable. Free information. Sherwood Publishing Co., Irvington, 11-Z, N. J.

"HOW To Make Money With Simple Cartoons"—a book everyone who likes to draw should have. It is free; no obligation. Simply address Cartoonists' Exchange, Dept. 92C, Pleasant Hill, Ohio.

TEST Free to prospective art students. American, Box 8066, Dallas 5, Texas.

OPTICAL Illusion! Makes drawing simple tracing. Bruce Enterprises, North Hollywood 2, Calif.

LEARN Cardwriting. Free details. O'Rourke, 1534 W. Valley, Alhambra, California.

MAKE Up to \$100 weekly cartooning, illustrating, designing and lettering at home. No experience necessary. Big, new, simplified method shows you how. Rush name for free trial offer. National Artists Bureau, Box 4248-M, Dallas 8, Texas.

9 ALPHABET 3 Numeral pattern sets and catalog, \$1.00. Sign Letter Distributors, P.O. Box 101, Mineola, N. Y.

DRAWING Stands direct from factory. Send for circular. Sutter-Craft, Dept. S12, Eau Claire, Wis.

SIGN Painting taught at home by an old master. Ben Kerns, Box 812, Greenville, S. C.

CHALK Talks. Laugh producing program, \$1.00. Catalog 10c. Balda The Cartoonist, Oshkosh, Wisconsin.

ADVERTISING AGENCIES, LETTER WRITERS, FOR ADVERTISERS

FREE! 1948 Advertisers Rate and Data Directory, 52 pages! E. H. Brown Advertising Agency, 20 N. Wacker, Chicago 6.

INCH Display advertisement Mailorder World, year \$24. Wood's Services, Atlantic City, New Jersey.

MAILING List, 1000 names, wealthy resort prospects, \$10.00 cash. BMA Co., 5027 Sunderland, Jacksonville, Fla.

ORIGINAL Sales letters \$3.00 per page. Wallace, Box 143, Sheboygan, Wis.

MAIL Order advtg. with a profit guarantee. 20 years experience. Write for special free offer. Azrael Advertising Agency, Chas. and Eager Sts., Baltimore 1, Md.

ADVERTISE: 24 Words, 40 newspapers \$3.50. Lists free. Advertising Bureau, 229-C Dixon, Uniontown, Penna.

ADVERTISING Sensation! Reach 2,200,000 families, \$28.00 inch. Helpful rate-book (newspapers, magazines, mailing lists), advertising assistance, free. Chicago Advertising Agency, 20-PM West Jackson, Chicago 4.

ADVERTISERS! Reach nearly 18,000,000 readers. 25 Sunday national key newspapers, 18 words, \$47.75. "Terrific pullers." 20 popular newspapers, \$9.75. "Free booklet." Special—One inch display 2,-821,198 circulation, \$42.00. Newmark's Advertising Agency. (Established 1893) 217-7th Ave., New York 11.

ADS Placed in out of town newspapers and magazines. Low rates. Catalogue free. Ideas that pay. Baker Advertising Agency, Successors Ankrum Agency, 189 W. Madison, Chicago 2.

MAILING Lists, certified, productive, inexpensive, \$5.00 1000. Homeworkers, agents, buyers, etc. Write Dixie Service, King, N. C.

24 WORDS In 64 weeklies \$4.96. H. J. Darnell, 730 Hays, Jackson, Tenn.

TYPEWRITERS, DUPLICATORS, OFFICE DEVICES

ADDRESSOGRAPH "70" Duplicator, 10 @ \$15 each. Guaranteed. Krzak, Pawtucket, Rhode Island.

DUPLICATORS \$9.95 Up. (New.) Immediate delivery. "Free circular." Rucker, 2836-PM Slevin, Louisville 12, Ky.

"PRINTOMATIC" Selffeeding post card stencil printing duplicators \$9.50 up. Office size duplicators, Speedoprints, Hilcos, Excellographs \$33.41 up. Literature free. Pittsburgh Typewriter Supply, 336-WK Fourth Avenue, Pittsburgh 22, Penna.

RECONDITIONED Typewriters, mimeograph, multigraph printing devices, appliances, supplies. Catalog. Dixiegraph Service, King, N. Carolina.

PRINTING, MULTIGRAPHING, MIMEOGRAPHING, GUMMED LABELS

FREE Introductory offer! 200 business cards with order, 500 white or blue letterheads \$3.50. Same offer 6¼ envelopes. Prompt service. Westerkamp Printing Co., 1135 M Spring St., Cincinnati, Ohio.

1000 BUSINESS Cards \$2.45, prepaid. Madison Printing Service, Madison, Ohio.

QUALITY Printing: Business, personal stationery. State requirements. Samples. Mero Products, 100 Morrison, Punxsutawney, Penna.

24 HOUR Printing service. Free samples. Mango, 555-A South 20th, Newark 3, N. J.

100 8½x11 HAMMERMILL Letterheads \$1.00. O. Bell, 215 W. 137 St., New York City 30, N. Y.

MIMEOGRAPHING—Any copy, reasonable. Free samples! Topical Emprise, 1527 Highland, Louisville 4, Kentucky.

LETTERHEADS, Envelopes, cards, reasonable. Samples, Hudson, 261 Woonasquattuck, Centredale, R. I.

LETTERHEADS, Envelopes, circulars, booklets, cards, ruled forms, other quality printing lowest prices. Small, large quantities. Journal Printing Co., Newark, Ark.

BARGAIN Offer, 200 6 $\frac{3}{4}$ envelopes, 100 8 $\frac{1}{2}$ x11 letterheads and 100 statements \$3.75. Two scratch pads free! Keyeskraft, Florida, Indiana.

MONARCH Envelopes, 24 lb. white printed \$4.50—1,000; 5,000—\$20.00; 10,000—\$36.00. 48 hour service. Finest quality printing. Order today. N. O. Press, 348 Foote, Jamestown, N. Y.

500 6 $\frac{3}{4}$ ENVELOPES Printed \$3.25 (postpaid). Libby Printing, Independence, Mo.

PRINTING: Circulars, booklets, folders, stationery, catalogs. Keith Press, Elizabethtown, New York.

OFFSET Printing—Circulars, booklets, price lists. Free estimates. Gard, 106 W. 3rd, Los Angeles 13.

RAPID Service on printing needs. Ad-Man Press, 305 $\frac{1}{2}$ Liberty Bldg., Indianapolis, Indiana.

100 **LETTERHEADS**, 100 Envelopes printed. \$1.25. Art Print, Herrick, Illinois.

500 3 $\frac{1}{2}$ x2 $\frac{1}{4}$ **FOUR Line** gummed stickers 35c; red border 50c. Moritz Printery, Saginaw, Mich.

6 $\frac{3}{4}$ **PRINTED Envelopes** \$2.75 per thousand in 5,000 lots. Michel, Box 76F, New York 16.

MIMEOGRAPHING, Booklets—any copy. Topical Emprise, 1527 Highland, Louisville 4, Ky.

1000 **BUSINESS Cards**, \$2.50, prepaid. Samples free. Reliable Print Shop, 905 E. Jefferson, Louisville 6, Ky.

125 **LETTERHEADS** (8 $\frac{1}{2}$ x11 Hammermill) \$1.00. Postpaid. Envelopes, business cards, same. Race Printing, Hudson, New York.

SEND 10c Now, for our 48 page 1948 price list—refunded first order. McCall Press, 1326 South 27th, Omaha, Nebraska.

BETTER Grade printing reasonable. Estimates on anything. Economic Press, Leonia, N. J.

QUALITY Printing—Reasonable prices. Fast service on catalogs, folders, publications. Write for prices. Bagby Printing Co., Georgetown, Ohio.

MIMEOGRAPHING—Letters, pricelists, formulas, instructions. Lowest prices. Lem's Letter Shop, 5710 Stanton, Detroit 8.

PRINTING OUTFITS AND SUPPLIES

SAVE Money! Build own inexpensive, workable printing press with easy to follow instructions. Details free. Otanco, Box 114E, Akron 5, Ohio.

PRESSES, Type, cabinets, supplies. List for stamp. Lincoln Press Company, 220A Hartwell, Fall River, Mass.

1948 **PRINTERS Supply catalog** 10c. Refunded with \$1.00 order. Brighton Printers Supply, 4234-M South Mozart, Chicago 32, Illinois.

LETTER Shop "How To Start" sent at cost! 50c. Quality rebuilt Multigraphs, Mimeographs, Multiliths. Folders. Hundreds office printing machine bargains. Catalog free. International Machines Co., 1516 Cleveland, Denver 2, Colo.

GOLD Imprinter \$3.25. Samples 10c. Garza, 8 Walden, Cambridge 40, Mass.

PRINTING Presses, type, supplies. Lists 3c. Turnbaugh Service, Loysville, Penna.

PRINTING Presses, type, supplies. Send dime for complete illustrated printer's supply book, details and press samples. Kelsey, Inc., A-11, Meriden, Connecticut.

HOME Made presses. Write Riegel, 1111 Harrison, Philadelphia 24, Penna.

INEXPENSIVE Home-made printing press. Details free. Novelty Shop, Downsville, Louisiana.

RUBBER STAMPS AND OFFICE SUPPLIES

3 **LINES Or less** 50c. Newman, Box 284, Fort Collins, Colo.

3 **LINE Stamp** 40c; pads 35c; 500 printed envelopes, 6 $\frac{3}{4}$, \$2.85 postpaid. Iden Charles, Wauwatosa, Wis.

SUPERB Quality, three lines 70c. Lentz, Box 402, Youngstown, Ohio.

RUBBER Stamps. Buy direct from manufacturer. Literature free. Lee-Vail Press, Box 1242, Indianapolis 6, Indiana.

PATENT ATTORNEYS

INVENTORS—Patent Laws encourage the development of inventions. The Rules of Practice of the U. S. Patent Office advises; unless an inventor is familiar with such matters; that he employ a competent registered attorney or registered agent, as the value of patents depends largely upon the skillful preparation of the specifications and claims. Write for further particulars as to patent protection and procedure and "Invention Record" form at once. No obligation. McMorow, Beriman & Davidson, Registered Patent Attorneys, 1346 Victor Building, Washington 1, D. C.

PATENT Protection—The U. S. Patent Office recommends—"an applicant is advised, unless familiar with such matters, to employ a competent registered Patent Attorney or registered Patent Agent, as the value of patents depends largely upon the skillful preparation of the specification and claims." Preliminary steps to take to obtain patent protection will be sent upon request. Victor J. Evans & Co., 331-B Merlin Building, Washington 6, D. C.

INVENTORS: Without obligation, write for information explaining the steps you should take to secure a patent. John N. Randolph, Registered Patent Attorney, 203 Columbian Bldg., Washington 1, D. C.

INVENTORS: When you are satisfied that you have invented something of value write me, without obligation, for information as to what steps you should take to secure patents or trademarks. Write Patrick D. Beavers (Formerly Randolph & Beavers) Registered Patent Atty., 935 Columbian Bldg., Washington 1, D. C.

INVENTORS: Learn how to protect your invention. The Patent laws afford inventors protection for the patentable features of their inventions. The United States Patent Office advises the inventor, unless familiar with such matters, to engage a competent registered patent attorney or agent to represent him. We maintain a staff of registered patent attorneys ready to serve you in the handling of your patent matters. "Patent Guide" containing detailed information concerning patent protection and procedure with "Record of Invention" form will be forwarded upon request—without obligation. Clarence A. O'Brien & Harvey Jacobson, Registered Patent Attorneys, 81B-A District National Building, Washington, D. C.

PATENT Practice before U. S. Patent Office. Validity and Infringement investigations and opinions. Booklet and form "Evidence of Conception" forwarded upon request. Lancaster, Allwine & Rommel, Registered Patent Attorneys, Suite 411, 815-15th Street, N.W., Washington 5, D. C.

C. A. SNOW & Co.—M-427, Snow Building, Washington 1, D. C. Registered Patent Attorneys. Write for information.

INVENTORS. For "Record of Invention" form, contact Carl Miller, Registered Patent Attorney, Woolworth Building, New York.

"**INVENTOR'S Guide**" free on request. Frank Ledermann, Registered Patent Attorney, 154 Nassau St., New York 7, N. Y.

PATENTS, "Proof of Invention" folder mailed without obligation. E. E. Vreeman, Registered Patent Attorney, 871 Woodward Building, Washington 5, D. C.

INVENTORS: Write for free brochure "Evidence of Invention." Labiner, World Building, New York 7.

PATENTS—Trade marks. Irving L. McCathran, 315 McLachlen Bldg., Washington 1, D. C. Registered Patent Attorney.

FOR INVENTORS

INVENTORS: If you have an invention for sale, patented or unpatented, write Institute of American Inventors, Dept. 40A, 1926 Eye St. N.W., Washington 6, D. C.

INVENTORS—Patent Laws encourage the development of inventions. The Rules of Practice of the U. S. Patent Office advises; unless an inventor is familiar with such matters; that he employ a competent registered attorney or registered agent, as the value of patents depends largely upon the skillful preparation of the specifications and claims. Write for further particulars as to patent protection and procedure and "Invention Record" form at once. No obligation. McMorow, Beriman & Davidson, Registered Patent Attorneys, 1346 Victor Building, Washington 1, D. C.

INVENTORS—Victor J. Evans and Co. has a staff of registered patent attorneys, available to assist inventors in the preparation and prosecution of their cases before the U. S. Patent Office. Detailed information and the steps to take to obtain patent protection will be sent to you upon request. Victor J. Evans & Co., 332-B Merlin Building, Washington 6, D. C.

IF Unfed aid, write Counselor Birsh, 712 Manhattan Ave., Brooklyn.

INVENTORS—Market-test your patented, unpatented invention. Get facts on possible cash value. Avoid costly mistakes. Booklet, literature, free. Direct Contacts, 11106-A3 Longwood, Chicago 43.

I'D Like to show you how I've sold my inventions. Write for free literature. George Pearce, 47-S Bartholomew St., Peabody, Mass.

TECHNICAL Questions in the field of radio, electronics and magnetism answered. Send your problems for price quotations. Minimum fee \$3.00. Satisfaction guaranteed. Inventors Consulting Service, 704 East 105th Place, Chicago 28, Illinois.

PATENT Drawings expertly prepared. Confidential. Paul Carlstedt, 9055 Phinney, Seattle, Wash.

INVENTION Record, Patent application and search forms plus invention sales data free. Charles Morton, 11 West 42nd Street, New York.

PATENT Protection Without Money—A book for poor inventors. Send for details. McLoughlin, 1101 Meade Avenue, Scranton, Pennsylvania.

INVENTORS: Without obligation, write for information explaining the steps you should take to secure a patent on your invention. John N. Randolph, Registered Patent Attorney, 202 Columbian Bldg., Washington 1, D. C.

INVENTORS: The usual first step is to have a search of the U. S. Patents conducted, so I can report on patentability. Write, without obligation, Patrick D. Beavers (Formerly Randolph & Beavers), Registered Patent Atty., 936 Columbian Bldg., Washington 1, D. C.

INVENTORS: Learn how to protect your invention. The patent laws afford inventors protection for the patentable features of their inventions. The United States Patent Office advises the inventor, unless familiar with such matters, to engage a competent registered patent attorney or agent to represent him. We maintain a staff of registered patent attorneys ready to serve you in the handling of your patent matters. "Patent Guide" containing detailed information concerning patent protection and procedure with "Record of Invention" form will be forwarded upon request, without obligation. Clarence A. O'Brien & Harvey Jacobson, Registered Patent Attorneys, 81A-A District National Building, Washington, D. C.

FREE Pamphlet! How to develop your inventions. Elo Development Company, Department P, Chatham Phoenix Building, Long Island City 1, New York.

FREE Service to inventors with inventions for sale. U. S. Industrial Research Committee, 23 Nelson Ave., Staten Island 8, N. Y.

INVENTORS: Reliable searches made in U. S. patent office \$6.00. Reports back in five days. Invention protection forms free. Write Raymond L. Smith, Patent Searcher, 703-M Albee Building, Washington 5, D. C.

CASH For your idea, 280 manufacturers need inventions, patented or unpatented. List free. Invention Bureau, 208 Clinton, Oak Park, Illinois.

I SELL Patents. Established in 1900. Charles A. Scott, 773PM Garson Ave., Rochester, N. Y.

FREE, Two months on trial. Patent News, Washington, D. C. 12.

"**INVENTOR'S Guide**" free on request. Frank Ledermann, Registered Patent Attorney, 154 Nassau St., New York 7, N. Y.

HIGHEST Royalties and cash for inventions when we market them. Free booklet without obligation. Universal Marketing Co., 126 Lexington Ave., New York 16, N. Y.

INVENTIONS WANTED

INVENTORS! Have you good patentable ideas? Write Patent Agent Metzler, 11 West 42nd, New York.

CASH For your idea, 280 manufacturers need inventions, patented or unpatented. List free. Invention Bureau, 208 Clinton, Oak Park, Illinois.

MANUFACTURERS Want patented or patent pending inventions! Write, Universal Guaranty Company, Lakewood, New York.

INVENTORS — Booklet "Self-Testing Your Patent or Invention" free on request. Avoid costly mistakes, wrong markets. Direct Contacts, 11106-A2 Longwood, Chicago 43.

INVENTORS: Hundreds of manufacturers have requested our assistance in locating marketable new products. Complete information, free. Institute of American Inventors, Dept. 40-D, 1926-Eye St. N.W., Washington 6, D. C.

SMALL inventions wanted by manufacturers. I'll help you sell your invention. Write for circular, Stanley Hull, 7829 Euclid, Cleveland, Ohio.

INVENTORS. Write for our sales plan. Complete service for inventors. Vision Engineering Inc. Security Building, West Bend, Wis.

PATENTED, Unpatented inventions wanted. We have tremendous lists of manufacturers who may pay cash royalties. Descriptive booklet free. National Invention Service, 1404-T Mitchell St., Oakland 1, Calif.

PATENTS FOR SALE

FLEXIBLE Adjustable lever drag, on royalty, Pat. 2347979. Vincent Antal, Brainerd, Minn.

TWO In one screwdriver, Patent 2378-775. A. Johnson, 2 York Street, Jamestown, N. Y.

PENDING—Crown cap for receptacles that automatically opens with ease by hand. Excellent for beer, soda, and etc., bottles. Works on present day capping machine. "Edward," 4445 Redwood Ave., Venice, California.

PATENT Pending, auto-air-cooler, easily manufactured, no moving parts; royalty only. Will mail official drawings upon request. H. S. Chambers, 1549 Valencia Ave., Pasadena 7, Calif.

INVENTORS: Test the commercial value of your patented or unpatented inventions, quickly and inexpensively. Write for free information. Institute of American Inventors, Dept. 40-B, 1926-Eye St. N.W., Washington 6, D. C.

MANUFACTURING

EXPERIMENTAL Models, designing, development work, patterns, dies, molds, etc. Small lot manufacturing, Ralph Greenberg, 82 American Legion Highway, Dorchester, Mass.

MANUFACTURING Dies, Do-All machine made, tools. Baum's Metal Specialties, Kansas City, Mo.

HYDRAULIC Pump, brand new; 1000 p. sl. pressure. Vickers piston type, 6 1/2"x3", shipping weight 6 pounds. \$12.50. Aero Parts Supply, Municipal Airport, Houston, Texas.

SMALL Lot production wanted. Aluminum castings; stampings; screw machine; plastics. J and M Company, Burlington, Kentucky.

MODELS—Small lot manufacturing. Metals, plastics, etc. Milburn, Burlington, Kentucky.

MODELS AND MODEL SUPPLIES

ONLY Hand tools required to build this steam boat with own power plant. Complete kit \$2.50. Steam engine kit requiring lathe \$1.75. Literature 10c. M. Kovick, 20179 Monte Vista, Detroit 21, Mich.

RAILWAY Models, complete informative catalog HO and O gauge. 132 pages, 50c. Walthers, 247 Erie, Milwaukee, Wisconsin.

SCALE Catalogue 25c (refund coupon included). Lionel or American Flyer list of available equipment every month upon request. Tri-Lor's, State Road, North Dantmouth, Mass.

SHIP Models, copper sails. Blinker light house, book ends. Construction sets. Catalogue 25 cents. Trade Wind Models, Box 171B, Lakewood, N. J.

STEAM Engines, boilers, castings. Catalogue 25c. Anton Bohaboy, 2297 Price, Rahway, New Jersey.

HOBBYIST'S Catalogs! Controllog-engine powered, line control model planes, 100 kit photos, construction, flying instructions 10c. Send large self-addressed stamped envelope for free folder featuring famous English Twin Trix 3-rail trains. 164 page ship model kit-fittings catalog 35c. Booklog—hundreds of model, hobby, craft books 10c. Send coin, stamps. Polk's Hobbies, "World's Leading Hobby House," 314(PM2) Fifth Avenue, New York 1.

BRASS Gears and model supplies for the inventors. Send 10c for catalog. Pierce Model Works, Tinley Park, Ill.

POWER Models—Steam and gasoline engines, steam traction engine, metals, tools. Catalog 35c. Chas. Cole, Ventura, Calif.

LANDLOCKED Sailors! Here's a beautiful, richly illustrated, fully descriptive catalogue of famous model ships—whalers, slavers, corvettes, etc., authentic in every detail. Send for it today. Only 25c. Halesite Yacht Service, Inc., Halesite, Huntington, N. Y.

SHIP Model kits and fittings, most complete stock in New England, of Boucher, Fisher, marine model, model shipways. Fittings, plans, tools, model yacht equipment. Illustrated catalogue 25c coin. James Bliss & Co., Inc., Dept. M, 220 State Street, Boston, Mass.

MODEL Railroads exclusively. Complete stock scale, Lionel, American Flyer. Send for catalog, 15c. State gauge. Eric Fuchs, 28 Brattle Street, Boston 8, Mass.

FUN Building models—Airplanes, trains, ships. Everything furnished. Giant catalogue 10c. Ben's Hobby Shop, 72 West Washington, Chicago 2, Illinois.

SHIP Models and yacht supplies complete. Large 64 page catalogue 30c. Bill Wild's, 510 East 11 St., New York City 9.

SHIP and Yacht model fittings; blueprints. Send 25c for illustrated catalog No. 20—listing hundreds of items. A. J. Fisher, 1002-1 Etowah Ave., Royal Oak, Mich.

MINIATURE Steam locomotives, 1/4", 1/2", 3/4" scales. Castings, parts, rail! Thorough drawings with instructions. Catalogue 25c. Little Engines, Wilmington, Cal.

SHIP Model supplies, catalog 25c coin. R. E. Hancock, 323 Douglas Ave., Portsmouth, Virginia.

HOME CRAFTSMEN

LAWN Chairs, toys, novelties, garden figures, furniture, etc. 62 popular plans for \$1.00. Mastercraft 2M, 7041 Olcott, Chicago 31, Illinois.

DO Your own professional felt flock finishing. Complete kit includes flock, undercoat, thinner, spray gun and instructions. \$9.25 post paid. Write for free color card and circular. Berott-Ross, Dept. 2A, 411 N. Foothill Road, Beverly Hills, Calif.

KEEP-SHARP. Get a Thompson's precision grinding wheel dresser. New and different. Only \$1.50. Write Thompson Mfg. Co., Inc., Erie, Penna.

MAKE-IT-With-Leather. Profitable hobby. Send card for free booklet. Artcraft Leather of California, Dept. PM-2, 271 Twelfth Street, Oakland 7, California.

BRASS-ALUMINUM Cold rolled steel, 21 round rods 12" long, one each 1/8, 3/16, 1/4, 5/16, 3/8, 7/16 and 1/2, the most handy assortment ever offered, only \$3.75 postpaid. Project Headquarters, Dept. PM-2, 1756 Henderson St., Chicago 13, Ill.

EMBED Shells flowers in clear plastic. Shell catalogue stamp, Dixie Shell Service, Lakeland, Fla.

RHINESTONES, Pearls, findings. Introductory assortment 25c. Herber, 1360-A Hicks, New York 67.

LEATHERCRAFT! Complete stocks of leathers, tools, supplies. Immediate shipment. Free catalog. Kit Kraft, Dept. PM2, 3203 W. Washington Blvd., Los Angeles 16, Calif.

HUNDREDS Full size patterns—Easily made plywood novelty furniture for jig and bandsawing. lawn ornaments, plaques, frames, silhouettes, letters, numerals, weathervanes, toys. 150 crafts-hobby books and booklets, hundreds of transfers. Catalog and folders illustrates 465 articles, 25c. (No stamps please). Refunded first order. Wo-Met Shop, Box 167, Ashburn, Georgia.

ARTIFICIAL Flower, novelty, making. Wonderful home business pays excellent profits. Literature free. Velva Artcrafts, 324M East 14, New York 3, N. Y.

START Flocking—Spray professional plush finish on everything. Easy, profitable, inexpensive. Supplies, equipment, instructions. Coast Industries, 1507 W. Manchester, Los Angeles 44, Calif.

METAL Tooling! Brass, copper, supplies. Immediate shipment. Free catalog. Kit Kraft, Dept. M2, 3203 W. Washington Blvd., Los Angeles 16, Calif.

STORM Windows (combination screen and glass) interchangeable from inside home. Make them yourself. We furnish the mouldings knocked down. Send glass size and over-all measurement of your windows. Write Weather-Rex, 155 Genesee Street, Buffalo, New York, for prices and description.

FREE Folder—"Amazing New Service." Materials furnished to build projects featured in this magazine. Project Headquarters, 1756A Henderson, Chicago 13, Ill.

SWISS Music units \$3.50, kits \$4.75. Irving Meyers, 126 Lexington Ave., New York 16, N. Y.

JEWELRY Hobbyists need our Sterling silver in sheets, wire, chains, and finished findings, along with rosary kits, chemicals, novelties, ideas, plastic and metal findings. Write today for latest beautiful catalog. Only 25c. (Refunded, first order.) Pittshire, Box 90E, Pittsfield, Mass.

SHELLS, Plastics, findings. Beginner's kit \$3.00. Free catalog. Stelle's, 230 Randall Avenue, Trenton 10, New Jersey.

IMITATION Miniatures for jewelry. Look like the real thing. Sample with setting, 15c. Trinity, 2498 65th St., Brooklyn 4, N. Y.

SHELLS, Plastics, Metal findings, Hobby Lobby, Box 468, St. A, St. Petersburg, Fla.

AIRCRAFT Hardware assortment—Nuts, bolts, screws, rivets, clamps, etc. Ten pounds, \$1.95. Twenty pounds for \$3.50. F.O.B. Aero Parts Supply, Municipal Airport, Houston, Texas.

SHELLCRAFT Instruction book and kit for \$6 worth, including 450 Caribbean shells \$1. Satisfaction guaranteed. Shell Company, Miami 36, Florida.

COLORED Plexiglas, 6 colors. Instructions, cameos, earcrows, pinback to make complete set two tone costume jewelry. \$1.00. Bradlee, P.O. Box 142, Buffalo 5, N. Y.

CEDAR Turning rounds, (3x12"). Twenty-\$5.00. Ray Sewell, Versailles, Ky.

MAKE Your own jewelry! Findings in metal and plastics; earwires, pinbacks, cameos, stones, beads, clasps, sprays, combs, hairbars, plastic and metal chains. Hobby Art Corp., Dept. 7, P.O.B. 276, New York 18, N. Y.

SHELLCRAFT! Make beautiful seashell jewelry. Income or hobby! Large illustrated catalog! Supplies, instructions, 10c postage. (Buy direct from manufacturer.) Pace's, Box 279M, Bradenton, Florida.

35 PATTERNS Toy furniture, action toys, etc. \$1.00. Continental Homecrafters, 907 Birch, Eau Claire 3, Wisconsin.

FAST Selling. Good profits making lawn chairs, furniture, toys. Illustrated folders of popular items, 25c. Refundable. Summercraft Studio, Dept. KN, 42 Vernon St., Newton 58, Mass.

COPPER Strips, cold rolled, .025 ins. thick. Assortment 5 sizes, 1, 2, 3, 4 and 6 inch widths, 12 inch lengths, \$1.90, 24 inch lengths, \$3.75 postpaid. Groundmaster Company, Box 657, Boulder, Colorado.

LEATHERCRAFT. Try Tandy Leather, Tulsa 1, Oklahoma, for supplies. Catalog free upon request.

SHELL Jewelry supplies. Wholesale only. McFarland Plastic Co., Sarasota, Fla.

LEATHER-CRAFTERS: Free 1947 catalog showing easily completed projects, full line of tools, hides and accessories. Ester Leather Co., 145 St. Paul St., Rochester 4, N. Y.

UNIVERSAL Shop stand. Send for circular. Sutter-Craft, Dept. S12A, Eau Claire, Wis.

OREGON Myrtlewood lumber and turning squares for sale. M. Weaver, 3923 SE Tibbetts, Portland 2, Oregon.

BAND And jig saw owners, let your machine and hobby bring you profits, fun. Free details. Nu-Art Designers, 33 Rosemont Rd., No. Weymouth, Mass.

LEATHERCRAFTERS! Belt kits, projects, leather, supplies. Write for catalog. Art Leather, 411 Joseph Ave., Rochester 5, N. Y.

LEATHER, Retail, mail orders, catalog, tools, lacing, supplies. National Handicraft Co., 30 Frankfort St., New York City 7.

TEXAS Ebony, America's most beautiful lathe turning wood. Large piece, \$1 prepaid. Sample, dime. Information on southern woods, stamp. Starcraft 1, Edinburg, Texas.

PLASTIC Jewelry supplies. Free catalog. J & M Novelties, Box 464P, Griffith, Indiana.

HOW To set up and run a mirror shop! Resilver mirrors. For price write—John Sprinkle V55, Marion, Indiana.

KNOCKDOWN Cedar chests. Lumber and veneers. Free price list. Giles & Kendall Company, Huntsville, Ala.

SPECIAL Offer: 80 full size toy, novelty, and lawn ornament patterns only \$1.00. Lynds, Medway, Mass.

CERAMIC Jewelry supplies, bar pins, ear screws, for ceramic and woodworkers; also glass and seashell assemblers. Free catalog. Philadelphia Badge Co., Dept. B-1, 1007 Filbert St., Philadelphia, Penna.

SHELLS, Plastics, findings. Lowest prices. Free catalog. Frances Jones, Box 251, Sarasota, Fla.

MAKE IT YOURSELF

ENJOY Soft water. Simple, easy, plans, instructions. \$1.00. Huff Engineering, 10230 San Carlos, South Gate, Calif.

SAVE Up to one third on heating bills. Our plans tell how. Free details. A. Claber Co., Box 491, Grandville, Mich.

BUILD Concrete block machines, portable sawmills. Shop, farm, home machines. 70 plans. Catalog-handbook free. Nichols Equipment Co., Dept. 710, Purvis, Miss.

PIRATES Ahoy! Treasure chest plans, 10c. Morgan, Box 127, Detroit 2.

BUILD Inexpensive, practical concrete block machine. New principle. Stamp brings literature. Clyde Lee, Mountain View 3, Oklahoma.

BUILD Your own aluminum cooking range. Cost very low. No dies required. Materials available. Simple, easy to understand plans and instructions. Literature free. Engineering Services Company, P. O. Box 73R, Pasadena 16, California.

SAVE \$50. Automatic attic ventilator fan. Complete plans \$2. Literature free. Engineering Development, Box 37, Station C, Lincoln, Nebraska.

SPECIAL. Full size patterns make over 100 toys. \$1.00. Complete plan for over 20 modern kitchen cabinets \$1.00. Free list. Masterprint, White Building, Buffalo 2, N. Y.

HOT Water free—From sunlight. System efficient any locality year round. Standard materials, easily built, low cost, facts free. Solar Water Co., Box 175, Dept. H, Coral Gables, Florida.

STORM Windows (combination screen and glass) interchangeable from inside home. Make them yourself. We furnish the mouldings knocked down. Send glass size and over-all measurement of your windows. Write Weather-Rex, 155 Genesee Street, Buffalo, New York, for prices and description.

"PREFABRICATED Homes." 38 page how to build picture book. \$1.00. Nelson Frissell, Civil Engineer, Gardner 95, Mass.

PLAYHOUSES And doghouses, scientifically designed. Plans and material list for 4 sizes of either, \$1.00 postpaid. C. Miller & Wutke, 253 Conant Hotel, Omaha, Nebr.

TRAILER Brakes, automatic. If you are building, build the best. Fully automatic hydraulic, built into hitch. No extra attachments to car. Build it yourself. Instructions \$2.00. Patent pending. W. P. McKinney, P. O. Box 1002, Flint, Mich.

SEASHELL Workers' supplies. Wholesale. Bargain list free. Shell Novelty, Box 1664, Fort Myers, Florida.

"CONCRETE Block homes." 32 page booklet: drawings, instructions on how to build. \$1.00. H. C. Lightfoot, Civil Engineer, Richboro 1, Penna.

WATCHES, OLD GOLD, JEWELRY

JEWELRY Findings, lowest prices. George Sassen, 154 Nassau Street, New York 7.

REAL Gold, Silver replated on watches, rings, jewelry. Free estimates, information. Send work. Amity Silver, 301 South 43rd, Philadelphia 4, Penna.

CHALET Watches. Wholesale. Illustrated catalog, free. Foreign inquiries invited. John Green-A, 210 Fifth Ave., New York 10.

WATCHES, Wholesale. Rebuilt-like-new Elgins, Walthams, Bulovas, etc., \$9.75 up. Catalogue free. Brookins, B-1975G, Little Rock, Ark.

GOLD \$35.00 Ounce. Mail old gold teeth, diamonds, jewelry, watches—receive cash by return mail. Satisfaction guaranteed. Free information. Dr. Weisberg's Gold Refining Company, 1500-Q Hennepin, Minneapolis, Minn.

WATCH Repairing easy learned by our home study course. Watch repairers are in demand and are among the highest paid craftsmen today. Write for free information. Houston Chronometer & Watch Co., P. O. Box 1140A, Houston 1, Texas.

CASH For old, broken jewelry. Highest prices paid immediately. Mail gold teeth, watches, rings, silverware, diamonds, spectacles. Satisfaction guaranteed. Information free. Rose Smelting Co., 29-A East Madison, Chicago.

GEMS, Precious and semi-precious, all genuine, from world wide sources. Deal direct, no overhead, save money. Catalog 10c. Hill Co., Route 7, Salem, Oregon.

TOBACCO, SMOKERS' SUPPLIES

CIGARETTES—Popular brands \$1.45 per carton delivered postpaid. Minimum 3 cartons. Check or money order. Service Sales, Dept. X, Box 3146, University City 5, Missouri.

"PIPE Lure," 24 page illustrated booklet shows how you can create smoking pipes easily with various materials. Includes romantic pipe traditions. Send 50c. Hippen, 719A Colquitt, Houston 6, Texas.

GOOD Cigars 5c. Direct from factory to you, retail for 8c each. Box 50 cigars postpaid \$2.50, check or money order. Rossi Cigars, 64 Stone St., Newark 4, N. J.

SURVEYING INSTRUMENTS

GUARANTEED Factory rebuilt transits and levels, sale, or rent, with purchase option. We will repair, trade or buy old instruments. Write for list M-48. Warren-Knight Co. (Manufacturers of Surveying Instruments), 136 North 12th St., Philadelphia 7, Penna.

RAZORS, BLADES, SHARPENING

DOUBLE Your shaves from your Schick Injector blades by simply turning them or get from twenty to forty shaves by stropping them inside a drinking glass. Simple as inserting a new blade. Send 50c piece and your name for gold plated (Pat. Pend.) tool for removing and inserting blades and simple instructions. Weeks Valve Company, 225 W. 34th St., New York City.

SHAVE Closer — Less irritation. 25c. Neway, 35P 9th St., Columbus, Ohio.

FOR THE HOME

WIK-FED, "Subirrigated" flower pot. Miraculous results in plant growth. Endorsed by leading colleges. Wick in reservoir base feeds plant roots moisture. Beautiful marbled plastic pots, 4" diameter. Ideal for African violets, ivies. \$1.00 postpaid. Money back guarantee. Water Master Sales, 19453 Ward, Detroit 21, Mich.

WASHING Machine parts and supplies, Lovell wringers, rolls and bearings. Humboldt Thor Shop, 3448 W. North Ave., Chicago 47.

INSULATE Your home yourself. Plans, instructions, illustrations \$1. Moneyback guarantee. Insulation, 200-A S. Arch, Alliance, Ohio.

BURGLAR-PROOF Common door locks. Foil lock pickers. Cheap insurance. Material, instructions \$1.00 postpaid. "Lockmaster," 19465 Ward, Detroit 21, Michigan.

LUXURY: Close your window from bed these cold mornings. Send \$1 for complete Whippersnap Window Closer, Box 199, Ithaca, N. Y.

FOR SALE—MISCELLANEOUS

ARMY Tents, covers, hammocks, clothing, paints. G. Jarashow, 10-19 Jackson, Long Island City, N. Y.

HULL Automobile compass, value \$4.95, brand new, \$2.50. Prisms for 6x30 or 8x30 binoculars, brand new, \$1.50 each. Offset prisms to be attached to 7x50 B. & L. binoculars, gives double the field of the ordinary 7x50 binocular. Cost \$98.00, special \$25.00. Green sunshades for binoculars, size 6x30 and 7x50, snap on type, value \$7.50, special \$1.25 per pair. Forward money order. No C.O.D. shipments. Send coin \$1.25 for Third Annual Edition of Gun Digest together with our complete catalog of new and used guns, ammunition, rifles, binoculars and powder flasks. Our separate catalog 25c. Public Sport Shops, 11 S. 16th Street, Philadelphia, Penna.

100 NEW Double edge razor blades, plus free gift, only \$1 prepaid. Agents wanted. Weiss, 309-11th Street, Union City, New Jersey.

"PUMP-IT" Dispenses tomato ketchup. \$1.00. Box 123, Hollywood 28, Calif.

GUNNERS Training table—New. The greatest value offered yet. Ideal for clubs, shooting galleries, automatic checking, counting, burglar alarms. Can be operated as a very profitable business. Comes complete with 7 a.c. 110 volt motors, sensitive electric eye, powerful amplifier, rotating mechanism; maple top table, etc. All parts can be used individually. Worth the investment for parts and mechanism alone. Limited time \$250.00. "Amazing Bachman's," 25 Herman Street, Rochester 5, N. Y.

PERSONAL

PRETEND Visiting northern Canada. Six postcards, dollar. You address, return. We stamp, remail. Bedeck, Bear Island, Lake Temagami, Ontario, Canada.

BORROW By mail. Loans \$50.00 to \$300.00 to employed men and women. Easy, quick. Completely private, confidential. No endorsers. Repay in convenient monthly payments. Details free in plain envelope. Write State Finance Co., 320 Securities Bldg., Dept. B-14, Des Moines 9, Iowa.

THICKER, More masculine hair for men. All about latest secrets, discoveries free. Write immediately. Henry Bruns, Dept. P, 3307 Fremont, Madison 4, Wis.

ARE You happy in your work? You can be and should be. Your handwriting reveals what you are best fitted for to gain success in life. Write fifty words on unruled paper giving occupation, age, ambitions, etc. Handwriting Bureau, 1370A Grant, Loveland, Colo.

GLOBAL Picture postcard supply; unusual novelties; worldwide letter remailing service. Free particulars. Travelpost, Box 1436, Brawley, California.

STAINLESS Steel toothbrush box. Polished finish, attractive, durable, sanitary. Will not warp or tarnish. \$1.00 postpaid. W. B. Willett, 2556 Ellison Ave., Omaha 11, Nebr.

HOW You can find out! Information discreetly developed, any matter, person, problem, anywhere. Personal-business assignments, representations, undertaken. Nation-wide. Officially licensed and bonded service established 1922. Reasonable. Confidential. William Herman, 170 Broadway, New York.

BEAT Inflation with extra income. Samples four leading opportunity magazines 25c. Wallace, Box 143, Sheboygan, Wis.

MEXICAN Address. Mail received, forwarded. Photographic postcards 15c. Remailed free. Mexican articles. Tillotson, Apdo. 1405, Guadalajara, Jalisco, Mexico.

SWAP! Trade! Anything, everything. Free information. "Swappers' Gazette-PM" Louisville 12, Kentucky.

RUPTURED? Positive comfort, no understraps, no steel, no elastic. Write Smith Manufacturing Company, Preston, Ontario.

HAIR Falling? Dandruff? Write Trichologist, 137 Lewis St., Phillipsburg, N. J.

MISCELLANEOUS

BOOKFINDERS! (Scarce, out-of-print, unusual books) Quickly supplied. Send wants. Clifton Company, Box 1377 pmm, Beverly Hills, Calif.

TREASURE Finders! Goldak's new 11 pound lightweight, gold, silver and mineral locator, money-back guaranteed superior any other device. Free information. The Goldak Co., 1542 West Glenoaks Blvd., Glendale 1, Calif.

POPPER And hotplate. Ideal for light cooking. \$5.95 f.o.b. Parcel's, 2701 Main, Elkhart, Indiana.

SORGHUM Molasses, 10# \$5.95. Black walnuts, or hickorynuts, 3# \$1.25 prepaid. Bob Pace, Combs, Ark.

MEN! Large size shoes, large size socks! We specialize large sizes 10 to 16, widths AA-EEE. Oxfords, hipops, work shoes. Guaranteed extra quality. Free catalog. Kingsize, 469, Brockton, Mass.

ORANGES, Grapefruit, lemons, tree ripened, straight or mixed. Bushel \$4.50 prepaid. Free literature. Davidson Groves, Dept. G 1118, Edinburg, Texas.

MEXICAN Jumping beans. Wholesale. July crop. Mexican Products Co., 126 N. Main, Tulsa 3, Oklahoma.

FILLING Stations, garages, homes—Clean stained commodes, lavatories, sinks like new. No rubbing, No scrubbing. Send 50c for formula and complete instructions. Nu-Method, 1377 Euclid Avenue, Atlanta, Georgia.

CRACKED Battery case repair cement. Can \$1.00. Guaranteed. Batteryman, Grand Junction, Colorado.

INFORMATION. Any subject. Rates \$2.50 up. The Roxbys, 747 S. New Hampshire, Los Angeles 5.

FREE! Unusual information catalog. Locksmithing; mailorder; formulas; treasure-mineral locating, etc. National, 378P Hooper Street, Brooklyn 11, New York.

INQUIRE Now about our Home Plan Service for 24'x26' and 24'x30' one floor, two bed-room homes. Write today for particulars. Columbia Small Home Plan Service, Dept. 10, 1570 Hawthorne Park, Columbus 3, Ohio.

MAKE Your own printing cuts. New, easy plastoplate process. Plastoservice, Argyle 1, Wisconsin.

SIX Room house \$2800 complete. Not pre-fabricated. Complete details free. Harmon, Box 1057, Newark 1, New Jersey.

RECEIVE Free samples, magazines, catalogues, moneymaking opportunities! Giant mails galore! Your name in all our Surefire mailing directories two years \$1.00. Nine months, 50c; three months, 25c. Stanford, 6220-M 16th, Philadelphia 41.

GOLD—Samples; lode gold exactly as taken from the vein, or placer gold just as found in the California streams! Mounted on illustrated folder with brief comment. State type samples wanted. Lode gold, 45c each; placer gold, 65c each. Lucky Prospector, P.O. Box 27, Yuba City, Calif.

ANTIQUE Toys—Illustrated price list 10c. Kowal, 1846 Cullerton, Chicago 8.

NEW Type handsaw, crosscuts, rips, cuts timber, cordwood fast! \$2.00. Details. Teeho-Tools, Maywood, Illinois.

SHOES, Health Spot. Liquidation sale men's and women's \$9.95 pair. Children's \$4.95 pair, plus postage or c.o.d. Thomas, 2407 Heard St., Columbus, Ga.

SWITZERLAND: Watches, anything, Factory prices. Catalog free. Postsach 954, Solothurn, Switzerland.

SWISS Music box units. Choice of tunes. Ready to install. \$3.25 postpaid. Request information. Swiss Novelty Co., Box 1201, Fall River, Mass.

BUY Direct from importers-distributors of Mexican, Indian and western goods. Write for free catalog. Navo-Mex Importers, 2351 East Van Buren, Phoenix, Arizona.

PANNING Gold. Learn how. Illustrated booklet-catalogue, mining books, supplies, free. Old Prospector, B89, Dutch Flat, Calif.

INDIAN River citrus fruits, Florida's best. For delivered prices write Schuyler Jackson, Wabasso, Fla.

FIREWORKS: Don't be disappointed. Get famous Banner Fireworks with all newest and startling effects. Giant cannon salutes that rock you like a crash of thunder. Whistling devils with weird unearthly noises. Skyrockets that burst in majestic colorful display. Gasp in amazement as you watch the battle in the clouds. Genuine Chinese firecrackers. Over 200 pieces including sparklers for little tots. Retail value \$11.25 for only \$4.95. Rush order today. Any quantity. Send money order, bank draft or currency. No c.o.d.'s. Big new catalog free. Banner Fireworks Mfg. Co., Inc., Dept. 112, 446 Capistrano, Toledo 12, Ohio.

"JITTERBUGGING?" Anyone can learn by the Engstrom Dance Guide. New and complete. As simple and easy to understand as moving pictures. No complicated descriptions and charts. Only \$1.00. Engstrom Dance Studios, P.O. Box 358, Grand Island, Nebr.

MAKE Money at home like I do. Details 10c. Bentz Jr., Chatawa 23, Mississippi.

GOVERNMENT Surplus. A thousand bargains. Write for list. Army Navy Surplus Goods, 320 13th St., Richmond, Calif.

DIVER. Scientific toy; all ages; inexpensive. Schiff, 2319 Newton, Milwaukee 11.

"RECEIVE Mail." Moneymaking offers, opportunities, catalogs. Name listed 10c. Ideal Service, 100, Park Ridge, Ill.

VETERANS Your favorite wallet-size photo or document put in transparent plastic. Free! Send item, we'll return plastic protected. Include former service address. Kovee Plastic Co., 3753 N, Marshfield, Chicago 13, Ill.

TWELVE Alnicov magnets, 100 experiments, \$3.00. Experiments, 25c. Disc magnet, \$1.00. Eljay, Box 891, Newark 1, N. J.

MAKE Money raising bees: Send for How To Succeed With Bees. 96-page book by experts. Contains 190 tested plans, guaranteed to help you or your money back, only \$1.00. Popular Mechanics Press, 200 East Ontario Street, Chicago 11, Illinois.

M-SCOPE Metal, mineral locators sensational new electronic lightweight models, immediate shipment. Fisher Research Laboratory, Inc., manufactures some of the finest metal locators for the U. S. Army. Built for Arctic, Tropic use. Unsurpassed efficiency, low prices. Time-payment plan available. Send for free 16-page illustrated booklet. Fisher Research Laboratory, Inc., Palo Alto, Calif.

TATTOOING Outfits, supplies. Illustrated list free. Zeis, 728 Lesley, Rockford, Illinois.

GLADIOLAS—Some newer, better. List. Robinsons Glad Heaven, Sebastopol, Calif.

70 BIBLE Lessons, 25c. Bulletin, Box 87, Cathedral Station, New York 25.

BUILD The Sovereign of the Seas. An unusual ship model within the reach of average craftsmen. Elaborate carvings easily produced, 62 page book gives complete details. Price \$1.00. Popular Mechanics Press, 200 East Ontario Street, Chicago, Illinois.

Now a DYNAMIC Industrial Transformer Type Super Charged WELDER

FOR AUTO, HOME APPLIANCE AND FARM REPAIRS

DESIGNED TO DO HIGH GRADE WELDING inexpensively—Maintenance Men, Farmers, Mechanics, Machine Shops, Foundries, Auto, General Repair and Job Welding Shops, all using the DYNAMIC find it so indispensable and useful that they can't afford to be without it.

EASY-TO-OPERATE. If inexperienced you can easily learn to do a variety of high grade welding jobs by following the practical, simplified *Welding and Operating instructions furnished.* Once you see the DYNAMIC in operation you won't want to be without it. Its simplicity will amaze you. In a year the DYNAMIC only costs you about 7c a day. Comes complete ready to operate with helmet, rods, cable, holder, operating and welding instructions, etc.

Saves You Valuable Time and Money!

This portable, industrial transformer type *Dynamic Welder* easily carried right to the job can be operated from any convenient properly wired 110 Volt 60 Cycle Line. **WORKS ON IRON, STEEL, BRASS, BRONZE and Other Metals.** Has 8 metallic and carbon arc heat stages. Does work you would think only possible with a larger more expensive machine ... Can also be supplied for 220 VOLT 60 CYCLE operation and other voltages and cycles at slight additional cost.

DYNAMIC WELDER CO., 15 East 23rd Street, C, CHICAGO 16, Ill.

FOR ONLY \$2850 COMPLETE

DO YOUR OWN WELDING

Just a few repair jobs will pay for this machine. A practical and profitable machine tool for any workshop. Make money doing repair work for others.

Write for Particulars Get Details on our 10 day Trial Offer Member Chicago Association of Commerce.

LEARN MEAT CUTTING EASILY-QUICKLY At Home-In Spare Time



The steady, dependable trade of Meat Cutting taught easily, quickly by improved HOME METHOD. National School, established over 25 years, has organized its famous "Learn By Doing" Classroom, Cutting room and Retail Market training system into sound, practical HOME STUDY form.

Now, by the miracle of this EXTENSION TRAINING you can prepare in Your Spare Time At Home, for a better job, bigger responsibilities or success and security in a store of your own. Remember, PEOPLE MUST EAT!

Buying, cutting, percentage, pricing, advertising, selling—a complete meat education. For beginner or men with ex-

perience. Thousands of successful graduates. Send coupon for FREE Bulletin NOW!

MAIL THIS COUPON TODAY FOR FREE BULLETIN

National School of Meat Cutting Div. U-90, Toledo 4, Ohio

Send me your FREE Bulletin on Meat Cutting and Meat Merchandising. No obligation. No Salesman will call.

Name _____
 Street _____
 City _____ State _____

COME TO LEARN STAY TO EARN— IN SOUTHERN CALIFORNIA



Learn Aviation Mechanics at California Flyers

Investigate the unusual opportunity for learning and earning in Southern California, the aviation capital of the world. Because of its close association with the industry, famous 17 year old California Flyers offers the best possible AVIATION MECHANICS training and in the shortest possible time. And, upon graduation,

Southern California's gigantic aircraft industry offers you your best opportunities for earning. So come to learn, stay to earn.

Protected by a Government License. The aviation mechanic is one of the few technicians granted a Government license, a license that protects you from competition of the unqualified.

APPROVED FOR VETERANS AND BY THE C-A-A • HOUSING AVAILABLE

CALIFORNIA FLYERS, School of Aeronautics, Dept. M-2
720 S. Redondo Blvd., Inglewood, California

Please send me illustrated brochure containing full information about courses, tuition, etc., and application blank. I understand this will not obligate me in any way.

Name _____ Age _____

Address _____

City _____ Zone _____ State _____

THERE IS NO FLYING INVOLVED IN AVIATION MECHANICS COURSES at CALIFORNIA FLYERS SCHOOL of AERONAUTICS

Learn NOVELTY MANUFACTURING!!



EASY TO MAKE Profitable to Sell!

Become a manufacturer of Novelties! Enjoy continuous business filling orders from chain stores, gift shops, etc. Regular orders amounting to thousands of dollars come from these customers. A business easy to get into. You need no experience. Make merchandise that has sold steadily and profitably for years. Demand for it is amazingly increasing. Gives you opportunity to enjoy splendid business right now.

Now, the demand for it is amazingly increasing. Gives you opportunity to enjoy splendid business right now.

START YOUR OWN THRIVING BUSINESS ON LITTLE MONEY

Successful manufacturer shows you how. Start in garage, basement, etc. No machinery needed, no priority on materials. You make large profits. Surprisingly easy and quick to learn. And, it doesn't matter what your age may be or what kind of work you have previously done, you'll find this a business made to order for you. Why not write at once for illustrated and descriptive folio enclosing 10c stamps or coin.

PLASTEX PRODUCTS

711-M LAGUNA ST.

SAN FRANCISCO 2, CALIF.

Learn MASONRY CARPENTRY



In a few short weeks you can be making big money in the building trades. Learn now while opportunities are greatest. Prepare for the future. You receive your training in our completely equipped shops under expert instructors. Fully approved for G.I. Training.

DEPT. A-12 MIDWEST SCHOOL OF BUILDING TRADES
411 N. Center Street Bloomington, Ill.

The American Institute of Specialized Watch Repair
270-276 East Building GRAND RAPIDS 6, MICHIGAN

A Fully Accredited School

You can learn this highly fascinating and profitable trade through this Institute, either at home by correspondence... or at the resident school.
Earn While You Learn



Write for Free Circular

Learn WATCH REPAIRING

ELECTRICIANS' SCHOOL

HOUSE AND COMMERCIAL WIRING • MOTOR REPAIR
AND REWINDING • ELECTRIC REFRIGERATION

Approved for Veterans Training

PENNSYLVANIA INSTITUTE SCHOOL OF ELECTRICITY

42nd and SPRUCE STS.

PHILADELPHIA 4, PENNA.



Balance 4" x 9" Base. With either \$7.00 Metric or Avoirdupois Weights ..

Catalog with 3000 Illustrations of laboratory apparatus, and over 10,000 prices sent for \$1.00.

LABORATORY MATERIALS CO.
7321 Vincennes Ave. Chicago 21, Ill.

LAW

STUDY AT HOME for PERSONAL SUCCESS and LARGER EARNINGS. 39 years expert instruction—over 108,000 students enrolled. LL.B. Degree awarded. All texts furnished. Easy payments. Send for FREE BOOK. G. I. approved.
AMERICAN EXTENSION SCHOOL OF LAW
Dept. 86-M, 646 N. Michigan Ave., Chicago 11, Ill.

Say You Saw It in POPULAR MECHANICS

MAKE MONEY IN YOUR OWN BUSINESS AT HOME!

A Permanent, Big-Profit Business with Small Investment
Enjoy security, success, independence in YOUR OWN BUSINESS! No Risk! Make products in big demand and keep ALL the profits! No experience needed—we furnish complete details and materials—**FLEXIBLE MOLDS** for casting statues, plaques, ash trays, book-ends, etc. **LIQUID RUBBER** for making your own flexible molds for above articles. Also **CAST SPONGE RUBBER** for toys, mats, coasters. **PLASTICS and MOLDS** for making jewelry articles, novelties—**PLASTIC BRONZE** for preserving baby shoes. Candlemaking instructions, plaster hardener and glaze. Many others.
Make articles and sell to stores, gift shops, friends by mail. Start Today—Write for FREE 1948 "Know-How" Catalog.

SO-LO WORKS D-803 Cincy Ave. Loveland, Ohio

POPULAR MECHANICS

Keep that Car "TICKING"

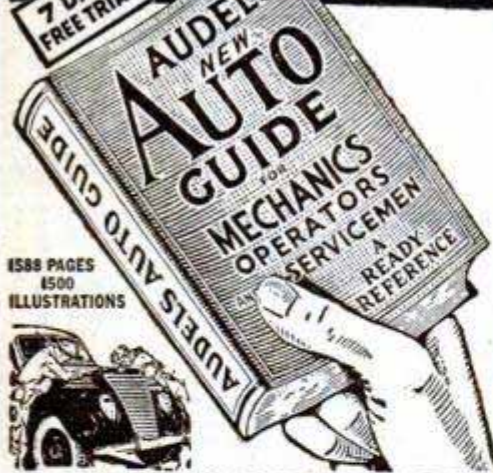

Every operator and mechanic needs AUDELS AUTO GUIDE.

This book saves time, money and worry. Highly endorsed. It presents the whole subject of auto mechanics:

- 1—Basic principles
 - 2—Construction
 - 3—Operation
 - 4—Service
 - 5—Repair
- Handy Size. Easily understood.

5888 PAGES
1500 ILLUSTRATIONS



NEW FLUID DRIVE, HYDRAULIC SHIFT AND DIESEL ENGINES FULLY COVERED

Over 1500 pages—1540 illustrations showing inside views of modern cars, trucks and buses with instructions for all service jobs.

ASK TO SEE IT!—To Get This Assistance for Yourself Simply Fill in and Mail Coupon Today.
\$4 COMPLETE • PAY ONLY \$1. A MONTH ←

MAEL Publishers, 49 West 23rd St., New York
MAIL AUDELS NEW AUTO GUIDE for free examination. If O.K. I will send you \$1 in 7 days; then remit \$1 monthly until price of \$4 is paid. Otherwise I will return it.

Name _____
Address _____
Occupation _____
Employed by _____ PM



**BIG MONEY
INDEPENDENCE**

*A PROFITABLE
LIFETIME
BUSINESS
OF
YOUR OWN!*

LEARN ELECTRICAL APPLIANCE REPAIRING

PREPARE NOW FOR THE FUTURE

If now employed, start your home appliance repair business NOW in your spare time and be set with a business of your own no matter what happens. You don't need elaborate fixtures or expensive equipment to be a successful repairman. Operate from your garage, basement, vacant store, etc. Work as many hours as you wish—the home appliance repairman is his own boss. It is a profitable occupation for on many types of repairs it is not unusual for a repairman to charge on the basis of \$5.00 to \$6.00 per hour. Don't gamble with your future—learn a trade that will always support you. Remember, as long as electrical appliances are used, there will be a need for electrical appliance repairmen.

If you are at all mechanically inclined—can hold and use tools—then you have all of the qualifications required for becoming a big money earning home appliance repairman. It does not matter if you have not had a great deal of schooling or had previous experience along these lines—**WE WILL TEACH YOU.** Age should be no barrier—nor should any minor physical handicap.

New Course Tells All

Profusely illustrated, our new course shows you in simple, easy to understand language and drawings how to make each repair on refrigerators, vacuum cleaners, washing machines, motors, etc. Explains and gives you a working knowledge of electricity, welding, nickel plating, etc. Shows you how to build the power tools you need and how to solicit and keep business coming to you. Not a theory course but an honest to goodness course written by and used by repairmen the country over. Price of course is so low that the savings on your own household appliance repairs will quickly pay for it. Act now! Mail the handy coupon below today.

— — — Read What Our Students Say About Course — — —

I really believe your course the best investment a mechanically minded man can make.—Claude E. Allen, Indianapolis, Ind.

I have received your Course in Appliance Repairing and I must say I am well pleased with same. I am only sorry I did not have said Course some years ago. I have learned so much more through this course I would not part with it.—Charles Schwarz, Hamilton, Ohio.

The Course in Appliance Servicing arrived a few days ago. Want to take out a few minutes of my valuable time to let you know that this is just what I have been looking for ever since I opened up my Fix-It shop. I must admit that you told the truth when you said that it contains quite a bit more information than I bargained for.—P. J. Bretl, Sebring, Ohio.

I am a mechanic for the Western Union Telegraph Co. Three days after receiving the lessons in refrigeration I earned the exact cost of the course.—Henry S. Lee, Washington, D. C.

I work day times at the shipyard and after 4:00 P.M. I operate from my cellar and garage. I average \$10.00 to \$15.00 clear every day.—Walter Hanhy, Brockton, Mass.

GET STARTED TODAY — MAIL THIS COUPON

CHRISTY SUPPLY CO.
2835 N. Central Ave., Dept. D-5403
Chicago 34, Illinois

Please send me free illustrated literature about America's Fastest Growing Industry—**ELECTRICAL APPLIANCE REPAIRING.**

Name.....

Address.....

City..... State.....



Stop Dreaming — Start Planning

for a Good-Paying Job in

RADIO-ELECTRONICS TELEVISION

CREI Home Study Training Can Help You Know More and Earn More...because it Starts with Fundamentals and can TAKE YOU ALL THE WAY TO A CAREER

Qualified Radio-Electronics Engineers and Technicians are in the driver's seat today. More openings exist than there are qualified men to fill them. Vast expansion of the industry has already taken place—and more is in view. The number of standard broadcasting stations has doubled since before the war. More than 350 FM broadcasting stations are on the air, hundreds more are being built. Television is here. New applications for electronics are discovered almost daily in practically every industry. Airplanes are radio and radar equipped. Mobile communications are spreading everywhere. Electronics is moving ahead—fast.

Are You Planning Your Future? The time is NOW! Get into this fast growing American industry. Prepare for a secure, well-paid future through CREI, an accredited Technical Institute that starts with fundamentals and can take you all the way to a career. Twenty years of teaching by home study has given CREI the reputation of being one of the leaders in technical radio education. Practical engineers and technicians in hundreds of key positions throughout the field of radio and electronics owe their successful training to CREI. Graduates of CREI are eagerly sought by industry—as large numbers of letters in our "jobs open" and "jobs filled" files prove.



CREI Goes "All The Way"

Even though commercial radio may be a new field for you, CREI can take you all the way. Military training in radio or radar will help you but is not essential, because CREI starts at the beginning. CREI takes you step-by-step through basic levels, into the more advanced study of radio engineering principles and practice. Finally you may elect training at career level in the highly specialized applications of Broadcasting, Television, and Aeronautical Radio.

START NOW—AT HOME —IN YOUR SPARE TIME

An attractive future in this interesting field is within the reach of the man willing to study in his spare time. Are you that man? Send for FREE book with complete information and see for yourself. Study the FREE sample lesson you will receive. (For an intelligent answer to your inquiry, please complete coupon in full.) **VETERANS:** You can get CREI training at home under the GI BILL. **NON-VETERANS:** Easy terms at pre-inflation rates are available.

CAPITOL RADIO ENGINEERING INSTITUTE
Dept. 12, 16th & Park Rd., N.W.
Washington 10, D.C.
Branch Offices:
New York 7: 170 Broadway
San Francisco 2: 760 Market St.



MAIL COUPON FOR FREE BOOKLET AND FREE SAMPLE LESSON

CAPITOL RADIO ENGINEERING INSTITUTE, Dept. 12
16th & Park Road, N. W., Washington 10, D. C.
Gentlemen: Please send me a free sample lesson and your free booklet, "CREI Training For Your Better Job in Radio-Electronics" describing opportunities and CREI home study courses in Radio-Electronics and Television.

NAME AGE
STREET
CITYZONESTATE
OCCUPATION

I AM ENTITLED TO TRAINING UNDER G. I. BILL

Check field of greatest interest:

RADIO-ELECTRONICS
 BROADCAST AND TELEVISION
 AERONAUTICAL RADIO ENGINEERING
 RECEIVER SERVICING INDUST. ELECTRONICS

VETERANS Learn WATCHMAKING

A Lifetime Profession

Regardless of Conditions, Age, Sex, or Physical Limitations
Veterans—Civilians!
Your Opportunity—
LEARN WATCHMAKING



Approved
G. I. Training

Lift yourself from a futureless job into a position paying better than your present work. Fit yourself for the job that will permit you to establish your own shop, or be employed in a pleasant environment.

Watch Repairing—Jewelry—Engraving will always be in ever greater demand. Our graduates wanted everywhere. Dignified positions \$50-\$75-\$100 per week. Veterans write today for latest FREE enrollment requirements.

Kansas City School of Watchmaking
Largest Horological School in America
617-621 Wyandotte St. Kansas City 6, Mo.

Do you want

- ➔ ..to go to College?
- ➔ ..or to enter a Profession?
- ➔ ..or get an Office Position?

To get anywhere, you practically MUST finish High School FIRST. You can complete our simplified High School Course in SPARE time at home, as FAST as your time and abilities permit. Equivalent to resident school work—prepares you for college, pre-professional examinations, business, industry. Standard texts furnished. Diploma. Credit for H. S. subjects already completed. Single subjects if desired. Low tuition, easy terms. American School, Chicago, est. 1897—endorsed by educators. Finish your high school education NOW, Write TODAY!

High School Course at Home

Many Finish in 2 Years

- American School, Dept. H245, Drexel Ave. at 58th St., Chicago 37, Ill.
- Gentlemen: Send me FREE information covering special training in subjects checked below. No obligation on my part.
- | | |
|--|--|
| <input type="checkbox"/> High School Course | <input type="checkbox"/> Diesel Engineering |
| <input type="checkbox"/> Architecture and Building | <input type="checkbox"/> Drafting and Design for Men & Women |
| <input type="checkbox"/> Automotive Engineering | <input type="checkbox"/> Plastics |
| <input type="checkbox"/> Business Management | <input type="checkbox"/> Private Secretary |
| <input type="checkbox"/> Electrical Engineering | <input type="checkbox"/> Mechanical Engineering |
| <input type="checkbox"/> Elec. and Gas Refrigeration | <input type="checkbox"/> Aviation |
| <input type="checkbox"/> Air Conditioning | <input type="checkbox"/> Salesmanship |
| <input type="checkbox"/> Railway Training | <input type="checkbox"/> Radio |
| <input type="checkbox"/> Electronics, Industrial | |

Name.....
Address.....

PLASTICS

OFFERS YOU A GREAT FUTURE!

BECAUSE MORE AND MORE
PRODUCTS ARE BEING
MADE OF PLASTICS!

LOOK AT THESE INDUSTRIES!

AUTOMOBILE

Dash Boards
Steering Wheels
Transparent Tops

CONSTRUCTION

Wall board
Plywood Laminates
Floor Coverings

ELECTRICAL

Wire Coatings
Insulating Materials
Control Panels
Bulb and Tube Components

TEXTILE

Hosiery
Clothing
Furniture Coverings

SPORTING GOODS

Golf Club Heads
Fishing Poles
Lines • Bowling Pins

RUBBER COMPOUNDS

Mechanical Rubber Goods
Kitchenware
Molds

LEATHER

Shoes
Luggage
Belts

MARINE

Hulls or Small Boats
Fittings
Ornaments and Controls

GENERAL MANUFACTURING

Radio Cabinets
Tooth Brushes
Combs
Pens and Pencils
Dishes, Jewelry,
Giftwares

ON AND ON — through industry after industry—thousands of useful, practical, every-day products made BETTER and CHEAPER from some kind of PLASTIC. That's why men and women trained in Plastics can qualify for a great future. YOU CAN GET THIS TRAINING NOW AT PLASTICS INSTITUTE, the world's largest and finest school devoted exclusively to Plastics.

STUDY AT HOME
or



YOU MAKE THINGS—Home study students get practical kit materials. You make handsome, useful articles. You form, dye, decorate, cast and laminate various types of plastics. You get experience designing and developing your own ideas.

AT PLASTICS INSTITUTE'S RESIDENT SCHOOL IN LOS ANGELES, CALIFORNIA

You can enroll for Plastics Institute's famous Home Study Course which prepares you for a career in plastics while you carry on your present activities. Or come to California for Resident Training in P.I.T.I. shops and laboratories.

START YOUR TRAINING NOW—Mail coupon below for complete details of Plastics Institute's training developed under guidance of industry leaders. No wasted time or padded lessons. You learn quickly, easily.

PLASTICS INDUSTRIES TECHNICAL INSTITUTE

New York • Chicago • Los Angeles



APPROVED
For Veterans

AVAILABLE
For Non-Veterans

Plastics Industries Technical Institute,
1601 S. Western Ave., Los Angeles 6, Calif. PM-28

Gentlemen: Please send me literature and information on your
Resident School Courses Home Training Courses

Name Age.....

Street Zone.....

City State.....

Veteran..... Non-Veteran..... Previous Education



NOW! you can LEARN ELECTRIC MOTOR REPAIR

... A good-paying, modern profession

for only **\$5**
for the complete training

IDEAL FOR BEGINNERS!

The expert who can install and repair electric motors is a valuable man in this Electrical Age! The field is tremendous. The pay is good. There are opportunities almost everywhere for full or part time work.

IT PAYS TO SPECIALIZE IN "SOMETHING DIFFERENT"!

NOW! . . . based on what can be learned at home from **ELECTRIC MOTOR REPAIR** . . . you can train for prompt, profitable installation, repairing, or even complete re-winding of practically any motor. This big, 580-page training course book teaches you step by step. Every subject is clearly explained in text and by more than 900 illustrations and diagrams. Quick reference guides tell you how to handle specific jobs.

TRAIN FOR GOOD PAY IN A FIELD THAT ISN'T CROWDED

ELECTRIC MOTOR REPAIR is the ideal training book for beginners or for actual bench use in busy shops. Unique Duo-Spiral binding divides book into two sections so that text and related illustrations can be viewed together. Covers the entire field of modern motors and generators. ALSO mechanical and electrical motor control systems. Right down the line it explains every detail of the work in a way that you can easily and quickly understand.



Try it for 5 full days . . . AT OUR RISK!

Send coupon today! See for yourself that really good home training doesn't have to cost a lot of money! If not more than satisfied, return book to us within 5 days. Your money will be refunded cheerfully and no questions asked.

A dozen courses in one!

Here are just a few of the subjects covered:

- Split-Phase Motors
- Capacitor Motors
- Repulsion-type Motors
- Polyphase Motors
- A-C Motor Control
- D-C Motors and Controls
- D-C Armature Winding
- Universal Motors
- Shaded-pole and Fan Motors
- D-C Generators
- Synchronous Motors and Generators
- Electronic Motor Control, etc.



A FIVE DAY MONEY-BACK GUARANTEE

Dept. PM-28, Murray Hill Books, Inc.
232 Madison Ave., New York 16, N. Y.

☐ Rush me a copy of "ELECTRIC MOTOR REPAIR" for which I enclose \$5 (\$5.50 foreign); or ☐ send C. O. D. (in U.S.A. only) and I will pay postman \$5 plus small postal charge when he delivers book. In either case, if book is not satisfactory, I will return it within 5 days and you guarantee to refund my \$5.

Name _____
Address _____
City and Zone _____ State _____

BIG PAY

1,054 Want Ads in Newspapers in One State in One Month Alone, Show Amazing Big Demand for

TRAINED AUTO BODY, FENDER and PAINT MEN



E. J. SWEENEY
87,675 men have come to E. J. Sweeney Schools
—WHY?

Here's A BIG OPPORTUNITY to earn more money in a steady, good pay job. This specialized trade taught you thoroughly and quickly the practical, modern way by the SWEENEY SYSTEM of Practical Experience. 87,675 auto and tractor mechanics taught since 1908 in my schools, nationally known. All the latest, modern equipment, expert teachers, tools furnished. YOU LEARN BY DOING—PRACTICALLY. Your future success depends on proper training—and getting into a business that is NOT overcrowded. Get the FREE PROOF, the full particulars about this most amazing opportunity for a quick, BIG PAY JOB. Write today.

APPROVED for VETERANS TRAINING Under P.L. 346 and P.L. 18

SWEENEY AUTO SCHOOL, Inc.
Dept. 18, 2901 East 14th St. Kansas City 1, Mo.

LEARN the LETTER SHOP

and DIRECT ADVERTISING Business



You can quickly learn this interesting, profitable business from A to Z via our thorough, easy-to-understand HOME-TRAINING, in your spare time. An ideal business for men or women, or husbands and wives, of all ages.

Write TODAY for our FREE BOOKLET

You can start with very little capital in your own home, or, take a well-paid job, if you prefer. Every business man, firm, club, church, etc., in your community is a prospective customer. Write for our FREE BOOKLET giving complete details about the opportunities in this wide open field, TODAY.

ARMSTRONG SCHOOLS

7217 SO. BROADWAY, DEPT. P-82
LOS ANGELES 3, CALIF.

New BRUSH Electroplater

ESPECIALLY BUILT FOR MECHANICS, MODEL MAKERS HOME CRAFTSMEN



Easy to Plate GOLD, SILVER, NICKEL, COPPER, etc... For Pleasure and Profit!

If you have a workshop—at home or in business—you need this new Warner Electroplater. At the stroke of an electrified brush, you can electroplate models and projects—you can replate worn articles, faucets, tools, fixtures, silverware, etc. with a durable, sparkling coat of metal... Gold, Silver, Nickel, Copper, Cadmium, and after a bit of practice, even Chromium! Everything furnished—equipment complete, ready for use. By doing a bit of work for others, your machine can soon pay for itself. So make your shop complete by getting a Warner Electroplater right away. Send today for FREE PLATING SAMPLE and illustrated literature. ACT AT ONCE.

WARNER ELECTRIC CO., Inc., Dept. R-27
1512 Jarvis Ave., Chicago 26, Ill.

FREE Details & Sample!

WARNER ELECTRIC CO., Inc., 1512 Jarvis Ave., Chicago 26, Ill., Dept. R-27
Gentlemen: Send Free Sample and Details to:

Name _____
Address _____
City _____ State _____

Find OPPORTUNITY Where DEMAND is Great!

AUTO BODY and FENDER REPAIRING



You men who are tired of being rutted in your job should look into a field where demand is huge—and gives every indication of growing even larger! Such a field is AUTO BODY and FENDER REPAIRING. As long as there are cars on the road, there'll be dents and bumps to be fixed, body repairs to be made, replacements of worn or damaged parts! The more cars—the more WORK!

Millions of old cars are on the road today, with fenders and bodies in great need of repair and refinishing. Thousands are rolling off production lines now. Within a short time they'll be coming into shops for maintenance.

Here is a Trade that Needs Manpower!

The man with ambition recognizes great opportunity here for lifetime work, either at a dependable job or in his own business. For AUTO BODY and FENDER REPAIR is the kind of business which can be started with small capital. And, what's more, AUTO BODY and FENDER REPAIRING, as taught by UEI, is easy to learn! No previous experience nor high school education is necessary—what's needed is a liking for mechanical work.

Old Established School Offers Practical Training HOME STUDY AND SHOP PRACTICE

UEI's Course in *Auto Body and Fender Repairing* is arranged so you can begin your study in spare time, without interfering with your present job. You learn about auto body repairs and refinishing, body alignment, and many other subjects. Then, when you have completed your home study, you continue your course here in our well-equipped residential school where you receive practical experience in the repairing and refinishing of damaged bodies, tops, doors and fenders, the replacing of door panels and turret tops, use of tools, spray painting, acetylene welding, under personal supervision of capable instructors.

GET FULL FACTS FREE!

Since 1927, UEI has trained thousands of men for new opportunity fields, and students are making good. If you want to get ahead, get full facts about Auto Body & Fender Repairing, and its opportunities. Don't wait—investigate now. Mail coupon today.

OTHER U. E. I. TRAINING OPPORTUNITIES

Practical Shop Training after preliminary Home Study.

DIESEL

Engine Operation, fuel systems, auxiliary equipment, repairs and maintenance.

WELDING

Arc and Acetylene. With fundamentals of metallurgy and supervised welding practice.

REFRIGERATION

Servicing and installation for all commercial and domestic types.

AIR CONDITIONING

Installation, operation and maintenance of home and industrial equipment.

WRITE FOR FREE INFORMATION

FILL OUT AND MAIL COUPON

G. I. Approved School

Founded 1927



UTILITIES ENGINEERING INSTITUTE

2523 Sheffield Ave., Dept. 128X, Chicago 14, Ill.

Utilities Engineering Institute, Dept. 128X
2523 Sheffield Ave., Chicago 14, Illinois

Yes! Send me the facts FREE about the field checked below.

- Auto Body and Fender
 Diesel Engine
 Welding
 Refrigeration
 Air Conditioning

NAME _____ Age _____

Address _____

City _____ ZONE or COUNTY _____ State _____

Check here for special information if you are under 17.

OPPORTUNITIES in AVIATION for You

Boost your earning power in an expanding industry. For a successful career in aviation, train at Spartan — an internationally famous aeronautical school, industry recognized and Government Approved. Personal instruction from industry-experienced teachers. You train on the same type aircraft, powerplants, radios and instruments at Spartan that you will work with after graduation. Complete, thorough courses in Flight, Mechanics, Radio, Meteorology, Instruments, Aeronautical Engineering, Airport Management and Operations. APPROVED FOR VETERANS. Investigate aviation's opportunities—write for Free Catalog.

Spartan School of Aeronautics
Tulsa, Oklahoma
Please send your free Catalog immediately.

Name _____ Age _____

Address _____

City _____ State _____

- Indicate which of these branches interests you:
- Flight
 - Instruments
 - Mechanics
 - Aeronautical Engineering
 - Radio
 - Airline Maintenance Engineering
 - Meteorology
 - Management and Operations

Spartan is approved for training under the G. I. Bill of Rights

SPARTAN SCHOOL OF AERONAUTICS

PM-28 TULSA, OKLAHOMA

RADIOMEN! ELECTRICIANS!

Get this Valuable Book **FREE** for Merely Examining Coyne's NEW Pay-Raising

5 VOLUME SET APPLIED PRACTICAL RADIO

Here's real news for every man interested in Radio. A sensational new PRACTICAL set of radio books just off the press! Gives you the "know how" on everything in Radio today. Basic principles to the newest in Television and F.M.—how to construct, install, service. Latest trouble-shooting methods. 1000 illustrations, over 1500 pages. To prove how valuable these great books can be to you, Coyne will give you a FREE copy of our new, helpful guide, "150 New Radio Diagrams Explained" just for looking over the 5 Volume Set. Applied Practical Radio is ideal for reference or home training. Coyne's 48 years of shop experience is behind it to help you to bigger pay, better jobs, greater opportunities in Radio. OFFER LIMITED—ACT NOW! Here's our offer to you—if you act promptly. We will send you the 5 volume set APPLIED PRACTICAL RADIO for 7 days FREE examination, together with the Radio Diagrams. Look the set over for 7 days. If you like it send either \$15 cash, or \$3 after 7 days and \$3 monthly until \$16.75 is paid. If you don't want the set, return it and you owe NOTHING. Either way you keep the Radio Diagrams Book absolutely FREE. SEND NO MONEY! Coupon below just asks to see the books free and get your gift book for doing it! Send coupon TODAY!

FREE BOOK COUPON



Educational Book Publishing Division
COYNE ELECTRICAL & RADIO SCHOOL, Dept. 28-R7
500 South Paulina St., Chicago 12, Illinois

OK. Send me, postpaid, Coyne's new 5 volume set, "APPLIED PRACTICAL RADIO" for 7 Days FREE TRIAL per your offer. Also send, absolutely FREE, "150 New Radio Diagrams Explained" as a gift.

NAME _____ AGE _____
ADDRESS _____
TOWN _____ ZONE _____ STATE _____

MAKE BIG MONEY IN FEW DOLLARS STARTS YOUR OWN PROFITABLE BUSINESS! LIQUID SYNTHETIC MARBLE

Here are 3 amazing, new opportunities to get into your own highly-profitable, dignified business—without previous experience—regardless of your age or sex. 1. LIQUID SYNTHETIC MARBLE—Easy to make and install beautiful synthetic Marble Slabs—pouring from liquid state. Big Demand for kitchen and bathroom walls, etc. 2. FIBRE-TITE FLOORING—Easy to make and install—in any color or color combination. Many years wear. Dustproof. Soundproof. Verminproof. 3. FLEXIBLE MOLDS—for Plaster Casting. \$1.00 in raw materials makes up to \$25 worth finished products. F. B., Iowa, writes: "Am on job that will net me \$150 for 4 days work." Get FREE details. No obligation. Write today!

Write for FREE DETAILS NOW!

COMPOSITION PRODUCTS CO.
5853 Delmar Blvd. Dept. 21 St. Louis 12, Mo.

LEARN WATCH REPAIRING



WITH OUR NEW KIT
This PRACTICAL SELF-TRAINING KIT is all you need to get started in this money making field. Contains new and complete book, "Modern Watch Repairing & Adjusting" and QUALITY TOOLS: TWEEZER, LOUPE AND SET OF 6 SPECIAL SCREW DRIVERS. Book is fully illustrated, easy to understand. Shows every step in repair, adjustment and use of tools. **\$5.75** Post Paid All for only (BOOK ALONE \$3.25)

(If C.O.D., plus charges.) MONEY BACK GUARANTEE

MODERN TECHNICAL BOOK & TOOL CO.

Dept. MMC, 55 W. 42nd Street, New York 18, N. Y.

JUST OUT! NEW ALL INCLUSIVE TOOL CATALOG
NEW REDUCED PRICES. Over 450 ILLUSTRATIONS AND IDENTIFICATION CHART. All tools, materials, complete Sets for STUDENTS, Watch-Clockmakers, Jewelers, Handicrafters. All books in these fields. **SEND 25c — Free with above order.**

SAY YOU SAW IT IN POPULAR MECHANICS

The Steady Pay Profession Good Times or Bad!

SCIENTIFIC CRIME DETECTION



It Is Easy to Learn!
I will teach you this fascinating science during your spare time at home. It pays to be an expert in Finger Printing, Firearms Identification, Police Photography and Criminal Investigation. I have trained hundreds of men and women now successfully serving in identification bureaus throughout America. You, too, may quickly prepare yourself to become a well-paid valued officer of the law, often sharing in the generous rewards offered for wanted criminals.

FREE! OVER 800

"BLUE BOOK OF CRIME"
This book is full of exciting information on scientific crimedetection. It will show how you can get started in a grand career. Now, at amazingly low cost. Clip coupon now...Mail it today.

of all Identification Bureaus in the U. S. employ students and graduates of I. A. S. A majority of these men are heads of Bureaus. Many of them knew nothing about crime detection before training with me. Now they have steady jobs, good salaries and a fine future. Write today for full particulars and free book. Give age.

INSTITUTE OF APPLIED SCIENCE

1920 Sunnyside Ave., Dept. 1352, Chicago 40, Ill.

INSTITUTE OF APPLIED SCIENCE
1920 Sunnyside Ave., Dept. 1352, Chicago 40
Gentlemen: Without any obligation on my part, send me the "Blue Book of Crime," and complete list of Identification Bureaus employing your students or graduates, together with your low prices and Easy Terms Offer. (Literature will be sent ONLY to persons stating their age.)

Name _____ Age _____
Address _____
RFD or Zone _____ State _____

Now! NO AUTO REPAIR JOB IS TOO TOUGH FOR YOU!

Let this New Short-Cut Save You Time and Work!

Used by U. S. Army and Navy

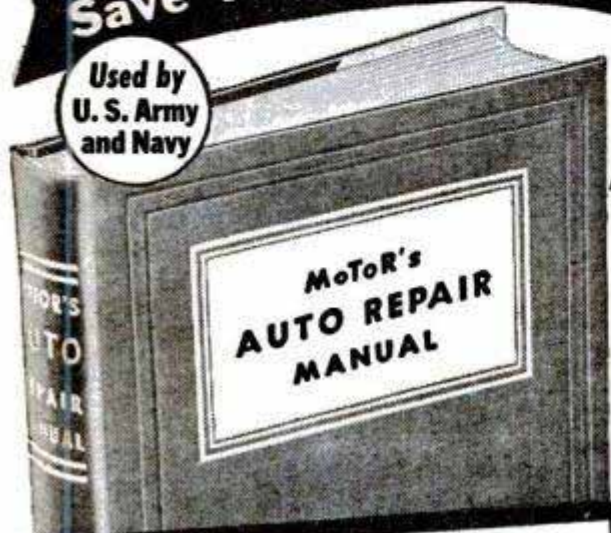

JOB ALL FINISHED IN ONLY HALF THE TIME!



Whether you do auto repairs either as full-time or as part-time work, no service or repair job can "throw" you when you've got MoToR's AUTO REPAIR MANUAL! Just look up make, model, and the job in the streamlined index—and you're ready to lick ANY job from carburetor to rear end, faster, easier, better!

Try it FREE for 7 Days!

MoToR's AUTO REPAIR MANUAL Shows You How to Service and Repair ANY Part of ANY Car Built Since 1935!

Nearly 200,000 service and repair facts on all 31 makes. 856 big pages; including 50 pages of carburetor text, charts, illustrations, covering all models. Over 500 charts, tables; Tune-up Chart; Valve Measurements; Compression Pressure; Torque Wrench Reading; Starting Motor; Engine Clearances; Generator; Clutch & Brake Specifications; Front End Measurements, etc.. Engines; Electric, Fuel, Cooling, Lubricating Systems; Transmissions; Universals, Front Ends; Wheels; Rear Ends, etc.

Covers All These Makes!

- | | | | |
|-----------|-----------|------------|--------------|
| American | Cord | La Salle | Packard |
| Bantam | Crosley | Lincoln | Pierce Arrow |
| Auburn | De Soto | Lincoln | Plymouth |
| Austin | Dodge | Zephyr | Pontiac |
| Buick | Ford | Mercury | Reo |
| Cadillac | Graham | Nash | Studebaker |
| Chevrolet | Hudson | Overland | Terraplane |
| Chrysler | Hupmobile | Oldsmobile | Willys |
| | Lafayette | | |

Try this great book for 7 days FREE! It's "headquarters" for 200,000 facts about service, repair, adjustment, replacement, and tune-up — on every car built from 1935 through 1946. The engineer-editors of MoToR Magazine built this Manual for YOU, by collecting and organizing all the vital information from 150 official factory shop manuals. Then they put ALL the facts into this ONE amazing workbook.

More Than 1,000 Pictures!

MoToR's AUTO REPAIR MANUAL not only TELLS you clearly what to do. It SHOWS you, too! — in over 1,000 cut-away photos, diagrams, drawings. 856 BIG pages (8½x11 inches) put the complete "know-how" right at your fingertips! And the fabric binding is strong, built for years of day-in-day-out service!

No wonder it is used by the U. S.

Army, Navy, trade and technical schools, thousands of auto servicemen and handymen everywhere! No wonder we're willing to have YOU try it, FREE, for 7 days! Once you use it—and see for yourself how much valuable time and hard work it saves—you'll never again want to be without it!

SEND NO MONEY 7-Day Free Examination

Don't send any cash — unless you wish to do so in order to save postage charges! Simply mail coupon NOW. When postman brings your book, pay him nothing. First make the book show you what it does for you! Unless convinced it's the greatest time-saver and work-saver you've ever seen—return book in 7 days, pay nothing. Mail coupon NOW! Address: MoToR Book Dept., Desk 1B, 572 Madison Avenue, New York 22, N. Y.

Same FREE 7-Day Offer Applies on MoToR's TRUCK REPAIR MANUAL

For mechanics, truck specialists, service stations, fleet owners. Covers EVERY job on EVERY truck made since 1936! 1400 pictures, 952 pages, 300,000 facts. Used by Armed Forces.

All types Gasoline Engines, Diesels, Hesselman, Fuel Systems, Governors, Lubrication Systems, Ignition Systems, Starters, Generators, Clutches, Transmissions, Axles, Torque Dividers, Transfer Cases, Brakes, Steering, etc.

ALSO SERVICES many buses, farm and industrial tractors, contractor and road building equipment, stationary power machinery, etc. (on all parts described in Manual.) Check box in coupon at right.

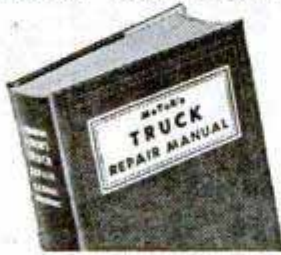

Published by MoToR, The Leading Automotive Business Magazine. MoToR's manuals assure high standards of repair work.

MAIL COUPON NOW FOR 7-DAY FREE TRIAL

MoToR Book Dept., Desk 1B, 572 Madison Ave., New York 22, N. Y.

Rush to me at once: (check box opposite book you want).

MoToR's AUTO REPAIR MANUAL. If O.K. I will remit \$1 in 7 days, (plus 35c delivery charge), then \$2 monthly for 2 months, and a final payment of 95c a month later. (Foreign price, remit \$8 cash with order).

MoToR's TRUCK REPAIR MANUAL. (Described at left.) If O.K., I will remit \$2 in 7 days, and \$2 monthly for 3 months, plus 35c delivery charges with final payment. Otherwise I will return book postpaid in 7 days. (Foreign price, remit \$10 cash with order).

Print Name..... Age.....

Print Address.....

City..... Zone No. (if any).....

State..... Occupation.....

Check box and SAVE 35c delivery charge by enclosing WITH COUPON entire payment of \$5.95 for Auto Repair Manual (or \$8.00 for Truck Repair Manual). Same 7-day return-refund privilege applies.

BUILD YOUR OWN LARGE IMAGE TELEVISION SET AT BIG SAVING IN COST WITH THE TRANSVISION TELEVISION KIT — NO TECHNICAL KNOWLEDGE REQUIRED!

Only about twenty hours of enjoyable work on the easy-to-assemble Transvision Kit—and you have a high-quality large-screen (12") television set! Here's a first-row seat at fights, games and plays.

Save 50% of expensive assembled set cost! At only \$289.50, the famous Transvision 12" Kit gives larger, clearer picture and sound than sets selling at \$500.00.

NOTHING EXTRA TO BUY. The Transvision Kit comes complete with all tubes,

pre-assembled and pre-tuned R.F. (tuning) unit and I.F. coils, antenna—even solder!

EASY TO ASSEMBLE. No technical knowledge required. All assemblies requiring test equipment are pre-wired for you. All you do is finish off the assembly with a screw-driver and soldering iron.

FLASH! Brand new 15" kits now available for large groups. Tremendous savings. Transvision 7", 10" and 12" Kits also ready for immediate delivery.

Write today. Learn how thousands have cut expensive television costs in half. Follow our step-by-step directions and save as much as \$250. Write for further free details to Dept. P.M.



SEND FOR FREE CATALOG

BEACON TELEVISION, INC.
785 THIRD AVENUE NEW YORK 17, N. Y.

Learn A Trade NOW! PRACTICAL SHOP TRAINING!

Approved for G.I.'s and Civilians

- | | |
|--|---|
| <input type="checkbox"/> AUTO MECHANICS | <input type="checkbox"/> DIESEL MECHANICS |
| <input type="checkbox"/> REFRIGERATION | <input type="checkbox"/> MACHINIST |
| <input type="checkbox"/> WELDING—ARC and GAS | <input type="checkbox"/> PIANO TUNING |

America's Leading School
7 Floors of Fully Equipped Shops
Over 45,000 Graduates
Expert Individual Instruction
Learn by Doing — Low Living Expense
Established 1902 — Day and Evening Classes

— CALL IN PERSON OR MAIL THIS AD TO —
GREER SHOP TRAINING

(Dept. 228) 460 South State St., Chicago 5, Ill.

Please send without obligation free information regarding trade checked above. (Specify whether you are a Veteran or Civilian)

Name _____ Age _____
Address _____
City _____ State _____

Famous BAILEY DIESEL SCHOOLS Now Accepting CIVILIAN STUDENTS!

Bailey has a national reputation for "finest training methods." Bailey teaches you fundamentals, plus the practical application of theory in plenty of actual shop work. Bailey is approved by industry. Bailey graduates get the jobs!

Civilian men and boys over 17 who are ambitious to get ahead will act now. Send for FREE catalog. No salesman will call.

BAILEY TECHNICAL SCHOOLS
1655 So. Grand Blvd., St. Louis, Mo.

MAKE MONEY CASTING AT HOME FREE FACTS SENT



X.L. RUBBER MOLDS
Make your own perfect rubber molds cheaply. Cast Thousands, of perfect Book Ends, Ash trays, Etc., from every mold. Enormous Profits. Start Small. Grow Big. X. L. Rubber. Pts. \$2.00. Qts. \$3.50. Gallons \$8.95. Models and enough rubber for 3 molds, \$1.00. Foreign \$1.50. Plastic Arts Studio, Rt. No. 2, Dept. 65, Muncie, Ind.

LOOK! **FINDER SAX-SLING**
NEVER SLIP OR KINK
HIGH SPEED ADJUSTING BALLBEARING
\$1.50 AT ALL GOOD DEALERS
Mfg. by FINDER, San Diego, Calif. **NEW!**

BE A REAL ESTATE BROKER FREE BOOK TELLS NOW

Start and run your own business Quickly. All phases of business taught in Home Study or Classroom—Both G. I. Approved. WRITE TODAY for Big Illustrated Book. **WEAVER SCHOOL OF REAL ESTATE.** 15 East Pershing Road, Dept. PH, Kansas City 8, Mo.

STAMMER? GET THIS FREE BOOK!

This new 128-page book, "Stammering, Its Cause and Correction," describes the Bogue Unit Method for scientific correction of stammering and stuttering—successful for 47 years. **Benj. N. Bogue,** Dept. 4824, Circle Tower, Indianapolis 4, Ind.

SAY YOU SAW IT IN POPULAR MECHANICS

GLOWS in the DARK FREE Sample!

Be the first to sell luminous house numbers, light switch plates, wall protectors, pull cords. Also luminous pictures, statues, decals, and a host of religious, nursery and other objects that glow in the dark. Get into this new and growing industry. Enormous demand... no competition... sensational demonstration... big profits. Represent a large manufacturer, established over 34 years. Write today for liberal money-making offer and free sample to show how they glow in the dark.
MADISON MILLS, 303 Fourth Ave. Dept. B-4, NEW YORK 10, N. Y.

DIESEL SPECIALIST

OR

AUTOMOTIVE TUNE-UP EXPERT

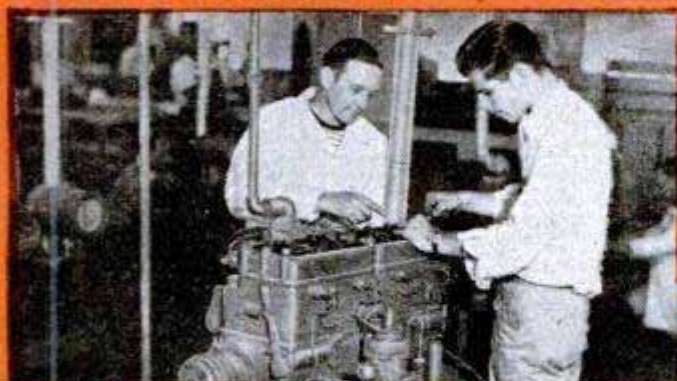

be **ONE** or **BOTH**...the

YOU CAN TRAIN TO BE A DIESEL SPECIALIST or an AUTOMOTIVE TUNE-UP EXPERT—or BOTH—the famous HEMPHILL SCHOOLS WAY. Here are the highlights of these two practical, intensive courses. **READ THIS PAGE—then SEND FOR COMPLETE DETAILS!**

HEMPHILL DIESEL TRAINING available to you at home. You can study by means of up-to-date **HOME STUDY COURSE.** Gives theory of Diesel engines, their operation and maintenance. Lessons are simple, easy to understand, fully illustrated by drawings and photographs. Diesels are supplying more and more of the power in transportation, trucking, shipping, power plants, agriculture, logging, construction and other industries. This means greater opportunities for trained Diesel men.

HEMPHILL DIESEL RESIDENT SCHOOL TRAINING available to you in large, well-equipped shops at Los Angeles, California; New York and Memphis, Tennessee. Get the best Diesel training available at America's pioneer Diesel schools under expert instructors.



HEMPHILL AUTO TUNE-UP COURSE available to you in Los Angeles and Memphis. You learn practical modern methods of automotive trouble shooting, ignition and electrical system service and repair, carburetion, etc., on modern equipment. Here is a short, intensive course to quickly qualify you for this well-paid opportunity field. **BE AN AUTOMOTIVE TUNE-UP SPECIALIST!**

This streamliner is "going places" on Diesel power. How about you?

HEMPHILL SCHOOLS HOME STUDY AND RESIDENT COURSES APPROVED FOR VETERANS—AVAILABLE FOR NON-VETERANS ON EASY PAYMENT PLAN

MAIL COUPON TODAY—Get Free Literature

Hemphill Diesel & Automotive Schools
1601 S. Western Ave., Dept. PM-28 Los Angeles 6, California

Please send me, without obligation, complete information on your Diesel Courses, Home Study
OR attend school in Los Angeles Memphis New York.
Auto Tune-up Course, Los Angeles Memphis.

Name.....Veteran Non-Veteran
Street..... Zone.....
City..... State.....

When your chance comes to step into a better job— WILL YOU BE PREPARED?

These are times of change in business . . . Jobs must be filled quickly— WITH ABLE MEN. These six volumes give you the practical knowledge that promotes executive efficiency—prepare you for a better job.



They cover methods of management most needed in the executive approach to business. Use them for immediate help on your present business problems—and to get the "know-how" for the bigger jobs ahead.

LIBRARY of BUSINESS MANAGEMENT

6 volumes, 1973 pages

1. Business Organization: How to organize a department or business . . . plan and control its workings . . . provide personnel.
2. Business Finance: Where and how to get money—the lifeblood of business.
3. Credit and Collections: How to reduce credit losses . . . how to modernize your credit system . . . establish credit policy.
4. Effective Marketing: How to improve sales methods . . . develop promotions.
5. Business Correspondence: How to write effective letters . . . save time and money with better methods.
6. Managing Yourself: How to conserve and direct your energies . . . how to handle detailed problems.

FREE TRIAL—EASY TERMS

McGraw-Hill Book Co., Inc., 330 W. 42d St., N.Y.C. 18
Send me the McGraw-Hill Library of Business Management, 6 volumes, for 10 days' examination on approval. In 10 days I will send \$2.50 and then \$3.00 monthly until \$17.50 is paid, or return the books postpaid.

Name _____
Address _____
City and State _____
Company _____ Position _____ PM-2-48
(For Canadian price, write McGraw-Hill Co. of Canada Ltd.,
12 Richmond Street E., Toronto 1.)

ELECTRICIANS

Get this Great Book

Book of 150 Shop Prints. Wiring Diagrams. Full Size 8 1/2 x 11"



FREE

For Merely Examining
Coyne's NEW Pay Raising

8 Volume Set APPLIED ELECTRICITY

Here's a brand new set of electrical books to give you the "know how" on all branches of electricity from appliance repairing to D.C. and A.C. refrigeration, Industrial Electronics, etc. 3,400 subjects, 11,500 facts, latest methods explained in easy to follow instructions. To prove how valuable and Practical this set can be to you, I'll give you a FREE copy of my book "150 Shop Prints and How to Read Them" just for looking over this set. Written by the Coyne Staff and backed by 47 years' experience, this set has helped many ambitious electrical workers to bigger pay and added opportunity.

OFFER LIMITED • ACT NOW! If you act promptly, I'll send you the 8 volume set Applied Practical Electricity for 7 days FREE examination . . . together with the 150 Shop Print Book. Look the set over 7 days. If you like it send either \$22.75 cash or \$3.00 after 7 days and \$3.00 per month until \$24 is paid. If you don't want the set, return it and YOU OWE NOTHING. In either event you keep the 150 Shop Print Book absolutely FREE.

Coupon below is just a request to see the books free and to get my gift book for doing it. ACT—Send coupon Today!
Technical Book Div. COYNE ELECTRICAL SCHOOL
500 S. Paulina St., Dept. 28-R6, Chicago 12, Ill.

FREE BOOK
Coupon

SEND NO MONEY

B. W. Cooke
Director
COYNE ELECTRICAL SCHOOL, Dept. 28-R6
500 South Paulina Street, Chicago 12, Illinois
O. K., send me, postpaid, Coyne's new 8 volume, "Applied Practical Electricity" for 7 Days FREE TRIAL per your offer. Also send, absolutely FREE, the book of 150 Shop Prints as a gift.

Name _____ Age _____
Address _____
Town _____ Zone _____ State _____

Men's Fully Guaranteed NEW \$13.95 PLUS TAX 15-JEWEL WRIST WATCH

ORIGINALLY sold up to \$55
Sacrificed because they're post-war surplus

LOOK AT THESE FEATURES:

Luminous dial . . . sweep second hand . . . waterproof . . . shockproof . . . anti-magnetic . . . imported Swiss precision movement and case. You get them now for a small fraction of original prices. Don't delay! Order now while they last. Send only \$1 down payment with order. Pay balance to postman on arrival, plus postage. Or we pay postage if you enclose \$13.95 plus \$1.30 Fed. Tax.

Receive Reg. \$2 expansion band FREE with prepaid order. Money back in 5 days if not delighted. Order now.



MARYLAND DISTRIBUTORS, Dept. 4
501 E. Baltimore St. Baltimore 2, Md.



48 PLANS

\$100

48 complete plans of toys, ash trays, garden ornaments, Dutch boys and girls, what-not shelves, and many other interesting projects. Finest selection available. Novel method allows you to make finished project any size desired. PLUS FREE Deluxe Plan of corner shelves. Send only \$1 to

Jackson, Dept. 30-5440 N. Shoreland Ave., Milwaukee 11, Wis.



COMB-A-TRIM The New Quick Trimmer

Something New! Trim your hair without any experience. It's easy! The excess hair comes off smoothly and easily by just pulling trimmer through hair like an ordinary comb. Save on hair-cut bills. . . Trim your own hair or the whole family's. Send 59c and your Comb-A-Trim will be sent at once, postpaid.

SPECIAL OFFER Send \$1.00 for 2 Comb-A-Trim Trims. Save 18c **2 for \$1** 5 Extra Blades (Year's Supply) **25c**
COMB-A-TRIM CO., CAREW TOWER, Dept. R-24, Cincinnati, Ohio

Ottawa Self-Propelled Buzz Master

CLEAR LAND FAST! Powerful 7-HP motor with friction clutch for safe operation. Cuts down timber, brush and hedge; turn blade vertically and saw logs to length. Also furnished with post hole diggers. Has clutch pulley for belt work.
OTTAWA MFG. CO., 1-827 Brush Ave., Ottawa, Kansas



RACING CAR EQUIPMENT FOR ALL CARS

Engines, Racing Heads, Manifolds, Carburetors, Mufflers, etc. Speed Instructions and literature \$1.00—refunded first order.

LEE MOTORCRAFT CO. 1412 Great Northern Bldg. Chicago, Ill.

SAY YOU SAW IT IN POPULAR MECHANICS

MEN OVER 50

MAKE A FORTUNE

NO INVESTMENT



Good salesmen in our organization have made fortunes. Our best men earn \$10,000 in a year and more . . . and many of them are over 50. Here is a field where mature, experienced, ambitious salesmen can really prosper. It's a chance of a lifetime to make the kind of earnings you've always wanted . . . and make them easily and continuously.

EXCEPTIONAL EARNINGS UP TO \$5,000-\$10,000—and more

We offer you this opportunity with a much-in-demand building maintenance product for all types of businesses and farmers. All you do is make contacts—we deliver and collect. Pay in advance. Write for the first step in our sensational plan for your success: "A Dozen Ways To Make \$10,000 In A Year."
TIFFANY ASPHALT AND GREASE WORKS
Dept. H, P. O. Box 676, Dayton 1, Ohio

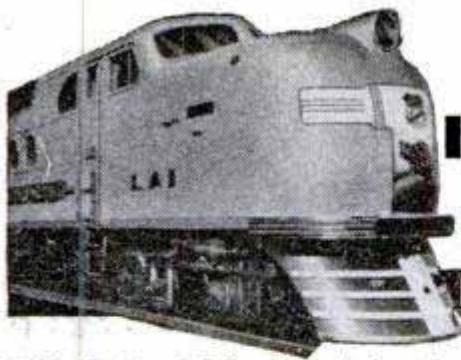

GET INTO DIESEL NOW!

Let this Great School qualify You!

LEARN AT HOME IN YOUR SPARE TIME

With National Schools' tested and proved Master Shop Method of Home Training, you can become a qualified Diesel and Automotive technician equipped to step right into a good paying job. One of America's great trade schools, established in 1905, stands behind your training!

National Schools-trained Diesel and Automotive Technicians Are Welcome Everywhere

Our files are filled with facts of National Schools-trained men who have reached success in their chosen field because of the thorough, practical and up-to-date instruction we gave them.

Diesel is becoming more and more important in transportation, industry and agriculture all over the world. Trained men who really know Carburetion, Ignition, Fuel-Injection, Motor Tune-up, etc., are in constant demand to fill interesting, good pay jobs. Opportunity is here now for you!

Every Word and Picture in Your Home Study Course Comes Out of the Great National Schools Training Shops

Behind all National Schools training is our permanent faculty of experienced instructors and engineers who will teach you about Diesel-electric, Internal Combustion Engines, including Diesel, Gasoline and Butane Types, High-octane fuels; Automotive Drive Systems, etc. National Schools instructors are daily teaching resident students in our modern, fully equipped Shops and Classrooms, using the same instruction methods and lessons you study at home in your spare time. These instructors know how to guide your home study!



Get These FREE BOOKS

It will cost you nothing to learn how you can grasp opportunity in the great Diesel industry. Send the coupon below for a sample lesson from National Schools' Home Study Course, and your big Opportunity Book giving further information.

TODAY'S GREAT OPPORTUNITIES IN DIESEL, AUTOMOTIVE AND ALLIED MECHANICS

G. I. APPROVED

NATIONAL SCHOOLS

LOS ANGELES 37, CALIFORNIA EST. 1905



MAIL OPPORTUNITY COUPON FOR QUICK ACTION

National Schools, Dept. PMD-2

4000 South Figueroa Street

Los Angeles 37, California

(Mail in envelope or paste on penny postcard)

Mail me FREE the book, YOUR FUTURE IN DIESEL, together with the Sample Lesson. I understand I may keep and use the information with no obligation.

Name _____ Age _____

Address _____

City _____ Zone _____ State _____

Check here if Veteran of World War II

LEARN TO USE THE SLIDE RULE

The Easy, Quick Way to Better Jobs— Bigger Pay — for All Who Use Figures

Get this new revised and simplified edition of the "Slide Rule and How to Use It." Thousands of older editions sold at much higher price. Now—a more simplified book at a lower price and a genuine Mannheim type Slide Rule included at no extra cost. Do all kinds of figure work. Stop wasted time. Stop pencil errors. Learn quickly to multiply, divide, extract roots, find ratios and percentages, squares, areas of circles, radii, volume, etc. Do it in a flash and learn now with this book and slide rule combination.

THE SLIDE RULE and how to use it

WITH ANSWERS

Including 5 PLACE Log Tables

COMPLETE, LIGHT AND PORTABLE

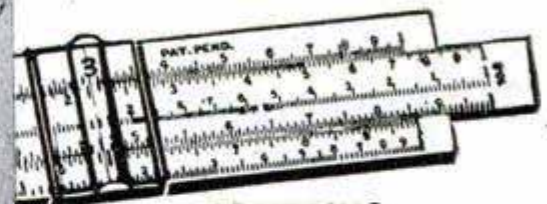

CONTAINS

Complete Slide Rule instruction, Five Place Logarithm Tables, Trigonometric Functions and a valuable Review of Mathematics from Arithmetic to Calculus.

FREE SLIDE RULE

10 in. SLIDE RULE and Famous Book Both for Only

Revised and Simplified \$2.48 Step by Step Method

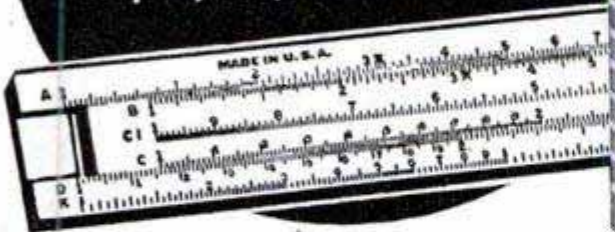

Nothing Mysterious—Learn in a Few Hours to Do Many Calculations

No other book like it. Contains complete instructions and work sheets that make the slide rule simple as A.B.C. Complete answers to check yourself on every problem. It can easily be worth hundreds of dollars to you in promotions, better pay, saving time and error. It's a book for students, mechanics, business men—

everyone should learn to use the slide rule, now that it is so easy. You'll be amazed at the problems you can solve in just a few hours. Mail the coupon now. Book and slide rule will be sent at once. Use them for 5 days, then if you are not satisfied in every way, return them and your money will be refunded without delay. Use the coupon. Mail now.

AUSTIN PUBLISHING CO., Dept. 12, 165 N. Pine Ave., Chicago 44, Ill.

Mail Coupon Money Back if Not Satisfied

AUSTIN PUBLISHING CO., Dept. 12
165 N. Pine Ave., Chicago 44, Ill.

Send me "The Slide Rule and How to Use It" and 10" Mannheim type Slide Rule. Total cost for both \$2.48. I understand you will refund amount paid if I return them in 5 days.

Remittance enclosed Send C.O.D. Postage and charges extra

Name _____

Address _____

City _____ State _____

Be a NEON Expert



I'll Show YOU How to
Make \$100 a Week
and UP in **NEON**



C. C. Biakely, Executive Director
Acme Neon Institute

★ Today's wide open field for ambitious men who want to make \$100, \$150 and more per week is the colorful, exciting business of Neon. I'll train you for a highly paid place in America's most fascinating industry. At Acme you become a Master Neon Technician. Learn Neon Tube Bending, Color Gassing, Neon Glass Blowing, Cold Cathode Lighting, Bombarding, other important skills.

COAST-TO-COAST OPPORTUNITIES

Demand for Acme Trained Men is greater than we can supply. We're getting calls from coast-to-coast. Today beginners have a once-in-a-lifetime chance to master an art and learn a profession that will pay big dividends for life. Our practical, intensive 500 hour course prepares you for thousands of BIG MONEY opportunities. Get a fine job, or go into business. Other Acme Trained Men are succeeding. So can you. Room Assistance for out-of-town students.

ACME NEON INSTITUTE
1648 W. Van Buren St. Chicago, Ill.
APPROVED UNDER G.I. BILL

FREE FACTS

Acme Neon Institute
Dept. B-3, 1648 West Van Buren Street
Chicago 12, Illinois

Send me the FREE FOLDER, "Your Big Opportunity" plus facts about training me for a highly paid job in Neon.

Name _____

Street _____

City _____



CHICKS ON 30 Days Trial

guarantee. Money refunded on any chicks not true to breed. No need to take chances. You get 30 days to make sure chicks are as represented. Male or pullet chicks furnished. Low prices. All varieties. Mo. Approved. Blood Tested. Easy buying plan. Bargain Prices and Chick Manual Free. MISSOURI STATE HATCHERY, Box 289, BUTLER, MO.

SEXED

MAGIC LIQUID MAKES PHOTOS APPEAR

Amazing discovery permits you to print pictures from any of your snapshot negatives on wood, cloth, leather or paper. Like magic your pictures will show on ties, handkerchiefs, purses, cards, and letterheads. Takes only a few minutes in broad daylight. Won't rub off or harm negative. An attractive set with enough material for over 100 pictures. ORDER TODAY. Send \$1.00 postpaid. C. O. D. pay postman a few cents more in addition. (Foreign \$1.50 money order only.)
STYLE-ARTS, Inc., Dept. PM-13, 2427 Cortland, Chicago 47, Ill.



How to Write

The demand for writers is creating great new opportunities for people with an urge to write. It's not as hard to succeed as you may imagine. Most famous authors come from ordinary walks of life. At home, you too may learn fiction writing, the best basis for all fields—short stories, novels, features, articles, radio scripts. Palmer Institute's Home Study Training (Established 1917) is endorsed by Rupert

PALMER INSTITUTE OF AUTHORSHIP • Desk T-28 • 1680 N. Sycamore • Hollywood 28, Calif.



LEXIPOWER

Acquiring a superior VOCABULARY is basic training for a top position in any profession, trade or business. To get in the upper brackets financially and socially, develop a masterful VOCABULARY through the fascinating, entertaining and profitable new science of LEXIPOWER. You are judged and rated by every sentence you utter. Executive ability and professional capacity are demonstrated by what you say—not by what your hands do. More POWER to you through LEXIPOWER. Benefit at once! You start using the POWER of LEXIPOWER after the first Lesson. Write NOW for FREE details about LEXIPOWER Dime-a-Day LESSON CLUB.

LEXIPOWER LESSON CLUB

517-K W. Deming Place Chicago 14, Ill.

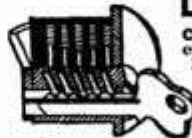

LOCKSMITHING AND KEY MAKING

COMPLETE UP-TO-DATE COURSE... Practical modern training for self-instruction. How to work on locks, de-code, make masterkeys, repair, install, service, etc., etc. For carpenter, fix-it shop, service station operator, hardware dealer, gunsmith, mechanic, home-owner. 53 easy illustrated lessons. Full price only \$5.95, postpaid—or C.O.D. plus postage. Satisfaction guaranteed or refund. Address below.

WATCH AND CLOCK REPAIRING

LEARN at HOME in Your Spare Time. Prepare for a happy future of prosperity and security—and get a good job NOW. A fascinating, thorough self-instruction training in American and Swiss watches, clocks. Special section on alarm clock repairs. Fast-growing field. Complete, \$4.95 postpaid—or C.O.D. plus postage. Satisfaction guaranteed! NELSON-HALL CO., Dept. B-02, 1139 S. Wabash Ave., Chicago 5, Ill.



IS YOUR JOB - JUST A JOB?

Perhaps you have talents, interests and abilities that are going to waste in your job. KNOW YOUR TRUE occupational interests which will help secure personal success. Your UNRECOGNIZED interests measured professionally. SEND \$1.00 now for test and report.

MIDWEST PSYCHOLOGICAL SERVICES
Dept. G, 920 N. Michigan Ave. Chicago 11, Ill.

TRI-STATE COLLEGE

B. S. Degree in 27 months in Civil, Electrical, Mechanical, Chemical, Aeronautical, Radio Engineering; Bus. Admin., Acc't and Sec. Science. Graduates successful. 64th year. Enter March, June, Sept., Jan. Catalog. 428 College Ave., Angola, Ind.

WORLD'S FUNNIEST TRICK

MULTIPLYING RABBITS—Biggest Selling Pocket Trick—Fascinating To All—Can easily be performed by Anyone—Send 50c for Sample Prepaid—\$2.00 Dz., \$21.00 Gr.

FREE: PRICE LIST ON REQUEST
ERNIE'S ENTERPRISES, 725 Pine St., St. Louis 1, Mo.

RADIO ENGINEERING

Broadcasting, Television, FM, Servicing, Electronics, Aviation, Marine & Police Radio taught thoroughly. Engineering course equivalent to 3 years' college radio work. Approved Veteran Training. Catalog free.

VALPARAISO TECHNICAL INSTITUTE, Dept. D, Valparaiso, Ind.



A AND N SUPPLY CO.

Thousands of Bargains in Military, Outdoor & Sport Goods for Hunter, Farmer, Scout. Send 10c for NEW 32-page catalog, just issued, returned with first order.

A and N SUPPLY CO.
4720 Lester St. Richmond 15, Va.



BRUSH PLATING OUTFITS

• for re-plating articles in the home and shop. No tanks necessary. Free particulars. •
GUNMETAL CO., AVE. M, DECATUR, ILLINOIS

Short Stories, Mysteries, Novels, Articles—at home in spare time

Hughes, Ruth Comfort Mitchell, Gertrude Atherton, Katharine Newlin Burt and other famous authors and by scores of successful graduates. Complete instruction material and professional coaching to develop your own style. FREE book explains how you may enjoy an ideal part time or full time career. Write today (no salesman will call). Veterans: advise us if you are eligible for G.I. Training.

TO BE THE BEST—GET THE BEST!

Get MODERN TRAINING in
ELECTRICITY
 on MODERN EQUIPMENT

In
**NATION'S
 LARGEST
 EXCLUSIVE
 ELECTRICAL
 SCHOOL**

**BIG PAY JOBS in ELEC-
 TRICITY ONLY WEEKS AWAY!**

M. T. I.—where all-around electricians are made. This is NOT A HOME STUDY COURSE—but practical resident shop experience . . . "Learn-by-seeing" MOVIES plus "Learn-by-doing" methods on actual equipment. Learn HOUSE WIRING, A.C., D.C. MOTORS, ARMATURE WINDING, POWER PLANT WORK, ETC. New classes start every few weeks. Part time work available. Living arrangements made. Train NOW in modern shops of M. T. I.

VETERANS. Train at Government expense on G.I. Bill. Get subsistence pay while training.

MICHIGAN TECHNICAL INSTITUTE

Department PM-2, 2281 West Fort Street, Detroit 16, Michigan



Student trouble-shooting large control panel in school shops.

MAIL TODAY FOR QUICK ACTION

MICHIGAN TECHNICAL INSTITUTE, Dept. PM-2
 2281 W. Fort St., Detroit 16, Michigan

- Send me catalog and complete information.
- I am a GI. Send special information.
- Married. Single.

NAME _____
 ADDRESS _____
 CITY _____ ZONE _____ STATE _____

Yes, **Stanley Piaskowski made
 an Important Decision**

• Mr. Piaskowski is not the president of a bank or a railroad. He is just an ambitious young man who faced a problem that may be very similar to the one you are facing today. He wasn't kidding himself and he didn't want others to kid him. All he wanted was a really worthwhile job—one that paid a good salary, offered him reasonable security, and a chance to advance to higher pay.

He decided to enroll for C.T.I. training. Now, a graduate, he writes as follows: "I have worked myself up to chief body man of this organization and I like my work very much . . . my average salary is now close to \$80.00 a week."

We believe the same opportunities that were within the reach of this C.T.I. man are within the reach of other ambitious men. We can give you the same help we gave him. We invite you to send for our FREE booklet and other information. The request for information does not obligate you in any way. **MAIL THE COUPON TODAY.**

VETERANS—C.T.I. Courses are approved under the G.I. Bill. Just mail coupon, we will handle all details.

NON-VETERANS—Don't let the lack of ready cash prevent you from taking this training now. Investigate our Low Easy Payment Plan and our Pay After Graduation Plan.



**Mail Coupon
 for FREE
 Booklet**

**Train at Home or
 in Big C. T. I. Shops**



Home of C. T. I.

Large, modern, well equipped shops. Located in excellent residential district only 1 block from Lake Michigan.

COMMERCIAL TRADES INSTITUTE, Dept. E2-2
 1400 W. Greenleaf Avenue, Chicago 26, Illinois

FILL OUT · CUT OUT · MAIL TODAY!

FACTS FREE FOR MEN WHO WANT TO GET AHEAD

COMMERCIAL TRADES INSTITUTE, Dept. E2-2
 1400 W. Greenleaf, Chicago 26, Ill.

Send free illustrated Brochures and other information about the field I have checked below.

- Refrigeration and Air Conditioning
- Electricity Diesel Mechanics
- Radio Servicing
- Automotive Mechanics
- Body & Fender Rebuilding
- Building Construction

Name _____
 Address _____
 City _____ State _____
 Veteran Non-Veteran

WAR SURPLUS OPTICAL BARGAINS

ASSEMBLE YOUR OWN BINOCULARS!

Complete Optics! Complete Metal Parts!
Save More Than 1/2 Regular Cost



Stock #842-H.....\$39.40 Postpaid, plus
\$4.80 for Case — Total \$44.20

OPTICS—Set includes all Lenses and Prisms you need for assembling 7X 50 Binoculars. These are in excellent condition—perfect or near-perfect—and have new low reflection coating.

Stock #5102-H.....\$25.00 Postpaid

NOTICE! If you buy both Binocular Optics and Binocular Metal Parts, add 20% Federal Excise Tax to above prices.

ARMY'S 6X 30 BINOCULARS

No Carrying Case with any Sets shown below. M-13A1 sets are waterproof model. M-3 sets are not waterproof.

COMPLETE OPTICS & METAL PARTS—Model M-13A1, 6X 30 Binoculars. Everything you need—ready for assembly. When finished will look like a regular factory job costing \$102 to \$120. The Optics are new, in perfect or near-perfect condition. Have new low reflection coating. Metal Parts are new and perfect, all completely finished. No machining required. Bodies factory hinged and covered. Complete assembly instructions included.

Stock #830-H.....\$40.00 Postpaid
plus \$8.00 tax—Total—\$48.00

COMPLETE OPTICS & METAL PARTS—Model M-3, 6X 30 Binoculars. The Optics in this set are new, perfect or near-perfect. Prisms have new low reflection coating. Factory mounted Eye Piece and Objective Assemblies not coated. Metal Parts are perfect, new, ready for assembly. When finished, this will look like a regular factory job, except a name has been filed off a cover plate. No machining required. Bodies factory hinged and covered.

Stock #831-H.....\$35.00 Postpaid,
plus \$7.00 Tax—Total—\$42.00

METAL PARTS ONLY—Model M-13A1, 6X 30 Binoculars. No Optics. Same Metal Parts as described for Stock #830-H.

Stock #832-H 6X 30 Metal Parts.....\$25.00 Postpaid

OPTICS FOR 6X 30 BINOCULARS (No Metal Parts). Perfect, and low reflection coated.

Stock #5130-H.....\$15.00 Postpaid

SAME OPTICS AS ABOVE (6X 30). Coated—but slight seconds.

Stock #5124-H.....\$12.75 Postpaid

If you buy both the Binocular Optics and the Binocular Metal Parts, your purchase becomes subject to 20% Federal Excise Tax. Be sure to add amount covering tax to your remittance or your order cannot be filled.

Optics and Metal Parts are Available for Monoculars (1/2 a Binocular). For Complete Details, Write for Bulletin #14-H



MOUNTED PROJECTING LENS SYSTEM

F.L. 91.44 mm. (just right for 35 mm. Projectors). Speed of F 1.9. Outside dia. of mount at one end 60 mm. Length of mount 64 mm.

Stock #4033-H.....\$3.00 Postpaid

THREADED OUTSIDE MOUNT FOR FOCUSING ABOVE SYSTEM (Not illus.)

Stock #715-H.....\$1.50 Postpaid

CONDENSING LENS SET—Consists of 2 Condensing Lenses with diameter of 2". Used for making 35mm. projectors or many other purposes.

Stock #4034-H.....75c Postpaid

35 MM. KODACHROME PROJECTING LENS SET—Consists of Achromatic Lens for projecting, plus a Condensing Lens and piece of Heat Absorbing Glass with directions.

Stock #4025-H.....\$1.95 Postpaid

SATISFACTION GUARANTEED

NEVER HAS THERE BEEN SUCH A SENSATIONAL BARGAIN AS THIS!

BUBBLE SEXTANT

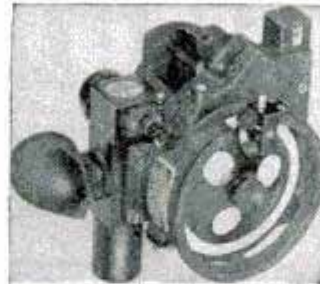

These Army Air Forces Bubble Sextants cost the Govt. about \$125.00 each. A real bargain at our price of \$12.50! Included with Bubble Sextant shipment is Wooden Carrying Case, 5 spare waxed paper discs, flashlight with rheostat for night use (uses ordinary flashlight cells— not furnished) aux. 2-power Galilean Telescope, Allen wrench, 1 spare marking point. War-time used, but where necessary completely repaired, collimated and put in good working order.

If not satisfied that Sextant is exactly as represented, return within 10 days and money will be refunded. Full directions for use accompany each shipment.

Stock #924-H.....\$12.50 Postpaid

Same SEXTANT as above, but **BRAND NEW** and with Automatic Electric Averaging Device and Illuminated Averaging Disc for nighttime use. Gov't. cost \$217. Though brand new we have re-checked Bubble and Collimation and **GUARANTEE** perfect working order.

Stock #933-H.....\$22.50 Postpaid

CONDENSING LENSES—Seconds, but suitable for Enlargers and Spotlights.

Stock #1061-H, 6 1/2" dia., 9" F.L. \$2.50 Postpaid

Stock #1082-H, 4 1/2" dia., 5 1/2" F.L. 70c Postpaid

We have a Limited Quantity of Condensing Lenses—seconds—ranging from 4 1/2" to 8 1/2" in dia. with various focal lengths. Send for Free Bulletin titled "MISCELLANEOUS CONDENSING LENSES—H."

POLARIZING VARIABLE DENSITY ATTACHMENT FOR BINOCULARS

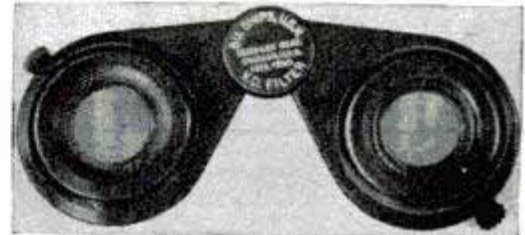

An amazingly effective unit for controlling amount of light reaching your eyes. Cuts down glare in sky and over-water observations. Easily snapped on and off over the eye cups of American-made 7X50 Binoculars. Govt. cost \$8.30 each.

Stock #20,000-H.....\$2.00 Postpaid

Above Polarizing Attachment also adaptable to Govt. 6X30 Binoculars with substitution of special Eye-cups.

Stock #20,010-H, 6X30 Eye-cups.....75c pr. Postpaid

LENS CLEANING TISSUE—1st quality, sheet size 11" x 7 1/2". Made to Govt. specs. Won't dust. Free of abrasives and lint.

Stock #721-H, 500 sheets.....\$1.00 Postpaid

SCHMIDT OPTICAL SYSTEM. Black plastic body, size 3-15/16" by 5 1/2", F.L. 2.4" with amazing speed of F.0.9. Used in Navy's Infra-Red Sniperscope and Signalling Units. Govt. cost \$134.

Stock #720-H.....\$6.00 Postpaid

\$200.00 DRIFT METER for \$4.95

These were used for determination of drift and true air speed. You can adapt to other uses or take apart to get 2 mounted Achromatic Lenses,—Mirrors—Field Lens—Pantograph—Engraved Scales—Sponge Rubber Discs—metal parts and other components. Instrument weighs 4 lbs.

Stock #936-H, \$4.95 f.o.b. Chicago, Ill. (Shipping weight 12 1/2 lbs.)



AIR FORCES GUN SIGHT—With Polarizing Variable Density Attachment. (Polarizing attachment alone is worth many times the price of entire unit.)

Stock #908-H.....\$5.00 Postpaid

Same Unit Without Polarizing Attachment

Stock #916-H.....\$2.50 Postpaid

We have literally millions of war surplus lenses and prisms for sale at bargain prices. Write for Catalog "H"—Sent Free!

Order by Stock No.

EDMUND SALVAGE CO.,

P. O. Audubon, New Jersey

Earn **BIG PAY** Now!

(thousands of ambitious men have been helped)

20 Years Service To American Industry

BE INDEPENDENT IN A BUSINESS — ALL YOUR OWN

HERE THEY ARE:

7 LEADING TRADES—

- **MACHINIST TRADE:** Machine Shop training in the set-up and operation of all types of machinery, layout and bench work, blueprint reading, etc.
- **TOOL AND DIE MAKING:** Practical instruction at the GREAT ALLIED SHOPS in making tools, dies, jigs, fixtures, layout and bench work, metallurgy, blueprint reading, etc.
- **TOOL AND DIE AND MACHINE DESIGNING:** Practical instruction in drawing and designing of tools and dies, jigs and fixtures, special machines, special devices, etc.
- **MECHANICAL DRAFTING:** Practical training in all phases of technical and mechanical drafting, machine drawing, and sheet metal drafting.
- **TOOL ENGINEERING:** Detailed study of Engineering Materials, Manufacturing Processes, Production Planning, Screw Machine Engineering, etc.
- **PRODUCTION ILLUSTRATION AND INDUSTRIAL PRODUCT DESIGN.**
- **STRUCTURAL DRAFTING:** Bridges, Buildings, Miscellaneous Structures, Tanks, etc.

Largest School of its Kind-

-In the World!

(FREE EMPLOYMENT SERVICE)

● **BIG SHOP TRAINING** ●

FREE!
This **BIG Metal Trades ILLUSTRATED BOOK**



● ● ●
Your Name and Address on a 1c Postcard brings this book FREE and complete information

... Established 1928

ALLIED SCHOOL OF MECHANICAL TRADES
1338-1340-1342 So. Michigan Ave.
422 Allied Bldg. CHICAGO 5, ILL.

You Can Learn QUICKLY and EASILY—

Learn To Earn More

—BY DOING . . . Here at the Allied School; a Technical and Mechanical Institute, we will train you in the GREAT ALLIED SHOPS for an IMPORTANT and HIGHLY-PAID POSITION in the Metal Trades Industry. The ever-increasing DEMAND FOR MACHINISTS, TOOL AND DIE MAKERS, DRAFTSMEN, TOOL AND DIE DESIGNERS, and TOOL ENGINEERS is your best guarantee for STEADY EMPLOYMENT AT HIGH PAY with RAPID PROMOTION. If you are mechanically inclined and want to increase your earning power . . . then we have exactly what you are looking for . . . Therefore do not delay . . . GET THE FACTS TODAY . . . A penny post card will do. All tools and working outfit available at the school.

VETERANS—The Allied School is Approved for Veterans . . . We also maintain a FREE EMPLOYMENT SERVICE while you are training, and after you graduate.

WRITE TODAY

APPROVED BY—Dept. of Registration and Education of the State of Illinois and
BY—United States Veterans Administration.

Write For This BIG FREE BOOK Today!

The Merriam-Webster Book of

Biographies

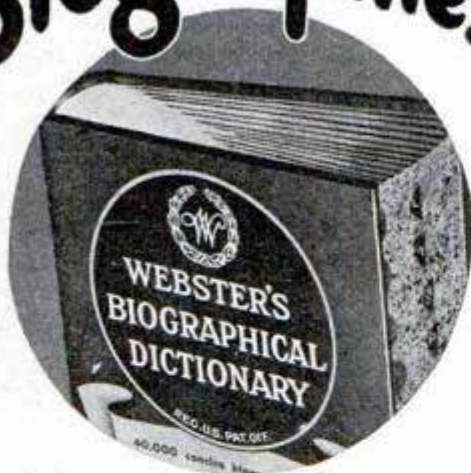

Essential Facts About 40,000 Noted People

WEBSTER'S BIOGRAPHICAL DICTIONARY contains more than 40,000 concise biographies, with pronunciation of names and all essential facts. Includes scientists, statesmen, explorers, writers, painters, actors, eminent figures from every other field. Prepared by the famous Merriam-Webster editorial staff. Valuable to writers, speakers, readers. 1,736 pages, thumb index. \$7.50. At your book-dealer, or from G. & C. MERRIAM CO., 727 Federal St., Springfield 2, Mass.

Buy Give-A-Book Certificates at Your Booksellers

AVIATION NEEDS YOU

... if you have the training and **EXPERIENCE ALLEN** gives you!

Yes, Allen not only gives you mechanical training, but **ACTUAL MECHANICAL EXPERIENCE** on operational equipment as well. Look at these requests to our Vocational Director from nationally known aviation concerns. "We are enclosing ten of our regular employment application forms which we would like to have completed and returned to us.*" . . . "We have employment opportunities for qualified, licensed Aircraft and Engine Mechanics **WHO HAVE HAD PREVIOUS EXPERIENCE.**" * Employers want men with **EXPERIENCE!** You get that experience at Allen where more than 25% of your time is spent working on *operational, commercial, aircraft.* You graduate from Allen as a fully **LICENSED** and **EXPERIENCED** Aircraft and Engine Mechanic in a minimum time of one year.

*Name and address on request.

VETERANS — ALL costs covered under GI Bill.

Immediate enrollment possible. Act now and assure yourself of a position in the new class!

ALLEN Airways & School
Founded 1930



Allen Airways, State Airport, Hills Grove, R. I.
Please send me your free catalogue **PM**

Name..... Age.....

Street.....

City..... State.....

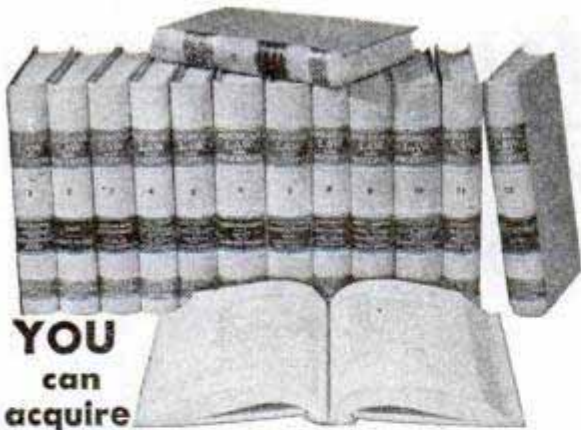

**YOU
can
acquire**

LAW NIGHTS AT HOME! L. L. B. DEGREE

LaSalle's famous Law Library—used as reference in many Law libraries and Law offices—has enabled thousands to master Law surprisingly fast, in spare hours at home, for business and professional advancement.

These 14 remarkable volumes, compiled by leading professors and lawyers, cover the whole basic field of Law in condensed, orderly, simplified manner.

You advance rapidly with this great library, plus special lectures furnished. We guide you step-by-step with personalized Problem Method of instruction . . . you learn by doing—handling legal problems—not by memorizing rules.

Send for two FREE 48-page booklets, "Law Training for Leadership," and "Evidence," answering questions about Law and its value to you, and telling how LaSalle Law graduates are winning rapid advancement in business and public life. Mail coupon below. No obligation.

LA SALLE EXTENSION UNIVERSITY A Correspondence Institution

417 S. Dearborn St. Dept. 264-L Chicago 5, ILL.

Send me your two FREE booklets described above, without obligation.

Name.....Age.....

Street.....

City, Zone & State.....



LOOK TALLER INSTANTLY!

**WEAR
HITE-BUILDERS
IN YOUR
OWN SHOES**

Want more respect? . . . more opportunities? Then increase your height INSTANTLY with Davis Hite-Builders. Slip them inside your own shoes. Invisible . . . comfortable . . . easy to wear. Made to last for years. Amazingly low-priced!

SEND NO MONEY

Rush name, address, and shoe size today. Pay postman only \$1.95 plus few cents postage for your pair of Hite-Builders, mailed in plain package. If not delighted with immediate result, just return them and we'll refund your money at once. Or send \$1.95 now and save postage. Same guarantee, . . . of course. Order today, look TALLER next week!

DAVIS MFG. CO.
DEPT. G-338, LOVELAND, OHIO



Only
\$1.95
A PAIR



PRACTICAL BOOKS ON HOME PLANNING BUILDING · REPAIRS

**MAIL
ORDER
TODAY**

Plan Now—Build When You Can
Books Sent C.O.D. Anywhere in U.S.A.

Select from this list of helpful books. In U. S. books sent postpaid if remittance accompanies order. Outside U. S. include 15% extra for shipping charges.

- How to Plan a House. \$5.00
- Your Home and How to Build It Yourself. \$3.00
- Painting, Decorating. \$1.75
- Carpentry \$2.50
- Painting, Furniture Finishing and Repairing
Includes floor renewal \$1.50
- How to Remodel a House Complete, practical. \$5.00
- Building Insulation .. \$4.50
- Concrete Handbook
Do work for yourself, others \$1.50
- Blueprint Reading for Building Trades \$1.50
- Practical Bricklaying. \$2.00
- Primer for Home Builders \$2.50

FAMOUS PLAN BOOKS

Books contain floor plans, photos, descriptions of homes.

AMERICA'S BEST LOW COST HOMES. 125 designs \$1.00

DE LUXE SMALL HOMES. 210 designs. \$1.00

OUR FUTURE HOME. Wide selection of residences, summer homes, garage apartments. \$1.00

MODERN HOME & GARDENING. 42 popular designs. Improvements, garden short-cuts, etc. 50c

**Set of
Four
Books
\$3.50**



**Stair
Building
\$2.50**

POPULAR MECHANICS PRESS

DEPT. 646 • 200 E. ONTARIO STREET, CHICAGO 11

INVENTORS

When you are satisfied that you have invented a matter of value—write me, without obligation, for full information as to what steps you should take to secure a Patent or Trademark.

The usual first step is to have a search of the prior U. S. Patents conducted, so that I can report to you on the question of Patentability.

PATRICK D. BEAVERS

(Formerly RANDOLPH & BEAVERS)

Registered Patent Attorney

934 Columbian Building Washington 1, D. C.

PATRICK D. BEAVERS, Registered Patent Atty.

934 Columbian Bldg., Washington 1, D. C.

Please send me full information on how to secure Patent Protection.

Name.....

Street.....

City..... State.....

HAND MICROPHONE



Top quality hand microphone with control button in handle. Highly sensitive. Has rubber covered cord and tel. plug. Fine for use on home recorders, public address systems, etc. Brand new—perfect. Shp. wgt. 2 lbs. Stock No. 170. Each... **\$1.95**

MESS KITS

Regulation two-piece Army Mess Kits with folding handle. Used, but perfect. Weight 2 lbs. No. A116—Ea. **69c**



CANTEENS

Reg. U. S. issue canteens. Plastic screw top chained to body. Slightly used but perfect. Wgt. 1 lb. 117—Metal **69c**
118—Plastic—Ea. **69c**



CANTEEN CUPS

All metal. Folding handle. Wgt. 1 lb. No. A120—Each... **25c**

CANTEEN COVERS

Heavy canvas. Button fastener. New No. 530—Each... **69c**
Used No. 119—Each... **35c**

ARMY BANDO-LEERS

Of fine heavy khaki. Big roomy pockets with snap button fasteners. Fine for hunters, campers, boy scouts, etc., also for shop work in carrying small parts, etc. Material alone is worth this price. Shp. wt. 1 lb. 11 Pocket **49c** | 5 Pocket **29c**
Type No. 129 Each | Type No. 128 Each

FLIGHT BOOTS

Gov't. type A-6. For cold weather fishing, hunting, trapping, driving, etc. Genuine shearing full fur lining. Rubber outers. Zipper closing. Heavy soles. Used but reconditioned like new. Give shoe size. Wgt. 4 lbs. No. 396. Pair **\$5.95**



AMMUNITION BOX

Used for 50mm ammunition. Heavy all metal design with latching top and folding handle. Provides safe, fire-proof storage for valubles, etc. Measures 12x 8x7 1/2 inches. Used but in new condition. Shp. Wgt. 8 lbs. No. 338—Each... **79c**

TANK TELESCOPE

Std. model M44 made by Bell & Howell for use as tank scope. Has 17 degree field of view at 39 feet. Highly polished and finely ground optics of 2X power. Rubber eye shield. Measures 22 1/2 in. long. 1 3/4 in. Diam. Used but perfect. Wgt. 6 1/2 lbs. No. 522—Each... **\$6.95**

DECORATIVE CHROME STRIPS

For your car, boat, furniture, etc. Highly polished chrome finished strips with clinched edges for flush mounting to any surface. The 3 pound kit provides approx. 15 pieces in lengths from 6 inches to 3 feet and average 3/4 inches wide. Wgt. 4 lbs. No. R224. **\$2.00**
3 lb. Assort. only

WAR SURPLUS AND HUNDREDS OF OTHER BARGAINS

POPULAR RECORD ASSORTMENT



No. A300—25 Records. All Dance. Wgt. 14 lbs. **\$4.88**

No. A301—25 Records. Hillbilly, Race and Blues. Wgt. 14 lbs. Set... **\$4.88**

No. 302—25 Records. All Hillbilly numbers. Wgt. 14 lbs. Set... **\$4.88**

Fifty records of modern dance, race, blues and hillbilly selections. No two alike. Famous name bands and artists included. Used in juke boxes, but guar. perfect. Shipped exp. collect only—no exchanges or refunds. Wgt. 28 lbs. No. A303—50 records... **\$9.64**

STIRRUP PUMP

Works with any pail or bucket. Shoots a high pressure stream up to 30 feet. Use it for spraying garden and trees, for whitewashing, fire fighting, drainage, etc. Complete with 10 foot flexible hose. All brand new. Regular \$3.80 value. No. 244—Each... **\$1.49**



15 JEWEL STOP WATCH U. S. AIR CORPS SURPLUS

Genuine Elgin 15 Jewel movement. Ideal for split second timing in racing, sports, time study, etc. Full sweep split second hand graduated in 1/10th seconds. Stem wind, start, stop and reset. Used but guaranteed perfect. A splendid value. Shp. wgt. 1 lb. No. 200—Each... **\$9.95**



27 LENSES, ALL NEW, PERFECT.

For experimental work in optics. Consists of 27 precision ground and polished prisms and lens elements in assorted diameters and focal lengths. Big variety, positive, negatives, etc. Actual value over \$100.00. A519—27 PIECES... **\$7.95**



BAYONET BLADE

Fine forged steel. Ground but not polished. May be made into throwing or hunting knife or spear. Blade 8 3/4 x 7/8 inches, 1 1/4 inches overall. Will take and hold a fine edge. Shp. wt. 1 lb. No. 664-R—Each... **49c**



2 MAN MOUNTAIN TENT

Regulation Army type two man mountain tent, complete with poles, guy ropes, etc. Of durable nylon with reinforced seams. Ideal for outdoorsmen, campers, etc. Shp. wgt. 10 lbs. A splendid value. Stock No. 202—Each... **\$9.95**



SHIP BELL

Purchased from U. S. Maritime Comm. Measures 10 inches high, 9 3/4 inch flare. Big 6 inch clapper. Weight 15 lbs. Fine for farms, clubs, estates, etc. All new. A-541, ONLY... **\$9.85**



RUBBER OVERBOARD SUIT

Here is a buy! All rubber suit with parka. Fits over your regular clothes and shoes. Can be cut apart for waist high waders, hip high or knee high boots, also arm length rubber gloves. Heavy gum rubber over fabric. Fine for those who work in the water, commercial fishermen, sewer diggers, etc. Use it as is or cut it up for waders. All brand new! Wgt. 14 lbs. No. 183, Each... **\$4.95**

7 LB. EXPERIMENTER PARTS ASSORT. KIT



A "gold mine" for the radio serviceman. Hundreds of valuable radio parts, new radar and electronic parts, and sub-assemblies, coils, resistors, trimming condensers—worth many times this low price. A130R—7 lbs. **\$1.79**

VEEDER-ROOT COUNTERS

Three wheel type — counts to 999 and repeats. Geared shaft end may be replaced with a pulley to regulate counting speed. Has hundreds of uses. All brand new. A splendid value. Shipping weight 1 lb. No. 241. Each... **98c**



SATCHEL POUCH

Heavy canvas pouch. Ideal for toting lunches, shopping, books, etc. Has 11x12 inch pocket. Brand new, guaranteed perfect. Has oversize flap with single strap fastener. A113—EACH **\$1.69**



FLEXIBLE NECK FLASH LIGHT

Ideal trouble shooter's flash light. Flexible neck lets you direct light around corners and inaccessible spots. Brand new! Plastic case with BX type neck. Uses 2 standard flash light batteries (less batteries). Shp. wgt. 2 lbs. No. 205—Each... **\$1.69**



Type A2 HORSEHIDE JACKET

The leather coat buy of the year! Brand new Army Air Force Type A2 with full length zipper, shoulder straps, knitted waist band and wrists and full satin lining. Finest horsehide—finest tailoring. Order by chest size. Shp. wt. 5 lbs. No. 201—Each... **\$22.50**



MEDICAL STERILIZER

Consists of alcohol burner and sterilizing tray in hinged metal case 1 7/8 x 1 1/8 x 2 5/8 inches. Burner may be used separately. Bright nickel finish. All brand new. A125—Ea. **98c**



Officers Watch Compass

Brand new gov't. surplus. Army-Navy model. Single jewel mounted needle. Silver colored dial. A splendid value. Shp. wgt. 1 lb. A174—Each... **98c**



BERNARD WIRE PLIERS

Parallel acting jaws. Wire cutter at top. Brand new. Wgt. 2 lbs. No. 168. Each... **\$1.29**



ORDER DIRECT FROM THIS AD

Values galore! Hundreds of hard-to-find items for home, shop and outdoors. Make remittances by money-order, bank draft or personal check. Send 25% deposit on C.O.D. orders. No C.O.D.'s on orders for less than \$5.00. Include sufficient postage on parcel-post orders—any overage will be promptly refunded. All quotations F.O.B. Chicago. Used items and materials are guaranteed serviceable and as described. Your money back if not more than satisfied.

BIG ILLUSTRATED CATALOG FREE
STARK'S
Dept. PM2
509 So. State St.
CHICAGO 5, ILL.

14

he's going places...
he's got *P.A.**



P.A. * means *Pipe Appeal*

Pipe Appeal is that distinctly masculine appearance of the man who smokes a pipe! Thousands of men fill their pipes with Prince Albert Smoking Tobacco!

• means *Prince Albert*

R. J. Reynolds Tob. Co., Winston-Salem, N. C.



CRIMP CUT P.A.'S
GREAT FOR CIGARETTES
TOO! ROLLS UP EASY—
TASTES GRAND!

• Prince Albert is the largest-selling pipe tobacco in America. Its choice tobacco is rich tasting...mild and easy on the tongue. P.A. is crimp cut—specially treated to insure against tongue bite. Try Prince Albert!

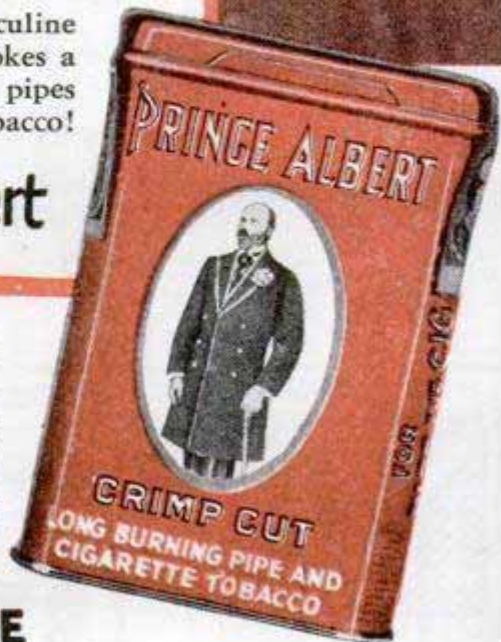

THE NATIONAL JOY SMOKE

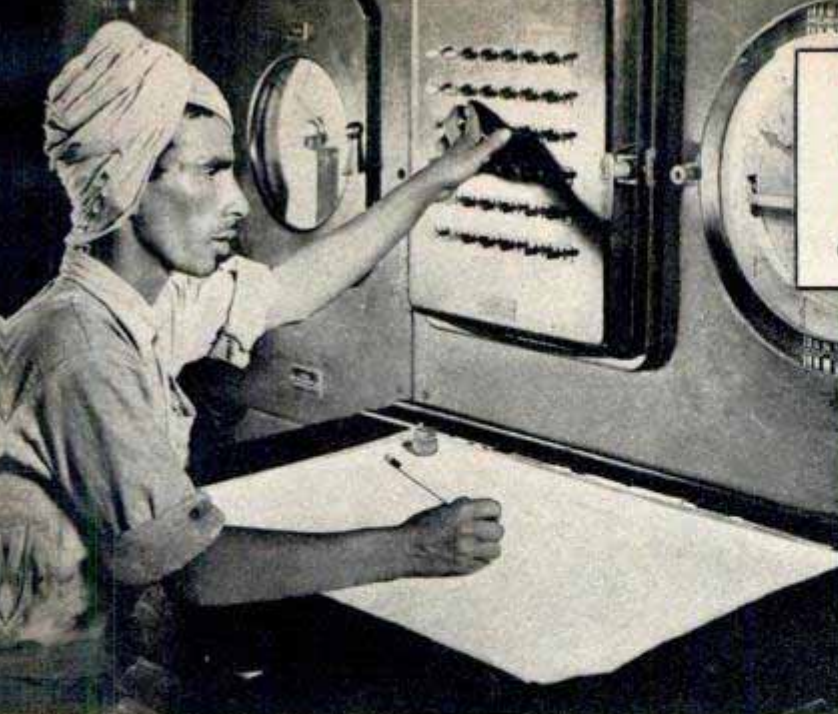

POPULAR MECHANICS

FEBRUARY
1948

WRITTEN SO YOU CAN UNDERSTAND IT
VOL. 89 NO. 2

Under the sands of Arabia lies the greatest oil pool known, and its development by a partnership of an Arab king and American businessmen has changed the life of the nomads

INDUSTRIAL REVOLUTION in the DESERT

A UNIQUE partnership between a past and a present civilization has been functioning in the desert country of Saudi Arabia and the end result may be of great moment to the economy of the world.

For eddying slowly beneath the 800,000 square miles of shifting sands of that sub-continent are proven reserves of approximately 6,000,000,000 barrels of oil. And oil, unless a developing atomic age changes the nature of all things, is the blood of 20th century economic life, either in peacetime or in wartime.

By John C. Henry

Actually, the proven figure of 6,000,000,000 barrels is merely the beginning as reflected in preliminary tests and production in hardly more than 20 percent of a 450,000-square-mile concession held by American interests. Oil geologists are virtually unanimous in considering the Saudi Arabia area as the greatest known petroleum deposit in the world.

Geologists jointly representing two American concerns, Standard Oil of California and the Texas Company, in the early 1930s established the existence of

Mirage? Far from it! The Ras Tanura refinery in Saudi Arabia produces 2,000,000 gallons of gasoline daily



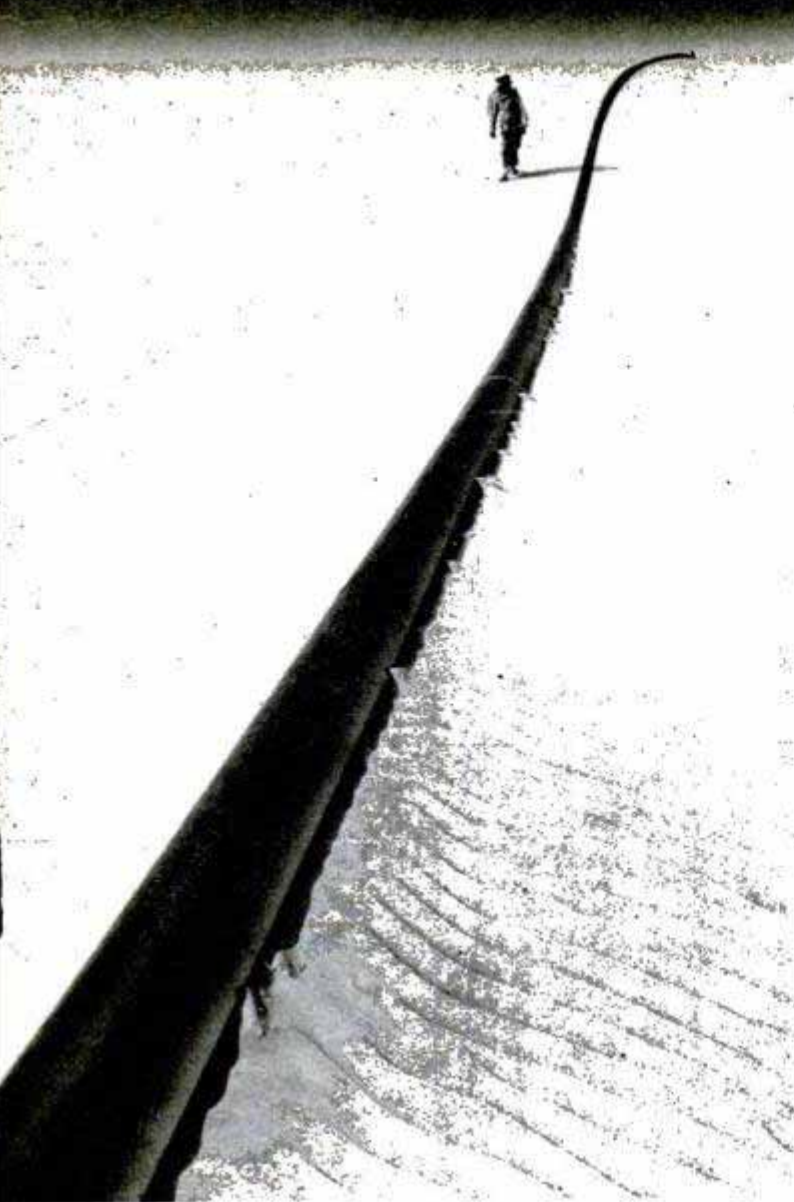

A strange traveler on the desert sands is an Arab patrolling the oil pipe line. Below, as new producing well is brought in, Arabian-American experts study data in Dammam field. The waste oil is burned

petroleum deposits on Bahrein Island, about halfway down the Persian Gulf. The discovery made almost certain the probability that similar oil-bearing structures would be found in the Arabian mainland and the stage was set for a high-stake game of international bidding. British, German, French, Italian and Japanese interests all prepared to enter—as did representatives of the two American companies.

Holding the prize was Abdul Aziz ibn Saud, desert chieftain who had won his kingdom by force of arms and who was already wise in the ways of foreign imperialism. A strict Moslem who viewed western ways of life with some distrust, he recognized in all bidders, other than the Americans, actual or potential instrumentalities of foreign governments ready to intervene in the affairs of the Arabian peninsula. The American bid represented private enterprise, technically skilled and separate from this government and, as such, representing no threat of interference in the politics of Arabia. On this basis he made his choice in 1933 and the result has been an Arab-American partnership of great mutual benefit. What effect the rising temper of the Arab world over the partition of Palestine will have on this partnership is a matter of immediate moment.

To the American personnel undertaking the Arabian development, the locale was a new frontier. Problems of climate, of communications, transportation, equipment and manpower were matched by the delicate intangible of establishing and maintaining good relations with a people and a

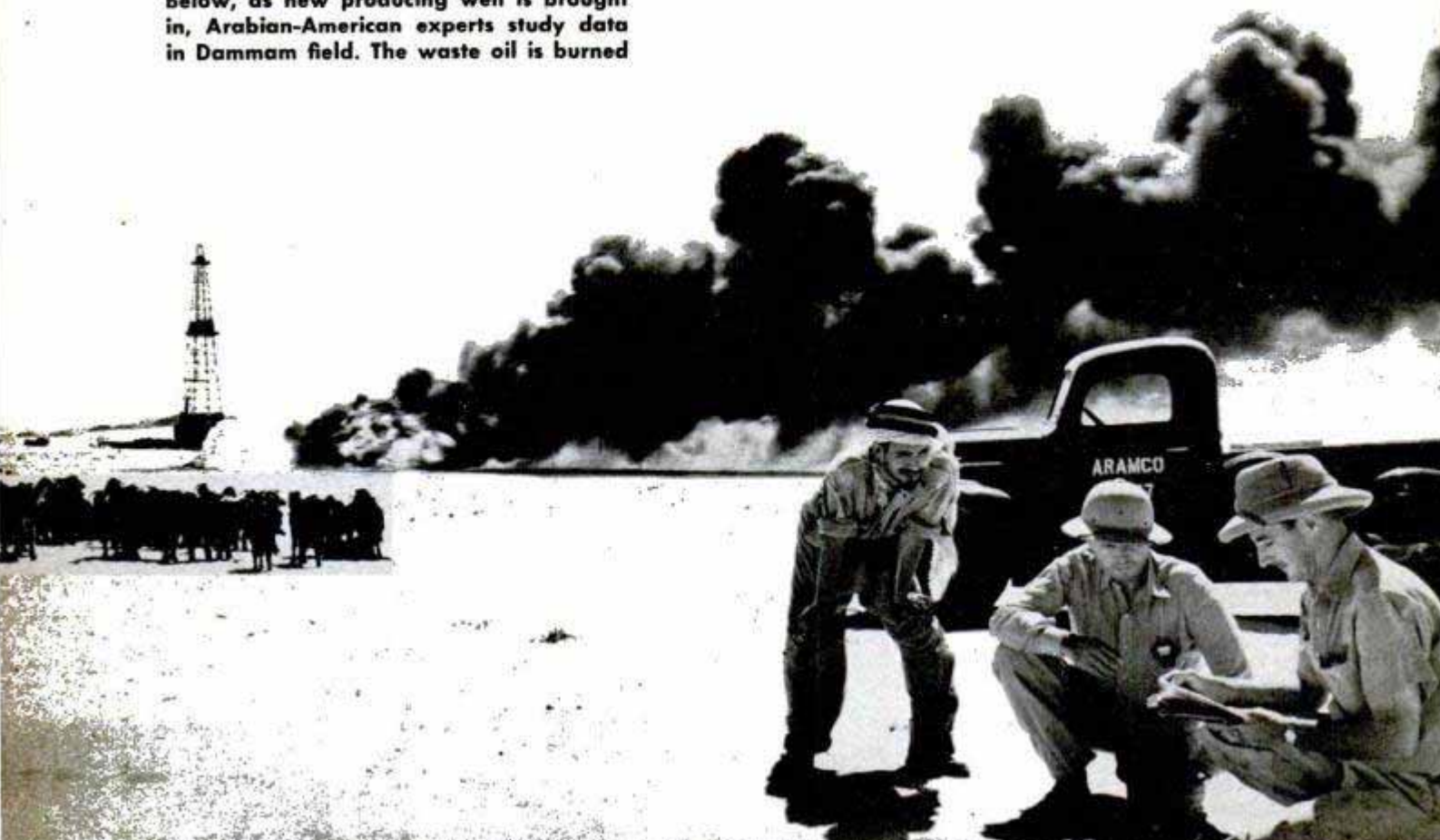

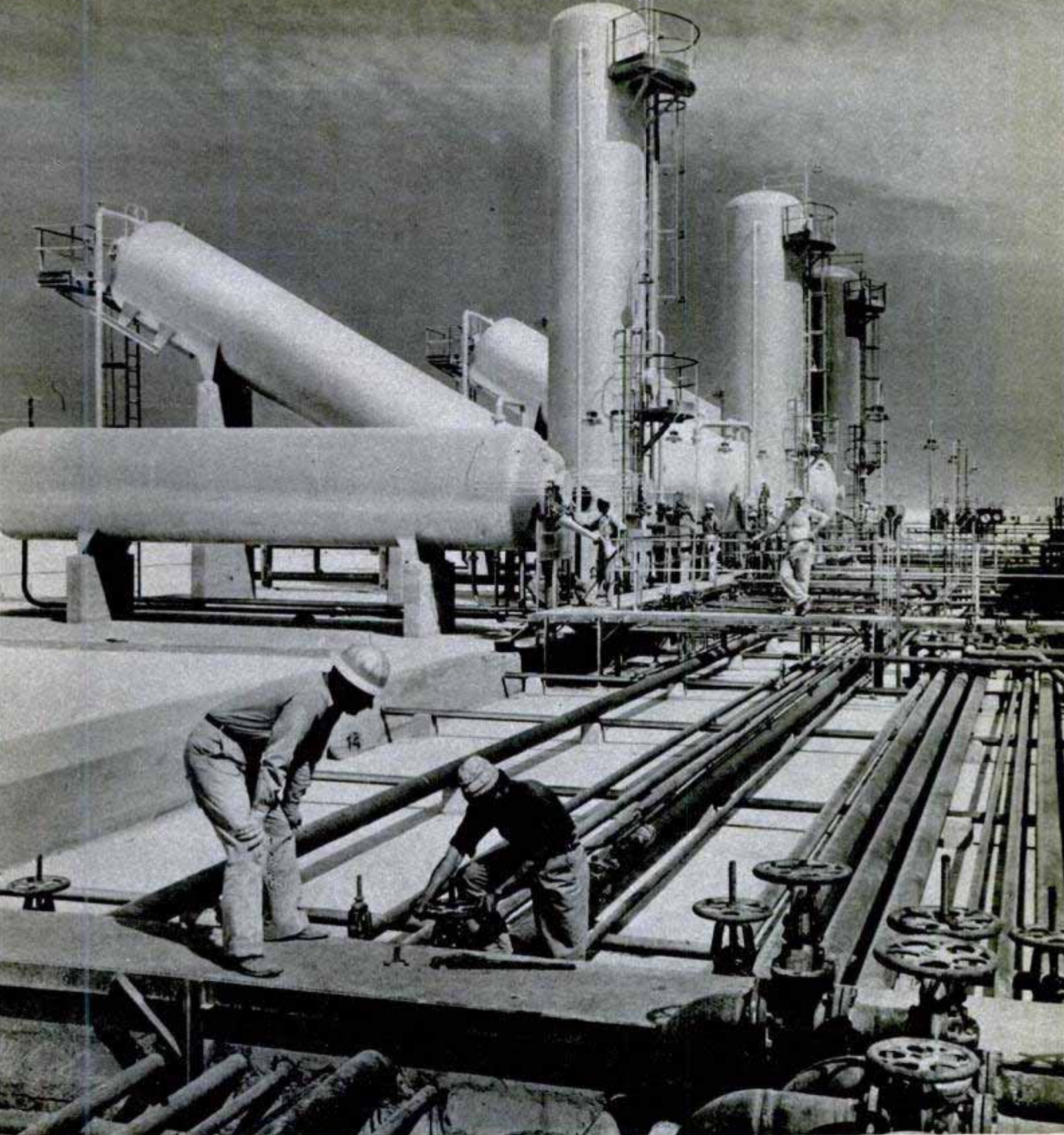

This is the treating plant at the Arabian-American Oil Company's Ras Tanura refinery along the Persian Gulf; here a major portion of Arabia's oil output is brought by desert and submarine pipe lines from three fields

government who were basically wary of Christian westerners. The development, both economically and sociologically, has been an interesting saga in pioneering—one which brought profit both to the oil interests and the Arab government and which someday might be even more vital to American public interest if ever again we are faced with a war of survival.

First of all, the Arabian-American Oil

Company recognized the obvious fact that water supply is a basic concern in Arabia as in any desert country. Company geologists determined that there were water tables not only in the neighborhood of the scattered natural oases, but under much of the rest of the country. Accordingly, at each experimental oil drilling and at many other strategically located points artesian wells were drilled, some of them going to



The water hole above is one of the few natural sources of fresh water in Saudi Arabia. The Arabian-American Oil Company started a large irrigation project using water from this source

800 feet before reaching a water source.

At Ibn Saud's capital city of Riyadh an entire system of wells was planned and drilled. Near Jidda, Red Sea city where the foreign missions are located, a company survey located a water table about 25 miles distant and a Saudi-government contract financed by oil royalties was let to a British engineering firm for installing the supply system, first of its kind in a city that previously had depended upon distribution of its water in drums.

Inland transportation likewise was an obvious necessity not only for the oil op-



erators but for modern development of the country. Except for a few unconnected highways on the Red Sea coast and even fewer along portions of the Persian Gulf shore, shifting desert trails followed by camel caravans constituted the only trans-Arabian links. The single-track Hejaz railroad connecting Damascus with the Holy City of Mecca, was destroyed by T. E. Lawrence and his followers during World War I.

As one of its initial projects, Aramco put American surveyors on the task of mapping the terrain for fixing the trails. As far as possible the yearly sand drift was plotted. Some dunes were found to move as much as 40 feet in a year and some rose almost 100 feet in height. A mixture of sand and bitumen was tested and the most effective formula determined for light and relatively inexpensive surfacing. Cars were fitted with oversize tires, extra flanges on the fenders as sand guards and heavier-than-ordinary transmissions.

Greatest stride in Arab transportation began during the war, however, when

Twenty-five wells are pumping 200,000 barrels of oil every day from a depth of 7000 feet under Abqaiq field

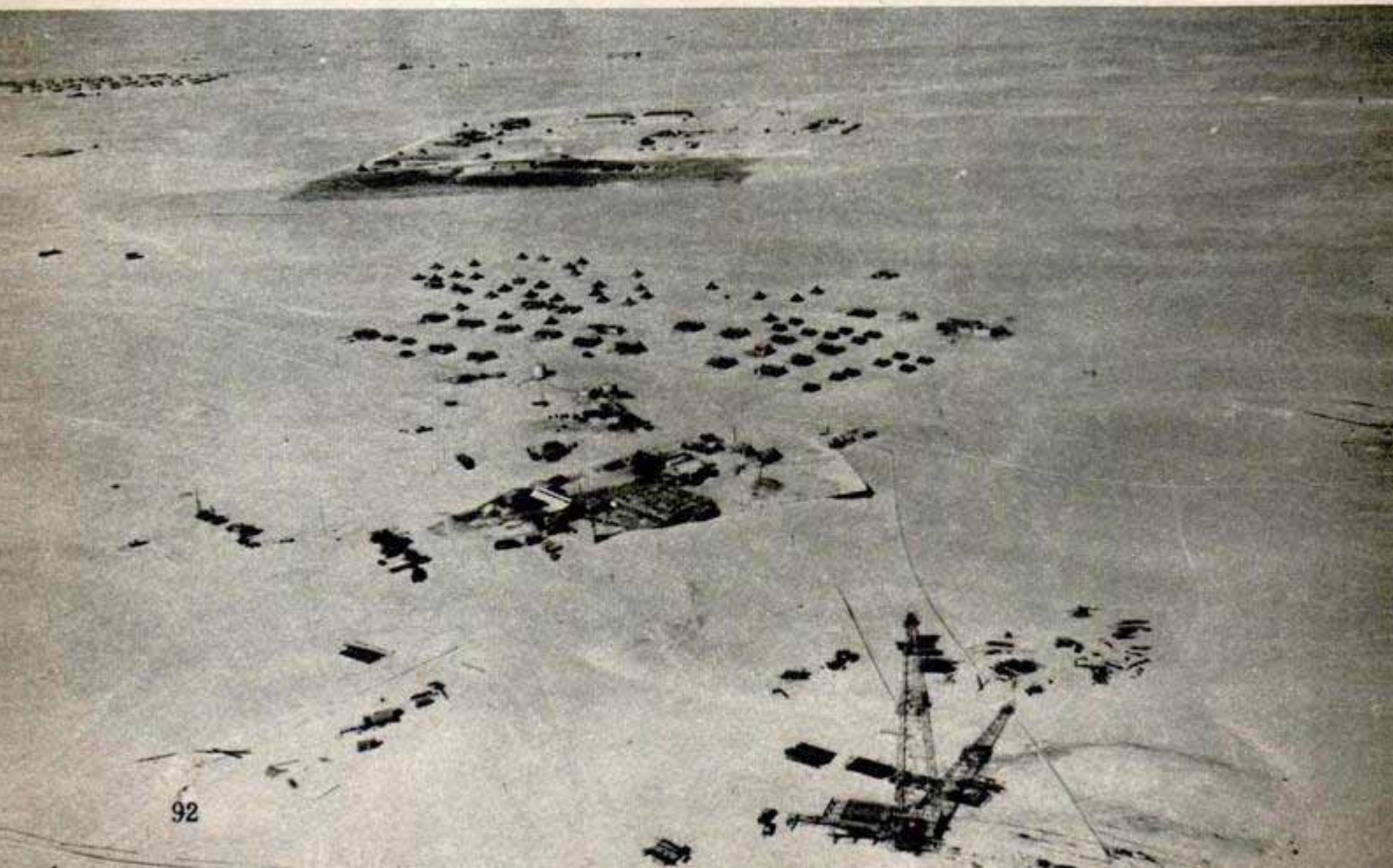



American planes made occasional stops at Dhahran, Persian Gulf headquarters town for Aramco. Several special missions even went into Riyadh by air, an improvised airfield being marked off on the desert with oily black lines and smudge pots. These first air "invasions" of the country required special diplomatic arranging but the king and his government were not slow to recognize the advantages of air travel over such terrain.

When American military strength began to flow from the European to the Asiatic theater an agreement was reached between the two governments for construction of a modern airfield at Dhahran. U. S. Army Air Engineers completed the job in March 1946, and by agreement the U. S. Air Forces will continue operation of the port until March 1949. Today, the field has two concrete runways, 6000 and 7000 feet; an operations and control building, hangars and other equipment.

The Saudi government financed an airline of its own, acquired a fleet of surplus DC-3 planes, leased its operation to Transworld Airlines and now runs a scheduled service connecting Jidda, Dhahran and several other Arabian points with Cairo, Baghdad, Basra and other key Middle-East cities. Aramco operates a fleet of more than 20 company planes in and out of Dhahran, Transworld makes Dhahran a regular stop on its U. S.-India service and BOAC (British) and KLM (Dutch) make fuel stops there. Dhahran traffic passed 400 aircraft per month in September 1947.

Three major railroad projects were approved and one is under construction. This first one will connect Dammam, Persian Gulf port site, with Riyadh by way of Abqaiq, center of one of the great oil fields. Aramco engineers made initial studies on this project, also, and the company

(Continued to page 264)

FEBRUARY 1948



Drinking fountain for camels at El Hani, way station on desert road in Saudi Arabia, was provided by oil company which drilled the well. Hundreds of camel caravans and Bedouins stop here



Through these pipe lines pass millions of barrels of refined products from Ras Tanura refinery to marine terminal on the Persian Gulf coast. Below, a typical bungalow in Dhahran for American oil workers brings a bit of the U. S. A. to Saudi Arabia

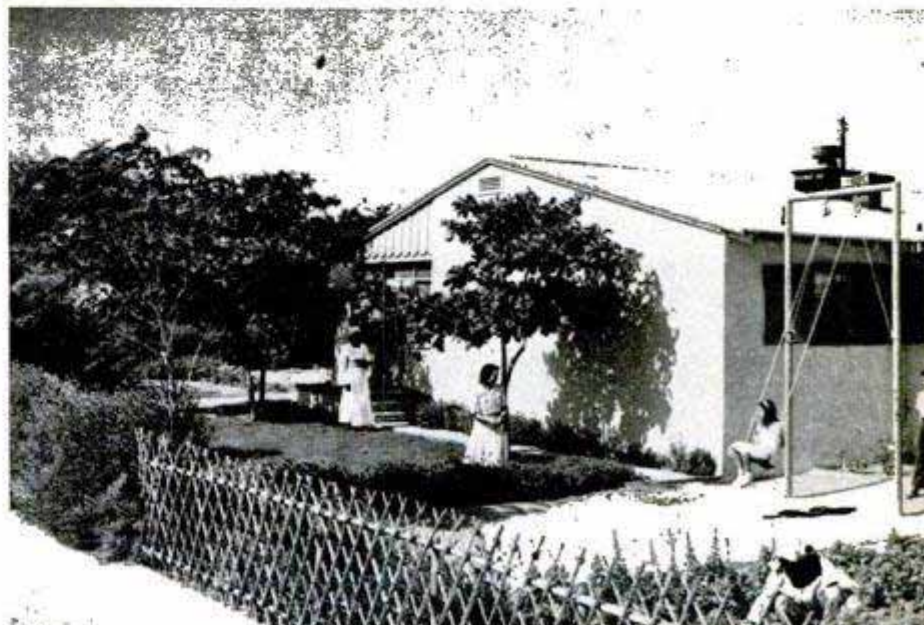

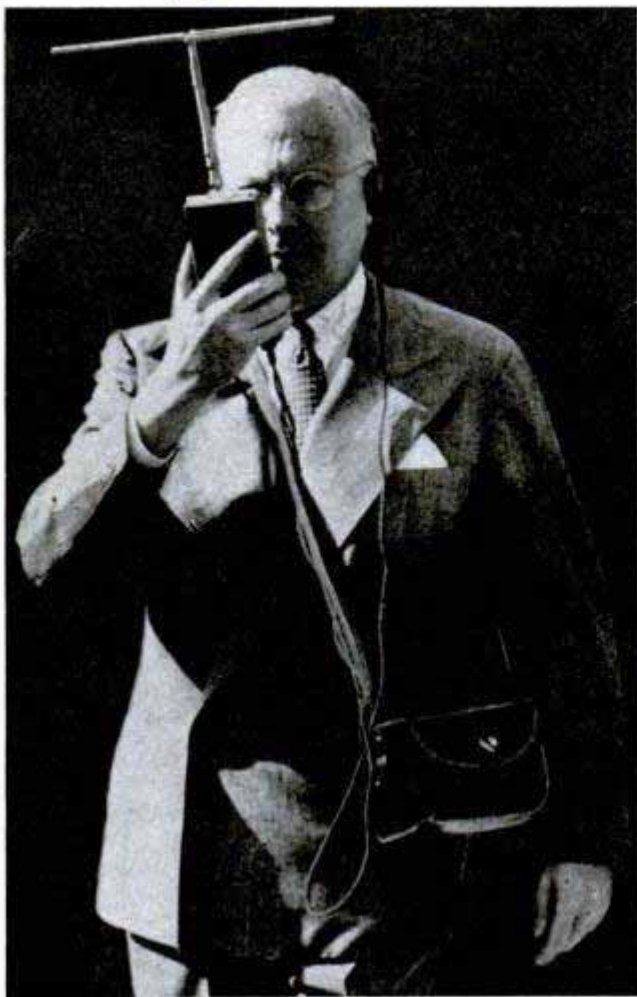

Walkie-Talkie Weighing 11 Ounces For Workers and Sportsmen

Workers and sportsmen who are normally far from ordinary kinds of communication can use a walkie-talkie that weighs only 11 ounces. Developed by a Cleveland firm, it is six inches long, about three inches wide and will be tuned to frequencies in the 460-470 megacycle range.

Swing Saw Has Depth Adjustment

Supported by a strong gooseneck column, a counterbalanced swing saw can be moved from job to job without difficulty. A swivel adjustment on the swinging arm permits miter cuts up to 90 degrees right or left. The saw, powered by any standard $\frac{3}{4}$ to 2-horsepower motor, cuts material up to 14 inches wide and can be adjusted for cuts up to 3 inches deep. The complete unit weighs only 330 pounds.

Many of the new products described in this issue of Popular Mechanics are either already available or are soon to be marketed. For additional information concerning these products, including the names and addresses of manufacturers or distributors, write to the Bureau of Information, Popular Mechanics Magazine, 200 E. Ontario St., Chicago 11, Ill. You will be answered promptly



Plastic Gas Pipes

Plastic tubing is replacing steel pipe in carrying fuel gas from the main to homes. The one-inch Tenite tubing is lightweight, easily handled, can be bent on the job, requires little equipment for joining and resists deterioration in most soils. Only those soils containing products of oil refining affect the tubing. Joints are made by coating the two ends with a solvent cement and slipping a slightly larger pipe over the splice. The cement "welds" almost instantly and is colored to permit visual inspection of the joint. Gradual bends can be made in the flexible tubing and right-angle bends are formed with prefabricated right-angle sections. The pipes withstand a maximum safety pressure of 30 pounds per square inch. Gas-tight fittings permit joining the tube to steel or copper pipe.

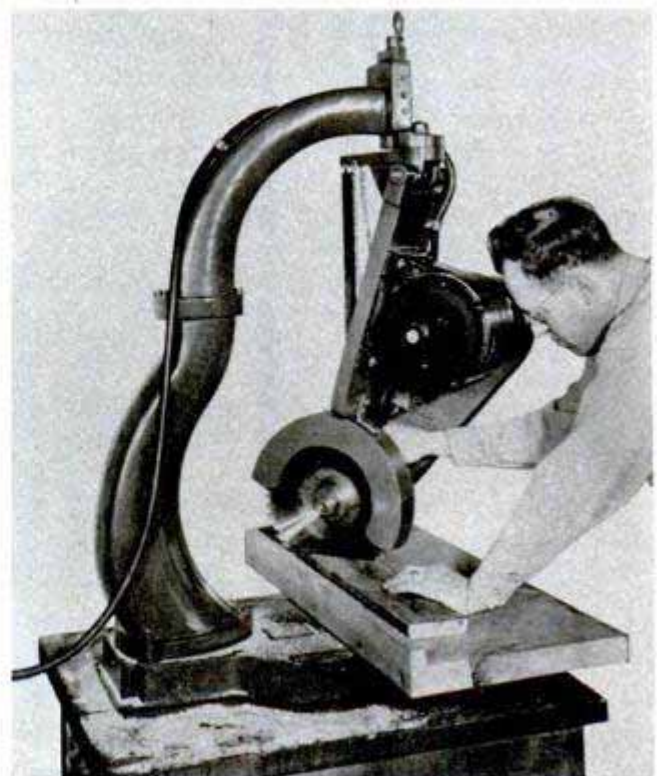

Ladder-Like Hoist Lifts 500 Pounds

Heavy materials climb a ladder by themselves when a power hoist that looks like an extension ladder is used. Made of aluminum, the hoist has two tracks in which the four wheels of the loading platform run. At the top, the tracks are curved for easy unloading of the material. Portable, the hoist can be assembled and taken down quickly and handles up to 500 pounds at a speed of 80 feet a minute. A small gasoline or electric motor provides the power. Movement of the platform is controlled by an operator at the base of the ladder.

Radioactive Gold Aids Cancer War

Radioactive gold is being used experimentally to treat cancer and leukemia patients. Results in treating chronic cases of leukemia have been as good if not better than with X-rays, according to Dr. Paul F. Hahn, associate professor of biochemistry at the Vanderbilt School of Medicine. Gold is made radioactive by the chain-reacting uranium pile at Oak Ridge, Tenn., which created the atom bomb. In treating leukemia, the radioactive gold is

injected into a patient's vein. In the case of a tumor or cancer, it is injected into the tissues to infiltrate the tumor with radioactive material. The treatments, which eliminate many of the undesirable features of radium, cost about \$5 each.

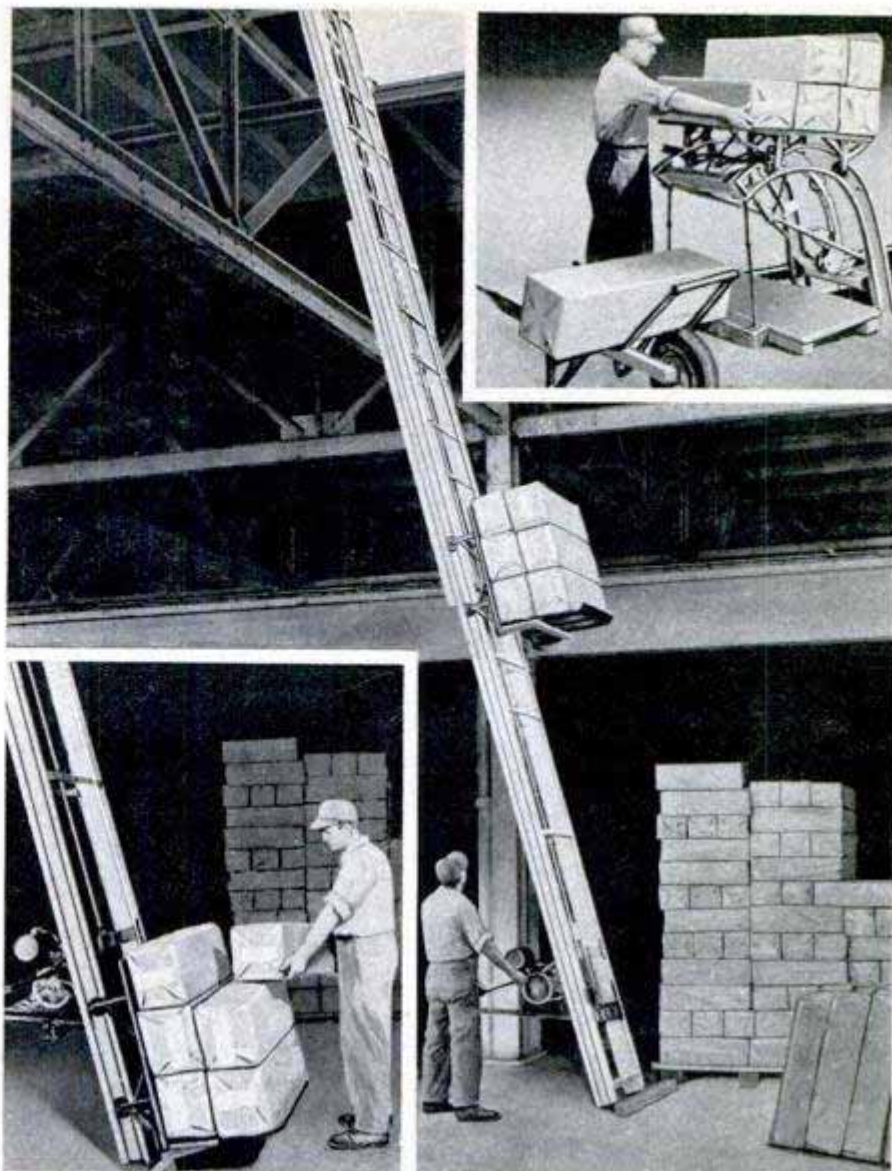

Midget Crawl-Type Tractor Has Engine in Rear

Designed for small farms, a small tractor has tracks instead of rear wheels and an engine mounted in the rear. The tractor's frame is made of welded steel and the tracks of fabric and rubber. The six-horsepower air-cooled engine delivers enough power to pull a 10-inch plow. The track mounting and the front axle permit 20-inch clearance for cultivating growing crops. Built into the frame is a power take-off for converting the tractor into a stationary power plant. The tractor has a reverse gear, travels 2 $\frac{3}{4}$ m.p.h. and operates four hours on a gallon of gas.



PACIFIC SWEET SPOT

By J. R. Farrington
Delegate to Congress from Hawaii

Hawaii, which soon may be the 49th state, pours a pipe line of sugar and pineapples to America from its highly mechanized plantations



Above, boom sprayer used in pineapple fields against mealybug, which once nearly wiped out the industry. Below, machine grading pineapples according to size

MAGIC CARPETS that move boxcar loads of sugar cane over ground in which even wheelbarrows become mired, and conveyor belts that whisk pineapples from the field to collecting bins are among the newest innovations to appear in Hawaii's sugar-cane and pineapple fields.

But they are just two of the countless machines and techniques the territory's two leading industries are developing to meet the competition from areas whose markets are closer and production costs are lower. Hawaii is the most remote of the world's important land areas. Her plantation employees are the world's best paid on a year-round basis.

The ultimate aim is to make all field operations completely mechanical, or as mechanical as complex farming jobs such as these can be.

In the canneries, ingenious machines known as Ginacas grasp the fruit, slice off the outer shell and remove the core, all in one operation, and deliver them at the rate of 100 a minute. It was this machine, invented by a Hawaiian, Henry Ginaca, in 1913, that made large-scale pineapple canning possible and helped make Hawaii the source of 90 percent of the world's supply.

Movement of cane through the sugar mill is a production-line operation. The stalks are fed in on an endless belt. Water, shot from sprays under great pressure, rips



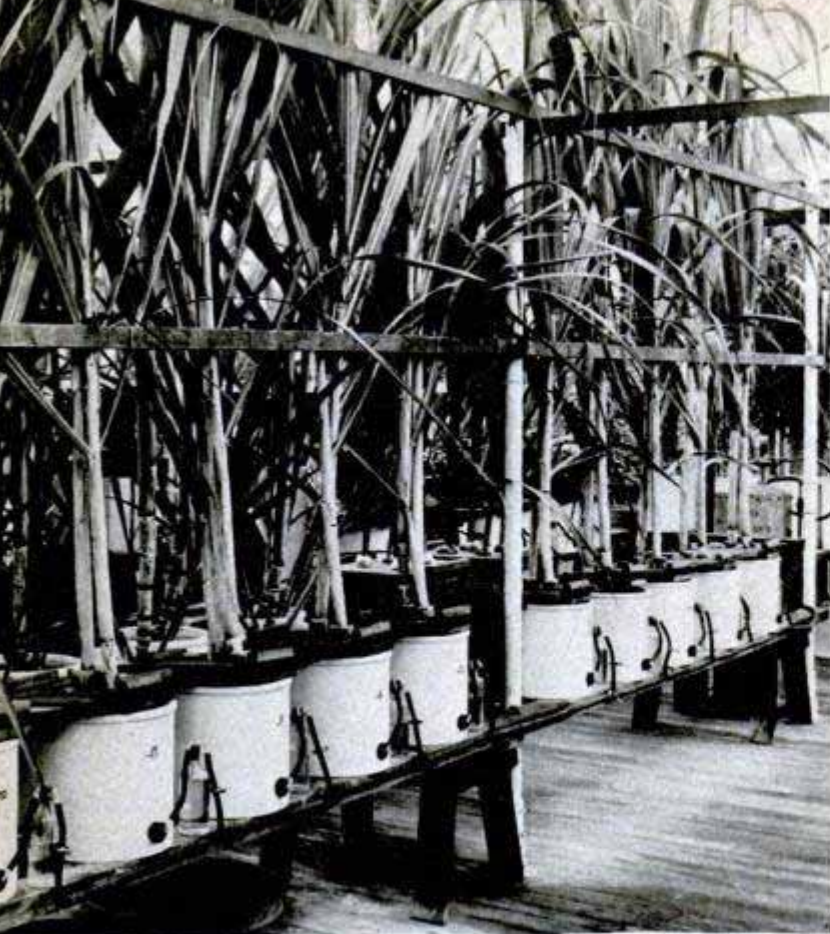

Breeding pest and disease-resistant sugar cane is a major goal at the planters' experiment station

off dirt and debris as the belt moves. Huge rollers and crushers squeeze and resqueeze the stalks until they resemble straw. After a complex settling and filtering process, the juice goes to a series of evaporators, boilers and vacuum pans which converts it into a sort of crude molasses. Whirling centrifuges convert it into raw sugar, ready for shipment to the mainland refinery.

It's a big job to bring techniques such

as these to the field, but important strides have already been taken and the future seems bright.

The magic carpet is only one step, and a relatively minor one, but it illustrates how some of the problems are being overcome.

Where rainfall is exceptionally heavy, moving the cane from the field to the industrial road by conventional means of transportation constituted an almost insurmountable problem. The lightest trucks often became hopelessly bogged down.

Plantation technicians finally hit upon the idea of applying the sled principle to the job, and the result was the magic carpet. It is a huge rubber mat which is dragged across the slick field by cables, hauling up to three tons of cane in one load.

Transporting cane to the mill is another problem. Almost every conceivable method is used, including flumes, overhead trolleys, railways and giant trucks built specially for the task. Uniformity is impossible because of Hawaii's varied terrain, ranging from snow-capped volcanic mountains to semiarid wasteland.

Most spectacular and costly of these methods is the flume—a wooden trough similar to those seen at logging camps—through which the cane is floated to the mill. Some stretch 50 miles or more—along ditches, at shoulder level across fields, and high in the air on spidery trestles over gorges and ravines.

Until quite recently, the most widely used transportation was the narrow-gauge railway. Most plantations have their own systems, ranging from a couple of miles of track and a few cars and engines to 100 miles of rail and more than 1000 pieces of rolling stock. During harvesting, portable track is run from the main line to the fields.

Introduction of more efficient motorized equipment, much of it developed by the plantations themselves, has cut down rail traffic. A recent survey showed 10 of 33 plantations use motorized equipment exclusively.

Some of these motorized giants are so large that their wheels would straddle even the widest highways. One plantation uses a model that carries up to 50 tons of cane.

Irrigation is another headache. Its magnitude

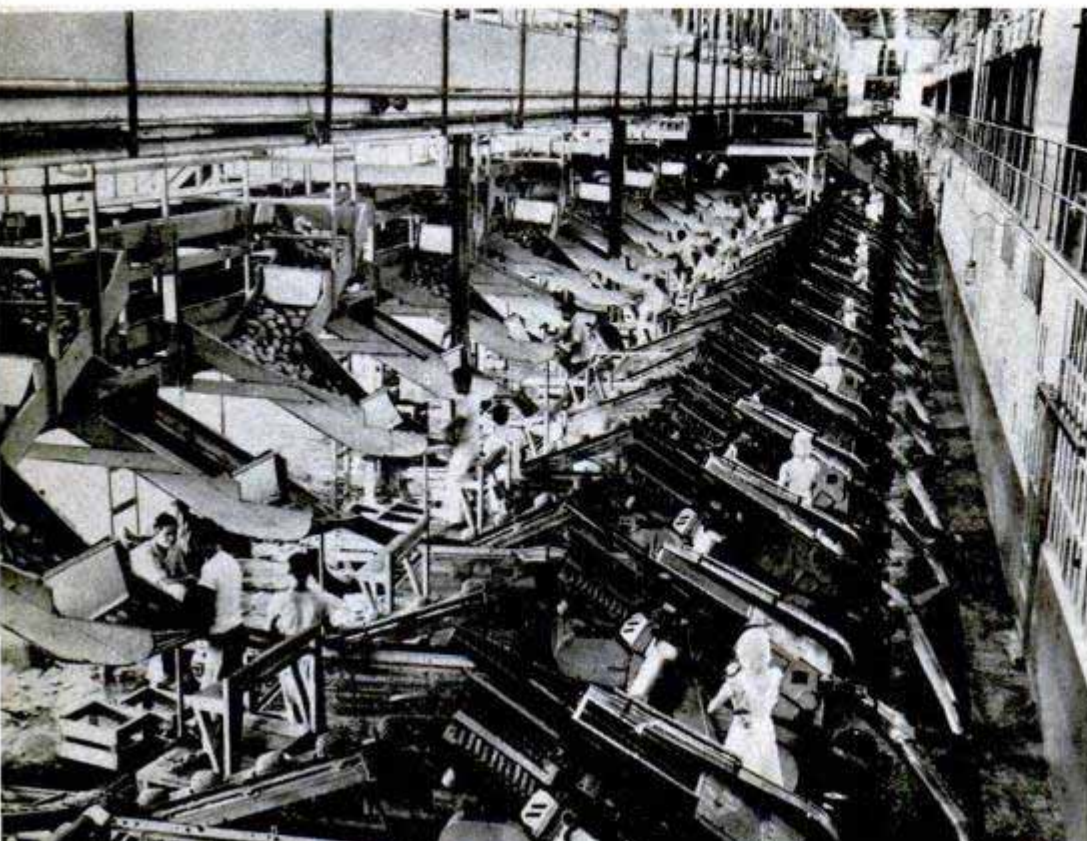

Ginaca machines that shell and remove core of 100 pineapples a minute started a big industry

can be appreciated by the fact that it takes one ton of water to produce a pound of sugar.

Several methods are used, most common of which is the irrigation "ditch." There are two on the island of Maui, one delivering 40,000,000 gallons daily from the mountains to the fields, and another pours out 50,000,000 gallons a day.

The water rushes down channels dug out of the mountainside, into tunnels cut two or three miles through the volcanic rock, through huge pipes and siphons. Hundreds of pumps are constantly at work along the way to maintain the flow.

One, prosaically designated "pump #7" of the Hawaiian and Commercial Company, is said to be the biggest and most powerful of its kind in the world.

Some plantations developed their own systems to meet special needs. One has a portable "ditch," consisting of a series of concrete pipes which can be fitted together and moved to wherever water is needed. Flow is regulated by sliding doors on the side of the pipe.

The plantations have more than \$40,000,000 invested in various systems, but they are constantly testing new methods.

Most of those currently being tested involve overhead sprinklers, both stationary and the whirling kind you use on your lawn. One type hurls its spray over an area of three or four acres. One big drawback of methods using fixed overhead pipes is interference with heavy farm machinery.

The biggest single problem in the drive for mechanization is development of a completely mechanical cane harvester. A small fortune awaits the man who can do for the Hawaiian sugar industry what the McCormick reaper did for the wheat growers and Whit-



Mechanics working on one of the big rollers that squeeze juice from cane

ney's cotton gin for the cotton planters.

Hawaiian cane has a perverse tendency to grow without direction. It will progress along the ground for five or six feet, grow up for a couple more, shoot out at right angles, and continue in that aimless way for its full length of 30 or 40 feet. Mechanical harvesters, with sharp knives that shear the stalk off near the root, operate successfully in Florida and Louisiana, but in those areas the cane seems to have some sense of direction.

The nearest Hawaii has come to mechanical harvesting is a method developed during the war, known as "grab and rake" harvesting. There are several methods.

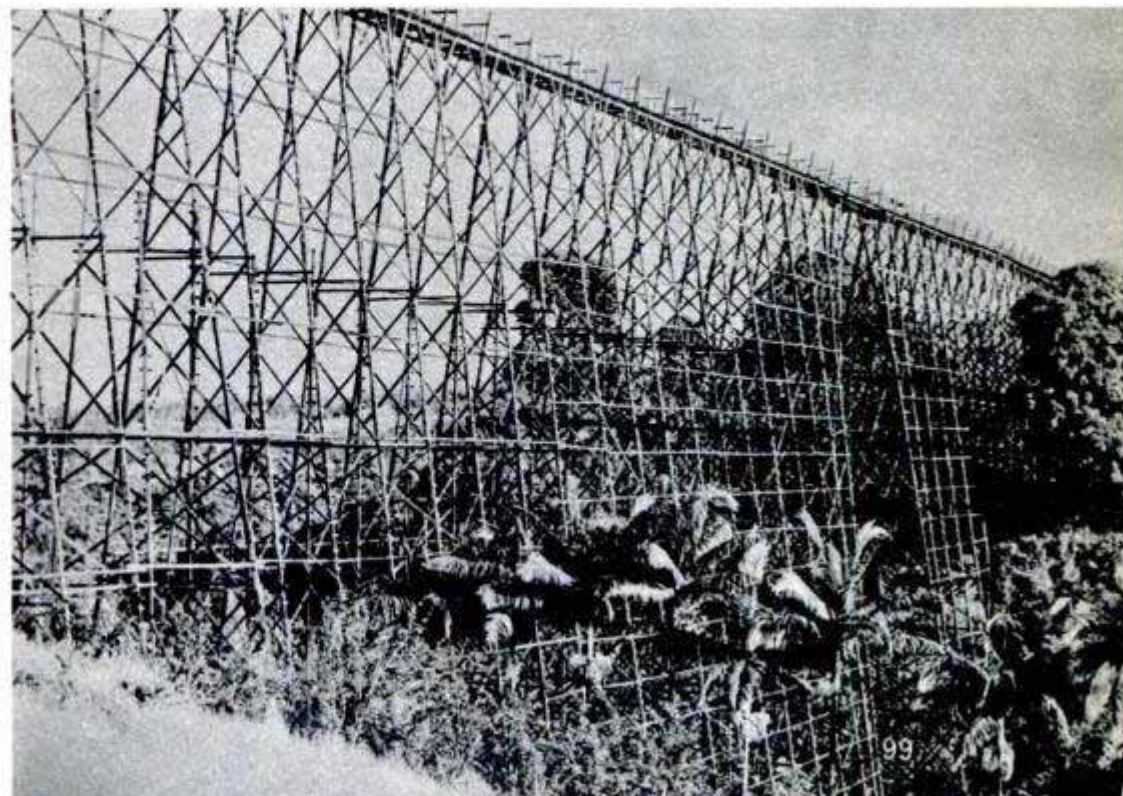

This looks like a scenic railway, but actually it is a cane-carrying flume bridging a gorge



Most Hawaiian plantations have their own narrow-gauge-railway systems, some with about 100 miles of track

One employs large crawler cranes like those used on construction jobs, but instead of a clamshell they are equipped with huge grabs. Steel fingers reach down into the cane, break it off at the roots, and load it onto waiting trucks or railway cars.

Sometimes the cane is bulldozed or raked into piles and then loaded by crane.

The choice of method depends on the terrain and field conditions.

These methods have serious drawbacks. Along with the cane often come trash, rocks, dirt and roots. Costly cleaning equipment has been installed, but rocks and other foreign matter still slip by, causing extensive damage to the crushing ma-

Specially built trucks, some carrying up to 50 tons, are rapidly replacing rail traffic on many plantations



chinery. On one plantation, a boulder weighing a ton was picked up by one of the grabs and got all the way to the mill before it was detected.

Four harvesters are now in various stages of development in the territory. Whether any of these holds the answer is anyone's guess, but there doesn't seem to be much doubt that the answer ultimately will be found.

Harvesting is also a problem which the pineapple industry has yet to solve. One of the chief difficulties is that pineapples ripen unevenly and it takes an experienced picker to select those ready for harvesting. No machine yet developed can tell a green one from a ripe one.

Prior to the introduction of the conveyor-belt system, pickers collected fruit in bags slung over their shoulders. It had to be carried to central collecting points every time it was filled. A full bag often weighs 100 pounds.

Under the new system, the conveyor, mounted on a truck, is extended right to the rows of fruit. The pickers simply place the pineapples on the moving belt, which deposits the load in a bin on the truck.

Actual planting of pineapple is still a hand process, but a large part of the work connected with it is done by very ingenious machines. Among them is a complex-looking contraption which comes on the field after it has been prepared for planting and lays long ribbons of mulch paper in parallel rows across the field. In the same operation the machine fumigates the field and fertilizes the soil. The paper is perforated in the center at even intervals, and the pineapple is planted through these holes.

The paper serves several highly important purposes: it regulates temperature, retains moisture, and keeps weeds out.

Much of the credit for these accomplishments

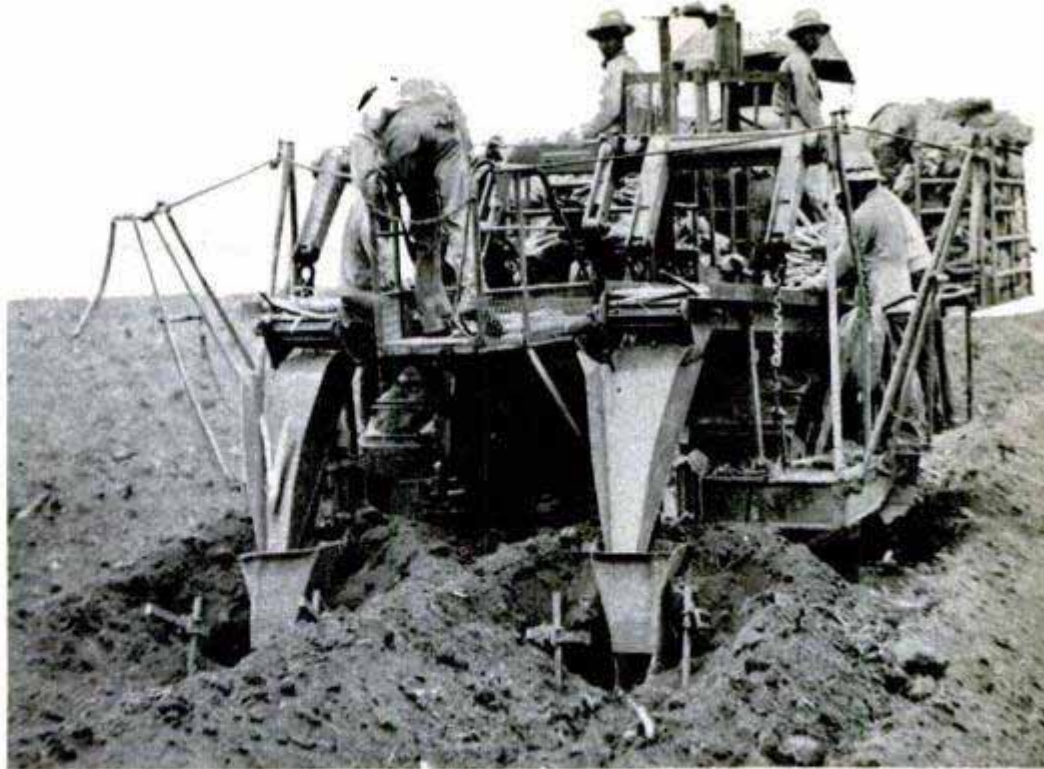

Evidence of mechanization in the field is this sugar-cane-seed planter

belongs to the Experiment Station of the Hawaiian Sugar Planters' Association and the Pineapple Research Institute.

Both operate along similar lines. They are maintained on a cooperative basis by all members of the industry, and serve as a central intelligence unit and testing laboratory. They are manned by staffs of scientists and researchers that would do credit to any first-rate university.

Their work includes developing new varieties of cane, maintaining an accurate

(Continued to page 272)

Irrigation ditches like this can deliver up to 50,000,000 gallons daily



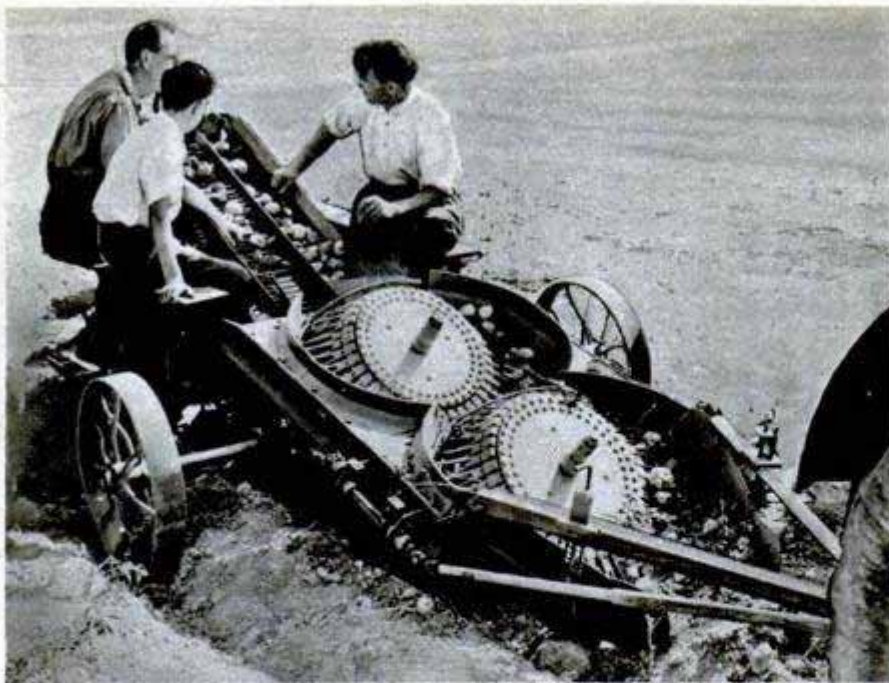

Tractor-Drawn Scoop Digs, Sacks "Spuds"

Drawn by a tractor, a potato harvester developed in England digs, cleans and sacks the potatoes in one operation. The harvester's two sections can be separated for ease of transportation. At the front end of the machine a digger lifts and cleans the potatoes, which are carried on a belt to bags. Stones are returned to the ground. The machine bags 3360 pounds per hour on a field producing nine long tons per acre.

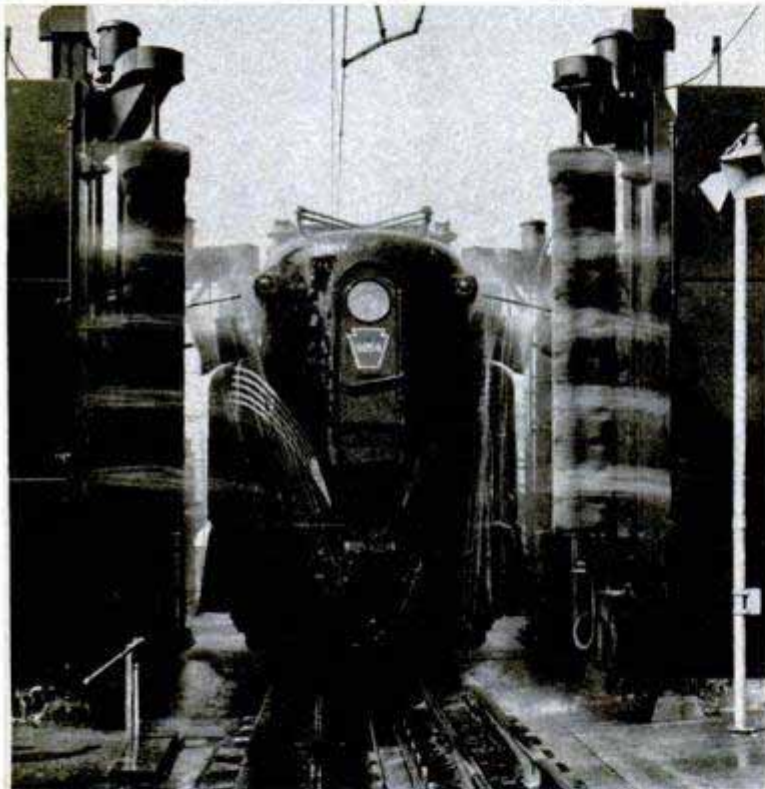

"Laundry" Scrubs Locomotives

Electric locomotives are scrubbed and polished by a 300-foot washing machine that employs revolving brushes and jets of steam and water. The machine, used by the Pennsylvania Railroad, launders one locomotive every 15 minutes, a job that requires almost three hours by hand. The installation towers 15 feet above the track on each side. A locomotive to be cleaned is stopped near the machine and a pusher takes over to move it through the brushes and water sprays. A solution of oxalic acid and cold water is sprayed from vertical pipes against the sides, and six large brushes swing into position to revolve against the sides, scrubbing off dirt and oil as the locomotive moves forward. Four large rotary washers emit high-pressure jets of hot water and steam to clean the frame, wheels, journal boxes and brake rigging. Eight more brushes polish the locomotive before a final rinse. Two men scrub the curved ends of the locomotives.

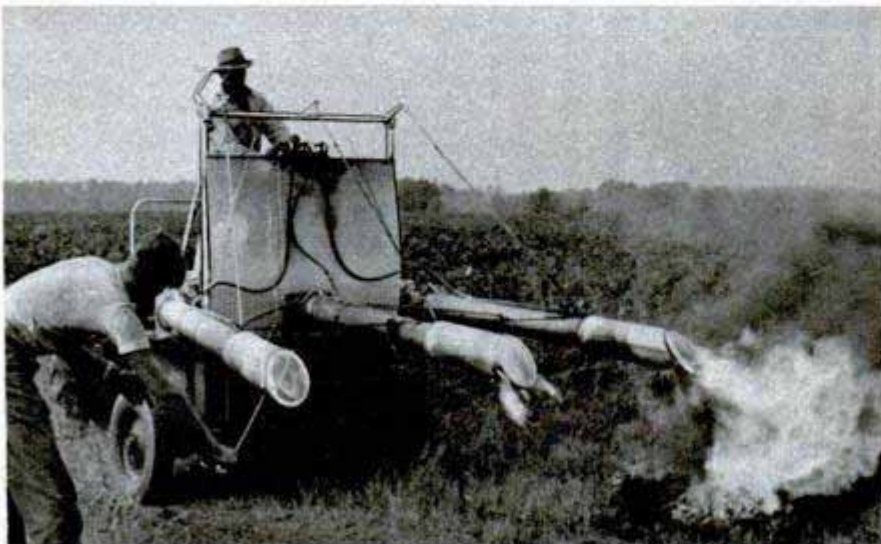

Potatoes "Toasted" To Speed Harvest

Bruising the tender skins of potatoes during harvesting is prevented by a "scorched earth" method used on Wisconsin farms. Flames from the jets of a weed burner kill the vines and allow the skins to toughen quickly. By reducing damage to the potatoes during harvesting, the process permits faster movement of the crop.

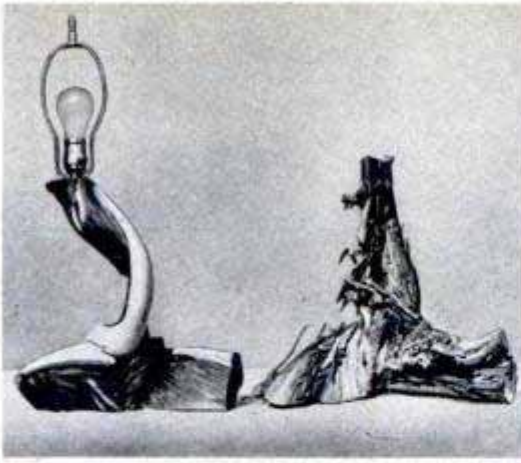

Wind-Blown Cedar Forms Lamp Base

Cedar burls, twisted by mountain winds, become two-color lamp stands after the bark has been removed and the wood polished. Lee Warren of Los Angeles discovered the unusually shaped burls while tramping through a remote forest in Utah. The cedar burls consist of sharply contrasted brown and white grained wood which takes a brilliant polish. Warren

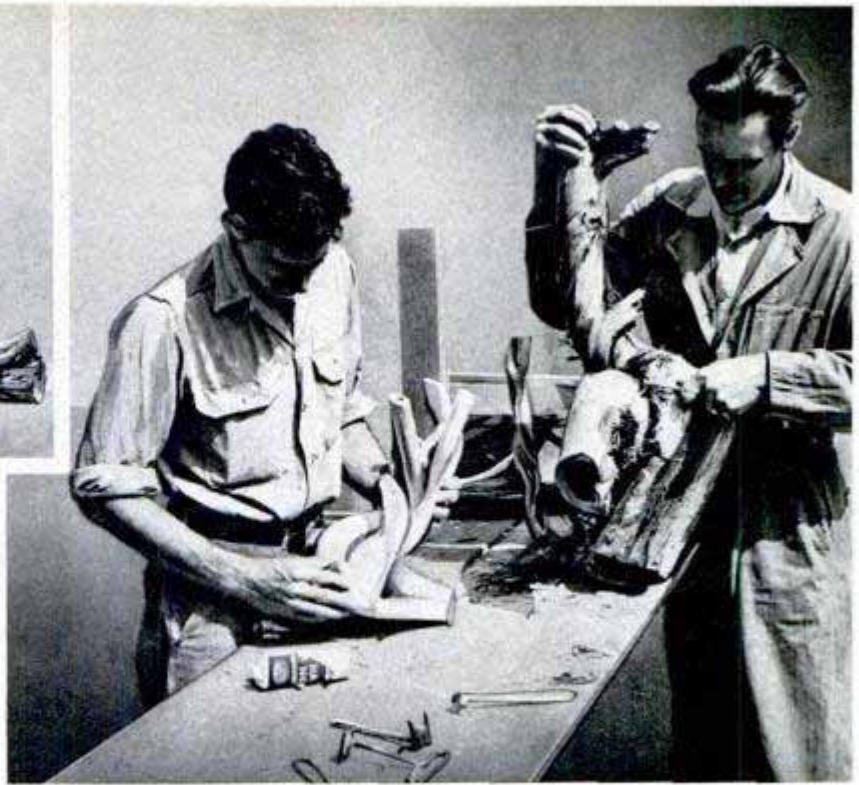

brings the burls down from the mountains on a pack horse. After the burls are trimmed and polished they are coated with natural lacquer and a lamp socket and shade fitting are added.

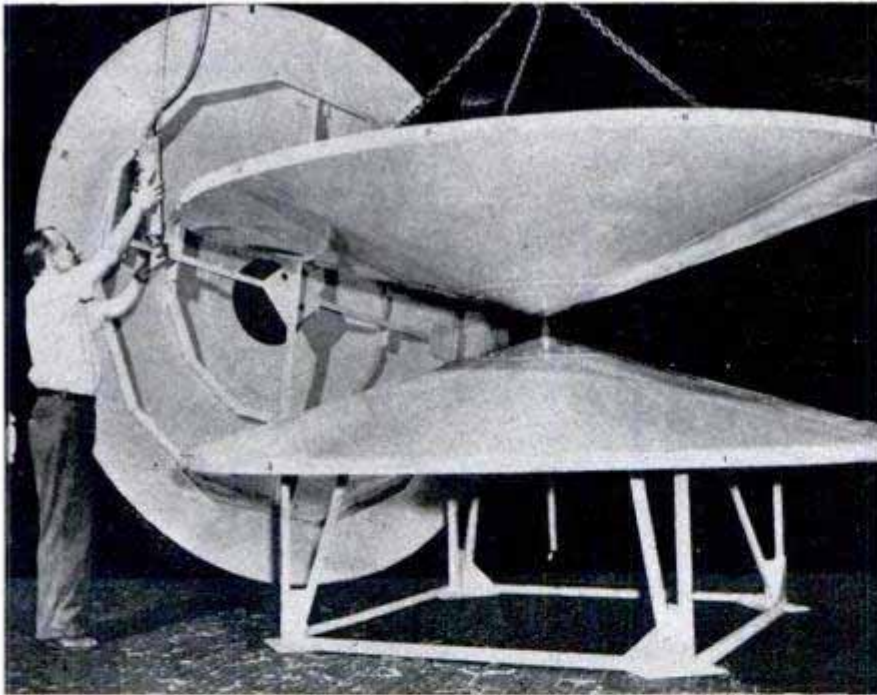

"Chicken-Brooder" Television Antenna

Sixteen times more sensitive than the usual vertical half-wave antenna, a new General Electric television receiving antenna looks like a chicken brooder when assembled. Designed for a Washington, D. C., station, the antenna will be used to pick up television signals from mobile field units for rebroadcast by the main transmitter.

Television receiving antenna is 16 times more sensitive than the usual type. The rear section is mounted above the other two to give it a chicken-brooder shape

Pigs Fatten More Quickly When Drug Is Used to Retard Gland Action

Fattening pigs is hastened by a drug called thiouracil which checks the action of the thyroid gland. In tests at the New Jersey Agricultural Experiment Station at New Brunswick, a small amount of thiouracil was added daily to the rations of ten 200-pound hogs, while ten others were fed the same rations but without the drug. In 38 days, the group receiving

thiouracil gained a total of 610 pounds, compared to 470 pounds gained by the untreated hogs. The thiouracil group gained 100 pounds of weight for each 524 pounds of feed consumed, whereas the other group required 723 pounds of feed for a 100-pound increase. When available, farmers are cautioned not to use the drug until the last 45 days of the fattening period.

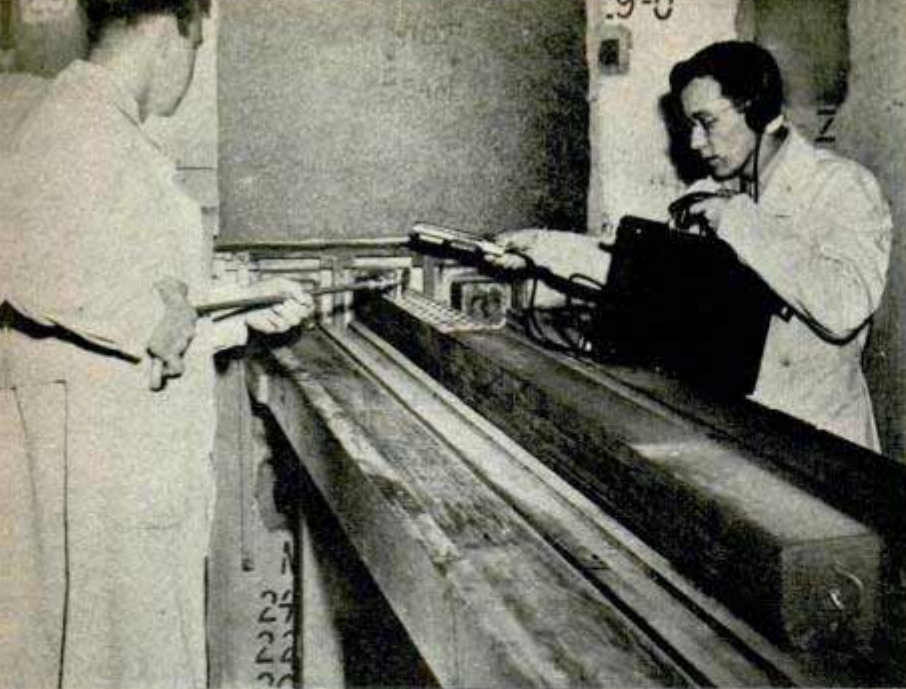

active materials in aluminum tubes from atomic pile. Man at right checks amount of radiation emitted. Lead-lined ball (A5), right, is the "torpedo"

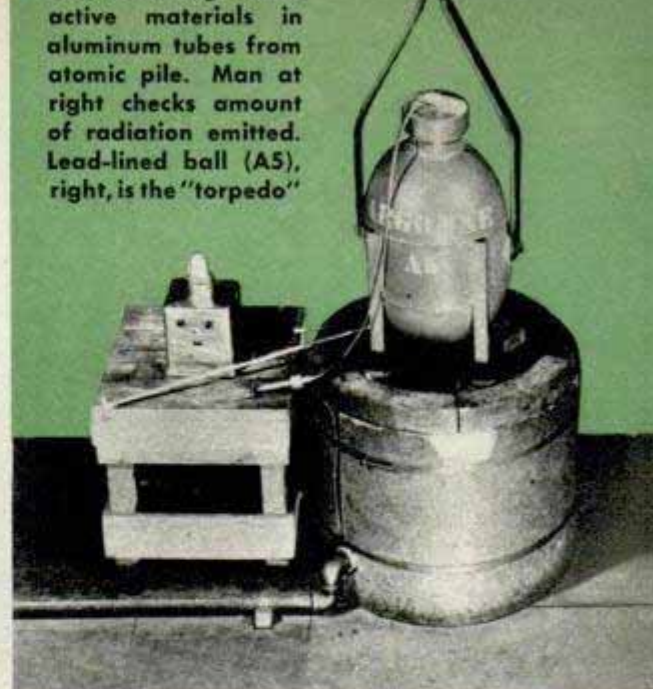

"Rabbits" Chase Atoms

"Rabbits" and "torpedoes" are two of many novel devices being used at Argonne National Laboratory near Chicago in hunting new fields for atomic energy. The former is a hollow container which darts into the atomic pile, or "furnace," with materials being subjected to only a few seconds of irradiation. It is moved through a pipe by compressed gas. The torpedo, a lead-lined ball, is lowered onto the furnace when large quantities of radioactive samples are to be extracted. Grappling tongs inserted through it lift out samples in such a way that practically no radiation escapes.

Left, putting "rabbit" into pipe for quick dash into "furnace." Below, control panels for graphite-moderated pile at Argonne

Argonne National Laboratory photos

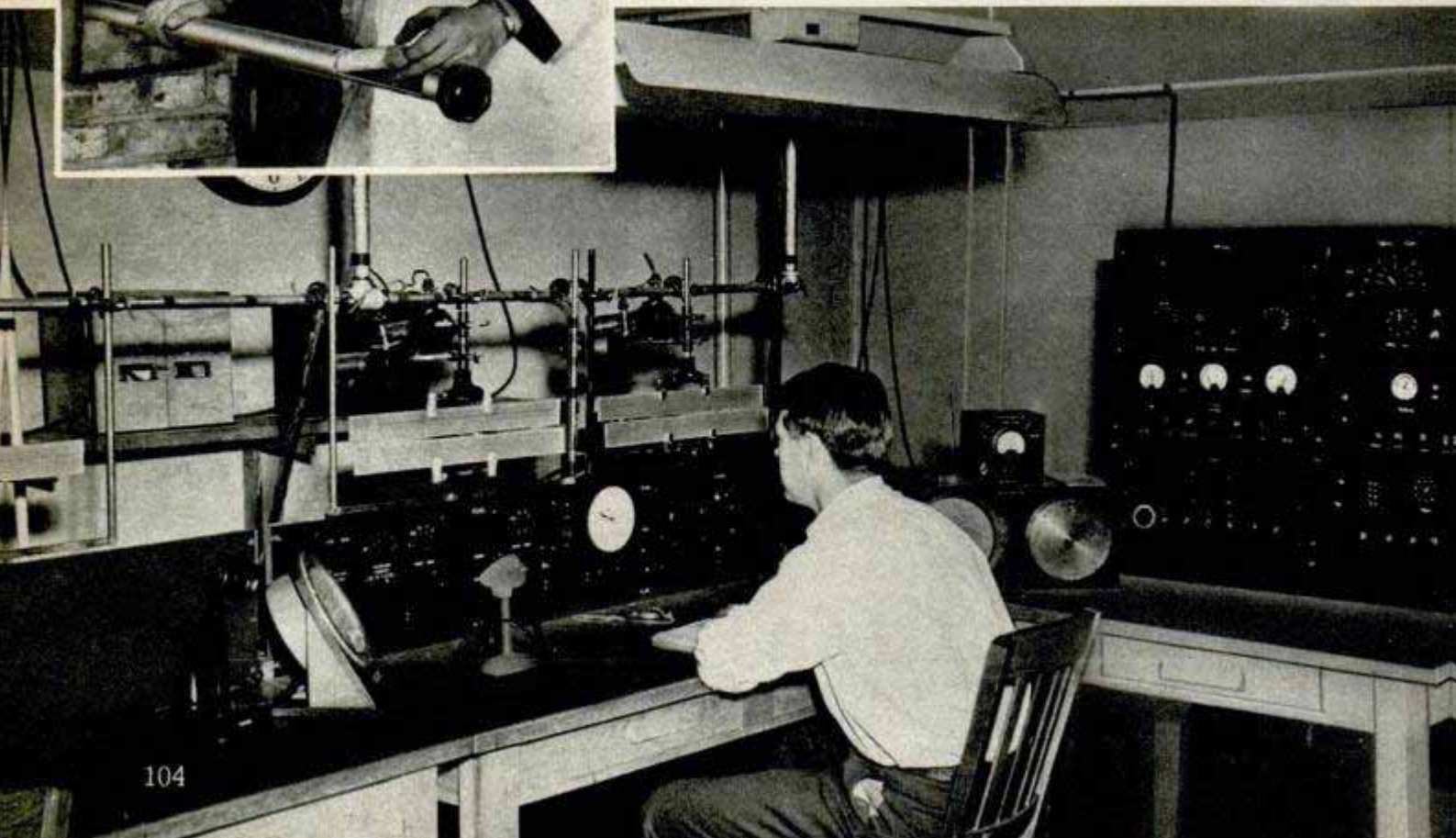

TEST YOUR SCIENCE

By Rex Taylor

TAKE an orange and a tape measure. Draw the tape snugly around the orange at its "equator." Let's say that it measures exactly nine inches around the waist.

Now let out the tape "belt" by three inches, so that its loop is extended from nine to 12 inches. If you stuffed paper between the orange and the tape, all around, you would find the tape was about $\frac{1}{2}$ inch distant from the orange at all points. In other words you have increased the circumference of the tape loop from nine inches to 12 inches ($33\frac{1}{3}\%$) and its diameter is an inch wider.

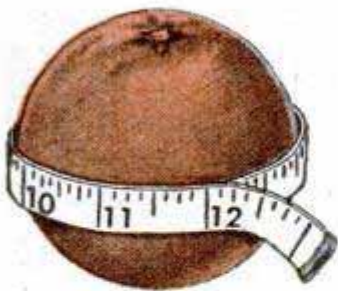

i.q.

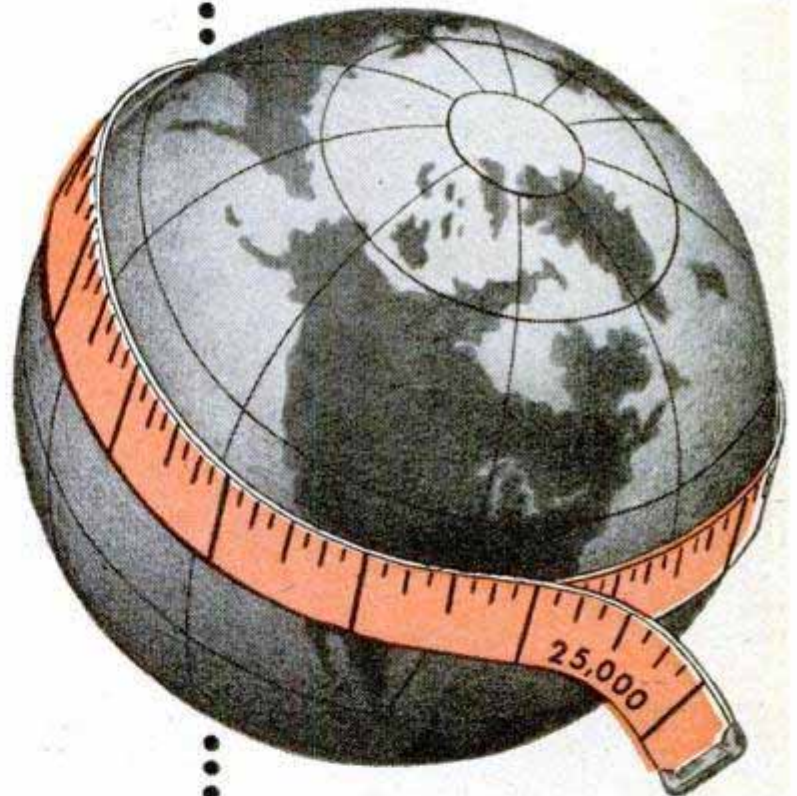

NOW

Imagine yourself drawing tightly around the earth at its equator a tape measure 25,000 miles long. For the sake of the problem we'll say it's exactly that distance. Now lengthen the tape loop three inches, as you did with the orange. What is the width of the space between the earth and the tape measure, extended to 25,000 miles and three inches?

Answer on Page 238



CARRYING SACK holds 25 pounds of sand to provide traction on ice or snow. With convenient handles and a long pouring spout the sack helps homeowners lug sand out to slippery driveways and walks, can be carried in car trunk

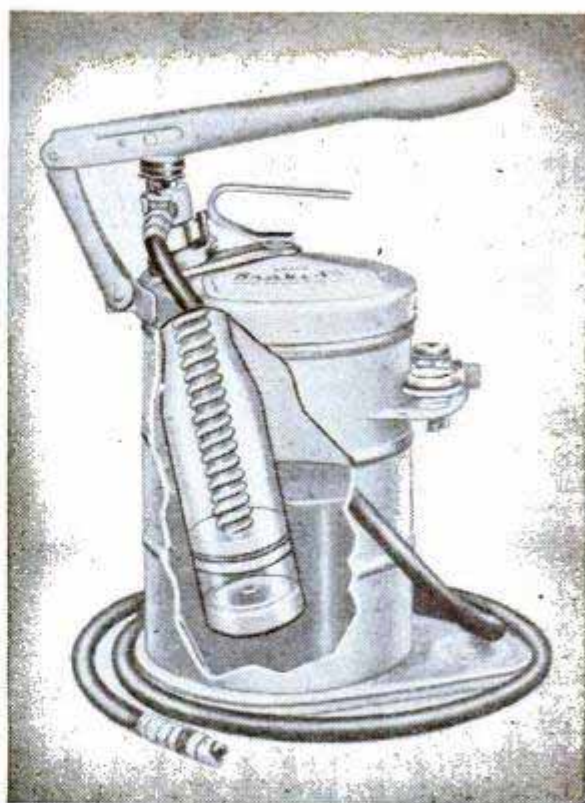

SPRING-OPERATED PUMP injects fluid into automobile brakes without hazardous bubbles which sometimes occur when a compressed-air pump is used and which can cause brake failure

TIRE MOUNTER rolls tires onto the rim as easily as turning a crank. Bottom photo shows tire being mounted merely by turning the crank after tire is centered on the machine. Top, tire is taken off rim by inserting bar and rotating

ROOF-TOP SPOTLIGHT for autos is controlled by a knob inside the car just above the windshield. The control knob switches on the light, directs the powerful beam, or locks it in any position

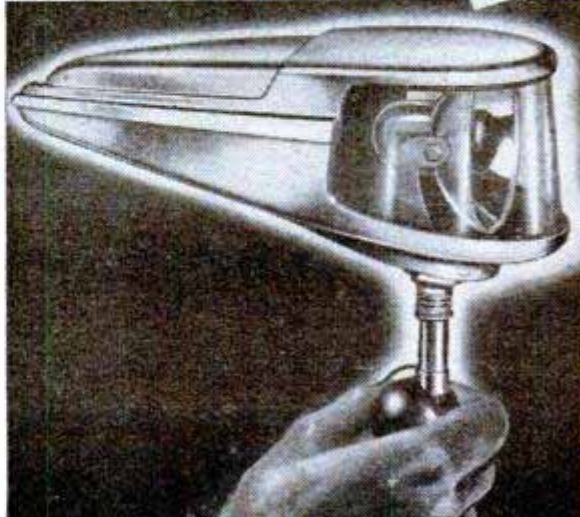
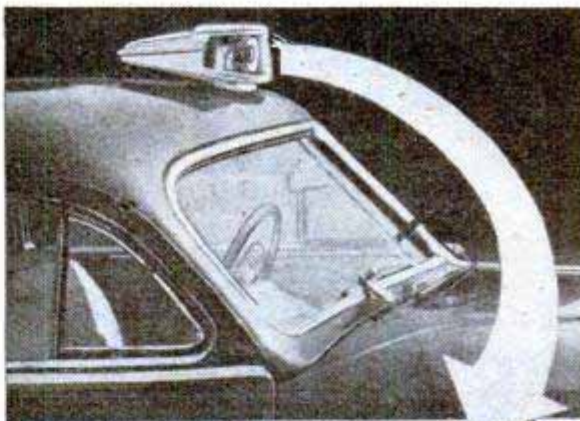

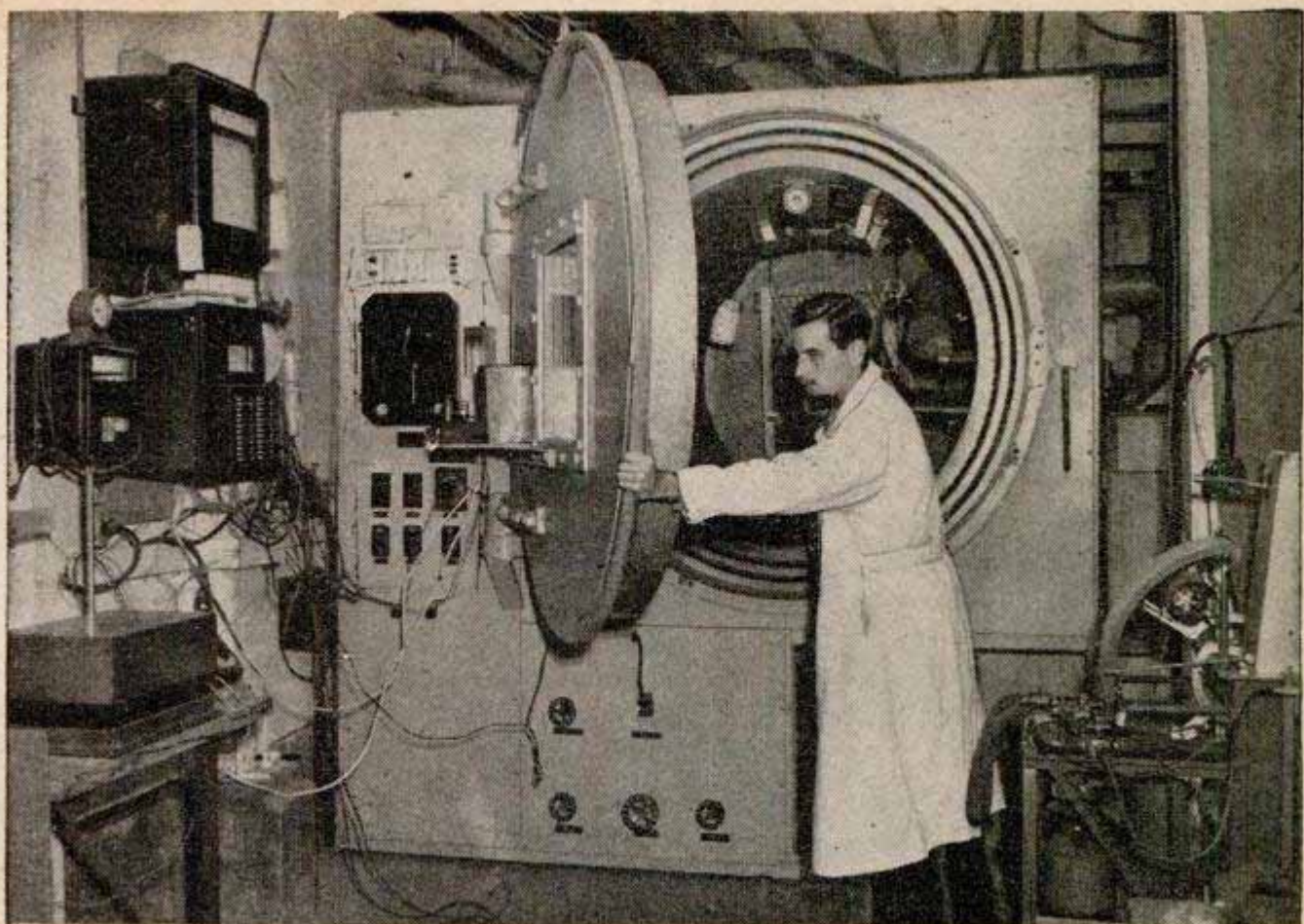

In this UCLA "hot box" Dr. Craig Taylor withstood record 262-degree heat. Many-buttoned potentiometer, below, records temperatures of parts of body

The BURNED-NOSE CLUB

WELL, BOYS, here's another candidate for the Burned-Nose Club," said Dr. Craig Taylor.

Stripped to his shorts, he fastened eight thermocouples to his arms, legs and body, stuck one up his nose and shoved another into his mouth. He looked like a fantastic figure in a Salvador Dali painting.

Then he put on twill-weave, summer-weight trousers and jacket of the United States Air Force. His sockless feet were thrust into a pair of white, canvas overboots with a felt lining. To protect his ears, he wrapped a towel around his head. Finally he pulled on a pair of pilot's gloves.

Dr. Taylor, 38, sandy-haired, stocky, an associate professor of engineering at the University of California at Los Angeles, was ready to try for a new heat-tolerance record. Although not related to Sam McGee of Robert Service's famous poem



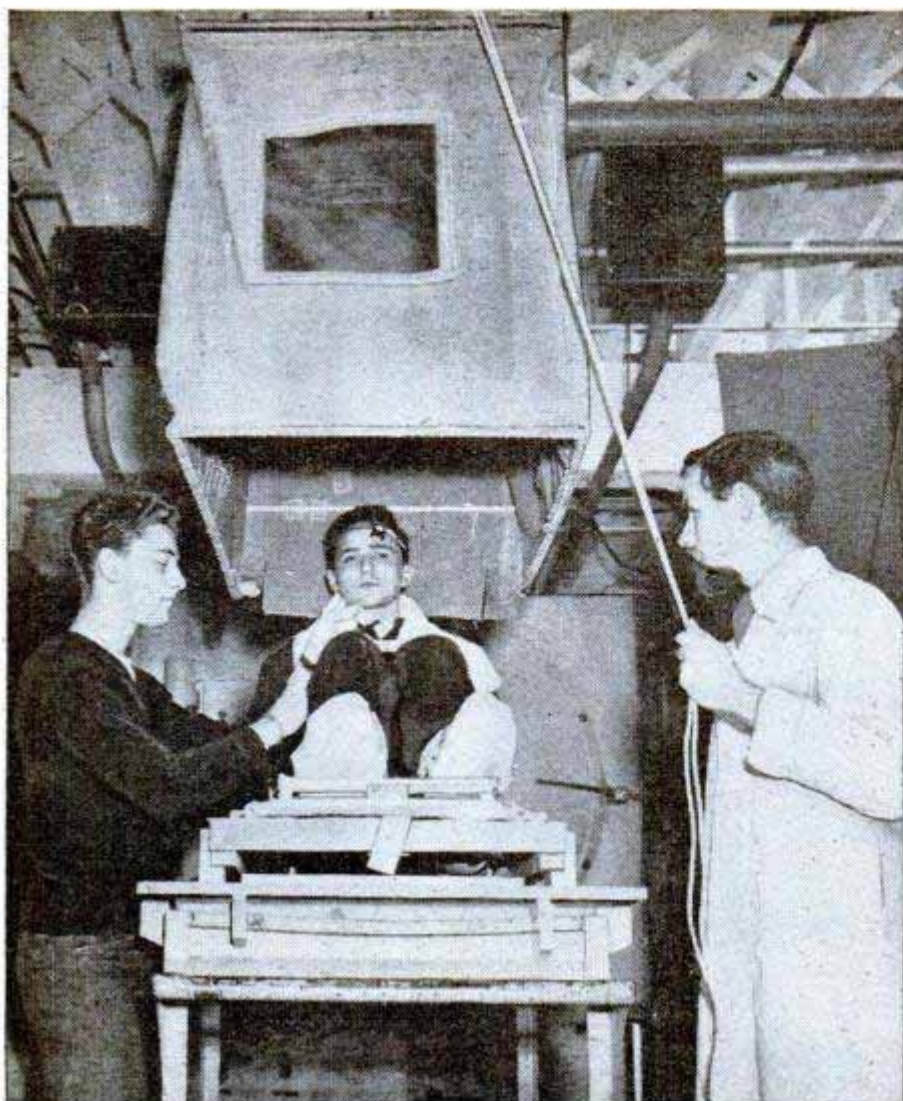

Subjects are "conditioned" briefly beneath heavy canvas hood before entering test chamber. Heating element under seat warms air. Below, photographed through glass door, subject shows effects of 200-degree-plus heat

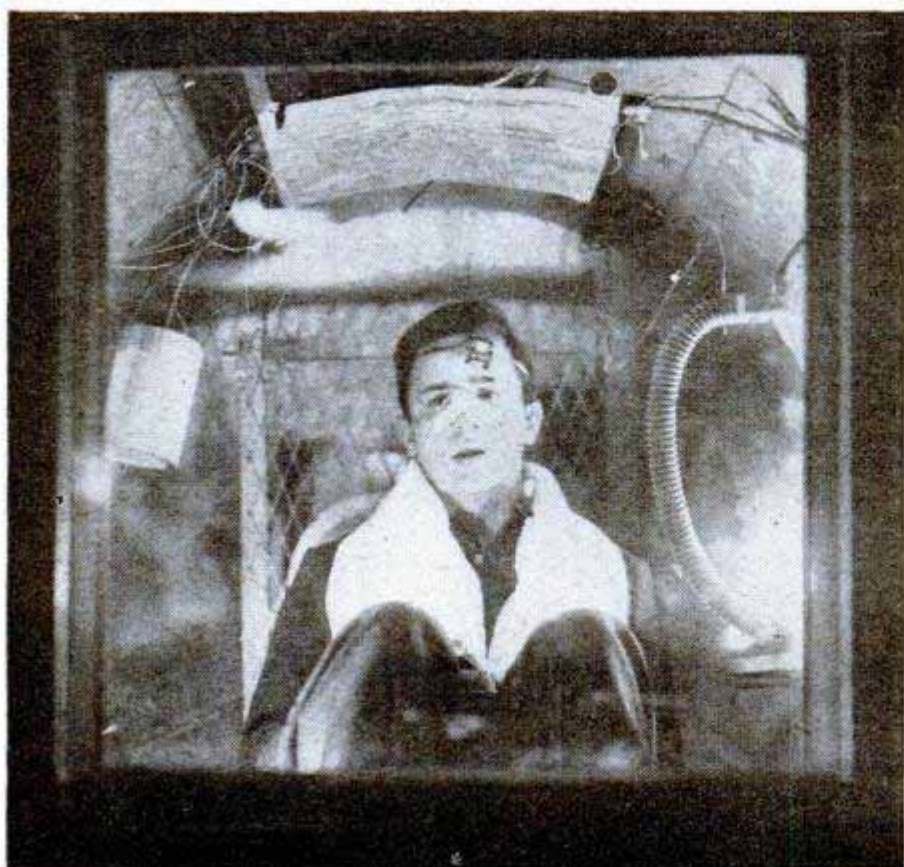

(who never really got warm until he was cremated) Dr. Taylor was going to enter a scientific oven at one of the highest temperatures that any man had ever voluntarily submitted himself to—and lived.

This was no trick—no circus sideshow—no Hollywood headline stunt. It was one of a number of serious experiments on human heat tolerances in the brand-new field of biotechnology. This research at UCLA has special and direct application to the supersonic speeds of the near future. The problem of jet aircraft is not cold but heat.

Fast-moving jet planes scoop air into their ram ducts. The ram heating effect may increase cockpit temperatures considerably. And the faster the ship flies the greater the heat. For example, at 600 miles an hour, the inside temperature is increased approximately 60 degrees over the air outside; at 800 miles an hour it is 120 degrees more, and at 1000 miles an hour it is raised 180 degrees.

There is also frictional heating of the plane's wings and fuselage as it swishes through the air. This may be as high as 85 to 100 percent of the ram heating effect. These high temperatures generated may be one of the important factors in limiting the speed at which man can fly.

Relatively simple refrigeration systems have been installed in cockpits of P-80s, P-84s and other jet planes to keep the thermometer at a comfortable level.

But what if a pilot forgets to turn them on? What if they get out of whack? Or if they are shot away in combat?

Research in the laboratory will tell transport

and military pilots and passengers just how long they can remain in furnacelike temperatures. Dr. Taylor's experiments already seem to indicate that our fear of heat may be partly mental and that man can exist in excessive temperatures somewhat longer than is popularly thought possible. An extra two or three minutes may mean that the pilot can make a landing field, put a strip of treacherous ocean behind him or reach friendly territory in which to bail out.

"Wheel me in," Dr. Taylor called as he climbed into a small seat on rollers—resembling the pilot's seat in a fighter plane.

The heat chamber is cylindrical in shape, five feet wide and looks like a giant Bendix washing machine. Seventy cubic feet of heated air a minute is pumped into the chamber. It is sheathed inside with sheet metal, insulated heavily with rock wool and is reached by a heavy, circular door. During the war it was used by Ryan Aircraft Company in San Diego to test instruments and was acquired recently by UCLA through the War Assets Administration.

Two assistants heaved open the door and a blast of searing air swept out. The small seat on which Dr. Taylor rested was pushed inside and the door slammed shut.

"How's it feel, Doc?" he was asked through the inter-com system.

"Hot as blazes!"

The thermometer, which had swung down to 175 degrees Fahrenheit when the door was opened, climbed rapidly back to 240 degrees. Through a glass window in the heavy door, the researchers watched Dr. Taylor's face grow red as a boiled lobster. After three minutes he broke into a profuse sweat which brought some relief.

At 14 minutes 30 seconds, he told his assistants that he'd had enough. The temperature inside had averaged 250 degrees and during the last two minutes had touched 262 degrees—a new record for the series. (Water boils at 212 degrees!)

Trained as a physiologist at Stanford University, Dr. Taylor became interested in biotechnology during the war when he served at Wright Field as a captain in the Air Force. After the war he came to UCLA and joined the College of Engineering to continue his experiments. He formed a research team consisting of a physiologist, W. V. Blockley, and an engineer, R. H. Holloway. Student assistants Philip Elliot, Sidney Freedlander and Lloyd Barnes round out the crew. All take their turns, acting as subjects and experimenters.

Graph illustrating how skin on different parts of body reacts to intense heat during 23 minutes in hot box

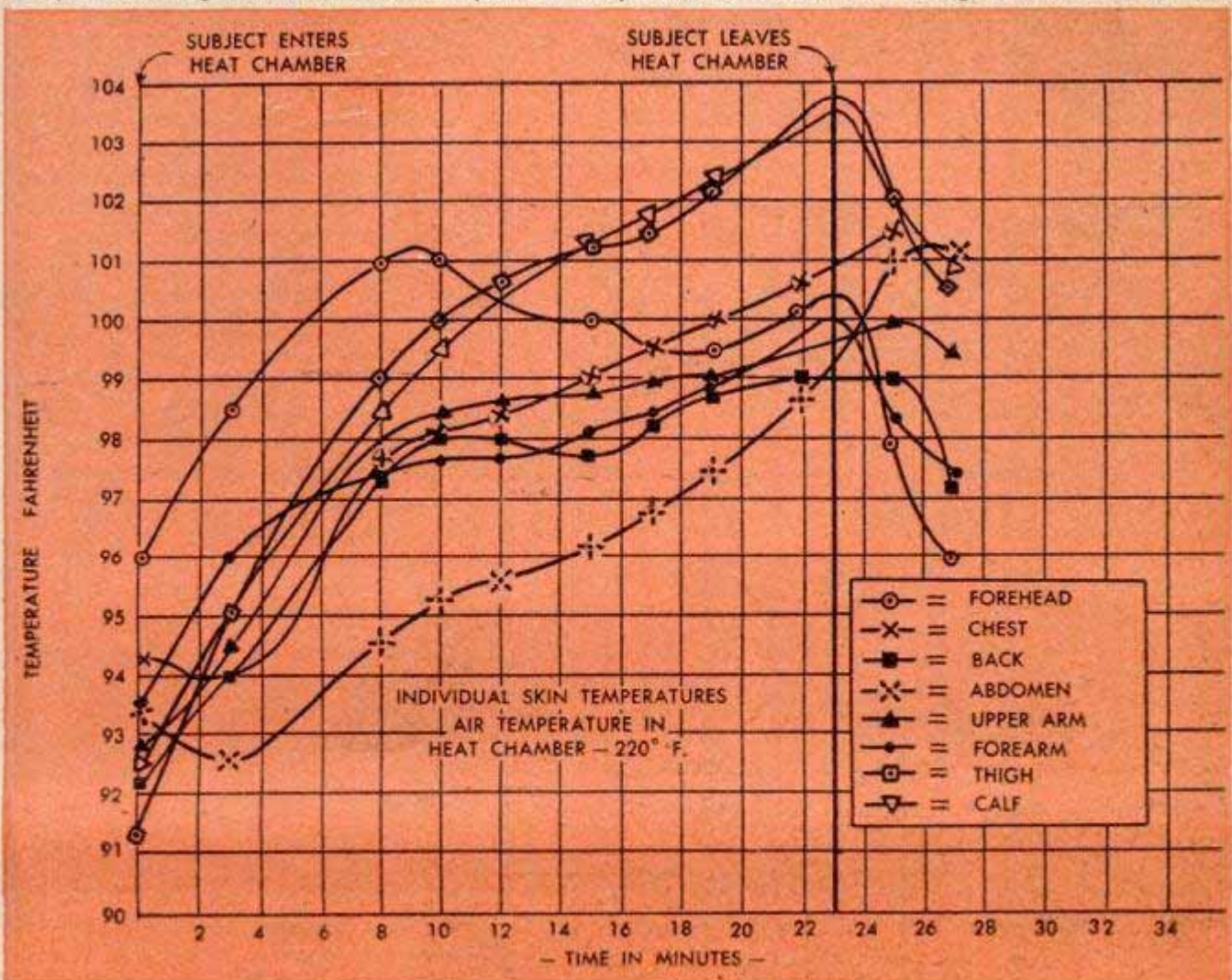

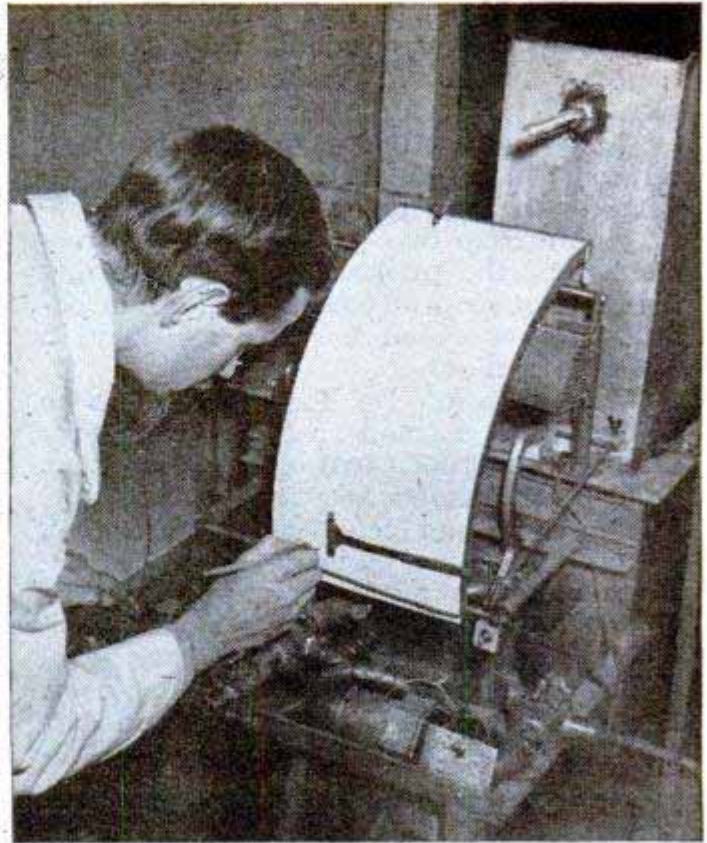

Respiration valve, left, separates exhaled and inhaled air so that volumes can be measured on meter at right

Heat tolerance is only one of several biotechnological problems being investigated by scientists at several university, industrial and Army and Navy laboratories in the United States. Some are working on acceleration and G-forces, some are engaged on high-altitude and lack-of-oxygen

experiments, some are devising plane controls so that man's brain and muscles may keep up with tremendous speeds at which the jet and rocket airplanes of the future will operate.

These problems of flight are not so much mechanical as they are physiological and psychological. Men trained in medicine often understand them better than those trained in mechanics. In the final analysis though, the physiologist and the engineer must work together to solve the puzzling aspects of super speeds.

Dr. Taylor believes man's fear of heat is probably as much mental as it is physical. Since the days of cave-living and club-wielding, human beings have been frightened by fire. Modern man is afraid of heat because he is not sure how much of it he can stand before setting into motion what science calls "irreversible processes"—death.

It is more than likely, Dr. Taylor believes, when tolerances are charted and known, that the Army and Navy will include heat indoctrination in their pilot training courses. Cold indoctri

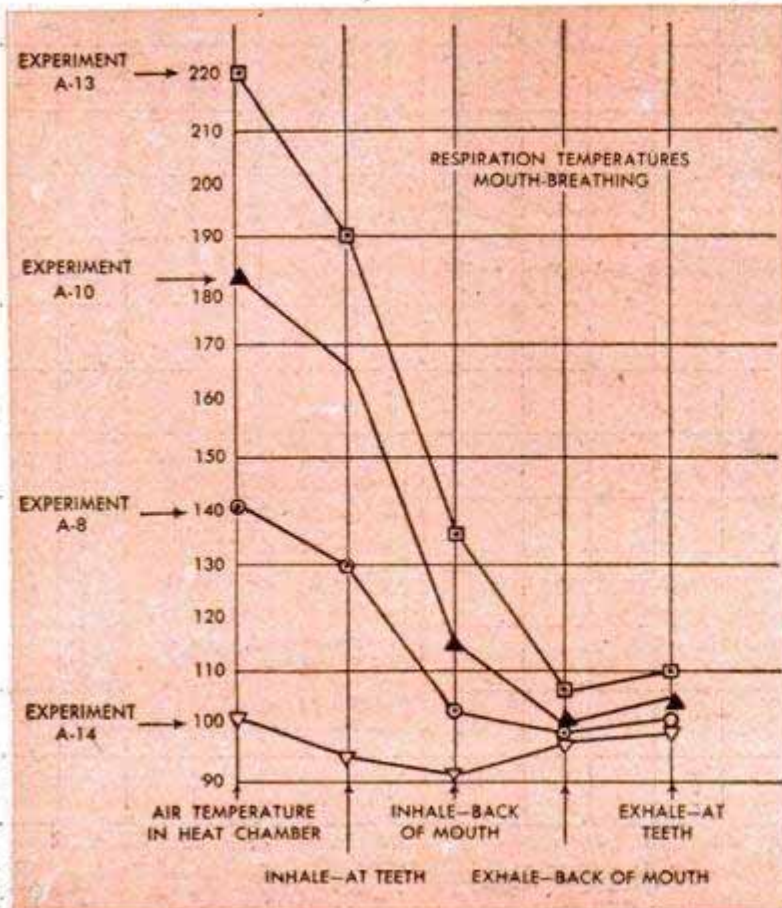

As chart indicates, body's cooling system lowers temperature of air as it is drawn into and out of lungs during respiration

nation—designed for men who might have been compelled to bail out into icy water or over arctic lands—was taught in some cases during World War II. As supersonic planes come into general use, heat indoctrination may become important also.

How can the human body withstand terrific temperatures 40 degrees or more above that of boiling water? Doesn't such ovenlike heat roast the skin of the face and hands—sear the eyeballs—scorch tender lung membranes—make the blood boil?

Surprisingly, none of these dire calamities occurs in the first quarter hour at 250-degree heat.

Soldiers from relatively cool areas like Colorado found they could stand the sweltering heat of the New Guinea jungle and the Arabian desert. In time they almost forgot their discomfort. So has it been with experimenters working with the "hot box."

Subjects are told what to expect and what temperatures others have been able to withstand.

(Continued to page 276)

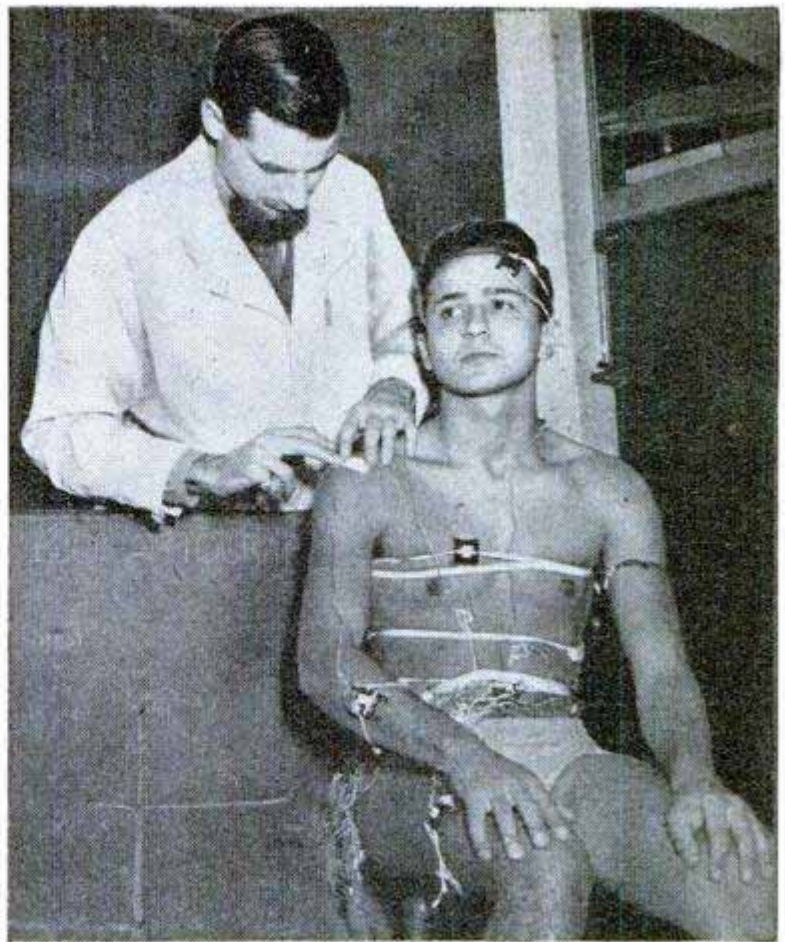

Above, physiologist checks harness which measures heat at eight points on body. Below, subject rolls out of chamber after test

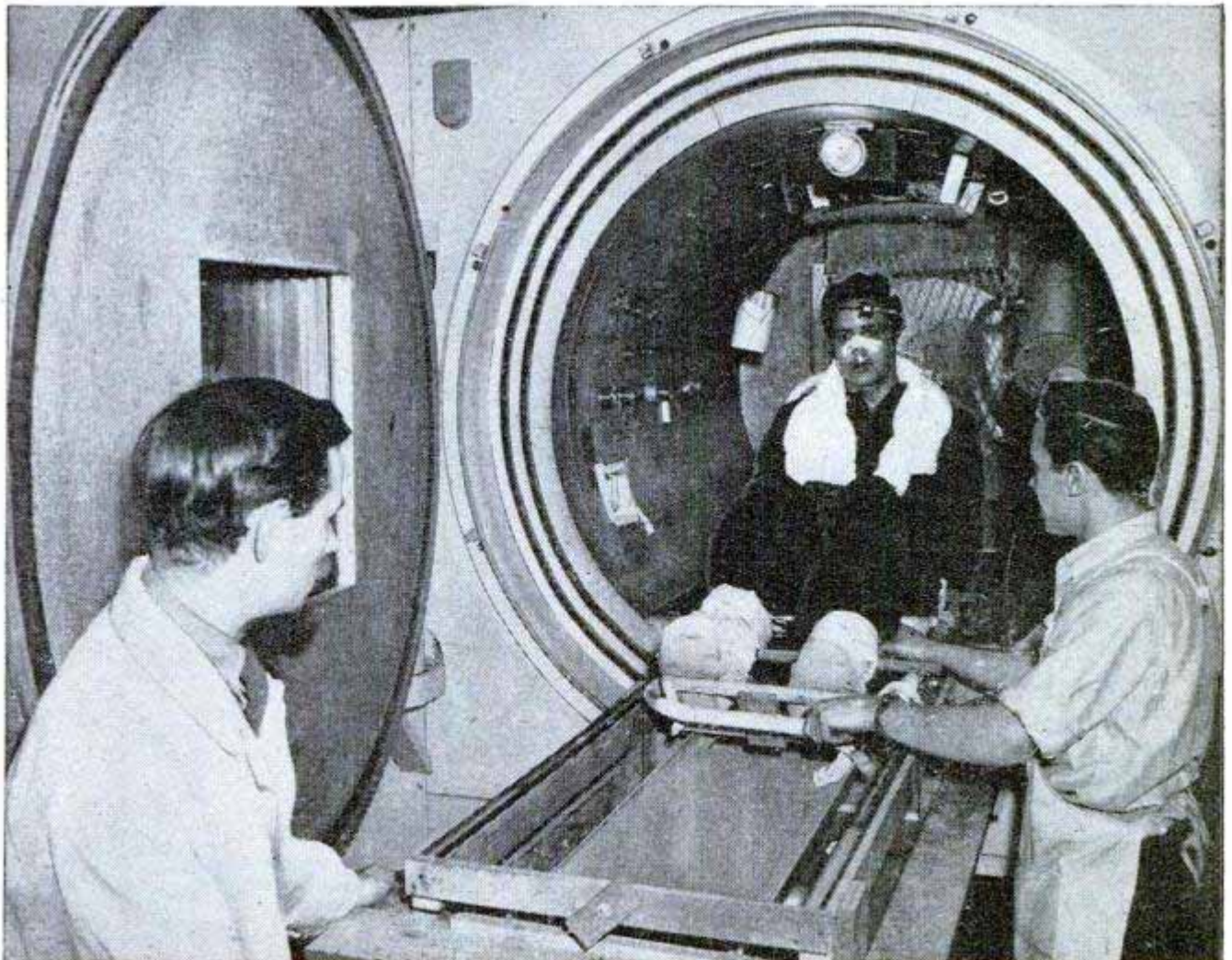



Left, all-metal kitchen has a built-in range, icebox and cupboards. Right, front view shows clearly the absence of heavy steel framework

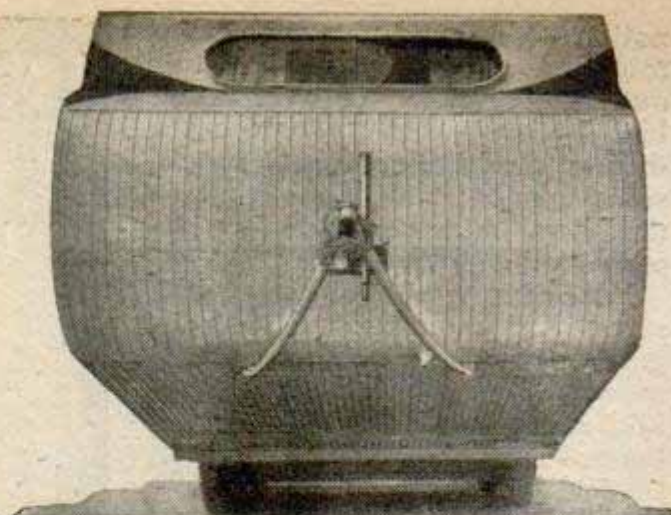

Frameless Trailer Is Light, Strong

Of semi-monocoque construction, a lightweight trailer coach has no need for the conventional heavy steel frame. Instead, the wheels and tow-bar supports are secured directly to the corrugated under-floor structure of aluminum alloy. Internal wall and roof structural members consist of aluminum-alloy Z-sections spaced to provide strength to the body shell. Because of its design, the trailer can be built in several basic parts such as the floor, sides, roof and ends, and assembled later. Wheels are independently sprung. Only 16 feet long, the trailer will accommodate four people.



Above, although only 16 feet long, the trailer sleeps four comfortably. Double bed in foreground folds into the wall during the day. Wardrobe closets are on the left wall. Below, well streamlined, the lightweight trailer tows easily. Windows on all four sides provide good ventilation



Flashing Lights Aid Piano Students

Students learning to play the piano are given visual instruction by a mechanical teacher that aids the music teacher in demonstrating the proper keys and fingers to use. A large plastic panel is installed above the teacher's piano. The panel includes a replica of the keyboard, a staff, musical symbols and an outline of two hands. A control cabinet is installed within the teacher's reach. As she plays the piano, the keys activate lights on the master keyboard to show the students the proper notes to strike on dummy keyboards held in their laps. Switches in the control cabinet permit the teacher to light up the proper fingers on the hand panel and the proper musical symbols on

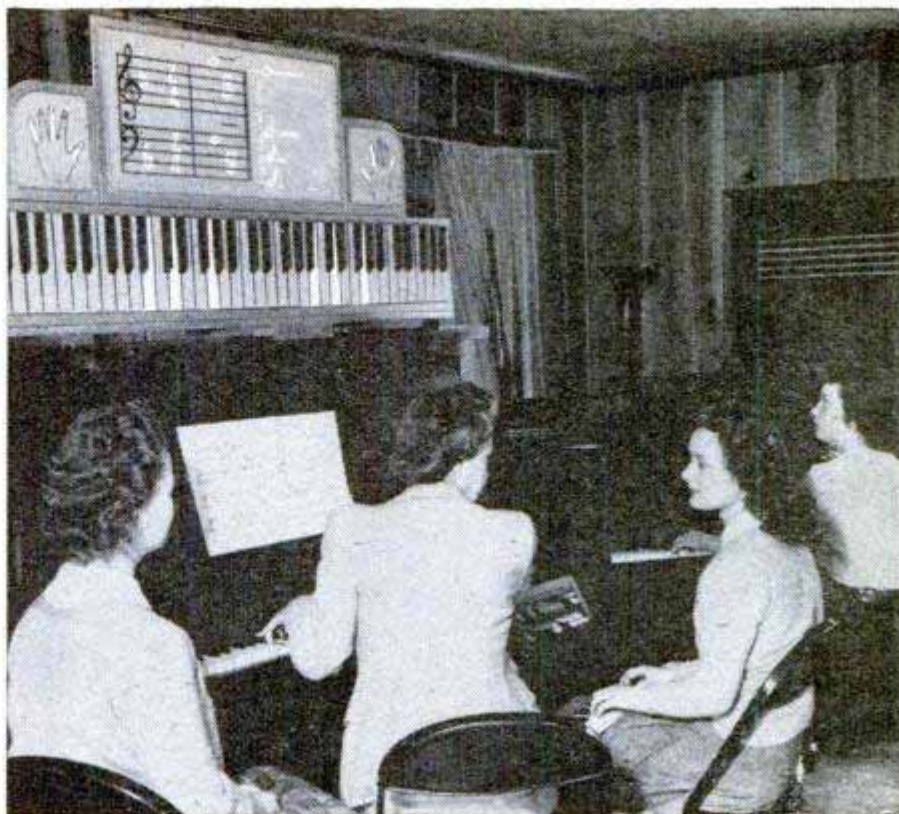
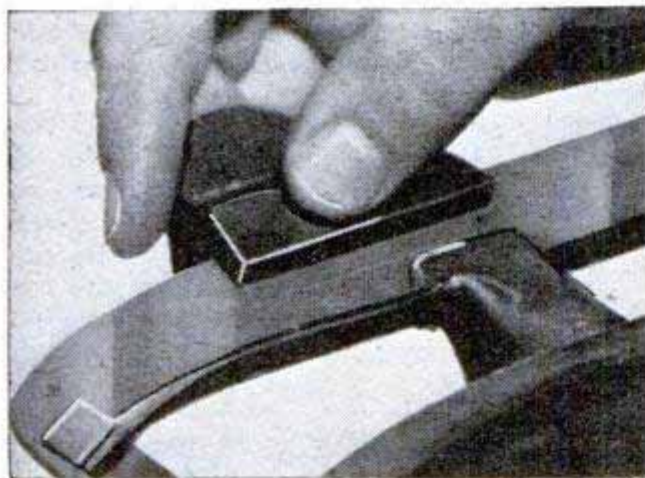

Photo from American Cyanamid

the staff. Several students, each equipped with a dummy keyboard, learn to play at the same time using the teacher's aid.



Pocket-Size Skate Sharpener Handy for Use at the Rink

Skates can be sharpened at the skating rink with a pocket-size sharpener that has a carbide blade. With the skate held in a horizontal position, the sharpener is drawn along the runner from toe to heel with smooth, steady strokes. No skill is necessary and hollow-ground blades are sharpened in a few minutes. The tool is slotted to fit around the skate blade and it is designed for use in either the left or right hand. Its aluminum body makes it light in weight and rustproof.

Junior Can "Drive" Now →

Children can "help" dad drive the car with a toy steering wheel that fastens to the dashboard. The wheel is made of hard rubber and is held in place by a suction cup. Sample-size drivers even have a horn to toot while steering.

Electric Slippers Soothe Feet

Soaking tired feet in hot water is old-fashioned now that electric slippers do the same thing with less mess and bother. The slippers are wired with a heating cord. You slip them on, plug them into the nearest outlet and in a few seconds your feet relax.



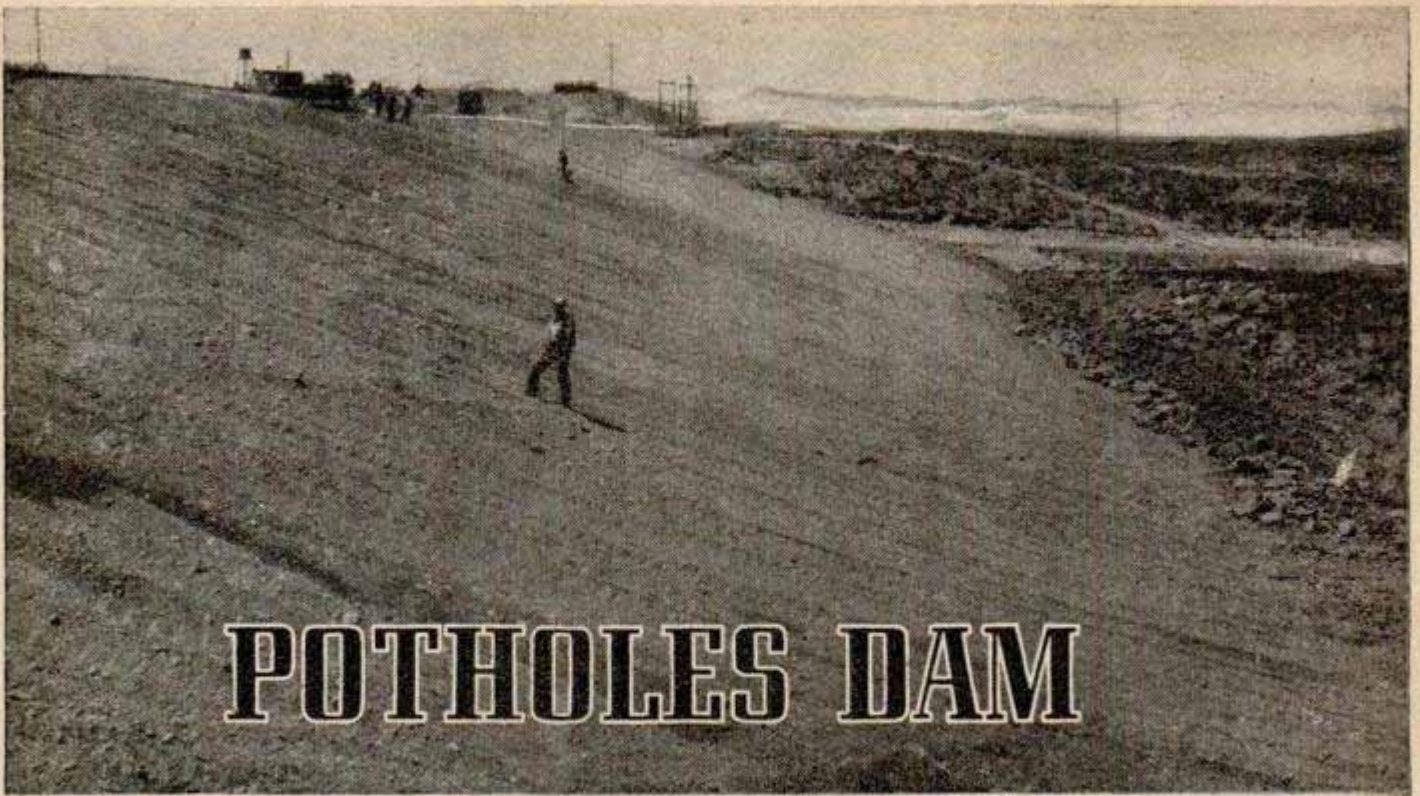

POTHOLES DAM

Layer upon layer of firmly tamped silt, clay, sand and gravel will be topped by three inches of rock. Below, machines at site



TAKING its name from the potholes, or ponds, in a desolate area in eastern Washington, an earth-rock storage dam is under construction to create a garden spot of 270,000 acres of land now barren. Potholes Dam will be 3½ miles long and the bulk of its structure will nearly equal that of giant Grand Coulee Dam, 66 miles to the north. The new dam will have a lake-reservoir covering 47 square miles, with fine sand beaches. Water for the reservoir will come from drainage of nearby land and irrigation canals.

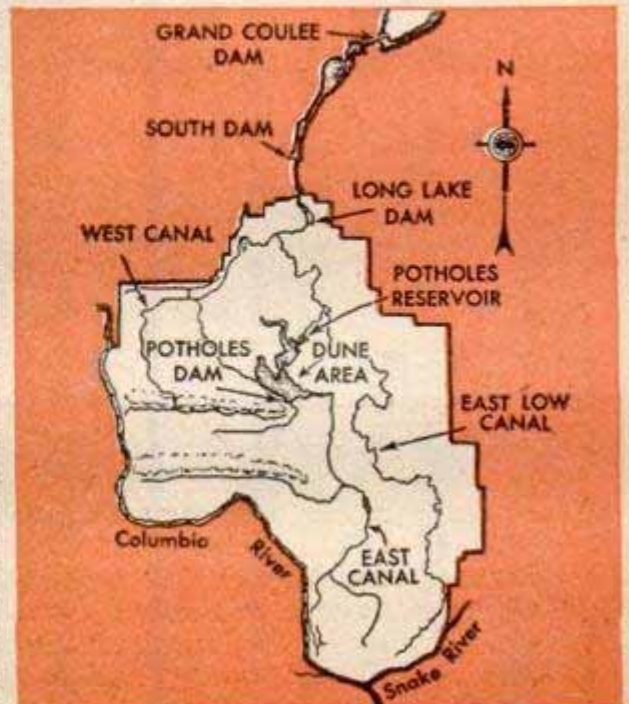



Above, pneumatic hammers tamp the soil firmly in places which sheep's-foot rollers cannot reach. The hammers compact the soil mixture so tightly that water cannot flow through it

Above at right, Phil C. Royer, a superintendent, uses short-wave radio to summon a mechanic to repair a disabled dragline. Radio equipment and roving mechanics prevent many bottlenecks

Right, close-up of a pothole. Big boulders now reduced to tiny pebbles ground out this hole thousands of years ago. When the pothole is cleared of rocks it will be filled with concrete

Below, dunes scene in the potholes area of the Columbia Basin Project. Potentially rich farm land surrounding this desolate region will be served by costly network of irrigation canals



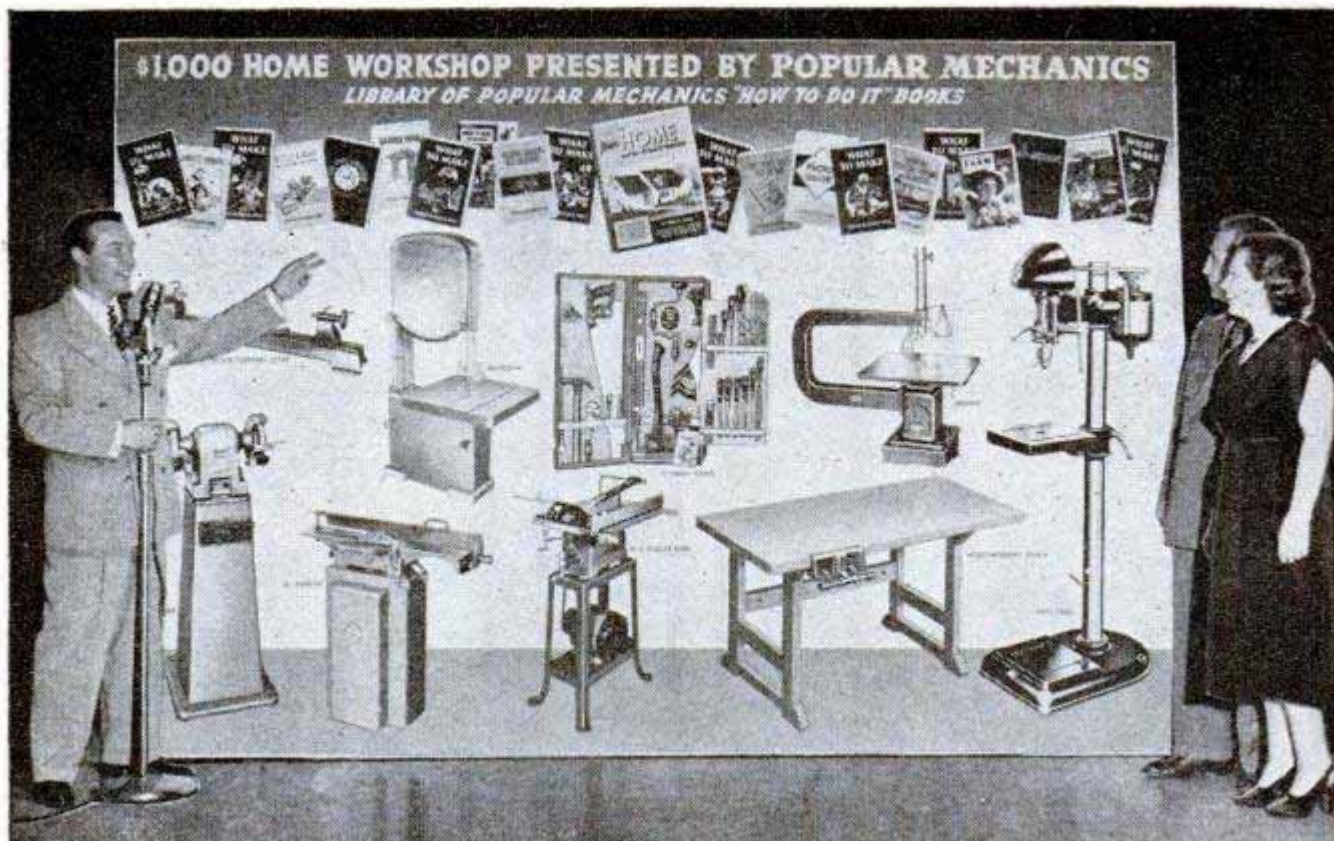

"MISS HUSH" WINNER GETS DREAM WORKSHOP

Workshop equipment that would be the dream of any home craftsman was the prize given by *Popular Mechanics Magazine* to the lucky winner of the "Miss Hush" contest recently on the Truth or Consequences radio program. The Craftsman Editor selected for the prize seven valuable power tools, a woodworker's bench and a kit of 39 hand tools.

Winner of the "Miss Hush" contest was Mrs. C. T. Subbie of Fort Worth, Tex. The tools constituting this basic set delivered to her by *Popular Mechanics* were a bandsaw,

jointer, jigsaw, eight-inch circular saw, drill press and six-inch grinder—all complete with motors and stands—and a wood-turning lathe, plus the packaged set of hand tools.

So that the owner will have full instructions on proper use of the tools and a variety of projects to build, a complete library of *Popular Mechanics* how-to-make-it books—What to Make, Shop Notes, the Garden Book, Home Kinks, Useful Ideas and many other workshop pamphlets—was presented as part of the prize.

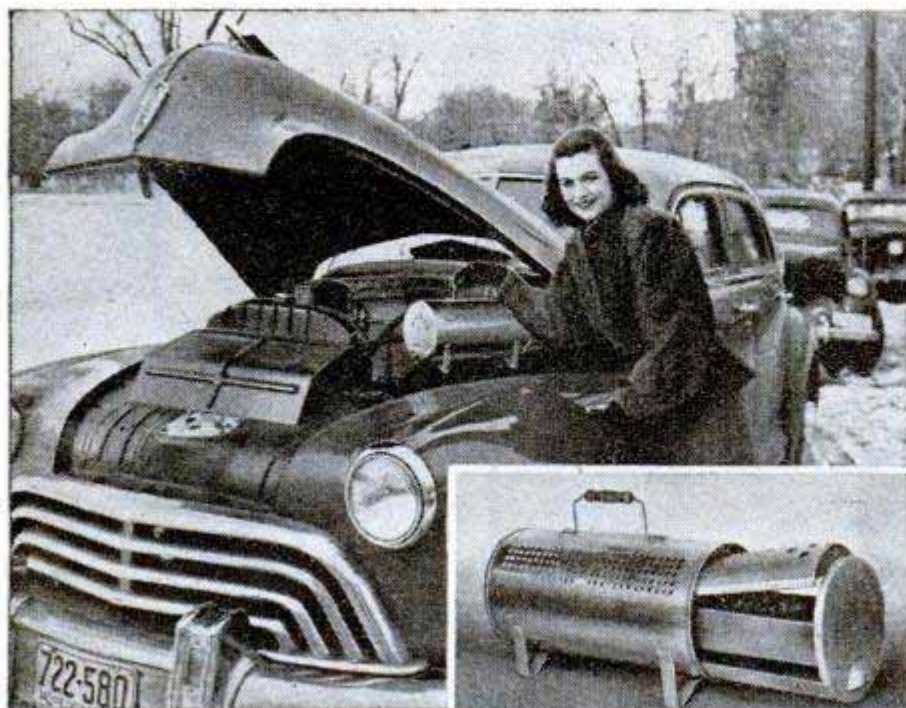

Auto-Engine Heater Burns Charcoal

Motorists can carry a heated garage right along with them in the shape of a compact charcoal heater. It heats without flame and requires no electricity. The heater consists of a removable heavy metal fuel tray and an outer casing of high-grade aluminum 14 inches long, 6½ inches wide and 6½ inches high. Fuel capacity of 18 briquets maintains an even heat for 12 to 30 hours. The heater can also be used for heating an insulated truck, cabin or duck blind.

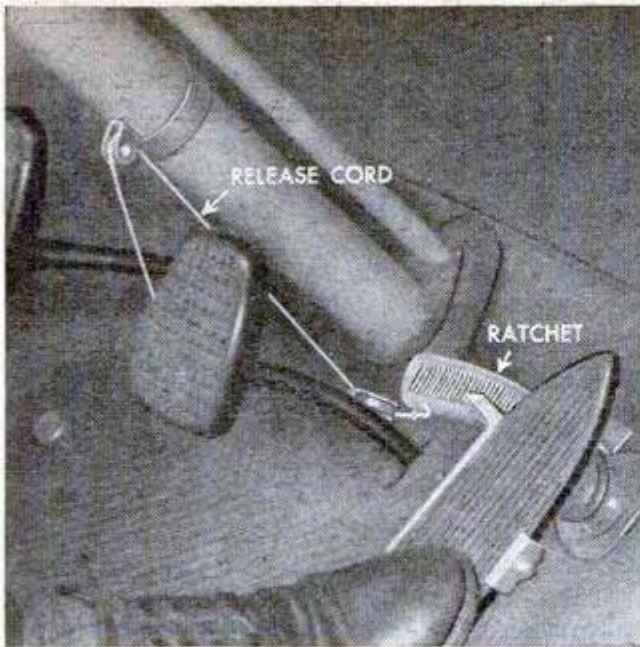

Control Holds Accelerator Pedal

Cars or trucks are held at any desired speed by a control that holds down the accelerator pedal. The control, which fits all conventional pedals, releases automatically when the brake is applied. A projecting arm fastened to the pedal fits grooves in a ratchet on the floorboard. When the pedal is depressed the two parts lock to hold down the accelerator. A cord from the ratchet is fastened to the brake pedal, releasing the control at the touch of the brake. For shifting gears and normal driving the control can be released by moving the accelerator slightly to the left. The control can be installed in a few minutes.



Adhesive "Welds" Carpet Padding

Strong enough to join sections of carpet padding without reinforcement, a rubber adhesive can also be used with binding tape or sewing to form a permanent seam on carpeting. On padding, the compound is painted on both square-cut edges. Held together and allowed to cure for an hour, the two sections become so firmly bonded that a strong pull tears the padding before it opens the seam. The material also makes carpets skidproof.



Huskies in Alaska Pull Cart Mounted on Two Oil Drums

When arctic ground thaws and becomes soft during the summer, an Eskimo at Point Barrow, Alaska, replaces his conventional dog sled with a novel vehicle. A cart with two 50-gallon oil drums as wheels

rolls him across the loose earth. His team of huskies pulls the sled in winter, when the tundra and streams are frozen, and switches to the cart when the snow disappears in early summer.

Every day new products for homes and workshops, farms and factories are appearing on the nation's markets, and every month you'll find them described in Popular Mechanics. For additional information about these products, write to Bureau of Information, Popular Mechanics, 200 East Ontario Street, Chicago 11



UNCLE SAM has gone native! The famous Everglades—the southernmost tip of Florida which includes the only tropical jungle within the United States—became the nation's 28th national park upon its dedication by President Truman

last December. This area of untamed beauty, abundant with wildlife and tropical growth, may become as famous a mecca for travel-minded Americans as Yellowstone National Park.

Included within the park boundaries are 454,400 acres of dense jungle, prairie marshland, countless islands and peninsulas crisscrossed by a maze of streams and waterways. There is only one road through the area. To see the wild regions, the giant rookeries of rare birds, visitors will travel by boat or hike along jungle trails.

The aim of the park staff is to maintain the 'Glades as a wilderness and to keep the wildlife undisturbed in its natural sur-

roundings. For that reason road building will be kept to a minimum.

But you'll be able to see the park on conducted tours by boat and on foot. Towers will be constructed to give you an eagle-eye view of the rookeries abounding in rare and odd-looking birds. You can drop a line into the rivers of the 'Glades, where more than 700 varieties of tropical fish abound. Ample fishing facilities will be available within a short time.

At present the 'Glades park is the eighth largest of the chain of national parks. But the park project—including lands expected to be added eventually—covers 2200 square miles. If this outlying land is obtained, the park will be second in size only to Yellowstone within the United States.

Most national parks feature geological phenomena such as the geysers of Yellowstone. The 'Glades will attract visitors through tropical growth and abundant wildlife.

The vast Everglades prairie is a sea of saw grass standing head-high and dotted with "hammocks" or groves of tropical trees rising out of the marshes like islands. At the mouth of Shark River is the giant

"Hammocks"—groves of trees—stand guard in a sunset over Everglades prairie. Prairie is a sea of saw grass

Uncle Sam's Jungle Playground



Riders explore the Everglades under moss-draped cypress trees. Map shows the only road through the national park and top inset shows park's relation to Florida. Below, a power boat is a popular form of transportation

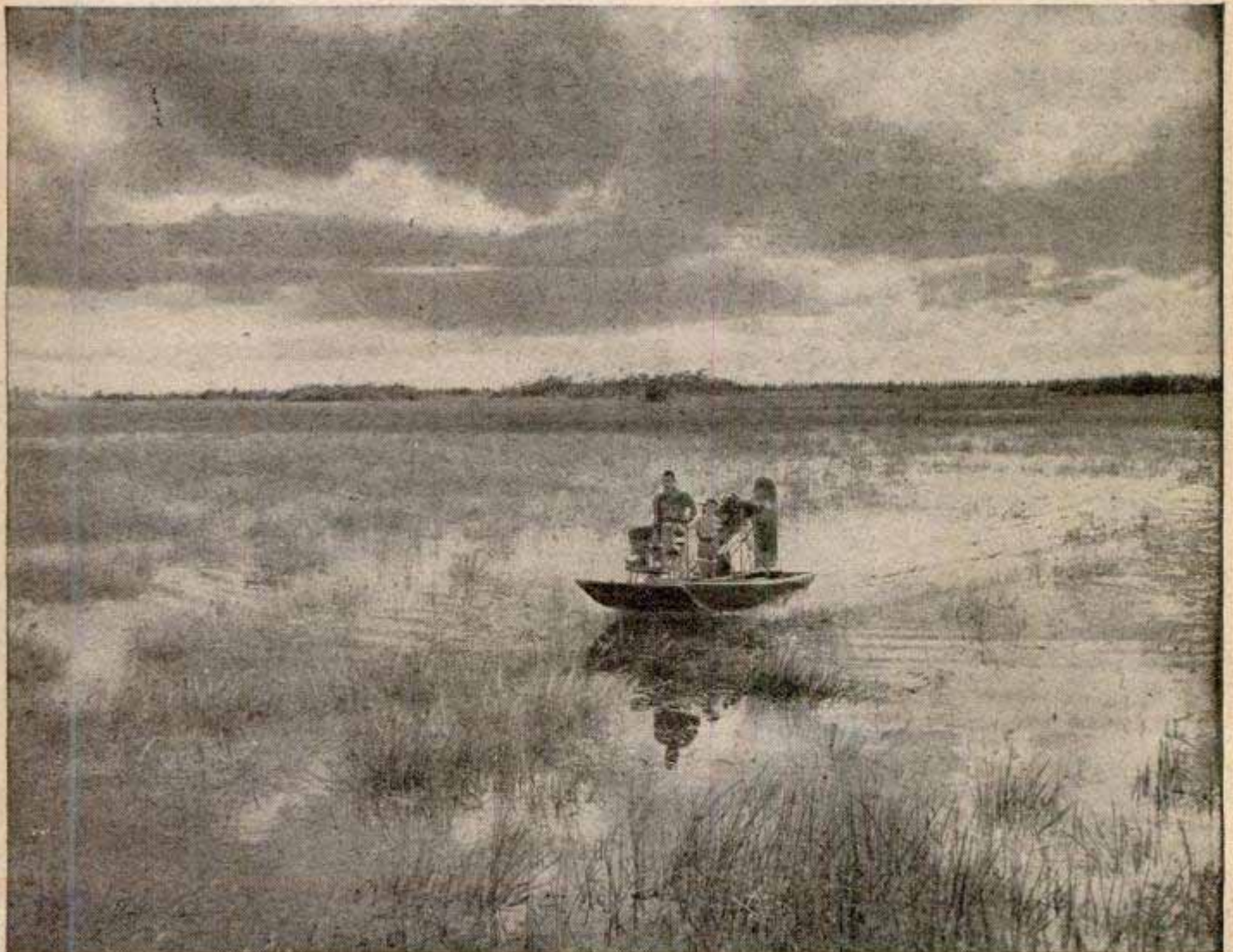

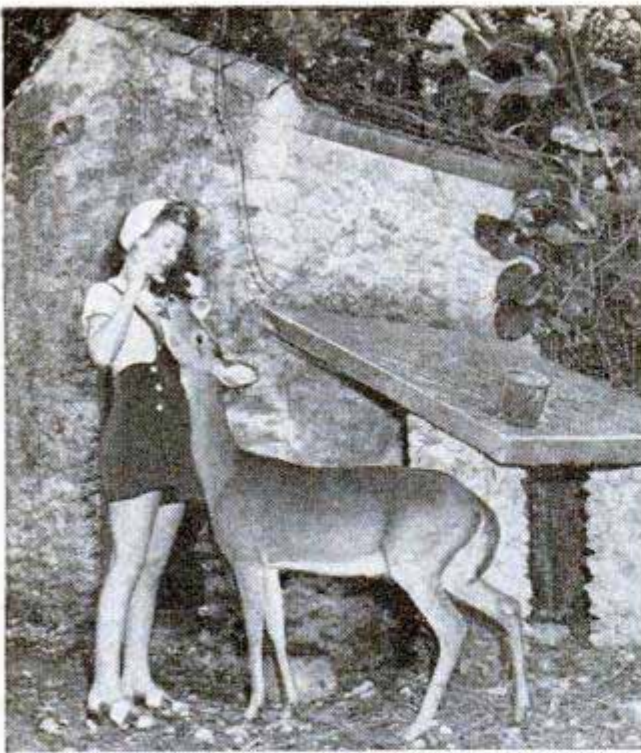

Wildlife abounds in the new playground. Here a visitor feeds a friendly doe that formerly ran wild

mangrove forest including mangroves towering more than 80 feet, three times the height of most trees of this kind.

Among the strange plants you can see are 84 varieties of orchids, which grow nowhere else in the United States, jungle cacti, ferns with fronds 15 feet long, giant Hippocratea vines with stems as large as your body and strangler vines that wrap themselves around trees, eventually choking them to death. Stands of cypress more

than 1500 years old were full-grown long before Ponce de Leon explored this area.

Birds will be the chief attraction of the 'Glades. This is the only habitat of the great white heron, a pure-white bird standing more than five feet high. Brilliant-feathered tropical birds, pelicans and waterfowl nest throughout the 'Glades.

Unusual forms of animal life include the only specimen of the crocodile within the United States. You'll see alligators in large numbers. Panthers and wildcats are making a comeback in the park area and Florida otters, raccoons and whitetail deer may explore your camping equipment.

Giant manatee, sometimes called sea cows, weighing up to 400 pounds feed on the grasses in the waterways. Sea turtles that tip the scale at 300 pounds nest along the beaches during the summer.

The Seminole Indians once fought a war with the United States and then retreated deep into the Everglades without signing a peace treaty. The park staff plans to establish a Seminole camp accessible to tourists, but no attempt will be made to lure large numbers of Indians back to the park.

At present only one road passes through the area, cutting across the peninsula from Homestead, south of Miami, to Cape Sable. Another road will be built, but its exact route has not yet been decided.

Facilities for tourists are limited at present, but eventually accommodations will be available. There'll be museums, roadside displays and lectures in addition to the escorted tours.

In the heart of the Everglades a Seminole Indian poles his dugout along waterway toward his thatched hut

Miami News Bureau photos

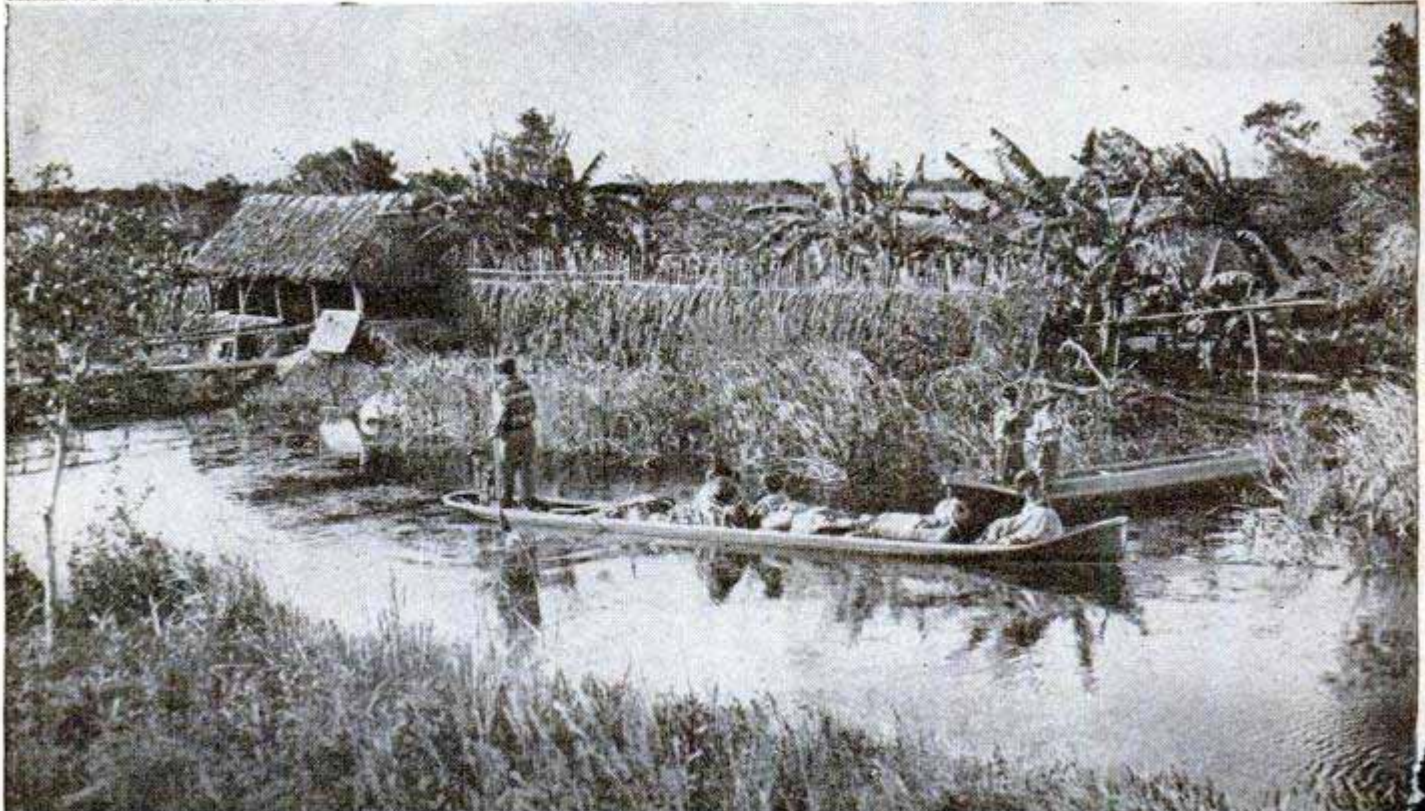



Model Steamer Tows Boat

Despite the gasoline shortage, one British boating enthusiast has discovered a way to eliminate the labor of rowing. A model builder, A. E. Squire, tows his boat with a steam-driven model of a British mine layer. Kerosene-fired, the twin-cylinder engine does 3000 r.p.m., and pulls the boat upstream without difficulty.

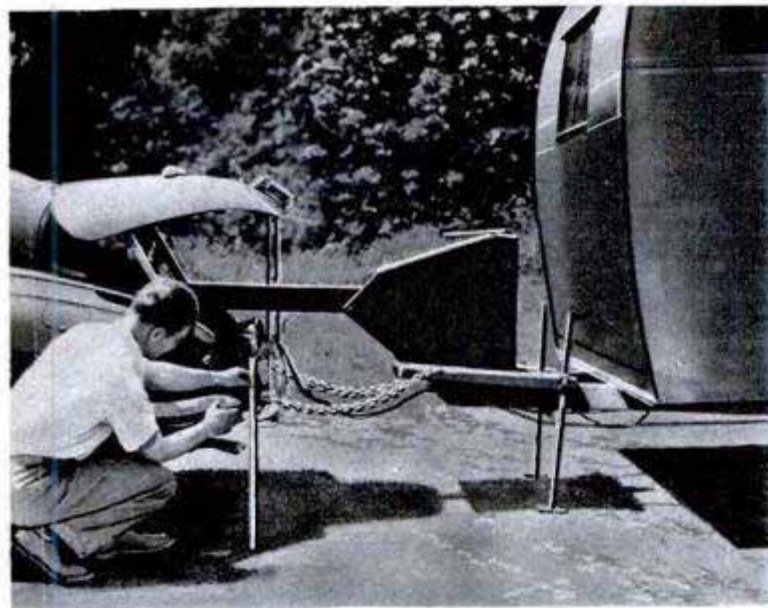
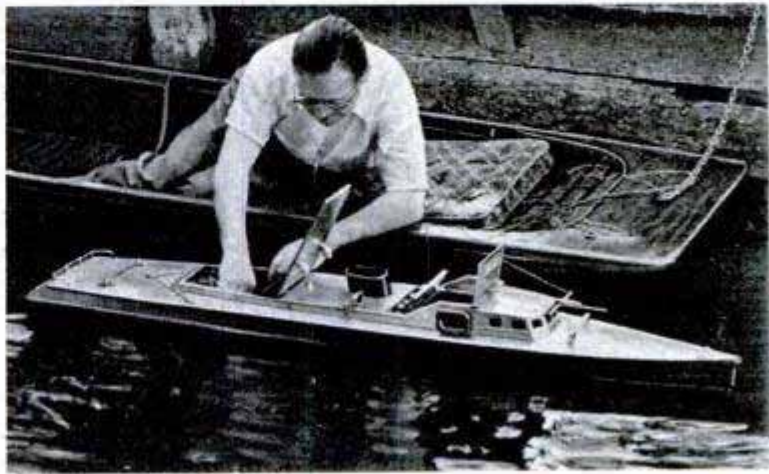

Trailer Hitch Fits in Trunk To Place Weight Over Axle

Attached directly above the rear axle, a trailer hitch moves the load forward to eliminate the need for dolly wheels, helper springs or oversize tires. Strain is removed from the bumper and rear end of the car. The tongue of the hitch connects with a ball inside the trunk, which is held open by a support when the trailer is used. A housing on the rear of the tongue permits the trailer to turn or back up with the tongue moving only an inch from the center of the trunk. Two adjustable rods support the trailer when parked.

Inflated Rowboat Weighs 62 Pounds

Weighing only 62 pounds, a 10-foot rubber boat has three independent air compartments and is sturdy enough for use with a five-horsepower outboard motor. Deflated, the boat folds into a carrying case about the size of a suitcase. The floor, a separate compartment, provides a cushion of air between the occupants and the cold water.



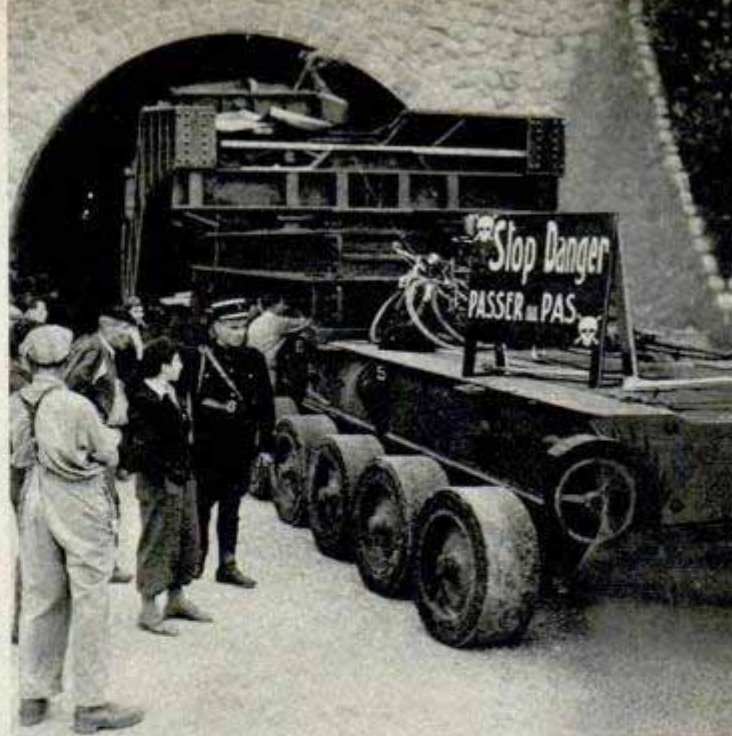

It took the crew 25 hours to inch the big generator through this mile-long tunnel on its way to the dam

Moving a Giant

Weighing 140 tons, a giant 70,000-kilowatt generator built by the French for the Genissiat dam was moved from the factory to the dam along a route that provided minimum clearances in many places. Two former German tank trailers plus two powerful tractors were used to transport the tremendous machine. Installation was completed six months ahead of schedule.

← With its huge load, the long vehicle stretches about a city block. Below, metal lining plates in the tunnel were removed to get necessary clearance

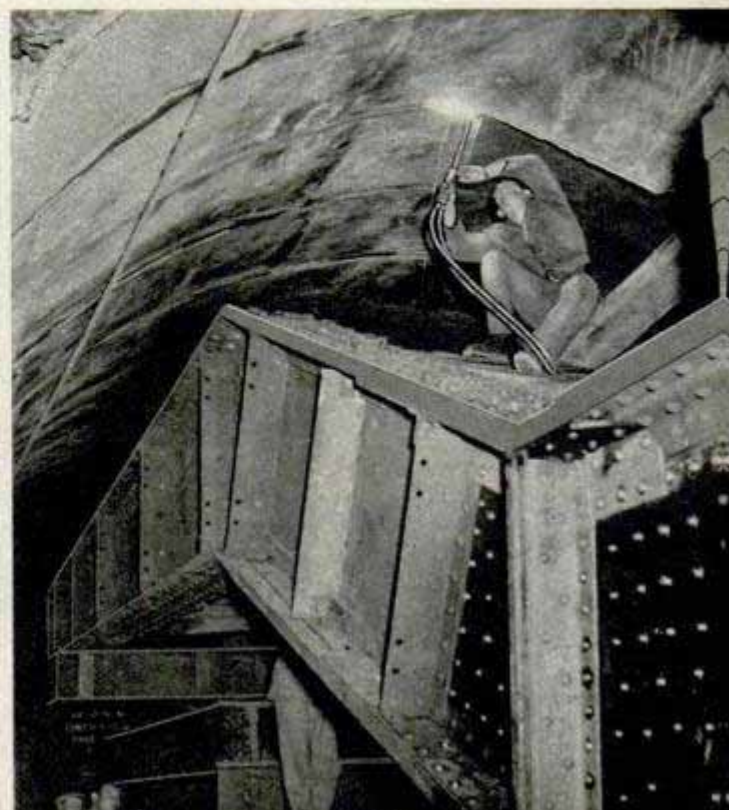

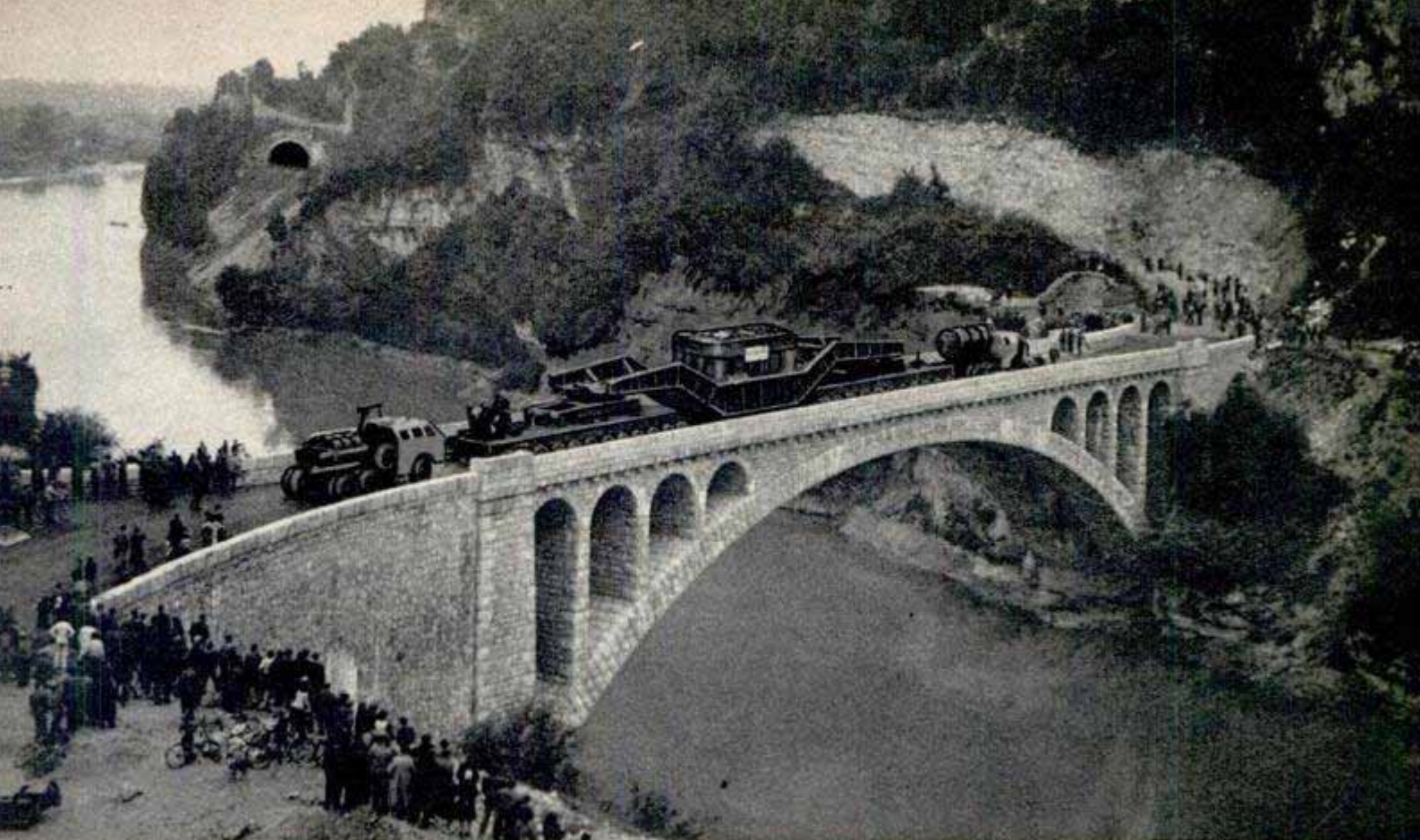

The tremendous weight caused this single-span bridge across the Rhone to sag only a fraction of an inch. With only one inch of clearance in this narrow street at Yenne, the expert drivers got the huge generator through without damage. A drainpipe on one of the houses was the only thing that was removed by the crew.



CALL AIRCRAFT CO.
AFTON, WYOMING

Even in a snowplane, snowshoes are handy to have with you. Toothed bar under body is used for braking



Windjammers of the Snowdrifts

BARKING HUSKIES and cries of "Mush" soon may be heard only in movies as the mechanical windjammers of the snowdrifts invade the Northwest.

The invaders are three-legged, insect-like snowplanes that skim over deep snow on broad skis at speeds that make dog teams look like sluggish glaciers. Called snowplanes, snowmobiles, snowcars, skeeters and other names, the windjammers look like wingless aircraft that, like the kiwi, run swiftly but never fly.

Although windjammers are not new in principle, it took the lightweight, small airplane engine to bring weights down to a low pound-per-horsepower ratio and provide pow-

er to skim through heavy snow.

When the snow is right, anything will skid over it, but plenty of power and little weight are indispensable for "planing" under bad conditions.

Western ranchers have found in the windjammer a solution to winter transportation problems. Instead of hibernating through the snowbound winter months,

At the end of the plowed road mail is transferred from the truck to a waiting snowplane





Rough country like this is as good as a highway for the lightweight windjammers of the snow

they climb into a snowplane and speed over the snow as fast as they travel in summer on gravel roads.

Star-route mail carriers once used saddle horses and relays of teams and sleds to cover as little as 35 miles a day. That made deliveries slow through the winter. Now they use snowplanes and the mail goes through quickly all year 'round.

But at times windjammers serve more exciting purposes than mail-carrying. One day last winter a storm struck without warning in the Snake River Canyon in Wyoming. A forest-service plane, out counting wild game in the trackless snow, was lost between Jackson Hole and Star Valley. The storm made air search impossible and volunteers prepared to snowshoe into the peaks.

Then the windjammers came to the rescue. They went skimming through narrow corridors the length of the canyon and scurried up tributary slopes.

While snowplanes were searching the area, a government trapper, Sam Young, Jr., telephoned into forest-service headquarters that he had located a survivor, alive but unconscious, in the snow. Immediate medical aid

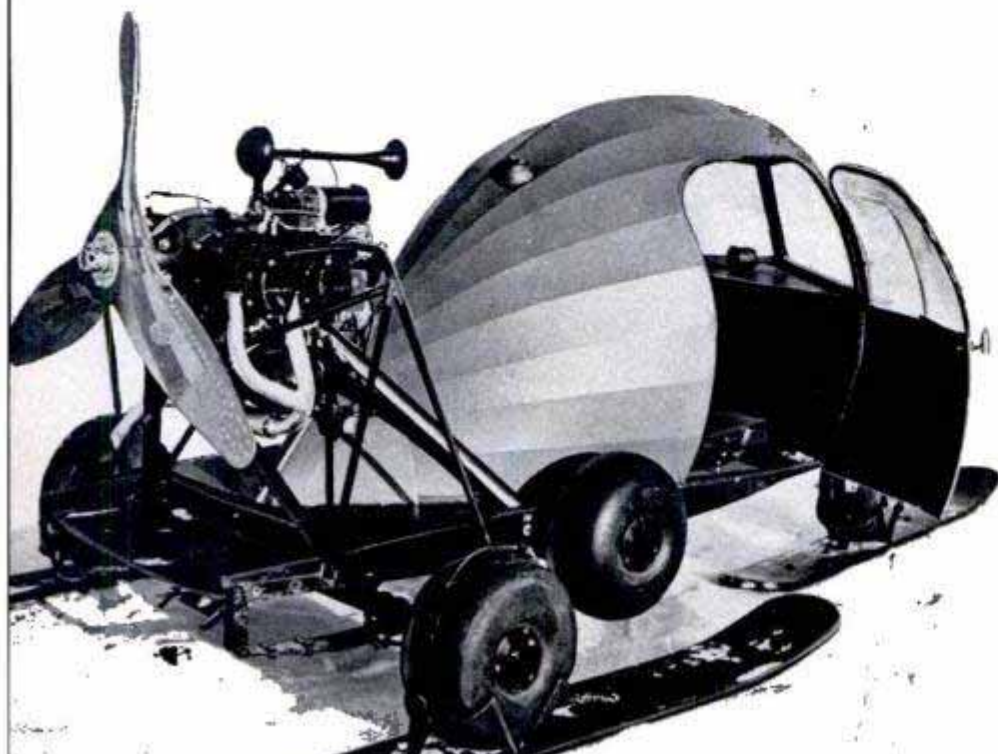

Detachable skis quickly convert wheeled snowplane for travel on snow-covered fields



This 400-pound snowcar carries two people at speeds up to 85 m.p.h.

was needed. Additional snowplanes were called into service. Hauled by truck over open highways to Alpine, they started up the trail to the wreck. Thirty-two miles up the snowbound canyon, one of them picked up the injured man and rushed him to a hospital before morning. Without the speedy windjammer the rescue would have taken several days.

Two well-known manufacturers of snowplanes are Fred Abercrombie of Jackson and Reuel Call of Afton, Wyo. The Call company builds six models carrying from one to six passengers and capable of speeds up to 90 miles an hour.

Dozens of snowplanes have been built in farm blacksmith shops and small ga-

Because of their light weight and wide runners, snowplanes have become a favorite with fishermen for transportation over frozen lakes



rages. They vary widely in appearance and power. The trend now is toward factory-built products ranging in price from \$750 to \$2500. Very popular for deep-snow driving is the two-place CallAir Car, an 85-horsepower model that weighs less than 400 pounds and sails over the snow like a leaf in the wind.

At Jackson, Sheriff Olin Emory has an Abercrombie Snowcar that he uses for mercy errands and law-enforcement. Most ranchers and stockmen live miles from any open road in winter but the sheriff makes his rounds quickly with the snowplane.

Game wardens patrol with them and conservation officials have found them indispensable for the winter task

of counting elk and deer.

Some models have wheels for use on snowless highways. When it's necessary to leave the road for snow-covered trails or fields, detachable skis that fit over the wheels are attached to the versatile vehicles. It takes less than five minutes to change over from wheels to skis.

Although speed depends on terrain, snow and wind conditions, it is not unusual for a snowplane to travel from Swan Valley, Ida., over Teton Pass, 9000 feet high, to Jackson, a distance of 50 miles, in less than two hours. On level roads, some 50-mile trips have taken less than an hour.

Some high-powered units have been clocked at 85 miles an hour on perfect snow in calm air. With a strong tail wind, snowplanes have whipped along at 100 miles an hour. On wheels they will go faster than it is safe to drive them on ordinary roads, but snowplane experts believe that on a course such as the Bonneville Salt Flats they might exceed 125 miles an hour.

Airplane-type throttles and front-ski steering are used in most models. The front ski is mounted off-center to compensate for propeller torque.

The roar of airplane motors and the whirr of spinning propellers may not be as picturesque as the bark of Eskimo dogs, but the Northwest is converting to snowplanes just the same. The windjammers get there—and fast.

Glass "Popcorn" Lightens Plaster

Seven tons of useless weight are eliminated in a seven-room house by the use of a lightweight plaster aggregate instead of sand. The new material is composed of tiny glass globules formed by heating volcanic glass to 2500 degrees Fahrenheit. When subjected to this terrific heat, the raw ore, called perlite, "pops" like corn to form tiny glass spheres. The ore is extracted from a mountain of volcanic glass in central Oregon that contains at least 20 years' supply of the nonmetallic material. After popping, the material weighs only 12 pounds per cubic foot as compared with



Insert shows how "popping" expands and whitens ore for mixing with plaster

sand's weight of 85 pounds per cubic foot. Plaster made with the new aggregate is highly resistant to checking and cracking.



Coiled Wire Springs Form Tires

Cyclists have no worries about punctures when riding on tires made of coiled springs such as those exhibited at the recent Paris Fair. The shortage of rubber tires in France led to the invention of this metallic substitute. Claimed to be as easy-riding as pneumatic tires, the steel tire has long-wearing qualities.

Camera That Took the Pictures Used to Make Enlargements →

Enlargements can be made with the same camera that took the pictures by means of a new enlarger. The enlarger is designed to use the lens and bellows of any camera with a removable back or one that opens 180 degrees. The camera is fastened to the bottom of the lamp house and the film placed in a glass carrier that racks up and down inside the lamp house for focusing. The movable film carrier permits use of fixed-focus equipment such as box cameras. Metal masks to fit popular camera sizes are provided with the enlarger.

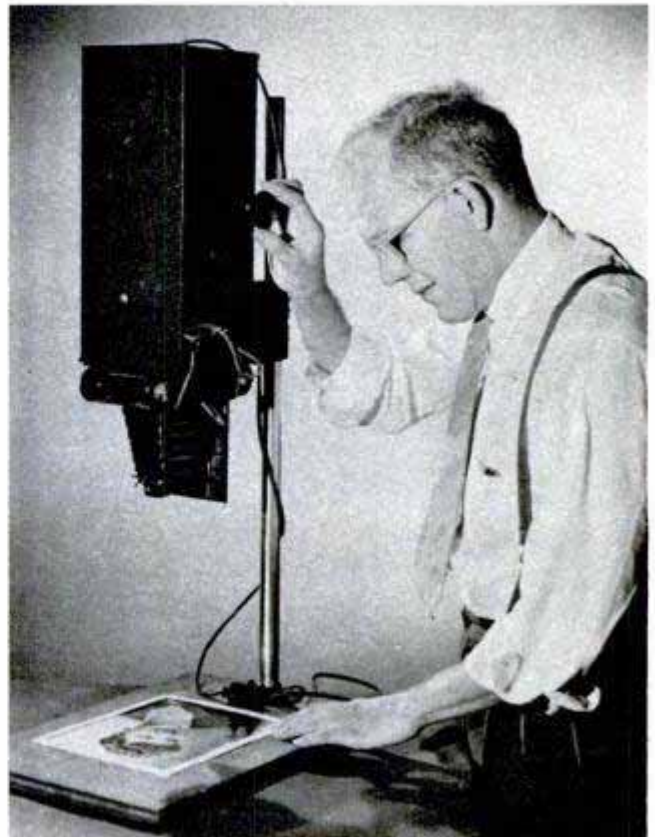



Baby Bottle Warmer for Trains

Mothers traveling with infants have the convenience of warming baby bottles at their seats with bottle warmers provided on Chesapeake and Ohio trains. The warmer is an aluminum block with spaces for the bottle and a hermetically sealed heating unit. The heating unit is dropped into the warmer and another tube placed on top of it which acts as a starter. A chemical action then warms the bottle. The warmer is small enough to be placed on the window sill beside the seat and heats the bottle to 102 degrees in three minutes.



Boom Spray Covers Wide Strip

Spraying several acres a day is possible with a portable sprayer equipped with a wide boom. Constructed at Michigan State College, the sprayer is used to apply 2, 4-D and other concentrates to lawns, pastures and cornfields. A five-gallon hand sprayer, mounted on a garden cultivator, is connected by rubber hose to the boom made of $\frac{1}{8}$ -inch pipe. An automobile gasoline filter in the line prevents clogging of the fan-type nozzles mounted at 18-inch intervals. Nozzles can be adjusted to use as little as six gallons per acre.

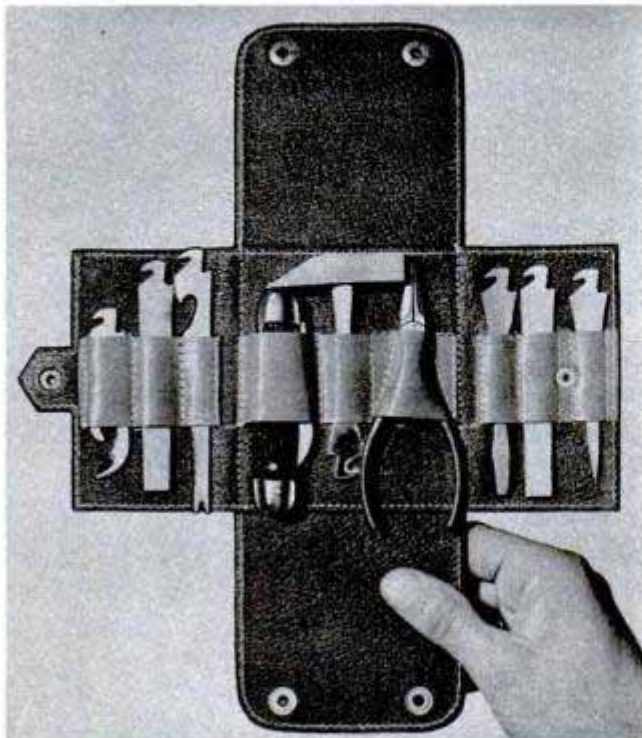

Pocket-Size Tool Kit

Nine tools are included in a pocket-size tool kit made of cowhide. The tools are jackknife, hammer, combination can opener and cap lifter, awl, chisel, screwdriver, flat file, scaler, disgorger and pliers. The jackknife serves as the handle for each tool which is equipped with a hook to attach to the knife.

"Toe Gauge" Records Blood Pressure

Blood pressure changes sufficient to alter the size of toes and fingers are measured by a newly devised plethysmograph. The patient's toe, or finger, is placed in a small cup which is sealed around that member. As the heart beats, pumping blood into the finger, the finger expands. This forces air out of the cup into a tube and to a recording device. The air "writes" a record of the change in the size of the finger as the blood flows in and out.

Air-Cooling System Provides Hot Water

Warm air in a house provides heat for an experimental water heater that may, after further development, air condition the entire house. Designed by J. C. Sharp of Hotpoint, Inc., the "heat pump," which is not yet perfected, reverses the function of a refrigerator. Freon, such as used in refrigerators, is piped into a coil in the room where it absorbs heat, becomes warm and evaporates, cooling and dehumidifying the room at the same time. The Freon, now a gas, is compressed by an electric pump further increasing its temperature. Pumped through coils in the water heater, the gas

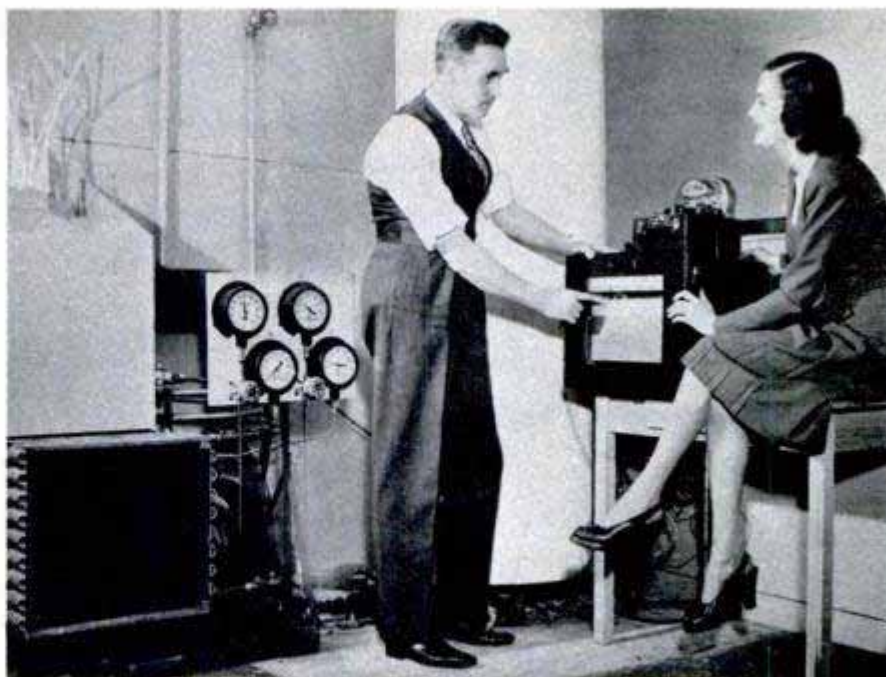

releases its heat to the water and is condensed. A liquid again, the Freon returns to the room coil and the cycle is repeated.

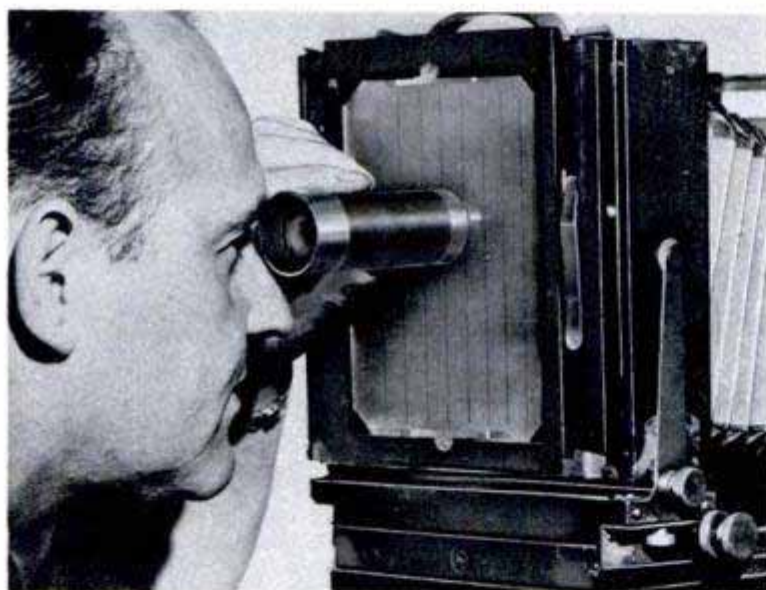

Magnifier Aids Focusing Of Ground-Glass Camera

Precise focusing without eye-strain is possible with a magnifying tube designed for use with any camera using ground-glass focusing. Placed against the ground glass, the fixed-focus magnifier brings the reflex image into sharp relief making critical focusing easy. The coated lens produces 3.5 magnification and can be used also in photomicrography and reflex focusing for enlarging. A flannel carrying pouch is provided with the tube to protect its exterior which is highly polished.

Guard on Posthole Digger Pushes Fence Out of Way

Attached to a tractor-operated posthole digger is a guard which holds fencing out of the way while the operator digs holes in a fence row. Other features are a cone clutch control to increase digging speed and forward and backward adjustments for hillside and angle digging and for such jobs as setting out trees, digging drainage ditches and for foundation digging.



It would take 40 "grain-of-wheat" lamps, used by surgeons in exploring body cavities, to produce as much light as a match.

Cut a Figure on Ice

By Roy Shipstad

The author, of Ice Follies fame, executes a "ball of twine" on ice blackened for the camera with ink

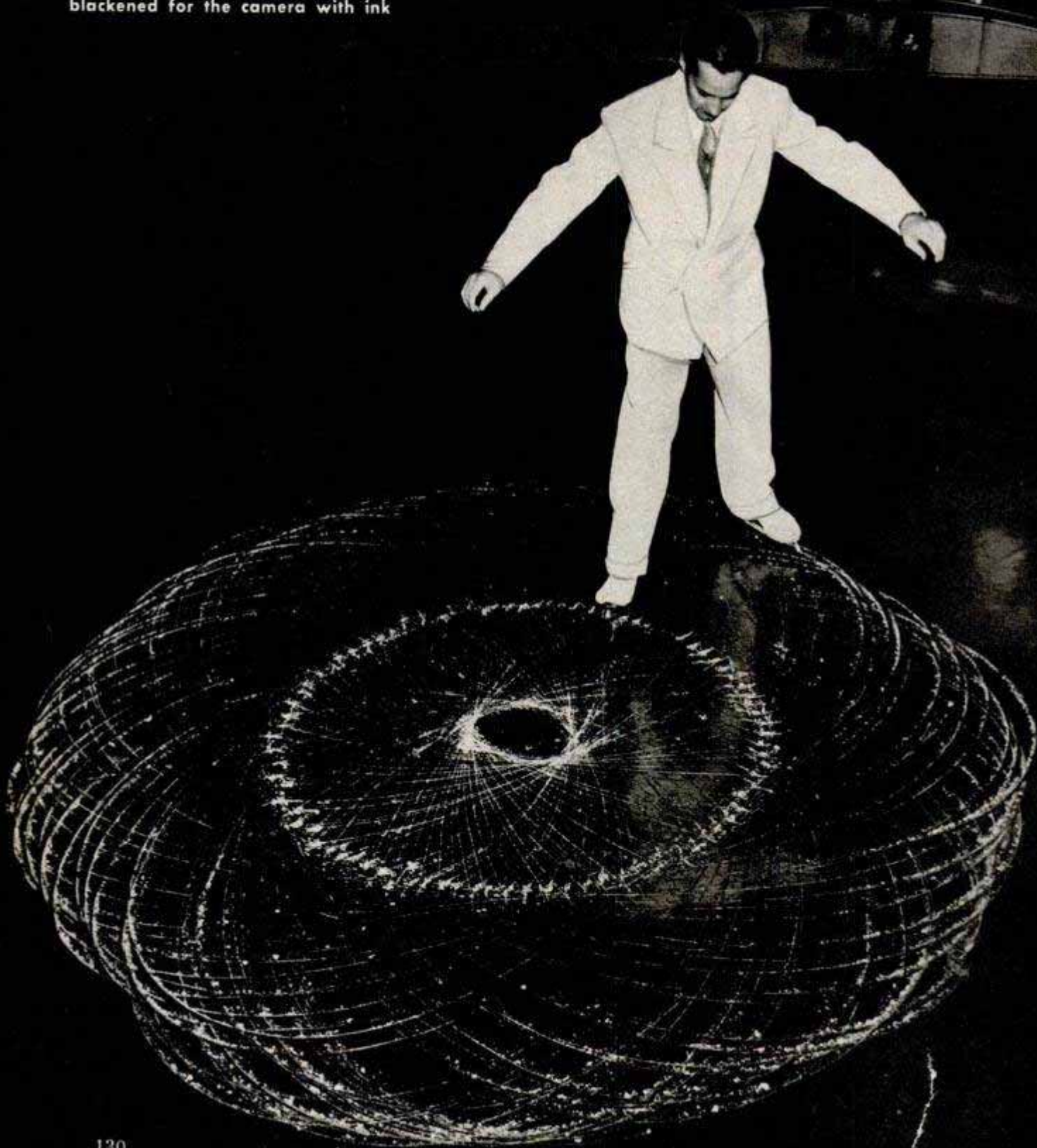

ICE SKATING'S biggest thrill, I believe, comes when you discover how easy it is to glide and swoop and turn on the ice, doing all sorts of stunts that are impossible on dry land.

What surprises you most is that you haven't had to learn anything really new; you are merely taking advantage of your natural sense of balance. The hardest part comes later when you strive for perfection, rehearsing a certain figure over and over again until you can do it exactly the same each time.

The first thing you need for good control is a pair of figure skates. These are hollow ground so that each blade has two edges. Their advantage is that when you use both edges you travel straight ahead and when you use one edge you curve in its direction. The teeth on the toe of the figure skate allow you to retard your speed when moving backward, to dig into the ice preparatory to a jump, to do scratch spins, and other kinds of toe work.

In the following paragraphs, remember that "right outside forward edge" means that you are to use the right foot, the outside edge of that blade, and that you are moving forward. "Left inside backward edge" means that you are moving backward on the inside edge of the left blade.

One of the easiest positions, after you have gained enough confidence to glide on one foot, is the so-called spiral. In this you move across the ice with arms outstretched and one leg stretched out behind. It may be done on either edge of either foot. Arch your back and raise one leg out behind while you are moving across the ice. This forces your body forward. Stretch your arms out at the same time and you are in the correct position. If you use the inside edge of the right foot you will travel in a spiral to the left, if you are using the right outside edge you spiral toward the right.

It is important in all skating to maintain a natural upright position except when you are trying such a posture as the spiral or are crouching for speed. You can compensate for most body motions with knee action. Always carry your shoulders level. If you don't, you will be off balance.

The Figure 8 is one of the basic school figures and when you learn to do it properly you'll have a good basis for more complicated maneuvers. The 8 consists of two lobes or circles, one of which you make with your right foot, the second with your left.

After selecting a spot on the ice that is to be the center of your Figure 8,



Mr. and Mrs. Harris Legg cut a fancy figure on stilts; note how steel brace from skate is secured to foreleg. Below, twin skaters shackled foot-to-foot and at wrists





It's the skate edge that counts when cutting a perfect Figure 8. Below, Harris Legg sprays cloud of ice in coming to stop after leap



strike out with a right outside forward edge. Your arms are stretched out and your shoulders and hips are turned away from the circle you are to make. As you glide, slowly rotate your shoulders and hips and gradually bring your unemployed leg forward. This causes you to move in a circle that should bring you back to your starting point. Here you strike out again, this time on the left outer edge. This edge turns you away from the first lobe and starts your second lobe. Complete it by rotating your body the same as in the first lobe. Each lobe should be about 15 feet in diameter.

The 8 sounds easy and it is, but it takes practice. Here are a few tips: your weight should be in the center of the skate or a shade back of center. Don't change your balance or raise or bend your knee during a lobe as this will make you wobble and spoil the pattern. It's well to have brought your arms, shoulders and hips entirely around by the time you complete the first lobe so that they can start your body in the opposite direction for the second lobe.

In all, there are four different ways to make a Figure 8. The above description uses the right and left outer edges. You can do the same figure with the inner edges and you can also do it with each edge while moving backward. You start a backward glide by pushing off with the free foot.

All figures such as the 8 must be traced three times in competitive skating and the judges watch to see how closely you can make your tracings look like one line. They watch you, too, for style and grace.

After you have mastered the 8 you should practice the turn used in making the Figure 3. The start is just as if you were going to make a Figure 8, using the right or left outside forward edge, depending on whether you are starting at the top or bottom of the 3. Your shoulders and hips come around more rap-

idly and you have rotated your body to the right (or left) by the time the lobe is half complete. This allows you to turn your skate on the ice so that you are traveling backward. (See illustration.) Shift to the inner edge and you continue to travel in an arc that will complete the lobe. Upon completing the first 3, strike out again, make the 3 turn, and finish the figure to make a pair of 3s somewhat resembling a Figure 8.

It's best to take lessons in figure skating and you can learn a good deal just by watching accomplished figure skaters on the ice. Notice how they control the patterns they make by the way they turn their arms and shoulders. Most people who take lessons are interested mainly in learning to skate to music in couples as in ballroom dancing, but if you learn how to use your edges and how to make 3 turns you can soon learn to skate to music.

One spectacular stunt is to spin like a top on the ice. It's not as hard as it looks. Try it first with both feet, standing flat-footed and a bit pigeon-toed. With your arms extended wide, twist your arms and shoulders to one side and then whirl them around in the opposite direction. This starts you spinning. When you begin to slow down, draw your arms in closer to your body and to your surprise you will pick up speed. Try lifting one foot and spinning on the other, rising slightly on your toe to cut down friction.

Bringing your arms in close to your body is the secret of a high-speed spin. You can start slowly with your arms outstretched, bring them in for speed, then extend them again to slow down. I've made 85 revolutions from a standing start simply by the control that the arms provide.

To do a sit spin, start to spin on one leg and then bend your knee and extend the unemployed leg, keeping the knees far apart. Pull the unemployed leg in slowly when you want more speed. Another way to get speed and revolutions is to start with your head tipped forward and slowly bring it up to its usual position. It's best to take a number of steps in the opposite direction when finishing a spin, to recover from your natural dizziness.

One simple trick is to glide across the ice from a standing start without any apparent movement of the body. Start with your feet close together and with your toes pointed out only a few degrees. Exert pressure as if you were trying to push your feet apart. The run of the blades keeps your feet from spreading and so you begin to move ahead, almost, it seems, by magic. An expert skater can glide 20 feet or more while the distance between his feet gradually widens to six or seven inches.

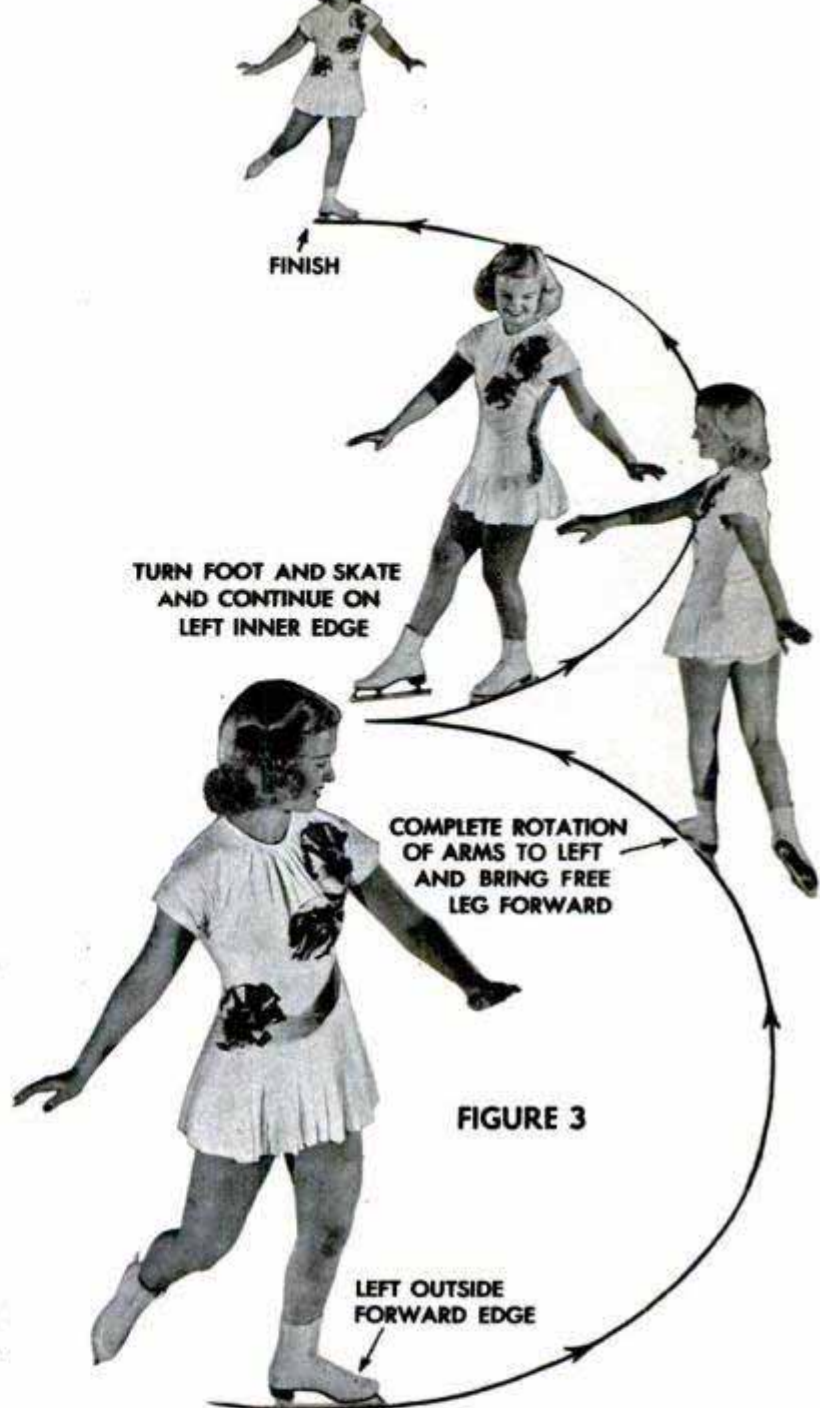

Half forward, half backward—the graceful Figure 3. Below, Evelyn Chandler does gliding “one-foot crouch”





Left, like a human top, Geraldine Huesing of Chicago Figure Skating Club performs difficult layback spin. Right, twin skaters show how beginner at left can be supported on the ice with partner's arm under her elbow

Being able to come to an abrupt stop from high speed is something that everyone should learn. The easiest way to stop is simply to turn your back foot at right angles and hold the blade down flat, making it skid sideways and bringing you to a slow stop. You will stop much faster by turning both feet sideways and keeping them parallel, bending your knees at the same time to keep your balance. Both

blades skid across the ice and you come to a stop in less than a foot. Expert skaters send the ice flying when they come to an abrupt stop by jumping at high speed and then landing with their feet turned sideways. The blades dig in and skid and the ice flies up in a cloud.

Everyone can expect a fall on the ice now and then. Even an experienced skater may take numerous falls while rehearsing a new stunt but he is rarely hurt. One of the first things to learn is to go limp when you lose your balance and allow your whole body to absorb the shock. If you relax when you fall it won't hurt nearly as much as you expected.

Boots that fit properly are extremely important. A skater should wear medium-weight socks and should lace each boot not too tightly, but firmly enough so that it feels like part of the foot. Loose boots cause spills and sprained ankles. Many more people would have confidence on the ice if they were careful to be properly fitted.

Roy Shipstad goes into his famed spin on right foot which is lifted as he starts whirl. Note the arm position



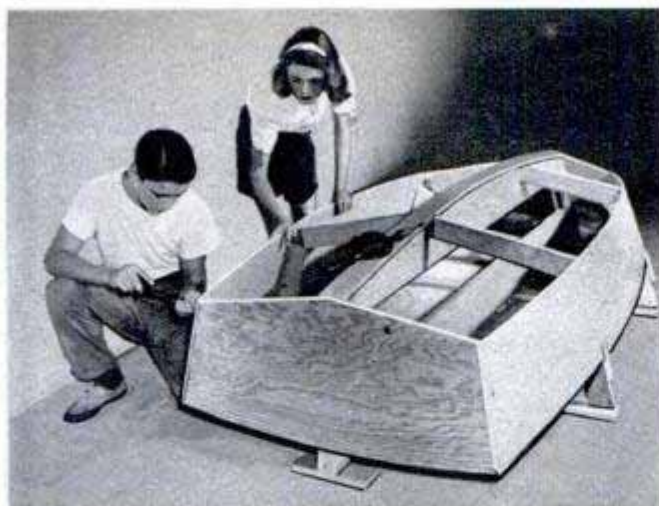

Top, your basement becomes a boat yard with the easy-to-assemble kit. Left, the plywood boat is roomy and has ample freeboard for safety. Right, an additional kit can be used to convert it into a sailing dinghy.

Eight-Foot Plywood Boat Is Built From Precut Kit

All construction materials for building a small boat are packaged in a kit with the major parts pre-cut from plywood. Only a screwdriver, drill and plane are needed to assemble the boat, which measures eight feet long and has a 48-inch beam and 16-inch inside depth. The dinghy is built on

construction frames that are supplied with the kit. Weighing only 65 pounds, it will accommodate a two-horsepower motor and can be converted to a sailboat with a conversion kit that includes a mast, boom, flooring, tiller, centerboard and rudder. The sides and bottom are $\frac{1}{4}$ -inch plywood.

British Station Wagon Runs at Low Cost on Electricity

Operated for about one cent a mile, a British station wagon is powered by an electric motor and seats 12 adults. Designed for short trips, the vehicle cruises at 20 miles an hour and goes 60 miles on a battery charge. As a school bus, the station wagon seats 20 children. An unusual electrical circuit provides a gearless shift system. Two strokes of the control pedal are necessary to accelerate from a stop to full speed. The first stroke, with the two halves of the battery in parallel, draws only half the full voltage. The second stroke, connecting the battery in series, draws full voltage to provide maximum speed.

Photo from Associated British Oil Engines, Ltd.

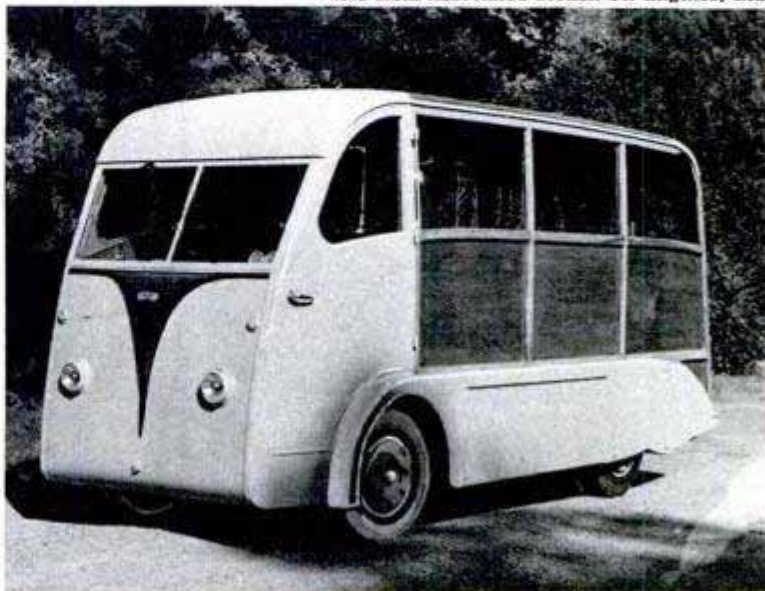



Foot Massaged by Rubber Ball

Tired feet are massaged by a hand-operated machine that rolls a rubber ball gently back and forth under the arch of the foot. The metal base has an adjustable heel rest and a wide strap holds the toes in the proper position during the treatment. Moving the handle back and forth rolls the ball across the bottom of the foot.

Loud-Speaker for Dictating Machine

By the use of a loud-speaker attachment, secretaries working with dictating machines do not need earphones while transcribing dictation. Loud enough to be heard two or three feet away, the speaker has an adjustable volume control. The earphones can be used when material of a confidential nature is being typed.

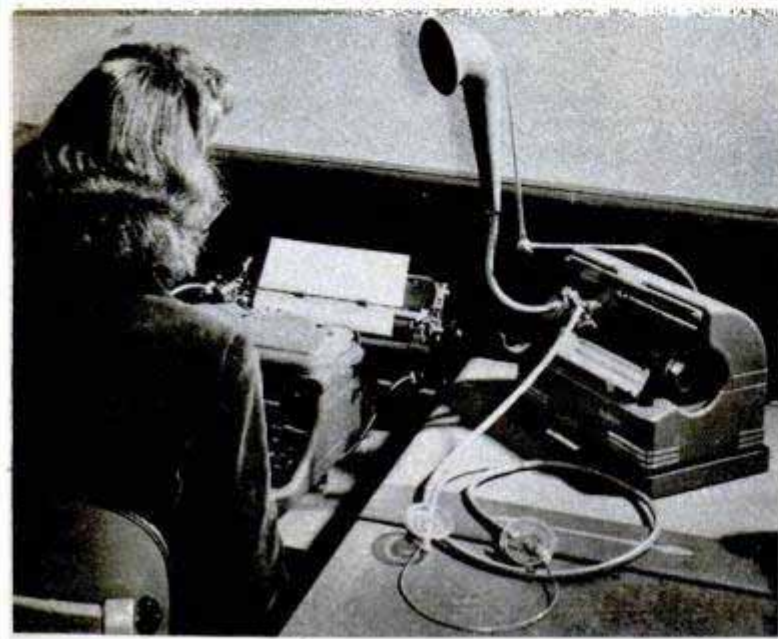

Plastic Bag Keeps Brush Soft

Paintbrushes can be put away without cleaning when placed inside an airtight Pliofilm container. An elastic band at the top of the container keeps the air from drying paint left on the bristles and provides a means of hanging the brushes. Brushes are kept soft and ready for use.

Disks Renew Worn Valve Seats

Valve seats are ground and polished quickly with a reseating tool that uses aluminum-oxide disks mounted on each side of a thin steel body. The disks are rotated by any brace equipped with a screwdriver bit. One side of the tool is a coarse abrasive for removing defects; the other is a polishing abrasive. The tools are packed in a kit that includes eight sizes.

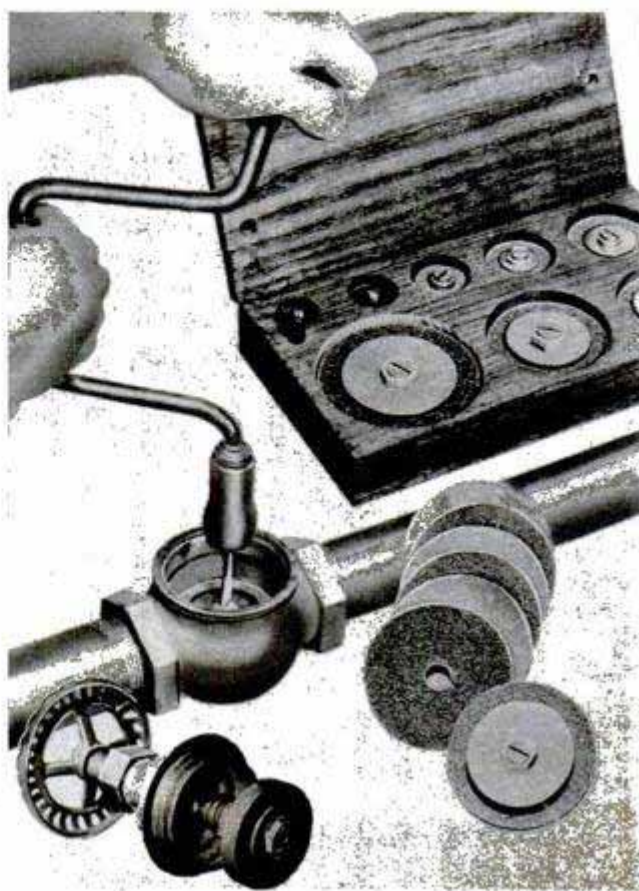



Midget Generator Produces 12,000 Volts

Weighing less than a pound, a high-voltage generator based on the principle of the Wimshurst induction generator produces 12,000 volts direct current from a six-volt battery. Designed in Germany, the new generator operates on the basic theory that unlike charges attract, like charges repel. The pocket-sized generator has a diameter of 4½ inches. A larger model delivers 30,000 volts and there is apparently no limit to the size that can be built to operate on the Wimshurst principle. Two layers of tin-foil strips are embedded in a plastic rotary disk and act alternately as inductors and carriers. Beneath the rotor are four aluminum plates, two of which are inductor plates and two storing plates. Directly above the rotor are four similar plates. A bound positive charge is induced on the foil as it passes over the negative inductor plate and free negative charges escape along a neu-

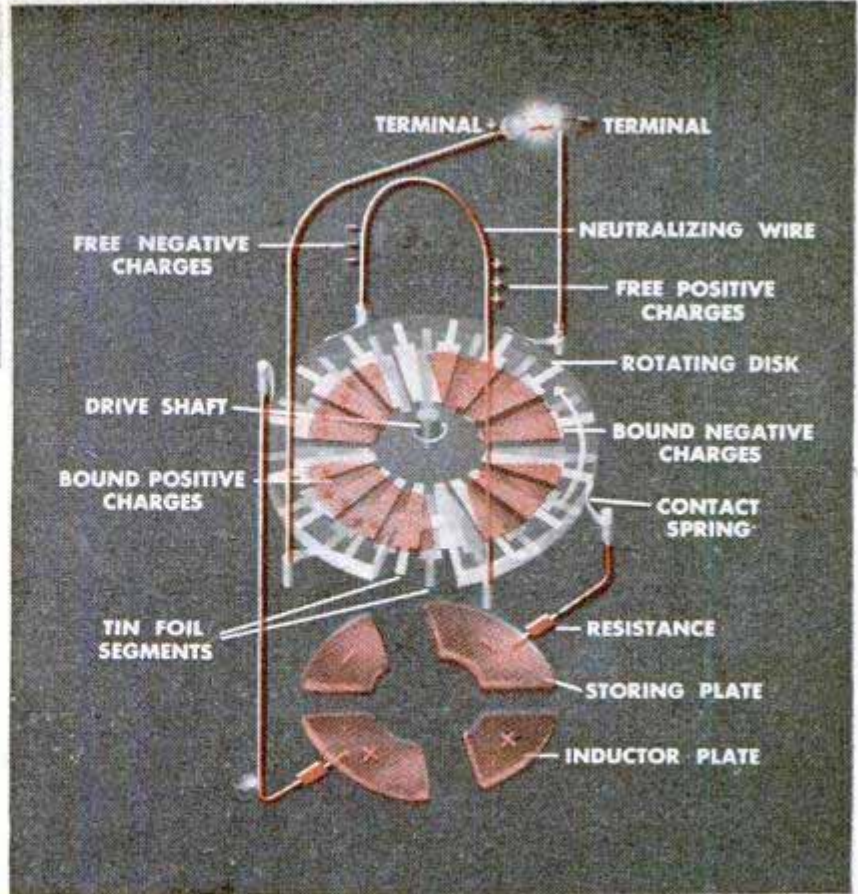

tralizing wire. The positive charge is shared with the storage plate through a contact spring connection. Just before it passes beyond the field of the storing plate, the foil touches a second spring leading to the terminal. The positive charge on the storing plate kicks the now unbound positive charge on the foil onto the terminal. A similar reaction is used to charge the negative terminal. The device may have important consequences in the problem of long-distance power transmission.

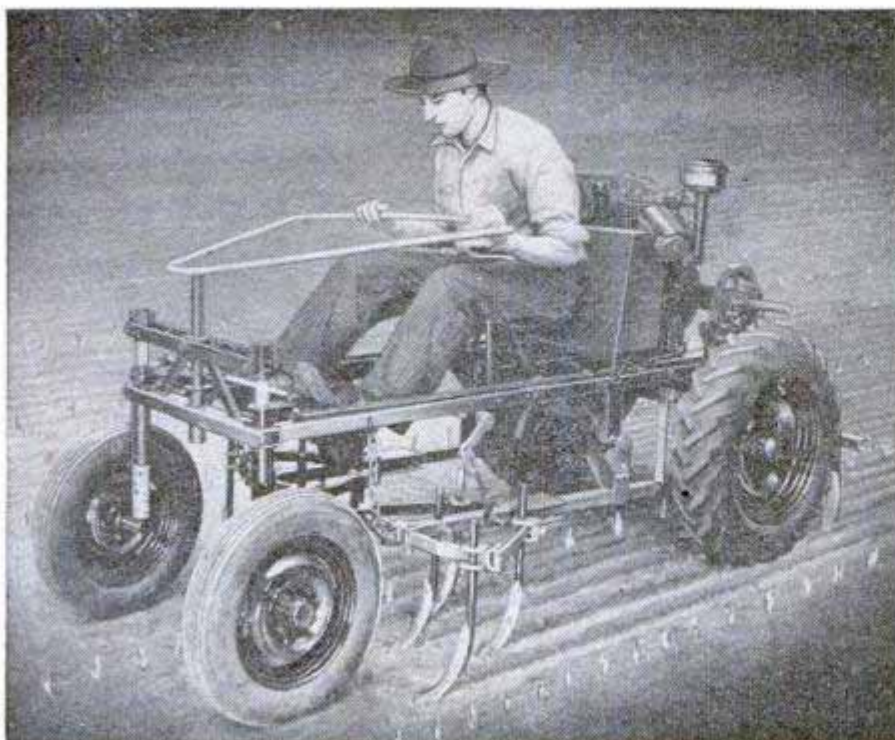

Fuel-Saving Tractor Has Engine in Rear

With the motor mounted in the rear, a lightweight tractor allows unobstructed vision from the driver's seat. The 1000-pound tractor has a triangular steering bar instead of the conventional wheel and it provides a crop clearance of 22 inches. Knee-action wheels keep the tractor level on uneven ground. For use between rows, the rear wheels can be adjusted for any width between 36 and 46 inches. The small, six-horsepower engine has a low fuel consumption.



WHAT'S NEW *For Your Home*

A four-page "shopping section"
dedicated to modern homemakers

SPLASHLESS WATER pours out of any faucet when an aerator is used to add millions of air bubbles to the liquid. The foamy water clings to all surfaces without splashing and it lathers rapidly with less soap

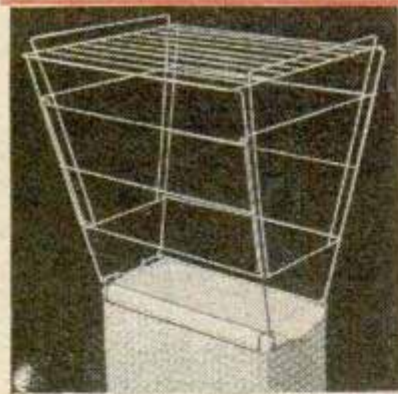

FOLDING CLOTHES DRIER provides 42 feet of drying space. Although designed to be used atop an electric heater, it can be set up by itself

KEYLESS DOOR LOCK opens when the correct combination is tapped out on push buttons. Lever below the knob is turned to lock the door

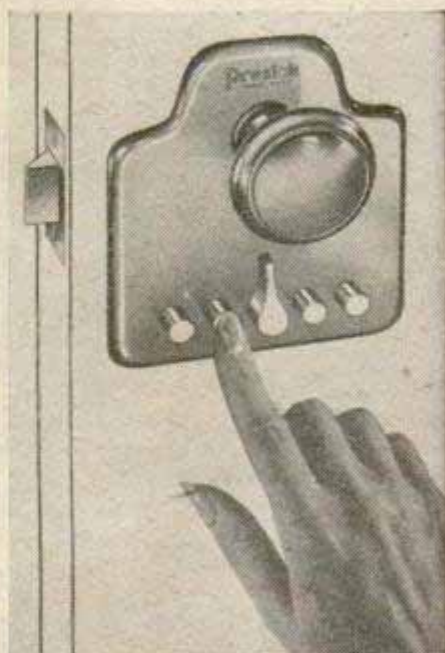

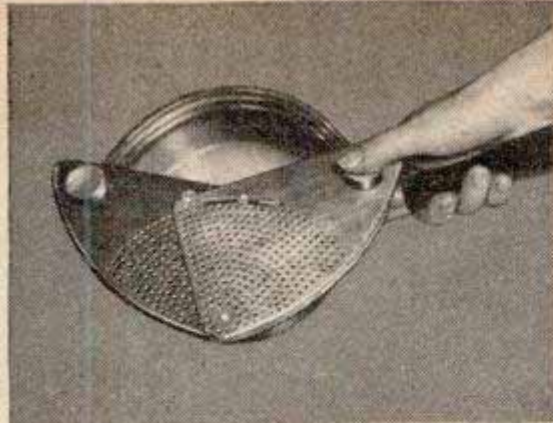

FOLDING STRAINER fits almost any pan. Two nonburn knobs are used to clamp it in place for pouring



ROLLER SHARPENER rolls an edge. The knife blade is placed in the groove between the stones and the sharpener is rolled along the table surface

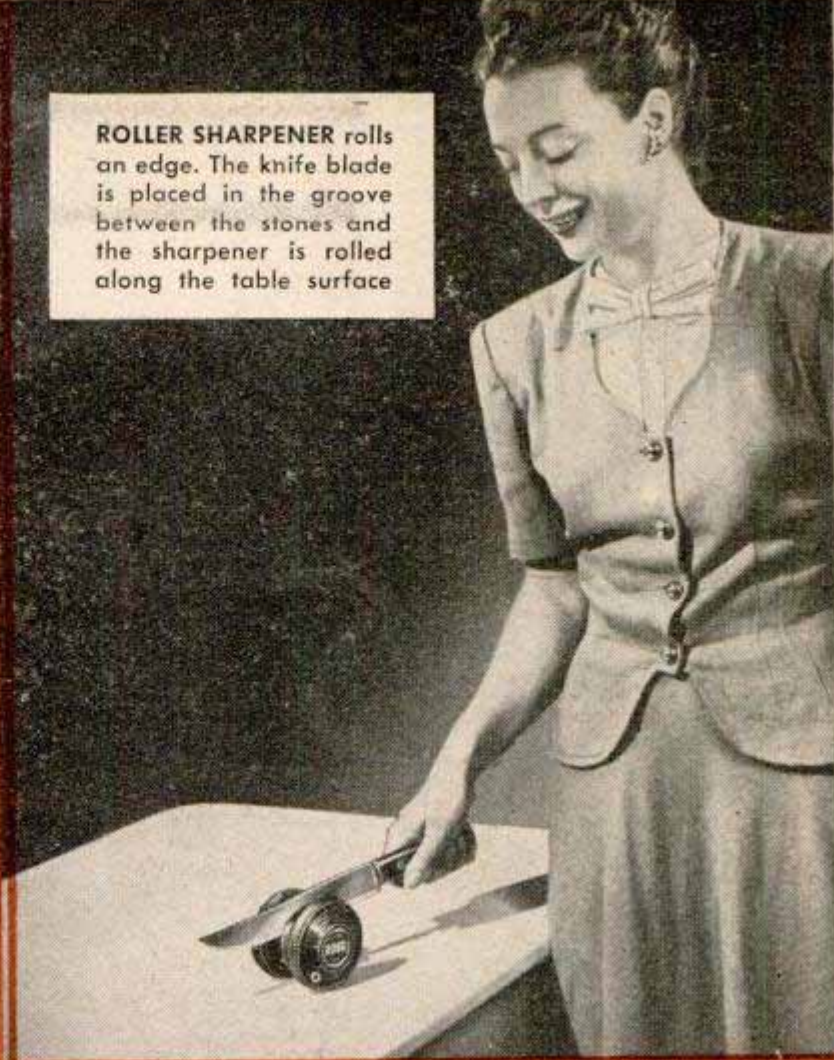

NO-DRAFT WINDOWS are washed on both sides from within house. Crank-operated, all sections are locked securely at any position

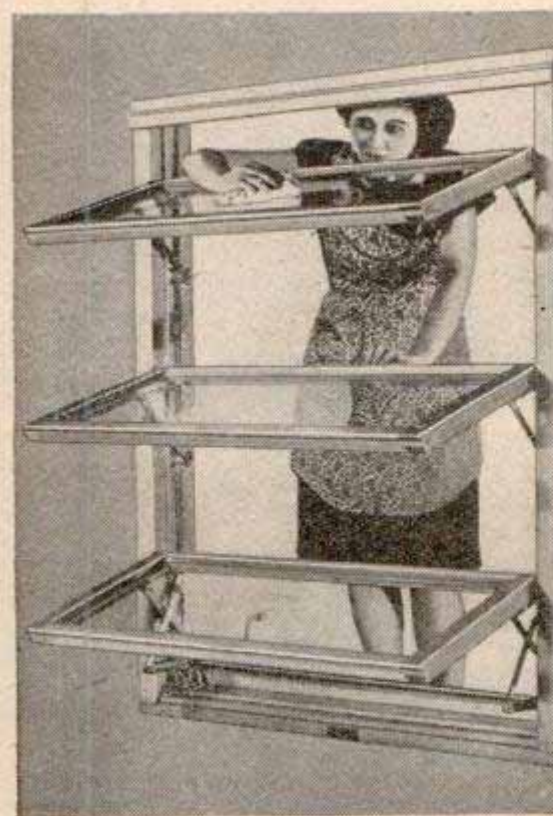

STORAGE CABINETS convert an ordinary studio couch into a comfortable sofa and also provide convenient storage space. Made of plywood, the cabinets are attached to the wall. The tops of the cabinets form an attractive shelf for books and knickknacks



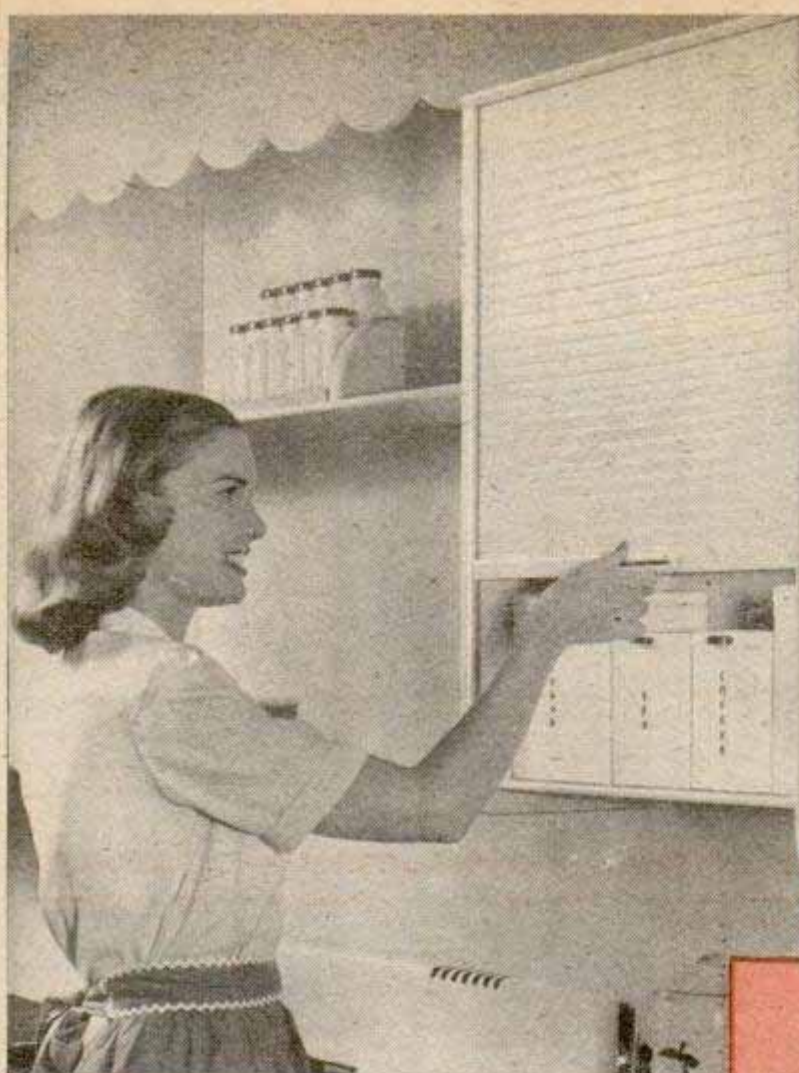

ROLLAWAY DOORS for kitchen cabinets end the danger of banging your head on swinging doors. Opened and closed easily, doors are made of colorful Tenite plastic

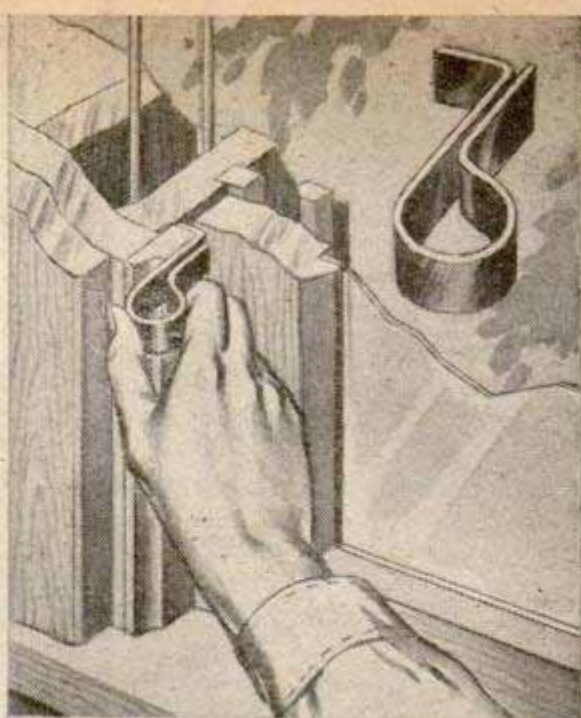

ANTI-RATTLER for noisy windows can be installed quickly. Pressing the window against the frame, it also cuts drafts

WHAT'S NEW *For Your Home*

Continued from preceding page



DISPOSABLE BAGS for garbage fit into a step-on holder. When filled, the waxed, odorproof bag is removed and discarded

NONSLIP PLUG assures good contact and cannot be pulled out accidentally. The plunger forces wedges along the prongs





↓ **BINDING TAPE** to prevent raveling of rug edges is applied by heat from an iron. No stitching is required and the tape is available in many colors



↑ **VENETIAN-BLIND CLEANER** not only washes slats, but waxes them at the same time. Two rubber sponges clean both sides of the slat and also apply the wax



↓ **ADJUSTABLE SOCK DRIER** fits all sock sizes from 9 to 13. The plastic stretcher prevents shrinkage and its smooth surface cannot snag



ROLLER SCREEN goes up and down with window. Made of plastic, the screen rolls up inside the nonrust aluminum box attached to the window sill



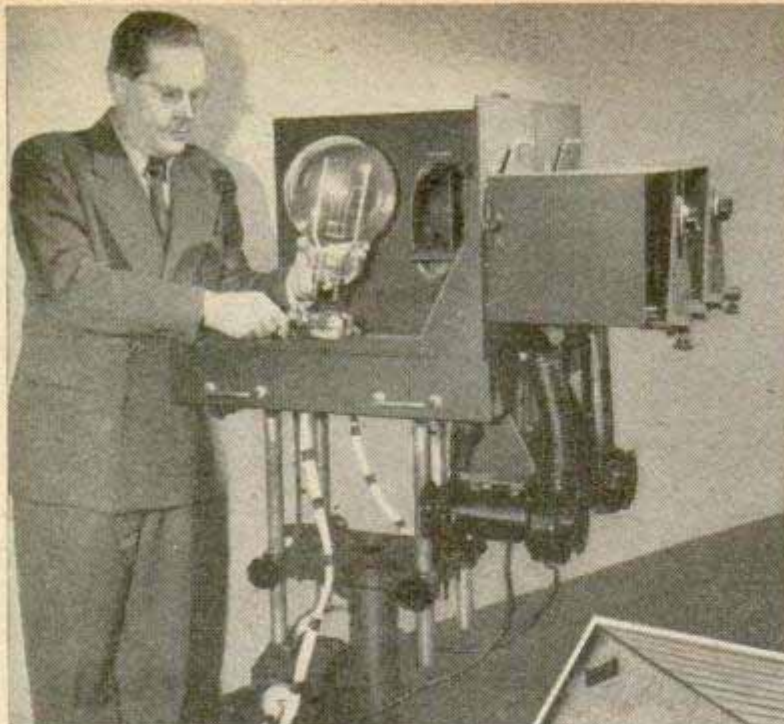

AIRPORT FLOOD LAMPS are light source of a powerful slide projector that magnifies up to 40 diameters. According to the inventor, A. A. Ostrander, a designer of fashion sets, there is no noticeable loss of color and clarity despite the enormous enlargement. Four blowers, mounted below the two lenses, force continuous streams of air through flexible tubing and against both sides of the slides to prevent their deterioration under the terrific heat of the lamps. Each lamp uses 5000 watts and is the same as those that illuminate airport runways for night operation. The projector was designed and built by Ostrander for use in fashion shows and exhibitions

KINDLING HOUSE is the proper name for this three-room bungalow because it is made of pine blocks sold as firewood. Glued together, the blocks form the frame. The house, located in Iowa, has a concrete roof

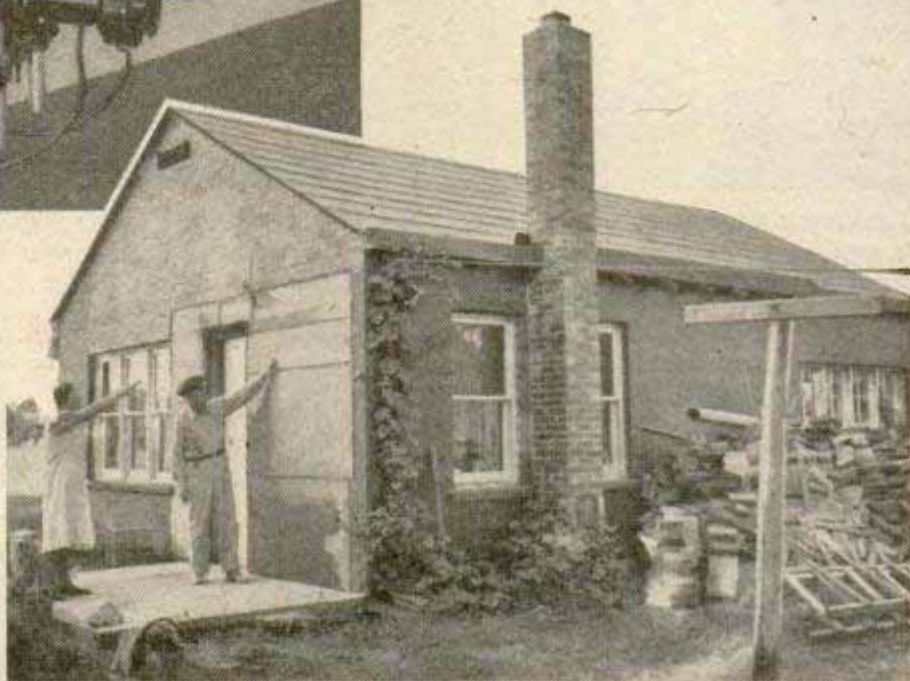

OCEAN-GOING CANOE is taking Mr. and Mrs. Ray Sullivan from Chicago to West Indies via the Mississippi. With both motor and sails to call on, they won't paddle the complete trip



Moving? Your House Can Go With You

Army barracks from Tinker Field are turning civilian to house married ex-GIs at Oklahoma City University. The barracks are raised by jacks and blocks, lowered onto a trailer, and towed to the campus (upper right). That's one way to move a building, but a new power mover (lower right) makes the jacks-and-blocks system as old-fashioned as a muzzle-loader. The U-shaped body of the rig is backed around the house and powerful electric hoists quickly raise it from the foundation. The power mover then rolls away, the house held securely at three points. At the new site, the building is eased down on the foundation, and the rig moves away, the job completed.

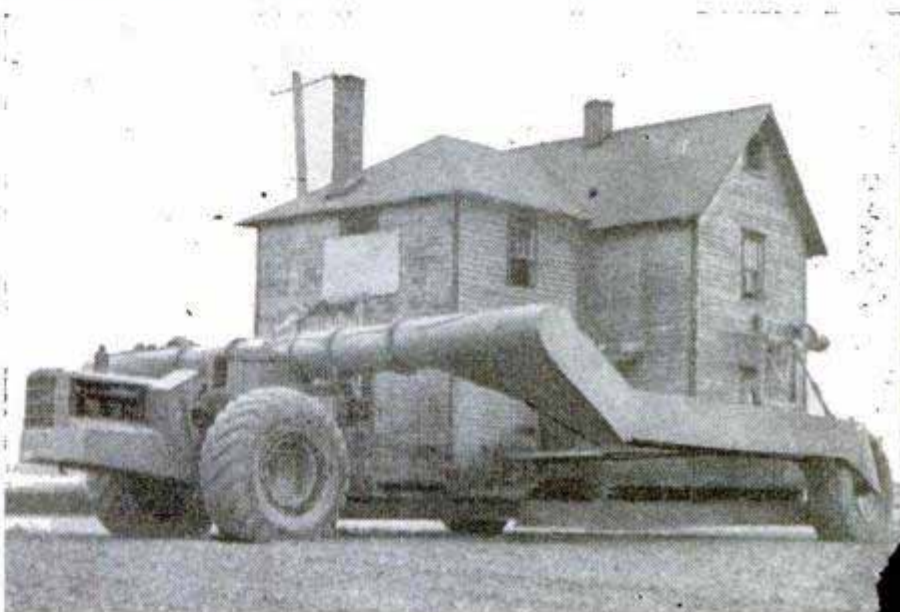

Onion "Mickey Finns" Potent Weed Killers

Mixing onion juice with 2,4-D makes the weed-killing chemical 20 times more effective. Experimenters at Michigan State College found the greatest effect came when one part onion juice and 20 to 30 parts of water were mixed with the chemical. Curiously, there was no increase

in killing power when garlic, a close botanical relative of the onion, was substituted, and tomato juice caused it to be even less effective.

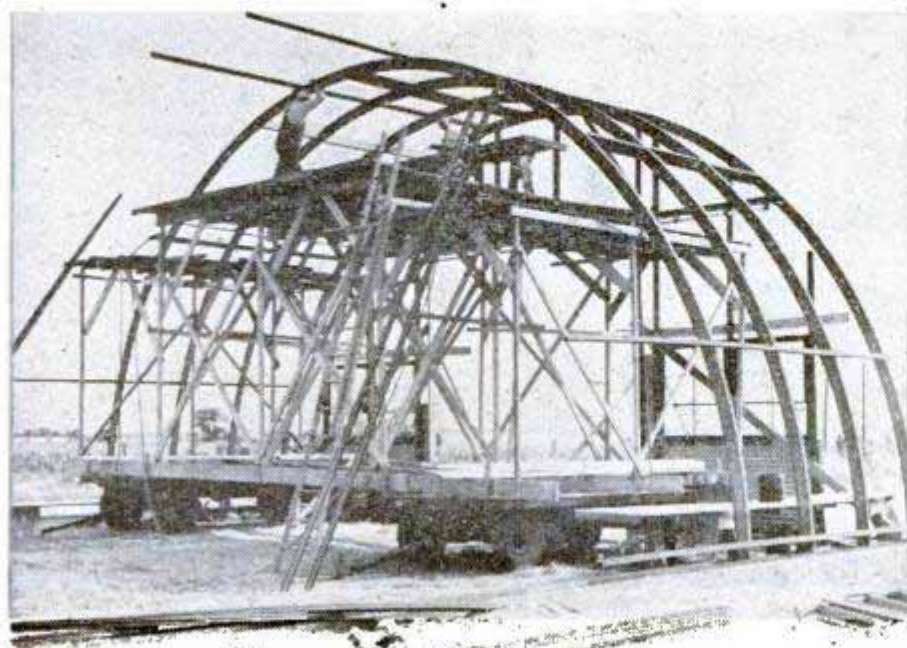

Two Farm Wagons Carry Moving Stage

Two farm wagons supported a moving stage in the construction of a steel-arch building at Kouts, Ind. As work progressed the rubber-tired vehicles were pulled forward and their tongues staked down for safety.

☞ Sugar, pepper and sage do a better job of preserving frozen pork sausage than the same seasonings with salt added, according to recent tests conducted by the Army.

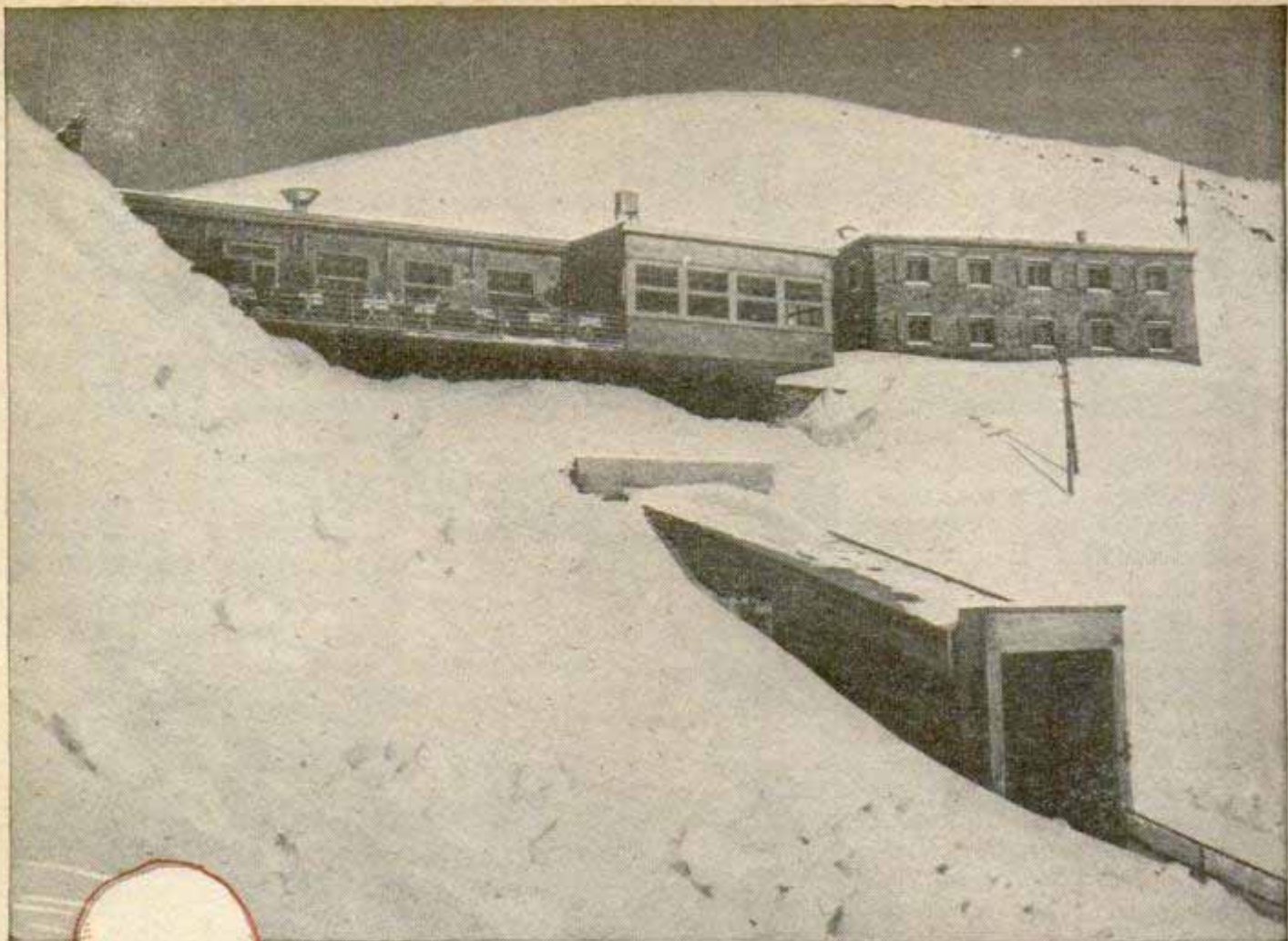

Avalanche "Lab"

"WHITE DEATH" is peaceful Switzerland's No. 1 enemy. On a single day in December, 1916, masses of snow and ice hurtling down the mountainsides killed 10,000. To study and "outguess" it, here are some techniques used at the Swiss Snow and Avalanche Research base in the Alps. Above, view of laboratories. Left below, device to measure force needed to cause a rupture in snow bed. Machine at right below gives data for setting up avalanche-proof construction

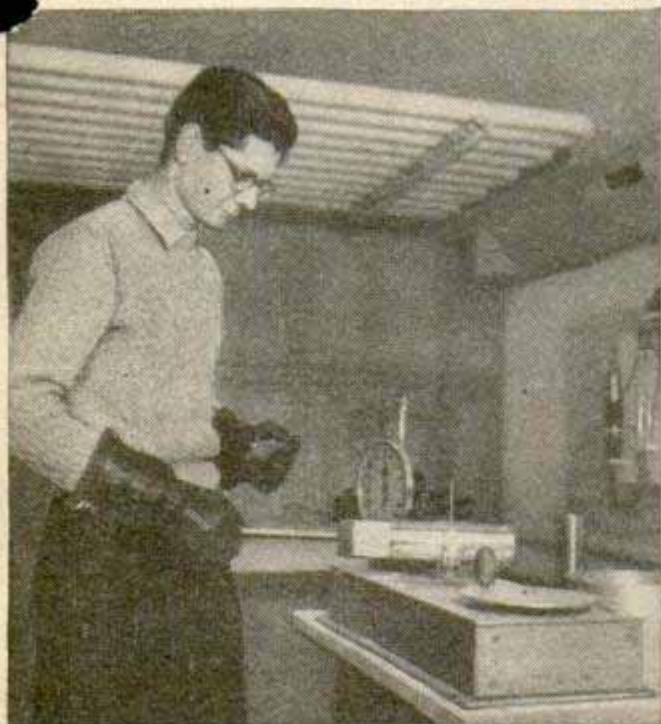



↑ Simple gauge to determine snow's water content. It helps foretell future behavior of big masses

•
Upper right, apparatus to measure pressure of snow falling from slope. Its force can uproot big trees

•
Right, method used by technicians to determine the resistance of snow. One of many field bases at rear

•
Below right, the characteristics of a snow-block's movement and speed are brought out by this device

•
↓ Worker at the avalanche laboratory subjects snow at left to traction, and at right to compression

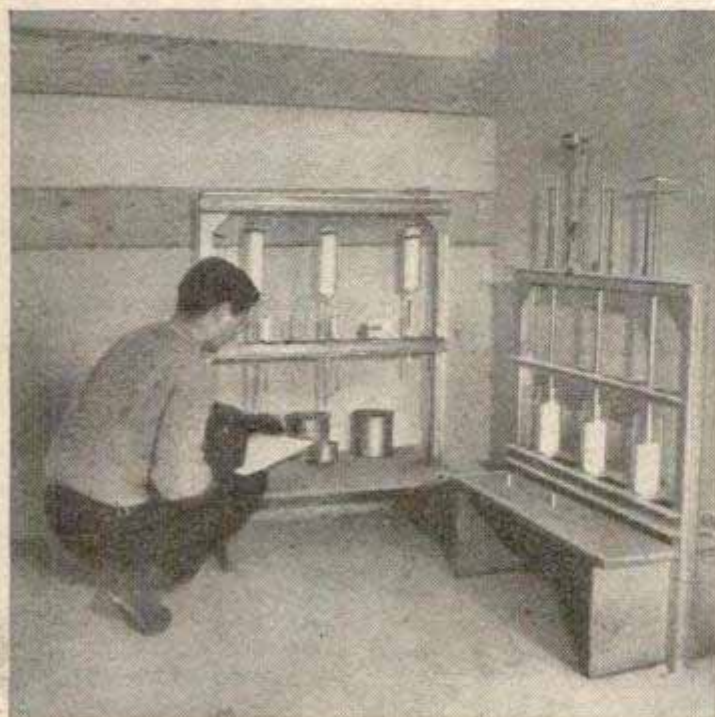



"Paddlewheel" on Lightweight Tractor Churns Soil

With its eight rotating tines mounted on rubber pads, a midget tractor chops and tills the soil smoothly even in hard ground. Weighing only 145 pounds, the tractor is chain-driven by a 1½-horsepower gasoline

engine. The complete frame, gear box and engine mount are cast in one piece of aluminum alloy treated to maximum toughness. A depth gauge is adjustable from one to five inches.



Trigger "Safe" Locks Out Accidents

Accidental firing of rifles and shotguns is prevented by a locking trigger "safe" that fits over the trigger assembly. Consisting of a felt-lined metal case, the guard has a brass-plated lock and key. On guns kept in the home, the device is locked to prevent tampering and dry-firing by children or curious adults. In the field, the safe can be used unlocked to prevent accidental firing while climbing over fences or through brush. A flick of the release button uncovers the trigger for quick firing. Lightweight, the guard comes in sizes that fit more than 150 models.

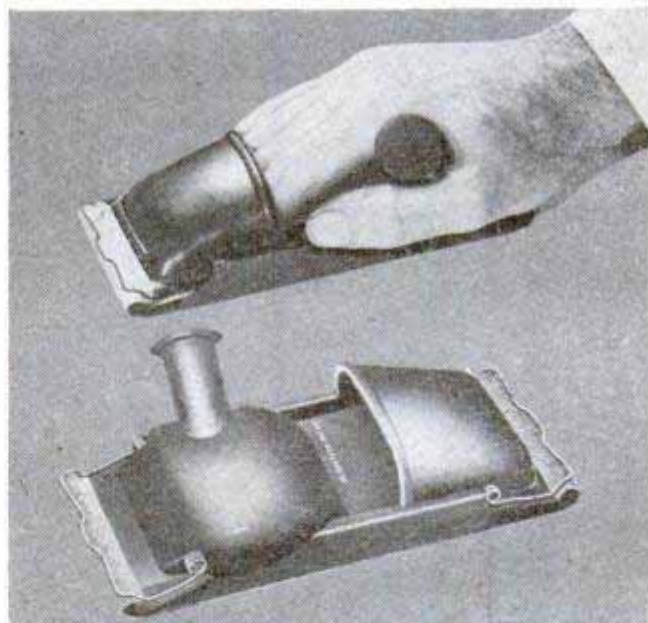

Rubber Block Speeds Sanding

So flexible that it follows any surface contour, a hand sander block eliminates waste in abrasive materials and cuts sanding time. The block takes one third of a standard sheet of abrasive paper and two spring clips hold the paper securely. A soft rubber heel rest and handle at the rear of the sander and a finger pocket at the front minimize hand fatigue. The pocket also protects the fingers. A lamb's-wool bonnet can be used with the block for polishing.

FLAMES "BURN" SNOW LEAVING ROAD CLEAR AND DRY

Terrific heat of flames melts snow leaving only small amount of water to be wiped off by squeegee. Guards prevent heat damage to tires. Radio is needed in airport use

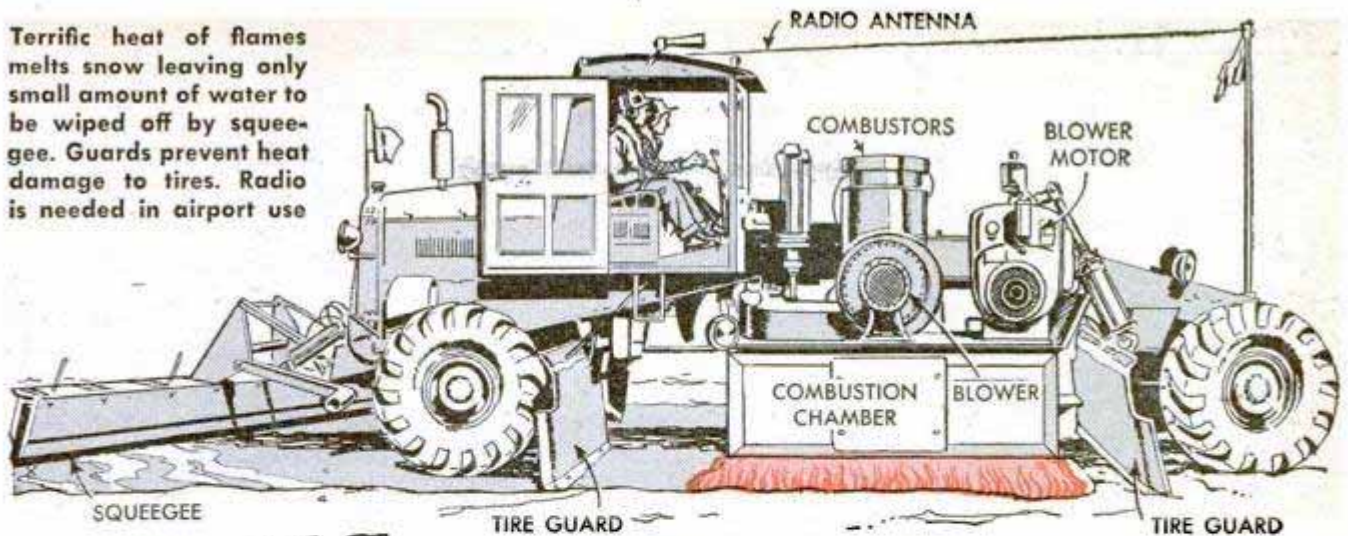

Snow and ice vanish in the air when a snow-melting machine is used to keep roads and airport runways clear. Like a huge blowtorch, the machine, mounted on a road grader, blasts flames against the pavement, melting the snow on a 12-foot strip while moving up to 15 m.p.h. Used as soon as snowing begins, the machine leaves a completely dry pavement. When deeper snow is being removed, water residue is wiped off the pavement by a heavy rubber squeegee. Built by a Pittsburgh airport engineer, the snow re-

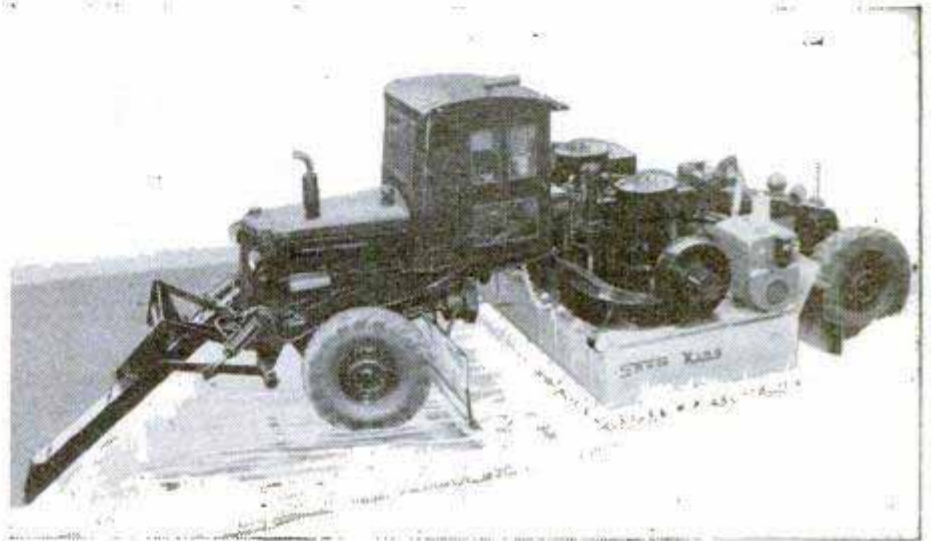

mover has two oil-burning combustors that "burn" snow for one cent a cubic yard, much cheaper than the old method.

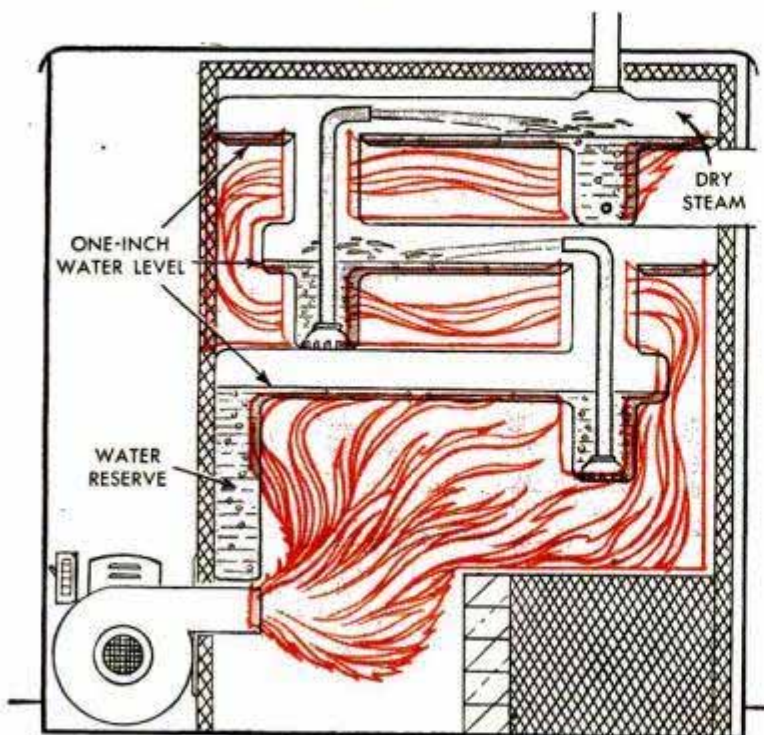

Percolator-Style Boiler

Steam generates in four minutes from a cold start with a boiler that works like a coffee percolator. Water at the bottom, near the most intense heat, is moved up through the steam heads by "geyser" tubes. This eliminates the need for raising all water in the boiler to steaming temperature. The geysers also act as a check to keep an unvarying film of water in each head and to boost foreign matter to a flushing receiver at the top. Maintenance of a low water line prevents water being carried up into the mains.

☞ To create the extremely high vacuums needed in one phase of the atomic-bomb project, pumps were designed which would evacuate 999,999,999 air molecules of every billion present.

Hunting Big Fish

Under the Ice

By Don Dornbrook

STURGEON fishermen in Wisconsin like to tell the story about a man who once speared a 200-pound specimen as it shot through the sluice gates of a dam. This hardy fisherman hastily hefted his catch onto his back and was struggling across a nearby railroad bridge when the ugly giant gave one healthy kick which sent fish and fisherman flying off the trestle into the water. They fished out the fisherman a few minutes later — his prize catch, never!

Spearing sturgeon is akin to hunting big game under the ice. Dragged by main strength through

← Whopper! No trick photo, sturgeon measures six feet. Below, woman tries luck. Note gaff hook and decoy at knee

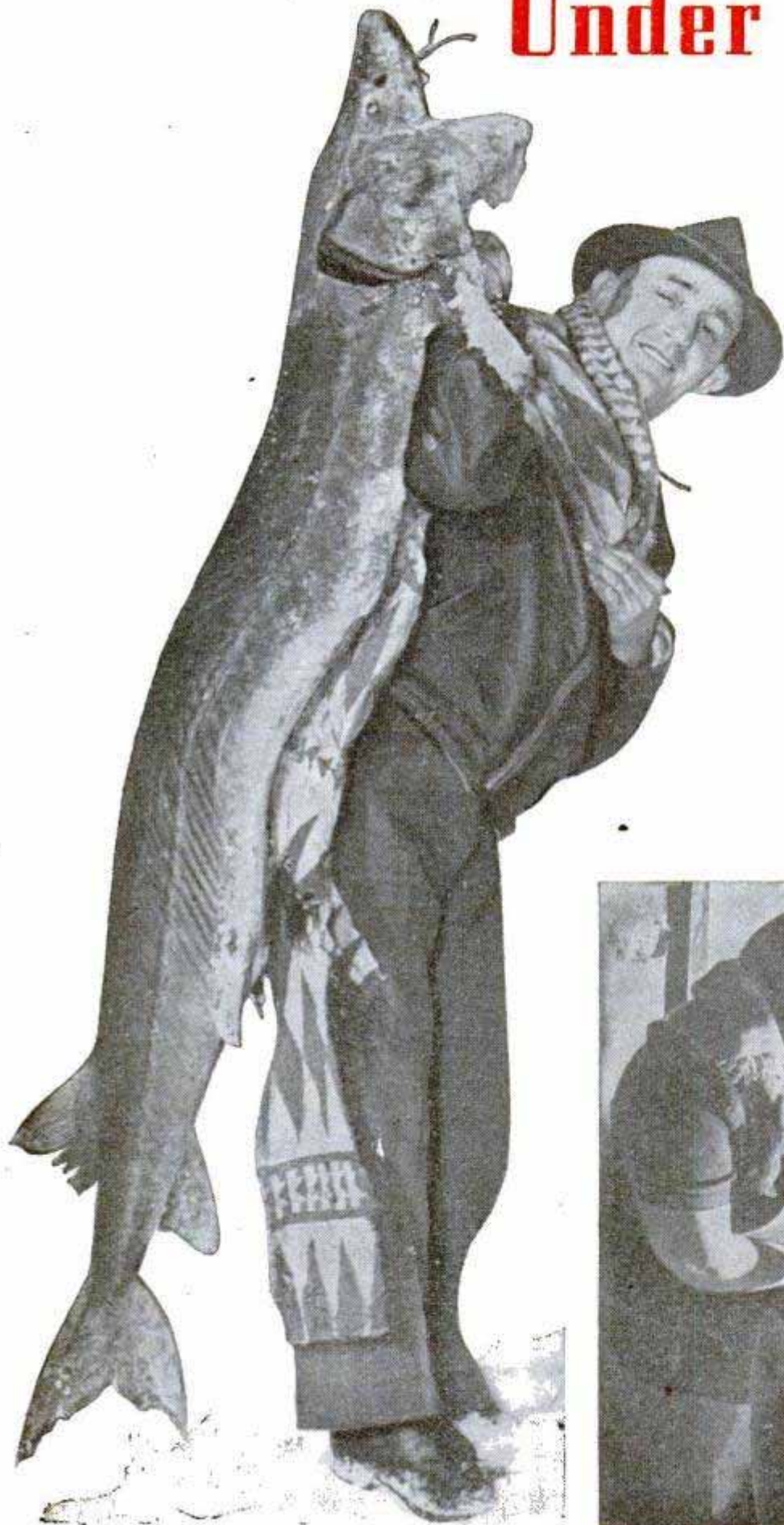

a 3 by 4-foot hole in the 22-inch-thick ice of Wisconsin's Lake Winnebago every February, many a sturgeon weighs more than the white tails brought home from the North during the deer-hunting season.

Nowhere else in the world is the sturgeon stalked with the spear as through the ice of Lake Winnebago. Three fourths of Wisconsin's lake sturgeon are found in Winnebago, the remainder in adjacent lakes—Winneconne, Butte des Morts, Poygan, Puckaway, Buffalo—and the Fox and Wolf Rivers. But it is out there on the bleak, icy reaches of the Badger state's largest inland lake—35 miles long, 10 miles wide—where a thousand or more fanatical fishermen peer into 10 or 15 feet of water, their devil-like, 8-foot-long spears poised for action. Men have been known to wait nine years for that thrilling moment. And when it finally arrived, some have been known to grow helpless—suddenly mesmerized by a sort of stage fright akin to "buck fever."

Winnebago—Indian for "dirty water"—is one of the nation's largest bodies of fresh water within the borders of one state, yet it is only 21 feet deep at most, averaging 18. It is in the east central part of the state, and its lake sturgeon—*Acipenser rubicundus*—is one of six types found in North America. Sturgeon six and eight feet long and weighing more than 200 pounds have been speared through holes in Winnebago's ice, although the average weight is between 40 and 50 pounds.

The Wisconsin Conservation Commission keeps a pretty accurate check on sturgeon spearing through the issuance of

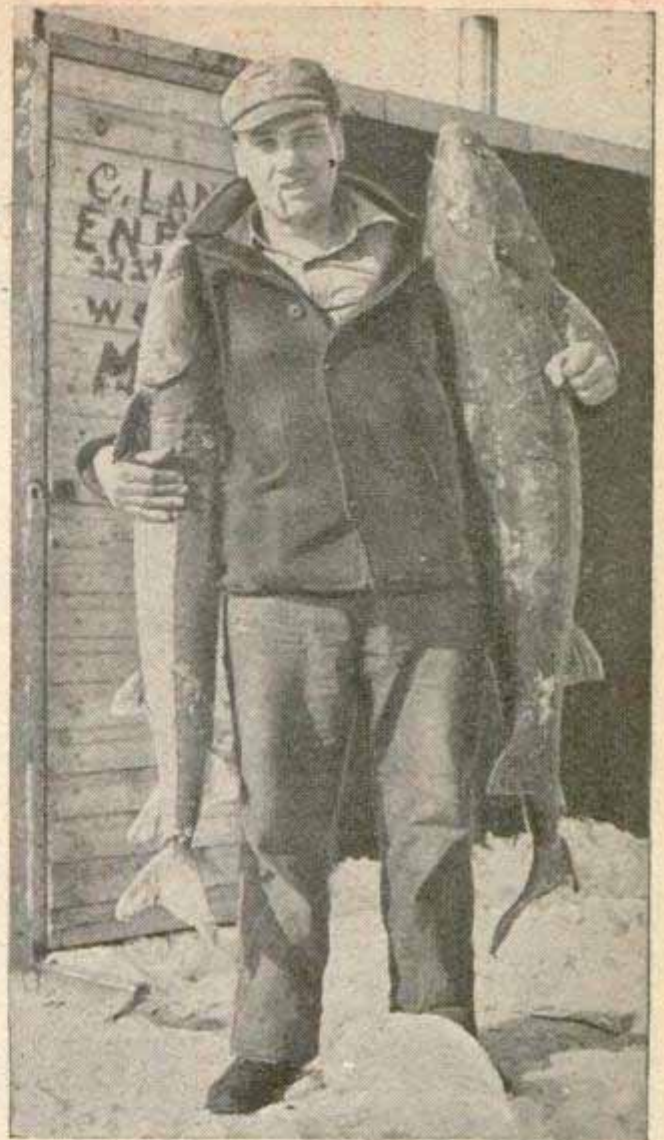

↑ Milwaukee fisherman hugs 104 pounds of fish

↓ Lonely ice shack holds stove, chair and high hopes





Needle-sharp spears look like barbed pitchforks. This one has detachable head. Right, 6-foot 3-inch fish weighs 148 pounds—4 pounds more than the man

sturgeon tags—at five cents each. Every sturgeon speared must have a small metal tag affixed to the tail. Fishermen are limited by law to one fish a day, five a season. The minimum legal length is 30 inches. Commission records show that in 1945—a good season—920 sturgeon weighing a total of 35,290 pounds were taken from Lake Winnebago. In 1944 the “take” was 1000; in 1943, 238; in 1942, 467; in 1941, 788. Veteran fishermen estimate the 1946 catch at nearly 2000—including a 141 and 142-pounder. Last season the unsettled, muddy water made the fishing so bad—it was the worst in history—that fishermen vainly appealed for an extension of the February 1 to March 1 season.

During the sturgeon season the vast whiteness of snow-covered, ice-locked Lake Winnebago is broken only by little villages of fish shanties. The biggest clusters of several hundred each are found on the eastern shore near Calumet Harbor and Stockbridge Harbor and on the western shore near the twin cities of Neenah and Menasha. In these tiny wooden shacks, the sturgeon spearer sits in silence and darkness. He is protected from storms on the lake which often reach blizzard proportions. More than one fisherman has become lost in one of these gales and occasionally some unlucky fellow drives an automobile through a crack in the ice.

A model shanty is about six feet square, with sidewalls about five feet high and a hip roof which comes to a point about three feet higher so that an eight-foot spear

can be set on the floor inside. About half of the shanty has a floor; the other half is open. This opening coincides with a hole chopped in the ice before the shanty is placed in position. There are no

windows, just one narrow door. The only light comes through the hole in the ice; it's surprising how much filters through even when the ice is covered with snow. Shanties are banked with snow to keep out the wind and heated by small, wood-burning stoves. It's a great sport.

Almost any easily moved shanty can be used. One fisherman made a shanty out of a sawdust hopper from an abandoned sawmill. Its conical top gave him plenty of room for his spear. Many a farmer in the area considers the sturgeon season his vacation. The best hours are from 10 a.m. to 2 p.m. The law says each fisherman must

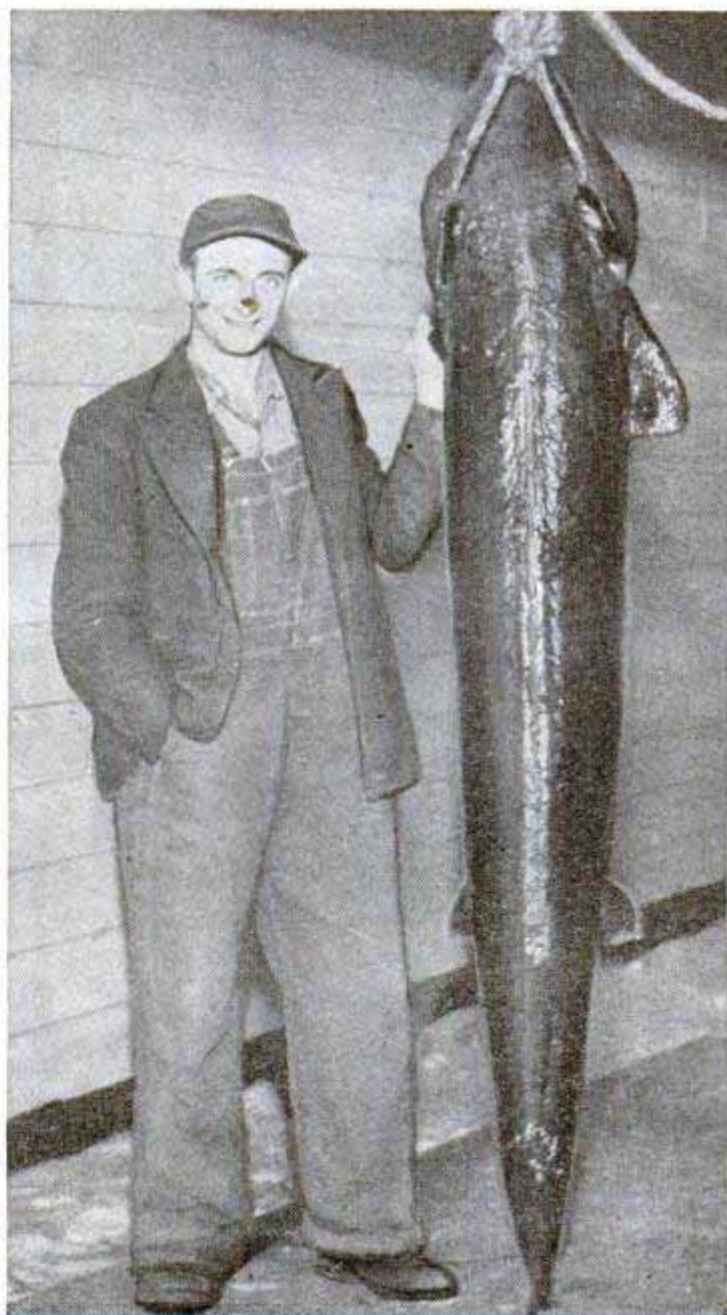

remove his shanty from the ice as the season ends, but often a sudden thaw swallows up whole villages of fishing shanties.

The most important piece of sturgeon fishing equipment is the spear—which looks a lot like the one pictured with Satan. Every hole watcher has his own notion of the ideal spear, but all are pronged, filed needle-sharp to pierce the tough, rough hide of the sturgeon, and mounted on an eight-foot wooden pole or one-inch pipe handle.

Some fishermen prefer detachable spears, in which the spear itself comes loose from the handle when the fish is struck. Both spear and handle are tied to a 30 to 50-foot length of rope. The purpose of the detachable handle is to allow the fish to fight and roll and spend himself without having a handle to snap off or to use as a lever to tear the spear out of his body. A simple model is made from an old Ford auto axle, drilled out on each end. The pole fits in one end, the five-tined spear in the other. The spear is held in place by a small metal pin so that when the fish is hit the fisherman can pull back on his rope and disconnect the handle from the spear.

Eastern-shore fishermen say that Edward Thuerwachter,
(Continued to page 236)



Old-timer inspects a spear-head he has just finished. He tailor-makes the spears with his own forge, anvil

Sturgeon master sorts out decoys. They are made of wood. Weighted with lead, they serve as good lures



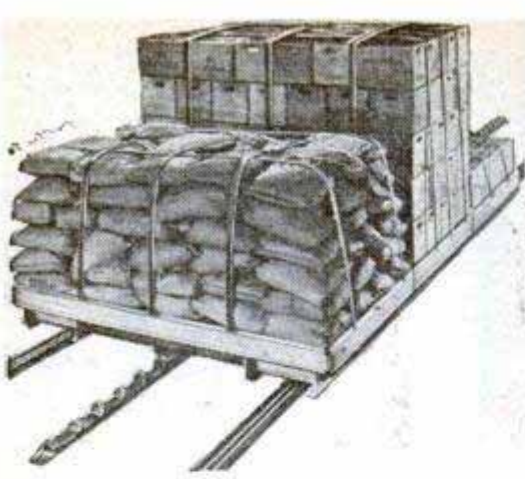

Rail-To-Ship Cargo System Cuts Loading Time

Cargo ships are loaded by rail with a new loading system that is expected to cut freight costs and speed the handling of cargo. Permanent rails are installed in rows on the pier, leading up to two gangplanks that connect the dock and the ship. Carriages more than 16 feet long and seven feet wide roll along the rails. Each carriage accommodates three aluminum pallets which are loaded with cargo. When the ship ties up at the dock, the gangplanks are installed and conveyor chains or pusher trucks move the carriages along the rails and up the gangplanks. Aboard ship, the carriages are distributed by elevators to the proper deck levels, and the carriages remain aboard when the ship puts out to sea. The ship is unloaded in the same manner. Under cargo-handling methods now in use, loading or unloading costs are estimated at four dollars a ton. With the new system the cost is expected to be less than 50 cents a

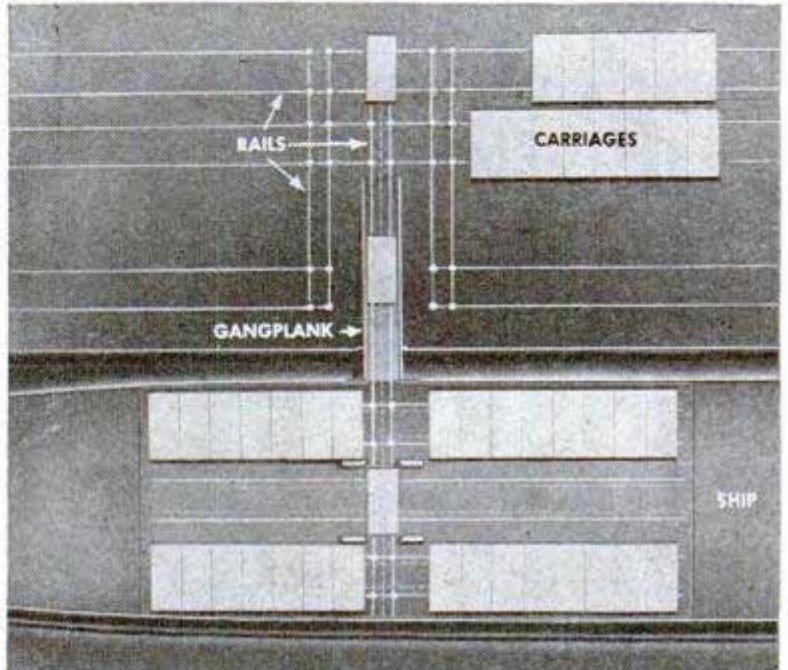
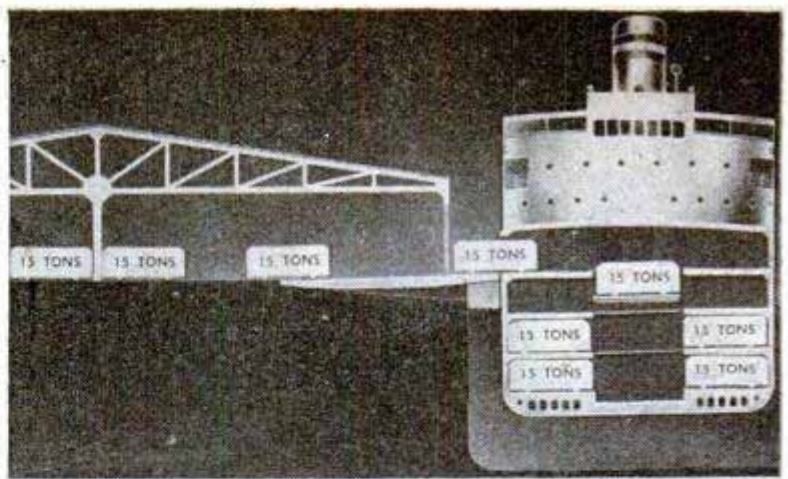

Top left, carts on rails carry loaded pallets up gangplank and aboard ship. Top, easily handled loads are stacked by elevator. Above, diagram shows how several side rails cross for loading

ton. Other advantages cited for the system are much faster loading and unloading, less breakage and the elimination of steel booms from the ship's deck, clearing the area for crew and passenger recreation.

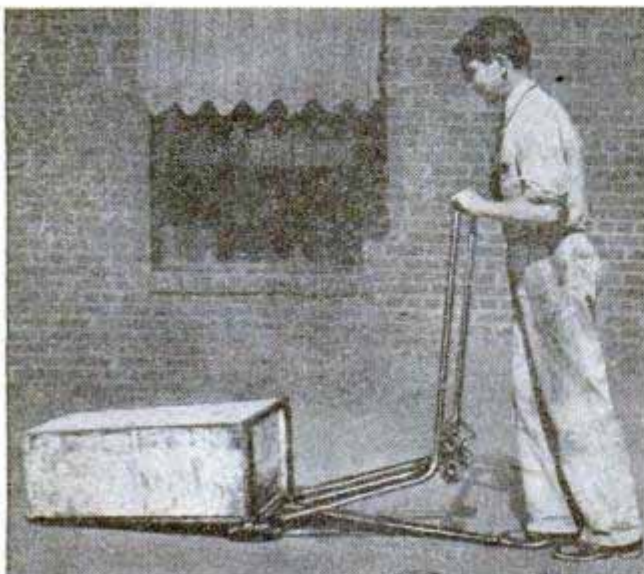

Hand Truck Eases Lifting

Weighing only 60 pounds, an all-welded hand truck is equipped with a patented lift to simplify the lifting and moving of crates weighing much more than the truck. It is constructed of steel tubing, formed into shape and then welded. Roller-bearing wheels are used at the front, and casters for the rear wheels.

You may wish to obtain additional information about the new products described each month in *Popular Mechanics*. If you want to know the name and address of the manufacturer or distributor, just write to Bureau of Information, *Popular Mechanics*, 200 East Ontario Street, Chicago 11, Ill.

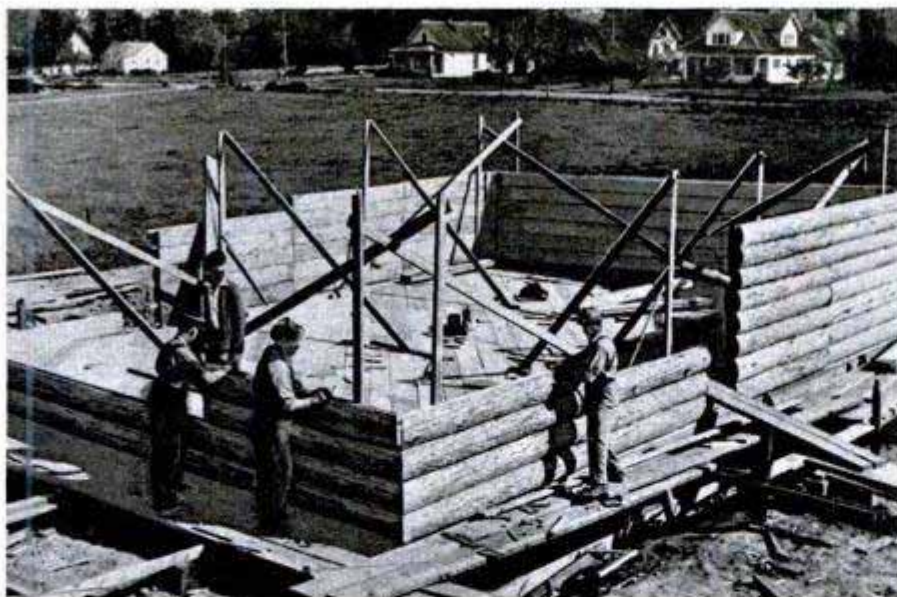

Top right, logs, squared on three sides, are held together by narrow wooden keys. Above, walls are erected quickly. Below, completed cabin

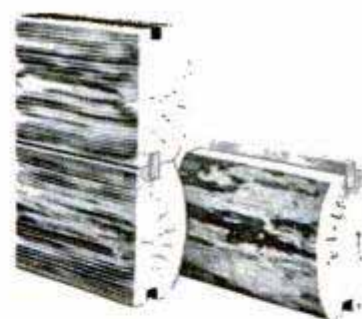

Precut Cabin Logs Held by Wood Key

Patented logs are used in constructing a log cabin that can be erected in 32 hours. The logs are squared on three sides and grooved for a wooden key that holds them together rigidly. The logs are about 5½ inches thick, 8 feet 6 inches long and from 6 to 12 inches wide. The outside bark is peeled and the logs are treated to prevent discoloration and resist weathering and dry rot.

Ⓞ Soap so mild that it can be used as a shampoo or in hospitals or kitchens has been made by the U. S. Army Chemical Corps from the incendiary fuel used in flame throwers and bombs.



Youth "Flies" Giant Plane With Homemade Controls

All the controls and dials of a four-engine plane are included in an instrument panel built by 18-year-old Harold Secrist, Jr., of Niagara Falls. Each of the controls works—lights flick on and off, a landing gear retracts, de-icers work on model wings, and flaps and ailerons respond. The panel was built from old alarm clocks, parts from pinball machines, springs, transformers and motors. From the rear it is a maze of 250 feet of string and 400 feet of wire. There are 160 controls on the panel. Secrist has demonstrated his panel before clubs, schools and fairs, and Generals Spaatz and Doolittle have seen and admired his handiwork.

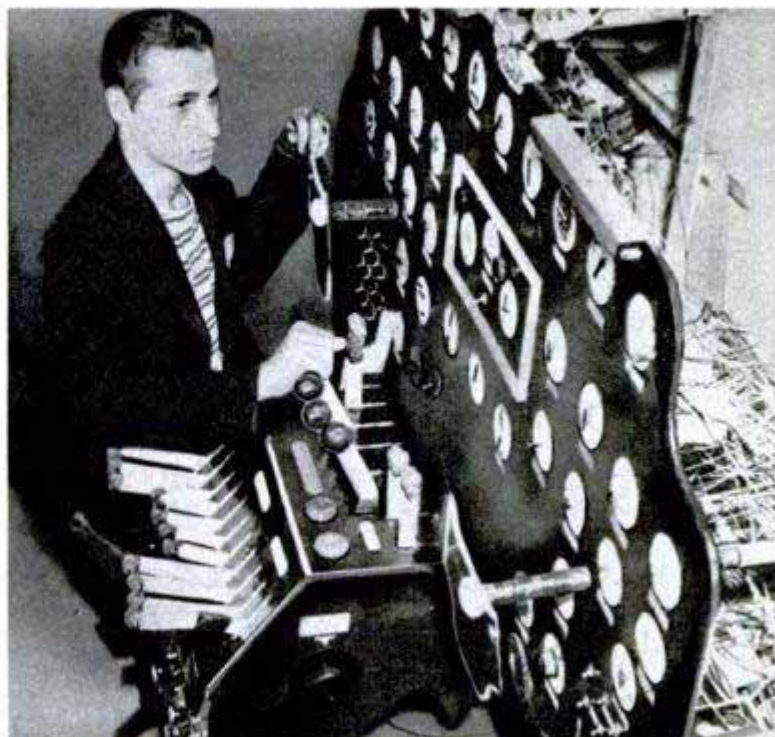



Consolidated Vultee Aircraft photos

Huge Bomber Gets Eight "Legs" To Distribute Weight Better

To make landings possible at a greater number of fields, the giant B-36's two 110-inch wheels have been replaced by eight 56-inch wheels. They are arranged in sets

of four to distribute the bomber's 278,000 pounds better. The new gears are also lighter, safer in the event of a blowout and have easier-to-service tires.

Fox photo



Geography Made Easy

British children can combine geography lessons with recreation at a beach resort on the Isle of Wight. A relief model of the island, built to scale, is included in a wading pool. The youngsters sail their model boats from one harbor to another and become familiar with the island's topography.

Industrial Uses for Bark

Bark of Douglas fir trees is converted into raw material for plastics, plywood glue, insecticides and soil conditioners by a process used in a western plant. Formerly, bark was considered almost worthless although it represents about 12 percent of a saw log. Approximately three quarters of the plant's output of an estimated 75,000 pounds daily is being used by plastics manufacturers. A series of grinding and screening operations prepares the bark for industrial use.

Movies Use Canoes As Aquatic Tripod

To film close-ups of actors rowing a boat on a Mexican river, movie technicians attached the rowboat to the bow of a raft made of native dug-out canoes. The men in the rowboat will appear to be all alone when the movie is shown. Actually, a full camera crew was behind them on the raft. The camera was shifted to one canoe for close-up shots.

Extra Wiper Arm Clears Windshield

Attached to any windshield wiper, an extension arm clears a large portion of an auto windshield covered with rain or snow. The extension consists of two plastic pieces, the longer one clamped to the regular wiper and the shorter one holding the extra blade. In motion, the spring action at the pivot joint and the dragging action of the small blade gives the wiper clearance to clean a large area.



Electric Roaster for Wieners Cooks Six in 90 Seconds

Hot dogs "electrocute" themselves in a table-type electric cooker to become thoroughly heated in 90 seconds. There is no heating element, as the wieners themselves act as conductors for the electric current. Their resistance causes the heat which cooks them. To start the action, water and salt are added to the cooker which holds six wieners.



JEEP POSSE

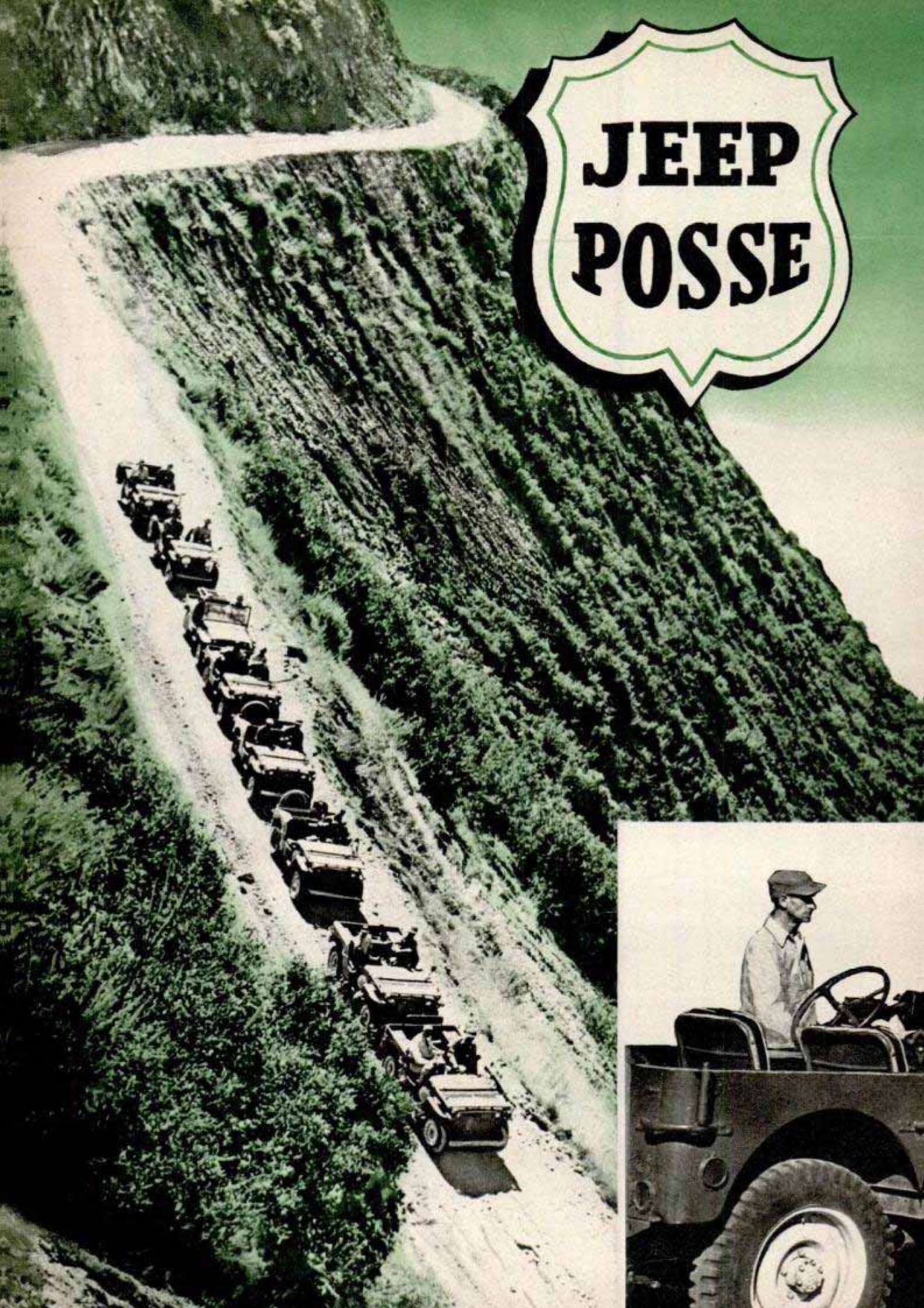

THE JEEP is telling the saddle horse in western stables to move over. Men who once tossed a saddle over their favorite horse, now jump into the seat of the versatile jeep and take off through the fields.

Out in Bountiful, Utah, these "jeepers" have discovered that the chubby cars will take them just about any place they want to go—and in a hurry.

One Sunday afternoon a group of jeep enthusiasts was talking about their mechanized horses at a local service station and before the afternoon was over they had formed a club. At first it was an informal organization of about 15 jeep owners. They met every Sunday just for the fun of it. Like motorcyclists, they rode up and down the winding mountain roads of the Wasatch Range in formation.

But the group, led by Merk Christensen and Bill Bissell, soon discovered that it could help the community and still have lots of fun. The members talked to the city council about the group's possibilities. Given certain limited powers of policing, the group became known as "Official Bountiful City Jeep Posse." Since then, the posse has been serving the city as an extra law-enforcement and fire-fighting body. Today there are 27 jeeps and 54 men in the posse.

After a recent plane crash in the city, several posse members arrived at the scene in jeeps within minutes to help control the fire. As trained volunteer firemen, they pitch right in with the regulars and the jeeps serve as handy transportation.

Posse members organize search parties for missing persons in the foothills of the mountains and during deer-hunting season they serve as mounted game wardens pa-

trolling the wooded area around Bountiful.

But their most important function is fighting forest fires. The steep slopes of the Wasatch Range are covered with thick timber that holds back the water. The canyons are precipitous and thousands of square miles of timber grow on slopes exceeding 45 degrees. As long as the trees are there, the water from heavy rains and melting snows does no damage. But if the slopes were denuded by fire, the narrow canyons would be endangered by floods.

Working with the forest rangers, the posse members patrol the watershed daily during dangerous dry periods. When smoke is sighted, the jeep rider rushes to the telephone and notifies the forest service and posse headquarters. Equipped with shovels, axes and other fire-fighting equipment, the jeeps can pour out of town and arrive at the fire in a few minutes.

Forest fires are best controlled at the start. In the first few hours, the fire can be handled by 30 to 40 trained fire fighters. The posse can get that many men to any fire within a 100-mile radius in quick time.

However, all the posse's activities are not work. The group meets Sundays for a session of fun and competitive driving. The members vie with each other at negotiating tough terrain in an exciting game of follow-the-leader. There are times, of course, when even jeep-lovers have to admit that the little car is not all-powerful. When this happens they pitch in to help the jeeps over rugged terrain. With eight or ten strong men working together, the light vehicles can go anywhere.

At a recent meeting the posse decided to pioneer a road up a granite cliff. The

Sunday afternoon the Jeep Posse turns out for its regular meeting. After the business is over, some of the members take off on a follow-the-leader ride over steep mountain roads (opposite page) they know so well



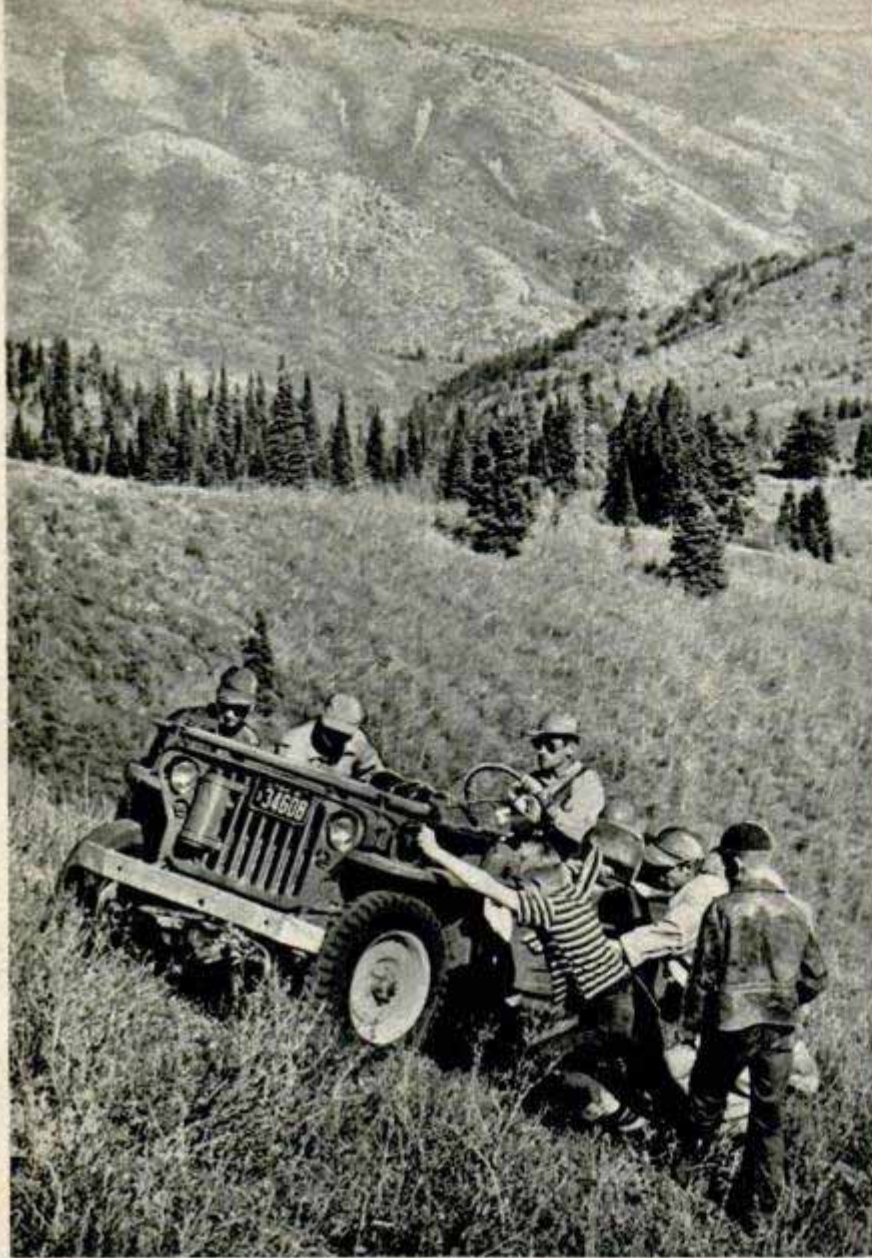

Above, even the powerful jeep has to admit defeat sometimes. Members of the posse help the tiny car up the steep incline. Below, atop a high ridge, the men relax after the rough ride

only way they could reach the top without a new road was over a winding trail that took hours of riding. With a new road they could reach the area in about an hour. So off they went.

The lead jeep started up the steep incline and at one of the dangerous spots it got out of control. The driver leaped to safety, but the car rolled down the slope like an awkward snowball. It turned over 20 times by actual count before landing upside down, suspended in some trees. It took ten men to get it back up the cliff.

Once back on its four wheels the rugged jeep went back to town under its own power! To be sure, it needed a new windshield, some new headlights and a few dents had to be pounded out of the body, but it was ready for the next attempt the following Sunday. This second time the posse made it and now there is a road—not a super-highway, of course, just a bare trail—up the granite cliff.

The Jeep Posse is busy this winter studying first aid, new fire-fighting techniques and planning new roads in the mountains.

While overseas, thousands of GIs dreamed of the day when they would be turned loose in the wide open spaces with a jeep and a tankful of gasoline. Today that overseas dream has come true for members of the Official Bountiful City Jeep Posse.



Loading a Barge? Sink Her First

Sinking a barge was the only way to load her in a recent drydock operation at the Todd Shipyards in Seattle. To be loaded aboard the barge were six surplus Army tugs for shipment to Argentina. The 168-ton tugs could not be hoisted aboard so the barge was floated into the drydock and holes burned in her hull. When the drydock was lowered, water flowed into the barge and she sank. Then the tugs were floated into position, fastened to the deck of the barge and the drydock was raised. With the barge out of the water the holes were welded shut.



The tugs were not sent on the 10,000-mile voyage under their own power because it would have been costly and hazardous.

Enclosed Ultraviolet Germ Killer Protects Eyes From Harmful Rays

By reducing airborne bacteria and other micro-organisms in the air, a small germicidal unit cuts down the spread of disease in schools, waiting rooms and business offices. The air is drawn over an ultraviolet lamp that is completely enclosed to prevent its rays from injuring the eyes. In addition to its germicidal function, the unit also filters the air to remove pollen and dust, keeps the air circulating to make the room more comfortable in summer, and has a heating element for warming the air in winter. It plugs into any 110-volt circuit.

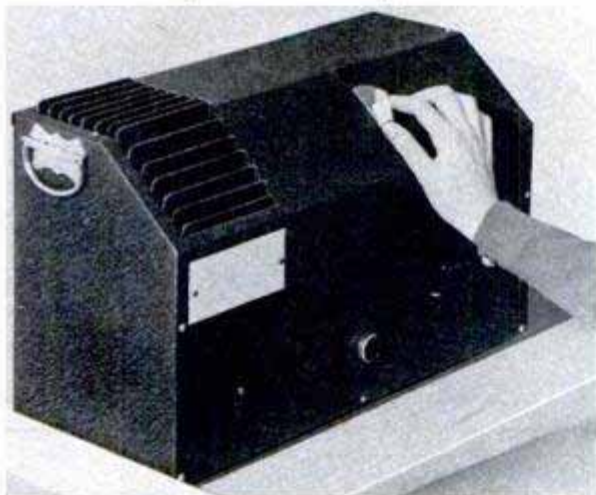

Flying Automobile Uses Two Engines

In contrast to previous designs, Consolidated-Vultee's experimental flying automobile keeps the main features of both kinds of transport. The 34½-foot wing, nacelle and 190-horsepower engine are a permanent unit. A separate Crosley engine powers the automobile. At the airport it is attached in a few minutes to a conventionally designed small automobile by bolts through the latter's roof. In flight it resembles a plane that has scooped up an automobile, bird-of-prey fashion. The craft is operated both in the air and on the



ground from the usual driver's location. The test model ran out of gas and crashed, but experiments will continue.

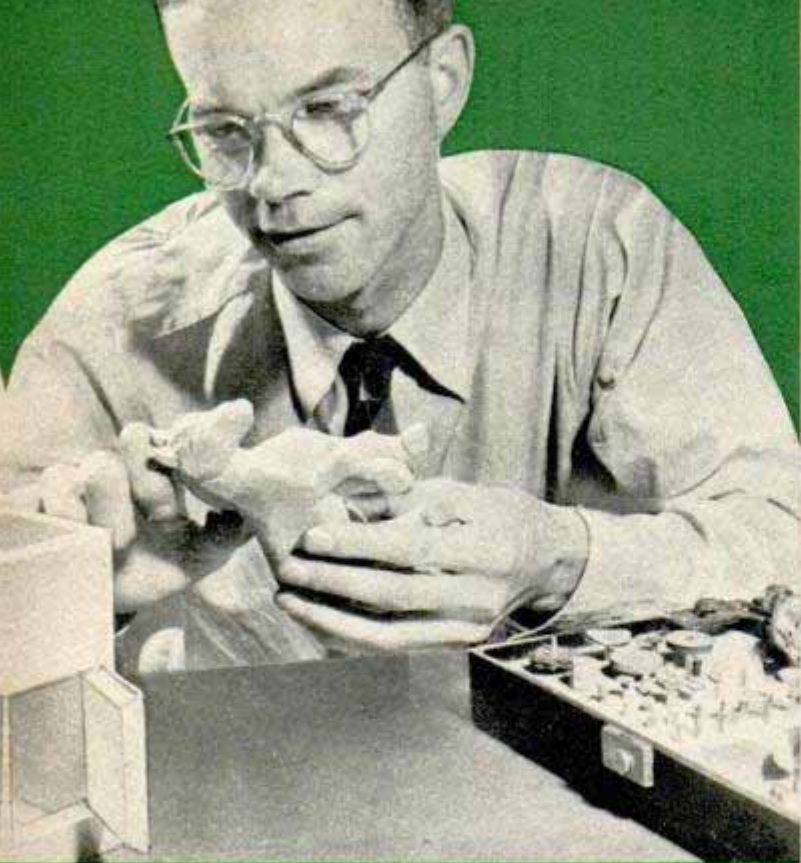

Perfectionist Ted Neumann carves Belgian wagon horse. Below, ticket wagons require intricate work

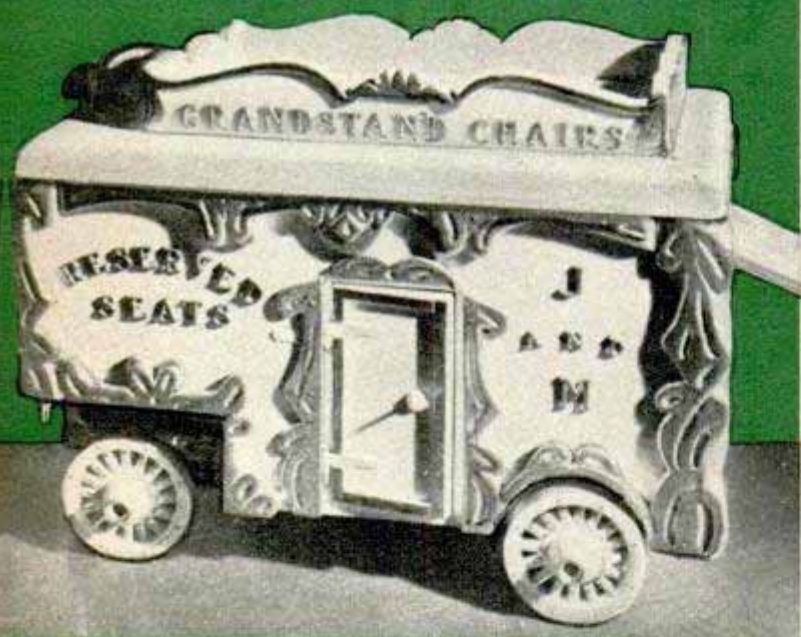

Even a stove and tiny pots distinguish the range wagon

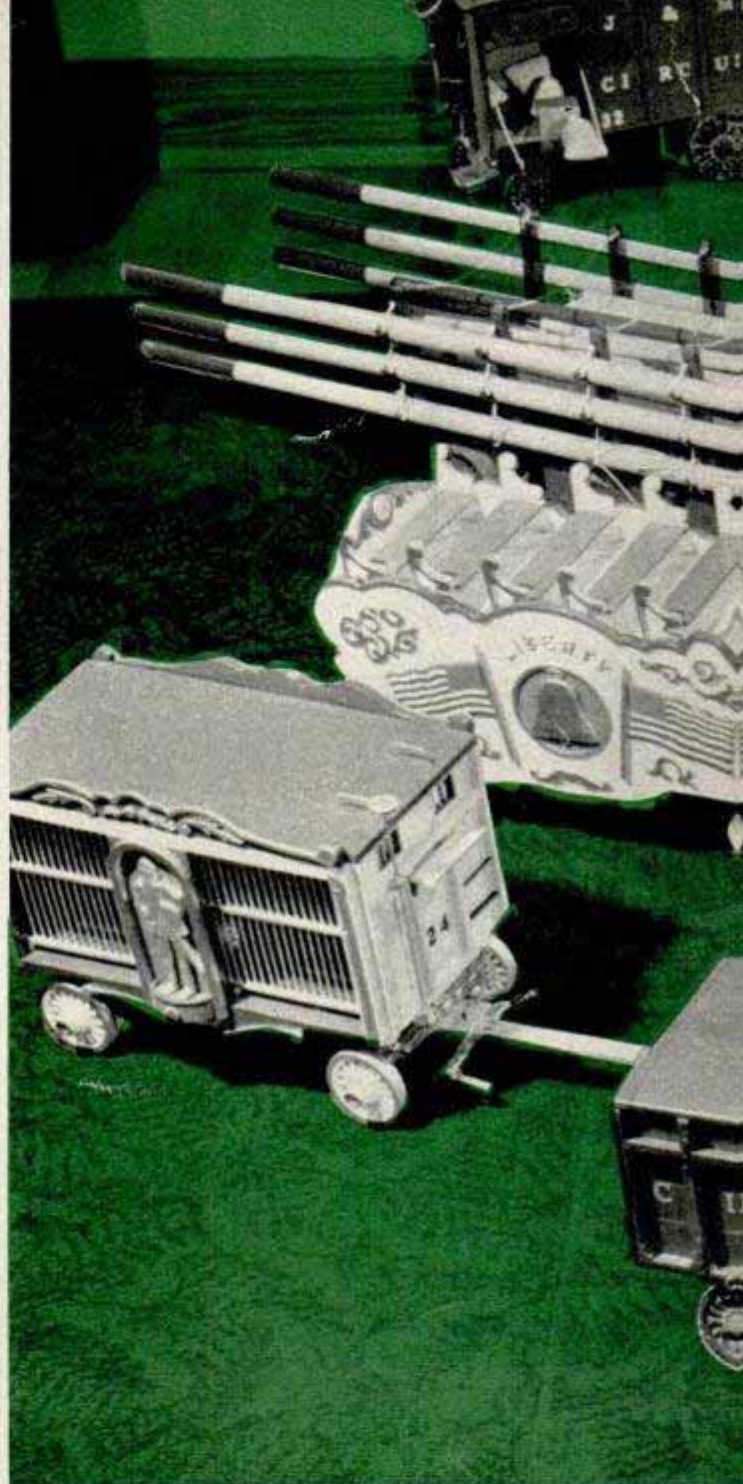
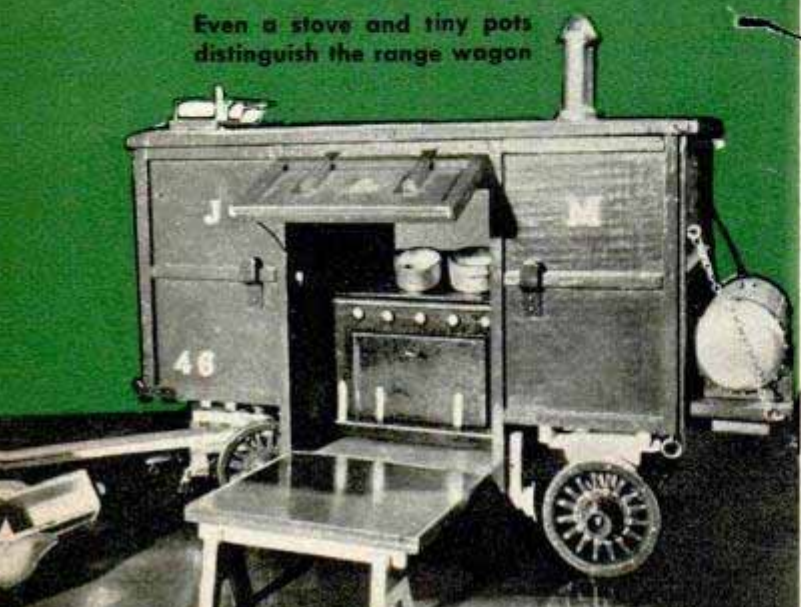

By Rod Van Every

Photos by John Sigrist



IF YOU are looking for a hobby that will be good for a lifetime, you can't do better than to choose the circus—a model circus, that is.

Most hobbyists would rather not be commercial about their hobbies, but the model circus can be job insurance and a swell moneymaker in a pinch. It can be taken "on the road" like a real one, or it can be leased to large city department stores, especially at Christmas time or circus time.

Circus time, too, is the time to gather your data, the minute detail which brings whoops of delight from the children.

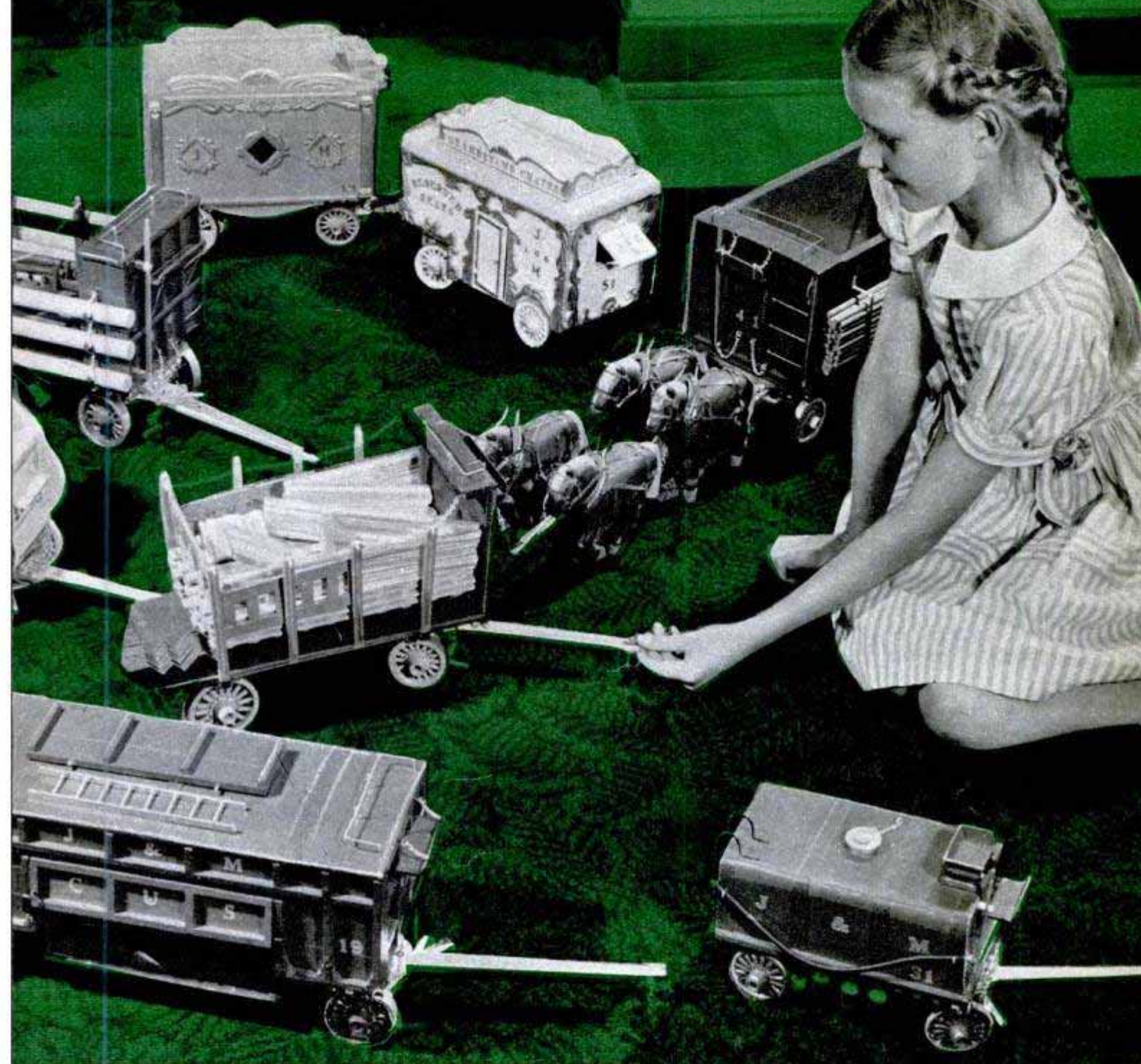

HAND-CARVED CIRCUS

Armed with a camera and a little nerve, you will find the circus itself is your best blueprint. Observe it and photograph it.

Don't expect, though, to finish your circus in one lifetime if it is to be a spare-time hobby. There is almost no end to it. The more detail you put into it—the more of a realist and perfectionist you are—the more lifelike it will be and the longer it will take you. That's part of the charm.

Most fans start with the wagons, one of the most colorful aspects of the circus. By the time you've built and carved 70 of them, you will be a few years older. Then

there are the teams on teams of heavy dray horses, the wild animals, the show horses (ring stock and "rosin backs"), the big top itself, the side shows and the circus train. If you still have a few years left in you, there are hundreds of human figures—workers, performers and audience.

All of this can be accomplished with a minimum of expense for materials and tools. And in the end—if you ever reach the end—you may have a hobby worth \$15,000, perhaps more.

The experience of one model-circus maker will serve as an example.



Plenty of room for spectators! All seats fit perfectly into wagon at left. Note tiny sleds in the foreground

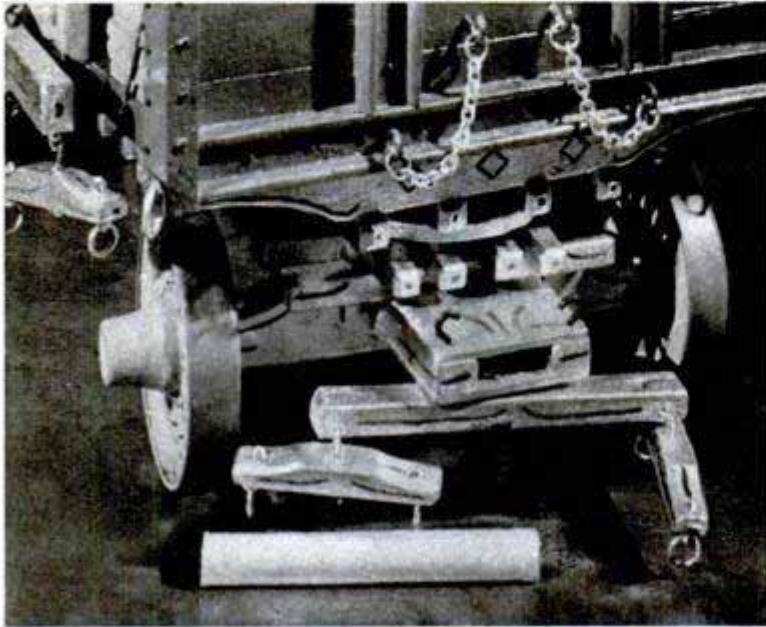

Close-up of wagon's front assembly, showing lead-tired wheels. Cigarette gives you some idea of vehicle's size



Marion Neumann gazes into rear doors of cook's supply wagon. Below, hobbyists strive for perfect detail. Hose is piece of old tubing and tongue is numbered to wagon

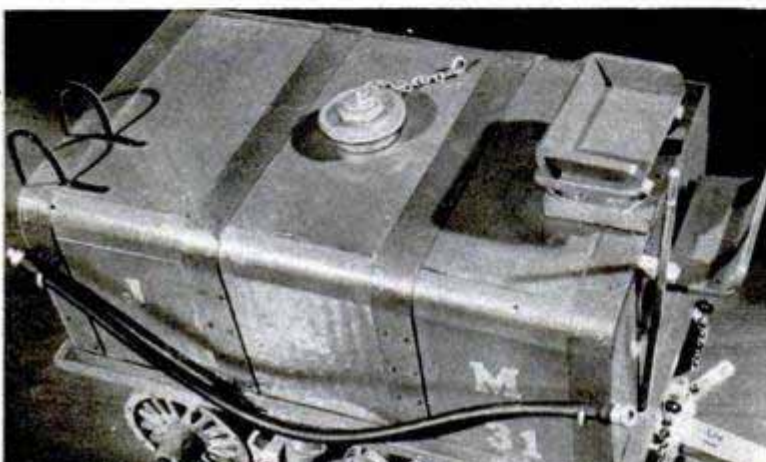

The J & M circus of 39-year-old Ted Neumann is at the two-year stage. He has built 24 wagons and carved four dray horses and assorted circus paraphernalia. All in wonderful detail, and that takes time.

Neuman lives in Manitowoc, Wis., where he works for a Great Lakes shipyard. There he finds, free, most of the materials for his circus. The well-seasoned, easy-to-carve pine and basswood come from discarded ship molds and patterns. Most metal parts are reworked scrap and wire. The bars on the animal cages are cotton-applicator sticks.

He has to buy paint, nails, glue, sheet lead for wagon tires, and gilded letters. Many times the difference between a professional-looking job and a strictly amateurish one is the lettering. Better buy them at a novelty or stationery store. The right paint is more difficult to mix than you might think. Circus colors are distinctive and not just any red, yellow or blue. All of Neumann's paints are from the ten-cent store.

His favorite and most-used tools are an old jackknife and an inexpensive set of carving knives. He also has a power-driven jigsaw and hand-size drill-grinder, but they can't do much that the old jackknife can't do, although they are great timesavers.

Neumann chose a scale of three quarters of an inch to one foot and selected the Ringling Bros. and Barnum & Bailey Combined Shows of 1936 as his model. Why 1936? Well, it was about then that the heavy circus horses began to give way to the tractors, trucks and "cats." A lot of romance was lost, and Neumann wanted that.

He named his circus the J & M for his son, Jack, and his daughter, Marion, but don't depend upon your son or daughter for more than a lively interest in playing with the models.

To obtain the detail for his work, Neumann spends several days a year with whatever circus is close to his home. He also joined the Circus Model and Owners Association, from which he obtained plans and specifications.

The circus never had a set plan for its wagons. It built a wagon to do a specific job, and that's why there is so much marvelous variety in them. There are animal cages, each different to fit the needs of the beast it houses; the blacksmith wagon with its forge, extra wheels, anvil and sledge hammers; the range (cook's) wagon, cook's supply, commissary (the only green wagon in the Ringling circus), canvas carriers,

(Continued to page 256)

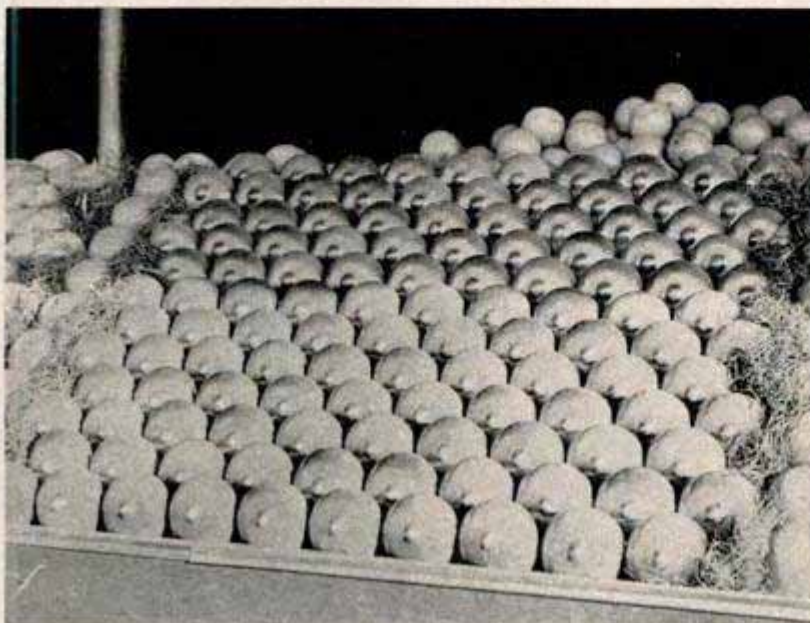

Above, strings of grapefruit permit faster arrangement of displays. Top left, which are real? The flat bases give only clue. Left, plaster onions

Dummy Foods Make Displays Attractive and Long-Lasting

Shoppers don't worry about how many customers have handled the food before them in some stores in California because the counter displays are artificial copies of the fruit and vegetables on sale. Several companies are making the displays. Some are made of plastic and others of plaster

reinforced with fiber. Usually, the dummies are made in rows to facilitate arranging. After painting, they look like the real thing, but they eliminate worry over rough handling by customers, dehydration by the sun and petty thievery. In addition, clerks do not have to change displays daily.

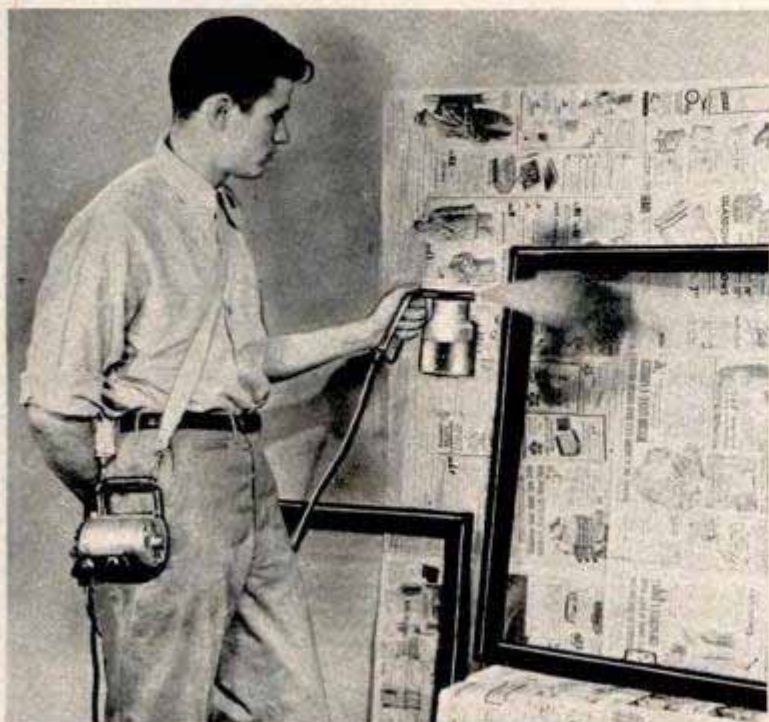

Over-The-Shoulder Sprayer Lightens Painter's Load

Less weight is carried in the hand with an electric paint sprayer that has a shoulder strap for supporting the motor. The sprayer consists of an a.c.-d.c. motor that develops 22 pounds of air pressure, the carrying strap, a four-foot air hose and the spray head with tank and nozzle. The nozzle can be adjusted to spray straight ahead or vertically. The electric cord is 10 feet long.

Information, including manufacturers' names, concerning products described in this issue may be obtained by writing Bureau of Information, Popular Mechanics, 200 E. Ontario St., Chicago 11

Engineer checks the depth of water gushing at 80 feet per second from one of the concrete flumes to sweep across the grass-lined test channel

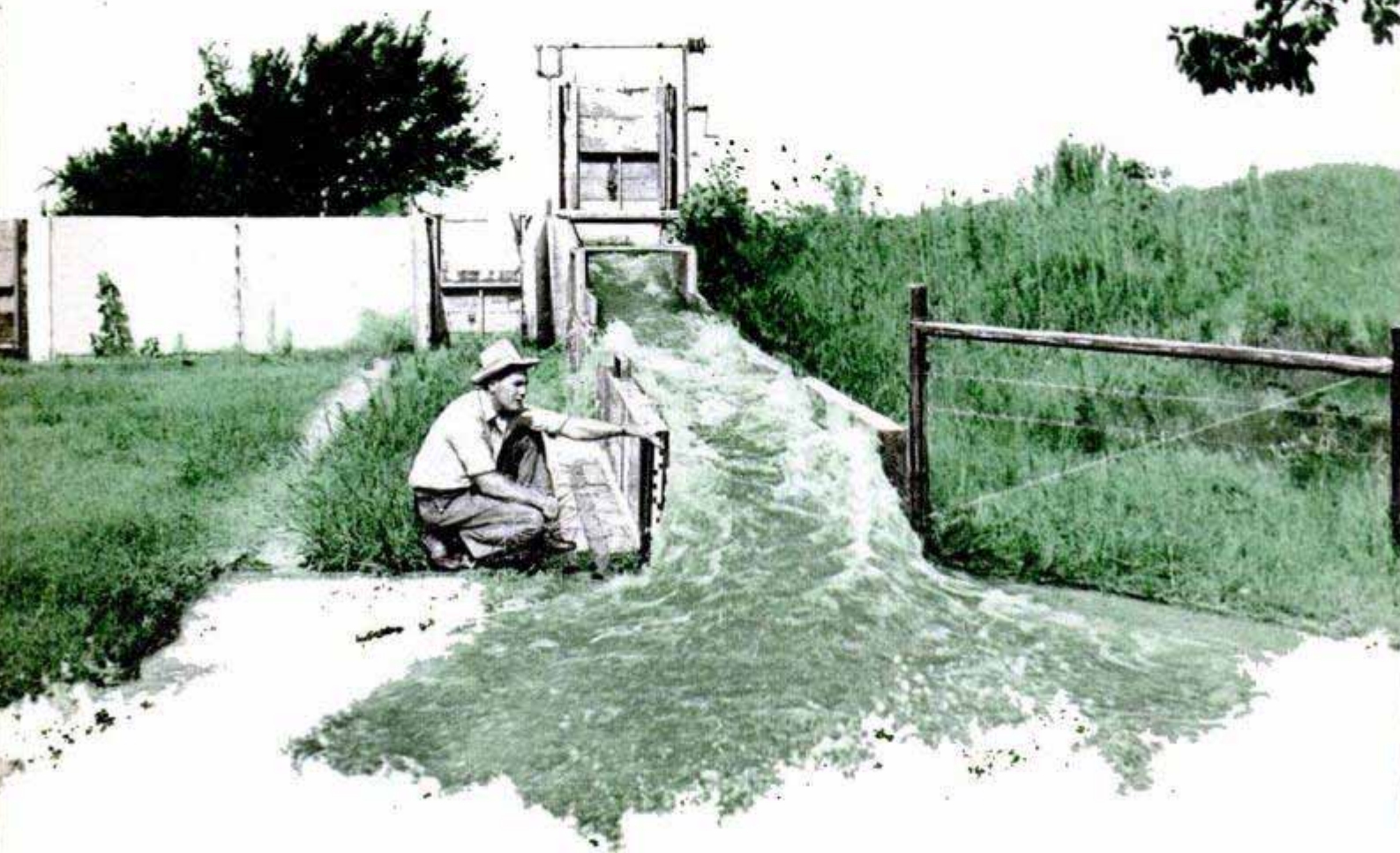

Testing ground for grass . . .

DOWN IN OKLAHOMA the state has gone into a partnership with the Federal Government to grow grass. Not a penny has been made from this enterprise—yet if the results are applied, the nation stands to save millions of dollars a year.

The testing ground is the Outdoor Hydraulic Laboratory at Stillwater, Okla., run cooperatively by the Soil Conservation Service and the Oklahoma Agricultural Experiment Station. Lab workers are growing many types of grasses to find out how firmly each one anchors the soil in place. If the nation applies the results it can save a good share of the 4,500,000,000 tons of topsoil that are washed down the drain each year as a result of erosion.

At Stillwater, under the direction of Bill Ree, a husky civil engineer, many experi-

ments have been conducted on the design of runoff channels and kinds of vegetation with the greatest holding ability.

The mechanics of controlling runoff water after a rain can be demonstrated very easily. Take a garden hose and turn it full blast against the bare soil of a flower bed. A hole will appear in the bed. Now turn this stream against your lawn at close range. Little or no soil will be removed. The grass deflects the water, and roots hold the soil in place. That in simple form is the problem that United States Department of Agriculture scientists are working on.

Study of drainage canals and vegetal cover began in 1935 at Spartanburg, S. C. However, in 1941 the laboratory was moved to Stillwater, Okla., where better facilities could be built. Located just below

By Andrew Hamilton

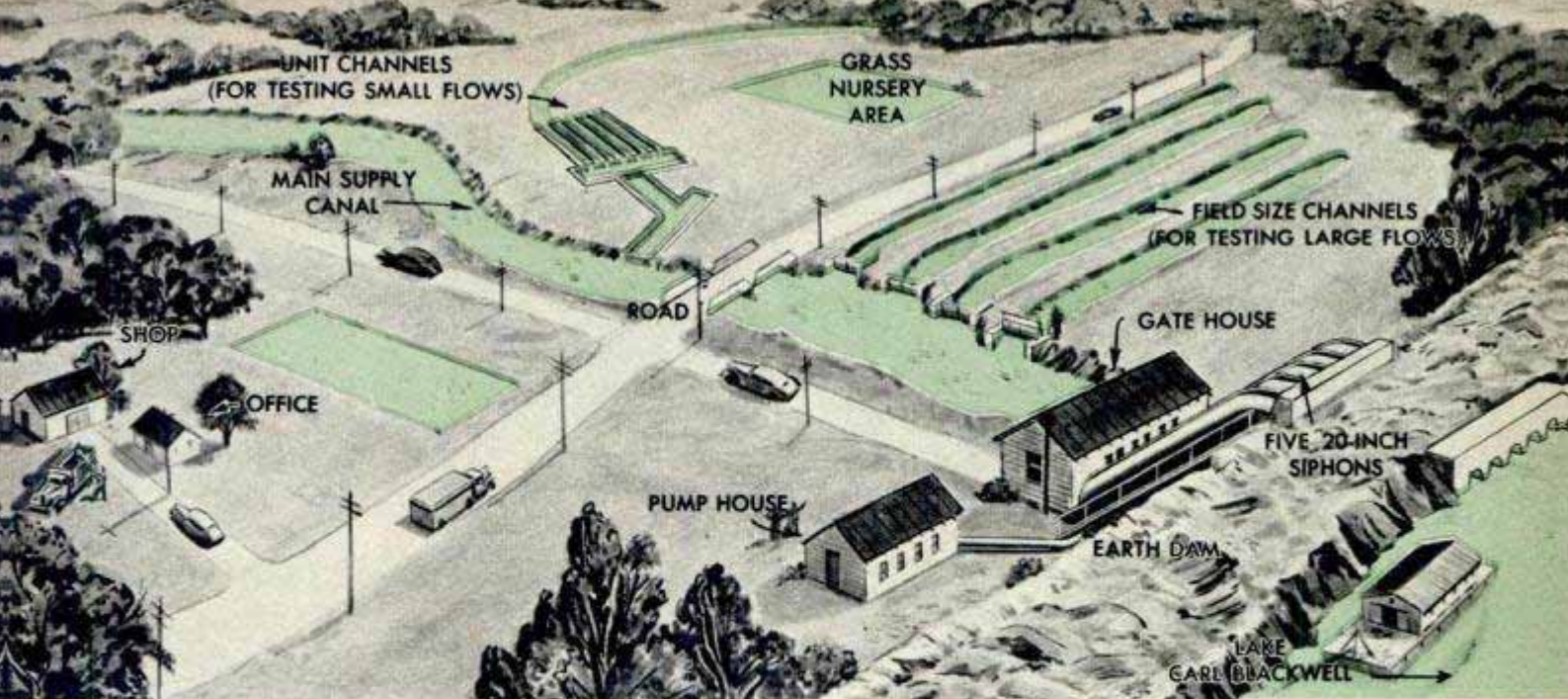

Artist's drawing of the test lab shows lake and siphons at lower right and test channels at upper right

the lip of 3000-acre Lake Carl Blackwell, the laboratory today comprises a \$50,000, 75-acre testing ground. From the lake five giant 20-inch siphons draw water at a rate of 200 cubic feet per second and distribute it into channels of various sizes and shapes, planted with a wide variety of grasses.

The open-air laboratory and channels were built by engineer Ree and his assistants. In addition, they have devised and

built much of their testing equipment in a machine shop on the laboratory grounds.

The problems of hydraulics have been studied since the early days of the Babylonians and Egyptians. But vegetated drainage ways offered new and challenging problems. What about steep and abnormally rough channels that carried rainwater only for short periods? The heavy silt load? These were engineering problems

Beneath this grass water is flowing. Workers check the depth of the shallow water with a point gauge

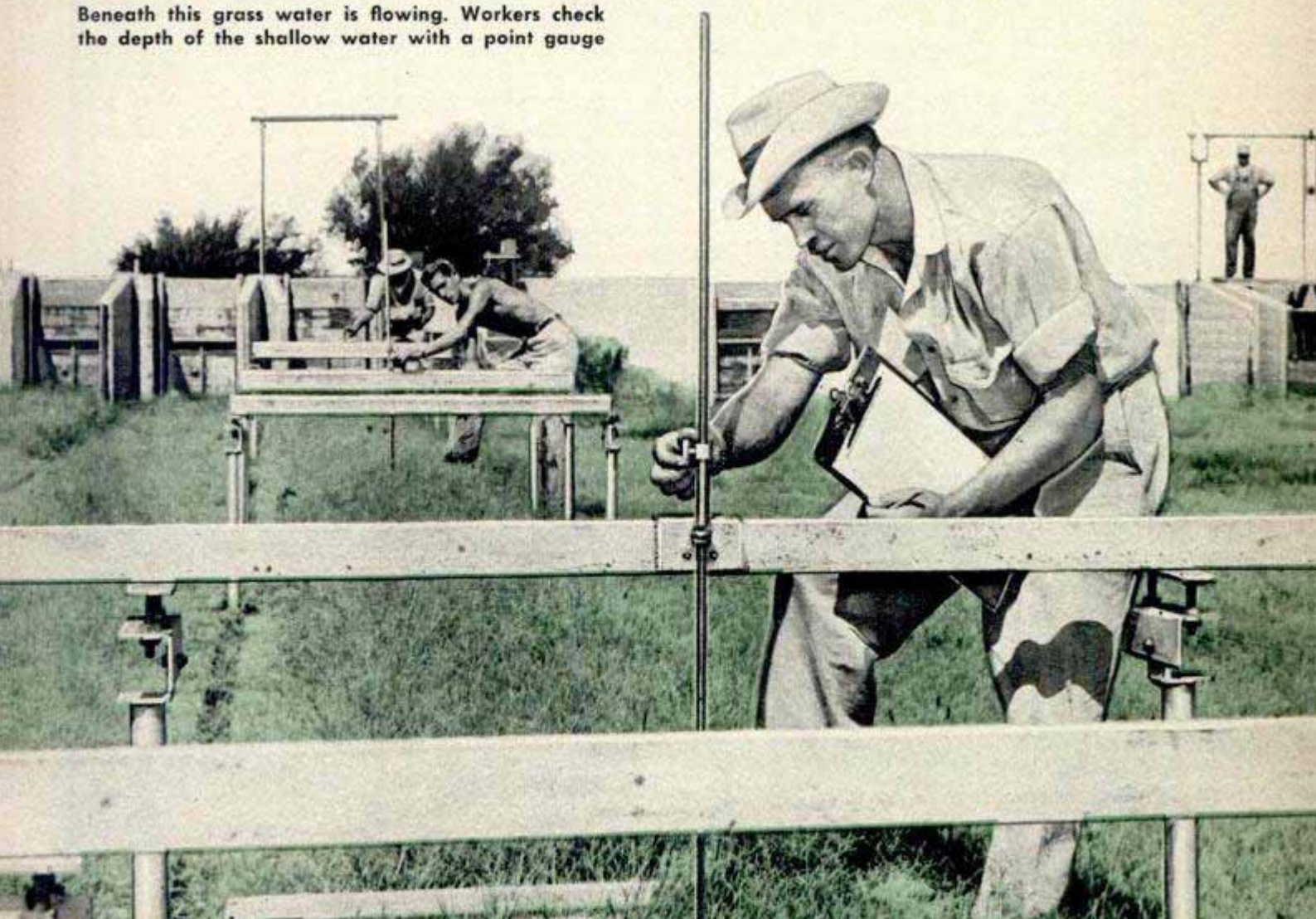



These two channels were exposed to the same flow of water, yet a gully a foot deep was scoured in the weeping lovegrass at the left, while the Bermuda grass at right shows no signs of damage from flowing water

that had not been worked out before. Would the drainage ways be cheap enough for the average farmer to build, yet structurally adequate for the purpose they were to serve?

The hydraulic problems of erosion are tackled in the same scientific manner as a bridge is built or a skyscraper is erected. Information on two principal subjects is sought: just how much and how fast water can flow down drainage channels before erosion sets in; and how effective var-

ious grasses are in slowing the speed of the flow of water.

Experiments involve the most exacting kind of hydraulic engineering. Ree and his co-workers measure the speed of water as it swirls down channels of various sizes; they calculate the amount of water passing a certain point; they note what happens to grass after water has raced across it for several hours; they compute results according to the slope of the channels; they record conditions under which erosion

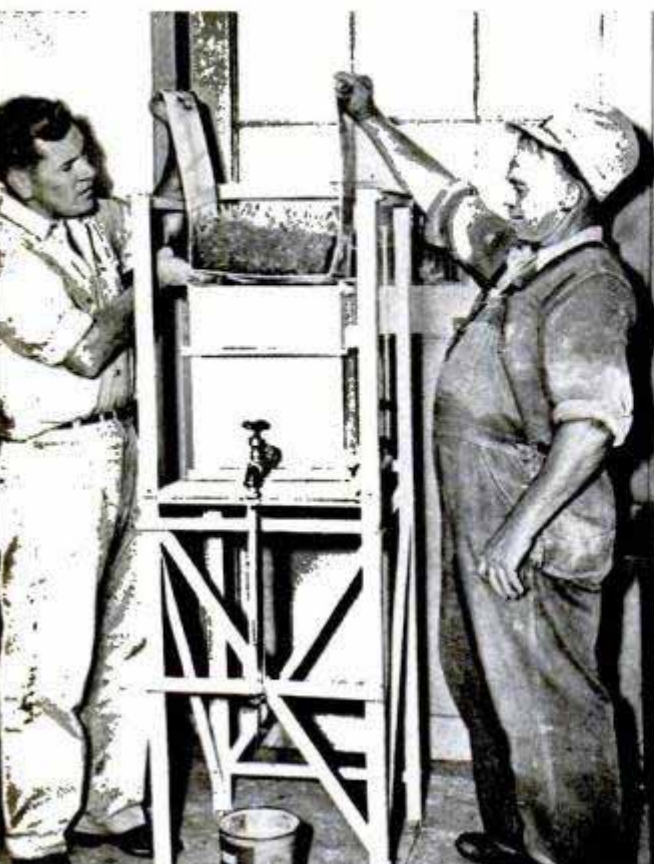

← Into a volume-measuring instrument goes a sample of sod. The device measures the density of vegetation. Below, tests made at Cornell University show that the water runoff from a field of potatoes is much greater than that from grass or forest land

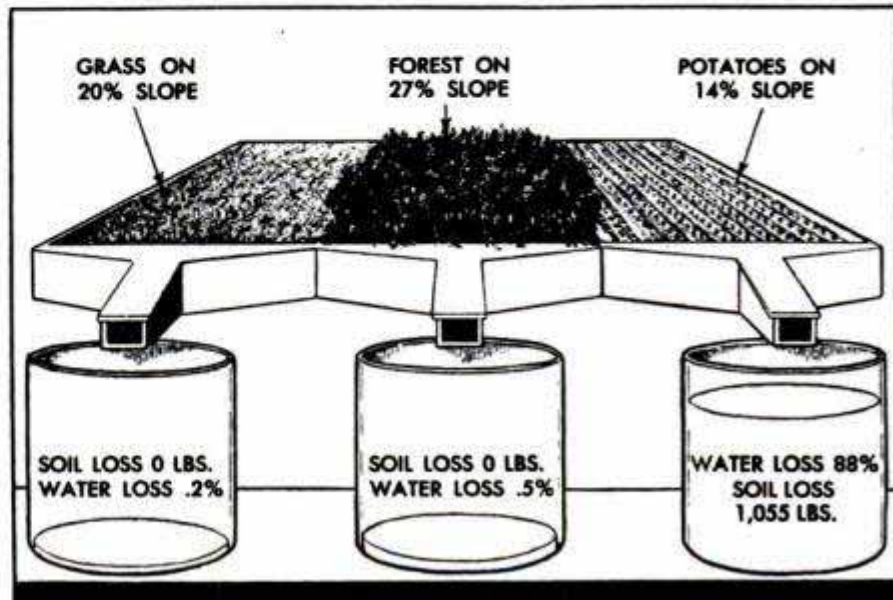

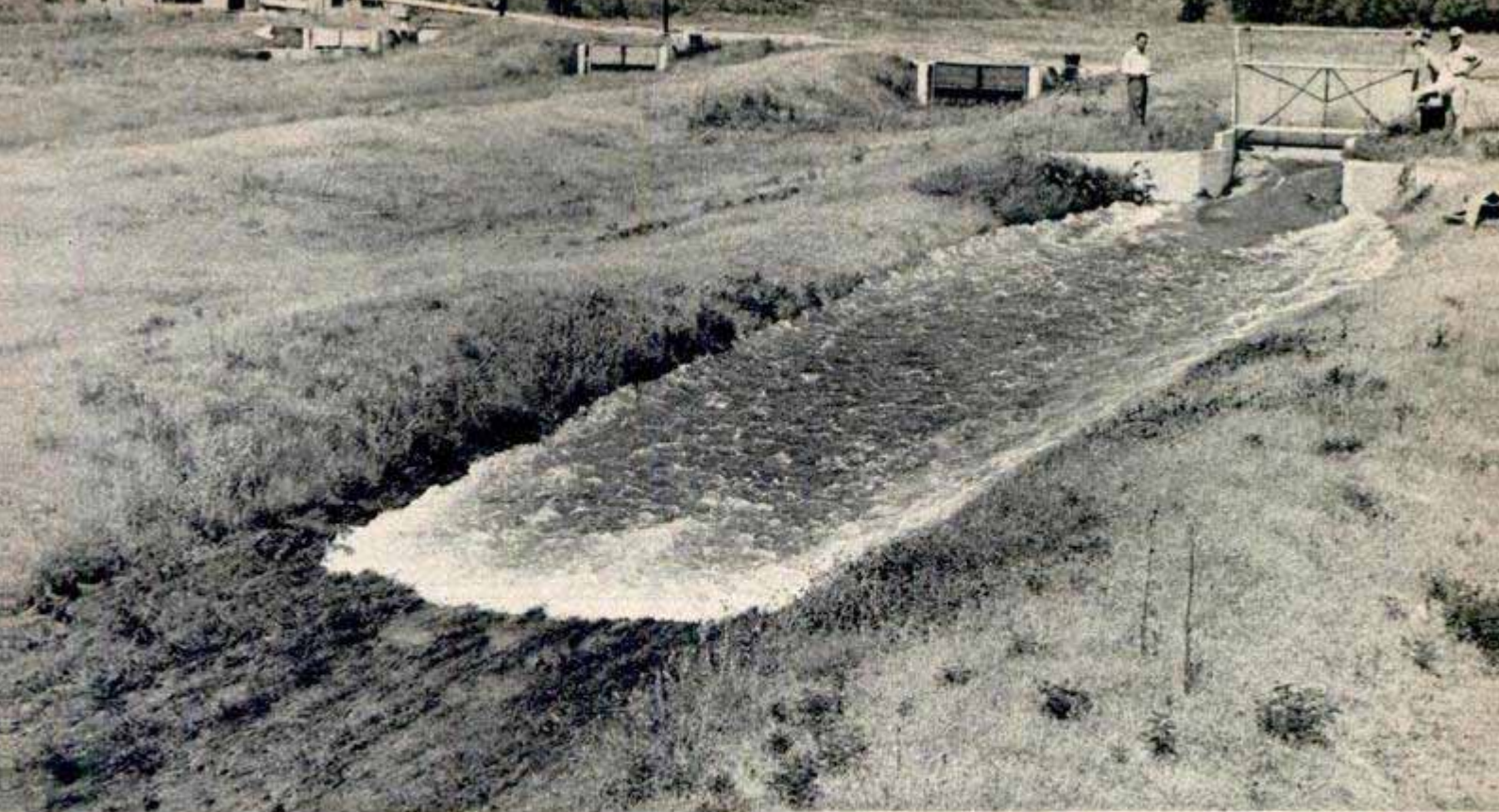

Out across one of the test channels rolls water at a rate of 75 cubic feet per second. The advancing crest has the characteristics of a roll-front flood wave. Measurements after the test will show the resulting erosion

starts to scour out the soil and carry it off.

Standard test procedure is to allow a steady flow of water to course down a test channel for 40 minutes. During this time surface observations are taken with point gauges (delicate instruments that measure in fractions of an inch). Before and after the flow, point-gauge measurements are made of the bed of the channel. The difference is considered scour or deposition—and gives an accurate measurement of the erosion processes at work.

Right, one of the research workers measures height and density of a clump of grass before flooding the channel. Diagram below shows various types of channels that can be built by a farmer on his own land

This information, recorded in tables, graphs and charts, might look like a foreign language to the average farmer. But it is the basis on which easy-to-read farm bulletins are prepared by the USDA. Farm advisers apply the results in sound, practical advice to farmers who wish to protect their land against erosion.

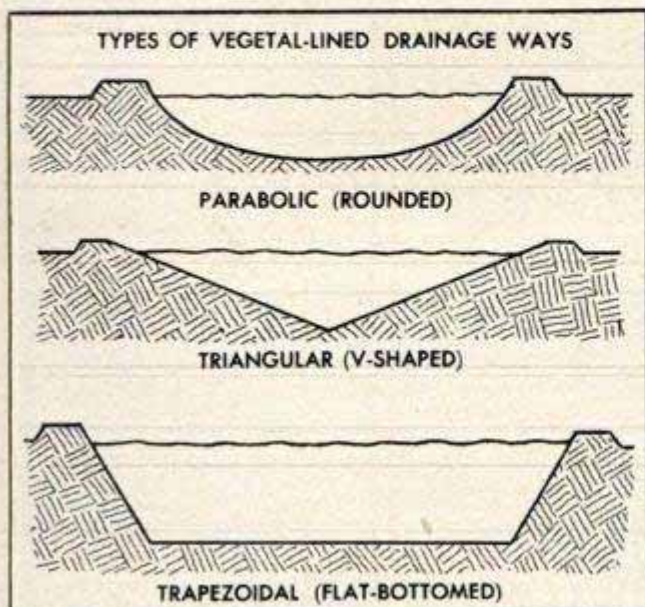

Concrete or asphalt-lined channels have proved to be the most efficient for carrying water. But they are too expensive for most farmers and act as a road block for farm machinery. Cheaper and more practical are broad, flat watercourses which can be crossed easily by tractors and animals and on which can be grown a hay crop. They are usually constructed in three shapes; parabolic (rounded); triangular (V-shaped); and trapezoidal (flat-bottomed).

Getting a grip on the earth with grass and other vegetal material seems to be the secret of defeating soil erosion. When an area is naturally wooded or protected by a good cover of grass, drops of rainwater strike branches and leaves, shattering into a fine spray which is absorbed by the soil and humus with blotting-paper action. In addition, roots help hold the earth in place.

But when there is no such protection and raindrops strike the bare earth, the action dislodges tiny particles of soil. From then on it's like a snag in a pair of stockings. The muddy mixture, obeying the laws of gravity, begins to flow downhill. First a rivulet, then a brook, and finally a river, the moving water gouges out great hunks of good topsoil.

Two hundred years ago erosion problems in this country weren't serious. Much of the United States was covered with virgin forest and the great plains of the Mid-

dle West were knee-deep in grass. But as the American homesteader moved toward the west, he cut down the forests and plowed the land. The climax was the tragedy of the dust bowl in the 1930s followed by the destructive spring floods of 1947.

Finding the right grasses to hold down America's barren acres is the second phase of the Outdoor Hydraulics Laboratory research program. Ree and his men have had to become botanists and agronomists as well as engineers. The ideal grass should furnish a complete cover as quickly as possible, not become a pest in adjacent fields, and must be able to withstand erosion.

Tests were made with approximately 25 different grasses including such well-known varieties as Bermuda grass, centipede grass, Kudzu, sericea, common lespedeza, redtop, Italian rye grass, weeping lovegrass, buffalo grass, Sudan grass, Kentucky blue grass, brome and King's Ranch strain yellow bluestem. Although the search for an ideal grass continues, the best so far seems to be Bermuda grass—sometimes called "devil grass" or "wire grass." Back-yard gardeners who discover it in their petunia beds sometimes call it even more unmentionable names.

One of the test channels containing Bermuda grass planted in silt loam was subjected to 13 hours of continuous flow of

(Continued to page 260)



Engineer adjusts current meter prior to checking the speed of the water, a measurement necessary in comparing tests

Grain Harvester "Mines" Lead

They're "mining" lead with a grain harvester on a five-acre tract near Kansas City, Mo. The lead is in the form of millions of shotgun pellets and it's being mined on a skeet range owned by Russ Elliott, who harvests an average of 8000 pounds a day. Elliott found that it would be too expensive to use city water in separating the pellets from the dirt. Last year he hit on the idea of using a grain harvester or combine to blow the dirt away from the lead. He located a screw-feed model and removed all the grain-handling equipment. Two men now mine the gun range, shoveling $\frac{3}{4}$ inch off the surface into the



combine. So far Elliott has harvested more than 100 tons of lead. He has recovered less than half the lead on the range—and the sportsmen are still shooting.

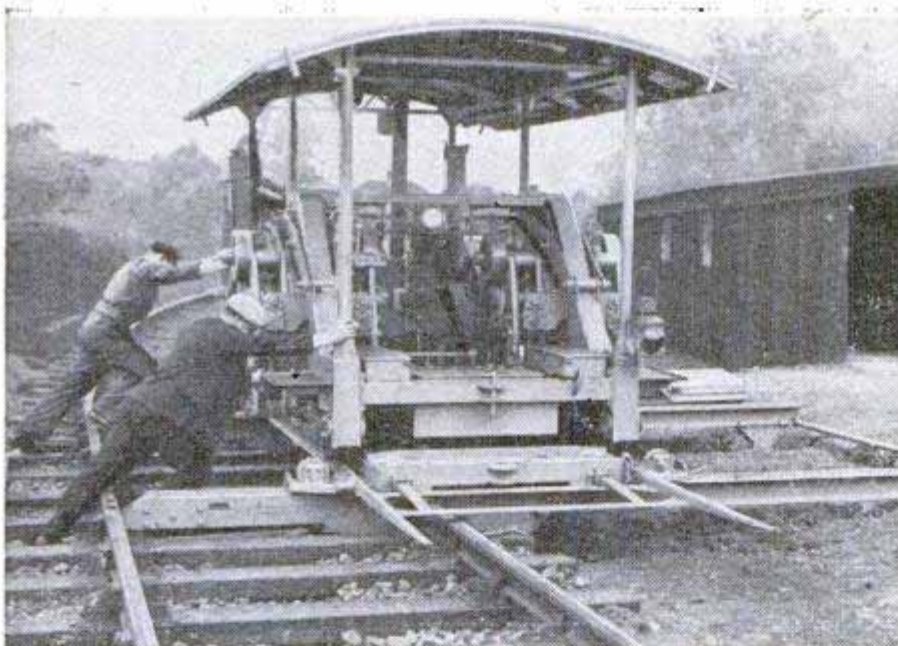

Gravel Tamper Levels Rail Ties

Developed by a Swiss manufacturer, a machine forces ballast under railroad ties to level the track. Much time and shovel work are saved as the device performs its job at the rate of four ties every 15 seconds. The machine, called a Matisa, is used by the London North Eastern Railway. Even though it weighs about eight tons, it can be pushed off a track in a few seconds. With two or three men pushing the Matisa, a derailer is used to steer it off the tracks.

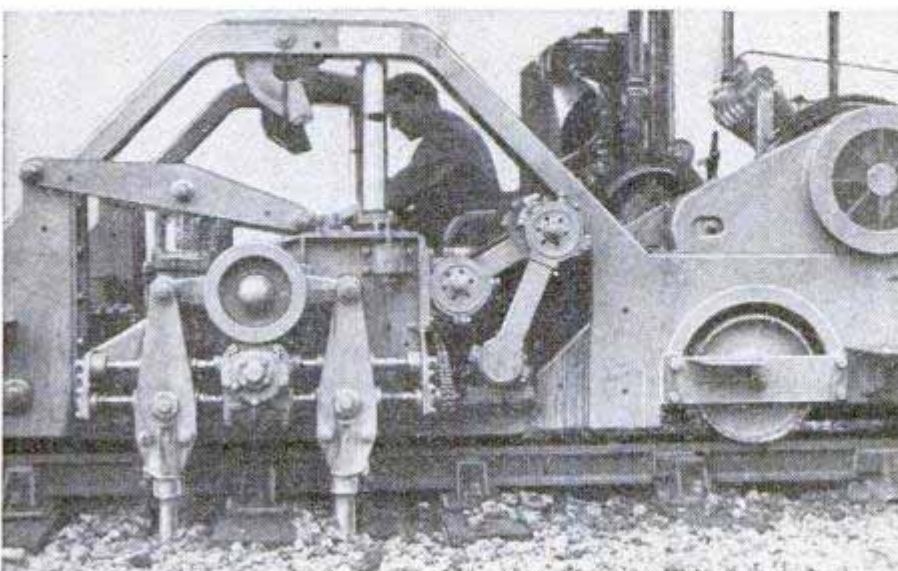

Top, the eight-ton machine can be pushed off the rails by two men to make way for a train. Bottom, tampers force ballast under four ties every 15 seconds

Streptomycin, the drug that successfully combats several infectious diseases in humans, kills certain types of germs that cause blight in plants, it was revealed in tests at the University of California.



Emergency Gasoline Can Has Attached Hose

Extra gasoline for emergencies can be safely stored in a can resembling an overnight bag. It measures 6½ by 9½ by 17 inches, low enough to stow beneath boat seats and in auto trunks, and holds 2½ gallons. When not in use, a flexible pouring hose, shaped to fit in a grooved channel in the can, returns automatically to the top and covers the air vent.

AUTOMATIC TOW BAR enables one driver to steer and apply the brakes on two vehicles simultaneously. Clamped on the cars' bumpers, the tow bar has two cables that operate the tie rod of the towed vehicle. Braking is accomplished when the tow car slows down causing pressure on the tow bar which moves a braking lever and applies the rear car's brakes. For reversing, an adjustment has to be made to disconnect the brake lever

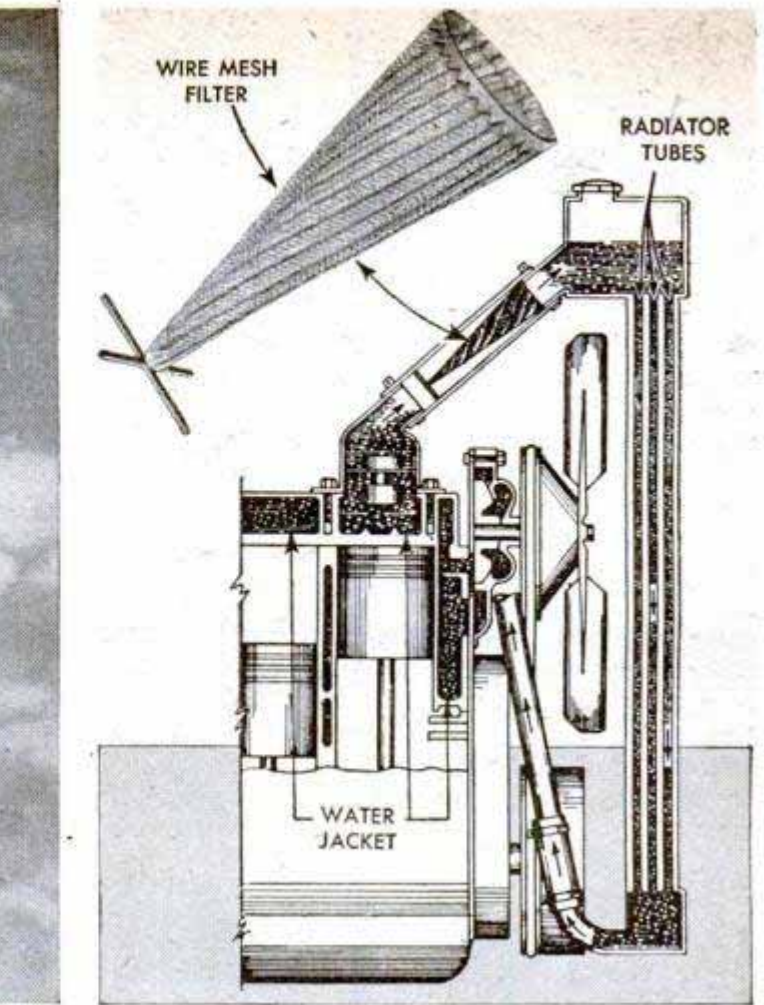
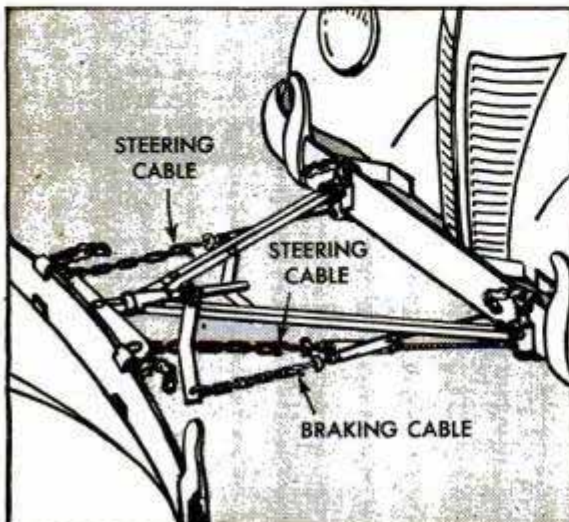

Filter Keeps Auto Radiators Clean

Rust and scale are kept out of auto radiators by a cone-shaped wire mesh filter that fits in the cooling line. Large particles from the water jacket are trapped as they move up from the motor to the radiator tubes. Pieces small enough to pass through produce a scouring action inside the tubes. The inverted cone's spiral design causes a swirling action that retards clogging and consequent reduction of the flow.

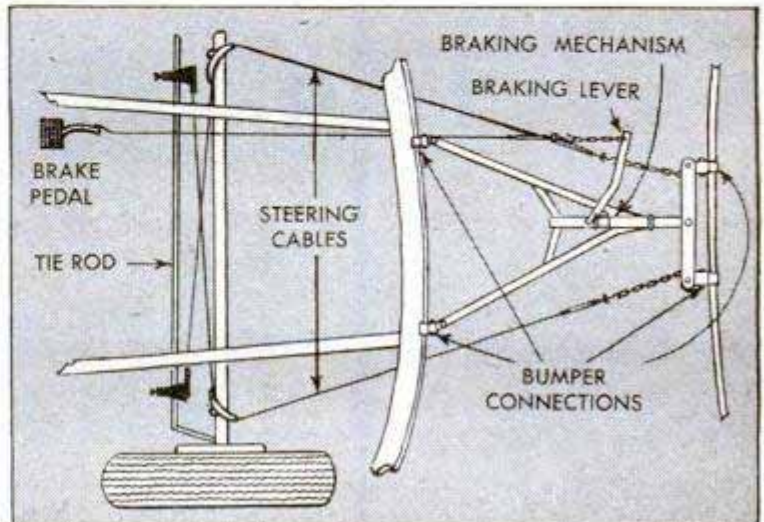

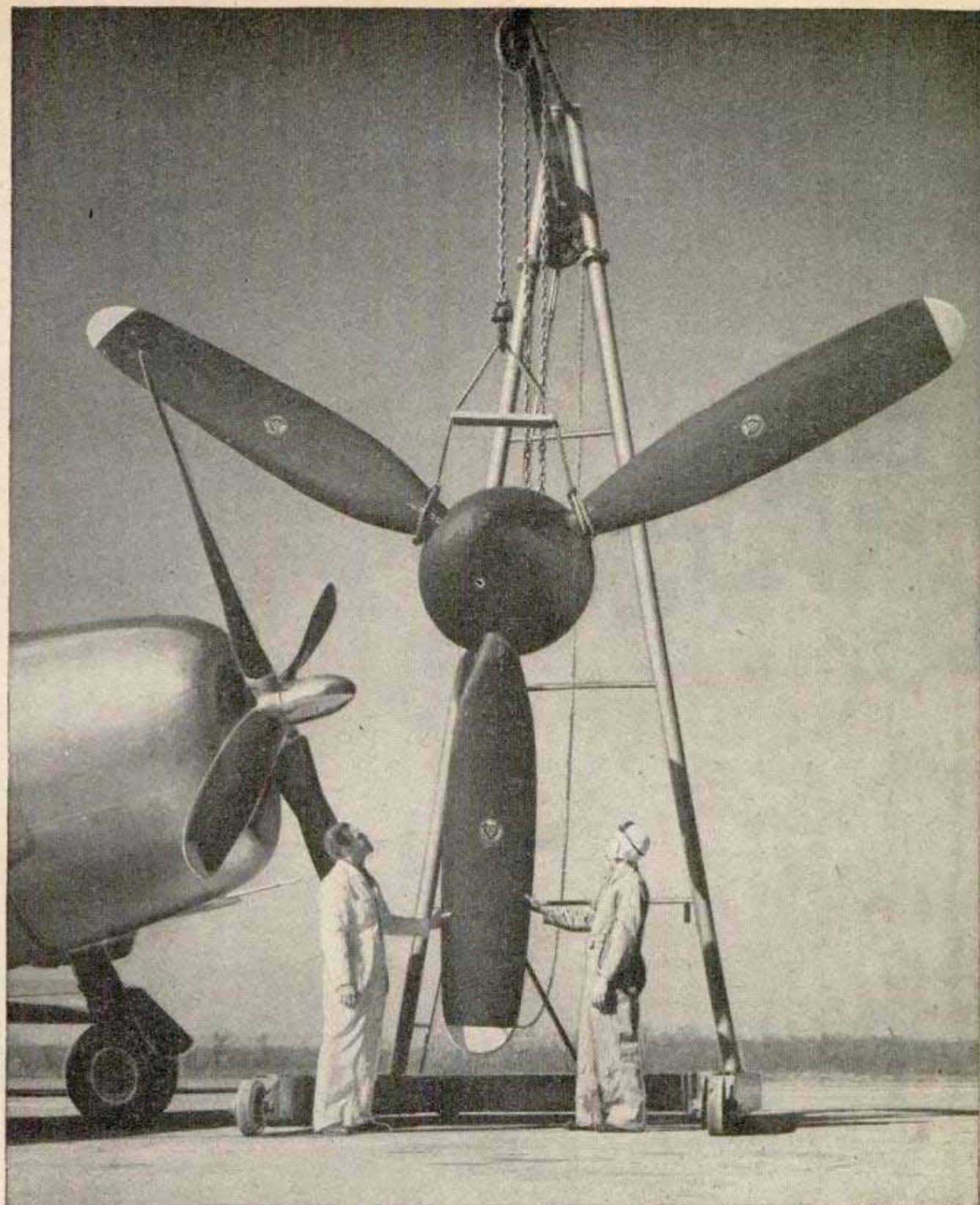

Curtiss-Wright photo

Not a last look, insists the author. Six of these 19-foot propellers pull the world's largest landplane, the XC-99, through the air. Blades' pitch can be reversed to brake landing run

Has the Propeller a Future?

WHEN JET PROPULSION was developed, hasty critics of old methods said the propeller was on the way out.

Yet today, engineers are readying a fantastic array of multiblade props and believe-it-or-not blade shapes that will make

By William Winter

it possible for propeller-equipped planes to penetrate the dread transonic region of "perpetual storm," from 600 to 700-odd miles an hour, where the spectre of split-second destruction of an airplane haunts its designers. When answers to this problem are found,

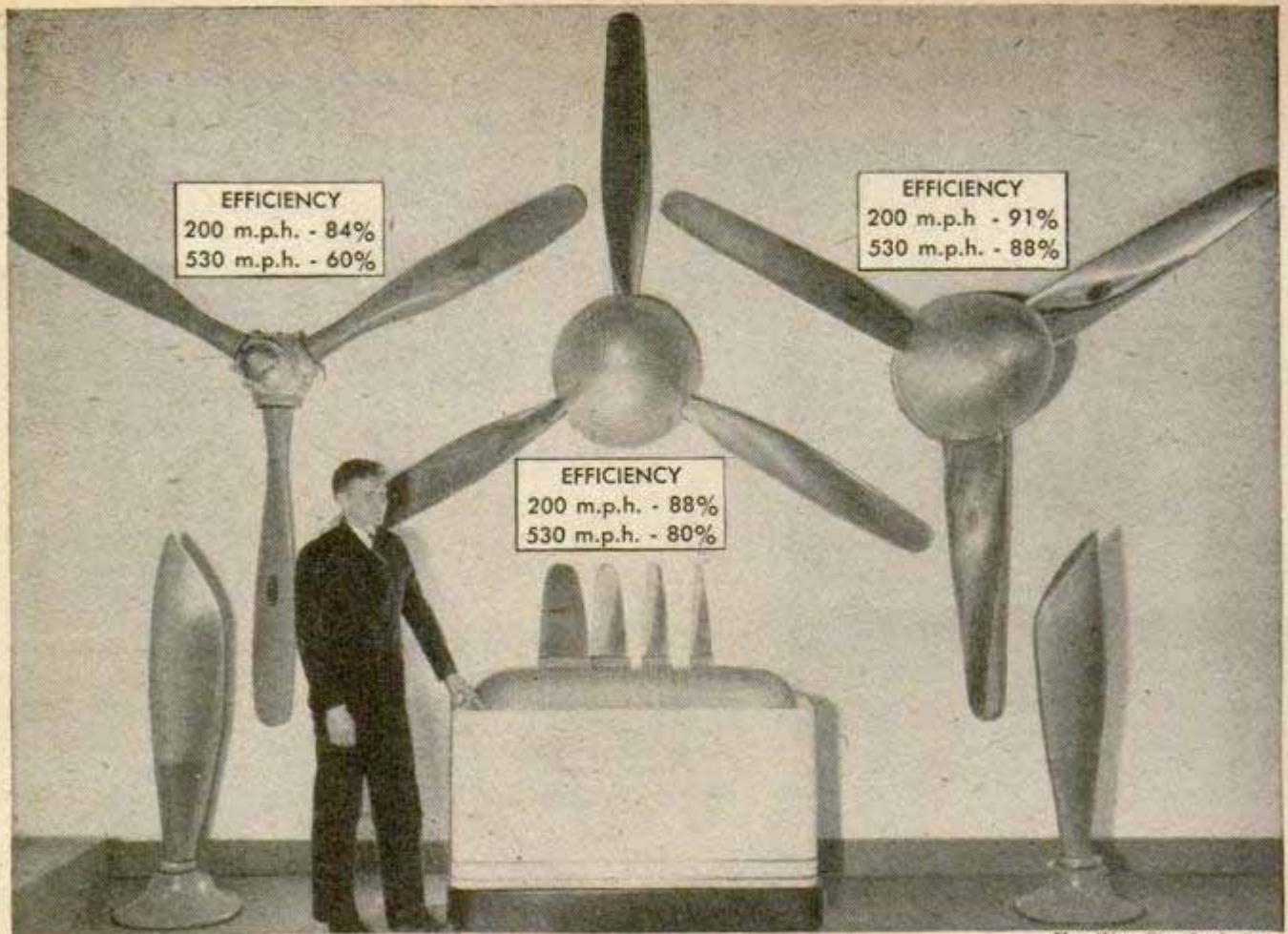

Hamilton Standard photo

the same basic airscrew device that pulled the Wright brothers' craft through the air is expected to be capable of supersonic speeds of at least 800 miles an hour.

In the propeller man's bag of tricks are future "fans" as big as 30 feet in diameter—special wind tunnels have been devised for possible propellers of 40 feet; eight and ten-bladed props that look like blowers; or props with abbreviated triangular blades. Some propellers won't even look like propellers, as we know them today.

Propellers are subject to the same high-speed teething troubles as airplanes. Fast-flying planes encounter "compressibility" effects where the air no longer streams smoothly over the surfaces of the ship, but slants off in shock waves like the waves from the prow of a motorboat. As 700-mile-an-hour speeds are approached compressibility plays gremlin tricks with the controls and will buffet any ordinary airplane to pieces. So the designers are working up strong knife-thin wing sections and wings of many strange shapes or planforms. Some are "delta" shaped like paper darts. All these difficulties were appreciated years ago by propeller engineers who necessarily must work five years or more in advance of projected airplanes.

The compressibility problem, with its abrupt changes in forces, is now believed to extend beyond the transsonic region. In

In propellers hanging on the wall, note progressive gains made by running widest section of blade into spinner. Below, drawings of an eight-bladed prop and double spinner for gas turbines of the future

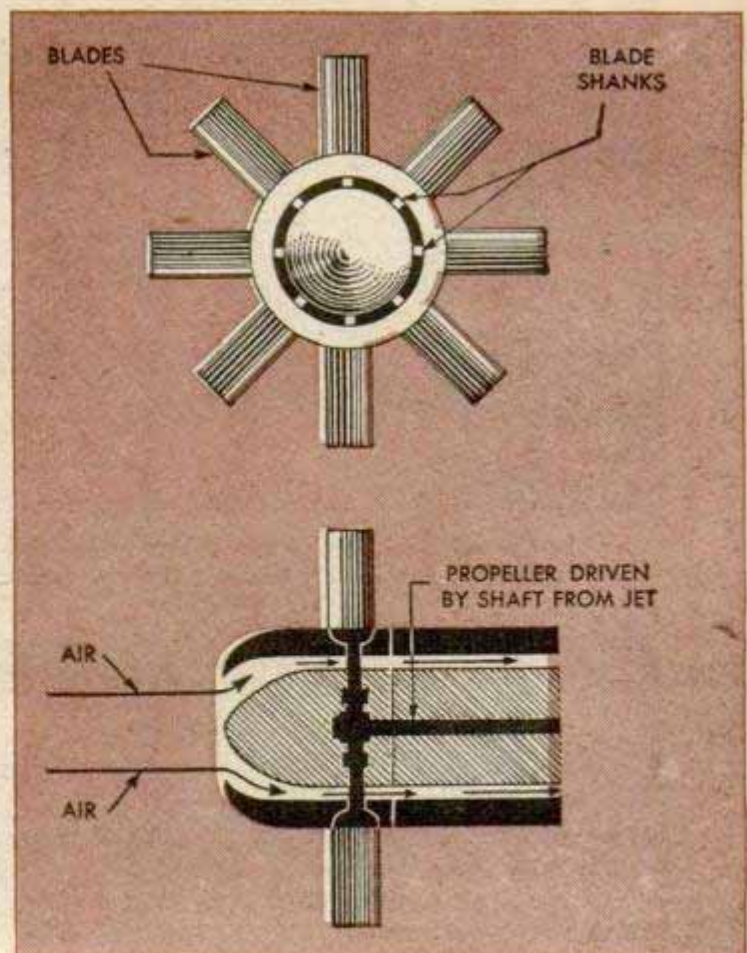

other words, it is doubtful that flight at supersonic speeds would be less rough than in the transsonic range.

For years many propellers had been operating with blade-tip speeds of as high as 650 miles an hour. When a Flying Fortress cruises, its propellers whirl with a tip speed of a bullet fired from a 45 Colt automatic! Charles M. Kearns, assistant chief engineer for Hamilton Standard, believes the present square-tipped paddle blade, which closely resembles the vanes of a Dutch windmill, will absorb at least 10,000 horsepower and be capable of speeds up to nine tenths the speed of sound, or close to 700 miles an hour.

At present, the counter or contrarotating propeller, in which two sets of blades are arranged in tandem with one set revolving clockwise and the other counterclockwise, is considered heavy and complex, but in the future it will be seen on turbines of 10,000 and even

Future gas turbines, in the above-10,000-horsepower class, will likely drive contrarotating props like those on the USAF's big flying wings

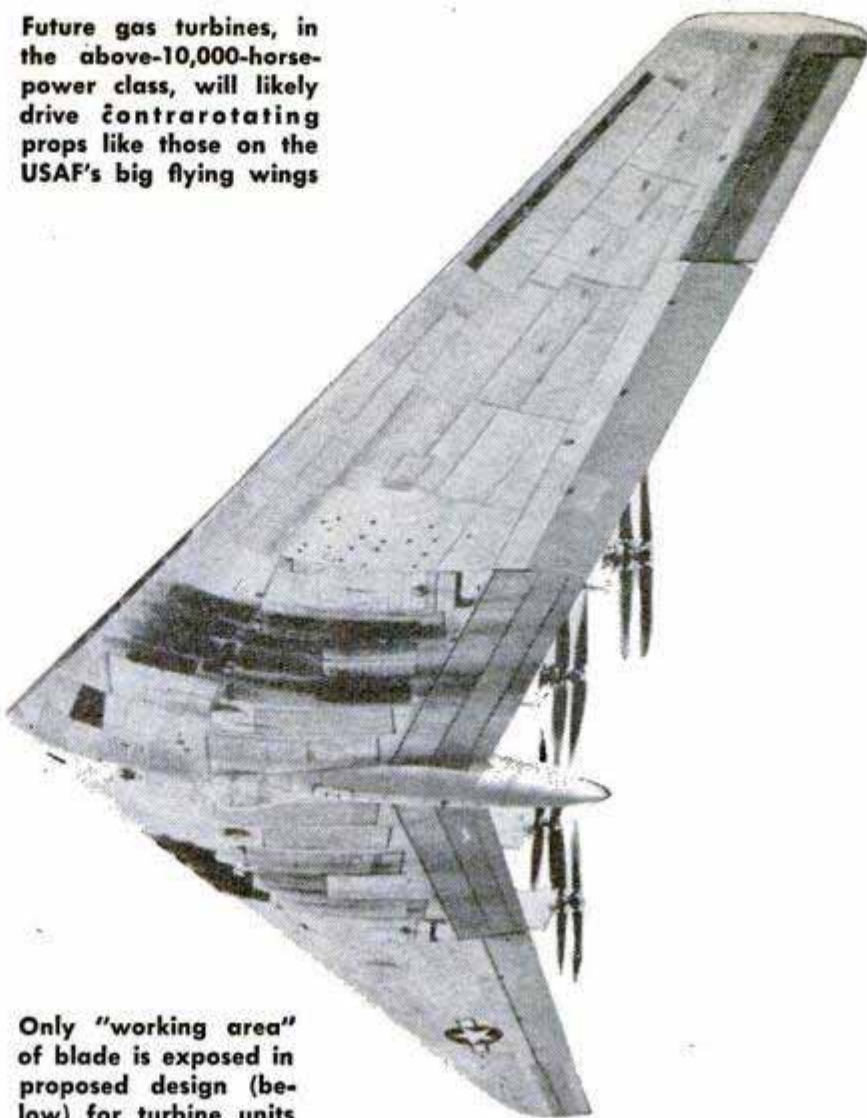

Only "working area" of blade is exposed in proposed design (below) for turbine units

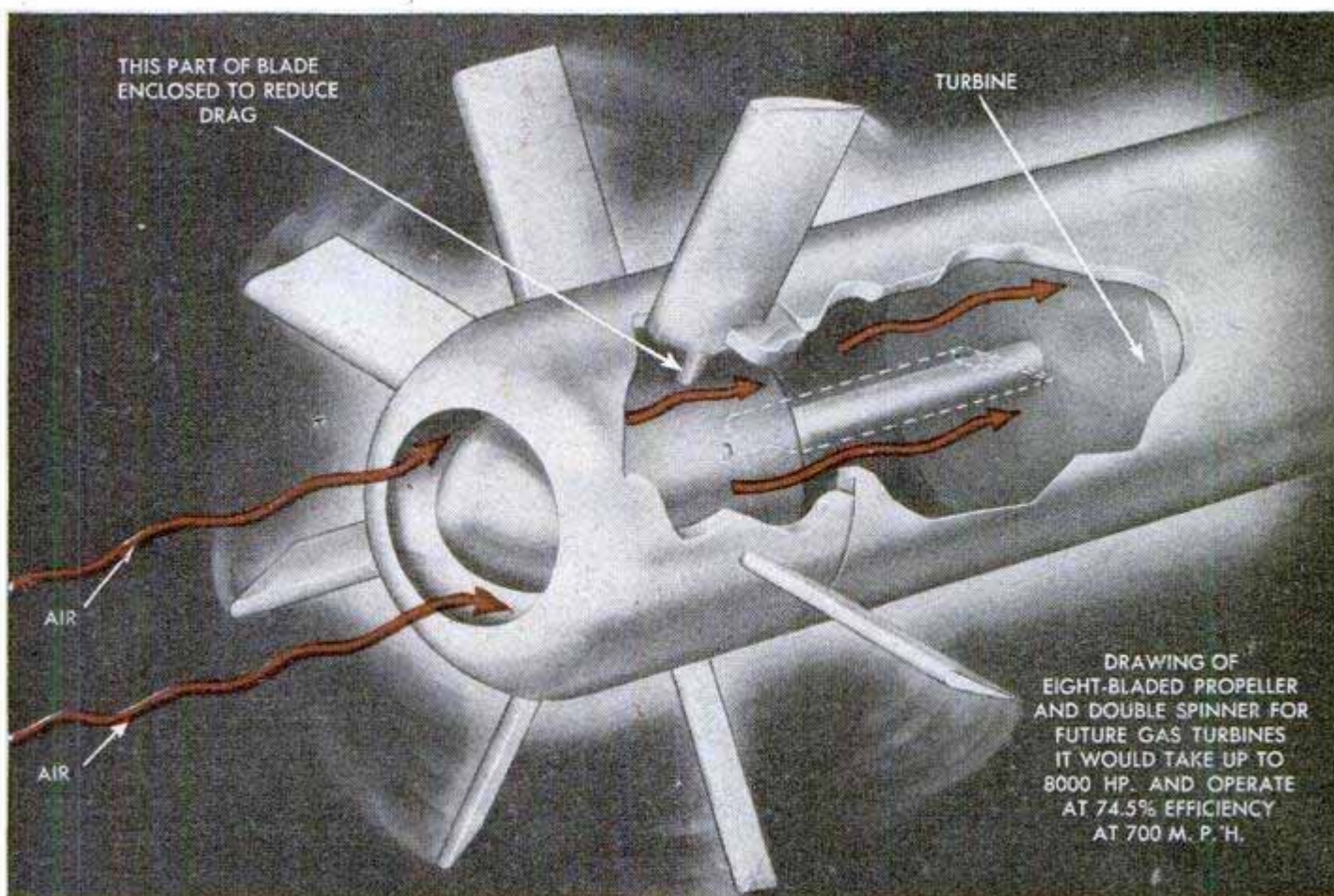

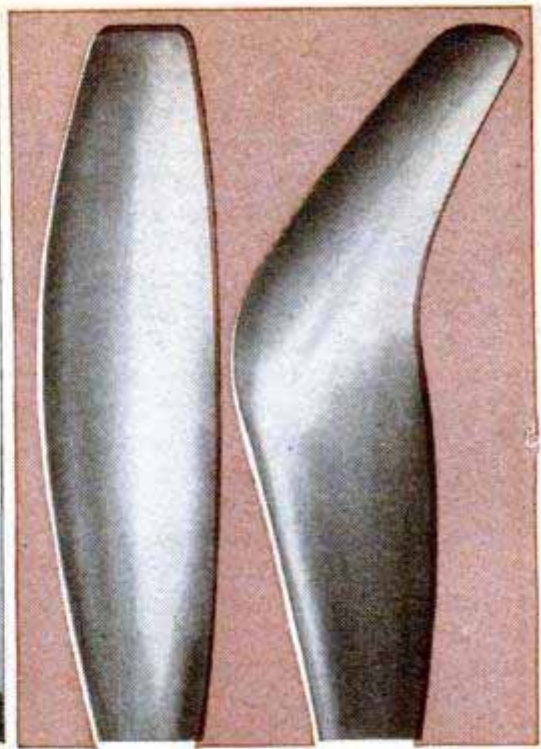
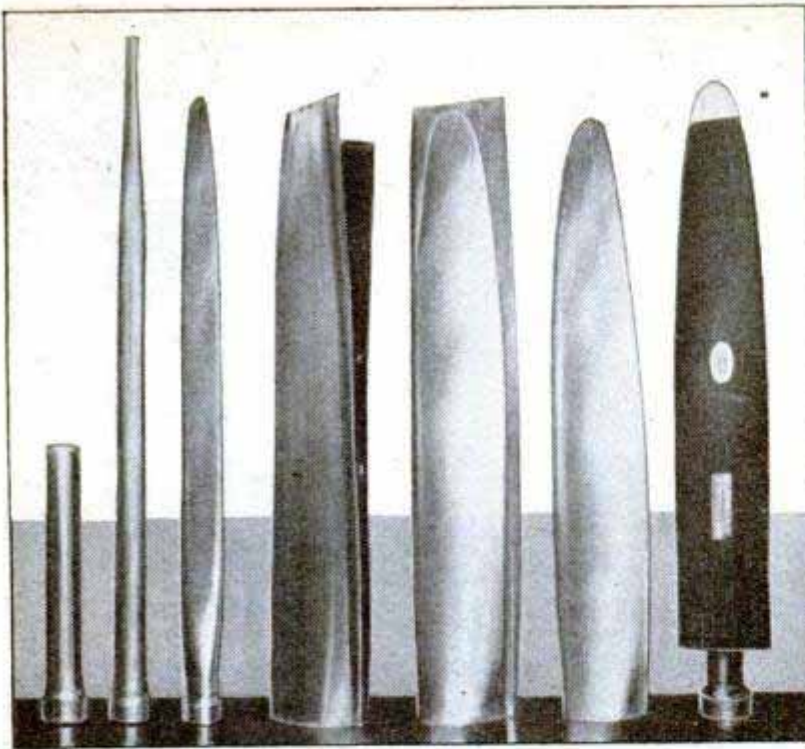

Above, steps in making hollow-blade propeller. Core at left fits inside sheet-metal-formed blades. Black sponge-rubber fill, shown in cross section at right below, prevents thin walls from "breathing." Above right, even slight distortions of blade's shape can often increase its efficiency 5 to 10 percent or more



20,000 horsepower. New blade shapes and other tricks will certainly take everything that such super power plants will dish out.

Chief among the early headaches was the fact that propeller-blade-tip speeds could not be further increased without serious losses in efficiency. Propeller usefulness seemed limited to 400-odd miles an hour. One difficulty was the steadily mounting power of new engines, another the great increases in airplane speeds that had the effect of stepping up blade-tip speeds disastrously. Bigger props were nec-

essary, but that meant greater tip speeds.

One solution was gearing down engines to revolve propellers more slowly, as on the Boeing B-29 bomber. Soon more and more blade area was being added to propellers, so much so that manufacturers had to find radically new ways of making lighter props. The hollow steel blade resulted. For the moment these massive, but light, propellers can handle the power problem at speeds up to 500 miles an hour or so. But sensationally fast fighters and bombers loom on the horizon and for them entirely new prop designs may have to be developed.

The National Advisory Committee for Aeronautics found that the ordinary three-bladed propeller has an efficiency of 84 percent at 200 miles an hour, but is only 60 percent efficient at 530 miles an hour. Simply by adding a spinner to streamline the hub section of the propeller, and by concealing part of the round blade shanks within the spinner,

(Continued to page 248)

Side view of another propeller shape under study. It is a triangle twisted about its own axis. It will take up to 18,400 hp. and be 74.5 percent efficient at about 700 miles an hour

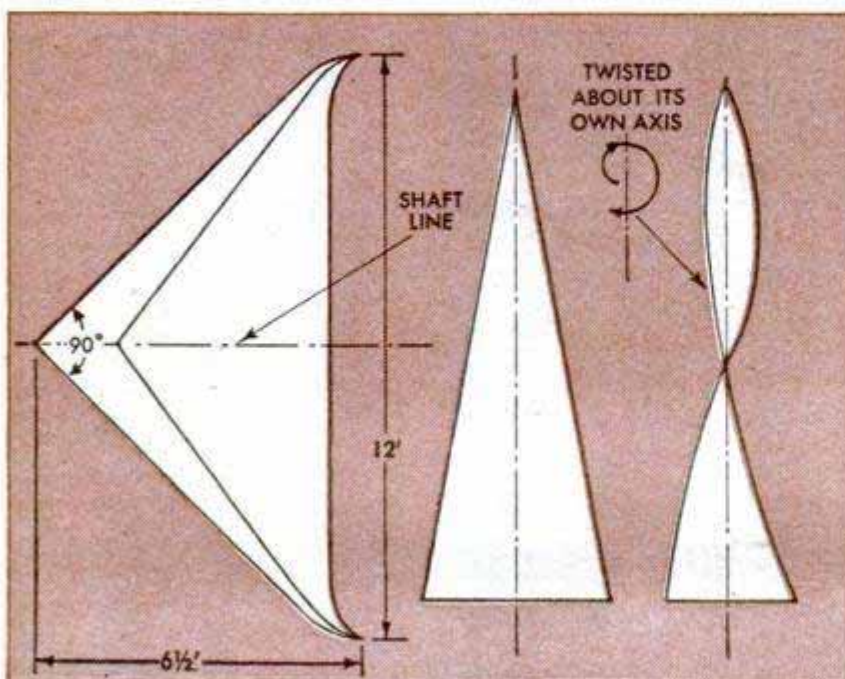



Model-T Modelmaker

Model-T Fords, with emphasis on the "model," are the hobby of C. B. McKennan of Clarksville, Ark. McKennan spends his spare hours building models of early Fords, complete even to keys in the ignition switches. The wheelbase of each car is five inches and the wheels, which will turn, have tin bearings to prevent stiffening in damp weather. Springs are made of clock springs, giving the models a realistic bounce when they are pushed. The steering system is an exact copy of the original and the fan revolves under the removable hood when the crank is turned. Only the frame, differential and motor are made of wood. The body, fenders, and hood of each model are cut from tobacco cans. Each interior is complete to a brake, clutch, reverse pedal, emergency brake and upholstery made of cloth. The headlight lenses, windshields and window panes are made of celluloid. McKennan already has built models of a 1927 pick-up, 1922 coupe, 1912 touring car, 1915 roadster and 1925 touring car. Eventually he hopes to make a model of every style of early Ford that was manufactured.

↑ Models include, left to right, '27 pick-up, '22 coupe, '12 touring car, '25 touring car and '15 roadster. Below, McKennan overhauls "engine" with tweezers

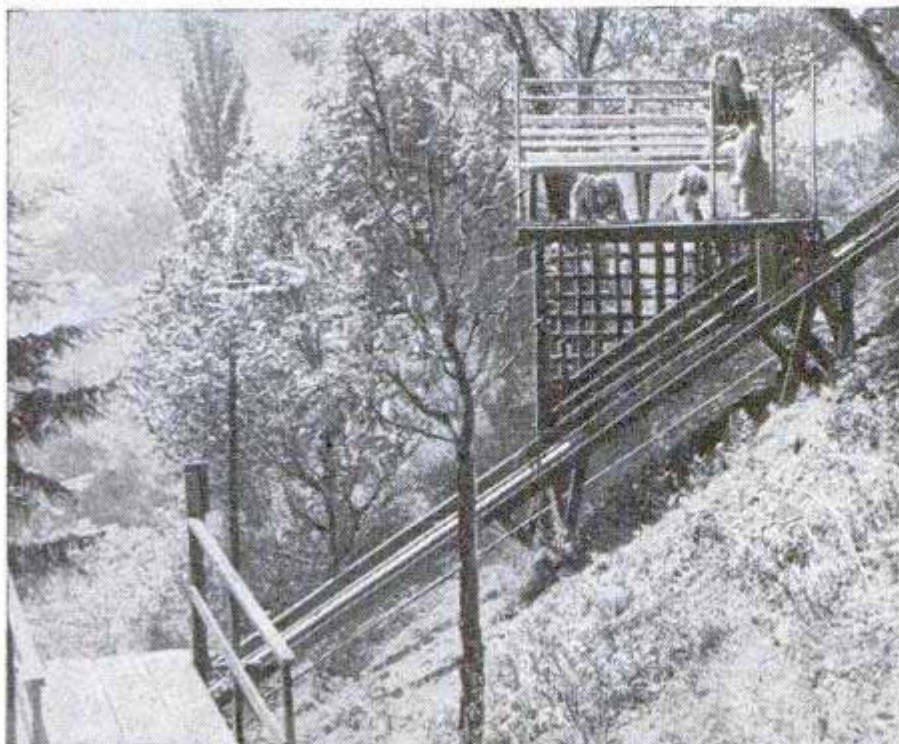
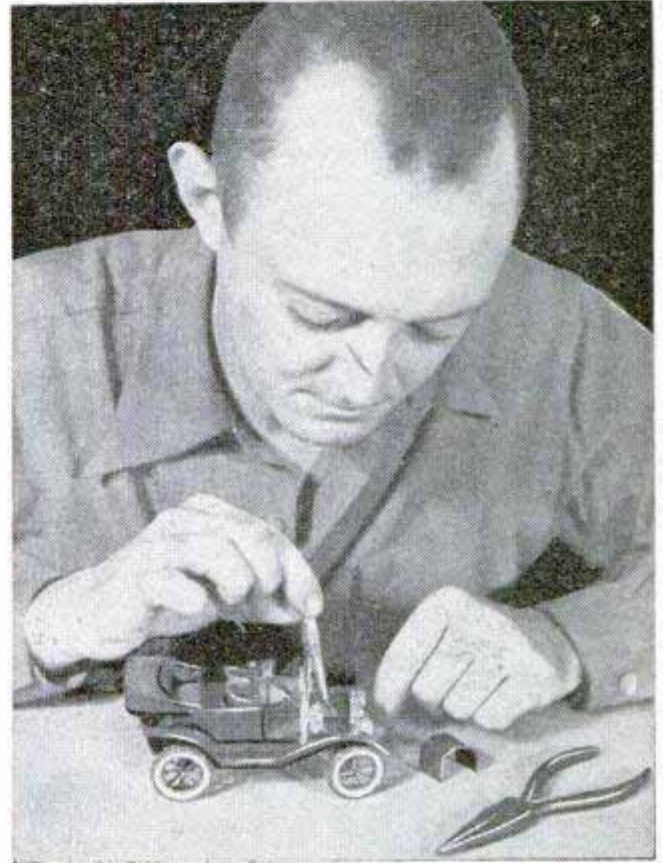

Hillside Elevator

Built of Army-surplus material, a small cable car with an 850-pound capacity provides an easy way of getting from the garage to a hilltop house in California. The car is pulled up the 145 feet of 50-percent grade by a three-horsepower electric motor geared through an Army-truck winch. Flanged wheels run on an angle-iron track. As a counterbalance, a smaller car made of a 600-pound iron slab runs on rails between the main tracks. If the motor fails, the high gear ratio of the winch stops the car.



GOING TO TOWN

↑ Car, truck and tractor—that's the role performed by a garden tractor specially equipped by Brooke Burnham of Cherry Hills Village, Colo. When his wife needed transportation to and from the village store he attached a cart to the tractor with a length of gas pipe. Now Mrs. Burnham sits at the front of the cart and drives the tractor to town on shopping trips while her children sit inside the cart. On the return trip the cart serves as transportation for the family purchases. The tractor travels only two miles an hour but, according to the Burnham family, that's better than lugging packages a few miles from the store to their home. Conversion cost was \$8.00

↓ Ray Strater's scooter car has everything in riding comfort, from an upholstered lounge chair to a "rumble seat." The forward passenger can use the bumper as a footrest. An extremely sparse gas user, it was the Mayfield, Ohio, high school boy's solution to the transportation problem. The teen lizzie has coil springs and lights

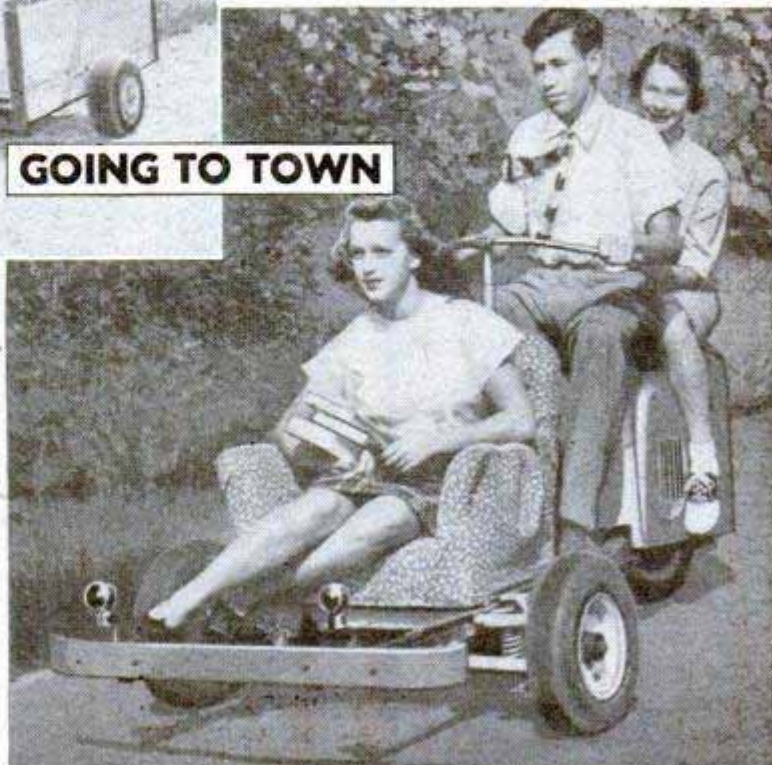

Spray Cleans Paint On Exterior Walls

Dingy, soot-covered house paint is cleaned without scrubbing by a spraying unit that pumps a chemical solution through a garden hose. The solution loosens surface dirt and dead paint and rinses them away uncovering clean, bright paint. It does not harm good paint, nor will it damage lawns and shrubbery. Pressure is provided by a pumping unit that connects to water and electrical outlets. Chemicals are placed in the tank of the unit where they are mixed with water.

Ⓞ A new record was set when a parachute carrying scientific instruments was released from a rocket at an elevation of 59 miles.

Popular Mechanics is always ready to supply further information to readers about various products described in any issue. Just write Bureau of Information, Popular Mechanics, 200 East Ontario St., Chicago 11, for quick reply

The CRAFTSMAN

★ To complete that Christmas tea service for the young hostess, we offer a folding table-and-chair set of exclusive design. We've tried to keep Dad's problem in mind, too, by making it easy to build. The story on page 178 goes into all details of making the set from plywood, large dowels and hardwood scrap.

★ If you like to see things take shape try basket weaving, page 201. It's one of the oldest of the handicrafts and still one of the most popular and profitable. Weaving materials can be purchased ready to use or you can prepare them yourself.

★ With a dozen or more rare old coins in your collection you'll feel more at home among collectors if you display them in a plunder chest. On page 190 you will find two designs in fine hardwoods.

★ For the shop man as well as the home workshop fan, a story on page 224 explains the dowel joint, its uses and how to make it.



DOWEL JOINTS



BASKETRY



CHILDREN'S TABLE
AND CHAIR SET

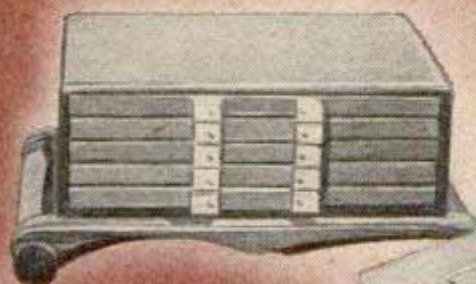

COIN COLLECTOR'S
BOXES



CHILD'S FOLDING TABLE AND

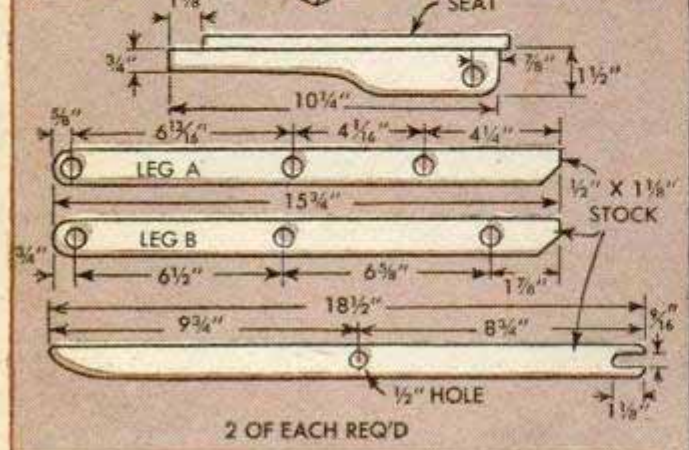
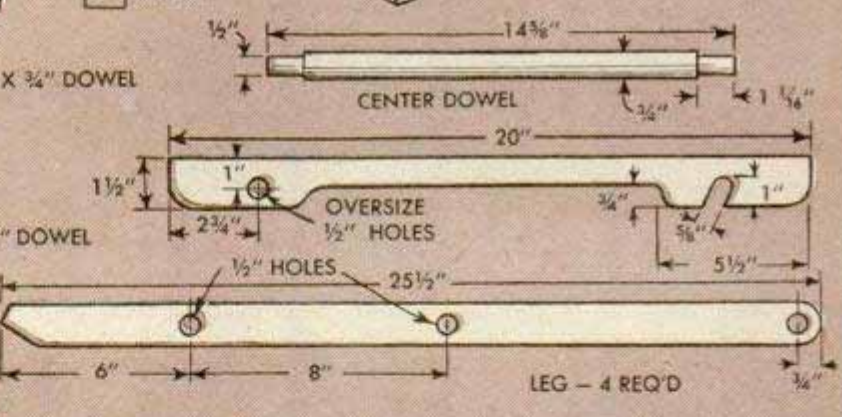
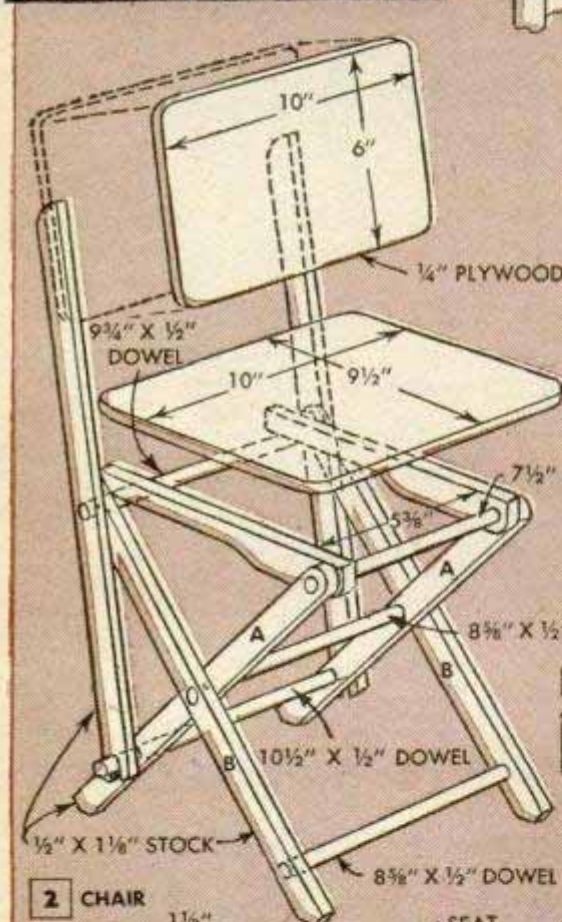
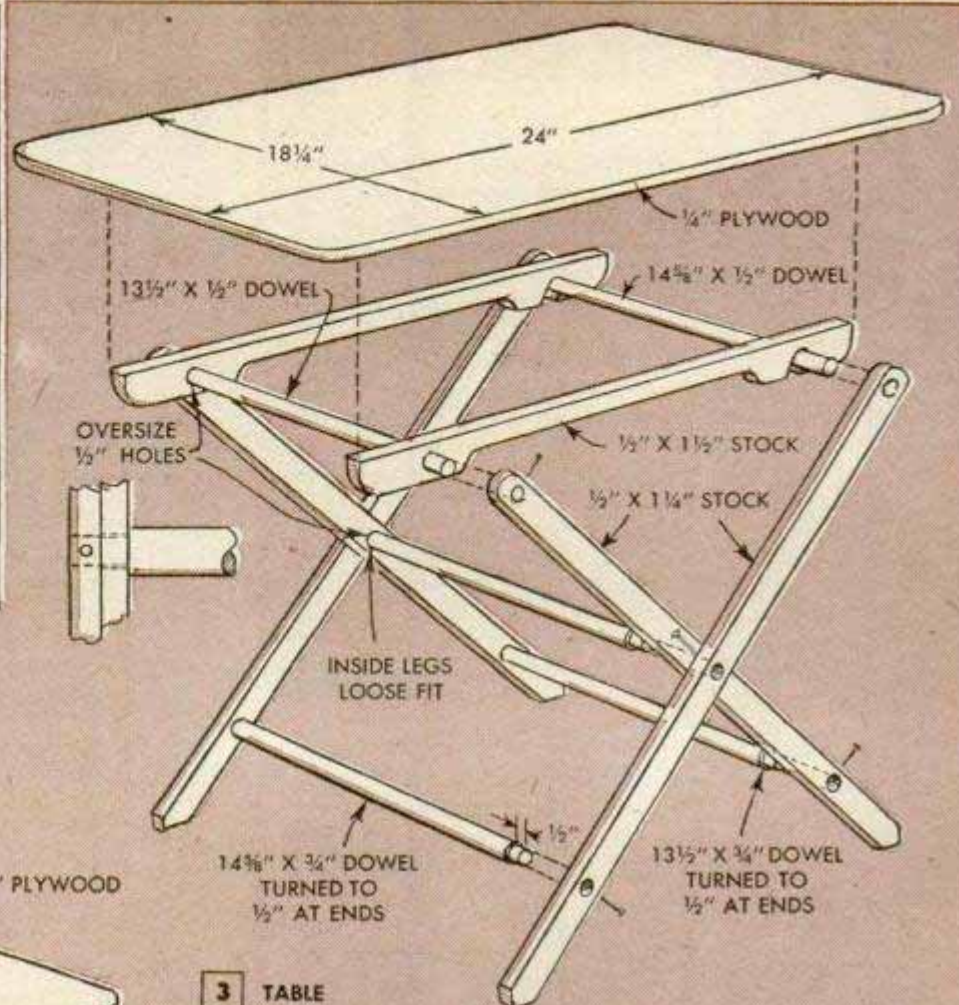

CHAIRS

Just the thing to make her Christmas set of dishes complete. Table and chairs fold compactly for storing

TEA PARTIES galore are in store for the little hostess of your family when she can entertain with this novel table-and-chair set. It is lightweight and folds as in Fig. 5, so that little tots can carry it easily. Very little material is required to make it.

The chairs: Any number of chairs can be made. Several duplicate parts can be cut and drilled at one time, Fig. 6, and if power tools are available, a setup can be used to mass-produce the parts quickly and uniformly. Fig. 2 details the assembly of the chair and the plan below it gives the size of the members comprising the framework. Note that the stretchers are standard dowel stock and are purchased ready-made. With the exception of the seat board and back rest, which are plywood, all parts are of $\frac{1}{2}$ -in. stock. Leg and back members are $1\frac{1}{8}$ in. wide, while the seat supports are shaped from stock $1\frac{1}{2}$ in. wide. Notice that the ends of the stretchers fit flush with the outside faces of the legs and that the lower rear one extends through the back legs about $\frac{7}{8}$ in. at each end, over which the notched back members hook. Except where the parts pivot, all stretcher holes should be bored for a light press fit, the others being made slightly oversize. In the

Here's how compactly the table and chairs fold. This is a welcome advantage in the home where storage space is limited. Set can include two or more chairs



By Richard Hanscom

latter case, the holes can be enlarged for a sliding fit with a round file or sandpaper wrapped around a smaller dowel. In assembling the parts, allow sufficient clearance between the joints. It's a good idea to use a metal or cardboard washer to prevent rubbing of the painted surfaces. Nails are driven crosswise through the legs and into the stretchers where indicated.

The table: Construction of the table is similar to the chairs. Fig. 3 shows how it goes together, and also gives the size of the parts required. Note that the stretchers are turned down at the ends to fit $\frac{1}{2}$ -in. holes in the legs. This adds rigidity, but, if desired, you can simply drive them into undersize holes and pin them. The top and its underframing must be ready for assembly at the same time as the other parts. The holes in which the top pivots are made

Where a number of chairs or several complete sets are to be made, cut and bore duplicate parts by mass-production methods, using simple jigs made of wood

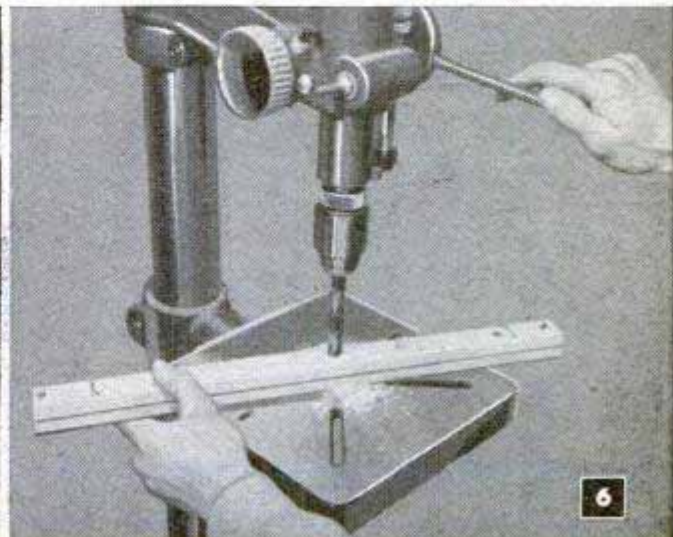
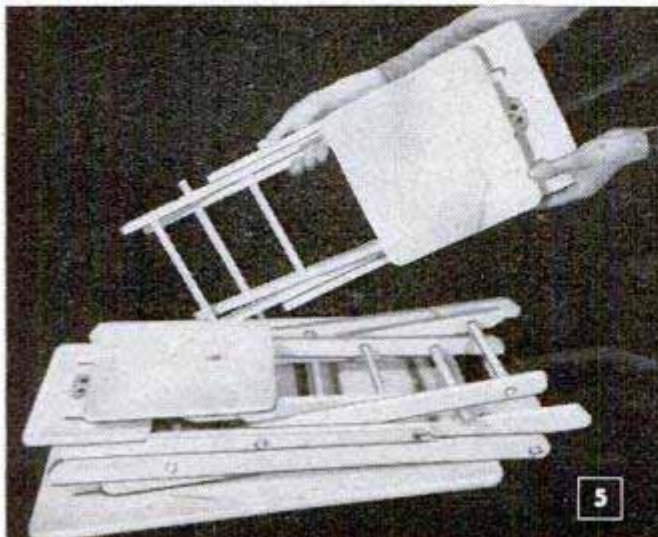

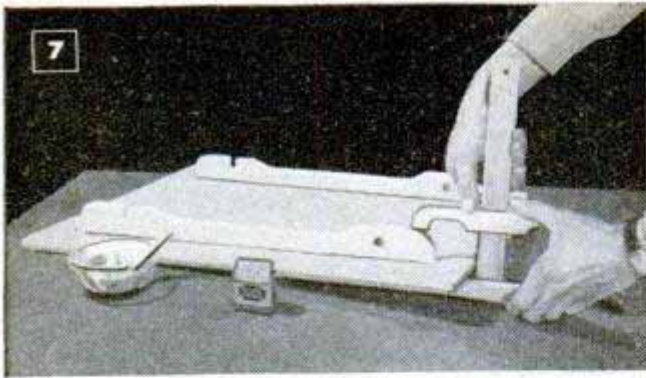

Above, clamping the underframing to plywood table top. Left, testing workability of chair before dismantling it for finishing. Spray gun speeds painting

oversize, and the notches at the opposite end are formed by first drilling $\frac{5}{8}$ -in. holes and then sawing in from the edge at an angle to meet the holes.

Finishing: The parts can be painted easily if done before assembly. Check to see that the chairs and table fold freely and then dismantle for finishing. Spray equipment turns the job into play and permits use of quick-drying lacquer. Give all the parts a coat of lacquer sealer first and when dry sand them lightly. Then finish with a couple coats of lacquer. Brushing lacquer is available but it requires considerable experience to apply. Very little brushing can be done and the lacquer must be applied with full brush loads in a sweep-

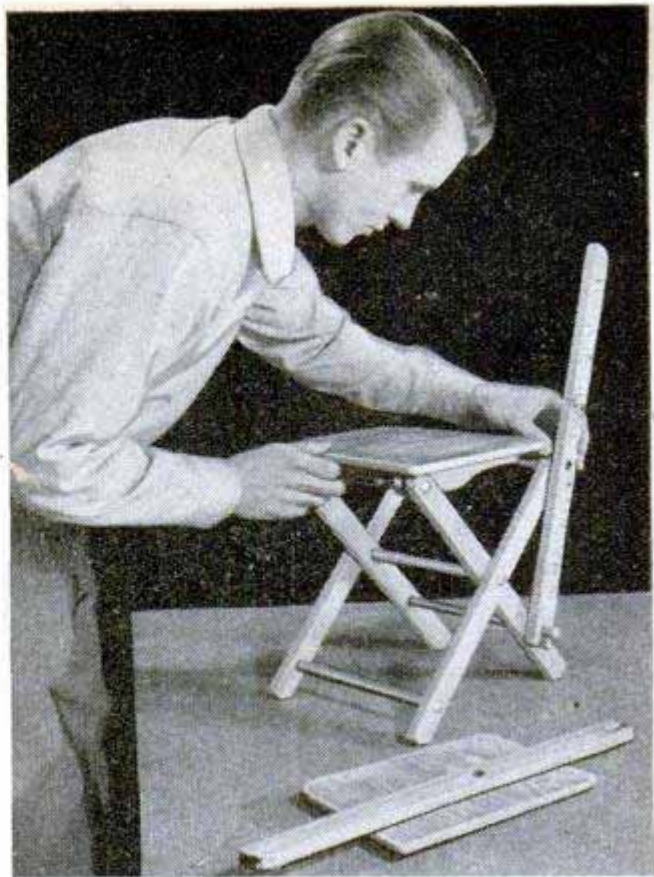

ing motion to avoid lap marks. Enamel, perhaps, is the best to use with a brush. The original set was done in light blue and striped in white as shown in Figs. 1 and 4. Decals can be added to the chair backs.

Law of Physics Is Demonstrated by "Diving" Medicine Dropper

The only equipment necessary for this amusing demonstration of Archimedes' principle is a medicine dropper and a bottle of water with a fairly long cork that fits loosely enough to act as a plunger. Paint a face on the rubber bulb of the dropper and tie short lengths of cord around the glass tube to simulate legs and arms. Use

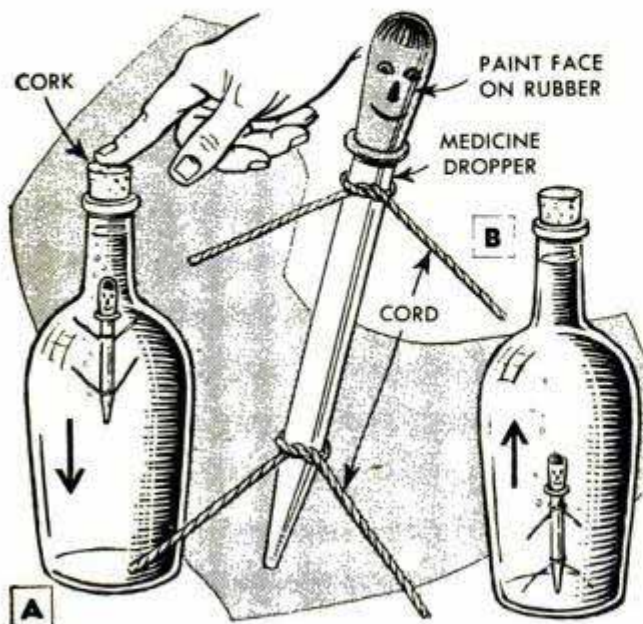

180

a large long-necked bottle filled with water well into the neck. Place the dropper inside the bottle. Twist the cork in the neck of the bottle until it moves easily, and press down on the cork. The dropper will descend slowly to the bottom of the bottle, A. Release the pressure on the cork and the dropper will rise to the top of the bottle, B. The dropper sinks because the air pressure inside the bottle is increased when the cork is pushed down, and since the pressure of the air inside the dropper remains the same, water is forced into the dropper until its weight is greater than that of the volume of water it displaces. Releasing the pressure on the cork, allows the air pressure in the bottle to decrease, and the air in the dropper expands. The expanding air forces water out of the dropper until it becomes buoyant and rises.

Monks' Cloth Reclaims Table Top

Table tops that are marred beyond the point of refinishing can be reclaimed by covering them with monks' cloth. Draw the cloth tightly over the top, tacking underneath, and apply a coat of varnish.

Wood-Lathe "Collet Chuck" Holds Faceplate Turnings

Handy in the home workshop for chucking a variety of faceplate work, this wood-lathe "collet chuck" also will work into a production schedule calling for rapid duplication of faceplate turnings. To make it,

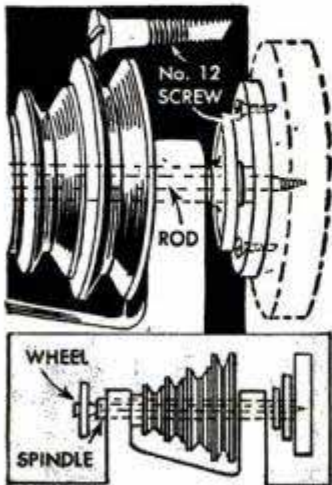

es through the hollow lathe spindle and projects at both ends. File wood-screw threads on one end of the rod and key or pin a handwheel on the other end. To use, simply place the work against the wooden faceplate and draw up on the handwheel until the work is pulled tightly against the faceplate. The chisel-point screws will bite into the work and serve as dogs. On duplicate work it will save time to center-punch each turning.

Russel I. Mann, Coopersburg, Pa.

Spring Catch Holds Drawer Closed



ble when the drawer is closed. Bend it from a strip of spring brass and mortise into the drawer side as shown, then attach with small flat-headed screws. As the drawer is closed, the hump bent in one end of the catch bears against the bottom of the drawer runner above. The spring can be adjusted so that a considerable pull will be required to open the drawer.

Wm. E. Danneman, Chicago.

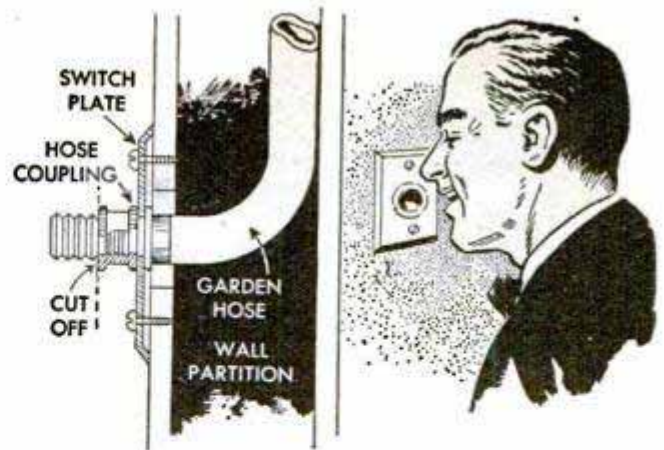

Home "Intercommunication" System Utilizes Garden Hose

Talking from the basement to an upper floor of a house, from the house to an attached garage, or from any other separate point is easy with this simple speaking tube, which is nothing more than a length of garden hose. It should be run up through partition walls, the upper and lower ends of the hose being brought out through the walls as shown.

Gilbert M. Brueckner, Milwaukee, Wis.

Flower Holder for Use in Cemetery Made From Tin Can

An attractive nontipping flower holder for use on a grave can be made from a fairly tall tin can and a length of stiff wire. Bend the wire so that it extends over the top and down the sides, letting several inches project from the bottom to anchor the holder. Solder the wire in place and finish the can in a dark green color.

Ivan Grosvenor, Richmond, Ind.

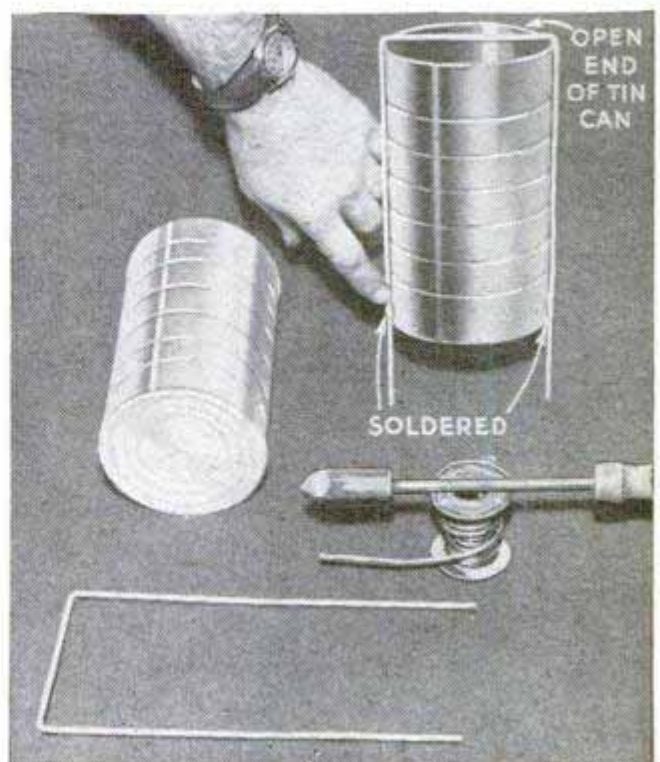

Solving HOME

The small space behind a metal sash lock on a double-hung window makes it difficult to remove accumulations of dust and dirt with a cloth. To reach this inaccessible spot, try using a toothbrush with some scouring powder



The small screws holding together the parts of an electric-appliance plug sometimes work loose and the nuts become lost. This will not happen if sealing wax or stick shellac is applied to the nuts

If you prefer to dry a freshly laundered sweater in the sun, it can be hung outside on a line without stretching out of shape if it is suspended with a clean towel passed through the arm holes as shown

An old curling iron provides a good match holder to ignite the burner under a gas oven. The iron grips the match firmly and enables you to keep your hand out of danger should there be a minor flash of flame

If your potted vine needs a trellis, place a flat stick in the center of the flowerpot and attach several spring-type clothespins to it horizontally. Clip them alternately to opposite sides of the stick



PROBLEMS

A good way to hang odd pieces of broken mirror for use in the basement or garage is to frame the glass in a length of rubber hose or tubing and nail the ends to a wall. One side of the hose is slit lengthwise and triangular gussets are notched in the hose at points where a bend is made. The edge of the mirror is inserted in the slit hose

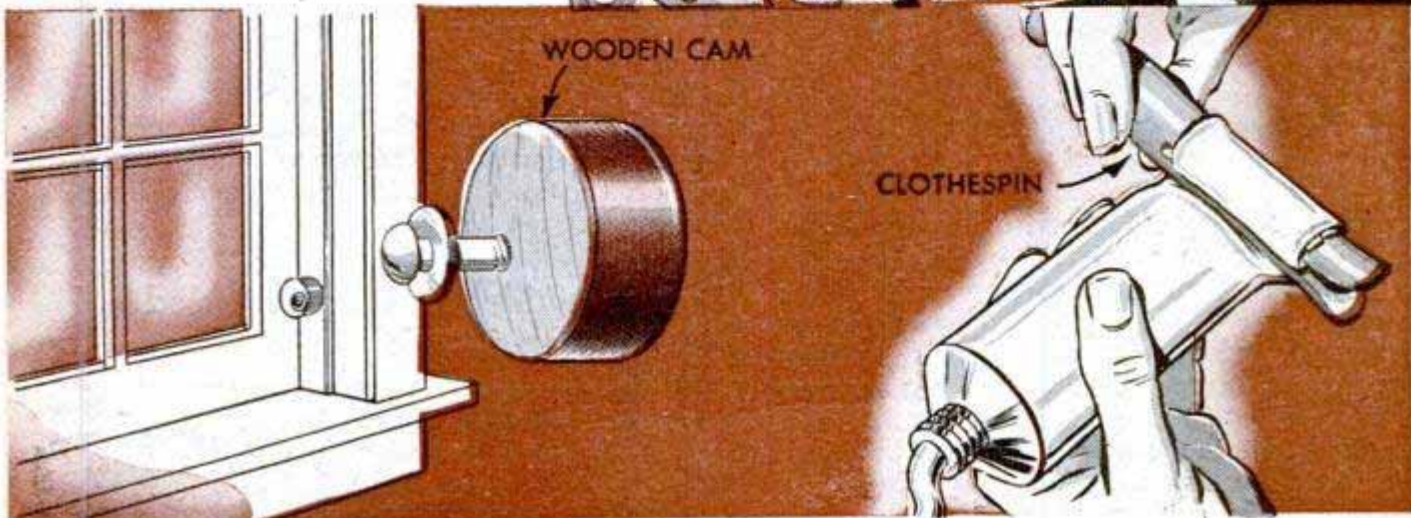

WOODEN CAM

CLOTHESPIN

To silence a rattling window, screw a small wooden cam to the stop in a position to bear against the sash. Make it of hardwood and drill it slightly off-center to provide a wedging action against the sash

Collapsible metal tubes containing toothpaste, shaving cream and other items can be emptied completely if they are rolled around a wooden clothespin. The pin is slipped over the tube and used like a key

Heat from a steam or hot-water radiator will be directed out into the room if you place a reflector between the radiator and the wall. A sheet of shiny tin, or cardboard painted aluminum, will do

This excellent pocket-type letter opener is made from a discarded hacksaw blade. First, grind off the teeth on the blade, then shape and sharpen a cutting edge at a 30-degree bevel on one end as shown



REFLECTOR

HACKSAW BLADE

PENCIL CLIP

How to Cut Holes for Outlet Boxes Without Cracking Plaster

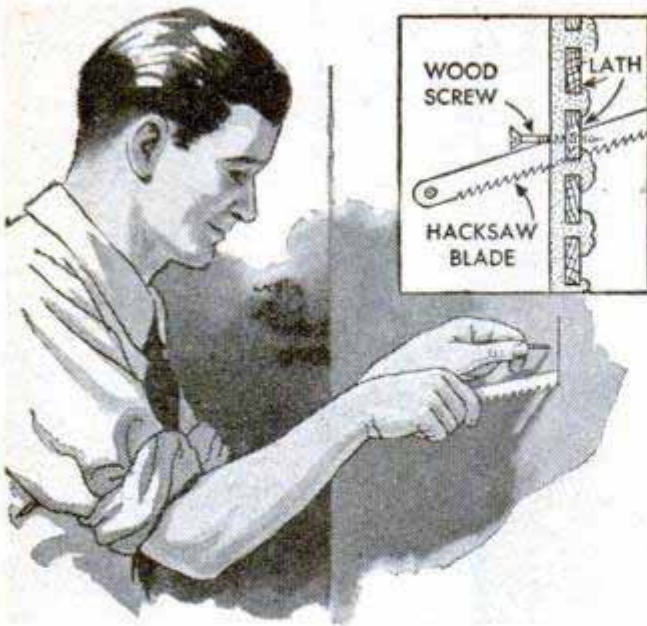

When cutting a hole in a lath-and-plaster wall for an electrical outlet box, the lath will frequently break away from the plaster and cause it to crack or become loose. One electrician avoids this by driving a wood screw into a lath at the approximate center of the hole to be cut. Then, pulling on the screw to hold the lath against the plaster, he cuts the hole with a hacksaw blade. The blade is held so the teeth make the cut on the pulling stroke.

Harold M. Freeman, Clinton, Iowa.

Cloth Basted by Using Tape

Instead of using thread to baste two pieces of cloth together preparatory to stitching the seam, my wife finds that she can save much time by using strips of masking tape for this purpose. The strips are applied across the seam and as close to-



gether as required to keep the edges together. When sewing the seam, the tape strips are removed ahead of the sewing-machine needle, one at a time.

Frank Shore, New York City.

Splicing Tool from Paper Clip

Handy for splicing small, lightweight rope, this tool consists of a wire paper clip and a dowel. The upper drawing shows how the clip is bent and the ends inserted into a dowel handle. The lower drawing illustrates the manner in which the splicer is used. Reference to any manual on the subject will show how splices are made.

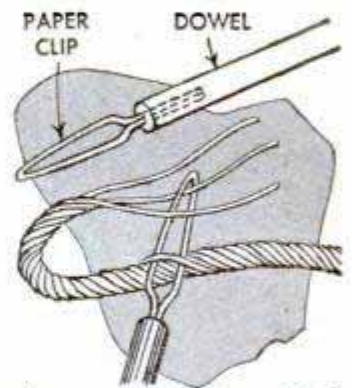

Prongs of Electric Plug Shielded With a Large Cork

If the prongs of the plugs on electric appliances in your home are sometimes dropped on the floor and damaged or stepped on and bent, get a few corks and use them as shields on the prongs when the plugs are pulled from the receptacles. Slits for the prongs are made with a knife.

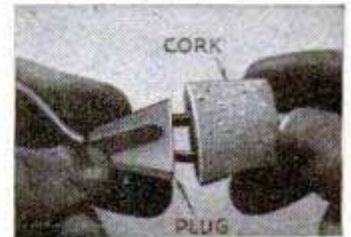

Kenneth Murray, Colon, Mich.

Making Extension Clamp

An excellent bar or extension clamp of practically any length can be made with very little expense from a C-clamp. Saw the clamp into two parts at the point indicated and then grind off the rib portion on each part as shown. Using two flat-iron pieces for rails, bolt the screw half of the clamp to one end. The other half is made adjustable by drilling a hole through it to take a pin. This pin, which is chained to the clamp for safekeeping, engages holes, spaced 2 in. apart, in the rails.

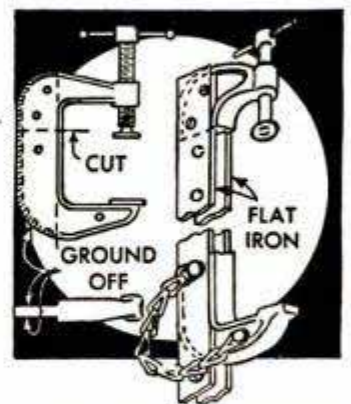

A. G. Mather, Ottawa, Ont., Can.

SILENT BUTLER

takes the "brush-off"

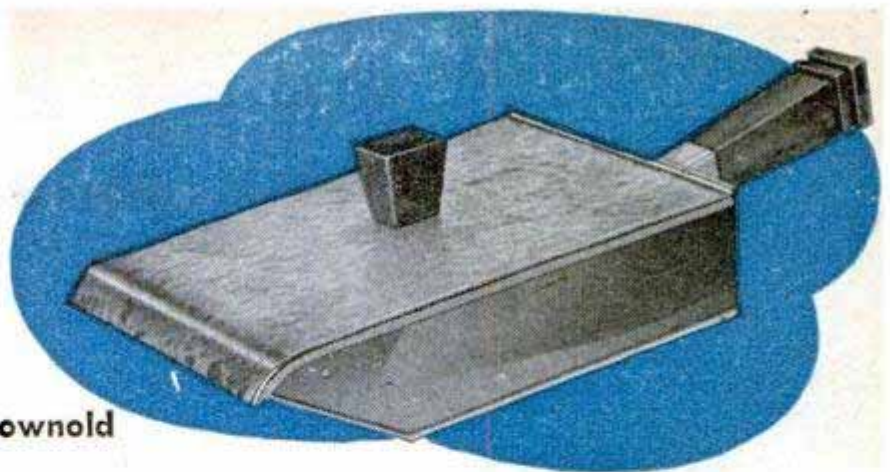

By Charles and Bertram Brownold

REQUIRING only three pieces of 18-ga. sheet copper and two blocks of wood, this attractive crumb tray is simple enough to complete in a couple of evenings. First, draw a full-size cardboard pattern of each of the metal parts, following the squared drawing in Fig. 5. Then trace the patterns on the metal with a sharp-pointed tool and cut out with tinner's shears as in Fig. 1. Next, cut a wooden block slightly smaller than the inside of the tray and use it as a bending form. After bending the sides of the tray against the block, Fig. 2, fasten each corner together with a small rivet. The lid of the tray is shaped by clamping it between two blocks as shown in Fig. 3. A $\frac{1}{8}$ -in. flange is formed along two sides of the lid by letting the metal project between the blocks and then bending the edge downward. The top surface of the lid is given a hammered finish with the round end of a ball-peen hammer, Fig. 4, after which the hinge tabs are formed around a stiff wire and the knob and handle attached. Brighten the metal by polishing with steel wool and apply clear lacquer to prevent tarnishing.

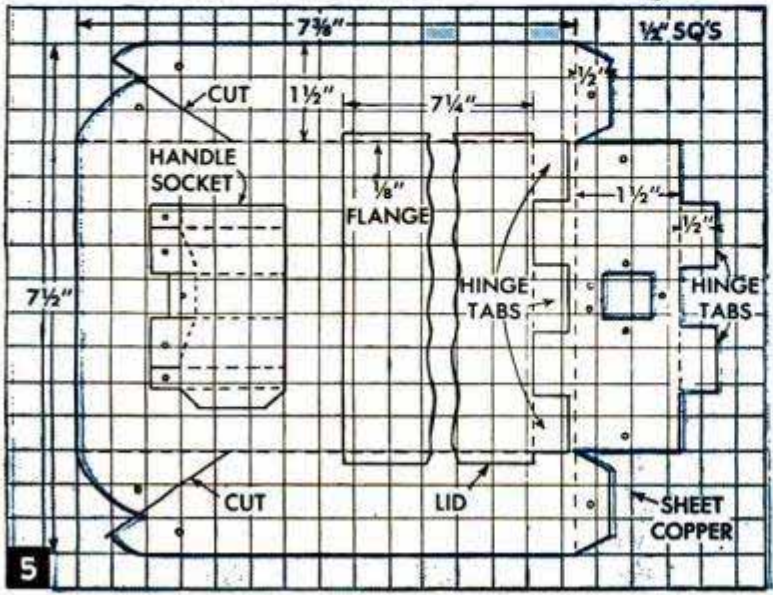
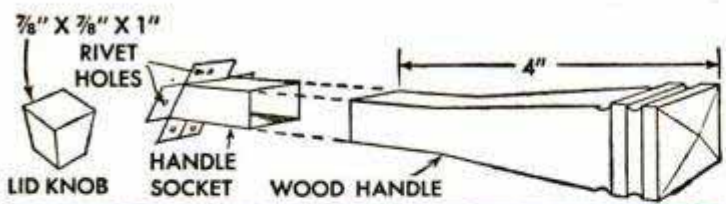
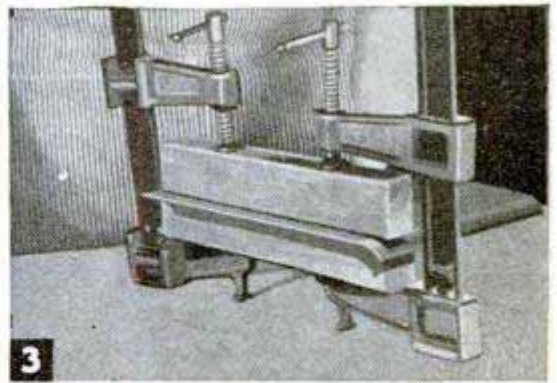
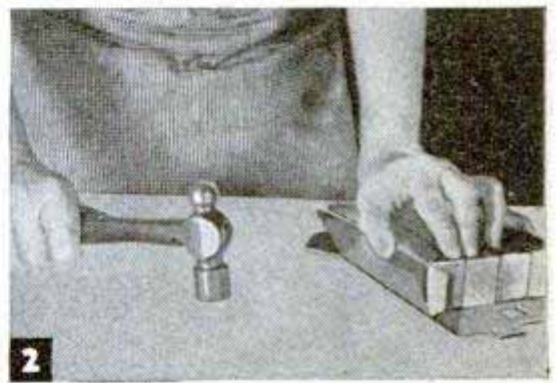
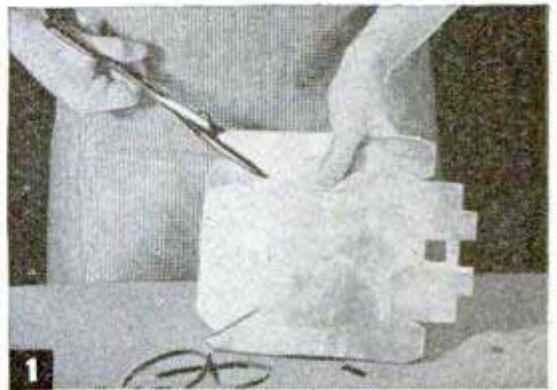

Novel Clothespin Flashlight Frees Hands for Work

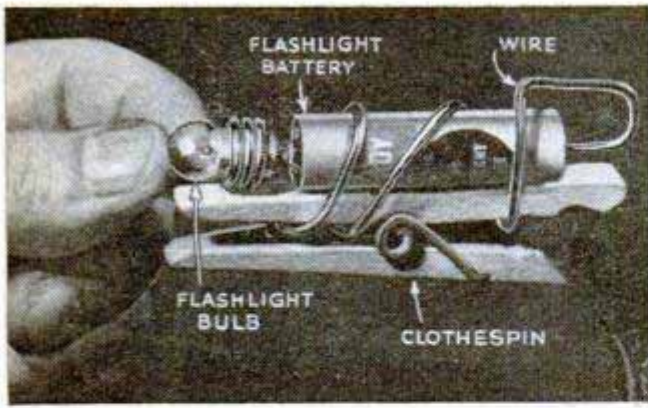

Light where you want it—that's the feature of this clothespin flashlight. You can clamp it to anything convenient, which makes it ideal for work where both hands are needed. Just four items are all you need to make it: A penlight dry cell and bulb, a length of heavy copper wire and a spring-type clothespin. Coil one end of the copper wire around the grooves in the base of the bulb to form a socket, then continue to wrap the wire around the dry cell and clothespin as shown. Finally, bend the end of the wire to bear against the bottom of the dry cell. Screwing the bulb in or out serves as a switch.

Pencil Substitutes as Depth Gauge

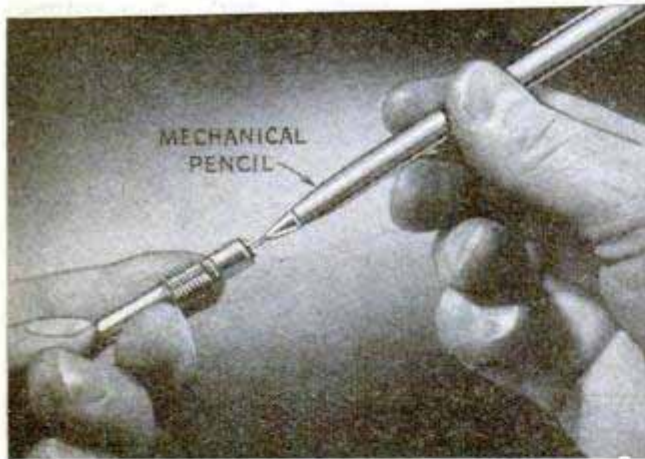

Depth of small holes can be measured quickly and with a fair degree of accuracy by using an ordinary mechanical pencil. Rest the tip of the pencil on the edge of the hole and screw out the lead until it touches the bottom. The distance from the end of the lead to the tip of the pencil is the depth of the hole.

"Weatherman" Indicates Humidity

If you like photo novelties, you will enjoy a "weatherman" or humidity guide. It is a chemically coated print that changes color when it absorbs or releases moisture.

The coating solution is made as follows: warm water, 4 oz.; cooking gelatin, 100 grains; cobalt chloride, 50 grains; and glycerine (water free), 10 drops. Dissolve the gelatin in the warm water, using a double boiler so that direct heat is not applied. Then dissolve the cobalt chloride and add the glycerine. Apply the warm solution by dipping the print or by covering lighter areas with a brush. Changes in moisture are indicated by the coated parts. They change from pink (in damp weather) to blue (when the air is dry).

Acid "Burns" Hole in Clock Spring

Instead of tedious drilling, holes can be "burned" in a clock spring by using hydrochloric acid. The best way to apply it

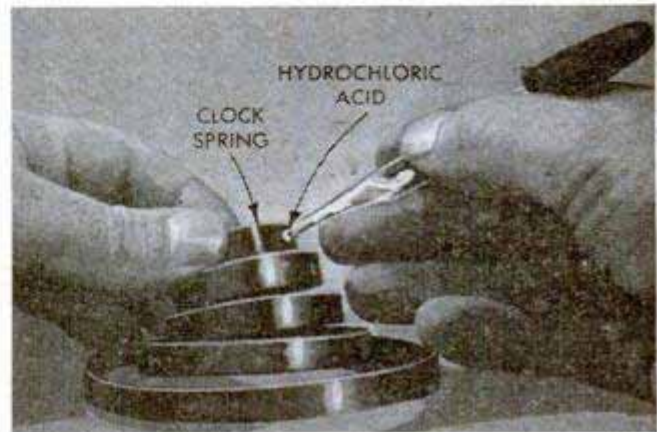

is with the tip of a medicine dropper as this will keep the acid from spreading over too great an area. Or, if desired, the spring can be coated with wax and a small portion scraped away where the hole is to be made. The wax acts as a dam into which the acid is poured.

Shoe Buffer Used to Apply Wax

A shoe buffer will make an efficient substitute for a lost or worn-out liquid-wax applicator. To adapt the buffer to an applicator, merely bore a hole at an angle in the top to take a handle.

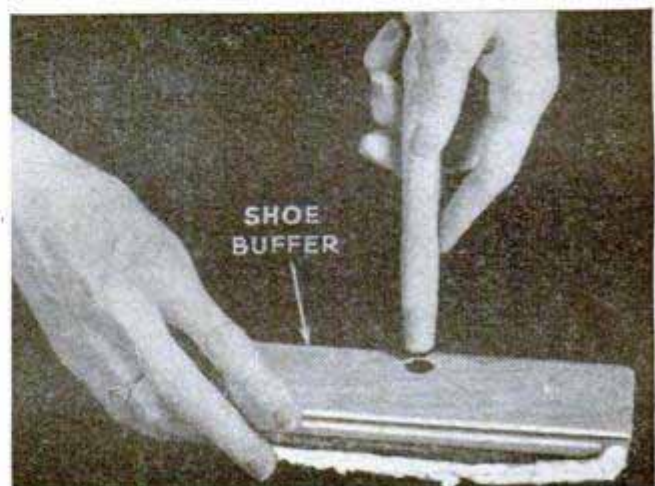

Personalized Lamp for Child's Playroom Made From Discarded Alphabet Blocks

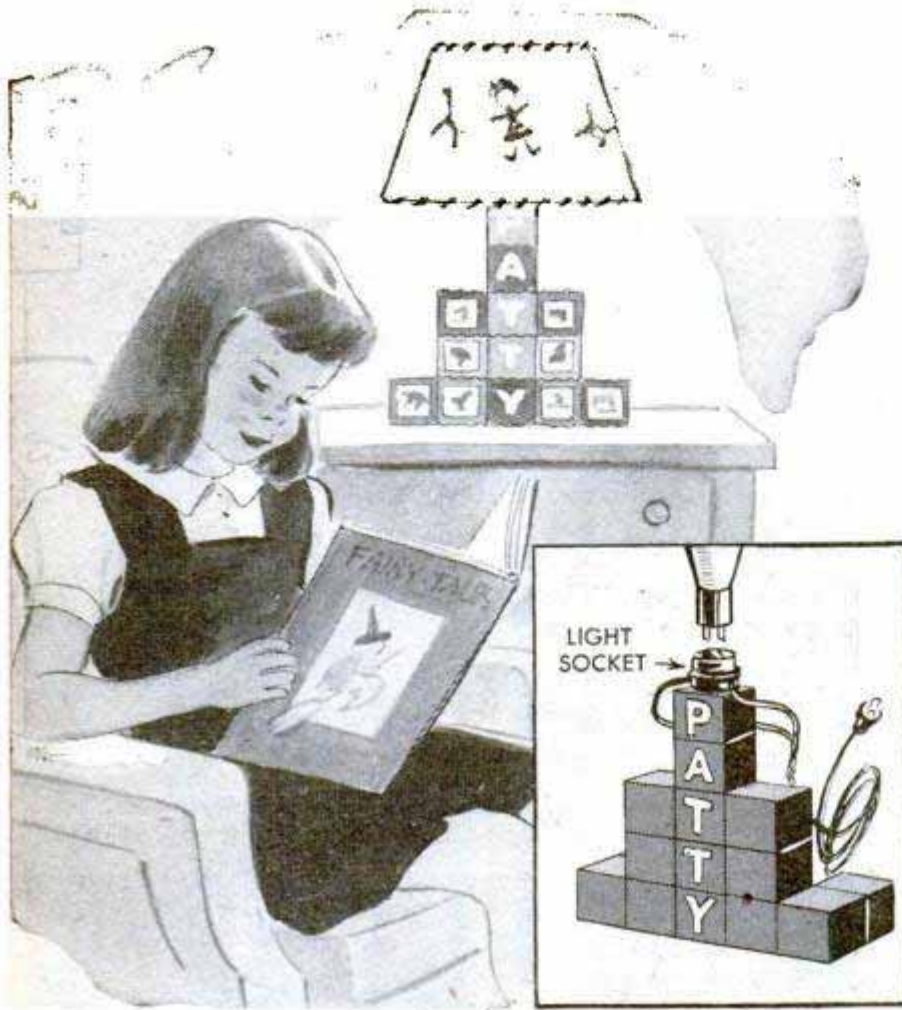

When your small child reaches the age where he or she is ready to discard a set of alphabet blocks for the toys and amusements of older children, keep the blocks to make this personalized table lamp for the playroom. As shown, the blocks in the center column are arranged to spell the child's name or nickname. Assembly of the lamp is simple. Airplane cement or a similar adhesive is used to glue the blocks together, and the socket is a flush-mounted fitting that screws to the top block. Although a two-prong socket and base are shown, a screw-type fitting may be used instead. Either type of flush-mounted socket eliminates drilling a hole through the center blocks and running a lamp cord out through the base. It will be necessary to do this, however, if a recessed fitting is used.—Edward L. Fisher, Milwaukee, Wis.

Duplicate Parts Are Mass-Produced With This Faceplate Sander-Chuck

Having to mass-produce a large number of handles like the one shown in detail 2, I devised this simple sanding chuck to do the job in a hurry. It consists of two hard-

wood disks, A and B, detail 1. Both have a hole E, through the center and disk A has slots for abrasive paper. The two disks are first screwed together, then fastened to a lathe faceplate for truing and boring the hole. Next, without removing the disks from the faceplate, saw cuts C and D are made across the face of disk A and tangent to hole E. Note that these cuts enter just inside the periphery of the hole. Use a narrow-gauge saw blade to make the cuts, especially cut C. The free half of disk A is made adjustable crosswise to take up wear of the abrasive strip, which is held with tacks as shown. In use, round the ends of work slightly to knock off the sharp corners and then simply insert the work in the chuck. With the chuck rotating and the work held stationary, the abrasive strips quickly form the work. The same idea can be applied to any similar job for producing duplicate parts in quantity.

Fred Strickland, Portland, Ore.

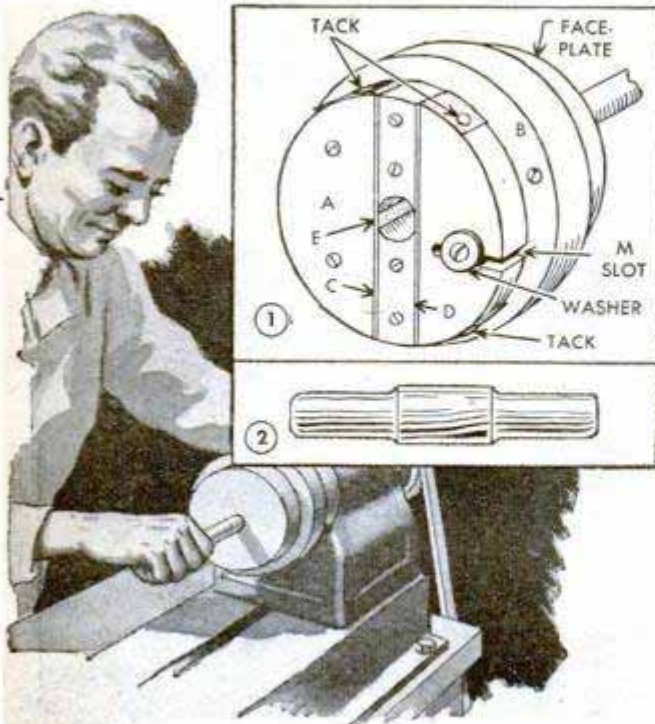

☞ To cut marshmallows and keep them from sticking together, use a pair of scissors dipped in lukewarm water frequently.

LAWN HOUSE NUMBERS



Nothing is more appreciated by your callers than a well-designed house number located where it is easy to see. The lawn is the ideal place, so try your hand at some of these. A jigsaw or coping saw and some 1/2 or 3/4-in. outdoor plywood are all you need. Stakes of 1/2-in. pipe will make ideal supports



PLUNDER CHESTS for Coin Collectors



By Alexander Maxwell

FOR EXHIBITING and storing valuable collections of rare old coins nothing so satisfies a coin collector as a plunder chest made of fine cabinet woods and inlaid with appropriate symbolic designs in contrasting colors. Carefully finished, the job looks like cabinet work at its finest, but essentially the work is little more difficult than that of building a small box to exact dimensions.

Proportions of the chest are determined by the number of coins to be displayed. For some collections consisting of only a few coins, the pocket-size chest with a hinged lid, Fig. 1, is best. For large collections, the trays of the pocket units are duplicated and fitted into a cabinet as drawers, Figs. 5 and 9. Use vermilion, rosewood or teakwood for all the parts. Fig. 4 details the construction of the pocket unit. Additional details are shown in cross section in Fig. 6. Start with the lid first. The bottom of the tray is cut to size and covered with rich velvet

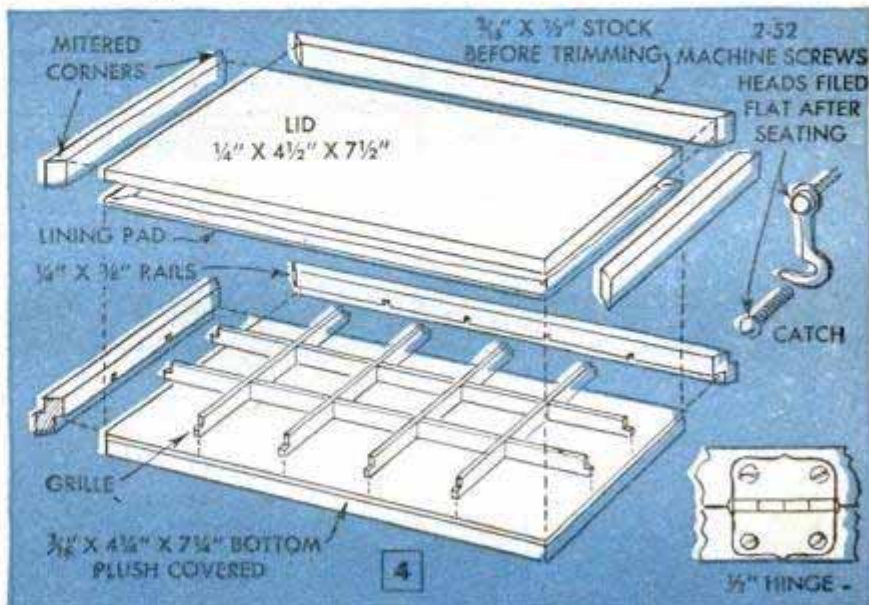
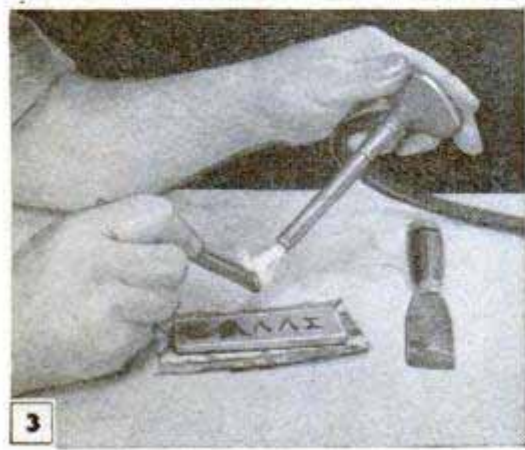
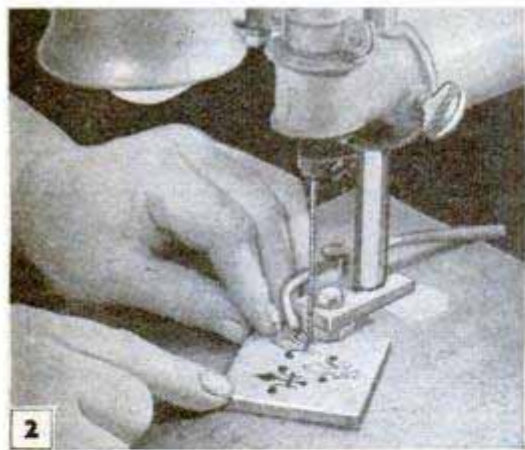
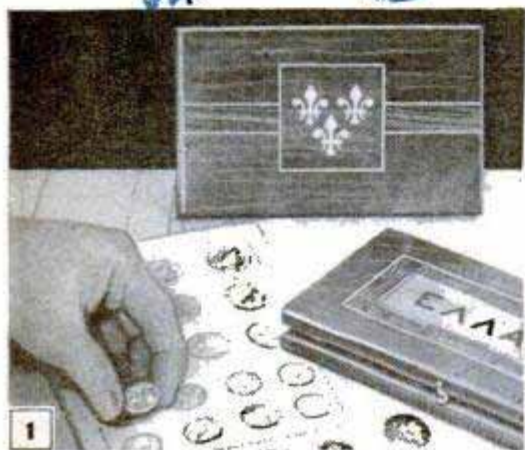



or plush of a dark color, preferably ruby red, purple or dark blue as these colors show the coins to the best advantage. The lid is lined with the same material, fluffed with cotton batting so it presses down on the coins and prevents them from rattling. If coins are of a uniform size a "lattice-work" grille or separator is suitable. It can be mortised into the sides and the whole tray assembled and glued as a unit, or the grille may be merely fitted in place, weighted down and "tacked" with airplane cement. Apply wax to the grille and interior parts and rub down to produce a soft luster. Odd-size coins require considerable planning to produce a suitable display. The built-up grille in the drawer of the center chest, Fig. 5, correctly displays the one large coin.

An effective and simple method of inlaying is done by simply jigsawing the design, Fig. 2, and filling it with melted sealing wax of the desired color, Fig. 3. If all the coins in the chest are from a single country, the inlaid motif may be taken from the symbol associated with that country. Again, the name may be spelled out, as in Fig. 1. Letter piercing such as this requires a stiff jigsaw blade, Fig. 7, which will hold to the line. Another novel form of inlaying is done by jigsawing the line only and filling the saw kerf with a black or contrasting colored wax. This calls for careful work as any irregularity in the kerf shows up badly. The trick in sawing such inlay is never to completely remove a segment. Stop short of the previous cut at each pass. As an example of this, the

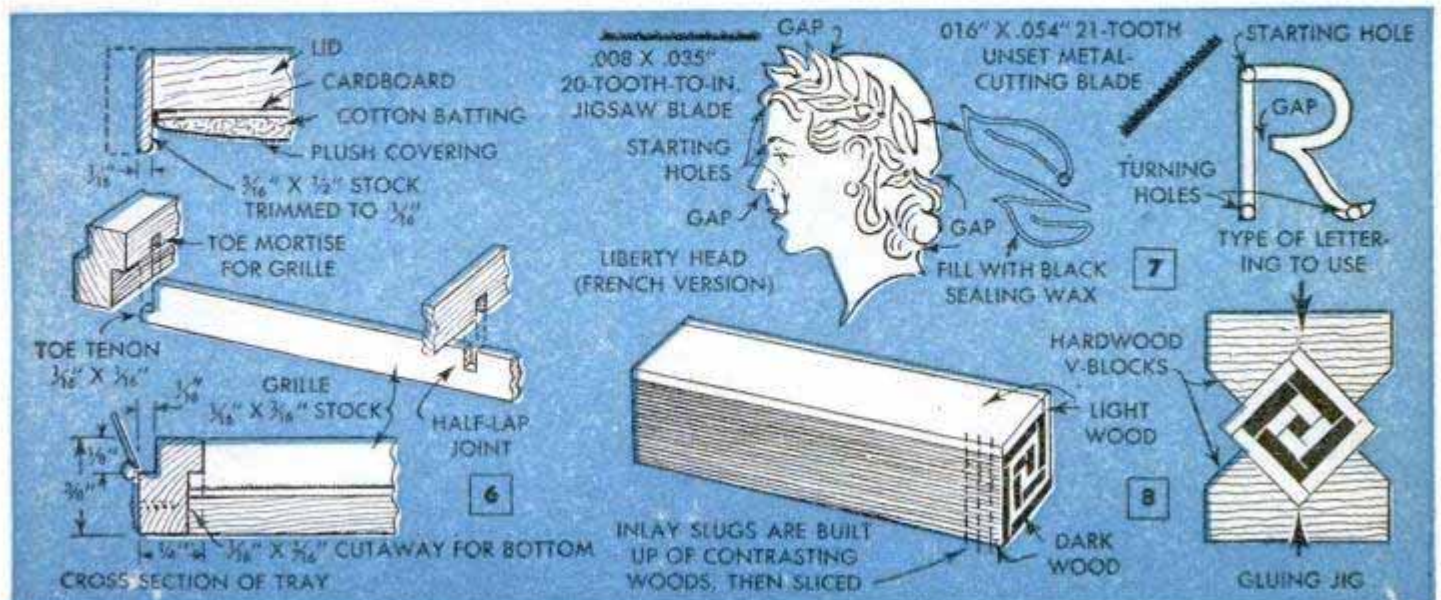

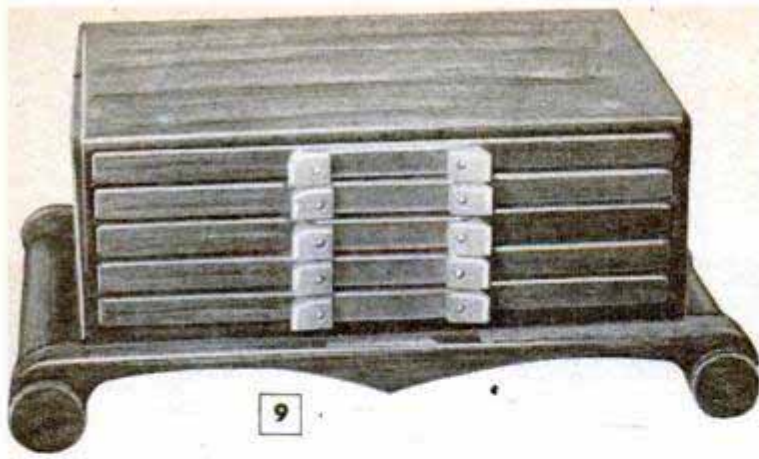

cabinet as for the trays or drawers. Rosewood, properly finished, makes a beautiful job. In the detail, Fig. 10, 1 by 6-in. dowels are indicated for the feet but you can easily turn these parts from genuine rosewood at small extra cost for material. Notice that the end pieces are rabbeted to take the top. This is a design characteristic and should not be omitted in authentic construction. Run grooves for the drawer sils, or runners, with a dado cutter or by making two or more passes over the circular-saw blade. Glue

Liberty head is shown, Fig. 7. Starting holes are bored in places which are normally accented and the blade is advanced and backed until cuts from the starting holes are completed. Then the cuts are filled with wax. Wooden inlay slugs can be made up in any pattern for inlaying in a recess. An example of this type of inlay is shown in Fig. 8. The pattern is continuous and is formed by gluing up a square composed of a number of strips of contrasting woods with the end grain showing in a simple geometric pattern. To get the two-color pattern shown, use white holly and black ebony.

When the lid is completed, sand it down to a smooth surface. As the natural tendency is to round the edges when sanding, make the ends, back and front slightly oversize. Then, after sanding, trim the whole box to finish dimensions. Finish with three thin coats of clear lacquer and rub down with rottenstone. On fine woods this treatment gives a surface which is pleasing to the touch, and brings out the natural beauty of the wood and inlay work.

Design of the cabinet pictured in Fig. 9 and detailed in Fig. 10, is of Chinese origin and is dimensioned for five drawers, each of which is of essentially the same construction as the tray in Fig. 4. It can be arranged to hold 60 or more coins, depending on size. Use the same wood for the

the runners in place. Rosewood, due to its very hard surface, does not glue well with ordinary adhesives. Airplane cement is best. When gluing up the parts, be sure to wipe off any excess cement that squeezes out of the joints. When the assembly is completed, place it on a flat surface and test for wobble. If there is any irregularity, sand one end of one of the feet slightly to correct it.

To be authentic in all details, the cabinet should be lacquered Chinese red with stenciled green, black and gold dragons. However, if you use genuine rosewood a natural-color finish is recommended. Use clear lacquer and polish as already described. The usual jade and silver drawer pulls are modernized by using clear plastic tipped with grips of translucent jade green. Slip a label behind the clear plastic, designating the contents of each drawer. The drawers may be partitioned by grilles as in Fig. 4, if desired. The grille is merely weighted in place and "tacked" with airplane or a similar type of cement.

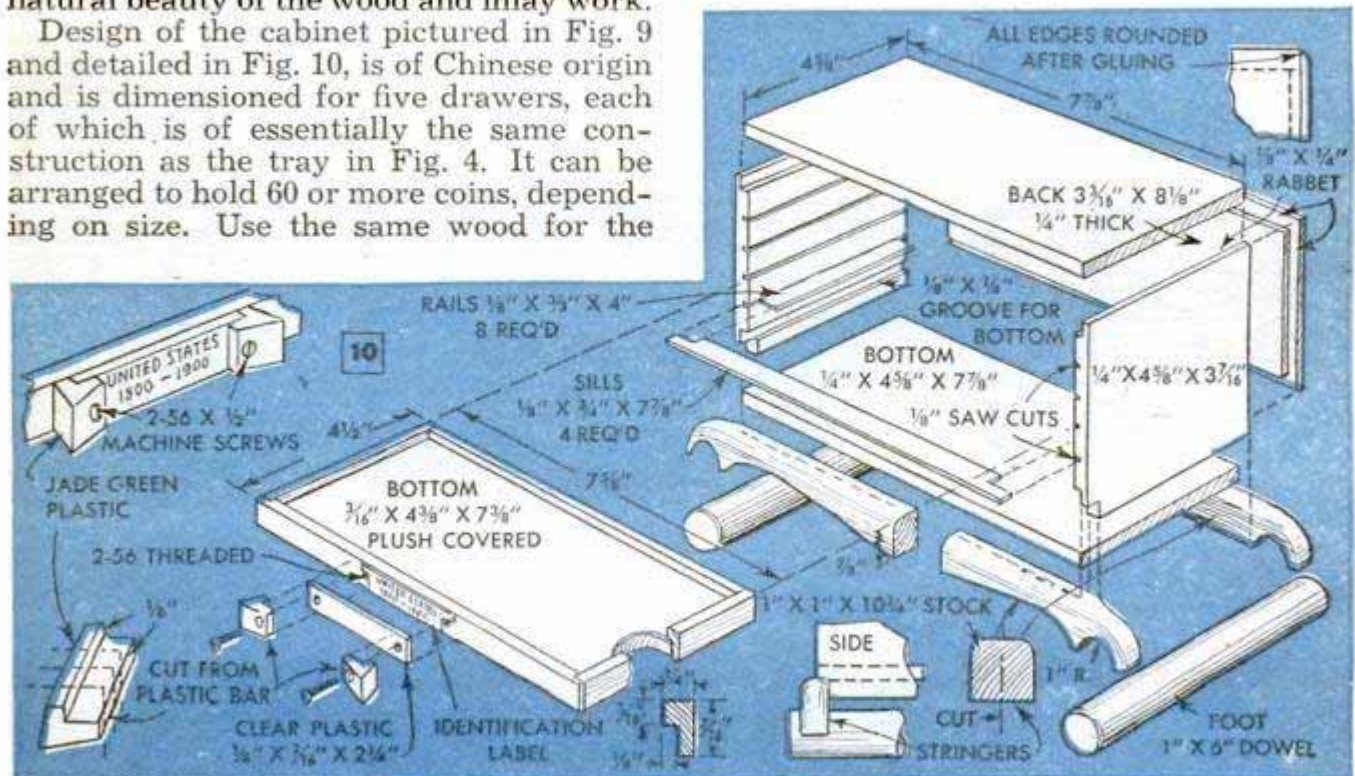

Door Latch Is Easily Forced To Rescue Child Locked In Bathroom

After my small child accidentally locked himself in the bathroom and I had to break a panel in the door to unlock it, I was determined that it would not happen again. First, I removed the turn bolt on the rear side of the lock. Then, from scraps of plastic, I assembled the simple latch shown, cementing the parts together where indicated, and screwed it to the door beyond the reach of the child. The latch was strong enough to keep the door locked, but being cemented together, it could be broken apart by pushing the door inward in the event the child should close the latch by climbing. To assure a good bond in cementing the parts together, roughen the contacting surfaces. This can be done by rubbing them with coarse sandpaper, after which cement is applied to both surfaces.

Herman R. Wallin, Washington, D. C.

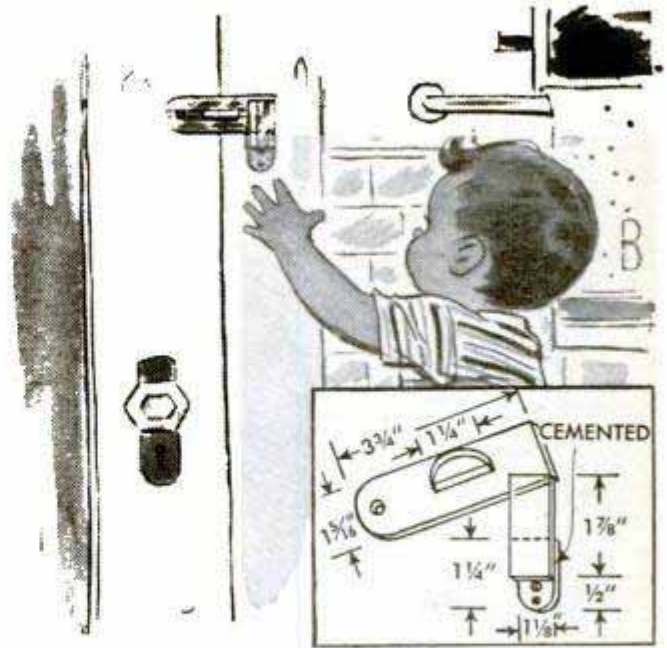

Snap-Action Switch on Soldering-Iron Stand Regulates Heat Automatically

Here is a stand that is just the thing for an electric soldering iron that is used intermittently. The regular stand is fitted with a snap-action switch, which cuts in the resistance of a lamp bulb to operate the iron at reduced temperature when it is placed on the stand. This prevents burning and the rapid oxidation of the tip which results from overheating. The wiring diagram shows the electrical hookup. Legs at one end of the stand are removed. Then the switch is fitted underneath with the striker or actuating arm projecting through the bottom of the stand in such a position that

when the iron is laid on the stand its weight will close the switch and cut in the lamp bulb, which is wired in series. The size of the lamp bulb should vary according to the size of the iron. Some experimenting will be necessary to determine the size of lamp bulb to use.



File Can Be Made Nonclogging By Rubbing Teeth With Chalk

Before starting to file nonferrous metals, such as brass, copper or aluminum, take this tip from a machinist: rub the teeth of the file with a cake of carpenter's chalk and they will not clog with filings. Then all you have to do to clean it is to tap the file against the bench occasionally. The chalk coating is renewed from time to time.

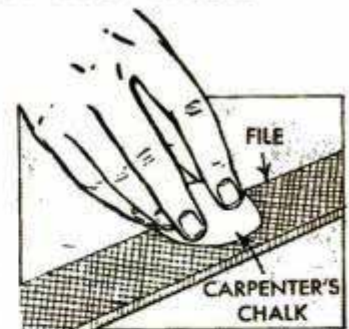

Match-Book Guard for Razor Blades

Double-edged razor blades are convenient for ripping seams, cutting thread and, in general, a handy tool to have in the sewing basket. However, careless handling will result in cut fingers. To prevent this, cut off one end of a paper match book, the end that has the striking surface, and slip it over one edge of the blade to act as a guard. The abrasive surface of the match-book end will afford a firm grip.

William Swallow, New York City.

8 REPAIR KINKS for BICYCLES

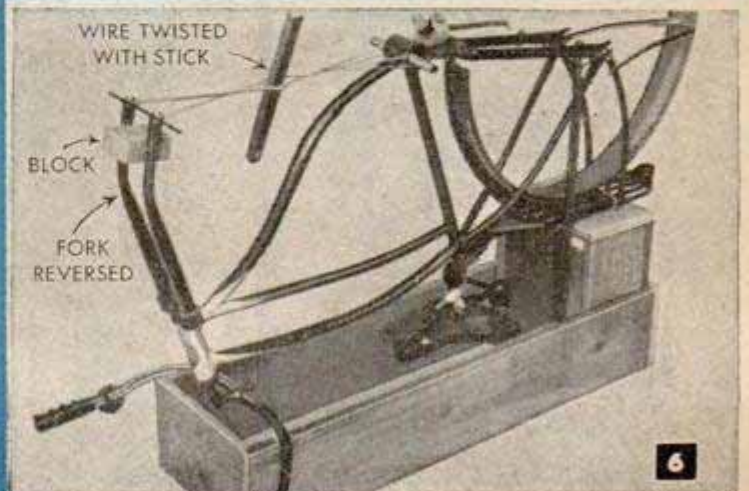
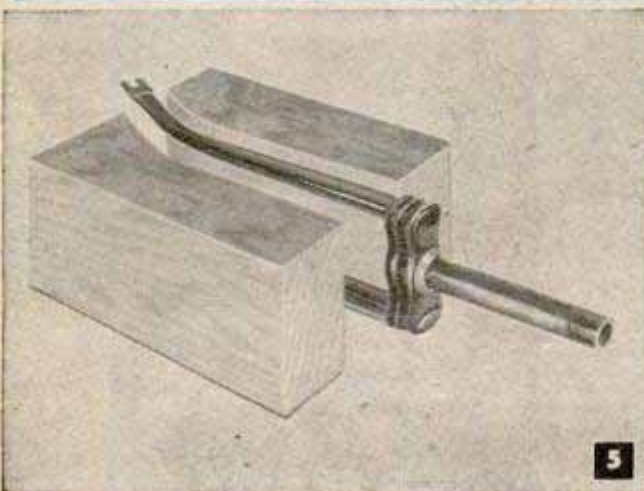
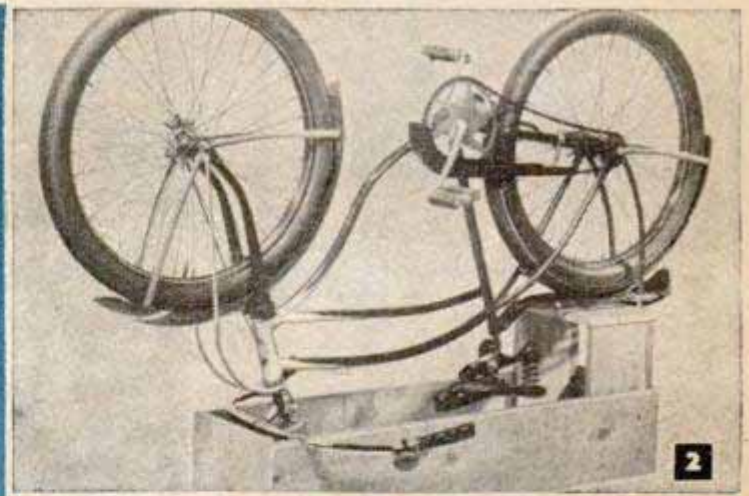
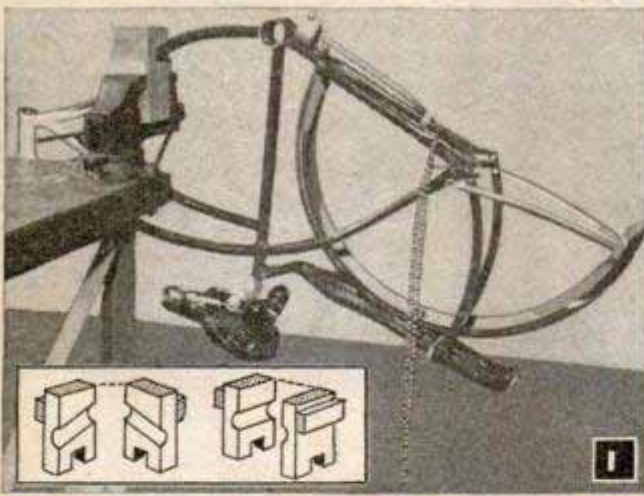
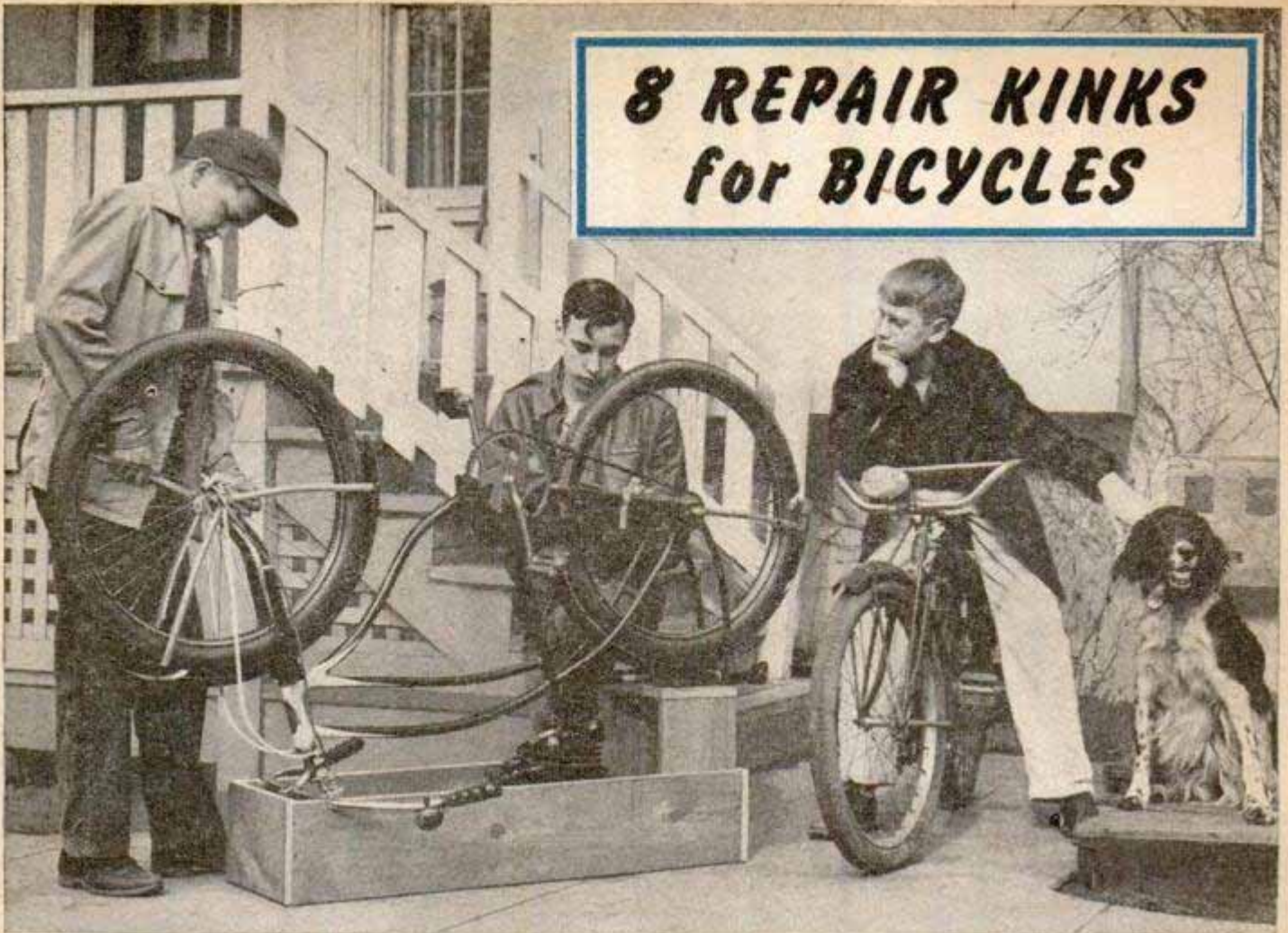

Why not make your own bicycle repairs and thus avoid the long delay of waiting for your turn at busy repair shops?

MOST bike repairs are quite easy to make if one takes the time to build a few simple jigs and clamping devices with which the work can be done in a professional manner. Ordinarily the frame of a bike is difficult to hold securely by any ordinary means, but with special pine clamping blocks detailed in Fig. 1, the frame of a dismantled bike can be supported rigidly in a bench vise in almost any position desired without damaging the finish or springing any part of the frame. A frame or fixture to hold the complete bicycle and into which it can be placed upside down in a jiffy is shown in Fig. 2. This is handy for repairing the chain and bearings, and also for removing the wheels. With the bicycle held in this fixture, every part of it can be disassembled except the fork.

For truing wheels, fasten flat-iron bars to a workbench or a rigid table as in Fig. 3. Notches in the ends of the bars receive the axle. These should be a snug fit, as any play here will interfere with proper adjustment. While rotating the wheel slowly with one hand bring a piece of chalk up to the rim and withdraw as soon as it touches. This will indicate where the rim

is out of true. The spoke on that side should be loosened, and the adjacent spoke tightened. Of course, this may also require adjustment of several adjoining spokes, and to compensate and tension the wheel properly it generally is necessary to slacken or tighten several spokes on the rim at a point opposite the first adjustment. All spokes should have as nearly equal tension as possible. To true up a fork which has been distorted or bent by a blow or collision requires great care because the two legs must be absolutely parallel when the work is finished. If one leg of the fork is bent sideways, clamp the shank between clamping blocks, Fig. 1, in the vise and spring the bent member back into place. If bent forward or back, place the fork on two hardwood blocks on the floor, and strike light blows on a third block placed on top as in Fig. 4. Accuracy can be checked with two straightedges.

Where the legs have an equal bend near the shank, use the method pictured in Fig. 6. Curved hardwood blocks are useful in bending forks in the vise, as in Fig. 5. Both forward and backward bends in the fork are also accomplished in the vise as indicated in Fig. 7, using a copper jaw on one side and leather on the other. Fig. 8 suggests a quick method of swinging the bicycle up out of the way in the garage.

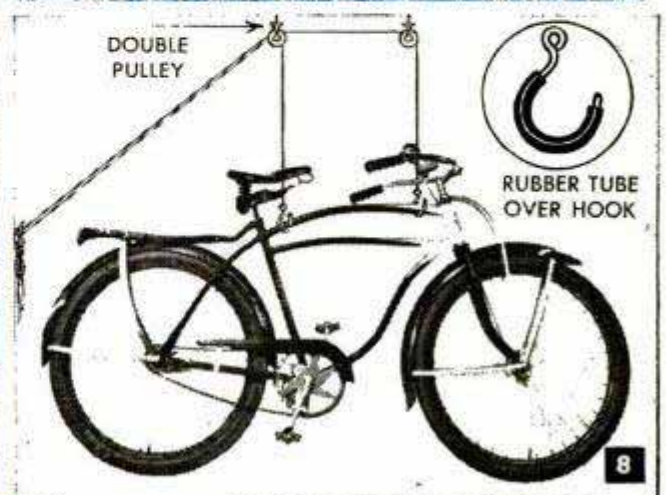
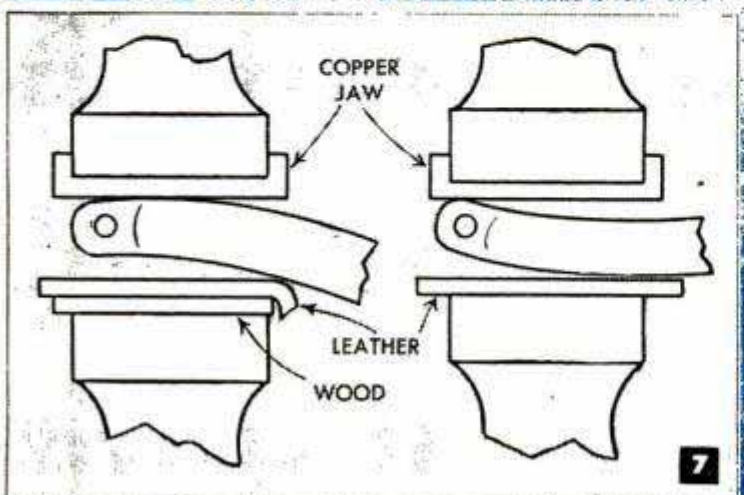
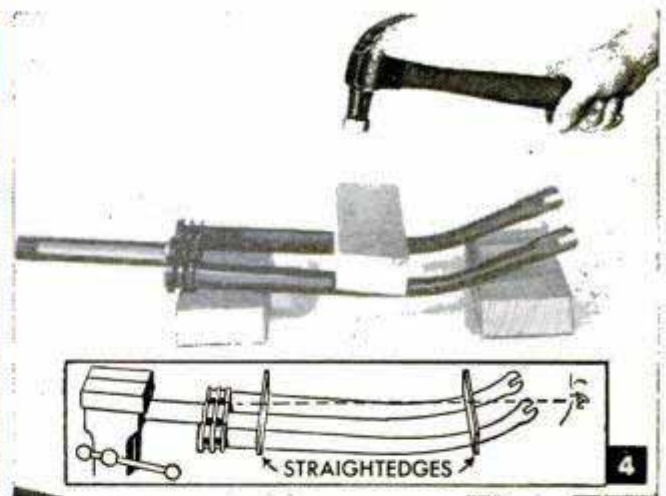
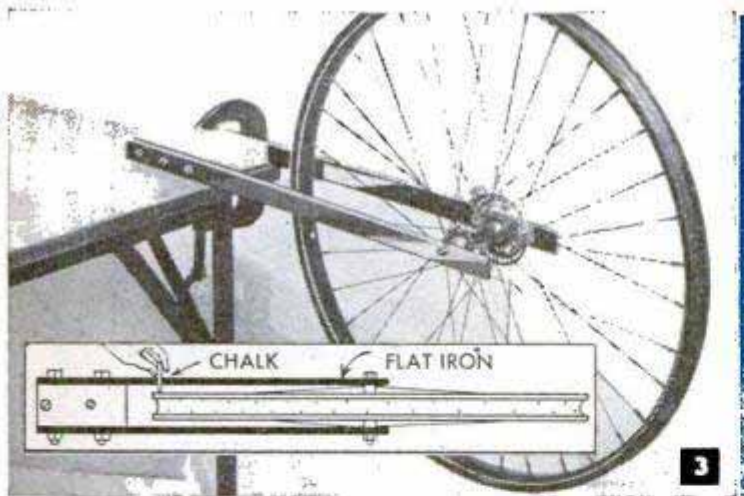

Holder Suspends Paintbrushes In Cleaning Solution



When paintbrushes are set in a can of cleaner to keep them from hardening between jobs, the bristles may become bent out of shape. A simple holder to keep the bristles off the bottom of the can may be bent from a piece of heavy wire. The can sets on the lower end of the holder.

Grip of Paper Clips Improved By Rubber Coating

If you have experienced trouble in having paper clips slip, especially when used on a stack of papers that is a little too thick, try coating them with a film of rubber. To do this, merely dip them in rubber cement, white rubber tire coating or even tire-patching cement. This will leave a film of rubber on the clip, which when dry, provides a non-slip surface on the clip.



Spring Restores Oilcan Action



An oilcan of the type pictured may wear so that the bottom will not snap back into place when pressed to force out the oil. However, you can restore the snap action with a spring. Cut off a piece of old screen-door spring and stretch

it to produce a compression spring. Insert one end into the lower end of the spout. Then, when the spout is screwed onto the can, the lower end of the spring will press on the bottom of the can. Length of the spring will depend on the depth of the can

and the distance the spring slips into the end of the spout. If the spout is too small to take a screen-door spring, any compression spring, or a tension spring that has been stretched, that will just enter the lower end of the spout will do.

Miniature Spur Center Is Handy For Turning Small Work



This tiny spur center, which can be held in a drill chuck in the wood lathe, is useful for driving small work such as dowel stock, ship-model masts, yardarms, arrow

shafts and other turnings too small to be driven by the regular spur center. To make it, first drill a $\frac{1}{8}$ -in. hole in one end of a 2-in. length of $\frac{3}{8}$ -in. steel rod. Shape the spurs with a triangular file, cutting two deep notches across the drilled end of the rod. Then grind one end of a short length of $\frac{1}{8}$ -in. drill rod to a sharp point to make the center pin. Force this into the hole drilled in the end of the spur center with the pointed end projecting about $\frac{1}{16}$ in. beyond the edges of the spurs.

Tire Coating Identifies Toys

There will be less chance for misunderstandings among small children in your home if each of their rubber toys are identified with the owner's name



or initials. You will find that white rubber tire coating is ideal for applying lettering to such articles as the rubber ball shown in the photo.

Making Bottles Shatterproof



If you have bottles of rare chemicals or other valuable materials, especially those in powder or granular form, it is a good idea to wrap the bottles with cellulose tape as indicated. Then, if they are accidentally dropped and broken, the bottles will not shatter and scatter the contents.

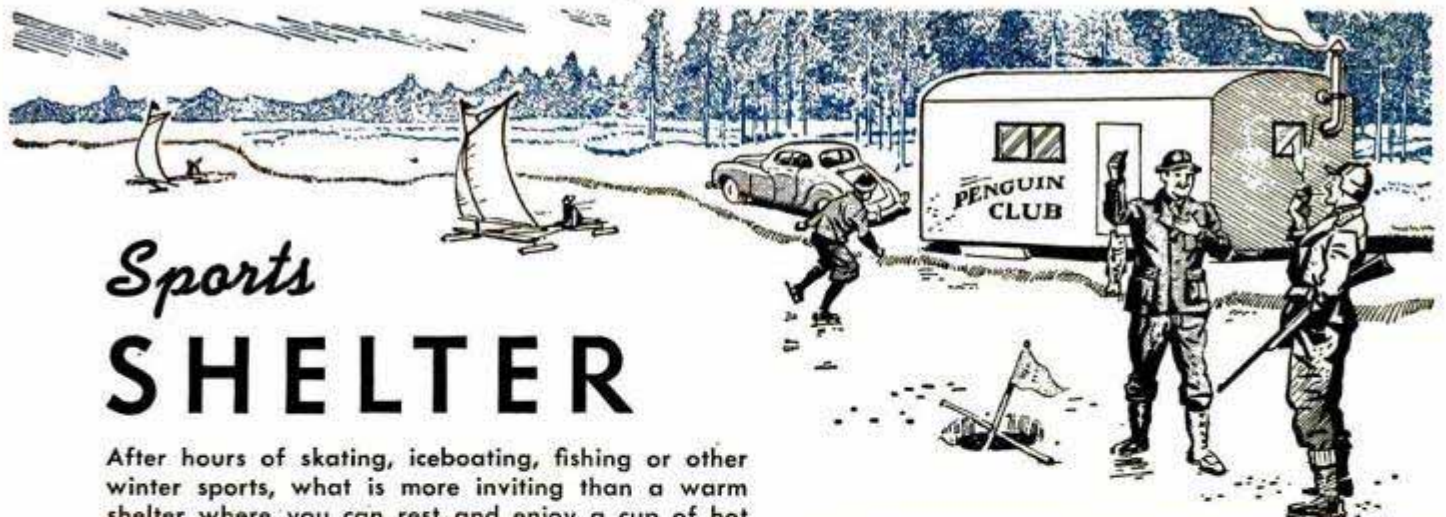

Sports SHELTER

After hours of skating, iceboating, fishing or other winter sports, what is more inviting than a warm shelter where you can rest and enjoy a cup of hot coffee? Such a shelter is not expensive to the individual if several sports fans pool their time and money to build it. This one, which is equipped with runners for towing, can be constructed of used or second-grade lumber. The framework may be covered with plywood, or canvas to reduce the weight for distant towing. The windows are Celluloid and the door is 1/2-in. plywood. Note that the floor should be insulated before covering it with linoleum, and that the roof is ribbed and covered with roll roofing. A small sheet-iron stove will furnish adequate heat, and by installing bunks, as shown, comfortable quarters will be had for an extended fishing trip

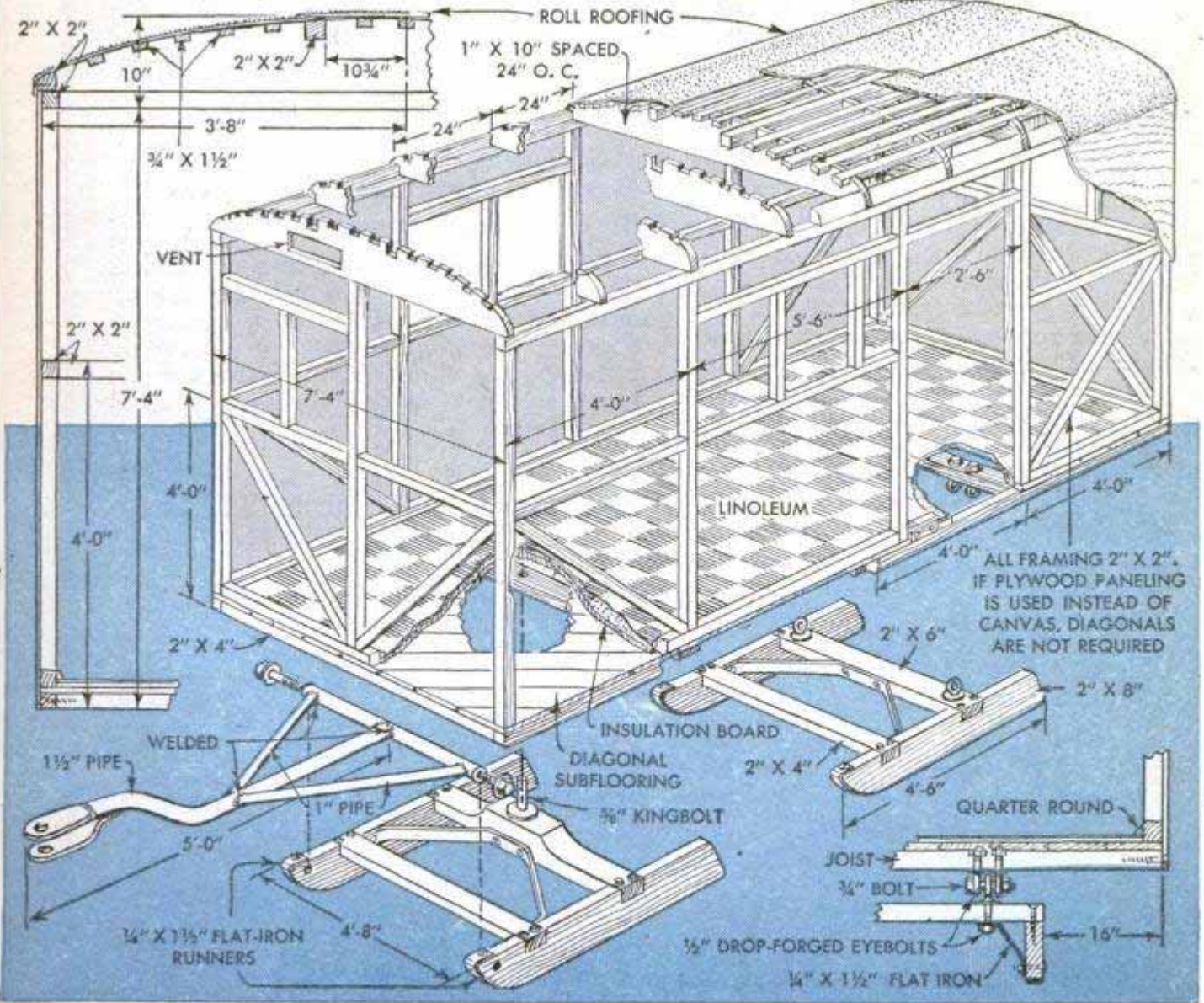
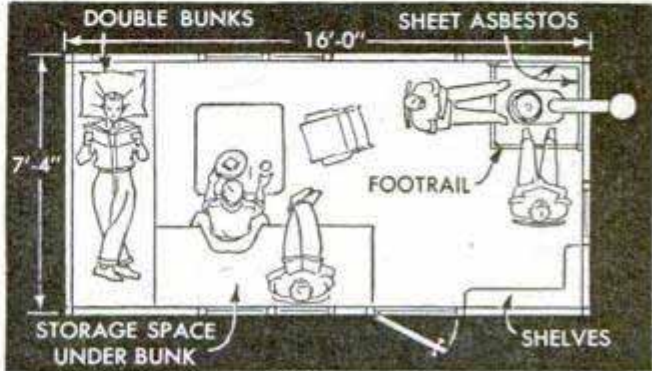

Caster-Fitted Luggage Is Pushed Like a Wheelbarrow

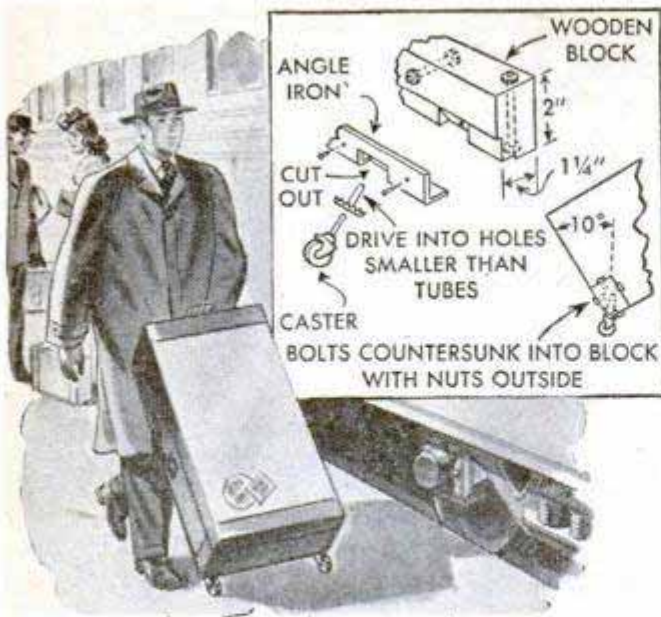

Instead of carrying heavy trunk-type luggage, mount detachable casters on one side and move it wheelbarrow fashion as indicated. The manner of attaching the casters is simple and does not mar the appearance of the luggage, as the only parts exposed are the caster sockets and casters; the bracing being installed on the inside. A hardwood block is used to anchor the caster sockets and this is cut to fit across one end of the luggage. Note in the detail that one edge of the block is rabbeted to receive a length of angle iron which has an opening cut in it near each end to admit a caster socket. The rabbeted edge of the wood behind the opening in the angle iron is beveled to give the caster a 10-deg. rake. Flat-headed screws are used to fasten the angle iron flush with the block and then bolts are used to attach the block in the corner of the trunk. Undersize holes are drilled through the luggage at the corner and into the wooden block for casters.

Clyde Cameron, Chicago.

Hollow Rivets Set With C-Clamp

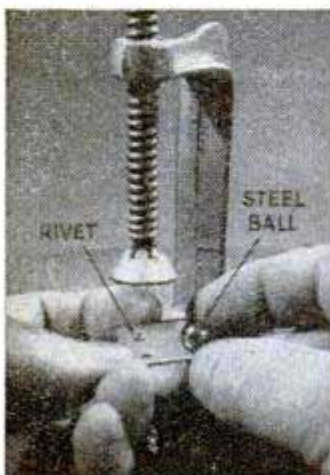

The next time you have a few hollow rivets to set, and there is no set at hand, try a C-clamp and a small steel ball that will just start to enter the open end of the rivet. After placing the rivet in position in the work, put it in the clamp with the open end

of the rivet upward. Place the ball on the rivet and apply pressure to it by turning the clamp screw.

Tape Wrapped Around Dry Cells Protects Flashlight Case

If a flashlight is used infrequently, the dry cells may corrode and swell, making it difficult to remove them from the case. Also, this may result in damage to the switch or case.

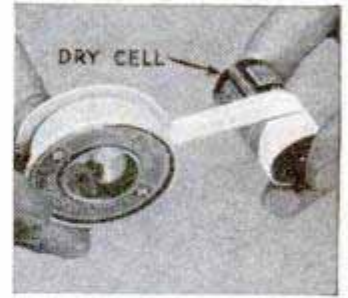

To prevent this, wrap the cells with waterproof adhesive tape, leaving top and bottom uncovered. A layer of tape is sufficient and will not interfere when the batteries are slipped in and out of the case.

How to Clean Furniture Hardware

Before cleaning furniture hardware, remove it to prevent marring the surrounding surface of the wood. Then, using an old toothbrush, scrub the metal with a mixture of pumice stone and water until all the dirt is removed. After the metal has dried, polish with dry whiting. To prevent tarnish, coat the hardware with lacquer.

Garments Held On Clothesline By Crossing Hangers

When airing garments on a clothesline, hang each one on two hangers hooked over the line with the hooks pointing in opposite directions as shown in the detail. If buttoned or pinned closed, the garments will not blow off the line even in a strong wind.—Opie Read, Jr., Chicago.

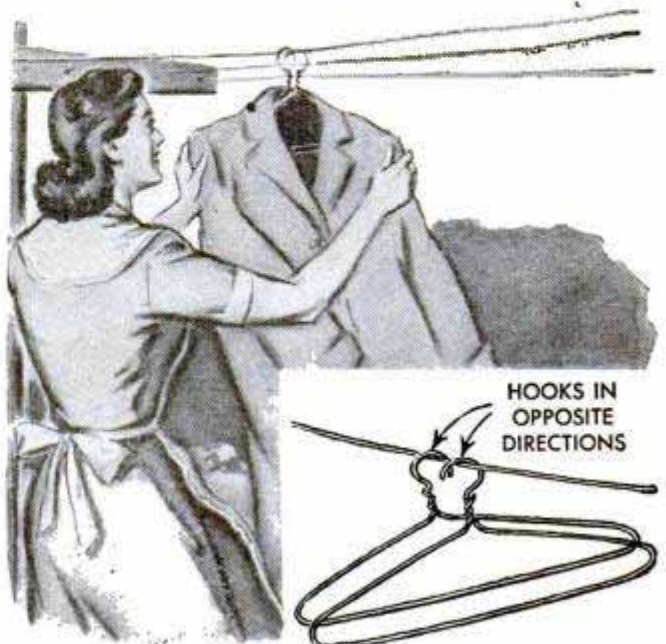

Children's Home "Movie" Shows Comic Strips

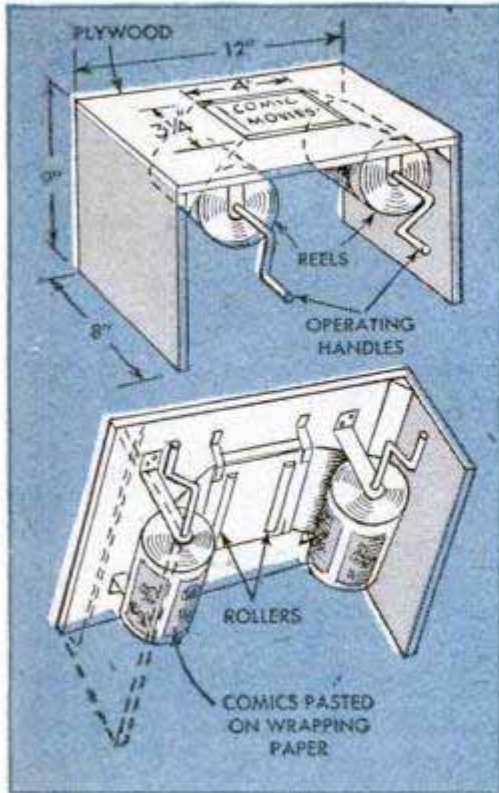

THIS easily constructed viewer will enable your children and their friends to get more enjoyment from newspaper comic strips. Make the box from thin plywood and the rollers, which keep the strip level, from $\frac{1}{4}$ -in. dowel. The dowel rollers are pinned in slots cut in a $\frac{3}{16}$ -in. wooden platform which is centered and suspended with metal brackets below the opening in the box. After the parts are made, assemble them as shown in the drawing. Clip the

comic strips from the newspapers for several days and glue them in sequence on a strip of heavy wrapping paper cut to fit wire reels or cranks. Be sure the glue is one that will not soak through the paper. Then wind the wrapping paper on the reels so that when one of the operating handles is turned the frames will appear in the opening of the box. If you wish, make several of these rolls so that the children can interchange them on the cranks.

Recessed Ceiling Light for Playroom Made From Auto Headlight

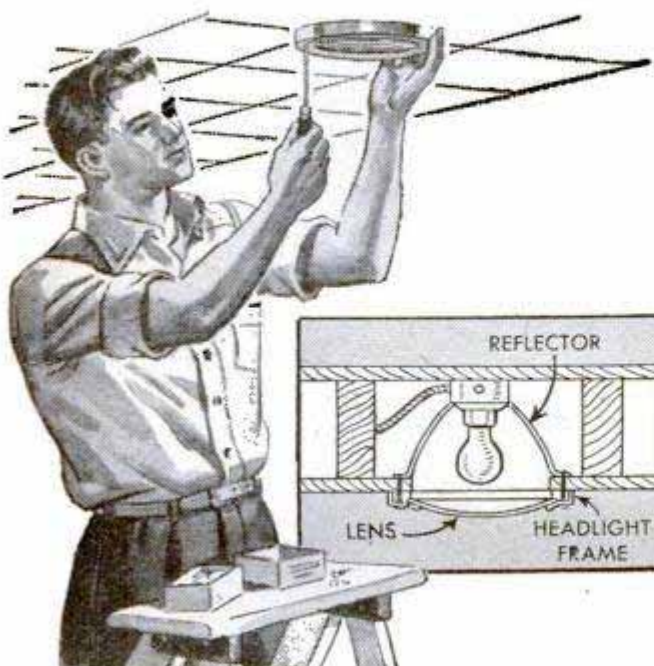

A recessed ceiling light in a playroom or workshop is less likely to become broken than one that is surface mounted. Although such fixtures are fairly expensive, one that will provide excellent illumination can be made from an auto headlight. Cut an opening in the ceiling about the same diameter as the front of the reflector. Then slot the edge of this opening so that the reflector can be slipped through it, first cutting an opening in the small end of the reflector for a porcelain socket. Fasten the socket in place and mount the reflector lens and headlight frame as indicated. To remove bulbs from the light, just unscrew the frame holding the lens.

☞ To remove iodine and Mercurochrome stains from the hands, satisfactory results can be obtained by using ordinary rubbing alcohol as a cleansing agent.

Roofing-Nail Cap "Spots" Position Of Plumb Bob

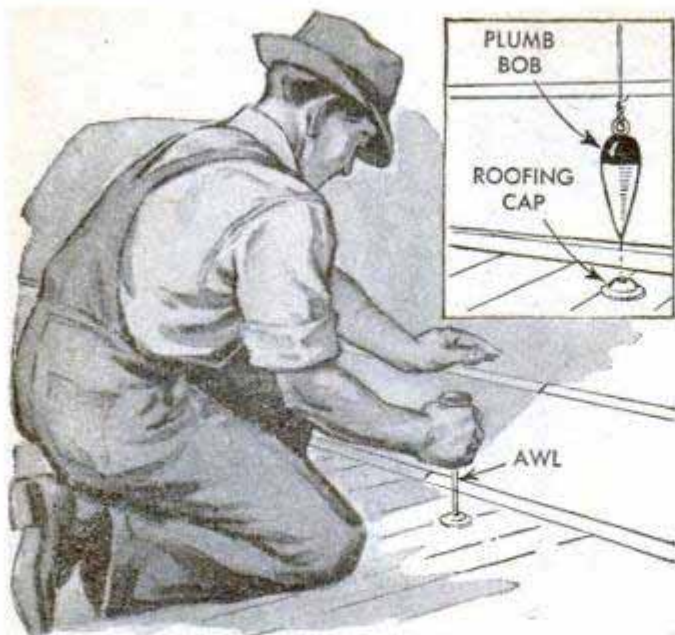

To eliminate the use of pencil marks, which often are difficult to find after they have been made, one plumber uses a roofing-nail cap and an awl to spot points located by a plumb bob. The hole in the cap is placed directly below the point of the bob and the mark is made with an awl. This method is accurate and it is easy to find the mark thus made because it can't be rubbed out accidentally.

G. E. Hendrickson, Argyle, Wis.

Marks on Wheel Indicate Balance

One way to help keep the front wheels of an auto in balance is to spot marks of bright paint on the edge of the rim and the tire, one directly above the other. Then, when a repaired tire is replaced on the rim, the marks are lined up.

Plates Keep Grease off Burners

When frying meat or any food that tends to spatter grease, place paper plates over the stove burners that are not being used.



This will protect them from grease spots and save much cleaning time. Remember, however, that the plates, being of paper, can catch fire easily, so be careful how they are handled.

Inner-Tube Band Around Oil Stone Retains Lubricant

Cut a wide band from an auto inner tube and fit it around the sides of an oil stone so that it projects above the surface. This will form a retaining wall to hold oil on top of

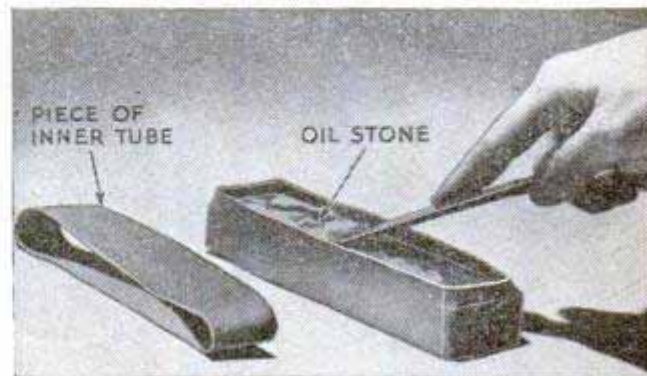

the stone when in use. In addition, the rubber protects the stone from being chipped or marred when clamped in a vise.

J. A. Richards, Saco, Maine.

Repairing Broken Clock Spring

If the mainspring in an inexpensive or worn alarm clock is broken, and the cost of a new one does not seem justified, here is one way to fix the spring and get additional service out of the timepiece. Remove the spring and overlap the ends about $\frac{3}{4}$ in.; clamp in a vise and file a series of small notches in both edges. Then wrap the overlapping parts with fine wire, winding it in the notches to prevent slipping.

Bruno Racine, St. Jacques, P. Q., Can.

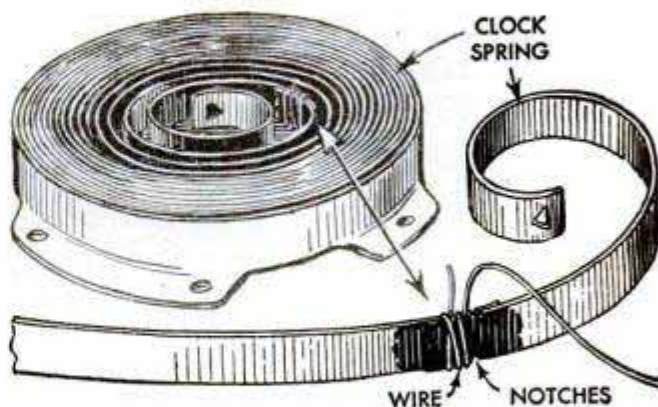

If a partition is soldered in a cleaning pail to divide it in half, both soapy water and clean water can be carried in the same container. This will reduce the amount of work necessary in washing windows and woodwork.

USEFUL BASKETS

woven from rustic materials

By *Hi Sibley*

ALTHOUGH it is one of the oldest of the handicrafts, basket weaving is still a popular and profitable hobby. Few crafts utilize so many different and inexpensive materials which are readily available almost anywhere. Only a few common hand tools are required: a small handsaw, hammer, drawshave, pliers and pocket knife take care of ordinary requirements.

Among the materials used are green willow twigs or switches, rattan, bamboo splints, wheat straw, dried cattails used flat or twisted, raffia, palm-leaf fibers, thin wood splints such as hickory and basswood, rawhide thongs, cane, twigs, dried reed and pampas grass, tough, twisted paper, and even twine. Most of these are illustrated in the details below. Nearly everyone is familiar with the basic principles of weaving even though they may not have experience in basket work. A few examples are shown in Fig. 3. These are the

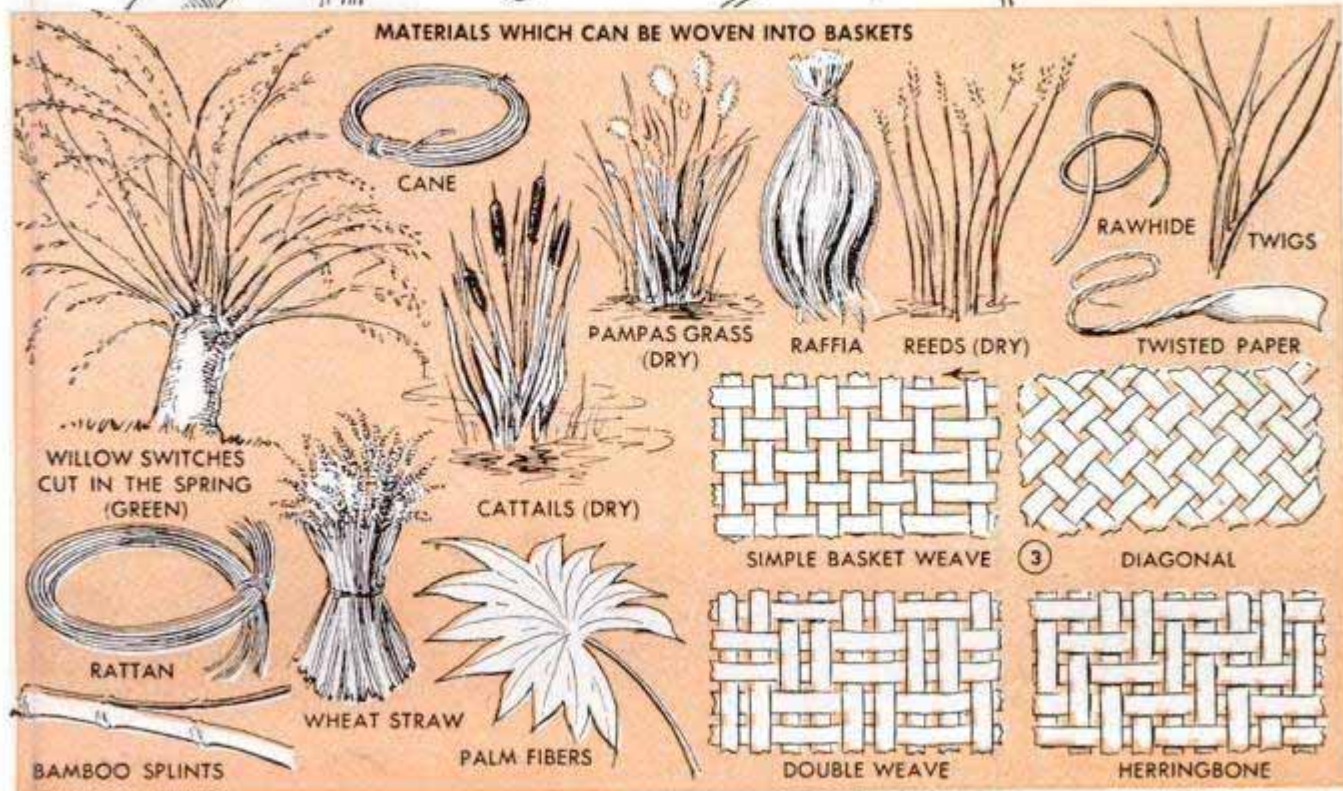
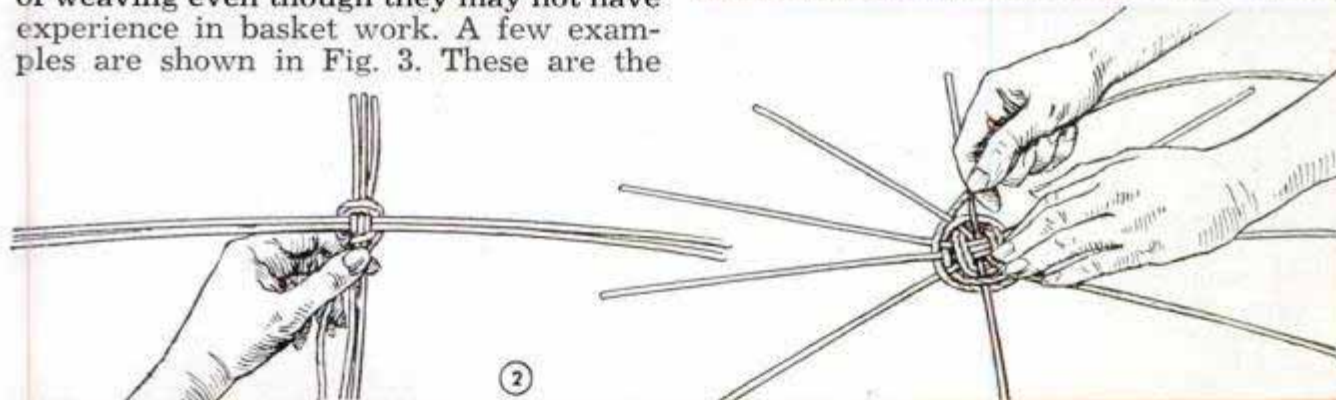

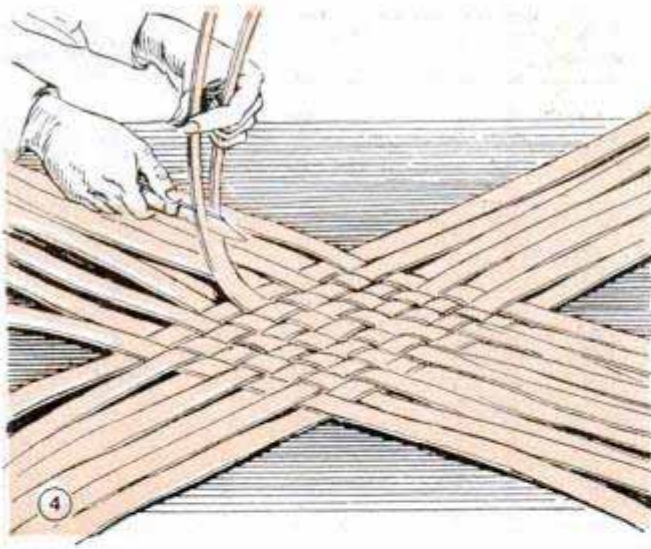

basket weaves done with flat strips, also willow, rattan, rawhide and similar materials adapted to tighter weaving. Several useful baskets of comparatively simple construction are illustrated in Fig. 5, along with the methods of weaving the different types. Most of this work classes as "under-over" weaving.

As a typical example, an attractive and very handy shopping bag made of dried cattails or rushes is detailed in Fig. 5. It is finished with a cotton-rope handle bound

around with narrow strips of cattail stems. Gather the longest cattail stems you can find and with a razor blade guided along a straightedge, cut them in 1-in. strips after they have been thoroughly dried in a shady spot exposed to a breeze. Some of the strips are stained lightly with a brown stain, others left in a natural color to give a two-tone pattern in the finished work. When the cattail strips are thoroughly dry, weave three 38-in. strips into fourteen 29-in. strips in a simple under-over weave as in the lower left-hand detail in Fig. 5. Then bend up the strips to form sides and weave in horizontal strips until the required height is reached. Some weavers split the vertical strips, Fig. 4, and tighten the weave so that the top is smaller than the body of the basket. Before finishing the top edge, note that there are two horizontal strips instead of one. Ends of the vertical strips are turned over and tucked in. A cloth lining, with pockets for purse, letters, etc., will add to the convenience of the bag. The dry cattails will support any load that can be carried easily.

A neat sewing basket, suitable for many other uses, is made as illustrated in the center detail, Fig. 5. There are two methods of starting the bottom of such a basket,

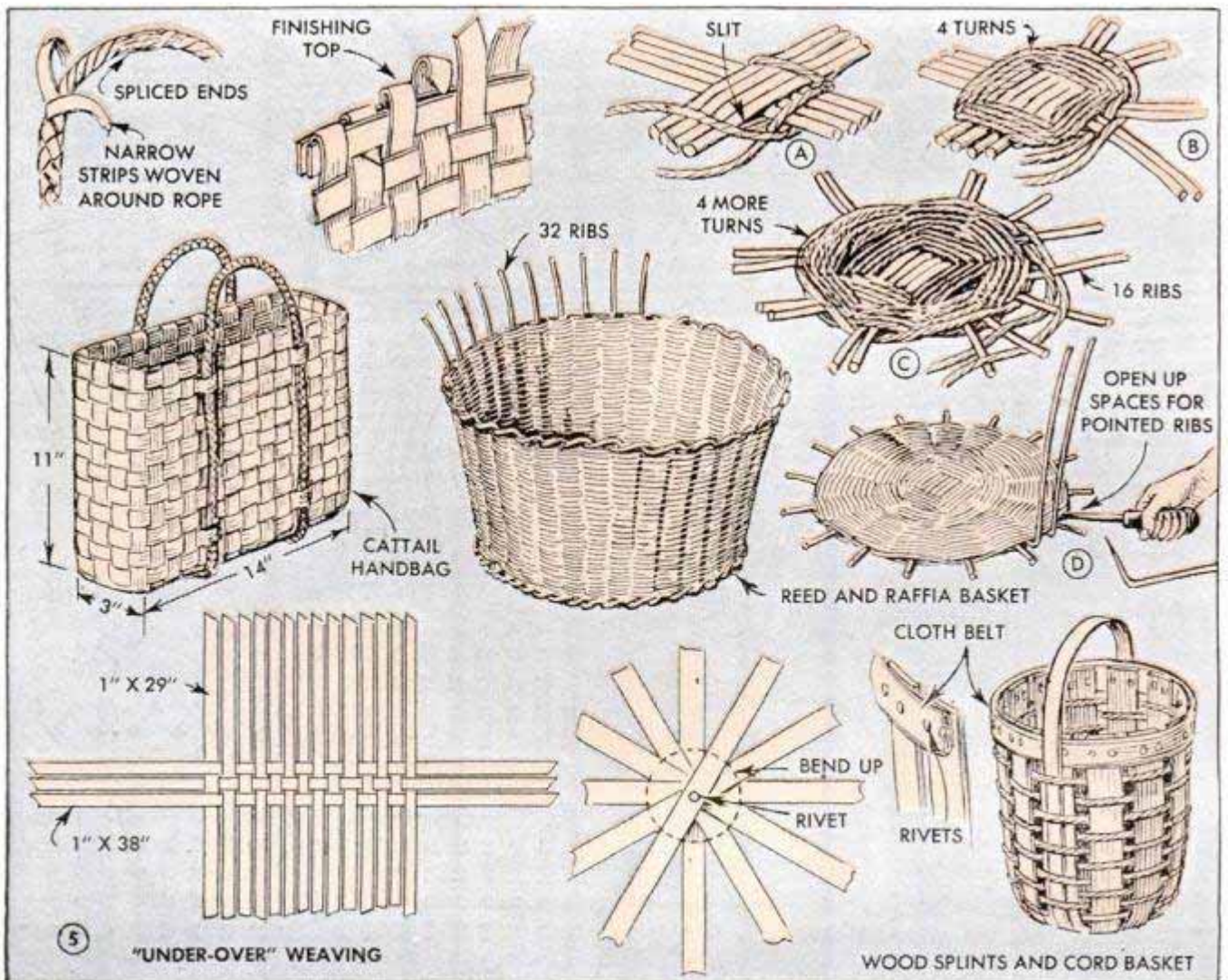

one in Fig. 2, the other in details A, B, C and D in Fig. 5. Employing the latter method, use reed sticks and a bundle of raffia. Cut four of the sticks 6 in. long, and with a sharp knife make slits in each at the center, 1 in. long. Cut four more reeds the same length, sharpen the ends and insert in the slits of the other four as in detail A. These are known as spokes and form the base of the basket. Bend the ends slightly downward so that the finished base will be concave and stable on a flat surface. Double a strand of raffia at its center and put it around one of the groups of four spokes, one in front and the other strand behind as in detail B. Work around the groups of four spokes in twined weaving four times around. Then separate the spokes into pairs and weave around again four times as in detail C. Space all the spokes evenly and continue weaving another four turns, making the complete base. Push the raffia toward the center and cut off the ends of the sixteen spokes. With an awl force an opening between the top and bottom strands, each side of every spoke, and insert sharpened reeds, pushing in as far as they will go, detail D. These form the ribs. Pinch the reeds at the base or close to the circular rim of the bottom, and bend up all 32 new ribs. Continue weaving until the wall is finished, leaving about 2 in. of each rib projecting. The top ends of the spokes are bent down and bound in place in the rim.

Another easily made basket suitable for heavier loads is shown in the lower right-hand details of Fig. 5. Six long, thin wood splints, 2 in. wide, are laid one over another, spoke fashion, riveted in the center and bent up over a large pot lid, wooden disk or whatever suitable object is handy. Heavy cord or other material is then woven around the upright splints, and the top ends are riveted to a doubled strip of heavy canvas. A rope or splint handle passing entirely around the basket completes the job.

Still another similar type of basket, heavy and exceptionally strong, is made by beginning with a number of splints woven at right angles over a box slightly smaller than the base area of the basket as in Fig. 6. Lay the woven splints on top of a box and fasten with a board nailed to the bottom of the box as shown. Next, bend the splints down all around and begin weaving the walls carrying these up to a height of three or four splints as in Fig. 7 and detail A of Fig. 8. Then the box can be removed and the tops of the splints held in place by a cloth strip, detail B. Next, point the end of each splint and when the basket is as high as you wish, bend these ends over and tuck into the horizontal splint which is

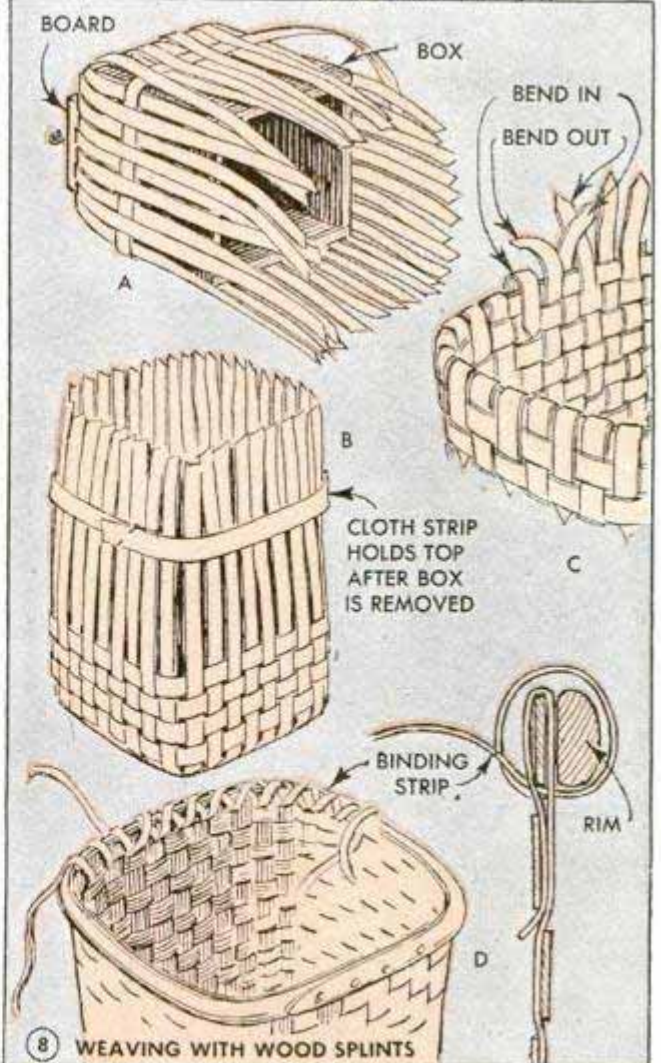
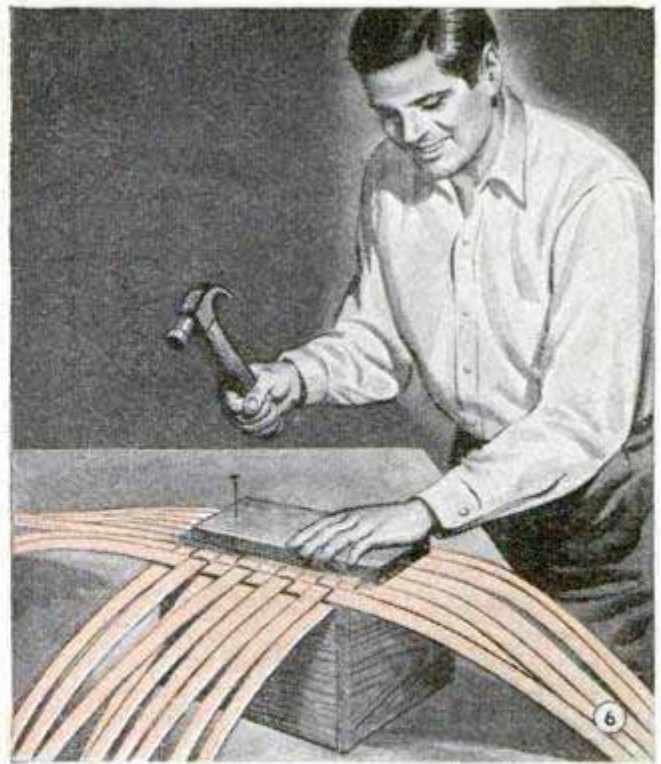

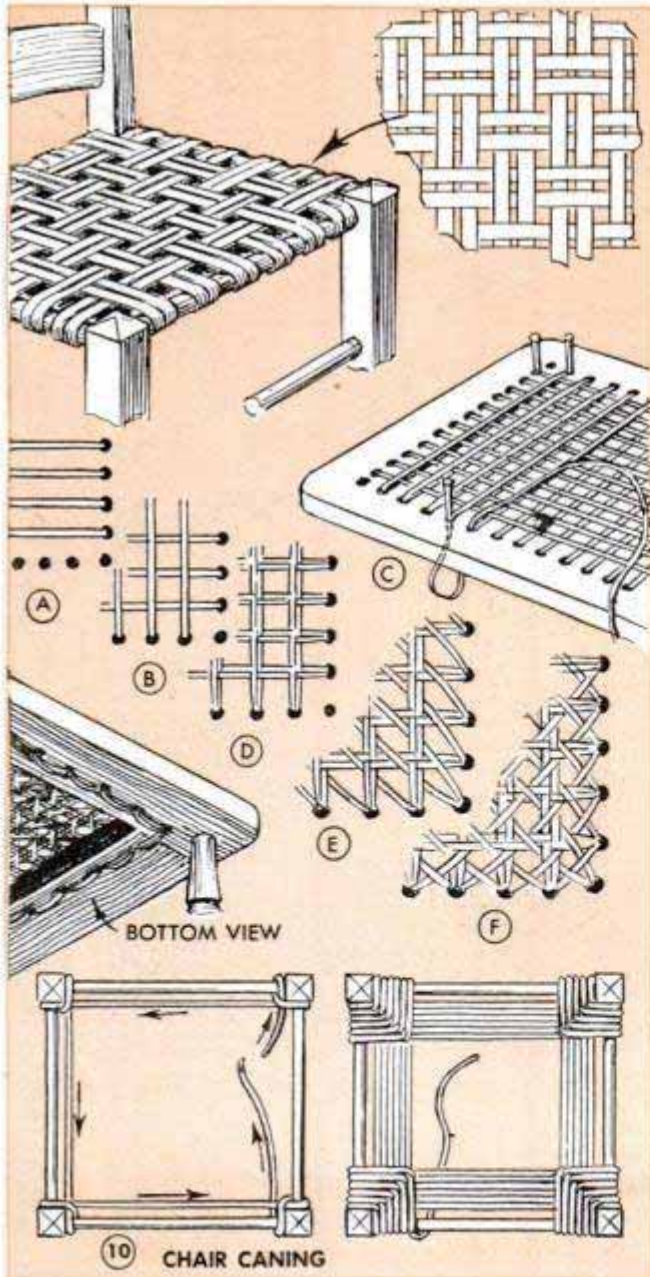

second or third from the top as the case requires, detail C. Make a rim of hickory, roughly trimmed to a half-round section. Lap and rivet the ends and fasten to the basket top with thin splints bound around in one direction, then other splints bound the other direction, so that they cross as in detail D. The ends are tucked under as in Fig. 9. Some weavers make hickory splints as in Fig. 1, but usually it is better to buy the splints ready-made.

Woven chair seats can be made from rawhide strips, twisted cattails, cord or rope and the old favorite, cane. A very simple rawhide job is illustrated in the upper details, Fig. 10, the strips being woven in pairs and the ends tied. Use the longest things you can obtain, and moisten them slightly so that they will be taut when dry. Don't soak the things, as in drying they may shrink and crack the rungs over which they are stretched.

Cane is commonly used in chair bottoms. A simplified pattern for the beginner is given in Fig. 10. This is easy to follow and makes a substantial seat. The conventional pattern is carried out in the various steps as shown in details A to F inclusive, Fig. 10. Holes are evenly spaced and the cane strip is brought up through a hole, second from the corner, and secured with a tapered wooden peg. Front-to-back strips are installed first, detail A, and then those at right angles, or crosswise, are completed over the first ones, detail B. Again continue with the parallel front-to-back strips and over these, the second layer of crosswise strips, detail D, securing the ends either by tying underneath or driving in a hardwood peg and cutting off the projecting end flush with the chair frame. On the diagonals the work becomes somewhat more complicated. All those running in one direction are installed first. They are followed with the strips running at right angles to the first set of diagonals. See details E and F. The cane should be soaked a short time before using, but be careful that it is merely damp, not wet. This is quite important in successful weaving.

Rush chair seats are made of dried, twisted cattails and, of course, substitutes are used. If you use cattails, cut them at the peak of growth. Dry them in a dark place and before twisting, soak in water. Ends of the reeds or stems can be joined in a square knot made only on the underside of the seat. This procedure is shown in the lower details, Fig. 10. Begin at the corners of the chair frame and work toward the center, twisting the material as you go. Before closing up the seat at the center pack the empty space between upper and lower strands with scraps of the same material to make a solid seat.

DUTCH CRADLE

PATTERNED after an original in Holland, this reproduction of an old Dutch cradle offers something unusual in a baby's bed. Its quaintness is typified by a curtain hood, originally provided to protect the baby from drafts. The sides are attached to the head and foot like the rails of a bed, using fasteners taken from an old bed, or purchased. Plywood, $\frac{3}{4}$ in. thick, will save gluing up solid stock for the head and foot pieces. The pattern for these, Fig. 1, can



be enlarged to suit; 4-in. squares will increase the pattern to the size of the original, but 3-in. squares will make it somewhat smaller and less difficult to handle when sawing. While a bandsaw is the tool to use, the work can be cut by hand with a keyhole saw.

Assembly of the bed is detailed in Fig. 2. Note that the sideboards are paneled and fitted with cleats on the inside to support slats or a spring. The cutout design in the head and foot can be simplified by boring seven holes in a circular pattern. Use an expansive bit and make clean-cut holes by backing the work with a scrap block or boring from each side. The bracket that supports the curtain is screwed to the head.—C. J. Stork, Utrecht, Holland.

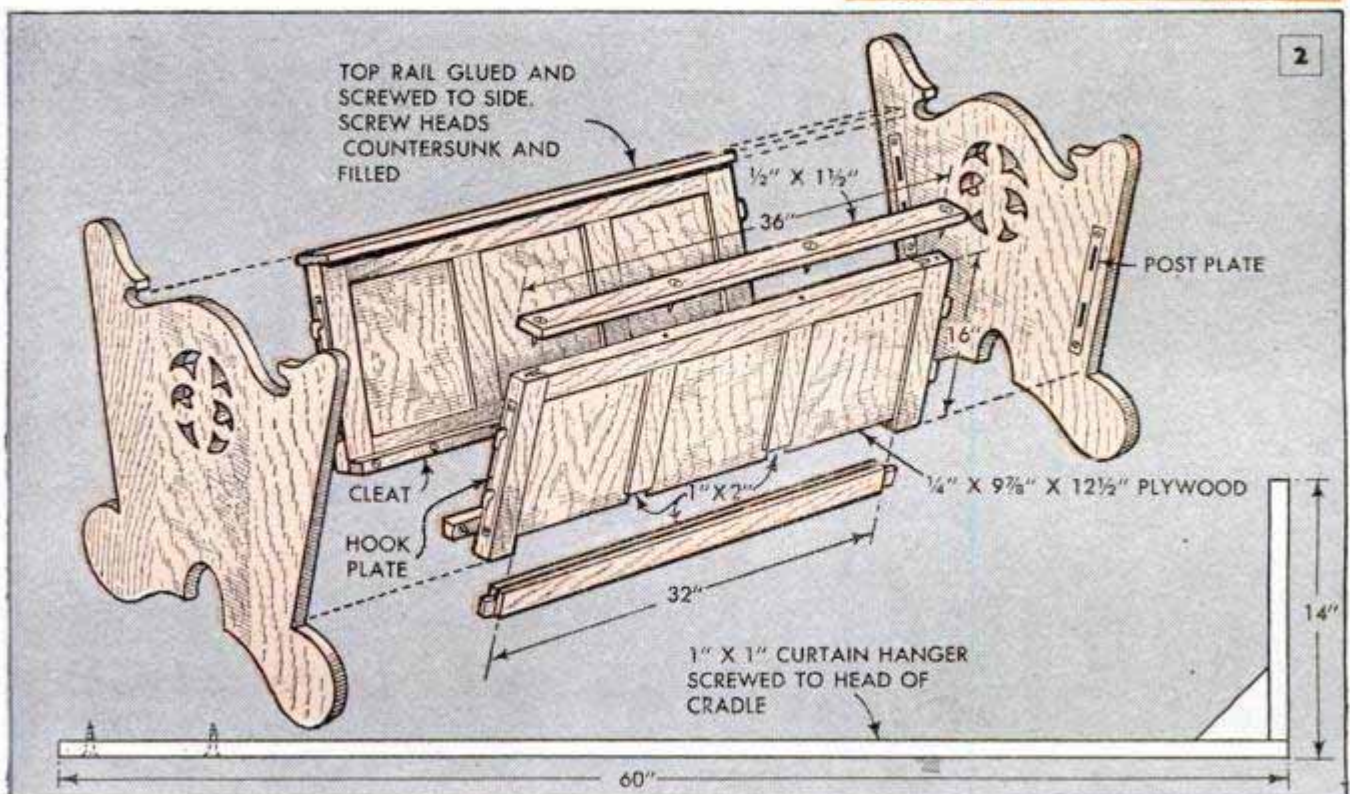
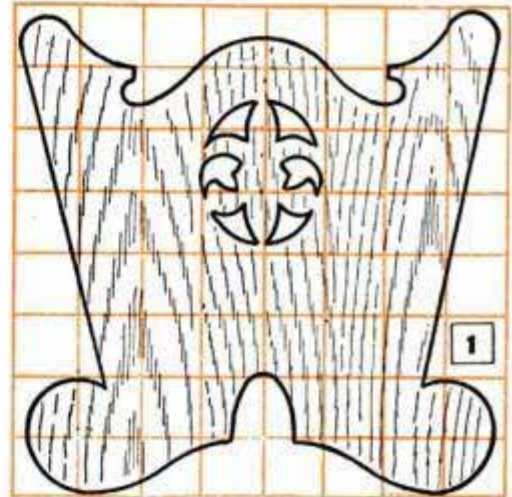

Marking Jig Locates Centers On Square or Round Stock

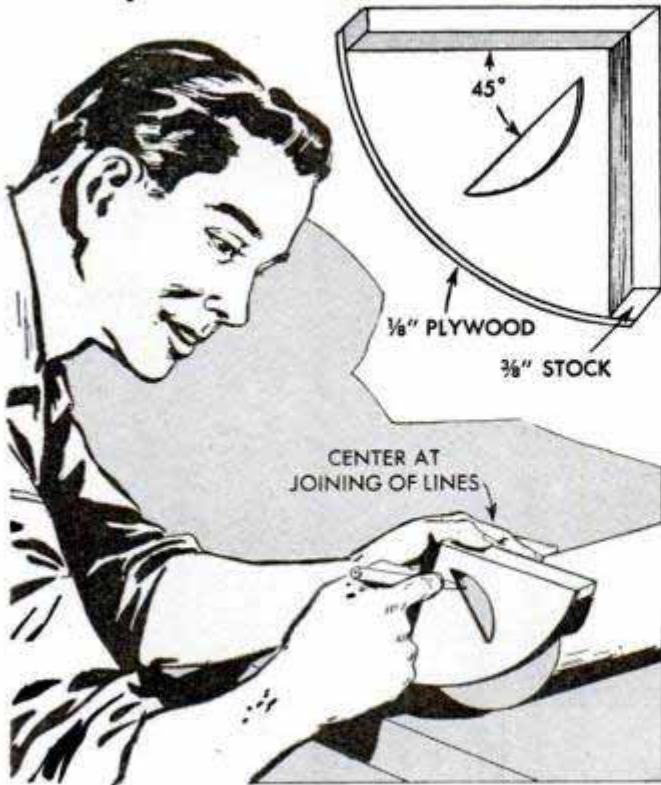

This jig makes quick work of locating and marking centers on square or round stock. To make it, cut a 90-deg. segment on a 5-in. radius from 1/8-in. plywood. Saw a half-moon opening in the segment with the straight side of the opening bisecting the 90-deg. angle. Then miter the ends of two pieces of 3/8 by 3/4-in. stock and glue and brad these pieces to the plywood segment. To use the jig, place it on the end of the stock and draw a line along the straight edge of the opening with a sharp pencil or scribe. Move the jig approximately 90-deg. and scribe another line intersecting the first. The center of the stock will be at that point where the lines intersect.

J. Harold Click, Elkin, N. C.

Sawing Cove Molding

With this simple miter-box setup, it is easy to cut accurately fitting joints in cove or crown molding wherever it is necessary

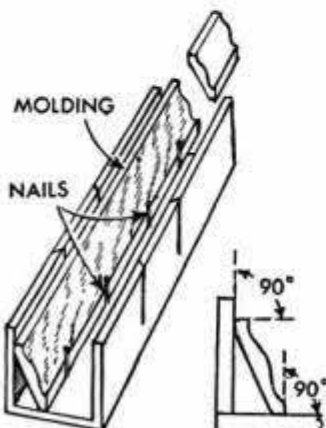

to make a miter joint. It is done by placing the molding at the same angle in the box as it will be when nailed to the wall and ceiling. Finishing nails driven into the base of the box hold the molding in the correct position. When sawing, be

sure to hold the molding firmly against the box to insure an accurate cut.

Aldo Gotta, Jamaica, L. I., N. Y.

Cellulose Tape Holds Shelf Paper

Thumbtacking shelf-lining paper to cupboard or pantry shelves often results in the paper shifting and tearing at the points where it is held by the tacks. This will not occur if cellulose tape is used instead of thumbtacks. Simply apply half the width of the tape to the front edge of the paper and stick the other half to the edge of the shelf as shown. When shelving paper is used which has a decorative edging, small tabs of tape can be applied at each end and across the back to hold it.

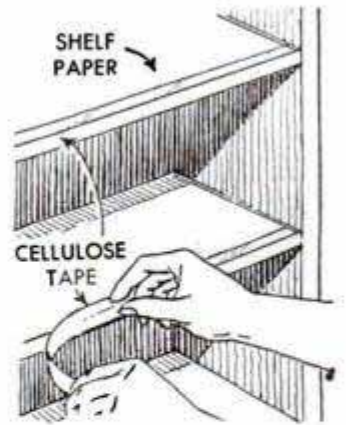

Sectional Holder for Small Drills Carried in Pocket

A number of small twist drills can be carried in a pocket without tearing the cloth or dulling drills if this sectional holder is used. Each section consists of a wooden block that is hollowed out to hold a drill. The sections are held together by small coiled springs running through holes near the top and bottom of each section. Drill sizes are printed on the blocks for ease in selection. Note that a blank strip or block attached to the springs is required to cover the opening in one end block.

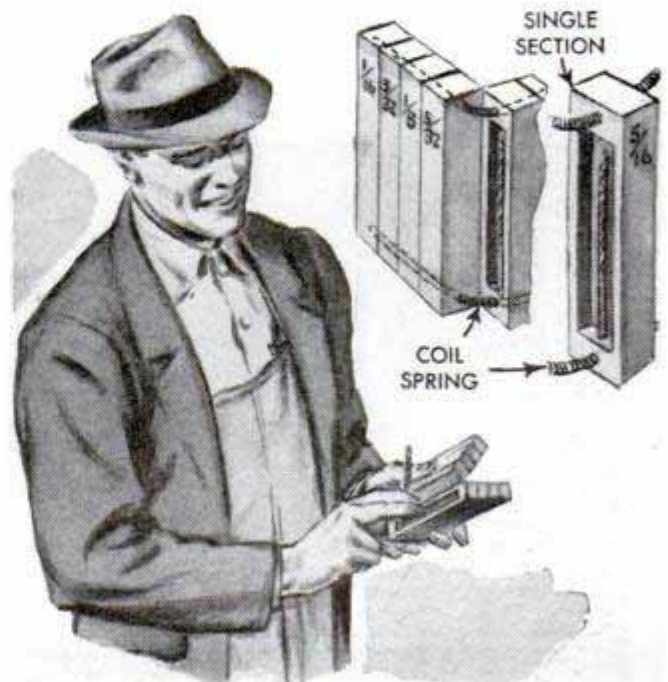

Collapsible Reflector for Outdoor Photographs

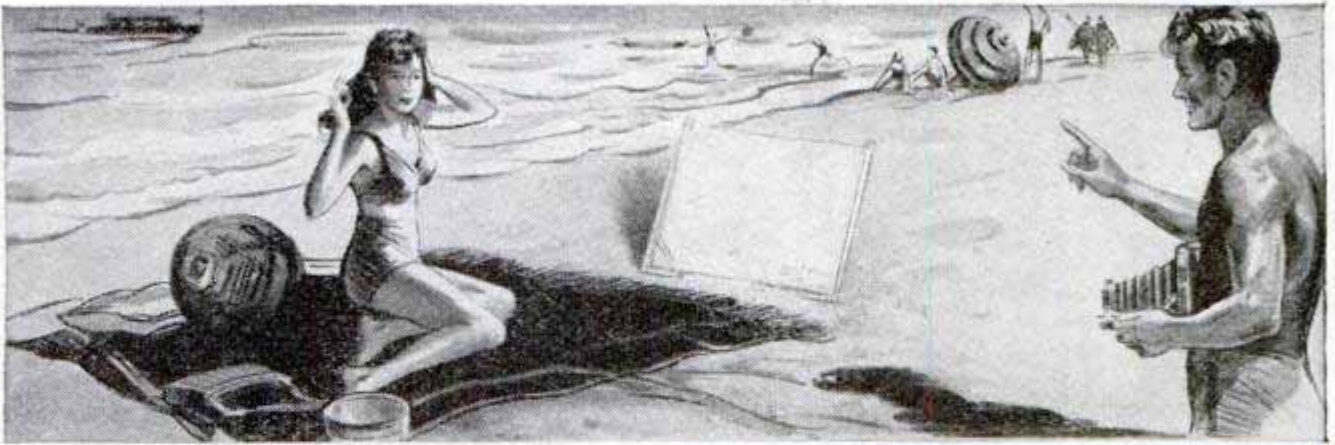

As an aid in taking photographs outdoors under natural lighting conditions, this portable reflector will enable you to direct the light wherever desired. In addition, it is useful indoors with either flash or photo-flood lighting. It can also serve as a wind-break when taking photos of flowers or other fragile objects. The reflector is merely a piece of white cotton cloth tacked to a three-sided wooden frame, which consists of three hardwood pieces, two arms and a base. These are hinged to fold compactly, card-table brackets being used as indicated to keep the reflector in the open position. If the brackets are not available, screen-door hooks and screw eyes can be substituted for them. A strap, fastened around the center, holds the reflector in a neat bundle. Keep the reflector close to the subject, as light intensity diminishes greatly with each foot of intervening distance.
Austin Phelps, Omaha, Nebr.

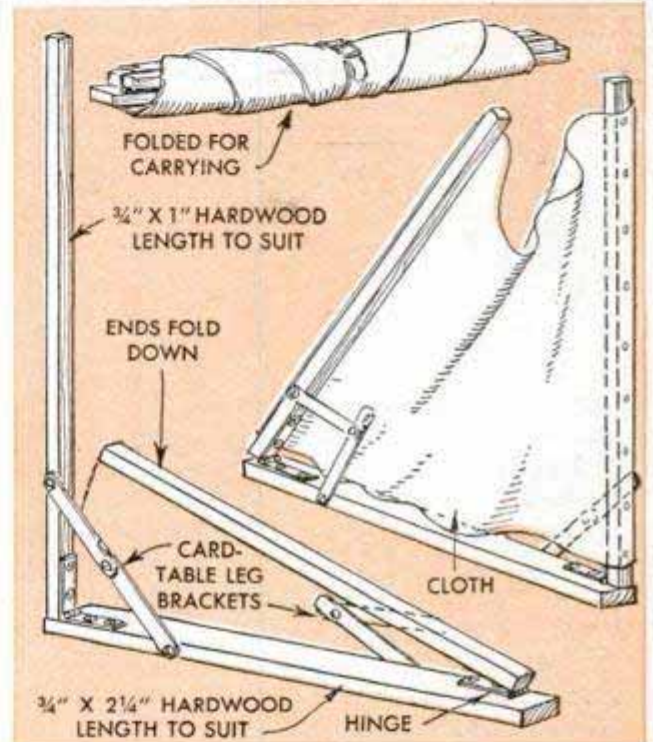

Hand Holes Cut Quickly With Dado Saw

Here's a simple production jig for cutting hand holes quickly and accurately in box ends, desk slides, breadboards, etc. It's done with a dado saw in the following manner: A wooden frame to position the work is made to suit the job at hand and is clamped to the top of the saw table. Then, the dado saw is set at the desired height, the heel of the work is placed in the corner of the frame and the work is lowered over the rotating saw. If the height of the dado saw is less than the thickness of the work, a blind hand hole is cut. If it is greater, an open-type hand hole is produced. Where the job requires a rectangular opening it can be squared up afterward with a jigsaw.

Joseph Ruel, Fifty Lakes, Minn.

☞ An old toothbrush, dipped in a saucer containing moistened baking soda, is handy for cleaning silverware or costume jewelry.

TABLE-TOP STUDIO for NATURE PHOTOS

By Paul Hadley

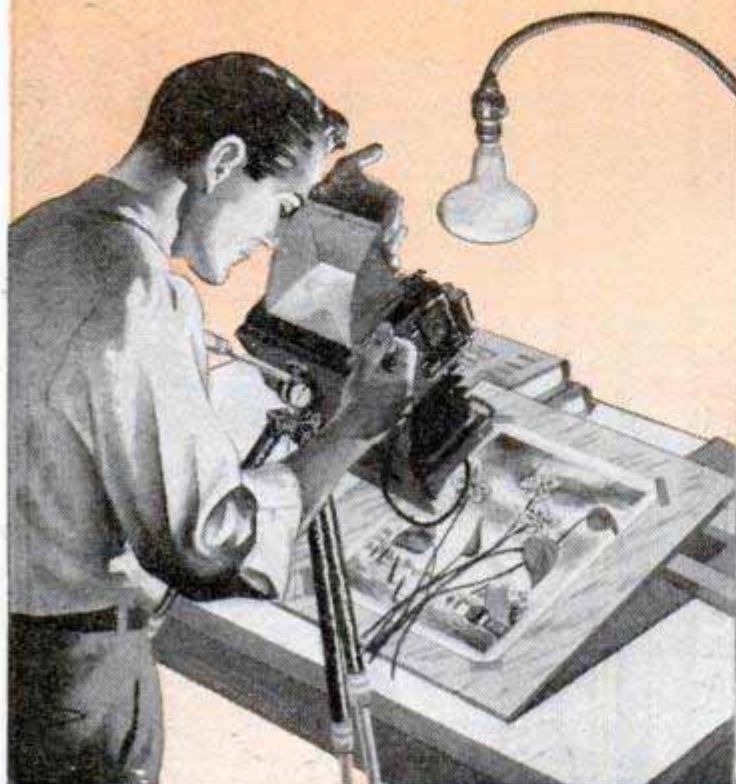

Obviously, this toad wasn't asked about having his picture taken. But here he is. The lens was only an inch or so above his own eye level

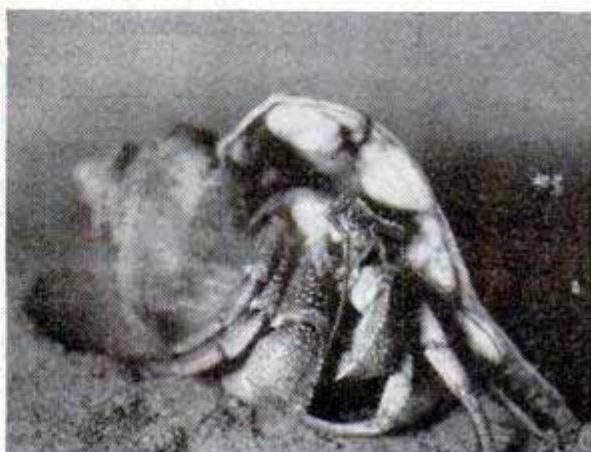

Sand spread on the worktable makes this hermit crab look and feel right at home. One floodlight gives the effect of bright sunlight



NATURE students who take close-up photos of live subjects for study purposes will find a simple indoor table-top studio most helpful in making these difficult shots. In this way, the subject can be placed at a convenient height and posed with props that simulate the characteristics of its natural habitat. As a rule the live subjects can be photographed on a table top with far less difficulty than one would experience when attempting to take the same shot outdoors in natural surroundings, for indoors both the lighting and the subject can be controlled.

Any worktable with a top that will not be damaged by building up sand, grass or mud props for use with various subjects will do. The standard table height of 30 in. is suitable for average work, where an adjustable camera tripod with tilting head is used. The photos show what can be done with the simplest setups. Backgrounds may be varied, of course, but a white one is most useful, as it closely represents the sky if kept

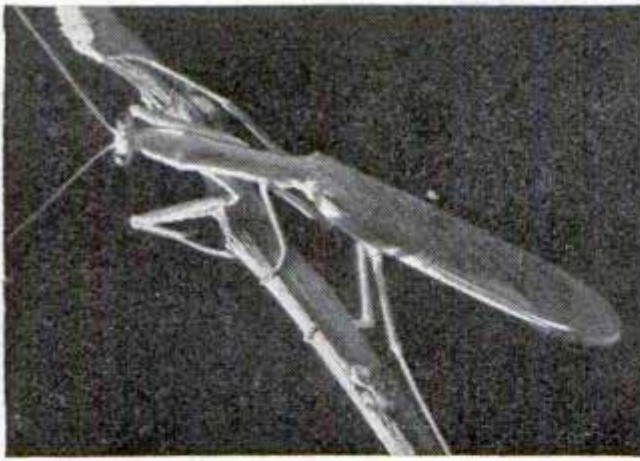

Sunlight coming through a window lighted this table-top shot of a praying mantis perched on a twig in a characteristic pose. Use a dull black background



Weeds "planted" in a bed of lawn clippings spread on the table top make a realistic background for this shot of baby rabbit. Camera is above subject



A fearsome creature, this huge beetle, especially when the shot is taken close-up from a low angle, which tends to accentuate the size of the subject



This baby blue jay, just sprouting his wing feathers, was easily induced to pose indoors for a table-top shot. Note the low angle. Background is crepe paper

free from shadows. A large cloud print makes a good natural background for close-ups of flowers. When photographing these, care should be taken in arranging the lighting to avoid unnatural shadows. In most cases, a single floodlight will give the necessary light intensity. The light should be placed directly over the subject and the camera elevated on the tripod and so located that the shadows do not register on the ground glass. Usually, flowers photograph best when placed on a tilted easel as shown in one of the illustrations. A large cloud print placed under the subject makes a realistic background. Being so nearly in the same plane as the subject, detail in the background print will be sharp, so it should be located carefully.

Photos of the sleepy toad and the hermit crab on the opposite page were made by spreading sand on the table and placing the subject on it in a realistic pose. In both these shots the camera was lowered to a point just above the eye level of the subject. Two of the other photos shown, the large beetle and the fledgling blue jay, were made with the camera below the eye level of the subject. The shot of the bird

perched on a flowering twig, was taken against a background of white crepe paper. In the photo of the praying mantis, a dark background was used, and extremely brilliant lighting was obtained by placing the subject in bright sunlight streaming in through a window. Several weeds pulled from the garden and "planted" in a bed of lawn clippings gave the proper background realism for the shot of the baby rabbit. Note the side lighting.

Live fish and other water creatures, also water plants, can be photographed on a table top by placing them in a large glass tank or aquarium filled with clear water. To prevent live subjects from getting out of focus by swimming away from the side of the tank, use a piece of glass just large enough to slip inside the tank lengthwise and block it in place a couple of inches back from the front surface through which the pictures are to be made. Placing the subjects in this restricted area will keep them in focus. Due to the necessary open lens setting and the slow exposure time which must be used when taking close-ups, wait till the subjects come to rest in a natural pose before tripping the shutter.



6 FT.

12 FT.

24 FT.

Reflecting View Finder on Camera An Aid When Focusing

Most folding cameras have a reflecting view finder that can be used to determine distances when focusing. To do this, select a subject—preferably a person of average height—and frame him in the finder so the image from the waist to the top of his head covers the glass. Next measure the distance from the camera to the object. Repeat the process, framing the person from head to foot, and then have him far enough away to fill half the finder. With these three distances known, it's easy to interpolate in between and set the scale on the camera accordingly. When focusing pictures, select a person or object of about the same height and you will be able to set the camera within close limits.—Bob Hurst, Chicago.

Storage Rack for Photo Bulbs

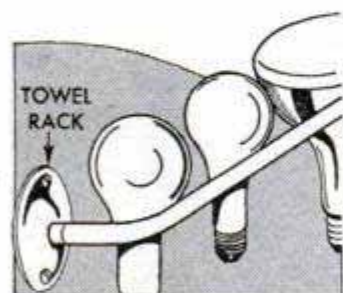

This storage rack will hold almost all sizes and shapes of photographic bulbs, and it will keep possible breakage at a minimum. It consists of an ordinary towel rack long enough to hold the bulbs you have. Several racks can be located in the studio so that a large assortment of bulbs will always be close at hand when needed.

Alexander Maxwell, Chicago.

Molding Cup Used as Light Diffuser

A molding cup of the kind used for gelatin salads provides an efficient diffuser for No. 1 photoflood bulbs to furnish a more even illumination. Punch four holes near the bottom of the cup and insert two wires crosswise, hooking them to the edge of the reflector. Stiff wire, such as is used in coat hangers, will do.

H. Klein, Pittsburgh, Pa.

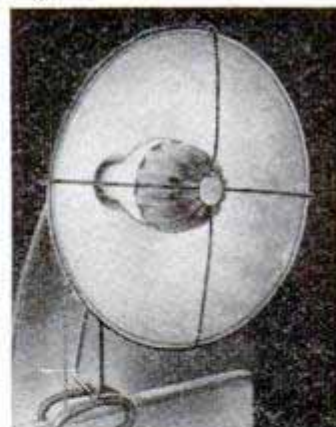

Labeling Chemical-Solution Bottles

Identification of bottles containing photographic solutions is both permanent and positive if the name is written on the glass with a hand power tool and an abrasive wheel. The writing will stand out clearly regardless of whether a transparent or dark-colored bottle is used.



Although photo-print tongs may be lettered "hypo" and "developer," it's easy to get them mixed up in the darkroom and find that the hypo tongs are in the developing solution and vice versa. One way to avoid confusion is to use tongs that have differently shaped heads. For example, developer tongs could have a round head and hypo tongs a square one.

Positive Identification of Print Tongs

R. F. Donavan, Jersey City, N. J.

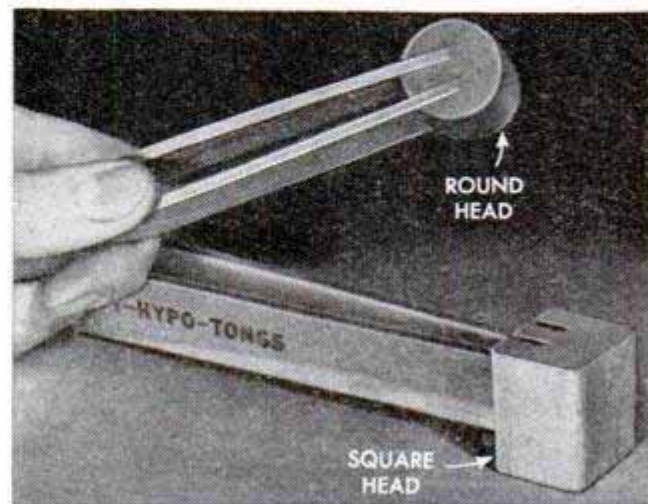

CRAFT QUIZ



1. Joint being made is—
 (a) Butt miter (c) Doweled miter
 (b) Box miter (d) Keyed miter

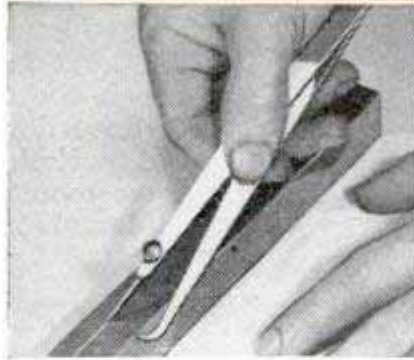

2. Nickname for this caliper is—
 (a) Jenny (c) Peg leg
 (b) Lizzie (d) Dingbat

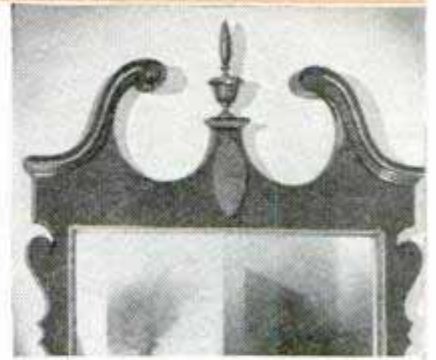

3. This mirror has a turned—
 (a) Filial (c) Gallery
 (b) Apron (d) Finial

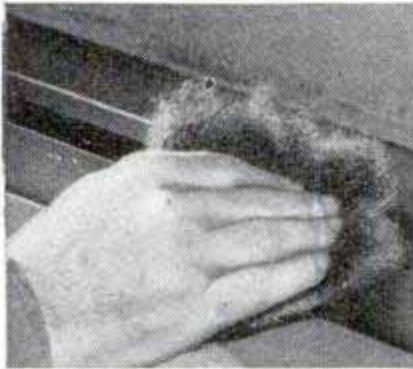

4. Medium steel wool is—
 (a) No. 2 (c) No. 00
 (b) No. 1 (d) No. 0

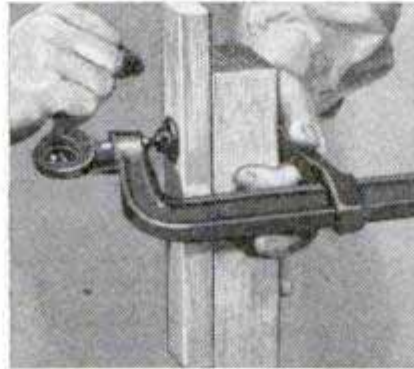

5. Clamp used here is—
 (a) Shielded (c) Concentric
 (b) "C" (d) Eccentric



6. He would know about—
 (a) Burls (c) Taper turning
 (b) Planimeters (d) Broadheads



7. Light finish on oak is—
 (a) Limed (c) Bog
 (b) Fumed (d) Mission



8. This room will have a—
 (a) Plate rail (c) Crown mold
 (b) Drop ceiling (d) Bay window

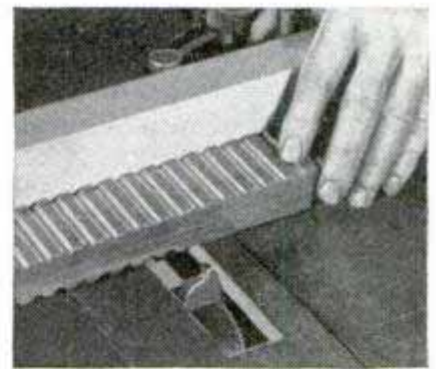

9. He is using a—
 (a) Molding head (c) Dado head
 (b) Cope cutter (d) Safety head

ANSWERS: 1—c; 2—a (also odd leg; true name, hermaphrodite caliper); 3—d; 4—b (No. 2 is medium-coarse); 5—d (clamps with eccentric movement of handle); 6—a (picture shows press frame used in making veneered panels); 7—a (also called frosted); 8—b (ceiling color or paper dropped down on sidewall); 9—a; 10—d; 11—c

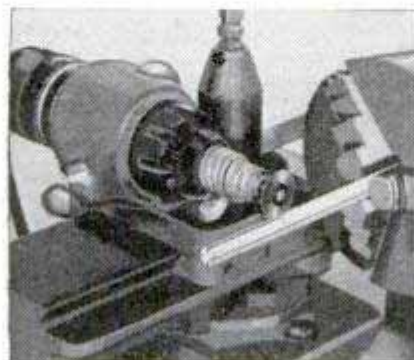

10. Simple lathe has a—
 (a) Flat bed (c) Cone drive
 (b) Change gears (d) Index head

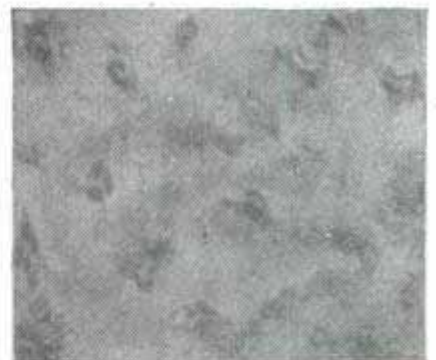

11. Wood figure shown is—
 (a) Ribbon stripe (c) Bird's-eye
 (b) Quilted (d) Fiddleback

Vest-Pocket Phone Directory Made From Match Pad

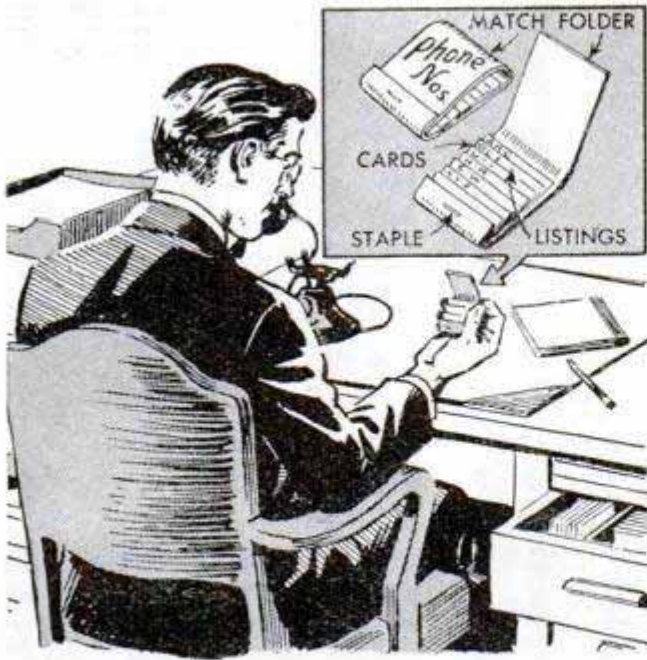

Just the right size to carry in a vest pocket, a book of matches can be converted into a handy little pad for phone numbers called frequently. Simply remove the wire staple and replace the match stubs with several little cards. Cut each card about $\frac{1}{8}$ in. shorter than the next one as shown to provide space for listing the numbers, and then restaple as before.

Indicator That Has Rotating Disk Shows Amount of Milk Needed

This indicator, which shows at a glance the amount of milk or cream needed, does away with the necessity of having to leave a note for the milkman each day. The front

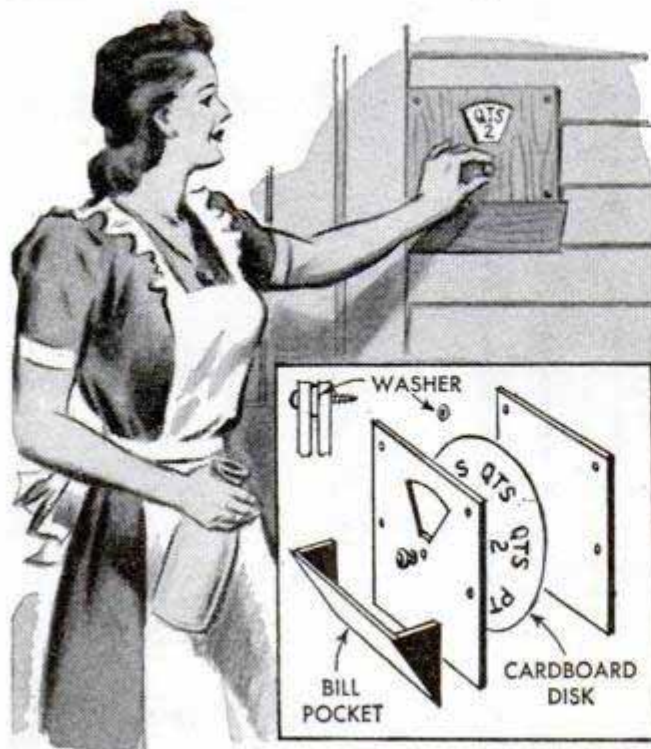

and back pieces or panels are made of lightweight plywood and the rotating disk is heavy waxed cardboard lettered to show the amounts of milk or cream required. Cut a window in the front panel, and use a metal knob and spindle to rotate the disk. The unit is assembled with washers between the front and back pieces so the cardboard will be free to turn. Note the bill pocket, in which the milkman can leave monthly statements.

Margaret E. Singleton, Rochester, N. Y.

Wallpaper Blister Pasted Down

Unightly wallpaper blisters may be pasted down by using an ordinary eye dropper that has been filled with liquid glue. Slit the blister horizontally near the top and insert the tip of the dropper to spread glue over the plaster. Then press the paper down with a piece of cloth. Avoid staining the paper by applying too much glue.



Container for Crankcase Oil

With this container, oil is drained from an auto or tractor crankcase and stored in the same receptacle into which it is emptied. This does away with the necessity of handling the oil several times, and it also permits draining without raising the auto or having to use a funnel. Cut a slit in the wide side of a 3-gal. can near the top and press the side in to form a V-shaped indentation or trough. Set the can under the auto so that oil will drain into the trough. Then set the can upright when storing it, after first determining that the oil level is below the slit.

Harold A. Nelson, Minneapolis, Minn.

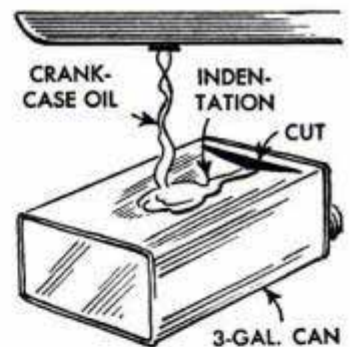

"Pick" to Clean Small Oilholes

To clean small oilholes and similar openings, use one of the filament-supporting wires from a discarded 60-watt light bulb as a pick. Break the bulb and remove the glass adhering to the base, which then serves as a handle. Leaving the stem intact, remove all but one supporting wire.



Turn it with Carbide Tools



Photo courtesy Carbology Co.

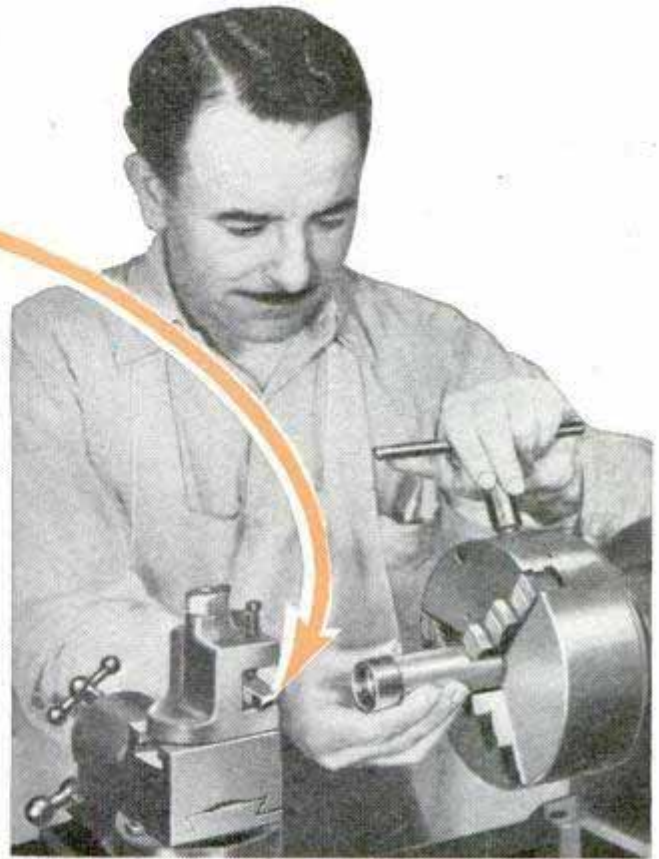

IF YOU have had the edge of a high-speed bit fold up when making the first "skin" cut on cast iron, you'll appreciate the way a carbide-tipped tool peels off the metal. This high-production cutting tool of industry can be put to work in the small machine shop as well as the home workshop. For besides being used in a tool post, it can be used freehand like a wood-turning chisel, Fig. 9, to turn brass, aluminum and plastics at wood-lathe speeds. Once ground and sharpened, carbide tools will stay sharp longer than any other cutting tool. They require only light honing at long intervals with a silicon-carbide stone to maintain the edge. Tools tipped with carbide can be purchased, or you can assemble chisels as shown in Figs. 10 and 11.

What is cemented carbide? The sketch at the bottom of the page explains cemented tungsten carbide graphically. The full-name description often is shortened to just "carbide." Cobalt is the bonding or cementing agent that binds the particles of tungsten carbide into a compact mass, which closely resembles polished steel. This metal is super hard—it scratches glass, Fig. 1, and it will cut the hardest file. Like all very hard materials, it tends to be brittle and will not stand excessive shock loads. By adding a greater proportion of cobalt, hardness is reduced slightly and toughness is increased. There are two main groups of carbide tools: The straight tungsten carbides, as already described and illustrated, and the combined

**CHROME STEEL
H. S. STEEL
HARDENED
TOOL STEEL
MARBLE
ETC.**

USE CARBIDE . . . FOR TURNING ALL SUPER-HARD MATERIALS

**FIBER
PHENOLICS
LAMINATES
HARD RUBBER
ASBESTOS
ETC.**

USE CARBIDE . . . FOR ALL MATERIALS HAVING AN ABRASIVE ACTION

**BRASS
COPPER
MILD STEEL
ALUMINUM
ZINC**

USE HIGH-SPEED STEEL . . . FOR AVERAGE TURNING UNLESS YOUR LATHE IS POWERED WITH AT LEAST 3/4-HP. MOTOR

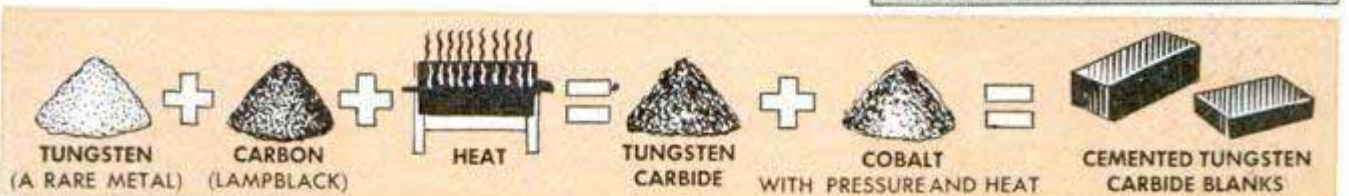



* SURFACE FEET PER MINUTE

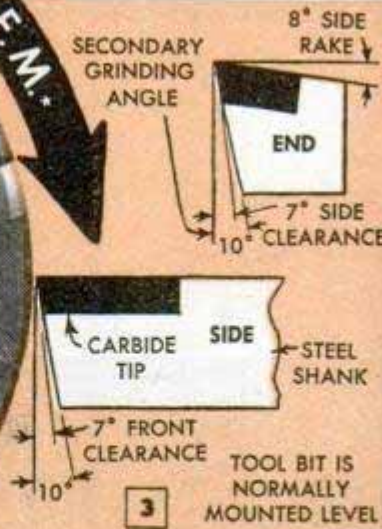

200 S. F. M.	
WORK DIA.	R. P. M.
¼	3056
½	1528
¾	1016
1	764
1¼	612
1½	508
1¾	436
2	382
2½	306
3	254
4	191
5	153

WORK 6" TO 12" DIAMETER CAN BE RUN AT 100 R. P. M.

A rule-of-thumb speed for carbide tools is 200 s.f.m. Table at right converts this to r.p.m.

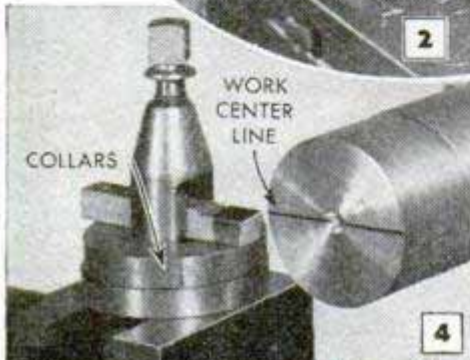

¾" AND ½" BITS CAN BE MOUNTED DIRECT IN TOOL POST

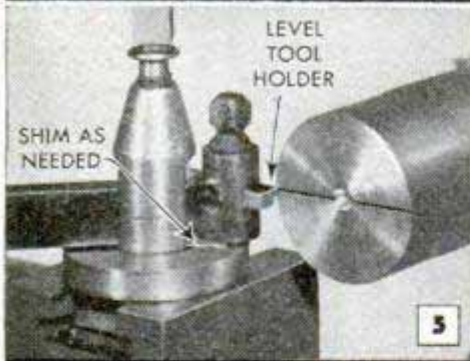

STANDARD TOOL BIT SHOULD BE USED IN LEVEL-TYPE HOLDER



POSITIVE RAKE IS RECOMMENDED FOR LIGHT CUTTING

carbides, which are tungsten carbide with titanium or tantalum added. The straight tungsten carbides are used for turning all materials except steel; the combined carbides are used for steel only. The difference is that steel tends to stick or build up on straight tungsten carbide, and the addition of tantalum or titanium helps to overcome this fault. However, for light turning, any kind of carbide tool can be used successfully on any type of material.

What can carbide do? Being extremely hard, carbide turns all materials at high speeds not possible with other cutting tools. Consider a sample job: In turning 1-in. mild steel it is an easy job for carbide to turn this at 300 ft. per minute with a .010 feed and 1/8-in. depth of cut. In other words, with the lathe running at 1150 r.p.m. the tool will peel off 4½ cubic inches of metal per minute. But such a heavy cut requires a lathe powered with a 2½-hp. motor. As the average home-workshop lathe is powered with a fractional-horsepower motor, it is apparent that the full cutting capacity of carbide cannot be utilized as even a high-speed steel bit will tax the capacity of the motor.

However, there is another side to the picture. Very often you will encounter a hard piece of steel which resists turning with high-speed bits. A good example of this is where a broken high-speed drill with Morse shank is turned down to make some other tool. That's where you can use carbide. Again, take a seemingly simple job like turning a ring in phenolic plastic. Most of these plastics are filled with metal, asbestos, wood flour or other material, all very abrasive and quick to turn the edge of carbon or high-speed steel tools. Here, again, the carbide tool does the job perfectly.

Carbide is excellent, too, for turning cast iron. Cast iron does not offer the resistance of steel, hence a fair bite can be made with the work running at 200 s.f.m.

How is carbide used? Just forget you have anything special in the way of a tool bit and use carbide the same as you would high-speed steel. Assuming your

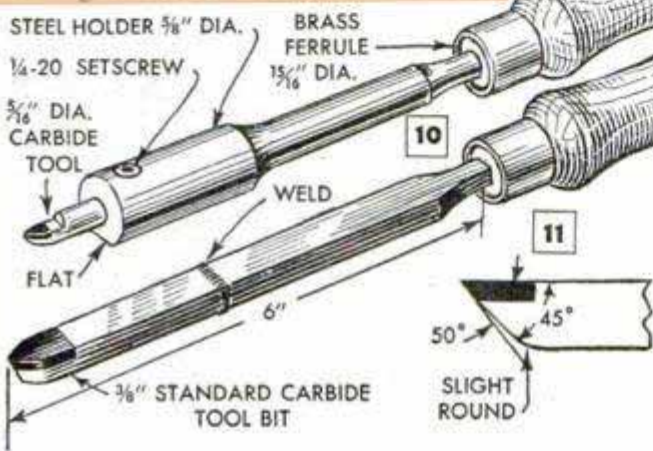
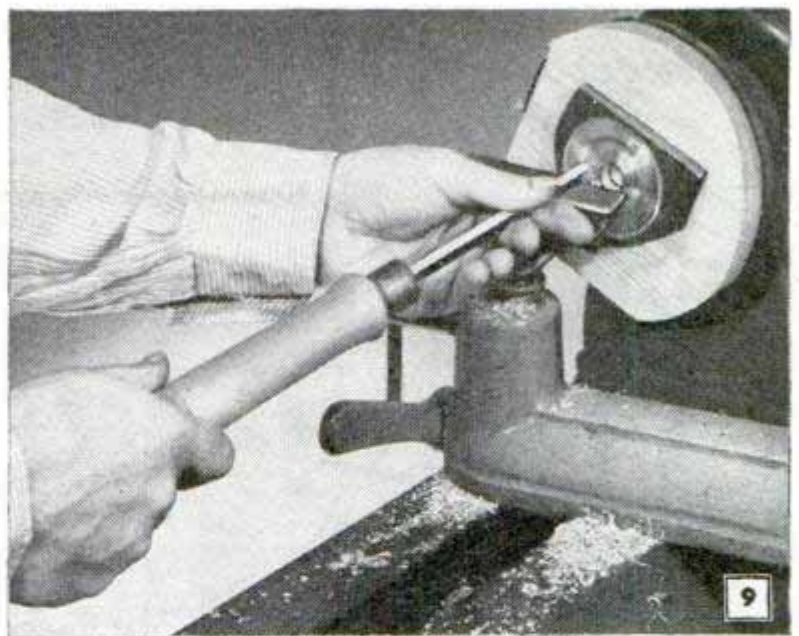
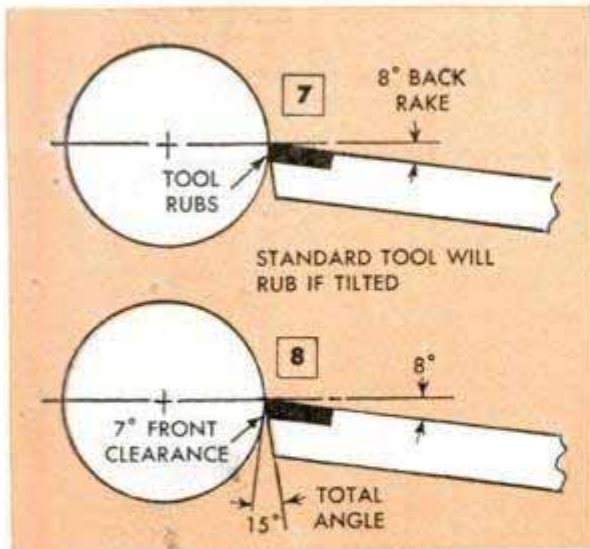

1 1/8" DIA.
 MAPLE HANDLE ABOUT 10" LONG OVER ALL
 HAND TOOLS CAN BE USED TO ADVANTAGE ON SPEED LATHE. PHOTO SHOWS ALUMINUM BEING TURNED AT 900 R. P. M.



GRINDING IS PREFERABLY DONE FREEHAND AND DRY ON SUITABLE GRINDING WHEELS

power is no greater than a 1/2-hp. motor, it is impossible to overtax carbide with any combination of speed and feed which the motor will pull. A good rule is, "200 feet per minute," and the table adjacent to Fig. 3 converts this to r.p.m. Ready-sharpened tool bits, available in various sizes and shapes, are intended to be mounted on-center and horizontal as shown in Fig. 3. Figs. 2, 4, 5 and 6 show various mountings. Although industry uses the standard shape, Fig. 4, best results on light equipment are obtained if tool-bit angles closely pattern those of high-speed steel. A good setup is shown in Fig. 7 where the tool is given 8 degrees back rake by the angle of the tool holder. In this case, it is necessary to provide more front clearance, as can be seen in Fig. 8.

How is carbide ground? Use a silicon-carbide wheel for grinding the tip, Fig. 12, and forget anything you may have heard about carbide being tough to grind. True, it is a super-hard metal and grinds slowly, but if you keep the tool moving to grind off small facets, the carbide wheel does the trick quickly. Double angles are commonly used in grinding carbide bits. Grind the tip at the required angle and then back off

the metal shank an extra two or three degrees. With this system, light sharpening can be done on the silicon-carbide wheel without running into the shank. Use an aluminum-oxide wheel if it is necessary to undercut or grind the shank.

Hand tools: Carbide hand tools do excellent work in turning brass, aluminum and plastics, as in Fig. 9, and can be purchased ready-made in square and round-nose patterns. It is also practical to make your own tools from standard tool bits, as shown in Figs. 10 and 11. Once ground and sharpened, these turning tools will stay sharp indefinitely and require only light honing on a silicon-carbide oilstone.

Shadow Screen for Copying Speeds Painting Signs



With this shadow screen, any number of duplicate paper or cloth signs can be hand lettered quickly from a master pattern. It consists of a wooden frame which is covered with screen wire and then hinged at a convenient slant to a wall. A large light bulb illuminates the screen from behind. In use, a master pattern of the sign is made and thumbtacked to the screen wire. Then, the cloth or paper sign material is placed on top of it. When the light is turned on, the lettering of the master pattern will show through from the back in silhouette outline, making it an easy job to copy.

Otto Woolley, Colorado Springs, Colo.

Gradometer Made From Protractor

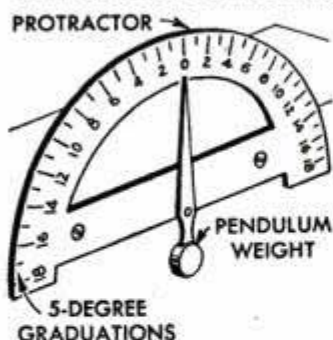

Here's a way to make a simple gradometer for measuring the incline of grades and slopes, and determining the fall of short runs of drain tile, water pipe and open ditches. Obtain a

draftsman's metal protractor, turn it over on a flat surface with the graduated side down. Next, lay off and mark a new set of graduations 5 deg. apart and number each mark as shown to represent the number of inches of rise per foot. Fasten a weighted metal pointer at the center index mark of the protractor, using a hollow rivet peened lightly so that the pointer will swing freely. Screw the protractor to a

mason's wooden level in such a position that when the spirit bubble shows level, the swinging pointer registers exactly zero on the protractor scale. Each 5-deg. division on the scale indicates an incline of approximately 1 in. to the foot. This is accurate enough for average work.

Drill Vise Takes Place Of Nontilting Table

Where it is necessary to tilt the work on a nontilting drill-press table, a simple work holder consisting of a wooden angle block fitted with two C-clamps will permit angle drilling. The block is

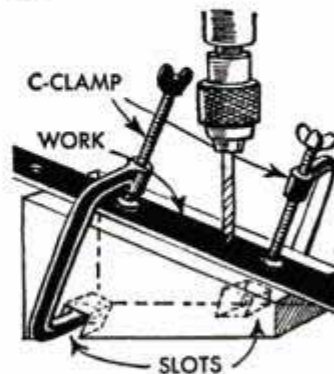

angle-cut to correspond with the angle of the hole to be drilled, that is, to drill a hole at a 60-deg. angle, the block must be cut at a 60-deg. angle. Notches in the block recess the clamp pads so that the block will set flat on the drill-press table.

Short Pencil Leads Salvaged To Use in Compass

Many draftsmen salvage short pencil leads for use in their compasses or bow pencils. A convenient way to keep these leads at hand is to attach them to the tacky surface of a strip of adhesive tape, which is fastened to the side of an equipment tray or drawer. Before attaching the leads to the tape, sort them according to degree of hardness and then write the hardness number on the tape.

Harry L. Spooner, Peoria, Ill.



Demountable Lugs Fit Rubber-Tired Garden Tractors

Ideal for use on garden tractors and lightweight farm machinery, these demountable rims with attached lugs are slipped over rubber-tired wheels to provide traction in mud or snow. The rim is a length of flat iron bent to fit closely around the periphery of the wheel when the tire is fully inflated. For lugs, short lengths of $\frac{3}{8}$ -in. flat iron are welded on edge to the rim and at an angle as shown, so they will "bite" into the mud. Then two crosspieces are tack-welded to fit across the outside of the wheel. Four short pieces are bent to form quarter circles, and are bolted in

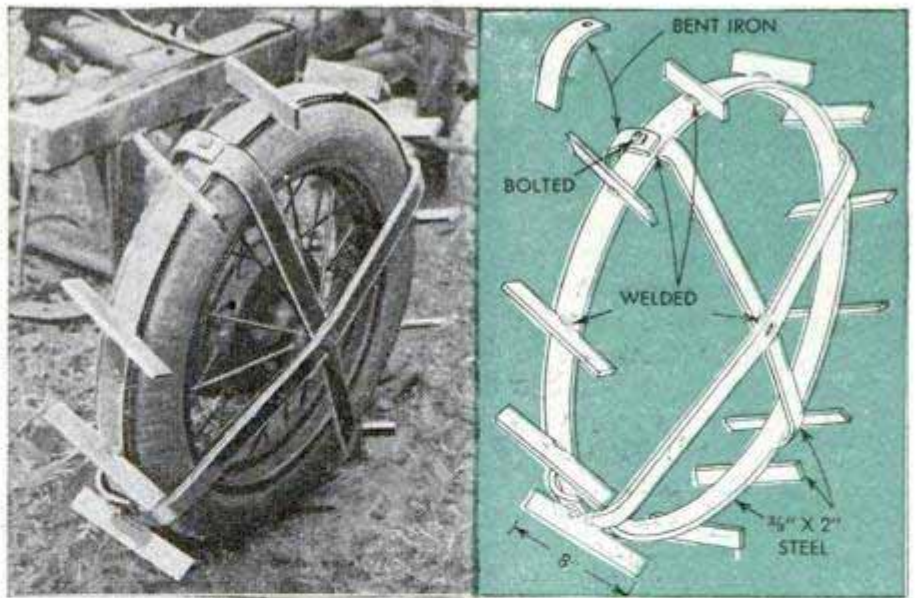

place where the crosspieces join the rim. These clamp against the inside surface of the tire. It will be necessary to deflate the tires when mounting the rims and then inflate them when the rims are in place.

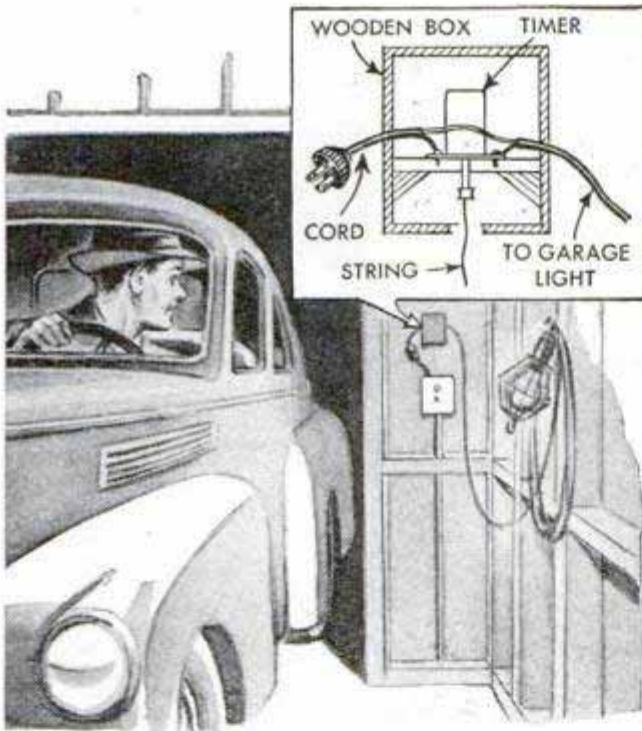

Time Switch Extinguishes Light After Backing From Garage

Especially handy in rainy weather, this time-switch device, when wired as shown in the detail, will turn off a garage light at a predetermined time and thereby make it unnecessary to get out of the car after backing from the garage. The switch consists of a timer of the type used on model-airplane engines, which can be set from 30 seconds to 3 minutes. Install the timer in a wooden box as shown, letting the pull cord from the timer extend out through a hole in the bottom.—Stuart E. Anderson, Grand Rapids, Mich.

Grease Drum Kept in Garbage Can

A garbage can of the type having a pedal-operated lid is an ideal container for a grease drum. Ordinarily, after the lid is removed from the drum, it is not replaced and the grease collects dust and dirt. When the lubricant is used, this dirt may find its way into the lubricating system of the car or other machine that is being greased and, in time, damage bearings or other parts. In addition to keeping the grease clean, the covered container also reduces fire hazard and gives the shop a neater appearance.



INSTALLING CAR SPRINGS

ALTHOUGH repairing or replacing a broken or damaged spring is a simple job, waiting for your turn to have it repaired may take several days. Rather than have your car or light truck out of service for this length of time, why not install the spring yourself? Figs. 2 to 6 inclusive detail the usual procedure in removing a spring. If the spring is to be replaced, or if it is necessary to replace the main leaf, it's important to know the exact length. Fig. 1 shows how to measure it correctly. Before loosening any of the parts or jacking up the car, block both the front and rear wheels securely. Use a roll-away jack if the work is done on a level floor. Assuming that a rear spring is to be removed, place the jack against the frame about 6 in. ahead of the spring. Raise the car until the spring assumes the normal "free" arch when tension due to weight of the car is removed. Wheels should not leave the floor. Block up under the frame at a point near the jack. Disconnect the shock absorber if it interferes. Then remove the U-bolts, Fig. 2, and the front and rear shackle pins to free the



eyes of the spring. On some late-model cars, such as Nash and Hudson, the emergency-brake cable is clipped onto the spring. In this case it will be necessary to cut the

clip bolt and replace it with a new one when the spring is installed.

Installing a spring after servicing or repairing it is just as easy as the removal if the correct procedure is followed. Figs. 7 to 10 inclusive detail the first steps. Arrange the spring leaves on a table according to size and length. If the center holes of the leaves are not equally distant from the ends, be sure before installing the center bolt that the long ends face the same way. Align the leaves with a straight pin or rod of the same diameter as the bolt, Fig. 7. Don't attempt to draw up the loose leaves with the center bolt; you are very likely to strip the threads. With the pin in place, tighten the spring in a heavy vise as in Fig. 8, or with C-clamps as in Fig. 9. Remove the pin and install the

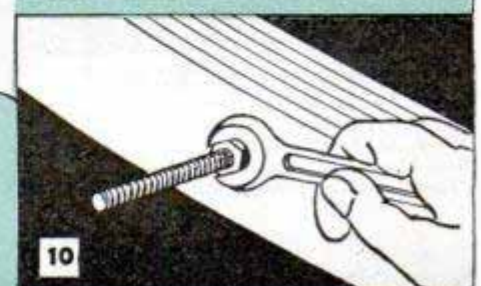
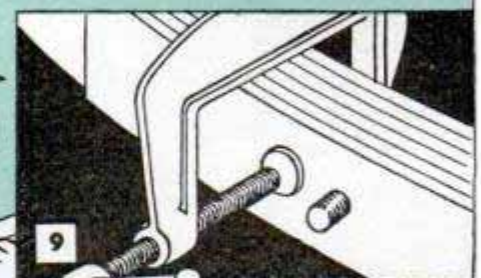
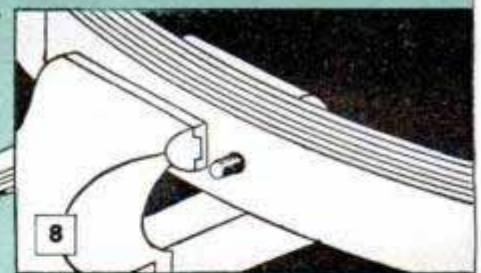
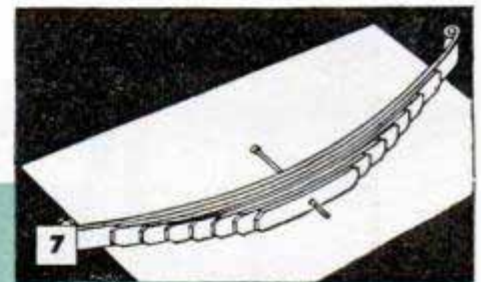
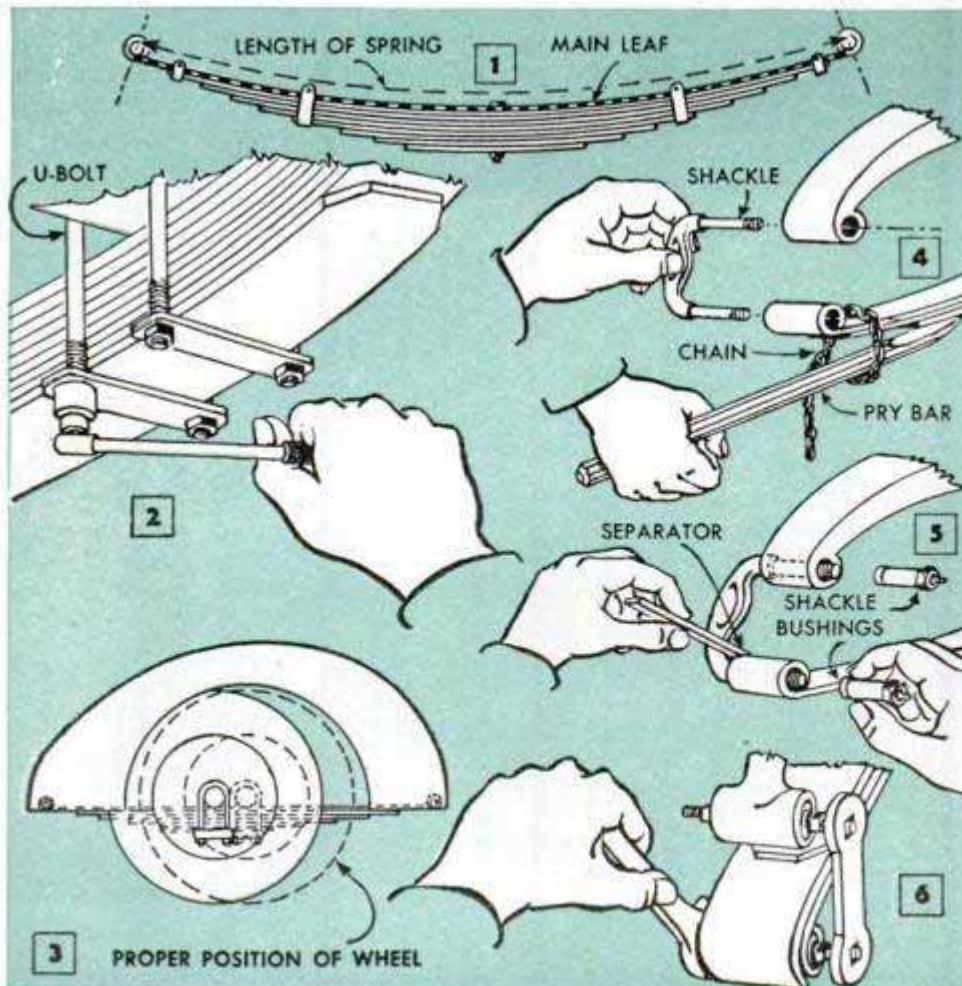

bolt as in Fig. 10. On overslung springs, the head of the center bolt should be on the short-plate side of the spring, but on underslung springs the head of the bolt should bear on the main leaf. Any projection of a new bolt beyond the nut after tightening, Fig. 10, should be cut off. Align the center-bolt head as in Fig. 18. The spring clips may now be installed, Figs. 11 to 14 inclusive. Place the U portion of the clip in proper position, with the nib fitting into the rivet hole. Apply the saddle so that the ends of the lower plate extend through the upper openings. Hammer down both ends firmly. Remove the clamps and the job is done.

When placing the spring back in position, be sure that you have it "right end to" so the car or truck axle will be in the correct position, Fig. 3. If the center bolt is in the center of the spring, and the eyes or bushings are the same at both ends, then there's nothing to worry about. But one must watch for springs with different eyes or bushings which must be matched with the shackles, to get the right end forward. Also some springs are made with the center bolt off-center. Sometimes this off-center distance is so small you won't notice it unless you measure carefully. Ex-

cept in a few instances, the short end of such a spring is always installed toward the front. Generally, the swinging shackle has ample freedom of movement so that assembly is easy. But for cars with U-shackles a separator must be used to keep the eye of the spring in position, Fig. 5. Also, it sometimes is necessary to place a jack under the spring near the center bolt and spread or flatten the spring sufficiently to bring the eye within reach of the shackle. Then with a pry bar and chain arranged as in Fig. 4 the spring can be brought into position so that the shackle will slip in place. If shackles are of the type shown in Fig. 6, place the shackle link on the stud of the perch bushing and line up with the spring-bushing stud. With a wrench turn the spring stud so that the opening in the link will fit over the squared section of the stud. Then turn on the nuts, tighten, and install cotter pins.

On Ford, Lincoln and Studebaker cars it is necessary to use a spring spreader made from a length of pipe and a threaded rod as in Fig. 16. When removing worn or defective perch bushings on Ford, Mercury and Lincoln cars use a bushing remover made from a cold chisel, Fig. 17. Regrind the edge as indicated. Install the rebound clips, Fig. 18. Tighten the U-bolt nuts in the order given in Fig. 19, drawing each nut a little at a time until tight.

Courtesy Maremont Automotive Products, Inc.

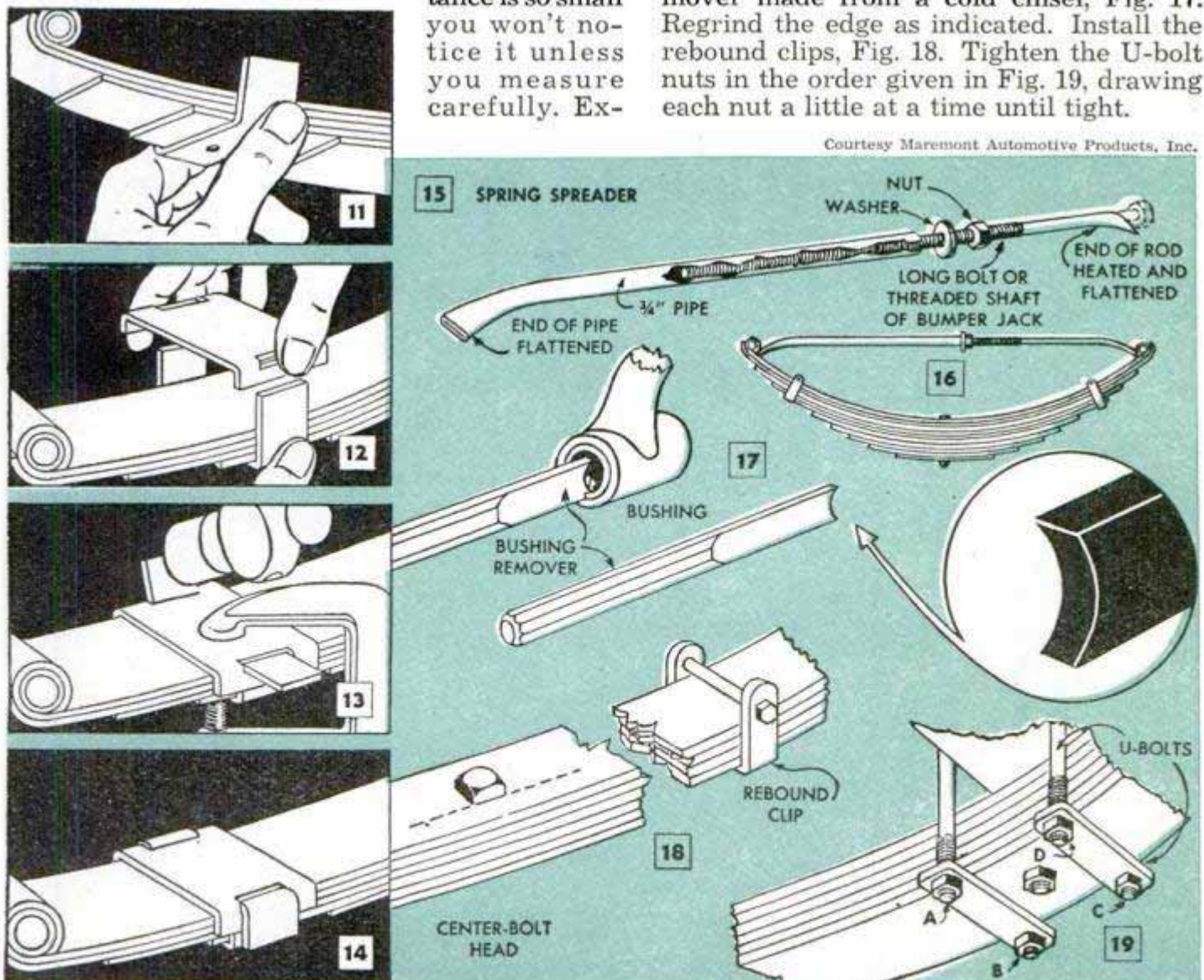

Tire-Casing Headrest on Creeper Contains Wiping Cloths



SECTION OF TIRE CASING

With a section cut from a tire casing, you can make a headrest for an auto creeper that also will provide storage space for wiping cloths. Spread the casing and fasten it to the creeper by means of nails driven through the bead. When stored inside the headrest, cloths are easy to get at and there is room for a good supply.

Coffee-Can Rack Holds Harness

Cut in half and mounted on a board, discarded coffee cans make handy harness racks. Unlike pegs or nails, they will not cause kinks in leather straps. To make the rack, nail a board to the barn studding and then nail on semicircular wood blocks that will fit inside the bottom half of a 1-lb. can

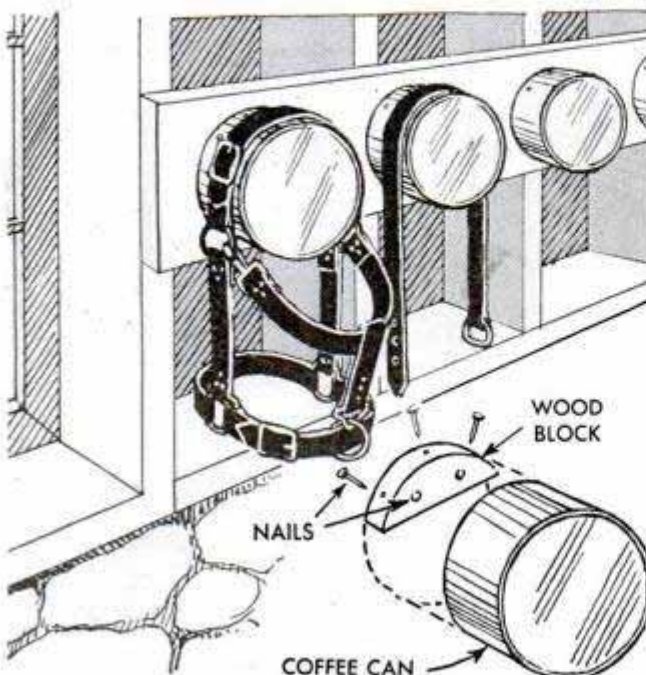

of the vacuum-sealed type. After the cans are nailed to the blocks, paint them white so they can be seen easily.

Match Book Checks Spark Plugs

If you ever find it necessary to set the electrodes on a spark plug and have no gauge at hand, an emergency setting may be obtained by using a paper match book as a gauge. The paper used in these books is approximately .020 in. thick, while most spark-plug settings are about .025 in. Therefore, if the electrodes are adjusted so that one side of the book will slide between them with a very slight drag, you will have a plug setting that will do until it can be adjusted with a gauge.

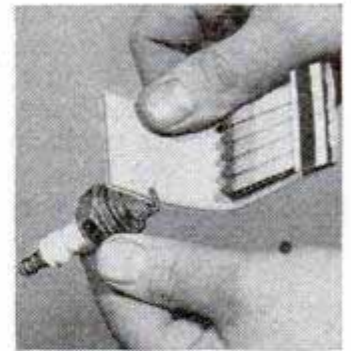

H. Leeper, Canton, Ohio.

Fitting Head Gasket to Save Wear

When replacing the cylinder-head gasket on an auto engine, fit the smooth side against the block and the side that has a rim running around the edges should be next to the cylinder head. Also, when a head is removed for an overhaul or for a blown gasket, look for wearing and grooving. If excessive, plane the head with a special grinder made for that purpose so the gasket will be a good fit.

D. W. Brentlinger, Richmond, Calif.

Ball Stop for Vise Handle Speeds Clamping

Opening and closing a machinist's vise repeatedly in clamping duplicate parts, is done more rapidly if the vise handle is centered in the vise-screw hub. The detail shows how this is done. Simply insert a steel ball and a small compression spring into a hole drilled and tapped in the screw hub of the vise. These parts are held in place with a socket setscrew. The steel ball engages a concave groove filed in the vise handle around the center. The spring should exert sufficient pressure to hold the ball in the groove and yet allow the handle to slide.

Nathan Bogoch, Winnipeg, Man., Can.



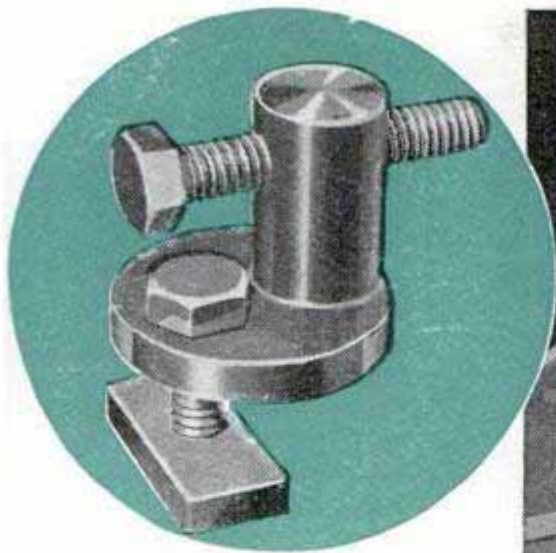

Quick-on

DRILL-PRESS CLAMPS

By Will Thomas

These clamps are so designed that they drop into the slots in the drill-press table and can be tightened in a jiffy. They are especially handy when doing close work because it's never necessary to remove nuts and washers from bolts that project under the table. As you see in Fig. 1, the individual clamps can be set in various positions to hold work which is irregular in shape. Fig. 2 details one unit, and you can make as many as you need by simply duplicating parts and operations. To make duplicate clamps, chuck 1½-in. round cold-rolled stock off-center as in Fig. 4, carrying the outer end of the piece on the tail center. Turn to the dimensions given in Fig. 2 and you have four cam shapes as in Fig. 4. Saw these apart, then drill and tap for the clamping bolts, Fig. 3. The rectangular-shaped nuts, Fig. 2, are cut from ¾-in. flat steel and finished by filing. Be sure that the nuts slip through the table slots. Drill and tap nuts exactly in the center so that strain is equalized when the bolts are tightened.

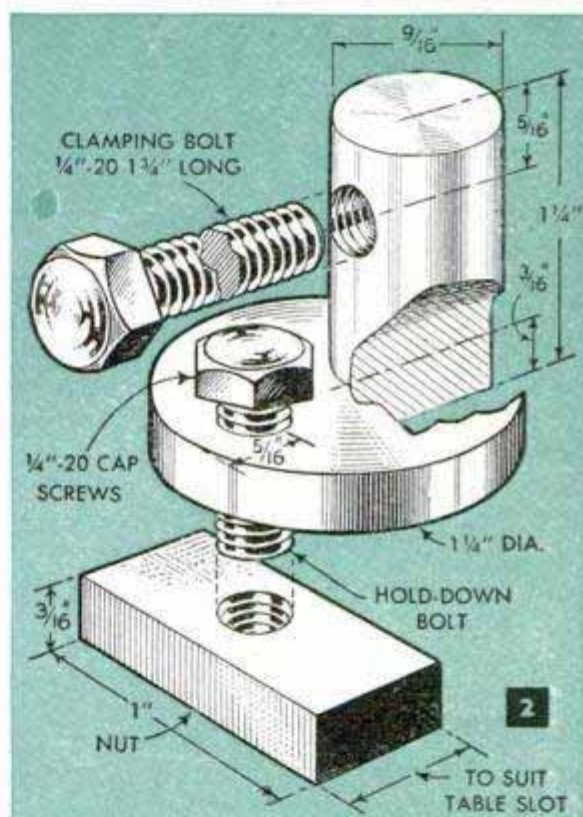
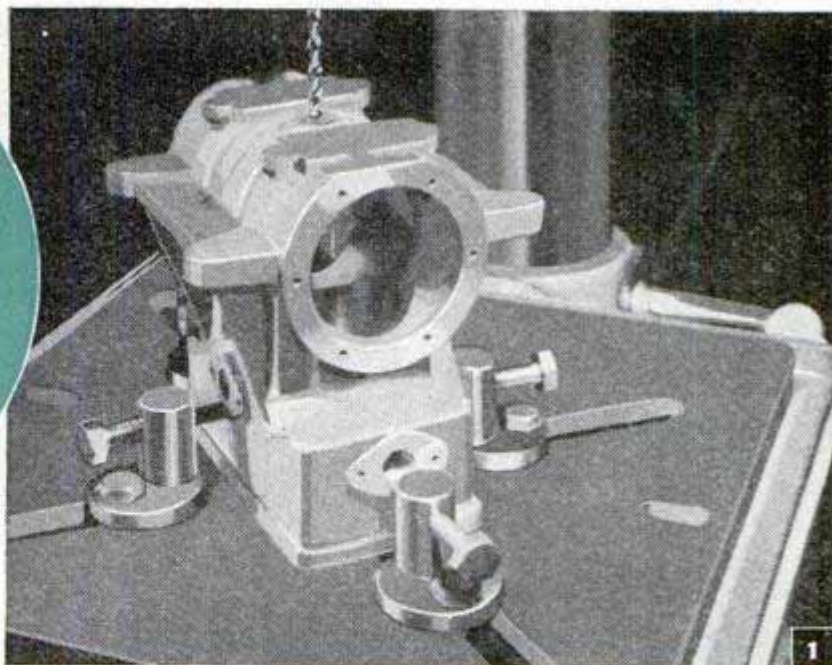

Clamps also can be used on a milling machine or lathe faceplate to hold irregular-shaped work

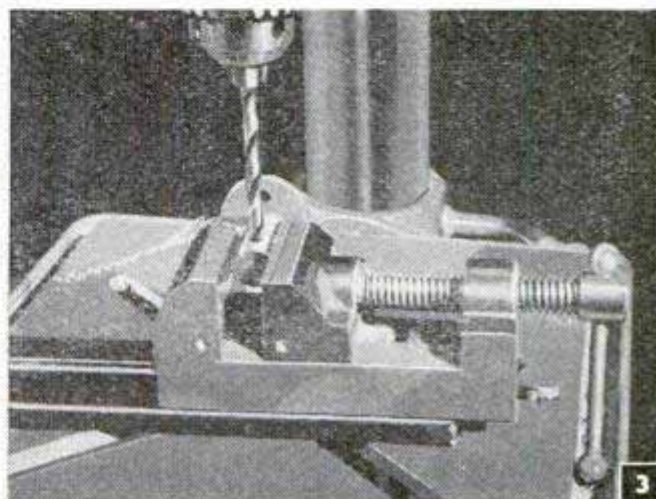
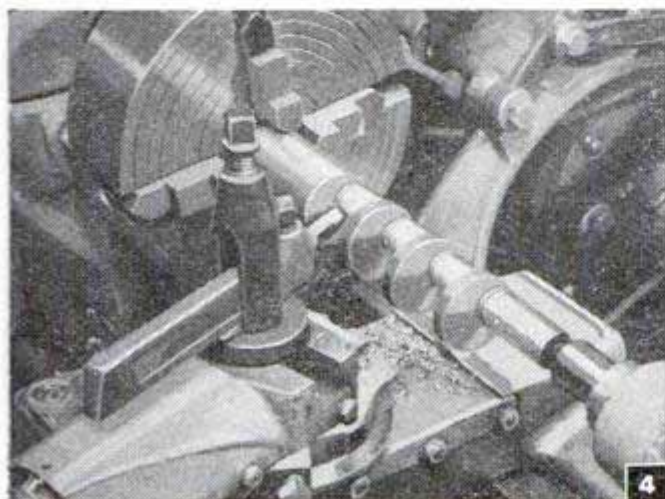

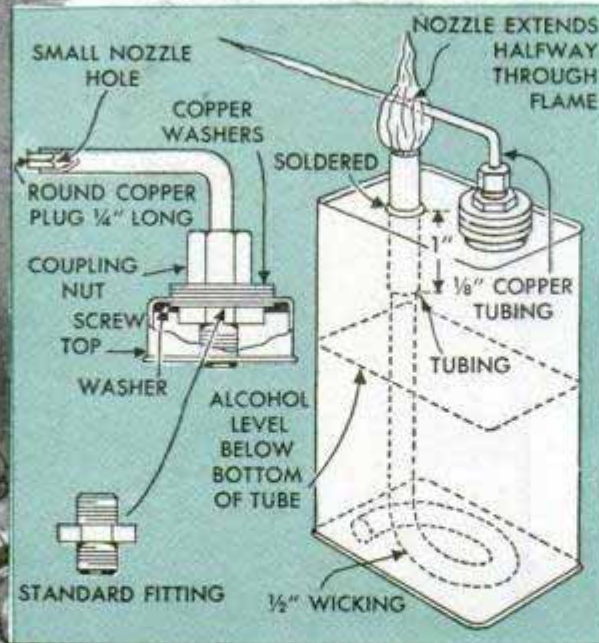

Alcohol Torch Made From Scrap Parts

Producing a hot, needle-point flame, this little blowtorch, which generates pressure by the expansion of alcohol vapor, will be found handy for many small soldering and light brazing jobs. The tank is a lighter-fluid can, and the nozzle, consisting of a length of $\frac{1}{8}$ -in. seamless tubing, is attached to the screw-top cap of the tank as shown. The wick is fed through a $\frac{1}{2}$ -in. tube which is soldered in the top of the can to extend 1 in. inside. Note that the hole in the nozzle must be very small.

Nonfriction Spinning Tool

Designed to spin with the work, this ball-bearing spinning tool offers several worthwhile advantages; it eliminates tool marks, keeps friction heat at a minimum and produces a finer finish on the metal being spun. The tool is used in conjunction with the compound rest of a metal-turning lathe and is manipulated by the cross and carriage feeds of the lathe. All parts of the tool are dimensioned in the drawing. It may be necessary to alter the size of the arm to suit the tool post at hand, and also the size of the wheel to fit the bearing. The wheel should be case-hardened, and the arbor a light press fit in both arm and bearing. Peening the ends of the arbor locks the wheel to the arm. In using the tool, it is advisable to coat the work with a lubricant such as lard oil, to reduce friction and produce a smooth job.

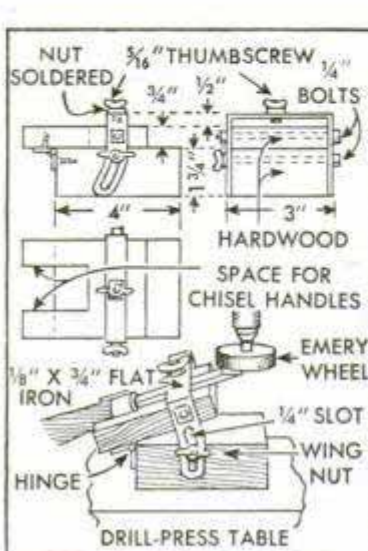
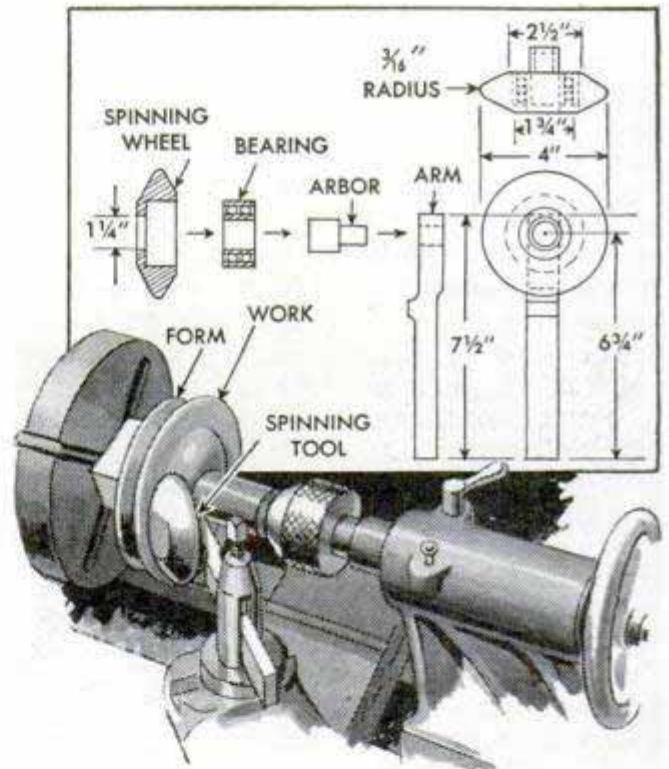

Adjustable Jig Positions Chisel For Grinding in Drill Press

With this jig, chisels, plane irons and other flat-bladed tools are held at the correct angle for sharpening in a drill press. The tilting top and base are cut as shown in the detail, the top being notched for chisel handles. Angle adjustment is provided by a metal strap bolted to the top and slotted for bolts and wing nuts in the base. Space is left between the strap and the tilting top to allow for insertion of the tool blade. A thumbscrew holds the tool.

Gust M. Larson, Cloquet, Minn.

Adjustable Fence For Drill Press

This drill-press fence can be used either to position flat pieces for drilling, detail A, or as a rigid support to which work can be clamped as in detail B. When not in use, the holder can be removed from the table or slid back out of the way. Assembly is shown in the right-hand detail. A slotted arm is welded to each end of the fence, which extends almost the width of the table. Holes are drilled and tapped in the drill-press table for two locking or adjusting screws. The latter consist of socket-headed cap screws with socket-type wrenches brazed in the heads of the screws. Besides being useful for drilling jobs, such a fence will be found handy for routing and shaping.

Edmund L. Johnson, Pittsburgh, Pa.

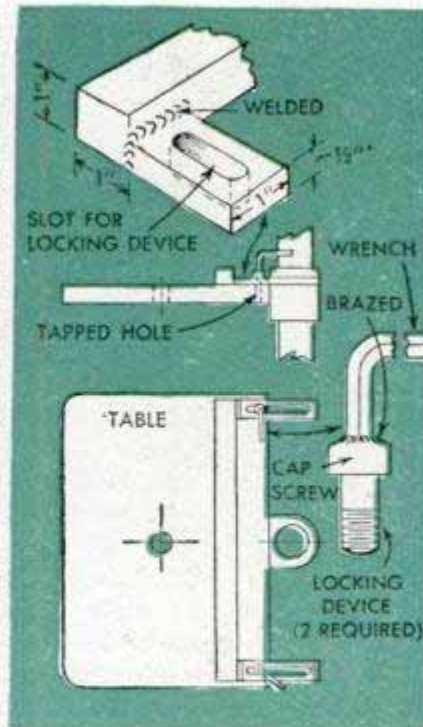
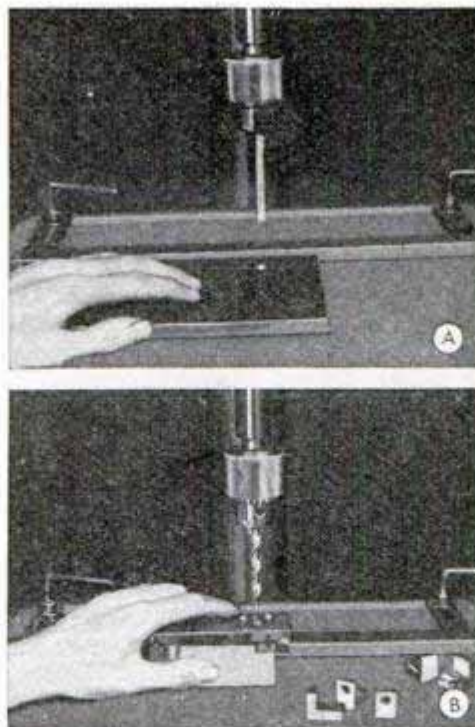

Bulletin Posted At a Filling Station Gives Motorists Weather Forecast

Salesmen, tourists and others driving through unfamiliar territory will appreciate the weather-bulletin service offered by one filling-station operator. The information, which includes road conditions as well as the weather, is posted on a blackboard suspended over the driveways near the gas pumps. The board slides on a wire between the station and a post, being high enough to clear the cars that pass under it. The sign is changed by sliding it over to a building or post so it will be accessible. Information about the weather can be obtained from the local weather bureau or over the radio.



Pressure Gauge on Heating Boiler Easy to Read With Magnifier

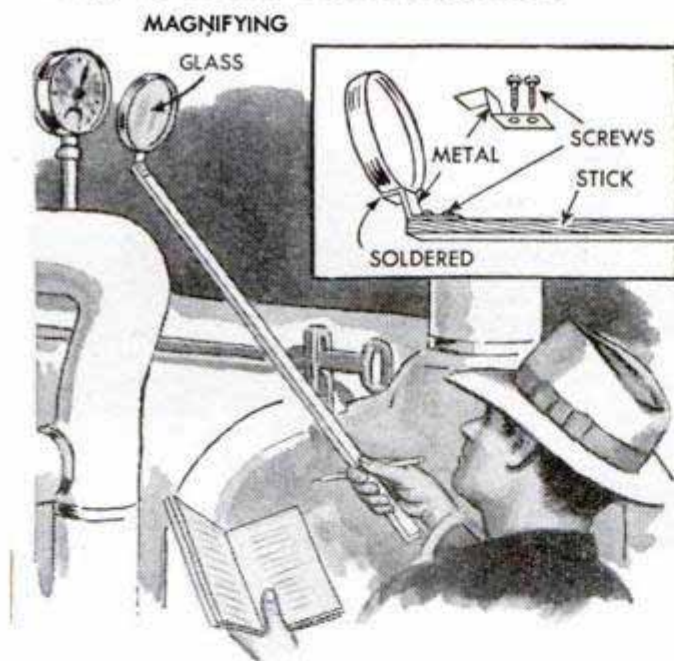

Usually the pressure gauge and other indicating instruments on a heating or power boiler are located on top of the unit, often in a dimly lighted spot, where they are difficult to read. To overcome this disadvantage, use a reading glass attached to a long handle so the glass can be held in front of the gauge. The rim of the glass is soldered to an offset metal clip, which in turn is screwed to the handle.

STRONG CABINET JOINTS

FOR MOST types of joinery, a good dowel joint is adequate. It can be made quickly and compares favorably in strength with mortise-and-tenon joints. It's the ideal joint for toys and light furniture construction.

Edge joints: Joining boards edge to edge is a common application of the dowel joint. The preferred method of working calls for clamping the boards together, face sides out, as in Fig. 1, and ruling crosslines to indicate the dowel position. A spacing of 8 to 10 in. between dowels is recommended, with two dowels at each end, Fig. 3. All drilling of holes is done with the face side of the work against a fence mounted on the drill-press table, as shown in Fig. 2. This automatically sets the crosswise spacing

By Sam Brown

and makes all dowel holes a uniform distance from the face surface. The fence itself should be short and of sufficient thickness to assure accurate alignment parallel with the drill.

In a second method of working, no pencil guide marks are used, and the work is simply held against the fence while the holes are spaced by eye. Dowel centers, or pops, are inserted in the holes, and then, by contacting the two boards face downward, Fig. 6, registering marks are transferred to the second board. Dowel centers can be purchased, or they can be turned from cold-rolled steel to the shape shown in Fig. 4. If drilling is done by hand, both methods described require a stop on the drill bit to set the depth. This can be

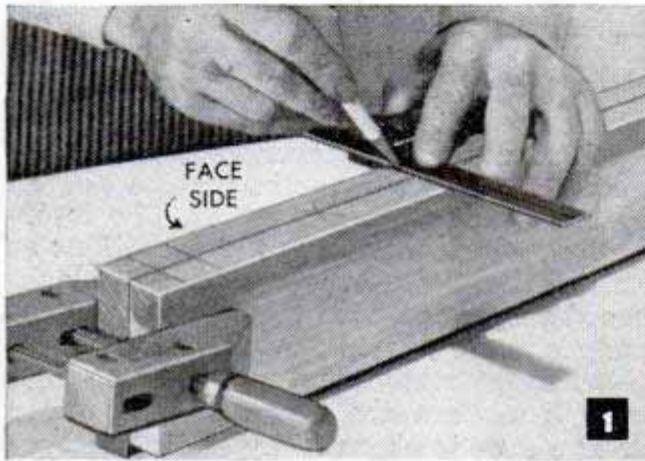

Clamp work together with face sides out and rule crosslines to locate dowel holes

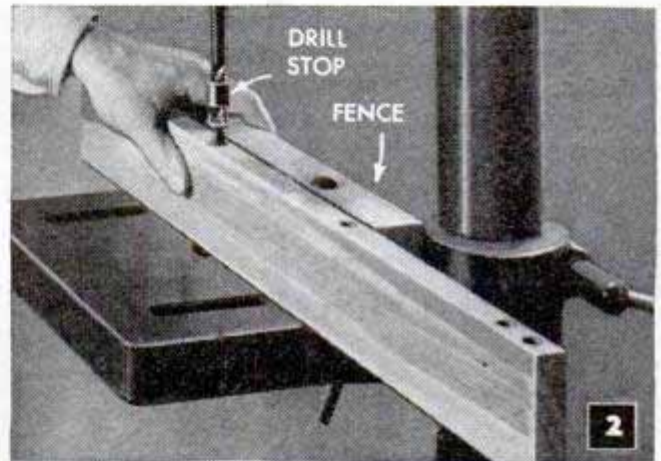

Center the work with face against the fence and bore dowel holes on the lines

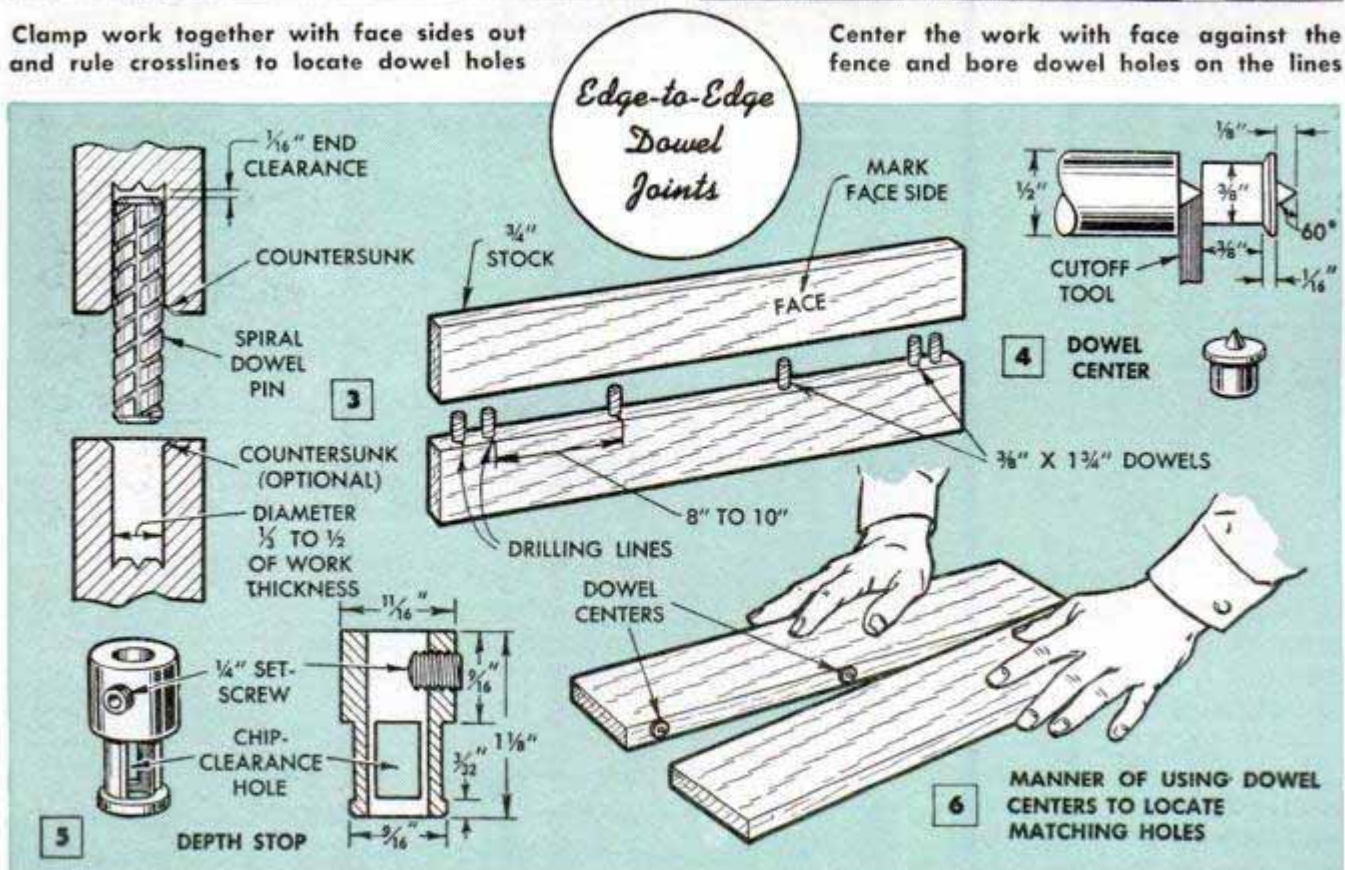

with DOWELS

made as shown in Fig. 5, or a short dowel can be drilled lengthwise and slipped over the bit. As most joints are made with $\frac{3}{8}$ -in. dowels, one size of stop will do. Occasional work requiring smaller or larger dowels can be drilled for depth by fastening adhesive tape around the bit.

Corner joints: This is the most used dowel joint. The best method of making it is to drill the end-grain holes first, Fig. 7, spacing them by eye, and then use dowel centers for locating the side holes in the second piece, as shown in Fig. 8. A fixed fence is not used for drilling the side holes, but it is advisable to use a backing block or floating fence, Fig. 9, to keep the work square with the table. The difficult part about this joint is drilling the holes in the

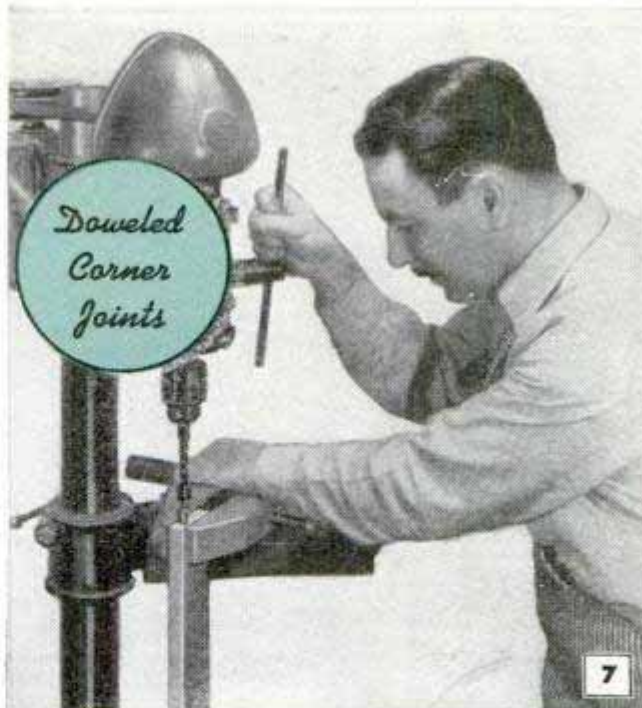

Bore holes in end grain first, spacing them by eye

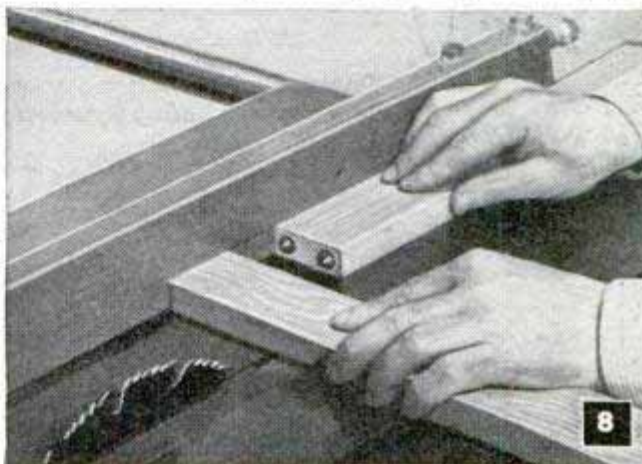
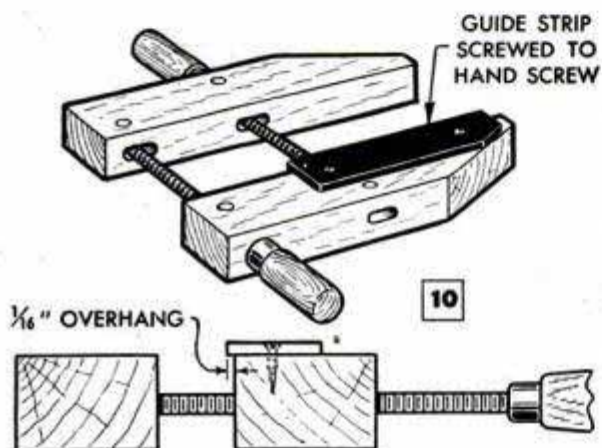

Above, locate position of side holes with dowel centers. Below, drill side holes with work against block

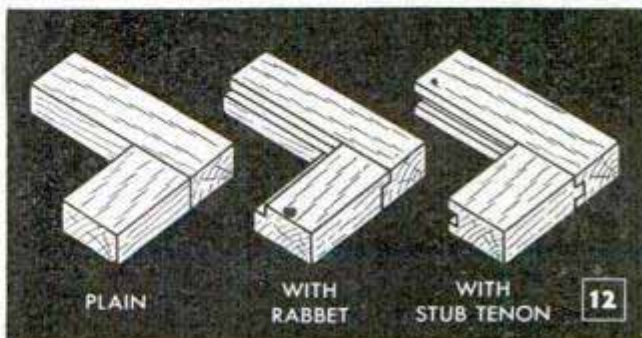
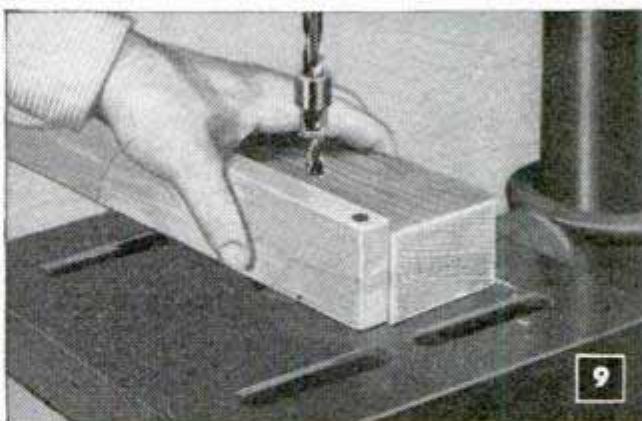
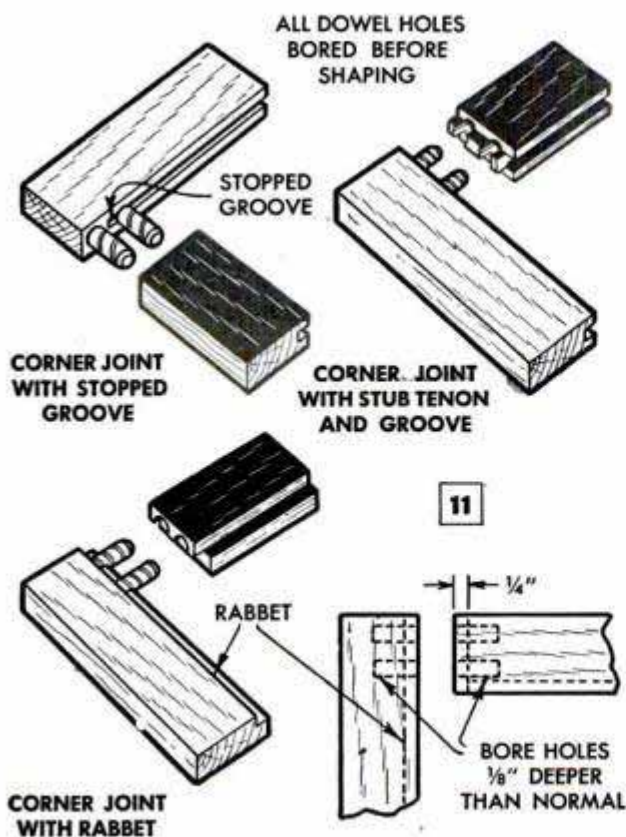

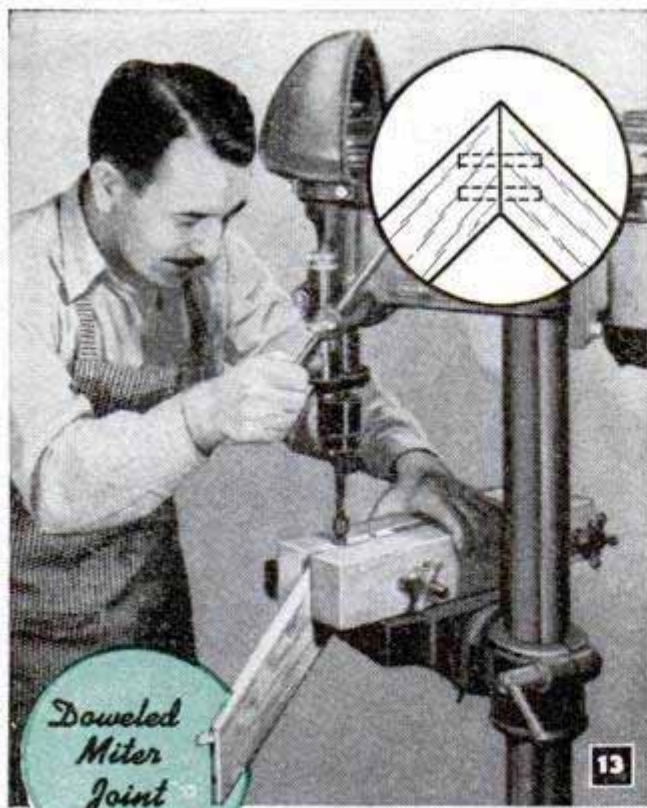

Doweled Miter Joint

Doweled miter joints are easy to make with boring jig below

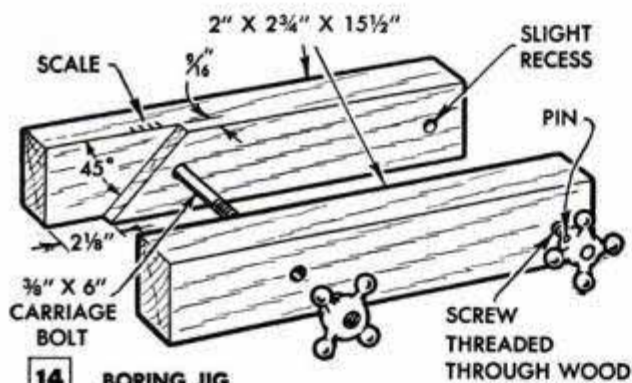

14 BORING JIG

end grain of the first piece. However, this is made easy with a handscrew fitted with a stop, as shown in Figs. 7 and 10. In use, the work is aligned with the bit by clamping it in the handscrew so that the end butts squarely against the stop attached to the jaw. Then the table is swung to one side to support the handscrew. Note that the table must be at right angles to the bit.

Various forms of the corner joint are shown in Figs. 11 and 12. Where the work is to be grooved or rabbeted, dowel holes should be drilled first. The stub tenon and rabbeted frames, Fig. 11, will lose $\frac{1}{4}$ in. at the joint when shaped, and this should be allowed for. Make rails $\frac{1}{2}$ in. longer than normal, and drill dowel holes $\frac{1}{8}$ in. deeper.

Doweled miter joint: Dowel holes are always bored at right angles to the contacting surfaces which are to be joined. This is fairly obvious in the 45-deg. miter joint, Fig. 13. Working with the handscrew setup, or with the somewhat similar boring jig shown in Fig. 14, the contacting surface of any joint is presented squarely to the drill. The method of making a miter joint is the same as a corner joint—eyespaces the first piece and then use dowel centers to locate holes in the second piece.

Various applications: While there are many uses for the dowel joint, all dowel joinery follows the same pattern, that is, two butting surfaces joined together with dowel pins. Typical work is shown in Fig. 15. For all occasional work, the dowel-center method of locating holes is used, and holes in end grain are drilled first, because it is difficult to mark accurately and spot a drill on this kind of surface.

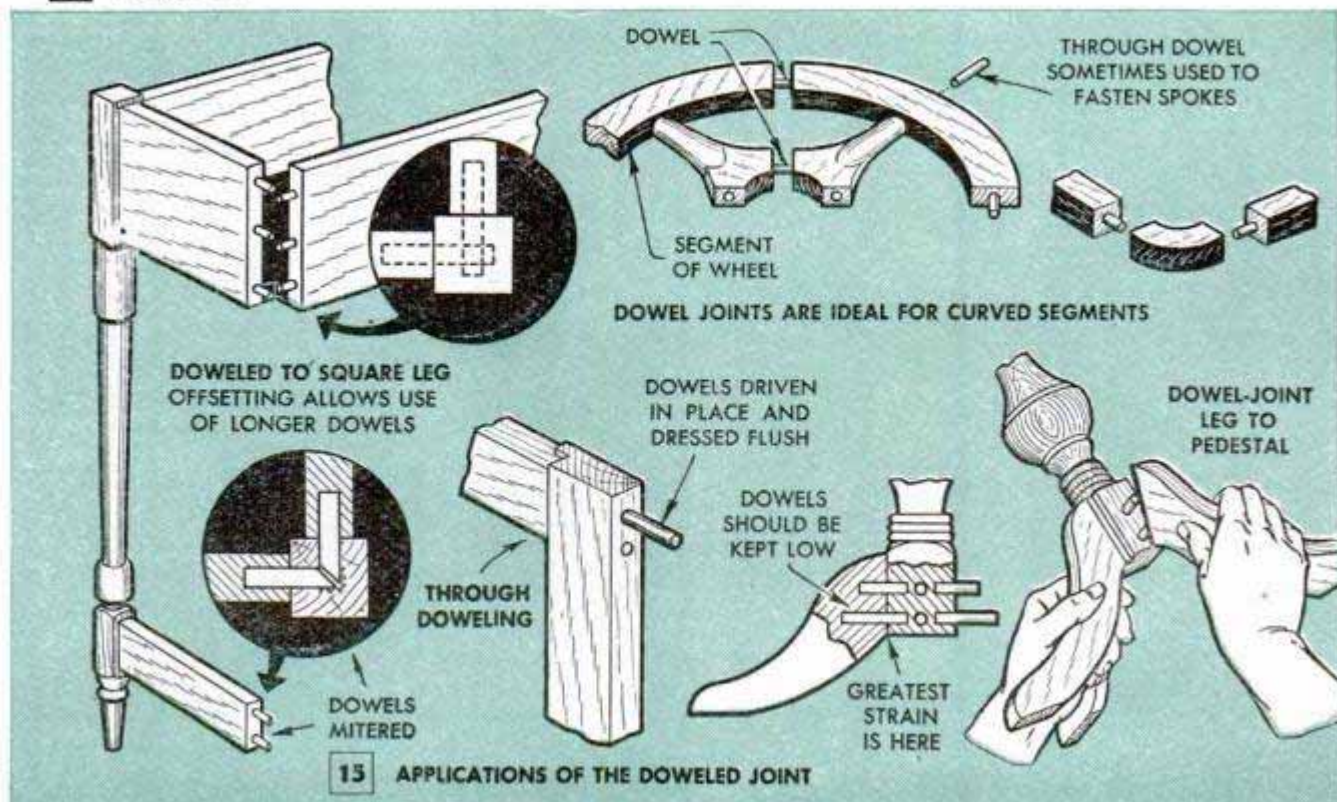

15 APPLICATIONS OF THE DOWELED JOINT

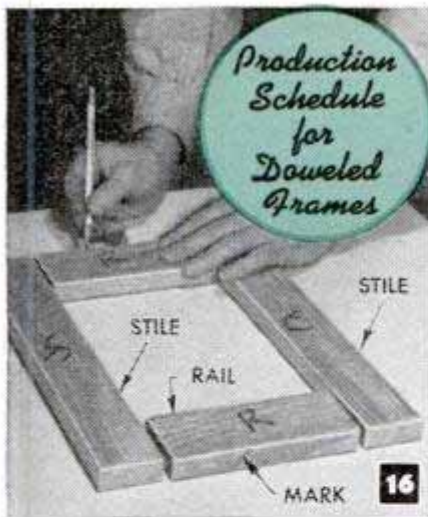

First, make rough assembly of frame, mark face side and outer edge of all members with pencil

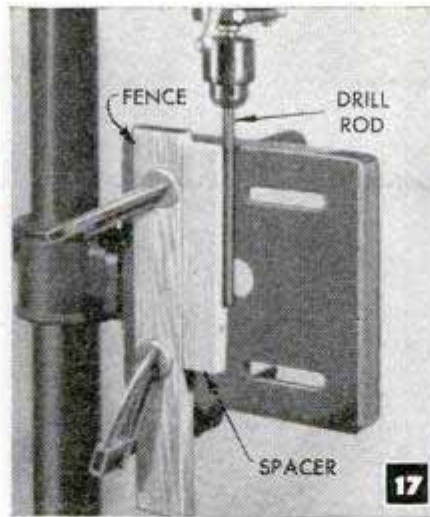

Next, with drill-press table tilted vertically, insert drill rod in chuck and align fence with rod

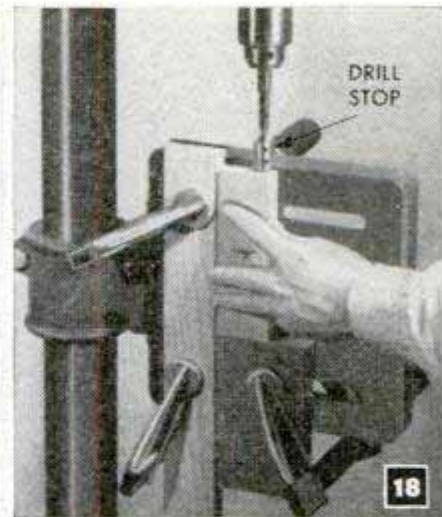

Drill the end holes in all rails first, placing the marked edges against a fence clamped to table

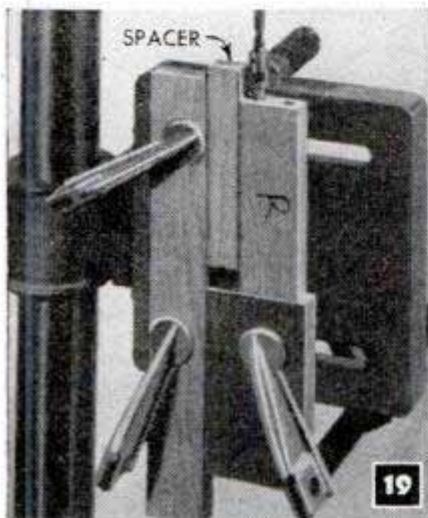

Drill second hole in end of rails by using same setup plus wooden spacer to space holes desired width

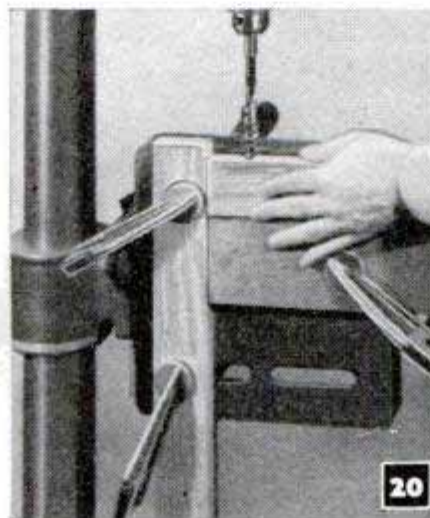

With work positioned by vertical fence plus horizontal rest, drill first end holes in stiles of frame

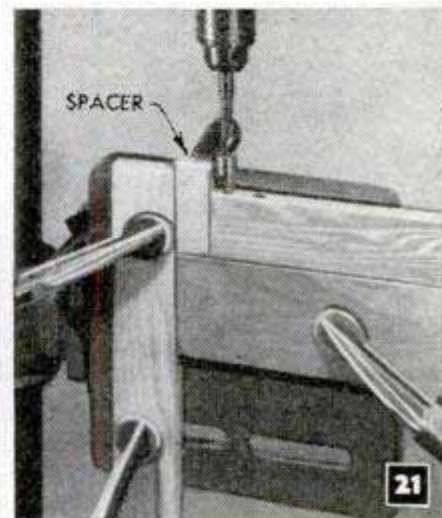

As in drilling second dowel hole in ends of rails, repeat same operation, using short spacer block

Production work: Dowel centers are too slow for production work, and various methods employing box jigs or spacers give better results. The schedule for a doweled frame is pictured in Figs. 16 to 21 inclusive. In this setup, one stop is clamped to the drill-press table, and this stop is used for both parts of the joint, giving perfect accuracy in the lengthwise spacing. As each joint consists of a right and left-hand member, the face side will alternately face toward and away from the fence. This makes it essential that, (1) the work be of uniform thickness, and (2) the drill must be exactly centered crosswise.

The dowel drill: The best type of drill for dowel work is the popular twist-drill pattern with spurs and brad point. The point should run true so that when rotating, it will seem to stand still and can be centered with hairline accuracy. Drill speed should be 1200 r.p.m. for hardwoods and 2400 r.p.m. for softwoods. Extension spurs on the drill should be short and

sharp to eliminate leading or wandering tendency when drilling end grain.

The dowel pin: The dowel pin itself is usually birch or maple and is purchased ready made. Specify a spiral, grooved pattern, which has the best holding power. The diameter of the pin should be one third to one half the thickness of the work—never less than one third. As a large percentage of all work is $\frac{3}{4}$ -in. stock, the $\frac{3}{8}$ -in. dowel is the size most used. The length should be five or six diameters for average work. Thus, a $\frac{3}{8}$ -in. dowel should be $1\frac{3}{4}$ or 2 in. long, and either of these stock sizes can be used for most jobs. When smaller or larger diameters are needed in small quantities, the dowel pins can be made from standard dowel rod. Cutting-off to length is done on the bandsaw, Fig. 22. If a spiral groove is desired, it can be cut very neatly by tilting the bandsaw table 15 or 20 deg., and then pushing the rod into the blade against a clamped fence, as shown in Fig. 23. The dowel rod will feed

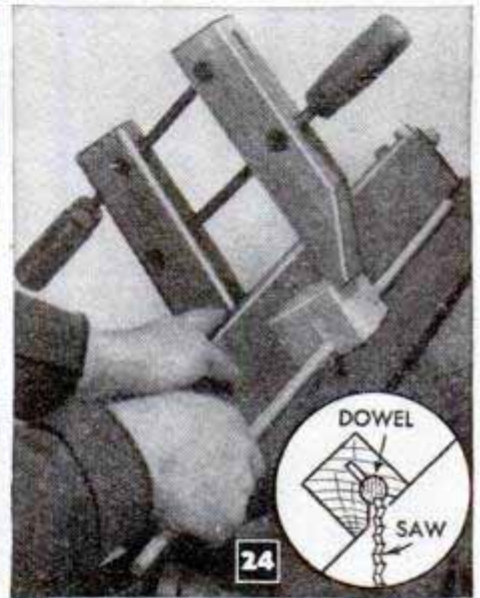
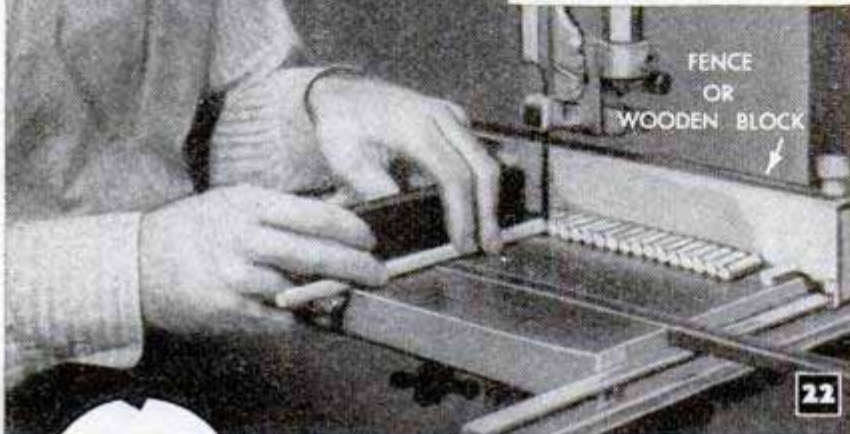
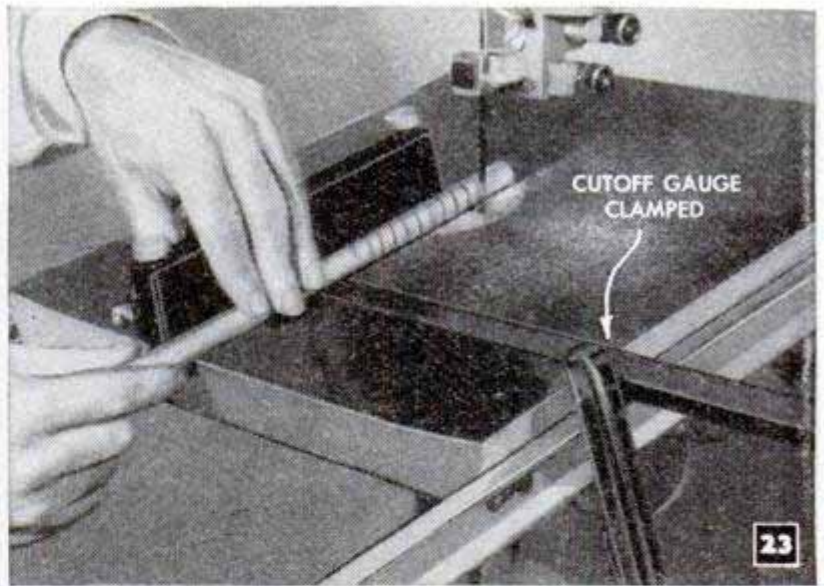

Dowel Pins

Dowel pins may be purchased, but odd sizes can be turned in short lengths on lathe. The photos show way of mass-cutting pins to length and spiraling on bandsaw. The glue groove, running lengthwise, is produced on bench saw

itself and requires only a slight hold-back hand pressure to prevent over-running. While the spiral groove is not essential, some kind of grooving should always be used to provide an outlet for excess glue. The straight groove is easily run with the saw setup shown in Fig. 24.

Gluing: Any cabinet glue, hot or cold, is satisfactory for doweled joints. A small dowel is used to put glue into the hole, and the dowel itself is dipped half its length

into the glue. If the joint is not to be assembled immediately, any excess glue should be wiped off. If the joint is to be assembled immediately, the small dowel stick is used to spread glue in the second hole and over the projecting part of the dowel. Then, the joint is pressed together and clamped. Slight countersinking of dowel holes, as shown to the left of Fig. 3, is a good idea and is intended to provide a recess for excess glue.

Depth Stop for Engine-Lathe Chuck Made From Tailstock Center

Work being turned on an engine lathe frequently will push back into the chuck. To eliminate this trouble, make a depth

stop from an old tailstock center. The point of the center is cut off as shown. Then the center is drilled and tapped to take a $\frac{5}{16}$ -in. machine screw. The screw is inserted in the center, and a nut is used to lock it in position. After adjusting the screw so that the work rests firmly against the head, place the assembly in the lathe chuck.

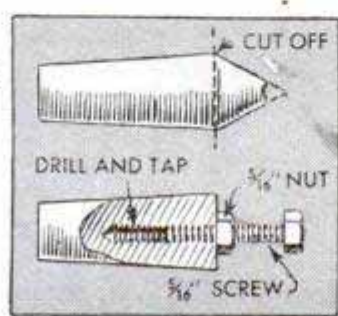
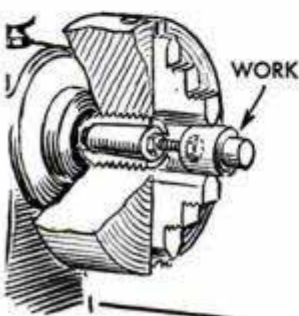

☞ To remove transfers from walls, lay a wet cloth over them and then apply heat with an electric iron. After the transfers are softened, they are scraped off.



EIGHT-TUBE HIGH-FIDELITY FM TUNER AND SPECIAL-PURPOSE AMPLIFIERS

LISTENING thrills that come when you hear music of your choice produced with full-scale fidelity, free from static, station interference and fading are now possible under all conditions if the equipment is selected to meet the requirements.

The quality of FM reproduction obtained through the audio stages of a good AM radio receiver is very satisfactory if a well-designed FM tuner having sufficient stages is employed. The 8-tube FM tuner shown in photos A and C tunes the entire new FM band from 88 to 108 megacycles and the audio fidelity is claimed to be flat within plus or minus 2 decibels from 50 to 15,000 cycles per second. The sensitivity of this FM tuner is rated at 40 microvolts, and the antenna input impedance is 300 ohms. When connected to a suitable dipole antenna with 300-ohm Amphenol twin-line, this Meissner FM tuner may be used with old AM-FM sets to provide full coverage of the new FM band.

For the critical FM listener any good phono amplifier such as the Thordarson Tru-Fidelity unit No. 1 in photos A and B is capable of fidelity in keeping with that attained with modern broadcast equipment. Type 6B4-G tubes are employed in the final output stage, and 10 watts of undistorted audio are available for the operation of a large permanent-magnet speaker which may be housed in an effective enclosure such as the Jensen "bass reflex" type shown or similar enclosures. Subject to rearrangement to meet individual requirements, this combination produces excellent results in the home, small hall or similar locations.

When selecting a larger audio amplifier for undistorted audio power in large indoor or outdoor areas, the output should be at least 25 watts. Amplifier No. 2, rear view of which is shown in photo D, is an efficient beam-power type that meets these requirements with only 7 tubes; two 6L6 tubes are employed in the push-pull output stage. Two or more large speakers are commonly used with powerful audio amplifiers of this description. Many other special-purpose applications are possible with this 25-watt high-fidelity audio amplifier. Provision is made for smoothly mixing two microphones with a phono input for a musical background.



Radio Data Service for All Postwar Receivers

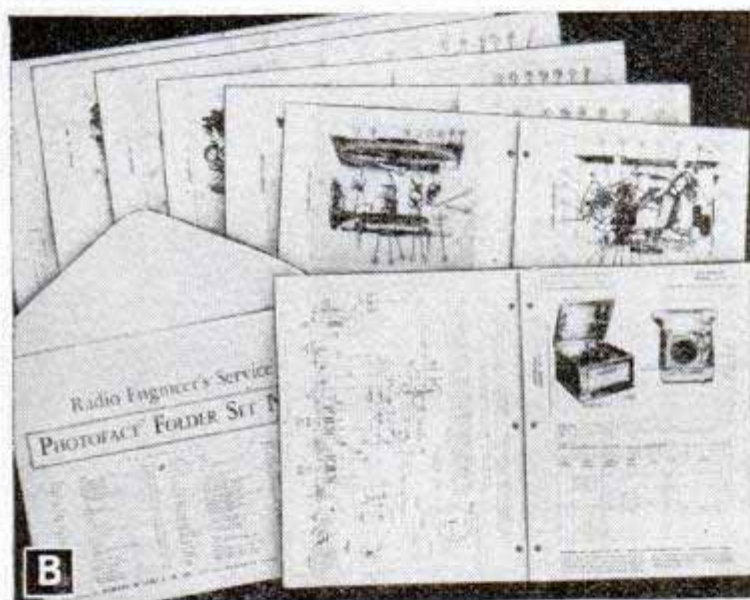

DEVELOPED to assist the nation's radio servicemen who are responsible for keeping receivers in about 39,000,000 American homes in working order, this illustrated "Photofact" data service is claimed to provide complete and accurate information on all postwar commercial receivers. The photos are taken and data prepared immediately upon their release by the manufacturers.

The information is contained in individual folders, covering from four to eight pages for each receiver as shown in photo B. Each radio set is actually analyzed in the laboratory, which is located in Indianapolis, Ind., under realistic servicing conditions. One corner of this laboratory is shown in photo A. Here engineers are measuring the stage gain and over-all performance of various receivers under check. In specially constructed copper screened test booths the r.f. and i.f. coils are carefully checked and then the receiver is disassembled down to its very last component. The circuit is carefully studied and all necessary data for the serviceman is compiled from the actual electrical and mechanical measurements.

This service includes photos of the top, bottom and other necessary views of the chassis to illustrate each component part clearly. Every part is assigned a key number which appears on the photograph and these numbers serve as a cross-reference to the replacement parts listings, alignment data and service notes which appear in the folder. The draftsman in photo C is coding pictorial diagrams with these reference numbers. New war-developed techniques, such as "exploded" views that clearly explain complicated devices, are employed. In addition to commercial home receivers, the service covers other equipment such as amplifiers, intercommunication systems, automatic record changers and recording units.

Many important details such as dial-cord stringing, commonly overlooked by manufacturers, are sketched and marked for reference. Speakers, power transformers, audio transformers and chokes are checked and replacements for them are carefully worked out with the cooperation of the manufacturers.



KODASLIDE PROJECTOR, MODEL 2A, answers the demand for better-than-average performance at a budget price. The Kodak Ektanon Lens 5-inch $f/3.5$ is highly color-corrected . . . Lumenizing of the entire optical system increases screen brilliance 50% . . . special heat-absorbing glass protects transparencies from overheating. It all adds up to more for your money. Price \$47.50.

KODASLIDE PROJECTOR, MODEL 1A (see below) is a star performer in any show. The whole family will get a kick out of its big, bright 40-inch-wide images . . . its sharp focusing with the Kodak Ektanon Lens 4-inch $f/3.5$. . . its stepped-up screen sparkle through the completely Lumenized optical system. Socket in base provides handy mounting on tripod during projection. 150-watt lamp and slide carrier included. Price \$27.50.

**One
is right
for you**

**. . . in performance
. . . in price**



KODASLIDE PROJECTOR, MASTER MODEL (see above) makes your transparencies shine with a new, living realism—at home or in an auditorium. Its 1000-watt lamp delivers more light to the screen than any other 2 x 2-inch projector. Choice of 5 superb Kodak Ektar and Kodak Ektanon Lenses to meet every need . . . entire optical system Lumenized for maximum light transmission . . . efficient turbine fan cools lamp and both sides of slide. Comes with protective carrying case. Priced from \$181 to \$295 depending upon lens choice.



Eastman Kodak Company, Rochester 4, N.Y.

"Kodak" is a trade mark.

Kodak

For Cabinet Finishing

use **PLASTIC WOOD**

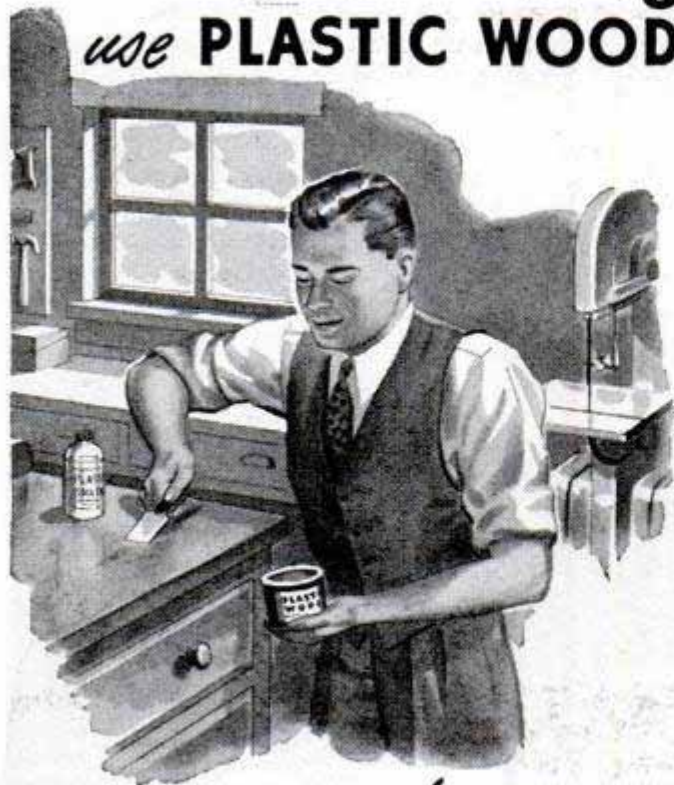

in your
HOME WORKSHOP!

If you'd like a satiny smooth, professional finish on your next cabinet job—use Plastic Wood! It's an ideal filler for cracks or rough grains, dries tight and hard, sands to a swell finish and takes paint, lacquer or varnish perfectly. Here's an extra hint—knot holes or gouges just disappear when this handiest filler is used! *Handles like putty—hardens into wood!*

... dozens of other uses

FOR FILLING ...

- Countersunk screws
- Chipped furniture
- Nail and screw holes

FOR REPAIRING ...

- Loose casters
- Broken balusters
- Broken furniture

- You'll want Plastic Wood SOLVENT, too. Get both at one time. It is made especially to control the consistency of Plastic Wood ... useful also in removing dried Plastic Wood from tools and fingers.

T. M. Reg. U. S. Pat. Off.

At all Hardware,
Paint and 10c Stores

PLASTIC WOOD

Tube or Can

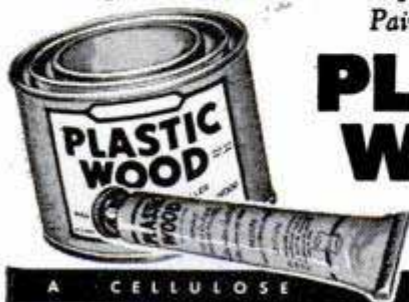

A CELLULOSE FIBRE FILLER

Low-Cost Progressive Receiver

(Continued from page 231)

bands, but it is highly useful for reducing the volume on strong standard broadcast stations.

The loud-speaker is separate from the receiver and may be housed in a cabinet or mounted on any type of baffle that the

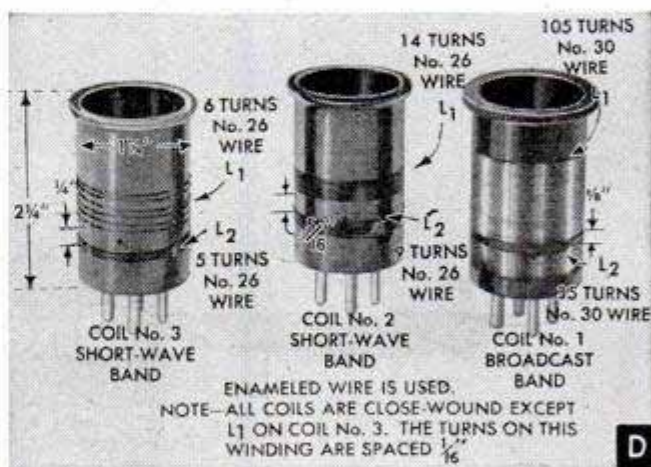

builder desires. The output transformer is to be mounted directly on the speaker, the primary leads being connected to a short 2-conductor cord provided with pin-jack plugs that are inserted in the jack strip. The speaker output transformer can be either the universal type indicated in Fig. 2 or any ordinary 5-watt output trans-

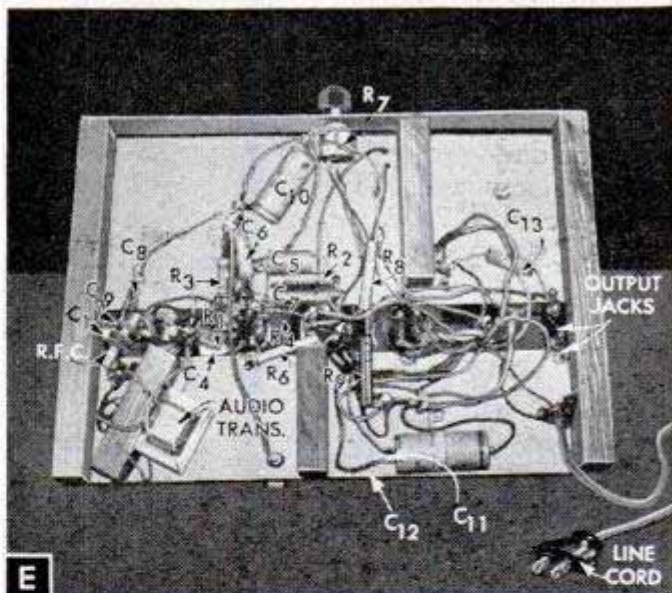

former with a 7000-ohm primary and a 3 1/2-ohm secondary. The speaker should always be connected to the jack strip before the power is turned on.

Test the receiver first on the broadcast band; plug in the standard broadcast coil and if everything is working properly you should have good volume on all local stations with only a 10-ft. indoor wire for an antenna. A good outdoor antenna will give

(Continued to page 236)

HOW TO TEST for a TRUE EDGE

A simple trick
to help you
"do it better"

● You've planed a board till it's slick and flat as a pane of glass . . . or at least you *think* so. "Now," you say to yourself, "I'll have a true edge for a perfect joint."

Well . . . maybe you will. And maybe you won't. But here is one way to be absolutely certain.

1 Place the planed edge on a surface you know to be absolutely straight — a straightedge if available. Then take your flashlight, powered with "Eveready" batteries (they outlast all other brands*), and . . .

2 . . . let the penetrating light from the flashlight play along behind board's edge. If joint is tight, is perfect, light won't get through. If there's an irregularity, light will come through. Simple, isn't it? And 100% sure!

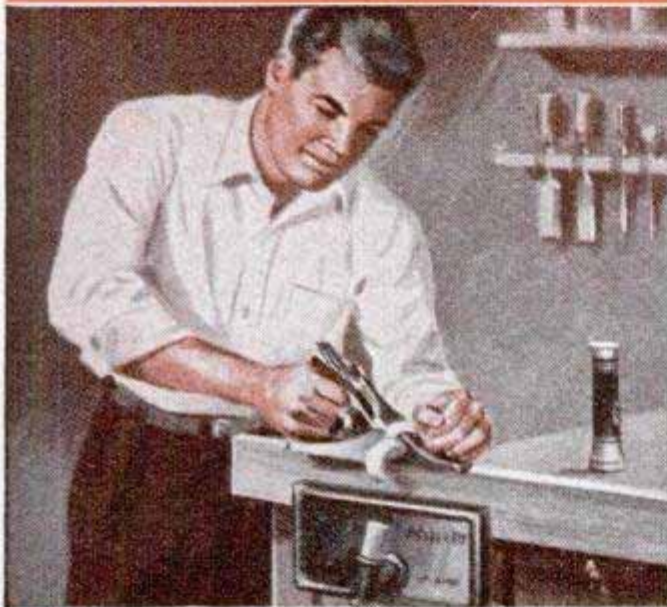

Proof! . . . in the laboratory . . . in your own flashlight . . .

**"EVEREADY" BATTERIES
OUTLAST ALL OTHER BRANDS!***

Brighter light, longer life! That's what you want in a flashlight battery. And that's what you get with "Eveready" brand batteries. Laboratory tests prove it. And the best "laboratory" of all—*your own flashlight*—proves it! That's why "Eveready" batteries *outsell* all other brands—because they *outlast* all other brands!*

*According to the "General-Purpose 4-Ohm Intermittent Test" of the American Standards Association, which most closely approximates average use.

The registered trade-mark "Eveready" distinguishes products of
NATIONAL CARBON COMPANY, INC.

30 East 42nd Street, New York 17, N. Y.

Unit of Union Carbide  and Carbon Corporation

Speed Sweep

THE BRUSH WITH
THE STEEL BACK



*Sweeps
cleaner, faster -
Out lasts ordinary
brushes 3 to 1!*

Mail Coupon Today

Milwaukee Dustless Brush Co.
530 N. 22nd St., Milwaukee 3, Wis.

Please send me complete information about
Speed Sweep brushes.

Name _____

Street Address _____

City, State _____

best results on both the standard broadcast band and the short-wave bands. For the short-wave bands, it must be as high and as long as you can make it. Good quality insulators are also essential for maximum results on distant short-wave stations. On the broadcast band, the receiver will work with just about any setting of the antenna tuning condenser (C1). For short waves, however, this condenser should be set at the maximum value (screw in) which will allow the set to oscillate on the band being tuned. If too much antenna coupling is used (condenser closed too far) the set will not oscillate. If insufficient coupling is used the signals may be weak. Detailed student material list R-363 for this complete 3-tube a.c. receiver is available from Popular Mechanics Radio and Electronics department upon receipt of ordinary letter postage.

Hunting Big Fish Under the Ice

(Continued from page 151)

74-year-old retired blacksmith, makes the "best sturgeon spear in the world." He will let no spear out of his tiny forge shop until he knows its five tines are perfectly tempered, until the beards on the tines are at the exact angle. Some spears are just hammered out and sharpened. But a Thuerwachter spear takes at least a day's work. He draws out his tines and lays them back in a long manual process.

His spears fit loosely at the end of an 8-foot, 1/2-inch water pipe. Once the spear is plunged into a sturgeon it comes loose from the handle, but a two-foot-long "tumbling line" connecting spear and handle holds the fish. It may writhe and tumble in the water without getting purchase to free itself. The tumbling line itself is painstakingly made out of 48 strands of linen harness thread braided into a four-strand rope. It is soaked with harness pitch. Spearmen will tell you:

"There isn't a sturgeon in Winnebago ever broke one of Ed's tumbling lines."

Even with a detachable spear the spearman has a tough time landing a big fish if the tines did not injure the fish's spine. If the spine is hurt, the sturgeon can be handled with a minimum of effort. But it takes plenty of strength to hold the fish on the line until he tires himself out and then drag him through the hole. A 100-pound sturgeon is powerful. Many times a thrashing monster has been hauled into a little shanty only to knock over the stove and tear up the floor boards in its mighty protests. Then the trick is to get him out of the shanty onto the ice.

(Continued to page 240)

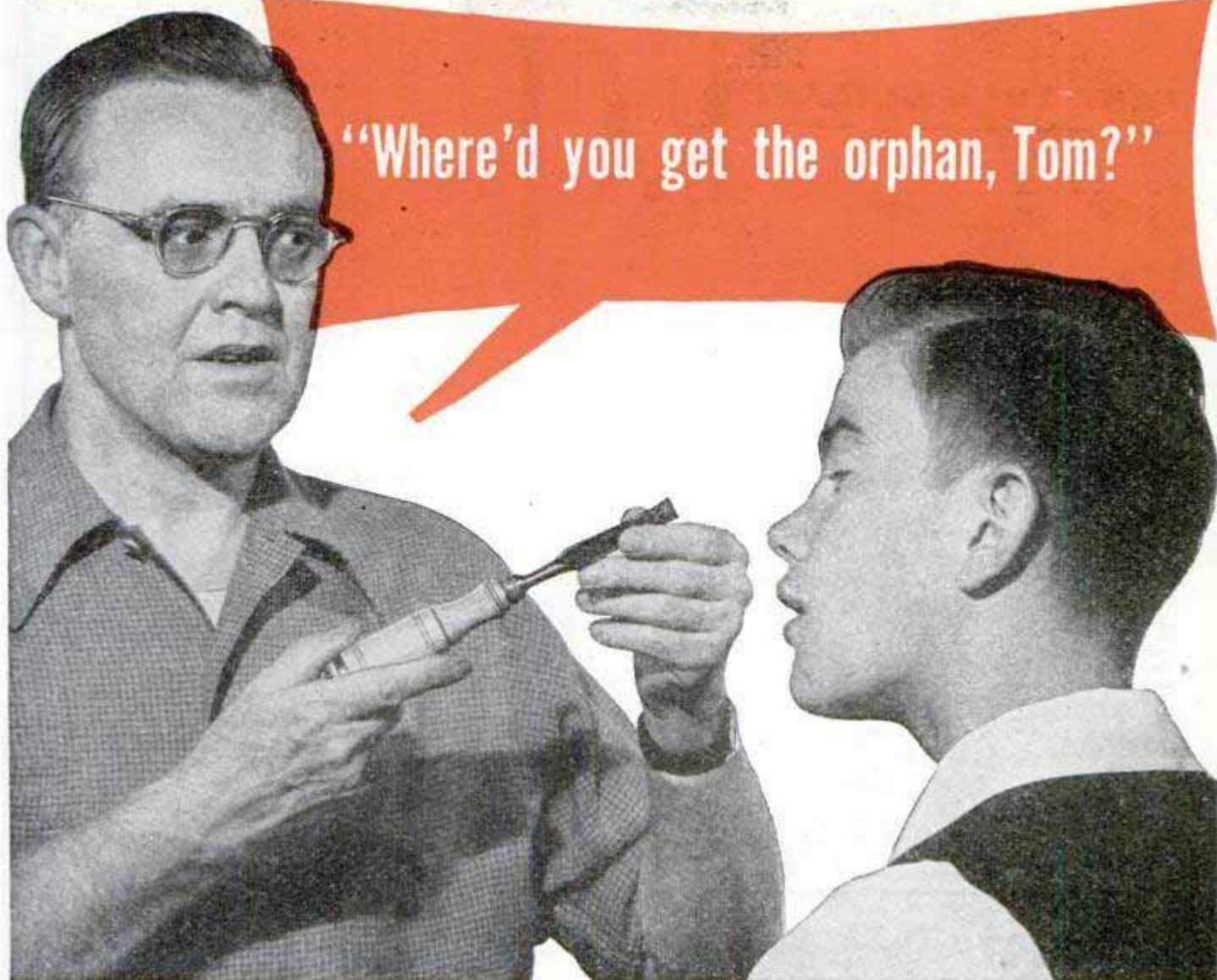

TOM: Orphan? What do you mean, Dad?

DAD: This chisel. There's no brand name on it.

TOM: What of it? Just feel that edge.

DAD: That's not much to go by when you're buying a chisel, son. Even a piece of cheese can have a sharp edge, you know.

TOM: You mean this chisel's no good?

DAD: I mean you can't be *sure* it's good. No brand name, no reputation to back it up. It's one of those bargain counter orphans—and they generally let you down.

TOM: Well, it didn't cost much, anyway.

DAD: Better get your money back—if you can. And then go over to the hardware store and buy a *good* chisel—one with an advertised brand name you can trust. The hardware man will always steer you right.

**Your HARDWARE DEALER sells QUALITY tools
and hardware... Buy from HIM**



POPULAR MECHANICS

TEST YOUR SCIENCE

i.q.

Answer to Problem on Page 105

The distance between earth and tape measure is about 1/2 inch—exactly the same as in the case of the nine-inch orange with its 12-inch belt. It's a simple matter of mathematics. The circumference of any circle is pi (3.1416) times its diameter; the radius is half the diameter. If you add three inches to the circumference of any circle you add about one-third that distance to its diameter, or one inch; and its radius becomes 1/2 inch longer.—By Rex Taylor

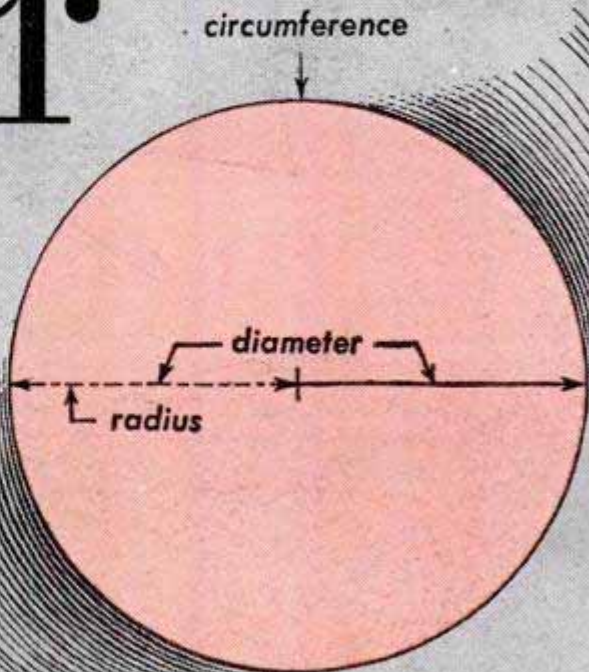

$Circumference = dia. \times \pi (3.1416)$

A "MUST"
for Modelbuilders
and
Homecraftsmen!



The New
No. 86 X-acto* Hobby Chest

Each blade super-sharp; each tool specially designed for accurate hobby work. Contains: 3 firm-grip X-acto knives with assortment of 21 different-shaped blades, gouges, routers; 2 punches; plus a planer, sander, stripper, spokeshave and 6-inch steel ruler. Complete in handsome wooden chest . . . Only \$10

Other X-acto knives, tools and sets 50¢ to \$50. At hobby, gift, hardware and department stores. (Prices slightly higher in Canada.)

X-acto 
HANDICRAFT KNIVES & TOOLS *Reg. U. S. Pat. Off.

X-acto Crescent Products Co., Inc., 440 Fourth Av., N. Y. 16
In Canada: Handicraft Tools, Ltd., Hermant Bldg., Toronto

The EXCEL HACKSAW

IS JUST WHAT YOU'VE NEEDED FOR THOSE TOUGH, TEDIOUS METAL SAWING JOBS.

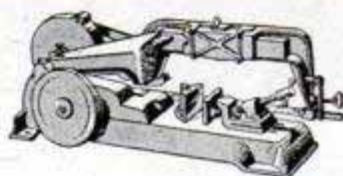

Only quality draw-cut, automatic shut off hacksaw at this amazingly low price.

Saws stock up to 4" diameter. Vise angles up to 45°.

ONLY \$44.75

LESS MOTOR, FOB, BENTON HARBOR, MICHIGAN.

Write Dept. PM-28 for free Bulletin.

EXCEL MACHINE TOOLS

Designed and Manufactured by

COVEL MANUFACTURING COMPANY

BENTON HARBOR,

MICHIGAN

The SPEED SAW FILER

Saves You Time, Money



Now you can do expert saw filing at home. Lifetime tool makes precision filing easy for even the most inexperienced. Two simple adjustments make it fit any type hand saw. Keep your saws extra sharp and true-cutting with a Speed Saw Filer. Complete with file, ready to use. Money back guarantee. Cash with order, prepaid (C.O.D. postage extra.)

THE SPEED CO., Dept. PM
2025 N.E. Sandy, Portland 12, Ore.

ORDER NOW!

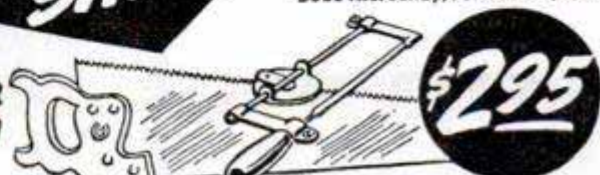

\$2.95



**You can't beat
riding a
HARLEY-DAVIDSON!**

It's freedom! It's fun! It's the lure of the open road that leads to faraway places. It's the thrill of exciting race meets, hill-climbs, endurance runs. It's the delight of "gypsy tours" and sightseeing trips. It's a wonderful way to say "Goodbye, care!

Here comes happiness!" It's the world's greatest sport — and it's yours with a Harley-Davidson! Owning a Harley-Davidson Motorcycle is easier than you think. See your Harley-Davidson dealer today. Fill out and mail the coupon now.



HARLEY-DAVIDSON
Motorcycles

HARLEY-DAVIDSON MOTOR CO., DEPT. P, MILWAUKEE 1, WIS.

Send free copy of ENTHUSIAST magazine, filled with motorcycle action pictures and stories; also literature on 1948 models.

Name.....

Address..... City..... State.....

FREE!



SEND FOR ALLIED'S BIG 164-PAGE RADIO CATALOG

Everything in Radio at Lowest Prices!

Here is *everything* you want in Radio! New home radios and phono-radios, Ham receivers and gear, new kits, thousands of parts, tubes, tools, complete PA equipment, diagrams, latest radio books. The most complete stocks anywhere—in one *big* book—all at money-saving low prices!

BUILD THIS AMAZING 5 TUBE RADIO

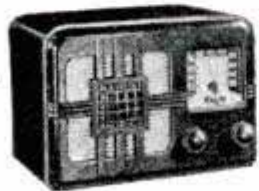

LOW-COST SUPERHET KIT Complete with Plastic Cabinet, Loop Antenna, and Tubes



It's here! The first ultra-modern 5 Tube AC-DC Superhet kit at so low a price! Here's what you get—full broadcast band coverage (550-1600 Kc); built-in loop antenna;

latest 5" PM dynamic speaker; handsome walnut plastic cabinet. Unbelievably easy to build; no special tools required. Sockets are riveted in place on chassis base; just assemble, wire and slip into cabinet. Outstanding for power and tone quality. Highest grade components only. Complete with all parts, tubes and full instructions. Nothing like it at the price! Shpg. wt., 10 lbs. **ONLY \$14.95**
No. 83-275. Complete.....

GET THESE VALUABLE ALLIED RADIO BOOKS!



- Radio Formulas & Data No. 37-752... 10c
- Dictionary of Radio Terms No. 37-751... 15c
- Radio Circuit Handbook No. 37-753... 25c
- Radio Builders' Handbook No. 37-750... 15c
- Simplified Radio Servicing No. 37-755... 10c
- Radio Data Handbook No. 37-754... 25c
- ALL 6 BOOKS above No. 37-799... \$1.00
- Parallel Resistance and Series Capacitance Calculator. No. 37-960... 25c
- R-F Resonance and Coil Winding Calculator. No. 37-955... 25c

ALLIED RADIO

ALLIED RADIO CORP.
833 W. Jackson Blvd., Dept. 5-B-8
Chicago 7, Ill.

**FREE
CATALOG**

- Rush FREE 164-page Catalog
 - Send Kit No. 83-275
 - Send 6 Books No. 37-799
 - Send Calculators checked above
- } \$.....enclosed

Name.....
Address.....
City.....Zone.....State.....

Stalking the shadowy sturgeon requires patience and practice—and more patience. Sometimes a man may sit out the entire season without so much as a glimpse of a sturgeon. Then again, like Bernard Bergen of Malone, and his brothers, Bill and Orlando, he might run into a school of sturgeon. In an hour's time during the 1946 season this trio speared three sturgeon—ranging from 58 to 112 pounds.

Sometimes it's luck. I knew two brothers who did a lot of spearing. Each had his own shanty. They had speared many a fish in their time, but never a real big one. One was always complaining about it.

Then came the afternoon of his big chance. He took careful aim and hit his quarry squarely. That big boy just straightened out the 30-foot rope while his would-be captor tried to slow him down. The fisherman got a severe case of rope burn for his trouble. The sturgeon never stopped. He snapped off the rope close to the spear and was gone. After the ice had gone out the next spring, that sturgeon was found washed up on shore with the spear still in his tough old hide. He was seven feet long and had weighed well over 200 pounds.

Veteran spearmen say the best spots are over mud flats because sturgeon feed on insect larvae, mollusks and a blood-red worm found in the mud. The sturgeon noses into the mud with its spadelike nose to free the worms. Muddy water, however, is the sturgeon stalker's biggest headache. Some years the lake is so clear that you can read headlines on a newspaper sunk 18 feet down to give the fish a white background. Another trick is to spread tinfoil, bits of broken white plates, or even large slices of white, raw potatoes on the bottom of the hole.

Many use decoys—usually green or red-painted wooden models of sturgeon suspended below the hole on a string and sometimes manipulated. Game Warden Charles Schlumpf of Fond du Lac, who made a study of sturgeon, says it's a curious fish that likes to examine objects in the water. Other fishermen use tin cans, oranges and lemons, or big ears of bright yellow corn in the same fashion. The depth of the lure varies with conditions, but usually is not too far off bottom as the sturgeon is a bottom feeder.

Sturgeon-fishing fanatics don't mind the monotony of waiting. As they stare into the green depths they are often entertained by schools of walleyes. Now and then a big gar swims by. They tell, too, of muskellunge up to 50 pounds nosing the decoys. (It's illegal to spear muskies in Wisconsin.)

(Continued to page 246)

IT'S A GRAND FEELING, TO BUILD A WINNER

Mr. Robert Brightman, photography editor of *Mechanix Illustrated*, is shown displaying Walter A. Musciano's splendid 32-inch control line model of the plane that Frank Hawks flew to fame in 1930. It has won two first prizes so far.



*IT'S A GRAND FEELING, TOO,
WHEN YOUR CAR IS
CUSHIONED WITH MARFAK
CHASSIS LUBRICATION*

THAT CUSHIONY FEELING LASTS LONGER WITH MARFAK!

The smooth, easy handling of a car with *Marfak* Chassis Lubrication is evidence that a tough, long-lasting lubricant is on the job. A *Marfak* job protects your chassis for a thousand miles or more. Ask your Texaco Dealer to give your car that "*Marfak* feeling" ... today!



THE TEXAS COMPANY

TEXACO DEALERS IN ALL 48 STATES

Tune in: TEXACO STAR THEATER presents the TONY MARTIN show featuring Alan Young every Sunday night. METROPOLITAN OPERA broadcasts every Saturday afternoon. See newspaper for time and station.

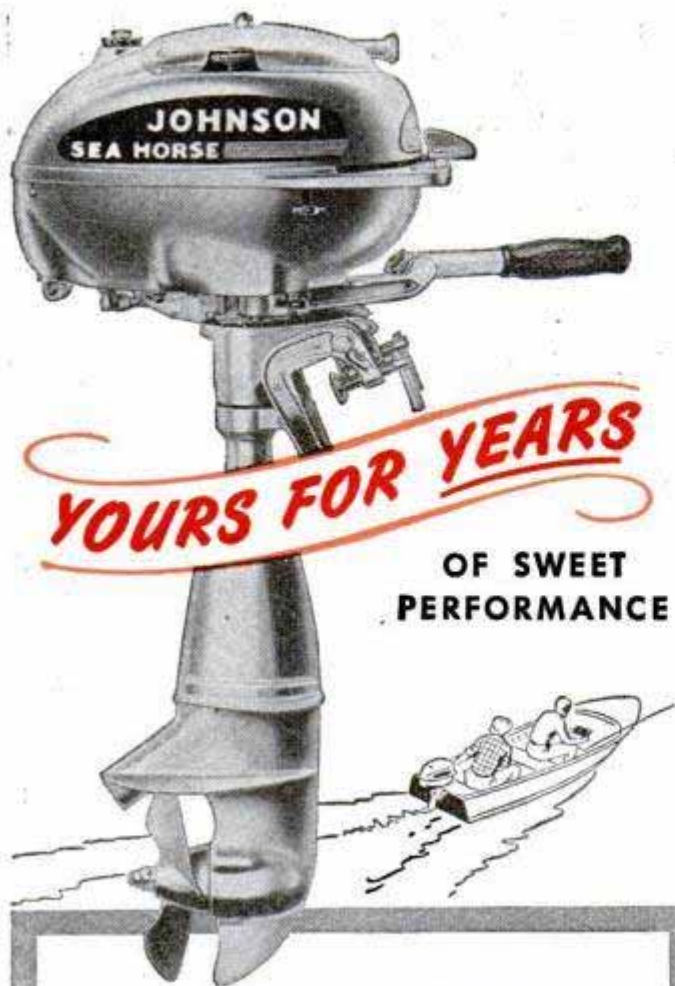

YOURS FOR YEARS

OF SWEET PERFORMANCE

WHO BUT JOHNSON OFFERS YOU ALL THIS?

- | | |
|----------------------------|---------------------------------|
| Nation-wide Service | Rubber Flow Shock Absorber |
| Long Life | Weedless Propeller |
| High Trade-in Value | Automatic Oiling |
| Perfected Alternate Firing | Large Grease Capacity |
| Reverse | Large Gas Capacity |
| Co-Pilot | Hardened Steel Gears |
| Dual Carburetion | Grease Seals |
| Ready-Pull Starter | Salt Water Protective Treatment |
| Positive Primer | Stainless Steel Propeller Shaft |
| Synchro-Control | -and much, much more |
| Rubber Rotor Pump | |

JOHNSON
SEA-HORSES
for *DEPENDability*

FREE HANDY CHART

New! Illustrates and charts the 5 great Johnsons for '48. Sent free. Write!... Look for the name of your Johnson Dealer under "Outboard Motors" in your classified phone book.

JOHNSON MOTORS, 400 Pershing Road, Waukegan, Illinois
Johnson Motors of Canada, Peterboro, Canada

Clinic



for Homemakers

As a service to our readers in solving the hundreds of problems pertaining to a home—inside or out—the editors of *Popular Mechanics* invite you to present your problems to The Clinic Editor for help and advice. Address your questions to The Clinic Editor, *Popular Mechanics Magazine*, 200 East Ontario Street, Chicago 11, Ill.

Sink Drain Clogs Quickly

Q—Our sink drain clogs easily because it runs horizontally to the vent pipe in the wall. Is there any way to simplify this frequent cleaning job?
T. B.—Harvey, Ill.

A—Substitute a pipe tee for the elbow where the trap connects to the horizontal pipe. Install the tee in the same plane as the pipe. You can then get at the pipe for cleaning it by simply removing a plug which closes the unused end of the tee.

Yellow Stains on Piano Keys

Q—How can I remove yellow stains from the ivory keys of my piano?
W.H.R.—New York City.

A—Wipe them with a cloth dampened with alcohol and sprinkled with powdered chalk. There is no effective treatment if the keys have yellowed throughout because of age.

Removing Stains from Concrete Floor

Q—Is there a safe method of removing oil stains from a concrete floor near our oil-burning heating plant?
I.A.P.—Colorado Springs, Colo.

A—Cover the stains with dry portland cement to a depth of 1/2 in. In a few days the cement will absorb the oil from the concrete, especially if the stains are fresh. Dry hydrated lime also is effective. Another method is to wash the stained spots with a hot solution consisting of trisodium phosphate, 4 oz., and water, 1 gal. All traces of the solution should be washed away with clear water.

How to Repair Rusted Eave Gutters

Q—A spot on one of the eave gutters of my home has rusted through at the bottom so that it leaks. Can you recommend a repair?
J.O.B.—Aurora, Ill.

A—Cut a piece of heavy canvas large enough to cover the spot and reach to both sides of the gutter. Soak the canvas in white lead or other heavy outdoor paint. Then clean the leaky spot thoroughly and paint it. Place the canvas inside the gutter over the leak and smooth it. When dry, give the canvas another coat of paint.

White Spots on Furniture

Q—Perfume bottles set on my vanity dresser have caused several white spots on the finish. How can I remove them?
B.A.W.—Mobile, Ala.

A—First rub the spots with a cloth dampened with spirits of camphor and then rub them briskly with a dry, soft cloth.

(Continued to page 244)

Revolutionary New



Dumore Carvit

makes you a skilled wood-carver in 20 minutes!

Here's a fascinating new hobby—complete in one tool. The unbelievable perfection of your first carving amazes your friends! Experienced craftsmen use the Carvit to give their woodworking projects

that professional touch.

With the Carvit, you make beautiful replicas of inexpensive objects you can find in any dime store or gift shop—in mahogany, walnut, and other fine woods.

You're an expert at once — with a Carvit!

Here's how the easy-to-use Carvit works: You clamp a model to the table below the tracer, and a wood block below the cutter. Then you switch on the motor and guide the tracer over the raised contours of your model. The cutter moves with the tracer to carve an exact duplicate of the model. With an index

attachment, you can carve objects in the round—statuettes, busts, etc.

Carving with the Carvit is fascinating fun for everyone. The Carvit is the ideal gift for your sweetheart, husband, or son! See this exciting new tool at your local hardware store today — or mail us the coupon below!

Satisfaction guaranteed or your money back in 10 days!

No skill or training needed to do work like this



Carve useful ornaments for the home — distinctive gifts for friends — fine carvings that sell!

Tear out coupon and mail today!

The Dumore Company, Dept. B-51, Racine, Wisconsin

- Please send complete information on the Carvit.
- Please send one Carvit. \$48.50 enclosed.
- Please send one Carvit with index attachment. \$58.25 enclosed. Shipping charges C.O.D.

Name _____
Address _____
City _____ State _____

H-5

New MILLING ATTACHMENT



Sizes for 8" to 16" metal lathes

BUILD IT YOURSELF from our sets of semi-machined castings and save \$\$. Can be finished on your lathe alone. Complete working drawings and step-by-step instructions furnished with castings.

Mill keyways, slots, splines, dovetails, flutes in reamers, taps, hobs, and special cutters; produce spur, bevel, mitre and worm gears, ratchets and racks; mill flat surfaces, square shafts, mill hexes, spot face, drill spaced holes, bore, etc. on your lathe with this precision attachment. It has a T-slotted table, a vise which swivels for angular milling, a gear cutting fixture and dividing centers.

FREE! Illustrated folder and price list. Includes milling cutters, keyway cutters, drill rod, slitting saws and many hard to get shop items. Mention your lathe. Write today.

HURON MACHINE AND TOOL CO.
YALE 4, MICHIGAN

Dexter UNIVERSAL LATHE CHUCKS

IMMEDIATE DELIVERY. Shipped postpaid from stock same day order received. Precision accuracy and construction assure you complete satisfaction.



Size	Fits Spindle	Price (Postpaid)	Note:
2"	1/2"-20	\$16.00	5" chuck also to fit following spindles 3/4" x 16 1" x 10 1" x 12 1" x 14 1" x 16 1 1/8" x 7
3"	1/2"-20	17.00	
4"	1"-8	21.00	
5"	1 1/2"-8	25.50	
6"	1 1/2"-8	33.00	

THE LEAVITT MACHINE COMPANY
ORANGE, MASSACHUSETTS

DISSTON

The saw most carpenters use

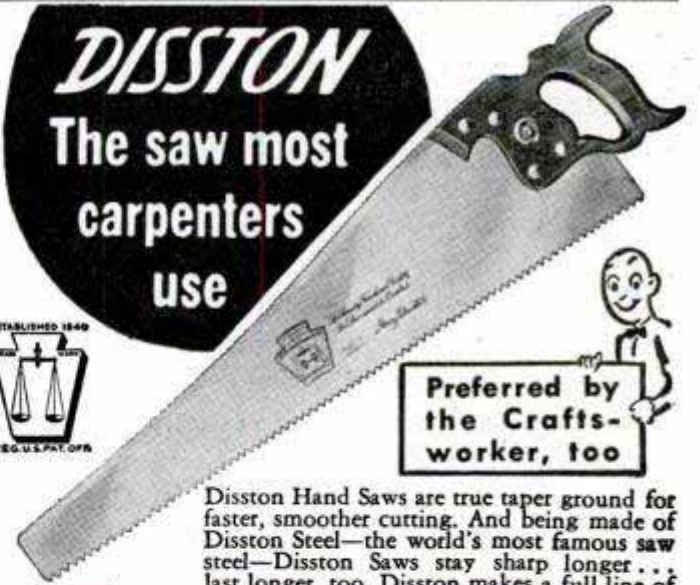

Preferred by the Craftsworker, too

Disston Hand Saws are true taper ground for faster, smoother cutting. And being made of Disston Steel—the world's most famous saw steel—Disston Saws stay sharp longer... last longer, too. Disston makes a full line of hand saws, circular saws, band saws, and dado heads for home workshop use. Ask your Hardware Retailer.



Mail Coupon for FREE COPY
The Disston Saw, Tool and File Manual tells how to choose, use and care for tools.

HENRY DISSTON & SONS, INC.
211 Tacony, Philadelphia 35, Pa., U. S. A.
Please send me FREE copy of Disston Saw, Tool and File Manual.

NAME _____
ST. & NO. _____
CITY _____ STATE _____



SAY YOU SAW IT IN POPULAR MECHANICS

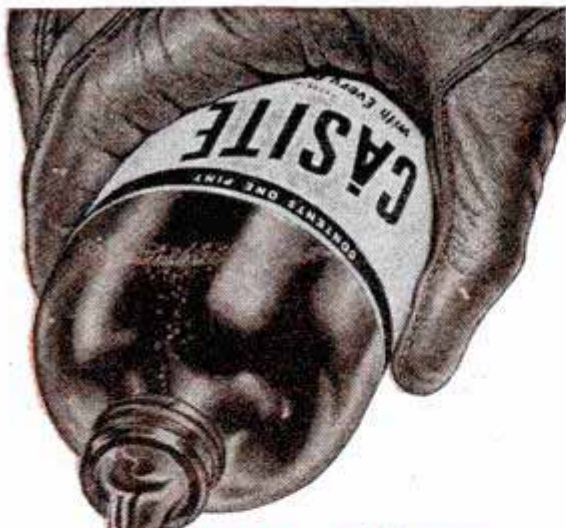

**Quick Starting
All Winter**

OR DOUBLE-YOUR-MONEY-BACK



● No more sitting out in the cold—struggling with a car that refuses to start. Casite guarantees quick starting in coldest weather or double-your-money-back. It retards congealing of oil . . . lets the motor spin over rapidly and go. Casite improves lubrication and reduces engine wear, too—gives better and smoother performance all-year-round. Get Casite added to your motor oil today—at your service station, garage or car dealer's. The Casite Corporation, Hastings, Michigan and the Casite Division, Hastings Ltd., Toronto.



Preventing Noisy Radiators

Q—We keep the valves on some of our steam radiators partially closed to regulate the heat, but when we do they pound. What causes this noise?
R.A.D.—Rochester, N.Y.

A—When the valves of steam radiators are partially closed, the passage through the valve is too small to permit both live steam and water from the condensed steam to pass through it at the same time. As a result water collects in the radiator and causes the live steam to enter in spurts, which causes the noise. The only way to eliminate the noise is to keep the valves completely open.

Removing Calcimine

Q—What is the best way to remove calcimine?
J.A.C.—Wilmington, Del.

A—Calcimine usually can be removed with a sponge and warm water. Go over a small patch with the wet sponge to soften the calcimine, wring out the sponge and then wipe off the softened calcimine. Household ammonia added to the water will help. A handful of washing soda to a gallon of water also is helpful. If the soda solution gets on painted walls or woodwork, it should be wiped off immediately to avoid damaging the finish.

Repair for Cracked Laundry Tub

Q—Is there any way I can repair a crack in one of our laundry tubs?
D.R.B.—Akron, Ohio.

A—If the tub is made of concrete, slate or soapstone, enlarge the surface of the crack by grooving so that a soft cotton string can be forced into it. Coat the string with white-lead paste and force it into place. Allow several days for the lead to dry before using the tub. Filling the crack with a paste of glycerin and powdered litharge also is effective.

Moisture on Window Sash Rots Wood

Q—The wood at the lower end of each glass pane of our windows is starting to decay because of moisture condensing on the glass and running down on it. Is there any way to protect the wood?
P.R.C.—Minneapolis, Minn.

A—Sand off the damaged wood and give it a coat of shellac and then repaint. A coat of shellac over the paint on undamaged windows will protect them.

Copper Screens Stain Exterior Walls

Q—We installed copper screens last summer and rain water running off the screens is staining the wall underneath. How can I prevent this trouble?
S.A.R.—La Porte, Ind.

A—Paint the screens with clear lacquer. Repeat at intervals of two or three years.

Water Shut Off Temporarily by Freezing

Q—I have a damaged fitting in a water line which I wish to replace, but have no means of shutting off the water for the short time necessary to replace the fitting. Can you suggest something?
R.O.B.—Enid, Okla.

A—Pack dry ice around the pipe for a distance of 4 or 5 in. on the pressure side of the fitting, using a strip of canvas or other heavy cloth to hold the ice in place. The ice will freeze the water inside the pipe and thus plug it. Remove the ice as soon as possible after completing the repair.

Paint on Plastered Wall Is Spotty

Q—The paint on a newly plastered wall in our home is becoming spotty. The paint seems to change color where these spots appear. What causes this condition?
S.R.W.—Bonaparte, Iowa.

A—Likely your trouble is caused by "hot spots" in the plaster. Actually the spots are not hot, but are caused by the presence of unslaked lime in the plaster which attacks the oil in the paint. Brushing the spots with a solution of zinc sulphate, 1 or 2 lbs. to water, 1 gal., will prevent the trouble. Repaint the spots. If the plaster has been applied less than one year, it would be a good idea to go over the whole wall with the solution and then repaint it.

**\$14⁹⁵ NEVER BOUGHT
SO MUCH IN
A POWER TOOL**

**New 22-piece CASCO Electr-O-Tool Kit
Puts 1001 Skills at Your Fingertips**

Here's what every hobbyist, home craftsman and mechanic has been waiting for! CASCO Power Tool is actually a complete, portable workshop. 20 easily installed accessories instantly transform it into a dozen different, useful tools that handle like a pencil. Powerful 20,000 R.P.M. motor is air-cooled in shockproof, unbreakable Tenite case. Exclusive finger grip permits closer work; on-off switch permits one-hand operation. Quiet; smooth-running; efficient; vibrationless high speed. Operates AC-DC. At leading stores everywhere.

CASCO

Another good buy: Casco Electri-Craft—has 36 accessories and extra sturdy steel storage chest—\$32.95 if purchased separately—an outstanding value at \$22.50.

**POWER TOOL COMPLETE
WITH 20 ACCESSORIES,
KIT AND PROJECT BOOKLET
ONLY \$14.95 — IF BOUGHT
SEPARATELY YOU'D
PAY \$23.45**



- It Engraves!
- It Cleans!
- It Cuts!
- It Grinds!
- It Carves!
- It Saws!
- It Sands!
- It Buffs!
- It Etches!
- It Drills!
- It Brushes!

CASCO PRODUCTS CORPORATION, BRIDGEPORT 2, CONN.

FULLSIZE, CUT-TO-SHAPE BOAT PATTERNS

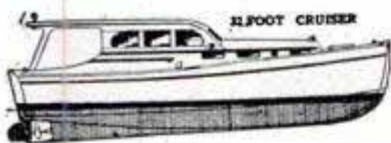

and specifications. Designed by Naval Architect. Cruisers, runabouts, sloops, outboards, sailing canoe, etc. Low prices. Send 10c (coin) for illustrated catalog. SPECIAL: Send \$1.00 for "HOW TO BUILD BOATS" book, postpaid.
Cleveland Boat Blueprint Co.
Dept. 666, Cleveland 13, Ohio

Electrically Welded Endless

Paramount

**BAND
SAW
BLADES**



Made in widths from 1/8" to 1-3/4"

Make your band saw do more work for you. The proper width of blade will extend the scope of this important machine. Burrill's Paramount Blades are made from tough Nickel Alloy Steel properly tempered. Teeth accurately set and filed, and all saws carefully straightened. Send order and check today. Delivery will be made as promptly as conditions permit, from a few days to a week or two. You can obtain these saws at the following prices:

- 1 1/8"-3/16"-1/4"-3/8" wide, 5'6" long..... \$1.04 each
- 1 1/8"-3/16"-1/4"-3/8" wide, 6'6" long..... \$1.16 each
- 1 1/8"-3/16"-1/4"-3/8" wide, 7'6" long..... \$1.27 each

Other sizes at proportional prices

NO C.O.D. SHIPMENTS ACCEPTED

State Make of Machine

Your satisfaction is guaranteed

BURRILL SAW & TOOL WORKS

407 E. Main St., Ilion, N.Y.

**SAVE TIME
AND WORK!**

**MAKE EXTRA
MONEY!**



**EASY TO
OPERATE**

**SHAW
"DU-ALL"**
and "PEPPY PAL"
GARDEN TRACTORS

PLOW

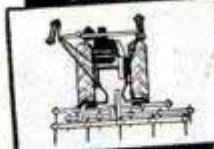

HARROW



CULTIVATE



MOW

**SHAW
MFG. CO.**

These sturdy walking and riding tractors ideal for dozens of uses around the farm, orchard, garden, golf course, estate and poultry farm.

DO DOZENS OF JOBS

Shaw Du-All or Peppy-Pal tractors do many jobs quickly and easily. Plow, cultivate, mow, disk, harrow, bulldoze, spray, grind, haul and saw wood. New uses discovered every day.

BUILT FOR RUGGED WORK

Sturdy, extra-strength construction means low upkeep, long life. Patented tool control allows quick shift for crooked rows. Attachments easy to change with improved "Jiffy Hitch."

CHEAP TO OPERATE

Operates on few cents an hour. Soon pays for itself in time and labor-saving plus low initial and operating costs.

LOW FACTORY PRICES

Buy direct and save! Almost anyone who has a garden can afford a Shaw Du-All or Peppy-Pal. Full year's guarantee.

PROMPT SHIPMENT

No waiting—order now for immediate delivery.

FREE—Illustrated folders giving complete details and price lists. Write today!

4502 Front St., Galesburg, Kans.
6686 North 4th St., Columbus, Ohio

No other tool like it!

BURGESS
vibro-tool

Trade Mark Reg. U. S. Pat. Off.

Writes on . . .

Watches
Glassware
Tools
Leather
Plastics

Costume
Jewelry
Pots and
Pans
Sporting
Equipment



\$7.50

Engrave your name . . . etch letters or designs . . . place permanent identification marks on anything with this unique hand tool. Carves wood and linoleum, cuts cardboard and balsa, tools leather. Just plug in on any 110 volt AC line. No home shop is complete without a Burgess Vibro-Tool. See your dealer or write for information.



DELUXE KIT

Vibro-Tool complete with 22 attachments in handsome, polished wood chest. . . . \$16.50

BURGESS Vibro-Tool Division

LAKE ZURICH, ILLINOIS

BANDSANDER

Is BACK AGAIN and ONLY

**NEW ECONOMY HOMESHOP
MODEL READY FOR DELIVERY**

\$14.95

FOB
Factory

THIS remarkable, economical home-shop tool is again available for immediate shipment! Quickly shapes, sands, carves and polishes wood, metal, plastics! Works equally well on inside cut-out openings or irregular outside edges. Gets at places no other can! Patented. Tilting table for beveling, chamfering. Rust-and-sweat proof top. Self-oiling sleeve bearings. Saves time, labor, money. Invaluable to homecraftsmen, hobbyists, modelmakers, etc. Normal band speed 1600 ft. per min. gives fast, smooth, clean cuts. 1/4 h.p. 1725 rpm motor recommended. Rush only \$14.95 with order—or \$5. balance COD. Immediate shipment! 5 Days Trial, Money Back Guarantee. Limited supply—so hurry! Dealers write! (Or send post-card for Free Circular.)

**QUICKLY
SHAPES,
SANDS,
CARVES,
GRINDS,
PROFILES,
CLEANS,
SMOOTHS, and
POLISHES
WOOD! METAL!
PLASTICS!**

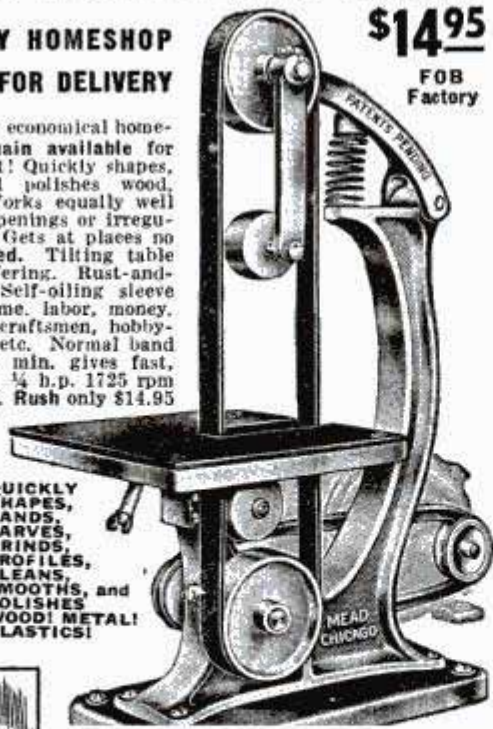

IMMEDIATE DELIVERY

MEAD SPECIALTIES CO.

4114 N. Knox Ave., Dept. 128
Chicago 41, Illinois



Techniques differ, but most fishermen are anxious to "get the iron into 'em." Absolute quiet is essential; shuffling feet on the shanty floor scare away the wary, sensitive "shadow." So does the thump of the spear carelessly snatched from its hook on the ceiling. Veteran Delmer Weenink operates on this theory:

"I let a sturgeon come in and look over the decoy. Then when he starts to move away I let him have it. I think they're like deer. You take a big buck standing there looking at you, eyes focused. He'll jump if you move. So you stand still and let him calm down and let him start to move off. That's the time to shoot. It's the same with sturgeon. When they start to move away slowly, they're looking at something else. That's the time to reach for your spear."

There are some 50 or 60 types of sturgeon. All are ugly. All have long, horny snouts and an elongated body covered with tough skin. The Lake Winnebago sturgeon has a dark gray or olive green back and a whitish gray belly. The mouth is small and toothless and is on the underside of the muzzle, with an eye and nostril on each side of the snout. Sometimes in summer they startle fishermen by leaping five feet out of the water to shake off the parasitical lampreys.

All sturgeon are relished for their firm white meat. The sturgeon has no bones other than the backbone and cuts into nice, horseshoe-shaped steaks. While the Winnebago sturgeon taken through the ice does not usually have eggs sufficiently developed for caviar, other types are prized for this. The Russians catch four kinds of sturgeon ranging from 20 to 3000 pounds in the Caspian Sea. The largest is the great white beluga, a good producer of caviar.

Lake Winnebago sturgeon have been known to reach the age of 100 years. The female does not spawn until she is about 25 years old. Wisconsin—by limiting the catch to sturgeon at least 30 inches long—gives the fish about 20 years of freedom from the spear. Sturgeon have no scales. On some other fish, scales reveal age by ring growths—much as trees do. Scientists have had to count the markings on the sturgeon's otoliths—or "ear stones"—under the microscope. Otoliths form inside the head, one on either side, and are similar to a part of the inner ear in man and animals.

Most people prefer smoked sturgeon, but it is also served fried, boiled or pickled. To a sturgeon fisherman, the eating is only a minor part of this major winter sport which affords more thrills than the highest ski jump.

Your weight does the work
with a "YANKEE"
**QUICK-RETURN SPIRAL
SCREW DRIVER**

● Save your wrist: drive and draw screws faster. Just push on a "Yankee" 130A Spiral Driver. Your weight and the spiral turns the screw without blisters or fatigue. Quick-return spring in handle holds blade in slot and returns the handle after every stroke.

★
Write for the
"YANKEE"
Tool Book
... FREE ..

"YANKEE" TOOLS
NOW PART OF

STANLEY

THE TOOL BOX
OF THE WORLD

**NORTH BROS.
MFG. CO.**
Philadelphia 33, Pa.



**A 10-Ton Press
at Low Cost**

Pressing, separating, bending, and straightening jobs in your shop are easy with this press. Ten-ton capacity provides ample pressure. Adjustable table takes work up to 18 inches wide and 11½ inches high. Send for free bulletin showing press and wide variety of accessories.

UT-10A Press f. o. b. factory \$31.00

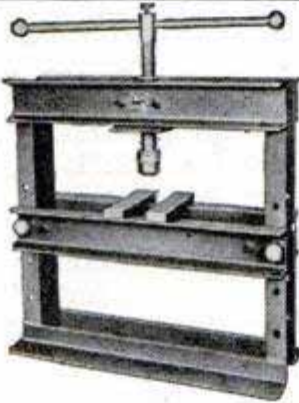

DAKE ENGINE COMPANY
624 Seventh Street, Grand Haven, Michigan

for AMAZING acceleration

DIXIE-WESTERN
DUAL INTAKE MANIFOLDS for
V-8 FORDS AND MERCURYS

\$15.00 Gas Line and Throttle Kit \$2.50 extra

Chrome Plated Velocity Stocks — \$1.50 ea.
By Test: Increased Acceleration by 26%
Increased Power and Speed by 11%

All DIXIE-WESTERN manifolds are brightly polished cast aluminum.

DIXIE-WESTERN MANIFOLD CO.
Box 364 • Los Angeles 43, California

DUAL INTAKE MANIFOLDS
Dealers Wanted

What holds with firmness, "peels" with ease;
What mounts rare stamps from Celebes?

Dennison
STAMP HINGES
At Stationery Departments Everywhere

**When
Caster
Guides
Work
Loose
Do This:**

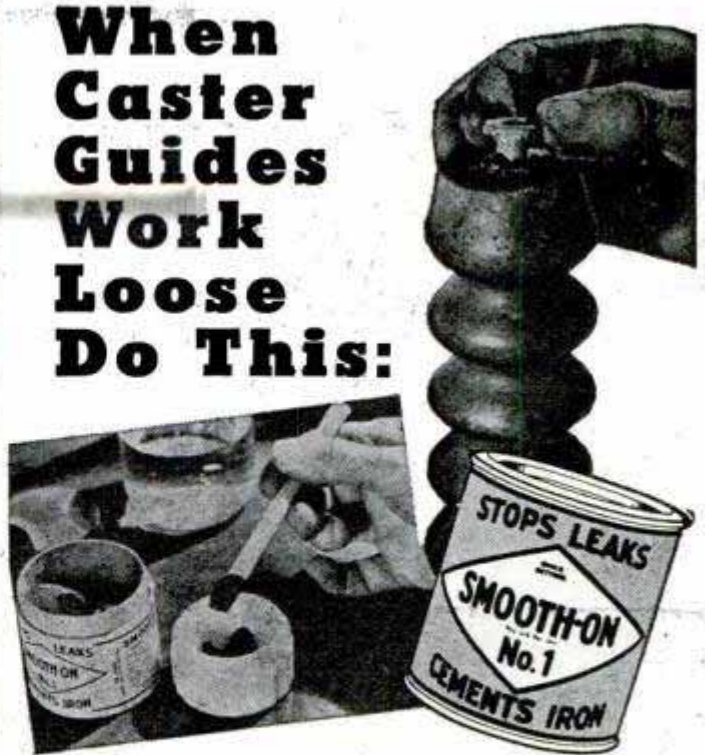

Mix Smooth-On No. 1 Iron Cement with water to consistency of soft putty and fill it into the hole in which guide goes. While cement is still soft insert the guide, driving it home. Smooth-On hardens quickly, expands slightly in hardening and holds guide firmly in place.

USE SMOOTH-ON FOR BIGGER REPAIRS, TOO

Use it to stop leaks and seal cracks in boilers, furnaces, piping, radiators and auto parts. Tighten loose handles, hinges, knobs, bolts, screws and rivets with Smooth-On. Professional repair men have been using Smooth-On for over 50 years. Buy it in 1¾-oz., 7-oz. or 1-lb. size from your hardware dealer—if he hasn't it, write us.

FREE 40-PAGE HANDBOOK

Filled with tested time- and money-saving repair ideas. 170 illustrations. Clear, simple directions. Just mail the coupon.

—SIGN AND SEND NOW—
Smooth-On Mfg. Co., Dept. 37B,
570 Communipaw Ave., Jersey City 4, N. J.

Please send me free Smooth-On Handbook.

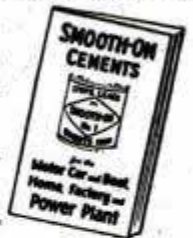

Name _____

Address _____

2-48 _____

Do it with **SMOOTH-ON**
THE IRON CEMENT OF 1 000 USES

SAY YOU SAW IT IN POPULAR MECHANICS

Has the Propeller a Future?

(Continued from page 174)

efficiency was upped to 80 percent at 530 miles an hour.

This suggested further experiments. Instead of making propellers with round blade shanks, why not continue the blade itself right into the spinner? Now efficiency jumped to 91 percent at 200 miles an hour and an encouraging 88 percent at 530 miles an hour. Then researchers went to work. They swept blades forward, backward, and tried all kinds of shapes.

Typical of the results is one study that shows exceptional promise for the future. This amazing blade shape is simply an isosceles or two equal-sided triangle twisted to form the screwlike propeller blade. A 12-foot-diameter propeller of such design is expected to be 80 percent efficient at 840 miles an hour and would absorb as much as 18,500 horsepower. This is at least six times the power absorption of comparably sized props of the late war. And, if the triangle were swept back like other trick blade shapes being tried, it would prove capable of still greater performance.

The propeller and engine or turbine combination is considered superior to jet and rocket propulsion at all speeds below that of sound. Only at supersonic speeds, where efficiency and economy are not always most important, are the rocket and jet supreme. Once compressibility is encountered an 800 percent increase in power is needed for every 20-mile-an-hour increase in speed.

Fuel consumption is greater with the jet. When the eight-turbine jet-propelled B-49, sister ship to the propeller-driven B-35 Northrop flying wing, was built, it proved to have half the range of the older ship though its speed was increased. Particularly because transport airplanes can make money only at subsonic speeds, authorities agree that the propeller has a bright future.

Major General Laurence C. Craigie, chief of the engineering division of the Air Materiel Command at Wright Field, said in a speech, "Our combat aircraft, for an interim period at least, will remain in the subsonic range. So far as power plants are concerned, the reciprocating engine is still our best bet for long-range, substratosphere flight at subsonic speeds. However, the propeller-driving gas turbine gives indication of becoming strong competition."

Ships like the Ryan Fireball, with one turbine in the nose for the propeller and another in the tail for the jet, operate at

(Continued to page 252)



STANLEY NO. 51 1/2
NAIL HAMMER

**Make the
most of
your skill**

● This nail hammer is one tool from the complete line of Stanley Tools...designed for experts...yet priced to appeal even to the occasional user. When you buy tools, look for this famous trade-mark at your hardware dealer's. Stanley Tools, New Britain, Conn.

COUPON BRINGS YOU TWO STANLEY TOOL BOOKS.

STANLEY

Reg. U. S. Pat. Off.

The first is free. "The Joy of Accomplishment", an introduction to tools and their uses. The famous textbook, "How to Work with Tools and Wood" costs only \$1.00, postpaid.



**Stanley Tools, 128 Elm St.,
New Britain, Connecticut.**

Please send by return mail:

- The **FREE** booklet: "The Joy of Accomplishment".
- 188-page book, cloth cover: "How to Work with Tools and Wood". \$1.00 enclosed.

(In Canada: Send order to Stanley Tool Co. of Canada, Ltd., Roxton Pond, Quebec.)

Name.....

Address.....

City.....State.....

CORRECTS Plaster Cracks — Creaky Floors THE CAUSE OF — Sticky Doors and Windows Levels and Supports Sagging Floors

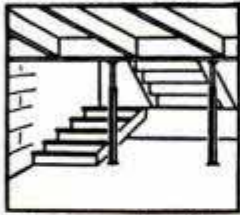

Raises sagging floors level. Provides permanent support.

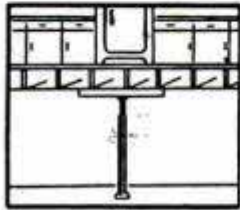

Gives needed extra floor support for heavy equipment.

Now, easily and at low cost, you can correct and prevent sagging floor trouble in your home. Tel-O-Post jacks up sagging beams to level — provides permanent safe support. Adjustable 5' 7" to 8' 4" to fit any basement height. All-steel, non-collapsible construction. Supports over 20,000 lbs. Tel-O-Post is approved by leading building codes — proved by over half a million home owners. Stop costly depreciation of your home. Tel-O-Post comes completely packaged, ready to install. On sale at leading building supply dealers. Be sure to insist on the genuine Tel-O-Post — it's safety engineered.

ONLY **\$7.95**

Slightly higher west of Mississippi River.

★ Write for free descriptive folder.

TEL-O-POST

THE ORIGINAL TELESCOPIC ADJUSTABLE ALL-STEEL BASEMENT POST

TEL-O-POST COMPANY • 140 Ash St., AKRON 8, OHIO

WANTED OPPORTUNITY SEEKERS



self all over the country are finding it a natural for big earnings. TRADIO has pioneered in this profitable postwar industry. Today, there are more TRADIOS installed throughout the country than any other coin radio.

If you're interested in a steady income—a substantial share of financial security for you and your family—you'll get in on the ground floor of this flourishing industry. Build a lucrative business of your own NOW with TRADIO, the radio functionally-designed for coin operation in hotels, hospitals, tourist camps, etc. Others like your-

Send for complete information. WRITE: Dept. N-2.

TRADIO, Inc. ASBURY PARK NEW JERSEY

AMERICA'S LOWEST PRICED BAND SAW



ENGINEERING FEATURES FOUND ONLY IN HIGHEST PRICED MACHINES

Practical, modern design; new improved model. Accurate, smooth operation. Cuts to center of large 14" circle, 2 1/2" thick. Genuine "Oilite" bearings, adjustable ball-bearing blade guide. Upper wheel micrometric four-way blade tension and adjustment. Safe, fully enclosed mechanism. Thoroughly proved construction, ruggedly designed with sturdy laminated plywood. Stands 24" overall. As illustrated—blade included. Immediate Delivery! See your dealer or send only \$16.95, and we'll pay shipping charges. Or, if you prefer, will forward C.O.D. Money-Back Guarantee: if not satisfied upon receipt of band saw, return immediately for refund.

Now \$16.95

SERRO MFG. CO., Dept. 102 ST. LOUIS 1, MO.

909 MARKET



When you want to fix things fast... remember Weldwood Glue. It's quick to mix... easy to use... tremendously strong... stain-free... rot-proof... and permanent. At hardware stores, lumber yards, chain stores.



WELDWOOD
PLASTIC RESIN
WATERPROOF GLUE

United States Plywood Corporation, New York 18, N. Y.

MAKE YOUR WORKSHOP PAY FOR ITSELF BY USING THIS *all-purpose* WHEEL!

Craftsmen, if you own a table saw or a bench grinder your equipment is not complete without this new, amazing all-purpose wheel. It saws, files, sharpens, cuts, forms and shapes metal or wood. It is fast, safe, easy . . . will cut BX cable, conduit, copper tubing, transite, celotex, brass, aluminum, steel, plastics, etc. It is as indispensable to your workshop as electric power. Try one yourself to be convinced. Send check or money order to-day. Wheel will be sent by return mail.

6" — \$1.65 Each 7" — \$2.15 Each 8" — \$2.80 Each

All wheels 3/32" thick with 1" hole. State size of shaft if smaller than 1". Proper bushing will be sent free.

POSTAGE PREPAID Anywhere in U. S. A. by: **Bay State Abrasive Products Co., Westboro, Mass.**

IMMEDIATE DELIVERY!

Speed Way

PORTABLE BENCH GRINDER

Here is an offer to take advantage of! "Sparky" is able to make immediate delivery of the SPEEDWAY No. 117 PORTABLE BENCH GRINDER — ANYWHERE IN THE COUNTRY! It has 3 times the power of its pre-war model and comes with 1 "coarse" and 1 "fine" grinding wheel of standard size, (4 1/2" x 3/8" x 3/8"). Replaceable from stock wherever grinding wheels are sold. The built-in thumb switch, is conveniently located in front. Complete with rubber covered cord and plug; ready for use. (AC only.) Order today! Send check or M.O. for \$14.95 and we pay the postage, or you pay the postman \$14.95 plus postage. No C.O.D.s outside of the U.S.A.

\$14.95

SPARKY SPECIALTIES, INC., 173 W. Madison, Chicago 2, Ill.

Remittance enclosed. Send C.O.D.

NAME _____

ADDRESS _____

CITY _____ ZONE _____ STATE _____

Shoots Light 800 Ft!

A genuine Delta for home and away. Spotlight and floodlight. 80-100 hrs. on a 6-volt battery. At hardware, sport, electrical stores. Less battery **\$4.25**

Delta ELECTRIC CO.
MARION, INDIANA

POWERlite

2-LITE ELECTRIC LANTERN

\$2.95

TORNADO

GAS TORCH

The Modern Way of Soldering

Ideal for hard and soft soldering. Will heat quickly; solder will flow freely and smoothly. No compressed air required. Self-adjusting. Safe. Economical. Can be used for annealing small parts and bending metal parts. Generates a heat of 1700° F. Simply connect to any illuminating gas jet with a rubber hose and operate. Tornado Torch No. 119 comes with three tips, (1/8", 1/4", 3/8" blast).

Tornado Gas Torch No. 119 — Complete with 2 tips, for Natural Gas or Bottled Gas; with 3 tips for Manufactured Gas. \$2.95 per set. See your dealer or order direct. Send check or money order — post paid.

Robco Corporation, 202 E. 44th Street, New York 17, N. Y.

WITH MOLLY YOU CAN FASTEN ANYTHING

and do it quickly, neatly and safely. MOLLY will hold fixtures securely to floors, ceilings or any hollow wall construction . . . Simple to install, all you need is a screw driver. Sold by leading hardware stores everywhere.

Write for Free Descriptive Folder

MOLLY

SCREW ANCHORS

MOLLY CORP.

522 COURT STREET
READING, PA.

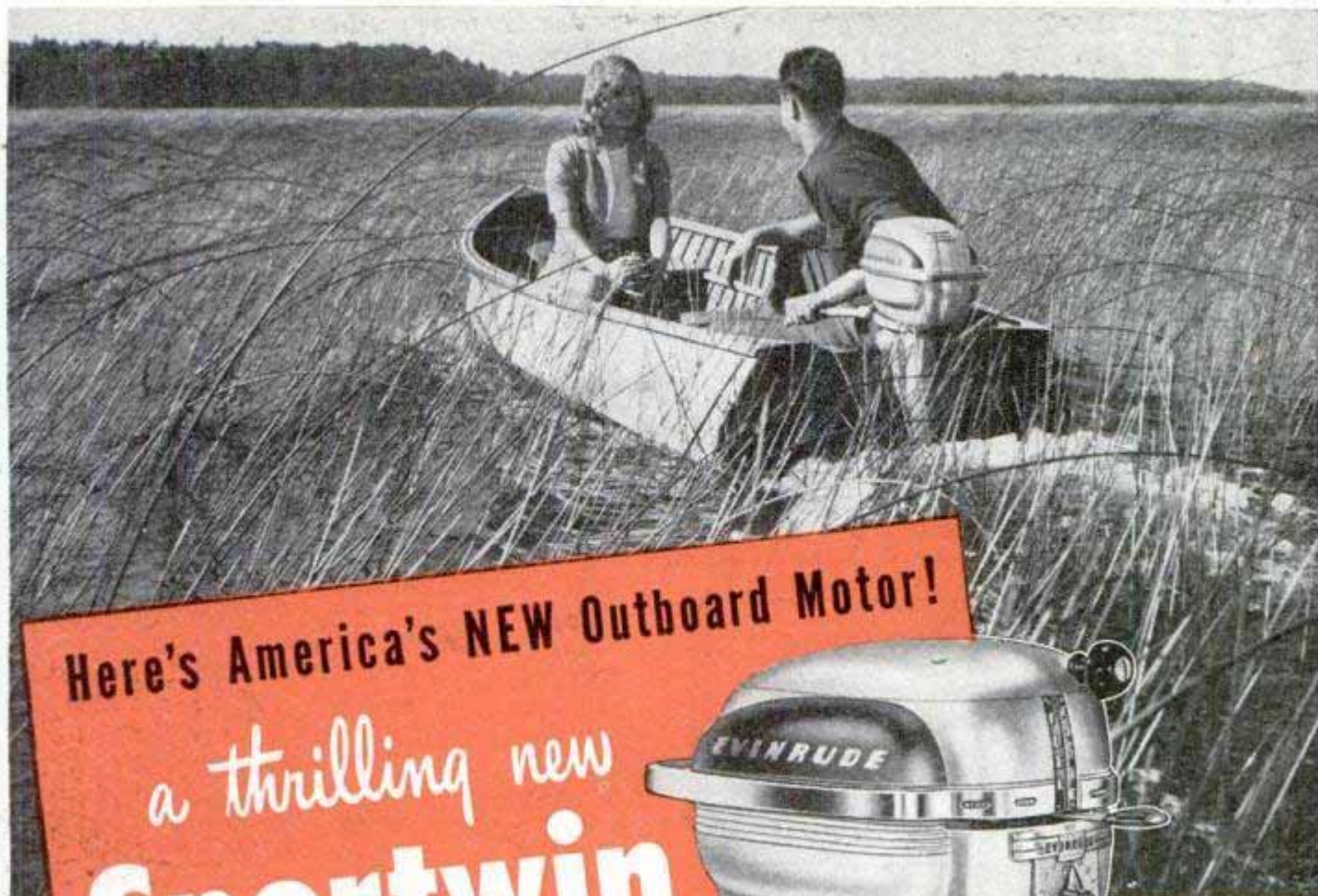

Here's America's **NEW** Outboard Motor!

a thrilling new

Sportwin

by **EVINRUDE**



YEARS AHEAD IN DESIGN • PERFORMANCE •

One glance tells you there's a brilliant new leader in the light motor field . . . one run, *and you know it's true!* You thrill to power that is incredibly smooth, flexible, quiet! You enjoy sparkling new features that give you an entirely new conception of light motor performance, convenience, handling ease! Here is the fuel gauge you've always wanted . . . and a score of other advancements including the amazing *Weedless Drive* that lets you highball through waters closed to other motors . . . gives you the all-clear through thick weeds and over rocks, snags, reefs . . . drives anywhere there is water to float your boat!

See Your Evinrude Dealer! Examine the new Sportwin and the complete Evinrude line for '48. Six great Evinrudes to choose from — three famed four-cylinder models — the right motor for every boat. Look for your dealer's name in your phone book under "Outboard Motors." Write for free catalog — address, **EVINRUDE MOTORS**, 5704 N. 27th Street, Milwaukee 9, Wis.
In Canada: Evinrude Motors, Peterboro, Ont.



FEATURES

YOURS IN THE NEW SPORTWIN

- these advancements, and many more • New alternate firing motor gives new flexibility and smoothness — 3.3 O.B.C. certified brake H.P. at 4000 R.P.M.
- New type Simplex Starter • "Full View" fuel gauge • New developments in automatic operation • New type Fuel Filler Closure for faster, easier fueling.
- New Transom Trigger for instant vertical adjustment • New type "Fore-and-Aft" carrying handles • Weedless Drive with rubber shock-cushioned propeller • 360° steering with full reverse.

FIRST IN OUTBOARDS **EVINRUDE**
 ... 39th YEAR

MAKE UP TO \$1000.00

**PER MONTH... OWN YOUR OWN
BUSINESS... BE YOUR OWN BOSS**

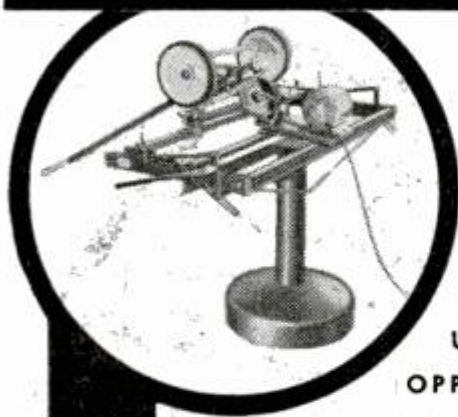

**EASY
MONEY!**

**EASY
WORK!**

**UNLIMITED
OPPORTUNITIES!**

EVERY HOME OWNER A CUSTOMER!

**Sign Long Term Profit Making
Contracts With Schools, Parks,
Playgrounds, Cemeteries, Golf Courses
And All Types Of Institutions.**

**THE MODERN LAWN MOWER SHARPENER
IS A PROFIT PRODUCER FOR YOU!**

Make more money the Modern way! Everywhere grass grows and lawn mowers are used offers you unlimited opportunities to make up to \$1000.00 per month in a business of your own. For the first time in history, you can sharpen any reel type lawn mower from a five inch edger to a thirty-six inch power mower in from ten to twenty minutes. Dismantling is unnecessary. Handle, wheels, roller and motor remain in place when sharpening even the most complicated mower. The Modern Lawn Mower Sharpener eliminates all hand filing. It precision grinds to extreme ends of both left or right twist reel blades. Bottom knife is held in same brackets for sharpening. No extra attachments required for grinding. Hand, power, gang or fairway units sharpened equally fast . . . equally easy for greater profits. Anyone can operate the Modern Lawn Mower Sharpener. It is simple in design and simple to operate. Send for details today!

START YOUR OWN BUSINESS TODAY

SMALL SPACE REQUIRED - SMALL INVESTMENT

Take steps today to start your own business. Send for **FREE** bulletin on Modern Lawn Mower Sharpener plus **FREE** booklet on how to organize your business plus ideas and plans for future expansion. Paste completed coupon to penny postcard and mail today!

**MAIL
TODAY**

**MODERN MANUFACTURING COMPANY
160 N. FAIR OAKS AVE., PASADENA 1, CALIF**

Gentlemen: Please send me your **FREE** booklets No. 10 and 10A.

NAME _____

ADDRESS _____

CITY _____ STATE _____

better than 500 miles an hour with propellers quite similar in appearance to wartime paddle-blade designs. More powerful turbines already on the way point to propeller-equipped fighters as fast or faster than the Douglas Skystreak.

George W. Brady, chief engineer of Curtiss-Wright's propeller division, thinks there are two ways of suitably improving prop designs for the fast planes just around the corner. One is to use thin blade sections, and the other a more radical idea for exposing to the wind stream only those parts of the propeller that produce thrust. Brady visualizes an interesting fanlike arrangement, as shown in the drawing of a future gas-turbine propeller.

A cross section of the hub portion of this propeller would reveal a double spinner (another NACA development), with the regular spinner inside a larger spinner whose lines flow nicely into the lines of the airplane fuselage. Between the two spinners is a passage to permit the flow of air to the turbine. Thus, the propeller-blade shanks would be entirely removed from the air stream. With a three-foot-diameter spinner, the eight-bladed prop would absorb 8000 horsepower with an efficiency of 81.5 percent at 500 miles an hour, and 74.5 percent at 700 miles an hour. As many as 10 blades may be used. The relatively small diameter of 10 to 12 feet compares with wartime designs.

The peculiar operating characteristics of the turbine affects propeller designs and even the installation of the power plant itself. Since a turbine operates most efficiently at the maximum number of revolutions per minute permissible for continuous operation, one proposal calls for a "double turbine" driving one propeller, the idea being to declutch one turbine when the plane reaches cruising altitude.

Because of widespread feeling that the turbojet will replace the propeller on all high-speed aircraft, it is interesting that the theoretical turbine-propeller fighter greatly outperforms the pure jet with the same power plant at the same rate of fuel consumption. The speeds are approximately the same but the propeller version takes off in half the distance, climbs twice as fast, and can turn 1200 feet inside the jet job at a practical maneuvering speed of 350 miles an hour.

Although odd blade shapes and other radical developments catch the eye, many other important strides are being made in the propeller world. Typical is the Hamilton Standard hollow steel blade, which provides reasonable lightness with great

(Continued to page 256)



HERE'S
WHAT YOU
GET!

a new Ferret Set

by **Snap-on**

A new design... strong... adaptable...
they squeeze into close places easily

(All units $\frac{3}{8}$ " Square Drive)
 $\frac{1}{4}$ " and $\frac{5}{16}$ " Single Broached Sockets
 11 — Double Broached Sockets
 from $\frac{3}{8}$ " to $\frac{7}{8}$ "
 1—Speeder Wrench 1—8" Ratchet
 1—Sliding Tee 1—Nut Spinner
 1—Universal Joint
 3", 6", and 12" Extensions
 —Complete in a metal box,
 19 $\frac{1}{2}$ " x 5 $\frac{3}{4}$ " x 1 $\frac{3}{8}$ " — specially
 designed for this set.
 Rich red enamel finish.

Yes, a new Ferret Set . . . new in design . . . way over par in performance — and they're twice as strong as you would expect such slim, slender handles and thin-walled sockets to be.

They squeeze into tight places and get those hard-to-reach nuts and bolts that defy the ordinary type wrench. Newly designed by Snap-on engineers, they make quick easy work on many of the tough jobs on modern motors and engines.

Be sure to ask your "Snap-on" man to show this set the next time he calls.

SNAP-ON TOOLS CORPORATION

8062-B 28th Avenue • Kenosha, Wisconsin
 INTERNATIONAL DIVISION: KENOSHA, WISCONSIN, U. S. A.



Now save as you shave

STROP YOUR RAZOR AS A BARBER DOES!



STROPS—CLEANS WITHOUT REMOVING BLADE

RAZOR, STROP AND 5 VALET BLADES

\$1.25

SELF-SHARPENING . . . ONE PIECE

READY CUT HOMES

Order Now

Homes \$1655.00 and up, freight paid. Orders filled in order received. Save \$500 at least on modern production method with builders' prices compared with builders' prices. Anyone can assemble. Complete. Plans furnished. Hardware, roofing, glass, nails, etc. Send 35c in coin for full color catalogue showing 57 modern low-priced homes and floor plans. Complete building plans ready for filing at low cost. Sold separately if desired.

Dept. PM-28
INTERNATIONAL MILL & TIMBER CO.
Bay City, Mich.

NEW COLOR CATALOG FOR ONLY 35c

V-8 DUALS & SINGLES

MUFFLERS

STEELS and ALUMINUMS with a motorboat tone

SINGLES, Chev., V-8, Plymouth, Steels \$5.50, Aluminum \$7.00. Chry., Olds., Buicks, etc., Steels \$7.50, Aluminum \$9.00. V-8 and MERCURY DUALS, Steel \$17.50, Aluminum \$21.00. Split Manifold Sets, Steels \$35.00, Aluminum \$45.00. Aluminum is guaranteed for life of your car.

DEALERS WANTED

SANDEE MUFFLER CO.
BOX 296 LA TIJ., LOS ANGELES 43, CALIF.
2624 W. SLAUSON AVE., LOS ANGELES, CALIF.

4 WHEELER (Illustrated) \$175

2 WHEELER \$125

WATSON DOUBLE-ACTION HYDRAULIC TRAILER DOLLY

60 miles per hour SAFELY — all day

THE WATSON AUTOMATIC MACHINE CO.
Glendale, Calif. Mansfield, Ohio

FURNACES FOR HOME AND SHOP

REALE-HEAT furnaces. Full line. Gas and oil circulating heaters and floor furnaces. Burners and Blowers. Of interest to Contractors and Builders. Dealers Franchises. Write for free details.

Peerless Sales
4318 Sheridan Lincoln 6, Nebr.

Amazing Lens Invention Makes New Advertising Sign Brilliant as Neon!

COSTS ONLY 1/2 AS MUCH!

600 POWERFUL Magnifying Lenses to EVERY SQ. INCH!

Center of every letter is clear so light shines through. Translucent edges give "aura" effect of Neon.

Choice of Thousands of Different Glass Panels

CHANGE ADVERTISING MESSAGE IN 10 SECONDS!

AGENTS! Fast Sales In Every Kind of Retail Store. Big Profit on Every Sale!



A FEW years ago, men who got in on the "ground floor" with Neon, cleaned up millions. Today, a few wide-awake men are offered a chance to cash in on another advertising opportunity that may be even bigger—a "once-in-a-lifetime" chance to get in on the "ground floor" with the new Fluorescent MAXILUME Business

Bullder—the advertising Display Sign that can change sales messages in 10 seconds! Here is an invention as startling, as revolutionary as Neon was 10 years ago. For it offers all the advantages of Neon at 1/2 the original cost and at an operating cost of only 2c a day!

FREE! Send Name for SAMPLE OFFER and FREE SELLING OUTFIT.

Every retail store, every large manufacturer, every advertiser in the United States is a prospect for one to 100 or more Business Builders. Space does not permit printing all facts. But if you want big,

quick profits in volume you never dreamed of, you'll get the facts in a hurry! Don't send a penny. Just your name on a penny post card brings Free Selling Outfit. Do this quick—for the biggest cash clean-up in the history of Direct Selling!

MAXILUME COMPANY, 125 W. Hubbard, Dept. 82-A, CHICAGO 10, ILLINOIS

Logan

A NAME TO REMEMBER WHEN YOU
THINK OF BETTER LATHES AND SHAPERS

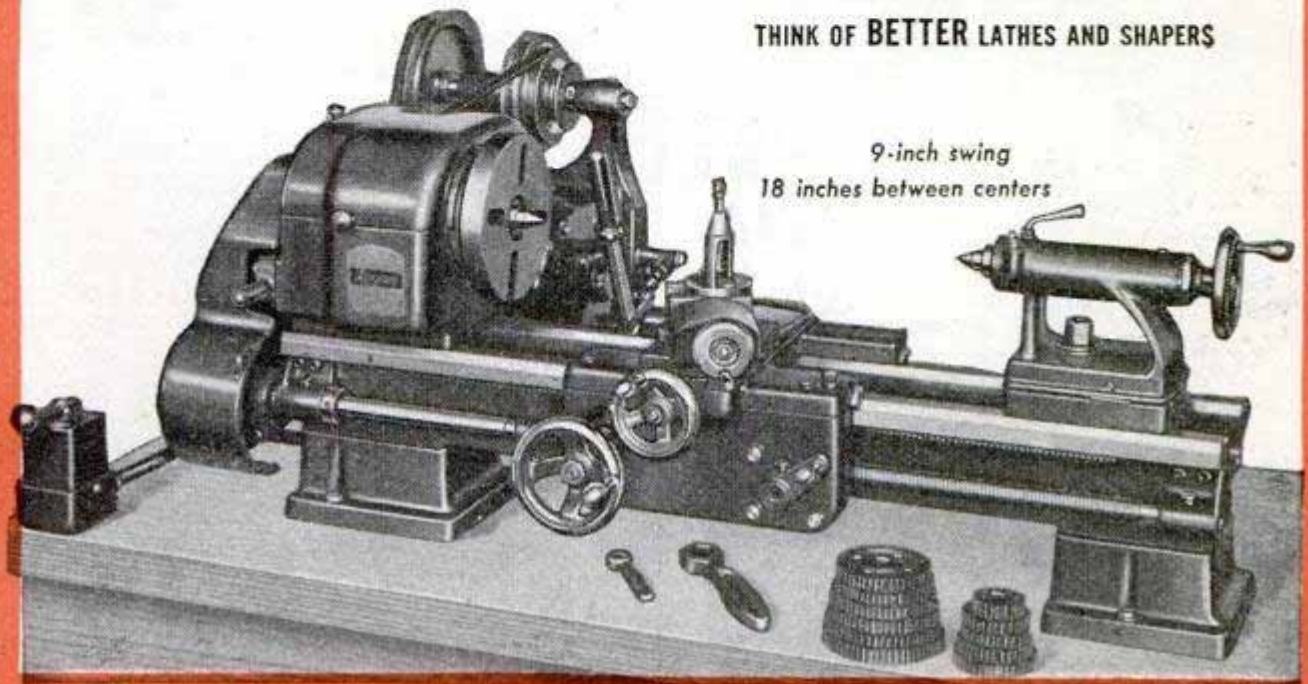

**A LATHE TO
DEPEND ON**

Logan Ruggedness
and Lasting Accuracy
... at \$159⁵⁰

This compact Logan 9-inch Lathe handles manufacturing operations with the same speeds and precision that make the larger Logan Lathes outstanding in industry. For general machine shop and tool room work, farm equipment maintenance, and home workshop projects, it is equally effective. The ball bearing spindle mounting, the self-lubricating bronze bearings at other vital points, and the V and flat bed ways precision ground to within .0005" of parallelism are typical of Logan advanced design. Rugged, rigid construction makes it steady on heavy cuts. See this outstanding 9-inch lathe at your Logan Lathe dealer's or write for information.

DISTRICT OFFICES: WOOLWORTH BLDG. 550 W. WASHINGTON BLVD. 1672 MISSION STREET 700 COMMERCE ST.
NEW YORK 7, N. Y. CHICAGO 6, ILLINOIS SAN FRANCISCO, CALIF. DALLAS 2, TEXAS
CO 7-8024 CENTRAL 1246 UNDERHILL 6682 CENTRAL 4075

LOGAN ENGINEERING CO., Dept. BB-2, CHICAGO 30, ILL.

MORE TIME for FUN-

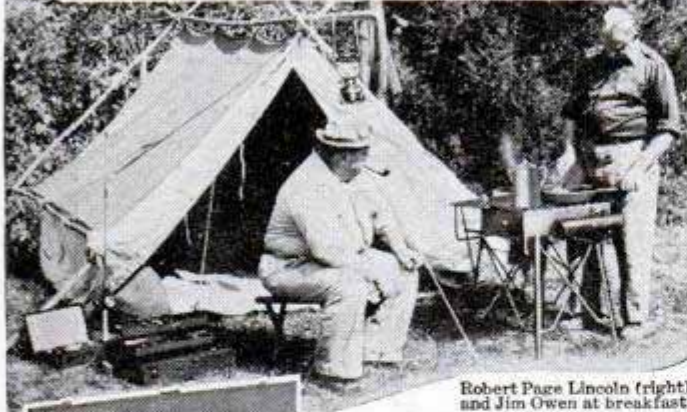

Robert Page Lincoln (right) and Jim Owen at breakfast.



**-When You
COOK
WITH A**

Coleman

Folding CAMP STOVE



Easy to Carry

Lights Instantly

"It's the Best of All Outing Pals!"

—says Robert Page Lincoln, famous outdoorsman, writer and authority on hunting and fishing.

"I was one of the first advocates of the use of the Coleman Stove and Lantern. The gleam of the Coleman Lantern in camp at night and bacon frying on a Coleman Stove are what I call 'tops'!"

COOK with GAS—Anywhere

The Coleman Camp Stove makes and burns its own gas from gasoline—cooks like city gas! Just set up—light up—and you're cooking. Two big windproof burners—easily removable tank. Ask your dealer for a demonstration!

FISH LATER—Have More Luck with a Coleman Floodlight LANTERN

You don't have to hurry back to camp at nightfall—the Coleman Floodlight Lantern—big, high candlepower light—will show the way. Safe, stormproof! See it at your dealer's.



**Coleman STOVES
LANTERNS**

THE COLEMAN CO., Inc., Wichita 1, Kansas

**FREE
FOLDER!**

THE COLEMAN CO., Inc.
Dept. 231 PM, Wichita 1, Kansas
Send me your folder on the Camp Stove and Lantern—no obligation.

NAME _____

ADDRESS _____

Help Prevent Forest Fires — COOK SAFELY

strength for the blade's large area. Its sponge-rubber filling has been heated and expanded to form a light, hard mass that prevents the blade's thin walls from "breathing" or moving in and out. Through the sponge rubber runs a fine network of electric wires which heats the leading edge of the blade for de-icing.

Curtiss-Wright solves the same problem by feeding heated air into the hollow blade. Fast automatic feathering devices now turn the propeller blades edgewise into the wind, in case of engine failure, in far less time than it formerly took a pilot to react and move the feathering controls. But no pitch-changing or governing device now in use will do for the turbine.

The kinetic energy of the whirling mass of the turbine makes it impossible for this type of power plant to respond quickly enough to changes in speed control. Pitch changing on present-day propellers is taken care of automatically by oil pressure or by electricity. Some entirely new system must be devised for the turbine's propeller.

A pilot may want emergency power to correct a faulty landing approach. Since the turbine responds very slowly, it will be necessary for a pitch-changing device to function within one second to allow the turbine pick up before the plane strikes the ground. Such problems will be solved. Meanwhile, don't count the propeller out.

As one engineer told us, "A propeller blade is only a wing spinning in the air to develop thrust. Since it is a wing, you will find it around just as long as airplanes have wings. Anything they can do to a wing we can do to a propeller blade."

Hand-Carved Circus

(Continued from page 162)

the long pole wagon, band, ticket, dressing wagons, water, seat, calliope, baggage and the corral (horse) wagons. Altogether, there should be about 70 of them.

In World War II the Army went to the circus to learn efficiency in setting up and breaking camp, and your model circus must also be a model of efficiency.

The poles which the pole wagon carries must be right to support Neumann's 5 by 14-foot big top, with its 7500 seating capacity. The seats and the bleacher supports must fit precisely into the seat wagon, just as they do in the real circus, and they must be made for quick assembly on the lot. Packing 18 sections of the main tent into canvas wagons is an exacting job.

All the little gadgets must work. Doors must open; wagon tongues, numbered to

(Continued to page 260)



Moto-Tool

THE "POCKET-SIZE MACHINE SHOP"

A TESTED TOOL THAT PACKS YEARS OF PLEASURE

Grinds, Routes,
Drills, Carves,
Engraves, Cleans,
Polishes, Finishes

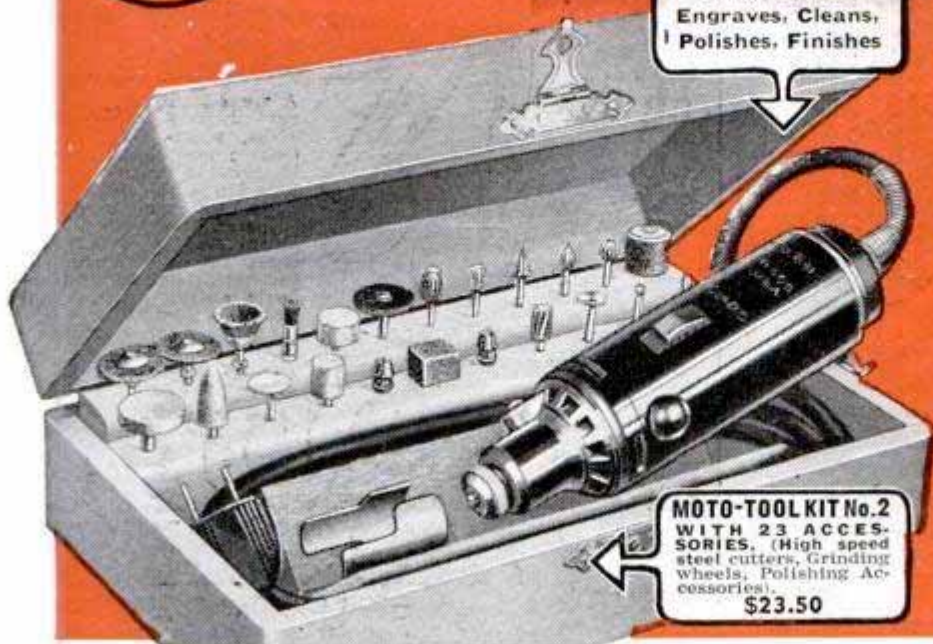

MOTO-TOOL KIT No. 2
WITH 23 ACCESSORIES. (High speed steel cutters, Grinding wheels, Polishing Accessories).
\$23.50



MOTO-TOOL No. 2
WITH EMERY POINT
\$16.50

MOTO-TOOLS have the Right Speed for efficient operation. Approximately 27,000 R.P.M. CUTS CLEANER—SAVES CUTTERS.

If you get a kick out of making things, you'll want a Moto-Tool . . . it does work better, faster . . . on practically any material. High speed plus dynamically balanced armature provides vibrationless finger-tip control. As a "War Veteran," Moto-Tool served in every branch of the Armed Forces. Compare Moto-Tool with other grinders and see for yourself why it's better.

MONEY-BACK GUARANTEE

Buy Dremel Moto-Tool from your dealer. If he cannot supply you, use coupon below to order on 10 day trial, money-back guarantee. Shipped postpaid for payment in full (send check or money order); or send only \$2, we will ship C.O.D. You pay postman balance plus postage.

DREMEL MFG. CO., Dept. 118-B, Racine, Wis.

14 REASONS WHY MOTO-TOOL IS A BETTER BUY

- Patented automatic chuck lock pin.
- Instant-action, wrenchless chuck.
- Oil-less, sealed, trouble-proof bearings.
- Oversize armature shaft, hardened, ground and polished.
- 110-volt, universal type motor.
- Easily replaced commutator brushes.
- Dust-filtered air-cooling system.
- About 27,000 R.P.M. Cuts cleaner . . . saves cutters.
- Sturdy, shockproof bakelite housing.
- Housing has "pencil-type" finger grip.
- Sliding snap type switch.
- Handy hanger hook; cord protector.
- Weighs only 13 oz. . . . shaped to fit the hand.
- Dynamically balanced for vibrationless operation.

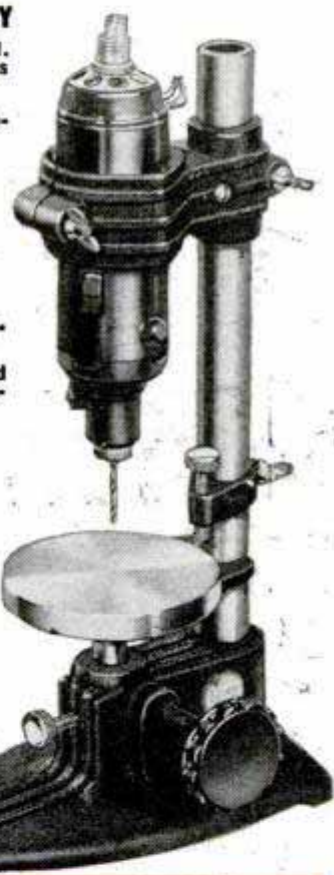

HERE'S BIG VALUE!

MODEL No. 1
MOTO-TOOL KIT
ONLY
\$17.50



This highly popular Kit contains Model No. 1 Moto-Tool and 34 practical accessories in attractive, lacquer-finish wood box. It's the biggest bargain in the field.

New
DREMEL DRILL PRESS
ONLY **\$9.95**
Less Moto-Tool

Owners of Moto-Tools will find the new Dremel precision Drill Press indispensable for handling fine work such as creating costume jewelry, model making, wood carving, routing, etc. Sturdy tool clamp accommodates Model No. 2 Moto-Tool. Power unit can be raised or lowered, swung in any direction or quickly removed for regular off-hand use in a few seconds.

IF YOUR DEALER CANNOT SUPPLY YOU, USE THIS COUPON TO ORDER

DREMEL MANUFACTURING COMPANY

DEPT. 118-B

RACINE, WISCONSIN

- Enclosed find \$_____ (Check or money order in full). Ship items checked below at once Postpaid.
- Enclosed find \$2.00 as part payment on items checked. I will pay postman balance plus postage upon C.O.D. delivery.
- Moto-Tool Kit No. 2 **\$23.50** Model 2 Moto-Tool **\$16.50** Moto-Tool Kit No. 1 **\$17.50** Model 1 Moto-Tool **\$9.85** Dremel Drill Press (Less Moto-Tool) **\$9.95** Free catalog of Dremel Tools and Equipment.

NAME _____ ADDRESS _____ CITY _____ STATE _____

HERE'S VALUE
Smooth Running... Vibration Free
TOMLEE JIG SAW



Weight
90 lbs.

PRICE
\$47.50

F. O. B.
Minneapolis

AVAILABLE NOW!

Vibration free action with adjustable blade to cut from front or side. Heavy cast iron construction makes a sturdy and serviceable tool.

- ★ Solid Cast Iron Construction
- ★ One-Inch Stroke
- ★ Cuts Two-Inch Lumber
- ★ Oilite Bearings
- ★ Runs in Crank Case of Oil
- ★ 45° Tilting Table
- ★ Table 10½" x 10½"
- ★ Three-Point Mounting

Available at Hardware Stores

TOMLEE TOOLS

THE BIG VALUE LINE

Tomlee Tool & Eng. Co., 740 No. Washington Ave., Minneapolis 1, Minn.

YOUR "STARS" Really SHINE



SCREEN

DA-LITE CHALLENGER
The preferred tripod screen for homes, schools, industry. Quickest set-up. Instant "Slide-A-Matic" locking. Handsome, sturdy, octagon case. Lightest weight.

Da-Lite's multi-layer Pyroxylin-faced, Crystal-Beaded fabric makes all pictures—movies or slides—"come to life" with sparkling brilliance. Built right by pioneers who have led in screen improvements for 39 years. Priced below 10 years ago.

Write for new **FREE** book on *Da-Lite Screens*, (41 sizes); has projection data and size charts.

DA-LITE SCREEN CO., INC.
2721 N. Pulaski Rd., Chicago 39, Ill.



WORLD'S LARGEST SELLING SCREENS SINCE 1909

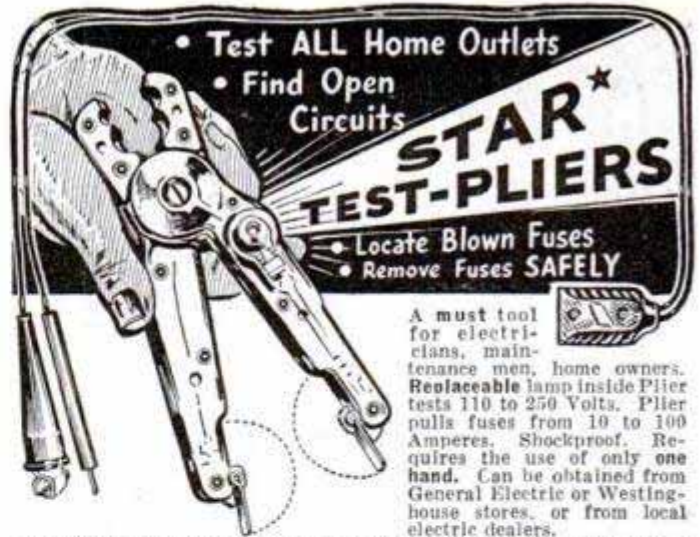

- Test ALL Home Outlets
- Find Open Circuits

STAR TEST-PLIERS

- Locate Blown Fuses
- Remove Fuses SAFELY

A must tool for electricians, maintenance men, home owners. Replaceable lamp inside Plier tests 110 to 250 Volts. Plier pulls fuses from 10 to 100 Amperes. Shockproof. Requires the use of only one hand. Can be obtained from General Electric or Westinghouse stores, or from local electric dealers.

Price \$2.75 without Leads, \$1.50 additional for Leads. Order TODAY.
STAR FUSE CO., 233 Canal St., New York 13, N. Y.

MEAD AIR PRESS

—FOR GREATER PRODUCTION!



For greater production at less cost, use Mead Air Press. Hundreds of industrial plants now employ them for staking, crimping, assembly and similar operations. Large model delivers 1200 lbs. pressure on 100 PSI, 7½" clearance — small model delivers 400 lbs. pressure on 100 PSI, 4" clearance. With foot control these presses speed up countless bench jobs, save muscular effort. Write for Free **MEAD AIR POWER CATALOG** of Air Presses, Air Vises, Air Collets, etc.

MEAD SPECIALTIES CO.

4114 No. Knox Avenue, Dept. PM-28
Chicago 41, Illinois

CIRCUIT TESTER

CAN BE USED IN PLACE OF MULTIMETER!



Complete with instruction book! **\$395**
TESTS: Indicates AC and DC Voltages • Fuses • Resistances of Circuits • Capacitors • etc. Unit in small, strong metal box. Weighs approx. 2 lbs. Test leads provided. Power may be supplied to test unit from 115 to 130 V. AC or DC. New. Shipped in original Sealed Metal Containers! Shipping Wt. 3¼ lbs. F.O.B. Chicago, Ill.

SCHUH'S RADIO PARTS 1253 Loyola Ave. Chicago 26, Ill.

NEW STOP LIGHT Auto FLASHER



For Fast, Snappy Drivers

Makes your Stop Light Shout. Flashes 115 times a minute. Fully automatic when brake is applied. Approved by leading Safety Engineers. **INSTANT ACTING.** If your dealer can't supply you, send check or M.O. for \$3.00. We pay postage. Dealers and Agents desired.

Patented. **MACCHI and COMPANY**
Simple to install. 927 Larkin Street • San Francisco 9, California

ACE LATHE TOOL SET



Be permanently tooled-up for every operation on your Metal Cutting Lathe

The ACE Set is complete—there's nothing more to buy. Drop forged by the manufacturers of cutting tools used by 96 per cent of the plants and shops in industry they are correctly designed, are of special steel, are finely finished, are stronger—will last a lifetime. You can cut easier, faster and more accurately with ACE TOOLS.

At your Hardware Store—

ARMSTRONG BROS. TOOL CO.

"The Tool Holder People"

5268 W. Armstrong Ave., Chicago 30, U.S.A.

- 3 Tapering Tools, 2 Cutting-off Tools, Knurling Tool, Boring Tool, Threading Tool, High Speed Steel Cutters and Blades, and 2 Wrenches in Fitted Steel Case.

SOUTH BEND LATHE COLLETS



Steel and Brass Collets for use in any make of lathe or other machine that they will fit.

SPECIFICATIONS

Collet No.	Thread Dia. In.	Thread Length In.	Th'ds Per In.	Body Dia. In.	Collet Length In.	Head Dia. In.	Head Taper Deg.
3	.650	3/4	26	.6495	2-11/16	.852	12
2	.855	13/16	20	.8595	3-5/16	1.095	15
5	1.250	3/4	20	1.2495	3-9/32	1.452	10
4	.950	13/16	20	.9495	3	1.150	10

	No. 3	No. 2	No. 5	No. 4
STEEL COLLET	\$3.75	\$4.00	\$4.75	\$4.25
BRASS COLLET	2.00	2.25	2.50	2.35

SOUTH BEND LATHE WORKS 455 E. Madison St. South Bend 22, Ind.



ASSORTED SPRINGS
FOR REPAIRING
AND REPLACING

\$1.10
POSTPAID

handy **SPRING kit**

Wide assortment of compression, extension and torsion springs—just what you need for a multitude of odd jobs requiring use or replacement of springs.

High quality—some springs that are made for topnotch manufacturers to their rigid specifications. Several dozen springs in kit.

Have the Handy SPRING Kit handy. Send a check or money order right now to Department B

NEW ENGLAND SPRING MFG. CO.
Unionville • Connecticut

SUPER JET BLOW TORCH

ONLY \$1.

1000 USES WITH AMAZING NEW DRY FUEL BLOWTORCH

It's Here! The tool that amazed famous science editors! Perfect for soldering, silver soldering, hardening or annealing small parts! Used and praised by model-makers, electricians, jewelers, mechanics, chemists, inventors, schools! 10 minutes intense heat (over 2000°F) with each tablet! Solid brass torch, air cooled handle, clear plastic tube. Guaranteed! Order Yours Today!



MAIL ORDER TODAY!

Send \$1.35 for torch, 12-tablet fuel box, mailing costs. No CODs. Wholesale Areas Open

BIRK MANUFACTURING CO. 552 HILLS STREET L. HARTFORD, CONN.

A. C. CURRENT ANYWHERE!

WITH
Katolight Plants and Generators

Furnish the same kind of Current as the highlines. Sizes 500 watts to 100 KW. Also Manufacturers of Rotary Converters, Frequency Changers, 32 and 110 Volt D.C. Motors in 1/4, 1/2, & 1 1/2 H.P. A.C. Motors (high line) in 1 1/2 and 2 H.P. only.

KATOLIGHT 1402 First Avenue MANKATO, MINN.

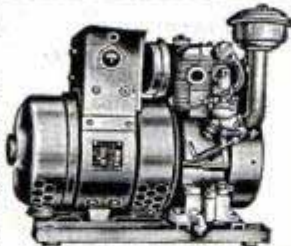

LAW

STUDY AT HOME for PERSONAL SUCCESS and LARGER EARNINGS. 39 years expert instruction—over 108,000 students enrolled. LL.B. Degree awarded. All texts furnished. Easy payments. Send for FREE BOOK, G. I. approved.
AMERICAN EXTENSION SCHOOL OF LAW
Dept. 86-M, 646 N. Michigan Ave., Chicago 11, Ill.

WOODWORKERS ... Get this
CONSTANTINE MASTER MANUAL

Get the Most Fun From Your Hobby
Indispensable to woodworkers. Newest, biggest edition, more pages, more color, helpful how-to-do-it articles, pre-war and new items, more bargains. Send 25c today and we will include **FREE! FULL YRS. SUBSCRIPTION** to Chips and Chats, published bi-monthly. Keeps you up-to-date on everything in woodworking, offers big money-saving bargains. Send now.

ALBERT CONSTANTINE & SON, Inc.
791-P 135th Street, New York 54, N. Y.



Simoniz Your New Car... From the Start!



Simoniz Keeps Colors from Fading ... Protects and Makes the Finish Last Longer

The sooner you SIMONIZ your new car the better! Your new car needs finish protection now ... to "build up" the beauty ... to give it brilliant beauty from first mile to last. SIMONIZ protects the finish from road grime and grit that scar ... against corrosive airborne chemicals that dull and destroy. SIMONIZ saves car washings, too. Dust and dirt wipe off easily with a cloth. Remember, you can SIMONIZ your car only with genuine SIMONIZ and Simoniz Kleener. Insist on them always!

LIQUID SIMONIZ KLEENER is wonderful for cleaning quickly new cars or those with finishes in average condition. Paste Simoniz Kleener cleans, restores lustre and makes dull cars look new again. Then apply SIMONIZ to make that restored beauty last years longer.

THE SIMONIZ COMPANY, CHICAGO 16, ILLINOIS



Motorists Wise

SIMONIZ

TRADE MARK REG.

KEEPS NEW CARS ... NEW LOOKING



in Reliability

AC Spark Plugs are engineered to the equipment specifications of car and truck manufacturers—which explains why more than 50% of new cars and trucks leave the factory equipped with AC plugs. AC's give you wider Heat Range per plug—greater freedom from oil and oxide coatings—the utmost in spark plug reliability.

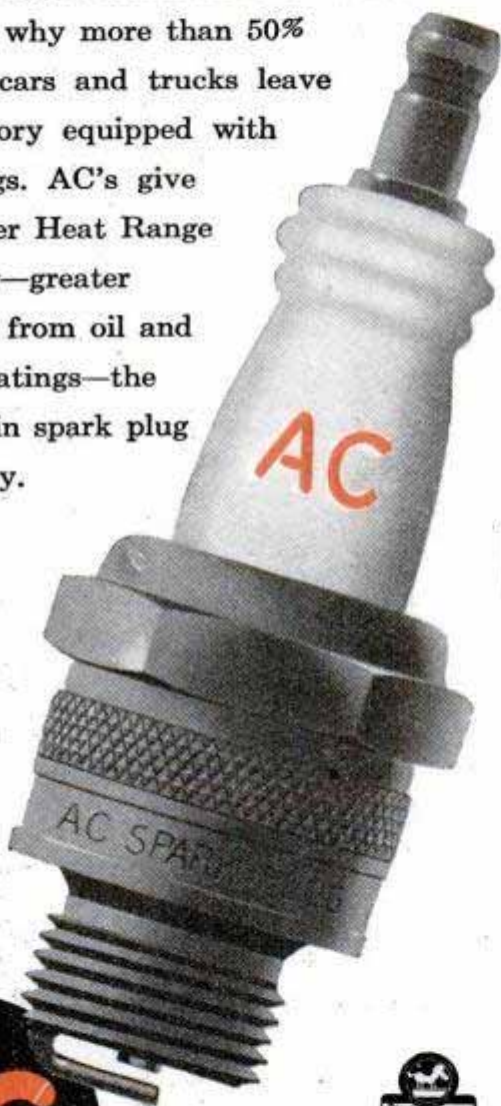

FIRST IN SERVICE, TOO

Your AC dealer will check your spark plugs to see that they are of the right Heat Range.

wagons, must be removable for storage aboard the circus train; wheel trucks must also be detachable. Much of the authenticity comes in duplicating exactly the small equipment, apparatus and furnishings like tools, lot stakes, flares, ladders, block and tackle, rings and ring tubs.

Animals are difficult to carve, and a lot of them are necessary. Neumann's circus will need 40 teams of heavy horses, mostly Belgians; at least 15 wild animals for the cages, a 30-elephant herd and scores of other performing animals.

Construction of the circus train takes the hobbyist into model railroading, a hobby in itself.

Probably the easiest method of turning out the hundreds of human performers, workmen and audience is to carve a number of each in different poses, make plaster molds, and then cast them in lead.

If you're still a member of this world after all that, you can start "setting up" for the neighborhood kids.

Testing Ground for Grass

(Continued from page 168)

water at an average speed of eight feet per second. Because of Bermuda grass' tough roots, which form a durable matting, less than 1/4 inch of soil was lost.

In contrast with a sod-forming vegetation like Bermuda, "clump" grasses like buffalo grass offer only about half the protection. Water begins to scour on the upstream side of the clumps, and gulying starts. One of the better "clump" grasses, however, is weeping lovegrass which is easily established, produces a good hay or pasture crop and sometimes a valuable seed crop. If used in a drainage way, its limitations must be considered and the waterway designed accordingly. Even an excellent gripper like Bermuda grass has its maximum capacity.

Best method of propagating Bermuda grass in runoff channels on a farm is to plow the bottom of the channel, disk in a quantity of roots raked from any other area where this grass grows, roll, fertilize and water. In about a year the cover will have grown high enough to check erosion. Where speedier growth is required, sod from other areas is cut in strips and laid in place.

Where Bermuda grass is not available, other grasses were found to be fairly suitable in the following areas of the United States: buffalo grass—Texas, Oklahoma; Kentucky blue grass—Missouri, Ohio, Kentucky, Wisconsin; centipede grass—

(Continued to page 264)

Now!
Set of
7
STRIPE
SIZES
at a
BARGAIN
PRICE

PAINTERS' STRIPING TOOL

Now you can paint 7 stripe widths on furniture, bikes, model planes, bulletins, wall board . . . make plain walls look like tile! Easier than using a pencil! Straight, curved, circular, even parallel stripes made expertly in any color! Regular price Type "M" Tool with tip for 1/16" stripe \$1.00. Extra tips 1/64", 1/32", 3/64", 1/16", 5/64", 3/32", 1/8" - 75c each. Special offer: Tool with complete set of 7 tips \$5.00. (C.O.D. orders 25c extra.) WENDELL MFG. CO., 4234-B Lincoln Ave., Chicago 18, Ill.

A TOOL . . . NOT A BRUSH



WITH 7 TIPS
\$5 POST PAID

Dealers Write Today!

SOLID BRASS 12 FT. PORTABLE RADIO ANTENNAS

Real \$15 Value Now Only \$4.95 Postpaid FOR HOMES, BOATS or AUTOS

JUST OUT! Gov't surplus used on Army tanks. These telescopic rustproof antenna have tremendous pickup eliminate dangerous wiring. Solid Brass throughout practically insuring NOISE FREE RECEPTION.

12 Exceptionally Rugged Sections compress into 1 ft. 4 in. Handy for Camping Trips, also Useful for Transmitting, FM & Television sets. Each antenna comes with clamps, nut, lug, and wire. Easy to install anywhere.

QUANTITY LIMITED
ORDER TODAY. A real \$15 value for only \$4.95 Postpaid. Mail check or money order now or sent C.O.D. plus postage. Money back in 10 days if not satisfied.

RADIO HOSPITAL 442 East 86th St., Dept. A-14 NEW YORK 28, N. Y.

NEW! DRILL PRESS PLANER

Planes - Rabbits - Tenons - Panels - Routs

NO HONING - NO ADJUSTING

Designed on an exclusive principle with a continuous cutting edge, it will not tear or gouge. Replace 5/8" band saw in 2 minutes. 2 3/4" planing area - fits 1/2" chuck. Write for literature on other time-saving tools.

MASTERCRAFT Boston, Mass. \$650



GOODBYE to BURGLARS

Protect your belongings and the lives of your family. Send \$1.50 (or 7/6) by International Money Order for complete plans for combined burglar alarm and automatic locking device (electrical). It's unique. You make it from scrap.

SAFETY INVENTIONS, 110 Cranbourne Ave., Benoni, South Africa

WHEELS AT BARGAIN PRICES

- ... 4" wheel & tire, 5/16" sleeve bearing & hub cap . . . \$0.45 ea.
- ... 5" wheel 5/8" solid tire 5/16" shaft hole . . . 0.65 ea.
- ... 6" wheel 5/8" solid tire 5/16" shaft hole . . . 0.75 ea.
- ... 7" wheel 3/4" solid tire 3/8" shaft hole . . . 0.85 ea.
- ... 8" wheel 1" solid tire 1/2" sleeve bearing . . . 1.25 ea.
- ... 8x2" wheel, semi-pneumatic tire 7/16" ball bearing . . . 2.50 ea.
- ... 10x1.75 wheel semi-pneumatic tire 7/16" ball bearing . . . 3.25 ea.
- ... 12x1.75 wheel semi-pneumatic tire 1/2" bronze bearing . . . 4.00 ea.
- ... 10x2.50 wheel semi-pneumatic 1/2" ball bearing . . . 4.50 ea.
- ... 6x2" wheel 5/8" ball bearing, solid tires . . . 3.95 ea.

BUILD YOUR OWN - Wagons - Scooters - Soap Box Racers - Welding Carts - Baby Pens - Etc.

To order above wheels write number wheels wanted in space provided, tear out and mail this ad with check or money order and your name and address. If other sizes are wanted write for FREE LIST.

TRULSON MFG. CO., 811 E. 31 St., Dept. PM 12, Kansas City, Mo.



Home Craftsmen—here are the Blue Star High Quality Tools you have been waiting for—tools that have served thousands of satisfied customers since 1921 — your guarantee of complete satisfaction.

★ 8-INCH TILTING ARBOR TABLE SAW

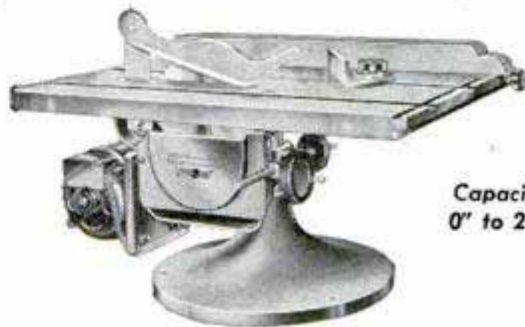

Capacity: 0" to 2 1/4"

High quality table saw of rugged cast-iron design for lasting and accurate performance. Ball-bearing tilting arbor construction with right and left hand gauges each 10" long; large 26" x 20" table; long rip fence with accurate gauge; and interchangeable throat blocks for dado head. A favorite tool among discriminating users.

★ 12-INCH TILTING TABLE BAND SAW

Capacity: 6 inches thick



Large production Band Saw, but priced far below what you would expect to pay. An 11" x 13" table tilts full 45° and locks rigidly at any angle. Cast-iron stand provides rigid base; simple to adjust, safe to operate.

★ 4 1/2-INCH JOINTER

New rugged, oversized machine of advanced design. Has exclusive new dial indicator for quickly and accurately adjusting depth of cut. Solid steel cutter head fitted with high speed Tungsten steel knives rotates at 5000 r.p.m. Extra long 22" table—large 4" x 22" fence.



Capacity: 3/8" deep—4 1/2" wide

Write at once for literature and prices.

BLUE STAR PRODUCTS

617 W. KIRKWOOD ST., FAIRFIELD, IOWA

FOREDOM FLEXIBLE SHAFT MACHINE

only
\$19.95

with **PENCIL SIZE HANDPIECE**
for **Finger-Tip Control**

Works effortlessly and with marvelous ease. Tens of thousands of users attest to its infinite superiority over other small grinders. Affords you vastly more satisfaction and fun.

5 REASONS WHY FOREDOMS ARE TOPS IN THE FIELD:

1. Extra power and longer motor life because motor not dwarfed to fit hand. 2. Correct handpiece size for deft, sensitive, finger-tip control. 3. No obstructed view of your work. 4. Freedom from gyroscopic action—hence better work. 5. Small handpiece size lets you get into hard-to-reach places.

Hundreds of Uses

Foredoms handle hundreds of tasks. Use them for pleasure or profit, for tinkering or expert craftsmanship. Their versatility is unlimited. Use them to grind, polish, mill, engrave, sharpen, slot, rout, saw, carve, clean, sand, etch, cut, etc. Ideal for internal carving of plastics, the astounding new craft. You can work on wood, glass, plastics and all metals with a Foredom.

OVER 60,000 FOREDOMS NOW IN USE

The power grinder you'll eventually buy if you want true operating ease and results which genuinely satisfy. Foredom's quarter century experience in building fine tools for home and industry is your assurance of superior performance.



37"
FLEXIBLE
SHAFT

USES
HUNDREDS OF
ACCESSORIES

PENCIL-SIZE
HANDPIECE

Order your Foredom today, direct on 10-day trial. Send check or M.O. for \$19.95 (price not increased since OPA) and we send postpaid in U. S. or send \$2.00 and you pay postman balance plus postage. 50-piece accessory set \$1.50 extra. Catalog on request.

FOREDOM ELECTRIC COMPANY, Dept. F113
27 Park Place • New York 7, N. Y.

GARDEN-ALL DOES EVERYTHING

... every gardening operation ...
grass cutting ... snow plowing!



Garden-All
LAWN and GARDEN TRACTOR

See it
before buying!

There's
nothing at
all... like
**GARDEN-
ALL!**

Write for Folder

Garden-All does everything because Garden-All has everything—an attachment for every season. And, best of all, you can attach or detach any one of them in less than a minute. Garden-All is so sturdy, so versatile, so efficient! It's so ruggedly powered yet so economical to operate. And easy to handle, too! See Garden-All before you buy! Available with all attachments: Plow, Disc, Spike Tooth Harrow, Cultipacker, Seeder, Cultivator, Sickle Bar, Lawn Mower, Utility Scraper and Dump Trailer.

Excellent Dealer Territories Open. Write for Details.

GARDEN-ALL TRACTOR, INC.
Dept. P, 100 W. UNION STREET, LIBERTY, INDIANA

U.S. NAVY 7X50 PRISM BINOCULARS WITH COATED OPTICS



Used but in
Excellent Condition

\$95

Complete with leather
carrying case and sling

Universal, 6x30 Navy Prism Binoculars, used but in excellent condition, complete with leather case and sling straps. **\$42.50**

With Coated Optics, \$10 Extra.

Engineers All Metal Army Type Hand-Sighting

LEVELS

\$2.00

PRECISION
QUALITY



Send \$1.25 for 3rd Edition of Gun Digest with our complete catalog of new and used guns, etc. Our separate catalog 25c.

PUBLIC SPORT SHOPS

11 S. 16th St., Phila. 2, Pa.

No COD's



Save Up
to 75%

SURPLUS BARGAINS

New Precision Bilt MICROMETERS

Chrome finished, nationally known makes. Give a lifetime of accurate detailed service. Individually Boxed.

1" Central\$3.50 1" Reed\$3.75
1" Lufkin\$4.25 2" Reed\$5.25
4" Central\$6.25 6" Slocumb\$7.50

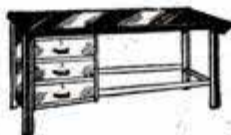

WORK BENCH

All Steel With 3 Drawers
Used — But Excellent Condition

(Govt. Surplus) A Heavy duty steel bench, 36" wide x 36" high x 72" long. Suitable for every type of bench work, home workshop, etc. Top 1/8" steel plate. 2 1/2" Angle iron legs. Shipping weight 340 lbs. They are not crated or knocked down. Prices FOB, K. C. **\$36³⁰**

Special Quantity Discounts. Write for Our New Catalog.

ATLAS SALVAGE & EQUIPMENT CO.

229 SW. BLVD.

KANSAS CITY, MO.

STAY HOME AND MAKE MONEY!

—Men! Women! Get into profitable, uncrowded profession you can operate from your home or small office after short home training course. No capital required. No goods to buy. No age limit. Others earn \$50.00 to \$100.00 per week making famous Stephenson corrective foot devices to order. Foot sufferers everywhere pay gladly for relief. Send today for FREE BOOKLET.

STEPHENSON METHOD, Established 1894, 12-28 S. Market St., Boston, Mass.



WAKE UP YOUR SCALP Want better looking hair? Embarrassed by falling dandruff, itching scalp? Then try VITABRUSH, new electric driven scalp brush that gives your scalp a vigorous and invigorating "workout" in just three minutes of fun. Cleans scalp. Stimulates blood supply. Restful. Pleasant. Write today for complete information and satisfaction-guaranteed offer. Hershey Mfg. Co., 3755 Field Bldg., Chicago 3

EARN BIG MONEY IN YOUR OWN BUSINESS Sharpening Lawn Mowers

BUILD A BUSINESS OF YOUR OWN WITH A UNIVERSAL GRINDER

In your basement or garage and earn \$150 a month. Mr. Felber of Ind. writes, "My UNIVERSAL GRINDER is faster and more accurate than any other grinder. Its efficiency enabled me to sharpen 450 mowers in 4 1/2 months. More than paid for itself the first month. Every customer satisfied." Mr. Hardy of Mississippi writes, "Received my Universal Grinder the first part of May and by August 18 had sharpened over 1000 mowers." Mr. Bacon of California writes, "The lawn mower business, with my Universal Grinder, has been a gold mine these last two years."



Only on the UNIVERSAL GRINDER can the inside face and edge of the stationary blade, as well as the reel blades, be ground to proper clearance

ALL IN ONE SET-UP

WITHOUT REMOVING ANY BLADE FROM THE MOWER

Write for Free Folder TODAY!

Rogers Mfg. Co., Dept. M-28, Lindsey, Ohio

Thompson BEATS the World on BOATS



Better Built Lower Prices



Canoes

Rowboats

Outboards

Safe Boats With Full Length Spray Rails

Keep passengers perfectly dry—even at high speeds. Catalog also shows two new models of "Take-Along" Boats. Two big factories—save you freight.

CATALOG FREE
Write for your copy. State kind of boat in which you are interested.

THOMPSON BROS. BOAT MFG. CO. (151)
213 Ann St. PESHIGO, WIS. Write to (either place) 113 Elm St. CORTLAND, N.Y.

SINGLE PHASE COIL HEAD



A fast and simple setup for winding single phase stator coils. Winds any length coils for motor slot length up to 6 inches, with 15 various widths. For motors up to 1 and 2 horse power.

The head is made of aluminum, weighing less than eight pounds. Has one inch hole and key-way for mounting on drive.

\$42.50

Immediate Delivery

FLETCHER ELECTRICAL SPECIALTY CO.
613 W. Pico Blvd., Los Angeles 15, Calif.

LATHE ACCESSORIES

● NEW Time and Money Saving Items for your Metal Working Lathe—LATHE MANDRELS in sets with a new and unusual feature—CENTER DRILL ARBOR sets—STUB MANDRELS—DUAL-PURPOSE BALL BEARING CONE and PIPE CENTERS for auto and electric motor ARMATURE and PIPE and TUBING WORK—EXTRA LONG HARDENED CENTERS—EXTRA LONG CUT-AWAY CENTERS—MORSE TAPER REAMERS—DRILL ROD—FLAT GAGE STOCK—CASE HARDENING COMPOUND—ETC.

Send 10¢ (coin) for complete descriptive literature on these hard-to-get lathe accessories.

HURON MACHINE & TOOL CO.
Yale 5, Michigan

NEVER BEFORE... A VALUE LIKE THIS!

NOW YOU CAN GET A FAMOUS ROYAL

"Dyna Flash" WELDER

Sensationally

Low-Priced at

ONLY \$19⁷⁵

COMPLETE
Delivered

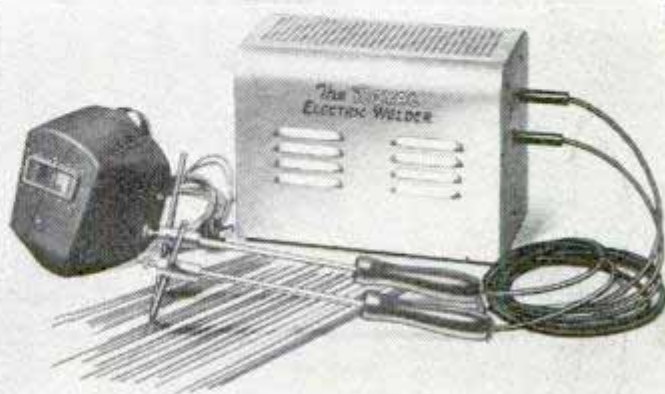

Welds, Brazes, Solders, All Metals

Here is the greatest welder value in America today! Sturdily made, powerful in performance, unequalled for all-around home, shop or farm use. Does high grade metallic and carbon arc welding, brazing, soldering, heating, etc. Handles steel, cast iron, brass, bronze, copper, aluminum and other metals. Completely portable. Operates on 110 volts.

Amazingly Efficient, Simple Operation

Get excellent results right from the start. You don't have to be an expert. Simplified instruction book furnished, tells you how to do expert work, make your own repairs, immediately.

Completely Equipped, Ready to Use

Complete outfit includes: power unit, metal case, carbon arc torch, metallic arc electrode holder, welding helmet, with special lens, ample supply of metallic arc rods, brazing rods, cast iron rods, aluminum rods, coated carbons, primary cable, 2 secondary cables with insulated plugs, fluxes and instruction book. Ready to operate, nothing else to buy.

10-DAY MONEY-BACK TRIAL

Sold on a money-back guarantee. You run no risk. Try it, test it; if, after ten days, you aren't satisfied, return it and your purchase price will be immediately refunded. Order yours today. We ship PREPAID if you include the full \$19.75.

MAIL THIS COUPON NOW!

CHICAGO PRECISION MACHINE CO., Dept. PM-248
926 S. Michigan Ave., Chicago 5, Illinois

Enclosed is \$19.75. Money-Order. Check. Send the Welder PREPAID.

Enclosed is \$5.00. Money-Order. Check. I will pay postman \$14.75 bal. plus postage.

Name _____

Street _____

City _____ State _____



**YOU, TOO, CAN
MAKE BIG MONEY
IN BUILDING
INDUSTRY!**

*Do it with
American*



BE YOUR OWN BOSS!

Big profits for you — be a floor surfacing contractor and sand both new and old floors! Prospects everywhere — that's why hundreds of men

make \$35 to \$50 a day in floor surfacing work with an American Floor Sander. Easy to operate — no big overhead — no large investment — no special schooling. Just be your own boss and get ahead! Send coupon for money-making booklet.

**A
AMERICAN
FLOOR MACHINES**

The American Floor Surfacing Machine Co.
535 So. St. Clair St., Toledo 3, Ohio

Enclosed find 25c in stamps or coin for booklet "Opportunities in Floor Surfacing", telling me how I can start my own floor sanding business.



Name

Street

City..... State.....

North and South Carolina, Alabama, Georgia; brome grass—Nebraska, Montana, Colorado.

During the war the research at the Outdoor Hydraulic Laboratory attracted the attention of the U. S. Army, faced with the problem of designing and building drainage areas around airfields. The laboratory also has exchanged information with highway engineers who are concerned with erosion and drainage problems.

The development of topsoil from the basic rocks of the earth is a slow geologic process. Under varying conditions it takes from 300 to 1000 years to build a single inch of topsoil. A torrential downpour of rain sometimes can destroy the work of a thousand years in a single afternoon.

To prevent wasting perhaps our number one natural resource, the USDA and the state agricultural colleges—through such projects as the Outdoor Hydraulic Laboratory at Stillwater, Okla.,—are showing the farmers of America how to anchor down the good earth with grass.

Industrial Revolution in the Desert

(Continued from page 93)

is assisting in the financing of it. Here again the shifting of desert dunes was of first importance and knowledge was drawn from railroading experience in the "snow states" of the Middle West where it was found that elevation of roadbeds by 18 to 24 inches will cause blowing snow to "roll over" without leaving obstructing drifts.

In the planning stage is a second rail line connecting Jidda with the Holy Cities of Mecca and Medina. The third rail project is a restoration of the Hejaz line.

For a country that boasted not a single automobile 15 years ago, it is evident that development of these land and air transport systems will play a major part in future economy. Communications—telephone, telegraph and most of all radio—have kept pace.

Of great long-range import, also, have been experiments in scientific irrigation for agriculture. With American assistance—Aramco, Foreign Economic Administration and Texas Extension Service—a scientific farming project is in operation at Al Kharj, a natural oasis of some 3500 acres about 30 miles from Riyadh. Wells, pumps, irrigation ditches were combined with fertilization, crop rotation and other practices of modern farming. The demonstrated potentialities of the desert have been amazing in high quality and quantity production. To a farmer, perhaps the most

(Continued to page 268)

LUBRI-GAS *for* 30 YEARS HAS BEEN SAVING WEAR and REPAIR on MOTORS

"The CAMEL is the SIGN of the WORLD'S BEST MOTOR FUEL"

• Thousands of auto, truck and tractor operators use LUBRI-GAS to save gasoline, as well as wear on the upper moving parts of motors—**WHY NOT YOU?**

Ask YOUR DEALER for LUBRI-GAS. If he cannot supply you, attach \$1.00 to COUPON. We will MAIL PREPAID ENOUGH LUBRI-GAS to TREAT 80 Gallons of GASOLINE, TRACTOR or DIESEL FUEL.

We Guarantee

• LESS WEAR • NO FRICTION
HEAT • NO CARBON • NO STICKY
VALVES • INCREASED MILEAGE
MORE POWER AND A COOL MOTOR
• CLEAN SPARK PLUGS

LUBRICATES AS IT POWERS



LUBRI-GAS

LUBRI-GAS INTERNATIONAL, Inc.
221 North La Salle St.
CHICAGO 1, ILL.

Send me ENOUGH LUBRI-GAS to TREAT
80 Gallons of GASOLINE, TRACTOR or
DIESEL FUEL.

Name.....

Address.....

City..... State.....

Attached is \$1.00

Attached is \$1.00 M.O.



**War
Surplus
Bargain!**

ALL STEEL CABINETS

Here's the home work-shop tool and storage cabinet you've been waiting for! Keep your tools, parts, equipment, safe and in one place. All-steel construction, with 11 large and 3 small drawers. Hinged top opens to roomy storage space for large tools, parts, etc. Large drawers have 32 removable metal dividers to make 60 bins of any size desired. 3 small drawers have 30 metal dividers make ideal nut, bolt, screw and small parts storage compartments. Each drawer has drop handles and index card holder. Rust-resistant baked-on enamel finish is an attractive green. Composition top makes handy desk or non-slip work table. 2 locking bars keep contents safe—need only 1 padlock. Sturdily constructed to last a lifetime. 39" high, 47" long; 24" deep.

Worth at least \$100.00
Our price to you.....

\$59.75

F.O.B.
Illinois Ordnance Depot
Marion, Illinois

ACME EQUIPMENT CO., INC.

128 South Clinton St.

Chicago 6, Illinois

"I always carry a MASTER

Streamline"

Says Mr. Charles A. Fuller...*



*501 E. 5th Street,
Mount Vernon, N. Y.

"The Streamline is perfect for quick, accurate measurements. It's my first choice in steel tape rules..."

If you're a home owner, hobby worker, craftsman, mechanic...or have occasion to use a handy measuring instrument, just try the beautifully designed, gleaming Master Streamline.

You, too, will find Streamline superior to any other steel tape rule in its class. Ask your hardware dealer about Master Streamline today, or use the coupon to order yours.

MASTER

REG. U.S. PAT. OFF.

WOOD AND STEEL TAPE RULES

Master Rule Mfg. Co., Inc.
201 Main Street, White Plains, N. Y.

PM-2

Gentlemen:
I enclose \$2.00. Please send my Streamline immediately.

Name.....

Address.....

City..... State.....

WAR SURPLUS AND OTHER BARGAINS

MOTOR-GENERATOR

Emerson Electric Mfg. Co. 3 HP Motor ... AAF Type D50 FD-222-0435, 28 Volts DC, compound, 3800 RPM, 115 Amp, windings glass insulated, blower cooled, shaft dimension $\frac{5}{8}$ ", Wgt. 27 Lbs. As Generator, puts out 115 Amps.

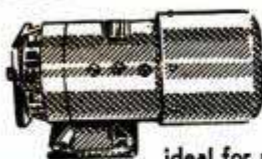

ideal for portable welder.. new \$13.95 each

SEND CHECK, MONEY ORDER or CASH

Transformer

Automatic Winding Co. Transformer, 5 to 42 V., 6 steps of 5 V. each, 2 steps of 3-6/10 V. each, 6 Amp. maximum. Suitable for use with war surplus gadgets, house chimes, heater relays, radio test filaments, electric trains, etc. Wgt. 5 lbs.

New... \$3.50 each.



EVINRUDE OUTBOARD MOTOR OVERHAUL KIT:

Contains 61 parts in original factory sealed pack, including complete magneto and fly wheel assembly, complete carburetor assembly, complete set of gaskets, connecting rod, upper and lower pump impeller, propeller, propeller shaft and propeller nut, piston, piston rings and numerous other springs, pins, rings and miscellaneous parts. This kit can be used on any 4 cylinder 5 HP Zephyr Model. Shipping Weight 16 lbs. All New... \$45.00 Each.



25% DEPOSIT REQUIRED ON C.O.D. ORDERS

MICROMETER

Chrome plated, precision engineered and carefully tooled to give long life and highest degree of accuracy... all new. 1" capacity \$1.65 each. 2" capacity \$3.50 each.



SHIP'S BELL
U.S. Navy Surplus. Solid Brass with smooth polished finish. 5" Diameter.

Great for Playrooms, Patios, Doorways, Ranches, etc. An unusual gift idea. Weight, 3 1/4 lbs. All New... \$5.95 Each.

CLAMPS: Adel Aluminum Co., Rubber lined, assorted sizes, hundreds of uses in any shop. 5 doz all new, ass't'd sizes \$1.00

ALL PRICES F.O.B. CULVER CITY, CALIF.



SPEED WRENCH: Blackhawk manufacturer's heavy-duty ratchet speed-wrench. Adjustable for right or left drive. Will take any size wrench socket with $\frac{1}{2}$ " drive. Sturdily constructed for years of service from high grade tool steel. A real time saver in garage or repair shop. Weight 2 lbs. All New... \$3.00 Ea.



HUNTING KNIFE
Hollow ground 6" blade of bright finish, high quality, tempered steel. Non-slip cowhide handle, with hand finished metal guard and butt. Stitched and riveted genuine leather shield. It's a knife you'll be proud of! All New... \$1.50 Each.

AIRBORNE SALES CO., INC. DEPT. PM 2 S CULVER CITY, CALIF.

101 Money-Making Ideas in New Larson Catalog.

EVERYTHING
In LEATHER

with **LARSON**
Leathercraft



Make Money

On easy-to-assemble belts, gloves, purses, wool-skin toys and mittens, many other useful items. Wide line to choose from. Moderate priced tooling leathers as well as top quality calfskins. All tools and accessories. No experience necessary; instructions come with materials.

Send ten cents at once for catalog.

J. C. LARSON COMPANY
4232 ARTHINGTON ST., CHICAGO 24, ILLINOIS



DRILL-INDEX

A compact container for indexing and filing twist drills. Eliminates search. Made entirely of steel in ten sizes. See your dealer or write to

HUOT MANUFACTURING CO.
555 No. Wheeler St. Paul 4, Minn.

NONE BETTER! SUPER DRILL GRINDER



Sharpens round shank drills from $\frac{3}{32}$ " to $1\text{-}1/16$ " in diameter, up to 11" long. Grinds old drills like new in 4 different point angles, using hand or power grinding wheels. Money-back guarantee.

Price only \$2.95

At Dealers or Postpaid

CRANDALL MFG. CO. 1512 W. Slauson, Dept. FA-26, Los Angeles 44, Calif.

SAY YOU SAW IT IN POPULAR MECHANICS

RAISE RABBITS, HAMSTERS
Cavies & Chinchillas
FOR FUR and BREEDING PURPOSES
Big Demand - Steady Income - From a Growing and **PROFITABLE INDUSTRY**

START A PAYING BUSINESS TODAY
Small space required, a ready market, descriptive folder and magazine 10¢. Book - RAISING SMALL STOCK and Magazine 25¢. All the above and magazine (Monthly) for one year \$1.00

Small Stock Farmer, Pearl River, 4 N. Y.

WRITE FOR YOUR FREE COPY OF THE NEW KRW HYDRAULIC PRESS BOOK

Describes all manner of Production and Shop Work on KRW Hydraulic and Bench Type Arbor Presses. 32 pages illustrating the new KRW Hand-operated, Electric-operated and Air-operated Hydraulic Presses. Write for your copy today.

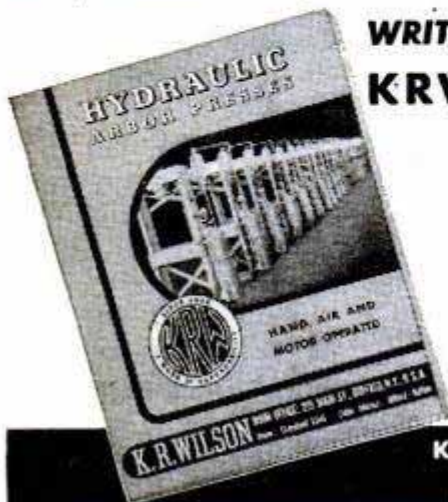

K. R. WILSON, DEPT. 17, 215 MAIN ST., BUFFALO 3, N. Y.
Builders of Shop Equipment for Ford Dealers Since 1916

IDEAL FOR HOME WORKSHOPS OR APPLIANCES

BASLER MOTOR

Shown at right is the 1/4 H.P. Split-phase BASLER MOTOR, fully guaranteed by an experienced electrical manufacturer. It is a continuous duty, permanently lubricated lifetime ball bearing, resilient mount, 1725 r.p.m., 110 volt, 60 cycle, AC, reversible rotation, electric motor.



POWER FOR LATHES — PUMPS — DRILL PRESSES — WASHING MACHINES — FANS — ETC.

\$18⁷⁵
FOB
St. Louis, Mo.

SHIPMENTS C.O.D.
5% DISCOUNT IF REMITTANCE WITH ORDER

THE *Delton* COMPANY

1110 ARCADE BLDG. ST. LOUIS 1, MO.

NEW ALL-PURPOSE SANDER



The Ideal 2 3/4" rotary sander for the home work shop. Fits drill presses, flexible shaft machines, lathes, hand drills and, with adaptor .50c extra, it fits directly to any 1/2" shaft motor.

Sander comes complete with 20 interchangeable silicon carbide discs that hold up longer and do a faster, more accurate job. Excellent for wood, plastics and metals. Sold only by mail order, \$1.50 postpaid. No C.O.D.'s. Add 50c if you require the adaptor. Extra discs, 20 for 50c.

ABSOLUTE MONEY BACK GUARANTEE

Only **\$1.50**

NEVEROIL PRODUCTS

Hamburg 1, Michigan



IF YOU HAD A HULL AUTOMOBILE COMPASS WE WOULDN'T HAVE TO FLIP TO SEE WHO GETS OUT TO ASK DIRECTIONS

BEACONLITE illuminated **\$5.95**



STREAMLINE, \$3.95

At your dealer's. Write for illustrated literature.

HULL MFG. CO., P.O. Box 246-D2, Warren, Ohio

IMPERFECT DIAMONDS



Unusual bargains in dazzling genuine diamonds which have slight imperfections. However, these do not mar the eye beauty of the gems, nor lessen their everlasting flash and fire! You will be amazed at the low prices.

Write for FREE catalogue. Address: DIAMOND DIVISION, Box 388, Dept. 21, Wheeling, W.Va.

FIND UNDERGROUND MINERALS and METALS with M-SCOPE

New sensational lightweight models, unsurpassed efficiency Low prices. Time-payment plan. Write for free 16 page booklet.

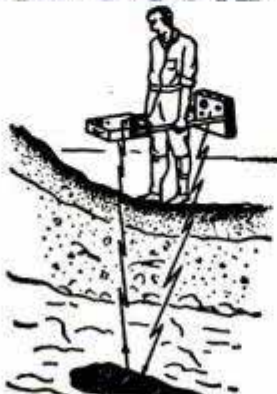

FISHER RESEARCH LABORATORY, INC. PALO ALTO CALIFORNIA

HOBART arc welders

are money makers for YOUR SHOP or GARAGE

prompt action means money to you... use the coupon



Start Your Own Business!

Here's your best opportunity to be your own boss and get into the big money! Start your own welding shop—minimum investment required. Hobart offers 1000 welding combinations with Multi-Range Control for better welds —Hobart's Remote Control speeds up work—makes you more profit!

You Can "Build Your Own" HOBART

Save hundreds of dollars, build your own gasoline drive Hobart arc welder. You need only a Hobart generator, a used auto engine and chassis. With this portable gasoline drive welder, you can go any place. Free booklet tells you how. Write for details.

The Finest A. C. Welder Ever Built

Hobart A. C. Arc Welder for single phase lines. Handles auto repairs economically — ideal for all types of light metal work. Use coupon for details.

HOBART WELDING SCHOOL

Individual instruction, expert instructors, low cost. Qualified under G. I. Bill of Rights.

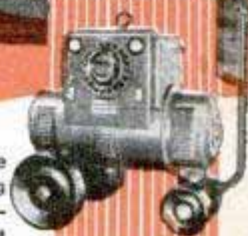

• Electric Drive



• Build Your Own



• A. C. Welder

Welders' Vest Pocket Guide

Free!

Hobart Brothers Co., Box M-28
Troy, Ohio "One of the World's
Largest Builders of Arc Welders"

I'm interested in Hobart Arc Welding. Send my free book, details on items checked.

- Gas Drive Welder Build Your Own
 A. C. Arc Welder Welding School

NAME _____

ADDRESS _____

Hobart Bros. Co., Box M-28, Troy, Ohio

SAY YOU SAW IT IN POPULAR MECHANICS

ANCO® RAIN-MASTER®

WINDSHIELD WIPER BLADES and ARMS

**Blade snaps on—Stays put
Can't fall off—Can't blow off**



Don't Blame Your Gas-Pump Man!

Sure, he knows how dangerous it is for you to drive your car . . . in stormy weather . . . with dull old windshield wipers that *smear* and **SMEAR!**

He'll gladly put on for you—quickly—a pair of keen new ANCO RAIN-MASTER Blades—or Blades and Arms.

HE NEGLECTS YOU?

He has RAIN-MASTERS . . . But he forgets to remind you? Too busy?

After all it's *YOUR* car to protect. . . So, *YOU* ask *HIM* for RAIN-MASTERS next time you buy gas. . . . Patented features. . . . Original equipment on DeLuxe Models of high-grade cars . . . because RAIN-MASTERS *Clean quicker—Clean cleaner—Last longer.*

*Get yours—next time you buy gas.
May save you a costly smashup!*

Made by ANCO . . . makers of the new CLEAR-FLEX* Wiper Blade—the only Blade worth more than RAIN-MASTER. Costs more. Ask your good ANCO dealer to show you why.

*Trade Mark

Quality Protected Under Fair Trade Laws
ANCO Patented Products—Patents Make Jobs

THE ANDERSON COMPANY
Established 1918
GARY, INDIANA

impressive statistic is that Al Kharj is now raising 18 cuttings per year of alfalfa, compared with a good average of four in the United States.

Another interesting development is the transformation, even in slight degree, in the nomadic Arab character. More than 9000 sons of the desert, never before pinned down to steady employment, are working for Aramco and nearly 400 have passed the 10-year mark in continuous service.

Thousands have left the company employ to apply their new skills to private enterprise and Aramco has set up an Industrial Development Department which applies itself solely to the task of training, organizing and launching the Arabs in private business. Ten years ago there were less than a half dozen private contractors in all Saudi Arabia; today there are more than 100 in such diversified enterprises as building, trucking, garaging, machine working, flour milling and brickmaking.

Dhahran, an American community of air-conditioned homes and buildings, is the headquarters hub of an oil operation extending over five proven petroleum fields and some 50 wells already in production. About 1600 American workers, nearly 200 of them with wives and families in the field, are employed and the total is expected to reach 4000.

Daily production already has surpassed 280,000 barrels of crude oil, but it would take 60 years at that rate to exhaust the proven reserves. Production offers no unusual engineering problems and actually is under ideal control conditions to assure natural flowing pressure and maximum drainage of each oil deposit. Royalty payments are on a basis of 23 cents per barrel, guaranteeing the Saudi government nearly \$20,000,000 per year toward its present \$30,000,000 annual budget.

An Aramco refinery at Ras Tanura, about 50 miles north of Dhahran, takes about 120,000 barrels per day while another 105,000 barrels are piped daily to a refinery on Bahrein Island. The remainder is shipped out as crude oil.

The U. S. Navy has been the principal customer, but the long-range planning calls for diversion of a substantial daily tonnage to the European markets. Trans-Arabian Pipe Line Company, a subsidiary of the same American parents, contemplates building an 1100-mile pipe line from the Arabian fields to the Mediterranean, near Sidon, Lebanon, to transport 300,000 barrels of crude oil per day. This work, however, may be delayed by the political crisis over the Palestine situation.

BIG FUN and PROFIT using AMAZING NEW JIG SAW!

NO MOTOR TO BUY! JUST PLUG IN! SAFE! CUTS CLEAN—NO SANDING!

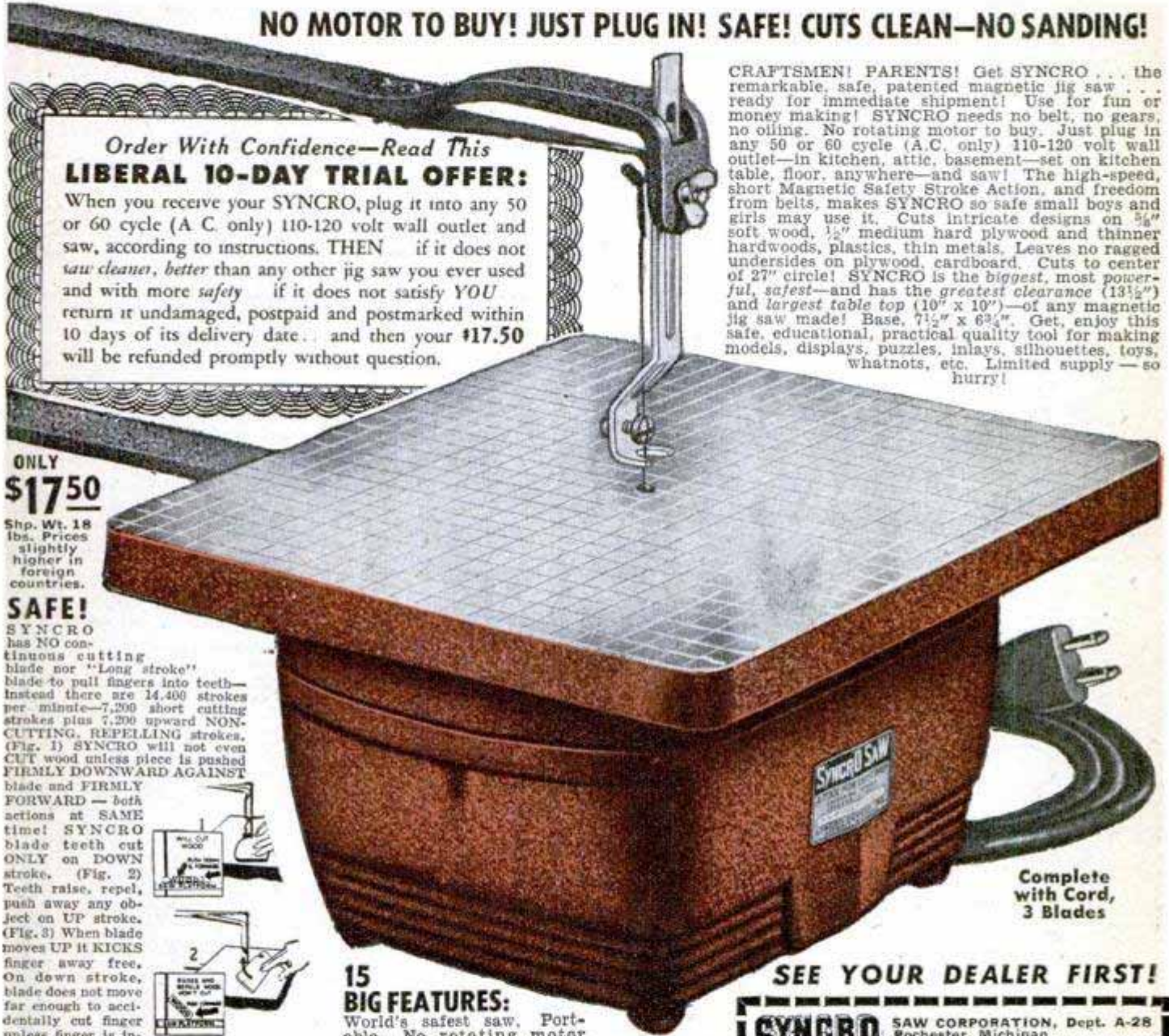

Order With Confidence—Read This LIBERAL 10-DAY TRIAL OFFER:

When you receive your SYNCRO, plug it into any 50 or 60 cycle (A.C. only) 110-120 volt wall outlet and saw, according to instructions. THEN if it does not saw cleaner, better than any other jig saw you ever used and with more safety if it does not satisfy YOU return it undamaged, postpaid and postmarked within 10 days of its delivery date. and then your \$17.50 will be refunded promptly without question.

CRAFTSMEN! PARENTS! Get SYNCRO... the remarkable, safe, patented magnetic jig saw... ready for immediate shipment! Use for fun or money making! SYNCRO needs no belt, no gears, no oiling. No rotating motor to buy. Just plug in any 50 or 60 cycle (A.C. only) 110-120 volt wall outlet—in kitchen, attic, basement—set on kitchen table, floor, anywhere—and saw! The high-speed, short Magnetic Safety Stroke Action, and freedom from belts, makes SYNCRO so safe small boys and girls may use it. Cuts intricate designs on 1/2" soft wood, 1/2" medium hard plywood and thinner hardwoods, plastics, thin metals. Leaves no ragged undersides on plywood, cardboard. Cuts to center of 27" circle! SYNCRO is the biggest, most powerful, safest—and has the greatest clearance (13 1/2") and largest table top (10" x 10")—of any magnetic jig saw made! Base, 7 1/2" x 6 3/4". Get, enjoy this safe, educational, practical quality tool for making models, displays, puzzles, inlays, silhouettes, toys, whatnots, etc. Limited supply—so hurry!

ONLY \$17.50

Shp. Wt. 18 lbs. Prices slightly higher in foreign countries.

SAFE!

SYNCRO has NO continuous cutting blade nor "Long stroke" blade to pull fingers into teeth—Instead there are 14,400 strokes per minute—7,200 short cutting strokes plus 7,200 upward NON-CUTTING, REPELLING strokes. (Fig. 1) SYNCRO will not even CUT wood unless piece is pushed FIRMLY DOWNWARD AGAINST

blade and FIRMLY FORWARD — both actions at SAME time! SYNCRO blade teeth cut ONLY on DOWN stroke. (Fig. 2) Teeth raise, repel, push away any object on UP stroke. (Fig. 3) When blade moves UP it KICKS finger away free. On down stroke, blade does not move far enough to accidentally cut finger unless finger is intentionally, deliberately fed into blade like wood is fed in Figure 1. No wonder SYNCRO is the world's SAFEST saw... a feature old and young users acclaim!



15 BIG FEATURES:

World's safest saw. Portable. No rotating motor needed as self-contained magnetic power unit transmits A.C. magnetic impulses to armature diaphragm—power transferred to blade. No rotating parts to wear out. 14,400 magnetic strokes per minute. Never needs oiling. Large 10" x 10" table top. Cross section engraved lines on top. Big 13 1/2" throat clearance. Finest steel blades. Rubber feet. 5' cable, plug. Varying voltage adjustment nut. Life-time, durability. Quality materials, workmanship, performance.

Complete with Cord, 3 Blades

SEE YOUR DEALER FIRST!

SYNCRO SAW CORPORATION, Dept. A-28
Rochester, Michigan
Export Address: 120 Wall St., N.Y.C.

Gentlemen: Here's my order for one SYNCRO MAGNETIC JIG SAW Model No. 2000, shpg. wt. packed, 18 lbs., \$17.50 FOB factory. Please send it complete with electric cable and plug, 3 blades, on your 10 Days' Money Back Trial Offer. I enclose \$17.50 as payment. Please ship saw:

- Express charges collect or Parcel Post charges collect.
- Express, for which I enclose an extra \$_____
- Parcel Post, for which I enclose an extra \$_____

Name _____
St. and No. _____
City _____ State _____
 I enclose no money — send FREE SYNCRO CIRCULAR.

AMERICA'S SAFE, BIGGEST SELLING JIG SAW!

SYNCRO

SAW CORPORATION, Dept. A-28, Rochester, Michigan
Export Address: 120 Wall St., New York City
WORLD'S LARGEST MAKERS OF ELECTRIC JIG SAWS

HOW TO ORDER DO IT NOW!

If no dealer near you, mail coupon with Postal Note, Money Order or check for only \$17.50 plus Parcel Post or Express carrying charges... or... send \$17.50 only and we will ship saw collect for Parcel Post or Express carrying charges only. Specify type of delivery on Coupon. Shipping weight, packed, 18 lbs. Hurry! Act promptly—order—we'll ship same day order is received. (No complete COD orders accepted.)

OUTDOOR MEN: LOOK!

LIKO BINOCULARS



WITH
NEW COATED OPTICS

- Inter-Pupillary Adj.
- Increased Magnification.
- 3 1/2 Power, Finger-Tip Focus.

Now you can be sure of "Up Front" pleasure from "way back!"

A REAL BUY AT
\$7.88

B-3 JACKET

Originally a \$60.00 value! A perfect item for farmers, repairmen, truckers, hunters and ranchers. Fleece, fluffy, sheeplined throughout. Full zipper-collar tabs—All leather shell. Unbeatable for sheer warmth. In sizes from 36 to 40. Best buy in America!

- Used, in good condition..... **\$14.88**
- Used, in excellent condition..... **\$17.88**
- Like New..... **\$19.88**



B-15 JACKET

Biggest jacket seller in the nation! Judged the favorite among drivers, routemen, laborers, students and sport enthusiasts. Features Mouton Lamb Collar, All Wool Alpaca Lining! Full zipper, knit cuffs and waist, snap pockets. In all sizes . . . Hurry, while they last! (BRAND NEW!) Sizes 36-46..... **\$15.88**



Army Blankets



Here is an item that is excellent for the car, home, barn and stadium. The 100% wool blanket that is the All time G.I. favorite. Sturdy... really keeps you cozy! Like New..... **\$4.88**

Flight Boots



These are the boots that kept air crews' feet warm at sub-zero altitudes! All sheeplined, rubber soles, leather upper, full zipper. Small - Medium - Large. (Like New)..... **\$5.88**

Navy Type Pea Coat



Made for GOBS of warmth and comfort! 100% sturdy brush wool and BRAND NEW! High collar protects you from whistling winter blasts. Deep, roomy slash pockets . . . An ideal coat for outdoor folks seeking high value at the lowest cost. Sizes 36-46.... **\$16.88**



ARMY TYPE WRIST WATCH

\$21.88

(Inc. Fed. Tax)

This handsome watch is YOURS at TERRIFIC savings! 17 Jewel Swiss movement . . . Sweep second hand . . . Waterproof, shockproof and Anti-Magnetic. Really a superb watch and 100% reliable. Why pay more for quality?

Send Orders to:

DRAKE Surplus Stores

1677 W. Odgen Ave.
Chicago 12, Ill.

No C.O.D.s. On orders \$10.00 or less, add 20c to cover mail costs. On orders over \$10.00, add 40c. Illinois residents add 2% for state tax.



NOW! YOU CAN HAVE YOUR OWN ELECTRO-PLATING Business

Plate GOLD - SILVER - CHROMIUM, etc.
It's Profitable - Simple - Pleasant

Do as hundreds of successful men are now doing — start your own business! You can plate on metals and non-metals with the VARI-PLATER. Your cost is low, profits are BIG! Don't let this money-making opportunity go by!



FREE! Write now for descriptive information and complete price list!

The VARI-PLATER — 110 V. A.C. complete **\$55.00** Postpaid

LEWIS ELECTRICAL MFG. CO. 1266-A Gun Hill Rd. New York 67, N. Y.

NOW YOU TOO CAN BUILD 15 RADIOS

COMPLETE KIT **\$14.75**

Absolutely No Knowledge of Radio Necessary
You Need NO Additional Parts

The PROGRESSIVE RADIO KIT is THE ONLY COMPLETE KIT. Contains everything you need. Instruction Book, Metal Chassis, Tubes, Condensers, Resistors and all Radio parts. The 36-Page Book written by Expert Radio Instructors teaches you to build radios in a Professional Manner. You start with a 1-tube receiver. Before you are done with this kit, you will have built 11 Receivers, 1 Public Address System and 3 Transmitters.



SPECIAL FREE OFFER!
Electrical and Radio Tester sent absolutely FREE with each Progressive Radio Kit. PLUS FREE membership in Progressive Radio Club. Entitles you to free expert advice and consultation service with licensed radio technicians.
Write for further information, or ORDER your KIT **\$14.75** NOW! ONLY.....

Postage prepaid with check or money order (Postage not prepaid with C.O.D. orders)
PROGRESSIVE ELECTRONICS CO., Dept. PM-7
22 Havemeyer Street Brooklyn 11, N. Y.

REAL GAS ENGINE \$6.95



The new THOR "B" — Sensational miniature gasoline engine that really works. Superpower performance. Smooth, velvety power that roars into action with a "twist of the wrist." Over 25,000 already sold. 1/8 H.P. Complete with coil and condenser. Ready to run, only \$9.95. In KIT form, fully machined, 5 minutes to assemble, \$6.95, without coil and condenser. Powers all models. Fully illustrated instructions. Send \$1.00—shipped collect same day C.O.D. FREE—Send for 24-page illustrated hobby catalog.

AMERICA'S HOBBY CENTER
Dept. B-28 156 W. 22nd St. N.Y. 11, N.Y.



A PENNY POSTCARD MAY CHANGE YOUR FUTURE . . .

Get full information on the coin-operated vending machine industry. Start with a few machines and build to a wonderful future. We'll give you complete advantage of our "know-how."
Send For Free Booklet Today—No Routes Sold!

PIONEER VENDING SERVICE

Address all mail to Dept. PM
461 SACKMAN ST. • BROOKLYN 12, N. Y.

PAINT YOUR CAR WITH WYPE for \$3.95!

There's no brushing, no masking or spraying. Thousands of car owners are delighted with the results. See your local dealer, department store or order direct. WYPE CORPORATION, Department 131-B, 2214 Dolman Street, St. Louis 4, Mo.



GARDEN TRACTOR

3, 4, 5 H.P. On market nearly a quarter century. No belts. No chains. Warm driven. 2 clutches. Power turning. All tractors guaranteed. Full line of attachments. Buy direct from factory. Write Dept. 102 for free catalogue.

RED E TRACTOR COMPANY RICHFIELD, WISCONSIN

SOUTH BEND MILL IT ON YOUR LATHE

This Milling and Keyway Cutting Attachment is ideal for shops not having a milling machine. It can be used for milling, boring, keyway cutting and other operations. Mounts on compound rest base of South Bend Lathes.

Lathe Size	Vise Cap.	Price	Lathe Size	Vise Cap.	Price
9"	1-1/2"	\$35	14-1/2"	4"	\$65
10"	1-3/4"	\$45	16"	4"	\$75
13"	2-7/8"	\$55	16/24"	4"	\$75

Write for dimension sheet

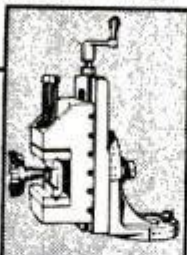

SOUTH BEND LATHE WORKS 455 E. Madison St. South Bend 22, Ind.



LET BAKONTROL GIVE NEW, PROFITABLE USES TO YOUR

WATER POWER

BAKONTROL gives automatic starting—fast acting governing—automatic stopping—of any hydro plant. Bakontrol hoards water, gives amazing convenience. Pays for itself. Lock up your power house and leave it for weeks, while it continues to deliver power automatically. Tell your friend with water power of this ad. Send now for free 12 page booklet B-1. Bakontrol Mfg. Co. 4867-A HAMILTON CLEVELAND 1, MICH.

STATION WAGON BODIES AND CABS FOR ALL CARS, JEEPS SMART MAPLE - OAK WOODS



Year around comfort for Jeep owners. Kiln dried hardwoods, safety glass. Finest hardware, varnishes, top materials. Full opening rear door, locks. Send 25¢ with order balance COD. \$165 FOB Cleveland. plus tax, complete, semi-assembled.

STATION WAGONS, INC. (PM)
6619 Euclid Avenue Cleveland, O.

OTHER CARS converted to station wagons. Write for details.



100% Fireproof Roofing

MIX yourself from local supplies. Apply like plaster. Slate like and insulates six times better. One half inch thick, costs approx. same as asphalt. No more lifting shingles. Any color.

WE TELL YOU HOW. Complete instruction \$1.00

NO AGENTS
RAY ROOFING CO.
P. O. BOX #255, PETERSBURG, N. Y.

For Outdoor Pleasure and Transportation

Ride a Royal Enfield



Famous English Lightweight Motorcycle...takes you anywhere

Royal Enfield's popular Model R. E. has everything—Style, Safety, Economy, Flexibility, 125 c. c. 2-stroke, single cylinder engine; 3-speed gears. Goes 100 miles per gallon of gas! 45 m. p. h.! Folder "P" gives you all details. Also 350 c. c. and 500 c. c. models. Dealer inquires given prompt attention.

Write Today:
WHITEHALL DISTRIBUTORS, Inc.
1385 Commerce Avenue, New York 61, N. Y.

PERFORMANCE GOES UP IN SMOKE

WHEN WORN ENGINE BEARINGS CAUSE OIL PUMPING

REPLACE HERE WITH FEDERAL-MOGUL BEARINGS FOR BETTER PERFORMANCE

Smoky exhaust means oil pumping by worn connecting rod bearings. They let excess oil reach combustion chambers. It burns to carbon — performance sags, costs rise. Restore performance with Federal-Mogul bearings. They are engineered for the job of oil control. Ask your mechanic!

FEDERAL-MOGUL SERVICE
COLDWATER, MICHIGAN
Division of Federal-Mogul Corporation

FEDERAL-MOGUL

Oil-Control Bearings

Replace in Sets with Genuine

SAY YOU SAW IT IN POPULAR MECHANICS

Now! YOU CAN INSTALL DUAL WHEELS

On your Trailer, Pick-up Truck, Farm Wagon or Jeep
IN LESS THAN TEN MINUTES

Only \$2850

Complete Set of Castings and
Extension Bolts for 2 Wheels.

Install with a rim-wrench—
easier than changing a tire.
New patent dual wheel con-
verter eliminates entirely
the expense of changing to
truck-type wheels and hub;
no need to change the en-
tire rear axle. Now you can

do the job at a fraction of the old cost. Guarant-
eed satisfaction or money back. Du-All Adapters
are scientifically designed so that load is trans-
ferred from outer wheel by the casting direct to
the hub . . . Absolutely will not damage the wheel
bearing or axles unless overload is carried to
extreme excess . . . Increase traction and increase
tire life with Du-All Adapters. Trailers can carry
up to 50% more.

JEEP WIDE TREAD ADAPTERS

Now you can convert your wheel tread to stand-
ard 58" width. Avoid trouble with ruts on
unpaved roads or driveways with these com-
pletely new type adapters. Set of 4 castings and
20 extension bolts, for all 4 wheels, can be in-
stalled or removed in 15 minutes. Safe. Sturdy.
Simple to install. Only \$36.00, complete set.

16" DROP CENTER WHEELS

For Model T Fords . . . and all old models
with off-standard hubs. Heavy duty, dou-
ble disc wheels to replace all obsolete wood
wheels of odd sizes—for trailers or pas-
senger vehicles. Two Sizes, Two Numbers,
Only \$5.95 ea. WF111N—For Model T
Fords. With all holes drilled, ready to bolt
on. WP400N—Universal Fit with Center
Hole in Blank Disc for drilling to size.

DEALERS: SEND FOR FREE CATALOG.

Northwestern Auto Parts Co., 834 N. 7th St., Mpls. 11, Minn.

CLIP THIS COUPON NOW

Please send me..... FORD CHEV DODGE-PLYM
 INTNTL (1/2 ton, 37 47) JEEP Dual Wheel Converters
at \$28.50 each set. (Ship. Wt. 33 lbs.)
 FORD ('36-39 Psgr. & Lt. Comcl.) Dual Wheel Converters.
Also fits 3/4 ton '38-42 at \$32.50 each set (Ship. Wt. 70 lbs.)
 JEEP Standard Tread Adapters.....\$36 for 4 wheel set.
 WF111N 16" Drop Center Wheels for Model T.. \$5.95 ea.
 WP400N 16" Drop Center Wheels for all others, \$5.95 ea.

Name.....

Address.....

City.....State.....

Northwestern Auto Parts Co., 834 N. 7th St., Mpls. 11, Minn.

DEALERS: Sell DUAL WHEELS. Many fine territories open,

Pacific Sweet Spot

(Continued from page 101)

check on soil conditions, finding the right
fertilizers and weed killers, and—perhaps
most important of all—combatting insect
pests and diseases.

It is in the latter field that they've done
their most spectacular work. Largely be-
cause there is no frost to kill them off,
crop-destroying insects and diseases
abound in such areas as Hawaii. They can
kill a crop overnight once they get a foot-
hold, and on several occasions almost have.

For example, around the turn of the cen-
tury a tiny grasshopper known as the sug-
ar-cane leaf hopper made its way to Ha-
waii from Australia, probably aboard a
ship. Within three years literally billions
of these pests swept across the cane fields
like storm clouds, destroying everything in
their path. The output of one plantation
dropped from 19,000 to 826 tons. The indus-
try's outlook seemed dark indeed.

Experiment station entomologists,
working on the theory that the hopper was
held in check in its native environment by
some natural enemy, went to Australia and
searched the cane fields. They finally found
it—a tiny parasite that laid its eggs in the
hopper's body.

Shipped to Hawaii, the parasite was let
loose in the fields. Almost immediately, the
hoppers began dying off in great numbers.
Later, parasite reinforcements brought in
by the scientists from Fiji, China and For-
mosa completed the rout. Today, you'd
have difficulty finding one hopper in Ha-
waii, outside those in the station's spec-
imen cases.

A few years later the industry was again
threatened with disaster, this time from a
mysterious root disease. The only hope of
salvation appeared to be through the
breeding of a new variety—a virtually un-
known procedure in the sugar industry.
Cane seeds are so microscopically small
that most sugar farmers had forgotten they
existed. New plants are grown from shoots
of mature cane.

Working under almost unbelievable dif-
ficulties, geneticists crossed and re-crossed
cane varieties until they had 5000 new
types under propagation. One of these
proved to be what they were looking for.
Planters conservatively estimated that
this single accomplishment was worth \$50,-
000,000 to the industry.

Only a decade ago the pineapple plan-
tations were confronted with a wilt dis-
ease. There was serious doubt whether the
industry could survive. The institute, then

(Continued to page 276)



32
DRAWER
UNIT
\$4.95

64 DRAWER \$7.95

for home
or shop

THE JIFFY ^{all metal} CABINET

THE HANDY WAY TO KEEP SMALL PARTS, WASHERS,
NAILS, SCREWS, NUTS, BOLTS AT HAND

DRAWER SIZE

1 1/4" DEEP
3" WIDE
6" LONG

CABINET SIZE

32 Drawer Unit
6" DEEP
12 3/4" WIDE
15 1/4" HIGH
Shipping Weight
9 lbs.

64 Drawer Unit
6" DEEP
25 1/2" WIDE
15 1/4" HIGH
Shipping Weight
18 lbs.

For small items, the low-cost Jiffy Cabinet, 32 or 64 drawer units that put office, shop, work bench, household and hobbyist needs at your fingertips. Metal flange drawer guides. Spot welded all metal cabinet with sturdy laminated drawers insures long time-saving service. Why fumble? With the Jiffy you know where it is. 32 drawer unit—\$4.95; 64 drawer unit—\$7.95. Send check or money order—No C.O.D.'s please. Ohio orders please add 3% Sales Tax.

KAYTEE PRODUCTS

Dept. M, Box 588 Canton, Ohio

ARMY BALLOONS and KITES

FOR RADIO ANTENNAS, WEATHER
OBSERVATION, AERIAL PHOTOGRAPHY
or JUST PLAIN FUN



Originally made to take up emergency radio antennas, these balloons and kites are beautifully made of the finest materials.

The balloons inflate to approximately 4 feet in diameter and have a lifting capacity of 3 to 5 lbs. They are made of extra heavy rubber and come sealed in metal cans. Each balloon has its own hydrogen generator which works when simply put in water.

The box kite is scientifically designed. Its strong aluminum frame folds up like an umbrella so the kite can be stored in a small space.

A complete kit consisting of 2 Balloons, 2 Generators, 1 Box Kite, all packed in a tubular canvas bag, is priced at only \$9.95. (Cost the Government about \$75.00.) Send your check (or M.O.) for \$9.95 and we will promptly ship your Balloon-Kite Kit via express. Quantity limited.



WELLS
SALES, INC.

320 N. La Salle St., Dept. P-2
Chicago 10, Illinois

SOLVES WOODWORKING PROBLEMS FAST!



Only 10¢
SPECIAL OFFER

● This easy-reading GREENLEE HANDY CALCULATOR swiftly solves your wood-working problems. Just set the dial: convert linear feet to board feet; get slope per foot in degrees; compare hardness, weights, shrinkage, warping and working ease of various woods. More, too: bit sizes for head, body, thread of screws; nail specifications; tool sharpening hints; protractor. 6" diameter, fits your tool kit. Heavily varnished cardboard. Special offer. Order now, send 10¢ (not stamps) in next mail. Greenlee Tool Co., 2102 Columbia Ave., Rockford, Ill.

GREENLEE



WAR! Surplus & other BARGAINS!



Surplus DUST MASKS
33¢

BRAND NEW. Here's a mask that will serve many purposes. Insecticide and paint spraying. Ideal for milling companies. Reg. \$1.50 value



AVIATORS STYLE
24 Karat GOLD RIM
SUN GLASSES
4 BASE CURVE

BRAND NEW The type the aviators used. Genuine 24-karat gold-plated rims, ophthalmic ground, 4-base curve. Eliminates 96% of ULTRA-VIOLET RAY. We sold thousands at twice the price.

288



Genuine NYLON PER HANK
59¢

PARACHUTE CORDS
3/16-in. diameter. Has a tensile strength of 500 lbs. Ideal for clotheslines, venetian blind and drapery cords. Each hank 50 ft. long.



BRAND NEW 17 JEWEL Military Style WATCH

24.95

PLUS 10% FED. TAX

The Greatest Watch Value in the U. S. A. Finest quality 17 jewel precision Swiss movement. DUST PROOF, WATER REPELLENT, SHOCK PROOF, ANTI-MAGNETIC, SWEEP SECOND HAND, Stainless Steel Case. Complete with strap. Be sure to include the 10% federal tax.

Surplus NAVY UNLINED FIELD JACKETS



BRAND NEW. Made of fine quality water-repellent poplin material. Unlined, full zipper front, 2 slash pockets. Here's an ideal utility jacket for all-around wear. Worth twice our price.

\$3.99

O. D. WOOL Serge SHIRTS AND PANTS

These were designated for reissue. Used, Absolute Perfect Condition. All have been cleaned and pressed by the Q. M. Corp. 100% wool serge. Less than the price of the cheapest overall.

69¢ Navy STYLE "T" SHIRTS



BRAND NEW Made of fine quality long staple cotton yarn. White only. Sizes: small, medium, and large.

SHIRTS SIZES 13 TO 15
269
PANTS SIZES 28 TO 33
295

U.S. NAVY WORK JACKETS

U. S. Navy Regulation
First Quality
Brand New
Full Cut Sleeves

169

Made of 3-oz. green herringbone twill. Tailored to Navy specifications. Ideal utility and work jacket.

FREE SURPLUS Circular

Send for

Write today for our FREE WAR SURPLUS CATALOGUE Over 150 war surplus items, also other outstanding values.

ORDER BY MAIL

Please send remittance with order. ADD APPROXIMATE POSTAGE. If desired, merchandise will be shipped C O D plus postage and C O D charges.

SIoux FALLS SURPLUS STORE
SIoux FALLS, S.DAK.



EASY PROFIT IN PAINT SPRAYING

Paints walls, ceilings, screens, furniture and machinery faster, better. All complete as shown less motor. Carry anywhere. Fully guaranteed. Could be used with 1/4 H.P. motor or less. Price \$35.00 less motor F.O.B. Chicago. \$5.00 deposit balance C.O.D. or see your dealer. Order 111-1-31.

IDEAL AUTOMATIC PUMP CO., Dept. P.M. 8
Chicago 7, Ill.

Build Your Own arc welder

For light or heavy work. 75-200 amperes. Complete PLANS 35c. Send today and we'll include FREE our big new catalog. LEJAY MFG. CO., 1347 LeJay Bldg., Minneapolis 8, Minn.

SAY YOU SAW IT IN POPULAR MECHANICS

TONGUE AND GROOVE - FLUTING - NOTCHING - INLAY - ANY JOINT

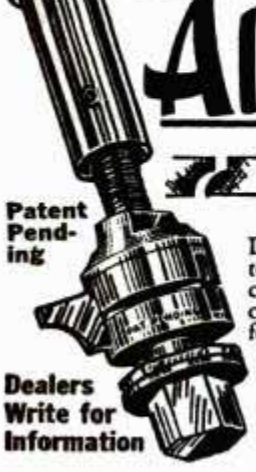

Aladdin's Tool



DeLux Model includes bottom bearing that anchors tool to bottom of press. Regular Model without bearing. Comes complete with adaptor and 6 blades making 12 standard cuts—balance blade—beautiful wood box. Over 100 different, practical cuts can be made with the 6 blades. See your dealer or send check or money order for delivery to your door. All other orders C.O.D. plus postage.

THE DESIGN COMPANY
531 Scarritt Bldg., Dept. F17, Kansas City 6, Mo.

AND YOUR DRILL PRESS
Makes any cut wood-shaping tools costing up to \$300.00 can make—more too. Sturdily built, lasts a lifetime.

TWO MODELS—IMMEDIATE DELIVERY



DELUXE MODEL \$11.95 with bottom bearing as illustrated
REGULAR MODEL \$7.95 without bottom bearing..

New! Economy-Priced! Built expressly for the home shop!

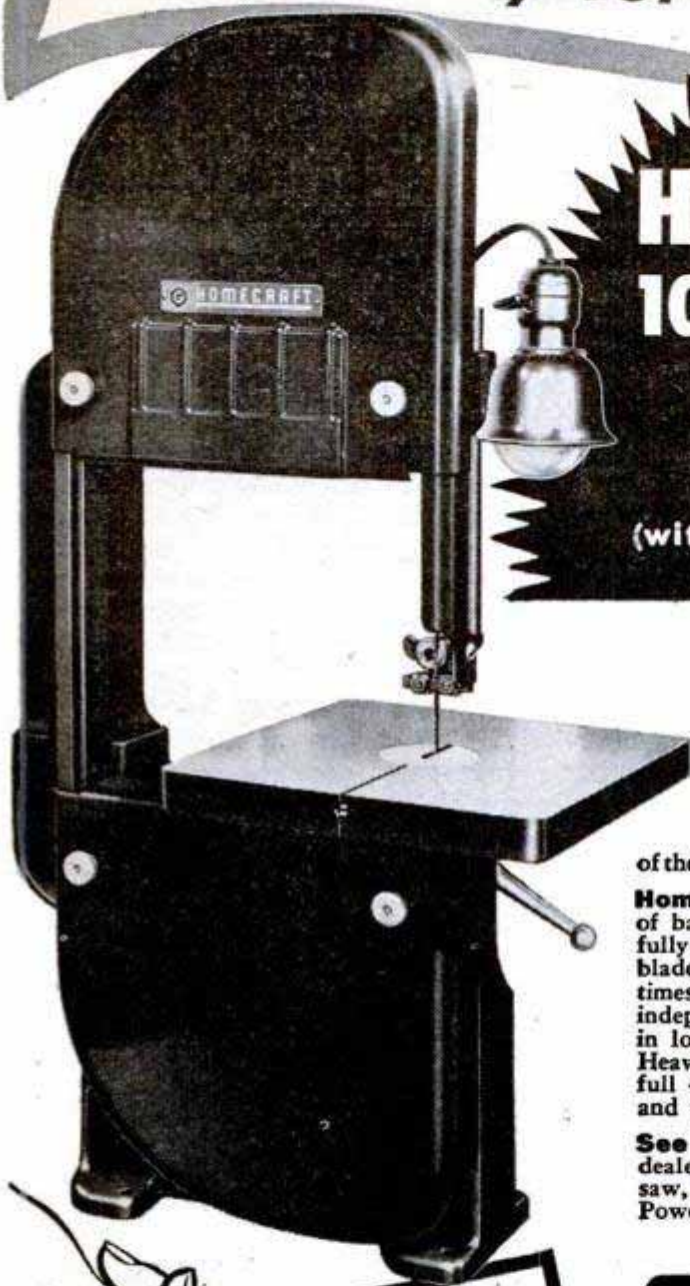

HOMECRAFT® 10-inch Band Saw

No. 28-110

Only \$36⁹⁵

(without motor or lamp attachment)

A practical hobbyist's band saw that has 6½" capacity under the guide and a throat capacity of 9½"

The 28-110 *Homecraft* Band Saw is an outstanding hobby-shop tool! It fulfills the demand for a good, dependable, popular-priced tool that fits the needs of the average hobbyist who "tinkers" with wood.

Homecraft features like this add up to a lot of band saw for the money: Blade guides are fully adjustable for different sizes and types of blades. Correct tension is kept on blade at all times. Ball-bearing blade support is adjustable independent of blade guides. Bronze bearing in lower wheel; needle bearing in upper wheel. Heavily-ribbed 10" x 10" cast-iron table tilts full 45° for angle-cutting, has convenient scale, and can be securely locked in place.

See It At Your Dealer! Ask your *Homecraft* dealer to show you this No. 28-110 new band saw, and his complete display of *Homecraft* Power Tools priced from \$29.95 to \$39.95.

Visit your *Homecraft* dealer now!



**HOMECRAFT®
POWER TOOLS**

General Sales Office — Chicago 2, Illinois

Descriptive Literature! Shows all *Homecraft* Power Tools and accessories. Sent to you free. Use coupon below, to get your copy.



Tilting table locks quickly and securely in place. Convenient scale tells you the angle of tilt.

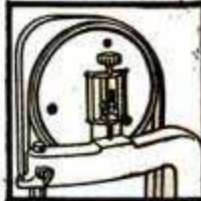

Wheel-tension and blade-tracking adjustments provide handy means of aligning blade and keeping correct tension at all times.

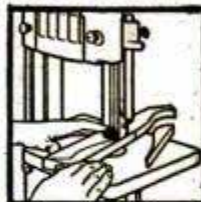

For safety, protection is provided by front blade guard which adjusts up and down with blade guides and ball-bearing blade support.

HOMECRAFT POWER TOOLS

are built by the makers of the famous Delta-Milwaukee Power and Machine Tools, the acknowledged leaders in accuracy, safety, and dependability. Thousands of Delta tools are used today in industry, in schools, and in home shops too. So, if your goal is the finest shop obtainable, equipped with high-quality power tools that embody the very finest principles of engineering, design, and construction, then insist on Delta-Milwaukee Power Tools. *Trade Mark Reg. U.S. Pat. Off.

HM-56

Tear out coupon and mail today!

DELTA MANUFACTURING DIVISION
Rockwell Manufacturing Company
681B East Vienna Ave., Milwaukee 1, Wisconsin

Please send descriptive literature on *Homecraft* Power Tools.

Name.....

Address.....

City..... (.....) State.....

Start a SAW REPAIR BUSINESS!

MAKE A GOOD LIVING IN YOUR OWN BUSINESS—sharpening saws with the Foley Automatic Saw Filer. It makes old saws cut like new again. All hand saws, also band saws and cross-cut circular saws can be filed on this ONE machine.

THERE ARE HUNDREDS OF SAWS TO BE FILED in your own neighborhood, used by farmers, carpenters, homes, schools, factories, etc. W. L. Tarrant writes: "I left my old job last September and in 10 months have filed 2,159 saws. We have a lovely business worked up and cannot keep up with the work."

IMMEDIATE DELIVERY!

Start your own business now, in spare time. **FREE PLAN** shows how, — no experience needed, no canvassing. Send coupon today.

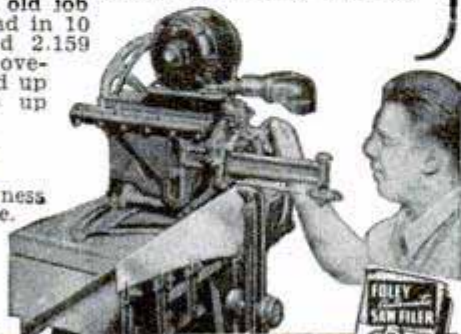

FOLEY Automatic SAW FILER

FOLEY MANUFACTURING CO.

216-8 Foley Bldg., Minneapolis 18, Minnesota
Send Free Plan on Saw Filing business, no obligation

Name _____

Address _____



NEW VISE-GRIP WRENCH

**NEW GEOMETRY:
MORE POWER
EASIER TO OPEN**

New Thin-Nose VISE-GRIP wrench has new Involute Jaw Curve, Knurled Jaw Tips and powerful Wire-Cutter. It's the world's most complete hand tool!

Locks to the work with Ton-Grip. Holds anything, any shape, with non-slip grip. Easy to open. Adjusts to ratchet action. Fine alloy steel.

SEE YOUR DEALER

With cutter 7" \$2.25; 10" \$2.50
Without cutter 7" \$1.85; 10" \$2.25

PETERSEN MFG. CO., Dept. M-2, DeWitt, Nebr.

in its infancy, set to work and discovered it was caused by an insect called the mealy bug which secreted a toxin. This bug, incidentally, seems to have some strange alliance with the ant. The ant constantly attends it, moves it from plant to plant, and protects it from its natural enemies. The pest was brought under control by measures developed by the scientists.

Both industries are constantly expanding their programs of scientific research. It costs the sugar planters alone more than \$1,000,000 to maintain the experiment station, but they feel it is well worth it.

The Burned-Nose Club

(Continued from page 111)

Assured that they will not be burned to a crisp, they are started out in temperatures of 100 degrees—not much more than a hot day at Coney Island. Next time they are jumped to 140 degrees—about like standing out-of-doors in the midday sun in Death Valley. In succeeding experiments temperatures go on up to 180, 220 and 260 degrees. Each succeeding time, the experimenters are better able to "take it."

The body is almost as effective in overcoming severe heat conditions around it as it is in combating severe cold. Through the mechanism of the sweat glands and other cooling processes, the human body strives to create around itself a cool "envelope" of air that is substantially lower than the rest of the air in the hot box.

For example, here are thermocouple temperatures recorded, toward the end of the experiment, at various places on the body when the hot-box air registered 220 degrees:

Forehead.....	101
Chest.....	101
Back.....	102
Abdomen.....	101
Upper arm.....	99½
Forearm.....	100
Thigh.....	104½
Calf.....	105

In this same experiment, rectal temperatures, taken to record body temperature, in general never went higher than about 100 degrees. Normal is 98.6 degrees.

It was thought at first that the eye, being perhaps the most delicately adjusted and constructed organ in the body, would probably suffer most under conditions of extreme heat. What the researchers underestimated was the eye's own cooling system of tears. Delicate thermocouples of #40 copper and constantan wire were

(Continued to page 280)

Free

CONCORD RADIO CATALOG

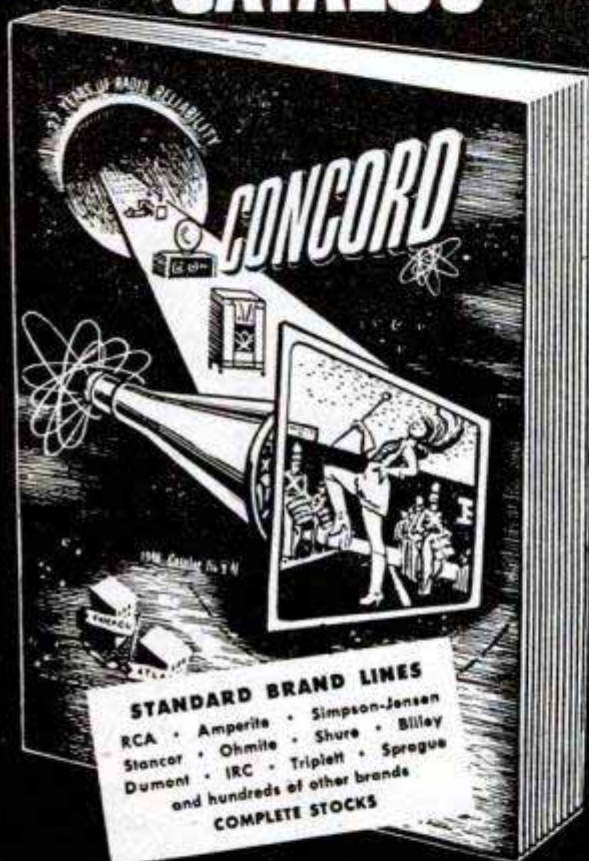

**LOWEST PRICES on Everything in
RADIO • TELEVISION • RADAR
ELECTRONIC EQUIPMENT**

- Thousands of items—parts, supplies and equipment—for every Radio and Electronic need.
- Special Bargains—hundreds of money-saving values in top quality Radio Parts.
- Immediate delivery from big complete stocks at Chicago and Atlanta.

MAIL COUPON FOR FREE COPY

CONCORD

RADIO CORPORATION

CHICAGO 7 ATLANTA 3
901 W. Jackson Blvd. 265 Peachtree St.
Downtown Chicago Branch: 229 W. Madison St.
Lafayette Radio Corp.

*A Few of the Thousands
of Great Money-Saving
Buys in this 160-Page
Radio Catalog!*

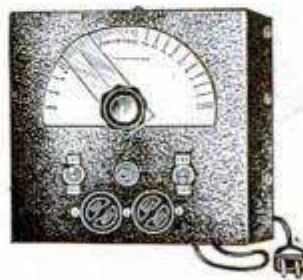

ELECTRONIC Photo-Print Timer

Time range from 1 to 60 seconds. Will control any electric appliance or lamp that does not draw more than 250 watts. The relay coil is in series with the plate circuit of the triodes-connected portion of a 117L7-GT tube. After a warm-up period, the tube conducts through the relay coil and closes the relay. Enlarged blueprint of all layout and wiring diagrams complete in every detail is furnished. Popular Mechanics No. R-339. Less tube. Shp. wt. **\$767**
6 lbs. C24518.....

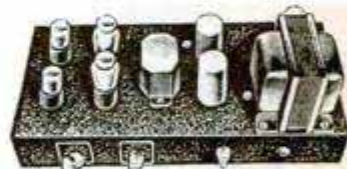

10-WATT AMPLIFIER

Wherever a good ten watt audio amplifier with negligible distortion is desired this conservatively rated unit "fills the bill." An exceptional bass reproduction method eliminates booming unnatural tones. The output stage is resistance coupled with a pair of 6A3 type tubes in push-pull being used. Circuit includes a phase inverter and a simple form of feed-back that prevents distortion and reduces hum level. Tubes employed: 6C5, 6N7, two 6A3, 5U4G. Kit complete less 10 inch PM speaker and tubes. Shpg. wt. 24 lbs. Popular Mechanics R331. **\$1995**
C24512.....



EVEN-SPEED PHONO-MOTOR

Model 80. Rim-drive phono motor. 9" turntable. Constant speed (78 r.p.m.) self-starting, forced draft air-cooled. For 10" and 12" records. 110 V. 60 cycles only. Wt. 4 lbs. **\$269**
X182.....



5-TUBE AC-DC KIT

Five-tube AC-DC superheterodyne. Includes automatic volume control, true tone reproduction. Streamlined airplane dial, wide tuning that covers 550 to 1600 KC, built in loop antenna and Alnico V speaker. Cabinet is beautiful brown plastic. Kit contains all parts to build complete receiver. C24456—With cabinet and tubes..... **\$1375**



CRYSTAL PICKUP

Quality crystal pickup mounted in arm for 10" and 12" records. Mounting included. Requires 1/2" hole. Shielded lead and cartridge case. Aluminum die cast arm finished in smooth dark brown. With semi-permanent needle. **\$159**
X143.....

Concord Radio Corporation, Dept. P-28
901 W. Jackson Blvd., Chicago 7, Ill.

Yes, rush FREE COPY of the comprehensive new Concord Radio Catalog.

Name.....

Address.....

City..... State.....

SEE IT TODAY!
EVERY FEATURE
YOU WANT FOR FINE
WORKMANSHIP

NEW
Atlas
10" TILT/ARBOR
FLOOR SAW

"ALL CONTROLS
 HANDY AND
 EASY-WORKING"



"CONVENIENT SAWDUST
 CLEAN-OUT"

"SMOOTH-
 RUNNING
 ON
 PRECISION
 BALL
 BEARINGS"

"2 BALL BEARINGS ON
 REAR FENCE RAIL"

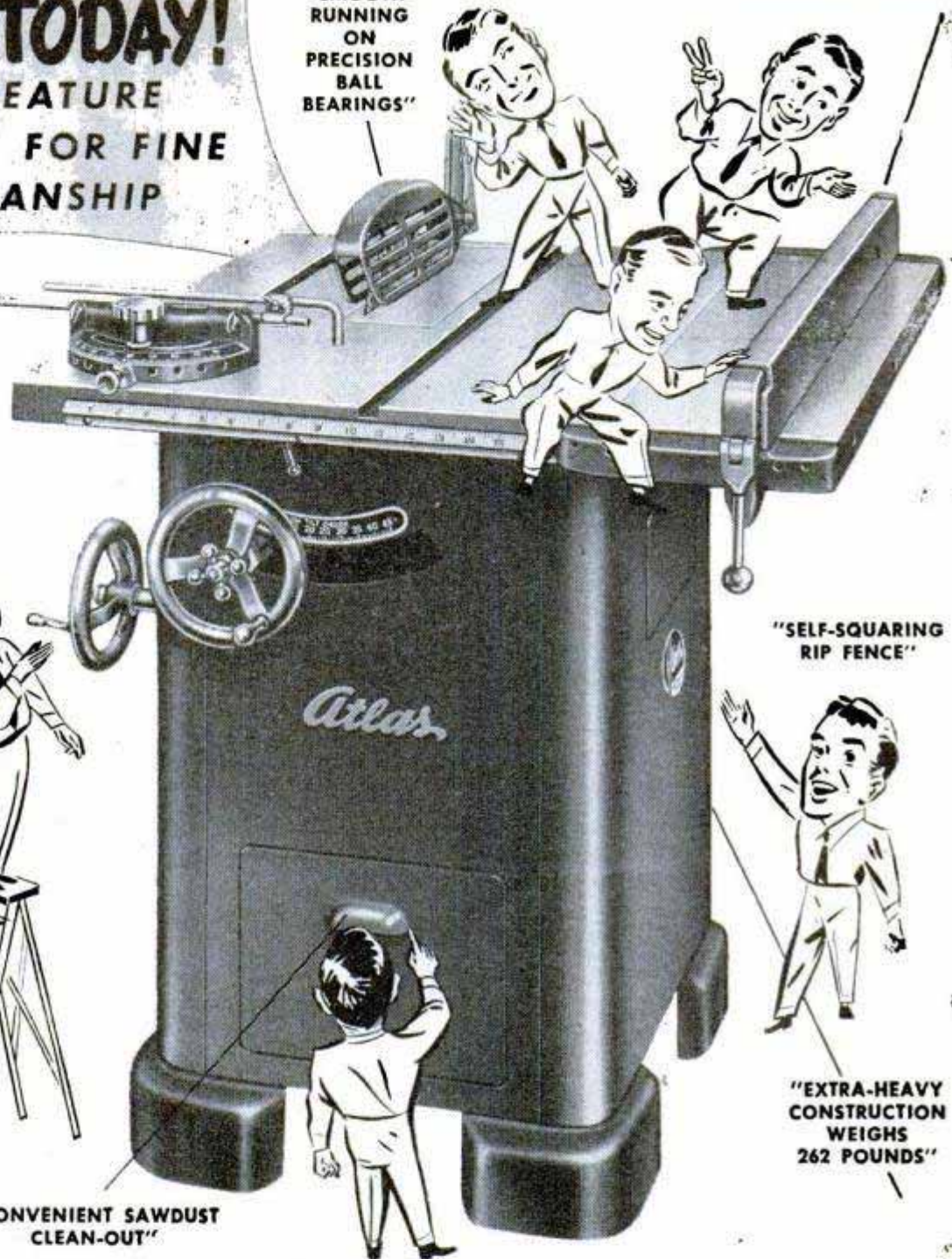

"SELF-SQUARING
 RIP FENCE"



"EXTRA-HEAVY
 CONSTRUCTION
 WEIGHS
 262 POUNDS"

Send for Free Illustrated Bulletin

ATLAS PRESS COMPANY
 243 N. Pitcher St., Kalamazoo 13D, Mich.

Please send me free illustrated bulletin on the
 new Atlas 10" Tilt/Arbor Floor Saw.

Name _____

Address _____

City _____ State _____

CHECK THIS NEW ATLAS SAW — inside and out — see everything *you* would specify in a made-to-order machine! It's a natural for cabinet makers, builders, lumber yards, manufacturers, and home workshops . . . built with metal-working tool precision for easier, *more accurate* sawing . . . with ruggedness to stand the gaff of steady, heavy-duty work. Examine its big table: 27½" x 27½", with 13¼" working surface ahead of the blade. Note the precision ball bearings for *permanent smoothness*. Go over the new-type rip fence — *self-squaring*, locks rigidly at both ends, *releases instantly* for positioning or removal — nothing else like it! This new Atlas is the last word in saw engineering — built for years of dependable service. Ask your Atlas distributor, or send for illustrated bulletin.



ATLAS PRESS CO.

243 N. Pitcher St. • Kalamazoo 13D, Michigan

Paint Your Own Car in *One Hour* with the **NEW AUTO ENAMEL**

YOU WIPE ON Like Magic with only a **POWDER PUFF**

LUSTR-WIPE

2 YEAR
Guarantee

TRADE MARK

Dries in about one hour to smooth, mirror-like professional finish.

GUARANTEED FOR 2 YEARS not to crack, chip, peel or fade, if simple directions are followed. Lustr-Wipe is NOT a wax or a polish but a marvelous new Auto Enamel.



NO Brushing
NO Spraying
NO Masking
NO Streaks

Just follow the simple instructions and LUSTR-WIPE will give your car that new "factory-look." No Streaks! No Lap-marks! Dries dust-free in about an hour! Goes over any other color, enamel or lacquer.

ONE QUART PAINTS YOUR ENTIRE CAR ANYONE CAN DO A BEAUTIFUL JOB

LUSTR-WIPE is the easy, speedy, economical, yet most successful way you've ever seen to PAINT YOUR OWN CAR. It's different-works almost like magic! All you need is ONE QUART of LUSTR-WIPE, the Miracle Auto Enamel, and the powder puff we send you AT NO EXTRA COST. Almost ANYONE, can do a magnificent job in about ONE SHORT HOUR. It seems unbelievable but true. JUST WIPE IT ON. No brush needed. No spray required. No masking of any kind. LUSTR-WIPE dries dust-free in about an hour. You'll be amazed—thrilled beyond words with the results! Your friends will think you spent \$75 to \$125 for a professional paint job. YOUR CAR WILL LOOK "LIKE NEW". Rush your order for a quart of LUSTR-WIPE TODAY.

WHICH OF THESE 10 COLORS DO YOU LIKE?

BLACK \$3.95 Qt. **Brewster GREEN (dark)** \$3.95 Qt.
MAROON \$3.95 Qt. **Jewel GREEN (light)** \$3.95 Qt.
Washington BLUE (dark) \$3.95 Qt. **Gunmetal GREY (dark)** \$3.95 Qt.
Monticello BLUE (light) \$3.95 Qt. **Air Wing Grey (light)** \$3.95 Qt.
RED \$3.95 Qt. **Sun BEIGE (tan)** ... \$3.95 Qt.

MAIL COUPON TODAY! SEND NO MONEY!

AGENTS WANTED FOR NEW MONEY-MAKING BUSINESS! CAN MAKE GROSS PROFITS UP TO \$275.00 IN ONE WEEK.

Go into business for yourself selling LUSTR-WIPE in cans, or painting cars yourself or having others to do the work. Owners of old cars everywhere (who can't get new cars) are easy prospects. Send now for our MONEY-MAKING PLAN.

DISTRIBUTORS WANTED: A few wonderful territories now available. Write at once for our SPECIAL OFFER. LUSTR-WIPE CORP. 166 W. Washington St. Dept. 2, Chicago 2, Ill.

This Price for Immediate Delivery

SAVE by
Ordering
NOW!

ORDER ONE
OR MORE
QUARTS TODAY

\$3.95
PER
QUART

Applicator
Furnished

LUSTR-WIPE CORP. 166 W. Washington, Dept. 2, Chicago 2, Ill.

Please send me _____ quarts of LUSTR-WIPE AUTO ENAMEL at the special price of \$3.95 per quart.

COLOR _____

Send Postpaid. Full Payment \$_____ enclosed.

Send C.O.D. plus Postal charges.

NAME _____

ADDRESS _____

CITY _____

ZONE _____

STATE _____

Send information regarding AGENT PLAN.

Send information regarding DISTRIBUTORSHIP.



MOTO-SAW

THE AMAZING ELECTRIC SCROLL SAW

Boys from 8 to 80 (and girls, too) have fun with a Moto-Saw . . . it works more like magic than any tool you ever saw! It takes no effort to run, no perceptible pressure to feed. Runs 7,200 strokes a minute . . . easily cuts intricate scroll designs in medium hard wood up to 3/4" thick. Blade holder faces blade 4 ways . . . permits you to saw sideways as well as forward and backward. No limit to length of stock it will cut . . . saws to center of 19" widths. **Moto-Saw is as safe as a hand saw . . . has only two moving parts . . . never needs oiling.** Uses 110-120 V. 50 or 60 cycle A.C. (only). Thousands of satisfied users.

MONEY-BACK GUARANTEE: If your dealer does not yet have Moto-Saw, send only \$5.85 . . . we'll pay postage. Or send \$1, and pay postman balance plus postage. Money back if not delighted after 5 days' trial.

DREMEL MFG. CO., DEPT. S-118-B, RACINE, WIS.



STOP LEAKS!

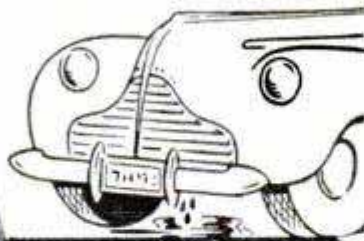

**Cooling Systems
Made Leak-Proof QUICKLY**

WARNER LIQUID SOLDER—Non-Metallic—Deposits Tiny Fibers to Repair Leaks Anywhere in Cooling Systems. Simply pour in! Finds and REPAIRS every crack or hole. Do it yourself—or see your service man.

Warner-Patterson Co., 920 S. Michigan Ave., Chicago 5

placed carefully against the eyeball after it had been partially anesthetized. At 180 degrees inside the heat chamber, the contact temperature of the eyeball remained at 107.9 degrees.

Even in inhaling and exhaling, through nose and mouth, it was discovered that the body's cooling system was at work substantially lowering excessive temperatures. At 220 degrees inside the hot box, air drawn past the lips measured only 190 degrees and when it got to the back of the mouth it was only 140 degrees. Exhaled air measured about 108 degrees at the back of the mouth and 110 degrees at the lips.

In general, those parts of the body which are injured first by extreme cold were affected first by extreme heat—tips of noses, ears, fingers and toes. At the highest temperature recorded to date—262 degrees—Dr. Craig Taylor's nose was slightly scorched around the delicate membranes of the nostrils. He was promptly elected a member of "The Burned-Nose Club."

In addition to skin and body temperatures, such factors as the humidity of the air, the loss of moisture through sweating, the increase in pulse rate, and the general condition after removal from the hot box were observed.

The heated air was kept at low humidity and this partially explained why researchers were able to stay in the oven for a matter of minutes. The experimenters found that they couldn't use a standard wet-bulb thermometer—the water dried up too rapidly in the high temperatures.

The experiments proved that human respiration can function for some time under extreme temperatures without ill effects. Sweating in all cases was heavy and increased as the temperature rose. For example, at 100 degrees Fahrenheit, the loss of weight (representing sweat loss) was estimated to be 145 grams per hour, while at 220 degrees the loss had increased to 2125 grams per hour.

An increase in pulse rate at all temperatures was noted. At 220 degrees, for example, it rose from 68 to 132—almost twice normal.

After hot-box sessions, the subjects reported a variety of experiences. One felt extreme suffocation. Another reported a dulled sense of hearing and sight. A third experienced nausea. When taken from the heat chamber and cold towels applied to faces and necks, all recovered quickly. In most cases, however, a feeling of fatigue lingered the rest of the day.

But the effects weren't lasting or serious. Twenty-four hours after he had set a

(Continued to page 284)



QUALITY

TABLE MODEL TILT-ARBOR SAWS

OIL IMPREGNATED BRONZE BEARINGS OR DOUBLE SHIELDED BALL BEARINGS, BOTH WITH THE PATENTED BALL BEARING TRANS-AXIAL MOTOR DRIVE

BRONZE BEARING
\$4495
F.O.B.
ROYERSFORD, PA.
(Less Blade & Motor)

IMMEDIATE
DELIVERY

Double
Shielded
Ball Bearings
\$5 Extra

TABLE 18" x 16"

Aluminum Guard
Easily Removed
for Dadoing

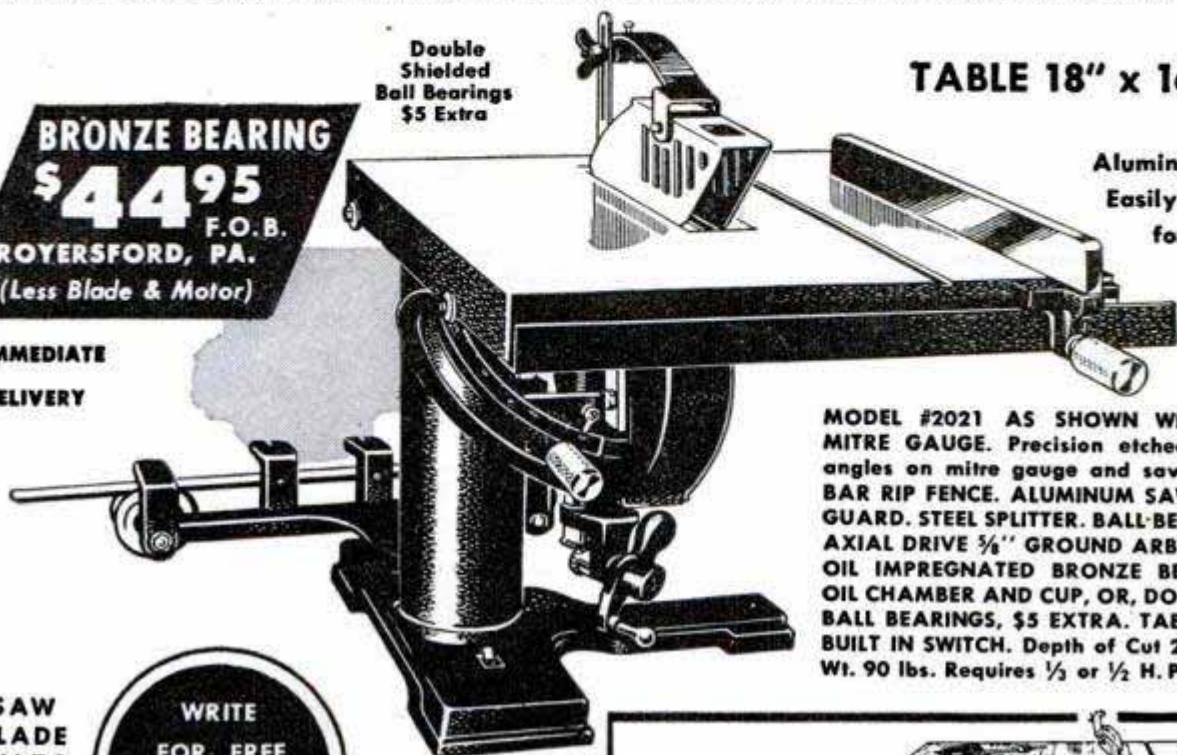

MODEL #2021 AS SHOWN WITH COMPLETE MITRE GAUGE. Precision etched scales show angles on mitre gauge and saw cradle. STEEL BAR RIP FENCE. ALUMINUM SAW INSERT AND GUARD. STEEL SPLITTER. BALL-BEARING TRANS-AXIAL DRIVE 3/4" GROUND ARBOR. "COMPO" OIL IMPREGNATED BRONZE BEARINGS WITH OIL CHAMBER AND CUP, OR, DOUBLE SHIELDED BALL BEARINGS, \$5 EXTRA. TABLE 18" x 16". BUILT IN SWITCH. Depth of Cut 2 5/16". Shipping Wt. 90 lbs. Requires 1/2 or 1/2 H. P. Motor.

SAW
BLADE
TILTS

WRITE
FOR FREE
ILLUSTRATED
FOLDER

TABLE
STAYS
LEVEL

FLOOR MODEL



37 1/2"

**BALL
BEARING**
\$7950
F.O.B.

Royersford, Pa.
(Less Blade
& Motor)

Table 18" x 32" including 18" x 16" extension. Additional extension available to increase table size to 18" x 48".

Complete as shown including Arbor with Double Shielded Ball Bearings and Trans-axial Ball Bearing Drive.

Model #2021
With 2 Extensions
Makes Table 18" x 48"



TABLES PRE-DRILLED FOR EXTENSIONS



EXTENSION
MAKES TABLE
18" x 32"

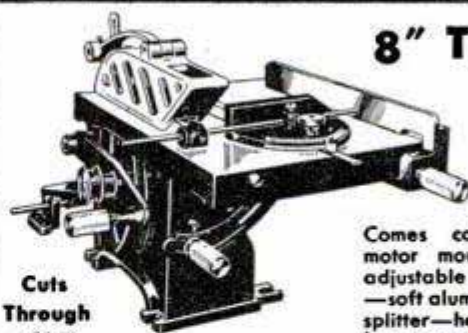

8" TILT TABLE BENCH SAW

Cuts
Through
2 5/16"

Comes complete with Floating motor mount—mitre gauge with adjustable stop—aluminum guard—soft aluminum insert—spring steel splitter—heavy gray iron fence—(no motor—no blade).

Table 12" x 14" Tilts to 45°—Oilite bearings. Shipping Wt. 50 lbs.

\$2495
F.O.B.
ROYERSFORD, PA.

COMPLETE AS SHOWN

MARCUS • POLLAK

AMERICAN MACHINE & TOOL CO. INC.

DEPT. 10
ROYERSFORD, PA.

MACHINE BUILDERS AND IRON FOUNDERS FOR OVER A QUARTER OF A CENTURY

BALL BEARING STEEL WHEELS

Complete with GOODYEAR, GATES or OSBORN PUNCTUREPROOF Semi-Pneumatic Tires . . . Also Solid and Pneumatic Tires . . . FUN . . . SPEED GALORE . . . BUILD YOUR OWN RACER, ETC.

Made To Outwear Other Type Wheels

SIZE	TIRE	BEARINGS	LOAD	ONE	TWO	FOUR
12" x 2 1/2"	Semi-Pneumatic	Ball 1/2" or 3/8"	150 Lbs.	\$ 5.50	\$10.00	\$18.00
10" x 1 3/4"	Semi-Pneumatic	Ball 1/2" or 3/8"	125 Lbs.	\$ 3.00	\$ 5.50	\$10.00
10" x 2 1/2"	Semi-Pneumatic	Ball 5/8"	250 Lbs.	\$ 5.50	\$10.00	\$18.00
20" x 1 3/4"	Semi-Pneumatic	Ball 7/16"	60 Lbs.	\$ 5.00	\$ 9.50	\$18.00
<small>(the above 20" is Bike type 20 Spokes)</small>						
6" x 1 5/8"	Solid	Ball 3/4"	480 Lbs.	\$ 7.85	—	—
6" x 1 7/8"	Solid	Ball 3/4"	640 Lbs.	\$10.35	—	—
4.00" x 8"	Pneumatic	T. R. 1"	700 Lbs.	\$13.50	\$26.00	\$50.00

(the above 4.00 x 8 is 4 Ply Goodyear with Tube and Taper Roller Bearings for 1 inch diameter straight axle.)
Add 10% For Prepaid Shipment in U.S.A.
SEND 10c FOR CIRCULAR ON: Model "C" Racer with 2 H.P. Gasoline Engine; 86" Long x 40" Wide and 4.00" x 8" Tires. Also Steering Wheel Assemblies . . . Auto Type Axles . . . Carts . . . Gasoline Power . . . Trucks . . . Pulleys . . . Belts . . . and many other interesting items.



**-NEW-
1948 MODEL "B" RACER**

REAL THRILL FOR ANY BOY!
76" Long x 30" Wide, 12" Steering Wheel; Left Side Steering, Two Passenger, 12" Wheels, Foot Pedals, Internal Brakes, 1-H.P. Gasoline Engine, Transmission, Etc., as shown **READY-TO-RIDE . . . ONLY \$175.00.**
Add 10% for Prepaid Shipment in U.S.A.
CHASSIS as shown less power plant, ONLY \$56.00
Add 15% For Prepaid Shipment in U.S.A.

ORDER NOW

OSBORN WHEEL COMPANY, 115 So. Main St., Dept. P-2, Doylestown, Penn.



You Can Make Up to \$5.00 Per Hour with the IDEAL

There are hundreds of lawnmowers in your neighborhood that will need sharpening at least once or twice each season. You can build up a profitable business with the Ideal Lawnmower Sharpener, and earn up to \$5.00 an hour while doing it.

You need no experience to operate the Ideal Lawnmower Sharpener. Just place the lawnmower in the Ideal, make a few simple adjustments, and in a few minutes you have a smooth-running, perfect-cutting lawnmower. The Ideal is not a "make-shift" sharpener, it has 45 years of engineering design behind it, . . . is sturdily built, and grinds both straight blade and reel knives to a precision-cutting edge. Write today and learn what the Ideal Lawnmower Sharpener can do for you.



DON'T DELAY

Send For FREE Book

The FATE-ROOT-HEATH CO.

DEPT. D-3, PLYMOUTH, OHIO

BUILD YOUR OWN TRAILER



Get these Modern Complete Plans

Select just the model you want—for hunting—travel—camping—or as a home. Each plan is complete with simple, step-by-step instructions and a bill of materials. Easy to follow. Three models!

STOCK No. H27 NATIONAL MODEL 27. A sleek 27-foot trailer with 3 rooms, lavatory, etc. Sleeps six. complete plan **\$1.00**

STOCK No. H20 NATIONAL MODEL 20. A good-looking, easily-built 20-ft. trailer. 3 rooms, sleeps four. complete plan **\$1.00**

STOCK No. H10 NATIONAL CAMPER. A compact unit for traveling, camping, hunting, fishing. Sleeps two. Complete plan **.50**

Special—Order all 3 of above plans.....\$2.00

FREE! Big parts catalog with any order

NATIONAL TRAILER STORES

Dept. 10 Box 2353 Terminal Annex - Los Angeles 34, Calif.

ELECTRIC MOTORS

Heavy Duty

Nationally known makes. Guaranteed capacitor type, ball bearing heavy duty motors, 110/220 volts.

**60 Cycle AC Single Phase
1725 RPM.**

1/4 HP	\$24.00
	Wt. 30 lbs.	
1/2 HP	\$34.50
	Wt. 36 lbs.	
3/4 HP	\$44.00
	Wt. 50 lbs.	
1 HP	\$57.00
	Wt. 80 lbs.	



These motors also furnished in 3450 R.P.M. at above prices. Prices are F.O.B. Chicago. Immediate delivery. Send check or money order today. **SOLD ON MONEY BACK GUARANTEE.**

C & M EQUIPMENT COMPANY

1831 S. STATE ST., DEPT. D-2 CHICAGO 16, ILL.



STOP

Save 80%

ASSEMBLE YOUR OWN ARC WELDER

ALL PARTS READY-MADE — READY TO ASSEMBLE

OWN A GENUINE INDUSTRIAL-TYPE HEAVY DUTY WELDER

Why pay expensive assembling and shipping costs? The ATOMIC WELDER PARTS come packed in a compact box—YOU SAVE THE DIFFERENCE!

60lbs. of Parts
Including secondary and shunt coils wound completely with double glass covered electro-litic copper.

EASY TO ASSEMBLE with simple, step-by-step instructions, in a few hours. Also included are 10 easy lessons in Arc Welding. **IDEAL HEAVY-DUTY WELDER** for all-purpose arc welding. Safe, rugged, compact and EFFICIENT. WILL OPERATE FOR ONLY A FEW CENTS PER DAY.

Plugs into either 110 or 220 AC line. Can be used consistently on 30 amp. fuse. ALL PARTS DESIGNED TO GIVE LIFETIME SERVICE.

SATISFIED USERS FROM COAST TO COAST SAY:

- "Have bought two other welders — Atomic Welder is the only one that lives up to claims."
- "Did not heat up after four hours of constant use."
- "Welds any thickness of material."

60 LBS. OF READY-MADE PARTS

\$24.95

only . . .



ORDER WITH CONFIDENCE! IMMEDIATE DELIVERY

Try your ATOMIC WELDER for 30 days. If not satisfied, return as is. Your money will be refunded with no questions asked. What could be fairer than that?

INCLUDED PLANS FOR BUILDING CASE — WRITE FOR BOOKLET P-14

NECESSARY PARTS ATOMIC WELDER COMPANY • 1038 So. 19th Street • Omaha, Nebr.

ELECTRIFY

Your Sewing Machine With a

"SEWING MACHINE MOTOR KIT"

The IDEAL GIFT for Mother... Wife... Sister!

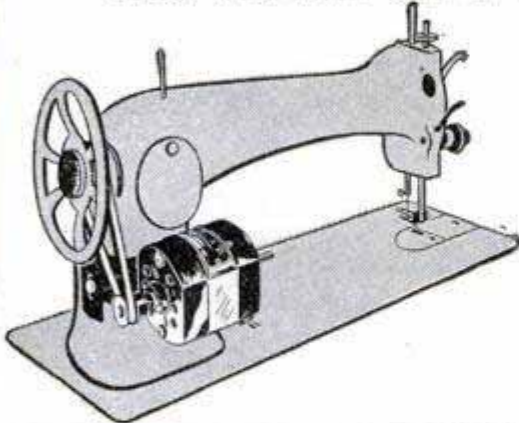

\$17.75
COMPLETE

ADJUSTABLE FOR USE WITH ANY TYPE OF SEWING MACHINE

ANYBODY CAN INSTALL IT!

Takes but a few seconds

COMPLETE SET CONSISTS OF:

(A) MOTOR & BRACKET—Universal AC or DC, 60 cycle, 115 Volts. (B) BELT—Long Wearing Rubber Belt. (C) PULLEY—Single Grooved Steel Hubbed Pulley. (D) BRACKET—New and Improved. (E) FOOT CONTROL—7 Step Rheostat. (F) CORD SET—Extension Cord fitted with plug and socket. (G) Installation Instruction Sheet.

SPECIAL NOTE: This 1/20 H.P. motor with double end shaft and rheostat can be used in all hobby workshops for flexible shaft attachments, grinding, drilling etc.

Special Offering to DEALERS!

MAIL THIS COUPON

Dept. PM-3

BROWNELL DISTRIBUTORS, INC.

308 Canal St., New York 13, N. Y.

Please rush _____ motor kits at \$17.75 each (postage prepaid) in:

Name _____

money order or check
 send C.O.D.—and I'll pay postman \$17.75 plus C.O.D. fees.

Address _____

City _____ Zone _____ State _____

LIGHT PLANTS

Used Gov't Surplus — Lowest Price Ever Offered—3,000 watt, 110 volts.

Powered by Briggs-Stratton or Wisconsin 6 H.P. air-cooled engine. For stationary or portable use. **RE-BUILT-GUARANTEED**, good mechanical and operating condition. Our price **\$149.50**



Limited Supply — Immediate Delivery — Order Now
Write for Illustrated Circular

MIDWEST SURPLUS SALES 1520 LOCUST ST. KANSAS CITY, MO.

MAGNETS OF ALL TYPES—10c UP
AMAZINGLY POWERFUL!
5 oz. Alnico Magnet, lifts 10 lbs. \$1.00. Our Leader, 15 oz. Magnet, lifts 40 lbs. \$1.95. New alloy—will not weaken! Useful for lifting valuables from tanks, jakes, or rivers easily! 7 small magnets \$1.00 with list of many shop and home uses. Satisfaction guaranteed.
R. EYRICH, 2566 N. 49TH ST., MILWAUKEE 10, WIS.



MINIATURE ENGINES

Gasoline—Steam
Air—Locomotive



THE WORLD'S MOST FASCINATING HOBBY

Build them yourself — In your own shop
With your own tools



Send 10 cents for my illustrated catalogue listing the world's largest selection of miniature engine castings and drawings.

McADED MODELS
1313 S. TALMAN AVE.
CHICAGO 8, ILLINOIS

MAKE YOUR OWN KEYS

In 20 Seconds!



SEGAL KEY MACHINE

The standard professional key duplicator used by locksmiths for over a quarter of a century.

- Duplicate All Types of Keys.
- Replace Lost Keys Quickly.
- Keep Closer Control Over Keys.

START A PROFITABLE BUSINESS!
Make keys for others! Small investment—big profits!

Write for Descriptive Folder and Price List

NORWALK LOCK CO.
Division of Segal Lock & Hardware Co.
395 Broadway, Dept. P.M. New York 13, N. Y.

His hobby is gunsmithing. He uses Nicholson files.



**YOU CAN TELL
A CRAFTSMAN
BY THE TOOLS HE USES**

ONE thing you'll notice about a real craftsman is the kind of tools he uses. They don't need to be fancy or intricate, but you can be sure they're top quality—the very finest made.

Files, for example, are selected with special care. For filing is an art. And the right file in hands that know how to give it "just the right touch" is often the deciding factor between a masterpiece and a failure. This is why you'll find a wide assortment of Nicholson or Black Diamond brand files on the work-benches of most artisans. Their superior performance far outweighs their small extra cost.

Try a few and see if they don't do better work, cut faster, last longer, cost less in the long run. They're easy to get—good hardware stores carry a practical variety.

Write for free book, "File Philosophy." It tells how to choose, use and take care of files.



**NICHOLSON FILE CO., 22 Acorn St.
Providence 1, R. I.
(In Canada, Port Hope, Ont.)**



**NICHOLSON
FILES FOR EVERY PURPOSE**

250-degree record, Dr. Taylor boarded a plane for Dayton, Ohio, made a hasty report to the Army and flew back to Los Angeles—getting but two full nights of sleep in four and not suffering noticeably.

The UCLA research team believes that heavy clothing will give protection against extreme heat in the same manner that it protects against extreme cold. They plan to follow this line of investigation in the near future.

At present their goal is to find the one organ of the body or particular skin area that will yield "critical temperature" information. In other words, if they could find one particular place in the human body that would indicate the limit of endurance, it would be relatively easy to devise an instrument to give a warning signal before such a temperature had been reached. It may be the eyeball, it may be the inside of the nose, it may be the back of the foot. Whatever it is, it has not yet been recognized as such.

Meanwhile the hot-box experiments are continuing. What the final record may be is not known, but the next series of experiments is aimed at 300 degrees.

Dr. Taylor once heard of a German who said he had withstood a temperature of 450 degrees in Nazi experiments during World War II. He was heavily clothed and remained inside the heat chamber only three minutes.

But the idea is intriguing and the UCLA engineering professor and his associates wonder if they'll ever be able to get up to 450 degrees. Such is the curiosity of scientists who produce the marvels of this modern age.

Atomic Explosions in Your Body

Approximately 150,000 radioactive carbon atoms explode every minute in every human, releasing energy equivalent to 21 billion electron volts, according to a new theory. Dr. Aristide V. Grosse of the Houdry Process Corporation at Marcus Hook, Pa., made the statement recently when he announced that cosmic rays produce radioactive carbon. Plants absorb carbon, he explained, by the chemical photosynthesis process of using sunlight. Additional carbon falls to the earth, according to Dr. Grosse, to be picked up by plants. Animals eat the plants, and man eats both the animals and the plants to acquire carbon. Dr. Grosse believes his theory will prompt a re-examination of the effects of radioactivity on the body, possible causes of cancer, and whether atom bombs are likely to cause as serious hereditary changes as some scientists have predicted.

MONEY SAVING SURPLUS BARGAINS



GENERAL ELECTRIC BC645 TRANSCIVER

A brand new Transmitter-Receiver covering 450-500 MC. Ideal for use in proposed citizens band between house, and car, boat, etc. 15 tubes alone cost \$58.00. Complete with conversion date for 110 VAC operation in sealed GE carton.

\$14.95

2 for \$27.00

Add postage for 25 lbs....

GN58 GENERATOR

Makes excellent home lighting plant, operated by wind propeller, waterfall, gas engine, or hand crank. Reduction gear allows full output at slow speed; supplies 6 volts at 2.45 amp., 425 volts at .115 amp. New. Add postage for 28 lbs.

\$7.95



DYNAMOTORS

Dynamotor A—Input 12 volts, output 1000 volts at 350 MA. Shipping weight, 72 lbs. **\$7.95**
 Dynamotor B—Input 6 or 12 volts, output 500 volts at 160 MA. Shipping weight, 30 lbs. **\$5.95**
 Dynamotor C—Input 28 volts, output 220 volts at 60 MA. Add postage for 6 lbs. **\$1.50**



BRAND NEW ARMY AIR FORCE

ASTROGRAPHS With Case

New B29 navigation instrument which can easily be used to make a good contact printer, strip map holder, etc. The plywood case 14 1/2"x11"x10" high is perfect as a tool kit, camera, projector case or for building a portable phonograph picnic kit, make up case, etc., has leather handle reinforced covers, 8 covered compartments in bottom. Cost Gov't \$125.00. Add postage for 20 lbs.

Only **\$3.95**



HEATHKIT AMPLIFIER KIT

Complete kit to build excellent 25 watt amplifier, ideal for P.A. system, phonograph amplifier, etc. Push pull circuit using best parts. Supplied with 4 tubes, punched chassis, blueprints and instructions. Add postage for 25 lbs.

\$14.95



G.E. BC375 TUNING UNIT

A beautifully constructed tuner containing the best in variable condensers, coils, vernier dials, etc., at least \$30.00 worth of parts, complete with conversion instructions to transmitter and receiver. Add postage for 20 lbs.

\$2.49



HEATHKIT TRANSMITTER KIT

Complete kit for building a fine amateur transmitter includes every part—tubes, cabinet, 80 meter coil, crystal, blueprints and instructions, less power supply. Add postage for 30 lbs.

\$19.50



HEATHKIT VACUUM TUBE VOLTMETER KIT

Build yourself this beautiful Electronic AC and DC voltmeter and ohmmeter ranges 3 volts to 1000 volts and to 1000 megohms. Every part supplied including blueprints. Add postage for 8 lbs. **\$24.50**

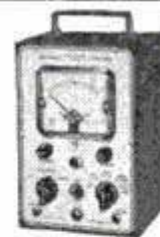

MINIATURE HEADPHONES

\$1.00

Hearing aid type, comfortable, keeps out outside noise, one of the army's best types. Add postage for 2 lbs.



THROAT MICROPHONE

Used by army in noisy applications in aircraft, tanks, etc. Many interesting home uses. Add postage for 1 lb.

\$1.00



WALKIE-TALKIE UNIT

BC746 Tuning Unit contains two crystals, receiving coil and condenser and transmitter tank coil, fine for radio builders. Add postage for 1 lb.

\$1.00

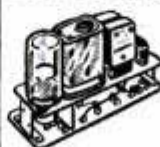

T32 TABLE MICROPHONE

One of the army's finest built by Kellogg. Ideal for public address, transmitters, etc. Add postage for 5 lbs.

\$2.95



POCKET TESTER KIT

Build this AC and DC voltmeter and save 2/3 the cost. Includes 2 1/2" meter, resistors, rectifier, and mounting. Reads 0 - 3 - 30 - 300 VDC and 0 - 300 VAC, instructions. Add postage for 2 lbs.

\$2.95



RADIO BUILDERS' KITS

- Power supply kit to convert army radios to 110 VAC **\$5.05**
- 5" P.M. loudspeaker for army radios..... **\$2.80**
- Experimenter's Kit, 5 lb. of radio parts for **\$1.00**
- Kit of 20 radio tube sockets for..... **\$1.00**
- Kit of 20 Bypass bathtub condensers..... **\$1.00**
- Kit of 10 radio volume controls..... **\$1.95**
- Kit of 10 Midget variable condensers **\$1.95**
- Kit of 100 color coded insulated resistors **\$1.95**

G.E. CIRCUIT BREAKER

\$2.95

Protect your electrical equipment, eliminate fuses. 50 AMP 220 Volt rating. Add postage for 4 lbs.



ARMY TRIPODS

Excellent for floodlights, screens, etc. Raises to 12 ft., folds to 5 ft. Rugged construction. Express shipment only

\$4.95



MINIATURE MOTOR

\$2.95

24V. D.C. size 1 1/4" x 1" x 2". Add postage for 1 lb.

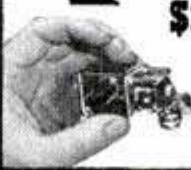

Power supply kit to convert motor to 110 V.A.C. Add postage for 6 lbs.

\$2.49

NO ORDERS under \$2.00

The **HEATH COMPANY**
DEPT. M . . BENTON HARBOR, MICH.

ARMY FIELD

Telephones

NOW as low as \$7.50

Used, but in good serviceable condition. (Originally cost govt. \$39.90 each.)

We have just obtained an additional large quantity of NEW and USED Army Field Telephones at low cost, and this **BIG SAVING** is passed on to you in these **NEW LOW PRICES! ORDER NOW!**

BATTLEFIELD PROVEN for quick, 2-way communication.

Performance equals present-day commercial telephones . . . up to 17 miles!

SCORES OF APPLICATIONS:

- | | | |
|---------|----------------|---------------|
| mills | garages | workshops |
| ranches | schools | warehouses |
| camp | nurseries | construction |
| mines | industrial | firing ranges |
| | hunting lodges | |

Anyone can install this handy, dependable telephone! Just hook up terminals to any two-strand wire; several phones on same line if desired. Operates on standard flashlight batteries with no external power required. Compact . . . rugged . . . portable. Every phone guaranteed.

Two phones comprise a set. Order as many as you need — in pairs or singly. Each phone delivered complete with hand generator and self-contained ringer.

USED—good, serviceable condition. Per pair: Now \$14.95 (formerly \$19.50), single phone now . . . \$7.50

NEW—with heavy canvas case. Per pair: now \$25.50 (formerly \$29.50), single phone now . . . \$12.75

NEW—with leather case. Per pair: now \$28.50 (formerly \$32.50), single phone now . . . \$14.25

NEW—canvas or leather case, with case slightly soiled, etc. Performance equals new telephones. Per pair: now \$21.50 (formerly \$24.50), single phone now \$10.75

RECONDITIONED for Government re-issue—good as new; same prices as above.

Extra wire. Genuine 2-strand W-110 Army Field Wire. New, 500 ft. \$3.50; 1/2-mile reel, \$10.50; 1-mile reel, \$16.00. (1/2 mile and one-mile reels sold only with purchase of telephones.)

WRITE FOR FREE FOLDER ON FIELD TELEPHONES

All shipments FOB Sacramento. No COD. In California, add 2 1/2% for sales tax.

SEND CHECK OR MONEY ORDER

LORIS SALES

P.O. Box 1896, Dept. B, Sacramento, Calif.

NO MORE BACK BREAKING MOWER PUSHING

Build a POWER LAWN MOWER yourself from your old HAND MOWER

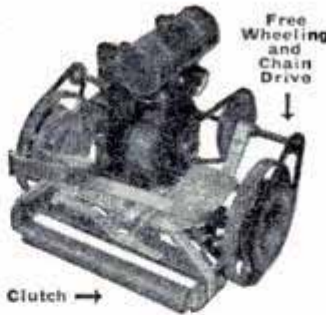

We supply complete ATTACHMENT that needs no welding. Easy to install in less than an hour, fits any make or size of mower for Electric Motor or Gasoline Engine. COMPLETE ATTACHMENT ONLY \$27.80.

ENGINE:

Our 1 1/2-2 H.P. 4 Cycle Air Cooled with High and Low Adjustable Jets Dependable Starting. Light weight, 30 lbs. ONLY \$62.15

Both the ATTACHMENT and the ENGINE are ABSOLUTELY GUARANTEED, you are getting the very best that money can buy at a price you can afford.

ATTACHMENT AND GASOLINE ENGINE ONLY \$89.95

Orders filled in seven days. Send Stamp for FREE FOLDERS.

ROYAL-OAK LAWN MOWER SHOP
Box 48 Royal-Oak, Mich.

PRECISION BUILT To Last A Lifetime

If you prefer:
Enclose \$10.00 deposit. I ship C.O.D. for balance.

NEW 30" SHEET METAL BRAKE



Forms angles, channels, vees, flanges, locks, zees, boxes. Handles 26 gage sheet steel, heavier gages or aluminum, copper, plastic, etc. Portable. Can be held in a bench vise, or bolted down. All steel construction. Wt. 40 lbs. \$24.50 Shipped exp. collect. ONLY \$24.50

12" BRAKE. Cast iron and steel construction. Price, \$14.50 PP.

18" CURVE FORMER. Forms cylinders, round corners and cones in sheet metal and strap iron. Price, 10.00 PP.

VISE IRON BENDER. Forms rings, hooks, eyelets, etc. in 1/2" round or square; 1/4" up to 2" wide in bar iron. All steel construction. 8 parts. Price \$10.00 PP. Immediate delivery. Order direct, cash or C.O.D., or send for folder.

VISE BRAKE MFG. CO.
1318 So. 30th Ave. Omaha 5, Nebr.

MARCOT KEY MACHINES

MARCOT No. 8 KEY MACHINE, mounted on Cabinet \$ 82.50

Auto Code Book and Auto Depth Keys 12.50

1,944 Popular Cylinder Key Blanks Set — Key File, Follow-Through Rods, Lock Picks, Bit Key Gauge, Thimble, Pins, Springs. . . 10.50

"Locksmith Trade Books": How to Open Locks without Keys or Picks; Secret of Locksmithing; How to Make Keys by the Impression Method; Master Key Systems. 6.75

TOTAL COST \$190.00

The \$77.75 cost of the Key Blanks would return to you \$486.00 or more. This would more than pay for your entire KEY MACHINE OUTFIT. IMMEDIATE DELIVERY—Motors available with Key Machine Orders. 1200 N. KEDZIE AVE. A. J. MARCOTTE CO. DEPT. PM, CHICAGO 51, ILL.

WAR SURPLUS

Lathes, Milling Machines, Drill Presses, Sawing equipment, Motors and thousands of miscellaneous items. Also information on Helicopters, Sleeper Trailers, Garden Tractors, Power Lawn Mowers, Welders, Jet Impulsion for Cars and Tractors etc. Rush name for free literature. THE WAYNE ENGINEERING CO., DEPT. 1133, GREENVILLE, OHIO



Hands Never Touch the Water—Can be put in Boiling Water. Housewives Like It.

48" Long Handle

Sales QUICK, EASY Every Locality

SALES ARE EVERYWHERE . . . Sells quick to Taverns, Clubs, Hotels, Hospitals, Stores, Restaurants, Large and Small Buildings and the Homes . . . Scores can be sold on a single street . . . Note the Drain Bracket in the illustration . . . This squeezes out the water so thoroughly that HANDS NEVER TOUCH THE WATER . . . Makes no difference what you ever sold, you will like this proposition . . . Your name on a Post Card will bring you FREE PARTICULARS.

CELL-U-MOP CO., Dept. P-2 FREEPORT, Ill.

Quick Easy Way to BIG PROFITS

Read What Others Are DOING!

"Enclosed you will find 56 orders representing 9 1/2 hours' work on Monday and Tuesday."
"Enclosed are twelve orders secured after supper this p.m."

Housewives are Enthusiastic

Everyone that sees this outstanding Cell-U-Mop immediately wants one . . . That's the reason why our distributors are so successful . . . You also have the advantage of our other QUICK SELLING PRODUCTS that step up your Volume Sales and Profits.

• We Teach You How •

Gets down under and around for MOPPING, DUSTING or WASHING

DOES THE WORK OF 6 TOOLS IN 1

Get Choice Territory NOW!

Holds 20 times its weight in water.



THIMBLE DROME THE MODEL RACING RACER SENSATION



Only
\$3.95

Speed! Action!
Can be adapted
for miniature
engine. CO2 Power Conversion Kit, \$2.00.
CO2 Engine \$4.95.

Weights 18 oz. Order one today — you can't beat this for fun! Rush order with check, M.O. or cash. \$3.95, postage, packing 25c additional. \$1.00 deposit for C.O.D.

HOME SHOP PRODUCTS CO., Dept. 12, 4821 Sheridan Road, Chicago

A. C. LIGHT PLANTS

LOWEST PRICE EVER OFFERED
WE INVITE PRICE COMPARISON

Original Cost
Over \$400.00.
Now Only.....

\$249.50

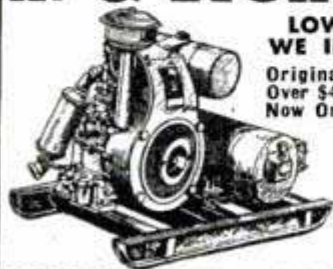

2500 Watts 110 AC Volts. Same as R.E.A. or City Current. Nearly new condition. Fully guaranteed. Powered by Briggs-Stratton 6 1/2 hp Air Cooled Engine. Prices FOB., K. C. Write for Illustrated Circular.

MIDWEST SURPLUS SALES 1520 LOCUST ST. KANSAS CITY, MO.

The Easy CENTER FINDER

With "Center-Rite," you can speedily find the exact center of any round, square, hexagon, octagon, or equilateral bar up to 2 1/2". Use it also for your basic angles—30°, 60°, 90°. "Center-Rite" is sturdily made of stainless steel to give you a lifetime of real service. It's a "must have" in every workshop. Order yours today. Only \$1.00 postpaid. No C.O.D.'s.

ABSOLUTE MONEY BACK GUARANTEE

Dealer Inquiries Invited

Pat. Pending

KEN-SHAW PRODUCTS INC.

1308 Penobscot Bldg.

Detroit 26, Michigan

BUILD YOUR OWN ZEOLITE WATER SOFTENER

You can do it inexpensively with only a wrench and a little spare time. Same Zeolite process as used by other leading water softeners. Send \$1 for easy-to-follow directions and list of materials. (Materials available locally or from us.) Your money back if not satisfied.

LAKE REGION MFG. CO.

4184-A Xenwood Ave.

Minneapolis 16, Minn.

DEMOUNTABLE BAR TYPE TRAILER HITCH

Custom built Utility Trailer Hitch for all new cars. Demountable bar type. Write for free particulars.



THE TRAIL-A-WAY CO., 25209 W. 8 Mile Rd., Detroit 19, Mich.

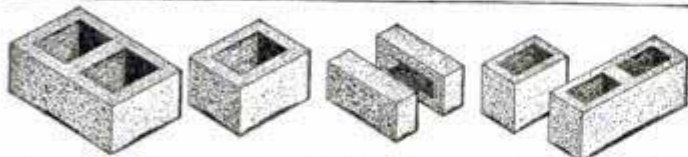

Make Concrete Blocks and Bricks

New superior method makes square, true, easy-to-lay units which will pass any building code. Small investment, high production, big profits. One \$30.00 machine will make four 5"x8"x12" blocks per minute. Pays for itself in a few days. Sell blocks or save 2/3 building cost by making and laying your own.

POST CARD BRINGS FREE FOLDER

Economy Manufacturing Company
Dept. P Stone Mountain, Georgia

FEBRUARY 1948

A TOOLSHOP IN YOUR HAND!

- GRIND • DRILL • ROUT
- POLISH • ENGRAVE
- CUT • SAND • SAW, etc.

Make Things From
Wood—Plastics—Metals—Glass—Linoleum—Leather—Alloys—Horn—Stone—Bone, etc.

***HANDEE** TOOL OF 1001 USES

THE FIRST TOOL OF ITS KIND AND TODAY'S FINEST Smooth, steady power at your fingertips! Perform precision operations not possible with any other portable tool! With a Handee you can turn out professional looking projects for pleasure or profit—ship, plane and train models, delicate, internally carved costume jewelry, wood carvings, puppets, initialed tumblers, etc. AC or DC. 25,000 r.p.m. Wt. 12 oz.



GET A GOOD START GET THE HANDEE KIT

HANDEE Tool and 40 most popular accessories packed in compact steel carrying case. You'll be amazed at what you can accomplish! Complete, \$27.50. Handee only, with 7 accessories \$20.50.

FOR YOURSELF OR A FRIEND... THE GIFT OF A LIFETIME!



NEW PLASTIC-CRAFT KIT

For internal carving. Contains special plastic cutters, buffers, sanding discs, buffing compounds, dyes, cement, a liberal supply of clear plastics, and instructions. At stores or postpaid\$6.95

*Reg. U. S. Pat. Off.

Get a Handee at stores everywhere. If they can't supply you we'll send it postpaid. Satisfaction guaranteed! Ask for free 52-page Manual

CHICAGO WHEEL & MFG. CO.

1101 W. Monroe St., Dept. PM, Chicago 7, Ill.

Send Handee Kit Handee Tool Plastic-Craft Kit C.O.D. Remittance enclosed Send Manual

Name.....

Address.....

SAY YOU SAW IT IN POPULAR MECHANICS

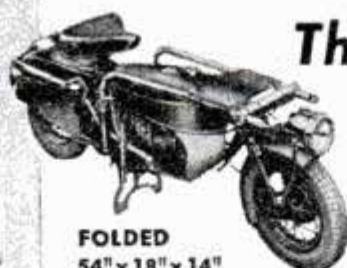
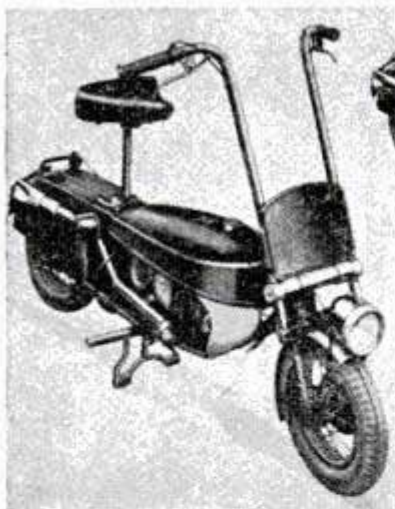

FOLDED
54" x 18" x 14"

Full Price \$257⁸⁵

Federal Tax paid—Freight prepaid. \$50.00 down—Balance C.O.D. Completely assembled with full instructions. Fill up and go!

The CORGI amazing little portable Motorcycle...

A portable motorcycle that you can store anywhere! Ideal for airplane and boat owners—fits into the trunk of your car. British Made—uses the famous one-cylinder 100 c.c. two-stroke "Spryt" motor. Will carry anyone 140 M.P.G. up to 35 M.P.H. Hand clutch, front and rear brake, twist grip throttle. Head lamp with "hi-lo" beam.

UNITED STATES MOTORCYCLE CO., 17 Battery Place, New York 1, N. Y.

New STEEL ADJUSTABLE BRACKETS & STANDARDS For HEAVY DUTY SHELVING



Locks in Place—

Easy to Raise or Lower

JIFFY STANDARDS and BRACKETS give every store, garage, factory, work-shop, home-owner and all others solid, easily adjusted shelving. JIFFY BRACKETS can be easily raised or lowered 1½" variation. They're all steel, engineered for strength, give strongest support required by heaviest load.

Anybody Can Install Jiffy Standards and Brackets

Standards are bolted or screwed into wall vertically. Brackets readily slide into place and are safely locked by patented principles. Rearrangement of shelving requires very few minutes. You can build mass displays for stores in a Jiffy. Homeowners will find this the neatest, easiest to install shelving available. Inexpensive—will last a lifetime. No special tools required for installation.



BIG PROFITS for Simple Installation Work—

You can earn big profits installing JIFFY EQUIPMENT in your neighborhood, spare or full time. Write for free literature giving complete details and prices.

JACKSON MFG. CO. Dept. M4, 622 East Third St. Kansas City 6, Mo.

SAVE ON Surplus Bargains

PERFECT ALL WOOL SLEEPING BAG

OLIVE DRAB

Handy for fishing trips, hunting, camping, boating, just roughing it or use as auto robe and many other purposes. Warmth of 2 blankets; zipper slide fastener; tie-strap on bottom; approx. Gov't cost \$12.00. Our Price each... **\$3.95**

Outside Cover for Sleeping Bag—Water repellent... **\$2.39**
PUP TENTS Perfect—2 man size for scouting, camping, etc. Without Pole... **\$2.95**

NEW GOGGLES Set comes complete. Kit with 1 extra interchangeable shatterproof, flexible, cellulose acetate lens. Green and white colors. A rubber flexible goggle frame. Back adjustment head strap. Cost Gov't approx. \$4.50. Ea... **98c**

BLANKET—Wool OD. perfect. Wonderful value... **\$3.95**

WELDING GOGGLES—NEW. many uses... **\$1.75**

PYRAMIDAL TENTS—16'x16', 8 man tent. Reconditioned, perfect. Of heavy duck. Complete with tie ropes. Cost Gov't over \$100.00... **\$24.95**

Our Sale Price... **\$19.75**

WALL TENT—9'x9', reconditioned, perfect... **\$19.75**

WATER PURIFIERS "Sunatill" New, used by Air forces and Navy to distill salt water into fresh drinking water. Complete with canister, wght. approx. 10 lbs... **\$4.95**

NEW PARACHUTES (Green Rayon) Approx. 36 sq. ft. Cloth good for making into ties, handkerchiefs, lining, etc. Complete with canister, wght. approx. 10 lbs... **\$2.95**

WE PAY POSTAGE—No COD—Send check or money order.

AMERICAN SUPPLY CO., Dept. P. M., 329 W. 5th St. Kansas City, Mo.



LOOK! NEW, FLYING HELICOPTER

Jet model—soars up 100 ft. Aluminum, with 12-inch rotor, only \$1.69. Send \$1 with your name and address. Pay postman balance of 69c plus postage. Order today.

THE ROBERT SALES CO. 727 Hennepin Ave. Minneapolis, Minn.

ELECTRIC SHEAR SHARPENER

Over 35,000 Sold — It Must Be Good



Genuine Carborundum wheel ideal for shop or home use. Send remittance with order and shipment will be made at once, prepaid to your door, complete with electrical goods catalogue.

\$9.75 complete with vise

WILLIAM MARVY COMPANY, Dept. 5 479 West St. Peter Street St. Paul 2, Minn.

DEEP TONE

DUAL MUFFLERS

LONG LIFE

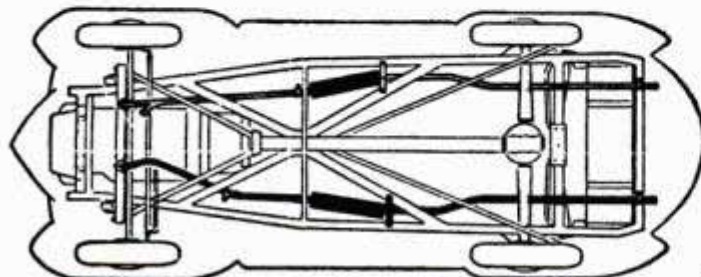

1935 TO 1947—V-8 FORD AND MERCURY ONLY

- More Horse Power
- Better Gas Mileage
- Blow-Out Proof
- Straight Thru Mufflers

FORD & MERCURY DUAL SETS ...\$20.00

C.O.D. - F.O.B. Los Angeles Order by Year and Model

No Welding, Cutting, Drilling of Holes. All Fixtures Furnished Rubber Insulated Clamps

DEEP TONED Ford, Chevrolet, Ply. \$4.86
SINGLE MUFFLER All others \$5.50

2½" CHROME TAIL PIPE TIPS \$1.75

Advance Mufflers 6800 SO. VERMONT AVE. LOS ANGELES 44, CALIF.

BALSA WOOD

**AMAZING
LOW PRICE!**

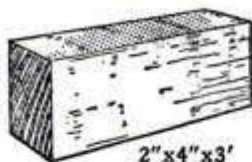

BALSA WOOD Solid Pieces of various dimensions measuring approx. 2" x 4" x 3". KILN DRIED IMPORTED from Costa Rica. Has a million and one uses. At the AMAZINGLY low price of 99c ea. Add 15c for mailing.

Mail orders promptly filled.

C. CORKIN & SONS INC., Randolph, Mass.
"LUMBER SPECIALTIES DIRECT TO THE CONSUMER"

Air Pistol that looks like a Luger Automatic SPORTSMAN JR. complete with ammunition

includes 2 extra barrels and all ammunition

Shoots:

- ★ Lead Pellets
- ★ B B Shot
- ★ Steel Darts
- ★ Corks

\$5 set
Gun Alone
\$3.50



A beautifully engineered air pistol that's amazingly accurate and unconditionally guaranteed. Compares with far costlier air pistols. A wonder for target practice. Rush in your order!

We Pay Postage! **J. J. ANTHONY** Dealers write for quantity prices!
1517 W. NORTH AVE. MILWAUKEE 5, WIS.



BRASS For Home Work Shops

Free Cutting Brass Rods
Round, Hexagon, Square,
1/2-Oval and Rectangle
Naval Brass Rods
Round and Hexagon.
Brass and Copper Tubing.
Brass Sheet.

Please send 10c
for Catalog No. 101

MEIER BRASS & COPPER CO.
1155 Bellevue, Detroit 7, Mich.

WOO-WEE AUTO HORN wolf whistle

Reproduces "Wolf Whistle" better than any savior. Squeeches, barks, whistles, imitates siren, moves any "road hog" off the highway in "double quick plus." Attract more attention than by driving a yellow Cadillac. Operates from manifold. Installed on any car in 15 minutes. Sturdily constructed. Cleverest novelty since the use of the auto. Be the first user in your neighborhood. Absolute money back guarantee. 6 dollars each. Order today. Ohio orders add 3% tax. Write for free literature on our Chrome Air Horns.



THE PROTECTUROD COMPANY • Dept. 101
4033 Windsor Road • Youngstown 7, Ohio

Burn-Rite Wood Burning Detachable Pen

Only one of its kind. Write for complete list of casting and wood burning sets. **\$1.50 EACH** POSTPAID
RAPAPORT BROS. INC.
Chicago, Illinois
Dept. PM2, 1830 S. Washtenaw Avenue

NEVERSLIP PULLEY

Transmits more power with less belt wear, unaffected by weather. No pulley covering, no belt dressing required. Replace troublesome pulleys with NEVERSLIPS. All sizes. Money-back guarantee. Ask for NEVERSLIP Pulleys on ALL power machinery you buy. Write for folder and prices.
ROSENTHAL CORN HUSKER CO.
Box 16-248 Milwaukee, Wisconsin

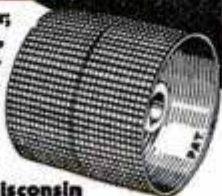

THE NEW "400" Precise fully automatic ADDING MACHINE



Light-weight—less than 5 lbs. Compact—4 3/4" high, 4 1/2" x 7" base.

**Fully
Guaranteed**

Only
\$17.50
Money Back if not satisfied

SEND NO MONEY

Mail coupon today. We will ship by return mail. You pay postman \$17.50 plus postage. If you prefer to save postage send \$17.50 with order.

A godsend to anyone who cannot afford a high priced adding machine. The new "400" does work of machines costing \$100 and more—yet costs only \$17.50. Will delight anyone who does figuring. Fills an urgent need for men and women in every walk of life... students, clerks, salesmen, farmers, accountants, bookkeepers, dentists, doctors, contractors, housewives. Easy to tuck away for use while traveling. Most remarkable adding machine ever developed. Adds and subtracts automatically—always shows magnified cumulative totals. 7 columns—counts up to 99,999.99. Clears with a touch of the handle. Accurate, speedy, easy to use. Operated with stylus. Precision built, sturdy, durable, handsome. Non-skid protective rubber feet. Fully guaranteed for one year. Liberal factory service policy thereafter. If not fully satisfied, return it within 10 days for full refund.

NATIONWIDE SALES CO., Dept. 7
2518 Montrose Ave., Chicago 18, Ill.

NATIONWIDE SALES CO., Dept. 7
2518 Montrose Ave., Chicago 18, Ill.
Please ship _____ Precise Adding Machines at \$17.50 each.
 Ship C.O.D. plus shipping charges.
 Ship postpaid. Check or Money order enclosed.

Name _____
Address _____
City _____ Zone _____ State _____

**GOVERNMENT PAID \$15,000
FOR COMPLETE UNIT
Portable Power Plant**

Mobile tow bar — 72" wheel base — 5 ft. high — 600x16 tires — Tail light — hand brake — Ford V 8 axle — 30 gal. gas tank — All steel frame and chassis — Ideal for hundreds of industrial uses — Also suitable as electric welder with small adjustments.

Same Unit as
300 AMP. ELECTRIC WELDER
\$995
(Cable 20c per ft.)

\$695
EACH
Lots of 3
\$650 Each

HERCULES 6 cyl.
gas engine—Model
JXD 4x4½ — air
cleaner—self starter

WESTINGHOUSE
¾ HP fan motor —
6-blade fan — 24"
diameter

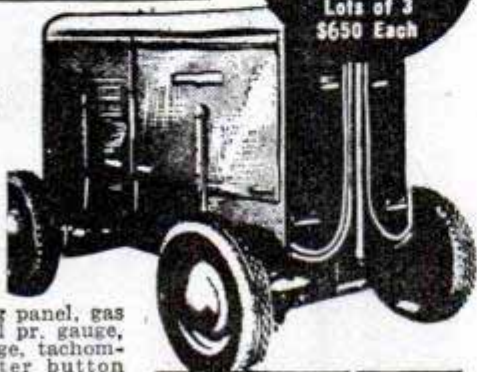

Complete operating panel, gas gauge, ammeter oil pr. gauge, temperature gauge, tachometer. Choke starter button throttle — 115V plug — 115V switch — Fan switch, winter, summer—Ignition switch—6V plug—Voltmeter—115V Amp-meter—300 A-rheostat—Main switch



Westinghouse marine generator, type SK — direct current — Style 1B7494 — 1100 RPM, 16.2 KW, 162 Amp., 100 volts—1400 RPM, 24.8 KW, 210 Amp., 118 volts

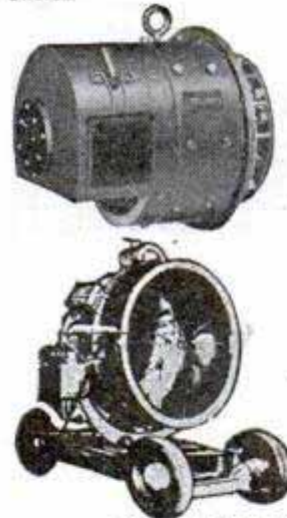

**800 MILLION CANDLE
POWER SEARCHLIGHTS**
Complete with remote
control station

(\$650 ea.
in lots
of 3) **\$695**
EACH

Mobile unit has four 600x16 tires. Performs perfectly with power plant. Ideal for carnivals, outdoor games, advertising purposes, hundreds of other uses.

(Send 25% with order, balance C.O.D.)

CHICAGO SURPLUS CO.

THE MOTOR TRUCK BROKER
4545 W. Madison St. Dept. P.M. 2 Chicago 24, Ill.

Every Driver Needs...

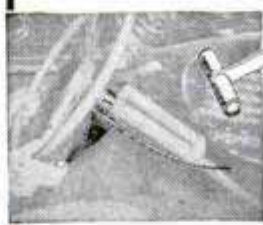

Pat. Pend.
only **\$4.95**
Postpaid Complete
HANDE-FEED
Finger-Tip Gas Control

DRIVE RELAXED! . . . install HANDE-FEED on your car and **MINIMIZE DRIVING FATIGUE!** Installed in about 15 minutes on most cars. Connects directly to carburetor. **RELIEVES AND RELAXES THE FOOT.** Minimizes back-roll on up-hill starts. Simply lift lever to increase engine speed, when released engine idles. Pivots for use with right or left hand. Does not interfere with gear shift or steering. All chrome finish. Complete instructions with every unit. **\$4.95 postpaid.** Send check or money order.

TRANS-CONTINENTAL IND., Dept. PM-1, 818 Olive, St. Louis 1, Mo.

AIR COMPRESSOR at a BARGAIN

Piston type, size 2 x 1¾, head in valves, bronze bearings splash lubrication. "V" Belt drive. Intake muffler and cleaner. Capacity 2.8 c.f.m. at 100 lbs. continuous pressure, or 150 lbs. intermittent pressure with ½ HP motor. Can be used with ¼ HP at lower speed. Weight 24 lbs.

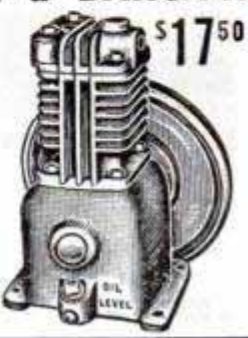

PRICE **\$17.50** F. O. B. CHICAGO
Immediate delivery. Send check or money order today. Sold on money back guarantee.

C & M EQUIPMENT COMPANY
1831 S. STATE ST. DEPT. D-2
CHICAGO 16, ILL.

PRECISION JEWELERS SCREW DRIVERS

Complete Set of 8 for Every "Hobbyist"



At last—a complete set of precision screw drivers to meet the needs of every model builder. Not a miniature but the same type set used by U. S. Navy for precision instruments and watches during the war. Brass knurled handles, hexagon heads, finest tempered steel blades. Sizes 2-9. Never before a set of this quality and precision at such a low price. Your money back if not satisfied. C.O.D. \$2.00 plus postage or send \$2.00 and we pay postage.

PINE WATCH CO., Rm. 40A, 29 Eldridge St., New York 2, N. Y.

NU-WAY HEAVY DUTY CUTTING UNIT
with Timken Roller Bearings

PRICE **\$16.50**
WHY PAY MORE

Build your own rotary type lawn or weed cutter. Take the hard work out of weed cutting. Build yourself an up-to-date weed and lawn mower with the Nu-Way heavy duty unit.



Write for Free Circular—We Supply Cutting Unit Complete
TRACTOR-LITE MFG. CO., Spirit Lake, Iowa

FREE Sample Of New PLASTIC Shows How To Make Leather and Leatherette LIKE NEW!

Magically Changes Cloth To Imitation Leather
SAVE MONEY-TIME AND EFFORT by renewing Luggage—Leather Covered Furniture—Golf Bags—Auto Seat Covers—Restaurant Furniture, Booths or any Leather or Leatherette item with new plastic discovery called Leather-New. Coat cloth or cloth covered items such as Glider Cushions, Tarpaulins, Porch Furniture, Etc. and make them look and wear like they were leather. Sores easily with brush or spray gun—leaves NO BRUSH MARKS. Simple Acids, Caustics and Alcohols do not stain this finish—it is sun and mildew proof. Stays Fresh and Clean as long as real leather. Comes in all standard colors. Just mail coupon for Free sample of Leather-New coated material which shows effects.

OWN A PROFITABLE LIFETIME BUSINESS
Cash in on big profits to be made in this new business—Profits up to \$700.00 monthly possible, renewing booths and furniture for bars, restaurants, grills, movie houses, etc. Mail name and address on 1c postcard—I'll show you how. Jack Edwards, Sales Mgr.

JUST MAIL COUPON
No Obligation

Leather-New, Leather-New Bldg., Dept. J22
4723 Troost, Kansas City, Mo.
Name
Address
City State
Fill Out—Mail Today

LEATHER-NEW, Leather-New Bldg., Dept. J22, 4723 Troost, Kansas City, Mo.

Parts For Military Type TRUCKS and JEEPS

We have for immediate delivery genuine parts for all makes and models. 4x2 — 4x4 — 6x4 and 6x6. All models from ¼ ton to 20 ton. All makes: Jeeps, Fords, Chevrolet, GMC, Studebaker, Reo, Auto Car, Federal, Diamond T, Brockway, Bierderman, Macks, Oshkosh, White and Sterling.



Special Discounts To Fleet Owners on Above Parts

ARMY SURPLUS TRAILER AXLES

NEW, heavy duty, complete with bearings, hubs, drums, brakes and wheels square type, 2 1/8" sq. and std. width. Tested up to 12,000 lbs. This axle is suitable for many types of trailers and wagons.

Equipped With Single 750x20 Budd Wheels \$59.50
... Shipping wt. 310 lbs.
Equipped with dual 750x20 Budd Wheels \$69.50
... Shipping wt. 430 lbs.



HYDRAULIC JACKS

Slightly Used, Guaranteed Serviceable. 5-ton, popular brands. Shipping weight 25 lbs. \$79.50

Prices FOB, Kansas City. Send money order or check.

AMERICAN AUTO PARTS CO., Inc. 1830 Locust St., Dept. P.M. Kansas City, Mo.



BIG SAVINGS HAND TOOLS

MILLERS FALLS THREAD GAGE 30 Leaf 1/2 Price at 89c. \$5.00 3 way gage. Feeler, Wire & Taper. A Precision Tool \$2.50. Send Check or M.O. Add 10% post.

New Illustrated Catalog Free

METAL MATERIALS CO.

3923 VAN BUREN PL. CULVER CITY, CALIF.

D. C. CONVERTERS

Eliminates need for tricky, expensive rewiring of war surplus radios, motors



110 volt A.C. to 24 volt D.C. power pack for only \$15.95

Direct current to operate WAR SURPLUS radios, charge storage batteries, operate small electroplating units, now available to you direct from manufacturer at low prices you can afford to pay. Ideal for fractional horsepower motors, solenoids, relays . . . anything designed for direct current.

Each unit utilizes full-wave bridge type selenium rectifier, transformer, circuit breaker, on-off switch. Ready to plug in and use.

24 volts output at 10 amperes 26.45
6 volts output at 4 amperes 11.45

Above prices FOB factory, shipments are made by express, freight collect. Check or money order must accompany all orders. For illustrated price list send three cent stamp.

SCINTILLA RAIL AND POWER WORKS, INC. NEW YORK 12, N. Y.
54 MACDOUGAL ST.



Bill Gets Bass On No. 1 Hawaiian Wiggler

Bill Guegel of Bay Camp, Park Rapids, Minn., writes:

"Here is a picture of myself with a limit string of both big and small mouth bass taken from Bass Lake in northern Minnesota. The No. 1 Hawaiian Wiggler works exceptionally well in rushes and rocky shore lines as this picture shows."



Deep Running No. 1 Hawaiian Wiggler \$1.10. See your dealer.

Write for FREE CATALOG

Our new 1948 catalog has many illustrations of record catches and information on our new baits. Write for a free copy.

Fred Arbogast & Co., Inc., 1602 North St., Akron 3, O.

3 REASONS WHY

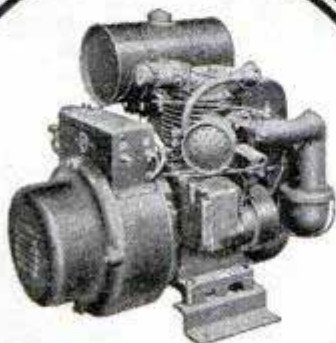

GLIMAX GENERATING SETS ARE THE BEST!

- 1—Electric or automatic start
- 2—Armature mounted on engine crankshaft. NO BEARINGS TO OIL
- 3—Quiet operation—Muffler equipped

MODELS AVAILABLE

6-12-32 Volts DC & 110 Volt AC from 300 - 1500 Watts

Write today for circular and prices. Specify output and start required.

FACTORY and HOME SUPPLIES CORP.
241 CANAL STREET—NEW YORK, N. Y.

\$35.95 BUYS A LOT OF DRILL!



Quality-Built by BLACK & DECKER to Help You Do Top-Notch Work

You'll handle drilling jobs with the ease and speed of a professional once you have a Home-Utility $\frac{1}{2}$ " Drill in your shop! With this handy Drill, you can build and repair furniture, cabinets, fixtures, appliances, models, toys—turning out work you'll be proud to call your own! This Drill is a great buy because: (1) it has extra capacity—up to $\frac{1}{8}$ " in hardwood; (2) it may be used as a portable Drill or Drill Press; (3) it drives twist drills, hole saws, wood augers; (4) it works in any material. And it's quality-built by BLACK & DECKER, a name famous in finest industrial tools for 37 years. For work requiring less capacity, there's a Home-Utility $\frac{1}{4}$ " Drill at only \$18.95.

Order HOME-UTILITY Tools from your hardware, electrical or implement dealer.



BENCH STAND \$17.45
quickly converts $\frac{1}{2}$ " drill into drill press!

ELECTRIC HOME-UTILITY TOOLS

Products of THE BLACK & DECKER MFG. CO., Dept. H-2, Towson 4, Maryland

IN ORIGINAL CRATES — BRAND NEW

TYPE P2 **DC GENERATORS**

BRAND NEW — ORIGINAL COST ABOUT \$300

NOW WHILE THEY LAST, EACH... \$10 F.O.B. Our Buffalo or Syracuse Plants

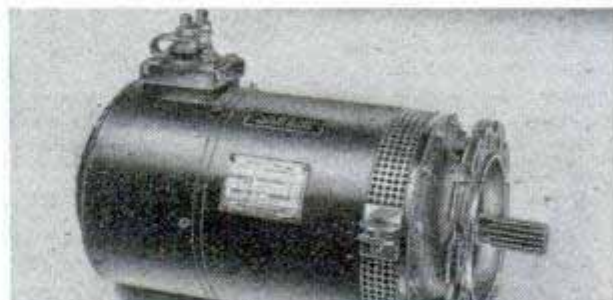

28.5 VOLTS—200 AMPS. DIRECT CURRENT

Manufactured by Bendix Aviation Corporation
SPEED RANGE 5000 TO 10,000 RPM

Experimenters, inventors, laboratory workers! Here's your opportunity to pick up a magnificent piece of equipment at about 3% of the original government cost. Net weight 38 pounds. Mail check or money order. Prompt shipment guaranteed.

HURWITZ BROS. INC.

P. O. Box 76, Syracuse, N. Y. P. O. Box 213, Buffalo, N. Y.

500,000 SURPLUS

• LENSES •

Send 3 cent stamp for "BARGAIN" list.

HOBBYIST LENS SET

Magnifiers, reducing lenses, positives, negatives, etc. 10 piece lens set \$1.00

A. JAEGER'S 123-26P ROCKAWAY BLVD. SO. OZONE PARK 20, N. Y.

Write For FREE Literature



Ball-bearing Attachment

Converts to a **POWER MOWER**
interchangeable saw and mower blades — Use as a saw or lawn mower.

Build Your Own POWER SAW

Clear Brush and Scrubs From Land Quickly and Easily

Now anyone can save time and work clearing brush and small trees from land by building their own power saw. Save hours of back breaking work — Save the cost of buying a power saw — Build your own quickly with parts and instructions we furnish. Write today for complete FREE information.

T & H Mfg. Co., 811 E. 31, Dept. MP12, Kans. City, Mo.

Now a DYNAMIC Industrial Transformer Type Super Charged WELDER

FOR AUTO, HOME APPLIANCE AND FARM REPAIRS

DESIGNED TO DO HIGH GRADE WELDING *inexpensively*—Maintenance Men, Farmers, Mechanics, Machine Shops, Foundries, Auto, General Repair and Job Welding Shops, all using the DYNAMIC find it so indispensable and useful that they can't afford to be without it. **EASY-TO-OPERATE.** If inexperienced you can easily learn to do a variety of high grade welding jobs by following the practical, *simplified Welding and Operating instructions furnished.* Once you see the DYNAMIC in operation you won't want to be without it. Its simplicity will amaze you. In a year the DYNAMIC only costs you about 7c a day. Comes complete ready to operate with helmet, rods, cable, holder, operating and welding instructions, etc.

Saves You Valuable Time and Money!

This portable, industrial transformer type *Dynamic Welder* easily carried right to the job can be operated from any convenient properly wired 110 Volt 60 Cycle Line. **WORKS ON IRON, STEEL, BRASS, BRONZE and Other Metals.** Has 8 metallic and carbon arc heat stages. Does work you would think only possible with a larger more expensive machine ... Can also be supplied for 220 VOLT 60 CYCLE operation and other voltages and cycles at slight additional cost.

DYNAMIC WELDER CO., 15 East 23rd Street, D, CHICAGO 16, Ill.

FOR ONLY

\$2850 COMPLETE

DO YOUR OWN WELDING

Just a few repair jobs will pay for this machine. A practical and profitable machine tool for any workshop. Make money doing repair work for others.

Write for Particulars Get Details on our 10 day Trial Offer Member Chicago Association of Commerce.



BICYCLE REPAIRS

FARM IMPLEMENTS

SHOP WORK

HOME APPLIANCES

AUTOMOBILE REPAIRS

For Higher Yields at Lower Cost ...
CROP CONDITION YOUR LAND
 with a **SEAMAN ROTARY TILLER**

USED FOR MANY
 YEARS BY U. S.
 DEPARTMENT OF
 AGRICULTURE



Many farmers report increased yields of 10% to 30% on Seaman-tilled land. Here are some of the reasons why this is possible:

The **SEAMAN TILLER** increases soil fertility by milling cover crops, manure and commercial fertilizer into the **GROWING AREA** of the seedbed . . . Holds more moisture in the seedbed, longer . . . Encourages the development of nitrogen-producing bacteria through soil aeration . . . Promotes early germination of seed by helping to maintain higher seedbed temperatures . . . Eliminates plant-starving air pockets in the seedbed . . . Helps to control weeds, grubs and many other crop pests . . . Makes crops more drought-resistant by promoting sturdier, healthier growth.

Write for "Questions and Answers" pamphlet. It tells you what you want to know about **SEAMAN TILLERS**. Full range of sizes, from 3 ft. to 7 ft. tillage widths, power take-off or motorized (gas or diesel-powered) models.

SEAMAN MOTORS, Inc., 364 N. 25th St., Milwaukee 3, Wis.

GET THE BEST IN
MUFFLERS
V-8
DUALS & SINGLES

Finest Norman custom-built muffler sets - steel pack - torpedo type - heavy, perforated steel cores - chrome enamel finish - mellow, deep tone (improves with use) - designed to fit - all ways superior - double economy.

DUALS.....	\$17.50	SINGLES.....	\$7.50
V-8 Ford-Mercury		Buick, Olds., Chrys.	
SINGLES.....	\$5.50	ORDER TODAY! Will outlast	three ordinary mufflers.
Chev., Ford, Plym.			

Dealers—Write Today for Full Details

NORMAN'S MUSICAL MUFFLERS

Dept. PM-5, 1216 W. Slauson Ave., Los Angeles 44, Calif.

PRESTO! ANYONE CAN
MASTER GLAZE

LEAVES HARD GLASS-LIKE FINISH
 EASY TO APPLY
 PROTECTS THE SURFACE
 WILL NOT FINGER-MARK
 NO OILY FILM AS WITH POLISH
 EASY TO KEEP CLEAR
 NO SMEAR OR STREAKS AS WITH WAX
 LASTS SIX MONTHS TO A YEAR



SAVES YOU MONEY

Car Owners! Meet Master Glaze—the sensationally different luster for new and used cars! Not a wax—not an oil polish—not a paint!—nothing that "smears" over the surface.

MASTER GLAZE is a unique discovery—a creamy liquid—quick and easy to apply! Gives a hard, glass-like surface. Even gasoline cannot dull it! Lasts six months to a year! Amazing luster—beautiful, sparkling clean and brilliant! Doesn't finger-mark—doesn't smear! A match box full glazes an entire car. Seals the pores—protects! **NOTHING LIKE IT!**

FREE SAMPLE
 Just send your name and address to

MASTER GLAZE CO., 7720-634 W. Harwood Ave., Milwaukee, Wis.

SAY YOU SAW IT IN POPULAR MECHANICS

"Factory" Fingertips
 at your

NEW
POWER KING
8" TILT/ARBOR
TABLE SAW



This new Power King saw in your shop is like adding the services of a highly skilled helper. It's versatile, *dependably accurate* . . . 10 times faster than tiresome hand sawing . . . greatly increases the number of cabinets, shelves, furniture, and other valuable articles you can make quickly, easily, and at low cost.

The new Power King 8" table saw has an extra-large (18" x 20"), precision-ground table. Blade *tilts*—table and work stay flat—for greater accuracy and safety. Saw cuts 2 3/8" deep. Rigid, *double-locking* rip fence *releases instantly* for positioning on either side of blade. Sealed precision ball bearings for permanent smooth operation. It's America's outstanding saw value! Send for literature and name of nearest dealer today.

POWER KING TOOL CORP.

220 Cleveland St.
 Warsaw, Ind.
 Division of
 Atlas Press Co.



POWER KING SPINDLE SHAPER



POWER KING JOINTER-PLANER



POWER KING 12" DRILL PRESS

SEND FOR FREE LITERATURE TODAY

POWER KING TOOL CORP.
 220 Cleveland St., Warsaw, Ind.
 Please send new Power King catalog sheets to:

Name _____

Address _____

City _____ State _____

Here's the Outstanding Value in Target Pistols

The Crosman

"Bullseye" Adjustable "power without powder" for accuracy with safety indoors and out! No noise, no recoil, no odor, no cleaning! Perfect balanced Rifled barrel! Fine gunsmithing! Low cost! THAT'S what you get in this new .177 cal. single-shot pistol of regulation target type and weight. Shoots Crosman Super-Pells at 1/4 cent per shot. No wonder they say no other pistol provides so much fun at such small cost. At your sporting goods or hardware dealer's . . . or write direct.



Adjustable "power without powder" for accuracy with safety indoors and out! No noise, no recoil, no odor, no cleaning! Perfect balanced Rifled barrel! Fine gunsmithing! Low cost! THAT'S what you get in this new .177 cal. single-shot pistol of regulation target type and weight. Shoots Crosman Super-Pells at 1/4 cent per shot. No wonder they say no other pistol provides so much fun at such small cost. At your sporting goods or hardware dealer's . . . or write direct.

Crosman Silent RIFLE

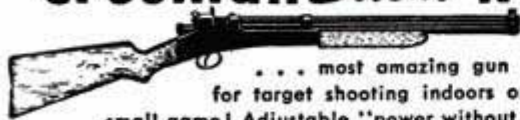

. . . most amazing gun ever invented for target shooting indoors or out and for small game! Adjustable "power without powder" . . . no noise, recoil, odor or cleaning. Rifled barrel. Shoots low-cost Super-Pells. .177 or .22 cal. single-shot or magazine models. At your dealer's . . . or write direct.

CROSMAN ARMS CO., INC.
3 HENRIETTA ST. • ROCHESTER 7, N. Y.



Socket Sets . . Sockets . . Parts

Your wrenches are always handy when they're in sets. 3/8" - 1/2" - 3/4" Square Drive. Ratchets, extensions, speeders, flex and deep wall sockets in rugged steel boxes. Literature gladly sent.



Buy them at Your Hardware Store

THE BILLINGS & SPENCER CO., HARTFORD 4, CONNECTICUT, U.S.A.

IT STAYS STUCK! WITH . . . MULTI-PURPOSE AMBROID



If you want permanent results from an adhesive, you can't equal multi-purpose Ambroid liquid cement — for home workshop, household or factory. A quality leader for 37 years, ready-to-use Ambroid is waterproof, transparent, quick-drying, extra strong. Flexible, heat and corrosion-resistant. For assembling, repairing or mending jobs, keep Ambroid handy. At your dealer's, or send 25¢ for big 2-oz. tube post-paid. Money back guarantee.

Also 50¢ 4-oz. tube. Pts., qts., gals., for industrial use.



303 Franklin St., Boston 10, Mass.

Super Charger Pump



Heavy duty super charger rotary pump designed to efficiently pump water, oil, gasoline, etc. Also used as a vacuum pump. Includes lovejoy coupling for 3/8" shaft, 1" outlet on top, 1" outlet on bottom. Size of pump 7 1/2" W. x 5" D. x 7" H. Compact and sturdy. Four mounting holes in base. Can be used with 1/4, 1/3, or 1/2 H.P. motors. Shpg. Wt. 19 lbs. List \$48.00. No. 8536—Each **\$15.95**

Send check or money order today plus postage.

FREE CATALOG—Send for new G. & E. APPLIANCE & PARTS CATALOG Dept. P. M. 9

G & E Equipment Supply Co. OGDEN AVE. AT FULTON CHICAGO 7, ILLINOIS



SPECIAL OFFER! Famous, patented, lock-stitch sewing awl complete with needles, waxed thread, direction folder. Hundred uses—sewing, repairing leather goods, canvas, belting, old or new harness, saddles, gun cases. Satisfaction guaranteed, or money back. Send currency, check, or money order, no stamps, please. Yates Mfg. Co., 611-H Main St., Lake Geneva, Wis.

NEWEST OTTAWA LOG SAW

SELF-PROPELLED — MOVES ANYWHERE on OWN POWER

World's fastest Log Saw. Powerful 6 H-P air-cooled motor. Attachments for sawing down trees, buzzing limbs, post hole digging and pulley for belt jobs. Big demand for wood, pulp, posts. Make big money sawing wood this easy way. Low factory-to-user prices. Nothing like it. **FREE** details. **OTTAWA MFG. CO., 7-827 Pine St., Ottawa, Kansas**



make your own Gems 29.50 F.O.B.

All necessary lapidary equipment is furnished, including a super-charged diamond blade for sawing, and all wheels for grinding, shaping and polishing; also complete instructions. The complete equipment as shown, less motor and belt, for only \$29.50. f.o.b., Burlington, Wisconsin. Write today for information and literature.

B & I MANUFACTURING CO. Dept. S Burlington, Wis.



NEW! LOW COST! RESPIRATOR

Wear when sanding, grinding, paint spraying, sweeping, dusting, furnace cleaning, etc. Handy as a pair of glasses. Just keep mouth closed and breathe through nose is all you do to operate. Protects against nuisance dusts, lint, coal, cement, grain dust, hay fever pollen. Has 9 sq. in. filter. For **EYE** protection against paint spray, dusts, gases, fumes, smoke, order our Fog-Proof Rubber **GOGGLES** \$2.00 p.p.



JERRY BRYANT, Dept. PM 919 N. Michigan Ave. Chicago 11, Ill.

Order Today \$1.00 POST PAID

SAY YOU SAW IT IN POPULAR MECHANICS



NEW Surface Plate V-Blocks, Angle Plate

SURFACE PLATE for laying out, surfacing, checking flat surfaces, etc. Precision ground top. 12" x 17" x 3", top 3/4" thick. Price . . \$37.50

V-BLOCKS for holding cylindrical parts. Hardened steel. All surfaces precision ground. Size 1-15/16" x 2-15/16" x 2-1/4". Capacity 1/4" to 2". Price per matched pair . . \$32.00

ANGLE PLATE. Precision ground on six sides. 3-1/4" x 3-1/4" x 4-1/4" with 5/8" V-groove. Price . \$20.00

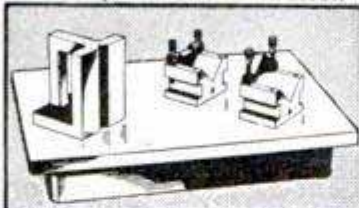

SOUTH BEND LATHE WORKS 455 E. Madison St. South Bend 22, Ind.

Hollywood WOLF WHISTLE



GIVE THE WOLF CALL

CAR HORN

— imitate BARKING DOGS and make other weird noises. You, too, can become a Hollywood Wolf. Have lots of harmless fun. Install a Hollywood Wolf Whistle on your car. Beautiful Hammertone finish. Self-lubricating bearings. Works off of the intake manifold. Simple to install in 15 minutes. Full instructions with every box. For cars, trucks, motorcycles, motor boats, outboard motors. Money back guarantee. If your dealer can't supply you, order today. Be the first to have this attention-getting horn. ONLY \$4.00 postpaid — Cash, Check, or Money Order. **QUITE A DEAL.**

DESCRIPTIVE LITERATURE ON REQUEST

YODER MFG. COMPANY

2403 East 103rd Street Los Angeles 2, California

Amazing! \$25 Is Yours!

For selling only 50 boxes greeting cards. Sells for \$1—your profit to 50c. Also Easter and gift cards, stationery and wrappings. Costs nothing to try. Write for samples on approval.

MERIT

70 William Street, Dept. Z Newark 2, N. J.

TRAILER BUILDERS!

Insist on Safety-Engineered

- Bull Dog Hitches and Parking Jacks
- Torq-Less Axles

HAMMER BLOW TOOL COMPANY
Dept. 119 Wausau, Wisconsin

Send for **FREE** Catalog

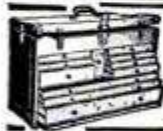

Gerstner TOOL CHESTS

Better, finer and more desirable for the good tools of Machinists and toolmakers. Free Catalog.

GERSTNER TOOL CHESTS

448 Columbia St. Dayton 7, Ohio

Big Money for Workers In Home or Shop



Licensed Concrete Specialists wanted. No experience needed. Make *Colorglazed* concrete pottery without molds. New, low cost, patented method. Cemetery products, novelties, tiles, etc. Basement leaksealing. Other big pay projects. Booklet, details free. Men only.

NATIONAL POTTERIES COMPANY
415 Third Avenue, W., Grand Rapids, Minnesota

MAKE *sure* OF BETTER PICTURES



2 great G-E meters to help you!

Get perfect shots every time... movies or stills. Easy with either one of these great G-E exposure meters. Tells you how to "set" your camera for full detail, rich color. Simple to use. Ask your photo dealer. *General Electric, Schenectady 5, N. Y.*



Famous Type DW-58. Extremely accurate. Sturdy. Dependable. A big value for only **\$19.95***
Federal tax included.

New! **Deluxe Type PR-1.** Remembers the light it sees... sensitive, compact, easy to use. Ask for the meter with a **MEMORY!** **\$32.50***
Federal tax included.



*In states where Fair Trade Contracts are in effect.

GENERAL ELECTRIC

606-13

SPEED LINER

REG. U. S. PAT. OFF.

Runabouts and Fishing Boats

**More Speed
Per H. P.**

14 FT.
TROPHY
5 Passenger



YOUR DREAM BOAT

IS HERE—Precision-built **SPEED-LINER** Boats set a new standard in appearance, operation and safety. 8 smart models for racing, fishing, family pleasure.

GENERAL MARINE COMPANY
Dept. 550 6th and Oak, ST. JOSEPH 25, MO.

Send Literature on Full Line Send Details on Exclusive Dealerships

NAME _____

ADDRESS _____

CITY _____ STATE _____



Get the
BEST
out of
Your GUN!

Equip with Marble's Precision Sights... clean with Marble's Nitro-Solvent Oil and Marble's Jointed or one-piece Rifle Rods.



MARBLE'S OUTING EQUIPMENT

Flexible
ear
\$5.50

Sheard
Front
\$1.75

Standard
Front
\$1.25

Jointed Rifle Rod, \$1.50

Nitro-Solvent
Oil

Ask your Dealer for Marble's Outing Equipment
MarbleArms&Mfg.Co. 578 Delta Ave. (218)
Gladstone, Mich., U.S.A.

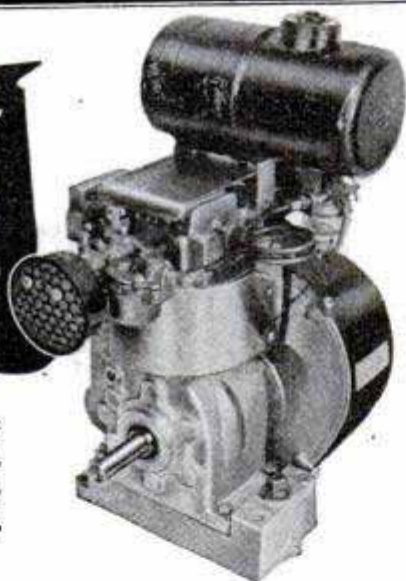

First in the field of small portable engines to successfully develop the Valve-in-Head system.

Light in weight...Economical...Powerful

The Scott air cooled valve-in-head engine is ideal for boats, scooters, lawn mowers, garden tractors, power plants, compressors, spray equipment and many other uses. Designed and manufactured to give more power with less gas consumption and lower maintenance costs. Easy starting in any weather with fast acceleration and smooth dependable power. Develops 2 1/4 H. P. Idles to a speed of 450 R. P. M. with or without load. Write for catalog sheet containing complete specifications. Available for immediate delivery. 25% deposit with order, balance C.O.D. **\$89.50**
Shipped complete

Dealers: Write us for territory franchise

SCOTT ENGINE COMPANY
3349 N. ASHLAND AVE., CHICAGO 13, ILLINOIS

Do You Ride a Bike?

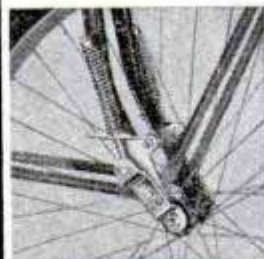

"SHOCKMASTER"
for all Bicycles

- LEVELS ROUGH ROADS
- PREVENTS BROKEN SPOKES, WHEELS, FORKS
- MAKES RIDING SMOOTHER, SAFER
- EASY TO INSTALL

"Shockmaster"—the front wheel shock absorber—is ruggedly constructed of nickel plated steel and engineered for years of real service. It'll pay for itself in added pleasure, saves tires and eliminates many costly repair bills. 20,000 satisfied users. Order yours today. Only \$3.69 postpaid. No C.O.D.'s. Complete satisfaction or money back. Dealers Wanted.

H. M. GIBB and COMPANY
1304 PENOBSCOT BLDG. DETROIT 26, MICH.

New! Navy Foul-Weather JACKETS

Made of water-repellent heavy jungle cloth, warmly lined with alpaca and alpaca collar. Zippered front with button flap over zipper, and drawstring at waist. A perfect jacket for work or \$12.45 post-sport. Sizes 36, 38 and 40 paid BLUE NAVY Foul-Weather Jackets. Wool-lined. Sizes 46, 48 and 50. \$12.45 postpaid.



Write for FREE 1948 CATALOG!

Send Check or Money Order **PACIFIC FUR & WOOL CO.**
WAR SURPLUS DEPT., BOX 926-PM, SACRAMENTO, CALIF.

DAM
leaky walls with
DRYEX

Make big money applying or selling Dryex, the amazing plastic that makes wet exterior walls dry and keeps them dry. Easy to brush on, easy to sell. Tough, flexible. Thousands of fine prospects. Write today for details.

LASTING PRODUCTS COMPANY
Franklinton Road Plant, Baltimore 23, Md.

UTILITY CABINET

36 Roomy Compartments
4-7" Drawers with Removable Partitions

A Thousand Uses For

**HOBBYISTS
MECHANICS
DRAFTSMEN
TECHNICIANS**

For home workshop, factory, laboratory, garage, outdoors, fishing and hunting. Made of heavy gauge aluminum. Strong airplane construction. Sag proof—Rust proof.



\$2.98

plus postage

Shipping Weight 2 lbs., 8 ozs.

Cut out this coupon and send with money

NAME.....

ADDRESS.....

CITY.....STATE.....

Enclosed find check or money order for \$2.98.
THE KNICKERBOCKER CO. ST. CLAIR, MICHIGAN

NEW DIRECT MAIL PLAN SAVES YOU BIG MONEY!

**DE LUXE QUALITY SCOTCH PLAID
Fibre AUTO SEAT COVERS**



*Slips on
in a jiffy!*
*Fits
most cars!*

- Check These QUALITY Features**
- ★ Colorful, Water Repellent Scotch Plaid Fibre
 - ★ Rich Leatherette inserts at points of greatest strain
 - ★ Elasticized slip-over sides for snug, smooth fit
 - ★ Heavily stitched seams for extra long wear

For Coupes and All Front Seats
Unbeatable Low Price **\$3.98** POST PAID

Sedans and Coaches COMPLETE SET Front and Back Seat **\$6.79** POST PAID

RICHLY GRAINED LEATHERETTE TRIM

We challenge comparison because nowhere... but nowhere will you get these fine seat covers at our low price! Yes, thanks to our amazing direct-from-distributor-to-you plan, you can now own long-wearing DeLuxe Auto Seat Covers at half the price you'd expect to pay. And don't let our low price lead you to confuse our fine covers with inferior auto slip-covers being sold elsewhere. No indeed! These are top quality, DeLuxe Seat Covers master-tailored of rugged, water-repellent scotch-plaid fibre and richly grained leatherette. Their smooth fit and handsome appearance will vastly improve the looks of your car, make it easy for you to slide in and out, protect your clothing and upholstery, and check driving discomfort.

- STYLE SA** 4-door sedan with 1-pc. seats and backs.
- STYLE SB** 2-door sedan with split back, 1-pc. seat.
- STYLE SC** 2-door sedan with separate seats.
- STYLE CA** Coupe with 1-pc. back.
- STYLE CC** Coupe with 2-pc. back.

HOW TO ORDER SEAT COVERS

Referring to your license card, list the **make, year, and model** of your car. Also give model number, body type. Also state seat style of your car as shown in illustrations at left. Put all information in coupon below and **MAIL TODAY!**

*Ask the Man
Who Owns One!
Over 50,000
Satisfied Users!*

SPECIAL! FOR CAR OWNERS WHO APPRECIATE THE REALLY GOOD THINGS IN LIFE!



COVERS ENTIRE BACK OF FRONT SEAT

An out-of-this-world bargain in Super-Fit, Easy-To-Install Custom Quality Seat Covers

- ★ Superb Materials
- ★ Skilled Craftsmanship
- ★ Luxurious Beauty
- ★ Long-Life Durability

Compare with \$16.50 Seat Covers

Coupes and Front Seats **\$6.50** POST PAID

Sedans and Coaches Complete Set **\$9.95** POST PAID

SOLD ONLY BY MAIL Order Direct and Save

SEND NO MONEY

Pay postman price of covers ordered plus postage or send cash and we pay postage. If not completely delighted return to us within 5 days for refund under our "you must be pleased—or your money-back" guarantee!

AMERICAN MERCHANDISING CO., Dept. FSC-60
9 Madison Ave., Montgomery 4, Ala. Price in Canada add 50c. No C.O.D.

Please rush me the following Seat Covers checked below:

DeLuxe Quality front seat \$3.98 DeLuxe Quality complete set \$6.79

Custom Quality front seat 6.50 Custom Quality complete set 9.95

MAKE _____ YEAR _____ MODEL _____

Body Type _____ Seat Style Style SA Style SB Style SC Style CA Style CC

Check I am enclosing \$_____ Ship postpaid.

One Ship C.O.D. I'll pay postman \$_____ plus postage.

Name _____

Address _____

City _____ Zone _____ State _____

PRICES SLASHED! ALUMINUM PIPES

\$4.50 pipe for \$1.00. Imported briar bowl, hard rubber stem, air-cooled aluminum shank. No filters required. Check or money order, we pay postage. G. O. D. orders filled on request. Write for FREE catalog of pipes and cigars.



\$1

SATISFACTION GUARANTEED OR YOUR MONEY BACK

Eddie THE CIGAR MAN

Dept. M-2, 1094 Bedford Ave., Brooklyn 5, N. Y.

BROKEN JEWELRY WANTED

All kinds. Highest prices paid for jewelry, rings, spectacles, gold teeth, diamonds, broken and usable watches, etc. Cash mailed promptly. Write for FREE shipping container.

LOWE'S, Dept. PM, Holland Bldg., St. Louis 1, Missouri

SOLDER NEW EASY WAY!

**NO BLOW TORCH
NO SOLDERING IRON**

... Less than 1¢ per Job

No Experience or Tools Necessary

Nothing Else to Buy..... only



Now, practically anyone can do soldering easily and quickly with this amazing, newly-invented Self-Soldering Tape that requires NO use of Soldering Iron or Blow Torch! Just wrap a small piece of Self-Soldering Tape around wire or other metal part to be soldered. Ignite the tape with a match, and as it burns, it solders! Self-Soldering Tape is used by both amateurs and skilled repairmen. Saves time and work—NO waiting for iron to heat, NO tinning the iron, NO need of an electric outlet or torch. Convenient to use in small places or when working on a ladder or pole. Both hands free while soldering. You can solder two or three spots at the same time! Contains no magnesium. You get 6 feet of Self-Soldering Tape for only \$1.00. As you use only 3/8" to 1" for each job, each job costs less than 1¢! Complete ready to use with full instructions. Order NOW! Send \$1.00 or order C.O.D. If you send money we pay postage, otherwise you do. SEECO, 510 St. Charles, Dept. 302-B, St. Louis, Mo.

\$1 POST-PAID

5 POWER TOOLS IN 1

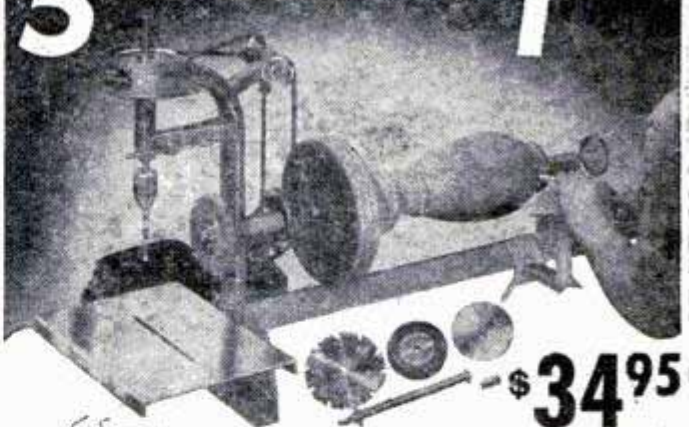

\$34.95

COMPLETE HOME WORKSHOP

Here is power tool pleasure and profit in a ruggedly built, HEAVY steel unit—the Emrick Universal Woodworker. Handles big work. Drill press pulls 1/2" drill in steel. Saw takes 6" to 8" blade. Lathe 10" swing, 30" centers, spindle dia. 3/4". Takes all standard accessories. Sander 8" dia. Emery wheel 5". Price does not include motor and saw blade. Order today.



10 DAY TRIAL

1732 CLINTON STREET
EMRICK, Inc. KALAMAZOO 24, MICH.

Ship on 10 Days Trial. I am enclosing \$17.50, balance C.O.D. Send free literature.

Name _____

Address _____ City _____

Save Money

KITS for
Amateurs
and
Experimenters

FREE RADIO CATALOG AND SUPPLEMENT

Build it yourself.

Thousands of radio values in this big book — Radios and radio phonographs, F.M., P.A., Ham Xmitters, receivers, kits, thousands of parts — whatever the job calls for Lafayette has it. And every item priced way down, to save you money!

RADIOS
KITS
HAM
P.A.

Lafayette Radio

RADIO WIRE TELEVISION, INC.

100 Sixth Ave., N. Y. 13 • 542 E. Fordham Rd., Bronx 58
110 Federal St., Boston 10 • 24 Central Ave., Newark 2, N. J.

LAFAYETTE RADIO, Dept. LB-8

100 Sixth Ave., New York 13, N. Y.

Rush catalog #88 Supplement #88S

Name.....

Address.....

City..... Zone..... State.....

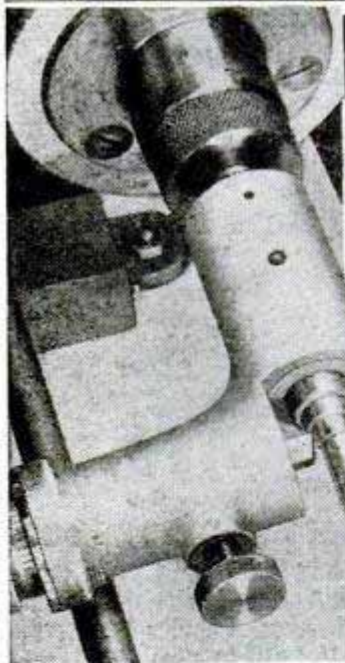

NEW!
TRU-TURN



It is now possible for home craftsmen . . . and garage-men, gunsmiths, and repairmen . . . to turn and cutoff metal without buying an expensive lathe. This new tool converts woodturning lathes, drill presses and grinder stands into precision metal lathes. TRU-TURN has a built-in micrometer . . . turns and cuts-off steel, brass, aluminum.

TRU-TURN TOOL — Two guide bushings; and bits for steel, brass and aluminum . . . only \$11.75

FACE-PLATE WORK-DRIVING CHUCK — For converting woodturning lathes. Chuck plus three adapter bushings . . . only \$4.50

Add 25c to each item for C. O. D. orders. Send money order or checks for prepaid shipment within U.S.A. Illustrated folder free.

MILLHOLLAND SCREW PRODUCTS CORPORATION
134 West 13th Street, Indianapolis 2, Indiana

NOW IT'S EASY to Properly Humidify Your Home



Put Low-Cost AUTO-VENTS on Your
Steam or Hot Water Radiators

No. 93 (steaming)
— replaces air
valve — each, \$5

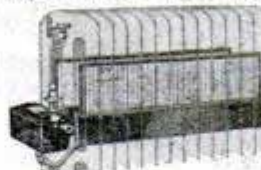

No. 34 (hot water) — automatically
filled from radiator or
separate supply — each, \$12

Home handymen can install either type without special tools. Both operate AUTOMATICALLY. Protect your health, your furniture and furnishings, save fuel, by having adequate humidity during heating season. Satisfaction guaranteed. Thousands in use. Immediate delivery. Send cash or check — we pay postage. Maid-O'-Mist Inc., 3222 N. Pulaski Rd., Chicago 41.

Mysterious Chinese ABACUS

Adds, Subtracts, Multiplies and Divides like Adding Machines that cost 100 times as much!



Most fascinating of all calculating devices. Used in the Orient for thousands of years, yet as practical and accurate today as the most expensive adding machine! Adds a whole column of figures quick as a flash. Multiplies, divides, subtracts with equally amazing speed. A wonderful way for children to learn arithmetic. A time, work and money saver in store or office. Learn to operate quickly. Free Book shows how.

Only \$8.50 While Limited Supply Lasts

10 DAY TRIAL OFFER! Send \$8.50 for your Chinese Abacus. Use it for 10 days. Then if you are not delighted in every way, return it to us and we will refund your \$8.50 in full. Write today to

LOY'S CHINESE CALCULATOR
1317 R. I. Ave., N.E., Dept. 82-M Washington 18, D. C.

AGENTS Exceptional opportunity in a few territories for those who write promptly. Rush inquiry today.

New PERSONAL RADIO... Pocket Size



This little radio is substantially built and is so constructed that, if dropped, it will not break. It has a beautiful red leatherette case. May be carried in your pocket wherever you go. Reception is guaranteed when used according to instructions.

There is no cost in operating this radio as there are no tubes and no batteries to buy, and no electricity needed. Instead, the new "Crystal diode" rectifier same as used in Army and Navy ultra hi-frequency radar set is being employed. It is not a toy, but a practical little radio for football or baseball games, news reports, or your favorite program. It is especially good to listen to in bed, or in hospitals, dormitories, barracks, and offices because it is not heard by anyone but yourself.

Send only \$1.00 (check, money order, cash) and pay postman \$3.95 plus delivery fees, or send \$4.95 for postpaid delivery.
SHEESS MFG. CO., LAKE GENEVA, WIS.

FASTEST PLANER in the WORLD at this Low Price... \$195.00

Belsaw Multi-Duty Planer



Needed by every saw mill owner and woodworking shop to Speed Up Production — Increase Profits.

Belsaw high speed thickness planer provides for single surfacing stock up to 12" wide by 6" thick at the high speed rate of 24 lineal feet per minute for HIGH PRODUCTION. Planes GREEN or DRY sawed lumber into higher priced, valuable smooth and worked forms. Machine has welded all STEEL frame . . . nothing to break. Safety-type all Steel cutterhead runs in heavy duty ball bearings. Three HIGH SPEED Steel knives make 42 cuts per inch for smooth finish.

Belsaw Multi-Duty Planer is REALLY ECONOMICAL. . . adequately powered by any motor developing 2 horsepower — REALLY PROFITABLE. . . lowest

investment and operating costs, and takes inexpensive attachments for all common planing mill operations: Jointing, Rabbering, Grooving, Matching. Produces S4S Finish surfaced four sides without the great investment required for S4S Sawmills. Simple accessories provide for SHARPENING and JOINTING its own knives.

You get BIG VALUE in Belsaw, and provide for your progressive growth. Write for FREE specifications, illustrations and low prices.

BELSAW MACHINERY CO., 1014 Field Building
315 Westport Rd. Kansas City 2, Mo.

World's largest manufacturer of light sawmill and woodworking equipment.



WAR SURPLUS BARGAIN SPECIAL

BRAND NEW! VACUUM-AIR HYDRAULIC GENERAL PURPOSE PUMP

Original Cost
\$45.00
Now Only
\$9.95

Postpaid in U.S.A.

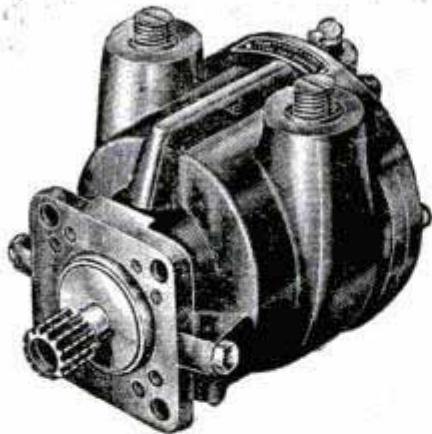

WORTH MANY TIMES THIS LOW SALE PRICE

USE THEM FOR
OIL BURNERS

SPRAYING
MACHINES

MILKING
MACHINES

COMPRESSORS

VACUUM PUMPS

HYDRAULIC
SYSTEMS

MANURE
LOADERS

PRESSES, etc.

Originally cost \$45.00. Used by the Air Corps to drive bomber de-icer boots, gyroscopes, automatic pilots, etc. May be used as air or fluid pump—for pressure or vacuum. Standard 3/4 inch pipe thread with interchangeable ports. Will pump 7 1/2 gal. SAE 30 oil per minute at 300 RPM. Builds air pressure of 30 lbs. per sq. in. at 1000 RPM. Vacuum will draw 26 inches of mercury at 1750 RPM. Develops up to 120 lbs. per sq. inch of hydraulic pressure, which in conjunction with a 3 inch hydraulic cylinder, will lift 840 lbs. minimum. Runs forward or reverse. Self-aligning shaft. Die cast aluminum housing 6x4x4 inches. Has stainless alloy steel vanes and impeller. Made by Bendix Avia, Corp. Spline terminal for direct drive—readily replaced with a pulley. Recommend a 1/4 H.P. or stronger electric motor as source of power. Rated capacity 1500 RPM with high overload factor. Special price for quantity users. Complete illustrated report and instruction booklet FREE with every pump. Send check or money order today. Postpaid in U.S.A.

\$9.95

GROBAN SUPPLY CO. 1522 So. Michigan Avenue
Dept. PM-2, Chicago 5, Ill.

Sand Casting — Forging — Heat Treating — Case Hardening

BRONZE FOUNDRY



In your own workshop allows you to design and build your own GASOLINE ENGINES, STEAM ENGINES, STATUARY, ART OBJECTS, SPECIAL TOOLS, NEW INVENTIONS, ETC. You can also make forgings and case harden steel. Your shop is not complete without a FOUNDRYETTE. Three sizes are available capable of making bronze castings of 1 1/2, 3 and 6 pounds weight, aluminum, copper, brass, etc., \$22.50, \$29.50, \$42.00 f.o.b. Kansas City. Domestic gas supply and 110 volt AC or DC energy required for operation. Write for circular.

KANSAS CITY SPECIALTIES CO.

Box 6022, Dept. P1

Kansas City, Mo.

250 PIECE MASTER ARBOR SET

catalog value \$28.00

for only

\$6.95

Post Paid

The very finest tools for your handy drill bench or anything with a chuck. 1/8" and 3/32" shafts.

Set contains the following mounted items: 15 burs, 8 stone grinders, 1 large stone point, 5 large carbon stones, 2 saws, 1 large buff, 3 ass't brushes, 1 rubber wheel polisher, 6 ass't stones, 5 cut-off wheels, jewelers polish, 2 rubber polishers, 100 ass't sanding discs, 100 black discs.

GENERAL AIRE CO. Dept. A
447 W. Norris St., Philadelphia 22, Pa.

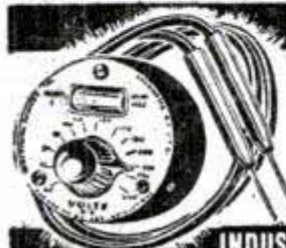

FLASH THAT VOLTAGE

Turn that knob. Extinguish the neon glow. Instantly read voltage right off dial. Mini-Volt measures 65 to 660 v. AC. Also DC. Tells whether AC or DC. Virtually burnout-proof. Guaranteed for 10,000 hours' operation. Bakelite case. 12" flexible test leads and test prods. A "must" in electrical and radio work. And only \$2.50 postpaid!

INDUSTRIAL DEVICES, INC., EDGEWATER, N. J.

DON'T YOU BELIEVE IT!

... PISTON RINGS ARE NOT SLICES OF CAST IRON PIPE

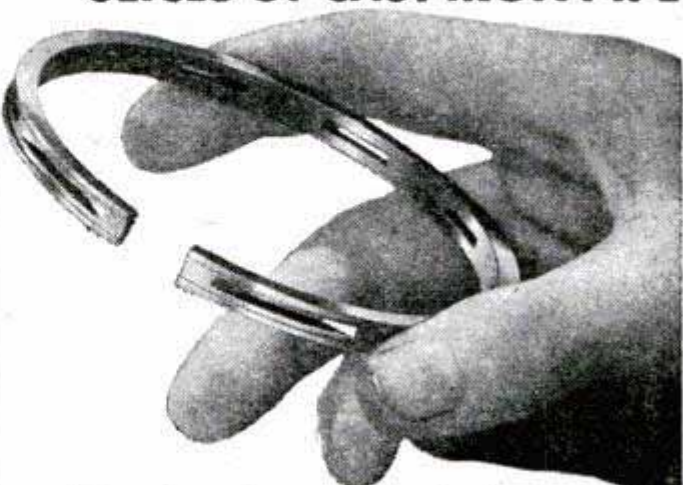

● A lot of people are under the impression that piston rings are sawed from cast iron pipe. Nothing could be farther from the truth. The modern piston ring is a product of an exacting science. Take Burd "Graf-Flox" Piston Rings for example: (1) They are individually cast of iron prepared in carefully controlled electric furnaces. Each type of ring has its own metal formula that imparts the right degree of hardness, flexibility, tension and long life. (2) Grinding, turning and finishing operations are held to an accuracy measured in ten-thousandths of an inch. (3) By an exclusive Burd process, deeply penetrating colloidal graphite is applied to the finished rings to insure faster seating ... without danger of scoring, seizing, or sticking in piston grooves. Burd "Graf-Flox" Piston Rings out-perform ordinary rings in rebuilt engines. Fuel and oil losses are stopped ... pep and power are restored.



BURD
AUTOMOTIVE
PRODUCTS

Engineered for results

MAIL THIS COUPON FOR THESE FREE BOOKLETS

BURD PISTON RING CO., DEPT. 118-B
Rockford, Illinois

I'd like copies of your "Servicemen's Handy Handbook" which tells how to keep my car in good working order, and the booklet "No Job For a Dub."

Name.....

Address.....

City..... State.....





a place in the Car
FOR YOUR

FAVORITE PIPE



ENDS BREAKAGE AND FIRE HAZARD

No more fumbling, spilling, or scoldings from The Little Woman because burning tobacco dumps all over clothing and upholstery! Using this new Pipe Holder helps make more expert drivers because it ends the old question—what to do with a pipe when you need both hands free.

Constructed of springy metal with suede finish, it can't scratch the pipe. Clamp type, the Holder keeps pipe firmly in upright position. Use it when in Home Workshop (see Left). It bends easily to fit the shape of any pipe (see Left, below), and is adjustable to drying angle. A genuine rubber vacuum cup attaches it to any smooth surface.

ONLY

\$1.00
POST PAID

ORDER TODAY

Just clip ad. Write your name and address in the margin, attach a dollar, and mail to the address below. No C.O.D.s.

BOYD F. SCHERNBECK

5045-A Portland Ave. Minneapolis, Minn.



A PENNY BUYS

Go places for pennies . . . with a Whizzer Motor on your bike! This sturdy, modern motor fits any balloon tire bike . . . takes you 125 miles per gallon, at speeds up to 35 m.p.h. It's America's thriftiest power transportation, engineered for years of trouble-free performance! Get in the Whizzer Parade!



A 6-MILE RIDE

RIDE ONE
AND YOU'LL
BUY ONE!



ONLY
\$97.55
PLUS TAX

FACTORY
PRICE

ON A WHIZZER

Whizzer Motor Company, Dept. 522, Pontiac, Michigan, enclose \$99.97, which includes \$2.42 Federal Excise Tax () check or () money order. Send me one Whizzer Motor complete, ready for installation. If descriptive literature only is desired, check here ().

Name _____ City _____
Street _____ State _____

POSTCARD ADS ARE POWERFUL!

NEW ADVERTISING
MACHINE PRINTS
AND ILLUSTRATES

1¢ POST CARDS

BRING BIG RESULTS FAST!



Send
NAME

FREE

Learn how thousands of business men, in every line, are boosting sales in spite of conditions—with 1¢ messages—printed and illustrated in a few minutes on gov't post cards—with amazing new patented **CARDMASTER**. Your "today's" ideas, read by your prospects next morning. Not a toy, but a sturdy advertising machine, built to last for years. Low price, sold direct. Guaranteed for five years. Send name today.

SEND NAME We'll send **FREE** illustrated book of money-making IDEAS for your business and complete, unique advertising plans. **RUSH YOUR NAME TODAY.**

CARDMASTER COMPANY
4546 RAVENSWOOD, Dept. 132. CHICAGO 40, ILL.

New! BLACK & DECKER

HOME-UTILITY
1/4 INCH
ELECTRIC DRILL



This portable electric drill handles hundreds of "odd jobs" in homes, hobby shops, farms, repair kits. Only 7 3/8" long, weighs 3 3/4" lbs. Will drill to 3/4" in steel. Has

fast-operating Jacobs hex-key chuck and an instant-release trigger switch. Operates from any 110 volt A.C. or D.C. circuit at 2250 RPMs. Order today for **\$18.95** immediate delivery.

Postpaid upon receipt of check or M.O.; C.O.D. you pay postage.

For General "all-purpose" drilling from 1/8" to 1 1/2" order the Black & Decker Home-Utility 1/2 inch Electric Drill. . . . **\$35.95**

ASTORIA REFRIGERATOR EXCHANGE

25-57 Steinway St. Dept. M Long Island City 3, N. Y.

KEEP WARM



(Left) **B-15 STYLE PILOT'S JACKET.** Water repellent green poplin; wool alpaca body & sleeve lining; 2 slash pockets; Genuine Mouton Fur Collar, zipper front.

38-46 **\$14.75**

(Right) **AAF F-2 PILOT'S JACKET.** Eisenhower style with soft shearing collar; 100% wool; dark green. Complete with all wool button-in liner; zipper front. Wear liner as separate jacket. Sizes 38-40. . . . **11.75**

LEATHER PANTS. Sheep Skin Lined, Navy Surplus. Suspenders. . . **\$6.75**

Write for **FREE** illus. list Army surplus. Orders sent postpaid except C.O.D. Satisfaction or Money Back

CONSUMER CLOTHING CO., Box 2-P, 26 Greene St., New York 13



U. S. SURPLUS BARGAIN

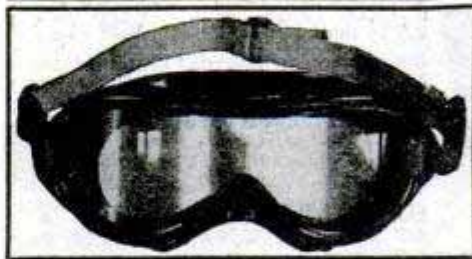

POLAROID GOGGLES

Brand new! In original packing. Each with three interchangeable lenses.

SHOCK PROOF FRAME — SHATTERPROOF LENSES

Use them for all-outdoors sports, beach, motorboating, boating—anything. Heavy windproof sponge rubber ventilated frame with snap button! Adj. elastic head band. Red, green, amber flexible shatterproof lenses, all instantly interchangeable. They won't last long at this price—it's smart to buy an extra. Post paid in U. S. A.

\$1.00
POST PAID

GROBAN SUPPLY CO., Dept. PM-2
1522 S. Michigan Ave. Chicago 5, Ill.



DEAFENED? LEARN WHY THOUSANDS RECOMMEND THESE NEW *Western Electric Hearing Aids*

NEVER BEFORE in Western Electric's long history as a maker of hearing aids has there been such immediate acceptance for newly announced instruments. Here's why:

FOR THOSE WITH MODERATE HEARING LOSS

The compact *all-in-one* MODEL 65 weighs only six ounces, including self-contained batteries. It brings out with particular clarity the all-important speech range of sound. Send coupon for more details.



FOR THOSE WHOSE HEARING LOSS IS SEVERE

All-in-one SUPER 66 users confirm laboratory reports that it is the finest hearing aid ever designed by Bell Telephone Laboratories. It supplies extra power to those who need it, superb fidelity over a wide tonal range.

Free! MAIL THIS COUPON TODAY

Send me, free, the new booklet, with details on Model 65 and Super 66. Also enclose my free copy of the helpful new book, "Modern Science and Your Hearing."

Western Electric, Dept. 380-PM2—195 Broadway, N. Y. 7, N. Y.

Name _____

Address _____

City _____ Zone _____ State _____

THIS MOTOR \$2.45

1/30 HP 24 volt DC motor 2450 R.P.M. .95 amps. 1/4" shaft size overall 3" x 4". Weight 3 lbs. Also operates on 32 volts. . . . only



USE AS 6 VOLT GENERATOR

Generate your own power. Can be operated on your bicycle wheel. Furnishes sufficient power for two 6 volt bulbs. Resistor furnished free with each motor enables you to maintain constant voltage. Special Price \$2.45, or 4 for \$7.50. Write for price in larger quantities.



Riveter and Chipping Hammer

Model AVC-11, like new. Takes up to 5/32" rivet. \$66.00 list. Special price \$6.95. Wt. 5 lbs.

Prices are F.O.B. Chicago. Immediate delivery. Send check or money order today. Sold on money back guarantee.

C & M EQUIPMENT CO. 1831 S. State St., Dept. D-2 Chicago 16, Ill.

BUILD YOUR OWN TILTING TABLE SAW!

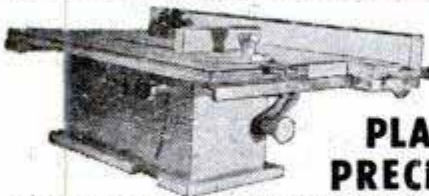

with

GIL-BILT

PLANS—PARTS PRECISION ARBOR

- 21 x 27 in. hardwood table reinforced with aluminum channel, tilts full 45 degrees; 13 in. capacity in front of blade.
- 8 in. blade mounted to cut from 0 to full 2 1/2 inches.
- Self-aligning and calibrated rip fence and miter gauge.
- No machining, no welding, no blueprint reading.
- Sturdy wood, steel, and aluminum construction. Build easily with common hand tools.

GIL-BILT Step-by-Step Plans—Simplified perspective drawings, full size patterns; illustrated with 15 actual photographs. Post-paid anywhere in the world. . . . \$1.00

GIL-BILT 5/8 in. Arbor—Machined spindle, two precision ground lubricated for life ball bearings, assembled ready to run in one piece cast aluminum housing. . . . \$6.95

GIL-BILT Special Metal Parts Kit—Includes Step-by-Step Plans, 5/8 in. ball bearing arbor, aluminum channel and bar, cast aluminum handwheels, steel hinges, V-pulley and all other metal parts (less blade). . . . \$14.95

Same Kit with high quality 8 in. combination blade. . . . \$18.95 (Prices include postage up to 600 miles)

GILLIOM POWER TOOLS P. O. BOX 1-M, LAMBERT FIELD ST. LOUIS 21, MISSOURI



ESPEY Television Kit

Designed around modern circuits, and manufactured of the finest materials, this ESPEY Television Kit offers you the opportunity of building your own personal television set at unbelievably low cost. Kit is supplied complete (less tubes and cabinet) with all parts, punched and welded chassis, instruction book, etc. \$69.50 for only.....

For full details, write to Dept. D

ESPEY MANUFACTURING COMPANY INC

528 EAST 72ND STREET-NEW YORK 21, N. Y.

WAR SURPLUS NYLON THREAD

Amazing Strong Thread used to sew Parachutes

NOW AVAILABLE

Hundreds of Uses . . .

This genuine Du Pont Nylon thread is practically unbreakable. What every hobbyist, sportsman, sailor, camper, wants. Used in model making, sail mending, tent repairing, bow and arrow winding, bamboo rod wrapping, kite flying and repairing, and many other uses. Used by Air Force on parachutes because of its amazing strength and dependability. Here is your chance to get a giant spool of 4800 feet—almost a mile of Nylon thread—at the sensational low war surplus close-out price of only \$1.49. Black or white. Order TODAY.



GIANT SPOOL
only
\$1.49
BLACK or WHITE
APPROX 4800 FEET

SEND NO MONEY, TEST AT OUR RISK

Just send your name and address. Specify white or black or two giant spools for only \$2.89. On arrival, deposit only \$1.49 per spool (\$2.89 for two spools) plus C.O.D. postage on our guarantee if you are not delighted, you can return in 10 days and your money back. Cash with order, we pay postage. Only limited amount available. Order Today.

LEEWARD PRODUCTS

Dept. 49-B, 189 W. Madison St., Chicago 2, Ill.

For . . . BIG Money-Making . . .
Doing ALL Work . . . 4 Great NEW



7"

EIFEL-GEARED PIERENCH KITS

● AGAIN . . . AMERICAN'S Plierench Kit Beats its Own performance Record . . . always far beyond other tools. Now . . . 5-second Jaw-Changes . . . 1-second Adjustments . . . 1-Oz. to 1-TON grips—in a Million sizes from 0"-3" . . . as against 1" for tools in its size!

● A Plierench KIT gives real ALL-Purpose SUPER-Tool service . . . Each of the 7" and 8½" KITS has: 1). Parallel Universal jaws with 4-way V-grooves; give 12-grips to a Turn of a Nut with Lock-&-ratchet action; for making Springs and do-All pliers and wrench work Easier. 2). A PIPE-Jaw with 4-point Toothed-V-grip that OUT-grips All others. 3). A WIRE-Jaw that turns an 'Eye' on ¼" Rod, Coils, Springs, etc. ::All for the Price of One Good tool!



8½"

The GIANT KIT

is the 8½" Kit plus this 4" GIANT-Jaw.

THE MASTER KIT

Comprises the 8½" Plierench + PIPE-Jaw + Wire-Jaw + TUBING—Cutter-Set + Grip-CLAMP and this 4" GIANT-Jaw . . .

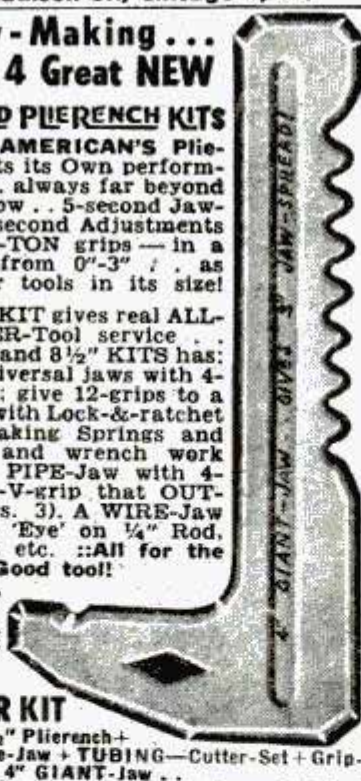

GET the Most Amazing Gripping-tool Facts Ever Printed

MAIL this Part of Ad TODAY . . . on a Postcard will do . . . Print Your address.

Get FREE—the 115-Picture MANUAL - M and the 120-Picture CATALOG - C . . . With BIG-Money-Making Offer for— Full-time DISTRIBUTOR ☐ . . . Part-time AGENT ☐ Or . . . User Offer ☐

AMERICAN PIERENCH CORP'N
4611 N. RAVENSWOOD AVENUE
DEPT. PM-82, CHICAGO 40, ILLINOIS



● Also FREE . . . this 3", 6-Edge, End-and-Angle, MULTI-TOOL— for Large and Small Screws in All positions and for countless useful jobs.

THE IDEAL OIL FOR THE Home Craftsman!

FIENDOIL

Better lubrication for small motors and mechanisms—a must for perfect lubrication and protection of fine equipment!

40¢ 3 OUNCE SPOUT CAN

Product of
McCambridge & McCambridge
Baltimore, Maryland

AT YOUR HARDWARE OR
SPORTING GOODS STORE



BUSINESS TRAILERS

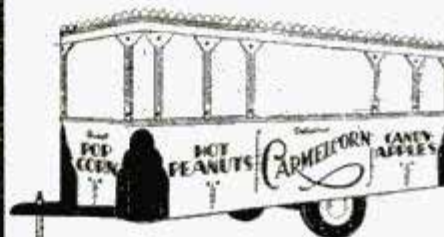

Write for large illustrated catalog on trailers and money making equipment.

KING CO., 82 Orchard St., Mt. Clemens, Michigan



FIX SEWING MACHINES

BIG MONEY. Spare or full time. Open your own neighborhood shop. Thousands need repairs. Send for complete Repair Manual—only \$1.98 postpaid. Money back guarantee.

SEWING MACHINE SERVICE CO., Hamilton 25K, Ohio

WAR SURPLUS BARGAINS BRAND NEW CLOTHING

Also commercial work clothing.
Write for your FREE copy of our Illustrated Circular.
ADDISON UNIFORM CO. • Dept. PM • CAMBRIDGE, OHIO

12 lbs. SURPLUS RADIO PARTS \$2.00

A gold mine of parts for repairmen, amateurs, and experimenters . . . sockets, condensers, resistors, transformers, coils, hardware, wire, etc. An outstanding bargain in usable parts! Send \$2.00 cash, check or M.O. today! (May small express charges on receipt.)

ELECTRONIC DISTRIBUTORS, Inc. Dept. M2620 W. Randolph St., Chicago 6, Ill.

SAY YOU SAW IT IN POPULAR MECHANICS



Modernize Your Gun! Improve Your Score!
Most durable grips made. Positively unbreakable! For Colt, Smith & Wesson, Hi-Standard, Ortgies, Luger & Mausers in a wide choice of beautiful designs in Ivory, pearl, walnut, onyx, etc. Low prices. FREE CATALOG. Dealers Wanted.
SPORTS, INC. (Mfrs.) 5501 Broadway, Dept. P-2, Chicago 40, Ill.

Hagerty Sea Shell*

\$35



Length 8' Depth 16"
Beam 4' Wght. 65 lbs.



Rugged for hunting and fishing



Easy to handle, light to carry



Takes an outboard up to 2 H.P.

**Assemble your own boat
... Save up to \$100.**



The Sea Shell is an inexpensive, all-purpose man-sized boat for salt water or fresh. Ideal for fishermen, duck hunters, yachtsmen and youngsters. It's easy to assemble, with precision-cut wood and waterproof plywood parts. Everything is furnished — all you need is a few hand tools, a little leisure time, and a pot of paint. Fun to build and fun to use — you can row it, tow it or use it with an outboard. Sailing kit extra. Ample freeboard makes the Sea Shell sturdy and safe. Fully guaranteed. Send for free illustrated booklet.

*
Reg. U.S.
Pat. Off.

● If not available at your dealer's, order direct. Dealers — write for attractive franchise information

Hagerty, 11 Border St., Cohasset, Mass.

Send me free booklet on Sea Shell kit.

Send Sea Shell freight collect. Enclosing check or M. O. for \$35.

Name _____

Street _____

City _____ State _____

THIS IS THE BUSINESS YOU DREAM ABOUT

QUICK STEADY PROFITS

CORADIO

The Coin Operated Radio

IT'S the new, fast-growing, depression-proof business. Coin operated radios are

placed in hotels, tourist courts, clubs, hospitals, etc. on a commission basis—play 1 or 2 hours for 25c and produce immediate profits. The best coin operated radio is CORADIO

ACT NOW

Start your own lifetime business, full or part time. Send For Free Catalogue And Complete Information.

WRITE TODAY Dept. P. M.



CORADIO

COIN OPERATED RADIO
108 W. 31st ST. N. Y. 1, N. Y. WISCONSIN 7-5902

AUTOMATIC IRON TESTER

Pilot Light Flashes on and off with thermostat.

For checking temperatures and re-setting thermostats. Graduated for RAYON, SILK, WOOL, COTTON, LINEN—Also in degrees from 200° to 700° F. Has a specially designed precision thermometer. Unsurpassed in quality. ONLY \$18.50 complete—MONEY BACK GUARANTEE.

Write for circular.

HANLAN CO., 1419-A, W. Jefferson, LOS ANGELES 7, CALIF.

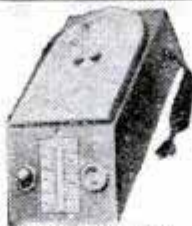

(Pat. Appl. For)

BUILD THIS

CONCRETE BLOCK MACHINE

Sell blocks; or build your home, garage, barn at 1/3 cost by making and laying your own blocks.

This simple machine which you can build yourself at a cost of about \$15 (excluding motor) will make a block in 30 seconds using only one form. 2 to 4 forms can be used on each vibrator.

Power driven concrete mixer plans also. Send dime for details and "How to Make and Lay Blocks."

U-BUILD-IT SERVICE

Dept. 3-A, 206 West Wilder Ave., Tampa 3, Fla.

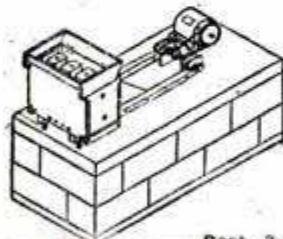

PRESSURE QUEEN

FOUR CYLINDER

PORTABLE AIR COMPRESSOR
SPRAY PAINTING OUTFIT

\$99.95
COMPLETE

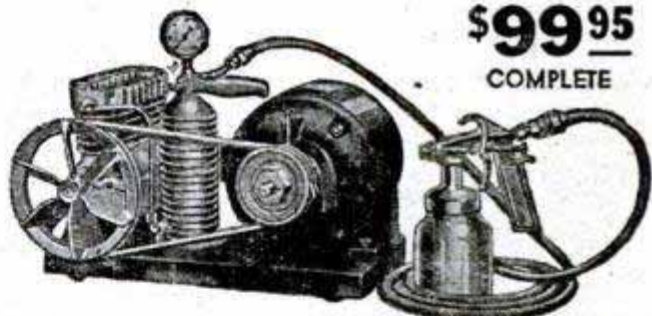

COMPACT • RUGGED • POWERFUL

The ideal air supply for home and farm workshop, machine shop, garage, service station and contracting painter. Inflates tires; refinishes automobiles, trucks, implements and furniture. Paints buildings better, faster and at lower cost than brush work. Compressor has 4 cylinders, drop forged crankshaft, heat treated valves and pistons, bronze bearings, forced feed lubrication. 50-60 lbs. pressure without pulsation. Price includes compressor as shown, with air gauge, 15 ft. hose, spray gun and 3/4 h.p. motor; fully guaranteed. With 1/2 h.p. motor—\$109.95.

IF YOUR DEALER DOES NOT SELL
PRESSURE QUEEN WRITE DIRECT.

THE CAMPBELL-HAUSFELD CO.

1046 RAILROAD AVE.

HARRISON, OHIO

BASS
IS BEST
WEEJUNS
LEISURE
COMFORT



BASS
IS BEST
QUAIL
HUNTERS
FIELD AND STREAM



BASS
IS BEST
SKI BOOTS
EXTRA
CONTROL



BASS IS BEST
SPORTCASINS
GOOD GOLF STRATEGY
G. H. BASS & CO.
60 MAIN STREET
WILTON, MAINE



Carries the Same 90 DAY GUARANTEE As a New Motor Assy.

Our Finest Precision REBUILT MOTOR BLOCK ASSEMBLIES

Sold Outright or Exchange

Rebuilt by skilled mechanics. Assembly has Reborn Block with New Pistons, Pins, Rings, Reground Crankshaft, All New Bearings. Guaranteed 90 Days.

Allowance on Old Motor
We ship at outright price. Send your motor prepaid, must be suitable for rebuilding. Send in notarized bill of sale showing title number if any. We refund difference when we receive your motor.

Chevrolet Outright Exch.
29-47 6 cyl. \$117.50 \$87.50

DODGE—3 1/4" bore
Year Type Outright Exch.
35-47 6 cyl. 139.00 109.00

Plymouth Outright Exch.
35-47 6 cyl. 139.00 109.00

\$5.00 Crating Charge

FORD BLOCK ASS'Y.
Year Type Outright Exch.
28-31 4 cyl. \$109.00 \$87.00
32-47 6 & 8 149.00 99.00

Mercury Outright Exch.
39-47 V8 149.00 99.00

We Can Supply REBUILT ENGINES, TRANSMISSIONS, REAR ENDS, Etc., for All Cars and Trucks. Write for Quotations!

POWER TAKE-OFF for JEEP ENGINE

Bolts to clutch housing on the Jeep engine. Has a spline shaft to engage with clutch and extending from rear is a key shaft on

which pulley can be mounted. Has a lever controls clutch. PF4N-23J—Each.

\$3750

NEW 5 Gal. CANS



FOR GAS, OIL OR WATER Vented for Safety. Self-locking Safety Cap Extra Heavy Construction Will Float When Full Size of can, 18" high, 6 1/4" thick, 12" wide. PA35-60—Lots of 5, ea. 1.15 Lots of 50, ea. 1.05 Lots of 100, Each 98c

New Willys JEEP Enclosed Power Unit

90 HP. 4 cyl. engine, 134.2 cu. in. displacement. 3 1/8" bore 4 1/2" stroke. Complete with radiator, gas tank, clutch power take-off with 1 1/2" keyed shaft, and all accessories.

READY TO RUN. NEW. PG60N-002. \$32500 F.O.B. Chicago.

We Can Also Supply JEEP ENGINES. Write for Prices!

SEND 25% CASH WITH ORDER, BALANCE C.O.D.

J.C. WHITNEY & Co.

1917 Archer Ave. Chicago 16, Ill.

STOPS LEAKS PERMANENTLY

Cut your fixture replacement, water and fuel bills with Economy Renewable Seats. Make economical, permanent repairs quickly and easily with the Junior Kit (illus.). Repair bathroom, kitchen and laundry fixtures. Everything you need included in steel box. This is a natural for the "Fixit" shops—get extra income from making permanent repairs on your customers' faucets.

Senior Master Kit also available—repairs faucets and valves up to 1" pipe. At Better Jobbers and Hardware Stores . . . or Write Direct

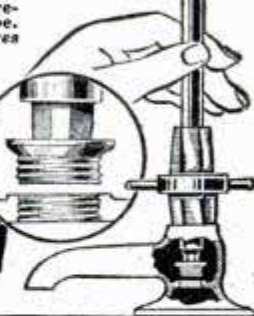
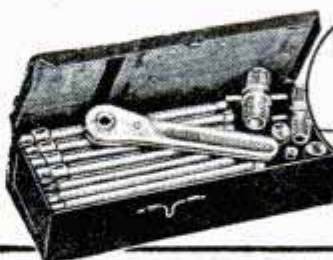

ECONOMY VALVE SEAT CO.

2811 W. Fletcher Street Chicago 18, Ill.

DIE-LESS DUPLICATING

Many small parts can be formed without dies. To duplicated accuracy of .001" with DI-ACRO Precision Machines. — Benders, Brakes, Shears. Save die expense and time delay. Ideal for experimental and research work, making samples, models, etc., as well as regular production runs. Write for descriptive literature.

O'Neil-Irwin Mfg. Company

343 8th Ave. Lake City, Minnesota

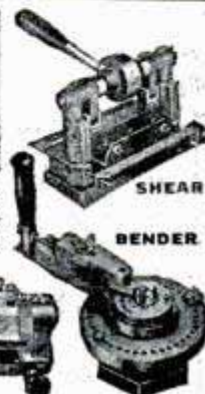

SHEAR

BENDER



BRAKE

*** "BELT HAND SANDER" *** High quality—Cut steel gears sealed in grease—Aluminum housing—Bronze bearings. Simply chuck to your 1/4" Electric Drill and you're ready to do a sanding job. Guaranteed. At your dealers' or direct. Sander with 2 belts \$19.95. Folder 10c. Catalog 1046 listing our tremendous Aluminum stock—Steel—Plastics—Equipment and Supplies 20c. Folder 047M listing Machine Kits for making your own machinery 10c. METLPLAS SUPPLY CO., 1420 South 16th Ave., Maywood, Ill.

AUTO ENGINE SPEED CONTROL GOVERNORS



In Montreal, 7546 Wiseman; in Skaneateles, N. Y., Horle Welding Supply.

Agents Wanted

CANDEE-SMITH GOVERNORS 2641 S. Hill St., Los Angeles 7, Calif.

2 BIG SPECIAL BARGAINS at LOW PRICES

BRIGGS & STRATTON LIGHTING PLANTS AND SPERRY S-1 BOMB SIGHTS

110 Volts D.C.

Made For the Government: All NEW . . . Never Used

BRIGGS & STRATTON Portable Lighting Plant priced at a fraction of the original cost. Built to rigid Government requirements. Especially built for Field Use or for permanent installation in Cottage, Farm, Trailer, Boat, etc. Complete with 1 3/10 H.P. Gasoline Engine, Hand Starter, Rated 250 Watts will develop 500 Watts. With Spare Parts and Tools. Mounted on permanent base . . . Rubber cushioned . . . Ready for Immediate Use anywhere . . . At this LOW PRICE they won't last long . . . Better Hurry only \$129.50.

SPERRY S-1 BOMB SIGHT—Here is an unusual opportunity to get one of these MARVELOUS Precision Mechanical Instruments . . . Marvelous beyond description. Contains hundreds of parts usable in 1061 ways . . . Regular and Bevel Gears, Shafts, Approx. 100 Roller Bearings, Electrical Parts, Precision Lenses and Prisms, Countless Gears, Dials, Knobs, Switches, Polaroid Filter, Calibrated Dials for Air Speed, Drift Indicator and Illuminated Spirit Level, Gyroscope, etc. . . . Excellent for Inventors, Experimenters, Hobbyists. Schools use for Study Demonstration. Only \$49.50.

Cash with order or we will ship C.O.D. if 25% deposit accompanies the order. These prices F.O.B. Chicago.



COMPLETE WITH POWER PLANT. ONLY \$12950

2 MORE BIG SPECIALS NEW

BRAND A-B-B . . . OXYGEN MASKS: Made of Genuine Rubber With Sponge Filters. ONLY \$2.75 Each
General Electric AIR COMPRESSOR . . . Catalog #T8252882G1 . . . Rated Pressure 1000 pounds to square inch . . . Dual Cylinders . . . Approx. Weight 6 pounds. ONLY \$9.95 Each

ACESURPLUS SALES CO., Inc., 1449 West 69th St., Dept. P-2, CHICAGO 36, ILL.



Complete on Metal Base and Strong Box Container with Lock (can be used for valuables)

ALL FOR— ONLY

\$4950

DEALERS: Write For Quantity Prices . . .

SENSATIONALLY LOW PRICES ON NEW SPEEDEX GARDEN TRACTORS



\$146.50

MODEL C
1½ Horsepower
With Cultivator
F.O.B. Ravenna

12 years experience enables us to offer you the newest model Speedex tractors at big savings. All enclosed gears running in a bath of oil, powered with Briggs and Stratton engine, easy-to-handle controls, equipped with 500-12 pneumatic tires and has many other features. Model C cultivates up to 2 acres per day. Replaces up to 5 or 6 men with a hoe.

SPEEDEX BIG BOY

Heavy-duty walking tractor powered with 6 horsepower Briggs and Stratton engine. Pulls 10" plow. Cultivates up to 5 acres. Replaces light team. Only \$265.00 F.O.B. Ravenna.

FULL LINE OF IMPLEMENTS
DELIVERIES NOW BEING MADE

WRITE FOR FREE CATALOG
Compare and you'll invest in
a Pond Speedex Garden Tractor.

POND GARDEN TRACTOR CO.
Box 216 Ravenna, Ohio

P-1247-79

METALS

sold in small quantities for the home workshop. Steel, Brass, Copper, Aluminum, etc. In Bars, Shapes, Tubes and Sheets. Write for free price list.

CASHMETALS CO., 2720 California Ave., Pittsburgh 12, Pa.

EXTRA MONEY QUICK

SELL PERSONAL INITIALED BELTS

SEND FOR SPECIAL OUTFIT OFFER

BUCKLES, CAP BADGES, TIE HOLDERS
2000 emblems to choose Fast profits repeats Write to-day Special outfit offer.

HOOKFAST SPECIALTIES, Dept. 51
BOX 1425 PROVIDENCE, R. I.

AMAZING SAVINGS JUST OUT OF PAWN! GENUINE HIGH QUALITY DIAMONDS

UNREDEEMED DIAMOND PLEDGES
DIRECT TO YOU! SAVE UP TO 50%!

Full cut genuine diamonds, expertly reset in beautiful modern mountings of 14 Kt. Yellow or White Gold, ladies' or men's, priced at a small fraction of retail value. Over 100,000 satisfied customers. Iron-clad guarantee. Wear your diamond 7 days. Your money refunded immediately if not delighted. Order from this ad.

Also write us for FREE illustrated catalog of other Unredeemed Diamond Pledges from \$5.00 to \$5000. Small deposit holds any diamond until wanted. Write us today. Bank Reference on request, or your own bank.



1/5 ct. (\$125 Value)

\$49.00

Tax included.

BERMAN'S COLLATERAL LOAN BANK
Dept. P-6, 636-38 W. Balto. St. Baltimore-1, Md.

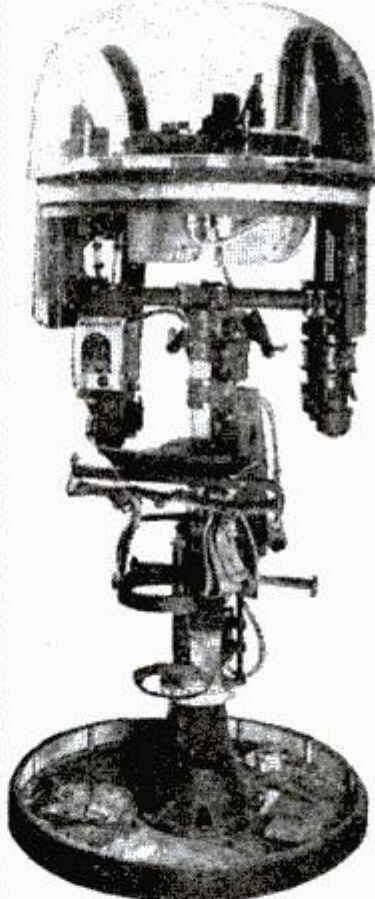

A \$2500 PIECE OF
Electrical and
Mechanical Equipment
for
\$25.00

GOVERNMENT SURPLUS

PILOT Trainer TURRET

3½ ft. in diameter
6½ ft. high

Chock full of all kinds of
gadgets, including:

- 2—1 H.P. Motors—Plexiglas Dome—Motorcycle Saddle—4-Lens Gunsight—Pistol Grip Controls—Oscillating Gun Mounts—Electric Trouble Lamp and 100 other attachments.

WHILE THEY LAST

\$25.00
EACH

Approximate shipping
weight—500 lbs.

IMMEDIATE SHIPMENT

Send Cash, Check, or Money Order to:

JOSEPH STERN
919 Union Central Bldg., Dept. 2 Cincinnati 2, Ohio

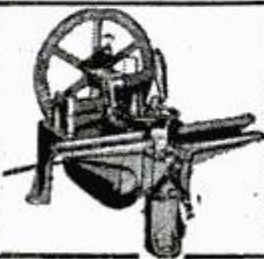

AUTOMATIC SAW SET

Set saw teeth automatically on hand or band saws—400 per minute without effort. Perfect hammer and anvil action sets teeth uniformly—No tooth breakage.



IMMEDIATE DELIVERY
Write Today

BURR MFG. COMPANY 8933-N Venice Blvd. Los Angeles 34, Calif.

AUTOMATIC RETOOTH

Cuts new saw teeth in 50 seconds—any size 4 to 16 points. Old teeth fall off as chips. Easy to operate. A perfect job.

FOR HAND SAWS



**A ★
Fisherman's
Dream
Come
True! ★**

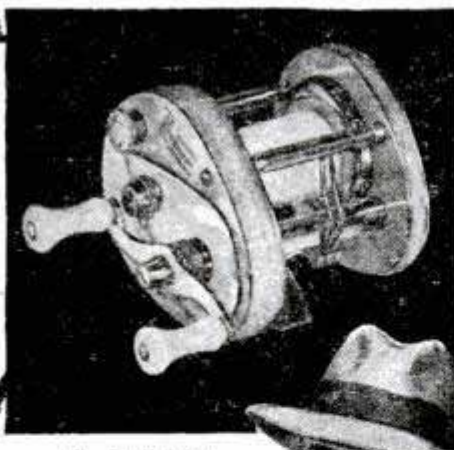

**Shakespeare's NEW
PRESIDENT REEL**



THE Finest Reel Ever Made

No other reel gives you the *faultless performance* . . . all the 9 better fishing features found expertly *custom-crafted* into the Shakespeare New PRESIDENT Reel!

In smooth, quiet operation . . . in instant response to your every cast, it is a fisherman's dream come true . . . *the finest reel ever made*. No longer any need to envy its fortunate owner . . . now available at your sport store.

**Shakespeare
FINE
TACKLE**
HONOR BUILT
FIFTY YEARS

FREE TACKLE BOOK and Pocket Fishing Calendar. Reels, Rods, Lines, Accessories, Fishing Tips. Send coupon.

Shakespeare Company, Dept. 82, Kalamazoo 2, Michigan
Send me your **FREE BIG TACKLE BOOK** and Pocket Fishing Calendar.

Name.....
(Please write address and zone no. below)

Another GREAT NECK First!



Blade lengths from 4" to 10"



ALL NEW!

**REVOLUTIONARY
MAXIMUM-GRIP
PLASTIC HANDLE
SCREW DRIVER**

**★ Unbreakable!
★ Twistproof!
★ Modern Design!**

GREAT NECK—leader in tool design—offers the new, handsome maximum-grip screw driver you've been waiting for! Richly colored unbreakable plastic handle is slip-proof, non-explosive, non-absorbent to grease or oils. Entire blade is of specially hardened and oil tempered quality alloy tool steel, highly mirror-polished. Bit is precision-ground to exact size. Blade is deeply embedded and twistproof. Here is a beautiful engineered tool to give good service for many years!

THE QUALITY TOOL FOR CRAFTSMEN, MECHANICS, HOBBYISTS—EVERYONE!

ASK FOR GREAT NECK TOOLS BY NAME

NOW AT HARDWARE COUNTERS

GREAT NECK SAW MFRS., INC. • MINEOLA, N. Y.



Why Pay More?

**FREE TUBE
With Each Order**
EVERY TIRE GUARANTEED
98% NON SKID, ORIGINAL TREAD
TRIPLE INSPECTED DEMONSTRATORS

Positively Not Re-caps!

600-16 .. 6.42	700-15 .. 8.42
650-15 .. 7.12	700-16 .. 8.82
650-16 .. 7.42	750-16 .. 9.42
900-16 .. \$7.52	900-20 \$17.52
650-20 .. 9.52	1000-20 17.52
700-20 12.52	1100-20 17.52
750-20(8) 12.52	32x6(8) 12.52
750-20(10) 13.52	32x6(10) 13.52
825-20 16.52	34x7(10) 13.52
7.50-20 MILITARY 8 PLY \$17.52	

1/2 million tires shipped to satisfied customers. Trial will convince you. Mail Orders Rushed on Receipt of Check or Money Order.

STANDARD
834 N. Broad St. Phila. 30, Pa.

\$2000 NAVIGATOR'S SEXTANT \$1750



GOV'T SURPLUS

A precision instrument of recognized quality. These Link Sextants are used for navigating by the stars or other celestial bodies, on large and small boats—for all types of aircraft—anywhere on the face of the earth. The Sextant is to the mariner what the transit is to the surveyor.

FINEST PRECISION CONSTRUCTION

The fine Link Sextants are the products of a famous name manufacturer. Original procurement cost was approximately \$2000.00. Now, as war surplus, you can buy one at a fraction of original cost. Instrument is equipped with easy-reading vernier type scale. Bubbles are checked for accuracy. Although slightly used, they are in perfect operating condition. Furnished complete with operating instructions and protective wood carrying case 8x12x4 inches. These are guaranteed to be the genuine Link A12 Sextants. Sold FOB Houston. Send check or money order. Rush your order.

\$1750

AERO PARTS SUPPLY, Dept. PM2

MUNICIPAL AIRPORT HOUSTON 17, TEXAS

**STOP
CHANGING!
MOTOR OIL!**



End this needless waste and expense forever with . . . "RECLAIMO"

Today's Most Advanced Oil Re-Refining Filter!

Continuously cleans and RE-REFINES motor oil as you drive (by utilizing motor heat)—keeps oil in high grade lubricating quality at all times—reduces motor wear to an absolute minimum! Proves conclusively that "Oil Does Not Wear Out Mechanically" as stated in U. S. Bureau of Standards, Bulletin 86.

"RECLAIMO"

REMOVES SOLIDS (by filtration) **PREVENTS Excess Fuel Dilution**
REMOVES WATER (by distillation) **PREVENTS Acid & Sludge Formation**
MAINTAINS Stable Viscosity **ELIMINATES All Oil Changes!**

CAR — TRUCK — TRACTOR OWNERS!

You'll want to know more about Reclamo's Oil, Motor and Money Saving Features. **FREE 40-PAGE BOOK "OIL FACTS"** gives you the complete "Reclamo" story plus details about our **NEW 90-DAY NO RISK—NO COST TRIAL OFFER!** Write for your copy today!

RECLAIMO MFG. CO.

5083 Elston Ave. Dept. 62 Chicago 30, Ill.



17 QUALITY TOOLS

with **DELUXE CHEST**

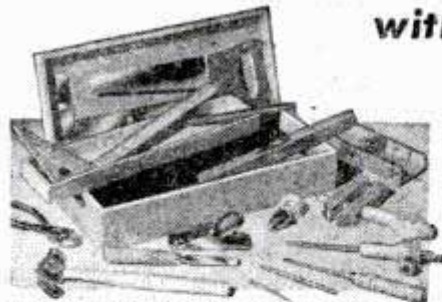

Complete Set
only \$550
postpaid

—at a fraction of the total cost of tools bought separately

Has tempered spring steel saw, claw type hammer, screw driver, chisel, all with hardwood handles, steel square 8" long, semi-steel pliers, wood level, hardwood clamp, triangle, semi-steel plane, 12" ruler, two steel punches, carpenter pencil, plumb bob, depth gauge, wood miter box. All tools are packed in beautiful Wood Chest with push button lock, hinged lid, end carrying handles of plated steel. Has wood tray 15 1/2" long, 3 1/4" wide. Size of chest 16" long, 6 3/4" wide, 3 3/4" high. Beautifully lacquered in natural finish. An ideal gift for man or boy. If your dealer does not have this "American DeLuxe Tool Chest," order from factory. Enclose check or money order. Money refunded if not satisfactory.

DEALERS:
Stock this item.
Write for catalog.

Write for our Catalog of other interesting items.

AMERICAN TOY & FURNITURE CO.
6130 N. CLARK, DEPT. 128, CHICAGO 26, ILL.

Assemble KING MIDGET



Practical highway racer runabout. We supply all parts. Just bolt together. Low cost. Ready for delivery NOW. One or two cylinder 40 m.p.h., 45 to 50 on ice or snow with skis, up to 100 miles per gallon. Send 25c for complete literature with large picture, 4-view drawings, price of parts, or send \$1 (refunded with first order) for the above, plus 24-page assembly book with 42 photographs and drawings; blueprints for converting for use on ice and snow, etc.

MIDGET MOTORS, Athens, Ohio



Print Your Own

Cards, stationery, circulars, tags, labels, photo and movie titles, advertising, etc. Save money. **Print for Others, Good Profit!** Easy rules sent. Raised Printing like Engraving, too. Send dime for press samples, supply book, all details and advice on your needs. No obligation. **KELSEY INC., B-37, Meriden, Conn.**

MICROSCOPES SUPPLIES-ACCESSORIES & SCIENTIFIC INSTRUMENTS
B&L SPENCER NEW & USED LEITZ ZEISS
BOUGHT-SOLD-EXCHANGED-REPAIRED MEDICAL INDUSTRIAL AMATEUR
Send for FREE LIST
NATIONAL SCIENTIFIC INSTRUMENT CO. 119 CHAMBERS ST NY7

AMAZING MYSTERY BUTTON

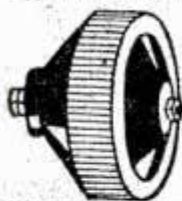

Startles Everybody. With this **Electronic Button** you can make your own Telephone—Amplifier—Detectophone. Attach this button to piece of cardboard—transmit conversation to another room. Music also transmitted to distant places. Most interesting electrical apparatus ever discovered. Enables you to perform hundreds of experiments. So tiny it can be concealed in dozens of places. A Pre-War Product. **Electronic Button** including 5000 word instruction booklet with 50 illustrated experiments. postpaid, only \$1.00
Electronic Products Company, Saint Charles 4, Ill.

CAST ALUMINUM DOUBLE EXHAUST BLOWERS \$15⁸⁵

FOR COAL FURNACE BLOWERS (SAVE 31% ON COAL BILL)—AIR CONDITIONERS — HUMIDIFIERS — DARK-ROOM DRIERS — LABORATORIES — WORKSHOPS — HOSPITALS — LAUNDRIES — OFFICES — PRINTERS.

Double intake and exhaust from 2 balanced sirocco type wheels. Will easily solve your forced draft and fresh air problems. Blower designed especially for quick and simple installation. Anyone can do it with ordinary household tools.

Blower housing is heavy cast aluminum to last indefinitely. Cont. duty motor is extraordinarily quiet. 110 V., A.C., 50-60 cycles. Cord attached, ready to plug in.

SINGLE EXHAUST BLOWER

While they last! Our famous single exhaust blower DELIVER 100 CU. FT. AIR PER MINUTE. Ready to install yourself with any household tools. It's built for that! 110 V., 50-60 cycles. Cont. duty motor.



NOW! ONLY \$10.00

Send check, money order. West of Mississippi add \$1.00 for mailing, handling. **IMMEDIATE DELIVERY.** Service men and dealers: Inquire about quantity discounts.

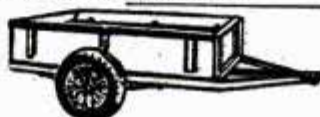

GREATEST BUY EVER! TRAILER CHASSIS

\$52.50

F.O.B. YONKERS

Here's what you get — All steel chassis, welded joint reinforced with steel plate for sturdy construction. Draw bar extends under body. 2 Standard type auto springs; with swivel joint shackle and fixed shackle. 2 Wire spoke wheels (that take standard 4.75 18 tires) 4 Timken roller bearings, 2 dust caps, bolts for assembly. Knocked down, less body and tires.



ALL STEEL COMMERCIAL BENCH LEGS

By simply placing boards across the top, you have a bench or table. Provides cross bars for adjustable shelves. Add ply-wood doors to shelves and you have a cabinet. O.D. 24"x30"—23 1/4" channel steel. Finished in gray. You'll find many uses for these legs.

\$4.75

ca. F.O.B. Yonkers

MINIMUM ORDER 2 LEGS

UNIVERSAL YONKERS CORP.

(Dept. M-2) 137 Alexander St.

Yonkers 2, N. Y.

Say You Saw It in
POPULAR MECHANICS

LOWEST PRICE IN HISTORY!

Sensationally New **WELDRITE** Electric Welding-Cutting Torch

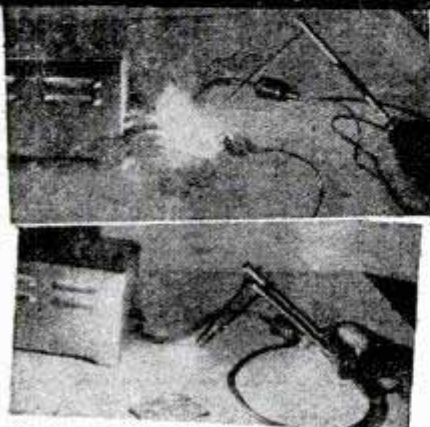

Plugs into any convenient AC-DC Socket
WELDS - BRAZES - CUTS - MELTS - SOLDERS - HEAT TREATS

The **WELDRITE** Torch—tested and proven by countless commercial and amateur users, is now offered direct to you at the amazingly low price of only \$12.00. No Gas—No Gauges—No Spark Lighter needed. Always ready for immediate use—Just plug **WELDRITE** into any 110 AC or DC outlet. Uses standard welding and brazing materials available at all welding supply stores. **WELDRITE** furnished complete with Converter Unit, Single Holder with attached Alligator clip, for Welding metal up to 3/16" thickness, using up to 3/32" rod, and Double Holder with Carbon-Tipped Dual Copper Electrodes for Cutting, Brazing, Heat Treating,

Soldering, etc. Supply of welding materials included free.

Ideal for home workshop. Invaluable for body and fender shops, garages, repair and machine shops, manufacturers, etc.

SEND NO MONEY. Order your **WELDRITE** Electric Welding-Cutting Torch today. Pay postman \$12 plus postage charges (wt. 4 lbs.) or send \$12 and we pay postage. Either way, if not satisfied, return **WELDRITE** in 5 days, and money will be refunded. California orders please add sales tax.

CALIFORNIA TECHNICAL PRODUCTS COMPANY

8510 Warner Drive • Culver City, California • Dept. A-2

NOW ONLY \$12 FULLY GUARANTEED

Here's a TOOL KIT that will save you a lot of TIME and MONEY

With this **MINUTE MAN** kit you can
cut keyways **IN ONE MINUTE**

in **GEARS**

CUTTERS
COUPLINGS
COLLARS
PULLEY HUBS
etc., etc.

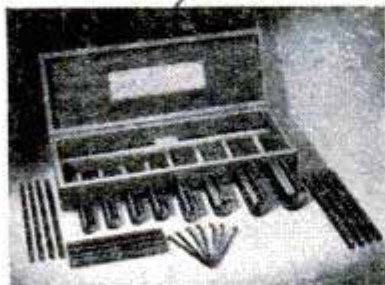

Kit contains everything you need to cut complete range of keyway sizes—precision hand broaches, slotted bushings, shims, keyway stock. Used with du Mont or other Arbor Press. Cut a few keyways and you've paid for the Kit.

Write for Descriptive Folder and Price List PM.

The duMONT CORPORATION

GREENFIELD, MASSACHUSETTS

WAR SURPLUS BARGAIN SPECIAL

**BELT DRIVEN
CENTRIFUGAL**

PUMP

**READY TO
USE ON ANY
LIQUID
PUMPING NEED**

**NOW ONLY
\$29.75**

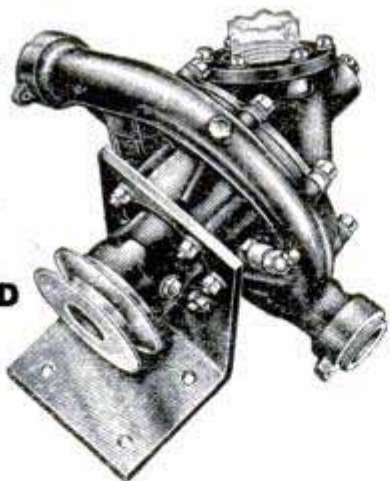

**FOR HOME WATER SYSTEMS, IRRIGATION, FIRE
PROTECTION, DRAIN BASEMENTS, PONDS, ETC.**

• A super value for all types of Intermittent service in pumping large volumes of liquid for stock watering, home and shop water systems, irrigation, draining pools, basements, etc. At 1750 RPM on 23 foot head will pump 42 gallons per minute; at 3600 RPM on 52 foot head will move 88 gallons per minute. Cast aluminum housing. Accurately machined bronze impeller vanes. Complete with mounting bracket and 3 1/2 inch V belt pulley. Run with electric motor, gasoline engine, power take-off on tractor, etc. Shaft rotates on sealed ball bearings with grease gun fitting. Has 1 1/2 inch threaded intake flange. Two 1 inch outlets. Use one or both as necessary. Made for Packard Motor Car Co. for use in Rolls-Royce Merlin Aircraft engines. Comes complete with pulley and mounting bracket. Original cost approx. \$147.00. Sold F.O.B. Chicago. Shipping weight 23 pounds. Complete engineering reports and operating instructions free with pump. You can't beat this pump value at anywhere near this price. Satisfaction guaranteed.

**ORIGINAL COST APPROX. \$147.00
IMMEDIATE DELIVERY FOB CHICAGO
SPECIAL PRICE, WHILE THEY LAST**

\$29.75

**GROBAN SUPPLY CO. 1522 So. MICHIGAN AVENUE
DEPT. PM-2, CHICAGO 5, ILL.**

IRON REPAIR KIT



Contains a complete assortment of terminals, pins, porcelain insulators, mica, etc. that will fit most "flat" irons and appliances. Practically every part necessary in the ordinary repairing of flat irons in one handy kit. Additional supplies obtainable so that your kit can be kept replenished. Entire kit sent postpaid for only \$3.10 plus 18c postage.

Electrical Appliance Repair Parts

Lead wire. Asbestos covered heater hook-up wire. 10 ft.	\$1.00
Heating element wire. 10 ft. coiled 1/4" O.D. #20.	2.55
Heating element wire. 10 ft. coiled 3/16" O.D. #22.	1.77
Ribbon element heating wire. Std. size 100 ft.75
Christy Electric Heating Element Welding FLUX for repairing flat irons, toasters, electric stoves, etc. Enough for 50 elements	1.00
Hot plate bricks 53/4" diameter. 6 for.	1.62
Element cement. Withstand 3000° F. 1 lb. package.	1.00
Carbon brush set. Assorted. 104 brushes. 15 Springs. Complete	3.00

Repair Elements for Electrical Appliances

Electric Range Elements. Fit all makes. Latest Super-high speed units. Each.	6.30
Renual Iron element. Guar. 1 year. Package of 8.	3.12
Irons. Porcelain shoes for 500-600 watt. Set of 4.	1.00
Percolator elements. Universal flat type. 1 Yr. guar. 2 for.	1.20
Percolator Element. Porcelain for new glass types. 2 for.	1.80

How To Fix It Books

Modern Electric & Gas Refrigeration—928 pages.	5.00
Armature & Magnet Winding—270 pages.	1.50
Practical Elec. & House Wiring—200 pages, 227 illustrations. .	1.50

Here is your opportunity to save on repairing
your own appliances and to earn extra money
repairing appliances for friends and neighbors.

CHRISTY SUPPLY CO.

2835 N. Central Ave. Dept. T-1350 Chicago 34, Ill.

NEW REVERSING SWITCH



Genuine Furnas 1 HP. switch for your workshop lathe or hobby equipment using reversible motors. Sturdy construction; plastic case, handle and rotor with built-in contacts. Case, 2 1/4 x 2 1/4 in. Easily wired; mounts on standard outlet box. Available also for OFF-ON duty. State which. Enclose \$3.75. We ship prepaid. **RAY SALES COMPANY, 637 S. 16th Ave., Maywood, Illinois.**

HEATERS

Gasoline, burning 40,000 B.T.U., built by Stewart Warner for USAAF as cabin and engine heaters. Brand new and in original cases. Ideal for installation in trucks, buses, trailers, small buildings, etc. No exposed flame. A bargain at \$28.50 each while they last. Send check or money order to:

MICHEHL INDUSTRIES

ATLANTIC BLDG.

WASHINGTON, D. C.

NEW 1948 PLASTICS SUPPLIES CATALOG

Just off press. Full details on Plexiglas, Lucite, rods, sheets, tubes, Acetates, cements, dyes, buffs, molding sets, tools, carving kits, accessories. Everything in plastics. Gives prices, sizes, colors, etc. Send 10c, stamps or coin, with ad for catalog.

PLASTICS MFG. & SUPPLY CORP.

Dept. M-2 4707 Euclid Ave., Cleveland 3, Ohio

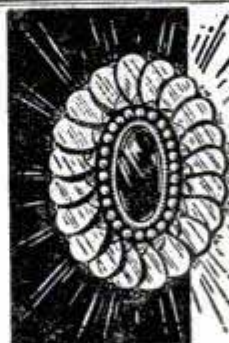

RICH OPPORTUNITIES IN JEWELRY

Shortages in the growing industry of jewelry manufacture and repair mean big opportunities for a well-paid job or a high-profit business of your own wherever you want to live. Our residential shop course approved by Veterans' Admin. is the most complete, ALL-ROUND jewelry training you can obtain. Moderate tuition, low living costs, no housing problem, congenial surroundings, your tools go with you after graduation.

COURSES IN

Designing
Engraving
Casting
Stone-setting
Stone identification
Plating
Repairing

New Castle Jeweler's Training School, Inc.
258 Pearson Street, New Castle, Pa.

Send 1948 Brochure and full details.

I am a VETERAN — Yes No

Name _____

Address _____

City _____ State _____ #582R

VEST POCKET SIZE!

**WORLD'S
LOWEST
PRICED
ADDING
MACHINE**



Fits vest pocket or purse. Guaranteed Accurate. Operated as easily, and as reliable, as machines costing many times as much. NOT A TOY OR GADGET. Precision made—very durable. Guaranteed for life against defects in construction. Beautiful looking, modernized design. Finished in silver with black numbers and red slides. You positively can't buy a Calculator of equal quality for as little money. **ACCEPTED AS THE FINEST LOW PRICED CALCULATOR FOR OVER 35 YEARS!** Now completely redesigned and improved. **BETTER THAN EVER BEFORE!** Operates with a flick of your finger. Adds, subtracts, multiplies, divides—counts up to one billion. Pays for itself over and over in mistakes avoided, and time saved.

MAKES IDEAL GIFT
Baby Calculator makes an ideal gift for every Gift occasion—Birthday—Graduation—Christmas—Anniversaries. For men, women, children—teachers, business people, home or shop use. **COMES PACKED READY FOR GIFT WRAPPING.**

TEN DAY TRIAL

Money Back Guarantee
Because we know that our machine is the very best calculator to be obtained at this low price, we make this 10 Day Trial offer on a positive money back guarantee!! Don't buy ANY Calculator without this guarantee! Send only name and address, pay postman \$2.95 plus postage (if cash is sent, we pay postage—you save up to 40c.) (Send full cash if outside U. S.) Money back within 10 days if not delighted.

AGENTS WANTED

CALCULATOR MACHINE CO. (Mfrs.)

DEPT. 199, P. O. Box 248

GLENVIEW, ILL.

Free Trial

ONLY

\$2.95
TOTAL
COST

Each Baby Calculator enclosed in beautiful rich-looking Leatherette Case—at no extra cost.

SEND NO MONEY

USE COUPON

CALCULATOR MACHINE CO., (Mfrs.)
P. O. Box 248, Dept. 199, Glenview, Ill.

Your Calculator is just what I've been looking for. Send one at once (C.O.D.) or (I am enclosing \$2.95).

Name _____

Address _____

City _____

State _____

TRUCKS • TRACTORS • AUTOS

A TWIST OF THE WRIST AND YOU

SAVE

WITH **CUNO** AIRCRAFT
TYPE
OIL FILTER

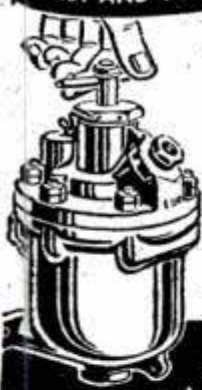

Keep oil clean without cartridge replacement...fits all cars, trucks and tractors...No parts to wear out...replaces all popular oil filters...installed at home in a few minutes...one turn of handle removes all dirt from permanent element...drain sludge and dirt from filter sump with each oil change...standard equipment on Airline Army and Navy planes...

Every car owner, farmer, truck or fleet operator will save tremendously with the famous CUNO oil filter...lasts for the life of many cars...save big money by ordering direct from this ad. Sent postage prepaid. Address Dept. 1417.

\$9.00

SHEFRIN SALES COMPANY

1329 W. 9th St.

KANSAS CITY, MO.

**STEEL
TUBING
KIT**



\$2.50

POSTPAID IN U.S.A.

For Home Craftsmen

NOW YOU CAN MAKE, REPAIR

LAMPS BUSHINGS HANDLES
JEWELRY NOZZLES SPRAYERS
TOOLS SHAFTS TOYS

HUNDREDS OF OTHER USES

12" Lengths
Longer lengths
on request.

8 Sizes
3/8" to 1 1/4" O.D.
Graduated in 1/8"

Precision-made, electric-welded tubing, 18-gauge, low-carbon, cold rolled steel. Free machining, bends, forms, rolls, beads, plates easily. Protected against rust.

SEND CASH OR MONEY ORDER

TOWERS CORPORATION, Dept. A-1
404 Public Square Bldg. • Cleveland 13, O.

**FOR SALE
1 ACRE
OF PLOWED GROUND
ONLY 35¢***



Yes sir!

**A BREADY
GARDEN
TRACTOR**

will plow an

acre on just two gallons of gas. BREADY, with complete line of all-purpose, year 'round implements, does all the work on small acreage, is a profitable auxiliary for larger farms. Easy-handling, powerful, low in cost. **WRITE TODAY for free folder!**

* Depending on price of gas.

Bready GARDEN
TRACTOR

THE BREADY TRACTOR & IMPLEMENT CO.
BOX NO. 230 SOLON, OHIO



MILL IT... ON YOUR LATHE!

PALMGREN

MILLING ATTACHMENT

3 SIZES

No. 250 Illustrated

2 1/2"

JAW

Only

24⁷⁵

CONVERT LATHE
IN 10 SECONDS

Now you can Mill, Slot, Grind, Groove, Square Shafts, Saw at Angles, Recess and many other important jobs. **SAVE TIME and MONEY!** Why send work out or use costly methods when a PALMGREN MILLING ATTACHMENT will solve your problem.

Precision built, it has accurate graduations for rotary angle adjustments, also graduated vertical feed screw. Fits South Bend, Atlas, Craftsman, Logan, Sheldon and all other lathes. Thousands now in use in small and large machine shops, repair shops, railroads, schools, home work shops, etc. **ORDER SIZE NEEDED TODAY!**—it will quickly pay for itself.

IMMEDIATE DELIVERY

Nos.	Width Jaws	Depth Jaws	Jaws Open	Weight Pounds	Fits Tool Post	Price F.O.B. Factory
150	1 1/2"	1"	1 1/2"	6 1/2	1" Dia.	\$18.75
250	2 1/2"	1 7/16"	2 1/2"	11	1 1/4" Dia.	24.75
400	4"	1 1/2"	4"	25	2" Dia.	39.75

Order From Your Dealer or Jobber: Write for Circular No. 351
Mfrs. of PALMGREN PRODUCTS
Since 1915

CHICAGO TOOL and
ENGINEERING CO.

8365 South Chicago Ave.
Chicago 17, Ill.

JUST A FEW OPERATIONS YOU CAN DO ON YOUR LATHE!

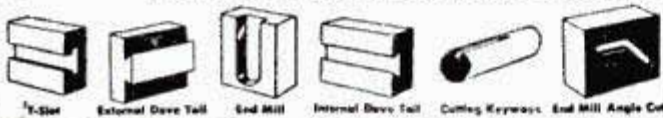

Now
for EVERY WORK SHOP!

NEW
Invention
Electroplates
by BRUSH

Easy to Plate CHROMIUM
GOLD, SILVER, NICKEL, COPPER
... For Pleasure and Profit!

If you have a workshop—at home or in business—you need this new Warner Electroplater. At the stroke of an electrified brush, you can electroplate models and projects—you can replate worn articles, faucets, tools, fixtures, silverware, etc. with a durable, sparkling coat of metal... Gold, Silver, Chromium, Nickel, Copper or Cadmium. Method is easy, simple, quick. Everything furnished—equipment complete, ready for use. *By doing a bit of work for others, your machine can pay for itself within a week.* So make your shop complete by getting a Warner Electroplater right away. Send today for FREE SAMPLE and illustrated literature. **ACT AT ONCE! Mail Coupon.**
WARNER ELECTRIC CO., DEPT. R-24
1512 Jarvis Avenue, Chicago 26, Ill.

FREE Details & Sample!

WARNER ELECTRIC CO., 1512 Jarvis Avenue, Chicago 26, Dept. R-24

Gentlemen: Send Free Sample and Details to:

Name _____

Address _____

City _____ State _____



"The gun that looks and feels like a Lever"

HY-SCORE

World's Most Powerful
AIR PISTOL

ACCURATE! FAST! HARD-HITTING... Expensively made piston-type pistol for use by experts. No pumping. 30 1/2 oz. 10 1/4" long. Cal. .177 or .22. \$19.85 for set including Hy-Score Pellets and darts*. Extra ammunition per 1000 rds. \$3.50 for cal. .177, \$3.00 for cal. .22.

Use HY-SCORE Pellets for best air pistol shooting.

*When available.

If your dealer cannot supply, write for free booklet, Dept. PM2
HY-SCORE ARMS CORP., BROOKLYN 1, N. Y.

RUGGED? YOU BET!

BELL WATERPROOF
SHOCKPROOF

Handsomely styled, precision tested, built to take hard usage, ready to go places.

No. PJ 220—ALL-STAINLESS STEEL CASE, 17 jewels, anti-magnetic, radium dial and hands, unbreakable crystal, sweep second hand. (Price includes Fed. Tax \$29.95 and Postage)



NOW AT NEW LOW PRICES



Order Direct from BELL. Mail check, money order or pay C.O.D. Write for FREE Booklet "PJ"

BELL WATCH COMPANY, INC.

Time and Life Bldg., Rockefeller Center, New York 20, N. Y.

BUILDING CONSTRUCTION



with composition cement and cheap wood builds good 3-room house for \$250; barns low as \$50.00. 100 illustrations and 100 money and labor saving suggestions. Get this newly revised and enlarged, guaranteed book before you build. \$1.00, postpaid. **SHEET METAL COTTAGES** and other buildings. Several new methods. Illustrated instructions, 50c. **FURNITURE OF COMPOSITION.** Cement, sawdust, asbestos, scrapwood, metal, etc. Ills., 50c.

SHOP MACHINES FROM OLD AUTO PARTS: Over 60 described, 50c. HOME MFG. ENTERPRISE. 50 home shop projects. Ills., 50c. Special! All five booklets described above, \$2.00 postpaid.

HOME INDUSTRIES, 1318 So. 30th Ave., Dept. P. M., Omaha 5, Nebr.

BRASS Social Security Plates

STAMPED WITH YOUR
NAME AND "SS" NUMBER



Beautifully satin-finished (shown 1/4 size). Please print information clearly. Priced at only 50c each, postage paid.

50¢

ACME STAMPING SERVICE
Box 836-PM Davenport, Iowa

Now CHEAP OIL BURNER

FOR HEATING AND COOKING STOVES - FURNACES

HEAT YOUR HOME, COOK YOUR MEALS

WITH CHEAP FURNACE OIL



NO MORE SHOVELING COAL OR ASHES. Sensational Fuelizer Starter Vaporizing System turns Cheap No. 1 Furnace Oil, also Range, Heater, Tractor Distillate, Kerosene and like oils into oil heat—one of the quickest, hottest fires known. **LIFETIME GUARANTEE.** \$1.00 Bonus Offer for Testing.

We will let you try it in your own stove or furnace for one month. Get yours for introducing. Big profits QUICK. Be first. Send in your name today for details and cash in on the tremendous demand for this Amazing Invention.

NORTHWEST MFG. CO., 608-B, Mitchell, S. Dak.





BOYS! GET THIS... POCKET SIZE RADIO

WEIGHS ONLY 4 OUNCES



ENJOY it at home, in bed, anywhere. No tubes, no battery, no electric plug in. Made by crystal radio specialists—manufacturers for

20 years. Mahogany finish plastic case and tuning-knob like big sets. Complete with extension Ear Phone.

GUARANTEED reception 25 to 50 miles when used according to directions supplied with set, or money back. Ideal gift for children. Buy direct from the factory at new low price. Widely used.

SEND ONLY \$1 and pay postman \$2.05 plus delivery. Or send full purchase price \$3.95 with order and we will ship Postpaid. (Foreign Orders \$5 U. S. cash with order.)

UNITED PRESSED PRODUCTS CO.

415 S. Aberdeen, Dept. 12 Chicago 7, Ill.

DRAIN YOUR CELLAR, POOL, WASH TRAYS, ETC.

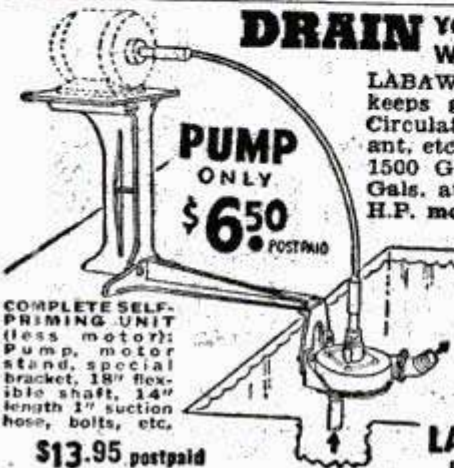

PUMP ONLY \$6.50
POSTPAID

COMPLETE SELF-PRIMING UNIT (less motor): Pump, motor stand, special bracket, 18" flexible shaft, 14" length 1" suction hose, bolts, etc.

\$13.95 postpaid

LABAWCO Type P Pump keeps garden pools fresh. Circulates oil or refrigerant, etc. **DOES NOT CLOG!** 1500 Gals. per hr. — 300 Gals. at 30'. Uses 3/8 to 1/2 H.P. motor.

Pump alone \$6.50. Pump with complete self-priming unit . . . \$13.95

POSTPAID if cash with order. West of Mississippi, add 50c.

SEND ORDER TODAY

LABAWCO PUMPS
BELLE MEAD 4, N.J.

FOR BIG MEN ONLY!



QUALITY SHOES IN SIZES 10 TO 16

We specialize in extra large sizes only—sizes 10 to 16; widths AA to EEE. Oxfords, High Tops, Work Shoes, Sox. **EXTRA quality—EXTRA comfort.** Prompt delivery. Satisfaction guaranteed. **FREE Catalog.**

KING-SIZE, Inc.
P. O. Box 798, Dept. 518
Brookton 64, Mass.

Write for **FREE Catalog**

WANTED MAN WITH CAR

No Time Like Now to Get In McNess Business

It's no trick to make good money when you use your car as a McNess "Store on Wheels." Farmers buy everything they can from McNess Men because McNess Products are tops in quality, represent extra values. Attractive business-getting prizes and premiums; also money-saving deals to customers make selling McNess daily necessities a snap.

We Supply Capital—Start Now!

There's no better work anywhere. Pays well, permanent, need no experience to start, and we supply capital to help you get started quick. You begin making money first day. Write at once for McNess Dealer Book. It's **FREE.** Tells all—no obligation.

THE McNESS CO., 576 Adams St., Freeport, Ill.



Use Your CAR to Raise Your PAY

NEW CROSLLEY STATION WAGON



Smart! Practical! Costs \$600 to \$700 less than any other station wagon—operates for about 1/2 as much. Seats 4 in comfort. With rear seat removed hauls 1/4 ton load.



Convertible: If you love sun and air.

Panel Delivery: Full 1/4 ton capacity.



Sedan: Over 20,000 now on the road.

Pickup: Cuts service and delivery costs.



Sports-Utility: For work or play—Rear seat obtainable. Low priced even for CROSLLEY—\$130 less than station wagon.

CROSLLEY

a FINE car

For beautiful, full-color catalog, write: Crosley Motors, Inc., 2532-HI Spring Grove Ave., Cincinnati 14, Ohio.

2 Bushels of Ripe TOMATOES from ONE VINE



Most productive of all tomatoes now **PELLETED** at No Extra Cost.

BURGESS CLIMBING

TRIP-L-CROP

Tomato rapidly grows 12 to 18 feet high on trellis or as a bush in garden. Beautiful crimson solid, meaty fruits of finest quality, weighing over 2 pounds.

NEW POST-WAR PROCESS for Better Gardening

PELLETED Seeds have been covered with a coating of protective materials to encourage better germination, healthier plants and faster growth.

Trial Packet of Pelleted Trip-L-Crop Tomato Seed **10c**

3 for 25c postpaid

1948 Garden Book **FREE.**

BURGESS SEED & PLANT CO.
217 C. T., Galesburg, Mich.

AVIATION ENGINE STARTER



Used, Guaranteed
Good Condition

Type 1257, Volts 24,
Style A, Clutch Set at
1200 ft. lbs. 7" dia.,
17" long. 50 lbs. ship-
ping weight.

\$8.95 F.O.B.
Chicago

Type G-16, G-17, G-18
Mfg. by
Eclipse Aviation
Div. of
Bendix Aviation Corp.

Barnard's Cutting Pliers

Drop forged. Natural Heat Treated
Metal Finish—Blue Black. Made of
nickel chrome alloy steel. Good side
cutter that really gets in tough places.
4 to 1 leverage. Parallel hardened
jaws with wire pulling groove. Special

\$1.29 each — \$1.10 lots of six
#102 6 1/2" overall length, shipping wt. 1 lb.
Pre-war selling price \$3.00.

Dealers write for prices.



New Surplus Rubber Gloves

MAN'S SIZE 14" LONG

Good for use in Garages, Plating Shops,
Removing Varnish, Etc. (Not for Elec-
tricians). Shipping wt. 2 lbs.

\$ 1.25 sample pair
12.00 dozen pair
10.00 dozen in gross lots

Dremel Moto Tools

We are authorized agency for DREMEL Moto Tools, Moto Saws and
handle a complete line of accessories. Send for complete catalogue.
Sorry no C.O.D. or Open Account orders. For economy send ship-
ping charges with M.O. All Government Surplus Stocks are un-
derstandably limited, so first come first served.

GOVERNMENT SURPLUS & HARDWARE SALES
1627 N. DAMEN AVENUE CHICAGO 47, ILLINOIS



MAKE MONEY
Sharpening
LAWN MOWERS

Every lawn mower needs
sharpening every season.

Cash in on this big demand with the Foley Lawn Mower
Sharpener. J. L. V. made as much as \$100 a week. W. A. T.
made over \$1000 in 9 months.

WORK AT HOME — part or full time. It's a repeat business
because customers come back time after time to get their
mowers Foley sharpened. The Foley Electrakeen System is
used and endorsed by lawn mower factories—mowers cut better
and stay sharp longer.

COMPLETELY AUTOMATIC—you simply put the lawn mower
in the machine — without removing handle — and turn on the
power. The Foley (on the market since 1929) automatically
sharpenes all blades at once. You can get immediate delivery.

SEND FOR FREE PLAN—Tells how to start—no canvassing—
99c out of every dollar you take in is clear profit for you!
Mail coupon now.

FOLEY LAWN MOWER SHARPENER

FOLEY MFG. CO., 207-8 Foley Bldg., Minneapolis 18, Minn.
Send FREE PLAN on Foley Lawn Mower Sharpening business.

Name _____

Address _____

WAR SURPLUS U.S. INFANTRY SOUND POWERED PHONES!



SENSATIONAL!

U. S. Infantry and Armed Forces

SOUND POWERED PHONES

- NO ELECTRICITY
- 2 WAY OPERATION
- NO BATTERIES
- PERFECT TO 1 MILE

Here is the battle proven U. S. Infantry SOUND POWERED
PHONES. Ideal for communication from house to garage, to
barn, to workshop, to field. Just hook up to any two strand
wire. No electricity or batteries needed. 2 magnetic type
receivers for hearing and speaking. Adjustable headband.
Perfectly safe. Even children can operate it. A remarkable value.

FREE

Send for free
illustrated cata-
logue. Has many
marvelous WAR
SURPLUS BAR-
GAINS.

2 STRAND WIRE—
WEATHERPROOF \$2.95
2 Cents Plus 35c
per Ft. postage per 100 Ft. Plus 25c
postage and handling

ALLIED SALES CO.

DEPT. PF • 88 CLAY STREET • SAN FRANCISCO 11, CALIFORNIA
Send check or money order. Sorry no C.O.D.s.

New Precision Built Commercial

Wood Shaper and Matcher

Now Within The Reach Of Every Home Workshop



Make corner matched joints, paneling, flut-
ing, routing, notching, inlay, tongue and
groove and joints. Designed for commercial
use, now simplified design and mass produc-
tion brings it within the reach of every
one. Just attach in chuck of drill press
and it's ready to use. Write for complete
FREE information.

Write for FREE Information **T & H Mfg. Co.** Dept. SP-1, Kans. City, Mo. 811 East 31 St.

FIELD JACKETS



A Super-value, fine poplin Army FIELD
JACKET can be yours for only \$2.88.
Quality features; full zipper-front,
100% blanket-lined, water repellent,
adjustable hip straps. Ideal for Farm-
ers, Lumbermen, Truck Drivers,
Sportsmen. Although used, every
jacket guaranteed perfect condition.
Sizes 34 to 40. State size and send
check or M.O. Supply limited. Hurry.

(War
Surplus)
ONLY
\$2.88
Postpaid

MARKO SURPLUS CO., Dept. PM. 2924 Logan Blvd., Chicago 47, Ill.

POWERFUL AIR PISTOL

"Sportsman Jr." is Safe, Accurate, Heavy;
balanced like real automatic. Shoots B-B's, Darts,
Pellets. Lots of fun for indoor target practice. With
adaptors, ammunition, packed in attractive gift box.
Send \$4.95 Check or M.O. Postpaid. 8 1/2" overall.



SIDNEY SMITH INTERNATIONAL

1112 Wilshire Blvd., Dept. MX-2, Los Angeles 14, Calif.

REAL DIESEL ENGINE



For Model Planes, Boats and Race Cars
Now you can own and run a real miniature diesel
engine that operates by the heat of compression.
No coil, condenser, wires, or annoying ignition
failures. Simply flip the prop or flywheel to
start. It's the new DEEZIL—a .125 cu. in. dis-
placement, 5 cc. engine that runs at 8000 RPM.
Order today; only \$12.95 p.p., less tank. Every
engine fully tested and guaranteed. DEEZILMIX
FUEL \$1.00; PROP 50c.

GOTHAM HOBBY

107 East 126th Street New York 35, N. Y., Dept. "P"

OTTAWA TRACTOR SAW



350 Cuts Per Minute—cuts them down, saws
them up, one man operates. Thousands in use, stiff heavy blade, built to
last, safety clutch control, uses power take-off any tractor. Low price.
OTTAWA MFG. CO., 2-827 Forest Avenue, OTTAWA, KANSAS

GUM GRIPPER

Tightens FALSE TEETH or NO COST

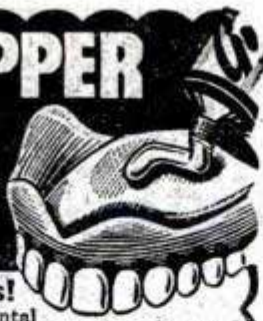

Lasts from 3 to 6 Months!

New discovery makes loose dental plates fit snug and comfortable for months—almost like having your own teeth again. For uppers and lowers. **Easy to Apply at Home...** Simply squeeze some "GUM GRIPPER" evenly on your denture, put plate in your mouth where it sets and hardens in few minutes. No heat—no fuss—no muss. Will not harm any denture.

SEND NO MONEY...

Order a tube today, for only \$1.00 (deposit with your own postman). Each application of "GUM GRIPPER" guaranteed to last from 3 to 6 months and delight you completely or your money will be cheerfully refunded.

GUM GRIPPER, INC.
127 N. Dearborn St., Dept. 71T, Chicago 2, Ill.

BREAK or TRAIN DOGS



Keep your dog from running undesired game; train him to run any game wanted. Use Pete Rickard's Famous Dog Musk. Simple, Safe, Sure. **STATE YOUR PROBLEM** for FREE information or include 1.00 for bottle which usually is enough. Complete instructions.

Satisfaction Guaranteed.

PETE RICKARD Dept. PM-2 Cobleskill, N. Y.

FLASHLIGHT LAMP ASSEMBLY

NEW—Govt. Surplus. Lights up the "Hard-to-get-at" places. Fine for mechanics, electricians, radio repairmen, filling station attendants, in the home, and many other uses. Plastic 12" extension (6" stiff and 6" flexible). Adjustable to any angle. Originally priced over \$4.00. Our price Postpaid.

\$1.80
Ea.

Write for descriptive list of other Surplus Items
National Surplus Sales Co. 1810 Charlotte
Kansas City 8, Mo.

WOOD WORKERS

LUMBER—PLYWOOD AVAILABLE
Harold Hunt wants to send new No. 15 catalog. Over 148 pages of woodworking ideas. **UNEQUALLED BARGAINS** in imported and American woods, supplies, hard-to-find hardware. Send only 15c to cover postage and handling.
CRAFTSMAN WOOD SERVICE CO.
2729 S. Mary St., Dept. A-90, Chicago 8, Ill.

only
15¢



HOME BARS 25 DESIGNS

HOME BARS for rental hosts. Fun to make and use. 25 designs... built-in, portable bars; cellarettes, only \$1.00. Send currency or check today. Money-back guarantee.
HOME-CRAFT PLANS
7241 Madison Kansas City 5, Mo.

Dept. P-107

MECHANICAL DRAFTSMEN!

TILT-HEX drafting template speeds, simplifies drawing Bolts and Nuts, **ALL VIEWS**, top, side and angles. 90 accurate cut-outs including **ELLIPSES**. Clear plastic 6x7". Used by leading aircraft and auto engineers. At drawing material dealers or sent postpaid, only \$2.00.
TIMELY CO. BOX 206C COLUMBUS 9, OHIO



LAW STUDY AT HOME FOR PERSONAL SUCCESS and LARGER EARNINGS.

39 years expert instruction—over 108,000 students enrolled. LL.B. Degree awarded. All texts furnished. Easy payments. Send for FREE BOOK. G. I. approved.
AMERICAN EXTENSION SCHOOL OF LAW
Dept. 86-M, 646 N. Michigan Ave., Chicago 11, Ill.

SATURDAY

ATTENTION—EXPERIMENTER—BUILDERS IF YOU ARE INTERESTED IN MAKING MINIATURE MACHINES, PARTS, DEVICES, attachments, improvements, makeshifts. Criticize, recommend, sketch, re-design. Work at this plant (In N.Y.C.) in your spare time, evenings or Saturdays, and build for us at home. Write JULIUS GREENBERG, Manager, 678 Bloomfield Ave., Montclair, N. J.

MASTER CRAFTSMEN

use these finest fillers!

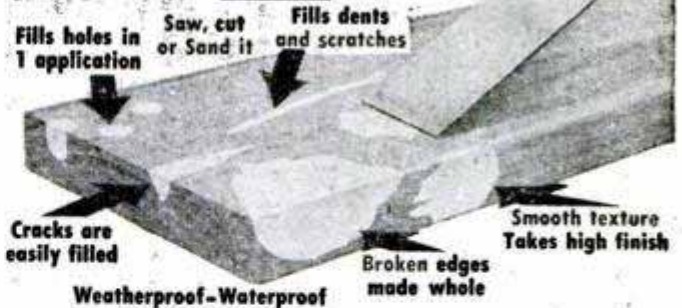

Fills holes in 1 application

Saw, cut or Sand it

Fills dents and scratches

Cracks are easily filled

Weatherproof—Waterproof

Broken edges made whole

Smooth texture Takes high finish

- SAVES TIME
- SMOOTH TEXTURE
- EASIER TO WORK
- SHRINKS ONLY 1%
- STAYS IN

FOR a perfect surfacing job on wood, metal or plastic—use the expert's choice—Duratite. Easy to use—faster—shrinkage is so slight, it fills completely in just *one* application—stays in! 7 wood colors. Ask your dealer or send for large tube.

WEBB PRODUCTS COMPANY

228 S. G ST., San Bernardino, Calif.

Enclosed find 25c, send large tube Duratite Wood Dough.

SEND FOR LARGE TUBE

Name _____

Address _____

City _____ State _____



WOOD DOUGH and SURFACING PUTTY

Road Gripper

AMAZING NEW INVENTION

Gets You out of the Rut!

EASY — QUICK — SURE

Saves a "Million" Headaches!

SNOW KING "road grippers" come to fit all popular tire sizes. SNOW KINGS are made of rust-proof steel and shaped to fit the contour of your tire. Slide over tire, turn adjusting screw forcing clamp firmly against side wall, and you'll pull out of a rut like "nobody's business." Send check or money order for one set of two (2) SNOW KINGS—good for life—only \$3.95 express prepaid. Or don't send a cent. Use coupon to have your set sent C.O.D.

Their ACTION is Their At-traction



BEZELS
SNOW
ICE
MUD
SAND

5 DAY TRIAL

SEND NO MONEY

DEALERS
Write to
CHRISTIAN BUEHLER
122 S. Michigan Ave.
Chicago, Ill.

BUFFUM AND COMPANY

333 N. Michigan Ave., Chicago 1, Ill.
Rush 2 SNOW KINGS on 5 day Trial I enclose \$3.95. Ship C.O.D. Tire Size _____

Name _____

Street _____

City _____ (B-1)

**NOW!
MULTIPLE
SPEEDS FOR ALL
POWER TOOLS!**

with McKELVEY'S RPM SELECTOR

(all patents applied for or pending)



RPM Selector on drill press, drilling 1 3/8" hole in cast iron counter balance.

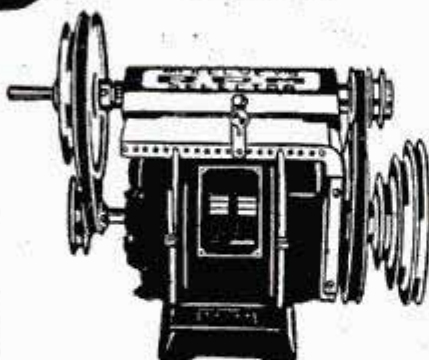

66 to 10,000 RPMs from average motor (up to 1 h.p.) On the average drill press or lathe with standard accessories and belts of the selector, 120 different speeds may be obtained—"spindle speeds" ranging from 25 r.p.m. and lower to a high of 3 times the leaving-the-motor speeds — almost unlimited operations from one power tool without changing the position of the motor!

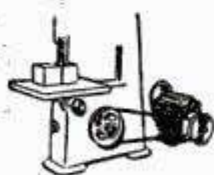

Band saw with RPM Selector easily saws through 6' x 6' 24 ST Dural.



Cutting 1" boiler plate is no problem on this RPM-equipped jig saw.

MONEY BACK GUARANTEE

At your dealer or order direct. Sent prepaid on receipt of check or money order for \$34.95. NO C.O.D.'S, PLEASE!

Dealer and distributor inquiries invited.

SUNSET EQUIPMENT CO.

1813 W. 11th St. • Los Angeles, Calif.

DUAL TAIL PIPE EXTENSION

Fits all cars—chrome plated. Deep tone produced by 2 1/2 inch outlets.

\$2.95

Postage free on prepaid orders. Dealer inquiries invited.

LYONS PRODUCTS COMPANY

2319 RIDGLEY DRIVE DEPT. PM2
LOS ANGELES 16, CALIFORNIA

HOW TO EARN EXTRA PROFITS

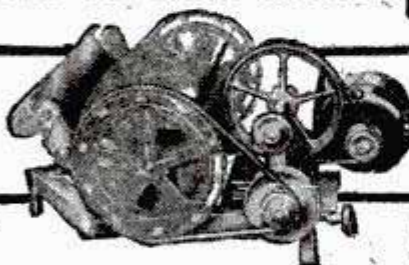

only
\$47.50
LESS MOTOR

for this popular

"QUAD-CITY SHARPENER"

Get into profitable lawn mower sharpening at low cost with this highly successful machine. Order direct from, **QUAD-CITY PRODUCTS CO., Box 42, Rock Island, Ill.**

PAINT SPRAY OUTFIT

Handles all Ordinary Paint Spray Jobs

Complete
Only **\$9.65**



CHANGE COLOR IN 5 SECONDS

Plastic Spray Gun, 7 1/2 ft. Air Hose, 4 Color Cans, Expansion Tank, New Foot Power Air Compressor. Uses paints, lacquers, varnishes, other finishes.

Spray painting is best for all kinds of finishing. Get this new low price complete spray outfit. Does a fine job, quick, easy, economically. Foot power compressor with expansion tank delivers ample steady air supply. Push button control on spray gun. Complete, as listed above, only \$9.65. Spray gun, air hose, 4 containers, only \$2.85. Order today with check or M. O. for prepaid delivery. If C. O. D. send \$1.00 deposit.

Home Shop Products Co., Dept. 11, 4821 Sheridan Road, Chicago

BUILD YOUR POWER TOOLS

WITH OUR GUARANTEED INDUSTRIAL POLY BALL BEARING ARBORS

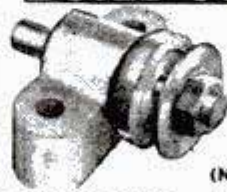

New Departure Self Lubricating Bearings

10,000 R.P.M.



(No extra charge for left hand threads) C5—3/8" Pictured

B33—\$4.95 PP. C4—1/2x12 1/2 spindle, housing 2x8 \$8.25 PP.
3/8 x 4 1/2 Spindle C5—3/8x12 1/2 spindle, housing 2x8, \$8.25 PP.
B15 Plain Spindle C6—3/4x12 1/2 spindle, housing 2 1/2x8, \$9.25 PP.
\$3.50 PP. D8—1x17 1/2 spindle, housing 2 1/2x11 \$17.00 PP.
SHAPER ARBORS 3 inches between collars. C4—1" \$14.25, C5—3/8" \$14.25, C6—3/4" \$15.25, D8—1" \$23.00, B25—1 1/2x2" cap. flange mount \$5.50.
SPECIAL SAW ARBOR LENGTHS for 1/2, 3/8, 3/4, add \$1.50.
PILLOW BLOCKS—Ball Bearing, 1/2 \$3.50, 3/8 \$3.50, 3/4 \$4.25.

POLY PRODUCTS, 2032-A E. Walnut, Pasadena 8, Calif.

ZIRCONS LOOSE PURE WHITE

Special: 3 Zircons approximate total weight 3-kts. \$3.00. We can supply Zircons in all sizes and mountings of all types. Send order or write for details today.

B. LOWE, Holland Bldg., Dept. PM St. Louis, Mo.

MEN'S SLACKS \$ SAVES \$ BUFFALO PLAID SHIRTS



On New Merchandise and Order by Mail
80% Wool, All Wool, Colors Black & Red, Black & Grey.
Dark Brown & Red, Black & Grey.
Only Sizes 29 to 36. Add 25c P. P. Ins.
Sizes Small, Medium, Large. Add 25c P. P. Ins.



\$6.95
Retail Value \$10.95

Broadway Mail Order Co.
1205 Broadway
New York 1, N. Y.
Mail Orders Promptly Filled.
Please Include Postage With Order. Write For Circular M.

\$6.75
Retail Value \$11.95

SAVES MANY ELECTRIC APPLIANCES

NICHROCITE REPAIRS HEATING ELEMENTS IN A JIFFY . . .

Simply overlap ends, apply Nichrocite Paste and turn on current. Used by large utility companies. Trial order, \$1.00; 4 oz., \$2.50; 1 pound, \$8.00.
COSOM INDUSTRIES, Dept. A
4234 25th Ave. S., Minneapolis 6, Minn.

SAY YOU SAW IT IN POPULAR MECHANICS

FREE LAND INDEPENDENCE! LIFETIME SECURITY!
Millions of acres Government land still available FREE. California, Florida, Oregon, many other states. Hook tells how to get your land FREE. Section on Alaska; section for veterans.
Send \$1.00 for your copy
GUIDE PRESS, 1714-M Chestnut St., St. Louis

NU-STONE HOMES New Building Material! Resurface old homes; build new ones. Colorful. Beautiful! Looks like real stone—molded on-the-job. PROFIT BY THE BUILDING BOOM—Other building compositions of Cement, Sawdust, Asbestos, Paper, Earth, etc. Home-made Forms make blocks, panels, TILE IN COLORS. Wallboard. Particulars Free.
CHEMICAL SERVICE • Dept. 80-X • EDWARDSVILLE, ILLINOIS

First Choice

Hand and power grinders to fit all needs. Sold at leading hardware stores.

LUTHER GRINDER & TOOL CO.
Sheboygan, Wis.

Luther
HAND AND POWER GRINDERS

Est. 1896



HAND GRINDER STONES

152 PIECE ASSORTMENT

MOUNTED STONES, FILES, BURRS, BUFFERS, etc.



ALL BRAND NEW

An amazing value for home and shop. Actually 152 pieces; mounted stones, abrasives, polishing and finishing parts, files, burrs, etc. You'll find hundreds of uses for this great array of wanted parts. Assortment includes the following:

- 8 Mtd. grinding stones on 1/8" shank
- 2 Fast cutting grinding wheels 3/4 x 1 1/2"
- 1 Circular Saw 3/4 x .023 x 1 1/2 in.
- 2 1" sewed muslin buffs
- 6 7/8" cut-off wheels
- 4 Cutters, ass't. shapes 1 1/2" shank
- 1 3/4 x 3/32 mtd. wire brush
- 3 Ass't. felt wheels
- 1 Drum sander on 3/32" shank
- 2 3/4 x 1 1/2 x 1/16 in. rubber wheels
- 3 Ass't. bristle brushes, mounted
- 3 Cutters 3/32" shank
- 4 Mtd. wheels on 3/32" shank
- 100 Emery discs, 7/8" med. grit
- 1 Roughing stone
- 6 Drum sleeves
- 1 Felt cone
- 5 1/2 x 1/16 in. mandrels

This great assortment will give you years of service. Regular retail value over \$20.00. Now postpaid in U.S.A. only **\$8.95**

41 PIECE STONE ASSORTMENT

A great value for home and shop. All parts are brand new—packed in an attractive set-up box as illustrated above. You'd pay well over \$15.00 if you bought these parts separately. Sent postpaid in U.S.A. Satisfaction guaranteed. Assortment consists of the following pieces—41 pieces in all.

- 20 Mounted Stones. Assorted shapes and grits, all on 1/2 inch shanks.
- 10 Mounted Stones. Assorted shapes, all on 3/32 inch shanks.
- 10 1 x 1/2 x 1/2 inch grinding wheels. Top quality and all brand new.
- 1 1/2 x 1/2 inch Mandrel.

THE WHOLE ASSORTMENT—POSTPAID, ONLY.. \$4.95

INSTALL AND SERVICE OWN OIL BURNER!

SAVE UP TO \$150! Send for the famous DELTA PHOTO-INSTALLATION MANUAL. Simple, easy step-by-step photos of a complete oil burner installation. Complete with all necessary plans, drawings and easy-to-follow directions. Published under exclusive copyright at \$5.00.

SPECIAL OFFER—CLIP \$1 to this ad and mail today. I am very much pleased with same... I am sure it is the most complete manual ever put out by any company... B. R., Whitehall, N. Y. DELTA HEATING CORPORATION, Dept. F 85-05 Northern Blvd. Jackson Heights, New York City



SAY YOU SAW IT IN POPULAR MECHANICS

BIG MONEY FOR YOU!

Just Telling Property Owners About **ZONE HEAVY-DUTY ROOF COATING** Sensational product cuts essential building repair cost up to 75%. Amazing demonstration gets orders in a hurry. Only six average orders a week can pay you well over \$190.00!! Complete FREE selling outfit includes everything you need to make big money right from the start. If 30 or over, this may be the opportunity of your life. Tell about yourself. Write, Jack Canning, Vice Pres. ZONE Company P.O. BOX 789, DEPT. B-12, FORT WORTH 1, TEXAS



AGENTS WANTED

Sell top-quality Nurses', Beauticians', Doctors' and Utility uniforms at lower-than-competitors' prices. Leading manufacturer. Very substantial commission. Write Dept. R.

MEDI-KOTE CO., INC.
ROCKVILLE CENTRE, NEW YORK

New Scientific "GUZZLIN CHARLIE"

MYSTERY DRINKING BIRD WITH ROLY POLY EYES



\$1.95 Complete with stand. No springs, no gadgets, no wires, not mechanical. Amazing "Guzzlin Charlie" drinks and drinks; he is always thirsty. You won't believe your eyes. Young and old go wild over him. Mail your order today.

ELECTRIC LIGHT JAZZ BOW TIE!

Astonish, amaze your friends. Be the life of the party. Have lots of fun. Easily put on. Flashes on and off by simply pressing battery button hidden in your pocket. Complete with attractive bow tie, cord, two bulbs and battery. **SEND NO MONEY.** Just send your name and address, pay postman, upon delivery, plus delivery charges or remit with order. Rush your order today. Special prices on all articles to dealers.

\$1.95



BERNARD FINE CO., INC.
501 Sixth Ave. Dept. PM9 N. Y. 11, N. Y.

ACTUALLY \$50.00 WORTH OF Grinding Wheels

Abrasive discs, felt and buffing wheels, mandrels, rotary files, sheets, etc.

The buy of a lifetime! 327 pieces including 35 ass't. Grinding and Cut-off wheels up to 10 inches diameter, 1/16 to 1 1/4 in. face, 1/8 to 3 in. holes. Assorted grits—all brand new—made by Norton, Carborundum, Macklin, Bay State, etc. Also included are 100 slotted disc cloths; 100 paper discs; 3 round wire brushes on handles; 2 felt bobs; 2 felt wheels; 1 4" rag buff; 3 honing stones; 10 abrasive sleeves; 10 mounted stones, 1/8 and 1/4 shank; 2 mandrels; 2 rotary files, 1/4 shank; 50 abrasive discs; 2 72" abrasive belts; 5 9x11 abrasive sheets. Satisfaction guaranteed. Order today. It's better than a \$50.00 value.

327 PIECES ASS'T. SIZES FOB CHICAGO ALL FOR ONLY \$6.95

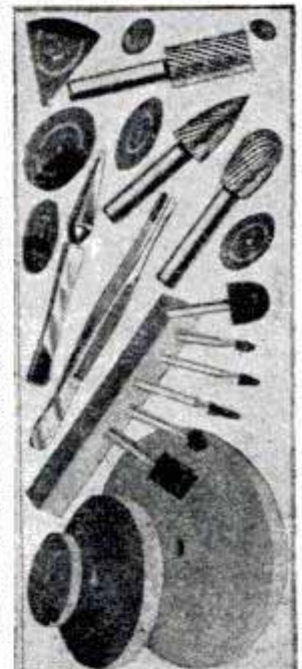

GROBAN SUPPLY CO. 1522 So. MICHIGAN AVENUE DEPT. PM2, CHICAGO 5, ILL.

U. S. SOUND PROJECTOR SERVICE OFFERS

Nationally known professional model 16 mm. Sound Projectors used by schools, industry, sales organizations, etc. Precision built high fidelity sound reproductions. This is a surplus item.

Set consists of two case unit complete with 12" P.M. speaker and seven tubes, 20 watt, amplifier, picture mechanism of high precision quality.

Can be had at a fraction of original cost while quantity lasts.

Write today for particulars

U. S. SOUND PROJECTOR SERVICE
1305 S. Laramie Cicero 50, Illinois

YOU CAN MAKE \$50 A DAY!

Be **INDEPENDENT** in your own business



with our
**15
TRADE
SECRETS**

START your own business in your spare time with our 15 private manufacturing processes—like **REMOVE-ALL** Paint Remover.

In your own home—garage, basement, kitchen, fill the demand for this revolutionary, non-flammable paint and varnish remover and 14 other wanted products.

We tell you **ALL!** How to **MAKE**. Where to **BUY** simple inexpensive materials. How to **Package**, **Promote**, **SELL**. If you can follow simple directions, here are 15 roads to success. We give you full details on all 15 processes!

The public **NEEDS** these 15 products. You, yes you, can make them. And you can have **OTHERS SELL THEM** for you, too.

Lose no time! Write for details!

CHEMICAL RESEARCH CO.

214 West 42nd St. New York 18, N. Y.



NEW! BETTER!
**AIR-COOLED CARBURETOR
INTAKE STACK!** FOR 2 1/2" CARBURETORS

Soup-up performance!
Increase Mileage!
Low Price, only... **\$2.00**

(Includes Postage)
Send Cash, Check, Money Order to:
MERCURY TOOL & DIE COMPANY
5977 Washington Blvd. Culver City, Calif.

SAY YOU SAW IT IN POPULAR MECHANICS

KAYAKS
AQUA V-18
Easy to Build

BOATS for Home Assembly
KAYAKS, ROWBOATS, DINGHIES, INBOARDS, OUTBOARDS, RUNABOUTS
Cut-To-Fit for Quick Assembly. Everything Complete plus Illustrated Instructions. No Experience Necessary. Simple as A. B. C.

25¢ COIN FOR ALL THREE

V-23 CRUISER
Length 23 Ft.
Beam 7 Ft., 10 In.
Draft 14 1/2 In.
Sleeps Two. Open or With Cabin.

AQUAMOBILE V-18
Designed for Auto Engines. Open or with cab. Length 18 ft. Fast VEE Bottom Hull.

KAYAK BOAT CO., 703P-WHITTIER ST., NEW YORK 59, N. Y.



● In NR (Nature's Remedy) Tablets, there are *no* chemicals, *no* minerals, *no* phenol derivatives. NR Tablets are different—act different. *Purely vegetable*—a combination of 10 vegetable ingredients formulated over 50 years ago. Uncoated or candy coated, their action is dependable, thorough, yet gentle, as millions of NR's have proved. Get a 25¢ box. Use as directed.

Nature's Remedy
NR TO-NIGHT TOMORROW ALRIGHT

ALWAYS CARRY **TUMS** QUICK RELIEF FOR ACID INDIGESTION



MAKE JEWELRY AND NOVELTIES AT HOME!

Work right on your kitchen table! No tools or experience necessary. Learn—earn within a week. Complete home instruction course, beautifully photographed, shows how to make 115 different designs of earrings, pins, sprays, brooches, hair ornaments, bracelets, candy dishes, ash trays, wall plaques, etc. Illustrates also 55 kinds of Sea Shells and Fish Scales often used. Explains fully home methods of dyeing, pearlizing, golding and glow-in-the-dark processes. Lists hundreds of raw materials with wholesale prices. Complete course only \$1. Beginner's Kit, \$3 (\$3.50 in Canada), postpaid. Immediate shipments.

HOUSE OF GIFTS, Box 4550-PM2, Coral Gables, Fla.

PATENTS AND TRADE MARKS
C. A. SNOW & CO.
REGISTERED PATENT ATTORNEYS
WRITE FOR INFORMATION TO
428 SNOW BUILDING, WASHINGTON 1, D. C.

PATENTS "Proof of Invention" Folder mailed without obligation.
E. E. VROOMAN, Registered Patent Atty.
871 Woodward Building, Washington 5, D.C.

INVENTORS

If you wish to protect your invention, you should take steps to protect it by a U. S. Patent. Write me for "Record of Invention" Form.

CARL MILLER
REGISTERED PATENT ATTORNEY

Woolworth Bldg., 35th Floor, Dept. 28A, New York City
Please send me "Record of Invention" form.

NAME _____

ADDRESS _____

NEW EASY WAY TO MAKE MONEY *at* HOME

Your cost only 5c
You get \$5.00.
Full or spare time.

It's easy to Bronze Baby Shoes. Business still in infancy. Get in on ground floor and skim cream of profit from rich and never-ending market. No experience needed. Learn in one week. Income up to \$1,000 a month full time—\$50 to \$75 weekly in spare time. We furnish complete kit and full instructions. So easy to understand that a 12 year old can become expert.

FREE FACTS. Write today. Don't send a penny. Just name and address in letter or post card. Be the first in your territory to reap rewards waiting. Costs only 5c to bronze shoes. Sell for \$5.00! This is too good to miss. Get facts today. Write to

KIKTAVI COMPANY

Dept. 16, 8620 So. Ruthelen Los Angeles 44, California

60 POWER TELESCOPE \$2.95

VARIABLE EYEPIECE 20X-40X-60X

NEW! Three telescopes in one, 3 different magnifications. 20 power for ultra-bright images with 40 and 60 power for extra long range. Guaranteed to bring distant objects, people, sports events, ships, moon, stars, etc., 60 times as close.



Most powerful for anywhere near the money. 5 sections. Closes to 1 ft. long. Contains 4 ground and polished lenses. Also used as a powerful compound microscope. Directions included. Mass production enables us to offer this high-powered instrument at the amazing price of only \$2.95. We pay the postage. Get yours immediately.

BROWSCOPE CO. Dept. 2M 24 West 45 St. New York 19, N. Y.



APPROXIMATELY 1500 FEET NYLON FISHING LINE

2 ply—Strong (25 pound breaking strength)—rubberized—waterproof—long life. Send remittance to—

ALLENDER & CO.

2346 So. Dearborn St., Chicago 16, Ill.

\$1.98

Postpaid (in U.S.A.)



BUILD a BOAT

- Row Boat—12 Foot
- Dinghy—8 Foot
- Dinghy—14 Foot Sailing
- Training Ship—5 Foot
- Sea Glid—9 Foot
- Outboard—12 Foot
- Cruiser—18 Foot
- Bicycle Boat—Kayak
- Row Boat—Sectional
- Dinghy—Sailing
- Canoe—16 Foot
- Sailing—12 Foot
- Outboard—12 Foot
- Outboard—Runsabout
- Pontoons Ice Yacht

FOR PLEASURE OR PROFIT DESCRIBES 17 LOW COST BOATS Get this outstanding book and build a boat at home for your own use or to sell at a profit. You can do it. Just the boat you've always wanted—power, sail or row boat—17 different kinds and sizes. Order **BUILD A BOAT** on postal card and pay only \$1.50 plus postage on delivery. Return in 5 days if not pleased and get money back. Or send \$1.50 with order and we'll pay postage. (Outside U. S. \$1.70 with order.) Order today.

POPULAR MECHANICS PRESS
Dept. 598, 200 E. Ontario, Chicago 11

New WHAT TO MAKE out now!

Every home craftsman and home workshop should have a copy of this wonderful collection of articles from the "CRAFTSMAN" Department of Popular Mechanics. Bigger and better than ever before, it has 240 pages and over 450 illustrations telling how to make hundreds of useful and unusual projects. Bound in its new soil-proof, Lamcote cover. What To Make is on sale at your News Dealer for \$1.00. We can supply only the cloth editions of What To Make—9 Vols. at \$1.75 each or \$14.00 for the set.

POPULAR MECHANICS PRESS

200 E. Ontario Street Chicago 11, Illinois

HELPFUL BOOKS

Send post card asking for FREE catalog

Popular Mechanics Press, 200 E. Ontario, Dept. 601, Chicago 11

SURPLUS BARGAINS



The Mart brings you the opportunity of a lifetime to share in the greatest money-saving values ever offered. A great array of war surplus items—practically all brand new—some slightly used but guaranteed perfect—at a fraction of their Gov't. acquisition cost; contract termination items at give-away prices. Thousands of articles you've been waiting for, built to stiff Government regulations. Watch for all The Mart ads. The Mart will bring you amazing values.

LINK SEXTANT

Bubble Type

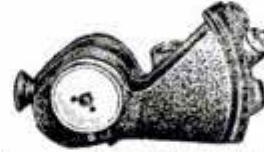

Built for the U. S. Army Air Corps by Link Aviation Devices, Inc. Includes two spare white discs. Complete directions for using. Sextants, while slightly used, are in "like new" condition and in top working order. Strong O.D. wood case has separate compartments for working parts, lined with felt. Weighs 6 lbs. 14 oz. Original cost \$230.00. A truly remarkable bargain at only **\$1750**

PISTOL GRIP SWITCH



Gives you trigger action for "ons" and "offs." Complete with rubber covered lead wire and plug. Made of enduring plastic. Adjustable tape for hand fastening. New. Use on any circuit up to 115 volts. Made by Cutler-Hammer. Hundreds of uses. Weighs 12 ounces. A **\$119** real buy at only.....

TOGGLE SWITCHES



Seven assorted toggle switches, all panel mounting types. All different. SP-ST, DP-DT, DP-ST. Brand new. Just the thing for your home made equipment, models, inventions, radio, electronic and other electrical equipment. Complete assortment. Weighs 11 oz. A bar- **\$169** gain at only.....

INDUSTRIAL GOGGLES



You get real eye protection with these Industrial Protective Goggles made by Wilson, Kimball, American Optical. Frame is ventilated for added wearer comfort. Lenses are clear for easy visibility and are truly shatterproof. Weighs 4 oz. Assures eye safety while grinding, buffing, etc. Real eye protection at **\$129** only.....

METAL BOX



Fireproof. For safekeeping your valuables, private papers, petty cash, stamps, etc. or in your shop for small parts, expensive tools, etc. New. All metal, most attractive brown, enduring finish; lock and key. 13 3/4" x 6" x 4 1/8" deep. Ideal for home, office, shop. Weighs 1 lb. **\$119** 9 oz. A splendid value at.

WOBBLE HAND PUMP

For Most Liquids



Originally designed for use as a liquid fuel hand pump. Brand new. Has standard one inch pipe thread intake and outlet. Type D-4. Made by Aero-Cor. With a 3' lift and 6' head at 60 strokes per minute, pumps 425 gallons per hour. Just rock the handle back and forth to quickly drain tanks, ponds, basements, any place where liquids gather or are stored. Not to be used for salt water nor acids. Weighs 6 lbs. 11 oz. A most useful buy at **\$1995** only.....

ORDER THIS EASY WAY

Print your name, address, list of items. Enclose check, money order, bank draft. Add sufficient postage if shipment is parcel post. Express postage immediately returned. On C.O.D.'s, include 25% deposit. Items are guaranteed as described. If not completely satisfied, after ten days, return goods and your money quickly refunded. Order your needs today.

FRACTIONAL H.P. MOTOR



Ideal for use on all types of mechanical displays wherever small power is required. Made by Oster. Shaft terminal has helical cut gear; readily and easily replaced by a pulley. New. Operates on door bell or chime transformer, AC-DC 12 or 24 V. Approximately 1/25th H.P. Use one to make your own hand grinder, other power tools. Weighs 13 oz. A value **\$298** at only.....

THE MART

DEPT. M-28
11 East Harrison Street
Chicago 5, Illinois

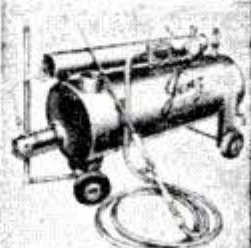

LOW PRICED STEAM CLEANER

Jenz Super Chief

Portable—No moving parts—Cleans anything—Motors—Chassis—Machinery—Floors—Buildings—Remove wallpaper—Dairy & Creamery—Oil Rigs etc. Oil fired—Economical—fully tested and warranted. 75# Steam in less than 10 min. Complete as illustrated. **\$276.50** F.O.B. factory.

HIPURE LABORATORIES
EVANSVILLE, IND.

BOICE-CRANE POWER TOOLS

for shop men and
homecraftsmen.



BAND SAWS



JIG SAWS



DRILL PRESSES



THICKNESS PLANERS



SPINDLE SANDERS

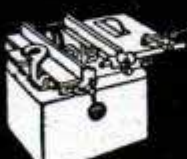

SAW-JOINTERS



LATHES



SPINDLE SHAPERS



BELT SANDERS

Write for literature on this
versatile, low-cost,
sturdy line.

BOICE-CRANE COMPANY
943 Central Ave., Toledo 6, Ohio

SURPLUS MONEY SAVING BARGAINS

AT A FRACTION OF ORIGINAL COST



HYDRAULIC PUMP

No. 1—New, gear type hydraulic pump; 1000 p.s.i., pulley drive. (Pulley not included). Ideal for hydraulic rams, struts, concrete machine (blocks) or any place power is needed. Built by Pesco. Readily converted for use as sump pump. **\$9.95**
Shp. wt. 5 lbs. Each



AIRPLANE GENERATOR

No. 2—Ideal for use on boats, trucks, light and power plants, light welders, water wheels, etc. 24 volts, 25 amps, RPM 2500, 3/8 inch diam. shaft. Measures 10x5 in. diam. Actual weight 23 1/2 lbs. Guaranteed brand new. Shp. wt. 28 lbs. Two for \$30.00. **\$17.50**
Each.....

All F.O.B. Houston. Mail orders promptly filled.
Send check or money order. Satisfaction guaranteed.

AERO INSTRUMENT COMPANY, Dept. PM 2
MUNICIPAL AIRPORT HOUSTON, TEXAS

New 1948 SHOP NOTES Now Ready!

Bigger and better than ever—240 pages crammed full with the best articles that have appeared in Popular Mechanics during the past year. Invaluable for the mechanic, painter, carpenter, auto-worker, electrician, welder, farmer, plumber and home craftsman; in fact for every man who uses tools. Attractively bound in the new soil-proof Lameote cover, it is on sale at your News Dealer for \$1.00 or obtainable from



POPULAR MECHANICS PRESS
200 E. Ontario Street Chicago 11, Illinois

Say you saw it in
POPULAR MECHANICS

FIVE ACRES AND INDEPENDENCE

*A Practical Guide to the Selection and
Management of the Small Farm*

By M. G. Kains

This book is a complete, practical guide to the selection and management of a small farm. It explains how a small farm can be self-supporting. What farms not to buy. How to choose the right farm, based on proper soil, location, irrigation, elevation, climate, etc. Then a detailed explanation of what crops to plant and how to make them yield results, sure-fire methods of grafting, rotation, transplanting, etc. Finally, how to make a profit by selling your excess crops, livestock and preserves. Written by an expert who has made a real success with many small farms. Revised, enlarged edition. 413 pages, profusely illustrated. Price \$2.50 Only \$2.50, Postpaid in U. S. A. (Outside U. S. \$2.75). Order Today



POPULAR MECHANICS PRESS Room 490 • 200 East Ontario St., Chicago

SANDING WHEEL

SANDS—WOOD, PLASTIC
OR SOLDER . . . A fast,
smooth sander. Will not
load up. Takes place of
sanding belt.
for all 1/2" shafts

**FOR SHARPENING
KNIVES . . . CHISELS . . . DRILLS**

only **\$3⁰⁰**
complete
Now keep kitchen knives
. . . workshop tools really
sharp.

Note—Emery cloth is
inserted in slot and tight-
ened with Allen Wrench.

order
from
BRAINARD & Co
Box 11
Moline Illinois





Ball-Bearing **SPEED WHEELS**



Juvenile wheels, solid tire—No Bearings

7" wheels	60c
6" wheels	50c
4" wheels	30c

Semi-pneumatic tired wheels

12 x 1.75"	\$3.25
10 x 1.75"	\$2.75
10 x 1.25"	\$2.00
8 x 2"	\$2.00

Industrial wheels for heavy loads

Semi-Pneumatic	
400 x 8, 2 ply tire and tube....	\$12.50
12 x 3.00", bolt hub, ea.....	\$9.75
10 x 2.75"	\$6.75
10 x 2.75" Single Tube	\$7.25
8 x 1"	\$4.90
6 x 2"	\$2.80

DEALERS WANTED

Free blueprints with all wheel orders.
Send check with order. Shipments f.o.b. Akron.

JIM BROWN TOY COMPANY
1097 Home Ave. Akron 10, Ohio

SPECIAL OFFER

Personal Initials in Solid Bronze
Beautiful polished bronze initials personalize home-craft items—fireplace sets, cigarette boxes, doors; many other uses. Easy to apply to metal, wood, leather or plastics. Order your initials today.

2 Sets Polished Bronze Initials, total 6 letters, 3/4" high, (\$1.50 regular price): Special offer, \$1 postpaid.
Send \$1.00 for 2 sets—money back guarantee.

H. W. KNIGHT & SON, INC., 41 Lane St., Seneca Falls, N. Y.

BUILD YOUR OWN FAST FREEZER

PLANS \$1



It's easy to build this household appliance with LeJay Plans. Made from new or used parts. Save up to 75%. No expert knowledge needed. Plans show 5 sizes and are easy to follow. All details clearly explained. Enjoy making one of these freezers. Mail \$1 for set of plans and catalog. **LEJAY MFG. CO., 447 LeJay Bldg., Minneapolis 5, Minnesota**

Liquid Plastic PROJECT MANUAL



NOW ONLY 25¢

Now make many swell articles with **CASTOLITE**, amazing New Liquid Plastic. Embroider flowers, butterflies, medals, photos. Make jewelry, figurines, gears, parts, models, toys. Can be sawed, drilled, carved, turned. Use home tools. New home project manual now ready. Shows how to get into fascinating, completely new field. Have fun, earn money. Send 25¢ today for your copy. **THE CASTOLITE COMPANY, Dept. B-1, Box 211, Kenilworth, Ill.**

ALL MAKES
AUTOMOTIVE HEAT OR TEMP. INDICATORS \$2.25
Repaired Like New—Any Condition—Guaranteed
AUTOMOTIVE INSTRUMENT SERVICE
3608 Montrose Ave. Chicago 18, Ill. PLUS POST

HOW TO SUCCEED WITH BEES

By E. WATKINS-K. HAWKINS



RAISE BEES SELL HONEY MAKE MONEY!

Get How to Succeed with Bees, written by two experts, which tells you all you need to know. Contains 190 tested successful plans to produce big crops of honey. Easy work and little capital required. There is always a ready market for honey and working with bees is fascinating. This 96-page well-illustrated book is only \$1.00 and is absolutely guaranteed to satisfy you or we shall refund your money. Send for your copy today!

POPULAR MECHANICS PRESS
200 E. ONTARIO STREET
CHICAGO 11, ILLINOIS

Craft Pal

THE COMBINATION DRILL GRINDER

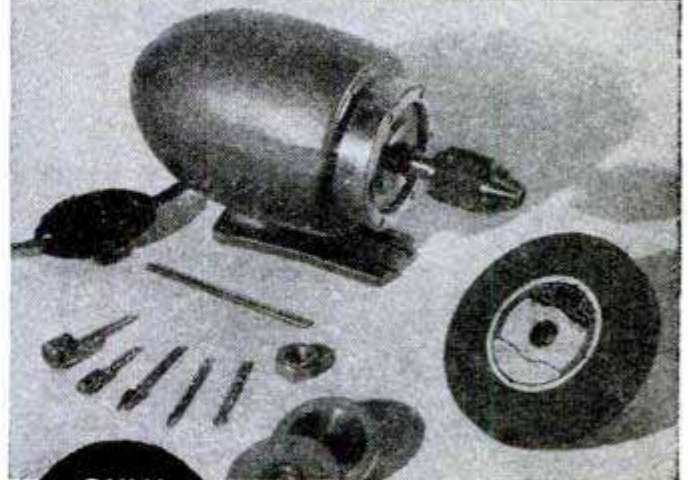

ONLY \$8.95

The "Craft Pal" is a combination Drill and grinder, complete with MOTOR-CHUCK-GRINDING WHEEL-SET OF 5 GRINDING STONES-STEEL WASHERS-LOCK PIN.

Home Craftsmen, Hobbyists, Small Shop Owners will find "Craft Pal" indispensable for doing light duty grinding and drilling. Motor is cool-running, 1/20 H.P., 60 C, 110 volts A.C., 3500 R.P.M., with finger control switch.

SEND NO MONEY - FILL IN AND MAIL TODAY

MINOR MACHINE CORP.
45 N. Division St., Buffalo, N. Y., Dept. PM-1
Send parcel post C.O.D. one "CRAFT PAL" complete with full equipment for \$8.95.

Name.....

Address.....

Charges Paid If Money Accompanies Order

**MINOR MACHINE CORP., 45 N. Division St.
BUFFALO, N. Y.**

ELECTRICITY *Anywhere*

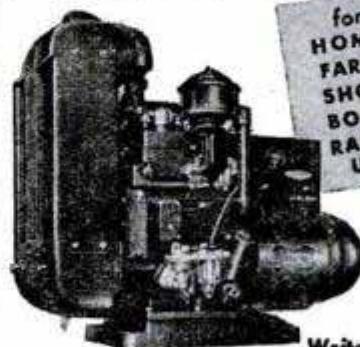

for HOMES FARMS SHOPS BOATS RADIO USE

Onan gasoline-engine-driven Electric Plants supply reliable, economical electric service for any use. Portable, stationary or stand-by models. Water or air-cooled, compact and rugged.

A.C.: 350 to 35,000 watts in all standard voltages and frequencies. D.C.: 600 to 10,000 watts, 115 and 230 volts. BATTERY CHARGERS: 500 to 3,500 watts; 6, 12, 24, 32 volts.

Write for folder

D. W. ONAN & SONS INC.
2538 Royalston Ave., Minneapolis 5, Minn.



Every MILE SAVES YOU MONEY!

"PAY AS YOU RIDE"



Cushman

MOTOR SCOOTER

75 MILES PER GALLON

Enjoy America's new ride—and save money every mile! The Cushman Motor Scooter travels 300 miles on a dollar's worth of gas. Operates for less than 1c per mile. Will carry 2 passengers. Has rugged 4 H. P. Cushman "Husky" engine, two-speed transmission, automatic clutch, balloon tires and knee-action springing for added comfort. Park anywhere. Gives you a "second car" at low cost.

FREE Write for Free Folders, name of your nearest dealer and details of new **TIME PAYMENT PLAN**

Cushman Engines

For 47 years Cushman has produced high quality small air-cooled and water-cooled engines. These engines are available to original equipment manufacturers and other users. Write for details.

CUSHMAN MOTOR WORKS, INC., Dept. M-200, Lincoln, Nebr.

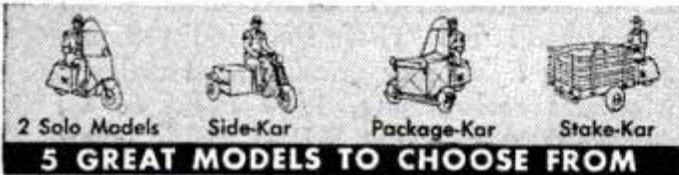

5 GREAT MODELS TO CHOOSE FROM

Write today for booklet on the new FLEX-O-SHAFT Tool Kit, illustrating this improved all-purpose power machine with the hand-piece that works as easily as a pencil. Motor with switch, foot-operated rheostat, and 66 accessories, all at a special low price. FLEX-O-SHAFT SALES CO., Dept. C, Prairieview, Illinois.

More Power to any shaver



ONLY \$4.95

RANGER Electronic Inverter

- ★ Changes a-c to d-c
- ★ Improves any shaver—old or new
- ★ Shaves faster, smoother—no pull
- ★ Better for motor—no a-c peak volts
- ★ Usually eliminates shaver radio static
- ★ Approved by Underwriters' Laboratories
- ★ Marvelous gift—appreciated every day
- ★ Ten-day money-back guarantee

If not in stock, order by coupon. Include dealer's name.

ELECTRONIC SPECIALTY CO.

3456 GLENDALE BLVD. • LOS ANGELES 26, CALIF. DEPT. PM

Under money-back guarantee plan, send me _____ RANGER Inverter(s) at \$4.95 each. Money order or check enclosed. Add sales tax in Calif.

NAME _____
 ADDRESS _____
 CITY _____ STATE _____

WAR SURPLUS BARGAINS

REVERSIBLE RATCHET WRENCH



1/2" sq. drive x 10" long. Mfg'd. by New Britain, polished. \$320 Each

9 PIECE SPARK PLUG SOCKET SET



Mfg'd. by Duro Chrome, 1/2" sq. Drive, 12 pt. extra deep to reach deep recessed spark plugs, also ideal for other work where a long reach is necessary. Sizes 1/2", 9/16", 5/8", 11/16", 3/4", 25/32", 13/16", and 7/8". Also ell handle and metal box. \$425 Each

ELECTRIC SOLDERING IRON



"HEXACON" 200 Watt 115 volts A.C. and D.C. \$420 Each

14 Piece SOCKET WRENCH SET



1/2" sq. Drive standard wrench parts of popular brands in cardboard box consisting of speeder wrench, sliding handle, 5" and 10" extensions, 10 assorted 12 pt. sockets 1/2" to 1". \$530 Each

ORDER TODAY — WE PAY THE POSTAGE!

INDUSTRIAL SUPPLY COMPANY

312 EAST 33rd ST. NEW YORK 16, N. Y.

PATENTS

TRADEMARKS

Patrick D. Beavers

REGISTERED PATENT ATTORNEY
 929 COLUMBIAN BUILDING

416 5TH ST. N.W.

WASHINGTON 1, D. C.

TT GAUGE 1/10"=1 ft. Table Top MODEL RAILROAD!

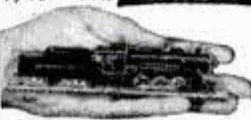

LOCOMOTIVES \$12.50 to \$28.50
 FREIGHT & PASGR. CARS \$1.50 to \$5.50

Imagine a roaring locomotive in the palm of your hand... cars not much bigger than this ad... all exact scale models that operate electrically on 16/32" track. You can have a whole layout on a card table or desk. Equipment easy to build from kits, or may be obtained ready-to-run, including freight and passenger cars, steam and diesel engines, track etc. See your Hobby Dealer or send dime for illustrated circular and price lists.

H.P. PRODUCTS CO., Hartford City, Indiana

ONE-MAN SAWMILL LESS THAN \$200⁰⁰ Easy To Turn Trees Into Money

Makes lumber, ties, shingles, crates, lath, studding.



Belsaw Models

in 10 to 24 foot sawing lengths.

MECHANICAL FEED, accurate set works and positive dogs. Use tractor or old auto engine for low cost power.

Thousands used for commercial sawing. Pays for itself quickly. Send post card today for FREE booklet, "How To Make Lumber" and Catalog of Woodworking Equipment.

BELSAW MACHINERY CO., 811 Field Bldg. 315 Westport Road Kansas City 2, Mo.

\$13⁵⁰ Value for Only \$1.95

8000 ohm impedance Headphones, produced to Air and Signal Corps specs. Extremely sensitive, lightweight (only 9 oz.) With 5 1/2 ft. cord, plug, jack and ear cushions. BRAND NEW.

No. 17A37 Spec., Per Pair... \$1.95 Plus 25c each for Postage.

FREE Catalog on Everything in Radio and Electronics.

Burstein-Applebee Co. 1012 McGee, Kansas City 6, Mo.

AGENTS 300% Profit SIGN LETTERS

For Store Fronts and Office Windows. Anyone can put them on. Free Samples. Liberal Offer to General Agents.

METALLIC LETTER CO., 430 N. Clark, Chicago 10

SIGNS EASILY AND EXPERTLY PAINTED WITH LETTER PATTERNS AND SHOWGARDS

MANY SIZES & STYLES WRITE FOR FOLDER!

JOHN F. RAHN 1330-31 N. Central Ave. CHICAGO 51, ILL.

**MAKE YOUR
ELECTRIC DRILL A TOOL
WITH USES UNLIMITED**

**WITH A
LAKO UNI-TOOL*
ATTACHMENT**



PRODUCTS



UNI-TOOL makes your drill a versatile tool with hundreds of uses never before possible. Can be attached to any size electric drill, air drill, flexible shaft or drill press that will receive a 3/4-in. shank and with speeds from 400 to 3000 RPM.

This precision attachment holds saw blades, knife blades, files, plus the **UNI-SANDER** and many other accessories.

UNI-TOOL is engineered for long, hard wear and makes any portable drill and drill press many times more valuable.

PRICE LIST

*Uni-Tool, 1 3/4 x 2 1/4 x 3 1/8" (2 lbs. 3 ozs.)	\$15.50
*Uni-Sander, 3 1/2 x 3 1/2 x 6" (1 lb. 4 oz.)	4.50
Metol Cutting Saw Blades, 1/2 x 5", 18, 24, 32 tooth HS, ea.	.35
Wood Cutting Saw Blades, 5", 6-tooth, 1/4", 3/8", 1/2", 5/8", ea.	.25
Wood Chisels, 1/16" x 6", 1/2", 3/4", 1", ea.	1.00
Files, 1/8" x 3/4" x 6", f-m-c, ea.	.60
Sandpaper, 3 1/2" x 10 1/4", Garnet or Alum. Oxide, any Grit, ea.	.05

All List Prices F.O.B. Factory

*Patents Pending — Trade Marks Registered. Ask for LAKO PRODUCTS at your dealer or if he can't supply, order by mail.

**NEW LAKO *UNI-CUTTER, *UNI-RIVETER
AND *UNI-PLANER AVAILABLE SOON!**
All LAKO Products Fully Guaranteed.

Manufactured by

LAKEVIEW MANUFACTURING COMPANY
P.O. BOX 4080 • PORTLAND 8, OREGON

See and Try
LAKO PRODUCTS
at the
**WORLD HOBBY
EXPOSITION**
Booth 12 and 13
Chicago Coliseum
February 21-28

MAIL COUPON IF DEALER CAN'T SUPPLY

Lakeview Mfg. Co., Box 4080, Portland, Ore.

My dealer can't supply LAKO Products, send

Uni-Tool Uni-Sander

Accessories as Listed on Attached Sheet.

Check or Money Order enclosed \$_____

(Postage prepaid if remittance with order.)

C.O.D. plus postage. PM-2-47

Name _____

Address _____

City _____ State _____



UNI-TOOL and saw attached to 1/4" 2500 RPM Electric Drill, cutting openings without necessity of drilling opening holes.



UNI-TOOL and LAKO WOOD CHISEL BLADE, chiseling 45° cut, box cut and bevel cut.

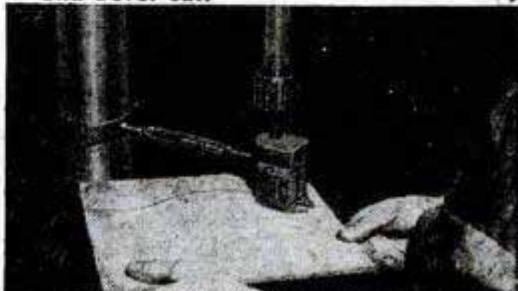

DRILL PRESS with **UNI-TOOL** and Adjustable Holding Attachment, sawing curvatures in plywood.



UNI-TOOL and **UNI-SANDER** sanding steel service plate.



UNI-TOOL with **UNI-SANDER** and Drill Press Attachment for vertical sanding, buffing and polishing.



UNI-TOOL with Adjustable Attachment converting drill press into filing machine.



UNI-TOOL with High Speed Blade cutting 1/4 x 1 1/2" cold roll bar.

TESTED DRILL PRESS TOOLS FOR HOME CRAFTSMEN



MULTI-PURPOSE WOOD PLANER
Fits any drill press. Exclusive hi-speed blade design performs precision surface planing, rabbeting, tenoning, paneling, grooving, routing, beading. Thousands now in home workshops, schools, cabinet and pattern shops. An indispensable lifetime tool for wood and plastic workers. Complete \$7.50



NEW STYLE DRUM SANDER
Fits any 1/2" drill press chuck. Used for sanding curves, contours, straight edges. Has many essential workshop applications. Complete with 5 spiral sanding sleeves.... \$3.95



4" ROTARY SURFACE SANDER
An exclusive type sander for drill presses, flexible shafts, motors, hand drills. Instantly sands woods, plastics and metals toagate smoothness. No waves, ripples, striations. Discs immediately interchangeable. With 20 discs... \$5.95



ALL METAL SHAPER FENCE
Precision built of hard alloy aluminum and steel. Nothing to rust, No wooden parts to warp. For moulding, jointing, shaping, rabbeting, tenoning. Fits all standard drill presses—shapers. Complete with two hold down springs. A real buy at \$7.95

AT YOUR DEALER—OR ORDER DIRECT
FREE Workshop Catalog
BARRON TOOL COMPANY, INC.
269 Architects Bldg., Detroit 1, Mich.



BARRON PRECISION TOOLS WORK SHOP

LAWN ORNAMENT-NOVELTY PATTERNS
28 Lawn Ornament Patterns, 25c. Other patterns: 15-20" high: Dutch Girl, Dutch Boy, Pirate, Bull Terrier, Mexican Girl, Mexican Boy, Dwarf, Penguin, Flower Girl, 10c each. 25 Novelty Patterns, 30c. All 62 Full Size Patterns, \$1.00 Postpaid. Strother Pattern Service, Dept. AF-8, Box 383, Belington, W. Va.

Foredom PRESTO-FLEX

←YOUR MOTOR

NOW! For Only \$5.95 You can have an Amazing New FLEXIBLE SHAFT TOOL

with PENCIL-SIZE HANDPIECE
Grinds, Polishes, Sharpens, Cleans, Mills, Carves, Engraves, Etches on Metal, Wood, Glass, and Plastic

Now you can turn your old motor, drill press, or electric drill into a Flexible Shaft Tool. Amazing new Presto-flex, latest addition to the Foredom flexible shaft family. Simply attach to your electric drill, drill press or motor. Presto—a flexible shaft machine! Off again in a jiffy! Pencil size handpiece gives you finger-tip control. Gets into tight places you can't reach with any other tool. Handy 35" overall length. And—only \$5.95 complete! Order NOW.

—SEND NO MONEY—
Just send your name and address. We will rush your Presto-flex COD. Pay postman \$5.95 plus postage or send \$5.05 now and WE pay postage. Money back if not delighted! If you order Presto-flex for use on motor, specify motor shaft diameter and add 50c for motor coupling. (Available for 1/4", 5/16", 3/8" and 1/2" shafts.) 50 piece accessory set available \$1.50 extra. Order TODAY from

FOREDOM ELECTRIC CO., Dept. 113
27 PARK PLACE NEW YORK 7, N. Y.

thinking of
building a
home?

Then you
need . . .



**PRIMER
for
HOME
BUILDERS**

The New Book by 12
Leading Home Building
Authorities That can so
Easily Save You Hundreds of Dollars!

**Answers These and Other
Perplexing Questions**

- ★
- Can I Afford to Build a Home?
- What Should I Know About Financing?
- What to Look for When Buying a Lot.
- What Community is Most Suitable for My Family?
- How to Go About Definite Planning.
- What is Most Suitable Inside Arrangement of Working and Living Space?
- Should I Employ an Architect?
- What Should Be My Guide When Buying an Older House?
- Legal Rights and How to Protect Them.
- How to Work with Contractors and Builders.

Whether you are actually planning to build a home or just hoping that some day you can, *Primer for Home Builders* is the most important book you can own. It's the combined work of twelve leading authorities and contains real down-to-earth facts on every phase of planning, contracting, building and financing a home, plus typical legal documents used in all real estate transactions. You can read it in a few hours but it can save you hundreds of dollars and a lot of time, trouble and tears.

**A Book for Beginners — That
Makes You Feel Experienced!**

You'll like the way this book goes right into the business of building a new home, or buying an old one. Right from the start of "just dreaming," through whether or not to employ an architect and how to select an architect and work with him and contractors, how to plan the house, how to finance it, how to avoid legal difficulties, up to the time you take possession. You'll learn a hundred things you ought to know and probably don't know now.

Get Primer for Home Builders Now!

Don't wait until you are ready to start building. Before you do another day of thinking or planning or dreaming, get this most practical 184-page book to help you save time, worry and money.

MAIL COUPON TODAY

WINDSOR PRESS
A Division of Popular Mechanics Co.
200 E. Ontario St., Chicago

Rush _____ copies of *Primer for Home Builders* at \$2.50 each. Remittance enclosed.

Name _____

Address _____

City _____ Zone _____ State _____

**GET INTO
BUSINESS FOR
YOURSELF**

*Be Your Own Boss
Good Income
Spare or Full Time*

**MEET THE DEMAND FOR
"Eternalized"
BABY SHOES**



BY THE EXCLUSIVE WARNER ELECTROPLATING PROCESS

We help you STEP by STEP!

- ★ **HOW TO GET STARTED**
- ★ **HOW TO PROCEED**
- ★ **HOW TO MAKE BIG AND STEADY PROFITS**

This is a lifetime opportunity, no matter what you're doing now! You can get set for the future while beating today's high cost of living. For if you are sincerely ambitious, this plan offers everything you need to know . . . a completely charted path to personal independence!

This plan is working right now. It's been tested and proved. Produced by a 25 year old company, it's sent to you on a No-Risk Trial, Positive Money-Back Guarantee!

The exclusive Warner Method applies an actual coat of pure metal, in genuine Gold, Silver or Bronze finish, "Eternalizing" Baby Shoes forever. The demand for these Metalized Keepsakes is big . . . and getting bigger every day. (More than a million dollars' worth last year.) In every way, it's a proved proposition. Proud parents everywhere buy on sight!

A Never Ending Market

No matter where you live, small town or big city, there is a never ending, ready-to-buy market for "Eternalized" Baby Shoes. The figures are amazing. Year after year, the number of newborn babies is tremendous . . . more than 3,500,000 during the last 12 months. NOW, IT'S YOURS TO PROFIT BY. This tested plan reaches out and brings in the business. Spare or Full Time, you can make money!



ISN'T THIS WHAT YOU ARE LOOKING FOR?

- (1) Steady Income
- (2) Permanent Future
- (3) Wide-open Market
- (4) No House to House
- (5) Plan Works for You
- (6) Backed by 25 Year Old Company
- (7) No-Risk Trial
- (8) Money-Back Guarantee

Be Your Own Boss

Get the facts on this new opportunity. Find out if you can qualify. Mail the coupon below . . . TODAY. We'll send you fully descriptive literature, on our No-Risk Trial and Positive Guarantee: "Money Back If You Say So."

World's Strongest Appeal

Every mother cherishes the tiny shoes in which baby took its first step. And that is the secret of this profitable business. Proud parents, sentimental relatives . . . all are eager to buy!

SEND THIS COUPON NOW FOR SURE!

Warner Electric Company, Dept. PM-2
1512 Jarvis Ave., Chicago 26, Illinois

Please send, without obligation, complete details about your No-Risk Trial, Money Back Plan for "Eternalizing Baby Shoes for Plus Profits"

NAME _____
ADDRESS _____
CITY _____ STATE _____
ZONE _____

PLASTIGLAST



THE GREATEST THING IN PLASTICS!

PLASTIGLAST is a liquid plastic; can be poured into ANY kind of mold or container. Hardens in a few minutes into a transparent solid, clear-as-glass, tough-as-steel plastic! No tools or machinery required. Ideal for imbedding flowers, butterflies, photos, souvenirs, and for making beautifully brilliant jewelry, gems, displays, fishing lures, magnifiers, lenses, knick-knacks and novelties. Easily cast into sheets, rods or blocks, ANY shape, ANY color. **EVERYTHING FURNISHED**, including 4 molds, for making over 200 attractive articles! C.O.D. orders accepted with \$1.00 deposit.

COMPLETE MASTER OUTFIT \$3.25
(Postpaid U.S.A. & Canada Only)



PLASTIGLASS Make extremely beautiful, colorful Ornaments, Jewelry, Butterflies, Tropical Fish, Birds, Corsages, etc., simply by bending wire to outline of subject desired and dipping in **PLASTIGLASS!** No heat, catalyst or tools required. Complete Outfit with materials for making hundreds of remarkably beautiful novelties only **\$4.00** ppd.

FREE A very attractive and useful novelty made of one of our products given absolutely free with every one of our catalogs! Catalog lists many new materials for making **MOLDS and CASTINGS** with Liquid Plastics, Liquid Ivory, Liquid Marble, Wax, Latex, Metal, Castwood, Plaster, etc.; also many molds listed. Price of catalog only 10c coin or stamps.

PLASTIGLAST CO. (Dept. C)
(Send order to nearest office)

5961 Madison St.
Chicago 44, Illinois

P. O. Box 987
Palo Alto, Calif.

Every Small Business Needs this **ADDOMETER**

ADDING MACHINE only **\$12.95**

No other adding machine can match all its advantages!

Adds, subtracts direct, multiplies—quickly, accurately. So easy to operate—no practice necessary. The perfect portable—11½x2½ in. size, weighs only 14 oz. Eight-column (\$999.999.99) capacity—models also to handle fractions, feet and inches. Over 100,000 in use—praised everywhere. Only \$12.95 postage prepaid—10 day money-back guarantee if not fully satisfied. Complete descriptive folder on request—or, send check or money order **NOW**.

Reliable Typewriter & Adding Machine Co.
Dept. E-2, 303 W. Monroe St. Chicago 6, Ill.

PAY RAISING—EXTRA MONEY BOOKS

Use these books to prepare for a better job—bigger pay—to start a profitable spare time or full time business of your own, improve your home, start a hobby. Popular Mechanics specializes in supplying outstanding self-help books on many subjects. Send for our **FREE** catalog.

- Shop Notes for 1948 Now ready. For every man who uses tools\$1.00
- Shop Notes Library 6 Vols.—1948, 47, 46, 45, 44, 42, (No Dup. Mat.) \$3.50
- Painting Furniture Finishing and Repairing\$1.50
- Rewinding and Servicing Electric Motors (No. 75) 25c
- Elementary School Subjects for Home Study Covers high points of grammar, spelling, arithmetic, history, science, geography, etc. 635 pages,\$1.89
- High School Self Taught Covers 25 subjects with study guide and self-testing quizzes. Completely revised and enlarged edition, 1280 pages, 300 illustrations, ...\$3.95
- Garden Book Build own trellises, lawn furniture, fireplaces, ornaments, etc.\$1.00
- Diving, Cutting and Welding in Underwater Salvage Operations Only book of its kind ..\$2.00
- Picture Framing Modern methods for making and painting picture frames. Fully illustrated,\$2.75
- Frog Industry Breeding, feeding, dressing and marketing\$1.00
- New Fields for the Writer Television, radio, film, drama\$1.00
- Making Amateur Photography Pay How and where to sell your pictures\$1.00
- 20 Careers of Tomorrow Covers plastics, metallurgy, textiles, radio, electronics, television, transportation, chemistry, etc.\$2.50
- Breaking Into Advertising \$1.00
- Into the Freezer and Out A complete handbook on the home freezing of foods.\$2.50
- Concrete Handbook New book on using concrete around home, garden, farm\$1.50
- The Vegetable Growing Business\$3.50
- This Way Up The successful philosophy of practical business men \$2.00
- Welding, Brazing and Soldering How to build own equipment and how to use it effectively\$1.25
- Modern Refrigeration Electric, Gas. Be service expert\$5.00
- Dyke's Auto Ency. (includes Diesels, airplane engines) New 20th Ed. World's greatest book for mechanics \$7.00
- Household Mechanics The "fix-it" book to end all "fix-it" books. Covers electric appliances, painting, carpentry, etc.\$2.75
- Oil Burner Handbook\$2.50
- Build Your Own Boat Describes 17 popular boats—rowboats, sailboats, plywood outboard, etc. 192 pages \$1.50
- House Wiring (No. 89)... 25c
- Turn Scrap Into Money Convert old auto generators into motors, welders, etc.\$1.00
- Woodworking for Everybody The first complete book on this subject. Considers tools, explains cutting and shaping of wood, and has 46 useful projects\$2.75
- Sheet Metal Work\$3.00
- Tool and Saw Sharpening (No. 92) 25c
- Forging Practice\$1.50
- Action Toys (No. 66) Plans for 21 easy-to-make toys 25c
- Foundry Work\$2.25
- Pattern Making Wood, metal\$2.25
- Forty Power Tools Build own saw, drill, lathe, sander, etc., from scraps—save money\$1.25
- Carpentry\$2.50
- The Young Craftsman Over 450 things boys can make\$1.50
- Five Acres and Independence How to make money on small farm\$2.50
- Your Home and How to Build It Yourself Step by step construction of the famous **POPULAR MECHANICS** house. Wonderfully illustrated\$3.00
- Artistic Penmanship Self Taught New self study course with 48 lessons of interesting and varied exercises\$2.95
- Knots, Ties and Splices For everyone who uses rope\$1.25
- Plastics Latest information on manufacture and use\$5.00
- LeJay Manual of Homemade Electric Equipment How to construct 100 items that are scarce and valuable\$1.50
- How to Estimate for the Building Trades: Material and labor costs for masonry, plumbing, electricity, carpentry, heating, hardware, painting, etc. \$2.50
- A Small Store and Independence Guide to successful retailing\$2.50
- Rabbits for Food and Fur\$2.50
- Tool Making\$4.00
- Tool Design\$4.50
- Plumbing Installation & Repair\$2.00
- Ropp's Calculator Figuring made easy .. 50c
- Slide Rule Simplified ... \$2.75
- Drake's Refrigeration Service Manual\$2.00
- Primer for Home Builders All the information you need to know in building a house\$2.50
- How to Remodel a House\$5.00
- Nothing is omitted ...\$5.00
- Toys You Can Make of Wood\$2.50
- A.B.C. of Poultry Raising \$2.50
- Ice Cream for Small Plants Some technical formulas for ice cream, ices and frozen desserts on a commercial scale\$2.50
- Furniture Joinery\$2.50
- Essentials of Upholstery . \$3.25
- Radio Physics Course A thorough training in radio fundamentals\$5.00
- Science Digest Reader Fascinating articles on astronomy, atomic energy, psychology, medicine, etc. \$3.00

MAIL THIS COUPON TODAY

Check the books you want, write your name and address below, and mail this advertisement with money order or check. Outside U. S. A. include 15% additional for shipping charges.

Books selected will be mailed promptly on our "money back if you're not entirely satisfied" guarantee.

Name _____
Address _____
City _____ State _____

Mail to **POPULAR MECHANICS PRESS**
Dept. 651—200 East Ontario St., Chicago 11, Ill.

Build Your Own BOAT

IT IS easy to build your own boat if you have one of our Craft Prints to follow. These plans show every little detail, including complete bill of materials. Being in enlarged size, they greatly simplify the work. In designing these boats, we have kept in mind that ease of construction, econ-

omy and safety are absolutely essential. You can't begin to appreciate the BIG value offered in these Craft Prints at the low price of 25c each until you actually see these splendid plans. Check the list over carefully and send your order today. Order by number using the coupon below.

ALL PLANS 25c EACH



Bicycle Boat—No. 69—25c



12 Ft. Portable Boat—No. 3—25c

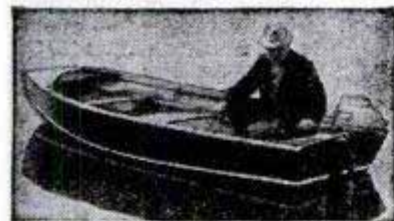

13 Ft. Utility Boat—No. 104—25c



10 Ft. Hydroplane—No. 100—25c



18 Ft. Cabin Cruiser—No. 78—25c

- No. 3—**ALL-PURPOSE PORTABLE BOAT.**
Length 12 ft., weighs less than 125 lbs. Easily made of plywood. Good car top boat.
- No. 55—**"FIRE FLY"—14-ft. Outboard Hydroplane**
Super speed runabout using 15 to 50 hp. engine. Can plane 6 persons with ease.
- No. 67—**"WINGS"—13-ft. Sailboat.**
Extremely fast, safe, and steady. Can be built with ordinary tools.
- No. 69—**BICYCLE BOAT.**
Make from scrap materials. Safe for children or adults. Make money renting it.
- No. 75—**"KINGFISHER"—9-ft. Pram.**
Rows easily, sails well, and propels nicely with small outboard motors. Weighs only 90-100 lbs. Seats 3 people.
- No. 77—**"WHITE DUCK"—14-ft. Rowboat.**
Ideal boat for fishing or hunting. Simple, inexpensive construction.
- No. 78—**"SPORTSMAN"—18-ft. Cabin Cruiser.**
General purpose cruiser for overnight trips or week-ends. For inboard motors 15 to 90 hp. Speeds 10 to 40 mph. Capacity 4 persons.
- No. 79—**"SHORE LARK"—13-ft. Runabout.**
This boat will afford long happy hours of sport and repay its construction many times. Adapted for outboards from 1 to 24 hp. Capacity 4 or 5 persons.
- No. 81—**"ROCKET"—15-ft. Inboard Hydroplane**
Fast and sporty. Uses light, converted auto or marine engine. Plywood over oak frame.
- No. 100—**"DRAGONFLY"—10-ft. Hydroplane.**
Adapted to all classes of outboard motors. Exceptionally fast. Plywood construction.
- No. 104—**"BUDDY"—13-ft. Utility Boat.**
You can row, sail, or run this plywood boat with an outboard motor from 1 to 12 hp. Seaworthy, stable, and widely adaptable.
- No. 105—**"TORPEDO"—13½-ft. Runabout.**
Streamlined plywood speedster. Uses motors 10 to 20 hp. Capacity 4 persons.
- No. 112—**"VICTORY"—12- 14- 16-ft. Sport Runabout**
Fast, stable and handles well at all speeds even with different sized outboard engines. Semi-vee bottom. Plywood construction.
- No. 138—**"SEA SCOUT"—14-ft. Inboard Speedboat**
Single cockpit for 1 or 3 persons. 45 hp. marine engine. Plywood construction.
- No. 150—**"NANCY JANE"—18 ft. Inboard Runabout**
Speedy, stable riding on open or sheltered waters. Uses marine or converted auto engine from 15 to 100 hp.

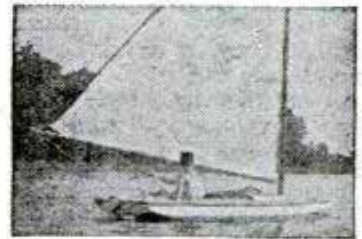

13 Ft. Sailboat—No. 67—25c



14 Ft. Row Boat—No. 77—25c



12 to 16 Ft. Runabout—No. 112—25c



9 Ft. Pram—No. 75—25c

CRAFT BOAT SHOP,

102 East Chestnut St., Dept. P-28, Chicago 11, Ill.

Enclosed is \$..... for which send me the following boat plans at your special rate of 25c each:

Nos.

NAME

ADDRESS

CITY ZONE..... STATE.....

SPEEDIZED! NORTHLAND SKIS



Ready for fast action, Northlands give you season after season of better skiing. Because they're hand crafted—perfectly matched, Northlands make good skiing easier for beginners and experts alike. Send 15 cents for Northland Ski Manual edited by Hannes Schneider... or write for free booklet.

NORTHLAND SKI MFG. CO.

Supplier to the U. S. Olympic Ski Team
95 MERRIAM PARK ST. PAUL 4, MINNESOTA

AIR RIFLES

BENJAMIN

AIR PISTOLS

PIONEERS - LEADERS

SEND FOR FREE FOLDER OF LATEST MODELS TODAY
If you want a REAL GUN for PRACTICAL USE inside or outdoors get a SAFE - CLEAN - ECONOMICAL - BENJAMIN with Adjustable Power and Amazing Accuracy. For BEST RESULTS use BENJAMIN H-C PELLETS. WRITE AT ONCE. BENJAMIN AIR RIFLE CO., 812 MARION ST., ST. LOUIS 4, MO.

MAKE \$ MORE MONEY

Applying or Selling

CORKSTONE

A General Purpose Magnesium Oxychloride Flooring

THE MODERN PLASTIC FLOORING

EASY TO APPLY
Here's your opportunity to get into business for yourself applying or selling Corkstone, the economical, top-grade plastic flooring. Plenty of profit Act without delay!

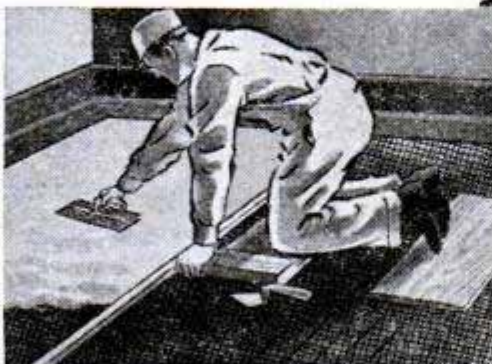

Dealers & Agents Wanted

WRITE FOR DETAILS

LASTING PRODUCTS COMPANY

Franklinton Road Plant, Baltimore 23, Md.

BUILD THIS HOUSE Yourself



Designed by Popular Mechanics and Famous Architects. Every Detail Simplified and Explained. No Previous Experience Needed!

Can you use everyday tools as well as the average Popular Mechanics reader? Then you, too, can easily build this modern house in any of its five designs, doing every part of the job yourself. The new Popular Mechanics Book, "Your Home—How to Build It Yourself" will show you how.

Space for Living and Family Growth

This beautiful, modern house is 1½ stories, with basement, living room, kitchen, dining nook, two bedrooms, bath, plenty of closets and space for two additional bedrooms on second floor. The house itself is 35' 9"x28' 11"; breezeway 20' 10"x8'; garage 20' 10"x12'.

The House That Has Everything

Designed for easy construction and the most living space for the least cost, the Build-It-Yourself House is also most attractive and suitable for any community and most income groups. The basic plan is adaptable to four other exterior designs.

Get Book and Plans Now—Build When You Can

You may never have thought about actually building a house yourself, but now that building restrictions have been lifted, it is easier than you think. So order book and plans today. Even if you engage a contractor to build for you, you will need the plans. And you certainly will want the book which can easily save you hundreds of dollars, whether you build this or any other house.

The Famous Popular Mechanics House

The picture below is from an actual photograph of the Build-It-Yourself House with breezeway and garage, as built by Jack Brownson, 23-year-old veteran, in Aurora, Illinois.

Mail Coupon for New Book and Plans!

Build It Yourself or Have It Built—Save Hundreds of Dollars!

PLANS YOU CAN READ AND FOLLOW

Plans consist of ten working-size blueprints—floor plans, elevations, construction notes, framing, joints, lumber and mill list, specifications, plumbing and wiring diagrams. Every measurement is marked—every detail made clear as ABO. Book has 100 pages—three-fifths are photographs and drawings. Some sections in colors, showing just how your house will look when finished.

BIG BOOK
8½x11 inches



MAIL COUPON FOR BOOK AND PLANS

POPULAR MECHANICS PRESS

200 E. Ontario St., Chicago, Ill

I enclose \$_____ Send me the items checked at once.

- Your Home and How to Build It Yourself.....\$ 3.00
 Complete set of plans for Popular Mechanics Home... 12.50
 Book and plans at reduced price..... 14.00
 Duplicate sets of plans..... 5.00

Name _____

Address _____

City _____ Zone _____ State _____

SAY YOU SAW IT IN POPULAR MECHANICS

POPULAR MECHANICS

UP TO SAVE 85% in WAR SURPLUS...SENSATIONAL VALUES
 at "GADGETEER'S HEAVEN" IN MANY ITEMS WE HAVE THE WORLD'S LARGEST SUPPLY

NEW HYDRAULIC Cylinders, Valves, Pumps, FITTINGS, HOSE & TANKS
 51 sizes & types.
The World's Largest Supply
 1001 Labor Saving Adaptations for pulling, pushing, lifting operations. Finest precision workmanship and materials. Liquid and/or air operation, developing terrific power.
20,000 Available
 PRICED TO SELL AT 15% GOVERNMENT COST!
 WRITE FOR CATALOGUE.



WINCH HOIST
 now equipped with mounting frame, handle, cable, etc. complete. Thousands of Satisfied Users! Hundreds have written, telling us it's the most wonderful tool in the world!
 Capacity 2500 lbs. 20-1 ratio
 Bronze Worm Gear
 Ideal for Garages, Truck loading, Machine Shops, Boat Builders, etc. \$14.59 ea.
 A few extra only stocks available to old customers at \$2.49 ea.



Pneumatic RIVET GUNS
 Pistol & Goose-neck Type
 #183
 #181 Pistol
 Chicago Pneumatic, Inc. Ingersoll Rand
 E3, E2, 3X, 2X, OY
 \$35 Value
\$8.95
PNEUMATIC ALLIGATOR SQUEEZER #186 \$30 Value
#188 \$15.95



CHECK VALVES
 METAL SEATS
 Standard Pipe Size 1/2" or 3/4"
 Usable with Air, Fuel, or Oil
 Can withstand back up pressure from 25 P. S. I. to 2000 P. S. I. #CVA 1/4" PIPE \$1.00 ea.
 #CVB - 1/2" PIPE \$1.25 ea.



Here's a Real "Life Special"
 Farm, Auto, New U. S. Navy Portable Pistol Grip. Sealed Beam, 12v. 24v. Search Spotter Emergency. Light - featherweight Gov. \$35.00 our price
3 Extra Filters - Red, Green & Amber \$2.95
93c Set Extra Seal Beam 95c ea.



Electric GYRO PILOT Assembly Part 2
 2 solenoids for reverse and forward motor control. 2 solenoids throw clutch to engage drive. With brake assembly. Can be used as boat rudder control. converted for lath tapping and slow speed motor tool. Wt. 29 lbs. Finest precision workmanship.
 Gov't. Cost \$1000
Your Cost \$8.95



AIR DRILLS
 CLECO ARO INGENSOL BRAND CHICAGO
PNEUMATIC 1/4" JCB Chuck
 Pistol \$12.95
 Anale Drill \$15.00



NEW PULMASON DUST RESPIRATORS
 Ideal for use where foreign materials foul air. Paint Spraying, Grinding, Dusting. 99c Sanding etc. - ea.



AIRFORCE GUNSIGHT
 #102 \$1.95
 #102 contains triple Lens. #103A N6A non-glare variable density Lens. plus other Lens. Valuable for Photo work \$3.55
 Lens in these sights are worth many times the entire cost of these items.



NEW AMPLIDYNE MOTOR GENERATOR
 With 24 volt current, it gives 80 watt output. This unit has been adapted to independent and rural lighting power. Welding and many other uses. Weight 28 lbs. Gov't. Cost Approximately \$237.00
A Steal at \$8.95



NEW FLEXIBLE GOOSENECK LAMP
 110 V. A. C. 13 ft. wire with socket switch and plug. In mounting bracket suitable for home or workshop. Wire alone worth our price of .99c each.



#505 COMPRESSOR
 Complete With Tank And Fittings. General Electric, 2 stage AC-DC. Rated pressure 1000 lbs. per sq. in. with 1/3 H.P. 27 volt, 7 AMP series wound motor, equipped with fan for cooling.
 Thousands now in use for spraying, inflating, laboratory use, etc. Can be adapted to 110 volt A. C. with transformers or 4 1000 heating elements. A tremendous value at approx. 5% of orig. cost Only \$17.95



#516 BATTERIES
NEW! FULL STRENGTH FOR PORTABLE RADIOS, SIGNAL LAMPS, BOATS, ELECTRIC TRAINS, ETC.
 #516 9 Volt 8 1/2 x 6 x 4 in. 3 run 24 or 27 Volt motor. 79c
 These batteries are especially suited to portable radios.
 #517 67 1/2 & 1 1/2 Volt Battery 69c
 #515 90 & 1 1/2 Volt 69c

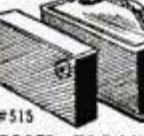

DC GENERATOR #G-1
 140 AMP Direct Current Generator, especially suited for adaptation to homemade welding unit.
A fast moving item at \$15.95



NEW PRESSURE TANKS
 Stainless steel - Shatter proof. Available in 2 different sizes. 1001 uses. G-1 12 1/2 x 24 inches - 3100 Cu. in. capacity \$4.75
 D-2 6 1/2 x 24 in. - 500 Cu. in. capacity \$2.49
 F-2 8 x 48 in. - 1000 Cu. in. capacity \$3.95
 - 14 cu. ft.
 Perfect portable air tank to carry in car or trailer. Ideal for painting, cooking, spraying, ocean buoy.



New Electric Motors
 1/6 H.P. 24 volt, D. C. series wound motor.
 #501 1/6 h. p. 24 V Series Wound New \$3.95
 #502 H.P. 24 V D. C. motor used \$9.95



VALUABLE GEARS BARGAINS!
 8 to 1 ratio, spindle drive #110 \$2.99
 8 to 1 with screw shaft #111 \$4.99
 85 to 1 (can be used for radio, antenna, etc.) #112 \$3.95
 #G-11 10-1 gear ratio \$3.95
 2 to 1 ratio 90° right angle #113 \$4.95
 10 tooth bevel steel boxed gear \$4.95
 113a 8 to 1 ratio 90° right angle \$4.95
 Flexible Gear Shafts With End Drives
 115 30" 69c ea.
 115a 60" 99c ea.
 Radio tuning shafts that can be used as Rex gear drives #115a 12 ft. 1/2" nut -15 tooth internal spline \$1.95 ea.
 #115b 25 ft. 1/2" nut 12 tooth with internal spline \$3.95
 #115c



Radio ANTENNA Reel
 Just the thing for tuning down antennas.
 Powered by 1 1/2 h. p. 24v. G. E. Motor. Removable 8" Red-Lined Switch - Can Warm gears, Rev. gear. Solenoid clutch.
 Motor engaged to gear reduction only when electrical contact made. Operates in either direction. Ideal for auxiliary power, auto-all, opening and closing doors, etc.
A TREMENDOUS VALUE \$4.95



OUR PALLEY SPECIAL ELECTRIC SOLDERING IRON
 110 Volt A. C. "SOLDER MASTER" \$8.50 Value **\$2.95** 200 Watts



PEXTO SIDE CUTTING PLIERS
 Breveted head, top joint. Size 8-9.0. Cuts wire, rolls strip, alloyed steel. Ideal for home, electrical, or shop use. A \$1.95 \$3.50 value for



HOBBYISTS! An Unequaled Value!
GADGET MIX
 Rivets, spacers, Clamps, bolts, nuts, Radio parts, gears, etc.
 A gold mine \$1.19

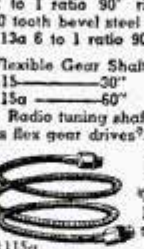

CLAMPS
 #120 Adel Aluminum, rubber lined. Mixed. #121 4 dozen 89c
 #122 Aero-Seal. Rust Resistant. Slotted with screw gear top. 1/2" to 7".
Regular 27c now 10c



FIRE EXTINGUISHER
 Kiddie Lux CO2 Type
 Push to Operate. 3 1/2 lb. trip. can. with 2000 psi. Fully recharged. 4 & 8 TYPE \$30.00 value #MIA \$11.75
 1 LB. CO2 TYPE \$22.50 value #402 \$8.75
 10 lb. Chgd. CO2 with horn. \$60.00 value #202 \$24.50
 15 lb. Chgd. CO2 with horn. \$80.00 Value #805 \$27.50
 indispensable for small or large planes, trucks, auto, home, factories.



All Purpose HAMMER
 As a hammer combination for wood & metal work. 2 1/2 lbs. 14 1/2" hardwood handle. Hard steel cutting edge. 69c
Compound METAL SNIPS
 Hard steel blades. Expansion spring. Locking device. Right Hand and New \$2.59 Left Hand



PERISCOPE M3 2 Power
 with small 3" telescope inside \$3.95 ea. Lenses in both \$2.02 P. Scopes worth more



SPRING MIX
 Torsion, compression and tension springs. Assorted sizes. #206
2 lbs. 89c
 A treasure chest for emergencies



Tank Telescope For Fun & Utility
 3 Power 3 1/2 in. wirebound telescope. Buy. com. 10" x 6".
 #201 T M-SAT \$4.95 ea.



BEARING MIX
 Needle, ball and roller bearings in excellent assortment. Sizes from 1/2" to 2".
 #170 Introducing this treasure chest assortment of 15 Bearings at \$2.95



PLASTIC PARALLEL STRAIGHT EDGE
 with knobs & rubber pads for non slippage on each section. A must for navigators, mechanics, draftsmen, Engineers... You've never seen 'em at 97c ea.



AIRCRAFT CABLE
 Alloyed steel, rust resistant, 3/16" dia 21 ft. long, with turnbuckle ends. 99c
 On reels in any length ea.
 2/32 4c Ft. 3/16 4c Ft.
 1/8 4c Ft. 5/32 4c Ft.
 3/32 4c Ft.

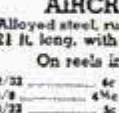

RUBBER GOODS
 NEOPRENE SNEEY RUBBER
 Thick. Approx. Price per sq. yd.
 #323 .015" 1/64 36" .60
 #325 .020" 1/64 36" .75
 #326 .037" 1/32 36" 1.00
 #327 .064" 1/16 36" 1.75
 #328 .175" 3/16 42" 6.00

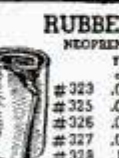

ORDER DIRECT FROM THIS AD
 FREE - LARGE ILLUSTRATED CATALOGUE

All sales final. Make remittances by money-order, bank draft or personal check. Purchase orders acceptable from D & B firms. All quotations F. O. B. Los Angeles. Send 1/3 deposit with C. O. D. orders. Also Complete Aircraft Supplies

PALLEY SUPPLY CO. THE LARGEST FIRM OF ITS TYPE IN THE WORLD DEPT. P. M. 28 - 6321 SAN FERNANDO RD. GLENDALE 1, CALIFORNIA

NEW!

SOUTH BEND 14" Drill Press

South Bend presents this new 14" Drill Press as a companion to the South Bend Precision Lathe. It is built with the same high standards of accuracy and skilled workmanship. Years of painstaking research and experimentation have gone into its designing. This has resulted in a superior tool that is unsurpassed for accuracy, ease of operation, versatility and dependable performance.

FEATURES and SPECIFICATIONS

BELT TENSION RELEASE

Quick-acting belt tension release lever simplifies speed changes. Keeps tension correct.

BUILT-IN LIGHT

Provides shielded illumination for work area. Separate on-off switch.

SPINDLE

Free-floating design prevents misalignment, side thrust, and whip. Travel 4"

BALL BEARINGS

Sealed, precision type. No oiling. 2 on spindle drive unit, 2 on spindle.

QUILL BEARING ADJUSTMENT

Compensates for wear.

DEPTH GAUGE

Graduated in inches. Adjustable collars control feed and return.

RUGGEDLY CONSTRUCTED

Precision-built for industrial and all other types of shops.

TWO MODELS

Bench or floor type.

CAPACITY

Maximum drill size in iron or steel $\frac{3}{16}$ "
Drills to center of 14" circle.

CHUCK

Capacity 0 to $\frac{1}{2}$ "

SPEEDS

Four—707 to 4322 r.p.m.

CHUCK TO BASE DISTANCE

Bench Model . . . 17"
Floor Model . . . 46 $\frac{1}{2}$ "

TABLE SIZE

10" x 10" . . . Tilt Type

COLUMN

2 $\frac{3}{4}$ " diameter. Accurately ground.

HEIGHT

Bench Model . . . 35 $\frac{1}{2}$ "
Floor Model . . . 65 $\frac{1}{2}$ "

SHIPPING WEIGHT

Bench Model . 195 lbs.
Floor Model . 235 lbs.

MOTOR REQUIRED—

$\frac{1}{2}$ h.p., 1725 r.p.m. Vertical mounting. On-off switch provided.

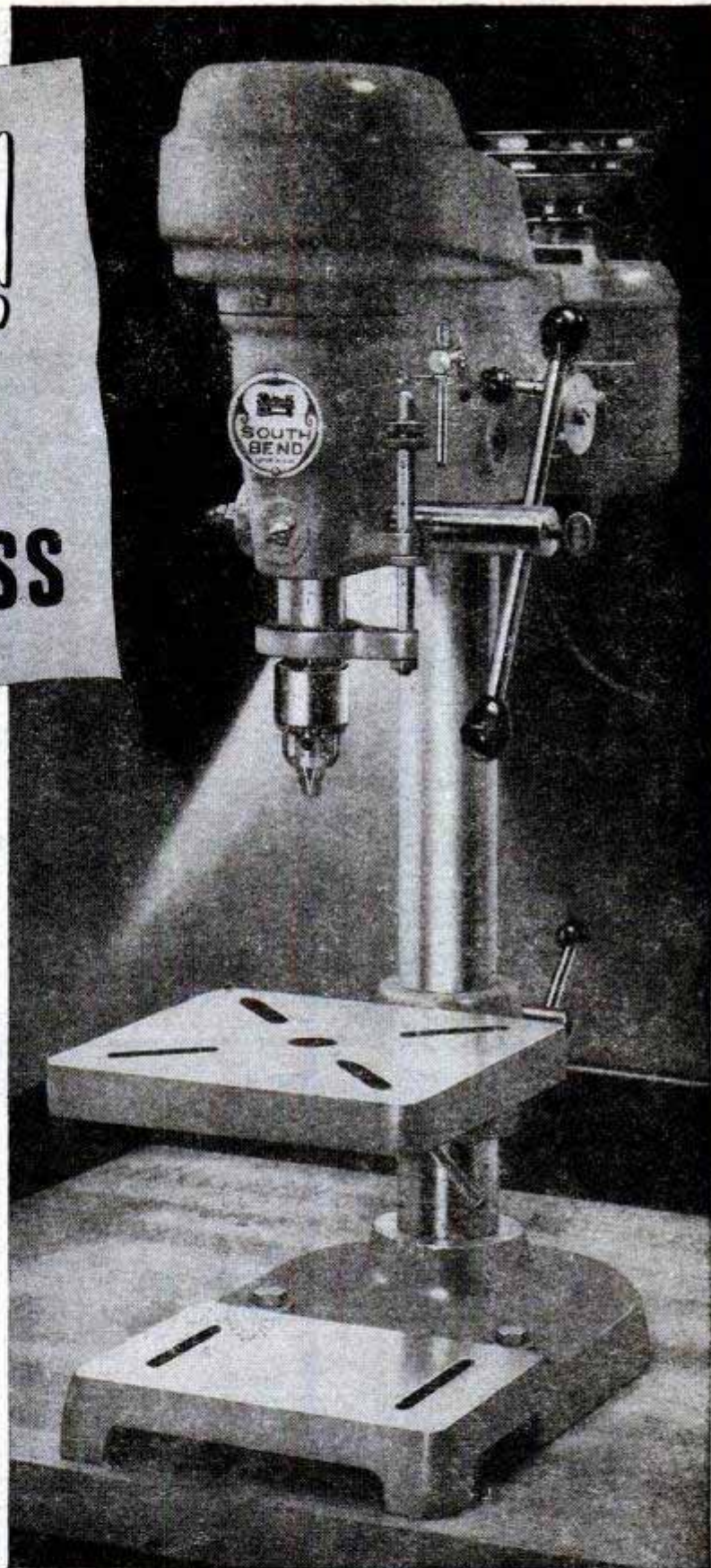

\$98⁰⁰ f.o.b. factory, with chuck, extension cord and switch; less motor.



SOUTH BEND LATHE WORKS

BUILDING BETTER LATHES SINCE 1906 • 455 E. MADISON ST., SOUTH BEND 22, IND.

Printed by Popular Mechanics Company, Chicago, Ill., U. S. A.

**SEALED
POWER
PISTON
RINGS**



**FRANCHISED
DEALER**



**EXPERT
ENGINE SERVICE**



"SURE I CAN GIVE YOUR ENGINE

THAT 'NEW-CAR FEEL' AGAIN!"

You can thrill to that "new-car feel" again! That same surge of pulsing power that gave you such a lift when your engine was new! Your Sealed Power Franchised Dealer knows how to make your old engine new again. See him today!

Your Sealed Power Franchised Dealer has a set of Sealed Power Piston Rings specifically engineered to do the best possible job in your engine, whatever the make, model, or cylinder wear condition. When he gets through installing those rings you'll thrill to that "new-car feel" again. And

Your Sealed Power Franchised Dealer also handles Sealed Power Pistons, Cylinder Sleeves, Valves, Water Pumps and Chassis Parts

you will get a lot more mileage on gas and oil, too!

Your Sealed Power Franchised Dealer uses Sealed Power Piston Rings because he knows they are the best piston rings made, the choice of leading engine builders for 37 years. Sealed Power Ring Sets include the famous MD-50 Steel Oil Ring—THE ONLY RING WITH THE FULL-FLOW SPRING.

Send a postal for illustrated, informative new booklet on 7 ways to save oil. It's free and may save you real money. Sealed Power Corporation, Dept. G2, Muskegon, Michigan. In Canada: Stratford, Ontario.

Sealed Power
PISTON RINGS

BEST IN NEW CARS!

BEST IN OLD CARS!

Experience
is the best
teacher!



HOCKEY STAR

CAL GARDNER
says —

Experience? New York
Ranger Cal Gardner has
15 years of hockey behind
him, including two
years with the junior
champions
of the world.

I'VE SMOKED MANY
DIFFERENT BRANDS...
AND COMPARED. **CAMELS**
ARE THE **CHOICE**
OF **EXPERIENCE**
WITH ME!

Let your "T-Zone" tell you why...

More people are smoking
CAMELS than ever before!



Your "T-Zone"
Taste...Throat

...that's your final proving
ground for any
cigarette.
Try Camels.
See if Camels
don't suit your
"T-Zone"
to a "T."

● You'll read about it . . . hear about it . . . you'll see it for yourself—In sports, in business, in homes all over America, smoker after smoker who has tried and compared different brands during the wartime cigarette shortage has found Camels the "choice of experience"!

Why? Hockey Star Cal Gardner says, "Of all the brands I tried, Camels suit my 'T-Zone' best!" And that's where you'll find the answer—in your "T-Zone."

R. J. Reynolds Tobacco Co.
Winston-Salem, N. C.

According to a Nationwide survey:

MORE DOCTORS SMOKE CAMELS
THAN ANY OTHER CIGARETTE

When 113,597 doctors were asked by three independent research organizations to name the cigarette they smoked, more doctors named Camel than any other brand!