

ANC



POPULAR MECHANICS

MAGAZINE

WRITTEN BY YOU CAN UNDER

REG. TRADE MARK GREAT BRITAIN No. 40426

REG. U.S. PAT. OFF.



With a Price
SEE PAGE 88

Dependable

CHAMPION

America's Favorite Spark Plug

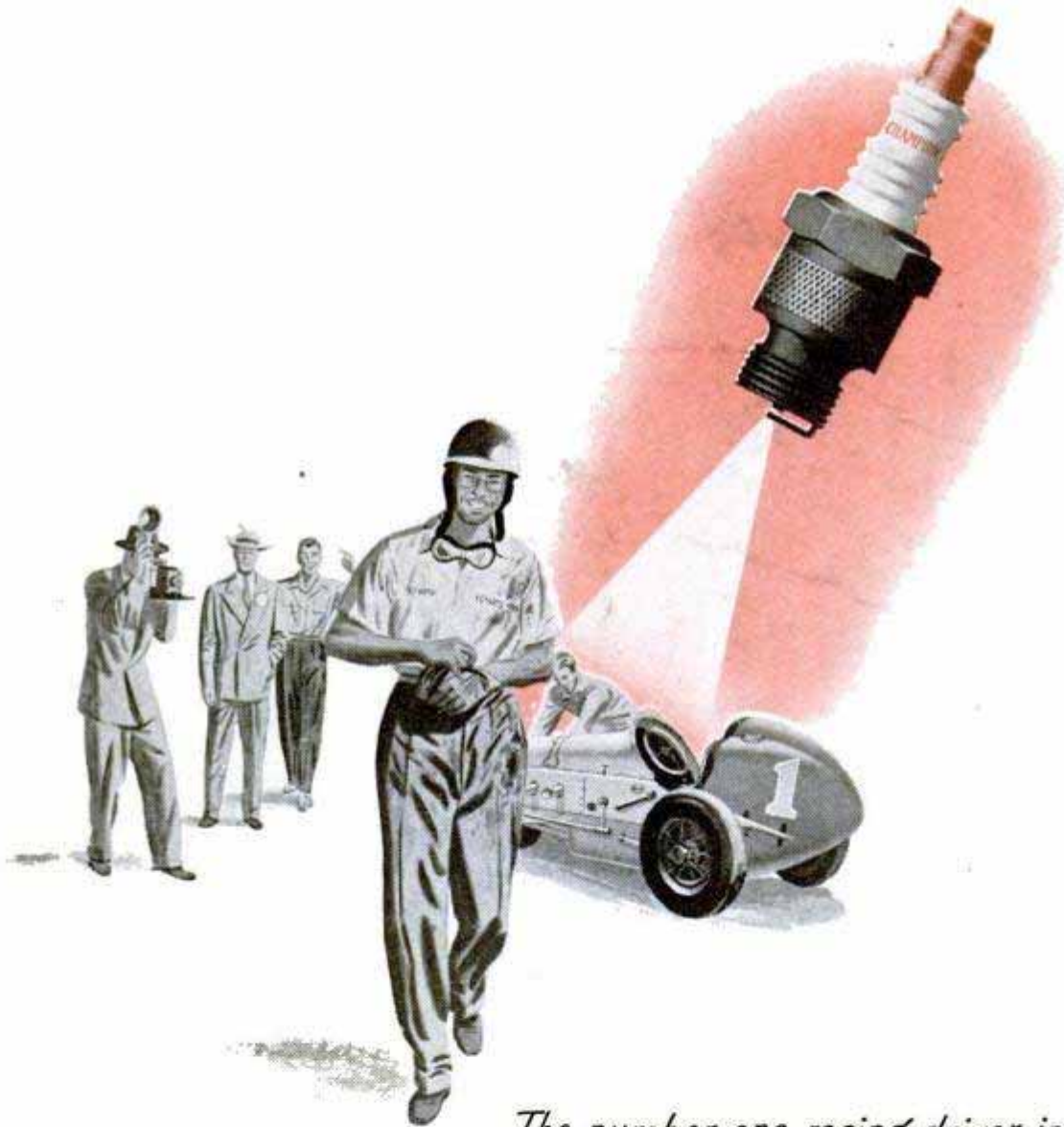

FOLLOW THE EXPERTS
DEMAND NEW DEPENDABLE
CHAMPIONS FOR YOUR CAR

*The number one racing driver in 1947—
as in 1946—used the number one spark plug
of the nation to win both crowns. Both
are true Champions—Ted Horn, national
AAA champion, and Champion Spark Plugs.*

CHAMPION SPARK PLUG COMPANY, TOLEDO 1, OHIO

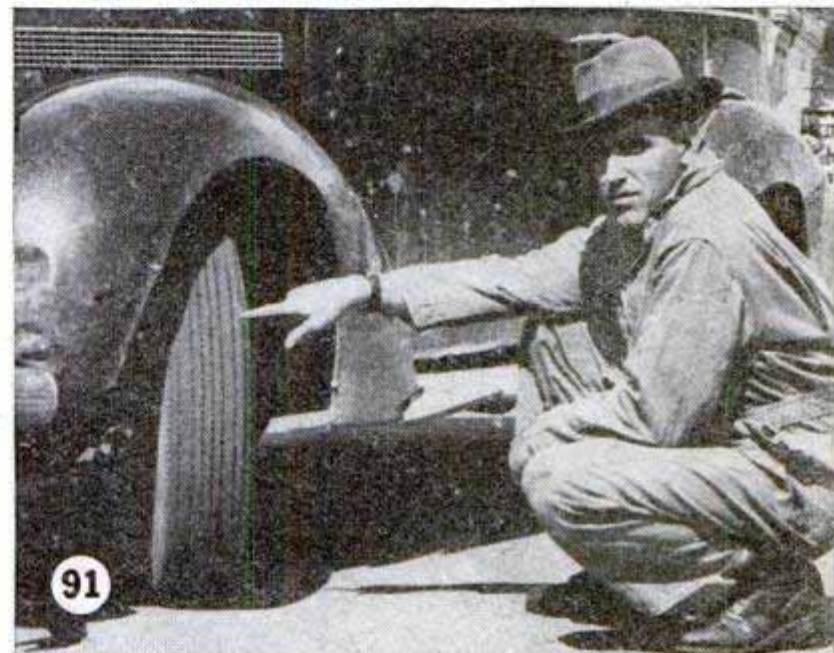

Typical examples: the B. F. Goodrich tire that outwears prewar tires

B. F. GOODRICH tires outwear prewar tires. This is backed by the personal experience of B. F. Goodrich owners. Here are three recent reports:

Typical example No. 82: "Outlasted any prewar tires." Pictured at left is Henry D. Anderson of Seattle, Washington, with B. F. Goodrich dealer Hugo Andiesen, Jr. Henry D. Anderson writes:

"I appreciate good tire mileage. It is one of the essential things when it comes to keeping costs down on my car. This B. F. Goodrich Silvertown tire which I am finally replacing had gone 43,275 miles (at the time of the picture). These were hard miles, ranging from driving on desert roads to the heavy pounding of

mountain truck trails. And since this car is used for fire and police work, much of this mileage was put on at high speeds and in all kinds of weather."

Typical example No. 91: "Never experienced better service from any tire." Shown here is H. F. Smith of Rt. No. 1, Unicoi, Tenn., who says:

"Half of my driving is over rock roads, the other half is on hard surface that has quite a lot of chuck holes in it. These B. F. Goodrich tires have not been petted, but have been subjected to 30,593 miles of rather rough treatment. In all my experience I have never received better service from any tire."

Typical example No. 88: "49,723

miles and still good!" P. U. Alexander of Goose Creek, Texas, shown in the photo at the top, states:

"I purchased two new B. F. Goodrich Silvertown tires in 1945. These tires had gone 49,723 miles when the picture was taken, and I believe they are good for another 10,000 miles."

This is a good time to buy tires. Your B. F. Goodrich dealer will give you a liberal allowance for your old tires if they are still good enough to be used or recapped. *The B. F. Goodrich Company, Akron, Ohio.*

B.F. Goodrich
FIRST IN RUBBER

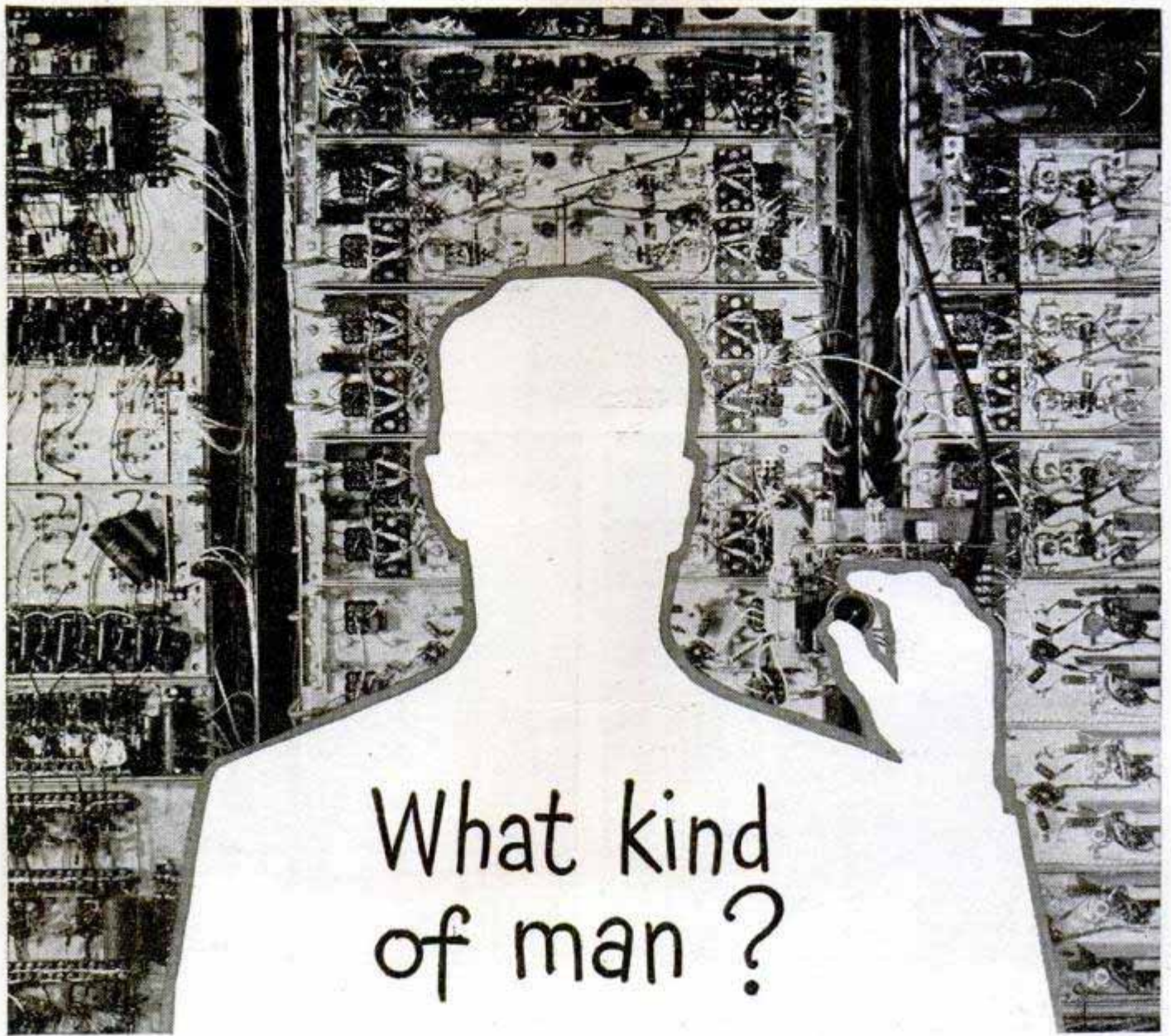

What kind of man ?

WHAT KIND of men are the 2,300 scientists and engineers of Bell Telephone Laboratories?

Men of many types, working in different fields of research, may contribute to each development.

But all have certain characteristics in common: Good minds as a foundation, many years of learning in the fundamentals of their science and the methods of research, and a co-operative attitude — for without co-operation of individuals these products of research could never be produced.

Above all else, however, they have “the spirit to adventure, the wit to question, and the wisdom to accept and use.”

That kind of men can produce the finest telephone equipment in the world — and have done so.



BELL TELEPHONE LABORATORIES EXPLORING AND INVENTING, DEVISING
AND PERFECTING FOR CONTINUED IMPROVEMENTS AND ECONOMIES IN TELEPHONE SERVICE

Popular Mechanics Magazine

Registered in U. S. Patent Office and Canada

H. H. WINDSOR, Founder

H. H. WINDSOR, Jr., Editor and Publisher

YOUR HOME is an endless procession of problems. A faucet leaks. The window sash is stuck fast. An old crack in the ceiling is causing trouble again. There's always something! So to your rescue—we come with the Clinic for Homemakers, a question-and-answer column starting this month on page 204. Whenever a home repair problem confronts you, write the Clinic Editor for help; whether or not your question is answered in the monthly column, you will be answered by mail with expert advice.

ROY SHIPSTAD, famous skater, tells how to "Cut a Figure on Ice" in the February issue.

HOW-to-build-it features in the Craftsman section next month include a folding table-and-chair set for young tea-party hostesses and chests for coin collectors.

WHILE "Digging Into Mexico's Past" for the article appearing on page 130, Andy Hamilton propped himself against an ancient ruin to dig into *Mecanica Popular*, our Spanish language edition. Our

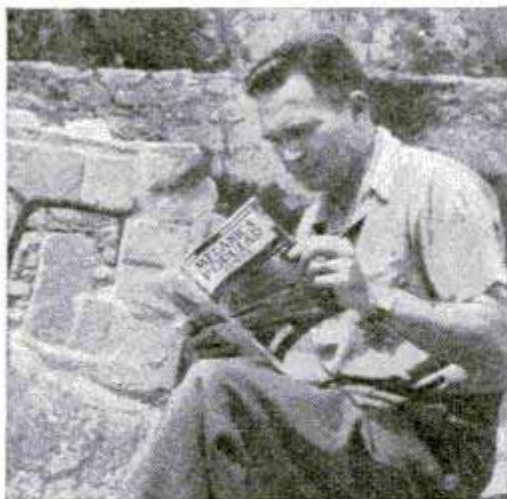

spy, armed with a camera, caught him in his siesta. Hamilton is a frequent contributor to our editorial pages, was a lieutenant commander on Admiral Nimitz' public relations staff, is now Director of Public Information at UCLA.

Volume 89 JANUARY 1948 Number 1

Managing Editor.....Roderick M. Grant
Assistant Managing Editor.....Wayne Whittaker
Shop Notes and Crafts Editor.....James R. Ward
Radio and Electronics Editor.....Frank L. Brittin
Aviation Editor.....Aubrey O. Cookman, Jr.
Associate Editor.....Clifford B. Hicks
Eastern Editor.....Bill Reiche
Western Editor.....Thomas E. Stimson, Jr.
Art Director.....Frank Beatty

Assistant Editors

Donald R. Brooks Charles D. Emerson Arthur R. Railton

Assistant Editors, Shop Notes and Crafts

W.Clyde Lammey Wayne C.Leckey Frank N.Stephany A.E.Youngquist

In This Issue

The "Coax" Has Nerves	81
Skiers Awaken a Bonanza Town	88
Jungle Home on Wheels	101
Sandfighters of the Columbia	106
Needle-Nose Rocket Plane	114
New Methods In Old Mines	118
200 Tons—and It Flies	124
Digging Into Mexico's Past	130
Time From the Stars	138
There's Money in Honey	145
Uncle Sam Looks Into Housing	156
Hints From a Hollywood "Pro"	164

For the Craftsman

Plastic Lamps	170
"Jeepers"—a Sidewalk Jeep	178
Make Weaving Your Hobby	188
Sound Effects for Home Recordings	194
Apartment Darkroom	200
How to Service Fluorescent Lamps	210
Radio and Electronics	221

Table of Contents Continued on Page 8

Published monthly by POPULAR MECHANICS COMPANY, 200 East Ontario Street, Chicago 11, Ill. H. H. Windsor, Jr., president; Paul H. Dunakin, vice president and general manager; D. F. Windsor, vice president and secretary-treasurer; William Harrison Petridge, vice president and assistant to the publisher; Clover L. Perkins, advertising manager; Alan M. Deyoe, circulation manager. Single copy in the United States and Canada, 25 cents; subscription rates in United States and possessions, Canada, Philippines and countries of the Pan-American Postal Union, 1 year, \$2.50; 2 years, \$4.50; 3 years, \$6.00. To all other countries add \$1.00 a year over United States prices for overseas postage. If you plan to move, notify us at least 30 days in advance so you will not miss an issue. Give both old and new addresses. Entered as Second Class Matter, September 15, 1903, at the Post Office at Chicago, Illinois, under Act of March 3, 1879. Entered as Second Class Matter at Post Office Dept., Canada. Copyright 1948 by Popular Mechanics Company. Copyright under International Copyright Union. Copyright in France. All rights reserved under Pan-American Copyright Union. Printed in the United States of America.

**A MUST FOR EVERY FARM FAMILY!
SAVES MONEY FOR HOME OWNERS
A PRICELESS GIFT TO SEND TO
A FAMILY ON THE FARM!**

POPULAR MECHANICS

FARM MANUAL

**Farm Help That Works
Every Day in the
Year For
Only \$3**

*A Thousand and
One Ideas You Can
Use on the Farm!*

Popular Mechanics Farm Manual is packed with practical ideas and usable information that can easily be worth hundreds of dollars to every farm family and to home owners everywhere. Here are a few of the things it covers:

Farm Machinery and Implements

How to make tractors, scoops, scrapers, cordwood saws, buckrake, power driven elevator, "Farm-ette" — odd job tractor, hoists, dump trucks, spreaders, seed-grain duster, posthole auger, etc.

Farm Workshop Equipment and Repairs

Welding on the farm, soldering, workshop power saws, home built air compressor, small shop forge, workbenches, curing gas engine troubles, hydraulic rams, drive your own wells, etc.

Poultry and Livestock

How to build poultry houses, incubators, brooders, at low cost, feeding, stock care hints, hog care gadgets, etc.

Vegetable Storage — Processing

All-winter vegetable storage, preparing food for home-freezer storage, how to make your own home freezer, charts, guides.

Farm Home Improvement

Fencing, repairing electrical appliances, plumbing, electrical wiring, saving coal, painting, curing leaky basements, hanging wall paper, making garden tools, garages, working with concrete, painting, etc.

Farm Hints and Kinks

Forty pages of illustrated practical ideas, short cuts, etc., that will save time, labor and money around every farm and city home.

POULTRY HOUSES You Can Build



Keep Your Tractor Rolling

MECHANICAL "Hired Man"

Special help with the mechanical problems of the farm. Includes: How to make a tractor, how to make a power driven elevator, how to make a seed-grain duster, etc.

INCUBATORS you can make

How to make a power driven elevator, how to make a seed-grain duster, etc.

Farm Dump Truck Snow-Shedding Off Load



Storing Vegetables for Winter



**Use This Book to Step up Farm Efficiency—
Increase Farm Production—Improve Farm
Appearance—Save Time, Labor, Money!**

This is the book that thousands of farmers and home owners have waited for. It is the experience of hundreds of successful operators brought together in one handy, easy-to-read, easy-to-use, working handbook by the editors of Popular Mechanics. It is brimful of short cuts, labor-saving ideas, ingenious apparatus and methods that will simplify the day's work and lighten some of the more tedious chores, make money and save money for you.

**284 FACT
PACKED PAGES
•
HUNDREDS OF
ILLUSTRATIONS
•
FULL SIZE
Library Binding**

HELPS IN THE FIELD — IN THE BARN — IN THE HOME

Every department of the farm is covered in the Farm Manual. Every member of the family will find in it something that he or she can use to tremendous advantage in farm operation, maintenance and improvement, from the building and care of equipment to painting the farm home and fast freezing fruits and vegetables. It covers all farm buildings, the farmhouse and other homes and is of interest equally to the woman looking for home improvement, beauty and convenience and the man striving for easier and more profitable operation.

ORDER TODAY — FOR YOURSELF — FOR A GIFT

Use the coupon below. Mail it today. Book will be sent at once, postpaid if you include payment with your order. If you don't think the Farm Manual is worth even more than you paid for it after three days' use, send it back by mail and your money will be refunded. This may be the best investment you ever made. Rush coupon today.

MAIL COUPON • Money Back if Not Satisfied

Popular Mechanics Press, Dept. 655
200 East Ontario St., Chicago 11, Ill.

Send _____ copies of the Farm Manual at once.
 Remittance (\$3.00 each) enclosed. Send postpaid.
 Send C.O.D. (\$3.00 each) plus delivery charges.
(If sent as a gift to another, send name and address on separate sheet.)

Name _____

Address _____

City _____ Zone or Route _____ State _____

Now

YOU CAN HAVE IMPROVED NO-DRIFT FM in the Sensational New 1948 **FM** **MIDWEST RADIOS**

NEW SERIES
16*
SUPER DELUXE
AM-FM
CHASSIS

Here is the finest radio Midwest has ever produced in its 28 years of manufacturing—a world-ranging, 5-band radio with improved Midwest No-Drift FM . . . plus Standard Broadcast and 3 short wave bands, Television Audio Switch-over, and Color-Ray Tone Selection. The Series 16* Super De Luxe Chassis is a powerful, magnificently-toned radio that challenges comparison for performance, sensitivity, selectivity, and advanced engineering features. Supplied with satin stripe copper finish panel—ready to mount in your present cabinet. Send today for the FREE 1948 Midwest Radio Catalog. Buy your radio direct from the manufacturer on Easy Terms and 30 Days Trial and SAVE!



14 1/2"
PANASONIC
SPEAKER

5
WAVE
BANDS

*Series 16
CHASSIS USES ALL THESE
LATEST TYPE TUBES,
RECTIFIER AND TUNING INDICATOR

30
DAYS
TRIAL

LOW
FACTORY-
TO-YOU
PRICES

EASY
TERMS

A COMPLETE LINE OF FINE RADIOS AND RADIO-PHONOGRAPHS . . . Available in Separate Chassis Like the Powerful Series 16* AM-FM Model above, or in beautiful Radio-Phonograph Consoles like this:

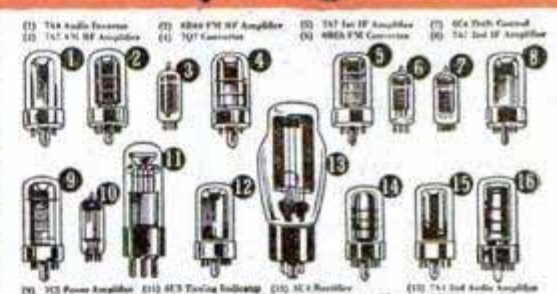

Scores of NEW Features such as the Exclusive MIDWEST TRI-MAGNADYNE COIL SYSTEM and COLOR-RAY TONE SELECTION



SYMPHONY GRAND AM-FM **RADIO-PHONOGRAPH CONSOLE** with NEW Intermix **AUTOMATIC** **RECORD CHANGER**

Our Finest! A superbly beautiful musical instrument . . . a masterpiece of furniture design and radio engineering that offers the sensational Midwest NO-DRIFT FM, Automatic Intermix Record-Changer, Exclusive Color-Ray Tone Selection, World-ranging 5-Band Reception, Television Audio Switch-Over, and many more new and exclusive features.

Rush for Free Catalog!
FILL IN COUPON AND MAIL TODAY OR JUST
SEND YOUR NAME AND ADDRESS ON 1c POSTCARD

MIDWEST RADIO CORP.
Dept. 25-S, 909 Broadway
Cincinnati 2, Ohio

Gentlemen: Please send me your new FREE catalog and details of your liberal 30 Days Trial.

Name _____
Address _____
City _____ Zone _____ State _____

MIDWEST RADIO CORP.
Dept. 25-S • 909 BROADWAY • CINCINNATI 2, OHIO



THE GREATEST
POWER ON
EARTH!

The Magic of Mind

WERE the great personages of the past victims of a stupendous hoax? Could such eminent men of the ancient world as Socrates, Pericles, and Alexander the Great have been deluded and cast under the spell of witchcraft—or did the oracles whom they consulted actually possess a *mysterious faculty of foresight*? That *the human mind can truly exert an influence over things and conditions* was not a credulous belief of the ancients, but a known and demonstrable fact to them. That there exists a wealth of infinite knowledge just beyond the border of our daily thoughts, which can be aroused and commanded at will, was not a fantasy of these sages of antiquity, but a dependable aid to which they turned in time of need.

It is time you realized that the rites, rituals and practices of the ancients were not superstitions, but subterfuges to conceal the marvelous workings of natural law from those who would have misused them. Telepathy, projection of thought, the materializing of ideas into helpful realities, are no longer thought by intelligent persons to be impossible practices, but instead, *demonstrable sciences*, by which a greater life of happiness may be had.

One of America's foremost psychologists and university instructors, says of his experiments with thought transference and the powers of mind—"The successes were much too numerous to be merely

lucky hits and one can see no way for guessing to have accounted for the results." *Have you that open-minded attitude of today which warrants a clear, positive revelation of the facts of mind which intolerance and bigotry have suppressed for years? Advance with the times; learn the truth about your inherited powers.*

Let this free book explain

The Rosicrucians (NOT a religious organization) have been leaders in introducing the ancient wisdom of mental phenomena. Established throughout the world for centuries, they have for ages expounded these truths to those thinking men and women who sought to make the utmost of their natural faculties. Use the coupon below—avail yourself of a pleasing book of interesting information which explains how you may acquire this most *unusual and helpful knowledge*.

The ROSICRUCIANS (AMORC)

USE THIS COUPON

Scribe K. T. S.
The Rosicrucians, AMORC,
San Jose, California.

I am sincerely interested in knowing more about this unseen, vital power which can be used in acquiring the fullness and happiness of life. Please send me, without cost, the book, "THE MASTERY OF LIFE," which tells me how to receive this information.

Name _____

Address _____

State _____



To the man who wants to enjoy
an ACCOUNTANT'S CAREER



IF you're that man, here's something that will interest you.

Not a magic formula—not a get-rich-quick scheme—but something more substantial, more practical.

Of course, you need something more than just the desire to be an accountant. You've got to pay the price—be willing to study earnestly, thoroughly.

Still, wouldn't it be worth your while to sacrifice some of your leisure in favor of interesting home study—over a comparatively brief period in your life? Always provided that the rewards were good—a salary of \$3,000 to \$10,000?

An accountant's duties are interesting, varied and of real worth to his employers. He has *standing*!

Do you feel that such things aren't for you? Well, don't be too sure. Very possibly they *can* be!

Why not, like so many before you, investigate LaSalle's modern Problem Method of training for an accountancy position?

Just suppose you were permitted to work in a large accounting house under the personal supervision of an expert accountant. Suppose, with his aid, you studied accounting principles and solved problems day by day—easy ones at first—then the more difficult ones. If you could do this—and if you could turn to him for advice as the problems became complex—soon you'd master them all.

That's the training you follow in principle under the LaSalle Problem Method.

You cover accountancy from the basic Principles right up through Accountancy Systems and Income Tax Procedure. Then you add C. P. A. Training and prepare for the C. P. A. examinations.

As you go along, you absorb the principles of Auditing, Cost Accounting, Business Law, Statistical Control, Organization, Management and Finance.

Your progress is as speedy as you care to make it—depending on your own eagerness to learn and the time you spend in study.

Will recognition come? The only answer, as you know, is that success *does* come to the man who is really *trained*. It's possible your employers will notice your improvement in a very few weeks or months. Indeed, many LaSalle graduates have paid for their training—with increased earnings—before they have completed it! For accountants, who are trained in organization and management, are the executives of the future.

Write For This Free Book

For your own good, don't put off investigation of *all* the facts. Write for our free 48-page book, "Accountancy, The Profession That Pays." It'll prove that accountancy offers brilliant futures to those who aren't afraid of serious home study. Send us the coupon *now*.

Over 2300 Certified
 Public Accountants among
 LaSalle alumni

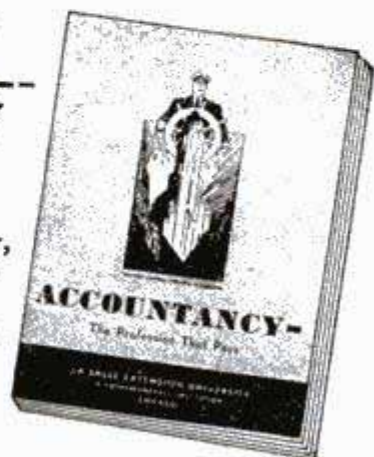

LASALLE EXTENSION UNIVERSITY

A CORRESPONDENCE INSTITUTION

417 South Dearborn Street, Dept. 164-H

Chicago 5, Illinois

I want to be an accountant. Send me, without cost or obligation, the 48-page book, "Accountancy, The Profession That Pays," and full information about your accountancy training program.

Name.....

Address..... City.....

Position..... Age.....

This one



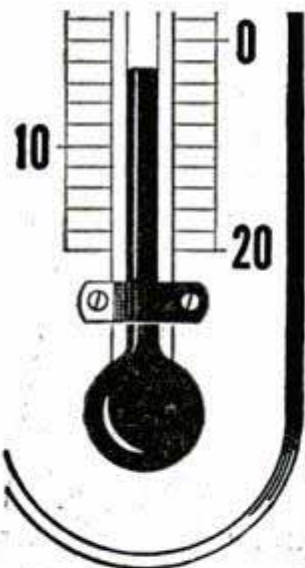

This is PYROIL WEATHER

This is PYROIL weather. When the thermometer goes down, your car is subjected to a new series of threats. Slow starts are not merely annoying. They drain the battery and, even worse, with dry cylinder walls, it means extra wear. Pyroil gives all the property of clinging to cylinder walls—it prevents "dry starts"—it prevents wear and battery drain. Ask your gas station attendant to add Pyroil — and add miles to your car.



Pyroil for Aircraft Engines

Use Aircraft Pyroil B for lubricating oil, Aircraft Pyroil A for gasoline.

Manufactured and Guaranteed by Pyroil Company,
75 Pyroil Bldg., La Crosse, Wisconsin

Canadian Distributors:
Central Purchasing Agencies, Ltd., Toronto, Ontario

PYROIL COMPANY

75 Pyroil Bldg., La Crosse, Wisconsin

I want my car to last and run properly. Please tell me more about Pyroil and how it can accomplish this for me.

Name _____

Address _____

City or Town _____

State _____



TABLE OF CONTENTS (Continued)

AUTOMOTIVE

Auto sunshades of plastic.....	94
Three-wheel Davis car.....	111
Pedal car is kept in house.....	137
Plastic top for convertibles is transparent.....	142
Rubber "chains" protect tire.....	150
Twin light beams align wheels.....	163

AVIATION

Electronic guide widens air lanes.....	93
Rotors test-flown on spinning tower.....	94
Huge howitzer and jeep parachuted from plane.....	96
Transport's four engines turn just two propellers.....	100
Air Force's swept-wing jet fighter gets tactical tests.....	100
Button in plane turns on runway lights.....	105
Four-foot metal bar used to tow gliders and jet fighters.....	112
Mask trips pilot ejector.....	137
Movie close-ups shot from helicopter.....	143
Speed of 7000 m.p.h. simulated in tests.....	151
Aerocar's high wing affords better view.....	151

BOATS

Boat speedometer registers knots and miles per hour.....	112
One-man "yacht" has outriggers.....	117
Battlewagon decks of pressed wood.....	122
Britain's first weather ship.....	136
Reflecting buoys.....	167

FARM

Radioactive vegetable seeds have larger yield.....	112
Merry-go-round mailbox.....	144
Spiral grain loader.....	163

HOUSE AND HOME

No more burned fingers.....	117
"Spray gun" jeep pumps bug-killing fog through building.....	142
What's new for your home.....	152
Paint-can lip prevents spilling.....	154
Fibers can't pull out of brush.....	154
Clip holds window open.....	162

INDUSTRY

Flaming hoop heats steel for welding operation.....	87
Model power plant for atomic energy.....	94
Industrial microscope.....	95
Giant press brake.....	96
Boiler gets 25 percent more heat from coal.....	104
Stand-by engine has robot controls.....	122
Telescoping lift truck.....	123
Bureau of Mines seeks way to ship lignite safely.....	123
Protruding "bustle" pipe encircles blast furnace.....	129
Dried almond hulls used to make syrup.....	142
Telephone cable spools are "shoes" for canal craft.....	144
Interlocking cargo containers.....	144
Mobile camera hoist.....	149
Steel bar at white heat punches hole in water.....	151
Refinery by-product becomes inexpensive refrigerant.....	155
"Traveling" forms speed canal work.....	161
Giant machine washes 16,800 bottles an hour.....	162
Sugar cane yields valuable wax.....	162
Water stream separates impurities from coal.....	168

OUTDOOR RECREATION

"Water polo"—firemen's version.....	111
Caddy cart measures drives.....	122
Plastic skis.....	154
Grip for putter guides hands.....	161

PHOTOGRAPHY

Contact printer kit.....	95
Periscope camera.....	123
Cut-film tank prevents sagging.....	154
Spin-drying speeds production of photo crystals.....	155
Math speeds tests of photo solutions.....	161
Dolly for movie cameras has four-wheel steering.....	163

RADIO AND ELECTRICAL

Television eye focuses on test of rocket motor.....	113
Hearing-aid selector.....	117
Detector "hears" leaking water.....	143
Midjet radio worn on wrist sends and receives broadcasts.....	143
Spotlight throws ultraviolet beam.....	150
Radar aids war on disease.....	168

TOOLS

Bricklaying speed is increased with metal guide.....	95
Welder's hammer has flexible head.....	105
Speed-up scaffold.....	136
Electric knife sharpener.....	137
Drill spins brush clean.....	149
Jack for laying floors.....	150
Brush guard keeps paint off glass.....	150

TOYS AND NOVELTIES

Tricycle control rod.....	123
"Pop bottle" racers hit 131 m.p.h.....	129
Cigarette lighter worn on wrist.....	137
Pastry tube decorates art objects.....	149
"Flyweight" steam engine.....	151
No more ricochets with bullet trap.....	155
Recordings on redwood.....	167

MISCELLANEOUS

Plastics invade the arts.....	86
Knee-action for trailer supports 1500 pounds.....	87
Plane minus wings becomes diner.....	87
Test your science I.Q.....	97
"Flip" pad folds up old memos.....	104
Here's a slow way to fill a glass.....	104
Shoe-shine delivery service.....	117
Self-threading needle.....	154
Dye detects cancer tissue.....	167
Firemen burn "tenement" in safety demonstration.....	167
Eye-glass cleaner in "lipstick" case.....	168

(Continued to page 10)

It's complete!

It's practical!

It's up-to-date!

the new **I.C.S. COURSE** in **RADIO SERVICING**

Build this 6-tube, two-band, AC/DC, superheterodyne receiver. Put it through various tests and analyses used in modern radio service shops. Learn by study! Learn by doing!

HERE IT IS! A Radio Servicing course that is complete, thorough, extremely practical. This is the training for the man who wants a good job in radio — or a profitable radio service business of his own.

It's new! It's up-to-the-minute! Texts and job sheets cover all the equipment you are likely to meet in practice, including facsimile, television and FM.

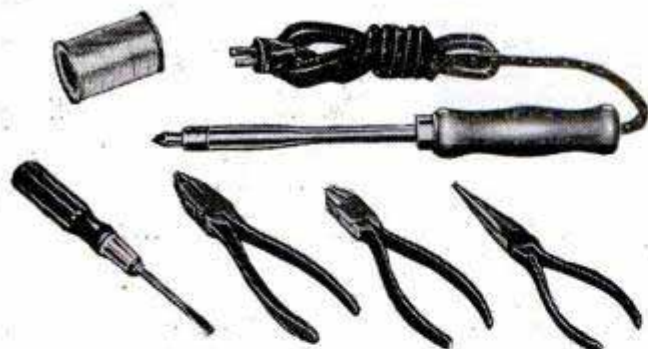

You get this set of professional-quality tools early in the course. Illustrated instruction sheets show you how to use them correctly.

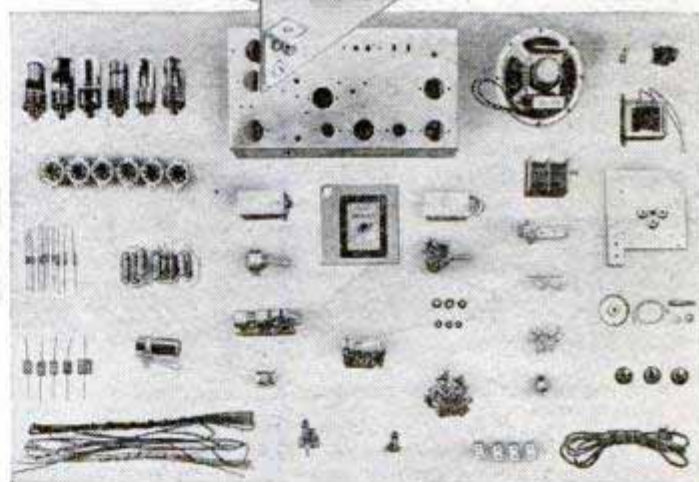
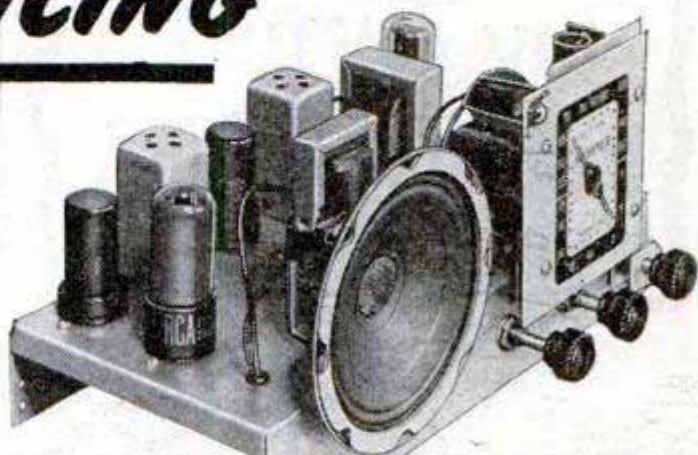

A complete kit of high-quality, standard-brand, matched radio parts is supplied with the course. Assignments cover assembly, wiring, soldering and testing.

Success-proved I. C. S. training methods — combined with the finest training equipment available — make this course an outstanding training opportunity. Find out more about it. Mail the coupon **TODAY**.



INTERNATIONAL CORRESPONDENCE SCHOOLS, Box 5619-K, Scranton 9, Pa.

Without cost or obligation please send me full information on the courses before which I have marked X.

RADIO SERVICING (with training equipment)

- | | |
|--|--|
| <input type="checkbox"/> Radio, General | <input type="checkbox"/> Electrical Engineering |
| <input type="checkbox"/> Radio, Operating | <input type="checkbox"/> Lighting Technician |
| <input type="checkbox"/> Electronics | <input type="checkbox"/> Practical Electrician |
| <input type="checkbox"/> Practical Telephony | <input type="checkbox"/> Business Administration |
| <input type="checkbox"/> Telegraph Engineering | <input type="checkbox"/> Salesmanship |

Name _____

Address _____

City _____ State _____

Age _____ Occupation _____ Working Hours _____ A.M. to _____ P.M.

"When Acid Indigestion haunts me, I reach for my Tums!"

Says **BORIS KARLOFF**

Famous Hollywood
Star of Many
Movie Chillers.

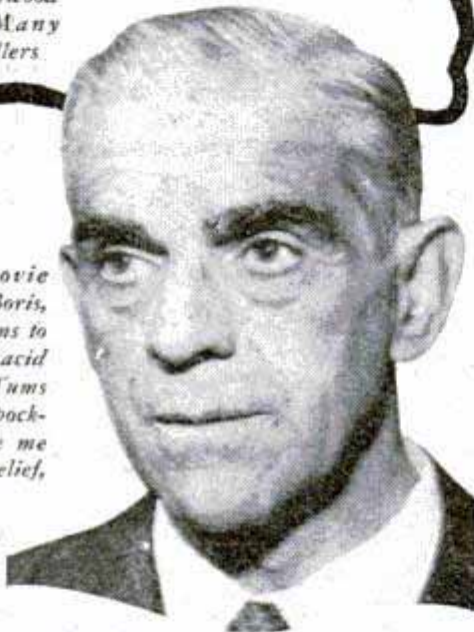

"I can scare movie audiences," says Boris, "but it takes Tums to put the chill on acid indigestion. So Tums are always in my pocket—ready to give me almost instant relief, on the set or off!"

• You never know when acid indigestion will strike. So for sweet relief, always carry Tums! Nothing *surer*, nothing *faster*, nothing *handier*! Easy to take as candy mints. Tums not only neutralize excess acid almost instantly—Tums also coat the stomach with protective medication, so relief is more prolonged. Tums relieve gas, heartburn and that bloated feeling. And when acid upset won't let you sleep, don't count sheep—count on Tums. No soda in Tums—no raw, harsh alkali to irritate your delicate stomach. *Never* overalkalize—always neutralize excess acidity with Tums—*genuine* Tums for the tummy!

Night and day, at home or away, always carry Tums!

10¢

Handy Roll

3-roll package,
a quarter—
everywhere



TUMS ARE ANTACID—not a laxative. For a laxative, use mild, dependable, all-vegetable **NR** (Nature's Remedy).
Caution: Take only as directed. Get a 25c box today.

(Continued from page 8)

Craftsman and Shop Notes Index

AUTOMOTIVE

Repairing crack in distributor cap.....	186
Rubber soles protect floor mat.....	193
Filling-station attendant carries map for customers' convenience.....	206
Valve-cap tool handy when removing auto-tire valve core.....	206
Body dents in car are repaired with gasket cement.....	208
Voltage drop in automobile headlight circuit located by using test prod.....	215
Temporary brake-rod repair.....	220

FARM

Disinfectant pad on barn-door sill provides sanitary protection.....	209
Modified monkey-wrench head serves as staple puller.....	218
Latch operated by lever keeps wire gate taut.....	220

HOUSE AND HOME

Solving home problems.....	174
Long-nosed pliers useful in kitchen.....	176
Books thumb-indexed with file and notched boards.....	176
Pillow slip protects fine garments in washing machine.....	184
Easy way to thread a needle.....	184
Oilcloth pockets on high chair hold infant's accessories.....	184
Scoop for household use from plastic tumbler.....	198
Clinic for homemakers.....	204

METALWORKING

Sectional rack for small parts.....	176
Pencil lubricates bolt threads.....	186
Cutting and spreading bolt end locks nut in position.....	192
Wet sponge prevents heat transfer when soldering adjacent joints.....	193
Hinge serves as secret lock on workbench.....	198
Blowtorch heats this high-temperature furnace.....	207
Self-centering punch marks screw holes to mount builders' hardware correctly.....	209
Test for small leaks in soldering.....	209
Replacement switch for operation of sump pump.....	215

OUTDOOR RECREATION

Three good trap sets that fool the wily mink.....	173
Keeping fishing holes free of ice.....	173
Keeping hands warm outdoors.....	208

PHOTOGRAPHY

Four-way tripod head.....	199
Funnel holds developing tank while being drained.....	202
How to make a set of lens filters.....	202
Novel camera carrying strap.....	202
Paper holder for enlargements.....	202
Iron supports photoflood lamp.....	202
Built-in thermometer fits agitator.....	202

RADIO AND ELECTRONICS

Group telephone conversations.....	221
Low-cost progressive receiver for beginners.....	222
Auto radio hints.....	224

TOOLS

Steering-wheel spinner on handle speeds vise operation.....	176
Vibration dampeners for power tool made from rubber heels.....	186
Sanding drum tail center eliminates "whipping".....	192
Craft quiz.....	203
Dowel pointer chucked in lathe sharpens work quickly.....	208
"Ring lock" holds toolbox hasp.....	209
Machinist's chest set on blocks provides more bench space.....	213
Screw jack supports tool bit.....	213
Bench stop with clamping-bar members has gripping action when holding work.....	214
Drill press made from pipe fittings.....	216
"Gun" clears plugged grease duct.....	218
Uses for discarded drills.....	218
Fence and table extension improve bandsaw.....	219
Pump puts air pressure on barrel to speed flow of oil.....	220
Drill gauge in screwdriver handle.....	220
Substitute lathe tailstock center.....	220

TOYS AND NOVELTIES

Novel pin-up lamp glows to light up silhouette.....	172
Shoehorn made of scrap plastic.....	176
"Painting" with dyed feathers.....	177
Polishing transparent plastics.....	184

WOODWORKING

False-front chest of drawers conceals writing desk.....	184
Bicycle pick-up trailer.....	185
Masking tape prevents splintering when sawing plywood.....	186
Pony sleigh.....	187
Accordion-fold door mat of hardwood scraps.....	192
Lightweight cart for wash basket.....	193
False bay window projection relieves plainness of wall.....	198
Wooden plug replaces screw cap.....	198

MISCELLANEOUS

Tread built from hose and slats makes slippery sidewalks safe.....	173
Mending a broken leather strap.....	186
Glycerine protects rubber stamp from deterioration.....	192
"Find-it" system for your shop.....	205
Wood on ferrule improves brush.....	206
Crosshatch spaced uniformly when drawing guide is used.....	207
Clothespin holds instructions for delivery of package.....	208
How to square concrete forms by using steel tape.....	208
Ball-point pen as stencil stylus.....	213
Wood-cutting hardware display promotes sale of tools.....	214
"Stethoscope" detects faulty valves and knocks in machinery.....	218

IMPORTANT NOTICE—It is the intention of this magazine to provide its readers with information regarding the latest developments in the mechanical arts. We take no responsibility as to whether the disclosures contained in our articles are covered by patents and advise readers to investigate this subject before making, using, or selling any of the products, machines, or processes described in order to avoid possible liability for patent infringements.

AUDELS REFRIGERATION & AIR CONDITIONING GUIDE.....\$4

New from Cover to Cover—1280 Pages, Fully Illus. Covering basic principles, servicing, operation & repair of household, commercial & industrial refrigeration & air conditioning. A gold mine of essential important facts for engineers, servicemen, users.

AUDELS CARPENTERS & BUILDERS GUIDES—4 Vols.\$6

A practical illustrated trade assistant on modern construction for carpenters, joiners, builders, mechanics and all woodworkers. 4 vols., 1600 pages, 3700 illustrations, flexible covers. Pocket size. Each volume sold separately \$1.50 a vol.

AUDELS AUTOMOBILE GUIDE.....\$4

A practical quick ready reference book for auto mechanics, service men, operators & owners. Explains theory, construction & servicing of modern motor cars, trucks, buses & auto type Diesel engines. 1700 pages, fully illustrated. 55 chapters. Indexed. A standard book for mechanics. New fluid drive covered.

AUDELS DIESEL ENGINE MANUAL..\$2

A practical, concise treatise with questions and answers on the theory, operation and maintenance of modern diesel engines including General Motors 2 cycle Diesel. 384 pages, fully illus., flexible binding, pocket size. All details plainly brought out, this book is of extreme value to engineers, operators & students.

AUDELS WIRING DIAGRAMS.....\$1

210 Pages. Illustrated. Gives practical facts on wiring of electrical apparatus. It shows clearly how to wire apparatus for practically all fields of electricity. Each diagram is complete & self-explanatory. Highly Endorsed Pocket Companion.

AUDELS PLUMBERS & STEAMFITTERS GUIDES—4 Vols.\$6

A Practical Trade Assistant & Ready Reference. Explains in plain language & by clear illustrations, diagrams, charts, graphs, pictures principles of modern plumbing practice including Marine Pipe Fitting and Air Conditioning. 4 Vols.—1670 Pages—3642 Diagrams. Pocket size. Each Vol. Sold Separately \$1.50 a Vol.

AUDELS SHEETMETAL WORKERS HANDY BOOK.....\$1

Practical inside information. Fundamentals of Sheet Metal Work. 388 pages. Illustrated. 11 sections. Clearly written. Essential & important facts, figures, pointers in everyday language. Ref. Index.

AUDELS SHEETMETAL PATTERN LAYOUTS.....\$4

Developed by Experts for Sheet Metal Workers, Layout Men & Mechanics. A Practical Encyclopedia in 10 Sections, size 7 x 10 x 2—1125 Pages—350 Layouts—1600 Illustrations. 1001 Key Facts. Fully indexed for ready reference in answering your layout problems. Covers all phases of sheet metal work including Pattern Cutting, Pattern Development & Shop Procedure.

AUDELS ANSWERS ON BLUE PRINT READING.....\$2

For Mechanics & Builders. Covers all types of blue print reading including ship & airplane. 416 pages, fully illustrated.

AUDELS NEW MACHINIST & TOOLMAKERS HANDY BOOK.....\$4

Covers modern machine shop practice in all its branches. 5 practical books in 1. New from cover to cover. Tells how to set up & operate lathes, screw and milling machines, shapers, drill presses and all other machine tools. 1600 pages, fully illustrated, 5 x 6 1/2 x 2. Indexed. 5 sections. 1—Modern Machine Shop Practice. 2—Blue Print Reading & How to Draw. 3—Calculations & Mathematics for Machinists. 4—Shop Physics. 5—How to Use the Slide Rule. 60 chapters. Easy to read and understand. A shop companion that answers your questions.

AUDELS MATHEMATICS & CALCULATIONS FOR MECHANICS \$2

Mathematics for home study or reference. 700 pages, 550 illus. Practical mathematics from beginning. How to figure correctly. Easy, correct methods covering complete review. Illus. & Indexed.

AUDELS HANDY BOOK OF PRACTICAL ELECTRICITY.....\$4

For maintenance engineers, electricians & all electrical workers. 1440 Pages, 2600 Illus. Covers important electrical information in handy form—including Marine Wiring, Radio Principles, Welding. Indexed. A Key to a practical understanding of electricity.

AUDELS RADIOMANS GUIDE.....\$4

A key to the practical understanding of radio including Frequency Modulation, Television, etc.. Aircraft & Marine Radio. For radio engineers, servicemen, amateurs. 914 Pages, 633 Illustrations & Diagrams. Photos. Review Questions & Answers, Reference Index. Authentic, clear, concise.

AUDELS ELECTRONIC DEVICES.....\$2

Tells What You Want to Know About Electric Eye. Easily Understood. Covers photo-electric cells & their applications. Amplifiers, illumination, frequencies, voltage, photocell, tubes, Ohm's Law, wiring diagrams, etc.

AUDELS WELDERS GUIDE.....\$1

A concise, practical text on operation & maintenance of all welding machines for all mechanics. Over 400 pages, illustrated. Covers all methods of electric and acetylene welding including airplane work.

AUDEL, Publishers, 49 W. 23 St., N. Y. 10

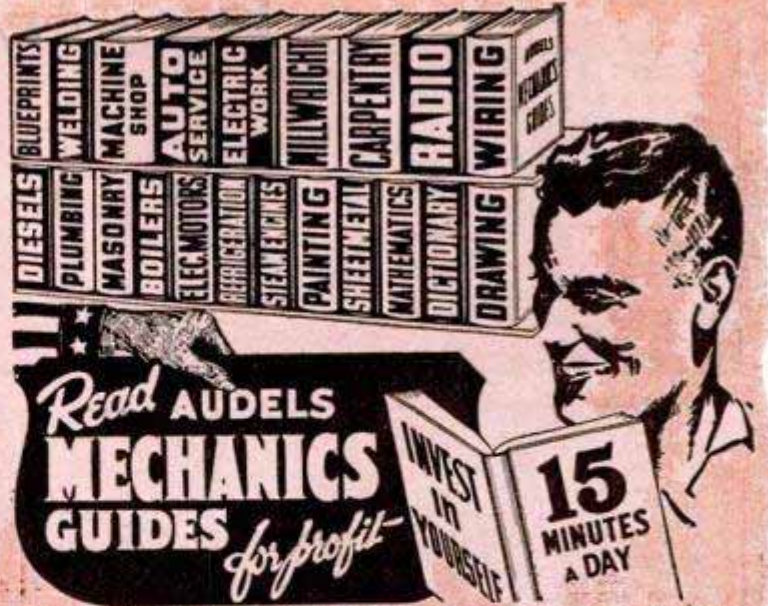

AN AUDEL GUIDE IS A GOOD FRIEND!

Step Up Your Own Skill with the Practical Facts and Figures of Your Trade. Save time and money with right methods, short cuts, labor saving ideas. CHECK NOW! You can look over any Audel Guide in your home. Start the Easy Payments if satisfied.

CUT HERE MAIL ORDER

THEO. AUDEL & CO., 49 W. 23 St., New York 10, N. Y.

Please mail me for 7 days' free examination the books marked (X) below. I agree to mail \$1 in 7 days on each book or set ordered, and to further mail \$1 a month on each book or set ordered until I have paid purchase price. If I am not satisfied with Guides I will return them.

- Audels ELECTRIC MOTOR GUIDE \$4.
- Audels OIL BURNER GUIDE 1.
- Audels REFRIGERATION & Air Conditioning Guide 4.
- Audels POWER PLANT ENGINEERS GUIDE 4.
- Audels PUMPS, HYDRAULICS & AIR COMPRESSORS 4.
- Audels WELDERS GUIDE 1.
- Audels BLUE PRINT READING 2.
- Audels SHEET METAL WORKERS Handy Book 1.
- Audels SHEET METAL PATTERN LAYOUTS 4.
- Audels AIRCRAFT WORKER 1.
- Audels MATHEMATICS and CALCULATIONS 2.
- Audels MACHINISTS & TOOLMAKERS Handy Book 4.
- Audels MECHANICAL Dictionary 4.
- Audels AUTOMOBILE GUIDE 4.
- Audels DIESEL ENGINE MANUAL 2.
- Audels MARINE ENGINEERS Handy Book 4.
- Audels MECHANICAL DRAWING GUIDE 1.
- Rogers MECHANICAL DRAWING and DESIGN 2.
- Audels MILLWRIGHTS and Mechanics Guide 4.
- Audels CARPENTERS and Builders Guides (4 vols.) 6.
- Audels PLUMBERS and Steamfitters Guides (4 vols.) 6.
- Audels MASONS and Builders Guides (4 vols.) 6.
- Master PAINTER and DECORATOR 2.
- Audels GARDENERS & GROWERS GUIDES (4 vols.) 6.
- Audels ENGINEERS & FIREMANS EXAMINATIONS 1.
- Audels ENGINEERS and Mechanics Guides 12.
- Nos. 1, 2, 3, 4, 5, 6, 7 and 8 complete 12.
- Audels Answers on Practical ENGINEERING 1.
- Audels ELECTRICIANS EXAMINATIONS 1.
- Audels WIRING DIAGRAMS 1.
- Audels Handy Book of PRACTICAL ELECTRICITY 4.
- Audels ELECTRICAL POWER CALCULATIONS 2.
- Audels ELECTRONIC DEVICES 2.
- Audels ELECTRIC Dictionary 2.
- Audels RADIOMANS GUIDE 4.
- Audels NEW ELECTRIC LIBRARY at \$1.50 a Volume 4.

Name _____
 Address _____
 Occupation _____
 Employed by _____

PM

I Will
Show You
How to

Learn RADIO

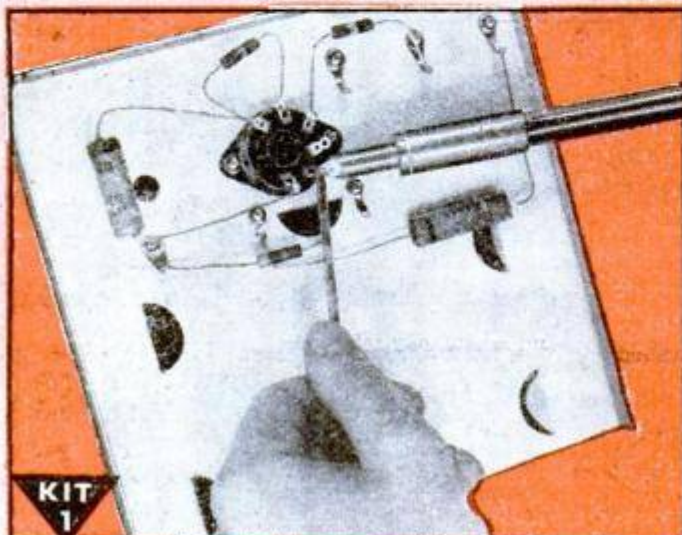

KIT 1

I send you Soldering Equipment and Radio parts; show you how to do Radio soldering, how to mount and connect Radio parts; give you practical experience.



KIT 2

Early in my course I show you how to build this N.R.I. Tester with parts I send. It soon helps you fix neighborhood Radios and earn EXTRA money in spare time.

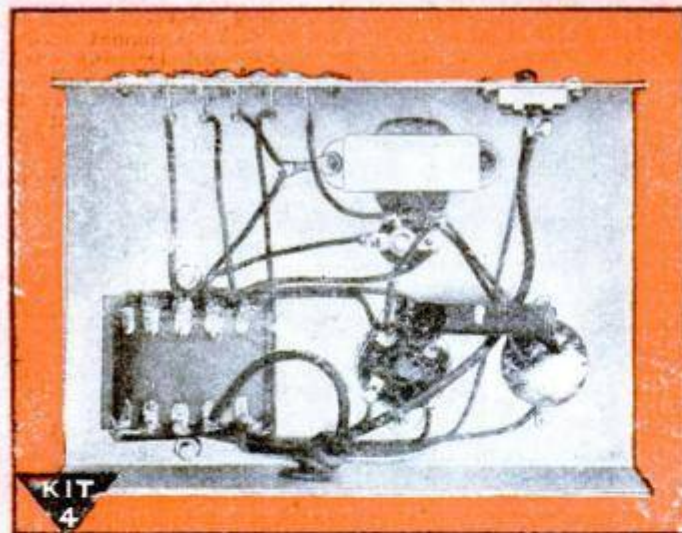

KIT 4

You get parts to build this Vacuum Tube Power Pack, make changes which give you experience with packs of many kinds, learn to correct power pack troubles.

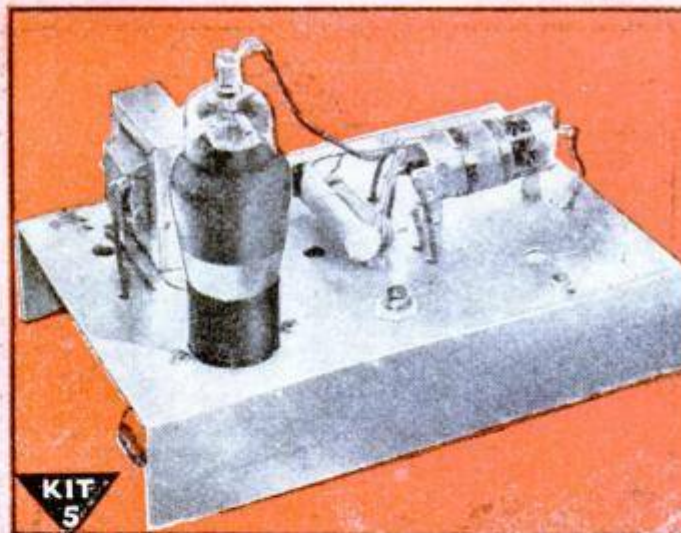

KIT 5

Building this A. M. Signal Generator gives you more valuable experience. It provides amplitude-modulated signals for many tests and experiments.

MEN I TRAIN AT HOME GET GOOD JOBS LIKE THESE

Made \$612, in 12 Months, Spare Time



"Soon after I finished my experimental kits lessons I tackled my first Radio service job. The neighbors were very cooperative. I soon had all the repair jobs I could handle in spare time. I have made \$612 in the past 12 months in spare time."
—J. W. CLARK, Wilmington, N. C.

Minister Makes \$10-\$20 Weekly Spare Time



"I am a minister. I am in a county seat now trying to serve the people in my church, also trying to keep their Radios playing. I have been making from \$10 to \$20 per week in spare time."
—L. H. SMITH, Benton, Tenn.

Knew Nothing About Radio



"I knew nothing about Radio when I enrolled. At present I am doing spare time work. I have more than paid for my Course and I have about \$200 worth of equipment which has paid for itself."
—RAYMOND N. STRICKLAND, 191 Dale Homes, MOLT CAMP, Vandalia, Ill.

Doing Good Spare Time Business



"I have been getting receivers to repair right along lately, and by using the methods taught me in the NRI Course, I don't have to spend much time on any of them."
—STANLEY N. STRICKLAND, 191 Dale Homes, Portsmouth, Va.

by Practicing in Spare Time

*I Send You
Big Kits
of Radio Parts*



KNOW RADIO *Win Success* I Will Train You at Home

Do you want a good-pay job in the fast-growing Radio Industry — or your own Radio Shop? Mail the Coupon for a Sample Lesson and my 64-page book, "How to Be a Success in RADIO — Television, Electronics," both FREE. See how I will train you at home — how you get practical Radio experience building, testing Radio circuits with BIG KITS OF PARTS I send!

VETERANS

You can get this training in your own home under G.I. Bill. Mail coupon for full details.

Many Beginners Soon Make Extra Money in Spare Time While Learning

The day you enroll I start sending EXTRA MONEY manuals that show how to make EXTRA money fixing neighbors' Radios in spare time, while still learning! It's probably easier to get started now than ever before, because the Radio Repair Business is booming. Trained Radio Technicians also find profitable opportunities in Police, Aviation, Marine Radio, Broadcasting, Radio Manufacturing, Public Address work. Think of even greater opportunities as Television, FM, and Electronic devices become available to the public! Send for FREE books now!

Find Out What NRI Can Do For You

Mail Coupon for Sample Lesson and my FREE 64-page book. Read the details about my Course; letters from men I trained; see how quickly, easily you can get started. No obligation! Just MAIL COUPON NOW in envelope or paste on penny postal. J. E. SMITH, President, Dept. 8AP, National Radio Institute, Pioneer Home Study Radio School, Washington 9, D. C.

Our 34th Year of Training Men for Success in Radio

MAIL NOW!

Mr. J. E. SMITH, President, Dept. 8AP, National Radio Institute, Washington 9, D. C.

Mail me FREE, your sample lesson and 64-page book. (No salesman will call. Please write plainly.)

Age _____

Name _____

Address _____

City _____ State _____

(Please include Post Office zone number)

Approved for Training under GI Bill

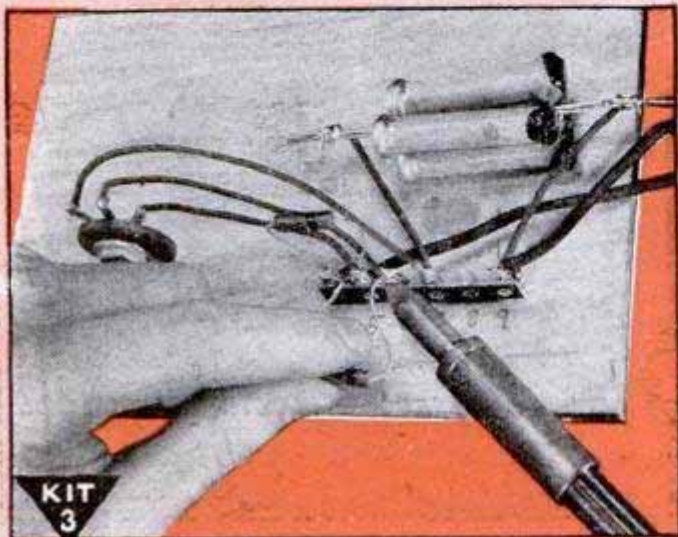

KIT 3

You get parts to build Radio Circuits; then test them; see how they work; learn how to design special circuits: how to locate and repair circuit defects.



KIT 6

You build this Superheterodyne Receiver which brings in local and distant stations—and gives you more experience to help you win success in Radio.

SAMPLE LESSON FREE

Gives hints on Receiver Servicing, Locating Defects, Repair of Loud-speaker, I.F. Transformer, Gang Tuner, Condenser, etc. Mail Coupon.

GETTING ACQUAINTED WITH
RECEIVER SERVICING

**My Radio Course Includes
TELEVISION • ELECTRONICS
FREQUENCY MODULATION**



HERE'S THE ABSOLUTE FINEST IN PRACTICAL ELECTRICIAN TRAINING



you do over
200 ELECTRICAL
 PRACTICE JOBS
 WITH
YOUR OWN HANDS!

WIND ALL TYPES
 of FRACTIONAL H.P.
 MOTORS

WIRE OVER 125
 BELL AND LIGHTING
 CIRCUITS

DO ACTUAL HOUSE
 WIRING—COMMERCIAL
 WIRING and ELECTRIC
 MOTOR REPAIR

PENNSYLVANIA INSTITUTE AMERICA'S LEADING ELECTRICAL SCHOOL
 OFFERS THE ONE BEST WAY TO
LEARN ELECTRICITY



PREPARE FOR A CONTRACTING BUSINESS of YOUR OWN
 ... or a **GOOD PAY JOB** as a **Practical ELECTRICIAN**

This is not a "home study" course. You come to Philadelphia, live in Philadelphia and **LEARN RIGHT!** We start you at the beginning, make it easy for you to understand and remember. All your Tools are supplied. You work with your own hands on modern Electrical Equipment. You see interesting Training Movies. No previous experience is needed. Our Instructors show you everything—guide you step by step. This **PRACTICAL** method gets **RESULTS!** You learn every impor-

tant phase of Electricity including Home, Commercial and Industrial wiring—Electric Motor Repair and Maintenance—Blueprint reading, Estimating and Installation. The Refrigeration portion of the Course is optional with the Student. When you graduate, you'll be ready to make money because you'll really *know your stuff*. Opportunities ahead are tremendous! Investigate this truly remarkable Training **AT ONCE!**

You Learn FAST
 and **NEVER FORGET**
 thru
 $\frac{2}{3}$ **SHOP PRACTICE**
 $\frac{1}{3}$ **Demonstrated THEORY**
OVER 45 REELS OF
TRAINING MOVIES

HOUSE WIRING
MOTORS
GENERATORS
ARMATURES
REFRIGERATION
LIGHTING

Mail
Coupon for 2 Valuable
FREE BOOKS!

Get your free copy of "ELECTRICITY", an immensely practical, well illustrated manual of basic Electrical information. Along with it we'll send a copy of our **SCHOOL CATALOG** fully describing our Course.

VETERANS
 You Can Get This Training Without Cost Under **THE G.I. BILL.**

PENNSYLVANIA INSTITUTE—School of Electricity
 Dept. M-1, 42nd and Spruce Sts., Philadelphia 4, Penna.
 Please rush my **FREE** copies of "Electricity" and your **SCHOOL CATALOG.** (If you are a G.I., check here)

Name _____ Age _____

Address _____

City and Zone _____ State _____
 (Paste on penny post card or mail in envelope)





INVENTORS



Learn how to protect your invention. The U. S. Patent Laws provide that any new and useful art, machine, article of manufacture, or composition of matter, or any new and useful improvement thereof, may be patented if the act of invention is involved. Therefore, every inventor with a valuable invention should take advantage of the Patent Laws and proceed for patent protection in order to safeguard his rights.

A patent gives the inventor the exclusive right to prevent others from making, using, or selling the invention claimed in the patent for a period of seventeen years.

The Patent Laws were enacted for the benefit of the inventor to give him protection for the features of his invention which are patentable. These features must be properly and concisely set forth and claimed in a formal application for patent, in order to comply with the requirements of the U. S. Patent Office. For that reason, the Patent Office advises the inventor, unless he is familiar with such matters, to engage a competent registered patent attorney or agent to represent him. We maintain a staff of registered patent attorneys ready to serve you in the handling of your patent matters.

A specially prepared booklet entitled "Patent Guide for the Inventor", containing detailed information with respect to patent protection and procedure, together with a "Record of Invention" form will be promptly forwarded to you without obligation upon request.

**Registered
Patent
Attorneys**

CLARENCE A. O'BRIEN & HARVEY B. JACOBSON
Registered Patent Attorneys

81-A District National Bldg., Washington 5, D. C.

Please send me copy of "Patent Guide for the Inventor" and also "Record of Invention" form. This request does not obligate me.

Name _____

Address _____

City _____ State _____

(Please write or print plainly.)

**CLARENCE A. O'BRIEN
& HARVEY B. JACOBSON**

81-A District National Building + Washington 5, D. C.

I'll Send You 8 Big Kits of Training Equipment
including

TWO-BAND 6 TUBE SUPER RECEIVER
AND 16 RANGE METER SET-UP
for Testing

Learn Fast... Earn Fast
HOME TRAINING
Planned For Your Needs
You Build All These
TESTERS... and MORE!

I give you a fine, moving-coil type Meter Instrument on Jewel Bearings—with parts for a complete Analyzer Circuit Continuity Tester. You learn how to check and correct Receiver defects with professional speed and accuracy.



Practice Does It!

Soldering, wiring, connecting Radio Parts... building circuits with your own hands—you can't beat this method of learning. When you construct this Resistor and Filter Resistor and Condenser Tester, etc., you get a really practical slant on Radio that leads to a money-making future.

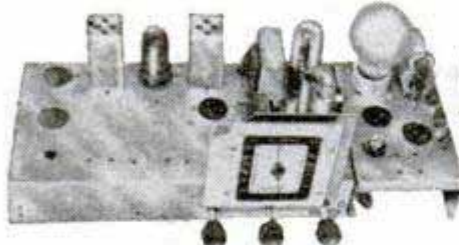
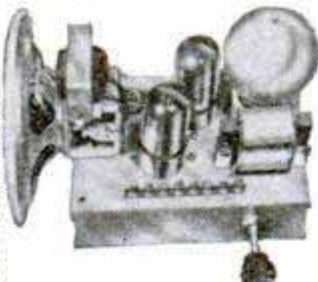

Building this Signal Generator and multi-purpose Tester will give you the kind of valuable experience and practice that is so important as a foundation for making good money in Radio. It makes a breeze out of fixing Radios, and you don't have to spend money on ready-made Equipment.

VETERANS:

Approved for G.I. Training under
Public Laws 16 and 346

PRACTICE WITH YOUR OWN HANDS!

Mind training through hand practice, that's the only way to LEARN and REMEMBER Radio. It's the most successful of Home Training methods.



OVER 175 PRACTICAL EXPERIMENTS

You'll find out how to build countless Radio Circuits. You'll learn a new, fast way to test Radio Sets without mfg. Equipment.



LOW COST HOME RADIO TRAINING!
Easy Monthly Payments!

My perfected Radio Training prepares you to start your own Radio Service Shop—or to land a big pay Radio job. With my help you get neighborhood Radio jobs while learning—for extra cash and rich experience. I train you RIGHT—by putting you to work with your hands in your own home during spare hours. You get 8 big kits of real professional Radio Parts and Equipment—and use them to build, test and trouble-shoot a powerful 6 tube superhet receiver, a 16 range test meter set-up and over 175 fascinating, instructive Radio experiments. My Training is down-to-earth, really PRACTICAL—it's the Training you need

to make money in Radio. Theory is cut to the bone—you don't need any previous schooling or experience. Sprayberry Training starts you out at the very beginning of Radio—the lessons are completely illustrated, simply written and easy to understand.

Get the facts about Sprayberry Training NOW. Find out what it can do for you—prepare for amazing opportunities in Radio Servicing, Television, FM, Radar and Industrial Electronics. Fill out and mail coupon for my two big Books—FREE. No obligation—and no salesman will call. Mail coupon TODAY!

MAIL COUPON FOR THESE 2 BOOKS!



"How to Read Radio Diagrams and Symbols" and "How to Make Money in Radio, Electronics and Television." Immense, practical value to you — and they're yours FREE!

F. L. Sprayberry, Pres.,
SPRAYBERRY ACADEMY OF RADIO,
1018 Sprayberry Bldg., Pueblo, Colo.

Please rush my FREE copies of "How to MAKE MONEY in RADIO, ELECTRONICS and TELEVISION" and "How to READ RADIO DIAGRAMS and SYMBOLS."

Name _____ Age _____

Address _____

City _____ State _____

Check here if a Veteran
(Mail in envelope or paste on penny postcard)

INVENTORS

Patent Laws Encourage The Development of Inventions

The Rules of Practice of the U. S. Patent Office advise—unless an inventor is familiar with such matters—that he employ a competent registered attorney or registered agent, as the value of patents depends largely upon the skillful preparation of the specifications and claims.

The firm of McMorrow, Berman and Davidson is registered to practice before the U. S. Patent Office. Additionally, it maintains a staff of attorneys able to readily understand inventors' disclosures, to advise concerning patentability, and to prepare appropriate specifications and claims for filing with the Patent Office.

If an inventor believes he has an invention, a search of the most pertinent prior U. S. patents should be made and a report obtained relative to its patentability. Where such report indicates that the invention appears patentable, in order to secure protection, diligence should be exercised in making application for a patent.

McMORROW, BERMAN & DAVIDSON

Registered Patent Attorneys

135-D VICTOR BUILDING, WASHINGTON I, D. C.

McMORROW, BERMAN & DAVIDSON

Registered Patent Attorneys

135-D Victor Building, Washington 1, D. C.

Send me further particulars as to patent protection and procedure and "Invention Record" form at once. I understand that this request does not obligate me.

Name _____

Address _____

City _____ State _____

(WRITE OR PRINT NAME CLEARLY)

©

The 97 Pound Weakling

who became "The World's Most Perfectly Developed Man"

"I'll Prove that YOU, too, can be a NEW MAN!"

Charles Atlas

I KNOW, myself, what it means to have the kind of body that people pity! Of course, you wouldn't know it to look at me now, but I was once a skinny weakling who weighed only 97 lbs.! I was ashamed to strip for sports or undress for a swim. I was such a poor specimen of physical development that I was constantly self-conscious and embarrassed. And I felt only HALF-ALIVE.

Then I discovered "Dynamic Tension." It gave me a body that won for me the title "World's Most Perfectly Developed Man."

When I say I can make you over into a man of giant power and energy, I know what I'm talking about. I've seen my new system, "Dynamic Tension," transform hundreds of weak, puny men into Atlas Champions.

Only 15 Minutes a Day

Do you want big, broad shoulders—a fine, powerful chest—biceps like steel—arms and legs rippling with muscular strength—a stomach ridged with bands of sinewy muscle—and a build you can be proud of?

Then just give me the opportunity to prove that "Dynamic Tension" is what you need.

No "ifs," "ands," or "maybes." Just tell me where you want handsome, powerful muscles. Are you fat and flabby? Or skinny and gawky? Are you short-winded, peppy? Do you hold back and let others walk off with the prettiest girls, best jobs, etc.? Then write for details about "Dynamic Tension" and learn how I can make you a healthy, confident, powerful HE-MAN.

"Dynamic Tension" is an entirely NATURAL method. Only 15 minutes of your spare time daily is enough to show amazing results—and it's actually fun! "Dynamic Tension" does the work.



CHARLES ATLAS
Holder of title, "The World's Most Perfectly Developed Man."

Send for FREE BOOK

Mail the coupon right now for full details and I'll send you my illustrated book, "Everlasting Health and Strength." Tells all about my "Dynamic Tension" method. Shows actual photos of men I've made into Atlas Champions. It's a valuable book! And it's FREE. Send for your copy today. Mail the coupon to me personally. CHARLES ATLAS, Dept. 8A, 115 East 23rd Street, New York, N. Y.

**CHARLES ATLAS, Dept. 8A,
115 East 23rd St., New York, N. Y.**

I want the proof that your system of "Dynamic Tension" will help make a New Man of me—give me a healthy, husky body and big muscular development. Send me your free book, "Everlasting Health and Strength."

Name _____ Age _____
(Please print or write plainly)

Address _____

City _____ State _____

SOUTH BEND

New Adjustable Collet Bushing Chuck

provides an accurate method for mounting centerless armature shafts and similar parts in a lathe. Use in either head or tail spindle.



(all prices f.o.b. factory)

The brass collets are adjustable for running or driving fits. Chucks supplied with 3 collets, 9/16", 5/8" and .637" capacity. Extra round collets, 1/4" to 1" by 16ths, \$1.00 each.

Chuck with No. 2 shank \$8.95

Chuck with No. 3 shank \$9.45

SOUTH BEND LATHE WORKS 455 E. Madison St. South Bend 22, Ind.

What Every Mason Wants



We have important Masonic books for Blue Lodge, Chapter, Commandery, Scottish Rite, and Shrine.

Our Rituals Are Used the World Over. Send for free catalog of books and rituals for Masons, Odd Fellows, Knights of Pythias, Knights of Columbus, etc.

EZRA A. COOK, Publisher, P. O. Box 796, P.J.Y., Chicago 90, Ill.

Enjoy

—WORLD'S MOST FASCINATING HOBBY! SEND FOR FULLY ILLUSTRATED BOOK TODAY!

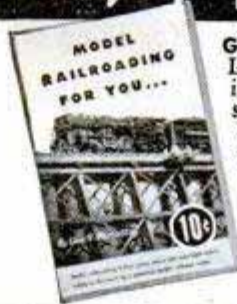

GET THE FACTS on model railroading! Leading authority shows how easily, inexpensively you can join in the absorbing hobby enjoyed by thousands of mechanics, business and professional men. Scale model railroads look, perform like the real thing!

GET STARTED NOW! Send 10¢ coin or stamps, for fully illustrated booklet, "Model Railroading for You".

MODEL RAILROADER MAGAZINE
Dept. 1513 Milwaukee 3, Wisconsin

LEARN MONEY-MAKING CARTOONING

IN SPARE TIME — by Easy Picture Chart Method

Same Simplified Method that has helped train creators of "Terry & Pirates," "Freckles," "Out Our Way," "Winnie Winkle," "Reg'lar Fellers," "Strange As It Seems," "The Neighbors," and many others. Earn while learning. Send 10¢ for Picture Chart (to test your ability), and full details. (State age.)

THE LANDON SCHOOL, 4801 Cleve. Transit Bldg., Cleveland, O.



LAW

STUDY AT HOME for PERSONAL SUCCESS and LARGER EARNINGS. 39 years expert instruction—over 108,000 students enrolled. LL.B. Degree awarded. All texts furnished. Easy payments. Send for FREE BOOK. G. I. approved.

AMERICAN EXTENSION SCHOOL OF LAW
Dept. 85-M, 646 N. Michigan Ave., Chicago 11, Ill.

Photography



for

PLEASURE or PROFIT

Learn at home. Spare time. Practical basic training. Long-established school. Many have earned while learning. Send coupon below for free booklet, "Opportunities in Modern Photography" and full particulars.

AMERICAN SCHOOL OF PHOTOGRAPHY

1315 Michigan Avenue Dept. 1351 Chicago 5, Illinois
Send booklet, "Opportunities in Modern Photography," full particulars and requirements. No salesman will call.

Name _____
Address _____
City _____ Zone _____ State _____

There's BIG MONEY in ADVERTISING!

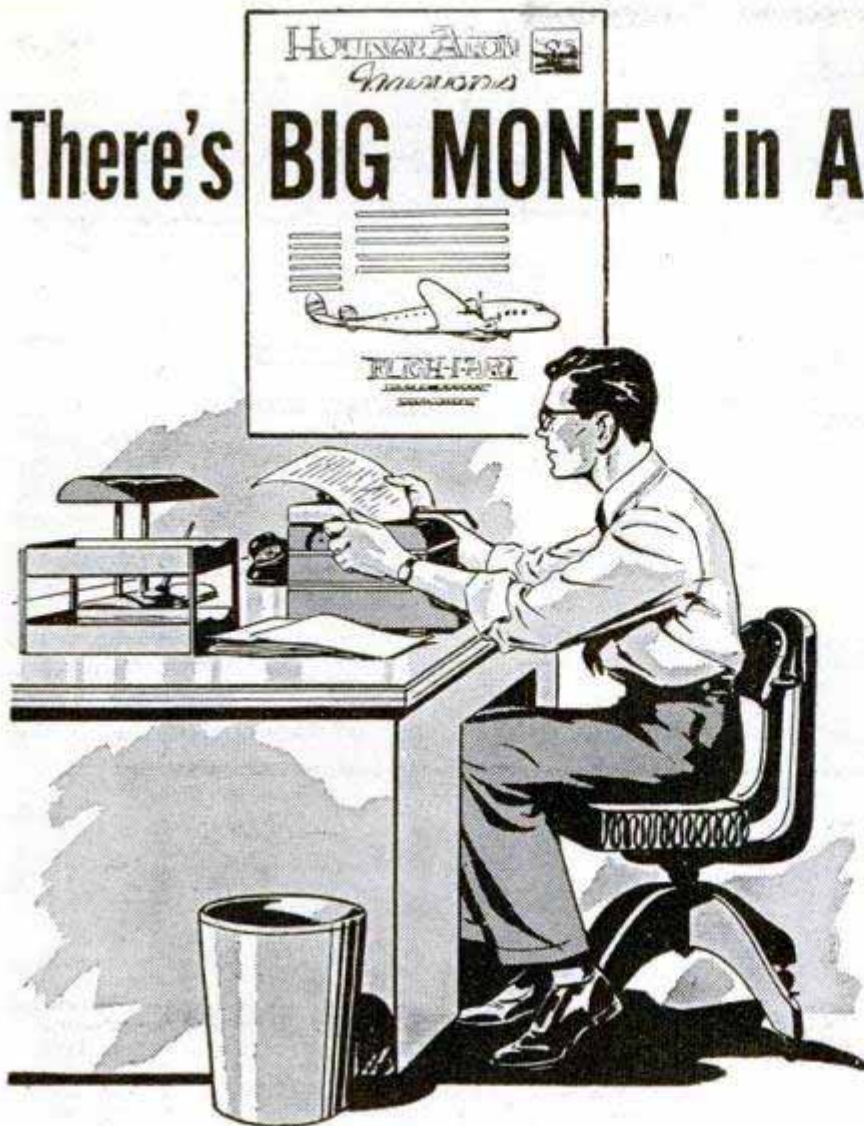

Don't waste your creative ability in uncongenial work! With I.C.S. training you can put your talent to work in advertising.

The I. C. S. Advertising Course covers the whole of this richly rewarding field. Here's instruction in writing advertisements for publication in national magazines. You learn about display, illustration, type.

"Specialty" subjects are included... retail and department store advertising, advertising letters, catalogs, booklets, folders, "house organs."

In many cases, I. C. S. students take positions before they have completed their courses. They make good in the world of advertising because they have learned by DOING.

Mark and mail the coupon for full information. Do it now!

INTERNATIONAL CORRESPONDENCE SCHOOLS



BOX 5620-K, SCRANTON 9, PENNA.

Without cost or obligation, please send me full particulars about the course BEFORE which I have marked X:

Business and Academic Courses

- Accounting
- Arithmetic
- Business Administration
- Business Correspondence
- Certified Public Accounting
- Commercial
- Commercial Art
- Cost Accounting
- Federal Tax
- First Year College
- Foremanship
- Good English
- Higher Mathematics
- Motor Traffic
- Salesmanship
- Sign Lettering
- Spanish
- Traffic Management
- Advertising
- Bookkeeping
- French
- High School
- Postal Service
- Secretarial
- Stenography

Air Conditioning and Plumbing Courses

- Air Conditioning
- Heating
- Refrigeration
- Plumbing
- Steam Fitting

Chemistry Courses

- Chemical Engineering
- Chemistry, Analytical
- Chemistry, Industrial
- Chemistry, Mfg. Iron & Steel
- Petroleum Refining
- Plastics
- Pulp and Paper Making

Civil Engineering, Architectural and Mining Courses

- Architecture
- Architectural Drafting
- Building Estimating
- Civil Engineering
- Coal Mining
- Contracting and Building
- Highway Engineering
- Lumber Dealer
- Reading Structural Blueprints
- Sanitary Engineering
- Structural Drafting
- Structural Engineering
- Surveying and Mapping

Communications Courses

- Electronics
- Practical Telephony
- Radio, General
- Radio Operating

Electrical Courses

- Radio Servicing
- Telegraph Engineering
- Electrical Drafting
- Electrical Engineering
- Electric Light and Power
- Lighting Technician
- Practical Electrician
- Power House Electric
- Ship Electrician

Internal Combustion Engines Courses

- Auto Technician
- Diesel-Electric
- Diesel Engines
- Aviation
- Gas Engines

Mechanical Courses

- Aeronautical Engineer's, Jr.
- Aircraft Drafting
- Flight Engineer
- Forging
- Foundry Work
- Heat Treatment of Metals
- Industrial Engineering
- Industrial Metallurgy
- Machine Shop
- Machine Shop Inspection

- Mechanical Drafting
- Mechanical Engineering
- Mold-Loft Work
- Patternmaking—Wood, Metal
- Reading Shop Blueprints
- Sheet-Metal Drafting
- Sheet-Metal Worker
- Ship Drafting
- Tool Designing
- Welding—Gas and Electric
- Ship Fitting
- Toolmaking

Railroad Courses

- Air Brake
- Diesel Locomotive
- Locomotive Engineer
- Locomotive Fireman
- Railroad Section Foreman
- Car Inspector

Steam Engineering Courses

- Boilermaking
- Combustion Engineering
- Engine Running
- Marine Engineering
- Steam Electric
- Steam Engines
- Textile Courses
- Cotton Manufacturing
- Rayon Weaving
- Textile Designing
- Woolen Manufacturing

Name _____ Home Address _____

City _____ State _____

Age _____ Present Position _____ Working Hours _____ A.M. to _____ P.M.

Special tuition rates to members of the Armed Forces. Special discount to World War II Veterans.
Canadian residents send coupon to International Correspondence Schools Canadian, Ltd., Montreal, Canada.

A D V I C E

for the I N V E N T O R

The United States Patent Office advises the inventor, unless he is familiar with such matters, to employ a competent registered patent attorney or agent as the value of patents depends largely upon the skillful preparation of the specification and claims.

PRELIMINARY STEPS *toward* PATENT PROTECTION

The Evidence of Invention form mentioned below is offered as a convenience to the inventor in making his disclosure of invention.

The inventor should date and sign his disclosure and have it witnessed by two or more persons who are capable of understanding his invention. The disclosure should then be mailed to the registered patent attorney or agent whom he selects to assist him. The dis-

closure should be accompanied by a letter authorizing the patent attorney or agent to conduct a preliminary search in the Patent Office among previously granted U. S. patents for similar types of invention. The patent attorney or agent then prepares a report of the probable patentability of the invention and recommends the further course the inventor should take, provided the report indicates possible patentability.

Victor J. Evans & Co. . . . has a staff of experienced, registered patent attorneys available to assist inventors in the preparation and prosecution of their cases before the Patent Office. The coupon below is suggested as a convenience to the inventor in starting action on his invention.

. . . VICTOR J.
EVANS & CO. . . .
Merlin M. Evans
 REGISTERED PATENT ATTORNEY
 330-A MERLIN BUILDING, WASHINGTON 6, D. C.

Please send detailed patent information together with convenient "Evidence of Invention" form.

Name.....

Address.....

City and State.....

.

Learn **RADIO**

IN A FEW SHORT WEEKS

IN THE GREAT SHOPS OF COYNE

48 Years of Successful Training

Work on Actual Radio, Sound, Television Equipment! Expert Instructors Train You by Famous **COYNE SHOP METHOD**

Get ready quickly for YOUR FUTURE. Big opportunities are waiting for properly trained men in Radio Manufacturing, Radio Sales and Service, Television, Sound, Public Address. With COYNE "All Around" Training, many branches of Radio are open to you.

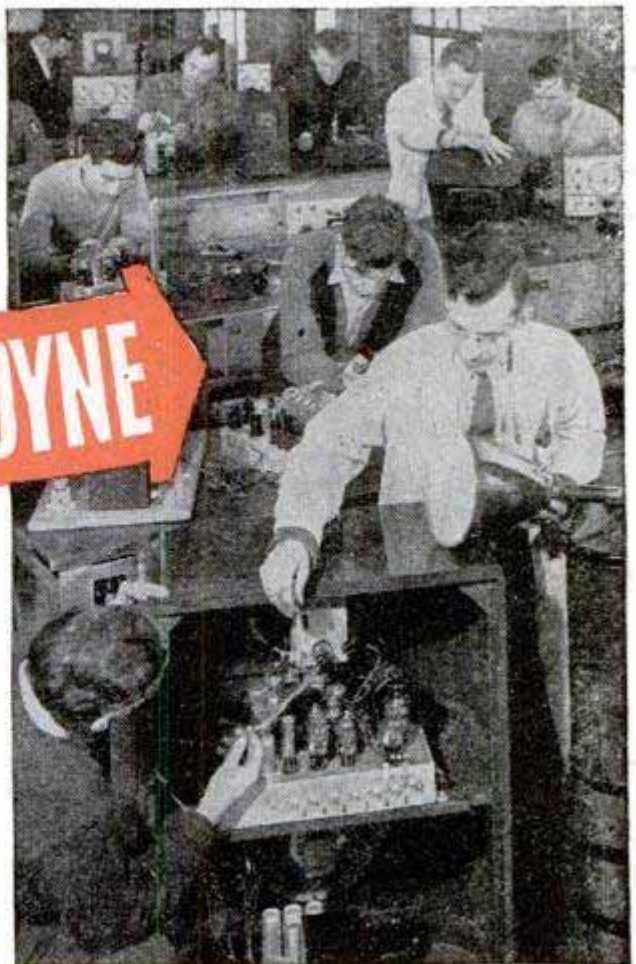

B. W. COOKE

NOT A "HOME-STUDY" COURSE

Learn Radio Fast!

As a Coyne student you work on real equipment in our great shops in Chicago — the Radio Center of the World. We do not teach by mail. All Coyne training is given right here in our big Shops in Chicago. You make rapid progress at Coyne because it's a shop course.

COYNE GRADUATES IN DEMAND

Whether you have had any actual Radio experience or not, we can train you in a few weeks for a better job, steady work and a real future in the Radio field.

ELECTRIC REFRIGERATION

This valuable training now included with our Radio course.

B. W. COOKE, President, Radio Division

COYNE

ELECTRICAL SCHOOL
500 S. Paulina Street
Dept. 18-3H
Chicago 12, Ill.
ESTABLISHED 1899



First we train you for a good Radio job, then help you get it. Coyne graduates may use our **Lifetime Employment Service** as often as they wish.

Easy to Start Own Shop

If your ambition is to be your own boss, COYNE makes it easy! We include special training in how to start your own Radio Shop, how to get business, keep records, etc., right along with our course. Then we have Free Merchandising Service for graduates to solve many problems.

SEND FOR BIG FREE BOOK!

Our new, fully illustrated Coyne Radio Book tells all about our great Chicago shops and our plans to help you. Packed with facts and pictures. No salesman will call. No obligation.

We'll Finance Your Training

Non-veterans who are short of cash can finance most of their tuition and pay it in easy monthly payments after graduation. You may earn while learning, to help defray living expenses. COYNE works with you to enable you to get the training you need.

VETERANS!

Coyne is authorized to train those who qualify under the G. I. Bill of Rights.

Physical Disabilities

Men with physical disabilities may qualify for training at no cost for tuition and subsistence. Coupon brings details.



B. W. COOKE, Pres., Radio Div., COYNE ELECTRICAL SCHOOL, 500 S. Paulina St., Dept. 18-3H, Chicago 12, Ill.

Dear Mr. Cooke: Send me your Big Free Radio Book and all the facts . . . also full details of your "Student Finance" plan.

NAME.....

ADDRESS.....

CITY..... STATE.....

MAIL FOR BIG Free BOOK



Satisfied with my JOB and PAY? **NOT ME!!**

"Some day I'll really get a break and go right on to the top."

That's wishful thinking.

You know that the "breaks" go to the man or woman who is prepared to take advantage of them—to the person who can fill the better job and is worth more money. He makes the "breaks" instead of waiting for them.

You can influence your own future by preparing now for the step forward—so that openings come because you are equipped for them—not as the result of luck.

Why not take the road that thousands of ambitious men and women have taken to help them to better jobs and more money.

Prepare now. Send the coupon below—check the business field of your choice and we'll send you without obligation our FREE 48-page book describing the opportunities and complete information on that field.

Send the coupon Now. It may be the turning point in your life to that better job and more money.

LASALLE Extension University A Correspondence Institution

417 S. Dearborn St., Dept. 164R. Chicago 5, Ill.

I want to make my own "breaks" by preparing for a better job. Send me your free 48-page booklet on the subject I have checked below.

- | | |
|--|---|
| <input type="checkbox"/> Foremanship | <input type="checkbox"/> Salesmanship |
| <input type="checkbox"/> Accounting | <input type="checkbox"/> Law: LL.B. degree |
| <input type="checkbox"/> Bookkeeping | <input type="checkbox"/> Business English |
| <input type="checkbox"/> C.P.A. Coaching | <input type="checkbox"/> Effective Speaking |
| <input type="checkbox"/> Industrial Management | <input type="checkbox"/> Stenotypy (Machine
Shorthand) |
| <input type="checkbox"/> Traffic Management | |
| <input type="checkbox"/> Business Management | |

Name.....Age.....

Position.....

Address.....

City.....Zone.....State.....

SEND FOR THIS

HOW to
BREAK
and
TRAIN
HORSES

FREE!

Make money with horses. Every farmer, every lover of horseflesh should have a copy of this booklet. If you want to know how to break, train and make money with horses, write today for full information FREE, together with my special offer of a course in Animal Breeding. If you are interested in Gaiting and Riding the saddle horse check here. Do it today—now. You'll never regret it.

BEERY SCHOOL OF HORSEMANSHIP
Dept. 1101 Pleasant Hill, Ohio

"How to Make Money With Simple Cartoons"

A book everyone who likes to draw should have. It is free; no obligations. Simply address

CARTOONISTS' EXCHANGE

Dept. 91D Pleasant Hill, Ohio

LEARN TO WRITE

a Good Hand!

FOR BUSINESS AND SOCIAL SUCCESS!

Easy to improve your handwriting at home quickly with my new instruction books just off the press. Master all the secrets of better penmanship. Simple and easy, fully illustrated, highly endorsed. Begin today. Write for: New Free Book, "How to Become a Good Penman," or check books wanted, \$1.00 each. Business Writing Artistic Writing Card Writing Engraving Alphabets Bird and Design Flourishing Complete Set \$4.50 Enclose 10c for your name beautifully written and special penpoint for shaded writing.

S. A. Ziller, President, **TAMBLYN SCHOOL OF PENMANSHIP**
441 Ridge Bldg. In Business Over 52 Years Kansas City, Mo., U.S.A.

LEARN TO PLAY AN

ACCORDION

"THE PAGANI WAY"

WRITE FOR DESCRIPTIVE CIRCULAR

O. PAGANI & BRO., INC. 289 Bleecker Street
New York 14, N. Y. Dept. P

THOUSANDS OF SUFFERERS USE

BREATHEASY

FOR

ASTHMA

CARRY IT WITH YOU
USE IT ANYWHERE

*Sold on Money-Back
Guarantee*

Write To Dept. PM

BREATHEASY DISTRIBUTORS, INC
65 CEDAR STREET
SEATTLE 1 WASHINGTON

WHICH OF THESE *Opportunities* INTERESTS *You* MOST?

Accounting
Air Conditioning
Architecture & Building
Automotive Engineering
Aviation—Practical
Aviation Drafting & Design
Better Foremanship
Bookkeeping
Business Management

Contracting
Diesel Engineering
Drafting & Design
Electrical Engineering
Electricity—Practical
Electronics, Industrial
High School Courses
Machine Shop Operations
Mechanical Engineering

Plastics Engineering
Plumbing—Practical
Private Secretary
Radio Operating & Servicing
Railway Training
Refrigeration
Sheet Metal Pattern Drafting
Shop Management
Tool Making

THINK! LOOK FORWARD!

Business is making big, new plans

Men and Women are preparing for the future

WHAT ARE YOU DOING ABOUT YOUR TOMORROWS?

● *Today*, choose the job you want—and prepare for it. Or if you are already engaged in the work you like best, start training *now* for quicker promotion. Acquire the knowledge that will help you to get ahead faster, make more money and have greater security.

Invest part of your spare time in more rapid progress. Start training now, in spare time in your own home. Be ready to grasp your opportunity and step out ahead of those who lack the ability you have attained.

American School, founded in 1897 as an educational institution *not for profit*, can help you to reach your goal just as it has helped others during the past fifty-one years. Give serious thought to the list above. Pick one or more subjects that interest you. Then check the coupon at right, add your name and address and mail it at once. The school will send you details on its training plan and outline of study prepared by specialists. There is no charge, no obligation, so send the coupon immediately.

PRACTICAL, EFFECTIVE HOME - STUDY TRAINING SINCE 1897

Take This First Easy Step

CHECK, CLIP AND MAIL COUPON NOW

AMERICAN SCHOOL, Dept. G145, Drexel at 58th, Chicago 37, Ill.
Without obligation, Please send FREE and postpaid, bulletin and details of the Subject checked.

- | | | |
|--|---|--|
| <input type="checkbox"/> PLASTICS ENG'R | <input type="checkbox"/> Accounting | <input type="checkbox"/> Drafting and Design for Men and Women |
| <input type="checkbox"/> Refrigeration | <input type="checkbox"/> Electrical Engr. | <input type="checkbox"/> Radio |
| <input type="checkbox"/> Architecture and Building | <input type="checkbox"/> Electricity-Pract. | <input type="checkbox"/> High School |
| <input type="checkbox"/> Contracting | <input type="checkbox"/> Electronics, Industr. | <input type="checkbox"/> Air Conditioning |
| <input type="checkbox"/> Practical Plumbing | <input type="checkbox"/> Bookkeeping | <input type="checkbox"/> Mechanical Eng. |
| <input type="checkbox"/> Automotive Engineering | <input type="checkbox"/> Private Secretary | <input type="checkbox"/> Shop Management |
| <input type="checkbox"/> Aviation Drafting | <input type="checkbox"/> Diesel Engineering | <input type="checkbox"/> Tool Making |
| <input type="checkbox"/> Aviation | <input type="checkbox"/> Sheet Metal Pattern Drafting | <input type="checkbox"/> Better Foremanship |
| <input type="checkbox"/> Business Mgmt | | <input type="checkbox"/> Machine Shop Operations |
| <input type="checkbox"/> Railway Training | | |

Name..... Occupation.....
Address..... Age.....
City..... State.....

AMERICAN SCHOOL

Dept. G145, Drexel at 58th Street, Chicago 37

Don't Wait for Success to Come to You
Go After it Now and be Sure of Your Future

Enjoy the Best Opportunities
in the Big Opportunity Field

GET STARTED Quick in DRAFTING

I Will Train You at Home Until
You Have a **GOOD**

PAY
JOB



Engineer Dobe

Take the first step now and step into Drafting—with the best opportunities in the big opportunity fields—as an experienced, well paid draftsman. Act now for a better job, better pay and better working conditions.

Drawing Tools and
Working Outfit
Included



All drafting instruments and table and other needed equipment sent when you start. Nothing for you to buy. You start right out on real drafting jobs using real professional equipment.

Industrial Design
Training Included

Some of the best paying jobs are in Industrial Design work, so I give you a complete extra course in this fascinating, profitable work. This is an Engineer Dobe extra and will cost you nothing.

Thousands of Opportunities

The field for draftsmen is bigger than ever before—and growing all the time for all new products, appliances, machines and construction must start with the draftsman. No invention—no development—can ever take the draftsman's place. He is a key man in every industry.

Learn From an Engineer

Get into drafting now. Learn from an engineer who has trained thousands of successful men. I will give you that same training at home in your spare time, give you actual work—the same kind of jobs you will do with the best paying firms. I will train you until you are competent, fully experienced, and holding a position that will bring advancement and pay raises.

Experience as You Learn

Your training will be experience because I give you practical jobs to do. And I list your experience and send it to employers as a reference when you are ready. All Dobe trained men start out with experience. You will too, because I will train you until you get a good job in drafting.

ACT NOW!

Take the first step now. Mail the coupon below so I can send you all the facts. Give age to get reply.

Mail Coupon for VITAL FACTS!

Engineer Dobe, Div. 11, Libertyville, Ill.

Send me the Vital Facts on Drafting and Industrial Designing, your FREE BOOK and advertised list of positions for Draftsmen and Designers wanted.

Name.....Age.....
Address.....
City.....Zone.....State.....

CONFIDENTIAL LOAN SERVICE

Borrow \$50 to \$300⁰⁰

Need money? No matter where you live you can borrow **BY MAIL** \$50.00 to \$300.00 this easy quick confidential way.

BY MAIL

IT IS EASY TO BORROW BY MAIL!
Completely confidential and private
CONVENIENT MONTHLY PAYMENTS

NO ENDORSERS NEEDED
EMPLOYED MEN and women of good character can solve their money problems quickly and in privacy with loans **MADE BY MAIL**. No endorsers or co-signers. We do not contact employers, friends or relatives. Convenient monthly payments. Send us your name and address and we will mail application blank and complete details **FREE** in plain envelope. There is no obligation.

NATIONAL LOAN PLAN, INC.
521 Temple Court Bldg., Dept. A-107, Denver 2, Colorado

Have an OFFICE of YOUR OWN!

LEARN NEW PROFITABLE PROFESSION
At Home in 60 Days, Men & Women, 18 to 70!

Be Your Own Boss and the Boss of Others. Be Respected. Meet Interesting People.

Earnings of men and women in this profession run as high as \$5,000-\$15,000 yearly. Others make good money in spare time. Little money needed to start. A business where your earnings begin sooner. Easy to learn. No selling or goods to buy. No experience necessary. A depression-proof business. A course of action to guide you step by step as you earn. All 53 lessons sent at once to use as operating manuals. Easy terms. Diploma. Money-back agreement. Write for **FREE BULLETIN**.



FRANKLIN CREDIT SCHOOL
Dept. 75-A ROANOKE 7, VIRGINIA

BY MAIL in Easy Lessons

ANY BOOK IN PRINT

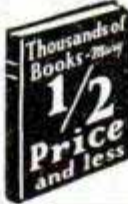

Delivered at your door. We pay postage. Standard authors, new books, popular editions, fiction, reference, medical, mechanical, children's books, etc. **Guaranteed savings.** Send for Clarkson's 1948 catalog.

FREE Write for our great illustrated book catalog. A short course in literature. The buying guide of 300,000 book lovers. **Free if you write now—today!**

CLARKSON PUBLISHING COMPANY
Dept. PM48, 1257 So. Wabash Ave. Chicago, Ill.

The American Institute of Specialized Watch Repair
270-276 East Building GRAND RAPIDS 6, MICHIGAN
A Fully Accredited School

You can learn this highly fascinating and profitable trade through this Institute, either at home by correspondence... or at the resident school.
Learn While You Learn

Write for Free Circular

Learn WATCH REPAIRING

SAY YOU SAW IT IN POPULAR MECHANICS

ANALYZE HANDWRITING

Illustrated Lesson **FREE**
and Grapho Analyst

shows you how to make money at home, full or spare time. Opportunities everywhere. **FREE Analysis Offer** for immediate answer. Must be over 21.
A. I. G. A. Inc., Wilhoit Bldg., Dept. 120-M, Springfield, Mo.

MONEY for MEN ALL DATA FREE

THE PLASTEX Industry needs manufacturers on small scale and for big production of Lamp and Clock Stands, Art Goods and Novelties in Plastex and Marble imitation. Experience unnecessary. 1gc material makes regular 10c store sellers. Rubber moulds furnished for speed production. Small investment brings good returns. Big chain store orders now being placed. Ambitious men have chance for real prosperity. Our Free booklet will interest and benefit you.

PLASTEX INDUSTRIES, Dept. A
3408 Third Ave. New York 56, N. Y.



E. B. De Vry, President
DeForest's Training, Inc.

HERE'S YOUR Big Chance

Profit Through Training in RADIO-ELECTRONICS

Prepare at HOME or in our CHICAGO LABORATORY to get REAL MONEY, a BETTER JOB, or a BUSINESS OF YOUR OWN

Our business is helping men . . . and young men . . . get into a well-paying future in the highly profitable fields of RADIO-ELECTRONICS. During the past sixteen years we have trained many men who desired better jobs or businesses of their own. We can effectively provide you with this same opportunity either in our new, modern Chicago laboratories or in the privacy of your own home.

TAKE YOUR CHOICE

If you choose to come to Chicago, we shall find comfortable living quarters for you. If you train at home, we shall send you modern, practical equipment. In either of these two methods, you will have the supervision of some of the finest instructors in the country. Fill in coupon below and we shall send you, absolutely FREE, full information about our program of building men for better opportunities in RADIO-ELECTRONICS. DeForest's Training, Inc. also includes instruction in FM Radio, Television and Industrial Electronics.

If you prefer to remain at home, you receive eight (8) big kits of radio parts and assemblies from which you can work out dozens of fascinating radio circuits to gain practical experience in your own home. In addition, you receive a 16 mm. motion picture projector and 12 information-packed reels of film which help you learn faster . . . easier. You also get modern looseleaf lessons with handy fold-out diagrams.

EMPLOYMENT SERVICE

When you complete your training our effective Employment Service helps you get started toward a real future. Mail coupon below today do not delay.

VETERANS

Both our (1) Chicago Laboratory and (2) Home Study training are accepted under the "G. I. Law." If you qualify, the Government will pay cost of either training you select.

MAIL THIS OPPORTUNITY COUPON NOW!

Mr. E. B. De Vry, President
DeForest's Training, Inc.
2533 N. Ashland Ave., Dept. PM-1
Chicago 14, Illinois

Please show me how I may get started toward a good job or a business of my own in Radio-Electronics.

Name.....Age.....

Address.....Apt.....

City.....Zone.....State.....

If under 16, check here for special information.

If a discharged Veteran of World War II check here.

DeForest's Training, Inc.

CHICAGO,
ILLINOIS

Associated with the DeVRY Corporation
Builders of Movie & Electronic Equipment



SO IT NEEDS FIXING

By S. T. CHRISTENSEN
the "Fix-it Man"

“WELL, I guess I'm the fellow to see, for I've repaired thousands of refrigerators (home and commercial both), vacuum cleaners, radios, washing machines, irons, fans, lamps, mangles, motors, etc. In fact, many of my customers call me their "electrical appliance doctor." And, "doctoring," I might add, has paid me a good substantial income for quite a few years. Funny, in a way, how I got started. Always liked to tinker and by experimenting around I found that most electrical appliances had many things in common. That, regardless of what the appliance was used for, or who the manufacturer was, the basic principles were much the same. From fixing my own appliances to fixing friends' and then for strangers at a fee, seems now to have been but a small step.

What to Charge?

At first, I let the owner decide the charge and, frankly, I was amazed at what I earned per hour. But then, when one figures what initial costs are involved in buying most electrical appliances, one can readily see that spending extra dollars for repairs is well worth while. Before long I was making more in my spare time repairing than from my regular job. The result . . . I went into business for myself. When war came, business boomed, for new appliances were not available.

For a while, repair parts (needed on some jobs) were a little difficult to get. But that situation

quickly adjusted itself and many repair parts were given the high priority rating of AA2. After all, we had to provide for the health and well-being of our civilian population.

The Future Offers

Friends ask me about my future. And, I think I've got a grand one. Age is no handicap in repairing. I have in my files enthusiastic letters from repairmen ranging in age from 18 to 79 years. Now the war is over we are certain to see hundreds of new products on the market . . . products that the average person never dreamt of. These new products and our old appliances are all going to need at some time or other "fixing." Well, I'll still be the fellow to do it. The field open for appliance repairmen is unlimited. I don't worry at all about too much competition.

If You Are Ambitious

To the contrary, I've prepared a complete course, chuck full of simple, easy to understand photos and drawings and written in the same non-technical language as this article. I know the course is good, because I have hundreds of men all over the country writing to me telling me how the course has helped swell their pockets with cash. If you too want to prepare now for your future, I suggest you read the next page and send me the handy coupon."

Advertisement



**BIG MONEY
INDEPENDENCE**

*A PROFITABLE
LIFETIME
BUSINESS
OF
YOUR OWN!*

LEARN ELECTRICAL APPLIANCE REPAIRING

PREPARE NOW FOR THE FUTURE

If now employed, start your home appliance repair business NOW in your spare time and be set with a business of your own no matter what happens. You don't need elaborate fixtures or expensive equipment to be a successful repairman. Operate from your garage, basement, vacant store, etc. Work as many hours as you wish—the home appliance repairman is his own boss. It is a profitable occupation for on many types of repairs it is not unusual for a repairman to charge on the basis of \$5.00 to \$6.00 per hour. Don't gamble with your future—learn a trade that will always support you. Remember, as long as electrical appliances are used, there will be a need for electrical appliance repairmen.

If you are at all mechanically inclined—can hold and use tools—then you have all of the qualifications required for becoming a big money earning home appliance repairman. It does not matter if you have not had a great deal of schooling or had previous experience along these lines—**WE WILL TEACH YOU.** Age should be no barrier—nor should any minor physical handicap.

New Course Tells All

Profusely illustrated, our new course shows you in simple, easy to understand language and drawings how to make each repair on refrigerators, vacuum cleaners, washing machines, motors, etc. Explains and gives you a working knowledge of electricity, welding, nickel plating, etc. Shows you how to build the power tools you need and how to solicit and keep business coming to you. Not a theory course but an honest to goodness course written by and used by repairmen the country over. Price of course is so low that the savings on your own household appliance repairs will quickly pay for it. Act now! Mail the handy coupon below today.

— — — Read What Our Students Say About Course — — —

I really believe your course the best investment a mechanically minded man can make.—Claude E. Allen, Indianapolis, Ind.

I have received your Course in Appliance Repairing and I must say I am well pleased with same. I am only sorry I did not have said Course some years ago. I have learned so much more through this course I would not part with it.—Charles Schwarz, Hamilton, Ohio.

The Course in Appliance Servicing arrived a few days ago. Want to take out a few minutes of my valuable time to let you know that this is just what I have been looking for ever since I opened up my Fix-It shop. I must admit that you told the truth when you said that it contains quite a bit more information than I bargained for.—P. J. Bretl, Sebring, Ohio.

I am a mechanic for the Western Union Telegraph Co. Three days after receiving the lessons in refrigeration I earned the exact cost of the course.—Henry S. Lee, Washington, D. C.

I work day times at the shipyard and after 4:00 P.M. I operate from my cellar and garage. I average \$10.00 to \$15.00 clear every day.—Walter Hanhy, Brockton, Mass.

GET STARTED TODAY — MAIL THIS COUPON

CHRISTY SUPPLY CO.
2835 N. Central Ave., Dept. D-5303
Chicago 34, Illinois

Please send me free illustrated literature about America's Fastest Growing Industry—**ELECTRICAL APPLIANCE REPAIRING.**

Name.....

Address.....

City..... State.....

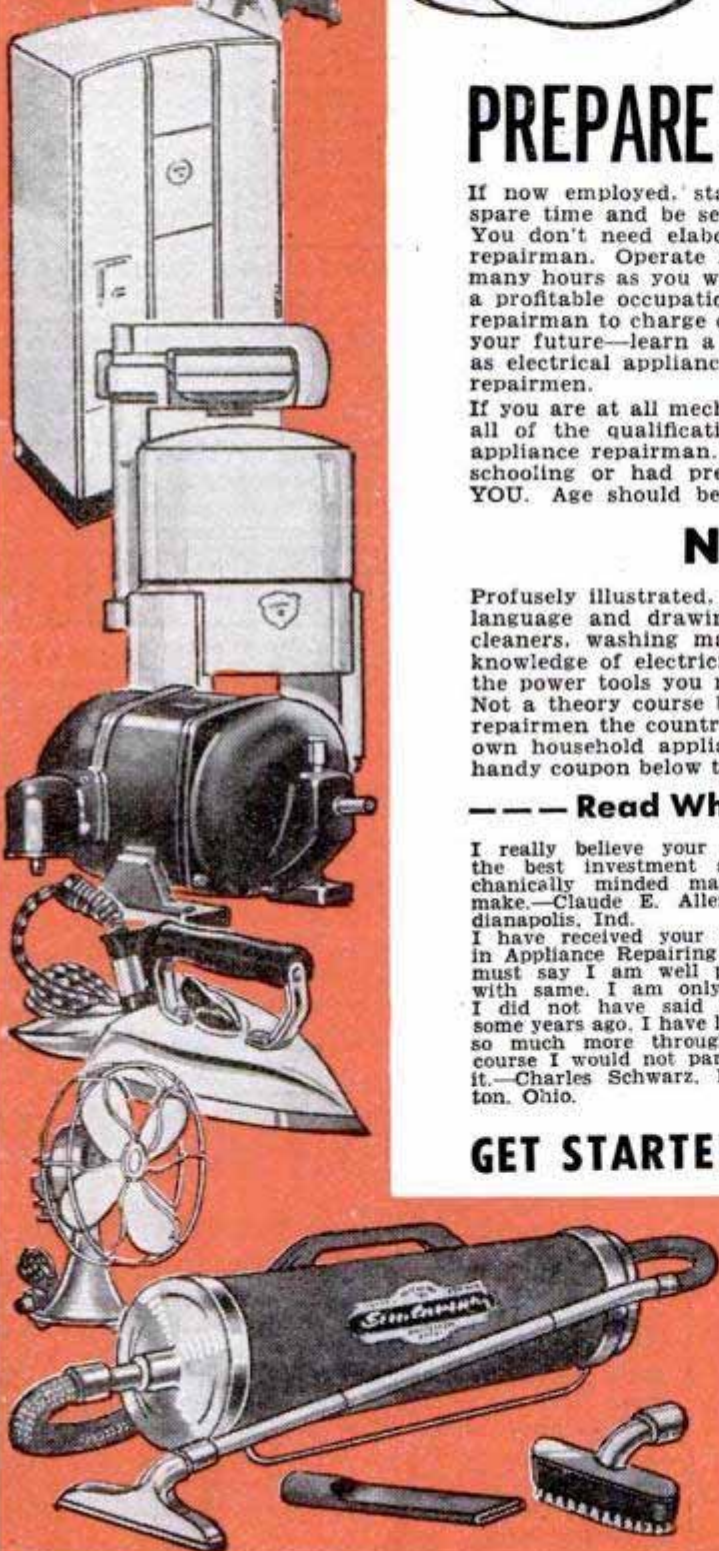

OIL BURNER

INFORMATION IN A HANDY FORM

JUST OUT!

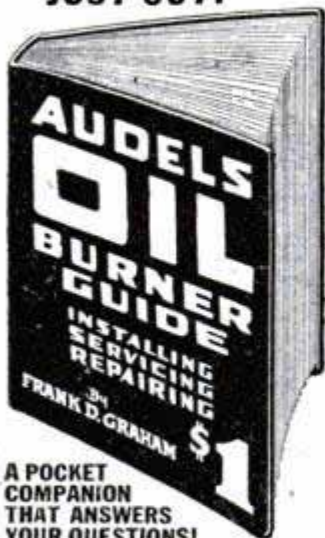

A POCKET COMPANION THAT ANSWERS YOUR QUESTIONS!

AUDELS OIL BURNER GUIDE

— A new practical, concise treatise, 384 pages—31 Chapters — 321 Diagrams and Illustrations — covering Domestic and Industrial Oil Burners.

New from Cover to Cover, for mechanics interested in Oil Burners. Gives practical inside working knowledge of theory, construction, installation, operation, testing, servicing and repair of all types of oil burners. Includes electrical hook-ups and wiring diagrams of automatic control systems.

PRICE \$1 POSTPAID

Get this information for yourself. Mail coupon today. No obligation unless satisfied.

ASK TO SEE IT

AUDEL, Publishers, 49 W. 23rd St., New York 10, N.Y.

Please mail AUDELS OIL BURNER GUIDE (Price \$1). If satisfactory, I will remit \$1 on its safe arrival, otherwise I will return the book.

Name _____
 Address _____
 Occupation _____
 Employed by _____ P.M.

8 BIG BUILDING BOOKS

For EXAMINATION SEND NO MONEY

Learn to draw plans, estimate, be a live-wire builder, do remodeling, take contracting jobs. These 8 practical, profusely illustrated books cover subjects that will help you to get more work and make more money. Architectural design and drawing, estimating, steel square, roof framing, construction, painting and decorating, heating, air-conditioning, concrete forms and many other subjects are included.

BETTER JOBS — BETTER PAY UP-TO-DATE EDITION
 The postwar building boom is in full swing and trained men are needed. Big opportunities are always for MEN WHO KNOW HOW. These books supply quick, easily understood training and handy, permanent reference information that helps solve building problems.

Coupon Brings Eight Big Books for Examination

AMERICAN TECHNICAL SOCIETY Vocational Publishers since 1898
 Dept. G119 Drexel at 58th Street Chicago 37, Ill.

You may ship me the Up-to-Date edition of your eight big books, "Building, Estimating and Contracting," without any obligation to buy. I will pay the delivery charges only, and if fully satisfied in ten days, I will send you \$2.00, and after that only \$3.00 a month, until the total price of only \$34.80 is paid. I am not obligated in any way unless I keep the books.

Name _____
 Address _____
 City _____ State _____
 Please attach a letter stating your age, occupation, employer's name and address, and name and address of at least one business man as a reference. Men in service, also please give home address.

10,000 HELPS TO BE YOUR OWN BOSS

IN THIS BIG BOOK!



IF IT'S RESULTS YOU WANT—GET ACTION QUICKLY WITH THESE PRACTICAL IDEAS

Never before has a more helpful book been printed for those planning a business of their own. Gathered in this large illustrated volume are the formulas, recipes, facts and secrets that have contributed so largely to America's great industrial progress. Capitalize on this information for making most any conceivable product without experience, special equipment or previous knowledge of chemistry or manufacturing. The experts who compiled this book are authorities, and present this information in simple, understandable language. They also give you wholesale supply sources for needed materials, short cuts and methods for the most profitable results.

START AT HOME—Expand out of profits.

Hundreds of good paying businesses have been built on a product made from a simple recipe. Choose from any of the 162,000 facts and 10,000 formulas of which the following are only a very few: Adhesives, Alloys, Anti-Freeze Solutions, Cosmetics, Beverages and Liquors, Candy, Gum, Casein, Celluloid, Ceramics, Cheese, Cleaning Preparations, Concrete, Copper, Cotton, Dentifrices, Depilatories, Dyes, Embalming Fluids, Enameling, Glass, Glazes, Household Formulas, Inks, Insecticides, Iron, Jewelers' Formulas, Lacquers, Laundry Preparations, Leather, Linoleum, Lubricants, Manicure Preparations, Marble (artificial), Metals, Mirrors, Oils and Ointments, Paints, Paper, Perfumes, Photography, Polishes, Powders, Remedies for Man, Beast or Fowl, Rubber Products, Refrigerants, Soaps, Solder and Soldering, Tooth Cements, Transfers, Transparencies, Varnishes and Thousands of others for making all sorts of profitable and practical things.

FREE
 "Knowledge is Power" contains a valuable list of information on 1000s of the most important Money-Making ideas in use today.

MANY FORTUNES MADE FROM A SINGLE IDEA!

This comprehensive book is an accepted authority by chemists, schools, industry, etc., and is the largest and most comprehensive book of its kind ever issued. Nothing else like it in existence. A single formula has been worth a thousand times this book's cost to countless owners. Crammed with money-making ideas, invaluable for reference. Ideal for Factory, Home, Farm, Office or Workshop. As necessary as the dictionary and more useful for manufacturers, chemists and salesmen who put up products for profit.



\$3.98 U. S. Funds. Postpaid anywhere in the world. (C.O.D. in U.S.A. only). Immediate shipment. Safe Delivery Guaranteed.

ADAMS BROWN COMPANY BOOKS OF APPLIED SCIENCE
 Dept. 801, Chestnut Hill 67, Massachusetts, U. S. A.

LEARN WATCH REPAIRING



AT HOME. By our modern and original system of instruction you can learn every part of the **WATCH REPAIRING TRADE AT HOME.** Prepare yourself for a well-paying position or start in business after completing our course of instruction. Good watch repairers are in demand and generally earn very good salaries. For particulars apply to the **Wisconsin School of Watch Repairing** 759 North Milwaukee St., Milwaukee 2, Wis.

WANTED DISTRICT PURCHASING AGENTS

No experience or money required. Exceptional opportunity for those who want to establish themselves in a steady, year 'round, well paying business.

For details: Write

PURCHASING MANAGER, DEPT. C
 2719 LAWRENCE AVE. CHICAGO 25, ILL.

RUPTURED?

Get Relief This Proven Way

Why try to worry along with trusses that gouge your flesh—press heavily on hips and spine—enlarge opening—fail to hold rupture? You need the Cluthe. No leg-straps or cutting belts. Automatic adjustable pad holds at real opening—follows every body movement with instant increased support in case of strain. Cannot slip whether at work or play. Light. Waterproof. Can be worn in bath. Send for amazing **FREE** book, "Advice To Ruptured," and details of liberal truthful 60-day trial offer. Also endorsements from grateful users in your neighborhood. Write:

CLUTHE SONS, Dept. 31, Bloomfield, New Jersey

Get Training *QUICK* in the Great Shops of **COYNE**



Learn
ELECTRICITY
in
a few
weeks

NOT a "Home-Study" Course!

Practical training pays! Thousands of successful electricians—men earning good money, with steady jobs and a real future—recommend the COYNE Shops in Chicago. We do not teach by mail. All instruction is given in our own big building in the heart of the World's Electrical Center. You make rapid strides here because it's a **shop course**.

Work on Full-Size Equipment!

In our great shops you actually operate, test, repair the same kinds of electrical apparatus you'll use later on the job. You do **REAL** house wiring; rewind **REAL** armatures; run a **REAL** switchboard. All this plus needed theory makes it easy to learn Electricity in a few short weeks here at COYNE.

No Experience Necessary

Many Coyne students have never had previous electrical experience. Others have had a smattering of it in one or two branches, but realize their need for "All-Around" training. We not only train you for a good job, we help you get it. **Lifetime Free Employment Service** to Coyne graduates.

SEND FOR FREE BOOK

Yours for the asking—big 40-page book on Coyne Electrical Training. Filled with fascinating pictures of our great shops and our plans to help you. Get your copy free. No cost or obligation; no salesman will call. Mail the coupon today!



B. W. COOKE,
President,
COYNE ELECTRICAL SCHOOL,
Dept. 18-72,
500 S. Paulina St.,
Chicago 12, Illinois.

Send me your Free Book and tell me about your plans to help me—including Student Finance and added Training in Industrial Electronics and Electric Refrigeration. Mail coupon today.

COYNE Shop Training Includes:

Alarm and Signal Work
D.C. Motors, Generators, Controls
A.C. Motors, Generators, Controls
House Wiring
Armature Winding
Stator Winding

Transformers
Switchboards
Home Appliances
—and many other branches including added training in **Industrial Electronics** and **Electric Refrigeration**.

NOW IN OUR 49th SUCCESSFUL YEAR



B. W. Cooke

Since 1899, Coyne has been training men and young men for practical, better-paying jobs. Here in our great Chicago Shops you will find the equipment, the friendly expert instructors, to prepare you for a real future in Electricity. Coyne graduates are in demand by many leading electrical firms. Coyne men are trained to make good in their own electrical shops. Come to COYNE!

VETERANS!
Coyne is authorized to accept Veterans for G. I. training. Coupon brings special G. I. Bulletin.

NON-VETERANS who are short of cash can finance most of their tuition and pay it in easy monthly payments after graduation. Many students earn while learning. We'll help you get part-time work while here if you need it to help defray living expenses.

ANY MAN WITH A PHYSICAL DISABILITY whether a Veteran or not may qualify for Coyne training at no cost to himself for tuition or subsistence. Send coupon for details.

B. W. COOKE, President

COYNE ELECTRICAL SCHOOL
Dept. 18-72
500 S. Paulina St., Chicago 12, Ill.

NAME.....

ADDRESS.....

CITY.....STATE.....

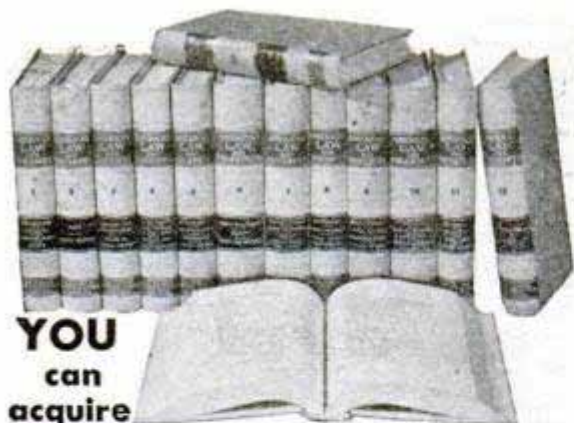

**YOU
can
acquire**

**LAW NIGHTS AT HOME!
L. L. B. DEGREE**

LaSalle's famous Law Library—used as reference in many Law libraries and Law offices—has enabled thousands to master Law surprisingly fast, in spare hours at home, for business and professional advancement.

These 14 remarkable volumes, compiled by leading professors and lawyers, cover the whole basic field of Law in condensed, orderly, simplified manner.

You advance rapidly with this great library, plus special lectures furnished. We guide you step-by-step with personalized Problem Method of instruction . . . you learn by doing—handling legal problems—not by memorizing rules.

Send for two FREE 48-page booklets, "Law Training for Leadership," and "Evidence," answering questions about Law and its value to you, and telling how LaSalle Law graduates are winning rapid advancement in business and public life. Mail coupon below. No obligation.

LA SALLE EXTENSION UNIVERSITY
A Correspondence Institution

417 S. Dearborn St. Dept. 164-L Chicago 5, ILL.

Send me your two FREE booklets described above, without obligation.

Name..... Age.....

Street.....

City, Zone & State.....

LEARN } **ACCOUNTING
SALESMANSHIP
SECRETARIAL
WORK**

Assure Your Future Now!

Hill's, one of America's outstanding Business Schools, offers you the opportunity to enter one of the three fields acknowledged to hold substantial earnings and a secure future. Our FREE book, "Through Hill's to Success," tells how and where the best positions are found and how you can qualify for them by study at home or in our resident school. We have thousands of successful graduates and maintain nationwide employment service. G. I. Approved.

**FREE
WRITE
TODAY**

USE THIS HANDY COUPON

**HILL'S EXTENSION SCHOOL
AND BUSINESS UNIVERSITY,**
619 W. Main St., Oklahoma City 2, Okla.
Please send me your Free book, "Through Hill's to Success."

NAME.....
ADDRESS.....
CITY..... STATE.....

LEARN the LETTER SHOP



and DIRECT ADVERTISING Business

You can quickly learn this interesting, profitable business from A to Z via our thorough, easy-to-understand HOME-TRAINING, in your spare time. An ideal business for men or women, or husbands and wives, of all ages.

You can start with very little capital in your own home, or, take a well-paid job, if you prefer. Every business man, firm, club, church, etc., in your community is a prospective customer. Write for our FREE BOOK-LET giving complete details about the opportunities in this wide open field, TODAY.

**Write
TODAY
for our
FREE
BOOKLET**

ARMSTRONG SCHOOLS

7217 SO. BROADWAY, DEPT. P-81
LOS ANGELES 3, CALIF.

Learn to Write

Good penmanship makes favorable impressions and helps you win success. Poor penmanship contributes to failure. It makes no difference how poor you now write, you can quickly and easily learn Business Writing, and you can learn Shaded Writing also right in your own home during spare time by my Simplified Method, without cost of going away to school. Easy Lessons. Diploma.

Send for this FREE Book

Write for my FREE BOOK, "How to Become an Expert Penman," which contains valuable information and many specimens of penmanship that show what others have learned by taking my Courses. If you enclose 10c, I will send you one of my Favorite Penpoints suitable for plain or shaded writing, and your name with a beautiful flourished bird written on a card. Write TODAY.

T. M. TEVIS, BOX 25K, CHILLICOTHE, MO.

LEARN TRIG QUICKLY - EASILY

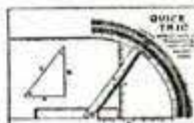

WITH QUICK TRIG, by competitive tests, it was found that QUICK TRIG gave answers faster to one with a slight knowledge of trig than to an expert on trig with a slide rule. Let it solve your trig problems. You need no previous training. Entirely automatic. Easy instructions included FREE. We mail C.O.D. plus postage or send \$1.00, the full price, and we will mail postpaid.

REED MFG. CO. 11350-D BURBANK BLVD. N. HOLLYWOOD, CALIF.

BE A REAL ESTATE BROKER PAYS BIG!

EASY TO LEARN—Start and run your own business quickly. Many graduates report making up to \$1000 a month. Course of study covers Sales, Property Management, Appraising, Loans, Mortgages and hundreds of related subjects. Course offered in home study or residential classrooms.

FREE Big new illustrated catalog from this nationally known school. Send Post Card Today. G. I. Approved.

WEAVER SCHOOL OF REAL ESTATE
Dept. KA-2, 15 E. Pershing Road Kansas City, Mo.

RUPTURED?

PAY NO MONEY! \$3.50 FOR THIS TRUSS

To all who try Newer Rupture Relief Method

All you do is try a Doctor's invention for reducible rupture in the privacy of your own home on our trial plan. Easy and comfortable to wear. Has no leg straps—no elastic belts—no leather bands. Holds rupture UP and IN. If for any reason you do not like it, return it within 30 days but keep the special \$3.50 Truss. It's our gift to you for making the trial. Write today for free measurement service and trial offer. **PHYSICIAN'S APPLIANCE CO.** 9272 Koch Bldg. 2906 Main Kansas City 8, Mo.

NOW! Build Your Future On

DIESEL

OPPORTUNITIES

IN INDUSTRY

ON WATER

ON LAND



DIESEL POWER IS GOING PLACES!

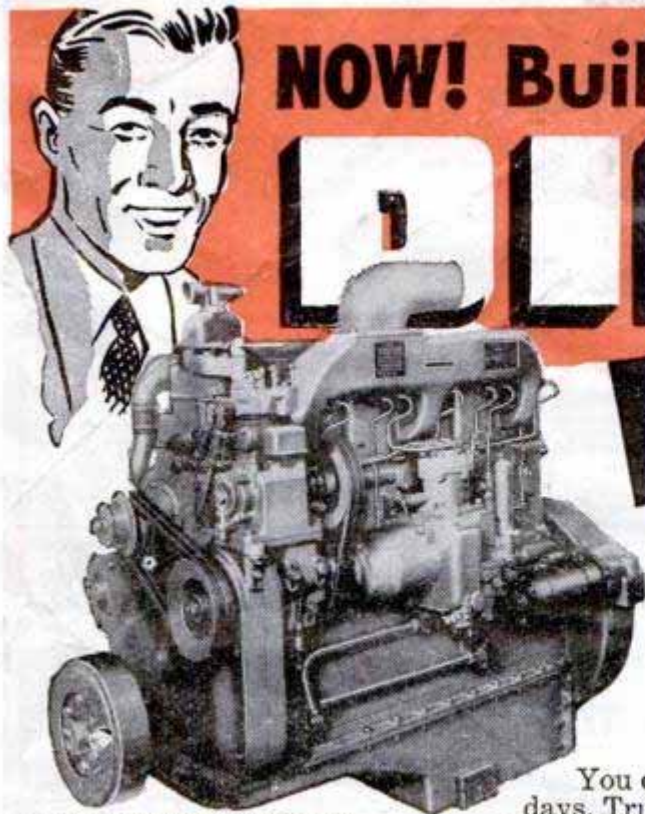

COMPACT DIESEL TRUCK ENGINE

6 cylinders, 5 1/2" bore and 6" stroke, maximum horse power rating 200 H.P. at 2100 RPM.

You don't have to look far to see Diesel Power in action these days. Trucks, buses, tractors, streamliners and switching engines, ocean-liners and small watercraft, power and lighting plants, farm and road equipment — more and more depend on Diesel each day. And now aircraft are experimenting with the lighter units. On the farm, in factories, in communities large and small — Diesel is growing as it proves to be efficient, economical, dependable, streamlined power.

Diesel Knowledge is Earning Power

THE NEW AND INCREASING USES OF DIESEL open a broad field for trained men who can install, maintain, operate and repair DIESEL EQUIPMENT. Diesel engines need DIESEL-trained men! Now is the time to prepare for these opportunities.

LEARN NOW WHILE YOU KEEP YOUR JOB Actual Shop Practice

If you are between 17 and 60 and mechanically inclined, you can get thorough, individual instruction right in your home. Through UEI balanced training, you learn first through home study the fundamentals of Diesel in all its phases, given to you in practical, easy to understand lessons from men with years of successful experience training this way. You will learn how Diesel Engines operate, how fuel systems work, how to make repairs, all about the latest accessories and auxiliary equipment, and a world of other Diesel basic "know how."

Then you get valuable practice in our big shop, working on costly equipment under Diesel men who really "know their stuff". This course is new and up to the minute, including latest techniques for handling new and old equipment under today's conditions. UEI offers placement service for graduates and has numerous other features which have contributed to the reputation of this outstanding school—now in its 20th success-making year. Coupon below brings complete information.

DO IT NOW! It costs you nothing to get all the facts about Diesel opportunities and training. Simply mail the coupon below. Time is important—and the time to begin is NOW! Make up your mind after you get the facts, but write for them at once. Send coupon today!

OTHER U.E.I. Training Opportunities

Practical Shop Training Follows Preliminary Home Study

AUTO BODY AND FENDER REPAIR
Includes Welding, Metal Work, Spray Painting and Refinishing.

MECHANICAL REFRIGERATION
Servicing and Installation for all commercial and domestic types.

WELDING
Arc and Acetylene. With fundamentals of metallurgy and supervised welding practice.

AIR CONDITIONING
Installation, operation and maintenance of home and industrial equipment.

Founded 1927



UTILITIES ENGINEERING INSTITUTE

2521 Sheffield Ave., Dept. 118-D, Chicago 14, Ill.

Mail Coupon FOR FREE FACTS

UTILITIES ENGINEERING INSTITUTE, Dept. 118-D
2521 Sheffield Ave., Chicago 14, Illinois

Please send me FREE facts about UEI training and opportunities in the field checked below.

- DIESEL WELDING
 REFRIGERATION AIR CONDITIONING
 AUTO BODY AND FENDER REPAIR

Name _____ Age _____

Address _____

City _____ Zone or County _____ State _____

If World War II veteran give length of service _____
 Check here for special information if you are under 17.

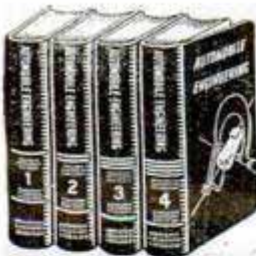

AUTO BOOKS ON APPROVAL



SEND NO MONEY. Just mail the coupon for a complete set of 4 Big, Thick Auto Books, 20th Edition. Over 2700 Pages! Whether you are a mechanic or helper, expert or apprentice, auto owner or driver, take immediate advantage of this **FREE EXAMINATION OFFER.**

MAKE GOOD MONEY NOW HOLD A PERMANENT JOB

America wants its automobiles kept in good repair. Men with "know how" are in demand, at big pay. These books will help you get and hold an important job, or give you a chance to go into business for yourself now or later. Any man who half tries to improve himself can learn auto servicing and repairing by this quick reference method. Use the **JEFFY INDEX** to find easily understood answer to any auto problem. These wonder books prepared by eleven of America's great automobile engineers. Many hundreds of valuable illustrations. Send the coupon **TODAY.**

A year's consulting privileges with our engineers now given with these books without extra charge. Vocational Publishers Since 1898

CAN YOU FIX IT?

These wonder books tell step by step **HOW** to make difficult repairs and adjustments, how to keep a car at maximum efficiency, including latest improvements in car design and operation. Engine troubles and how to correct them well covered.

4 BIG, THICK VOLUMES Over 2700 Pages, 2000 Illustrations, wiring diagrams, etc., including Diesel engines. Beautiful modernistic, washable cloth binding.

AMERICAN TECHNICAL SOCIETY, Dept. A119
Drexel Ave. at 58th St., Chicago 37, Ill.

I would like to examine your 4-Volume Set of Auto Books. I will pay the delivery charges only, but if I choose I may return them express collect. If after 10 days' use I prefer to keep them, I will send you \$2 and pay the balance at the rate of only \$3 a month until \$24.80 has been paid. Include consulting service as offered above.

Name _____
Address _____
City _____ State _____
Please attach letter stating age, occupation, employer's name and address and name and address of at least one business man as reference. Men in service, also please give home address.

AVIATION Career

MAXIMUM TRAINING IN MINIMUM TIME

CAL-AERO TECH TRAINING will add dollars to your pay check all the rest of your life. Specializing in **AERONAUTICAL ENGINEERING** and **MASTER AVIATION MECHANICS** since 1929, Cal-Aero Tech training is carefully designed for just one thing—**TO MAKE MORE MONEY FOR YOU.** An alumni of over 6000 successful graduates proves our career training is unsurpassed.

VETERANS —Write us about Aviation Training, as provided under "G.I. Bill of Rights."



CAL-AERO TECHNICAL INSTITUTE
MAJOR C. C. MOSELEY PRES. SINCE 1929
FORMERLY CURTISS-WRIGHT TECHNICAL INSTITUTE

GRAND CENTRAL AIR TERMINAL
GLENDALE 1, CALIFORNIA
LOS ANGELES COUNTY

MAIL THIS COUPON TODAY!

Cal-Aero Technical Institute, Grand Central Airport, Glendale 1, California
Please send full information on Aviation Training **FREE**—without obligation. Dept. PM-1

Name _____ Birth Date _____
Street _____
City _____ State _____

Do You Make These Mistakes in English?

MANY persons say "between you and I" instead of "between you and me"—or use "who" for "whom"—or don't know whether to spell certain words with one or two "c's" or "m's" or "r's," or with "ie" or "ei," etc. Every time you speak or write you show what you are. Mistakes in English reveal lack of education, refinement. Lack of language power prevents you from presenting your thoughts in the strongest way. Real command of English will help you reach ANY goal. Stop making mistakes in spelling, punctuation, pronunciation, grammar. Increase your vocabulary.



Sherwin Cody

WONDERFUL INVENTION

Only 15 minutes a day with Sherwin Cody's new invention—and you can actually **SEE** your English improve. It teaches by **HABIT**—makes it easier to do the **RIGHT** way. Wonderful self-correcting lessons.

FREE BOOK ON ENGLISH Lack of language power may be costing you friendships, income, every year. See what Mr. Cody can do for you; it costs nothing to find out. Write this very minute for free book, "How You Can Master Good English in 15 Minutes a Day." It will prove a revelation. **WRITE NOW, SHERWIN CODY SCHOOL OF ENGLISH, 51 B & O Bldg., Rochester 4, N. Y.**

ENGINEERING DEGREE IN 27 MONTHS

INDIANA TECHNICAL COLLEGE

Aeronautical, Chemical, Civil, Electrical, Mechanical, and Radio Engineering (inc. television). Drafting, 1-yr. Gov't approved for G.I.'s. Low rate. Earn board. Large industrial center. Students from 48 states, 28 countries. Demand for graduates. Enter March, June, Sept., Dec. Catalog.

518 E. Washington Blvd., Ft. Wayne 2, Ind.

WHY DON'T YOU WRITE?

Writing short stories, articles on business, homemaking, travel, gardening, sports, shop crafts, local and club activities, etc., will enable you to earn extra money. In your own home, on your own time, the **New York Copy Desk Method** teaches you how to write the way newspaper men learn—by writing. Our unique "Writing Aptitude Test" tells whether you possess the fundamental qualities essential to successful writing. You'll enjoy this test. Write for it, without cost or obligation.

Veterans: This course approved for Veterans' Training.
NEWSPAPER INSTITUTE OF AMERICA
SUITE 5598-A, ONE PARK AVENUE NEW YORK 16, N. Y.

ANALYZE Handwriting

Uncrowded, fascinating field. Gratifying earnings reported by graduates in Employment, Credit, Social Service, Police and Entertainment fields. Others have developed profitable private practice, full or spare time, as Personal Problem and Vocational Counselors. Send for 2000 word **TEST LESSON** and Grapho Analyst **FREE.**



A. I. G. A. Inc.

Wilhoit Bldg., Dept. 120 Springfield, Mo.

STAMMERER?

This new 128-page book, "Stammering, Its Cause and Correction," describes the Bogue Unit Method for scientific correction of stammering and stuttering—successful for 47 years. **Benj. N. Bogue, Dept. 4824, Circle Tower, Indianapolis 4, Ind.**



ARTISTS MAKE MONEY

Do you like to draw? Send name, address, age and occupation for **FREE ART TEST**, to find out your ability.

ART INSTRUCTION, Inc.
1138 ART INSTRUCTION BLDG., MINNEAPOLIS 15, MINN.

SAY YOU SAW IT IN POPULAR MECHANICS



WALL CLEANER
Saves Costly Redecorating!
AMAZING INVENTION. Banishes old-style housecleaning mess and more. No sticky "dough"—no red, swollen hands. No more dangerous stepladders. Literally erases dirt like magic from walls, ceilings, window shades, upholstered furniture, etc. **Endurodormer! SAVES REDECORATING!**
SAMPLES FOR AGENTS Sample offer sent immediately to all who send name at once. A penny postal will do. **SEND NO MONEY—just your name. KRISTEE CO., 77 Bar Street, AKRON, OHIO.**

ACE Hollywood Experts WILL TRAIN YOU AT HOME to MAKE GOOD in

RADIO

TELEVISION-ELECTRONICS

through practical EXPERIMENTS with

10 BIG KITS of RADIO PARTS R.T.A. GIVES YOU!



YOU WILL DO SCORES OF PRACTICAL JOBS AND EXPERIMENTS

The 10 BIG KITS R.T.A. GIVES YOU enable you to do many practical jobs. Illustrated above are only a few of the many job-exercises you do. You build a TRF Receiver, a High-Frequency Converter, a complete, powerful 6 Tube AC-DC Superheterodyne receiver, and perform more than a hundred other fascinating and valuable experiments. These jobs you do give you ACTUAL SHOP EXPERIENCE so vitally necessary to future success. Thus R.T.A. methods assure you BALANCED TRAINING—Theory PLUS Real Experience.

TEAR OUT COUPON AND MAIL TODAY

MASTER HOLLYWOOD TECHNICIANS Guide You

It was no accident that R.T.A. — RADIO TRAINING ASSOCIATION OF AMERICA — chose HOLLYWOOD as their headquarters. Hollywood has long been recognized as the very heart of America's Broadcasting, Television, Radio and Sound industries. Thus, R.T.A. is right "on-the-spot" where new technical improvements are introduced, and is in the best possible position to bring students ACTUAL METHODS and TECHNIQUES developed BY the RADIO-TELEVISION industry, leading to real money-making opportunities!

OPPORTUNITIES NOW WIDE OPEN for Properly Trained Men

Latest reports estimate 400 MILLION new radio and television sets will be built in the next ten years... and more than 72 million dollars is being spent RIGHT NOW just for radio repairs ALONE! When you are

thoroughly trained by R.T.A.'s Hollywood Experts—who have their fingers on the pulse of the Radio-Television industry—you can imagine what undreamed-of opportunities await you in Your Own Radio Sales & Service Business, Television, Aviation, FM, Manufacturing and Communications, etc.

EARN EXTRA MONEY while learning AT HOME

Under R.T.A.'s amazingly easy, practical home-training plan there is no need for you to quit your present job. You study in SPARE TIME ONLY and R.T.A.'s Hollywood Experts show you how to earn WELCOME EXTRA CASH, even BEFORE FINISHING YOUR TRAINING! In fact, when friends and neighbors know you are studying Radio-Television you may—like many R.T.A. students—actually get MORE REPAIR WORK THAN YOU CAN HANDLE.

25 Year Success Record

Backed by more than 25 years of experience in the home

training field, R.T.A.'s practical "learn by doing" methods assure you quick, step-by-step progress. So begin preparing for your future in Radio-Television NOW, while the time is ripe. If you are at all mechanically inclined, and have a grammar school education, R.T.A. can teach you how to MAKE GOOD as a Radio-Television technician.

R. T. A. GRADUATES SAY:

- ★ Thanks to R.T.A. I started my own radio store... am making 220 percent more than when I enrolled.—W. E. Thon, Chicago.
- ★ Truly thankful for the day I enrolled for R.T.A. Course... it fitted me splendidly for my present position.—N. R. Hoffman, Radio Station WCOD, Harrisburg.
- ★... R.T.A. sure opened my eyes to big money... thanks for all you have done for me.—Ernest Lancott, Cleveland.

APPROVED for VETERANS

GET FACTS! SEND FOR FREE BOOK!

telling all about R.T.A.'s streamlined home-training plan, developed by technicians in the heart of the booming Radio-Television field. Fill out the coupon TODAY and your FREE BOOK, entitled "How To Make Good In Radio-Television" will go out to you AT ONCE! No Obligation. R.T.A. APPROVED FOR VETERANS.



RADIO TRAINING ASSOC. OF AMERICA, DEPT. PMA
5620 Hollywood Blvd., Hollywood 28, Calif.

Send FREE BOOK showing how to make good in Radio-Television through training by Hollywood experts.

NAME _____ AGE _____

ADDRESS _____

CITY _____ ZONE _____ STATE _____

Check box if VETERAN of World War II

**FOUR CAREER
FIELDS**



**FOR YOUR
SUCCESS**

PLASTICS

WATCHMAKING



This student is learning to operate a hydraulic press used to mold thermo-setting plastics. Plastic Institute's modern laboratories and shops provide training facilities which are thoroughly practical

PLASTICS AND YOUR FUTURE!

Decide to make your future career in some branch of Plastics. Then you've hitched your future to a young, growing industry. Why? Because more and more products are being made successfully from some type of plastic. Fabrics, poker chips, toys, kitchenware, lamp shades, radio cabinets, fly rod containers, golf clubs and thousands more—useful, everyday products. This means a bigger industry, more jobs, more opportunities for men to operate their own business—**MORE OPPORTUNITIES FOR TRAINED PLASTICS MEN AND WOMEN.**

PLASTICS INSTITUTE is the oldest and largest training school devoted entirely to Plastics education. Headed by widely known leaders in the Plastics Industry, the complete training program, both **HOME STUDY AND RESIDENT SCHOOL**, has been carefully designed to equip men and women to enter the Plastics Industry with the knowledge necessary to get ahead.



GET KIT OF PLASTIC MATERIALS

You receive practical experience making useful, attractive articles as part of your Home Study training. Many students have earned money selling articles of their own manufacture. It's creative and exciting.

GET FREE LITERATURE. MAIL COUPON TODAY.

See what Plastics Industries Technical Institute offers you and read what many successful graduates say about their training. Mail coupon below for complete information. Be sure to indicate whether you are interested in **HOME TRAINING** or desire to come to Los Angeles, California, for resident training.

Approved for Veterans—Non-Veterans

Plastics Industries Technical Institute
Dept. PM-4-1-B, 1601 S. Western Ave., Los Angeles 6, Calif.

Gentlemen: Please send me free literature and information on your practical courses. I am interested in Home Training attending school in Los Angeles .

Name (Print).....

Street.....Age.....

City.....Zone.....State.....

Veteran.....Non-Veteran.....

- What **TIME** do you get up?
- What **TIME** do you go to work?
- What **TIME** does your train leave?
- What **TIME** do you eat lunch?
- What **TIME** does the game start?
- What **TIME** do you have dinner?
- What **TIME** does the movie start?

Everyone is guided by **TIME**. That is the reason why it is important for you to seriously consider **WATCHMAKING** as your career. This interesting field demands trained minds and hands. You can get this training at American School of Watchmaking.



At American School of Watchmaking students get the best of training under the careful supervision of expert instructors.

YOUR OWN BUSINESS

Trained men and women in Watchmaking can get into business for themselves, or work for good pay in pleasant surroundings. Many students of **AMERICAN SCHOOL OF WATCHMAKING** are achieving success in this profitable field.

STUDY IN GLAMOROUS CALIFORNIA

Enroll in American School of Watchmaking and combine your serious training program with all that Southern California offers you.

Member of: United Horological Association
National Council Technical Schools

Approved for Veterans—Non-Veterans

American School of Watchmaking
Dept. PM-4-1-B, 5145 W. San Fernando Rd.
Los Angeles 26, Calif.

Gentlemen: Please send me free booklet and information on your training.

Name (Print).....

Street.....Age.....

City.....Zone.....State.....

Veteran.....Non-Veteran.....

**CHOOSE THE
ONE**



**THAT FITS
YOU BEST**

DIESEL

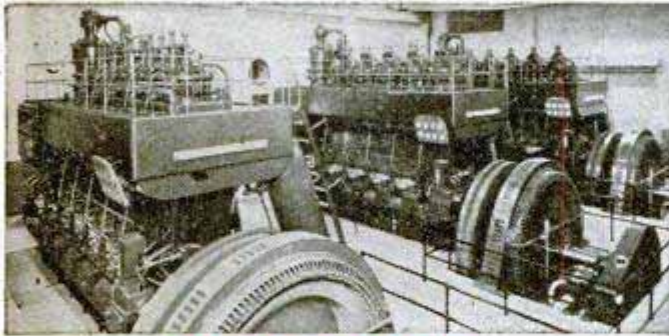

A typical modern Diesel plant.

If you are mechanically inclined and ambitious to get into a field offering a great future—then **LEARN DIESEL THE HEMPHILL WAY!** Many successful Hemphill School graduates have positions of responsibility operating, installing, repairing, and servicing Diesel engines in trucks, ships, power plants, logging operations, construction jobs and other fields. The scope and future of the trained Diesel man is broad and offers opportunities to specialize. If you want to see the world, remember, Diesels are used in transportation, mining, construction and drilling operations in distant countries. Perhaps you like agriculture or railroading or shipping—in almost every field you find Diesels. And remember, trained Diesel men are required to operate and maintain them. **YOU CAN BE A TRAINED DIESEL MAN.** You can learn quickly and easily the famous **HEMPHILL WAY!**

STUDY AT HOME

Learn Diesel at home in your spare time, without interfering with your present activities. Easy-to-understand **HOME STUDY** course result of years of Hemphill Schools' successful teaching. Or take practical resident school training at Los Angeles, New York or Memphis. **INDICATE YOUR CHOICE ON COUPON BELOW.**

Hemphill Specialized Automotive Engine, Carburetor, Electrical and Ignition Tune-up Course offered at Los Angeles and Memphis. Check coupon.

Approved for Veterans—Non-Veterans

Hemphill Diesel and Automotive Schools
Administrative Office: 1601 South Western Ave.
Dept. PM-4-1-8, Los Angeles 6, Calif.

Gentlemen: Please send me **FREE BOOKLET** and information on your Diesel Courses. I am interested in Home study Resident School at New York Memphis Los Angeles Send information on Auto Tune-up at Memphis Los Angeles

Name.....Age.....
Street.....Zone.....
City.....State.....
Veteran.....Non-Veteran.....

AIRCRAFT INSTRUMENTS

After overhauling a Rate of Climb Indicator, student tests it for proper range deflection, maintaining very rigid tolerances, on a special test unit.



This student is testing for accuracy a Turn and Bank Indicator against time, using a stop watch, and against another instrument of known accuracy.



FLASH! C-54 four-engined Skymaster, known as "The Big Push" flies Atlantic without a hand on the controls!

Delicate INSTRUMENTS made this feat possible! **TRAINED AIRCRAFT INSTRUMENT TECHNICIANS** manufactured, installed and serviced these instruments. Such men are essential to the continuing progress of Aviation!

GET INTO THIS IMPORTANT FIELD!

American Schools of Aircraft Instruments teaches you in 34 short weeks to qualify as an Instrument Technician. Hundreds of successful graduates employed in the industry or have own business.

HERE'S WHAT YOU LEARN

At A.S.A.I. you study instruments in pressure, mechanical and gyroscopic groups. Installation, service, repair and line maintenance. Aircraft instrument training also applicable to many industrial fields.

Come to American Schools of Aircraft Instruments in Los Angeles where much Aviation history begins and where you can enjoy all else that Southern California offers you.

Approved by National Council of Technical Schools. C.A.A. approved Instrument Repair Station License No. 1028.

Approved for Veterans—Non-Veterans

American Schools of Aircraft Instruments
Dept. PM-4-1-8, 5145 W. San Fernando Rd.
Los Angeles 26, Calif.

Gentlemen: Please send me **FREE** and **WITHOUT OBLIGATION**, illustrated booklet describing Aircraft Instrument field.

Name (Print).....Age.....
Street.....Zone.....State.....
City.....Zone.....State.....
Veteran.....Non-Veteran.....



**START AS HIGH AS
\$3,021 A YEAR**

**(Veterans Get Special Preference)
Get Ready Now for Next Examinations**

City Mail Carriers, Post Office Clerks

Clerks and Carriers now get \$2,100 the first year of regular employment and automatically increase \$100 a year to \$3,100. Open to Men—Women 18 to 50. Clerks and Carriers can be promoted to other postal positions paying as high as \$7,100.00.

Railway Postal Clerks

Railway Postal Clerks get \$2,300 the first year of regular employment, being paid on the first and fifteenth of each month. (\$95.84 each pay day.) Their pay is automatically increased yearly to \$3,400 and \$3,600 in large organizations. Advance may be had to Chief Clerk at \$5,400 a year. Veterans Only.

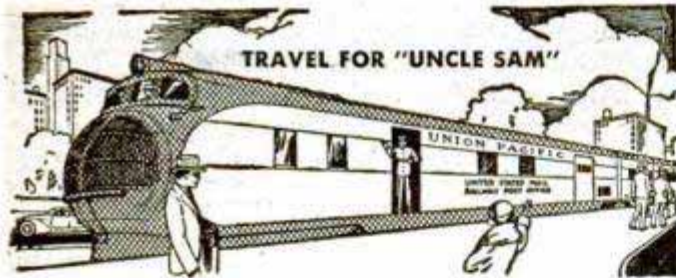

3 Days On — 3 Days Off — Full Pay

Railway Postal Clerks on long runs usually work 3 days and have 3 days off duty or in the same proportion. During this off duty their pay continues just as though they were working. They travel on a pass when on business. When they grow old, they are retired with a pension.

Many Other Positions

Many other positions are obtainable. Rural Carriers—Stenographers—Typists—Patrol Inspectors—Assistant Statistical Clerks—etc. Those wishing these positions should qualify at once.

Get Free List of Positions

Fill out the following coupon. Tear it off and mail it today—NOW, at once.

This can result in your getting a big-paid government job.

FRANKLIN INSTITUTE, Dept. S86, Rochester 4, N. Y.

Rush to me, entirely free of charge (1) a full description of U. S. Government Jobs; (2) Free copy of illustrated 32-page book, "How to Get a U. S. Government Job" with (3) List of U. S. Government Jobs; (4) Tell me how to prepare for one of these jobs.

Name _____

Address _____ Veteran? _____

**Use This Coupon Before You Mislay It.
Write or Print Plainly.**

SAY YOU SAW IT IN POPULAR MECHANICS

**NEW, EASY WAY TO LEARN
Show Card Writing
MAKE EXTRA \$\$
SPARE TIME or FULL TIME**

STOREKEEPERS will pay you good money for show cards because they increase sales up to 70%. And you DON'T have to be an artist to make sales-booming show cards the new, easy way. Fascinating, big book shows ANYONE how to be really expert at this interesting, profitable work. Make it your full or spare-time business; a hobby that produces extra cash.

SIMPLIFIED SHOW CARD WRITING teaches you the easy way to make show cards that shop-owners want. Fully-illustrated; spiral binding lies flat so that you can copy; special section of 100 prize-winning show cards.

**Send No Money
Free 10 Day Examination**

NOW, you can examine this wonder-working book FREE for ten days. If not satisfied, return book without obligation. Otherwise send only \$3.00 plus postage. In a short while, it can help you make many times that small price. So, mail card or letter TODAY for FREE 10 days' trial. (If you enclose \$3.00 WITH your letter now, WE will pay postage. You still have the ten day return-for-refund privilege.)

**BUTTERICK CO., Dept. 21
161 Sixth Ave. New York 13, N. Y.**

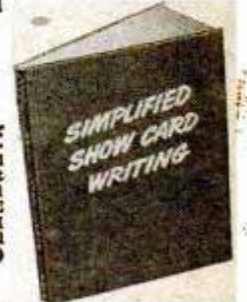

LAW FREE BOOK

Write today for FREE 48-page-book, "THE LAW-TRAINED MAN," which shows how to learn law easily in spare time at home through the Blackstone course prepared by 60 well-known law authorities. We furnish all material including 18-volume Modern American Law library. Many successful attorneys among our graduates. LL.B. degree. Moderate cost; easy terms; Money-Back Agreement.

**BLACKSTONE COLLEGE OF LAW
225 N. Michigan Ave., Dept. 51, Chicago 1, Ill.
A Correspondence Institution Founded in 1890**

TRIGONOMETRY

SPEED UP YOUR TRIG. LEARN SWIFTLY.

Get Correct answers speedily, easily, with Josselyn's great Trigonometry magic circle chart. Amazing Short-cut to SPEED & ACCURACY. Saves students, engineers, craftsmen, hours & days of needless work. Solve swiftly almost any Plane Trig problem. Helps prepare exams. Let it simplify Trig & work for you at once, accurately, precisely. We mail C.O.D. plus postage fee, or send \$1.00 & we mail postpaid.

**EDCO SCIENTIFIC MFG. CO.
Box 531, Hollywood Station 28, Hollywood, Calif.**



LEARN LANDSCAPING

Profitable career—absorbing hobby for men and women! Thorough home-study course in landscaping, garden design. 45 lessons beautifully printed and illustrated. Learn in spare time 8-12 months. Hundreds of successful graduates all over the world. 32nd year. Write for Free Catalog.

**AMERICAN LANDSCAPE SCHOOL
6479 Grand Ave., Des Moines 12, Ia.**

Learn BAKING At Home

Baking is one of America's high industries in wages. Nearly depression-proof. Thorough basic home course lays sound foundation. If you have aptitude, write for FREE BOOKLET, "Opportunities in Commercial Baking." National Baking School, 1315 Mich. Ave., Dept. 1351, Chicago 5

TURN YOUR LONGHAND INTO

**SHORTHAND in
6 Weeks at Home**

Famous Speedwriting system. No signs or symbols; no machines; uses ABC's. Easy to learn; easy to write and transcribe. Fast preparation for a job. Surprisingly low cost. 100,000 taught by mail. Used in leading offices and Civil Service. Write for free booklet. **SPEEDWRITING, Dept. 1501-8, 55 West 42 St., N. Y. 18**



You receive all parts, including tubes, for building this fine, modern Superheterodyne Receiver. This and other valuable standard equipment becomes your property.

Learn RADIO TELEVISION, ELECTRONICS *by* SHOP METHOD HOME TRAINING

Let NATIONAL SCHOOLS, of Los Angeles, a practical Technical Resident Trade School for over 40 years, train you for today's unlimited opportunities in Radio

these two FREE books will tell you how

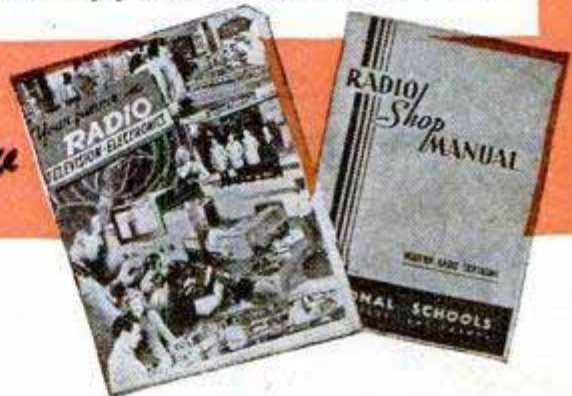

Good Jobs Await the Trained Radio Technician

You are needed in the great, modern Radio, Television and Electronics industry! Trained Radio technicians are in constant and growing demand at excellent pay—in Broadcasting, Communications, Television, Radar, Research Laboratories, Home Radio Service, etc. National Schools Master Shop Method Home Study Course, with newly added lessons and equipment, can train you in your spare time, *right in your own home*, for these exciting opportunities. Our method has been proved by the remarkable success of National Schools-trained men all over the world.

You Learn by Building Equipment with Standard Radio Parts We Send You

Your National Schools Course includes not only basic theory, but practical training as well—you learn by doing. We send you complete standard equipment of professional quality for building various experimental and test units. You advance step by step until you are able to build the modern superheterodyne receiver shown above, which is yours to keep and enjoy. You perform more than 100 experiments—build many types of circuits, signal generator, low power radio transmitter, audio oscillator, and other units. The Free Books shown above tell you more about it—send for them today!



NOW! NEW PROFESSIONAL MULTITESTER INCLUDED

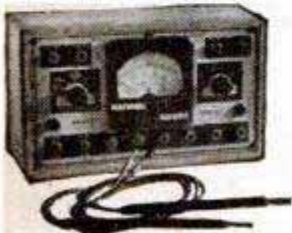

This versatile testing instrument is portable and complete with test leads, batteries and tubes. Simple to operate, accurate and dependable. You will be able to quickly locate trouble and adjust the most delicate circuits. You can use the Multitester at home or on service calls. It is designed to measure AC and DC volts, current, resistance and decibels. You will be proud to own and use this valuable professional instrument.

GET THE DETAILS—SEND THE COUPON

LESSONS AND INSTRUCTION MATERIAL ARE UP-TO-DATE, PRACTICAL, INTERESTING

National Schools Master Shop Method Home Training gives you basic and advanced instruction in all phases of Radio, Television and Electronics. Each lesson is made easy to understand by numerous illustrations and diagrams. All instruction material has been developed and tested in our own shops and laboratories, under the supervision of our own engineers and instructors. A free sample lesson is yours upon request—use the coupon below.

Here's Just a Few of the Interesting Facts you Learn with the FREE MANUAL

1. Routine for diagnosing Radio Troubles.
2. Preliminary inspection of Receivers.
3. How to Test and Measure Voltages.
4. How to Test Speaker in Audio Stages.
5. How to Trace the Circuit and Prepare Skeleton Diagram.
6. Complete Reference Table for Quickly Locating Receiver Troubles.



VETERANS

If you are a veteran, qualified for training under the G.I. Bill, check the coupon for a Special Bulletin.

G. I. APPROVED

NATIONAL SCHOOLS

LOS ANGELES 37, CALIFORNIA EST. 1905



MAIL OPPORTUNITY COUPON FOR QUICK ACTION

National Schools, Dept. PM-1
4000 South Figueroa Street
Los Angeles 37, California

(Mail in envelope or paste on penny postcard.)

Mail me FREE the books mentioned in your ad including a sample lesson of your course. I understand no salesman will call on me.

NAME _____ AGE _____

ADDRESS _____

CITY _____ ZONE _____ STATE _____

Check here if veteran of World War II

NOW! ALL 5 FAMOUS JOWETT COURSES - 1 COMPLETE MUSCLE BUILDING VOLUME! FOR ONLY 25¢

LET ME PROVE I can make YOU

AND MY PHOTO BOOK OF FAMOUS STRONG MEN! FREE!



COMMANDO-TOUGH OR IT WON'T COST YOU A CENT!

by George F. Jowett WORLD'S GREATEST BODY BUILDER

GIVE ME 10 MINUTES A DAY LEARN MY TIME TESTED SECRETS OF STRENGTH

I'll teach you the "Progressive Power Method" through which I rebuilt myself from a physical wreck the doctors condemned to die at 15, to the holder of more strength records than any other living athlete or teacher! "Progressive Power" has proven its ability to build the strongest, handsomest men in the world. And I stand ready to show you on a money back basis — that no matter how flabby or puny you are I can do the same for you right in your own home. Let me prove I can add inches to your arms, broaden your shoulders, give you a man-sized chest, powerful legs and a Rock-like back—in fact, power pack your whole body so quickly it will amaze you! Through my proven secrets I bring to life new power in you inside and out, until YOU are fully satisfied you are the man you want to be.

PROVE IT TO YOURSELF IN ONE NIGHT

Send only 25c for my 5 easy-to-follow, picture-packed courses now in 1 complete volume "How to Become a Muscular He-Man." Try it for one night! Experience the thrilling strength that surges through your muscles.

10 DAY TRIAL

Think of it—all five of these famous courses now in one picture-packed volume for only 25c. If you're not delighted with this famous muscle-building guide—if you don't actually FEEL results within ONE WEEK, send it back and your money will be promptly refunded!

Photo Book Of Famous Strong Men!

I am making a drive for thousands of new friends fast—REGARDLESS OF COST!

SO GET NOW MY 5 Muscle Building COURSES (Valued at \$5 each)

All in 1 Great Complete Volume Packed With How-To-Do-It Pictures!

Now, this "get-acquainted," extremely low price of only 25c is your chance to build a body you'll be proud of! Follow Jowett's easy method of muscle building NOW!

For Only 25c

FREE!

Photos that inspire you to might and muscle. Free with order.



How to BECOME A MUSCULAR HE-MAN

With these 5 Complete Courses on Building an Amazing Body:

1. A Mighty Grip
2. A Mighty Chest
3. A Mighty Back
4. A Mighty Arm
5. A Mighty Leg

FREE GIFT COUPON!

Jowett Institute of Physical Culture
230 Fifth Avenue, New York 1, N. Y. Dept. PM-81

George F. Jowett:—Please send by return mail, prepaid, **FREE** Jowett's Photo Book of Strong Men, along with all 5 Muscle Building Courses. 1. Molding a Mighty Chest. 2. Molding a Mighty Arm. 3. Molding a Mighty Grip. 4. Molding a Mighty Back. 5. Molding Mighty Legs—Now all in One Volume "How to Become a Muscular He-Man." Enclosed find 25c. NO C.O.D.'S.

George F. Jowett
Champion of Champions

NAME _____ AGE _____
(Please Print Plainly, Include Zone Number)

ADDRESS _____

HOBBY CATALOG

NEW, BIG COLLECTION OF MATERIALS

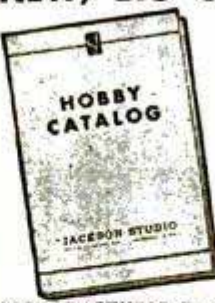

Get this catalog for your shop. It lists and shows a wide variety of tools and materials—some hard-to-get items in addition to a big 20 page section on books and project information. A gold mine of practical help. Shows how we test and approve all materials and tools in our own shop before we offer them to you—your assurance that they are tops in quality—everything fully guaranteed or your money refunded. Hurry to get this catalog, save money with our new Book Dividend Plan. Send 25c today—do it now, to

JACKSON STUDIO, Dept. 39, 5440 N. Shoreland Ave., Milwaukee 11, Wis.

FLOYD CLYMER'S unbiased book "INDEPENDENT TEST REPORT ON KAISER-FRAZER CARS"



Read what 3000 owners now think of their K-F cars. Expert, part-by-part analysis. 100 photos. Tells all. 3000-mile test run, Pike's Peak closed car record, gas mileage. Thousands are buying. Order now, \$1.50 postpaid. \$2.50 deluxe ed. Cash, money-order, or specify C. O. D. Money-back guarantee. Clymer, Publisher, Dept. A-1 2125 W. Pico, Los Angeles 6, Calif.

Master Watchmaking

The life-long profitable trade of thousands as taught by the Sweazey System.

"FAMED THE WORLD OVER" CHICAGO SCHOOL OF WATCHMAKING

Founded in 1908 by Thomas B. Sweazey
1608 N. Milwaukee Ave., Dept. 118 Chicago 47, Ill.

COMBAT JUDO

Fiercest fighting technique known. Learn trick knock-outs, police tactics, and the art of Defense and Attack. Expert instructions in THREE volumes with 200 photographs and illustrations. Complete... only \$2.25

VARIETY HOUSE
Box 46-BA Wall St. Sta., New York 5, N. Y.

Photo Penmanship

HOW'S YOUR PENMANSHIP? If poor, I'll Guarantee to correct it to your satisfaction in 10 days with my definite Hand Controls—No failures. Write, OZMENT, 34-R, St. Louis, Mo.

HI-SPEED EQUIPMENT

High Compression Heads—Dual Manifolds
Dual Air Cleaners For V8's

Use these simple conversions to increase horsepower, speed acceleration, and increase top speed of your car. Write today for prices and full information.

SANDEE MUFFLER CO. 7523 S. Western Ave. Los Angeles, Calif.

V-8 DUALS & SINGLES

MUFFLERS STEELS and ALUMINUMS with a motorboat tone

SINGLES, Chev., V-8, Plymouth, Steels \$5.50, Aluminum \$7.00. Chry., Olds., Buicks, etc., Steels \$7.50, Aluminum \$9.00. V-8 and MERCURY DUALS, Steel \$17.50, Aluminum \$21.00. Split Manifold Sets, Steels \$35.00, Aluminum \$45.00. Aluminums are guaranteed for life of your car.

DEALERS WANTED

SANDEE MUFFLER CO.
BOX 296 LA TIJ. LOS ANGELES 43. CALIF
2624 W. SLAUSON AVE., LOS ANGELES, CALIF.

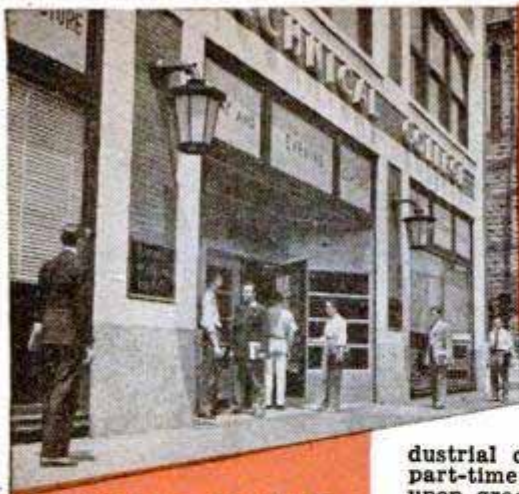

Learn ENGINEERING DRAFTING...BUILDING in Chicago, Industrial Hub

Approved for **G.I. Training** **Time-Saving Courses** **Day & Evening Classes**

Get your training at Chicago Tech in the Nation's industrial center. Chicago provides unequalled opportunities for part-time employment while training and for permanent positions upon graduation. Many other cultural and recreational advantages described in Catalog. — sent Free!

Chicago Tech, founded 43 years ago, has trained thousands of men now occupying important places in industry the world over. Training combines theory and practice in 1 year, 2 year, and 3 year (Degree) courses. Saving in time means earlier graduation, — and consequently earlier employment.

Terms start January, April, July and October. Get information now to arrange for early admission and accommodations.

CHICAGO TECHNICAL COLLEGE

A-82 Tech Bldg.
2000 So. Michigan Ave.
Chicago 16, Ill.



MAIL COUPON TODAY

CHICAGO TECHNICAL COLLEGE

A-82 Tech Bldg., 2000 So. Michigan Ave.
Chicago 16, Ill.

Please send me without obligation free booklet on Time-Saving Technical Training.

Name _____ Age _____

Address _____

City _____ Zone _____ State _____

1 YEAR • 2 YEAR
3 YEAR COURSES

BUILDING

DRAFTING

ENGINEERING

AIR CONDITIONING

REFRIGERATION

ELECTRICITY

RADIO



CARTOONING

Taught by 9 Professionals

Here's a new idea in cartooning schools—45 Lessons created by NINE Famous Professionals: Boltinoff, Lariar, Nofziger, Roir, Ross, Roth, Salo, Schus and Wolfe. Over 2000 Instruction Drawings! Complete course includes: COMIC STRIPS • MAGAZINE CARTOONING • SPORT CARTOONS • POLITICALS • ANIMALS • ADVERTISING COMICS • BOOK ILLUSTRATION • CUTE GIRLS, etc.

Learn the modern way! Your homework personally criticized by all 9 famous teachers. Up to 2 years to finish. Approved as a Correspondence School under the laws of the State of New York. For literature write to:

The PROFESSIONAL SCHOOL OF CARTOONING, Inc.
Dept. A 342 Madison Avenue • New York 17, N.Y.

OLD GOLD JEWELRY WANTED

Dental gold teeth, plates and bridges with metal attached. Any broken pieces of gold jewelry. Immediate payment and free mailing container to you or your friends upon request.
LOWES, DEPT PM Holland Bldg., St. Louis 1, Mo.

DETECTIVES!!!

Study SCIENTIFIC Criminology at Home. Be an Investigator. Send for FREE BOOKLET. Write Dept.-L
PACIFIC SCHOOLS, INC.

601 S. VERMONT AVE. LOS ANGELES 5, CALIF.

Name _____
Address _____

Make More
Money in

AUTO BODY and FENDER REPAIRS

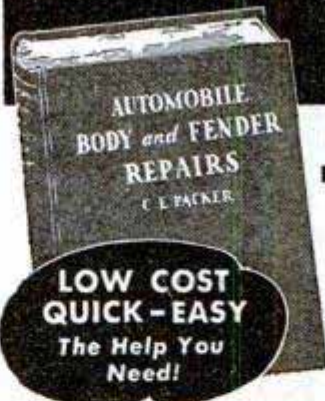

GET THIS BOOK NOW

In Your Own Home **FREE TRIAL**
Send No Money

LOW COST
QUICK-EASY
The Help You
Need!

233 PICTURES—DIAGRAMS
325 PAGES OF VITAL FACTS

Covers methods, tools, materials—How to get business—How to start your own shop. Latest information and pictures.

Get yourself a share of the big money car owners are spending to keep their older cars looking good. This practical book will put you right into this profitable business. No experience needed. Get a good job or start a business of your own with little or no capital. Biggest selling book of its kind. Thousands in use. Mail coupon today — money back if not fully satisfied.

Mail Coupon

Goodheart-Willcox Co., Dept. 11-A
2009 S. Michigan Avenue, Chicago 16, Ill.

Send Auto Body and Fender Repair, \$3.50. If not satisfactory I will return in 5 days and you will refund money paid.

Remittance enclosed, send postpaid.
 Send C.O.D. Postage extra.

Name _____

Address _____

City _____ State _____

FREE

SEND FOR

ALLIED'S Big 164 Page RADIO CATALOG!

WRITE TODAY!



SAVE ON EVERYTHING IN RADIO!



NEW HOME RADIOS



SERVICE SUPPLIES BUILDERS' SUPPLIES



AMATEUR GEAR



SOUND SYSTEMS

164 Value-Packed Pages

Send for your FREE copy of the most complete Buying Guide for Everything in Radio! Here's the Catalog for Servicemen, Dealers, Soundmen, Amateurs, Builders and Experimenters. Features the world's largest and most complete stocks of radio and electronic supplies—quality equipment at lowest prices! Get the speedy service and expert help you want from ALLIED—Radio's Largest Supply House. Depend on ALLIED!

MORE THAN 10,000 ITEMS

Get everything for every radio use: Latest type home radio models, phono-radios, recorders, communications receivers, Ham kits, and gear, code apparatus, radio parts, tubes, tools, test instruments, public address equipment, low-cost easy-to-build radio kits, diagrams and matched parts lists, largest selection of instructive radio books—all at lowest prices!

ALLIED RADIO

ALLIED RADIO CORP.
833 W. Jackson Blvd., Dept. 5-AA-8
Chicago 7, Illinois

Rush FREE 164-Page Catalog

Name.....

Address.....

City..... Zone..... State.....

FREE CATALOG

STUDY AT HOME

With An Educational Institution

Men with specialized training win higher positions, insure larger earnings, and are bigger successes in business and public life. Opportunities NOW greater than ever before. Send for our Catalog.

ARTS and SCIENCES

Courses in Philosophy; Education; Letters; Public Health; Medical Jurisprudence; Psychology; Sociology; Physics; Chemistry; Plastics; Geology; Political Science; Theology; Business and Commerce; Accounting; Mathematics; Statistics; Agriculture.

ENGINEERING

Courses in Electrical, Civil, Mechanical, Drafting, Architectural, Steam, Aeronautical, Radio, Structural, Mining, Industrial, Petroleum, Marine, Chemical, Diesel, Automobile, Refrigeration, and Air Conditioning Engineering.

LAW

Complete Professional Law Course includes 18 Hornbook Series college grade textbooks. Courses also in Commercial Law, Patent Law and Medical Jurisprudence.
McKinley-Roosevelt Incorporated, 4610-K, Sheridan Rd., Chicago 40, Ill.

DEVELOP RUGGED STRENGTH!



Strong Men's Club of America offers FREE Membership!

Send for your personal membership card and Strength Secrets. No dues! No obligations! Many valuable privileges! Send name, address, age, on penny postcard.

JOE BONOMO Strong Men's Club of America
Director (Dept. PM1) 1841 Broadway, N. Y. 23, N. Y.



DENTAL TECHNICIANS

Nationwide openings for trained men. Learn by simple home study—with theory and actual practice as a guide. EASY STEP-BY-STEP TECHNIQUE

for information write to DEPT. PM-1

DENTAL ARTS INSTITUTE
1122 MARKET STREET, SAN FRANCISCO 2, CALIF.

THERE'S MONEY IN CARTOONS!

RAYE BURNS will teach you HOW to CREATE ORIGINAL CARTOONS at home that you may SELL! Course contains 26 lessons and over 600 illustrations. All for Only... **\$2.85**

Send name and address for free details.

RAYE BURNS SCHOOL, Dept. M, Box 3583, CLEVELAND, OHIO

LEARN THE SECRET OF CONTENTMENT, HAPPINESS!

Free book tells how to solve mental worries, gain peace of mind thru META-PHYSICS, PSYCHOLOGY. Win the degree of Ps.D. or Ms.D. Experience the revelation of truth. Chartered college. Write

COLLEGE OF UNIVERSAL TRUTH, 5153-V North Clark St., Chicago

LEARN TO WRITE

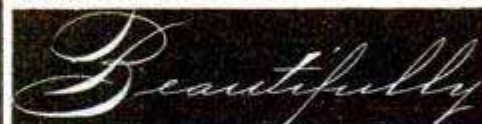

FREE TRIAL IN YOUR HOME

BE AN EXPERT PENMAN — NO TEACHER NECESSARY

RIGHT in your own Home you can learn to write a beautiful hand in an amazingly short time. New simplified method originated by J. D. Rice, 40 years head Penmanship Dept., Chillicothe, Mo. Bus. College. Artistic writing will win you prestige, admiration, help you influence employers. Contains same type material as expensive courses, yet costs you ONLY **\$2.95**

EDUCATIONAL PUBLISHERS
7241 Madison, Kansas City 5, Mo.

EXAMINE THIS GREAT COURSE FREE (U.S.A. only)

Please send me your new course ARTISTIC PENMANSHIP SELF TAUGHT. Within 10 days I will either return the course, or send you \$2.95, plus postage.

Name..... (Please Print)

Address..... (Outside U. S.—Please enclose remittance with order) PM-Jan. 48

Now While these Great Industries Go Forward

AIM HIGH — PICK ONE OF THESE BIG FIELDS

- REFRIGERATION AND AIR CONDITIONING
- AUTOMOTIVE MECHANICS
- BODY, FENDER REBUILDING
- ELECTRICITY ● RADIO
- BUILDING
- DIESEL

Make Your Decision

For a Better Job
or a
BUSINESS of YOUR OWN
NOW'S the TIME

INDUSTRY is rapidly making up for lost time. There may never again be such opportunities for men who want better jobs or business of their own to get in on ground floor and go up fast! Yes — **FOR MEN WHO ACT FAST, THINGS CAN HAPPEN FAST!**

**YOU CAN'T AFFORD TO WAIT
YOUR FUTURE DEPENDS
ON WHAT YOU DO TODAY.**

A Few Short Weeks Can Make All the Difference

COMMERCIAL TRADES INSTITUTE was only civilian school selected by Army to train service men for refrigeration. In motive trades our institute gained nation wide fame training Auto Mechanics for U.S. Army. Same quality training available to you now. If over 17 and under 60 learn how you can get started. **CONSULTATION AND PLACEMENT SERVICE WHETHER YOU ARE INTERESTED IN WORTHWHILE JOB OR SETTING UP YOUR OWN BUSINESS.**

TRAIN AT HOME
IN SPARE TIME OR IN OUR
WELL EQUIPPED SHOPS

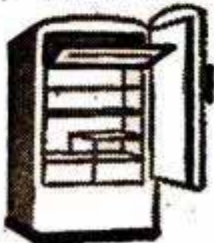

REFRIGERATION *and* AIR CONDITIONING

Trained men paid well to service, install, maintain, repair, rebuild household and commercial refrigerators. Important new developments such as Frozen Foods, and many new industrial uses. Opportunities for full time, spare time earnings. Begin training at home in spare time, finish in our big modern shops, or come directly to shops.

At home you get C.T.I.'s **SHOP PROVED HOME STUDY** instruction—actual shop experience has gone into the practical lesson assignments. That is why it is easy for mechanically inclined men to learn by our Home Study training, and start on actual refrigeration work.

AUTOMOTIVE MECHANICS · BODY & FENDER REBUILDING

Progress rapid by our learn-by-doing **SUPERVISED SHOP TRAINING**. Efficient auto mechanics get excellent pay. Learn to overhaul and repair engines, transmissions, differentials and other assemblies.

Body and Fender Rebuilding offers profitable work. Get good, practical "all-around" training—welding, aligning, mixing and matching colors, spray painting, power and hand tools. Values increased when used cars are made to "look like new."

RADIO SERVICING

Vastly increased number of radio receivers, development of FM broadcasting, installation of public address systems, demand services of trained men who can repair receiving sets, install p.a. equipment. Men who can quickly, efficiently service receiving sets earn good pay, have excellent opportunities to start own business. Get practical training in the big C.T.I. shops. Learn Radio Servicing — pay is good!

ELECTRICITY ELECTRICAL SERVICING

Get ready for good job or business of your own. Electricity is the heart of modern industry. Electricians always needed, earn higher pay, work year around. Make rapid progress in step-by-step practical shop training in Electrical Wiring and Circuits; Armature Winding; Electrical Appliance Repairs; Electro Plating and Welding. Rural Electrification, the Building Boom, many new uses of Electricity opening more opportunities in this vast field. Get training under thoroughly experienced instructors, be ready in few short weeks for Job Opportunities in Electricity.

DIESEL

Diesel engines are used to power entire fleets of trucks and buses, to drive tractors and other farm equipment. Diesels have revolutionized the railroads, are employed for passenger and freight trains as well as for switching engines. They are used to power road equipment, and even are being tested for airplanes and passenger cars. A big field that promises even bigger things in the years right ahead. Modern shop training on actual equipment under experienced instructors. Learn Diesel under direction of men who trained Diesel mechanics for U. S. Army.

HOME OF
C.T.I.



VETERANS —

Veterans qualifying under "G.I. Bill" have tuition paid by Government plus monthly subsistence allowance while in school. Just mail coupon, we will handle all details. **(LOW TUITION, EASY TERMS if you are not a veteran.)**

BUILDING CONSTRUCTION

Do you want to be on the inside in the building boom — where big money is made? Learn about opportunities for building contractors whether or not you have previous experience in this field. Millions of dollars are going to be made in home and farm buildings, in construction of stores, garages, small industrial buildings. Building industry uses men by thousands in construction, supervision, management, sales.

**COMMERCIAL TRADES INSTITUTE, Dept. E-21
1400 GREENLEAF AVENUE CHICAGO 26, ILLINOIS**

FILL OUT · CUT OUT · MAIL TODAY!

FACTS FREE FOR MEN WHO WANT TO GET AHEAD

**COMMERCIAL TRADES INSTITUTE, Dept. E-21
1400 W. Greenleaf, Chicago 26, Ill.**

Send free illustrated Brochures and other information about the field I have checked below.

- | | |
|---|---|
| <input type="checkbox"/> Refrigeration and Air Conditioning | <input type="checkbox"/> Automotive Mechanics |
| <input type="checkbox"/> Electricity | <input type="checkbox"/> Diesel Mechanics |
| <input type="checkbox"/> Radio Servicing | <input type="checkbox"/> Body & Fender Rebuilding |
| | <input type="checkbox"/> Building Construction |

Name _____

Address _____

City _____ State _____

Veteran Non-Veteran

VETERANS Learn WATCHMAKING

A Lifetime Profession

Regardless of Conditions, Age, Sex, or Physical Limitations Veterans—Civilians! Your Opportunity—**LEARN WATCHMAKING**



Lift yourself from a futureless job into a position paying better than your present work. Fit yourself for the job that will permit you to establish your own shop, or be employed in a pleasant environment.

Watch Repairing—Jewelry—Engraving will always be in ever greater demand. Our graduates wanted everywhere. Dignified positions \$50-\$75-\$100 per week. Veterans write today for latest FREE enrollment requirements.

Kansas City School of Watchmaking
Largest Horological School in America
617-621 Wyandotte St. Kansas City 8, Mo.

Earn an Aviation Mechanic's HIGH SALARY

Quickly in Southern California and be protected by a **GOVERNMENT LICENSE**



YOU GET CREDIT FOR EXPERIENCE

Here in California is your big opportunity. Aviation mechanics at high salaries are in wide demand. Famous California Flyers can prepare you for your government license in an amazingly short period of time. Licensed California Flyers' graduates are protected by the government from unskilled competition. Established in 1930, California Flyers is one of the nation's oldest aeronautical schools, hundreds of successful graduates in top positions all over the world. You, too, can reap big rewards. Clip coupon for complete information. If you've had previous aviation experience write giving us a complete record.

ment from unskilled competition. Established in 1930, California Flyers is one of the nation's oldest aeronautical schools, hundreds of successful graduates in top positions all over the world. You, too, can reap big rewards. Clip coupon for complete information. If you've had previous aviation experience write giving us a complete record.

APPROVED FOR VETERANS AND BY THE C-A-A • HOUSING AVAILABLE

CALIFORNIA FLYERS, School of Aeronautics, Dept. M-1
720 S. Redondo Blvd., Inglewood, California

Please send me illustrated brochure containing full information about courses, tuition, etc., and application blank. I understand this will not obligate me in any way.

I am interested in Mechanics

Name _____ Age _____

Address _____

City _____ Zone _____ State _____

THERE IS NO FLYING INVOLVED in AVIATION MECHANICS COURSES at CALIFORNIA FLYERS SCHOOL of AERONAUTICS

CAUGHT BY THEIR FINGER PRINTS



During the past 30 years the I. A. S. has trained hundreds of men at home to fill positions of responsibility and steady pay as finger print experts. This fascinating, profitable profession can be learned at home during spare time. More than 800 American Identification Bureaus employ I. A. S. graduates or students. Write today for complete list of these Bureaus.

YOU
Can Train for **CRIMINAL INVESTIGATION and IDENTIFICATION WORK AT HOME!**

Send Now for "BLUE BOOK of CRIME"

Thrilling, inspiring, helpful. Be sure to state your age when sending for book. **FREE!**

INSTITUTE OF APPLIED SCIENCE

Dept. 1351, 1920 Sunnyside Ave., Chicago 40, Ill.

Learn to SPEAK SPANISH FRENCH GERMAN ITALIAN

Famous Cortina Method Makes It EASY



Count Cortina

BIG OPPORTUNITIES Await Americans who speak **SPANISH**. Learn as a child learns—"by listening" to these new **CORTINA** recordings. The **CORTINAPHONE METHOD**, famous for 65 years, teaches you to speak **SPANISH** as a **NATIVE** speaks! Right at home, relaxed and at ease.



Listen to this Record!

SENT ON 5 DAYS' APPROVAL

Write today for our amazing free book, "The Cortina Short-Cut." State language interested in.

CORTINA ACADEMY
DEPT. 641, 105 WEST 40TH ST.
NEW YORK 18, N. Y.

FREE BOOK

CODE SPEED SHORT CUT

Be an expert. Learn to be a Telegraph or Radio Operator. Thousands of men needed. Intensely interesting work—good pay. Learn at home or wherever you are, quickly, easily with the famous Candler Speed System. Book of particulars Free. **CANDLER SYSTEM CO., Dept. 5-A, Box 928, Denver 1, Colo., U.S.A.**

LAW

STUDY AT HOME for **PERSONAL SUCCESS** and **LARGER EARNINGS**. 39 years expert instruction—over 108,000 students enrolled. LL.B. Degree awarded. All texts furnished. Easy payments. Send for **FREE BOOK**. G. I. approved. **AMERICAN EXTENSION SCHOOL OF LAW**
Dept. 85-M, 646 N. Michigan Ave., Chicago 11, Ill.



LEARN MEAT CUTTING

through actual practice. Profitable Meat Cutting and Successful Meat Merchandising taught easily, quickly. **LEARN BY DOING** at Toledo in just six short weeks under actual market conditions. For beginners or men with experience. All subjects taught thoroughly and completely. Diploma. Job help. Get store of own. People must eat. School in operation nearly 25 years. Approved for G. I. training. Send today for **FREE** literature. No obligation. **NATIONAL SCHOOL OF MEAT CUTTING, Dept. 37, Toledo 4, Ohio**

TRAIN Your VOICE!

Results GUARANTEED

We build, strengthen the vocal organs—not with singing lessons—but by sound, scientifically correct silent and vocal exercises and absolutely guarantee complete satisfaction with results. Write for Voice Book, **FREE**. Sent to no one under 17 years old unless signed by parent. Perfect Voice Studios, Studio 1351, Kimball Hall Bldg., Chicago 4, Ill.



H. T. ARMSTRONG
General Manager

ENJOY the HAPPINESS
of owning
YOUR OWN BUSINESS

Learn



ELECTRIC APPLIANCE

REPAIRING & SERVICING

This is an **ELECTRICAL WORLD!** Every home is a customer for the man who knows how to service electric appliances. It's a wide-open, expanding field for men of all ages who are handy with tools . . . who seek the independence, happiness and rewards that come to the man who owns his own business. Our practical, thorough course teaches you this interesting well-paid business **AT HOME**—during your spare time. A grade school education is all you need. Without obligation, I'd like to send you our new booklet telling about our method of instruction—about today's money-making possibilities in this field—and why I believe this business offers you the depression-proof security, happiness and opportunity you seek.

EARN WHILE LEARNING

Pay For Your Course With Part Time Work

You can actually start making money before your course is finished. With your first set of lessons, I show you easy jobs that can be done in your spare time, at home. Remember—**ONE GOOD REPAIR JOB** will pay for your entire training. You can also start this business **AT HOME**, in your garage or basement, with the tools I send you, also in your **SPARE TIME**, if you like. Or, you can take a well-paid job . . . as there's always a big demand for trained men.



A Business That Gets Better Every Year!

Every year, more and more new electrical appliances are being developed. Hundreds of thousands of new homes being built . . . and others wired for electricity for the first time—through gigantic government electrification projects. Thus, this business gets better every year. And, when you own your own business, **YOU** get the profits when times are booming. If depression comes, you can't lose your job. It usually **IMPROVES** the service and repair business. Let's talk it over by mail!

I'll Train You
AT HOME
in your spare time



YOU LEARN

how to repair electrical appliances such as washing machines, vacuum cleaners, ranges, lamps, irons, motors, etc.—**HOUSE WIRING** and also

REFRIGERATION

which we now include at no extra cost. Our lessons are understandable and easy to grasp.



Send for FREE BOOKLET and complete details

NO SALESMEN WILL CALL

NEW BOOK "HOW TO START YOUR OWN BUSINESS"

Sent if you act promptly

This valuable book covers locating your shop, contains drawings of how to build and wire work-benches, where and how to advertise, what to charge, how to hire solicitors, etc. Sent without charge to students who enroll promptly.

MAIL COUPON TODAY!

H. T. ARMSTRONG, General Manager,
PACIFIC TRAINING SCHOOL, Dept. P-81
7217 So. Broadway, Los Angeles 3, Calif.

Dear Sirs: Please send me, without obligation, your **FREE BOOKLET, "Today's Big Opportunity, Appliance Servicing"** and full details.

Name _____
Address _____
City _____ State _____

It's YOUR future — Make the most of it!



Start now to earn the bigger pay in electrical repair

WAS there ever such an opportunity to get started in electrical maintenance and repair—and at top-notch wages? Are you ready—with experience and ability—to cash in on it? Others are getting just the sort of background needed—quick! practical!—to handle the great variety of electrical maintenance and repair work TODAY—from this well-known electrical library. You can too!

THE LIBRARY OF ELECTRICAL MAINTENANCE AND REPAIR

5 vols., 1826 pages, 1724 illustrations

Gives you the "know-how" to tackle any wiring or motor job. Five books show you HOW—to install all types of motor and generator units—to inspect and repair motor starters and generators—to diagnose motor and generator troubles—to figure new windings for old cores—DC and AC windings—to test armature windings—test induction motors, etc., etc. One book is full of trouble-shooting charts that show quickly symptoms, causes, specific remedies, etc.

Take the first step toward improving YOUR future—Mail this coupon TODAY

No money down—special price—easy payments—FREE trial

McGraw-Hill Book Co., 330 W. 42 St., New York 18, N. Y.

Send me for ten days' free examination the Electrical Maintenance and Repair Library. If satisfactory I will send you \$2.50 in 10 days and \$3.00 monthly until the price of \$17.50 is paid. If not wanted I will return books postpaid. (To insure prompt shipment write plainly and fill in all lines.)

Name

Home Address

City and State

Company

Position

PM-1-48

Learn A Trade NOW! PRACTICAL SHOP TRAINING!

- | | |
|--|--|
| <input type="checkbox"/> AUTO MECHANICS | <input type="checkbox"/> BODY AND FENDER |
| <input type="checkbox"/> DIESEL MECHANICS | <input type="checkbox"/> TOOL AND DIE |
| <input type="checkbox"/> REFRIGERATION | <input type="checkbox"/> MACHINIST |
| <input type="checkbox"/> WELDING—ARC and GAS | <input type="checkbox"/> PIANO TUNING |

America's Leading School
7 Floors of Fully Equipped Shops
Over 45,000 Graduates
Expert Individual Instruction
Learn by Doing — Low Living Expense
Established 1902 — Day and Evening Classes

YOU HEAR IT EVERYWHERE:

**"GREER SHOP TRAINING
IS THE BEST"**

—CALL IN PERSON OR MAIL THIS AD TO— GREER SHOP TRAINING

(Dept. 218) 460 South State St., Chicago 5, Ill.

Please send without obligation free information regarding trade checked above. (Specify whether you are a Veteran or Civilian)

Name _____ Age _____

Address _____

City _____ State _____

BE A GOVERNMENT LICENSED AIRPLANE AND ENGINE MECHANIC Train Now at LINCOLN



EARN BIG PAY IN AVIATION

Our new enlarged school now offers these courses: MASTER AVIATION MECHANICS, CAA Approved 1 Yr. Airplane & Engine Mechanics Course, REFRESHER AIRPLANE & ENGINE MECHANICS. Designed for veterans with aviation mechanics experience. Either course is available to veterans under the G. I. Bill of Rights. Write today for complete information.

LINCOLN AVIATION INSTITUTE
UNION AIR TERMINAL DEPT. P1 LINCOLN, NEBRASKA

BOYS-IT'S FREE!

Exciting, new book tells about "ATOMIC ENERGY" and "THE WONDERS OF CHEMISTRY"

Also shows how to amaze friends with Chemcraft magic and do many exciting home experiments. Free. Send today!
THE PORTER CHEMICAL CO., 10 Prospect Ave., Hagerstown, Md.



HORSE MASTERY!

A FINE HOBBY — A GREAT VOCATION!

"The EXPERT HORSEMAN"

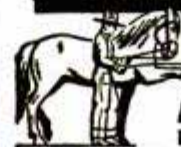

FREE BOOK — Tells how You can learn to: BREAK COLTS, GAIT SHOW HORSES, TRAIN RODEO, STOCK and RACE HORSES, BREAK BAD HABITS, HANDLE ANY HORSE, TRAIN CIRCUS TRICK HORSES. WRITE TODAY!

ANIMAL LOVERS ASSOCIATION
BOX KA-111 TARZANA, CALIFORNIA

SUBSCRIBE TODAY
50¢
One Year

SHOE REPAIR OFFERS BIG INCOME LEARN IN 12 WEEKS TIME

In 12 weeks time you can own your own shop or earn big income as skilled shoe repairman. Growing demand everywhere at top wages for men who know how. We teach you quickly by actually working on shoes and modern machines. Costs nothing under G. I. Bill of Rights. We help you get big pay job or start your own shop in 12 short weeks! School open to all from 18 to 60 years of age. FREE BIG 16 PAGE BOOK explains everything. Send for your copy today.

MODERN SHOE REBUILDING SCHOOL
Established 1927
2937 Belmont Ave., Chicago, Ill. RUSH POSTCARD TODAY

FENCING World's Finest Sport Exciting Fun—Harmless



Just Out! Two 3 ft. Spring Steel Fells with Safety Rubber Buttons. Complete Outfit 2 fells (swords) with hand guards and Free Instruction Book Now Only \$1.98 Postpaid. A healthful and clean sport, makes you Strong and Alert. Instruction Book teaches Quickly—Easily. Mail check or Money Order for \$1.98 Today. Add 28c for Foreign Postage.

LEE PRODUCTS CO., 1613-E First Ave., New York 28, N. Y.

Bar Bells



Buy Direct From Factory
Write for free booklet **\$8.95** up
and price list

INDEPENDENT IRON WORKS
2416 East 23rd Street, Dept. B
Los Angeles 11, Calif.

500 TRICKS MAGIC TRICKS

It's FUN to do MAGIC



Amaze — mystify — entertain. Be Popular. You, too, can enjoy this fascinating hobby which has swept America. Only 10c brings you our famous Catalog of 500 TRICKS, profusely illustrated, containing all the latest in easy-to-do magic for pocket, parlor, stage. Join in the fun! Send 10c today. Douglas Magician, Dept. C, Dallas 1, Texas

NOTICE: As many replies will result from this announcement, it will help if you answer the questions below. B.L.M.

Learn EXPORT!

BIG MONEY IN FOREIGN TRADE BOOM



GREECE



SPAIN



EGYPT



AFRICA



INDIA



CHINA



NEW ZEALAND



PUERTO RICO



PHILIPPINES



BRAZIL



HIGH INCOME • Travel • ADVENTURE

If you are tired of looking forward to a life of humdrum, low-paid work in overcrowded fields, **THIS IS FOR YOU!** COMPARE World Trade's 18 BILLION DOLLAR VOLUME with anything else you've considered. LOOK in any telephone book under "Exporters and Importers" and see how few you find, compared to the "struggle to live" lines. You have room to prosper and opportunities for World Travel in Export-Import.

SALARIES UP TO \$1000 A MONTH

...are common in World Trade. But—the sky's the limit in your own business. Commissions of \$10,000 to \$20,000 a year are quite possible. World Trade is almost three times that of the prewar thirties and now ready to break all records. Export-Import men and women are in big demand.

Buy For Others

Your customers in other lands tell you by mail or cable what they want. You buy it for them and ship at their expense. My course shows you how to get customers and how to find the goods they want.

Past Experience Unimportant

No previous experience or special schooling is necessary—only common school education. I teach you at home in your spare time by simple methods based on my own 25 years of practical experience. You use my experience. You can operate a World Trade business on a mountain top in Virginia or on the plains of Nebraska—in your own home—anywhere. You don't have to live in a city. Your customers are all over the world in this practical profitable business.

I TEACH YOU AT HOME

I have trained others in as little time as one

month because my methods are direct, free of non-essentials and red tape. You can start your own mail order World Trade business at home—on practically no investment.

Big Profits In Import Too

As you export, you receive opportunities to import. I give you practical lessons on how to handle this profitable business too. Many imported articles bring fabulous prices and tremendous profits here.

Practical—No Theory

I give you a FREE KIT of actual export documents and other helpful guides—and a full year's free consultation service even if you



finish my course in one month. I even give you a list of 150 proven foreign representatives to help get you started earning fast. A World Trade Certificate will be awarded you on successful completion. Other very special features I'll tell you about when you write me.

Start Today—Get FREE Details

Expansion of World Trade is at fever heat. Rush the coupon to me today for free details. The low cost of this course will surprise you. (No Salesman will call.) Air Mail reaches me over night.

MAIL COUPON NOW

B. L. Mellinger, Director, The Mellinger Co.
1416-D Westwood Blvd., Los Angeles 24, Calif.
Please send FREE LITERATURE showing how I may enter the profitable career of World Trade.

Name _____
Address _____
City _____ State _____
Veteran? _____ Occupation? _____ Age? _____
Location preferred? _____

MANUFACTURERS: If you have capacity for extra production write us for proof of how you may get profitable foreign sales. Describe products and approximate export production capacity. Address Manufacturers Division.



SWITZERLAND

Train with one of America's Foremost Technical Institutes

RADIO! ELECTRONICS! TELEVISION!

CREI TRAINING CAN HELP YOU EARN MORE MONEY
Because it STARTS WITH FUNDAMENTALS and CAN TAKE YOU ALL THE WAY TO A CAREER



Tremendous opportunities exist for the career-trained man in the fast-growing radio-electronics industry. With over 1400 AM stations (double what it was before the war) in operation now, with more than 300 FM stations in operation already and hundreds more on the way, with new applications for electronics in practically every industry, with television beginning to hit full stride, with all commercial aircraft radio-equipped and mobile communications active in every city, there are many, many more openings for practical electronics engineers than there are qualified men to fill them. Now's the time for you to do something about a secure future in this interesting field—and CREI is the school to help you do it.

Go all the way with CREI
Nationally recognized as a leader in technical radio education, CREI is an Accredited Technical Institute. Hundreds of practical engineers with key positions in industry and in radio broadcasting, FM and television stations owe their successful training to CREI. Twenty years of teaching by home study has given CREI the background and

experience you want in the school of your choice. Even though commercial radio may be a new field for you, CREI can take you all the way to the practical engineering level. If you had military service training in radio or radar, and if you have a knack for math, so much the better. CREI starts with fundamentals. It takes you carefully through those fundamentals and builds a firm foundation. CREI DOESN'T DROP YOU OFF AT THE ELEMENTARY JOB-TRAINING LEVEL. You quickly get into the more advanced study of radio engineering principles and practice. Finally you may elect training at career level in the highly specialized applications of Broadcasting, Television, and Aeronautical Radio.

Begin training now at home
There are outstanding opportunities for men who want security and high-income positions at career-level. Act now! Enroll in this tested and proved home study course—the course which is the basis of that studied at the nationally known CREI residence school. Send for FREE book with full information. For an intelligent answer to your inquiry, please complete the coupon in full.

Approved under G. I. Bill
VETERANS: You can get CREI training at home under the GI Bill. (Easy Terms at pre-inflation rates if you are not a Veteran.)

CAPITOL RADIO ENGINEERING INSTITUTE
Dept. 11, 16th & Park Rd., N.W., Washington 10, D. C.
Branch Offices:
New York 7: 170 Broadway
San Francisco 2: 760 Market St.



MAIL COUPON FOR FREE BOOKLET AND FREE SAMPLE LESSON

CAPITOL RADIO ENGINEERING INSTITUTE, DEPT. 11
16th & Park Road, N. W., Washington 10, D. C.

Gentlemen: Please send me a free sample lesson and your free booklet, "CREI Training For Your Better Job in Radio-Electronics" describing opportunities and CREI home study courses in Radio-Electronics and Television.

NAME AGE

STREET

CITYZONESTATE

OCCUPATION

I AM ENTITLED TO TRAINING UNDER G. I. BILL

(Check field of greatest interest:

RADIO-ELECTRONICS

BROADCAST AND TELEVISION

AERONAUTICAL RADIO ENGINEERING

RECEIVER SERVICING INDUST. ELECTRONICS

SAY YOU SAW IT IN POPULAR MECHANICS

Amazing New Books Reveal Secrets Success

AT HOME WITH ARTISTIC PENWORK—Copyrighted
Now you can be at home with Artistic Penmanship for fun and profit. These new authoritative books just off the press give you most modern, streamlined methods for perfecting your skill as a penman.
Written by S. A. Ziller, President, Tamblin School of Penmanship, Ac. claimed by leading authorities as the finest books on penmanship ever written.

Order Today—\$1.00 Each

These books are sensationally new and different. Each covers its subject fully and completely. You can select one or more—or get the whole series of five at the special introductory price of only \$4.90. Money on set of books deducted in full from tuition on signing up for professional course of school instruction.

BOOK 1	<i>Business Writing</i>	Write legibly—Be Recognized because of Your Writing.	<input type="checkbox"/>
BOOK 2	<i>Artistic Writing</i>	Earn Money—Amuse Your Friends.	<input type="checkbox"/>
BOOK 3	<i>Card Writing</i>	For Fun and Profit. Write cards, invitations.	<input type="checkbox"/>
BOOK 4	<i>Engrossing Alphabets</i>	Letter diplomas, complete Alphabets Given.	<input type="checkbox"/>
BOOK 5	<i>Bird and Design Flourishing</i>	A good outlet for your artistic interest. Fascinating designs, birds, quills.	<input type="checkbox"/>

Complete Set of All Five Books—Special Introductory offer. Prepaid, \$4.90. Money Back Guarantee.
FREE BOOK—How to become a good penman. Tells how others learned in spare time. Initiate the professional, avoid mistakes, earn extra money—be a popular friend.
Enclose 10c for a penpoint suitable for shaded writing and your name beautifully written.
Write today, check the squares—attach to your name and address, enclose remittance, and send to

Stephen A. Ziller, Pres., The Tamblin School of Penmanship
8-441 Ridge Bldg., Kansas City, Mo., U.S.A. In business over 52 years

INVENTING

—FOR PROFIT! If you have an inventive turn of mind, write for free 28-page booklet explaining how the Institute of American Inventors is helping inventors pre-test the profit possibilities of proposed devices to fill today's unprecedented demand for useful new inventions.

INSTITUTE of AMERICAN INVENTORS
Dept. 4, 1926 Eye St., NW, Washington 6, D. C.

LEARN MOVIE PROJECTION THEATRE MANAGEMENT

The Motion Picture Theatre Business offers big opportunities for trained men. Get into a fascinating field with a promising future. Train at home in spare time. Free Catalog. Established 20 years.

THEATRE SCHOOL, 370 Washington St., Elmira, New York

Learn LANDSCAPE GARDENING!

A thorough, constructive, interesting home-training, covering your regional conditions, for those who wish to become LANDSCAPERS, DESIGNERS, GARDENERS, etc., for profit or pleasure. Write today for FREE INFORMATION, without obligation. APPROVED FOR VETERANS.

NATIONAL LANDSCAPE INSTITUTE
Dept. P-1, 310 So. Robertson, Los Angeles 36, California

TRI-STATE COLLEGE

B. S. Degree in 27 months in Civil, Electrical, Mechanical, Chemical, Aeronautical, Radio Engineering; Bus. Admin., Acct and Sec. Science. Graduates successful. 64th year. Enter Jan., March, June, Sept. Catalog. 418 College Ave., Angola, Ind.



MAKE JEWELRY AND NOVELTIES AT HOME!

Work right on your kitchen table! No tools or experience necessary. Learn—earn within a week. Complete home instruction course, beautifully photographed, shows how to make 115 different designs of earrings, pins, sprays, brooches, hair ornaments, bracelets, candy dishes, ash trays, wall plaques, etc. Illustrates also 55 kinds of Sea Shells and Fish Scales often used. Explains fully home methods of dyeing, pearlizing, golding and glow-in-the-dark processes. Lists hundreds of raw materials with wholesale prices. Complete course only \$1. Beginner's Kit, \$3 (\$3.50 in Canada), postpaid. Immediate shipments.

HOUSE of GIFTS, Box 4550-PM, Coral Gables, Fla.



Learn BUILDING

AT HOME • All Blue Print Building Plans, Specifications, Lessons Furnished

FIND OUT ABOUT TRAINING AND OPPORTUNITIES FOR YOU IN BUILDING

Established in 1904, Chicago Technical College offers you thorough, practical training in Building, by home-study. Mail coupon for free information. See what this Course has done for others, what it can do for you. Read what Chicago Tech graduates say about their work, earnings, success. Learn the rewards awaiting trained builders—and how quickly, easily you can get started. Simply MAIL COUPON TODAY in an envelope or paste on a penny postcard.



CHICAGO TECHNICAL COLLEGE
A-152, Tech Building, 2000 South Michigan Ave.
Chicago 16, Illinois

MAIL COUPON NOW

CHICAGO TECHNICAL COLLEGE
A-152, Tech Bldg., 2000 So. Michigan Ave.
Chicago 16, Illinois

Mail me FREE building Lesson and information about big opportunities in BUILDING and how I can train at home.

Name _____ Age _____

Address _____

City _____ Zone _____ State _____



Learn by Mail to Mount Birds

Animals, Game-Heads, Fish, Pets, to Tan Skins

Men, Boys! Be a Taxidermist. Learn at home in spare time. Easily, quickly learned. Grand Fun. A wonderful, profitable hobby, for expert hunters, also for amateurs, even young boys. Mount wild-game, although wild-game is not necessary. Use common, domestic specimens, squirrels, pigeons, even frogs. This famous, reliable school in business more than 35 years. **More than 300,000 delighted students. Think of that!**

Hunters Save Your Trophies — Have a Home-museum Be a Taxidermy Artist

You will be **THRILLED** and **DELIGHTED**. You learn **QUICKLY**, easily **AT HOME**. Your friends will be amazed. Hunters from near and far will bring their **TROPHIES** to be mounted. You can earn fine **profits** in **spare time**. Many students earn \$60 to \$100 a month, in season. **Rush the coupon today**, and learn all about wonderful taxidermy. **DO IT NOW!**

Save your own hunting trophies. Have a lifelong hobby. Have a home museum that you are proud of, and that makes you popular and well-known far and wide. **BOYS**, wild-game is not necessary. Use common specimens, squirrels, pigeons, owls, domestic birds and animals. **It's wonderful. Inquire today. Kill fewer game-birds. Double your fun and pleasure.**

Fun — Fascination — Profit

And so easily learned in spare time. Wild-game is growing scarcer. Help preserve it. Shoot only a **FEW** fine ducks and other game-birds, **MOUNT THEM** for home and den, and have **MORE FUN** and **PLEASURE** than killing the legal limit every day. **Help preserve the wild-game.**

Remember you learn to mount expertly, **birds, animals, game-heads, fish, pets, to tan skins and furs.** Investigate! You will be delighted. Send for free book today. **"Eat your trophies and have them too."**

THE N.W. SCHOOL OF TAXIDERM, 3371 Elwood Bldg., Omaha 8, Nebr.

FREE BOOK!

Yes **FREE**, 44 pages, with 100 unique pictures of taxidermy work. No other book in the world like this. It will amaze and thrill you. **Ask today for your free copy. State your AGE.**

Send the Coupon!

Write name plainly in coupon or margin, or a **post card** will do. **Rush** your request, as **free books** may be exhausted quickly. **Decide now.** Don't wait a moment. **State your age.**

FREE BOOK

Northwestern School of Taxidermy, 3371 Elwood Bldg., Omaha, Neb.

Send me your free illustrated book, "How to Mount Game". Also tell me how I may learn this fascinating art easily and quickly by mail. No obligation. **State your age.**

Name _____ Age _____

Address _____





**“GET ON”
“Uncle Sam’s”
PAYROLL**

START
As high as \$3,021.00
YEAR

MANY 1948 APPOINTMENTS

**Common Education Usually Sufficient
Influence Not Needed**

**City Mail Carriers, City
Post Office Clerks**

Clerks and carriers now get \$2,100.00 the first year regular and automatically increase \$100 a year to \$3,100.00. Open to men—women, 18 to 50.



Railway Postal Clerks

Railway Postal Clerks get \$2,300 the first year regular, being paid on the first and

fifteenth of each month. (\$95.84 each pay day.) Their pay is automatically increased yearly to \$3,400. Advance may be had to Chief Clerk at \$5,400 a year. (\$225.00 each pay day.) Male veterans only.

Customs Patrol Inspector

Salary \$3,021 to start. Men 21 to 45. Work connected with patrolling the Canadian and Mexican borders and preventing smuggling.

Clerk

Open to Men—Women 18 to 53. Entrance salary \$1,954 a Year. Appointments as File Clerks and Statistical Clerks in the Departments at Washington, D. C., and throughout the country are made from this examination.



Many Other Positions

Many other positions are obtainable. Experience is usually unnecessary and political influence is not permitted. Let us show you how to get a government job.

Free List of Positions

Fill out the following coupon. Tear it off and mail it today—now, at once.

This may result in your getting a big-paid government job.

FRANKLIN INSTITUTE, Dept. 585, Rochester 4, N. Y.

Gentlemen: Rush to me, FREE of charge, list of many U. S. Government big pay jobs. Send me FREE 32-page book describing salaries, vacations, hours, work, and full particulars telling how to get one of these jobs.

Name _____

Address _____

SAY YOU SAW IT IN POPULAR MECHANICS



DRAFTING

**AERONAUTICAL... ELECTRICAL
ARCHITECTURAL... MECHANICAL**

A comfortable future is yours in the Design Field. Learn "Know How" from a group of highly successful Designers. In clear, easy steps learn Projection, Sections, Views, Flat Pattern Development and "Graphical Analysis of Conic Lines" all offered for the first time exclusively in this course.

PLUS

JOB PLACEMENT INFORMATION

This Engineering Drafting Course was developed and is supervised by a prominent and active Aircraft and Power Plant Designer who helped design the B-25, the Mustang, the Phantom, the Banshee, XP-85, XP-67, Bonanza (Beech) and Guided Missiles for the Navy. He taught this course at Washington University during the war years to train hundreds of men and women who are now successful in their chosen fields of Aeronautical, Architectural, Electrical and Mechanical Design!

**DON'T DELAY...WRITE NOW!
FOR FULL INFORMATION TO**

**WEST COAST ENGINEERING
CONSULTING ENGINEERS**

**BOX 2303 TERMINAL ANNEX
LOS ANGELES 54, CALIFORNIA**

Be A MASTER PLUMBER

Earn \$15 To \$50 A Day

DON'T ENVY THE PLUMBER — BE ONE

Every skilled workman will tell you that Plumbers have the best of it. WINTER and SUMMER the Plumber is busy at top wages. No skilled Plumber is ever out of a job—compare his opportunities with any trade, plus the opportunities of having your own shop. We teach you Plumbing with TOOLS (not books) under Licensed Master PLUMBERS in one of the finest equipped schools in America. We make you a Plumber, every branch is taught thoroughly—Lead Work—Blueprint for plan reading—all other tricks.

LEARN IN 30 WEEKS WITHOUT PREVIOUS EXPERIENCE

If you like to work with tools you owe it to yourself to investigate. No need to ever work as an apprentice. Get free bulletin. Write now! G.I. APPROVED. Our 24th year.

UNIVERSAL PLUMBING SCHOOL

815 HOLMES STREET

KANSAS CITY, MO.

LEARN WATCH REPAIRING

IN YOUR HOME!



THERE'S BIG MONEY and a secure future for YOU in watch repairing even if you're just a beginner. Get PRACTICAL SELF-TRAINING through our new and complete book, "MODERN WATCH REPAIRING & ADJUSTING." Easy to understand. Every step in repair, adjustment, construction. Theory, operation. Covers all needed tools and their use. Fully illustrated. Only **\$2.95** Post Paid (if C.O.D., plus charges.) MONEY BACK GUARANTEE

MODERN TECHNICAL BOOK & TOOL CO.

Dept. MMC, 55 W. 42nd Street, New York 18, N. Y.

**JUST OUT! NEW ALL INCLUSIVE TOOL CATALOG
OVER 450 ILLUSTRATIONS. Shows all tools, material, complete SETS for STUDENTS, Watch-Clockmakers, Jewelers, Handicrafters, and ALL Books in these fields.
Send 25c—FREE with above book order.**



**CORRESPONDENCE COURSES IN
RADIO and ELECTRICAL ENGINEERING**

**Tuition
\$25**

ELECTRICAL ENGINEERING. Get good grasp of wide electrical field. Modern. Very understandable. Theory made easy.
RADIO ENGINEERING. Extra fine course in radio, public address, photo-electric work. Trains you to be super-service man, real vacuum tube technician. Tuition ONLY \$25, either course. Deferred payment plan. Servicemen needed badly.
FREE Write for free copies of school catalogs, student magazines, etc.
LINCOLN ENGINEERING SCHOOL, Box 931-P-109, Lincoln, Nebr.

**STOPS FOGGY WINDSHIELDS
NEW Chemical Mitt**



Amazing Discovery! Autoists will love new "NO-FOG" Windshield Cleaner. Simply glide over windshield. chemically-treated Mitt—at once glass sparkles crystal clear. Cloudy haze, mist, dust, grime disappear like magic. Stops fogging. Sells like wild!

SAMPLES FOR AGENTS Sample offer sent immediately to all who send name at once. A penny postal will do. **SEND NO MONEY—just your name.** KRISTEE CO., 678 Bar Street, AKRON, OHIO

Now Any AUTO REPAIR JOB Can Be a "Push-Over" for You!

**IN LESS TIME —
WITH LESS WORK —
AND MORE PROFITS!**

MoToR's new AUTO REPAIR MANUAL shows you how to service and repair ANY part of ANY car! Now you can lick even the toughest jobs when you have this amazing Manual to make your work easier!

Every job on every car built since 1935 is explained as simply as A-B-C. Clear, illustrated instructions lead you step by step. NOW you can tackle ANY job from carburetor to rear end—and do it quick, easy, right, the FIRST time! Just look up make, model, and the job in the quick index of MoToR's AUTO REPAIR MANUAL—and go to work!

ONLY Manual of Its Kind

No wonder this manual is used by the U. S. Army, Navy, trade and technical schools everywhere, and thousands of successful auto servicemen!

To make this great book possible, the engineer-editors of MoToR Magazine condensed all the meat from 150 official factory manuals for you. They dug out all the information you need; made sure every word is crystal-clear; and put "the whole works" into this one great, handy book!

MoToR's AUTO REPAIR MANUAL is a big book: 856 large pages, 8½ x 11 inches, bound in sturdy covers. Nearly 200,000 serv-

ice, repair, adjustment, replacement, tune-up facts on every car built from 1935 through 1946!

Over 1,000 Pictures!

More than 1,000 cutaway photos, diagrams, drawings, charts, SHOW you what the clear text TELLS you! No wonder thousands of men call this amazing book their Auto Repair "Bible"! No wonder it will save YOU countless hours of work—and help you make MORE MONEY from auto repairs!

See for yourself—without cost!—what a work-saver, time-saver, and "life-saver" MoToR's AUTO REPAIR MANUAL will be for you! TRY it FREE—for 7 days. Learn first-hand how it can pay for itself the first few times you use it!



Clear, Pictured Facts on Every Job on Every Car Built Since 1935!

Nearly 200,000 service and repair facts on all these makes:

American	Crosley	La Salle	Packard
Bantam	De Soto	Lincoln	Pierce
Auburn	Dodge	Lincoln	Arrow
Austin	Ford	Zephyr	Plymouth
Buick	Graham	Mercury	Pontiac
Cadillac	Hudson	Nash	Reo
Chevrolet	Hupmobile	Oldsmobile	Studebaker
Chrysler	Lafayette	Overland	Terraplane
Cord			Willys

856 big pages; including 50 pages of carburetor text, charts, illustrations covering all models. Over 500 charts, tables: Tune-up Chart; Valve Measurements; Compression Pressure; Torque Wrench Reading; Starting Motor; Engine Clearances; Generator; Clutch & Brake Specifications; Front End Measurements, etc.; Engines; Electric, Fuel, Cooling, Lubricating Systems; Transmissions; Universals; Front Ends; Wheels; Rear Ends, etc.

**FREE
7-DAY OFFER
SEND NO MONEY**

Just mail coupon below—without money! When the postman brings your book, examine it thoroughly. Make it show you what it's got! Unless you agree this is the greatest time-saver and work-saver you've ever seen—return book in 7 days and pay nothing. Mail coupon today! Address: MoToR Book Department, Desk 1A, 572 Madison Ave., New York 22, New York.

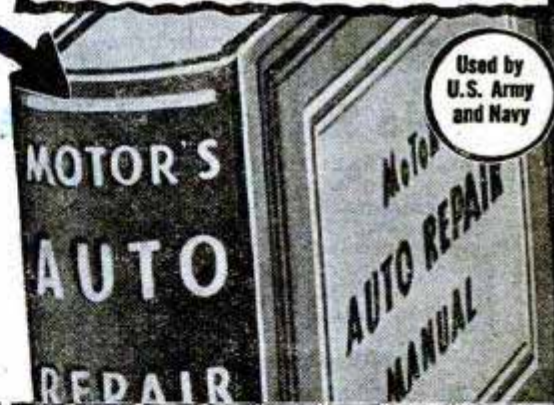

Same FREE 7-Day Offer Applies on MoToR's Truck Repair Manual

For mechanics, truck specialists, service stations, fleet owners. Covers EVERY job on EVERY truck made since 1936! 1400 pictures, 952 pages, 300,000 facts. Used by Armed Forces. Warranted to contain every essential fact you need to know. Strong binding, size 8½x11.

Covers all types Gasoline Engines; Diesels and Hesselmans. Fuel Systems, Governors, Lubrication Systems, Ignition Systems, Starters, Generators, Clutches, Transmissions, Axles, Torque Dividers, Transfer Cases,

Brakes, Steering, etc., etc.

Also services buses, farm and industrial tractors, contractor and road building equipment, stationary power machinery, etc. (on all parts described in Manual.)

Offered on same FREE 7-Day examination as Auto Repair Manual. Check box in coupon at right.



Published by MoToR, The Leading Automotive Business Magazine. MoToR's manuals assure high standards of repair work.

MoToR Book Dept., Desk 1A, 572 Madison Ave., N. Y. 22

Rush to me at once: (Check box opposite book you want)

MoToR's AUTO REPAIR MANUAL. If O.K. I will remit \$1 in 7 days, plus 35c delivery charges; \$2 monthly for 2 months and a final payment of 95c a month later. Otherwise I will return book postpaid in 7 days. (Foreign price, remit \$8 cash with order.)

MoToR's TRUCK REPAIR MANUAL. (Described at left.) If O.K. I will remit \$2 in 7 days, and \$2 monthly for 3 months, plus 35c delivery charge with final payment. Otherwise I will return book postpaid in 7 days. (Foreign price, remit \$10 cash with order.)

Print Name _____ Age _____

Print Address _____ Zone No. _____

City _____ (if any)

State _____ Occupation _____

Check box and SAVE 35c delivery charge by enclosing WITH COUPON entire payment of \$5.95 for Auto Repair Manual (or \$8.00 for Truck Repair Manual). Same 7-day return-refund privilege applies.

"OWN a Business" Coupon

Duraclean Co.
 Division of HOME SERVICE CO.
 16-1 Ct., Deerfield, Illinois

With no obligation to me, send booklet and letter giving full details. Tell me how I may OWN a growing business of my own built upon satisfied customers.

Name _____

Address _____

City _____ State _____



Are You The Man?

If you are dependable, honest and willing to work to own a large-profit, lifetime business and become financially independent, we invite you to mail the above coupon for full details. We are now enlarging this 17-year-old, nation-wide chain of individually-owned CERTIFIED Service businesses. We'll establish you in

YOUR OWN business and help finance you. You use successful methods of established Duraclean dealers. This is a sound, steady, lifetime business. Dealer gross profits (above materials and labor) are up to \$20 for a day's service on EACH of his service men. Easy to learn . . . quickly established.

Revive, Clean and Protect Upholstery and Rugs!

This remarkable service restores the natural fiber lubrication of wool and other animal fibers. Resiliency returns to the pile. It rises again. Brilliant colors revive. Results in many instances are almost unbelievable.

This service banishes the need of cleaning upholstery, rugs and carpeting by harsh machine scrubbing and soaking. It eliminates harmful solvents and strong soaps.

The aerated foam, created by the patented electric Foamovator, cleans by ABSORPTION—not by scrubbing. Dirt, grease and many unsightly spots vanish. Your service is recommended nationally by America's foremost furniture and department stores.

Immunizes Against Moths, Beetles, Mildew

The patent protected immunizing service not only kills moths and carpet-beetles but is WARRANTED to make fabrics non-eatable to both. The U. S. Government says, "Moths are present in practically every household . . . No section of the country seems free from such infestations." Damage to household goods and wearing apparel is greater from moths than from fire. This modern treatment DEFINITELY PROTECTS rugs, carpets, upholstery, furs, clothing, blankets, pianofelts, auto interiors, etc.

Dealer Comments:

R. Kimbrough: "Finished First White House of Confederacy and am to Duraclean the Governor's Mansion."

P. Wilson: "My business comes from recommendations of satisfied customers."

O. D. Heffelbower: "People who have seen the work have expressed amazement."

Q. Corbett (Canada): "Several hundred dollars in jobs lined up from canvassing."

S. Edsall: "Have 5 women's clubs interested in the work."

H. T. Satterfield: "We Duracleaned a chair for the largest department store and got an order for 60 to 75 chairs, couches and davenportes."

E. Schalchlin: "Have on hand 5 orders totaling over \$500.00 . . . obtained from recommendations of customers."

F. R. Jones: "Your offer is the best and most amazing I've ever had."

No Shop Needed—EASY to Learn

No overhead expense. Service may be rendered in homes, offices, hotels, theaters, institutions, etc., by your service men. Auto dealers have upholstery revived in used cars. Foamovator converts to carrying case. Some establish shops or an office—others operate from their homes.

Start Part or Full Time

No experience needed. We show you 18 ways to get customers. Almost every building in your territory houses a potential customer. There is a waiting market in small and large towns alike. These are year-around services for which there is always a constant need. Free booklet and our first letter explain everything. Just mail coupon.

EASY TERMS:

A moderate payment establishes your own business—pay balance from profits. We furnish electric machines, folders, store-cards, introduction slips, sales portfolio, demonstrators and enough materials to return your TOTAL investment. You can have your business operating in a very few days. Just mail the coupon. No obligation.

Copyright 1947 by

Duraclean Co., 16-1 Ct., Deerfield, Illinois

Repeat & Voluntary Orders

Demonstrations win new customers. Men in this business find REPEAT and VOLUNTARY orders become a major source of income. Customers are not merely satisfied—many are enthused at results and tell friends and neighbors.

Double Profits

You enjoy large profits on both materials and labor, after paying service-men and salesmen. At the start, you may want to render service yourself. You have national prestige and cooperation of a national organization interested in YOUR success.

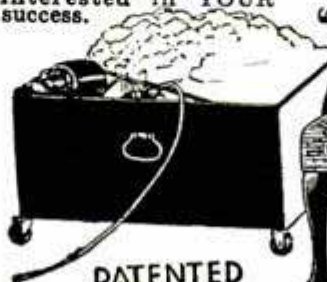

PATENTED



Mail Coupon TODAY—While Territory is Open!

OWN a Growing BUSINESS

FREE Booklet

Our first letter and 16 page illustrated booklet will explain everything—these modern urgently needed services, the waiting market, how business grows, your large profits, easy terms and protected territory.

Send for It—Mail Coupon

**WORLD'S
BEST
WANT AD
MEDIUM**

CLASSIFIED Advertisements



Advertisements in this section 75 cents per word, each insertion, minimum 10 words, payable in advance
To be inserted under proper classification, copy must be in our office the 25th of the
second month preceding date of issue

F. W. Johnson, Manager, Classified Advertising

Popular Mechanics Magazine, 200 East Ontario Street, Chicago 11, Illinois

1236

CLASSIFIED ADVERTISEMENTS

1236

OPPORTUNITIES FOR YOU

AUTOMOBILES, MIDGET CARS

FROM Speedway to roadway! Track-proved hi-speed heads and manifolds now available for passenger cars! No special tools needed! Increase horsepower 25%! Astounding getaway! Free illustrated catalog. Speedsport, 5747-D Waveland, Chicago 34.

JEEP Plans. Station wagon body \$1.00. Diesel conversion water injection \$1.00. Illustrated circular 20c. Craftsman Books, Box 1153, Milwaukee 1, Wis.

AUTOMOTIVE Trouble shooting, 500 questions and answers, \$1.00 postpaid. Charles Nelson, 2908 Washington Avenue, Santa Monica, California.

HOT-ROD Manual, fast Fords, photos, instructions, \$1.50. Airmailed \$1.75. Racing parts list 25c. Hollywood Hot-Rod, Los Feliz, Box 9626P, Hollywood 27, California.

"1948" CUSTOM Styling Manual. Easily make car look Hollywoodized, custom-built, ultra-beautiful! Latest customizing, restyling, streamlining methods simplified for all cars. Photographs, illustrations, instructions, etc. \$2. Alquist Engineering, Box 660-F, Brooklyn 1.

DRIVE A new King Midget, world's lowest priced automobile. We supply all parts ready to bolt together, 45 miles per hour, 90 miles per gallon. Beautiful racer-roadster body. Full accessories, including ski adapters for snow and ice. 24-page assembly book, drawings, photos, blueprints plus detailed illustrated circular \$1 (refunded first order). Circular only 25c. Midget Motors, Athens, Ohio.

PHOTOGRAPHS. World's finest automobiles. List 10c. Box 1028, Minneapolis, Minnesota.

MIDGET Car Book—Includes plans for easily building midget autos, speedy midget racers, two passenger highway runabouts, sporty 3-wheel "Motor-Ette," inexpensive scooter car. Simplified construction instructions, photographs, drawings, supply lists, \$1.98. Alquist Engineering, Box 660-F, Brooklyn 1.

"VAPO-STEAMATIC" Water injection. Amazing winter performance! Moist humidity system, completely automatic, developed by Air Force engineers! Easily built for about \$1.00 cost. Greatly increases horsepower! Speed! Cuts gasoline costs 1/4! Eliminates ping, carbon! Reduces wear! Smoother engine! Fully illustrated Injection Handbook, copyrighted, including installation instructions, \$1.00. Newhouse Industries, 5941-B Hereford, Los Angeles 22.

"HYDRO-CHARGER"—Water injection that really works! Easily construct "Automatic Vaporizer" for only 50c. Speedway performance, more power, pick-up, 30% gas saving! Cooler, cleaner, smoother motor! Eliminates ping, carbon. Reduces wear, sludge, oil pumping. "Quick-Installation" Manual includes "hop-up" tips. \$1. EA Engineering, Box 660-F, Brooklyn 1.

I AM Not a mechanic. But, I can tell what is wrong with any auto, boat or tractor because I know the definite non-technical purpose of each part comprising the four systems, (gasoline, electrical, timing and drive). This knowledge can be yours. Send \$1 for your copy of "The Four Systems" to 1300 Taylor St., N.W., 102, Washington 11, D. C. Money back guarantee.

NEWER Than the new cars! Push-button controlled parking brake! Illustrated instructions \$1. Chas. Gates, Pecos 1, Tex.

SPEED & Mileage Manual—Obtain greater speed, mileage, racing performance from any automobile! Includes simplified methods, speed tuning, gas saving secrets. Instructions on building economizers, speed equipment, duals, mufflers, superchargers, racing fuels, fast conversions, "hot-rods." Parts lists, \$1.98. Alquist Engineering, Box 660-F, Brooklyn 1.

HEATERS—Easier starting, quicker warm-up, less oil dilution. Clip over intake manifold to preheat carburetor and intake system. Operates off battery. \$2.00 each postpaid. Michehi Industries, Atlantic Bldg., Washington, D. C.

INCREASE Horsepower, water vapor injection method, controlled input, adjustable mix, for high speeds. Methods \$1.00. Stevens, 11 Main, Le Roy, New York.

DUALTONE Chrystaline packed, California mufflers, single or twin for all automobiles. Carburetor velocity stacks. Compression cylinder heads. Dual manifolds. Large double or single chromed tailpipe extensions. Chromed station wagon stacks, fender skirts. Request catalogue. Dualtone Mufflers, 2636C India Street, San Diego 1, California.

SPEED Equipment. Marine and automotive. We have only the best, made by leading southern California manufacturers including—Edelbrock, Meyers, Weland, Winfield, Jahns, Offenhauser, etc. Complete line of high compression heads, dual manifolds, racing pistons, camshafts, dual ignitions, etc. Send 25c for illustrated catalog. So-Cal Speed Shop, 1104 S. Victory, Burbank, California.

AUTOMOBILE Racing, Sixth Edition. 100 illustrations. Working drawings with building instructions for Ford-60 midget, California roadster, Offenhauser racer. Details on racer parts. Sample entrance blank. World's record 158.5 m.p.h. rear engine four-wheel drive car. Interesting information for fans, drivers, mechanics. \$2.00 postpaid; \$2.25 c.o.d. Ray Kuns, Department 63, Cincinnati 27, Ohio.

CUSTOMIZE Your automobile! Revised, enlarged book, latest restyling, complete, sharp, 50 photographs! \$1 pp. Post Publications, Box 723-SE, Arcadia, California.

CHROME Air horns—For all makes of automobiles. Send for free literature. Pro-Youngstown Company, 4033A Windsor #1, Youngstown 7, Ohio.

CUSTOM-CAR Photograph album. Fascinating automobile style classics, Coachcraft, Summers, independents, photo-packed! \$1 pp. Post Publications, Box 723-AE, Arcadia, California.

R & R Mfg. Co., Marine and Auto Division, Robert M. Roof, Box 546-P, Anderson, Indiana, U.S.A. \$1.00 for new speed and power equipment catalogue with price sheet, showing racing cars, midgets, speed boats. Recommendations for rebuilding your motor for racing. Cylinder heads for Ford-Ferguson, Model A, V-60-100, Mercury Fords, Studebaker Champion and Willys. Dual intake manifolds, pistons, camshafts, compound valve springs, Lynite flywheels and numerous other supplies.

AUTOMOBILE Racing book, fifth edition, well illustrated. Instructions on building bodies, frames, engines. Ford A and B conversions. Plans, AAA rules, specifications. Roadster racing. Indianapolis cars. \$1.00 postpaid, \$1.30 C.O.D. Ray Kuns, Dept. 47, Madisonville, Cincinnati 27, Ohio.

USED-CAR Buyer's Handbook. Save dollars, grief. Photographs, dealers' tricks, complete tests. \$1 pp. Post Publications, Box 723-TE, Arcadia, California.

INSTALL V-8 engine in your Model A for extreme acceleration, more top speed, smoother performance. Complete details, photographs, \$1 postpaid. A-V-8, Box L-1, Eaglerock, Los Angeles 41, Calif.

PROFESSIONAL Midget racer, motor-scooter, midget roadster, and midget motorcycle. Plans, specifications for all four contained in illustrated handbook, 25c. Big list bargain priced used motors, motorscooters, servicycles, etc., included free! Midwest, 3839 Drummond, Toledo, Ohio.

MAKE Your Model "A" do 100 m.p.h. Lightning acceleration, breath-taking top speed. Complete details, photographs. \$1 postpaid. Four Barrel, Box L-1, Eaglerock, Los Angeles 41, Calif.

BUILD Automatic clutch, scooters, midget autos, tractors, shop machines. Catalog free. Nichols Equipment Co., Dept. 511, Purvis, Miss.

MAKE Your Ford fast! Complete details, photographs. How to construct 120 m.p.h. Hotrod. \$1 postpaid. California Bill, Box L-1, Eaglerock, Los Angeles 41, Calif.

BUILD Speedy midget track racer from castoff parts! Plans, specifications, construction information, \$1.00. Motor Supply, Box CS-1682, Toledo, Ohio.

AUTO SUPPLIES AND EQUIPMENT

ENGINE Ping? Ignition skip? Before you buy a new distributor ask your garage for a Spark-O-Liner or write How Spark-O-Liner, Minneapolis 4, Minn.

GOGGLES—Surplus military type. All new. Two styles: Style "A" with laminated cellulose-acetate lens, leatherette frames, adjustable elastic band, 2 pair for \$1 (one polarized lens, one clear); Style "B" with ground optical glass lens in red or amber, nickel plated metal frames, side wire shields, mother of pearl nose rest, metal case, \$2 each. All orders f.o.b. Culver City. Send check, cash or money-order to Airborne Sales Co., Dept. PMG-1-8, Culver City, Calif.

"PEPY" Governors make automobile motors power units. Enclosed, \$15.00. Circular. Harris Machinery, Minneapolis, Minn.

GASOLINE Saving vacuum supercharger \$12.50. Self addressed stamped envelope for pamphlet. McDowell, 2000 NE. Union, Portland 12, Ore.

STOP Automatic choke trouble with Redex hand choke adapters, \$3.00. Details. Redex Co., 1301 Ridgeway, Rochester 13, New York.

AUTO Parts. New or rebuilt. Prompt shipment. Write requirements. Save money, buy direct, Factory Warehouse, Mechanics Auto Parts, 3807-PM North Ashland Ave., Chicago 13.

CAR Trouble? Specialists in transmissions, motors, mufflers, all operating parts. New, used, rebuilt. Lowest prices. Describe needs. Atlas, 2226F State, Chicago 16.

WELDING Bodies, repairing fenders, pays good profits using Hobart's a.c. arc welder. Catalog free. Write Hobart Welders, Box M-182, Troy, Ohio.

WELDERS For all requirements. Free catalog. Write Hobartweld, Box M-183, Troy, Ohio.

SPRAY Paint your automobile. Complete professional instructions, \$1.00. 155 Tasso, Palo Alto, California.

SPEED And Power Handbook—Construct own superchargers, water injectors, compression heads, fuel saving devices! Get racing speed, acceleration, dynamic power increases from any car. Mileage tips! Speed secrets. Ignition tuning! Hot-rods! Carburetion tricks. Fuels! Including "Restyling Ideas"—streamlining, model revising! Customizing. Sport changes! Accessories! \$1.98. Newhouse Industries, 5941-B Hereford, Los Angeles 22.

INSTALL Surplus jeep engine in model "A" Ford, details \$1.00. Thad Huffman, R. 3, Pratt, Kansas.

SENSATIONAL Seat covers. Jobber's discounts. Mono, 6545 Santa Monica Blvd., Hollywood, Calif.

FILTERMASTER'S Flo-meter tells when to change oil filters and crankcase oil. This instrument eliminates guessing from engine lubrication. Increases useful engine life, pays for itself quickly. \$2.80 at automotive stores or \$2.00 postpaid with return this ad. Get yours now. Fully guaranteed. Information on request. Filtermaster, Dept. PM-5, 440 E. Schantz, Dayton 9, Ohio.

AUTO Parts for all cars, transmissions, motors, differentials, fenders, carburetors. Security Auto Parts, 1923-PM Grace, Chicago 13.

NEW Plymouth owners—Light plastic hood ornament. Equipment, instructions, \$1.00. Deloplane, 441 King, Pottstown, Penna.

EASY Starting at 30 below with Hove Spark Plug extensions. Keep plugs dry. Six cylinder set \$2.00, 8 cylinder \$2.50 prepaid. Specify make and model car. Hove Engineering Company, Minneapolis 4, Minnesota.

CAR-BED. Make it yourself. Inexpensive. Fits any 2 or 4 door sedan. Plans \$2.00, easy to follow. Martins, Box 297, Upper Darby, Penna.

BURN Water in your car. Costs less than gas. More power. Cleaner motor. Mail card for data on \$17.50 Octa-Gane Water Injecting Carburetor. Advanced Automotive Products, 563-2 Lake Road, Webster, N. Y.

NEED Auto accessories, parts, hardware, ammunition, home supplies? Cutrate catalog available. Main Supply, Fairfield, Ill.

BATTERY Men—We have plates, cell groups, parts and tools. Battery Parts Distributor Co., 1328 Chestnut St., Philadelphia, Penna.

GUARANTEED Winter starting ignition on two volts. Eliminate burned points. Unit \$16. Plans for making your own \$1.00. Give car make, model. Ignition Engineering Co., 3344-A Beard No., Minneapolis, Minn.

EXTRA Winter starting ignition for less than \$2.00. Send \$1.00 for plans to C. Young, Box 93, Villa Park, Illinois.

AUTOMOBILE Glass! Rubber floor mats! Shock absorbers! Direct factory prices! Immediate shipment or quotations. Cooper Automotive Services, 3135 W. Lawrence, Chicago 25.

GRILLES For all cars. Meyers Auto Parts, 820 Dryades, New Orleans, La.

NEW And used automobile and truck parts. Lowest prices. Complete stock. Prompt reply. Babbitt Auto Parts, 2833 W. Chicago Ave., Chicago 22.

PLATING Outfits for auto parts. Connect to a battery. No tanks used. Free particulars and proofs. Gunmetal Co., Ave. J. Decatur, Ill.

AUTO TRAILERS

STREAMLINER Trailer, 17 ft. plans manual \$1.00. Circulars. Illustrated trailers to 27 ft. 20c. Craftsman Books, Box 1153, Milwaukee 1, Wis.

SAVE 50%—Build your trailer; 1948 Plan booklet, all types, house, camp, sport, and utility. Plus complete trailer parts catalog and booklet "Trailer Building." Send \$1.00. Marine Mart, Buffalo 7m, New York.

TRAILERCOACHES—Learn about all types; sports, living or travel. Approximately 100 pages monthly; magazine tells all. Special rate, \$1 the year in U. S., \$1.50 to Canada, \$2.00 foreign. Trail-R-News, Box 431-A, Glendale, California.

BUILD Your own trailer! Save money! Have every feature you want! Plans for house, sport, camp and utility trailers. Catalog describing 9 models 10c. 15c in Canada and overseas. Jim Dandy, Box 125-A, Wausau, Wisconsin.

MOTORCYCLES, BICYCLES, MOTORSCOOTERS AND SUPPLIES

EXPERT Rebuilding of racing and stock motorcycle engines. Largest stock of parts and accessories in middle west. Write for details. Bernard Cycle Co., 1214 Jackson Blvd., Chicago 7, Illinois.

CUSTOM Motorcycle accessories. Leather jackets, men, women, \$36.95. New seat covers, bright colors, molded cushions, \$8.75. Sideland, British machines, \$10.50. Free folder! Pacific Cycles, Dept. A2, 1208 Pine, Seattle, Washington.

MOTORCYCLE News, monthly. Yearly subscription \$1.00. Latest worldwide information. Motorcycle News, 5424-A Sawyer, Chicago 25.

BARGAINS Galore. Parts for that hot rod. Bargains in motorbikes and scooters. Send 25c. Behnke's, 5721 Leland, Chicago 30, Ill.

NOW Available for all 1945-46-47 American Moto-Scoots. Bendix lighting system—generator, sealed beam headlight with attachments. Give model when ordering. Genuine Moto-Scoot parts also in stock. American Moto-Scoot Co., 630 W. Lake St., Chicago 6, Ill.

AUTO-PED Motorscooter \$10; midget racer less motor \$14; midget track racer, new motor \$65; Indian '45 motorcycle \$45; Indian Chief \$40; Harley single engine \$4; Whizzers \$30 up; 4500 small tires \$1 up. Mailorder only. Plenty brand new and surplus gasoline engines, motorscooters, midget cars. Send 25c for Big War-Bargain catalogue number 23, just out, listing the above and over 400 other bargains in motors, motorscooters, midget racers, parts, plans, etc. (35c by first class mail). Midget Motors Directory, Athens, Ohio.

WHIZZER Wanted. Drastic bargain only. List of all offers 10c. Thomas Fuscaldo, 429 Freakness Ave., Paterson, New Jersey.

HARLEY-DAVIDSON Supplies, parts, accessories, oil service, tires all sizes, repaired 45" motors. Send \$2.25 for Army Motorcycle Manual, 10c for bulletin. Knuth's (Harley-Davidson Dealers), 2491 Fondulac, Milwaukee, Wis.

CHROME Plating on all motorcycle parts. Doll up your bike. Free literature. Master Silverplaters, 2031 Caniff Ave., Detroit, Michigan.

BICYCLE Supplies, wholesale, retail. List, 10c. Universal, 4713 Virginia, St. Louis, Mo.

SCHWINN Bicycles for Christmas. Send dime for list. Wholesale. Retail. Century Cycle, 3447 Lawrence, Chicago 25, Illinois.

HARLEY-DAVIDSON Parts, accessories, batteries, and tires, 24 hour service. Authorized factory dealer. Philadelphia Harley-Davidson Company, 857 North Broad Street, Philadelphia 23, Penna.

CUSHMAN Motorscooter \$15. Shaw bicycle motor \$15. Harley-Davidson motorcycle, \$35! Send 25c for bargain catalog #8 packed with money saving buys in motorscooters, motorbikes, midget cars, motors, wheels, tires and parts. Gall and Company, 538 Erie, Toledo, Ohio.

WHEELS! Build wagons, scooters, mowers, trailers, wheelbarrows, grocery carts, baby carts, play pens, baby carriages. 4" to 16" Free list. Trulsen Mfg. Co., 811 E. 31, Kansas City, Mo.

TIRES And industrial wheels, suitable for scooters, wheelbarrows, farm equipment, etc. All sizes. Bicycles and accessories. Largest assortment in America. Send dime for list. Cycle Transport Company, 1241 So. Michigan Ave., Chicago 5, Illinois.

BUILD America's lowest priced motorscooter speedster! Complete plans, specifications, \$1.00. Big list bargain priced used motors, etc., included free! Motor Supply, Box 1882-CS, Toledo, Ohio.

LARGE Stock Indian parts. Expert motor rebuilding. New and rebuilt Chief motorcycle, motors only. Indian Motorcycle Sales, Kansas City 1, Mo.

CUSHMAN Motorscooter \$20 (includes motor and extra tires). Midget racer \$15! Send 25c for big catalog #938 listing these and scores of other sensational bargains in motors, wheels, motorscooters, motorbikes, servicycles, tires, etc. Associated, Box CS-1784, Toledo, Ohio.

AVIATION

FLYING Quiz for aviation enthusiasts. Big 96-page book, printed in large legible type, check full of pilot information. Over 1,000 questions and answers that a pilot needs to know. \$1 cash postpaid, money back guarantee, no c.o.d. Hangar Flying, Dept. 4H1, 112 E. Grove, Bloomington, Ill. Clip this.

VETERANS: Flight training under the G. I. Bill. Tuition paid. Private, commercial, flight instruction, instrument and multi-engine ratings. Opportunities to work for living expenses or tuition, if not a veteran. Write Gottschalk School of Aeronautics, Adrian, Mich.

AIRFORCE Sextants, marine or air navigation, Fairchild \$12.50; Bausch-Lomb \$29.75. Aerial cameras \$175; Elgin stop watches \$12.75. (Free bulletin.) Pan American Navigation Service, 12021-C Ventura Blvd., N. Hollywood, Calif.

JET Propulsion experiments. New design. Drive bicycle. Circular on plans. Rush name. Maupin, Tipp City 5, Ohio.

PROPELLERS—2 & 3 Blade, designed for ice-snow sleds, boats. Literature. Standard Aircraft, Box 387, Ft. Worth, Texas.

JET Propulsion gas turbine model engine. Build a real turbo-jet model engine with single-stage centrifugal compressor and turbine. Send \$2.00 for complete plans for construction, design formulas and curves for checking performance and testing to Rotojet, Dept. 3, Box 757, Los Angeles 25, California.

SUPERCHARGERS—Aircraft, turbine driven, government cost \$3,000. Convert to turbines, blowers, jets, etc. \$15.00 each f.o.b. Washington, D. C. Michehl Industries, Atlantic Bldg., Washington, D. C.

GET Into aviation! Train now at this Lincoln Aviation Institute for responsible position with an airline, aircraft factory or private airport operator. Good jobs open! Big money paid! We assist graduates in locating positions. Write today for information to Registrar, Lincoln Aviation Institute, Union Air Terminal, Lincoln, Nebraska.

GIANT Glider kites. Double, 14x10 ft. Lifts 100 lbs., tows car, etc. Cost government \$108. Yours for \$20. Satisfaction guaranteed. Great Northern Mart, North Adams, Mass.

NEW Airplane tires, tubes and wheels, complete with bearings and spindle. For installation on harvesters, farm implements, low bed tractor trailers, etc. A size for every load. The world's largest stock. Send post card for details, Dept. B, Post Office Box 89, Merced, California.

B-29 COMPUTERS, 400 Cycle dynamometers, 60VDC amplidyne and servo amplifiers, turret drives, bomb releases, starter solenoids, collector rings, etc. List. Eresco, 2912 Hewitt, Everett 1, Washington.

SKI-TOWS, Portable, auto-powered, 500 ft. long. Pulls you both ways. Up, level or downhill. Set up in 20 minutes. Only \$125. Send card for particulars. Great-Northern Mart, North Adams, Mass.

BATTERIES, GENERATORS

\$150.00 NEW Generators, only \$33.00. See Greer advertisement under "Welding."

GENUINE Edison storage battery. Light, power, non-acid, odorless. Fifteen year life. Has none of the acid type diseases. Five year unconditional guarantee. Illustrated literature. See-Jay Co., 321 Yonkers Ave., Yonkers, New York.

ELECTRICAL SUPPLIES, EQUIPMENT

FREE Catalog—Motors, welders, welding supplies, generators, fences, electric mowers, freezers, other electrical items. LeJay Company, Minneapolis, Minn.

\$150.00 NEW Generators, only \$33.00. See Greer advertisement under "Welding."

ALNICO Magnets, free list. Terry Sales Company, 3726 South Detroit Avenue, Toledo 9, Ohio.

LIGHT Plants—Kohler and Delco; new and used. Write for free bargain list. Moutoux, 511 Locust Street, Evansville, Indiana.

ELECTRIFY Any make sewing machine \$16.95. Complete outfit, motor, control, bracket, pulley, belt, ready to plug in. Instructions makes easy installation. Associated Maintenance Company, 210 East 34th Street, New York City.

LAMP Parts—New 1948 illustrated catalog just out. Send 10c Every part necessary to build, convert or repair lamps. Gyro Lamps, 5416P Clark, Chicago 40.

LAMP Sockets, mogul sockets, three way switches, tumbler switches, receptacles, cordsets, electrical repair parts, lamp parts, wires, etc. Catalog 10c. Gearon Company, 6405 North Oakley, Chicago.

MOTORS 1/4 H.P., 115 v., 60 cy., 1750 r.p.m. Heavy duty, \$21.00 plus postage. Small G.E. fan motors 115 v., 60 cy., 1600 r.p.m. \$6.75. Magnet wire. John Weeks, 527 Worden, Grand Rapids 7, Mich.

VACUUM Cleaner heavy dustproof cloth dustbags, \$2.00 postpaid. State model. Vacuum Service, 1671 3rd Ave., New York City.

ELECTRIC Pencil: Engraves all metals. \$1.00 postpaid. Beyer Mfg., 229-H Dixon, Uniontown, Penna.

BUILD Your own lamps. Save half. Free photos. Buddy Products, Dept. 30, 1123 Belmont, Chicago, Ill.

ELECTRIC Pencil—Writes, engraves all metals. 110 volts. Complete \$2.95 postpaid. Reb Industries, Dept. 265-DA, Elmhurst, Illinois.

FIX Your own electrical appliances. Amazing instruction booklet with complete diagrams shows you step by step how to repair flat irons, fans, vacuum cleaners, clocks, washing machines, lamps, etc. A little course in itself. Worth dollars. Costs you only 25c. Ask for #111. Popular Mechanics Press, 200 E. Ontario Street, Chicago 11, Illinois.

FLUORESCENT Fixtures. Assembled, parts, supplies. State requirements. Naturalite, 1520 Ardmore, Chicago 26.

NEW Surplus wire and cable. 200 sizes and types. Armored, Tirez, lead. Free list. Ercco, 2912 Hewitt, Everett 1, Washington.

VOLTAGE Regulators. Autolite, silver contacts and large radio filter. Like new condition. Original cost \$140.90. Price \$5.95 prepaid. Also new Delco Remy regulators. Platinum contacts. \$8.95 prepaid. Both 24 volt, 50 amp. State Ignition, 2521 Indiana, Chicago 16, Ill.

WELDING, SOLDERING, PLATING

NEW Aircraft lighting generators. War surplus. Only \$49.50. Original cost \$250.-00. Can be used for lighting or converted for use as welder, electric plater, fast battery charger, auxiliary power unit, etc. Model R. 2, manufactured by Jack & Heintz, 30 volts, 300 amp. d.c., shipping weight 68 lbs. Size 16"x7". Also new G. E. and Westinghouse P.1 generators, d.c. 200 amp., 28½ volts, cost \$150.00, price \$33.00 each. Immediate shipment. Check with order. Greer, Dept. PMC, 460 South State Street, Chicago, Illinois.

A.C. Welders 110 v. welds ½" steel. \$29. Morris Welding Service, 1850A State St., Schenectady 4, N. Y.

PORTABLE Arc welder. "build your own." Your engine plus Hobart welding generator saves \$350. Starts paying business. Free instruction book. Write Hobart Welders, Box M-184, Troy, Ohio.

WELDERS For all requirements. Free catalog. Write Hobartweld, Box M-185, Troy, Ohio.

OXY-ACETYLENE Welders—Cut perfect circles with "Whitway" attachment. Complete \$3.00; plans 50c. White's Machine Shop, Cashon, Okla.

SAVE 50% On a.c. welders. 110-220 volts. Holgerson's Service, Canton, Kans.

WELDERS. New and popular makes, drastically reduced prices \$14.95 and up. Guaranteed. Send for sales bulletin for buying and save. M. J. Lalick & Associates, 6859 So. Anthony Ave., Chicago 37, Illinois.

WELDER—New portable Champion special transformer welder; 110/220 volts, a.c. 8 heat stages. Welds, brazes, solders, cuts all metals. Complete with electrode holder, helmet, rods, carbons, fluxes, cables. Also special flame weld torch. Easy to use. Full directions. Splendid for shop, farm and home repairs. Guaranteed. Only \$27.50. Money back guarantee. Also resistor model, now \$14.95. Magic Welder Co., 239 MP Canal St., New York, N. Y.

OXY-ACETYLENE Welding outfit including: Pull oxygen and acetylene cylinders, \$72.95 complete, f.o.b. Cleveland, Ohio. New, supply limited. Check or deposit with order, balance c.o.d. Cylinders can be refilled anywhere. Ideal for hobbyists, garages, repair shops, etc., includes supply of rod. The Burdett Oxy-Weld Equip. Co., 3399 Lakeside Avenue, Cleveland 14, Ohio.

OXY-ACETYLENE Welding and cutting outfit complete with cylinders and carrying case. Designed especially for hobby-shops, small repair shops, refrigeration and electrical service men. You own the cylinders. Free literature. A-A Welding Supply Co., C9228 S. Ada St., Chicago 20, Ill.

30 AMP. Selenium plating rectifiers with Powerstat control, \$85.00. Lead lined tanks, geared motors for agitation. Complete line of bronzed baby shoe mounts. Hollywood Bronze Supply, 1770 N. Vermont, Hollywood 27, Calif.

BUY Direct from factory. Welding outfit \$48.36; soldering outfits \$12.70 to \$9.70 complete prepaid. Box 331, Hamilton, Ohio.

MACHINERY, TOOLS AND SUPPLIES

CASTINGS. Blueprints, materials for woodworking and metalworking machine tools. Suitable for commercial or home shop production. 23 items, catalog 10c. Lewis Machine Tool Co., 3217 Union Pacific Avenue, Dept. M, Los Angeles 23, California.

SHEBEL Saw filer. Files all saws. Circular. A. P. Shebel, 730 B. So. 2nd St., Milwaukee 4, Wis.

9" LOGAN Lathe—Brand new, \$159.50. 18" between centers, immediate delivery. Send for circular. Travers Tool Co., Dept. S 5 Court Square, Long Island City, N.Y.

ANYONE Can sharpen saws using the Teeho-Tool! New 25c model. Write, Teeho, 316 North Maywood, Illinois.

INTERNAL Pipe wrenches for close fits and removing broken pipe. Set of three, ½", ¾", 1" only \$10.50 postpaid. Check with order. Porst Sales, 132 West Union Street, Pasadena, California.

JEWELER'S Lathes, engraving blocks, chucks, tools. Miles Co., Bedford, Virginia.

HOME Lathe owners—Build your own attachments. Send for photograph, sample of work and list of blueprints. Cut gears, ratchets, etc. Make neat screws easy way. The Home Shop, 415 Raymond Ave., Glendale 1, Calif.

MACHINE Shops, garages, machinists, home craftsmen, hobbyists. Get our prices on tools, supplies. Catalogue 10c. Refunded. Precision Tool Service, Dept. M, 55 E. Washington, Chicago 2, Illinois.

ELECTRIC Sanders low as \$7.85. Circulars. Kalder Engineering, Grand Rapids 6, Michigan.

FOR Sale—Keyway machine, use in electric drills, real machine tool, cuts ½ to ¾ inch keyway. Seventy five dollars postpaid. Distributors wanted. Holt Equipment, Independence, Oregon.

HARDWARE. Tools, drills, belts, pulleys, pattern, model supplies, electrical equipment, steel, brass, drill rod. Catalog 5c. Terek, 6304 Patterson, Chicago 34.

BENCH Saws \$17.50, band saws \$25.00. Bargain lists 3c. Sunshine, Berkshire Heights, Penna.

MACHINE Shop tools released for private industry; Gridley Auto Screw Machine \$300. 14"x6" Engine lathe \$160. 15"x6", \$180. 16"x6" quick change Engine lathe \$580. #3 Brown & Sharpe miller \$730. Snyder 25" drill \$140. 5 h.p. single phase motor \$100. 36" band saw \$225. Van Norman "Relio" grinder \$140. Money back guarantee. Conversion Parts Co., 278 Adams St., Boston 22, Mass.

ARC Welders. A.C. or D.C. 150-600 amperes. Portable, stationary. Prompt delivery. Reasonable terms. Also electrodes and accessories. Free catalogs. Write Hobart Welders, Box M-186, Troy, Ohio.

DRILLS—Taps reconditioned, up to seventy-five percent off list. Send for free circular just published. Perry Screw and Bolt Corporation, 4250 Grand-River, Detroit 8, Michigan.

FOOT Switch—Operates all power tools. \$3.95 postpaid. Reb Industries, Dept. 265-DB, Elmhurst, Illinois.

MECHANICS. Machinists, hobbyists—Amazing dual-drive assembly, geared 7 to 1 reduction, is driven by powerful 1/5 h.p. a.c. or d.c. motor, operates on 6-27, or 110 volts with transformer. Simple standard attachments convert this amazing unit into a dual, hand or table drill, polisher, buffer, router, sander, countless other uses. May be used as individual drill, sander, etc., by detaching flexible drive shaft. Complete with step down transformer, worth half the investment; which can also be used to convert nearly all aircraft motors to regular house current. \$300.00 value! While they last, \$19.50. No c.o.d. "Amazing Bachman's," 23 Herman St., Rochester 5, N. Y.

FOR Sale—Anvil, ideal for garage work or hobby shop, weight 22 pounds, six dollars postpaid. Holt Equipment, Independence, Oregon.

GEAR Reductions! Values ranging from \$500 to \$1100 each. All new! Complete with ½ h.p. motor a.c. or d.c. 110 volt. 25 or 60 cy. Single phase. Variable speeds. Bearing assembly with machined gears. Absolutely the thing for sanders, polishers, winches, hoist, conveyors. Adaptable for many uses. Special \$39.50. No c.o.d. "Amazing Bachman's," Dept. PM, 23 Herman Street, Rochester 5, N. Y.

100 ASSORTED Scissor screws \$6.50. Scissor screw wrench \$2.50. Overland Saw Service, Independence, Iowa.

NEW Quick change sander. No cement. Clamp cloth in place. \$2.95 postpaid. Free literature. Wasco Manufacturing, P.O. Box 111, Blue Island, Ill.

"WAR Surplus" bargains! All new! Flexible drive cables! Three sizes, 10"; 25"; 72". Over \$5.00 value. Combination offer of all three sizes, \$1.75. Precision built right angle drives. Complete with flexible drive cables. Only \$3.50. Magnet wire ½ lb. coils No. 22, 10 rolls for \$3.27 volt geared head (120 r.p.m.) motor \$30.00 value; all new; special \$2.95. Bushings and spacers, all new, aluminum and steel. 25 variety assortment. Special! Minimum 5 pounds \$4.75. Bolt and screw assortment; over 50 varieties. Special! 5 pound \$4.75. Rivet assortment, copper, steel, aluminum, over 250 varieties. Extra special! 5 pound minimum \$4.75. Micro switches; new; 6 variety assortment. \$15.00 value, only \$4.75. Order today! No c.o.d. "Amazing Bachman's," 23 Herman Street, Rochester 5, N. Y.

DRILL Grinder for twist drills \$2.95. See ad on page 258.

CONCRETE Block machines \$39.50 up. Catalog free. Concrete Machine Company, 5466 Gravois, St. Louis 16, Missouri.

METALS: Aluminum, brass and steel in all shapes. Write for free catalog. F & H, 87 Warren St., New York 7, N. Y.

CHUCKS S. Independent, Universal, threaded 1½"-8 for South Bend, Atlas, Logan, Clausing, Craftsman lathes. Top value. Free literature. Westcott Chuck Co., 3600 Walnut, Oneida, N. Y.

ASSORTMENT. Aircraft small parts. Clamps, fasteners, terminals, rivets, nuts and bolts. All new. 3 lbs. postpaid anywhere in U. S. only \$1.00, cash with order. Satisfaction guaranteed. Limited supply. Conner Sales Co., 917 S. Main St., Fort Worth, Texas.

WE Offer 60 tons of new war surplus bolts, nuts, washers, screws, etc. All popular sizes. A good mixture for hobby shops, garages, machine shops and farms. A big 40 lb. box for only \$6.85. War Surplus Co., Morris and John Sts., New Brunswick, N. J.

DRILL Grinder—Grinds drills to factory accuracy. Calipers with direct reading scales. Circle cutters. New Tool grinder. Lowest prices. Free literature. Factory, 811-B East 31st, Kansas City 3, Mo.

ENGINES, MOTORS, DYNAMOS

\$150.00 NEW Generators, only \$33.00. See Greer advertisement under "Welding."

MOTORS! ½ H.P. D.C. converted to A.C. All new. High speed 110 volt. 25 or 60 cycle, ball bearing motors. Actual value about \$75.00. Now \$15.00 each or 3 for \$40.00. Countless uses for home mechanics. Can be used in any position. Order today! Immediate delivery! No c.o.d. orders. "Amazing Bachman's," 27 Herman Street, Rochester 5, New York.

NEW 1/6 HP., 110 volt 60 cycle a.c., 1750 speed, double shaft, overload protection, Westinghouse motors \$22.00 each. ½ hp. ditto \$30.00. ½ hp. \$38.00. ½" new portable drills \$39.00. Check with order. M. Solon, 2410 E. 8th St., Duluth 5, Minn.

WELDING Generator, 150 ampere, \$47.50. Other bargains. Butler, 1885 Milwaukee, Chicago.

NEW Double end shaft ½ hp. motor, a.c. \$29.54. Abar, 55 E. 8th St., New York 3, N. Y.

SELSYNS—All new! Transformers, GE Model 2J1G1, 57.5-57.5V 400 cy.; generators, GE Model 2J1F1, 115-57.5V 400 cy. With gears. Sensational offer! \$1.50 each. Quantity lots \$15 dozen. Order now! No c.o.d. "Amazing Bachman's," 23 Herman Street, Rochester 5, N. Y.

BARGAINS in war surplus motors, switches, hydraulic transmissions, gears, bearings, etc. Delta Sales, 738 Kirby, Shreveport, La.

MOTORS, Gunsights, etc. War surplus. List free. F. Siefke, Box 18, Sta. E, Buffalo 11, N. Y.

MOTOR Repair men, get our bulletins on stator winding tester and a.c. motor winder. Motor Industries, Quincy, Illinois.

"BUILD Your own" portable arc welder. Your engine plus Hobart welding generator saves \$350. Starts paying business. Free instruction book. Write Hobart Welders, Box M-187, Troy, Ohio.

WELDERS For all requirements. Free catalog. Write Hobartweld, Box M-188, Troy, Ohio.

FRACTIONAL Horsepower motors. 1/6, ¼, ½, ¾ in stock. From \$14.69 up. W. Pollak, Johnstown 4, N. Y.

25 USED D.C. 110 and 32 volt motors. 1/6 to 2 h.p. Edward Hindahl, Mason City, Illinois.

RANGER Engine-Aircraft—All new in original case. 570 h.p. 13 cyl. V type. Engine Spec. No. 177. Complete with spark plugs. Original government cost over \$12,000.00 each. Special offer \$200. Crated weight 1200 lbs. No c.o.d. Write for complete description. "Amazing Bachman's," 23 Herman Street, Rochester 5, N. Y.

NEW A.K. Wisconsin air cooled engines. 3 to 4 h.p. complete, \$85 f.o.b. R. H. Kuehne, 136 Northampton St., Buffalo 8, N. Y.

DYNAMOTORS. All new! 400-cycle. GED21NJ3A. 27 v.d.c. to 100 v.a.c. 485 watts. Sensational offer! \$8.00 each. Three for \$20. Order today! No COD. "Amazing Bachman's," 23 Herman St., Dept. PM, Rochester 5, N. Y.

AMPLIDYNE Motor - generators. All packed—new! GE5AM 31N9A. Output 60 v.d.c. input 27 v.d.c. 530 watts. Original cost \$120.00. Now! \$7.95 each. Three for \$20. Order today! No c.o.d. "Amazing Bachman's," 23 Herman Street, Rochester 5, N. Y.

WINDING Data, listing 225 motors, single and three phase, \$1.00. Motor Data Co., Box 7631, Kansas City 3, Mo.

BOATS, OUTBOARD MOTORS, ETC.

P-38 BELLY Tanks, new, steel, 10 ft. 2 in. 165 gallon \$9.95. Anzio Boat Co., Box 89H, Merced, Calif.

ANYBODY Can build an "E" from the Campbell plans for this famed runabout. \$25.00 complete. Builder Copperhead, (70.245 m.p.h., others). Great ski tower. Write for literature. Willard (Bill) Campbell, 5589 Riviera, Long Beach 3, Calif.

BELLY Tanks—75 gallon, new, steel. 6 ft. 4 in. \$7.50. Anzio Boat Co., Box 89H, Merced, Calif.

P-38 BELLY Tank speed boat. Complete plans, instructions \$1.00. Twintank Boat Company, 1032 62nd Street, Oakland, California.

\$35 SEA Shell pre-fabricated 8' plywood rowboat. Free illustrated folder. Hagerty Company, Cohasset, Mass.

MARINE Catalog, 15,000 deliverable items pictured and priced. Send \$1.00. Marine Mart, Buffalo 7, N. Y.

PLEASURE And profit fishing boat plans \$1. Albert Schantz, Baden, St. Louis 15, Mo.

OUTBOARD Motor parts. New-used, all makes. New pistons (standard, oversize). Cylinders rebored. Outboard Motor Mart, 309 Atlantic Ave., Boston 10, Mass.

POR Sale—Boat loading winch for trailer, holds 75 feet, 1/4 inch cable, ten dollars postpaid. Holt Equipment, Independence, Oregon.

PACKAGED Boats, molded and sheet plywood boat kits, all parts precision cut, and boats ready for easy assembly; finest designs, materials, and workmanship, \$39.50 up. Send 25c coin for illustrated literature. Marine Mart, Buffalo 7, N. Y.

BARGAIN \$20. Make your own boat now with readymade streamlined laminated one piece hull as developed for Navy. Light, sturdy, leakproof. Anyone can convert into dinghy, outboard scooter, cartopper, other craft. 9'x4'. Write Warwood, 480 Lexington, New York 17.

HAND Pump, 23" long, metal, with wood handle, rubber hose. Ideal for boat bilge pump, water fire extinguisher; garden sprayer, etc. Good used condition. \$1.95. Postpaid \$2.25. Aero Instrument Co., Municipal Airport, Houston, Texas.

OUTBOARD Rowboats, kayaks, Weld-Wood ready cut kits, booklet. E. J. Croot Co., 103D Basking Ridge, N. J.

BOAT Pattern catalog—Fifty famous plywood designs, with full size, cut-to-shape patterns; blueprints; kayaks to cruisers, by the outstanding specialists, MacGregor and Deed, plus William Deed's booklet, "Plywood Boats." Send \$1.00. Marine Mart, Buffalo 7, N. Y.

COMPLETE Kayak kit. Nothing additional needed. Excellent present for dad, brother, son. Literature. Play-Yacks, Dedham, Mass.

OUTBOARD Motors—Good values, used motors. Also used parts for most makes and models. Crandall-Hicks Co., 911 Commonwealth, Boston, Mass.

TWENTY Plywood boat plans \$1.00. 6 to 20 feet, sail, power. The Rudder, 15 Murray Street, New York.

NEW, Used, rebuilt marine motors. Marine conversions, fittings. Free catalog. Stokes Marine Supply, Dept. 24, Coldwater, Michigan.

ALL Copper water jacketed exhaust manifolds for marine conversions of automobile and aviation engines and marine engine replacements; any make, model or age. Joseph Van Blerck & Son, 391 Woodcleft Ave., Freeport, N. Y.

BOATS And all about them. How to select, build, repair and operate. For 40 years the leading practical boating magazine. Half price trial subscription. 12 issues for \$1.00. Motor Boat, 62 Gold Street, New York 7.

BOAT Designers are highly paid professionals. Complete course by mail. Catalog. Westlawn, Montville, N. J.

ATHLETIC EQUIPMENT, BODY BUILDING COURSES

MUSCLES: Powerful bulging muscles with "Herculex Crusher Grip Outfit," \$3.00 postpaid, includes course and big pictured arrangement of equipment and weight lifting story. Nat Berent, 1090 W. 43rd, Norfolk 8, Va.

HANDBALANCING Self-taught. Power, 923a W. Vine, Kalamazoo, Michigan.

10 MINUTE Barbell course \$1.00; abbreviated course 50c. Texas Barbell, Palestine, Texas.

BARBELLS \$11.00 up. Stamp for folders. Jackson International Barbells, Springfield, N. J.

BARBELLS Exercise equipment. Courses. Free booklet. Good Barbell Co., Reading, Penna.

SPORTING GOODS, GUNS, FISHING TACKLE, ARCHERY, TRAPPING

START Business yourself. Send for list of spinner blades, shafts, beads, rudders and parts for constructing lures that will catch fish. Spinner Specialties, Inc., Lewiston, Idaho.

FISHING Canes, bamboos, supplies. 3-piece jointed native cane \$2.75. Aluminum rod, jointed, Nylon-wrapped guides, locking reel seat, length adjustable five, seven or nine feet, case three feet. Light weight. Extra nice, \$6.95. Dealers write. Bob Pace, Combs, Ark.

THROWING Knives, perfectly balanced, handcrafted, with sheath, \$1.50. Dealers write. Frank Stark, 1718-K Walnut, Allentown, Penna.

SEND 10c For list 100 used guns. Frayseth's, Willmar, Minnesota.

SHOTGUNS, Rifles, revolvers, over 500 modern, obsolete. Also cartridges, list 10c coin. Ed Howe, 52 Main, Coopers Mills, Maine.

GUN Grips, pearl, Jobber's price. Miracle Product, 44 N. Albany, Chicago.

BOOKS On gunsmithing. Catalog 10c. W. Joseph O'Connor, Baker, Oregon.

SHOOT For fun, shoot to kill. Make a powerful, accurate, "folding crossbow pistol." Complete plans \$1.00. Louis P. Loutrel, Box 266P, Jamaica 1, N. Y.

AUTOMATIC Lure—Positively weedless. Greatest invention in ages. Nothing like it. Circular free. Babcock Reel Co., Oak Harbor, Ohio.

CARTRIDGES, Firearms, ammunition complete list 25c. Frank Parish, Vicksburg, Mississippi.

5000 BARGAINS, Firearms, binoculars, war relics. Catalog 40c. Smith Firearms, Runnemed, New Jersey.

TAXIDERMY

FINEST Glass eyes; taxidermy supplies. Catalog free. Etwood Company, Department 234, Omaha 2, Nebr.

FIELD GLASSES, TELESCOPES, MICROSCOPES, MAGNIFIERS

GUARANTEED Optical equipment. 3X field glasses, \$6.60. 3X binoculars, \$5.10. 5X spy glass, \$1.25. 50X microscope with accessories, \$2.98. Literature. W. Wardell, 2509-A Clarendon Road, Brooklyn 26, New York.

VARIABLE Density, Polaroid filter device. 2 3/8" diameter, \$2.35. Glass only, 2 for \$2.00. Ross, C-68 West Broadway, New York, N. Y.

ARMY-Navy Surplus, Telescopes, binoculars, lenses, prisms, etc. Send 3c stamp for bargain list. H. A. Jaegers, 123-26 Rockaway Boulevard, South Ozone Park 20, N. Y.

POWERFUL Astronomical telescopes easily made. Perfect lenses and instructions. 100 power \$2.50. 100 and 200 power \$3.50. 100, 200 and 400 power \$5.50. Clear vision and full power guaranteed. Instructions alone 10c. Suffolk Science Service, Manorville, N. Y.

PORRO Prisms for 6x30, 7x50 binoculars, 50c each. Ross, C-68 West Broadway, New York, N. Y.

TELESCOPES, Microscopes, binoculars, barometers, cameras, books; buy, sell, repair. Lists 10c. Rasmussen-Beece, Amsterdam, N. Y.

TELESCOPES, Binoculars, microscopes, big bargain catalog free. Brownscope Company, 24 West 45th Street, New York.

REFLECTING Telescopes, complete. 3 1/2" diameter, equatorially mounted. View planets, stars, \$19.75. Write Sky-scope Company, 475-P 5th Ave., New York.

BINOCULARS, Telescopes, watches, Buy, sell, trade. Paul Schweer, Donnellson, Iowa.

DOGS, PETS, BIRDS, RABBITS

GUARANTEED Chin-Chin Giant Chin-chilla rabbits. Greatest amount of delicious meat. Largest, finest, most valuable furs. Tremendous demand for breeding stock. We buy youngsters. Contact world's largest breeder. Willow Brook Farm, R15, Sellersville, Penna.

RACCOONS, Minks, skunks, foxes. Bred females, Baby skunks. Catalog 25c. Shady Fur Farm, Springfield, Minnesota.

RAISE Guinea pigs. Make money at home. Big demand. Booklet free. Taylor, Box 426A, Hapeville, Georgia.

STANDARD Rabbit Journal, Milton, Penna. 3 years \$1.00, sample time.

MONEYMAKING Opportunity raising Giant Chinchilla Rabbits. Waters Rabbit Farm, Glennville, Georgia.

PEDIGREED, Newfoundland puppies, Protection assured family. Earl Thurston, Hartsville, Indiana.

RAISE Rabbits. Market provided, breeding stock furnished on production pay plan. Literature 25c, with hutch plans \$1. Hansen's Rabbit Institute, 1347 Miller Avenue, Salt Lake City 6, Utah.

ANGORAS, Giant Chinchillas, Heavy-producing prize winners. Literature free. Grinsteads, Edwardsville, Illinois.

RAISE Guinea pigs. Details 25c. Greenwood, 234 S. Muscatel, San Gabriel, California.

5 CENTS Day starts \$1000 pair Chinchilla ranching. Complete booklet \$1.00. Montana Fur Farm, Billings, Montana.

INCREASE Your income by raising domestic rabbits. Small space needed. Ready market for delicious meat, fur and wool. Largest magazine in the industry tells you how. \$1.50 per year. Sample 15 cents. No stamps. Small Stock Magazine, Lamoni 50, Iowa.

SUPERIOR Chinchilla giants—Other varieties. Breeding stock supplied credit terms. Beautiful picturesque catalogue. Complete instructions, 25c. Behrens Farms, Pearl River 4, New York.

RAISE Hamsters. New wonder animals from Syria. Delightful pets. Laboratories need thousands. Profitable. Free information. Hamstery, 1519 Basil, Mobile, Ala.

\$50.00 WEEKLY Raising Angoras for us. Free literature. Angorville, 1215-34th Northeast, Cedar Rapids, Iowa.

\$2000 PER Year raising Angora rabbits. We buy your output. Contract particulars free. Wilsons, 1065 Shryer, St. Paul 8, Minn.

RAISING Rabbits, Cavies, Hamsters, Chinchillas is a growing and profitable industry. Magazine 10c. Descriptive book and magazine 25c. Book and magazine (monthly) one year \$1.00. Address Small Stock Farmer, Pearl River 15, N. Y.

FREE—"Amazing New Book"—"Profits From Classified Advertising." Tells how and what to advertise. Be sure to read this book before you invest one cent in advertising. Remember—it's free! Write for your copy now. F. W. Johnson, Classified Advertising Manager, 200 East Ontario Street, Chicago 11, Illinois.

FARMS, FARM LAND, REAL ESTATE

HITCH Your future to a farm! Security unlimited may await you on any one of the hundreds of bargains described in United's exciting big new winter catalog, just off press. Farms, ranches, orchards, tourist courts, country homes, resorts, retirement havens—covering mid-west to west coast. Here's your invitation to independence. Write for your free copy today! United Farm Agency, 1408-FPM Consumers Bldg., Chicago 4, Illinois.

GOOD Farms—Ranches, Washington, Minnesota, Montana, Idaho, Oregon, North Dakota. Dependable crops, favorable climate. Write for literature. Lists describing typical farm opportunities. Specify which state. J. W. Haw, 119 Northern Pacific Ry., St. Paul 1, Minn.

OSARK Lands for all purposes. Actual river frontages. 5 acres \$90.00 and upwards. Free list and literature. Hubbard, 424-I Minnesota Ave., Kansas City 4, Kansas.

WEST'S Latest catalogue: Over 1000 farm and business bargains. 180 representatives, 16 states. Free. Write West's Farm Agency, HE-12, Pittsburgh 17, Penna.

\$5.00 MONTHLY Buys 40 acres near town; price \$200.00. Free list. Box 425-P, Carthage, Mo.

PALM Springs area, California, sacrificing 2 bedroom desert home. Healthy, sunny climate year-round. Magnificent mountain view. \$7,500. Worth double. Mainick, 6912 Hollywood Boulevard, Hollywood, Calif.

FARMS, Ranches. All kinds, sizes. Choice of location, climate, production. Information on irrigation projects Columbia and Missouri River Basins. Resorts, summer homes, Milwaukee Railroad territory: Washington, Idaho, Montana, Dakotas, Wisconsin, Upper Michigan, Central corn belt. Free folders, price lists. L. H. Robbins, 604 Union Station, Chicago 6, Illinois.

STROUT'S Big farm catalog—mailed free. Describes over 2800 outstanding bargains. Coast to coast. Time-money saver. Write today. Strout Realty, 255-P 4th Ave., New York 10, N.Y.; 20 W. 9th St., Kansas City 6, Mo.; 453 S. Spring, Los Angeles 13, Calif.

HOMESITES \$450—Convenient payments. California's finest garden section. On Morro Bay's scenic shores. Wonderful fishing, hunting, boating, bathing. Fertile soil, softest water, temperate climate, congenial community. Free literature. Richard Otto, Department M, San Luis Obispo, California.

SEEDS, NURSERY AND GARDEN SUPPLIES

SUDBURY Soil Test Kits—Save money on fertilizer, grow bigger crops! Easy to use, no knowledge of chemistry needed. Test anytime, anywhere; for nitrogen, phosphate, potash, and acidity. No waiting for reports. Make fertilizer produce up to three times as much, because you know what your soil needs. Over 100,000 Sudbury Soil Test Kits used by farmers, county agents, agricultural schools, gardeners. Money-back guarantee. Complete equipment in handsome hardwood chest, a lifetime investment for only \$22.50. Sent prepaid if cash with order, or we'll ship c.o.d. Order today! Sudbury Laboratory, Box 400, South Sudbury, Mass.

DAHLIAS. Ask for 1948 book. 400 varieties. Springhill Dahlia Farm, R. 2, Box P, Grand Rapids, Mich.

WE Sell on the installment plan. Best varieties peach and apple trees, low as 12c; grapevines 4c; shrubs 13c; evergreens 15c. Berries and plants. Catalog free. Benton County Nursery, Box 542, Rogers, Arkansas.

LYCOPodium Easter bouquet 25c. Flower dyeing course. Memorial wreaths. Naranjilla, passion flower, orchid, tomato-earbol, helichrysum seeds 50c package. Lycopodium Foundation, St. Paul 8, Minn.

FARM MACHINERY AND SUPPLIES

FREE—Big 1948 new and used tractor parts catalog. Satisfaction guaranteed. Write Irving's Tractor Lug Company, Fargo, North Dakota.

POULTRY, FARM SUPPLIES

MAKE Money with turkeys. Magazine with experimental farm explains how. Early start increases profits. Introductory bargain offer six issues for \$1.00. Send remittance today! Turkey World, Dept. 20, Mount Morris, Ill.

SAVE Up to 3c a chick. Get Colonial's early order cut prices on 200-336 egg pedigree chicks. Purebreds, cross-breeds, as hatched or sexed. Catalog free. Colonial Poultry Farms, Box 703, Pleasant Hill, Mo.

PRODUCE Your own eggs and poultry the "back yard" way. Laying batteries for eighteen hens now available for immediate delivery. Combination batteries with one deck for brooding 50 chicks, two decks for raising broilers, and one deck for six laying hens also available. Write for full descriptive literature to Bussey Products Co., 6000-99 W. 51st St., Chicago 38, Ill.

BABY Chicks, champion mated. 25 varieties, 6 hybrids, licensed inspected, blood-tested. Rush postal, large colored book free, low prices. Berry's Farm, Route 12, Clarinda, Iowa.

SUPERIOR Best chicks with 200 to 336 egg bloodlines. Leghorns, Rocks, Reds, Hampshires, Wyandottes, Orpingtons, Austra-whites and Legorcas, as hatched or sexed. Low prices save you \$1 to \$3 per 100. Old, reliable, established 1919. Big free catalog. Superior Hatchery, Windsor, Missouri.

SUCCESS In the poultry business. You, too, can enjoy country life, home grown food, increased income, if you have specialized knowledge. For 27 years our home study course has helped thousands obtain that knowledge. Write today for prospectus describing courses, methods, opportunities, service. National Poultry Institute, Dept. 50-C, Adams Center, N. Y.

RAISE Fryers new easy way. One-man home plant earns \$500 monthly. Booklet free. Poultry Guild, 1046-A So. Olive, Los Angeles 15, California.

RAISE Turkeys the new way. Write for free information explaining how to make up to \$3000.00 in your own backyard. Address National Turkey Institute, Dept. 3, Columbus, Kansas.

POULTRY-RAISERS—Increase poultry profits with Experimental Farm advice. Latest tested helps. 24 months for only \$1.00. Subscribe now! Poultry Tribune, Dept. S, Mount Morris, Ill.

KNOW How to raise poultry for profit. Read Northeastern Poultryman. Every issue packed with helpful hints and practical suggestions. Latest articles on breeding, feeding and management. Subscribe now. 1 year 65c. 2 years one dollar, foreign subscriptions \$1.00 a year. Northeastern Poultryman, Dept. P.M., 376 Boylston St., Boston 16, Mass.

PROFITABLE OCCUPATIONS

MECHANICALLY Inclined men—Own and operate general appliance repair shop. Complete, illustrated course shows you how. Welding, refrigeration, motor repair, how to get business, etc., all phases covered. Free literature. Christy Supply, Dept. 477, 2835 N. Central Ave., Chicago.

MAGAZINE Agents attention! Looking for prompt service, co-operation, consideration? Write Cassell Publishers Service, Westfield, New Jersey.

"MOST Everybody likes candy." Learn to manufacture in a professional manner. (Our 38th year). Ragsdale Candies, #107, East Orange, N. J.

NO Selling, operate vendors, amazing profits, details free. Silver-King, 622 Diversey, Chicago 14, Ill.

SOURCES: Where to buy (or sell) thousands articles, supplies, etc. Folder free. Reinhardt's, Ashburn, Georgia.

START Lamp factory. Profitable, fascinating, easy to learn. Illustrated course teaches you. Complete instructions, wholesale catalog, \$1.00. Gearon Company, 6405 North Oakley, Chicago.

BE The Popular Mechanics representative in your neighborhood and earn big profits in your spare time. Write Popular Mechanics Magazine, Room 408, 200 E. Ontario St., Chicago 11.

EXTRA Money? Free details. Trable, 1018 1/2 Elm, Dallas, Texas.

START Flocking—Spray beautiful plush finish on everything. Easy, profitable, inexpensive. Supplies, equipment, instructions. Coast Industries, 1507 W. Manchester Avenue, Los Angeles 44.

YOU Can make real money raising Golden Hamsters, the new amazing tiny animal. Food costs less than 10c monthly per animal. Breeds in 16 days! Easily raised in basement, attic, garage, barn, or shed. Write for convincing details. Hudson Hamstery, R.F.D. #1, Newfound-land, N. J.

INSTALL Automatic heat damper control sets. Cost \$10.00, resell \$25.00. Hasko, 879 10th Avenue, New York.

PROFITABLE Business in making and building with interlocking blocks. Delaware Industries, Dept. 10, Muncie, Indiana.

METALIZE Baby shoes for pleasant profits. Write Enterprise, Box 189-MP, Wilkes Barre, Penna.

"ALASKA" The last frontier offers unlimited opportunities. \$1 brings official government map and copyrighted report with listing of firms: Fishing, construction, mining, aviation, homestead lands, prospecting business. Alaska Opportunist, P.O. Box 883, Hollywood 28, Calif.

LOCKSMITHING Secrets. Key fitting, lock opening, repairing, prices to charge, supply sources. Illustrated book only \$1.00. Wechsler Supply, 7 W. 36, New York City.

MAKE Beautiful mirrors from inexpensive window glass. No special equipment required. Details free. Tes-Co, Box 189-MP, Wilkes-Barre, Penna.

PERMA-FLEX Molds, made from B. F. Goodrich Company's Koroseal flexible molding compound. Stock or custom built molds. Send 25c for catalog and sample mold. The Perma-Flex Mold Company, Columbus 15, Ohio.

INTERESTED In Latin American and foreign employment? \$1 brings copyrighted Foreign Service Directory listing firms with interests in construction, oil, mining, aviation, manufacturing by personnel expert. Hot list of companies hiring. Global Reports, P.O. Box 883, Hollywood 28, Calif.

"FROG Raising"—New book tells how! Marlboro, 1035 Marlborough, Detroit 15, Michigan.

1947-1948 LEATHERCRAFT Supply catalog 10c. Art Craft Supply, 1205 Throckmorton, Fort Worth, Texas.

WOULD You pay 3%—first \$350 made? Color-illustrated book "505 Odd, Successful Enterprises" free! Some offer occasional "day off." Work home. Expect something odd! Pacific, Oceanside, Calif.

"THERE'S Big money in junk," and repairing batteries. Write, Batterymen, Grand Junction 5, Colorado.

HOW To set up and run a mirror shop! Resilver mirrors. For price write, John Sprinkle V50, Marion, Indiana.

MUSHROOMS Grown. Boxes, Barrels. Illustrated instructions 50c. Spawn \$1.00. Gordons, 553 William, Winnipeg, Manitoba.

TYPEWRITER Repairsmen urgently needed. Earn \$40 to \$50 weekly spare time. Our easy to learn home study course teaches how to repair typewriters. Write for free information. Houston Typewriter Repair Service, P.O. Box 5357A, Houston 12, Texas.

ELECTRIC Clocks are every where you go, buildings, homes, parking lots, factories. Repairs increasing. Our easy to learn course with pictures and drawings teach you how to repair these clocks. Electronic Supply Co., P.O. Box 2350A, Houston 1, Texas.

\$40.00 WEEKLY Made growing mushrooms, fresh, dried. Dominion patent 331583. Free spawn. North American, 169P Yonge, Toronto, Canada.

BOOKS, PERIODICALS, PICTURES, POSTCARDS

VIEWS Of the hereafter. For copy of the remarkable book by Emanuel Swedenborg "Heaven and Its Wonders and Hell," send 5c to cover mailing. Swedenborg Foundation, Room 1649, 51 East 42nd St., New York 17, N. Y.

SELF-EXPLAINING Bible: Illustrated circular free. Box 446-P, Minneapolis, Minn.

WHAT Every Mason wants. We have Masonic books for Blue Lodge, Chapter, Commandery, Scottish Rite and Shrine. Our rituals are used the world over. Send for free catalog of books and rituals for Masons, Odd Fellows, Knight of Columbus, etc. Ezra A. Cook, Publisher, P.O. Box 796-PJY, Chicago 90, Ill.

BIG Sparetime profits taking magazine subscriptions. Complete supplies, confidential catalog free. Cassell Publishers Service, Westfield, New Jersey.

TWENTY-FIVE Assorted Navy ship postcards, 25c. Liberty Picture Co., Richmond, California.

LONE Fir, interest for gardeners, hobbyists. Sample 10c. Hebron Press, Box 8431, Portland 7, Oregon.

MAGAZINES—Trade and class. Current copies. All fields. Free price list. Commercial Engraving Publishing Co., 34C North Ritter, Indianapolis 19, Indiana.

SHIP'S Photographs, passenger, freighters, tankers, list 10c. Scozzafava, 1643 59th St., Brooklyn 4, N. Y.

WE Can supply you with almost any book. House of Kilroy (Booksellers), Box 772, Detroit 33, Mich.

INSPIRATIONAL—Send \$1.00 for "Five Point Self Development." Anna Crews, 7609-A Champlain Ave., Chicago 19, Ill.

1000 DIFFERENT Pocket books. Catalog 5c. Gordon's, 2613 Crenshaw, Los Angeles 16.

BOOKS Galore: Extra fine, unusual books. Catalog free. Superior Distributors, 916 Hayes Street, San Francisco 17, Calif.

BACK Number magazines, reasonable. Reedmore, 240 East 9th, New York, N. Y.

THE Story of American Railroads, profusely illustrated, \$4.00. Art of Drawing Women \$1.00. Free catalogue, interesting books, A. Fallor Company, 201 Dewey Street, Newark 8, New Jersey.

UNUSUAL Fascinating books. Five \$1.00. Free catalogue. Kogan, 1032-FL, New York 8.

ART And craft books. Send for free catalog of 500 titles of leading art and craft books selected from the stocks of all publishers. Painting, drawing and sketching, printmaking, advertising and commercial art, cartoons and caricatures, costume and fashion, architecture, sculpture, leathercraft, pottery, jewelry, metalcraft, plastics, woodcraft, puppets and dolls, masks, weaving, home decoration, etc. Watson-Guptill Publications, Inc., 341 Hudson Street, New York, N. Y.

BACK-DATE Magazines, books. Specific issues—years. Arkell's, Tarzana, Calif.

BOOKS Found free! All subjects. Send wants! Jaher Book Service, 620-P East 178 Street, New York 57.

MAGIC TRICKS, PUZZLES, JOKER NOVELTIES

FREE! Large catalog of magical apparatus if you remit 25c for "Magic Is Fun" magazine. Robbins Co., 152-F West 42nd Street, New York.

DOLLAR Magic set free with gigantic catalog. 25c! Mysto, 4462 Germantown, Philadelphia.

SENSATIONAL Radar pencil. Automatically finds mentally selected card. Astound everyone! Plus surprise trick \$1.00. Funalogue 10c. Thor Sales, 853 46 Street, Brooklyn 20, N. Y.

MASTER Cigarette vanisher will fool even your wife! Details free. Scheetz's, Sellersville, Penna.

REMARKABLY Inexpensive pocket tricks! Catalogue, 5c. Postways, Box 5325, Philadelphia 42.

LEARN Magic, ventriloquism, mind-reading. Write for particulars. Quackenbus. Big Flats, N. Y.

SNEEZING, Itching powders, eighteen other tricks free with joker's catalog. 25c. 2404-N Fifteenth, Philadelphia.

TRICKY Magic matchbox. It turns around, it stands, it opens. Confuses, amuses everyone, easy to do. Free to you if you send 25c for big illustrated catalog of 425 magic tricks. Magician, 2463-C, Kensington Ave., Philadelphia, 25, Penna.

GUARANTEED Magic tricks! Amateur, professional. Big 8 1/2 x 11 illustrated catalog. 10c. Newton's, Box 202-A2, Bonham, Texas.

"VENTRILLO". Professional voice-troubling instrument and catalog 25c. Box 971-PM, Philadelphia.

500 TRICKS. Send only 10c for Douglas' famous 112-page catalog 500 tricks. New magic for amateur, professional. America's fastest service for 25 years. Douglas Magician, Dept. 1, Dallas, Texas.

MAGICIAN'S Pin, ghost illusion. Houdini escape, giant catalog. Everything complete 35c. Magic Wand-M, 9 W. Colorado, Pasadena 1, Calif.

PERFORM Over 100 baffling sleight-of-hand tricks with ordinary thimble. Easy! 42 action photos, complete instructions \$1.00. Garnet Specialties, Box 502-A, Valparaiso, Ind.

HOWARD Thurston's card tricks, only 50c. Specialty House, Box 542, Danville, Illinois.

PROFESSIONAL Catalog. 112 pages. 25c. Williams, 900 Plymouth, Ellwood City, Penna.

200 ELECTRIC Stunts. 110 volts. \$1. Kutting Sons, Campbell, Calif.

BIG Magic magazine, trick and price lists—25c. Lloyd M. Jones, 4064 39th Avenue, Oakland 2, California.

BE A magician. Large professional magic catalog of latest tricks. 25c. Ireland, C-109 North Dearborn, Chicago 2.

VENTRILLOQUISM Taught. 3c stamp bring particulars. Smith, 801 Bigelow, Peoria 5, Ill.

VANISHING Half dollar trick and catalog 25c. Sterling Magic Co., Royal Oak, Mich.

WORLD'S Largest professional magic shop. keeps you in touch with latest tricks. To receive mailings, send 35c for new catalog. Holden's, M220 West 42nd St., New York.

MAGIC Tricks, puzzles, books, cards, punch boards. Catalog 10c. Specialty, Box 671, St. Louis 1, Mo.

COINS, TOKENS, CURRENCY

INDIAN Head penny with list 10c. Charles Banker, Salina, Kansas.

50 WORLD Coins \$1.00. Harry Elsholz, Box 9014, Pittsburgh 24, Penna.

FREE! Foreign coin, banknote and coin collectors illustrated catalog to approval service applicants. Send 3c postage. Tatham Coinco, Springfield-125, Mass.

12 WOODEN Nickels \$1.00. Whitman folders 25c, handbook 75c. 20 coins from 20 countries \$1.00. Large retail catalogue 15c. Bebee Coin Company, 1180 East 63rd, Chicago 37, Illinois.

GENUINE Roman coins 2000 years old. Two for \$1.00; 10 diff. \$4.00. DeMonte, 725 West 172, New York 32.

SPECIAL Offer—80 different foreign coins; ancient coin 2,000 years old, 5 Indian cents, U. S. eagle cent, 2c piece and 5 foreign paper bills. The lot \$5.00. Pappas, 356 Wadsworth Ave., New York 33, N. Y.

OLD Money wanted. Will pay fifty dollars for nickel of 1913 with Liberty head (no buffalo). We pay cash premiums for all rare coins. Send 4c for large coin folder. May mean much profit to you. Numismatic Co., Dept. 20, Fort Worth, Texas.

50 DIFFERENT Coins and bills, \$1.00. 100 different bills \$1.00. Oddehon, Box 482, St. Louis, Mo.

25 INDIAN Cents \$1.00. 48 page coin value guide 50c. Royal Coin, 3 School, Boston.

GET Profit and pleasure in collecting old coins. Send 10c for 56 page illustrated coin catalog. You'll be delighted with it. Send for it now. B. Max Mehl, 370 Mehl Bldg., Fort Worth, Texas. Largest rare coin establishment in U. S. Established 48 years.

20 DIFFERENT Fine coins, 50c. Bishop, Box 2201, Kansas City, Mo.

BARGAINS! Rare collection contains United States large cent before 1848, flying eagle cent, white Indian cent, 2c piece, 3c silver, 3c nickel, half dime, shield nickel, liberty seated dime, Civil War cent, fractional currency note, confederate bill, foreign coin, foreign bill and our complete buying, selling catalogue, all for \$3.00. Catalogue alone, 25c. 25 dates Indian cents \$1.00. 50c before 1840-1.00. Pilgrim or Lexington 50c-1.25, half cent before 1810-75c, large cents 1826 to 1856-35c each, colonial coin before 1790-1.00, \$100.00 confederate bill \$1.00, 1780 foreign silver dollar \$1.00. Worthy Coin Corporation, 152-D Washington, Boston, Mass.

FOR Sale: 1893 Columbian World's Fair half dollar, 75c; U. S. 2-cent pieces or 3-cent pieces, 25c each; 50 assorted Indian head cents, \$1.25; large 50 page U.S. coin catalog, listing thousands of coins for sale at reasonable prices, 25c; Giant 72 page foreign copper-silver-gold catalog listing over 10,000 coins for sale, 25c. Ben's Coin Company, 72 West Washington, Chicago 2, Illinois.

COINS For collectors, reasonable prices. Free lists. Hutchinson, 3463 "I" Street, Philadelphia 34, Penna.

COMMEMORATIVE 1/2, Oregon, Texas, Kentucky, Cleveland, Long Island, \$2.00 ea. Illustrated catalogue 25c. Norman Shultz, Salt Lake 9, Utah.

COINS Wanted, will pay up to \$2000 for certain coins, send 25c for catalogue. Burton's, 111 So. Third, Columbus, Ohio.

OLD STAMPS WANTED

I WILL Pay \$100.00 each for 1924 1c green Franklin stamps, rotary perforated eleven (up to \$1,000.00 each unused). Send 10c today for large illustrated folders showing amazing prices paid for old stamps and collections. Vernon Baker, PM-81, Elyria, Ohio.

STAMP COLLECTING

DANDY United States approvals. Write immediately. Sullivan, Endicott Building, St. Paul, Minnesota.

EXCHANGE Stamps universe. Particulars free. "Exchangers," Bry 126, Seine, France.

200 DIFFERENT Stamps, 6c, to approval service applicants. Tatham Stamp Company, Springfield 30, Mass.

FREE! Canadian sets, royal visit. George VI, George V, coronation, jubilee, others, to approval applicants. Ensign, Box 118-M, South Orange, N. J.

100 DIFFERENT Including scarce diamond-shaped airmail 3c to approval service applicants. Avalon Stamp Co., Dept. M, Springfield 8, Mass.

GIBRALTAR Packet free—Nice collection Gibraltar, New Zealand Centennial, British Uganda, French Colonials, early British Colonial, West Indies, South American, war stamps plus Philatopic Monthly Magazine. All for 5c postage. Empire Stamp Company, Dept. PM, Toronto 5, Canada.

BETTER Grade pictorials, singles, sets, attractively priced. Marvic Stamp Company, 280 Troy Avenue, Brooklyn 13, New York.

NORFOLK Island first day cover 20c with requests for approvals. G. Stickeler, 20 Belvidere St., Brooklyn 6, N. Y.

NICARAGUA "Tin Pan Alley" diamond, Ecuador showing George Washington, and American flag in natural colors, Fezzan, Trieste, "American Army" stamp, first U. S. commemorative, \$100.00 Shanghai, Corsica, Anzac, Antique, others. All 5c. Approvals, Capital Stamp Co., Dept. 2, Little Rock, Ark.

FREE! Greenland-Iceland packet. Postage. Fritz, 1699 Riverview, Decatur, Illinois.

POSITIVELY Greatest free offer—latest Scott's International \$6.00 stamp album—covering entire world, contains 36,000 illustrated descriptive spaces; Scott's 1948 Standard \$7.00 catalogue "Philately's Encyclopedia"—absolutely free to applicants for foreign approvals becoming customers. "Approval Service," Box 1700, San Francisco, California.

25 DIFFERENT India—3c with approval. Premiums with purchases. Brandwein Stamp Co., Box 92-H, Bayonne, N. J.

UNITED States stamps on approval. Bargain prices. Metropolitan, 140-B Nassau, New York 7.

BET You haven't these! South Georgia, South Orkney, Grahamland, South Shetlands, shortlived Falkland Dependencies. Everything 3c with approvals. Viking, 130-Z Clinton St., Brooklyn, N. Y.

FREE. Fascinating airmail collection, including obsolete Liberian issue, with approvals. Raymax, 123-Z William St., New York City 7.

BOLIVIA, National anthem set, Ethiopia Red Cross, Roosevelt triangle, France coat of arms, fourteen beauties, only 10c with approvals. Huffman, Box 331, Miami 3, Fla.

OLD Scarce U. S. seconds on approval. Slightly defective. Specially priced. Hernefield, 551 Clinton, Newark 8, N. J.

YOU'LL Like my approvals and gift. Walter Kotowski, 5864 Staubin, Detroit 11, Mich.

SCARCE Byrd imperf. stamp on first day cover 10 cents. Approvals. Knobel, 1918 SW 12th Street, Miami 35, Florida.

2,000 WORLD Diff. \$6.00. Mendelsohn Stamp Co., 1900 W. 25, Cleveland, Ohio.

GIFT Packet with approvals. Russell, 519 Crystal Ave., Findlay, Ohio.

77 DIFFERENT United States 17c. Many commemoratives included to approval applicants. Standard, 3817 Sackett, Cleveland 9, Ohio.

U. S. Price list free. Sikes, 1831 E. Allegheny, Philadelphia 34, Penna.

FREE—1,000 Different stamps to approval applicants becoming customers. Enclose 3c postage. Sobel, 4333 Drake, Chicago 18.

50 DIFFERENT Hungary stamps and our price list, one silver dime. Stamp-sales, Box 1649P, Oakland 4, California.

100 DIFFERENT Stamps 10c. Bob Stovall, 235 Cortland, Detroit 3, Michigan.

AMAZING Bargain 25 Vaticans only 10c. Wilhelm, 14646 58 Road, Flushing, N. Y.

FREE—Commemoratives, airmails, pictorials. Approvals. Wisheart, 303 Second, Frankfurt, Ohio.

3 DIFFERENT United States \$5.00 stamps and large illustrated catalog 10c to approval applicants. Tatham Stamp, Springfield-125, Mass.

LIBERIAN Triangular set, 10c with approvals. Vargo Stamps, 6044 South Fairfield, Chicago 29, Illinois.

GIGANTIC Packet free. Bargain approvals. Verne, 916-K Fallowfield, Charleroi, Penna.

PENNY Approval bargains—Write Department PM, 1267 Tutwiler, Memphis 7, Tennessee.

GENERAL Collection breaking up approvals. Lion, 200 W. 81 Street, New York 24.

51 DIFFERENT Belgium beauties, unused, used, pictorials, parcel post. Catalogs way over \$1.00, only 5c if you request approvals. L. Frazer, Box 4600, Portland 2, Oregon.

25 DIFFERENT Stamps. Russia, Vatican, Hyderabad, Manchukuo, Jamaica, Ukraine, etc. for 3c with approvals. Standard, Box 1616, Miami Beach, Florida.

HITLER Heads cataloging \$1.05. 25c with approvals. Miller, Box 600-A, Palo Alto, California.

ROOSEVELT Stamp collection, seven countries, 22 different. \$5.00. President Truman stamp, 25c. Cuba catalog \$1.25, only 50c. All three offers only \$2.00 to adults requesting approvals and furnishing references. Green, Box 73, Coconut Grove, Miami 33, Florida.

35 DIFFERENT Greece or 100 different world, 10c, approvals 1/2c up. Kingman, Highbridge, Box 42, New York 52.

FRANCE Collection, 120 different, many pictorial 25c with approvals. Fields of Cleveland, 1939 E. 85, Cleveland 6, Ohio.

50 DIFFERENT United States 10c. No approvals. Seidenberg, Cassopolis, Mich.

TOPS, tops in value, priced to please. United States approvals. Jarr Stamps, P.O.B. 217, Madison Square, New York 10.

BIG Money in stamps. Buy at low cost. Sell at big profit. New book "How to Sell Stamps by Mail" reveals startling stamp secrets. Send no money. Just your name on penny postcard to D. P. Kelly, 9544 Whitcomb, Detroit 27, Mich.

100 DIFFERENT Nice Canadian and Newfoundland stamps. Catalogued over \$3.00 or 500 mixed Canadian over 75 different \$1.00. T. Johnstone, 421 Mt. Pleasant Rd., Toronto 12, Canada.

50 U. S. Airmails, commemoratives 25c. Norwood Exchange, 4005 Ivanhoe, Norwood, Ohio.

GOOD U. S. approvals. Rock bottom prices. Panther Stamps, Dorchester 24, Mass.

20 OLD (10-75 Years) U. S. 20 U. S. commemoratives. All different. Send only \$1. Honest Joslin, 204-14 42nd Ave., Bay-side, N. Y.

FREE—The Stamp Finder. Big new edition. 32 pages profusely illustrated! Identifies all difficult stamps immediately. Also: 25 different stamps from Vatican City, Palestine, Cyprus, San Marino, etc. All sent to approval applicants enclosing 3c postage. Garcelon Stamp Co., Box 900, Calais, Maine.

GREENLAND 1-3 Regularly 25c only 15c. Approvals. Ramsay, Brainard 2, N. Y.

GIANT Bicolored royal visits, Malta pictorials, gorgeous Guianas, Goose airmail, Scandinavian packet and illustrated stamp publication, 10 cents with approvals. Crown Stamps, Box 331, Toronto, Canada.

FREE! Japanese airmail set! Complete, unused, obsolete. Request approvals. Riedell, Greensburg, Pennsylvania.

MONACO Roosevelt error? 50c airmail showing Roosevelt as philatelist, with six fingers on his left hand. Free to approval applicants. Eliot Stampco, 86-31 Eliot Ave., Rego Park, Long Island, N. Y.

200 DIFFERENT Stamps 10c with approvals. John Hammell, Box 865-A, Waterbury 87, Conn.

50 DIFFERENT Finland free with approvals. Robert Ompach, 1312 West Washington, Fort Wayne 2, Ind.

FIVE Old U. S. mint stamps, catalogues 56c. No. 498, 552, 554, 634, 687. 10c to general approval applicants. Middleton Stamp Company, 78-14 Woodside Avenue, Elmhurst, L. I., N. Y.

U. S. AND Foreign approvals. Vet Stamp Co., 1136-P Flatbush Ave., Brooklyn 26, N. Y.

YOU Need these. Twelve beautiful Austrian scenery stamps. Only 10c with approvals. Jack Dudak, Streator 4, Illinois.

NEWEST Stamp magazine. Articles, cartoons, puzzles, bargains. Sample copy, big stamp packet, all 15c. Walcott, Box 821M, New Orleans 2, Louisiana.

APPROVALS To general collectors 19th and 20th century. Ross, 2606 N. 60th St., Omaha, Nebr.

STAMPS From 40 countries, including Fiji 10c. No approvals. Elsea, Bowling Green, Ohio.

15 DIFFERENT U. S. over 40 years old. 10c special to applicants for our bargain U. S. approvals. Bill Portney, 1806 East 22 St., Brooklyn 29, N. Y.

FREE Stamps to approval applicants. Surf Stamp Co., Box 2296, Miami Beach, Fla.

GRAND Value packet, 5 sets, free with approvals. Stoll Stamp Service, 2631 Burnett, Louisville 10, Kentucky.

TRIANGLES! Diamonds! Octagons! Midgets! Roosevelts! Hitlers! U. S. \$5.00, \$10.00 stamps! Thirty scarce stamps! Big stamp magazine! Everything 10c with approvals! Thrifty Stamps, Silver Spring, Maryland.

PRISONERS Of war, Austria, six new, unusual mint stamps. Only 7c to approval applicants. GeeKay Stamps, 13 Overlea Ave., Baltimore 6, Md.

6000 STAMPS Collected by British Hospitals, weighs 2 lbs. \$1.00. Canadian 1 lb. (2500) 95c. Netherlands 1 lb. (3000) \$1.50. British Colonials (1000) \$3.00. Gigantic lists free. Price & Co., London, Ontario, Canada.

IRAQ! Mint stamps! Face +5% minimum \$5 registered please. Benjamin, 64/178 Dahana, Baghdad, Iraq.

SUPER Value penny approvals. None higher. Arthur Terreson, Box 479, Bellmore, N. Y.

MAP Stamps, 15 different plus world's smallest triangle, scarce, only 5c with approvals. R. George, Box 2774, Phoenix, Arizona.

ALLEGORICAL Glory figure set, free. Approvals. Logan Stamps, Box 4, New Lots Station, Brooklyn 8, N. Y.

FREE! Airmails with approvals. Deane Stamps, Box 87, Miami 35, Florida.

"NUDE Duchess" set 5c with approvals. Royal Stamp Company, Tamaqua, Penna.

75 **UNSORTED** Newfoundland 25c. Real value. Mayfair, 86 Regal Rd., Toronto 10, Canada.

DEALERS, Get "How To Make Money In Stamps." Write George Wentz, San Marcos, Texas.

AMAZINGLY Beautiful collection of stamps depicting ships, trains, locomotives, beasts, bridges, as people in foreign lands picture them. Only 3c with our superb approvals. Universal Stamp Company, Hollis 7, N. Y.

USED 1938 Presidentials 5c, 10c, 15c, 18c, 19c, 20c, 25c, 50c, \$1. Given to approval applicants. R. B. Rossom, 218 West 59th St., Chicago 21, Ill.

BERLIN Bears; complete set of eight and 100 different stamps only 10c to approval applicants. Reich Stamp Co., 4647 Kenmore, Chicago 40, Ill. Dept. M11.

300 **MIXED** including triangle. Free with approvals. Inclose 3c postage. McCurdy, P. O. Box 1312, Salt Lake City, Utah.

U. S. \$5 Stamp given free to approval buyers. Bala Stamps, Bala Cynwyd, Pa.

"UNITED States-Invasion-of-Germany," complete set; also twelve different Confederate States; also scarce U. S. \$5.00 stamps with inverted surcharge; also complete issue United States mint stamps overprinted Canal Zone. Entire collection 25c. Approval applicants only. "Stamps," Albany 1, New York.

NINE, Cooks, Samoa Peace used sets, \$1.00 lot. Exchange with collectors Pacific. Sub \$1.00 includes magazine, Oceania Exchange Club, Mangapeehi, New Zealand.

GIVEN Free—Roosevelt-Churchill, Hitler-Mussolini with approvals. Imperial, Box 1491, Tampa, Florida.

FINE U. S. Washington Bicentennial set. Used 10c. Approvals, Quinn, 570, Madison 1, Wis.

WORLDWIDE Packet 50 Stamps 5c with approvals. Carlin's Approval Service, 1832 Thomas, Fresno, Calif.

25 **ROMANIA**, 5c with approvals. Wonder Stamps, 3401-B, Council Bluffs, Iowa.

LOVELY 1947 Triangle, airmails, pictorials, south seas, Africa, worldwide, 25 stamps from 25 countries. Only 5c with approvals. Grand bargain, Valleyhome Stamps, Denair, Calif.

RECEIVE \$1 Worth of desirable stamps of your choice from our gigantic selection. Send only 25c to Cosmopolitan Stamp Co., 1457 Broadway, New York.

72 DIFFERENT U. S., 10c with approvals. Album Service, Box 2006, Soledad, Calif.

CHINESE Hand made postage stamp picture with approvals. Pelican Stamp Co., 1605 23rd Ave. N., St. Petersburg, Fla.

300 DIFFERENT Given free with approvals. Postage 3c. Windsor Stamps, 1435 East 67th Place, Chicago 37.

FREE—Famous Americans set, plus Flag Set, plus the National Parks Set, plus the Presidential Set to the \$5. A total of 90 stamps absolutely free to customers for our unsurpassed U. S. or foreign selections. Send 3c postage for 15 of the above mentioned stamps and full particulars. Triboro Stamp Company, 145 Nassau St., Dept. 112, New York.

WOW! \$10.00 Worth of fun. Only 10c! What a treasure hunt! Big package 500 foreign stamps from foreign missions, other sources. Includes stamps from Africa, South America, Free French, Cape Juby, Palestine, etc. Includes airmails, commemoratives and stamps worth up to 50c. This offer sent for 10c to approval applicants only. Jamestown Stamp Co., Dept. 22, Jamestown, N. Y.

START Your own stamp business. Write for free circular. Donald Shepard, Box 5139, Chicago 2.

\$1.00, \$2.00, \$5.00 U. S., Roosevelt, Hitler, airmails, free with approvals. Tami-ami Stamps, Box 2188, Miami 13, Florida.

CANADA—75 Diff. 25c. Approvals, Lists. Victoria Stamp Co., London 4, Canada.

FREE! Triangle Roosevelt, Vatican, Ethiopia, Hitler heads. With approvals. Florida Stamp Company, Box 807, Miami 5, Fla.

ATTRACTIVE Medium priced approvals. Esslinger, 5260 Montgomery Rd., Norwood 12, Ohio.

FREE Beautifully illustrated monthly New Issues Bulletin. Lory's, Villa Park, Ill.

ROOSEVELT Mint San Marino set. 10c to applicants requesting approvals. Michalicka, 101 3rd Ave., Newark, New Jersey.

400 **CHAMBA**, Nabha, Bhopal, Jaipore, Patiala, Gwallor, Indore. Fine lot \$2.00. India House (1937), Karol Bagh, Delhi, India.

SPECIAL! 40 Different Scandinavian. 5c. Approvals. Lee Stampco, Box 156M, Forest Hills, New York.

FREE: 20 Different Hitler heads, with 500 different Germany \$2.50 or 1000 different Europe \$2. Henry Zuntz, 5633 Cottage Grove, Chicago, Illinois.

\$5 **CREDIT** Slip, Columbus set of 8 values, Famous Americans and Flag sets are some of the premiums which are free to buyers of our U. S. or foreign approvals. Write for a selection today! Full particulars included. S. C. Engel & Co., 38 Park Row, New York.

FREE! 100 Worldwide different stamps to approval buyers. Big U.S. and illustrated bargain lists sent with approvals. Bookman, Maplewood, N. J.

75 DIFFERENT Countries, 75 stamps. 10c to approval applicants. Rae Stamps, 14 Stratford Rd., Buffalo 16, N. Y.

WHAT Have you to offer? Collection? "Shoobox" accumulations? Anything in stamps? We urgently need them. Spot cash paid. Cosmopolitan Stamp Co., 1457 Broadway, New York City.

200 DIFFERENT Stamps cataloging up to 50c each; only 3c to approval applicants. Littleton Stamp Co., Littleton 42, N. H.

FLAG Stamp free with U. S. approvals. Wenigman, 929 Oakdale, Chicago.

WORLDWIDE, Different 200, 25c; 500, 60c; 1000, \$1.50; 2000, \$4.25. Beacon Sales, Maynard 2, Mass.

HISTORICAL Collection! Cavalry charge! Bulgaria, Flaming Sword! Ireland, Big She-wolf! Italy, Fort! Dominican Republic, Field Marshall! New Zealand, Pitcairn Mutiny Island! Commemoratives! Pictorials! Only 3c. Approvals. Star Stamps, Lakewood, New York.

FREE! Crystal-mount samples! Harisco; 202 Transit Bldg., Boston.

UNITED States approvals complete coverage, fine quality, attractive prices. Seminole Stamps, Box 1138-P, Coral Gables, Florida.

YOUR Money's worth! Seychelles, Djibouti, Angola, Chinese hunger stamps and over 100 different other stamps. Everything 10c to approval applicants. Atlas Stamps, 4220 West 16th, Dep't L, Little Rock, Ark.

WHOOPE! Wow! 25c worth of U. S. stamps free! No obligations! Write M & N Co., 742A Sheffield Ave., Brooklyn 7, N. Y.

55 DIFFERENT United States, 5c. Approvals. Utchts, 1143-C North Keeler, Chicago 51.

128-PAGE United States catalog—1000 illustrations, 10c. Harris & Co., 202 Transit Bldg., Boston.

UNITED States approvals. Low prices! Gordon Davison, Box 1019X, Manchester, N. H.

50 DIFFERENT Stamps, triangle, airmails, etc., 5c with approvals. Carlton's, 10243 Silverton, Tujunga, California.

BRITISH, Spanish and French Colonies, Vatican, Hitler heads, and airmail packet, free with approvals. Pan-American Stampco, Box 145, New York 33, N. Y.

STAMP Collections wanted. Complete collections, duplicate lots, surplus stock, mint and used. Prefer trade for printing or other items, buy outright if priced right. What have you, what's wanted? Vanroy Shirk, Lebanon, Penna.

U. S. Price list. Send postage. State Stamp Service, 1225 Park Building, Pittsburgh 22, Penna.

DEALERS—Wholesale list. Postage 3c. Frank, 5031 Queensberry, Baltimore 15, Md.

ZOWIE-E! A barrel of fun for only a dime. 500 United States stamps—absolutely unpicked and unsorted—just as received from church missions. Many varieties, including large commemoratives, airmails, high denominations up to \$5.00! Stampdom's biggest package of fun—and you might find something really valuable! Price only 10c to serious approval service applicants. Money back if not delighted. Illustrated bargain lists with each order. Mystic Stamp Company, Dept. 80, Camden, New York.

U. S. Price list. Send postage. Stanley Gibbons, 38-P Park Row, New York.

ANTIQUES, RELICS, INDIAN GOODS, CURIOS

10 FINE Arrowheads \$1.00. Catalog free. Nirscher, 27 South 10th, Belleville, Illinois.

SEND \$1 For book listing 1202 Currier and Ives prints and their values. I also buy prints. Earl Romey, Bluffton, Indiana.

SWORDS, Rapiers, daggers, pistols, armor. Illustrated catalog 50c. Robert Abels, 860-A Lexington Ave., New York.

HOBBIES AND COLLECTIONS

HOBBIES Bring amazing profits. Learn how. Valuable information free. Maule, 1007-13th Street, Niagara Falls, N. Y.

NEW—15 Different match covers 10c. Box 202, Rochester 1, N. Y.

MILLIONS Of dollars in prize contests being given away. Contest Magazine will help you win. Send 25c today for sample copy. It has helped thousands to win. Contest Magazine, Drawer 259, Upland, Indiana.

UNUSED Match book covers. 100 all different \$1.00. Free catalog. Charles Edelman, 1311C East 84, Cleveland 3, Ohio.

FOREIGN Campaign ribbon packet, and illustrated book \$1.00. Insigniacrafts, 236 28th Avenue N.W., Calgary, Canada.

"WANTED:" Old cigarette cards. Write Charles Bray, East Bangor, Penna.

KLONDIKE! For hobby jewelry makers! Novelty jewelry findings swept from tables of large manufacturers—parts for bracelets, pins, earrings, etc.—unfinished chains, rings, pins, stones, clips, beads—many other items. 1 lb. bags—\$3.00 sample bag—\$2.00 per bag in 5 bag lots. Pre-paid only. Mdse. Distributing Co., 19 E. 16 St., New York 3, Dept. P.S.

INVENTING Can be an interesting and profitable hobby. Write for complete particulars. Institute of American Inventors, Dept. 40-E, 1926-Eye St. N. W., Washington 6, D. C.

"SWAPPER'S Hobby Bulletin." What's cha got? What'd'ye want? Trial two dimes. Royal Oak 128, Mich.

PRECIOUS STONES, MINERALS

"GENUINE" Deep red Arizona rubies (garnets). Send quarter for packet. Mineral Specimen Company, Box 2651, Phoenix, Arizona.

MINERAL Specimens, rough gems. Sapphire 10c. List free. Mission Mart, 818 Fort Stockton Drive, San Diego 3, Calif.

BEAUTIFUL Arizona agates, jaspers, petrified woods, Chrysocolla with blue agate and green malachite. Listings and polished samples \$2.00. Unpolished samples \$1.00. Arizona Agate Mines, Cave Creek, Arizona.

PETRIFIED Wood, rare, beautifully grained. 12 cubic inches \$2. Flossie Lee, Mountain View, Okla.

"LUCKY" Lodestones, highly magnetic natural magnets. Perform many extremely interesting experiments. Two large specimens only 50c postpaid. National Scientific Company, 2204 W. North Ave., Chicago 47, Illinois.

METAL Detectors. The very latest circuit. Free literature. Hedden Metal Detectors, 538 N. Homewood Ave., Pittsburgh 8, Penna.

CAMERAS AND PHOTO SUPPLIES

OIL Coloring photographs can be a fascinating hobby or profitable sideline for those with artistic talent. Learn at home. Easy simplified method. Send for free booklet. National Photo Coloring School, 1315 Michigan, Dept. 3432, Chicago 5, Ill.

PHOTOGRAPHY For pleasure or profit. Learn at home. Practical basic training. Long established school. Write for booklet. American School of Photography, 1315 Michigan, Dept. 3432, Chicago 5.

BUILD Your own enlarger. Takes negatives up to 4"x5". Detailed plans one dollar. Emby Co., Birmingham 5, Michigan.

PHOTO Printer kit \$1.00. Spada Enterprises, 10 Lexington, Wethersfield 9, Conn.

CARRYALL Case for folding cameras up to 120 size. Carries film and accessories. Brown or black Levant grain finish. Lined. Neckstrap. Shipped postpaid \$2.94. Information free. York, 146 Harrison, Westfield, N. J.

35MM. Film fans—Save with war surplus bulk film—unprecedented low price only \$3.00. total cost for three rolls 100-ft. Dupont Superior #2 or #3, postpaid! No c.o.d.'s. Air Photo Supply Co. (Dept. PM), 555 East Tremont Ave., New York City 57.

FREE 2x2 Color slide and fine grain negative! Send self addressed stamped envelope for samples and catalog. Slidecraft, 5855-A Hollywood Blvd., Hollywood 28, California.

FILM Sale Gevaert Superchrome close out. October, 1948 dating. 127, 20c. 6 rolls \$1.00. 120-620, 25c. 5 rolls \$1.00. 116-616, 4 rolls \$1.00. Film Sales, Des Plaines 1, Illinois.

FILTERS! Supplementary lenses! Fodata Dollar Bulletins give easy, practical directions for making your own. Get acquainted, send one dollar for both with bulletin list and membership details. Fodata Division, Chamelon Press, Eustis, Florida.

OIL Coloring photographs wonderful hobby. Free details. Home study course. Goynes, Lock Drawer 1784-G, Orange, Texas.

PHOTOGRAPHERS, Build a portable repeating flash strobolite. Simple plans, pictures, parts list \$1.00. Sidmur Electronics, Box 98, Dept. P, Midwood Station, Brooklyn 30, New York.

CAMERAS, Enlargers, projectors. Lowest prices. Free catalog. Cavalier Camera, 1822 Center, Pittsburgh 19, Penna.

CAMERAS Repaired, all makes, all size bellows installed. Camera Repair Service, 121 Broadway, San Diego 1, Calif.

BASS Says! At the sign of the old "Horse Trader." 37th year. Thousands of satisfied customers everywhere! Finest brands including Kodak, Bell & Howell, Argus, Zeiss, Leitz, etc. Satisfaction always guaranteed, or your money back! Bass buys 'em, sells 'em, trades 'em. Write or wire. Bass Camera Company, Dept. AG, 179 W. Madison St., Chicago 2.

PHOTO FINISHING

PHOTOGRAPHY For pleasure or profit. Learn at home. Practical basic training. Long established school. Write for booklet. American School of Photography, 1315 Michigan, Dept. 3451, Chicago 5.

8 PRINTS All enlarged to nearly postcard size from your roll or negatives 25c; 16-50c. (Trial offer). Willard Studios, Box 3535A, Cleveland, Ohio.

POSTCARD Size enlargements 5c. 5x7, 2 for 25c. Kobylak, 50 Downs, Binghamton, N. Y.

ENLARGEMENTS—5x7, 15c; 8x10, 25c; glossy or dull. Gorgeously oil colored 50c extra. Negatives made from pictures 50c up. Special photo services, send for list. L&R, P.O. Box 1476, Milwaukee, Wis.

THREE 8x10" Enlargements, \$1.00. Send negatives. Phototron, Dept. M, Andover, Mass.

SENSATIONAL Introductory offer! Send snapshot or negative, this ad and 10c. We'll send you a beautiful 7x5" enlargement! Or, Kodak roll developed and printed (with free coupon) only 25c; or 8 giant prints from roll, 30c. Reprints from negatives, any quantity, regular size, 3c; Giant size 4c. Candid rolls—36 exp. 35mm. developed, vaped, enlarged to 3x4, \$1.00, 18 exp. 50c. Free mailers. Free premium offers sent on request. American Studios, Dept. 364, La Crosse, Wisconsin.

HURRY—Limited trial offer 16 prints 20c. Arcastles Studios, 7050 Van Buren, Hammond, Indiana.

FINEST Quality. Fastest service guaranteed. Roll developed and 16 Velox prints, 25c. Reprints 2c. 100 \$1.50. Dick's Photos, Louisville, Ky.

BARGAIN Prints. Five prints from your best negatives for 10c and six camera fan names and addresses. Studers, 402 San Pedro, San Antonio 6, Texas.

FREE Government surplus film, 116-120-620 only. Send 3c stamp for postage. Free Films, Des Plaines, Illinois.

TRUE Color prints. Fast service. 8x10 \$4.00; 5x7 \$2.50; 35mm. 2 1/2 x 3 1/4 60c; 3 1/4 x 4 1/4 \$1.00; Ex. G. I. Color Film \$1.00 per roll. J. C. Benison, 5850 Hazeltine Ave., Van Nuys, Calif.

"BETTER Photo finishing." Jumbo prints 40c a roll, Reprints 3c. Best by test. Fast service. Sealstone Photo, Box 468, Seal Beach, Calif.

16 DECKLEDGE Prints from any standard 8 exposure roll 25c. Quick service. Professional work. Skrudland, Lake Geneva, Wis.

FREE Price list on quality developing, printing, enlarging. Write for it today. Bryan's Photo Shop, Dept. M, Panama City, Florida.

TWO Beautiful prints from each picture on roll 25c. Twenty-six years of satisfied customers. Quick service. Lens Photos, Dept. J4, Janesville, Wis.

8 BEAUTIFUL Double size pictures and roll developed 30c. 8 hour service. Free mailers. Pacific Photo Service, Box 666, San Francisco, Calif.

2 BEAUTIFUL Hi-Gloss prints each good negative and enlarging coupon with each 6 or 8 exposure roll developed 28c. Owlphoto Co., Weatherford, Oklahoma.

PROFESSIONAL Enlargements—Oil colored from your favorite negative. 8x10, \$2.00; 5x7, \$1.50. Shamrock Photos, 2610 University, San Diego 4, Calif.

MOTION PICTURES AND SOUND EQUIPMENT

MOVIE Films—100' 16mm. \$2.25, three rolls \$6.00, 25' double 8mm. \$1.25, developing included. Ambassador, 479-A Quincy Street, Brooklyn 21, N.Y.

RARE 8-16MM. Silent-sound films. International, 2120 Strauss, Brooklyn, N.Y.

SEND 10c for catalogue of movie cameras, movie projectors, films, etc. Sterling's, 679 Northampton, Easton, Pennsylvania.

WESTON 50! Guaranteed film. Free processing! 25' (8-8) \$1.45. 100' 16mm. \$3.45. M K Photo, 451 Continental, Detroit 14, Michigan.

EXTRAORDINARY 8mm.-16mm. Film, equipment bargain catalog, 5c. Towers, 935 North 40th, Philadelphia 4.

"MISS America, 1947." "Atomic Fury." (Bikini tests), 53 other 8mm.-16mm. Kodachrome home movies. Catalog, 25c. Projection length sample, "Miss America," \$1.00. World In Color Productions, Elmira, N. Y.

500 WATT 8mm. projector \$49.50. Others available. Selco, Danvers, Massachusetts.

I BUY, Exchange, swap movie films. Rental catalogue 25c. Harvey Iris, Box 539, Brockton, Mass.

35MM. Sound features, westerns. C. Rogers, Box 26, East Atlanta, Ga.

YOU Develop it. Get a 33 ft. developing rack, safe light, all chemicals, tray and instructions for \$4.20. Fully guaranteed. Free circulars and film samples. Fromader Genera, Davenport 4, Iowa.

EARN \$8 To \$10 daily with your movie projector. Details free. Metcalf, 10806 Glenroy, Chicago 43, Ill.

DISTRIBUTORS Wanted. Make big money selling our new sensational movies. Send for sample today 16mm. Snd. \$10.00, 16mm. Sll. \$7.50, 8mm. \$2.50, and receive free our wholesale price list. Standard Pictures Corporation, Dept. A, Universal City, Calif.

FREE Movie catalog. Superior Film Service, Box 713, Dept. 3, Troy, N. Y.

MOVIE Cameras! New Lektro Junior 16mm. electric, magazine-load F3.5 anastigmat lens, battery, cord. Complete, ready-to-operate only \$59.50. Money back guarantee. Free literature. Panchromatic magazine film for this camera \$2.50, free processing. Army-Navy GSAP, original condition, value \$200, new \$32.50, used \$19.50. Other Panchromatic film—25 ft. double 8mm. \$1.65; 100 ft. 16mm., \$2.95; includes processing. Fotoshop, Room 79, 18 E. 42nd St., New York City.

MOVIE Film processing—Finest automatic machine processing, 8mm., 16mm. 48 hour service. Also duplicating, editing, titling, other lab services. Send for list of prices. Fotoshop, Inc., Room 103, 18 E. 42nd St., New York City.

PROCESS Your own movie film. Literature. Duro Products, 1519 Eggert, Eggertsville 21, N. Y.

SILENT To sound—Convert your silent 16mm. projector into sound with our guaranteed sound conversion equipment. Fits any silent 16mm. projector. Includes: Sound head kit (easily assembled); radio film adapter (plays sound through your radio) and complete instructions. Total price \$48.95. Send check or money order to Apex Video Co., 12209P Branford St., Roscoe, Calif.

SOUND, Silent movie film, 8mm. cartoons, 16mm. comedies, 35mm. shorts. Simpson, 155 High, Dayton, Ohio.

MOVIE Film at tremendous savings! Kodak Super X, Gov't stock, tested, guaranteed! 16 mm. 100 ft., \$2.95; 50 ft. magazine, \$2.50; double 8 mm. 25 ft., \$1.65. Super XX, 50c add'l each roll. Free processing. Fast service. Photo Surplus Sales, Box J-7, 12 Duane St., New York City.

35MM. Sound-silent films, projectors. Bought, sold. Edward Elwell, Brockport, N. Y.

EXCLUSIVE Home movies. Select films. Write for free lists. Home Pix, 1674 Broadway, New York 19, N. Y.

35 MM. Silent, sound films, supplies. Bedner, 5300 S. Talman, Chicago.

ARMY Surplus 50' 16mm. magazine Super X Weston 50 films, \$1.00. Processing 75c. Guaranteed. Filmcraft, 828 West 39th, Kansas City 2, Missouri.

GUARANTEED Fresh anti-halo outdoor movie film! Weston 16! Daylight loading! Processing free! Three spools double 8mm. \$4.50! 100 ft. 16mm. spool, \$4.50! Postpaid! Catalog. ESO-S, 828-B West 39th, Kansas City 2, Missouri.

SPECIAL! Free subscription offer! Amateur Screen Photography, 3021A Narragansett, Chicago 34.

WE BUY, Sell, rent, exchange home movies. Details for dime. Midland, Box 429, Oak Park 4, Ill.

RENT 16MM. sound films 50c reel. Large selection; free catalog. Film Service, 128 Chestnut St., Roselle Park, N. J.

LEARN Movie projection, management. Free catalog. Theatre Institute, Elmira, N. Y.

16 AND 35MM. films, projectors (sound). Savarese, Woodcliff Lake, N. J.

8-16MM. Silent-sound films. Complete rental library. All latest subjects. Free catalogue, (sample film 10c). Garden Film, 317 West 50th, New York 19.

BASS Says! 37 years of leadership means satisfaction to you! Finest equipment, 8 and 16 mm., sound cameras, sound projectors. Bass buys 'em, sells 'em, trades 'em. Satisfaction always guaranteed, or your money back! Bass Camera Company, Dept. A, 179 W. Madison St., Chicago 2.

BEAUTIFUL Kodachrome slide and lists 25c. Slide Supply Service, 3111 West Tuscarawas, Canton, Ohio.

"The World's Greatest Passion Play," all sizes sound and silent. Write Hemenway Film, 33-F Melrose St., Boston 16, Mass.

MUSIC AND MUSICAL INSTRUMENTS

SONGWRITERS! Ethical composing offer. Hibbler, C5, 2157 N. Avers, Chicago.

CHORD Charts for piano, accordion, guitar, saxophone, trumpet, bass. 50c each. Carol Music Charts, P.O. Box 21, Lefferts, Brooklyn.

GUITAR Beginners: New automatic chord-changer eliminates "fumbling." Home study course teaches quickly. Also popular music supplies. Sell to schools, churches, friends, etc.. Guitar Headquarters, Box 886, Ventura, California.

SONGWRITERS: Honest outstanding music writing offer. Len-Tex Studios, Leonard, Texas.

DIAL-A-Song: Beginners can learn to play any popular song on the piano, the beautiful way. No experience necessary. \$5.00. Nelson Studios, 9304 Edmunds, #102, Cleveland 6, Ohio.

PROFESSIONAL Piano part to lyrics \$10.00. Edward Graul 511 E. 6th St., Los Angeles, Calif.

FREE Accordion pickup with each accordion purchased. New or used accordions for sale. Cash or terms, wholesale or retail. Write for bargain list. Del Principe, 307 So. Wabash, Chicago.

REAL Composer of music will co-operate with lyric writers in song production. Fine publication proposition. National distribution of publication. C. Isabel Mayer, Box 3896, Portland 8, Ore.

WESTERN, Popular records—Late numbers 29c, catalog 3c. F-L Shop, Box 19-L, New York 35, N. Y.

ACCORDIONS, Streamline, wholesale. Request circular. Metro Accordion, 44 North Albany, Chicago.

MUSIC Arranged. Songs printed. Frank Wildt, Music Publisher, Lancaster, Penna.

SONGWRITERS—Send for new special offer. Jas. Crane, Box 154, Providence, R. I.

SONGWRITERS—Protect your songs. Get the facts first. Free booklet, attractive offer. Song Service, 331-C West 46th, New York.

POEMS Wanted for musical setting. Send poems for free examination. Five Star Music Masters, 630 Beacon Bldg., Boston, Mass.

BRAND New records. Distributor's surplus. Columbia and other major labels. \$3.50 per dozen, \$25.00 per 100. Indicate hillbilly, race, or popular selections. F.O.B. Cleveland, Record Rack, 7909 St. Clair Ave., Cleveland, Ohio.

AMPLIFY Your accordion with our new Del Principe pickup, \$22.50. Install it yourself in one minute. Makes any accordion sound like an organ. Works with any amplifier. Special Del Principe amplifier and pickup only \$72.50. Write for details. Del Principe, 307 So. Wabash Ave., Chicago.

POEMS Wanted for musical setting! Send poem for immediate consideration. Hamann Service, 614 Manhattan Building, Milwaukee, Wisconsin.

POEMS Wanted to be set to music. Free examination. Send poems. McNeil, Master of Music, 510-PM S. Alexandria, Los Angeles, California.

SONGWRITERS: Send poems for free examination and outstanding offer. United Music Service, 150, Salem, Indiana.

SONG Writer's attention! The amazing demand for phonograph records, accelerated by more than 300,000 juke boxes and the hits popularized warrants your immediate consideration. We are offering song-poem writers the rare opportunity of having established composers collaborate on appealing material received this month. Recola Records, Box 987P, Hollywood 28, Calif.

WRITE Songs. Big money and reputation. Write for information. J. Gordon Pub Co., 201 N. Hoyne Ave., Chicago.

RADIOS, SUPPLIES, INSTRUCTION

EXTRA Loud crystal radio \$2.50. Guaranteed. Build "loudest" crystal radio: instructions, loud crystal, 25c. Amorose Radio, Route Four, Richmond, Virginia.

LEARN Radio Servicing. Train at home in spare hours. Intensive "shop-bench" practical instruction method. Prepare for good pay radio job or your own service shop. Approved for veterans. Catalog and sample lesson free. Sprayberry Academy, 1118 Sprayberry Building, Pueblo, Colorado.

MAKE Big money—easily. We show you how. Radiomen, servicemen, beginners: surprising information, free. Write Merit, 216-32P 132nd Avenue, Springfield Gardens 13, New York.

HEADPHONES \$1.25, headbands 50c. Finest quality for repair and service men and radio specialists. Send check or money order. Nico Supply, 1700 Walnut, Philadelphia 3, Penna.

FIX Any radio. Amazing new instrument locates radio troubles double quick. Simple instructions show you how. Thousands in use. Write today for 24-page booklet, "The Inside Story." Feller Engineering Co., 945 George St., Dept. PM, Chicago 5, Illinois.

RADIO Parts bargains! 1619 tubes (similar to 6L6 output) 19c; 12-watt universal output transformer, single or push-pull tubes \$1.19; RG8/U coaxial cable 100' \$2.89; 3 1/2" Dejur meter, 10MA movement \$2.95; 78" 2-conductor cable with PL55 plug 49c; permeability tuned 455KC IF transformer 39c; double button carbon throat mike 19c; J37 adjustable telegraph key 29c. Order from this ad. Send 50¢ deposit. Balance c.o.d. plus postage. Write for free catalog. Mid-America, Dept. CA-10, 2412 S. Michigan, Chicago 16, Illinois.

24 PAGE Plans "18 Long Distance Crystal Sets," catalog, "Radiobuilder" all 25c. Laboratories, Eye-c, San Carlos, Calif.

MAKE Selective distance getting crystal radios. Also one tube radios. Improved designs. Complete instructions and crystal 25c. Radio Leader, La Verne 4, Calif.

RADIO Controlled garage door opener—works from button in car. Complete plans \$1.00. Radio, Box 3236, Birmingham, Alabama.

RADIO And television catalog—free! Money saving prices on radios, hard-to-get parts, record changers, wire and disc recorders, amplifier systems, tubes, books, amateur and test equipment. Write today! Radionic Equipment Co., Dept. 201, 170 Nassau Street, New York 7, N. Y.

WANTED. Inverters, Pioneer instrument type 12118-2-A, 24 volts, 4000 cycle 5 amps d. c. Input, 115 volts 45 amps 400 cycle a. c. output, single phase. Chicago Aerial Survey Company, 674 N. Kingsbury Street, Chicago 10, Illinois.

ALL Types hard to get radio tubes, parts. Radio Mail Order, 4613 188 Street, Flushing, New York.

FCC License. Learn radio. How to prepare for theory exam in four weeks. Copyrighted method of study free. Bond Radio, Box 41, Steubenville, Ohio.

RADIO Bargain, crystal radio, aerial wire, lead-in wire, insulators and ear phones complete, postpaid \$7.00. Radio City, Fifth and Ash, San Diego 1, Calif.

26 YEARS Experience radio repairing at your fingertips. I've repaired 45,000 radios. Have perfected simple system you can follow step by step. No calculations or formulas. Total price \$2.00 postpaid or c.o.d. Moneyback guarantee. Ross Radio, 14615-A Grandriver, Detroit 27, Michigan.

RADIO'S Latest! Build your own printed type circuit crystal receiver complete in empty 12-ga. shotgun shell. Inexpensive, powerful. Detailed plans, 30c. Caring, Box 1308, Chicago 90, Illinois.

EXPERIMENTERS—One tube, all wave radio kit. Free circular. Artlin Company, Knickerbocker Station, Box 25, New York 2.

AMERICA'S Best buys. Radio tubes 29c up. Free bargain lists. Potter, 1314-P McGee, Kansas City 6, Mo.

MAKE Simple, tubeless, batteryless, distance-getting crystal radios. Crystal and illustrated instructions 25c postpaid. Allen, 427-P, Clinton, Missouri.

U. S. SIGNAL Corps featherweight ear-phones \$1.00. Radio service men and experimenters send stamp for our giant radio catalogue. Save dollars. United Radio Co., (100-V) Newark 1, N. J.

RADIO Technician and radio service courses. Training for federal licenses. American Radio Institute, 101 W. 63 St., New York City. Approved under G. I. Bill of Rights.

BUSINESS OPPORTUNITIES

EARN Money with textile painting course. Details. Gundrum, LeRoy, Mich.

TREMENDOUS Profits mailing literature. Boundless mailorder opportunities. Generalprint, East Orange, N. J.

OPERATE America's most popular low priced precision penny vending machine. Big profits. Be independent. Write for bulletin and prices. Stock shipments. Fielding Mfg. Co., Desk 148PM, Jackson, Michigan.

PLASTIC Tablecloth covers, curtains, drapes, baby pants, bowl covers and other plastic articles selling like wildfire! Make big money now! Free details. Write Plastics, Dept. 58-A, 206 N. Fourth, St. Louis, Mo.

CONSULT—Mitchell Engineering, 6430 Evans, Chicago 37, Ill. Electrical; mechanical; product design; patent engineers.

YOUR Own plastic business at home. Produce costume jewelry, novelties, statuettes. Liquid plastics, liquid marble. Flexible molds. Write for free book. American Trades, Box 89-A-2, Cincinnati 29, Ohio.

EXCLUSIVE Distributor. Plasticized beauty-protection for auto finishes. Used like polish. Must fin. own stock. Plasticize, 2254 N.W. 62nd St., Miami, Fla.

A FACTORY in your home garage! Mfg. and sales rights, mechanics' waterless hand cleaner. \$500-\$800 monthly. No special equipment necessary. Western Aircraft Mfg., Dept. D, Los Angeles 6, Calif.

FOR An extremely profitable lifetime business, operate a Collection Agency-Credit Bureau. Easily learned. Free folder. Cole & Associates, Syracuse 2, N. Y.

AT Home—Your own manufacturing business; making popular \$1.00 novelties. Cost you 3c to 15c. Everything supplied. Write So-Lo Works, Dept. C-600, Loveland, Ohio.

MECHANICALLY Inclined men—Own and operate general appliance repair shop. Complete, illustrated course shows you how. Welding, refrigeration, motor repair, how to get business, etc., all phases covered. Free literature. Christy Supply, Dept. T-178, 2835 N. Central Ave., Chicago.

EARN Up to \$5000.00 in a year. C.L.G. Specialties, Box 302, Lincoln, Nebr.

DISTRIBUTORS. All territories, new simplified bookkeeping and tax system. Many salable features, \$16.25 profit each sale. Repeats. Money maker. State previous experience. National Accounting Service, Box M-1, Lynbrook, New York.

LEARN Piano tuning, repairing, at home. Tremendous field! Piano parts, tools furnished. Established 1935. Empire School of Piano Tuning, 606-B East University Ave., Champaign, Ill.

RECAST Old batteries into new. Latest achievements. Battery Laboratories, Minneapolis.

OPERATE Home mail business. Write. Kent, 3414 Spring, Dallas, Texas.

PARATOL Supreme "706" Molder—A newly developed compound. The toughest rubber ever made for molding purposes. Supreme molds, precision reproductions, double strength. For the operator who wants the finest. There is no substitute. Direct to consumer prices: \$1.90 per quart, 1 gal. cans \$6.20, 5 gal. cans \$5.60 per gal. Paratol 705 standard grade still available prices as before: \$1.60 per quart, 1 gal. cans \$4.90, 5 gal. cans \$4.45 per gal. On request 4 oz. samples at 25c to cover mail handling. Be sure specify grade. No shipments outside U. S. A. Testworth Laboratories, Inc., 407 S. Dearborn, Chicago 5, Ill. Manufacturers of rubber coating and adhesive compounds.

\$6000 Y E A R L Y Possible operating "own" chain-office, easily-learned, small investment. Write Hunt Associates, Box 308, Burlingame, Calif.

MEN-WOMEN. "Most everybody likes candy." Learn to manufacture professionally at home. (Our 38th year.) Ragsdale Candies, Dept. 4, East Orange, N. J.

OPERATE Profitable home mail order business on \$5 capital. Details free. Notte, 2718 W. Cambridge Street, Philadelphia 30, Penna.

BE A used car dealer. Tested plan \$1. or details from E. H. Smith, 17A Rockland Ave., Yonkers, N. Y.

MAIL Order business, splendid opportunity. Write Joseph Vassar, 312 Harden St., S.E., Atlanta, Ga.

MAKE Money casting new 1948 metal toys and novelties. Latest scale model autos, original ashtrays, savings banks, water pistols, etc. Enormous wholesale and chain store demand keeps manufacturers busy. Spare or full time. No experience or special place necessary. Write for details and illustrations of patterns needed. Metal Cast Products Co., Dept. A, 1696 Boston Road, New York 60, N. Y.

LEARN To publicize yourself for increased income in your business or profession. Details free. Publicity Systems, Box 322, Jacksonville, Illinois.

ONYX And plastic mountings for bronzed baby shoes; 15 styles, also hardening solution. Wholesale, Box 2095, Wichita, Kansas.

MAKE Your own rubber molds. Free 50c book tells how to mold castings, giftwares, novelties, with liquid rubber. Special offer, 1/2 pint liquid rubber \$1.00 postpaid. Rubber-For-Molds, Inc., Dept. 49-A, 6044 N. Avondale, Chicago 31, Ill.

YOUR Own business at home. Write, Werner Lindquist, 1210E 3rd Avenue, Rockford, Ill.

MAIL Profits opportunity! New fast selling books, "Leaders," complete line attractive "imprints." Get associate's mail sales rights. Rush quarter for sample "leader," plan. Publishers Associates, 1005 F Belmar, New Jersey.

BOOKS Wanted bulletin, sample copy, 25c. Fortunes in back number magazines. Details 10c. \$10,000 per year in junk. Details 10c. Jos. J. O'Brocta, Mountain Home, Ark.

OPERATE Profitable mail order business. Splendid opportunity. For details write Underhill, Gorman, W. Va.

"PLASTICS," Trade secrets. Send 3c stamp. Free information. Plastic Research Bureau, 3873 California, San Diego 1, California.

MAIL Order businesses bought, sold, brokered. Write for free bulletin of exclusive opportunities. Turnipseed, Inc., Box 681, St. Louis, Mo.

100 GIRLS Sell for you. Free plan. PM-3, 7305 Melrose, Hollywood 46, Calif.

MILLION Articles wholesale. "Supply Source Directory" 10c. Publishers, Box 1302-P1, Detroit 31.

BUILD Fully rigged ship in a bottle, single ship sells for as much as \$50.00, materials cost few pennies. Particulars free. Mariner, Box 2095, Wichita, Kansas.

OPERATE Profitable mail order business. Splendid opportunity. For details write VanBurlough Service System, 157 State St., New Haven, Conn.

START Your own business. Write Village Sales, Box 305, Oak Park 3, Ill.

EARN \$200 Weekly installing new amazing "Styron" plastic wall tile in homes, offices. Easily applied. Tile your own kitchen, bathroom, too. Instructions, everything furnished. Literature free. U. S. Tile Co., 30 W. Washington St., Chicago 2, Ill.

SOURCES: Where to buy (or sell) thousands articles, supplies, etc. Folder free. Reinhardt's, Ashburn, Georgia.

MILLION Dollar industry awaits you! 50,000,000 prospects, unlimited demand. Small capital required. Free details. Rapolz, Sanborn Ave., Ashland, Wis.

START Home manufacturing business making Cleaning Compounds, Soaps, Insecticides, Cosmetics, Polishes, Food Flavors. No machinery. Literature free. Kemix, Park Ridge, Ill.

\$5000 PROFIT Yearly selling wholesale, retail. Personal business quickly established. Particulars free. Young's, Kent 4, Ohio.

BABY Shoes, we metallize hundreds and will teach you how. Easily learned in quick time. No experience needed. Schoettle, Friendship, Ohio.

START Profitable mail business at home. Unusual opportunity. Literature free. William Hawkins, Box 45, North Hartland, Vermont.

OPERATE Home business that may mean the road to independence. Write Sunray, 4756 N. Bernard, Chicago 25, Illinois.

ANNOUNCING Home study course in commercial baking. Practical basic training. Good field for those with aptitude. Nearly depression proof. Send for free booklet, "Opportunities in the Baking Industry." National Baking School, 1315 Michigan Ave., Dept. 3432, Chicago 5, Ill.

UNPAINTED Plaques, statues. Varied designs, free list. ArBo Products, A 195 E. 7th, St. Paul, Minn.

GENUINE Natural latex for rubber molds. Only two coats for thick mold. Make money reproducing statuary, plaques, novelties. Generous trial supply \$2.00. Write: Major Chemical Co., 131C Inman Street, Cambridge 39, Mass.

SUPPLY Sources for most anything wholesale. Formulas. Humphrey Specialty, Box 898, Santa Monica, California.

METALLIZE Baby shoes. Excellent profits. New system assures success. Free details. Treasures Forever, 89 Henry Ave., Lynn, Mass.

FREE: Complete method raising fish-worms; 10c postage. Stoner's, Chattanooga 4, Tenn.

100 OPPORTUNITY Plans 10c. Shooke, Rt. 10, Charlotte, N. C.

MOLD Plastics, compositions, plasters. Commercial methods simplified for home use. Profits tremendous. Investment small. Literature. Digest, 2917k Michigan, Kansas City 3, Mo.

START Home plaster novelty business. Amazing course tells how. Literature free. Kemo-Courses, 4862 Catalpa, Chicago 30, Ill.

BUYERS Wanted for plaster novelties and religious statuary. Painted, unpainted. Retail, wholesale. Write today for free information. Bing Products, 88-X8A Broad, Boston 10, Mass.

BRAND New plan! Never before offered to opportunity seekers. Has been operated successfully by originator for three years. Using plan is not only a money maker but has brought discoverer state-wide recognition, free newspaper publicity, free radio advertising. Not a syndicate scheme but original. Complete plans \$1.00. R. H. Chisholm, 704 Securities Building, Des Moines, Iowa.

LIQUID Marble—Colorful, glossy! Mold, brush, spray. Plastic ivory, flexible molds, composition floors. Particulars free. Marbleizing Service, Edwardsville, Illinois.

PLASTER Paris gets hard as stone. Just mix in "ROC," amazing new chemical. Air bubbles come to surface, disappear. Finished casts hard, ring like a bell. Enough for 2,000 casts only \$1.00 postpaid. Money back guarantee. So-Lo Works, Dept. B-200, Loveland, Ohio.

FAMOUS Vitalife health and beauty bath equipment now available lease basis. Your own business. Big earnings. Glossbrenner Manufacturing Company, 330 West Court Street, Indianapolis.

HOME Workers wanted to hand-spin Angora wool. Either sex. House of Angora, M-I, Springfield, Illinois.

LIQUID Marble—Make in any color. Soundproof plastic flooring. Flexible molds. Cast novelties, plaques, statuary. Big money—your own business. Catalog free. Write—Bing Products, 88 Broad Street, Boston 10, Mass.

COUNTY Dealerships available for Marvel Automatic Kill-Fyr Extinguishers. Fights fire alone. Low in price, good profits. Sells on demonstration. Immediate shipment. General Machine Co., Camden, N. J.

MAKE Mailorder produce handsome income at home. Prospex Unlimited, 5440 Schubert, Chicago 39.

METALLIZE Baby shoes. Instructions \$1.00. Don Brady, 1618 Sage, Topeka, Kans

OWN A mail-order paper products business. Sell envelopes, tags, bags, boxes—wholesale. Tremendous demand. Steady profits. Omaha Envelope Service, Dept. 233, 4721 California, Omaha 3, Nebraska.

MAKE Profits in mail order business. Astounding course shows how. Details free. Jimton Service, Lock Box 1373 E, Mobile 8, Alabama.

OPEN Office in your home with letter-shop work—steadiest profits. Write Jane Advertising, 519 Main, Cincinnati 2.

MAKE Quality perfumes at home. Particulars free. Torrey, 93A Federal, Boston.

OPERATE Profitable mail order business. Write Walter Service, 4159 East 112th, Cleveland 5, Ohio.

MEN—Women: start candy kitchen at home. Big profit. Folder free. Thompson Co., Dept. P.M., Baldwin, Michigan.

SIX (Different) leading mailorder magazines, 20c. American Directory, Robstown 4, Texas.

200 M. O. Business offers sent monthly, year 10c. Rush. Commonwealth, 5708-PM, Carothers, Cincinnati 27, Ohio.

START in business with \$1 down. Pay balance from profits. Operate from home. Self starter to independence. Send \$1 for instructions. National Supply, Fosstown, Minn.

YOU, Too, can start profitable home business on small capital. Full instructions, many angles, \$1 postpaid. Satisfaction guaranteed. Details free. Leveque, 823-A Howard, San Antonio 1, Texas.

LET US help you to independence, with our monthly "New Products Bulletin," listing 100 newest products, copy \$1.00, "Twenty Tested Advertisements," \$2.00, brand new book, "From Nothing to Independence" with 49 successful selling helpers; \$2.00. \$4.50 buys the three handy money making tools. Details free, satisfaction guaranteed. Educational Book Co., 2907 Berwick Ave., Baltimore 14, Maryland.

BOOKKEEPING Service-by-mail. Comprehensive, nation-wide survey shows why and how of phenomenal growth. Free details. Management Engineers, Box 33, Forest Hills, N. Y.

BE A tax consultant. Bookkeepers, etc. can qualify quickly. Details free. Smith, 17 Rockland, Yonkers 5, N. Y.

MAKE Rubber stamps. Metallize baby shoes, silver mirrors, make plaster novelties. Catalogue of "20 Ideas" free. Universal, Box 1076-A, Peoria, Ill.

SENSATIONAL 64 page booklet, "Get Rich in Spite of Yourself." \$1.00 postpaid to W. Taylor, P. O. Box #911, Santa Monica, Calif.

LEARN "First Steps in Mail Order." 25c. Guaranteed. Sams, 3009 15th, Ensley 8, Ala.

BABY Shoes preserved. Formulas, instructions \$1.00. Novelty Bronzing, Box 56, Hyde Park 36, Mass.

START Your own business at home. Pleasant work. Write Gantz, 1778 Crawford Rd., Cleveland 6, Ohio.

SPECIAL Rubber for making molds. Literature and sample free. Universal, Box 1076-A, Peoria, Ill.

INVENTIONS Protected in 30 days. Patents for sale. Patent News, 12, Washington, D. C.

MACHINES Available for making new designs of interlocking concrete building blocks. Delaware Industries, Dept. 11, Muncie, Indiana.

300% PROFIT Selling repeat item, mail, local. Dade Products, Box 1720H, Cleveland, Ohio.

START A profitable business of your own or obtain a better paying job. Details free. Gunn, 504-A, Thirty-Second St., Oakland 9, Calif.

A PROFITABLE Business and hobby. Amazing Liquid Ivory, Liquid Glass. The most marvelous synthetics ever developed. Hard to tell from expensive genuine. Easy to start. Experience unnecessary. Immediate profits. Write for valuable free information. Empire Trades, Dept. MC1, Box 1340, St. Louis, Mo.

NATURAL Molding Latex. Extra thick. Free sample. W. Wooley, 115-A Donald, Peoria, Ill.

START Real estate business. America's finest profession spare time. Details free. Educational Book Co., 2907 Berwick Ave., Baltimore 14, Md.

HOMEWORKERS—\$50.00, \$100.00 weekly! Castwood plastic gifts, novelties. Material, instructions furnished. (Sample Moldkit) rubber scottie mold, woodcut ash-tray, 1-pound castwood, big list supplies \$1.00 postpaid. Standard Products, 1416-R Fletcher, Chicago.

SEX No barrier to success in this uncrowded mail business. Money maker for men and women. Hardinger, Tinley Park 1, Illinois.

DOLLARS To you at home. Write for details. W. A. Jones, Box 395, Upper Darby, Penna.

"HOW To Build Your Own Mail Order Business." Idea book for beginners. Mail dealers. Quarter. Satisfaction guaranteed. Edgar Gilchrist, 622-M, Mass. Ave. N.E., Washington 2, D. C.

SUCCEED! Build permanent mailorder business with fastest money making methods. Write Arthur's Service, Longacre, West Virginia.

"PLASTIC Balloons"—New amazing novelty. Easily made. Large profit. Complete formula \$1.00. Ideal Service, Park Ridge 5, Ill.

START Mailorder bookshop—Everything furnished. 25c brings booklet, samples, exciting ideas. General Publications, Ossining, N. Y.

COLORGLAZED Concrete pottery made without molds. Patented method. Cemetery products, novelties, tiles. Basement leak-sealing. Money-making projects. Booklet, details free. Men only. National Potteries Company, Grand Rapids, Minnesota.

MAKE Liquid marble, flexible molds, statuary, art goods, novelties, artificial marble floorings. Literature free. Kemico, Park Ridge 50, Ill.

EARN Money at home by mail. Information free. Goodrich, Edgewood Terrace, Longmeadow, Mass.

RUBBER Moulds for casting novelties. Latex for making moulds. Use thoroughly tested and approved products. Eastern Latex Laboratories, Box 153, Mattapan 26, Mass.

LIQUID Rubber for making flexible molds. Cast novelties. Sample bottle 25c. Free literature. Chaney, 1180 E. 16th St., Jacksonville 5, Fla.

LATEX For making flexible rubber moulds. Thoroughly tested. No shrinkage. Complete instructions with each order. Stoneham Rubber Co., Box 244, Stoneham 80, Mass.

GOODYEAR—Has Malaya liquid rubber for mold making. Quart \$3.00; gal. \$10.50; pint \$1.50. Write full particulars. Goodyear, Lake Geneva, Wis.

HANDYMEN—Earn money home operating Community "Fix-It" Shop. Write Stafford, 708 Rawlings, Carbondale, Ill.

PUBLISHING Opportunity. Local Amusement Guide offers profits to \$10,000 yearly. cities over 50,000. Small investment. no experience. inexpensive operation. Investigate! Ward Associates, Dept. J2B, Greendale, Wis.

SIGNS Made easily. Instructions and ten sets modern alphabets, numerals, patterns. Sizes up to eight inches. All for \$1.00. Co-operative Business, 7 West Madison, Chicago 2.

LEARN The mail order business. \$1.00. Harold's Service, 145 S. Bannock St., Denver, Colorado.

BIG Money in vending machines. Smallest capital start brings immediate profits that build permanent profitable business. Starting instructions free. Becker Vendors, 105-A Dewey, Brillion, Wis.

START Key making business at home. Wonderful profits. Experience unnecessary. Complete outfit furnished for as low as \$50.00. Write Campbell's Locksmith Supply, 319 S. Division St., Grand Rapids, Mich.

START Your own electroplating business, highly paid, uncrowded field. Learn at home in spare time. Send postcard for free electroplating booklet and proof. Plater-Hyde, Room 521, 432 "F" Street, San Diego 1, California.

BE Independent, tune pianos, musical knowledge unnecessary. Practical Piano Tuning shows you how. \$2.00 postpaid. Mayberry, P3122 Lawrence Drive, Corpus Christi, Texas.

METALLIZING Baby shoes makes you money! Learn this simple, profitable, low investment business from nationally recognized authority. Get professional results with professional "know-how"! Free particulars. Joseph B. Kushner, Metal Finishing Engineer, Stroudsburg 23, Penna.

GET Hundreds money making deals, business ideas, plans and manufacturing. Amazing folio free. Austin Mail Service, 5538 Lexington, Chicago, Illinois.

MAKE Money in home mailorder business. Work only in sparetime. Amazing opportunity catalog and complete details sent free. Forest Sales Co., R60 West, Rupert, W. Va.

RUBACREAM! Natural rubber latex! Makes molds quicker! Thicker! Free sample convinces! Castcraft Studios, 509-P Fifth Avenue, New York 17.

TWO Amazing new typing opportunities. Earn up to several dollars hour, right at home. New, exclusive, different. Write Schroder, 221 E. Bush, Covington, Ky.

LEARN Mold making, plaster casting. We furnish materials and teach you. Particulars free. Artcraft Industries, 411 Wolverton, Ardmore, Okla.

YOU Can build a successful mail order business at home! Free "How" information. J. Scott, 283 West 117th St., New York 26.

MANY Inventions make millionaires. Particulars free. Patent News, 12, Washington, D. C.

"MAIL Order Magic"—Free monograph sent anyone interested in mail selling! Crompton, Box 2567-M, Hollywood 28, Calif.

BELTS! Make 'em and make money. No tools! Sample 50c. Artnic Leather, 411 Joseph Ave., Rochester 5, N. Y.

SEA Shells, plastics, metal findings, free catalog. "Secors," 238 Bradenton Beach, Florida.

CONVERT Hand mowers to power mowers. Sell the handy-dandy lawn mower conversion kits. Easily installed on any make mower in 3 hours. Used with any small gasoline or electric motor (Maytag, Power Products engines) in stock. Quick delivery. Kits can be purchased with or without engines. Fits 16 to 20 inch mower. Dealers wanted. Write for details. Le Claire Manufacturing Co., Le Claire, Iowa.

\$6 FROM Square foot plywood. Jigsaw necessary. Write, Woodarts, X-38, Bridgewater, Mass.

TREMENDOUS Profits selling real estate. Authoritative new manual shows how to start full or part time business of your own. Complete only \$2.00. Details free. Schuitz House, 3116 Seminary, Chicago 13.

RUBBER Molds, liquid rubber, statuary plaster, kits for beginners. Complete "Plastercraft" course free on request. Blue Rapids Supply, Blue Rapids, Kansas.

DO It with sea shells. Beautiful jewelry, novelties. Big profit spare time. Free lesson. Werts (P.), 1429 56th Avenue, Oakland 3, Calif.

AGENT Or exclusive distributor for cigarette lighter mfg. MacGregor, Tahoe Valley 16, Calif.

START Home business making statuettes, plaques, artificial marble flooring, liquid marble, flexible molds, metalizing baby shoes. Amazing profits. Folder free. Creative, 236-L, Winnetka, Illinois.

UNPAINTED Bookends, plaques, statuettes, figurines. List. Haverty Products, 1219 8th Ave., Altoona, Penna.

FELLOW Workers, no bosses. National opportunity to become independent with business of your own. Details free. P. Padney, 307 York St., Jersey City 2, N. J.

RE-NEW Leather and leatherette—Make cloth into imitation leather with plastic discovery called Leather-New. Opportunity to make real profits taking care of sales resulting from national advertising. Write for free sample of Leather-New covered material and complete deal. 701 Land Bank, Kansas City, Missouri.

BRONZED Baby shoe mountings and supplies. All metal bronze bookends, picture frames, ash trays, etc. Onyx ash trays, desk sets, plaques. Hardening solution. 30 amp. plating rectifiers with powerstat control, \$85.00. Geared motors for agitation. \$15.00. Lead lined tanks. Write for list. Hollywood Bronze Supply, 1770 N. Vermont, Hollywood 27, Calif.

READ "Advance"—The Voice of Mail Order. Offers money-making opportunities, sources of supply, personal guidance, etc. Issued monthly. Sample copy 25c. Yearly subscription \$2.00. American Mail Trade Association, 313 East 21st Street, Suite 45, New York 10, N. Y.

UP To \$1500 yearly selling by mail in spare time interest you? New ideas and plans every month. Details free. Idea of Month Club, Box 118-A, Baltimore 18, Md.

WHITE Liquid rubber for making flexible molds! Quick drying! Safe! For home, classroom, or industry! Quart \$2.00. Gallon \$5.95. Full instructions! Beginner's booklet on molding and plaster casting 25c. Free with order! Plastercraft Supply Company, 1406 East 43rd Street, Cleveland 3, Ohio.

POPCORN Machines. Potato chip outfits. Long Eakins Co., 4760 Hi St., Springfield, Ohio.

WOULD You pay 3%—first \$350 made? Color-illustrated book "505 Odd, Successful Enterprises" free! Some offer occasional "day off." Work home. Expect something odd! Pacific, Oceanside, Calif.

GET It for them wholesale. Be community buyer nationally-known merchandise: radios, refrigerators, washers, sweepers, typewriters, etc. Savings up to 50%. This pleasant, easy work can earn up to \$5000 per. Get details today. Kraft, Aurora 8, Missouri.

MAILING Postcards selling repeat merchandise is profitable. Everything supplied. Details free. Gordan Publishers, Box 23, Pawtucket, R. I.

COIN Machines earn big money! Machines are now available at \$11.75 that can earn as high as \$7 weekly profit. Place machines in stores, hotels, filling stations, etc., and your income starts immediately. Routes can be operated in spare or full time with no experience needed. We'll tell you how and send you a catalogue describing our nut, candy, gum, and postage vendors, also scales, amusement games, etc. Write immediately to Parkway Machine Corp., Dept. P, 623 W. North Ave., Baltimore 17, Md.

CO-PUBLISH And advertise in The Central Mail Advertiser. Sample copy for stamp. Low rates. Large circulation. Bagby Printing Co., Georgetown, Ohio.

HOW To set up and run a mirror shop! Resilver mirrors. For price write—John Sprinkle V60, Marion, Indiana.

MAKE Perfumes. Profitable business. Free book tells how. Walter Lawson, 21 Joiner, St. Augustine, Florida.

MAIL Order opportunities. Full or spare time. Hundreds of chances. No charge. Postal brings copy. Blackstone Press, Somerville, New Jersey.

GREAT Opportunities and profits in mail order business at home. Free literature. F. Webster, Box 1972C, Hollywood, Calif.

ELITE Collection contains 137 practical money-making plans; local and mail order. New edition. Particulars free. Elite Co., 220 Grand St., New York 13.

QUICK Money! "Repairing car batteries." At home! Easy too! Write. Batteryman, Grand Junction 5, Colorado.

SELL By mail!—Books and novelties! 35 different items! Large profits! Catalog free! Elfco, 432 N. Wells, Chicago 10.

OPERATE Profitable home business selling merchandise by mail. Fast sellers. Large profits. Powell Service, 5713 Euclid, Cleveland 3, Ohio.

COPUBLISH Leading m.o. paper. Latest copy Mail Sale Advertiser and proposition, commemorative stamp. Vanroy Shirk, Lebanon, Penna.

START A clock shop. Fascinating, easily learned profitable business requiring little capital. We teach you how to repair all kinds of clocks. Information free. Houston Clock Shop, P.O. Box 5086A, Houston 12, Texas.

HOW And where to obtain capital. Fully explained. Particulars free. Star Service, Wapakoneta, Ohio.

SPECIALTY Manufacturing, the big money business that can be operated anywhere, start on a very small capital; we supply dependable formulas and complete instructions; get interesting free booklet. "Moneymaking Opportunities in Specialty Manufacturing." Howard Robinson, Ph.G., 1300-A South Ohio Street, Sedalia, Mo.

\$25 WEEKLY Working two hours daily. No canvassing. No manufacturing. Lycke, Box 2471, Cleveland 12, Ohio.

137 WAYS To make money, in home or office, business of your own. Full particulars free. Elite Co., 220 Grand St., New York 13.

BRUSH Plating outfits connect to a battery. No tanks necessary. Good paying business at home plating autoparts, bathroom fixtures, bicycles, reflectors, silvering mirrors. No shop or experience required. Outfits furnished. Free booklet. Gunmetal Co., Ave. H, Decatur, Ill.

MONEYMAKING OPPORTUNITIES

HUGE And profitable field in mail order business. Details free. Clinton Sales, 88 Weaver Ave., Buffalo 6, N. Y.

START Home business making beautiful, authentic wood carvings from inexpensive models. Sell gift shops, department stores, novelty stores, etc. No experience necessary with new, amazing "Carvit" duplicating machine. Cash in on your spare time. Dumore Co., Dept. A-56, Racine, Wis.

SEWING Machine repairmen make big money lifetime. Start neighborhood shop. Complete repair manual, covering all makes, \$1.98 postpaid. Money back guarantee. Sewmachine Serviceman, Hamilton 9-J, Ohio.

FINE Watches cheap for resale. Write Wodicka, 339 East 11th, New York, N. Y.

HUNDREDS Golden money making opportunities selling by mail. Details free. Granor Service, Box 1185, Lewiston, Maine.

UNPAINTED Plaster ornaments: Beautiful designs, easily decorated with water colors or oil paints. Profit or hobby. Illustrated list free. Distributors of New Loxite, a Firestone product, for molds, Midwest Novelty Mfgs., 108A Cedar, Anaconda, Montana.

WHOLESALE Home business plans, opportunities, Holm Sales, 12A, Oakland, Indiana.

BOTTLED Cooking heating gas business makes \$7 per hour. Book \$2. Literature free. Enso, Box 73A, Pasadena 16, California.

"FORMULA For Mail Order Success" and big mail for 25c. Box 150-M, Portland 7, Oregon.

SOURCES: Where to buy (or sell) thousands articles, supplies, etc. Folder free. Reinhardt's, Ashburn, Georgia.

THOUSANDS Articles wholesale. "Supply Source Directory" 10c. Ideal Service, Park Ridge 40, Illinois.

INCREASE Your earnings! Local business opportunities; mail order information; wholesale supply sources; valuable money-making tips; information. Free details, rush name! Wilkin Company, Hillsboro, Ohio.

METALLIZE Baby shoes. Further information 3c stamp. Metal Crafts, Box 125-R5, Tampa 4, Florida.

FREE Tips to mail order beginners. Griffin, 756 Broadway, Everett 49, Mass.

START Your own business! Big money manufacturing novelties, plaques, statuary. Free catalog. Write Bing Products, 88-A4E Broad Street, Boston 10, Mass.

SPRAY Glowing velvet covering on lamps, jewelry, etc. Complete outfit with instructions only \$2.95. Guaranteed. V-Sparks, 1145 Queen Anne, Los Angeles 6.

EXTRA Money? Free details. Trable, 1018 1/2 Elm, Dallas, Texas.

MAKE Big money. Build your own lamps and sell. Free photos. Buddy Products, Dept. 25, 1123 Belmont, Chicago, Ill.

START Your own mail order business. Free literature. Schmaltz, Box 335, Mar Vista, California.

EARN Up to \$480 month part or full time keeping books for small firms. Simplified system. Write Tax-Saver System, Dept. v, Ft. Worth, Texas.

ELECTRICALLY Inclined men: Amazing illustrated literature free, proving \$5000-10,000 yearly possible installing and maintaining fluorescent lighting installations. Earn \$5 hourly rebuilding used fixtures. Make beautiful fluorescent lights—for 50c each and less. Write, Willis Service, 101 York St., Brooklyn 1, N. Y. Dept. C.

WHOLESALE Anything imaginable. New guaranteed list 25c. Refundable. La-salle Novelties, Box 2188, Waterloo, Iowa.

MONEY Making opportunities. Exclusive supply sources. Benefits, etc. 25c. Satisfaction or money back. Evergreen Enterprises, Darrington, Washington.

SELL New tool to farmers. Ideal mail order item. Imprinted circulars available. \$1.00 brings sample. Copy Progressive Mail Trade free upon request. Beginners especially welcomed. Kerk's Supply, Box 454, Wellston 12, Missouri.

RESILVER Mirrors at home. Formula 25c. Ideal Service, Park Ridge 6, Illinois.

BEAT Competition—Cash in with newest products. New Products Bulletin Service brings monthly advance notice of 100 newest items. Be first. Copy \$1.00. Details free. H. Heberlein, 17-A Prospect Street, Elizabeth 4, N. J.

EARN Money at home! Thousands do "Home Worker Magazine" tells how. Sample, 25c. Sizemore, Box 7, 4917 Kostner, Chicago 30, Ill.

EARN Money at home! Steady income! Colliers course tells how! Sample lesson 25c (coin). Write Successful Income Builders, 508-A, Hollywood, California.

MAKE—Sell new amazing auto paint you simply wipe on. Complete formula \$1.00. Ideal Service, Park Ridge 8, Ill.

MAKE Money right from home. Mitla, Box 207-P, Mena, Arkansas.

EARN Money evenings, copying and duplicating comic cartoons for advertisers. Adservice, Argyle 1, Wisconsin.

OPPORTUNITIES In mailorder. Sample magazine 10c. Adam Palmer, Blacklick, Penna.

100% PROFIT Beautiful line fishscale and shell costume jewelry and novelties. \$2.00 brings 5 samples, returnable. Wonderland Studio Inc., Box 709, St. Petersburg, Fla.

WIN Contest money. General Contest Magazine gives hundreds of tips. Lists current contests and rules. Sample 25c. General Contests, 1609 1/2 East 5th, Duluth, Minn.

BIG Profits. Sensationally new. Every home, office, store prospective buyers. No competition. Exclusive dealerships. Sherwood Products, Erie, Penna.

WOULD You pay 3¢—first \$350 made? Color-illustrated book "505 Odd Successful Enterprises" free! Proven! Work at home, office. Expect something odd! Pacific, Oceanside, Calif.

THERE'S Big money in junk, and repairing batteries. Write, Batteryman, Grand Junction 5, Colorado.

\$246.50 MAKING Unusual secret device without skill, machinery, from former war material costing \$1.50! Simple, baffling invention, unbelievably profitable! Illustrated proofs free. Rolls Enterprises, 115-D West 16th, New York 11.

FORTIFY The future! Start own business: home, office. Booklet describing "Collection of 137 Tested Plans" free. Elite Co., 220-A Grand St., New York 13.

PUBLISH Your own magazine. Hand-some 52 page format, well edited, illustrated. Cost low as \$1.00 month. Brings you prestige, profits. 25c brings sample, details. National, Ord, Nebr.

FORMULAS, PLANS, ETC.

PROVED Formulas. Artificial wood, crack filler, furniture polish, hand lotion. Make cheap, high profit. All for \$1.00. Dominion Chemical Service, Weyers Cave, Va.

BURGOO. Kentucky's famous formula. Made by Campbell Doggins, burgoo prince. Simple to make from choice meats and vegetables, juices. Delightfully different. \$1.00. Box 949, Lexington, Kentucky.

PRODUCTS Duplicated, improved. Formulas Analyses. Consulting Scientific Company, Swarthmore, Pennsylvania.

PRESERVE Baby shoes. Gold, silver, bronze. Formula \$1.00. Johnson, 2611 Harriet, Minneapolis 8, Minn.

NATIONWIDE Antifreeze shortage affords wonderful profit possibility. Mix certain inexpensive ingredients usually obtained locally. Protects 30 degrees below. Formula \$1. Continental Products, 2508 Woodburn, Cincinnati 6, Ohio.

21 POPCORN, Candy apple, etc. formulas. All money-makers. \$1.00. We can supply equipment. Concession Supply Co., Dept. "A," Box 133 Sta. "B," Toledo, O.

FORMULAS For home, workshop, farm. Cosmetics from chemist. \$1 each. Formulas, Box 410, Bloomington, Indiana.

100 SINGLE Ingredient formulas 25c. Tes-Co., Box 189-M6, Wilkes Barre, Penna.

MANUFACTURE Cleaners, soaps, polishes, flavors, cosmetics. Literature free. Kemico, Park Ridge-16, Illinois.

10,000 FORMULAS And trade secrets. Free literature. Stillman, 555 Kingston Ave., Brooklyn 3, N. Y.

REAL Manufacturing formulas. Lists free. Cummings, Chemist, Gordon Ave., Syracuse 4, N. Y.

PLASTICS

LUCITE—Rods, tubing, sheets. Catalog dime. Mid-West Plastic, 1717 No. 66, Omaha 4, Nebr.

PLASTIC Injection machines, Plexiglas, dyes, jewelry findings, kits, etc. Free catalog. G. Baker Company, River Edge, New Jersey.

FABROS Pre-fabricated plastic kits and supplies. Sample kit 50c. Catalog free. Fabros, Box 156 Station F-1, Buffalo 12, New York.

PLASTICS—Ready-to-assemble smoking set. Sheets and rods. Stamp brings prices. Hanson Plastics, 7625 South Parkway, Chicago 19, Dept. 66.

LEARN Internal carving of plastics for pleasure and profit. It's easy, exciting to carve flowers, animals, landscapes of colorful, thrilling beauty in solid Plexiglas plaques and cubes. Send 10c for complete instruction folder, jewelry findings catalog and big plastics price list. Plastic Parts, Dept. H-2018, 1157 S. Kingshighway, St. Louis 10, Mo.

FORMALIN for lustrous color-castings. Free literature. Complete line plastics casting supplies. Sample kit \$3.00 f.o.b. Formalin, Romeo, Michigan.

PLASTIC (New type) internal carving cutters, not reground drills. Juniors, 2 for \$1.25; students, 75c each; professionals, \$1.25 each; commercials \$1.75 each. 10c for mailing. Plastic cut to size for carvings, also coloring dies. Over \$2.00. 10% of order. Plastics Hobby Club, Box #97, Sheepshead Bay Station, Brooklyn 29, New York.

INTERNAL Carved swans, bluebirds, goldfish, butterflies, etc.; pins, \$1.50, 2 1/2 x 2 1/2 paperweights, \$2.50; roses, costume jewelry sets, \$1.50 less findings; 2x2x2 paperweights, \$2.00. Crystal Floral Novelty Co., Somerville, New Jersey.

PLASTICS. Supplies. Free list. Exceptional kits, \$3.00 and \$5.00 f.o.b. Plasmet Sales and Engineering, 4648 Shirley Pl., St. Louis 15, Mo.

PLASTICS. Best materials, lowest prices. Send for free list. Plastex Products, Curtis-Filbert, Baltimore 26, Maryland.

DON'T Throw away broken plastic articles. Use WestCol plastic cement. Any color. 40c postpaid. WestCol Mfg. Co., 108 N. 3rd, Grand Junction, Colo.

WHEELS With spokes, lucite, up to 6 in. diameter. Free specifications and price list. Hudgens Plastic, Norcross, Georgia.

PLASTICS—Sheets, rods, tubes, all colors; dyes, supplies; findings. Illustrated fabricating manual, prices, 10c. Lucite sample, 35c. Gem-O'-Lite, Box 686F, North Hollywood, Calif.

INTERNAL Carvings, drills, dyes, jewelry findings, tools. Plexiglas masked sheets, 12"x12", 1/16" \$1.00, 1/8" \$1.25, 3/16" \$1.55, 1/4" \$1.85. Include 10% postage. Rods, tubes, dyes, cements, buffing compounds. Free listings. Craft Plastics, Somerville, New Jersey.

RENEW Leather and leatherette—Make cloth into imitation leather with plastic discovery called Leather-New. Opportunity to make real profits taking care of sales resulting from national advertising. Write for free sample of Leather-New covered material and complete deal. 704 Land Bank, Kansas City, Missouri.

PLASTIC—Sheets, rods, tubes, etc. Free list. Plastic Supply Co., 2618 St. Louis Ave., St. Louis 6, Mo.

PLASTIC Costume jewelry, beautiful designs. Free catalogue. Howard Schultz, 115-83 229 St., St. Albans 11, N. Y.

CHEMISTRY

LEARN Chemistry at home, from the house of Winn. Home of supplies for student chemists. New idea chemical and apparatus outfits for home experimenting. Semi-professional microscopes and accessories. Send 10c for retail catalogue. Established 1931. John H. Winn, Dept. 501, 124 West 23 Street, New York 11, N. Y.

FREE Catalog: Chemistry, mineralogy, physics, biology, Tracey Laboratories, Evanston, Illinois.

CHEMICAL Questions answered. \$1.00 minimum. Send with or without money. Box 131, Maywood, Ill.

COMPLETE 1948 Catalogue. Send 10c. Lab Chemical, Box 206, Oak Park, Ill.

CHEMICAL Apparatus bargain catalog for stamp. Ross, C-68 West Broadway, New York, N. Y.

LABORATORY Supplies, chemicals, glassware, etc., low prices. Large catalog 15c. Microscopic stain catalogue 20c. Both for 25c. National Scientific Company, Established 1908, 2204 W. North Ave., Chicago 47, Ill.

COMPLETE Supply catalog, 10c. Pilgrim Chemical, 348R Edith, Salt Lake City 4, Utah.

APPARATUS, Chemicals, ounce quantities, catalog 10c. Fleischer's Laboratories, Everett 49, Mass.

CHEMICALS—LAB. Supplies. New catalog 10c. Mel-Glo Chemical Co., 258 Fourth Avenue, Brooklyn 15, N. Y.

CHEMICALS And apparatus for industrial, analytical, and private laboratories. Complete supply service for correspondence school students. Send 3c for catalog. Dept. M-43, Biological Supply Co., 1176 Mt. Hope Ave., Rochester 7, New York.

NEW Laboratory supply catalog of chemicals and apparatus, contains over 5000 items with illustrations, 212 pages. Send 50c. Standard Science Supply Co., 1232 No. Paulina Street, Chicago 22, Ill.

HANDBOOK For chemical experimenters, illustrated, hundreds of experiments, 50c. Experiment booklet 15c. Supply catalog 5c. Reading Scientific Company, Reading, Penna.

HELP WANTED

BOYS Wanted. Over \$50 week! Sell name plates for front doors. Write National, 214 Summer, M. Boston, Mass.

AGENTS WANTED

ABSOLUTELY Free! Big package actual sample fabrics and style presentation of dresses, lingerie, hosiery, etc. Take orders. Commissions big. Send no money. Melville Co., Dept. 4568, Cincinnati 3, Ohio.

BIG Commissions. Boost income quickly. Sell stores, restaurants, bars. Plastic tick-ets, shelf moulding, menu covers, signs. Write today. Pricing Press, 124 White St., Dept. P, New York 13, N. Y.

NEW "Sponge" wall cleaner. Erases dirt like magic. Wallpaper, painted walls, ceilings. Saves redecorating. Lightning seller. Samples sent on trial. Kistee, 117, Akron, Ohio.

CALL on friends with greeting card assortments, birthday, get-well, others. Floral stationery. Gift wrappings. Big profits. Experience unnecessary. Samples on approval. Wallace Brown, 225 Fifth Ave., Dept. A4, New York 10.

FREE! Big box actual full size packages foods, groceries, home needs, sent f.o.b. factory. Try them at home and show friends. World beating money making opportunity. Write Zanol, Richmond St. Dept. 6089-A, Cincinnati 3, Ohio.

FREE Sample! Big profit opportunity with amazing glow-in-the-dark house numbers, switch plates, pictures, decals, religious articles. Represent large manufacturer. Madison Mills, 303 Fourth Avenue, New York, N. Y.

EARN Big money fast! Sell finest-quality advertising work uniforms to garages, factories, filling stations, etc. Free selling kit. Topps, Dept. PM-148, Rochester, Ind.

LARGE Variety general and essential merchandise 50c to \$3 sellers. Manufacturers, 264 5th Ave., New York.

SELL White shirts, pajamas, nylon slippers. Free sales kit. Jarod Manufacturing Corp., Rockville Centre 15, N. Y.

EARN Big money. 21 Sunshine everyday cards for \$1 with beautiful floral lined envelopes. Sensational value. Take orders galore. Costs 50c. Sells \$1. Also 1948 Sunshine notes, birthday, monogram stationery 50 for \$1. Gift wraps. Samples on approval. Write today. Sunshine Art, 115 Fulton St., Dept. PM-1, New York City.

SILVER Cleaning, plating, polishing, liquid (NuSilver). Apply with cloth. Re-news silverplated ware, articles, pieces. Silverplates brass, copper, bronze. Female, male, selling representatives wanted. Part time or full. Retail, wholesale. Profitable. Exclusive. NuProcess Products, Aurora, Illinois.

MAKE Money fast showing exquisite greeting cards—Birthday, Valentine, Easter, wrappings, notes, stationery. Full, spare time. Amazing profits, bonus. Special offers. Opportunity for organizations. Free stationery samples. Feature \$1.00 All Occasion Assortment on approval. Write today. Hedenkamp, Dept. J-42, 343 Broadway, New York 13.

\$1 STARTS You in business. Sell DeLuxe ties, 100% wool interlining. Costs you only \$7 per dozen, you make \$5.00 dozen. Send \$1.00 for special introductory offer two DeLuxe ties. Catalog complete line free. Phillip's Neckwear, 20 West 22nd St., Dept. K-18, New York 10.

EASY! Fascinating! Profits to 100%. Bonus. 30 new greeting card boxes 30c up. 5c and 10c individual cards, stationery. Request free name imprinted and floral stationery samples, free 32-page catalog and \$1.00 All Occasion Assortment on approval. Special offers. New England Art Publishers, North Abington 62, Mass.

SELL Ultra blue stock signs to stores, 1000 slogans, comedy, general, religious. 7x11, cost 6c, sells 35c. Make money. Sample free. Lowy, 8 West Broadway, Dept. 356, New York City 7.

STEADY Large earnings; real staple, rubber hose; sell jobber, wholesaler, consumer. Industry, automotive; no territory restrictions, no investment. Advertised line, generous, protective deal, full or part time. Ace Hose & Rubber Co., 769 Van Buren St., Chicago 7, Ill.

BE First: Get free details. Earn big money at home. Spare time. Easy, pleasant, exciting. Unlimited. 1930 Adoline, Fresno, California.

EARN Big money. Be a one-person-department-store. Take orders for shirts, ties, hosiery, lingerie, household goods, etc. Cooperative Merchandisers, 110 West 34 Street, New York City 1.

A DRESS Yours with every 3 you order for yourself and family. Amazing new bonus plan. Everything free. Harford Frocks, Dept. H-9128, Cincinnati, Ohio.

AGENTS, Distributors: A real money-maker. Flo-Glo Plastic Linoleum finish. Acme, Box 404, Mount Vernon, N. Y.

AT Last! Something new and sensational in everyday cards. New gorgeous satin and velvet designs. Get orders fast. Big profits. Imprinted stationery. 14 assortments for year 'round occasions, retail 60c to \$1. Get samples on approval. Puro Co., 2801 Locust, Dept. 840-A, St. Louis 3, Mo.

100% PROFIT. No investment, handle quality Fotostamps. Amazing glossy photographs, gummed stamp form. Business year round. Free samples, particulars. American Photo Stamp Co., 103 East 125th St., Dept. PM1, New York 35.

SOURCES: Where to buy (or sell) thousands articles, supplies, etc. Folder free. Reinhardt's, Ashburn, Georgia.

GREETING Card money-makers. Birthday, everyday, Valentine. Write for folder. Greenport Art Company, Dept. 818P, Brooklyn 15, New York.

PROFIT Now! Substantial earnings made in magazine subscription sales. Trade price list and supplies free. Instructor Subscription Agency, Dept. PM, Dansville, New York.

EXCITING Details, shows "how" you make big profits with our fast-selling new lines! Plastic tablecloths, aprons; personalized, cotton pillow cases, many other sales-appealing items, novelties! Write for big discount price list, "Special Deals." Hurry! Royalty, Box 748-A, Passaic, N. J.

\$4 PROFIT Each sale; deluxe auto seat covers; no investment; big earnings; bonus. Free sales kit. Smart Fit Manufacturing Co., Brooklyn 18, New York.

\$2 FIRE Extinguishers. 200% profit. Sample \$1 postpaid. Lorrac Products, Box 1086, Albany 1, N. Y.

EXCELLENT Opportunity for men and women. Sell beautiful chrome-plated monograms for cars, motorcycles, luggage, purses, wallets, keychains, etc. Contact Charleston Monogram Co., P.O. 1291, Charleston, W. Va.

BIG Profit. Quick sales. Automatic adding machine sells for \$21.50. Your profit \$10.00. Write for selling plan. Allied, 2518 W. Montrose, Dept. M, Chicago 18, Ill.

EASY To sell "Black Witch" Plastic Auto Cleaner. Amazing results and sales on demonstration. Cleans glass, chrome, and white sidewall tires like magic! Removes frost and ice from windshields. Trial box of dozen sent c.o.d. upon request. Write Plastics Division, Strayer & Dunn, 835 Oaklawn N.E., Grand Rapids, Michigan.

SELL Process embossed business stationery. Samples free. Sperry's, Williamsport 10, Penna.

WANT Pleasant outdoor work in a business of your own? Good profits selling over 200 widely advertised Rawleigh home/farm necessities. Pays better than most occupations. Hundreds in business 5 to 20 years or more! Products-equipment on credit. No experience needed to start. We teach you how. Write today for full particulars. Rawleigh's, Dept. A-145-PPM, Freeport, Ill.

EARN Easy money! No selling required. Large commissions paid! PPS, Box 208, Manchester, Connecticut.

STARTLING. Sensational combination fluorescent desk lamp and photo frame. Easy seller. Big profit. E.C.A., 2518 W. Montrose, Dept. M, Chicago 18, Ill.

MYSTERY Photos sell on sight. 3 samples 25c. 20, \$1.00. Lewis, 1108-P, E. 42nd Place, Chicago 15, Ill.

MAKE Money in your spare time! Helps furnished. Easy sales. Voluntary repeat orders. Liberal commissions. Send for free wholesale price list today! Write McGregg or Magazine Agency, Dept. 12, Mount Morris, Illinois.

BIG Profits. Sell photo enlargements. Photo Rich, 215 West 98th, New York.

FREE Nylons given your customers if Kendex hosiery runs or snags within guarantee period! Sensational written guarantee amazes everybody. Three magic words: "Guaranteed Against Everything" enough to make sales. Earn wonderful income writing orders. We deliver and collect. Spare or full time. No money or experience needed. Liberal advance cash profit plus big cash bonus. Your name and address brings you complete free money-making sales outfit prepaid. Write today; start earnings next week! Kendex Co., Dept. 114, Babylon, N. Y.

NO Money or experience needed. Spare or full time. Steady income writing orders guaranteed men's hose. Variety 20 styles. We deliver and collect. Liberal advance profit. 33% cash bonus. Write today for complete free sales outfit. Kentcraft, Dept. AM, 44 Court St., Brooklyn 2, N. Y.

DISTRIBUTORS! New, sensational "Tame-Flame" fire extinguishers. Retail only 89c. Big profits. Choice territories open. P.M. 961, 113 W. 42 St., New York 18.

REFLECTO-Ten-Pins—Brand new bowling novelty wanted by millions. Details free, sample 50c. Western Sales, 5024 S. Maplewood, Chicago 32, Ill.

CAN You walk? Can you talk? Then you can earn up to \$30.00 per day selling our Lucite business card holders, engraved name plates and edge-lite signs, full or part time. For particulars write Golintra Plastics, 200 Veronica Place, Brooklyn 26, N. Y.

DEALERSHIPS. Sweetline No-Rub Re-finish, revolutionary cleaner-polisher. Instantly cleans, renews, leaves high gloss finish on hard surfaces without rubbing. For factories, stores, hotels, banks, theatres, restaurants, lobbies, bars, etc. Repeat sales. Utilized by Army, now available generally. H. C. Sweet Co., 3727 Fenkell, Detroit, Michigan.

YOUR Profit \$1.80 each sale. Samples \$2.00. Hamel, Leedsville, Megantic, Canada.

MAKE Money at home like I do! Write immediately. Duffy, Covington 4, Ky.

AGENTS Make big profits selling sensational new diapers which require no folding. Every new mother a prospect. Rush name for free sample. Fred Dexter and Staff, 234 West 17th, Houston 8, Texas.

VIRGIN Territory; first time advertised, sensationally new sweeter, milder smoking pipe, big profits sideline, refund guarantee. Details, sample, two dollars. Agud, Box 861, Seattle 11, Washington.

SCHOOL Seniors: Sell classmates superb Craftcards for super profits. Write Craft-cards, Box 235(AK), Pittsburgh 30, Pennsylvania.

MAKE More money selling personal initialed individualized belts, buckles, cap badges, tie holders. 2000 emblems to choose. Big profits, whole or part time. Write today special outfit offer. Hookfast Specialties, Box 1425, Dept. 6, Providence, R. I.

MAKE, Sell over 100 products at home without machinery or experience. Write, Kohen, 506 West 45th, Chicago 9

EXTRA Money. Send for new plan. Inspirational Books, Box 106 Old Chelsea Station, New York 11, N. Y.

DISTRIBUTORS Wanted for unusual household products. Levine's, 15-X Boulevard Station, New York 59, N. Y.

FREE Water and our concentrates, makes flavors, lotions, shampoos. 72 products, labels, bottles furnished. Qualco, E-20030 Russell, Detroit.

AGENTS. Sell finest food products direct to homes. Successfully sold for 25 years. Big profits. Powerful combination sale plans make sales easy. Permanent repeat business. Samples furnished. Live territories open to distributors. Mother Hubbard Products Co., 4139 Grand, Dept. P.M., Chicago.

INFORMATION — Wholesale supply sources. Money-making plans. Increase your income! Write Reynard Service, Smithfield 3, Ohio.

QUICK Sure money. Selling Annie Blain flavors. New Brunswick, New Jersey.

AGENTS—Big line including food products. Fast selling premium and bargain deals. Low prices. Send card for big outfit offer with gift. Ho-Ro-Co, 2725 Dodder, St. Louis 7, Mo.

SCHOOL Seniors—Earn 40% commission selling classmates America's most beautiful graduation name cards. Largest selection. Outsell all others. Send for free sample kit. Printcraft, 1425 E. Elm St., Scranton 5, Penna.

SCHOOL Seniors! Your postal will bring our wonder, Kwick-Sell Cardalog of popular graduation name cards. Biggest profits! Only firm giving free souvenir chest and card case. Don't miss out! Hurry that postal! Craftcards, Box 235(L), Pittsburgh 30, Pennsylvania.

100% PROFIT With new electric gas lighter, eliminates matches, pilot. Write Optical Research Products, Fairview, N. J.

EXCELLENT Sideline for printing and advertising salesmen. Decalomania name plates in small quantities. Great demand. Also, make money with our line of automobile initials and sign letters. Free samples. "Ralco" XL-Roxbury, Boston 19, Mass.

AGENTS: Stamping names on pocket-key protectors. Sample check with your name, address, 25c. Stamping outfits. Emblem checks, check-fobs, name plates. Hart Mfg. Co., 303 Degraw St., Brooklyn, N. Y.

MAGIC Cleaner and laundry soap deal. Hotter than a firecracker. Big profits. Sample free. Bestco, 5007 Irving Park, Chicago.

137 COMPLETE Plans for starting own business: local—mail order. Particulars free. Elite Co., 220 Grand St., New York 13.

AGENTS—300 % Profit selling genuine gold window letters; stores and offices. Free samples. Metallic Letter Co., 438-B North Clark, Chicago.

GOLD Lacquered window sign letters. Large sizes penny each. New foils. Absolutely beautiful. Free samples. Atlas, 544 W. 79th, Chicago 20.

SELL Personalized soap. Name on every cake. Ideal for gifts. Get sample offer. Dunbar Soap, New Brunswick, N. J.

HIGH-GRADE SALESMEN

ADVERTISING Book matches—Cash in on political campaigns. Sell union label matches. Cuts for all businesses and political parties. Free powerhouse selling kit. Low prices. Protection guaranteed on repeat orders. Cash commissions. Superior Match Co., Dept. M18, 7530 Greenwood, Chicago.

MAKE More money with Red Comet Automatic Fire Extinguisher. Low price. Proved success. Fine outfit furnished. No deposit. Some good territory open. Exclusive. Write quick. 449 Red Comet Bldg., Littleton, Colorado.

SELL Delicious candies, nuts, gum. Immediate delivery. Write Casterline, 2031-PC Sunnyside, Chicago 25, Illinois.

AGENTS Wanted to sell fast-moving, nationally advertised soap products. Be secure for life. Profitable 12 months a year. Exclusive territory. Be our salesman or be in your own business. Big profits. Easy sales. Britex Corp., Dept. C1, Boston 35, Mass.

PHOTO-SALESMEN — Agents. Sell beautiful hand colored plastic enlargements. Collect deposit, we deliver. Profitable sideline. Send card, for free sample kit. Novel Portrait, 3343 North Ave., Chicago, Ill.

POCKET Pal: The all-purpose cutting tool, wagon jobbers, salesmen. Sell to retailers and jobbers, 50c seller. Steady repeat item. Exceptional profit. Sample 25c. Nelson Manufacturing Company, 222 W. Kellogg, St. Paul 2, Minn.

ADVERTISING Specialties — Unusual line. Plastic, leather, felt, etc. Embroidered insignia. Prices right. Steady proposition. Give experience. Sample deposit \$1.00. Ad Crafters of America, Office and Plant: Plaistow 10, New Hampshire.

BIG Profits daily taking every family's magazines subscriptions. Give unlimited choice of valuable books free. Publishers, 323-5 Hammond, Cincinnati 2, Ohio.

AMAZING New zipper shoe sells on sight. Big cash profits for salesmen. Leads line 200 splendid styles. Territory open. Get free sample outfit. Write Consolidated, Dept. S-46, Chippewa Falls, Wis.

SALESMEN. Here's a natural. New patented tool multiplies man's strength 31 times. Sell retailers. Needed by autoists, farmers, lumbermen, builders, transports, garagemen, public works. Immediate deliveries from our U. S. plant. Write or wire for attractive proposition. Palfoscel Co., Ltd., Cornwall, Ont., Canada.

"WORLD'S Latest" Since line of calendars and advertising specialties open for hard-hitting, qualified men. H. W. Singleton Co., Dept. PM, Salt Lake City.

ADVERTISING Book matches—World's largest direct selling manufacturer of advertising book matches offers opportunity for profitable year 'round selling; every business a prospect. No experience needed to start; full or part time. Factory service. Low prices for high quality; repeats; sales kit furnished. Match Corp. of America, 3433-43 West 48th Place, Dept. E-14, Chicago 32, Illinois.

SALESMEN Wanted for shortest complete bookkeeping system on market; copyrighted; bookkeeper's aid; four for \$1. Mixon Accounting Agency, 1412 Great Northern Building, Chicago, Illinois.

FACTORY-SALESMEN: Profitable line of electrical supplies is your chance for good, steady income. Only go-getter wanted. Starco, 235 Canal St., New York, N. Y.

LONG Needed invention. Proved success. Powerful demonstration. Every home, factory, store, office a prospect. Low price, long profit. Exclusive. Fine outfit furnished. No deposit. Get facts quick. Write 412 Red Comet Building, Littleton, Colorado.

\$221.90 IN One week—Unusual? Not at all! Just look at one week's earnings of these representatives, SWB \$247.84, JRS \$252.80, HMT \$242.75, HC \$252.93, HET \$319.38, OP \$442.40. Direct mail campaign brings hot leads right into your home. Remarkable product does part of 10 men's work—a "natural" during these labor problem days. Has perfect sales story—sells year 'round. As modern as radar! Free equipment offer! We extend credit, deliver and collect. No capital required—no experience necessary. You make big profit on first sale and full credit on repeat business. Every business, store, home, factory, etc. are prospects. Write John Porter, 2433 Indiana, Dept. 303, Chicago 16, Ill.

50% TO 60% Profits with far superior automatic fire extinguishers. Free sales kit. Red Ball Co., Box 1552, Salt Lake City, Utah.

MEN Wanted at once. Full or part time. Just send name, address for free copy of Specialty Salesman Magazine giving hundreds of immediate openings with reliable firms. Sales experience unnecessary as we also send free 42 page book telling how. Specialty Salesman Magazine, Dept. PM-11, 307 N. Michigan, Chicago 1.

LOOK Here! Wanted—Men to start in business on our capital. Sell some 200 farm-home products. Thousands our dealers now make quick sales, big profits. For particulars write Rawleigh's, Dept. A-192-PPM, Freeport, Ill.

INCREASE Your sales. Make sure of orders using effective advance cards. Details free. Theodore Ponto, 504 South Bonnie Brae Street, Los Angeles.

FACTORY Repr. powered units. Gas-electric. Farm Products, M-2008, Excelsior Springs, Mo.

"DO'S And Don'ts of Selling" by top flight sales executive, 25c. Box 392, Clementon, N. J.

AMAZING Discovery, Master Glaze, puts brilliant glass-like surface on cars. Free sample, information. Big commissions. Master Glaze, Dept. 631, 7720 Harwood, Milwaukee, Wis.

BIG Cash profits daily taking orders; uniforms, shirts, ties, personal initialed individualized buckles, belts, cap badges, tie holders, 2,000 emblems. Repeats. Write today. Special outfit offer. Hook-Fast Company, Box 480-PM, Roanoke, Virginia.

JOBS Open in selling! Send name, address for free copy Opportunity Magazine, listing hundreds of companies who need men now, full or spare time. Experience not essential. Opportunity, 28 E. Jackson, Dept. 17, Chicago 4, Ill.

BIG Money taking orders. Shirts, ties, Sox, pants, jackets, sweaters, shoes, uniforms, etc. Sales equipment free. Experience unnecessary. Nimrod, 4922-AN Lincoln, Chicago.

WAGON Salesmen—Fast moving carded goods and 10c line. Long profits. Free facts. Peerless, 2720 Dodier, St. Louis 7, Mo.

EDUCATIONAL AND INSTRUCTION

NOW You can have an office. Learn credit-collection business by new home study course. Many earn up to \$5000-\$15,000 annually. Free bulletin. Franklin Credit School, Dept. 202A, Roanoke 7, Va.

ARE You job satisfied? Get a government job! Men, women. Vets get preference. Prepare now for 1948 examinations. Booklet, particulars free. Write today. Franklin Institute, Dept. S24, Rochester 4, N. Y.

INVESTIGATOR Training. Phillips Secret Service, 1917B North Kenneth, Chicago 39, Illinois.

NEW Writers needed. Want to cash editors' checks? If you can read, we can teach you how to write for pay. Earn as you learn. First lesson free on request. No obligation. Send postcard today. Comfort Writer's Service, 200 S. 7th St., Dept. 11, St. Louis 2, Mo.

MAKE Up to \$30-\$40 week as a trained practical nurse! Learn quickly at home. Booklet free. Chicago School of Nursing, Dept. M-1, Chicago.

BECOME A Doctor of Psychology or Metaphysics. Teach secret of contentment, happiness. Win degree of Ps. D. or Ms. D. Solve mental worries. Free book. College of Universal Truth, 5153-C North Clark, Chicago.

BOOKKEEPERS! Increase your earnings! Operate your own simplified "dollar-a-week" bookkeeping and tax service. Full or spare time. Details free. No obligation. Ellis, Box 207-F, Cedar Grove, North Carolina.

STUDY For work in forests, parks and game refuges. Details sent free. Write Delmar Institute, M11, Denver, Colo.

GOOD Jobs and a sound substantial future await you in hotel and institutional field. Men and women—all ages—needed for well-paid positions that offer color, excitement, ever-new and fascinating duties. Record-breaking travel means even greater opportunities for trained men and women in hotels, clubs and institutions. Lewis School receiving calls for managers, assistant managers, stewards, hostesses, purchasing agents and 55 other types of important positions! From coast to coast there are important positions that offer splendid opportunities for advancement in a business where you are not dropped because you are over 40. Previous experience proved unnecessary! No need to leave your job to qualify. A good grade school education, plus Lewis Training qualifies you at home, in spare time. Our National Placement Bureau helps to place you—and our amazing Certified Job Plan—actually certifies you will "make good" when placed. Write today for Free book! Veterans: Course approved for Veteran's training. Lewis Hotel Training School, Room NA-368, Washington 7, D. C. (First and only School of its kind—now in its 32nd year).

WANT A good job? Or better one at higher pay? I'll tell you how to get amazing results quickly. Nothing else like it. Sampson Company, Box 388, Oklahoma City, Oklahoma.

CORRESPONDENCE Tutoring in mathematics—high school level. M. V. Smith, Herrick, Ill.

FOOT Correction! Extension National School of Foot Correction, Juneau, Alaska.

CONSULTATION: Correspondence schools queries answered 25c. graduate. Fleege, 2316 94 Street, Jackson Heights, New York.

OIL Painting—Economical, home study course. Write Carlos Art Academy, Correspondence Division, Watertown, N. Y.

SPEECH Power—A book that will influence your life. How to gain inspiration and enthusiasm. How to speak correctly with feeling and dramatic effect. How to sway millions by word pictures over radio, on stage and screen. Surprising facts simply told. Send postcard for free folder. Billmy Publishers, 1640-C North Kenmore, Hollywood 27, Calif.

VALUABLE Information on your memory; famous feats of memory; super-memory; free. Write today. Thor Books, CM-1, Box 1210, Chicago.

HIGH Prices paid for used correspondence courses. Send yours today with particulars as to original price paid. An estimate sent by return mail. Talcott, Box 546A, Cortez, Colorado.

CORRESPONDENCE Courses, all books. New, used, bought, sold. Baker, 5509-B Winthrop, Chicago 40.

EXPERT Bookkeeping, easily learned. 15 lesson course \$5, introductory lesson 35c. Bernard Buchalter, 1280 Ocean Ave., Brooklyn 30, N. Y.

DO Arithmetic problems mentally. Complete course \$2.00. Mental Arithmetic, 749 Parkview, St. Paul, Minn.

USED Correspondence courses and educational books bought, sold, rented. Catalog free. Educational Exchange, Henagar, Ala.

JOURNALISM, Advertising, poetry writing courses. Boyle Kellogg, Clinton, New York.

LEARN Photo-engraving at home or in oldest, largest school in America. Work for newspaper or establish own profitable business. New Tasope' Photo-Engraving equipment available soon. Write for information. Veterans ask about G.I. training. The Aurora School of Photo-Engraving. Tasope' Bldg., Aurora, Mo.

MONOGRAPH Clear method successful, helpful self-suggestion \$1.00. Griffith Service, 1229 W. 8th, Anderson, Ind.

LEARN Piano tuning and repairing at home. Course by Dr. William Braid White. Write Karl Bartenbach, 1001-H Wells Street, Lafayette, Indiana.

BECOME Sanitation supervisor. Seven easy lessons. Certificate, profits, promotion. Institute, 2385-A Edgewater, Los Angeles 26.

PRACTICAL Mathematics. Details free. Math Tutor, Box 1214, Indianapolis 6, Indiana.

HOME Study course, drugless therapy. Free literature. Institute of Drugless Therapy, Tama, Iowa.

MEDICAL Laboratory technicians in great demand. We train you in your spare time, in your own home. You can practice while studying. Write for free catalogue. Imperial Technical Institute, Box 973-E, Austin, Texas.

USED Educational books on all subjects sold, rented, also bought and exchanged. Moneyback guarantee. Write today for free catalog and details. Lee Mountain, Pisgah, Alabama.

SECRET Investigation. Experience unnecessary. Investigators particulars free. George Wagner, M 125 West 86th, New York.

TRAIN Horses by circus methods. Free book. American Horse Training Institute, Box R-110, Columbus, Kansas.

PLAYS, STORIES, MANUSCRIPTS

PROFITABLE Book publication on even the limited sale of your book is possible. Details in our free copy of "A Decade of Publishing." Dept. K, Exposition Press, One Spruce Street, New York 7, N.Y.

I WANT New writers to cash hundreds of checks for \$1 to \$100, offered each month. The easiest way to write for pay. No previous experience necessary. Send for free details. No obligation. Saunders M. Cummings, 467-M Independence Bldg., Colorado Springs, Colo.

EVERY Help for all writers. Low cost. National Writers Club, 1837 Champa, Denver 2, Colo.

BUSINESS SERVICE

MAIL Receiver and re-forwarder. For price rates and types of services, consult us. Dunn Mail System, 216 West 69th Street, Box 42, New York 23, N.Y.

BUY For less. Enjoy buying advantages of huge corporations. Any item. Details free. Kelly & Co., 9544-Q Whitcomb, Detroit 27, Michigan.

TO Whom it may concern: We will represent you in all principal cities of the world. Personal or business assignments. James W. Farley, Citizens Bldg., Cleveland 14, Ohio. Note: Representatives wanted. Will send you assignments immediately. State qualifications.

PURCHASING. Professional service. Advise requirements. Russell, 413 Pedretti Road, Cincinnati, Ohio.

SPECIAL SERVICES

POSTMARK Your mail, "Washington, D.C." Letters mailed, 25c each. Complete (receiving, re-forwarding) service, \$3.00 monthly. "Hawkins", 1300 Taylor-NW.

CONFIDENTIAL Montreal mail-address \$7.50 yearly. Information. General Business Service, 7425 Henri-Julien, Montreal, Canada.

EXPORTS To Transjordan. Manufacturers and exporters of all classes of goods, wishing to increase trade and sales with Transjordan are invited to send offers to: El-Far Brothers, P. O. B. 230, Amman, Transjordan.

LETTERS Remailed 25c, three 50c. H. N. Johnson, Desk B, Box 85, Jacksonville 1, Fla.

SPECIAL Supply source on any article or material made, \$1.00. Business Service, Shreveport 49, Louisiana.

MFG.-WHOLESALE Sources. Most any item. "Service," 1332 Findlay, New York City 56.

FLORIDA—Want inexpensive Florida vacation? We tell how for \$1. Jewett, 100 Ararat St., Worcester 6, Mass.

CARTOONING, COMMERCIAL ART, SHOWCARD WRITING, SIGN PAINTING

"HOW To Make Money With Simple Cartoons"—a book everyone who likes to draw should have. It is free; no obligation. Simply address Cartoonists' Exchange, Dept. 91C, Pleasant Hill, Ohio.

OPTICAL illusion: makes drawing simple tracing. Bruce Enterprises, North Hollywood 12, Calif.

LEARN Cardwriting. Free details. O'Rourke, 1534 W. Valley, Alhambra, California.

MAKE Up to \$100 weekly cartooning, illustrating, designing and lettering at home. No experience necessary. Big, new, simplified method shows you how. Rush name for free trial offer. National Artists Bureau, Box 4248-M, Dallas 8, Texas.

LEARN Showcard writing in spare time. Fascinating profitable business of your own. No special skill needed. Free information. Sherwood Publishing Co., Irvington, 11-T, N. J.

FREE! Sign painting ability test. Signways, 4933 Erie St., Chicago 44.

9 ALPHABET 3 Numeral pattern sets and catalog. \$1.00. Sign Letter Distributors, P.O. Box 101, Mineola, N. Y.

DRAWING Stands direct from factory. Send for circular. Sutter-Craft, Dept. 812, Eau Claire, Wis.

SIGN Painting taught at home by an old master. Ben Kerns, Box 812, Greenville, S.C.

TALENT Test free. American School Commercial Art, Box 8066, Dallas 5, Texas.

CHALK Talks. Laugh producing program, \$1.00. Catalog 10c. Balda The Cartoonist, Oshkosh, Wisconsin.

ADVERTISING AGENCIES, LETTER WRITERS, FOR ADVERTISERS

FREE! 1947 Advertisers Rate and Data Directory. 52 pages! E. H. Brown Advertising Agency, 20 N. Wacker, Chicago 6.

ADVERTISING Service will greatly increase your volume of business through superior mail order ads for national advertising. New ideas. Free estimate! Gary A. Ruben Advertising Agency, Peoples Bank Bldg., Indianapolis, Indiana.

ORIGINAL Sales letters \$3.00 per page. Wallace, Box 143, Sheboygan, Wis.

FREE: Want ad advertising rate bulletin covering the southern states. Alabama Advertising Agency, Exchange Building, Birmingham 3, Alabama.

MAIL Order advtg. with a profit guarantee. 20 years experience. Write for special free offer. Azrael Advertising Agency, Chas. and Eager Sts., Baltimore 1, Md.

ADVERTISE: 24 Words, 40 newspapers \$3.50. Lists free. Advertising Bureau, 229-C Dixon, Uniontown, Penna.

ADVERTISE In Palmer's Magazine—new national magazine reaching waiters and waitresses coast to coast. Splendid market for many products. \$9.00 inch display (2 1/4" column); classified 15c word—20-word minimum. Send orders now for issue out Feb. 15th. Andrew Palmer, Publisher, 4348 Broadway, Chicago 13, Ill.

FRESH Names! Trial list, over two hundred farmers \$1.25 from my home and nearby vicinities. S. M. Burnett, Box 1343, San Francisco, Calif.

ADVERTISING Sensation! Reach 2,200,000 families, \$28.00 inch. Helpful ratebook (newspapers, magazines, mailing lists), advertising assistance, free. Chicago Advertising Agency, 20-PM West Jackson, Chicago 4.

ADVERTISERS! Reach nearly 18,000,000 readers. 25 Sunday national key newspapers, 18 words, \$47.75. "Terrific pullers," 20 popular newspapers, \$9.75. "Free booklet," Special—One inch display 2, \$21,198 circulation, \$42.00. Newmark's Advertising Agency, (Established 1893) 217-7th Ave., New York 11.

ADVERTISE: 24 Words, 77 weekly newspapers \$5.00. Write for free rate directory. A. Burton Carnes Advertising Agency, 410 South Michigan Ave., Chicago 5.

ADS Placed in out of town newspapers and magazines. Low rates. Catalogue free. Ideas that pay. Baker Advertising Agency, Successors Ankrum Agency, 189 W. Madison, Chicago 2.

MAILING Lists, certified, productive, inexpensive, \$5.00 1000. Homeworkers, agents, buyers, etc. Write Dixie Service, King, N. C.

24 WORDS In 64 weeklies \$4.96. H. J. Darnell, 730 Hays, Jackson, Tenn.

TYPEWRITERS, DUPLICATORS, OFFICE DEVICES

DUPLICATORS \$9.95 Up. (New.) Immediate delivery. "Free circular." Rucker, 2836-PM Slevin, Louisville 12, Ky.

"PRINTOMATIC" Selffeeding post card stencil printing duplicators \$9.50 up. Office size duplicators, Speedoprints, Hilcos, Excellographs \$33.41 up. Literature free. Pittsburgh Typewriter Supply, 336-WK Fourth Avenue, Pittsburgh 22, Penna.

RECONDITIONED Typewriters, mimeograph, multigraph printing devices, appliances, supplies. Catalog. Dixiegraph Service, King, N. Carolina.

RUBBER STAMPS AND OFFICE SUPPLIES

3 LINES, Cushioned, indexed, 50c. Signatures \$2. Stampright, Wauwatosa, Wis.

BLUE Airmail inside red arrow. One impression. Free illustrated folder. Multi-Color Stamp Co., Keene, Texas.

SUPERB Quality, three lines 70c. Lentz, Box 402, Youngstown, Ohio.

RUBBER Stamps. Buy direct from manufacturer. Literature free. Lee-Vall Press, Box 1242, Indianapolis 6, Indiana.

3 LINES Or less 55c. Newman, Box 284, Fort Collins, Colo.

PRINTING, MULTIGRAPHING, MIMEOGRAPHING, GUMMED LABELS

PRINTING. Photo-engraving price list free. Write Fidelity Company, Parkersburg 14, W. Va.

ENVELOPES Or Hammermill letterheads, 100-\$1.00. Benneville, Box 1931, Pittsburgh 30, Penna.

500 3/4x2 1/4 FOUR Line gummed stickers 35c; red border 50c. Moritz Printery, Saginaw, Mich.

24 HOUR Printing service. Samples free. Mango Printco, 555A South 20th, Newark, N. J.

6 1/2 PRINTED Envelopes \$2.75 per thousand in 5,000 lots. Michel, Box 76F, New York 16.

100 ENVELOPES \$1.00 postpaid, free envelope list. Doerr, Lewiston, New York.

1000 GUMMED Labels \$1.00. List free. Box PM-135, Spiro, Okla.

MIMEOGRAPHING, Booklets—any copy. Topical Emprise, 1527 Highland, Louisville 4, Ky.

PRINTED Business stationery, 250 full size letterheads, 250 envelopes, \$5. Vic Lamb, Hale Center, Texas.

1000 BUSINESS Cards, \$2.50, prepaid. Samples free. Reliable Print Shop, 905 E. Jefferson, Louisville 6, Ky.

MIMEOGRAPHING—24 Hour service. Send sample for airmail quotation. Jay, 1028m East 63rd, Chicago 37.

QUALITY Mimeographing, accurate, reasonable. Riddle, 360 S. Hill, Los Angeles 13, Calif.

BUSINESS Cards 1000, \$2.45, prepaid. Madison Printing Service, Madison, Ohio.

125 LETTERHEADS (8 1/2x11 Hammermill) \$1.00. Postpaid. Envelopes, business cards, same. Race Printing, Hudson, New York.

SEND 10c Now, for our 48 page 1948 price list—refunded first order. McCall Press, 1326 South 27th, Omaha, Nebraska.

POSTCARD Brings our samples, prices. Valley Print Shop, St. Elmo, Tennessee.

1948 CALENDAR Cards with your ad. Now ready. Printing price list. Cassel, R4 Box 72, Middletown, N. Y.

QUALITY Printing: Business, personal stationery. State requirements. Samples. Mero Products, 100 Morrison, Punxsutawney, Penna.

MIMEOGRAPHING Specialists—Any copy. Reasonable. Mailers Service, Box 606-A, Chicago 90, Ill.

ENVELOPES, Letterheads, card printing. Samples free. Gehling, 1834 Fuller, Philadelphia 15, Penna.

BETTER Grade printing reasonable. Estimates on anything. Economic Press, Leonia, N. J.

QUALITY Printing—Reasonable prices. Fast service on catalogs, folders, publications. Write for prices. Bagby Printing Co., Georgetown, Ohio.

MIMEOGRAPHING—Letters, pricelists, formulas, instructions. Lowest prices. Lem's Letter Shop, 5710 Stanton, Detroit 8.

VARI-TYPING, Mimeographing, offset printing. Postal brings samples and prices. Compare. Vari-Typing Service, Box 33, Forest Hills, N. Y.

MIMEOGRAPHING Experts. Samples free. Martin Mimeographing, 3212 Harper, Saint Louis 7, Missouri.

NEARGRAVURE Embosso letterheads! Distinctive! Unique! Samples 10c. Be surprised. Solldays, Knox, Indiana.

PRINTING OUTFITS AND SUPPLIES

PRINTERS Are made! Details free. Rainone, 7526 Metropolitan, Middle Village, N. Y.

EXPAND Or start printing; excellent field. Fully equipped, Multigraphs, multiliths, streamlined floor model mimeographs. Folders, cutters, addressographs. Sacrifice rebuilt. International Machines Company, 1516 Cleveland Place, Denver 2, Colo.

TYPE. Printing and multigraph. Fonts, composition. Ace Printing, Brentwood, Maryland.

PRINTING Presses, type, supplies. Lists 3c. Turnbaugh Service, Loysville, Penna.

PRINTING Presses, type, supplies. Send dime for complete illustrated printer's supply book, details and press samples. Kelsey, Inc., A-11, Meriden, Connecticut.

HOME Made presses. Write Riegel, 1111 Harrison, Philadelphia 24, Penna.

INEXPENSIVE Home-made printing press. Details free. Novelty Shop, Downsville, Louisiana.

PATENT ATTORNEYS

INVENTORS—Patent laws encourage the development of inventions. The Rules of Practice of the U. S. Patent Office advise—unless an inventor is familiar with such matters—that he employ a competent registered attorney or registered agent, as the value of patents depends largely upon the skillful preparation of the specifications and claims. Write for further particulars as to patent protection and procedure and "Invention Record" form at once. No obligation. McMorro, Berman & Davidson, Registered Patent Attorneys, 1344 Victor Building, Washington 1, D. C.

PATENT Protection—The U. S. Patent Office recommends—"an applicant is advised, unless familiar with such matters, to employ a competent registered Patent Attorney or registered Patent Agent, as the value of patents depends largely upon the skillful preparation of the specification and claims." Preliminary steps to take to obtain patent protection will be sent upon request. Victor J. Evans & Co., 331-A Merlin Building, Washington 6, D. C.

INVENTORS: Learn how to protect your invention. The Patent laws afford inventors protection for the patentable features of their inventions. The United States Patent Office advises the inventor, unless familiar with such matters, to engage a competent registered patent attorney or agent to represent him. We maintain a staff of registered patent attorneys ready to serve you in the handling of your patent matters. "Patent Guide" containing detailed information concerning patent protection and procedure with "Record of Invention" form will be forwarded upon request—without obligation. Clarence A. O'Brien & Harvey Jacobson, Registered Patent Attorneys, 81B-A District National Building, Washington, D. C.

PATENT Practice before U. S. Patent Office. Validity and infringement investigations and opinions. Booklet and form "Evidence of Conception" forwarded upon request. Lancaster, Allwine & Rommel, Registered Patent Attorneys, Suite 411, 815-15th Street, N.W., Washington 5, D. C.

C. A. SNOW & Co.—M-427, Snow Building, Washington 1, D. C. Registered Patent Attorneys. Write for information.

INVENTORS. For "Record of Invention" form, contact Carl Miller, Registered Patent Attorney, Woolworth Building, New York.

"**INVENTOR'S Guide**" free on request. Frank Ledermann, Registered Patent Attorney, 154 Nassau St., New York 7, N. Y.

PATENTS. "Proof of Invention" folder mailed without obligation. E. E. Vrooman, Registered Patent Attorney, 871 Woodward Building, Washington 5, D. C.

INVENTORS: Without obligation, write us for information as to what steps an inventor should take to secure a patent. Randolph & Beavers, Registered Patent Attorneys, 21-C Columbian Bldg., Washington 1, D. C.

INVENTORS: Write for free brochure "Evidence of Invention." Labiner, World Building, New York 7.

PATENTS—Trade marks. Irving L. McCathran, 315 McLachlen Bldg., Washington 1, D. C. Registered Patent Attorney.

FOR INVENTORS

INVENTORS—Patent laws encourage the development of inventions. The Rules of Practice of the U. S. Patent Office advise—unless an inventor is familiar with such matters—that he employ a competent registered attorney or registered agent, as the value of patents depends largely upon the skillful preparation of the specifications and claims. Write for further particulars as to patent protection and procedure and "Invention Record" form at once. No obligation. McMorro, Berman & Davidson, Registered Patent Attorneys, 1343 Victor Building, Washington 1, D. C.

SELL Your invention. Charles Dimmick, 477A Adair St., Long Beach 5, Calif.

INVENTORS—Victor J. Evans and Co. has a staff of registered patent attorneys, available to assist inventors in the preparation and prosecution of their cases before the U. S. Patent Office. Detailed information and the steps to take to obtain patent protection will be sent to you upon request. Victor J. Evans & Co., 332-A Merlin Building, Washington 6, D. C.

INVENTORS: Learn how to protect your invention. The patent laws afford inventors protection for the patentable features of their inventions. The United States Patent Office advises the inventor, unless familiar with such matters, to engage a competent registered patent attorney or agent to represent him. We maintain a staff of registered patent attorneys ready to serve you in the handling of your patent matters. "Patent Guide" containing detailed information concerning patent protection and procedure with "Record of Invention" form will be forwarded upon request, without obligation. Clarence A. O'Brien & Harvey Jacobson, Registered Patent Attorneys, 81A-A District National Building, Washington, D. C.

INVENTORS—Don't invest more money in your invention until you read our free, illustrated booklet, "Industrial Design and the Inventor." Ettel Industrial Design, Room 80, 112 South 106th Street, Seattle 88, Washington.

INVENTORS — Market-test your own patented, unpatented invention. Get facts on cash value. Avoid costly mistakes. Booklet, literature free. Direct Contacts, 11106-A3 Longwood, Chicago 43.

FREE Pamphlet! How to develop your inventions. Elo Development Company, Department P, Chatham Phoenix Building, Long Island City 1, New York.

FREE Service to inventors with inventions for sale. U. S. Industrial Research Committee, 23 Nelson Ave., Staten Island 8, N. Y.

INVENTORS: Reliable searches made in U. S. patent office \$6.00. Reports back in five days. Invention protection forms free. Write Raymond L. Smith, Patent Searcher, 703-M Albee Building, Washington 5, D. C.

CASH For your idea, 280 manufacturers need inventions, patented or unpatented. List free. Invention Bureau, 208 Clinton, Oak Park, Illinois.

I SELL Patents. Established in 1900. Charles A. Scott, 773PM Garson Ave., Rochester, N. Y.

THE Inventor who believes he has a new and useful invention, and needs advice, should consult a competent registered patent attorney or agent. Without obligation, write for full information on how to secure patent protection. Randolph & Beavers, Registered Patent Attorneys, 11-E-Columbian Bldg., Washington 1, D. C.

FREE. Two months on trial. Patent News, Washington, D. C. 12.

INVENTIONS Wanted: Patented or pending. Inventors Exchange (B), Hartford 1, Connecticut.

HIGHEST Royalties and cash for inventions when we market them. Free booklet without obligation. Universal Marketing Co., 126 Lexington Ave., New York 16, N. Y.

INVENTORS: Avoid unnecessary expense. Write for free booklet explaining how our consulting and advisory service can assist you in deriving greatest profit from inventing. Institute of American Inventors, Dept. 40-A, 1926-Eye St. N.W., Washington 6, D. C.

"**INVENTOR'S Guide**" free on request. Frank Ledermann, Registered Patent Attorney, 154 Nassau St., New York 7, N. Y.

INVENTIONS WANTED

INVENTORS! Have you good, patentable ideas? Write Patent Agent Metzler, 11 West 42nd, New York.

CASH Or royalty paid for acceptable inventions by the manufacturers. Write, John D. & Son, Box 3213, PM1, 285 Howard, Bridgeport 5, Conn.

WANT New or improved product for manufacturing with steady market potential. Interested in products requiring facilities of sheet metal shop, machine shop and assembly lines. Will finance and market. Established mid-western firm of 20 years' engineering and manufacturing experience. Address: Robert Martin, 300 BMA Bldg., Kansas City, Mo.

CASH For your idea, 280 manufacturers need inventions, patented or unpatented. List free. Invention Bureau, 208 Clinton, Oak Park, Illinois.

MANUFACTURING And national promotional organization seeking novelty and household inventions. Penn Products Co., 35-54 73rd St., Jackson Heights, New York.

INVENTORS — Booklet "Self-Testing Your Patent or Invention" free on request. Avoid costly mistakes, wrong markets. Direct Contacts, 11106-A2 Longwood, Chicago 43.

MANUFACTURERS Want patented or patent pending inventions! Write, Universal Guaranty Company, Lakewood, New York.

INVENTORS: Hundreds of manufacturers have requested our assistance in locating marketable new products. Complete information, free. Institute of American Inventors, Dept. 40-D, 1926-Eye St. N.W., Washington 6, D. C.

SMALL Inventions wanted by manufacturers. I'll help you sell your invention. Write for circular. Stanley Hull, 7829 Euclid, Cleveland, Ohio.

INVENTORS. Write for our sales plan. Complete service for inventors. Vision Engineering Inc. Security Building, West Bend, Wis.

PATENTED, Unpatented inventions wanted. We have tremendous lists of manufacturers who may pay cash royalties. Descriptive booklet free. National Invention Service, 1404-T Mitchell St., Oakland 1, Calif.

PATENTS FOR SALE

PATENT Pending, auto-air-cooler, easily manufactured, no moving parts; royalty only. Will mail official drawings upon request. H. S. Chambers, 1549 Valencia Ave., Pasadena 7, Calif.

PATENT 2418527. Mechanical fish lure. Mechanism imparts realistic movements to any number of lures representing natural live bait. William H. Riggan, Rt. 1, Box 167A, Warrenton, N. C.

AUTOMOBILE Tool, patent pend. Particulars. A. P. Slavico, 21 E. 21st St., Baltimore 18, Md.

INVENTORS: Test the commercial value of your patented or unpatented inventions, quickly and inexpensively. Write for free information. Institute of American Inventors, Dept. 40-B, 1926-Eye St. N.W., Washington 6, D. C.

MANUFACTURING

DIES, Gears, stampings, Do-All sawing. Baum's Metal Specialties, Kansas City, Mo.

SMALL Lot production wanted. Aluminum castings; stampings; screw machine; plastics. J and M Company, Burlington, Kentucky.

MACHINES, Products, designed, manufactured. Metal, plastics. Buschle Company, 718 Heck Avenue, Dayton 3, Ohio.

PERMANENT Moulds for plastics, aluminum castings. Send drawings. Unamit Mould & Machine Company, Bunker Hill, Ill.

MODELS — Small lot manufacturing. Metals, plastics, etc. Milburn, Burlington, Kentucky.

MODELS AND MODEL SUPPLIES

LANDLOCKED Sailors! Here's a beautiful, richly illustrated, fully descriptive catalogue of famous model ships—whalers, slavers, corvettes, etc., authentic in every detail. Send for it today. Only 25c. Halesite Yacht Service, Inc., Halesite, Huntington, N. Y.

FREE Booklet navy ship model kits. Liberty Picture Co., Richmond, California.

SHIP Model kits and fittings, most complete stock in New England, of Boucher, Fisher, marine model, model shipways. Fittings, plans, tools, model yacht equipment. Illustrated catalog 25c coin. James Bliss & Co., Inc., Dept. M, 220 State Street, Boston, Mass.

MODEL Railroads exclusively. Complete stock scale, Lionel, American Flyer. Send for catalog, 15c. State gauge. Eric Fuchs, 28 Brattle Street, Boston 8, Mass.

BUILD Your own model homes, garages, doll houses, displays, etc. Strong wood panels milled to faithfully reproduce shingles, lapsiding and brick in three scale sizes. Write postcard for free picture folder. Scale-Built Materials Inc., 4624 Ravenswood Ave., Chicago 40, Ill.

STEAM Engine kit, runs beautifully. Lathe and drill press required, no milling. Tin can for boiler. All material, flywheel casting, print, \$1.75. M. Kowick, 20179 Monte Vista, Detroit 21, Mich.

RAILWAY Models, complete informative catalog HO and O gauge, 148 pages, 50c. Walthers, 247 Erie, Milwaukee, Wisconsin.

FUN Building models—Airplanes, trains, ships. Everything furnished. Giant catalog 10c. Ben's Hobby Shop, 72 West Washington, Chicago 2, Illinois.

POWER Models—Steam and gasoline engines, steam traction engine, metals, tools. Catalog 35c. Chas. Cole, Ventura, Calif.

SHIP Models and yacht supplies complete. Large 64 page catalogue 30c. Bill Wild's, 510 East 11 St., New York City 9.

SHIP and Yacht model fittings; blueprints. Send 25c for illustrated catalog No. 20—listing hundreds of items. A. J. Fisher, 1002-1 Etowah Ave., Royal Oak, Mich.

MINIATURE Steam locomotives, 1/4", 1/2", 3/4" scales. Castings, parts, rail! Thorough drawings with instructions. Catalog 25c. Little Engines, Wilmington, Cal.

SHIP Model supplies, catalog 25c coin. R. E. Hancock, 323 Douglas Ave., Portsmouth, Virginia.

FREE Estimates on patent models. Wood, metal, plastic. Rogay Industrial Models, 3818 Beecher Street, N.W., Washington 7, D. C.

HOME CRAFTSMEN

MAKE Your own jewelry! Findings in metal and plastics; earwires, pinbacks, cameos, stones, beads, clasps, sprays, combs, hairbars, plastic and metal chains. Hobby Art Corp., Dept. 7, P.O.B. 276, New York 18, N. Y.

SHELLCRAFT! Make beautiful seashell jewelry. Income or hobby! Large illustrated catalog! Supplies, instructions, 10c postage. (Buy direct from manufacturer.) Pace's, Box 279M, Bradenton, Florida.

MAKE-It-With-Leather. Profitable hobby. Send card for free booklet. Artercraft Leather of California, Dept. PM-1, 271 Twelfth Street, Oakland 7, California.

SEASHELLS, Plastics, jewelry findings. Wholesale only. Catalog. Beachcomber Novelty Company, Box 551, Fort Myers, Florida.

BLEACH Old furniture blond. New easy tritone method gives amazingly professional results. Kit includes one pint each: bleach, fixer, remover, cleaner, lacquer, sander, brushes, full instructions. \$3.98 check, money order. Boersch Laboratories, 25-17 41st Avenue, Long Island City, N.Y. Express charges collect.

PATTERNS—40 Pictures of new jigsaw projects. Folder 10c. Joannes Patterns, P. O. Box 141, Omaha 7, Nebr.

RHINESTONES, Pearls, findings. Introductory assortment 25c. Herber, 1360-A Hicks, New York 67.

JEWELRY Hobbyists need our Sterling silver in sheets, wire, chains, and finished findings, along with rosary kits, chemicals, novelties, ideas, plastic and metal findings. Write today for latest beautiful catalog. Only 25c (refunded, first order). Pittshire, Box 90E, Pittsfield, Mass.

35 PATTERNS Toy furniture, action toys, etc. \$1.00. Continental Homecrafters, 907 Birch, Eau Claire 3, Wisconsin.

A HANDY Tool—Tru-Edge Sander. Send for Folder T. Village Sales, Box 305, Oak Park 3, Ill.

DO Your own professional felt flock finishing. Complete kit includes flock, undercoat, thinner, spray gun and instructions. \$9.25 post paid. Write for free color card and circular. Berott-Ross, Dept. 1A, 411 N. Poothill Road, Beverly Hills, Calif.

CRAFTSMEN'S Deals—Exotic veneers, turning squares, blocks, cabinet lumber, plywood, hardware. Sedlo Company, P. O. Box 7161, New Orleans, La.

SHELL Jewelry supplies. Free offers weekly. Get on our mailing list, save money. Low prices. Prompt service. Send for free offer and catalogue today. Jungle Novelty Co., Box 344-A, St. Petersburg 2, Fla.

SPECIAL 77 Full sized patterns. Lawn ornaments, toys and novelties \$1.00. Modern Woodcraft, Saginaw, Michigan.

LUMBER. Odd lots tropical and other woods, many rare. Suitable craftsmen, cabinet makers, small mfrs., schools. Send for descriptive price list. J. L. Regan, Dobbs Ferry, New York.

LEATHERCRAFT Designs—Handbags \$1.00, billfolds \$1.00, belts \$1.00. All three \$2.50. Lampkin Artercrafts, Box 641-M, Culver City, Calif.

BOLTS, Nuts, screws and washers, assortment, 4 lbs. \$1.00. Assorted aluminum rivets, 4 lbs. \$1.50. Columbia Salvage Company, 173-3rd Avenue North, Nashville, Tenn.

SHELL Jewelry. Shells, plastics, metal findings. "Hobbylobby," Box 795, RR2, Largo, Fla.

CONTACT Other craftsmen; worldwide; exchange ideas. Information free. Hobby Directory, South Orange, New Jersey.

WOODWORKERS. Get yours. Woodworking treatise, complete supplies catalogue. Discounts. 15c handling. Kress, 1710 New Haven, Pittsburgh 16, Penna.

\$46.00 FROM Square foot plywood. Jigsaw necessary. Write. Woodarts, H-38, Bridgewater, Mass.

BALSA Wood, large piece \$1.00. Price list free. Hickberry & Harper, Owings Mills, Md.

FAST Selling. Good profits making lawn chairs, furniture, toys. Illustrated folders of popular items. 25c. Refundable. Summercraft Studio, Dept. KN, 42 Vernon St., Newton 58, Mass.

COPPER Strips, cold rolled, .025 ins. thick. Assortment 5 sizes, 1, 2, 3, 4 and 6 inch widths, 12 inch lengths. \$1.90. 24 inch lengths, \$3.75 postpaid. Groundmaster Company, Box 657, Boulder, Colorado.

HAVE You an idea for new home workshop tool? We will pay you cash. Hove Engineering, Minneapolis 4, Minn.

LEATHERCRAFT. Try Tandy Leather, Tulsa 1, Oklahoma, for supplies. Catalog free upon request.

BRASS-ALUMINUM Cold rolled steel, 21 round rods 12" long, one each 1/8, 3/16, 1/4, 5/16, 3/8, 7/16 and 1/2, the most handy assortment ever offered, only \$3.75 postpaid. Project Headquarters, Dept. PM-1, 1756 Henderson St., Chicago 13, Ill.

SHELL Jewelry supplies. Wholesale only. McFarland Plastic Co., Sarasota, Fla.

LUMBER Packages for home woodcraft work. Oak, Maple, Gum, Pine. G. B. Hill Lumber Co., Cochran, Ga.

COPPER, Brass for tooling, supplies, and tools. Catalog free. Kit Kraft, 3203 West Washington Blvd., Los Angeles 16, Calif.

LEATHER-CRAFTERS: Free 1947 catalog showing easily completed projects, full line of tools, hides and accessories. Ester Leather Co., 145 St. Paul St., Rochester 4, N. Y.

UNIVERSAL Shop stand. Send for circular. Sutter-Craft, Dept. S12A, Eau Claire, Wis.

OREGON Myrtlewood lumber and turning squares for sale. M. Weaver, 3923 SE Tibbetts, Portland 2, Oregon.

HUNDREDS Patterns: Plywood novelty furniture, lawn ornaments, silhouettes, weathervanes, letters, numerals, 200 craftsmen's books and booklets, hundreds decal transfer decorations. Other lines. Large illustrated catalog. Write Wo-Met Shop, Ashburn, Georgia.

BAND And jig saw owners, let your machine and hobby bring you profits, fun. Free details. Nu-Art Designers, 33 Rosemont Rd., No. Weymouth, Mass.

LEATHERCRAFTERS! Belt kits, projects, leather, supplies. Write for catalog. Art Leather, 411 Joseph Ave., Rochester 5, N. Y.

LEATHER, Retail, mail orders, catalog, tools, lacing, supplies. National Handicraft Co., 30 Frankfort St., New York City 7.

TEXAS Ebony. America's most beautiful lathe turning wood. Large piece, \$1 prepaid. Sample, dime. Information on southern woods, stamp. Starcraft 1, Edinburg, Texas.

PLASTIC Jewelry supplies. Free catalog. J & M Novelty, Box 464P, Griffith, Indiana.

HOW To set up and run a mirror shop! Resilver mirrors. For price write—John Sprinkle V55, Marion, Indiana.

KNOCKDOWN Cedar chests. Lumber and veneers. Free price list. Giles & Kendall Company, Huntsville, Ala.

SPECIAL Offer: 80 full size toy, novelty, and lawn ornament patterns only \$1.00. Lynds, Medway, Mass.

CERAMIC Jewelry supplies, bar pins, ear screws, for ceramic and woodworkers; also glass and seashell assemblers. Free catalog. Philadelphia Badge Co., Dept. B-1, 1007 Filbert St., Philadelphia, Penna.

LEATHERCRAFTERS! Send for free catalog listing leathers, tools, supplies. Kit Kraft, 3203 W. Washington Blvd., Los Angeles 16, Calif.

SHELLS, Plastics, findings. Lowest prices. Free catalog. Frances Jones, Box 251, Sarasota, Fla.

HOME Craftsmen—You can now reproduce your ideas by the hundreds from your own designs by using "Steel Rule Dies" cuts on cork, leather, cardboard, cloth. Write for details. Howard Schultz, 115-83-229 St., St. Albans 11, New York.

MAKE IT YOURSELF

GAS Range \$30. Book and plans \$4. Literature free. Enasco, P. O. Box 73, Pasadena 16, California.

BUILD Concrete block machine. Vibrator or hand. Easy. Economical. 125 blocks hourly. Build house, shop, garage, other buildings. Save half, sell blocks, make money. Free details. Clyde Lee, Dept. A, Mountain View, Okla.

SEASHELL Workers' supplies. Wholesale. Bargain list free. Shell Novelty, Box 1664, Fort Myers, Florida.

BUILD Airplane swing for your boy. Blueprints \$1. Camp Drafting, 2910 Erdman Ave., Baltimore 13, Md.

SEPTIC Tank hand book compiled from fifteen years' experience. Drawings showing correct and incorrect installations. Order now. Only \$5.00. Dept. M, Reuben Seifridge, Septic Tank Engineer, Clymer, N.Y.

HOT Water free; from sunlight. System efficient any locality year round. Standard materials, easily built, low cost, facts free. Solar Water Co., Box 175, Dept. D, Coral Gables, Florida.

GRANDFATHER Clock building plans, \$1. Simple, shop-tested, thousands built, with pictured prices fine Westminster weight movements. Kuempfle Clock Works, Minneapolis 16, Minn.

BUILD Concrete block machine. 2 blocks per minute. Build concrete mixer. See illustrated ad, page 258. U-Build-It Service, Tampa, Florida.

STOP Wasting money through heat loss. Our plans tell how. Free details. A. Claber Co., Box 491, Grandville, Michigan.

BUILD Concrete block machines, portable sawmills. Shop, farm, home machines, 70 plans. Catalog-handbook free. Nichols Equipment Co., Dept. 510, Purvis, Miss.

"CONCRETE Block homes." 32 page booklet: drawings, instructions on how to build. \$1.00. H. C. Lightfoot, Civil Engineer, Richboro 1, Penna.

BUILD The Sovereign of the Seas. An unusual ship model within the reach of average craftsmen. Elaborate carvings easily produced. 62 page book gives complete details. Price \$1.00. Popular Mechanics Press, 200 East Ontario Street, Chicago, Illinois.

PLANS AND BLUEPRINTS

"PAULTON Home"—You too can build it! Low cost construction plans \$1.00. Paulton, 3353 Pasadena, Detroit 6, Mich.

PROJECTS For house and yard. Matched modern dining room, living room and bedroom sets. Original designs in coffee tables, end tables, etc. No enlarging or cutting. Full size plans transfer directly to material. 25c brings catalogue. Craftsman Design Service, 823 Eckart, Ft. Wayne 5, Indiana, Dept. G1.

BUILD Your own home for less. details sent free. F. C. Williams, 200 Center Ave., Pittsburgh 29, Penna.

WATCHES, OLD GOLD, JEWELRY

GOLD \$35.00 Ounce. Mail old gold teeth, diamonds, jewelry, watches—receive cash by return mail. Satisfaction guaranteed. Free information. Dr. Weisberg's Gold Refining Company, 1500-Q Hennepin, Minneapolis, Minn.

WANTED. Old gold jewelry, watches. Money return mail. Satisfaction or goods returned. Collord, Jeweler, Everett, Washington.

JEWELRY. \$2.00 Brings samples. Guaranteed value \$6.00. George Sassen, 154 Nassau Street, New York 7.

WATCHES. Wholesale. Rebuilt-like-new Elgins, Walthams, Bulovas, etc., \$10.50 up. Catalogue free. Brookings, B-1975F, Little Rock, Ark.

CHALET Watches. Wholesale. Illustrated catalog, free. Foreign inquiries invited. John Green-A, 210 Fifth Ave., New York 10.

WATCHMAKERS, Beginners; watches; movements. Price list! Box 1874, Chicago 90, Ill.

JEWELRY Findings, cameos, semiprecious stones, earwires, chains, flowers, hearts, crosses, clasps, pinbacks, moonstones, beads, many others. Catalogue 10c. Dime refunded on first order. Pickwick Jewelry Findings, Box 780, Stamford, Conn.

WATCH Repairing easy learned by our home study course. Watch repairers are in demand and are among the highest paid craftsmen today. Write for free information. Houston Chronometer & Watch Co., P.O. Box 1140A, Houston 1, Texas.

CASH For old, broken jewelry. Highest prices paid immediately. Mail gold teeth, watches, rings, silverware, diamonds, spectacles. Satisfaction guaranteed. Information free. Rose Smelting Co., 29-A East Madison, Chicago.

GEMS, Precious and semi-precious, all genuine, from world wide sources. Deal direct, no overhead, save money. Catalog 10c. Hill Co., Route 7, Salem, Oregon.

TOBACCO, SMOKERS' SUPPLIES

"PIPE Lure," 24 page illustrated booklet shows how you can create smoking pipes easily with various materials. Includes romantic pipe traditions. Send 50c. Hippen, 719A Colquitt, Houston 6, Texas.

GOOD Cigars 5c. Direct from factory to you, retail for 8c each. Box 50 cigars postpaid \$2.50, check or money order. Rossi Cigars, 64 Stone St., Newark 4, N.J.

REJECTS \$5.00 Pipes 65c. Briar blocks, bits. Literature free. Carvapipe, 2829-H Dixie, Hamilton, Ohio.

FOR THE HOME

INSULATE Your home yourself. Old or new. Complete plans, instructions, illustrations, \$1.00. Moneyback guarantee. Insulation, 616 S. Liberty, Alliance, Ohio.

LUXURY: Close your window from bed these cold mornings. Send \$1 for complete Whippersnap Window Closer, Box 199, Ithaca, N. Y.

BURGLAR-PROOF Common door locks. Pool lock pickers. Cheap insurance. Material, instructions \$1.00 postpaid. Lokmaster, 19465 Ward, Detroit 21, Mich.

WASHING Machine parts and supplies. Lovell ringers, rolls and bearings. Humboldt Thor Shop, 3448 W. North Ave., Chicago 47.

"REPLACEMENTS" Stoves, furnaces, grates, firepots, linings. Magix, Royal Oak 128, Mich.

FOR SALE—MISCELLANEOUS

HULL Automobile compass, value \$4.95, brand new, \$2.50. Prisms for 6x30 or 8x30 binoculars, brand new, \$1.50 each. Offset prisms to be attached to 7x50 B. & L. binoculars, gives double the field of the ordinary 7x50 binocular. Cost \$98.00, special \$25.00. Green sunshades for binoculars, size 6x30 and 7x50, snap on type, value \$7.50, special \$1.25 per pair. Forward money order. No C.O.D. shipments. Send coin \$1.25 for Third Annual Edition of Gun Digest together with our complete catalog of new and used guns, ammunition, rifles, binoculars and powder flasks. Our separate catalog 25c. Public Sport Shops, 13 S. 16th Street, Philadelphia, Penna.

BIG Money making the new plastic balloon material. Complete formula and source of ingredients \$2.00. Concrete Machinery Co., Hickory, N. C.

MODERN Popcorn machines \$675.00. Box 712, Corsicana, Texas.

CALCINATOR — Nationally advertised gas fired home garbage disposal unit. Retail for \$124.95. Shipped \$69.95 FOB Borger, Texas. Send check or money order to J. H. O'Neal, Box 345, Borger, Texas.

NEW, Sensational "Tame Flame" fire extinguisher acts pronto, only foot long; ten ounces. Attractive, colored bakelite with wall attachment. Harmless, stainless, simple operation. 89c postpaid. At this amazing price order several for home, garage, car, etc. Advance Products, 64 West 48th, New York City.

WANTED MISCELLANEOUS

FOOD Products for resale to wagon jobbers. Jolly Hop Nut Co., 5404 Second Ave., Pittsburgh 7, Penna.

PERSONAL

BORROW By mail. Loans \$50.00 to \$300.00 to employed men and women. Easy, quick. Completely private, confidential. No endorsers. Repay in convenient monthly payments. Details free in plain envelope. Write State Finance Co., 320 Securities Bldg., Dept. A-14, Des Moines 9, Iowa.

HOW You can find out! Information discreetly developed, any matter, person, problem, anywhere. Personal-business assignments, representations, undertaken. Nation-wide. Officially licensed and bonded service established 1922. Reasonable. Confidential. William Herman, 170 Broadway, New York.

BEAT Inflation with extra income. Samples four leading opportunity magazines 25c. Wallace, Box 143, Sheboygan, Wis.

GOODNESS Gracious, here in New York, Boston, Providence. Amaze friends. 3 postcards, 25c. 15—\$1.00. You address, return, I remail. Kennedy, 201 Clifford, Providence 3, R. I.

WE Mail, receive, forward letters, 25c. Box 712, Corsicana, Texas.

MEXICAN Law. General practice attorney. 1203 Arizona Street, El Paso, Texas.

MEXICAN Address. Mail received, forwarded. Photographic postcards 15c. Remailled free. Mexican articles. Tillotson, Apdo. 1405, Guadalajara, Jalisco, Mexico.

PRETEND Visiting historic Philadelphia! Five view cards 25c; remailed free. Stanford, 6220-16th, Philadelphia 41.

SURPRISE Friends. Pretend visiting Chicago. Scenic post cards, 3-25c. Address, return, remailed from Chicago. Letters 25c. Small, Midlothian, Illinois.

I FELT The strangler's grip! Instantly he was paralyzed with broken fingers, though twice my size. New, natural, impulse method of defense. Write Inspiration, 3108A Hillside, Harrisburg, Penna.

FIVE Pounds Texas finest papershell pecans \$3.75. Box 712, Corsicana, Texas.

PALM Beach vacation \$1.00. You address, stamp, we mail 6 postcards, beach, hotel scenes, \$1.00. Cocoanuts mailed \$1.00 each. General Intel. Service, 602 Guaranty Bldg., West Palm Beach, Fla.

SWAP! Trade! Anything, everything. Free information. "Swappers' Gazette-PM" Louisville 12, Kentucky.

RUPTURED? Positive comfort, no understraps, no steel, no elastic. Write Smith Manufacturing Company, Preston, Ontario.

HAIR Falling? Dandruff? Write Trichologist, 137 Lewis St., Phillipsburg, N. J.

NIFTY Shirt holder helps hold shirt down, pants up. Simple. Send dime. Nifty, Box 812, Oakland, Calif.

SAVE Money, trim own hair. Comb-A-Trim, 60c, two \$1.00. Moyer, B-252-P, Milton, Penna.

NASHVILLE Tennessee. Scenic view postcards, 5-25c. You address, return, I remail. Ivan Lanier, 1404 Lischey Ave.

MISCELLANEOUS

TREE Ripened. Grapefruit and oranges, \$2.50. Mixed bushel. Free price list. Davidson Groves, Dept. G, Box 1118, Edinburg, Texas.

WELD Small steel parts with an ordinary blowtorch. Instructions \$1.00. Cameron's Sewing Machine Shop, Camrose, Alta, Canada.

"WATERBUG." New water toy. Propeller driven, 9"x15". \$1.00. Satisfaction guaranteed. Hare Products, Whitinsville, Mass.

INDIAN River citrus fruits, Florida's best. For delivered prices write Schuyler Jackson, Wabasso, Fla.

FIREWORKS: Don't be disappointed. Get famous Banner Fireworks with all newest and startling effects. Giant cannon salutes that rock you like a crash of thunder. Whistling devils with weird unearthly noises. Skyrockets that burst in majestic colorful display. Gasp in amazement as you watch the battle in the clouds. Genuine Chinese firecrackers. Over 200 pieces including sparklers for little tots. Retail value \$11.25 for only \$4.95. Rush order today. Any quantity. Send money order, bank draft or currency. No c.o.d.'s. Big new catalog free. Banner Fireworks Mfg. Co., Inc., Dept. 112, 446 Capistrano, Toledo 12, Ohio.

PANNING Gold. Learn how. Illustrated booklet-catalogue, mining books, supplies, free. Old Prospector, B79, Dutch Flat, Calif.

HOSTS Of parties, M.C.'s, club stewards. New. Any number can play. Sample, mailing, 15c. Two (different) 25c; Pkg. 20, \$1.00. Banty Industries, 1706 Vine, Philadelphia, Penna.

REWARD! Answer ad, receive valuable free catalog money-making information; locksmithing, mineral locating, mailorder; formulas; hunting, treasure seeking; other subjects. National, 378P Hooper Street, Brooklyn 11, New York.

CONTRACT Bridge lessons. Twenty-five cents each. Bridge Studio, 195 Wabash Ave., Kenmore, New York.

LUCKY Coin—Lord's Prayer, Crucifixion, or Ten Commandments on penny. 25c each, 3 for 50c. Peerless, 2726-D Sturtevant, Detroit 6, Mich.

MILLION Articles wholesale. "Supply Source Directory" 10c. Press, Box 1302-P1, Detroit 31.

LOS Angeles. Your personal questions about Los Angeles answered promptly. \$1.00. Pomeroy Information Service, 11926 Wilshire Blvd., Los Angeles 25.

BUY Direct from importers-distributors of Mexican, Indian and western goods. Write for free catalog. Navo-Mex Importers, 2351 East Van Buren, Phoenix, Arizona.

FINEST Quality sorghum molasses, 10 lbs. \$5.95. Bob Pace, Combs, Ark.

SWISS Musical units \$3.50 postpaid. Musical albums. Music Boxes, 131 West 42nd, New York 18.

RECEIVE Free samples, magazines, catalogues, money-making opportunities galore! Have fun opening plenty of interesting mail! Your name in all our "sure fire" mailing directories two years, \$1.00. Nine months, 50c; three months, 25c. Hurry! Stanford, 6220-M 16th, Philadelphia 41.

NEW Design treasure and mineral finder, amazing. Diagrams \$2.50. Robertson, 364 Douglas St., Salt Lake City 2, Utah.

"JITTERBUGGING?" Anyone can learn by the Engstrom Dance Guide. New and complete. As simple and easy to understand as moving pictures. No complicated descriptions and charts. Only \$1.00. Engstrom Dance Studios, P.O. Box 358, Grand Island, Nebr.

MAKE Money at home like I do. Details 10c. Bentz Jr., Chatawa 23, Mississippi.

FOOT Sufferers get quick relief with Kindschi Foot Balancers. Thousands of satisfied customers. Free literature tells how. Kindschi Foot Appliances, Dept. A5, 321 W. Jefferson, Dallas 8, Texas.

PHOTOS, Color slides. Scenic, ghost towns, art, etc. Unusual, different. Sample photo, 25c. Slide 50. List. Novelty Supply, 1227 E. Van Buren, Phoenix, Arizona, Dept. B.

MEXICAN Gift shop items. Feather cards, pottery, drawnwork. Wholesale, retail. Mexican Products, 126 N. Main, Tulsa 3, Okla.

GOVERNMENT Surplus. A thousand bargains. Write for list. Army Navy Surplus Goods, 320 13th St., Richmond, Calif.

SEEK Buried treasure. Methods, mysteries, devices explained. Circulars free. Century Press, Box 151-B, Glen Elyn, Ill.

HAVE You read "Hi Neighbor." (A fascinating saga of today). Postpaid \$1.10. Money back guarantee if not satisfied. Please print name in full. Write in care of "Hi Neighbor," William A. Horn, P.O. Box 231, Alton, Illinois.

DIVER. Scientific toy; all ages; inexpensive. Schiff, 2319 Newton, Milwaukee 11.

REAL Western belt buckle. Beautiful metal with tip and loops, bronze steer head, \$1.00 postpaid. Aircraft Industries, 411 Wolverton, Ardmore, Okla.

VETERANS Your favorite wallet-size photo or document put in transparent plastic. Free! Send item, we'll return plastic protected. Include former service address. Kovee Plastic Co., 3753 N. Marshfield, Chicago 13, Ill.

"RECEIVE Mail." Money-making offers, opportunities, catalogs. Name listed 10c. Ideal Service, 100, Park Ridge, Ill.

BOOKS—All Kinds—Homecraft, Radio, Plastics, Boat Building, Photography, Model Building, Catalog free. Popular Mechanics Press, 200 E. Ontario St., Chicago 11, Ill.

PREVENT Moth damage with one easy application. Permanent mothproofing compound makes one quart solution, 50c postpaid. Money back guarantee. Lee Laboratories, 10108 S. Vermont, Los Angeles 44, Calif.

MEN! Large size shoes, large size socks. We specialize in large sizes 11½ to 16, widths AA-EEE. Oxfords, hipops, work shoes. Guaranteed extra quality. Free catalog. Kingsize, 426, Brockton, Mass.

TWELVE Alnicov magnets, 100 experiments, \$3.00. Experiments, 25c. Disc magnet, \$1.00. Eljay, Box 891, Newark 1, N. J.

M-SCOPE Metal, mineral locators sensational new electronic lightweight models, immediate shipment. Fisher Research Laboratory, Inc., manufactures some of the finest metal locators for the U. S. Army. Built for Arctic, Tropic use. Unsurpassed efficiency, low prices. Time-payment plan available. Send for free 16-page illustrated booklet. Fisher Research Laboratory, Inc., Palo Alto, Calif.

TATTOOING Outfits, supplies. Illustrated list free. Zels, 728 Lesley, Rockford, Illinois.

GLADIOLAS—Some newer, better. List. Robinsons Glad Heaven, Sebastopol, Calif.

70 BIBLE Lessons, 25c. Bulletin, Box 87, Cathedral Station, New York 25.

SURPLUS Army mine detectors, complete with batteries. \$26.40. Highbridge, 343 Canal St., New York 13, N. Y.

STAMPS Wanted by thousands of our readers. Your ad in this space will bring you some nice orders. One advertiser sold 150,000 stamps. Write for positive proof. F. W. Johnson, Classified Advertising Manager, Room 301, 200 East Ontario St., Chicago 11.

Genius— NOT WANTED

AN ANNOUNCEMENT OF PROFESSIONAL OPPORTUNITY of Special Importance to Earnest, Determined Individuals Who Wish to Become Professional Artists in 1948!

BECOMING a professional artist is NOT a matter of chance or the fortune of birth. Inborn talent for drawing, financial condition, age, sex, education count for very little in the making of an artist.



JEAN S. JONES
No genius, but definitely a winner.

Only one or two characteristics are of any importance and they can be summed up in the question: "Have you earnestness and determination?"

THE above is not a rash or idle statement. For exactly fifty years we have been training PROFESSIONAL artists and in that time, you will admit, we must have gained some idea as to the type of individual most surely prepared. We will freely pass up the person with so-called talent. But we do want the earnest, conscientious individual who will not be ashamed or afraid to study and practice. He may be a doubtful starter but he is a sure finisher.

SUPPOSE, through an unfortunate accident, you lost your right arm and not only had to learn to write all over again



Drawn from life by
Student Wallace B. Jones
Training, practice bring professional skill.

THIS is the year to prepare in! Opportunities in PROFESSIONAL ART were never more numerous or more remunerative. If you are serious-minded and want to take the gamble out of your future security, then do not fail to use the attached coupon. It will bring you "Building a Future"—the hard but straight path to success!

with your left hand but decided to become a professional artist. You will agree that the undertaking would be no easy one—that a lot of perseverance would be required. Yet, we have among our students a woman who did exactly that and prepared herself capably for PROFESSIONAL art!

SUPPOSE again that you were a married woman—like the one pictured here—who without particular talent wanted a professional career and financial independence. She, like hundreds of others who relied upon us, combined average intelligence with earnest spare-time study to gain PROFESSIONAL skill WITHIN a year.

OR, suppose you were a man of fifty who had not lost the ambition to enter a profitable and interesting profession. There are many like Mr. Careaga, shown here, who by determination alone achieved that goal—at the stage in life when time meant everything.

Want a job in art in 1948? Want to draw, paint, illustrate for MONEY? Want a PROFESSIONAL income, that will steadily grow?

The crying need today is not alone for steel, automobiles, new dwellings; it is also for artists. Artists must illustrate the thousands of books and periodicals that appear yearly. Artists must provide the laughs that the public demands in gag-cartoons and comic strips. Artists must draw and design the many new products of this industrial age. The demand is staggering. To cash in, it is only necessary to get PROFESSIONAL training.

And that's where we come in—to give the serious-minded student professional skill without waste of time, energy, or



DONALD HATCH
"You are sincere."

MUTUAL RESPECT

An earnest student is sure to recognize and appreciate sincere help. Student Donald Hatch of Waddington, N. Y. writes: "Once before I enrolled for a course but it was a fraud. I can see that you are sincere. I am more than pleased."



ALVARO CAREAGA
After fifty—a bright vista.

money. For complete details concerning this remarkable professional opportunity and the spare-time study program that will prepare earnest, determined individuals for PROFESSIONAL life in 1948, write for our free, illustrated book—BUILDING A FUTURE. You may have it now—without obligation—if you wish to make 1948 YOUR year. Use the coupon below.



Drawn by Student Verda Eck
Not a scene that a genius would choose, but yet up to professional standards in all respects.

GRANT SCHOOL OF ART,
53 W. Jackson Blvd.,
Chicago 4, Illinois
Gentlemen:

I am earnestly desirous of becoming a PROFESSIONAL artist and would like to learn more about your spare-time study program to prepare as such in 1948. Please send me at once—without obligation, of course—your descriptive and interesting booklet, "Building a Future."

Name _____ Age _____

Address _____

City _____ State _____

FREE

ILLUSTRATED BOOK

Amazing Lens



600 POWERFUL Magnifying Lenses to EVERY SQ. INCH!

Center of every letter is clear so light shines through. Translucent edges give "aura" effect of Neon.

Choice of Thousands of Different Glass Panels

CHANGE ADVERTISING MESSAGE IN 10 SECONDS!

Invention Makes New Advertising Sign Brilliant as Neon!

COSTS ONLY 1/2 AS MUCH!



AGENTS! Fast Sales In Every Kind of Retail Store. Big Profit on Every Sale!

A FEW years ago, men who got in on the "ground floor" with Neon, cleaned up millions. Today, a few wide-awake men are offered a chance to cash in on another advertising opportunity that may be even bigger—a "once-in-a-lifetime" chance to get in on the "ground floor" with the new Fluorescent MAXILUME Business

FREE! Send Name for SAMPLE OFFER and FREE SELLING OUTFIT. Every retail store, every large manufacturer, every advertiser in the United States is a prospect for one to 100 or more Business Builders. Space does not permit printing all facts. But if you want big,

Builder—the advertising Display Sign that can change sales messages in 10 seconds! Here is an invention as startling, as revolutionary as Neon was 10 years ago. For it offers all the advantages of Neon at 1/2 the original cost and at an operating cost of only 2c a day!

quick profits in volume you never dreamed of, you'll get the facts in a hurry! Don't send a penny. Just your name on a penny post card brings Free Selling Outfit. Do this quick—for the biggest cash clean-up in the history of Direct Selling!

MAXILUME COMPANY, 125 W. Hubbard, Dept. 81, CHICAGO 10, ILLINOIS

Put your future in your own hands



BE AN ARTIST

Here's the Amazing Way We Teach You Step-by-Step to Draw At Home in Spare Time

Draw for money. Prepare yourself now for a fascinating, pleasant and profitable Art career. **COMMERCIAL ART, DESIGNING, CARTOONING**—all in one complete home study course. No previous art experience necessary. We teach you step-by-step and prepare you for good jobs in advertising, newspaper and magazine publishing, department stores, printing, engraving, or in art studios where you can become your own boss. For 34 years our graduates have been "making good"—**WHY NOT YOU?**

Trained Artists Are Capable of Earning \$50-\$60-\$75 and MORE a WEEK

Write for **FREE BOOK**, "Art for Pleasure & Profit"—tells about our course, what our graduates say, commercial opportunities and how this fine, low cost training can help you. **TWO ART OUTFITS** and other features included with training. **Veterans! Course "G.I." Approved**

FREE BOOK gives details!

WASHINGTON SCHOOL OF ART, Studio 121M
1115—15th St., N.W., Washington 5, D. C.
Please send me full information and your Free Book, "Art for Pleasure and Profit."

Name _____ AGE _____
Street _____
City _____ Zone _____ State _____
 I am entitled to training under the GI Bill

SAY YOU SAW IT IN POPULAR MECHANICS

RADIO PARTS "Jack Pot"

You hit the "jack pot" in value when you get our kit of war surplus radio parts. Over \$25.00 worth of merchandise for only \$3.98. Think of it—over 200 parts. Transformers, coils, condensers, resistors, sockets, controls, etc. Ideal kit for the radio experimenter. Send check or M.O. today.

MARKO SURPLUS CO.
2924 Logan Blvd.
Dept. A1-R Chicago 47, Ill.

\$3.98
ORIGINAL VALUE OVER \$25

Thrilling Work COLORING PHOTOS

Fascinating vocation learned at home by those with aptitude. Thrilling pastime. National method brings out life-like colors. Free booklet.

EASY TO LEARN

NATIONAL PHOTO COLORING SCHOOL
1315 S. Michigan, Dept. 1351, Chicago 5

A PROFITABLE TRADE! AN EXCITING HOBBY!



Learn... PHOTO NEGATIVE RETOUCHING

AMATEURS! IMPROVE YOUR PICTURES 100%

This new home study five-week course, one lesson each week, will teach you how to improve your pictures... how to impart that "professional finish." And don't forget that photo negative retouching is a fine profession for both men and women... a profitable business that you can conduct from your own home.

This complete copyrighted course of lessons on Retouching, Modelling, Etching, Collecting, and Spotting is priced at only

\$17.50

COURSE IS DESIGNED FOR BOTH, AMATEURS and PROFESSIONALS GIVEN AT NO EXTRA COST with each course is all the equipment you need, consisting of:

- RETOUCHING STAND
- ETCHING KNIFE
- RETOUCHING PENCILS
- CHINESE SPOTTING
- RETOUCHING DOPE
- INK
- SPOTTING BRUSH
- EMERY CLOTH

—and a different assortment of **PRACTICE NEGATIVES FOR EACH LESSON**... also included is a **PROOFING DEVICE AND PROOF PAPER** to check your results!

SEND IN THIS HANDY COUPON TODAY!

Remember, if you are not completely satisfied and return the first lesson in good condition within 5 days, you will receive a full refund.

PROFESSIONAL RETOUCHING by MARSHALL PHOTOGRAPHERS, Inc.
162 N. State St., Chicago 1, Ill. School Division, Dept. PM-1

- I enclose \$17.50. Send course prepaid.
- Send course C.O.D. I'll pay postage.
- Send information and easy payment plan.

NAME _____
ADDRESS _____
CITY _____ ZONE _____ STATE _____

(ALL TRANSACTIONS BY MAIL ONLY!)

POPULAR MECHANICS

NOW... you can learn



WATCH REPAIRING

IN YOUR SPARE TIME AT HOME
from the LARGEST APPROVED SCHOOL OF ITS KIND

HOME TRAINING WITH TOOLS

**Quickly Prepares You For
BIG PAY EARNINGS
In An Uncrowded Field**

Today's high living costs demand high earning power. Here then, is your opportunity to increase your earning power and insure your future — by learning the fascinating art of watch repairing in your spare time at home. No loss from your present work! No mechanical experience needed!

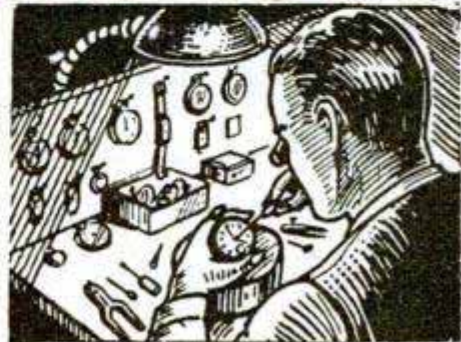

*No Previous
Mechanical Experience
Necessary!*



● ACTUAL WATCH REPAIRING WITH EACH LESSON

Our spare time Home Training thoroughly instructs you in all the rudiments of Watch Repairing. Enables you to master the complete 10-lesson course quickly, easily with a Diploma issued upon your graduation. We furnish all necessary tools and teach you actual watch repairing with the use of these tools. You learn how to take any watch apart and put it together in fine working order—to make part replacements—to clean and expertly repair any watch. Ours is a proven course. It has taught and is teaching both men and women expert watch repairing. It can do the same for you.

● WATCH MAKERS WANTED

An enormous need exists for trained Watch Makers everywhere and this need is increasing daily with increased watch production. Watch repairing is a big pay profession that is steady the year around. No dull seasons. Work for others or start your own shop.

FREE WATCH and WORKING TOOLS
included as part of your course

● Get All the Facts—Then Judge

Just clip and mail coupon — now — for free information that gives you all the startling facts about our truly amazing Spare Time Home Training Course — and our easy payment plan.
EARN WHILE YOU LEARN SPARE TIME PLAN HELPS YOU TO PAY FOR YOUR COURSE!

ILLINOIS SCHOOL OF WATCH REPAIRING
2870 ELSTON AVENUE
CHICAGO 18, ILLINOIS

ILLINOIS SCHOOL OF WATCH REPAIRING
2870-V ELSTON AVE., CHICAGO 18, ILL.

Kindly send me FREE LITERATURE on your Spare Time Home Training Course in WATCH REPAIRING. I understand no salesman will call on me.

Name _____

Address _____

City _____ Zone _____ State _____

Right Before Your Eyes
in this Magazine

PROOF

of the vast OPPORTUNITIES
in

Mechanical Engineering

& Industrial Design

From cover to cover in this magazine you see a multitude of mechanical and scientific achievements . . . new ideas, new products, improved products. Here is the work of men trained in Mechanical Engineering and Industrial Design. Their knowledge, their talents are needed more than ever before. The products of their hands and minds are demanded in ever-mounting numbers by industry, business, and the public. Here is a world of opportunity for you to make your imagination, your mechanical aptitude, bring you rich rewards.

Train at Northrop

. . . birthplace of outstanding design and aircraft achievements. The Institute course in Mechanical Engineering and Industrial Design requires only 2 years study. For complete details, send coupon.

APPROVED FOR VETERANS

NORTHROP

Technical and Aeronautical
INSTITUTE

Division of Northrop Aircraft, Inc.
127 East Broadway
Hawthorne, Los Angeles County
California

Please send me the Institute catalog and complete information, including starting dates of classes. I am interested in

- Mechanical Engineering Aeronautical Engineering
 Aircraft and Aircraft Engine Mechanics (A&E)

Name _____

Address _____

Age _____

City _____

Zone _____

State _____

Check one: Veteran

In Service

Civilian

M-1

MAKE BIG MONEY IN FEW DOLLARS STARTS YOUR OWN PROFITABLE BUSINESS!

LIQUID SYNTHETIC MARBLE

Here are 3 amazing, new opportunities to get into your own highly-profitable, dignified business—without previous experience—regardless of your age or sex. 1. **LIQUID SYNTHETIC MARBLE**—Easy to make and install beautiful synthetic Marble Slabs—pouring from liquid state. Big Demand for kitchen and bathroom walls, etc. 2. **FIBRE-TITE FLOORING**—Easy to make and install—in any color or color combination. Many years wear. Dustproof. Soundproof. Verminproof. 3. **FLEXIBLE MOLDS**—for Plaster Casting. \$1.00 in raw materials makes up to \$25 worth finished products. F. B., Iowa, writes: "Am on job that will net me \$150 for 4 days work." Get FREE details. No obligation. Write today!

Write for
**FREE
DETAILS
NOW!**

COMPOSITION PRODUCTS CO.

5853 Delmar Blvd.

Dept. 11

St. Louis 12, Mo.

ELECTRICAL TRAINING

Intensive 32 weeks residence course in fundamentals of industrial electrical engineering, including radio, electronics. Prepares for technician, engineering aides. Approved for veteran training. 55th year. Catalog.

BLISS ELECTRICAL SCHOOL

7624 Takoma Ave., Wash. 12, D. C.



MOTION PICTURE

INSTRUCTION LEARN AT HOME

Professional instruction in Hollywood. Business, Free Lance, and Educational film technique. Personal supervision by authorities. For career or hobby, write today for FREE CATALOG.

MOTION PICTURE INSTITUTE • BIRMINGHAM 14, MICHIGAN
APPROVED FOR VETERANS UNDER G. I. BILL

MECHANICAL DRAFTSMEN!

TILT-HEX drafting template speeds, simplifies drawing Bolts and Nuts, ALL VIEWS, top, side and angles. 90 accurate cut-outs including ELLIPSES. Clear plastic 6"x7". Used by leading aircraft and auto engineers. At drawing material dealers or sent postpaid, only \$2.00.
TIMELY CO. BOX 206C COLUMBUS 9, OHIO



LIQUID MARBLE PLASTIC IVORY

Mold, Brush, Trowel, or Spray it! Mold Novelties, Statuary, Art Goods in Flexible Plastic Molds. 5c material makes \$1 seller. Make Marbleized floors, tile walls. Colorful, glossy, amazing! Easily learned; start in garage or basement. Particulars free.
RAPID MARBLEIZING SERVICE, Dept. 10-E, Edwardsville, Illinois

Learn RADIO TELEVISION ELECTRONICS

Train at home, in spare time, for a good pay job or start a business of your own without capital—under our proven 2-Way method that helps you get into this money-making field of radio quicker. You receive Lessons plus Home Shop Practice including 9 kits of radio parts to make hundreds of tests. Many students earn money in spare time while learning. Write for FREE book "Your Opportunities in Radio" to Hollywood Radio & Television Institute, (Established 1929), Dept. A-13, 810 W. 6th St., Los Angeles 14, Calif.

LOOK for Rupture Help

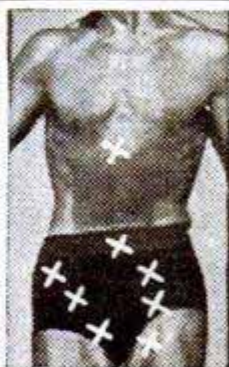

Try a Brooks Patented Air Cushion appliance. This marvelous invention for most forms of reducible rupture is GUARANTEED to bring YOU heavenly comfort and security—day and night—at work and at play—or it costs you NOTHING! Thousands happy. Light, neat-fitting. No hard pads or springs. For men, women, and children. Durable, cheap. Sent on trial to prove it: Not sold in stores. Beware of imitations. Write for Free Book on Rupture, no-risk trial order plan, and Proof of Results. Ready for you NOW!

Brooks Company, Dept. 161B, Marshall, Mich.

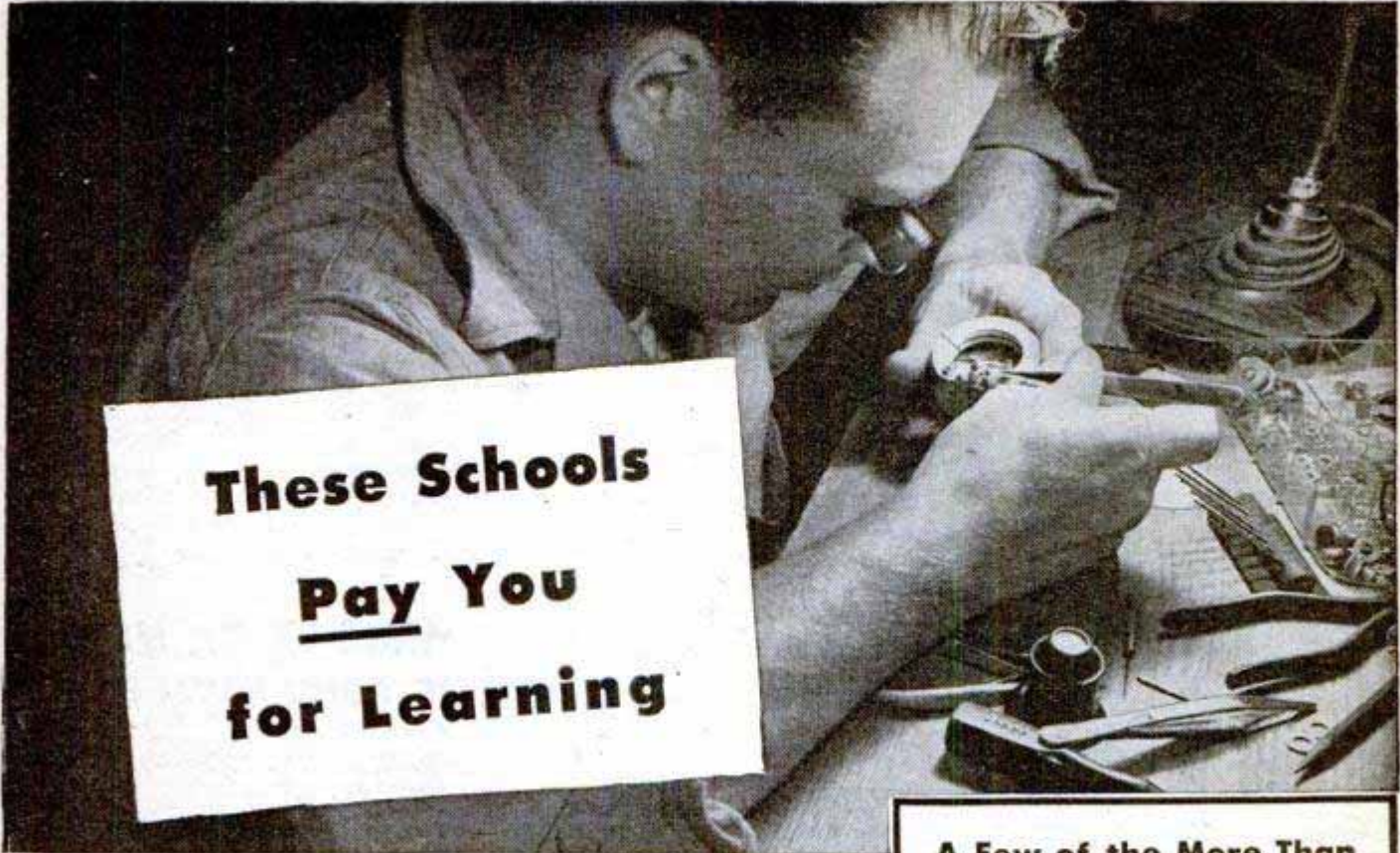

**These Schools
Pay You
for Learning**

HERE'S an amazing opportunity for high school graduates—a chance to learn any one of over 60 skills...and earn good pay while doing it!

This opportunity is open to young men 18 to 34 inclusive (17 with parents' consent) who enlist now in the United States Army Ground Forces for not less than 3 years. You must, of course, measure up to the Army's high mental, physical and moral standards.

Here's how it works. Go to your nearest U. S. Army and Air Force Recruiting Station. Look over complete list of courses. Choose one. The Recruiting Officer will help you fill out your application and will send it in for you. As soon as there is an opening in your specialty, you will be notified. **THEN—AND THEN ONLY—YOU ENLIST.** After a short period of basic training, you will be sent to technical school for the training of your choice.

High Army pay—the highest in the history of the Armed Forces—starts the minute you are accepted. Sound good? Then, get all the facts now about this new Army Career Plan at your nearest U. S. Army and U. S. Air Force Recruiting Station.

U. S. Army and U. S. Air Force Recruiting Service

**A Few of the More Than
60 Technical Courses Now
Available to High School
Graduates**

GENERAL ELECTRICITY
LIAISON AIRPLANE AND
ENGINE MAINTENANCE
LOCOMOTIVE REPAIR (DIESEL)
LOCOMOTIVE REPAIR (STEAM)
MAP REPRODUCTION
MARINE AND RAILROAD BOILER
FABRICATION
MEDICAL EQUIPMENT AND
MAINTENANCE
POWER GENERATORS
RADIO OPERATION AND REPAIR
REFRIGERATION EQUIPMENT,
INSTALLATION AND REPAIR
SHEET METAL WORK
SHIP CARPENTER
SHIP FITTING STENOGRAPHY
TELEPHONE AND TELEGRAPH
INSTALLATION AND REPAIR
WATCH REPAIR

CAREERS WITH A FUTURE

**U. S. Army and
U. S. Air Force**

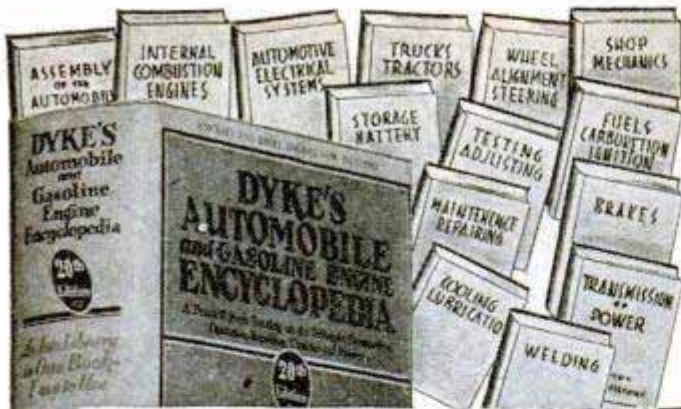

20th EDITION • Auto Library in ONE Book
Leader for 37 Years
WORLD'S GREATEST AUTO BOOK

New Material on Transmissions, Trucks, Tractors, Diesels, Aircraft and Auto Engines

Now, with millions of cars needing repairs and thousands of men needed to do the work, you need the famous DYKE Auto Book more than ever before. 20th Edition covers all principles, construction, repair, adjustments, testing, troubles and remedies. Over a half million copies of 20 editions of Dyke's have been sold. Gives specifications of old and many newer cars. World's biggest book value, \$7.00. This big book, a complete auto library in one volume, has 1483 pages—4600 illustrations and diagrams—weighs 6 lbs.—equal to all books shown above.

MAIL COUPON

Goodheart-Willcox Co., Dept. 11, 2009 S. Michigan Ave., Chicago
Send Dyke's Auto Book at once. C.O.D. \$7.00 Enclosed. Payment refunded in 5 days if not pleased.

Name _____

Address _____

City _____ State _____

Going Places ?

OR STUCK IN A RUT

If you're stuck in a rut, now's the time to pull out. Photographic training can give you a bright new future.

Our files hold hundreds of letters from N.Y.I. Home Study graduates who are now successful professional photographers. They are ambitious men and women who studied at home in their spare time while they held other jobs.

For 38 years, the New York Institute of Photography, oldest and most famous photographic school in the country, has trained men and women who wanted success enough to go after it. Our instructors supplement the beautifully-illustrated, easy-to-read, easy-to-understand lessons with helpful criticism and ideas for the improvement of your work.

No expensive equipment is necessary. Our pay-as-you-go plan is easy on your budget, and while you learn you can earn.

FREE! Plan your future! Send the coupon right now for our big book in color showing the important phases of photography.

NOTE: Resident training is available under the G.I. Bill.

NEW YORK INSTITUTE OF PHOTOGRAPHY
10 West 33 Street New York 1, N. Y.

LEADERSHIP SINCE 1910

New York Institute of Photography
Dept. 49, 10 West 33 Street
New York 1, New York

Please send me your beautiful four-color catalog illustrating all the different phases of photography and describing the N.Y.I. Home Study Course.



Name _____ (Please Print)

Address _____

City _____ Zone _____ State _____



This Easy Way TEACHES GUITAR
to Your Satisfaction in 30 Days Or Money Back



Astounding new Jim Major Home Method teaches you to play guitar easily, quickly, without long hours practicing scales or exercises. *No musical knowledge necessary.* Play many popular songs, hymns in very short time. 30 lessons, complete course for only \$1.69. EXTRA — BIG 53 SONG BOOK included without additional cost. Send no money . . . pay postman \$1.69 plus postage. (Cash with order we pay postage.) Money back guarantee. Send today to Jim Major, Room 49-A, 230 East Ohio, Chicago 11, Ill.



MAKE EXTRA MONEY BE YOUR OWN BOSS!

\$1.00 Value
25c
40,000 WORDS
IN TEXT
MONEY BACK GUARANTEE
NATIONAL PLANS COMPANY
P. O. Box 26X, Ansonia Station, N. Y. C. 23, N. Y.

In "CASH IN" you now get THE real money-makers—dozens of profitable tested mail order plans, confidential business secrets, dozens of practical tested formulas, successful tested schemes—actual experiences of men who have started on a shoestring—with less than \$10 capital.

25c a copy postpaid. Send U.S. stamps, money order, or coin.

AUDELS Carpenters and Builders Guides 4 vols. \$6



Inside Trade Information for Carpenters, Builders, Joiners, Building Mechanics and all Woodworkers. These Guides give you the short-cut instructions that you want—including new methods, ideas, solutions, plans, systems and money saving suggestions. An easy progressive course for the apprentice and student. A practical daily helper and Quick Reference for the master worker. Carpenters everywhere are using these Guides as a Helping Hand to Easier Work, Better Work and Better Pay. To get this assistance for yourself, simply fill in and mail the FREE COUPON below.

Inside Trade Information On:
How to use the steel square—How to file and set saws—How to build furniture—How to use a mitre box—How to use the chalk line—How to use rules and scales—How to make joints—Carpenters arithmetic—Solving mensuration problems—Estimating strength of timbers—How to set girders and sills—How to frame houses and roofs—How to estimate costs—How to build houses, barns, garages, bungalows, etc.—How to read and draw plans—Drawing up specifications—How to excavate—How to use settings 12, 13 and 17 on the steel square—How to build hoists and scaffolds—skylights—How to build stairs—How to put on interior trim—How to hang doors—How to lath—lay floors—How to paint



AUDEL, Publishers, 49 W. 23rd St., New York 10, N. Y.
Mail Audels Carpenters and Builders Guides, 4 vols., on 7 days free trial. If OK I will remit \$1 in 7 days and \$1 monthly until \$6 is paid. Otherwise I will return them. No obligation unless I am satisfied.

Name _____

Address _____

Occupation _____

Employed by _____

PM

New Plastic Discovery MAKES LEATHER and LEATHERETTE ITEMS - LIKE NEW!

Make Cloth Into An Imitation Leather

A new plastic discovery has recently been put on the market which is called Leather-New. This amazing plastic coats Leather, Leatherette and Cloths and gives them a new leather-like finish in just five seconds. Quickly and easily spread over any material with a brush or spray gun it dries quickly. One quart of Leather-New covers approximately 60 square feet. Even inexperienced hands can spread it on smoothly as it leaves no brush marks. Costs only a fraction of the cost of new leather goods. With this amazing discovery old leather and leatherette covered items can be made to look like new. Cloth covered Gliders, Deck Chairs, Porch Furniture, Tarpaulins and many other items can be given a water and weatherproof, coating—making them much more valuable than they were with ordinary cloth coverings.

Save Cost of
Re-Covering With
New Leather

GIVES LEATHER and LEATHERETTE NEW FINISH and COLOR

Does Not Crack, Peel or Scuff

The color of leather and leatherette items can be quickly changed by coating them with this new plastic discovery. Leather-New does not crack, peel or scuff in coldest weather. Does not get sticky in hottest weather. Get a FREE sample of Leather-New covered material—see for yourself just what this amazing plastic does—simply fill out coupon and mail it on a 1c postcard today.

Alcohol, Simple Acids or Caustics Do Not Harm This Finish

A Leather-New coated job is easily cleaned and will stand repeated washings with strongest soaps—soot, dust or dirt wash away like magic with a damp cloth. Simple Acids, Alcohol or Caustics do not stain its finish. It will remain clean and new looking as long as real leather. Leather-New will save many dollars on leather goods that otherwise would have to be thrown away. Act quick—mail 1c postcard today for FREE sample of Leather-New coated material.

**JUST SPREAD IT ON WITH A PAINT BRUSH
—LEAVES NO BRUSH MARKS**

Get Into This MONEY-MAKING BUSINESS

I'll Show You How to "Cash In" On Big Jobs Such as Coating The
Leather Furniture Of Bars — Grills — Restaurants

\$5000 to \$50000 Possible on a Single Job

This business offers tremendous profits to men who can see its possibilities. Let me give you an exclusive territory in which to handle Leather-New Sales and Service — Let me help you build your own profitable business in your exclusive territory. You do not risk one penny — simply send me your name and address on a 1c postcard — I'll do the rest.

Jack Edwards, Sales Mgr.

LEATHER-NEW PRODUCTS

701 LAND BANK BLDG., Dept. J11, KANSAS CITY 6, MO.



Leather
Covered
Furniture



Luggage and
Handbags

Hassocks



Cafe-Bar
Restaurant
and Kitchen
Furniture

Auto Seat Covers
Golf Bags - Shoes
Any Leather or
Leatherette Item

**FREE
SAMPLE**

Of Leather - New
Coated Material

NOT A
PAINT
BUT PLASTIC

SAVE
MONEY

JUST MAIL COUPON

LEATHER-NEW PRODUCTS

701 Land Bank Bldg., Dept. J11, Kansas City 6, Mo.

Mr. Edwards, rush me FREE sample and complete details about Leather-New. I understand this does not obligate me in any way.

Name _____

Address _____

City _____

State _____

(Fill out—Tear out—Paste on 1c Postcard—
Mail Today)

NOW! All 5 Famous JOWETT COURSES—1 COMPLETE MUSCLE BUILDING VOLUME!
 FOR ONLY **25¢** AND MY PHOTO BOOK **FREE!**

Let Me Prove I Can Make **YOU a HUSKY HE-MAN!**

Let me give YOU a big powerful build like these champs. Yes! They came to me WEAKER THAN YOU probably are now!

GIVE ME 10 PLEASANT MINUTES A DAY and see the RESULTS for YOURSELF!" says George F. Jowett—World's Greatest Builder of HE-MEN.

I'LL GIVE YOU A PAIR OF CHAIN-BREAKING ARMS LIKE THESE!

1. How You Can Build a Mighty Arm—Complete Course



The strongest-armed man in the world, George F. Jowett, planned this course for you. His great experience stands as proof that YOU, TOO, can get the arms men respect and women admire. —A. PASSAMONT. First prize for physical perfection.

PROUD OF HIS ROCK-LIKE BACK, HE SAYS "JOWETT WORKED WONDERS FOR ME!"

3. How You Can Build a Mighty Back—Complete Course

Chas. Schaffer says, "You are head and shoulders above the rest in your profession." Let me help YOU, TOO, build a back of power. Square shoulders with enviable military spread. A spine as strong as a steel shaft. —CHAS. SCHAFER. An amazing Jowett product. Once a puny weakling. Now versatile athlete.



YOU, TOO, CAN HAVE THE BIG HEROIC CHEST OF THIS JOWETT PUPIL!

2. How You Can Build a Mighty Chest—Complete Course

A powerhouse of energy, Ferris writes, "I want to add my sincere gratitude to that of thousands of pupils for wonderful results from your course. Your course is by far the best." If you have a narrow, sunken chest I can improve it so that you will be proud to show it off.—REX FERRIS, Champion of South Africa, says, "I owe everything to Jowett methods."



I'LL GIVE YOU, TOO, A BONE-CRUSHING GRIP!

4. How You Can Build a Mighty Grip—Complete Course

YOU, TOO, can have a Manly Grip like this Jowett pupil. What would you give for a forearm like that? Fingers strong as steel pincers. A hand like an iron vise. I have proved to thousands this is no mere dream. Let me mold a grip of might. A hand-shake that will win friends—success.—W. BURNS. A Jowett-made Olympic Strength Champion.



"LET ME SHOW YOU HOW I INCREASED MY THIGHS 8" AND CALVES 5!" SAYS JOWETT!

5. How You Can Build Mighty Legs—Complete Course

What would you give to have the all-around ho-man strength of Bob Mitchell? I'll help you build legs that are real props of leaping, tireless power! —BOB MITCHELL, A Jowett Champion—not in words but by ACTUAL RECORDS.

10-DAY TRIAL!

If you're not delighted with this famous muscle-building guide—if you don't actually FEEL results within 10 days, send it back for refund.

PHOTO BOOK OF FAMOUS STRONG MEN!

FREE!



George F. Jowett
 Champion of Champions

Photos that inspire you to might and muscle. Free with order.

2 FREE GIFTS!

Jowett Institute of Physical Culture Dept. PM-81
 230 Fifth Avenue, New York 1, N. Y.

George F. Jowett:—Please send by return mail, prepaid, FREE Jowett's Photo Book of Strong Men, along with all 5 Muscle Building Courses: 1. Molding a Mighty Chest, 2. Molding a Mighty Arm, 3. Molding a Mighty Grip, 4. Molding a Mighty Back, 5. Molding Mighty Legs—Now all in One Volume "How to Become a Muscular He-Man." Enclosed find 25c. NO C.O.D.'S.

NAME _____ AGE _____
 (Please Print Plainly, Include Zone Number)

ADDRESS _____

Famous BAILEY DIESEL SCHOOLS
 Now Accepting
CIVILIAN STUDENTS!

Bailey has a national reputation for "finest training methods." Bailey teaches you fundamentals, plus the practical application of theory in plenty of actual shop work. Bailey is approved by industry. Bailey graduates get the jobs!

Civilian men and boys over 17 who are ambitious to get ahead will act now. Send for FREE catalog. No salesman will call.

BAILEY TECHNICAL SCHOOLS

1653 So. Grand Blvd., St. Louis, Mo.

ONE-MAN SAWMILL LESS THAN \$200.00
 Easy To Turn Trees Into Money

Makes lumber, ties, shingles, crates, lath, studding, siding,



Belsaw Models

in 10 to 24 foot sawing lengths. MECHANICAL FEED, accurate set works and positive dogs. Use tractor or old auto engine for low cost power. Thousands used for commercial sawing. Pays for itself quickly. Send post card today for FREE booklet, "How To Make Lumber" and Catalog of Woodworking Equipment. BELSAW MACHINERY CO., 28117 Field Bldg. 315 Westport Road Kansas City 2, Mo.

Say You Saw It in
POPULAR MECHANICS

YOU CAN KEEP FROM WASTING YOUR LIFE!

Now we can give you the benefit of scientific methods which will show you the career that fits your abilities, brings you the greatest monetary rewards and also the greatest happiness in life. We can help you discover your true talents, get out of a "blind alley" job, and on the right road to success, doing the things you like to do. Eugene J. Bengt, originator of the Personal Progress Course, and internationally recognized industrial human relations engineer, has done this work for scores of outstanding corporations in the United States for the past 20 years—helping them select the right men for good jobs. Now we can show you how to be the type of man they select. Test your aptitudes, your personality, your interests. We will help you find yourself—stop drifting—SUCCEED! Ask us to prove it to you! Send for Free booklet "HOW TO KEEP FROM THROWING YOUR LIFE AWAY" MAIL COUPON TODAY to Personal Progress Institute, Dept. P-148, 20 N. Wacker Drive, Chicago 6, Ill.

MORE MONEY • BETTER HEALTH • HAPPINESS

I CAN HELP YOU GET



PERSONAL PROGRESS INSTITUTE
 20 N. Wacker Drive, Chicago 6, Ill. Dept. P-148

Send me, absolutely free, your booklet "HOW TO KEEP FROM THROWING YOUR LIFE AWAY"
 Show me how you can help ME succeed!

NAME _____

ADDRESS _____

CITY _____ STATE _____

FREE

THESE 5 TRADES ASSURE YOU

HIGH PAY • Future Security

- **PLUMBING** Every phase of plumbing: Pipe-Cutting and Threading, Lead-Wiping, Rough-in Projects on Installations, Completed Installations of entire plumbing systems, Blueprint reading, Estimating.
- **DRAFTING** College-level courses in General Machine and Architectural Drafting, with fundamentals in Drafting Mathematics—all under graduate engineers.
- **SHOE REPAIRING** From simplest repairs on boots and shoes to the finest details of reconditioning and rebuilding, under expert craftsmen.
- **ELECTRICAL** Technical and shop training include Basic Electricity, Residential Wiring, Industrial Wiring, General Testing and Trouble Shooting, and Appliance Repair.
- **AUTOMOTIVE & TRACTOR** Applied training on latest model automobiles and tractors, including engine overhaul, transmission and differentials, carburetion, generator and ignition systems, engine tune up, Hydramatic and Vacumatic Transmissions, and general service.

"There's Always a Demand for the Man who KNOWS!"

CHOOSE ONE OF THESE 5 LEADING TRADES

Get Out of that Rut... Be a Skilled Tradesman! Have a Lifetime Career... Own Your Own Business and Be Secure in Your Old Age.

NOW while Enrollment is still open, send for FREE information.

THE 5 DIVISIONS OF

NATIONAL TRADE SCHOOL

2610 Grand Ave., Kansas City 8, Mo.

- Plumbing
- Drafting
- Shoe Repairing
- Electrical
- Automotive & Tractor

NAME _____

ADDRESS _____

CITY _____ STATE _____

VETERAN _____ OCCUPATION _____

Choose One of these 5 Essential Trades

Our complete courses of thorough training prepare you to go right into the field as a Qualified Tradesman at High Pay in only 34 weeks (39 in Shoe Repair). All courses under especially trained instructors with practical experience. 6 Hour Classes 5 Days a Week. Our Employment Department helps you.

VETERANS "Approved for veterans' training by the State Department of Education under Public Law 346."
"Approved for veterans' training by the Veterans' Administration under Law 16."

Send Coupon for Free Information Now

REAL RELIEF FOR RUPTURE



Thousands of wearers tell of real relief. Scientifically shaped, made of strong washable materials, gives the RIGHT support WHERE NEEDED. Satisfaction GUARANTEED. Write for FREE literature NOW.

The WEB Truss Co. Dept. P-8. Hagerstown, Md.



FIELD JACKETS

A Super-value, fine poplin Army FIELD JACKET can be yours for only \$2.88. Quality features: full zipper-front, 100% blanket-lined, water repellent, adjustable hip straps. Ideal for Farmers, Lumbermen, Truck Drivers, Sportsmen. Although used, every jacket guaranteed perfect condition. Sizes 34 to 40. State size and send check or M.O. Supply limited. Hurry.

(War Surplus) ONLY \$2.88 Postpaid

MARKO SURPLUS CO., Dept. A1-J, 2924 Logan Blvd., Chicago 47, Ill.

LEARN MEAT CUTTING EASILY - QUICKLY At Home - In Spare Time



The steady, dependable trade of Meat Cutting taught easily, quickly by improved HOME METHOD. National School, established over 25 years, has organized its famous "Learn By Doing" Classroom, Cutting room and Retail Market training system into sound, practical HOME STUDY form.

Now, by the miracle of this EXTENSION TRAINING you can prepare in Your Spare Time At Home, for a better job, bigger responsibilities or success and security in a store of your own. Remember, PEOPLE MUST EAT!

Buying, cutting, percentage, pricing, advertising, selling—a complete meat education. For beginner or men with ex-

perience. Thousands of successful graduates. Send coupon for FREE Bulletin NOW!

MAIL THIS COUPON TODAY FOR FREE BULLETIN

National School of Meat Cutting Div. U-89, Toledo 4, Ohio

Send me your FREE Bulletin on Meat Cutting and Meat Merchandising. No obligation. No Salesman will call.

Name _____

Street _____

City _____ State _____

**Bigger Opportunities
Than Ever in . . .**



**AUTO
BODY
AND
FENDER
REPAIR**

●THE FIELD IS STILL GROWING after more than 40 years . . . expanding with the giant auto industry! Millions of new cars are getting to market, millions of old ones are still on the road—THE NEED for MAN-POWER in the service field is INCREASING!

**TRAIN NOW . . . FOR THE
OPPORTUNITIES AHEAD!**

Don't be stuck in a low-pay job! Opportunity here is big enough for thousands to find big-pay work either in a reliable job or in their own shops. UEI teaches Auto Body & Fender Repairing the *easy* way. No special education or experience needed . . . you can start in your spare time, right at home . . . keep your job while you learn. Then, when home study is finished, you continue at the well-equipped UEI shops getting practical experience. Fix and refinish damage; replace panels and tops. Learn up-to-date methods in use of tools, spray painting, welding, metal work—all under expert supervision.

GET THE FACTS . . . FREE!

UEI HAS TRAINED THOUSANDS for opportunity fields, and students are making good. If you want to get ahead, send coupon today for free facts on AUTO BODY AND FENDER REPAIRING. Don't delay!

**AUTOCRAFTS DIVISION
UTILITIES ENGINEERING
INSTITUTE**

2523 Sheffield Ave. Dept. 118-X
Chicago 14, Illinois

Approved for
training under
G. I. Bill

Founded
1927



FILL OUT AND MAIL . . . TODAY!

Autocrafts Division
Utilities Engineering Institute, Dept. 118-X
2523 Sheffield Ave., Chicago 14, Ill.

Yes, I'm interested! Send me those Free Facts about Auto Body and Fender Repairing.

NAME _____ Age _____

ADDRESS _____

CITY _____ Zone or
County _____ STATE _____

If veteran of World War II check here
 Check here for Special Information if under 17.

TODAY'S BIG PAY FIELD . . .

**INVESTIGATION
& CRIME DETECTION!**

Now you can earn important money, by learning Crime Detection by methods similar to those taught to, and used by famous G-Men. There's never a dull moment in this uncrowded field, the work is always interesting, and operatives taught by the AMERICAN method always command the best jobs, and get the highest pay.

Trained men always get the best jobs, and the most money. When you enroll with the A.I.C. you get your training from men who have been on the firing line, men who have worked in the F.B.I.—men with extensive experience in government intelligence work—Men who know from actual experience what it is all about. You learn at home. There's no need to give up your present job—you learn while earning.

Thousands of jobs are open for men thoroughly trained in Crime Detection. Jobs in stores, in industry, and in municipal and Federal departments are waiting for capable men—and these jobs all pay well too! Or you can start your own, well paying business!

If you are interested in this BIG PAY FIELD, write today. There is no obligation.

AMERICAN INSTITUTE OF CRIMINOLOGY

30 North LaSalle Street

Chicago, Illinois

Sponsored by Chicago Law School—Founded 1896

Learn
**EASY!
QUICK!** **SPRAY PAINTING**
MAKE MONEY
Doing Work You Will Like



**MAIL COUPON FOR QUICK DELIVERY!
MONEY BACK IF NOT SATISFIED!**

Get this new spray painting book to help you on the job. Use it also for better and time-saving paint work around the home. Thoroughly practical—covers every phase of spray painting technique—industrial, commercial, auto, studio and sign work, interior decorating and exterior painting. Tells what paint or other finish to use, how to mix colors, how to use all types of equipment, how to make new flock and suede finishes. If you do any kind of painting you need this book. 125 pages, cloth binding, illustrated. Only \$1.25 postpaid. Check No. 1 on coupon below. Order now under money back guarantee.

to make new flock and suede finishes. If you do any kind of painting you need this book. 125 pages, cloth binding, illustrated. Only \$1.25 postpaid. Check No. 1 on coupon below. Order now under money back guarantee.

ALSO NOTE THESE OTHER VALUABLE DRAKE BOOKS

- No. 2. House Painting Methods—with Brush and Spray gun. 400 pages, over 150 illus. and color chart. Only \$2.50.
- No. 3. Wood Finishing. Plain and Decorative. 360 pages, only \$2.50.
- No. 4. Cyclopedia of Painting and Decorating. 350 pages, 288 illus. Only \$3.50.

Mail Coupon

Fred'k. J. Drake & Co., Dept. 11
500 W. Van Buren St., Chicago 7, Ill.

Please send me the books checked below. If not satisfied I will return them in 5 days and money will be refunded.

1 2 3 4 (Circle numbers wanted)

Check or money order enclosed \$_____ Send books postpaid.

Send C.O.D. plus postage.

Name _____

Address _____

City _____ State _____

Drake Books Are Sold By Leading Booksellers

JOB NEWS

SHORTAGE OF ELECTRICAL WORKERS NATION-WIDE

GET QUICK TRAINING IN

ELECTRICITY

VETERANS

Learn this great trade and get monthly subsistence on G. I. Bill at no cost to you.

In
NATION'S
LARGEST
EXCLUSIVE
ELECTRICAL
SCHOOL



"LEARN-BY-SEEING" MOVIES + "LEARN-BY-DOING" METHODS

There's a place for YOU in a high-pay job or your own business. All-around M.T.I. shop experience gets you ready quickly. Learn HOUSEWIRING, A. C., D. C. MOTORS, ARMATURE WINDING, POWER PLANT WORK, ETC. Not a "Home Study" course. Friendly, skilled licensed instructors. New classes start every few weeks. Part-time work available. Living arrangements made.

MAIL TODAY: FOR QUICK ACTION

MICHIGAN TECHNICAL INSTITUTE, Dept. PM-1,
2281 W. Fort St., Detroit 16, Michigan

- Send me catalog and complete information.
 I am a GI. Send special information.
 Married Single.

NAME _____

ADDRESS _____

CITY _____ ZONE _____ STATE _____

MICHIGAN TECHNICAL INSTITUTE

Department PM-1, 2281 West Fort Street, Detroit 16, Michigan

TO THOSE WHO THINK LEARNING MUSIC IS HARD

Just strike these notes and you're playing the beginning of the 'Merry Widow' Waltz

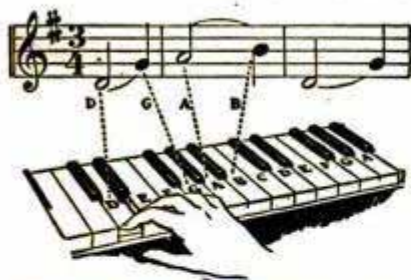

Look at the diagram. The first note of the music is "D." Following the dotted line to the keyboard you'll find "D" is the white key between the two black keys near the middle of the keyboard. Now read below how you can learn to play any instrument quickly and easily.



EASY AS A-B-C—COSTS JUST A FEW CENTS A DAY!

• Perhaps you think learning music is a tedious grind. It isn't any longer! Long hours of practicing scales and monotonous exercise are over.

You have no excuse for not getting started toward musical good times now! For through an easy method you can now learn to play right at home—without a teacher—for a few cents a day.

Learn to Play by Playing

The lessons come to you by mail from the famous U. S. School of Music . . . complete instructions, clear diagrams, and all the music you need. You learn to play by playing real tunes by note. First you are told how to do a thing. Then a picture shows you how. Then you do it yourself and hear it. Remember, don't confuse our method with any system claiming to teach music "by ear" or by trick methods. We teach you to play only from real notes!

SUCCESS!

Here's what one of our thousands of pupils writes: "I learned more from your course than many of my friends who studied under private teachers have for years. The fact that I've already taken 2 courses and am now enrolling for a third should speak for itself." F. A. S., Indiana.

Don't delay. Send now for our illustrated Free Booklet and "Print and Picture" Sample which fully explain this remarkable method. So decide which instrument you want to play and mail the coupon today. U. S. School of Music, 71 Brunswick Bldg., New York 10, N. Y. (Successful 50th Year)

FREE PRINT AND PICTURE SAMPLE

U. S. School of Music, 71 Brunswick Bldg., New York 10, N. Y. Please send me Free Booklet and Print and Picture Sample. I would like to play instrument checked below.

- | | | |
|--|--|--|
| <input type="checkbox"/> Piano | <input type="checkbox"/> Saxophone | <input type="checkbox"/> Modern Elementary |
| <input type="checkbox"/> Guitar | <input type="checkbox"/> Trumpet, Cornet | <input type="checkbox"/> Harmony |
| <input type="checkbox"/> Hawaiian Guitar | <input type="checkbox"/> Reed Organ | <input type="checkbox"/> Mandolin |
| <input type="checkbox"/> Violin | <input type="checkbox"/> Tenor Banjo | <input type="checkbox"/> Practical Finger |
| <input type="checkbox"/> Piano Accordion | <input type="checkbox"/> Clarinet | <input type="checkbox"/> Control |

Name _____ Have You Instrument? _____

Address _____

City _____ State _____

Save 2c—Stick Coupon on Penny Postcard

Be a NEON Expert



I'll Show YOU How to
Make \$100 a Week
and UP in **NEON**

C. C. Blakely, Executive Director
Acme Neon Institute

★ Today's wide open field for ambitious men who want to make \$100, \$150 and more per week is the colorful, exciting business of Neon. I'll train you for a highly paid place in America's most fascinating industry. At Acme you become a Master Neon Technician. Learn Neon Tube Bending, Color Gassing, Neon Glass Blowing, Cold Cathode Lighting, Bombarding, other important skills.

COAST-TO-COAST OPPORTUNITIES

Demand for Acme Trained Men is greater than we can supply. We're getting calls from coast-to-coast. Today beginners have a once-in-a-lifetime chance to master an art and learn a profession that will pay big dividends for life. Our practical, intensive 500 hour course prepares you for thousands of BIG MONEY opportunities. Get a fine job, or go into business. Other Acme Trained Men are succeeding. So can you. Room Assistance for out-of-town students.

ACME NEON INSTITUTE
1648 W. Van Buren St. Chicago, Ill.
APPROVED UNDER G.I. BILL

FREE FACTS

Acme Neon Institute
Dept. A-3, 1648 West Van Buren Street
Chicago 12, Illinois

Send me the FREE FOLDER, "Your Big Opportunity" plus facts about training me for a highly paid job in Neon.

Name _____

Street _____

City _____

SAY YOU SAW IT IN POPULAR MECHANICS

Learn MASONRY CARPENTRY

In a few short weeks you can be making big money in the building trades. Learn now while opportunities are greatest. Prepare for the future. You receive your training in our completely equipped shops under expert instructors. Fully approved for G.I. Training.

Dept. A-11 **MIDWEST SCHOOL OF BUILDING TRADES**
411 N. Center Street Bloomington, Ill.

Play a Saw

Quickly produce saw music of amazing, voice-like beauty. Without knowing one note from another, without using music, soon play such songs as "Long, Long Trail," "Till We Meet Again," and other favorites old and new. No notes to read, no dreary practice—success guaranteed.



Since 1921, thousands of our students have amazed themselves and friends... many have starred in shows and broadcasting orchestras. This is your opportunity to gain quick popularity, and to make money entertaining at parties, dances, lodges, clubs, church entertainments, everywhere.

You Play or NO PAY!

5 DAYS TRIAL

If you can sing, whistle or hum a tune then you can play the Musical Saw. To prove how quickly and easily you can learn, we allow you FIVE DAYS TRIAL. Play at the next party! Write TODAY for details to...

MUSSEHL & WESTPHAL
Musical Saws to the Profession since 1921
11 Fort Street
Fort Atkinson, Wis.

LEARN WATCH & CLOCK REPAIRING At Home



STEADY WORK • SECURITY • HIGH PAY

Prepare yourself now for this fascinating high-grade occupation. You can earn while you learn. This UP-TO-DATE COURSE IN HOROLOGY shows you how to get the practical working experience you need for big-time success. THOROUGH SELF-INSTRUCTION TRAINING in American and Swiss watches, clocks, etc. Interesting **LEARN-BY-DOING** teaching method makes lessons easy. No previous experience necessary. Watchmaking is BASIC TRAINING for many scientific and mechanical precision jobs. Full price only \$4.95, complete. Satisfaction or money-back guarantee. Get into this fast-growing field NOW... big opportunities. Order C.O.D. plus postage—or send \$4.95 for postpaid shipment.

LOCKSMITHING & Key Making

Practical modern course for self-instruction. How to work on locks, de-code, make masterkeys, repair, install, service, etc., etc. For carpenter, fix-it shop, service station operator, hardware dealer, gunsmith, mechanic, home-owner, 53 easy illustrated lessons. Full price only \$3.95 postpaid—or C.O.D. Plus postage. Satisfaction or money back!

SEND NO MONEY Mail this Now

NELSON-HALL CO., Dept. A-02, 1139 S. Wabash Ave., Chicago 5, Ill.
On your money-back guarantee please send me the following courses:

- Watch & Clock Repairing, only \$4.95
 - Locksmithing & Key Making, only \$3.95
- I enclose \$_____ in full payment. Ship postpaid.
 Send COD for \$_____ plus small postage fees.

Name _____
Address _____

5¢ EACH LITTLE BLUE BOOKS

Send postcard for our FREE CATALOGUE. Thousands of bargains. Address: **HALDEMAN-JULIUS CO.** Catalogue Dept., Desk M-2442, GIRARD, KANSAS

LEARN WATCH and CLOCK REPAIRING

Start training now for a better paying job or your own profitable business. Qualified Watch Makers are in demand... Unlimited opportunities. Intensive practical training by experienced watch makers. Veteran operated. Write for full details. Specify if veteran.

SCIENTIFIC SCHOOL OF WATCH MAKING, Dept. PM-1
3923 San Fernando Road Glendale 4, Calif.

NEW YORK SCHOOL OF MECHANICAL DENTISTRY

America's OLDEST school of Dental Technology. State licensed. Approved for G I Vets. Immediate enrollment. Day and eve. Ask for free Bulletin "P."
138 Washington St., Newark 2, N. J.

Be an Investigator!

Our course in scientific crime detection may be studied in the quiet of your own home. Investigation training course written and supervised by former U. S. Government Investigator. Write today for full particulars and free booklet. No obligation whatever.

PACIFIC SCHOOLS, INC.
601 S. VERMONT AVE., DEPT. M-2 LOS ANGELES 5, CALIFORNIA

RELEASE the Full Power of YOUR MIND

Send for free booklet telling how you can achieve success and reach your personal goals. Find out how to remove frustrations, inferior feelings and worry thru **PSYCHO-MENTALISM**. Learn how to make your subconscious mind work for, not against, you. Write today. No obligation. **PSYCHO-MENTALIST INSTITUTE**, Administration Building, Dept. 18A, Covina, California

\$200 GROSS IN MY FIRST WEEK!



Some Make More, Some Less . . . Start This Business for YOUR OWN

Would YOU like to own a permanent, year-round business in which it is possible to take in as much as \$200 gross the first week, as did L. A. Eagles? R. E. Traynor says, "I made \$62 gross in one day." R. R. Newlin reports, "I have averaged \$173 gross per week." Others report gross from \$100 per week to \$12,000 per year.

Surely YOU will want to investigate a golden opportunity like that. You need not have any special skill or experience, but if you are ambitious, honest and courteous, we will help you to start and succeed in YOUR OWN money-making business where net profits are high.

No Shop Necessary

Our Electric Rug Washer cleans rugs and carpets like new right on the customer's floor. This quick, thorough and highly efficient method removes dirt and grime, thus restoring the natural, fresh beauty of floor coverings. Anyone can run it. Rugs and carpets are not harmed.

There are hundreds of possible customers in YOUR vicinity. Most of them have several rugs needing regular cleaning. To get a quick start,

FREE BOOK! MAIL COUPON

VON SCHRADER MFG. CO.
A181, Racine, Wis.

Send at once (no obligation) your FREE booklet containing information about your Electric Rug Washer and how I can own my own permanent, profitable business.

Name _____
Address _____
City _____ (Zone) _____ State _____

shampoo a few rugs or carpets. These customers tell their friends and soon you should have an independent, prosperous business, and you should be able to keep it growing. Send the coupon RIGHT NOW for booklet that explains everything.

Every Machine Guaranteed and Easy to Own

You take no risk. These wonderful, fully guaranteed machines have been used and endorsed by largest hotels, railroads—also used by U. S. Government. Many individuals have built up successful businesses that made big profits. Mail the coupon TODAY and we will send complete information, including how to start and succeed in YOUR business without a large investment. Don't delay your BIG opportunity. Send the coupon AT ONCE.



MAIL COUPON TO

VON SCHRADER MFG. CO., A181, RACINE, WIS.

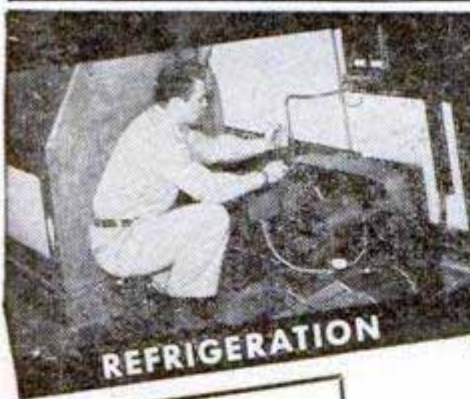

REFRIGERATION



ELECTRONICS



WELDING

SPECIALIZE In 6 Months to 3 Years COURSES

SERVICE

6 to 12 Months

- Electricity
- Welding
- Refrigeration
- Heating

TECHNICIAN

1 to 2 Years

- Electricity
- Radio
- Electronics
- Refrigeration, Heat-
ing, and Air
Conditioning

PROFESSIONAL

3 Years

- Electrical Engineering
Bachelor of Science
Degree
Major in Machinery or
Electronics

PRACTICAL TECHNICAL TRAINING

Train for a substantial career in industry . . . or a business of your own. Our time-tested Concentric System enables you to build your career step by step. Each 6-month course is complete in itself, yet prepares you for advanced courses. Stay as long as circumstances permit, until you reach the top step in your technical training. More than 1,538 students now enrolled from 48 states and 13 overseas countries. Faculty of 72 specialists. World-wide alumni counselor committee. Terms start January, April, July. SEND COUPON TODAY!

MILWAUKEE SCHOOL OF ENGINEERING A Technical Institute

Milwaukee School of Engineering
Dept. PM-148, N. Broadway and E. State, Milwaukee, Wis.
Without obligation send me free booklet "Career Building" and more details on course in _____
Name _____ Age _____
Address _____
City _____ State _____

WAR SURPLUS OPTICAL BARGAINS

ASSEMBLE YOUR OWN BINOCULARS!

Complete Optics! Complete Metal Parts!
Save More Than 1/2 Regular Cost



GOVERNMENT'S 7X 50 BINOCULARS

Complete Optics, new and ready for assembly. We supply full instructions. Limit—1 Set of Metal Parts and 1 Set of Optics to a customer.

METAL PARTS—Set includes all Metal Parts—completely finished—for assembly of 7X 50 Binoculars. No machining required. Bodies have been factory hinged and covered. A sturdy Binocular Carrying Case is optional with each set of Metal Parts.

Stock #842-H.....\$39.40 Postpaid, plus \$4.80 for Case—Total \$44.20

OPTICS—Set includes all Lenses and Prisms you need for assembling 7X 50 Binoculars. These are in excellent condition—perfect or near-perfect—and have new low reflection coating.

Stock #5102-H.....\$25.00 Postpaid
NOTICE! If you buy both Binocular Optics and Binocular Metal Parts, add 20% Federal Excise Tax to above prices.

ARMY'S 6X 30 BINOCULARS

No Carrying Case with any Sets shown below. M-13A1 sets are waterproof model. M-3 sets are not waterproof.

COMPLETE OPTICS & METAL PARTS—Model M-13A1, 6X 30 Binoculars. Everything you need—ready for assembly. When finished will look like a regular factory job costing \$102 to \$120. The Optics are new, in perfect or near-perfect condition. Have new low reflection coating. Metal Parts are new and perfect, all completely finished. No machining required. Bodies factory hinged and covered. Complete assembly instructions included.

Stock #830-H.....\$40.00 Postpaid plus \$8.00 tax—Total—\$48.00

COMPLETE OPTICS & METAL PARTS—Model M-3, 6X 30 Binoculars. The Optics in this set are new, perfect or near-perfect. Prisms have new low reflection coating. Factory mounted Eye Piece and Objective Assemblies not coated. Metal Parts are perfect, new, ready for assembly. When finished, this will look like a regular factory job, except a name has been filed off a cover plate. No machining required. Bodies factory hinged and covered.

Stock #831-H.....\$35.00 Postpaid, plus \$7.00 Tax—Total—\$42.00

METAL PARTS ONLY—Model M-13A1, 6X 30 Binoculars. No Optics. Same Metal Parts as described for Stock #830-H. Stock #832-H 6X 30 Metal Parts.....\$25.00 Postpaid

OPTICS FOR 6X 30 BINOCULARS (No Metal Parts). Perfect, and low reflection coated.

Stock #5130-H.....\$15.00 Postpaid

SAME OPTICS AS ABOVE (6X 30). Coated—but slight seconds.

Stock #5124-H.....\$12.75 Postpaid

If you buy both the Binocular Optics and the Binocular Metal Parts, your purchase becomes subject to 20% Federal Excise Tax. Be sure to add amount covering tax to your remittance or your order cannot be filled.

Optics and Metal Parts are Available for Monoculars (1/2 a Binocular). For Complete Details, Write for Bulletin #14-H

\$15.00 BUYS A \$500.00 TELESCOPE WITH BIG 3" OBJECTIVE



3 power instrument, brand new with plastic Optics and fixed focus. Objective Lens has F.L. of 14.9". 23" long. Wt. 31 lbs. Wide field of view.

Stock #929-H.....\$15.00 f.o.b. Chicago, Ill. (Shipping Wt. about 70 lbs.)

35 MM. KODACHROME PROJECTING LENS SET—Consists of Achromatic Lens for projecting, plus a Condensing Lens and piece of Heat Absorbing Glass with directions. Stock #4025-H.....\$1.95 Postpaid

SATISFACTION GUARANTEED

EDMUND SALVAGE CO.,

NEVER HAS THERE BEEN SUCH A SENSATIONAL BARGAIN AS THIS!

BUBBLE SEXTANT

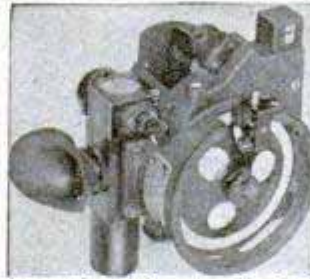

These Army Air Forces Bubble Sextants cost the Govt. about \$125.00 each. A real bargain at our price of \$12.50! Included with Bubble Sextant shipment is wooden Carrying Case, 5 spare waxed paper discs, flashlight with rheostat for night use (uses ordinary flashlight cells—not furnished) aux. 2-power Gallilean Telescope, Allen wrench, 1 spare marking point. War-time used, but where necessary completely repaired, collimated and put in good working order.

If not satisfied that Sextant is exactly as represented, return within 10 days and money will be refunded. Full directions for use accompany each shipment.

Stock #924-H.....\$12.50 Postpaid

Same SEXTANT as above, but **BRAND NEW** and with Automatic Electric Averaging Device and Illuminated Averaging Disc for nighttime use. Gov't. cost \$217. Though brand new we have re-checked Bubble and Collimation and **GUARANTEE** perfect working order.

Stock #933-H.....\$22.50 Postpaid

CONDENSING LENSES—Seconds, but suitable for Enlargers and Spotlights.

Stock #1061-H, 6 1/2" dia., 9" F.L. \$2.50 Postpaid

Stock #1082-H, 4 1/2" dia., 5 1/2" F.L. 70c Postpaid

We have a Limited Quantity of Condensing Lenses—seconds—ranging from 4 1/2" to 8 1/2" in dia. with various focal lengths. Send for Free Bulletin titled "MISCELLANEOUS CONDENSING LENSES—H."

POLARIZING VARIABLE DENSITY ATTACHMENT FOR BINOCULARS

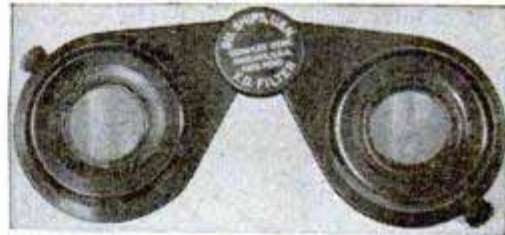

An amazingly effective unit for controlling amount of light reaching your eyes. Cuts down glare in sky and over-water observations. Easily snapped on and off over the eye cups of American-made 7X50 Binoculars. Govt. cost \$8.30 each.

Stock #20,000-H.....\$2.00 Postpaid

Above Polarizing Attachment also adaptable to Govt. 6X30 Binoculars with substitution of special Eye-cups.

Stock #20,010-H, 6X30 Eye-cups.....75c pr. Postpaid



MOUNTED PROJECTING LENS SYSTEM

F.L. 91.44 mm. (Just right for 35 mm. Projectors). Speed of F 1.9. Outside dia. of mount at one end 60 mm. Length of mount 64 mm.

Stock #4033-H.....\$3.00 Postpaid

THREADED OUTSIDE MOUNT FOR FOCUSING ABOVE SYSTEM (Not illus.)

Stock #715-H.....\$1.50 Postpaid

LENS CLEANING TISSUE—1st quality, sheet size 11" x 7 1/2". Made to Govt. specs. Won't dust. Free of abrasives and lint.

Stock #721-H, 500 sheets.....\$1.00 Postpaid

SCHMIDT OPTICAL SYSTEM. Black plastic body, size 3-15/16" by 5 1/2". F.L. 2.4" with amazing speed of F 0.9. Used in Navy's Infra-Red Sniperscope and Signalling Units. Govt. cost \$134.

Stock #720-H.....\$6.00 Postpaid

AIR FORCES GUN SIGHT—With Polarizing Variable Density Attachment. (Polarizing attachment alone is worth many times the price of entire unit.)

Stock #908-H.....\$5.00 Postpaid

Same Unit Without Polarizing Attachment

Stock #916-H.....\$2.50 Postpaid

We have literally millions of war surplus lenses and prisms for sale at bargain prices. Write for Catalog "H"—Sent Free!

Order by Stock No.

P. O. Audubon, New Jersey

Earn **BIG PAY** Now!

(thousands of ambitious men have been helped)

20 Years Service To American Industry

BE INDEPENDENT IN A BUSINESS — ALL YOUR OWN

HERE THEY ARE:

7 LEADING TRADES—

- **MACHINIST TRADE:** Machine Shop training in the set-up and operation of all types of machinery, layout and bench work, blueprint reading, etc.
- **TOOL AND DIE MAKING:** Practical instruction at the GREAT ALLIED SHOPS in making tools, dies, jigs, fixtures, layout and bench work, metallurgy, blueprint reading, etc.
- **TOOL AND DIE AND MACHINE DESIGNING:** Practical instruction in drawing and designing of tools and dies, jigs and fixtures, special machines, special devices, etc.
- **MECHANICAL DRAFTING:** Practical training in all phases of technical and mechanical drafting, machine drawing, and sheet metal drafting.
- **TOOL ENGINEERING:** Detailed study of Engineering Materials, Manufacturing Processes, Production Planning, Screw Machine Engineering, etc.
- **PRODUCTION ILLUSTRATION:** Industrial Pictorial Drawing.
- **AIRCRAFT DRAFTING:** Detailed study of Aircraft Drafting and Design.

Largest School of its Kind-

-In the World!

(FREE EMPLOYMENT SERVICE)

● **BIG SHOP TRAINING** ●

FREE!
This **BIG Metal Trades ILLUSTRATED BOOK**

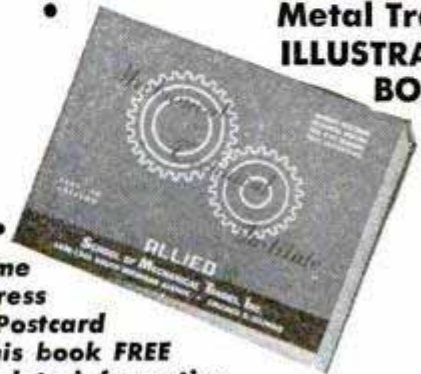

Your Name and Address on a 1c Postcard brings this book **FREE** and complete information

You Can Learn **QUICKLY** and **EASILY**—

Learn To Earn More

—BY DOING . . . Here at the Allied School: a Technical and Mechanical Institute, we will train you in the GREAT ALLIED SHOPS for an IMPORTANT and HIGHLY-PAID POSITION in the Metal Trades Industry. The ever-increasing DEMAND FOR MACHINISTS, TOOL AND DIE MAKERS, DRAFTSMEN, TOOL AND DIE DESIGNERS, and TOOL ENGINEERS is your best guarantee for STEADY EMPLOYMENT AT HIGH PAY with RAPID PROMOTION. If you are mechanically inclined and want to increase your earning power . . . then we have exactly what you are looking for . . . Therefore do not delay . . . GET THE FACTS TODAY . . . A penny post card will do. All tools and working outfit available at the school.

VETERANS—The Allied School is Approved for Veterans . . . We also maintain a FREE EMPLOYMENT SERVICE while you are training, and after you graduate.

WRITE TODAY

APPROVED BY—Dept. of Registration and Education of the State of Illinois and
BY—United States Veterans Administration.

Write For This BIG FREE BOOK Today!

... Established 1928
ALLIED SCHOOL OF MECHANICAL TRADES
1338-1340-1342 So. Michigan Ave.
421 Allied Bldg. CHICAGO 5, ILL.

Learn to Use the **SLIDE RULE**
EASY! QUICK! NEW LOW COST!
Newly Revised and Simplified Step by Step Method

10 in. SLIDE RULE and Famous Book \$2.48 Both for Only

Lucite Magnifying Indicator

208 PAGES LOG TABLES
Helpful Review of Mathematics

THE SLIDE RULE and how to use it
Including 5 PLACE Log Tables

Practical Help for Bigger Pay — Better Jobs — for Mechanics, Draftsmen, Shop Men, Accountants — All Who Use Figures

Get this new revised and simplified edition of the "Slide Rule and How to Use It." Thousands of older editions sold at much higher price. Now — a more simplified book at a lower price with genuine Mannheim type Slide Rule included at no extra cost. Do all kinds of figure work. Stop wasted time. Stop pencil errors. Learn quickly to multiply, divide, extract roots, find ratios and percentages, squares, areas of circles, radii, volume, etc. Do it in a flash and learn now with this book and slide rule combination.

Practical Step by Step Guidance

No other book like it. Contains complete instruction and removable work sheets that make the slide rule simple as A, B, C. Also Five Place Logarithm Table, Tables of Trigonometric Functions of Angles, review of Mathematics from simple arithmetic through calculus, and with complete answers to check yourself on every problem. It can easily be worth hundreds of dollars to you in promotions, better pay, saving time and error. It's a book for students, mechanics, business men—everyone should learn to use the slide rule, now that it is so easy.

Learn in a Few Hours to Do Many Calculations

There is nothing mysterious about the slide rule and its use. Just read the book and follow the rules. You'll be amazed at the problems you can solve in just a few hours. Mail the coupon now. Book and slide rule will be sent at once. Use them for 5 days, then if you are not satisfied in every way, return them and your money will be refunded without delay. Use the coupon. Mail now.

Mail Coupon
Money Back if Not Satisfied

Austin Publishing Co., Dept. 11
165 N. Pine Ave., Chicago 44, Ill.

Send me "The Slide Rule and How To Use It" and 10" Mannheim type Slide Rule. Total cost for both \$2.48. I understand you will refund amount paid you if I return them in 5 days.

Remittance Enclosed Send C.O.D. Postage and Charges Extra
Send Postpaid

Name _____
Address _____
City _____ State _____

AUSTIN PUBLISHING CO., Dept. 11, 165 N. Pine Ave., Chicago 44, Ill.

TRAIN FOR GOOD PAY ... IN A FIELD THAT ISN'T CROWDED!

Learn to repair all types of electric motors. The field is tremendous, the pay good. Motor repair experts are scarce and in big demand. **ELECTRIC MOTOR REPAIR** teaches you at home—in spare time—for only \$5 for the entire training.



BE AN ELECTRIC MOTOR REPAIR EXPERT!



Learn a trade that really counts!

Based on the big 560-page **ELECTRIC MOTOR REPAIR** training course book, you can train for fast, profitable service on practically every kind of electric motor in common use—also motor control systems. You study every phase of the work from minor repairs to complete rewinding. Each step is made crystal clear by both text and over 900 pictures. Written especially for beginners—previous motor experience not necessary. You learn fast—you learn right—and for only \$5. If broken into course form and sent as monthly lessons, you'd say the book was a bargain at \$50 or more. Practice from it for 5 days at our risk. Your money back if you're not more than satisfied.

5-DAY MONEY-BACK GUARANTEE!

Dept. PM-18, Murray Hill Books, Inc.
232 Madison Ave., New York 16, N. Y.

Send me the big **ELECTRIC MOTOR REPAIR** book for which I enclose \$5 (\$5.50 foreign) or send C.O.D. and I will pay postman \$5 plus postage when he delivers it to me (no foreign C.O.D.'s). If not satisfactory, I'll return book in 5 days and you guarantee to refund my money.

Name _____
Street _____
City and Zone _____ State _____

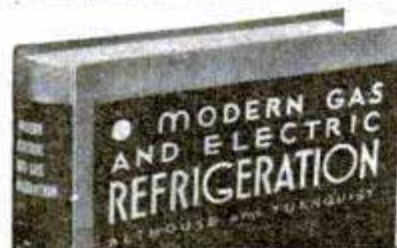

20 Million Refrigerators Need Service and Repairs

REFRIGERATION

Made Easy! Biggest Opportunity in Many Years!

NEW PRINTING — ALMOST 1000 PAGES

408 Pictures—17 Diagrams in Colors Makes All Refrigerator Service Maintenance, Repairs Simple as A.B.C.

Millions of refrigerators need service and repairs. Owners are paying big for competent service which will be needed more and more as these refrigerators get older. Get **MODERN GAS AND ELECTRIC REFRIGERATION**, the non-technical guide to all types of refrigerators and get your share of this new profit. Get a job or start your own service business. This book will help you make money anywhere. Thousands of copies have been sold. Used by trade schools, manufacturers training programs and U. S. Army. Mail coupon. Send \$5.00 or we will send C.O.D. Money back in 5 days if not satisfied. Act now—this may be the opportunity you have been waiting for.

SEND NO MONEY!
Mail Coupon

GOODHEART-WILLCOX CO.,
2009 S. Michigan Ave.,
Dept. 511, Chicago 16, Ill.

Send Gas and Electric Refrigeration. \$5.00 enclosed. Send C.O.D. (in U. S. or Possessions). I will return book in 5 days if not satisfactory and you will refund my money. If remittance accompanies order we will pay postage charges.

Name _____
Address _____
City _____ State _____

Now for EVERY WORK SHOP!

NEW Invention

Electroplates by BRUSH



Easy to Plate CHROMIUM GOLD, SILVER, NICKEL, COPPER ... For Pleasure and Profit!

If you have a workshop—at home or in business—you need this new Warner Electroplater. At the stroke of an electrified brush, you can electroplate models and projects—you can replate worn articles, faucets, tools, fixtures, silverware, etc. with a durable, sparkling coat of metal... Gold, Silver, Chromium, Nickel, Copper or Cadmium. Method is easy, simple, quick. Everything furnished—equipment complete, ready for use. *By doing a bit of work for others, your machine can pay for itself within a week.* So make your shop complete by getting a Warner Electroplater right away. Send today for **FREE SAMPLE** and illustrated literature. **ACT AT ONCE! Mail Coupon.**
WARNER ELECTRIC CO., DEPT. R-23
1512 Jarvis Avenue, Chicago 26, Ill.

FREE Details & Sample!

WARNER ELECTRIC CO., 1512 Jarvis Avenue, Chicago 26, Dept. R-23

Gentlemen: Send Free Sample and Details to:

Name _____
Address _____
City _____ State _____

GOOD JOB



BIG PAY

1,054 Want Ads in Newspapers in One State in One Month Alone Shows Amazing Big Demand for

TRAINED AUTO BODY, FENDER and PAINT MEN

Here's A **BIG OPPORTUNITY** to earn more money in a steady, good pay job. This specialized trade taught you thoroughly and quickly the practical, modern way by the **SWEENEY SYSTEM** of Practical Experience. 87,675 auto and tractor mechanics taught since 1908 in my schools, nationally known. All the latest, modern equipment, expert teachers, tools furnished. **YOU LEARN BY DOING—PRACTICALLY.** Your future success depends on proper training—and getting into a business that is **NOT** overcrowded. Get the **FREE PROOF**, the full particulars about this most amazing opportunity for a quick, **BIG PAY JOB.** Mail coupon below **NOW.**

APPROVED for VETERANS TRAINING Under P.L. 346 and P.L. 16

SWEENEY AUTO SCHOOL, Inc.

Dept. 17, 2901 East 14th St., Kansas City 1, Mo.



E. J. SWEENEY
87,675 men have come to E. J. Sweeney Schools
—WHY?

FREE
LITERATURE
POSTPAID

MAIL COUPON FOR DETAILS

E. J. Sweeney, President,
Sweeney Auto School, Inc.
Dept. 17, 2901 East 14th St.
Kansas City 1, Mo.

Name _____
Address or RFD _____
City _____ State _____
 Veteran Non-Veteran

To Help You Get Ahead in

ELECTRICITY OR RADIO

A COYNE BOOK OF DIAGRAMS IS YOURS

Free

FREE TO MEN INTERESTED IN RADIO

FREE TO MEN INTERESTED IN ELECTRICITY



Just for Asking to See THESE GREAT NEW

ELECTRICAL OR RADIO BOOKS

Get a valuable electrical or radio diagram book ABSOLUTELY FREE! If you are interested in ELECTRICITY, Coyne will give you their "150 ELECTRICAL SHOP PRINTS" Book, of large size, easy-to-read prints for which electrical workmen have paid 10c to 25c apiece. It's yours free for merely looking over their great set, "APPLIED PRACTICAL ELECTRICITY." If RADIO is your choice, your free "get acquainted" gift is the brand new "150 NEW RADIO AND TELEVISION DIAGRAMS EXPLAINED," showing latest circuits, including FM and Television, and full instructions on reading and using diagrams. You get this FREE book for merely examining Coyne's new 5 vol. set APPLIED PRACTICAL RADIO.

EASY WAY TO BIGGER PAY

Get the "know how" you need to "go places" in Electricity or Radio with these easy-to-understand, practical sets of Electrical or Radio books. They have been prepared out of 48 years of Coyne training experience to help the man who wants to get ahead in these two big money, big opportunity trades.

They are written in easy-to-understand language, loaded with hundreds of interesting examples, pictures and diagrams that "sink in" at once. All the facts you need are "boiled down." They have the answers to thousands of questions that come up in electrical or radio work to help you earn more pay and even own your own profitable full time or part time business.

USE BOOKS 7 DAYS FREE!

SEND NO MONEY! Ask to see the set you prefer—at our risk—and receive the FREE book described above. Use the books for 7 days. Then if you do not want to keep them, send them back at Coyne's expense and you don't owe a penny! If you keep the set you can use the liberal payment plan explained at the right. If you can pay cash after 7 days you save money. But remember, you keep the FREE BOOK even if you return the set! But you must act promptly — this offer is limited.

SEND COUPON TODAY — IT COSTS NOTHING. Coupon is merely a request to examine the set free and get the Free Book.

MAIL TODAY!

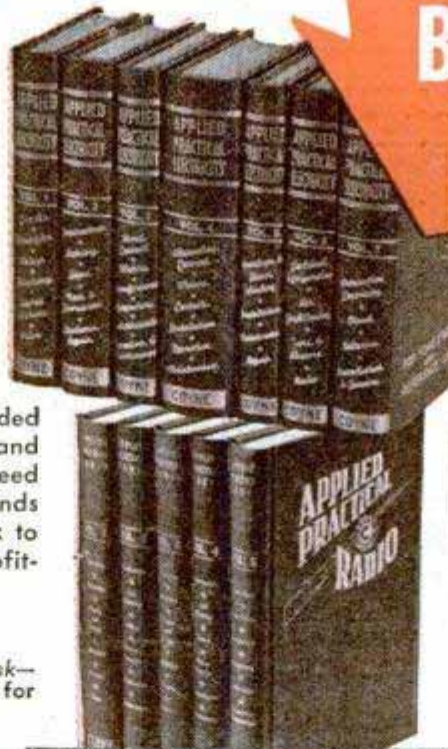

"APPLIED PRACTICAL ELECTRICITY"—7 volumes

10,000 electrical facts — 3000 subjects—hundreds of diagrams, photos, charts, tables, etc. Covers electricity, automotive, diesel, refrigeration, air conditioning, electronics, etc. Price \$21.00 on time—at \$3.00 in 7 days and \$3.00 per month — \$19.75 cash (you save \$1.25).

"APPLIED PRACTICAL RADIO"—5 volumes

Just out. Up-to-the-minute information, from basic principles to High Frequency, Short-Wave, Multi-Bands, FM and Television, etc. Radio testing instruments and service short cuts, phototubes, etc., etc. Price complete \$16.75 on time—\$3.00 in 7 days and \$3.00 per month—\$15.00 cash (you save \$1.75).

FREE BOOK - FREE TRIAL COUPON

Educational Book Publishing Division
COYNE Electrical & Radio School
500 S. Paulina St., Dept. 18-R5, Chicago 12, Ill.

O.K.! Send me postpaid the set checked below for 7 days examination, and FREE BOOK, as per your ad.

- APPLIED PRACTICAL ELECTRICITY (7 vols.) and FREE Shop Prints Book
 APPLIED PRACTICAL RADIO (5 vols.) and FREE Radio Diagram Book

NAME _____ AGE _____

ADDRESS _____

CITY _____ ZONE _____ STATE _____

Check here if you want the books sent C.O.D. You pay cash price shown in the ad when books are delivered. Same 7-day Money-Back Guarantee.

EDUCATIONAL BOOK PUBLISHING DIVISION
COYNE ELECTRICAL AND RADIO SCHOOL

500 S. PAULINA ST., DEPT. 18-R5, CHICAGO 12, ILL.

Keep that "TICKING" Car

7 DAYS FREE TRIAL



Every operator and mechanic needs AUDELS AUTO GUIDE. This book saves time, money and worry. Highly endorsed. It presents the whole subject of auto mechanics:

- 1—Basic principles
- 2—Construction
- 3—Operation
- 4—Service
- 5—Repair

Handy Size, Easily understood.

NEW FLUID DRIVE, HYDRAULIC SHIFT AND DIESEL ENGINES FULLY COVERED

Over 1500 pages—1540 illustrations showing inside views of modern cars, trucks and buses with instructions for all service jobs.

4 COMPLETE • PAY ONLY \$1. A MONTH ←
 ASK TO SEE IT!—To Get This Assistance for Yourself Simply Fill in and Mail Coupon Today.

AUDEL Publishers, 49 West 23rd St., New York
 MAIL AUDELS NEW AUTO GUIDE for free examination. If O.K. I will send you \$1 in 7 days; then remit \$1 monthly until price of \$4 is paid. Otherwise I will return it.

Name.....
 Address.....
 Occupation.....
 Employed by..... PM

Learn this Profitable Profession



IN 90 DAYS AT HOME
Money-Making Career Open to Men and Women, 18 to 50

Hundreds of men and women between 18 and 50 make \$10 to \$20 in a single day giving scientific Swedish Massage and Hydro-Therapy treatments. There is big demand from doctors, hospitals, sanatoriums and clubs. Graduates earn large full time incomes from these or in private practice in their own offices. Others make good money from home treatments given in spare time. Learn this interesting, money-making profession in your own home, through our home study course. Same instructors as in our nationally known resident school. You can win independence and prepare for future security by qualifying for your Diploma. Course can be completed in 3 to 4 months. Many earn while they learn. Begin your training at once.



Anatomy Charts & Booklet FREE

Enroll now and we will include, at no extra cost, many needed supplies. Fit yourself to help meet growing demand for Scientific Swedish Massage. Send the coupon at once for complete details. Anatomy Charts and 32-Page Illustrated Booklet, FREE, postpaid.

THE COLLEGE OF SWEDISH MASSAGE
 Dept. 864A, 100 East Ohio St., Chicago 11, Illinois
 Please send me FREE and postpaid, Anatomy Charts, 32-page Booklet and complete details on Home Training.

Name.....
 Address.....
 City..... State.....

TELEVISION

"AMERICA'S NEXT GIANT INDUSTRY"

... Dr. Lee de Forest*



Practically every major sports event in America is currently being shown on television screens. And this is only the beginning! Imagine what the next few years will bring when the great broadcasting and manufacturing companies' plans are put into effect.

Now is definitely the time to get ready for new television opportunities. Plan to become qualified for a responsible position in a growing industry. Select the largest, most elaborately equipped Television Institute in the country—the school that teaches every phase of Television—engineering, operation, maintenance, Television program production, stage direction, writing, lighting and scene designing.

Learn how you can take your preliminary training at home at no cost or obligation. Write your name and address on a penny postcard and mail it to us today.

Approved for Veteran's Training

*Dr. de Forest, the inventor of the radio tube, is American Television's Director of Training and Research. He is not associated with any other school.



American Television, Inc.
 5050 Broadway • Chicago 40, Ill.

Do you want

- ➔ .. to go to College?
- ➔ .. or to enter a Profession?

(Such as Accounting, Architecture, Nursing, Dentistry; Teaching, Social Work, Osteopathy, Beauty Culture, Optometry, Embalming, Chiropody, Law, Medicine, etc.)

- ➔ .. or get an Office Position?

To get anywhere, you practically MUST finish High School FIRST. You can complete our simplified High School Course in SPARE time at home, as FAST as your time and abilities permit. Equivalent to resident school work—prepares you for college, pre-professional examinations, business, industry. Standard texts furnished. Diploma. Credit for H. S. subjects already completed. Single subjects if desired. Low tuition, easy terms. American School, Chicago, est. 1897—endorsed by educators. Finish your high school education NOW, Write TODAY!

High School Course at Home

Many Finish in 2 Years

- American School, Dept. H145, Drexel Ave. at 58th St., Chicago 37, Ill.
 Gentlemen: Send me FREE information covering special training in subjects checked below. No obligation on my part.
- | | |
|--|--|
| <input type="checkbox"/> High School Course | <input type="checkbox"/> Diesel Engineering |
| <input type="checkbox"/> Architecture and Building | <input type="checkbox"/> Drafting and Design for Men & Women |
| <input type="checkbox"/> Automotive Engineering | <input type="checkbox"/> Plastics |
| <input type="checkbox"/> Business Management | <input type="checkbox"/> Private Secretary |
| <input type="checkbox"/> Electrical Engineering | <input type="checkbox"/> Mechanical Engineering |
| <input type="checkbox"/> Elec. and Gas Refrigeration | <input type="checkbox"/> Aviation |
| <input type="checkbox"/> Air Conditioning | <input type="checkbox"/> Salesmanship |
| <input type="checkbox"/> Railway Training | <input type="checkbox"/> Radio |
| <input type="checkbox"/> Electronics, Industrial | |

Name.....
 Address.....



WILLARD 1 1/2 VOLT STORAGE BATTERY

A rechargeable, wet plate battery good for years of service. Brand new. Battery is shipped dry but fully charged — any battery station will add acid. Use singly or in multiples for radio sets, bell circuits, alarm systems, etc. Measures 5 1/4 x 4 x 3 inches. Ball floats indicate proper level for filling. Shp. wgt. 4 lbs. Stock No. 297—Each Only... **\$2.95**

WAR SURPLUS AND HUNDREDS OF OTHER BARGAINS

7 LB. EXPERIMENTER PARTS ASSORT. KIT



A "gold mine" for the radio serviceman. Hundreds of valuable radio parts, new radar and electronic parts and sub-assemblies, coils, resistors, trimming condensers — worth many times this low **\$1.79** price. A130R—7 lbs..



Brand New
For Utmost
Warmth and
Comfort

TYPE B-15A FLYING JACKET

Built for warmth. Made of heavy duty zelan treated cloth with quilted fly under front zipper. Two large slash pockets. Heavy knitted waist band and cuffs. Mouton fur collar. Two roomy inside pockets. Use it for all outdoor activities—hunting, driving, working, etc. It's a real bargain at this low price. Shp. wgt. 5 lbs. Stock No. 373—**\$14.95**
Each

NEOPRENE IMPREGNATED INDUSTRIAL APRONS for Shop and Home Use



A high quality, neoprene impregnated, open back industrial apron — extra long and with full length elastic bound sleeves to provide full protection to clothes and wearer. Has hundreds of industrial uses in shops, garages, etc. Use one at home for washing the car and other jobs. The heavily coated fabric is soft and pliable. Adjustable take up strap at back of neck—string tie at waist. All brand new! Small, medium and large sizes. Shp. wgt. 3 lbs. Stock No. 294

Each only
\$1.49



ARMY AIR FORCE TYPE A-2 HORSE HIDE JACKET

Brand new, Army Air Force type A-2 jacket of genuine horsehide. Full length zipper front. Two large size pockets with flaps. Heavy knitted waist and cuffs. Leather-shoulder straps. Will keep you warm and toasty in the coldest weather. Will give you years of service. Shp. wgt. 5 lbs. Give chest size when ordering. Stock No. R26R—Ea. **\$22.50**



AMMUNITION BOX

Used for 50mm ammunition. Heavy all metal design with latching top and folding handle. Provides safe, fireproof storage for valuables, etc. Measures 12x6x7 1/2 inches. Used but in new condition. Shp. wgt. 8 lbs. No. 338—Each... **79c**

POPULAR RECORD ASSORTMENTS



Assortment of 50 popular dance, race, blues and hillbilly records—no two alike. Famous name bands and artists included. Used in juke boxes but guaranteed perfect. Shipped exp. collect only. **\$9.64**
No exchanges or refunds. Wgt. 28 lbs. Stock No. 303—50 records

No. A300—Special assortment of 25 dance records. No two alike. All popular numbers. Wgt. 14 lbs. Stock No. A300—25 records.... **\$4.88**

No. A301—Special assortment of 25 records, mixed hillbilly, race and blues selections. No two alike. Wgt. 14 lbs. Stock No. A301—25 records.... **\$4.88**

No. A302—Special assortment of 25 hillbilly records. No two alike. All popular numbers. Splendid value! Wgt. 14 lbs. Stock No. A302—25 records.... **\$4.88**

RUBBER OVERBOARD SUIT



Here is a buy! All rubber suit with parka. Fits over your regular clothes and shoes. Can be cut apart for waist high waders, hip high or knee high boots, also arm length rubber gloves. Heavy gum rubber over fabric. Fine for those who work in the water, commercial fishermen, sewer diggers, etc. Use it as is or cut it up for waders. All brand new! Wgt. 14 lbs. No. 183—Ea.... **\$4.95**



BERNARD WIRE PLIERS

Parallel acting jaws. Wire cutter at top. Brand new. Wgt. 2 lbs. No. 168—Ea.... **\$1.29**



ALL PURPOSE PLIERS

A high grade 8 inch drop forged piler, with milled teeth on the jaws and center wire cutter. Ideal for all general purpose farm, home and shop use. You'll want more than one pair at this low price. Full 8 inches long. Shp. wgt. 2 lbs. Stock No. 296—Each Only... **69c**



BAYONET BLADE

Fine forged steel. Ground but not polished. May be made into throwing or hunting knife or spear. Blade 6 3/4 x 7/8 inches, 11 3/4 inches overall. Will take and hold a fine edge. Shp. wgt. 1 lb. No. 664-R—Each.... **49c**

ORDER DIRECT FROM THIS AD

Values galore! Hundreds of hard-to-find items for home, shop and outdoors. Make remittances by money-order, bank draft or personal check. Send 25% deposit on C.O.D. orders. No C.O.D.'s on orders for less than \$5.00. Include sufficient postage on parcel-post orders—any overage will be promptly refunded. All quotations F.O.B. Chicago. Used items and materials are guaranteed serviceable and as described. Your money back if not more than satisfied.

BIG ILLUSTRATED CATALOG FREE

STARK'S

Dept. PM148
509 So. State St.
CHICAGO 5, ILL.

SATCHEL POUCH

Heavy canvas pouch. Ideal for toting lunches, shopping, books, etc. Has 11x12 inch pocket. Brand new, guaranteed perfect. Has oversize flap with single strap fasteners. A113—EACH **\$1.69**



Heavy
Duty
Rubber
Gloves

Brand
New

Extra heavy—extra long. Brand new, high quality gum rubber for softness and ease in use. Designed for heavy duty industrial service—protection in handling chemicals, acids, etc. A real bargain at this low price. Stock No. 295—**79c**
Per Pair, Only.....

You score high
when you've got

P.A.*



P.A.* means *Pipe Appeal*
It's that distinctly masculine look of the pipe-smoking man that appeals to *her*—and it's rich-tasting, cool-smoking Prince Albert that appeals to *him* in his pipe.

P.A. means *Prince Albert*

Rich tasting . . . mild and easy on the tongue—that's Prince Albert—the National Joy Smoke! P.A.'s choice tobacco is specially treated to insure against tongue bite. More pipes smoke P.A. than any other tobacco!

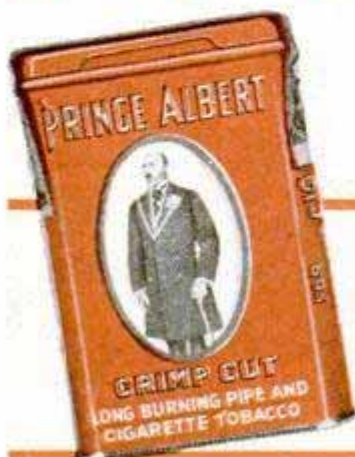

THE NATIONAL
JOY SMOKE

ROLL YOUR OWN? IT'S EASY
WITH CRIMP CUT P.A. AND
IT'S GREAT SMOKING!

R. J. Reynolds Tobacco Co., Winston-Salem, N. C.





Converted lumber carrier rolls along highway with two reels of cable during construction of coaxial line

THE "COAX" HAS NERVES

By Thomas E. Stimson, Jr.

THE NATION'S NEW 3000-mile telephone line has a nervous system like a man's. Every time a slight break occurs anywhere along the transcontinental coaxial cable, the system has all the symptoms of a pain. A signal shoots along its nerves, telling trouble shooters across the country that the doctor's needed. Damage by sleet, earthquake, flash flood or lightning sends "shooting pains" to sound the alarm.

Linking New York with Los Angeles, the coaxial cable is no thicker than your arm in the size laid along most of the route. Yet it can carry as many as 1300

telephone conversations and 2500 teletype and telegraph messages at once. With auxiliary equipment it will carry an even greater load or, when the time comes, it will transmit three television programs each direction at the same time.

Not only does the cable call the doctor to repair its own injuries, it makes various routine repairs to itself.

Suppose a mythical businessman named Brown of Pittsburgh is quoting prices over the phone to a customer on the West Coast. Almost anything could happen along the cable that carries his voice. For example,

Cable-layer threads an eight-foot desert trench with coaxial cable, part of the line linking New York with Los Angeles

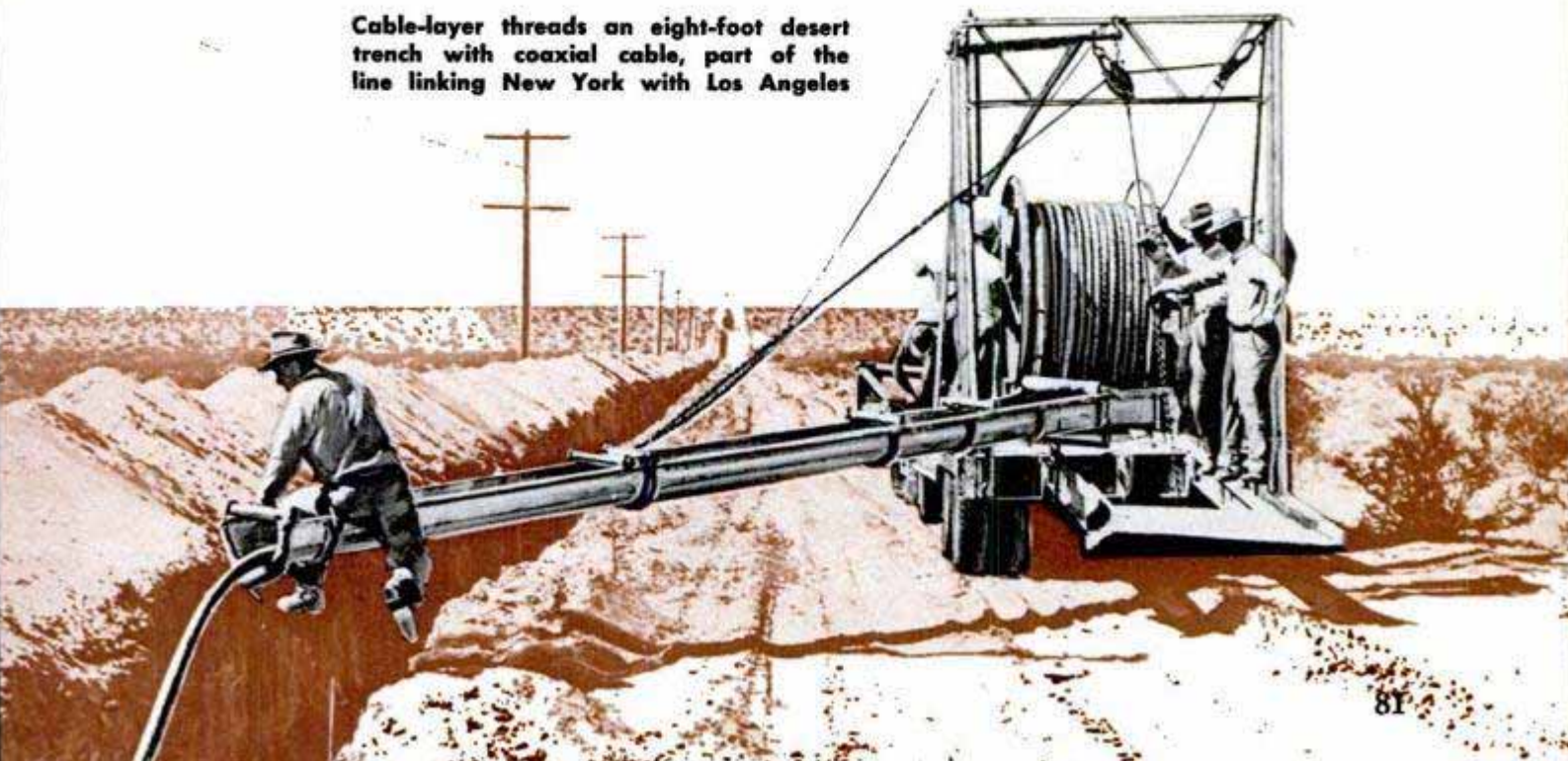

**CROSS-SECTION VIEW OF
TYPICAL COAXIAL CABLE**

- MAINTENANCE WIRES
- COAXIALS CARRY 1440
LONG-DISTANCE CIRCUITS
- PAPER INSULATION
- INSULATED WIRES FOR
SHORT-HAUL CIRCUITS
- PAPER INSULATION
- LEAD SHEATH
- LAYERS OF
THERMOPLASTIC
- COPPER JACKET FOR
LIGHTNING AND RODENT
PROTECTION
- ASPHALT IMPREGNATED
CLOTH



Coaxial cable (stripped at left) can carry more signals than three ordinary cables at far right

energy of a lightning bolt that struck near its right-of-way across North Carolina.

Flash floods can't rip out the cable, for it is buried and securely anchored under the streams it crosses. Stray electrical currents in the ground won't affect it because the cable carries its own cathodic charge. Not even a boulder or snag that might break the cable beneath the turbulent

Colorado River could cut off communications, for a duplicate cable some distance downstream also is energized.

If the volume at a repeater fails, robot volume regulators attempt to restore the volume to normal. If the volume didn't fall too low it will be restored without notice to the mother station. But if it's too big a job, or if transmission is interrupted, the

Technician raises portable antenna above test car in search for radio phone site in Death Valley



regulator notifies the mother station that it can't correct the condition and the mother station then switches to the spare "coax" which is always standing by. The switch is made so fast that neither Mr. Brown nor his customer will notice it.

Still another warning signal is flashed to the nearest trouble board if the sheath around the cable becomes torn. The entire cable is filled with nitrogen gas under pressure. The alarm sounds if the gas pressure falls below a certain point. Measure-

ments are made to determine the location of the leak, and during repairs additional gas is forced through the cable, flowing out at the break to prevent the entrance of moisture that might disrupt service.

The coaxial cable consists of either six or eight copper tubes, each about as big around as a pencil. Each contains a central wire held in place by insulating disks spaced an inch apart. By use of the carrier principle, hundreds of conversations can be carried over a pair of tubes simultane-

ously. Each conversation is stepped up to a certain high frequency so that no conversation interferes with others that are being transmitted at other frequencies. This is comparable to the way radio stations broadcast at the same time without interfering with each other because they are on different frequencies.

At the receiving end, the message is switched off the coaxial

← Coaxial network will carry hundreds of conversations between New York and Los Angeles. Branches will run to other cities

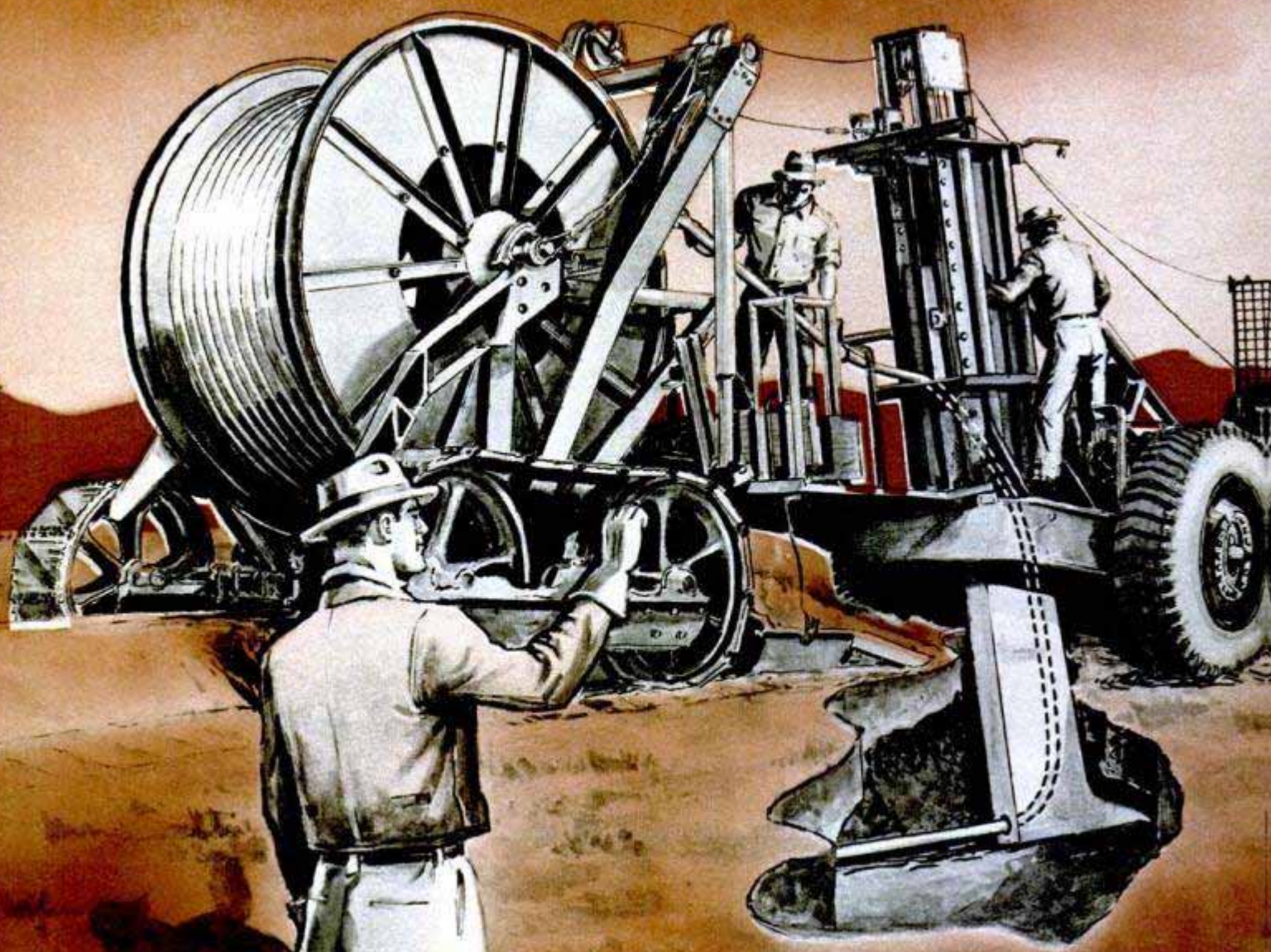

tube by an apparatus that is tuned to the frequency of the circuit. Normally, three pairs of tubes in the cable are to be in service while the fourth pair will stand by for use if any of the others fails.

Actually, no one knows exactly how many circuits can be carried by the "coax." When the cable was designed it was estimated that each of the three pairs of tubes could carry 480 conversations, or 18 telegraph circuits in place of one phone circuit.

Recent improvements to auxiliary equipment stepped up the estimate to 600 voice channels per pair of tubes. Now this figure can be multiplied by four if the number of repeater stations is doubled. In peak future use the cable will carry an estimated 7200 simultaneous conversations. At present only a few hundred circuits are activated.

In addition to the tubes, the cable carries a core made up of copper wires for maintenance communication. The alarm circuits are included in the core together with other telephone systems. One set of wires may be

Right, splicer connects ends of two coaxial cables
↓ "Plow-in train" carries the cable, digs the trench, lays cable and covers it with earth in one operation



used by a cableman along the right-of-way for talking to the nearest station. A second connects the repeater stations with the mother station, and an express circuit is used for communication between main stations about 150 miles apart. Finally, a superexpress circuit connects major stations including New York, Atlanta, Dallas and Los Angeles.

The cable is designed to handle a number of "short haul" circuits in addition to its main transcontinental job. A thick layer of paper-insulated wires runs through the cable around the coaxial tubes. The wires carry as many as 198 voice-frequency circuits and later they will transmit some 200 low-frequency circuits for local calls along the line.

Those portions of the cable that are laid in existing telephone ducts are protected by a heavy lead sheath. Cross-country sections that are buried in the earth are further protected by two layers of rubber-like thermoplastic material and a corrugated copper jacket. These in turn are covered by an outer coat of cloth impregnated with asphalt. Wherever the cable crosses a river it has two additional wrappings of wire.

The transcontinental cable, extending from New York to Los Angeles via Atlanta, Dallas and El Paso, is now complete and in use except for a section between Atlanta and Charlotte, N. C.,

(Continued to page 268)

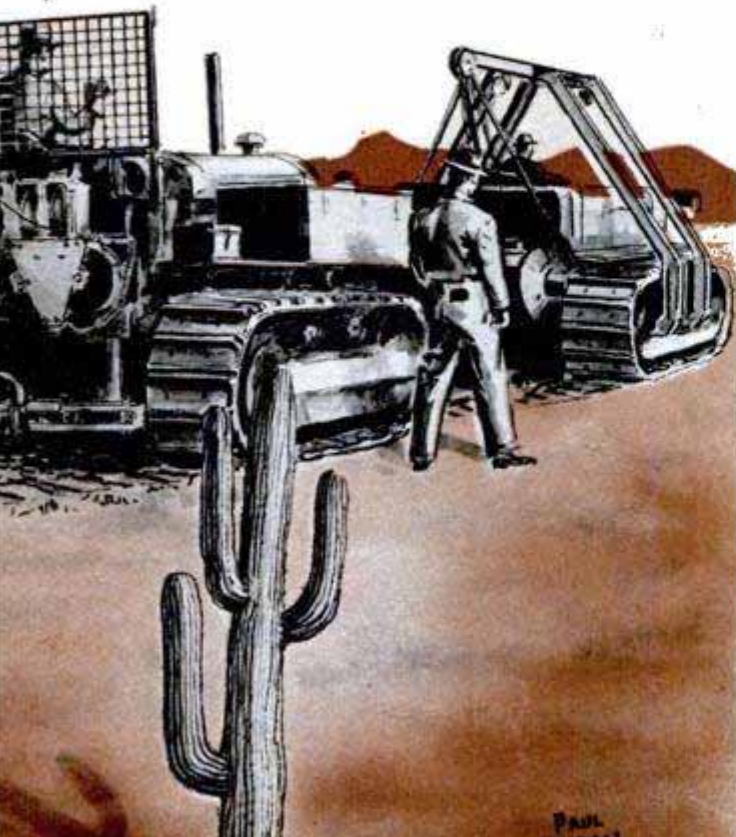



PLASTICS INVADE THE ARTS

Sculptors have a new medium—plastics that can be tinted or dyed to resemble marble, bronze, granite, aluminum or almost any material. The material, phenol resin, can be carved or cast. Work on the first plastic casting is shown here. Above, sculptors complete a head of Dr. James E. Pyle, director of the General Electric Chemical Laboratory where the process was perfected, before making the plastic casting. The head, modeled in Plastalina, which does not dry out as rapidly as clay, is used for making a plaster mold. The mold, made of two coats of plaster, is dried and painted with a special black paint to fill the pores of the plaster. Left, phenol resin, heated to 200 degrees, is poured into it. Splash bubbles are avoided by pouring along a glass rod. When full, the mold is baked in an oven heated to between 160 and 180 degrees for five days to cure the plastic. Lower left, the mold is cut open with a chisel. Below, after the surface has been smoothed by brushing and sand-blasting, the plastic head looks like ivory. The mottled base is of the same material, but a black dye was added to the liquid plastic before casting

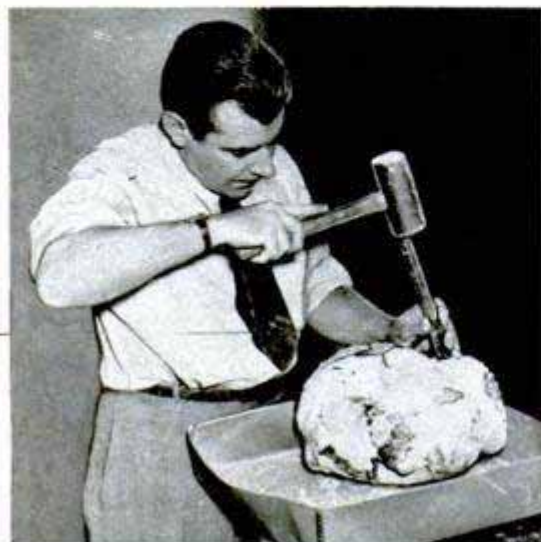
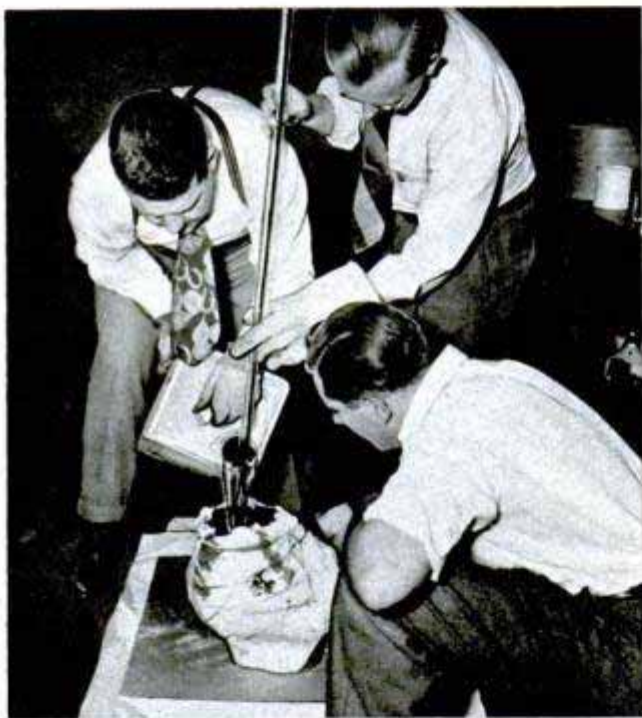

Plane Minus Wings Becomes Diner

Roadside diners once were made from old rail cars, but Herman C. Weist of Louisville, Ky., has given the idea a new twist by building a diner from a surplus C-54 plane. Few changes have been made in the exterior appearance of the fuselage, but Weist cut off the wing and tail sections. Inside the fuselage are a bar and eight tables with seats for 42 patrons. The rest of the interior is divided into a kitchen, washrooms and a counter. Three 50-foot flatcars were required to move the plane from Arkansas, where it was purchased.



Knee-Action for Trailer Supports 1500 Pounds

Knee-action for trailers is provided by a spring-suspension system that will carry a 1500-pound load. The individual unit consists of a short axle fastened to a casting which is bolted and shackled to a short steel spring. The axle is held in place by tension on the spring. The unit is installed by bolting it to a channel iron. As each wheel is individually suspended, the wheels may be staggered to provide an easy riding trailer.



Flaming Hoop Heats Steel For Welding Operation

Looking more like the circle of flame in a circus acrobat's act than an industrial technique, a huge gas burner is used to preheat ball-mill cylinders for welding. The shell, made of armor plate and mild steel, is heated evenly by hundreds of pinholes in the gas tube. The arc welder works on the opposite side of the cylinder.

Information, including manufacturers' names, concerning products described in this issue may be obtained by writing Bureau of Information, Popular Mechanics, 200 E. Ontario St., Chicago 11

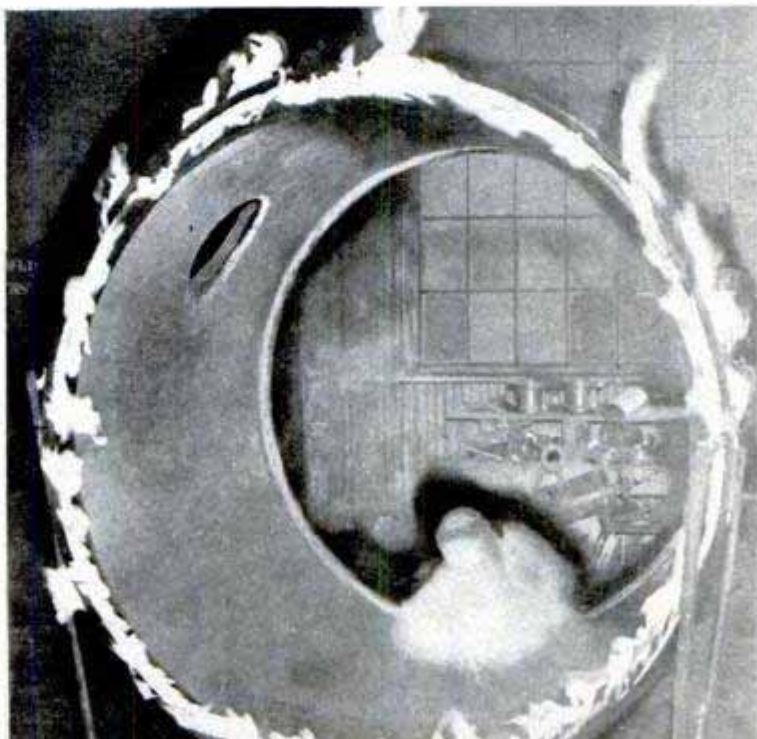



Skiers
AWAKEN A
Bonanza Town



Perhaps you don't know Aspen, Colo., but it's a town of superlatives. Once site of the richest silver mine, it has emerged from quiet old age as a sports area with the world's longest ski lift

By Aubrey O. Cookman, Jr.

AFTER half a century, Aspen, Colo., is a boom town again. The spark that set it off this time was completion of the world's longest chair lift for skiers, instead of the world's richest silver horde.

In 12 years after the original 1880 strike, its mines turned out \$44,000,000 in silver and lead. One, the Mollie Gibson, was the richest in the world. The tiny camp, nestled nearly 8000 feet up in the rugged Rockies, overnight became the state's second largest city, with a population approaching 30,000. It had three daily and two weekly newspapers, seven fine churches, elegant hotels, an opera house, two railroads, schools, hospitals and a race track. Nor, like any bonanza town, did it lack a flourishing collection of saloons and gambling palaces.

Despite its spectacular growth, the town was carefully platted, with wide, tree-lined streets, parks and substantial public buildings. Its Victorian-style homes were well built and filled with furniture, brocades and tapestries from Paris. Guests at the Hotel Jerome were lifted by a water-powered elevator, a mechanical sensation of that day. Ordinary things couldn't satisfy the suddenly wealthy prospectors.



Remindful of the town's silver heyday, "gingerbread" Victorian architecture still prevails in Aspen. Free paint was given householders to help rejuvenate town

Aspen's "crash" came in 1889, when Congress restricted the coinage of silver. One by one mines closed, homes and shops were abandoned and fire nearly destroyed the Wheeler Opera House. To hasten the exodus, gold was discovered at Cripple Creek in the Denver region. Though a thin trickle of mining activity continued and a growing army of anglers was attracted to the region's streams, the town steadily dwindled to a shell of its former eminence. By 1940 only 400 remained, of whom one fourth were pensioners.

The seeds for Aspen's rebirth were sown in 1935, when Swiss expert Andre Roche labeled its skiing possibilities the best in North America, and further nurtured in 1939, when Chicago industrialist Walter



Grouped around the sun deck at the top of the 14,000-foot lift, skiers enjoy a panorama of the snow-covered Rocky Mountains

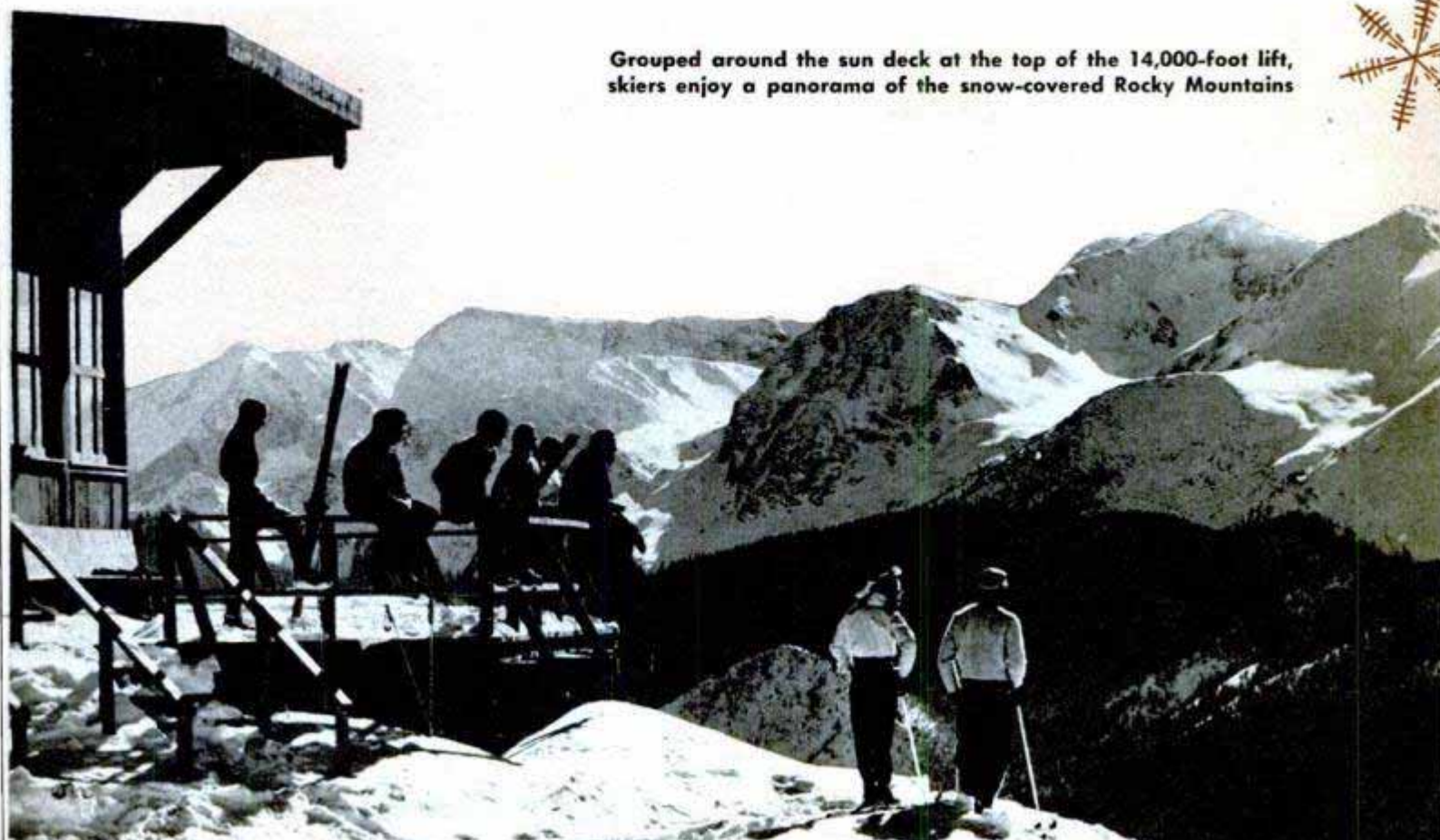



Friedl Pfeifer, head of the ski school, demonstrates a pole-jump turn. He was one of the many Camp Hale ski soldiers who returned to Aspen

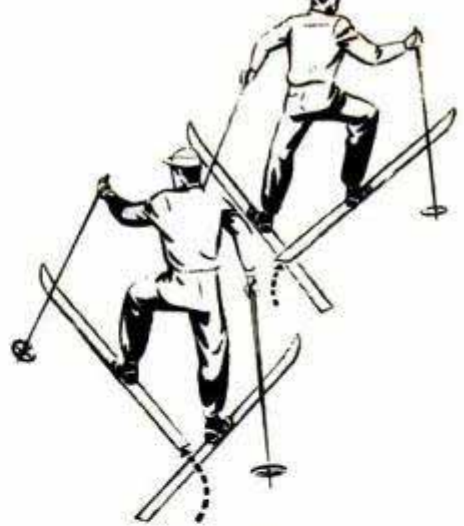

HERRINGBONE

In this maneuver, used for short, steep ascents and narrow trails, the weight is on inner edges of the skis. Trailing ski is lifted ahead over rear of forward ski

DOUBLE-STEM TURN

WEIGHT EQUALLY DISTRIBUTED ON SKIS IN SNOWPLOW POSITION

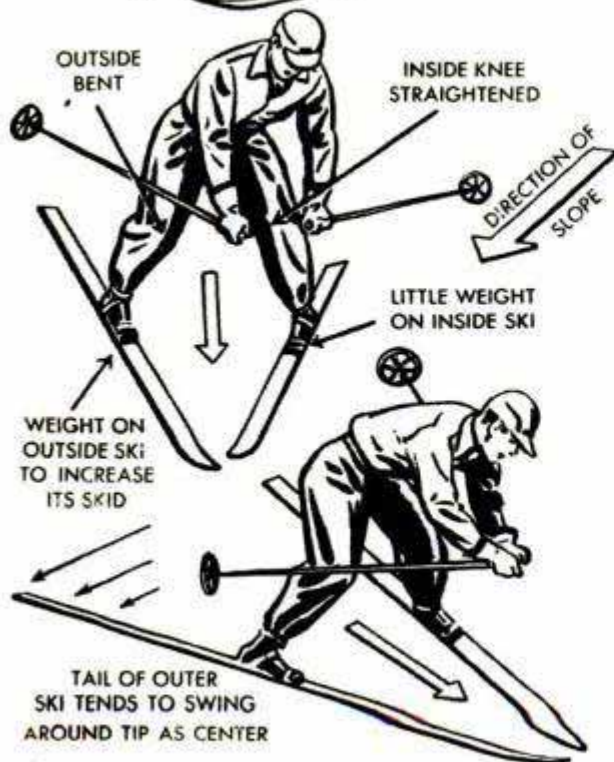
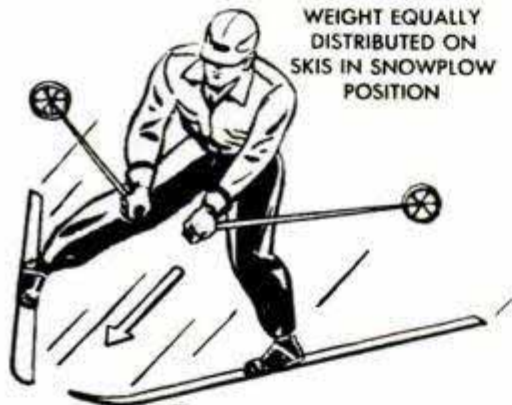

establishment of Camp Hale nearby as a war-time training center for ski troops.

Paepcke and those he interested saw it as a "complete community" and cultural center, with sufficient industry to keep it prosperous the year around. Along with artisans who'd make it a native crafts center, they wanted to attract writers, artists, musicians and scholars who would give it fine music, theater and educational opportunities. The quaint flavor of its Victorian architecture was to be preserved in new and restored homes, even to offering free paint to old residents who would follow a recommended color scheme.

To start the ball rolling, they wanted a spectacular attraction to exploit their most popular asset, near-perfect skiing. Given a healthy start, they were confident the rest of their hopes for the town's renaissance would be completed. The answer was to build a chair lift for skiers—the longest in the world!

Erecting it from the streets of Aspen to the 11,400-foot top of Ajax Hill was a major engineering feat, but it was hustled through from survey to dedication in less than a year. Passengers, most of them wearing skis, are "scooped" up in individual chairs suspended from a cable. During a 30-minute ride to the top, they gain 3500 feet in altitude. The lift's capacity is about 275 an hour.

Moving noiselessly and alone through space, above a carpet of white snow, green pines and aspen, some describe the trip as being "like a ride to Heaven." Sometimes the treetops are just a few feet below the ski-shod riders, while at others the chairs are 85 feet above the ground. Riders travel more than 500 feet a minute, in complete safety.

The lift is in two sections, with the 8400-



GELÄNDESPRUNG

Useful in clearing obstacles, for this maneuver both poles are swung forward and planted in snow. As skier springs, knees are brought up, skis are almost at same level as tops of poles

foot lower one the longer, and passengers walk just a few yards to transfer. In contrast to the upper, the lower section is a monocable system in which chairs hang from the same inch-thick cable that pulls them up. On the bicable upper section, the chairs are suspended from one cable and pulled forward by another.

At the upper terminal of each is a rubber-grooved wheel 10 feet in diameter, driven by an electric motor, around which the continuous cable is turned. At the lower ends are weighted tension stations, with similar grooved wheels, around which the cables travel.

Spaced along the 14,000-foot route are 46 steel supporting towers, with two or four pairs of rollers to guide the cables. They vary in size, according to their location on the mountain's profile, and are mounted in concrete bases averaging six feet thick, sunk below topsoil.

Though the swift, and sometimes steep, ride is thrilling, it isn't dangerous. The lower cable is tested to hold more than 40 tons, about six or seven times what its filled chairs generally carry, and the upper cable can support more than 12 times its usual load. According to its builders, the Heron Engineering Company of Denver, parts of the cables will be removed every five years and sent to laboratories for exacting tests. All the



In slalom racing, above, contestants travel down a narrow, twisting course between flags arranged in rows or pairs. They reach speeds approaching a mile a minute. Below, passengers at the lower end of Aspen's lift are scooped up, skis and all, and carried 14,000 feet to the top in a 30-minute trip. Riders gain 3500 feet in altitude

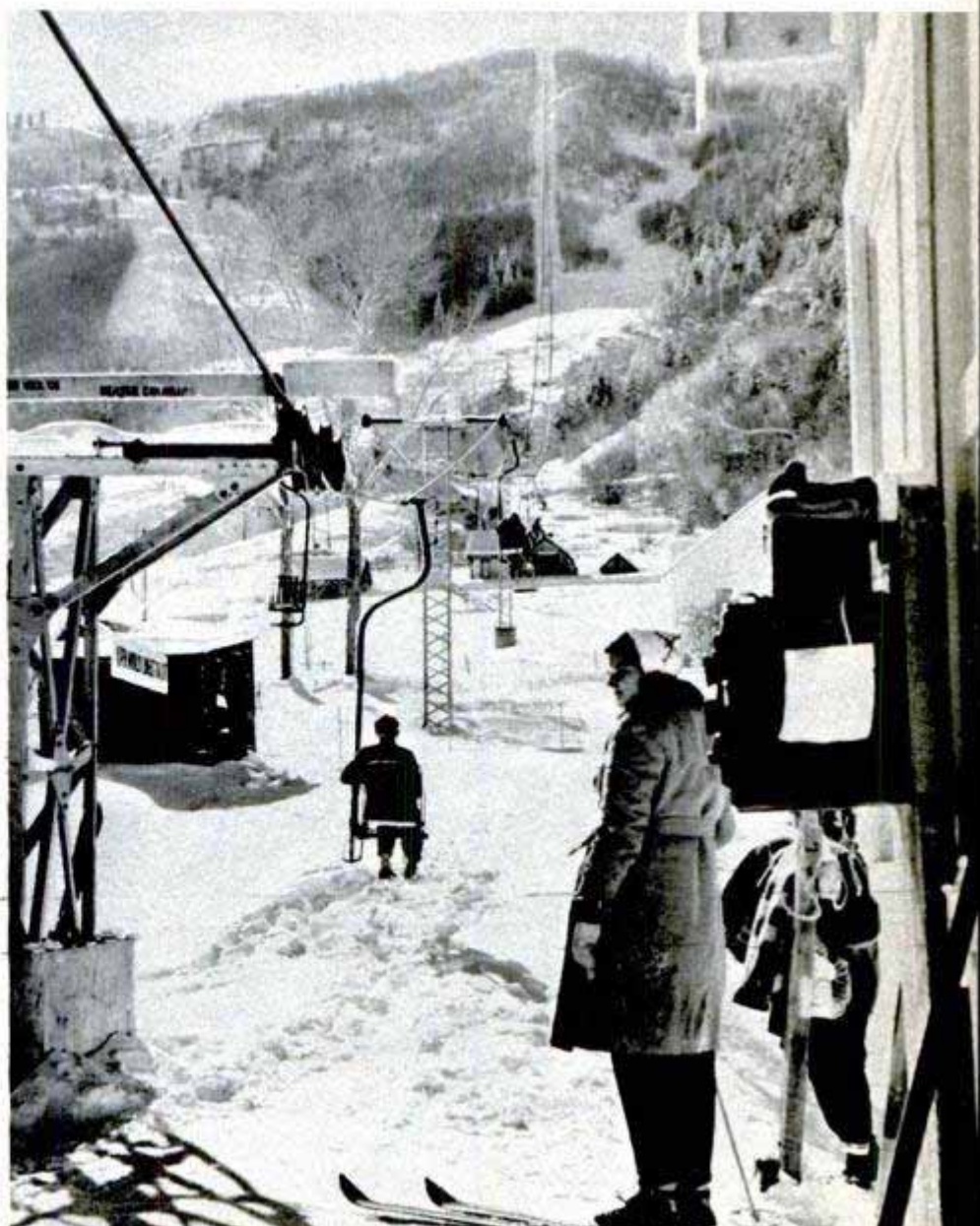

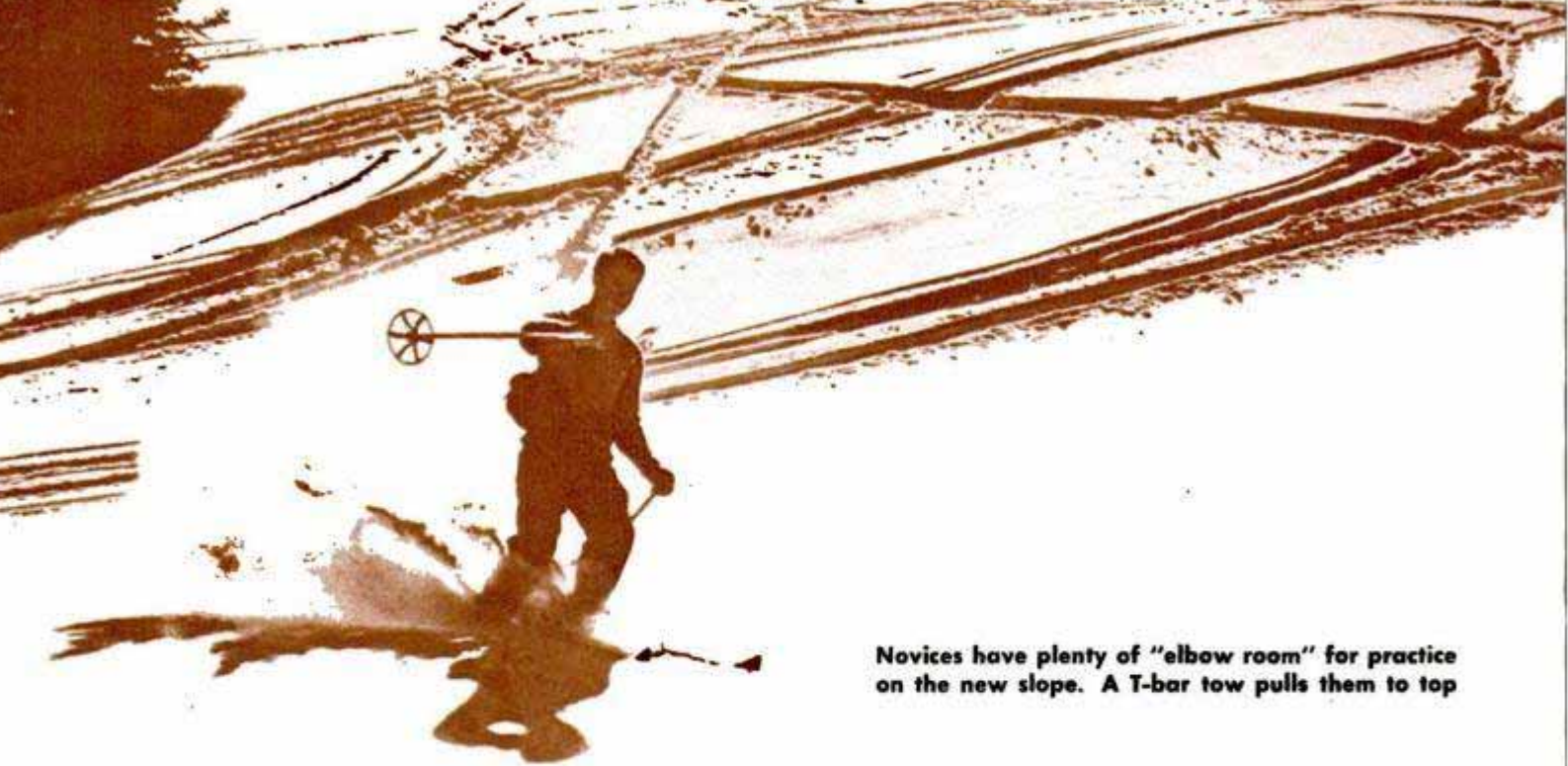

Novices have plenty of "elbow room" for practice on the new slope. A T-bar tow pulls them to top

wheels they operate on are rubber filled.

The tubular steel chairs have arms, a hinged safety bar that swings across the front and a rung for feet or skis. For protection against wind or snow there are canvas hoods. Since both sections are two-way, with chairs constantly circling back to pick up new customers, the lift gets a good play from nonskiers, from 8 to 80 years old, who want an unequalled view of the gorgeous mountain panorama.

The skiers' reward at the top is the fine, powdery snow they prize and an assortment of excellent trails, starting from an octagonal-shaped sun deck. The shelter's

unusual design, incidentally, helps provide water for its restaurant. The roof is concave, so that trapped snow is made to course toward a flue in the center, a flue which passes down behind a five-sided fireplace, melting the snow.

For the more skilled at Aspen there is the famed Roch Run, scene of the 1941 national championships; Gentlemen's Ridge, Little Annie Basin and others. To answer an initial criticism that most of the courses were too tough for beginners, a gently sloping practice hill, 2200 feet long and 400 feet wide, was cleared. Called Little Nell, a

(Continued to page 260)

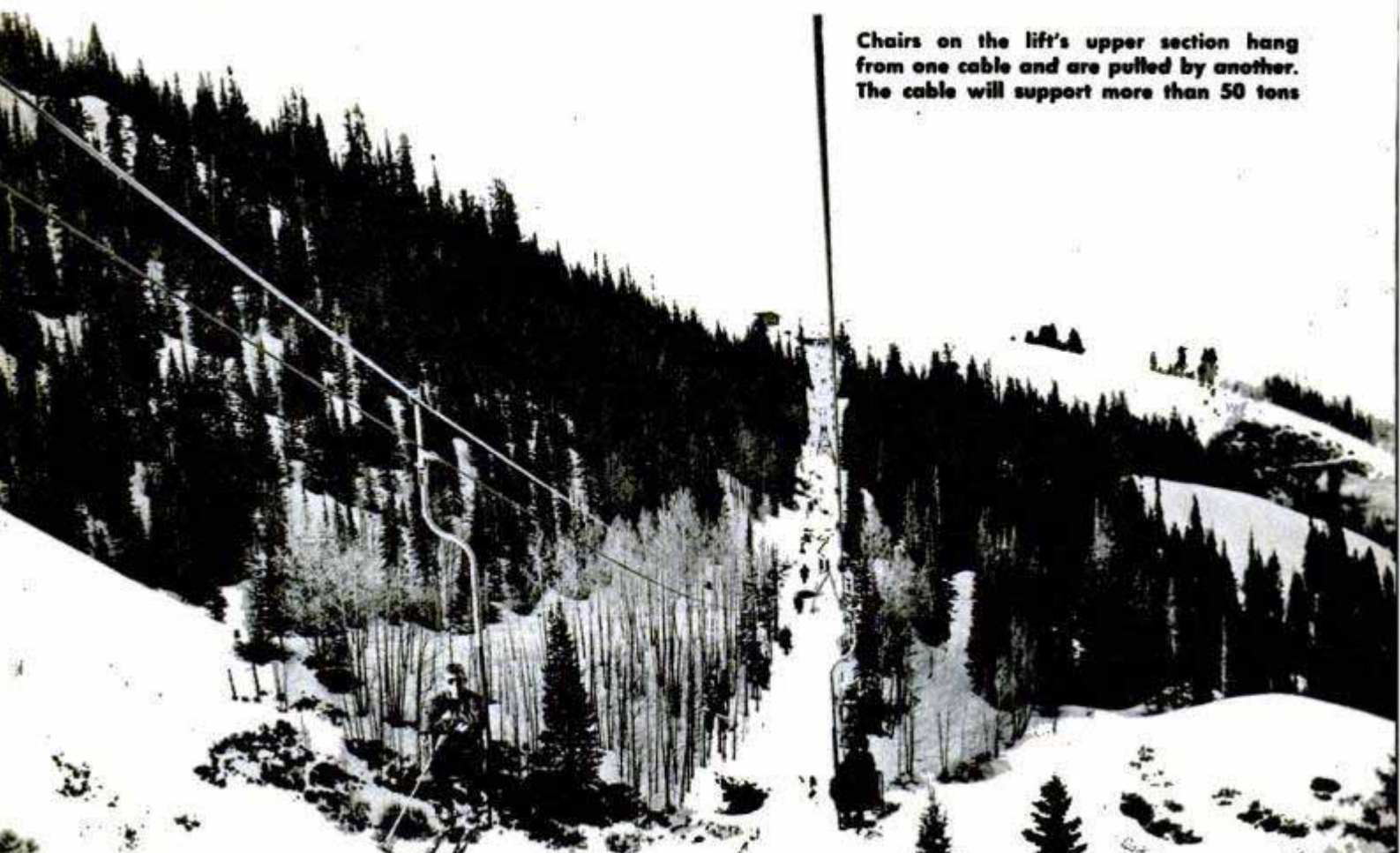

Chairs on the lift's upper section hang from one cable and are pulled by another. The cable will support more than 50 tons

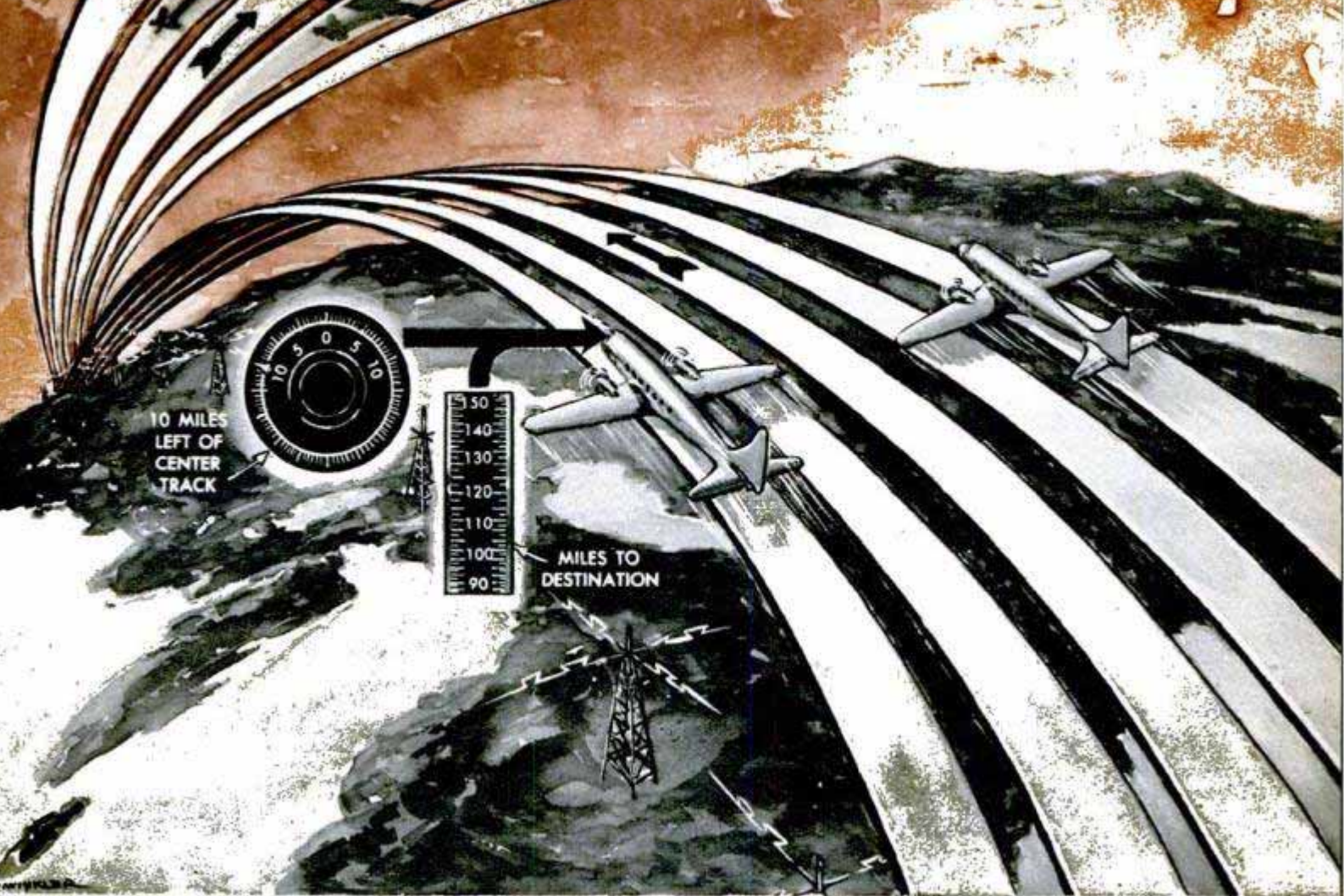

Electronic Guide Widens Air Lanes

Air traffic lanes can be made 10 times as wide, "stacking" eliminated and schedules followed precisely with an electronic navigator called the B-D Computer. The B stands for bearing and D for distance. Instead of flying directly down the beam, the pilot sets into it an off-course calibration of 5, 10 or more miles to the left or right of the center "track." When given flight instructions, he need only turn a dial to the designated miles off course. The device compensates for wind variables in flight and automatically holds the plane on track to the destination. With this parallel spacing, 10 times the present number of flights can operate at the same level. The computer's operation depends on signals received from two radio transmitters located together at a known reference point. One, similar to Shoran, gives the plane's distance from the point; the other indicates the plane's direction from it. Changes from one ground reference station to another are made automatically as the flight pro-

Artist's drawing illustrates how the computer, a test model of which is shown below, widens beam into multiple-lane airway

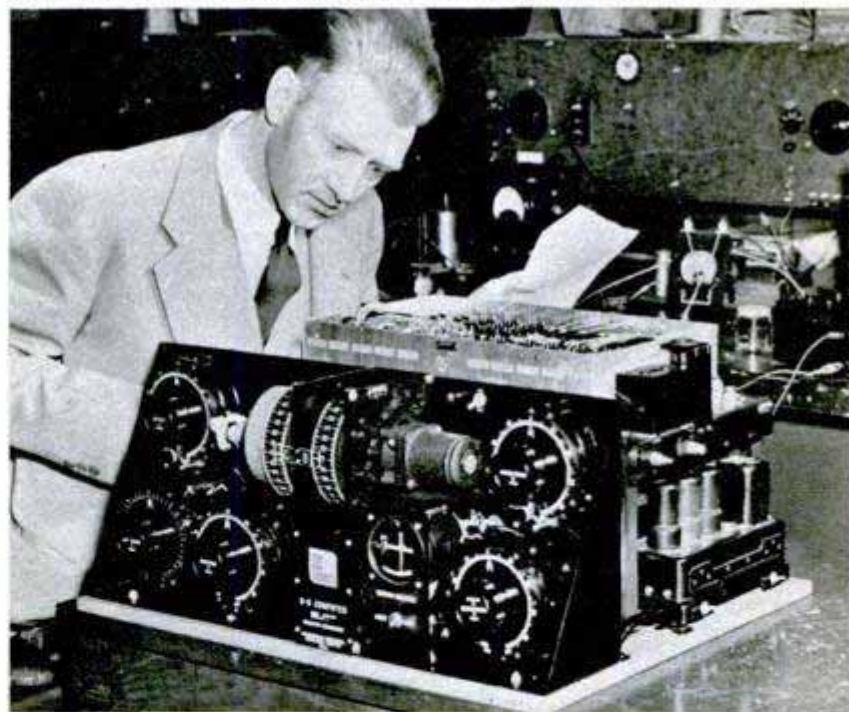

ceeds. An estimated-time-of-arrival dial and a mileage-to-destination indicator keep the pilot constantly informed of his progress. The computer's developer, Minneapolis-Honeywell Regulator Company, likens its action to "widening a single-lane country road to a 10-lane superhighway."

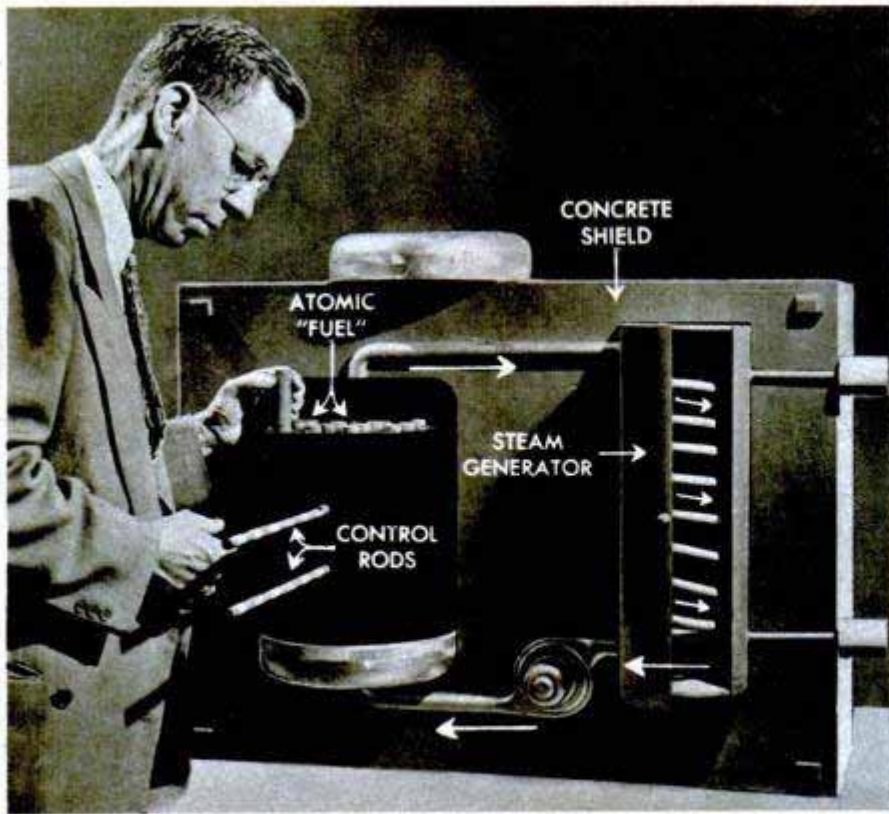

Model Power Plant For Atomic Energy

Peaceful use of atomic energy is forecast by a model power plant using a heat-exchanging fluid to eliminate the danger of atomic radiation. Constructed by General Electric, the model is not built to scale, but it does show a proposed method of harnessing the power of the atom for turning the wheels of industry. The heat-exchanging fluid is pumped through the atomic pile and into a boiler where water is converted to steam.

Scientist lowers fuel rod into atomic pile. Controls regulate atom-splitting that heats fluid pumped through generator coils

Auto Sunshades of Plastic

Transparent sunshades for the side windows of automobiles protect occupants from the direct rays of the sun without obstructing their view. Made of plastic, they are attached permanently to the door and give protection from rain and snow as well as the sun by overhanging open windows. The shades, which are available in blue or green plastic, permit hinged ventilation windows to be opened.

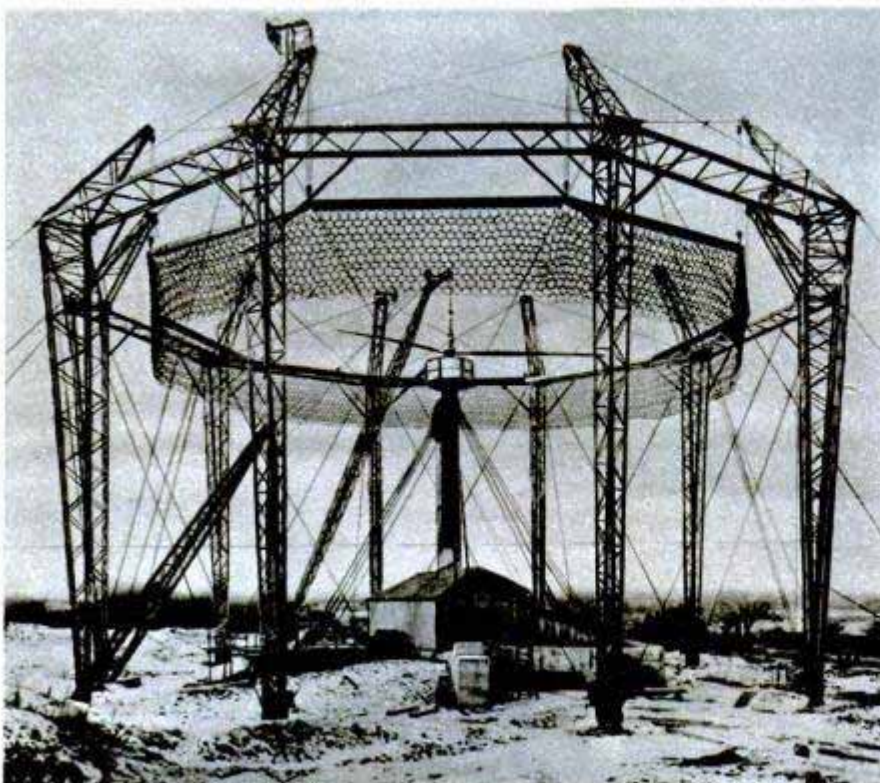
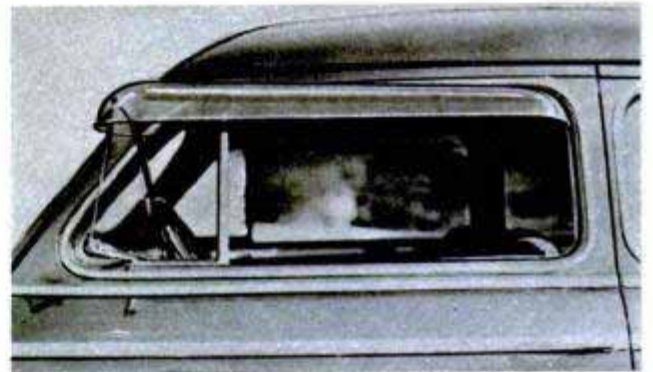

Rotors "Test Flown" On Spinning Tower

Flight conditions more severe than those likely to occur in the air can be simulated by a test tower for helicopter rotors at Filton, England. Rotors with blades up to 60 feet in diameter are mounted on the 50-foot tower and driven by a 1000-horsepower motor. Any flight angle can be duplicated by adjusting the tension of six double cables supporting the tower. Netting suspended from a ring of 70-foot pylons around the tower acts as a safeguard against blade accidents. The netting can be adjusted to fit any rotor position.

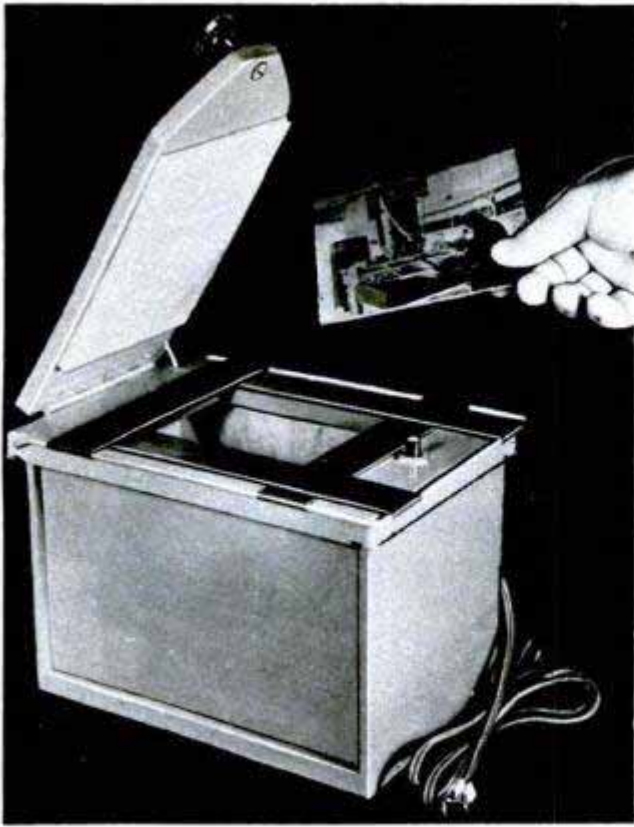

Contact Printer Kit

Photographers can make a contact printer with a kit that requires only a screwdriver for assembly. The printer will take negatives from 35 mm. to 4 by 5 inches. A sponge-rubber platen holds the negative and paper firmly in position. Operated by the platen, an automatic switch controls the printing bulb and safelight.



Industrial Microscope

Holes as small in diameter as a human hair are drilled accurately when the operator watches the process through a new industrial microscope. Specially designed for manufacturing processes, the microscope has two eyepieces through which the magnified image is seen without distortion or inversion. The microscope is used in such exacting operations as drilling holes in Diesel injection jets and assembling miniature radio tubes.

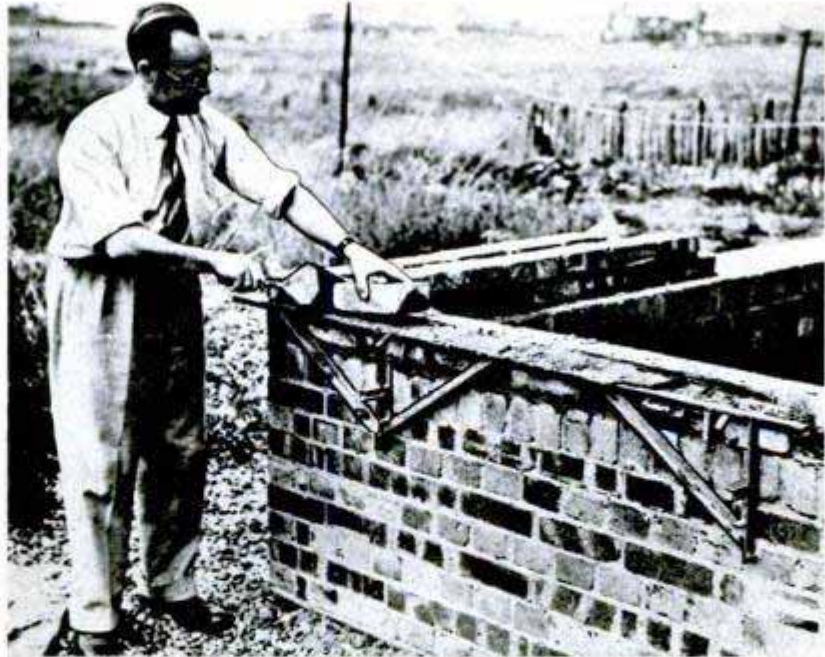

Fox photos

Bricklaying Speed Is Increased With Metal Guide

With a metal guide invented in England, bricklaying time is cut more than half. Replacing level and plumb lines, the guide clips on the top course of brick and has

built-in spirit levels. In tests, the inventor laid 100 bricks in 30 minutes, the equivalent of 1600 bricks in a day. Normal rate with the old method is about 500 a day.

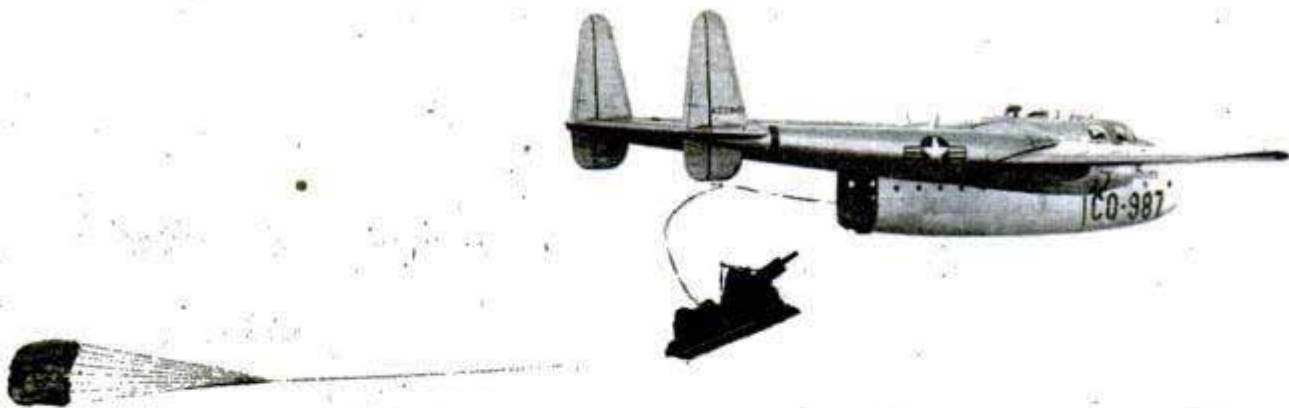

Huge Howitzer and Jeep Parachuted From Plane

Army field equipment weighing more than $3\frac{1}{2}$ tons is ready for immediate action after being parachuted to earth from a C-82 transport. Tests at Ft. Bragg, N. C., to develop techniques for dropping bulky airborne materiel, were conducted with a $1\frac{1}{2}$ -ton jeep and a 4400-pound 105-mm. howitzer. Both were mounted on wooden platforms resting on rollers and loaded on a C-82. A tiny, spring-released chute was first out, pulling a 16-foot ribbon-type parachute which jerked the equipment from the plane. As soon as the big gun was clear of the twin tail booms, two 96-foot

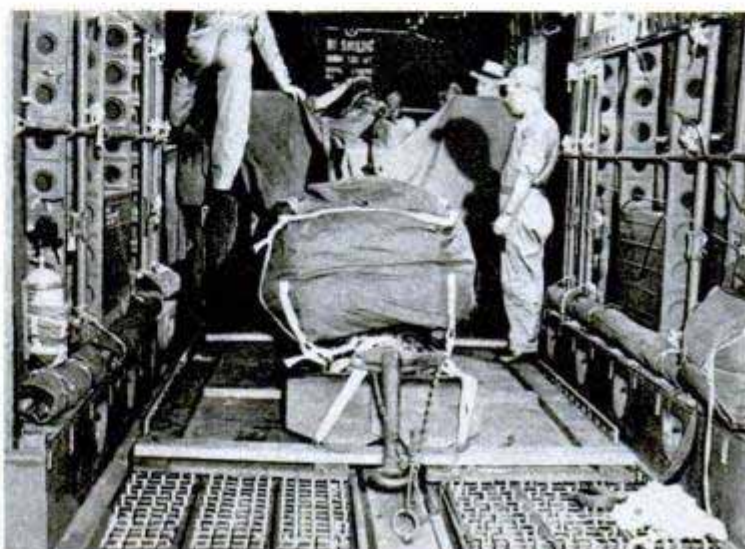

Fairchild Aircraft photos

canopy chutes billowed out to lower it to the ground. A single 96-foot parachute was used for the jeep.

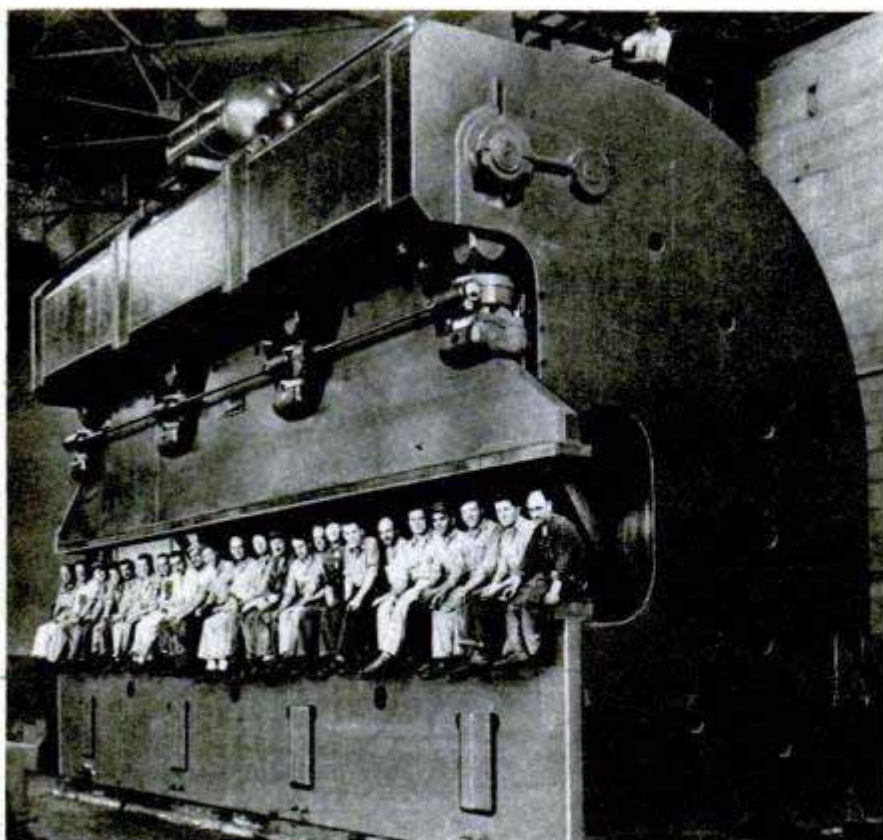

Giant Press Brake

Exerting a pressure of more than 1000 tons, a giant mechanical press brake bends a right angle in a $\frac{5}{8}$ -inch steel plate up to 36 feet long in a single stroke. The brake, built by the Warren City Manufacturing Company, will be installed in a steel plant. Weighing 500,000 pounds without dies, it is more than 36 feet long, 16 feet wide and 20 feet high. The machine makes 15 strokes per minute, with all moving parts counter-balanced by air cylinders. A 75-horsepower electric motor drives the 10,000-pound flywheel at 450 revolutions per minute. The machine is controlled by one operator.

TEST YOUR SCIENCE



By Rex Taylor

THE LAW of centrifugal force states that matter will move outward from a center of rotation. The expression "centrifugal force" was first used by astronomers to explain why the planets do not fall into the sun.

This ancient law is apparently refuted by an experiment which requires only a spoonful of sugar, a glass, some water and a spoon. First, place the spoonful of sugar in the empty glass. Spin it on a smooth table. The sugar piles up in a ring around the bottom of the glass, thrown there by centrifugal force. So far the sugar is obeying the law.

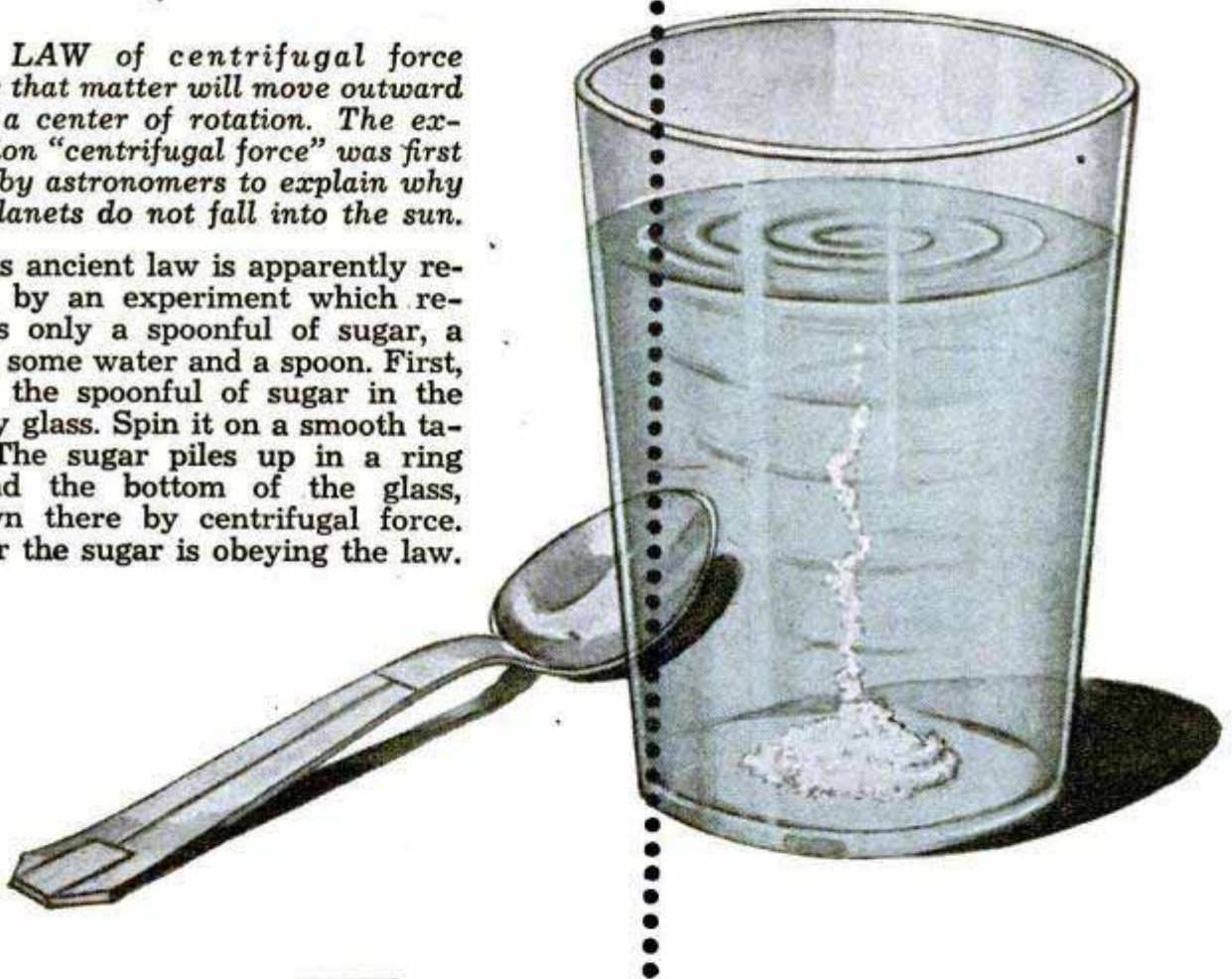

THEN

Here comes the test which seems to disprove the law. Take the glass containing the spoonful of sugar and add cold water (or any chilled liquid) and stir rapidly with a spoon. After vigorous stirring, remove the spoon. According to the law of centrifugal force the rapidly spinning liquid should throw the sugar outward to the wall of the glass. But it doesn't! The sugar collects in the center. Why?

Is there a flaw in the law of centrifugal force?

Answer on Page 230.



Head-bolt heater makes motors start easily in sub-zero weather by warming the water in the block to driving temperature. The heater, a long bolt with an immersion element on the end, replaces a standard head bolt in the engine. When the extension cord on the heater is plugged into a 110-volt outlet, the heater warms the engine to quick-starting temperature in 30 minutes. A permanent installation, the heater is tightened into the block like an ordinary head bolt.

Brake-pedal depressor eliminates the necessity for a second man to hold down the brake pedal during brake alignment inspections. Suitable for use on any type of car or truck, the depressor is quickly adjusted to a variety of lengths. The forked end of the all-metal tool is centered on the pedal and the long shaft pushed forward until the brake is applied. The upper bracket has a friction catch that locks it in place against the seat cushion to hold the pedal down. In addition to its use during brake alignment inspections, the depressor can be used when checking casters or kingpin inclination.

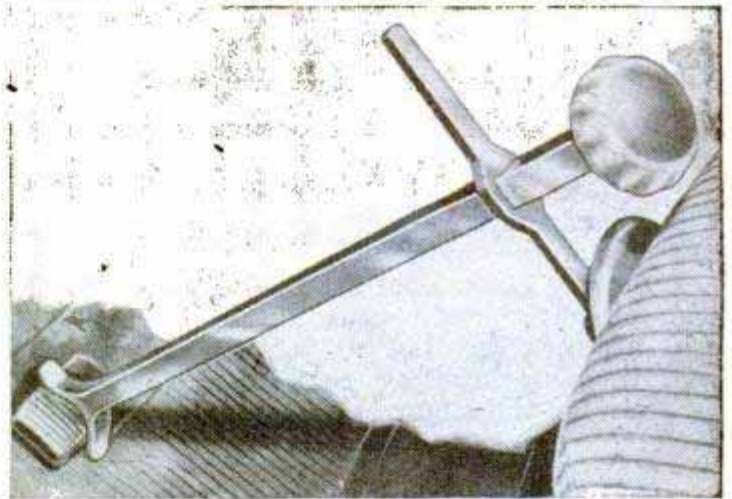

Motor-oil pump dispenses lubricating oil without the bother of cans or bottles. The oil is pumped directly into the crankcase through a flexible hose like those used on gasoline pumps. At the nozzle end of the hose is a meter that shows the quantity dispensed in gallons and quarts. The hose retracts inside the dispenser body when not in use. Several pumps are connected as a unit to provide a convenient supply of various oils. The dispenser speeds up oil changes and reduces spillage and waste.

FOR MOTORISTS



Built-in hydraulic jacks that operate automatically when a control knob on the dashboard is turned make changing a tire almost a pleasure. The 1948 Princess and Sheerline models of the Austin have this convenient feature incorporated into the chassis. Without getting out of the car, the driver can jack up both front wheels, both rear wheels, or all four wheels. The jacks are connected to a separate hydraulic system and are located on each axle near the springs. Both models are in the luxury class and were especially designed for the American market by Austin, England's largest manufacturer of motor cars. Two less expensive models do not have the automatic jack feature. These smaller cars have 40-horsepower motors and cruise at 65 miles an hour. All four models were built with a left-hand drive for American use.

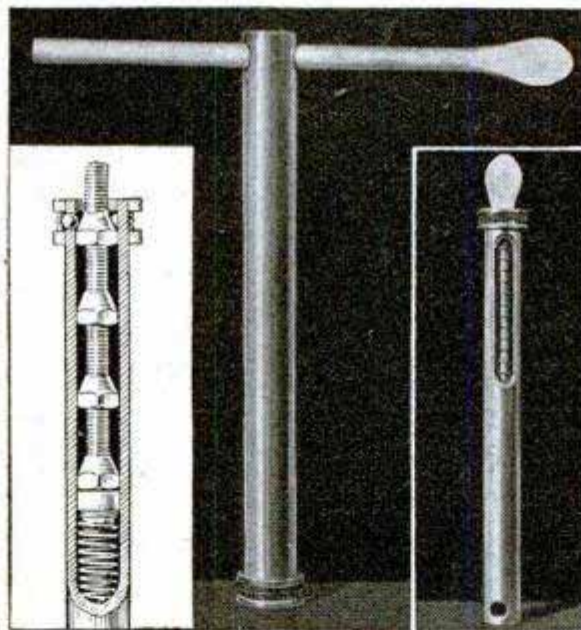
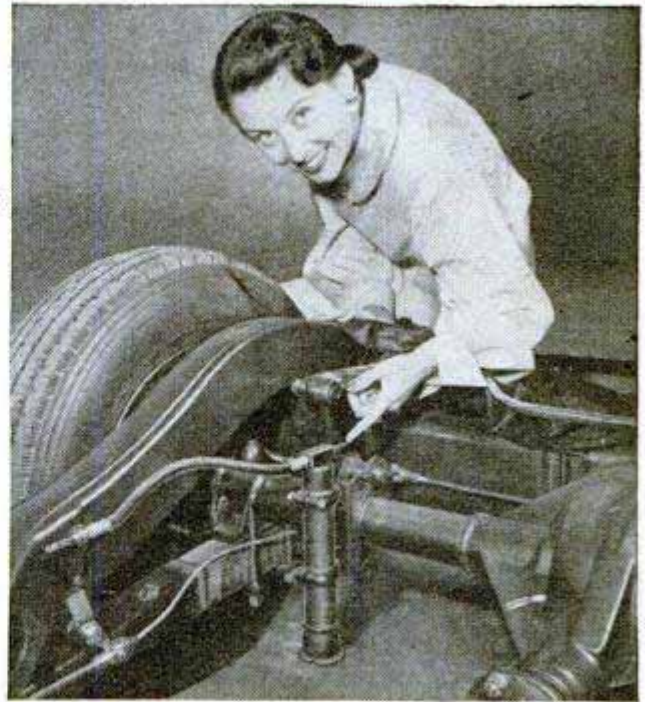

Lugs can't be lost when a new lug wrench is used for changing tires. The wrench is made of heavy tubing and the lugs push inside against a spring to be retained until reinserted in the drum. A spring-loaded plunger moves the lugs forward one at a time and they are held in position for replacement so that it is unnecessary to handle them at all. A spade end on the handle, which slips inside the tube when not in use, removes hub caps without marring them.

Gap-setting tool for spark-plug electrodes has eight retractable feeler gauges and a heavy electrode-bending fixture. Small enough so that it can be carried in the mechanic's pocket, the tool is sturdy and rustproof. Selection of any one of the eight wire gauges is done by a micrometer-type selector at one end of the tool. The gauges range in size from 15 to 40 mils to provide accurate gauging of standard gaps. When not in use, the wire feelers can be retracted into the aluminum body of the tool. The bending fixture, made of hardened tool steel, has four slots milled to fit all sizes of regular ground electrodes. Over-all length of the tool is $3\frac{3}{4}$ inches and its weight is $1\frac{1}{4}$ ounces.

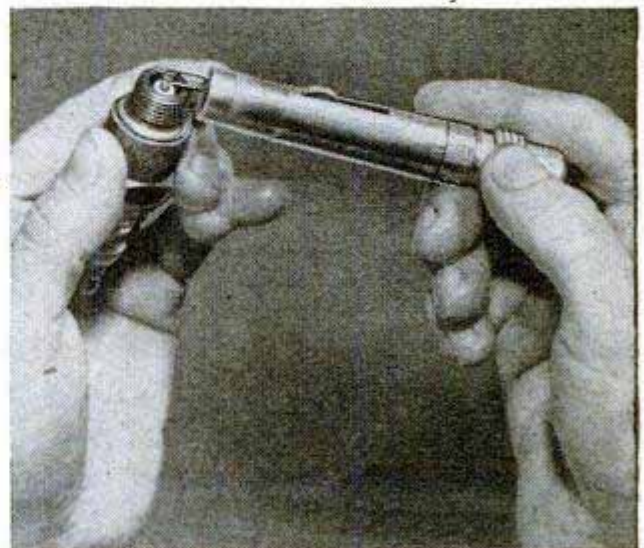

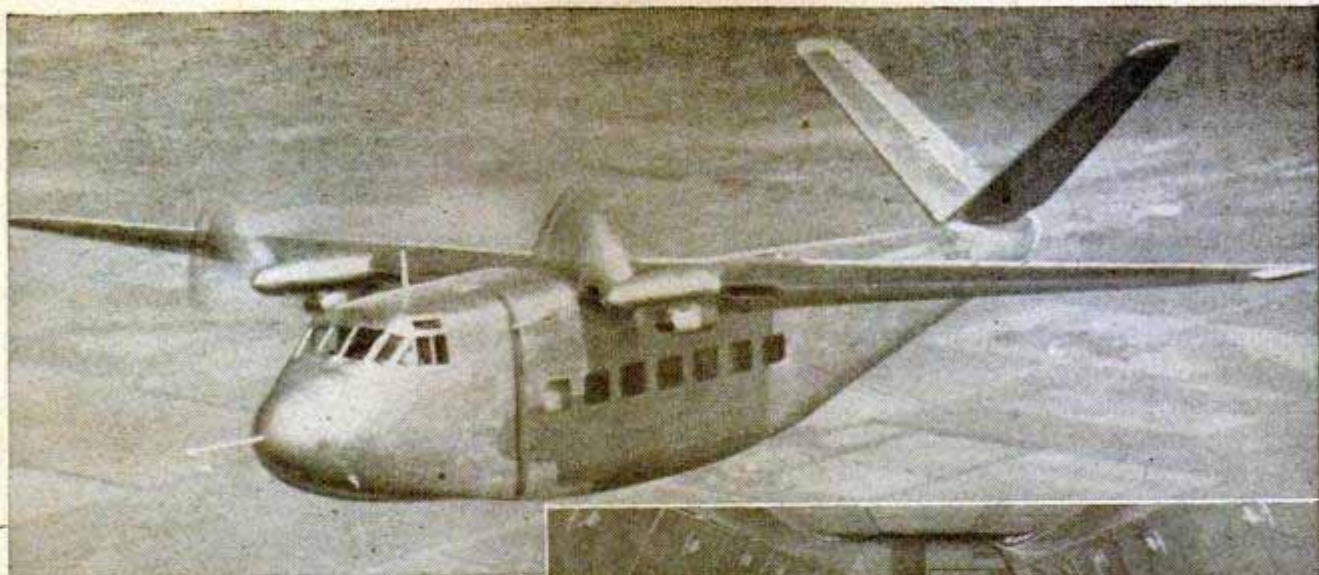

Transport's Four Engines Turn Just Two Propellers

Four engines buried in the wings run the two propellers of Beechcraft's Model 34 Twin-Quad. Other unusual features are built-in emergency landing keels and a V-type tail for large planes. The new model carries up to 20 passengers or cargo, cruises 180 miles an hour and has a 1400-mile range. A combined bulkhead and door as well as seats can be shifted in a few minutes to vary the proportions of passenger and cargo space.



Beech Aircraft photos

Air Force's Swept-Wing Jet Fighter Gets Tactical Tests

With the XP-86, the U. S. Air Force gets its first chance to explore the tactical possibilities of swept-wing fighters. The six-ton jet was built by North American for

speeds in the lower subsonic brackets, below 650 miles an hour, and for altitudes well above 40,000 feet. It has extra large ailerons to offset control problems of the

swept-back design and fuselage dive brakes for the approach slow down. The pilot is perched up high, beneath a pressurized bubble canopy. There are three .50-caliber machine guns on either side of the air intake in the nose and facilities for smoke tanks, bombs, rockets and depth charge in the wings.

Ⓛ Fifty-one different models of aircraft, including four helicopters, were offered on the civil market last year by 25 American manufacturers, compared with 47 by 29 firms in 1946.

North American Aviation photo

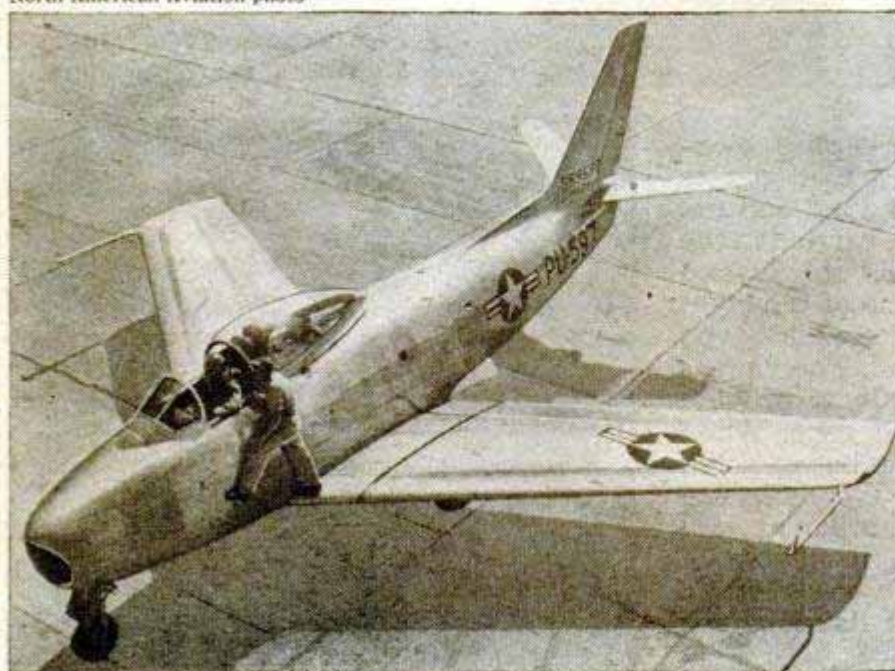



Jungle Home on Wheels

They make their own roads! The Russells plow through miles of tropical underbrush on their camping trips

IT TAKES A RUGGED vehicle to plow through jungle underbrush, ford streams and climb steep grades, carrying an adventurous couple, their living accommodations and paraphernalia for treasure hunting, fishing and exploring.

S. Robert Russell and his wife, of Key West, Fla., solved the problem by picking up a used Army command car and adding a hand-built, folding body with trimmings

that include most of the comforts of home.

The result is a powerful truck that has sleeping bunks, icebox, dining-room table, typewriter and stand, water tanks and plenty of storage space for fishing and camping equipment.

The Russells found the front-wheel-drive Dodge in a Miami used-car lot. Its canvas cover was torn across the top and the steel bows that framed the canvas were

Sides and tail gate down and ceiling raised, "camp" is ready for the night



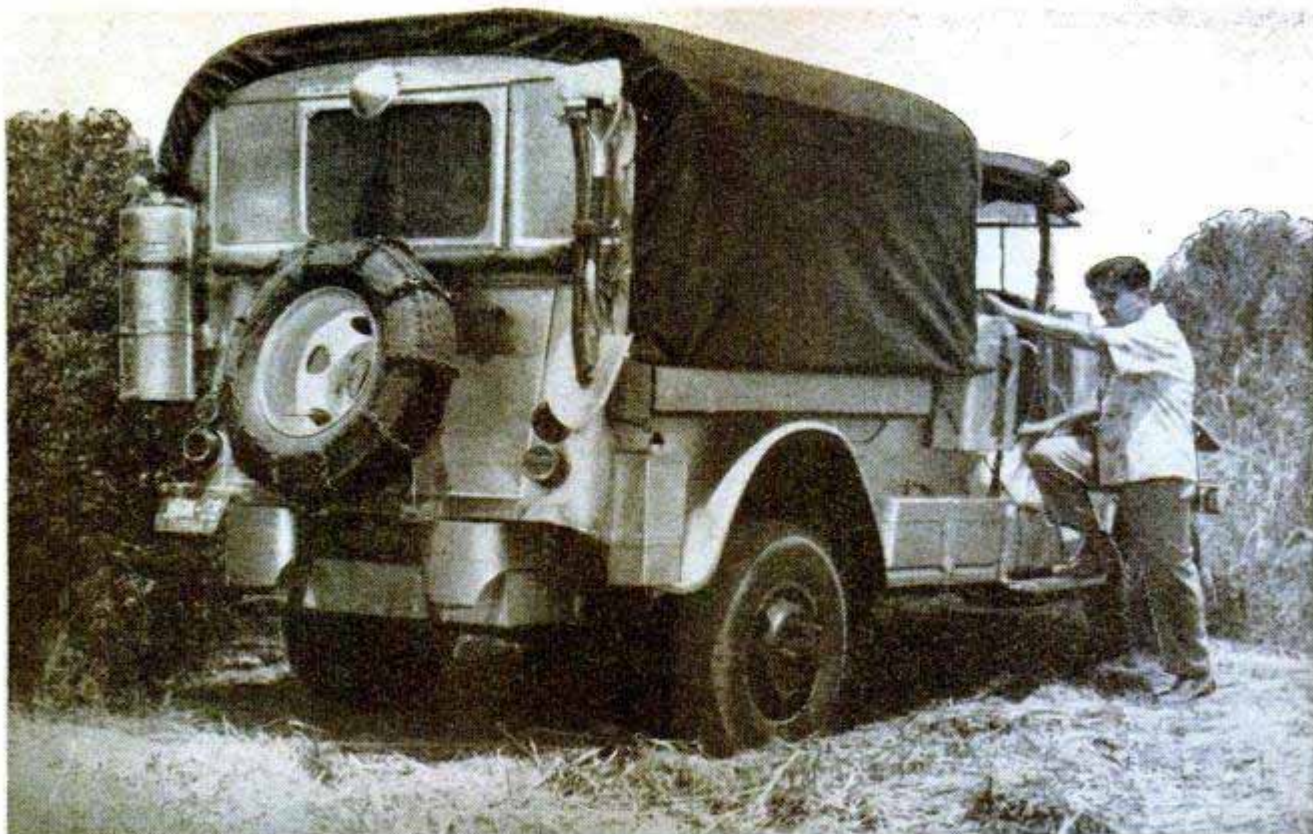

Stern view shows compact land cruiser ready for the road. Aluminum paint reflects heat to keep interior cool

bent. One tire was flat, the body was dented in several places and the paint was rough and peeling.

Russell was about to walk away from the car when he decided to check the engine. It sounded smooth and powerful, and the transmission and transfer-gear case were in excellent condition. The running gear showed no looseness due to wear. The tires were fair and the flat needed only air. The vehicle looked like a good gamble.

He bought the car, had it greased and drove the 100 miles to his cottage. The ride convinced him the jalopy was a good buy, and his mind filled with plans for converting it into a land schooner.

Working as a team, the Russells built a new top over the front seat and made a few

other emergency repairs. Then they loaded the body with half a ton of sand and set out to test the car's jungle ability.

Driving along a highway, they spotted a road fill that made an ideal testing ground. Powerful brakes eased the car down a steep grade and into heavy jungle-like underbrush. Russell pulled back the lever which engages the front wheels and shifted into low-low.

Gears growled and the car inched forward. A sapling bowed before the weight and power of the vehicle, brush scraped along the side, and branches smacked against the passengers in the open cab. But the machine kept moving at about three miles an hour.

A fallen tree was pushed aside easily, a



← Here's "Tramp" before work started. Below, wheel flange makes winch for tow cable



mud hole was negotiated with all four wheels spinning. After crashing through a stand of young palmettos, Russell turned the car around, climbed the steep grade and rolled down the highway, convinced that the car was a good exploration vehicle.

That was the last ride the Russells took for a month. For 30 days they worked from morning to night—and sometimes under lights—building a body to meet their requirements. Mrs. Russell worked constantly, sawing, hammering, painting and hemming the 7 by 16-foot tarpaulin which was to cover the body.

With no electric drill, the Russells had to drill hundreds of holes through the steel body by hand. Materials were hard to find. The adventurers combed the beaches, removing needed hardware from wrecked ships. A crumbling house trailer supplied an undamaged window.

At the end of 30 days the job had been roughed in. Comfortable bunks, complete to mattresses, could be folded snugly into the sides. Hinged extensions to the front and back could be raised, carrying the top with them, thus providing full headroom inside. The entire unit was screened and rainproofed.

Many conveniences remained to be built or installed, but the Russells were impatient to try out their "campmobile." They bought a collapsible stove, several cans of fuel, a five-gallon can for water, a few dishes, and headed for Key West, which was only 30 miles from their cottage on the outskirts of Marathon.

It took them all day to cover that 30 miles because they frequently pulled off the highway to plow through interesting jungle and to drive along remote stretches of beach that never before had felt the weight of a car. At Key West, they cut an opening in the truck body and fitted a 15-gallon water tank against the chassis under the

(Continued to page 226)



Hand crank can be substituted for the electric winch. The cable will help the "Tramp" across streams or lower Russell down a cliff



↑ In low-low with all four wheels churning, few grades are too steep

↓ There's no waste space in interior. Dining table slides into channel to reveal typing table. At left, upholstered icebox forms a seat



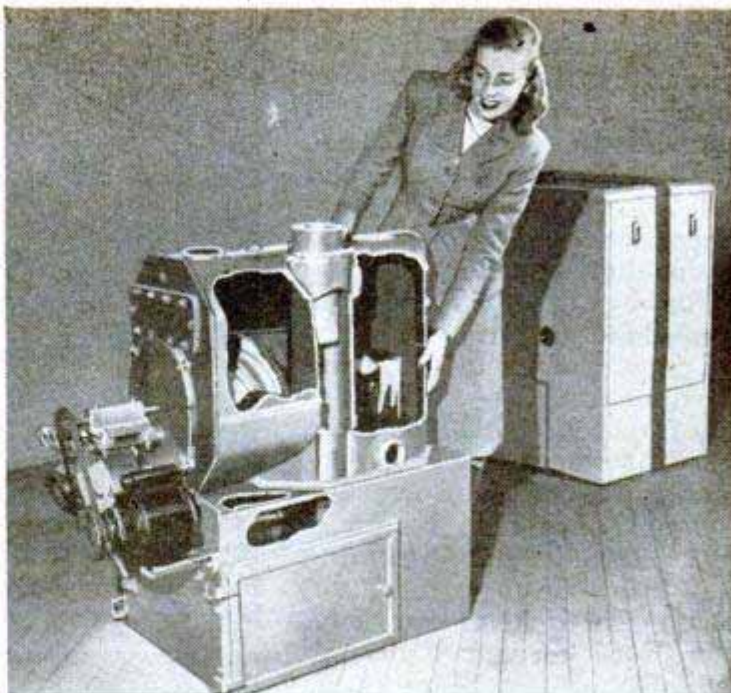
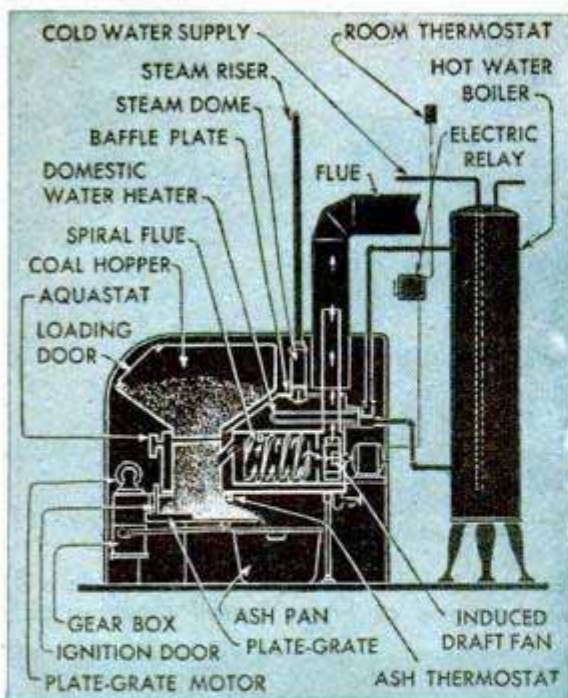

Left, cutaway of hopper-fed boiler-burner that gets more heat out of coal. Right, screw-fed boiler-burner

Boiler Gets 25 Percent More Heat From Coal

Coal produces about 25 percent more heat in an automatic boiler-burner unit developed by the Anthracite Institute. The firebox is completely surrounded by a water jacket, with the heat used secondarily by being drawn off as gas by a squirrel-cage fan. The fan swirls the hot gases against the heat transmitting surfaces of the boiler, breaking through a layer of

cooler gases which normally insulates it from the hotter gases. Heat wastage up the flue is much less than in conventional furnaces. Ashes are automatically removed by an agitator that starts working when a thermostat detects ash temperature falling below a set level. Called an anthratube, it is made in hopper and screw-fed models for steam and hot-water heat.

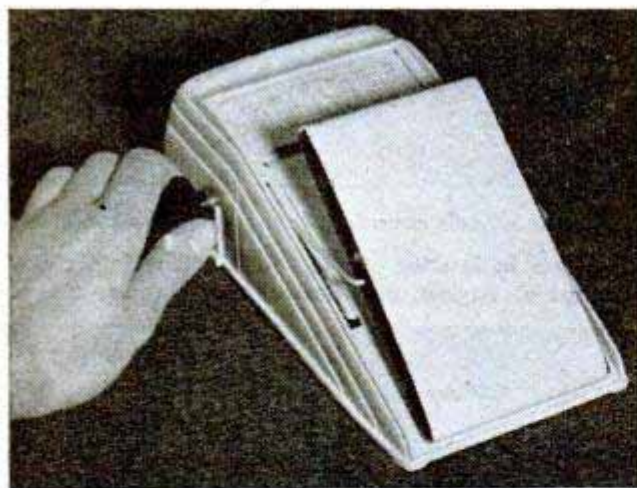

"Flip" Pad Folds Up Old Memos

Months of memo writing are provided by a continuous memo pad mounted on a board that can be flipped over to pull a clean writing surface into position. The writing surface is about equal to a page in most memo pads. Notes are not torn off and discarded, but are folded into the holder. A knob on either side is turned to refer to old notes. Designed for desk use, the pad has a calendar at the top.

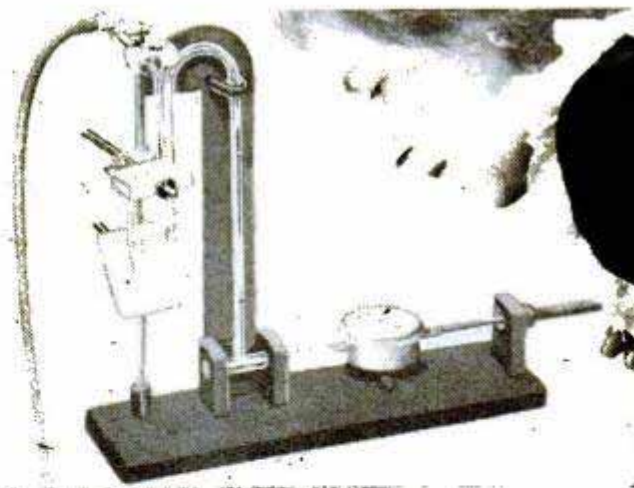

Here's a Slow Way to Fill a Glass

Drops of liquid so small it would take 800 years to fill a drinking glass at one drop a second are measured by an ultramicroburet. Used in measuring liquid for microanalysis, the device has a slender piston fitted in a tube filled with liquid. Movement of the piston, expelling the liquid, is measured by a micrometer and this measurement is used to compute mathematically the amount of liquid expelled.

Welder's Hammer Has Flexible Head

Considerable time is saved when cleaning slag from welds with a hammer that has five separate heads attached to the handle so that each can move up and down separately. Thus, one blow of the hammer strikes the weld in five different places along the irregular-shaped surface, the equivalent of five separate strokes with a single-pick tool. The head segments, which can be resharpened on a grinding wheel like an ordinary chisel, are free to slide $\frac{3}{8}$ inch and thus wrap the force of the blow around a convex bead, follow the contour of a concave fillet or the surface of crevices in deep-groove welds.

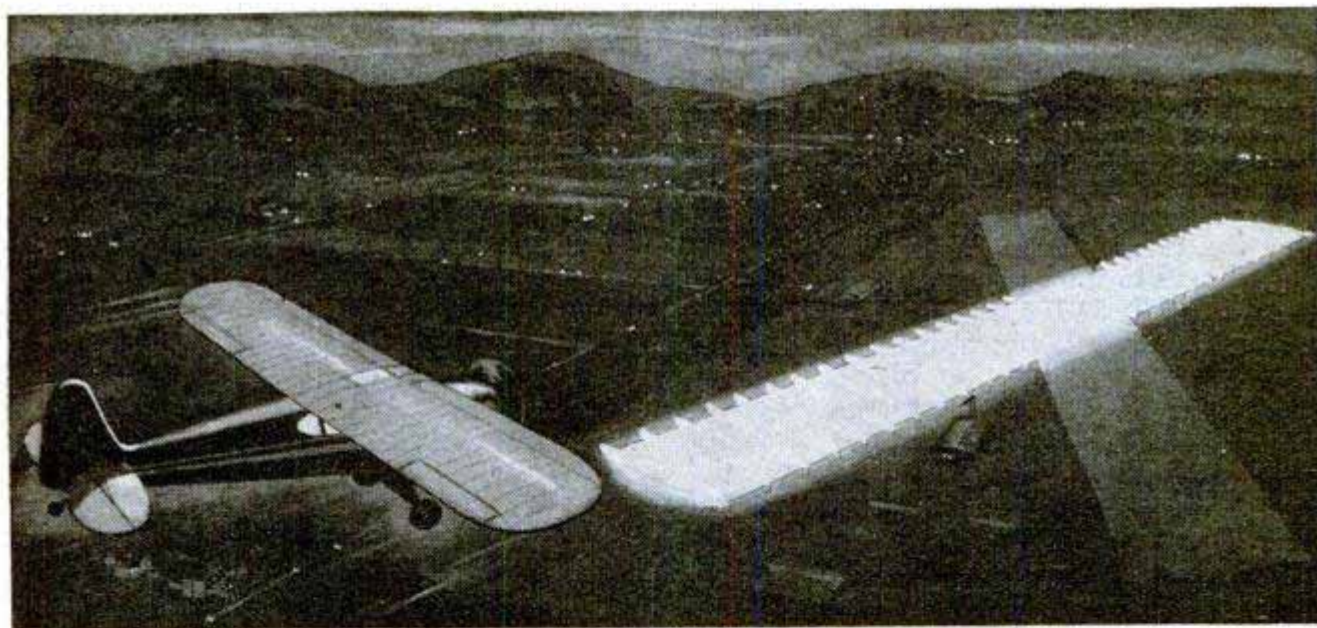
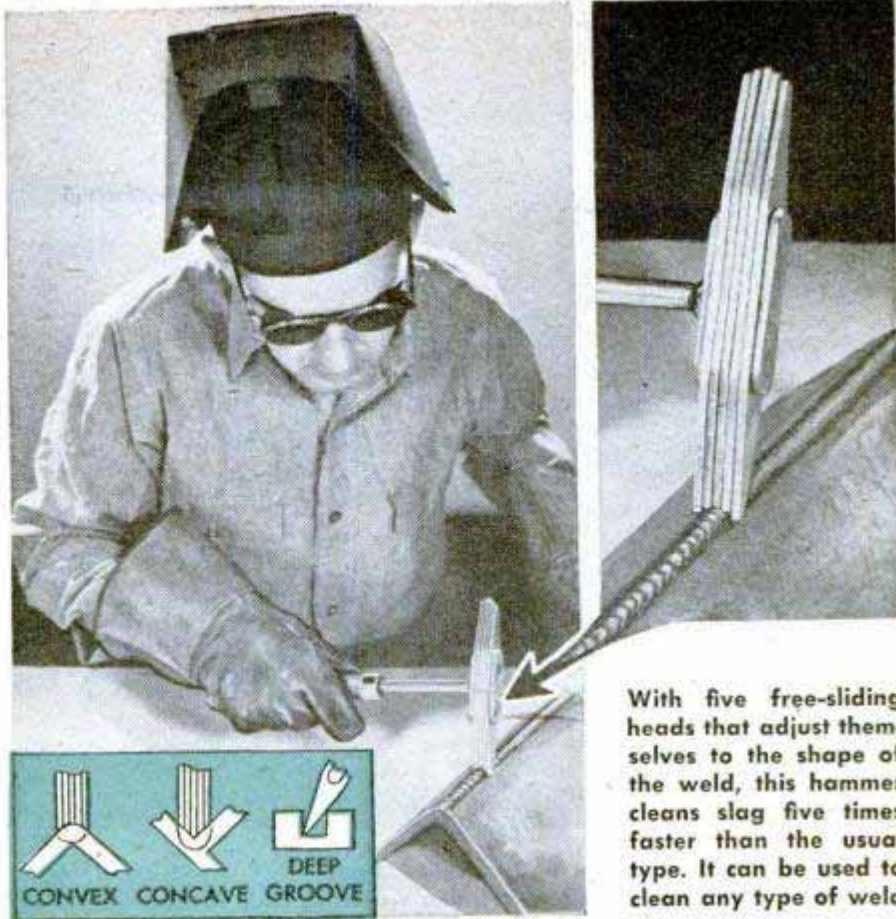

Button in Plane Turns on Runway Lights

Lights at unattended airports could be switched on by pressing a button in incoming planes equipped with a device invented by Vernon L. Mallory of Minerals Wells, Tex. The only extra item in the plane is a box four inches square and weighing about 20 ounces, which plugs into the radio transmitter. Pushing the button sends a tone to a ground receiver about the size of a table model radio, which converts it to an impulse that turns on the lights. Selection of the runway to be lighted is made by a switch connected to a wind sock or tee. A wind shifting midway between runways lights them both, giving the pilot a choice between two cross-wind landings. Operating range can be set by adjusting the receiver's sensitivity. It can be set to cut the lights off after a predetermined period or they can be shut off at the ground receiver





From the suction dredge's 24-inch discharge pipe pours a torrent of sand-laden water

By Thomas E. Riley

ON THE PACIFIC COAST a perpetual battle is raging between the U. S. Engineer Department and the sands of the Columbia.

For the Columbia is an important navigable river, one of the mightiest in North America. It must carry the huge, barnacled ocean liners to the seaport of Portland, Ore. which actually is 100 miles from the sea.

The Columbia is not a mile-wide stream of meandering water that placidly carries the ships—it is a mile-wide torrent of channel-choking sand that bears the curses of every river pilot who has tried to predict its moods. A tremendous, roaring stream of surprisingly clear water, it contains an enormous amount of sand, and when left unchallenged this overgrown mountain stream playfully wrecks ships, moves channels, and throws sand bars so high under the docks that even a rowboat cannot anchor. Rivermen hate the sand.

The engineers have promised to maintain a channel 35 feet deep and 500 feet wide. They man a fleet of sand-eating ships in Portland's back yard where, practically unknown to local residents, they battle the river 24 hours a day. For eight months each year the fleet fights to keep the main channel to the promised 35-foot depth. The battle must be won in eight months as dredging is virtually impossible during the four months of flood stage.

The dreadnoughts of the fleet are the

Sandfighters of the Columbia

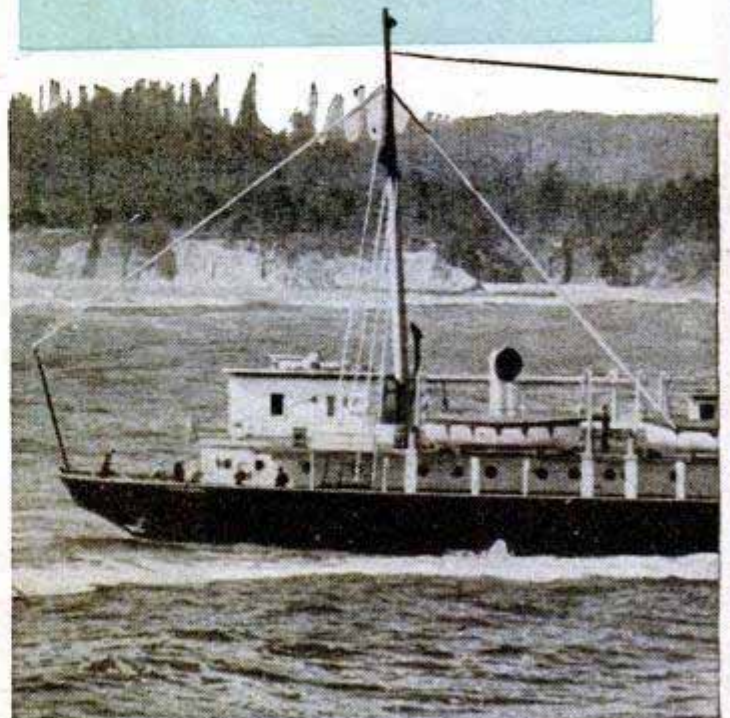

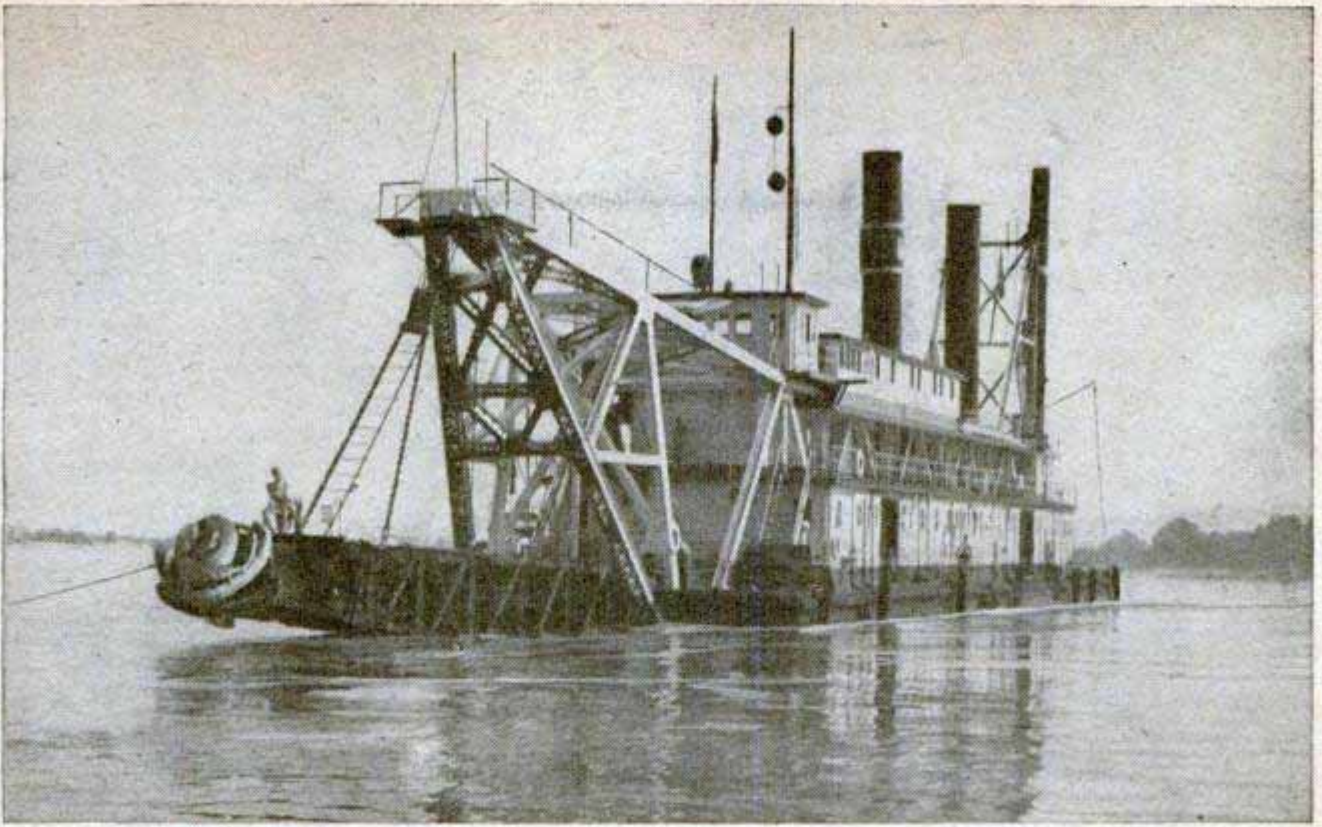

Revolving head of the dredge is raised for repairs. It breaks up hard-packed material on the river bottom

huge hydraulic sand dredges, sometimes called suction dredges. These not only move great quantities of sand but also build dikes and fill lowlands with their discharge pipes to further control the river. There are four in action today: the Multnomah, the Wahkiatum, the Raymond and the Luckiamute.

The Raymond has fought other foes as well as the Columbia. Boarded up to withstand ocean voyages during the late war, she was towed overseas where she downed two enemy planes and shared credit on a

third while dredging in Manila Harbor.

The largest of the hydraulics are the Multnomah and Wahkiatum, sister ships. Each carries staterooms and a galley on the upper deck for the 50-man crew. The lower decks and the holds are crowded with boilers, engines, winches and the centrifugal sand pump.

There are no propellers on these hydraulic dredges—yet they move by themselves. For lengthy trips between dredging sites they must be towed, but when working along the river they travel without

Portland District Corps of Engineers photo

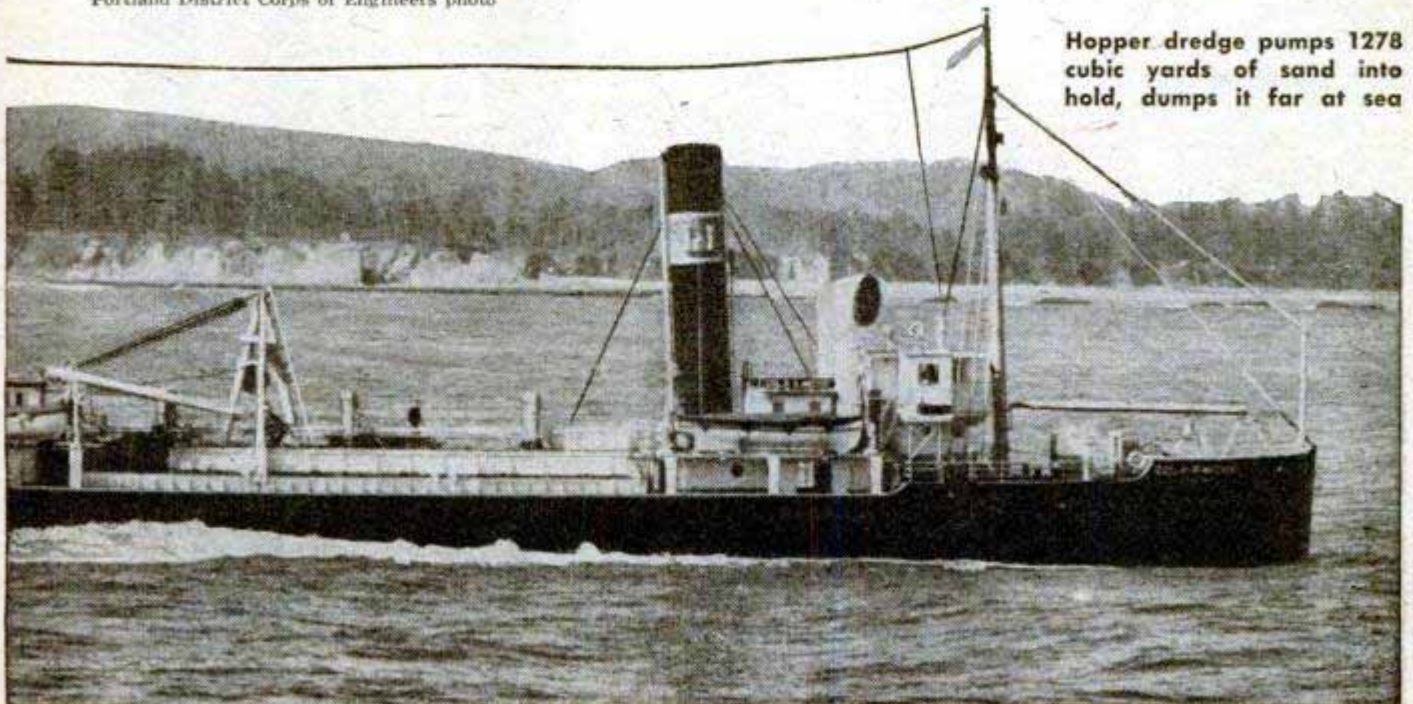

Hopper dredge pumps 1278 cubic yards of sand into hold, dumps it far at sea

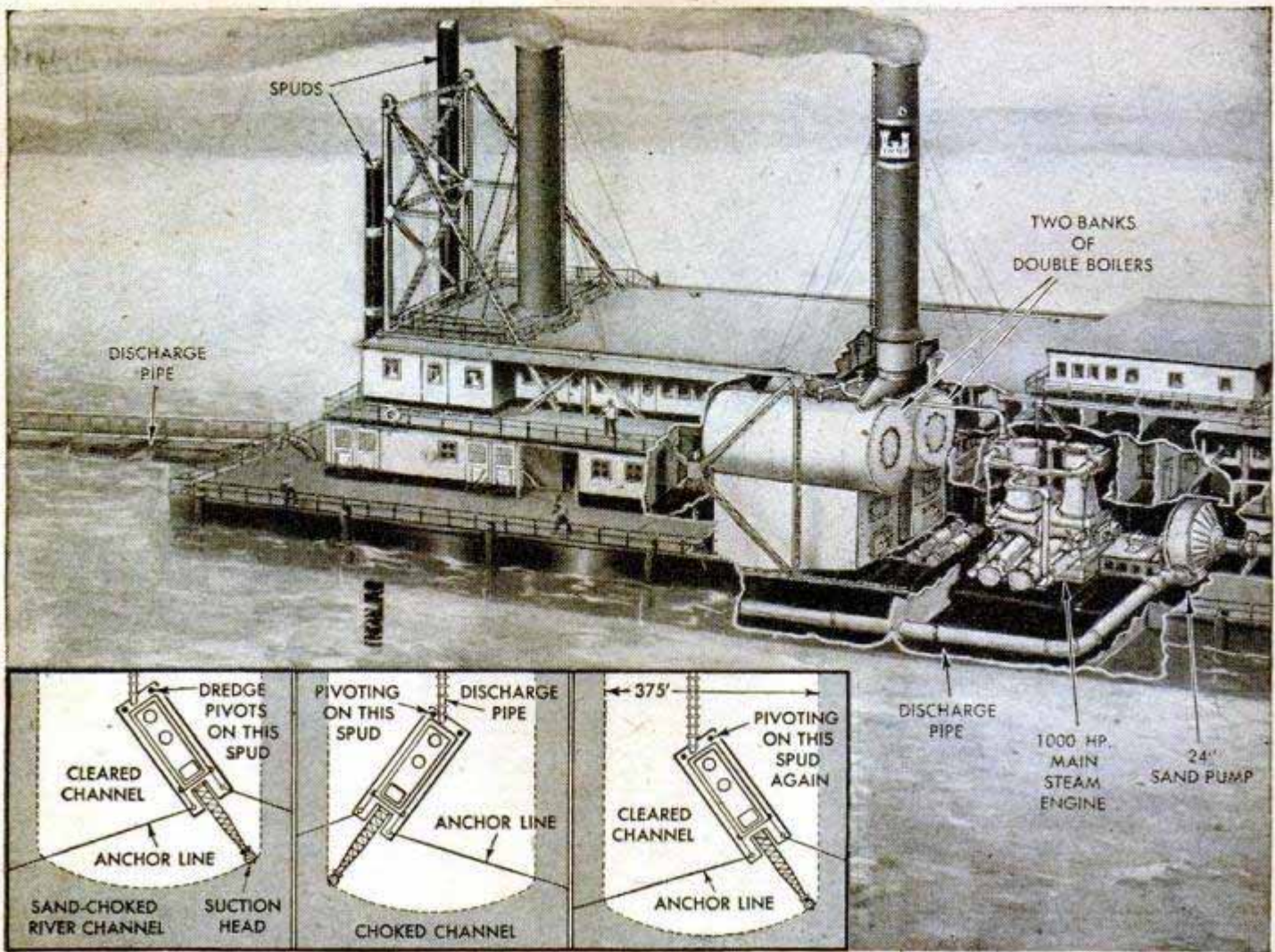

Insets demonstrate the dredge "walking on stilts" to move along river. Below, lever room of the Multnomah

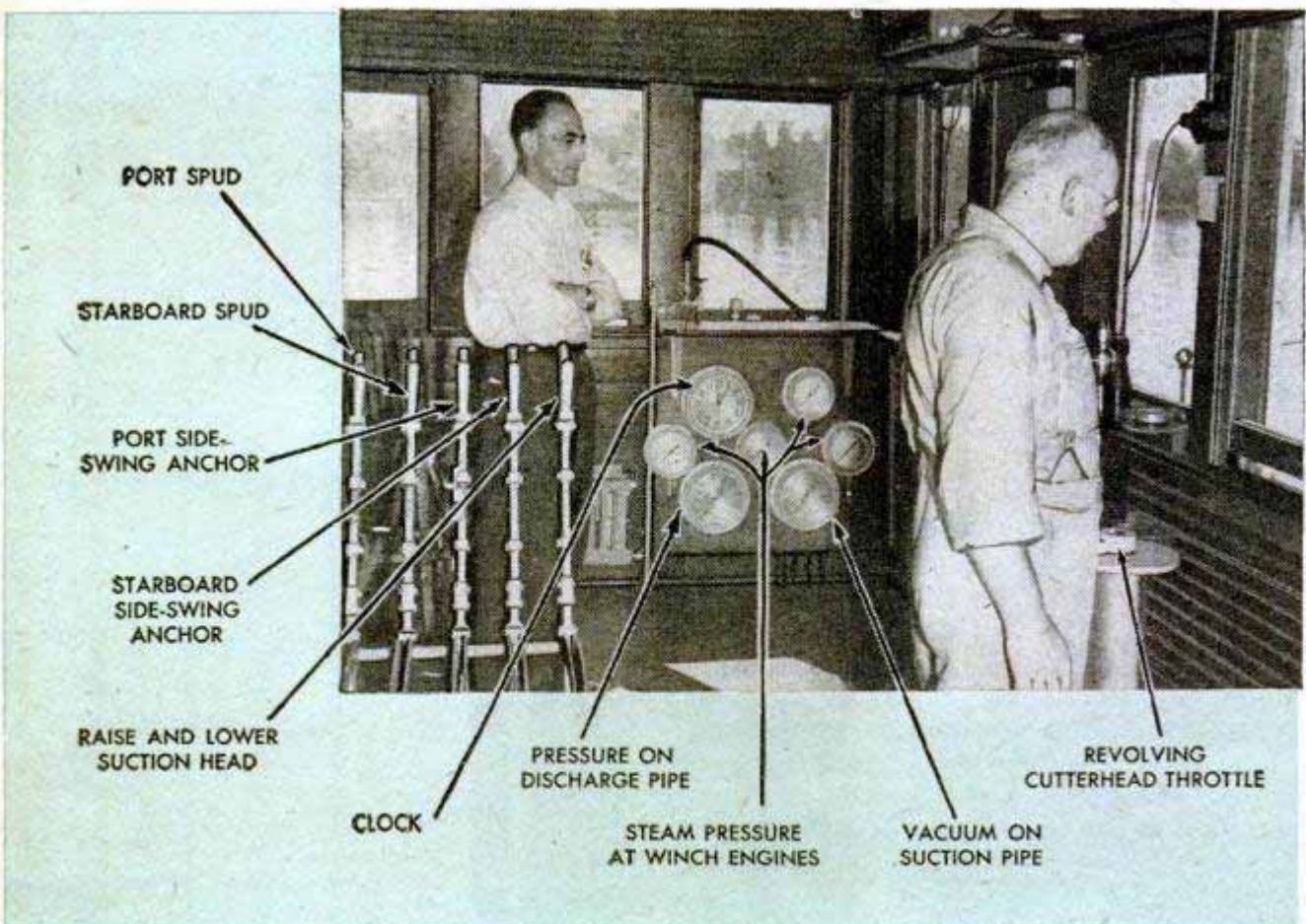

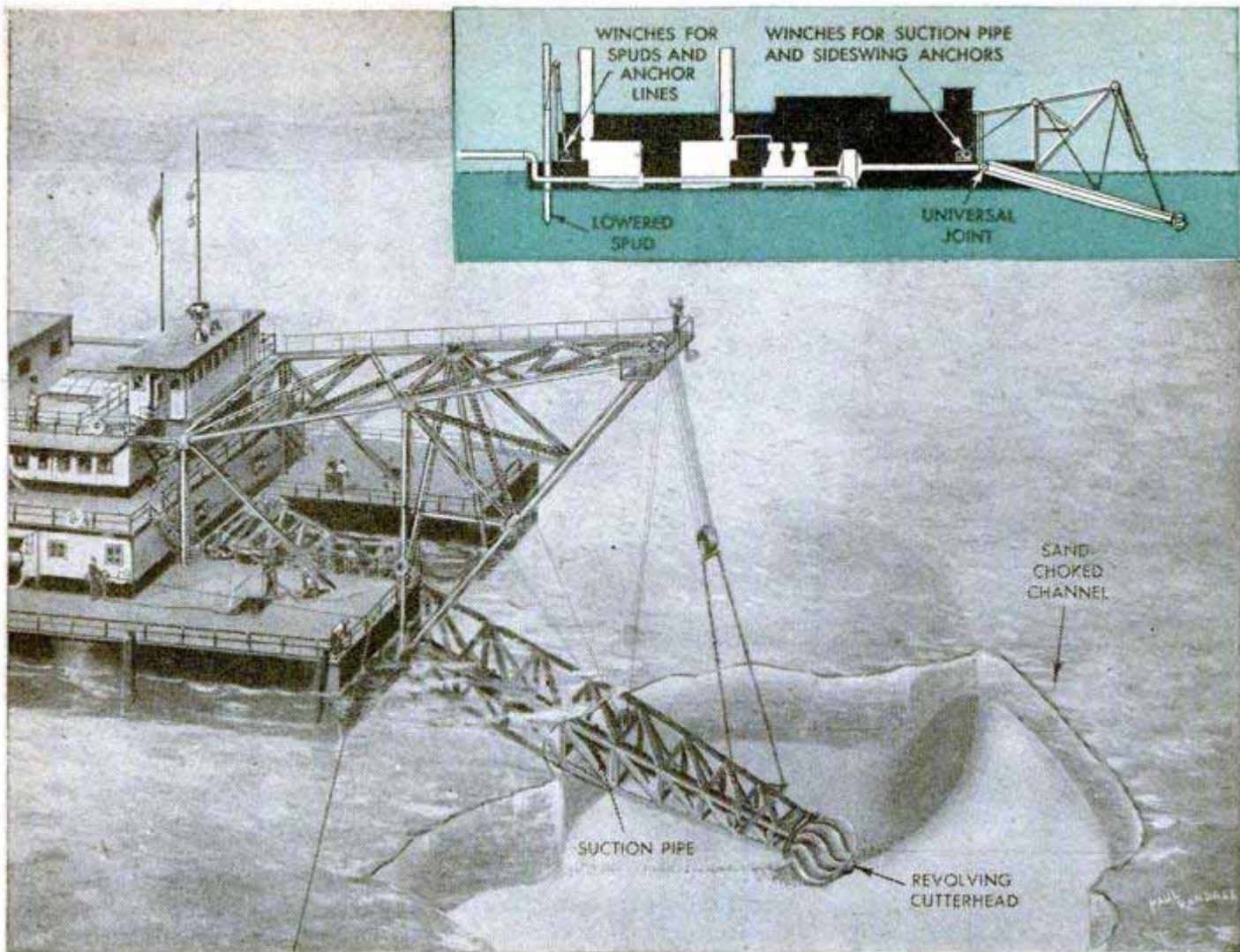

Drawing and inset show parts of ship. Cutterhead and pipe pick up sand, which is discharged to form dike

propelling power. As Captain Elton O. Reed of the *Multnomah* explains:

"People think a dredge squats for a week in one spot. Not at all—a hydraulic walks like a man on stilts and sweeps the channel like a housewife's broom."

The hydraulics walk on two "spuds," 90-foot timbers, three feet in diameter, that extend down through the stern. One spud is thrust down into the bed of the river like a stiff leg. The dredge pivots sideways on this spud by winching in on anchors far out to the side, bringing the opposite spud a few feet forward as it swings. Then the second spud is lowered and the dredge pivots back in the other direction—stepping itself forward.

As the dredge makes each swing, the gigantic "broom"—the 24-inch-diameter suction pipe in the bow—sucks up the sand, its revolving head (powered by steam) loosening hard-packed material and grinding up small logs and other debris.

The actual dredging operations are controlled by a single man, the leverman. Standing in the lever room, the pilothouse of a dredge, he controls every winch and pump on the 265-foot craft. Most of the 50-man crew is engaged in moving the an-

chors forward for the side-swing cables and in moving the pipe line forward along the river bank to follow the dredge—and in maintenance.

"Sand," states Captain Reed, "is the worst enemy any machine ever had. It cuts through the lining of the main pump in 7 to 30 days. And the revolving cutterhead on the suction pipe wears out in about the same time. Inside the pump's bearings we have to maintain 70 pounds of oil pressure, just a bit more than the water pressure, to keep the sand from entering. If that pressure drops for a minute, we're out of action for days. We have a complete machine shop aboard, including a lathe with 12½-foot bed, and we need it!"

The hydraulics also need quite a flotilla of smaller ships. A tug moves the dredge over long distances and tows barges of fuel oil alongside. The dredge itself is so loaded with machinery that only three days' supply of oil for the four boilers can be carried. A smaller tug and a launch move the side-swing anchors ahead. These craft are directed by two-way radio from the lever room. "Sea mules" have replaced the old steam winches on small barges that move and hold the half-mile of discharge

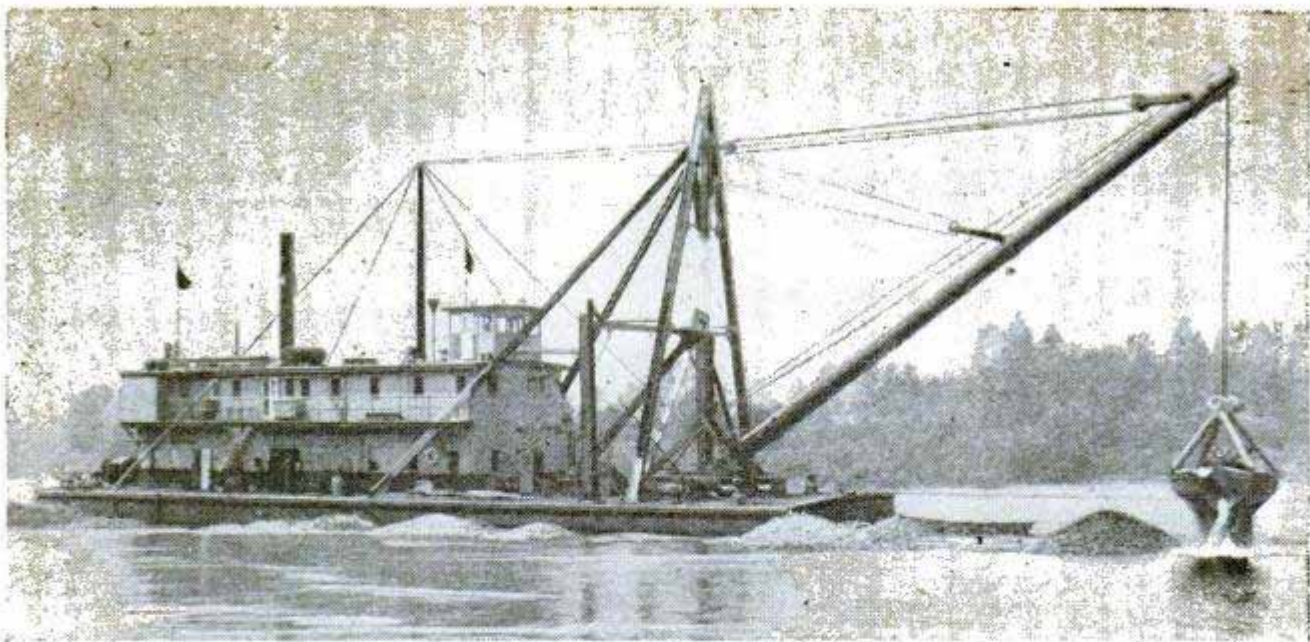

Dredge with a clamshell bucket cleans a Columbia tributary. This type of craft sweeps the channel in congested areas

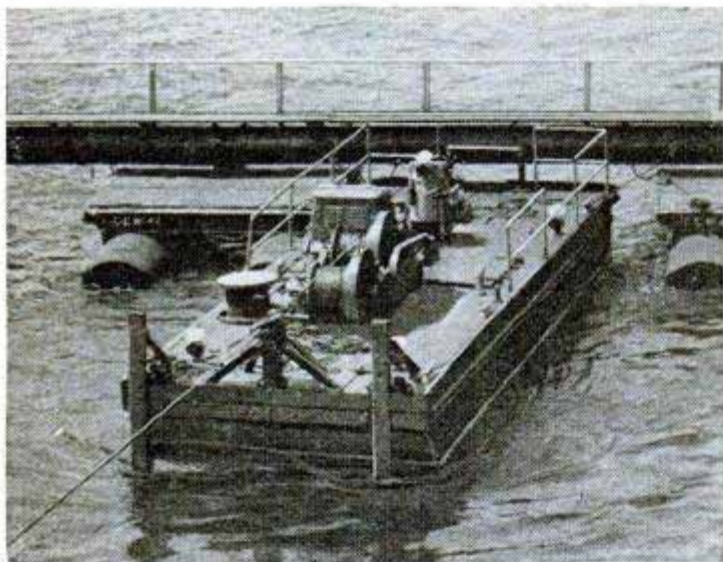

War surplus "sea mule" moves and anchors heavy discharge pipe in the swift current. Below, the PT boat of the sand-eating fleet is a baby hydraulic with eight-inch discharge

Portland District Corps of Engineers photos

pipe in the swift current. These sea mules are war surplus equipment with which our armed forces moved docks and ships in combat ports. Carrying two 1000-foot anchor lines and powerful engines, they could not have been better designed, according to the dredgemen, for handling the heavy 24-inch pipe.

A new hydraulic recently appeared on the river to become the PT boat of the fleet. This miniature dredge was designed to clear small fishing ports along the Northwest coast, and for use on the upper Columbia above The Dalles, Ore., where the river is so swift it clears itself fairly well for the few river boats that chance the dangerous rapids. The dredge is only 12 by 30 feet, although it pumps an 8-inch discharge. It walks, sweeping its suction

(Continued to page 264)

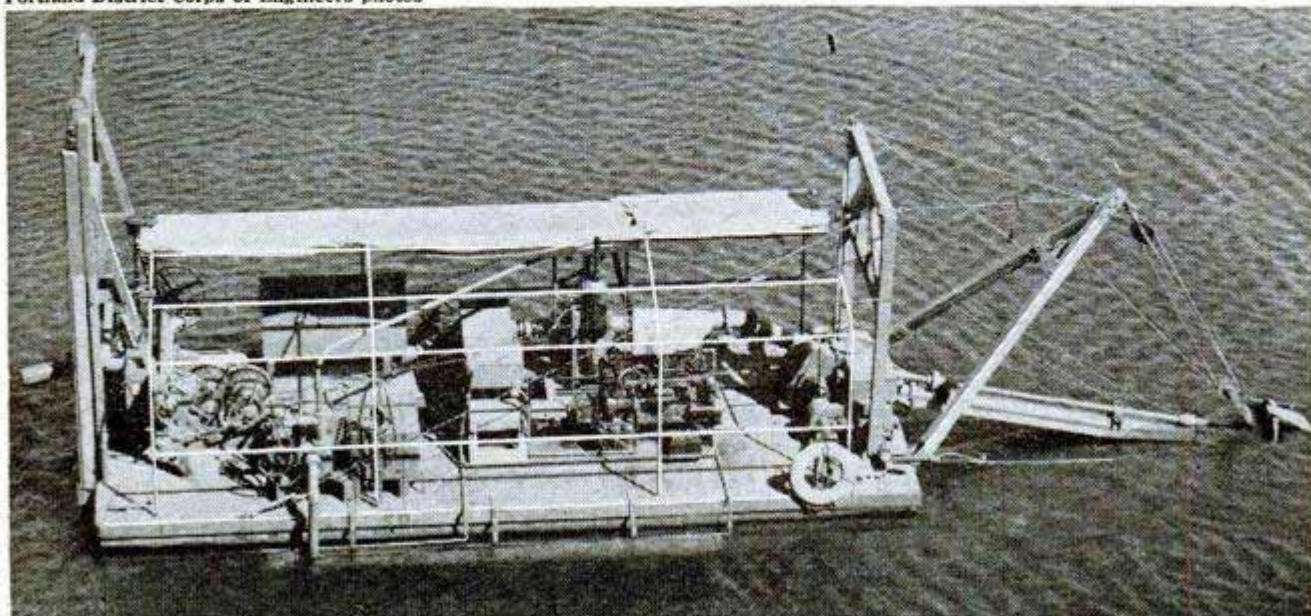

Three-Wheel

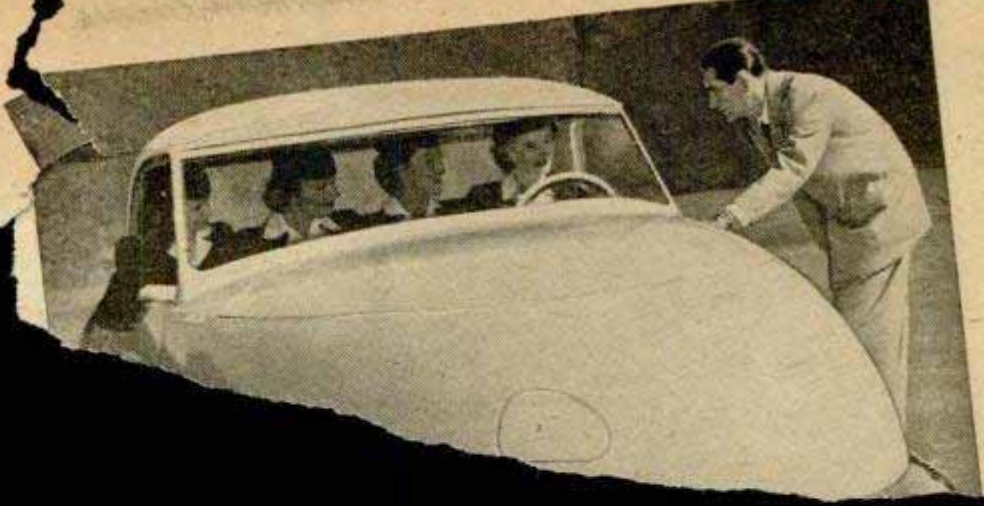

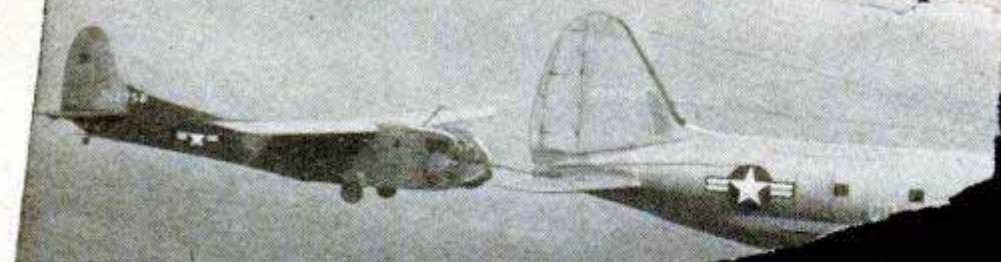

Three-Wheel Davis Car

Aircraft principles are incorporated in the design of the three-wheel, four-passenger Davis car. The designer and builder, Gary Davis, contends that if tricycle landing gears are strong enough to withstand the take-offs and landings of heavy passenger planes they should easily support an automobile weighing 1385 pounds. The car is powered by a four-cylinder 60-horsepower Hercules engine and is said to have a top speed of 116 miles an hour. Gasoline consumption, depending on speed, varies from 35 to 50 miles per gallon. The wheelbase is 108 inches and the over-all length from bumper to bumper is 15 feet. Width of the single seat is 64 inches. Aluminum body panels and top are removable, the latter being secured by four toggle bolts which are taken out to convert the coupe into a roadster. The body of the tenderless car is protected by wrap-around spring-steel bumpers.

Other features are a 72-inch windshield, three-inch tubular-steel frame, hydraulic brakes, hydraulic shock absorbers and coil-spring suspension. Deluxe models will have built-in hydraulic... the Davis plant at Van Nuys...

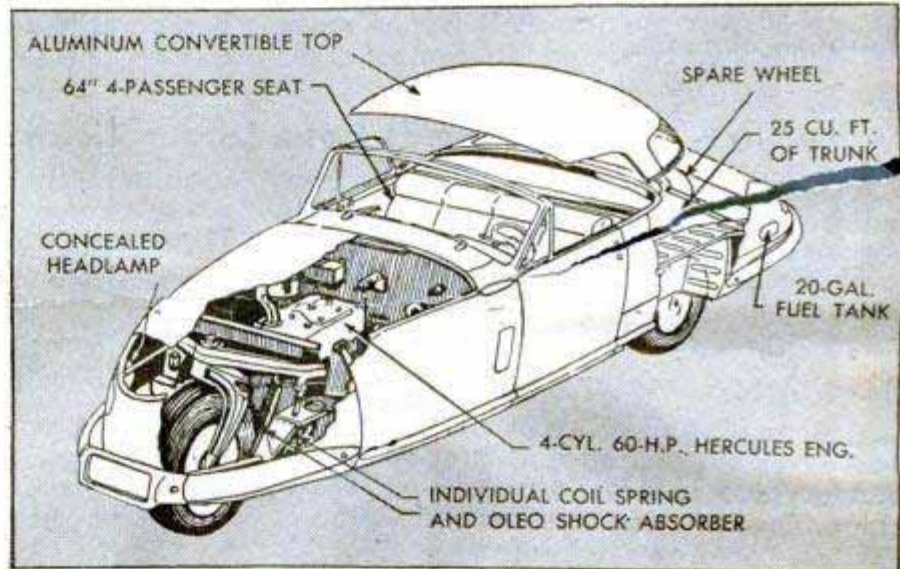
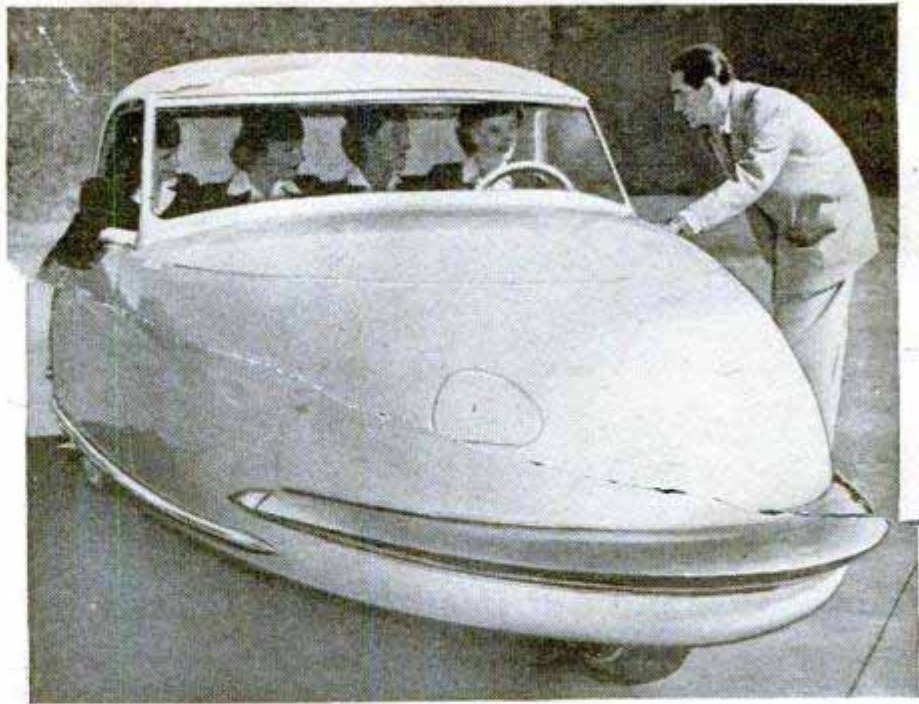

production schedule of 50 cars a day and expansion plans to boost production to 1000 cars daily. Designed to compete in the midget-class market the car will sell for about \$995 F.O.B. Los Angeles, according to the manufacturer.

"Water Polo"—
Fireman's Version

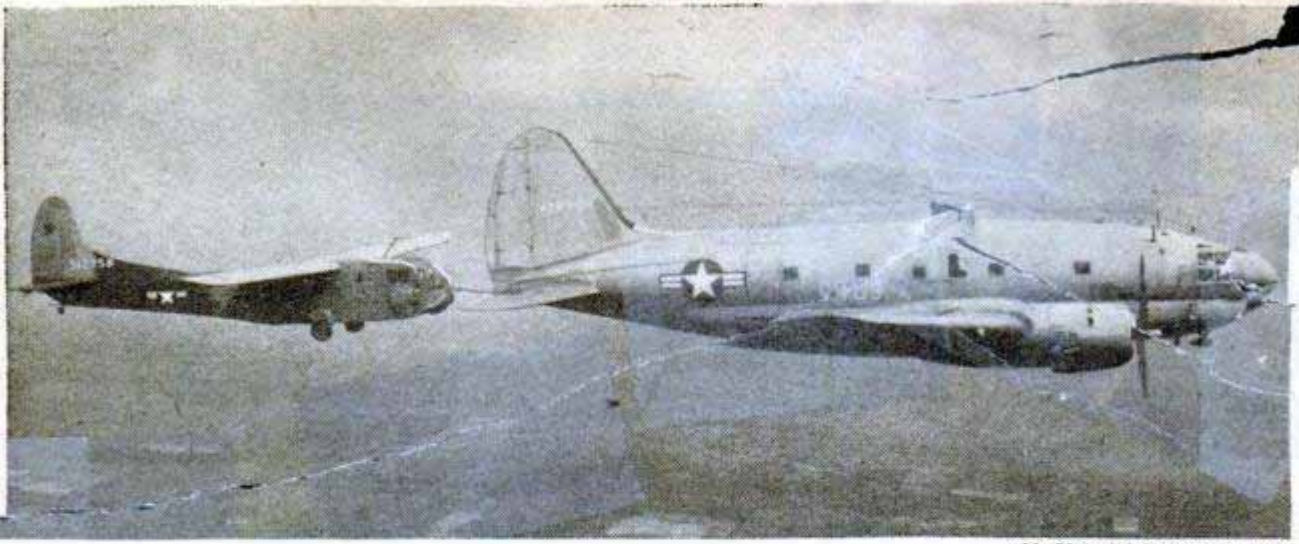

Air Materiel Command photo

Four-Foot Metal Bar Used to Tow Gliders and Jet Fighters

Use of a metal bar instead of rope may make it possible to tow gliders and jet fighters in instrument weather. If tests with P-80s are successful it would mean that they could be towed into combat areas

and their own power conserved for actual fighting. Experiments with gliders have already proved satisfactory. The 48-inch bar permits two craft to maintain direct contact and to operate as a unit.

Radioactive Vegetable Seeds Have Larger Yields

Treating vegetable seeds with salts from radioactive elements increases their yield about 10 percent, according to reports by Paul Becquerel, noted French botanist. Peas dipped in a 1 to 10,000 solution of

uranium nitrate produced vines that yielded 10 percent more than untreated peas. When a growth-promoting hormone, phenylacetic acid, was added to the solution, the increase amounted to 27.5 percent.

Boat Speedometer Registers Knots and Miles Per Hour

Both knots and miles per hour are registered on a vacuum-type marine speedometer designed for rowboats or battleships. The speedometer is an adaptation of

the Venturi-vacuum system in which water rushing through a horizontal tube causes a partial-vacuum pull in a vertical tube. The principle has long been known but has been difficult to apply to boat speedometers because water was pulled by the vacuum into the tube when the boat stopped, and was difficult to eject. In the speedometer, a special venturi tank is





Firemen at Mebane, N. C., play their own leisure-time brand of "water polo." Each team mans a fire hose and with powerful streams of water they attempt to shove an empty oil drum across their opponent's goal line. Knowing where to aim the water pressure for best results is one of the game's fine points.

JANUARY 1948

111

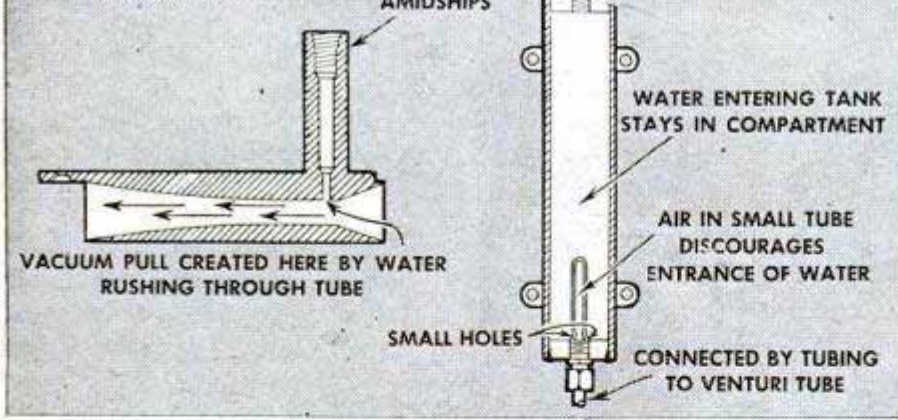

the tube when the boat stops remains in the separation tank. A tube inside the tank discourages the entrance of water.

Information, including manufacturers' addresses, concerning products described in this issue may be obtained by writing Bureau of Information, Popular Mechanics, 200 E. Ontario St., Chicago 11

Television Eye Focuses on Test Of Rocket Motor

Television was lifted from the entertainment to the scientific field to give observers 700 feet away close-up views of dangerous tests of a high-thrust rocket motor. With the action less than two feet from the lens, the camera's images were relayed by coaxial cables to three screens. The sharply lighted close-up gives engineers opportunity to detect fuel leaks and firing malfunctions which could result in an explosion. It eliminates the need for observation blockhouses, with safety glass and mirrors that cloud from effects of gaseous fumes. The camera is heavily mounted and blanketed with layers of sponge rubber to reduce vibration that would affect transmitted images. It can be run remotely after the focusing. The technique was developed at the Azusa, Calif., testing grounds of the Aerojet Engineering Corporation.

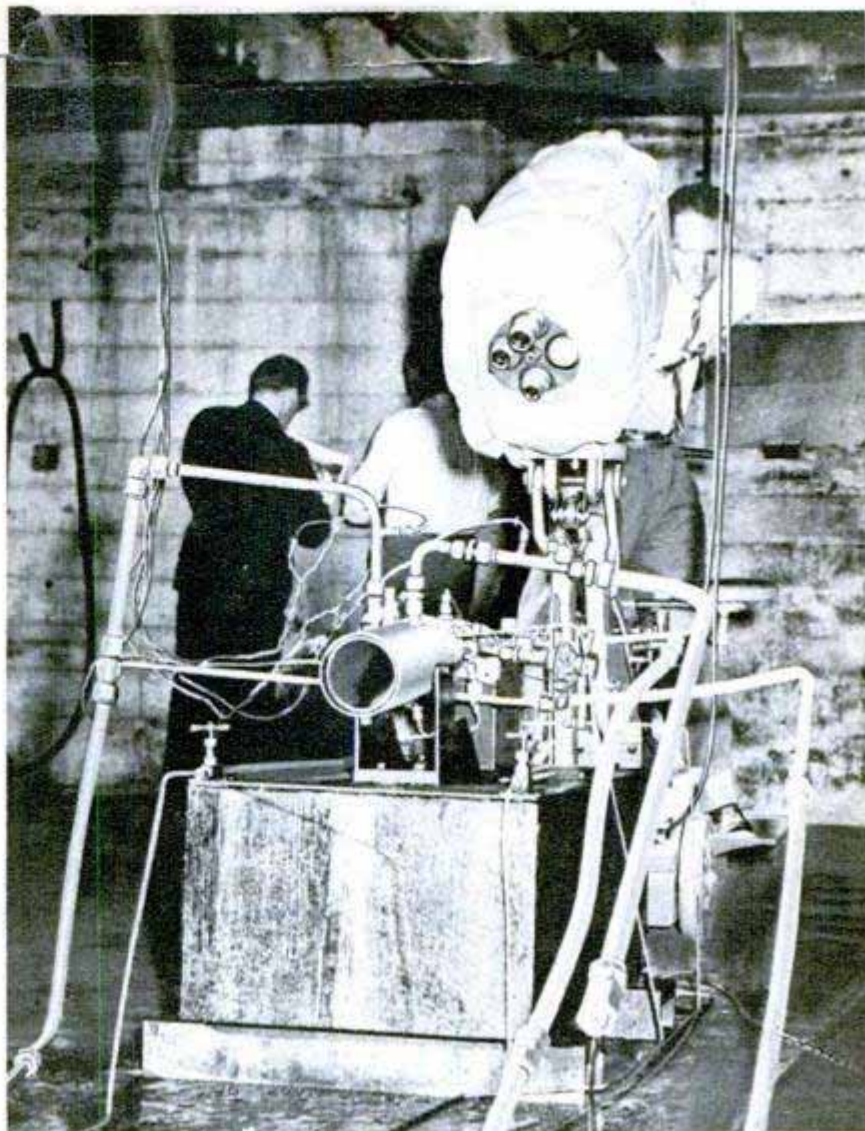

Above, setting up shockproofed television camera behind rocket motor on test block. Below left, placing camera to record readings of control room instruments. Below right, observers 700 feet away watching test



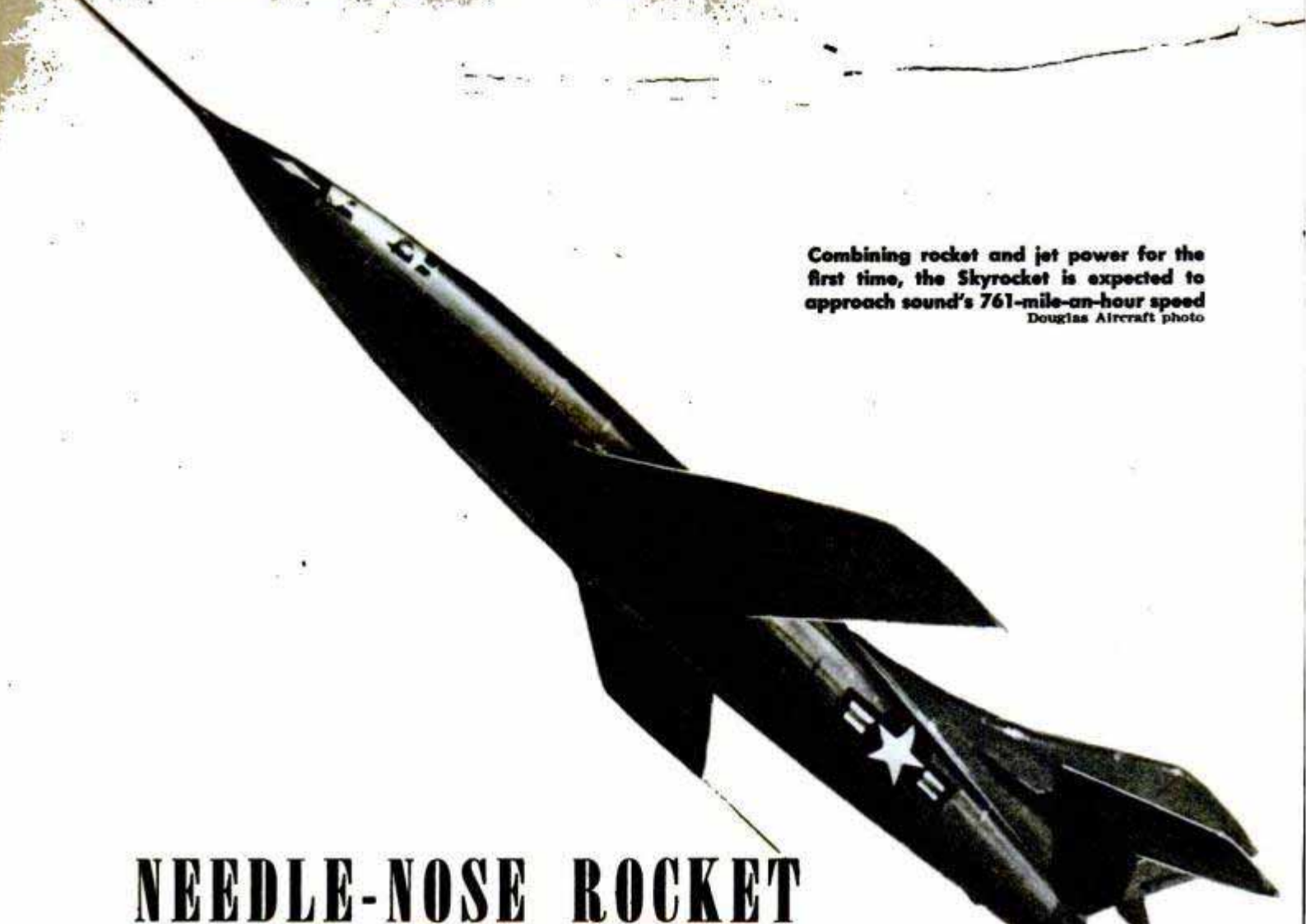

Combining rocket and jet power for the first time, the Skyrocket is expected to approach sound's 761-mile-an-hour speed
Douglas Aircraft photo

NEEDLE-NOSE ROCKET PROBES SONIC SPEED

ROCKET AND JET power team for the first time in the Navy's needle-nose Skyrocket in an attempt to outrace sound. Together they give the tiny plane almost as much driving force as the largest bomber.

With this tremendous power, and embodying the latest discoveries in sonic aircraft design, it is believed capable of more than 700 miles an hour. Sound's speed at sea level is 761 miles per hour.

In a typical run, jet thrust alone will fly the plane above 25,000 feet, before the four-barrel rocket engine goes into action. For a two-minute lunge, while 1½ tons of fuel burns up, pent-up gases will roar from the rocket tubes in an all-out speed effort. When this is exhausted, the jet will take the plane back home. The combined units can deliver the equivalent of approximately 18,000 horsepower.

The Skyrocket differs radically in appearance from its sister Douglas-built ship, the Skystreak, holder

of the 650.8-mile-an-hour speed record, and the Bell XS-1. Its stubby wings, only 25 feet from tip to tip, sweep back at a 33-degree angle and the tail at an even sharper 40 degrees. While the XS-1 was solely rocket powered and had to be carried up for tests, the Skyrocket takes off and lands under its own power.

The comparatively thick swept-back wing's effectiveness is increased by being dipped down five degrees, instead of tilting slightly upward. Stall-control vanes, acting as "dams," prevent spanwise air flow and resulting loss of lift.

At low speeds the stalling bugaboo is licked by using Handley-Page automatic slots over the ailerons, maintaining their control to much greater stalling angles. Small braking flaps on the fuselage sides aid in slowing down for landings.

No "bubble" breaks the plane's clean lines. The pressurized cockpit, equipped with oxygen, refrigeration

By Aubrey O. Cookman, Jr.



and heat, is housed completely inside the highly polished fuselage. Keeping the cockpit livable at 760 miles an hour, a task that would tax the cooling facilities of 40 household-size refrigerators, is done by a 16½-pound unit. This combination cooling turbine and air-to-heat exchanger, developed by the AiResearch Company, drops jet-engine air temperature from over 500 degrees Fahrenheit to under 40 at high speeds.

While figures aren't available on the Skyrocket, its predecessor,

Short, swept-back wings and a needle nose mark Navy's new sonic plane

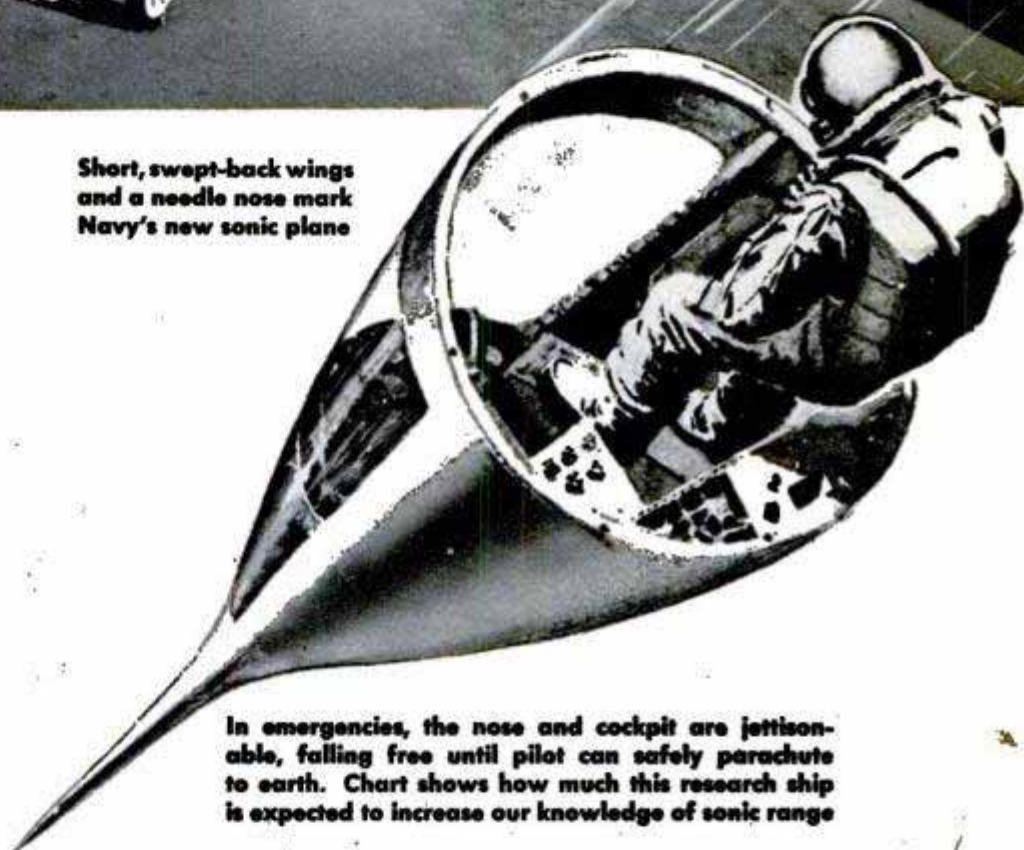

In emergencies, the nose and cockpit are jettisonable, falling free until pilot can safely parachute to earth. Chart shows how much this research ship is expected to increase our knowledge of sonic range

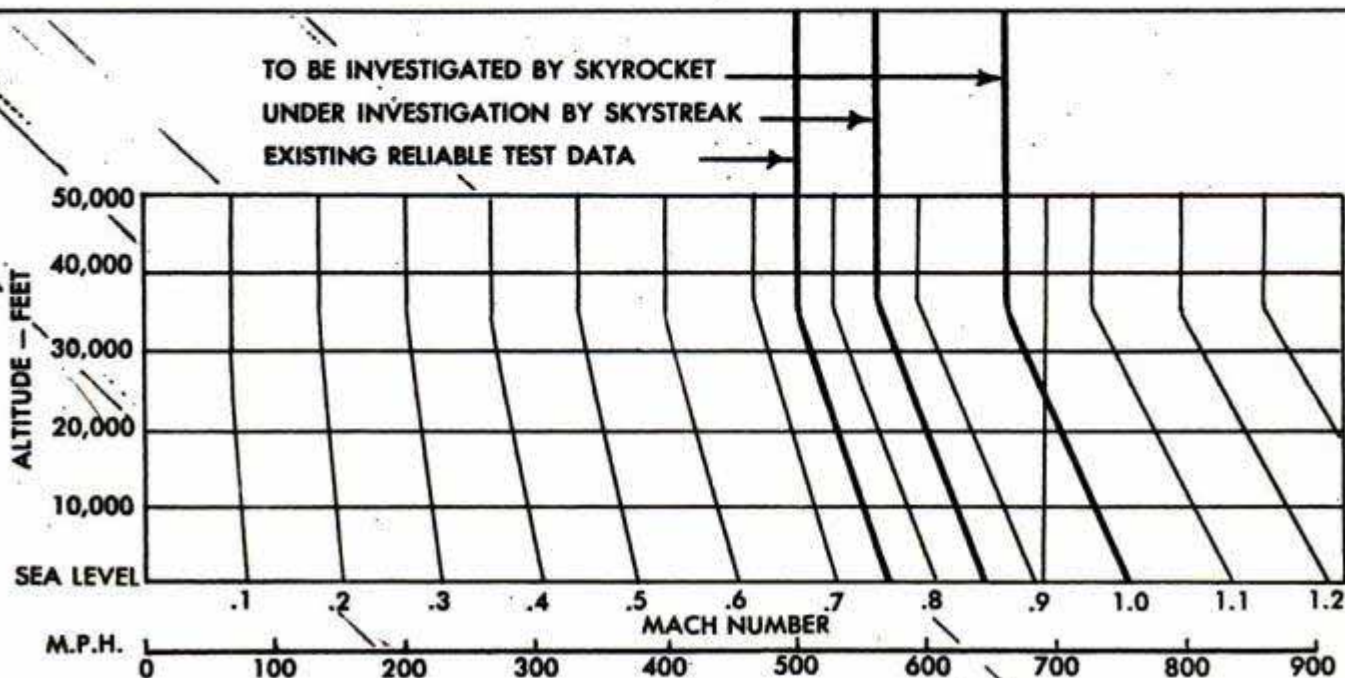



Instruments on nose are to measure plane's yaw and pitch characteristics. The "gill" at right is one of two air intakes for the powerful jet unit

the Skystreak, would have recorded cabin temperatures of 180 degrees during its record-breaking run without such refrigeration. At the rocket-jet's expected pace this would get above 212 degrees, the boiling point of water, and flying personnel would boil like lobsters in a kettle.

In comparison with everyday refrigeration methods, this new principle of air expansion cooling, with its dollar-sized impeller wheel, saves its weight every three minutes of flight. If ice were used, 5½ pounds would melt every minute of flight, faster than is possible in a home oven.

Two air intakes or "gills" that feed the Westinghouse 24-C turbojet are on the lower sides, to the rear of the cockpit. A jet exhaust is on the belly between wing and tail. Since it carries its own oxygen, the liquid-rocket system requires no inlet and the tail cone is removed before flight

When rocket power is used, tail cone is removed to provide exhaust vent

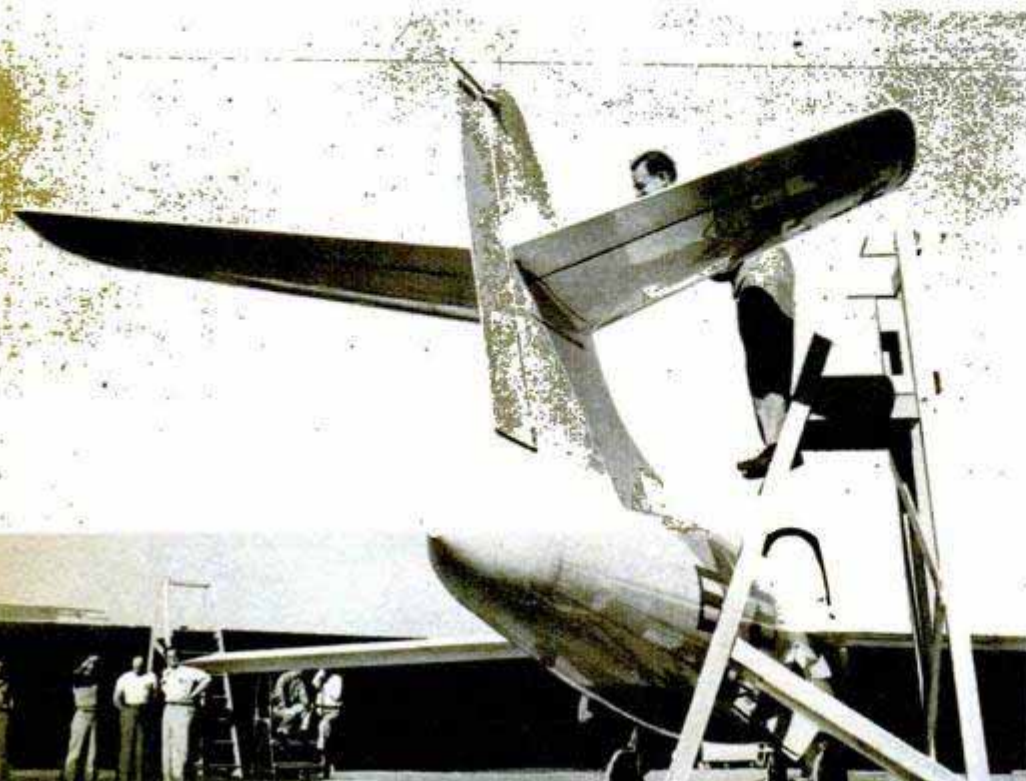

to open an exhaust vent. About 6000 pounds of thrust comes from the rocket engine, built by Reaction Motors, and approximately 3000 pounds is supplied by the jet.

A quick-release emergency device jettisons the pilot's compartment. It falls free until it reaches an altitude and speed where the pilot can parachute safely.

There's no provision for armament, but the Skyrocket carries a payload of equipment to measure air pressure at 400 places on the wing and tail surfaces. In addition,

over 900 strain gauges and oscillographs will measure and record forces and stresses on the structure. A photographic flight recorder will keep track of the standard flight instruments.

Most of the fuselage is built of tough magnesium alloy, with wings and tail chiefly of aluminum alloy. The 45-foot-long fuselage is tipped by a needle-like nose, containing a pitot static tube for the air-speed indicator. Gross weight of the plane is close to 15,000 pounds. There is tankage for 250 gallons of aviation gasoline, not kerosene, for the jet engine, in addition to special fuel for the rocket.

The Skyrocket has a memorable birthday—VJ Day in the summer of 1945, at Douglas' El Segundo, Calif., plant. A short time afterward it was decided to shift from a short, straight wing, like the Skystreak's, to research swept-wing prospects.

Rocket power was included when it was found that even the most powerful jet engines then available wouldn't give the swept-back design a thorough high-speed testing. At another stage thought was given to discarding the jet engine and its 3000 pounds of weight, and using a mother ship to carry it high enough for launching. They finally decided, however, to keep both.

By March of 1946 a mockup was completed and less than 20 months later the finished article was ready. The Skyrocket's official Navy designation is D-558-2.



No More Burned Fingers

There's no chance of burning fingers on boiled eggs when egg tongs are used. Made of stainproof metal, these tongs hold the egg from the time it is taken out of the water until the shell is discarded. Rolling the egg on the table top while still in the tongs breaks the shell neatly around the middle. The egg halves are then separated and the cooked portion of the egg removed from the shell.

Hearing-Aid Selector

Merely by pressing the control button on a hearing-aid selector, the hard-of-hearing person can test as many as 140 different hearing-aid circuits. The deafened person tries the various circuits until he finds the one that does most to eliminate his handicap. During the fitting, it is possible to switch from one circuit to another in the middle of a sentence without changing the earpiece or any external wiring.



Shoe-Shine Delivery Service

Keeping their shoes well-shined is made easy for busy people in Houston, Tex. A speedy delivery service picks up the shoes at the customer's home and returns them the same day gleaming like new. The shine shop polishes hundreds of shoes daily. Free pick-up and delivery by motor scooter are made seven days a week.

One-Man "Yacht" Has Outriggers

Described as a one-man "yacht," a tiny Japanese sailboat weighs only 55 pounds. Two outriggers attached to the stern of the craft prevent it from capsizing. The center section is only 16 inches wide and 5 feet 5 inches long.

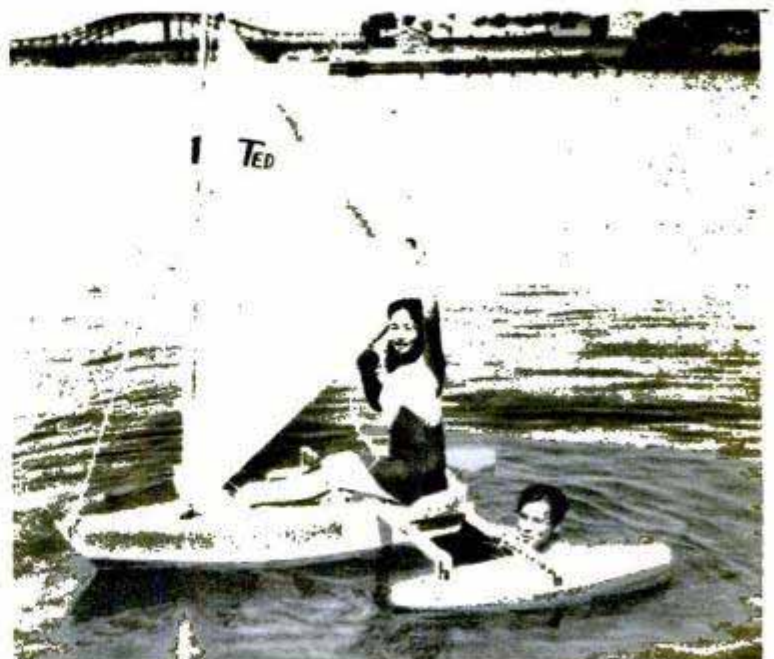

NEW METHODS IN OLD MINES

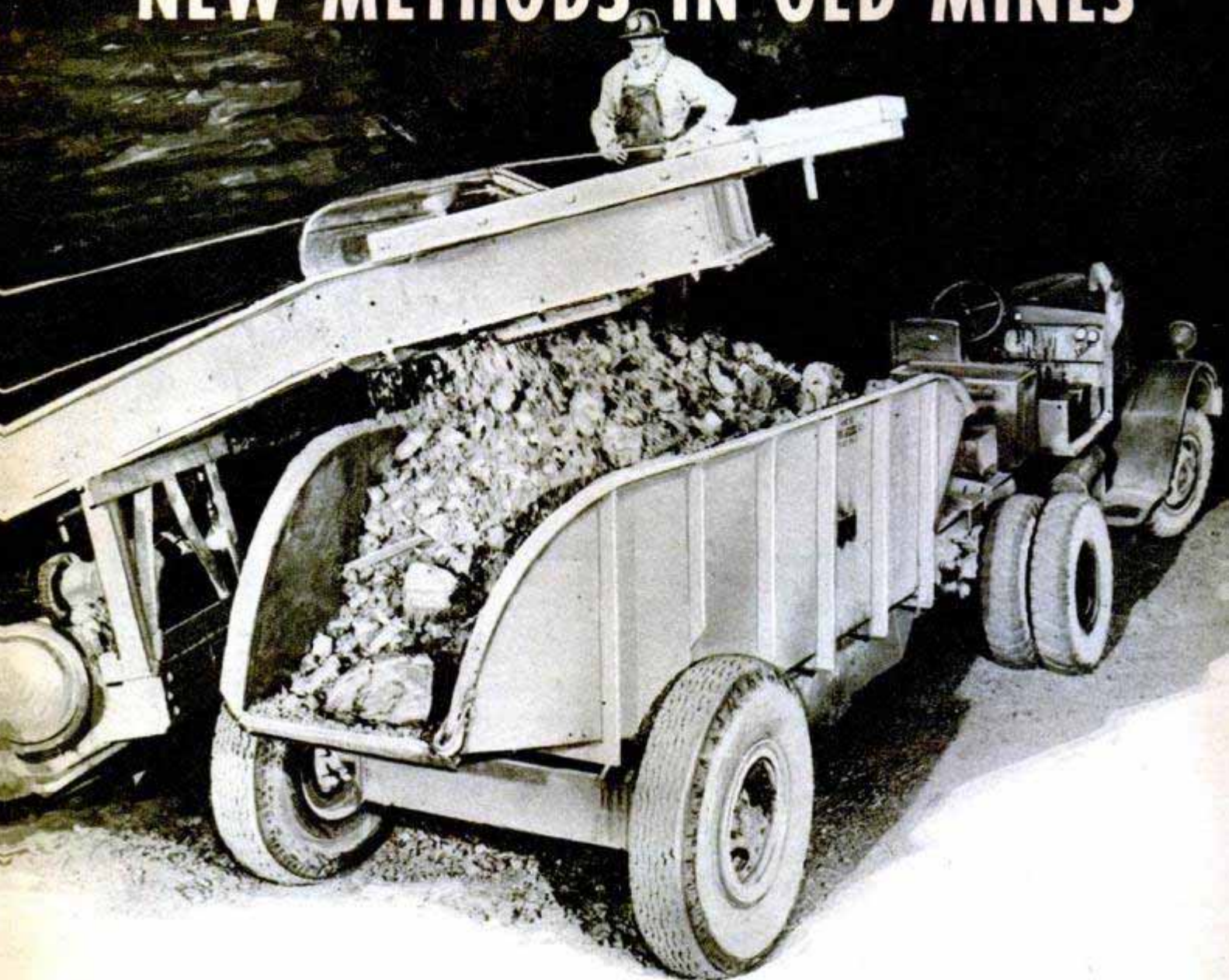

↑ Conveyor belt drops ore in Diesel tractor-trailer fitted with system for making exhaust nonpoisonous

BUT YOU CAN'T operate Diesel trucks underground," the visiting engineer argued. "The carbon monoxide fumes will kill every man in the mine."

The visitor was deep in an Eagle-Picher lead-zinc mine in Oklahoma and had just watched a big Diesel tractor rumble by, towing a 10-ton load of ore.

The mine's superintendent grinned. "Usually that's true," he admitted, "only these trucks don't give off carbon monoxide. There's a constant chemical change in the exhaust pipe, transforming the monoxide to carbon dioxide. We feed pure oxygen into the exhaust from a tank on the truck and the nonpoisonous gases that come out of the pipe are swept away by normal mine ventilation. The drivers and miners work all day in perfect safety."

In European mines where adequate ventilation exists or can be created, air compressors, bulldozers and hundreds of in-

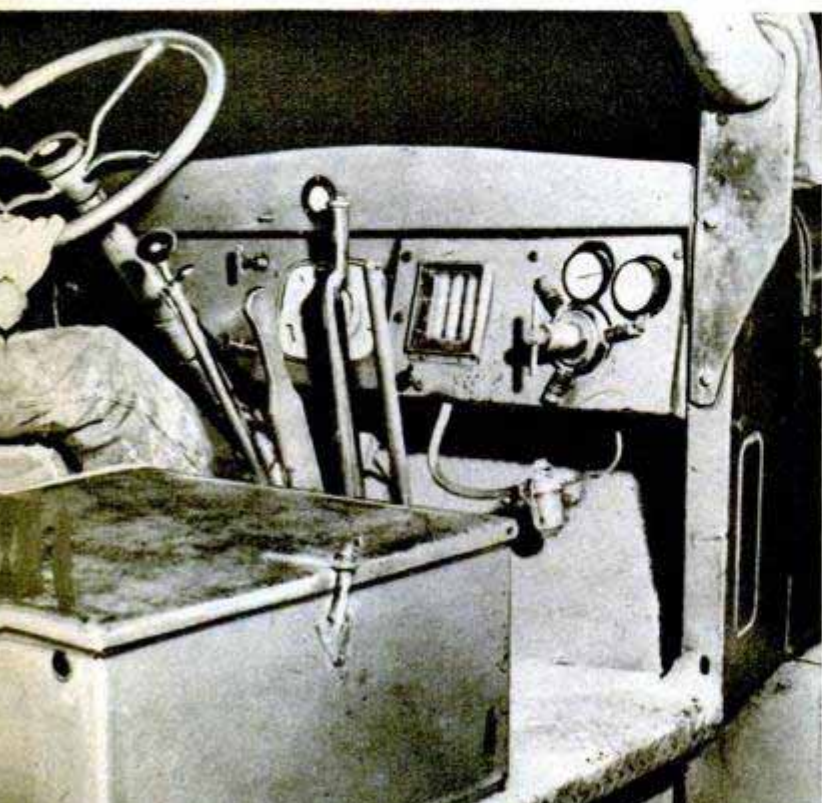

Panel control feeds oxygen from tank under floor into exhaust, converting fumes into carbon dioxide

ternal-combustion locomotives are being operated underground.

Once a pick-and-shovel operation, underground mining is being mechanized to an almost automatic procedure. This is more and more necessary as some of our richest ores become exhausted. That doesn't mean, says the mining industry, that the United States is approaching the status of a "have not" nation in reserves. Temporary shortages in such metals as copper have been due to a high demand plus rising extraction costs, factors that eventually level themselves out.

The fact is that vast amounts of metallic and nonmetallic minerals are still in the ground, in many cases in quantities sufficient for our needs for centuries. Some of these reserves, however, are in the form of low-grade ores that cannot be worked profitably by methods used in the past. More efficient and safer ways of handling the material underground and better ways of concentrating and refining it are being developed.

The exhaust purifier is one innovation in underground transport; another is the use of rubber conveyor belts for moving ore from a working face through the tunnel system and up to the surface. The endless belts follow the configuration of seams, can carry materials around sharp corners, and can boost heavy loads up steep grades to the surface.

One immense conveyor belt, half a mile long, is being installed by Goodyear Tire & Rubber Company in an Alabama coal mine. It will raise 600 tons of coal per hour to the surface from 715 feet underground, perhaps the greatest climb ever attempted by a conveyor belt.

Forty-two inches wide and weighing 42 tons, the belt is reinforced by 330 steel cables in its carcass in place of the usual fabric cords. Two 300-horsepower motors rotate the belt, which will carry its load up a slope of approximately 17 degrees.

Underground air conditioning is receiving considerable study as a safety measure in gaseous or dusty mines and for greater comfort. In some deep mines without air conditioning, the constant temperature stands at 100 degrees or higher. Telephones are replacing pipe-rapping and other makeshift signaling methods and in some mines electric eyes sound horns at tunnel intersections to warn of the approach of ore trains.

Tungsten-carbide points on rock drills are being adopted because they permit faster drilling with fewer bit changes. Mine timbers can be set by a new machine that does the work of a gang of men, and push-button elevators in some of the mines are saving travel time as well as eliminating

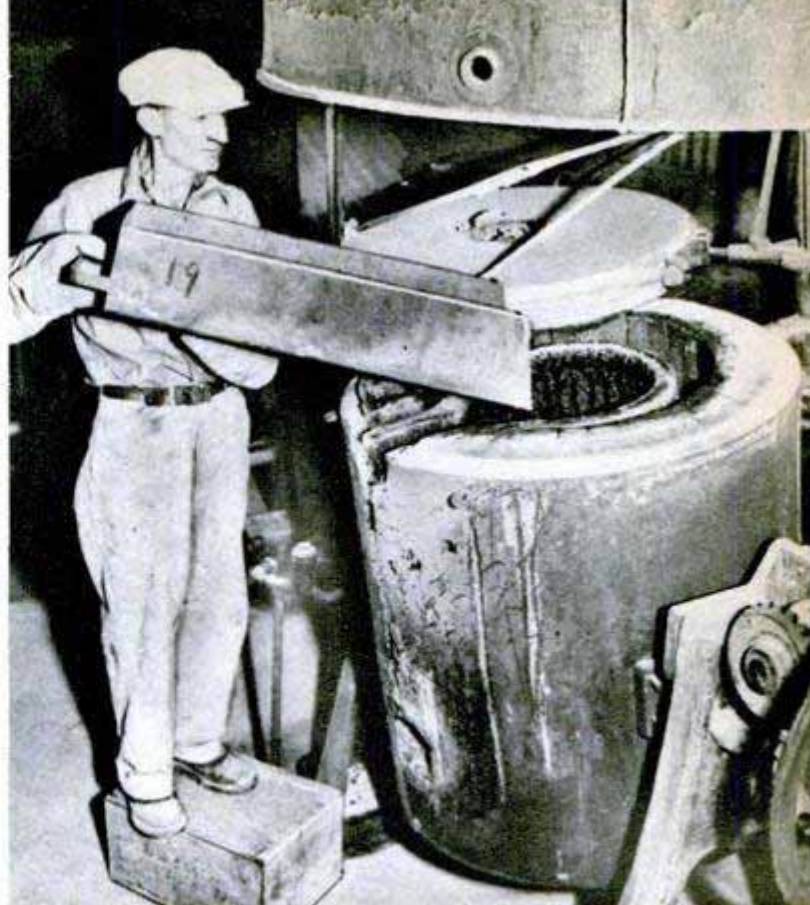

↑ Gold concentrates are tipped into a fuel-oil furnace for melting into bullion. Below, huge "tables" wash impurities from iron ore in a reopened mine

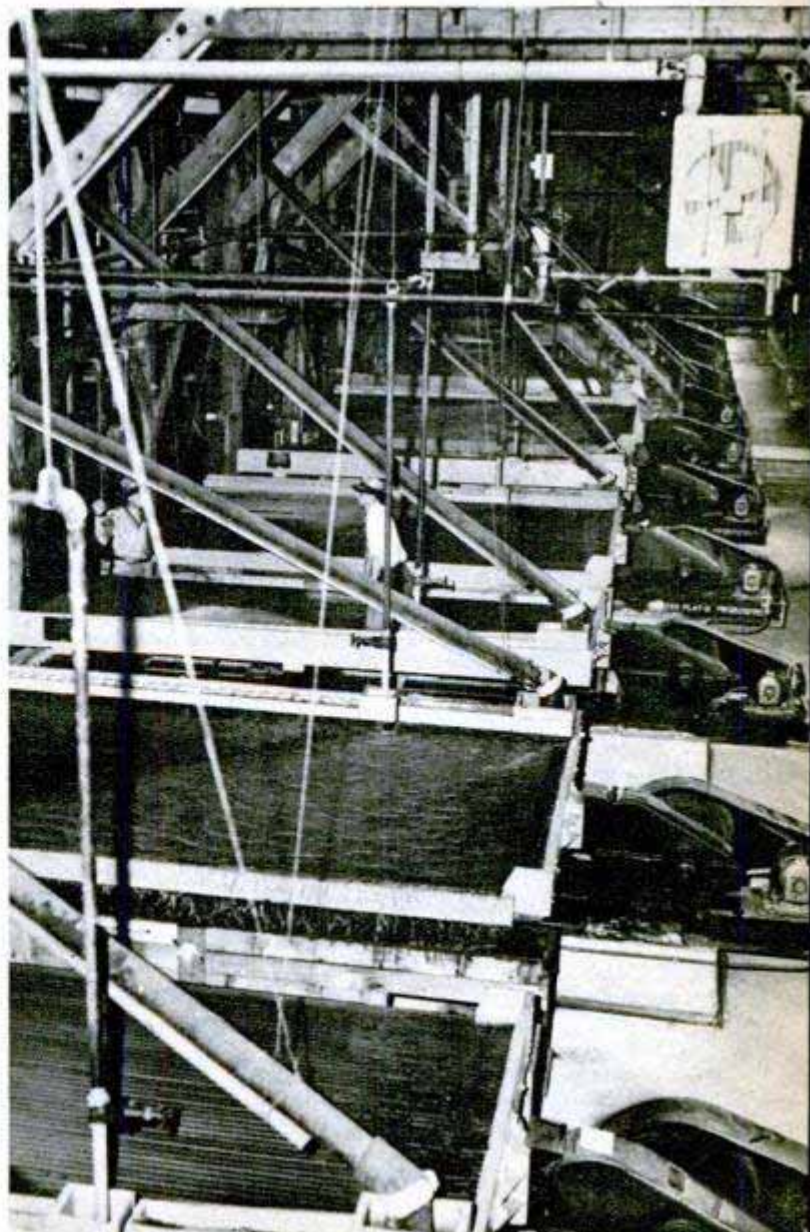

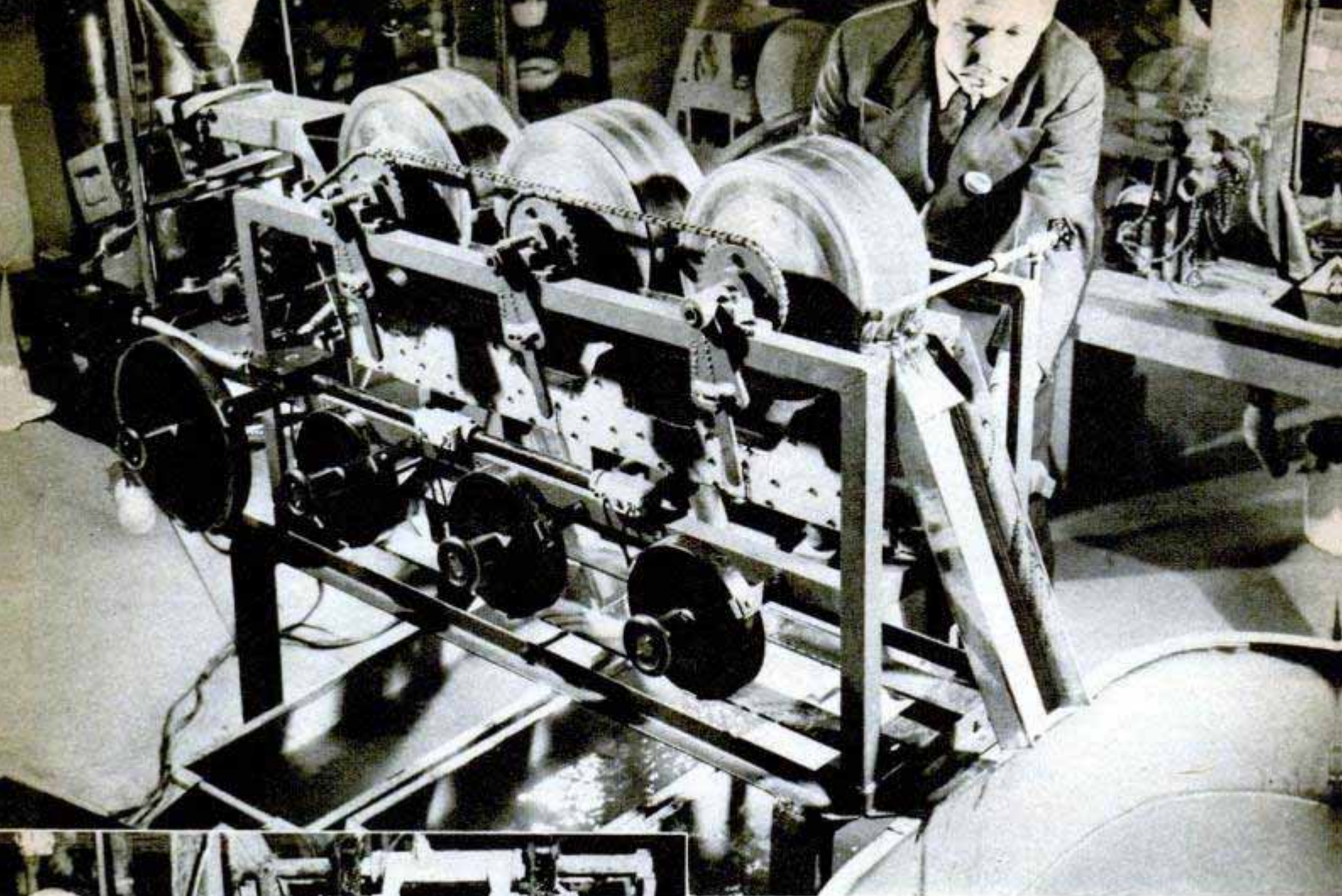

Battelle Memorial Institute photo

↑ Engineer checks wet magnetic separator, which isolates valuable iron oxide from iron ore by magnetism

← With a strainer, worker tests fineness of pulverized rock mixed with water flowing from a ball mill

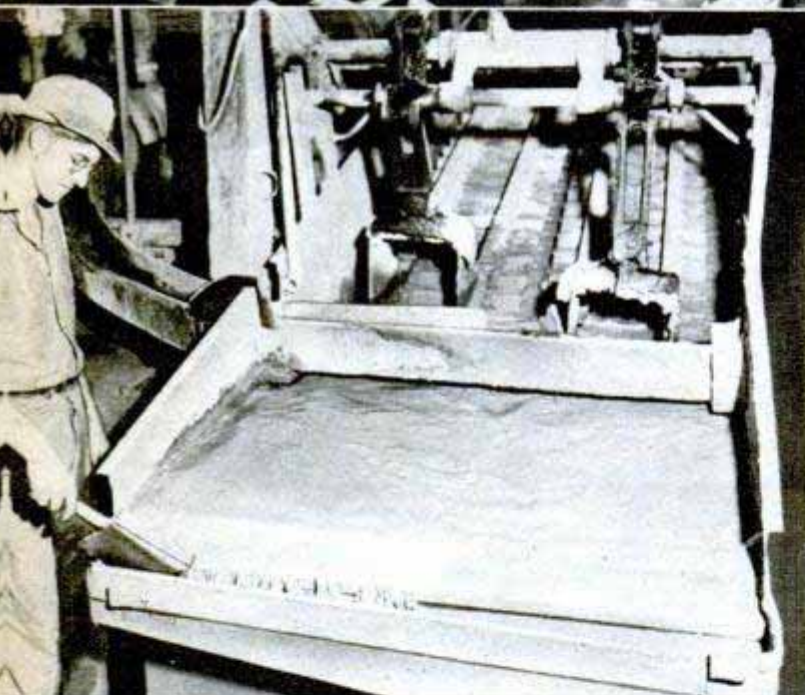

ores has been improved and extended. New chemicals have been added for floating minerals, other chemicals that assist in depressing unwanted materials have been found, and wetting agents such as Aerosol are being employed to increase the efficiency of the operation.

A development hailed as one of the most important since flotation came into use is the recent adaptation to big-scale operations of the "sink float" concentrating process, which is a method formerly used only in the laboratory.

Sink-float process automatically sorts the useless and lowest grade materials from an ore, leaving a concentrate that can be milled at minimum expense.

When coarse preliminary crushing of an ore and the sink-float separation are performed underground, as is contemplated, the cost of hoisting tons of useless material to the surface, transporting it to the mill, and running it through the mill will be avoided entirely.

The sink-float process consists of passing an ore through a bath composed of a heavy

(Continued to page 244)

practically all ladder climbing. In open-cut operation on the surface, massive pieces of equipment that take bigger bites or handle bigger loads than ever are in use.

An electric cable that won't spark when short-circuited may help prevent coal-mine explosions. A fine strand of copper wire between two layers of insulation catches any current "leaks" before an arc can occur. The wire carries current to a circuit breaker which cuts off the power.

The flotation process that gleans the valuable ingredients from a wide range of

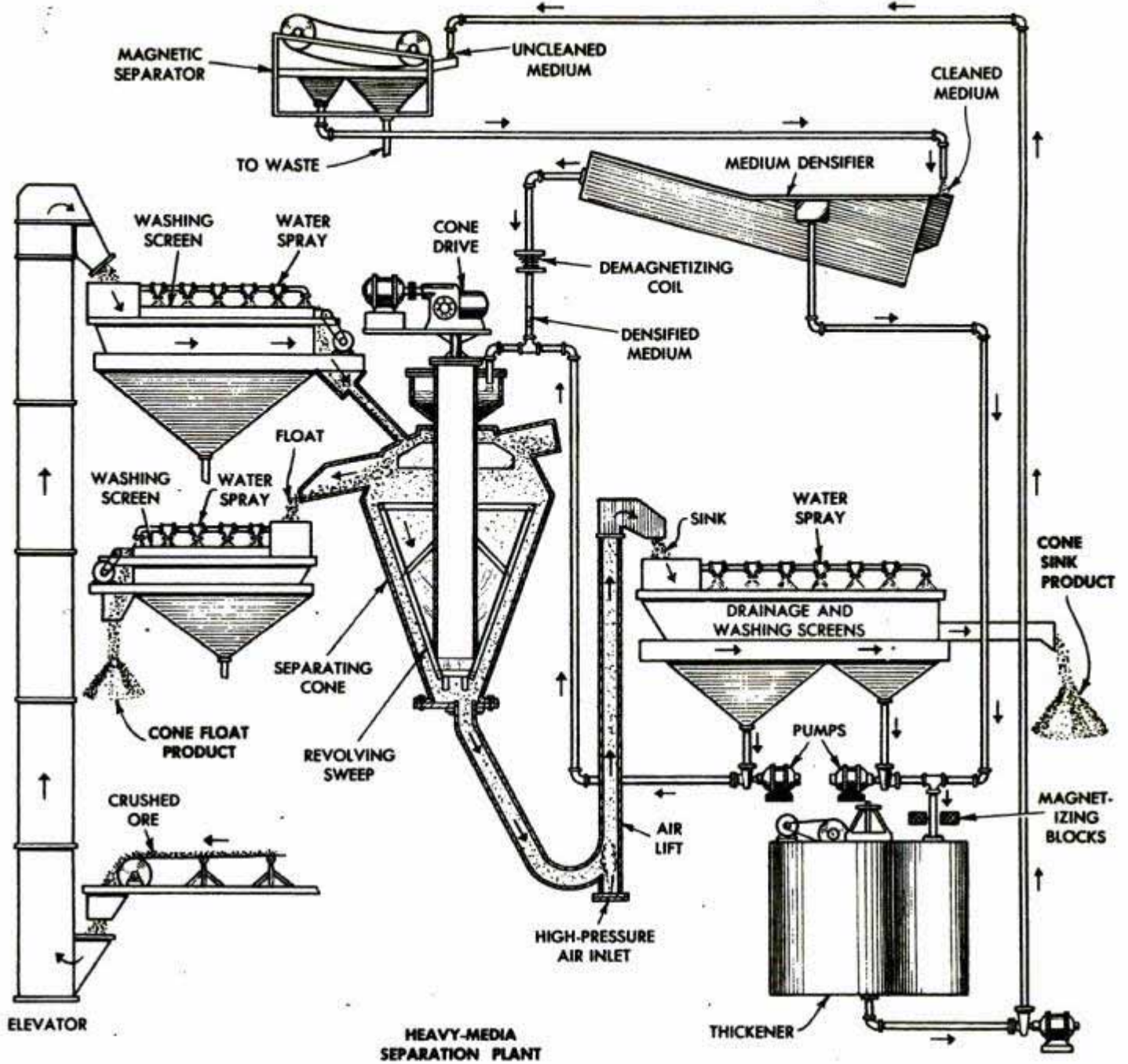

HEAVY-MEDIA SEPARATION PLANT

In American Cyanamid's Heavy-Media process, ore is hoisted into cone containing heavy liquid. Concentrate floats off top, waste sinks, or vice versa. Material in suspension is recovered by magnetism. Below left, ore and waste move across parallel washing screens. Right, section is added to the conveyor belt as tunnel grows

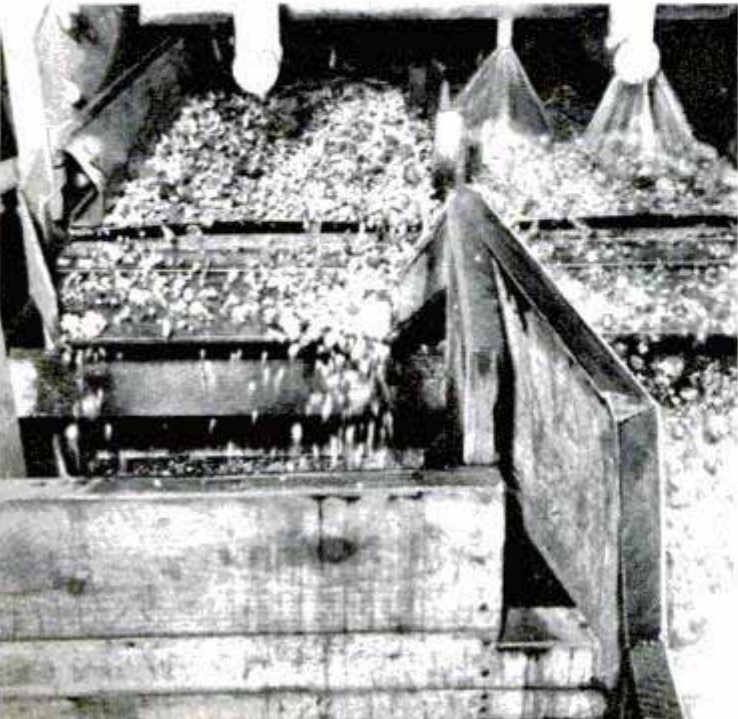

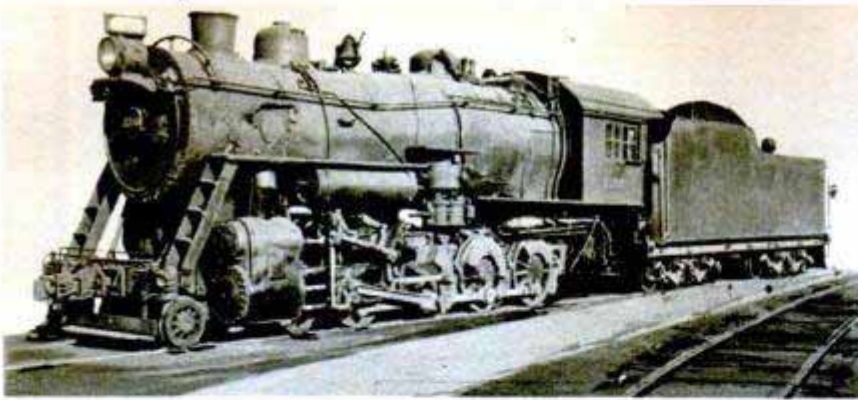

Stand-By Engine Has Robot Controls

Rebuilt from a 1910 locomotive, a new steam switcher that burns coal has many of the quick-operating advantages of switchers burning other types of fuel. The locomotive, rebuilt by the Norfolk & Western Railway, has automatic stand-by mechanisms which keep it ready for service even after it has been left unattended for several hours. Automatic controls maintain the pressure in the boiler and fix the ratio of air and coal. A stoker has been added and the front end of the locomotive extended for a fan which provides an in-

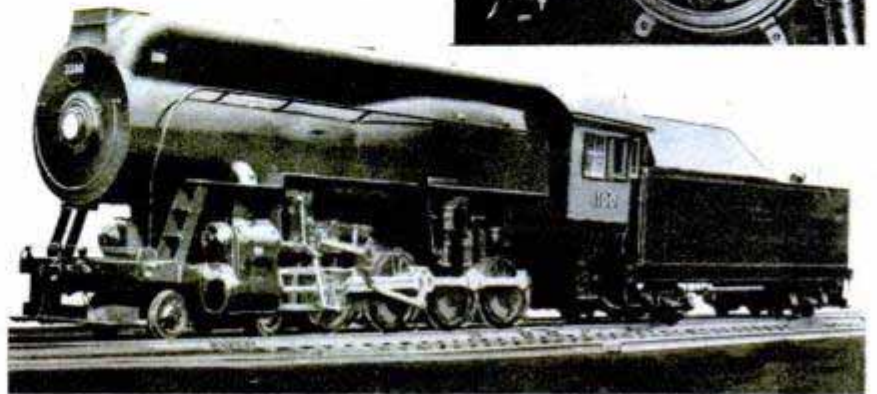

Top left, 1910 engine before conversion to the sleek "round the clock" switcher shown above. Inset shows panel which includes switch to actuate robot controls, a fuel-air ratio control and steam-pressure control

duced draft. Separate stacks discharge the combustion gases and cylinder exhaust. In addition to its quick availability, the switcher is more economical to operate.

Caddy Cart Measures Drives

Golfers can check the length of their drives with a new caddy cart that has a meter on one wheel. Each turn of the wheel is recorded, with the distance computed in yards on the meter. The caddy cart has wide-tread wheels, and only one strap secures a golf bag.

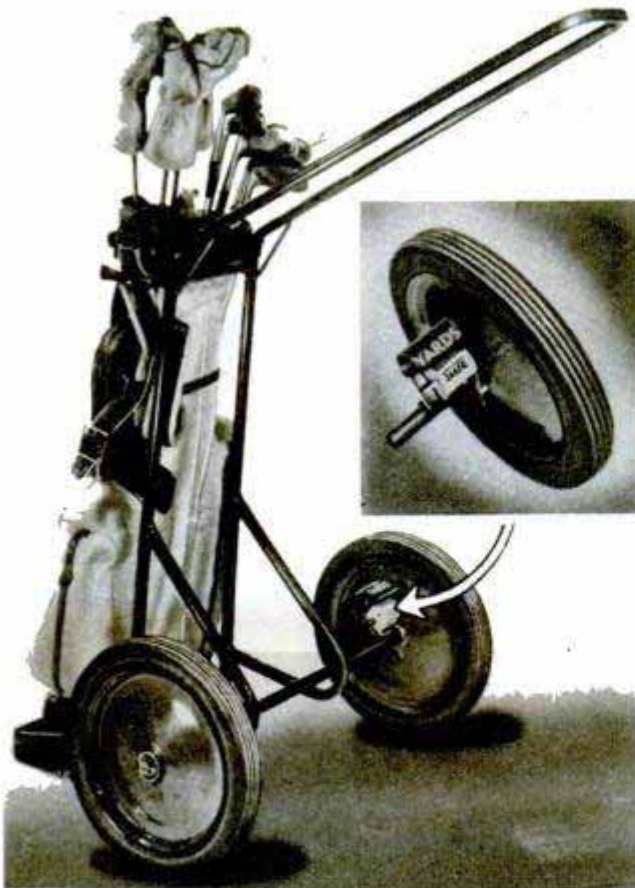

Battlewagon Decks of Pressed Wood

For nearly half a century the decks of ships of the U. S. Navy have been made of imported lumber, but a composition made of American woods has been developed that will make the Navy independent of foreign wood. Burma teakwood has long been considered ideal for battleship decks because of its strength and durability. Teakwood's new rival is a combination of American woods, treated with resins and compressed. One type is made of redwood and cottonwood, another of basswood and hard maple. The new product, developed by the Navy and the U. S. Forest Products Laboratory, was installed on the landing deck of a giant carrier and has withstood 18,000 airplane landings.

The good.
 Children's bicycles are prevented from washing into traffic or otherwise endangering themselves by a remote-control rod attached to the rear of the cycle. The British tricycle also has a compartment between the rear wheels for mother's groceries. The jointed rod folds for storage.

Periscope Camera

Clipped over the eyepiece of a submarine periscope, a camera developed by Eastman Kodak takes pictures at the rate of one per second. Designed for photographing shore lines before invasions, the camera can be loaded with a film that is developed in daylight in one minute. For strip pictures of long areas, the camera uses aerial film.



Telescoping Lift Truck

Fully extended, a new hydraulic lift truck raises 4000 pounds to a height of 11 feet, but it can be lowered to an over-all height of only six feet. This telescoping feature permits use in freight cars and cramped places. The sloping front provides excellent visibility, enabling the driver to see the load to be picked up. Scoops, forks and other attachments are available for handling a variety of heavy or bulky materials.

Bureau of Mines Seeks Way To Ship Lignite Safely

If the Bureau of Mines can find a safe way to ship lignite long distances, this country's usable fuel reserve will be increased 30 percent. Lignite, commonly called brown coal, can't be shipped many miles because it ignites when dried in air. Most U. S. deposits are in the Dakotas and Montana. The bureau's research staff hopes to find a way to ship the fuel to eastern industrial areas.



Builder Howard Hughes at the controls of his giant flying boat. This compartment alone is larger than an ordinary living room. Floor is 28 feet above water

200 TONS-- AND IT FLIES!

PUT WINGS on Noah's Ark and you have some conception of Howard Hughes' fabulous plywood flying boat. Weighing 200 tons and capable of carrying 700 troops, approximately the number in a battalion, it is by far the largest plane that has ever flown. It cost \$25,000,000 to build.

The most amazing thing about the colossus is that it flies. Only Hughes and a handful of loyal followers believed that a few years ago.

If you can imagine a 32-story building, stretched out on its side and flying, you'll appreciate how onlookers at Long Beach, Calif., harbor felt when this Gargantua of the skies first rose from the water. That size comparison is equivalent to the 320-foot wing span. Length from the nose to the

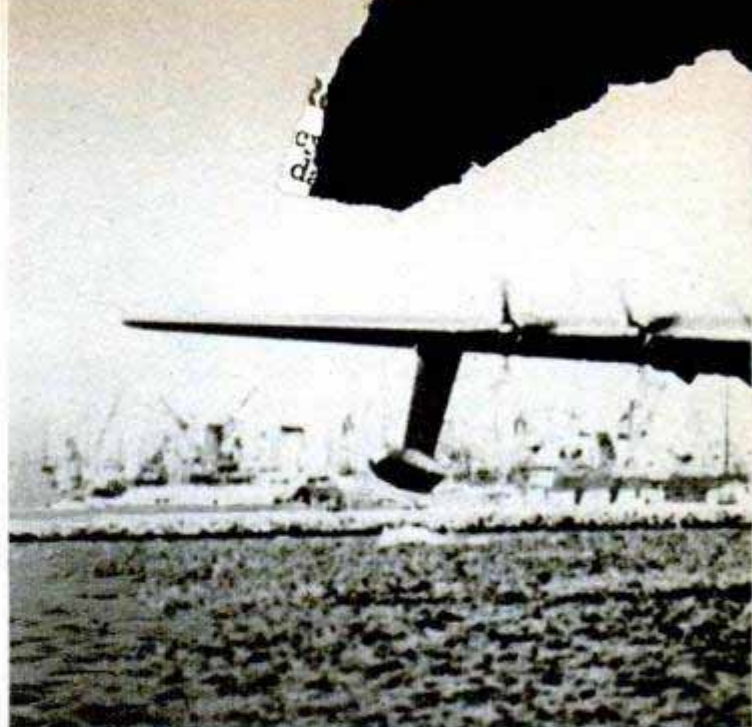

Above, in a surprise move during taxiing tests, plane was first flown about 70 feet over water for a mile

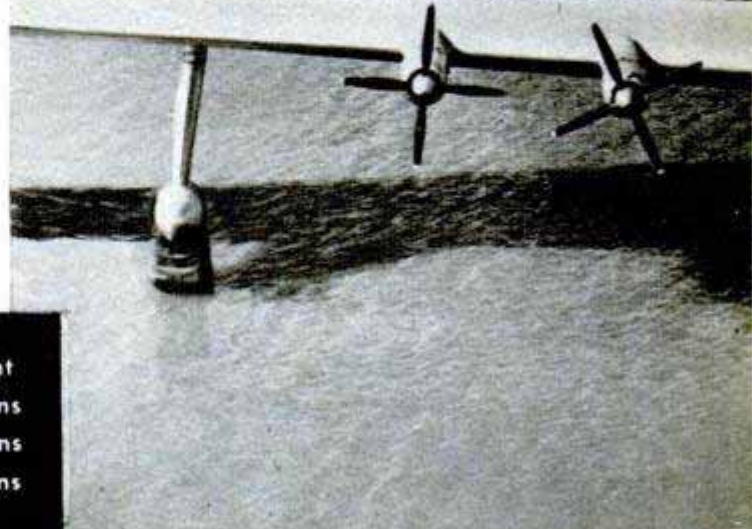
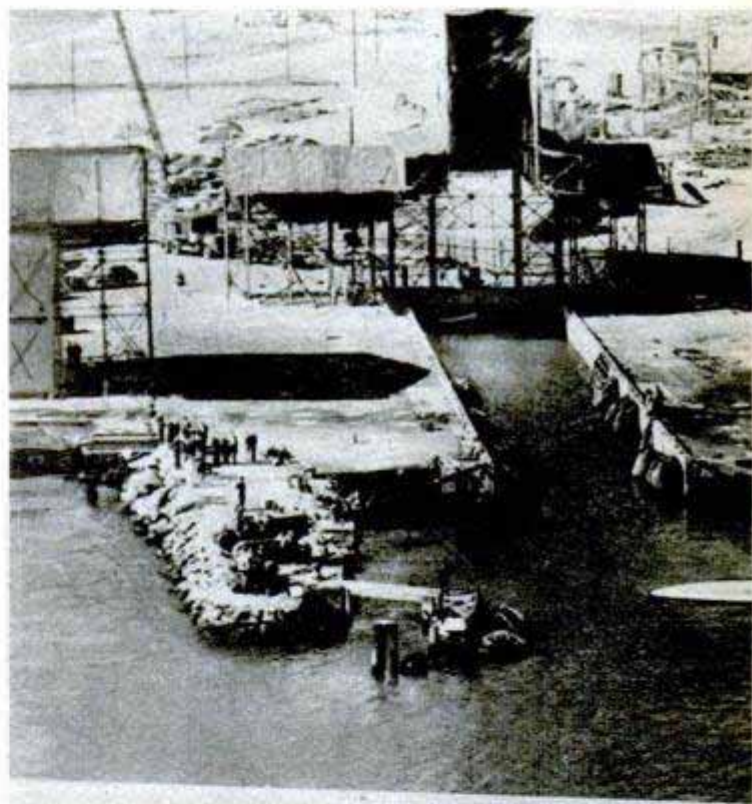

	Wing Span	Length	Weight
Hughes Flying Boat	320 ft.	219 ft.	200 tons
B-36 (largest bomber)	230 ft.	163 ft.	139 tons
DC-6 (52-passenger air liner)	117½ ft.	100½ ft.	46 tons



Below, boats and even the drydock in the background are dwarfed by the monstrous plane. Its 320-foot wing span is more than three times that of the wartime Flying Fortresses and it weighs six times as much

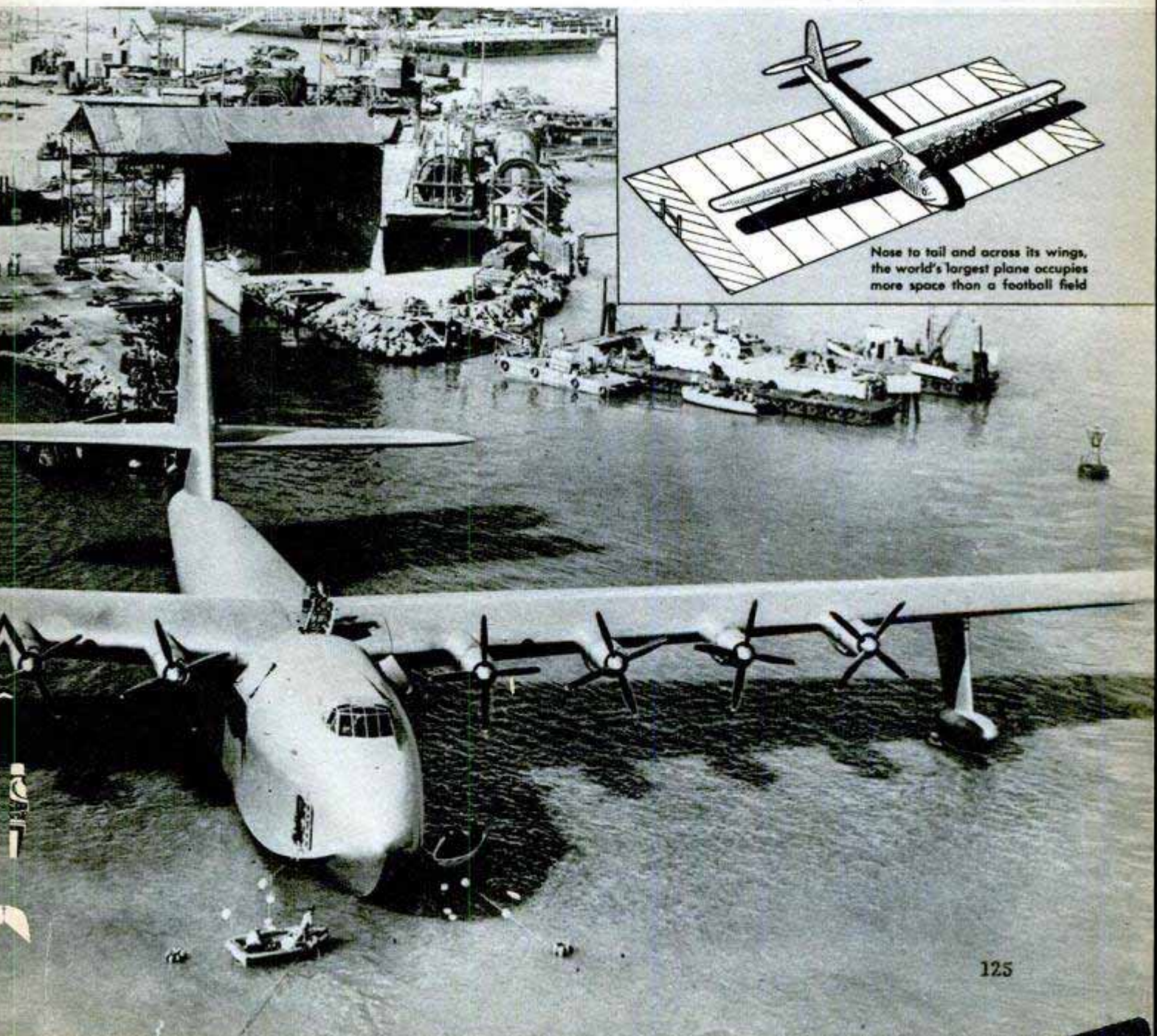

Nose to tail and across its wings, the world's largest plane occupies more space than a football field

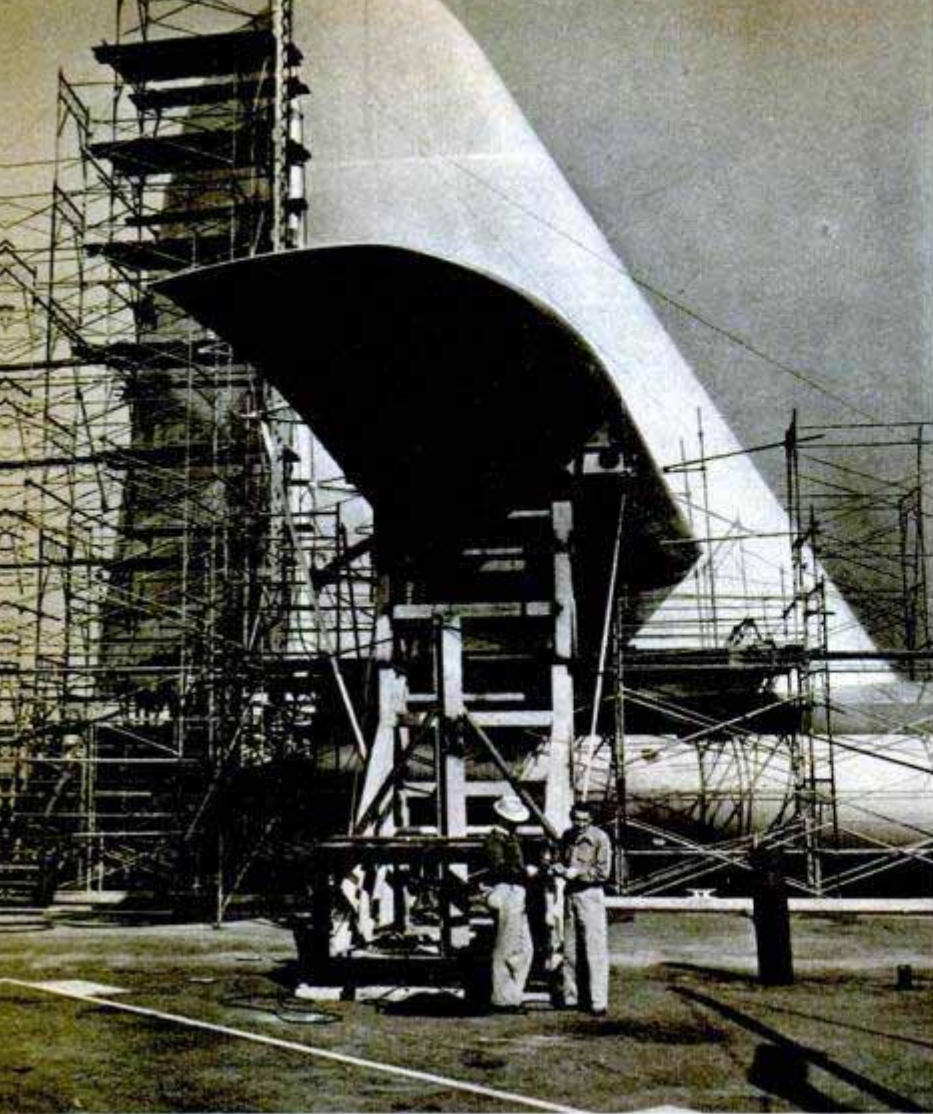

Tail being installed, above, is 52 feet high. Below, Hughes with flight engineer and radio man in forward part of flight deck. All their stations are on the upper level of the 219-foot hull

tip of the tail measures 219 feet.

Describing the plane requires liberal use of superlatives. Its thin rudder towers 80 feet above the keel and the wings are about 11 feet thick at their roots. Fully loaded, it draws eight feet of water. Pilot and copilot are 28 feet above the waterline in a compartment larger than an ordinary living room. Its normal operating crew will be about 15 men.

Eight 3000-horsepower engines give it a total of 24,000 horsepower, double that of any other aircraft. After initial take-off, when it left the water at about 80 miles an hour, Hughes said he used only 2200 horsepower on each in taxiing and 1200 in the air. Fuel capacity is 14,000 gallons, enough for several thousand miles of flying.

Nothing now in the air or under construction even approaches it in size. Britain's Brabazon, scheduled for service as a 120-passenger air liner, is only 126 tons; from nose to tail it stretches 177 feet, with a wing span of 230 feet. Consolidated's XC-99 transport, tipping the scales at 139 tons, is expected to carry 50-ton loads. It has the same wing span as the Brabazon and is 182½ feet long.

Though scoffers labeled it the "Spruce Goose" and the "Flying

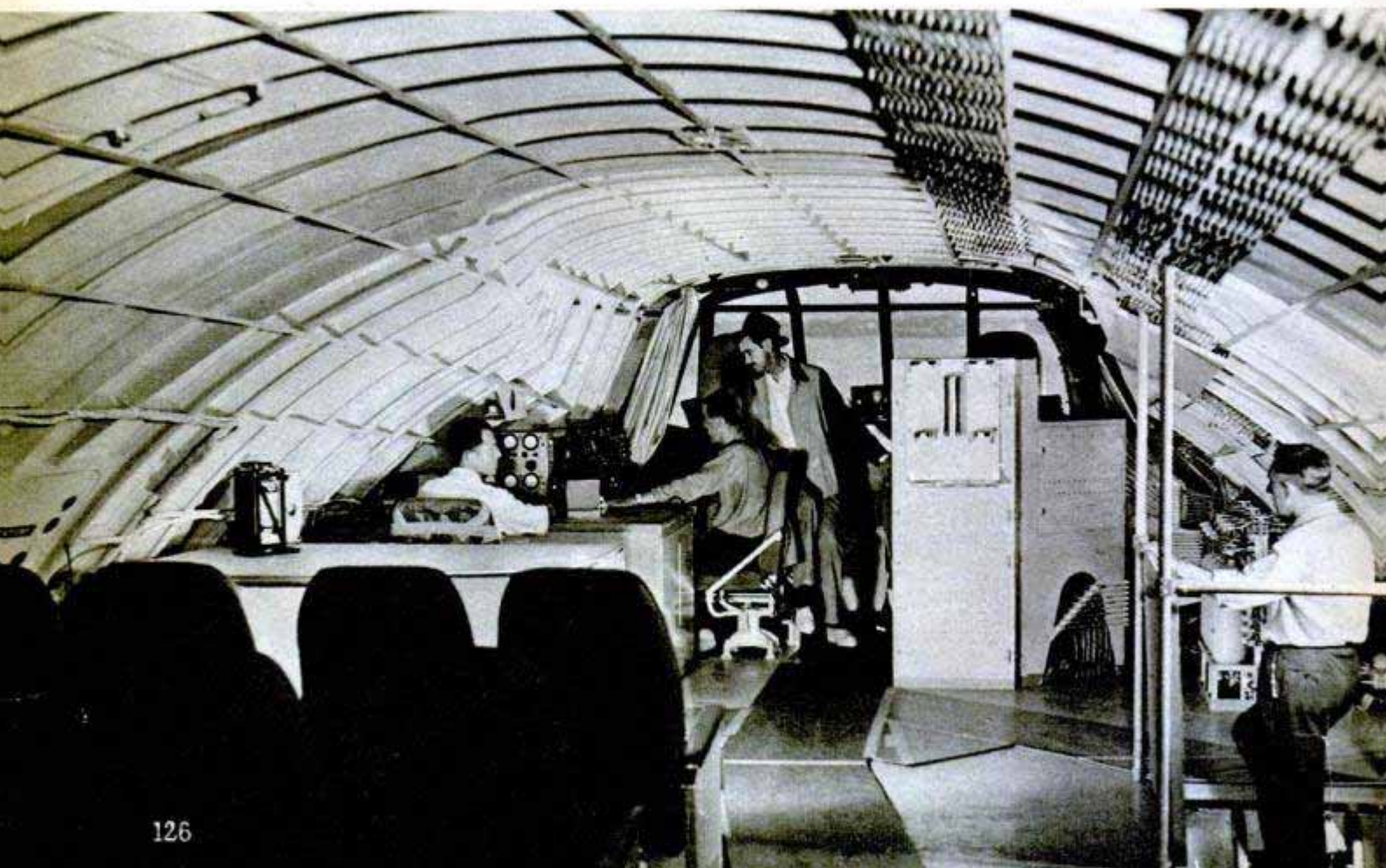

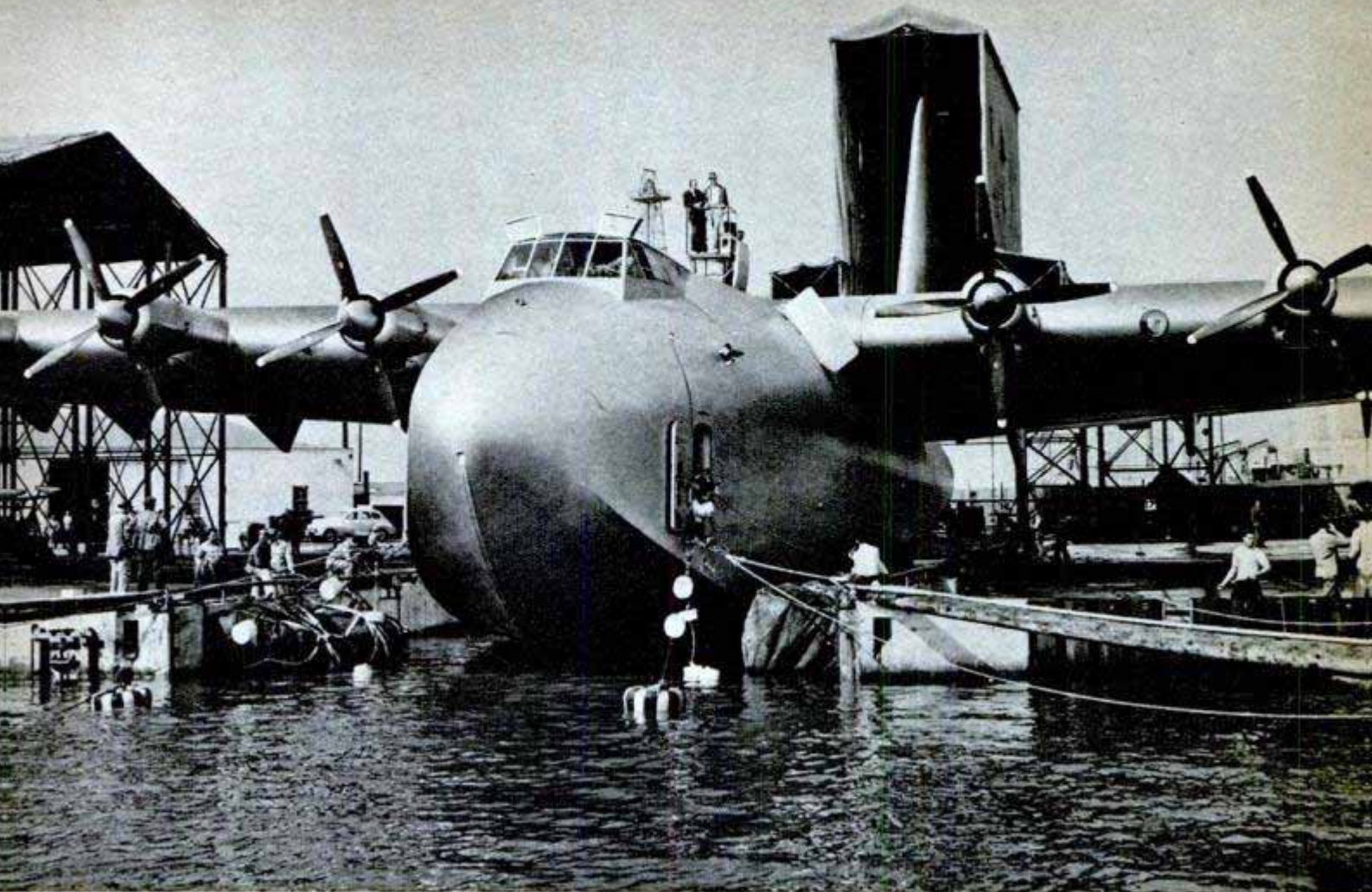

Getting ready to tow NX37602 to deep water after flooding its drydock. Housing at rear sheltered the tail

Lumberyard," there's been no name officially selected for the plane. Hughes prefers not to follow the usual practice of giving it a popular trade name. The government designation is NX37602.

Many problems were licked in converting it from a drawing board dream to something that actually flew. For the first time on any airplane, the control surfaces are so large that no man in the world can operate them. The customary steel cables from the pilot's rudder pedals and control wheels to the tail and wing tips were useless, yet their job had to be done.

As a result, a sensitive power-operated control system, providing 26,000 pounds of pressure and as reliable as the structure of the plane itself, had to be devised. Engine failures, even all eight, would permit a forced landing. But if the controls failed, a crash, death and destruction were inevitable.

Since the plane was begun in

1943, when the metal shortage was still acute, engineers had to use laminated wood, with each thin sheet carefully inspected before gluing, to form the heavy sections. Solid beams weren't acceptable because there was no way to examine them inside to detect possible weaknesses and semi-rot. In the gluing, very high-frequency electrical current was used in applying high pressures and temperatures

Inboard engines are started first. Warming up all eight takes full half hour

JANUARY 1948



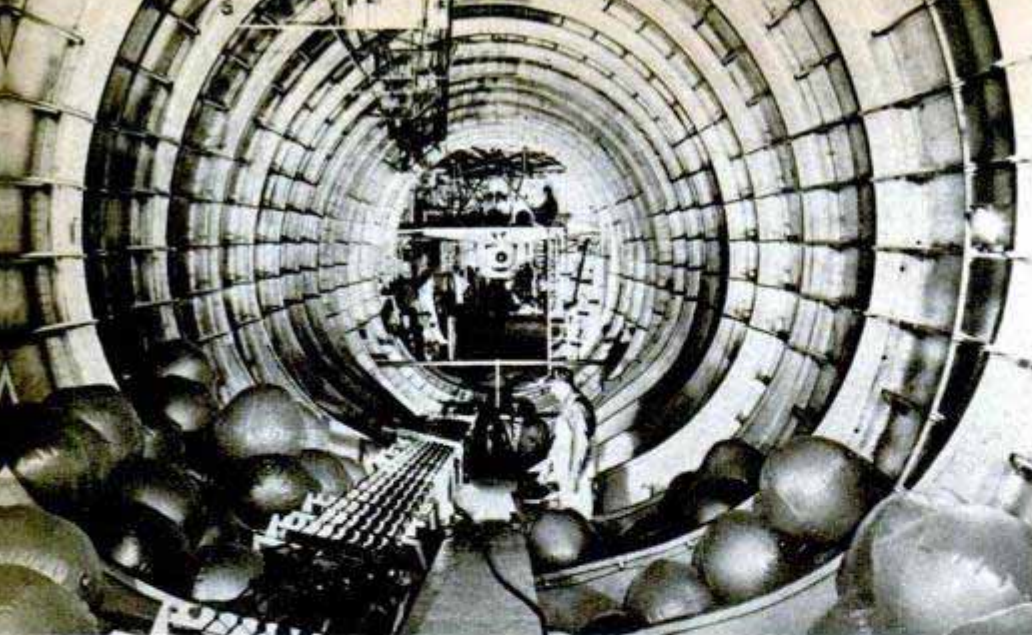

General view of cargo compartment. Plastic balloons in foreground are portion of 2500 carried along on test flights as emergency buoyancy

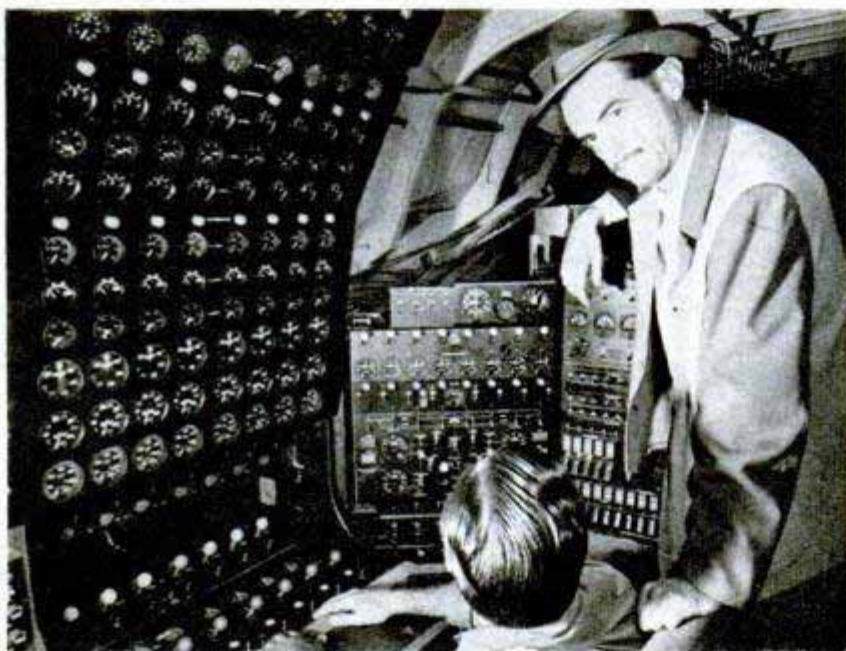

Above, flight engineer's panel where check is kept on eight 3000-horsepower engines. Below, horizontal stabilizer at the tail spans 113½ feet, wider than the entire wing of wartime bombers like the B-17 and B-24

uniformly to the heavy laminated members.

Sheer size was another problem. Where previous planes had been 10 to 50 percent larger than their predecessors, at the time of design Hughes' plane was three times bigger than anything ever attempted. There were no comparisons available in construction or in flight problems to be encountered.

Moving huge sections of the plane 35 miles to the harbor for assembly was an engineering feat in itself. It was accomplished for less than \$100,000, well under the cost of erecting another plant near the water.

No major flights are planned for the big boat until March or April. Until then there'll be only brief, cautious trials close to the water, "feeling out" the craft's handling qualities. Questions that once existed only on paper will begin to get answers in the air.

The giant's assignment will likely remain undecided until Hughes completes tests and turns it over to the government, its owner. But, regardless of its final role, the NX-37602 is slated to be for many years the biggest plane that ever flew!

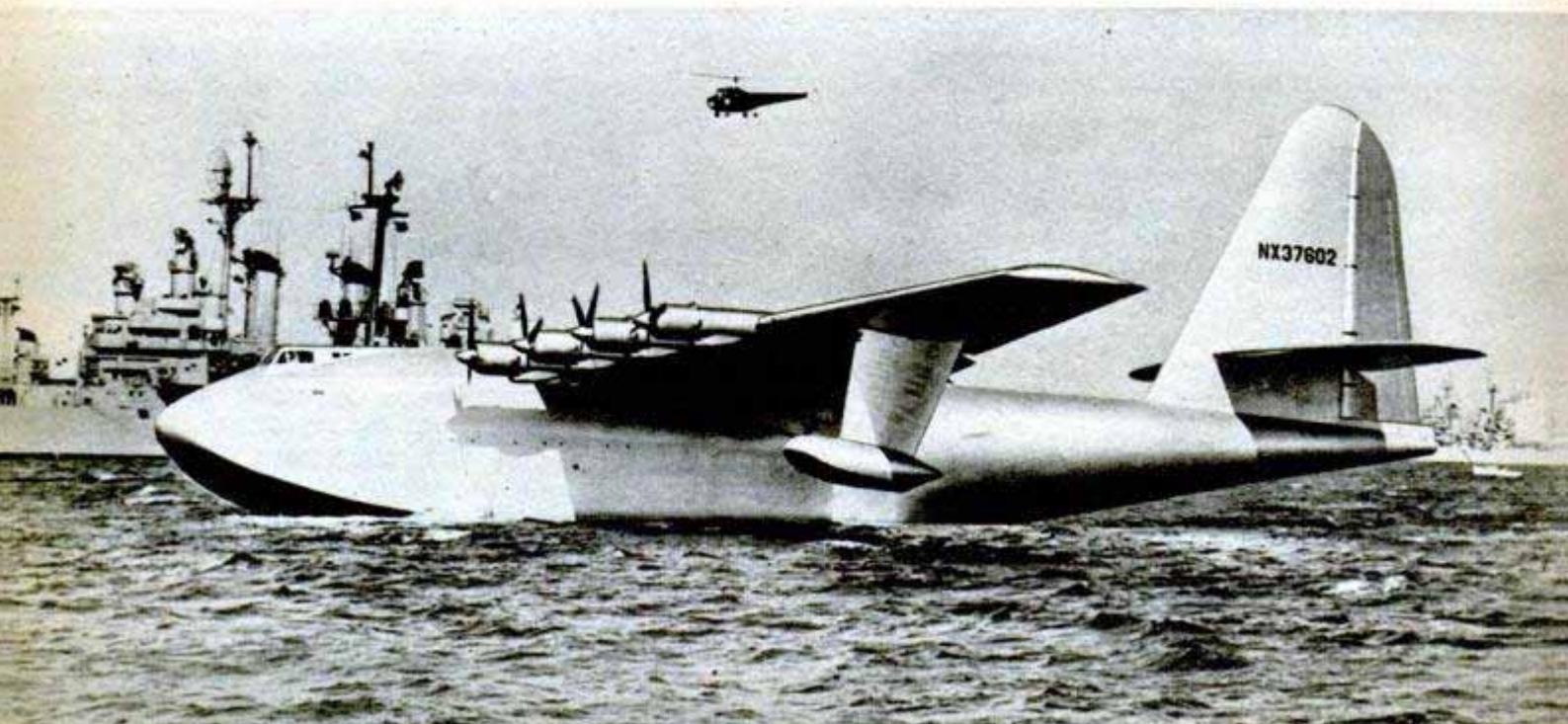

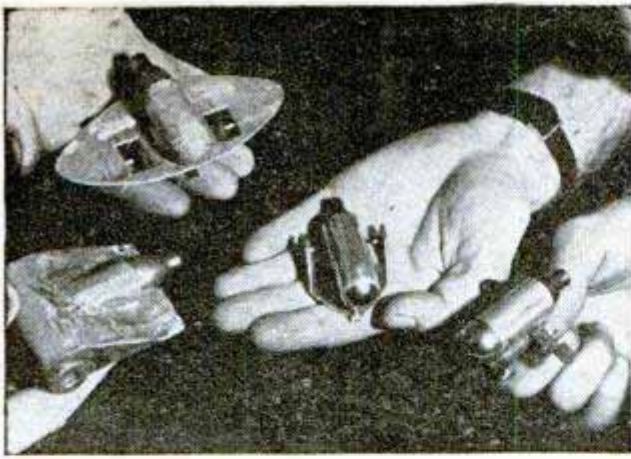

"Pop Bottle" Racers Hit 131 M.P.H.

Midget racing cars zoom down a copper wire, starting from a dead stop to hit 131 miles an hour within one second at the Pittsburgh plant of the Westinghouse Corporation. The little racers, often weighing less than a quarter of an ounce, are powered by the carbon-dioxide cartridges used in home siphon bottles. Engineers started building the midgets, which they call "pop bottle" racers, as a hobby. The "track" is the 160-foot-long corridor of an office building. Attached to the copper wire by an agate fish-pole guide, the racers are timed electronically. At the end of the course they crash into a pile of rags. Made

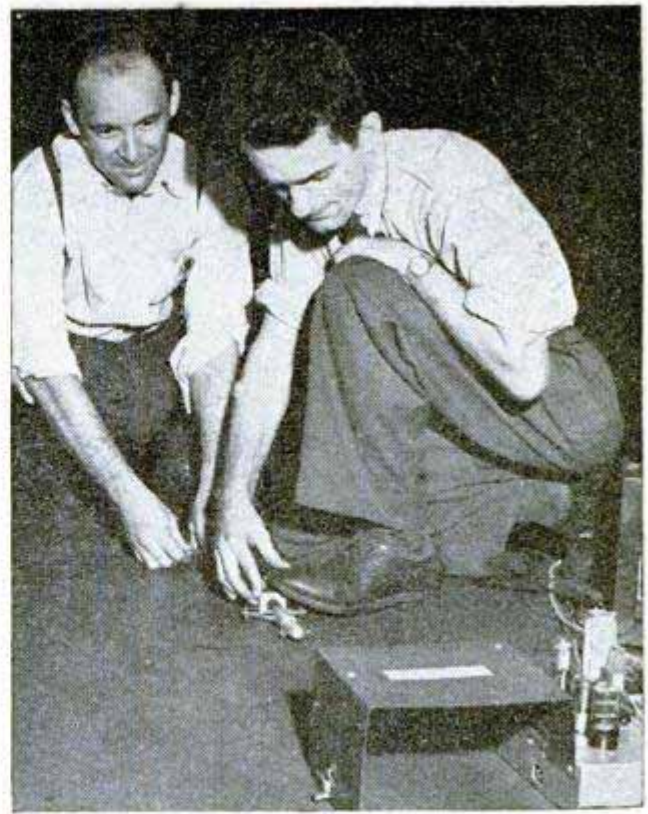

of steel, aluminum and balsa wood, they are little more than containers to hold the cylinder. They are started by inserting the rear of the cartridge in a block of wood and puncturing it with a phonograph needle.

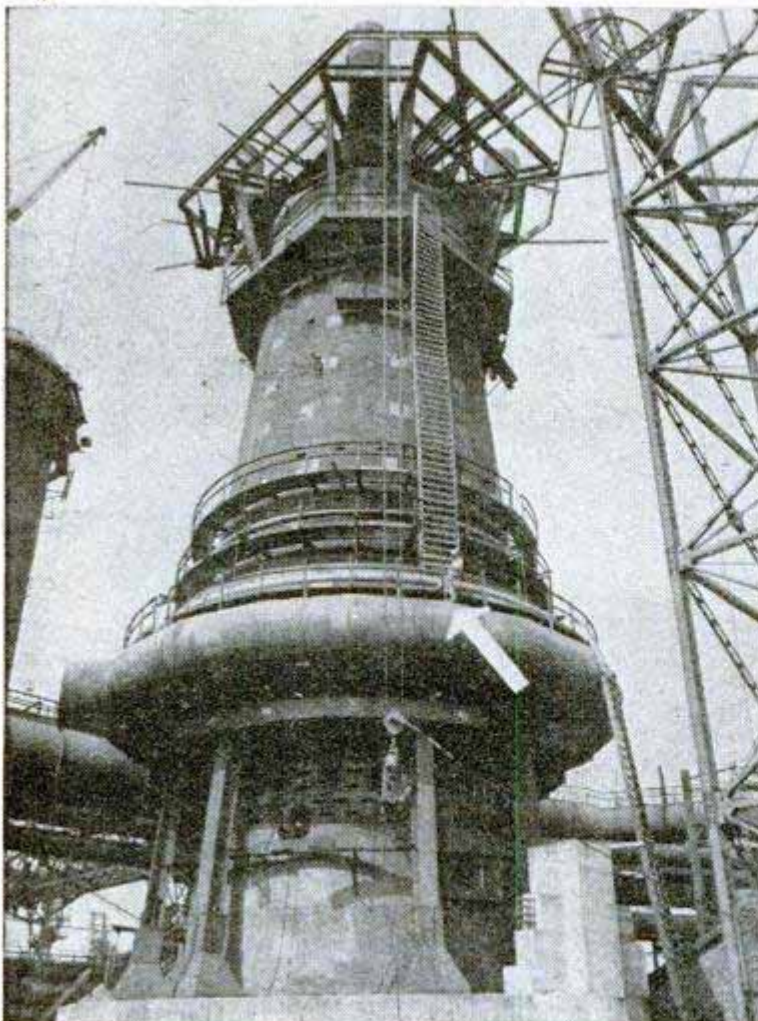

Protruding "Bustle" Pipe Encircles Blast Furnace

Under construction in U. S. Steel's South Chicago Works is a giant blast furnace encircled by a huge pipe which will carry a blast of hot air to the furnace at a rate of 90,000 cubic feet per minute. A blast furnace is known to the steel industry as a "lady" so workmen are calling the protruding pipe her "bustle." The furnace, which is one of the largest in the world, is one of three such blast furnaces built in the Chicago area since the end of the war. Workman, indicated by the arrow, is dwarfed by the huge pipe.

Vapor Unit Peps Up Engine

By dampening the gas-air mixture after it goes through the carburetor, a compact vapor-power unit improves engine performance for trucks and automobiles. According to the manufacturer, the device provides increased horsepower, eliminates motor "ping" and reduces carbon deposits. The unit is easy to install in an engine.

DIGGING INTO MEXICO'S



Covering more than 12 acres, the Pyramid of the Sun at Teotihuacan attracts thousands of tourists annually

IN THE National Museum in Mexico City are several life-sized stone figures called Chac Mools. They lie on their backs with bowls resting on their stomachs. These reclining statues are supposed to have been Mayan altar decorations and the bowls once held incense, blood or other offerings.

According to rumor, an archeologist went mad trying to explain more than this.

By Andrew Hamilton

He was found in the museum, whispering into a Chac Mool's stony ear.

Whether or not the tale is true, it illustrates a point: there is so much of archeological and anthropological interest in Mexico that a man might well go crazy trying to put all the pieces together.

Mexico is a huge outdoor museum and the shovel-wielding scholars who dig into its history have hardly scraped its sur-

PAST

face. A score of archeological sites have been worked, but hundreds more remain untouched beneath plowed fields, creeping tropical jungle or the paved streets of modern cities. Nine feet below Mexico City, for example, are the remains of the ancient Aztec capital of Tenochtitlan. These ruins probably never will be investigated because it means digging up the center of Mexico City.

So important is archeology to Mexico that a National Institute of Anthropology and History supervises all excavation projects. Staffed by some of Mexico's ablest archeologists, it is financed by government grants of 2,500,000 pesos a year.

Before the Institute was created in 1896, foreign expeditions (including some from the United States) worked Mexico's ruins, crated the findings and shipped them out of the country. The loot included rare gold and silver objects, stone carvings and even an entire pyramid in one instance.

Mexico finally realized that she was being stripped of valuable historical objects and put a stop to this practice with a law that makes all archeological treasures the property of the nation.

Today, several American expeditions, including those from the University of California, the University of New Mexico, the Carnegie Institution, the National Museum of History, the American Viking Fund and others, are working with Mexican archeologists—not to rob Mexico of her ancient, pre-Spanish art objects,

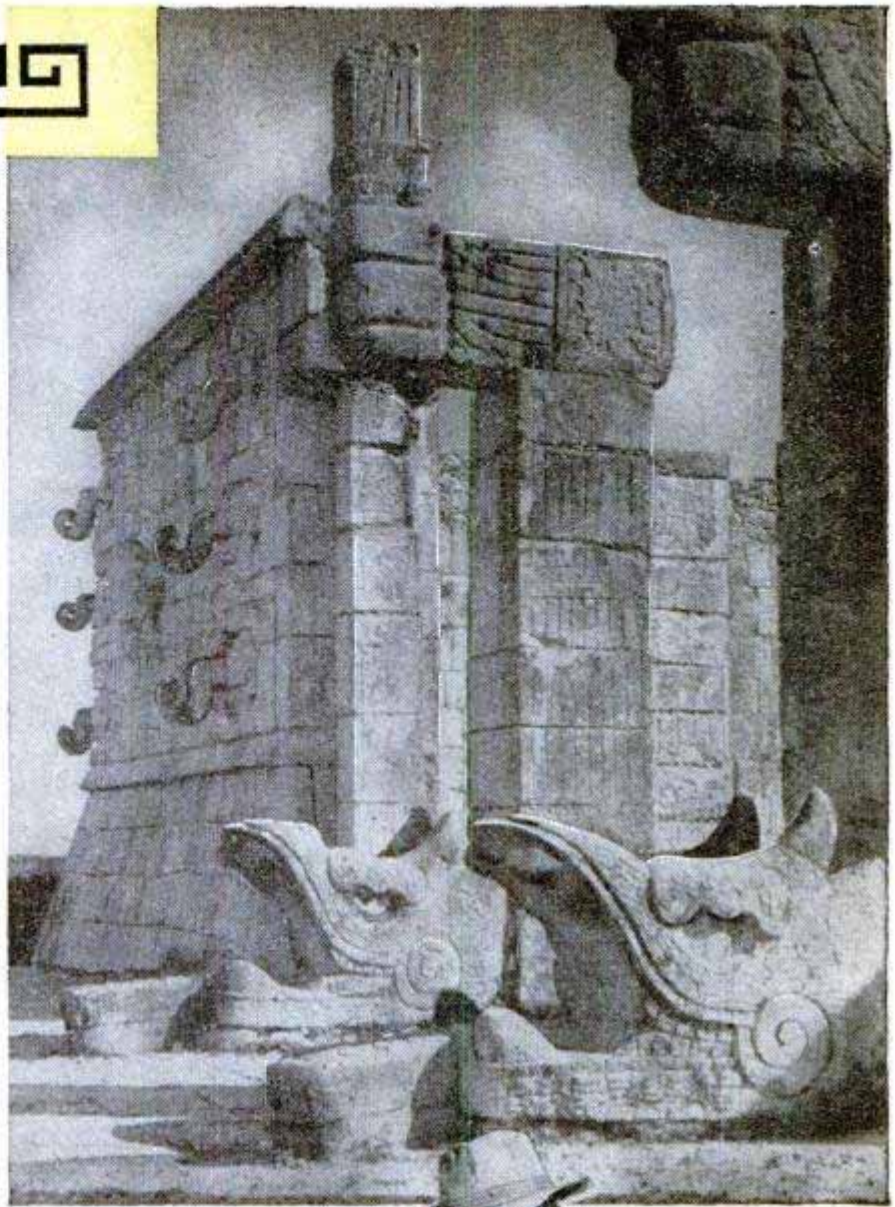

↑ Temple of the Warriors, part of a Maya city; was built of limestone blocks

↓ Archeologists find the skull of a primitive man who died 15,000 years ago

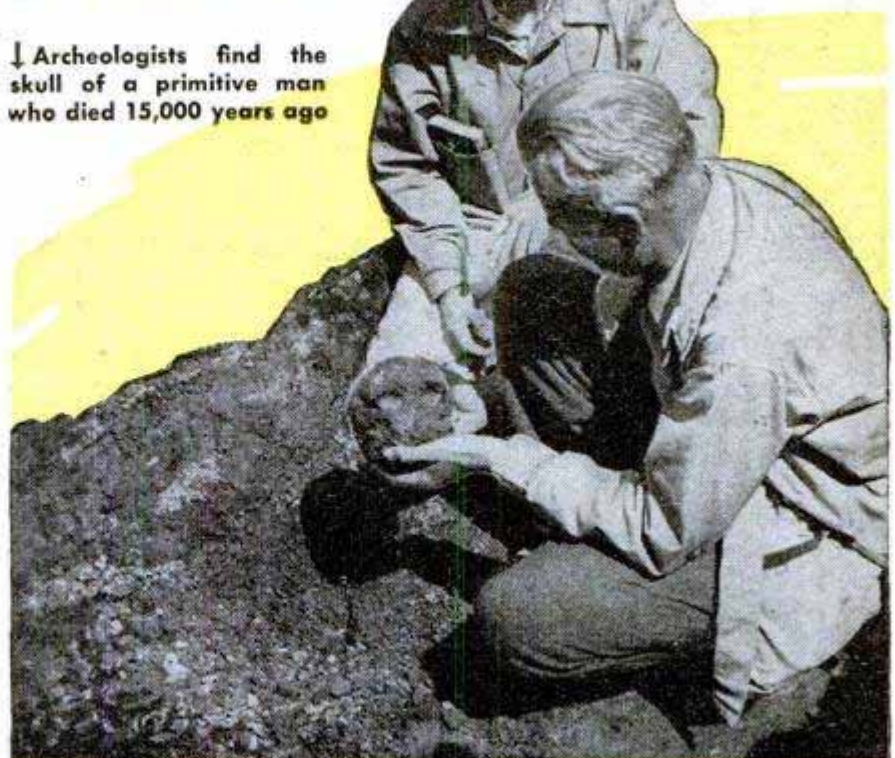



↑ A life-size stone statue, called a Chac Mool, is thought to have been an ancient altar piece.
← Potentiometer detects location of buried ruins

but to help reconstruct the fascinating story of North America.

Mexico has become the archeological "hot spot" of the world. The great civilizations of Egypt, Greece, Babylon and the Malay peninsula have been pretty thoroughly investigated and now the spotlight is on Mexico.

Seven major archeological sites have been uncovered so far: Teotihuacan and Tula near Mexico City; Mitla, Monte Alban and Palenque in the Isthmus of Tehuantepec region; Chichen Itza and Uxmal in Yucatan.

Teotihuacan, 30 miles north of Mexico City, is the location of the well-known Pyramids of the Sun and

↓ Although smaller than some in Egypt, the Pyramid of the Sun towers 216 feet above the plateau near Mexico City. Unlike the Egyptian pyramids, it has a flat top

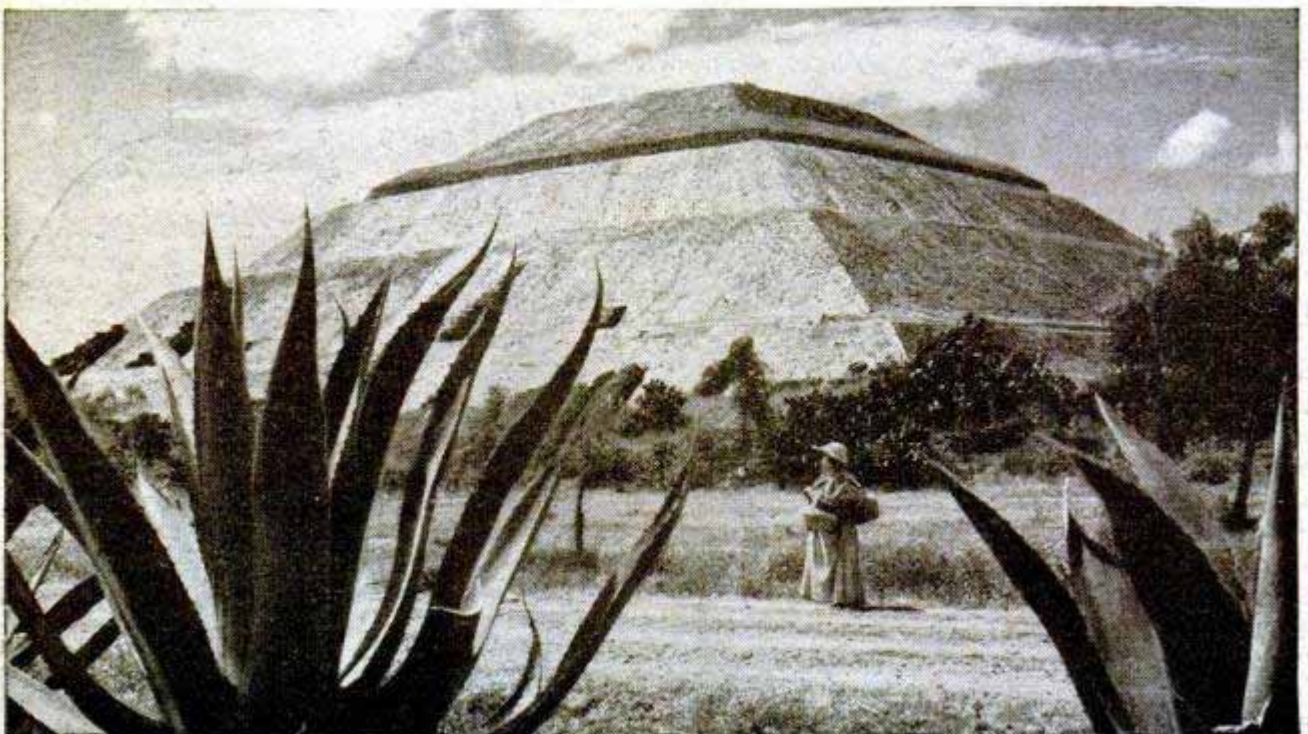

Moon. To date, only 500 acres of an area covering four square miles have been excavated.

Tula, 50 miles north of Mexico City, was a legendary capital of an ancient people celebrated in song and history. Many stone idols have been uncovered here. Today, it is the scene of some of the most significant excavations in Mexico.

Monte Alban, near Oaxaca, 300 miles south of Mexico City, features temples and pyramids facing a great court called the Temple of the Sun. Some of its tombs have yielded gold and silver objects and precious stones.

Mitla, not far from Monte Alban, was known as the "Place of the Dead." Its tombs and temples were supposed to be a resting place for spirits who returned to the earth after death.

Palenque, located a few miles inland from the lower bend of the Gulf of Mexico, was once a sacred city. Ancient American civilization is said to have reached its highest peak in this region.

Chichen Itza, perhaps the best-known ruin in Mexico so far as the American public is concerned, is an example of the Maya civilization. Excavations have been carried on in this Yucatan city for years by the Carnegie Institution and the Mexican government. Two miles of buildings have been uncovered, but others still remain.

Uxmal, which means "three times destroyed," is another Mayan site in Yucatan. Its temples and palaces, now overrun by jungle, still hold important archeological secrets.

What do archeologists expect to find as they peel back the layers of dirt and time?

First, they hope to solve the riddle of the origin of the North American Indian. At present, it is generally believed that he migrated from the other side of the Pacific. A few Australian natives made their way to the Tierra del Fuego country at the tip of South America; a few Polynesian islanders in their canoes reached the shores of both North and South America; and a few Chinese junks may have been swept by the Japanese current to western Canadian shores. But the

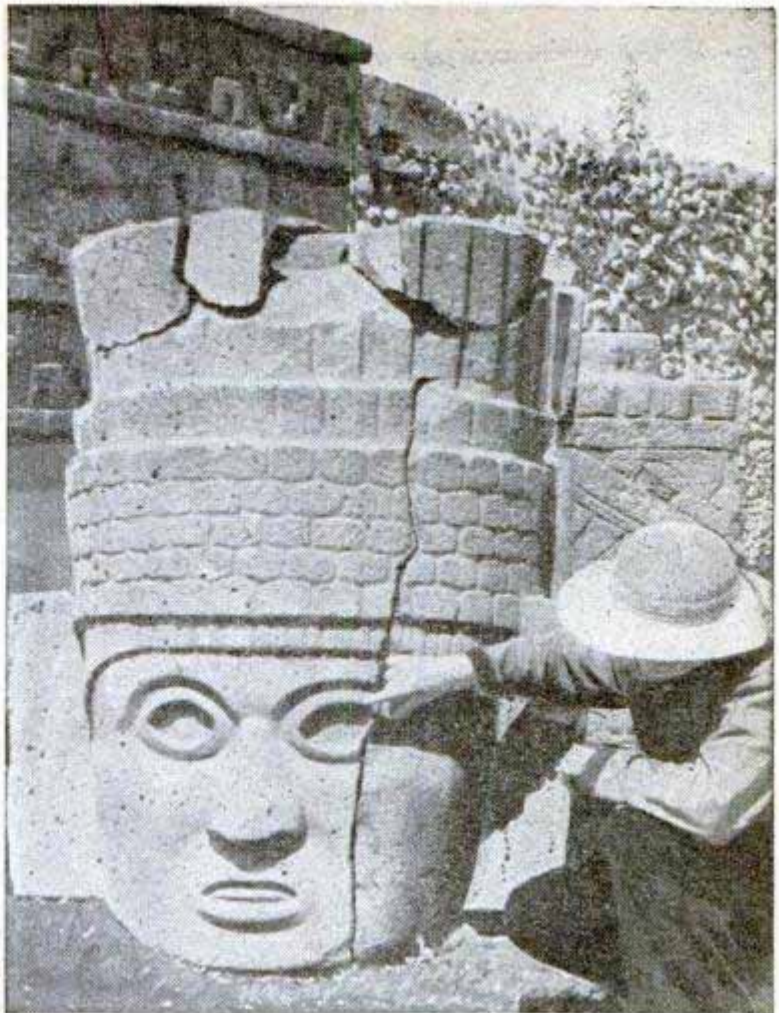

↑ Archeologist examines a stone head found at Tula, a city celebrated in song and legend as the capital of an ancient people

↓ Uncovering the "Serpent's Walk" at Tenyuca, near Mexico City

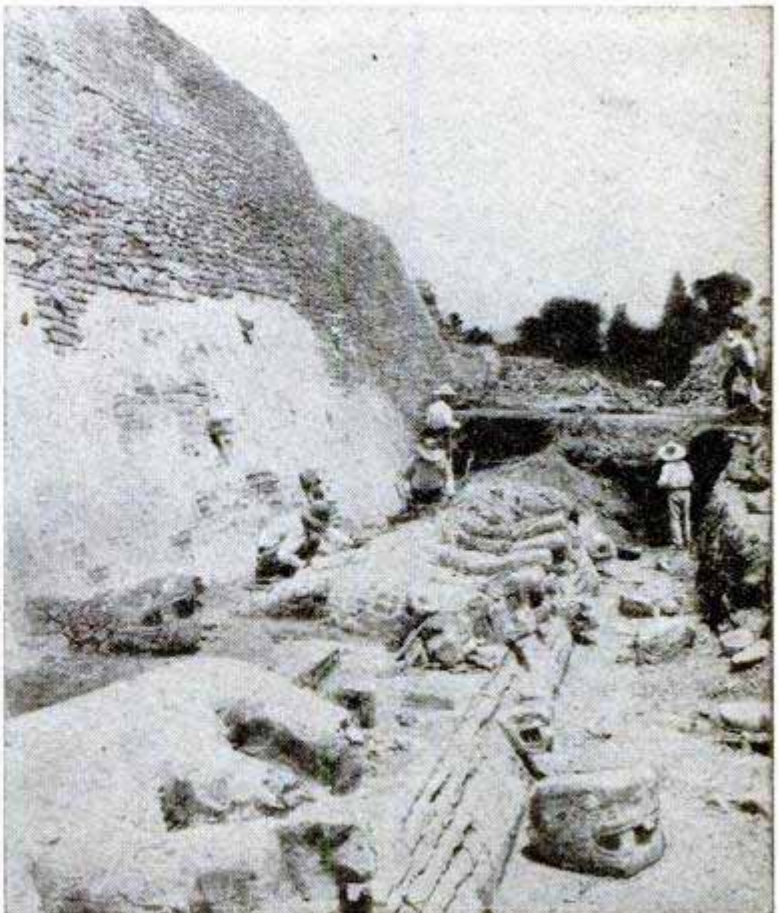

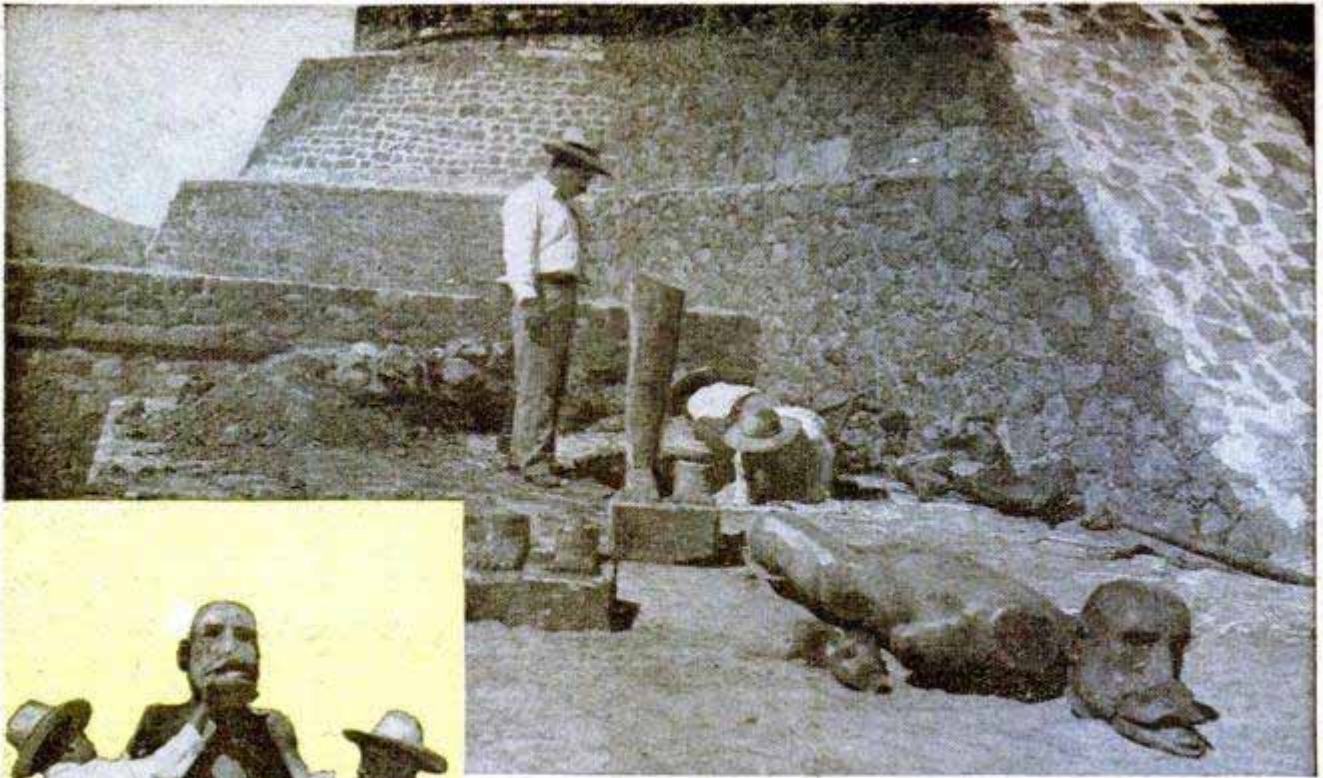

↑ Broken stone idol as it appeared when uncovered at Calixtlahuaca in the Toluca Valley. Left, the idol as it looks after restoration.
↓ Steps leading to the top of a small pyramid-temple at Teopanzolco

heaviest migration, archeologists believe, came across the Bering Strait from Siberia. A land bridge existed there before the last glacial epoch (about 15,000 years ago) and early ancestors of the American Indian poured down into the Americas.

Hair, skin and blood types of present-day Mexican Indians resemble those of Asiatic peoples. Visitors to Mexico are startled by native faces which often resemble those of the Chinese or Japanese. There is, however, one difference: the Mexicans do not have the folded upper eyelid which gives a slant-eyed effect.

But then, neither do all Asiatics. It is believed that the ancestors of present-day American Indians were nonslant-eyed natives of Siberia.

Archeologists are excited over a discovery that sheds additional light on the origin of the American Indian. Near Mexico City a long, narrow skull with heavy eyebrow ridges was found recently. Although modern in shape, this old skull suggests a primitive type such as the Peking Man or the Neanderthal Man. However, it is not as old as either of these, being but a comparative youngster—10,000 to 15,000 years old.

This earliest American apparently met his death while on an elephant hunt. His skull and a few other bones were found about three feet below the surface of the earth near a great quantity of mammoth bones, tusk and teeth in an area that earlier had produced obsidian arrowheads.

Second, the archeological ruins of Mexico are expected to present a more complete picture of what these ancient Amer-

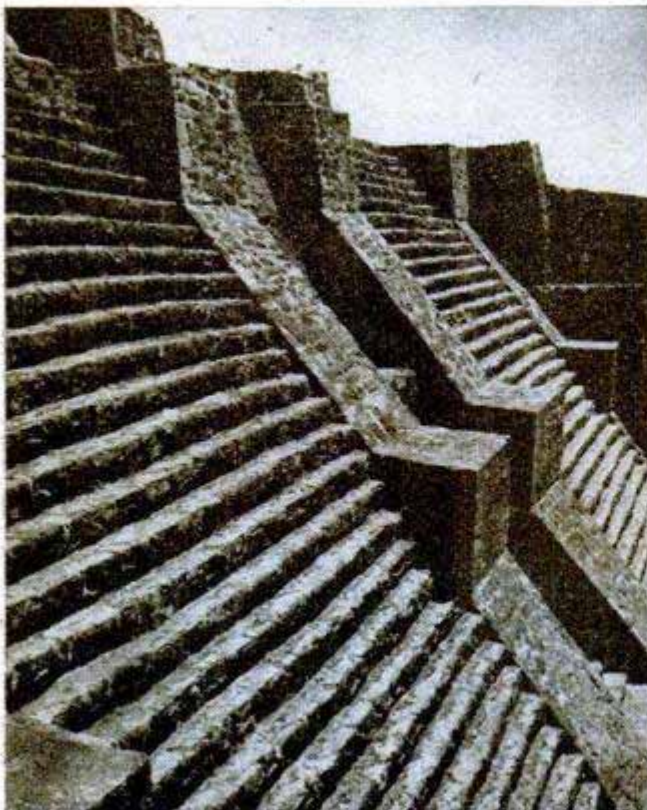

ican civilizations were like. What kinds of houses the people lived in, how they dressed, what they ate, how they were governed, and what their religions were.

European archeologists once scoffed at the ancient peoples of Mexico. But evidence has piled up to prove that the Mayas, the Toltecs, the Aztecs, the Mixtecs, the Zapotecs and other races built a colorful and complex civilization before the invasion by the Spaniards about 1520. The "Golden Age" of their history was from the time of Christ to 1200 A. D.

During this Golden Age they constructed pyramids, erected ornate temples and palaces and built irrigation systems. They knew some of the mysteries of astronomy and mathematics and cultivated many foods that we eat today: corn, beans, squash, avocados, yams and chocolate. They were aware of some uses for rubber and devised a game similar to basketball. It was played on a court and consisted of tossing a rubber ball through a stone hoop.

But they went down before the Spaniards because tribal wars had weakened their organization, because they had not developed

(Continued to page 236)

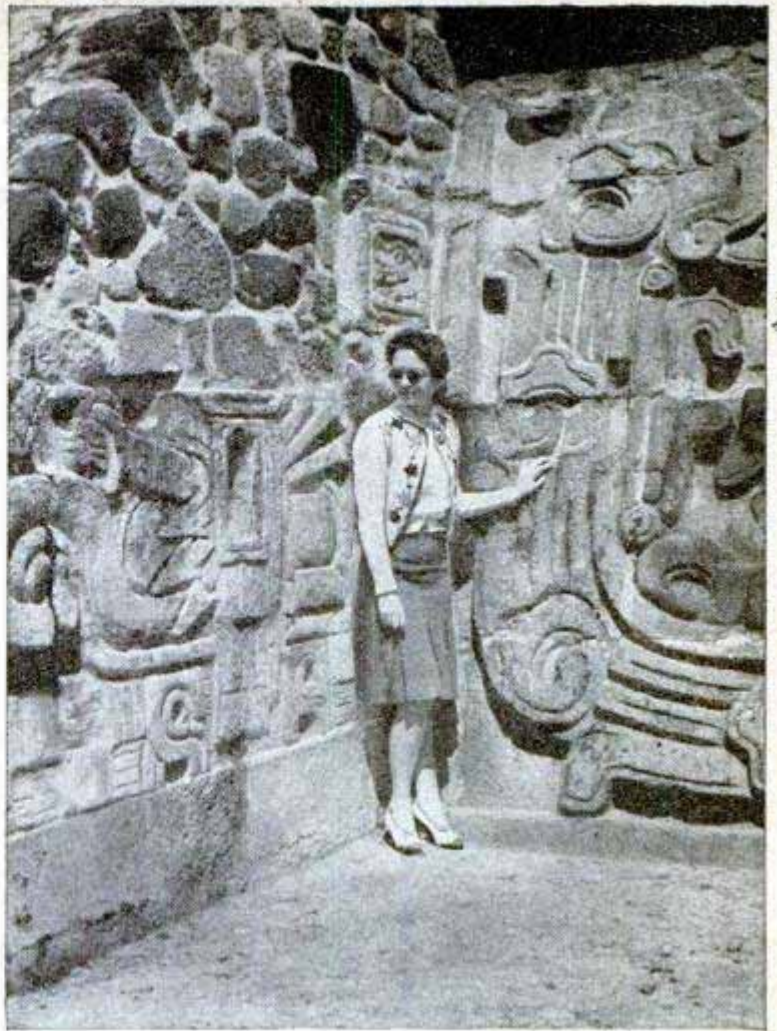

↑ Tourist admires a complex design at the Xochicalco pyramid

↓ At Chichen Itza, workers slide a heavy stone block beneath the hoist before restoring it to its place in the temple wall

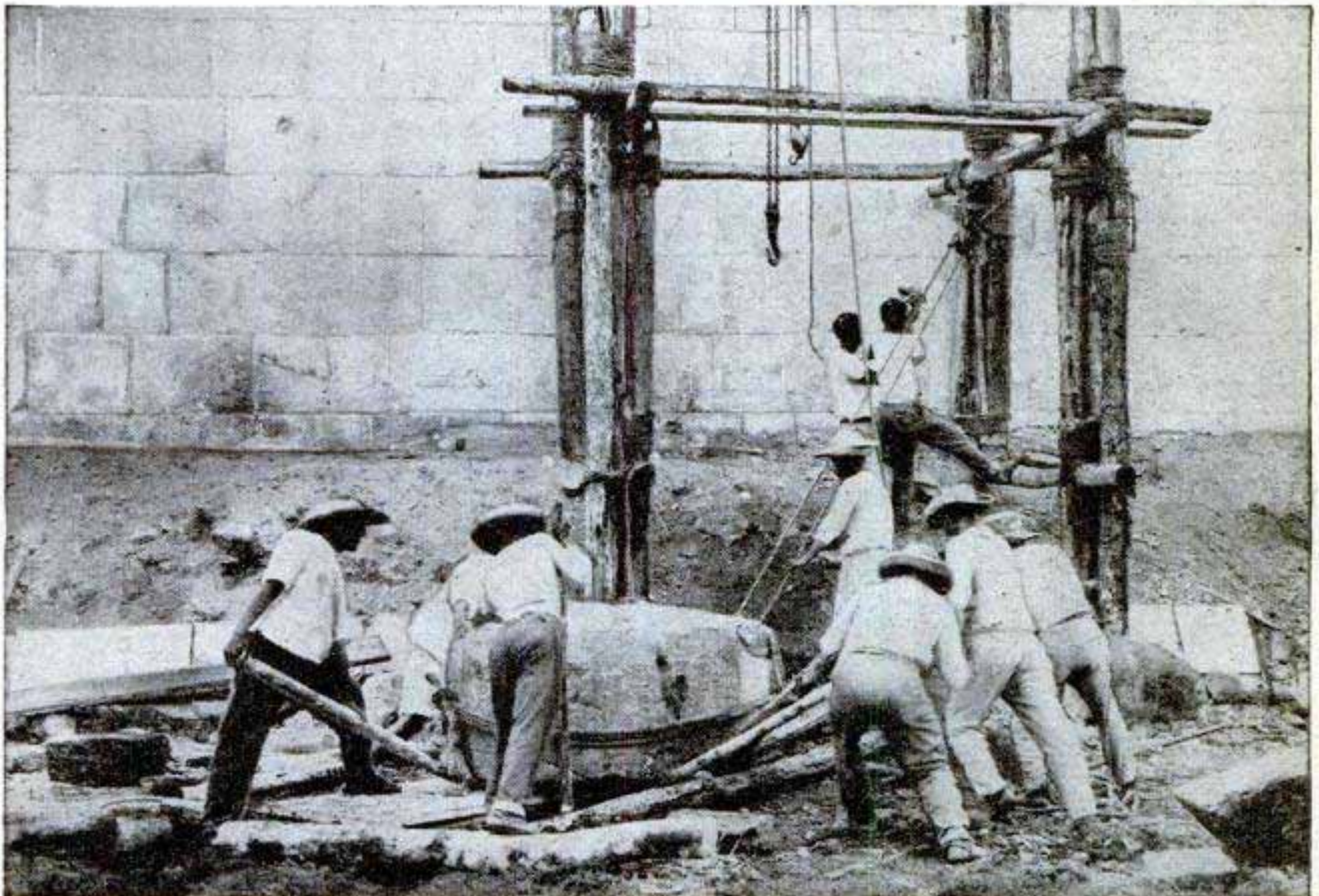

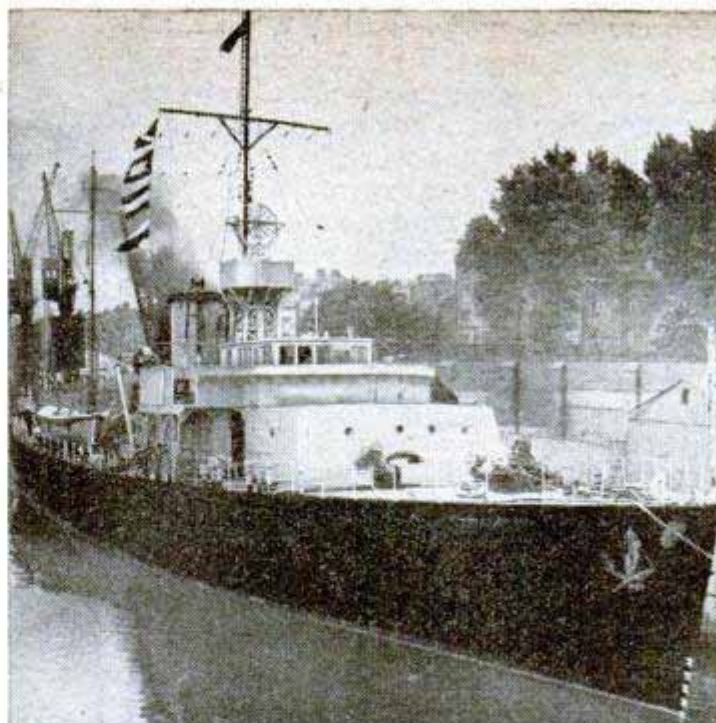
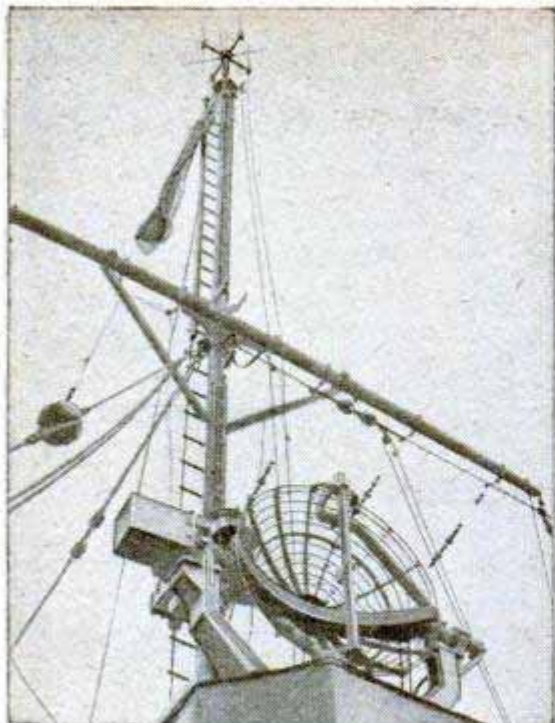

Britain's First Weather Ship

With a bright yellow funnel and superstructure making it easily recognizable, Britain's first weather ship has joined the 13-station network spanning the North Atlantic. The internationally sponsored fleet makes and transmits weather observations for surface and air craft, as well as aiding in search and rescue missions. Ten nations are maintaining it. The Weather Observer, a 200-foot former corvette, will stay within a half mile of its assigned ocean position for 21-day stretches, alternating with another ship. It has aboard the latest meteorological and navigation equipment, along with two motor lifeboats, scrambling nets and rubber dinghies for rescue work.

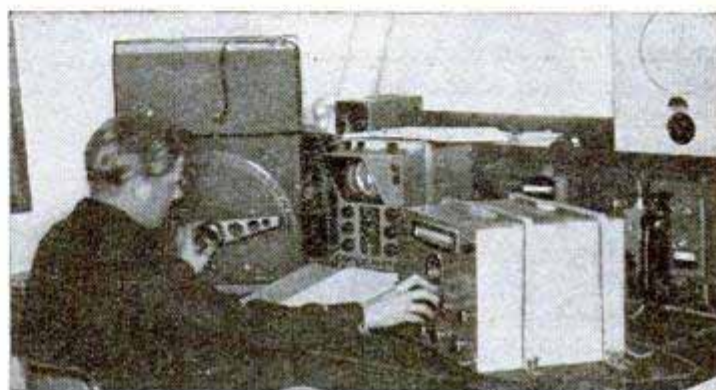

Copyright "Mechanics"

For 21-day stretches the Weather Observer, upper right, will stay at assigned station in the North Atlantic, compiling and sending meteorological reports. Radar, upper left and below, scans for storm clouds and keeps check in upper air

Each of the 26 ships in the fleet carries three meteorologists and four observers in its 52-man complement.

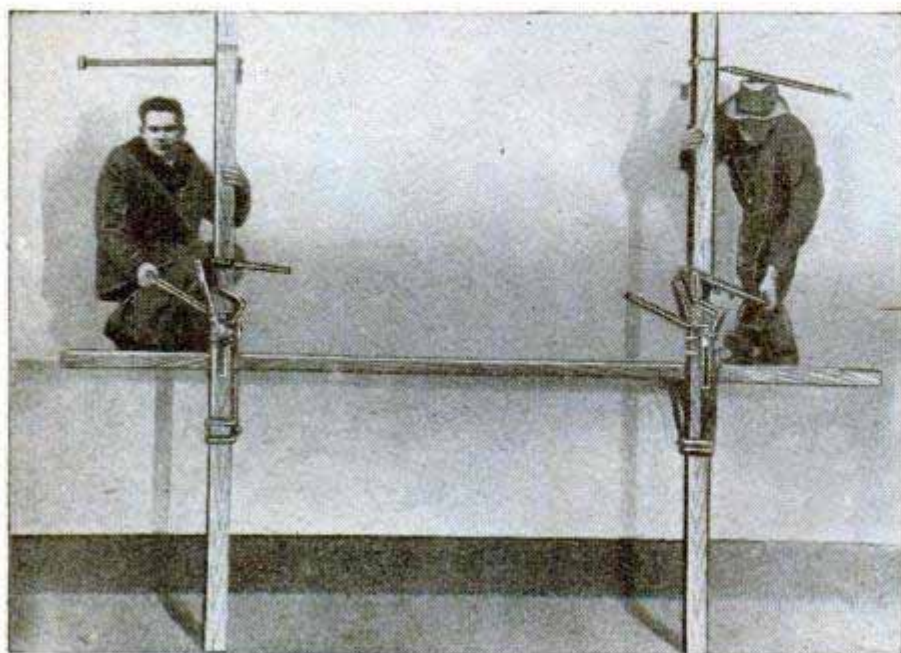

Speed-Up Scaffold

Requiring no ropes, hooks or nails, a new method for securing scaffolding makes it possible to scaffold one side of a 60-foot building in 25 minutes. The scaffold is held to the beams by means of pumps employing three grips. This gives triple safety as any one grip is sufficient to hold the scaffold under normal weight. The pumps accommodate a 24-inch painter's scaffold and can be adjusted to 15 or 18-inch scaffolds.

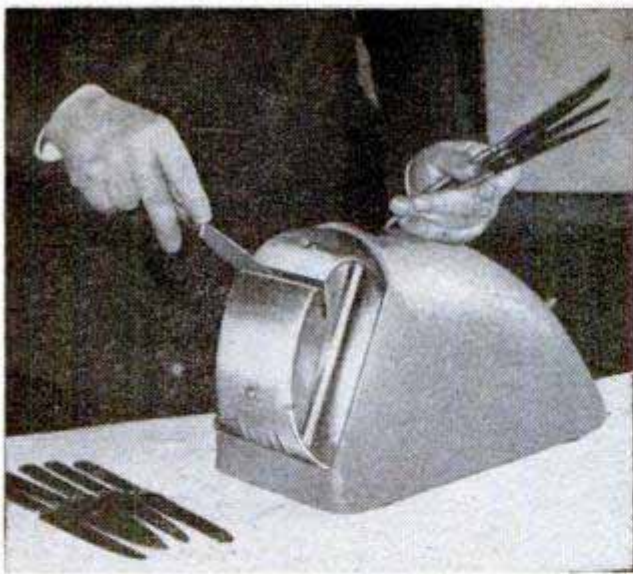

Electric Knife Sharpener

Because it sharpens only one side of the blade, an electric knife sharpener removes a minimum amount of metal and thus makes knives last longer. Inserted in a slot at the front of the machine, the blade is held at the proper angle. According to the manufacturer, the sharpener does not scratch or mar the blade.

Mask Trips Pilot Ejector

By pulling a heavy cloth mask down over his face, a pilot sets off an ejection device that throws him and his seat clear of the plane. The shield protects his face from the sudden impact of air. After a short interval, the seat drops away, automatically opening the pilot's parachute. At Chalgrove Airfield, England, a pilot was thrown safely from a plane going over 500 miles an hour.

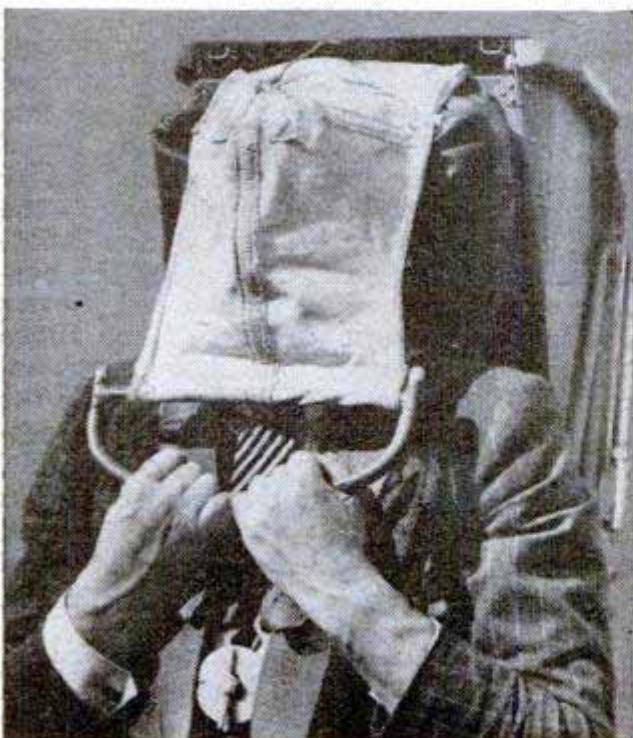

Cigarette Lighter Worn on Wrist

Resembling a wrist watch, a cigarette lighter manufactured by an English concern straps to the wrist. When the cover is flicked back, the lighter automatically throws out a flame.

Pedal Car Is Kept in House

Having no garage in which to keep an ordinary-sized automobile, an Englishman living at Eastcote, Middlesex, decided to build a small pedal car that could be kept in his home. This economical car transports the family at low cost and saves buying an expensive English road license. It is light enough to be carried down steps.

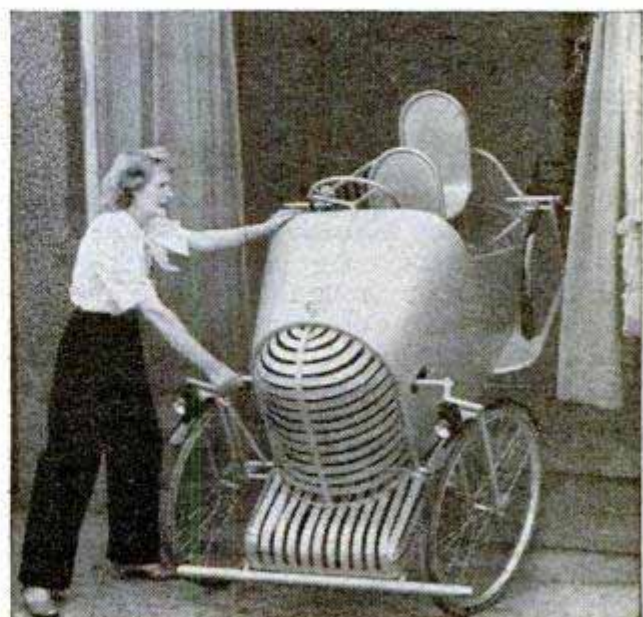

E. A. Wheeler
 Willow Bungalow
 West End Road
 South Ruislip
 Middlesex England

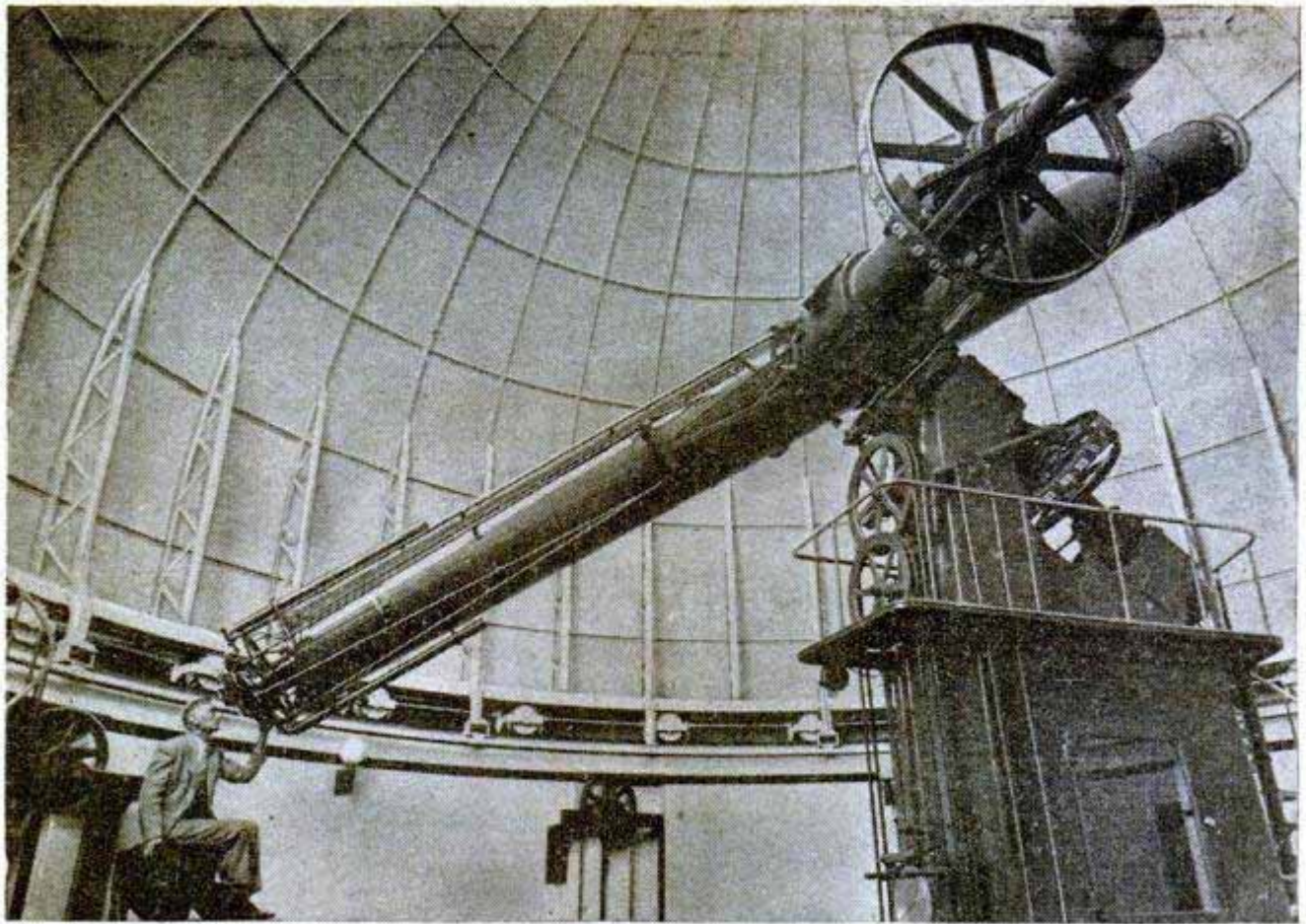

Still in use, this 26-inch refractor at the Naval Observatory was acquired by the government in 1873

TIME *from the* STARS

By John L. Kent

SETTING YOUR WATCH by radio time signals is an easy operation. We have become so accustomed to having this convenient check on our timepieces that we're apt to accept it as something automatic and without effort.

But that is far from the truth. Time signals are based on observations of the stars and the U. S. Naval Observatory in Washington has a complicated set-up that assures exact time for this country and other places in the world. From the observatory, time signals—accurate to $\frac{1}{1000}$ of a second—are relayed by radio and telegraph to control clocks throughout the country and to ships at sea.

If Father Time had an earthly counter-

part, he would probably be Paul Sollenberger, chief of the Time Service at the Washington observatory. No matter what time zone you live in, the time used by your broadcasting station, airport and railroad station comes from Sollenberger's master transmitter clock. This clock is kept accurate by daily observations of the stars.

The correct time was not always as accessible as it is today. There was a time, not long before the beginning of the present century, when clocks were checked at noon each day by the dropping of large time balls mounted atop high buildings. Naval Observatory time signals, first sent out by telegraph in 1865, were used to drop the time ball on the old Western Union Building in New York. Before leaving the harbor, mariners checked their chronometers at noon by the dropping of this ball. Since then, the observatory time signals have become the standard for clocks all over the country. The accepted basis of time measurement is the earth's rotation on its axis, causing the sun and stars to appear to cross the sky from east to west. If the interval between two successive passages overhead of the sun or a star is measured, the time of rotation of the earth is obtained.

To reduce the possibility of human error, a specialized telescope, known as a photographic zenith tube, is used. It "shoots"

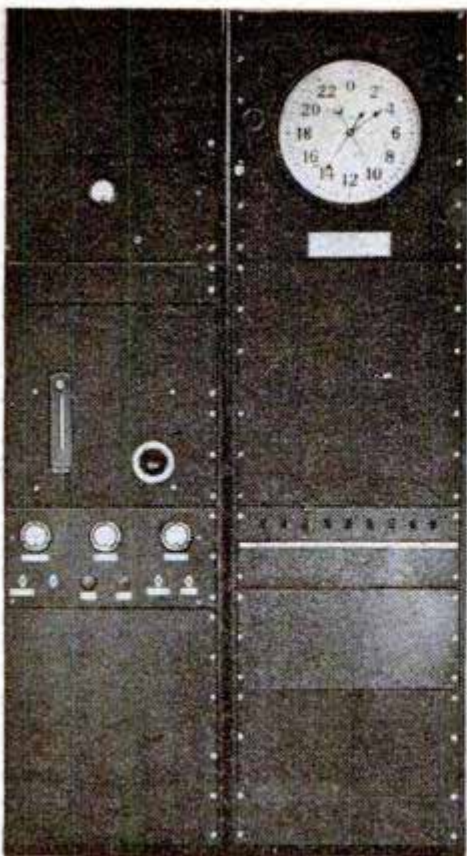

Above, operator adjusts the mechanism of the master crystal clock that sends out radio time signals from Washington

Left, front panel of the master clock from which all time signals originate

Right, Western Union subscriber's self-winding clock. Cutaway shows device that synchronizes it with master clock



only those stars that cross the meridian within one-sixth of a degree of the zenith.

The zenith tube is an upright metal pipe, open at the top but closed at the bottom. The lower end of the tube is filled with mercury. Light from a star passes through a lens at the upper end of the instrument, continues down through the tube, is reflected from the mercury surface, and comes to focus on a sheet of photographic film located just under the lens.

A synchronized electric motor drives a rotary film holder that permits the taking of about a dozen photographs of each star in quick succession.

As each star is being photographed by the zenith tube, a chronograph automatically records electric signals produced by the movement of the film carriage in the telescope and also signals produced by the ticking of one of the standard clocks attached to the tube mechanism. Thus, the clock time of the star's transit is determined within a fraction of a second. By comparing these clock times with the known times of star transit computed beforehand, the clock error is determined.

Several standard clocks are constantly corrected in this way. A master transmitting clock is in turn corrected from these standard clocks.

The master clock is of the quartz-crystal type, the crystal serving the same purpose as a pendulum. The frequency of oscillation, however, is usually from 50,000 to 100,000 per second, many times that of an ordinary clock pendulum.

Below, although seldom off more than one second in 24 hours, Western Union's master clock is checked regularly over direct wire to the Naval Observatory. Here, operator receives a time signal via telephone

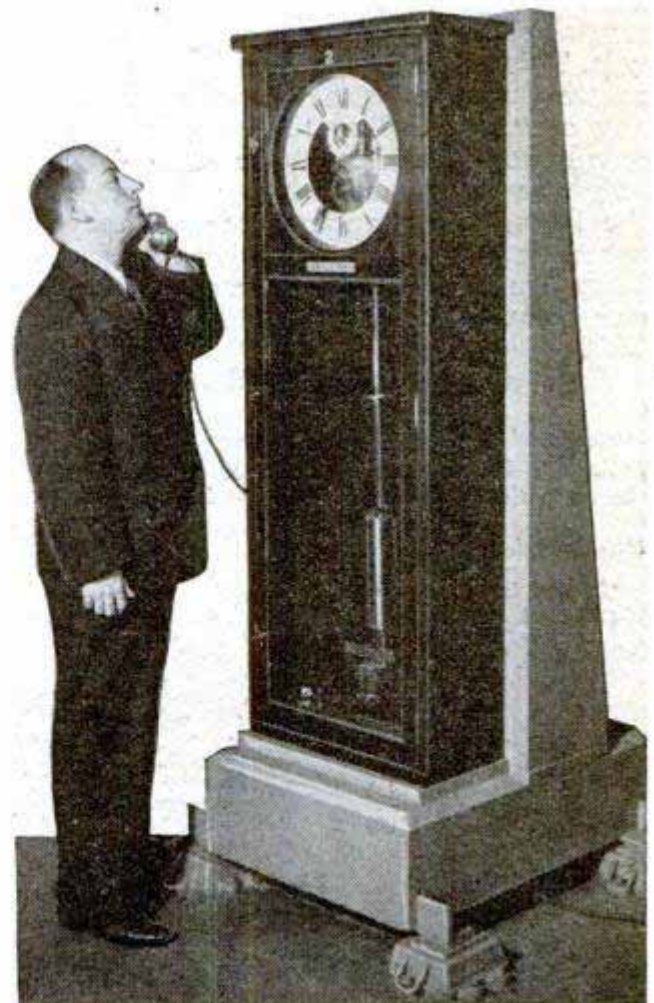

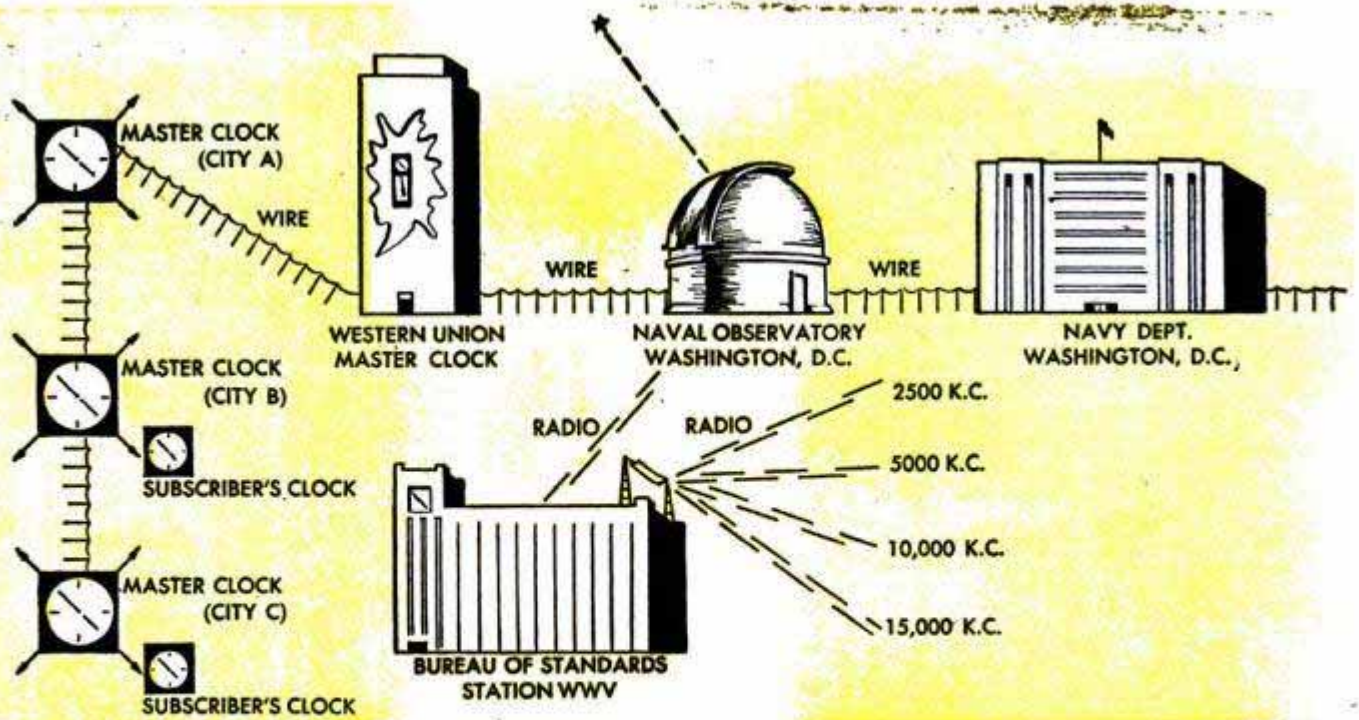

Diagram illustrates how time signals, taken from stars above observatory, are transmitted by wire and radio

Since the crystal clock is affected by the temperature, pressure and humidity of the air around the quartz plate, these are controlled by sealing the plate in a glass or metal enclosure.

The Naval Observatory supplies the Bureau of Standards with the correct time, but the Bureau has its own equipment and crystal clock for broadcasting time intervals. This crystal clock furnishes the only continuous time-signal service provided by any country. Unlike the signals sent by naval radio stations which can be heard only on receivers suited to code reception, the Bureau of Standards signals may be heard on an ordinary short-wave receiver. They are broadcast continuously on carrier frequencies of 2500, 5000, 10,000 and 15,000 kilocycles.

Time signals transmitted from Station

NSS, the Naval Radio Station at Annapolis, Md., are controlled directly from the observatory. Other naval stations transmit signals based on the observatory's code.

The observatory has no special agreement with any telegraph company, but furnishes time signals free to all firms and individuals who provide wires for the purpose. A radio station may tune in on the time signals and rebroadcast them.

Western Union has a direct wire connection with the observatory and transmits time signals for a period of three minutes before noon, Eastern Standard Time, each day to its offices throughout the country. These time beats use the observatory's code, which omits a beat at the 29th second and follows an identifying pattern during the last ten seconds of each minute.

(Continued to page 232)

Transmitted for three minutes before noon every day, the Naval Observatory time signals are given a varied pattern to indicate the minute. During the final 10 seconds of each minute, certain beats are omitted as shown in the diagram. A 10-second pause precedes the noon beat. The 29th second is silent in all signals

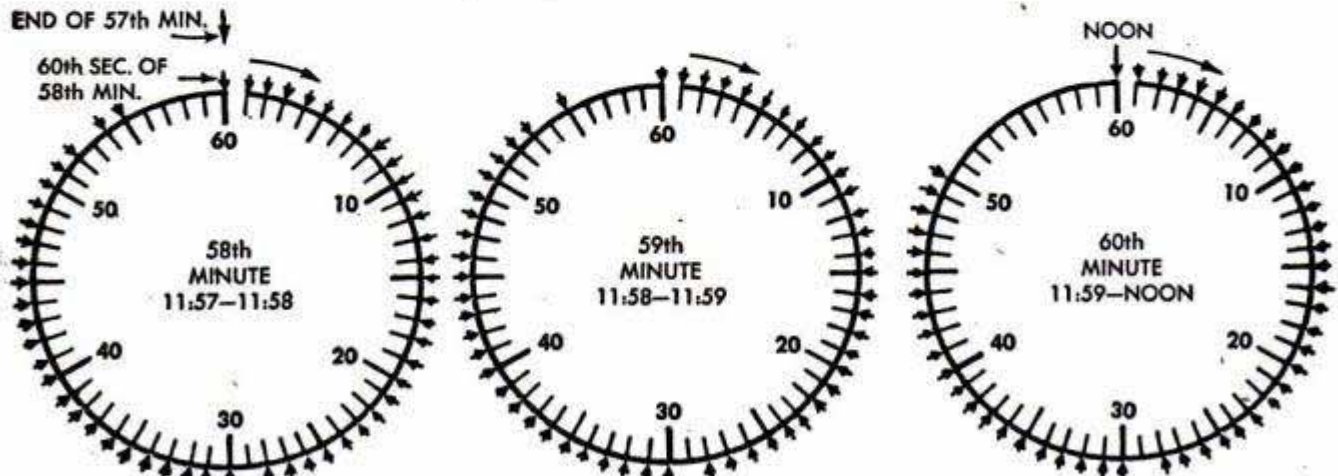

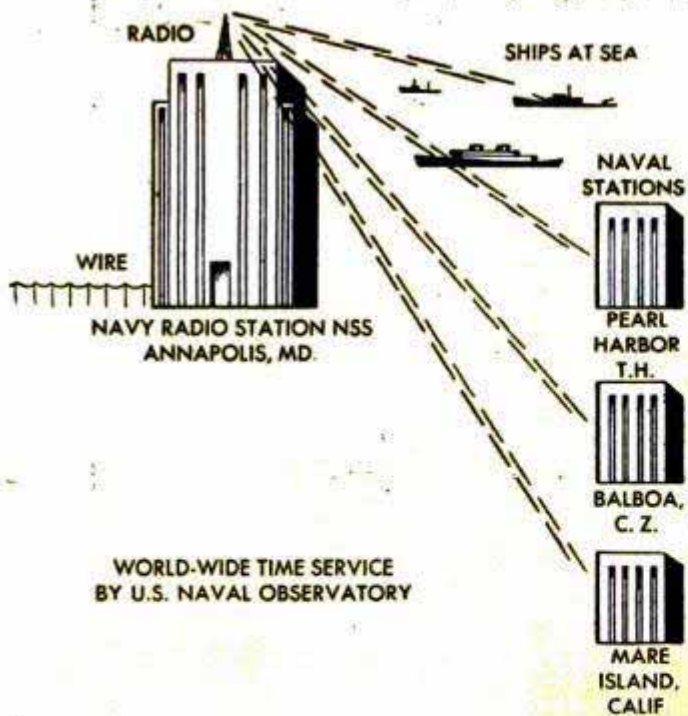

WORLD-WIDE TIME SERVICE
BY U.S. NAVAL OBSERVATORY

Right, prior to 1890, New Yorkers set their watches when this time ball atop the Western Union Building was dropped at noon by signal from the observatory

Below, by recording the time required for a star to pass overhead, the photographic zenith tube provides an accurate check on the observatory's master clock

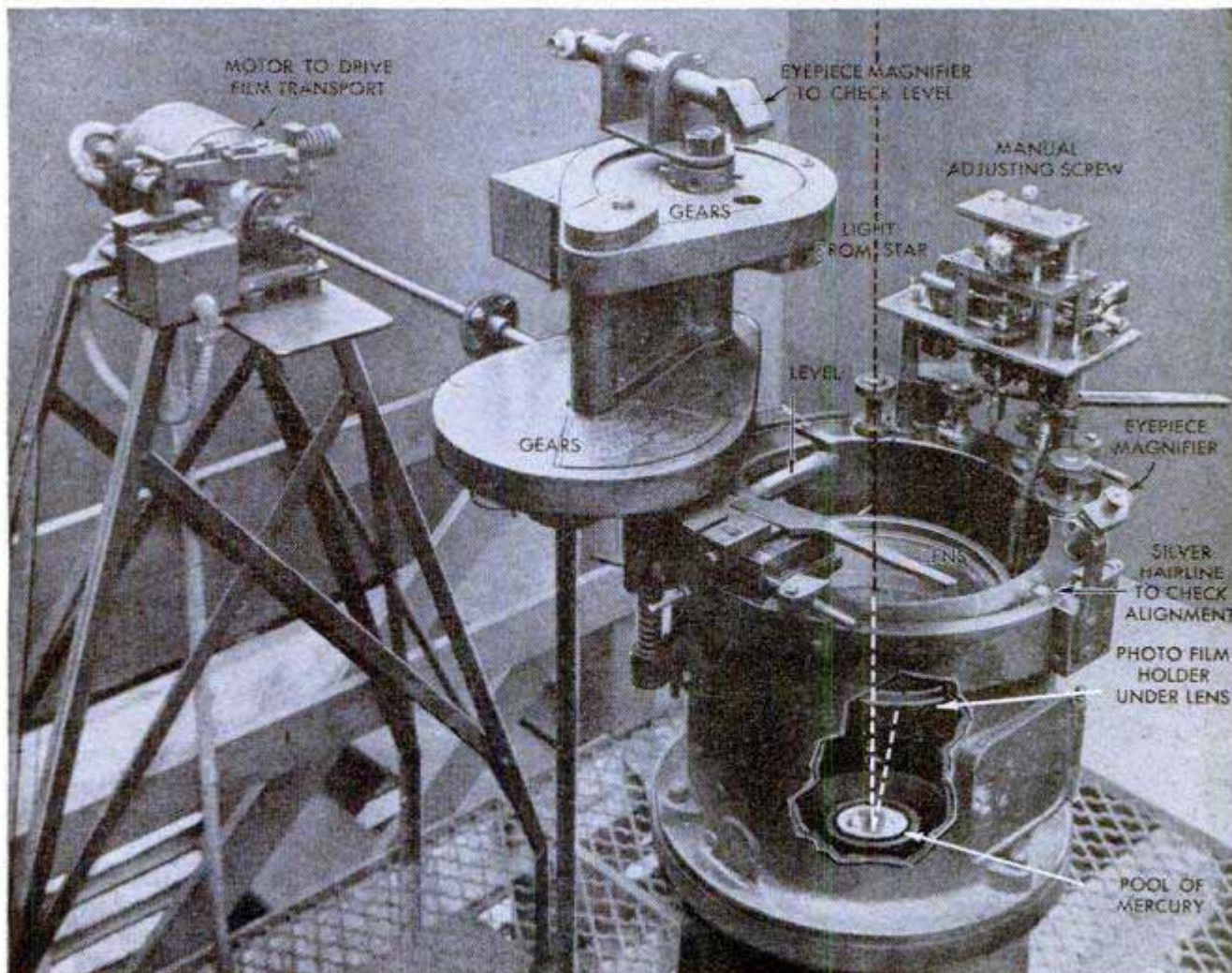
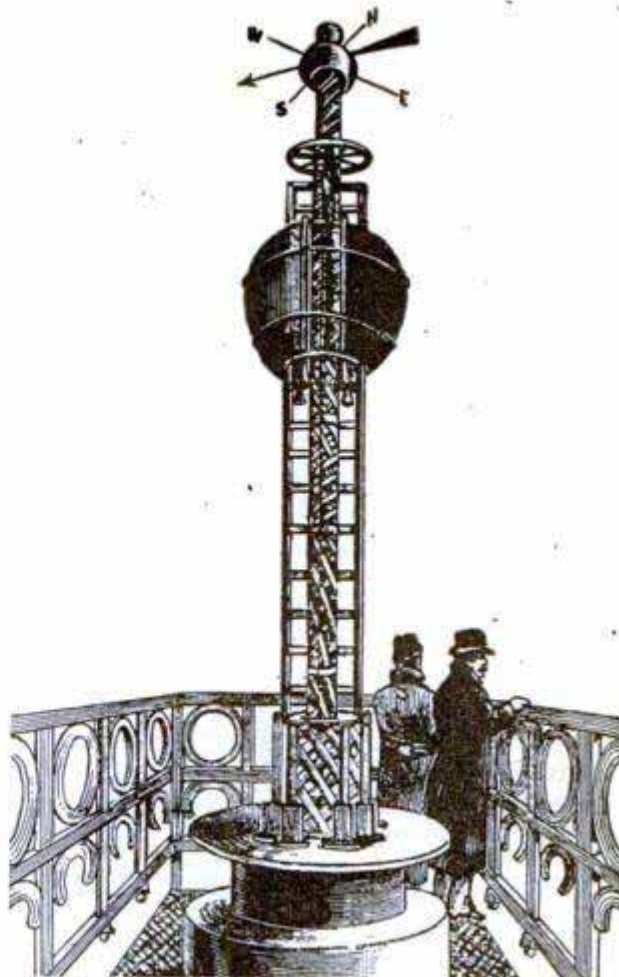



Rohm and Haas Co. photo



PLASTIC TOP FOR CONVERTIBLES IS TRANSPARENT

Completely transparent, a Plexiglas top for convertibles gives the occupants unobstructed view on all sides. Available in colors to harmonize or contrast with the body, the easily cleaned top is installed in 15 min-

utes and fastens to the body at five points. Car windows fit into rubber channels to make a tight seal against wind and rain. The tops are available in tints that admit or exclude burning rays of the sun.

"Spray-Gun" Jeep Pumps Bug-Killing Fog Through Buildings

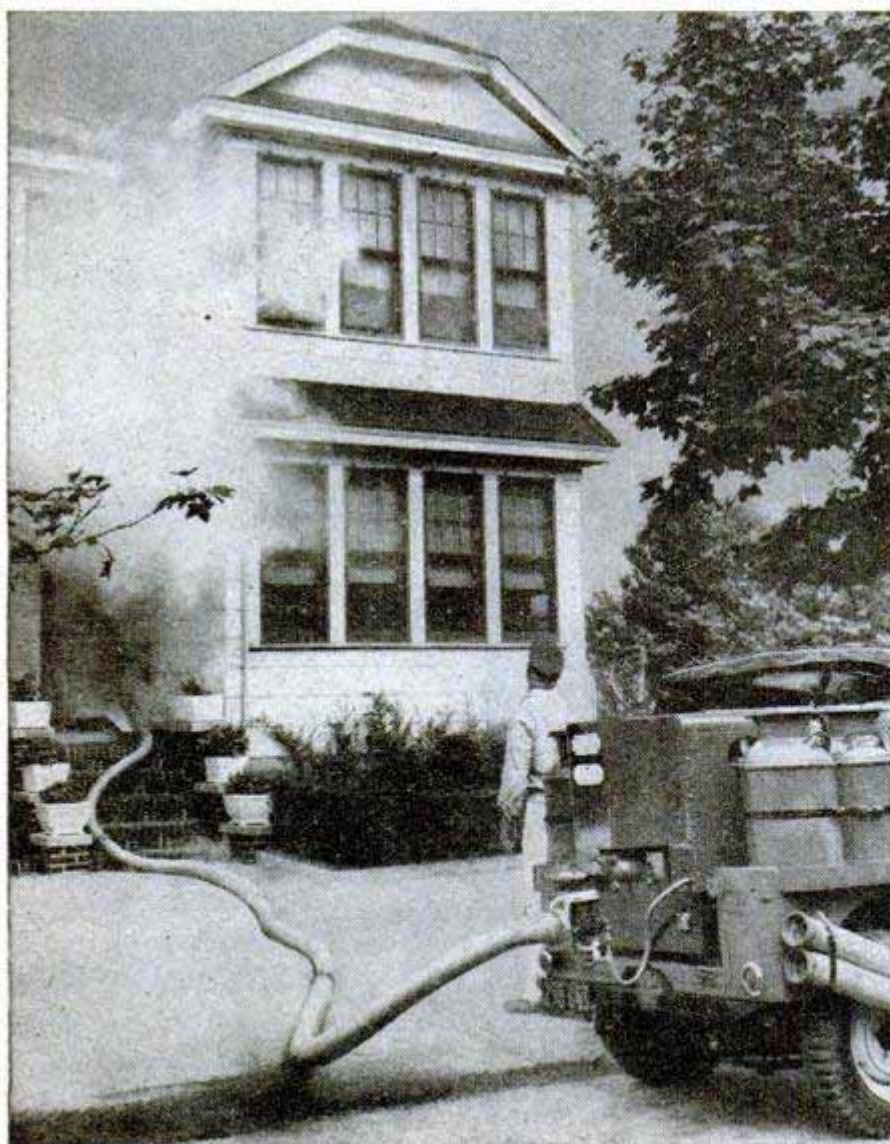

Insects of all kinds are killed by a fog dispersed through houses with an applicator small enough to be hauled on a jeep. The end of the applicator tube is placed in an open doorway and the fog, consisting of a mixture of DDT, pyrethrin, chlordane and kerosene, is pumped into the house for 20 minutes. Windows and doors are left closed for 1½ hours to enable the fog to penetrate all cracks and crevices. The treatment is said to be effective against the most common insects.

Dried Almond Hulls Used to Make Syrup

Table syrup is made from dried almond hulls, which are 25 percent sugar, by a process worked out at the University of California. Experiments show that 100 gallons of syrup can be made from a ton of the hulls. Beet-sugar factories may be used during off-seasons to make the syrup.



Detector "Hears" Leaking Water And Locates Break in Pipe Line

Leaks in pipes carrying liquids under pressure are located quickly with a midget detector. Operated by batteries, this light-weight detector amplifies the sound of leaking liquid so it is heard in the ear-phones. The contact tip is held against the pipe and the sound increases in volume as the tip is moved toward the leak. An extension tip is used for pipes that are difficult to reach. Underground leaks are detected by pushing the extension tip into the earth above the pipe.



Midget Radio Worn on Wrist Sends and Receives Broadcasts

Now in the process of development, a miniature radio is designed to be worn on the wrist. Equipped with a tiny tube, the set has no wiring and contains instead a stencil coated with silver chloride. Holding up development is the problem of finding a battery small and powerful enough for the set. When the power supply problem is solved, the wrist radio will send and receive short-wave broadcasts in addition to receiving standard broadcasts. It is being tested at the U. S. Bureau of Standards.

Movie Close-Ups Shot From Helicopter

Aiding movie realism, a cameraman edged close to his subjects in a helicopter as they paused after a long run "alone through deserted fields." The helicopter was used for shooting other scenes in "Your Red Wagon" that would otherwise have been impossible.



Names and addresses of manufacturers of new products featured in this issue will be supplied promptly by the Bureau of Information, Popular Mechanics Magazine, 200 East Ontario St., Chicago 11

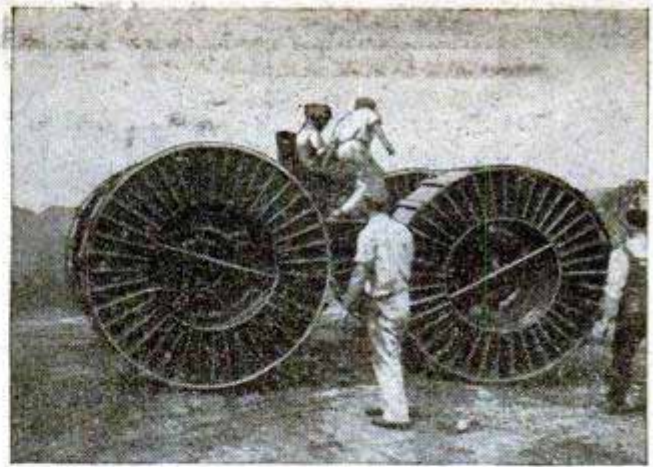
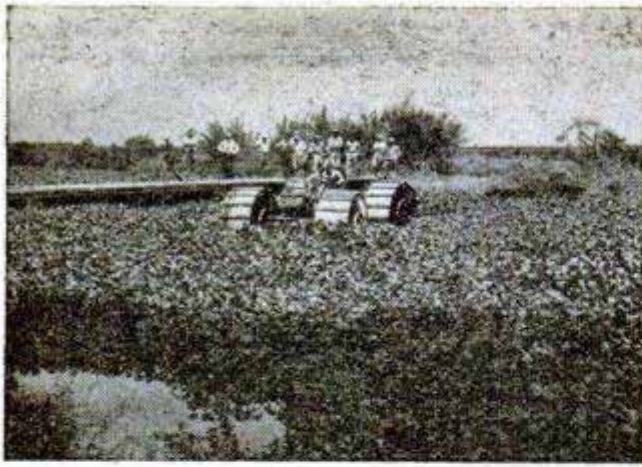

Telephone Cable Spools Are "Shoes" for Canal Craft

Telephone cable spools made watertight are the "shoes" on which spraying outfits can either drive or float in Florida's plant-

choked canals. They were devised by the Everglades Drainage District for the campaign to curb growth of water hyacinths.

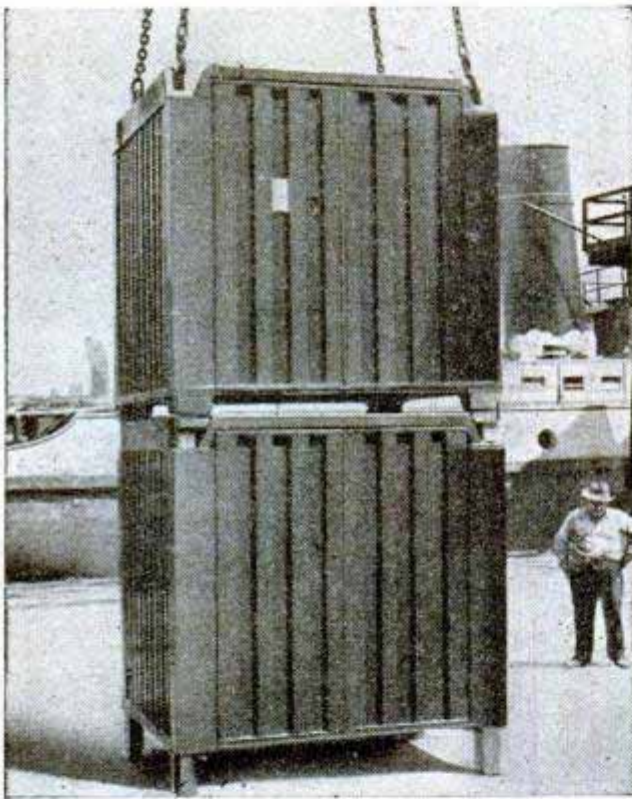

Interlocking Cargo Containers

Steel shipping containers with legs that fit roof recesses of another save cargo handling time and minimize theft. Lightly packaged merchandise can be packed in the 277-cubic-foot interior and locked for shipment. Lugs in the roof's four corners facilitate crane handling and the legs give sufficient clearance underneath for the use of fork trucks. Weathertight so they can remain in the open during transit, the containers weigh 1650 pounds empty and are 7 feet 9 inches long, 6 feet 5 inches wide and 6 feet 10½ inches high. They carry loads up to 12,000 pounds and can be unloaded four or five times faster than loose tonnage.

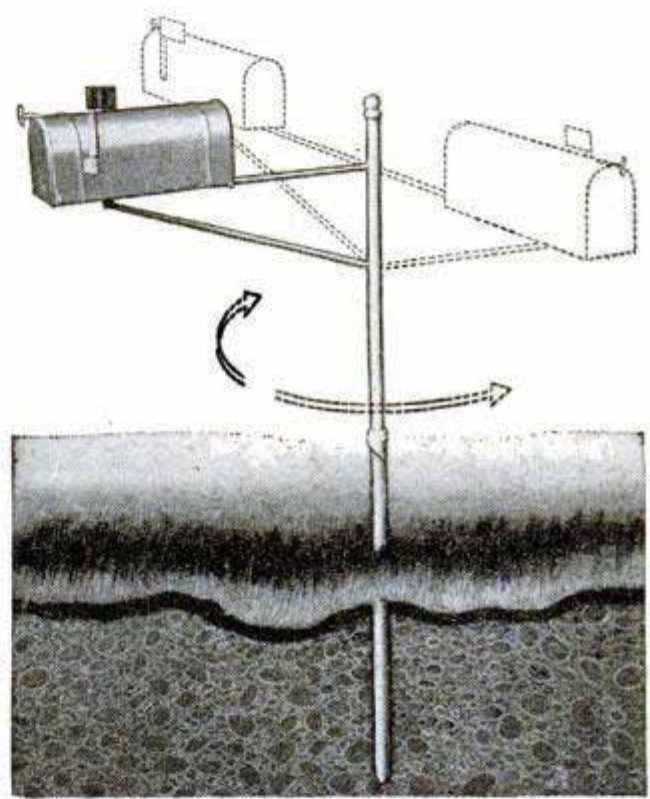

Merry-Go-Round Mailbox

Revolving on a spiral cam, a rural mailbox swings out of the way when hit by a truck, tractor or snowplow and then returns to its normal position. The mailbox is supported by two lengths of steel pipe. The lower section is driven three feet into the ground and the upper section fits inside it, resting on the cam which permits the mailbox to revolve but always returns it to the proper position. The box can be adjusted in height from three feet to five feet six inches. The horizontal arm which holds the box is three feet long, permitting the vertical support to be set three feet from the edge of the road. Another model of the box is made for suburban use.

THERE'S MONEY IN HONEY

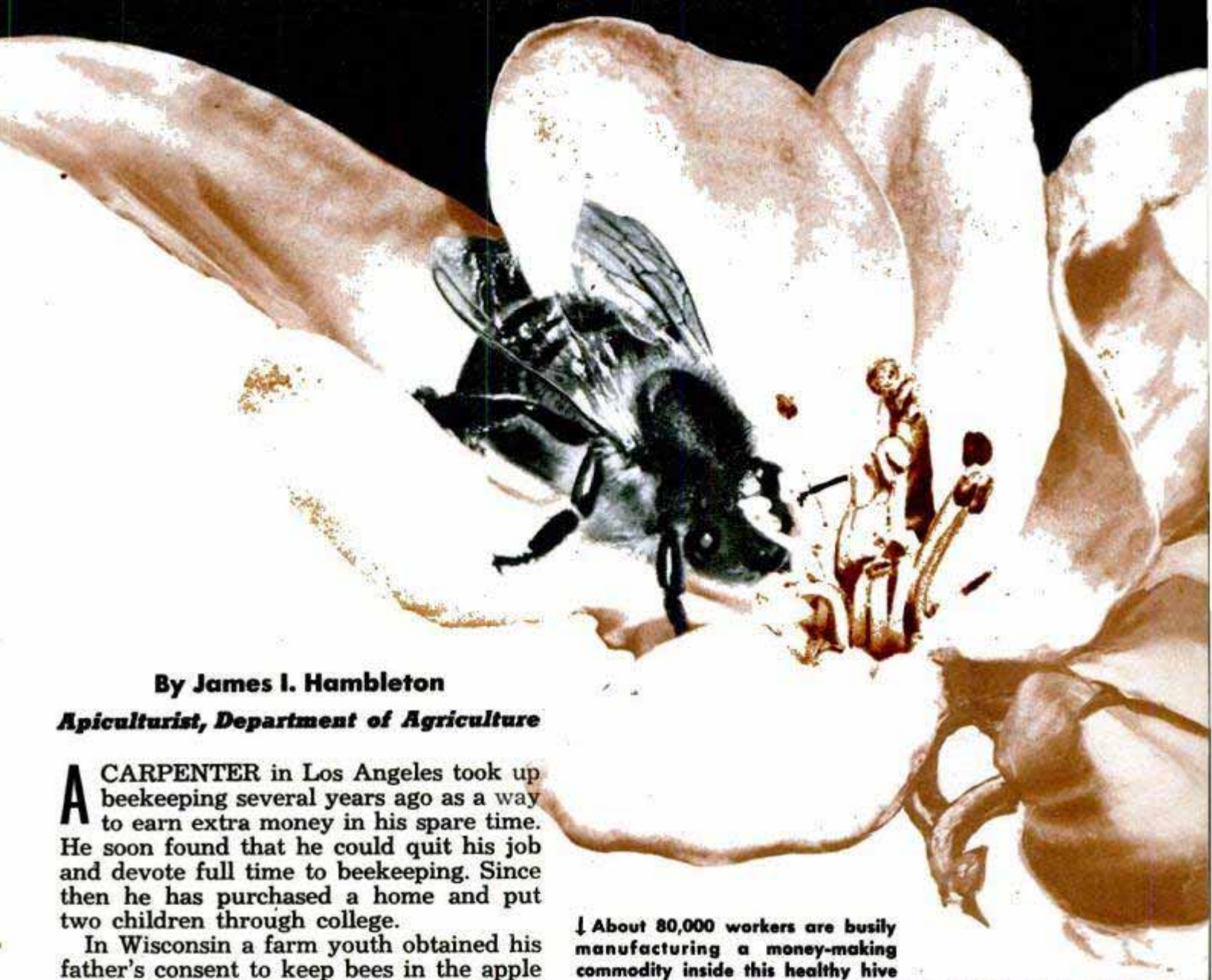

By James I. Hambleton

Apiculturist, Department of Agriculture

A CARPENTER in Los Angeles took up beekeeping several years ago as a way to earn extra money in his spare time. He soon found that he could quit his job and devote full time to beekeeping. Since then he has purchased a home and put two children through college.

In Wisconsin a farm youth obtained his father's consent to keep bees in the apple orchard. Two hives have been expanded to 40 and a net profit of \$1200 annually has been realized during the past three years.

A mother in Washington, D.C., decided to place a single observation hive on her apartment roof to show her children the community life of a colony. Beginning with an investment of \$10, her honey business expanded so that she had to move to the country and hire a man to help.

As a hobby, beekeeping can be both interesting and profitable. You may keep as few or as many hives as you wish. If you aren't careful, though, beekeeping may sneak up on you to become a full-time business. It combines easily with almost any type of outdoor work and can be enjoyed even in large cities.

Beekeeping entails no round-the-clock care like the feeding and egg-gathering of chickens. Maybe that is the real secret of its appeal. You may work at beekeeping

↓ About 80,000 workers are busily manufacturing a money-making commodity inside this healthy hive

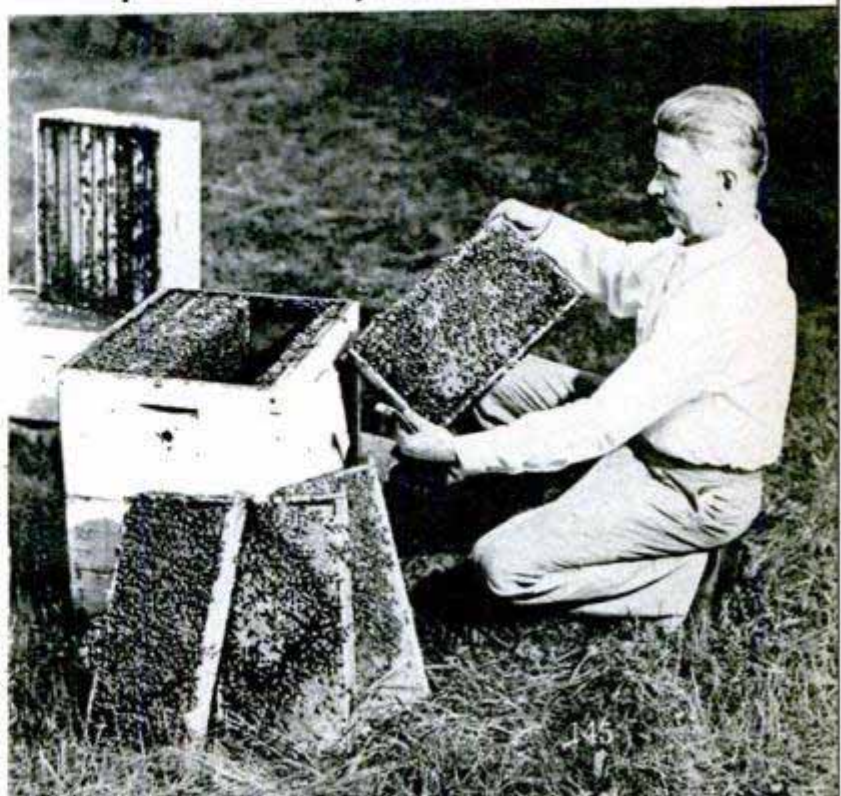

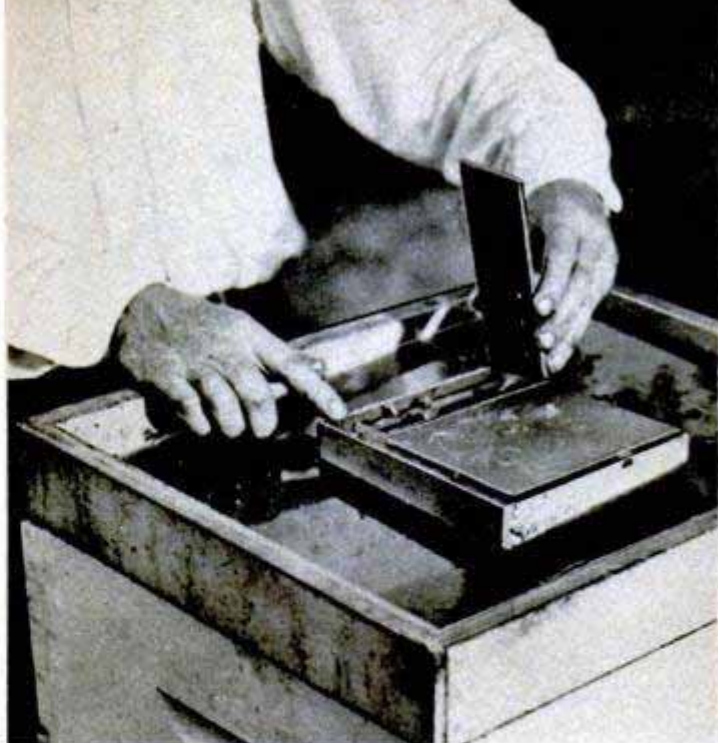

Photographed at Lis Honey Farm, Des Plaines, Ill.

↑ Angry bees are quieted with smoke. Only experienced beekeepers work without a veil. Right, one keeper designed this system for feeding supplementary syrup. Bees can drink from this "fountain" without drowning

on your own hours except at certain critical times—and may literally neglect them for weeks without any serious consequences. Naturally, the spring of the year when bees are most active calls for more work than fall or winter.

Many farmers are adding bees for reasons other than the hobby or profit motive. Because of a greater use of insecticides and the practice of "clean" farming which destroys the homes of many beneficial earth-dwelling insects, pollinators such as bumblebees, wild bees and others are decreasing rapidly. Honeybees are raised to insure proper pollination of apples, melons, berries, clover, alfalfa and more than 50 other important food, fruit and seed crops.

Although bees may be raised in every state, California, Ohio, Michigan, Illinois, Iowa and Wisconsin produce the largest quantities of honey. At present there are about 5,787,000 colonies of bees in the United States. With the average colony numbering about 45,000 individuals, there are more than 2,500,000,000 honey-pro-

Equipment for beginner, exclusive of hive, includes a veil, smoker, hive tool, wire and spur embedder

ducers and pollinators buzzing across the landscape. They produce 200,000,000 pounds of honey and 4,000,000 pounds of beeswax annually.

If you're interested in raising bees as a hobby, if you're going into the business to make money, or if you want to provide sure-fire pollination for your crops, you should know the proper way to start.

The best time to begin beekeeping will be next April when fruit trees and flowers are in bloom. But now is the time to get all the information you can on beekeeping and to study as much about the subject as possible. Write to your State Agricultural College, State Department of Agriculture or Agricultural Experiment Station for information. The Superintendent of Documents, Government Printing Office, Washington, D. C., also has such publications.

Practical knowledge gained through a season's work with an experienced beekeeper will prove invaluable to the beginner. But if you can't question a veteran beekeeper, acquire a couple of colonies and strike out on your own. Experience is your best teacher.

Beekeeping requires a fundamental knowledge of bee behavior and a genuine liking for the insects. Locating your colonies close to available sources of nectar is important. To insure a good crop of honey, bees should be within flying range—one to two miles—of such nectar-secreting plants as clover, alfalfa, cotton or orange trees. Good beekeeping locations are to be found in almost every state.

With proper experience and a liking for bees, a person in a favorable location can obtain a return that will compare favora-



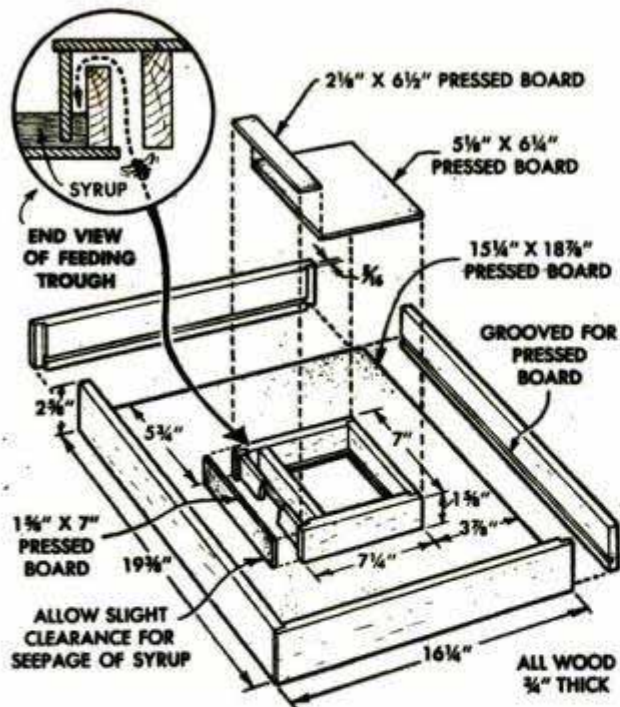

Detail of feeding system shows how syrup flows into narrow space where bee always can touch side walls

bly with most other agricultural pursuits. Beekeeping, however, has its financial hazards and you can lose your shirt in this business as easily as in any other. A beginner should start slowly and not invest too heavily at first.

A common method of starting a colony is to purchase a package of bees—preferably three pounds with a queen—and install this package in a hive equipped with frames containing sheets of brood foundation. Instructions for installing usually come with the package.

The yellow-banded Italian bee is the variety recommended for the beginner. It is hardy, industrious, fairly gentle and can readily be obtained in pure stock since it is the most common bee in this country.

↓ Brood foundation is a sheet of wax impressed with design of a comb upon which the bees build their honey. Right, "trap" designed for experiments scrapes pollen off the bees and deposits it in a box below the hive

Department of Agriculture photo

Another way to get started is to purchase established colonies. Be certain, however, that they are in modern hives, acquired from a reliable beekeeper and accompanied by a certificate of inspection to insure freedom from disease.

A beginner's minimum outfit may consist of the following: a three-pound package of bees; one 10-frame hive—including a bottom board, two hive bodies complete with frames and brood foundation, two to four shallow supers complete with frame and thin super foundation, one outer and one inner cover; one smoker; one bee veil; one hive tool; approximately 10 to 15 pounds of granulated sugar; No. 28-gauge wire; one spur embedder.

The equipment can be varied and more can be added after you have become experienced enough to manage large colonies.

Ordinarily the most satisfactory results will be obtained with factory-made equipment. However, some beekeepers prefer to construct their own hives. If you plan to do this, try to purchase or borrow a complete hive to use as a model. It is essential that all dimensions are exact. Otherwise the bees will build combs and add propolis (a gummy wax) where it is not wanted. Likewise, careful construction is necessary so that all hive parts are readily interchangeable. The standard 10-frame hive is generally used in the United States.

Here are the cardinal points of beekeeping you should know:

In the spring, bees need an abundant store of pollen honey (15 pounds or more at all times), plenty of room for brood rearing, a source of water, protection from the wind and exposure to sunlight.

Because swarming results in a loss of honey, it should be controlled so far as

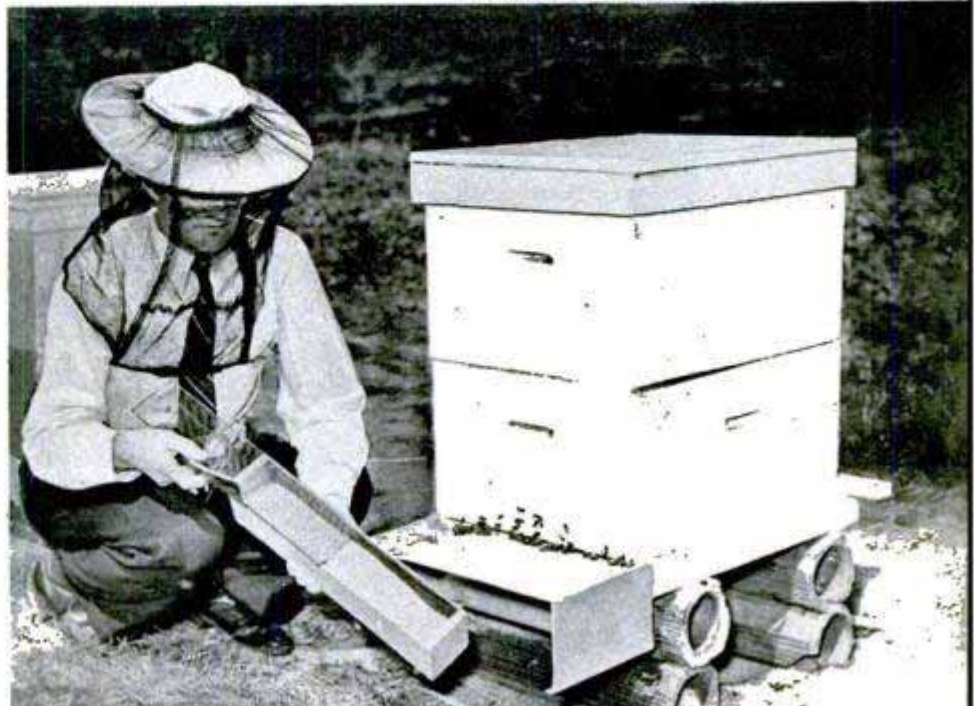



Uncapping knife heated by electricity slices away the wax foundation to expose honey for extraction

possible. What makes bees swarm is still somewhat of a mystery.

There should be empty comb space in the hives at all times preceding and during a honey flow. If every cell becomes occupied with brood, pollen or honey, the bees will stop working or swarm. Either situation causes loss of honey if it occurs just before or during a honey flow.

For successful wintering, a colony should have a young queen of high-producing stock, a large cluster of young, fall-raised bees, at least 60 pounds of sealed honey and several combs containing large areas of pollen. For these requirements a colony must have a two-story standard hive with a gross weight in October of about 130 pounds.

It is unprofitable to keep bees in box hives or hollow logs and in many cases illegal to sell such honey.

It does not pay to cultivate any one flowering plant for bees alone. Nectar resources may be improved, however, by planting such crops as sweet clover on wasteland.

Starvation is one of the principal causes of unprofitable beekeeping. If bees are short of honey stores, a syrup of two parts of clean granulated sugar to one of water should be fed. Plan carefully and avoid feeding by leaving the bees plenty of honey at all times.

Diseases cause large annual losses of bees, honey and equipment. Learn to recognize early symptoms.

While it is normal to find a few dead bees at the hive entrance, the presence of a large number indicates abnormal conditions. The presence of trembling or paralyzed bees, or bees crawling and unable to fly, should arouse suspicion.

Two of the most common abnormal conditions are poisoning by insecticides and Nosema disease. Bees suffering from these two and other harmful effects may all appear to behave alike. Laboratory tests, however, will point to the disease which is causing the loss. Sometimes a diagnosis must include an observation of the colony affected.

In many parts of the United States, beekeepers suffer losses from American or European foulbrood—two of the most serious brood diseases. European foulbrood can be controlled by proper corrective measures. American foulbrood, the more serious and prevalent of the two, requires more drastic treatment. Both bees and

(Continued to page 256)

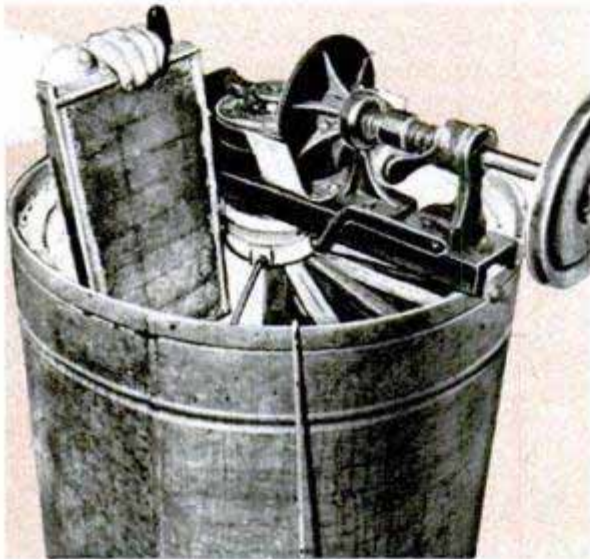

↑ Comb is slipped into the extractor, which revolves rapidly to throw the honey into the drum

↓ Honey is strained through a Nylon parachute into container from which it is drawn to fill the jars

Photos courtesy Lia Honey Farm, Des Plaines, Ill.





Pastry Tube Decorates Art Objects

Ornate table pieces molded from clay are decorated with the help of a pastry tube by Orville Hanchey of Natchitoches, La. Hanchey, who is a member of the art department of Northwestern State University, molds the art objects, then forces thinned clay through the small hole in the end of the pastry tube to achieve special effects. His most outstanding piece of ceramics is a circus horse posed with a clown. Hanchey used the tube in making the horse's harness, and put hair on the clown's head with a tea strainer.



Mobile Camera Hoist

High-angle movie shots are taken on location with a mobile hydraulic hoist and attached camera platform. This innovation was introduced by a Hollywood studio to eliminate the usual 20-foot camera towers that ordinarily are erected for each scene. The hoist is similar to those used to load large transport planes. Guy ropes tied to stakes steady the platform.

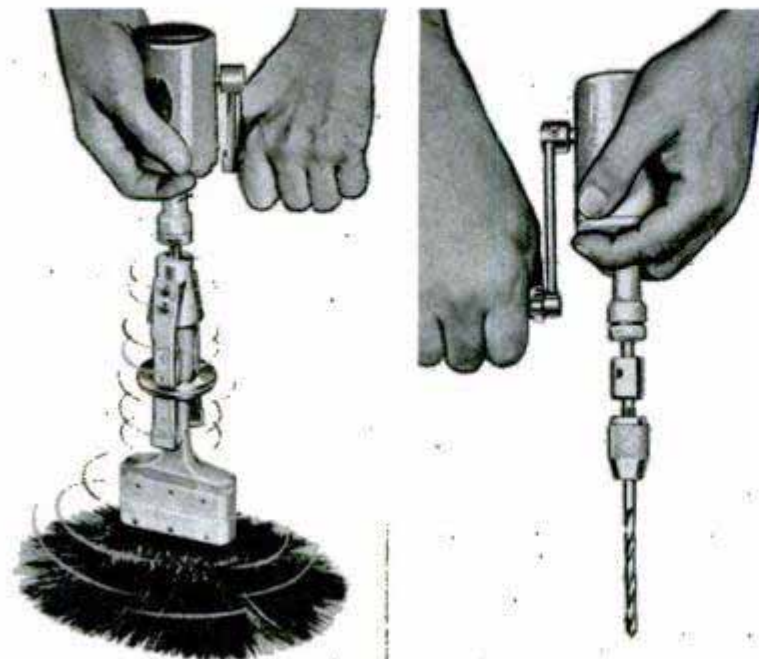

Drill Spins Brush Clean

Quickly converted from hand drill to paintbrush cleaner, a dual-purpose tool enables painters to change from dark to light paint without changing brushes. The brush is soaked in paint solvent for 30 seconds, then lifted from the liquid and spun clean and dry in about a minute. For drilling holes up to $\frac{1}{4}$ inch, the brush holder is removed and a drill chuck attached to the shaft.

Information, including manufacturers' names, concerning products described in this issue may be obtained by writing Bureau of Information, Popular Mechanics, 200 E. Ontario St., Chicago 11



Jack for Laying Floors

Operating on the principle of a jack, a tool equipped with an anchor head, lever and plates provides tight-fitting joints when applying flooring, siding or sheathing. A hammer tap against the anchor head sets it into position on the joists, and lever action against the pressure plates squeezes the boards tightly together. The tool holds the boards, leaving the worker's hands free to pound nails.

Rubber "Chains" Protect Tire

Mud hooks made of rubber for automobile wheels can't damage tires and can be adapted for use on icy roads. Each mud hook is a slotted rubber strap that fastens over the tread of the tire. To install the hooks, a steel bracket is slipped through the wheel slot and connected to shackles on the rubber strap. For winter use, rubber "chains" are available consisting of six straps held across the tread by a steel ring on each side of the wheel. The chain can be left on all winter and cleats slipped under the straps when roads become icy.

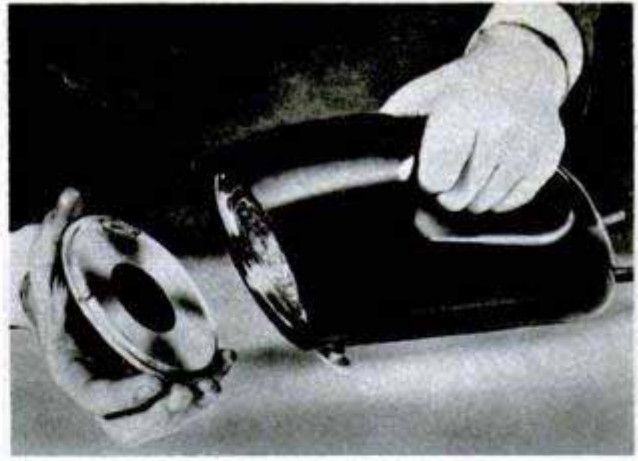
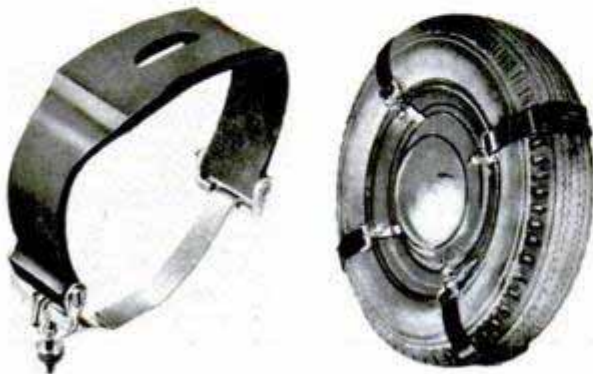

Spotlight Throws Ultraviolet Beam

Diseases are detected and infections are prevented from spreading by a surgical spotlight which throws an ultraviolet beam. When fitted with a special filter the lamp can be used to detect the early stages of ringworm and other skin disorders which show up in characteristic colors under the rays. In other cases, the lamp can aid in preventing the spread of infection by concentrating a beam of ultraviolet rays on tissue to kill the bacteria. A transformer inside a housing built of Durez plastic energizes a special quartz-glass tubing to produce the ultraviolet rays.

Brush Guard Keeps Paint Off Glass

Shaped like an arrow, a metal guard attached to paintbrushes prevents paint from marring window glass when the sash is painted. The guard can be attached to any brush, flat or round, up to 1½ inches in width. It is useful for painting door trim or chair rails. The guard can be retracted for painting flat surfaces.



Speed of 7000 M.P.H. Simulated in Tests

Speeds up to 7000 miles an hour are simulated by towing models of plane parts through water $\frac{1}{4}$ inch deep. The water wave patterns are similar to shock waves created by high-speed aircraft. Models are towed by a wheeled stand, which also holds a camera to photograph wave patterns. While not as accurate as wind-tunnel tests, according to North American Aviation engineers, they're useful for qualitative studies of supersonic flow.

"Flyweight" Steam Engine

Working in nickel silver, a Norwegian modelmaker has fashioned a steam engine weighing $\frac{1}{7}$ ounce. Sixteen of them will fit into a pocket matchbox.

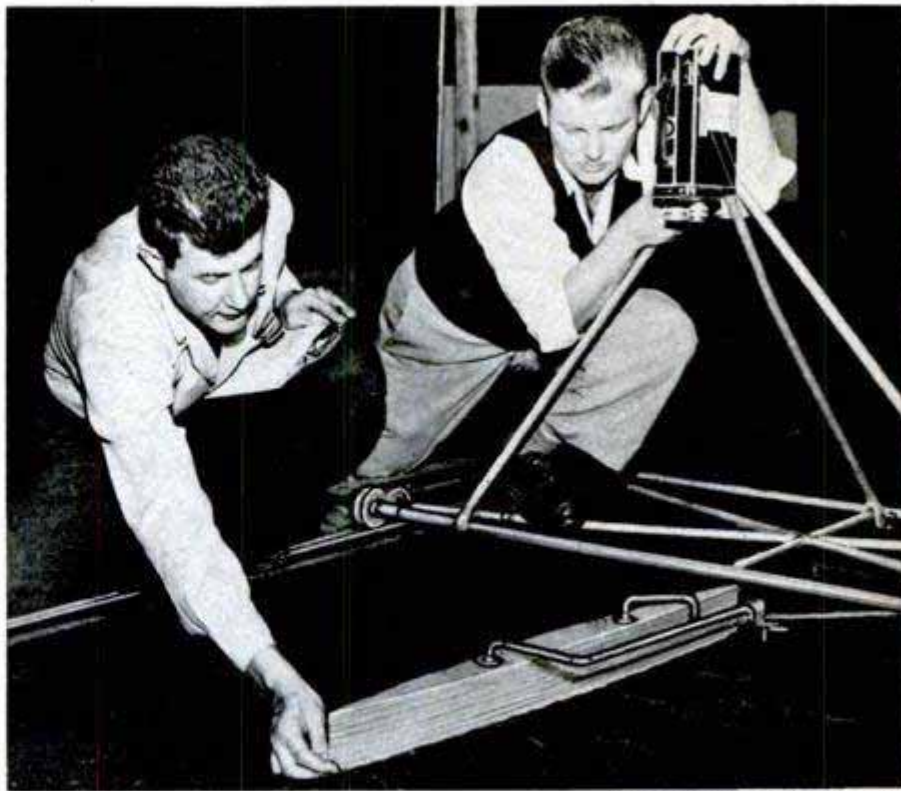

North American Aviation photo



Aerocar's High Wing Affords Better View

One of Britain's most unusual looking additions in the light transport class is the snub-nosed Portsmouth Aerocar. It is a twin-boom design, with a high wing that affords passengers an unrestricted downward view. Its span is 42 feet, length 26 feet and it has two 155-horsepower engines.

Steel Bar at White Heat Punches Hole in Water

Ever see a hole punched in water? It's done every day in the treatment of steel. The "hole," with smooth walls of water, recently was photographed at the research laboratory of the United States Steel Corporation, Kearny, N. J. Because the hole lasts only a split second it had to be photographed at an exposure of $\frac{1}{10,000}$ second. Actually the space between the bar of white-hot steel and the wall of water is filled with invisible vapor that holds back the water for an instant. Quenching gives steel new physical properties including hardness and greater wear resistance. It may be done in oil, air, water and brine.

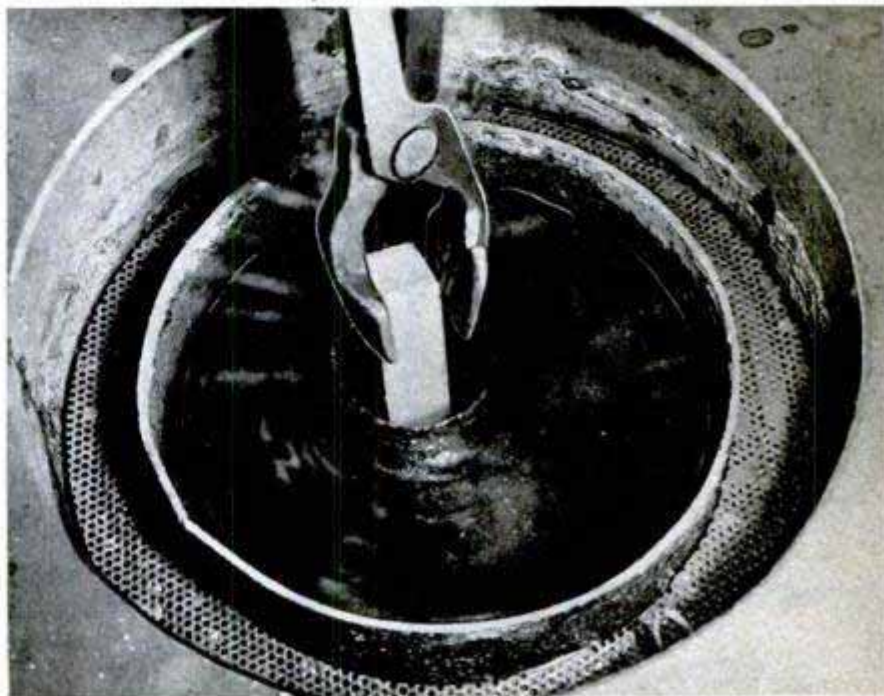

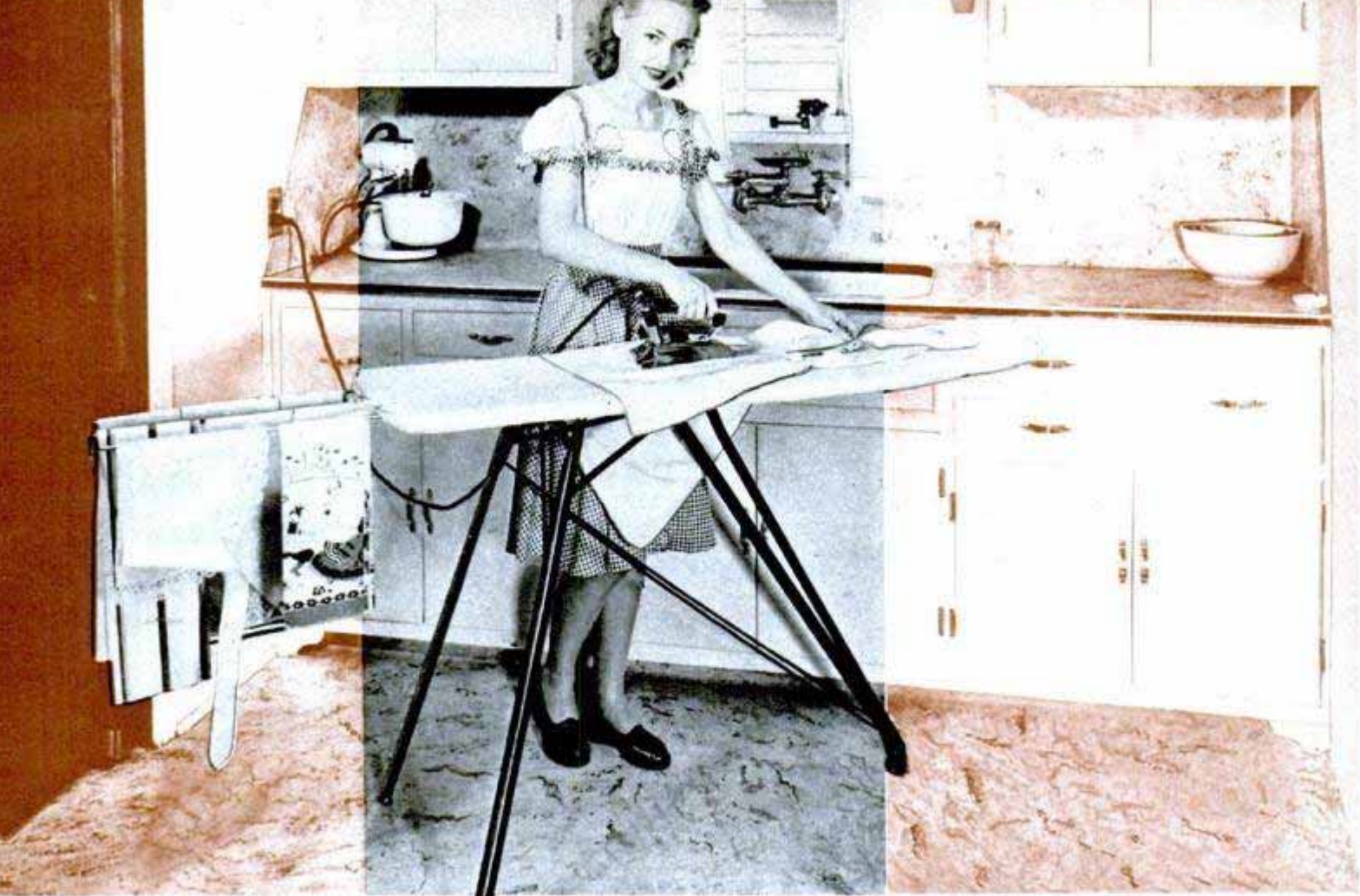

★

WHAT'S NEW

For Your Home

↑ **DRYING RACK** on metal ironing board provides hanger space for freshly ironed clothes. The board's all-steel frame supports an aluminum top perforated with hundreds of holes to permit rapid evaporation of moisture during ironing. The rustproof drying rack slips out of the heel end of the top. A positive lock on the frame prevents accidental closing while in use



DRIP STOPPER which holds the lid of a coffee or teapot in place has a rubber sponge to catch the runover drops

FINGER GUARDS made of Celanese plastic mask the finger while nail polish is being applied. Excess polish falls on the guard, leaving the fingers clean

MINIATURE DISHWASHER attaches to faucet, forces water over the dishes. A small cake of detergent supplies the suds

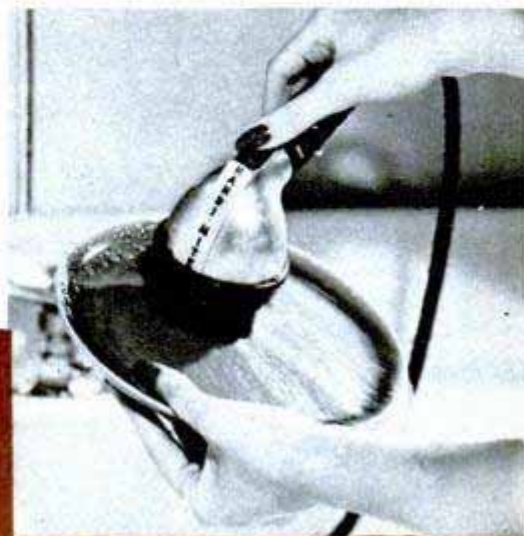

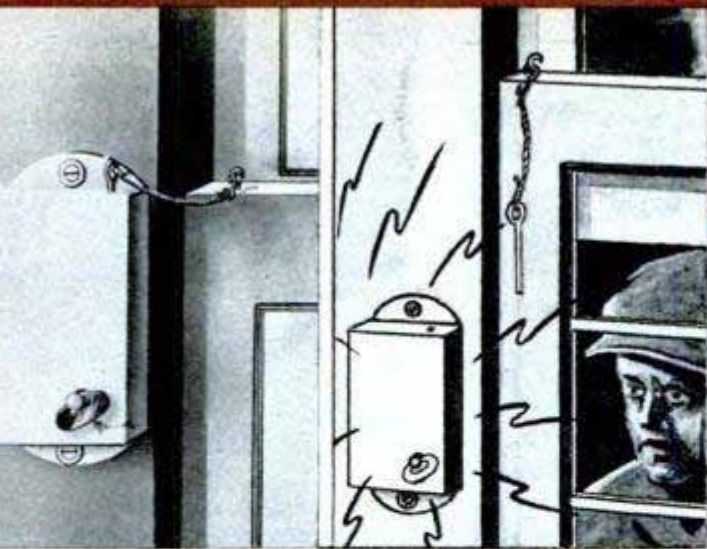

↑ **BURGLAR ALARM** winds up like alarm clock. Attached to window frame, it is invisible from outside, rings when raised sash pulls plug



↑ **DRIPLESS POURING SPOUTS**, made in several sizes to fit milk bottles and other containers, return last drops to the bottle



↓ **PAPER WASHCLOTH** can be dried and re-used many times. Perforations hold suds for dishwashing or use in tub or shower

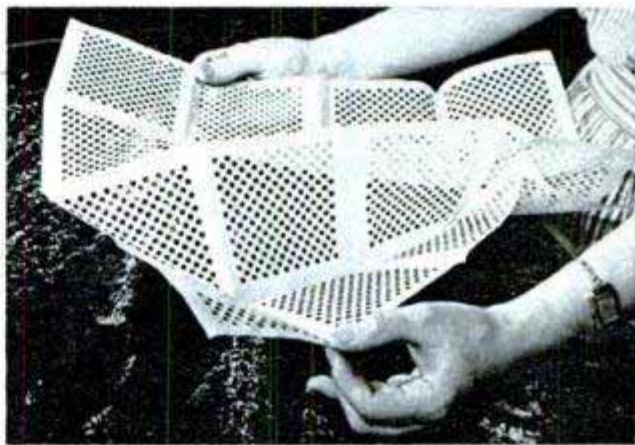

DECORATIVE FIRE EXTINGUISHER at right hangs on any wall and looks like door chimes. Two "chimes" contain compressed carbon dioxide which flows from funnels to smother the fire when a valve is turned

↓ **HAND-CRANKED SHREDDER** cuts or peels vegetables and fruit. A cover guard protects hands from the cutting cones. The shredder also crumbs soft or hard bread and cuts potatoes in waffle design for frying





Paint-Can Lip Prevents Spilling

Metal lips that fit on the rims of paint cans prevent spilling when pouring the paint from one container to another. They also serve as holders for wet brushes.

Self-Threading Needle

Blind persons who like to sew are aided by a self-threading needle with a split, pronged opening which makes it possible to thread a needle by the sense of touch. The user puts the thread in the slotted top and pulls downward to secure the thread. The New York Guild for the Jewish Blind, 1880 Broadway, New York City, offers such needles free to any blind person.

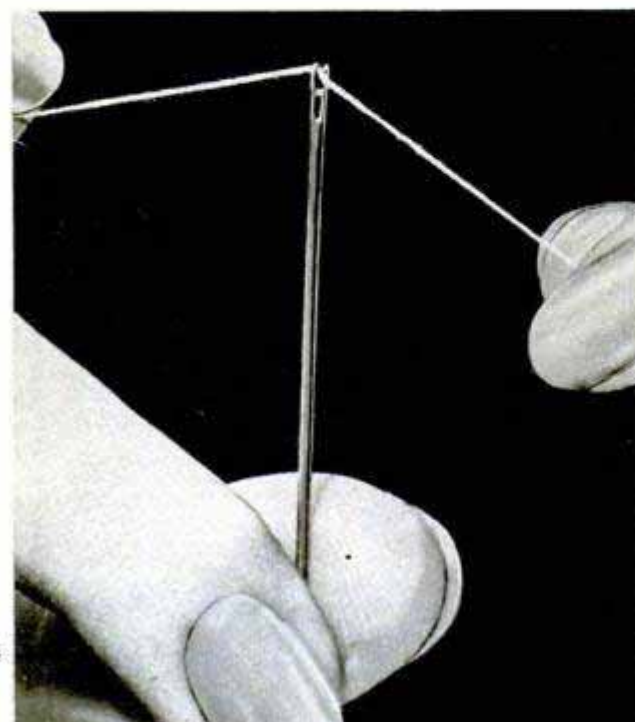

Fibers Can't Pull Out of Brush

Calcimine brushes with fibers that won't pull out are made by bending the fibers in half and locking them into the block with a rectangular plug. The block is made of plastic and the plugs are bonded to the grooves by a cement that is impervious to any known paint. The brushes are designed for applying calcimine, stucco, paste and cold-water paints.



Plastic Skis

Plastic skis, requiring neither waxing nor steel edges, have been developed by Fred C. Smith of Ogden, Utah. They are made of molded laminated plastic and are flexible, yet extremely strong. Tests have demonstrated that the new skis glide well on any kind of snow. The great flexibility at the front end of the ski enables it to glide over small mounds in snow with ease. Skiing tests caused no hollows to wear in the skis. Other features of the skis, which are dark green, are the elimination of split tips, splinters and pulling edges.

Cut-Film Tank Prevents Sagging

Films can't sag or touch during development in a new developing tank for cut film and film packs. The contour of the loading grooves puts the film under tension to prevent sagging. A loading guide slides along a channel, stopping above each groove to facilitate darkroom loading. Four buttons on the bottom of the tank permit agitation by gentle rocking. The tank, which has a capacity of 12 negatives, can be adjusted to accommodate all cut-film sizes from 2¼ by 3¼ to 4 by 5 inches.

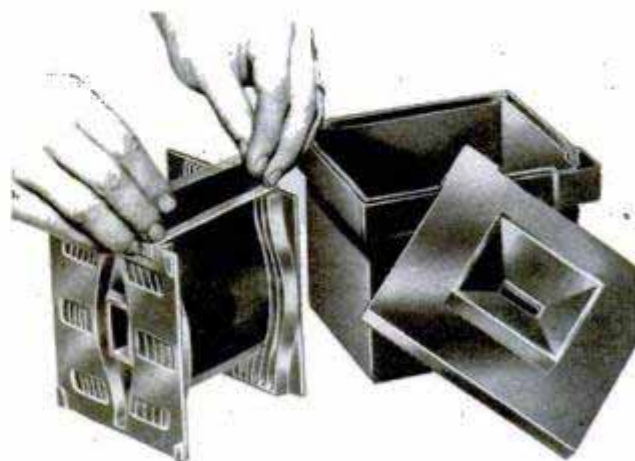



Left, silver-nitrate crystals, basic ingredient of photographic film, are piped into centrifuge basket for quick drying by new process. Right, previously the crystals were formed by slow evaporation in open dishes

Spin-Drying Speeds Production of Photo Crystals

Eliminating the slow, open-dish evaporation method, a new technique in the production of silver-nitrate crystals has been developed at Eastman Kodak. The crystals, light-sensitive material that forms the image on photographic films and papers, are produced from silver chunks dissolved in nitric acid and crystallized by continuous agitation in 1000-gallon stain-

less-steel tanks. Still wet, the crystals are piped into perforated centrifuge baskets where they are whirled until nearly dry. Then the process is repeated and, finally, the crystals are dumped into a rotary drying drum for complete moisture removal. The new process reduces evaporation time from several days required by the open-dish method to a few minutes.

Refinery By-Product Becomes Inexpensive Refrigerant

Propane, an inexpensive by-product of all oil refineries, is used as the refrigerating gas in a new chilling machine. The compressor required for the cooling cycle operates by centrifugal force instead of reciprocating action. Carrier Corporation engineers, who designed the compressor, report that it occupies only 66 percent of

the space required for the older-type machines. Because propane is used as the refrigerant, the process may open a new field of use for by-products of oil refineries. The first installation of the machine will be in a refinery where it will be used to chill oil to approximately 25 degrees below zero in order to remove the wax base.

No More Ricochets With Bullet Trap

Bullets can't ricochet when fired into a combined target holder and backstop made of heavy sheet steel. The backstop, designed for use in home shooting galleries, can be used safely with bullets up to .45 caliber. The bullets are pulverized when they strike the back wall and drop on a tray that is removable for cleaning. Cardboard targets

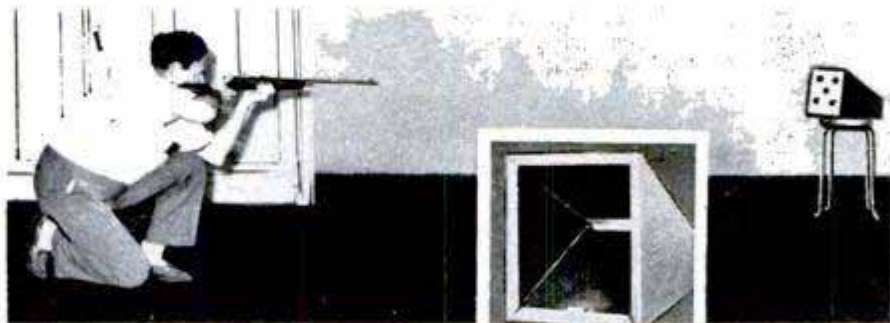

of various sizes are inserted in a slot in the backstop. A carrying handle makes it easy to carry on vacations and picnics.

UNCLE SAM LOOKS INTO HOUSING

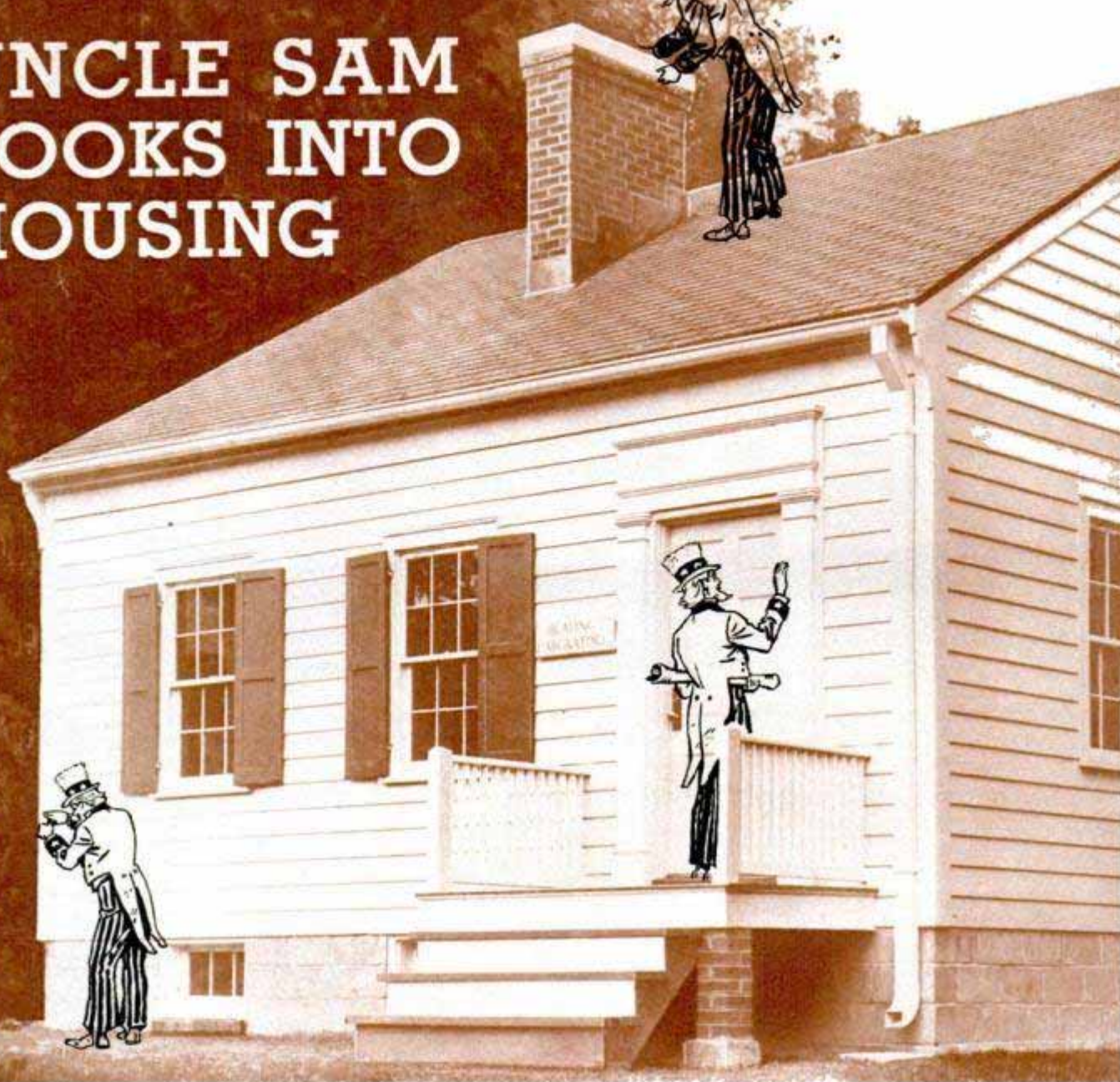

Floating ceilings which can be changed in height from nine to seven feet are a feature of this test bungalow erected by the National Bureau of Standards to study heating equipment for low-cost-housing projects

FLAMES were shooting out of several windows and smoke was pouring from the roof of the one-story concrete block building when one of the men in the small group watching the fire turned around and shouted for the fire hose.

The others opened a way for two men dragging a hose between them which was already spouting water. Someone shouted, "Here they come!"

Getting a firmer grip on the nozzle which had become alive under the pressure of water, one of the two straddled the hose and pointed the stream of water at—no, not the burning building, but a small metal shed alongside.

As the water ran down the metal roof of the shed, which was not burning at all, flames were licking at the eaves of the roof of the burning structure. The would-be firemen had no intention of putting out the

By John L. Kent

fire. They were merely protecting the metal shed. The fire was set by National Bureau of Standards fire-resistance engineers for the specific purpose of observing its action.

As the fire hungrily devoured the carefully prepared interior "furnishings," it was giving up some of its secrets to a little group of engineers huddled around recording meters in a brick building about a block away.

Within the burning building was a score of metal pipes extending from the ceiling into various parts of the interior. Inside these pipes were thermocouples with wire connections which carried temperature and location indication signals to the group around the instruments.

This recent test was the latest in the quest for information on fire resistance. Such an experiment is one of the methods used by housing-research scientists at the

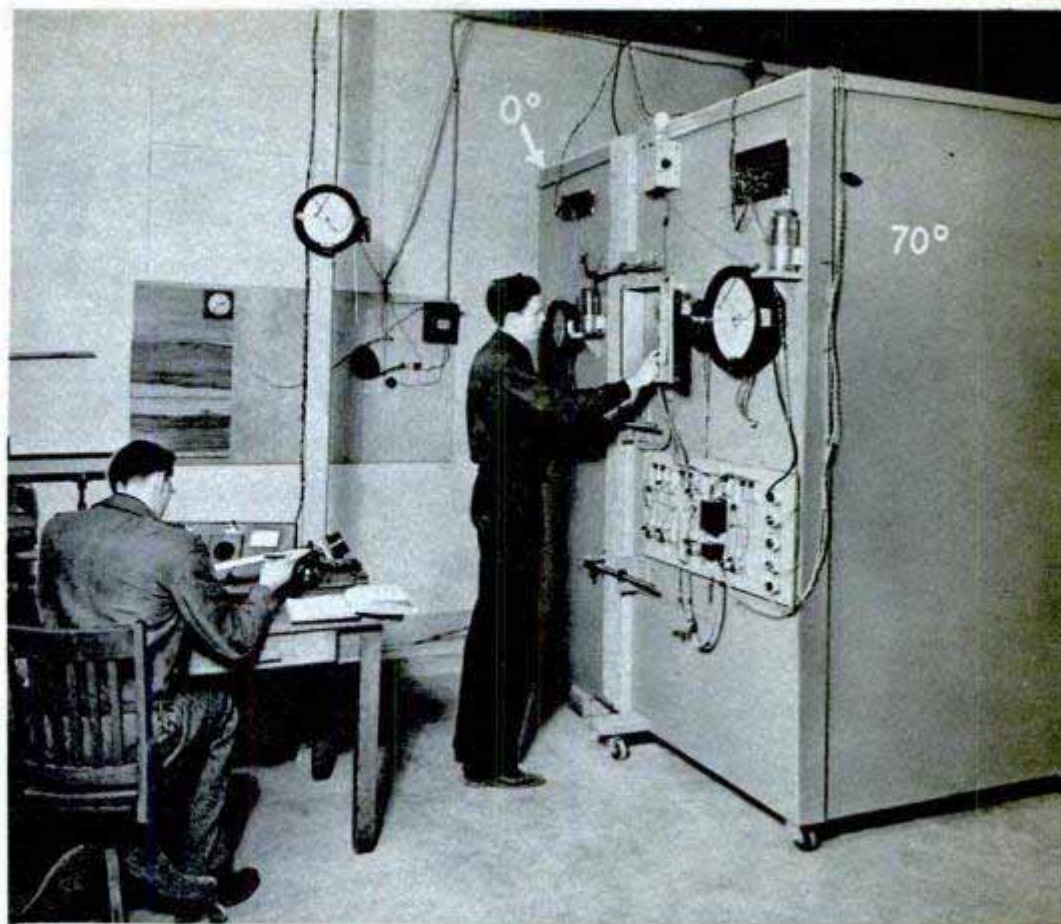
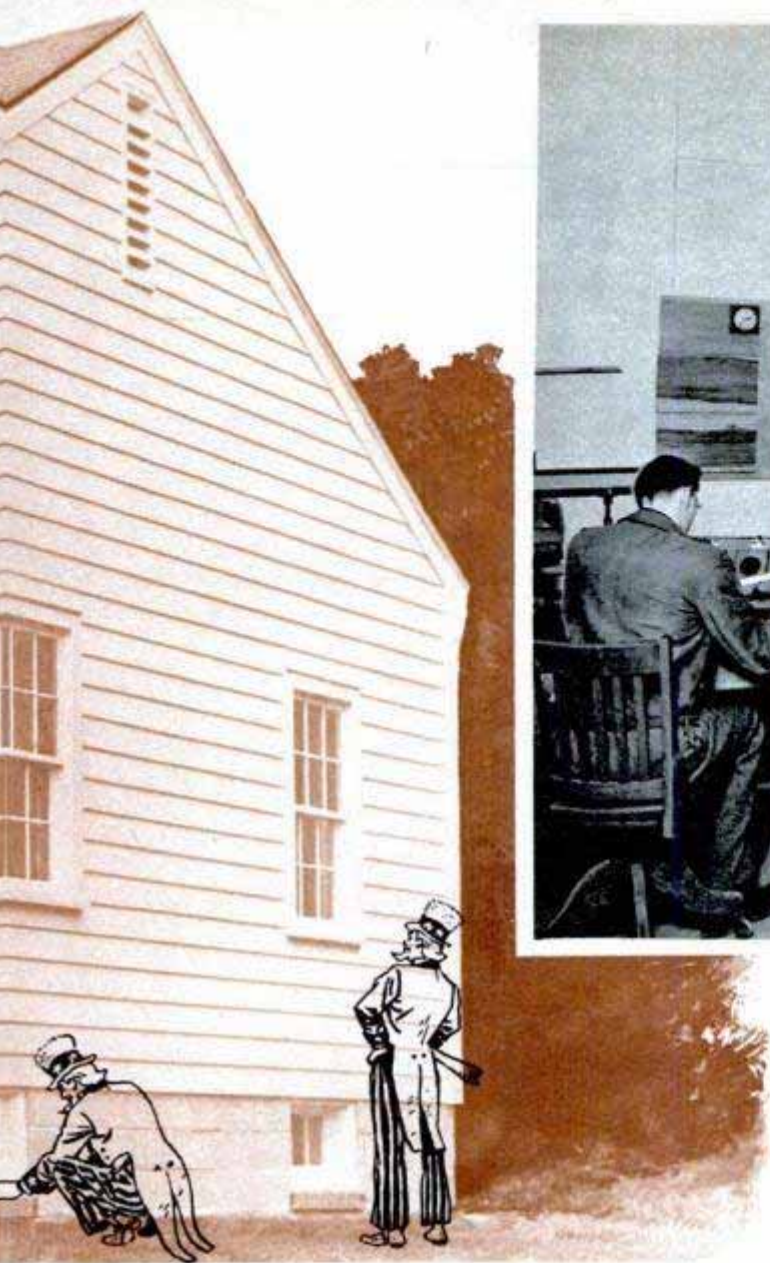

Sandwiched between heated cabinet at right and adjoining cold cabinet is an exterior wall section under test. Below, turning bolt to raise ceiling of room in the bungalow shown on opposite page

bureau's Washington laboratories to find facts which will result in making houses more fireproof, durable and economical.

The human habitation has many natural enemies such as the sun, wind, fire and water. In a score of government and private research laboratories men are seeking to find ways of combating the evil effects of nature upon man's home.

Large-scale housing research by the government was started in 1937 when Congress included \$198,000 in an appropriation for the Bureau of Standards for carrying out research on materials and methods suitable for use in low-cost housing.

Early in the program engineers realized that the need was for research directed toward the house as a whole rather than toward the individual materials of which the house was made. The manufacturers of building materials have for many years been utilizing the facilities of the bureau to test their products, but no one had ever tested a complete housing unit. While every

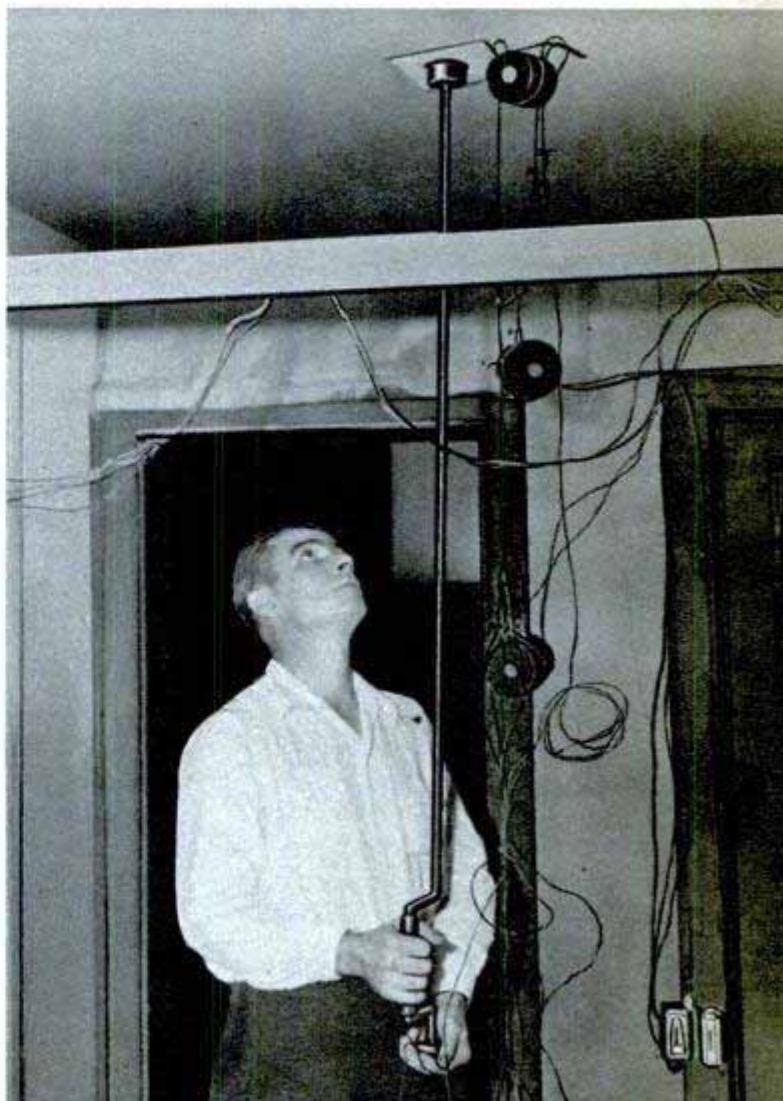

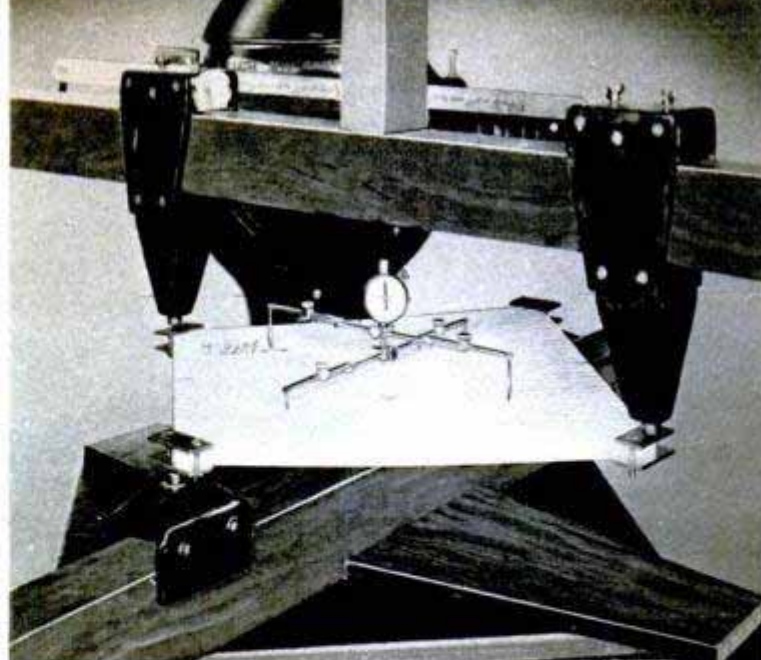
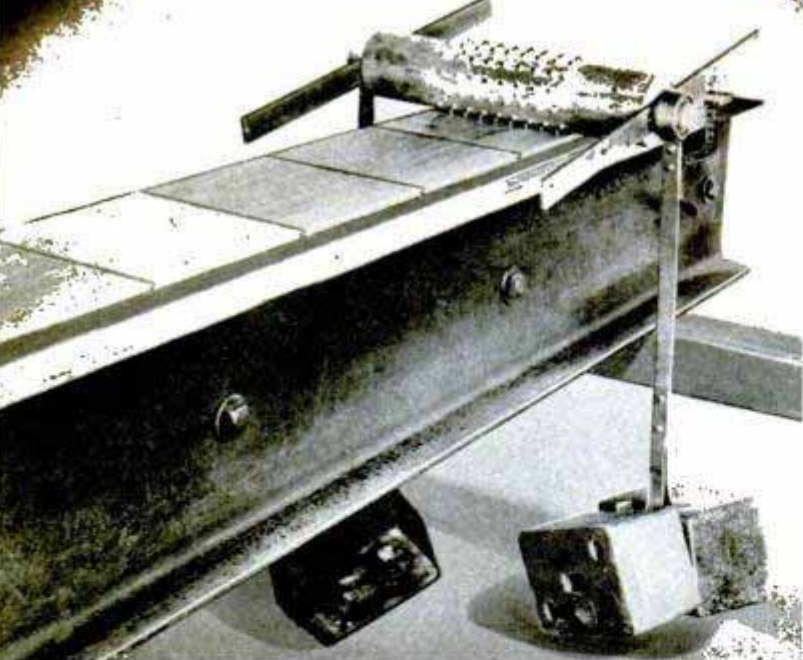

Above left, testing wood flooring section with heavily weighted roller studded with hobnails. Indentations are carefully noted. Above right, testing wood panel with machine which applies upward pressure on two opposite corners and downward pressure on the other two corners

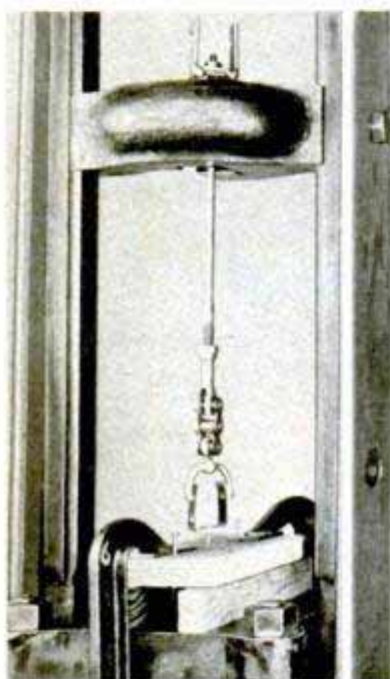

← Nail-pulling machine tests holding strength of building materials

Below, putting squeeze on window frame from opposite corners to test strength at famed Forest Products Laboratory

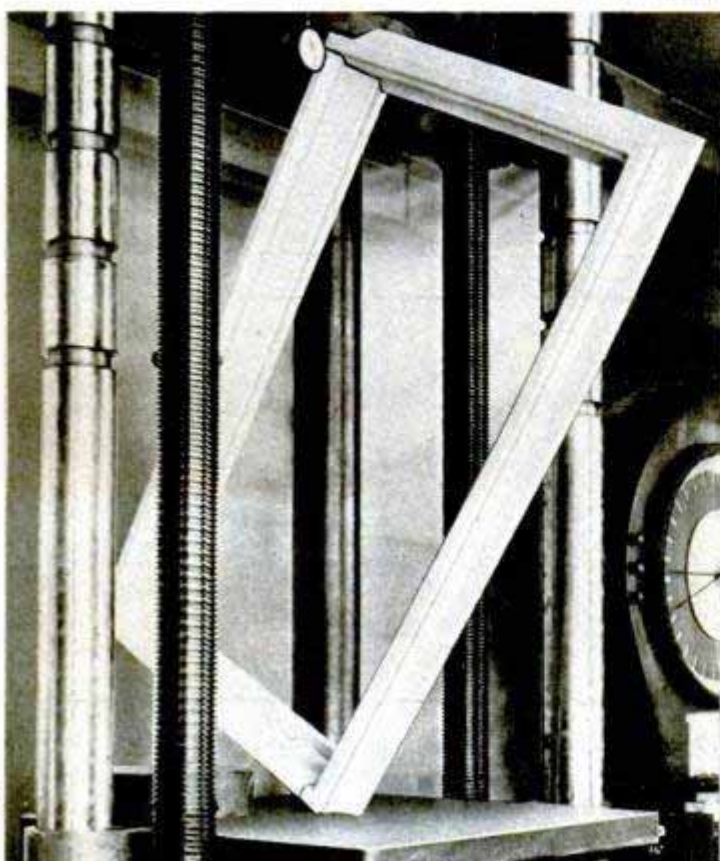

manufacturer would guarantee the performance of his product, no one would assume the responsibility for the house as a whole even though his product was used extensively in its construction.

The bureau immediately began testing not only the materials of construction such as brick, steel and cement, but also complete components such as walls, roofs, windows and doors. The climax was the erection last year of a complete bungalow on the bureau's grounds.

A house to be livable must be heated during the winter in the greater part of the United States. Heating a house costs money. To hold heat in the building the owner usually insulates his home. Yet, some of the heat escapes.

Bureau of Standards engineers worked out a unique method of measuring heat losses through walls, thus pointing the way to improved insulation.

A shielded "hot box" heat-transfer apparatus was built consisting of two cabinets, each with one open side. The wall specimen to be tested is sandwiched between the open sides of these cabinets.

One cabinet is known as the cold box and temperature in it is kept at zero degrees F. The other cabinet, known as the hot box, has an inner box called the metering box, which contains recording instruments. Heat is generated within the hot box and given a gentle motion by electric fans to promote uniformity of temperature. Heat losses are calculated from air and specimen-surface temperatures which are measured by thermocouples and thermometers.

One of the oldest problems of the homeowner is the accumulation of moisture within the outside walls during cold weather. Ironically, air conditioning, devised to make houses more comfortable, is making the problem worse.

"Newly developed methods of adding moisture to the air by so-called air-conditioning heating units," say bureau technicians, "have produced conditions that are conducive to the condensation of moisture within walls unless adequate measures are taken to prevent vapor entering from the warm sides."

Several experiments have already been carried out to find information on how best to prevent condensation. In one experiment seven wall sections, each representing a specific type of frame construction, were installed in a test structure. Wood and fiber sheathing were used. A vapor barrier consisting of a 2-ounce copper foil bonded with asphalt to a backing of kraft paper was placed at various locations within the wall. Several of the sections were not provided with this copper barrier.

The humidity and temperature of the inside air were controlled to produce an

average vapor-pressure drop across the wall of about $\frac{1}{2}$ pound per square inch.

Condensation of moisture occurred in every instance where no vapor barrier was used on the warm side of the wall. In all instances where condensation occurred, the accumulation of moisture was greatest at the bottom of the walls, near the sills. This accumulation would, in all probability, result eventually in the decay of the sill and of the lower ends of the studding.

The addition of a moistureproof sheathing paper to the cold side of a wall tended to cause an accumulation of moisture between the walls even when an excellent barrier was used on the warm side. No difference in this respect was found between the performance of walls of standard wood frame construction and those sheathed with fiberboards. But, a vapor seal should not be used on the cold side of outside walls if inside air is humidified.

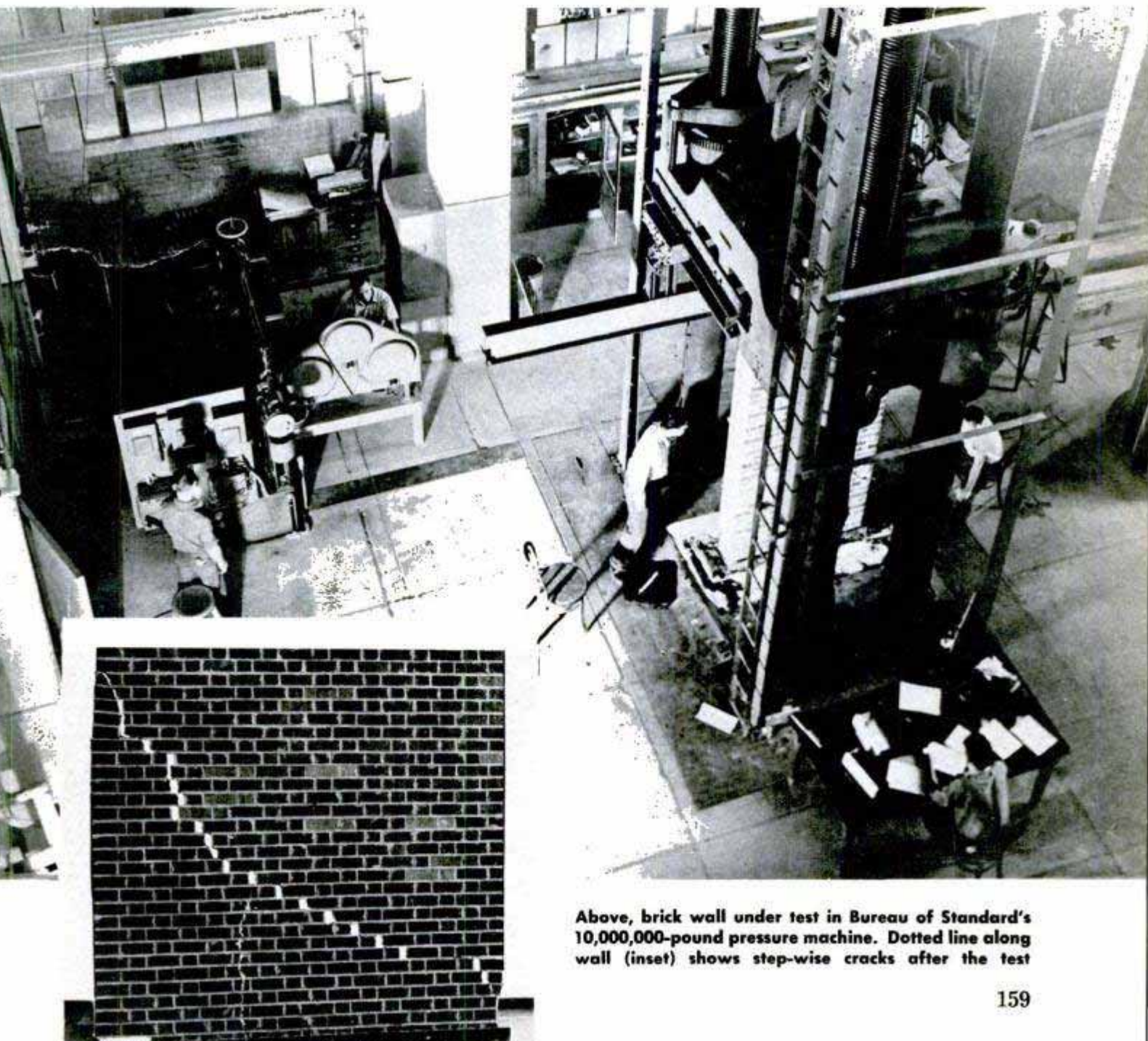

Above, brick wall under test in Bureau of Standard's 10,000,000-pound pressure machine. Dotted line along wall (inset) shows step-wise cracks after the test

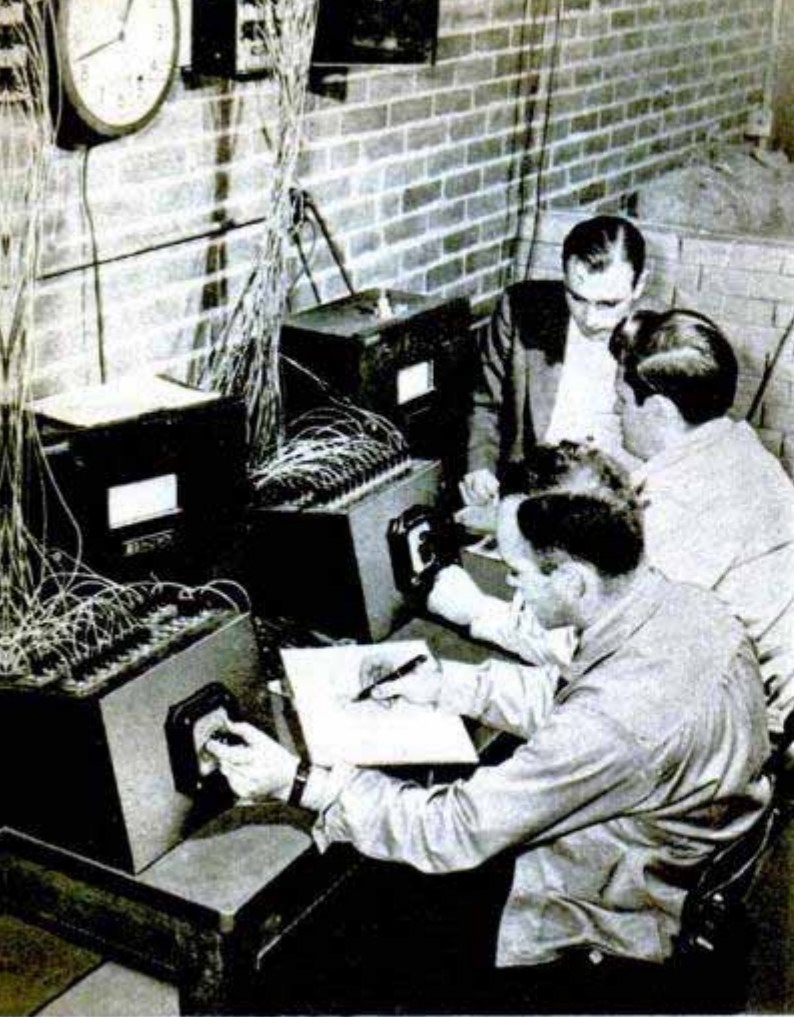

During burning building test below, the instruments above registered 450 temperature readings for various parts of building; temperature went to 2200 F.

Modern civilization has brought another new problem in house building, especially in our cities. Most of us want to keep out street noises, and soundproofing is thus an important consideration in modern house construction.

At the Bureau of Standards a unique reverberation chamber is used to test the sound-absorption qualities of wall and ceiling coverings. The reverberation chamber is really a building within a building. It has no windows and only one entrance. This entrance is closed by a series of four doors and is separated from the outside wall of the building by a dead air space.

If no sound-absorbing material is in the chamber, noises will echo back and forth between the walls for a considerable time.

When tests are to be made, various sounds of known intensity are produced through loud-speakers. These sounds are picked up by microphones and the length of time it takes for them to die away is measured. The material to be tested is then placed on the floor of the chamber and the same sounds are made again. The sounds die away more quickly than they did when the room was empty. The more quickly the sounds disappear, the more sound-absorbent the material is.

The reverberation chamber test is one of

(Continued to page 248)



"Traveling" Forms Speed Canal Work

Eliminating the need for handmade wooden forms, a \$57,000 machine provides the mold for making 25-foot concrete barrels to line irrigation canals. Used in the Bureau of Reclamation's Columbia Basin Project in eastern Washington, the machine consists of two telescoping inside forms and one outside form. The concrete is poured between them. When it has hardened, the forms are withdrawn and reused.

Math Speeds Tests Of Photo Solutions

Mathematical equations are eliminating time-consuming chemical analysis of photographic solutions used in continuous-bath processing. The new equations, worked out in Kodak Research Laboratories, determine the degree of dilution and exhaustion of developer, rinse and fixing solution.

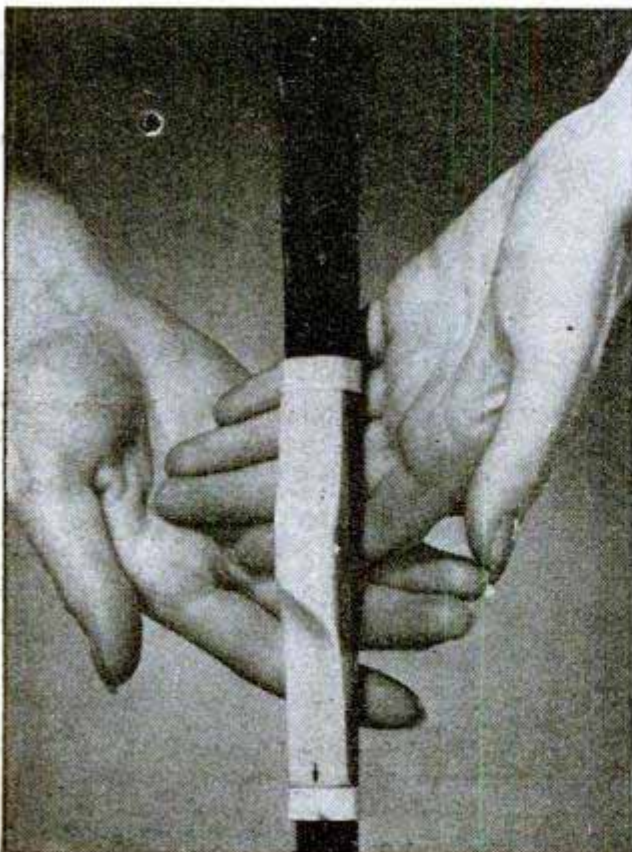
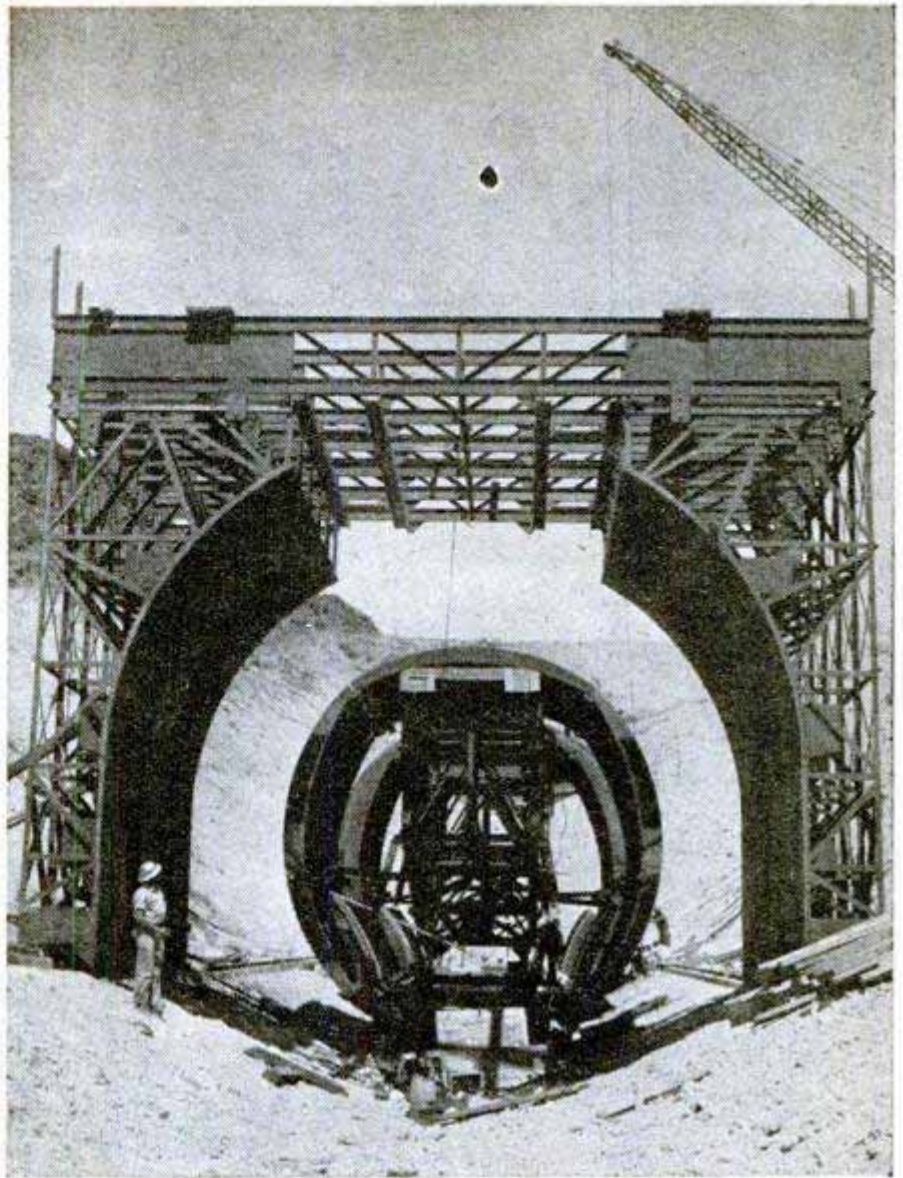

Grip for Putter Guides Hands

Golfers are guided in the correct way to hold a putter by a grip finder that lines up both hands. Made of Tenite plastic, the guide is cut away at each end at the proper angle to keep the hands together and the thumbs in line. The guide is fastened to the putter with adhesive tape and can be adjusted to the spot on the handle which feels most natural to the user.

DDT Checks Elm Disease

DDT is effective in battling the spread of the Dutch elm disease that menaces American elms, according to entomologists of the U. S. Department of Agriculture. The insecticide kills bark beetles that carry the disease fungus from sick trees to healthy ones. Entomologists recommend that healthy trees be sprayed twice each season, first with a two-percent solution, then 75 days later with a one-percent solution. This kills the beetles before they begin to feed. Dying or dead trees should be sprayed with a mixture of oil and DDT to kill beetles before they can migrate.

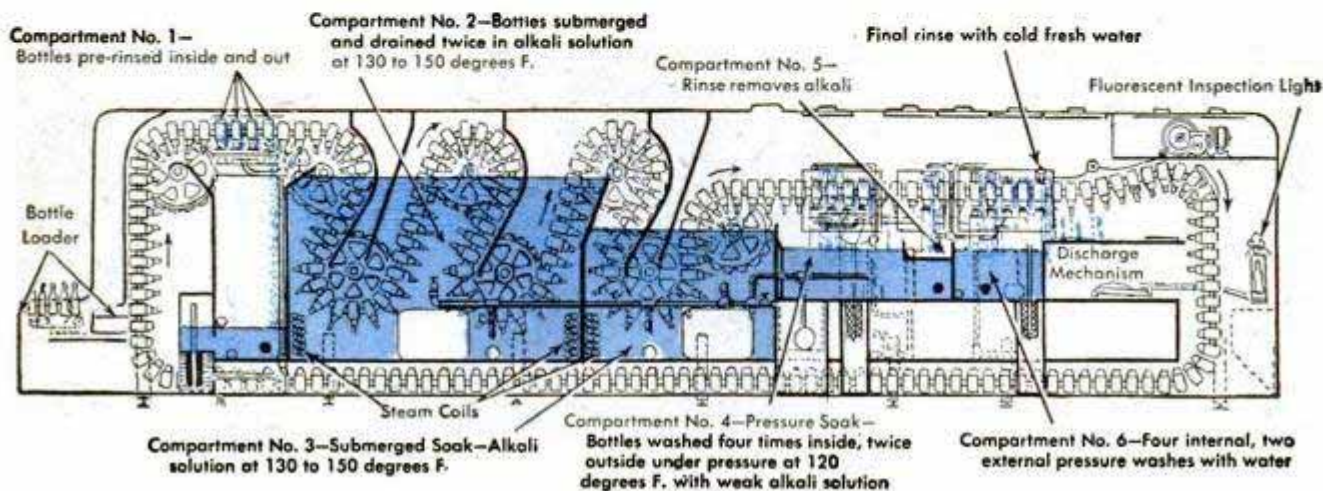
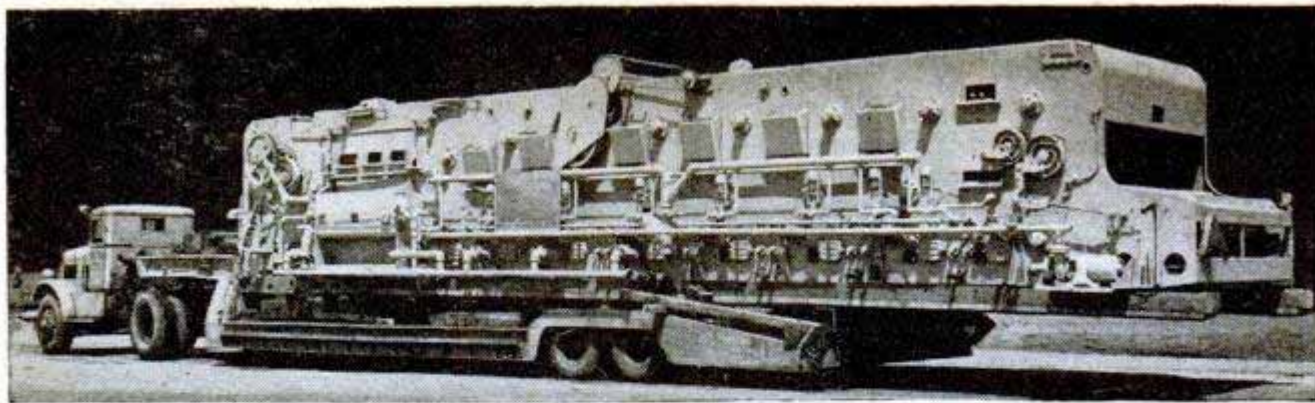

Giant Machine Washes 16,800 Bottles an Hour

Beverage bottles are washed at the rate of 16,800 an hour by a soaker-hydro washing machine 48 feet long and weighing 65 tons. It holds 12,768 bottles and operates automatically. Bottles come in one end, pass through six compartments, and are cleaned for 30 minutes by pressure water

jets and successive soakings in caustic solutions at temperatures up to 180 degrees. Sparkling clean and sterilized bottles come out the other end where they are picked up by a conveyor to be filled, capped, mixed and cased automatically. The machine was built by the Heil Co., of Milwaukee.

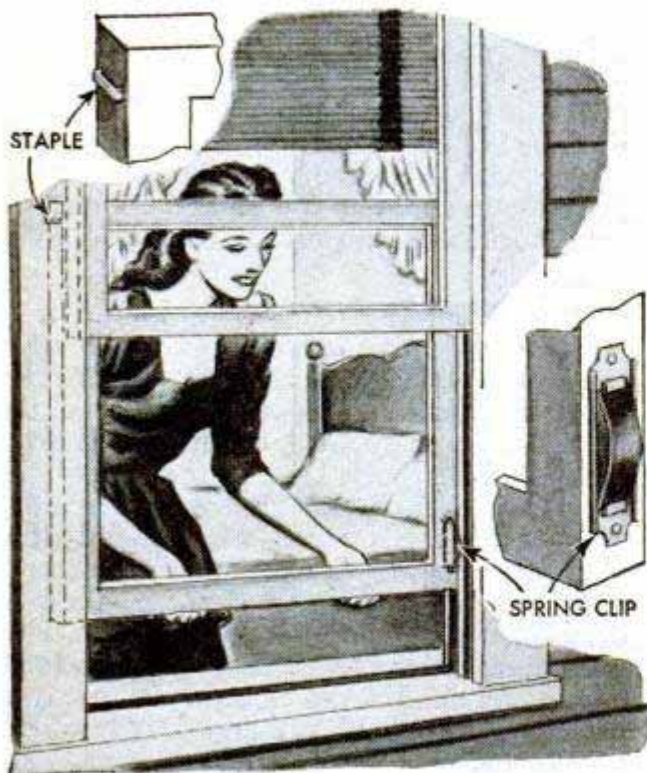

Clip Holds Window Open

Windows are held open without weights by a small spring clip that is attached to the outside edge of the sash. A metal staple on the opposite side of the window keeps it centered between the uprights. Conventional frames are not necessary as the device can be used in windows installed against studding.

Sugar Cane Yields Valuable Wax

Wax is processed from the waste fiber of sugar cane through a process developed at the Houma, La., laboratory of the U. S. Department of Agriculture. The wax may replace expensive carnauba used in manufacturing shoe polish, phonograph records, carbon paper and floor and furniture polishes. About 850 pounds of fully refined wax can be processed from 1000 tons of cane. More wax could be recovered each year from U. S. sugar cane than was used before the war.

Twin Light Beams Align Wheels

By the use of cross-hair projectors, automobile wheel alignment is accomplished quickly and accurately. Two projectors, one for each front wheel, send light beams against gridded charts to show the exact amount of correction needed. The cross hairs are enlarged eight times by projection to make a $\frac{1}{8}$ -inch correction become an inch movement on the screen. As corrections are made to the wheels, the cross hairs move across the charts showing the mechanic when the wheels are in exact alignment.

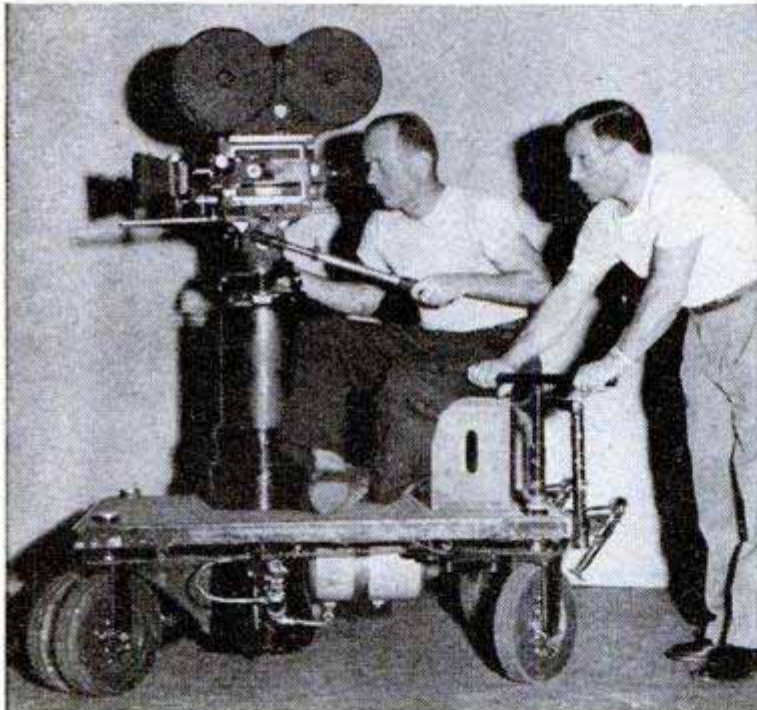
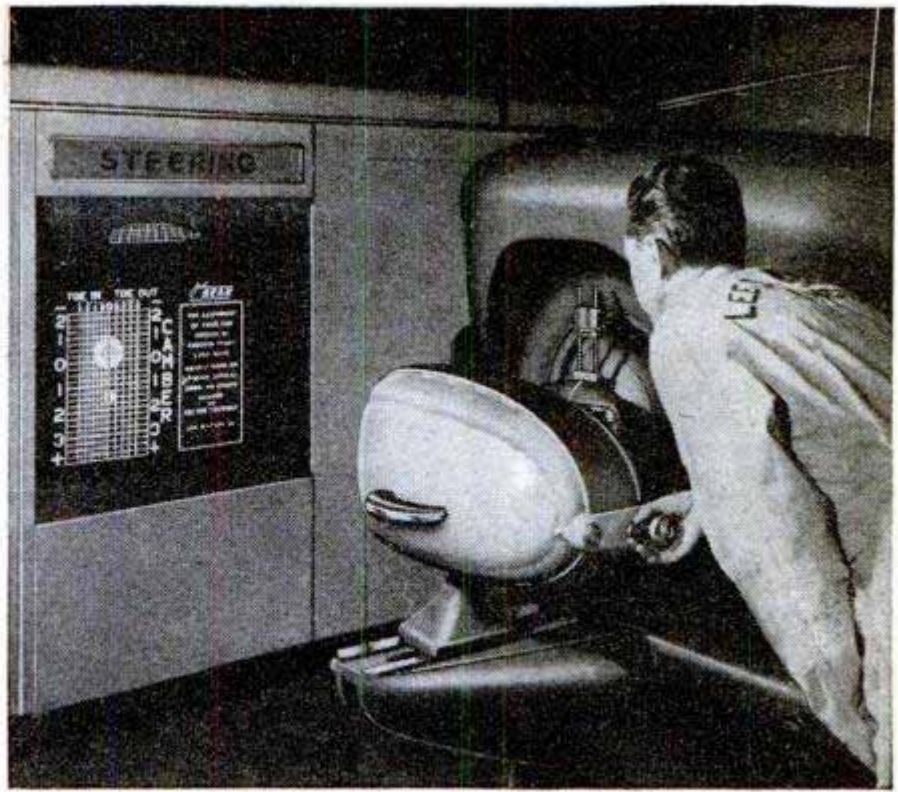

Dolly for Movie Cameras Has Four-Wheel Steering

With direct steering of all four wheels, a new camera dolly enables movie cameras to travel in any direction while following actors around the set. Steering is controlled by a bar mounted at the rear of the dolly. Previous dollies moved forward and backward only and required a specially constructed track. The camera, mounted on a hydraulic lift, can be raised from 36 inches above the floor to a height of 70 inches. Because of its mobility, the new dolly permits continuous filming of action lasting up to three minutes that formerly required as many as 28 different film sequences that were later pieced together.

Spiral Grain Loader

Mounted on an adjustable tripod, a spiral grain loader can be swung and tilted by hand without moving the wheels. It can be raised high enough to load bins from the grain truck or lowered to load from ground level. Powered by a small gasoline engine located near the center of the 18-foot tube, the 6-inch spiral moves from 10 to 17 bushels of grain a minute.

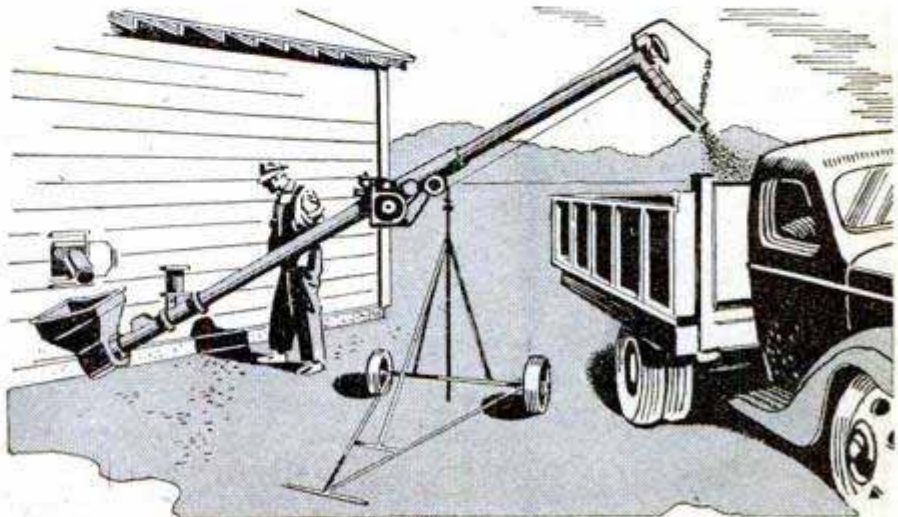

HINTS from a HOLLYWOOD "PRO"

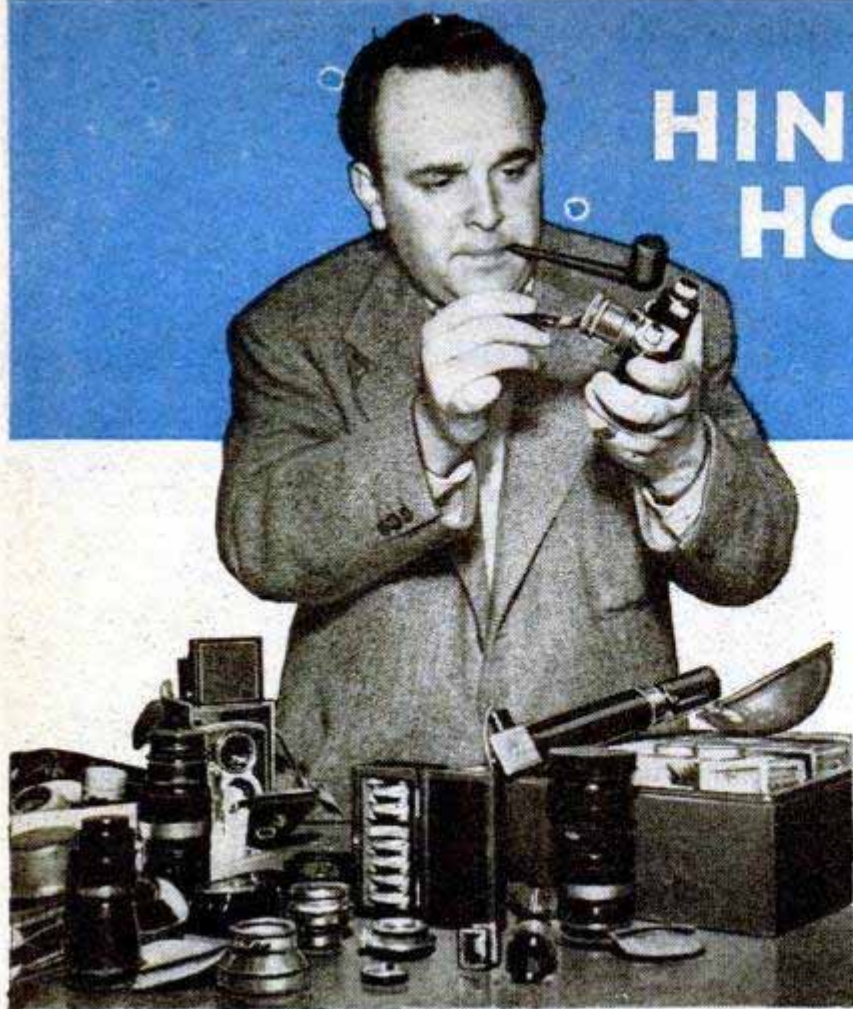

Small cameras are what Sidney likes for personal "shooting." Auxiliary lenses and other accessories equip him for all conditions. Here, he's using a camel's-hair brush to dust off the lens of one of his cameras



But when he goes to the studio, he works with big cameras. Below, the director is suspended from an overhead boom as he checks the angle of an enclosed camera that will be lowered to take underwater movies

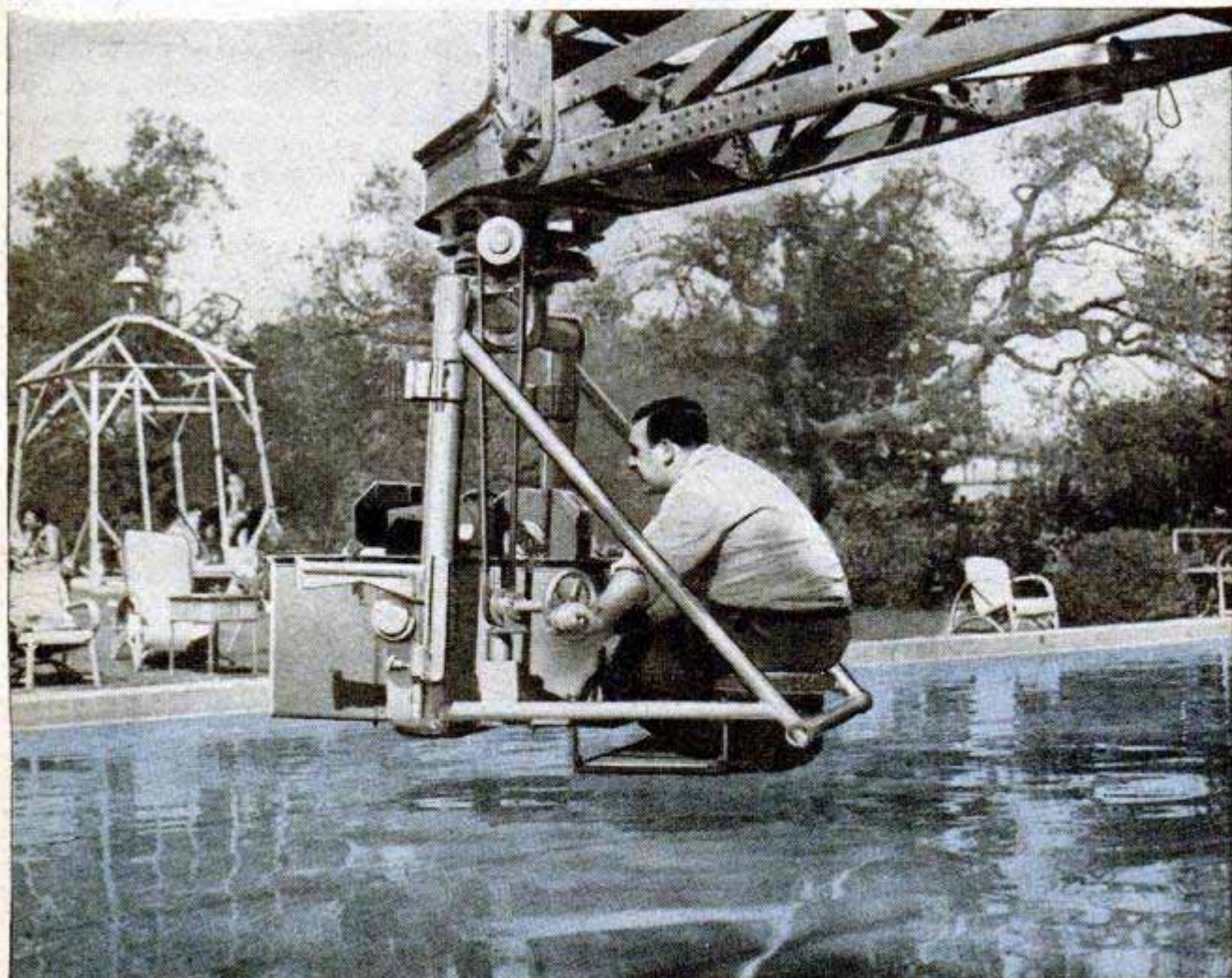

GEORGE SIDNEY is like the postman who takes a walk on Sunday. He collects salary checks from Metro-Goldwyn-Mayer as a motion-picture director, and on or off the set he's always shooting pictures.

Any ordinary camera fan would go green with envy over the opportunities that are Sidney's. Being surrounded by such photogenic subjects as Lana Turner and Esther Williams and a few hundred other stars and starlets he should never run short of targets, displayed under the best lighting and improved by the best of makeup.

He does pack his camera all over the lot and he does shoot the stars. But he prefers the candid snapshot and nature-made lighting and he thinks some of his best photographs are unguarded portraits of his friends. The enlargements that come from his darkroom are often as impressive as if a whole studio crew had worked a full day to capture the effect.

"Some amateur snapshots show a friend obviously having his picture taken. He stands stiffly in the middle



In his chair beside the big sound camera, Director Sidney raises his reflex to take a candid photograph of some action on the movie set

From his collection of prints, Sidney points out an interesting cloud shot he enlarged from a miniature



Until his new home with a built-in darkroom is finished, Sidney uses a big enlarger at the MGM studio

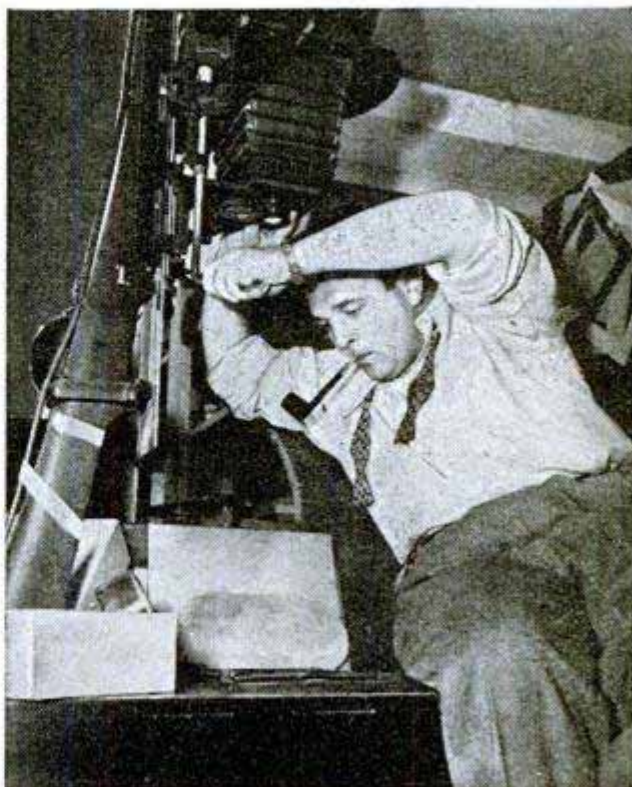



With a telephoto lens on a 35-mm. camera, he takes candid photos on the set from the director's chair

Sidney and a camera crew film the graceful patterns formed by girls swimming below the camera platform

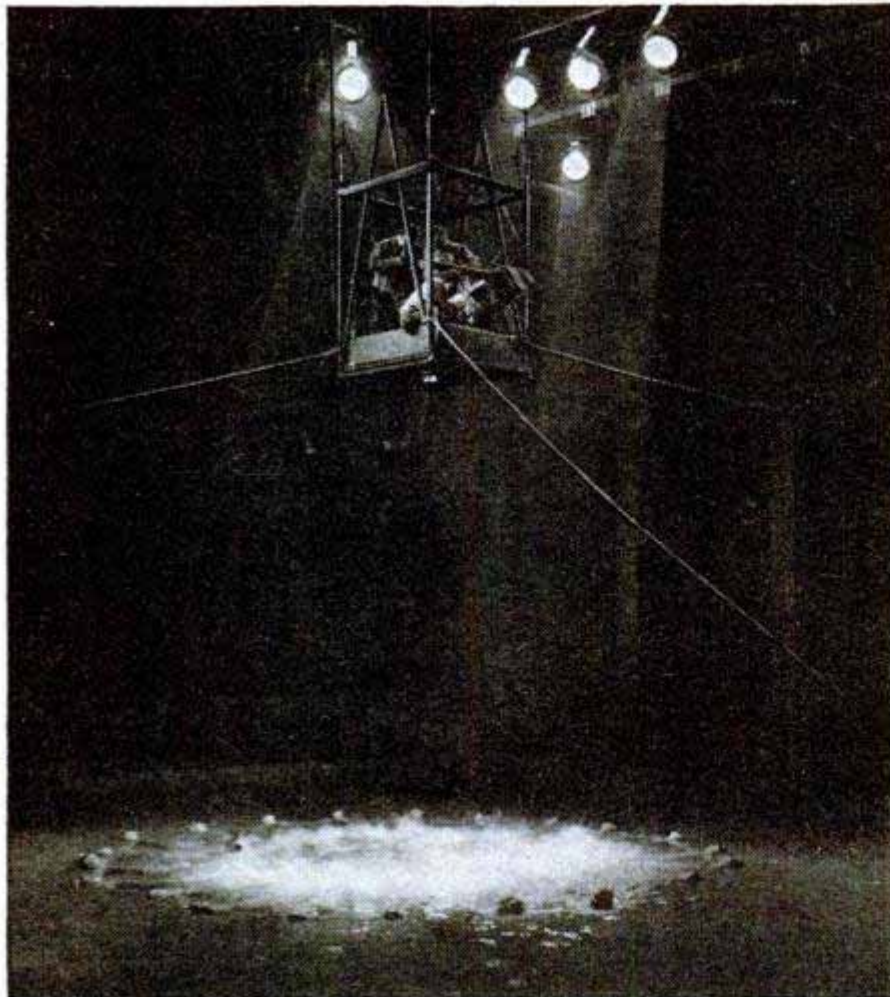

distance staring at the camera," Sidney says. "Pictures like these seem a waste of film to me. It's better to get close to your subject and make half a dozen candid shots from different angles. Forget about the pose and concentrate on getting a sharp, well-exposed negative. A twin-lens reflex is good for this work.

"Probably most of your pictures won't be worth printing, but there will be some that stand out. I take as many as 500 snaps a month and some of them are terrible.

"You will be surprised at how good some of your shots appear when you enlarge them. The little 2¼ by 2¼-inch contact print doesn't look important, but an 11 by 14 enlargement of the same negative, mounted on stiff board, with your name signed under it, often attracts attention."

Taking good pictures, Sidney says, requires practice the same as playing good golf or good tennis. Take at least one picture every day and between photos practice estimating exposures by picking out a camera shot and estimating the amount of light present. Check your estimates now and then with a meter. It's wise to use a tripod or some other rest. Even a neck strap helps steady the camera if you pull against the strap. Instead of using many different films, standardize on one slow emulsion for outdoors and one fast emulsion for indoors.

The movie director likes pictures shot from odd angles and this has paid off in his profession. Sidney goes under water with a camera crew to make movies of swimmers and he climbs aerial platforms to shoot scenes from directly overhead.

He has invested hundreds of dollars in lenses and attachments for his 35-mm. camera, but he's partial to his reflex. It uses convenient 120 film and produces a square negative that is large enough, when fine-grain developer is used, to permit giant enlargements.

"The pictures that you like are the ones that you should enlarge and hang up for everyone to see," Sidney says. "Not everyone may agree with you on the fine points of a photograph, but, after all, it's your picture. Hang it up and enjoy it."

Recordings on Redwood

Phonograph recordings are made on thin slices of redwood by Ben Shuemaker of Eureka, Calif., who developed the novel disks as souvenirs for tourists. Wood used in the recordings comes from burls which develop from buds that remain dormant instead of growing into branches. Shuemaker splits cross sections $\frac{1}{40}$ inch thick from the burl and cements one slice of the wood on each side of an aluminum disk. When the cement is dry the record is sanded and a layer of shellac $\frac{1}{500}$ inch thick applied. After the surface is polished the recording is made with a small recording machine. Studio recording equipment cannot be used because the needle cuts too deeply into the wood. Tourists record personal messages on the redwood disks.



Dye Detects Cancer Tissue

Removal of cancer tissue by surgery is aided by the use of a dye that glows under ultraviolet light. The dye, sodium fluorescein, is injected into the patient's vein three to eight hours before the operation. Under ultraviolet light, the cancer tissue glows with a

vivid yellow color making detection easier. Good results were obtained in 31 out of 46 cases, with most consistent success in brain-tumor operations.



Firemen Burn "Tenement" In Safety Demonstration

With a five-story "tenement" especially constructed for the occasion, members of the New York Fire Department recently demonstrated fire-fighting techniques in Madison Square Garden. Under the glare of spotlights, smoke pots poured fumes from the windows and firemen raced up and down the ladders to put out the fire. The demonstration was part of a show to raise money for the department's welfare fund.

Reflecting Buoys

Channel buoys with reflecting collars that pick up searchlight beams are making night shipping safer in New England harbors and the Mississippi River area. The Coast Guard has equipped several thousand buoys with collars made of sheet metal coated with crystals. Similar to reflecting signs, the markers are red or black, depending upon the color of the buoy.

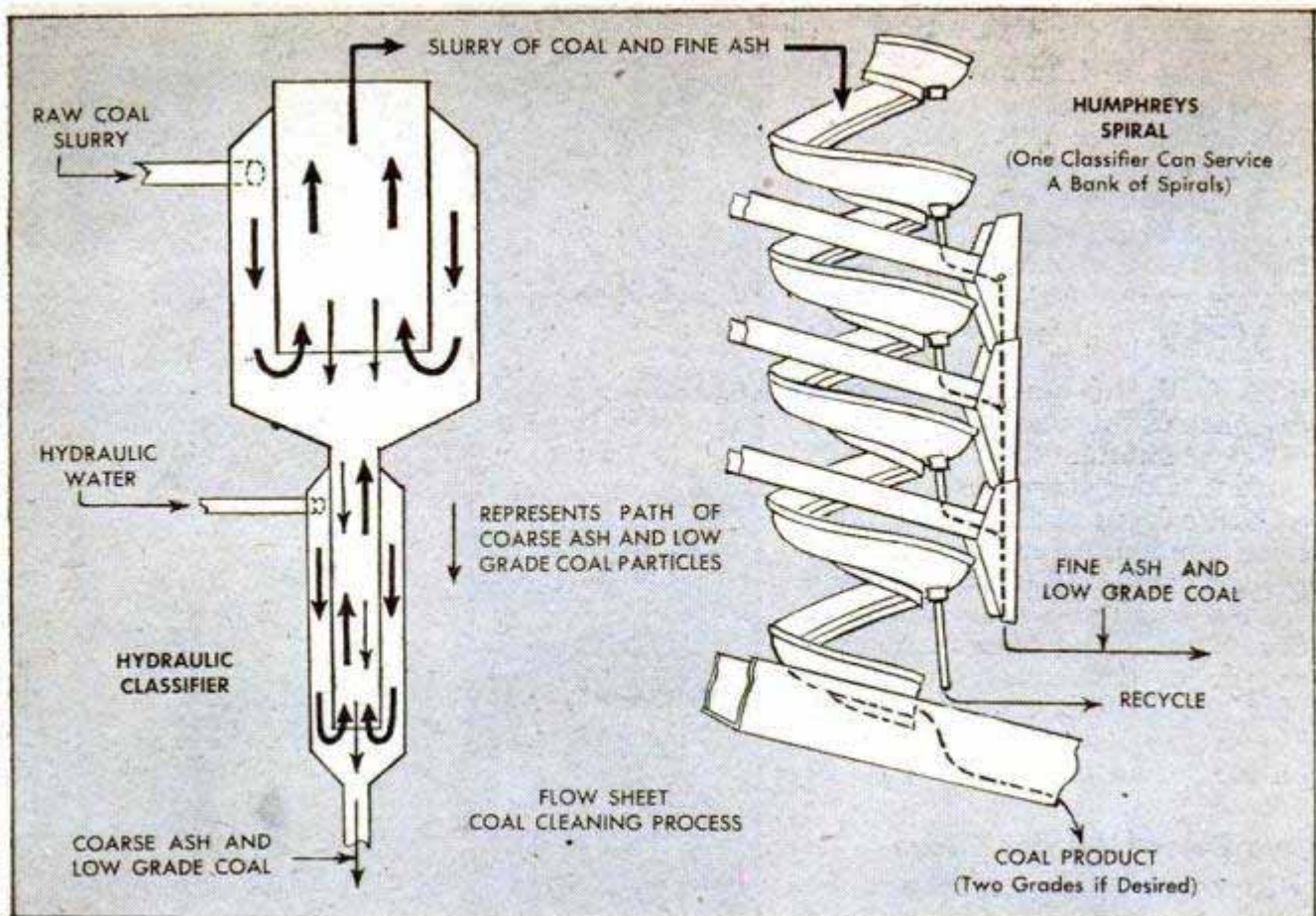

Water Stream Separates Impurities From Coal

Impurities are removed from bituminous coal through a new process that lowers the ash content, decreases sulphur and increases the recovery of coal that is mined. Developed by Donald A. Dahlstrom of Northwestern University, the process ferrets out impurities by gravity. The instrument used is a two-inch pipe placed inside a three-inch pipe. A current of water flows up through the inner pipe at a rate of 20

to 25 gallons a minute. The coal to be purified passes through the outer pipe and then into the stream of water, where the impurities, having a higher density, fall against the current to the bottom of the instrument and the lighter coal passes out through the top. The partially-cleaned coal then passes down a spiral track, where the fine ash and low-grade coal separate from the premium coal.

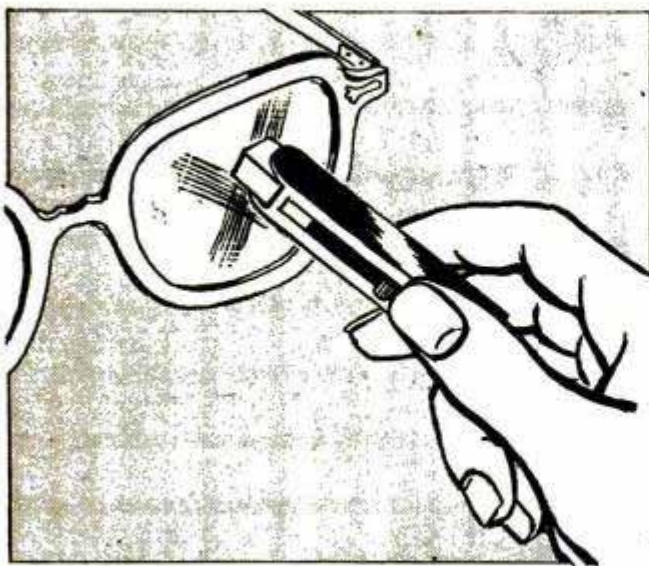

Eyeglass Cleaner in "Lipstick" Case

Eyeglasses are polished with a cleaning compound held in a small container much like a lipstick case. Pulling down a knob on the container ejects the wax-like compound from the top. Used once a day, the original supply of compound will last about six months. Refills are available.

Radar Aids War on Disease

Radar is replacing short-wave diathermy in heating living tissues for treatment of certain diseases. Since radar can be beamed and localized like a spotlight, there is no need for encumbering cables, pads and toweling commonly used with short-wave diathermy. Medical use of radar was under study as early as 1937, but military use of equipment forced a postponement of the work until after the war.

☐ Liquid oxygen injections, in combination with water injection, boost a 2000-horsepower engine nearly 300 horsepower.



SERVICING FLUORESCENT LAMPS

WEAVING LOOM

SOUND EFFECTS FOR RECORDINGS

The CRAFTSMAN

★ "Jeepers," we call it, and that's what the neighborhood gang will exclaim with envy when your youngster rides by in the sidewalk "jeep" shown on page 178. It's more than a toy—it runs! The plans are clear; it will be tough to turn down demands that you build it. "Jeepers" has automotive-type steering, welded frame, and electric-motor drive through a hydraulic transmission. Start building today for spring showing.

★ Many hobbyists turn a neat profit from spare-time weaving of rugs, table runners and similar items. An article on page 188 tells how to build a table-top loom with several features that make weaving easier.

★ On page 210 we present practical helps for servicing fluorescent lights, correcting ballast hum, testing the tubes and improving light efficiency.

★ Want to cut your own records, with sound effects? An N.B.C. engineer tells, on page 194, how to produce sound effects to make home recordings more dramatic.

SIDEWALK JEEP



PLASTIC LAMPS

By R. BARSAMIAN

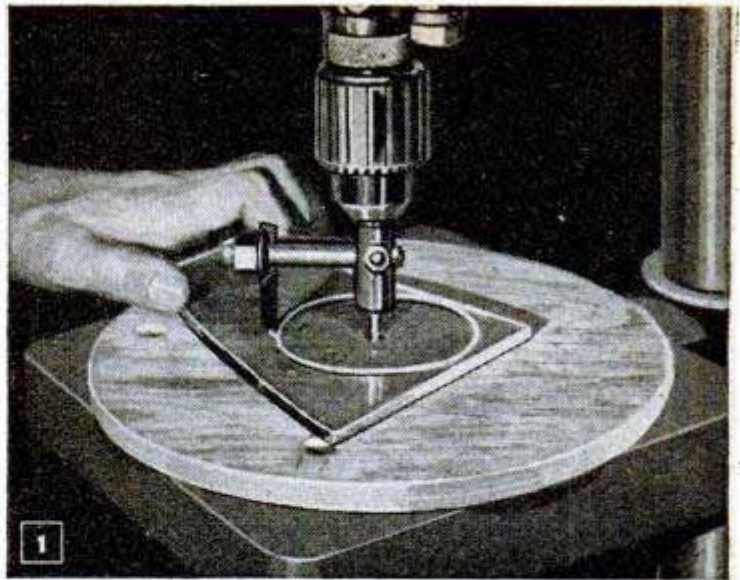

1

A fast way to cut spacer disks from sheet plastic is to use a circle cutter in a drill-press chuck. Uniformity is had, and, a cutter having a pilot bit of proper size, will form pipe hole at same time

THOSE CHOICE BLOCKS of fancy wood that you have been saving from other jobs will do nicely in combining wood with plastic to make attractive "laminated" lamp bases at very little cost. Layers of aluminum, interspaced with layers of plastic, can be used, or all three materials, plastic, wood and metal may be combined to produce unusual and distinctive bases. Size, shape and thickness of the laminations make the number of variations almost endless. You can cut them square, all the same size, or, every other one can be made smaller to serve as spacers between the

"Disks" may be round, square or octagonal, of plastic, metal or wood. Aluminum or brass spacers combined with clear or colored plastic, or laminations of fancy wood, make attractive bases

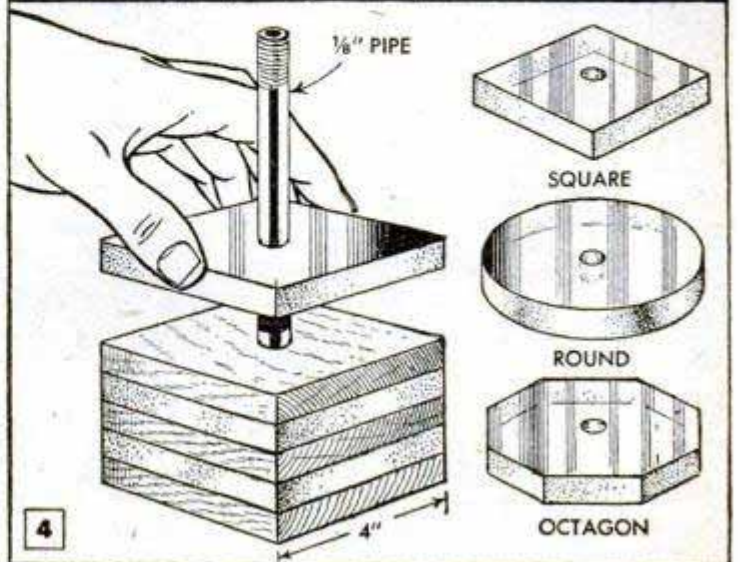

4

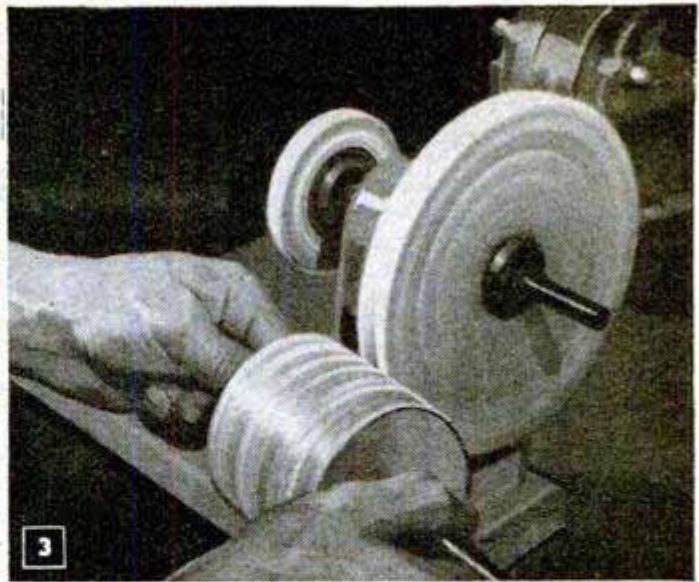
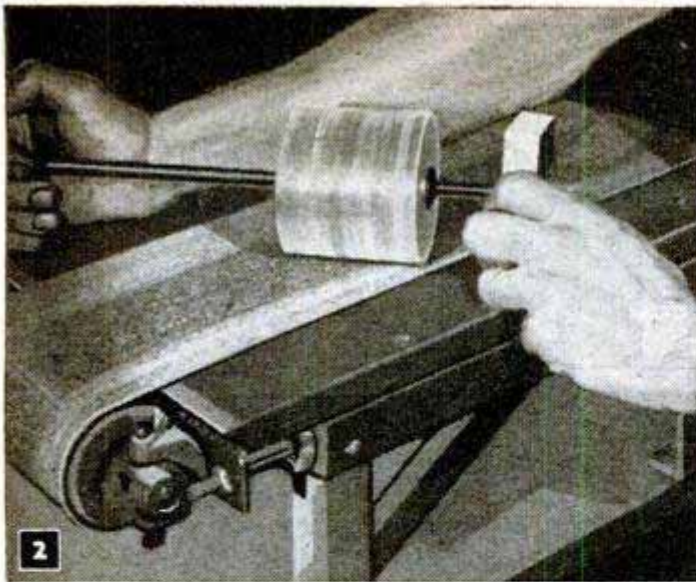

2 Sanding rough edges of the disks on a belt is done at one time by mounting disks on a pipe shaft, letting the shaft rotate in wood blocks as shown. Same setup could be held in lathe to dress edges

3 Polishing is done while disks are still on shaft. Cloth buffing wheel, charged with rouge and rotating at high speed, produces high luster quickly. Keep work moving across wheel to prevent "burning" plastic

plastic. The same applies to bases built up of disks. Variety also is achieved by using, alternately, layers of clear and colored plastic. Still another variation is had by combining thick and thin layers of two different materials as shown in Fig. 8. Here, for economy, the plastic layers should be kept thin as the cost of plastic in thick sheets is somewhat expensive, especially in $\frac{3}{4}$ and 1-in. sizes.

Figs. 1 to 3 inclusive show progressive steps in mass-producing disk-shape laminations of plastic. Those of one size are cut, drilled and grouped together on a shaft for final finishing all at one time. As-

sembly of the lamp bases is shown in Figs. 4 and 7 and is typical in building up each base regardless of design. Essentially, the layers, whether round, square or octagon shaped, are coated with cement and slipped over a length of electrical fixture pipe and then clamped. A strong cement for bonding plastic to plastic or plastic to wood and metal is made by mixing ethylene dichloride (available at most paint stores) with fine shavings of clear plastic to a consistency of thick syrup. Do not use until the mixture is entirely dissolved and clear. Pour some of the cement into a shallow container, such as a

In assembling square or octagon shapes, edges of the layers are aligned and kept flush by clamping blocks temporarily to opposite sides. Veneer press provides even pressure, but C-clamp can be used

Any unevenness too great to remove by hand sanding can be trimmed flush with a power saw, provided the work is not too large. Use a fine blade and pass the work slowly to prevent chipping plastic laminations

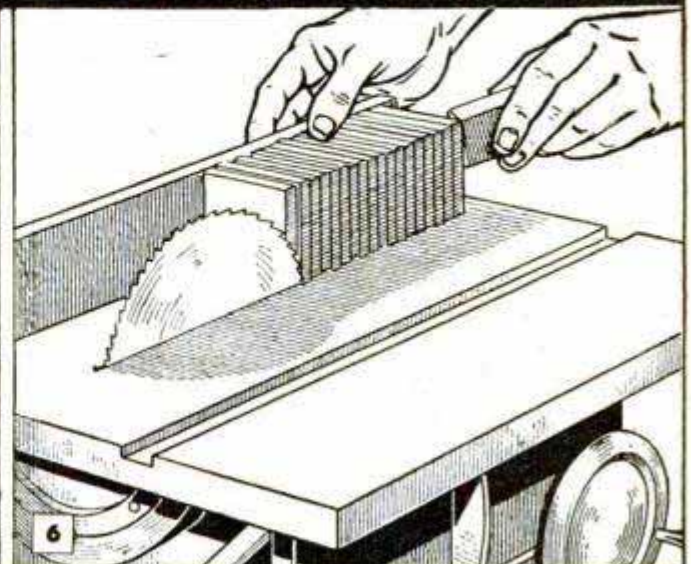
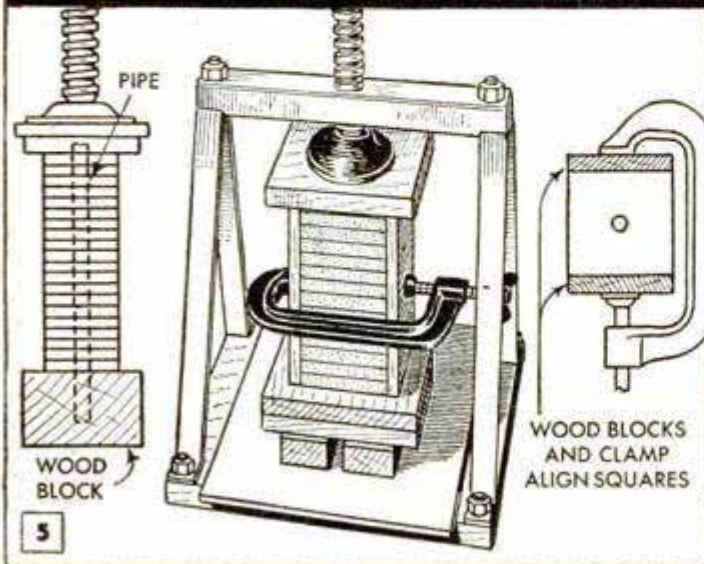

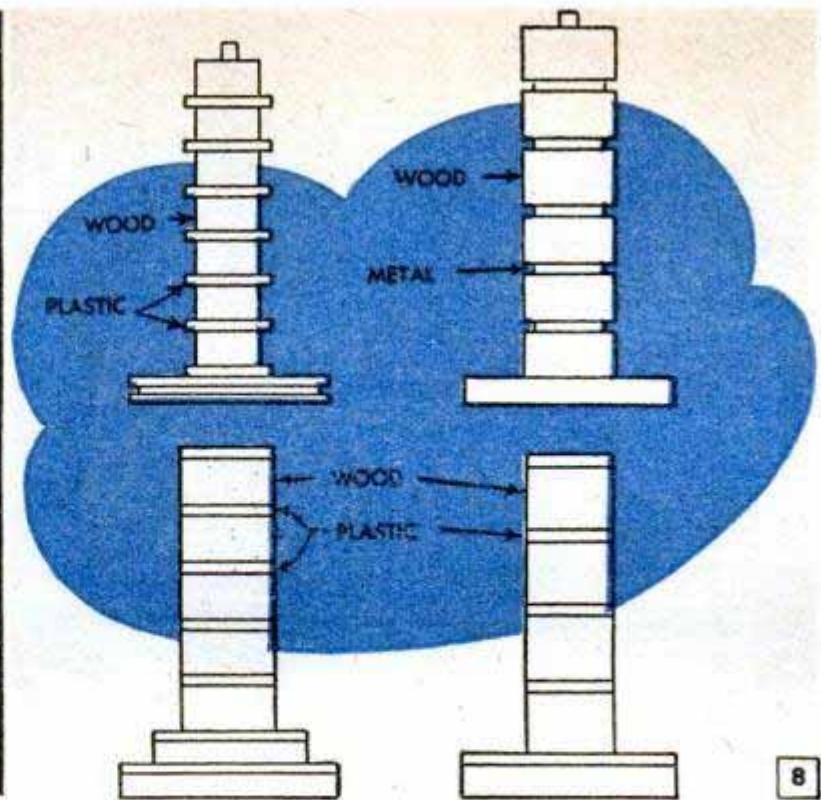
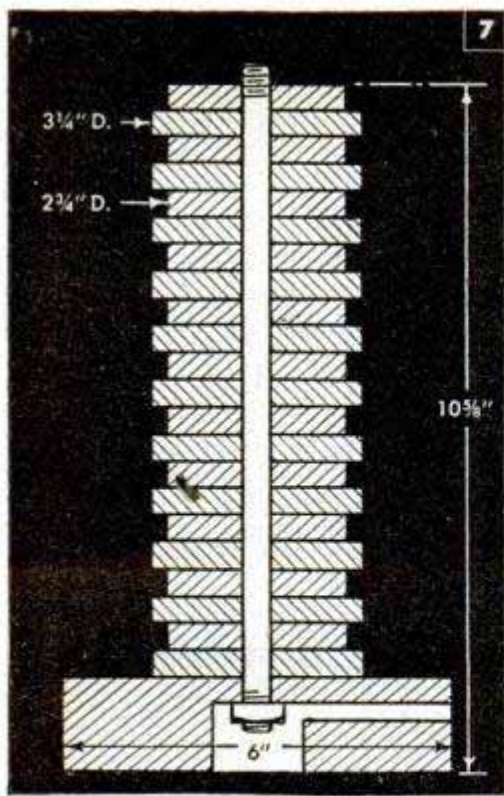

saucer, and coat the surface of each lamination by dipping it into the cement. Work fairly fast as the cement has a tendency to dry quickly. In clamping the assembly, apply sufficient pressure to eliminate air bubbles, but avoid squeezing out all of the cement. A veneer or paper press is ideal to provide uniform pressure, but you can use a couple of large C-clamps. In clamping square-shaped laminations, the setup shown in Fig. 5 should be used to align the edges. Remove the wooden guide pieces before the cement sets, however. Any unevenness too great to remove by hand sanding can be trimmed flush with a fine

saw blade or a cutoff wheel as in Fig. 6. The base piece of the lamp is drilled according to the sectional view in Fig. 7 for the lamp cord. Then the two parts of the base are held together by a washer and nut fitted to the end of the pipe.

A word about sanding and polishing plastics: Sawed edges of the material must be sanded perfectly smooth and all tool marks removed. If a lathe is available, the edges of disks can be trued and sanded glass-smooth by mounting them on a shaft and chucking between centers. A cloth buffer is used to polish plastic by holding it against a wheel charged with rouge.

Novel Pin-Up Lamp Glows To Light Up Silhouette Encased in Bulb

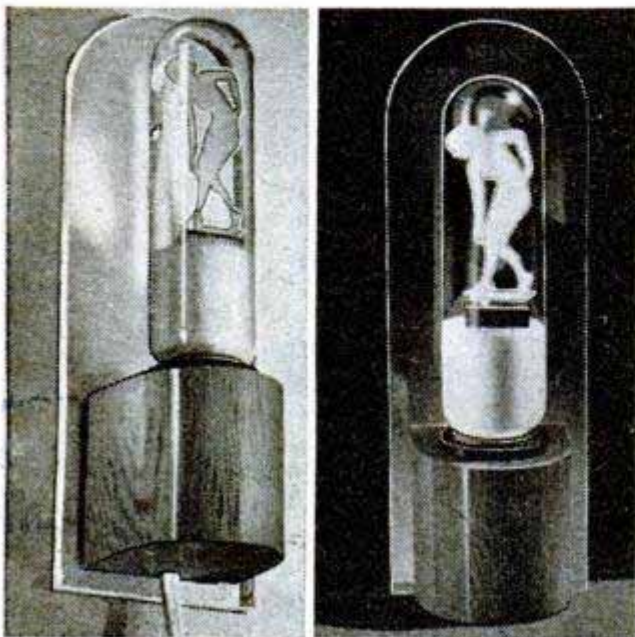

Suitable as a night light, or purely for decoration, this novel pin-up lamp employs a special gas-filled bulb which produces a faint glow of fluorescent quality to illuminate a silhouette inside the bulb. This type of bulb can be purchased at most electrical stores. The sconce or bracket part of the lamp consists of a "reflector" of clear plastic having a socket-fitted block screwed to it. The block is bored to take the inside portion of a regular push or key-type, drop-cord socket. Remove the brass shell and switch buttons and wire it with a length of lamp cord. Then press the socket and its fiber sleeve into the hole in the block, running the wire out through a hole in the bottom. Be sure that the switch is in the "on" position before encasing it in the block. A mirror may be used instead of plastic.—Newell Hartley, Devon, Conn.

Three Good Trap Sets That Fool the Wily Mink

If there are mink in your locality here are three good trap sets that should get results. When setting the traps, if it's at all possible, stand in the water to avoid leaving any scent that might warn the animal. A lure is used and one suggested here is made from trout heads. Place them in a wide-mouth jar which is left standing in the sun until an oil forms. Strain this and pour it into a bottle that is tightly stoppered. The first location, shown in the top illustration, is on the shallow shelf of a stream that has an overhanging bank. A few drops of the lure are placed on the bank and the bait is pegged to the ground behind the trap and secured with a drowning stake driven in deeper water. The other two locations are blind sets and require no bait. In one the trap is placed near a tile drain, and in the other it is where a spring-fed brook drains into a

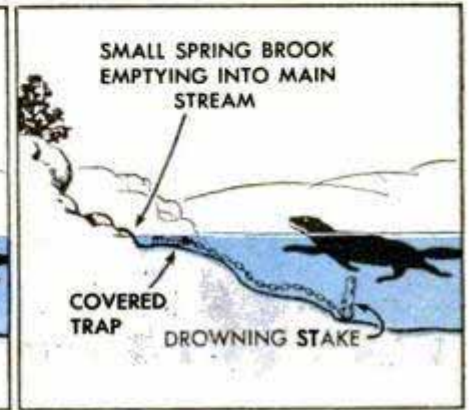
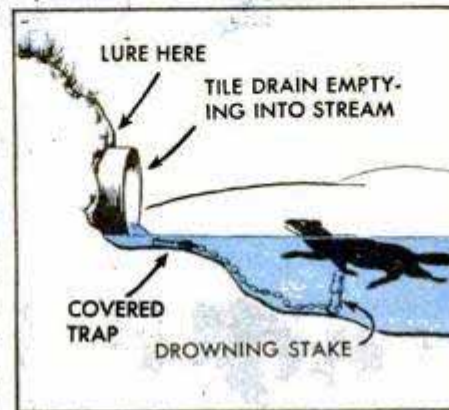

larger stream. In both cases the stake is pegged in deeper water.

R. A. Jenkins, St. Louis, Mo.

Tread Built From Hose and Slats Makes Slippery Sidewalk Safe

Assembled from two lengths of discarded garden hose and wooden slats, this auxiliary walk or tread will prevent slip-

ping on an icy sidewalk and it does away with having to sprinkle the walk with ashes or salt. It is necessary to remove snow,

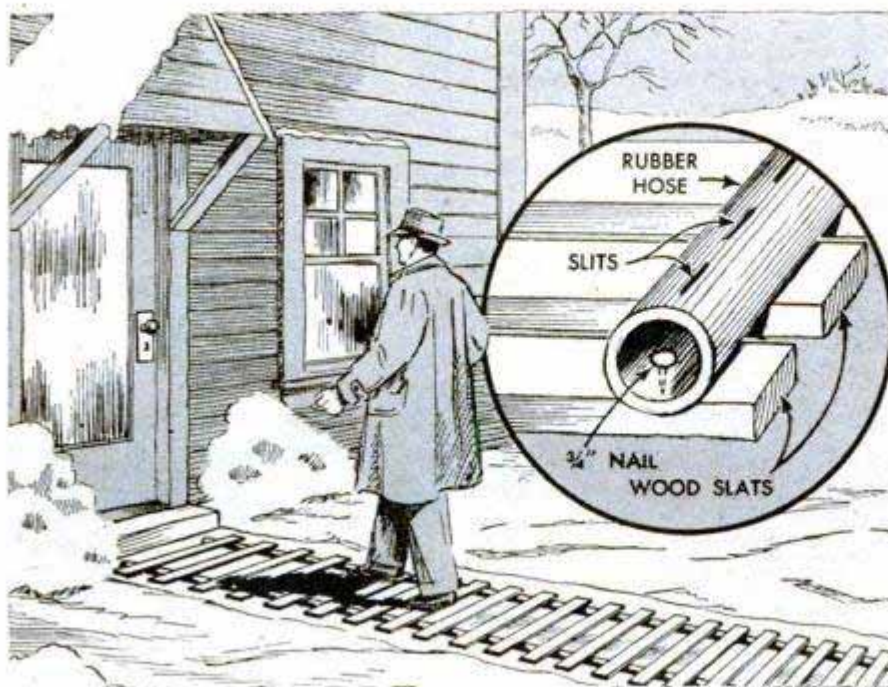

but not a thin layer of ice, before "laying" the walk. During the time when it is not in use it can be rolled up and stored. To make the tread, slits are cut in the hose and nails are driven through them into the slats, as indicated in the detail.

Keeping Fishing Hole Free of Ice

To retard freezing over of holes cut in the ice for fishing, pour enough glycerine or olive oil on the water to form a thin film. This will keep the holes open for some time.

Solving HOME PROBLEMS



Above, to wash vegetables and be sure that dirt is rinsed from them thoroughly, set an inverted wire dish rack in the sink and lay the vegetables on top. Then allow water from the faucet to run over them. A spray attachment will help you do a better job

Below, screen-door springs attached across the inside of kitchen-cabinet doors will hold pot covers and pie tins. Use a wooden cleat as a ledge to keep pie tins under spring



A screw-top jar with a slot in the cover as below, provides a handy "bank" in which to drop buttons when removing them from old garments, or when they come off while laundering

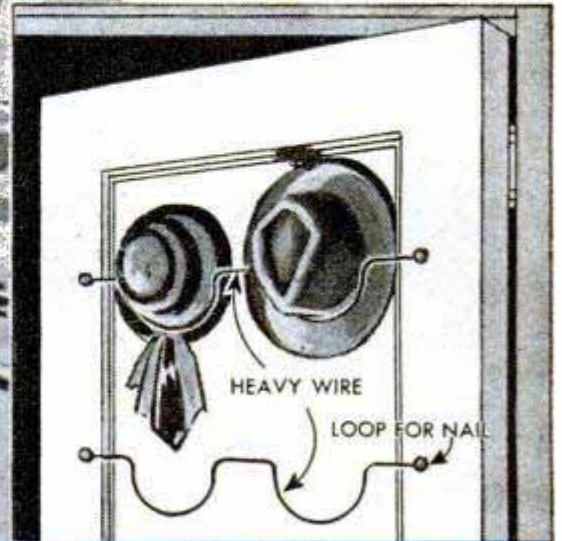

Racks formed from heavy wire and nailed across a paneled door as indicated above provide hat holders

Leave part of the top on a carrot for a grip as below, and it can be grated without injuring the fingers

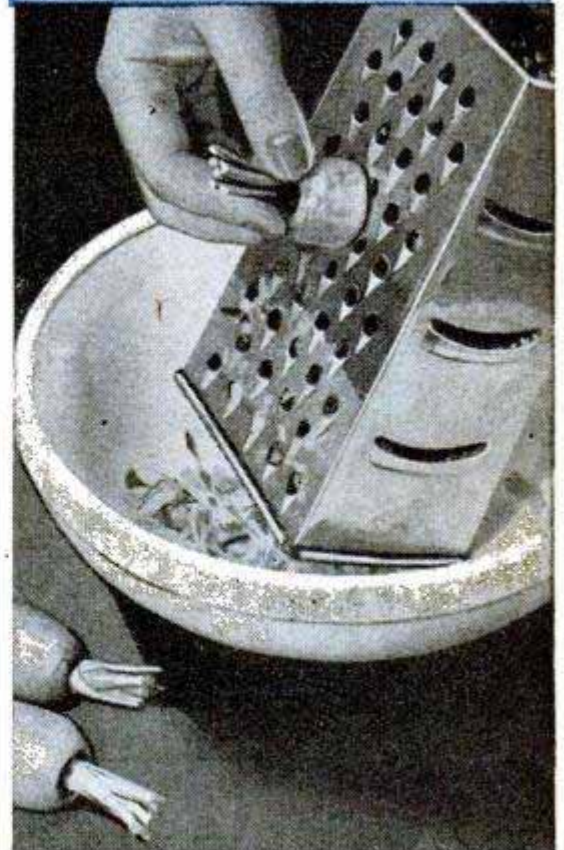

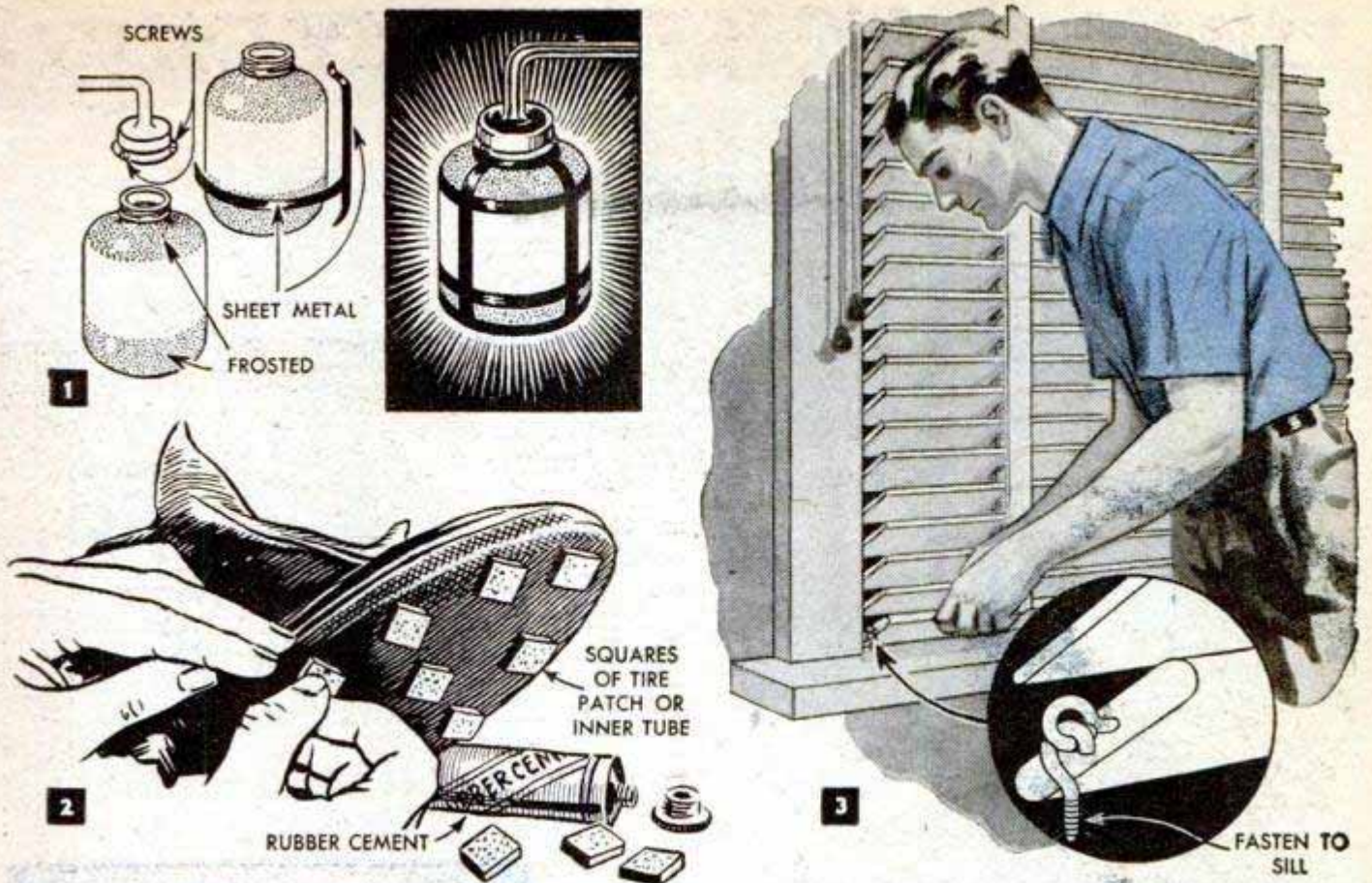

1. An attractive globe for an outside entrance light can be made from a wide-mouthed coffee jar having a frosted top and bottom and a clear band around the center. The jar will fit into globe holders of many types. For decoration, and also for protection from broken glass, add a guard of sheet metal strips riveted together

2. When the soles of a pair of rubbers or galoshes wear smooth so there is danger of slipping on ice or snow, "retread" them with pieces of rubber cut from a tire patch or inner tube. Cut the material into squares and, if using patching, apply by following directions on the container. If inner-tube rubber is used, rubber cement makes a good adhesive

3. Unless anchored in some manner, venetian blinds will rattle against the window frame if the window is open and there is a breeze. This can be eliminated if cup hooks are screwed into the sill and screw eyes are fastened to the ends of the bottom strips of the blind. Engage the hooks in the eyes and provide tension by raising the blind slightly

4. Adhesive tape will hold a metal patch in position on a sloping or curved surface while it is being soldered in place, thus leaving both hands free. Shape the metal patch to the curvature of the surface to be repaired, and then tape it in position. Tack-solder the patch, then remove the tape and complete the job. If adhesive from the tape adheres, remove it before applying the solder

5. During the winter, cold drafts are apt to leak through the space between the bottom of a door and the sill, causing uneven room temperatures and an increased heating bill. This will be prevented if a draft "stop" is used. It is made from a piece of fairly heavy cloth about 8 or 9 in. wide and as long as the width of the door. Sew a seam along the side and one end, leaving the other open. Fill with sawdust, loosely packed, and close the open end

Books Thumb-Indexed With File And Notched Boards

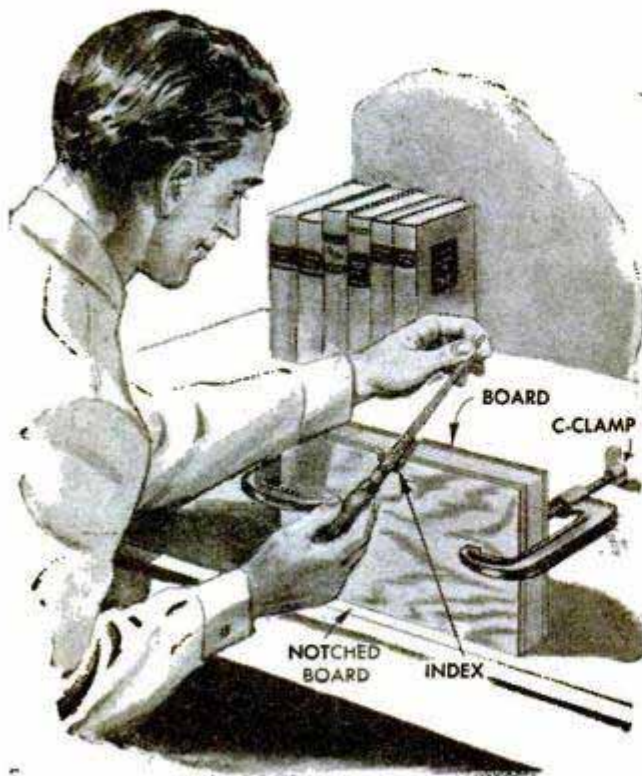

Thumb-indexing the pages of books to be bound or books already bound is a simple operation requiring two notched boards, a couple of C-clamps and a round file. The boards serve as clamping jaws and as a guide in filing. The notch in the facing board is cut half round to suit the size of the thumb index desired, while the notch in the rear board is cut somewhat smaller to produce a tapered notch in succeeding pages. The pages for each section are clamped together tightly and flush with the top edges of the two boards. Then the paper is filed down to the depth of the notches. Guide boards are shifted for each section, so the notching will be staggered. Remember that the final page of a section is not notched, as it has the index letter.

R. S. Martin, Iowa City, Ia.

Shoehorn Made of Scrap Plastic

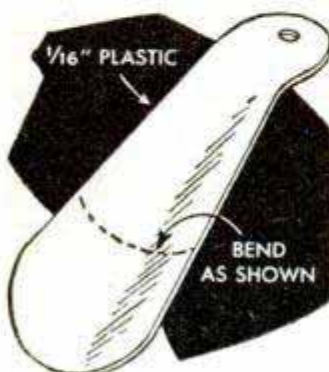

smooth the edges with fine sandpaper. Drill a hole in the top to hang the horn. Then heat the plastic to about 300 deg. F. in an

For the beginner working with plastics, here's a way to make a shoehorn by using a small piece of $\frac{1}{16}$ -in. plastic material. Cut the piece to the approximate shape shown in the drawing and

oven and bend as indicated by the dotted line. Shape the top to provide a grip.

Frank Shore, New York City.

Sectional Rack for Small Parts

This rack is ideal for the workbench because any particular tray can be swung within easy reach while the others are out of the way. The trays are hammered from sheet-metal disks, each one having a lip drilled for the $\frac{3}{8}$ -in. rod that serves as a standard. Spacers between trays are wooden spools. A pipe flange into which the standard is screwed serves as a base.

Fred Strickland, Portland, Ore.

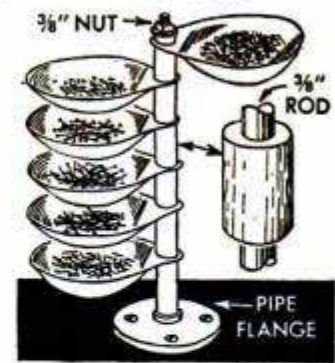

Long-Nosed Pliers Useful in Kitchen

Keep a pair of long-nosed pliers in the kitchen drawer as a utility tool. Among the uses for the pliers are: Removing pin feathers from a chicken, lifting hot pads from a stove, pulling out skewers and opening cans that require key openers.

W. S. Head, El Cajon, Calif.

Steering-Wheel Spinner on Handle Speeds Vise Operation

If a steering-wheel spinner is attached near one end of a vise handle, opening and closing the vise will be easy and quick. The spinner is especially convenient when setting and adjusting work because the knob can be located without removing your eyes from the work in the vise. To keep the spinner clamp from slipping, wrap friction tape around the handle where the clamp is fastened.

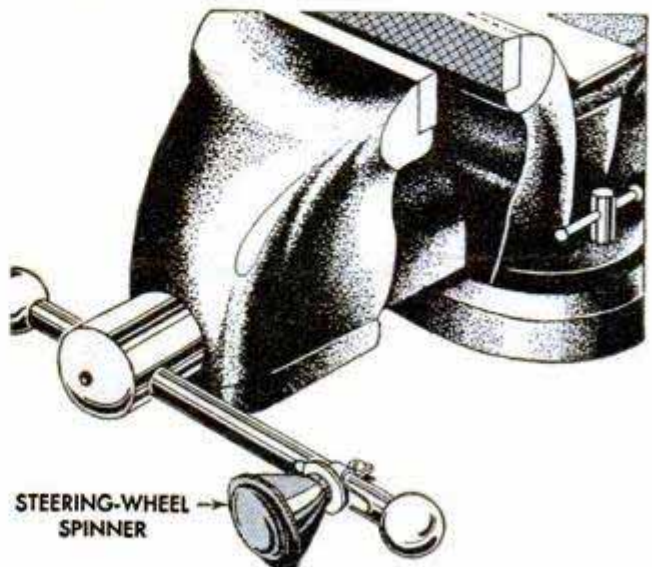

POPULAR MECHANICS

'Painting' With DYED FEATHERS

By Elma Waltner

"PAINTING" pictures with feathers is merely the trick of arranging dyed feathers over the traced outline of some familiar object, such as a bird or bouquet of flowers. Start with white feathers, preferably chicken feathers plucked from the breast or back. Do not use wing or tail feathers with heavy, stiff spines. Wash feathers in mild soapsuds and warm water to remove the natural oil. Rinse thoroughly.

Ordinary fabric dyes are used. Follow the dye manufacturer's directions as to quantities and methods of preparation. Feathers usually dye best if dipped when wet. Right after rinsing is the time to dip so have the dye ready then. Dip the whole feather so that the color "takes" uniformly. Place on newspapers to dry, taking care that the feathers are not curled when laid on the paper.

Details below give crosshatched outlines and key the colors of the feathers used in making the bouquet and bird pictures shown in the photos at the right. Notice in the details that the flower petals and leaves are made by gluing the colored feathers over the outlines. However, the vase is painted directly on the paper using either blue water colors or artists' oil colors. Likewise, in the bird picture the lilies, pads, and the body, head and tail of the bird, and the heads and leaves of the cattails are made by gluing the colored feathers over the outlines. Balance of the details are filled in with water colors. Pictures are framed under glass in ordinary picture frames which can be hung on the wall or made into attractive serving trays by gluing handles to the frames as indicated in the lower photo. Short lengths of dowel in various sizes make attractive handles.

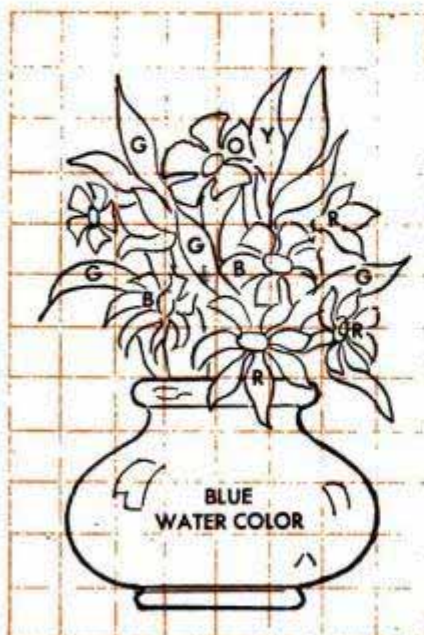

COLOR GUIDE

- A—AQUA
- B—BLUE
- BR—BROWN
- G—GREEN
- O—ORANGE
- R—RED
- V—VIOLET
- Y—YELLOW



Reprinted What to Make 44
 Also Toys You Can Make

"Jeepers"

By Anthony W. Mentells
 658 E. Chesterfield
 Mendota 20
 Mich.

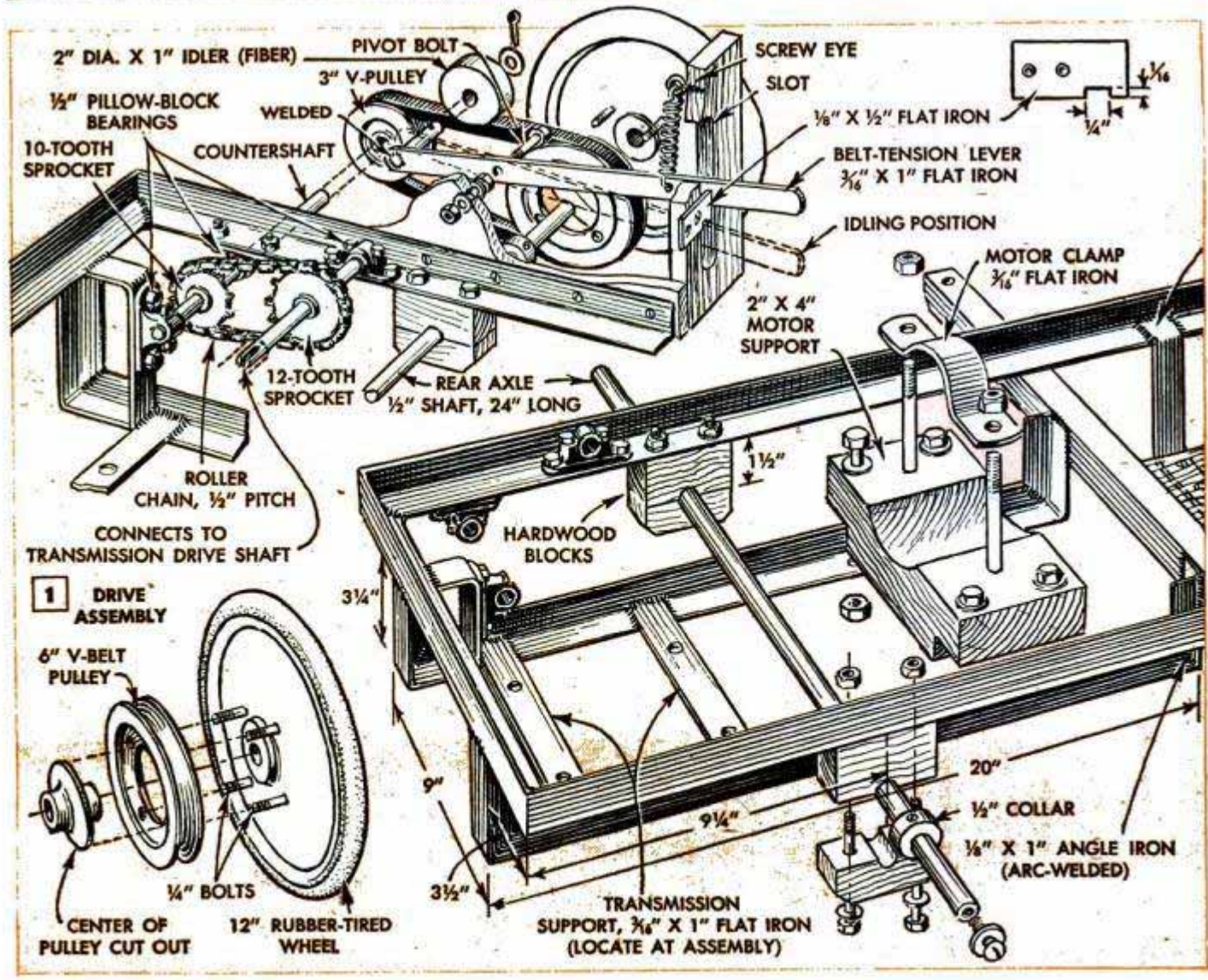
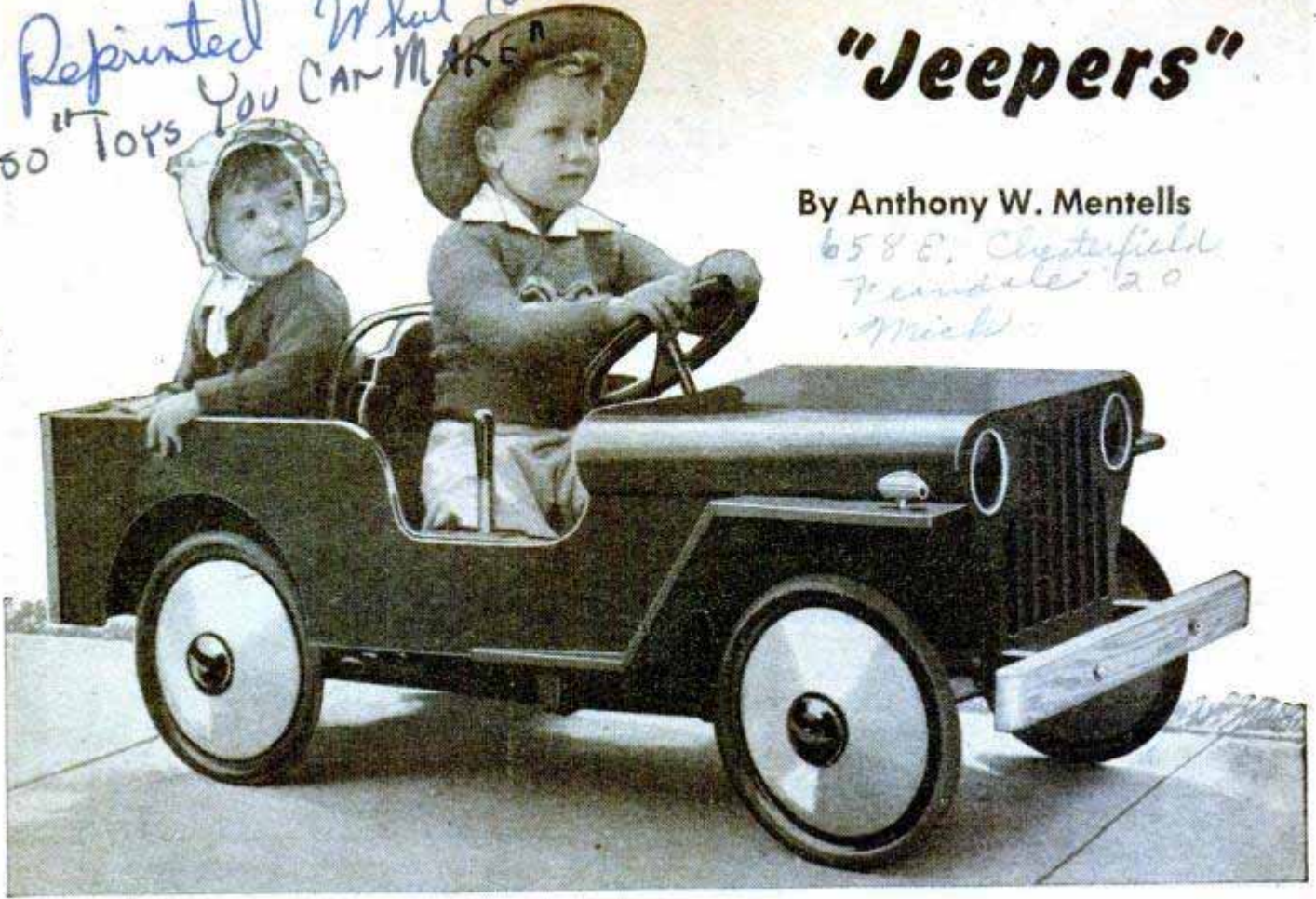

a Sidewalk JEEP

Powered by an auto-starting motor, it's just the right size for sidewalk use. Without motor, it's an ideal coaster or pusher

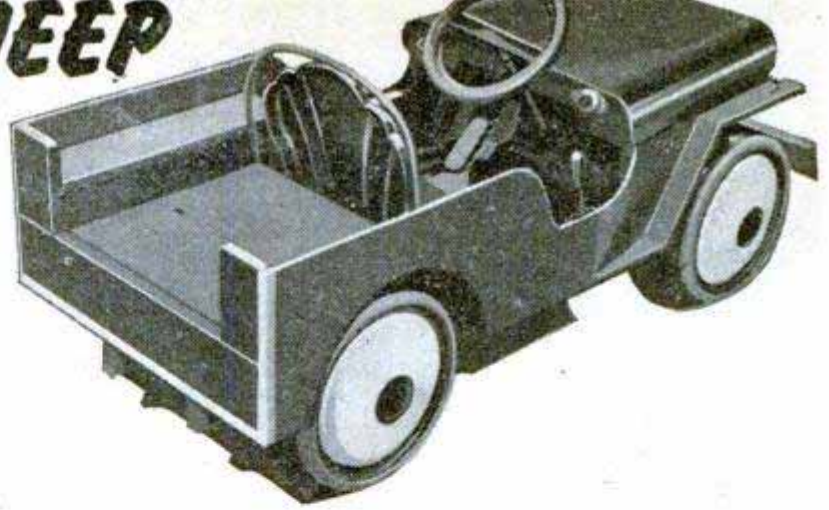

THERE are happy playdays in store for lively youngsters when dad decides to build this sidewalk jeep. "Jeepers" looks and runs very much like the real thing, and by using second-hand parts it can be built for less than \$50. Special features are auto-type steering gear, auto-starting-motor drive through a hydraulic transmission, and electrically welded angle-iron frame.

Start with the frame detailed in Fig. 2. Care should be taken to get the three cross members at the front spaced according to the dimensions given. In assembly, the front axle is mounted on wooden blocks, or pads, while the rear axle is supported in split hardwood blocks bolted to the side frame members. The latter are offset 2 in.

on each side, giving a front width of 12 in. and a rear width of 16 in. Floor boards and the transmission and starting-motor mountings are carried on underslung supports, or cradles, as shown in Fig. 2. Fig. 3 details the construction of the auto-type front axle. Wheel spindles are turned from 1-in. square cold-rolled steel. Steering arms are welded to the square section of the spindle, which is drilled at the center of the square section for a $\frac{3}{8}$ -in. kingbolt. Note that when assembled, the axle is set

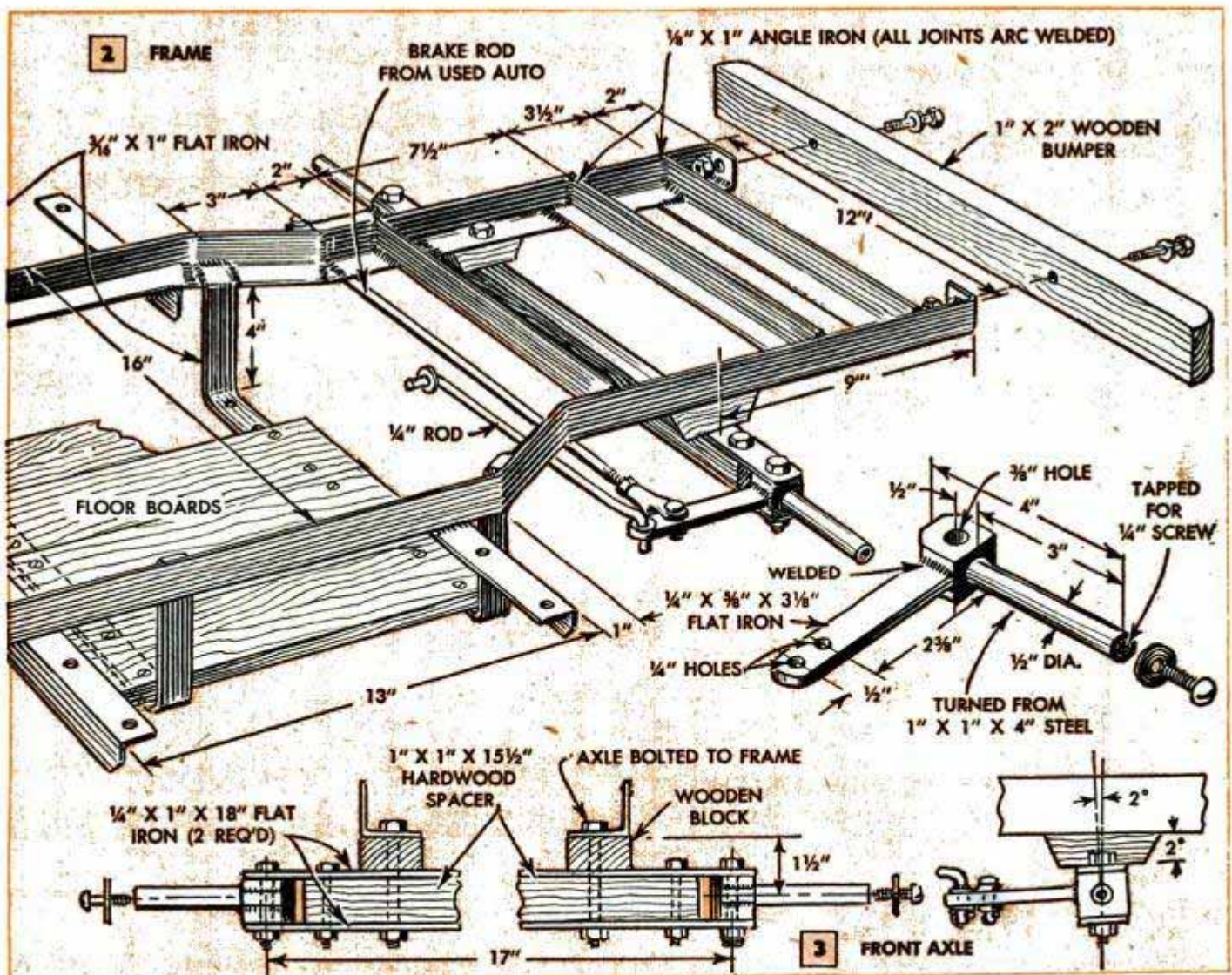

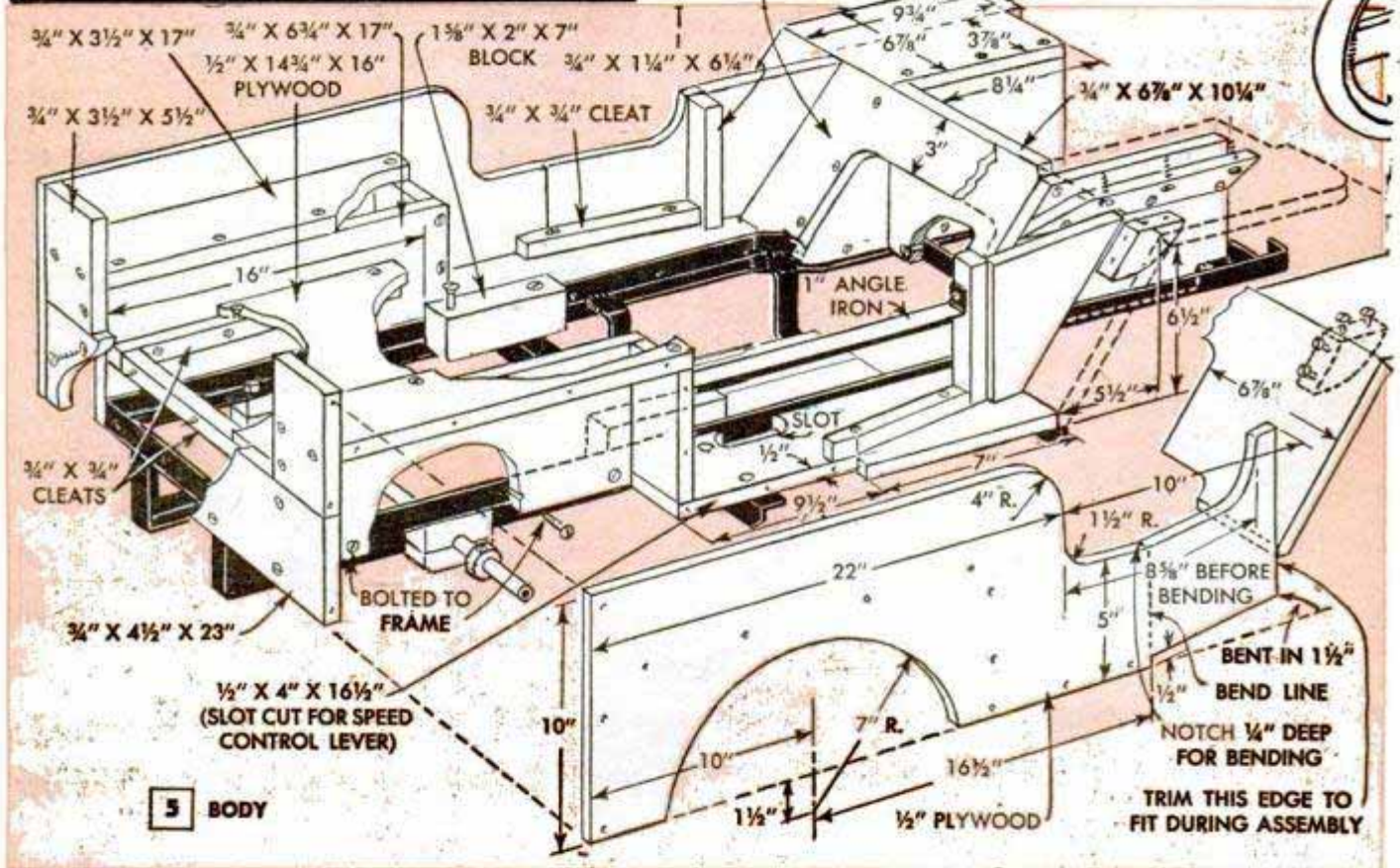
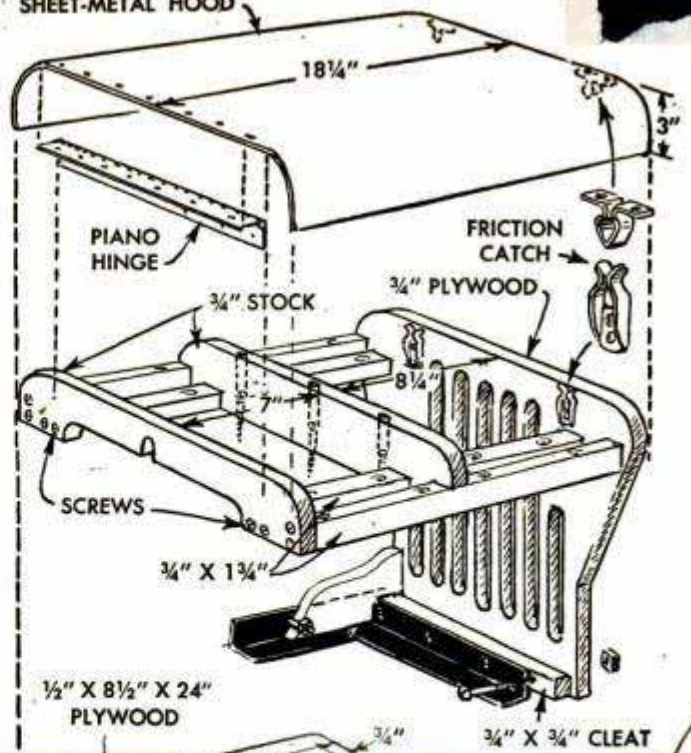
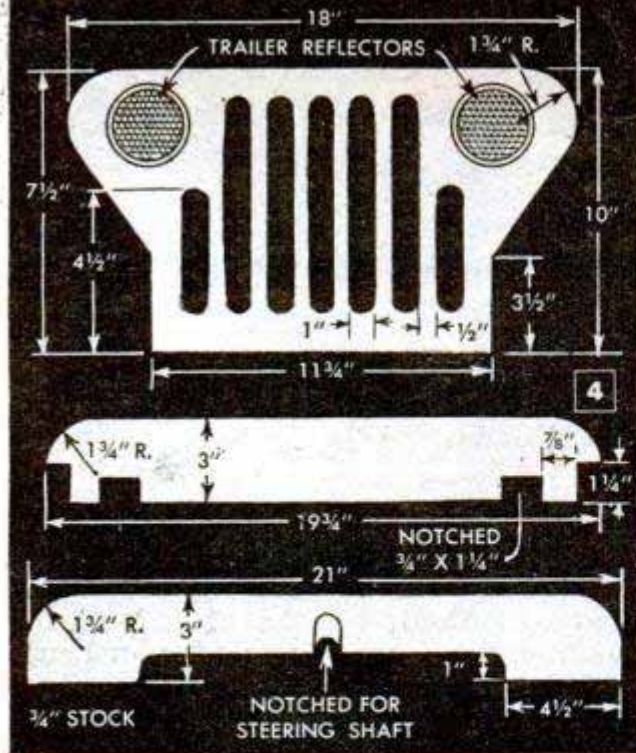

to a 2-deg. caster to make steering easier. The countershaft, Fig. 1, runs in pillow-block bearings and carries a 10-tooth sprocket for 1/2-in. pitch roller chain. Drive from the transmission is through a 12-tooth sprocket to the countershaft as detailed in Fig. 1. Outboard end of the transmission-shaft extension is carried in a pillow-block bearing bolted to the frame. Although not shown, a shaft collar may be required between the bearing and the sprocket to prevent end play of the extension shaft due

to the pin-coupling drive. Drive from the countershaft to the rear wheel is through a short 1/2-in. V-belt and pulleys as detailed in the upper view, Fig. 1. A V-pulley is attached to the left rear wheel as in the lower detail, Fig. 1. A lever-controlled idler rides the slack side of the V-belt and, when in driving position, places sufficient tension on the belt to transmit power from the countershaft to the rear wheel. Only the wheels rotate, the rear axle does not turn. When the controlling lever is placed in the

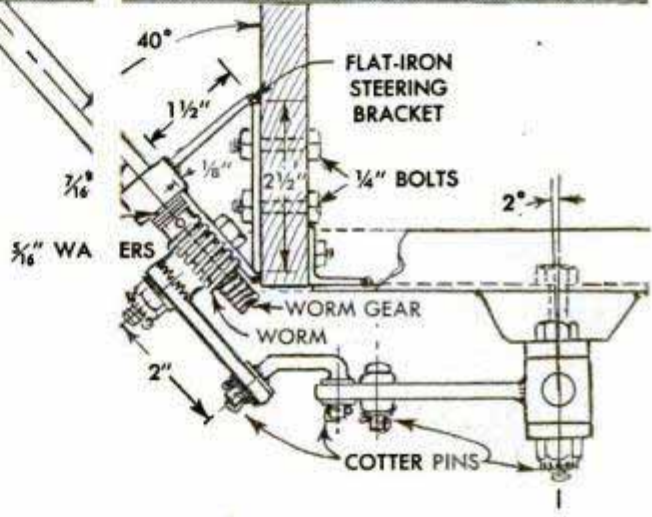
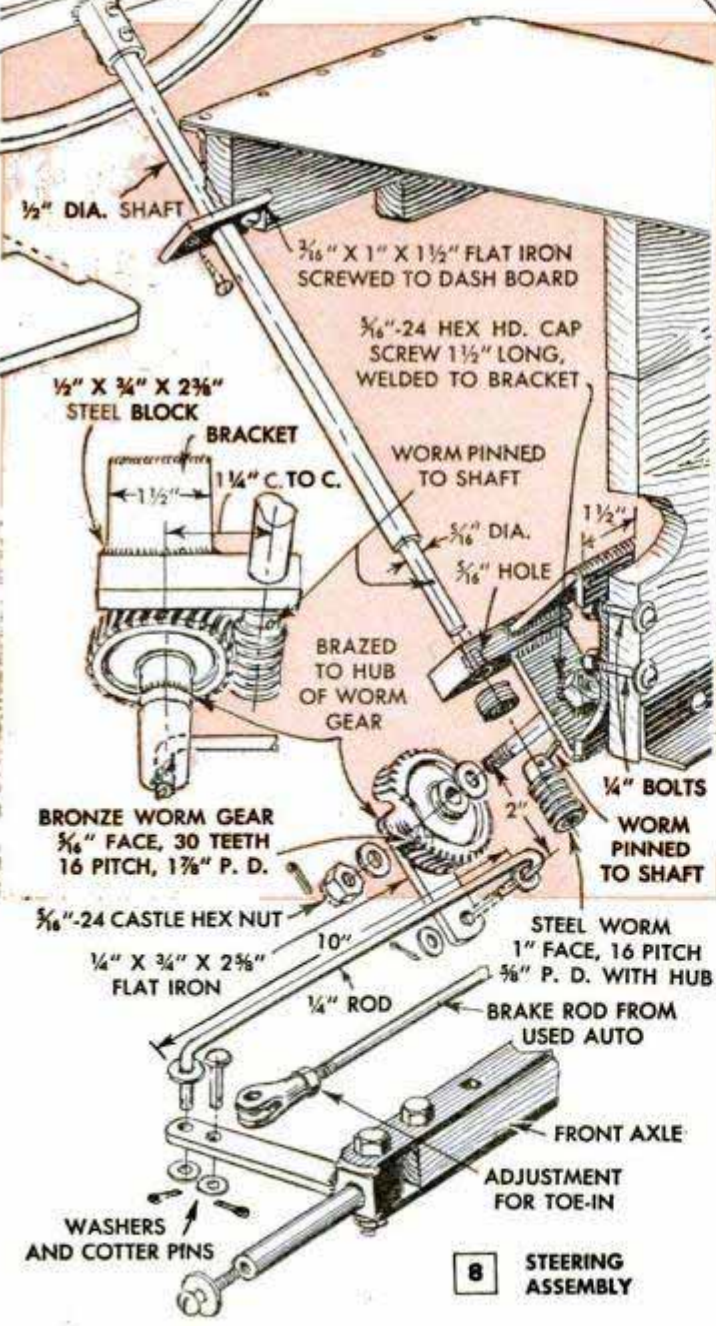
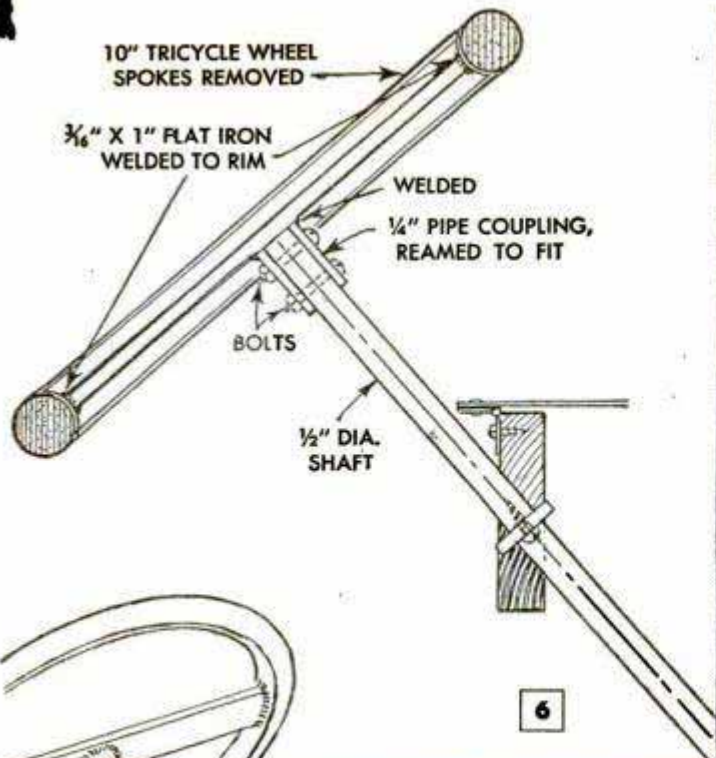

idling position, tension on the belt is released and the jeep can be pushed about easily as the belt is sufficiently slack to slip on the countershaft pulley.

The body is detailed in Fig. 5. All parts are joined with screws and glue. It will help if you study the top and bottom view of the parts. Wheel-well covers form side seats for extra passengers in the rear compartment. Hood frames and the grille are detailed in Fig. 4. The hood is formed from sheet metal with opposite edges rolled to a 1 3/4-inch radius. Note that the hood is attached to the "instrument" panel with a continuous hinge. Friction catches of the type used on cabinet doors hold the forward end closed and keep the whole thing from rattling. A metal ventilator grille of the liver type used in window ventilators is attached to the back of the grille, and trail "caution" reflectors are mortised into the front side of the grille to simulate light. As will be seen from Figs. 7 and 9

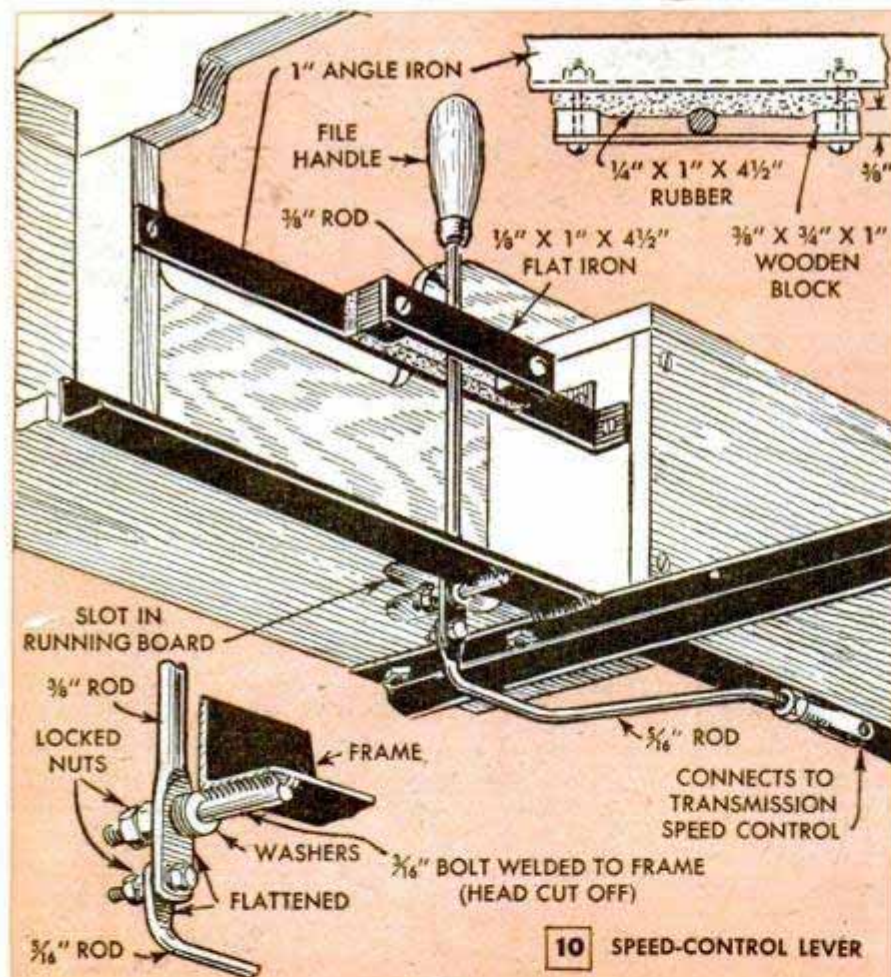
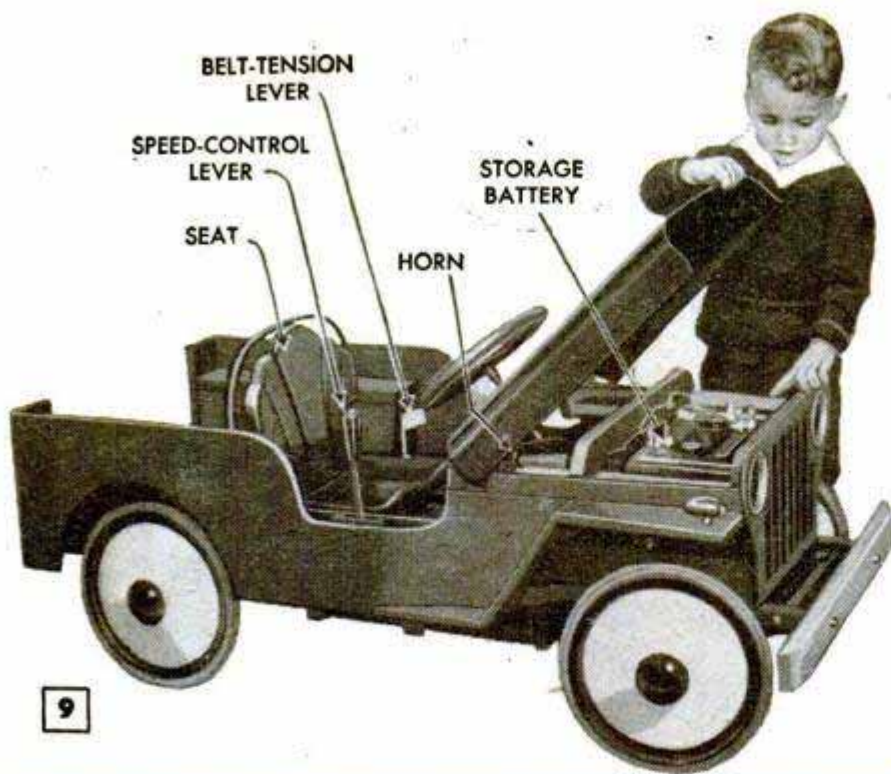

a part of the space under the hood is partitioned and floored to form a compartment for the storage battery. Use a 6-volt auto-type storage battery of 100-ampere-hour output rating.

Complete details on the installation of the steering gear are given in Figs. 6 and 8. The worm-gear assembly is mounted on a triangular bracket formed from three

pieces of flat iron and bolted to the dash panel. A steel block welded to the outer ends of the bracket side pieces is drilled to form a bearing for the lower end of the steering shaft and worm gear, Fig. 8. A piece of flat iron mortised into the bottom of the instrument panel at an angle forms the upper bearing for the shaft. A steering arm is brazed to the hub of the worm gear. A hex-headed cap screw welded to the supporting bracket forms the shaft for the gear, and a pinned castle nut and washer hold it securely. Steering tie rod is made from a discarded auto brake rod, the adjustable yoke on the rod providing a means of adjusting the front wheels for toe-in. Steering wheel is a tricycle wheel with spokes and hub removed and a piece of flat iron welded across the rim. This is bolted to the steering shaft as in Fig. 6.

Next, the speed-control lever is mounted on the right side of the driver's seat as in Fig. 10. The hydraulic transmission, shown in place in Figs. 11 and 12 and obtainable with bronze spline shafts as war surplus, is of the type that was used to drive tank turrets and is very sensitive and smooth in operation. It is mounted on the underslung cradle in such a position that the drive-shaft extension aligns with the pillow-block bearing bolted to the main frame, Fig. 2. The auto-starting motor is clamped into a saddle made from a hard-

wood block. Care must be taken to get this block cut to the correct size so that the starting-motor shaft aligns with the drive shaft on the transmission. Drive from starting motor to transmission is through a conventional flexible coupling. Starting motor should be in good condition. Clean the commutator and brushes before installing. An ordinary auto-starting switch with

pedal is installed under the dash, as in Figs. 11 and 12, to control the motor. Install cable from battery to motor and to the starting switch. Ground from battery to the jeep frame in the conventional way. When the drive is completely installed connect the control-lever rod to the speed-control arm on the transmission. Slight movements of the control lever give forward and reverse speeds.

The wheels shown have solid-rubber tires. Somewhat easier riding qualities and still more realistic appearance can be had by fitting pneumatic-tired wheels, although these will be more expensive. The seat and back from a child's lawn chair make a good driver's seat. Or, you can make one of the bucket type, the back being rolled from sheet metal. Weld a length of $\frac{3}{16}$ -in. metal rod to the edge of the back and finish smooth. Bottom of the seat can be cut from pine and upholstered in imitation leather. All wooden parts of the body should be sanded thoroughly and the corners and edges of the parts rounded and sanded smooth preparatory to finishing. Apply a sealer coat to the wood first, then finish with two coats of enamel or lacquer, preferably sprayed, for a professional-appearing job. The name "Jeepers" can be stenciled or hand lettered on the side of the hood, or across the bumper.

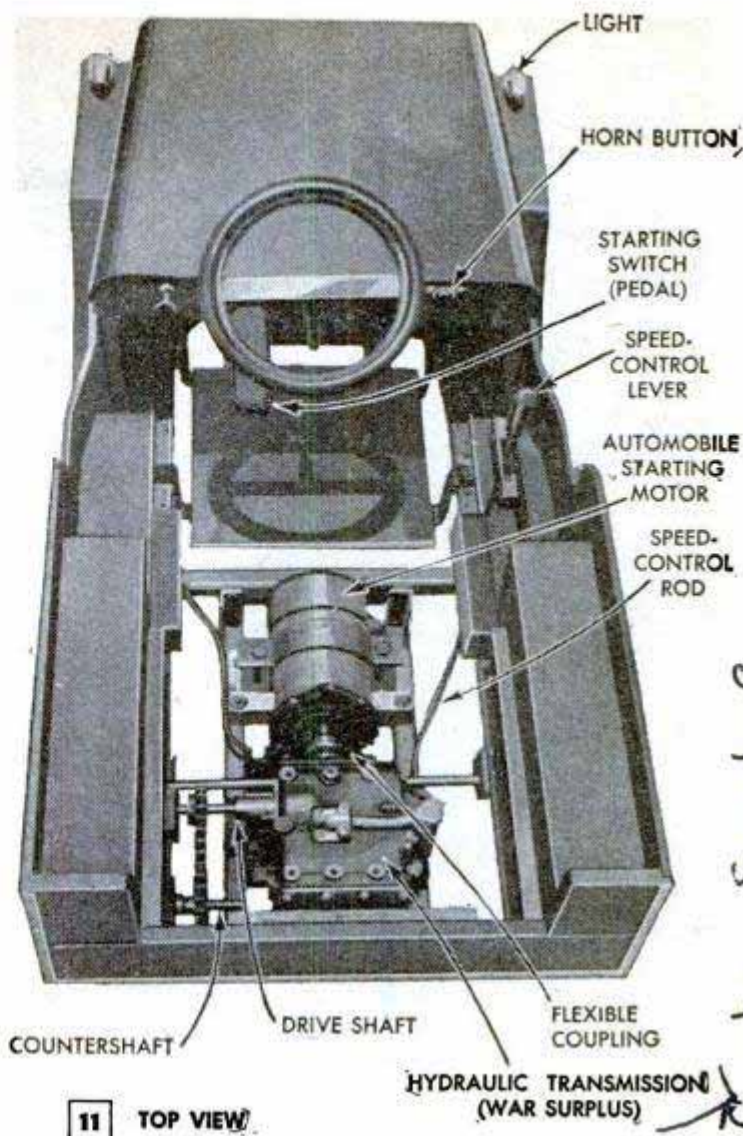

Groban Supply Co
1507 S. Michigan
Chicago, Ill.

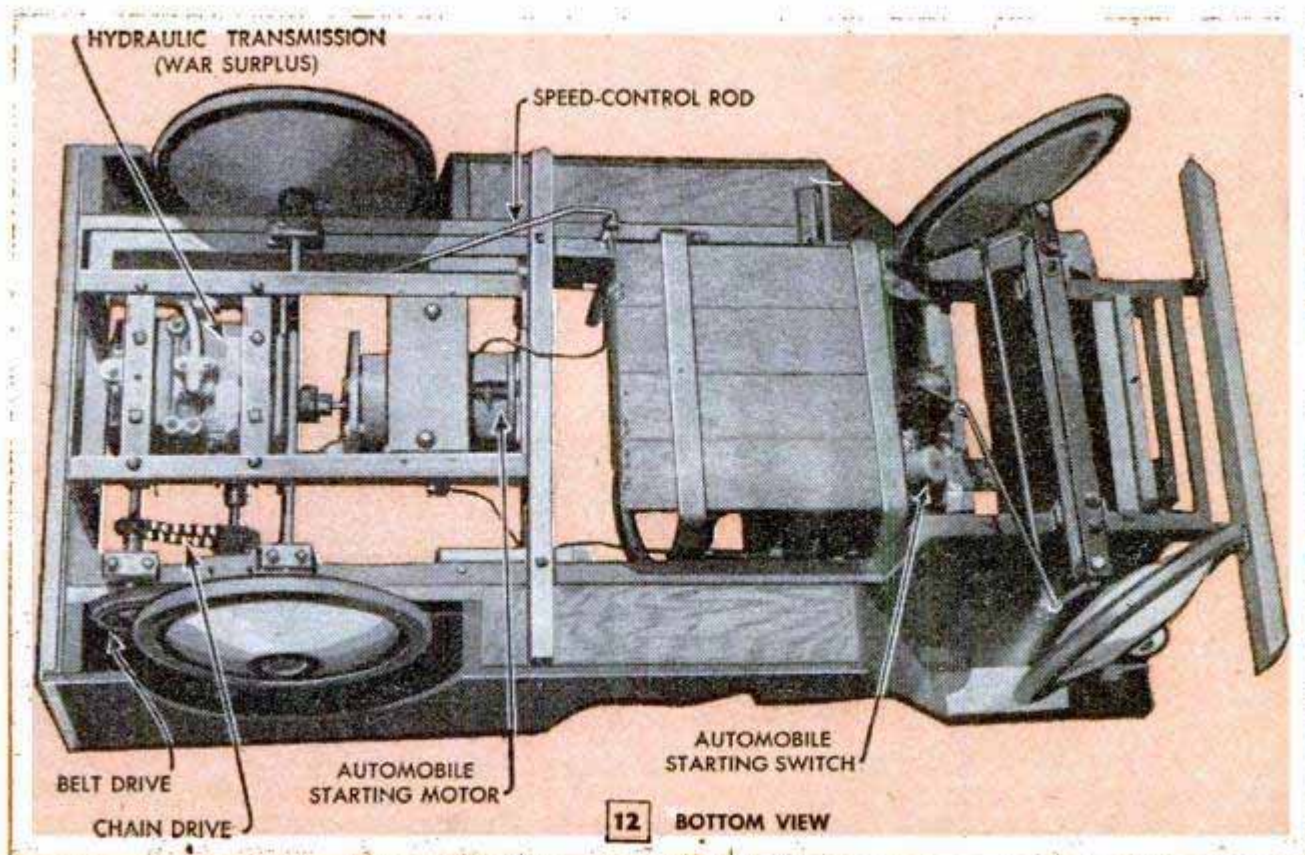

Pillow Slip Protects Fine Garments In Washing Machine



It is not necessary to wash silks and other fine garments by hand to guard against the damage they sometimes suffer when laundered in the washing machine along with other clothing. Simply place several of the garments in a pillow slip and pin or tie the open end. Garments may be removed from the slip and run through the wringer separately or may be wrung dry by hand.

False-Front Chest of Drawers Conceals Writing Desk

If there's an old chest of drawers around the house, it can be made into a writing-desk-and-chair unit that's ideal for a child's room or in some other place where

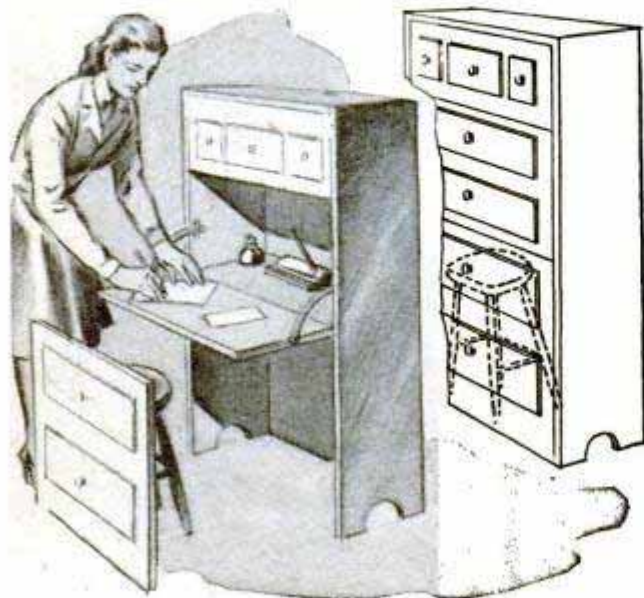

the appearance of the desk is not too important. As the illustration shows, the drawer fronts are removed and mounted on several panels, one folding down to serve as a writing surface while the other has a chair fastened to it. The top drawers are used for papers and writing supplies.

Easy Way to Thread a Needle

To thread a needle easily, hold the eye against a white background so that both it and the thread can be seen clearly. This works especially well when using dark thread. The same principle can be applied when threading a sewing machine if a piece of white paper is held behind the needle.

Margaret Tatroe, Edmonton, Alta., Can.

Oilcloth Pockets on High Chair Hold Infant's Accessories

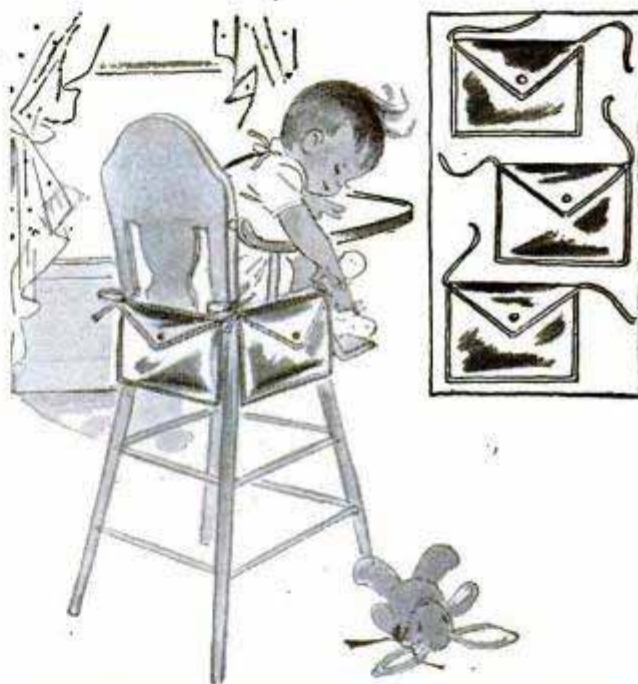

Pockets or envelopes made of oilcloth and fitted with tie strings can be attached to an infant's high chair to hold such necessities as a bib, silverware, etc. The pockets are tied to the chair at seat level. It's a good idea to provide the pockets with snap fasteners to keep the baby from getting into them.

Polishing Transparent Plastics

Try an abrasive cleaner of the type used on auto bodies to give a bright sheen to objects made of transparent plastic materials. Apply the cleaner as you would a polishing compound, using a paper dustcloth folded two or three thicknesses to form a soft, resilient pad. This combination will impart a brilliant luster to the plastic surface.

Dorothy E. Kilmer, Gloversville, N. Y.

MAKE WEAVING

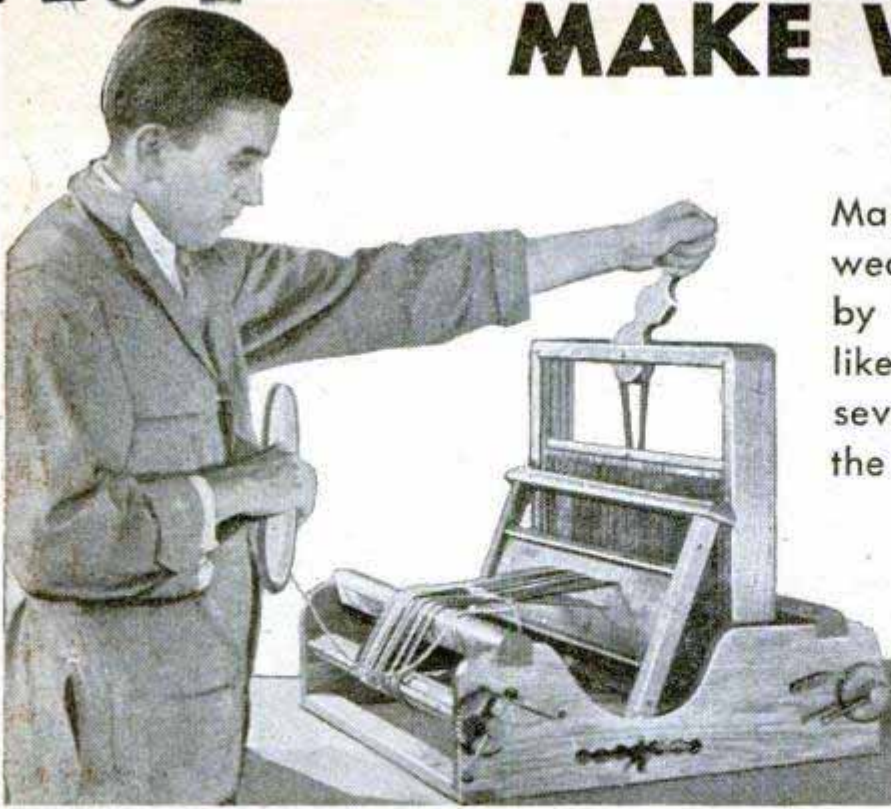

Many people have made weaving a profitable hobby with table-top looms like this one, which has several features to make the work easier and faster

By
Stanley J. Dragek

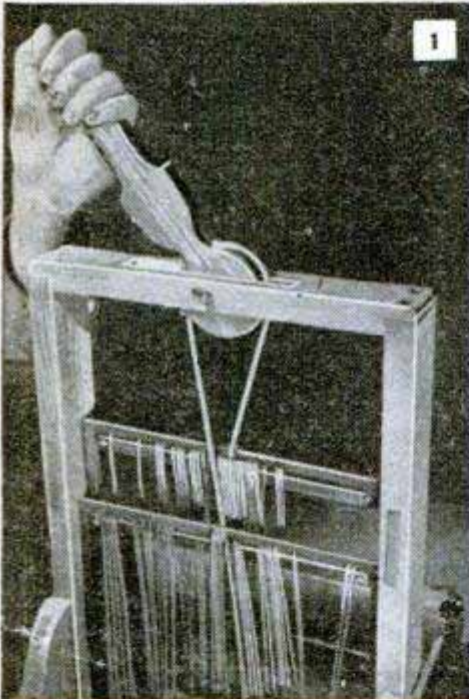

WEAVING scarves, table runners, scatter rugs in varied colors and similar articles is not only an interesting pastime for long winter evenings, but it also can be developed into a profitable hobby. Once you have mastered the technique with a little practice, you will be able to produce woven articles that will find ready sale at a good price.

With the loom pictured above, you can produce many salable articles. It consists of a frame which supports such moving parts as the warp and whip beams, heddles and frames, a reed or beater and a shuttle, the latter being a separate part which is manipulated by hand. The shuttle carries the weft thread through the shed, a triangular space between the warp threads which is made by shifting the heddles after each stroke, or pass, of the shuttle. The beater or reed, hand-operated on small looms, is pivoted to the frame of the loom and is for the purpose of beating the weft thread into the warp after the shuttle has passed through the shed. The table loom detailed in Fig. 4,

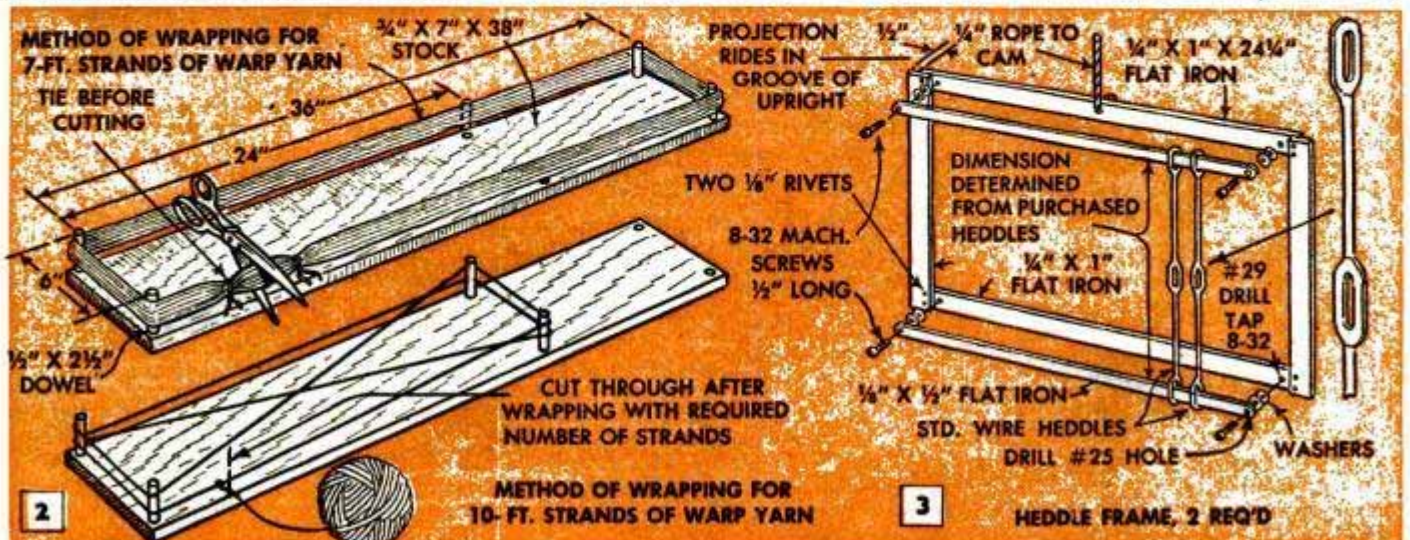

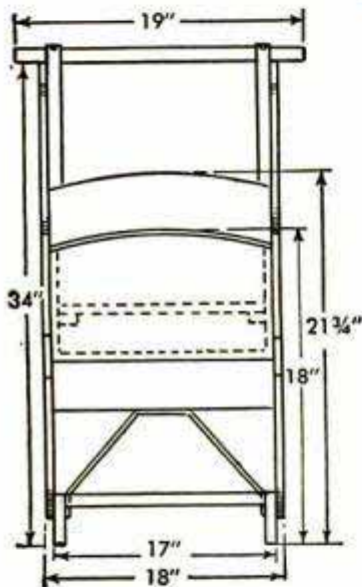
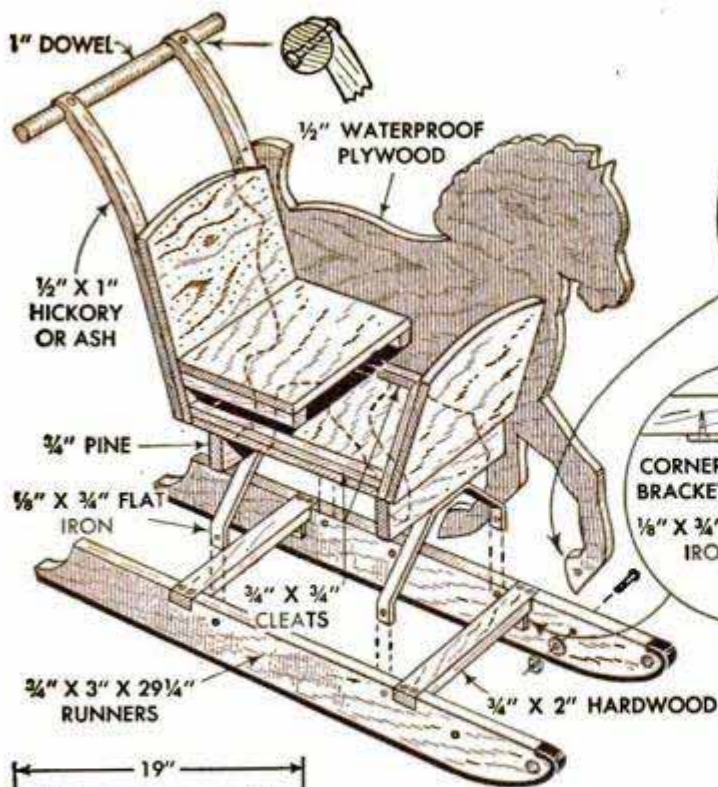

PONY SLEIGH

Any small child will be happy riding between these prancing ponies that are "harnessed" with jingling sleigh bells. A feature of the sleigh is that the seat is high enough so a child can be lifted in or out without having to bend over. Method of assembly, dimensions and materials are given in the detail and the pattern for sawing the ponies is shown on the crosshatched drawing. The hickory or ash handles are steamed and bent to shape. Finish the sleigh in bright colors.

Hi Sibley, Nuevo, Calif.

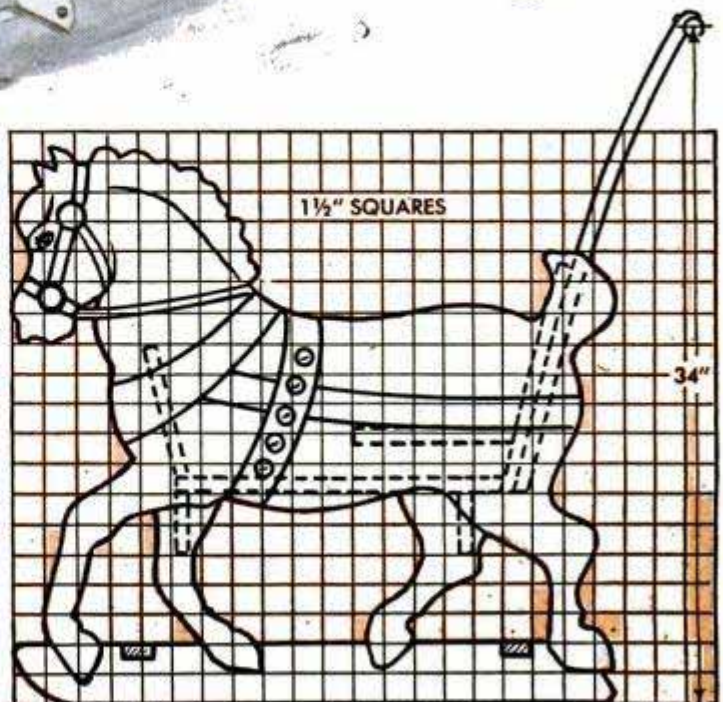

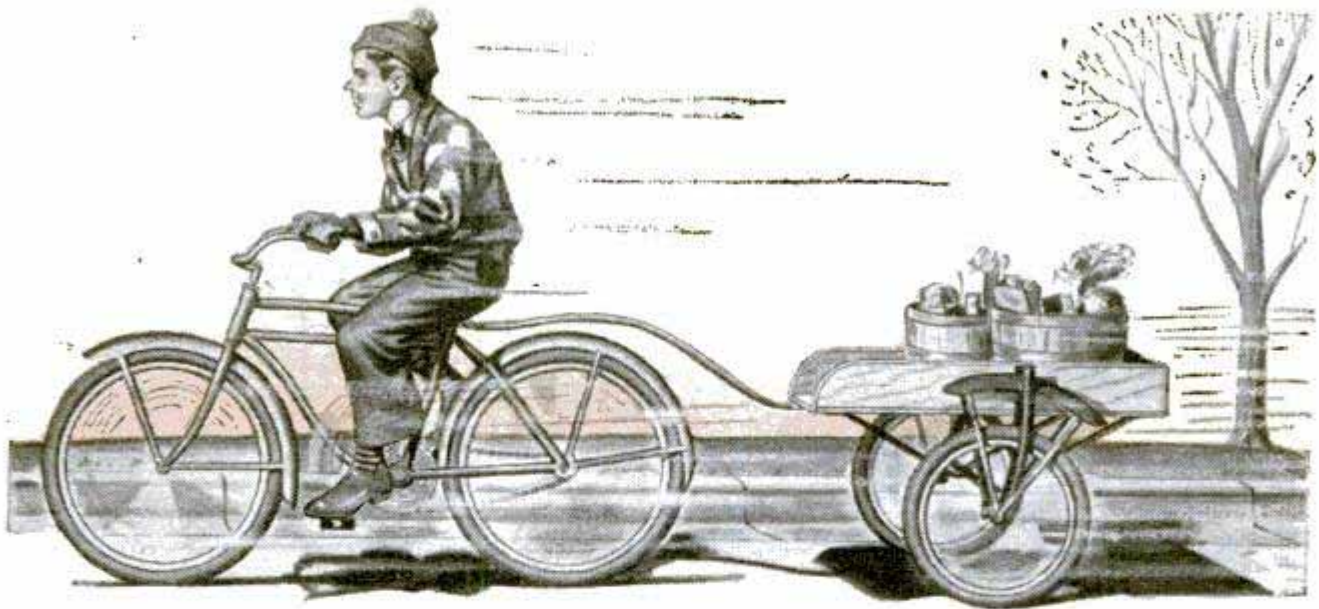

BICYCLE PICK-UP TRAILER

With a "pay load" capacity of about 300 lbs., this bicycle trailer is a welcome piece of equipment for light-delivery work. When not used for commercial purposes, it is handy to transport equipment on a camping trip or, if fitted with a removable seat, it can be used to carry an extra passenger. The bed of the trailer body is made of $\frac{1}{2}$ -in. outdoor plywood, and the three side pieces are of $\frac{3}{4}$ -in. solid material. Glue-and-screw construction is used. Mounting the flat-iron chassis and the bi-

cycle front-wheel forks and wheels comes next. They must be aligned so the wheel spindles will fit the holes drilled for them in the chassis. This is determined by trial. Before finally bolting the parts in place, be sure the fit and balance are correct. Sections cut from wide-type fenders are used as mud guards, and they are braced at each end with regular fender brackets. Construction of the trailer hitch is given in the detail. Note that it pivots to allow for movement between the bicycle and trailer.

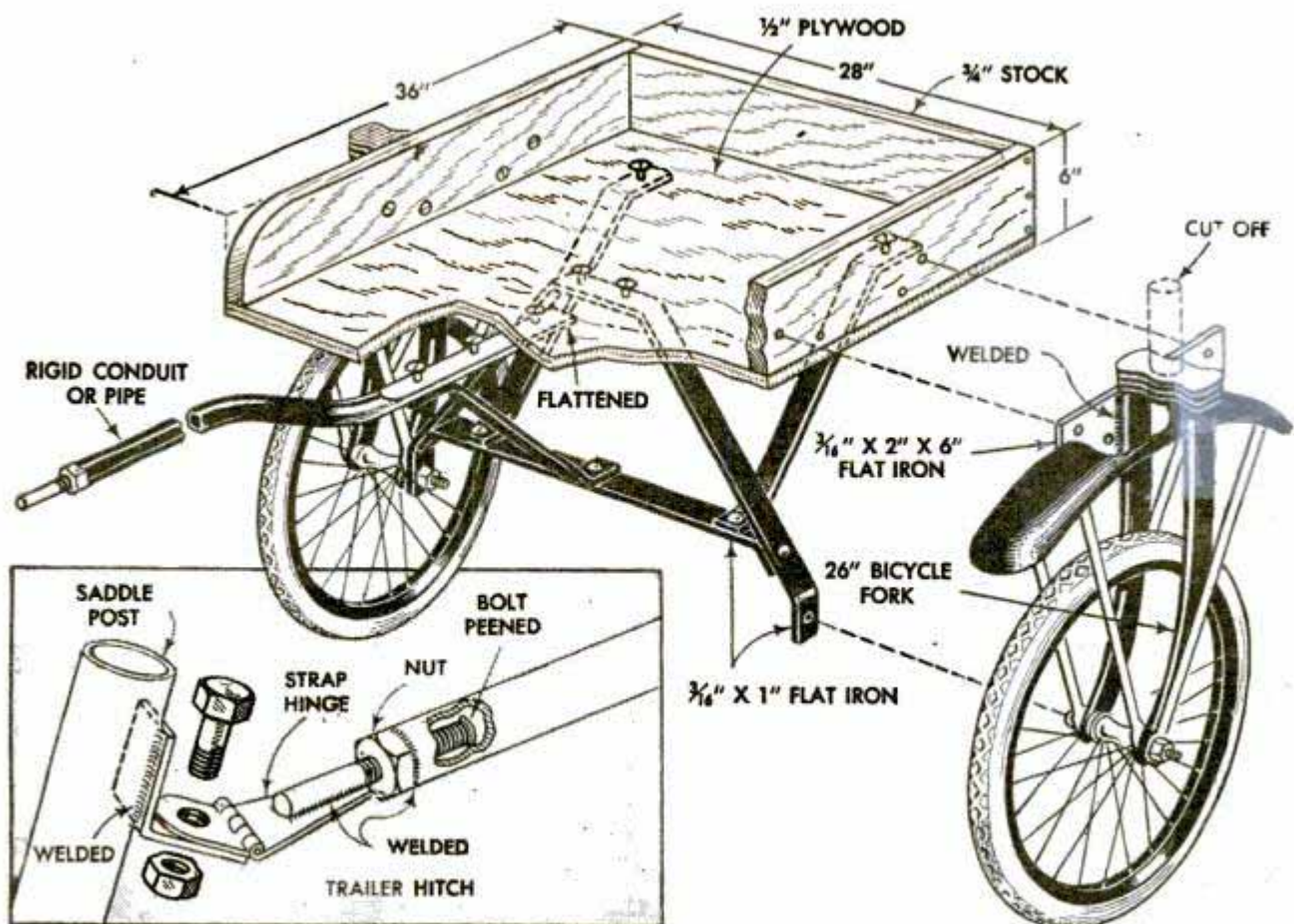

Vibration Dampeners for Power Tool Made From Rubber Heels



Small bench machines sometimes set up annoying vibrations when operated on individual floor stands. A good way to remedy this is to cut rectangular sections from ordinary rubber heels and bolt them to the legs of the stand, two sections, or blocks, to each leg as shown. The lower ends of the rubber blocks should project $\frac{1}{4}$ in. or more below the end of the leg. Dampeners made in this way not only quiet the machine effectively, but retard any tendency of the stand to creep while the machine is in operation.

J. A. Richards, Saco, Maine.

Mending a Broken Leather Strap

Without using rivets or thread, a broken leather strap can be repaired in the manner shown. The two ends are trimmed to

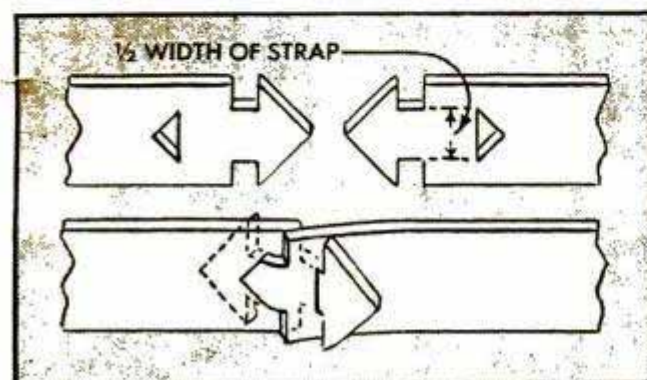

the shape of an arrowhead, and triangular pieces are cut out where indicated. Interlocking the ends completes the repair.

Masking Tape Prevents Splintering When Sawing Plywood

One way to keep plywood from splintering when making a crosscut is to wrap a strip of masking tape around the board just inside the cutting line.

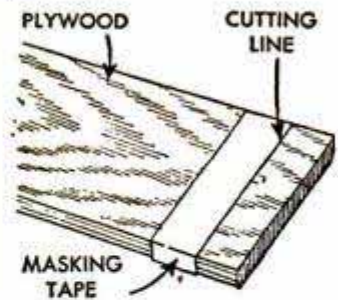

Best results are obtained if several layers of tape are used. If you want to keep both cut ends from splintering, wrap tape on both sides of the cutting line.—Opie Read, Jr., Chicago.

Pencil Lubricates Bolt Threads

Providing an easy-to-carry lubricant, the lead in a carpenter's pencil, applied to bolt threads, will cover them with a lubricating coating of graphite.

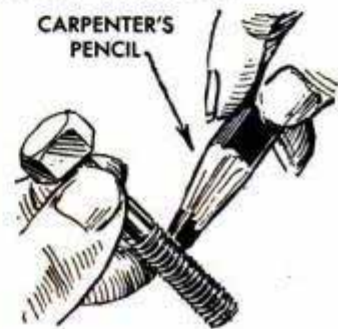

Be sure that the lead is rubbed thoroughly into the threads because graphite does not adhere as readily as a liquid lubricant. China marking pencils, which contain wax, can be used also.

Repairing Crack in Distributor Cap

A common source of ignition trouble that will cause an auto engine to misfire or fire erratically is a cracked distributor cap. This is because high-tension current follows the crack and jumps from one lead to another,

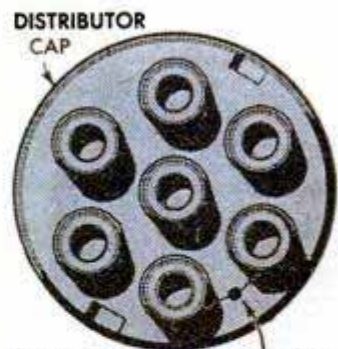

resulting in short circuits. This may occur when you are miles from a garage where a new cap cannot be obtained. However, if you have a pocket knife, it is possible to make a temporary repair that will work until you can get a new cap. Simply cut a hole in the center of the crack and then close the hole either with a wooden or rubber plug. The plug acts as an insulator.

YOUR HOBBY

has two new features which make operation easier and faster. The heddles are shifted by a cam arrangement mounted on the top cross member of the frame and operated as in Fig. 1. Second important feature is the adjustable beater pivot detailed in Fig. 4. This adjustment gives five different positions of the beater pivot and enables the weaver to keep the reed always at 90 deg. with the cloth for more uniform work. A cloth beam fitted with a removable spline, Figs. 4 and 7, makes it unnecessary to tie knots in the warp threads when stringing the loom preparatory to weaving.

Before starting assembly, determine the size of the loom from the maximum width of cloth you desire to weave, keeping in mind, of course, the size limitations of the table-top type. As an example, the loom detailed in Fig. 4 is designed for a cloth width of 24 in. A smaller size also can be made with an over-all width of 16 in. for a cloth width of 12 in. This size is especially suited to weaving table runners, scarves, etc. Hardwood

TEXTILE TERMINOLOGY

WARP BEAM: The roller of a loom upon which the warp is wound.

HEDDLES: Vertically held parallel wires having an eye in the center through which the warp is drawn.

WARP: Threads that pass through heddles and reed.

SHED: Space between warp when heddles are raised or lowered.

WEFT (WOOF): Threads or yarn interlacing the warp at right angles.

SHUTTLE: An instrument upon which weft is wound for passing through warp shed while weaving.

REED (BEATER): A device to comb or beat the weft between the strands of the warp.

HOWARD BROS. MFG. CO.
Worcester, MASS.

WATSON-WILLIAMS MFG. CO.
LEICESTER, MASS.

STEEL HEDDLE MFG. CO.
2110 W. ALLEGHENY AVE.
PHILADELPHIA, PA.

FOR HEDDLES, ETC.

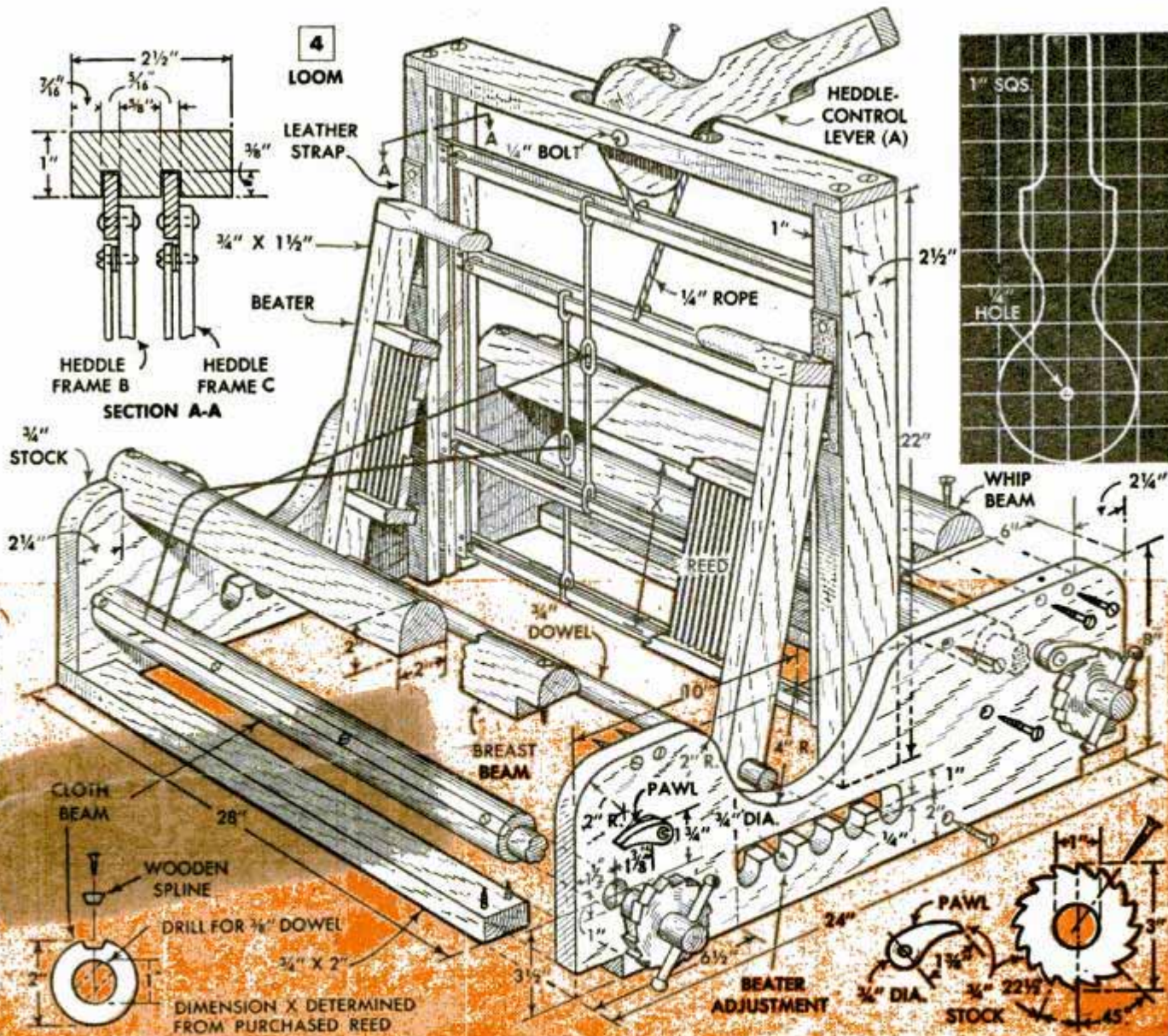

Stringing

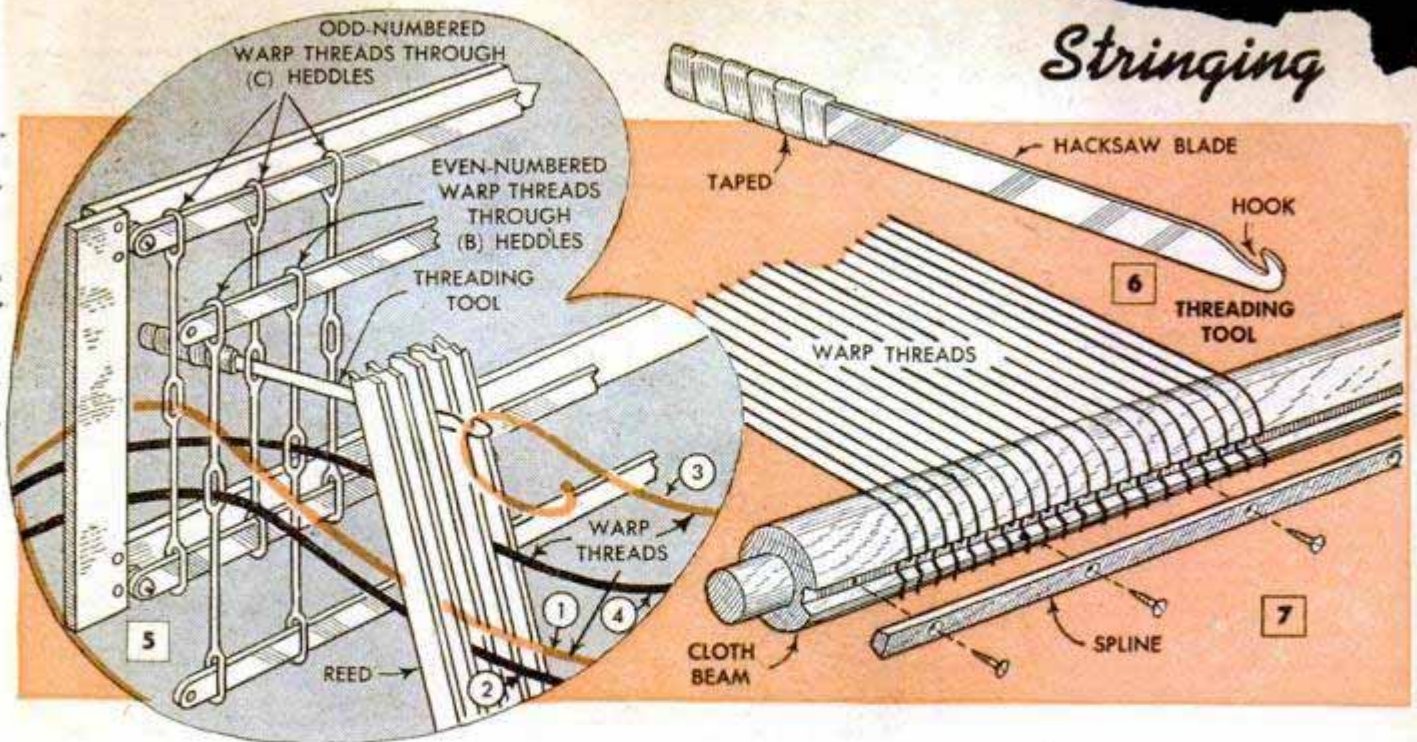

is used for all parts of the loom frame, the beater frame, rollers, and the breast and whip beams. Maple is good but birch does equally well and saws and planes somewhat easier. The heddles and heddle frames, Fig. 3, and the reed may be purchased from dealers in craftwork supplies. These parts are inexpensive and obtaining them ready-made saves a lot of time. For average weaving a 30-dent reed—30 spaces per inch—is satisfactory, as running the warp thread through each dent will give 30 warp threads per inch. Other combinations are possible.

The heddle frames slide in grooves cut in the frame uprights, Fig. 4. The grooves should be about $\frac{1}{16}$ in. oversize so that the frames will slide easily. Two dimensions, one on the heddles in Fig. 3 and another on the reed in Fig. 4, must be determined from these parts. Have the parts at hand before assembling the loom. Hardwood ratchets and pawls on the rollers, Fig. 4,

are for the purpose of keeping tension on the warp threads and for rolling up the finished cloth on the cloth beam as the weaving progresses.

Fig. 2 shows methods of cutting 6 and 10-ft. warp yarn, or threads, to exact length. This done, you string the loom as in Figs. 5, 6 and 7. Notice in Fig. 5 how the odd-numbered warp threads are pulled through the heddles (C) with a threading tool made as in Fig. 6. The even-numbered threads go through the heddles (B). Both sets of threads pass over the whip beam and are wound on the warp beam at the rear of the loom. Study Fig. 9, which shows the warp threads in exaggerated size and in two colors for clarity. Also compare with the shed formed by shifting the heddle-control lever, Fig. 13, to the right-hand position as in Fig. 14. Fig. 7 shows how the ends of the warp threads are locked to the cloth beam with a spline which fits in a groove cut in the roller. Figs. 13 to 15 inclusive show the

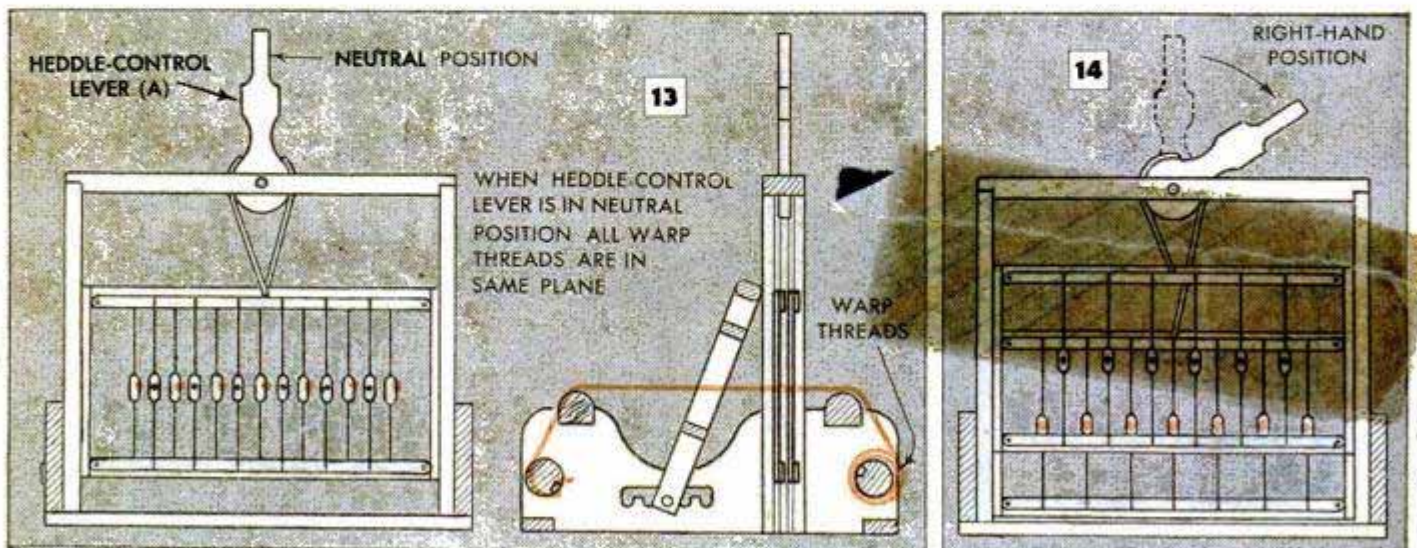

the Loom

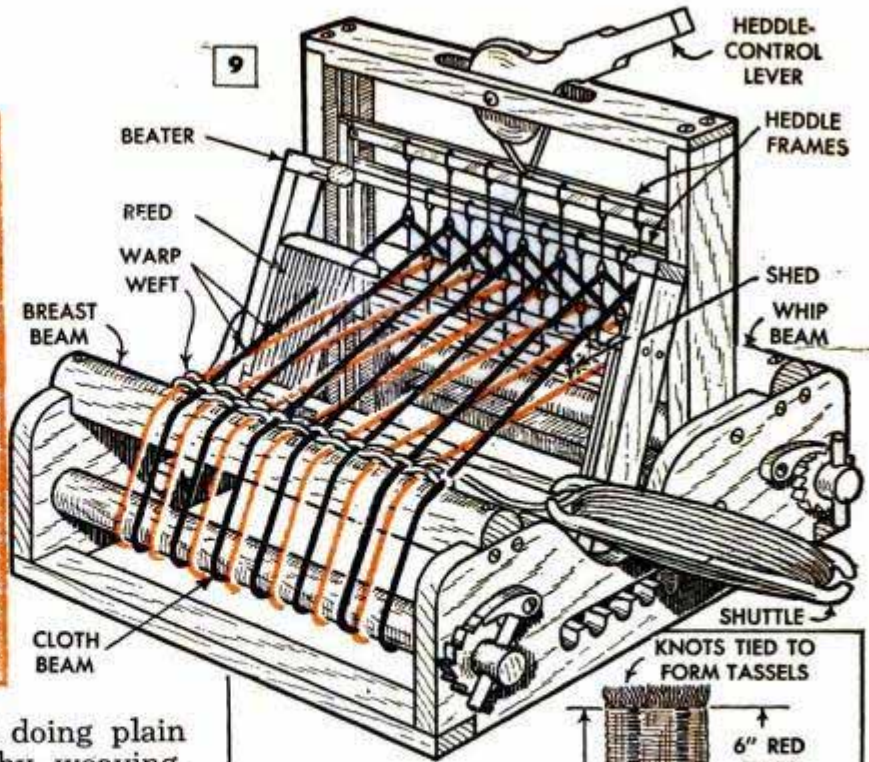
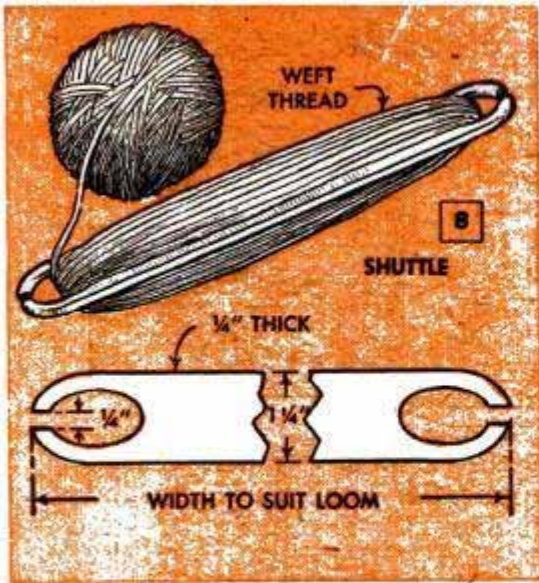

operation of the loom when doing plain weaving. Fig. 10 shows tabby weaving. Notes on the detail drawings, Figs. 13 to 15, explain the sequence of operations clearly. One thing to watch in weaving is the tendency to pull the weft too tightly. This forms what weavers call a waist, Fig. 11, and causes the woven strip to become narrower as the weaving progresses. Generally, tension on the weft must be watched more closely on coarsely woven cloth. The greater the number of warp threads per inch the less tendency there is for this fault to appear in weaving.

Fig. 12 shows a vari-colored pattern woven in a table scarf. Here variations are made in the warp threads and two shuttles are used, one carrying the red and one the blue filler or weft. Shuttles are made from a strip of hardwood with the ends shaped as in Fig. 8. Length of the shuttle should be approximately half the width of the cloth being woven, although some weavers prefer a shorter shuttle.

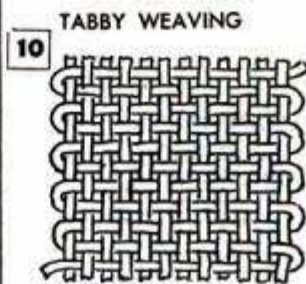

10 TABBLY WEAVING
TENDENCY TO PULL WEFT TOO TIGHT FORMS WAIST

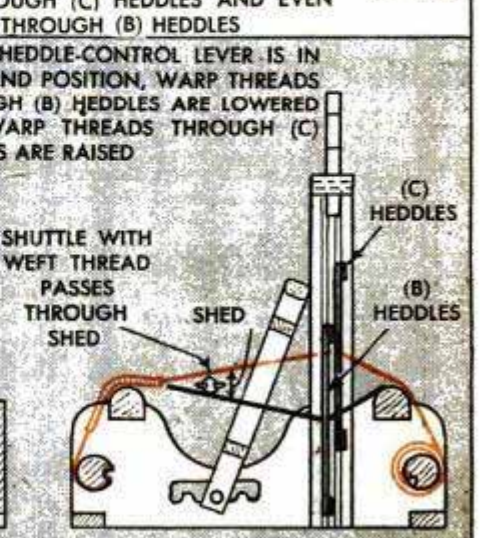
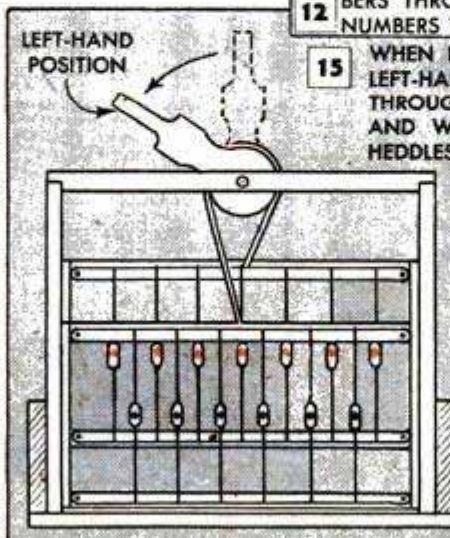
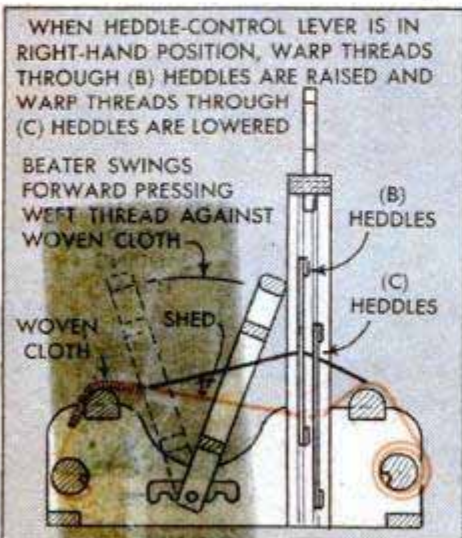
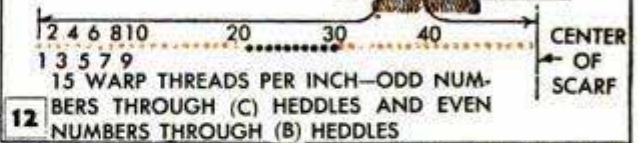
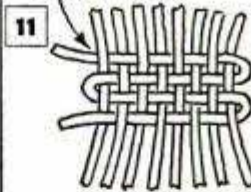

Accordion-Fold Door Mat Of Hardwood Scraps

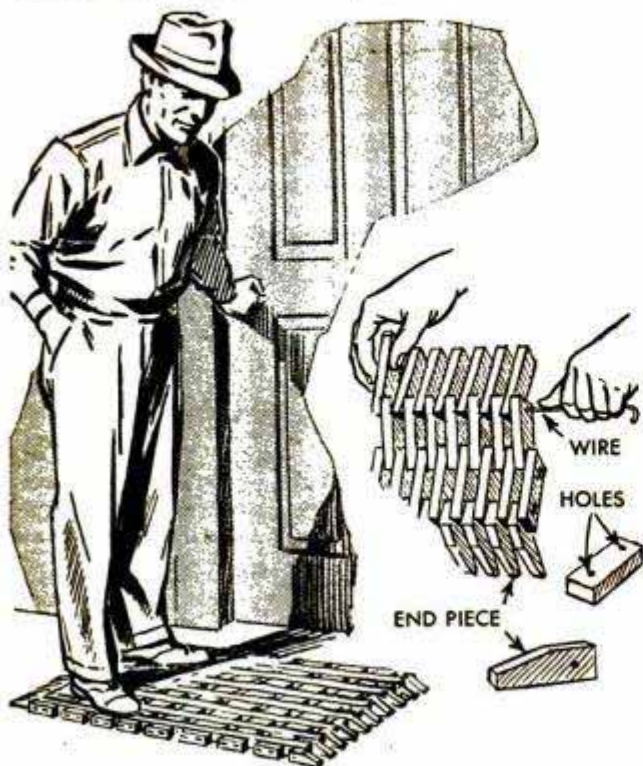

This novel wooden door mat folds into a small bundle when not in use and opens out, accordion fashion, to lie flat. It is an interesting project for the individual craftsman and also is a good commercial item for small woodworking shops that make use of hardwood scrap, as it can be mass-produced almost wholly on a circular saw by setting up to cut duplicate small blocks from $\frac{1}{2}$ or $\frac{3}{4}$ -in. scrap stock. For a mat of average size cut the blocks $\frac{3}{4}$ by 1 by 4 in. Exact dimensions are not important but the blocks must all be the same size. Note from the detail that the end pieces are beveled. Two holes large enough to take No. 9 wire are drilled through each block. Then the blocks are arranged with the ends alternately overlapping and are pinned together with lengths of wire.

Ralph C. Taylor, Pueblo, Colo.

Cutting and Spreading Bolt End "Locks" Nut in Position

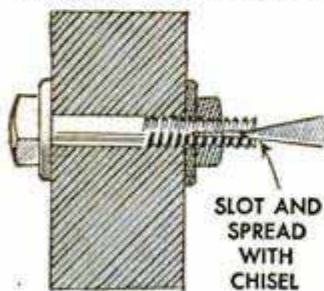

If bolt threads are worn or stripped or if a bolt is subject to vibration, the nut can be made to hold by spreading the end of the bolt. To do this, split the end of the bolt

with a hacksaw before it is inserted in the hole. Then, when the bolt is in place and the nut has been drawn up, spread the end

with a chisel to lock the nut. This will not damage the threads and the nut still can be removed.

Glycerine Protects Rubber Stamp From Deterioration

Glycerine, if applied occasionally to the imprinting surface of a rubber stamp that is used infrequently, will be found effective in preventing the rubber from deteriorating to the point where it no longer will pick up ink. A thin application is all that is needed to keep the rubber soft.



Sanding-Drum Tail Center Eliminates "Whipping"

Chucking a sanding drum in a drill press is common practice, but here is how you can eliminate the usual whipping that results from the pressure of work against the drum. As shown in the detail, the device consists of an improvised tail center, which clamps in the center hole of the drill-press table. The end of the sanding-drum spindle is cupped to match the conical shape of the center and aligning of the two is done automatically by leaving the wing nut loose, lowering the spindle to ride on the point and then tightening the center. Lubricate the center, and add a wooden auxiliary table to the drill press.

Alexander Graham, New York City.

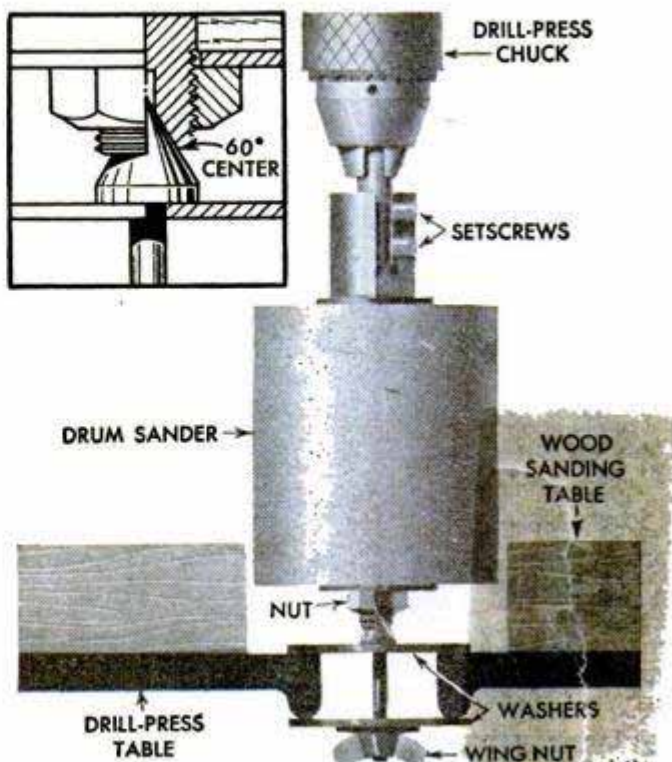

Lightweight "Cart" For Wash Basket

Much of the drudgery of wash day will be eliminated if this wash-basket cart is used when hanging clothes on the line. Although it is sturdy enough to handle a full basket of damp washing, it is light in weight and, when not in use, requires no more space than a folding chair. Frame construction and dimensions are given in the detail, although the latter can be varied. Use glued-and-screwed joints so they will be sufficiently rigid to support the weight of the basket and clothing. The only hardware items needed are the bolts and washers on which the two sections pivot. Discarded leather belts will do for the two straps. Note that reinforcing blocks are used to mount the casters. Drill the caster holes so that the shanks will be a snug fit. Although fairly small casters are shown,

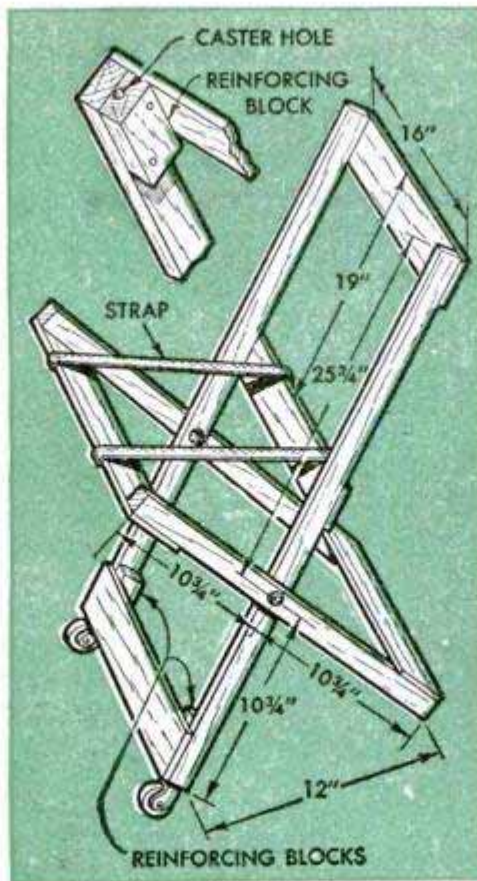

if larger ones are used it will be easier to wheel the unit about on the lawn. When not in use, hang the carrier on a wall in the laundry where it will be out of the way.

R. Hoppough, Waukegan, Ill.

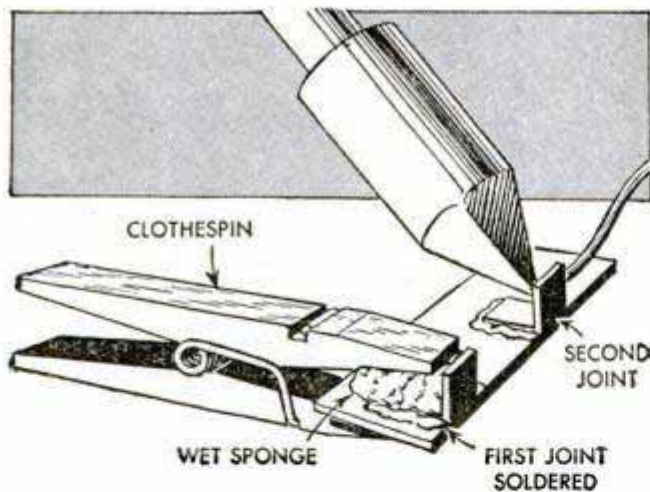

Wet Sponge Prevents Heat Transfer When Soldering Adjacent Joints

If you have ever had a freshly soldered joint loosen when soldering another one adjacent to it, here is a simple method of preventing heat from being transferred from one joint to the other. Just apply a wet sponge to the joint that has been soldered. In some cases, it may be necessary to clamp the sponge in position. A spring-type clothespin is ideal for this purpose on a small joint.

Ronald Eyrich, Milwaukee, Wis.

Rubber Soles Protect Floor Mat

Don't let your heels wear holes through the floor mat of your car below the brake and clutch pedals. Cement a pair of rubber half soles (boot size) to the mat where it receives the most wear. If this is done with a new mat and the soles are renewed from time to time, the mat will last indefinitely.

Scott Soyer, Chicago.

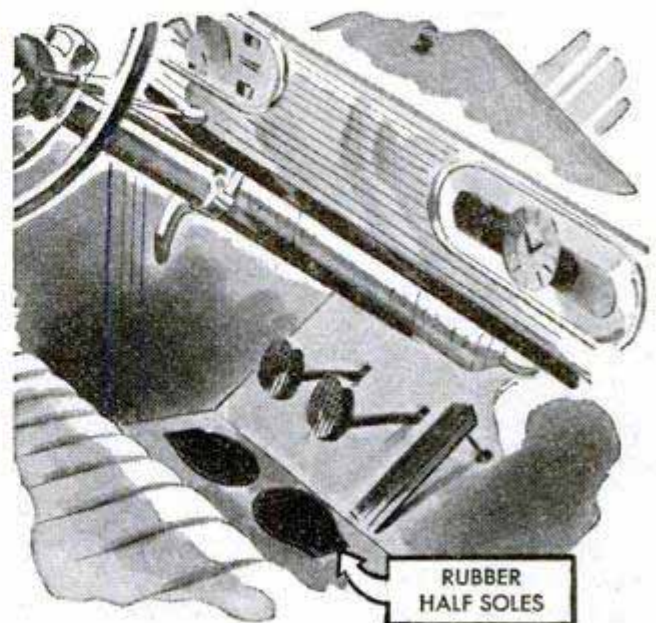

SOUND EFFECTS

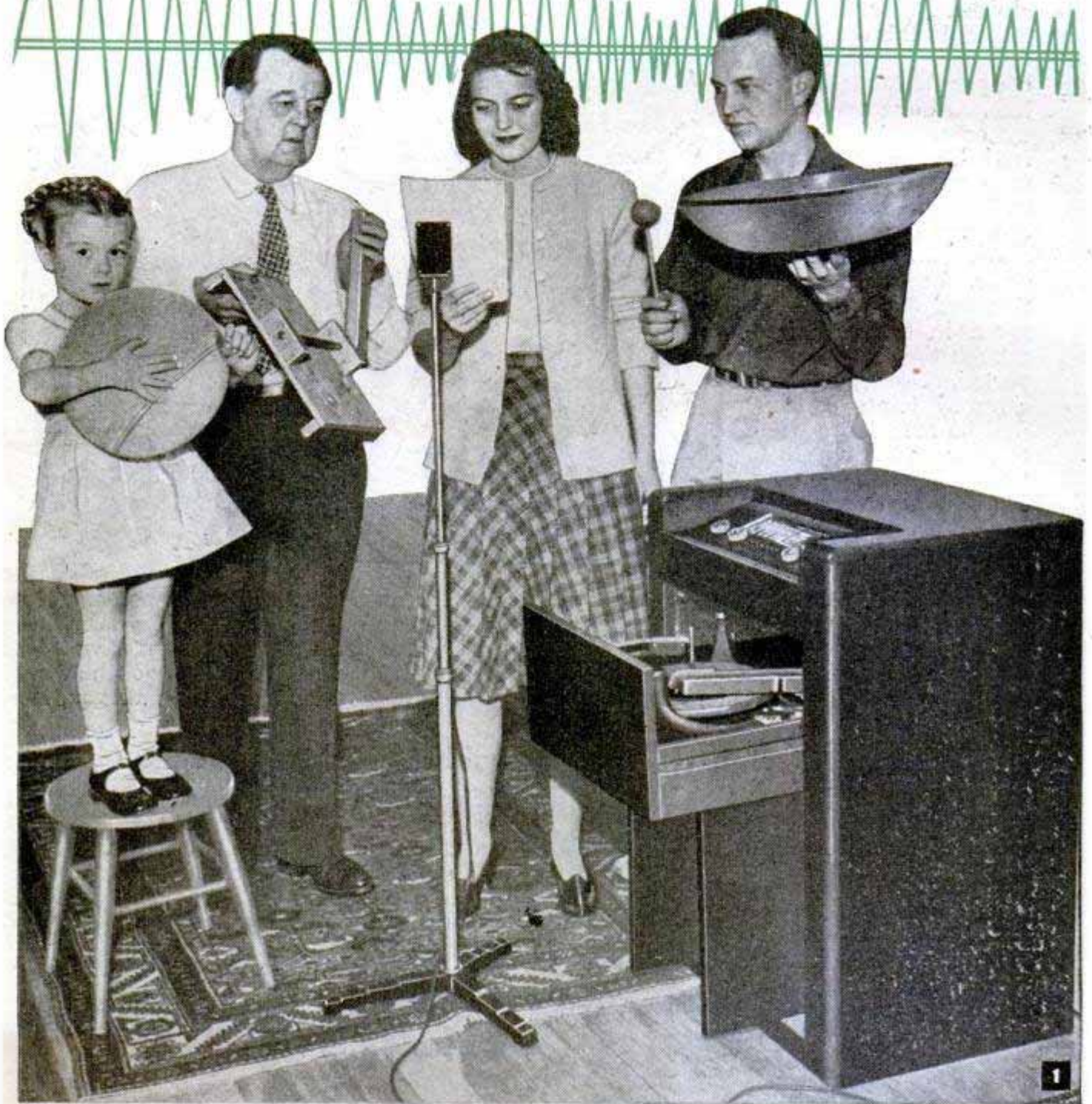

SOUND EFFECTS

added to your home recordings fill in the thin spots in dialogue and action sequences and pep up the listening interest of home-cut disks. Suppose, for example, you wish to reproduce the noise of a thunderstorm, an explosion, or the firing of big guns. It's simple. Pour a teaspoonful of BB shot into a toy balloon, blow it up, and then shake. Talking into a short length of hose sounds exactly like a voice from the depths of a well or cave, or speech coming through the engine-room

By Ed Ludes

Sound Engineer, National Broadcasting Company

intercommunications system used on board ships. Talking across the open mouth of a water tumbler gives a good imitation of a voice from the other end of a telephone. Put a straw in a glass of water and blow gently and you have the sound of water boiling. To make rain, pour salt on a piece of tissue paper held so that salt runs over the surface. A man's hatbox and a package of BB shot are the only items needed to create the pounding of surf upon a beach. Empty the shot into the hatbox

FOR HOME RECORDINGS

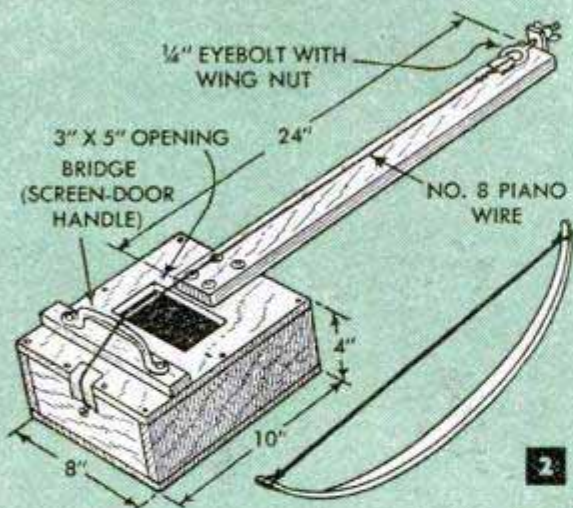

Sound-effects engineers call this a "twang" box. They use it to produce comedy effects

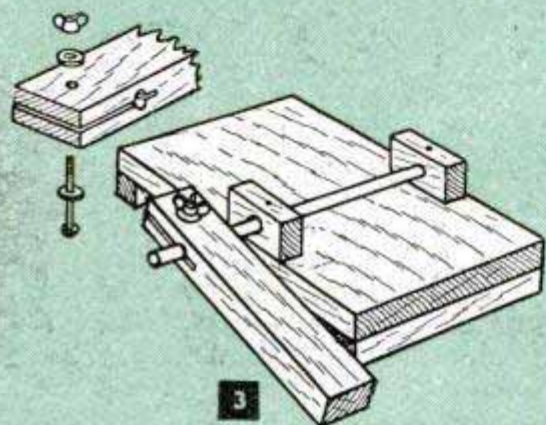

A "squeak" box reproduces the creaking of a ship's rigging, squeaky floors, rusty hinges

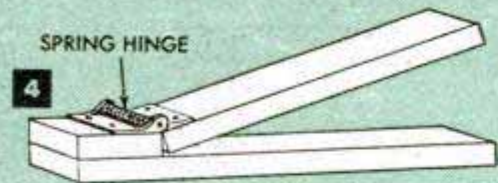

Lift the hinged arm of this device and release suddenly to get the sharp crack of a whip

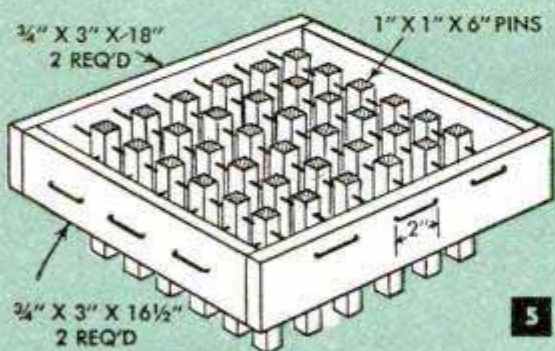

An arrangement of hardwood pins in a wooden frame makes realistic sound of marching feet

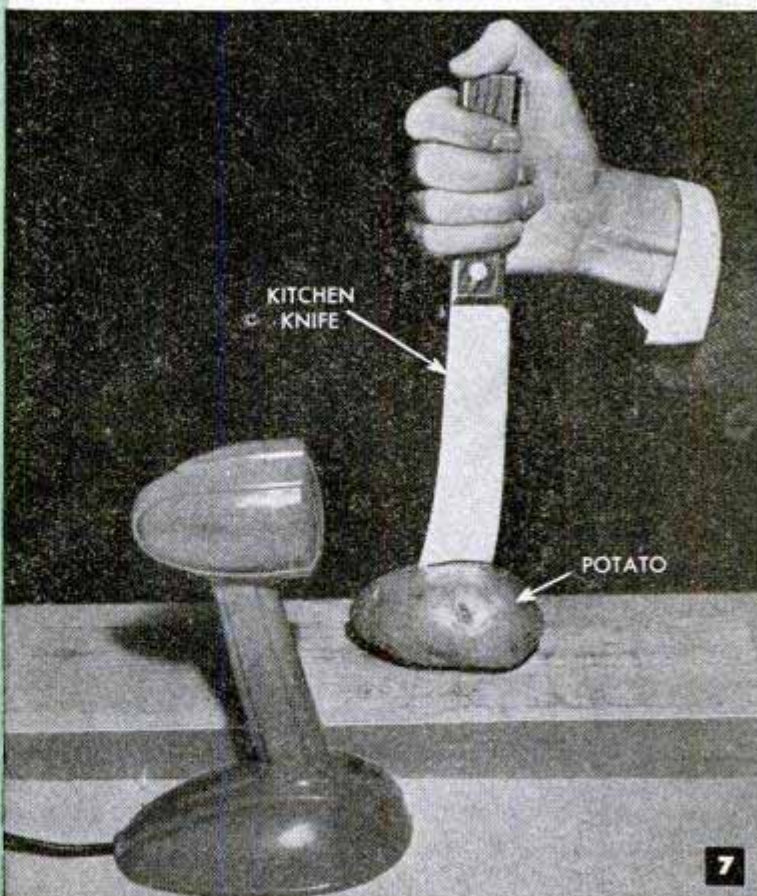
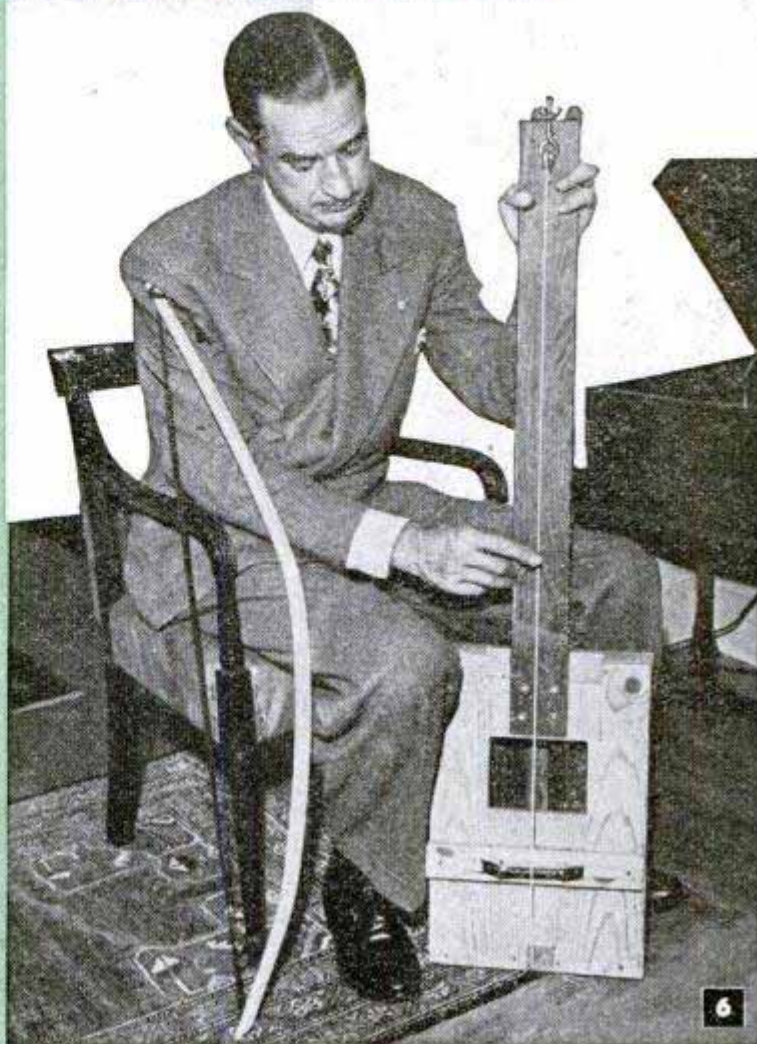



and tilt it slowly from side to side.

The sound of bells, chimes and gongs is readily reproduced. Hold a large metal fruit bowl by supporting it on the tips of three fingers. By striking it with a drumstick, a rubber-faced mallet, or a small metal hammer, any number of tones such as fire and church bells, a chime clock, and cow and locomotive bells can be reproduced. The unit in Fig. 11 also will reproduce these sounds. It is made from a pipe, a sheet of flat brass and a $\frac{1}{4}$ -in. brass rod bent U-shaped. The units are attached to the pipe with cord in the manner indicated.

Two old-style doorbells of the type that will ring as long as the switch button is held down, plus a dry cell attached to a wooden base as in Fig. 10, will give a number of effects for home recordings. Each bell must have its own push-button switch, and must be arranged so that the clapper of one of the bells will strike both gongs. You'll need this to simulate a telephone ringing, as one bell will not give the correct sound. To portray a riveting machine, dampen the bell by putting your hand on it. A buzzer sound is made by removing the gong or bending the striker arm slightly so that it does not touch the gong.

In Fig. 1 the family "sound engineers" are supporting the script reader with the explosion balloon, squeak box, Fig. 3, and a metal bowl held ready to simulate the



bells or chimes effect. For certain comedy sound effects, the studios use what they call a "twang" box, Figs. 2 and 6. You can duplicate it by following the details in Fig. 2. The bow is strung with heavy fishline. By raising and suddenly releasing the spring-hinged arm of the gadget in Fig. 4 you get the sharp crack

of a whip. Hardwood pins supported on cords strung in a square wooden frame as in Fig. 5, make the sound of marching feet when you hold the device in both hands and "walk" it across a table top. It is raised and lowered at regular intervals as it is walked along. In Fig. 7 the villain stabs the hero, that is, in effect. The sound-effects man has merely plunged the knife into a potato placed near the mike.

Many effects, such as the opening of doors and desk drawers or starting a car, Fig. 9, are captured by simply holding the microphone close to the actual operation. The sounds made by insects, birds, dogs and chickens are recorded in the same way. The opening of an envelope is "pictured" in sound by tearing a piece of paper close to the mike.

Twisting the ends of two tin cans together gives a good imitation of opening a safe. Machine noises and the clatter of gears can be produced for entertainment purposes by turning an egg beater. Let the blades beat in a pan of water and you have a speeding motorboat. By striking the bottom of a pan with the revolving blades you have a broken-down jalopy struggling along. An electric sewing machine or the kitchen-mixer motor in operation will sound like an elevator going up or down. Push a roller skate along a board, Fig. 12, and stop it suddenly against a metal cleat. This is the opening

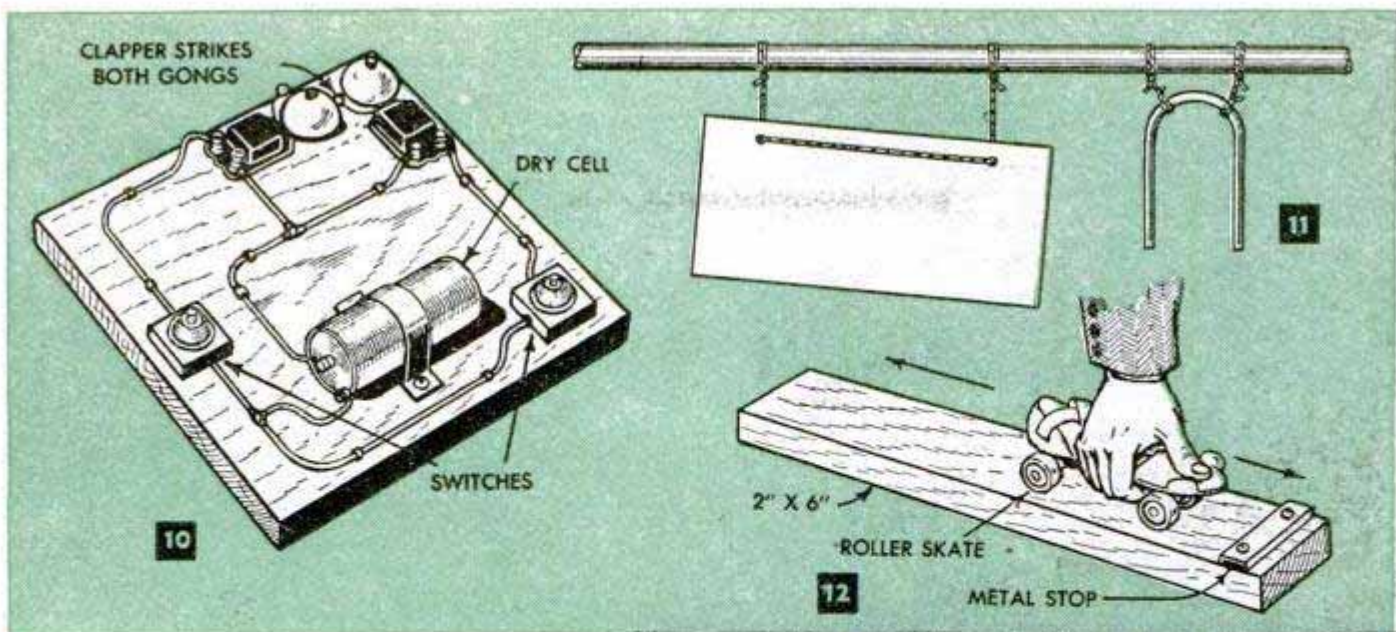

and shutting of an elevator door.

The swish of a tennis racket past the mike will record like the swing of a golf club. Let the water from a faucet splash into a pan, and you have a waterfall. For top comedy effects, fill a metal pan with scraps of metal, pipe, bottle caps and washers. Grasp this "crash tub" firmly and shake vigorously. Squirt water from a Seltzer bottle into an empty pail, the stream hitting the side of the pail as in Fig. 8, and you have the sound of someone milking a cow. Use the two halves of a coconut shell to imitate the "clop" of a horse's hoofs, also shown in Fig. 8. Crumple Cellophane in the hands to get the crackle of a camp fire. Fill a bag with cornstarch, then press alternately on the bag with the thumbs and you get the sound of footsteps in snow. A bundle of bamboo splints twisted together gives the sound of a forest fire. All three methods are pictured in Fig. 13. For the sound of a steam locomotive cover the open top of a wooden box with light sheet metal in which rows of holes have been punched with a nail, as in Fig. 14. Using a bundle of wires taped together, brush over the perforations. With a little practice you can simulate the sound of a starting or running locomotive realistically enough to deceive even a practiced ear.

To be useful, such "canned" effects must be put on your record at definite intervals so you can locate them quickly. Leave a place uncut before each sound.



Crush Cellophane slowly or twist a bundle of bamboo splints to simulate fires burning. Fill a bag with cornstarch and press with the thumbs to imitate the sound of footsteps in the snow

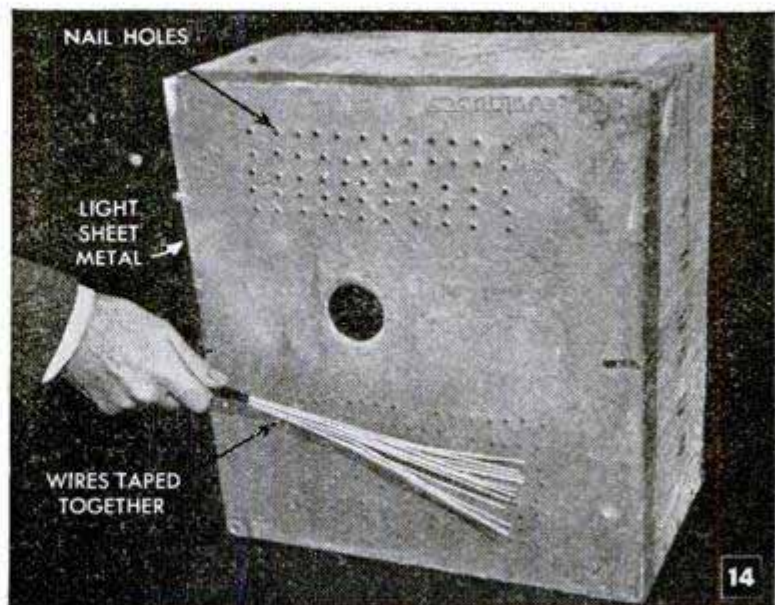

Top of this box is covered with sheet metal in which rows of holes have been punched. Brushing the perforated surface with a small bundle of wires gives the sound of a steam locomotive

Scoop for Household Use From Plastic Tumbler



Instead of discarding a cracked plastic water tumbler, convert it into a scoop that will be convenient for measuring flour, sugar and other condiments—or you can use it in a darkroom to handle dry chemicals. To make the scoop, cut and sand the cracked tumbler to the approximate shape shown in the detail and drill a hole in the bottom. Then attach a wooden handle by means of a brass screw driven through the hole. Use a brass washer to keep the scoop from pulling off the handle.

Simon S. Palestrant, New York City.

False "Bay Window" Projection Relieves Plainness of Wall

Here is an attractive and practical way of dressing up a window to relieve plainness of an exterior wall. It consists of a fretwork projection in the form of an open-wall shelf which is designed to hang over a wide window and create the effect of a

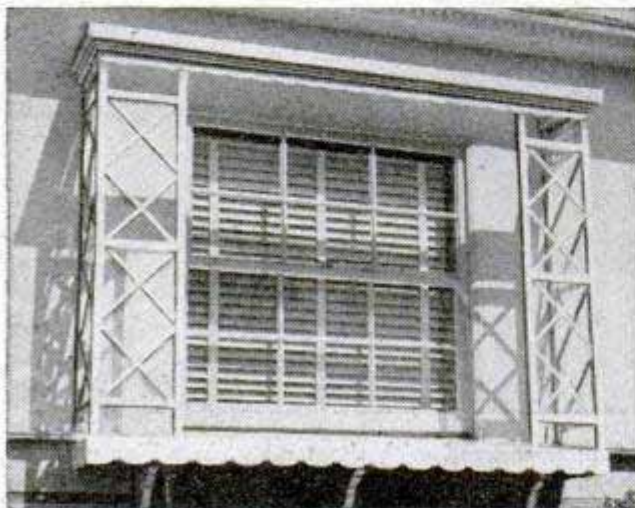

bay. It forms a perfect setting for a flower box or a row of potted plants and the fretwork ends will give ivy something to cling to. The whole unit is supported at window-sill height by corbels bandsawed from thick stock. Angle brackets are used at the top to attach the unit to the house.

Hinge Serves as Secret Lock On Workbench Drawer

This simple drawer lock defies detection mainly because it is hidden and also because the nail which operates the lock appears to be one of those used to fasten the bench top to the legs. As the detail shows, the lock, consisting of a strap hinge with a nail release pin

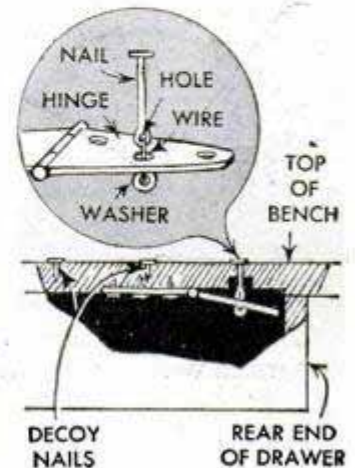

attached to one leaf, is recessed into the underside of the bench over the drawer. One leaf of the hinge is screwed flush in the recess and the other leaf is left free to swing downward to form a stop, which prevents the drawer from being pulled out. The nail release pin is attached loosely to the hinge with wire and a washer. Should the nail become detached from the hinge, a shallow notch cut in the top of the drawer in line with the hinge at the time the lock is installed, will provide clearance so that the drawer can be withdrawn. Several decoy nails should be driven where shown.

C. L. Meehan, Lakeview, Ont., Can.

Wooden Plug Replaces Screw Cap

To save time in screwing the cap on and off a soap-paste container, one mechanic replaced the screw cap with a tapered plug turned to fit snugly into the open top. A wooden drawer pull attached with a screw driven through the plug from the bottom serves as a handle for lifting. This same kink can be used on other screw-top containers which are opened and closed frequently.



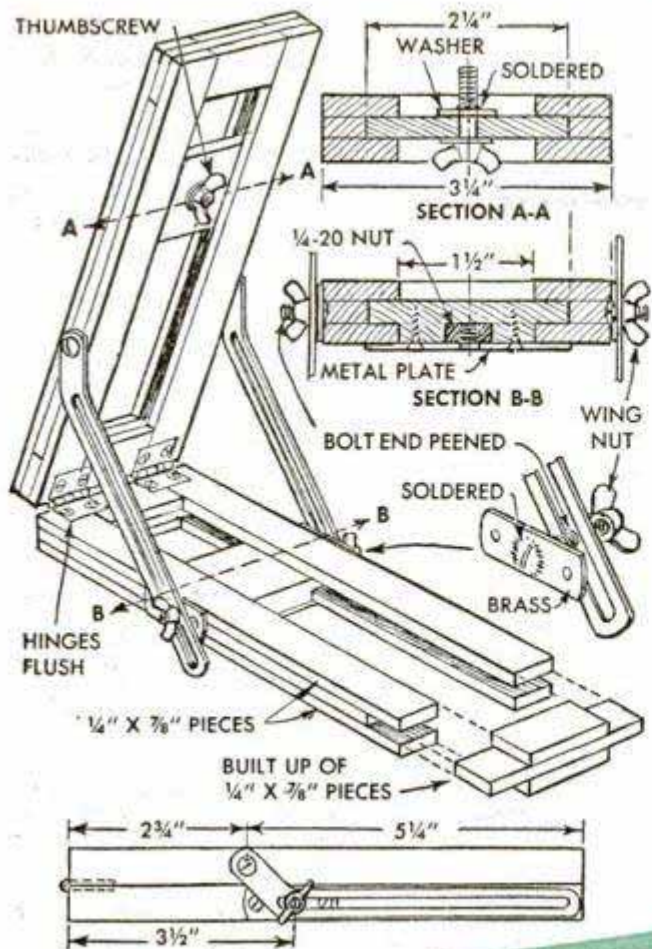

4-way TRIPOD HEAD

Adjustable to the positions shown in the photos, this tripod head is provided with a sliding base which permits shifting the camera so the center of weight is over or near the center of the tripod. This means that a fairly heavy camera can be supported firmly on a lightweight head without becoming unbalanced. Follow the details given in the drawing, using birch or maple for the wooden parts and brass hardware, if it is available.—E. Peter Smith, Los Angeles, Calif.

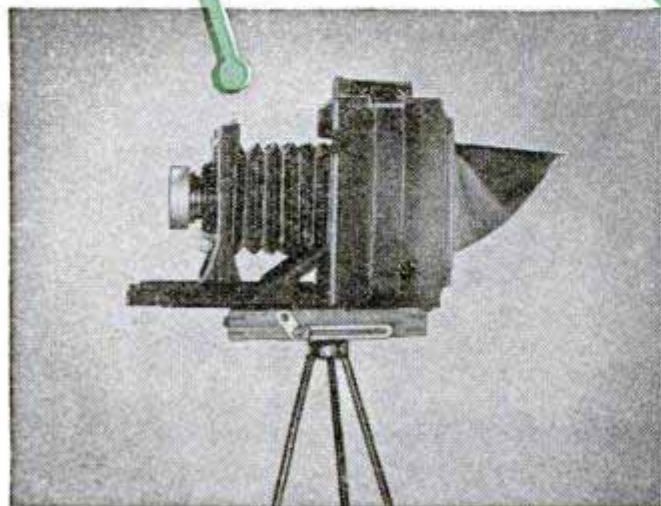
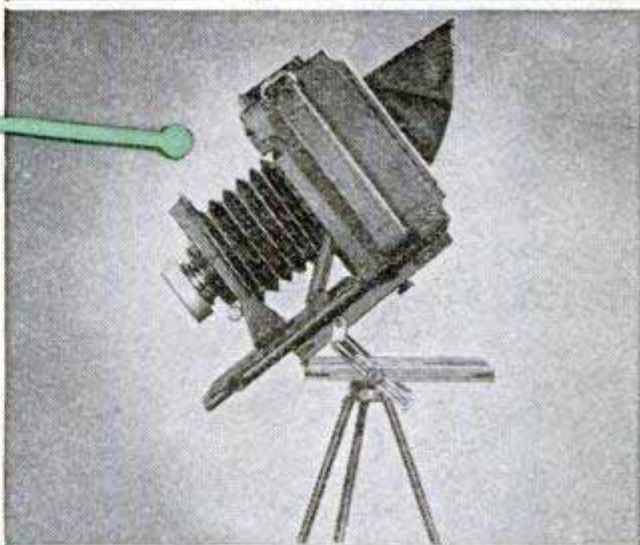

Ref. C.C.S. 1-11

Apartment DARKROOM

Made to order for apartment dwellers. Has everything but running water—all equipment is stored compactly in a portable, folding cabinet—ready for use

By Walter S. Marsh

IF PHOTO PROCESSING is your hobby, but you're handicapped by lack of a handy place to work, then this self-contained darkroom should make you happy—especially if you live in an apartment. It does away with makeshift methods, saves time normally spent in getting ready and keeps everything together. Just swing open the top and bottom doors, lower the front and you're all set to begin work, with everything at hand, except running water. It folds compactly—as shown in Fig. 3 for storing in a corner.

The cabinet is designed with a specific place for each item of equipment and the keyed list and drawing in Fig. 4 shows where each goes. The front of the cabinet, when lowered, provides a roomy worktable, which is supported at a convenient height by swinging open the door below it. The table forms a large working area which will accommodate three 11 by 14-in. trays, side by side, as shown in Fig. 1. A separate block of wood should be at hand to place under the "gate-leg" door to prevent the cabinet from tipping forward. Note that a standard safelight is hinged to illuminate the worktable, and that there is a handy overhead white light that can be swung out over the work. The door which supports the worktable is fitted with shelves for storage of photo chemicals as shown in Fig. 2, with additional space for other supplies in the bottom of the cabinet.

The cabinet is of simple butt-joint construction. As dimensioned in Fig. 4, it is a little over 7 ft. high. Plywood and solid stock can be combined in making it, plywood being used for the back of

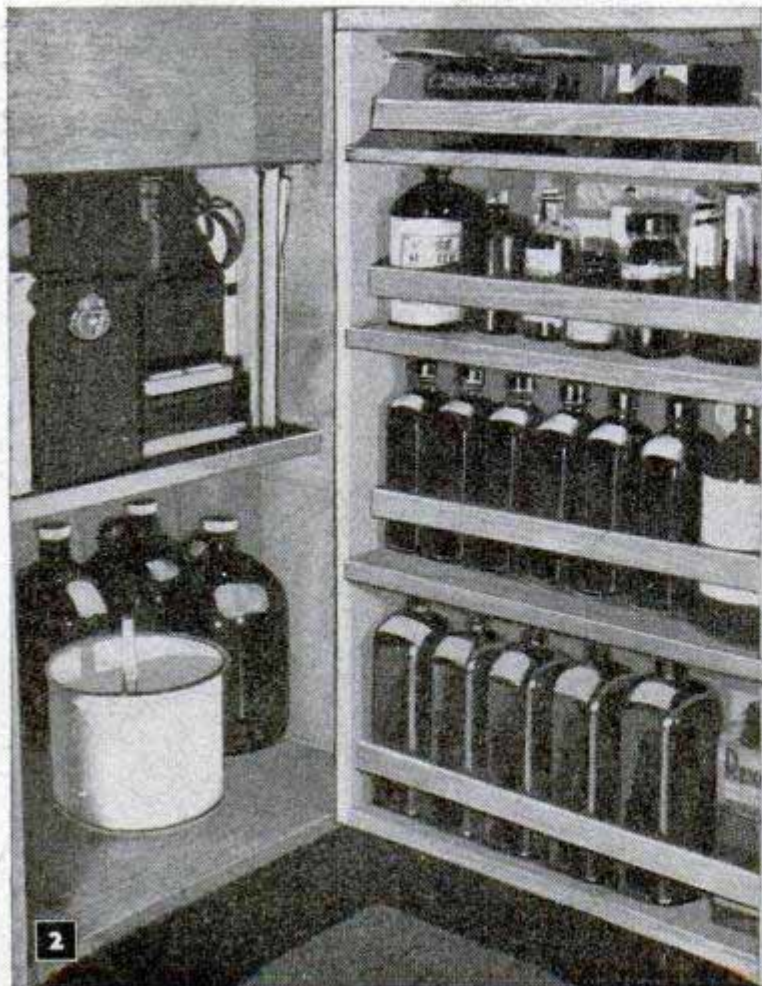

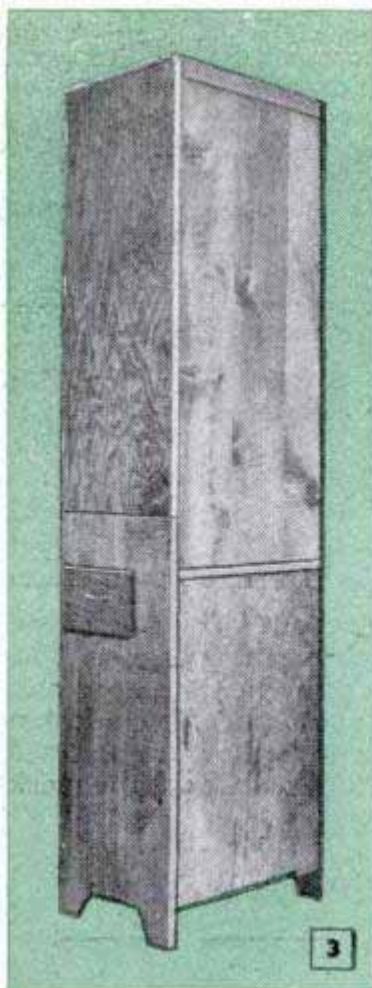

This shows how compactly cabinet folds. Doors nest flush with sides and are held closed with cupboard friction catches

the cabinet and for facing the two doors. The drawer opening in the side of the lower part can be cut out with a keyhole saw by first boring a $\frac{3}{4}$ or 1 in. hole in each corner. Notice that the legs of the cabinet are a part of the side, and that the center shelf is narrower than the bottom one to allow for the thickness of the shelf-fitted door. The surface of the worktable can be given two coats of acid-resistant lacquer, or it can be covered with linoleum. The doors are held shut with cupboard-type friction catches. A multiple outlet and extension cord should be installed in the cabinet for plugging in an enlarger and contact printer.

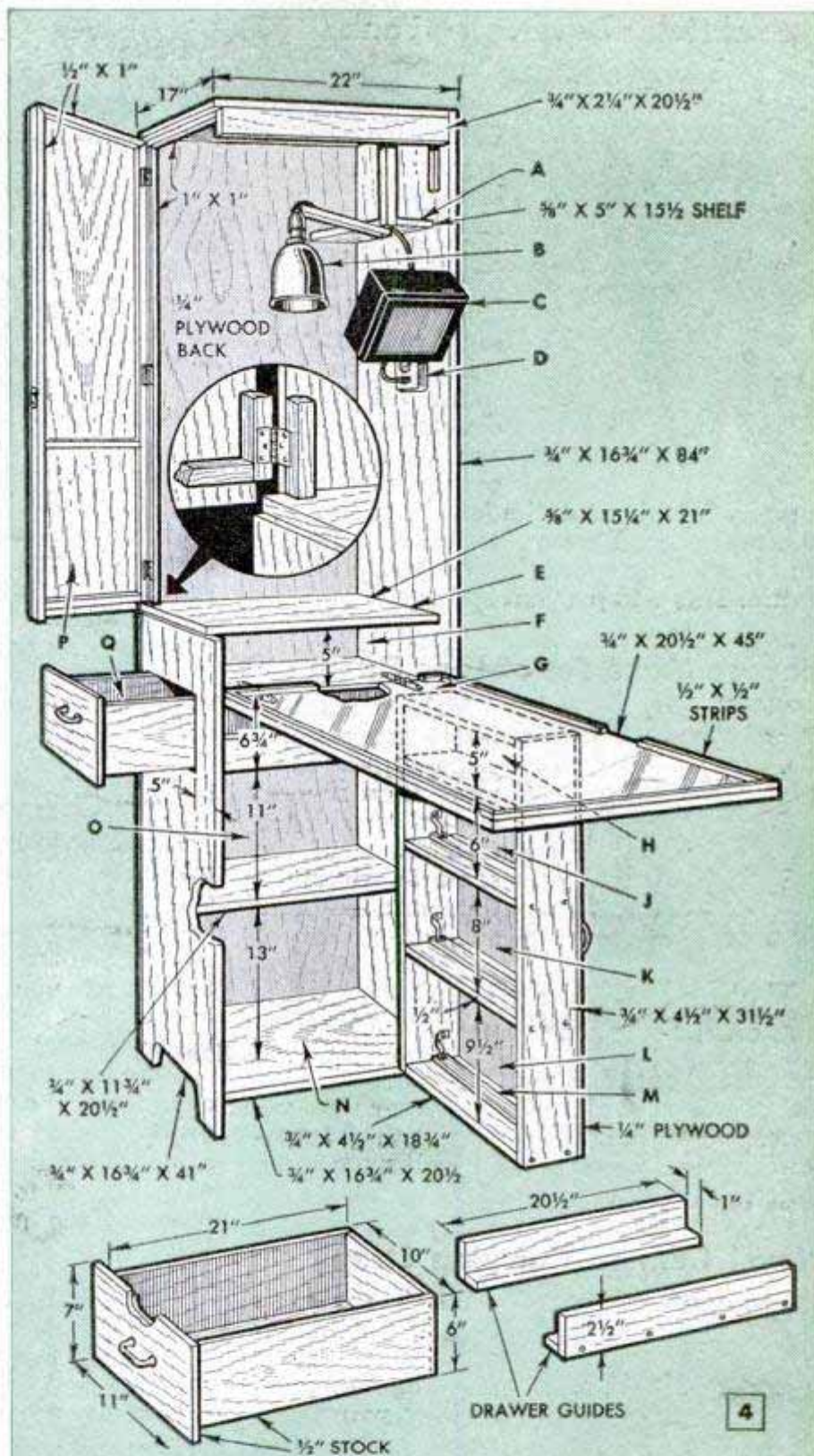

KEY TO EQUIPMENT

A—Shelf for contact printer. B—Swivel white light. C—Safelight (red). D—Electric outlet for enlarger, safelight and white light. E—Shelf for 4 by 5-in. enlarger. F—Tray storage, three 11 by 14-in. and three 8 by 10-in. G—Worktable. H—Dry chemicals, etc. J—Film tanks, graduates, etc. K—Eight pint bottles. L—Six quart bottles. M—Elastic-band straps for holding contents. N—Storage bottles, $\frac{1}{2}$ and 1-gallon size. O—Photofloods, camera, etc. P—Ferrotype tins. Q—Drawer for film, film holders, film-pack adapters, small accessories

Funnel Holds Developing Tank While Being Drained



Many plastic developing tanks, because of the light-trap arrangement in the lid, are not easy to drain in a hurry. But by setting the tank in a funnel which has the spout set in the developer or fixer bottle, draining can proceed with-

out any further attention on the part of the photographer. Be sure to select a funnel that has a long spout that fits well into the bottle. This will prevent spillage.

How to Make Set of Lens Filters

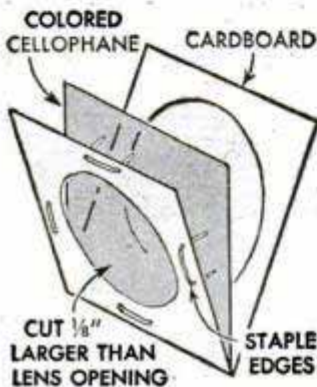

cardboard cut to fit your filter holder, with the opening cut about $\frac{1}{8}$ in. larger than the lens. Staples hold the filter together. Exposure factors for each filter will have to be determined by experiment.

Novel Camera Carrying Strap

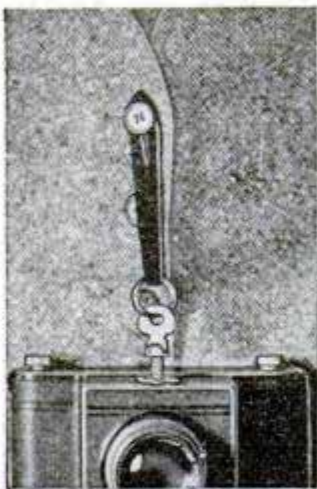

suspender strap. Then a flat key is cut down and soldered into the slot of a $\frac{1}{4}$ -in. screw that fits the tripod connection. The

key ring is fastened to the key, the strap is buttoned to your vest and your camera is carried in a safe manner.

Paper Holder for Enlargements

Having many enlargements of the same size to make, one photographer found this mask a great time saver. The base is plywood and the mask is lightweight, galvanized sheet metal. Cut the mask so that when it lays over the paper, it is about $\frac{1}{4}$ in. smaller all around. This allows for the border. The corner angle is to position the paper and is located by trial and error. Rivets fasten the mask to the base. A door button clamps the mask to the board.

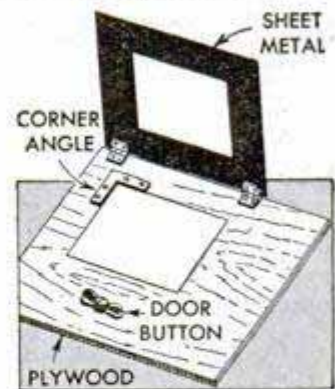

Iron Supports Photoflood Lamp

An electric iron makes a substantial, yet easily moved, support for a photoflood lamp used in taking table-top pictures. The clamp-on reflectors commonly used are top heavy and often it's difficult to find a way to set them at the proper height on the table. With this arrangement, the lamp can be moved about with little trouble.



William Swallow, Brooklyn, N. Y.

"Built-In" Thermometer Fits Agitator

Instead of removing the agitator from a film-developing tank to test the temperature, drill a hole lengthwise through it and insert a dial-type thermometer, as shown. Then you can read the temperature of the developer within the tank at any time. The thermometer does not interfere with operation of the agitator.—Kenneth Murray, Colon, Mich.



CRAFT QUIZ



1. He is tightening the—
 (a) Jib (c) Compound
 (b) Gib (d) Fence

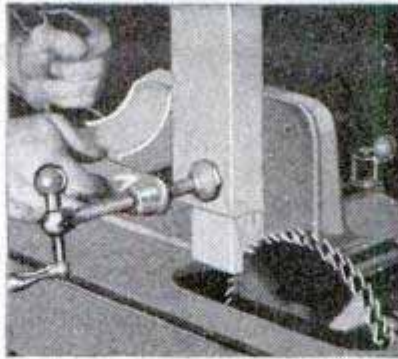

2. He is making double—
 (a) Cheek cuts (c) Crosscuts
 (b) Shoulder cuts (d) Cut-offs



3. These gadgets are—
 (a) Fuses (c) Cleat sockets
 (b) Pipe plugs (d) Extension sockets

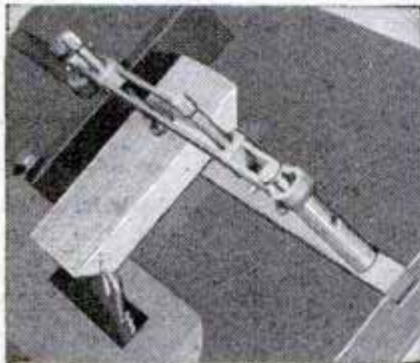

4. This joint will need a—
 (a) Dowel (c) Key
 (b) Spline (d) Tenon

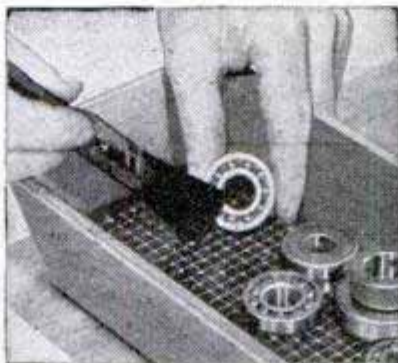

5. No fire hazard with—
 (a) Gasoline (c) Carbon tet.
 (b) Benzol (d) Naphtha



6. This helps in—
 (a) Turning (c) Finishing
 (b) Sanding (d) Threading

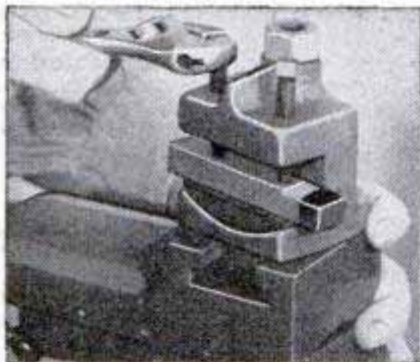

7. Tool holder shown is—
 (a) English-type (c) Spring
 (b) Turret (d) Box

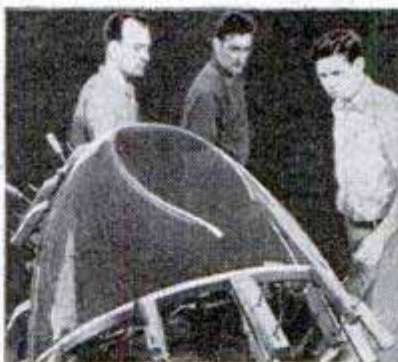

8. Job here is clamped with—
 (a) Hand screws (c) Bar clamps
 (b) C-clamps (d) Screw boxes



9. Reflector holder made from—
 (a) Street els (c) Couplings
 (b) Tees (d) Reducers

ANSWERS: 1—b; 2—a; 3—d; 4—b; 5—c (carbon tetrachloride is non-inflammable); 6—a (sawing surplus wood from corners eliminates much rough turning); 7—a (more commonly, open side); 8—a; 9—a (street elbows); 10—b (revolutions per minute); 11—c (jaws should be parallel to clamp work evenly)

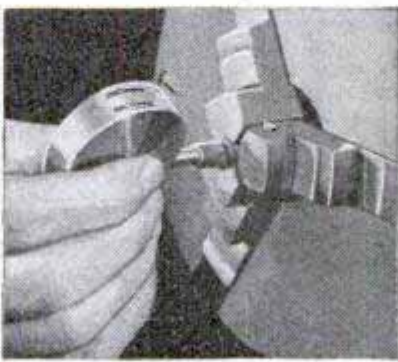

10. He is checking the—
 (a) F.P.M. (c) C.F.M.
 (b) R.P.M. (d) B.H.P.

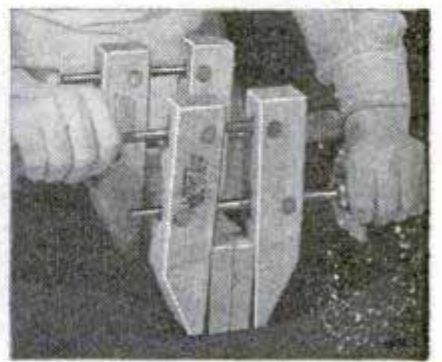

11. What's wrong?
 (a) Hands (c) Jaw alignment
 (b) Kind of clamp (d) Clamp position

Clinic



for Homemakers

With this issue, *Popular Mechanics* inaugurates a new reader service to help homemakers solve the hundreds of problems that confront them everyday. The Clinic Editor is waiting to hear from you and, because of limited facilities, asks that you confine your questions to those pertaining to your home—inside or out—and its immediate grounds. Address your questions to The Clinic Editor, *Popular Mechanics Magazine*, 200 East Ontario Street, Chicago 11, Illinois

Stopping Squeaks in Hardwood Floors

Q—What can I do to eliminate squeaks in hardwood floors?

M.E.L.—Phoenix, Ariz.

A—If you can get at the floor from below, drive short wood screws up through the subfloor into the hardwood floor. Have one or more persons stand on the spot where the squeak occurs and draw up the screws tightly. If you cannot get at the floor from below, try working powdered graphite into the joints of the boards to lubricate the edges. If this does not stop the squeaks, your only recourse is to drive finishing nails at alternate angles through the hardwood floor into the subfloor and then set the nail heads and putty over them.

Relieving Air-Bound Radiators

Q—How can I relieve an air-bound radiator in a gravity hot-water heating system?

G.C.S.—Iron Mountain, Mich.

A—In an upfeed system where the supply rises from below, each radiator should have a valve for air relief. If valves are not installed, air may fill the supply pipe at the point of connection to the radiator and impede circulation. For a down-feed system, in most cases, it is unnecessary to relieve each radiator as air will rise through the supply pipe and accumulate at the high point in the system, where it should be vented.

Wood Stain Discolors Paint

Q—We painted stained-wood trim in our home and the stain is darkening the paint. Can we prevent this trouble?

O. W.—Riverdale, Ill.

A—Likely the stain was an aniline dye, which would bleed through the paint coat. The best remedy is to give the wood a coat of stain sealer, which you can purchase, and then paint it again.

Noise From Furnace Transmitted by Air Ducts

Q—Is there any way to prevent noise from our furnace blower being transmitted through the air ducts to rooms above?

S.M.J.—Syracuse, N.Y.

A—Cut a section about 1 in. wide from the air duct leading from the furnace to the blower unit. Then cover the opening thus made with a strip of heavy canvas, attaching the canvas with a good adhesive and metal bands or clamps. The canvas prevents vibration, which causes the noise, from being transmitted to the furnace casing and then through the air ducts. Also, it may be necessary to cut out a section of the cold-air duct leading to the blower unit.

Soot Streaks on Wall Near Window Trim

Q—Can you tell me what causes soot streaks on the wall near the edges of some of our window casings?

M.E.W.—Mt. Sterling, Ia.

A—The streaks are caused by soot-laden air leaking around your window frames. Caulking around the frames on the outside to prevent entrance of air will stop the trouble, and also reduce fuel costs.

Water Freezes on Porch Steps

Q—Some of our porch steps are worn down in the center so that water accumulates, and in winter freezes. How can I drain them?

J.L.D.—Louisville, Ky.

A—Drill two or three small holes through each step at the lowest point so water can escape.

How to Drill Cork

Q—Can you tell me how to drill clean-cut holes through cork?

J.F.W.—Denver, Colo.

A—Use a metal tube of the same outside diameter as the hole you wish to drill in the cork. Grind or file one end to a sharp bevel. Provide some kind of a handle or grip on the other end so that you can rotate the tube easily as it is pressed into the cork.

Leaks in Oil Tank

Q—A large tank that I use for kerosene has developed two or three small leaks in the bottom. Is there any way to repair them as I am anxious to keep the tank in service?

S.O.R.—Detroit, Mich.

A—Your best bet is to first enlarge the holes where the leaks occur to remove the damaged metal, and then plug them. You can use a small toggle bolt and lead washer for each hole. Insert the toggle end of the bolt into the tank, slip on the lead washer, outside the tank, and back it up with a steel washer of the same diameter. Then turn on a nut and pull it up to squeeze the lead washer tightly against the tank and seal the hole.

Chewing Gum Removed From Upholstery

Q—My youngsters have put chewing gum on the upholstery of a new chair. What will take it out?

U. B. G.—Chicago

A—Moisten the gum with carbon tetrachloride, and while it is still wet, carefully scrape the gum with the edge of a dull knife. Or, hold an ice cube on the gum to harden it. When brittle, the gum can be crumbled and removed.

Shoe Mold Opening Up

Q—The shoe molding around my kitchen is opening up and leaving a crack between it and the linoleum. What is causing this?

A. B. T.—St. Louis, Mo.

A—Improper nailing combined with shrinkage will cause this trouble. See if the molding has been nailed to the baseboard instead of to the flooring. When this is done, the baseboard, in drying out, will pull the molding with it. The remedy is to remove the molding and nail it to the floor.

Softening Hardened Putty

Q—Several of my storm sash need reglazing. Is there something I can apply to loosen the putty?

R. O. B.—Duluth, Minn.

A—Application of a hot soldering iron will usually do the trick. Use a large one for sufficient heat and pass it slowly over the putty. The heat will take the oil from the putty, leaving it in a crumbling state, after which it usually can be removed with a wood chisel or a putty knife.

Wall Openings Improve Space Heater

Q—Can you tell me how to improve warm-air circulation from a space heater to adjoining rooms?

W. H. F.—Rome, N. Y.

A—One of the best ways to improve circulation of warm air between rooms is to install grille-covered openings in the walls between the rooms. The openings should be at ceiling height and should be long and narrow. A size 10 by 30 in. will do in most cases.

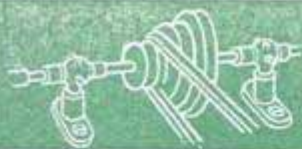

"FIND-IT" SYSTEM for Your Shop

By Walter E. Burton

IF YOU HAVE ever spent a lot of time searching in a multiple-drawer shop cabinet for some item badly needed at the moment, then you can appreciate the efficiency and speed of this simple shop-filing system. It is set up for a cabinet with any number of drawers, or it can be used with a number of small boxes, glass jars or other individual containers, to store such items as bolts, nuts, washers, screws, steel wool, felt, small tools, radio parts, etc. The same system will serve when filing photo negatives or newspaper clippings in envelopes.

In setting up the filing system for items stored in a cabinet, first number each drawer 1, 2, 3 and so on, as in Fig. 2. Numbers are painted on the drawers free-hand, or applied with a stencil or rubber stamp. Proceed the same way in numbering other containers used in place of cabinet drawers. Each drawer of a storage cabinet may contain several different kinds of objects. Where this is so, it will be still handier to place each group of small articles, washers, nuts and the like, in a separate container which is placed in the drawer along with others containing other small parts. Then prepare an index with 3 by 5-in. cards and

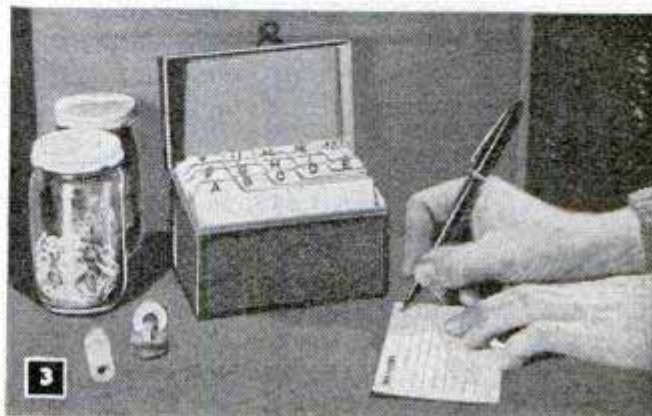

file case such as that shown in the photo at the left of Fig. 1. List all items in each drawer on separate cards, Fig. 3, and file under the correct index letter, as washers, wire, worm gears, under "W," and so on through the alphabet. Place all these items listed under "W" in one drawer. In many cases it is possible to label the container or object with the number of the drawer it is kept in as in Figs. 1 and 4. In this way a container or part which has been taken from the drawer to the bench may be returned to the same drawer without consulting the index to determine its proper place.

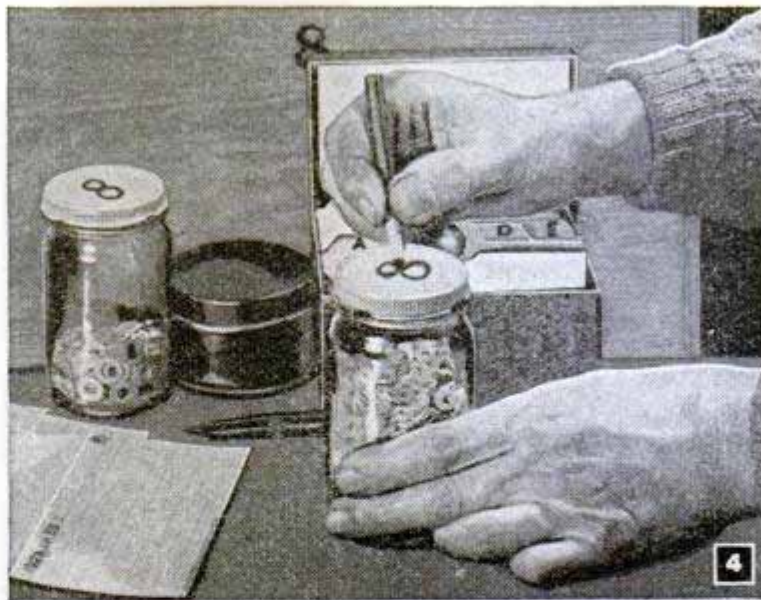

Filling-Station Attendant Carries Map for Customer's Convenience



As a special service for customers, attendants at one filling station carry road maps hooked to their belts for ready reference. This makes it unnecessary for the driver to get out of his car and go into the station to check his route or obtain other road information. The map is glued to a plywood panel, being folded so that one-half of the map is on each side. A sheet of Cellophane covers the map and panel, and the edges are bound with tape.

Wood on Ferrule Improves Brush

For those who use small brushes when lettering, striping and filling, plastic wood molded around the ferrule of the brush makes it easier to handle. After the wood is applied to the brush, allow it to dry and sandpaper to a smooth finish. Advantages of the larger grip are: It's easier to pick up, and permits a firmer hold on the brush.

Valve-Cap "Tool" Handy When Removing Auto-Tire Valve Core

Tires on many cars do not have valve caps with a core-removing stem and, for that reason, one filling-station attendant made this tool, which he carries in a pocket, to remove valve cores. It consists of a $\frac{5}{16}$ -in. hexagon-headed cap screw turned tightly into a valve cap of the correct type. Additional purchase afforded by the head of the screw makes it easy to loosen cores that are "frozen" in the stem.

Lincoln U. Glos, Maywood, Ill.

☐ Clean holes with a minimum of tearing in using an ordinary twist drill can be obtained by sharpening the drill to an included angle of 135 degrees and operating the drill at a fairly high speed.

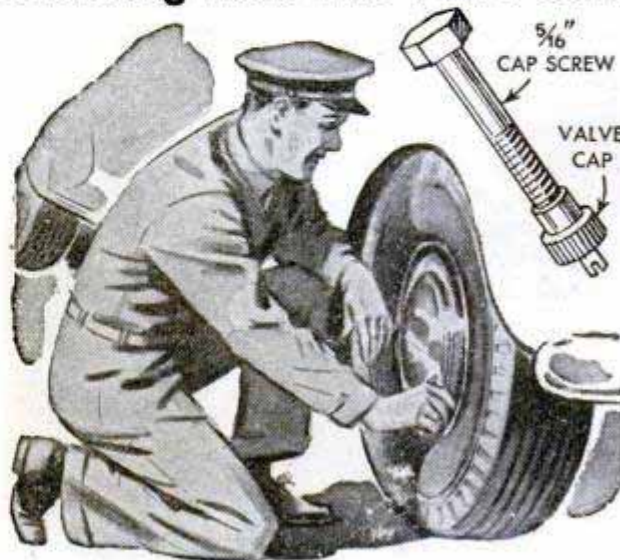

Blowtorch Heats This High-Temperature Furnace

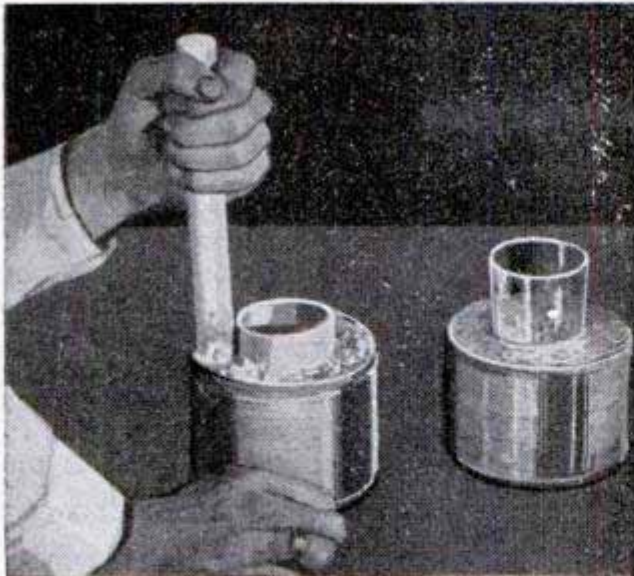

Made from two coffee cans lined with refractory cement, and fired by an ordinary blowtorch, this high-temperature furnace will melt aluminum, sterling silver and other alloys having melting points in the same range. First, cut a 1¼-in.-dia. hole in the side of one can at a point about midway between the top and bottom. Mix ground firebrick, 1 part, and fire clay, 1 part, with enough water to make a thick paste. Cover the bottom of the can with this mixture to a depth of 1 in. and allow it to harden. Then cut a 2½-in.-dia. cardboard tube to about 4 in. long; also cut a 1¼-in. hole in the tube at the same height as the hole in the can. Center the tube in the can with the hole in the side in alignment with that in the can. Insert a short length of broomstick through the two holes. Then fill the space around the tube with the cement mixture and tamp down as in the photo above, left. Withdraw the broomstick piece and the cardboard form before the cement hardens. Proceed in the



same way in lining the top or cover, except that no hole is cut in the can or the cardboard form. After the cement has hardened, place a small glass tumbler, 2-in. dia., inside the bottom can. Pack the space around the tumbler with a fire-clay mixture. This gives a smooth lining. Do the same with the top, or cover can. Withdraw the tumbler before the cement hardens. Drill a ½-in. hole through the bottom of the cover can and through the refractory lining. This will vent pressure from the torch flame. Set up the furnace as in the photo at the right, place metal to be melted in a small clay crucible and set it in the bottom half of the furnace. The nozzle of the torch should be about ¾ in. from the fire hole for best results.

Martin O. Koehler, River Grove, Ill.

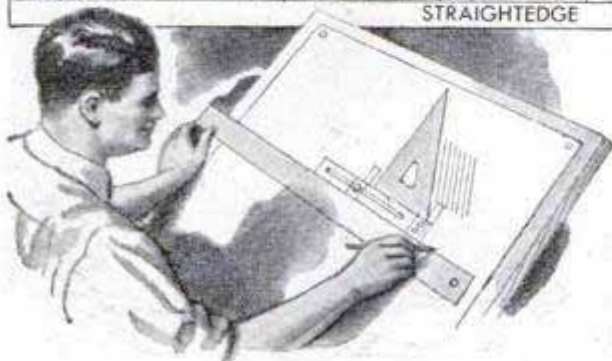
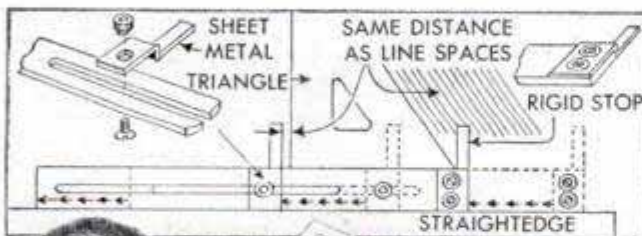

Crosshatch Lines Spaced Uniformly When Drawing Guide Is Used

To space crosshatched lines evenly, and to avoid undue eyestrain, one draftsman uses this line guide. It consists of a straightedge to which one rigid or fixed and one movable stop are attached. The right-hand stop is fastened by two bolts, as shown in the detail, and the left-hand stop slides in a slot. To use the guide, place the triangle against the rigid stop and set the movable stop the width of one crosshatch space away from the vertical leg of the triangle. Draw a line; place the triangle against the movable stop and, holding it, slide the straightedge to the left until the fixed stop touches the triangle. Then repeat as before.

Clothespin Holds Instructions For Delivery of Package

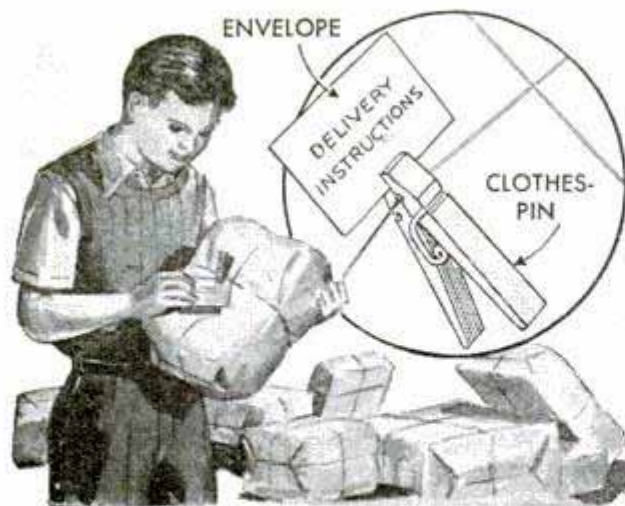

To avoid mixups in deliveries, one merchant places the instructions in an envelope and clips it to the package with a spring-type clothespin. The pins are painted in bright colors, each color being for a certain driver. After delivery the pins are returned to the shipping room to be used again.—Wm. P. Houser, Organ, N. Mex.

Dowel Pointer Chucked in Lathe Sharpens Work Quickly

By cutting the square shank off a dowel pointer and inserting it in a lathe chuck, I was able to chamfer both ends of over 1000

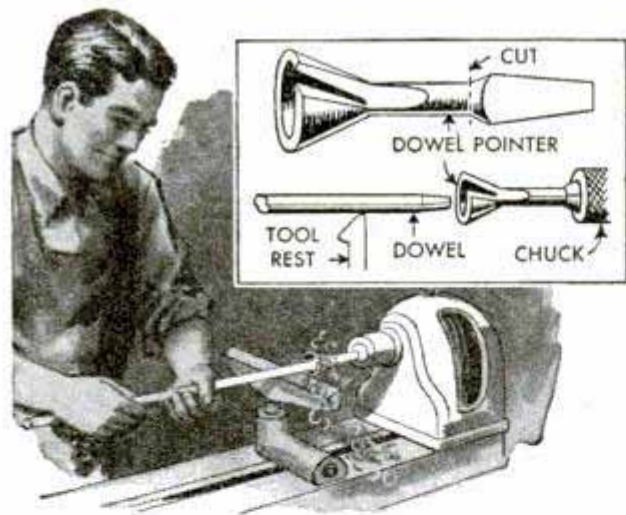

dowels in an hour. The tool rest is adjusted so that the work, when supported on it, is on a level with the center of the pointer. Samuel Silberman, New York City.

Keeping Hands Warm Outdoors

Trappers and ice fishermen who find it necessary to submerge their hands in cold water to set traps and rig lines can keep their hands free from chapping during cold

weather by rubbing them with olive oil. The coating of oil will keep the hands almost as warm as a pair of gloves.

How to Square Concrete Forms By Using Steel Tape

Here's a quick way to check a concrete form with a steel tape and determine whether or not the corners are square: Measure a distance of 6 ft. from one corner along the side and, from the same corner, measure 8 ft. along the joining side. Mark these two points and determine the length of the hypotenuse of the triangle thus formed. This should be a distance of 10 ft. If the form that you are checking is too

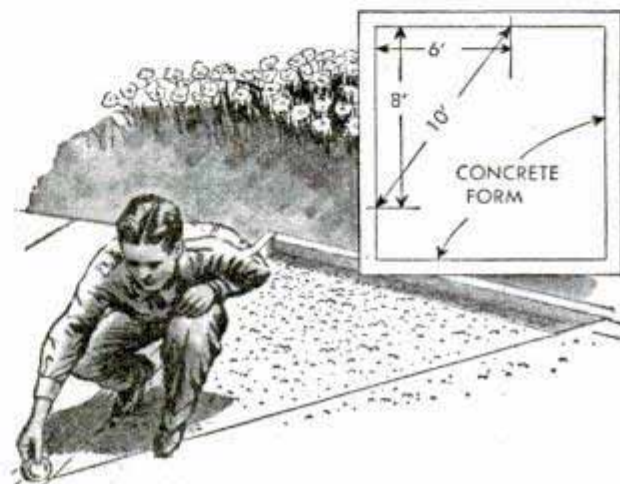

small for these distances, they can be halved; that is, measuring 3 ft. on one side and 4 ft. on the other will result in a triangle having a hypotenuse of 5 ft. On forms that are extremely large, double the dimensions for an accurate check.

Body Dents in Car Are Repaired With Gasket Cement

For a quick and inexpensive way to repair small, shallow dents in a car, try using gasket cement. First fill the dent and allow the cement to harden. Then sand the filled part flush with the surrounding metal. Finally, paint the repaired area the same color as the adjacent finish.

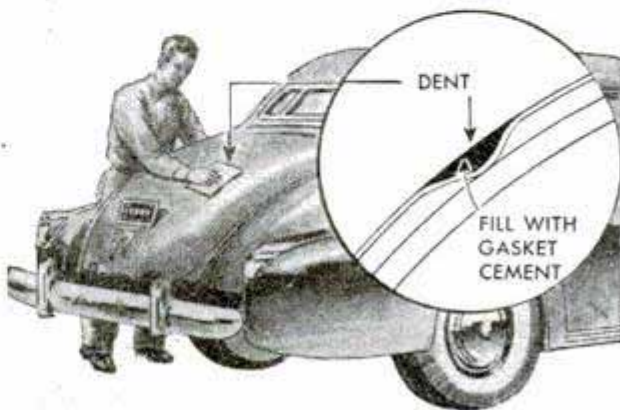

Here is a self-centering punch for marking countersunk holes in hinges, locks, brackets and other builders' hardware. The punch consists of a sleeve or barrel with a beveled tip that fits into the countersink, and a pointed member, which slides in the barrel and makes the mark for the screw in the exact center of the hole. This eliminates inaccurate sighting by eye, which is done when an ordinary punch or a pencil is used. The sleeve is turned from a piece of $\frac{1}{2}$ -in. cold-rolled steel approximately $2\frac{7}{8}$ in. long, which is drilled as shown, and beveled at a 50-deg. angle. All necessary dimensions for turning it are given in the detail. For the "point," use $\frac{1}{4}$ -in. drill rod for best results. Note that the dimensions given are for a

Self-Centering Punch Marks Screw Holes To Mount Builders' Hardware Correctly

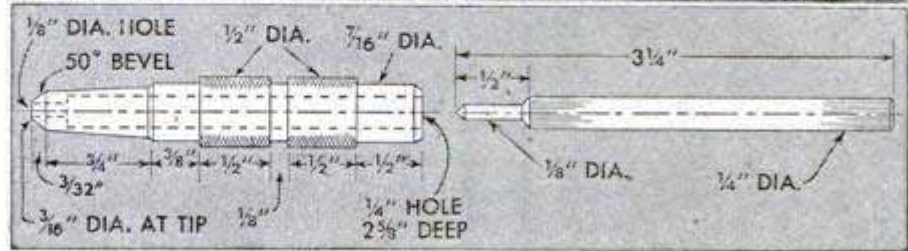
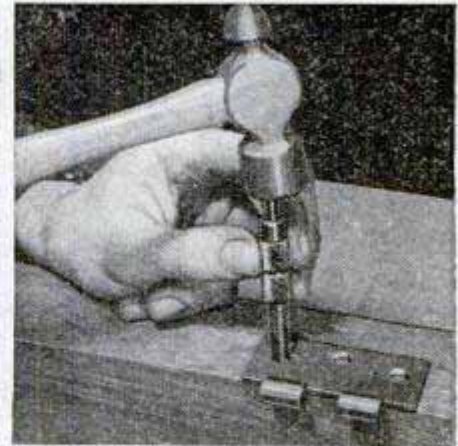
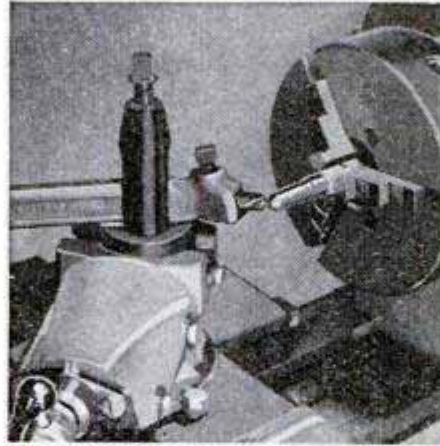

punch that will be a convenient size for ordinary hardware; for smaller work, reduce the dimensions proportionately.

punch that will be a convenient size for ordinary hardware; for smaller work, reduce the dimensions proportionately.

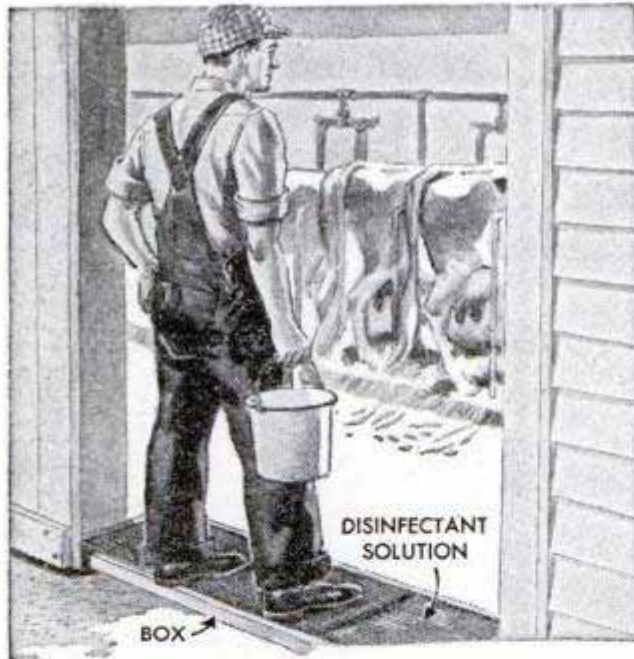

Disinfectant Pad on Barn-Door Sill Provides Sanitary Protection

To aid in keeping a dairy barn or poultry house sanitary, provide a disinfectant pad at the door to be used as a "foot mat." This will serve to prevent the spread of germs. The pad consists of a shallow box or tray in which burlap bags are placed. The cloth is kept thoroughly saturated with disinfectant solution. Persons entering the barn or poultry house make it a practice to clean their shoes on the pad.

Test for Small Leaks in Soldering

Testing a soldered hole for a leak is easy if a small rubber vacuum cup is available. Moisten the edge of the cup and press it over the hole. If there are no leaks, the cup will stay firmly in place, but if there are leaks, air will get under the cup and it will come off. Of course, the surface around the soldered hole must be smooth. This is a handy way to test tanks, and large pans where it would be difficult to fill them with water.—John Lawrence, Bristow, Okla.

"Ring Lock" Holds Toolbox Hasp

It is not necessary to padlock a toolbox to keep the lid from coming open when carrying the box around on a job. A "lock" that will keep the hasp closed is made by cutting a transverse slot at a slight angle to the hasp slot or eye and then fitting the staple with a ring. Make the slot just large enough to clear the ring easily. To open or close the hasp, align the ring with the slot.

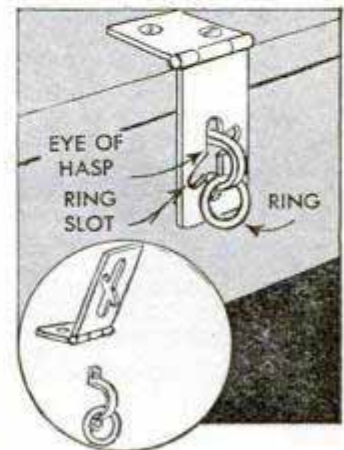



1
Starter Switch
 . . . STARTS THE LAMP AND DOES NO FURTHER WORK IN ACTUAL OPERATION. PHOTO SHOWS SWITCH REMOVED—LAMP REMAINS LIGHTED

How to Service

FLUORESCENT

By Sam Brown

BALLAST, tube and starter switch—these are the three units requiring service in fluorescent lighting installations. Since the ballast is more or less trouble-free, common servicing is simply a matter of replacing a burned-out tube or defective starter.

The tube: Both ends of the tube are alike, Fig. 4. The electrode or filament furnishes a terminal for the arc and originally is covered with an electron-emissive material. This is dissipated during the life of the lamp and is deposited inside the tube, causing the familiar end blackening, Fig. 3, which is a fair index of the "life expectancy" of the lamp. Early end blackening indicates faulty starting.

Starter switch: Following the lamp diagram below, it can be seen that when the starter switch is closed, power is supplied to the tube

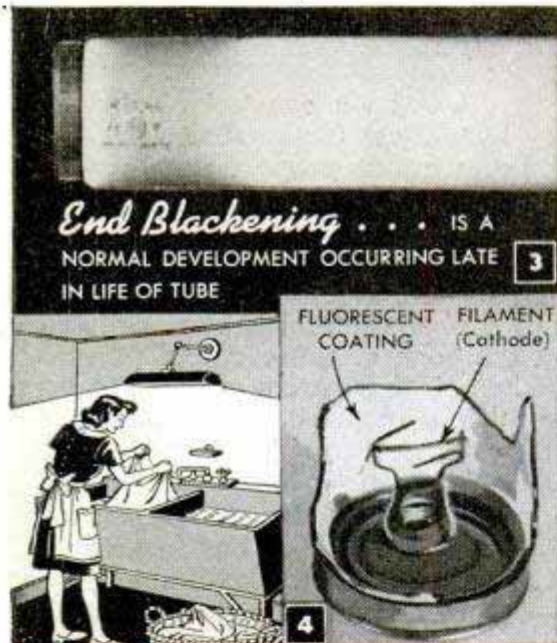

How the Fluorescent Lamp Works

MAIN SWITCH 1, IS TURNED ON. BALLAST 2, LIMITS CURRENT TO AMOUNT REQUIRED BY LAMP. STARTER SWITCH 3, IS CLOSED (USUALLY AUTOMATIC) TO COMPLETE CIRCUIT. LAMP FILAMENTS BECOME HEATED AND SEND OUT ELECTRONS 4, AND IN A FEW SECONDS THE ARC 5, STRIKES. STARTER SWITCH THEN IS OPENED AUTOMATICALLY OR MANUALLY AND PLAYS NO FURTHER PART IN OPERATION. ARC 5, SENDS OUT SHORT-WAVE, INVISIBLE LIGHT, WHICH ACTIVATES FLUORESCENT COATING ON INSIDE OF TUBE CAUSING IT TO GLOW AND PRODUCE VISIBLE LIGHT.

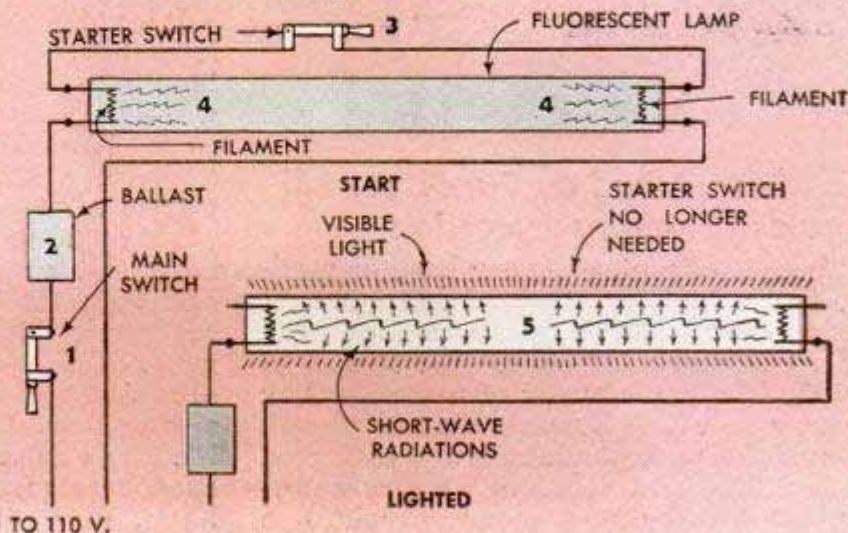

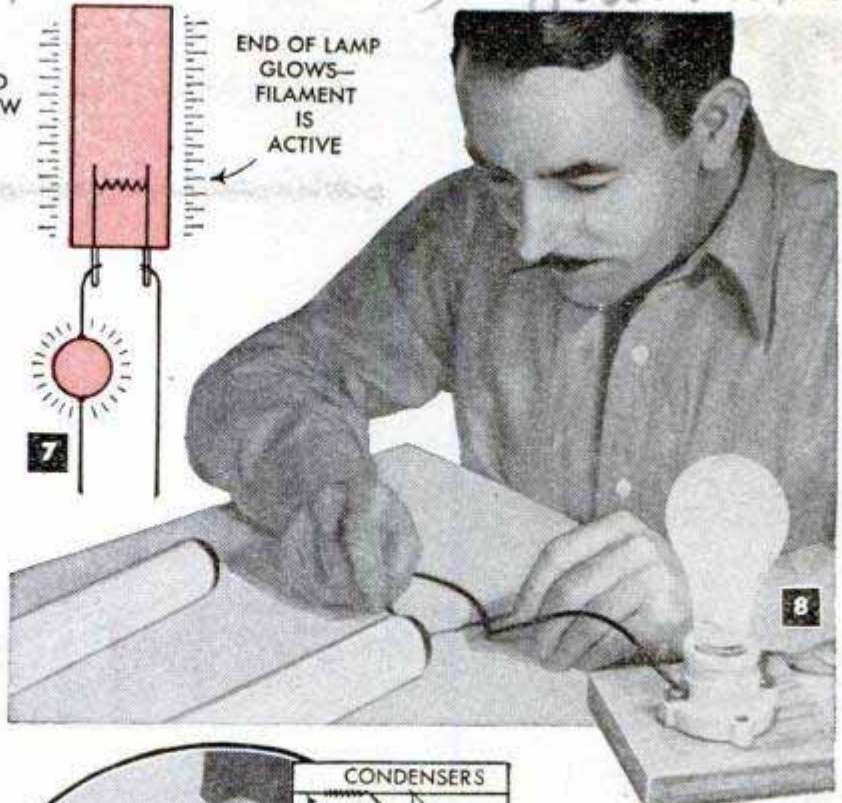
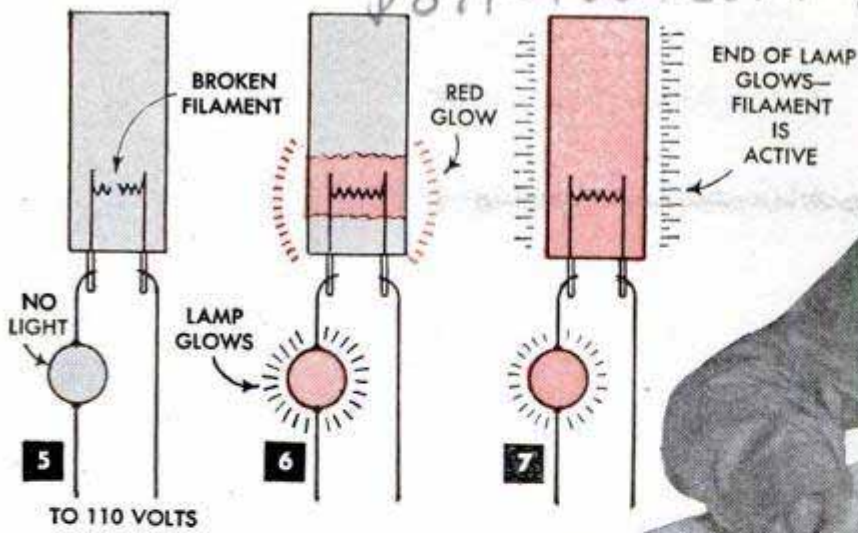

LAMPS

filaments, and they heat and become a dull red. Modern fixtures are fitted with an automatic starter, commonest of which is the glow lamp, Fig. 2. When the fluorescent fixture is turned on, the glow switch receives a full supply of current, causing the movable metal strip to heat and make contact. When the arc strikes, voltage to the glow switch is lowered and the metal strip cools and opens the circuit. Because the glow switch must heat on a certain voltage and not heat on a slightly lower voltage, it is impractical to test the

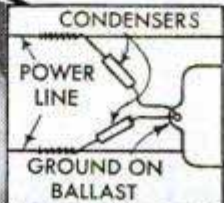
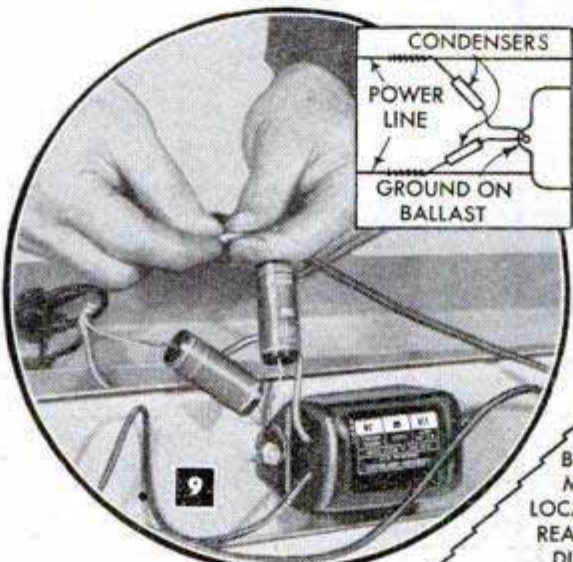

Testing Lamps . . .

IS DONE BY USING A TEST LAMP AS SHOWN. THE PROPER SIZE TEST LAMP MUST BE USED.

Radio Interference . . .

IF PRESENT, CAN BE HELD TO A MINIMUM BY HOOKING A SMALL CONDENSER ACROSS THE POWER LINE

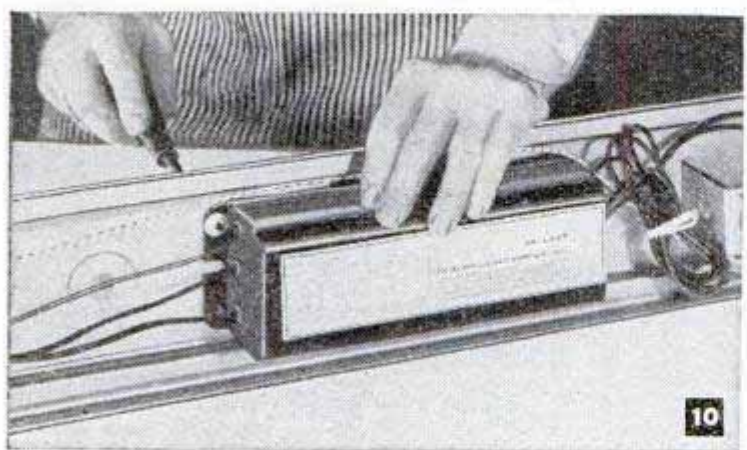
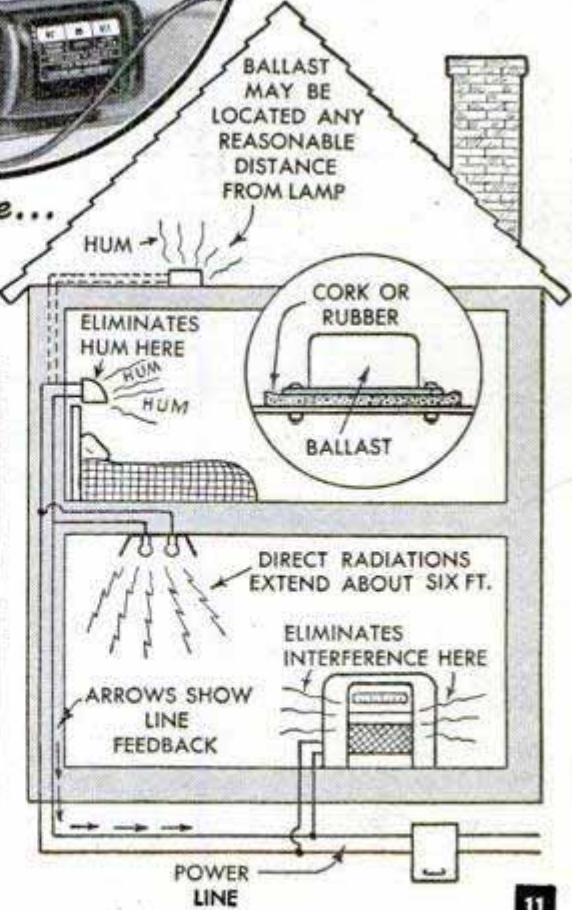

Ballast Hum . . . USUALLY IS LOW AND INAUDIBLE UNDER AVERAGE CONDITIONS. BALLAST CAN BE INSULATED TO MINIMIZE HUM, OR IT CAN BE LOCATED SOME DISTANCE FROM LAMP

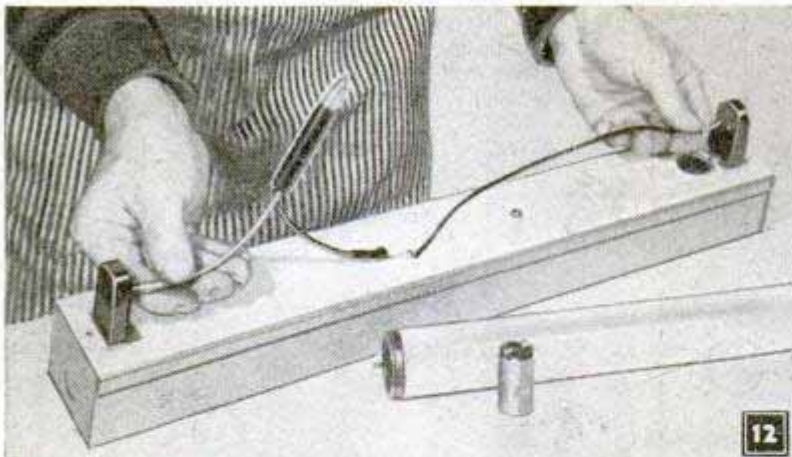

Circuit Testing . . . CAN BE DONE WITH A TEST LAMP. ONE SIDE OF EACH SOCKET SHOULD BE ALIVE AND LIGHT SHOULD SHOW BETWEEN THEM.

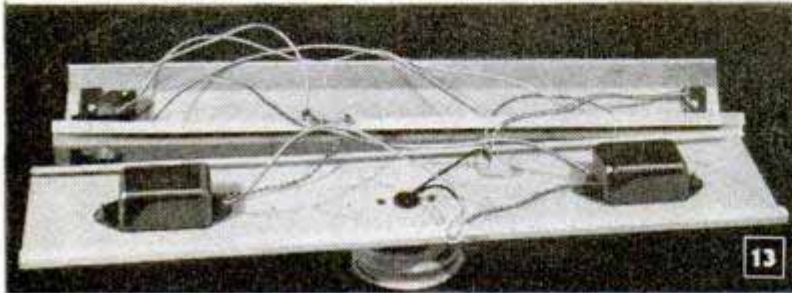

switch electrically by any method other than placing it in the fixture.

Lamp blinking: Near the end of life, the electron-emissive deposit on tube filaments is exhausted, the filaments are no longer self-sustaining and a cycle of blinking continues until either lamp or starter ceases to function. To prevent blinking, auxiliary equipment was added to the glow switch, making a double switch, the second switch turning off the first when the fixture is not functioning correctly.

Testing lamps: Use an extension cord with the ends scraped clean. Connect a socket in one of the power lines, as in Figs. 5 to 8 inclusive. When the test wires are touched to the prongs of the tube, the test lamp should light. If it does not, a broken filament is usually indicated.

14

FLUORESCENT-LAMP, TROUBLE-SHOOTING CHART

FAULT	POSSIBLE CAUSE	REMEDY
LAMP BLINKS (This fault should be corrected at once to avoid undue wear on lamp and starter)	END OF LIFE (Normal life is 2500 hours)	INSTALL NEW LAMP
	DEFECTIVE STARTER	TEST WITH NEW STARTER
	LOOSE CONTACTS	CHECK CONTACTS AT LAMP ENDS
	WITH NEW LAMP: MAY BE CAUSED BY DEFECTIVE LAMP	CHECK WITH A LAMP KNOWN TO BE SATISFACTORY
	WITH PLUG-IN FIXTURES: LOOSE CONNECTION AT PLUG	CHECK PLUG. TRY NEW PLUG-IN. TEST FROM DIFFERENT OUTLET
POOR OR SLOW START	USUALLY DEFECTIVE STARTER	REPLACE STARTER
	COLD WEATHER (Fluorescent lamps are unsatisfactory below 50° F.)	SHIELD LAMP (A special lamp for low-temperature operation is available)
NO START	LAMP OR STARTER OR CIRCUIT DEFECTIVE	CHECK LAMP, STARTER AND CIRCUIT IN ORDER NAMED
ENDS OF LAMP REMAIN LIGHTED	DEFECTIVE STARTER	REPLACE STARTER
BALLAST HUM	NORMAL. MOST PRONOUNCED IN CHEAP SINGLE-LAMP BALLAST	INSULATE WITH RUBBER BASE. TIGHTEN SCREWS. BE SURE BALLAST HAS SOME MEANS OF VENTILATION. (See also Fig. 11)
RADIO INTERFERENCE	DIRECT RADIATION FROM LAMP OR LINE FEEDBACK	MOVE RADIO AWAY FROM LAMP. CONNECT CONDENSER ACROSS POWER LINE
STROBOSCOPIC EFFECT	NORMAL TO SOME EXTENT WITH ALL SINGLE-LAMP BALLASTS	REPLACE FIXTURE WITH TWO-LAMP UNIT USING TWO-LAMP BALLAST
	MOST PRONOUNCED WITH BLUE AND DAYLIGHT LAMPS	CHANGE TO WHITE LAMPS
FLICKER OR SWIRL	NORMAL, ESPECIALLY WHEN LAMP IS FIRST USED, BUT MAY OCCUR AT ANY TIME	SWITCH LAMP ON OR OFF A FEW TIMES OR LET IT ALONE AND IT WILL CLEAR UP ITSELF
DECREASE IN LIGHT OUTPUT	LIGHT OUTPUT DURING FIRST 100 HRS. IS ABOVE NORMAL	LAMPS ARE RATED AT 100 HR. VALUE (About 10% above normal)
	COLD WEATHER. A LIGHT LOSS OF ABOUT 1% PER DEGREE BELOW 65° F.	ENCLOSE OR PROTECT LAMP. USE SPECIAL COLD-WEATHER LAMP
END BLACKENING	NORMAL NEAR END OF LIFE. CAUSED BY BURNING OF COATING ON FILAMENT	IF OCCURRING EARLY IN LIFE, CAREFUL CHECK OF ENTIRE FIXTURE SHOULD BE MADE

If the tube glows red, Fig. 6, the filament is operating correctly but the activating material has been burned off. When the lamp lights and the end of the tube glows, Fig. 7, that end of the tube is good. If both ends test, the tube is satisfactory. For accurate results, and also to avoid overloading the tube filament, the test lamp should be 60 watts for 14, 15, 20 and 30-w. tubes. Use a 100-w. test lamp for 40-w. tube; 20-w. test lamp for 65 and 100-w. tubes; 25-w. test lamp for the small miniature tubes.

Radio interference: Direct radiation from the tube is eliminated easily by simply moving the lamp or radio. Line feedback can be cut to a very low level by connecting a small condenser across the line, Fig. 9. Special condensers are made for this purpose. Ground the free end of each condenser to some part of the fixture.

Ballast hum: Correction for ballast hum often is made by simply tightening loose screws holding the ballast, as shown in Fig. 10. A rubber shim under the ballast, Fig. 11, will give a more positive reduction of noise. For complete elimination of noise, the ballast can be moved any reasonable distance from the lamp without affecting its performance, Fig. 11. As a general rule, keep ballast within 50 ft. of lamp, avoid damp locations and air temperatures of 120 deg. F. and above.

Circuit testing: If both lamp and starter check correctly, the fault is in the circuit. Test with an electrical tester or a 220-v., 100-w. lamp, as shown in Fig. 12. If the test lamp does not light, the fault is farther along the line and the whole wiring system must be systematically checked.

Power factor: This means that the line must carry an over-supply of current in order to transmit a smaller amount of current which is actually used. Thus, if a ballast requires twice as much current in the line as it actually uses, it has a low power factor of 50 percent. Power factor does not affect lamp performance. Its only effect is that heavier wiring is needed.

Stroboscopic effect: This should not be confused with an actual flicker or blink. Stroboscopic effect shows itself on moving machinery, where, when the moving part and the lamp cycle happen to be timed just right, rotating parts may appear to stand still or to rotate backwards. The highest correction is obtained by using two lamps arranged so that one is "off" while the other is "on." However, a two-lamp fixture is not insurance against stroboscopic effect. Many two-lamp fixtures are two single lamps, each with separate ballast, Fig. 13. Current surge of each lamp is the same. Stroboscopic correction is made only with a two-lamp high power-factor ballast.

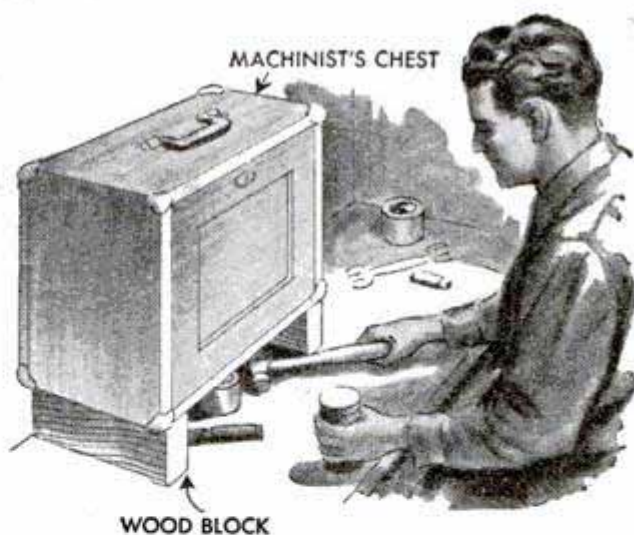

Machinist's Chest Set on Blocks Provides More Bench Space

Machinists and mechanics can gain extra bench space by setting their tool chests on two wood blocks placed under the ends. Lengths of 2 by 4-in. stock will do well for this purpose. The space gained can be used for tools or parts, or for the tool-chest cover.—Edmund L. Johnson, Pittsburgh, Pa.

Ball-Point Pen as Stencil Stylus

Ball-point pens now on the market will serve a dual purpose when used as a stylus for duplicating stencils. Results obtained are comparable with that of the regular stylus. The pens' writing efficiency is not impaired and it is not necessary to remove the ink magazine from the pen.

Waldo T. Boyd, West Des Moines, Iowa.

Screw Jack Supports Tool Bit

When a lathe job requires that the tool bit extend so far from the holder that it may chatter or break, a small screw jack will support the bit and keep it steady. The base of the jack rests on the cross slide. With this arrangement, wear on the tool is lessened because it is held rigidly.

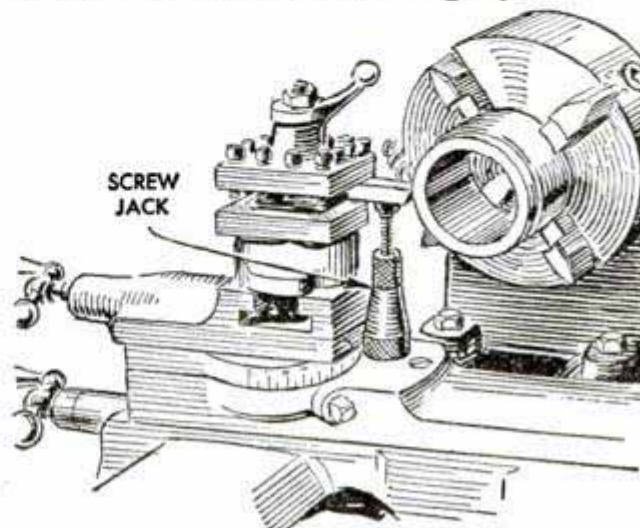

Bench Stop With Clamping-Bar Members Has "Gripping" Action When Holding Work

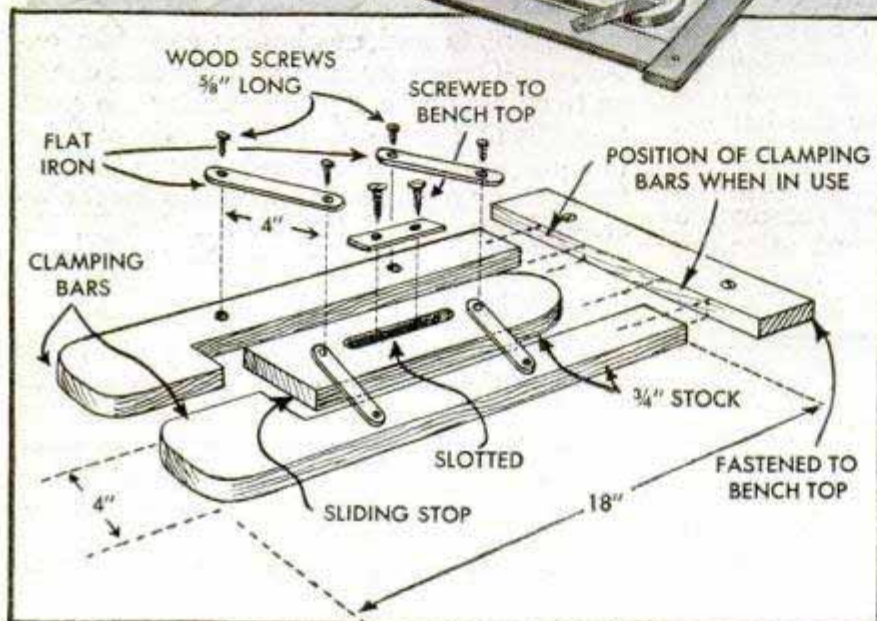
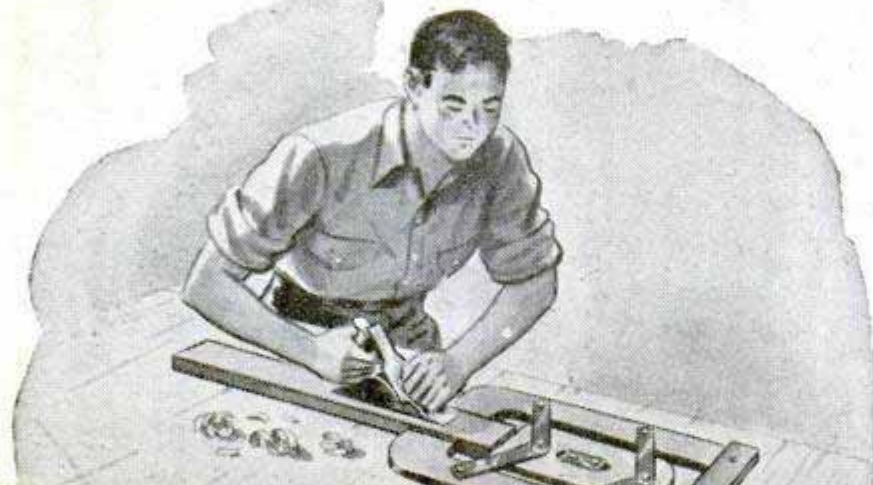

Made from two clamping bars, a sliding member or stop and a fixed piece, this bench stop adjusts itself automatically to various widths, and holds the work in a vise-like grip. Only a few general dimensions are given; the others can be determined by the size of the work to be handled. Remember that the length of the flat-iron pieces to which the clamping bars pivot, will determine the width of boards that the stop will take. After the bars and sliding member have been cut out of $\frac{3}{4}$ -in. hardwood stock, assemble them as shown in the detail, fastening the pivots to the bars and the stop with wood screws $\frac{5}{8}$ in. long. Then fasten the fixed piece in place and determine the position of the sliding stop. When this is located, screw it in place using flat-headed wood screws and a length of flat iron drilled for the screws. Since the unit is fastened to the workbench by only four screws, it is removed easily if additional space is required.

"Wood-Cutting" Hardware Display Promotes Sale of Tools

This simple attention-getter is more likely to promote interest and stimulate sales of tools than merely placing the tools in the window in the ordinary manner. To show the superior quality of his planes, knives and chisels, one hardware merchant displayed them on a wooden board or panel with shavings curling up from the blades of the tools. The shavings are strips of brown wrapping paper fastened to the panel near the blade of the tool to look as though cut from the wood. Brown paper tape, if wide enough, can be used instead of wrapping paper. Curl the paper so the shavings will look realistic.

☐ Frequently map pins are difficult to remove because they are hard to grip. If the rubber bulb from a medicine dropper is slipped over the head of the pin, it will be easy to remove.



Replacement Switch for Operation of Sump Pump

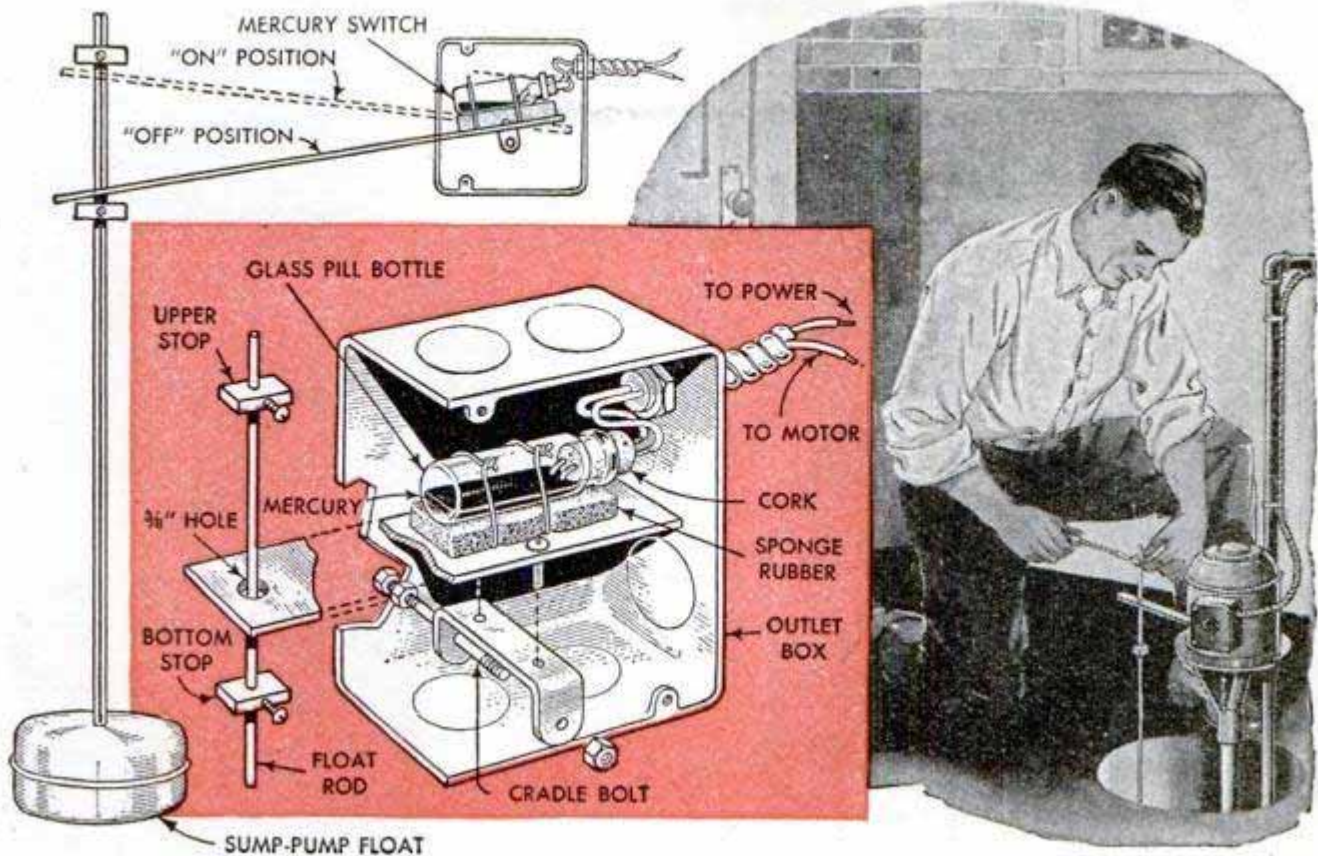

Relatively few parts are required for this mercury-operated sump-pump switch and, once installed and adjusted, it should give long and trouble-free service. Heart of the unit is a glass bottle or tube partially filled with mercury which, when tilted in one direction, covers the switch leads to close the circuit to the motor and, when tilted in the opposite direction, uncovers the leads and opens the circuit. The switch is installed in an electrical outlet box. A hole is drilled in one end for the armored cable that conducts the leads to the mercury tube. Then a hole is made in each side of the switch box for the cradle bolt, see detail. The actual switch assembly consists of a glass pill bottle and cork, a sponge-rubber "bed" to which the bottle is wired, a lever that extends through a hole cut in one end of the case and slips over the float rod, and a

cradle and cradle bolt. Refer to the detail for the method of assembly of the various parts. No dimensions are given as these will vary according to the material on hand. Note the manner in which the leads are brought into the tube through the cork and bent downward. Remember that the cork must seal the bottle tightly. The amount of mercury in the tube is determined by experiment after the switch is assembled. Keep the cradle bolt tight enough so that, while the bottom stop on the float rod can push the lever up, it will remain in this position until the upper stop starts to pull it down. Care should be taken when assembling and testing the unit to make sure that the switch makes and breaks without arcing. For convenience, mount the box on the motor housing.

Dwight A. Williamson, Glen Ellyn, Ill.

Voltage Drop in Automobile Headlight Circuit Located by Using Test Prod

If headlights on a car are dim, even when the battery is fully charged, and it is suspected that there is a voltage drop somewhere in the lighting circuit, here's one way to locate the possible source of trouble: Make a testing instrument by attaching a battery clip to one end of a length of No. 14 insulated wire and a test prod to the other end. When it is dark—or in a darkened space—turn the lights on a screen or white wall. Fasten the clip to the positive terminal and force the prod through

the insulation at a point near the light. If the light becomes noticeably brighter, the voltage loss is probably in a switch, which may need replacing. If the lights remain dim, the ground circuit or the headlight connections may be the cause of the trouble and should be checked.

Hal Geihm, Aurora, Ill.

☐ When chipping carbon off a cylinder block or piston, always wear safety goggles to protect your eyes.

similar one in Plans at REPRINT 60 Power Tools

DRILL PRESS MADE FROM PIPE

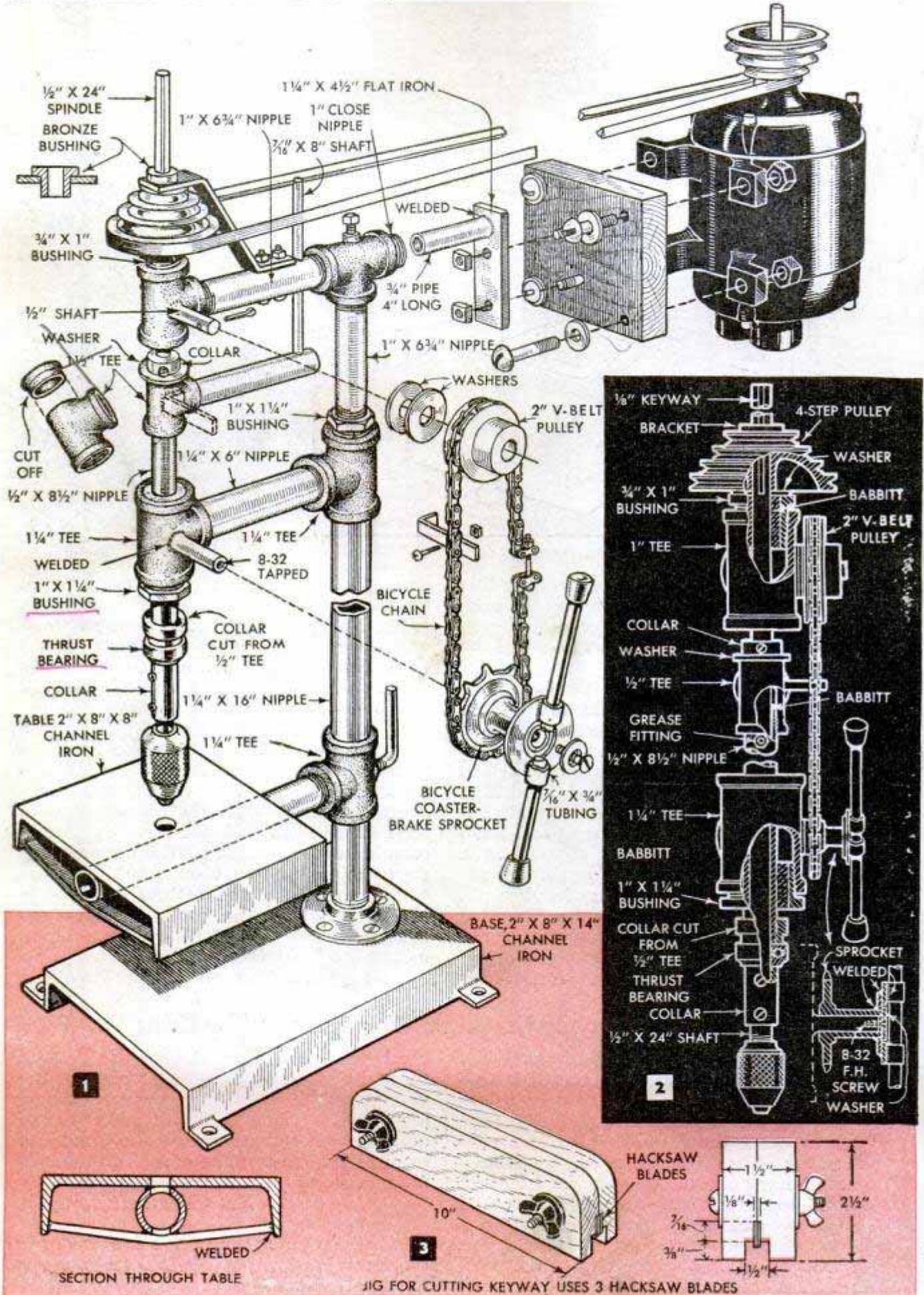

FITTINGS

A practical tool for minimum outlay of time and money—that's the main feature of this 15-in. drill press made from pipe fittings

By James L. LeSuer

INEXPENSIVE and easy to assemble, this bench-type drill press is made mainly from pipe fittings. The hand-feed arrangement is simple and sensitive in action, giving a positive spindle feed which prevents breakage of small drills. Drill-press accessories driven by a 1/2-in. chuck, such as router bits, plug cutters, planer heads and disk sanders, can be used.

Fig. 1 details the assembly of the column and head and names the fittings used. First make the base, which is simply a piece of 8-in. channel iron cut to the length given, with four bolt lugs welded to the legs of the channel. While you are at it, make up the drill table also. For the column, use a 16-in. black-pipe nipple. This is easier to polish than galvanized pipe. Place the nipple in a vise and polish smooth with a strip of abrasive cloth. Grasp the abrasive strip at each end and loop it once about the pipe. Then pull alternately on the ends of the strip. Ream the 1 1/4-in. pipe tee, on which the table swivels, to an easy fit over the column. Drill a 5/16-in. hole through the top of the tee and weld on a 5/16-in. nut. Thread one end of a short length of 5/16-in. rod, bend at right angles just above the thread and you have the locking screw to hold the table

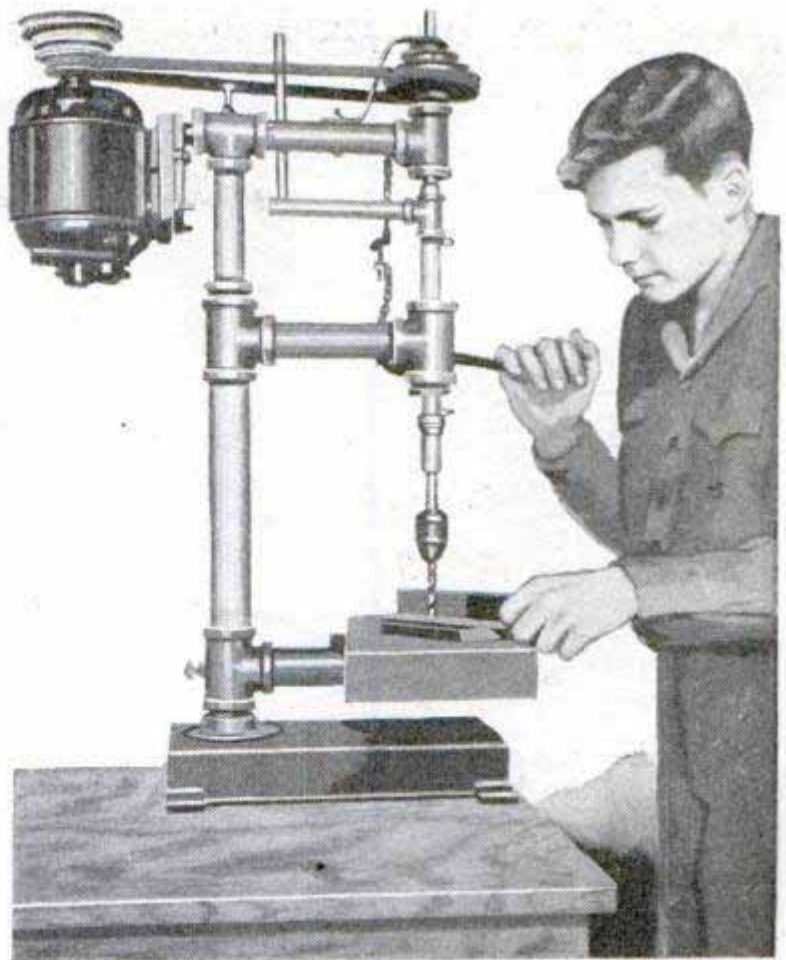

securely in any position on the column.

Build up the column and arms, beginning with a 1 1/4-in. floor flange attached to the base with four 5/16-in. flat-headed cap screws, finishing this part of the assembly with all nipples, bushings, and all tees except those two which will form bearings for the spindle. Draw all joints tight. Weld 1/2-in. shafts to the bearing tees for the sprocket and idler pulley of the raising-and-lowering mechanism, Fig. 1. Then screw the tees onto the nipples and line them up. Fig. 2 details the spindle assembly. As indicated in Fig. 1 the spindle is 24 in. long and the first operation on it is cutting a 1/8-in. keyway extending from the top of the spindle to the bottom of the 4-step pulley, Fig. 2. Have this milled at the local machine shop or do it by hand with the improvised keyway cutter detailed in Fig. 3. Thread the lower end of the spindle to take the tapped mounting sleeve of a 1/2-in. chuck. By checking the spindle assembly in Figs. 1 and 2 you can see the sequence of operations necessary to put the parts together correctly. Because the supporting parts are made from pipe fittings, it is impossible to give precise dimensions for the location of bearings, collars and guides. This must be worked out by trial assembly. Fig. 4 shows how the babbitt bearings are poured, using a counterbored wooden block as a retainer.

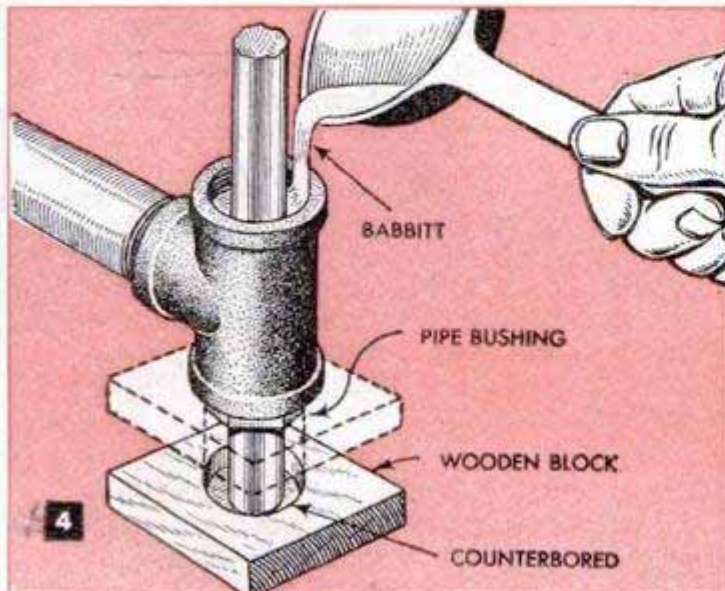

Modified Monkey-Wrench Head Serves as Staple Puller

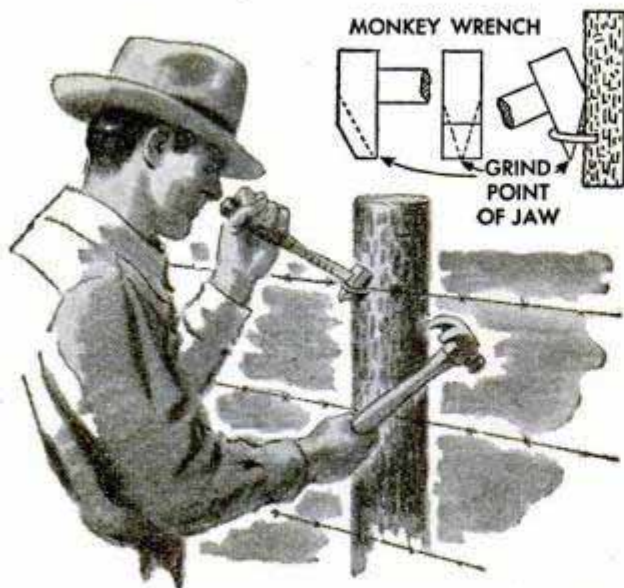

A monkey wrench that has the movable jaw broken can be converted into a very serviceable staple puller. Remove the broken jaw and grind the head of the other jaw to a beveled point. In use, the pointed jaw is held against the post and the point is forced through the staple with a hammer. The wrench lifts out the staple.

"Stethoscope" Detects Faulty Valves And Knocks in Machinery

To check valve action and locate knocks in compressors, pumps and engines, this "stethoscope" will be a definite aid because it magnifies sound and enables the operator to keep away from moving parts of the machinery while listening. The instrument is made by inserting a $\frac{1}{4}$ -in. rod about 36 in. long in the spout of an oilcan and soldering it in place. Note that the

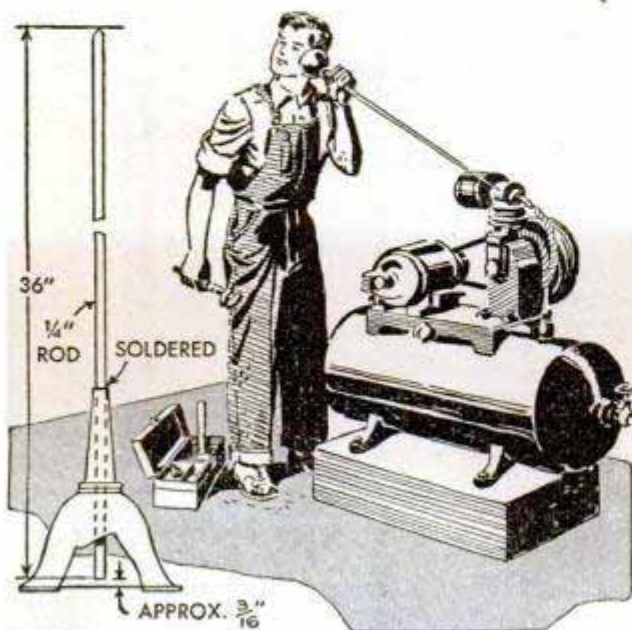

end of the rod clears the bottom of the can, which acts as a diaphragm, by about $\frac{3}{16}$ in. To locate a knock, move the tip of the rod about until the noise reaches its greatest intensity. To check valve action, listen for distinct, clicking sounds that will indicate proper opening and closing.

"Gun" Clears Plugged Grease Duct

Plugged grease ducts on autos, farm machinery and other equipment having standard $\frac{1}{8}$ -in. pressure fittings can be cleared easily by using this plunger gun. It consists of a $\frac{1}{8}$

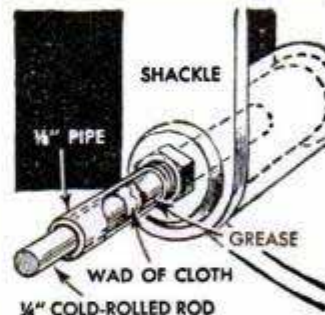

by 6-in. length of threaded pipe, a $\frac{1}{4}$ -in. cold-rolled rod and a piece of cloth to serve as wadding. To use the gun, remove the fitting from the plugged duct and screw the pipe in its place. Pack grease in the pipe, insert the cloth wadding and, using the rod as a plunger, drive the grease through the duct with light hammer blows. This will dislodge dried or stuck particles and clear the duct. Be careful not to drive the cloth into the duct and go easy with any bearing fitted with grease seals.

Wm. Riederich, Elmhurst, Ill.

Uses for Discarded Drills

Instead of throwing away worn drills, put them to some other use about the shop. For example, by grinding a short drill to approximately a 90-deg. angle and then grinding the web

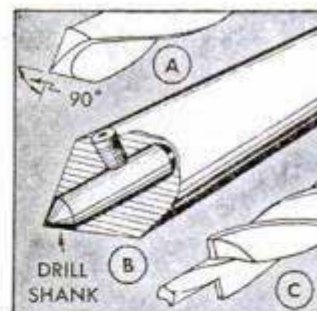

at the point for penetration, you will have a good starting drill for lathe work, as shown at A. Fitted into a lathe center, as in detail B, a drill shank made of high-speed steel will outwear some ordinary center points. It may be necessary to use a socket-head setscrew to hold the point in place. Still a third use, detail C, is as a counter-bore. It should be ground with a pilot as indicated. Be sure to back off the cutting edges for clearance.

ⓘ Before cutting linoleum, score the line to be cut with an ice pick or scratch awl. This mark serves as a guide for the knife and keeps it from slipping.

Fence and Table Extension Improve Bandsaw

By Edward R. Lucas

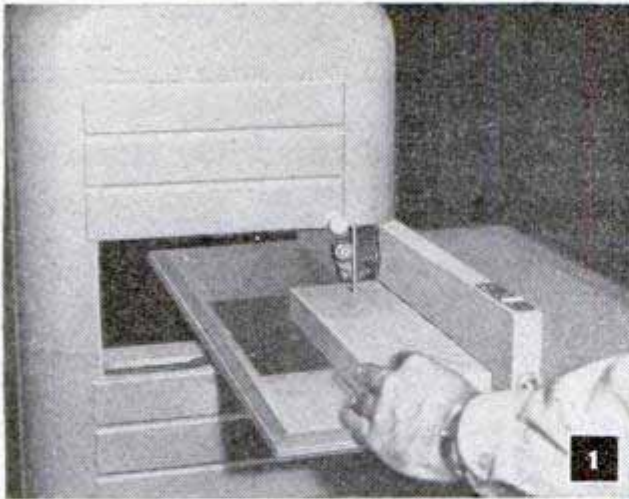

The photos above and below show the bandsaw-table extension being used for straight and bevel cuts

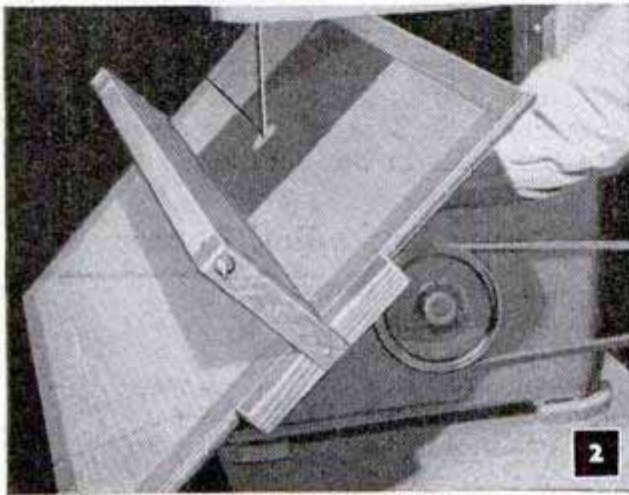

An enlarged working area and provision for a long rip fence are advantages of this bandsaw-table extension. The fence is shown in use in Fig. 1, and Fig. 2 shows the table tilted for a bevel cut. Because sizes of bandsaw tables and throats vary, no overall dimensions are given as the extension must be made to suit the saw being used. Fig. 3 shows how the parts are cut and assembled. The table extension consists of a piece of plywood having edges faced with solid stock. These are tongue-and-groove joints glued flush with the surface of the plywood. The opening for the bandsaw table is jigsawed for a snug fit. Four cleats are screwed around the opening on the underside and holes are drilled in them for $\frac{1}{4}$ -in. bolts. Matching holes are drilled and tapped in the sides of the bandsaw table, and the extension is attached to the table with bolts through these holes. Next, add the beveled guide rails for the rip fence and cut the slot for the saw blade, being sure that it is aligned with the slot in the metal table. The rip fence is detailed in Fig. 3. Note that the guide blocks are grooved to fit the guide rails and attached to the end pieces by half-lapped joints. Then one end piece is screwed to the fence and the other is hinged and drilled for a hanger bolt and wing nut for clamping the fence in place. The lower right-hand detail shows how the fence is assembled.

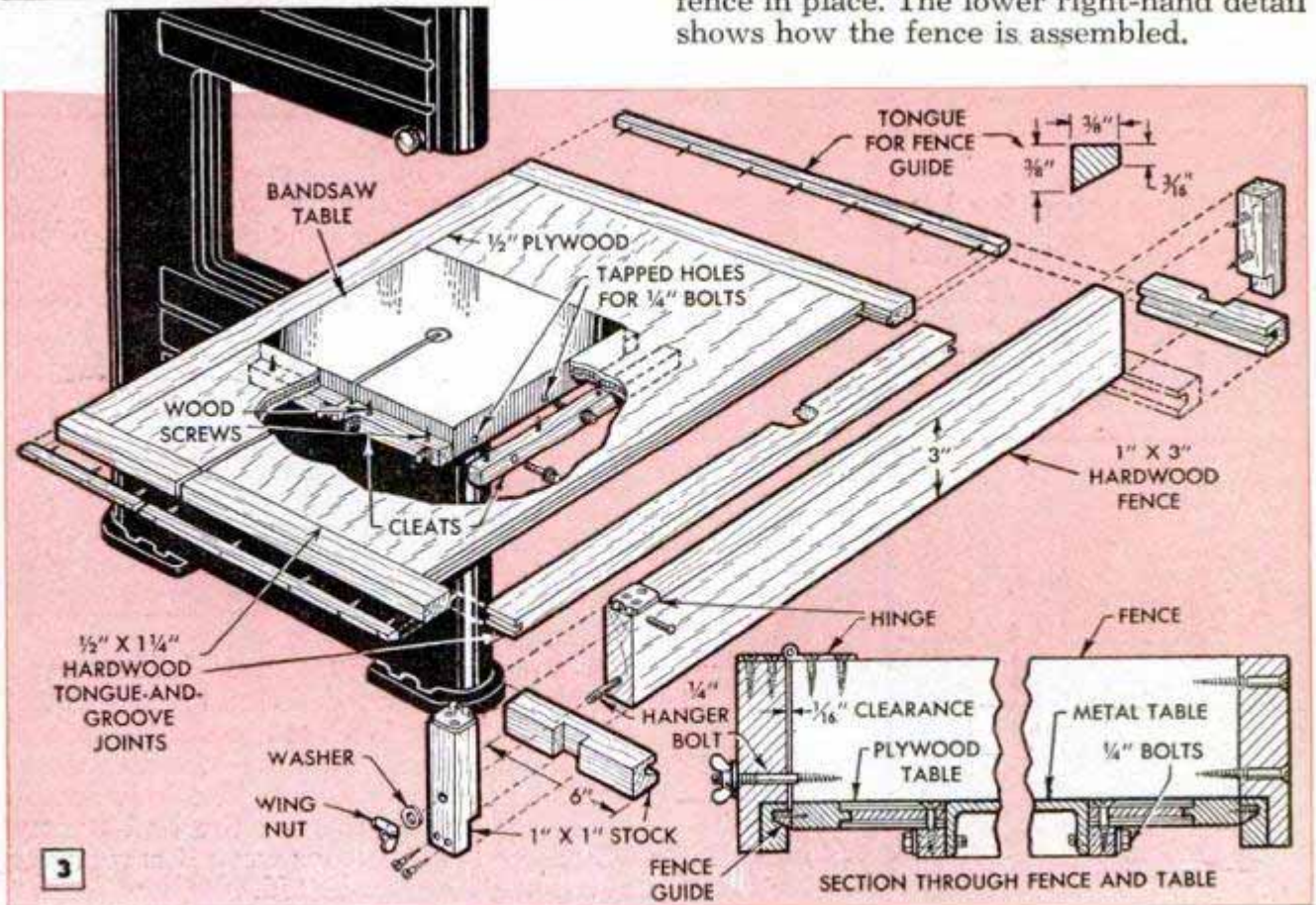

Pump Puts Air Pressure on Barrel To Speed Flow of Oil

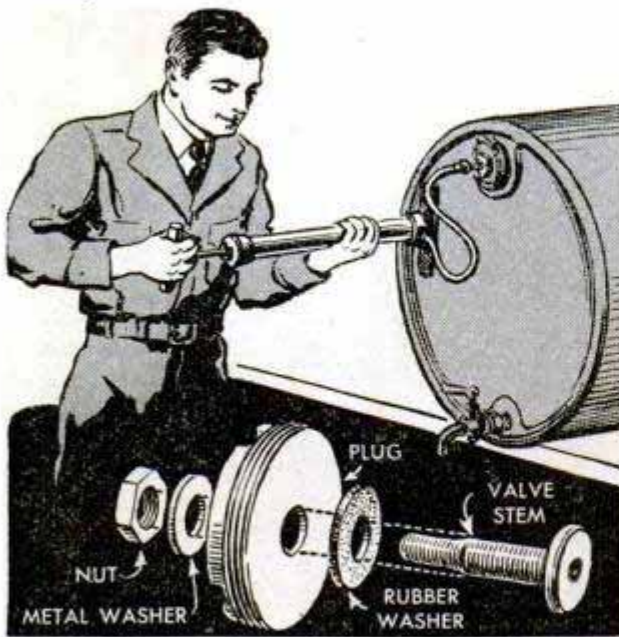

Lubricating oils and other heavy fluids stored in barrels or drums kept in unheated rooms are apt to flow sluggishly during cold weather. To overcome this, remove the barrel plug and drill it to take the valve stem and core from an automobile inner tube. Slip a rubber washer over the stem and insert the latter in the plug, securing it with a metal washer and nut. After screwing the assembly into the drum, put air pressure on the barrel by using an automobile or bicycle hand pump. This will speed the flow of oil from the spigot. If an air hose is used instead of a hand pump, be sure not to put too much pressure on the barrel.—Jerry Pokorny, Kewanna, Ind.

Latch Operated By Lever Keeps Wire Gate Taut

Desiring a means of keeping a fence-wire gate taut, one farmer hit upon the idea of using a discarded implement lever and quadrant as a latch. He attached a hook to

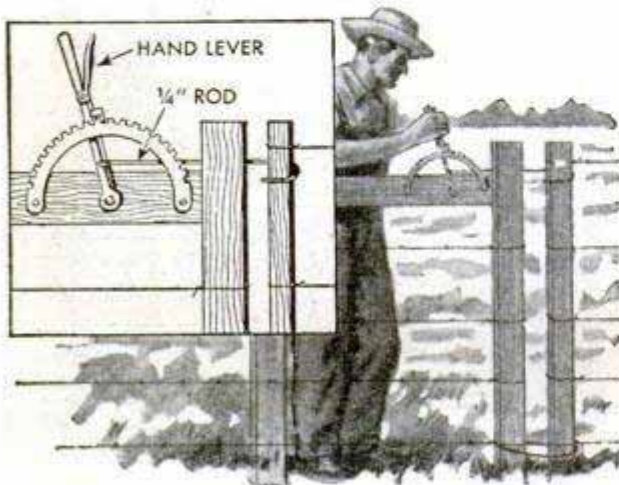

the lever and mounted both parts on a board nailed between the gate posts. A loop of wire around the gate and end posts helps secure them. The hook should be long enough to free the gate when disengaged.

Drill Gauge in Screwdriver Handle

With a drill gauge in the handle of your screwdriver where it cannot be lost, you can determine in a jiffy the correct size of twist drill to use for any small machine screw or bolt of unknown diameter.

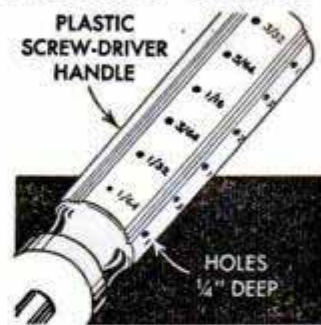

The handle, preferably the plastic type, is drilled with each size twist drill you have, drilling the holes in rows $\frac{1}{4}$ in. deep and stamping their size. In using the gauge, it is simply a matter of comparing the size of the screw or bolt with the holes in the handle.

Temporary Brake-Rod Repair

If the threads holding the yoke fitting on the end of a brake rod become stripped and you are unable to replace the rod at the moment, a temporary repair can be made in the following way: Drill a hole crosswise through both yoke and rod and then lock the two together with a machine bolt. To prevent end play, the bolt should fit the hole closely.



H. C. McMullen, Lincoln, Nebr.

Substitute Lathe Tailstock Center

When a tailstock center is damaged on a job and another isn't available, here's a substitute that will work as well, if not better. All that's needed are a tailstock drill chuck, a shank from a discarded drill bit and a steel ball. The shank is placed in the chuck and the end faced off. Then the face is counter-bored to receive the ball. The hole should be small enough to take the ball tightly. When the ball becomes worn it is removed and a new one is inserted.

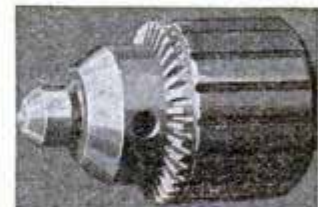



GROUP TELEPHONE CONVERSATIONS

WITHOUT the use of individual telephones and headsets, groups can now "sit in" on meetings with other groups or individuals at remote points, by means of a new instrument that looks like a console radio and a microphone. This electronic device, known as the Jordaphone, is not actually connected with the telephone line.

To use it on outgoing or incoming calls, the owner lifts the ordinary telephone handset from the telephone on his desk and places it in the top of the instrument as illustrated in photos A and B. Immediately telephone conversations may be carried on permitting all those in the room to hear what comes in over the wire, and any person in the group may reply without leaving his chair. Automatic amplifiers are claimed to amplify voices far from the microphone and tone down those nearby so that all words reach the listener or listeners with about the same volume. These amplifiers may be seen in the rear view, photo C. When the telephone handset is placed in the inset, photo B, all outside noises are cut out from the receiving and transmitting ends of the handset. The magnetic fields surrounding the receiving and transmitting ends are the means by which conversations are picked up and fed through the loud-speaker.

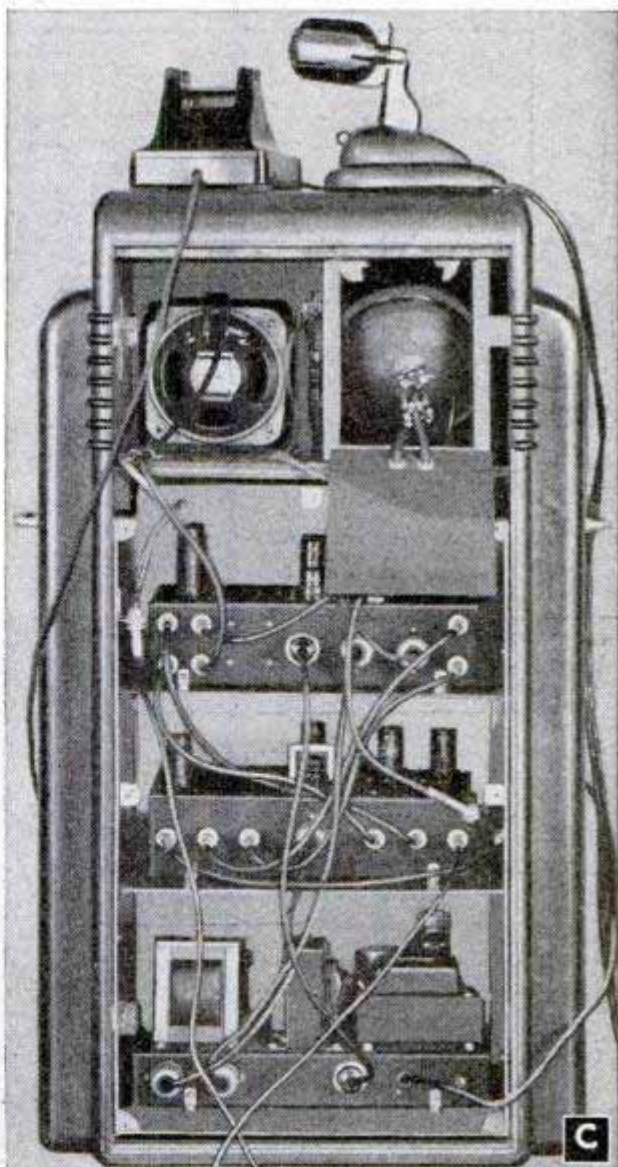

1948 LOW-COST PROGRESSIVE

By S. A. Johnson



SPECIALLY PLANNED for the beginner who wishes to build a one-tube broadcast receiver that can later be expanded at low cost into a larger set that will include the short-wave bands, this No. 1 set in the 1948 series of easy-to-build student units has a surprising "wallop" due to the use of a dual-purpose tube. The 6LS7-GT tube is actually two separate tubes in one envelope; one half of the tube is used as a regenerative detector and the other as an audio amplifier.

In this new model of the popular two-set progressive series, the No. 1 set is so designed that the filament, or "A" power is obtained from a transformer, but the "B" power comes from a standard 45-volt B-battery. Using a B-battery has much to recommend it for the beginner who is building his first set. The large power transformer is used for the "A" supply in receiver No. 1 as this same transformer will be used in set No. 2 to make it all-electric.

Set No. 2 in the series, to be described in the February issue, employs the same parts, with a few inexpensive additions, and there is very little change in the layout. If the builder does not contemplate building the second set some money can be saved by substituting a standard 6.3-volt, 1.5-amp. filament transformer for the large transformer.

The simple chassis is of rather unusual type as it is made of aluminum panels and wood as detailed in Fig. 2. The aluminum or similar sheet metal provides considerable shielding by the way it is used, and, as there are no large holes to be drilled for mounting the sockets, this thin sheet metal is just about as easy to work as the hard-pressed-wood panels used in previous sets of this type. The sockets are merely

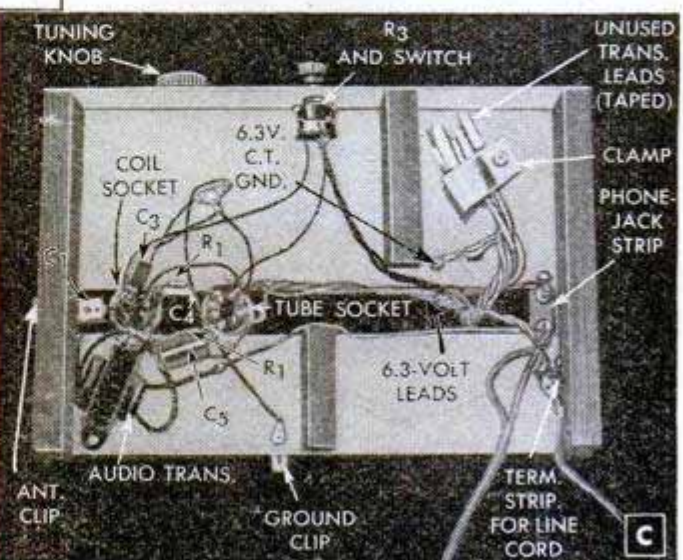
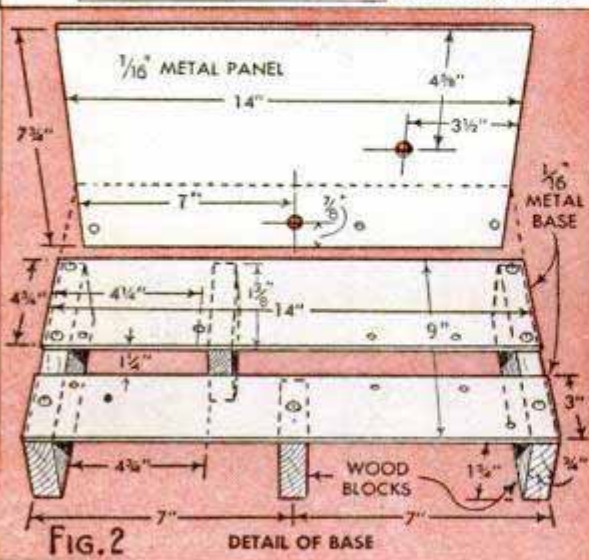
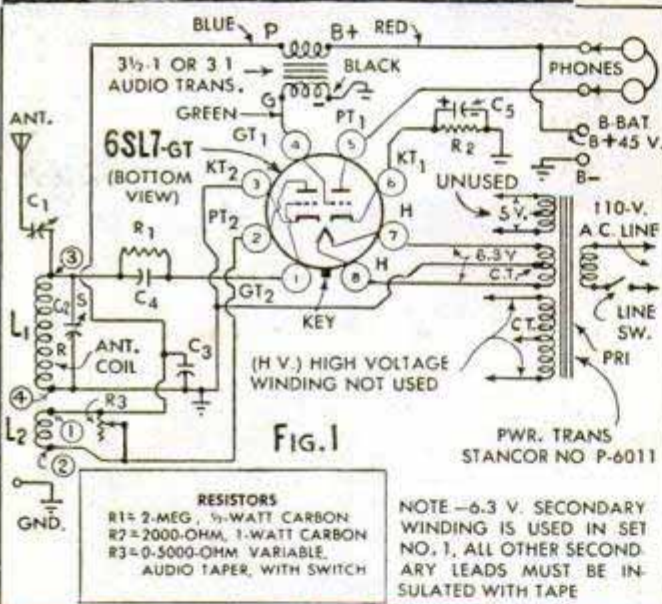
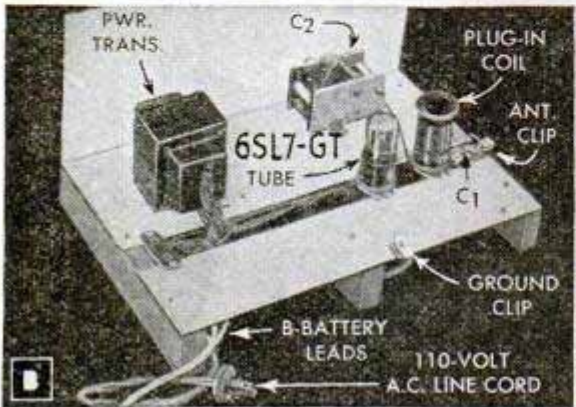

RECEIVER FOR BEGINNERS-SET No. 1

mounted across the separated base panels and fastened with short machine screws. A carefully detailed schematic circuit diagram appears in Fig. 1, and the pictorial wiring diagram with all parts located and specified is shown in Fig. 3. All leads and parts that are on the top of the base panels are indicated with dotted lines. R3 can be 25,000 ohms in both sets.

To begin construction, build the complete chassis (Fig. 2) first, then mount the various parts, following Fig. 3 and photos A, B, C and D. The power transformer is mounted on four 1/2-in. angle brackets. Next comes the wiring, which should be done with considerable care to avoid mistakes. The coil for this set is wound on a standard 4-prong coil form. This was done so that the coils for the larger set, No. 2, in the series can be added without making any changes. Wind the coil as detailed in Fig. 3 and make sure that the windings are exactly as shown by checking the prong numbers so that it will be "poled" correctly. After all wiring is completed, and the unused transformer secondary lead ends carefully taped, plug the coil into the coil socket, connect the set to the power and turn it on. The tube should light. If it does,

(Continued to page 226)

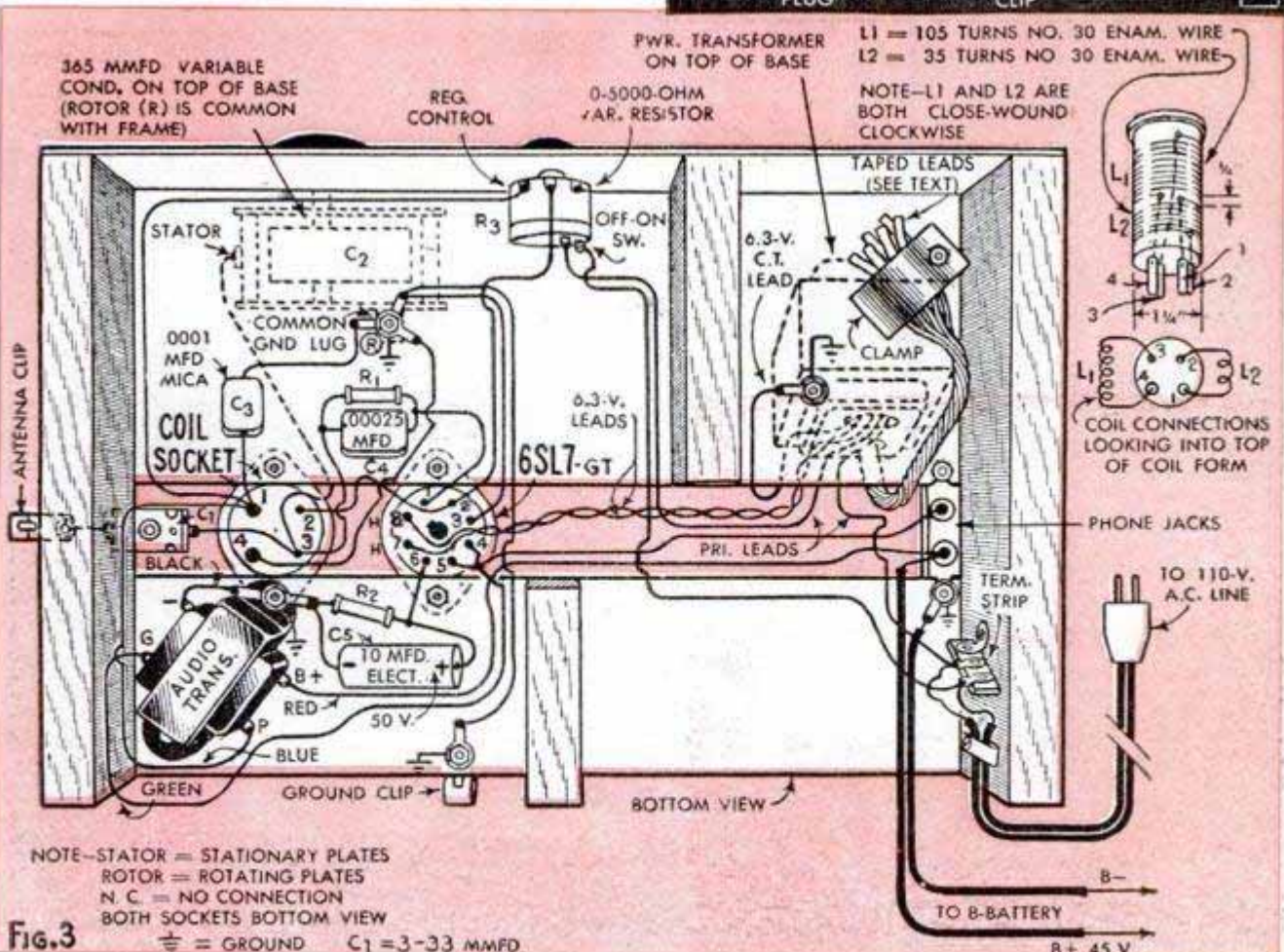
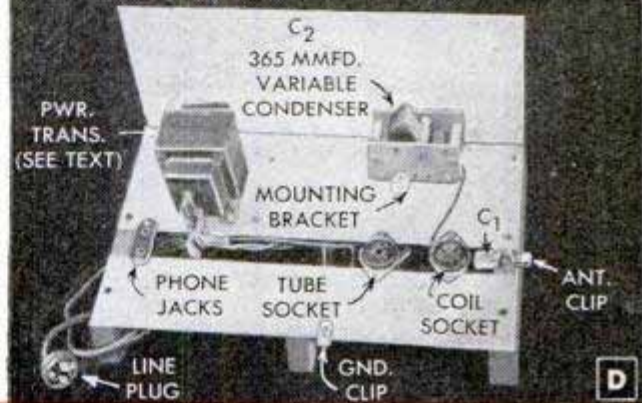

Auto Radio Hints



A—Rear-deck car radio speaker permits passengers in both front and rear seats to enjoy clear reception without distracting the driver. This added speaker is installed in the deck under the rear window. The toggle switch, Fig. 1, is mounted on the dash and turns the rear speaker on and off. **B**—

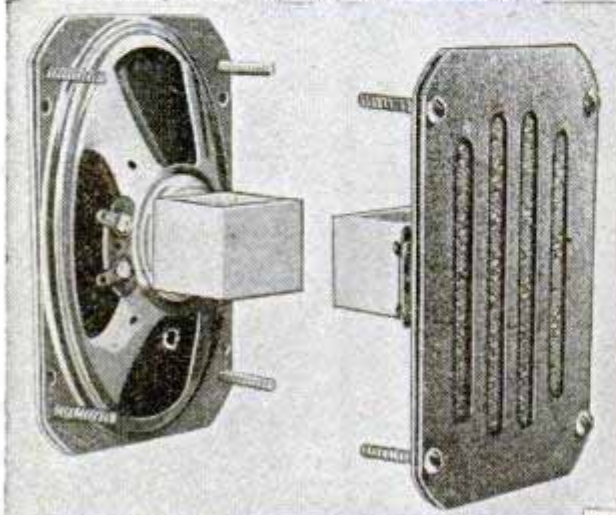

Direct-current ammeter of 30 or 40-amp. type indicates defects in auto radio. Normal reading in series with one battery lead should be 5 to 15 amp., higher reading may indicate defective vibrator or tube. **C**—Pushing down variable-condenser assembly with fiber tuning tool aids in checking loose connections. **D**—Holding soldering iron with tip raised speeds outdoor service heating. **E**—Noise may be caused by poor cable-fuse contacts; terminals should be cleaned with emery cloth. **F**—Cleaning plug-in terminals of antenna cable with emery cloth and working the plug back and forth in the socket several times will insure good contact. **G**—Handy tool for rotating tuning condenser or volume control in auto sets out of the car. It is made from flexible shafting with "spade" terminal soldered to one end and a slotted fitting on the other, as in photo No. 1; photo No. 2 shows tool in use.

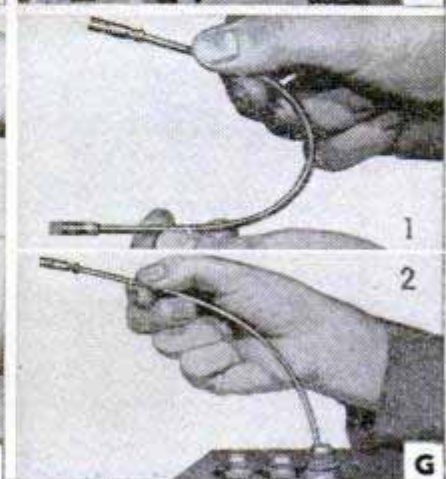
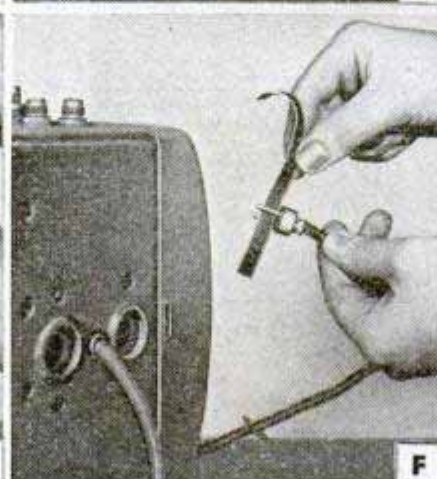
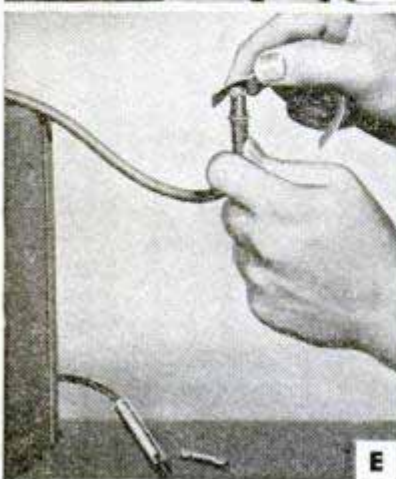
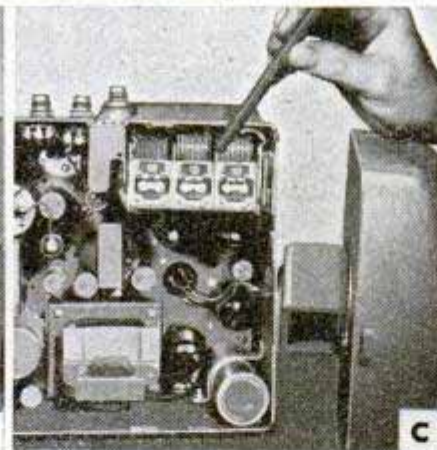
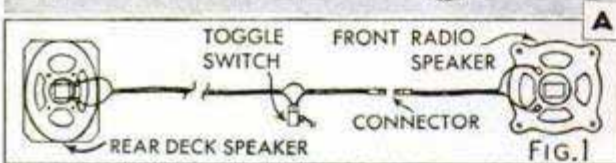

Ingenious New Technical Methods

To Help You
Simplify Production

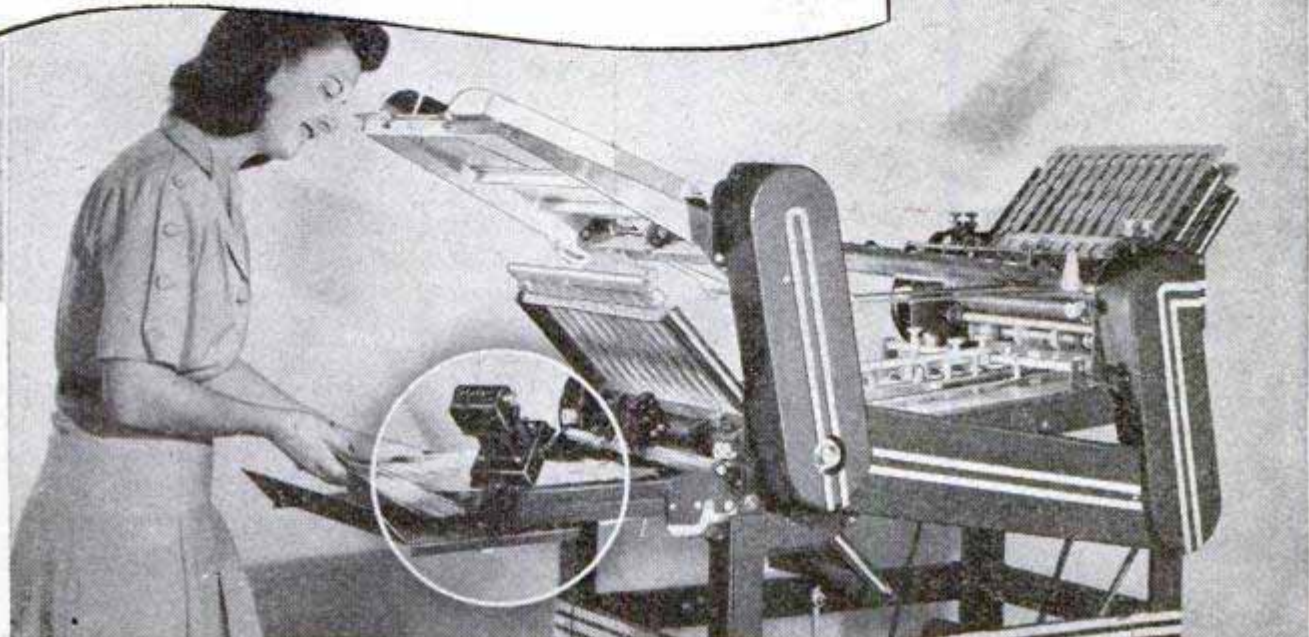

Instantaneous Production Control with Improved Electric Counter

Accurate, up-to-the-minute counting of the production on this Davidson Folding Machine is done with the WIZARD Electric Counter.

New opportunities for more efficient production and elimination of over-run waste are created by WIZARD Electric Counters. These electrically-operated devices count any object or motion that will operate a switch, relay or photo-electric unit. Objects can be counted photo-electrically without physical contact and without risk to fragile or freshly-painted objects.

The Counters can be installed at any distance from the switch or photo-electric unit where the count originates. Or, they can be mounted on panels in the Production Department and arranged so that a production supervisor can maintain up-to-the-instant counts of all operations throughout the entire plant.

You can also count on chewing gum to help employee's on-the-job efficiency. Chewing gum helps relieve tension—keeps the throat moist—and prevents "false thirst" yet leaves hands free for work. That's why more and more plant owners are making Wrigley's Spearmint Gum available to everyone.

Complete details may be obtained from Production Instrument Company, 710 West Jackson Boulevard, Chicago 6, Illinois.



The Wizard Electric Counter



AC-54

AMAZING *New* WAY TO PAINT-CUTS TIME 75%



ELECTRIC PAINTER

Now you can get professional results in painting, even if you've never painted before! The new Lowell Electric Painter actually gives a fine "factory-finish." Paints rooms, furniture—even your car! At stores, everywhere.



PAINTS BEHIND RADIATORS!

Lowell Electric Painter actually atomizes paint. Covers area in a minute. Directional nozzle sprays paint straight ahead, up, down or sideways.

FURNITURE PAINTING EASY!

Use any kind of paint with the Lowell Electric Painter—enamel, flat paint, or varnish. Holds a quart. Easy to use. Small, efficient AC/DC motor. Weighs 8 lbs.



FASCINATING BOOKLET

Write for fascinating, new booklet: "40 Ways to Beautify Your Home." Send 10c to Lowell, Dept. 72, 589 East Illinois Street, Chicago 11, Illinois.

© 1947 L.M. Co.
Guaranteed



"Thoro-Spray"™

Electric Painter
COMPLETE
No Extras To Buy

\$34.95

Slightly higher in western territories.



*T. M. REG. U. S. PAT. OFF.

LOWELL
Manufacturing Co.
World's Largest Manufacturer of
Sprayers and Dusters Exclusively

1948 Low-Cost Progressive Receiver for Beginners—Set No. 1

(Continued from page 223)

then connect the B-battery—a process which should give a loud click in the headphones as the battery is connected. Now, with the antenna and ground connected, rotate the variable condenser C2. If the regeneration control has been advanced far enough you will hear some "whistles," indicating stations, as you rotate the condenser. Tune to one of the "whistles," then back off the regeneration control until the station comes in clear, with maximum volume. It is important that the unused secondary wires be individually insulated with friction tape and carefully secured to the chassis with a metal bracket as shown in Fig. 3. Some of these wires carry the unused high voltage in set No. 1, and must be insulated both from each other and from the metal chassis. The 6.3-volt filament leads are green; primary black. Use an outdoor antenna; however, an indoor antenna will give satisfactory reception on local stations. Detailed student material list R-362 for this one-tube progressive set No. 1 is available from Popular Mechanics Radio and Electronics department upon receipt of ordinary letter postage.

Jungle Home on Wheels

(Continued from page 103)

passenger's seat. It projected just enough to make a convenient step for getting in and out. GI gas and water cans were mounted in handy locations on the body.

The Russells bought a gasoline stove and icebox, and built lockers into every available cranny within the body. Side curtains with windows of transparent, fireproof plastic made the cab watertight. The curtains roll up when not needed and can be zippered into place from inside the cab.

The car came equipped with only one spare wheel, but Russell figured he should have two spares which could be added to the rear wheels to give added traction in case he got stuck. The only space available was on the tail gate, so he contrived a hinged carrier and attached it there.

At the same time, he decided to add a lean-to. He dropped the tail gate and fitted it with canvas sides and cover. The result was a small, enclosed back porch for storing up to 20 cubic feet of surplus gear when the Russells camp.

Field trials revealed the need for various additions and improvements in equipment. A second storage battery was added

(Continued to page 228)

Save WEAR and REPAIR
on YOUR MOTOR!

ASK YOUR DEALER
for **LUBRI-GAS**

"The CAMEL is the SIGN of the WORLD'S BEST MOTOR FUEL"

We Guarantee

• LESS WEAR • NO FRICTION
HEAT • NO CARBON • NO STICKY VALVES •
INCREASED MILEAGE • MORE POWER AND
A COOL MOTOR • CLEAN SPARK PLUGS

Sold in the UNITED STATES since 1917

Ask YOUR DEALER for **LUBRI-GAS**. If he cannot
supply you, attach \$1.00 to COUPON. We will MAIL PREPAID ENOUGH
LUBRI-GAS to TREAT 80 Gallons of GASOLINE, TRACTOR or DIESEL FUEL.

LUBRI-GAS INTERNATIONAL, Inc.
221 North La Salle Street, CHICAGO 1, ILLINOIS



I WON'T RUN HOT



LUBRI-GAS INTERNATIONAL, Inc.
221 North La Salle St.
CHICAGO 1, ILL.

Send me ENOUGH **LUBRI-GAS** to
TREAT 80 Gallons of GASOLINE,
TRACTOR or DIESEL FUEL.

Name.....

Address.....

City..... State.....

Attached is \$1.00.....

Attached is \$1.00 M. O.

Speed Sweep

THE BRUSH WITH
THE STEEL BACK



*Sweeps
cleaner, faster—
Outlasts ordinary
brushes 3 to 1!*

Mail Coupon Today

Milwaukee Dustless Brush Co.
530 N. 22nd St., Milwaukee 3, Wis.
Please send me complete information about
Speed Sweep brushes.

Name _____

Street Address _____

City, State _____

for inside lights. A small air-cooled engine was installed in a well in the left fender to drive a large generator; it consumes only a pint of gasoline per hour.

Four-wheel-drive cars have a handy lever for disconnecting engine power from the front wheels when traveling on highways. But even when not pulling, these wheels are turning the front axles, universals, differential and drive shaft, which means wasted power and wear on the tires.

Russell eliminated this condition by substituting blank hub flanges for the originals which were splined to the driving axles. Now the wheels spin freely on their bearings and nothing turns within the front assembly. And it takes only 10 minutes to change back to the original driving flanges.

By eliminating the wasteful drag and adding a special oil cooler, gasoline mileage was increased from 14 to 17 miles per gallon on a highway at 35 miles per hour.

Mr. and Mrs. Russell christened their juggernaut "The Tropical Tramp" and set out to live the life of carefree adventurers traveling in comfort. Their bunks are narrow, but comfortable. Their quarters are somewhat cramped, but seats fold out of the way to provide a restful front porch.

The dining table lifts and slides into metal channels which also house a smaller table for typing articles about their travels. The top of the icebox is upholstered to provide a comfortable seat.

The "Tramp" is cool. The outside was painted with aluminum paint to reflect the heat. The back end has two windows, the front two windows and a door. Each bunk has an 18-inch DDT-coated screen running its full length, and there is a transom in the roof. These openings, plus the windshield lowered, provide ample ventilation.

Now the Russells can enjoy driving to a beach that no ordinary car could reach. In 10 or 15 minutes they have their camp set up. Then they fish, swim, or just plain loaf until another secluded spot beckons.



Actual Size V-Plug

**Model Builders
Attention!**

	V	V-2	V-3
Hex	1/2"	3/8"	5/16"
Thread	3/8"-24	1/4"-32	1/4"-32
Thread Length	7/32	7/32	5/32
Weight, Grams	8	3 1/2	2 1/2

Champion Spark Plugs for model gas engines give the same dependable performance as regular Champions. Champion Ceramic insulation—Sillment sealed. Alloy needlepoint electrodes for easy starting. One piece construction.

CHAMPION

SPARK PLUG COMPANY • TOLEDO 1, OHIO

"Hope this won't make you mad, Jerry..."



JERRY: What's on your mind, Uncle Pat? I can take it.

UNCLE PAT: Well, you'd better return that saw and get your money back—if you still *can*.

JERRY: What do you mean? What's the matter with this saw?

UNCLE PAT: It's one of those bargain counter orphans, Jerry. No brand name. No reputation. Nothing behind it to back it up. It'll let you down just as sure as you're born.

JERRY: Brand names aren't *that* important, are they?

UNCLE PAT: They are to *me*. I want *quality* when I buy tools. That's why I always do my buying at the hardware store, where they carry the best in every line. And believe me, I never put my money down till I see a brand name I can trust.

Your **HARDWARE DEALER** sells **QUALITY** tools
and hardware... Buy from HIM



POPULAR MECHANICS

i.q.

Answer to Problem on Page 97

Action of the sugar does not refute the law of centrifugal force, but occurs due to natural causes. Due to the shape of the spoon and irregularities of stirring, the sugar in the rapidly moving column of liquid is well scattered. When the spoon is removed, the liquid settles down to a regular rotary motion which builds up a pressure area on the wall of the glass. As rotation is retarded, the liquid in the lower part slows down first due to friction with the bottom, making the pressure against the wall less at the base. As pressure always tries to equalize, there is a flow of liquid down the wall equal from all sides so it flows radially from the center of the floor and then upward. This flow carries the sugar with it, tending to pile it up in the center.—By Rex Taylor.

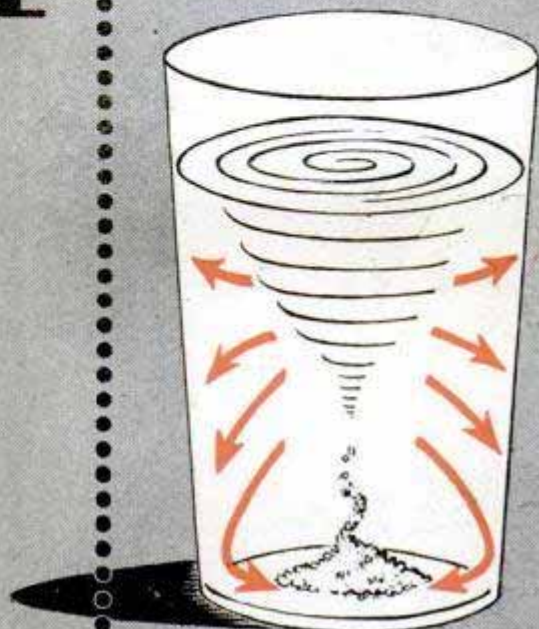

BACKLASHES
spoiled my
FISHING FUN...

Until I Got Wise to
Shakespeare's
WONDEREEL

So backlash free you can learn to cast with it in 5 minutes. You get a bonus of long, accurate casts, too. That is why **WONDEREEL** is perfect if you don't fish a lot, are out of practice or fish at night.

Try this reel with *casting skill built in*. Your sports store has it in DeLuxe, Lightweight, and Regular.

Free Tackle Book and Pocket Fishing Calendar
Reels, Rods, Lines, Accessories, Fishing Tips. Mail coupon.

Shakespeare
FINE TACKLE
HONOR BUILT FOR FIFTY YEARS

Shakespeare Company
Dept. 81, Kalamazoo 2, Michigan
Send me your **FREE TACKLE BOOK** (off press in February) and Pocket Fishing Calendar.

Name.....
(Please write address and zone No. below)

DISSTON
The saw most
carpenters use

A Favorite
with Crafts-
workers, too

LIKED FOR MANY GOOD REASONS

Disston Saws are made of Disston Steel to assure highest quality and uniformity. True taper ground for faster, easier sawing. Being scientifically hardened and tempered throughout, they require less frequent setting and filing, stay sharp longer... last longer, too. Disston makes a complete line of...

SAWS FOR EVERY HOME WORKSHOP NEED

Ask your Hardware Retailer for Disston Hand Saws and Back Saws, Compass and Coping Saws, Band and Circular Saws. All are described in the Disston Saw, Tool and File Manual, which contains valuable home workshop data. Write for a **FREE Copy**.

HENRY DISSTON & SONS, INC.
111 Tacony, Philadelphia 35, Pa., U.S.A.

AMAZING NEW SAFE MAGNETIC JIG SAW

READY FOR PROFIT and PLEASURE!

Number 2000

SYNCRO

Only
\$17.50

Shpg. Wt., 18 Lbs.
Slightly higher in
foreign countries.

For Hobbyists

Craftsmen, Light Production

**GREATEST CLEARANCE, LARGEST TABLE TOP
OF ANY MAGNETIC SAW MADE!**

Get SYNCRO . . . the remarkable, safe, patented magnetic jig saw . . . ready for immediate shipment! Use for fun or money-making! SYNCRO needs no belt, no gears, no oiling. No motor to buy. Just plug in any 50 or 60 cycle (A.C. only) 110-120 volt wall outlet—in kitchen, attic, basement—set on kitchen table, floor, anywhere—and saw! The high-speed, short Magnetic Safety Stroke Action, and freedom from belts, makes SYNCRO so safe small boys and girls may use it. Cuts intricate designs on $\frac{3}{8}$ " soft wood, $\frac{1}{2}$ " medium hard plywood and thinner hardwoods, plastics, thin metal. Leaves no ragged undersides on plywood, cardboard. Cuts to center of 27" circle! Get, enjoy this safe, educational, practical quality tool for making models, displays, puzzles, inlays, silhouettes, toys, whatnots, etc. Limited supply—so hurry!

**WHY
SYNCRO
IS
SAFEST!**

SYNCRO has NO continuous cutting blade nor "Loose stroke" blade to pull fingers into teeth—instead there are 14,400 strokes per minute—7,200 short cutting strokes plus 7,200 upward NON-CUTTING, REPELLING strokes! (Fig. 1) SYNCRO will not even CUT wood unless piece is pushed FIRMLY DOWNWARD AGAINST blade and FIRMLY FORWARD—both actions at SAME time! SYNCRO blade teeth cut ONLY on DOWN stroke. (Fig. 2) Teeth raise, repel, push away any object on UP stroke. (Fig. 3) When blade moves UP it KICKS finger away free! On down stroke, blade does not move far enough to accidentally cut finger unless finger is intentionally, deliberately fed into blade like wood is fed in Figure 1. No wonder SYNCRO is the world's SAFEST saw . . . a feature old and young users acclaim!



Complete with Cord,
3 Blades

**ORDER NOW
ON 10 DAY TRIAL!**

Order with complete confidence on this liberal Trial Offer: When you get your SYNCRO, plug it in and saw, as per directions. Then, if it does not saw cleaner, better than any other jig saw you ever used, and with more safety . . . if it does not satisfy YOU . . . return it undamaged, postpaid and post-marked within 10 days of its delivery date . . . and we will refund the saw price promptly without question!

SEE YOUR DEALER FIRST!

"Family Saw"

"The SYNCRO POWER SAW ordered from you in 1940 is still sawing merrily away. My son (then 8) has used it in the attic, kitchen, his room, and basement shop. I use it too. We never worry about accidents due to its MAGNETIC SAFETY STROKE feature. It's truly a family saw."—Mr. B. H. Smith, Rexburg, Idaho.

15 OUTSTANDING SYNCRO FEATURES:

(1) World's safest saw. (2) Portable. (3) No rotating motor needed as self-contained magnetic power unit transmits A. C. magnetic impulses to armature diaphragm—power transferred to blade. (4) No rotating parts to wear out. (5) 14,400 magnetic strokes per minute. (6) Never needs oiling. (7) Large 10"x10" table top. (8) Cross

section engraved lines on top. (9) Big 13 $\frac{1}{2}$ " throat clearance. (10) Finest steel blades. (11) Rubber feet. (12) 5' cable, plug. (13) Varying voltage adjustment nut. (14) Lifetime durability. (15) Quality materials, workmanship, performance . . . guaranteed by the famous "SYNCRO" trademark name.

SYNCRO

SAW CORPORATION
Dept. A-18
Rochester, Michigan

EXPORT ADDRESS: 120 Wall St., N.Y.C.

WORLD'S LARGEST MAKERS OF ELECTRIC JIG SAWS

JANUARY 1948

SYNCRO

SAW CORPORATION
Dept. A-18, Rochester, Michigan
Export address: 120 Wall St., N. Y. City

Gentlemen: Here's my order for one SYNCRO MAGNETIC JIG SAW, Model No. 2000, shpg. wt. packed, 18 lbs. \$17.50 FOB Factory. Please send it complete with electric cable and plug, 3 blades, on your 10 Days Money Back Trial Offer. I enclose \$17.50 as payment. Please ship saw:

Express charges collect or Parcel Post charges collect
 Express, for which I enclose an extra \$_____
 Parcel Post, for which I enclose an extra \$_____

NAME _____

ST. & NO. _____

CITY _____

STATE _____

I enclose no money—send FREE SYNCRO CIRCULAR

WALKIE-TALKIES!

Complete Army Sets Ready to Operate

Portable radio telephone sends and receives 10 to 15 miles! Used by the Army with great success. Ideal for amateurs, police, explorers, airports, utilities, boat owners, Government services, etc. Operates anywhere in the 28 to 52 MC band. Renewed by the Government and guaranteed. Shipped, ready to operate, complete with tubes, microphone, telescope antenna and new batteries. Price—only **\$45.00** each.

F.O.B. Chicago
Extra batteries (80 hours continuous service) \$4.75 each



Radio-Telegraph Sending Keys

Real S-37 Signal Corps keys for your radio or telegraph set or for code practice. They have coin silver contacts and full adjustments. Valued at 3 times our low price. Send \$1.00 plus 20c for postage anywhere in U. S. Guaranteed.



WELLS SALES, INC.

320 N. La Salle St., Dept. P-1
Chicago 10, Illinois

No other tool like it!

BURGESS
vibro-tool

Writes on . . .

Watches
Glassware
Tools
Leather
Plastics
Costume Jewelry
Pots and Pans
Sporting Equipment



\$7.50

Engrave your name . . . etch letters or designs . . . place permanent identification marks on anything with this unique hand tool. Carves wood and linoleum, cuts cardboard and balsa, tools leather. Just plug in on any 110 volt AC line. No home shop is complete without a Burgess Vibro-Tool. See your dealer or write for information.

DELUXE KIT

Vibro-Tool complete with 22 attachments in handsome, polished wood chest. . . . \$16.50



BURGESS BATTERY COMPANY
HANDICRAFT DIVISION
LAKE ZURICH, ILLINOIS

Time From the Stars

(Continued from page 140)

As many as 100,000 customers, including business houses, depots, radio stations and schools, receive Naval Observatory time via Western Union. The time beats regulate 2000 Western Union master clocks.

Although these master clocks seldom drift more than a second from accurate time in 24 hours, they are reset daily to keep them in time with the observatory's signals. The clocks have an hourly contact that synchronizes the subscribers' self-winding clocks.

Subscribers' clocks are of the spring-wound, pendulum-controlled type. A small electric motor, energized by two dry-cell batteries, assures constant operation regardless of outside power failure. Electrical impulses actuate a synchronizer in each clock which resets the hands each hour.

The synchronizing service is the most popular of three kinds of time services furnished by Western Union. A second service, known as "noon beats," requires the subscriber to set his own clock. This service consists of a wire connection with the circuit carrying the Naval Observatory time beats during a three-minute period ending at noon (EST). These signals are sent by Morse sounder to jewelers, laboratories and local telegraph and railroad offices for checking timing devices.

A third service is called "jewelers' beats." It is a transmission from one of the central master clocks equipped with a coded contact wheel that repeats the five-minute observatory pattern of second beats over and over through the day.

There are many uses for accurate time service other than checking the operation of clocks and other timepieces. Accurate measurement of time is of importance in seismology, geodesy and navigation. Time signals are used by schools, scientific laboratories, manufacturers and users of radio communications equipment.

All these services are based upon observations made at the Naval Observatory. Since 1844, the observatory has been located atop a knoll about two miles north of the Lincoln Memorial. Then out of the settled area, today it is surrounded by the city of Washington. Smoke and dust so obscure observations that a move to a more isolated area has become necessary.

The transfer will take place over a period of years and the time signals and observations will not be interrupted. During its transfer and after its establishment in the new location, the Naval Observatory will continue to supply accurate time to all who need it as it has since 1865.



MOTO-TOOL ★ The "Pocket-Size Machine Shop"



PRE-WAR PRICES STILL PREVAIL

Moto-Tool Kit No. 2 about \$39.00; you save \$6.50. (high speed steel cutters, grinding wheels, polishing accessories and heavy-duty professional Model 2 Moto-Tool in natural-finish, hard-wood case... \$23.50 (Items purchased separately would cost

Moto-Tool No. 2 with one emery point \$16.50.

Moto-Tool Kit No. 1 with 34 accessories and Model 1 Moto-Tool in wood case \$17.50

Model 1 Moto-Tool with one wheel point... \$9.85.

A TOOL THAT PACKS EXTRA YEARS OF PLEASURE

... LOOK AT THE REST, THEN BUY THE BEST

Here's a tool to please a man's heart... one that holds promise of endless creative hours. Dremel Moto-Tool is a "war-veteran"... used by all branches of the Armed Forces in far-flung repair bases... helped to set production records at General Electric, Westinghouse, Remington Arms, Ford and others. Hobbyist or expert craftsman, first choice is Model 2 Moto-Tool Kit with its handsome felt-lined, highly finished wood case with rows of tools begging to be put to work. Write for FREE catalog of Moto-Tool attachments and accessories.

14 REASONS WHY MOTO-TOOL'S A BETTER BUY

- Housing has "penetl-type" finger grip
- Instant-action, wrenchless chuck
- Oil-less (sealed) trouble-proof bearings
- Patented automatic chuck-lock pin
- Over-size armature shaft, hardened, ground and polished
- 110 volt, universal type (AC-DC) motor
- Easily replaced commutator brushes
- About 27,000 R.P.M. cuts cleaner... saves cutters
- Sliding snap-type switch
- Handy hanger hook
- Sturdy, shockproof bakelite housing
- Dust filtered, air-cooling system
- Weighs only 13 oz. ... shaped to fit the hand
- Dynamically balanced for vibrationless operation.



Do These Better - Faster

- Approx. 27,000 R. P. M.
- Finishing
 - Sharpening
 - Burnishing
 - Engraving
 - Touching Up
 - Mortising
 - Polishing
 - Cleaning
 - Rasping
 - Brushing
 - Dressing
 - Burring
 - Grinding
 - Routing
 - Sanding
 - Drilling
 - Inlaying
 - Sawing
 - Scoring
 - Carving
 - Cutting

Free Both Hands With Moto-Tool Attachments

Moto-Tool Stand (left) made of heavy cast iron, holds Moto-Tool at any position or angle... \$4.50

Moto-Tool Shaping Table \$2.50. (Shown with stand, right). Aids accuracy in routing, grinding.

MONEY BACK GUARANTEE

Buy Dremel Moto-Tool from your Dealer. If he cannot supply you, order direct from factory on 10 day trial. Shipped postpaid for payment in full (send check or money order); or send only \$2.00, we will ship C.O.D. You pay balance plus postage.

DREMEL MFG. CO. DEPT. 118-A RACINE, WISCONSIN

\$24.95 Full Set



MICROMETERS

Six piece set, in velvet lined leather case. Special price, only \$24.95. Precision machined in one thousandths, up to 4" outside and 3 3/4" inside measurements. Guaranteed accurate, easy to read and adjust. Satisfaction or money back. Also indicators and gauges. Shipped prepaid on receipt of \$24.95. (Out of U. S. \$25.95.) On C.O.D.s send \$2.00-deposit.

FREE FOLDER

MICRO PRODUCTS, 8655 E. Jefferson, Detroit 14, Mich.

P
O
R
T
A
B
L
E

Speedy Sprayer

SENT DIRECT

ONLY \$26.95 LESS MOTOR

Uses 1/4 Hp. Motor

P
O
W
E
R
F
U
L

For home, farm, or shop. Sprays paint, varnish, lacquer, disinfectants. Paint anything—do it better—five times faster! Generate compressed air, inflate tires, other uses.

No. 890. Outfit complete as shown, with "V" Belt, motor pulley, 15 ft. high test air hose and No. 112 gun, but without motor. **\$26.95**

No. 444. Outfit, Twin Cyl. 4 cu. ft. production type gun, 15 ft. air hose, reg. and gauge. "V" belt and motor pulley. Uses 1/2 hp. motor. Complete less motor. **\$47.50**

HOME UTILITY BLACK & DECKER DRILLS—110 AC-DC
—With Jacobs Hex Key Chuck—Pistol grip, 1/4", 2250 rpm... **\$18.95**

ELECTRIC MOTORS—capacitor, 110/220 V. 1725 rpm, 1/4 HP—\$24.75. 1/2 HP... \$37.50

Special—Closing Out All Hobbycraft Supplies! Send for Bargain List.

IMMEDIATE DELIVERY on above. Add 5% west of Mississippi. Prepaid if check or M.O. enclosed. C.O.D. receipt of 25% deposit. Write for FREE Catalog: Spray Guns and Equipment, Power Tools, Radios, Toys. Address:

INDIANA APPLIANCE CO., Dept. PM-148, Evansville 9, Ind.

5 DAYS TRIAL!

NEW WONDER TOOL Ready!

IMMEDIATE SHIPMENT!

The remarkable Bandsander Economy Homeshop Model is again available to hobbyists, craftsmen, model-makers, etc. for **immediate shipment!** Try it 5 days in your own workshop. See how it quickly shapes, sands, curves and polishes wood, metal, plastics—how it works equally well on inside cut-out openings or irregular outside edges, on intricate scrolls, curves! Gets at places no other can! Patented. Tilting table for bevelling, chamfering. Rust-and-sweat proof top. Self-oiling sleeve bearings. Saves time, labor, money. Normal band speed 1600 feet per min. gives fast, clean, smooth cuts. 1/4-h.p. 1725 rpm motor recommended. Rush only \$14.95 with Bandsander order — or \$5. balance C.O.D. — 5 Days' Trial, Money Back Guarantee. Limited supply, so hurry! (Dealers write.)

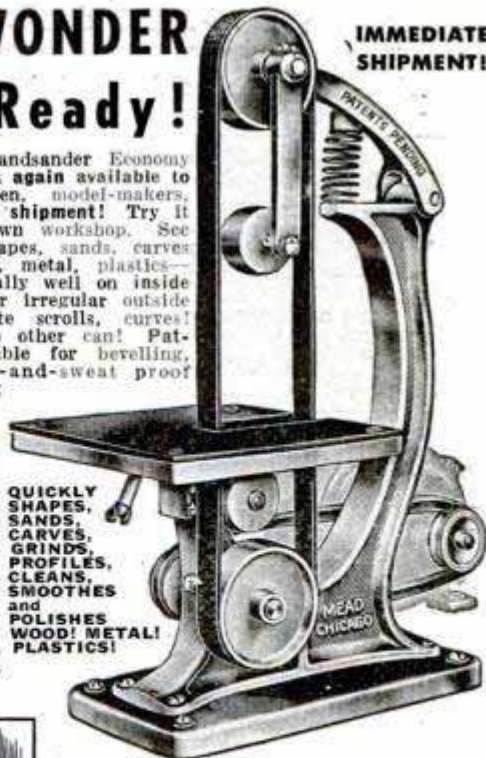

QUICKLY SHAPES, SANDS, CARVES, GRINDS, PROFILES, CLEANS, SMOOTHES and POLISHES WOOD! METAL! PLASTICS!



ORDER NOW or Circular FREE!

Order—or write for details on "the machine that amazed the experts!" Send postal NOW.

MEAD SPECIALTIES CO.

4114 N. Knox Ave., Dept. 118, Chicago 41, Ill.

**40 MILES
PER GALLON**



When you choose CROSLY, you get a truly sensible, truly economical car. Weighing only about $\frac{1}{2}$ as much and operating for about $\frac{1}{2}$ as much as more cumbersome, expensive automobiles, CROSLY delivers sensational performance.

Herbert B. Irmer, Amsterdam, Holland, toured 13,000 miles while in this country, averaging 40 miles per gallon of gas.

And you'll be proud of your CROSLY. These smart, ultra-modern passenger cars seat 4 big people, plus luggage—give you a smooth, safe ride. CROSLY'S narrower width "requires 20 inches less than your half of the road".



In the all-steel, $\frac{1}{4}$ ton PICKUP, you get true economy for service calls, light deliveries, etc.

In every CROSLY you get the amazing COBRA (Copper BRAZed) steel engine with $7\frac{1}{2}$ to 1 ratio; 35 to 50 miles per gallon—carefree cruising lightning pickup, eager speed.

CROSLY

a FINE car

For information and literature, write: Crosley Motors, 2532-MH Spring Grove Ave., Cincinnati 14, Ohio

AIR RIFLES BENJAMIN AIR PISTOLS
PIONEERS - LEADERS

SEND FOR FREE FOLDER OF LATEST MODELS TODAY
If you want a REAL GUN for PRACTICAL USE inside or outdoors get a SAFE - CLEAN - ECONOMICAL - BENJAMIN with Adjustable Power and Amazing Accuracy. For BEST RESULTS use BENJAMIN H-C PELLETS. WRITE AT ONCE. BENJAMIN AIR RIFLE CO., 812 MARION ST., ST. LOUIS 4, MO.

READY CUT HOMES

Order Now

Homes \$1655.00 and up, freight paid. Orders filled in order received. Save \$500 at least on modern production method with builders' prices, compared with builders' prices. Anyone can assemble with simple plans furnished. Complete, including paint, hardware, roofing, glass, nails, etc. Send 35c in coin for full color catalogue showing 57 modern low-priced homes and floor plans. Complete building plans ready for filing at low cost. Sold separately if desired.



NEW COLOR CATALOG FOR ONLY

Dept. PM-18
INTERNATIONAL MILL & TIMBER CO.
Bay City, Mich.

35c



New MILLING ATTACHMENT

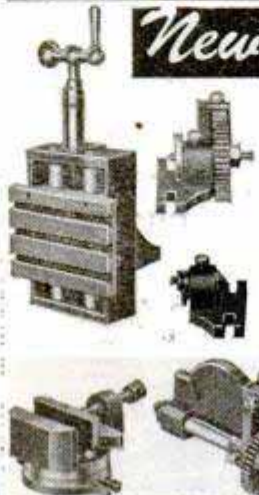

Sizes for 8" to 16" metal lathes

BUILD IT YOURSELF from our sets of semi-machined castings and save \$8. Can be finished on your lathe alone. Complete working drawings and step-by-step instructions furnished with castings.

Mill keyways, slots, splines, dovetails, flutes in reamers, taps, hobs, and special cutters; produce spur, bevel, mitre and worm gears, ratchets and racks; mill flat surfaces, square shafts, mill nexes, spot face, drill spaced holes, bore, etc. on your lathe with this precision attachment. It has a T-slotted table, a vise which swivels for angular milling, a gear cutting fixture and dividing centers.

FREE! Illustrated folder and price list. Includes milling cutters, keyway cutters, drill rod, slitting saws and many hard to get shop items. Mention your lathe. Write today.

HURON MACHINE AND TOOL CO.
YALE 4, MICHIGAN

FIND UNDERGROUND MINERALS and METALS with M-SCOPE

New sensational lightweight models, unsurpassed efficiency
Low prices. Time-payment plan. Write for free 16 page booklet.

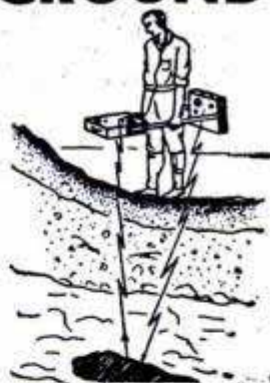

FISHER RESEARCH LABORATORY, INC.
PALO ALTO CALIFORNIA

MOST POPULAR "FELLA" in the CELLAR



A few of the thousands of cuts possible with this wheel.

EDGE CAN BE USED

SIDE CAN BE USED

Craftsmen, if you own a table saw or a bench grinder your equipment is not complete without this new, amazing all-purpose wheel. It saws, files, sharpens, cuts, forms and shapes metal or wood. It is fast, safe, easy . . . will cut BX cable, conduit, copper tubing, transite, celotex, brass, aluminum, steel, plastics, etc. It is as indispensable to your workshop as electric power. Try one yourself to be convinced. Send check or money order to-day. Wheel will be sent by return mail.

6" — \$1.65 Each 7" — \$2.15 Each 8" — \$2.80 Each

All wheels $\frac{3}{32}$ " thick with 1" hole. State size of shaft if smaller than 1". Proper bushing will be sent free.



POSTAGE PREPAID Anywhere in U. S. A. by: Bay State Abrasive Products Co., Westboro, Mass.



Indian

WORLD'S FINEST
MOTORCYCLE

Send for FREE ILLUSTRATED MAGAZINE, "Indian News"
 . . . DEALER INQUIRIES INVITED . . .
 Dept. 8M, Indian Motorcycle Co., Springfield 9, Mass.



Thompson BEATS the World on BOATS

Better Built Lower Prices

- Canoes
- Rowboats
- Outboards
- Light Boat for Auto

Safe Boats With Full Length Spray Rails
 Keep passengers perfectly dry—even at high speeds. Catalog also shows two new models of "Take-Along" Boats. Two big factories—save you freight.

CATALOG FREE
 Write for your copy. State kind of boat in which you are interested.

THOMPSON BROS. BOAT MFG. CO. (151)
 213 Ann St. PESHIGO, WIS. (Write to either place) 113 Elm St. CORTLAND, N.Y.



DUAL TAIL PIPE EXTENSION FOR YOUR CAR. \$2.95

DEEP TONE,
 PRODUCED BY 2½ IN. OUTLETS
 Chrome Plated -- Fits All Cars

Postage Free on Money Order, Check or Cash
 PAT. PEND. LYONS PRODUCTS Co. 2319 Ridgeley Dr. Los Angeles 16, Cal.

SAY YOU SAW IT IN POPULAR MECHANICS



The Modern PLASTIC for lasting Home Repairs

PERMANENTLY mends cracks or holes in wood, tile, stone or plaster. Sticks and stays put—Does not chip, shrink or fall out. Easy to use. Economical. Mold it, chisel it, polish or paint it. If unobtainable from your lumber, paint or hardware dealer, the big 4-lb. can will be sent you post-paid (in U.S.) for only \$1. Full money-back guarantee, order now.

DONALD DURHAM CO.
 Box 804-M, Des Moines, Iowa

MAKE UP TO \$1000.00 PER MONTH . . . OWN YOUR OWN BUSINESS . . . BE YOUR OWN BOSS

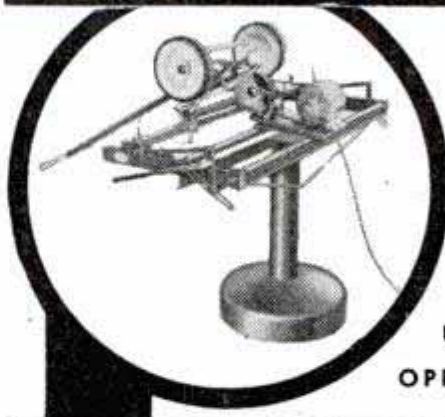

EASY MONEY!
 —
 EASY WORK!
 —
 UNLIMITED OPPORTUNITIES!

EVERY HOME OWNER A CUSTOMER!

Sign Long Term Profit Making Contracts With Schools, Parks, Playgrounds, Cemeteries, Golf Courses And All Types Of Institutions.

THE MODERN LAWN MOWER SHARPENER IS A PROFIT PRODUCER FOR YOU!

Make more money the Modern way! Everywhere grass grows and lawn mowers are used offers you unlimited opportunities to make up to \$1000.00 per month in a business of your own. For the first time in history, you can sharpen any reel type lawn mower from a five inch edger to a thirty-six inch power mower in from ten to twenty minutes. Dismantling is unnecessary. Handle, wheels, roller and motor remain in place when sharpening even the most complicated mower. The Modern Lawn Mower Sharpener eliminates all hand filing. It precision grinds to extreme ends of both left or right twist reel blades. Bottom knife is held in same brackets for sharpening. No extra attachments required for grinding. Hand, power, gang or fairway units sharpened equally fast . . . equally easy for greater profits. Anyone can operate the Modern Lawn Mower Sharpener. It is simple in design and simple to operate. Send for details today!

START YOUR OWN BUSINESS TODAY
 SMALL SPACE REQUIRED - SMALL INVESTMENT

Take steps today to start your own business. Send for FREE bulletin on Modern Lawn Mower Sharpener plus FREE booklet on how to organize your business plus ideas and plans for future expansion. Paste completed coupon to penny postcard and mail today!

MAIL TODAY

MODERN MANUFACTURING COMPANY
 160 N. FAIR OAKS AVE., PASADENA 1, CALIF

Gentlemen: Please send me your FREE booklets No. 10 and 10A.

NAME _____
 ADDRESS _____
 CITY _____ STATE _____

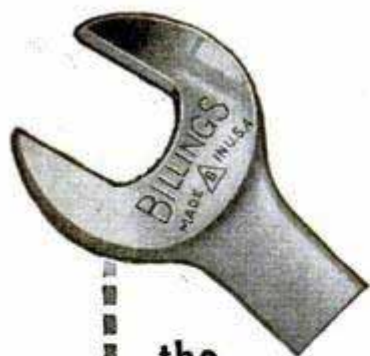

the
name
to
know
in
QUALITY
wrenches

BILLINGS

WRENCHES



Buy them at Your Hardware Store

THE BILLINGS & SPENCER CO., HARTFORD 1, CONNECTICUT, U.S.A.

NOW A Great Value

IN A DIVIDING HEAD
L-W MODEL SD
6 1/2" Swing



The Fine **NEW** UNIVERSAL DIVIDING HEAD
only **\$95**

Well built for hard usage. Alloy steel spindle has a tapered bearing. Bored for #9 B & S taper. Threaded spindle nose. Distance from center of spindle to top of table 3/4". Head tilts to 90° + in vertical position. Special alloy steel worm and bronze worm wheel cut to close limits for accuracy. End thrust is taken out by bronze bearings. Complete with three index plates for dividing all numbers to 50, and even numbers to 100, with the exception of 96T. Index chart shows all divisions obtainable to 380.

ORDER TODAY or write for complete catalog

MFORS. UNIVERSAL AND INDEPENDENT LATHE CHUCKS • MILLING MACHINE VISES • POWER HACK SAWS • DIVIDING HEADS • MAGNETIC CHUCKS • RECTIFIERS • DEMAGNETIZERS

L. W. CHUCK CO., 31 So. St. Clair St., Toledo 4, Ohio

Digging Into Mexico's Past

(Continued from page 135)

the simple wheel to provide a means of transporting men and goods over long distances, and because they had never heard of the Chinese invention of gunpowder.

Finally, archeologists are looking for treasures of gold and precious stones which are thought to be buried in the ruins of Mexico. From a strictly scientific point of view, such treasures are incidental to the exploration of ancient civilizations. But they do lend a spice to the scientific excavating. Furthermore, they stimulate search by amateur archeologists and spur on native workers hired to help with the digging.

At Monte Alban, the famous Tomb Seven in 1932 produced more than 300 valuable items: a pearl as large as an egg; many smaller pearls and turquoises; goblets of gold, silver and rock crystal; a golden mask; engraved and filigreed gold jewels; necklaces, bracelets, earrings and lip and nose plugs.

To follow the trail of ancient civilizations, an archeologist must be an expert in many fields. In addition to being a scholar of history and languages, he should know how to analyze soils, build a scaffold, hoist weights weighing tons, take good photographs, preserve crumbling art objects and manage men. He should also have an "eye for the country"—for random digging is not scientific digging.

Archeology is not a science that calls for a steam shovel or a bulldozer. Best results are obtained by natives doing the rough work with hoe and basket, followed by trained archeologists with trowel, brushes, screens and microscopes.

Occasionally, however, the archeologist borrows the techniques of the coal miner. A likely looking mound may be tunneled vertically or horizontally. If it still seems promising, it will be completely excavated.

Aerial photography has proved useful to the present-day archeologist. Mapping planes are sent over hard-to-get-to jungle and desert areas that are believed to cover important ruins. After a site has been excavated, its location and dimensions may also be thoroughly rechecked by aerial photography.

Latest scientific device used to locate important archeological ruins is the potentiometer. In locating the skull of the oldest man near Mexico City, Dr. Hans Lundberg, Canadian geophysicist, and Dr. Helmut de Terra, American geologist, used the principle of earth conductivity.

(Continued to page 240)

Your Guide to Long Lived Saws!



Bulletin 1047—just off the press—will prove a dependable guide to greater saw service per dollar expended. In Chicago Saws, the finest steel and expert craftsmanship are supplemented by the most modern production and heat-treating facilities.

The Chicago line includes solid tooth rip and cut-off, flat ground combination, planer, hollow-ground trimmer, thin rim, dado and band saws. Also soft-metal saws and circular knives. Special saws and complete saw repair service. Every Chicago Saw is guaranteed to be correctly heat treated, balanced and accurately fitted. Prompt deliveries. Ask your supplier or dealer for Chicago Saws.



CHICAGO SAW WORKS

5044 S. Wentworth Ave., Chicago 9, Ill.

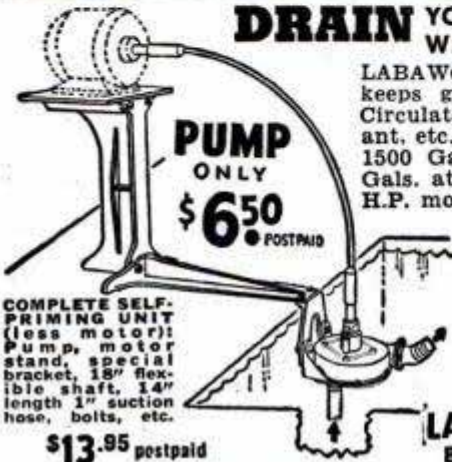

DRAIN YOUR CELLAR, POOL, WASH TRAYS, ETC.

LABAWCO Type P Pump keeps garden pools fresh. Circulates oil or refrigerant, etc. **DOES NOT CLOG!** 1500 Gals. per hr. — 300 Gals. at 30'. Uses 1/8 to 1/4 H.P. motor.

PUMP ONLY \$6.50 POSTPAID

COMPLETE SELF-PRIMING UNIT (less motor): Pump, motor stand, special bracket, 18" flexible shaft, 14" length 1" suction hose, bolts, etc.

\$13.95 postpaid

Pump alone \$6.50. Pump with complete self-priming unit . . . \$13.95

POSTPAID if cash with order. West of Mississippi, add 50c.

SEND ORDER TODAY

LABAWCO PUMPS
BELLE MEAD 4, N.J.



ASSORTED SPRINGS
FOR REPAIRING AND REPLACING

\$7.10 POSTPAID

handy SPRING kit

Wide assortment of compression, extension and torsion springs—just what you need for a multitude of odd jobs requiring use or replacement of springs.

High quality—same springs that are made for topnotch manufacturers to their rigid specifications. Several dozen springs in kit.

Have the Handy Spring Kit handy. Send a check or money order right now to Department B

NEW ENGLAND SPRING MFG. CO.
Unionville • Connecticut

SAY YOU SAW IT IN POPULAR MECHANICS

HI-SPEED HUB & WHEEL ASSEMBLY

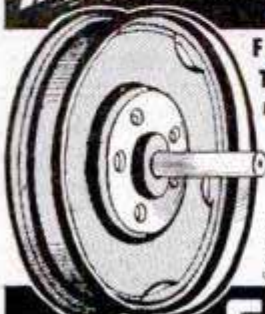

FOR TRAILERS TRUCKS-WAGONS

NEW LOW PRICES

Many Implements

HEAVY DUTY 5 STUD 6-00 X 16 WHEEL, EQUIPPED WITH TIMKEN BEARINGS.

COMPLETE & ASSEMBLED WITH 1 1/2" x 4 1/2" SPINDLE. SPINDLES MADE TO ORDER AT SLIGHT EXTRA COST.

1 to 12 . . . \$22.50 pr.
13 to 25 . . . \$22.00 pr.
26 to 50 . . . \$21.00 pr.
51 or more . \$20.00 pr.

MADE IN U.S.A.
SOLD ONLY IN PAIRS
F.O.B. OMAHA

1000 LB. LOADING PER WHEEL!

GRIFFITH INC.
230 KEELINE BLDG. OMAHA 2, NEBR.

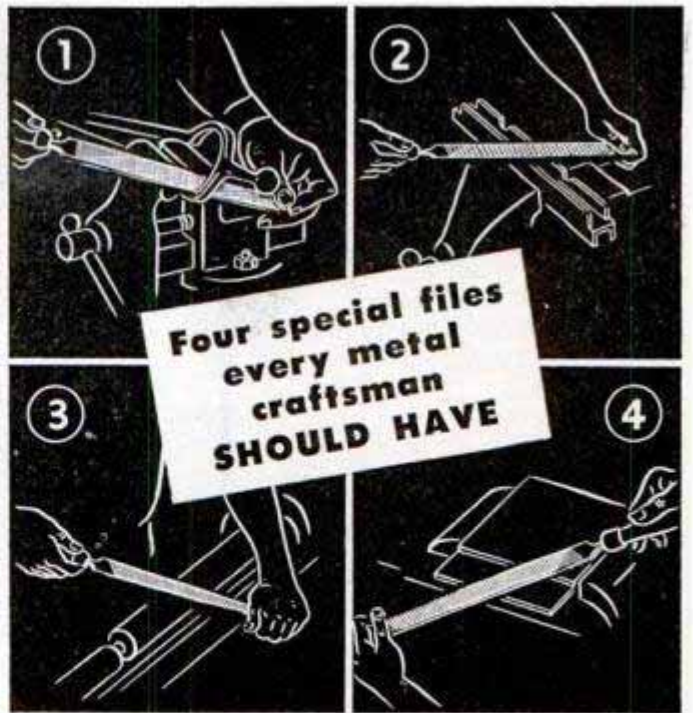

Four special files every metal craftsman SHOULD HAVE

The use of *The right file for the job* gives craftsmen greater speed and assures better work. Nicholson has carefully designed special file cuts for use on different metals. Four of such files are shown here.

1. BRASS. For this soft, ductile metal you need this file with its long overcut and short upcut designed to break up the filings and clear out the chips.

2. ALUMINUM. This "Type A" file overcomes "chatter" and clogging tendency through "open-throat" upcut teeth and fine overcut.

3. LATHE FILING. Long-angle single cut gives this file clean-shearing, self-clearing qualities that enable you to do a fine smoothing job.

4. STAINLESS STEEL. Sturdy, specially sharpened teeth keep this file cutting better and longer under the abrasive action of the hard chromium and nickel content of dense, tough stainless steel.

Your hardware dealer can provide these and many other Nicholson or Black Diamond files for you. **FREE BOOK—"FILE PHILOSOPHY."**



NICHOLSON FILE CO.
22 Acorn St., Providence 1, R. I.
(In Canada, Port Hope, Ont.)

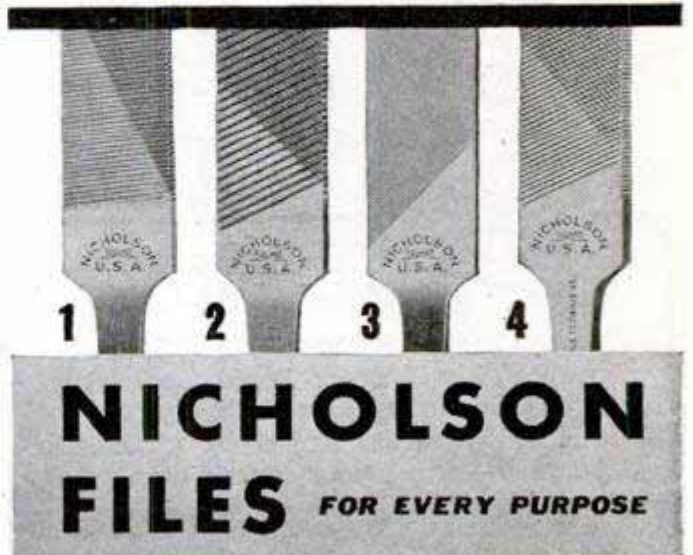

NICHOLSON FILES FOR EVERY PURPOSE



Only
\$5.85

(with 3 saw blades)
Postpaid



MOTO-SAW

THE AMAZING ELECTRIC
SCROLL SAW

Boys from 8 to 80 (and girls, too) have fun with a Moto-Saw . . . it works more like magic than any tool you ever saw! It takes no effort to run, no perceptible pressure to feed. Runs 7,200 strokes a minute . . . easily cuts intricate scroll designs in medium hard wood up to 3/4" thick. Blade holder faces blade 4 ways . . . permits you to saw sideways as well as forward and backward. No limit to length of stock it will cut . . . saws to center of 19" widths. **Moto-Saw** is as safe as a hand saw . . . has only two moving parts . . . never needs oiling. Uses 110-120 V. 50 or 60 cycle A.C. (only). Thousands of satisfied users.

MONEY-BACK GUARANTEE: If your dealer does not yet have Moto-Saw, send only \$5.85 . . . we'll pay postage. Or send \$1. and pay postman balance plus postage. Money back if not delighted after 5 days' trial.

DREMEL MFG. CO., DEPT. 5-118-A, RACINE, WIS.



STOP LEAKS!

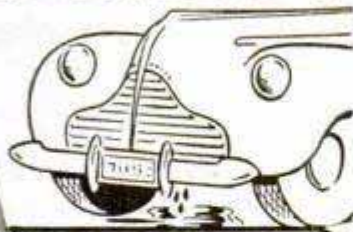

Cooling Systems
Made Leak-Proof QUICKLY

WARNER LIQUID SOLDER—Non-Metallic—Deposits Tiny Fibers to Repair Leaks Anywhere in Cooling Systems. Simply pour in! Finds and REPAIRS every crack or hole. Do it yourself—or see your service man.

Warner-Patterson Co., 920 S. Michigan Ave., Chicago 5

NEW—A PERFECT TOOL



WHALE Pli-rench

SUPER POWER LOCKING

it's all in
the SELF
ALIGNING
RED JAW

Every farmer, home owner; mechanic needs this miracle, all-purpose hand tool.

- Use as pliers, wrench, clamp, vise.
- Self-aligning jaw gives full length grip on straight or angular objects.
- Locks work with tons of pressure . . . hands free.

If not yet at dealer's order direct and please send us his name. Send for free circular.

WHALE TOOL CORP., DEPT. M
1767 Broadway, New York 19, N.Y.

\$1.95

10" SIZE
FULLY GUARANTEED



PRESS-TITE CAULKING AND SEALING CORDS



Keep cold out!
Seal holes and cracks!

Soft, rope-like Press-Tite Cords effectively seal windows and doors against cold and dust. Save fuel.

Press-Tite Cords will not harden—they stay soft and seal tight. Use also to fill any cracks or holes in wood, plaster, masonry or brick. Just press into place—no tools needed.



PRESTITE ENGINEERING CO.

3978 Chouteau Ave., St. Louis 10, Mo.



BRASS

For Home Work Shops

Free Cutting Brass Rods
Round, Hexagon, Square,
1/2-Oval and Rectangle
Naval Brass Rods
Round and Hexagon.
Brass and Copper Tubing.
Brass Sheet.

Please send 10c
for Catalog No. 101

MEIER BRASS & COPPER CO.
1155 Bellevue, Detroit 7, Mich.

Lathe Owners Attention

If your present metal lathe is without power cross-feed, you can now build your own. All parts available from your nearest mill supplier or jobber and scrap box. Positive non-slip performance—no belts used. Adaptable to all metal screwcutting lathes. Make the most of this winter in your shop. Detailed pictorial drawing and complete instructions sent postpaid \$2.95. Send Money Order today to:

JAMES B. WATERS, Jr.

4412 Georgia Ave., N.W.

Washington 11, D. C.

SAY YOU SAW IT IN POPULAR MECHANICS

NU-WAY HEAVY DUTY CUTTING UNIT

with Timken Roller Bearings

PRICE

\$16.50

WHY PAY MORE



Build your own rotary type lawn or weed cutter.

Take the hard work out of weed cutting. Build yourself an up-to-date weed and lawn mower with the Nu-Way heavy duty unit.

Write for Free Circular—We Supply Cutting Unit Complete

TRACTOR-LITE MFG. CO., Spirit Lake, Iowa

Can You Equal This Home for **2475**

Shipped Direct from Our Mill



Save 30% to 40% on Your New Home..

Act Now!

Don't pay several hundred dollars more than necessary when you build a home! Buy it direct from our mill at our low factory price. We ship you the materials—lumber cut-to-fit, ready to erect. Paint, glass, hardware, nails, etc., all included in the price—no extra charges. Plans furnished—also complete building instructions. No wonder our customers write us that we saved them 30% to 40%. Prices subject to change without notice.

BIG BOOK of House Plans in Colors **25¢**

Handsome Big CATALOGUE

Pictures wonderful homes in colors at money-saving prices. Designs to suit everyone. Send 25¢ for catalogue today.

LEWIS MANUFACTURING CO.

1281 Lafayette Ave., Bay City, Michigan

SOUTH BEND

New Ball Bearing Live Center

Designed for maximum strength and rigidity, the *Ball Bearing Live Center* is recommended for high speeds, heavy

roughing cuts, etc. 60 degree point runs in substantial precision ball bearing which is easily replaceable.



Center with No. 2 taper shank — **\$11.50**
With No. 3 shank — **\$13.50**

(all prices f.o.b. factory)

SOUTH BEND LATHE WORKS 455 E. Madison St. South Bend 22, Ind.

BIG SAVINGS **HAND TOOLS**



Reg. \$1.75 Miller Falls Screw Pitch Gage 30 leaf, 89¢ Add 10¢ P.P. • Wood Chisels, highgrade steel, 3/8" or 1/2" 69¢; 1" — 89¢ • 2" TURNING \$1.39, Add 15¢ P.P. • DEPTH GAGE, adj. angle, Miller Falls, \$1.25, Add 10¢ P.P. • \$5.00 COMB. GAGE Feeler, Thickness & Taper, precision tool steel \$2.50, 10¢ P.P. No C.O.D.'s please. Catalogs 10¢

METAL MATERIALS CO.

3923 VAN BUREN PL. CULVER CITY, CALIF.

The SPEED SAW FILER

Saves You Time, Money

Now you can do expert saw filing at home. Lifetime tool makes precision filing easy for even the most inexperienced. Two simple adjustments make it fit any type hand saw. Keep your saws extra sharp and true-cutting with a Speed Saw Filer. Complete with file, ready to use. Money back guarantee. Cash with order, prepaid. (C.O.D. postage extra.)

THE SPEED CO., Dept. PM
2025 N.E. Sandy, Portland 12, Ore.

Now FILE Your OWN SAWS

ORDER NOW!

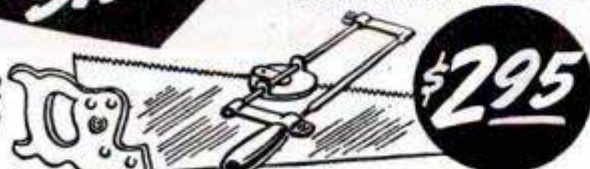

\$295

JANUARY 1948

HOW TO STOP LEAKS IN YOUR HEATING SYSTEM

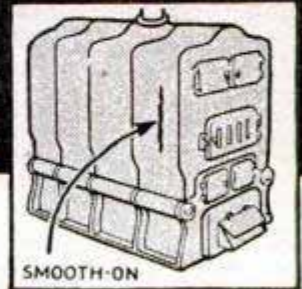

Leaks in your heating system can be securely sealed with Smooth-On No. 1 Iron Cement. And you can do the job yourself . . . quickly and inexpensively.

No heat required. No special experience necessary. Just tamp Smooth-On No. 1 securely into the crack or leak. It expands as it hardens and stays tight.

You'll find Smooth-On No. 1 a time-saver and money-saver for stopping leaks in your boiler, furnace, flues, piping, radiators, etc.

Keep a can of Smooth-On No. 1 handy and you'll always be ready to tackle emergency jobs like these, promptly and efficiently. Get it at your hardware store in economical 1 1/4-oz., 7-oz. or 1-lb. size. If they haven't Smooth-On, write us.

40-PAGE REPAIR HANDBOOK FREE

Simple ways to make effective repairs on household equipment, autos, etc. Pocket size manual with 170 illustrations. A book you should have. Send for your free copy today.



—Sign and Mail Now—

Smooth-On Mfg. Co., Dept. 37A,
570 Communipaw Ave., Jersey City 4, N. J.

Please send me my Smooth-On Handbook.

Name _____

Address _____

1-48

Do it with **SMOOTH-ON**
THE IRON CEMENT OF 1 000 USES



in ceramics

AC's new *patented* aluminum oxide insulator material is another "first" in the manufacture of spark plug ceramic insulators. As early as World War I, AC developed the *first practical ceramic aircraft spark plug*, for Liberty engines. It was perfected and ready for World War II—and its ceramic aluminum oxide insulator material was used in spark plugs, exclusively by American war planes.

Now you can have that same patented aluminum oxide insulator material in AC Spark Plugs especially designed for your car, truck or tractor engine—plugs that can take terrific punishment—plugs whose wider Heat Range adapts them to a wider range of engine temperatures. For easier starting — better idling — steadier firing under heavy load, buy AC's. They give you *utmost reliability*.

= Al_2O_3



AC SPARK PLUG DIVISION • GENERAL MOTORS CORPORATION

Electric current was introduced into the ground, the potential of the soil was measured at many points, and the lines of equal potential were plotted. At the point where the lines showed the highest resistance the archeologists dug—and successfully.

In spite of modern aids to archeology, digging is a slow and painstaking process. Because of this fact and because Mexico possesses many sites still to be worked, it may, as someone has said, "take 100 expeditions with 100 fat budgets 100 years to complete the job."

Reel Brake Ends Backlash

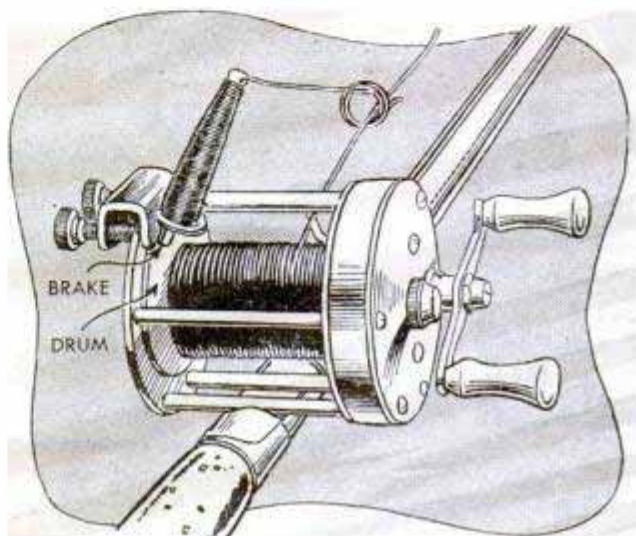

Backlash and over-run are eliminated automatically by a brake that attaches to any fishing reel. The brake stops reel spin the moment the bait touches water and the line slackens. Tension on the line, which is threaded through an eyelet on the brake, holds the brake shoe away from the reel during casting. When the line slackens, the coiled spring presses the brake against the reel, stopping its motion.

Double Life for Tin Cans

Discarded tin cans, which represent an enormous waste of metal each year, may be salvaged and re-used through a method patented by T. P. Keogh and H. A. Fink of New York. The method is especially applicable to seamless cans produced by drawing out metal blanks. After the can has been used it is cleaned and the upper section cut off just below the double-rolled seam that secured the lid. The can then is drawn out a second time to restore its original capacity, refilled and a new lid rolled on. In a variation of the method the can originally is built with a false bottom. When the can is to be used again the bottom is pushed down nearly flat, thus increasing the volume.



For only **\$327***
 you can get
 all the masonry for the
 walls of this 37' x 24' home

Now you can build of masonry without price penalty. You can get the strength, endurance, safety and economy of masonry—at a new peak point of beauty and scientific design—at a lower-than-lumber price.

The house pictured above is only typical of Dunbrik-Dunstone low price for an 8-inch masonry wall.

You can get the same per-sq. ft. price on whatever plan you have in mind—home, store, school, factory,

or for any other kind of construction.

Dunbrik is regular size brick—strong, water-resistant and color-impregnated Dunstone is a multiple of Dunbrik—made in a range of sizes up to 12 1/4" x 25". Unlimited opportunity for modern scientific styling. Note how the two combine to form the 8-inch cavity wall.

Prices are low because Dunbrik-Dunstone is locally manufactured in home-owned plants throughout the U. S. Write for Bulletin No. 40 and name of nearest plant.

Sponsored by

W. E. Dunn Mfg. Co., 610 W. 24th St., Holland, Mich.

* National Average

Territories are open for a few more local plants. If interested in this manufacturing opportunity ask for Prospectus O. M. O.

**DUNBRIK
 DUNSTONE**

THE BEST "Communications" OFFERS

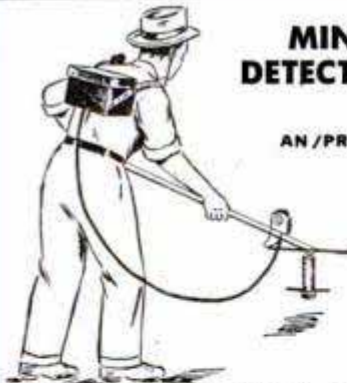

MINE DETECTORS

AN / PRS 1

Will indicate buried metallic and non-metallic objects, such as: water pipes, water pockets, roots, sewer pipes, rocks, etc. Earphones and meter for both aural and visual indication. A MUST for every camper, prospector and home owner. Detector unit and amplifier, all tubes, cables, etc. in wooden packing case.
 New, complete \$12.75
 With batteries \$21.65

MINIATURE AIR COMPRESSORS

Type No. MK 23/AP. Miniature air compressor unit operates on 27 V. DC. Contains 1/50 H.P. motor (10,000 RPM) driving an air pump. Has automatic, adjustable cut off valve, thermostatic cut off, pilot light, etc. Unit is compact, lightweight, efficient. Completely enclosed in metal case. All units are new. Size: 6" x 4" x 3". Weight: 284 lbs. Each.....\$8.50

DYNAMOTORS

PE 73 CMG.E) Power supply for BC 373 Input: 28 VDC Output: 1000 VDC @ 350 Ma. New \$5.95
 RD 77 KM Power supply for BC 191 New, with spare fuse links, etc. \$5.95
 MFRS: Write for quantity prices and discounts on above items.
 PE 101-C, Input 13/26 VDC @ 12.6/6.3 A. Output: 400 VDC @ 135 Ma., 800 VDC @ 20 Ma., 9 VAC @ 1.12 A. \$3.49

MOTOR



MODEL MAKERS ATTENTION:

Fractional H.P. motors ideal for running small drills, grinders, etc. Extended 7/32" shaft permits use of various attachments. Size: 6" x 4" x 3 3/4". Each. . \$4.50

BELL



ELECTRIC BELL

operates on 110 V. 60 cycle or magneto. Excellent for warning systems, annunciators, etc. Bell diameter is 3". Only \$7.75 Each, or 2 for \$12.25

MAGNETS

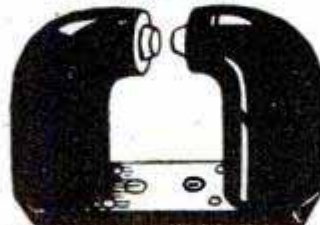

For experimenters, inventors, students, etc. These magnets are of exceptional quality and high power. All magnets come with keeper bars.
 Type #A. Field strength: 4,850 Gauss. Air gap: 5/8". Pole diameter: 3 3/4". Size: 7 1/2" x 5 1/2" x 2". Weight: 14 1/2 lbs. New, each \$4.50
 Type #B. Field strength: 2099 Gauss. Air gap: 1 1/8". Pole diameter: 3 1/4". Size: 5 3/4" x 4" x 1 1/8". Weight 4 lbs. New, each \$4.00

SKATING SAIL

HAVE FUN THIS WINTER

For ice skating and ice boating enthusiasts... Sail made of lightweight oilskin with wood mast and boom. For summer use take it on to your canoe or small boat. Large sail area (18 sq. ft.) Collapsible for easy handling. Entire sail weighs only 8 1/2 lbs. A limited quantity on hand, so order yours today at this exceptional price \$9.95



HEADSETS

HS-30 Headsets. A comfortable, high efficiency unit. Plug in phones reduce outside noise to a minimum, and low impedance (500 ohms) assures high fidelity. With 6 extra pairs of earplugs, ORDER NOW!!
 \$1.00
 Matching transformer, 500 ohms to 8000 ohms \$2.50

DYNAMIC MIKE AND HEADSET COMBINATION

Originally used with B-19 tank sets. High quality, high efficiency units. Both microphone and headset dynamic, require no batteries. New \$2.75

R-15 HEADSETS

High impedance (8000 ohms), come with 8' cord and PL-55 plug, sponge rubber cushions. Buy now at this low price. New, \$2.50
 R-15 headsets, used, but in excellent condition \$2.75

ALL MERCHANDISE GUARANTEED. Mail orders promptly filled. All prices F.O.B. New York City. Send Money Order or Check. Shipping charges sent C.O.D.

COMMUNICATIONS EQUIPMENT CO.

131-M Liberty St., DI 9-4124

New York City 7, N. Y.

**NEWEST
WAR
SURPLUS
RELEASE!**

GOVERNMENT
COST \$60.00

HEAVY
SHEEPSKIN—
PILE LINED



FULL ZIPPER
FRONT

LEATHER
REINFORCED
AT POINTS
OF STRAIN

FOR WORKERS! FOR SPORTS! UTILITY WEAR!

B-3 FLIGHT JACKETS

\$16.⁸⁸

Heavy leather, with sheepskin lining and collar. Every one is guaranteed to be in perfect condition. Just like brand new, these Flight Jackets were used and reconditioned for service to servicemen overseas. Positively safe from tears or rips. Sizes 34, 36, 38, 40. Order one size smaller than civilian size.

Send Check or Money Order (No C. O. D.'s) to:

WORLD WAR SURPLUS STORES, Dept. PJ
2450 SOUTH HALSTED STREET CHICAGO, ILL.
Allow 10 Days Delivery

IDEAL — For Lawnmower Sharpening Profits

PRECISION-BUILT

GRINDS ALL MAKES
OF LAWNMOWERS

AUTOMATIC OPERATION

NO EXPERIENCE REQUIRED

MAKE UP TO \$200 PER WEEK

OPERATE in YOUR OWN GARAGE or BASEMENT

Ideal Lawnmower Sharpener sharpens blades easily, speedily, accurately. Grinds reel knives to fit the straight blade perfectly. Behind Ideal's strong, sturdy construction are nearly 50 years of engineering experience. Handles maximum width lawnmowers. Get ready for the lawnmower sharpening rush now.

Send for **FREE Book**

The FATE-ROOT-HEATH CO.

Dept. D-3, Plymouth, Ohio

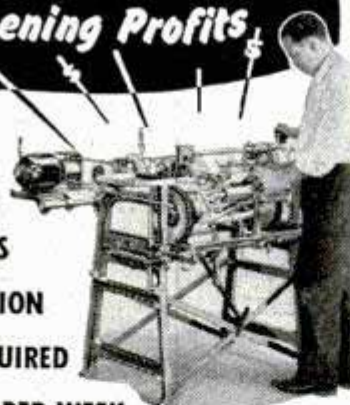

ELECTRICITY *Anywhere*

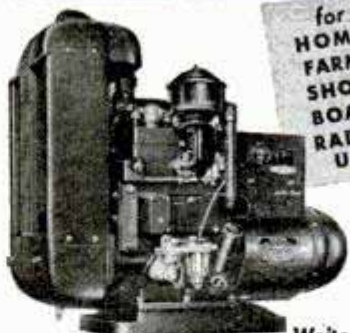

for
**HOMES
FARMS
SHOPS
BOATS
RADIO
USE**

● Onan gasoline-engine-driven Electric Plants supply reliable, economical electric service for any use. Portable, stationary or stand-by models. Water or air-cooled, compact and rugged.

A.C.: 350 to 35,000 watts in all standard voltages and frequencies. D.C.: 600 to 10,000 watts, 115 and 230 volts. BATTERY CHARGERS: 500 to 3,500 watts; 6, 12, 24, 32 volts.

Write for folder

D. W. ONAN & SONS INC.

2537 Royalston Ave., Minneapolis 5, Minn.



BA

12½ Foot ANTENNA TELESCOPES DOWN TO 16 INCHES

Stk. No. 38A39
\$15.00 Value For Only..... **\$1.95**

Has tremendous pick-up—just the antenna for mobile equipment, portable receivers, and transmitters. 12 ruggedly constructed sections of Solid Brass—smooth telescopic action. 7/8" dia. base with 3/8" threaded shank. Add 25c for Postage.



FREE Radio Catalog

Many other BARGAINS in this BIG NEW 1948 B-A Catalog (sent Free on request). It also contains the latest developments in Radio and Electronic parts and devices, newest Ham gear, gadgets.

Burstein-Applebee Co. 1012 McGee, Kansas City 6, Mo.

Get genuine full-color KODACHROME PRINTS

and look for the name stamped on the back

Order through your Kodak dealer

EASTMAN KODAK CO., Rochester 4, N. Y.

Assemble KING MIDGET



Practical highway racer runabout. We supply all parts. Just bolt together. Low cost. Ready for delivery NOW. One or two cylinder 40 m.p.h., 45 to 50 on ice or snow with skis, up to 100 miles per gallon. Send 25c for complete literature with large picture, 4-view drawings, price of parts, or send \$1 (refunded with first order) for the above, plus 24-page assembly book with 42 photographs and drawings; blueprints for converting for use on ice and snow, etc.

MIDGET MOTORS, Athens, Ohio

FREE—Big illustrated broadside. Shows 5' Parachute Jump, other action models built with Erector. Gilbert Chemistry sets. Other Gilbert Scientific Toys.

A. C. GILBERT CO., 313 Erector Square, New Haven, Conn.

BUILD YOUR OWN ZEOLITE WATER SOFTENER



Troubled by water hardness? Build a LAR water softener for as little as \$40.00. Requires only a wrench. Quickly pays for itself by savings in soap and clothing alone. Send \$1.00 for complete plans and operating instructions. Money back if not satisfied. LAKE REGION MFG. CO., Box 2732-P, Minneapolis 7, Minn.

**U.S. NAVY 7X50
PRISM
BINOCULARS
WITH COATED OPTICS**



Used but in
Excellent Condition
\$139.50
Tax
Included

Complete with leather
carrying case and sling

Universal, 6x 30 Navy Prism Binoculars, used but in excellent condition, complete with leather case and sling straps. **\$42.50**
With Coated Optics, \$10 Extra.

**Engineers All Metal Army Type Hand-Sighting
LEVELS**

\$2.00 PRECISION
QUALITY 

Send \$1.25 for 3rd Annual Edition of Gun Digest with our complete catalog of new and used guns, etc. Our separate catalog 25c.

PUBLIC SPORT SHOPS

13 S. 16th St., Phila. 2, Pa.

No COD's

*In all the
wanted colors
-LUMINALL
PAINT*



Brighten your rooms at
modest cost... Redecorate
with Luminall. There's
a dealer near you.

Luminall Paints, Chicago 9.



NEW OTTAWA Wood Saw



FOR TRACTORS Makes wood sawing fast; easy. Cuts enough wood to pay for itself quickly. Easily moved while attached. Big blade; send for FREE details. **OTTAWA MFG. CO., 1-827 Oak Ave., Ottawa, Kans.**

WAR SURPLUS!

New B-24
Aircraft Lighting **GENERATORS**



**30 Volts
300 Amp. D. C.
\$49.50**

Original cost \$250
MODEL R. 2, BUILT BY
JACK & HEINTZ, CLEVELAND, O.

Can be used for lighting or converted for use as welder, electric plater, fast battery charger, auxiliary power unit, etc. Small but mighty. Size 16"x7". Air cooled. Shipping weight 68 lbs. Immediate shipment. Original crates. Send check with order to save time. We also offer new 200 Amp. G.E. and Westinghouse Lighting Generators, 30 Volts D.C. Model P. 1 at \$33.00. (Cost \$150.00.)

GREER CO. 460 S. State St., Dept. PMD
Chicago 5, Ill., Phone Harrison 4075

COMPLETE HOME WORKSHOP

5 POWER TOOLS IN 1



LATHE 10" swing, 30" between centers, 3/4" spindle, face plate, spur center, tool rest.

\$34.95

SAW

Takes 6" to 8" blade. Arbor handles scratch brush, grinder, buffer. Saw blade not included.

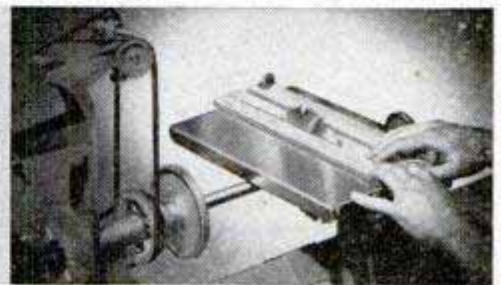

DRILL PRESS

Takes drills to 1/2". 2" travel, 1/2" spindle. Drills to center of 12" circle.

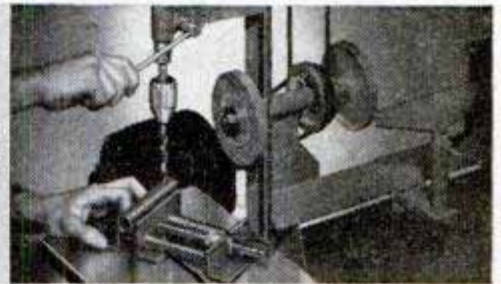

GRINDER

5" Emery wheel furnished. 4 step cone pulley. Spindles mounted in replaceable bronze bearings.

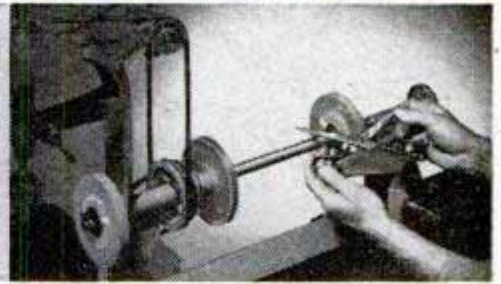

SANDER

8" diameter disc takes any type abrasive. Heavy construction lasts for years. Motor not included in price.

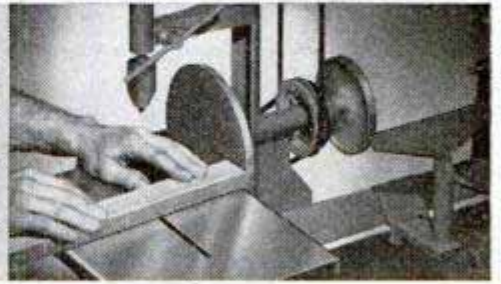

**10
DAY
TRIAL**

EMRICK, Inc., 1731 Clinton St., Kalamazoo 24, Mich.

Ship on 10 Days Trial. I am enclosing \$17.50, balance C.O.D. Send Free Literature Send Free Tool List

NAME _____

ADDRESS _____ CITY _____

You can build this
Attractive outdoor
BARBECUE

for only \$5⁰⁰ worth of materials

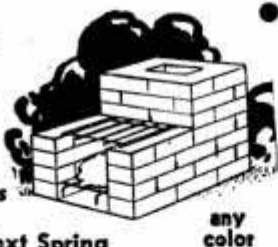

Mold Block Now—Lay Them Next Spring
The Kreger Concrete Block Mold...makes a block a minute...for 3 cents each! This barbecue is made of 40 block... easily put together. Over 50,000 satisfied users.

FOR HOUSES—FOUNDATIONS—GARAGES



You can build or repair anything from a foundation to a complete house with block you make yourself. They meet all building codes.

THIS AMAZING MOLD LASTS A LIFETIME—COSTS ONLY \$15.00

The No. 4816 Kreger Concrete Block Mold, standard block—4' x 8' x 16'—will be shipped prepaid with complete instructions for only \$15.

KREGER PATIO BLOCK MOLD

The No. 4810 Kreger Patio Block Mold for walks or patios makes block 8' x 16' x 2 1/2' (or thinner). Only \$6.50, prepaid.

KREGER DRIVEWAY BLOCK MOLD

The No. 4812 Kreger Driveway Block Mold makes driveway block 16' x 8' x 4', at a cost of 6¢ each (100 linear feet of double track for only \$18.00!). Cost is only \$7.00, prepaid.

Order Your Molds Today or Write for Full Details.

The L. F. Kreger Mfg. Co., 544-B W. 35th Street, Chicago 16, Ill.

IT STAYS STUCK!

WITH ...

MULTI-PURPOSE AMBROID



If you want permanent results from an adhesive, you can't equal multi-purpose Ambroid liquid cement — for home workshop, household or factory. A quality leader for 37 years, ready-to-use Ambroid is waterproof, transparent, quick-drying, extra strong. Flexible, heat-and corrosion-resistant. For assembling, repairing or mending jobs, keep Ambroid handy. At your dealer's, or send 25¢ for big 2-oz. tube post-paid. Money back guarantee.

Also 50¢ 4-oz. tube. Pts., qts., gals., for industrial use.



303 Franklin St., Boston 10, Mass.

New Methods in Old Mines

(Continued from page 120)

liquid with a specific gravity between the gravities of the good and useless ores. Waste rock bobs to the surface of the bath and floats away; chunks containing the valuable heavier ingredient sink to the bottom or the ore may rise and the waste seek the bottom.

A simple example of the process would be the separation of wood chips from gravel by dumping a mixture of the two materials into a tub of water. The wood chips float and the gravel sinks.

There are a number of heavy liquids that can be used similarly to separate lightweight and heavyweight pieces of rock. Most of them are expensive and somewhat toxic. It usually is more practical to manufacture a heavy liquid by stirring into suspension in water a quantity of finely ground particles of some heavy solid. Such a bath has all the properties of a true liquid and may be enriched or diluted to the exact specific gravity desired.

Chunks of ore that pass through the bath pick up some of the suspended material and carry it away, changing the gravity of the bath and sometimes creating extra milling problems. In the case of Heavy-Media Separation, the name of the sink-float process controlled by the American Cyanamid Company, these difficulties are overcome by a unique means.

American Cyanamid, in most cases, uses a bath that contains fine particles of magnetite or ferrosilicon, each a heavy and a highly magnetic material. Water sprays wash the material from the ore and waste and the material is then removed from the spray water by electromagnets. After being demagnetized by passing through a special coil, the magnetic material then is returned to the sink-float bath.

The first Heavy-Media Separation plant for continuous operation was installed at a zinc mine in Tennessee to replace a jig apparatus that had been used as a concentrator. The new process discarded 20 percent more material than did the process it replaced, reduced the load that went to the mill by that amount and at the same time produced a concentrate that was four percent richer.

Zinc-lead, magnesite, fluor spar, tin, gem and abrasive garnet ores are all being concentrated by Heavy-Media Separation. Pilot-plant operations prove that the process also is suitable for concentrating copper, silver, gold, pitchblende, tungsten, nickel, manganese, chrome, phosphates, potash,

(Continued to page 248)

Electric WONDER PEN

Burns Beautiful Designs in Wood

DECORATE Leather, Cork, etc.

Works like Magic for Lining, Etching, Shading!

Learn in One
FREE
Easy Lesson

Amaze your friends with this exciting new craftsmanship. Enjoy this magical art for pleasure or profitable income. Make gifts or sell your work direct or to gift shops. With

this great electric pen you quickly learn to burn, etch or shade thousands of articles in gorgeous varied tones of rich sepia brown. Also apply colors, or varnish finishes, etc. We supply everything in one big Special Offer. You get the only Electric Woodburning Pen guaranteed for 800 working hours and 25 accessories. All materials, Tools, 9 Plates, Book Ends, Brushes, colors, varnish, nails, sandpaper—everything you need—ready for etching plus your FREE easy lesson. A thoughtful gift to any adult or youngster. If your dealer does not have the genuine "Wonder Pen," order from factory. Enclose check or money order. Money refunded if not satisfied.

SPECIAL OFFER
only \$3.00 postpaid



DEALERS:
Stock this
item. Write
for Catalog.

Write for our Catalog of other interesting items.
AMERICAN TOY & FURNITURE CO.
6130 N. Clark, Dept. 118 Chicago 26, Ill.

Ball-Bearing SPEED WHEELS

Juvenile wheels, solid tire—No Bearings

7" wheels60c
6" wheels50c
4" wheels30c

Semi-pneumatic tired wheels

12 x 1.75".....\$3.25
10 x 1.75".....\$2.75
10 x 1.25".....\$2.00
8 x 2".....\$2.00

Industrial wheels for
heavy loads

Semi-Pneumatic
400 x 8, 2 ply tire and tube....\$12.50
12 x 3.00" bolt hub, ea.....\$9.75
10 x 2.75".....\$6.75
10 x 2.75" Single Tube.....\$7.25
8 x 1".....\$4.90
6 x 2".....\$2.80

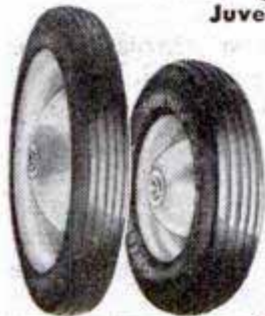

**DEALERS
WANTED**

Free blueprints with all wheel orders.
Send check with order. Shipments f.o.b. Akron.

JIM BROWN TOY COMPANY
1097 Home Ave. Akron 10, Ohio

REAL GAS ENGINE \$6.95



The new THOR "B"—Sensational miniature gasoline engine that really works. Superpower performance. Smooth, velvet power that roars into action with a "twist of the wrist." Over 25,000 already sold. 1/6 H.P. Complete with coil and condenser. Ready to run, only \$9.95. In KIT form, fully machined, 5 minutes to assemble, \$6.95, without coil and condenser. Powers all models. Fully illustrated instructions. Send \$1.00—shipped collect same day C.O.D. FREE—Send for 24-page illustrated hobby catalog.

AMERICA'S HOBBY CENTER
Dept. B-18, 156 West 22nd Street
New York 11, New York



"MAC" REVOLVING CENTER

Do a better job with less waste on ALL METAL or WOOD working lathes with "MAC." Easily interchangeable spindles adapt "MAC" for METAL or WOOD working. Specify type spindle wanted when ordering. PRICED LOW! #2 M.T.—\$7.50 (extra spindle \$3.00), #3 M.T.—\$11.50 (extra spindle \$4.00), #4 M.T.—\$13.50 (extra spindle \$5.00) post paid. M.O. or check with order. (C.O.D. slightly higher.) ORDER DIRECT FROM MANUFACTURER! SATISFACTION GUARANTEED! (Distributors wanted.)

WHITFIELD MFG. CO.

Washington C. H., Ohio

Help yourself
to **SUCCESS** in
arc welding
with a **HOBART**
"Build Your Own"

Save \$350 to \$500

over the cost of a complete
factory built portable gaso-
line engine drive arc welder.

Handle The "Big Pay" Jobs

in the field. Portable welders earn twice as much as shop welders and by "Building Your Own" your investment is slightly more than a good shop welder. FREE booklet tells you how to build it.

Hobart A. C. Arc Welders

for shop use can be purchased from your "Build Your Own" welder profits. This way you can start small and build your shop into a large, profitable job welding business.

Let Hobart Train You!

More and more dissatisfied workers are turning to the valuable arc welding trade. You, too, can learn the profitable welding trade. Sign up today for an intensive course at the Hobart Trade School. Qualified under G. I. Bill. Check coupon for FREE booklet "Learn Arc Welding."

Hobart Brothers Company,
Box M-18, Troy, Ohio

Free! Vest Pocket Guide.
A handy book containing
useful welding information.
Check coupon for your copy.

Hobart
"One of the World's Largest
Builders of Arc Welders."

HOBART BROTHERS CO., BOX M-18, TROY, OHIO

I'm interested in building my own portable welder, send me complete information and FREE book. Also data on items checked. A. C. Welder (Industrial Type)

Electric Drive Welder A. C. Welder (Shop Type)
 Vest Pocket Guide Welding School

NAME _____

ADDRESS _____

CITY _____

STATE _____ PHONE _____



Stationary Electric



Industrial AC



Trans-
former
AC



LOWEST PRICE IN HISTORY!

Sensationally New WELDRITE Electric Welding-Cutting Torch

NOW ONLY
\$12
FULLY GUARANTEED

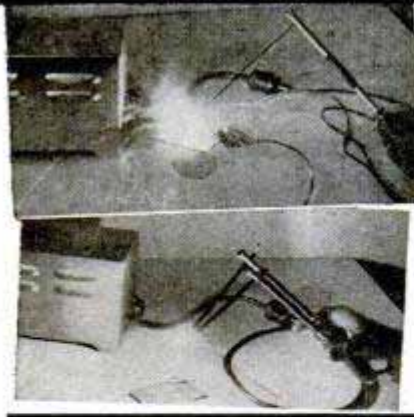

Plugs into any convenient AC-DC Socket
WELDS - BRAZES - CUTS - MELTS - SOLDERS - HEAT TREATS

The WELDRITE Torch—tested and proven by countless commercial and amateur users, is now offered direct to you at the amazingly low price of only \$12.00. No Gas—No Gauges—No Spark Lighter needed. Always ready for immediate use—Just plug WELDRITE into any 110 AC or DC outlet. Uses standard welding and brazing materials available at all welding supply stores. WELDRITE furnished complete with Converter Unit, Single Holder with attached Alligator clip, for Welding metal up to 3/16" thickness, using up to 3/32" rod, and Double Holder with Carbon-Tipped Dual Copper Electrodes for Cutting, Brazing, Heat Treating, Soldering, etc. Supply of welding materials included free.

Ideal for home workshop. Invaluable for body and fender shops, garages, repair and machine shops, manufacturers, etc.

SEND NO MONEY. Order your WELDRITE Electric Welding-Cutting Torch today. Pay postman \$12 plus postage charges (wt. 4 lbs.) or send \$12 and we pay postage. Either way, if not satisfied, return WELDRITE in 3 days, and money will be refunded. California orders please add sales tax.

CALIFORNIA TECHNICAL PRODUCTS COMPANY
8510 Warner Drive • Culver City, California • Dept. A-1

SAVE GAS

AND DRIVE MORE SAFELY!

GET A Snow GASOLINE MILEAGE GAUGE

You know your exact gas mileage at any speed, under any driving conditions, right while you're driving when you use a Snow Gasoline Mileage Gauge! It's easy to cut gas consumption at least 100% and drive more safely too, because the Snow Gauge shows up fuel waste in careless acceleration, high speed driving and other bad driving habits—thus economy becomes a constant safety reminder!

cut repair bills, too!

Fouled spark plugs, faulty valves and other engine troubles show up on the Snow Gauge in lower gas mileage—you catch these troubles in time and save costly repair bills—thanks to your Snow Gasoline Mileage Gauge!

Your dealer will install your Snow Gasoline Mileage Gauge quickly—no special tools or drilling necessary. Made for Ford 85 and 100; Mercury; Chevrolet; and Plymouth only. If your dealer can't supply, send \$6.00 to Snow Plastics Corporation, 221 E. 26th St., Chicago 16, Illinois. Specify make of car!

BUILD YOUR OWN TRAILER

Get these Modern Complete Plans

Select just the model you want—for hunting—travel—camping—or as a home. Each plan is complete with simple, step-by-step instructions and a bill of materials. Easy to follow. Three models!

STOCK No. H27 NATIONAL MODEL 27. A sleek 27 foot trailer with 3 rooms, lavatory, etc. Sleeps six. complete plan	\$1.00
STOCK No. H20 NATIONAL MODEL 20. A good-looking, easily-built 20-ft. trailer. 3 rooms, sleeps four. complete plan	\$1.00
STOCK No. H10 NATIONAL CAMPER. A compact unit for traveling, camping, hunting, fishing. Sleeps two. Complete plan	.50
Special—Order all 3 of above plans.....	\$2.00

FREE! Big parts catalog with any order

NATIONAL TRAILER STORES
Dept. 10 Box 2353 Terminal Annex - Los Angeles 34, Calif.

HEAT PUMP... BUILD YOUR OWN REVERSE CYCLE HEATING and AIR CONDITIONING PLANT

Send for complete designs and specifications of THREE easily built types you can make yourself. Designs prepared by REGISTERED ENGINEERS.

Send \$1.00 to: **GENERAL ENGINEERING WORKS**
P.O. Box 1176, Portland 7, Oregon

STAY HOME AND MAKE MONEY!

—Men! Women! Get into profitable, uncrowded profession you can operate from your home or small office after short home training course. No capital required. No goods to buy. No age limit. Others earn \$50.00 to \$100.00 per week making famous Stephenson corrective foot devices to order. Foot sufferers everywhere pay gladly for relief. Send today for FREE BOOKLET.

STEPHENSON METHOD. Established 1894, 12-28 S. Market St., Boston, Mass.

SAY YOU SAW IT IN POPULAR MECHANICS

DEEP TONE DUAL MUFFLERS LONG LIFE

- More Horse Power
- Better Gas Mileage
- Blow - Out Proof
- Straight Thru Mufflers

FORD & MERCURY DUAL SETS ...\$20.00
C.O.D. - F.O.B. Los Angeles Order by Year and Model
No Welding, Cutting, Drilling of Holes.
All Fixtures Furnished Rubber Insulated Clamps

DEEP TONED	Ford, Chevrolet, Ply.	\$4.86
SINGLE MUFFLER	All others	\$5.50
2 1/2" CHROME TAIL PIPE TIPS		\$1.75

Advance Mufflers 6800 SO. VERMONT AVE. LOS ANGELES 44, CALIF.

1935 TO 1947—V-8 FORD AND MERCURY ONLY

STAR UNIVERSAL NO-LEAK TESTER



Combines in one tool the two methods of testing constantly used by electricians for repair and maintenance.

- FOR CONTINUITY testing on your bench or at the job. Simply plug into any outlet — no batteries needed.
- FOR LINE AND POWER testing, the plug is inserted into the insulated frame as shown to the right, and circuits of 110-600 volts are positively tested.

Motors, fixtures, and appliances are quickly tested for open circuits, dangerous grounds or short circuits. Traces circuits in wiring, radios, airplanes and signal circuits.

Postage 10c
PRICE ONLY \$2.50

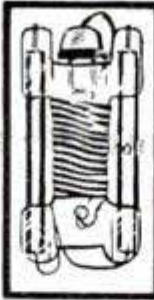

Send for free illustrated circular describing uses.

STAR FUSE CO., INC. 233 CANAL STREET
NEW YORK 13, N. Y.



Surplus Special! ELECTRIC RELAY ASSORTMENTS

No. 101—All brand new! At least 10 in assortment. Misc. types. Electricians, electronic and radio experimenters will welcome this value. All are standard make, precision units. Shp. wt. 6 1/2 lbs.

10 ASST.
RELAYS
ALL FOR
ONLY **\$5.95**

ALL F.O.B. HOUSTON. MAIL ORDERS PROMPTLY FILLED.
SEND CHECK OR MONEY ORDER. SATISFACTION GUARANTEED.

SOUTHWEST AERO SUPPLY, Dept. PM1
P.O. DRAWER 488 SOUTH HOUSTON, TEXAS

MARCOT KEY MACHINES

MARCOT No. 8 KEY MACHINE, mounted on Cabinet \$ 82.50
Auto Code Book and
Auto Depth Keys 12.50
1,944 Popular Cylinder Key Blanks 77.75
Set — Key File, Follow-Through

Rods, Lock Picks, Bit Key Gauge, Tumbler, Pins, Springs... 10.50
"Locksmith Trade Books" 6.75
How to Open Locks without Keys or Picks; Secret of Locksmithing; How to Make Keys by the Impression Method; Master Key Systems.

TOTAL COST \$190.00

The \$77.75 cost of the Key Blanks would return to you \$486.00 or more. This would more than pay for your entire KEY MACHINE OUTPUT.

IMMEDIATE DELIVERY—Motors available with Key Machine Orders.
A. J. MARCOTTE CO. DEPT. PM, CHICAGO 51, ILL.

BUILD YOUR OWN MACHINE TOOLS! Blueprints \$1.00—Catalog FREE

Make your own Milling Machines, Shapers, Drill Presses, 8" Circular Saws, 6" Jointers and similar tools with Lewis ready-to-machine castings. Save up to 80% of finished machine cost. \$1.00 brings complete blueprint specifications for above 6 tools. Catalog describing Lewis line sent free with blueprint order.

WRITE TODAY!

LEWIS MACHINE TOOL CO.
P.O. Box 7446, Sta. L, Dept. M, Los Angeles 23, Calif.



MINIATURE ENGINES

Gasoline—Steam
Air—Locomotive



THE WORLD'S
MOST FASCINATING HOBBY

Build them yourself — In your own shop
With your own tools

Send 10 cents for my illustrated catalogue listing the world's largest selection of miniature engine castings and drawings.

McADED MODELS
1313 S. TALMAN AVE.
CHICAGO 8, ILLINOIS



TRY THIS AMAZING NEW ANCO® CLEAR-FLEX WINDSHIELD WIPER BLADE

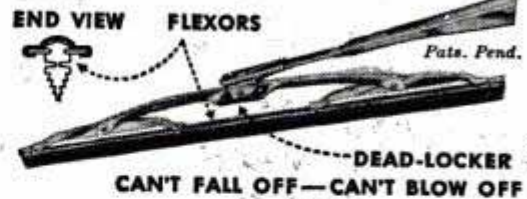

FLEXES TO CLEAR THE LOW SPOTS

Know CLEAR-FLEX . . . the first Wiper Blade to conform fully to all windshield surface irregularities. Even wipes uniformly all types of curved windshields. Keeps clear those annoying hard-to-reach low spots common to all FLAT windshield glass. Clears quickly blinding road muck . . . slapped against your windshield from sloppy pavements . . . by passing cars. CLEAR-FLEX already has engineering approval for original equipment on coming models of high-grade cars.

THRILL WITH CLEAR-FLEX AS OUR "GUEST"

Deposit with your dealer only the regular retail price. Use CLEAR-FLEX through the next storm. Then IF you are willing, dealer is authorized to remove CLEAR-FLEX and refund all your money.

ANCO DEAD-LOCKER®



WIPER ARM

ANCO Arm fits quickly any wiper shaft. Suits any good wiper motor. Holds Blade true . . . at correct pressure. If not now on your car, ask serviceman to install a PAIR quickly for you. More than 250,000 good gas stations and service stores sell ANCO BETTER Blades and Arms.

Made by the makers of long-famous ANCO RAIN-MASTER® Blades and Arms . . . original equipment for years on DeLuxe models of high-grade cars. Your dealer knows ANCO.

Get yours next time you buy gas.
May save you a costly smashup.

Quality Protected Under Fair Trade Laws
ANCO Patented Products—Patents Make Jobs

THE ANDERSON COMPANY
Established 1918
GARY, INDIANA

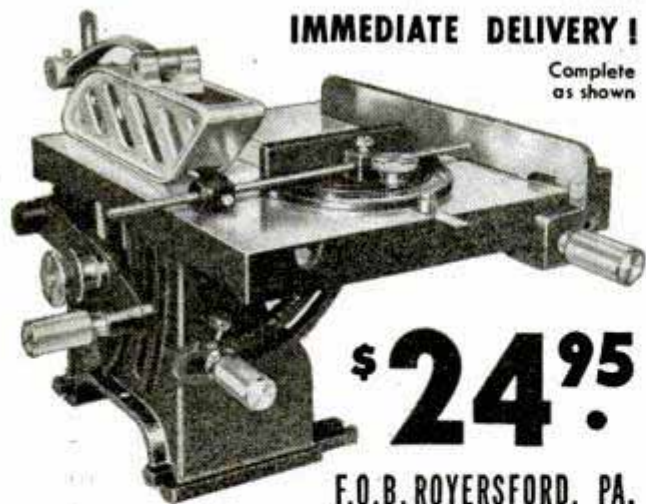

IMMEDIATE DELIVERY!

Complete
as shown

\$ 24⁹⁵

F.O.B. ROYERSFORD, PA.

QUALITY 8" BENCH SAW
CUTS THROUGH 2⁵/₁₆"

UNCONDITIONALLY GUARANTEED ONE YEAR

(Write for Free Booklet and Guarantee Bond)

Comes complete with Floating motor mount—miter gauge with adjustable stop—aluminum guard—soft aluminum insert—spring steel splitter—heavy gray iron fence—(no motor—no blade). Table 12" x 14". Tilts to 45°—Oilite bearings. Shipping Wt. 50 lbs.

AMERICAN MACHINE & TOOL CO. Inc.
DEPT. 100 ROYERSFORD, PA.



SAW FILING

You can have a good, steady, cash business of your own reconditioning saws with the Foley Automatic Saw Filer, which makes old saws cut like new again. The Foley is the **ONLY** machine that files all hand saws, also band and circular saws. Easy to operate—no eyestrain.

IMMEDIATE DELIVERY is now available on a Foley Saw Filer. Free Plan shows how to start in spare time. No canvassing. Mail coupon today.

FOLEY Automatic SAW FILER

FOLEY MANUFACTURING CO.
116-B Foley Bldg., Minneapolis 18, Minnesota
Send Free Plan on Saw Filing business, no obligation

Name _____

Address _____



gypsum, and cement rock ores. Even diamonds can be collected by Heavy-Media Separation and a plant is being built in Africa for this purpose.

Heavy-Media Separation automatically removes slate and other refuse rock from coal. One such plant for cleaning coal is in use and others are under construction.

The process also is of value to the operator of small mines. In the western states there are numerous deposits of valuable ores that contain tonnages too small to warrant full-sized mine and mill operation. Now these ores may be mined and concentrated and the concentrate hauled to a mill for final processing. One western manufacturer builds small prefabricated Heavy-Media Separation plants for this purpose, with capacities from 5 to 25 tons per hour.

Many old mine dumps contain values that can't be recovered profitably by crude methods but that can yield a return after sink-float concentration. Test batches of low grade tin-tungsten dump material from England, treated by Heavy-Media Separation, resulted in retention of 62 percent of the tin and 83 percent of the tungsten in the ore after rejecting nearly 70 percent of all the material that was fed into the cone.

Some of the old ore dumps at such ghost towns as Virginia City, Tombstone and Panamint City have been worked profitably two or three times in the past by taking advantage of new handling techniques. Even these dumps may be made to yield additional precious metal by employing modern methods.

Uncle Sam Looks Into Housing

(Continued from page 160)

several standard tests used on building materials. There is a standard fire-resistance test and several tensile-strength tests. In the fire-resistance test a sample section of a wall is exposed to flames in a special furnace. To pass the test the wall must not crack so as to permit flames to pass through it, or must not become so hot on the unexposed side as to set fire to cotton waste placed against it.

To test whether specific walls can carry the weight of the roof, a hydraulic press is used to exert pressure until the wall is crushed. A weight equivalent to 10,000,000 pounds can be applied. A smaller press is used to test structural materials of smaller dimensions.

Not all government research on housing is carried out at the Bureau of Standards.

(Continued to page 252)



AXLE ASSEMBLIES

LIMITED
OFFER
ORDER
TODAY!

with a hundred uses
Complete as illustrated, 1½" square, 58" tread. With 6:00 x 16 recap tires \$52.50
Without tires \$45.00

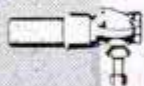

• BULL DOG HITCHES—with tongue-ends for every need.

HAMMER BLOW TOOL COMPANY

DEPT. AC, WAUSAU, WISCONSIN

HOLD-E-ZEE

AUTOMATIC GRIP
SCREWDRIVERS

MORE WORK
IN LESS
TIME!



UPSON
BROS., INC.,
85 Exchange St.,
Rochester 4, N. Y.

Hold-E-Zees do the job better, faster. They excel wherever screwdrivers are used. Gripper instantly released by spring action, sliding up out of way when not in use. All materials highest quality.

AT LEADING DEALERS EVERYWHERE

A BIG 25¢ WORTH OF TOOL TIPS



• Everything about tools . . . at a glance. More than 2000 views of boring and cutting tools, squares, gauges, jigs, etc. Years of tool experience in one, low-priced book . . . 25¢ postpaid. Write today. Stanley Tools 118 Elm St., New Britain, Connecticut.

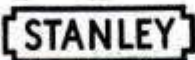

Reg. U. S. Pat. Off.

SAY YOU SAW IT IN POPULAR MECHANICS

DAM leaky walls with DRYEX

Make big money applying or selling Dryex, the amazing plastic that makes wet exterior walls dry and keeps them dry. Easy to brush on, easy to sell. Tough, flexible. Thousands of fine prospects. Write today for details.

LASTING PRODUCTS COMPANY
Franklintown Road Plant, Baltimore 23, Md.

A TOOLSHOP IN YOUR HAND!

- GRIND • DRILL • ROUT
- POLISH • ENGRAVE
- CUT • SAND • SAW, etc.

Make Things From
Wood—Plastics—Metals—Glass—Linoleum—Leather—Alloys—Horn—Stone—Bone, etc.

***HANDEE** TOOL OF 1001 USES

THE FIRST TOOL OF ITS KIND AND TODAY'S FINEST
Smooth, steady power at your fingertips! Perform precision operations not possible with any other portable tool! With a Handee you can turn out professional looking projects for pleasure or profit—ship, plane and train models, delicate, internally carved costume jewelry, wood carvings, puppets, initialed tumblers, etc. AC or DC. 25,000 r.p.m. Wt. 12 oz.



GET A GOOD START GET THE HANDEE KIT

HANDEE Tool and 40 most popular accessories packed in compact steel carrying case. You'll be amazed at what you can accomplish! Complete, \$27.50. Handee only, with 7 accessories \$20.50.

FOR YOURSELF OR A FRIEND . . .
THE GIFT OF A LIFETIME!



NEW PLASTIC-CRAFT KIT

For internal carving. Contains special plastic cutters, buffers, sanding discs, buffing compounds, dyes, cement, a liberal supply of clear plastics, and instructions. At stores or postpaid \$6.95

*Reg. U. S. Pat. Off.

Get a Handee at stores everywhere. If they can't supply you we'll send it postpaid. Satisfaction guaranteed! Ask for free 52-page Manual

CHICAGO WHEEL & MFG. CO.

1101 W. Monroe St., Dept. PM, Chicago 7, Ill.

Send Handee Kit Handee Tool Plastic-Craft Kit C.O.D.
 Remittance enclosed Send Manual

Name.....

Address.....

**NEWEST
WAR
SURPLUS
RELEASE!**



FIELD JACKETS

- 100% Wool Lined • Water Repellent
 - Zipper Front • Adjustable Hip Straps
- \$1.88**

SIZES: 32, 34, 36, 38 and 40

Full zipper-front Army Field Jacket with bi-swing back. Every one is guaranteed to be in perfect condition. They have been cleaned, sterilized and washed. These jackets were used and reconditioned for service to servicemen overseas. Positively safe from tears or rips. Add 20c postage; Illinois Residents add 2% tax.

Send Check or Money Order (No C. O. D.'s) to:
WORLD WAR SURPLUS STORES, Dept. PJ
 2450 SOUTH HALSTED STREET CHICAGO, ILL.
 Allow 10 Days Delivery

PRESSURE QUEEN

FOUR CYLINDER
 PORTABLE AIR COMPRESSOR
 SPRAY PAINTING OUTFIT

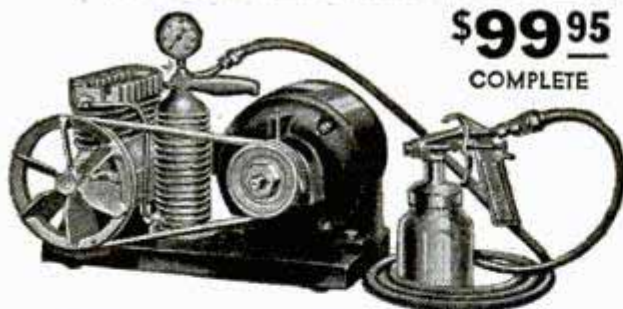

\$99.95
 COMPLETE

COMPACT • RUGGED • POWERFUL

The ideal air supply for home and farm workshop, machine shop, garage, service station and contracting painter. Inflates tires; refinishes automobiles, trucks, implements and furniture. Paints buildings better, faster and at lower cost than brush work. Compressor has 4 cylinders, drop forged crankshaft, heat treated valves and pistons, bronze bearings, forced feed lubrication. 50-60 lbs. pressure without pulsation. Price includes compressor as shown, with air gauge, 15 ft. hose, spray gun and 3/4 h.p. motor; fully guaranteed. With 1/2 h.p. motor—\$109.95.

IF YOUR DEALER DOES NOT SELL
 PRESSURE QUEEN WRITE DIRECT.

THE CAMPBELL-HAUSFELD CO.
 1046 RAILROAD AVE. HARRISON, OHIO

**STRIPE
 WITH
 PAINT
 EASY
 AS
 USING
 A
 PENCIL**

PAINTERS' STRIPING TOOL

NOW you can do your own expert striping on furniture, bikes, model planes, bulletins, autos, toys, signs, linoleum, wall board . . . make plain walls look like tile! It's easy to paint straight, curved, circular, even parallel lines with any color. Handiest paint tool in your workshop! Type "M" Master Painters' Striping Tool complete with tip for 1/16" stripe, \$1.00. Extra tips 1/64", 1/32", 3/64", 1/16", 5/64", 3/32", 1/8"—75c each. Tool with complete set of 7 tips \$5.00. (C.O.D. orders 25c extra.)
WENDELL MFG. CO., 4234 -B Lincoln Ave., Chicago 18, Ill.

**A TOOL . . .
 NOT A BRUSH**

Dealers
 Write
 Today!



\$1.00
 POST
 PAID



WHEELS AT BARGAIN PRICES

- ... 4" wheel & tire, 5/16" sleeve bearing & hub cap . . . \$0.45 ea.
- ... 5" wheel 5/8" solid tire 5/16" shaft hole . . . 0.65 ea.
- ... 6" wheel 3/4" solid tire 5/16" shaft hole . . . 0.75 ea.
- ... 7" wheel 3/4" solid tire 3/8" shaft hole . . . 0.85 ea.
- ... 8" wheel 1" solid tire 1/2" sleeve bearing . . . 1.25 ea.
- ... 8x2" wheel, semi-pneumatic tire 7/16" ball bearing . . . 2.50 ea.
- ... 10x1.75 wheel semi-pneumatic tire 7/16" ball bearing . . . 3.25 ea.
- ... 12x1.75 wheel semi-pneumatic tire 1/2" bronze bearing . . . 4.00 ea.
- ... 10x2.50 wheel semi-pneumatic 1 1/2" ball bearing . . . 4.50 ea.
- ... 6x2" wheel 5/8" ball bearing, solid tires 3.95 ea.

BUILD YOUR OWN—Wagons—Scooters—Soap Box Racers—Welding Carts—Baby Pens—Etc.
 To order above wheels write number wheels wanted in space provided, tear out and mail this ad with check or money order and your name and address. If other sizes are wanted write for FREE LIST.

TRULSON MFG. CO., 811 E. 31 St., Dept. PM 11, Kansas City, Mo.



HEAT BURNERS FURNACES GAS - OIL

Circulating Room Heaters, L.P. Gas burners, Floor Furnaces, Cabinets and blowers, Oil Burners, Controls, Card for free literature. Wholesale and Retail. **DEALERS WANTED.**

Peerless Sales

4318 Sheridan Blvd. Lincoln 6, Nebr.

**EXTRA
 MONEY
 QUICK**

SELL PERSONAL INITIALED BELTS

SEND
 FOR SPECIAL
 OUTFIT
 OFFER

BUCKLES, CAP BADGES, TIE HOLDERS
 2000 emblems to choose. Fast profits repeats. Write to-day. Special outfit offer.

HOOKFAST SPECIALTIES, Dept. 51
 BOX 1425 PROVIDENCE, R. I.

GOODBYE to BURGLARS

Protect your belongings and the lives of your family. Send \$1.50 (or 7/6) by International Money Order for complete plans for combined burglar alarm and automatic locking device (electrical). It's unique. You make it from scrap.

SAFETY INVENTIONS, 110 Cranbourne Ave., Benoni, South Africa



VENETIAN BLIND MACHINERY and EQUIPMENT

Write us for our Catalog
WRIGHT SALES CO., INC.
 9600 Carr Ave. • Cleveland 8, Ohio

FASTEST PLANER in the WORLD at this Low Price... \$195.00

Belsaw Multi-Duty Planer



Needed by every saw mill owner and woodworking shop to **Speed Up Production — Increase Profits.** Belsaw high speed thickness planer provided for single surfacing stock up to 12" wide by 6" thick at the high speed rate of 24 lineal feet per minute for HIGH PRODUCTION. Planes GREEN or DRY sawed lumber into higher priced, valuable smooth and worked forms. Machine has welded all STEEL frame... nothing to break. Safety-type all Steel cutterhead runs in heavy duty ball bearings. Three HIGH SPEED Steel knives make 42 cuts per inch for smooth finish. Belsaw Multi-Duty Planer is REALLY ECONOMICAL... adequately powered by any motor developing 2 horsepower — REALLY PROFITABLE... lowest



In investment and operating costs, and takes inexpensive attachments for all common planing mill operations: Jointing, Rabbeting, Grooving, Matching. Produces S4S Finish (surfaced four sides) without the great investment required for S4S Surfaces. Simple accessories provide for SHARPENING and JOINTING its own knives. You get BIG VALUE in Belsaw, and provide for your progressive growth. Write for FREE specifications, illustrations and low prices.

PRECISION JEWELERS SCREW DRIVERS

Complete Set of 8 for Every "Hobbyist"



At last—a complete set of precision screw drivers to meet the needs of every model builder. Not a miniature but the same type set used by U. S. Navy for precision instruments and watches during the war. Brass knurled handles, hexagon heads, finest tempered steel blades. Sizes 2-9. Never before a set of this quality and precision at such a low price. Your money back if not satisfied. C.O.D. \$2.00 plus postage or send \$2.00 and we pay postage.

PINE WATCH CO., Rm. 40A, 29 Eldridge St., New York 2, N. Y.

NEW Inspection FLASHLIGHT

Excellent for garage mechanics, service station attendants, electricians, and many uses in home. Heavy plastic case. Flexible metal neck. Uses two standard flashlight cells. Our price postpaid... \$1.50. Write for our FREE Circular of other bargains.

248 W. 15th ST. FORT WORTH, TEXAS

Ottawa Self-Propelled Buzz Master

CLEAR LAND FAST! Powerful 7-HP motor with friction clutch for safe operation. Cuts down timber, brush and hedge; turn blade vertically and saw logs to length. Also furnished with post hole diggers. Has clutch pulley for belt work. No Other Like It!

OTTAWA MFG. CO., 1-827 Brush Ave., Ottawa, Kansas

BUILD THESE PROJECTS

For garden or lawn. Easy to build. Easy to sell. Detailed Blueprints Model B-25 Dutch Windmill 50c; Model OM-60 Old Mill, 85c. Lawn Figure Patterns—Sunbonnet Girl, Dutch Boy, Tulip Girl, Holland Pair, 35c each, all 4—\$1. Catalog illustrating many models, send 10c, today.

CRAFTSMAN'S MODEL CO., Dept. P-111, 2030 N. 41st St., Milwaukee, Wis.

NEW 30" SHEET METAL BRAKE

Forms angles, channels, vees, flanges, locks, zebs, boxes. Handles 26 gage sheet steel, heavier gages of aluminum, copper, plastic, etc. Portable. Can be held in a bench vise, or bolted down. All steel construction. Wt. 40 lbs. Shipped exp. collect. ONLY \$2450

12" BRAKE. Cast iron and steel construction. Price, \$14.50 PP.

18" CURVE FORMER. Forms cylinders, round corners and cones in sheet metal and strap iron. Price, 10.00 PP.

12" VISE IRON BENDER. Forms rings, hooks, eyelets, etc. in 1/2" round or square; 1/4" up to 2" wide in bar iron. Price \$10.00 PP.

Immediate delivery. Order direct, cash or C.O.D., or send for folder.

1318 So. 30th Ave. Omaha 5, Nebr.

Yes, only \$18.95

Home Utility 1/4" Electric Drill

--and Made by BLACK & DECKER

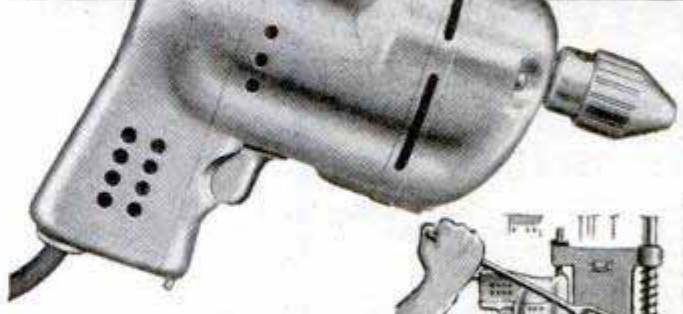

For the "home mechanic" who wants to turn out better work, faster!



You'll turn out "professional" jobs in jig-time—get a lot more fun out of building and repairing home and workshop items—with this versatile Home-Utility 1/4" Drill! It drives twist drills, augers, wire brushes, sanding arbors and light grinding wheels—in metal, wood, plastics. Here's a Drill you'll be proud to own because it's well-built by BLACK & DECKER, leading makers of quality industrial tools for 37 years. A real buy at \$18.95! And the handy Bench Stand (for only \$11.45) quickly makes the Drill a useful drill press. See your hardware, electrical or farm implement dealer for HOME-UTILITY Drills and Stands.

ELECTRIC HOME-UTILITY TOOLS

Products of THE BLACK & DECKER MFG. CO., Dept. H-2, Towson 4, Maryland.

SOUTH BEND Quality Lathe Dogs

Made of heavy malleable iron for maximum strength and long service. Standard Lathe Dog has square head set screw. Safety Lathe Dog has headless set screw. Prices (f.o.b. factory) apply to either style.

Capacity	Price*	Capacity	Price**
1/2"	\$ 0.80	3/8"	\$ 0.70
3/4"	.95	1/2"	.75
1	1.05	3/4"	.90
1-1/4	1.20	1	1.00
1-1/2	1.40	1-1/4	1.10
1-3/4	1.55	1-1/2	1.35
2	1.70	*13-inch or larger lathes.	
2-1/2	1.95	**9-inch and 10-inch lathes.	
3	2.20		
3-1/2	3.00		
4	4.00		



SOUTH BEND LATHE WORKS 455 E. Madison St. South Bend 22, Ind.

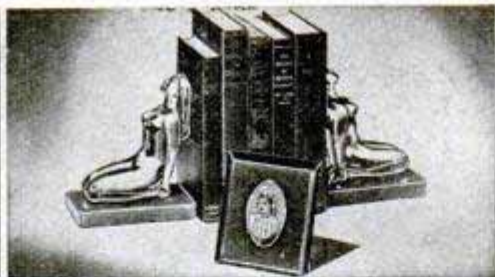

NEW LIQUID PLASTIC

**MAKES SWELL GIFTS,
NOVELTIES, THINGS
TO SELL!**

Thousands are having fun, making big extra money, using CASTOLITE, the wonder Liquid Plastic that pours without heat or pressure. Use crystal clear or with brilliant colors. Embed real flowers, butterflies, coins, medals, photos, for plaques, paper weights, novelties. Make useful objects like book ends, trays, picture frames, coasters, jewelry, toys. Also make gears, parts, models. Can be sawed, carved, drilled, turned.

20-PROJECT KIT \$3.50

(West Coast, Canada, Mexico \$3.75)

Special Casto-Kit now ready. Contains materials and instructions to make useful objects at once. Get into this fascinating new field now, and have unusual distinctive gifts or make fine sales. Send \$3.50 (West Coast, Canada and Mexico, \$3.75) for your Casto-Kit, postpaid. Or order C.O.D. No overseas shipments. For instruction manual alone, send 25c. The Castolite Company, Dept. A-1, Box 211, Kenilworth, Ill.



The plastic with 1001 uses.
DEALERS—Write for literature and prices.

SNOW CLEARANCE
made easy with a
BOLENS HUSKI
2-WHEEL TRACTOR!

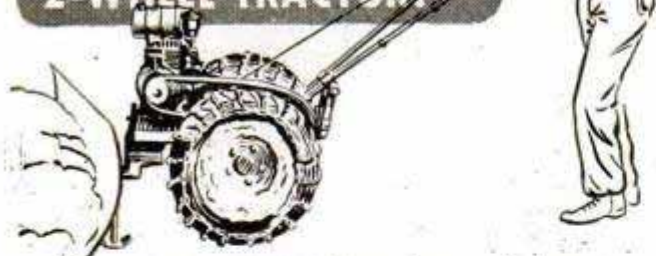

CLEAR AWAY SNOW — fast and clean, from your drives, lanes, walks, roadways, with this sturdy 42"-Blade Snowplow Attachment for Bolens HUSKI Power-Ho or Gardener Tractors. Saves you time and labor. Amazingly low first cost and operation. Easily attached to Tractor.

See Your Bolens Dealer Now!

BOLENS PRODUCTS DIVISION

Food Machinery
Corporation

265-1 Park Street,
Port Washington, Wis.

Bolens HUSKI
2-WHEEL
TRACTORS

THE STANDARD FOR OVER 40 YEARS

Research on wood in construction, for example, is done principally at the Forest Products Laboratory of the Department of Agriculture at Madison, Wis.

Wood is still the major building material. According to figures recently released by the Department of Agriculture, 57 percent of timber cut is wasted. Some of this waste is unavoidable as much of the lumber is unusable.

As a result of Forest Products Laboratory experiments on this cull lumber, Tennessee Valley Authority engineers became interested and developed a method of using this type of lumber in laminated boards suitable for flooring.

Short logs are cut lengthwise into strips, kiln-dried, sorted and machine-surfaced on all four sides. The strips are cut into one-foot lengths and the plies assembled with resin glue to produce a board 12 inches wide. The best grade is chosen for the top surface, the second best for the bottom and the poorest for the middle ply. The strips are fed into a continuous hydraulic press. Leaving the press the boards pass to a side-matching machine which cuts the tongue and groove. The width of the boards speeds the laying of floors.

Samples have been produced using oak, walnut, hickory, maple, ash and mesquite. Some of the surfaces have been quarter-sawn to produce a richly grained texture. A private firm has leased the original machinery used in the research from TVA and the flooring is expected to be on the market shortly.

Another attempt to utilize waste lumber is being made by the Office of Technical Services of the Department of Commerce. The OTS is sponsoring research to develop prefabricated houses using a new type of wood veneer made from low-grade and presently unused peeler logs.

Under the terms of a six-month contract with a private research organization, a complete model prefabricated structure incorporating the veneer panel will be designed, built and tested under the specifications of the National Housing Agency.

The panel, called "K-Veneer," uses a veneer $\frac{3}{16}$ inch thick made from western hemlock peeler logs. Depending on its intended use, the veneer is strengthened by an overlay of sheet aluminum, sheet steel, heavy paper or other material glued to it.

Plans call for shipping the veneer in rolls to prefabricated-housing manufacturers for assembly into panels complete with interior and exterior walls and studs ready for site erection, according to procedures to be developed in the research project.

(Continued to page 256)

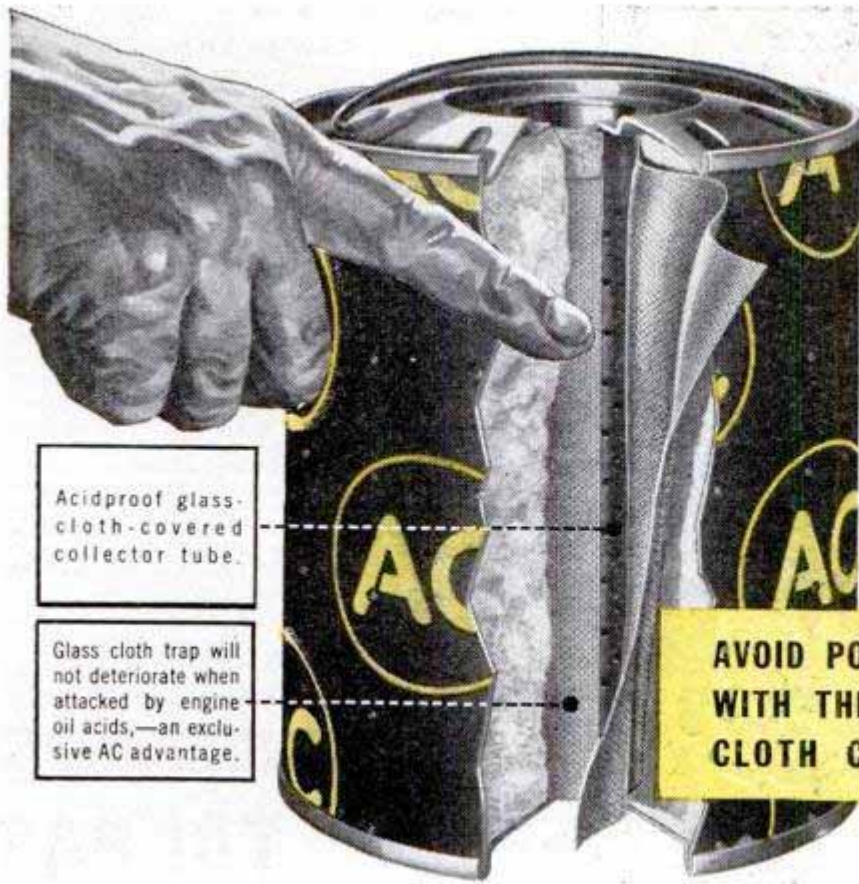

Acidproof glass-cloth-covered collector tube.

Glass cloth trap will not deteriorate when attacked by engine oil acids,—an exclusive AC advantage.

CAN'T ROT!

AVOID POLLUTION OF ENGINE OIL WITH THIS EXCLUSIVE AC GLASS CLOTH COLLECTOR TUBE TRAP

Don't take a chance when buying an oil filter. Only the AC "5-Star Quality" Oil Filter and Element give you the glass cloth Collector Tube Trap, which prevents pollution of the oil stream and assures a free flow of clean engine oil. It is not harmed by acids in engine oil. It can't rot. And, for extra protection, it filters the oil a second time.

AC makes Oil Filters for nearly every make of engine—and Replacement Elements for nearly every make of oil filter—all to AC's highest quality standards of material and workmanship.

**AC SPARK PLUG DIVISION
GENERAL MOTORS CORPORATION**

BUY WHERE YOU SEE THIS SIGN

WHEN YOU WANT A NEW OIL FILTER BUY AN AC "5-STAR QUALITY" OIL FILTER . . .
and get these additional advantages

- Positive End Seals
- Extra Sturdy Bail
- Machined Gasket Seat
- High Outlet Restrictor Position
- Even Distribution of Flow
- Outside-in Flow
- Long Fibre Virgin Cotton, Ram Packed
- Extra Heavy Metal Case
- Extra Large Hex Drain Plug



Oil Filters

**NEWEST
WAR
SURPLUS
RELEASE!**



**Bib-Top
Suspender
Style**
•
**Wool Blanket
Lined**
•
**Storm Tabs on
Bottom of Legs**

**Button and
Zipper Front**

**Water Repellent
Cloth**

**Government
Cost \$10**

BRAND NEW! FOUL WEATHER!

NAVY OVERALL PANTS

FOR OUTDOOR MEN! FARMERS! \$3⁸⁸
CONSTRUCTION WORKERS!

They cost less than ordinary cotton overalls, yet these are lined with wool and made to wear like iron. Sizes: S has 34 to 36" waistline; M, 38 to 40" waistline; L, 42 to 44"; XL, 46 to 50".

Send Check or Money Order (No C. O. D.'s) to:

WORLD WAR SURPLUS STORES, Dept. PJ
2450 SOUTH HALSTED STREET CHICAGO, ILL.
Allow 10 Days Delivery

New BRUSH Electroplater

**ESPECIALLY BUILT FOR
MECHANICS, MODEL MAKERS
HOME CRAFTSMEN**

**Easy to Plate GOLD, SILVER, NICKEL,
COPPER, etc... For Pleasure and Profit!**

If you have a workshop—at home or in business—you need this new Warner Electroplater. At the stroke of an electrified brush, you can electroplate models and projects—you can replat worn articles, faucets, tools, fixtures, silverware, etc. with a durable, sparkling coat of metal... Gold, Silver, Nickel, Copper, Cadmium, and after a bit of practice, even Chromium! Everything furnished—equipment complete, ready for use. By doing a bit of work for others, your machine can soon pay for itself. So make your shop complete by getting a Warner Electroplater right away. Send today for **FREE PLATING SAMPLE** and illustrated literature. **ACT AT ONCE.**

WARNER ELECTRIC CO., Inc., Dept. R-26
1512 Jarvis Ave., Chicago 26, Illinois

FREE Details & Sample!

WARNER ELECTRIC CO., Inc., 1512 Jarvis Ave., Chicago 26, Ill., Dept. R-26
Gentlemen: Send Free Sample and Details to:

Name _____
Address _____
City _____ State _____



DUNTILE

More Local Plants are Badly Needed

Amazing demand for DUNTILE—World's Most Beautiful Roof—opens up new manufacturing opportunities for men of modest capital, backed by vision and aggressiveness. Ties in with the great building industry, now starting its biggest period in history. Duntile is masonry—strong, safe, enduring. Smart design, in choice of many select colors. Has pride-appeal to every home owner. Definitely economical. With these advantages it has unlimited market possibilities. Manufacturing is easy; we supply all equipment. Excellent profits—100%-125% mark-up on basic costs. Write immediately for Prospectus Y.C.B. Get into this business NOW!

W. E. DUNN MFG. CO.

619 W. 23rd Street, Holland, Michigan

MANUFACTURING OPPORTUNITY

AN OUTSTANDING MANU



\$2⁹⁵

TORNADO GAS TORCH

The Modern Way of Soldering

Ideal for hard and soft soldering. Will heat quickly; solder will flow freely and smoothly. No compressed air required. Self-adjusting. Safe. Economical. Can be used for annealing small parts and bending metal parts. Generates a heat of 1700° F. Simply connect to any illuminating gas jet with a rubber hose and operate. Tornado Torch No. 119 comes with three tips, (1/8", 1/4", 3/8" blast).

Tornado Gas Torch No. 119—Complete with 2 tips, for Natural Gas or Bottled Gas; with 3 tips for Manufactured Gas. \$2.95 per set. See your dealer or order direct. Send check or money order—post paid.

Robco Corporation, 202 E. 44th Street, New York 17, N. Y.

**HANDYMAN'S
Steel-Cutting**



SHEAR

Cuts flat steel up to 1/8" thick, with ease. Can be mounted in vise or bolted to bench. Built for hard use by maker of famous "Handy" Machine Shop tools. EXTRA: Has built-in die for cutting rods up to 5/16" dia. Shipped express prepaid **ONLY \$27⁵⁰** for cash with order.

National Machine Tool Co., Dept. 158-A, Racine, Wis.

BUILD YOUR OWN POWER LAWN MOWER

**WHY BREAK YOUR BACK
MOWING FIELD OR LAWN?**

**WRITE
FOR
FREE
LITERATURE**
The Rite-Way
Mower
Attachment
Ball Bearing



**SAVE MONEY
SAVE TIME**

Now anyone can save time and effort mowing field or lawn by building their own whirl type power mower. Build according to your own ideas and needs at small cost. Cut close to fences, walks, buildings, etc. Build in short time with parts and instructions we furnish. Save hours of time and back breaking labor. Write today for **FREE** information.



IT'S FUN TO BUILD

T & H MFG. CO., Dept. MP-11
811 E. 31, Kan. City 3, Mo.

**THIS AMAZING
ADDING MACHINE
SOLVES 101 PROBLEMS**

**only
\$12.95**

If you're bothered with figures

you can't be without this Addometer **ADDING MACHINE**—especially handy for *income tax work!* Adds, subtracts direct, multiplies—*quickly, accurately.* So easy to use—11½x2½ in. size, weighs only 14 oz. Does work of expensive machines; 8-column (\$999,999.99) capacity—models also to handle fractions, feet and inches. Over 100,000 in use—praised everywhere. Only \$12.95, postage prepaid—10-day money-back guarantee if not satisfied. Descriptive folder on request—or, send check or money order for your Addometer now.

RELIABLE TYPEWRITER & ADDING MACHINE CO.
Dept. E-1, 303 W. Monroe St. • Chicago 6, Ill.

**SOLID BRASS 12 FT. PORTABLE
RADIO ANTENNAS**

Real \$15 Value Now Only \$4.95 Postpaid
FOR HOMES, BOATS or AUTOS

12
Exceptionally Rugged Sections compress into 1 ft. 4 in. Handy for Camping Trips, also Useful for Transmitting, FM & Television sets. Each antenna comes with clamps, nut, lug, and wire. Easy to install anywhere.

JUST OUT! Gov't surplus used on Army tanks. These telescopic rustproof antenna have tremendous pickup eliminate dangerous wiring. Solid Brass throughout practically insuring **NOISE FREE RECEPTION.**

QUANTITY LIMITED
ORDER TODAY. A real \$15 value for only \$4.95 Postpaid. Mail check or money order now or sent C.O.D. plus postage. Money back in 10 days if not satisfied.

RADIO HOSPITAL 442 East 86th St., Dept. A-13
NEW YORK 28, N. Y.

**BUILD YOUR POWER TOOLS
WITH OUR GUARANTEED INDUSTRIAL
BALL BEARING ARBORS**

10,000 R.P.M.
B25-1/2 \$5.50 P.P.
Shaper Flange Mount Capacity 1/2 x 2"

10,000 R.P.M.
New Departure Self Lubricating Bearings

10,000 R.P.M.
C5-5/8 Pictured

(No extra charge for left hand threads)

C4-1 1/2 x 12 1/2 spindle, housing 2x8 58.25 PP.
C5-5/8 x 12 1/2 spindle, housing 2x8 58.25 PP.
C6-3/4 x 12 1/2 spindle, housing 2 1/4 x 8 59.25 PP.
D8-1 x 17 1/2 spindle, housing 2 5/8 x 11 \$17.00 PP.
1 INCH BETWEEN WASHER AND COLLAR

\$14.25, C6-3/4 \$15.25, D8-1 \$23.00, B25-1/2 cap. flange mount \$5.50.
SPECIAL SAW ARBOR LENGTHS for 1/2, 3/8, 3/4, add \$1.50.
POLY PRODUCTS, 406 S. Chester, Ct. 1a, Pasadena 5, Calif.

ONE-MAN SAWMILL LESS THAN \$200.00
Easy To Turn Trees Into Money

Makes lumber, ties, shingles, crates, lath, studding, siding.

Belsaw Models in 10 to 24 foot sawing lengths. **MECHANICAL FEED**, accurate set works and positive dogs. Use tractor or old auto engine for low cost power. Thousands used for commercial sawing. Pays for itself quickly. Send post card today for FREE booklet, "How To Make Lumber" and Catalog of Woodworking Equipment.

BELSAW MACHINERY CO., 2811X Field Bldg.
315 Westport Road Kansas City 2, Mo.

QUALITY **8" FLOOR MODEL TILT-ARBOR SAW**

UNCONDITIONALLY GUARANTEED 1 YEAR

SAW TILTS • TABLE STAYS LEVEL

Complete as shown with Trans-axial Ball Bearing Motor Drive, Ball Bearing Saw Arbor, Table including extension 18" x 25", Aluminum Fence & Saw Insert, Complete Mitre Gauge, 3 1/2" steel column and cast iron base, Precision segments on mitre gauge and cradle.

\$79.50 F.O.B. ROYERSFORD, PA. **UNUSUAL VALUE**

BENCH MODEL, \$59.50
Shipping Wt., 118 lbs.

Cast iron table extension bracket furnished. Will support plywood top much larger than 9" x 18". Motor pulley and belt furnished. Blade & Motor NOT included. Overall height 35 1/2", Shipping Wt. 156 lbs.

AMERICAN MACHINE & TOOL CO. Inc.
DEPT. 110 ROYERSFORD, PA.
Write for free illustrated folder.

**MAKE \$ MORE
MONEY**

Applying or Selling

CORKSTONE

A General Purpose Magnesium Oxychloride Flooring

THE MODERN PLASTIC FLOORING

EASY TO APPLY

Here's your opportunity to get into business for yourself applying or selling Corkstone, the economical, top-grade plastic flooring. Plenty of profit Act without delay!

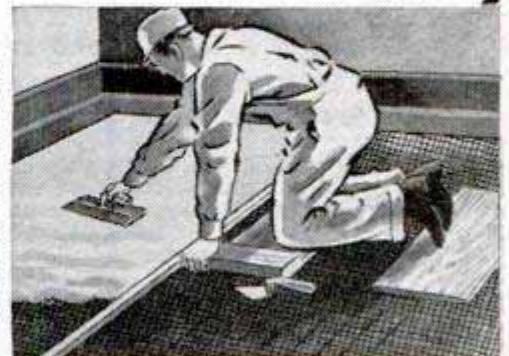

Dealers & Agents Wanted

WRITE FOR DETAILS

LASTING PRODUCTS COMPANY

Franklinton Road Plant,

Baltimore 23, Md.

TESTED DRILL PRESS TOOLS FOR HOME CRAFTSMEN



MULTI-PURPOSE WOOD PLANER
Fits any drill press. Exclusive hi-speed blade design performs precision surface planing, rabbeting, tenoning, paneling, grooving, routing, beading. Thousands now in home workshops, schools, cabinet and pattern shops. An indispensable lifetime tool for wood and plastic workers. Complete..... **\$7.50**



NEW STYLE DRUM SANDER
Fits any 1/2" drill press chuck. Used for sanding curves, contours, straight edges. Has many essential workshop applications. Complete with 5 spiral sanding sleeves..... **\$3.95**



4" ROTARY SURFACE SANDER
An exclusive type sander for drill presses, flexible shafts, motors, hand drills. Instantly sands woods, plastics and metals to agate smoothness. No waves, ripples, striations. Discs immediately interchangeable. With 20 discs... **\$5.95**



ALL METAL SHAPER FENCE
Precision built of hard alloy aluminum and steel. Nothing to rust. No wooden parts to warp. For moulding, jointing, shaping, rabbeting, tenoning. Fits all standard drill presses—shapers. Complete with two hold down springs. A real buy at **\$7.95**

\$7.95



AT YOUR DEALER—OR ORDER DIRECT
FREE Workshop Catalog
BARRON TOOL COMPANY, INC.
269 Architects Bldg., Detroit 1, Mich.

BARRON PRECISION TOOLS WORK SHOP



32
DRAWER
UNIT
\$4.95
64 DRAWER \$7.95

for home
or shop

THE JIFFY all metal CABINET

THE HANDY WAY TO KEEP SMALL PARTS, WASHERS,
NAILS, SCREWS, NUTS, BOLTS AT HAND

DRAWER SIZE

1 1/4" DEEP
3" WIDE
6" LONG

CABINET SIZE

32 Drawer Unit
6" DEEP
12 3/4" WIDE
15 1/4" HIGH
Shipping Weight
9 lbs.

64 Drawer Unit
6" DEEP
25 1/2" WIDE
15 1/4" HIGH
Shipping Weight
18 lbs.

For small items, the low-cost Jiffy Cabinet, 32 or 64 drawer units that put office, shop, work bench, household and hobbyist needs at your fingertips. Metal flange drawer guides. Spot welded all metal cabinet with sturdy laminated drawers insures long time-saving service. Why fumble? With the Jiffy you know where it is. 32 drawer unit—\$4.95; 64 drawer unit—\$7.95. Send check or money order — No C.O.D.'s please. Ohio orders please add 3% Sales Tax.

KAYTEE PRODUCTS

Dept. M, Box 588 Canton, Ohio

The Office of Technical Services is also sponsoring research to determine the materials and methods most suitable for constructing floors in low-cost houses without basements.

A house will be built at the University of Illinois into which various types of experimental slab-on-the-ground floors will be fitted for different kinds of tests. Each type of floor will be put through a series of tests, including the measurement of surface temperatures, heat losses and moisture absorption and condensation. At the same time tests will be made on various kinds of floor coverings, wall panels and heating systems.

These experiments and other research now going on in public and private laboratories will add much to our store of information on better housing. A lot has already been learned since the first World War when housing research was born. Because houses are built for a lifetime, and usually last several lifetimes, evidence of progress is not immediately widespread. The number of houses added each year to the total existing is comparatively small. But, over a longer period of time, research is providing better houses for an intensely "home-minded" nation.

There's Money in Honey

(Continued from page 148)

combs of the infected colonies should be destroyed by burning.

Apiary inspection is a function of the states and is maintained by most State Departments of Agriculture. You should refer to them all questions concerning apiary inspection, diagnoses and proper methods of control. As a service to beekeepers, however, the Division of Bee Culture of the U. S. Department of Agriculture examines, without cost, samples of brood and adult bees. Reports of diagnoses are sent to beekeepers and state apiary officials.

If you send a sample, observe these simple rules: mail a four-inch square of the comb which contains the affected brood or brood remains. Avoid including any honey if possible. In the case of adult bees, send from 100 to 200 sick or dead bees. All samples should be mailed in a wooden or heavy cardboard box. Do not use tin, glass or waxed paper. Address all samples to: Division of Bee Culture, Agricultural Research Center, Beltsville, Md.

A couple of questions that always are asked by beginners are: How do you avoid bee stings? Do the bees leave you alone after they are acquainted with you?

(Continued to page 260)



The New **HOOVER** Fractional Horsepower Motors

1/4 horsepower and up

You can be sure of getting the finest in fractional horsepower motors when the name "Hoover" appears on the name plate.

These great new motors are built with the same engineering skill and dependability that go into the world-famous Hoover Cleaners. Compact, precision made, they deliver their power with work-horse stamina.

A Hoover fractional horsepower motor will give you years of efficient, trouble-free service.

FEATURES OF THE HOOVER MOTOR

Induction run . . . single phase . . . 60 cycles . . . dual voltage—110/220 . . . 1725 R.P.M.

Capacitor start . . . more than 300% full load starting torque with minimum current flow.

No vibration or "shift" . . . integral feet, carefully machined to give solid mounting and quiet operation.

Low temperature . . . electrical and mechanical design for low-temperature operation. Ventilated open type. 40° C. Rise.

Laminated steel rotor . . . carefully ground and balanced for maximum efficiency.

Centrifugal starting switch . . . designed and built for years of trouble-free operation.

High-grade ball bearings . . . sealed against dust and grit, give smooth performance and long wear.

Rotation . . . clock or counterclockwise.



Sold only through retail outlets.
THE HOOVER COMPANY
Electric Motor Division—North Canton, Ohio
Hamilton, Ontario, Canada



WRITE FOR YOUR **FREE** COPY OF THE NEW KRW HYDRAULIC PRESS BOOK

Describes all manner of Production and Shop Work on KRW Hydraulic and Bench Type Arbor Presses. 32 pages illustrating the new KRW Hand-operated, Electric-operated and Air-operated Hydraulic Presses.

Write for your copy today.

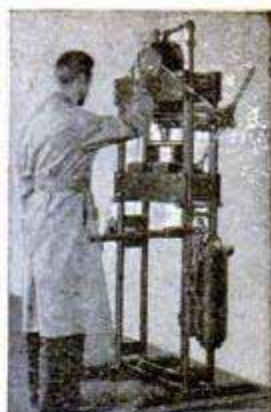

K. R. WILSON, DEPT. 17, 215 MAIN ST., BUFFALO 3, N. Y.
Builders of Shop Equipment for Ford Dealers Since 1916

WAR SURPLUS BARGAIN!

NEW-UNUSED FIRE EXTINGUISHERS

Get Real Fire Protection
at lowest cost

- UNDERWRITER APPROVED
- READY TO USE
- 3 1/2 GAL. CAPACITY

Put out those fires before they do serious damage! Be ready for fire when it comes—regrets won't restore lost lives or property. These fire extinguishers are made to Government standards. Easy to use—easy to refill. Stored Pressure type Carbon Tetrachloride extinguishers like these are providing real fire protection in plants, warehouses, farms, ranches, homes, summer resorts, etc., everywhere.

Regular List Over \$200.00



Our Price **\$45.00**

F.O.B. ILL. ORDNANCE PLANT,
MARION, ILL.

ACME EQUIPMENT CO., INC.

126-28 S. Clinton St.

Chicago 6, Ill.

SAY YOU SAW IT IN POPULAR MECHANICS

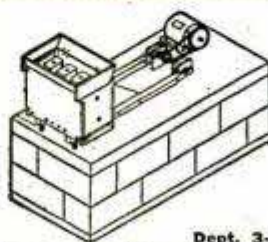

BUILD THIS CONCRETE BLOCK MACHINE

Sell blocks; or build your home, garage, barn at 1/3 cost by making and laying your own blocks.

This simple machine which you can build yourself at a cost of about \$15 (excluding motor) will make a block in 30 seconds using only one form. 2 to 4 forms can be used on each vibrator.

Power driven concrete mixer plans also. Send dime for details and "How to Make and Lay Blocks."

U-BUILD-IT SERVICE

Dept. 3-A, 206 West Wilder Ave., Tampa 3, Fla.

NONE BETTER! **SUPER DRILL GRINDER**

Sharpens round shank drills from 3/32" to 1-1/16" in diameter, up to 11" long. Grinds old drills like new in 4 different point angles, using hand or power grinding wheels. Money-back guarantee.

Price only \$2.95
At Dealers or Postpaid

CRANDALL MFG. CO. 1512 W. Slauson, Dept. FA-25, Los Angeles 44, Calif.

\$1.00
POSTPAID

SPECIAL OFFER! Famous, patented, lock-stitch sewing awl complete with needles, waxed thread, direction folder. Hundred uses—sewing, repairing leather goods, canvas, belting, old or new harness, saddles, gun cases. Satisfaction guaranteed, or money back. Send currency, check, or money order, no stamps, please. Yates Mfg. Co., 611-H Main St., Lake Geneva, Wis.

48 PLANS **\$1.00**

48 complete plans of toys, ash trays, garden ornaments, Dutch boys and girls, what-not shelves, and many other interesting projects. Finest selection available. Novel method allows you to make finished project any size desired. PLUS FREE Deluxe Plan of corner shelves. Send only \$1 to Jackson, Dept. 29-5440 N. Shoreland Ave., Milwaukee 11, Wis.

"I'LL TAKE THE WHITE ONE EVERY TIME!"



WYTEFACE
TRADE MARK
STEEL MEASURING TAPES

K+Σ
KEUFFEL & ESSER CO.

FREE!

NEW COMPLETE *Concord* RADIO CATALOG

160 Value-Packed Pages of the
Latest and Best in RADIO • TELE-
VISION • Electronic Equipment!

The Only Complete Up-to-the-Minute Catalog
of Radio Parts — Sets — Amplifiers — Testers —
Ham Gear — Kits • Immediate Shipment.

**TRouble-FREE SERVICE from
STANDARD BRAND PARTS**

RCA • Amperite • Simpson-Jensen • Stancor
• Ohmite • Shure • Bliley • Dumont • IRC •
Triplet • Sprague • Cornell-Dubilier •
Meissner... and hundreds of other brands
MAIL COUPON FOR FREE COPY



Five Tube AC-DC Radio Kit

With Plastic Cabinet! Covers 550 to
1600 KC. AC-DC superhet using 12SA7,
12SK7, 12SQ7, 50L6 and 35Z5. Includes
automatic volume control, airplane dial,
built-in loop antenna, and new Alnico V
speaker. Cabinet is a beautiful modern
design in brown plastic. Kit contains
all parts to build complete receiver.
C24456—With Cabinet and \$1475
Tubes



Jack Box

Consists of one 3
circuit jack, one
single circuit jack,
one 150,000 ohm
potentiometer, 5
position rotary
switch enclosed in
aluminum case 4 1/2" long,
3" wide, 3" high. With knobs. Circuit
diagram inside cover. Ship. Wt. **25c**
2 lbs. **5B3959**

Save on Values Like These!



AC Solenoid

Compact solenoid, DC resist-
ance 20 ohms. Wound on
brass tube with ID of .210".
Operates on 6 to 10 volts AC,
constant duty, or 4 to 7.5 volts
DC constant duty. 1-11/16"
long, 9/16" dia. **19c**
C10282



Carbon Throat Microphone

Will work into any 200
ohm impedance input cir-
cuit. Adjustable strap to
fit neck. Allows full use
of hands and head while
speaking. Ideal for ultra
high frequency mobile
amateur work. With strap,
10" cord and plug. **29c**
5B7060

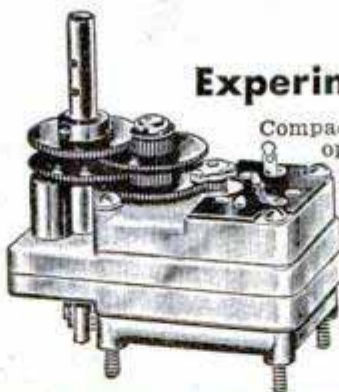

Experimenters Motor

Compact induction type AC motor
operates from 25 to 30 volts
AC, 60 cyc. Motor speed
2400 rpm with gear train
driving 1/4" shaft at 24
rpm. Thermal cutout pre-
vents overload damage to
motor. Measures 2 x 1 3/4
x 3", excluding shaft
which is 1/4" dia. extend-
ing 2 3/8". **\$250**
C14699

CONCORD

RADIO CORPORATION

CHICAGO 7
901 W. Jackson Blvd.

ATLANTA 3
265 Peachtree St.

Downtown Chicago Branch: 229 W. Madison

Lafayette Radio Corp.

JANUARY 1948

Concord Radio Corporation, Dept. P-18
901 W. Jackson Blvd., Chicago 7, Ill.

Yes, rush **FREE COPY** of the comprehensive new
Concord Radio Catalog.

Name.....

Address.....

City.....State.....



**NEW
"WORK
RANGE"
FOR YOUR
SHOP
THIS YEAR**

**New POWER KING
12" BAND SAW**

A key tool to increase your shop's "capacity" is the new Power King band saw. Gives you new speed and accuracy in every band saw operation in wood, plastics, and light metals.

You can be sure of smooth, accurate sawing with the Power King—it's a solid 135 pounds of properly engineered weight. Big (14" x 14"); precision-ground table has 12" capacity from blade to frame 6½" from table to guide—tilts 45° to right. Saw cuts to center of 24" circle. Saw wheels turn on 4 precision ball bearings. Blade is guided by 4 oilite bronze bearings—supported in back by 2 ball bearings.

Here's a quality tool you'll be proud to have in your shop—built for years of service. Send coupon for complete details and name of nearest dealer.

**POWER KING
TOOL CORP.**

DIVISION OF ATLAS PRESS CO.
120 Cleveland St.
Warsaw, Indiana

**OTHER TYPES OF
POWER KING
SAWS**



**POWER KING
7"-8" TILT/ARBOR
TABLE SAWS**



**POWER KING
15" JIG SAW**



SEND FOR FREE LITERATURE TODAY

**POWER KING TOOL CORP.,
120 Cleveland St., Warsaw, Ind.**

Please send new Power King catalog sheets to.

Name _____

Address _____

City _____ State _____

Although often classed as domestic animals along with horses, cats, dogs and pet canaries, bees have remained untamed in spite of all the care that man has lavished upon them. They will sting if hungry or if they are handled in cool weather. After a bee stings you, his death comes quickly. A sting is a sacrificial act committed in defense of the hive.

A beekeeper must dress for his work. A hat and veil should be worn at all times to protect the face. Gloves, a heavy jacket and trousers—tied tightly around wrists and ankles—will keep bees from stinging through. White is said to be most soothing to bees while the smell of perspiration, liquor, perfume or lipstick often will arouse them to a fighting-mad pitch.

If you dress properly, keep your bees well fed, handle them gently at all times and use your smoker to quiet them, bee stings should be few and far between. When bees are swarming, they are not inclined to sting. On such occasions you can put a queen on your chin and soon have a heavy beard of living insects.

Beekeeping can be a fascinating hobby. It is designed both for the lazy man who enjoys the sun and for the ambitious, hard-working man who increases his hives to a point where they will produce a comfortable living for himself and his family.

Skiers Awaken a Bonanza Town

(Continued from page 92)

special lift has been built just to serve it.

Friedl Pfeifer, a wartime ski-trooper and one of the best known instructors of the Arlberg system, heads the ski school. He favors class over individual instruction, with his most experienced aids handling the beginners. Pfeifer's school stresses snowplows and snowplow turns, made by pointing the skis in a "V" and shifting weight to the leg opposite the direction of the turn to be made.

Down below, in town, the restoration spirit has taken a firm hold. "Gingerbread" homes are being repaired, repainted and reoccupied, old business places are beginning to hum again and new shops are springing up. Much of the initiative and manpower is coming from those Camp Hale ski soldiers, who promised they'd come back to Colorado to live, after fighting brilliantly in Italy's mountains.

Though still in small numbers, writers, artists and musicians are establishing full or part-time homes in Aspen. Famous concert stars like Burl Ives, the Chicago Symphony Trio and Richard Dyer-Bennet are

(Continued to page 264)

NOW MORE GOOD NEWS

FOR YOU from

Atlas

**New 10 INCH
TILT/ARBOR
FLOOR SAW**

NEW—from its large, precision-ground table to its extra-heavy base . . . built to exacting industrial standards for commercial or home shop use . . . designed for easier, more accurate sawing . . . that's this new Atlas 10" Tilt/Arbor floor saw!

You really have to see it to appreciate its advanced engineering and precision construction. The large 27½" x 27½" table gives you 13¼" working surface ahead of the blade. New engineering design gives you maximum blade rigidity in any position with easy-working height and angle controls. Saw arbor turns on precision ball bearings.

An outstanding feature is the rip fence—*self-squaring*, locks at both ends, releases instantly for positioning or removal—with two ball bearings on rear rail for easy sliding.

This new Atlas saw is really built—to give you years of dependable service. Ask your Atlas distributor, or send the coupon for free illustrated bulletin.

ATLAS PRESS CO.

143 N. Pitcher St. • Kalamazoo 13D, Mich.

SEND FOR FREE BULLETIN

ATLAS PRESS COMPANY
143 N. Pitcher St., Kalamazoo 13D, Mich.

Please send me the free illustrated bulletin about the new Atlas 10" Tilt/Arbor Floor Saw.

NAME _____

ADDRESS _____

CITY _____ STATE _____



- 27½" x 27½" table — with 13¼" working surface ahead of blade; 19½" to right, 8" to left
- Cutting depth: 3¼"
- Blade tilts to 45°—locks rigidly at any height or angle
- Sealed, precision ball bearings for permanent smooth operation
- Dual V-belt drive — uses standard 3450 RPM motor
- Massive construction



STROP YOUR RAZOR
AS A BARBER
DOES!

**Renew
the edge
for every
shave**

\$1.25

RAZOR, STROP
AND
5 VALET BLADES



STROPS—CLEANS
WITHOUT
REMOVING BLADE

SELF-SHARPENING . . . ONE PIECE
SAY YOU SAW IT IN POPULAR MECHANICS

22 Big Money-Makers in a Single Line!
Amazing New Fluorescent Lights with Circular Tubes

THE
HOMELITER



**FREE Sales
Outfit**

Don't send a penny. Sample
Outfit is FREE. Rush name
on penny post card for money-
making facts about sensational
new "CIRCLINE" Fluorescents. Latest scienti-
fic development gives you 22 new type circular
tube fixtures for kitchens, dinettes, halls, and
play rooms. Also Floor and Table lamp for
living rooms and pin-ups for shaving and vanity
tables. Sells on sight to homes, restaurants,
stores, offices. No other fluorescents like
CIRCLINE. Salesmen who order samples
quickly reorder in large quantities. All fixtures
complete with tubes. No waiting. Also imme-
diate delivery on all standard type Fluorescent
Fixtures. This is too good to miss. Big, quick
profits waiting. Rush name on postcard today
for FREE Sales Outfit.



**NEW MAXILUME
PIN-UP
MIRROR LIGHT**

MAXILUME COMPANY • 125 W. HUBBARD • DEPT. 81-A • CHICAGO 10, ILLINOIS

AMERICA'S LOWEST PRICED

BAND SAW

Now

\$16.95



**ENGINEERING FEATURES
FOUND ONLY IN
HIGHEST PRICED MACHINES**

Practical, modern design; new im-
proved model. Accurate,
smooth operation. Cuts to
center of large 14" circle,
2 1/2" thick. Genuine "Oilite" bearings, ad-
justable ball-bearing blade guide. Upper wheel
micromatic four-way blade tension and adjust-
ment. Safe, fully enclosed mechanism. Thor-
oughly proved construction, ruggedly designed
with sturdy laminated plywood. Stands 24" over-
all. As illustrated—blade included. **Immediate
Delivery!** See your dealer or send only \$16.95,
and we'll pay shipping charges. Or, if you prefer,
will forward C.O.D. Money-Back Guarantee: if
not satisfied upon receipt of band saw, return
immediately for refund.

SERRO MFG. CO., Dept. 102

909 MARKET

ST. LOUIS 1, MO.

**V-8
DUALS
& SINGLES**



DEALERS WANTED

MUFFLERS

**STEELS and ALUMINUMS
with a motorboat tone**

SINGLES, Chev., V-8, Plymouth,
Steels \$5.50, Aluminum \$7.00. Chry.,
Olds., Buicks, etc., Steels \$7.50,
Aluminum \$9.00. V-8 and MERCURY
DUALS, Steel \$17.50, Aluminum
\$21.00. Split Manifold Sets, Steels
\$35.00, Aluminum \$45.00. Aluminums
are guaranteed for life of your car.

SANDEE MUFFLER CO.
BOX 296 LA TIJ, LOS ANGELES 43, CALIF
2624 W. SLAUSON AVE., LOS ANGELES, CALIF.

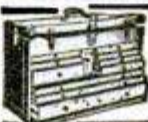

Gerstner TOOL CHESTS

Designed and built by good Craftsmen for
good machinists, Tool, die and pattern-
makers. Free Catalog.

GERSTNER TOOL CHESTS
448 Columbia St., Dayton 7, Ohio

UTICA TOOLS

FOR MORE TOOL MILEAGE



TOOL NO. 523-7"
General Purpose Gripping Pliers

UTICA DROP FORGE & TOOL

CORPORATION

UTICA 4, NEW YORK

**MONEY
SAVING**

SURPLUS BARGAINS

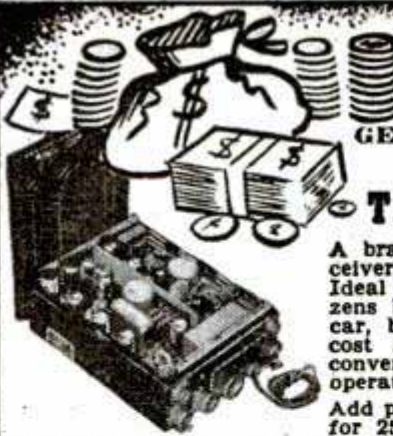

**GENERAL ELECTRIC
BC645**

TRANSCEIVER

A brand new Transmitter-Receiver covering 450-500 MC. Ideal for use in proposed citizens band between house, and car, boat, etc. 15 tubes alone cost \$58.00. Complete with conversion date for 110 VAC operation in sealed GE carton. Add postage **\$14.95** 2 for for 25 lbs.... **\$27.00**

GN58 GENERATOR

Makes excellent home lighting plant, operated by wind propeller, waterfall, gas engine, or hand crank. Reduction gear allows full output at slow speed; supplies 6 volts at 2.45 amp., 425 volts at .115 amp. New. Add postage for 28 lbs. **\$7.95**



DYNAMOTORS

Dynamotor A—Input 12 volts, output 1000 volts at 350 MA. Shipping weight, 72 lbs. **\$7.95**
Dynamotor B—Input 6 or 12 volts, output 500 volts at 350 MA. Shipping weight, 30 lbs. **\$5.95**
Dynamotor C—Input 28 volts, output 220 volts at 60 MA. Add postage for 6 lbs. **\$1.50**



BRAND NEW ARMY AIR FORCE

ASTROGRAPHS With Case

New B29 navigation instrument which can easily be used to make a good contact printer, strip map holder, etc. The plywood case 14 1/2"x11"x10" high is perfect as a tool kit, camera, projector case or for building a portable phonograph picnic kit, make up case, etc., has leather handle reinforced covers, 8 covered compartments in bottom. Cost Gov't \$125.00. Add postage for 20 lbs. **Only \$3.95**



**HEATHKIT
AMPLIFIER KIT**

Complete kit to build excellent 25 watt amplifier, ideal for P.A. system, phonograph amplifier, etc. Push pull circuit using best parts. Supplied with 4 tubes, punched chassis, blueprints and instructions. Add postage for 25 lbs. **\$14.95**



G.E. BC375

TUNING UNIT

A beautifully constructed tuner containing the best in variable condensers, coils, vernier dials, etc., at least \$30.00 worth of parts, complete with conversion instructions to transmitter and receiver. Add postage for 20 lbs. **\$2.49**



**HEATHKIT
TRANSMITTER KIT**

Complete kit for building a fine amateur transmitter includes every part—tubes, cabinet, 80 meter coil, crystal, blueprints and instructions, less power supply. Add postage for 30 lbs. **\$19.50**



**HEATHKIT VACUUM TUBE
VOLTMETER KIT**

Build yourself this beautiful Electronic AC and DC voltmeter and ohmmeter ranges 3 volts to 1000 volts and to 1000 megohms. Every part supplied including blueprints. Add postage **\$24.50** for 8 lbs.



MINIATURE HEADPHONE

\$1.00 Hearing aid type, comfortable, keeps out outside noise, one of the army's best types. Add postage for 2 lbs.

THROAT MICROPHONE

Used by army in noisy applications in aircraft, tanks, etc. Many interesting home uses. Add postage for 1 lb. **\$1.00**



WALKIE-TALKY UNIT

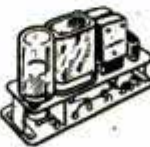

\$1.00 BC746 Tuning Unit contains two crystals, receiving coil and condenser and transmitter tank coil, fine for radio builders. Add postage for 1 lb.

T32 TABLE MICROPHONE

One of the army's finest built by Kellogg. Ideal for public address, transmitters, etc. Add postage for 5 lbs. **\$2.95**



POCKET TESTER KIT



\$2.95 Build this AC and DC voltmeter and save 2/3 the cost. Includes 2 1/2" meter, resistors, rectifier, and mounting. Reads 0 - 3 - 30 - 300 VDC and 0 - 300 VAC, instructions. Add postage for 2 lbs.

RADIO BUILDERS' KITS

- Power supply kit to convert to army radios 110 VAC **\$5.95**
- 5" P.M. loudspeaker for army radios **\$2.50**
- Experimenter's Kit, 5 lb. of radio parts for **\$1.00**
- Kit of 20 radio tube sockets for **\$1.00**
- Kit of 20 Bypass bathtub condensers **\$1.00**
- Kit of 10 radio volume controls **\$1.95**
- Kit of 10 Midget variable condensers **\$1.95**
- Kit of 100 color coded insulated resistors **\$1.95**

G.E. CIRCUIT BREAKER



\$2.95 Protect your electrical equipment, eliminate fuses. 50 AMP 220 Volt rating. Add postage for 4 lbs.

ARMY TRIPODS

Excellent for floodlights, screens, etc. Raises to 12 ft., folds to 5 ft. Rugged construction. Express shipment only **\$4.95**



MINIATURE MOTOR

\$2.95 24V.D.C. size 1 1/4"x1"x2". Add postage for 1 lb.



Power supply kit to convert motor to 110 V.A.C. Add postage for 6 lbs. **\$2.49**

**NO ORDERS
under \$2.00**

The HEATH COMPANY
DEPT. M . . BENTON HARBOR, MICH.

14,000 sanding strokes per min. with SAND-O-FLEX

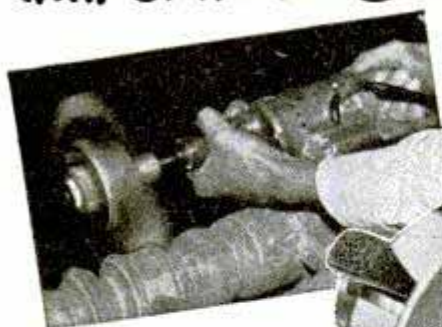

—Compare this speed with hand sanding!

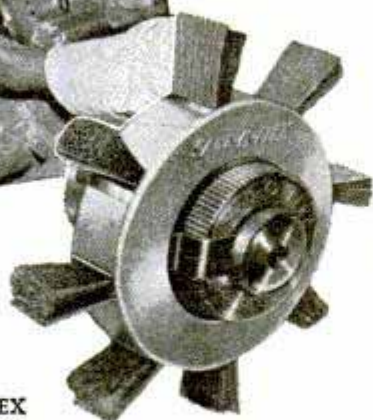

Quickly cleans and finishes intricate curves, contours on metals, wood, etc.

EACH SAND-O-FLEX sanding wheel contains 8 abrasive strips backed up by 8 separate brushes. When rotated at usual motor speed, you get 14,000 sanding strokes per minute!

Not only does SAND-O-FLEX finish faster—it gets in and around complicated forms. Brushes mold to the work shape and rapidly sand, de-burr, finish. Produces beautiful satin finishes on metal. Abrasive strips unreel when worn. Replacement cartridges in many grits available at low cost.

Use SAND-O-FLEX on your present tools—motor shaft, electric drill, flexible shaft, drill press, lathe, etc. SAND-O-FLEX has unlimited uses in home, farm and industrial workshops—3 sizes. See your dealer or write for free literature.

MERIT PRODUCTS, INC., 4373 Melrose Ave., Los Angeles 27, California

PLAN YOUR GARDEN EARLY

And put Garden-All's rugged power to work for you!



Garden-All

LAWN and GARDEN TRACTOR

**STURDY
VERSATILE
EFFICIENT**

With all attachments:
Plow, Disc, Spike Tooth
Harrow, Cultipacker,
Seeder, Cultivator, Sickle
Bar, Utility Scraper and
Dump Trailer.

Write for Folder

Make your garden more productive! Grow more food with less effort by putting Garden-All to work for you. Garden-All is built to handle every garden chore. There's a tool for every job and you can attach or detach any tool in less than a minute. It's economical to operate too! See Garden-All before you buy any power garden equipment.

Excellent Dealer Territories Open. Write for Details.

GARDEN-ALL TRACTOR, INC.

Dept. P, 100 W. UNION STREET, LIBERTY, INDIANA

once more gracing the boards of the Wheeler Opera House.

Again the center of social activity is the Hotel Jerome, but now smartly garbed skiers instead of heavy-booted miners crowd the lobbies. For those who want simpler accommodations, there are the Victoria, Floradora and Gibson Girl guest houses for individuals or small groups. Still lower priced are the Roaring Fork and Ski Barn dormitories, and space is being provided at the Prince Albert for those who bring bed rolls to sleep for 75 cents a night.

Within its "fence" of 40 of the tallest peaks in the Rockies, Aspen again lives a bustling existence. This time, natives and newcomers assure you, it's forever!

Sandfighters of the Columbia

(Continued from page 110)

head in much the same manner as its bigger sisters. Its main advantage is that it can be transported by truck. It has become extremely valuable for clearing sand from the widely separated locks and canals that by-pass the worst of the rapids.

Two bucket dredges are also used on the river, the Monticello and the No. 501. Similar in operation to construction cranes, they work in small, congested areas.

But at the mouth of the river an entirely different kind of dredge is needed. Here is the delta of the Columbia, a tremendous deposit of sand through which test drills have been lowered a thousand feet without finding any other material. And the creeping sandspits there have wrecked hundreds of ships—Peacock Spit is dreaded by mariners of many nations.

Hydraulics cannot operate at the mouth of the river. Their pipe lines are too vulnerable to the buffeting of storms. Bucket dredges cannot work in the heavy Pacific rollers. So a different type, sea-going hopper dredges, are fighting the sandspits. These are a form of hydraulic dredge but also are full-rigged 250-foot ships. With accommodations for 10 officers and 44 men, they draw up 1278 cubic yards of sand through suction pipes set amidships and carry the sand in hoppers in their holds. Then they steam over the bar to dump their loads in the depths of the Pacific.

The river sometimes wins. Peacock Spit constantly is thrusting out new shallows to catch a ship. And the immensity of sand in the length of the Columbia makes all the dredges seem puny in comparison. But the sand-eating fleet fights on, cleaning out the channels and building levees out of the river's own weapon.

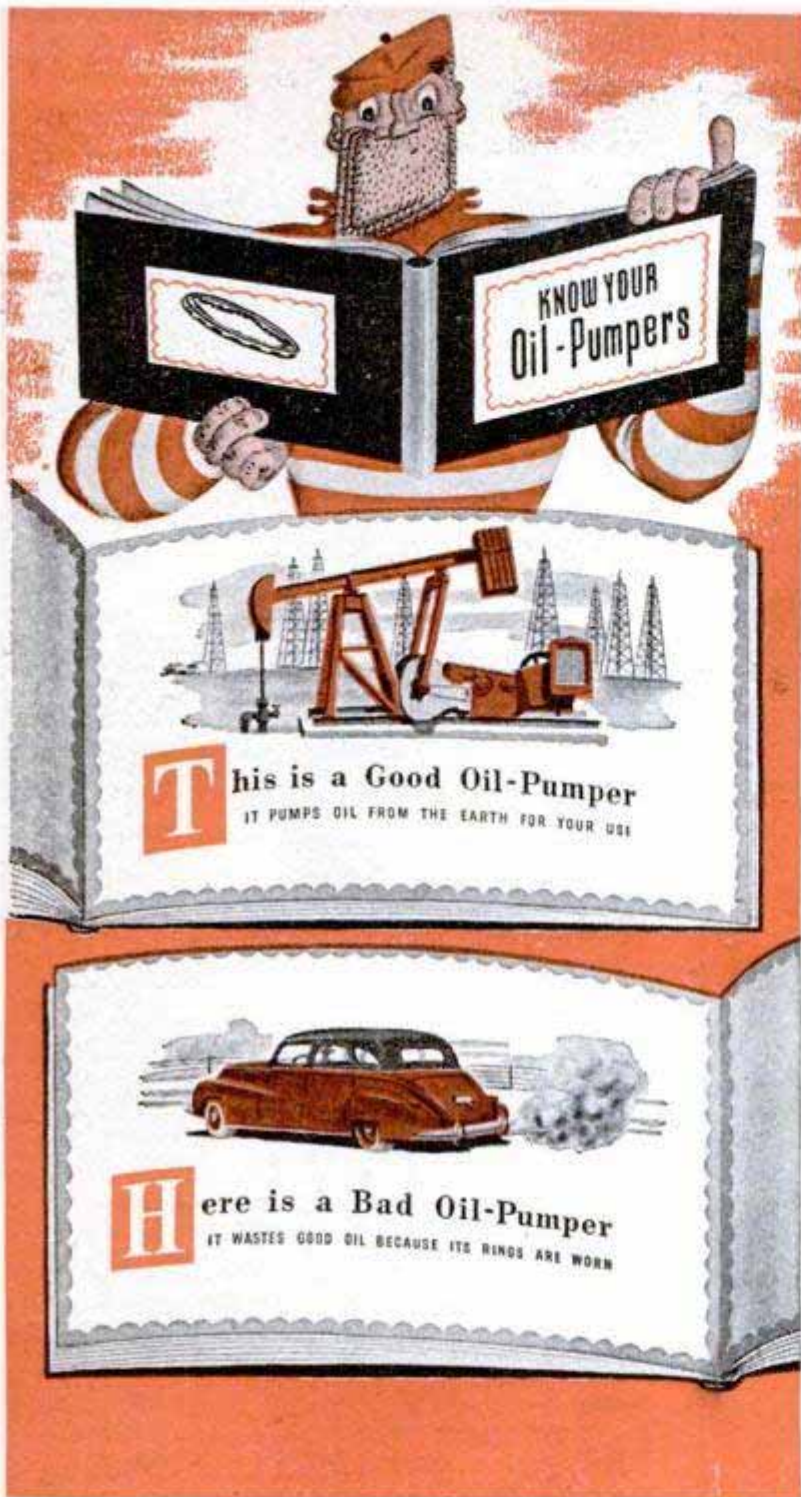

OIL-PUMPING in your car warns that you need new piston rings. It's the *first* sign of worn-out rings and the danger signal of undue engine wear.

Fortunately, rings are *replacement* parts. And when you replace with Hastings Steel-Vent piston rings, you *stop* oil-pumping, *check* cylinder wear and *restore* performance. It's the best money you can spend on your car.

HASTINGS MANUFACTURING COMPANY
HASTINGS, MICHIGAN
HASTINGS LTD., TORONTO

TOUGH BUT OH SO GENTLE



HASTINGS

STEEL-VENT PISTON RINGS

TOUGH on Oil Pumping
GENTLE on Cylinder Walls

Emergency Bottled Power!

New DOUBLE-PURPOSE AIR-O-FLATER

FIRE EXTINGUISHER
TIRE INFLATER



Distributors
WANTED



New
LOW PRICE
\$5.45

Complete with
mounting bracket

A "MUST" FOR CAR OWNERS!

Puts out gas, oil and electrical fires—contains the new CO₂ fire-fighting gas, under high pressure. Safe and easy to operate, non-injurious and quick-acting. Also inflates tires "in a jiffy"—simply attach hose connection to valve stem and turn lever of AIR-O-FLATER—tire is inflated in about 3 seconds. See your dealer, or mail check (or M.O.) for \$5.45—satisfaction guaranteed or money refunded. Refill—75c.

GENERAL AIR PRODUCTS CORP.

3318 MONTROSE AVE. • CHICAGO 18, ILL.

SURPLUS MONEY SAVING BARGAINS AT A FRACTION OF ORIGINAL COST



HYDRAULIC PUMP

No. 1—New, gear type hydraulic pump; 1000 p.s.i., pulley drive. (Pulley not included). Ideal for hydraulic rams, struts, concrete machine (blocks) or any place power is needed. Built by Pesco. Readily converted for use as sump pump. \$9.95 Shp. wt. 5 lbs. Each



AIRPLANE GENERATOR

No. 2—Ideal for use on boats, trucks, light and power plants, light welders, water wheels, etc. 24 volts, 25 amps, RPM 2500, 3/8 inch diam. shaft. Measures 10x5 in. diam. Actual weight 23 1/2 lbs. Guaranteed brand new. Shp. wt. 28 lbs. Two for \$30.00. \$17.50 Each.

PHOENOLIC PLASTIC (SPAGHETTI) TUBING

Has high insulating factor. Use it for covering "live" wires and improved appearance to any wiring job. In red, white or transparent. Inside diam. .160 or approx 1/4 inch. Brand new! 100 ft. length. Only \$2.25

INTERPHONE AMPLIFIER

No. 6—Type RL-7. Contains tubes, coils, condensers, plugs, fuse holders, switches, 24 volt dynamotor with 250 volt output. Used but good. Wgt. 9 lbs. \$5.95 Each.

SCREW & RIVET ASSY.

No. 7—A full 10 lb. ass't. of popular size screws, rivets, bolts, washers, etc. Loose and mixed but all new and perfect. Fine for home and shop. Shp. wgt. 12 lbs. Com. \$1.95 plate only.

All F.O.B. Houston. Mail orders promptly filled. Send check or money order. Satisfaction guaranteed.

AERO INSTRUMENT COMPANY, Dept. PM 1
MUNICIPAL AIRPORT HOUSTON, TEXAS

POLISHES! SANDS! GRINDS!

CURVED & FLAT

SURFACES - FASTER -

EASIER! Works with any

1/4" Electric
Power Drill,
Flexible Shaft

You Can Use It To:
Fix Bodies, Fenders;
Wax, Polish
Cars, Floors, Linoleum;
Refinish Furniture,
Wood, Metal
Surfaces; Smooth,
Reduce Welds; etc.



Bends
To Take
Curved
Surfaces

On Flat Surface

On Curved Surface

NEW FLEX Sander - Polisher

Works with your electric drill, flexible shaft or chuck equipped motor. Speeds up all grinding, sanding and polishing jobs—fits any 1/4 inch chuck. Rubber face plate flexes into curves for fast, smooth, clean work. Outfit includes 6 1/2 inch rubber disc, with metal flange and shank, fibre backed sanding disc, and heavy sheep's wool polisher. Makes your drill the equal of any \$75.00 grinding or polishing outfit. Satisfaction guaranteed. \$4.95 Order today. F.O.B. Chicago. Only.....

DEALERS WRITE

PREHLER PROVED PRODUCTS

Division Norbert Prehler & Co. Chicago 47, Ill.
Dept. PM-1, 1623-S Milwaukee Ave.

New! BLACK & DECKER

HOME-UTILITY

1/4 inch

ELECTRIC DRILL



This portable electric drill handles hundreds of "odd jobs" in homes, hobby shops, farms, repair kits. Only 7 7/8" long, weighs 3 1/4 lbs. Will drill to 1/4" in steel. Has fast-operating Jacobs hex-key chuck and an instant-release trigger switch. Operates from any 110 volt A.C. or D.C. circuit at 2250 RPMs! Order today \$18.95 for immediate delivery.

Postpaid upon receipt of check or M.O.; C.O.D. you pay postage. For General "all-purpose" drilling from 1/8" to 1/2" order the Black & Decker Home-Utility 1/2 inch Electric Drill..... \$35.95

ASTORIA REFRIGERATOR EXCHANGE

25-57 STEINWAY ST. LONG ISLAND CITY 3, N. Y.

STATION WAGON BODIES

AND CABS FOR ALL CARS, JEEPS
SMART MAPLE-OAK WOODS

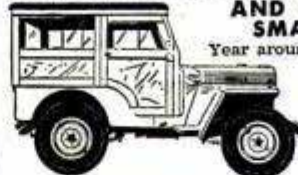

Year around comfort for Jeep owners. Kiln dried hardwoods, safety glass. Finest hardware, varnishes, top materials. Full opening rear door, locks. Send 25% with order balance COD. \$165 FOB Cleveland..... plus tax, complete, semi-assembled.

STATION WAGONS, INC. (PM)

6619 Euclid Avenue Cleveland, O.

OTHER CARS converted to station wagons. Write for details.

HOW TO EARN EXTRA PROFITS

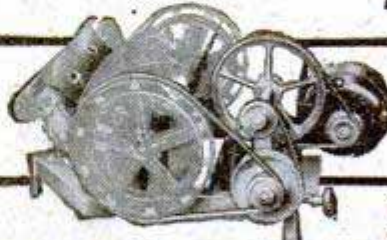

only
\$47.50
LESS MOTOR

for this
popular

"QUAD-CITY SHARPENER"

Get into profitable lawn mower sharpening at low cost with this highly successful machine. Order direct from QUAD-CITY PRODUCTS CO., Box 42, Rock Island, Ill.



Blade guide aids close following of a line or pattern.



Steel universal chuck holds all blades, files, and sanding attachments.



Because spring hold-down tilts with table to hold work firmly, you enjoy smooth operation always.



V-jaws of universal chuck hold files with 1/8" or 1/4" shanks.



Using sanding attachment, you finish exterior and interior surfaces easily.

HM-54

Furnished with 4-inch pulley, pulley guard, removable table insert, 3 saw blades, blade guard, dust blower tube, 2 wrenches.

Saws wood up to 2 inches thick — cuts light metals, and plastics. Cuts to center of 32-inch panel.



New!
HOMECRAFT®
16" SCROLL SAW
built expressly for the hobbyist

Only \$29.95
(Less lamp attachment and motor)

It's now available at your dealer's store, at surprisingly low cost — this good-looking Homecraft 16" Scroll Saw.

With its speed of 1275 cutting strokes per minute, you can do fast, accurate scroll-sawing of all types: fret work, inlay work and marquetry, jig saw puzzles, etc.

Made by a Leading Tool Builder!

Behind the Homecraft 16" Scroll Saw is the engineering skill of the men who make Delta Power Tools. In schools and factories, as well as home shops, Delta tools have long been recognized as outstanding for safety, accuracy, and dependability.

Having a home shop equipped with Delta Power Tools some day is the dream of practically every craftsman who wants the very best!

Worthwhile Features!

With the Homecraft 16" Scroll Saw, Delta



Catalog Sheets!— Show all Homecraft Power Tools and accessories. Sent to you free. Use coupon, for your copies.

answers the demand for a good, popular-priced tool that is adequate for the average limit-

ed needs of the hobbyist who "putters around" with woodworking.

Delta engineers have included features that make it a real value for the money — a tool you've every right to be proud to own:

Bearings are constantly lubricated from the splash system in the crankcase. . . . Universal blade chuck fits all types of blades, files, and sanding attachments. . . . Pump in head supplies continuous air flow, to keep cutting line free from sawdust. . . . 11" x 11" table tilts 45 degrees to the right and 15 degrees to the left, for angle-cutting. . . . Guides are fully adjustable. . . . Upper and lower chucks rotate 90 degrees, for unlimited-length side cuts. . . . Accurately-machined one-piece casting forms base and arm. . . . Pulley guard provides safety.

See It At Your Dealer!

Ask your Homecraft dealer to show this scroll saw, and his complete display of Homecraft Power Tools that range in price from \$29.95 to \$39.95.

Visit your Homecraft dealer now!

Tear out coupon and mail today!

DELTA MANUFACTURING DIVISION
Rockwell Manufacturing Company
681A E. Vienna Ave., Milwaukee 1, Wis.
Please send free catalog sheets on Homecraft Power Tools.

Name.....
Address.....
City..... (..) State.....



General Sales Office • Chicago 2, Illinois

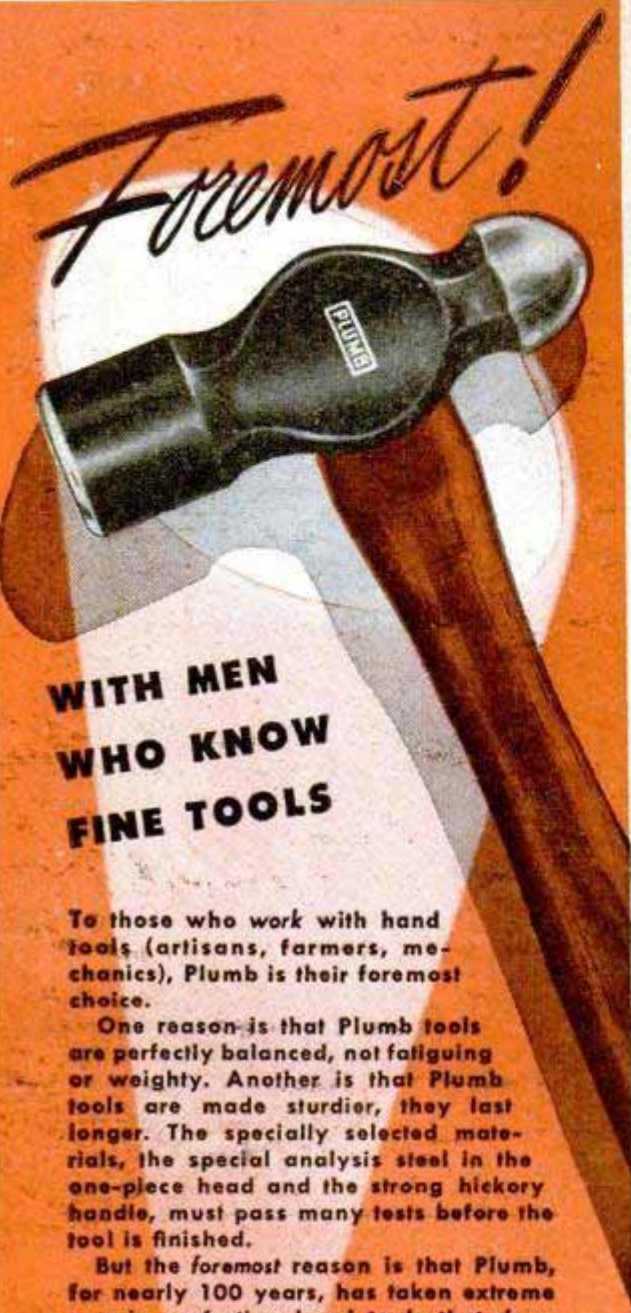

**WITH MEN
WHO KNOW
FINE TOOLS**

To those who work with hand tools (artisans, farmers, mechanics), Plumb is their foremost choice.

One reason is that Plumb tools are perfectly balanced, not fatiguing or weighty. Another is that Plumb tools are made sturdier, they last longer. The specially selected materials, the special analysis steel in the one-piece head and the strong hickory handle, must pass many tests before the tool is finished.

But the foremost reason is that Plumb, for nearly 100 years, has taken extreme care in perfecting hand tools that do a better job faster. Fayette R. Plumb, Inc., Philadelphia 37, Pa.

*The red handle with the black head
—exclusively Plumb.*

**Quality Comes FIRST
PLUMB
is FIRST in Quality**

PLUMB

HAMMERS • HATCHETS • AXES • FILES

The "Coax" Has Nerves

(Continued from page 85)

which is being built at the present time.

To date the Bell System has installed more than 4000 miles of coaxial cable in the United States and has accelerated its program of laying more cable along the busiest routes. By the end of 1949 approximately 11,000 miles of coaxial cable are expected to be installed, linking virtually all the large cities of the East, Middle West and Pacific Coast.

Meanwhile, technicians are experimenting with radio-relay systems for long-distance phone circuits, and radio routes are being extended. A radio link between New York and Boston is almost ready for use and a branch to Providence is under construction. A long-haul radio-relay system connecting New York and Chicago, with service to cities along the route, is planned for use in 1949.

Radio holds the promise of providing phone service to subscribers who live great distances from existing facilities. Subscribers who live in the Death Valley region, for example, now are connected with the outside world by a 27-mile radio link between Death Valley Junction and Specter Mountain. Rural radio service is being tested in eastern Colorado by circuits to eight ranches located 11 to 21 miles from an exchange. The radio sets are installed in the ranch houses, eliminating the need for stringing wires to each ranch.

Remote Control for Hot-Water Heater

Tiresome trips to the basement to turn on gas-fired, sidearm water heaters are eliminated by a remote-control switch installed on the first or second floor of a home. The switch can be set for automatic operation to maintain a constant supply of water, or it can be turned on and off to provide hot water when needed. The pilot is a thermocouple type which generates its own power to operate the valve.

Frozen Sandwiches Ease Lunch Problem

Putting up lunches for Junior and Dad doesn't have to be a daily chore for Mother. By freezing the sandwiches, she can use mass-production methods to turn out several weeks' supply at one time. Dr. Faith Fenton of Cornell University has discovered that the lunches will thaw at room temperature in about three hours and when eaten, will taste like sandwiches made fresh that morning. Fillings suitable for freezing include cheddar and cream cheese, sliced and ground meat, poultry, fish and cooked egg yolk.

Logan

**SPEED, ACCURACY
AND RUGGEDNESS**

**Make This 9-Inch
Logan Lathe a
Stand-Out at \$159.50**

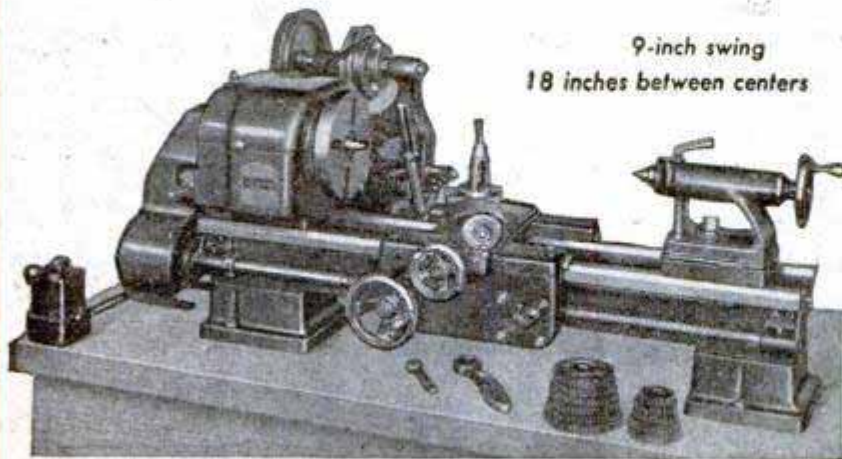

9-inch swing
18 inches between centers

● Here in compact, 9-inch size are the speed, accuracy and precise, rugged construction that make the larger Logan Lathes outstanding industrial performers. High speed, ball bearing spindle stays accurate. Self lubricating bronze bearings protect vital points. Bed ways precision ground to within .0005" of parallelism. See it at your Logan Lathe dealer's, or write for information.

DISTRICT OFFICES Woolworth Bldg. New York 7, N. Y. Cortland 7-8024
550 W. Washington Blvd. Chicago 6, Illinois Central 1246
1672 Mission Street San Francisco, Calif. Underhill 6682
700 Commerce St. Dallas 2, Texas Central 4075

LOGAN ENGINEERING CO.,

Dept. BB-1
CHICAGO 30, ILLINOIS

**TOOL STEEL
DRILL ROD**



\$1.95
POSTPAID
in Continental U.S.
C.O.D.'S ACCEPTED

25 RODS SAMPLER KIT 25 SIZES

Ground and Polished to a Perfect Finish
1001 Uses for Craftsmen, Hobbyists, Mechanics, etc.

FREE
For Making Punches, Chisels, Engraving Tools, Shafts, Etc. Free machining, easily worked, yet can be made file hard or hardened to spring temper. Hardening instructions included!
With Every Kit or first order 6" Steel comb, rule and depth gage with pocket clip and latest price list.

FLAT TOOL STEEL

The Precision ground flat tool steel with the satin-smooth finish. Simple to work, easy to harden, ready to use.

SHOP ASSORTMENT 5 dif. Pieces—1/32" to 1/8" thick 1/2" wide; 18" long. \$4.80

BOTH KITS — \$6.50

Complete ALUMINUM—BRASS—STAINLESS and TOOL STEEL Stocks include 25c postage on orders under \$5.00.

BESSEMER STEEL COMPANY OF AMERICA, Dept. FC-13
1958 W. 59th St. Chicago 36, Illinois

TOOLS SURPLUS BARGAINS

One of the largest stocks of tools, and other items such as motors, compressors, equipment, etc.



A TO Z STEEL PUNCH SETS

LETTER 1/4" — \$6.50, 3/8" — \$7.95, 1/16" — \$1.95, 1/8" — \$2.95

BALL PEIN HAMMERS

2# — \$1.29, 1 1/2# — \$1.00, 1# — 89c, 8 oz. — 69c

10" ERWIN SCREW DRIVER—79c

POLISHING HEADS

All bronze, new. List price \$5.25 . . . sale price, ea., \$3.49

Craftsmen Pipe WRENCHES

18"—\$3.49, 24"—\$4.49

New CENTURY ELECTRIC DRILLS—1/4" complete with 14 drill bits up to 1/4" in steel box, only . . . \$25.50

EAGLE DRILL same as above \$19.50

Prices FOB, K. C. Order Now—Immed. Shipment

ATLAS SALVAGE & EQUIPMENT CO.

229 S. W. Blvd. Ma 7654 Kansas City, Mo.

New



A MUST FOR EVERY CAR OWNER!

A CONSTANT REMINDER!

**EMERGENCY
BRAKE SIGNAL
LITE**

**AUTOMATIC SIGNAL WARNS DRIVER
TO RELEASE HAND BRAKE**

- Reduces wear on brake lining . . . Eliminates scored brake drums
- Will serve as a handy light for night reading of notes and road maps by removing cap
- Cuts down on repair bills . . . makes driving safer

**ONLY
\$2.00
P.P.**

The moment your ignition goes on, your EKLIND EMERGENCY BRAKE SIGNAL-LITE flashes a brilliant red light to warn you that your emergency brake is ON. Most drivers know the hot, smoky smell of dragging brakes—the "too-late" warning that the emergency brake is on—EASILY INSTALLED—complete instruction sheet with each lite. FITS ANY CAR OR TRUCK.

Order now from your dealer. If he cannot supply you, send us \$2.00 (M.O. pref.) and we will ship promptly postpaid in U.S.A.

EKLIND TOOL & MFG. CO.

2627 N. Western Avenue

Chicago 47, Ill.

**Time & Date
AT A GLANCE**



BELL
GUARANTEED
CALENDAR WATCH

Tells time, name of day and date.
Day name changes automatically.

No. MP 383 — 17 jewels, water-shock resistant, anti-magnetic, radium dial and hands. ALL STAINLESS STEEL CASE..... **\$55.00**

OTHER SPORT WATCHES WATER-SHOCK RESISTANT

Precision tested, 17 jewels, anti-magnetic, radium dial and hands, unbreakable crystal, sweep second hand.
No. MP 197—Stainless Steel Back.....**\$29.75**
No. MP 945—ALL STAINLESS STEEL CASE **\$37.50**

Other fine watches from **\$12.65** Tax Incl.

ORDER BY MAIL: Send check, money order or pay C.O.D. THESE LOW PRICES INCLUDE FED. TAX & POSTAGE. Write for FREE Booklet "MP".

Repair Service

All types and makes of quality watches repaired expertly and promptly. Free estimate on request.

BELL WATCH COMPANY, INC.

Time and Life Bldg., Rockefeller Center, New York 20, N. Y.

SAY YOU SAW IT IN POPULAR MECHANICS

WAR SURPLUS BARGAIN SPECIAL

**BELT DRIVEN
CENTRIFUGAL**

PUMP

**READY TO
USE ON ANY
LIQUID
PUMPING NEED**

**NOW ONLY
\$29.75**

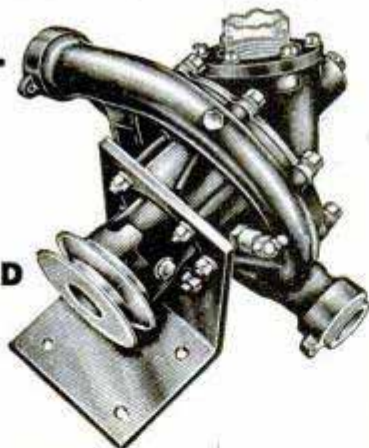

FOR HOME WATER SYSTEMS, IRRIGATION, FIRE PROTECTION, DRAIN BASEMENTS, PONDS, ETC.

● A super value for all types of intermittent service in pumping large volumes of liquid for stock watering, home and shop water systems, irrigation, draining pools, basements, etc. At 1750 RPM on 23 foot head will pump 42 gallons per minute; at 3600 RPM on 52 foot head will move 88 gallons per minute. Cast aluminum housing. Accurately machined bronze impeller vanes. Complete with mounting bracket and 3 1/2 inch V belt pulley. Run with electric motor, gasoline engine, power take-off on tractor, etc. Shaft rotates on sealed ball bearings with grease gun fitting. Has 1 1/2 inch threaded intake flange, two 1 inch outlets. Use one or both as necessary. Made for Packard Motor Car Co. for use in Rolls-Royce Merlin Aircraft engines. Comes complete with pulley and mounting bracket. Original cost approx. \$147.00. Sold F.O.B. Chicago. Shipping weight 23 pounds. Complete engineering reports and operating instructions free with pump. You can't beat this pump value at anywhere near this price. Satisfaction guaranteed.

ORIGINAL COST APPROX. \$147.00

IMMEDIATE DELIVERY FOB CHICAGO

SPECIAL PRICE, WHILE THEY LAST

\$29.75

GROBAN SUPPLY CO. 1522 So. MICHIGAN AVENUE
DEPT. PM-1, CHICAGO 5, ILL.

**EARN BIG MONEY
IN YOUR OWN BUSINESS
Sharpening Lawn Mowers**

**BUILD A BUSINESS OF YOUR OWN
WITH A UNIVERSAL GRINDER**

In your basement or garage. Earn \$150 a month. Mr. Felber of Ind. writes, "My UNIVERSAL GRINDER is faster and more accurate than any other grinder. Its efficiency enabled me to sharpen 450 mowers in 4 1/2 months. More than paid for itself the first month. Every customer satisfied." Mr. Hardy of Mississippi writes, "Received my Universal Grinder the first part of May and by August 18 had sharpened over 1000 mowers." Mr. Bacon of California writes, "The lawn mower business, with my Universal Grinder, has been a gold mine these last two years."



Only on the UNIVERSAL GRINDER can the inside face and edge of the stationary blade, as well as the reel blades, be ground to proper clearance

ALL IN ONE SET UP

without removing any blade from the mower.
Tool grinding rest included.

Write for Free Folder TODAY!

Rogers Mfg. Co., Dept. M-18, Lindsey, Ohio

**Save Fingers
with
Steel-Grip Finger Guards**



Hundreds of factories are saving time and protecting workers with Steel-Grip Finger Guards. Used for handling rough, sharp articles, buffing, grinding, sanding, polishing, punch press work, many other jobs. Wear on fingers or thumb, front or back. Durable leather, elastic web back for snug, cool, comfortable fit. Easy on and off. One size fits all, men or women. Send 10c each for samples or trial order box of 50 at \$4.25 less 10%.

Catalog of Steel-Grip Safety
Apparel free on request.

INDUSTRIAL GLOVES COMPANY
646 Garfield Blvd., Danville, Ill.
(In Canada: Safety Supply Co., Toronto)

**Stucco Spraying
• Today's Outstanding
Business Opportunity**



Beauty and protection are sprayed on old and new buildings . . . exterior and interior surfaces . . . by COLORCRETE. It's a plastic, water-resistant material, spread evenly over surfaces and forced into cracks by air pressure. Fuses to masonry with enduring tenacity. Many textures. Range of 30 smart colors. Fully proven by 20 years of actual use under all conditions.

Big Earnings for Colorcretors

Colorcrete ties in with today's huge building program. Renews old buildings. Makes new construction more attractive and enduring. Large waiting market, because building owners get long lasting beauty and protective values at low price. Yet your selling price can be several times your basic cost. Machine is easy to operate. Moderate investment. Write or wire for complete information.

COLORCRETE INDUSTRIES, INC.
570 Ottawa Avenue Holland, Michigan

COLORCRETE

• Test ALL Home Outlets
• Find Open Circuits

STAR TEST-PLIERS

• Locate Blown Fuses
• Remove Fuses SAFELY

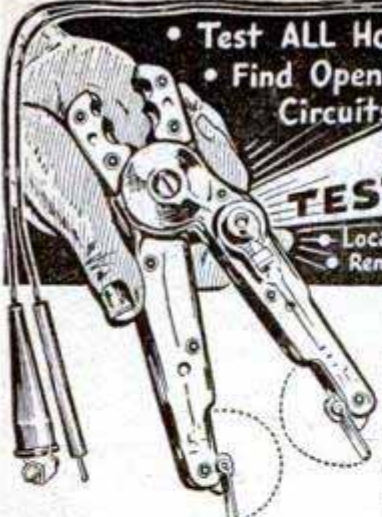

A must tool for electricians, maintenance men, home owners. Replaceable lamp inside Plier tests 110 to 250 Volts. Plier pulls fuses from 10 to 100 Amperes. Shockproof. Requires the use of only one hand. Can be obtained from General Electric or Westinghouse stores, or from local electric dealers.

Price \$2.75 without Leads, \$1.50 additional for Leads. Order TODAY.
STAR FUSE CO., 233 Canal St., New York 13, N. Y.

ARC WELDING

FOR PROFIT OR PLEASURE

60 LBS. OF READY MADE PARTS

Only \$19.95

EASY TO ASSEMBLE!

Easy to Operate. Do all-around welding on Steel, Cast Iron and other Metals. Earn BIG PROFITS. Repair AUTO, HOME or FARM EQUIPMENT. This HEAVY-DUTY Welder gives 100% penetration. OPERATES ON 110 OR 220 AC.

Complete with Instruction Manual. You Can Do Expert Welding in a Few Hours.

Sold on 30 Day Money-Back Guarantee.

FREE: WRITE TODAY FOR FULLY ILLUSTRATED BOOKLET

ATOMIC WELDER CO.

1038 So. 19th St., OMAHA, NEBR.

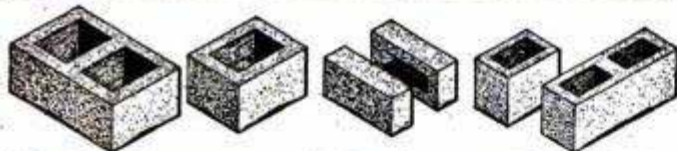

Make Concrete Blocks and Bricks

New superior method makes square, true, easy-to-lay units which will pass any building code. Small investment, high production, big profits. One \$30.00 machine will make four 5"x8"x12" blocks per minute. Pays for itself in a few days. Sell blocks or save 2/3 building cost by making and laying your own.

POST CARD BRINGS FREE FOLDER

Economy Manufacturing Company
Dept. P Stone Mountain, Georgia

SAY YOU SAW IT IN POPULAR MECHANICS

MOTORS

IMMEDIATE SHIPMENT

ELECTRIC: 60 Cycle — Single Phase — 1750 RPM
110-120 V. — CAP.+REP.=IND.

1/4 HP.	\$19.50	1 1/2 HP.	\$79.50
1/3 HP.	\$27.50	2 HP.	\$99.50
1/2 HP.	\$37.50	3 HP.	\$139.50
3/4 HP.	\$49.50	5 HP.	\$198.50
1 HP.	\$62.50		

F.O.B. ELGIN, ILL.
Send Check or Money Order

FOX VALLEY FORGE

ELGIN, ILLINOIS

MAKE \$35 TO \$50 A DAY

*Here's How!
with American*

Be Your Own Boss!

Right now—cash in on the building boom with an American Floor Sander! Hundreds of men have found they can make \$35 to \$50 a day in floor surfacing work with an American. Prospects everywhere! Sand new and old floors.

American Sanders are easy to operate—no big overhead—no special schooling—and you are your own boss! Send for "money-making" booklet entitled "Opportunities in Floor Surfacing"—use coupon and enclose 25c in coin or stamps to cover handling.



Sand NEW or OLD Floors

AMERICAN FLOOR MACHINES

The American Floor Surfacing Machine Co.
535 So. St. Clair St., Toledo 3, Ohio

Enclosed find 25c in stamps or coin for booklet "Opportunities in Floor Surfacing", telling me how I can start my own floor sanding business.

Name

Street

City..... State.....



It's New! Unsurpassed!

**DIRECT READING
BEAM-COMPASS
and adjustable rule**



\$2.95 cash with order.

No C.O.D.'s. Postage prepaid.

Here is a complete Beam Compass and Measuring Device, all in one. Strong, compact, accurate, direct-reading. Has genuine 72" Lufkin Steel Rule Nickel Plated.

For architects, draftsmen, carpenters, woodworkers, sheet metal men, stone cutters, millwrights, pattern makers.

- 1—Easy, accurate to use.
- 2—Sets by direct-reading scale.
- 3—Locks in position.
- 4—Has reversible pivot, a hard metal point for drafting table and soft surfaces—a blunt point for scribing on metal and other hard surfaces.
- 5—Uses lead or stylus. (Both included.)
- 6—Draws circles up to 12 ft. diameter.
- 7—Complete, no accessories needed.
- 8—Beautifully designed. In brown variegated, non-rusting plastic case.

AMERLINE INC.

1753 NORTH HONORE STREET, CHICAGO 22, ILLINOIS

Say you saw it in Popular Mechanics!



RIDE TO WORK

Tired of waiting for streetcars, buses? Be your own transportation boss with a WHIZZER Motor on your bike. You'll go 125 miles and more on a gallon of gas—that's six miles for just one cent! Speeds up to 35 miles per hour . . . 2 1/2 sturdy horsepower. Backed by eight years of progressive engineering. Fits any man's balloon tire bike.

FOR JUST ONE CENT

RIDE ONE AND YOU'LL BUY ONE!



WHIZZER

Whizzer Motor Company, Dept. 521, Pontiac, Michigan. I enclose \$99.97, which includes \$2.42 Federal Excise Tax () check or () money order. Send me one WHIZZER Motor complete, ready for installation. If descriptive literature only is desired, check here ().

Name _____ City _____
Street _____ State _____

3-ROLL BARGAIN

1 1/2" — 100 and 400 Grit
2" — 100, 120, 150 Grit
**3-50 YD. ROLLS
ABRASIVE CLOTH \$5.95**
Now Only



Tremendous bargain in abrasive cloth rolls. Three 50 yd. aluminum oxide rolls of finest abrasive cloth from mfgs. like Minn. Mining, Carburundum, Sandpaper Inc. A \$27.60 list value for only \$5.95. Specify widths and grit sizes. Send check or M.O. Or send on \$2.00 deposit and let bal. come C.O.D.

D. SCHUPACK
Dept. PM-1R
7331 Cottage Grove Ave.
Chicago 19, Ill.

GUARANTEE: Our abrasives guaranteed to be top quality. Return for money back IN FULL if not satisfied.

BE A DEALER or DISTRIBUTOR



**Plastique Nu-Flo
LIQUID PLASTIC FINISH**

Retails for **\$2.95** as low as... **Qt.**

Can be obtained at all leading paint and hardware stores.

- Sets Dust Free in 30 Min.
- 7 Beautiful Shades
- Spray or Brush

PLASTIQUE NU-FLO PRODUCTS CO.

109-111 S. Clinton St.

Chicago 6

HEADPHONES

- (Army HS-23) 8000 ohms. Leather covered, adjustable. With 18" double cord and PL-354 plug. . . . \$1.25
- RUBBER PHONE CUSHIONS. Per pair20
- HEADBAND (HB-7) only39
- !! SPECIAL !!—GIANT "GRAB-BAG" RADIO PARTS KIT. A real buy for the RADIO AMATEUR, BUILDER AND EXPERIMENTER in new and dismantled parts. 15 FULL POUNDS OF RESISTORS, CONDENSERS, WIRES, HARDWARE, CO. L'S, SOCKETS, ETC., ETC. \$1.95
- All for



- 6V. TELEGRAPH KEY AND BUZZER (Western Electric). Fully adj. key, platinum contacts. 1/4" bakelite base. \$1.25
- Key only49
- Variety of powerful ALNICO MAGNETS in stock. Write for supplement. GET ON OUR MAILING LIST—ALWAYS SOMETHING NEW. PLEASE ADD SUFFICIENT POSTAGE.

LEOTONE RADIO CO., 65 Dey St., New York 7, N. Y.

EVINRUDE Catalog Free



Describes complete line of 1948 Evinrude Outboard Motors—sensational new "Sportwin" model — 2 models with revolutionary "Weedless Drive" — 3 thrilling four-cylinder models. Gives helpful information on boats, speeds, etc. Profusely illustrated. Write

EVINRUDE MOTORS
5689 N. 27th St., Milwaukee 9, Wis.

BUILD YOUR OWN TRAILER

Complete Assembly ONLY \$67.30 Inc. Axle, Springs, 2 Wheels with tires, fenders, draw bar and hitch

WITH NEW FACTORY-BUILT PARTS

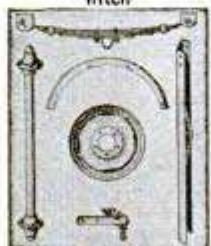

- Parts and Assemblies**
- Axle Assembly—tubular steel, with Timken bearings, hubs, wheel bolts, nuts, dust caps \$13.30
 - Axle Assembly—complete with steel disc wheels, 6.00x16 4-ply tires. 47.25
 - Spring Assembly—with brackets, U bolt and grease fittings. 5.65
 - Disc Wheels—for 6.00 or 6.50 by 16 tires ea. 4.25
 - Heavy Fenders ea. 2.10
 - Draw Bar ea. 2.45
 - Hitch ea. 2.10
- (F.O.B. Milwaukee)

ORDER NOW! IMMEDIATE DELIVERY
10% with order, balance C.O.D.

MILWAUKEE TRAILER MFG. CO.
622 N. WATER ST., DEPT. M, MILWAUKEE, WIS.



**DUMORE
DUPLIX
GRINDER**

**More Power, More Capacity,
and More Versatility —
than any other handgrinder!**

Makes your work easier, faster, twice the fun!

Here's the handgrinder you've always wanted for your workshop — the tool that gives you more of everything you want, than any other handgrinder. Its full 1/14 HP motor has the extra power for "heavy" jobs. Its extra-capacity chuck takes all 3 tool sizes—1/4", 1/8", 3/32".

With a simple, easy-to-use attachment, your Duplex becomes a flexible-shaft tool. Other attachments convert it in-

stantly for bench or lathe work.

Think what you can do with the extra power, capacity, and versatility of the Dumore Duplex! Work in wood, metal, and plastics is faster, easier — and twice the fun!

The powerful Duplex is the perfect gift for any hobby-minded man or boy. See it in your local hardware store today — or send in the coupon below!

Satisfaction guaranteed or your money back in 10 days!



Flexible shaft attachment doubles the usefulness of your Duplex.



With a toolpost bracket, your Duplex serves as a lathe-grinder.



Bench stand converts your Duplex into a third tool.

If you want a good handgrinder — buy a Dumore!

Tear out this coupon and mail today!

The Dumore Company, Dept. A-51, Racine, Wis.

- Please send complete information on Duplex Grinder.
- Send me DeLux Duplex Kit (27 accessories as illustrated); \$27.50 enclosed.
- Send me Standard Duplex Kit (9 accessories); \$19.75 enclosed. Shipping charges C.O.D. Attachments are extra.

Name _____
Address _____
City _____ (____) State _____

H-68



AAF-B-3 FLYING JACKET

Leather, sheepskin lined, zipper front, reclaimed for reissue like new. The perfect coat for all outdoor sports and outdoor work. Takes the toughest wear. It's warm as toast. All sizes. Army combat field jacket \$3.95. All merchandise reconditioned. Sent C.O.D. Free catalogue of G.I. work clothing.

\$21.95

LEHMAN DISTRIBUTING CO., Dept. M1
1214 BROADWAY NEW YORK, N. Y.

The Pipeline

**PIPES COAL IN!
PIPES ASHES OUT!**

WARMTH WITHOUT WORK

All the work of furnace tending is done automatically by *The Pipeline* Coal Burner. Pipes bituminous coal from any bin to your present furnace, burns it smokelessly and efficiently, and even pipes ashes to dust-proof containers! Modulated warmth regulated by automatic controls.

Conversion models and complete winter air conditioners. Field-tested since 1934. Write for free 20-page booklet.

FITS ANY
COAL BIN

FITS ANY
FURNACE

DUSTPROOF
ASH CONTAINER



POCAHONTAS FUEL COMPANY INCORPORATED
Stoker Division • 344 East 131st Street • Cleveland 8, Ohio

Everyone is a Mechanic

Buy Your Boy

**A CLINTON
ENGINE**

Today is a day of mechanical achievements—as you and your dad liked horse power on the hoof, your son likes horse power built of iron. The Clinton Engine gives a wonderful education in modern engineering and machine design. It's a development of outstanding sturdy characteristics—1 to 2 H.P.—4-cycle — air-cooled for powering his implement of pleasure or work—



See your dealer—There is one in your community — or write — Dept. 100-PM

CLINTON MACHINE CO.
CLINTON, MICHIGAN

Amazing New Invention
NOW AVAILABLE FOR THE FIRST TIME
 EVERYONE NEEDS THIS HANDY
**12 IN 1 VEST POCKET
 "TOOL SHOP"**

For Only
\$1.00 (SOLD ONLY BY MAIL)
 POST PAID



INCLUDES
 ALL THESE TOOLS
 IN ONE HANDY
 COMBINATION!

LESS THAN 9c PER TOOL

ORDER SEVERAL...
 * For the office
 * For your kitchen
 * For your car
 * For your pocket
 * For your work shop
 2 for \$1.75
 3 for \$2.50

OVER 1000 USES for this handy 12-in-1 tool that slips right into your vest pocket. Why be bothered with pockets bulging with tools? Now you can find every handy household essential you need, simply by reaching into your vest pocket. Think of it... TWELVE precision engineered tools, made by one of America's foremost electronic manufacturers, all combined in one smartly styled, lightweight unit. Get yours before the sell-out. Mail only \$1 today!

MAIL \$1 with NAME and ADDRESS to
THE POCKET WORKSHOP, Dept. B
 32 N. State St. Chicago 2, Ill.



Modernizing?
 Remodeling? Use..
CHROMTRIM
 "Trim-it-Yourself"
 METAL MOULDINGS

You'll find hundreds of uses for this handy metal trim around your home. Kitchen, bathroom, stairs or attic can be streamlined in a jiffy. Chromtrim comes in convenient 6' lengths, 8 shapes, all ready to tack on.

Chromtrim is easy to cut - Economical to use - Bends simply to any shape.

Send 10c for "Trim Ideas" - 16 pages brimming with Chromtrim projects, ideas, and directions for use

R. D. Werner Co., 291 Fifth Ave., N.Y. 16
 Enclosed is 10c for CHROMTRIM "Trim Ideas" booklet P. M.

Name _____
 Address _____
 City _____ Zone _____ State _____

R. D. WERNER CO., INC.
 295 Fifth Avenue, New York 16, N. Y.

Freedom PRESTO-FLEX

← YOUR MOTOR

NOW! For Only \$5.95 You can have an Amazing New FLEXIBLE SHAFT TOOL

with PENCIL-SIZE HANDPIECE

Grinds, Polishes, Sharpens, Cleans, Mills, Carves, Engraves, Etches on Metal, Wood, Glass, and Plastic

Now you can turn your old motor, drill press, or electric drill into a Flexible Shaft Tool. Amazing new Presto-flex, latest addition to the Freedom flexible shaft family. Simply attach to your electric drill, drill press or motor. Presto—a flexible shaft machine! Off again in a jiffy! Pencil size handpiece gives you finger-tip control. Gets into tight places you can't reach with any other tool. Handy 35" overall length. And—only \$5.95 complete! Order NOW.

—SEND NO MONEY—

Just send your name and address. We will rush your Presto-flex COD. Pay postman \$5.95 plus postage or send \$5.95 now and WE pay postage. Money back if not delighted! If you order Presto-flex for use on motor, specify motor shaft diameter and add 50c for motor coupling. (Available for 1/4", 5/16", 3/8" and 1/2" shafts.) 50 piece accessory set available \$1.50 extra. Order TODAY from

FOREDOM ELECTRIC CO., Dept. 112
 27 PARK PLACE NEW YORK 7, N. Y.

POWERFUL AIR PISTOL

"Sportsman Jr." is Safe, Accurate, Heavy; balanced like real automatic. Shoots B-B's, Darts, Pellets. Lots of fun for indoor target practice. With adaptors, ammunition, packed in attractive gift box. Send \$3.95 Check or M.O. Postpaid, Dept. MX.



SIDNEY SMITH INTERNATIONAL

1112 Wilshire Blvd. Los Angeles 14, California

BUILDING CONSTRUCTION



with composition cement and cheap wood builds good 3-room house for \$250; barns low as \$50.00. 100 illustrations and 100 money and labor saving suggestions. Get this newly revised and enlarged, guaranteed book before you build. \$1.00, postpaid. SHEET METAL COTTAGES and other buildings. Several new methods. Illustrated instructions, 50c. FURNITURE OF COMPOSITION. Cement, sawdust, asbestos, scrapwood, metal, etc. Ills., 50c.

SHOP MACHINES FROM OLD AUTO PARTS: Over 60 described, 50c. HOME MFG. ENTERPRISE. 50 home shop projects. Ills., 50c. Special: All five booklets described above, \$2.00 postpaid. HOME INDUSTRIES, 1318 So. 30th Ave., Dept. P.M., Omaha 5, Nebr.

FREE LEARN ALL ABOUT AMAZING PLASTICS that POUR



LIQUID IVORY LIQUID GLASS Get Free Facts Today
 Send name and address for valuable information about the most amazing synthetics ever developed. LIQUID IVORY, looks like genuine ivory. LIQUID GLASS, easy to make, looks like expensive crystal. Send for FREE catalog today.
EMPIRE TRADES & HANDICRAFTS
 DEPT. PM1, BOX 1340 ST. LOUIS, MO

for **AMAZING** acceleration

DIXIE-WESTERN
 DUAL INTAKE MANIFOLDS for
 V-8 FORDS AND MERCURYS

\$1500 Gas Line and Throttle Kit \$2.50 extra

Chrome Plated Velocity Stocks — \$1.50 ea.
 By Test: Increased Acceleration by 26%
 Increased Power and Speed by 11%

All DIXIE-WESTERN manifolds are brightly polished cast aluminum.

DIXIE-WESTERN MANIFOLD CO.
 Box 364 • Los Angeles 43, California

Dealers Wanted

SMALL EFFICIENT SPEED REDUCER

Just the thing for the Home Work Shop, Hobby Shop, Bench Work, Animated Displays, Light Production work. Used daily in thousands of homes and shops. Sturdy, compact. (see dimensions). Case of aluminum. Gears. SAE 65 (British) Gear Bronze. Worm of case hardened steel. Timken Bearings throughout. Torque capacity 100 inch pounds. Available in 4 different assemblies (shown below) and in these standard ratios:



\$18.56
NET - POSTPAID

4-1	25-1	64-1	200-1
8-1	30-1	75-1	300-1
10-1	40-1	80-1	400-1
16-1	50-1	100-1	600-1
20-1	60-1	150-1	800-1

When ordering be sure to specify assembly and ratio required. Shipping weight in carton, 8 lbs. Full money back guarantee. Prompt deliveries.

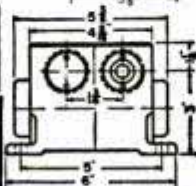
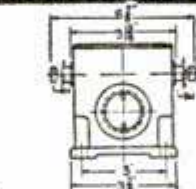
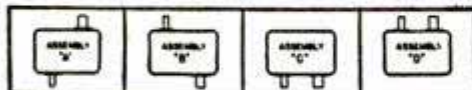

THE OHIO GEAR CO.
1401 EAST 179th ST. - CLEVELAND 10, OHIO



4 WHEELER
(Illustrated)
\$175

2 WHEELER
\$125

WATSON DOUBLE-ACTION HYDRAULIC TRAILER DOLLY

60 miles per hour SAFELY - all day

THE WATSON AUTOMATIC MACHINE CO.

Glendale, Calif.

Mansfield, Ohio

Auto FLASHER

For Fast, Snappy Drivers
Makes your Stop Light Shout. Flashes 115 times a minute. Fully automatic when brake is applied. Approved by leading Safety Engineers. **INSTANT ACTING.** If your dealer can't supply you, send check or M.O. for \$3.00. We pay postage. Dealers and Agents desired.

Patented. **MACCHI and COMPANY**
Simple to install. 927 Larkin Street • San Francisco 9, California

AROUND THE WORLD FOR 10¢
NEW, INTERESTING, EDUCATIONAL HOBBY. Collect beautifully colored official EMBLEM STICKERS of world famous airlines, railroads, steamships, major league ball clubs, hotels, etc. Be the first among your friends to start a collection, form a club. Send 10c for big bargain package, illustrated catalog, and Honorary Membership card in TRAVELERS CLUB with your name in gold.

TRAVELERS CLUB 401 Carnegie Hall, Dept. P12, Cleveland, Ohio

SAY YOU SAW IT IN POPULAR MECHANICS

HOW TO CUT RAFTERS

New vest pocket book gives lengths, Side cuts, Plumb cuts, Deductions. For all rafters for any building from one inch to forty feet wide. Gives numbers to cut on square. Also degrees for same cuts for Radial Saws. All standard pitches from 1/4 to 3/4. Just open book to pitch page and there are your lengths, side cuts, etc. Anyone who knows what a jack rafter is can frame a roof if he has this great book. Price one dollar pre-paid. **BUILDERS' TOPICS, Dept. M, Lock Box 828, Seattle, Washington, CARPENTERS, PLUMBERS, PLASTERERS, ELECTRICIANS, ETC.** subscribe for Builders' Topics, the monthly magazine for HE MAN CONSTRUCTION WORKERS. Only \$1.00 per year. Sample copies 25c.

SOLVE Your Transportation Problems...



with the new

MARMAN ★
TWIN

THE ONLY BIKE MOTOR WITH EXTRA TWIN CYLINDER POWER

Ride to work, school, shopping, anywhere—easily, inexpensively. No parking problems, no prohibitive maintenance costs. Saves your car... faster and cheaper than a bus or streetcar... loads of fun for everyone.

SUPERIOR DESIGN AND PERFORMANCE

With the Marman Twin you'll have faster getaway, easy hill climbing, effortless cruising speed of 35 MPH, because the Marman Twin has 3 1/4 H.P. . . more than 25% greater than any other bike motor.

You'll get over 100 miles per gallon . . . greater efficiency and horsepower per pound and per dollar from the 2-cycle, horizontally opposed engine.

Smoother, faster acceleration . . . easy idling at stops . . . no pedalling because of the automotive type, multiple plate dry disc clutch.

LOW MAINTENANCE COST With only 5 moving parts in the motor, upkeep is kept to a minimum. No valves or tappets to wear or renew. The clutch replaces the traditional belt slipping arrangement and saves wear and tear.

TOP STYLING Chrome plated gas tank, tool compartment, muffler and pipes, to harmonize with any color bike. Makes a bike look like an expensive motorcycle.

Easily installed on any man's balloon tire bike. Money back guarantee.

Factory price \$129.50 plus tax

IF NO LOCAL DEALER...USE THIS COUPON

MARMAN
PRODUCTS CO. INC.

P. O. Box 89, Inglewood, Calif., Dept. P.M.

MARMAN PRODUCTS COMPANY, INC.

P. O. Box 89, Inglewood, California ★ Dept. P.M.

- Send me prepaid, one Marman Twin Motor with complete installation instructions. I enclose \$136.97 () check or () money order which includes \$7.47 Federal Excise tax.
- Send me further information and descriptive literature only.

Name _____

Address _____

City _____ State _____

Dealers and distributors write for information. Many desirable territories open.

QUICK PROFITS!



\$8400

**A WEEK FROM
2 SALES A DAY**

SELL RANDOLPH Fire Extinguishers

Every building holds a prospect. Homes, Boats, Cars, Garages, Gas Stations, Shops, Laundries, Farms, Hotels, Stores, Factories.

THEY WANT A RANDOLPH with its panic-proof trigger action that smothers the fire instantly in a snowy blanket of carbon dioxide. No mess, no water, no damage, even to food. It evaporates without a trace.

YOU CAN QUALIFY for exclusive territory to sell the famous, nationally advertised Randolph used by leading industrial concerns everywhere. Approved by Underwriters' Laboratories.

Quick profits await those who act at once. Four sales a day net \$168.00 a week. Write today for full or part-time plan, territories, demonstration kit, etc. Don't delay.

Randolph Laboratories, Inc.

6 EAST KINZIE ST. CHICAGO 11, ILLINOIS, U. S. A.

This Is the Way! To Make MONEY!

"MADE \$1025.00 IN 9 MONTHS"—says W. A. T.—"and a substantial increase each year proves beyond any doubt that Foley Lawn Mower Sharpener does very satisfactory work." J. L. V. made as high as \$100 a week clear profit. C. A. B. says: "Am doing fine—paid for my machine in 4 weeks." These men (names on request) know that as the grass grows, it grows profits for them!

REPEAT CASH BUSINESS — PART OR FULL TIME

The Foley Lawn Mower Sharpener turns out perfect work—uses same system as lawn mower factories. Simply put mower in machine with handle on—sharpens all sizes and types in 15 or 20 minutes—no experience needed.



SEND FOR FREE PLAN

Tells how to start—no canvassing necessary. 99c out of every dollar you take in is clear profit. Machine comes equipped with motor—and is available immediately. Send coupon now!

FOLEY MFG. CO., 107-8 Foley Bldg., Minneapolis 18, Minn.
Send FREE PLAN on Foley Lawn Mower Sharpener business.

Name _____
Address _____

SAY YOU SAW IT IN POPULAR MECHANICS

REALISTIC MODEL KITS



Famous Lockheed P-80 jet fighter. Try your hand at a model airplane and build one of the latest. This P-80 "solid" kit has balsa parts, shaped fuselage and canopy, landing wheels, template for curved parts, and decal. A beautiful show model for mantel or shelf. P-80 Solid **50c**
Plus 15c postage.



Conestoga Covered Wagon. Live again the days of the Overland, Oregon, and Santa Fe Trails as you build this sturdy little "prairie schooner" in authentic 1/2" to ft. scale. Canvas, completely shaped ribs, die-cut plywood parts, free rolling wheels, etc. **\$1.10**
Covered Wagon
Plus 15c postage.

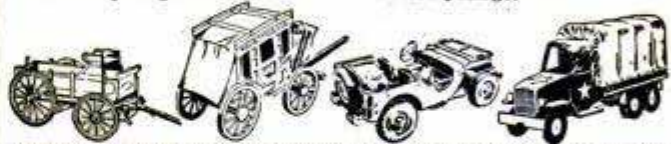

Forget your cares on long winter evenings. Build these scale mementos of the old West and of World War II! Miniature Army Truck and lifelike Jeep in 1/4" scale; Western Ranch Buckboard Wagon and Wells Fargo Stage Coach in 1/2" scale. Precision parts die-cut from white pine and plywood for easy assembly. Free-rolling wheels, real metal parts. O. D. canvas, formed ribs, leather springs, etc., full size plans. Order now—save at "combination" prices. Add 15c per set for postage and wrapping costs.

Buckboard Kit **\$1.00**
Stage Coach Kit **\$1.50**
\$2.00

2 1/2 Ton Army Truck **\$1.25**
U. S. Army Jeep **\$1.25**

BOTH FOR.....
Plus 15c postage

BOTH FOR.....
Plus 15c postage

HOLLYWOOD MODELS POST OFFICE BOX 389
BURBANK, CALIFORNIA

For Outdoor Pleasure and Transportation Ride a Royal Enfield



Famous English Lightweight
Motorcycle...takes you anywhere

Royal Enfield's popular Model R. E. has everything—Style, Safety, Economy, Flexibility. Performance! Best quality steel tubing; 125 c. c. 2-stroke, single cylinder engine; 3-speed gears. Goes 100 miles per gallon of gas! Folder "C" gives you complete details.
Dealer inquiries given prompt attention.

Write Today

WHITEHALL DISTRIBUTORS, Inc.
1385 Commerce Avenue, New York 61, N. Y.



NEW! BETTER! AIR-COOLED CARBURETOR INTAKE STACK! FOR 2 1/2" CARBURETORS

Soop-up performance!
Increase Mileage!
Low Price, only..... **\$2.00**

(Includes Postage)

Send Cash, Check, Money Order to:

MERCURY TOOL & DIE COMPANY
5977 Washington Blvd. Culver City, Calif.



WAKE UP
YOUR
Scalp

BE FAIR TO YOUR HAIR Want better looking hair? Embarrassed by falling dandruff, itching scalp? Then try VITABRUSH, new electric driven scalp brush that gives your scalp a vigorous and invigorating "workout" in just three minutes of fun. Cleans scalp. Stimulates blood supply. Restful. Pleasant. Write today for complete information and satisfaction-guaranteed offer. Hershey Mfg. Co., 3735 Field Bldg., Chicago 3.

POPULAR MECHANICS

"PROFITABLE KEY DUPLICATING"

WITH THE

HOUK KEY MACHINE

IS FULLY EXPLAINED IN OUR **FREE** ILLUSTRATED CIRCULAR ... *send for it today!*

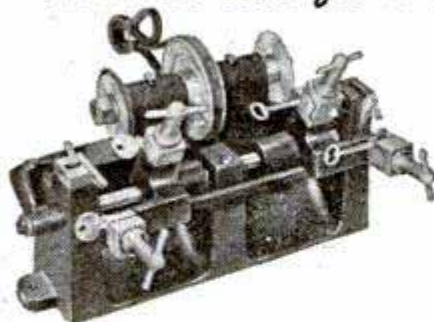

only
\$82.50
EACH FOB NY
IMMEDIATE
DELIVERY

WHITLOCK CORP. 17 WARREN ST. NEW YORK 7

Surplus
New
War

HOIST & WINCH

Eliminates Back Breaking Ordeals



Small But Mighty. Were made to be used on B-29s for lifting bombs. 2,000 lbs. capacity. Weight 16 lbs., perfect for lifting or moving loads in trailers or onto trucks, tractors, or any other movable machinery.

Fine for garages, implement stores, warehouses, assembly lines contractors and many other uses. Original cost, approx. \$100.00.

Sale Price complete with mounting brackets, cable and hook and Hand Crank, only... **\$26.30**

Send check or money order for immediate delivery

SESCO ENGINEERING & SUPPLY CORP.

15th Ave. and Clay St. Dept. PM No. Kansas City, Mo.

CARBOLOY TOOLS

FOR HOME WORK SHOP

Now—Develop more skill as a machinist with these diamond-ground carbide tools. Fits tool post of Atlas, Logan, etc. I.H. I.H., Point & Square Nose & 60° Threading Tools. State style and if for steel, cast iron, brass or plastics, when ordering. Just send check or money order with your name and address. We ship promptly.

\$1.00
Each
Paid
Post

IRWIN PRODUCTS CO.

200 Washington Ave. North, Minneapolis, Minn.

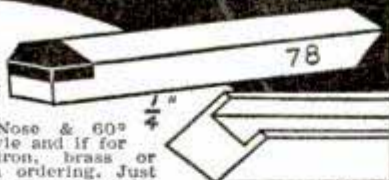

Above: Holder for 1/4" tool bits, 50c each, postpaid.

UTILITY CABINET

36 Roomy Compartments
4-7" Drawers with Removable Partitions

A Thousand Uses For

HOBBYISTS
MECHANICS
DRAFTSMEN
TECHNICIANS

For home workshop, factory, laboratory, garage, outdoors, fishing and hunting. Made of heavy gauge aluminum. Strong airplane construction. Sag proof—rust proof.



\$2.98
plus
postage

Shipping
Weight
2 lbs.,
8 ozs.

Cut out this coupon and send with money

NAME.....

ADDRESS.....

CITY..... STATE.....

Enclosed find check or money order for \$2.98.

THE KNICKERBOCKER CO. ST. CLAIR, MICHIGAN

WAR SURPLUS AND OTHER BARGAINS

MOTOR-GENERATOR

Emerson Electric Mfg. Co. 3 HP Motor ... AAF Type D50 FD-222-0435, 28 Volts DC, compound, 3800 RPM, 115 Amp, windings glass insulated, blower cooled, shaft dimension 3/8", Wgt. 27 Lbs. As Generator, puts out 115 Amps. ideal for portable welder.. new **\$13.95** each

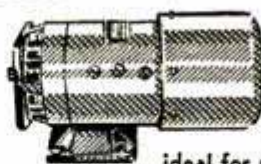

SEND CHECK, MONEY ORDER or CASH

AIRCRAFT WHEEL



1 2 1/2" x 4 1/2" heavy duty tire and tube; I.D. of shaft 1"; high speed heavy duty bearings; 2 bushings; quick change pull-apart hub suitable for trucks, trailers, small mobile units. Wgt. 11 lbs. New... **\$14.50** each.

MICROMETER

Chrome plated, precision engineered and carefully tooled to give long life and highest degree of accuracy... all new. 1" capacity **\$1.65** each. 2" capacity **\$3.50** each.



CLAMPS: Adel Aluminum Co., Rubber lined, assorted sizes, hundreds of uses in any shop. 500—all new, ass't'd sizes **\$5.00**



Transformer

Automatic Winding Co. Transformer, 5 to 42 V., 6 steps of 5 V. each, 2 steps of 3-6/10 V. each, 6 Amp. maximum. Suitable for use with war surplus gadgets, house chimes, heater relays, radio test filaments, electric trains, etc. Wgt. 5 lbs. New... **\$3.50** each.

25% DEPOSIT REQUIRED ON C.O.D. ORDERS

ELECTRIC DRILL



Operates on 110 V., DC or AC. Full load speed 900 R.P.M., 1/4" capacity in steel or hard wood. Six ft. flexible rubber cord, bronze bearings, chrome plate and rust-proof finish. Carries manufacturer's guarantee. Wgt. 4 lbs. New... **\$17.95** each.

GEAR PUMP



For circulating liquids... oil or water. Will operate on 1/10 H.P. Pumps 3 gals. per minute at 1700 R.P.M. Hardened steel gears, bronze bushings, aluminum housing. 2" diameter, 3 1/4" long. Wgt. 2 lbs. New... **\$3.50** each.

GOGGLES



Military type, with laminated cellulose-acetate lenses, leatherette frames and elastic cloth adjustable band, all new... 2 pair for **\$1.00** (one polarized and one clear).

ALL PRICES F.O.B. CULVER CITY, CALIF.

EXPLODING RIVET KIT

A real time saver... rivets in places where ordinary rivets can't be used. DuPont #4 Exploding Rivet Gun (110V., 750W.) with wattage regulator and six tips for 1/8", 5/32", 3/16" brazier and countersunk rivets; Starlette Micrometer for measuring metal thickness from one side only; 5 drills... nos. 40, 29, 17, 6 and 3.5 mm.; 8 Go and No Go Gauges; approximately 10,000 explosive rivets... 1/8", 5/32", 3/16" in proper lengths for metal thickness of .045" to .245" by .02" graduations; long rubber covered extension cord; packed in fitted metal case. Wgt. 4 1/2 lbs. New. **\$79.00** each.

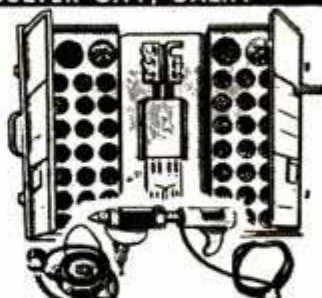

AIRBORNE SALES CO. DEPT. PM 1-B CULVER CITY, CALIF.

BOICE-CRANE POWER TOOLS

for shop men and
homecraftsmen.



BAND SAWS



JIG SAWS



DRILL PRESSES



THICKNESS PLANERS



SPINDLE SANDERS

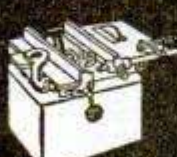

SAW JOINTERS



LATHES



SPINDLE SHAPERS



BELT SANDERS

Write for literature on this
versatile, low-cost,
sturdy line.

BOICE-CRANE COMPANY
943 Central Ave., Toledo 6, Ohio

ADD TO YOUR INCOME

Profit by Increasing Demand
for Belts, Purses, Gloves
Woolskin Toys —

with **LARSON**
Leathercraft

No Experience Necessary

Sell popular, useful, easy-to-assemble items from Leathercraft Headquarters. Complete stock. All tools and accessories. Instructions come with materials. Immediate delivery.



101 Ideas

Send ten cents at once for catalog of money-making ideas.

For new, 16-page catalog,
write to J. C. LARSON COMPANY
176 N. Wacker Dr., Chicago 6, Ill.

SAVE ON **Surplus Bargains**

PERFECT ALL WOOL **SLEEPING BAG**
OLIVE DRAB

Handy for fishing trips, hunting, camping, boating, just roughing it or use as auto robe and many other purposes. Warmth of 2 blankets; zipper slide fastener; tiestrap on bottom; approx. Gov't cost \$12.90. Our Price each... **\$3.95**

Outside Cover for Sleeping Bag—Water repellent... **\$2.39**

PUP TENTS Perfect—2 man size for scouting, Camping, etc. Without Pole... **\$2.95**

NEW GOGGLES Set comes complete. Kit with 1 extra interchangeable shatterproof, flexible, cellulose acetate lens. Green and white colors. A rubber flexible goggle frame. Back adjustment head strap. Cost Gov't approx. \$4.50. Ea... **98c**

NEW BENCH LAMPS Adj. type for work benches and many other uses. Cost Gov't approx. \$15.00. Only... **\$3.95**

HYDRAULIC JACKS FOR HEAVY DUTY WORK (Perfect) 8 ton 20 ton... **\$44.95**

WATER PURIFIERS "Sunstill" New, used by Air forces and Navy to distill salt water into fresh drinking water. Complete with canister, wght. approx. 10 lbs... **\$4.95**

NEW PARACHUTES (Green Rayon) Approx. 36 sq. ft. Cloth good for making into ties, handkerchiefs, lining, etc. Complete with canister, wght. approx. 10 lbs... **\$2.95**

WE PAY POSTAGE — No COD — Send check or money order.

AMERICAN SUPPLY CO., Dept. P. M., 329 W. 5th St. Kansas City, Mo.

NEW EASY WAY TO MAKE MONEY *at* HOME

Your cost only 5c

You get \$5.00.

Full or spare time.

It's easy to Bronze Baby Shoes. Business still in infancy. Get in on ground floor and skim cream of profit from rich and never-ending market. No experience needed. Learn in one week. Income up to \$1,000 a month full time—\$50 to \$75 weekly in spare time. We furnish complete kit and full instructions. So easy to understand that a 12 year old can become expert.

FREE FACTS. Write today. Don't send a penny. Just name and territory to reap rewards waiting. Costs only 5c to bronze shoes. Sell for \$5.00! This is too good to miss. Get facts today. Write to

KIKTAVI COMPANY

Dept. 14, 8620 So. Ruthelen Los Angeles 44, California



BE YOUR OWN BOSS!

LEARN ELECTROPLATING

HIGHLY PAID FIELD



UNCROWDED, interesting business. Part or full time. Common school education sufficient. Chromium, Nickel, Silver, Gold, etc., money making trade secrets. Learn at home in spare time. Send postcard today for **FREE** electroplating idea booklet.

PLATER HYDE

432 F Street Room 520
San Diego 1, California

New Designs in **FRANZITE GRIPS**



Modernize Your Gun! Improve Your Score!

Most durable grips made. Positively unbreakable! For Colt, Smith & Wesson, Hi-Standard, Ortgies, Luger & Mausers in a wide choice of beautiful designs in ivory, pearl, walnut, onyx, etc. Low prices. **FREE CATALOG.** Dealers Wanted.

SPORTS, INC. (Mfrs.) 5501 Broadway, Dept. P-1, Chicago 40, Ill.

WOO-WEE AUTO HORN wolf whistle

Reproduces "Wolf Whistle" better than any savior. Screeches, barks, whistles, imitates siren, moves any "road hog" off the highway in "double quick plus." Attract more attention than by driving a yellow Cadillac. Operates from manifold. Installed on any car in 15 minutes. Sturdily constructed. Cleverest novelty since the use of the auto. Be the first user in your neighborhood. Absolute money back guarantee, \$6 dollars each. Order today. Ohio orders add 3% tax.
THE PROTECTUROD COMPANY - Dept. 101
4033 Windsor Road - Youngstown 7, Ohio



POPULAR MECHANICS

Do You Ride a Bike?

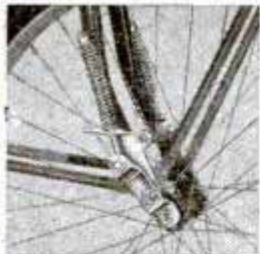

"SHOCKMASTER" for all Bicycles

- LEVELS ROUGH ROADS
- PREVENTS BROKEN SPOKES, WHEELS, FORKS
- MAKES RIDING SMOOTHER, SAFER
- EASY TO INSTALL

"Shockmaster"—the front wheel shock absorber—is ruggedly constructed of nickel plated steel and engineered for years of real service. It'll pay for itself in added pleasure, saves tires and eliminates many costly repair bills. 20,000 satisfied users. Orders yours today. Only \$3.69 postpaid. No C.O.D.'s. Complete satisfaction or money back. Dealers Wanted.

H. M. GIBB and COMPANY
1304 PENOBSCOT BLDG. DETROIT 26, MICH.

Get A SEAMAN ROTARY TILLER

Better Yields—Better Crops



Because this farm-size rotary tiller prepares seedbeds most ideally suited to your soil and crop conditions, it helps produce higher yields and better quality crops. Can be adjusted for fine pulverization, coarse or medium tillage . . . just the way you want it. Mixes fertilizer and humus into the GROWING AREA of seedbed; aerates soil; eliminates air pockets and hard plow soles; conserves moisture; promotes earlier and more complete germination of seed; helps to destroy many crop pests and certain varieties of fungus; provides effective weed control; reduces erosion . . . all with ONE machine!

SEAMAN ROTARY TILLERS are available in power take-off and motorized models 3 to 7 ft. tillage widths. See your Seaman dealer and write for complete information.

SEAMAN MOTORS, Inc. 364 N. 25th Street
Milwaukee 3, Wis.



CROSMAN Silent RIFLE

POWER
without POWDER

You'll like a Crosman because there is no recoil to spoil your aim . . . no noise . . . no odor . . . no cleaning! Rifled barrel for greater accuracy . . . adjustable power, too, for short or long range shooting indoors or out. Available in .177 and .22 cal. models.

AT YOUR DEALER OR WRITE DIRECT

CROSMAN ARMS CO., INC.

3 HENRIETTA ST., ROCHESTER 7, N. Y.



HAVE FUN—WIN FRIENDS WITH THIS
SENSATIONAL

ELECTRIC LIGHT GLO-BOW

Be the hit of the party with this swanky electric light GLO-BOW. Comes complete with attractive bow tie, 2 built electric bulb jewels, on 3 and secret battery. Flashes on and off as you touch hidden button in your pocket. Amaze your friends! Have fun. Order yours today, and let your personality glow with GLO-BOW. Easy to put on. Money back if not delighted. SEND NO MONEY!

On arrival just pay postman \$1.75 plus postage charges. Or enclose \$1.75 and we pay postage. Order now!

HOPKINS TIE COMPANY

100 HOPKINS PLACE, DEPT. P.M.(1), BALTIMORE #1, MARYLAND

REPAIR CRACKED BLOCKS AND HEADS—

External and internal leaks in blocks, cylinders and valve ports quickly and easily with LUSCO PLASTIC SEAL. 90 day Service Guaranteed or your money back. Send money order or check for full pint—more than sufficient for average repair. . . \$3.00 Postpaid

C. F. LUSK CO., 5924 BONNA AVE., CLEVELAND 3, OHIO

SAVE \$200*

OR MORE ON YOUR
TELEVISION SET

TRANSVISION'S

15" GIANT
TUBE KIT
(120 Sq. In.)
yours for only
\$348.75

NO EXTRAS



TRANSVISION

• AT LOW COST you now can have one of these huge screen TRANSVISION Television Receivers, preferred by engineers. Kit is complete from tubes to antenna. 20 hours of the most fascinating kind of work you've ever tackled gives you all the big sporting events, on-the-spot news, movies; ladies will see fashion shows, musical comedy, stage shows, the kids will be wild about the circus, rodeo, animated cartoons—and there are hundreds of other stupendous entertainment features available to the whole family. Suitable for large rooms.

• ANYONE CAN BUILD IT. Step-by-step crystal-clear instructions designed to make assembly easy Top-flight performance guaranteed by manufacturer. Soldering iron and screw driver only tools needed. Absolutely no instruments or technical knowledge required. Simply follow directions Thousands of people have assembled these superb TRANSVISION Receivers and now enjoy highest quality performance formerly available only in costliest factory-built sets.

ORDER NOW FOR IMMEDIATE DELIVERY OR WRITE FOR FURTHER DETAILS

(Terms: 10% deposit, balance C.O.D. We pay express charges if full payment is sent with order.)
Fine walnut finished cabinets for above kits available at moderate cost.

12" tube
kit
as above
289.00

SPECIAL OFFER: To see for yourself, you may order the instructions separately. Includes parts list, schematic diagrams, stage by stage drawings, etc. Send \$1.75, credit applied to your kit when ordered.

*Based on average cost of receivers of comparable price and quality.

RADIONIC EQUIPMENT COMPANY

Tribune Theatre Entrance, 170 B NASSAU ST., N. Y. 7
CABLE 'CHANSLOR' TELEPHONE: WOrth 2-0421

SAY YOU SAW IT IN POPULAR MECHANICS

The SPEEDY STITCHER

for repairing boots, shoes, leather coats, gloves, straps, auto tops, saddles, etc. Can be used to sew grain bags, burlap, wire cuts on horses and cattle. Sewa quick and strong.



Each stitcher comes ready to use with a reel of waxed thread and 3 needles, assorted sizes. Needles are carried in handle. A handy tool for home or on hunting, fishing or camping trips.

Price Postage prepaid \$1.00.

LYMAN BRADFORD CO.
Box #201 KINGSTON, MASS.

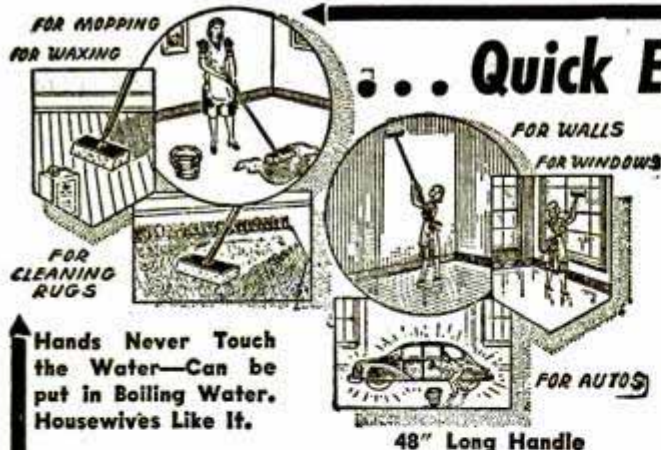

... Quick Easy Way to BIG PROFITS

Read What Others Are DOING!

"Enclosed you will find 56 orders representing 9 1/2 hours' work on Monday and Tuesday."
 "Enclosed are twelve orders secured after supper this p.m."

Housewives are Enthusiastic

Everyone that sees this outstanding Cell-U-Mop immediately wants one... That's the reason why our distributors are so successful... You also have the advantage of our other QUICK SELLING PRODUCTS that step up your Volume Sales and Profits.

Hands Never Touch the Water—Can be put in Boiling Water. Housewives Like It.

48" Long Handle

Sales QUICK, EASY Every Locality

SALES ARE EVERYWHERE... Sells quick to Taverns, Clubs, Hotels, Hospitals, Stores, Restaurants, Large and Small Buildings and the Homes... Scores can be sold on a single street... Note the Drain Bracket in the illustration... This squeezes out the water so thoroughly that HANDS NEVER TOUCH THE WATER... Makes no difference what you ever sold, you will like this proposition... Your name on a Post Card will bring you FREE PARTICULARS.

CELL-U-MOP CO., Dept. P-1 FREEPORT, Ill.

• We Teach You How •

Gets down under and around for MOPPING, DUSTING or WASHING

DOES THE WORK OF 6 TOOLS IN 1

Get Choice Territory NOW!

Holds 20 times its weight in water.



SOLDER Without TOOLS

This SENSATIONAL NEW WAY!

No More Blow Torch or Soldering Iron—LESS than 1c per Job

Now, even a boy or woman can do soldering easily and quickly with this amazing, new Self-Soldering Tape that requires NO use of Soldering Iron or Torch! Just wrap a small piece of Self-Soldering Tape around wire or other metal part to be soldered. Ignite the tape with a match, and as it burns, it solders! Self-Soldering Tape is used by both amateurs and skilled repairmen. Saves time and work—NO waiting for iron to heat, NO tinning the iron, NO need of an electric outlet or torch. Convenient to use in small places or when working on a ladder or pole. Contains no magnesium. 6 feet of Self-Soldering Tape costs only \$1.00 (uses 3/4" to 1" each job). Complete ready to use with full instructions. Order NOW! Send \$1.00 or order C.O.D. If you send money we pay postage, otherwise you do.



ENOUGH for 72 to 100 JOBS



RALFIS COMPANY

510 ST. CHARLES DEPT. A-1 ST. LOUIS, MO.

ALUMINUM PANS, BOXES, CONTAINERS

9 DIFFERENT SIZES

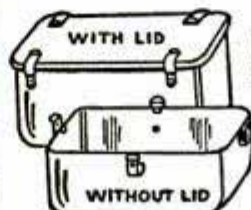

Non-Rusting, last a lifetime. Furnished with a snap on tight fitting lid. Suitable for fisherman, hunters, campers, homes, for storing small articles or cooking. For Deep Freeze units, any liquids. 1,000's of uses. Sizes from 7 1/2" x 5" x 1 1/2" to 18" x 10 1/4" x 3 1/2".

Price from 39c to \$1.39

Price FOB. K.C. — write for descriptive circular

MIDWEST BUY ANYTHING CO.

1520 LOCUST ST.

KANSAS CITY, MO.

KEEN-EDGE KNIFE

WITH 4 SHARP BLADES (WILL ALSO HOLD HACKSAW BLADE)

PRICE \$2.50



Sharp as a Surgeon's Scalpel—Sturdy as a Woodman's Ax! Cuts paper, cardboard, beaverboard, cartons—accurately, cleanly. Pistol grip allows heavy cutting pressure without danger of twisting or slipping. Hundreds of uses in business, hobby, sports. Two 4-edge and two 2-edge interchangeable blades FREE. Extra blades \$1.00 doz. LIBERAL COMMISSION to agents. At better hardware dealers, or direct from—

WEAVER UTILITool, P. O. Box 625, Tulsa 1, Okla.

AUTOMATIC IRON TESTER

Pilot Light Flashes on and off with thermostat.

For checking temperatures and re-setting thermostats. Graduated for RAYON, SILK, WOOL, COTTON, LINEN—Also in degrees from 200° to 700° F. Has a specially designed precision thermometer. Unsurpassed in quality. ONLY \$18.50 complete—MONEY BACK GUARANTEE.

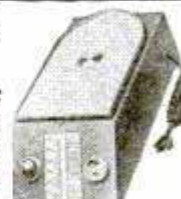

Write for circular.

(Pat. Appl. For)

HANLAN CO., 1419-A, W. Jefferson, LOS ANGELES 7, CALIF.

SAY YOU SAW IT IN POPULAR MECHANICS

BERRY'S AUSTRALIA-WHITES

RUGGED AS A MULE EASY-TO-RAISE PROFIT SENSATION

3 1/2 to 4-WKS.-OLD PULLETS

Grow extra fast. Resist disease. Mature extra early. Extra thrifty. Turn feed into more meat and eggs. Live extra good. Cross of 2 World's Champion Egg Breeds—Lay the year around. 20 other hybrids & purebreds at LOW FARM PRICES. Day-old or started. CATALOG FREE.

Write either GEORGE BERRY, 1117 Berry Rd., QUINCY, ILL. or ERNEST BERRY, 1117 Berry Rd., NEWTON, KANS.



DEAFNESS EXPLAINED

IN NEW FREE BOOKLET

New, authoritative booklet, fully illustrated, can help you solve your hearing problems. Learn more about hearing loss—its causes—its correction.

Western Electric Dept. 380-PMI
 195 Broadway, New York 7, N. Y.

Send free copy of "Modern Science and Your Hearing." Include illustrated booklet on two new all-in-one Western Electric Hearing Aids.

Name _____

Address _____

City _____ Zone _____ State _____

Distributed in Canada through Northern Electric Co., Ltd.

SAVE TIME AND WORK - MAKE MONEY with

SHAW "DU-ALL" and "PEPPY-PAL" TRACTORS

RIDING and WALKING MODELS - 1½ to 9 H. P.

Backed by
45 YEARS
OF MANUFACTURING
"KNOW-HOW"

PROMPT SHIPMENT

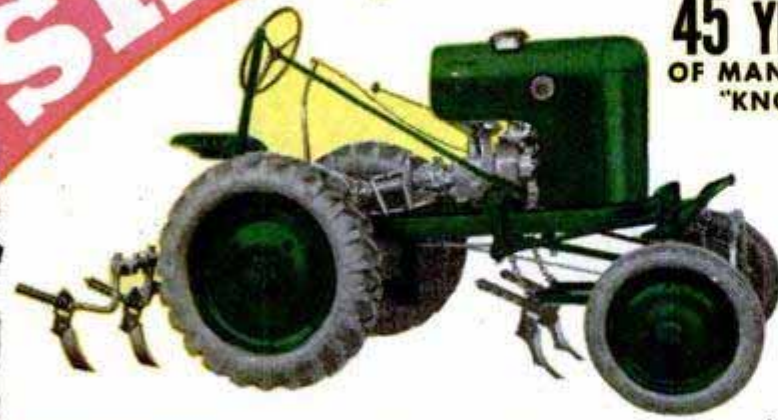

Dozens of Jobs Done Quickly and Easily

Do all kinds of hard jobs the easy way with Shaw Du-All or Peppy-Pal tractors . . . jobs that produce more food and feed, in less time with less work . . . at less cost. You can plow, cultivate, mow, harrow, disk, spray, grind, bulldoze, plow snow, saw wood and do many kinds of belt jobs, dig, haul, seed and scores of other jobs with these sturdy, powerful tractors.

Their extra-strength construction, precision engineering and efficient power utilization mean top performance on the most rugged job.

IDEAL FOR GARDENS, SMALL FARMS

Shaw walking and riding tractors are dependable, all-around economical workers . . . ideal for truck farms, gardens, orchards, nurseries, poultry farms, golf courses, estates, and cemeteries. They're always ready, always willing . . . a size to fit your needs - 1½ to 9 H.P.

Many outstanding features make Shaw tractors easy to operate - women and children enjoy running them. Equipment is easily attached with the "Jiffy Hitch," handles are adjustable. Models with variable speeds - forward and reverse. Also power turn.

SOON PAYS FOR ITSELF

Shaw tractors save so much time and labor and get so much work done, at such low cost, they pay for themselves quickly and many times over. Hundreds of operators use Shaw tractors to earn spare-time money.

CHEAP TO OPERATE

Just a few cents an hour will operate your Shaw tractor. They're strong, rugged, well-built . . . give you years of good service with very low maintenance expense. The initial cost is amazingly low . . . write today for full information and price lists.

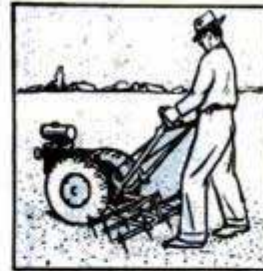

HARROWS



MOWS

SAWS WOOD - Does Many Kinds of Belt Jobs!



ACT NOW!

MAIL COUPON FOR
Send no money PRICE LIST AND FREE FOLDER

SHAW MANUFACTURING CO.

4501 Front Street, Galesburg, Kansas or
668-G North 4th Street, Columbus, Ohio

Please send me Free Folder and price list.

Name _____

Address _____

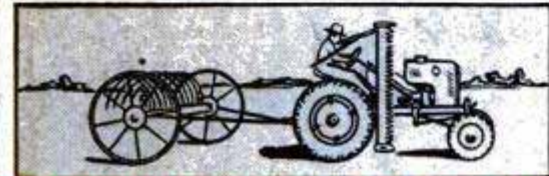

CUTTER BAR and HAY RAKE



PLOWS and CULTIVATES

Shaw tractors are the result of more than 45 years' experience in building tractors and other farm equipment. They're built by men who have the "know-how" of both farming and mechanics. That's why every Shaw tractor carries a full year's guarantee protecting you against any defect in workmanship or material.



PLOWS



CULTIVATES

TOP QUALITY MATERIALS

Built almost entirely of steel, arc-welded and consisting of thoroughly field-tested parts, Shaw tractors are famous for their dependability, utility and low upkeep. You can buy them with complete confidence.

LOW FACTORY PRICES

A modern factory and streamlined production methods assure you substantial savings. Shaw Du-All and Peppy-Pal tractors are available through dealers or direct from the factory. Mail the coupon for full information and special price list.

FREE FOLDER and Price List!

INTERNATIONAL SKI STAR

Blanche Christian agrees...

"Experience is the best teacher!"

in skiing and in choosing a cigarette"

Experience—and perfect coaching—have taught Blanche Christian the finer points of skiing.

CAMELS ARE THE CHOICE OF EXPERIENCE WITH ME!

R. J. Reynolds Tobacco Co., Winston-Salem, North Carolina

More people are smoking CAMELS than ever before!

Your "T-Zone" Will Tell You Why!

T for Taste . . . T for Throat . . .

that's your proving ground for any cigarette. See if Camels don't suit your "T-Zone" to a "T."



LOVELY Blanche Christian is one of millions of smokers who had a revealing experience during the war-time cigarette shortage.

"I smoked many different brands," says Miss Christian. "Naturally, I compared them for quality. I learned by experience that Camels suit me best!" Like Miss Christian, thousands of smokers compared . . . found Camels the "choice of experience."

According to a Nationwide survey:
MORE DOCTORS SMOKE CAMELS THAN ANY OTHER CIGARETTE

When 113,597 doctors were asked by three independent research organizations to name the cigarette they smoked, more doctors named Camel than any other brand!