

ANC



POPULAR MECHANICS

MAGAZINE

WRITTEN SO YOU CAN UNDERSTAND IT

REG. U.S. PAT. OFF. TRADE MARK GREAT BRITAIN NO. 40428

REG. U.S. PAT. OFF.



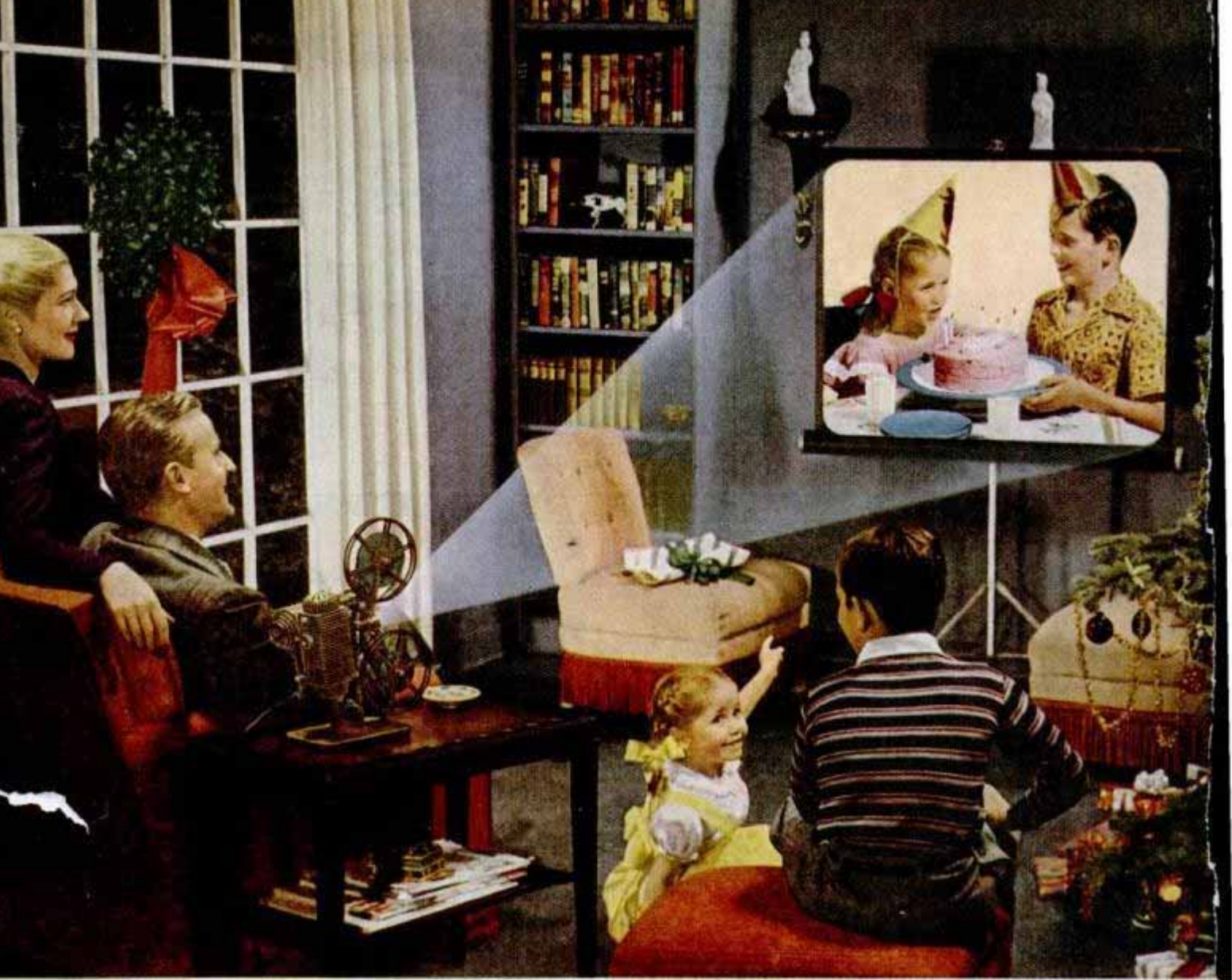

The gift of pleasure all will treasure...

Children are such natural home movie "stars"! What more priceless pleasure can you give than a permanent record of their precious talents, of all family-shared fun . . . filmed at Christmas time, birthdays, etc. . . . Movie-making with Revere is so easy, a child can do it. So inexpensive, too, on 8mm film. Color movies, per scene, cost scarcely more than snapshots . . . black-and-white, even less. See superb Revere Eight equipment now at your dealer.

REVERE CAMERA COMPANY, CHICAGO 16, ILLINOIS

Revere

—EIGHT

In pursuit of happiness Revere adds to your pleasure



Revere "85" Projector
Theatre-like performance. Complete.
\$120, inc. tax.



Revere "70" Magazine
Camera F 2.8 Bausch
& Lomb coated lens,
\$127.50, inc. tax.



Revere "95"
Turret Camera
With F 2.8 Bausch
& Lomb coated lens,
\$110, inc. tax.



Revere "88" Camera
With F 2.5 Wollensak
Anastigmat coated lens,
\$77.50 inc. tax.



Revere "60" Magazine
Turret Camera
With F 2.8 Bausch
& Lomb coated lens,
\$152.50, inc. tax.



Revere Curvomatic
Splicer
An appreciated gift
for the home movie
fan, \$16.50, inc. tax.

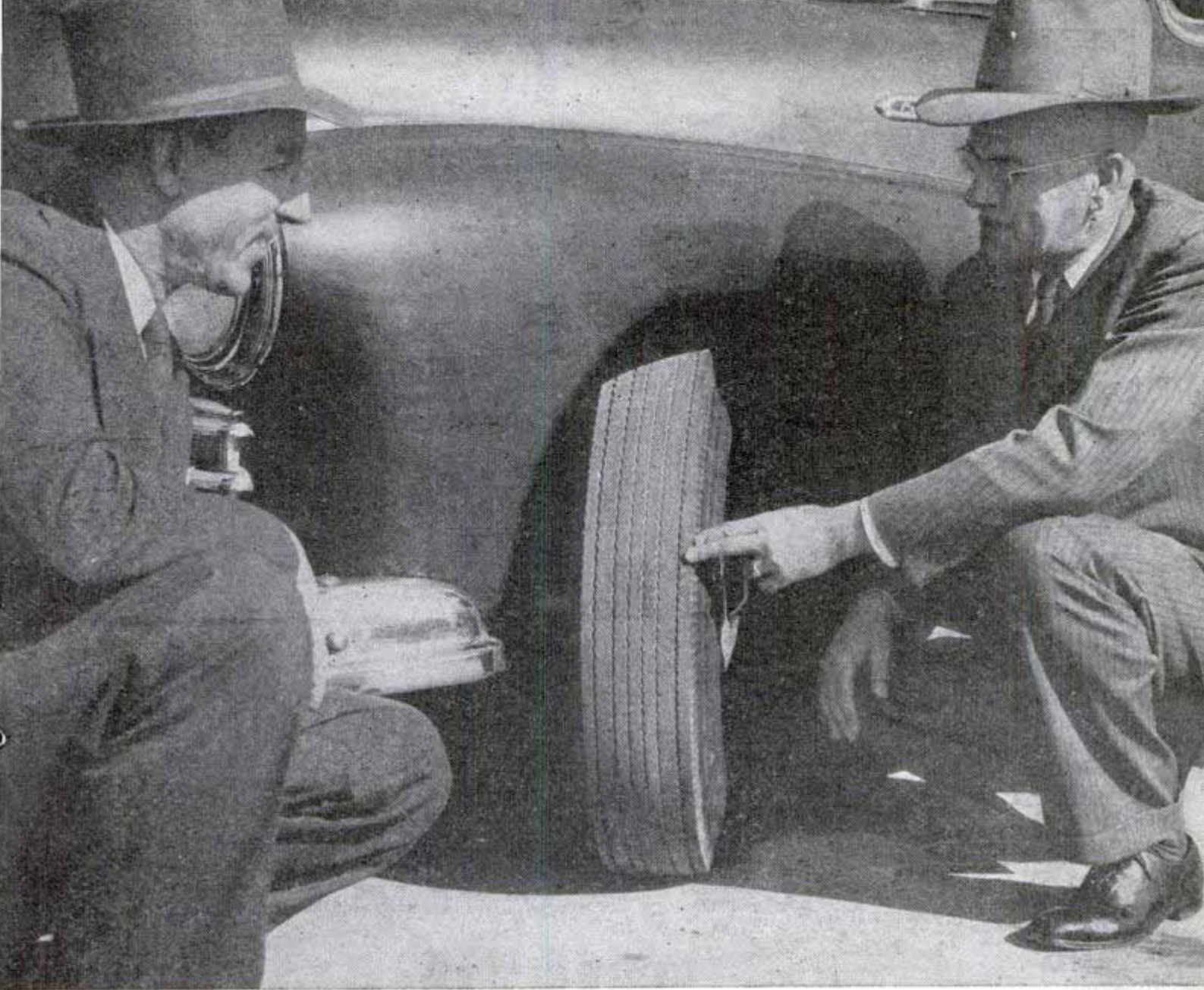

Typical example: the B. F. Goodrich tire that outwears prewar tires

B. F. GOODRICH tires outwear prewar tires. Here's a letter from M. C. Dameron, Deputy U. S. Marshal, Pueblo, Colorado—typical of hundreds we have received from B. F. Goodrich owners. The picture, with Mr. Dameron pointing to the tire, was taken at the time this letter was written.

"On June 4, 1946, I put a complete set of B. F. Goodrich tires on my 1946 sedan in place of the ones which came with the car as original equipment. The speedometer at that time read 902 miles. I drive over all kinds of roads at all kinds of speeds. There are times

when it is necessary for me to drive at very high speeds.

"All four tires are still in service on this car and the speedometer now reads 43,956 miles. This means they have gone 43,054 miles and the original tread is still good on two of them.

"This mileage is considerably more than I have ever experienced with any tire, even before the war. My work calls for dependable tires, and I must say that these new B. F. Goodrich tires have certainly filled the bill."

Some of the reasons why B. F. Goodrich tires give more mileage

under severe conditions are:
1. Broader, flatter tread to distribute the wear over a wider area.
2. Tougher tire body made with stronger cords resists bruises, protects against blowouts.

Even at today's low prices your B. F. Goodrich dealer will give you a good allowance on your old tires if they are still good enough to be used or recapped. *The B. F. Goodrich Co., Akron, Ohio.*

B.F. Goodrich
FIRST IN RUBBER

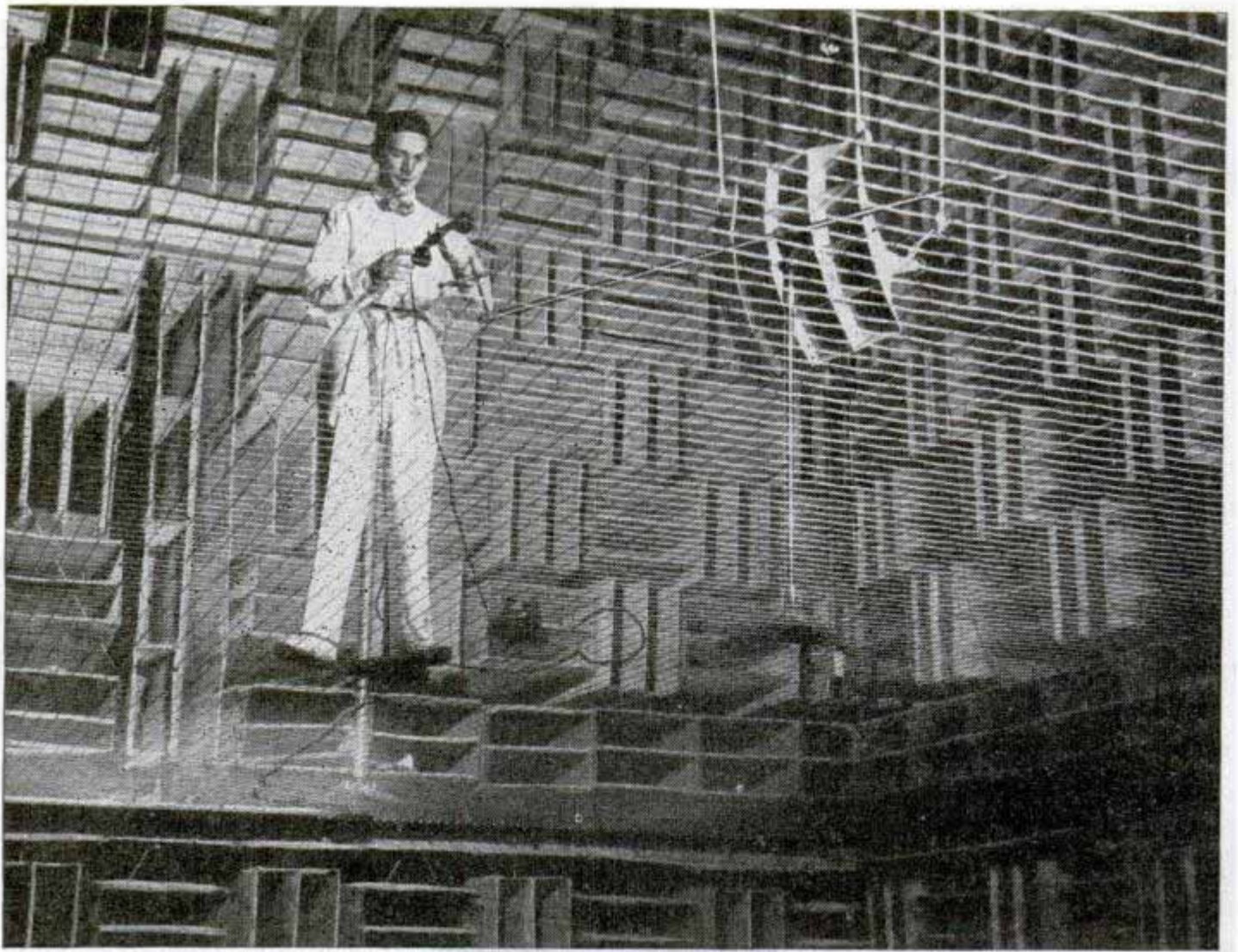

A telephone listens to a loud speaker in the new "free field" acoustic test room at Bell Telephone Laboratories. The sound-transparent "floor" is built of steel cables.

Test-tube for Sound

This giant "test-tube" is actually an echoless sound room at Bell Telephone Laboratories. Here engineers seek new facts about sound which will help them make telephone service still better and more dependable.

Bell scientists know a great deal about what happens to sound in electrical systems. This new room will give them a powerful tool to find out more about what happens to sound in the air.

In an ordinary living room, most of the sound addressed to you comes by way of reflections. At 10 feet less than 10% reaches you directly.

Sound that *bounces* at you from walls, ceilings, and your body is all right for hearing—but it poses questions for scientists who would study it uncontaminated by reflections.

The Bell Laboratories "test-tube" gives telephone people the chance to produce pure sound and analyze it reliably with respect to intensity, pitch, and direction. The entire room is lined with glass wool, contained in wire-mesh cases, wedge-shaped to give maximum absorbing area. Sound bounces along the sloping surfaces, sifts into the soft glass wool, and is gradually stifled.

This is one more example of Bell Laboratories' constant work to learn more about everything which can improve telephone service.

BELL TELEPHONE LABORATORIES

Exploring and inventing, devising and perfecting for continued improvements and economies in telephone service.



Popular Mechanics Magazine

Registered in U. S. Patent Office and Canada

H. H. WINDSOR, Founder

H. H. WINDSOR, Jr., Editor and Publisher

Next Month

HOW could a ship which does not have propellers, sidewheel, sails, oars or jet propulsion move under its own power? The answer is: on stilts! Huge hydraulic sand dredges used in the Columbia River actually walk on 90-foot timbers extending down through the stern. How these dredges operate in the never-ending battle against sand in the Columbia is told in a January feature.

ASPEN, Colo., skiing paradise, has a chair-lift which holds two records. It's said to be the longest (14,000 feet) in the world and to have the greatest vertical rise (2200 feet in 8400). The chairs move 550 feet a minute. Visit this resort on our January pages.

ONE HOBBY which costs little to start and pays off big dividends both in enjoyment and cash is bee-keeping. A January feature tells why "There's Money in Honey"—also when not to handle a bee.

JEEPERS is what we've named an electrically driven jeep described in next month's Craftsman section. This is an ideal father-son project: father builds it and son rides in it. Jeepers looks and runs like the real thing. For craftsmen who make weaving a hobby, or a spare-time business, there's a story giving detailed construction of a cam-operated loom of the two-harness type. A newly designed spline roller makes it unnecessary to tie individual knots in the warp threads. Another article tells how to make realistic sound effects for home recordings. Shop feature for the month concerns construction of a drill press made mostly from pipe fittings.

RADIO beginners can start with a new and highly efficient one-tube progressive set in the Radio and Electronics section next month.

Volume 88 DECEMBER 1947 Number 6

Managing Editor.....Roderick M. Grant
Assistant Managing Editor.....Wayne Whittaker
Shop Notes and Crafts Editor.....James R. Ward
Radio and Electronics Editor.....Frank L. Brittin
Aviation Editor.....Aubrey O. Cookman, Jr.
Associate Editor.....Clifford B. Hicks
Eastern Editor.....Bill Reiche
Western Editor.....Thomas E. Stimson, Jr.
Art Director.....Frank Beatty

Assistant Editors

Donald R. Brooks Charles D. Emerson Arthur R. Railton

Assistant Editors, Shop Notes and Crafts

W. Clyde Lammey Wayne C. Leckey John F. Shrock A. E. Youngquist

In This Issue

How Fast Can Man Fly—and Live?	89
Research Brains for Hire	100
Push-Button Pilot	108
The '48 Cars Begin to Roll	116
Killing War's Unexploded Bombs .	123
<u>Caricatures in Wood</u>	<u>132</u>
<u>Hollywood on the Move</u>	<u>138</u>
<u>Outsmarting the Smugglers</u>	<u>148</u>
<u>Land of the Scooter and Cycle . . .</u>	<u>153</u>
<u>His Tripod Is a Plane</u>	<u>172</u>

For the Craftsman

Three-Piece Wall Ensemble	178
Christmas Dollhouse	188
Fun With Common Gases	194
Pad It With Foam Rubber	198
Shoot 'em Close-Up	204
Table Saw Has Tilting Arbor	217
Brazing With Illuminating Gas . . .	224
Radio and Electronics	229

Table of Contents Continued on Page 8

Published monthly by POPULAR MECHANICS COMPANY, 200 East Ontario Street, Chicago 11, Ill. H. H. Windsor, Jr., president; Paul H. Dunakin, vice president and general manager; D. F. Windsor, vice president and secretary-treasurer; William Harrison Pettridge, vice president and assistant to the publisher; Clover L. Perkins, advertising manager; Alan M. Deyoe, circulation manager. Single copy in the United States and Canada, 25 cents; subscription rates in United States and possessions, Canada, Philippines, and countries of the Pan-American Postal Union, 1 year, \$2.50; 2 years, \$4.50; 3 years, \$6.00. To all other countries add \$1.00 a year over United States prices for overseas postage. If you plan to move, notify us at least 30 days in advance so you will not miss an issue. Give both old and new addresses. Entered as Second Class Matter, September 15, 1903, at the Post Office at Chicago, Illinois, under Act of March 3, 1879. Entered as Second Class Matter at Post Office Dept., Canada. Copyright 1947 by Popular Mechanics Company. Copyright under International Copyright Union. Copyright in France. All rights reserved under Pan-American Copyright Union. Printed in the United States of America.

Gone with the wind currents!

THE U. S. Air Force is making time these days against its gusty old antagonist, the head-wind. With the newly developed Minimal Flight Path, Air Force pilots now harness the wind currents going their way — speed up their time of arrival by as much as 20% in flights over 500 miles long.

Use of the new system, which can be computed in 30 minutes or less by experienced weather men, frequently means leaving the Great Circle route — long recognized as the shortest distance between points on the earth's surface — but such deviations bring favorable tail-wind currents into the flight path and compensate for the added distance.

In terms of navigational progress, the Minimal Flight Path means substantial reductions in fuel loads with a corresponding increase in pay-loads. Later on, as seasonal and other fluctuations are determined, air routes the world over may be in for some drastic, time-saving revisions.

Such progress, typical of Air Force leadership in aviation, is made by men who believe in the future of this great new science. If you're interested in joining a pioneering organization, ask at your nearest U. S. Army and Air Force Recruiting Station for details on Air Force career opportunities today!

**U. S. ARMY AND U. S. AIR FORCE
RECRUITING SERVICE**

**CAREERS WITH A FUTURE
U. S. Army and
U. S. Air Force**

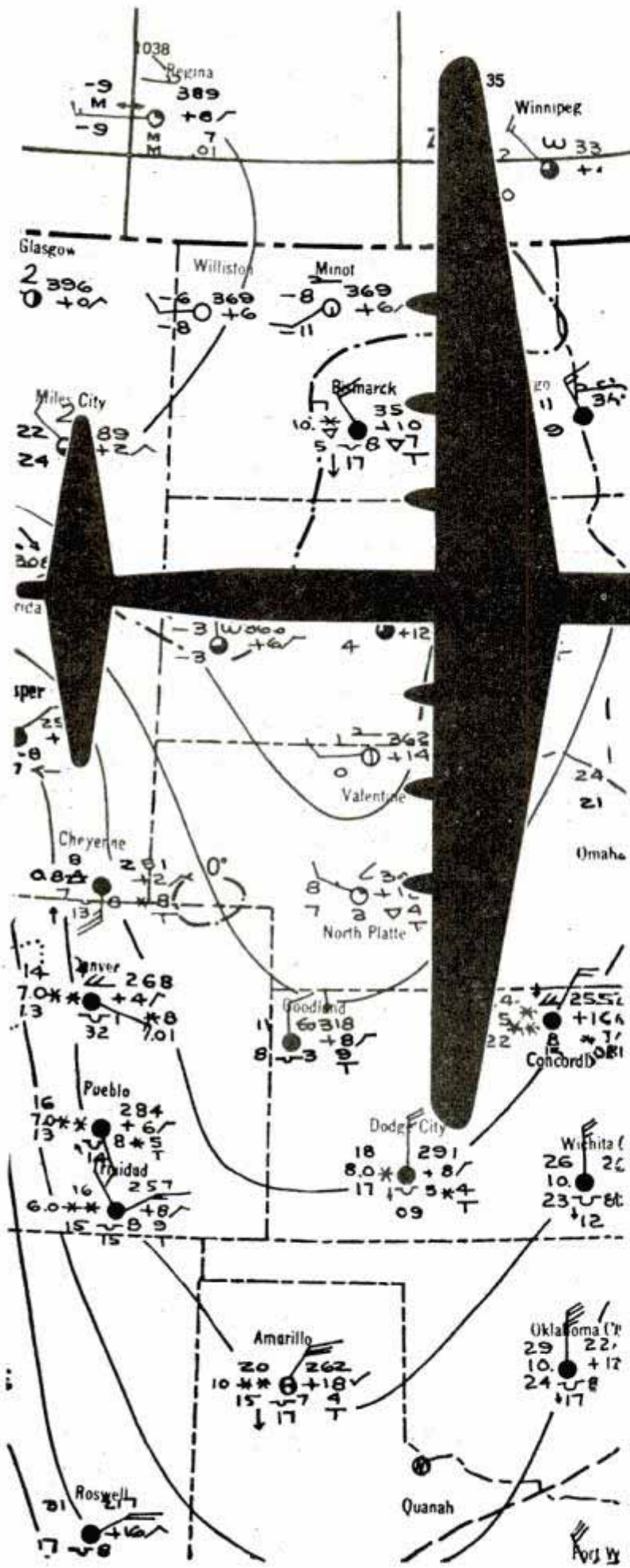

THE CADETS ARE FLYING AGAIN.
ASK FOR FULL DETAILS NOW.

Controlled HEAT TREATMENT INSURES UNIFORMLY SUPERIOR **CRESCENT* TOOLS**

This automatically-controlled, rotary-type electric furnace assures uniform heat-treatment of every Crescent Tool.

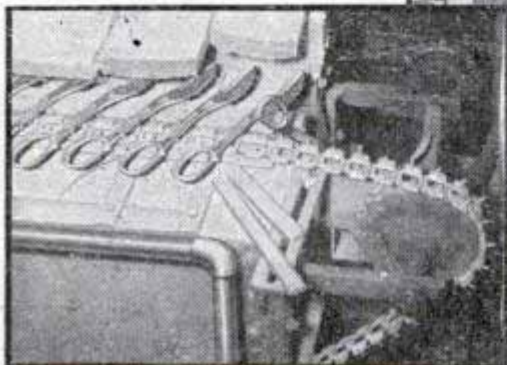
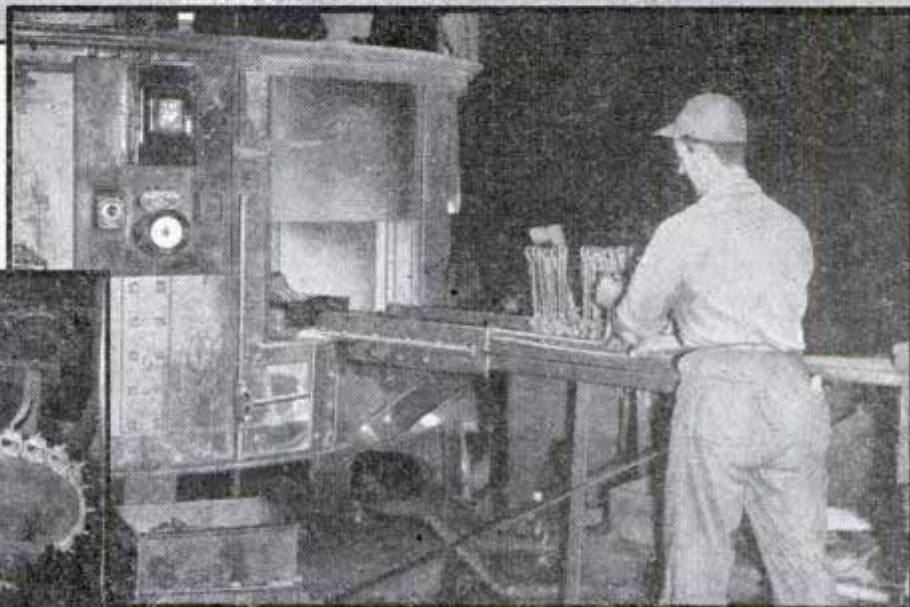

Automatic timing and automatic heat control insure accuracy of hardening in snips and pliers going through this furnace.

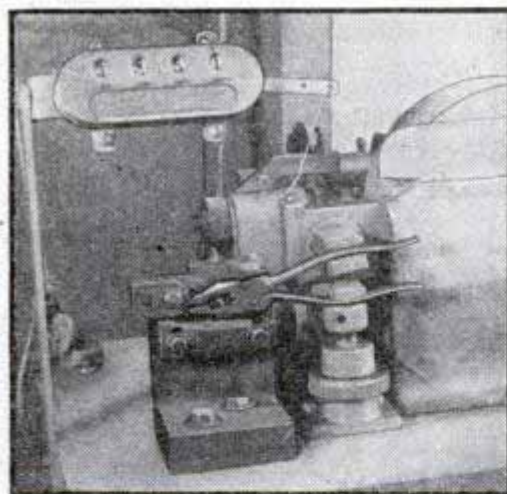

Both Crescent and competitive pliers are tested to destruction in this continuous cutting machine. Quality of product as compared to other makes can be easily determined.

● There are definite reasons for the consistently better-than-average performance of Crescent Tools.

Automatic controls in this hardening furnace overcome the possibility of errors made by operators.

Degree of temperature is automatically controlled. Doors through which tools are inserted and removed open automatically at pre-determined intervals. These automatic methods are used throughout all Crescent heat treating and tempering operations.

In this way inferior tools cannot reach the ultimate consumer, which is another reason for the wide popularity of Crescent products.

***CRESCENT TOOLS**
Give Wings to Work

CRESCENT TOOL COMPANY, Jamestown, N. Y.

*"CRESCENT" is our trade-mark registered in the United States and foreign countries for wrenches and other tools. "Crescent" tools are made only by Crescent Tool Company of Jamestown, N. Y., and are sold by leading distributors everywhere.

Thoughts . . . THAT MOVE MOUNTAINS



. . . IS MIND POWER REAL?

HAVE YOU READ volumes on the power of thought? Perhaps you have listened to lengthy theoretical addresses on the forces of mind. You may have wondered if these same writers and lecturers on mind power know how to use it. How many mountains of personal obstacles—everyday trials and tribulations—have *they* moved? What are these subtle principles whereby man can skillfully remove the barriers that impede his progress? How can *you* displace the obstructions and hindrances to *your* goal... the mountains in *your* life? Can practical information about inner power be reduced to mere words... words for public dissemination? Or, is there a secret method especially and uniquely preserved for the worthy seeker...practicable only under ideal circumstances? If so, who has the secret method? Where can it be found?

The

ROSICRUCIANS (AMORC) San Jose, California

Investigate the Rosicrucians (NOT a religion), the oldest *practical* philosophical fraternity on earth. See if they cannot show you a method for attainment such as you may not have dreamed possible. Thousands of men and women today are enjoying mental mastery...realization of ideals...the attainment of their objectives. They *know* the secret methods for converting mountains of personal problems into green valleys of achievement.

ACCEPT THIS OFFER

A FREE book, *The Mastery of Life*, is yours for the asking. It explains how easily you may enter upon the path of attainment. Fill in and send coupon *today!*

SCRIBE J. J. W.
THE ROSICRUCIANS (AMORC)
San Jose, California

Please send me the book, *The Mastery of Life*, which explains how I may learn to use my faculties and powers of mind.

Name _____

Address _____

City _____

Zone Number _____ State _____

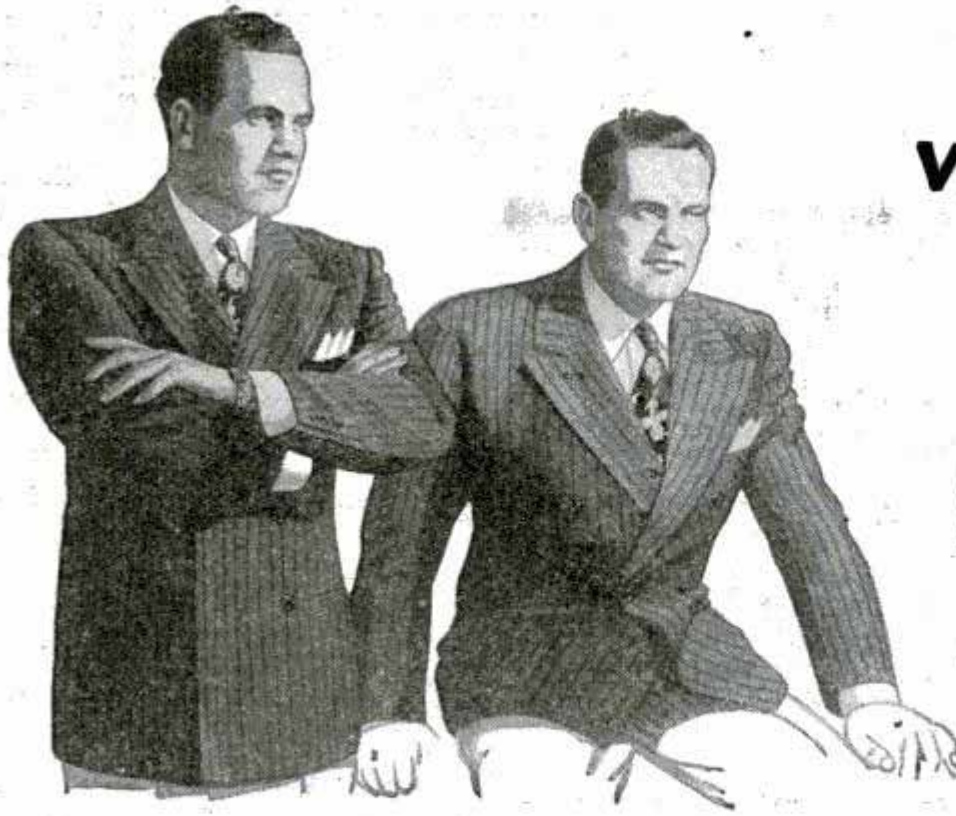

If YOU were Boss would YOU promote "YOU"?

valuable asset to any business organization. He never wants for a good job and above average earnings. He gets ahead.

Be honest now—

suppose that a better job had opened up in your company—carrying with it promotion and more money—could you qualify?

If you were boss, would you select "YOU" for that better job?

Consider before you answer.

First of all, could you *fill* the job? Has your experience fitted you for the step forward—have you been preparing for promotion apart from experience gained on the job?

Or have you just been filling a niche, doing daily tasks well but making no real and intelligent effort to learn and qualify for the job ahead so that if an opening should occur you would be ready to fill it?

The man who gets real promotion makes his own breaks—the man who slaves in the ordinary job at low pay just wishes and dreams of promotion and more money. Which are you?

Business is always willing to pay the man who knows—and pay him well. The man who is ready and willing to take responsibilities—and capable of directing the efforts of other men is a

We have helped thousands of men achieve promotion and more money—success sometimes beyond their dreams—a success that was started by a coupon similar to the one below.

Get out of that rut—don't be satisfied with a mediocre job at small pay—be a success in business—this coupon may be your first step.

So send it today—right now—tomorrow never comes for the man who consistently puts things off.

La Salle Extension University A Correspondence Institution

Dept. 1264-R

417 S. Dearborn, Chicago 5

If you can help me get the ability and knowledge for real promotion, I want to know it. Please send me your free 48 page booklet telling how I can succeed in the field I have checked below. I understand you will send this without obligation to me.

- | | |
|--|--|
| <input type="checkbox"/> Accounting | <input type="checkbox"/> Salesmanship |
| <input type="checkbox"/> C. P. A. Coaching | <input type="checkbox"/> Law: LL.B. Degree |
| <input type="checkbox"/> Bookkeeping | <input type="checkbox"/> Foremanship |
| <input type="checkbox"/> Business Management | <input type="checkbox"/> Industrial Management |
| <input type="checkbox"/> Effective Speaking | <input type="checkbox"/> Traffic Management |
| | <input type="checkbox"/> Business English |
| <input type="checkbox"/> Stenotypy (Machine Shorthand) | |

Name.....

Position.....

Address.....

City and State.....

This One



AUE9-671-J31Y

Here is why PYROIL helps you to a QUICK START



When you change to winter oil, you are changing to a low viscosity oil which helps cold weather starting. However, once you start, your engine temperatures are practically the same as summer temperatures. When you stop, the low viscosity oils quickly drain off cylinder walls leaving them dry. Starting again introduces the extra load of friction and the wear attendant to dry starts.

Pyroil gives oil the property of *clinging* to cylinder walls, permitting quick, easy starting on lubricated surfaces and reducing wear and corrosion.

Pyroil-better driving is easy to get. Simply ask your gas station attendant to add Pyroil—and add miles to your car.

Pyroil for Aircraft Engines

Use Aircraft Pyroil B for lubricating oil, Aircraft Pyroil A for gasoline.

Manufactured and Guaranteed by Pyroil Company, 74 Pyroil Bldg., La Crosse, Wisconsin.

Canadian Distributors:
Central Purchasing Agencies, Ltd., Toronto, Ontario

PYROIL COMPANY

74 Pyroil Bldg., La Crosse, Wisconsin

I want my car to last and run properly. Please tell me more about Pyroil and how it can accomplish this for me.

Name _____

Address _____

City or Town _____ State _____

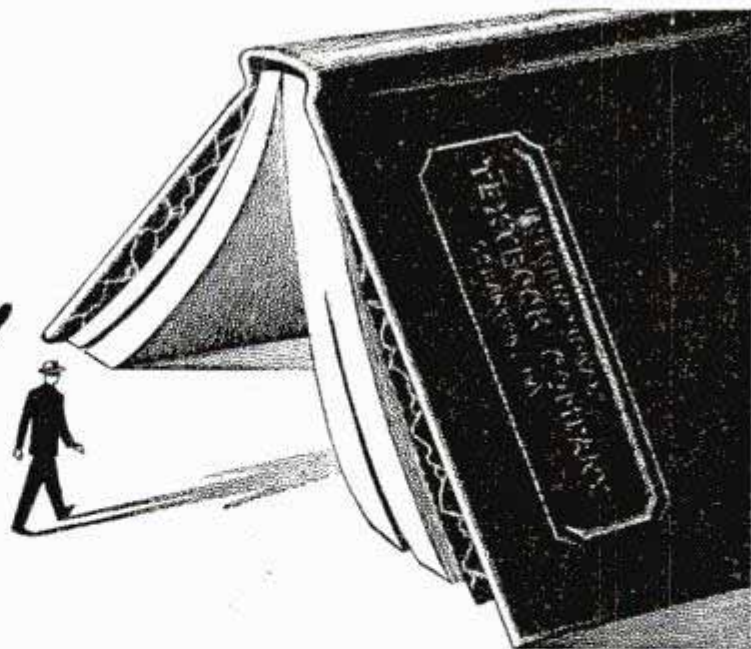

TABLE OF CONTENTS (Continued)

AUTOMOTIVE	
Armrest supports driver's right arm.....	157
"Tap" measures brake drums.....	113
Gas hand feed for cars.....	113
Waterproof canopy covers luggage on top of car.....	115
Three-wheeled racing car has clamshell tail.....	127
Adhesive makes linings easy to apply.....	136
Roller grooves rims for safety.....	147
"Hot dog" heater for car.....	162
Hangers hook on car door.....	163
AVIATION	
Biggest European flying boat will carry 46.....	94
Beacon has automatic "spare".....	113
Flying "semitrailer".....	115
Duck leaves water in 1300 feet.....	120
Robot rockets challenge sonic barrier.....	128
Boring Stratocruiser folds its tail.....	136
Sand shafts "dry out" airport.....	146
Air-line ticket vending machine.....	159
"Tanker" refuels planes in flight.....	168
"Drop-tank" glider in midjet class.....	168
All planes in area show on one "scope".....	170
Auxiliary gas tanks carry drained oil.....	171
BICYCLES AND MIDGET CARS	
Bicycle shock absorber.....	94
Midget Japanese car.....	96
Jet-propelled bicycle.....	99
Lightweight Japanese bicycle.....	135
FARM	
Sliding glass panels form cold frame.....	96
Adjustable weed cutter.....	104
Twenty-foot sprayer bar covers side of road.....	126
Roadside trimmer mows steep banks.....	130
Fast wood splitter made from scrap.....	152
Homemade mower pushes eight-foot unit.....	171
HOUSE AND HOME	
Foolproof water softener has single control lever.....	106
Storm windows stored safely.....	131
Here's that better mousetrap.....	135
Chemical capsule changes water to strong antiseptic solution.....	143
INDUSTRY	
Glass-enclosed car rides British rails.....	96
Train travels 200,000 miles without pay load.....	98
Compact gas storage.....	99
Bomb debris made into tile for Berlin roofs.....	104
House of the cyclotrons.....	119
Steam "gun" blasts upholstery fiber from yucca leaves.....	120
Old railway car makes trestle for irrigation flume.....	126
Rolling "bank" brings pay.....	127
"Disk-whirler" tests metal alloys.....	131
Blower dries paint quickly.....	135
Microscopically thin wire.....	147
Coach "bends" around curves.....	152
Sand-slinger rides high.....	159
Two-car diner-kitchen seats 91 passengers.....	169
Fork truck lifts 45,000-pound freight car.....	170
Car shaker unloads coal in a hurry.....	171
Rule totals hours, minutes rapidly.....	176
OUTDOOR RECREATION	
Cross-wire rifle sight.....	106
Slingshot sharpshooter.....	107
Swayback cabin.....	171
PHOTOGRAPHY	
Sound for 8-mm. movies.....	122
Synchronizer dims photofoods.....	163
Meter "remembers" exposure reading.....	176
Pistol-grip tripod.....	176
RADIO AND ELECTRICAL	
Rivermen use radar to steer in fog.....	99
Electric "fence" safeguards fish.....	114
Portable electroplater built into small case.....	126
Half-circle fluorescent lamps can be used singly or in pairs.....	130
Push-button panel sends telegrams.....	137
Testimony recorder.....	137
Talking on the drill rig.....	144
Power line on wheels.....	159
Television on full-size screen projected by huge mirror.....	163
Indicators on portable lamp show need for recharging.....	169
TOYS AND NOVELTIES	
Electric speedboats.....	94
Midget railroad engine is built to scale.....	95
Cigarette holder permits use of both hands.....	95
Invisible Christmas cards.....	106
"Jumper" sled.....	122
All-plastic city.....	127
Plastic balloon kit.....	147
Toy milk car unloads cans.....	162
Flexible molds easy to make.....	162
Control for model planes has thumb-wheel operation.....	175
Junior "jets".....	175
TOOLS	
Air hammer has multi-angle head.....	98
"Hypo needle" for grinding wheel.....	98
"Third hand" for solderers feeds solder to tip of iron.....	164
MISCELLANEOUS	
"Mechanical fly".....	97
Test your science I.Q.....	105
Train telephone service.....	107
Infrared lamp treats earaches.....	113
Paddle-in theater has screen on raft.....	114
High-speed spinner revolves at 187,000 r.p.m.....	119
Mudding a sled.....	121
Once barber chair, now an X-ray table.....	130
Cradle-shaped air mattress.....	131
Lettering device for layouts.....	135
Chinese typewriter can print 90,000 characters.....	143
Dry-land "warships" for training naval reservists.....	146
Push-button menu.....	147
Fire shutters seal Escalator.....	163
Power jets aid shipping.....	171

(Continued to page 10)

GATEWAY TO OPPORTUNITY!



I.C.S. textbooks have been just such a gateway for thousands of men now established as leaders in American industry and business. They include the presidents, production chiefs and top technical men of some of the largest railroads, airlines, car manufacturers, publishing enterprises and steel, chemical and electric companies.

The same route they took is open to you. You study I. C. S. Courses in your spare time . . . Learn as you Earn . . . prepare

yourself for the advancements that go to *trained* men and women.

Business management or accountancy . . . aviation or plastics . . . drafting or engineering . . . whatever your interest, there's an I. C. S. Course covering it.

Mark and mail the coupon *right now*. The records of I. C. S. graduates show that today's I. C. S. student is tomorrow's leader. This is *your* today. Don't miss out on the rewards of tomorrow!

INTERNATIONAL CORRESPONDENCE SCHOOLS



BOX 5617-K, SCRANTON 9, PENNA.

Without cost or obligation, please send me full particulars about the course BEFORE which I have marked X:

- | | | | | |
|---|---|---|---|---|
| <p>Air Conditioning and Plumbing Courses</p> <p><input type="checkbox"/> Air Conditioning
<input type="checkbox"/> Heating
<input type="checkbox"/> Refrigeration</p> <p><input type="checkbox"/> Plumbing
<input type="checkbox"/> Steam Fitting</p> <p>Chemistry Courses</p> <p><input type="checkbox"/> Chemical Engineering
<input type="checkbox"/> Chemistry, Analytical
<input type="checkbox"/> Chemistry, Industrial
<input type="checkbox"/> Chemistry, Mfg. Iron & Steel
<input type="checkbox"/> Petroleum Refining
<input type="checkbox"/> Pulp and Paper Making</p> <p>Civil Engineering, Architectural and Mining Courses</p> <p><input type="checkbox"/> Architecture
<input type="checkbox"/> Architectural Drafting
<input type="checkbox"/> Bridge and Building Foreman
<input type="checkbox"/> Building Estimating
<input type="checkbox"/> Civil Engineering
<input type="checkbox"/> Coal Mining
<input type="checkbox"/> Contracting and Building
<input type="checkbox"/> Highway Engineering
<input type="checkbox"/> Lumber Dealer
<input type="checkbox"/> Reading Structural Blueprints
<input type="checkbox"/> Sanitary Engineering
<input type="checkbox"/> Structural Drafting</p> | <p><input type="checkbox"/> Structural Engineering
<input type="checkbox"/> Surveying and Mapping</p> <p>Communications Courses</p> <p><input type="checkbox"/> Electronics
<input type="checkbox"/> Practical Telephony
<input type="checkbox"/> Radio, General
<input type="checkbox"/> Radio Operating
<input type="checkbox"/> Radio Servicing
<input type="checkbox"/> Telegraph Engineering</p> <p>Electrical Courses</p> <p><input type="checkbox"/> Electrical Drafting
<input type="checkbox"/> Electrical Engineering
<input type="checkbox"/> Electric Light and Power
<input type="checkbox"/> Lighting Technician
<input type="checkbox"/> Practical Electrician</p> <p>Internal Combustion Engines Courses</p> <p><input type="checkbox"/> Auto Technician
<input type="checkbox"/> Diesel-Electric
<input type="checkbox"/> Diesel Engines</p> <p>Mechanical Courses</p> <p><input type="checkbox"/> Aeronautical Engineer's, Jr.
<input type="checkbox"/> Aircraft Drafting
<input type="checkbox"/> Flight Engineer
<input type="checkbox"/> Forging
<input type="checkbox"/> Heat Treatment of Metals</p> | <p><input type="checkbox"/> Industrial Engineering
<input type="checkbox"/> Industrial Metallurgy
<input type="checkbox"/> Machine Shop
<input type="checkbox"/> Mechanical Drafting
<input type="checkbox"/> Mechanical Engineering
<input type="checkbox"/> Mold-Loft Work
<input type="checkbox"/> Patternmaking—Wood, Metal
<input type="checkbox"/> Reading Shop Blueprints
<input type="checkbox"/> Sheet-Metal Drafting
<input type="checkbox"/> Sheet-Metal Worker
<input type="checkbox"/> Ship Drafting
<input type="checkbox"/> Tool Designing
<input type="checkbox"/> Toolmaking
<input type="checkbox"/> Welding—Gas and Electric</p> <p>Railroad Courses</p> <p><input type="checkbox"/> Air Brake
<input type="checkbox"/> Diesel Locomotive
<input type="checkbox"/> Locomotive Engineer
<input type="checkbox"/> Locomotive Fireman
<input type="checkbox"/> Railroad Section Foreman</p> <p>Steam Engineering Courses</p> <p><input type="checkbox"/> Boilermaking
<input type="checkbox"/> Combustion Engineering
<input type="checkbox"/> Engine Running
<input type="checkbox"/> Marine Engineering
<input type="checkbox"/> Steam Electric</p> | <p>Textile Courses</p> <p><input type="checkbox"/> Cotton Manufacturing
<input type="checkbox"/> Rayon Weaving
<input type="checkbox"/> Textile Designing
<input type="checkbox"/> Woolen Manufacturing</p> <p>Business and Academic Courses</p> <p><input type="checkbox"/> Accounting
<input type="checkbox"/> Arithmetic
<input type="checkbox"/> Business Administration
<input type="checkbox"/> Business Correspondence
<input type="checkbox"/> Certified Public Accounting
<input type="checkbox"/> Commercial
<input type="checkbox"/> Commercial Art
<input type="checkbox"/> Cost Accounting
<input type="checkbox"/> Federal Tax
<input type="checkbox"/> First Year College
<input type="checkbox"/> Foremanship
<input type="checkbox"/> Good English
<input type="checkbox"/> Higher Mathematics
<input type="checkbox"/> Motor Traffic
<input type="checkbox"/> Salesmanship
<input type="checkbox"/> Sign Lettering
<input type="checkbox"/> Spanish
<input type="checkbox"/> Traffic Management</p> | <p><input type="checkbox"/> Advertising
<input type="checkbox"/> Bookkeeping
<input type="checkbox"/> Ship Fitting
<input type="checkbox"/> Car Inspector
<input type="checkbox"/> Gas Engines
<input type="checkbox"/> Steam Engines</p> |
|---|---|---|---|---|

Name _____ Home Address _____

City _____ State _____

Age _____ Present Position _____ Working Hours _____ A.M. to _____ P.M.

Special tuition rates to members of the Armed Forces. Special discount to World War II Veterans.
Canadian residents send coupon to International Correspondence Schools Canadian, Ltd., Montreal, Canada.

NEW HOME MOVIES YOU WANT TO OWN!

PICTOREELS

for 8 mm.—16 mm.
sound-silent home projectors

BELLES OF BALI

Picture pageant of life in lovely, languorous Bali—heavenly island you've dreamed about!



PUPS' CHRISTMAS

What a crazy Christmas morn when pups get tangled in the presents. See them battle Tuffy—the terrific toy tank!

SNOW FUN

A dozen ways to have fun on ice or snow. Thrills and spills in your favorite winter sports!



FREE YOUR DE LUXE NEW PICTUREEL

catalog of sound and silent home movies is ready. Send for it!

Please send the home-movies checked below. I enclose remittance Send COD

2,	COMPLETE			STREAMLINER	
	16 snd	16 sil.	8mm	16mm	8mm
BELLES OF BALI	\$17.50	\$8.75	\$5.50	\$2.75	\$1.75
PUPS' CHRISTMAS					
SNOW FUN					

Name _____

Address _____

City _____ State _____

Dept. A-12

PICTORIAL FILMS, Inc.

625 MADISON AVE., NEW YORK 22, N. Y.

(Continued from page 8)

Craftsman and Shop Notes Index

AUTOMOTIVE

Oilcloth envelopes behind seat makes convenient carryall.....	184
Concealed switch foils car thief.....	193
Masking tape covers rusted holes in auto body or fender.....	212
Handle welded to socket wrench reaches inaccessible parts.....	212
"Hot" wire removes broken key from car lock.....	223
Carbon removed from threads by using spark plug.....	226
Sleeves for muffler connections keep pipes from "freezing".....	228

FARM

Improvised valve for insect sprayer.....	196
Slats fasten temporary fencing.....	216
Cattle guard eliminates need for gate on road running through pasture.....	222
Feeder for pullets on range.....	223
Barbed wire unrolled safely.....	227

HOUSE AND HOME

Solving home problems.....	182
Improvised lead-headed nails.....	184
Yarn dyed with knitted garment assures match when mending.....	186
Fuses stored in light sockets.....	186
False bottom for dresser drawer conceals valuable articles.....	200
Repairing cracked glass jar.....	200
Salt poured over soiled spot cleans baking oven.....	202
Reversed guard on safety razor protects edges of blade.....	212

METALWORKING

Costumer converted to hold tools.....	180
Matrix casting.....	185
Decorative inlay bands cast in gavel.....	200
Wire chain produced quickly with simple jig.....	215
Better way to tap thin metal.....	216
Pointed dowel serves as scriber.....	228

OUTDOOR RECREATION

Nonslip soles on wading boots.....	184
Disk soldered to bilge pump prevents marring boat.....	186
Tripod supports boots while drying.....	196

PHOTOGRAPHY

Wooden print tongs held by spring-type clothespins to prevent warping.....	208
Portrait lighting for slender and stout subjects.....	209
Glass "carrier" simplifies centering prints on mounting board.....	209
Ordinary thermometer converted for use in darkroom.....	210
Safe way to wash roll film.....	210
Replacing reflector-clamp tubing.....	210
Locating tripod hole in dim light.....	210
Enlarging grip on cable release.....	210

RADIO AND ELECTRONICS

Five-tube a.c.-d.c. receiver kit for students.....	229
High-fidelity self-contained tuner for the new FM band.....	230
Radio-electronic hints.....	232

STORE AND OFFICE

Numbered strip pasted on ruler helps check invoices.....	226
Greeting cards displayed neatly on plywood Christmas tree.....	228
"Figure-eight" trigger holder keeps safety-can lids open.....	228

TOOLS

Craft quiz.....	211
Position of blind holes transferred with socket-head setscrew.....	214
Emery-cloth holder used like steady rest to polish turned work.....	214
Adjustable stop attached to handsaw regulates depth of sawcut.....	215
Extra drift slot for taper sleeve speeds removal of drill.....	216
Bolt head can't turn in T-slot if fitted with special washer.....	216
Installation of porcelain sockets speeded with hole punch.....	222
Springs at end of guide line serve to keep it taut.....	222
Bandsaw blades are brazed by using slotted jig.....	227
Carpenter's steel square locates center of circle.....	227
Cutting-tool edge examined with magnifying mirror.....	227

TOYS AND NOVELTIES

Substitute ornament hangers.....	180
Safe "javelin" for young boys has padded head.....	184
Template guide to cement plastics.....	184
Christmas tree "growing" through roof makes novel attraction.....	186
Inexpensive tree ornaments made of seed pods.....	187
Xylophone produces novel effects when played with double hammer.....	196
Gaily decorated window shades add holiday touch.....	196
Ball-ornament centerpiece for Yuletide table.....	200
Springboard fastened onto wall amuses young children.....	202

WOODWORKING

Closet-door shoe rack.....	180
Baby's swing doubles as safe high chair.....	181
Spring holds molding in miter box.....	186
Drill-press fence removed quickly.....	193
Duplicate stencil printing.....	197
"Row" sled.....	201
Playroom furniture of bowling pins.....	203
"Salty Sam" twine holder of plywood has handy razor-blade cutter.....	203
Windshield wiper spreads glue.....	212
All-purpose bench for light repair work.....	213

MISCELLANEOUS

Folded envelope corners in album keep records from falling out.....	180
Postal card pasted inside cover assures return of book if lost.....	187
Self-adjusting scooter brakes.....	193
Top "tab" saves book binding.....	193
Waterproofing paper match book.....	196
Holder for assortment of drawing pencils is attached to drafting-board lamp shade.....	202
Taking data from nameplates by using modeling clay.....	216

IMPORTANT NOTICE—It is the intention of this magazine to provide its readers with information regarding the latest developments in the mechanical arts. We take no responsibility as to whether the disclosures contained in our articles are covered by patents and advise readers to investigate this subject before making, using, or selling any of the products, machines, or processes described in order to avoid possible liability for patent infringements.

AUDELS REFRIGERATION & AIR CONDITIONING GUIDE.....\$4

New from Cover to Cover—1280 Pages, Fully Illus. Covering basic principles, servicing, operation & repair of household, commercial & industrial refrigeration & air conditioning. A gold mine of essential important facts for engineers, servicemen, users.

AUDELS CARPENTERS & BUILDERS GUIDES—4 Vols.\$6

A practical illustrated trade assistant on modern construction for carpenters, joiners, builders, mechanics and all woodworkers. 4 vols., 1600 pages, 3700 illustrations, flexible covers. Pocket size. Each volume sold separately \$1.50 a vol.

AUDELS AUTOMOBILE GUIDE.....\$4

A practical quick ready reference book for auto mechanics, service men, operators & owners. Explains theory, construction & servicing of modern motor cars, trucks, buses & auto type Diesel engines. 1700 pages, fully illustrated. 55 chapters. Indexed. A standard book for mechanics. New fluid drive covered.

AUDELS DIESEL ENGINE MANUAL..\$2

A practical, concise treatise with questions and answers on the theory, operation and maintenance of modern diesel engines including General Motors 2 cycle Diesel. 384 pages, fully illus., flexible binding, pocket size. All details plainly brought out, this book is of extreme value to engineers, operators & students.

AUDELS WIRING DIAGRAMS.....\$1

210 Pages. Illustrated. Gives practical facts on wiring of electrical apparatus. It shows clearly how to wire apparatus for practically all fields of electricity. Each diagram is complete & self-explanatory. Highly Endorsed Pocket Companion.

AUDELS PLUMBERS & STEAMFITTERS GUIDES—4 Vols.\$6

A Practical Trade Assistant & Ready Reference. Explains in plain language & by clear illustrations, diagrams, charts, graphs, pictures principles of modern plumbing practice including Marine Pipe Fitting and Air Conditioning. 4 Vols.—1670 Pages—3642 Diagrams. Pocket size. Each Vol. Sold Separately \$1.50 a Vol.

AUDELS SHEETMETAL WORKERS HANDY BOOK.....\$1

Practical inside information. Fundamentals of Sheet Metal Work. 388 pages, illustrated. 11 sections. Clearly written. Essential & important facts, figures, pointers in everyday language. Ref. Index.

AUDELS SHEETMETAL PATTERN LAYOUTS.....\$4

Developed by Experts for Sheet Metal Workers. Layout Men & Mechanics. A Practical Encyclopedia in 10 Sections, size 7 x 10 x 2—1125 Pages—350 Layouts—1600 Illustrations. 1001 Key Facts. Fully indexed for ready reference in answering your layout problems. Covers all phases of sheet metal work including Pattern Cutting, Pattern Development & Shop Procedure.

AUDELS ANSWERS ON BLUE PRINT READING.....\$2

For Mechanics & Builders. Covers all types of blue print reading including ship & airplane. 416 pages, fully illustrated.

AUDELS NEW MACHINIST & TOOLMAKERS HANDY BOOK.....\$4

Covers modern machine shop practice in all its branches. 5 practical books in 1. New from cover to cover. Tells how to set up & operate lathes, screw and milling machines, shapers, drill presses and all other machine tools. 1600 pages, fully illustrated, 5 x 6 1/2 x 2. Indexed. 5 sections. 1—Modern Machine Shop Practice. 2—Blue-Print Reading & How to Draw. 3—Calculations & Mathematics for Machinists. 4—Shop Physics. 5—How to Use the Slide Rule. 60 chapters. Easy to read and understand. A shop companion that answers your questions.

AUDELS MATHEMATICS & CALCULATIONS FOR MECHANICS \$2

Mathematics for home-study or reference. 700 pages, 550 illus. Practical mathematics from beginning. How to figure correctly. Easy, correct methods covering complete review. Illus. & Indexed.

AUDELS HANDY BOOK OF PRACTICAL ELECTRICITY.....\$4

For maintenance engineers, electricians & all electrical workers. 1440 Pages, 2600 Illus. Covers important electrical information in handy form—including Marine Wiring, Radio Principles, Welding. Indexed. A Key to a practical understanding of electricity.

AUDELS RADIOMANS GUIDE.....\$4

A key to the practical understanding of radio including Frequency Modulation, Television, etc., Aircraft & Marine Radio. For radio engineers, servicemen, amateurs. 914 Pages, 633 Illustrations & Diagrams. Photos. Review Questions & Answers, Reference Index. Authentic, clear, concise.

AUDELS ELECTRONIC DEVICES.....\$2

Tells What You Want to Know About Electric Eye. Easily Understood. Covers photo-electric cells & their applications. Amplifiers, illumination, frequencies, voltage, photocell, tubes, Ohm's Law, wiring diagrams, etc.

AUDELS WELDERS GUIDE.....\$1

A concise, practical text on operation & maintenance of all welding machines for all mechanics. Over 400 pages, illustrated. Covers all methods of electric and acetylene welding including airplane work.

AUDELS, Publishers, 49 W. 23 St., N. Y. 10

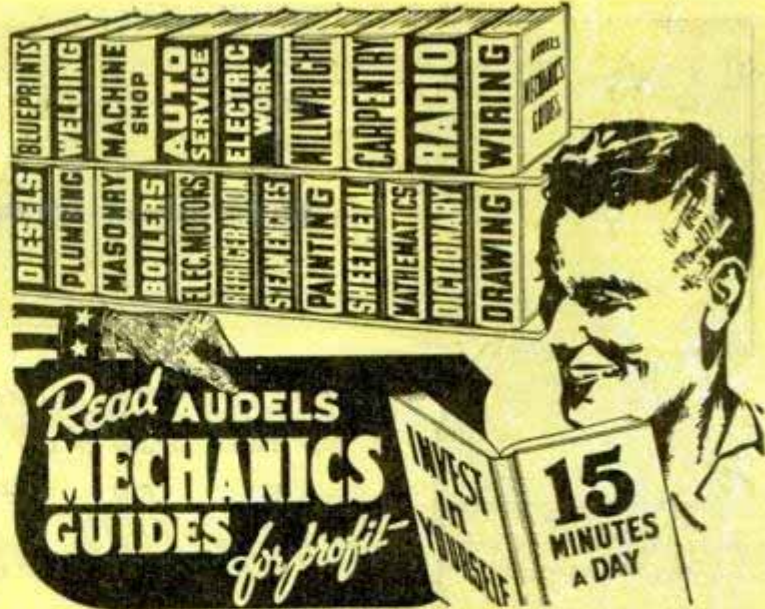

AN AUDEL GUIDE IS A GOOD FRIEND!

Step Up Your Own Skill with the Practical Facts and Figures of Your Trade. Save time and money with right methods, short cuts, labor saving ideas. CHECK NOW! You can look over any Audel Guide in your home. Start the Easy Payments if satisfied.

CUT HERE MAIL ORDER

THEO. AUDEL & CO., 49 W. 23 St., New York 10, N. Y.

Please mail me for 7 days' free examination the books marked (X) below. I agree to mail \$1 in 7 days on each book or set ordered, and to further mail \$1 a month on each book or set ordered until I have paid purchase price.

- If I am not satisfied with Guides I will return them.
- Audels **ELECTRIC MOTOR GUIDE** \$4.
 - Audels **OIL BURNER GUIDE** 1.
 - Audels **REFRIGERATION & Air Conditioning Guide** 4.
 - Audels **POWER PLANT ENGINEERS GUIDE** 4.
 - Audels **PUMPS, HYDRAULICS & AIR COMPRESSORS** 4.
 - Audels **WELDERS GUIDE** 1.
 - Audels **BLUE PRINT READING** 2.
 - Audels **SHEET METAL WORKERS Handy Book** 1.
 - Audels **SHEET METAL PATTERN LAYOUTS** 4.
 - Audels **AIRCRAFT WORKER** 1.
 - Audels **MATHEMATICS and CALCULATIONS** 2.
 - Audels **MACHINISTS & TOOLMAKERS Handy Book** 4.
 - Audels **MECHANICAL Dictionary** 4.
 - Audels **AUTOMOBILE GUIDE** 4.
 - Audels **DIESEL ENGINE MANUAL** 2.
 - Audels **MARINE ENGINEERS Handy Book** 4.
 - Audels **MECHANICAL DRAWING GUIDE** 1.
 - Rogers **MECHANICAL DRAWING and DESIGN** 2.
 - Audels **MILLWRIGHTS and Mechanics Guide** 4.
 - Audels **CARPENTERS and Builders Guides (4 vols.)** 6.
 - Audels **PLUMBERS and Steamfitters Guides (4 vols.)** 6.
 - Audels **MASONS and Builders Guides (4 vols.)** 6.
 - Master **PAINTER and DECORATOR** 2.
 - Audels **GARDENERS & GROWERS GUIDES (4 vols.)** 6.
 - Audels **ENGINEERS & FIREMANS EXAMINATIONS** 1.
 - Audels **ENGINEERS and Mechanics Guides** 12.
 - Audels **Nos. 1, 2, 3, 4, 5, 6, 7 and 8 complete** 12.
 - Audels **Answers on Practical ENGINEERING** 1.
 - Audels **ELECTRICIANS EXAMINATIONS** 1.
 - Audels **WIRING DIAGRAMS** 1.
 - Audels **Handy Book of PRACTICAL ELECTRICITY** 4.
 - Audels **ELECTRICAL POWER CALCULATIONS** 2.
 - Audels **ELECTRONIC DEVICES** 2.
 - Audels **ELECTRIC Dictionary** 2.
 - Audels **RADIOMANS GUIDE** 4.
 - Audels **NEW ELECTRIC LIBRARY at \$1.50 a Volume** 4.

Name.....
 Address.....
 Occupation.....
 Employed by.....



BE YOUR

*I will show you how to start
a Radio Service Business
Full Time or Spare Time without capital*

J. E. SMITH, President
National Radio Institute
The man who has directed the Home Study
Training of more men
for the Radio Industry
than any other man
in America.

VETERANS

You can get this training right in your own home under G. I. Bill. Mail coupon for full details.

I Trained These Men



MADE \$612, IN 12 MONTHS, SPARE TIME
"Soon after I finished my experimental kits lessons I tackled my first Radio Service job. The neighbors were very cooperative. I soon had all the repair jobs I could handle in spare time. I have made \$612 in the past 12 months in spare time." — J. W. CLARK, Wilmington, N. C.



KNEW NOTHING ABOUT RADIO

"I knew nothing about Radio when I enrolled. At present I am doing spare time work. I have more than paid for my Course and I have about \$200 worth of equipment which has paid for itself." — RAYMOND HOLTGAMP, Vandalia, Ill.



**MY COURSE INCLUDES
TELEVISION
ELECTRONICS
FREQUENCY MODULATION**

SAMPLE LESSON FREE SEE OPPOSITE PAGE

Do you want a good-pay job in Radio—or your own money-making Radio Shop? Mail Coupon for a FREE Sample Lesson and my FREE 64-page book, "How to be a Success in RADIO—Television, Electronics." See how N.R.I. gives you practical Radio experience at home—building, testing, repairing Radios with BIG KITS OF PARTS I send!

Many Beginners Soon Make Good Extra Money in Spare Time While Learning

The day you enroll I start sending EXTRA MONEY manuals. You LEARN Radio principles from my easy-to-grasp, illustrated lessons — PRACTICE what you learn with parts I send — USE your knowledge to make EXTRA money fixing neighbors' Radios in spare time while still learning! From here it's a short step to your own full-time Radio Shop or a good Radio job!

Future for Trained Men is Bright in Radio, Television, Electronics

It's probably easier to get started in Radio now than ever before because the Radio Repair business is booming. Trained Radio Technicians also find profitable opportunities in Police, Aviation, Marine Radio, Broadcasting, Radio Manufacturing, Public Address work. Think of even greater opportunities as Television and Electronics become available to the public!

Find Out What N.R.I. Can Do for You

Mail Coupon for Sample Lesson and my 64-page book. Read the details about my Course. Read letters from men I trained, telling what they are doing, earning. See how quickly, easily you can get started. No obligation! Just MAIL COUPON NOW in an envelope or paste it on a penny postal. J. E. SMITH, President, Dept. 7NP, National Radio Institute, Pioneer Home Study Radio School, Washington 9, D. C.

Our 33rd Year of Training Men for Success in Radio

A TESTED WAY

OWN BOSS

LEARN RADIO BY PRACTICING IN SPARE TIME
with Big Kits of Radio Parts I Send You!

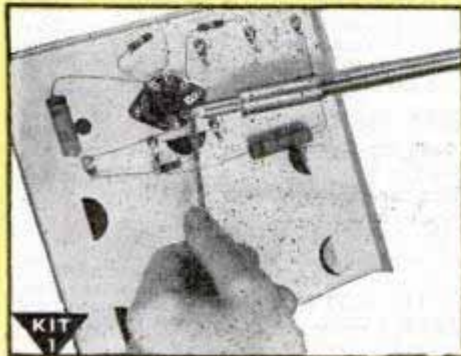

KIT 1

I send you Soldering Equipment and Radio Parts; show you how to do Radio soldering; how to mount and connect Radio parts; give you practical experience.

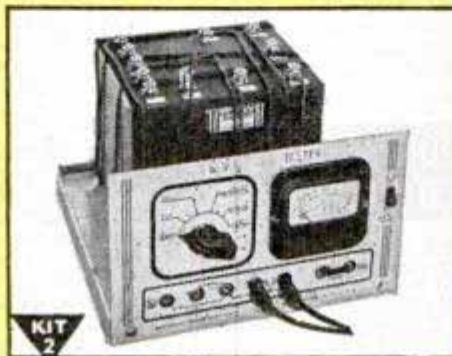

KIT 2

Early in my Course I show you how to build this N.R.I. Tester with parts I send. It soon helps you fix neighborhood Radios and earn EXTRA money in spare time.

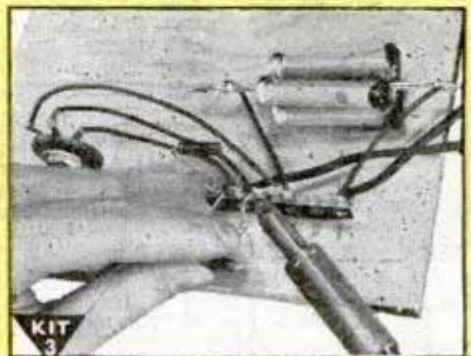

KIT 3

You get parts to build Radio Circuits; then test them; see how they work; learn how to design special circuits; how to locate and repair circuit defects.

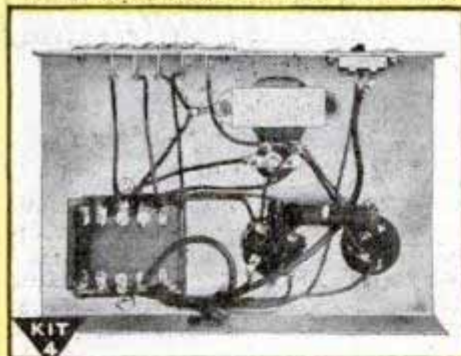

KIT 4

You get parts to build this Vacuum Tube Power Pack; make changes which give you experience with packs of many kinds; learn to correct power pack troubles.

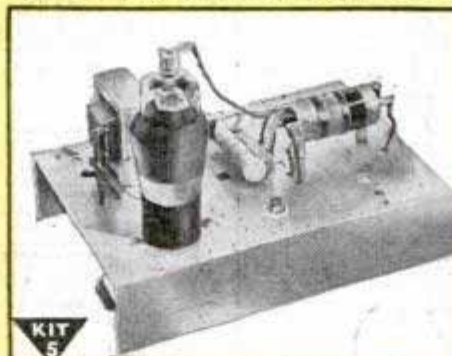

KIT 5

Building this A. M. Signal Generator gives you more valuable experience. It provides amplitude-modulated signals for many tests and experiments.



KIT 6

You build this Superheterodyne Receiver which brings in local and distant stations—and gives you more experience to help you win success in Radio.

SAMPLE LESSON

FREE

I will send you a FREE Lesson, "Getting Acquainted with Receiver Servicing," to show you how practical it is to train for Radio at home in spare time. It's a valuable lesson. Study it—keep it—use it—without obligation! Tells how Superheterodyne Circuits work, gives hints on Receiver Servicing, Locating Defects, Repair of Loudspeaker, I.F. Transformer, Gang Tuning, Condenser, etc. Thirty-one illustrations.



MAIL COUPON FOR FREE LESSON AND 64-PAGE BOOK

Good for Both FREE

MR. J. E. SMITH, President, Dept. 7NP
National Radio Institute, Washington 9, D. C.
Mail me FREE, without obligation, Sample Lesson and 64-page book about how to win success in Radio—Television, Electronics. (No salesman will call. Please write plainly.)

Age _____

Name _____

Address _____

City _____ Zone _____ State _____

Approved for Training under GI Bill



TO GOOD PAY

NEW! FOR BEGINNERS Learn ELECTRIC MOTOR REPAIR!



Easily, Quickly, at home for only \$5

Every day, more and more electric motors are being used BOTH in industry and in home appliances. The motor repair expert is a valuable man in this Electrical Age! **ELECTRIC MOTOR REPAIR**, the new big book for only \$5, teaches all about this fascinating work — quickly and easily. Explains every detail of motor trouble diagnosing, repair and rewinding.

TRAIN FOR GOOD PAY IN AN UNCROWDED FIELD!

Covers alternating — and direct-current motors, synchronous motors and generators and BOTH mechanical and electrical motor control systems. Quick-reference guides at end of every chapter show exactly how to handle specific jobs. Invaluable for either beginners who want to learn HOW—or for actual bench use in busy repair shops. There's big money in the work. The field is not overcrowded.

580 pages
900 illustrations
and diagrams

SHOWS YOU HOW EVERY STEP OF THE WAY!

Based on what you can learn at home from this big book, you can train for prompt, profitable service on practically any motor in use. Every step of the work is demonstrated VISUALLY by more than 900 easily-understood diagrams. These are indexed for quick on-the-job reference. The unique Duo-Spiral Binding divides book into 2 sections permitting BOTH text and related illustration to be seen AT THE SAME TIME. Lies open flat on bench while you work!

Unique Duo-Spiral binding



FREE!

Check coupon for free literature on famous **GHIRARDI RADIO-ELECTRONIC Training Books**.

"BORROW" IT FOR 5 DAYS

Send coupon now. Practice from **ELECTRIC MOTOR REPAIR** for 5 full days. If not more than satisfied with the book, return it to us. Every cent of your money will be cheerfully refunded — and no questions asked. What could be fairer?

5-DAY MONEY-BACK GUARANTEE

Dept. PM-127, Murray Hill Books, Inc.
232 Madison Ave., New York 16, N. Y.

Enclosed find \$5 (\$5.50 foreign) for my copy of the big **ELECTRIC MOTOR REPAIR** book; or send C.O.D. (in U.S.A. only) for this amount plus postage. In either event, if unsatisfactory for any reason, I may return book in 5 days and have my money refunded.

CHECK HERE for free literature on Ghirardi **RADIO-ELECTRONIC** books.

Name _____

Address _____

City & Dist. No. _____

State _____

Make MORE MONEY

Learn **Screen Process Printing**
I SHOW YOU HOW
This Easy Way at Home!

1 HOW TO START YOUR OWN BUSINESS
—My training shows you how you may start your own business and cash in on the tremendous field open to you in Screen Process—with an investment of a few dollars.

2 HOW TO GET A GOOD PAY POSITION
—Many of my students earn extra money in spare time at home, while learning. My special "Earn While You Learn" lessons, with the Kit of Supplies I give you—show you how.

3 HOW TO EARN EXTRA MONEY IN SPARE TIME—If you are in the rut of a low pay, uninteresting job, Screen Process work offers you the opportunity to earn good wages and the better things of life for you and your family.

Send for FREE BOOK

My big free illustrated book, "Opportunities in Screen Process," explains the big demand for Screen Process printed Signs and Displays, Toys and Games, Textiles, Decal Transfers, Plastics and Glass, Pictures and Greeting Cards, Advertising Agencies and other businesses. No art or previous experience required. You Learn While Doing with the 2 **BIG KITS OF SUPPLIES** I give you. Write **TODAY**. State if veteran.

No machinery. Print thru stencil mounted on silk stretched frame.

Make own stencils. Trace lines on stencil film. No art experience necessary.

You can print signs, displays, toys, etc., with this simple equipment.

CALIFORNIA SCHOOL OF SCREEN PROCESS
3740 OVERLAND BLVD., DEPT. PM127, LOS ANGELES 34, CALIF.

ANALYZE Handwriting

Uncrowded, fascinating field. Gratifying earnings reported by graduates in Employment, Credit, Social Service, Police and Entertainment fields. Others have developed profitable private practice, full or spare time, as Personal Problem and Vocational Counselors. Send for 3000 word **TEST LESSON** and Grapho Analyst **FREE**.

A.I.G.A. Inc.

Wilhoit Bldg., Dept. 120 Springfield, Mo.



NEW!

HOBBY HANDBOOK



A GOLD MINE of INFORMATION on NEWEST EQUIPMENT, TOOLS for HOME CRAFTSMEN & MECHANICS

If you work in metals, wood, plastics or glass you need this **Giant NEW Book** of equipment, tools, parts and materials... including dozens of hard-to-get items you can't find in stores. Many things you must have for your home hobby or shop.

A WAREHOUSE OF THINGS YOU NEED AND WANT

Over 100 items including Spray Guns; Power Bench Tools; Lathe; Drill Press; Drills; Grinders; Tank and Brush Electroplaters; Telephone System; Tool Chest; Model Tools; "Pin Money" Makers for your sparetime fun and profit! **SEND NAME and ADDRESS and 10c TODAY!** Price of Handbook refunded on first order.

HELPS YOU GET MORE PLEASURE, MORE PROFIT in

- HOME CRAFTS
- METAL CRAFTS
- WOODWORKING
- PLASTIC CRAFTS
- HOME REPAIRS

WARNER ELECTRIC CO., Dept. P-16
1512 JARVIS AVENUE, CHICAGO 26, ILLINOIS



INVENTORS



Learn how to protect your invention. The U. S. Patent Laws provide that any new and useful art, machine, article of manufacture, or composition of matter, or any new and useful improvement thereof, may be patented if the act of invention is involved. Therefore, every inventor with a valuable invention should take advantage of the Patent Laws and proceed for patent protection in order to safeguard his rights.

A patent gives the inventor the exclusive right to prevent others from making, using, or selling the invention claimed in the patent for a period of seventeen years.

The Patent Laws were enacted for the benefit of the inventor to give him protection for the features of his invention which are patentable. These features must be properly and concisely set forth and claimed in a formal application for patent, in order to comply with the requirements of the U. S. Patent Office. For that reason, the Patent Office advises the inventor, unless he is familiar with such matters, to engage a competent registered patent attorney or agent to represent him. We maintain a staff of registered patent attorneys ready to serve you in the handling of your patent matters.

A specially prepared booklet entitled "Patent Guide for the Inventor", containing detailed information with respect to patent protection and procedure, together with a "Record of Invention" form will be promptly forwarded to you without obligation upon request.

Patents
Trademarks
Copyrights

Registered Patent Attorneys

**CLARENCE A. O'BRIEN
& HARVEY B. JACOBSON**

71-M District National Building + Washington 5, D. C.

CLARENCE A. O'BRIEN & HARVEY B. JACOBSON
Registered Patent Attorneys
71-M District National Bldg., Washington 5, D. C.

Please send me copy of "Patent Guide for the Inventor" and also "Record of Invention" form. This request does not obligate me.

Name _____

Address _____

City _____ State _____

(Please write or print plainly.)



If you want to
LEARN RADIO
 I offer you the finest,
 most practical training
AT LOWEST COST!

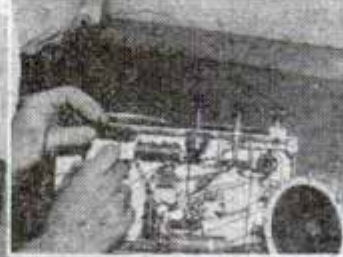
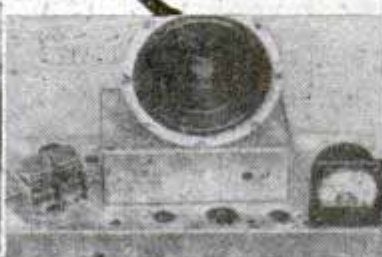

**I TRAIN YOUR MIND BY PUTTING
 YOUR HANDS TO WORK!**
*You Get 8 Big Kits of Radio Parts and
 Equipment, Including a Two-band 6
 Tube Super Receiver! 16-Range Meter
 for Testing!*

**INVESTIGATE
 SPRAYBERRY TRAINING
 FOR YOUR OWN GOOD!**
MAIL COUPON FOR 2 FREE BOOKS!



VETERANS
 Approved for G. I. Training Under
 Public Law 346

SPRAYBERRY ACADEMY OF RADIO
 F. L. Sprayberry, President
 Room 10127, Pueblo, Colorado

Please rush my FREE copies of "How to MAKE MONEY in RADIO, ELECTRONICS and TELEVISION" and "How to READ RADIO DIAGRAMS and SYMBOLS."

Check here if a Veteran.

Name _____ Age _____

Address _____

City _____ State _____

(Mail in envelope or paste on penny postcard)

INVENTORS

Patent Laws Encourage The Development of Inventions

The Rules of Practice of the U. S. Patent Office advises— unless an inventor is familiar with such matters — that he employ a competent registered attorney or registered agent, as the value of patents depends largely upon the skillful preparation of the specifications and claims.

The firm of McMorro, Berman and Davidson is registered to practice before the U. S. Patent Office. Additionally, it maintains a staff of attorneys able to readily understand inventors' disclosures, to advise concerning patentability, and to prepare appropriate specifications and claims for filing with the Patent Office.

If an inventor believes he has an invention, a search of the most pertinent prior U. S. patents should be made and a report obtained relative to its patentability. Where such report indicates that the invention appears patentable, in order to secure protection, diligence should be exercised in making application for a patent.

McMORROW, BERMAN & DAVIDSON

Registered Patent Attorneys

PATENTS — TRADE-MARKS — COPYRIGHTS

135-C VICTOR BUILDING, WASHINGTON 1, D. C.

McMORROW, BERMAN & DAVIDSON

Registered Patent Attorneys

135-C Victor Building, Washington 1, D. C.

Send me further particulars as to patent protection and procedure and "Invention Record" form at once. I understand that this request does not obligate me.

Name _____

Address _____

City _____ State _____

(WRITE OR PRINT NAME CLEARLY)

Lend Me 15 Minutes A Day



..and I'll prove I can make you a NEW MAN



I'M "trading-in" old bodies for new! I'm taking men who know that the condition of their arms, shoulders, chests and legs—their strength, "wind," and endurance—is not 100%. And I'm making NEW MEN of them!

If you can simply raise your arm and flex it, I can add SOLID MUSCLE to your biceps—yes, on each arm—in double-quick time! I can broaden your shoulders, strengthen your back, develop your whole muscular system INSIDE and OUTSIDE!

What Only 15 Minutes a Day Can Do

I can add inches to your chest, give you a vise-like grip, make those legs of yours lithe and powerful. I can shoot new strength into your old backbone, exercise those inner organs, help you cram your body so full of pep, vigor and red-blooded vitality that you won't feel there's even "standing room" left for weakness and that lazy feeling! Before I get through with you I'll have your whole frame "measured" to a nice, new, beautiful suit of muscle!

I Was a 97-lb. Weakling

All the world knows I was ONCE a skinny, scrawny 97-pound weakling. And NOW it knows that I won the title, "The World's Most Perfectly Developed Man." Against all comers! How did I do it? How do I work miracles in the bodies of other men in only 15 minutes a day? The answer is "Dynamic Tension," the amazing method I discovered and which changed me from a 97-pound weakling into the champion you see here!

FREE THIS FAMOUS BOOK "EVERLASTING HEALTH AND STRENGTH"

Almost two million men have sent for and read my book, "Everlasting Health and Strength." It tells you exactly what "Dynamic Tension" can do. And it's packed with pictures that SHOW you what it does. Results it has produced for other men. RESULTS I want to prove it can get for YOU!

Learn how you can actually become a NEW MAN, right in the privacy of your own home and in only 15 minutes a day! Mail this coupon NOW! CHARLES ATLAS, Dept. 812, 115 East 23rd St., New York 10, N. Y.

Charles Atlas

Actual photo of the man who holds the title, "The World's Most Perfectly Developed Man."



CHARLES ATLAS, Dept. 812, 115 East 23rd St., New York 10, N. Y.

I want the proof that your system of "Dynamic Tension" will help make a New Man of me—give me a healthy, husky body and big muscular development. Send me your free book, "Everlasting Health and Strength."

Name _____ Age _____
(Please Print or Write Plainly)

Address _____

City _____ State _____

HOW to BREAK and TRAIN HORSES

SEND FOR THIS FREE!



Make money with horses. Every farmer, every lover of horseflesh should have a copy of this booklet. If you want to know how to break, train and make money with horses, write today for full information FREE, together with my special offer of a course in Animal Breeding. If you are interested in Galting and Riding the saddle horse check here. Do it today—now. You'll never regret it.

BEERY SCHOOL OF HORSEMANSHIP
Dept. 11012 Pleasant Hill, Ohio

LEARN WATCH REPAIRING



AT HOME. By our modern and original system of instruction you can learn every part of the **WATCH REPAIRING TRADE AT HOME.** Prepare yourself for a well-paying position or start in business after completing our course of instruction. Good watch repairers are in demand and generally earn very good salaries. For particulars apply to the **Wisconsin School of Watch Repairing** 759 North Milwaukee St., Milwaukee 2, Wis.

LAW...

STUDY AT HOME Legally trained men win higher positions and bigger success in business and public life. Greater opportunities now than ever before.

More Ability: More Prestige: More Money We guide you step by step. You can train at home during spare time. Degree of LL.B. We furnish all text material, including 14-volume Law Library. Low cost, easy terms. Get our valuable 48-page "Law Training for Leadership" and "Evidence" books FREE. Send NOW. **LASALLE EXTENSION UNIVERSITY, 417 South Dearborn Street** A Correspondence Institution Dept. 1264-L, Chicago 5, Ill.



BUILDING HUMAN STATURE

"I grew 6 inches during a year I followed instructions given in "BUILDING HUMAN STATURE," says the younger man at left. "Now I am a head taller than my father."

If you wonder why you are short send for FREE outline of this remarkable book loaded with practical information.

CARILLON BOOKS
Dept. 165, 3439 Michigan Ave., Chicago 16, Ill.

LEARN MONEY-MAKING CARTOONING

IN SPARE TIME — by Easy Picture Chart Method
Same Simplified Method that has helped train creators of "Terry & Pirates," "Freckles," "Out Our Way," "Winnie Winkle," "Regular Fellers," "Strange As It Seems," "The Neighbors," and many others. Earn while learning. Send 10c for Picture Chart (to test your ability), and full details. (State age.)



THE LONDON SCHOOL, 4712 Cleve. Transit Bldg., Cleveland, O.

RUPTURED?

Get Relief This Proven Way

Why try to worry along with trusses that gouge your flesh—press heavily on hips and spine—enlarge opening—fail to hold rupture? You need the Cluthe. No leg-straps or cutting belts. Automatic adjustable pad holds at real opening—follows every body movement with instant increased support in case of strain. Cannot slip whether at work or play. Light. Waterproof. Can be worn in bath. Send for amazing FREE book, "Advice To Ruptured," and details of liberal truthful 60-day trial offer. Also endorsements from grateful users in your neighborhood. Write: **CLUTHE SONS, Dept. 31, Bloomfield, New Jersey**

HOW TO GET AHEAD AT 40



What if you are 40? Your chances of reaching success are as good as they were twenty years ago!

Look at it this way. You're twenty years wiser. You have acquired valuable experience. You're in a position to handle a lot more responsibility. A "second wind" at this point can put you well ahead of the field.

By now you must be well aware of the value of *training*. You have seen it pay off, time and again. I.C.S. specializes in adult education —has the training you need.

Any of the famous I.C.S. business or technical courses costs just a few dollars monthly. The rewards are unlimited. Mark and mail the coupon today for full information.

INTERNATIONAL CORRESPONDENCE SCHOOLS



BOX 5618-K, SCRANTON 9, PENNA.

Without cost or obligation, please send me full particulars about the course BEFORE which I have marked X:

- | | | | |
|--|--|---|--|
| <p>Business and Academic Courses</p> <ul style="list-style-type: none"> <input type="checkbox"/> Accounting <input type="checkbox"/> Arithmetic <input type="checkbox"/> Business Administration <input type="checkbox"/> Business Correspondence <input type="checkbox"/> Certified Public Accounting <input type="checkbox"/> Commercial <input type="checkbox"/> Commercial Art <input type="checkbox"/> Cost Accounting <input type="checkbox"/> Federal Tax <input type="checkbox"/> First Year College <input type="checkbox"/> Foremanship <input type="checkbox"/> Good English <input type="checkbox"/> Higher Mathematics <input type="checkbox"/> Motor Traffic <input type="checkbox"/> Salesmanship <input type="checkbox"/> Sign Lettering <input type="checkbox"/> Spanish <input type="checkbox"/> Traffic Management <p>Air Conditioning and Plumbing Courses</p> <ul style="list-style-type: none"> <input type="checkbox"/> Air Conditioning <input type="checkbox"/> Heating <input type="checkbox"/> Refrigeration | <p>Chemistry Courses</p> <ul style="list-style-type: none"> <input type="checkbox"/> Chemical Engineering <input type="checkbox"/> Chemistry, Analytical <input type="checkbox"/> Chemistry, Industrial <input type="checkbox"/> Chemistry, Mfg. Iron & Steel <input type="checkbox"/> Petroleum Refining <input type="checkbox"/> Pulp and Paper Making <input type="checkbox"/> Civil Engineering, Architectural and Mining Courses <input type="checkbox"/> Architecture <input type="checkbox"/> Architectural Drafting <input type="checkbox"/> Building Estimating <input type="checkbox"/> Civil Engineering <input type="checkbox"/> Contracting and Building <input type="checkbox"/> Highway Engineering <input type="checkbox"/> Lumber Dealer <input type="checkbox"/> Reading Structural Blueprints <input type="checkbox"/> Sanitary Engineering <input type="checkbox"/> Structural Drafting <input type="checkbox"/> Structural Engineering <input type="checkbox"/> Surveying and Mapping <input type="checkbox"/> Communications Courses <input type="checkbox"/> Electronics <input type="checkbox"/> Practical Telephony <input type="checkbox"/> Radio, General <input type="checkbox"/> Radio Operating | <p><input type="checkbox"/> Radio Servicing</p> <p><input type="checkbox"/> Telegraph Engineering</p> <p>Electrical Courses</p> <ul style="list-style-type: none"> <input type="checkbox"/> Electrical Drafting <input type="checkbox"/> Electrical Engineering <input type="checkbox"/> Electric Light and Power <input type="checkbox"/> Lighting Technician <input type="checkbox"/> Practical Electrician <input type="checkbox"/> Power House Electric <input type="checkbox"/> Ship Electrician <p>Internal Combustion Engines Courses</p> <ul style="list-style-type: none"> <input type="checkbox"/> Auto Technician <input type="checkbox"/> Diesel-Electric <input type="checkbox"/> Diesel Engines <p>Mechanical Courses</p> <ul style="list-style-type: none"> <input type="checkbox"/> Aeronautical Engineer's, Jr. <input type="checkbox"/> Aircraft Drafting <input type="checkbox"/> Flight Engineer <input type="checkbox"/> Forging <input type="checkbox"/> Heat Treatment of Metals <input type="checkbox"/> Industrial Engineering <input type="checkbox"/> Industrial Metallurgy <input type="checkbox"/> Machine Shop <input type="checkbox"/> Machine Shop Inspection | <p><input type="checkbox"/> Mechanical Drafting</p> <p><input type="checkbox"/> Mechanical Engineering</p> <p><input type="checkbox"/> Mold-Loft Work</p> <p><input type="checkbox"/> Patternmaking—Wood, Metal</p> <p><input type="checkbox"/> Reading Shop Blueprints</p> <p><input type="checkbox"/> Sheet-Metal Drafting</p> <p><input type="checkbox"/> Sheet-Metal Worker</p> <p><input type="checkbox"/> Ship Drafting</p> <p><input type="checkbox"/> Tool Designing</p> <p><input type="checkbox"/> Welding—Gas and Electric</p> <p>Railroad Courses</p> <ul style="list-style-type: none"> <input type="checkbox"/> Air Brake <input type="checkbox"/> Diesel Locomotive <input type="checkbox"/> Locomotive Engineer <input type="checkbox"/> Locomotive Fireman <input type="checkbox"/> Railroad Section Foreman <p>Steam Engineering Courses</p> <ul style="list-style-type: none"> <input type="checkbox"/> Boilermaking <input type="checkbox"/> Combustion Engineering <input type="checkbox"/> Engine Running <input type="checkbox"/> Marine Engineering <input type="checkbox"/> Steam Electric <p>Textile Courses</p> <ul style="list-style-type: none"> <input type="checkbox"/> Cotton Manufacturing <input type="checkbox"/> Rayon Weaving <input type="checkbox"/> Woolen Manufacturing |
|--|--|---|--|

Name _____ Home Address _____
 City _____ State _____
 Age _____ Present Position _____ Working Hours _____ A.M. to _____ P.M.

Special tuition rates to members of the Armed Forces. Special discount to World War II Veterans.
 Canadian residents send coupon to International Correspondence Schools Canadian, Ltd., Montreal, Canada.

ADVICE for the INVENTOR

The United States Patent Office advises the inventor, unless he is familiar with such matters, to employ a competent, registered patent attorney or agent as the value of patents depends largely upon the skillful preparation of the specification and claims.

PRELIMINARY STEPS *toward* PATENT PROTECTION

The Evidence of Invention form mentioned below is offered as a convenience to the inventor in making his disclosure of invention. The inventor should date and sign his disclosure and have it witnessed by two or more persons who are capable of understanding his invention. The disclosure should then be mailed to the registered patent attorney or agent whom he selects to assist him. The disclosure should be accom-

panied by a letter authorizing the patent attorney or agent to conduct a preliminary search at the U. S. Patent Office among previously granted U. S. Patents for similar types of invention. The patent attorney or agent then prepares a report of the probable patentability of the invention and recommends the further course the inventor should take, provided the report indicates possible patentability.

Victor J. Evans & Company has a staff of experienced registered patent attorneys available to assist inventors in the preparation and prosecution of their cases before the Patent Office.

The **COUPON BELOW** is suggested as a convenience to the inventor in starting action on his invention.

**VICTOR J.
EVANS & Co.**

Merlin M. Evans
REGISTERED PATENT ATTORNEY

230P Merlin Building, Washington 6, D. C.

PLEASE SEND DETAILED PATENT INFORMATION TOGETHER WITH CONVENIENT "EVIDENCE OF INVENTION" FORM.

Name.....

Address.....

City and State.....

Learn RADIO

in a Few Weeks



In the GREAT SHOPS of COYNE

NOT A "HOME-STUDY" COURSE!



B. W. Cooke

Men, here's the quick, easy way to learn Radio—with practical training in the Great Shops of COYNE. All training given on full-size equipment under friendly, helpful instructors, plus necessary theory. We do not teach by mail. At Coyne you learn Radio Set-building and Trouble-shooting, Public Address and Sound Systems, Television, Electronics, how to start your own shop. Prepare NOW for better jobs, bigger pay. Mail coupon today!

ATTENTION, NON-VETERANS!

Don't let lack of money hold you back. Our Student Finance Plan has helped thousands. Pay most of tuition after you graduate. We also help you get part-time work while here, if you wish. Lifetime Job Service FREE to Coyne-trained men.

INCLUDED!

Added training in Electric Refrigeration Now Included with Radio Course.



VETERANS!

COYNE is authorized to train men who qualify under the G. F. Bill. Coupon brings special G. I. Bulletin.

SEND NOW FOR BIG FREE BOOK

Dozens of actual photos taken in the Great Shops of Coyne—also vital facts about YOUR opportunities in Radio-Electronics and Television. Coyne gives you ALL-AROUND Training, to prepare for many branches of the vast Radio field. Send for this book today. No obligation, and no salesman will call on you. Rush the coupon—new class starting soon!



Founded 1899

B. W. COOKE, President, Radio Division

COYNE ELECTRICAL SCHOOL
500 S. PAULINA ST. Dept. 97-3H CHICAGO 12

FREE BOOK COUPON

B. W. COOKE, President
COYNE ELECTRICAL SCHOOL, Radio Division
500 S. Paulina St., Dept. 97-3H, Chicago 12, Ill.

I want to build a REAL FUTURE for myself. Send your big FREE BOOK on RADIO, also details of Student Finance Plan and Lifetime Employment Service. This does not obligate me in any way, and no salesman will call.

NAME.....
ADDRESS.....
CITY.....STATE.....

...MAIL THIS TODAY!

OIL BURNER

INFORMATION IN A HANDY FORM

JUST OUT!

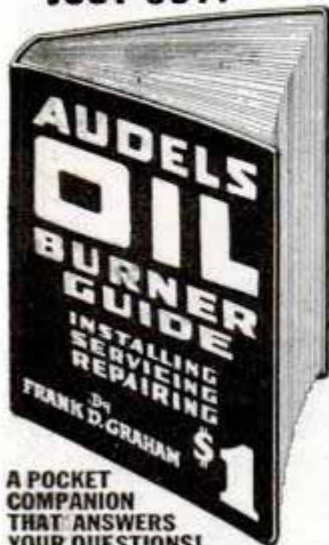

A POCKET COMPANION THAT ANSWERS YOUR QUESTIONS!

AUDELS OIL BURNER GUIDE

— A new practical, concise treatise, 384 pages—31 Chapters—321 Diagrams and Illustrations—covering Domestic and Industrial Oil Burners.

New from Cover to Cover, for mechanics interested in Oil Burners. Gives practical inside working knowledge of theory, construction, installation, operation, testing, servicing and repair of all types of oil burners. Includes electrical hook-ups and wiring diagrams of automatic control systems.

PRICE \$1 POSTPAID

Get this information for yourself. Mail coupon today. No obligation unless satisfied.

ASK TO SEE IT

AUDELS Publishers, 49 W. 23rd St., New York 10, N.Y.

Please mail AUDELS OIL BURNER GUIDE (Price \$1). If satisfactory, I will remit \$1 on its safe arrival, otherwise I will return the book.

Name _____

Address _____

Occupation _____

Employed by _____ PM

AVIATION Career

MAXIMUM TRAINING IN MINIMUM TIME

CAL-AERO TECH TRAINING will add dollars to your pay check all the rest of your life. Specializing in AERONAUTICAL ENGINEERING and MASTER AVIATION MECHANICS since 1929, Cal-Aero Tech training is carefully designed for just one thing—TO MAKE MORE MONEY FOR YOU. An alumni of over 6000 successful graduates proves our career training is unsurpassed.

VETERANS —Write us about Aviation Training, as provided under "G.I. Bill of Rights."



CAL-AERO TECHNICAL INSTITUTE
 MAJOR C. C. MOSELEY PRES. SINCE 1929
 FORMERLY CURTISS-WRIGHT TECHNICAL INSTITUTE
 GRAND CENTRAL AIR TERMINAL
 GLENDALE 1, CALIFORNIA
 LOS ANGELES COUNTY

MAIL THIS COUPON TODAY!

Cal-Aero Technical Institute, Grand Central Airport, Glendale 1, California
 Please send full information on Aviation Training FREE—without obligation. Dept.: PM-12

Name _____ Birth Date _____

Street _____

City _____ State _____

BE YOUR OWN BOSS! LEARN ELECTROPLATING

HIGHLY PAID FIELD



UNCROWDED, interesting business. Part or full time. Common school education sufficient. Chromium, Nickel, Silver, Gold, etc., money making trade secrets. Learn at home in spare time. Send postcard today for FREE electroplating idea booklet.

PLATER HYDE

432 F Street Room 520
 San Diego 1, California

"How to Make Money With Simple Cartoons"

A book everyone who likes to draw should have. It is free; no obligations. Simply address
 CARTOONISTS' EXCHANGE

Dept. 912D Pleasant Hill, Ohio

The American Institute of Specialized Watch Repair
 270-276 East Building GRAND RAPIDS 6, MICHIGAN
 A Fully Accredited School

Write for Free Circular

You can learn this highly fascinating and profitable trade through this Institute, either at home by correspondence... or at the resident school.
 Earn While You Learn



Learn WATCH REPAIRING

WANTED

DISTRICT PURCHASING AGENTS

No experience or money required. Exceptional opportunity for those who want to establish themselves in a steady, year 'round, well paying business.

For details: Write

PURCHASING MANAGER, DEPT. C

2719 LAWRENCE AVE. CHICAGO 25, ILL.

LEARN ACCOUNTING SALESMANSHIP SECRETARIAL WORK

Assure Your Future Now!

Hill's, one of America's outstanding Business Schools, offers you the opportunity to enter one of the three fields acknowledged to hold substantial earnings and a secure future. Our FREE book, "Through Hill's to Success," tells how and where the best positions are found and how you can qualify for them by study at home or in our resident school. We have thousands of successful graduates and maintain nationwide employment service. G. I. Approved.

USE THIS HANDY COUPON

HILL'S EXTENSION SCHOOL AND BUSINESS UNIVERSITY
 619 W. Main St., Oklahoma City 2, Okla.
 Please send me your Free book, "Through Hill's to Success."

NAME _____
 ADDRESS _____
 CITY _____ STATE _____

WHICH OF THESE *Opportunities* INTERESTS *You* MOST?

Accounting
Air Conditioning
Architecture & Building
Automotive Engineering
Aviation—Practical
Aviation Drafting & Design
Better Foremanship
Bookkeeping
Business Management

Contracting
Diesel Engineering
Drafting & Design
Electrical Engineering
Electricity—Practical
Electronics, Industrial
High School Courses
Machine Shop Operations
Mechanical Engineering

Plastics Engineering
Plumbing—Practical
Private Secretary
Radio Operating & Servicing
Railway Training
Refrigeration
Sheet Metal Pattern Drafting
Shop Management
Tool Making

THINK! LOOK FORWARD!

Business is making big, new plans

Men and Women are preparing for the future

WHAT ARE YOU DOING ABOUT YOUR TOMORROWS?

● *Today*, choose the job you want—and prepare for it. Or if you are already engaged in the work you like best, start training *now* for quicker promotion. Acquire the knowledge that will help you to get ahead faster, make more money and have greater security.

Invest part of your spare time in more rapid progress. Start training now, in spare time in your own home. Be ready to grasp your opportunity and step out ahead of those who lack the ability you have attained.

American School, founded in 1897 as an educational institution *not for profit*, can

help you to reach your goal just as it has helped others during the past fifty years. Give serious thought to the list above. Pick one or more subjects that interest you. Then check the coupon at right, add your name and address and mail it at once. The school will send you details on its training plan and outline of study prepared by specialists. There is no charge, no obligation, so send the coupon immediately.

PRACTICAL, EFFECTIVE HOME • STUDY TRAINING SINCE 1897

Take This First Easy Step

CHECK, CLIP AND MAIL COUPON NOW

AMERICAN SCHOOL, Dept. G945, Drexel at 58th, Chicago 37, Ill.

Without obligation, Please send FREE and postpaid, bulletin and details of the Subject checked.

- | | | |
|--|--|--|
| <input type="checkbox"/> PLASTICS ENG'R | <input type="checkbox"/> Accounting | <input type="checkbox"/> Drafting and Design for Men and Women |
| <input type="checkbox"/> Refrigeration | <input type="checkbox"/> Electrical Engr. | <input type="checkbox"/> Radio |
| <input type="checkbox"/> Architecture and Building | <input type="checkbox"/> Electricity-Pract. | <input type="checkbox"/> High School |
| <input type="checkbox"/> Contracting | <input type="checkbox"/> Electronics, Industr. | <input type="checkbox"/> Air Conditioning |
| <input type="checkbox"/> Practical Plumbing | <input type="checkbox"/> Bookkeeping | <input type="checkbox"/> Mechanical Eng. |
| <input type="checkbox"/> Automotive Engineering | <input type="checkbox"/> Private Secretary | <input type="checkbox"/> Shop Management |
| <input type="checkbox"/> Aviation Drafting | <input type="checkbox"/> Diesel Engineering | <input type="checkbox"/> Tool Making |
| <input type="checkbox"/> Aviation | <input type="checkbox"/> Sheet Metal | <input type="checkbox"/> Better Foremanship |
| <input type="checkbox"/> Business Mgmt | <input type="checkbox"/> Pattern Drafting | <input type="checkbox"/> Machine Shop Operations |
| <input type="checkbox"/> Railway Training | | |

Name..... Occupation.....

Address..... Age.....

City..... State.....

AMERICAN SCHOOL

Dept. G945, Drexel at 58th Street, Chicago 37

The Importance of Choosing a Long Established Technical Institute

Of utmost importance to anyone considering entering a technical institute, is that organization's history — also its facilities, faculty, and record of successful alumni. The Milwaukee School of Engineering, for 44 years has been training men for specific and substantial careers in industry. More than 35,000 former students now in industries the world over attest the career-building value of the Milwaukee School of Engineering, through its exceptional facilities in buildings, shops, laboratories, classrooms — and the comprehensive, practical technical courses under the supervision of its faculty of 72 specialists.

SPECIALIZE IN 6 MONTHS TO 3 YEARS

COURSES

SERVICE

- 6 to 12 Months
- Electricity
- Welding
- Refrigeration
- Heating

TECHNICIAN

- 1 to 2 Years
- Electricity
- Radio
- Electronics
- Refrigeration, Heating and Air Conditioning

PROFESSIONAL

- 3 Years
- Electrical Engineering Bachelor of Science Degree
- Major in Machinery or Electronics

Our time-tested CONCENTRIC SYSTEM enables you to build your career step by step. Each 6-month course is complete in itself, yet prepares you for advanced courses. You train as long as circumstances permit — until you reach the "top step" in your desired occupational objective. 1,400 students now enrolled from 48 states and 8 overseas countries.

Terms Start January, April, July

MILWAUKEE
SCHOOL of ENGINEERING
A Technical Institute

MAIL COUPON TODAY!

Milwaukee School of Engineering, Dept. PM-1247
N. Broadway and E. State, Milwaukee, Wisconsin

Without obligation, send me free booklet "Career Building",
and more details on course in.....

Name Age

Address

City State

LAW FREE BOOK



Write today for FREE 48-page book, "THE LAW-TRAINED MAN," which shows how to learn law easily in spare time at home through the Blackstone course prepared by 60 well-known law authorities. We furnish all material including 18-volume Modern American Law library. Many successful attorneys among our graduates. LL.B. degree. Moderate cost; easy terms; Money-Back Agreement.

BLACKSTONE COLLEGE OF LAW
225 N. Michigan Ave., Dept. 59, Chicago 1, Ill.
A Correspondence Institution Founded in 1890

ENGINEERING DEGREE IN 27 MONTHS

INDIANA
TECHNICAL
COLLEGE

Aeronautical, Chemical, Civil, Electrical, Mechanical, and Radio Engineering (inc. television), Drafting, 1-yr. Gov't approved for G.I.'s. Low rate. Earn board. Large industrial center. Students from 48 states, 18 countries. Demand for graduates. Enter Dec., March, June, Sept. Catalog.

5127 E. Washington Blvd., Ft. Wayne 2, Ind.



THERE'S
MONEY
IN

CARTOONS!

RAYE BURNS will teach you HOW to CREATE ORIGINAL CARTOONS at home that you may SELL! Course contains 26 lessons and over 600 illustrations. All for Only...

\$2.85

Send name and address for free details.

RAYE BURNS SCHOOL, Dept. M, Box 3583, CLEVELAND, OHIO



Bar Bells

Buy Direct From Factory

Write for free booklet
and price list

\$8.95
up

INDEPENDENT IRON WORKS
2416 East 23rd Street, Dept. B
Los Angeles 11, Calif.

INVENTING

—FOR PROFIT! If you have an inventive turn of mind, write for free 28-page booklet explaining how the Institute of American Inventors is helping inventors pre-test the profit possibilities of proposed devices to fill today's unprecedented demand for useful new inventions.

INSTITUTE of AMERICAN INVENTORS

Dept. 4, 1926 Eye St., NW, Washington 6, D. C.



CODE-SENDING-RECEIVING SPEED

Learn to send and receive Radio Code with greater speed. Stop nervous tension. Have confidence. Be proficient. Same system used by radiotelegraph specialists. Thousands of operators needed. Rush name for FREE book.

CANDLER SYSTEM CO.

Dept. 5-O, Box 928, Denver 1, Colo., U. S. A.

Photography

for

PLEASURE or PROFIT

Learn at home. Spare time. Practical basic training. Long-established school. Many have earned while learning. Send coupon below for free booklet, "Opportunities in Modern Photography" and full particulars.



AMERICAN SCHOOL of PHOTOGRAPHY
1315 Michigan Avenue — Dept. 1359 — Chicago 5, Illinois
Send booklet, "Opportunities in Modern Photography," full particulars and requirements.

Name
Address
City Zone State

Now You can Use.



ALL OF THESE RADIO PARTS

to help You learn

RADIO

FASTER-EASIER

AT HOME

Or in our Chicago Laboratory

YOU CAN BUILD **133**
FASCINATING EXPERIMENTS.

At home—in your spare time—you get real Radio experience from these many interchangeable Radio parts and sub-assemblies. Our handy "Block System" eliminates unnecessary mechanical work; the convenient spring clip connections save a great deal of time. You quickly build Radio circuits that work. You experiment with Photo-Electric Cell "Magic" . . . a 5 tube Superheterodyne Receiver . . . a Radio-Telephone, and scores of other fascinating projects. Little wonder learning Radio at home is so practical . . . effective and real fun—with this modern "Home Laboratory."

YOU USE "LEARN-BY-SEEING"
MOVIES!

Think of the pleasure, as well as help, you get from the use of a 16 mm. Motion Picture Projector and exciting "movie" TRAINING FILMS. You will be surprised how much faster . . . easier . . . Home Movies help you understand Radio-Electronic fundamentals. Here's a preferred training method of tomorrow—yours today. SEE the principles of what you're learning—in motion . . . ANIMATED! See circuit actions otherwise hidden from the eye. You get this big Radio home training advantage—exclusively from DeForest's Training, Inc. So act now! Mail coupon for complete details.

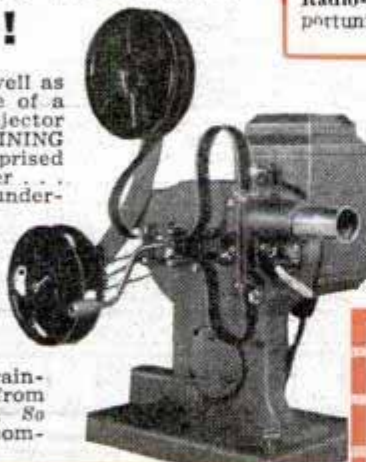

VETERANS!

Big things are happening at DeForest's Training, Inc., for veterans! See how we can prepare you WITHOUT COST for a GOOD JOB or a BUSINESS OF YOUR OWN in the vast Radio-Electronic opportunity field.

See how our fascinating SHOP METHOD Radio Training at home can help you toward a good start in the Billion Dollar Radio-Electronic Field. Write for our BIG FREE book, "VICTORY FOR YOU!" that has helped many to good pay jobs. You'll be surprised at the opportunities ahead in F.M. Radio, Aviation Radio, Broadcast Radio, a Profitable Business of Your Own, Motion Picture Sound Equipment, Electronics—plus the exciting future possibilities ahead of Television, Radar, etc.

You Get "ALL THREE"

Where else can you get such a combination of PROVED MAJOR training features as—(A) modern loose-leaf lessons that are well illustrated with helpful diagrams; (B) the use of "Learn by Seeing" home movie films and a 16mm. MOVIE PROJECTOR—and (C) eight big kits of

"Home Laboratory" Radio parts to give you valuable practical Radio experience—at home.

You Also Get EFFECTIVE EMPLOYMENT SERVICE . . . to help you get started toward a Radio-Electronic job or a business of your own. Residential training in our Chicago laboratories also available!

DeForest's Training, Inc., includes instruction in Motion Picture Sound Equipment, FM Radio and Television . . .



DeFOREST'S TRAINING, INC., Dept. PM-D12
2535-41 N. Ashland Ave., Chicago 14, Illinois, U.S.A.
Send—FREE and WITHOUT OBLIGATION—illustrated book, "VICTORY FOR YOU" and KIT SUPPLEMENT, showing how Home Movies and Home Laboratory can speed my preparation for a place in the Radio-Electronics industry.

Name _____ Age _____
Address _____ Apt. _____
City _____ Zone _____ State _____

If under 16, check here for special information.
 If a discharged veteran of World War II, check here.

DeFOREST'S

TRAINING, INC.

CHICAGO 14, ILLINOIS

AFFILIATED WITH THE DEVRY CORPORATION

FREE

SEND FOR

ALLIED'S Big 164 Page RADIO CATALOG!

WRITE TODAY!



SAVE ON EVERYTHING IN RADIO!



164 Value-Packed Pages

Send for your FREE copy of the most complete Buying Guide for Everything in Radio! Here's the Catalog for Servicemen, Dealers, Soundmen, Amateurs, Builders and Experimenters. Features the world's largest and most complete stocks of radio and electronic supplies—quality equipment at lowest prices! Get the speedy service and expert help you want from ALLIED—Radio's Largest Supply House. Depend on ALLIED!

NEW HOME RADIOS



SERVICE SUPPLIES BUILDERS' SUPPLIES



AMATEUR GEAR



SOUND SYSTEMS

MORE THAN 10,000 ITEMS

Get everything for every radio use: Latest type home radio models, phono-radios, recorders, communications receivers, Ham kits, and gear, code apparatus, radio parts, tubes, tools, test instruments, public address equipment, low-cost easy-to-build radio kits, diagrams and matched parts lists, largest selection of instructive radio books—all at lowest prices!

ALLIED RADIO

ALLIED RADIO CORP.
833 W. Jackson Blvd., Dept. 5-MM-7
Chicago 7, Illinois



Rush FREE 164-Page Catalog

Name.....

Address.....

City..... Zone..... State.....

THOUSANDS OF SUFFERERS USE

BREATHEASY FOR ASTHMA

CARRY IT WITH YOU
USE IT ANYWHERE

Sold on Money-Back Guarantee

Write To Dept. PM

BREATHEASY DISTRIBUTORS, INC.
65 CEDAR STREET
SEATTLE 1 WASHINGTON

ELECTRICAL TRAINING

Intensive 32 weeks residence course in fundamentals of industrial electrical engineering, including radio, electronics. Prepares for technician, engineering aides. Approved for veteran training. 54th year. Catalog.

BLISS ELECTRICAL SCHOOL
7646 Takoma Ave., Wash. 12, D. C.



WHY DON'T YOU WRITE?

Writing short stories, articles on business, homemaking, sports, shop crafts, local and club activities, etc., will enable you to earn extra money. In your own home, on your own time, the New York Copy Desk Method teaches you how to write the way newspaper men learn, by writing. Our unique "Writing Aptitude Test" tells whether you possess the fundamental qualities essential to successful writing. You'll enjoy this test. Write for it, without cost or obligation.

Veterans: This course approved for Veterans' Training.

NEWSPAPER INSTITUTE OF AMERICA
SUITE 559-W, ONE PARK AVENUE, NEW YORK 16, N. Y.

LEARN WATCH and CLOCK REPAIRING

Start training now for a better paying job or your own profitable business. Qualified Watch Makers are in demand... Unlimited opportunities. Intensive practical training by experienced watch makers on American and Swiss time pieces. Write for full details.

SCIENTIFIC SCHOOL OF WATCH MAKING, Dept. PM-10
3923 San Fernando Road Glendale 4, Calif.

Learn CARTOONING

HAVE FUN! MAKE MONEY! Cash in on your sense of humor at HOME—BY MAIL. No experience needed to start. Write today FOR FREE TRIAL LESSON and full particulars.

MoN Gag Cartoon School, Dept. P, Fall Creek, Wis.



STAMMER ?

This new 128-page book, "Stammering, Its Cause and Correction," describes the Bogue Unit Method for scientific correction of stammering and stuttering—successful for 46 years. Benj. N. Bogue, Dept. 7805, Circle Tower, Indianapolis 4, Ind.



MONEY for MEN ALL DATA FREE

THE PLASTEX Industry needs manufacturers on small scale and for big production of Lamp and Clock Stands, Art Goods and Novelties in Plastex and Marble imitation. Experience unnecessary. 12c material makes regular 10c store sellers. Rubber moulds furnished for speed production. Small investment brings good returns. Big chain store orders now being placed. Ambitious men have chance for real prosperity. Our Free booklet will interest and benefit you.

PLASTEX INDUSTRIES, Dept. A
3408 Third Ave. New York 56, N. Y.



GET INTO THE NEW FIELD OF

INDUSTRIAL *Electronics*



THRILLING NEW FRONTIER OF OPPORTUNITY



AMERICA'S FOREMOST SCHOOL OF PRACTICAL TRAINING

Here is a **NEW** Industry—one that points the way to a vast new field of opportunity—Opportunities that beckon alike to men looking for new fields, and to experienced electrical men seeking a way to bigger earnings and a more secure future.

Industrial Electronics is *not* Radio. It has nothing to do with radio transmitters and receivers. It is a totally new application of electric power, applied to modern production by means of the magic of the vacuum tube. Everywhere industrial electronic devices are replacing the old-time electrical controls, and processes. Industrial Electronics is *Modern Industrial Electricity*.

GET READY NOW!

Now is the time to get into Industrial Electronics, while the field is in its infancy . . . and while it is rapidly developing a need for thousands of trained experts. Tomorrow's leaders are training today.

And here is a School equipped in every way to train you for Industrial Electronics work—one of the largest and most completely equipped, and one of the few of its kind in America—a School that already has trained thousands of men for industrial opportunities.

LEARN AT HOME OR COME TO OUR SCHOOL

Learn Industrial Electronics—now, while the time is ripe. You don't need any advanced schooling or previous experience. If you are at all mechanically inclined and have gone to highschool for at least one year or have an equivalent education, we can teach you Industrial Electronics.

You can take most of your training at home, in your spare time—or you can come to Chicago and take your entire training in our completely equipped shops and laboratories. Either way you quickly acquire the fine points, practical skill, and broad, technical "know how" that makes the expert Industrial Electronics Technician.

"Every electrician should know — must know — Industrial Electronics." That's what many Union leaders are telling their members today. They know that the use of Industrial Electronics devices is growing by leaps and bounds. They know that to install and service this equipment, even the best of present-day electricians must first have had special

FACTS ABOUT THE I. T. I.

Founded in 1916. Has trained more than 400,000 men for practical work in industrial fields. From 1942 through 1945 trained specialized technicians, exclusively, for the Army, Navy, and Marine Corps. Now training thousands of veterans under the G. I. Bill, both in its Residence Schools and by home-study. Occupies five buildings of its own. Has over \$500,000 invested in training facilities, with an instruction staff of more than 100 men. Known everywhere as America's foremost school of practical training for industry.

training.

Get all the facts about the opportunities in this interesting field of work and about the I.T.I. system of training that has helped so many men into key jobs in industry. Fill out the information, coupon below and mail it **TODAY**. You will be under no obligation whatsoever.

AUTHORIZED TO ACCEPT VETERANS FOR G. I. TRAINING



GET THE FACTS ABOUT AMERICA'S FOREMOST SCHOOL OF PRACTICAL TRAINING

REGISTRAR, P1M

**INDUSTRIAL TRAINING INSTITUTE,
2150 LAWRENCE AVE., CHICAGO 25, ILL.**

Please send me, **FREE**, your "Camera Visit" booklet and information about the opportunities for trained men in **INDUSTRIAL ELECTRONICS**. It is understood that I will be under no obligation.

NAME.....
ADDRESS.....
CITY.....STATE.....
ARE YOU A VETERAN?.....

8 BIG BUILDING BOOKS

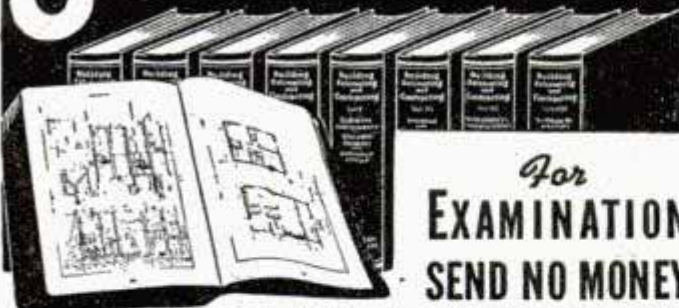

For
EXAMINATION
SEND NO MONEY

Learn to draw plans, estimate, be a live-wire builder, do remodeling, take contracting jobs. These 8 practical, profusely illustrated books cover subjects that will help you to get more work and make more money. Architectural design and drawing, estimating, steel square, roof framing, construction, painting and decorating, heating, air-conditioning, concrete forms and many other subjects are included.

BETTER JOBS — BETTER PAY UP-TO-DATE EDITION
The postwar building boom is in full swing and trained men are needed. Big opportunities are always for MEN WHO KNOW HOW. These books supply quick, easily understood training and handy, permanent reference information that helps solve building problems. These books are the most up-to-date and complete we have ever published on these many subjects.

Coupon Brings Eight Big Books for Examination

AMERICAN TECHNICAL SOCIETY Vocational Publishers since 1898
Dept. G919 Drexel at 58th Street Chicago 37, Ill.
You may ship me the Up-to-Date edition of your eight big books, "Building, Estimating and Contracting," without any obligation to buy. I will pay the delivery charges only, and if fully satisfied in ten days, I will send you \$2.00, and after that only \$3.00 a month, until the total price of only \$34.80 is paid, I am not obligated in any way unless I keep the books.

Name _____
Address _____
City _____ State _____
Please attach a letter stating your age, occupation, employer's name and address, and name and address of at least one business man as a reference. Men in service, also please give home address.

Keep that "TICKING" Car

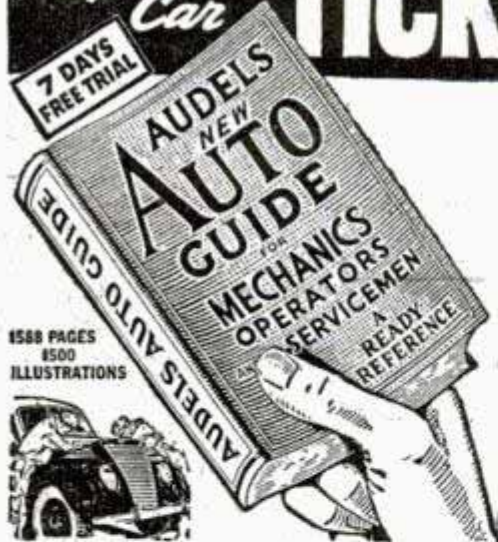

Every operator and mechanic needs AUDELS AUTO GUIDE.

This book saves time, money and worry. Highly endorsed. It presents the whole subject of auto mechanics:

- 1—Basic principles
 - 2—Construction
 - 3—Operation
 - 4—Service
 - 5—Repair
- Handy Size, Easily understood.

NEW FLUID DRIVE, HYDRAULIC SHIFT AND DIESEL ENGINES FULLY COVERED

Over 1500 pages—1540 illustrations showing inside views of modern cars, trucks and buses with instructions for all service jobs.

ASK TO SEE IT!—To Get This Assistance for Yourself Simply Fill in and Mail Coupon Today.

4 COMPLETE • PAY ONLY \$1. A MONTH ←
AUDEL Publishers, 49 West 23rd St., New York
MAIL AUDELS NEW AUTO GUIDE for free examination. If O.K. I will send you \$1 in 7 days; then remit \$1 monthly until price of \$4 is paid. Otherwise I will return it.

Name _____
Address _____
Occupation _____
Employed by _____ PM

Have an OFFICE of YOUR OWN!

LEARN NEW PROFITABLE PROFESSION
At Home in 60 Days, Men & Women, 18 to 70!

Be Your Own Boss and the Boss of Others. Be Respected. Meet Interesting People.

Earnings of men and women in this profession run as high as \$5,000-\$15,000 yearly. Others make good money in spare time. Little money needed to start. A business where your earnings begin sooner. Easy to learn. No selling or goods to buy. No experience necessary. A depression-proof business. A course of action to guide you step by step as you earn. All 53 lessons sent at once to use as operating manuals. Easy terms. Diploma. Money-back agreement. Write for FREE BULLETIN.



FRANKLIN CREDIT SCHOOL
Dept. 75-N ROANOKE 7, VIRGINIA

BY MAIL in Easy Lessons

BE A REAL ESTATE BROKER

PAYS BIG! EASY TO LEARN—Start and run your own business quickly. Many graduates report making up to \$1000 a month. Course of study covers Sales, Property Management, Appraising, Loans, Mortgages and hundreds of related subjects. Course offered in home study or residential classrooms.

Big new illustrated catalog from this nationally known school. Send Post Card Today. G. I. Approved.

WEAVER SCHOOL OF REAL ESTATE
Dept. KA-1, 15 E. Pershing Road Kansas City, Mo.



ACCOUNTANT

BECOME AN EXPERT

Executive Accountants and C. P. A.'s earn \$2,000 to \$40,000 a year. Thousands of firms need them. We train you thoroughly at home in spare time for C. P. A. examinations or executive accounting positions. Previous experience unnecessary. Personal training under supervision of staff of C. P. A.'s. Placement counsel and help. Write for free book, "Accountancy, the Profession That Pays."

LASALLE Extension University, 417 So. Dearborn St.
A Correspondence Institution Dept. 1264-H Chicago 5, Ill.

What Every Mason Wants



We have important Masonic books for Blue Lodge, Chapter, Commandery, Scottish Rite, and Shrine.

Our Rituals Are Used the World Over. Send for free catalog of books and rituals for Masons, Odd Fellows, Knights of Pythias, Knights of Columbus, etc.
EZRA A. COOK, Publisher, P., O. Box 796, PD, Chicago 90, Ill.

TRI-STATE COLLEGE

B. S. Degree in 27 months in Civil, Electrical, Mechanical, Chemical, Aeronautical, Radio Engineering; Bus. Admip., Acc't and Sec. Science. Graduates successful. 64th year. Enter Jan., March, June, Sept. Catalog. 4127 College Ave., Angola, Ind.

Become a Doctor of PSYCHOLOGY

Win the degree of Ps.D. Teach the secret of contentment, happiness. Solve mental worries. Experience the revelation of truth. Chartered college. Individual help. Write for FREE book. COLLEGE OF UNIVERSAL TRUTH, 5153-B North Clark St., Chicago.

Say You Saw It in
POPULAR MECHANICS

ARTISTS MAKE MONEY

Do you like to draw? Send name, address, age and occupation for FREE ART TEST, to find out your ability.

ART INSTRUCTION, Inc.
12137 ART INSTRUCTION BLDG., MINNEAPOLIS 15, MINN.

Learn BAKING At Home

Baking is one of America's high industries in wages. Nearly depression-proof. Thorough basic home course lays sound foundation. If you have aptitude, write for FREE BOOKLET, "Opportunities in Commercial Baking."

National Baking School, 1315 Mich. Ave., Dept. 1359, Chicago 5



LAW

STUDY AT HOME for PERSONAL SUCCESS and LARGER EARNINGS. 39 years expert instruction—over 108,000 students enrolled. LL.B. Degree awarded. All texts furnished. Easy payments. Send for FREE BOOK. G. I. approved.
AMERICAN EXTENSION SCHOOL OF LAW
Dept. 84-M, 646 N. Michigan Ave., Chicago 11, Ill.

Learn

ELECTRICITY

in the
GREAT SHOPS OF COYNE

ACTUAL SHOP
SCENES AT
COYNE

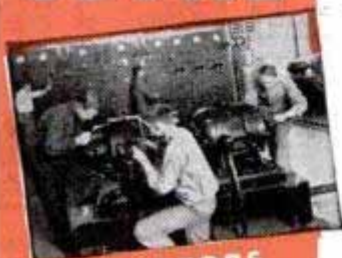

MOTORS



ARMATURES



REFRIGERATION



LIGHTING

COYNE

ELECTRICAL SCHOOL
500 S. Paulina St.,
Dept. 97-72,
Chicago 12, Illinois



ESTABLISHED 1899

NOT A "HOME-STUDY COURSE"

For nearly 50 years, the Great Shops of COYNE in Chicago have been training men to step into the better-paying jobs in ELECTRICITY. Here in just a few short weeks YOU can quickly prepare for amazing opportunities.



B. W. COOKE

As a Coyne student you work on real equipment—just like you'll use later on the job. We do not teach by mail. You get actual shop work plus necessary theory. Coyne training is practical. You make rapid progress at COYNE because it's a shop course.

GET ALL-AROUND TRAINING in a Few Short Weeks

Why be satisfied with a "one-operation" job? At Coyne you learn Motors, Armature Winding, House and Factory Wiring, Appliances, Power Plant Work, Illumination, Electrical Maintenance—plus the fast-growing branch of Industrial Electronics. Whether you're experienced or not, we train you for a good job, then help you get it! Coyne graduates may use our Lifetime Employment Service as often as they wish.

INDUSTRIAL ELECTRONICS and REFRIGERATION Included

Added training in Electric Refrigeration—principles, testing, repairing—is included with this course. Industrial Electronics given as part of our "all-around" Electrical Training.

VETERANS! Coyne is authorized to accept veterans for G. I. Training. Coupon brings special G. I. Bulletin.

NON-VETERANS who are short of cash can finance most of their tuition and pay it in easy monthly payments after graduation.

ANY MAN WITH A PHYSICAL DISABILITY whether a Veteran or not may qualify for Coyne training at no cost to himself for tuition or subsistence. Mail coupon for details.

MAIL COUPON for Big FREE Book

Find out NOW what Coyne offers in training for your future. Coupon brings big book filled with fascinating pictures of our great shops and our plans to help YOU. Get your copy FREE. No cost or obligation, and no salesman will call. Rush the coupon TODAY.



B. W. Cooke, President,
COYNE ELECTRICAL SCHOOL, Dept. 97-72,
500 S. Paulina St., Chicago 12, Ill.

Send me your Free Book and tell me about your plans to help me—including Student Finance and added Training in Industrial Electronics and Electric Refrigeration.

NAME.....

ADDRESS.....

CITY.....STATE.....

AUDELS ELECTRIC MOTOR GUIDE

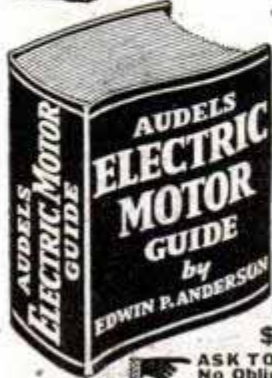

**1000 PAGES OF PRACTICAL
MOTOR INFORMATION**

JUST OUT! Audels Electric Motor Guide covering the construction, hook-ups, control, maintenance and trouble shooting of all types of motors including armature winding. Explains entire subject in every detail. 31 Chapters, 617 Illustrations and Diagrams. A Handy Guide Fully Indexed for Electricians and all Electrical Workers.

\$4 COMPLETE • PAY \$1 A MO.

**ASK TO SEE IT!—Get This Information for Yourself
No Obligation Unless Satisfied.**

MAIL ORDER

AUDELS, Publishers, 49 W. 23rd St., New York 10, N. Y.
MAIL AUDELS ELECTRIC MOTOR GUIDE for free examination. If O. K. I will send you \$1 in 7 days; then remit \$1 monthly until price of \$4 is paid. Otherwise, I will return it.

Name.....
Address.....
Occupation.....
Employed by..... PM

Do you want

- ..to go to College?
- ..or to enter a Profession?
- (Such as Accounting, Architecture, Nursing, Dentistry; Teaching, Social Work, Osteopathy, Beauty Culture, Optometry, Embalming, Chiropody, Law, Medicine, etc.)
- ..or get an Office Position?

To get anywhere, you practically **MUST** finish High School **FIRST**. You can complete our simplified High School Course in SPARE time at home, as FAST as your time and abilities permit. Equivalent to resident school work—prepares you for college, pre-professional examinations, business, industry. Standard texts furnished. Diploma. Credit for H. S. subjects already completed. Single subjects if desired. Low tuition, easy terms. American School, Chicago, est. 1897—endorsed by educators. Finish your high school education **NOW**, Write **TODAY!**

High School Course at Home

Many Finish in 2 Years

American School, Dept. H945, Drexel Ave. at 58th St., Chicago 37, Ill.

Gentlemen: Send me **FREE** information covering special training in subjects checked below. No obligation on my part.

- | | |
|--|--|
| <input type="checkbox"/> High School Course | <input type="checkbox"/> Diesel Engineering |
| <input type="checkbox"/> Architecture and Building | <input type="checkbox"/> Drafting and Design for Men & Women |
| <input type="checkbox"/> Automotive Engineering | <input type="checkbox"/> Plastics |
| <input type="checkbox"/> Business Management | <input type="checkbox"/> Private Secretary |
| <input type="checkbox"/> Electrical Engineering | <input type="checkbox"/> Mechanical Engineering |
| <input type="checkbox"/> Elec. and Gas Refrigeration | <input type="checkbox"/> Aviation |
| <input type="checkbox"/> Air Conditioning | <input type="checkbox"/> Salesmanship |
| <input type="checkbox"/> Railway Training | <input type="checkbox"/> Radio |
| <input type="checkbox"/> Electronics, Industrial | |

Name.....
Address.....

10,000 HELPS TO BE YOUR OWN BOSS IN THIS BIG BOOK!



IF IT'S RESULTS YOU WANT—GET ACTION QUICKLY WITH THESE PRACTICAL IDEAS

Never before has a more helpful book been printed for those planning a business of their own. Gathered in this large illustrated volume are the formulas, recipes, facts and secrets that have contributed so largely to America's great industrial progress. Capitalize on this information for making most any conceivable product without experience, special equipment or previous knowledge of chemistry or manufacturing. The experts who compiled this book are authorities, and present this information in simple, understandable language. They also give you wholesale supply sources for needed materials, short cuts and methods for the most profitable results.

START AT HOME—Expand out of profits.

Hundreds of good paying businesses have been built on a product made from a simple recipe. Choose from any of the 162,000 facts and 10,000 formulas of which the following are only a very few: Adhesives, Alloys, Anti-Freeze Solutions, Cosmetics, Beverages and Liquors, Candy, Gum, Casein, Celluloid, Ceramics, Cheese, Cleaning Preparations, Concrete, Copper, Cotton, Dentifrices, Depilatories, Dyes, Embalming Fluids, Enameling, Glass, Glazes, Household Formulas, Inks, Insecticides, Iron, Jewelers' Formulas, Lacquers, Laundry Preparations, Leather, Linoleum, Lubricants, Manicure Preparations, Marble (artificial), Metals, Mirrors,

BE FREE!

Work when you wish. Avoid clock-punching, forced lay-offs, payroll deductions. Enjoy life. Be independent.

Paints and Ointments, Patents, Paper, Perfumes, Photography, Polishes, Powders, Remedies for Man, Beast or Fowl, Rubber Products, Refrigerants, Soaps, Solder and Soldering, Tooth Cements, Transfers, Varnishes and Thousands of others for making all sorts of profitable and practical things.

MANY FORTUNES MADE FROM A SINGLE IDEA!

This comprehensive book is an accepted authority by chemists, schools, industry, etc., and is the largest and most comprehensive book of its kind ever issued. Nothing else like it in existence. A single formula has been worth a thousand times this book's cost to countless owners. Crammed with money-making ideas. Invaluable for reference. Ideal for Factory, Home, Farm, Office or Workshop. As necessary as the dictionary and more useful for manufacturers, chemists and salesmen who put up products for profit.

POSTPAID
\$3.98
ANYWHERE IN THE WORLD

\$3.98 U. S. Funds. Postpaid anywhere in the world. (C.O.D. in U.S.A. only). Immediate shipment. Safe Delivery Guaranteed.

ADAMS BROWN COMPANY BOOKS OF APPLIED SCIENCE
Dept. 712, Chestnut Hill 67, Massachusetts, U. S. A.

SHOE REBUILDING OFFERS BIG INCOME

Own your own shop or earn big money as skilled shoe rebuilder. Growing demand everywhere at top wages for men who know how. We teach you quickly at only school of its kind in United States. Costs nothing under G.I. Bill of Rights. We help you get big-pay job or start your own shop.

FREE! BIG 16 PAGE BOOK explains everything. Send for your copy today.

C. W. GUSIAS, MODERN SHOE REBUILDING SCHOOL

2935 W. Belmont, Dept. PM, Chicago. RUSH POSTCARD TODAY

MAKE MAGIC YOUR HOBBY



BE A MAGICIAN FOR FUN OR PROFIT!

Rush 25c for a sample copy of "MAGIC IS FUN," magazine that teaches how to do tricks with coins, cards, ropes, etc. **FREE**, with order, large catalog of magical apparatus. D. Robbins & Co., Dept. M-130, 152 W. 42 St., N. Y. 18, N. Y.



CORRESPONDENCE COURSES IN RADIO and ELECTRICAL ENGINEERING

Tuition
\$25

ELECTRICAL ENGINEERING. Get good grasp of wide electrical field. Modern. Very understandable. Theory made easy.
RADIO ENGINEERING. Extra fine course in radio, public address, photo-electric work. Trains you to be super-service man, real vacuum tube technician. Tuition **ONLY \$25**, either course. Deferred payment plan. Servicemen needed badly.
FREE Write for free copies of school catalogs, student magazines, etc.
LINCOLN ENGINEERING SCHOOL, Box 931-P108, Lincoln, Nebr.

SAY YOU SAW IT IN POPULAR MECHANICS



NEW CHEMICAL MITT

Sensational! **DRY** Window Cleaner! Uses no water, no messy liquids. Chemically Treated. Simply glide over windows; leaves glass sparkling clear. No heating water, no heavy buckets to carry. No rags, powders, sponges, chemicals. No mess or fuss. No red-clapped hands. Dust, dirt, grime, fog disappear like magic. *Wonderful for auto windows, windshield!*

SAMPLES FOR AGENTS Sample offer sent immediately to all who send name at once. A penny postal will do. **SEND NO MONEY**—just your name. **KRISTEE CO., 675 Bar Street, AKRON, OHIO.**

Now

YOU CAN HAVE IMPROVED No-DRIFT FM
in the Sensational New 1948
MIDWEST RADIOS

NEW SERIES
16*
SUPER DELUXE
AM-FM
CHASSIS

Here is the finest radio Midwest has ever produced in its 28 years of manufacturing—a world-ranging, 5-band radio with improved Midwest No-Drift FM . . . plus Standard Broadcast and 3 short wave bands, Television Audio Switch-over, and Color-Ray Tone Selection. The Series 16* Super De Luxe Chassis is a powerful, magnificently-toned radio that challenges comparison for performance, sensitivity, selectivity, and advanced engineering features. Supplied with satin stripe copper finish panel—ready to mount in your present cabinet. Send today for the FREE 1948 Midwest Radio Catalog. Buy your radio direct from the manufacturer on Easy Terms and 30 Days Trial and SAVE!



14 1/2"
PANASONIC
SPEAKER

5
WAVE
BANDS

*Series 16
 CHASSIS USES ALL THESE
 LATEST TYPE TUBES,
 RECTIFIER AND TUNING INDICATOR

30
DAYS
TRIAL

LOW
FACTORY-
TO-YOU
PRICES

EASY
TERMS

A COMPLETE LINE OF FINE RADIOS AND RADIO-PHONOGRAPHS . . . Available in Separate Chassis Like the Powerful Series 16* AM-FM Model above, or in beautiful Radio-Phonograph Consoles like this:

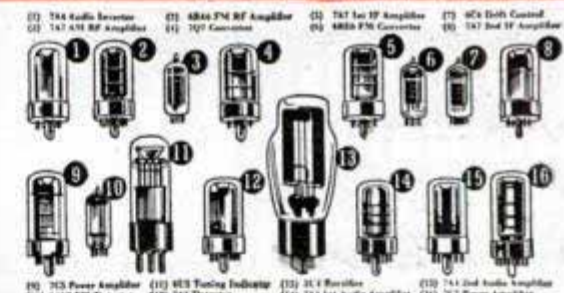

Scores of NEW Features such as the Exclusive MIDWEST TRI-MAGNADYNE COIL SYSTEM and COLOR-RAY TONE SELECTION



SYMPHONY GRAND AM-FM
RADIO-PHONOGRAPH CONSOLE
 with NEW Intermix AUTOMATIC
RECORD CHANGER

Our Finest! A superbly beautiful musical instrument . . . a masterpiece of furniture design and radio engineering that offers the sensational Midwest NO-DRIFT FM, Automatic Intermix Record-Changer, Exclusive Color-Ray Tone Selection, World-ranging 5-Band Reception, Television Audio Switch-Over, and many more new and exclusive features.

Rush for Free Catalog!
 FILL IN COUPON AND MAIL TODAY OR JUST
 SEND YOUR NAME AND ADDRESS ON 1c POSTCARD

MIDWEST RADIO CORP.
 Dept. 25-P, 909 Broadway
 Cincinnati 2, Ohio

Gentlemen: Please send me your new FREE catalog and details of your liberal 30 Days Trial.

Name _____
 Address _____
 City _____ Zone _____ State _____

MIDWEST RADIO CORP.
 Dept. 25-P • 909 BROADWAY • CINCINNATI 2, OHIO

START YOUR OWN REFRIGERATOR REPAIR SHOP!

Learn at Home In Your Spare Time

Our practical, shop-tested home-training teaches you quickly and easily how to repair and install all types of REFRIGERATION and AIR-CONDITIONING. No experience is needed. A grade school education is enough. You may either take a well-paid job or start your own shop with as little as \$50 worth of tools. The opportunities are endless in this huge, well-paid, expanding field. Let us tell you all about it with no obligation. Mail coupon now.

WRITE FOR OUR FREE BOOK



START SMALL GROW BIG



MECHANICS TRAINING SCHOOL

7217 So. Broadway, Dept. P-112, Los Angeles 3, Calif.

Dear Sirs: Please send me without obligation, your free book giving full details about your training.

Name _____

Address _____

City _____

State _____

Learn this Profitable Profession



IN 90 DAYS AT HOME

Money-Making Career Open to Men and Women, 18 to 50

Hundreds of men and women between 18 and 50 make \$10 to \$20 in a single day giving scientific Swedish Massage and Hydro-Therapy treatments. There is big demand from doctors, hospitals, sanatoriums and clubs. Graduates earn large full time incomes from these or in private practice in their own offices. Others make good money from home treatments given in spare time. Learn this interesting, money-making profession in your own home, through our home study course. Same instructors as in our nationally known resident school. You can win independence and prepare for future security by qualifying for your Diploma. Course can be completed in 3 to 4 months. Many earn while they learn. Begin your training at once.

Anatomy Charts & Booklet FREE

Enroll now and we will include, at no extra cost, many needed supplies. Fit yourself to help meet growing demand for Scientific Swedish Massage. Send the coupon at once for complete details. Anatomy Charts and 32-Page Illustrated Booklet, FREE, postpaid.

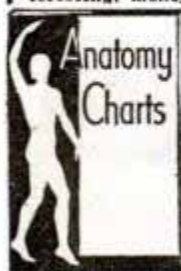

THE COLLEGE OF SWEDISH MASSAGE
Dept. 764R, 100 East Ohio St., Chicago 11, Illinois

Please send me FREE and postpaid, Anatomy Charts, 32-page Booklet and complete details on Home Training.

Name _____

Address _____

City _____

State _____

START BUSINESS FOR YOURSELF



\$13⁹⁵ EACH

Send 1/3 Deposit on Orders, Balance C.O.D.

CAMEO VENDING DISTRIBUTORS

432 West 42 Street

New York, N. Y.

Own-Operate Silver King Bubbleball Gum Vending Machine in any retail store. Gum 65c per lb. Globe capacity 6 lbs. — 170 balls to the lb. You pay the store-keeper 20% of the gross and you will have a profit of \$4.25 per refill.

SHORTHAND in 6 Weeks at Home

Famous Speedwriting system. No signs or symbols; uses ABC's. Easy to learn; easy to write and transcribe. Fast preparation for a job. Surprisingly low cost. 100,000 taught by mail. Used in leading offices and Civil Service. Write for free booklet.

SPEEDWRITING, Dept. 1512-7, 55 W. 42 St., N. Y. 18

PROFESSIONAL TRAINING IN A MINIMUM OF TIME BROADCAST & TELEVISION RADIO ENGINEERING

An Accredited Technical Institute; preparing high school graduates for technical careers. CREI graduates are in demand—in every branch of radio. Classes start every Monday. Comprehensive courses in Radio-Electronics Engineering. Broadcast and Television Engineering or Servicing; 2,100 hours classroom and laboratory study.

Write for FREE booklet. "Radio Engineering as a Career."

CAPITOL RADIO ENGINEERING INSTITUTE
Dept. P-12, 16th & Park Road, N.W., Washington 10, D. C.



TALK-SING thru your own radio with RADIO MICROPHONE

Be the life of the party. Put on your own broadcasts at home. Talk-Sing make announcements from any room. Wonderful voice practice. Microphone easily attached to any radio. Follow enclosed instructions. SEND NO MONEY—pay postman \$1.98 plus postage. Send Money Order or check and save postage.



EMPIRE RADIO & TELEVISION CO. (Dept. R2) 1521 Bedford Ave. Brooklyn 16, N. Y.

OLD GOLD JEWELRY WANTED

Dental gold teeth, plates and bridges with metal attached. Any broken pieces of gold jewelry. Immediate payment and free mailing container to you or your friends upon request. LOWES, DEPT. PM Holland Bldg., St. Louis 1, Mo.



Thrilling Work COLORING PHOTOS

Fascinating vocation learned at home by those with aptitude. Thrilling pastime. National method brings out life-like colors. Free booklet.

NATIONAL PHOTO COLORING SCHOOL
1315 S. Michigan, Dept. 1359, Chicago 5



FIBRE ARMS AND LEGS!

Light, correctly fitted, strong and comfortable. Natural appearance. Braces for all deformities. Scientific design. Fair Terms.

BUCHSTEIN-MEDCALF

223 S. 6th St., Minneapolis, Minn.



RAISE CHIN-CHINS

No experience needed. Just a few minutes daily and a few feet of backyard, garage or barn space. Several females and a male starts a large, profitable herd. WE FURNISH FREE INSTRUCTIONS. TREMENDOUS DEMAND for breeding and laboratory stock, meat, and world's most beautiful rabbit fur. Brokers, cut off from imported rabbit pelts by world famine, NEED CHIN-CHIN FURS NOW, and for years to come! Write for free illustrated catalog today.

WILLOW BROOK FARM • R-36, SELLERSVILLE, PENNA.

LEARN TO MOUNT BIRDS and ANIMALS



SPORTSMEN • MEN, BOYS -

Here is something **NEW** — something **MARVELOUS**. Act **NOW**.
Learn **TAXIDERMISTRY** at home. Save your wild-game trophies.

HAVE A HOME MUSEUM

Here is the **GRANDEST HOBBY** in the world for **hunters, anglers, sportsmen**. **DOUBLE** your interest in hunting and fishing. Save your marvelous trophies. Mount **Birds, Animals, Heads, Fish**, all kinds of beautiful specimens, wild or tame. Tax leathers and fine furs. It is grand to be a **TAXIDERMIST**. You become well known and famous.



WILD-GAME NOT NEEDED

Mount common specimens, squirrels, crows, fish, frogs, pigeons. Make useful and humorous groups. A highly interesting hobby. You will be amazed and delighted.

TAN SKINS

Learn easily, fine **KROME-TAN METHODS**. Make sole, rawhide, harness leather, and **TAN skins and furs**. Create beautiful rugs. Decorate your home and **MAKE FINE PROFITS** doing work for others.

CRAFT-TAXIDERMISTRY!

Make wild-game and domestic specimens into alluring **CRAFT-ART**, like the lamp shown above. You can devise a vast variety of alluring creations. **Easily learned**. Decorate with mounted specimens, **book-ends, door-stops, hat-racks, match and pen-holders**, and scores of delightful and **USEFUL** home articles and gifts. We teach you so easily, both **wild-game** and also **craft Taxidermy**. Investigate **NOW**.

Rush Coupon TODAY!

The beautiful book will go to you by **RETURN MAIL**. Nothing like its strange and amazing art ever seen before. It is **FOR SPORTSMEN and NATURE-LOVERS**, and it is **FREE** if you send the **COUPON NOW**. Hunters, Men, Boys. Mail the coupon **this MINUTE**. You will **WIN**, new interests.

NORTHWESTERN SCHOOL OF TAXIDERMISTRY
3379 Elwood Bldg., Omaha 2, Nebr.

FUN • PROFITS

THINK of the fun and joy of mounting and saving your own hunting trophies. Right in your home, will be the prizes of your fine hunting and outing trips. It's simply great!

SPARE-TIME PROFITS

All of your sportsmen friends will be proud of you and your work. **THEY WILL URGE YOU TO MOUNT THEIR SPECIMENS**. They will be delighted to pay you liberally. Many students earn splendid profits while learning. **YOU can now be a Taxidermist, for pleasure and profits.**

300,000 Students

Many of our vast number of students are employed in the **BIGGEST AND FINEST MUSEUMS**, which **endorse** our school. No higher recommendation can be had in America. **WE CAN TEACH TAXIDERMISTRY TO YOU**, men, boys, and women. Yes, more than 300,000 are members of this fine school, and endorse it enthusiastically. Here is your opportunity, long awaited. Send the **COUPON** without fail.

GET THE FREE BOOK

This new, strange, unique **FREE BOOK** will open a new world of fine pleasure to you. Write for it **NOW**. **IT TELLS THE WHOLE STORY**. 44 pages, over 100 photos of wild-game, and stories of success that will thrill you. Shoot fewer specimens; double your fun, and help conserve the wild-game.

Send the **COUPON THIS MINUTE**. State your **AGE**.

Mail Coupon Now

Northwestern School of Taxidermy,
3379 Elwood Building, Omaha 2, Nebr.

Please Rush the FREEBOOK to Me. I am interested. Please send the **FREE BOOK ON TAXIDERMISTRY** and tell me about how I can **BECOME A FINE TAXIDERMIST**.

Without obligation on my part, explain how I can **double my interest** and fun in hunting, outdoor life.

Name.....

Address..... Age.....



Start \$1,756 to \$3,021 a Year

**Get Ready Now for 1948
Examinations In Your Section**

Veterans Get Preference

Railway Postal Clerks

Railway Postal Clerks get \$2,300 the first year regular, being paid on the first and fifteenth of each month. (\$95.70 each pay day.) Their pay is automatically increased yearly to \$3,400. Advance may be had to Chief Clerk at \$5,400 a year. (\$225.00 each pay day.)

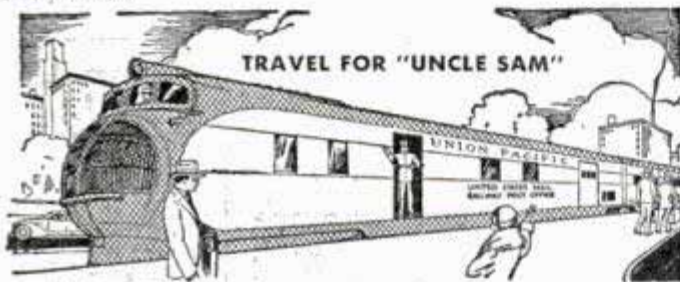

3 Days On—3 Days Off—Full Pay

Railway Postal Clerks on long runs usually work 3 days and have 3 days off duty or in the same proportion. During this off duty their pay continues just as though they were working. They travel on a pass when on business. When they grow old, they are retired with a pension.

City Mail Carriers, Post Office Clerks

Clerks and Carriers now get \$2,100 the first year on regular and automatically increase \$100 a year to \$3,100. Open to men-women 18 to 50.

**GOVERNMENT
CLERK**



Many Other Positions

Many other positions are obtainable. Rural Carriers—Stenographers—Typists—Assistant Statistical Clerks—Customs Inspectors—Office Machine Operators—etc. Those wishing these positions should qualify at once.

Get Free List of Positions

Fill out the following coupon. Tear it off and mail it today—NOW, at once.

This investment can help you to get a big-paid government job.

FRANKLIN INSTITUTE, Dept. R85, Rochester 4, N. Y.

Rush to me, entirely free of charge (1) a full description of U. S. Government Jobs; (2) Free copy of illustrated 32-page book, "How To Get A U. S. Government Job"; (3) List of U. S. Government Jobs; (4) Tell me what to do to prepare for one of these jobs.

Name _____
Address _____
City _____ State _____ Zip _____

Use This Coupon Before You Mislaid It. Write or Print Plainly.

**SUCCEED IN THE
POULTRY BUSINESS!**



**YOU CAN MAKE A
Good, Comfortable
LIVING WITH POULTRY**

**Enjoy country life—grow your own
food—and let poultry pay expenses**

Get ready now—the easy, scientific, inexpensive way! For 27 years, we've been helping thousands to greater success. During 27 years we have trained thousands of students, showing them how to establish poultry farms—how to avoid mistakes—how to cut losses—how to increase profits on established plants—how to have their own small profitable breeding plant and make a good living at it.

Proper management and "know-how" makes profits ANY season, for life. Our courses cover all phases of poultry raising, including plans for buildings, breeding, hatching, culling, sexing, caponizing, marketing, judging, exhibiting, and many others, etc., as planned by Harry M. Lamont, former Senior Poultryman for the United States Dept. of Agriculture. Endorsed by leading colleges, poultrymen everywhere. Write today for this Catalog "How to Raise Poultry for Profit." It fully describes courses, methods, service, opportunities, and easy payment plan.

National Poultry Institute
Dept. 50, Adams Center, N. Y.



**YOU CAN SUCCEED...
Send for this Prospectus TODAY**

Now! BOOK BARGAINS

Increase your technical knowledge for a better job... better pay! Authoritative information by noted technical writer Emanuele Stieri. Pocket size. Smartly bound with hard covers. 75 to 200 illustrations. 200-

MACHINE SHOP SERIES 300 pages each book. \$5.00 value. Your choice
Planers Shapers Millers The Engine Lathe The Turret Lathe Drill Presses

AIRCRAFT SERIES 4 for \$1.00
Aircraft Instruments Aircraft Engines Aircraft Welding Postage Paid

ENGINEERING DRAWING (\$4.00 value) . . . \$2.00 Postpaid
Fundamentals of Engineering Drawing, Descriptive Geometry, Machine Drawing by leading authority Isaac Carter. Size: 9" x 11". 264 pages. Beautiful simulated leather, flexible binding. Over 400 illustrations, Conversion Tables, Formulas, etc. International Correspondence School text.

ORDER TODAY! Send check or Money Order. No C.O.D.'s.
WILLIAMS BOOK STORE, 35 Washington St., Boston, Mass.

**FENCING World's Finest Sport
Exciting Fun—Harmless**



Just Out! Healthful, Clean, makes you Strong & Alert. FREE BOOKLET (with foils) teaches Quickly—Easily. HARMLESS 3 ft. Spring Steel Foils (swords) have Safety Rubber Buttons. Complete outfit, 2 foils (swords) with hand guards. Free Instructions. Now only \$1.98; Postpaid.

Mail check or M. O. today. Add 28c for Foreign Postage.
LEE PRODUCTS CO., 1613 D- First Ave., New York 28, N. Y.

SAY YOU SAW IT IN POPULAR MECHANICS

Learn to Write

Good penmanship makes favorable impressions and helps you win success. Poor penmanship contributes to failure. It makes no difference how poor you now write, you can quickly and easily learn Business Writing, and you can learn Shaded Writing also right in your own home during spare time by my Simplified Method, without cost of going away to school, Easy Lessons, Diploma.

BEGIN NOW! Write for my FREE BOOK, "How to Become an Expert Penman," which contains valuable information and many specimens of penmanship that show what others have learned by taking my Courses. If you enclose 10c, I will send you one of my Favorite Penpoints suitable for plain or shaded writing, and your name with a beautiful flourish written on a card. Write TODAY.

T. M. TEVIS, BOX 25K, CHILLICOTHE, MO.

Send for this FREE Book

**WE BRING
NATIONAL SCHOOLS
TO YOU FOR
HOME TRAINING IN**

RADIO TELEVISION & ELECTRONICS

**For over 42 years one of
America's Leading Trade Schools**



RADIO SHOP AT NATIONAL



BROADCAST STUDIO AT NATIONAL

Partial View of the
Facilities that Stand
Behind Your National
Schools Home Training



Since 1905



TELEVISION STUDIO AT NATIONAL

National Schools Shop Method Home- Training Will Start You Right

We will train you today to get started tomorrow in one of the thousands of opportunities opening in the field of Radio, Television and Electronics. The fields of Home Radio Service . . . Television sales and service . . . Electronics . . . Radar . . . Radio aboard ships and airplanes . . . Frequency Modulation in Broadcasting . . . all are becoming more important. The list of Radio applications is endless, and every one represents increasing opportunities in our modern world for the *Radio, Television, and Electronics Technician with a Solid Technical Background.*

YOU CAN BE A NATIONAL SCHOOLS MAN

It is not a question of opportunity but rather how to take advantage of existing opportunity. Only proper training can make these opportunities a *reality*. National Schools of Los Angeles, one of the oldest and largest technical trade schools in the United States, offers you *Shop Method Home Training, a proved method that builds qualified technicians.* Here is Home Training that **BRINGS RESULTS.**

Behind *all* training from National Schools stands a permanent faculty of experienced instructors and engineers. These men are daily teaching resident students right in our own

Shops and Laboratories. From first hand experience with students here at school, our instructors understand the needs and ambitions of men like you. All of our instructors, both Home Study and Resident, have ideal facilities to make your training practical, up-to-the-minute, interesting. It takes years of experience to know how to train men, especially in the practical technical trades. Established almost 50 years ago, National Schools has a rich background of experience to help you to take full advantage of the opportunities in the Radio, Television and Electronics Industry.

G. I. APPROVED



**YOU GET ALL THIS RADIO
EXPERIMENTAL EQUIPMENT
TO USE AND KEEP AT HOME**

Learn by Doing is the basic principle of National's Shop Method Home Training. We send you standard Radio parts for an interesting series of experiments, which demonstrate the fundamentals of Radio, Television and Electronics. You build many different types of circuits, a fine, long distance **Modern Superheterodyne Receiver**, signal generator, low-power Radio-transmitter, audio oscillator, etc. This **practical work** develops your knowledge of Radio step-by-step, makes you a practical Radio technician.

VETERANS
During the war, National trained enlisted men under contract with the War Department. Both the Armed Forces Institute and Marine Corps Institute used our lesson texts on a wide scale. Now, we are training veterans, both resident and home study, through the Veterans Administration. If you are a veteran of World War II—and qualified for training under the G. I. Bill of Rights, check the coupon for special information.

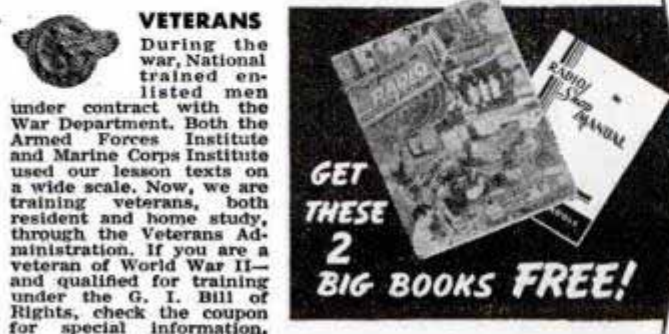

NATIONAL SCHOOLS

LOS ANGELES 37, CALIFORNIA EST. 1905



MAIL OPPORTUNITY COUPON FOR QUICK ACTION

National Schools, Dept. 12-PM
4000 South Figueroa Street
Los Angeles 37, California

(Mail in envelope or paste on reply postcard.)

Mail me **FREE** the books mentioned in your ad including a sample lesson of your course. I understand no salesman will call on me.

NAME _____ AGE _____

ADDRESS _____

CITY _____ ZONE _____ STATE _____

Check here if veteran of World War II

Learn Modern RAILWAY AIR BRAKES and Get Ahead

SEND NO MONEY



THIS BIG BOOK SENT ON APPROVAL

SEND NO MONEY. Just mail the coupon and we will send you this BIG book on approval. Whether you are a locomotive engineer, fireman, or shop man, or whether you want to prepare for one of these good jobs, take advantage of your opportunity to examine this up-to-date book of necessary information.

**551 LARGE SIZE PAGES
443 ILLUSTRATIONS**

Fourteen books prepared by practical railroad men, and selling for a total of \$25.00, have been combined into one sturdy volume at a big saving (see coupon below). This BIG book, with its hundreds of large charts, extra long diagrams (some in four colors), and detail illustrations, is packed full of latest information men must have to become experts. It will be a big help in passing required examinations. Send the coupon today. Examine this book for 10 days.

(A year's consulting privileges with our engineers given with this book without extra cost.)

Vocational Publishers Since 1898

AMERICAN TECHNICAL SOCIETY

Dept. R919, Drexel Ave. at 58th St., Chicago 37, Ill.

I would like to examine your Big Book on Railway Air Brakes. I will pay the delivery charges, but if I choose I may return it express collect. If after 10 days I prefer to keep it, I will send you \$2.50 and send you \$3.00 each month for four months, which is a total of only \$14.50.

Name _____

Address _____

City and State _____

Please attach letter stating age, occupation, employer's name and address, and name and address of at least one business man as reference. Men in service, please also give home address.

AUDELS Carpenters and Builders Guides 4 vols. \$6



Inside Trade Information for Carpenters, Builders, Joiners, Building Mechanics and all Woodworkers. These Guides give you the short-cut instructions that you want—including new methods, ideas, solutions, plans, systems and money saving suggestions. An easy progressive course for the apprentice and student. A practical daily helper and Quick Reference for the master worker. Carpenters everywhere are using these Guides as a Helping Hand to Easier Work, Better Work and Better Pay. To get this assistance for yourself, simply fill in and mail the FREE COUPON below.

Inside Trade Information On:

How to use the steel square—How to file and set saws—How to build furniture—How to use a mitre box—How to use the chalk line—How to use rules and scales—How to make joints—Carpenters arithmetic—Solving mensuration problems—Estimating strength of timbers—How to set girders and sills—How to frame houses and roofs—How to estimate costs—How to build houses, barns, garages, bungalows, etc.—How to read and draw plans—Drawing up specifications—How to excavate—How to use settings 12, 13 and 17 on the steel square—How to build hoists and scaffolds—skylights—How to build stairs—How to put on interior trim—How to hang doors—How to lay floors—How to paint



AUDEL, Publishers, 49 W. 23rd St., New York 10, N. Y.

Mail Audels Carpenters and Builders Guides, 4 vols., on 7 days free trial. If OK I will remit \$1 in 7 days and \$1 monthly until \$6 is paid. Otherwise I will return them. No obligation unless I am satisfied.

Name _____

Address _____

Occupation _____

Employed by _____

STUDY AT HOME

With An Educational Institution

Men with specialized training win higher positions, insure larger earnings, and are bigger successes in business and public life. Opportunities NOW greater than ever before. Send for our Catalog.

ARTS and SCIENCES

Courses in Philosophy; Education; Letters; Public Health; Medical Jurisprudence; Psychology; Sociology; Physics; Chemistry; Plastics; Geology; Political Science; Theology; Business and Commerce; Accounting; Mathematics; Statistics; Agriculture.

ENGINEERING

Courses in Electrical, Civil, Mechanical, Drafting, Architectural, Steam, Aeronautical, Radio, Structural, Mining, Industrial, Petroleum, Marine, Chemical, Diesel, Automobile, Refrigeration, and Air Conditioning Engineering.

LAW

Complete Professional Law Course includes 18 Hornbook Series college grade textbooks. Courses also in Commercial Law, Patent Law and Medical Jurisprudence.

McKinley-Roosevelt Incorporated, 4610-K, Sheridan Rd., Chicago 40, Ill.

LEARN MEAT CUTTING



through actual practice. Profitable Meat Cutting and Successful Meat Merchandising taught easily, quickly. LEARN BY DOING at Toledo in just six short weeks under actual market conditions. For beginners or men with experience. All subjects taught thoroughly and completely. Diploma, Job help. Get store of own. People must eat. School in operation nearly 25 years. Approved for GI training. Send today for FREE literature. No obligation.

NATIONAL SCHOOL OF MEAT CUTTING, Dept. 36, Toledo 4, Ohio

BE A NAVIGATOR OF SHIPS • OF PLANES

Train at home, in spare time for a fascinating, good pay job in marine or air navigation. Weems Course enables you to meet CAA requirements for commercial airline navigators—and navigation requirements for Master's or Mate's license in Merchant Marine. Many Weems graduates now officers in Navy, Coast Guard, Army-Navy Air Forces and Commercial Airlines. Write today for free descriptive catalog. G. I. Plan. **WEEMS SCHOOL OF NAVIGATION** Dept. 2, Annapolis, Md.

LEARN TRIG QUICKLY - EASILY

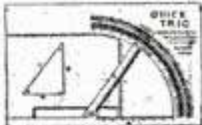

WITH QUICK TRIG, by competitive tests, it was found that QUICK TRIG gave answers faster to one with a slight knowledge of trig than to an expert on trig with a slide rule. Let it solve your trig problems. You need no previous training. Entirely automatic. Easy instructions included FREE. We mail C.O.D. plus postage or send \$1.00, the full price, and we will mail postpaid.

REED MFG. CO. 11350-C BURBANK BLVD. N. HOLLYWOOD, CALIF.

SAY YOU SAW IT IN POPULAR MECHANICS

Learn RADIO TELEVISION ELECTRONICS

Train at home, in spare time, for a good pay job or start a business of your own *without capital*—under our proven 2-Way method that helps you get into this money-making field of radio *quicker*. You receive Lessons *plus* Home Shop Practice including 9 kits of radio parts to make hundreds of tests. Many students earn money in spare time while learning. Write for FREE book "Your Opportunities in Radio" to Hollywood Radio & Television Institute, (Established 1929), Dept. A-12, 810 W. 6th St., Los Angeles 14, Calif.

TRIM YOUR OWN TRIM HAIR AT HOME—SAVE BARBER BILLS

Trims hair as it combs! Easy! Quick! Keeps men's, women's, children's hair trim, neat, freshly-cut looking all the time! Trims, tapers, thins out uneven hair. Use like ordinary comb. Safe. Simple. No experience required. Fine for legs, underarms! *Sells Like Wild!*

SAMPLES FOR AGENTS

Sample offer sent immediately to all who send name at once. Penn. postal will do. **SEND NO MONEY.** Just your name. **KRISTEE CO. 676 BAR ST., AKRON, OHIO**





H. T. ARMSTRONG
General Manager

ENJOY the HAPPINESS
of owning
YOUR OWN BUSINESS



Learn

ELECTRIC APPLIANCE

I'll Train You
AT HOME
in your spare time



YOU LEARN

how to repair electrical appliances such as washing machines, vacuum cleaners, ranges, lamps, irons, motors, etc.—HOUSE WIRING and also

REFRIGERATION

which we now include at no extra cost. Our lessons are understandable and easy to grasp.

Send for
FREE
BOOKLET
and complete details

NO
SALESMEN
WILL CALL



NEW BOOK

"HOW TO START YOUR OWN BUSINESS"

Sent if you act promptly

This valuable complete book covers locating your shop, contains drawings of how to build and wire work-benches, where and how to advertise, what to charge, how to hire solicitors, etc. Sent without charge to students who enroll promptly.

REPAIRING & SERVICING

This is an ELECTRICAL WORLD! Every home is a customer for the man who knows how to service electric appliances. It's a wide-open, expanding field for men of all ages who are handy with tools . . . who seek the independence, happiness and rewards that come to the man who owns his own business. Our practical, thorough course teaches you this interesting well-paid business AT HOME—during your spare time. A grade school education is all you need. Without obligation, I'd like to send you our new booklet telling about our method of instruction—about today's money-making possibilities in this field—and why I believe this business offers you the depression-proof security, happiness and opportunity you seek.

EARN WHILE LEARNING

Pay For Your Course With Part Time Work

You can actually start making money before your course is finished. With your first set of lessons, I show you easy jobs that can be done in your spare time, at home. Remember—ONE GOOD REPAIR JOB will pay for your entire training. You can also start this business AT HOME, in your garage or basement, with the tools I send you, also in your SPARE TIME, if you like. Or, you can take a well-paid job . . . as there's always a big demand for trained men.



A Business That Gets Better Every Year!

Every year, more and more new electrical appliances are being developed. Hundreds of thousands of new homes being built . . . and others wired for electricity for the first time—through gigantic government electrification projects. Thus, this business gets better every year. And, when you own your own business, YOU get the profits when times are booming. If depression comes, you can't lose your job. It usually IMPROVES the service and repair business. Let's talk it over by mail!

MAIL COUPON TODAY!

H. T. ARMSTRONG, General Manager,
PACIFIC TRAINING SCHOOL, Dept. P-112,
7217 So. Broadway, Los Angeles 3, Calif.

Dear Sirs: Please send me, without obligation, your FREE BOOKLET, "Today's Big Opportunity, Appliance Servicing" and full details.

Name _____
Address _____
City _____ State _____

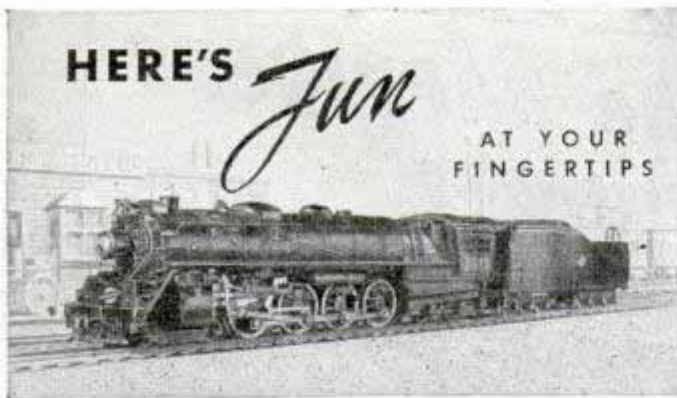

HERE'S *Fun* AT YOUR FINGERTIPS

Now EVERYONE can enjoy
RAILROADING IN MINIATURE!

Build true reproductions of famous trains that are actual working models! Our "00" Gauge kits are especially scaled for home use where layout space and time are limited. Yet these kits are as accurate in detail as our larger model, the "0" Gauge. Kits contain every part needed to build the model with only common tools. Made of fine materials, rugged, realistic . . . Scale-Craft Model Railroading kits provide a challenging, thrilling hobby. The Scale-Craft Catalogue and Data Book fully describes layouts, types of kits and model railroad practice, with room to add supplemental information, and costs only 25c postpaid.

Send stamp TODAY for your How to Begin folder. Address Dept. M-3



SCALE-CRAFT & CO. 1731 N. HIGHLAND AVE. HOLLYWOOD 28, CALIF.

HEATING with RADIANT HEAT PLUMBING AIR CONDITIONING REFRIGERATION

Here is the practical, low-cost help you need—to earn more—to make jobs easier—to save money on your own home upkeep. Thousands already in use. Select the help you need and order by number now, under money-back guarantee.

- 1. HEATING.** Cooling and Air Conditioning. New edition with big added section on Radiant Heat, new heating sensation. Use this book to hold the best jobs. Now 732 pages, 373 illustrations. \$4.00.
- 2. PLUMBING.** Installation and repair. Do your own work. 256 pages, 162 illus. \$2.00.
- 3. PIPING OFFSETS.** New book makes difficult offset piping jobs easy in all plumbing work. \$1.50.

Big Opportunities IN THE BIGGEST FIELDS OF ALL Help for Home Improvement Jobs!



- 4. REFRIGERATION.** Service Manual. Covers standard service, repair and maintenance work. 317 pages, 148 illus. \$2.00.
- 5. HOUSE WIRING.** Practical and up-to-date. Fine book for handy home owner. \$1.50.

Mail Coupon NOW FOR QUICK DELIVERY

Frederick J. Drake & Co., Dept. 19
600 W. Van Buren St., Chicago 7, Ill.

Send me the books checked. If not satisfied I will return them in 5 days and money will be refunded.

Check or Money Order enclosed \$_____ Send books postpaid.
 Send C.O.D. plus postage.

Name _____
Address _____
City _____ State _____

Drake's Books are Sold by Leading Booksellers

BE A **GOVERNMENT LICENSED AIRPLANE AND ENGINE MECHANIC**
Train Now at **LINCOLN**
EARN BIG PAY IN **AVIATION**

Our new enlarged school now offers these courses:
MASTER AVIATION MECHANICS, CAA Approved 1 Yr. Airplane & Engine Mechanics Course, **REFRESHER AIRPLANE & ENGINE MECHANICS**. Designed for veterans with aviation mechanics experience. Either course is available to veterans under the G. I. Bill of Rights. Write today for complete information.

LINCOLN AVIATION INSTITUTE
UNION AIR TERMINAL DEPT. 12 LINCOLN, NEBRASKA

500 TRICKS **MAGIC TRICKS**
It's FUN to do MAGIC
Amaze—mystify—entertain. Be Popular, You, too, can enjoy this fascinating hobby which has swept America. Only 10c brings you our famous Catalog of 500 TRICKS, profusely illustrated, containing all the latest in easy-to-do magic for pocket, parlor, stage. Join in the fun! Send 10c today, Douglas Magicland, Dept. C, Dallas 1, Texas

Learn **LANDSCAPE GARDENING!**

A thorough, constructive, interesting home-training, covering your regional conditions, for those who wish to become **LANDSCAPERS, DESIGNERS, GARDENERS**, etc., for profit or pleasure. Write today for **FREE INFORMATION**, without obligation. **APPROVED FOR VETERANS.**

NATIONAL LANDSCAPE INSTITUTE
Dept. P-12, 310 So. Robertson, Los Angeles 36, California

Learn **WATCH REPAIRING**
AT HOME
Watch repairing instructions with final Diploma equips you for big earnings. Earn while you learn. Write for free facts!

WATCH and Tools Included

ILLINOIS SCHOOL OF WATCH REPAIRING
2870-Q Elston Ave. Chicago 18, Ill.

LEARN TO PLAY AN **ACCORDION**
"THE PAGANI WAY"
WRITE FOR DESCRIPTIVE CIRCULAR
O. PAGANI & BRO., INC. 289 Bleecker Street New York 14, N. Y. Dept. P

WANTED - Ambitious Men
who would like to go to this famous school. Stream-lined courses in Diesel, Diesel Electric, Electricity, Radio Mechanics, Refrigeration, Air Conditioning. Write for **FREE** catalog.

BAILEY TECHNICAL SCHOOLS
1650 SO. GRAND BLVD. ST. LOUIS, MO.

ENSHRINE THEIR MEMORIES WITH
U.S. MONUMENTS \$14. UP
Freight Paid
There is none better. Our free catalog is ready for you. Write today. A-18 U. S. Marble & Granite Co., Oneco, Fla.

I'd like to show you how I sold my
INVENTIONS
Write for Valuable Free Booklet
GEORGE PEARCE
47V Bartholomew St. Peabody, Mass.

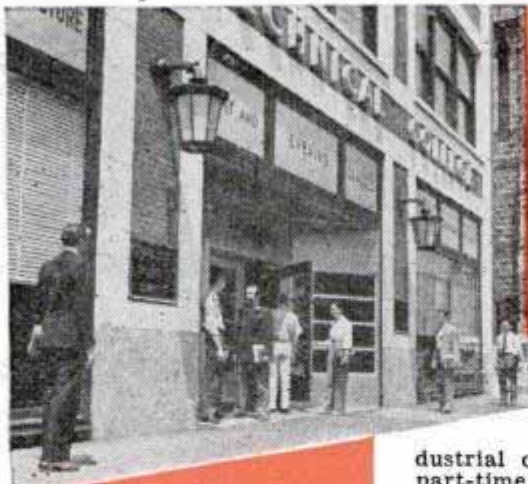

Learn ENGINEERING DRAFTING...BUILDING in Chicago, Industrial Hub

Approved for G.I. Training Time-Saving Courses Day & Evening Classes

Get your training at Chicago Tech in the Nation's industrial center. Chicago provides unequalled opportunities for part-time employment while training and for permanent positions upon graduation. Many other cultural and recreational advantages described in Catalog. — sent Free!

Chicago Tech. founded 43 years ago, has trained thousands of men now occupying important places in industry the world over. Training combines theory and practice in 1 year, 2 year, and 3 year (Degree) courses. Saving in time means earlier graduation, — and consequently earlier employment.

Terms start January, April, July and October. Get information now to arrange for early admission and accommodations.

CHICAGO TECHNICAL COLLEGE

S-81 Tech Bldg.
2000 So. Michigan Ave.
Chicago 16, Ill.

1 YEAR • 2 YEAR
3 YEAR COURSES

BUILDING
DRAFTING
ENGINEERING
AIR CONDITIONING
REFRIGERATION
ELECTRICITY
RADIO



MAIL COUPON TODAY

CHICAGO TECHNICAL COLLEGE
S-81 Tech Bldg., 2000 So. Michigan Ave.
Chicago 16, Ill.

Please send me without obligation free booklet on Time-Saving Technical Training.

Name _____ Age _____

Address _____

City _____ Zone _____ State _____



IT'S FUN! BE YOUR OWN MUSIC TEACHER!

YES, it's a great pastime learning music this short-cut, Print and Picture way, right at home. You learn to play by playing real tunes by note with the very first lesson.

No boresome exercises. No lengthy, baffling explanations. Instead of hard work, learning to play becomes a genuine pleasure. You start with simple melodies. As you improve, you take up more difficult pieces. And soon you're amazed to find that you can pick up many popular tunes and play them right off.

And that's not all. You can take up any instrument this easy, home-study way for only a few cents a day. Surprise your friends—win new popularity—by learning your favorite instrument at home.

If interested, send for our Free Booklet and Print and Picture Sample which explain all. U. S. School of Music, 712 Brunswick Bldg., New York 10, N. Y.

*Actual name on request. Picture by professional model.

FREE! Print and Picture Sample

U. S. School of Music, 712 Brunswick Bldg., N. Y. 10, N. Y. I am interested in music study, particularly in the instrument indicated below. Please send me your free booklet "How to Learn Music at Home" and your Print and Picture Sample. (Do you have instrument _____)

Piano Piano Accordion Reed Organ Clarinet
Guitar Saxophone Tenor Banjo Trombone
Violin Trumpet, Cornet Ukulele Other Instruments

Name _____ Please Print

Street _____

City _____ State _____

Check here if under 16 years of age.

SAVE 2c—Stick coupon on penny postcard



It's easy as A-B-C!

Yet it's from that stirring favorite of the South, "Dixie"



PLAYS ON RADIO . . .
"As a proud student I can't keep from telling you that as a result of my course I have a good position playing from KTHS every morning."

*J. S. Heavener, Okla.

Diagrams like this explain everything

Follow the dotted lines from the notes to the piano keyboard and before you know it you're playing the famous "Dixie."

MAKE MORE MONEY IN AUTO BODY and FENDER REPAIRS



Get This
Famous
Book Today
FREE
TRIAL
in Your
Home
MAIL
COUPON

**QUICK, EASY, LOW COST!
THE HELP YOU NEED!**

Do it now! Get yourself a share of the big money car owners are spending to keep their older cars looking good. Get this famous and practical book that will put you right into this profitable business. No previous experience needed. Get a good job or start a business of your own with little or no capital.

**Covers Methods, Tools, Equipment! Tells How to
Get Business — How to Run a Shop and Make Money**

Thousands of copies in use. A winner everywhere. Written by a man who knows the business thoroughly. Easy to use and easy to understand. Covers the use of tools and equipment, gives approved methods; describes materials and shows you how to actually do a professional job, operate a shop, etc. The very latest information and pictures on all interior and exterior body work and fender repairs—the kind of work people everywhere want and will pay big for when you can do it. Ideal for shop owners and every man who wants to get in on the millions being spent to make old cars look newer. Mail coupon today.

OTHER MONEY-MAKING BOOKS

HOUSE WIRING. New 6th edition. Gives complete, practical instruction. Goes further than most books on subject. Gives National Electric Code. 400 pages. 669 illustrations. Electrical work now at new high. Get this fine book. \$3.00

SHEET METAL LAYOUT. Makes sheet metal layout work so simple that anyone can learn. Get this new instructor and get into the easiest, cleanest and best paying part of all sheet metal work. 143 jobs worked out in drawings and carefully explained. Size of book 8½ x 11 inches. Price \$3.50

GET STARTED NOW

To make money, get into body and fender work now—or one of the other big pay fields covered by these books. Select the book or books you need and order now.

Send No Money • Mail Coupon Today

Goodheart-Willcox Co.
2009 S. Michigan Ave., Dept. 510, Chicago 16, Ill.

Send books checked C.O.D. including charges. If not satisfactory I will return in 5 days and you will refund money paid. (Outside U.S. remit with order). We will pay all postage charges if remittance accompanies order.

Body and Fender Repair, \$3.50 House Wiring, \$3.00
 Sheet Metal Layout, \$3.50

Name _____

Address _____

City _____ Zone _____ State _____



**SCENIC and HISTORIC SAN ANTONIO
THE PHOTOGRAPHERS' WONDERLAND
VETERANS MAY ENROLL UNDER G.I. BILL
LEARN PHOTOGRAPHY NOW
FASCINATING WORK — EXCELLENT PAY
FREE BOOKLET ADDRESS: DEPT. 14**

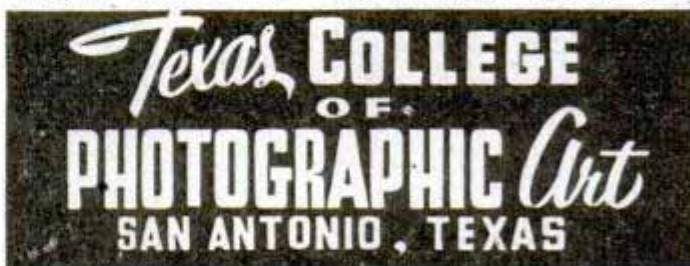

"ONE BLOCK FROM THE ALAMO"

**AT LAST! A HOBBY THAT OFFERS YOU
PROFIT AS WELL AS PLEASURE!**

**GENUINE LEATHER
Hand Crafted
LINK BELT**

Easy to Make—Easy to Sell

Get started today on a fascinating hobby where you can earn up to \$10 or \$15 a week in spare time! Send for your complete profit-producing Handicraft Kit with all the material needed to make 6 genuine leather link belts. Sell all you make at \$2 each to people expecting to pay far more for genuine hand-made belts. Kit for 6 belts costs you only \$3.50—can easily be sold for \$12—leaving you a profit of \$8.50. Send \$3.50 for your Kit today, or mail only a dollar for sample Kit! Or C.O.D., you pay postage. Money back if not delighted.

FREE . . . IF YOU ACT NOW!

Beautiful Plastic Identification Card Case, Value 25c. Free with \$1.00 Kit. Yours to keep, even if you return belt kit. Also, on request, big new 40-page CRAFT CATALOG FREE with or without order.

DWINNELL CRAFT SHOP, Dept. P712, Elm Grove, Wheeling, W. Va.

BUILD YOUR OWN FAST FREEZER PLANS \$1

It's easy to build this household appliance with LeJay Plans. Made from new or used parts. Save up to 75%. No expert knowledge needed. Plans show 5 sizes and are easy to follow. All details clearly explained. Enjoy making one of these freezers. Mail \$1 for set of plans and catalog. **LEJAY MFG. CO.**, 447 LeJay Bldg., Minneapolis 8, Minnesota

5 sizes
8 to 40 cu. ft.

GLOWS in the DARK **FREE Sample!**

Be the first to sell luminous house numbers, light switch plates, wall protectors, pull cords. Also luminous pictures, statues, decals, and a host of religious, nursery and other objects that glow in the dark. Get into this new and growing industry. Enormous demand... no competition... sensational demonstration... big profits. Represent a large manufacturer, established over 34 years. Write today for liberal money-making offer and free sample to show how they glow in the dark.

MADISON MILLS 303 Fourth Ave., New York 10, N.Y.

ON-THE-JOB METHODS

ON-THE-JOB EQUIPMENT...

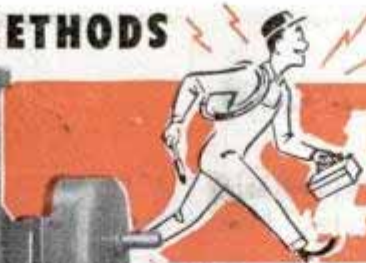
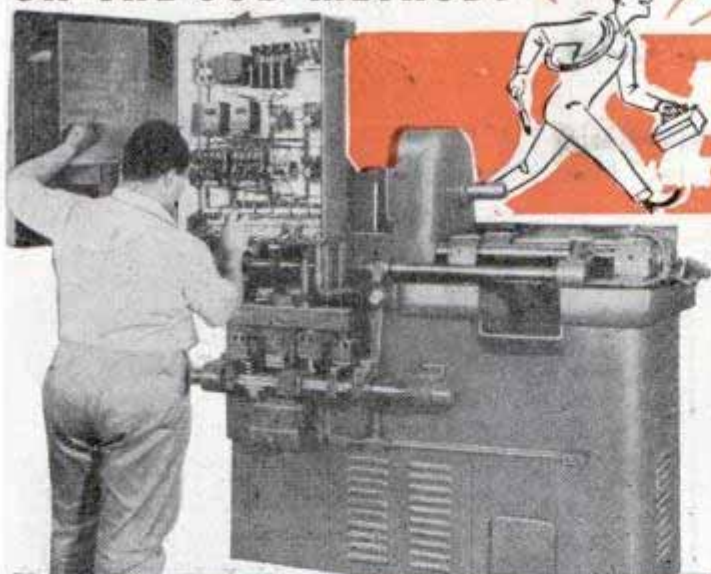

ELECTRICITY

LEARN THE PRACTICAL WAY

on equipment like this in the large shops of the nation's largest exclusive electrical school!



ABOVE: WIRING IN FACING MACHINE

RIGHT: TROUBLE SHOOTING ON LARGE CONTROL PANEL

Electricians are always in demand—make big money... Get "A to Z" experience quickly in our large shops—not "home-study"... **YOU DO ACTUAL WORK** on real equipment. Learn housewiring, armature wiring, motor rebuilding, factory installation, etc. New classes start every few weeks. Living arrangements made.

NO COST TO VETERANS Train at Gov't. expense. Receive \$65 to \$90 month while learning. Coupon brings details.

MICHIGAN TECHNICAL INSTITUTE
Department PM12, 2281 West Fort Street, Detroit 16, Michigan

MICHIGAN TECHNICAL INSTITUTE, Dept. PM12
2281 W. Fort St., Detroit 16, Michigan

- Send me catalog and complete information.
- I am a GI. Send special information.
- Married. Single.

NAME _____

ADDRESS _____

CITY _____ ZONE _____ STATE _____

THESE 5 TRADES ASSURE YOU

HIGH PAY • Future Security

- **PLUMBING** Every phase of plumbing Pipe-Cutting and Threading, Lead-Wiping, Rough-in Projects on Installations, Completed Installations of entire plumbing systems. Blueprint reading, Estimating
- **DRAFTING** College-level courses in General Machine and Architectural Drafting, with fundamentals in Drafting Mathematics—all under graduate engineers.
- **SHOE REPAIRING** From simplest repairs on boots and shoes to the finest details of reconditioning and rebuilding, under expert craftsmen.
- **ELECTRICAL** Technical and shop training include Basic Electricity, Residential Wiring, Industrial Wiring, General Testing and Trouble Shooting, and Appliance Repair
- **AUTOMOTIVE & TRACTOR** Applied training on latest model automobiles and tractors, including engine overhaul, transmission and differentials, carburetion, generator and ignition systems engine tune up, Hydramatic and Vacumatic Transmissions, and general service

"There's Always a Demand for the Man who KNOWS!"

CHOOSE ONE OF THESE 5 LEADING TRADES

Get Out of that Rut... Be a Skilled Tradesman! Have a Lifetime Career... Own Your Own Business and Be Secure in Your Old Age

NOW while Enrollment is still open, send for FREE information.

THE 5 DIVISIONS OF

NATIONAL TRADE SCHOOL
2610 Grand Ave., Kansas City 8, Mo.

- ___ ● Plumbing ___ ● Drafting
- ___ ● Shoe Repairing ___ ● Electrical
- ___ ● Automotive & Tractor

NAME _____

ADDRESS _____

CITY _____ STATE _____

VETERAN _____ OCCUPATION _____

Choose One of these 5 Essential Trades

Our complete courses of thorough training prepare you to go right into the field as a Qualified Tradesman at High Pay in only 34 weeks (39 in Shoe Repair). All courses under especially trained instructors with practical experience. 6 Hour Classes 5 Days a Week. Our Employment Department helps you.

VETERANS "Approved for veterans' training by the State Department of Education under Public Law 346."
"Approved for veterans' training by the Veterans' Administration under Law 16."

Send Coupon for Free Information Now

HOW TO Fight! Wrestle! Jiu-Jitsu!

FREE



Plus Weight Lifting! Strong Man Stunts!

Be prepared to protect your family, friends, yourself in any emergency! Be admired! George F. Jowett, Champion of Champions, gives you free his "SMASHING CHAMPION SECRETS." Contains many "HOW-TO-DO-IT" pictures that quickly and simply show you how to powerfully deliver a knockout, how to break any hold, how to overpower any opponent plus weight lifting and strong man stunts! Inside professional "Tricks of the Trade" proved successful by police, armed forces, fighters, wrestlers, etc.

You Need He Man Fitness to Handle Any Tough Situation!



NOW! All 5 Famous Jowett Courses IN 1 COMPLETE MUSCLE BUILDING VOLUME!

25c

LET ME PROVE I CAN MAKE YOU—

COMMANDO-TOUGH OR IT WON'T COST YOU A CENT!

says *George F. Jowett* WORLD'S GREATEST BODY BUILDER

Give Me 10 Minutes a Day Learn My Time Tested Secrets of Strength

I'll teach you the "Progressive Power Method" that rebuilt me from a physical wreck condemned to die at 15, to the holder of more strength records than any other living athlete or teacher! Has proven it builds the strongest, handsomest men in the world. Let me prove on a money back basis—that no matter how flabby or puny you are that I can add inches to your arms, broaden your shoulders, give you a man-sized chest, powerful legs and a rock-like back—in fact power pack your whole body so quickly it will amaze you—right in your own home! I'll bring to life new power in you inside and out, until YOU are satisfied you are the man you want to be.

PROVE IT TO YOURSELF IN ONE NIGHT

Send only 25c for my 5 easy-to-follow, picture-packed courses now in 1 complete volume, "How to Become a Muscular He-Man." Try it for one night! Experience the thrilling strength that surges through your muscles.

I am making a drive for thousands of new friends fast—REGARDLESS OF COST!
SO GET NOW MY 5 Muscle Building COURSES
(Valued at \$5 each)

All in 1 Great Complete Volume Packed With How-To-Do-It Pictures!

Now, this "get-acquainted," extremely low price of only 25c is your chance to build a body you'll be proud of! Follow Jowett's easy method of muscle building NOW!
For Only **25c**

10 DAY TRIAL
Think of it—all five of these famous courses now in one picture-packed volume for only 25c. If you're not delighted with this famous muscle-building guide—if you don't actually FEEL results within ONE WEEK, send it back and your money will be promptly refunded! Photo Book of Famous Strong Men!

FREE!

Photos that inspire you to might and muscle. Free with order.



2 FREE GIFTS!

Jowett Institute of Physical Culture
230 Fifth Avenue, New York 1, N. Y. Dept. PM-712

George F. Jowett: Please send by return mail, postpaid, FREE "Smashing Champion Secrets" and FREE Jowett's Photo Book of Strong Men, along with all 5 Muscle Building Courses. 1. Molding a Mighty Chest. 2. Molding a Mighty Arm. 3. Molding a Mighty Grip. 4. Molding a Mighty Back. 5. Molding Mighty Legs—Now all in One Volume "How to Become a Muscular He-Man." Enclosed find 25c. NO C.O.D.'s.

George F. Jowett Champion of Champions

NAME _____ AGE _____
(Please Print Plainly, Include Zone Number)

ADDRESS _____



THE GREATEST THING IN PLASTICS!

PLASTICAST is a liquid plastic; can be poured into ANY kind of mold or container. Hardens in a few minutes into a transparent solid, clear-as-glass, tough-as-steel plastic! No tools or machinery required. Ideal for imbedding flowers, butterflies, photos, souvenirs, and for making beautifully brilliant jewelry, combs, displays, fishing lures, magnifiers, lenses, knick-knacks and novelties. Easily cast into sheets, rods or blocks, ANY shape, ANY color. **EVERY-THING FURNISHED**, for making over 200 attractive articles! C.O.D. orders accepted with \$1.00 deposit.

COMPLETE MASTER OUTFIT (postpaid U.S.A. only)..... \$300

MULTIPLEX MOLD COMPOUND makes flexible molds in 15 minutes from any original. Never spoils, can be used over endlessly. Excellent for casting plastics, plaster, etc. **\$1.75** pound. (Add 25c for postage).

FREE SPECIAL OFFER! 3 attractive molds free with every Outfit! Also free, valuable manual on **MOLD MAKING** and **CASTING** with Liquid Plastics, Liquid Ivory, Liquid Marble, Wax, Plaster, Alloys, Latex, Plastic Wood, etc. Sent free with catalog of casting materials for 3c stamp.

PLASTICAST CO. (Dept. C)
(Send order to nearest office)

5961 Madison St.
Chicago 44, Illinois

P. O. Box 987
Palo Alto, Calif.

BRASS Social Security Plates

STAMPED WITH YOUR NAME AND 'SS' NUMBER



Beautifully satin-finished (shown 1 1/2 size). Please print information clearly. Priced at only 50c each, postage paid.

ACME STAMPING SERVICE
Box 836-PM Davenport, Iowa

BRUSH PLATING OUTFITS

for re-plating articles in the home and shop. No tanks necessary. Free particulars.

GUNMETAL CO., AVE. M, DECATUR, ILLINOIS

Please Mention Popular Mechanics When Answering Ads



DAM leaky walls with DRYEX

Make big money applying or selling Dryex, the amazing plastic that makes wet exterior walls dry and keeps them dry. Easy to brush on, easy to sell. Tough, flexible. Thousands of fine prospects. Write today for details.

LASTING PRODUCTS COMPANY
Franklinton Road Plant, Baltimore 23, Md.

LEARN DRAFTING NOW FOR BEST OPPORTUNITIES IN ALL THE BIG OPPORTUNITY FIELDS!

Engineer
Dobe

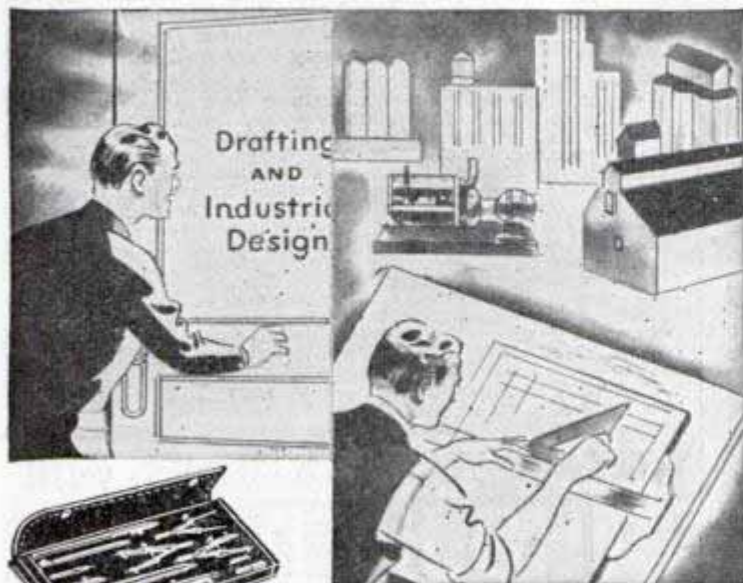

Drafting
AND
Industrial
Design

I Will Train You at Home Until You Get a GOOD PAY JOB!

Engineer Dobe

Plan now for a better job and better pay as America surges into the biggest production record in history. Drafting is the field—now bigger than ever before. And countless thousands of draftsmen and designers must come first—before any new production or construction can begin. Get into Drafting now!

You Get Experience While You Learn

I will train you at home in your spare time and give you actual experience on actual work—the same kind of jobs you will do for the best paying firms later on. You will be trained until you are competent, experienced, and are actually holding a position that will bring advancement and pay raises as deserved.

And what's more, I will give your experience as a reference to employers when you become competent. Lack of previous experience or higher education should not hold you back.

ACT NOW!

Delay gets you nothing. Mail the coupon today and get all the details and see what drafting can do for you. No obligation. No salesman will call. Give age to insure reply.



Tools and Other Equipment Sent When You Start!

Be A Draftsman . . . Always First in Every Kind of Production

Draftsmen rank top because drafting is such important work. Before anything can be made or built from common gadgets to locomotives, the draftsman's work comes first. His pay is big—his working conditions are the best.

Professional instruments, drawing table and other tools included and sent to you when you start. Nothing for you to buy

Mail Coupon for VITAL FACTS!

Engineer Dobe, Div. 10, Libertyville, Ill. Send me the Vital Facts on Drafting and Industrial Designing, your FREE BOOK and advertised list of positions for Draftsmen and Designers wanted.

Name.....Age.....
Address.....
City.....Zone.....State.....

DRAW for MONEY . . . Be an ARTIST !

Trained Artists are Capable of Earning \$50, \$60, \$75 and MORE a WEEK!

You can learn to draw at home in your spare time the well-known WSA way. COMMERCIAL ART. DESIGNING, CARTOONING all in ONE complete course. No previous Art experience necessary—we teach you step-by-step. Prepare for a fascinating hobby or profitable career. For 33 years WSA graduates have been making good—WHY NOT YOU?



VETERANS! WSA Approved for Training Under G. I. Bill. Write for FREE BOOK, "Art for Pleasure and Profit," fully describes course method of instruction and commercial opportunities for you. TWO ART OUTFITS included with training. Mail coupon today.

Washington School of Art, Studio 1212H
1115—15th St., N.W., Washington 5, D.C.
Please send me full information and your Free Book, "Art for Pleasure and Profit."
Name.....AGE.....
Street.....
City.....Zone.....State.....

I am entitled to training under "G.I." Bill

U.S. GOVERNMENT JOBS!

\$1,756 to \$3,021 FIRST YEAR

RAILWAY POSTAL
CLERKS

Veterans Get
Special Preference



Many other Government Jobs, City and Rural Carriers — Postoffice Clerks — Meat Inspectors — Storekeeper — Gaugers — Stenographers — Typists—etc. Prepare now for 1948 Examinations.

FRANKLIN INSTITUTE,
Dept. R86, Rochester, N. Y.
Sirs: Rush to me, without charge, copy of 32-page book, "How to Get a U. S. Government Job," list of positions, and full particulars telling how to prepare for them.

Name.....
Address.....
..... Vet?

THE LUMISCOPE

The newest in Creative Art.

A complete kit to make Beautiful Color Creations THAT GLOW IN THE DARK plus a complete course of simple instructions.

SAFE, NON-TOXIC, EDUCATIONAL PLUS PROFITABLE FUN

a wonderful XMAS present for young and old alike.

KIT INCLUDES:

- 6 Luminous Water Colors
- 6 Luminous Sand Colors
- 4 Plaques 1 Magic Slate
- 10 Lessons in Luminous Art

ORDER NOW—Satisfaction Guaranteed



*YOUTH CRAFT INDUSTRIES

DEPT. M., 2029-31 S. HALSTED ST., CHICAGO 8, ILL.

I enclosed \$2.98 for which I am to receive complete kit as above, postage prepaid.

NAME _____
 ADDRESS _____
 CITY _____ ZONE _____ STATE _____

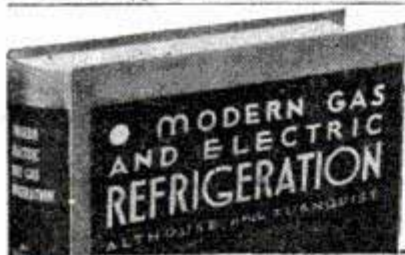

20 Million Refrigerators Need Service and Repairs

REFRIGERATION Made Easy! Biggest Opportunity in Many Years!

NEW PRINTING — ALMOST 1000 PAGES

408 Pictures—17 Diagrams in Colors Makes All Refrigerator Service Maintenance, Repairs Simple as A.B.C.

Millions of refrigerators need service and repairs. Owners are paying big for competent service which will be needed more and more as these refrigerators get older. Get MODERN GAS AND ELECTRIC REFRIGERATION, the non-technical guide to all types of refrigerators and get your share of this new profit. Get a job or start your own service business. This book will help you make money anywhere. Thousands of copies have been sold. Used by trade schools, manufacturers training programs and U. S. Army. Mail coupon. Send \$5.00 or we will send C.O.D. Money back in 5 days if not satisfied. Act now—this may be the opportunity you have been waiting for.

SEND NO MONEY! Mail Coupon

GOODHEART-WILCOX CO.,
 2009 S. Michigan Ave.,
 Dept. 10, Chicago 16, Ill.

Send Gas and Electric Refrigeration. \$5.00 enclosed. Send C.O.D. (in U. S. or Possessions). I will return book in 5 days if not satisfactory and you will refund my money. If remittance accompanies order we will pay postage charges.

Name _____
 Address _____
 City _____ State _____

MAKE UP TO \$5⁰⁰ AN HOUR In Your Own YEAR 'ROUND Business!

ONLY A FEW DOLLARS PUTS YOU IN BUSINESS!

Many Clearing as High as \$20 to \$30 a Day NET Renewing Rugs, Carpets, Upholstery. New Method Now Used for Auto Upholstery. Write for Facts About Quick, Easy Way to Get Started

Here is the chance you've been looking for to step into a pleasant, dignified, big-pay business of your own that offers you a steady, year 'round income. Start on "a shoe-string," full or spare time, right from your own home. Equal opportunities for men and women, young or old, in small towns or big cities. No experience needed. Many making big money with new Americlean System just cleaning auto upholstery. Easy to learn. We send you complete instructions and quick-cleaning supplies so you can start making money the very first day! Quick method cleans upholstery, rugs and carpets like new without taking off floor! Tremendous demand in homes, apartments, hotels, stores, office and public buildings. Steady repeat business. Territories going fast. Write today for full FREE facts. No cost or obligation. Rush letter or postcard now to AMERICLEAN CO., Inc.; Dept. G-12; 211 North 7 St.; St. Louis 1, Mo.

WRITE FOR FREE DETAILS NOW!

GET INTO YOUR OWN BUSINESS WITH

LIQUID IVORY

A GREAT MONEY-MAKING OPPORTUNITY

Regardless of your age, sex, previous experience we will send you astonishing free facts about your own profitable business with amazing replica LIQUID IVORY, one of the most marvelous synthetics ever developed. With it you can easily produce a wide variety of wonderful items that almost defy detection from genuine ivory. An amazing opportunity to start your own profitable business.

EASY TO START! NO LONG WAIT FOR PROFITS!

Send Letter or Post Card for Free Details!

EMPIRE TRADES & HANDICRAFTS, DEPT. PM12 BOX 1340 ST. LOUIS, MO.

NEON SCHOOL Approved for G.I. Training

LEARN NEON and get into America's fastest growing field for ambitious men. Our intensive 500 hour course qualifies you as a trained Neon Technician—ready to start your own business or take a high-pay job. Acme Graduates in big demand. We teach you Neon Tube Bending, Neon Glass Blowing, Color Gassing, Cold Cathode Lighting, Bombarding, other important branches of the Neon Art. At Acme you learn by doing, under personal supervision of experts. Send at once for copy of new FREE folder, "Your Big Opportunity."

ACME NEON INSTITUTE
 Dept. P-3, 1648 West Van Buren Street Chicago, Ill.

RADIO—FM—TELEVISION

Lucrative positions open to technical specialists. WRCI graduates now employed as Broadcast Operator-Engineers, Airline Flight and Ship Radio Officers, CAA and Police Radio Operators, Radio Shop Owners, Radio-Television Technicians. Modern equipment—uncrowded facilities. Start monthly. Morning or afternoon classes. Free illustrated booklet available. Approved for veterans. Non-veterans accepted.

WESTERN RADIO COMMUNICATIONS INSTITUTE
 631 West Ninth Street, Dept. PM Los Angeles 15, Calif.

LEARN JAZZ FROM JAZZ STARS

- TEDDY WILSON** piano
- CHARLIE VENTURA** saxophone
- OSCAR MOORE** guitar
- BOBBY HACKETT** trumpet
- HERBIE FIELDS** clarinet

Now America's Jazz Masters Will Teach You at home, by correspondence courses. Send coupon now for information.

WESCO SCHOOL OF MUSIC, INC. pm10
 657 High Street, Newark, N. J.

Name _____
 Address _____



Have you
considered a
career in
PLASTICS?



A job with a promising future goes a long way toward making you happy —at work and at home.

Do you know of the fine opportunities for advancement that are available in the plastics industry? Do you want to share in the development of a great new plastics era? *Trained men*, who have plastics know-how, will fill the well-paying positions in the industry. If YOU want to be one of them act NOW to prepare yourself.

Every day you can read glowing descriptions of how plastics are improving old products and creating new ones. Learn the hundreds of interesting phases of the plastics industry and be ready for the position that will give you the security and satisfaction you want.

EXCLUSIVELY PLASTICS—Plastics Institute is America's oldest and largest educational organization which devotes all of its facilities exclusively to plastics. **IMMEDIATE ENROLLMENT** can be arranged. Write for information *today!*

COMPLETE COURSES—You learn the various phases of plastics from these courses... materials, designing, molding, fabricating, laminating

Write Dept. PM12-7 1601 S. Western Ave., Los Angeles 6, California

Home Training Courses and Resident School APPROVED FOR VETERANS

and testing. You acquire a basic knowledge of plastics that can be invaluable to you in acquiring the type of position you want.

YOU MAKE THINGS—We supply materials. To give you practical experience in working with plastics, we supply handsome, colorful rods, sheets and tubes of plastics from which you make useful, attractive creations. You form, dye, decorate, cast and laminate various types of plastics. You also design and develop your own ideas. You can make and sell plastics articles to earn while learning.

START YOUR FUTURE TODAY—Mail the coupon below, now! You will get an interesting, illustrated, free booklet with valuable information about plastics. Get complete details about the world renowned Plastics Institute Resident School, located in beautiful Southern California. Also learn about the comprehensive Plastics Home Training Course, which prepares you for a future in plastics while you continue your present job. Clip this coupon and mail it TODAY!



PLASTICS INSTITUTE in the heart of sunny Los Angeles. Here modern laboratories and shops give Resident School students facilities for practice on the finest of industry-type plastics equipment. Also the headquarters for HOME TRAINING.

Plastics
INDUSTRIES TECHNICAL INSTITUTE
NEW YORK CHICAGO LOS ANGELES

Plastics Industries Technical Institute
Dept. PM12-7, 1601 S. Western Ave., Los Angeles 6, Calif.

Mail in Envelope or
paste on penny postcard

Gentlemen: Please send me the booklet "World of Plastics" and information on your Resident School Courses Home Training Courses. I understand there is absolutely no obligation.

Name (PRINT) Occupation

Street (PRINT) Age

City Zone State

Important: Please fill out coupon *completely*. If Veteran, please check. If in Armed Services now, please check.

FREE BOOKLET
Send For It Today!

Wow! Now
CHEMCRAFT
 has **ATOMIC ENERGY!**



Safe! Exciting! Real!
ATOMIC ENERGY
 Exclusive with **CHEMCRAFT!**

Safe, exciting Atomic Energy Experiments make Chemcraft more fun than ever before. And listen, fellows . . . Chemcraft's Atomic Energy feature is the **REAL THING!** You actually conduct your own experiments with the awesome, mysterious and breath-taking force of Atomic Energy. Yet *all* materials, experiments and apparatus are absolutely safe . . . even the Uranium Ore released to Chemcraft by the U. S. Atomic Energy Commission. Send today for new **FREE** descriptive booklet. Mail coupon below. *Insist on . . .*

CHEMCRAFT

AMERICA'S LEADING CHEMISTRY OUTFITS

Atomic Energy comes to you as an **EXTRA SPECIAL ADDITION** to the many other exciting, exclusive features which have made the name **CHEMCRAFT** famous among millions of boy and girl chemists.

Experiments, Instruction Manuals, Chemical Magic, Bryan Chemical Illustrators, Glass Blowing, Chemcraft Chemistry Charts, "The Story of Chemistry" booklet and other popular, exclusive features are included in the larger Chemcraft outfits as usual. No other chemistry outfits give you such a broad assortment of high-grade chemicals, in such large quantities. Ask for it by name.

CHEMCRAFT—SOLD BY LEADING STORES EVERYWHERE
 . . . No Poisons, No Explosives, No Unpleasant Chemicals

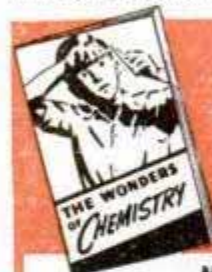

BOYS-IT'S FREE!

Exciting book tells all about "The Wonders of Chemistry" and Atomic Energy. Also describes many fascinating home experiments, tells of many amazing things made possible by chemistry.

Mail coupon for your **FREE** copy today!

THE PORTER CHEMICAL COMPANY
 75 Prospect Avenue Hagerstown, Md.

Mail me **FREE**, without obligation, your new booklet, "The Wonders of Chemistry". (Print plainly)

Name.....Age.....

Address.....

City.....Zone.....State.....

LEARN IN THE GREAT ALLIED SHOPS

— Est. 1928 —

Practical Courses in:

- TOOL AND DIE MAKING:** Instruction in making tools, dies, jigs, fixtures, etc. Layout and assembly work, heat treating, etc.
- MACHINIST TRADE:** Shop training in setup and operation of all-around machine work, layout and assembly.
- TOOL AND DIE AND MACHINE DESIGNING:** Comprehensive instruction in designing of tools and dies, jigs and fixtures, special machines, special devices, etc.
- MECHANICAL DRAFTING:** Practical training in all phases of technical and mechanical drafting, machine drawing, and sheet metal drafting.
- TOOL ENGINEERING:** Detailed study of Engineering Materials, Manufacturing Processes, Pattern Design, Inspection Methods, Production Planning, Welding Methods, Screw Machine Engineering, etc.

Learn under the supervision of an Accredited Staff.

Day and Evening Classes Approved for Veterans
 Send for **FREE** Illustrated Bulletin.

4212 Allied Bldg., 1338 S. Michigan Ave., Chicago 5, Ill.

ALLIED SCHOOL OF MECHANICAL TRADES

25c The Original MOORE'S Educational TOY MOTOR



Patent 1857209

For twenty-five cents you get all parts necessary to build this electric motor, which will make over 6,000 revolutions per minute. It runs on a single No. 6 dry cell battery. Over 3,000,000 Moore Toy Motors have been sold. As an aid to teaching electrical science it is unsurpassed and has been purchased by many schools.

GEORGE W. MOORE INC., 99 Beaver St., Waltham, Mass.

LEARN WATCH REPAIRING



IN YOUR HOME!
HERE'S BIG MONEY and a secure future for **YOU** in watch repairing even if you're just a beginner. Get **PRACTICAL SELF-TRAINING** through our new and complete book, "MODERN WATCH REPAIRING & ADJUSTING." Easy to understand. Every step in repair, adjustment, construction. Theory, operation. Covers all needed tools and their use. Fully illustrated. Only **\$2.75** Post Paid (if C.O.D., plus charges.) **MONEY BACK GUARANTEE**

MODERN TECHNICAL BOOK & TOOL CO.
 Dept. MMC, 55 W. 42nd Street, New York 18, N. Y.

JUST OUT! NEW ALL INCLUSIVE TOOL CATALOG
OVER 450 ILLUSTRATIONS. Shows all tools, material, complete SETS for STUDENTS, Watch-Clockmakers, Jewelers, Handicrafters, and ALL Books in these fields. Send 25c — **FREE** with above book order.



DENTAL TECHNICIANS

Nationwide openings for trained men. Learn by simple home study — with theory and actual practice as a guide. **EASY STEP-BY-STEP TECHNIQUE**

for information write to DEPT. PM-1

DENTAL ARTS INSTITUTE
 1122 MARKET STREET, SAN FRANCISCO 2, CALIF.

LEARN LANDSCAPING

Profitable, healthful career — absorbing hobby, for men, women. Thorough 45-lesson home-study course takes 8-12 months spare time. Hundreds of successful graduates all over the world. 31st year. Send for **FREE** catalog.

American Landscape School, 6478 Grand Ave., Des Moines, Iowa

Let BLEECKER START YOU in a BIG PAY BUSINESS!

Sensational Selling Outfit Furnished

Here's the moneymaking opportunity of a lifetime! Chance to get into your own big paying business with the world's fastest selling line of home and farm necessities. High quality, startling, low, money-saving prices. Sensational bargain deals to win quick, permanent customers. Special offer for limited time to fill quota of new dealers. Write to learn how you can get valuable sales outfit of big, fast-selling line without paying one cent extra, if you act quickly. **The Bleecker Co.**
 Dept. M-127 Farmington, Minn.



Now YOU Can Lick Any AUTO REPAIR JOB!

IN LESS TIME—WITH LESS WORK



**FREE
7-DAY OFFER**

MoToR's New Auto REPAIR MANUAL shows you how to service and repair ANY part of ANY car!

No auto repair job is too tough when you've got MoToR's AUTO REPAIR MANUAL! YOU can repair anything from carburetor to rear end—quickly, easily, right! Just look up make, model, and the job in the quick index—and go to work! Clear, illustrated instructions lead you step by step.

To make such an amazing book possible, the engineer-editors of MoToR Magazine collected and "broke down" 150 official factory shop manuals for you, spotted all the vital repair information you need, dove-tailed it all together into ONE handy, easy-to-understand book.

No Other Manual Like It!

This BIG book—856 pages, 8½x11 inches, bound in sturdy fabric—brings you nearly 200,000 service, repair, adjustment, replacement, tune-up facts on every car built from 1935 through 1946! More than 1000 cut-away photos, diagrams,

drawings show you exactly WHAT to do and HOW to do it! Used by the U. S. Army, trade and technical schools everywhere, thousands of auto servicemen.

Now YOU—without cost—can see for yourself what a wonderbook MoToR's Auto Repair Manual really is. TRY it—FREE for 7 days! Learn first-hand how it can pay for itself the first few times you use it.

SEND NO MONEY 7-Day Free Examination

Just mail coupon below—without money! When the postman brings your book, pay him nothing. First make it show you what it's got! Unless you agree this is the greatest time-saver and work-saver you've ever seen—return book in 7 days and pay nothing. Mail coupon today! Address: MoToR Book Department, Desk 1-P, 572 Madison Ave., New York 22, New York.

USED BY
U. S.
ARMY

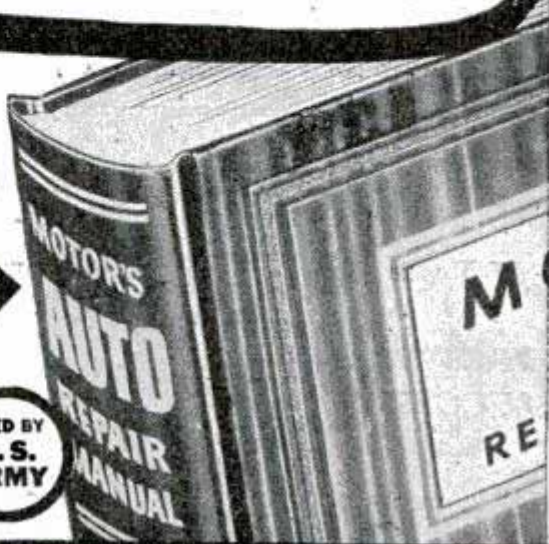

Clear, Pictured Facts on Every Job on Every Car Built Since 1935!

Nearly 200,000 service and repair facts on all these makes:

American	Ford	Oldsmobile
Bantam	Graham	Overland
Auburn	Hudson	Packard
Austin	Hupmobile	Pierce
Buick	Lafayette	Arrow
Cadillac	La Salle	Plymouth
Chevrolet	Lincoln	Pontiac
Chrysler	Lincoln	Reo
Cord	Zephyr	Studebaker
Crosley	Mercury	Terraplane
De Soto	Nash	Willis
Dodge		

856 big pages; including 50 pages of carburetor text, charts, illustrations, covering all models. Over 500 charts, tables: Tune-up Chart; Valve Measurements; Compression Pressure; Torque Wrench Reading; Starting Motor; Engine Clearances; Generator; Clutch & Brake Specifications; Front End Measurements, etc.; Engines; Electric, Fuel, Cooling, Lubricating Systems; Transmissions; Universals; Front Ends; Wheels; Rear Ends, etc.

Same FREE 7-Day Offer Applies on

MoToR's TRUCK REPAIR MANUAL

For mechanics, truck specialists, service stations, fleet owners. Covers EVERY job on EVERY truck made since 1936! 1400 pictures. 952 pages. 300,000 facts. Used by Armed Forces. Warranted to contain every essential fact you need to know. Sturdy binding, size 8½x11.

Covers all types Gasoline En-

gines; Diesels and Hesselmans. Fuel Systems. Governors. Lubrication Systems. Ignition Systems. Starters. Generators. Clutches. Transmissions. Axles. Torque Dividers. Transfer Cases. Brakes. Steering, etc., etc.

ALSO SERVICES buses, farm and industrial tractors, contractor and road building equipment, stationary power machinery, etc. (on all parts described in Manual). Offered on same FREE 7-Day examination as Auto Repair Manual. Check box in coupon at right.



MoToR Published by MoToR, The Leading Automotive Business Magazine. MoToR's manuals assure high standards of repair work.

MAIL COUPON NOW FOR 7-DAY FREE TRIAL

MoToR Book Dept., Desk 1-P, 572 Madison Ave., New York 22, N. Y. Rush to me—at once: (check box opposite book you want)

MoToR's AUTO REPAIR MANUAL. If O.K. I will remit \$1 in 7 days, (plus 35c delivery charge), then \$2 monthly for 2 months, and a final payment of 95c one month later. (Book's price \$5.95.) Otherwise I will return book postpaid in 7 days. (Foreign price, remit \$8 cash with order.)

MoToR's TRUCK REPAIR MANUAL. (Described at left.) If O.K. I will remit \$2 in 7 days, and \$2 monthly for 3 months, plus 35c delivery charge with final payment (\$8.35 in all). Otherwise I will return book postpaid in 7 days. (Foreign price, remit \$10 cash with order.)

Print Name..... Age.....

Print Address.....

City..... Zone No. (if any).....

State..... Occupation.....

SAVE 35c! Check here if enclosing full payment (Check, M.O. or Postal Note) WITH coupon. We pay 35c shipping costs. Same 7-day return-refund privilege.

We'll establish you in Your Own Business and help finance you!

Ever said to yourself, "I don't like the idea of working for others. Someday I'd like to have my own business, and be my own boss." Here, then, is an opportunity made-to-order for you. We are NOW enlarging this 17 YEAR OLD, Nationwide chain of individually-owned Certified Service business. If you are dependable, honest and willing to work, we invite you to mail coupon below for details on how to become financially independent in a profitable, lifetime

business of your own. We will establish you in your own business and arrange finance terms to help get you started. You use the proven, successful methods of long established DURACLEAN Dealers. Here is truly a sound, steady, lifetime business. Dealerships grow from REPEAT and VOLUNTARY orders. Your gross profits (above materials and labor) are up to \$20 for a day's service on EACH of your service men. It's easy to learn . . . quickly established.



Foamovator becomes carrying case

17 Years
of
PROVEN
SUCCESS

You Become an Expert in cleaning and protecting Rugs and Upholstery!

DURACLEAN cleans by absorption. An aerated foam, created by the patented electric Foamovator, restores the natural lubrication of wool and other animal fibers in rugs and upholstery. Dirt, grease and many unsightly spots vanish as if by magic. Fabrics and floor coverings are cleaned with a new consideration for their life and beauty.

Cleaning is done right in the home! Fabrics dry in just a few hours. No inconvenience for customers. Rug pile again stands erect and even. Furnishings are left clean, fresh and enlivened.



DURAPROOF is another year round service rendered right in the home, office or institution—without removing furnishings. It protects carpets, upholstery, furs, clothing, piano felts and auto interiors against damage by moths, carpet beetles or mildew. The U. S.

Government says, "Moths are present in practically every household. . . No section of the country seems free from such infestations." **DURAPROOF** not only kills moths and carpet beetles . . . it makes materials non-eatable to both

and also protects against mildew. To our knowledge, **DURAPROOF** is the only mothproof service backed by a National MONEY BACK, 4 YEAR WARRANTY.

Fabrics last longer because this modern, safe cleaning process avoids the use of strong soaps and harmful solvents that so often damage dyes or fabrics. . . . No machine scrubbing! This eliminates unnecessary wear on pile and the breaking of fibers.

Easy To Learn • No Overhead Expense

Start Full or Part Time

No experience necessary! Some dealers establish shops or an office . . . others operate from their own homes. At the start you may want to render service yourself. Service may be rendered in homes, offices, hotels, theaters or institutions. Auto dealers buy your **DURACLEAN** Service to revive upholstery in used cars. Foamovator converts to easy carrying case. Almost every building in your territory houses a potential customer needing one or both services.

Repeat and Voluntary Orders

Demonstrations win new customers. Men with **DURACLEAN** Dealerships find REPEAT and VOLUNTARY orders become a major source of income. Customers are not merely satisfied—many are enthused with results and tell their friends and neighbors. Furniture and department stores and interior decorators turn over rug and upholstery cleaning and mothproofing to **DURACLEAN** Dealers. We show you 18 ways to get new customers.

Two-Way Profit

You enjoy big profits on both materials and labor—after paying service men and salesmen. These are year round services for which there is always a constant need. You have National prestige and the cooperation of a National 17 YEAR OLD organization interested in your services. The rapidly growing need for Certified Service makes TODAY the ideal time to become the owner of a **DURACLEAN** Certified Service business.

Dealer Comments:

R. Kimbrough: "Finished First White House of Confederacy and am to **DURACLEAN** Governor's Mansion."

O. D. Heffelbower: "People who have seen the work have expressed amazement."

E. Schalchlin: "Have on hand 5 orders totaling over \$500.00 . . . obtained from recommendations of customers."

EASY TERMS!

A moderate payment establishes your own business. Easy terms permit you to pay balance from your sales. We furnish electric machines, folders, store cards, introduction slips, sales portfolio, demonstrators and enough material to return your TOTAL investment. You can have your business operating in a very few days. Mail coupon today! No obligation.

Copyright 1947 by

DURACLEAN CO. 16 — D Street
Deerfield, Ill.

FREE Booklet

Our first letter and 16 page illustrated booklet will explain everything—the two modern, urgently needed services, waiting market, how business grows, your large profit, easy terms and PROTECTED territory.

Send Coupon TODAY!

"OWN a Business" Coupon

Duraclean Co.

Division of HOME SERVICE CO.

16 — D Street, Deerfield, Illinois

With no obligation to me, send booklet and letter giving full details. Tell me how I may OWN a growing business of my own built upon satisfied customers.

Name _____ Age _____

Address _____

City _____ State _____

**WORLD'S
BEST
WANT AD
MEDIUM**

CLASSIFIED Advertisements



Advertisements in this section 75 cents per word, each insertion, minimum 10 words, payable in advance
To be inserted under proper classification, copy must be in our office the 25th of the
second month preceding date of issue

F. W. Johnson, Manager, Classified Advertising
Popular Mechanics Magazine, 200 East Ontario Street, Chicago 11, Illinois

1461

**CLASSIFIED
ADVERTISEMENTS**

1461

**OPPORTUNITIES
FOR YOU**

AUTOMOBILES, MIDGET CARS

SPEED Equipment. Marine and automotive. We have only the best, made by leading southern California manufacturers including — Edelbrock, Meyers, Weiland, Winfield, Jahns, Offenhausser, etc. Complete line of high compression heads, dual manifolds, racing pistons, camshafts, dual ignitions, etc. Send 25c for illustrated catalog. So-Cal Speed Shop, 1104 S. Victory, Burbank, California.

AUTOMOBILE Racing, Sixth Edition. 100 illustrations. Working drawings with building instructions for Ford-60 midget, California roadster, Offenhausser racer. Details on racer parts. Sample entrance blank. World's record 158.5 m.p.h. rear engine four-wheel drive car. Interesting information for fans, drivers, mechanics. \$2.00 postpaid; \$2.25 c.o.d. Ray Kuns, Department 63, Cincinnati 27, Ohio.

MIDGET Car Book—Includes plans for easily building speedy midget racers, two passenger highway runabouts, sporty 3-wheel "Motor-ette," inexpensive scooter-car. Large book, photographs, drawings, supply lists. \$1. EA Engineering, Box 660-H, Brooklyn 1.

AUTO Seat covers, nylon stitching, real vinyl leatherette trim, holiday sale. Free colorful circular. Sunrise Tires, 121 Sunrise Hwy., Rockville Centre, N. Y.

"VAPO-STEAMATIC" Water injection. Easily assemble yourself (parts anywhere; only \$1.00). Latest "controlled humidity" system (developed by former airforce engineers!) "Cuts" fuel consumption! Greatly increases horsepower, speed! Eliminates detonation, carbon, oil pumping, Cooler, sm-o-o-ther motor! Copyrighted "Water Injection Handbook," fully illustrated — including "Installation Instructions" \$1.00. Newhouse Industries, 5941-PM Hereford, Los Angeles 22, Calif.

1947 SUPERIGNITIONER. Atomic starting, pep, mileage, \$5.50. 13 improvements. \$1.00. EG Mfg. 355A East 149th, New York 55.

AUTOMOBILE Racing book, fifth edition, well illustrated. Instructions on building bodies, frames, engines. Ford A and B conversions. Plans. AAA rules, specifications. Roadster racing. Indianapolis cars. \$1.00 postpaid, \$1.30 C.O.D. Ray Kuns, Dept. 47, Madisonville, Cincinnati 27, Ohio.

HIGH Compression heads, V-8. More speed, acceleration, power. Offenhausser or Edelbrock \$75.00 complete set. Dual manifolds complete with throttle kit, fuel lines. Edelbrock \$49.00, Offenhausser \$55.00. Give make, model V-8. Catalog 10c. Clymer, Dept. A-113, 2125 W. Pico, Los Angeles 6, Calif.

SPEED And Mileage Manual — Obtain greater speed, mileage, racing performance from any automobile! Includes simplified methods, speed tuning, gas saving secrets. Instructions on building economizers, speed equipment, duals, mufflers, superchargers, racing fuels, fast conversions, "hot-rods." Parts lists. \$1.98. Almqvist Engineering, Box 660-H, Brooklyn, 1.

REX May's Racer \$3.00. Kun's Auto Racing Book 6th edition just out \$2.00 postpaid. Clymer, Dept. A-119, 2125 W. Pico, Los Angeles 6, Calif.

"1948" Custom Styling Manual. Easily make car look Hollywoodized, custombuilt, ultra-beautiful! New simplified customizing, restyling, streamlining methods. Instructions, photographs. Plans for sporty accessories, refinishing, mufflers, model changes—all cars. \$2. Almqvist Engineering, Bx. 660-H, Brooklyn, 1.

AUTO Repair manuals, by Victor Page. Complete non-technical data all mechanical features, operation, repair. Ford V-8 cars, trucks, 823 pages, 369 illustrations. \$3.50 postpaid. Chevrolet six and truck, 896 pages, 363 illustrations. \$3.50 postpaid. Clymer, Dept. FC-1, 2125 W. Pico, Los Angeles 6, Calif.

DUALTONE Chrystaline packed, California mufflers, single or twin for all automobiles. Carburetor velocity stacks. Compression cylinder heads. Dual manifolds. Large double or single chromed tailpipe extensions. Chromed station wagon stacks. Fender skirts. Xmas shipments. Request catalogue. Dualtone Mufflers, 2636C India Street, San Diego 1, California.

MAKE Your Model "A" do 100 m.p.h. Lightning acceleration, breath-taking top speed. Complete details, photographs. \$1 postpaid. Four Barrel, Box L-1, Eaglerock, Los Angeles 41, Calif.

BUILD Automatic clutch, scooters, midget autos, tractors, shop machines. Catalog free. Nichols Equipment Co., Dept. 511, Purvis, Miss.

CALIFORNIA Mufflers and speed equipment. Doll-up accessories. Save freight cost from California. Bill Von Esser, 2840 No. Kedzie Ave., Chicago 18, Ill.

HOLLYWOOD Hot-Rods, photos, instructions for fast Fords, etc. \$1.50 p.p. Racing parts list. Cams, manifolds, heads, etc. 25c p.p. Hollywood Hot-Rod. Los Feliz, Box 9626P, Hollywood 27, Calif.

SPEED AGE. The auto racing magazine. Ideal Christmas gift. \$3.00 year. Box 237-P, Hyattsville, Maryland. Also on newsstands.

WATER Injection for your car. More power, greater fuel economy. \$14.65 complete. Free booklet sent on request. Speed-Dee Products, 2409 South Tenth Street, Tacoma 6, Washington.

NO. 4 Clymer Historical Scrapbook. Entirely new, different. 224 pages, advertisements, photographs 250 early automobiles, motorcycles. \$1.50. Deluxe edition \$2.50 postpaid. Clymer, Dept. A-118, 2125 W. Pico, Los Angeles 6, Calif.

FILTERMASTERS. Heat exchanger regulates oil filter temperatures by using coolant water. Temperature regulation more than doubles filter efficiency. Easy five-minute installation really makes filters work. Get yours now for greater engine usefulness at \$3.95 p.p. Filtermaster, Dept. PM-21, 440 E. Schantz, Dayton 9, Ohio.

1947 INDIANAPOLIS Race History. Enlarged, 56 pages. 125 photographs, charts, complete details cars, drivers, specifications. \$1.00 postpaid. 320-page Indianapolis history book 1909 to now \$3.50. DeLuxe Edition \$5.00 postpaid. Clymer, Dept. A-110, 2125 W. Pico, Los Angeles 6, Calif.

AUTO Parts. We have them. New or rebuilt. Prompt shipment. Write requirements. Save money, buy direct. Factory warehouse. Mechanics Auto Parts, 3807-PM N. Ashland Ave., Chicago 13.

TRUNK Hinges. Chrome. 1935-36 Chev., Olds, Pontiac, Buick, Also 1936 Ply., Dodge, Chrysler, DeSoto. \$3.00 pair postpaid. Send money order to Arrow Products, 4137 Ogden, Chicago 23, Illinois.

KAISER-FRAZER. Floyd Clymer's new book (no connection with Kaiser) gives uncensored, impartial report 3000-mile test including Pike's Peak, Kansas City-Denver record runs, economy test. Part by part equipment analysis. Good, bad comments, no punches pulled. \$1.50 postpaid. Clymer, Dept. A-111, 2125 W. Pico, Los Angeles 6, Calif.

CHROME Air horns—For all makes of automobiles. Send for free literature. Protected Company, 4033A Windsor #1, Youngstown 7, Ohio.

R & R Mfg. Co., Marine and Auto Division, Robert M. Roof, Box 546-P, Anderson, Indiana, U.S.A. \$1.00 for new speed and power equipment catalogue with price sheet, showing racing cars, midgets, speed boats. Recommendations for rebuilding your motor for racing. Cylinder heads for Ford-Ferguson, Model A, V-60-100, Mercury Fords, Studebaker Champion and Willys. Dual intake manifolds, pistons, camshafts, compound valve springs, Lynite flywheels and numerous other supplies.

JEEP Station wagon blueprints, manual \$2.00. Diesel conversion, water injection systems. Blueprints, manuals \$2.00. Circulars, photos, 20c. Craftsman Books, Box 1153, Milwaukee 1, Wisconsin.

CLYMERTONE. Twin muffler sets, beautiful sound, complete with necessary welded pipes, E-Z installation. Ford V-8, \$20.00. Chevrolet set with split manifolds, \$37.50. Specify car model. Clymer, Dept. A114, 2125 W. Pico, Los Angeles 6, Calif.

CUSTOMIZE Your automobile! Revised, enlarged book, latest restyling, complete, sharp. 50 photographs! \$1 pp. Post Publications, Box 723-SE, Arcadia, California.

AUTO Racing magazine subscriptions. Pacific Speedway News, \$6.00 yearly. National Speed Sport, \$4.00. Illustrated Speedway News, \$4.00. All give complete data midget, big car race results. Sample copy each 50c. Specify publication wanted. Clymer, Dept. A112, 2125 W. Pico, Los Angeles 6, Calif.

CUSTOM-CAR Photograph album. Fascinating automobile style classics. Coachcraft, Summers, independents, photo-packed! \$1 pp. Post Publications, Box 723-AE, Arcadia, California.

SEE Our ad under Motorscooters for midget car bargains. Midget Motors Directory, Athens, Ohio.

PHOTOGRAPHS. World's finest automobiles. List 10c. Box 1028, Minneapolis, Minnesota.

USED-CAR Buyer's Handbook. Save dollars, grief. Photographs, dealers' tricks, complete tests. \$1 pp. Post Publications, Box 723-TE, Arcadia, California.

BRITISH Sports cars. New book. 96 makes described. Fine illustrations, specifications. \$3.00 postpaid. Clymer, Dept. A117, 2125 W. Pico, Los Angeles 6, Calif.

CLYMER-LITE Aluminum pistons for Chevrolet. More speed, power, acceleration. Less vibration, heat. Complete with pin, rings. \$5.00 each. Semi or finished. State size. Clymer, Dept. A116, 2125 W. Pico, Los Angeles 6, Calif.

MIDGET Racing car blueprint. 1943 professional design \$1.98. Sawin, Box 31b, Seekonk, Mass.

INSTALL V-8 engine in your Model A for extreme acceleration, more top speed, smoother performance. Complete details, photographs. \$1 postpaid. A-V-8, Box L-1, Eaglerock, Los Angeles 41, Calif.

PROFESSIONAL Midget racer, motor-scooter, midget roadster, and midget motorcycle. Plans, specifications for all four contained in illustrated handbook, 25c. Big list bargain priced used motors, motorscooters, servicycles, etc., included free! Midwest. 3839 Drummond, Toledo, Ohio.

MAKE Your Ford fast! Complete details, photographs. How to construct 120 m.p.h. Hotrod. \$1 postpaid. California Bill, Box L-1, Eaglerock, Los Angeles 41, Calif.

BUILD Speedy midget track racer from castoff parts! Plans, specifications, construction information, \$1.00. Motor Supply, Box CS-1682, Toledo, Ohio.

AUTO SUPPLIES AND EQUIPMENT

BURN Water in your car. Costs less than gas. More power. Cleaner motor. Mail card for data on \$17.50 Octa-Gane Water Injecting Carburetor. Advanced Automotive Products, 563-2 Lake Road, Webster, N. Y.

NEED Auto accessories, parts, hardware, ammunition, home supplies? Cutrate catalog available. Main Supply, Fairfield, Ill.

GLARE Eliminator. Patent pending. Drawings. Specifications \$1.00. John, 11822-81 Street, Edmonton, Alberta.

BATTERY Men—We have plates, cell groups, parts and tools. Battery Parts Distributor Co., 1328 Chestnut St., Philadelphia, Penna.

ELIMINATE Windshield fog with treated wiping cloth. 25c. Rapolz, Sanborn Ave., Ashland, Wis.

"QUICK Start" for your car in coldest weather—relieves storage battery of long grinds. Booster battery with necessary accessories to give hot sparks to engine plugs. Complete with full instructions for installation. \$6.00 postpaid. RCH Engineering Co., P.O. Box 93, Riverside, Ill.

WELDING Bodies, repairing fenders, pays good profits using Hobart's a.c. arc welder. Catalog free. Write Hobart Welders, Box M-1272, Troy, Ohio.

WELDERS For all requirements. Free catalog. Write Hobartweld, Box M-1273, Troy, Ohio.

GUARANTEED Winter starting ignition on two volts. Eliminate burned points. Unit \$16. Plans for making your own \$1.00. Give car make, model. Ignition Engineering Co., 3344-A Beard No., Minneapolis, Minn.

WANT To save gas? Free literature on simple carburetor part installed in one minute. Write Albert Peek, 1514 Driscoll, Houston 6, Texas.

FORD-MERCURY Owners 1941-47, operate your dome lights from both front doors. Easily installed, no drilling. Door light switches with wiring \$2.50 per pair postpaid. Danby Manufacturing Company, Portland, Michigan.

AUTO Parts, new and used. Rearend and transmission specialists. Describe needs. Arrow Auto Wreckers, 4128 Ogden Ave., Chicago 23, Illinois.

EXTRA Winter starting ignition for less than \$2.00. Send \$1.00 for plans to C. Young, Box 93, Villa Park, Illinois.

ANTI-FREEZE. Make your own. Instructions 25c. Rapolz, Sanborn Ave., Ashland, Wisconsin.

PUNCH-LOK Hose clamp kit for automotive replacement and service station maintenance. Stops leaky connections. Free details. Water Master, 19465 Ward, Detroit 21, Michigan.

WATER Injection Manual—Easily make own system (for less than \$1). "Vapor Injection" increases speed, power, acceleration—30% gas saving! Better performance! Eliminates ping, carbon. Reduces wear, sludge, oil pumping. Instructions include "Hop-up Tips." \$1.00. EA Engineering, Bx. 660-H, Brooklyn 1.

CARBURETOR Repair kits, miscellaneous parts for most popular carburetors. State requirements. Carburetor Service, 600 LaPrairie, Ferndale 20, Mich.

OIL Pumping motors—brought back to normal without ring job. Send address on postcard for free details. Mullner Co., Box 3102, St. Paul 1, Minn.

AUTOMOBILE Glass! Rubber floor mats! Shock absorbers! Direct factory prices! Immediate shipment or quotations. Cooper Automotive Services, 3135 W. Lawrence, Chicago 25.

SPRAY Paint your automobile. Complete professional instructions, \$1.00. 155 Tasso, Palo Alto, California.

PATENTED Gasoline saving vacuum supercharger, uses gasoline motors waste. \$12.50. Self addressed stamped envelope for pamphlet. McDowell Co., 2000 NE Union Portland 12, Oregon.

HEAT Booster. Raises temperature of water entering your hot water heater. Aluminum casting bolts to exhaust manifold. Cuts down warm-up time, increases heat, solves problem for sluggish heaters. Russell Machine Co., 416 Scribner, Grand Rapids, Mich.

PARTS For autos and trucks guaranteed from 1916 on. Describe part when ordering. Bill's Auto Parts, Valley Falls, R. I.

STOP Automatic choke troubles with easily attached hand choke adapters. \$3.00 postpaid guaranteed. Details free. Redex Co., 1301 Ridgeway, Rochester 13, New York.

GRILLES For all cars. Meyers Auto Parts, 820 Dryades, New Orleans, La.

NEW And used automobile and truck parts. Lowest prices. Complete stock. Prompt reply. Babbitt Auto Parts, 2833 W. Chicago Ave., Chicago 22.

PLATING Outfits for auto parts. Connect to a battery. No tanks used. Free particulars and proofs. Gunmetal Co., Ave. J, Decatur, Ill.

AUTO Parts for all autos and trucks. Trans., motors, differentials, fenders, carburetors. Also body parts. Security Auto and Truck Parts, 1923 BJ Grace, Chicago 13.

BUILD Your own trailer—midget house, utility. Complete details 25c. Popular Mechanics Press, (C-43), 200 E. Ontario, Chicago.

AUTO TRAILERS

LUXURIOUS 26 Ft. trailer. Manual, drawings, parts list \$2.00. Six view blueprint \$1.00. Illustrated circular 20c. Craftsman Books, Box 1153, Milwaukee 1, Wisconsin.

HOUSE-TRAILER. Complete housekeeping facilities built into this beautiful trailer. Size 7½x17 by 6 ft. 4" inside measurements. Sleeps 4 comfortably. All steel chassis. Our plans make it easy to build. Complete plans \$1.50. Popular Mechanics Press, 200 East Ontario St., Chicago 11, Ill.

TRAILERCOACHES—Learn about all types; sports, living or travel. Approximately 100 pages monthly; magazine tells all. Special rate, \$1 the year in U. S., \$1.50 to Canada, \$2.00 foreign. Trail-R-News, Box 431-A, Glendale, California.

BUILD Your own trailer! Save money! Have every feature you want! Plans for house, sport, camp and utility trailers. Catalog describing 9 models 10c. 15c in Canada and overseas. Jim Dandy, Box 125-A, Wausau, Wisconsin.

MOTORCYCLES, BICYCLES, MOTOR-SCOOTERS AND SUPPLIES

HARLEY-DAVIDSON Supplies, parts, accessories, oil service, tires all sizes, repaired 45" motors. Send \$2.25 for Army Motorcycle Manual, 10c for bulletin. Knuth's (Harley-Davidson Dealers), 2491 Fondulac, Milwaukee, Wis.

MOTORCYCLES, Parts, new and used. Harley, Indian, Henderson, Super-X. List 10c. Ballak, 811 N. 9th, St. Louis 1, Mo.

CHROME Plating on all motorcycle parts. Doll up your bike. Free literature. Master Silverplaters, 2031 Caniff Ave., Detroit, Michigan.

BICYCLE Repairing, complete illustrated manual 65c. Robert Klausner, Shelbyville, Ill.

BICYCLE Supplies, wholesale, retail. List. 10c. Universal, 4713 Virginia, St. Louis, Mo.

MIDGET Racer less motor \$25; Midget car complete \$58; Factory built motor-scooters \$50 up complete; others \$25 up; German Sachs motorcycle \$50; 74 Harley \$25; Henderson motor \$5; others as low as \$3; plenty of brand new two horsepower gasoline engines in original crates; plenty new midget highway racers; plenty brand new motor-scooters; over 5,400 small tires \$1 up. (Mail Order Only). Send 25c for Big War-Bargain Catalogue Number 22, just out, listing the above and hundreds of other bargains in motor-scooters, midget cars, motorcycles, engines, parts, plans, etc. (35c by first class mail). Midget Motors Directory, Athens, Ohio.

T. T. RACING. New, exciting, accurate book of world famous English road racing history. Just printed. \$3.00 postpaid. (See our advertisements under auto.) Clymer, Dent, TT-1, 2125 W. Pico, Los Angeles 6, Calif.

FREE! Illustrated folder custom motorcycle accessories. New seat covers, bright colors, molded cushions, \$6.75. Leather jackets, \$36.95. Chrome muffler-loud-speaker, \$15. Pacific Cycles, Dept. A1, 1208 Pine, Seattle, Washington.

THREE - WHEELED Scooter, 1 HP. \$100.00. Jim Gills, Whitethorn, Bluefield, W. Va.

SCHWINN Bicycles for Christmas. Send dime for list. Wholesale, Retail, Century Cycle, 3447 Lawrence, Chicago 25, Illinois.

BICYCLE Repairing. Begin at once. Manual explains everything. Make money from start. Postpaid, one dollar. Cahill Cycle Shop, Centerville, Maryland.

MOTOR Scooters, bicycle engines. 120 miles gallon. Dime for catalog. Clymer, Dept. A115, 2125 W. Pico, Los Angeles 6, Calif.

JUST Out. Bulletin containing bargains in race cars, motorbikes, motorcycles and motors. Send 25c. Behnke's, 5721 Leland, Chicago 30, Ill.

HARLEY-DAVIDSON Parts, accessories, batteries, and tires, 24 hour service. Authorized factory dealer. Philadelphia Harley-Davidson Company, 657 North Broad Street, Philadelphia 23, Penna.

CUSHMAN Motorscooter \$15. Show bicycle motor \$15. Harley-Davidson motorcycle, \$35! Send 25c for bargain catalog #8 packed with money saving buys in motor-scooters, motorbikes, midget cars, motors, wheels, tires and parts. Gail and Company, 538 Erie, Toledo, Ohio.

WHEELS! Build wagons, scooters, mowers, trailers, wheelbarrows, grocery carts, baby carts, play pens, baby carriages. 4" to 16" Free list. Trulsen Mfg. Co., 811 E. 31, Kansas City, Mo.

TIRES And industrial wheels, suitable for scooters, wheelbarrows, farm equipment, etc. All sizes. Bicycles and accessories. Largest assortment in America. Send dime for list. Cycle Transport Company, 1241 So. Michigan Ave., Chicago 5, Illinois.

BUILD America's lowest priced motor-scooter speedster! Complete plans, specifications, \$1.00. Big list bargain priced used motors, etc., included free! Motor Supply, Box 1682-CS, Toledo, Ohio.

LARGE Stock Indian parts. Expert motor rebuilding. New and rebuilt Chief motorcycle, motors only. Indian Motorcycle Sales, Kansas City 1, Mo.

CUSHMAN Motorscooter \$20 (includes motor and extra tires). Midget racer \$15! Send 25c for big catalog #938 listing these and scores of other sensational bargains in motors, wheels, motor-scooters, motor-bikes, servicycles, tires, etc. Associated, Box CS-1764, Toledo, Ohio.

AVIATION

JET Propulsion experiments. New design. Drive bicycle. Circular on plans. Rush name. Maupin, Tipp City 4, Ohio.

NEW Airplane tires, tubes and wheels, complete with bearings and spindle. For installation on harvesters, farm implements, low bed tractor trailers, etc. A size for every load. The world's largest stock. Send post card for details. Dept. B, Post Office Box 89, Merced, California.

LIGHT Plane blueprints, manuals. Circular illustrates designs, motors 10c. Craftsman Books, Box 1153, Milwaukee 1, Wisconsin.

PROPELLERS For ice-snow sleds, air boats. Catalog 10c. Banks-Maxwell, R.F.D. 12, Ft. Worth, Texas.

B-29 COMPUTERS, 400 Cycle dynamometers, 60VDC amplidyne and servo amplifiers, turret drives, bomb releases, starter solenoids, collector rings, etc. List. Eresco, 2912 Hewitt, Everett 1, Washington.

FREE Catalog describes world's most complete line of navigation instruments and texts. Includes famous Weems Mark II Plotters, Dalton E6B and Mark VII Computers, protractors, star charts, plotting boards, watches, celestial coordinators, charts, sextants, navigation notebooks, many more. Weems equipment standard with Army-Navy air forces, commercial airlines. Write Dept. 2, Weems System of Navigation, Annapolis, Md.

PROPELLERS—2 And 3 blade, designed for ice-snow sleds, boats. Literature. Standard Aircraft, Box 387, Ft. Worth, Texas.

SKI-TOWS. Portable, auto-powered. 500 ft. long. Pulls you both ways. Up, level or downhill. Set up in 20 minutes. Only \$125. Send card for particulars. Great-Northern Mart, North Adams, Mass.

4' 6" PUSHER Propellers, Three blade pusher propeller. Finest birch laminated construction, brass tipping. 50 to 85 h.p. for boats, sleds, etc. \$75.00. Same type as used on the famous CallAir SnowCar. CallAir, Afton, Wyoming.

GIANT Glider kites. Double. 14x10 ft. Lifts 100 lbs., tows car, etc. Cost government \$108. Yours for \$20. Satisfaction guaranteed. Great Northern Mart, North Adams, Mass.

WOOD Propellers, all types duplicated. Universal Aircraft Co., Box 2256, Fort Worth, Texas.

BATTERIES, GENERATORS

\$150.00 NEW Generators, only \$33.00. See Greer advertisement under "Welding."

EDISON Non-acid lifetime storage batteries for home lighting, motors, radios, etc. Free complete interesting literature. T. Hawley Smith Company, Croton Falls, N. Y.

ELECTRICAL SUPPLIES, EQUIPMENT

ELECTROPLATING Has a thousand and one uses when working with electrical supplies and equipment. Warner Electroplaters permit you to easily plate chromium, gold, silver, nickel, copper, etc. Plating equals costly commercial jobs. Pay for your electroplater in a short time by plating for others at a profit. Write today for free sample and literature. Warner Electric Co., Dept. ES-12, 1512 Jarvis Avenue, Chicago 26, Ill.

MOTORS. Blowers, oil burners, oil furnaces, gas burners, gas furnaces, pumps, Superior, Monrovia, Calif.

LAMP Parts—New 1948 illustrated catalog just out. Send 10c. Every part necessary to build, convert or repair lamps. Gyro Lamps, 5416P N. Clark, Chicago 40.

A NEW Lighted plastic sign or advertising clock. As low as \$24.75. Interstate Laboratories, 4049 Minnehaha Ave., Minneapolis, Minn.

LAMP Sockets, mogul sockets, three way switches, S.P. tumbler switches, duplex receptacles, cordsets, electrical repair parts, lamp parts, wires, etc. Catalog 10c. The Gearon Company, 6405 North Oakley, Chicago.

AMAZING New Pencilator. It gives you ohm's law, wire sizes and amperes to 500MCM, motor sizes and amperes to 60 h.p. a.c.-d.c. and 3 phase current. A guaranteed mechanical pencil for only \$1.50. H. E. Zarek Co., 317 W. Palm St., Compton, Calif.

BUY Wholesale quantities! Get wholesale price! Male rubber plugs 100 for \$5.00, cube taps 2 prongs, 3 outlets 50 for \$4.00, pullchain current taps 5 for \$2.00, pull-chain ceiling receptacles 5 for \$2.50, duplex flush receptacles 5 for \$1.00. Jarott Supply, Box 156, Woodside, N. Y.

TATTOOING Machines, outfits, world's finest. Free catalogue. Jensen, 120 West 83rd Street, Los Angeles 3.

NEW Surplus wire and cable, 200 sizes and types. Armored, Tlrex, lead. Free list. Ereco, 2912 Hewitt, Everett 1, Washington.

ELECTRIC Appliances—Our new booklet No. 111 gives hints on the care and repair of all electric appliances from clocks to washing machines. Also details for making simple time switches to control appliances. Only 25c. Popular Mechanics Press, 200 East Ontario Street, Chicago, 11, Ill.

NEON 75c per foot. Direct from factory. Interstate Laboratories, 4049 Minnehaha Ave., Minneapolis, Minn.

FLUORESCENT Lights. Make your own, ideal for home and shop. Complete electrical parts for 20-watt fixture with detailed instructions. Postpaid only \$2.00. Write Fluorokit, 332 E. Reservoir, Milwaukee, Wisconsin.

CHRISTMAS Tree light sets and bulbs. Jeannette Electric, 159 West 23rd St., New York 11, N.Y.

\$150.00 NEW Generators, only \$33.00. See Greer advertisement under "Welding."

MAGNET. "Alnico" 4 oz. horseshoe, powerful (lifts about 5 lb.) \$1.00, 8 oz. (lifts 10 lb.) \$1.50, 3 lb. (lifts 20 lb.) \$6.00; all postpaid. Ross, C88 West Broadway, New York, N. Y.

VOLTAGE Regulators. Autolite, silver contacts and large radio filter. Like new condition. Original cost \$140.90. Price \$5.95 prepaid. Also new Delco Remy regulators. Platinum contacts, \$8.95 prepaid. Both 24 volt, 50 amp. State Ignition, 2521 Indiana, Chicago 16, Ill.

FREE Catalog of welders, welding supplies, generators, fencers, electric lawn mowers, freezers, and other electrical items. LeJay Company, Minneapolis, Minn.

ELECTRIC Pencil—Writes, engraves all metals. Battery model \$1.00—110 volt model \$3.00. Complete. C.O.D.'s accepted. Reb Industries, Dept. 265-CC, Elmhurst, Illinois.

THERMAL Switches 22c. Bargains in war surplus motors, rheostats, Vickers hydraulic speed transmissions, gear reducers, flexible shafts, relays, etc. Delta Sales, 738 Kirby, Shreveport, Louisiana.

ELECTRIC Pencil: Writes, engraves all metals. \$1.00 postpaid. Beyer Mfg., 229-H Dixon Blvd., Uniontown, Penna.

WELDING, SOLDERING, PLATING

D. C. WELDERS: New 300 ampere generators complete with accessories \$47.50. 200 ampere aircraft generators \$25.00. Blackhawk Distributors, Olathe, Kansas.

ELECTROPLATING Has a thousand and one uses. Warner Electroplaters permit you to easily plate chromium, gold, silver, nickel, copper, etc. Plating equals costly commercial jobs. Pay for your electroplater in a short time by plating for others at a profit. Write today for free sample and literature. Warner Electric Co., Dept. WS-12, 1512 Jarvis Avenue, Chicago 26, Ill.

NEW Model electric welder, 110 volt a.c.-d.c.; will weld all metals; easy to use; full directions. Complete with power unit, flame and metallic arc attachments, carbons, fluxes, rods, mask; all for \$19.95. Used by the navy. Magic Welder Mfg. Co., 239 MP12 Canal St., New York City.

MIRROR Silvering supplies; electro plating supplies. John Sprinkle, V66, Marion, Indiana.

WELDERS For all requirements. Free catalog. Write Hobartweld, Box M-1275, Troy, Ohio.

PORTABLE Arc welder, "build your own." Your engine plus Hobart welding generator saves \$350. Starts paying business. Free instruction book. Write Hobart Welders, Box M-1274, Troy, Ohio.

WELDERS, Automobile mechanics, body, fender, handy men, fixit shops become expert on white metal. Use own rod made from scrap. LaCombe, Oakland 6, Calif.

ATOMIC-VALUE—Porto electric welder—New 1948 model. Anyone can operate it. 115V a.c.-d.c. Welds all metals. Complete in sturdy fibre carrying case: 3 heat power unit, metallic arc and flame welding torches, full protection welder mask, arc cable and clamp, asbestos work block, generous supply of rods, flux, carbons, simple instruction manual. Will save you a hundred times its price of only \$19.95. Ideal Xmas gift. Money back guarantee. Order today! Universal Equipment Co., (Dept. PW 12), 24 W. 25th St., New York 10, N. Y.

OXY-ACETYLENE Welding outfit including: Full oxygen and acetylene cylinders. \$72.95 complete, f.o.b. Cleveland, Ohio. New, supply limited. Check or deposit with order, balance c.o.d. Cylinders can be refilled anywhere. Ideal for hobbyists, garages, repair shops, etc., includes supply of rod. The Burdett Oxy-Weld Equip. Co., 3399 Lakeside Avenue, Cleveland 14, Ohio.

SAVE 50%—A. C. Welders 110-220 volts. Holgeron's Service, Canton, Kans.

ACETYLENE Welding outfit approved by Underwriters and oxygen and acetylene cylinders I.C.C. inspected. All for \$75.00 complete. Best's Service, M8215 S. Honore St., Chicago 20, Ill.

OXY-ACETYLENE Welding and cutting outfit complete with cylinders and carrying case. Designed especially for hobby-shops, small repair shops, refrigeration and electrical service men. You own the cylinders. Free literature. A-A Welding Supply Co., C9228 S. Ada St., Chicago 20, Ill.

NEW Aircraft lighting generators. War surplus. Only \$49.50. Original cost \$250.00. Can be used for lighting or converted for use as welder, electric plater, fast battery charger, auxiliary power unit, etc. Model R.2, manufactured by Jack & Heintz, 30 volts, 300 amp. d.c., shipping weight 68 lbs. Size 16"x7". Also new G.E. and Westinghouse P.I. generators, d.c., 200 amp., 28½ volts, cost \$150.00, price \$33.00 each. Immediate shipment. Check with order. Greer, 460 South State Street, Chicago, Illinois.

BUY Direct from factory. Welding outfit \$48.36; soldering outfits \$12.70 to \$9.70 complete prepaid. Box 331, Hamilton, Ohio.

NEW Portable champion special; transformer welder; 110/120 volt a.c.; 8 heat stages. Welds, brazes, solders, cuts all metals. Complete with electro holder, mask, rods, carbons, fluxes, cables, also special flame weld torch. Full directions, easy to use. Splendid for shop, farm and home repairs. Guaranteed 1 year. Only \$27.50. Magic Welder Mfg. Co., 241 NW Canal St., New York City.

30 AMP. Selenium plating rectifiers with Powerstat control, \$85.00. Lead lined tanks, geared motors for agitation. Complete line of bronzed baby shoe mounts. Hollywood Bronze Supply, 1770 N. Vermont, Hollywood 27, Calif.

MACHINERY, TOOLS AND SUPPLIES

POLISHING And Buffing Kit for all metals. Compounds and buff wheels, \$1.95. Specify center hole size. 5" wheel special, 25c. Virginia Buffs, 1208 Hazel St., Charlottesville, Virginia.

WAR Surplus bargains! Special offer of tool kits consisting of 18 important tools for only \$7.75. Just what you need for home, shop or farm. Also a hardware unit of 18 pieces of necessary and useful items at the special bargain price of \$5.65. Ask today for our free war surplus bargains catalog listing scarce and hard-to-get items that you can use—all offered at bargain prices. Central Steel Supply Co., War Surplus, Dept. F, 294 Washington Street, Boston 8, Mass.

GEARS For inventors, experimenters, model makers, schools, work shops, laboratories, etc. Government surplus made of brass, bronze, dural steel and stainless steel. 12 matched pairs, 24 gears, bevel, spur and ratchet. List price \$12.00, our price \$2.50. 25 matched pairs; 50 gears, includes larger gears, also sets of worm gears. List price \$30.00, our price \$5.00. Limited quantity. Order now. Write for our bulletins on ball bearings, rectifiers, relays, selcons, horns and government surplus materials. Met Exchange, 323 Canal Street, New York.

SANDING Belts, 6"x54½", New, aluminum oxide, 60-240 grit, 45c. Raynix, 5736 Calmont, Ft. Worth 7, Texas.

ARC Welders, A.C. or D.C. 150-600 ampere. Portable, stationary. Prompt delivery. Reasonable terms. Also electrodes and accessories. Free catalogs. Write Hobart Welders, Box M-1276, Troy, Ohio.

MACHINE Tool castings for woodworking and metalworking tools. Machine them yourself, save up to 80%. Catalog describing 23 Lewis tools and projects sent for 10c. Lewis Machine Tool Co., 3217 Union Pacific Avenue, Dept. M, Los Angeles 23, California.

ELECTROPLATING Has a thousand and one uses when working with machinery, tools and supplies. Warner Electroplaters permit you to easily plate chromium, gold, silver, nickel, copper, etc. Plating equals costly commercial jobs. Pay for your electroplater in a short time by plating for others at a profit. Write today for free sample and literature. Warner Electric Co., Dept. MT-12, 1512 Jarvis Avenue, Chicago 26, Ill.

GENERATORS—War surplus, original crates. Westinghouse, Delco, D.C., 200 amps, 28.5 volts. \$39.50. Box 519, Warren, Mass.

CONCRETE Block machines \$39.50 up. Catalog free. Concrete Machine Company, 5466 Gravois, St. Louis 16, Missouri.

SALVAGE Tools, high speed steel, limited lot, new and used. Small drills, end mills, and cutters; tool bits; metric taps. Most items 2c to 50c, list 10c. Assortment 12 resharpened odd size small drills with list \$1.00 postpaid. J. Dickey, Newfield, New York.

BUILD 8" Tilt, adjustable bench saw. Kit furnished. Free circular. Cornelius Tools, 3629 Shady Court, Ft. Wayne 6, Indiana.

TILTING Arbor saw, no kits required, parts from neighborhood stores. Plan booklet \$1.00. Craftsman, Rowayton, Conn.

HARDWARE, Tools, drills, taps, dies, pattern, model supplies, electrical equipment, steel, brass, drill rod. Catalog 10c. Terek, 6304 Patterson, Chicago 34.

FARMERS, Garages, industries. Guaranteed, heavy-duty 110/220v arc welders. Lowest prices. ½" electric drill, Jacobs chuck, \$34.95. ¼" drill \$11.95. Electric bench grinder \$14.95 complete. Illustrated literature. Williams Sales, Box 4100, Portland 8, Oregon.

PRECISION V-Blocks to suit your needs. Low prices. Free literature. Miles Products, 2532 Wabash, Chicago 16.

BENCH Saws \$17.50, jig saws, sanders, etc. Circular 3c. Sunshine, Berkshire Heights, Penna.

THREAD Restorer! Eight sizes in one! Pays for itself by saving that worn bolt, shaft, or stud thread. #1 for 11, 12, 13, 14, 16, 18, 20, 24; #2 for 9, 10, 15, 16, 20, 26, 28, 32 threads per inch. Either tool \$2.00 postpaid. Bowers Hardware, Sta. A, 175A Canton, Ohio.

DRILL Press planer, rabbets, tenons, grooves, finishes wood and plastic rapidly and accurately. Price \$6.45. Free literature. Miles Products, 2532 Wabash, Chicago, 16.

DRILL Grinder for twist drills \$2.95. See ad on page 258.

METALS: Aluminum, brass and steel in all shapes. Write for free catalog. F & H, 87 Warren St., New York 7, N. Y.

CHUCKS, Independent, Universal, threaded 1½"-8 for South Bend, Atlas, Logan, Clausung, Craftsman lathes. Top value. Free literature. Westcott Chuck Co., 3600 Walnut, Oneida, N. Y.

COMPRESSORS, 100-1500 lbs./sq.in. \$32.50. New, portable. Details free. Hilker Products, 614 Jefferson Ave., Brooklyn 21.

ELECTRIC Sanders \$7.85 up. Circular 1948 models. Handy Tools, 255 Charles, Grand Rapids 6, Michigan.

ASSORTMENT, Aircraft small parts. Clamps, fasteners, terminals, rivets, nuts and bolts. All new. 3 lbs. postpaid anywhere in U. S. only \$1.00, cash with order. Satisfaction guaranteed. Limited supply. Conner Sales Co., 917 S. Main St., Fort Worth, Texas.

WOODWORKING Machine knives. Low prices. Also precision sharpening service. Free circular. Colman Tools, 204 North Buchanan, Amarillo, Texas.

DAYTON "V" belts and pulleys. All sizes for every need; prompt shipments. Free circular and prices. Hydraulic Products Co., East Main Street, Southold, N. Y., Box 206.

LATHE Milling attachment. Photograph for dime. Depoy Model Shop, Muncie, Ind.

12" BAND Saw, tilting table, Oilite bearings, \$35.00. 6" jointer, ball bearing, 43" long, \$59.50. Spindle shaper, ball bearing, 15x20 table, interchangeable spindles, \$49.50. 8" bench saw, large tilting table, ball bearing, complete, \$29.50. Immediate delivery. Dealers wanted. Write for catalog. Backus Machine Co., Boyd, Wis.

ELECTRIC Foot switch—For power tools. Leaves both hands free. Just plug it in. \$3.95 postpaid. C.O.D.'s accepted. Reb Industries, Dept. 265-CB, Elmhurst, Illinois.

DRILLS, High speed, 1-60 \$10.95. Send dime for sample and list. V-B Sales, Roselle, Illinois.

WE Offer 60 tons of new war surplus bolts, nuts, washers, screws, etc. All popular sizes. A good mixture for hobby shops, garages, machine shops and farms. A big 40 lb. box for only \$6.85. War Surplus Co., Morris and John Sts., New Brunswick, N. J.

SHEBEL Saw Filer files all saws. Circular. A. P. Shebel, 730B So. 2nd St., Milwaukee 4, Wis.

BALL Bearings one-fourth list price; gears, switches, rheostats. Free list. Burgess, Box 168, Ferguson, Mo.

HOME Shop owners attention.—Send for actual photograph and sample of the work our attachments will do. The photograph and sample speak for themselves. Have fun in your home shop. Cut gears, sprockets, ratchets, lay out holes accurately, cut keyways, build complete clocks and other interesting jobs. Build these attachments yourself from our reasonably priced blue prints. Don't limit your lathe to round work only. The Home Shop, 415 Raymond Avenue, Glendale 1, California.

DRILL Grinder—Grinds drills to factory accuracy. Calipers with direct reading scales. Circle cutters. New Tool grinder. Lowest prices. Free literature. Factory, 811-B East 31st, Kansas City 3, Mo.

ENGINES, MOTORS, DYNAMOS

NEW Lauson 4 cycle motors, ¾ H.P. Also 1½ to 2 H.P. Arthur Gershel, 51 Chambers St., New York 7.

"BUILD Your own" portable arc welder. Your engine plus Hobart welding generator saves \$350. Starts paying business. Free instruction book. Write Hobart Welders, Box M-1277, Troy, Ohio.

WELDERS For all requirements. Free catalog. Write Hobartweld, Box M-1278 Troy, Ohio.

¼ H.P. Rebuilt motors \$12.50, ½ h.p. \$30.00, sizes to 7½ h.p. A. C. Motors, 3101 N. 32nd, Philadelphia 32, Penna.

MOTOR Repair men, get our bulletins on stator winding tester and a.c. coil winder. Motor Industries, Quincy, Ill.

MOTORS—New, 1/150 HP. 110 V. a.c. 3200 r.p.m., capacitor type, complete \$3.75. No C.O.D. Nafco Products, 5258 Byron, Chicago 41, Ill.

A. C. REBUILT Motors, ¼ H.P. \$14.50. Other sizes; prompt shipment. EMSCO, 85 Reynolds, Rochester 8, New York.

\$150.00 NEW Generators, only \$33.00. See Greer advertisement under "Welding."

MIDGET Motors—4 r.p.m., 110 volts, 60 cycle a.c. Perfect for timing machines, displays, models. Price delivered \$5.00 each. McLaren Products Co., P.O. Box 1021, Riverside, California.

WINDING Data, listing 225 motors, single and three phase, \$1.00. Motor Data Co., Box 7631, Kansas City 3, Mo.

BOATS, OUTBOARD MOTORS, ETC.

CONVERT Your Ford motor (domestic and foreign) to marine use. Water-cooled manifolds, bronze gear pump, copper tubing and fittings. Complete for only \$89.50. Also marine reverse gears. Complete catalogue 25c. Arthur Gershel, 51 Chambers St., New York 7.

BUILD Your own boat now with Brooks Knock Down Kits, Simple and enjoyable. Outboards, inboards, sail and racing. Send 10c for literature. Brooks Boat Company, Dept. PM, Carrollton, Michigan.

NEW Marine reverse gears—open type (Borg Warner) \$45, suitable for Jeeps and any 60 to 80 H.P. engine. Arthur Gershel, 51 Chambers St., New York 7.

\$35 SEA Shell prefabricated 8' plywood rowboat. Free illustrated folder. Hagerty Company, Cohasset, Massachusetts.

CONVERT Your Jeep for marine use. Immediate delivery on kits and marine reverse gears. Complete catalogue 25c (domestic and foreign). Arthur Gershel, 51 Chambers St., New York 7.

COMPLETE Kayak kit. Nothing additional needed. Excellent present for dad, brother, son. Literature. Play-Yacks, Dedham, Mass.

BUILD Marine motors, Ford or jeep. Federal Marine Motors, 230 W. Superior St., Chicago 10, Ill.

BUILD Your own boat by the Welch System with knock down kits. Save 2/3 cost. Rowboats to cruisers. Send 25c for new complete illustrated catalog. Midwest Boat Company, Menomonee Falls, Wis.

SILVERTROL Streamlined electric trolling motor. Quiet as a whisper. Ample power for light craft on small lakes, etc., where strong currents don't exist. Uses six or twelve volt battery. Water cooled; full reverse steering; easy handling; lightweight, yet rugged for long service. Thousands sold at \$79.50. New low price \$49.50 warranted and shipped prepaid. Wonderful Christmas gift! Order today, check or money order. Send \$5.00 with C.O.D. orders. Silver Creek Precision Corp., Silver Creek, New York.

LATEST Manual on small boat construction, an excellent gift. December special \$1.00 postpaid. Build from our full size paper patterns, thirty designs, boats representing forty years careful designing. Send 10c for folders. Germain Boat Company, Dept. 3, Saginaw, W. S., Michigan.

OUTBOARD Motors—Good values, used motors. Also used parts for most makes and models. Crandall-Hicks Co., 911 Commonwealth, Boston, Mass.

FREE Catalog describes famous Weems line of navigation instruments and texts. Write Dept. 2, Weems System of Navigation, Annapolis, Md.

P-38 BELLY Tank speed boat. Complete plans, instructions \$1.00. Twintank Boat Company, 1032 62nd Street, Oakland, Calif.

CATALOGUE—Over 30 world's best plywood designs sent with Wm. Deed's book "Plywood Boats." Send \$1.00. Marine Mart, Buffalo 7, N. Y.

TWENTY Plywood boat plans \$1.00. 6 to 20 feet, sail, power. The Rudder, 15 Murray Street, New York.

MOLDED And sheet plywood boat kits, ready to assemble, 8 to 14 ft. \$40.00 up. Genuine weldwood marine type plywood in various thicknesses and lengths. Send 25c for literature. Marine Mart, Buffalo 7, N. Y.

MARINE Catalogue—15,000 deliverable items pictured that should be pictured at price. Send \$1.00. Marine Mart, Buffalo 7, N. Y.

MARINE Power—Easily convert any Jeep or Ford motor (domestic or foreign) with Convo parts and kits. Complete catalog 25c (coin). Osco Motors Corporation, 2020B East Orleans Street, Philadelphia 34, Penna.

P-38 BELLY Tanks, new, steel. 10 ft. 2 in. 165 gallon \$9.95. Anzio Boat Co., Box 89, Merced, California.

OUTBOARD Motor parts, new and used, for all makes. New pistons, standard and oversize. Cylinders rebored. Outboard Motor Mart, Inc., 309 Atlantic Ave., Boston 10, Mass.

NEW, Used, rebuilt marine motors. Marine conversions, fittings. Free catalog. Stokes Marine Supply, Dept. 24, Coldwa-

ALL Copper water jacketed exhaust manifolds for marine conversions of automobile and aviation engines and marine engine replacements; any make, model or age. Joseph Van Blerck & Son, 391 Woodcleft Ave., Freeport, N. Y.

MARINE Conversions for Ford and Jeep engines. Catalog 10c. Lehman Manufacturing Company, Department D, Newark 2, New Jersey.

BOATS And all about them. How to select, build, repair and operate. For 40 years the leading practical boating magazine. Half price trial subscription. 12 issues for \$1.00. Motor Boat, 62 Gold Street, New York 7.

BOAT Designers are highly paid professionals. Complete course by mail. Catalog. Westlawn, Montville, N. J.

ATHLETIC EQUIPMENT, BODY BUILDING COURSES

ELECTRIC Vibrator five applicators scalp body massage \$6.50. Schramm Company, 2755 Carmen, Chicago 25.

MUSCLES—Strength, Fast. Training with the New Jiffy Gym Exerciser. Courses and big pictured list and strength story. All for only \$1.50 postpaid. No C.O.D.s. Nat Berent, 1090 W. 43, Norfolk 8, Va.

PERSONAL Course—barbells. Massive proportions quickly, easily. EG, Elmsford, N. Y.

BARBELLS! Free course and catalog! 95 pound set \$9.80; extra plates 9c pound. Bur Barbell Co., Lyndhurst, N. J.

10 MINUTE Barbell course, amazing results. \$1.00. Texas Barbell, 201 Pine, Palestine, Texas.

DEADLY Judo—Fiercest fighting technique. Trick knockouts. (200 photographs—plus illustrations). Expert instructions. Three volumes. Complete \$2.25. Variety House, Box 46-BY Wall Station, New York 5.

HANDBALANCING—Acrobatics easily learned. Write. Power, 923a W. Vine, Kalamazoo, Michigan.

BARBELLS \$11.00 up. Stamp for folders. Jackson International Barbells, Springfield, N. J.

BARBELLS, Exercise equipment. Courses. Free booklet. Good Barbell Co., Reading, Penna.

SPORTING GOODS, GUNS, FISHING TACKLE, ARCHERY, TRAPPING

SNOW Shoes—our third car-load of government war surplus Army snow shoes. Sparkling brand new. Trail type models. Size 10 by 58 inches. Postpaid by insured mail for only \$6.95 per pair. A real bargain. Over twenty seven hundred trappers, hunters and sportsmen bought snowshoes from us. They also make fine wall ornaments for your den. Send money order. No c.o.d. please. Frank Smatlak, Rice Lake, Wisconsin.

GUN Grips, pearl. Jobber's price. Miracle Product, 44 N. Albany, Chicago.

BOOKS On gunsmithing. Catalog 10c. W. Joseph O'Connor, Baker, Oregon.

SHOOT For fun, shoot to kill. Make a powerful, accurate, "folding crossbow pistol." Complete plans \$1.00. Louis P. Lourel, Box 266P, Jamaica 1, N. Y.

GOLFER'S Gift—Ideal for Christmas. Golfer will enjoy personalized golf balls with his or her name stamped permanently on balls. All balls are top-quality and newly-manufactured by nationally known manufacturers—no seconds! Prices as follows: Wilson K-28 Black (for low handicap players) or K-28 Red (durable distance ball) 95c each. Wilson Flag-Hi 70c each. John Robert 95 (95c value) 69c each. John Robert 70 (70c value) 49c each. Print clearly name to be stamped on balls (maximum 13 letters). We pay postage; gift card enclosed on request. Minimum order three balls. No C.O.D.'s please. Send check or money order to John Robert Sales Co., Box 1, Dept. J-1, Clayton 5, Missouri. Order with confidence direct from ad or write for detailed circular.

FOOTBALLS \$4.50. Soccer and basketballs \$8.45. Roller skates \$3.75. Ice skates \$9.45. Free; write for complete sport catalog. No. C.O.D., postage prepaid. Earl & Dalton, 395A Nostrand Ave., Brooklyn 16, N. Y.

SHOTGUNS, Rifles, revolvers. Over 500 modern, obsolete. Also cartridges. List 10c coin. Ed Howe, 52 Main, Coopers Mills, Maine.

AUTOMATIC Lure—Positively weedless. Greatest invention* in ages. Nothing like it. Circular free. Babcock Reel Co., Oak Harbor, Ohio.

CARTRIDGES, Firearms, ammunition complete list 25c. Frank Farish, Vicksburg,

5000 BARGAINS. Firearms, binoculars, war relics. Catalog 40c. Smith Firearms, Runnede, New Jersey.

AMMUNITION—New and used shotguns, rifles, handarms, fishing tackle. List 10c. Rudolph's, Atchison, Kansas.

TAXIDERMY

"MODERN Taxidermist Magazine," Greenfield Center, N. Y. Devoted exclusively to taxidermy. Two sample copies 25c.

FINEST Glass eyes; taxidermy supplies. Catalog free. Elwood Company, Department 234, Omaha 2, Nebr.

FIELD GLASSES, TELESCOPES, MICROSCOPES, MAGNIFIERS

LENSES—Condenser 5" diameter by 13" focal length. First quality \$3.00, seconds \$2.50. Mitchell Optical Company, P. O. Box 3755, Kirkwood 22, Missouri.

TELESCOPES, Microscopes, binoculars, barometers, cameras, books; buy, sell, repair. Lists 10c. Rasmussen-Reece, Amsterdam, N. Y.

7x50mm PRISM Binoculars. Zeiss design. New, save to 75%. Sacrificed \$49.50 plus tax. Write DuMaurier Co., 20 State, Elmira, N. Y.

MICROSCOPES, New, guaranteed, amazingly low prices include delivery; 65x-200x, \$29.50; 75x-400x, achromatic lenses, \$52.50. Universally used precision instruments. Include remittance; immediate shipment. "Lifetime Christmas present." Laboratory Supply, 424 So. Broadway, R706, Los Angeles, Calif.

POWERFUL Astronomical telescopes easily made. Perfect lenses and instructions. 100 power \$2.50. 100 and 200 power \$3.50. 100, 200 and 400 power \$5.50. Clear vision and full power guaranteed. Instructions alone 10c. Suffolk Science Service, Manorville, N. Y.

BINOCULARS, Cameras, telescopes hard coated, repaired and collimated. Prompt service, all work guaranteed. Optical Coating Laboratory, Route #1, Clinton, Maryland.

SAVE Money, build your own reflecting telescope from complete kit of finished optical parts: 3" diameter, 39" focal length, mirror and diagonal both hard aluminized, plus 3 lenses for high power eyepieces. All \$6.00. Ross, C68 West Broadway, New York 7, N. Y.

TELESCOPES, Binoculars, microscopes, big bargain catalog free. Brownscope Company, 24 West 45th Street, New York.

REFLECTING Telescopes, complete, 3 1/2" diameter, equatorially mounted. View planets, stars, \$19.75. Write Sky-scope Company, 475-P 5th Ave., New York.

BINOCULARS, Telescopes, watches. Buy, sell, trade. Paul Schweer, Donnellson, Iowa.

DOGS, PETS, BIRDS, RABBITS

RAISE Guinea pigs. Make money at home. Big demand. Booklet free. Taylor, Box 426A, Hapeville, Georgia.

STANDARD Rabbit Journal, Milton, Pa. 3 years \$1.00, sample dime.

RAISE Guinea pigs. Details 25c. Greenwood, 234 S. Muscatel, San Gabriel, California.

5 CENTS Day starts \$1000 pair Chinchilla ranching. Complete booklet \$1.00. Montana Fur Farm, Billings, Montana.

SUPERSONIC "Silent" dog whistle! Your dog can hear it, humans can't. Precision made. Attractively finished, rust-proof metal. \$1.00 postpaid! Anywhere U.S.A. R. Anderson Ltd., 2205 S.E. Grant St., Portland 15, Oregon.

FOR That puppy you want, write today to "Royal" Chazy, N. Y.

INCREASE Your income by raising domestic rabbits. Small space needed. Ready market for delicious meat, fur and wool. Largest magazine in the industry tells you how. \$1.50 per year. Sample 15 cents. No stamps. Small Stock Magazine, Lamoni 50, Iowa.

ANGORA, Giant chinchillas. Finest pedigree! World's most profitable rabbits. Literature free. Grinsteads, Edwardsville, Illinois.

SUPERIOR Chinchilla giants—Other varieties. Breeding stock supplied credit terms. Beautiful picturesque catalogue. Complete instructions, 25c. Behrens Farms, Pearl River 4, New York.

RAISE Hamsters. New wonder animals from Syria. Delightful pets. Laboratories need thousands. Profitable. Free information. Hamstery, 1519 Basil, Mobile, Ala.

\$50.00 WEEKLY Raising Angoras for us. Free literature. Angorville, 1215-34th Northeast, Cedar Rapids, Iowa.

\$2000 PER Year raising Angora rabbits. We buy your output. Contract particulars free. Wilsons, 1065 Shryer, St. Paul 8, Minn.

\$250.00 MONTHLY Raising angora rabbits. Particulars free. White's Rabbitry, Newark, Ohio.

ST. BERNARD Pups: Champion sired beauties. Franklin Young, R4, Riverhead, Long Island, New York.

70 VARIETIES—Pigeons, rabbits, pheasant, peafowls. Catalogue 10c. Jim Houck, Tiffin, Ohio.

GUARANTEED Chin-Chin giant Chinchilla rabbits. Greatest amount of delicious meat. Largest, finest, most valuable furs. Tremendous demand for breeding stock. We buy youngsters. Contact world's largest breeder. Willow Brook Farm, R15, Sellersville, Penna.

ZOOLOGICAL And pet animals for sale. Illustrated catalogue, literature, 25c. Trails End Zoo-5, St. Stephen, S. C.

RAISING Rabbits, Cavies, Hamsters, Chinchillas is a growing and profitable industry. Magazine 10c. Descriptive book and magazine 25c. Book and magazine (monthly) one year \$1.00. Address Small Stock Farmer, Pearl River 15, N. Y.

MONEY Raising rabbits. Investigate. Folder 10c. Close's Farm, Tiffin 1, Ohio.

FARMS, FARM LAND, REAL ESTATE

FARMS, Ranches. All kinds, sizes. Choice of location, climate, production. Information on irrigation projects Columbia and Missouri River Basins. Resorts, summer homes. Milwaukee Railroad territory: Washington, Idaho, Montana, Dakotas, Wisconsin, Upper Michigan, Central corn belt. Free folders, price lists. L. H. Robbins, 604 Union Station, Chicago 6, Illinois.

CANADA—for literature and information re: general farming, ranching and fruit lands, write H. S. Williams, Department of Immigration & Colonization, Canadian Pacific Railway, Vancouver, B. C.

20 ACRES Good land, \$300.00. \$10 down. \$10 monthly. R. W. Stewart, Inverness, Florida.

STROUT'S Big farm catalog—mailed free. Describes over 2800 outstanding bargains. Coast to coast. Time-money saver. Write today. Strout Realty, 255-P 4th Ave., New York 10, N. Y.; 20 W. 9th St., Kansas City 6, Mo.; 453 S. Spring, Los Angeles 13, Calif.

HOMESITES \$450—Convenient payments. California's finest garden section. On Morro Bay's scenic shores. Wonderful fishing, hunting, boating, bathing. Fertile soil, softest water, temperate climate, congenial community. Free literature. Richard Otto, Department M, San Luis Obispo, California.

CALIFORNIA Farmers have highest per capita income of any state. Free bargain catalog. Allied Farm Agency, 1938G E. Colorado, Pasadena 8, California.

NEW Free winter catalog of farm bargains, 20 states, many equipped, many illustrated. Write today! United Farm Agency, 220-PM South State St., Chicago 4, Illinois.

\$5.00 MONTHLY Buys 40 acres near town; price \$200.00. Free list. Box 425-P, Carthage, Mo.

GOOD Farms—Ranches. Washington, Minnesota, Montana, Idaho, Oregon, North Dakota. Dependable crops, favorable climate. Write for literature, lists describing typical postwar farm opportunities. Specify which state. J. W. Haw, 119 Northern Pacific Ry., St. Paul 1, Minn.

OZARK Lands for all purposes. Actual river frontages, 5 acres \$90.00 and upwards. Free list and literature. Hubbard, 424-I, Minnesota Ave., Kansas City 4, Kansas.

POULTRY, FARM SUPPLIES

BABY Chicks, champion mated, 25 varieties, 6 hybrids, licensed inspected, blood-tested. Rush postal, large colored book free. low prices. Berry's Farm, Route 12, Clarinda, Iowa.

RAISE Turkeys for more spare-time dollars! Monthly advice from leading turkey authorities yours at bargain rate. Six big issues only \$1.00. Subscribe now! Turkey World, Dept. 20, Mount Morris, Ill.

RAISE Fryers: new easy way. One-man home plant earns \$500 monthly. Booklet free. Poultry Guild, 1046-A So. Olive, Los Angeles 15, California.

PRACTICAL Money-making poultry raising helps from experimental farm only \$1.00 for 24 months! Sixty months, \$2.00. Subscribe today! Poultry Tribune, Dept. S, Mount Morris, Ill.

RAISE Turkeys the new way. Write for free information explaining how to make up to \$3000.00 in your own backyard. Address National Turkey Institute, Dept. 3, Columbus, Kansas.

KNOW How to raise poultry for profit. Read Northeastern Poultryman. Every issue packed with helpful hints and practical suggestions. Latest articles on breeding, feeding and management. Subscribe now. 1 year 65c. 2 years one dollar, foreign subscriptions \$1.00 a year. Northeastern Poultryman, Dept. P.M., 376 Boylston St., Boston 16, Mass.

PROFITABLE OCCUPATIONS

KEY Making machine—makes keys from duplicate or by code. Complete with motor, code book, 75 doz. key blanks, simple instructions. Price \$179.50. Circular free. Koehlinger Bros., Fort Wayne, Indiana.

ELECTROPLATING Has a thousand and one uses. Make good money in spare or full time. Warner Electroplaters permit you to easily plate chromium, gold, silver, nickel, copper, etc. Plating equals costly commercial jobs. Pay for your electroplater in a short time by plating for others at a profit. Write today for free sample and literature. Warner Electric Co., Dept. PO-12, 1512 Jarvis Avenue, Chicago 26, Ill.

MAKE Money raising bees: Send for How To Succeed With Bees, 96-page book by experts. Contains 190 tested plans, guaranteed to help you or your money back, only \$1.00. Popular Mechanics Press, 200 East Ontario Street, Chicago 11, Illinois.

"ALASKA" The last frontier offers unlimited opportunities. \$1 brings official government map and copyrighted report with listing of firms: Fishing, construction, mining, aviation, homestead lands, prospecting business. Alaska Opportunist, P.O. Box 883, Hollywood 28, Calif.

MAKE Rubber stamps, metalize baby shoes, silver mirrors, raise earthworms. Free booklet. Universal, Box 1076-A, Peoria, Ill.

EXTRA Money—Spare time at home. Details 10c. Brown Company, Dept. M, Box 1412, Wichita, Kansas.

PERMA-FLEX Molds, made from B. F. Goodrich Company's Koroseal flexible molding compound. Stock or custom built molds. Send 25c for catalog and sample mold. The Perma-Flex Mold Company, Columbus 15, Ohio.

START Lamp factory. Profitable, fascinating, easy to learn. Illustrated course teaches you. Complete instructions and wholesale catalog \$1.00. The Gearon Company, 6405 North Oakley, Chicago.

PANNING Gold—Learn how. Illustrated booklet-catalogue of mining books and supplies. Free. Old Prospector, B-67, Dutch Flat, Calif.

BRONZE Molds for metal novelty casting. Fritz Foundry, 622 N. Fulton, Allentown, Penna.

LOCKSMITHING Secrets. Key fitting, lock opening, repairing, prices to charge, supply sources. Illustrated book only \$1.00. Wechsler Supply, 7 W. 36, New York City.

MAKE Beautiful mirrors from inexpensive window glass. No special equipment required. Details free. Tes-Co, Box 189-MP, Wilkes-Barre, Penna.

RAISE Chickens to sell profitably as broilers and fryers in eight weeks. Based on actual experience. Full description one dollar. Small Business Services, P.O. Box 1158, San Antonio, Texas.

INTERESTED In Latin American and foreign employment? \$1 brings copyrighted Foreign Service Directory listing firms with interests in construction, oil, mining, aviation, manufacturing by personnel expert. Hot list of companies hiring. Global Reports, P.O. Box 883, Hollywood 28, Calif.

LEARN Gagwriting. Profitable diversion. Particulars and comic gagster, 10c. Frankel, 1508 South Homan, Chicago 23.

"FROG Raising"—New book tells how! Marlboro, 1035 Marlborough, Detroit 15, Michigan.

RAISE Earthworms. Instructions \$1.00. Huffman's Worm Ranch, R.R., Rives Junction, Michigan.

1947-1948 LEATHERCRAFT Supply catalog 10c. Art Craft Supply, 1205 Throckmorton, Fort Worth, Texas.

ANNOUNCING Home study course in commercial baking. Practical basic training. Good field for those with aptitude. Nearly depression proof. Send for free booklet, "Opportunities in the Baking Industry." National Baking School, 1315 Michigan Ave., Dept. 3431, Chicago 5, Ill.

TYPISTS—Profitable business at home. Complete copyrighted information, 50c. Gaunt, 3521A Broadway, Chicago 13, Ill.

YOU Can make real money raising Golden Hamsters, the new amazing tiny animal. Food costs less than 10c monthly per animal. Breeds in 16 days! Easily raised in basement, attic, garage, barn, or shed. Write for convincing details. Hudson Hamstery, Box 78-P, Palisades Park, N. J.

WOULD You pay 3%—first \$350 made? Color-illustrated book "505 Odd, Successful Enterprises" free! Some offer occasional "day off." Work home. Expect something odd! Pacific, Oceanside, Calif.

NO Selling, operate vendors, amazing profits, details free. Silver-King, 622 Diversey, Chicago 14, Ill.

"THERE'S Big money in junk," and repairing batteries. Write, Batteryman, Grand Junction 5, Colorado.

HOW To set up and run a mirror shop! Resilver mirrors. For price write, John Sprinkle V50, Marion, Indiana.

MUSHROOMS Grown. Boxes. Barrels. Illustrated instructions 50c. Spawn \$1.00. Gordons, 553 William, Winnipeg, Manitoba.

TYPEWRITER Repairing instructions, standard typewriters, Webers', Box 1008, Canton, Ohio.

\$40.00 WEEKLY Made growing mushrooms, fresh, dried. Dominion patent 331583. Free spawn. North American, 169P Yonge, Toronto, Canada.

TYPEWRITER Repairmen urgently needed. Earn \$40 to \$50 weekly spare time. Our easy to learn home study course teaches how to repair typewriters. Write for free information. Houston Typewriter Repair Service, P.O. Box 5357A, Houston 12, Texas.

ELECTRIC Clocks are every where you go, buildings, homes, parking lots, factories. Repairs increasing. Our easy to learn course with pictures and drawings teach you how to repair these clocks. Electronic Supply Co., P.O. Box 2350A, Houston 1, Texas.

BOOKS, PERIODICALS, PICTURES, POSTCARDS

WHAT Every Mason wants. We have Masonic books for Blue Lodge, Chapter, Commandery, Scottish Rite and Shrine. Our rituals are used the world over. Send for free catalog of books and rituals for Masons, Odd Fellows, Knight of Columbus, etc. Ezra A. Cook, Publisher, P.O. Box 796-PD, Chicago 90, Ill.

NAVY Divers manuals \$2. Deep-sea diving gear. Jack's Diving Service, 402 Alleghany, Vallejo, Calif.

TEN New colored postcards of west and price list dime. E. Hall, Box 3660, San Francisco 19.

750 DIFFERENT Pocket books. Catalog free. Gordon's, 2613 Crenshaw, Los Angeles 16.

SHIP Photographs, passenger, freighters, tankers. List 10c. Scozzafava, 1648 59th St., Brooklyn 4, N. Y.

FREE Particulars for book bargains. Rosenthal, 200 Ross, Brooklyn 11, N. Y.

SELF-EXPLAINING Bible: Illustrated circular free. Box 446-P, Minneapolis, Minn.

HOW To get what you want. Psychology method. 24 page booklet \$1.00. Booklovers, 28 Cassius, New Haven 11, Conn.

BOOKFINDERS! (Scarce, out-of-print, unusual books). Quickly supplied. Send wants. Clifton, Box 1377pm, Beverly Hills, Calif.

50 COLORED Art pictures \$1.00. Kronlage, 5900 Patton, New Orleans 15, La.

FREE—60 Books on interesting subjects. Complete information, 25c. Self-Helps, Box 426, Buffalo 5, N. Y.

SAVE! Buy all your magazines by the year. Over 3000. Name yours. Marvin Helle, 11714 E. Jefferson, Detroit 14, Mich.

MAGAZINES. Trade and class. Current copies. All fields, free price list. Commercial Engraving Publishing Co., 34C North Ritter, Indianapolis 19, Indiana.

WE Can supply you with almost any book. House of Kilroy (Booksellers), Box 772, Detroit 33, Mich.

FREE Catalogue, featuring Christmas gift, and general interest books. Websters New American Dictionary \$2.00; New American Encyclopedia \$2.15; American Square Dance, including call cards \$1.50. Free bookplates with order. A. Fuller Company, 201 Dewey Street, Newark 8, New Jersey.

"SCIENTIFIC Boxing, military jiu-jitsu." \$1.00! Agents wanted. Hirsch's, Spring Valley, N. Y.

LITTLE Library of Useful Information, 112 different books. Catalog free. Popular Mechanics Press, 200 E. Ontario St., Chicago 11, Ill.

CORRESPONDENCE Courses. All books. Free bargain catalogue. Baker, 5509-B Winthrop, Chicago 40.

BOOKS. Out-of-print. Hard-to-find. Any book. Banker Book Co., Dept. 6, Sherman Oaks, Calif.

COLORED Lithographs for framing. Lists free. Curtis Specialties, Box 1916-B, Denver 1, Colorado.

HISTORICAL Postcards. Twenty-five, one dollar. Hill, 1208 Church, Flint 3, Mich.

UNIQUE Book plan will save you money. Send for free details. Royal Sales Co., Box 1452, Waterbury, Conn.

BACK-DATE Magazines, books. Specific issues—years. Arkell's, Tarzana, Calif.

EARN Extra money handling magazine subscriptions, books, greeting cards. Excellent commissions. Cassell Publishers, Westfield, New Jersey.

BOOKS Found free! All subjects. Send wants! Jaher Book Service, 620-P East 178 Street, New York 57.

GAMES AND ENTERTAINMENT

TEN-PING. New, different game. Fun for all. Two, four players. 50c postpaid. Send coins. Ludecke Co., 5809A Franklin Ave., Hollywood, California.

MAGIC TRICKS, PUZZLES, JOKER NOVELTIES

SEND 50c And we will send you our 94 page catalogue. Also 50c trick free to get you started. The Mystery Mart, Dept. PM-1, 737 N. Jackson St., Milwaukee 2, Wis.

PERFORM Over 100 baffling sleight-of-hand tricks with ordinary thimble. Easy! 42 action photos, complete instructions \$1.00. Garnet Specialties, Box 502-A, Valparaiso, Ind.

MAGIC You can do! Ten baffling tricks complete with all props plus big booklet jammed with legerdemain. Only \$1.00. Modern Merchandise, Dept. P-12, 412 S. Market, Chicago, Ill.

GIFT Novelty—Famous slip block puzzle. Postpaid \$1.00. Ketko, Box 20, Cincinnati 24, Ohio.

MYSTIFY Your friends. New illustrated narrated card trick, copyrighted. \$1.00. Box 691A, Atlantic City, N. J.

GUARANTEED Magic tricks. Amateur, professional. Big 8½x11 illustrated catalogue 10c. Newton's, Box 202-A1, Bonham, Texas.

WOW 'Em with DeLand's spectacular "card locator!" Locate any card in ordinary deck! Deal straight royal flush! 25c catalog of magic, rare courses and books, included. Ar-Ges Company, 790 Broad St., M13, Newark 2, New Jersey.

"MAGIC As A Hobby," book of 108 simple, mystifying tricks, 50c. Ernest Byrn, Box 4005E, Knoxville, Tennessee.

MAGNETIC Tricky dogs. Amusing, unusual, instructive, mounted on strong Alnico magnets, \$1.00—four pair. Gross \$18.00. Auerbach, 14 East 34, New York City.

EXPLODING Automatic pencil. Terrifically funny! Harmless. \$1.50 prepaid. Funalogue 10c. Thor Sales, 853 46 Street, Brooklyn 20, N. Y.

MAGICIANS' Headquarters. 400-page professional catalogue, pocket, parlor, stage tricks. World's finest magic. Send \$1.00 for catalogue (refunded first \$5.00 order). Kanter's, M-1311 Walnut, Philadelphia 7, Penna.

HOWARD Thurston's card tricks, only 50c. Specialty House, Box 542, Danville, Illinois.

PROFESSIONAL Catalog, 112 pages, 25c. Williams, 900 Plymouth, Ellwood City, Penna.

HURRY! Christmas special! Men's 24k gold plated gift set. Tie, collar, money clips plus key chain. \$3.00 prepaid. Thor Sales, 853 46 Street, Brooklyn 20, N. Y.

TRICKS Of Guerilla self-defense make you a superman! Prepaid \$1. Free details. Inspiration, 3108 Hillside Road, Harrisburg, Penna.

BLOW Colored plastic bubbles! Kit \$1.00. Ace, Box 22, Los Angeles 7.

NEW Magic monthly, year 25c. Sample copy and new magic catalogue free. Magic Factory, Minneapolis 2, Minn.

200 ELECTRIC Stunts, 110 volts, \$1. Kutting Sons, Campbell, Calif.

LARGE Catalogue of the best magic for professionals and amateurs. Send 25c. Mazda Magic Co., 1135 Westgate Ave., Oak Park, Ill.

BIG Magic magazine, trick and price lists—25c. Lloyd M. Jones, 4064 39th Avenue, Oakland 2, California.

"MAGIC Vanishing card." Throw it into air, it completely disappears, reproduce it later from spectators pocket. Easy to do. Complete, 25c with magic catalog. The Magician, 2463-C Kensington Ave., Philadelphia 25, Penna.

TRUE Secret of ventriloquism. Send for booklet. Quackenbus, Big Flats, N. Y.

BE A magician. Large professional magic catalog of latest tricks, 25c. Ireland, C-109 North Dearborn, Chicago 2.

VENTRILLOQUISM Taught, 3c stamp bring particulars. Smith, 801 Bigelow, Peoria 5, Ill.

VANISHING Half dollar trick and catalogue 25c. Sterling Magic Co., Royal Oak, Mich.

WORLD'S Largest professional magic shop, keeps you in touch with latest tricks. To receive mailings, send 35c for new catalog. Holden's, M220 West 42nd St., New York.

MAGIC Tricks, puzzles, books, cards, punch boards. Catalog 10c. Specialty, Box 671, St. Louis 1, Mo.

COINS, TOKENS, CURRENCY

FOR Sale: 1893 Columbian World's Fair half dollar, 75c; U. S. 2-cent pieces or 3-cent pieces, 25c each; 50 assorted Indian head cents, \$1.25; large 50 page U.S. coin catalog, listing thousands of coins for sale at reasonable prices, 25c; Giant 72 page foreign copper-silver-gold catalog listing over 10,000 coins for sale, 25c. Ben's Coin Company, 72 West Washington, Chicago 2, Illinois.

LINCOLN Cent bargains—1909SVDB \$10.00; 1909S 65c; 1914D \$2.25; 1922P \$1.75; 1922D broken D 90c; 1931S 65c. All other Lincolns, your selection any 10, \$1.00. 12 wooden nickels \$1.00; Ringling Brothers Circus set (6) \$1.00. Whitman coin albums 25c; handbook 50c; large retail catalogue 15c. Bebee Coin Company, 1180 East 63rd, Chicago 37, Illinois.

OLD Money wanted. Will pay \$100.00 for 1894 dime, S. mint. \$50.00 for 1913 Liberty head nickel (not buffalo). Big premiums paid for all rare coins. Send 4c for large coin folder. May mean much profit to you. Numismatic Co., Dept. 20, Fort Worth, Texas.

FOREIGN Coin approvals on request, Demonte, 725 West 172, New York 32.

NEW Coin magazine, 10c. Gives values of coins, information, best markets. Large, Box 575, Lowell, Mass.

CASH For old coins and war relics. 48-page coin value guide, 50c. 25 different foreign coins, \$1.00. Royal Coin, 3 School St., Boston.

18 DIFFERENT Nice foreign coins 50c. Bischof, Box 2201, Kansas City, Mo.

40 MIXED Indian pennies \$1.00. 50 different foreign coins \$2.00. International, 656 W. 171, New York 32.

\$10.00 EACH, For certain Lincoln pennies; Indianheads \$50; dimes 1000.00! Send dime for catalogue of prices paid. Franklin Coin Company, Mishawaka 20, Indiana.

WHITMAN Albums 25c. Bargain list 10c. Olson, 434 North Menard, Chicago 44.

CHINESE DoHar bill, 10c. Japanese Yen; bill 20c. Glenn Godwin, 5 Mildred Ave., Binghamton, New York.

START A collection, twenty different dated Indian head cents \$1.00. E. Walton, 7 Water, Boston 9, Mass.

NEW Coin buying list 10c. 209 South Church, Rockford 27, Ill.

WE Pay \$2 to \$200 each for hundreds of old or odd coins. Indianhead, Lincoln and foreign coins wanted. You may have valuable coins. Keep all until posted. Send 20c for new Ill's Coin Value Book. 4x6. Buying and selling prices, 40 years in business. Coin Exchange, (7), LeRoy, N. Y.

50 DIFFERENT Coins and bills, \$1.00. 100 different bills, \$1.00. Oddehon, Box 482, St. Louis, Mo.

COINS For collectors, reasonable prices. Free lists. Hutchinson, 3463 "I" Street, Philadelphia 34, Penna.

100 FOREIGN Coins \$4.00 postpaid. Parker, 1122 Market, San Francisco 2, Calif.

COMMEMORATIVE \$½, Oregon, Texas, Kentucky, Cleveland, Long Island, \$2.00 ea. Illustrated catalogue 25c. Norman Shultz, Salt Lake 9, Utah.

WORLD Coins—30 different \$1.00. Harry Elsholz, Box 9014, Pittsburgh 24, Penna.

LINCOLN Cent collectors; scarce 1922 D 25c. Complete list free. Reynolds, 1118 Mathews, Flint 3, Michigan.

COINS Wanted, will pay up to \$2000 for certain coins, send 25c for catalogue. Burton's, 111 So. Third, Columbus, Ohio.

GET Profit and pleasure in collecting old coins. Send 10c for 56 page illustrated coin catalog. You'll be delighted with it. Send for it now. B. Max Mehl, 370 Mehl Bldg., Fort Worth, Texas. Largest rare coin establishment in U.S. Established 47 years.

STAMP COLLECTING

VICTORY Packet free—Includes stamps from Tanganyika, British Cayman Islands, animal, scarce babyhead, Coronation, early Victorian, airmail, map stamps. Including big illustrated catalogue. Send 5c for postage. Gray Stamp Company, Dept. PM, Toronto, Canada.

300 DIFFERENT Given free with approvals. Postage 3c. Windsor Stamps, 1435 East 67th Place, Chicago 37.

WOW! Try and beat this offer if you can. Nicaragua diamond shaped stamp, tiger stamp from Congo, map stamp of Cacos Islands (Pirates' Treasure Island), Argentina Roosevelt, plus 75 other good stamps, plus book for 100 stamps, plus perforation gauge, plus hinges. Only 5c to approval applicants. Moumblow, 740 Hegney, Bronx 58.

FREE—Famous Americans set, plus Flag Set, plus the National Parks Set, plus the Presidential Set to the \$5. A total of 90 stamps absolutely free to customers for our unsurpassed U. S. or foreign selections. Send 3c postage for 15 of the above mentioned stamps and full particulars. Triboro Stamp Company, 145 Nassau St., Dept. 112, New York.

WOW! \$10.00 Worth of fun. Only 10c! What a treasure hunt! Big package 500 foreign stamps from foreign missions, other sources. Includes stamps from Africa, South America, Free French, Cape Juby, Palestine, etc. Includes airmails, commemoratives and stamps worth up to 50c. This offer sent for 10c to approval applicants only. Jamestown Stamp Co., Dept. 22, Jamestown, N. Y.

STAMPS Wanted by thousands of our readers. Your ad in this space will bring you some nice orders. One advertiser sold 150,000 stamps. Write for positive proof. F. W. Johnson, Classified Advertising Manager, Room 301, 200 East Ontario St., Chicago 11.

LEE Beal offers foreign stamps, inflation banknotes for classical phonograph records. What have you? Full sheet 100 Japanese stamps, \$1.00. 7 Greek inflation bills, totaling 2,041,501,000 drachma, \$1.00. Sample 10,000,000 and 1,000,000,000 pengo Hungarian bills, 25c. 402 Grand Avenue, Oakland 10, California.

POSITIVELY Greatest free offer—Latest Scott's International \$6.00 stamp album—covering entire world, contains 36,000 illustrated descriptive spaces; Scott's 1948 standard \$7.00 catalogues "Philately's Encyclopedia"—absolutely free to applicants for foreign approvals becoming customers. Plymouth Specialty Company, Dept. A9, Bell, California.

FREE! Mint British Colonies from Solomon Islands, Caymans, Grenada, Dominica, Turks Caicos. Absolutely free to new approval applicants. Viking, 130-Z Clinton St., Brooklyn, N. Y.

101 DIFFERENT Belgium beauties, unused, used, pictorials, parcel post. Catalogs over \$2.00, for only 10c if you request approvals. L. Frazer, Box 4600, Portland 2, Oregon.

FREE. Fascinating airmail collection, including obsolete Liberian issue with approvals. 3c postage please. Raymax, 123-Z William St., New York City 7.

TWO-CENT Approvals. Stamps of the world mounted by countries with catalogue numbers. C. B. Herron, 3721 Townes, Memphis 8, Tenn.

ROOSEVELT Triangle 5c. Approvals. Herman, 539B East 54 St., Brooklyn 3, N. Y.

COMMON U. S. on paper mixture 5 lbs. \$1.00 plus postage. P. M. Henrico, Box 1621, Erie, Penna.

FREE 50 Different U. S. with approvals. Ehlert, 2456 Monroe, Kansas City, Mo.

SOUTH African 1937 Coronations. One dollar bill per set of ten. Mint or used. J. Cathcart, Box 9418, Johannesburg, South Africa.

FREE \$35.00 Catalog value. Information, approvals. Burris, Route 4, Center, Texas.

START Your own stamp business. Write for free circular. Donald Shepard, Box 5139, Chicago 2.

\$15. PLUS, Scott catalogue value, \$2. Approvals. Ramsay, Brainard 2, N. Y.

LATIN America, 30 different, perforation gauge and lists 5c. Dr. Rowell, Star Route, Lawton, Okla.

GIVEN! Attractive pictorial set. Bargain approvals. Verne, 916-J Fallowfield, Charleroi, Penna.

\$1.00, \$2.00, \$5.00 U. S., Roosevelt, Hitler, airmails, free with approvals. Tami-am Stamp Co., Box 2188, Miami 13, Florida.

77 DIFFERENT United States stamps, many commemoratives included. 17c to approval applicants. Standard Stamp Co., 3817 Sackett, Cleveland 9, Ohio.

DUPLICATE Stamps traded for full value. Free details. Stamp Ranch, 2804 Rio-Grande, Austin 21, Texas.

50 DIFFERENT Belgium stamps and our price list, one silver dime. Stamp Sales, Box 1649P, Oakland 4, California.

CHINA Set catalogues \$1.40. Only 10c to approval applicants. Rainier Stamp Company, 207 S. 24th Avenue, Yakima, Wash.

FREE! Complete Balkan aviation set with approvals. Beaman, Elliston, Virginia.

FREE! Tiny Chinese "midget" war set. Approvals. Seminole, Elliston, Virginia.

CANADA—75 Diff. 25c. Approvals, Lists. Victoria Stamp Co., London 4, Canada.

15 OLD United States stamps (before 1900) fifty cents. Wheeler, 16 West, Worcester, Mass.

FREE Copy Philatelic Report. New outstanding collectors magazine. You'll like it. Write to Thomas, Box 115P, Northside Branch, Atlanta, Ga.

FREE! Triangle Roosevelt, Vatican, Ethiopia, Hitler heads. With approvals. Florida Stamp Company, Box 807, Miami 5, Fla.

SHEPARD'S Stamp Advertiser, 10 issues 10c. Shepard, Box 5139, Chicago.

FREE 25 Different Netherlands with approvals. Karl Scheerer, 1736 Mahantongo St., Pottsville, Penna.

U. S. Price list free. Sliques, 1831 E. Allegheny, Philadelphia 34, Penna.

300 COMMEMORATIVES, Pictorials, etc., plus surprise packet, \$1.00. Schneider, Box 1012, Chicago 90.

25 CHINA Mint. (face over \$1000.00) 10c. Approvals. O. Burgett, Lima, Ohio.

STAMP Tongs, hinges, foreign mixture, 10c with approvals. Pomeroy, Minnetonka Beach, Minnesota.

FREE! 25 Different British Colonies. Approvals. Stamphouse, 7235-A Sheridan, Chicago 26.

FREE Gift with approvals. Dept. B, 1267 Tutwiler, Memphis 7, Tenn.

MEXICO Collection with currency 10c. 5632 Hollywood Blvd., Hollywood 28, Calif.

BEAUTIFULLY Illustrated catalog—Stamps, accessories, 5c. Paramount Stamps, Station A, Flushing, New York.

CROW Airmail, 10c coin with approvals. Robert Ewing, Wapakoneta, Ohio.

U. S. And foreign approvals. Vet Stamp Co., 1136-P Flatbush Ave., Brooklyn 26, N. Y.

ATTRACTIVE Medium priced approvals. Esslinger, 5260 Montgomery Rd., Norwood 12, Ohio.

FREE. Beautiful new issues, eight countries, with approvals. Green and Company, Norwood 12, Ohio.

FOREIGN, 1000-\$1.25. Includes commemoratives. Lists free. Alatalo, Maynard 14, Mass.

NEW France Boy Scout Jamboree stamp free with application for our beautiful approvals. Larry Hendry, York, Penna.

ROMANIAN, 44 Different, 3c. Approvals. Gross, 1768 Stuart Street, Brooklyn 29, N. Y.

AUSTRALIAN Commemorative and State issues. Used or mint \$3.00 U. S. (or equiv. other currency) brings bargain selection. McNear, Longford, Tasmania.

FREE Beautifully illustrated monthly New Issues Bulletin. Lory's, Villa Park, Ill.

A REAL Roosevelt bargain. No stamps are more attractive, none are more popular than the famous Roosevelt issues by 17 different countries. We have them all for approvals and will send the complete Roosevelt issue of Honduras, the complete Roosevelt issue of Cuba, the Nicaragua bi-colored Roosevelt, and the Monaco Roosevelt triangle, all for only 10c to approval applicants. Please state whether approvals shall consist of U. S. or foreign stamps or both. Globus Stamp Company, 266 Fourth Avenue, New York 10, N. Y. Dept. 214.

CANADIAN Collection—From 1870 to date, 80 face different stamps including many pictorial. A \$1 value for only 25c if you request approvals. Fields of Cleveland, 9328 Amesbury Ave., Cleveland, Ohio.

NICARAGUA Roosevelt mint set of three, 10c with approvals. Murray, 2152 Vogel Road, Evansville 14, Indiana.

STAMP Collectors attention. Stamp exchange club now organizing. Mail inquiries with commemorative stamps and enclose self-addressed stamped envelope. International Hobbies' Caterers, 225 South Broadway St., Los Angeles 12, Calif.

DEALERS. Wholesale catalog 3c. Frank Oakes, 344 Normal Parkway, Chicago 21.

"UNITED States invasion of Germany" complete set; also twelve different unused Confederate States; also scarce U. S. \$5.00 stamp with inverted surcharge; also complete mint set United States stamps surcharged for use in Canal Zone. Entire collection 10c to approval applicants only. "Stamps," Box 67, Albany 1, New York.

POCKET Stock book, linen-hinged 10c. Approvals. Shoaps, Dept. 9, 5010 Hillsboro Ave., Detroit 4, Michigan.

SEND \$1.00 For fine selection U. S. stamps. Herman Jacot, Greenwich, Conn.

400 FOREIGN 47c. 200, 27c. Pacific, P.O. Box 5704, Los Angeles, Calif.

ROOSEVELT Mint San Marino set, 10c to applicants requesting approvals. Michalicka, 101 3rd Ave., Newark, New Jersey.

FREE Exchange stamps with my approvals. Andy Anderson, Box 6992, Chicago, Illinois.

HINDENBURG Zeppelin set. Free approvals. Thode, 14302G 119 Avenue, Jamaica, New York.

U. S. Approvals. Large selections, low prices. Panther, Box X-76, Dorchester 24, Mass.

PHILATELY For the fun of it! You collect for fun; we select our stamps for beauty and interest. We'll prove it! Send 10c, receive beautiful set German semi-postals with approval selection. H. Favill, Box 2005, Madison 5, Wis.

STAMPENDOUS! United States approvals that please plus unique premiums to customers. Get them from Jarr, Box 217-Z Madison Square, New York 10.

MOZAMBIQUE, Beautiful "triangle" commemoratives (10), free with approvals. William Deems, Ravenswood, W. Va.

400 CHAMBA, Nabha, Bhopal, Jaipore, Patiala, Gwalior, Indore. Fine lot \$2.00. India House (1937), Karol Bagh, Delhi, India.

SPECIAL! 40 Different Scandinavian, 5c. Approvals. Lee Stampco, Box 156M, Forest Hills, New York.

BIG Opportunity! France Coat of Arms, Vatican Pope Pius, Hitler, Mussolini, plus 25 airmails and pictorials. Only 10c with approvals. Georgian, 244 Peachtree Arcade, Atlanta, Georgia.

WORLDWIDE Mission mixture! 500 stamps 25c. Garrow, 84-M Montevista, Chula Vista, California.

"NUDE Duchess" set (two values), 5c to approval applicants. Royal Stamp Company, Tamaqua, Penna.

50, SOUTH, Central America, 20c. Northeast, Box 6618, Kansas City, Mo.

50 STAMPS From 50 countries 50c. Mendelsohn Stamp Co., 1900 W. 25 St., Cleveland, Ohio.

MONACO Roosevelts, 4 beautiful pictorials to approval applicant 10c. G. A. Hegenbarth, 1545 Ardmore Ave., Chicago 26, Ill.

"ARTISTS" Austria's beautiful semi-postal set. Ten large beautiful stamps, 10c. Approvals. Jack Dudak, Streator 3, Illinois.

NO Stamps sold more than half catalog value! Vatican #32-4, catalogs \$7.00, special \$1.00. Lowest prices on new issues. Approvals on request. Gannisia Enterprises, 1566 58th Street, Brooklyn 19, N. Y.

NEW Philippine Roosevelt free with approvals. Granada, 4891 Southwest Fifth Street, Miami 34, Florida.

NICARAGUA Diamond (Managua) set, 10c with approvals. Vargo Stamps, 6044 South Fairfield, Chicago 29, Illinois.

50 DIFFERENT United States 6c. No approvals. Price list free. Seidenberg, Cassopolis, Mich.

FREE: 20 Different Hitler heads, with 500 different Germany \$2.50 or 1000 different Europe \$2. Henry Zuntz, 5633 Cottage Grove, Chicago, Illinois.

MALTA, 30 Different stamps, \$1.00 only. Portell, 1535 Highland, Detroit, Mich.

FREE! 25 Different Switzerland, with approvals. Eric Kardell, 1175-M Clay, San Francisco 8, California.

100 DIFFERENT Including Argentine, San Marino Roosevelts, plus 5c from first approvals; only 10c. Harry Bradley, Clayville, Virginia.

UNPICKED! 5000 U. S. \$2.00; 3000 foreign \$2.00; 1000 Australia \$1.00. Satisfaction guaranteed. Kuhn, 3315 80th, Jackson Heights, New York.

500 MIXED Foreign 20c. Frank Richard, 9844 12th, Detroit 6, Michigan.

\$5 CREDIT Slip, Columbus set of 8 values, Famous Americans and Flag sets are some of the premiums which are free to buyers of our U. S. or foreign approvals. Write for a selection today! Full particulars included. S. C. Engel & Co., 38 Park Row, New York.

FREE! 100 Worldwide different stamps to approval buyers. Big U.S. and illustrated bargain lists sent with approvals. Bookman, Maplewood, N. J.

GIVEN! 55 Different with approvals. H. P. Wisehart, Frankfort 1, Ohio.

FIFTY British Empire 10c. Approvals. Arcadiac, Box 21, Station "J," Toronto.

NEW—10c packets on approval. Used CIPEX sheet to applicants. Quantity limited, hurry. Paul Hunter, 2655 East 27th, Oakland 1, Calif.

UNITED States fine mint commemoratives 5c each: #702, 705, 707, 741, 772, 773, 782, 5c each: #859, 865, 869, 870, 874, 875, 880, 10c each: #654, 655, 657, 658, 706, 718, 736, 10c each: #743, 837, 838, 858, 864, 866, 881. Minimum order \$1.00. List 105-PX free. David Chassy, 38 Park Row, New York 7.

LEOPARDS, Natives, warriors, pictorials. \$1.00 catalogue value only 10c with approvals. Congo Stamps, 148, Wapakoneta, Ohio.

NEW Issues, also sets and singles for Scott albums. Free gift plan. Crown, 412A Maple, Holyoke, Mass.

WOWIE! 77 Different foreign western hemisphere packet only 10c to approval applicants. Commemoratives, bi-colors, airmails included. Also British Guiana, Jamaica, Guatemala, Nicaragua, Salvador, Elcerrito, 5611 Meade, San Diego 5, California.

FREE. Five San Marino airmails, ten Siam; Approvals. Newton, 1511 Portage Road, Niagara Falls, Canada.

FREE Surprise packet, request approvals. Schmidie, Box 2551, Portland 3, Oregon.

BOOKLET! Collecting stamps—how, when, what? 35c with request for approvals and/or monthly illustrated price list. Hildenbrand, 5811 Hadfield St., Philadelphia 43, Penna.

188 U. S. Commemoratives, etc. 10c Dorenbusch, 501 Ridgeway, Cincinnati 29, Ohio.

SUPERB Approvals, net prices. Stamps 1/3 to 1/2 catalog. P. G. Beals, 170A Tremont St., Boston, Mass.

FREE! Airmail packet with approvals. Deane Stamps, Box 87, Miami 35, Florida.

SEND 10c And we will mail you 100 valuable foreign stamps, and each month we will send you many stamps on approval. Inter-Ocean, 168B West 46th, New York 19, N. Y.

FREE! \$27.00 Airmail! Tanganyika! Thailand! Philippines! Approvals. Keating, 637-P Bergen, Jersey City, N. J.

FREE: Twenty different foreign commemorative stamps to new approval applicants. Modern Stamp Service, Box 12, Wakefield Station, N. Y.

3 LIBERIA Airmail triangles 3c to approval applicants only. GeeKay Stamp Co., 13 Overlea Avenue, Baltimore 6, Md.

FOREIGN—Complete mint sets and new issues on approval. Woodco, 5719 Wabash, Kansas City 4, Missouri.

FLAGS! Flags! Flags! Beautiful collection foreign flag stamps, plus perforation gauge, plus packet 25 countries, including big Roosevelt triangle, airmails, scarce Tasmania, Negri Sembilan, old Victoria, etc. Total value \$1.00. Bargain price 10c to approval applicants. Odd Stamps Company, Dept. A6, 5391 Metropolitan Station, Los Angeles.

SELECTED Penny approval to build your collection. Henry Jay Service, 15 Park Row, New York 7, N. Y.

100 U. S. Commemoratives, etc. 10c; 300 25c. Box 457, Newark 1, N. J.

CHRISTMAS Offer. 500 different worldwide 50c. No approvals. Arthur Terreson, Box 479, Bellmore, N. Y.

GREEK Allegorical figure set. Free approvals. Logan Stamps, Box 4, New Lots Station, Brooklyn, N. Y.

MINT Stamps free to approval applicants. Surf Stampco, Box 2296, Miami Beach, Fla.

75 DIFFERENT Countries, 75 stamps, 10c to approval applicants. Rae Stamps, 14 Stratford Rd., Buffalo 16, N. Y.

WHAT Have you to offer? Collection? "Shoobox" accumulations? Anything in stamps? We urgently need them. Spot cash paid. Cosmopolitan Stamp Co., 1457 Broadway, New York City.

FREE—U. S. stamp mixture. Seconds. Send postage. Howard Smith, 36 Alcott, East Hartford 8, Conn.

SURPRISE Beginner's assortment—25c! Packet pricelist free! Neptune Stamps, Neptune 4, N. J.

ABSOLUTELY Free! 25 different valuable mint Chinese new issues with approvals. Barton, Box 321, Elizabeth, N. J.

FAMOUS Chinese "Sun" set of five, catalog 40c, huge Antarctica and 100 different 10c. Kalumet Stamps, 523 Detroit, Hammond, Ind.

BREAKING Up large foreign collection. Approvals by countries. Lion, 200 W. 81 Street, New York 24.

WHOLESALE Bargain list, dealers only. Borkman, 3414 10 Street, Tampa, Florida.

120 DIFFERENT Stamps only 3c with approvals. Appleman, Ida, Mich.

MINT Black Harding 10c to approval applicants. Louis Merrill, 1623 5th, Portsmouth, Ohio.

1/2c UP U. S. or foreign approvals by countries. Hurt & Fosse, Blue Ridge, Va.

RECENT And new issues. Illustrated booklet free. Stamps, 5805 Delmar, St. Louis 12, Mo.

50 DIFFERENT Finland 10c with 1/4-1/2c approvals. Carroll's, 4357A S. Hoover, Los Angeles 37, Calif.

SAN Marino Roosevelts—Mint set of six only 5c to approval applicants. Clayton Doll, 85 Audubon Ave, New York 32, N. Y.

25c SENT With your request entitles you to \$1 worth of stamps, your choice, from our gigantic first approval selection. Cosmopolitan Stamp Co., 1457 Bway, N. Y.

200 DIFFERENT Stamps cataloging up to 50c each; only 3c to approval applicants! Littleton Stamp Co., Littleton 42, N. H.

FREE—Hitler heads, airmails, French Coat of Arms, Vatican with approvals. Gulfstream, Box 103, Teaneck, New Jersey.

FLAG Stamp free with U. S. approvals. Wenlgman, 929 Oakdale, Chicago.

CANADA Peace set 10c with attractive approvals. Rheume, 8949 Routhier, Montreal 12, Canada.

WORLDWIDE, Different 200, 25c; 500, 60c; 1000, \$1.50; 2000, \$4.25. Beacon Sales, Maynard 2, Mass.

HISTORICAL Collection! Cavalry charge! Bulgaria, Flaming Sword! Ireland, Big She-wolf! Italy, Fort! Dominican Republic, Field Marshall! New Zealand, Pitcairn Mutiny Island! Commemoratives! Pictorials! Only 3c. Approvals. Staf Stamps, Lakewood, New York.

NICE Clean U. S. approvals, numbered and classified; mounted with peelable hinges; postpaid both ways. Jess T. Green, Bonita Ave., Route 2, Box 111, Mountain View, California.

FREE! Crystal-mount samples! Har-risco; 202 Transit Bldg., Boston.

UNITED States approvals complete coverage, fine quality, attractive prices. Seminole Stamps, Box 1138-P, Coral Gables, Florida.

PHILATELIC Printing. Stock forms. Samples for postage. Acmeprint-6, R-#5, Hendersonville, No. Car.

OLD Stamps wanted. Send 30c for catalogue. Stamp Market, 356-P Clinton, Columbus 2, Ohio.

BEGINNERS, 100 Different stamps 5c. General approvals. Return postage paid. Burton, 413 C SW, Ardmore, Oklahoma.

1000 MIXED U. S. old and new—25c; 2 lb. \$1.25. Weatherby, Medina, Ohio.

YOUR Money's worth! Seychelles, Djibouti, Angola, Chinese hunger stamps and over 100 different other stamps. Everything 10c to approval applicants. Atlas Stamps, 4220 West 16th, Dep't L, Little Rock, Ark.

SCARCE United States stamps nearly 100 years old; Roosevelt set complete; \$5.00, \$10.00 stamps; Army, Navy, Marines, Coast Guard, Columbian Exposition commemoratives; 19th century revenues. Everything 5c to buyers U. S. approvals. Metropolitan, 140-B Nassau, New York City 7.

\$10.00 FOR \$1.00. Box full stamps valued Scott's \$10.00 and stamp album. Everything \$1.00. Longacre Shop, 108k West 42nd, New York City 18.

WOOPIE! Wowie! 25c worth of U. S. stamps free! No obligations! Write M & N Co., 742A Sheffield Ave., Brooklyn 7, N. Y.

55 DIFFERENT United States, 5c. Approvals. Utechts, 1143-C North Keeler, Chicago 51.

128-PAGE United States catalog—1000 illustrations, 10c. Harris & Co., 202 Transit Bldg., Boston.

FREE—The Stamp Finder. Big new edition—32 pages profusely illustrated! Tells at a glance the country to which any stamp belongs and so where to place it in your album! Also: 25 different stamps from Vatican City, Palestine, Cyprus, San Marino, etc. All sent to approval applicants enclosing 3c postage. Garcelon Stamp Co., Box 900, Calais, Maine.

UNITED States approvals. Low prices! Gordon Davison, Box 1019X, Manchester, N. H.

FIRST Day covers on approval. Knobel, 1918 S.W. 12th St., Miami, Florida.

50 DIFFERENT Stamps, triangle, airmails, etc., 5c with approvals. Carlton's, 10243 Silverton, Tujunga, California.

ILLUSTRATED Stamp Magazine, 26 weeks 25c. Stamp Journal, Kalamazoo Michigan.

BRITISH, Spanish and French Colonies. Vatican, Hitler heads, and airmail packet free with approvals. Pan-American Stampco, Box 145, New York 33, N. Y.

DANDY U. S. approvals; write immediately. Sullivan, Endicott Building, St. Paul, Minnesota.

STAMP Collections wanted. Complete collections, duplicate lots, surplus stock, mint and used. Prefer trade for printing or other items, buy outright if priced right. What have you, what's wanted? Vanroy Shirk, Lebanon, Penna.

U. S. Price list. Send postage. State Stamp Service, 1225 Park Building, Pittsburgh 22, Penna.

OLD Scarce U. S. seconds on approval. Slightly defective, nice appearance, bargain prices. Hernfield, 551 Clinton, Newark 8, N. J.

WORLD'S Largest diamond and triangle stamps, free stamp magazine, stamps from fighting Free French, 20 stamps from 20 different countries, pictorials, airmails, big bargain 5c with approvals. Capital Stamps, Dept. 2, Little Rock, Ark.

DEALERS—Wholesale list. Postage 3c. Frank, 5031 Queensberry, Baltimore 15, Md.

ZOWIE-E! A barrel of fun for only a dime. 500 United States stamps—absolutely unpicked and unsorted—just as received from church missions. Many varieties, including large commemoratives, airmails, high denominations up to \$5.00! Stampdom's biggest package of fun—and you might find something really valuable! Price only 10c to serious approval service applicants. Money back if not delighted. Illustrated bargain lists with each order. Mystic Stamp Company, Dept. 80, Camden, New York.

U. S. Price list. Send postage. Stanley Gibbons, 38-P Park Row, New York.

PENNY Approvals, that satisfy. Neil Gronberg, Box 5441-P, Philadelphia 43, Penna.

CHRISTMAS Bargains: 1200 U. S.; 1500 foreign; 2000 Britain; 750 Australia; 400 Ireland; dollar each; Seiden, 1331-M, Intervale, New York 59.

HOBBIES AND COLLECTIONS

"HOBBYISTS." The monthly magazine for everyone with a hobby. Outstanding articles, contests. Introductory three months, 25c. Hobbyists Publication, 19 South Third, St. Louis 2.

MILLIONS Of dollars in prize contests being given away. Contest Magazine will help you win. Send 25 cents today for sample copy. It has helped thousands to win. Contest Magazine, Drawer 259, Upland, Indiana.

"WANTED:" Old cigarette cards. Write Charles Bray, East Bangor, Penna.

"SWAPPER'S Hobby Bulletin." What's-cha got? What'd'ye want? Trial two dimes. Royal Oak 128, Mich.

HOBBY And school catalogue, (biological), 10c. Quivira Specialties, Topeka, Kansas.

COLLECT Cigar bands? \$1.00 starts you. Cibanco, Box 21 PM, Garwood, N. J.

COLLECTORS, Sportsmen. Beautiful wild ram's heads, whittled from mahogany. Horns measure eight inches. A treasured gift. \$10. Picture on request. Eddy Radtke, Dover, N. J.

KLONDIKE! For hobby jewelry makers! Novelty jewelry findings swept from tables of large manufacturers—parts for bracelets, pins, earrings, etc. — unfinished chains, rings, pins, stones, clips, beads—many other items. 1 lb. bags—\$3.00 sample bag—\$2.00 per bag in 5 bag lots. Prepaid only. Mdse. Distributing Co., 19 E. 16 St., New York 3. Dept. P.S.

WOOD And ivory carvings made to order. Hermania Anslinger, 918 West 4th Ave., Spokane, Wash.

CIRCUS Photos. List and sample 10c. Box 1028, Minneapolis, Minnesota.

UNUSED Match book covers. 100 all different \$1.00. 35 Royal Flash covers \$1.00. Free catalog. Charles Edelman, 1311C East 84. Cleveland 3, Ohio.

INVENTING Can be an interesting and profitable hobby. Write for complete particulars. Institute of American Inventors, Dept. 40-E, 1926-Eye St. N. W., Washington 6, D. C.

CAMPAIGN Ribbons—Beginner's package. Introductory price 50c. Contains 15 assorted ribbons. L.H.G. Company, 19 E. 16 St., New York 3.

ANTIQUES, RELICS, INDIAN GOODS, CURIOS

20 COMMON Or 7 fine arrowheads, \$1. Lynn Crandall, Box 697, Idaho Falls, Idaho.

600 ANTIQUE Gun bargains. Catalogue 25c. Gil Hebard, Knoxville, Illinois.

6 PERFECT Birdpoints \$1.00, list free. H. L. Talburt, Calico Rock, Ark.

SWORDS, Rapiers, daggers, pistols, armor. Illustrated catalog 50c. Robert Abels, 860-A Lexington Ave., New York.

PRECIOUS STONES, MINERALS

BEAUTIFUL Arizona gems, petrified woods, agates jaspers, \$1.00 brings polished samples and listings. Arizona Agate Mines, Cave Creek, Arizona.

"LUCKY" Lodestones, highly magnetic natural magnets. Perform many extremely interesting experiments. Two large specimens only 50c postpaid. National Scientific Company, 2204 W. North Ave., Chicago 47, Ill.

MINERAL Specimens, rough gems from around the world. Fluorescents. List free. Mission Mineral Mart., 818 Fort Stockton Drive, San Diego 3, Calif.

"GENUINE" Deep red Arizona rubies (garnets). Send quarter for packet. Mineral Specimens Company, Box 2651, Phoenix, Arizona.

METAL Detectors. The very latest circuit. Free literature. Hedden Metal Detectors, 538 N. Homewood Ave., Pittsburgh 8, Penna.

ZIRCONS. Mined and mastercraftsman cut in Siam. Flash, fire, sparkle of diamonds. Reputed to bring good luck. Sample \$2.00, two \$3.50. Imhuxer PM, Box 232, White Plains, N. Y.

CAMERAS, PHOTO SUPPLIES

LOOKING For a bargain? Cameras, enlargers, projectors, film and everything photographic at unequalled lowest prices. Postcard brings big list. Washington Foto Bargains, Box 185-M, Washington 4, D. C.

PRINT Photos from negatives without darkroom. Automatic machine \$4.95. Perfect Christmas gift. Send for free folder. Craftex Products, 6751 Clyde Ave., Chicago 49, Ill.

GIFT Catalog free, photographic other Christmas items. Westwood Corp., 635 Victoria Street, San Francisco, Calif.

AMATEUR Photographers! Save money. Make your own enlarger. Plans \$1.00. State negative size. Photo Lab., Salina Star Route, Boulder, Colorado.

REPAIRS Made on all cameras and other photographic equipment. Free estimates. Dept. PM, Northwest Camera Repair Co., 209 Loeb Arcade, Minneapolis 2, Minn.

HOW To Develop. Print and Enlarge Pictures shows the amateur photographer in picture and text how to economically and professionally do his own work. 210 illustrations; large book. \$1.25 postpaid money back if not satisfied. Franklin Watts, Inc., 285 Madison Avenue, New York 17, N. Y.

SAVE! 5 Fresh 35mm. Ansco color (20 exposure) cartridges, \$5.00. 100 foto-stamps, any photo, \$2.00. Anderman's, 1914 N. Curson, Hollywood 46, California.

35MM. Film, 100' rolls, DuPont Superior #2, from surplus, outdated but guaranteed. Load your own cartridges for less than 10c each! \$1.25 each; 3 for \$3.50. Delta Photo Supply, 690-M Third Avenue, New York 17, N. Y.

MAKE Prints in daylight! No dark-room necessary. Complete outfit for making your own photographs in natural "flesh-tone." A new process. Outfit includes aluminum tray, printing frame, print paper, chemicals, print dryer and illustrated instruction book. Sent postpaid for \$1.00. Randolph Studios, Mishawaka 2, Indiana.

CAMERAS, Projectors. Lowest prices. Free catalog. Cavalier Camera, 1822 Center, Pittsburgh 19, Penna.

OIL Coloring photographs wonderful hobby. Free details. Home study course. Goynes, Lock Drawer 1784-F, Orange, Texas.

KODABROMIDE Enlarging paper, 4 1/4 x 8 1/2 feet rolls, enough for almost 2,000 4x5 enlargements. Single weight. Actual tests prove its worth. Fully guaranteed. Reduces printing costs to a fraction of a cent apiece. Value over \$30.00. Our price \$2.25 postpaid in U. S. A. Delta Photo Supply, 690-M Third Avenue, New York 17, N. Y.

CAMERAS Repaired, all makes, all size bellows installed. Camera Repair Service, 121 Broadway, San Diego 1, Calif.

BASS Says! At the sign of the old "Horse Trader," 37th year. Thousands of satisfied customers everywhere! Finest brands including Kodak, Bell & Howell, Argus, Zeiss, Leitz, etc. Satisfaction always guaranteed, or your money back! Bass buys 'em, sells 'em, trades 'em. Write or wire. Bass Camera Company, Dept. AG, 179 W. Madison St., Chicago 2.

DEVELOPING And printing kit, complete \$4.95. Kit #1: Three 4x6 trays, one set of printing masks, one safe-light, four Universal M-Q developer, one qt. acid fixing powder, one pkg. (24 sheets) print paper, one graduate, one 4x6 all-metal print frame, one thermometer, two film clips, one instruction booklet. Kit #2: Same as above but includes a candid type camera that takes 16 pictures on each roll of film, complete \$7.95. We can supply all items needed for replacement listed in above kits. Send money order or check today and include 75c to cover handling and postage. Sorry, no C.O.D. orders. Simon Bros., 144 Elmora Avenue, Elizabeth, N. J.

PHOTOGRAPHY For pleasure or profit. Learn at home. Practical basic training. Long established school. Write for booklet. American School of Photography, 1315 Michigan, Dept. 3431, Chicago 5.

HAVE You a camera? Improve your hobby of photography and learn how to make better pictures. Write today for our latest book catalog and sample copy of American Photography, containing articles and pictures by the world's foremost writers and photographers. Camera House, 601, 353 Newbury St., Boston 15, Mass.

OIL Coloring photographs can be a fascinating hobby or profitable sideline for those with artistic talent. Learn at home. Easy simplified method. Send for free booklet. National Photo Coloring School, 1315 Michigan, Dept. 3431, Chicago 5, Ill.

PRINT Your own pictures. Kit \$1.00. Spada, 10 Lexington, Wethersfield 9, Conn.

BUILD Your own enlarger. Takes negatives up to 4"x5". Detailed plans one dollar. Emby Co., Birmingham, Michigan.

PHOTO FINISHING

PROFESSIONAL Enlargements; one 8x10, \$1.00, oil colored \$2.00; complete in frame \$5.00, prepaid. Leon's Studio, 103 S. Main, Independence, Missouri.

STREAMLINE Oversize border prints. Really different. Send three negatives, and a dime (no stamps), for sample prints. Films finished 30c. Goodall Photo Co., Winnipeg, Manitoba, Canada.

ENLARGEMENTS Four 4x6 or three 5x7 25c. Oil colored 85c. Personalized Christmas cards. Globe Photo, Dept. 412, LaCrosse, Wis.

ABSOLUTELY Finest quality 8x10 enlargements from your negative 22c. Foto Portraits, 1172 Ogden, New York 52.

ERECT A statuette of yourself right in your home. From enlargement of your favorite photo. Details free. N. Carter, 210 S. Flower, Los Angeles, Calif.

ROLL Developed and 8 prints 30c. Send for free mailers and price list. Techni-print Laboratories, 3634 Madison Rd., Cincinnati 9, Ohio.

PROFESSIONAL 5x7 Enlargement 15c, 2 for 25c. Jerome Printing Service, 1969 Jerome, New York 53.

SLIDES, Black and white, from your favorite snapshots, 6 for \$1 in 2x2 cardboard mounts. Send any pictures under 8x10 (returned). No negatives. Jane Sherer, 16 Victory Street, Waukegan, Illinois.

ENLARGEMENTS, Double weight, 5x7 20c, 3 for 50c, 7 for \$1.00. Biehl, 313 W. 106th Place, Chicago 28, Ill.

HURRY! Limited trial offer 16 prints 20c. Aircastles Studios, 7050 VanBuren, Hammond, Indiana.

50 VELOX Reprints \$1. Suburban Studio, 1410-M Bond, Rockford, Ill.

16 DECKLEDGE Prints from any standard 8 exposure roll 25c. Quick service. Professional work. Skrudland, Lake Geneva, Wis.

18 CHRISTMAS Cards and envelopes \$1.00, 60-\$3.00, send negative. Three prints each 8 exposure roll 40c. Two each 35c. One each 25c. Reprints 3c. Fred D. Eastman, Bode, Iowa.

8 HOUR Service. Your 8 exposure roll printed jumbo or regular size 25c; 12 exposures, 35c; 16 exposures, 50c; 36 exposures, \$1.00. Reprints, jumbo or regular, 3c. Regular prints deckled. Fine grain developing. Send for free mailers. Quality Photo Service, Box 468, San Francisco 1, Calif.

FREE Price list on quality developing, printing, enlarging. Write for it today. Bryan's Photo Shop, Dept. M, Panama City, Florida.

TWO Beautiful prints from each picture on roll 25c. Twenty-six years of satisfied customers. Quick service. Lens Photos, Dept. J4, Janesville, Wis.

8 BEAUTIFUL Double size pictures and roll developed 30c. 8 hour service. Free mailers. Pacific Photo Service, Box 666, San Francisco, Calif.

2 BEAUTIFUL Hi-Gloss prints each good negative and enlarging coupon with each 6 or 8 exposure roll developed 25c. Owlphoto Co., Weatherford, Oklahoma.

PHOTOGRAPHY For pleasure or profit. Learn at home. Practical basic training. Long established school. Write for booklet. American School of Photography, 1315 Michigan, Dept. 3452, Chicago 5.

PROFESSIONAL Enlargements — Oil colored from your favorite negative, 8x10, \$2.00; 5x7, \$1.50. Shamrock Photos, 2610 University, San Diego 4, Calif.

MOTION PICTURES AND SOUND EQUIPMENT

EXTRAORDINARY 1948 Film-equipment bargain catalog. 5c. Color camera film, 8mm., -\$3.25; 16mm., -\$5.98. "Atomic Fury" Movies, 8mm., -\$1.75; 16mm., -\$3.50. Towers, 935 North 40th, Philadelphia 4.

DISTRIBUTORS Wanted. Make big money selling our new sensational films. Send for sample and free wholesale price list. 16mm. sound, \$10.00; 16mm. silent, \$7.50; 8mm., \$2.50. Standard Pictures Corp., Universal City, Calif., Dept. A.

SEND 10c For Christmas gift catalogue of cameras, projectors, films, etc. Sterling's, 679 Northampton, Easton, Pennsylvania.

JIU-JITSU Movies, "How To Throw A Puncher," 16mm. \$2.75; 8mm. \$1.75. M. Stone, Box 171-B, Canal Sta., New York 13, N. Y.

EXCLUSIVE Home movies. Select films. Write for free lists. Home Pix, 1674 Broadway, New York 19, N. Y.

ROAD Showmen, schools, 16mm. Sound features for rent. Catalog. Howard Minor, Columbia, Tenn.

EXCITING Films. Thrill your audiences with unusual movies. For "Glamorous Exciting Stars" (state 8-16mm.) send only \$1.00 to Exciting Films, 1071-E El Centro, Hollywood, Calif.

SURPLUS 16MM. sound war films for sale. Write Room 603PM, 84 East Randolph Street, Chicago, Illinois.

35 MM. Silent, sound films, supplies. Bedner, 5300 S. Talman, Chicago.

ARMY Surplus 50' 16mm. magazine Super X Weston 50 films, \$1.00. Processing 75c. Guaranteed. Filmcraft, 828 West 39th, Kansas City 2, Missouri.

GUARANTEED Fresh anti-halo outdoor movie film! Weston 16! Daylight loading! Processing free! Three spools double 8mm. \$4.50! 100 ft. 16mm. spool, \$4.50! Postpaid! Catalog. ESO-S, 828-B West 39th, Kansas City 2, Missouri.

16MM., 8MM. sound silent films, projectors. Free rental sales catalogues. Osborn Films, Lebanon, Ohio.

8-16MM. Film subjects—Black and white and color; sound or silent. Largest selection ever compiled; 75c to \$75.00. Write for new, deluxe catalog, profusely illustrated; 25c (coin) refunded first purchase. Hollywood Movie Supply, Hollywood, California.

FILM—Movetone is back. It's Weston 12 nonhalation. Free processing 100 ft. 16mm. \$3.25, 25 ft. double 8mm \$1.50. Bulk film without processing 100 ft. 16mm. \$2.25, double 8mm. \$2.45. Free circulars. Promader Genera, Davenport 4, Iowa.

BARGAINS In 16mm. sound projectors, films, reels, splicers. Harris, 303 West 42nd Street, New York 18.

SPECIAL! Free subscription offer! Amateur Screen Photography, 3021A Narragansett, Chicago 34.

NEW Aesop's Fables cartoons for home movie fans. 16mm and 8mm. 13 different subjects never before released. Write for free circular. Supreme Cinema Co., Dept. PM, 175 Fifth Ave., New York 11, N. Y.

8MM MOVIE Projectors \$22.50. Becco, Box 675, Charleston, S.C.

FINEST Movie screens, inexpensive, make them yourself. Free literature. Snow White Screen Company, Danville, Illinois.

WE BUY, Sell, rent, exchange home movies. Details for dime. Midland, Box 429, Oak Park 4, Ill.

SOUND Films, Special discount. Eastern Film Supply Co., Baldwin, New York.

RENT 16MM. sound films 50c reel. Large selection; free catalog. Film Service, 128 Chestnut St., Roselle Park, N. J.

LEARN Movie projection, management. Free catalog. Theatre Institute, Elmira, N. Y.

PROCESS Your own 8mm.-16mm. movie film. Literature. Duro Movie Products, 1519 Eggert, Eggertsville 21, N. Y.

16 AND 35MM. films, projectors (sound). Savarese, Woodcliff Lake, N. J.

8-16MM. Silent-sound films. Complete rental library. All latest subjects. Free catalogue. (sample film 10c). Garden Film, 317 West 50th, New York 19.

COMPLETE Stocks always of Castle, Official, Pictorial films, 8mm., 16mm., sound. Musicals, soundies, free catalogs. We exchange your films and equipment, or buy them for cash. Frank Lane, 5 Little Bldg., Boston, Mass.

PROJECTORS \$16.00 Up. Cameras, film available. Selco Products, Danvers, Mass.

RARE 8-16MM. silent-sound films. International, 2120 Strauss, Brooklyn, N. Y.

BASS Says! 37 years of leadership means satisfaction to you! Finest equipment, 8 and 16 mm., sound cameras, sound projectors. Bass buys 'em, sells 'em, trades 'em. Satisfaction always guaranteed, or your money back! Bass Camera Company, Dept. A, 179 W. Madison St., Chicago 2.

BEAUTIFUL Kodachrome slide and lists 25c. Slide Supply Service, 3111 West Tuscarawas, Canton, Ohio.

"THE World's Greatest Passion Play," all sizes sound and silent. Write Hemenway Film, 33-F Melrose St., Boston 16, Mass.

I BUY, Exchange, swap movie films. Harvey Iris, Box 539, Brockton, Mass.

NEW Medical film listing available to doctors, groups and responsible individuals. 8mm. and 16mm. Kodachrome and B & W. Medical Research Film Library, Dept. J, 1569 Broadway, Brooklyn 7, N. Y.

MUSIC AND MUSICAL INSTRUMENTS

DIAL-A-CHORD. The new piano keyboard sensation. Beginners learn to play attractive piano in a few weeks. Also very essential for the advanced student, composers and songwriters. \$5.00. Literature free. Nelson Enterprises, 102-1651 E. 93, Cleveland 6, Ohio.

GENUINE Hohner harmonicas, marine band \$2.95, chromatic \$9.00. Illustrated list on request. St. Johns Music Store, Winnipeg, Canada.

SWISS Musical units \$3.25. Musical albums. Music Boxes, 131 West 42nd, New York 18.

BACK Popular music. List 10c. Forbe's, M-3151 High, Denver 5, Colorado.

PIANO—Play by ear. Easy. Bodine, 10353 Peoria, Chicago, Ill.

PHONOGRAPH Records cheap. Catalogue. Paramount, ML-313 East Market, Wilkes-Barre, Penna.

POEMS Converted into popular songs. Grant, Box 45, Jamaica 1, N. Y.

MUSIC Printing \$5-\$100. Complete service. Auto-Litho Co., Jensen, Fla.

FREE Offer to song-writers. Write Sholl, song-specialist, 2222 N. 5th St., Harrisburg, Penna.

SONGWRITERS Investigate outstanding service. Song poems, melodies. Publishers list free. Song Productions, Dept. B-12, 113 W. 48 St., New York 19.

MUSICAL Instruments, 5 day trial. Free bargain list. Meyer's, 454-D Michigan, Detroit 26, Michigan.

GUITAR Beginners, make money. Plan, book, \$1.00. Mel-O-Chord, Box 886, Ventura, California.

REAL Composer of music will co-operate with lyric writers in song production. Fine publication proposition. National distribution of publication. C. Isabel Mayer, Box 3896, Portland 8, Ore.

CHORD-O-MATIC Guitarists greatest discovery. Instantly play any chord, key, position, transpose. No books. \$1.00. Trebb Sales, Lorain 5, Ohio.

WESTERN. Popular records—Late numbers 29c, catalog 3c. F-L Shop, Box 19-L, New York 35, N. Y.

ACCORDIONS. Streamline, wholesale. Request circular. Metro Accordion, 44 North Albany, Chicago.

PLAY Piano by ear. Book and "Mayberry" Chord-Slide (pocket size keyboard) \$2.00 postpaid. Chord-Slide, P3122 Lawrence Drive, Corpus Christi, Texas.

MUSIC Written to poems, \$3.00. Williams, Box 5030, San Francisco, Calif.

SONGWRITERS! Music composed, arranged reasonable. Billy Hannon, 6703 Oshkosh, Chicago 31.

SONGWRITERS. Publication, collaboration. Newark Publications, GPO Box 1226, Syracuse, N. Y.

PLAY Piano by ear in one week. Amazing new system very simple. English, French. Write The Little System Reg'd., Ancienne-Lorette, Quebec, Canada.

MUSIC Arranged. Songs printed. Frank Wildt, Music Publisher, Lancaster, Penna.

SONGWRITERS—Send for new special offer. Jas. Crane, Box 154, Providence, R. I.

BRAND New records. Distributor's surplus, Columbia and other major labels. \$3.50 per dozen, \$25.00 per 100. Indicate hillbilly, race, or popular selections. F.O.B. Cleveland. Record Rack, 7909 St. Clair Ave., Cleveland, Ohio.

SONGWRITERS—Protect your songs. Get the facts first. Free booklet, attractive offer. Song Service, 331-C West 46th, New York.

SONGWRITERS: Outstanding, honest music writing offer. Dick Reynolds, Leonard, Texas.

POEMS Wanted for musical setting. Send poems for free examination. Five Star Music Masters, 630 Beacon Bldg., Boston, Mass.

PIANISTS: Master popular music chord charts show names, symbols, readings, notation, indexes; 648 treble, 180 bass positions. Terrific! For you! \$1.00. Carol Music Chart Co., P.O. Box 21 P.M. Lefters, Brooklyn 25, N. Y.

FREE Accordion pickup with each accordion purchased. New or used accordions for sale. Cash or terms, wholesale or retail. Write for bargain list. Del Principe, 307 So. Wabash, Chicago.

DUO-FLEX Reeds, for clarinets and saxophones. Eliminate your reed troubles. Circular free. Duo-Flex Reeds, 1204 First Ave., Evansville, Ind.

AMPLIFY Your accordion with our new Del Principe pickup, \$22.50. Install it yourself in one minute. Makes any accordion sound like an organ. Works with any amplifier. Special Del Principe amplifier and pickup only \$72.50. Write for details. Del Principe, 307 So. Wabash Ave., Chicago.

POEMS Wanted for musical setting! Send poem for immediate consideration. Hamann Service, 614 Manhattan Building, Milwaukee, Wisconsin.

POEMS Wanted to be set to music. Free examination. Send poems. McNeil, Master of Music, 510-PM S. Alexandria, Los Angeles, California.

SONGWRITERS! Outstanding ethical offer. Hibbler, C5, 2157 N. Avers, Chicago.

SONGWRITERS: Send poems for free examination and outstanding offer. United Music Service, 150, Salem, Indiana.

SONG Writer's attention! The amazing demand for phonograph records, accelerated by more than 300,000 juke boxes and the hits popularized warrants your immediate consideration. We are offering song-poem writers the rare opportunity of having established composers collaborate on appealing material received this month. Recola Records, Box 987P, Hollywood 28, Calif.

WRITE Songs. Big money and reputation. Write for information. J. Gordon Pub Co., 201 N. Hoyne Ave., Chicago.

RADIO, SUPPLIES, INSTRUCTION

RADIO And television catalog—free! Money saving prices on radios, hard-to-get parts, record changers, wire and disc recorders, amplifier systems, tubes, books, amateur and test equipment. Write today! Radionic Equipment Co., Dept. 2012, 170 Nassau Street, New York 7, N. Y.

24 PAGE Plans "18 Long Distance Crystal Sets," including "Radio-bulder," catalog 25c. Laboratories, Eye-c, San Carlos, California.

ELECTROPLATING Has a thousand and one uses when working in radio. Warner Electroplaters permit you to easily plate chromium, gold, silver, nickel, copper, etc. Plating equals costly commercial jobs. Pay for your electroplater in a short time by plating for others at a profit. Write today for free sample and literature. Warner Electric Co., Dept. RS-12, 1512 Jarvis Avenue, Chicago 26, Ill.

YOU Can accurately align superheterodyne receivers without signal generator or other expensive instruments. Complete, simple instructions, \$1 (refunded if not satisfied). Chas. Gates, 302 Ross Blvd., Pecos, Texas.

EXPERIMENTERS, Technicians, engineers! Build a laboratory tube tester. Emission, transconductance, power output tests. More economical and flexible than best commercial models. Illustrated pamphlet \$2.00. Polytech Laboratories, Salina Star Route, Boulder, Colorado.

BEGINNERS — "Radio Amateur New-comer," complete 160-page book. Building simple equipment, operating, passing license examinations. \$1.10 postpaid. Editors and Engineers, 1304 Kenwood, Santa Barbara, Calif.

EXTRA-LOUD Crystal radio, \$2.39. Guaranteed. "Loudest" crystal set building instructions and crystal, 25c. Amorose, Route Four, Richmond, Virginia.

TEST Your crystals. Choose loudest one. Simple inexpensive methods, and crystal, 25c. Radio Leader, La Verne 2, Calif.

FIX Any radio. Amazing new instrument locates radio troubles double quick. Simple instructions show you how. Thousands in use. Write today for Folder "PM." Free. Feiler Engineering Company, 945 George Street, Chicago 14, Ill.

RADIO Bargain, crystal radio, aerial wire, lead-in wire, insulators and ear phones complete, postpaid \$7.00. Radio City, Fifth and Ash, San Diego 1, Calif.

26 YEARS Experience radio repairing at your fingertips. I've repaired 45,000 radios. Have perfected simple system you can follow step by step. No calculations or formulas. Total price \$2.00 postpaid or c.o.d. Moneyback guarantee. Ross Radio, 14615-A Grandriver, Detroit 27, Michigan.

RAZOR Blade or crystal radio. Make one. Headphones \$1.25, headbands 50c. Complete plans 25c. Send check or money order. Nico Supply, 1700 Walnut, Philadelphia 3, Penna.

PLAY Radio all you please. Make batteries from cans, other junk. Sample battery, full instructions \$1.00. Satisfaction guaranteed. Ed Penick, Security, Texas.

BUILD A portable radio tube tester; improved design, checks all type radio receiving tubes; complete kit with easy to follow assembly blueprints; saves you \$20. Brand new factory parts; Standard Appliance Co., Dept. A, 1438 West Third Street, Dayton, Ohio.

ORTOLA Phonographs A.C. D.C. table model \$12.95, small portable \$14.95, Ortola 5 tube A.C. D.C. superhet table model radio, walnut cabinet \$13.95. Portable wireless phonograph plays through any radio \$12.95. Send money order. R. C. Radio Parts, 731 Central, Kansas City 6, Kansas.

RADIO'S Latest! Build your own printed type circuit crystal receiver complete in empty 12-ga. shotgun shell. Inexpensive, powerful. Detailed plans, 30c. Caring, Box 1308, Chicago 90, Illinois.

EXPERIMENTERS—One tube, all wave radio kit. Free circular. Artlin Company, Knickerbocker Station, Box 25, New York 2.

ACT Now for Xmas 1948 radios, 110 volt a.c. or d.c. superhet. Famous make. Manufacturers guarantee enclosed. \$19.95. Check or money order prepaid or c.o.d. Rated established company. We ship at once. Belmont Radio & Appl. Co., 440 Common Street, Belmont 78, Mass.

AMERICA'S Best buys. Radio tubes 29c up. Free bargain lists. Potter, 1314-P McGee, Kansas City 6, Mo.

FM Television antennas, Ham parts, bargain list, Wholesale Supply, 347 Lunenburg St., Fitchburg, Mass.

MAKE Simple, tubeless, batteryless, distance-getting crystal radios. Crystal and illustrated instructions 25c postpaid. Allen, 427-P. Clinton, Missouri.

U. S. SIGNAL Corps featherweight ear-phones \$1.00. Radio service men and experimenters send stamp for our giant radio catalogue. Save dollars. United Radio Co., (100-V) Newark 1, N. J.

RADIO Technician and radio service courses. Training for federal licenses. American Radio Institute, 101 W. 63 St. New York City. Approved under G. I. Bill of Rights.

BUSINESS OPPORTUNITIES

ELECTROPLATING Has a thousand and one uses. Make good money in spare or full time. Warner Electroplaters permit you to easily plate chromium, gold, silver, nickel, copper, etc. Plating equals costly commercial jobs. Pay for your electroplater in a short time by plating for others at a profit. Write today for free sample and literature. Warner Electric Co., Dept. OB-12, 1512 Jarvis Avenue, Chicago 26, Ill.

LUSTER-IZE Car finish preserver. Produces lasting hard mirror-like luster. Exceptional opportunity for distributors. Dealers, Lustr-ize, 8635 N. E. Skidmore, Portland, Ore.

UNPAINTED Plaques, figurines. Emerson, 142 Bay 14 St., Brooklyn 14, N. Y.

OPERATE America's most popular low priced precision penny vending machine. Big profits. Be independent. Write for bulletin and prices. Stock shipments. Fielding Mfg. Co., Desk 1247PM, Jackson, Michigan.

"PLASTIC Balloons"—New amazing novelty. Easily made. Large profit. Complete formula \$1.00. Ideal Service, Park Ridge 5, Ill.

START Mailorder bookshop—Everything furnished. 25c brings booklet, samples, exciting ideas. General Publications, Ossining, N. Y.

FAST-Selling items. Large profits! Velazquez, Box 55, Hamilton Grange, New York 31.

GET Into business for yourself. Stop being a wage slave. Send for descriptive circulars on opportunities and money making plans. Village Sales Co., P. O. Box 305, Oak Park, Ill.

GET Free details on how to run profitable magazine subscription business at home. Easy, interesting. Start at once—no capital needed. Write today. McGregor Magazine Agency, Dept. PM-11, Mount Morris, Ill.

OPERATE Dependable mail order business supplied by us. Progress Mail Order, Box 1374, Indianapolis 6, Indiana.

COLORGLAZED Concrete pottery made without molds. Patented method. Cemetery products, novelties, tiles. Basement leak-sealing. Money-making projects. Booklet, details free. Men only. National Potteries Company, Grand Rapids, Minnesota.

MAKE Profits in mail order business. Astounding plans describing method sent free. C. Jinton Service, Lock Box 1373, Mobile 8, Ala.

MAKE Liquid marble, flexible molds, statuary, art goods, novelties, artificial marble flooring. Literature free. Kemico, Park Ridge 50, Ill.

BEST Tested money-makers. 68 page book, 40,000 words 25c. Tannehill, 745 N. Central Ave., Chicago 44, Ill.

MAKE Money at home! Literature free! Ludwig Apostle, Clayton, N. J.

BRONZED Baby shoes mountings, 12 styles, onyx and plasticide. Also hardening solution. Box 2095, Wichita, Kansas.

2345 OPPORTUNITY Seekers names \$2.50. Donald Shepard, Box 5139, Chicago.

LIQUID Marble—make in any color. Soundproof plastic flooring. Flexible molds. Cast novelties, plaques, statuary. Big money—your own business. Catalog free. Write Bing Products, 88-A4A Broad Street, Boston 10, Mass.

MEN—WOMEN. Start candy kitchen in your own home. Big profit, folder free. Thompson Co., Dept. PM, Baldwin, Michigan.

LIQUID Rubber for making flexible molds. Cast novelties. Sample bottle 25c. Free literature. Chaney, 1130 E. 16th St., Jacksonville 6, Fla.

AN Independent, fascinating and profitable business making novelties, plaques, religious figures, etc., but you must have professional production moulds. Send for colorful story and catalog. Universal Art-craft Co., 7148 Huron River Drive, Ypsilanti, Michigan.

\$40 WEEKLY. Spare time, own home business. Many plans. Literature free. Carroll Service Company, 521-A North Pine, Little Rock, Ark.

BUILD Full rigged ship in a bottle, single ship sells for as much as \$50.00; materials cost few pennies. Particulars free. Old Mariner, Box 2095, Wichita, Kansas.

YOUR Own plastic business at home. Produce costume jewelry, novelties, statuettes. Liquid plastics, liquid marble. Flexible molds. Write for free book. American Trades, Box 89-A-1, Cincinnati 29, Ohio.

BE Your own boss. Manufacture and sell your own products. Details free. Duncan's Home Furnishing, 225-A North Logan, Gaffney, S. C.

START Your own business today. 24 tested formulas and instructions \$1.00. Bracken, 115 Nicholson, Harrison, Arkansas.

YOU Too can start profitable home business with limited capital. Details free. B. E. Leveque, 823 Howard Street, San Antonio 1, Texas.

EARN Money at home by mail. Information free. Goodrich, Edgewood Terrace, Longmeadow, Mass.

RUBBER Moulds for casting novelties. Latex for making moulds. Use thoroughly tested and approved products. Eastern Latex Laboratories, Box 153, Mattapan 26, Mass.

OPERATE Profitable mail order business. Splendid opportunity. For details write M. Gent, 1910 Maple Ave., Evanston, Ill.

START Profitable home business. Operate anywhere. Sparetime. Amazing facts free. Bryant Howell, Earle, Arkansas.

BUYERS Wanted for plaster novelties and religious statuary. Painted, unpainted. Retail, wholesale. Write today for free information. Bing Products, 88-X7A Broad, Boston 10, Mass.

SAWDUST. Turn it into money. Six methods. Instructions 25c. Charles, 12-AZ, Norwood, Ohio.

NATURAL Rubber latex. Extra thick. Sample jar 25c. Literature free. W. Wooley, 115-A Donald, Peoria, Ill.

MEN—WOMEN. "Most everybody likes candy." Learn to manufacture professionally at home. (Our 38th year). Ragsdale Candies, Dept. 4, East Orange, N. J.

TOYS. Make, sell, sawdust stuffed toys. Spare, full time. Instructions, five patterns, postpaid, \$1.00. Sawdust, 3873 California Street, San Diego 1, California.

LATEX For making flexible rubber moulds. Thoroughly tested. No shrinkage. Complete instructions with each order. Stoneham Rubber Co., Box 244, Stoneham 80, Mass.

ACCOUNTANTS, Bookkeepers. Now is the time to begin operation of SBKS bookkeeping system. No franchise fee. No postals. Barnhart & Kennedy, Chambersburg, Penna.

FLEXIBLE Molds—Cast statuary, pottery, novelties. Start in garage or basement. 5c material makes \$1.00 seller. Composition floors, waterproofing, roofing, plastic homes. Free particulars. Marbleizing Service, Edwardsville, Illinois.

GOODYEAR—Has Malaya liquid rubber for mold making. Quart \$3.00; gal. \$10.50; pint \$1.50. Write full particulars. Goodyear, Lake Geneva, Wis.

PLASTIC Tablecloth covers, curtains, drapes, baby pants, bowl covers and other plastic articles selling like wildfire! Make big money now! Free details. Write Plastics, Dept. 58-N, 206 N. Fourth, St. Louis, Mo.

OPERATE Profitable home mail order business on \$5 capital. Details free. Nette, 2718 West Cambridge, Philadelphia 30, Penna.

HANDYMEN—Earn money home operating Community "Fix-It" Shop. Write Stafford, 708 Rawlings, Carbondale, Ill.

MAIL Order opportunities. Send postal. Griffin, 756-A Broadway, Everett 49, Mass.

PUBLISHING Opportunity. Local Amusement Guide offers profits to \$10,000 yearly, cities over 50,000. Small investment, no experience, inexpensive operation. Investigate! Ward Associates, Dept. J2B, Greendale, Wis.

START Home mail order business with small capital. Earn extra dollars every day. Quarter brings factual booklet of plans and instructions. Satisfaction or double your money back. Herrold, 537P Woodland, Kenmore 17, N. Y.

SIGNS Made easily. Instructions and ten sets modern alphabets, numerals, patterns. Sizes up to eight inches. All for \$1.00. Co-operative Business, 7 West Madison, Chicago 2.

LEARN The mail order business, \$1.00. Harold's Service, 145 S. Bannock St., Denver, Colorado.

OPERATE Coin machines sideline or exclusively. All kinds for sale. Write for list. Coin Machine Distributor, Box 452, Tuscaloosa, Ala.

IDEAL Business stamping metal key protectors, social security plates. Information upon request. General Products, 11 No. Pearl (M), Albany, N. Y.

START Mail order business. Small capital. Particulars free. Lefferts, Box 48, Brooklyn 25, N. Y.

BOOKKEEPERS—Operate own bookkeeping service, part or full time. Free course, "How To Operate A Contract Bookkeeping Service." A. Judson Hawthorne, Public Accountant, Decatur, Ala.

EARN Extra cash selling popular kitchen item; housewives buy on sight. Territories still open. Box 73, Hazleton, Penna.

SPECIAL Rubber for making molds. Literature and sample free. Universal, Box 1076-A, Peoria, Ill.

BIG Money in vending machines. Smallest capital start brings immediate profits that build permanent profitable business. Starting instructions free. Becker Vendors, 105-A Dewey, Brillion, Wis.

START Key making business at home. Wonderful profits. Experience unnecessary. Complete outfit furnished for as low as \$50.00. Write Campbell's Locksmith Supply, 319 S. Division St., Grand Rapids, Mich.

MAIL Order business, splendid opportunity. Write Joseph Vassar, 312 Harden St., S.E., Atlanta, Ga.

RUBACREAM! Natural rubber latex! Makes molds quicker! Thicker! Free sample convinces! Castcraft Studios, 509-P Fifth Avenue, New York 17.

TWO Amazing new typing opportunities. Earn up to several dollars hour, right at home. New, exclusive, different. Write Schroder, 221 E. Bush, Covington, Ky.

MONEY? Learn candy-making. Instruction \$1.00. Artie Barnes, Box 997-PM, Wichita, Kansas.

START Your own electroplating business, highly paid, uncrowded field. Learn at home in spare time. Send postcard for free electroplating booklet and proof. Plater-Hyde, Room 521, 432 "F" Street, San Diego 1, California.

BE Independent, tune pianos, musical knowledge unnecessary. Practical Piano Tuning shows you how. \$2.00 postpaid. Mayberry, P3122 Lawrence Drive, Corpus Christi, Texas.

METALLIZING Baby shoes makes you money! Learn this simple, profitable, low investment business from nationally recognized authority. Get professional results with professional "know-how"! Free particulars. Joseph B. Kushner, Metal Finishing Engineer, Stroudsburg 23, Penna.

GROW, Sell potted flowers, vegetable plants. Details free. Bowers, Loyalton, Penna.

EXCLUSIVE Distributor. Plasticized beauty-protection for auto finishes. Used like polish. Must fin. own stock. Plasticize, 2254 N.W. 62nd St., Miami, Fla.

OPERATE Pushcarts, \$5.00 profit. Sample 10c. Varsales, 1058-P North Rockwell, Chicago 22, Ill.

MAKE Money in home mailorder business. Work only in sparetime. Amazing opportunity catalog and complete details sent free. Forest Sales Co., R60 West, Rupert, W. Va.

WHAT Do you want to buy? We furnish supply sources for most anything. Formulas of all kinds also supplied. Let us know your wants. Humphrey Re Search, Box 898, Santa Monica, California.

LUCRATIVE Mail order printing business. \$50 equips you. Write Globe, 605 W. 151, New York 31.

GET Hundreds money making deals, business ideas, plans and manufacturing. Amazing folio free. Austin Mail Service, 5538 Lexington, Chicago, Illinois.

SAWDUST Turned into cash. Simple instructions 25c. Rapolz, Sanborn Ave., Ashland, Wis.

MAIL Dealers: "Smart and easy money." Amazing, sensational disclosures. Tremendous seller! Confidential information free. Vancamp, 453 Reno Ave., Reno, Nevada.

MAGAZINES—Trade and class. Current copies. All fields. Free price-list. Commercial Engraving Publishing Co., 34BF North Ritter, Indianapolis 19, Indiana.

FLASH! Million articles wholesale. Directory 10c. Publishers, Box 1302-P12, Detroit 31.

OPERATE Profitable mail order business. Splendid opportunity. For details write Underhill & Co., 4 Mabis Ave., Gormaniana, W. Va.

REAL Estate business. America's finest profession spare time. Details free. Educational Book Co., 2907 Berwick Ave., Baltimore 14, Maryland.

SIMPLE Proved method of guerilla self-defense makes you the master! Particulars free. Inspiration House, 3108 Hillside, Harrisburg, Penna.

AMAZING New invention! Screw holding screw drivers! Remove, hold, insert screws hard-to-get places! Exclusive distributor appoint salesmen selling to stores, factories, Millen Mfg., 683 Miller Bldg., Boston, Mass.

LEARN Mold making, plaster casting. We furnish materials and teach you. Particulars free. Artcraft Industries, 411 Wolverton, Ardmore, Okla.

GENUINE Natural latex for rubber molds. Only two coats necessary for thick mold. Make money reproducing statuary, plaques, novelties. Low cost. Write Major Chemical Co., 131A Inman Street, Cambridge 39, Mass.

A CHICAGO Address. On your letterhead. Builds prestige. Mail, telegrams, received and forwarded. Foreign concerns invited. Strictly confidential. Write Faultless, P-3439 Michigan, Chicago 16.

FAMOUS Kruse Vita-Life health and beauty equipment earns chosen operators big money. Proven, effective methods past 34 years assures success, any community 5000 up. Clean, dignified. Your own business. Write immediately for details. Glossbrenner Manufacturing Corporation, 330 West Court Street, Indianapolis, Indiana.

SELL Printing. Lowest prices in America! Adams-MP, 30 West Washington, Chicago 2.

YOU Can build a successful mail order business at home! Free "How" information. J. Scott, 282 West 117th St., New York 26.

SPARE Time money. Teaching "Book-keeping in a Month" and "Improve Your Writing" courses to classes formed by you. Details free. Educational Book Co., 2907 Berwicke Ave., Baltimore 14, Maryland.

OPPORTUNITIES Galore! Four big mailorder trade magazines 25c (refundable). Wehner, Box 142-B, Roxbury 19, Mass.

RECEIVE Moneymaking opportunities, mails galore! Name in "Surefire" mailing directories two years \$1.00. Nine months, 50c; three months, 25c. Stanford, 6220-P 16th, Philadelphia 41.

WHOLESALE Bargains, business plans, opportunities. Holm Sales, 12A, Oaklandon, Indiana.

MANY Inventions make millionaires. Particulars free. Patent News, 12, Washington, D. C.

MOLD Plastics, compositions, plasters. Simplified, profitable methods. Free instructive literature. Digest, 2917B Michigan, Kansas City 3, Mo.

HOME Workers wanted to hand-spin Angora wool. Either sex. House of Angora, M-12, Springfield, Illinois.

MOULD Keys—Outfit and metal for fifty keys, illustrated instructions, cooking heat only. \$2.00. H. H. Heard, 212 N. 7th St., Wilmington, N. C.

100 GENUINE Ways to success. Literature. Continental Publications, Elmhurst, New York.

300% PROFIT Selling repeat item by mail, local. Dade Products, Box 1720H, Cleveland, Ohio.

OWN A mail-order paper products business. Sell envelopes, tags, bags, boxes—wholesale. Tremendous demand. Steady profits. Omaha Envelope Service, Dept. 228, 4721 California, Omaha 3, Nebraska.

MAKE Strange plastic—1c pound. Makes durable, attractive floors, walls. Build with waste. Save half. Bays Laboratory, Oklahoma City 9.

RUBBER—Genuine "India" makes molds (one day) pint \$1.50, gallon \$7.00. Rubber Products, 3151R Southport, Chicago.

FROZEN Custard is sweeping the nation. Operate your own highly profitable drive-in. Save time and money with our "Know-how." Booklet, \$5.00. Penguin Enterprises, 21373 Stratford Ave., Cleveland 16, Ohio.

FINANCIAL Independence can be yours. Earnings \$150 week easy, everything furnished. Owen Kofod, 1030 Yale Station, New Haven, Conn.

WANTED Unused U. S. postage stamps, small discount. Advance Stamp Company, 24 East 23rd Street, New York.

MAKE Money selling "C-E Automatic Water Heaters." \$7.50 to \$26 on each sale. Write Crane Electric, Eugene 4e, Oregon.

STORM Windows. (Combination glass and screen interchangeable). Make them in your own shop—sell. Will furnish knock down stock. Territory still open. \$3000 required. Description and prices on request. Weather-Rex, 155 Genesee Street, Buffalo, New York.

INCORPORATE Your business. Delaware laws. Many advantages, free details. Tax Research Bureau, Inc., Delaware Trust Building, Wilmington, Delaware.

ACCOUNTING Practice—Twelve proven clientele building methods. Eight selected, powerful sales letters. Inquiries invited. Organization Consultants, Box 33, Forest Hills, N. Y.

OPERATE Home business that may mean the road to independence. Write Sunray, 4756 N. Bernard, Chicago, Illinois.

STOP Looking further. New combination two-way mail order business. Free information. United Mail Order Bureau, 1310 N. Wells, Chicago 10, Ill.

BUILD Your own mail order business. Beginner's fact-packed treatise, 25c. Satisfaction guaranteed. Homan, 1407-D North 33rd, Omaha 3, Nebr.

BASKETS, wholesale to the trade only. Hardware stores, general stores and etc., write for price list. Durham's Basket Market, North Branch, N. J.

OPERATE Simplified repair business. Locally or by mail. Large profits. Free! Literature. Cline-Porter, Box 6346PM, Pittsburgh 12, Penna.

BIG Money. Make novelties, plastics, formulas, etc. Instructions \$1. Circular stamp. Brooks, B120M, Arkansas, Wis.

"MAIL Order Magic"—Free monograph sent anyone interested in mail selling! Crompton, Box 2567-M, Hollywood 28, Calif.

SIMPLIFIED "Know How." Start your own electric motor repair shop. Electrical Engineering Consultation Service, 3013 East 6th St., Long Beach 14, California.

BELTS! Make 'em and make money. No tools! Sample 50c. Artinc Leather, 411 Joseph Ave., Rochester 5, N. Y.

A HIGHLY Profitable factory in your own home or garage! Amazing waterless hand cleaner. Formula and instructions free. Western Aircraft, Dept. D, Los Angeles 6.

START Home manufacturing business making Cleaning Compounds, Soaps, Insecticides, Cosmetics, Polishes, Food Flavors. No machinery. Literature free. Kemix, Park Ridge, Ill.

READ—"From Nothing To Independence." Descriptive literature free. Maciolek, 7738-A Dayton St., Detroit 10, Mich.

BE A tax consultant. Bookkeepers, etc. can qualify quickly. Details free. Edw. H. Smith, 17 Rockland Ave., Yonkers, N. Y.

ELECTRICALLY Inclined men. Amazing illustrated literature free, proving \$100-\$250 weekly possible installing, maintaining fluorescent lighting. Rebuild fixtures for excellent profits. Make beautiful lights for 50c each and less. Free sample materials. Write Willis Fluorescent Service, 101 York Street, Brooklyn 1, New York, Dept. C.

SEA Shells, plastics, metal findings, free catalog. "Secors," 238 Bradenton Beach, Florida.

WINDSHIELD Wiper rebuilding brings big profits. Free particulars. H & H Products, Box 430, East Akron 5, Ohio.

CONVERT Hand mowers to power mowers. Sell the handy-dandy lawn mower conversion kits. Easily installed on any make mower in 3 hours. Used with any small gasoline or electric motor (Maytag, Power Products engines) in stock. Quick delivery. Kits can be purchased with or without engines. Fits 16 to 20 inch mower. Dealers wanted. Write for details. Le Claire Manufacturing Co., Le Claire, Iowa.

1001 MONEYMAKING Ideas! Free details. Newway Institute, Box 5463-M, Chicago 80.

METALLIZE Baby shoes. Excellent profits. New system assures success. Free details. Treasures Forever, 89 Henry Ave., Lynn, Mass.

"MAILORDER Fundamentals" for mail-order beginners. \$1.00. Mecca, 30 West Washington, Chicago 2.

\$46 FROM Square foot plywood. Jigsaw necessary. Write. Woodarts, X-38, Bridge-water, Mass.

BIG Mail 6 months 25c. Roth, 1455B Cornelia, Chicago 13, Ill.

OPERATE Profitable mail order business. Splendid opportunity. For details write J. Kavaz, 54 Seigel Street, Brooklyn 6, New York.

UNPAINTED Plaster ornaments made from new, wonderful loxite. Beautiful designs easily decorated with water colors or oil paints. For profit or hobby. Illustrated list free. Midwest Novelty Mfg. Co., 108A Cedar St., Anaconda, Montana.

WANT To sell your brains? Publish and sell your own knowledge for money. Publisher tells how. Free details. Write today. Royal Publishers, Auburn 3, Alabama.

TREMENDOUS Profits selling real estate. Authorative new manual shows how to start full or part time business of your own. Complete only \$2.00. Details free. Schultz House, 3116 Seminary, Chicago 13.

GOLD. Silver plating at home. New, amazing outfit. Does marvelous work and so simple. Just plug into electric socket and in a jiffy you begin to plate. Not a toy. No experience needed. Everything furnished. Absolutely guaranteed. Make money plating for others. Write immediately for full details. Louric Mfg. Co., 1809-W Callowhill Street, Philadelphia 30, Penna.

MAIL Order businesses, franchises, distributorships, bought and sold. Write for free bulletin of exclusive opportunities. Turnipseed, Inc. Box 681, St. Louis, Mo.

REMNANTS—Amazing values. Housewives buy on sight. Good profit. Write B & M Textiles, 415 East 26th Street, Paterson 4, N. J.

RUBBER Molds, liquid rubber, statuary plaster, kits for beginners. Complete "Plastercraft" course free on request. Blue Rapids Supply, Blue Rapids, Kansas.

DO It with sea shells. Beautiful jewelry, novelties. Big profit spare time. Free lesson. Werts (P.), 1429 56th Avenue, Oakland 3, Calif.

UNPAINTED Plaques, statues. Variety of designs, free list. ArBo Products, A 195 E. 7th St., St. Paul, Minn.

EXCLUSIVE Distributorships available. New sensational home labor saving device ready October first. Wonderful money making opportunity. Write Sherwood Products, Erie, Penna.

SECURITY. Happiness, independence. Selling by mail. Free details. W. Young, Box 1477, Portland 7, Ore.

AGENT Or exclusive distributor for cigarette lighter mfg. MacGregor, Tahoe Valley 16, Calif.

YOU Too can start profitable home business with \$5.00 capital. Details free. B. E. Leveque, 823 Howard Street, San Antonio 1, Texas.

START Home business making statuettes, plaques, artificial marble flooring, liquid marble, flexible molds, metalizing baby shoes. Amazing profits. Folder free. Creative, 236-L, Winnetka, Illinois.

UNPAINTED Bookends, plaques, statues, figurines. List. Havery Products, 1219 8th Ave., Altoona, Penna.

FELLOW Workers, no bosses. National opportunity to become independent with business of your own. Details free. P. Padney, 307 York St., Jersey City 2, N. J.

RE-NEW Leather and leatherette—Make cloth into imitation leather with plastic discovery called Leather-New. Opportunity to make real profits taking care of sales resulting from national advertising. Write for free sample of Leather-New covered material and complete deal. 701 Land Bank, Kansas City, Missouri.

BRONZED Baby shoe mountings and supplies. All metal bronze bookends, picture frames, ash trays, etc. Onyx ash trays, desk sets, plaques. Hardening solution. 30 amp. plating rectifiers with powerstat control. \$85.00. Geared motors for agitation, \$15.00. Lead lined tanks. Write for list. Hollywood Bronze Supply, 1770 N. Vermont, Hollywood 27, Calif.

FREE Literature describing many money making plans. Albert Pearson, Box 1182, Milwaukee, Wisconsin.

LEARN To metalize baby shoes! Complete instructions \$1.00. Don Brady, 1618 Gage St., Topeka, Kan.

ELEVEN Formulas, also diagram of electroplating outfit for \$1.00. (coin). Emery, 482-40th Street, Oakland 9, California.

READ "Advance"—The Voice of Mail Order. Offers money-making opportunities, sources of supply, personal guidance, etc. Issued monthly. Sample copy 25c. Yearly subscription \$2.00. American Mail Trade Association, 313 East 21st Street, Suite 45, New York 10, N. Y.

IF You'd like your own, high income but easily learned office business, write for free details today. Cole Associates, Syracuse 2, N. Y.

PROFITABLE Letter shop operation. Details free. Wollard, Box 268-E, Newark, Ohio.

UP To \$1500 yearly selling by mail in spare time interest you? New ideas and plans every month. Details free. Idea of Month Club, Box 118-A, Baltimore 18, Md.

\$5 COMMISSION On booked distant moving jobs you recommend. United, 243 West 60th Street, New York, N. Y.

POPCORN Machines. Potato chip outfits. Long Eakins Co., 4760 Hi St., Springfield, Ohio.

GET It for them wholesale. Be community buyer nationally-known merchandise; radios, refrigerators, washers, sweepers, typewriters, etc. Savings up to 50%. This pleasant, easy work can earn up to \$5000 year. Get details today. Kraft, Aurora 8, Missouri.

WHITE Liquid rubber for making flexible molds! Quick drying! Safe! For home, classroom, or industry! Quart \$2.00. Gallon \$5.95. Full instructions! Beginner's booklet on molding and plaster casting 25c. Free with order! Plastercraft Supply Company, 1406 East 43rd Street, Cleveland 3, Ohio.

INVESTIGATE Mail order or home business. 140 new ideas. Write Marshall, Box 655, Centralia 13, Washington.

MAILING Postcards selling repeat merchandise is profitable. Everything supplied. Details free. Gordon Publishers, Box 23, Pawtucket, R. I.

WOULD You pay 3%—first \$350 made? Color-illustrated book "505 Odd, Successful Enterprises" free! Some offer occasional "day off." Work home. Expect something odd! Pacific, Oceanside, Calif.

BIG Profits and your own business casting latest 1947 metal toy autos, airplanes, ashtrays, savings banks, etc. Enormous wholesale and chain store demand keeps manufacturers busy. Spare or full time. No experience or special place needed. For full information write Metal Cast Products Co., Dept. A, 1696 Boston Road, New York 60, N. Y.

COIN Machines earn big money! Machines are now available at \$11.75 that can earn as high as \$7 weekly profit. Place machines in stores, hotels, filling stations, etc., and your income starts immediately. Routes can be operated in spare or full time with no experience needed. We'll tell you how and send you a catalogue describing our nut, candy, gum, and postage vendors, also scales, amusement games, etc. Write immediately to Parkway Machine Corp., Dept. P, 623 W. North Ave., Baltimore 17, Md.

CO-PUBLISH And advertise in The Central Mail Advertiser. Sample copy for stamp. Low rates. Large circulation. Bagby Printing Co., Georgetown, Ohio.

HOW To set up and run a mirror shop! Resilver mirrors. For price write—John Sprinkle V60, Marion, Indiana.

OPERATE Profitable mail order business. Write Walter Service, 4159-A East 112th, Cleveland 5, Ohio.

RECAST Old batteries into new. Latest achievements. Battery Laboratories, Minneapolis.

BIG Mail income. Free particulars. Murray's, 196 Circle, Forestville, Conn.

MAKE Perfumes. Profitable business. Free book tells how. Walter Lawson, 21 Joiner, St. Augustine, Florida.

MAIL Order opportunities. Full or spare time. Hundreds of chances. No charge. Postal brings copy. Blackstone Press, Somerville, New Jersey.

GREAT Opportunities and profits in mail order business at home. Free literature. F. Webster, Box 1972C, Hollywood, Calif.

BOOKKEEPERS—Operate your own simplified "Dollar-A-Week" bookkeeping and tax service. Full or spare time. Details free. Ellis, Box 200, Cedar Grove, North Carolina.

ELITE Collection contains 137 practical money-making plans; local and mail order. New edition. Particulars free. Elite Co., 220 Grand St., New York 13.

QUICK Money! "Repairing car batteries." At home! Easy too! Write. Batteryman, Grand Junction 5, Colorado.

SELL By mail!—Books and novelties! 35 different items! Large profits! Catalog free! Elco, 432 N. Wells, Chicago 10.

OPERATE Profitable home business selling merchandise by mail. Fast sellers. Large profits. Powell Service, 5713 Euclid, Cleveland 3, Ohio.

COPUBLISH Leading m.o. paper. Latest copy Mail Sale Advertiser and proposition, commemorative stamp. Vanroy Shirk, Lebanon, Penna.

START Profitable mail order business. PMT lists new propositions available; products, sources, accurate methods. Covers ad writing, letter logic, trade information. Send 10c for copy and get free instruction folio offer. Progressive Magazine, Sheboygan, Wisconsin.

START A clock shop. Fascinating, easily learned profitable business requiring little capital. We teach you how to repair all kinds of clocks. Information free. Houston Clock Shop, P.O. Box 5086A, Houston 12, Texas.

HOW and where to obtain capital. Fully explained. Particulars free. Star Service, Wapakoneta, Ohio.

SPECIALTY Manufacturing, the big money business that can be operated anywhere, start on a very small capital; we supply dependable formulas and complete instructions; get interesting free booklet, "Money-making Opportunities in Specialty Manufacturing." Howard Robinson, Ph.G., 1300-A South Ohio Street, Sedalia, Mo.

\$25 WEEKLY Working two hours daily. No canvassing. No manufacturing. Lycke, Box 2471, Cleveland 12, Ohio.

137 WAYS To make money, in home or office, business of your own. Full particulars free. Elite Co., 220 Grand St., New York 13.

BRUSH Plating outfits connect to a battery. No tanks necessary. Good paying business at home plating autoparts, bathroom fixtures, bicycles, reflectors, silvering mirrors. No shop or experience required. Outfits furnished. Free booklet. Gunmetal Co., Ave. H, Decatur, Ill.

MONEYMAKING OPPORTUNITIES

SEWING Machine repairmen make big money lifetime. Start neighborhood shop. Complete repair manual, covering all makes, \$1.98 postpaid. Money back guarantee. Sewing Machine Serviceman, Hamilton 9-G, Ohio.

ELECTROPLATING Has a thousand and one uses. Make good money in spare or full time. Warner Electroplaters permit you to easily plate chromium, gold, silver, nickel, copper, etc. Plating equals costly commercial jobs. Pay for your electroplater in a short time by plating for others at a profit. Write today for free sample and literature. Warner Electric Co., Dept. MO-12, 1512 Jarvis Avenue, Chicago 26, Ill.

START A home business in spare time. Make extra money. Experience not essential. Literature free. Luteski, 317 Augustine St., Rochester 13, N. Y.

RESILVER Mirrors at home. Formula 25c. Ideal Service, Park Ridge 6, Illinois.

START Your own business! Big money manufacturing novelties, plaques, statuary. Free catalog. Write Bing Products, 88-A4B Broad Street, Boston 10, Mass.

MONEYMAKING Opportunity raising giant chinchilla rabbits for meat, fur and breeding stock. Waters Rabbit Farm, Glennville, Ga.

SIX (Different) leading mailorder magazines, 20c. American Directory, Robstown 4, Texas.

EARN Up to \$480 month part or full time keeping books for small firms. Simplified system. Write Tax-Saver System, Dept. R, Ft. Worth, Texas.

IMMEDIATE Home moneymaker; gold-leafing baby shoes, frames, art pieces. Free details. Prodex, 509 Fifth Avenue, New York 16, N. Y.

BIG Money welding gasoline tanks safely. Information \$1. Alfred Schlatter, Francesville, Indiana.

BEAT Competition—Cash in with newest products. New Products Bulletin Service brings monthly advance notice of 100 newest items. Be first. Copy \$1.00. Details free. H. Heberlein, 17-A Prospect Street, Elizabeth 4, N. J.

CASH In on your hobby! Make and sell beautiful, authentic wood carvings from inexpensive models. No experience necessary with new, amazing "Carvit" duplicator. Start your own business or make your spare time show a profit! Dumore Co., Dept. M-58, Racine, Wis.

MR. Mail order man; start right; start today that business of your own, with the 100 newest products monthly "New Products Bulletin," sample copy \$1.00. The 49 successful way new book "From Nothing To Independence," \$2.00. The "Twenty Ad" tested plans \$2.00. All three sell big money plans for \$4.50. Details free, satisfaction guaranteed. Educational Book Co., 2907 Berwick Ave., Baltimore 14, Maryland.

INVESTIGATE Specialty manufacturing, for large profits with small capital. Bemcroft, 15 Park Row, New York 7, N. Y.

START Flocking—Spray beautiful plush finish on everything. Easy, profitable, inexpensive. Supplies, equipment, instructions. Coast Industries, 1507 W. Manchester, Los Angeles 44.

FREE! Folio 24 complete home businesses. Lyle, Box 1231, Santa Barbara, Calif.

BUSINESS At home casting plaster novelties. Generous trial kit \$2.00. Major Chemical Co., 131A Inman Street, Cambridge 39, Mass.

XMAS gift that earns money for children, adults. Just spray glowing velvet covering on photo frames, boxes, etc. Spray gun, instructions and kit (red, blue or brown) only \$2.95. Guaranteed. V-Sparks, 1145 Queen Anne Place, Los Angeles 6.

EARN Money at home! Thousands do! "Home Worker Magazine" tells how. Sample, 25c. Sizemore, Box 7, 4917 Kostner, Chicago 30, Ill.

MONEY? "Pocket Millionaire." 112 pages, 1269 basic money-getting secrets of the rich. \$1 postpaid. Order now! Satisfaction guaranteed. Free circular. Stanley Service, 544 E. Jersey St., Elizabeth 1, N. J.

GET Security—Big profits, in spare time. \$3.00 per hour! Sell by mail if desired. Barrows, 28-C Stebbins, Worcester, Mass.

MEN And women! Repair Venetian blinds. Build machine. Little cost. Make money. No experience needed. Complete plan \$3.00. G. E. Service, Box 749, Long Beach, Calif.

EARN Money at home! Steady income! Colliers course tells how! Sample lesson 25c (coin). Write Successful Income Builders, 508-A, Hollywood, California.

BOOKKEEPING And tax service—Nation-wide survey confirms amazing growth, large earnings. Tax Consultants, Box 33, Forest Hills, N. Y.

CLUB Plan brings in dollars. Details. Business Plans Co., 1242 Park Ave., San Jose 11, Calif.

MAKE—Sell new amazing auto paint you simply wipe on. Complete formula \$1.00. Ideal Service, Park Ridge 8, Ill.

FREE Magazines, publishers' offers. 5c stamp. Ritzy, 939 Fteley, Bronx 61.

A HIGHLY Profitable factory in your own home or garage! Amazing waterless hand cleaner. Formula and instructions free. Western Aircraft, Dept. E, Los Angeles 6.

THOUSANDS Articles wholesale. "Supply Source Directory" 10c. Ideal Service, Park Ridge 40, Illinois.

WIN Contest money. General Contest Magazine gives hundreds of tips. Lists current contests and rules. Sample 25c. General Contests, 1609½ East 5th, Duluth, Minn.

START Mail forwarding. Details 10c. Instructions \$1.00. Banas, Box 285, Syracuse 1, N. Y.

EARN Money evenings, copying and duplicating comic cartoons for advertisers. Adservice, Argyle 1, Wisconsin.

OPPORTUNITIES In mailorder. Sample magazine 10c. Adam Palmer, Blacklick, Penna.

"KNOCK 'Em Cold" teaches secrets everyone should know. Free particulars. Milson, 1818A Tyler Parkway, Louisville, Ky.

100% PROFIT Beautiful line fishscale and shell costume jewelry and novelties. \$2.00 brings 5 samples, returnable. Wonderland Studio Inc., Box 709, St. Petersburg, Fla.

METALLIZE Baby shoes. Further information free. Metal Crafts, Box 356-R5, Tampa 4, Fla.

MAKE Money right from home. Mitla, Box 207-P, Mena, Arkansas.

SOAPMAKING, 25 Pages of easy instructions. 40 formulas. No machinery needed. \$1.00. U.S. or foreign. C. Brown, 9111 Hoyne, Chicago 20.

1947 GIGANTIC Directory of opportunities, advertiser's supplies, sources, trade information, mail order ideas, products, wholesalers, valuable tips—just published! Descriptive literature free. Wilkin & Co., Hillsboro, Ohio.

BIG Profits. Sensationally new. Every home, office, store prospective buyers. No competition. Exclusive dealerships. Sherwood Products, Erie, Penna.

SCHOOL Seniors—Sell classmates America's most beautiful graduation name cards. Largest selection. 40% commission. Outsells all others. Send for free sample kit. Printercraft, 1425 E. Elm St., Scranton 5, Penna.

EARN Up to \$2,000 year, inventing simple items. Special cash markets. Hendrickson, Argyle 7, Wisconsin.

LEARN To make seashell jewelry, pins, earrings, hair ornaments, novelties. Book of instructions and designs free with \$2.00 and \$5.00 kits, postpaid. Herbert Diamond Co., Box 4619, Miami 31, Florida.

WOULD You pay 3%—first \$350 made? Color-illustrated book "505 Odd Successful Enterprises" free! Proven! Work at home, office. Expect something odd! Pacific, Oceanside, Calif.

THERE'S Big money in junk, and repairing batteries. Write, Batteryman, Grand Junction 5, Colorado.

\$246.50 MAKING Unusual secret device without skill, machinery, from former war material costing \$1.50! Simple, baffling invention, unbelievably profitable! Illustrated proofs free. Rolls Enterprises, 115-D West 16th, New York 11.

FORTIFY The future! Start own business; home, office. Booklet describing "Collection of 137 Tested Plans" free. Elite Co., 220-A Grand St., New York 13.

PUBLISH Your own magazine. Hand-some 52 page format, well edited, illustrated. Cost low as \$1.00 month. Brings you prestige, profits. 25c brings sample, details. National, Ord, Nebr.

FORMULAS, PLANS, ETC.

RESEARCH: Any formula \$1. Guaranteed. "Research," Box 161, Knoxville, Tennessee.

21 POPCORN, Candy apple, etc. formulas. All money-makers. \$1.00. We can supply equipment. Concession Supply Co., Dept. "A," Box 133 Sta. "B," Toledo, O.

PROVED Formulas. Artificial wood, crack filler, furniture polish, hand lotion. Make cheap, high profit. All for \$1.00. Dominion Chemical Service, Weyers Cave, Va.

FORMULAS For home, workshop, farm. Cosmetics from chemist. \$1 each. Formulas, Box 410, Bloomington, Indiana.

FORMULA'S, Sure moneymakers. 15 for 25c. Rapolz, Sanborn Ave., Ashland, Wis.

MAKE Cosmetics, perfumes, soaps, etc. 100 formulas \$1. M. Elsbury, 717 N. Dearborn, Chicago 10.

100 SINGLE Ingredient formulas 25c. Tes-Co., Box 189-M6, Wilkes Barre, Penna.

A HIGHLY Profitable factory in your own home or garage! Amazing waterless hand cleaner. Formula and instructions free. Western Aircraft, Dept. F, Los Angeles 6.

MANUFACTURE Cleaners, soaps, polishes, flavors, cosmetics. Literature free. Kemico, Park Ridge 16, Illinois.

NEED Chemists? Products duplicated? Formulas? Analyses? Consulting Scientific Company, Swarthmore, Pennsylvania.

10,000 FORMULAS And trade secrets. Free literature. Stillman, 555 Kingston Ave. Brooklyn 3, N. Y.

REAL Manufacturing formulas. Lists free. Cummings, Chemist, Gordon Ave., Syracuse 4, N. Y.

PLASTICS

PLASTICS, Supplies. Free list. Exceptional kits. \$3.00 and \$5.00 f.o.b. Plasmet Sales and Engineering. 4648 Shirley Pl., St. Louis 15, Mo.

PLASTICS—Smoking set to assemble. Sheets and rods. Stamp brings prices. Hanson Plastics, 7625 South Parkway, Chicago 19, Dept. DD.

INTERNAL Carved swans, bluebirds, goldfish, butterflies, etc.; pins, \$1.50; roses costume jewelry sets, \$1.50; less findings. 2" cubes with roses, \$2.00. Crystal Floral Novelty Co., Somerville, N. J.

FABRICATE For profit. Five Plexiglas Lucite proven household projects, \$1.50. Vespa Plastic, 129 Addison Ave., Elmhurst, Ill.

LUCITE, Plexiglas, masked sheets. Any size. Cost square foot (12"x12") 1/16" 85c; 1/8" \$1.10; 3/16" \$1.30; 1/4" \$1.60. Also Lucite rod, tubing. Include 10% postage. Almac Plastics, 230 Fifth Avenue, New York 1, N. Y.

PLASTICS, Best materials, lowest prices. Send for free list. Plastex Products, Curtis-Filbert, Baltimore 26, Maryland.

DON'T Throw away broken plastic articles. Use WestCol plastic cement. Any color. 40c postpaid. WestCol Mfg. Co., 108 N. 3rd, Grand Junction, Colo.

PLASTIC Xmas gifts, kits, supplies. Exceptional values. Catalog 10c (refundable). Plastic Products Co., 211 7th St., Canton 2, Ohio.

POLISH Plastics with flame. Complete kit and instructions. Nothing additional needed. \$2.00 postpaid. Barnett Specialty Co., 5104 Hollywood Blvd., Hollywood 27, Calif.

ACETATE, Clear, transparent, 20"x50", two \$1.00; dozen \$5.00. Daniels Press, Statesville, North Carolina.

WHEELS With spokes, lucite, up to 6 in. diameter. Free specifications and price list. Hudgens Plastic, Norcross, Georgia.

"ESTONITE" Transparent liquid casting plastic. Quarts \$3.95; pints \$2.25. Complete instructions. Estonite, 3211 Webb, Detroit 6, Mich.

MAKING Money With Plastics. \$1.00. G. C. Going, Box 1544, Muskogee, Okla.

NEW Liquid plastic. Clear, colors. Cast without heat. Embed flowers, insects, coins. Saw, drill, carve. Manual tells how. Send \$3.50 (West Coast, Canada, Mexico \$3.75) for complete 20 project kit including one pound liquid Castolite. Castolite, Dept. P-21, Box 211, Kenilworth, Ill.

WONDERFUL New thermoplastic. Literature free. Sample 25c. Jalco, 161 Dille, Memphis, Tenn.

ELECTRIC Pencil—Writes, engraves all metals. Battery model \$1.00—110 volt model \$3.00. Complete. C.O.D.'s accepted. Reb Industries, Dept. 265-CC, Elmhurst, Illinois.

PLASTIC Injection machines, tenite, plexiglas, dyes, polystyrene rods, jewelry findings, etc. Special get acquainted shellcraft kit—big assortment \$2.50. Free list. G. Baker Company, River Edge, New Jersey.

PLASTICS—Sheets, rods, tubes, all colors; dyes, supplies; findings. Illustrated fabricating manual, prices, 10c. Lucite sample, 35c. Gem-O'-Lite, Box 686F, North Hollywood, Calif.

INTERNAL Carvings, drills, dyes, jewelry findings, tools. Plexiglas masked sheets, 12"x12", 1/16" \$1.00, 1/8" \$1.25, 3/16" \$1.55, 1/4" \$1.85. Include 10% postage. Rods, tubes, dyes, cements, buffing compounds. Free listings. Craft Plastics, Somerville, New Jersey.

RENEW Leather and leatherette—Make cloth into imitation leather with plastic discovery called Leather-New. Opportunity to make real profits taking care of sales resulting from national advertising. Write for free sample of Leather-New covered material and complete deal. 704 Land Bank, Kansas City, Missouri.

PLASTIC—Sheets, rods, tubes, etc. Free list. Plastic Supply Co., 2618 St. Louis Ave., St. Louis 6, Mo.

PLASTIC Costume jewelry, beautiful designs. Free catalogue. Howard Schultz, 115-83 229 St. St. Albans 11, N. Y.

MAKE Money assembling our pre-fabricated plastic kits. Sample kit 50c. Catalog free. Fabros, Box 156, Station F-1, Buffalo 12, N. Y.

CHEMISTRY

LEARN Chemistry at home, from the house of Winn. Home of supplies for student chemists. New idea chemical and apparatus outfits for home experimenting. Semi-professional microscopes and accessories. Send 10c for retail catalogue. Established 1931. John H. Winn, Dept. 512, 124 West 23 Street, New York 11, N. Y.

COMPLETE Supply catalog, 10c. Pilgrim Chemical, 348R Edith, Salt Lake City 4, Utah.

FREE Catalog. Chemistry, mineralogy, physics. Tracey Laboratories, Box 615, Evanston, Illinois.

CHEMICAL Sets. Chemicals of all kinds. Special attention to small orders. Free catalogue. Lab Chemical Company, Box 206, Oak Park, Ill.

LABORATORY Supplies, chemicals glassware, etc. Low prices. Large catalog 15c. Microscopic stain catalog 20c. Both for 25c. National Scientific Company, established 1908, 2204 W. North Ave., Chicago 47, Ill.

CHEMICAL Magic: Interesting, educational, mystifying. Complete set 50c. Wholesale \$3.00 per dozen, 10 dozen \$25.00. Make money selling your friends. Dytex Chemical Co., Dept. M, 145 Cray St., Providence 3, R. I.

APPARATUS, Chemicals, ounce quantities, catalog 10c. Fleischer's Laboratories, Everett 49, Mass.

CHEMICALS—LAB. Supplies. New catalog 10c. Mel-Glo Chemical Co., 258 Fourth Avenue, Brooklyn 15, N. Y.

CHEMICALS And apparatus for industrial, analytical, and private laboratories. Complete supply service for correspondence school students. Send 3c for catalog. Dept. M-43, Biological Supply Co., 1176 Mt. Hope Ave., Rochester 7, New York.

SPECTROSCOPE For quick chemical analysis \$3.98. Cutting Co., Box 457, Campbell 1, Calif.

NEW Laboratory supply catalog of chemicals and apparatus, contains over 5000 items with illustrations, 212 pages. Send 50c. Standard Science Supply Co., 1232 No. Paulina Street, Chicago 22, Ill.

HANDBOOK For chemical experimenters, illustrated, hundreds of experiments, 50c. Experiment booklet 15c. Supply catalog 5c. Reading Scientific Company, Reading, Penna.

HELP WANTED

BOYS Wanted. Over \$50 week! Sell name plates for front doors. Write National, 214 Summer, M. Boston, Mass.

EXTRA Money—Quick profits; selling personalized buckles, belts, cap-badges, tie clasps, 2000 emblems, caps, shirts, ties. Write, Hook-Fast Products, Dept. A, Columbus 6, Ohio.

AGENTS WANTED

TOP Quality paint line available to established manufacturers' agents calling on contractors, builders, industrial accounts, stores, etc. Attractive discounts. Exclusive territory available. Write Lasting Products Company, Baltimore 23, Maryland.

AGENTS—Distributors. Manufacturer of nationally known razor blades desires agents, distributors to sell high quality blade. Generous profit. Excellent repeater. Small investment for stock. Write for samples, details. Columbia Razor Blade Corp., Mfrs., 517 East 9th St., Los Angeles 15, California.

NEW! Different! Use no water! Getzol Mechanics Hand Cleaner. Instantly removes dirt, grease, paint, tar, ink, etc., leaving hands smooth and soft. Constant repeat sales to garages, machine shops, plumbers, painters, printers, motorists, aviators, farmers, etc. Sample jar 50c postpaid with descriptive matter. Big discounts! Goetz Petro-Chemical Co., 34 Manitoba Street, Buffalo, N. Y.

LOOK Here! Wanted—men to start in business on our capital. Sell some 200 farm-home products. Thousands our dealers now make quick sales, big profits. For particulars write Rawleigh's, Dept. L-192-PPM, Freeport, Ill.

ODOR "Mufflers" finest refrigerator deodorizer for ice boxes. Retail \$2.00. Sell consumer. Big profits, exclusive territory. Write L. A. Muffler, Continental Bldg., Los Angeles.

SELL Perfumes and toilet waters, large commission. Write Drams Company, 213 Tenth Avenue, N. Y. C.

NO Investment, throw rugs, big profits, good repeaters. Investigate this opportunity. Warren Rug Mills, Box 243K, Phillipsburg, New Jersey.

STRANGE "Dry" window cleaner. Sells like wild. Replaces messy rags, liquids. Simply glide over glass. Samples sent on trial. Kristee 116, Akron, Ohio.

DOLL House furniture puzzle! Write Rickett, 2551 So. Wanamaker, Philadelphia 43, Penna.

AGENTS Show new hot \$1 item to stores. Sells-on-sight. Free sample proves deal. 100% profit. Write or wire. Presto Company, Dept. A-4, Glendale, Calif.

SILVER Plating liquid. Apply with cloth. Cleans, silverplates, polishes, one rubbing. Genuine silver. Renews silverplated ware. Also silverplates brass, copper and some other metals. Female and male selling representatives wanted. Part time or full. Splendid profits. Exclusive territory. Sells by showing and demonstrating. Retail and wholesale. NuProcess Products, Aurora, Illinois.

SCHOOL Seniors: Sell classmates superb Craftcards for super profits. Write Craftcards, Box 235(AK), Pittsburgh 30, Pennsylvania.

SELL Luminous paint (shines), sample bottle \$1.00 (refundable). Details, "Gem-lite," PM-345, Wilkes-Barre, Penna.

FINE Watches cheap for resale. Write Wodicka, 339 East 11th, New York, N. Y.

AGENTS—Make big money with low-priced plastic table covers. Saves on laundry bills. Over 100% profit. Samples free. Carwell, 330 So. Wells, Chicago.

MAKE Money stamping key protectors, etc. Stamping outfits. Sample check with name and address 25c. Rasco, 413 Pedretti Road, Cincinnati, Ohio.

SELL Ultra blue stock signs to stores, 1000 slogans, comedy, general, religious. 7x11, cost 6c, sells 35c. Make money. Sample free. Lowy, 8 West Broadway, Dept. 350, New York City 7.

SELL Jewelry. \$2.00 brings samples. Guaranteed value, \$6.00. George Sassen, 154 Nassau Street, New York 7.

YEAR End subscriptions, renewals offer you big money as magazine subscription representative. Send for free book. Get started quick, work full-spate time. McGregor Magazine Agency, Dept. PM-5, Mount Morris, Ill.

ABSOLUTELY Free! Big package actual sample fabrics and style presentation of dresses, lingerie, hosiery, etc. Take orders. Commissions big. Send no money. Melville Co., Dept. 4567, Cincinnati 3, Ohio.

50 DOLLARS Week easy. Sell new revolutionary rubber stamp ink to all businesses. We show you how. Hudson, 934-0 Lakeside, Chicago.

EXCLUSIVE Agents wrought iron house markers and weather vanes. Send 10c for catalog. Bartells, McAllen, Tex.

MEXICAN Feather pictures. Unusual novelty. \$1.00 (stamps) brings \$2.00 worth samples, details. Refunded if unsatisfied. Aztec Art-P, Apartado 762, Mexico City.

MYSTERY Kit produces gold-silver raised lettering like engraving with common pen, women wild about it. Cost 25c, sells \$1.00. Sample writing free. Western Chemical, Salem, Oregon.

MAKE \$100.00 Month on your spare time. Everyone that carries keys is your customer. Sell an article for lost keys service. We will send directions how to get orders. Send us \$2.00 for samples, if you are unable to sell them, return them, we will refund your money. Write today. Lost Keys Service, 111 W. North Ave., Chicago 10, Ill.

MAKE More money selling personal initialed individualized belts, buckles, cap badges, tie holders. 2000 emblems to choose. Big profits, whole or part time. Write today special outfit offer. Hookfast Specialties, Box 1425, Dept. 6, Providence, R. I.

NO Money or experience needed. Spare or full time. Steady income writing orders guaranteed men's hose. Variety 20 styles. We deliver and collect. Liberal advance profit, 33% cash bonus. Write today for complete free sales outfit. Kentcraft, Dept. SM, 44 Court St., Brooklyn 2, N. Y.

AGENTS—America's finest shampoo. Laboratory Products, 5027 Maffitt, St. Louis, Mo.

CASH In now! Big profits selling new deluxe 24 karat gold plated watch bands. A bargain at \$2.50 retail. Sample only \$1.00. Robert Sales, Room 507, 727 Hennepin, Minneapolis, Minnesota.

BIG Profits. Gifts, etc. DeLuxe Sales, Blue Earth, Minn.

\$28-\$140. DAILY Possible, agents-distributors, domestic-foreign, Flo-Glo plastic linoleum-wood finishes. Acme, Box 404-pm, Mount Vernon, N. Y.

JOKERS Novelties. Hundred pieces dollar! Wholesaler Pauly, 2295 Concourse, Bronx 53, N. Y.

FREE Selling kit. "Print-o-press" stencil letter duplicators. World's lowest priced, \$9.95 up. Pays continuous profits with supplies. Rush name, address. No investment. Professional Products, 32 Madisonville, Cincinnati.

SENSATIONAL Seller. Tiny ball point pen, key chain attached. Send \$1.00 for sample set. Janss, Box 85, Irvington, N. J.

MAKE Christmas money quick selling sensational necklace and earring sets. Boxed. Low wholesale prices. Mission, 2328D West Pico, Los Angeles 6, Calif.

AGENTS. Big money for you selling our patented rubber base wet mops. Erases dirt and prolongs life of mop. Write. Burtz Fibre Broom Co., Columbia, Penna. Dept. A.

EARN Big money year 'round. Be a one-person-department-store. Take orders for shirts, ties, hosiery, lingerie, household linens, etc. For information. Cooperative Merchandisers, Dept. PM1, 110 West 34 Street, New York 1, N. Y.

ENTIRELY New household necessity. All homes prospects. Sample 35c. One dozen \$3.00. H. T. Brown, Box 502, Dayton, Ohio.

MAKE, Sell over 100 products at home without machinery or experience. Write. Kohen, 506 West 45th, Chicago 9

TREMENDOUS Profits selling specialties, household products. Renschler's, Carrollton (D-2), Kentucky.

JUST Take orders. We deliver. "Gadgets," 210 Fifth Ave., New York.

ARE You selling? If you're not earning at least \$25 a day, send for our proposition. Sell nationally advertised aluminum-ware, silverware, pressure cookers, and jewelry direct to consumer. Big profits, no investment. Write Continental Products, Dept. M, Box 210, Providence, R. I.

EXTRA Money. Send for new plan. Inspirational Books, Box 106 Old Chelsea Station, New York 11, N. Y.

LOCAL Representative appoint agents for manufacturer of America's newest gift sensation. Millions waiting to see amazing item that sells itself. Send for free details. Manufacturers, Suite 535, 1947 Broadway, New York 23.

MAKE Money with our line of beautiful, new heavy-quality, waterproof tablecloths. Needs no laundering. Saves time and money. Retail for \$1.89. Costs you only 62c each in dozen lots. Sample order of three assorted colors shipped to you for \$2.00 postpaid. We refund \$2.00 to you on first one dozen order. E. F. Bernhold, Inc., Box 128, Brookfield, Ill.

FREE Nylons given your customers if Kendex hosiery runs or snags within guarantee period! Sensational written guarantee amazes everybody. Three magic words: "Guaranteed Against Everything" enough to make sales. Earn wonderful income writing orders. We deliver and collect. Spare or full time. No money or experience needed. Liberal advance cash profit plus big cash bonus. Your name and address brings you complete free money-making sales outfit prepaid. Write today; start earnings next week! Kendex Co., Dept. 111, Babylon, N. Y.

NO Money or experience needed. Spare or full time. Steady income writing orders guaranteed men's hose. Variety 20 styles. We deliver and collect. Liberal advance profit, 33% cash bonus. Write today for complete free sales outfit. Kentcraft, Dept. WM, 44 Court St., Brooklyn 2, N. Y.

\$3 FIRE Extinguisher; quick sales, wholesale or direct; liberal profits. "Fire-Killer," 109 N. Franklin, Syracuse 1, N. Y.

MAKE Money at home like I do! Write immediately. Duffy, Covington 4, Ky.

MAKE Money taking orders for "C-E Automatic Water Heaters." Write Crane Electric, Eugene 4b, Oregon.

EARN 40% Clear cash profit with fast-selling quality neckwear at \$1, \$1.50 and \$2. Finest, exclusive fabrics, latest patterns, expert workmanship assure many orders. Excellent side-line! Write Lomax Neckwear Co., Dept. A-13, 221 W. Lomax Place, Chicago, Illinois.

FREE. Wholesale catalogue profitable quality home products. Beebe Company, 40 Whittier Road, Wellesley Hills 82M, Massachusetts.

SELL Oil burners for kitchen stoves. Great demand; terrific profits. Oil Burner Supply, Box 327, Cambridge, Mass.

MAKE Money at home like we do. Free details. Phoenix, 493-G Northwest Sta., Detroit 4, Mich.

SAVE Your coal. Five fuel saving compounds 50c prepaid. Compounds on approval. Coalalite, Waterloo, Iowa.

100% PROFIT Or more. No investment. Handle top quality Foto Stamps. Amazing, glossy photographs year round. Free samples, and particulars. American Foto Stamp Co., 103 E. 125th St., Dept. 500, New York 35, N. Y.

\$1 STARTS You in business. Sell DeLuxe ties, 100% wool interlining. Costs you only \$7 per dozen, you make \$5.00 dozen. Send \$1.00 for special introductory offer two DeLuxe ties. Catalog complete line free. Philip's Neckwear, 20 West 22nd St., Dept. K-17, New York 10.

DISTRIBUTORS—28% To 75% profit selling Reflex spark plugs (guaranteed) to garages, service stations, fleets, along with other lines, steady repeat business. Exclusive territory. Reflex Spark Plug Co., 10902 Madison Ave., Cleveland 2, Ohio.

DISTRIBUTORS Wanted for unusual household products. Levine's, 15-X Boulevard Station, New York 59, N. Y.

BIG Commissions. Boost income quickly. Sell stores, restaurants, bars. Plastic tickets, shelf moulding, menu covers, signs. Write today. Pricing Press, 124 White St., Dept. P.K., New York 13, N. Y.

FREE Water and our concentrates, makes flavors, lotions, shampoos. 72 products, labels, bottles furnished. Qualco, E-20030 Russell, Detroit.

NEW Sensational seat covers. Mono, 6545 Santa Monica Blvd., Hollywood 38, Calif.

AGENTS. Sell finest food products direct to homes. Successfully sold for 25 years. Big profits. Powerful combination sale plans make sales easy. Permanent repeat business. Samples furnished. Live territories open to distributors. Mother Hubbard Products Co., 4139 Grand, Dept. P.M., Chicago.

A NATURAL! Big money, selling new line one piece, lace plastic tablecloths! Sizes to 54x108. Also women's aprons; novel, embroidered cotton pillow cases. Free, "Interesting details." Royalty, Box 748-K, Passaic, N. J.

INFORMATION — Wholesale supply sources. Moneymaking plans. Increase your income! Write Reynard Service, Smithfield 3, Ohio.

BIG Money for Xmas. Sell beautiful plastic lace table covers, raincoats. Twenty other terrific gift items. Free swatches. Star, 261 Fifth Avenue, New York.

QUICK Sure money. Selling Annie Blain flavors. New Brunswick, New Jersey.

BIG Profits selling used clothing. Operate from home, auto or store. Men's suits \$4.00. Overcoats \$4.00. Field jackets \$2.00. Ladies' coats \$1.50. Army shirts \$1.50. Other big bargains. Catalog free. Kadet-sky & Son, 702 Barber Street, Dept. 14, Chicago 7, Ill.

AGENTS—Big line including food products. Fast selling premium and bargain deals. Low prices. Send card for big outfit offer with gift. Ho-Ro-Co, 2725 Dodier, St. Louis 7, Mo.

AMAZING New Glow in the dark house numbers, switch plates, decals, pictures, religious articles, etc. Factory representative wanted. Wonderful opportunity. Free samples. Madison Mills, 303 Fourth Avenue, New York, N. Y.

SCHOOL Seniors—Earn 40% commission selling classmates America's most beautiful graduation name cards. Largest selection. Outsell all others. Send for free sample kit. Printcraft, 1425 E. Elm St., Scranton 5, Penna.

SCHOOL Seniors! Your postal will bring our wonder, Kwick-Sell Cardalog of popular graduation name cards. Biggest profits! Only firm giving free souvenir chest and card case. Don't miss out! Hurry that postal! Craftcards, Box 235(L), Pittsburgh 30, Pennsylvania.

100% PROFIT With new electric gas lighter, eliminates matches, pilot. Write Optical Research Products, Fairview, N. J.

LARGE Variety fast selling items from \$1. Manufacturers, 264-5th Ave., New York.

MAGIC Cleaner and laundry soap deal. Hotter than a firecracker. Big profits. Sample free. Bestco, 5007 Irving Park, Chicago.

EXCELLENT Sideline for printing and advertising salesmen. Decalomania name plates in small quantities. Great demand. Also, make money with our line of automobile initials and sign letters. Free samples. "Ralco" XL-Roxbury, Boston 19, Mass.

JUST Out! History of World War II. Huge volume. Popular price. Authentic text. Official photographs. Big profits. Riverside Book Company, Iowa Falls, Iowa.

BIG Bargains for big profits. Over 100 sensational values. Men's used suits \$2.00, pants 35c, topcoats \$1.25, overcoats \$2.00, shoes 20c. Experience unnecessary. Free wholesale catalog. Superior, 1250-B Jefferson, Chicago 7.

AGENTS: Stamping names on pocket-key protectors. Sample check with your name, address, 25c. Stamping outfits, Emblem checks, check-fobs, name plates. Hart Mfg. Co., 303 Degraw St., Brooklyn, N. Y.

137 COMPLETE Plans for starting own business: local—mail order. Particulars free. Elite Co., 220 Grand St., New York 13.

AGENTS—300 % Profit selling genuine gold window letters; stores and offices. Free samples. Metallic Letter Co., 438-B North Clark, Chicago.

GOLD Lacquered window sign letters. Large sizes penny each. New foils. Absolutely beautiful. Free samples. Atlas, 544 W. 79th, Chicago 20.

SELL Personalized soap. Name on every cake. Ideal for gifts. Get sample offer. Dunbar Soap, New Brunswick, N. J.

HIGH-GRADE SALESMEN

SALESMEN Wanted. Excellent opportunity for progressive full or part time salesmen to solicit taverns, clubs and lodges. All steel modernistic bottle crushers. Federal laws compel breakage of whiskey bottles. Eliminates danger from flying glass. Holds sixty to seventy broken bottles. All taverns are good prospects. Nothing like it on the market. Retail for only \$39.50. Commission. Call or write for details. Wm. Carmel, 33 N. LaSalle St., Chicago 2, Ill.

BRAND New! "Circline" fluorescent sweeping country! Fabulous profits selling stores, offices, homes. Also exclusive fluorescent table lamp. Complete line modern fixtures. Rush name for free sales kit, sample offer. Rose Co., 529LC South Franklin, Chicago.

SOMETHING New in fire extinguishers. Red Comet Automatics. Company established 1931. All year job. Exclusive territory. Dealers earning up to \$10,000. Write 479 Red Comet Bldg., Littleton, Colorado.

AUTOMATIC Fire extinguishers. Free sales kit, 50% to 60% profit. Red Ball Co., Box 1552, Salt Lake City, Utah.

START Your own business on our capital. Always your own boss. Hundreds average \$6,000 to \$25,000 annual sales. We supply stocks, equipment on credit. 200 home necessities. Selling experience unnecessary to start. Wonderful opportunity to own pleasant, profitable business backed by world-wide industry. Write Rawleigh's, Dept. L-U-PPM, Freeport, Ill.

SELL Delicious candies, nuts, gum. Immediate delivery. Write Casterline, 2031-PB Sunnyside, Chicago 25, Illinois.

BIG Commissions selling post cards to hotels, resorts, business. Protected territories for producers. "Free sales kit." Beals, 215 East Third, Des Moines 9, Iowa.

JOBS Open in selling! Send name, address for free copy Opportunity Magazine, listing hundreds of companies who need men now, full or spare time. Experience not essential. Opportunity, 28 E. Jackson, Dept. 17, Chicago 4, Ill.

SELL The new \$3.45 electric device everyone needs. To stores or individuals. Cash daily. We deliver. Sample kit \$2.00. Sibert Company, Newark 3, New Jersey.

BIG Profits daily taking every family's magazine subscriptions. Give wide choice of valuable books free. Publishers, 323-1 Hammond, Cincinnati 2, Ohio.

BIG First commissions, sensational automatic repeats, with new sales building plan for retailers. First since V-J Day. Customers get big value tableware; cost retailers nothing. Positively hottest deal in selling. Rush name for facts. Alco Sales Company, 215 West Ontario, Dept. C-615, Chicago 10, Illinois.

AMAZING Daily profits, steady repeat business selling Colt's famous foot-balance shoes direct. Exclusive features make selling easy. 216 styles! Experience unnecessary. Patented foot-o-graph assures accurate fitting. Free selling outfit. Colt Shoes, 601-D12 Atlantic, Boston 10, Mass.

ADVERTISING Book matches—World's largest direct selling manufacturer of advertising book matches offers opportunity for profitable year 'round selling; every business a prospect. No experience needed to start; full or part time. Factory service. Low prices for high quality; repeats; sales kit furnished. Match Corp. of America, 3433-43 West 48th Place, Dept. E-13, Chicago 32, Illinois.

\$221.90 IN One week—Unusual? Not at all! Just look at one week's earnings of these representatives. SWB \$247.84, JRS \$252.80, HMT \$242.75, HC \$252.93, HET \$319.38, OP \$442.40. Direct mail campaign brings hot leads right into your home. Remarkable product does part of 10 men's work—a "natural" during these labor problem days. Has perfect sales story—sells year 'round. As modern as radar! Free equipment offer! We extend credit, deliver and collect. No capital required—no experience necessary. You make big profit on first sale and full credit on repeat business. Every business, store, home, factory, etc. are prospects. Write John Porter, 2433 Indiana, Dept. 302, Chicago 16, Ill.

MAKE Money taking orders for "C-E Automatic Water Heaters." Write Crane Electric, Eugene 4a, Oregon.

SALESMEN: Everybody buys from you. Radios, toys, gloves, advertising novelties, coin machines. Collect commission in advance. State your age, territory. Sales portfolio free. Diverso Products Corporation, Milwaukee, Wisconsin.

BIG Money taking orders. Shirts, ties, Sox, pants, jackets, sweaters, shoes, uniforms, etc. Sales equipment free. Experience unnecessary. Nimrod, 4922-AN Lincoln, Chicago.

ADVERTISING Book matches—Cash in on political campaigns. Sell union label matches. Cuts for all businesses and political parties. Free powerhouse selling kit. Low prices. Protection guaranteed on repeat orders. Cash commissions. Superior Match Co., Dept. M127, 7530 Greenwood, Chicago.

BONUS Commissions selling photographic creations. Samples. Creative Photography, Box 315M, Cooper Station, New York City 3.

MONEY in your pocket. \$1.00 brings two plans telling how to sell by long distance telephone. Larger sales. Bigger commissions. R. L. Mackin, 1512 Roblyn, St. Paul 4, Minnesota.

NEW Auto accessory, \$8.50 seller. Big profits. Write Aero, 4836-M Joy, Detroit 4.

PHOTO-Salesmen-Agents. Sell beautiful hand colored plastic enlargements. Collect deposit, we deliver. Profitable sideline. Send card, for free sample kit. Novel Portrait, 3329 North Ave., Chicago, Ill.

POCKET Pal: The all-purpose cutting tool, wagon jobbers, salesmen. Sell to retailers and jobbers. 50c seller. Steady repeat item. Exceptional profit. Sample 25c. Nelson Manufacturing Company, 222 W. Kellogg, St. Paul 2, Minnesota.

AMAZING Profits selling personal initialed individualized buckles, belts, cap badges, tie holders, flexible cap bands, 2000 emblems to choose from. Repeats. Write today special outfit offer. Hook-Fast Company, Box 480-PM, Roanoke, Virginia.

WAGON Salesmen—Fast moving carded goods and 10c line. Long profits. Free facts. Peerless, 2720 Dodier, St. Louis 7, Mo.

AGENCIES WANTED

NEW Products and merchandise marketed. A. H. Whitcomb, 645 29th St., Newport News, Va.

ARGENTINE Engineer wishes to represent your new products in South America. Write David Lerner, Fabre 1190, Buenos Aires, Argentina.

EDUCATIONAL AND INSTRUCTION

GOOD Jobs and a sound substantial future await you in hotel and institutional field. Men and women—all ages—needed for well-paid positions that offer color, excitement, ever-new and fascinating duties. Record-breaking travel means even greater opportunities for trained men and women in hotels, clubs and institutions. Lewis School receiving calls for managers, assistant managers, stewards, hostesses, purchasing agents and 55 other types of important positions! From coast to coast there are important positions that offer splendid opportunities for advancement in a business where you are not dropped because you are over 40. Previous experience proved unnecessary! No need to leave your job to qualify. A good grade school education, plus Lewis Training qualifies you at home, in spare time. Our National Placement Bureau helps to place you—and our amazing Certified Job Plan—actually certifies you will "make good" when placed. Write today for Free book! Veterans: Course approved for Veterans' training. Lewis Hotel Training School, Room LX-368, Washington 7, D. C. (First and only School of its kind—now in its 32nd year).

BIG Money training horses by circus methods. Trick, saddle and cow horses, mules, colts, cattle. Free book. Write: American Horse Training Institute, Box R-110, Columbus, Kansas.

WANT A Government job? \$1,756—\$3,021 year. Men-women. Veterans get preference. Prepare now for next examinations. Booklet, sample lessons free. Write today. Franklin Institute, Dept. R-24, Rochester, N. Y.

NOW You can have an office. Learn credit-collection business by new home study course. Many earn up to \$5000—\$15,000 annually. Free bulletin. Franklin Credit School, Dept. 202N, Roanoke 7, Va.

YOU Can master mathematics. Universal School of Mathematics, 623 Story Bldg., Los Angeles, Calif.

BOOKKEEPERS! Increase your earnings! Operate your own simplified "Dollar A Week" bookkeeping and tax service. Full or spare time. Details free. No obligation. Ellis, Box 207-F, Cedar Grove, North Carolina.

STANDARDS, Suggestions and glossary for engineers, draftsmen and students. 50 8 1/2 x 11 pages for only \$1.50 prepaid. Monson Engineering Service, 4525 Bryan Place, Downers Grove, Ill.

LEARN Photo-engraving at home or in oldest, largest school in America. Work for newspaper or establish own profitable business. New Tasope' Photo-Engraving equipment available soon. Write for information. Veterans ask about G.I. training. The Aurora School of Photo-Engraving, Tasope' Bldg., Aurora, Mo.

OIL Painting—Correspondence course. Write Carlos Art Academy, Correspondence Division, Watertown, N. Y.

GRADUATE Work in all subjects. Degrees available in one year. Resident and extension classes. Golden State University, Hollywood, Calif.

MONOGRAPH Clear method successful, helpful self-suggestion \$1.00. Griffith Service, 1229 W. 8th, Anderson, Ind.

PREPARE For Civil Service Examination. Pay for course after securing position. Write Free School, Kokomo, Ind.

GOOD Paying jobs, Hotel Transcript Clerk. Short course prepares you. Hotel Transcript School, P.O. Box 3915, Miami 24, Fla.

3800 LATEST Used correspondence courses, catalog 50c. EG, Elmsford, N. Y.

LEARN Piano tuning and repairing at home. Course by Dr. William Braid White. Write Karl Bartenbach, 1001-H Wells Street, Lafayette, Indiana.

READ "Inflation is Coming." New book informs you of what may happen. Be prepared. Protect your family. Price \$1.25 postpaid. Lucille Rasmus, Box 205, Station F, Buffalo 12, N. Y.

STAMMERING Corrected. Booklet gives full information. Write: William Dennison, 543-A Jarvis St., Toronto, Ont.

MOTION Picture sound projection, 35-16mm. Learn for pleasure or profit by correspondence course from old established school. Write for details. Hollywood Sound Institute, Hollywood 27, California

STEP-UP Your brains, income. Amaze with super-memory. Facts, figures, faces stick like burrs. Write for free details. Thor Books, CM-12, Box 1210, Chicago.

CIVIL Service instructions. Free particulars. Baker, 5509-Z Winthrop, Chicago 40.

LEARN Cardwriting. Free details. O'Rourke, 1534 W. Valley, Alhambra, California.

LEARN Paint. Estimating, blue print reading at home. Approved easy system, prepared by expert. Write for interesting facts. Fred T. Schuttler, 5017 No. Wolcott, Chicago 40, Ill.

BECOME Sanitation supervisor. Seven easy lessons. Certificate, profits, promotion. Institute, 2385-A Edgewater, Los Angeles 26.

PRACTICAL Mathematics. Details free. Math Tutor, Box 1214, Indianapolis 6, Indiana.

AMAZE Others. Add faster than adding machine. Free details. Math Institute, Box 633, Mobile 4, Ala.

HOME Study course, drugless therapy. Free literature. Institute of Drugless Therapy, Tama, Iowa.

USED Educational books on all subjects sold, rented, also bought and exchanged. Moneyback guarantee. Write today for free catalog and details. Lee Mountain, Pisgah, Alabama.

INVESTIGATOR Training. Phillips Secret Service, 1917B North Kenneth, Chicago 39, Ill.

29 LANGUAGES By Linguaphone. Russian, Spanish, Portuguese—Direct conversational method for mastering any language quickly, easily, correctly at home. Available under G.I. Bill of Rights. Send for free book. Linguaphone Institute, 83 RCA Bldg., New York 20.

MEDICAL Laboratory technicians in great demand. We train you in your spare time, in your own home. You can practice while studying. Write for free catalogue. Imperial Technical Institute, Box 973-E, Austin, Texas.

SECRET Investigation. Experience unnecessary. Investigators particulars free. George Wagner, M 125 West 86th, New York.

PLAYS, STORIES, MANUSCRIPTS

I WANT New writers to cash hundreds of checks for \$1 to \$100, offered each month. The easiest way to write for pay. No previous experience necessary. Send for free details. No obligation. Saunders M. Cummings, 467-M Independence Bldg., Colorado Springs, Colo.

EVERY Help for all writers. Low cost. National Writers Club, 1837 Champa, Denver 2, Colo.

NEW Writers needed. Nonfiction material demand is booming. Many magazine editors buy features and "fillers" from new writers. Our earn as you learn lessons prepare you to meet their requirements. Experience unnecessary. Reasonable price, unexcelled service. Details, sample lesson free on request. Use postcard. No obligation. Comfort Writer's Service, 200-PN S. 7th St., St. Louis 2, Mo.

BUSINESS SERVICE

BUY For less. Enjoy buying advantages of huge corporations. Any item. Details free. Kelly & Co., 9544-Q Whitcomb, Detroit 27, Michigan.

CONFIDENTIAL New York mail-address disclosed. Information. Levitt, 330 East 19th, New York City.

CONSULTANT. Before investing in manufacturing your product or selling for someone else, be sure of your markets. Avoid failure. Save money. Know marketing methods. Financing. Packaging. Advertising. Trade contacts. Write me your problem in confidence—better still arrange a personal visit. Custom made plan to solve your problems. John Harder Fenstermacher, Management Consultant, Corry, Pennsylvania.

SHORTEST Complete bookkeeping and income tax system on market; copyrighted; merchant's time saver; bookkeeper's aid. Complete system \$1, tax bulletins free. Mixon Accounting Agency, 1412 Great Northern Building, Chicago.

INCREASE Business with your own monthly magazine. 500 copies complete with your own full page advertisement, only \$3.50 per month. Particulars free. D'Yarmett Printing, Newark, Ohio.

TO Whom it may concern. We will represent you in all principal cities of the world. Representatives wanted. Will send you assignments immediately. James W. Farley, Citizens Bldg., Cleveland 14, Ohio.

SPECIAL SERVICES

CONSULTING Engineer, chemist, laboratory analyses, formulas. Robert Beaudoin, Hollywood, Illinois.

PHOTOSTATS. Exact reproductions up to 8 1/2x14. 35c. Work mailed same day received. Avil, 43-30 48th St., Long Island City, N. Y.

LOCATE Any article manufactured. \$1.00. Business Service, 1101 Kings Highway, Shreveport, Louisiana.

MFG.—Wholesale sources. Most any item. "Service," 1332B Findlay, New York City 56.

CONFIDENTIAL New York mail-address. Your mail received, forwarded. Free details. Arlington, 131-H West 42nd, New York 18.

WASHINGTON, D. C., remail address. Your business, personal letters received, reforwarded, 10c each. Complete service, \$3.00 monthly. "Hawkins," 1300 Taylor-b N.W.

MAIL Forwarded. 25c each letter. Monthly \$2.00. Banas, Box 285-C, Syracuse 1, N. Y.

CARTOONING, COMMERCIAL ART, SHOWCARD WRITING, SIGN PAINTING

BECOME A cartoonist and commercial artist quickly with our new, easy method. Free trial offer. National Artists, Box 4248, Dallas 8, Texas.

LEARN Showcard writing at home in spare time. Fascinating, profitable business of your own. No special skill needed. Free information. Sherwood Publishing Co., Irvington, 11-R N. J.

CUB Artists—Stop dreaming—Sell your work. Successful commercial artist (27 years in business) offers sensational plan. \$2.00 prepaid (refundable) brings beautifully illustrated 1947 copyrighted 88 page commercial art catalog, containing thousands of potential sales opportunity ideas with complete information. Brouillet Syndicate, 30 E. Superior St., Duluth, Minn.

"HOW To Make Money With Simple Cartoons"—a book everyone who likes to draw should have. It is free; no obligation. Simply address Cartoonists' Exchange, Dept. 912C, Pleasant Hill, Ohio.

PAINT Beautiful pictures quickly, easily, inexpensively. Free literature. Art Book Shop, Arnold, Mo.

9 ALPHABET 3 Numeral pattern sets and catalog. \$1.00. Sign Letter Distributors, P.O. Box 101, Mineola, N. Y.

DRAWING And painting courses. Information free. Joseph Bolger, 148 Concord, River Edge, New Jersey.

CARTOONISTS' Magazine. 25c lessons, markets. Hartman Studios, 2776 California Ct., Lincoln 8, Nebraska.

DRAWING Stands direct from factory. Send for circular. Sutter-Craft, Dept. S12, Eau Claire, Wis.

ENJOY Independence, security. Learn sign painting! Signways, 4933 Erie, Chicago 44.

SIGN Painting taught at home by an old master. Ben Kerns, Box 812, Greenville, S.C.

TALENT Test free. American School Commercial Art, Box 8066, Dallas 5, Texas.

CHALK Talks. Laugh producing program. \$1.00. Catalog 10c. Balda The Cartoonist, Oshkosh, Wisconsin.

BOOKS—All Kinds—Homecraft, Radio, Plastics, Boat Building, Photography, Model Building. Catalog free. Popular Mechanics Press, 200 E. Ontario St., Chicago 11, Ill.

ADVERTISING AGENCIES, LETTER WRITERS, FOR ADVERTISERS

ADVERTISING Sensation! Reach 2,200,000 families, \$28.00 inch. Helpful rate-book (newspapers, magazines, mailing lists), advertising assistance, free. Chicago Advertising Agency, 20-PM West Jackson, Chicago 4.

ADVERTISERS! Reach nearly 18,000,000 readers. 25 Sunday national key newspapers, 18 words, \$47.75. "Terrific pullers." 20 popular newspapers, \$9.75. "Free booklet." Special—One inch display 2.-821,198 circulation, \$42.00. Newmark's Advertising Agency, (Established 1893) 217-7th Ave., New York 11.

LATE Mailing lists! Guaranteed accurate all classifications. Write Business Service, 1101 Kings Highway, Shreveport, Louisiana.

INCH Display advertisement Mailorder World, year \$24. Wood's Popular Services, Atlantic City, New Jersey.

FREE!—Advertisers rate and data bulletin covering the southern states. Alabama Advertising Agency, Exchange Building, Birmingham 3, Alabama.

ADVERTISE: 24 Words, 77 weekly newspapers \$5.00. Write for free rate directory. A. Burton Carnes Advertising Agency, 410 South Michigan Ave., Chicago 5.

MAIL Order ads, circulars, letters, by leading advertising agency in mail order field. Low prices. Moran Advertising Agency, Box 104, Wilkes-Barre 3, Pennsylvania.

ADVERTISE: 24 Words, 40 newspapers \$3.50. Lists free. Advertising Bureau, 229-C Dixon Blvd., Uniontown, Penna.

ADS Placed in out of town newspapers and magazines. Low rates. Catalogue free. Ideas that pay. Baker Advertising Agency, Successors Ankrum Agency, 189 W. Madison, Chicago 2.

MAILING Lists, certified, productive, inexpensive, \$5.00 1000. Homeworkers, agents, buyers, etc. Write Dixie Service, King, N. C.

24 WORDS in 64 weeklies \$4.96. H. J. Darnell, 730 Hays, Jackson, Tenn.

TYPEWRITERS, DUPLICATORS, OFFICE DEVICES

NEW Watches \$5.00; adding machines \$12.95; postcard duplicators \$10.50; Conn Alto Saxophone \$195.00; used typewriters \$22.50; ship anywhere. Typewriter Service, 118 Spruce, Wichita, Kansas.

ADDING Machines, lowest prices. Free literature. Brown Company, Dept. M, Box 1412, Wichita, Kansas.

DUPLICATORS \$9.95 Up. (New.) Immediate delivery. "Free circular." Rucker, 2836-PM Slevin, Louisville 12, Ky.

"PRINTOMATIC" Selffeeding post card stencil printing duplicators \$9.50 up. Office size duplicators, Speedoprints, Hilcos, Excellographs \$33.41 up. Literature free. Pittsburgh Typewriter Supply, 336-WK Fourth Avenue, Pittsburgh 22, Penna.

RECONDITIONED Typewriters, mimeograph, multigraph printing devices, appliances, supplies. Catalog. Dixiegraph Service, King, N. Carolina.

RUBBER STAMPS AND OFFICE SUPPLIES

RED. White and blue airmail rubber stamp, ink-pad, paper weight all in one. New invention that prints red arrow and blue airmail on white envelope. Makes attractive paper weight. Complete stamp, ink-pad, two bottles ink. Prepaid only \$2.00. Dealers write for prices. Multi-Color Stamp Co., Box 96, Keene, Texas.

RUBBER Stamps, Buy direct from manufacturer. Literature free. Lee-Vall Press, Box 1242, Indianapolis 6, Indiana.

3 LINES Or less 55c. Newman, Box 284, Fort Collins, Colo.

LINE 20c; 2-35c; 3-50c. Stamp Works, Auburn, Nebraska.

PRINTING, MULTIGRAPHING, MIMEOGRAPHING, GUMMED LABELS

100 8 1/2x11 HAMMERMILL Letterheads and 100 6 3/4 envelopes, \$1.50. W. A. Simons, 1036 Fernwood Ave., Henderson, Ky.

SEE Before you buy. Send 10c now for the "Hand Pack" generous sample assortment of usable shipping, address labels and price list. (10c refunded first order). Handy Label Press, Box 342, Huntsville, Missouri.

500 6 3/4 ENVELOPES, \$2.35. Mango Printing Co., 555-A South 20th, Newark 3, N. J.

125 LETTERHEADS \$1.00. Postpaid. Envelopes same. Arthur Clark, Sabetha, Kansas.

1000 BUSINESS Cards, \$1.75. Walker Print, Box 1298, Amarillo, Texas.

PERSONAL Stationery, the ideal Christmas gift. 100 sheets, 100 envelopes, fine quality Hammermill bond paper printed three lines, \$2.25. Mills Press, Highland, North Abington, Massachusetts.

250 8 1/2x11 BOND Letterheads and envelopes. \$4.00. Samples free. Rex, 446 East 87th Place, Chicago 19.

ENVELOPES. 150 Printed \$1.00. 500, \$3.00. Harold Haus, Lancaster, Ohio.

1000 BUSINESS Cards \$2.45, 1000 6 3/4 envelopes \$4.95. Prepaid. Quick, Madison, Ohio.

PERSONAL Stationery. Beautiful Hammermill rippletone. 100 sheets, 100 envelopes. Your name, address. Ideal gift. Only \$1.98 postpaid. Hyde Park Printshop, 2017 Platt, Tampa, Florida.

GET Our printing prices first. Crane, Box 7625-D, Kansas City 3, Missouri.

100 8 1/2x11 HAMMERMILL Letterheads, \$1.00 postpaid, envelopes same. Herbert Hudson, 261 Woonasquatucket, Centredale, R. I.

SPECIAL. Business cards, 100-50c; 500-\$1.50, prepaid. Adcraft Press, 19165 Gallagher, Detroit 12, Mich.

SEND 10c Now, for our 48 page 1948 price list—refunded first order. McCaill Press, 1326 South 27th, Omaha, Nebraska.

PRINTING. Quality, reasonable prices. Business, personal stationery. State your requirements. Free estimates—samples. Westerkamp Printing Co., 1135M Spring St., Cincinnati, Ohio.

1000 EMBOSSED Business cards \$2.95. Ortiz, 1050 Fox Street, New York.

BETTER Printing at reasonable prices. Send requirements. Free samples sent upon request. Mills Press, Highland, North Abington, Massachusetts.

POSTCARD Brings our samples, prices. Valley Print Shop, St. Elmo, Tennessee.

BUY Your printing wholesale! Lowest prices in America. Adams-PM, 30 West Washington, Chicago 2.

QUALITY Mimeographing, accurate, reasonable. Riddle, 360 S. Hill, Los Angeles, 13.

1948 CALENDAR Cards with your ad. Now ready. Printing price list. Cassel, R4 Box 72, Middletown, N. Y.

LABELS—Printing every description. AD-Man Press, 305 1/2 Liberty Bldg., Indianapolis, Indiana.

STATIONERY—Name and address in blue. Box 100 sheets, 60 envelopes, \$1.49 postpaid. Sprague's Plastex Arts, Berlin, Wisconsin.

MIMEOGRAPHING—Designs; letters, booklets composed. Free samples. Topical Emprise Corporation, 1527 Highland, Box 42P, Louisville 4, Kentucky.

SPECIAL! 250 two color letterheads \$1.50 postpaid. Howard's, St. Johnsbury 2, Vt.

QUALITY Printing: Business, personal stationery. State requirements. Samples. Mero Products, 100 Morrison, Punxsutawney, Penna.

MIMEOGRAPHING Specialists—Any copy. Reasonable. Mailers Service, Box 606-A, Chicago 90, Ill.

ENVELOPES. Letterheads, card printing. Samples free. Gehling, 1834 Fuller, Philadelphia 15, Penna.

QUALITY Printing by Mail: Distributors. 730 West Gift, Peoria 5, Illinois.

1000 BUSINESS Cards prepaid \$2.50. Samples free. Reliable Print Shop, 901 E. Jefferson St., Louisville 6, Ky.

MIMEOGRAPHING—24 Hour service. Reasonable rates. Free samples. Jay Service, 1028m East 63rd, Chicago 37.

BETTER Grade printing—reasonable. Estimates on anything. Economic Press, Leonia, N. J.

QUALITY Printing—Reasonable prices. Fast service on catalogs, folders, publications. Write for prices. Bagby Printing Co., Georgetown, Ohio.

500 3/4x2 1/4 FOUR Line gummed stickers, 35c. Moritz Printery, Saginaw, Mich.

MIMEOGRAPHING—Letters, pricelists, formulas, instructions. Lowest prices. Lem's Letter Shop, 5710 Stanton, Detroit 8.

BOOKS—All Kinds—Homecraft, Radio, Plastics, Boat Building, Photography, Model Building. Catalog free. Popular Mechanics Press, 200 E. Ontario St., Chicago 11, Ill.

PRINTING OUTFITS AND SUPPLIES

BARGAINS. Presses, type, supplies. Send stamp. Garza, 8 Walden, Cambridge 40, Mass.

PRINT At home—Send 10c for catalogue—presses, type, supplies. Barnhard Co., 6 Columbia St., Newark 5, N. J.

BARGAINS—Presses, type, supplies, stereo-casters, catalogs. Customprint, 211, Springfield, Missouri.

MAKE Your own Plastoplate printing cuts. Simple, easy process. Plastoservice, Argyle 1, Wisconsin.

TYPE. Printing and multigraph. Fonts, composition. Ace Printing, Brentwood, Maryland.

CUTS—Make real halftones, linecuts yourself! Sample 25c. Particulars free. Chemical Service, Edwardsville, Illinois.

PRINTING Presses, type, supplies. Lists 3c. Turnbaugh Service, Loysville, Penna.

PRINTING Presses, type, supplies. Send dime for complete illustrated printer's supply book, details and press samples. Kelsey, Inc., A-11, Meriden, Connecticut.

HOME Made presses. Write Riegel, 1111 Harrison, Philadelphia 24, Penna.

INEXPENSIVE Home-made printing press. Details free. Novelty Shop, Downs-ville, Louisiana.

PATENT ATTORNEYS

INVENTORS: Learn how to protect your invention. The United States Patent Office advises the inventor, unless familiar with such matters, to engage a competent registered patent attorney or agent to represent him. We maintain a staff of registered patent attorneys ready to serve you in the handling of your patent matters. Special booklet "Patent Guide for the Inventor" containing detailed information concerning patent procedure with "Record of Invention" form will be forwarded upon request—without obligation. Clarence A. O'Brien & Harvey Jacobson, Registered Patent Attorneys, 71B-K District National Building, Washington, D. C.

INVENTORS—Send today for "Detailed Patent Information" outlining preliminary steps to be taken toward patent protection, also convenient "Evidence of Invention" form. Victor J. Evans & Co., 231-P Merlin Building, Washington 6, D. C.

INVENTORS—Patent laws encourage the development of inventions. The Rules of Practice of the U. S. Patent Office advises—unless an inventor is familiar with such matters—that he employ a competent registered attorney or registered agent, as the value of patents depends largely upon the skillful preparation of the specifications and claims. Write for further particulars as to patent protection and procedure and "Invention Record" form at once. No obligation. McMorro, Berman & Davidson, Registered Patent Attorneys, 134-Z Victor Building, Washington 1, D. C.

REGISTERED Patent attorney offers services. Sanders, 6430 Evans, Chicago 37.

C. A. SNOW & Co.—M-427, Snow Building, Washington 1, D. C. Registered Patent Attorneys. Write for information.

INVENTORS. For "Record of Invention" form, contact Carl Miller, Registered Patent Attorney, Woolworth Building, New York.

"**INVENTOR'S Guide**" free on request. Frank Ledermann, Registered Patent Attorney, 154 Nassau St., New York 7, N. Y.

PATENTS. "Proof of Invention" folder mailed without obligation. E. E. Vrooman, Registered Patent Attorney, 871 Woodward Building, Washington 5, D. C.

INVENTORS: Without obligation, write us for information as to what steps an inventor should take to secure a patent. Randolph & Beavers, Registered Patent Attorneys, 21-C Columbian Bldg., Washington 1, D. C.

INVENTORS: Write for free brochure "Evidence of Invention." Labiner, World Building, New York 7.

PATENTS—Trade marks. Irving L. McCathran, 315 McLachlen Bldg., Washington 1, D. C. Registered Patent Attorney.

PATENT And Trade-Mark Practice before U. S. Patent Office. Validity and infringement investigations and opinions. Booklet and form "Evidence of Conception" forwarded upon request. Lancaster, Allwine & Rommel, Registered Patent Attorneys, Suite 411, 815-15th Street, N.W., Washington 5, D. C.

FOR INVENTORS

INVENTORS—Patent laws encourage the development of inventions. The Rules of Practice of the U. S. Patent Office advises—unless an inventor is familiar with such matters—that he employ a competent registered attorney or registered agent, as the value of patents depends largely upon the skillful preparation of the specifications and claims. Write for further particulars as to patent protection and procedure and "Invention Record" form at once. No obligation. McMorro, Berman & Davidson, Registered Patent Attorneys, 1341 Victor Building, Washington 1, D. C.

INVENTORS—Victor J. Evans and Co. has a staff of registered patent attorneys, available to assist inventors in the preparation and prosecution of their cases before the U. S. Patent Office. Detailed information and the steps to take to obtain patent protection will be sent to you upon request. Victor J. Evans & Co., 232-P Merlin Building, Washington 6, D. C.

INVENTORS: Learn how to protect your invention. The United States Patent Office advises the inventor, unless familiar with such matters, to engage a competent registered patent attorney or agent to represent him. We maintain a staff of registered patent attorneys ready to serve you in the handling of your patent matters. Special booklet "Patent Guide for the Inventor" containing detailed information concerning patent procedure with "Record of Invention" form will be forwarded upon request—without obligation. Clarence A. O'Brien & Harvey Jacobson, Registered Patent Attorneys, 71A-K District National Building, Washington, D. C.

I SELL Patents. Established in 1900. Charles A. Scott, 773PM Garson Ave., Rochester, N. Y.

THE Inventor who believes he has a new and useful invention, and needs advice, should consult a competent registered patent attorney or agent. Without obligation, write for full information on how to secure patent protection. Randolph & Beavers, Registered Patent Attorneys, 11-E-Columbian Bldg., Washington 1, D. C.

STYLING And presentation can help sell your invention. Free booklet. Ettel Industrial Design, Room 318, 112 South 106th Street, Seattle 88, Washington.

I'D Like to show you how I've sold my inventions. Write for free literature. George Pearce, 47-S Bartholomew St., Peabody, Mass.

FREE. Two months on trial. Patent News, Washington, D. C. 12.

INVENTIONS Wanted: Patented or pending. Inventors Exchange (B), Hartford 1, Connecticut.

INVENTIONS Sold, prior patents may kill value of yours. Have patent office search made. Cost \$6.00. Patent Applications prepared. Protection forms free. Charles Morton, 11 West 42nd Street, New York.

PATENTED. Unpatented inventions promoted. M. Joyce Humphries, 1424 Land Title Bldg., Philadelphia 10, Penna.

HOW To sell unpatented inventions. Charles Dimmick, 477A Adair St., Longbeach, California.

HIGHEST Royalties and cash for inventions when we market them. Free booklet without obligation. Universal Marketing Co., 126 Lexington Ave., New York 16, N. Y.

RELIABLE Patent searches complete with patent copies \$6.00. Protection forms free. Write Raymond L. Smith, Patent Searcher, 703-M Albee Building, Washington 5, D. C.

INVENTORS: Avoid unnecessary expense. Write for free booklet explaining how our consulting and advisory service can assist you in deriving greatest profit from inventing. Institute of American Inventors, Dept. 40-A, 1926-Eye St. N.W., Washington 6, D. C.

"**INVENTOR'S Guide**" free on request. Frank Ledermann, Registered Patent Attorney, 154 Nassau St., New York 7, N. Y.

INVENTIONS WANTED

AUTOMOTIVE Manufacturer selling millions of patented parts wants new inventions. Send details to Hove Engineering Co., 601-11th Ave. So., Minneapolis 4, Minn.

MANUFACTURING And national promotional organization seeking novelty and household inventions. Penn Products Co., 35-54 73rd St., Jackson Heights, New York.

INVENTORS! Have you good, patentable ideas? Patent agent Metzler, 11 West 42nd, New York.

MANUFACTURERS Want patented or patent pending inventions! Write, Universal Guaranty Company, Lakewood, New York.

CASH Or royalty paid for acceptable inventions by the manufacturers. Write, John D. & Son, Box 3213, PM12, 285 Howard, Bridgeport 5, Conn.

ROYALTY Wanted. Patented kitchen utensil. Write 4365 Central, Western Springs, Ill.

"**WANTED**" Inventions — Patents of merit purchased. Suitable for manufacture and sales, outright or royalty basis. Regional Sales Company, 429 S.W. 4th, Portland, Oregon.

INVENTORS — Booklet "Self-Testing Your Patent or Invention" free on request. Avoid costly mistakes, wrong markets. Direct Contacts, 11106-A2 Longwood, Chicago 43.

INVENTORS: Hundreds of manufacturers have requested our assistance in locating marketable new products. Complete information, free. Institute of American Inventors, Dept. 40-D, 1926-Eye St. N.W., Washington 6, D. C.

SMALL Inventions wanted by manufacturers. I'll help you sell your invention. Write for circular. Stanley Hull, 7829 Euclid, Cleveland, Ohio.

INVENTORS. Write for our sales plan. Complete service for inventors. Vision Engineering Inc. Security Building, West Bend, Wis.

PATENTED. Unpatented inventions wanted. We have tremendous lists of manufacturers who may pay cash royalties. Descriptive booklet free. National Invention Service, 1404-T Mitchell St., Oakland 1, Calif.

PATENTS FOR SALE

SHEETMETAL Shops; patent pending. Building material. Modern design. Ideal for aluminum. Roy Wilhelm, St. Johns, Arizona.

PATENT Pending. Convertible bed-chair, single or davenport; simple construction, wood or metal. Outright or royalty. H. Carlson, 229 Shipley St., San Francisco, Calif.

INVENTION For sale. Inexpensive, portable, waitress signaling device. Patent pending. T. Kereluk, Box 188, Wilcox, West Virginia.

FREE—Styling, presentation and manufacturing analysis of your invention. Send details to Ettel Industrial Design, Room 648, 112 South 106th Street, Seattle 88, Washington.

PATENT Pending No. 763196. Mechanical anti-freeze outlet valve protects the motor block from cracking as the freezing point endangers the motor if there is insufficient anti-freeze or none at all. Readily installed in popular type of cars. Complete details mailed to manufacturer only upon request. Address A. Merdan, P. O. Box 41, Bronx 54, New York.

INVENTORS: Test the commercial value of your patented or unpatented inventions, quickly and inexpensively. Write for free information. Institute of American Inventors, Dept. 40-B, 1926-Eye St. N.W., Washington 6, D. C.

MANUFACTURING

TOOLS. Models, machinery parts made, gears. Baum's Metal Specialties, Kansas City, Mo.

20 MANUFACTURERS' Addresses. for any item, \$1.00. Parry Enterprises, 1423 Arch, Berkeley 8, California.

DESIGNING. Drafting, experimental and development work. Models; patterns; assembling. Short run and quantity manufacturing. Henry, 2815E Hudson Boulevard, Jersey City 6, N. J.

PERMANENT Moulds for plastics, aluminum castings. Send drawings. Unamit Mould & Machine Company, Bunker Hill, Ill.

PLASTIC Molding, fabricating. Quick service! Plastic Products Co., 211 7th St., Canton 2, Ohio.

MODELS. Dies, molds made to your drawings. Short run stampings, specialties manufactured. National Machine & Tool Co., 249 Stanton Ave., Akron 1, Ohio.

SMALL Lot production wanted. Aluminum castings; stampings; screw machine. J and M Company, Burlington, Kentucky.

EXPERIMENTAL Work, models. Reasonable. Nelson Manufacturing, 948 First, Woodburn, Oregon.

MODELS—Small lot manufacturing. Metals, plastics, etc. Milburn, Burlington, Kentucky.

MODELS AND MODEL SUPPLIES

FUN Building models—Airplanes, trains, ships. Everything furnished. Giant catalog 10c. Ben's Hobby Shop, 72 West Washington, Chicago 2, Illinois.

STEAM Boiler for model engines. Uses "Sterno." Withstands 300 lb. pressure. Cast bronze, silver soldered. Complete with gauge and fittings. \$22.50. Ross, C68 West Broadway, New York, N. Y.

BIG Illustrated model engine catalog 10c. Active Products & Supply Co., 53 W. Jackson, Chicago 4.

MINIATURE Steam engine. Working model. Brass and iron. Bore 9/16; stroke 11/16; weight 2 pounds. Assembled \$17.50. Ross, C68 West Broadway, New York, N. Y.

BRASS Gears and model supplies for the inventors. Send 10c for catalog. Pierce Model Works, Tinley Park, Ill.

JET Powered model racing cars up to 100 m.p.h. Three different aerodynamic designs. Easy to build. Complete blueprints 25c each, three for 65c. C. Michels, Box 218, Newark 1, New Jersey.

CIRCUS Photos. List and sample 10c. Box 1028, Minneapolis, Minnesota.

RAILWAY Models, complete informative catalog HO and O gauge. 148 pages, 35c. Walthers, 247 Erie, Milwaukee, Wisconsin.

BUILD The Sovereign of the Seas. An unusual ship model within the reach of average craftsmen. Elaborate carvings easily produced. 62 page book gives complete details. Price \$1.00. Popular Mechanics Press, 200 East Ontario Street, Chicago, Illinois.

MACHINE Gun kit, 30 caliber Browning, 40 machined parts. 1/4 scale complete with plans 75c. Plans only 20c. U. S. only. Vancraft, 17792 Northrop, Detroit 19, Mich.

ARE You a model maker, hobbyist or home craftsman? Send 25c (refunded on first order) for new illustrated 1947 catalog listing books, kits and tools for your favorite pastime. Jar Hobby Mart, Box 137M, Iselin, N. J.

MINIJET Engine kit now \$9.95 pp. U.S.A. Assemble real pulse-jet at home. Send m.o. today. No c.o.d.'s. Minijet Motors Sales Company, Box 406, Pasadena, California.

FOUR Large 1/8" scale houses. Kit contains 72 wood and cardboard pieces, 16-page instruction booklet. Infinite variety possible. Only \$1.50 postpaid. Peck Publication, 372 Bloomfield Avenue, Verona, New Jersey.

POWER Models—Steam and gasoline engines, steam traction engine, metals, tools. Catalog 35c. Chas. Cole, Ventura, Calif.

SHIP Model kits and fittings, most complete stock in New England. Boucher, Fisher, Marine Model and Model Shipways fittings, blueprints and model yacht equipment at standard prices. Send 25c for new illustrated 1947 catalog and price list. Dept. M. James Bliss & Co., Inc., 220 State Street, Boston, Mass.

LANDLOCKED Sailors! Here's a beautiful, richly illustrated, fully descriptive catalogue of famous model ships—whalers, slavers, corvettes, etc., authentic in every detail. Send for it today. Only 10c. Halesite Yacht Service, Inc., Halesite, Huntington, N. Y.

SHIP Models and yacht supplies complete. Large 64 page catalogue 30c. Bill Wild's, 510 East 11 St., New York City 9.

SHIP and Yacht model fittings; blueprints. Send 25c for illustrated catalog No. 20—listing hundreds of items. A. J. Fisher, 1002-1 Etowah Ave., Royal Oak, Mich.

MINIATURE Steam locomotives, 1/4" 1/2" 3/4" scales. Castings, parts, rail. Thorough drawings with instructions. Catalog 25c. Little Engines, Wilmington, Cal.

SHIP Model supplies, catalog 25c coin. R. E. Hancock, 323 Douglas Ave., Portsmouth, Virginia.

STEAM Engines, boilers, castings. Catalog 25c. Anton Bohaboy, 2297 Price, Rahway, New Jersey.

FREE Estimates on patent models. Wood, metal, plastic. Rogay Industrial Models, 3818 Beecher Street, N.W., Washington 7, D. C.

HEMOCRAFTSMEN

SHELL Jewelry. Shells, plastics, metal findings. Hobby Lobby, Gen. Del. Sarasota, Fla.

GENUINE Leather scraps for leathercraft items, assorted colors, 6 pounds, \$2.00. Send 10c for sample. International Cushion Co., 515-AB North Halsted, Chicago 22, Illinois.

AMERICA'S Most complete line of quality handicraft kits. Leathercraft, jewelry, shellcraft, wood inlay, plastics carving, cedar chests, metal tapping and many others. Send dime for most interesting catalog you ever read. Beaver Crafts Incorporated, 11558-K Wentworth, Chicago 28.

GLUE, Ready mixed. Works "magic wonders." Sets within half hour. Woodwork, cabinets, craftsmen. Workshop, home, office. If dealer cannot supply "Sun-Set" glue. Send \$1.25 for generous supply. Postpaid. Sunrise Specialties Mfg. Co., Roseland, N. J.

GAS Range from surplus materials. Build it yourself for \$30. Write for free literature. Enesco, 2055B Allen Avenue, Altadena, California.

SHELLCRAFT Supplies. Wholesale only. Free catalog limited to dealers only. Beachcomber Novelty Co., Box 551, Fort Myers, Florida.

RARE And native woods for homecraftsmen. Rosewood, the Ebonies, Boxwood, Cocobolo, Mahogany, Walnut, Cherry, etc.; turning blocks and squares. 1 1/2 x 1 1/2 x 12" Rosewood 60c; 2 x 2 x 24" West Indian Boxwood, 3 lbs., \$1.40, plus postage. We manufacture every piece from imported logs. Send for price list. Dept. M. Salisbury Cutlery Handle Co., Since 1884, Salisbury, Conn.

DRILL Sets—Save almost 50%. Brand-new Cleveland twist drills #1 through #60, carbon steel. War surplus bargain at \$4.95 a set. Waterproof, rustproof packed. Mercantile Wholesalers, 2107 Pennsylvania N.W., Washington 7, D. C.

SHELL Jewelry supplies. Wholesale only. McFarland Plastic Co., Sarasota, Fla.

SURPLUS Electrical circuit testers, new, original packages. Contains 24 Mazda 28 volt, type 313 bayonet bulbs, 24 miniature sockets, 28 feet rubber covered lamp cord. Make your own Christmas tree lights, light model cities, signal and control systems for electric trains, many other applications. Terrific value at \$3.00, postpaid with money order. Bulbs alone list at \$7.20. Bardana Engineering Company, Inc., 1222 West Washington Blvd., Whittier, California.

CHRISTMAS Present for your boy. Full size plans, 10 unique, animated animals, toys, \$1. Easily made. Engineering Development, Box 37, Sta. C, Lincoln, Nebraska.

CELLULOID—New postwar, beautiful assortment. Mottles, opaques, onyx pearls. Used by ring makers everywhere. One pound assortment, pieces approximately 30 sq. in. each. Price \$1.00. Please add 10c for postage. Craft Service, 337 University Avenue, Rochester 7, New York.

WALNUT, Wild cherry wood, all dimensions to 8 feet long. Widths and thickness to 8 inches, 100 board feet \$20.00. Ozark-sawyer, Route 1, Fayetteville, Arkansas.

LUMBER Packages for home woodcraft work. Oak, Maple, Gum, Pine, G. B. Hill Lumber Co., Cochran, Ga.

TRY Tandy Leather Company. Tulsa 1, Oklahoma, for leathercraft supplies. Catalog free upon request.

COPPER, Brass for tooling, supplies, and tools. Catalog free. Kit Kraft, 3203 West Washington Blvd., Los Angeles 16, Calif.

WOODCRAFTERS—40 Pictures of new woodworking projects. Folder 10c. Joannes Patterns, P.O. Box 141, Omaha 7, Nebr.

EMBED Shells, flowers, etc., in Dixie Klearkast Plastic. Kits \$3.95. Shell kits dollar up. Catalogue stamp. Dixie Shell Service, Lakeland, Fla.

LEATHERCRAFT. Pleasant, profitable. Easily learned. Send card for free booklet. Artcraft Leather of California, Dept. PM-12, 271 Twelfth Street, Oakland 7, California.

SWISS Music units \$3.50. Musical piano kits \$4.75. Irving Meyers, 126 Lexington Ave., New York 16, New York.

ENGRAVING. Learn latest internal plastic carving, lettering, trophies, etc. Details free. Renzelman, 611 S.W. 23rd Road, Miami 36, Fla.

LEATHER-CRAFTERS: Free 1947 catalog showing easily completed projects, full line of tools, hides and accessories. Ester Leather Co., 145 St. Paul St., Rochester 4, N. Y.

LEATHER Billfold complete with lacing and needle \$1.50 post paid. Harte's Craft Shop, Holyoke, Colorado. Catalog 10c.

STORM Windows. Knocked down, build for yourself or neighbors. Instructions and prices sent on request. Weather-Rex, 155 Genesee Street, Buffalo, New York.

UNIVERSAL Shop stand. Send for circular. Sutter-Craft, Dept. S12A, Eau Claire, Wis.

SHELL-O-CRAFT Co., Box 365, Station A, St. Petersburg, Fla. Most distinctive shell kits for novelties and jewelry \$2.60. Also \$1.00 kits postpaid. Catalogue free.

OREGON Myrtlewood lumber and turning squares for sale. M. Weaver, 3923 SE Tibbetts, Portland 2, Oregon.

WAR Surplus for camping or hobbies. 100% down sleeping bags, clothing, tools, machines, skis, and thousands of other articles. We buy direct—Government to consumer. Save half regular retail price. Send now for money saving catalog 10c. Coast Distributor Corp., Dept. T-D, 9025 Bothell Way, Seattle 5, Washington.

SHELLCRAFT Supplies. Make money! Illustrated instructions catalogue. 10c. Beginners kit \$1.69 postpaid. Shell-Art Novelty Company, 5th and Moore, Philadelphia, Penna.

HUNDREDS Patterns: Plywood novelty furniture, lawn ornaments, silhouettes, weathervanes, letters, numerals, 200 craftsmen's books and booklets, hundreds decal transfer decorations. Other lines. Large illustrated catalog. Write Wo-Met Shop, Ashburn, Georgia.

LEATHER Designs for tooling or carving. Ten handbags \$1.00; twenty billfolds, \$1.00; fifty belts, \$1.00. All three, \$2.50. Lampkin Artcrafts, Box 641-M, Culver City, Calif.

ANTIQUÉ Reproductions metal pulls, knobs, escutcheons. Kiln dried mahogany, walnut, other woods. Highly figured veneers. Sedlo Company, P.O. Box 7161, New Orleans, Louisiana.

BAND And jig saw owners, let your machine and hobby bring you profits, fun. Free details. Nu-Art Designers, 33 Rosemont Rd., No. Weymouth, Mass.

DESIGN And specification prints of 6 wood earthmoving toys including power shovel, dump truck and loader. \$1.50 postpaid. Earthmover Toys, E. Lansing, Mich.

LEATHERCRAFTERS! Belt kits, projects, leather, supplies. Write for catalog. Art Leather, 411 Joseph Ave., Rochester 5, N. Y.

LEATHER. Retail, mail orders, catalog, tools, lacing, supplies. National Handicraft Co., 30 Frankfort St., New York City 7.

TEXAS Ebony, America's most beautiful lathe turning wood. Large piece, \$1 prepaid. Sample, dime. Information on southern woods, stamp. Starcraft 1, Edinburg, Texas.

PLYWOOD Cabinet kitchen plans 25c. Playne Cabinets, 4617 Johnson Avenue, Western Springs, Illinois.

PLASTIC Jewelry supplies. Free catalog. J & M Novelties, Box 464P, Griffith, Indiana.

HOW To set up and run a mirror shop! Resilver mirrors. For price write—John Sprinkle V55, Marion, Indiana.

SHELLCRAFT Supplies. C. A. Werts, 1429-56th Avenue, Oakland 3, Calif.

BUILD And sell lawn chairs. Plans \$1.00. We tell you how and where we sell. The Woodcraft Shop, Danby, Vermont.

SHELLCRAFT Supplies. Beginner's kit with instruction book \$3.00. Price list free. Stelle Shellcraft Industries, 230 Randall Avenue, Trenton 10, New Jersey.

KNOCKDOWN Cedar chests. Lumber and veneers. Free price list. Giles & Kendall Company, Huntsville, Ala.

SPECIAL Offer: 80 full size toy, novelty, and lawn ornament patterns only \$1.00. Lynds, Medway, Mass.

CERAMIC Jewelry supplies, bar pins, ear screws, for ceramic and woodworkers; also glass and seashell assemblers. Free catalog. Philadelphia Badge Co., Dept. B-1, 1007 Filbert St., Philadelphia, Penna.

35 PATTERNS of action pull toys, trucks, carts, toy furniture, etc. \$1.00. Continental Homecrafters, 907 Birch, Eau Claire 3, Wisconsin.

LEATHERCRAFTERS! Send for free catalog listing leathers, tools, supplies. Kit Kraft, 3203 W. Washington Blvd., Los Angeles 16, Calif.

SHELLS, Plastics, findings. Lowest prices. Free catalog. Frances Jones, Box 251, Sarasota, Fla.

EXPERIMENTERS! Interested in electrical, mechanical devices from war surplus? List free. F. Siefke, Box 18, Station E, Buffalo 11, N. Y.

HOME Craftsmen—You can now reproduce your ideas by the hundreds from your own designs by using "Steel Rule Dies" cuts on cork, leather, cardboard, cloth. Write for details. Howard Schultz, 115-83-229 St., St. Albans 11, New York.

MAKE IT YOURSELF

BUILD Concrete block machine. Vibrator or hand. Easy. Economical. 125 blocks per hour. Build house, shop, garage or other buildings. Save half. Sell blocks. Make money. Free details. Clyde Lee, Dept. A, Mountain View, Oklahoma.

STOP Wasting money through heat loss. Our plans tell how. Free details. A. Claber Co., Box 491, Grandville, Michigan.

PLANNING A home? Draw your own plans. Simplified system makes it easy. Complete kit \$1.00. Satisfaction guaranteed. Planahome, Box 319, Santa Rosa, California.

BUILD Compact pinhole camera. Takes wide angle views without distortion. Complete plans, 50c. Box 41, Fenton, Mich.

VENTILATOR Fan, automatic. Build now for summer! Complete plans \$2. Literature free. Engineering Development, Box 37, Sta. C, Lincoln, Nebraska.

HOT Water free, from sunlight. System efficient any locality year round. Standard materials, easily built, low cost, facts free. Solar Water Co., Box 175, Dept. Y, Coral Gables, Florida.

PLASTIC Wallet. Complete material, equipment and instructions for making men's or ladies' plastic wallet. Nothing else to buy. Prepaid, U.S.A. only, \$2.00 (c.o.d. \$2.21). Details free. Lakeshore Supply Co., Dept. PM, 534 Surf St., Chicago 14, Ill.

MAKE Own patterns for beautiful plaques. Literature free. Werner Lindquist, 1210B 3rd Ave., Rockford, Ill.

WARSHIP Plans! 30 types! Three cruisers, three destroyers \$1.75. Destroyer plan, complete list 25c. Edward Wiswesser, 2537 Cumberland Ave., Mt. Penn., Reading, Penna.

OPEN And close garage doors (swing out type) with air plans, \$1.00. W. Hughes, Box 465, Port Jefferson Sta., N.Y.

BUILD Concrete block machines, portable sawmills. Shop, farm, home machines. 70 plans. Catalog-handbook free. Nichols Equipment Co., Dept. 510, Purvis, Miss.

BUILD Your own home-freezer unit. Simple, easy to understand plans. Reaches 30-degrees-below temperature. Freezing compartment size 10x16x28". Storage compartment 24x28x36". Complete plans 50c. Popular Mechanics Press, 200 E. Ontario St., Chicago 11, Ill.

STORM Windows (combination screen and glass) interchangeable from inside home. Make them yourself. We furnish the mouldings knocked down. Write Weather-Rex, 155 Genesee Street, Buffalo, New York, for prices and description.

SPECIAL. Full size patterns make over 100 toys, \$1.00. Complete plan for over 20 modern kitchen cabinets \$1.00. Free list. Masterprint, White Building, Buffalo 2, N. Y.

"CONCRETE Block homes." 32 page booklet: drawings, instructions on how to build. \$1.00. H. C. Lightfoot, Civil Engineer, Richboro 1, Penna.

PLANS AND BLUEPRINTS

BUILD Your own home for less, details sent free. F. C. Williams, 200 Center Ave., Pittsburgh 29, Penna.

WATCHES, OLD GOLD, JEWELRY

STUN Your friends with genuine, sparkling, brilliant-white zircons. Cut, polished, mounted just like diamonds. Amazing diamond-like appearance. Top-quality. Hard for even experts to tell the difference. Beautiful settings 14K gold. Over 100 gorgeous latest-style rings to choose from. Attractive low prices. Send for big free catalog. U. S. Zircon Syndicate, 139 N. Clark, Dept. ZG-127, Chicago 2.

GENUINE Diamonds at out-of-pawn low prices from unredeemed loans and cash buys. We offer beautiful gems at far less than original cost. Shipped free for inspection, appraisal. Write for free list showing fine diamonds at amazing low prices. Lloyd J. Butler, President, Prudential Loan Association, 133 North Clark, Dept. J-127, Chicago 2.

WATCHMAKERS. Beginners; watches; movements. Price list! Box 1874, Chicago 90, Ill.

RHINESTONES; Pearls; findings. Introductory assortment 25c. Herber, 1360A Hicks, New York City 67.

STAINLESS Steel expansion bands for wrist watches. Factory special, 2 for \$1.00. No c.o.d.'s. Natco Supply, 1090 W. 43rd, Norfolk 8, Va.

BACK Again, 2 yr. guaranteed American made, 14 size nickel plated stem wind watch. C.O.D. \$2.98 plus tax. One to a customer. Wineholt Co., BX CW5, Woodbine, Penna.

WATCHMAKERS' Journal contains valuable information for watchmakers. Send 15c for new January issue. Dean Co., 116 Nassau St., New York 17, N. Y.

JEWELRY Findings, cameos, semiprecious stones, earwires, chains, flowers, hearts, crosses, clasps, pinbacks, moonstones, beads, many others. Catalogue 10c. Dime refunded on first order. Pickwick Jewelry Findings, Box 780, Stamford, Conn.

LEARN Watchmaking. Complete instruction course, \$3.50. Tools, materials. Catalog free. Stewart's, 727 Market St., St. Louis, Mo.

GOLD \$35.00 Ounce—Mail old gold teeth, diamonds, jewelry, watches—receive cash by return mail. Satisfaction guaranteed. Free information. Dr. Weisberg's Gold Refining Company, 1500-Q Hennepin, Minneapolis, Minn.

WATCH Repairing easy learned by our home study course. Watch repairers are in demand and are among the highest paid craftsmen today. Write for free information. Houston Chronometer & Watch Co., P.O. Box 1140A, Houston 1, Texas.

CASH For old, broken jewelry. Highest prices paid immediately. Mail gold teeth, watches, rings, silverware, diamonds, spectacles. Satisfaction guaranteed. Information free. Rose Smelting Co., 29-A East Madison, Chicago.

GEMS, Precious and semi-precious, all genuine, from world wide sources. Deal direct, no overhead, save money. Catalog 10c. Hill Co., Route 7, Salem, Oregon.

TOBACCO, SMOKERS' SUPPLIES

FACTORY Rejects—Genuine imported briar smoking pipes from regular \$2.50-\$10 retailers. Have surface flaws not affecting smoking qualities. 2 for \$1.00. Gaylords, Dept. L, Brockton, Mass.

CIGARS, Choicest quality. Trial package, \$1.65 postpaid. Other prices on request. S. & E. Co., Dept. PM, Red Lion, Penna.

PIPE Carving kits \$1.00. Seconds \$5.00 pipes 65c. Literature free. Carvapipe, 2829-H Dixie, Hamilton, Ohio.

MAKE A pipe. Manual of instructions \$1.00. Briar blocks, stems, rough pipes. Free list. Harold Mangus, R.D. 3, Alliance, Ohio.

PIPE Lovers magazine! Pictures, articles, gadgets, ideas. 532P Pine, Long Beach 12, Calif.

SURVEYING INSTRUMENTS

GUARANTEED Factory rebuilt transits and levels, sale, or rent, with purchase option. We will repair, trade or buy old instruments. Write for list M-48. Warren-Knight Co. (Manufacturers of Surveying Instruments), 136 North 12th St., Philadelphia 7, Penna.

FOR SALE—MISCELLANEOUS

HULL Automobile compass, for accurate road direction, brand new, \$2.50. Prisms for 6x30 or 8x30 binoculars, brand new, \$1.50 each. Offset prisms to be attached to 7x50 B. & L. binoculars, gives double the field of the ordinary 7x50 binocular. Cost \$98.00, special \$25.00. Green sunshades for binoculars, size 6x30 and 7x50, snap on type, value \$7.50, special \$1.25 per pair. Forward money order. No c.o.d. shipments. Send coin \$1.25 for Third Annual Edition of Gun Digest together with our complete catalog of new and used guns, ammunition, rifles, binoculars and powder flasks. Our separate catalog 25c. Public Sport Shops, 13 S. 16th Street, Philadelphia, Penna.

WE Make molds for almost anything. Send 25c to C. Mach. Co., Box 2248, Hickory, N. C.

TURBO-SUPERCHARGERS Built for Thunderbolts and other war planes, now at a fraction of the original cost. Fascinating fun for mechanics who like to experiment. Practical too. Adaptable to pressure blower jobs. 2 sizes; \$25, \$35. Write Silver Steel Co., Racine, Wisconsin.

NEON 75c Per foot. Direct from factory. Inter State Laboratories, 4049 Minnehaha Ave., Minneapolis, Minn.

RUBBER Toys! Fifty perfect assorted size balls, funny balloons, noisy dolls, Christmas gift, also party assortments. \$12.00 value, \$6.50 delivered. Hurry. Ellswood Distributors, LaJunta, Colorado.

WANTED MISCELLANEOUS

ANYTHING Bought, sold, traded. Free list. Buyers Bulletin, P.O. Box 415, Evansville, Indiana.

WHAT Do you have to sell that I can sell in my stores. Farm and labor trade. Lou Curtis, 214 E. 17th, Olympia, Wash.

MERCURY (Quicksilver). Write for quotation stating quantity. Metallurgical Products Co., 35th and Moore Sts., Philadelphia, Penna.

FOR THE HOME

NAMEPLATES, Key, dog tags. Free circular. Bronx Nameplates, 2080 Daly Avenue, New York 60.

"REPLACEMENTS" Stoves, furnaces, grates, firepots, linings. Magix, Royal Oak 128, Mich.

STEAM Heat owners. Let us show you how to keep your house warmer this winter with less fuel by an amazing new vaporizing valve you can install yourself. Details free. Write Ralph M. Arato, 1651 East 14th Street, Brooklyn 29, N. Y.

"AIRGUIDE" Indoor-outdoor thermometer. Handsome scientific instrument shows outside temperature indoors. Ideal gift. \$6.00 postpaid. Circular free. Trade Winds, Dept. M, 727 30th Street, Rock Island, Illinois.

VELVETEEN Xmas stockings with sequined name \$8.00. Box 712, Corsicana, Texas.

PERSONAL

PRETEND Visiting Hawaii. Five Hawaiian glamour cards and instructions \$1. Box 997, Honolulu, Hawaii.

LOSING Hair? Have dandruff? Write for free, confidential booklet on care of scalp and hair. Eugene Burt, State and Hohl, Kansas City, Kansas.

CALIFORNIA. Ten postcards, dollar. You address, return. We remail. Smiths, Box 1373, San Diego 12.

ASTOUND Your friends with your name in headlines of New York newspaper; any six words; 3 copies, \$1.00. Smith Headlines, 1621 58th Street, Brooklyn, N. Y.

PALM Beach vacation \$1.00. You address, stamp, we mail 6 postcards, beach, hotel scenes, \$1.00. Cocoanuts mailed \$1.00 each. General Intel. Service, 602 Guaranty Bldg., West Palm Beach, Fla.

MEXICAN Address. Mail received, forwarded. Photographic postcards 15c. Remail free. Mexican articles. Questions answered about Mexico 50c. Tillotson, Apartado 1405, Guadalajara, Jal., Mexico.

POOL Friends. Pretend visiting nation's capital. Three Washington postcards 25c. Address return, we remail from Washington; 25c each letter. Barbers, 22G Hillside, Greenbelt, Md.

ST. PETERSBURG, Fla. Tropical view cards 5-25c remailed. Craig, 1401 12th St. So.

BUYING Agency. List your needs. Spada Enterprises, 10 Lexington, Wethersfield 9, Conn.

THICKER, Lovellier hair for men and women. All about latest secrets, discoveries free. Write immediately. Bruns, 3307-D Fremont, Madison 4, Wis.

SWAP! Trade! Anything, everything. Free information. "Swappers' Gazette-PM" Louisville 12, Kentucky.

RUPTURED? Positive comfort, no understraps, no steel, no elastic. Write Smith Manufacturing Company, Preston, Ontario.

HAIR Falling? Dandruff? Write Trichologist, 137 Lewis St., Phillipsburg, N. J.

HOW You can find out! Information discreetly developed, any matter, person, problem, anywhere. Personal-business assignments, representations, undertaken. Nation-wide. Officially licensed and bonded service established 1922. Reasonable. All inquiries confidential. William Herman, 170 Broadway, New York.

FOOL Friends. Flash billfold-size photo of picture beauty, intimately inscribed to you! 50c each. Blonde, redhead, brunette. Remember how, when, where you met her? Fool friends. Marson, Box 185, Hollywood Station, Hollywood 28, Calif.

STAMMER? Let me help you. Details free. Sauers, Box 139-5, Mars, Penna.

NIFTY Shirt holder helps hold shirt down, pants up. Simple. Send dime. Nifty, Box 812, Oakland, Calif.

TEN Ranch postcards. You address, return, we remail, \$1.00. Box 712, Corsicana, Texas.

SAVE Money, trim own hair. Comb-A-Trim, 60c, two \$1.00. Moyer, B-252-P, Milton, Penna.

MISCELLANEOUS

HOME Owners—A rigid support for eave gutters. No nails through shingles. \$1.00 for plans and specifications. Charles Henry, Hennessey, Oklahoma, Box 327.

PHOTOS, Color slides, Scenics, ghost towns, art, etc. Unusual, different. Sample photo, 25c. Slide 50, List, Novelty Supply, 1227 E. Van Buren, Phoenix, Arizona, Dept. B.

IDEAL Xmas gift, Calfskin zippered picture wallets \$3.50 postpaid. Samuels Novelty, 2653 Evergreen, Chicago, Illinois.

SEW Electrically—Motors, lights, easily attached. Ray's Service, Box 803, Marion, Indiana.

PHOTOCOPIES, Documents, etc., one side 25c, two sides 50c. Militello, 877 Park Ave., Brooklyn, N. Y.

NEW "Easy-to-See" thermometer, 3 1/2" transparent dial with glass cover. Attaches firmly anywhere on outside of window pane. Big figures easily read 10 ft. away. Weatherproof, reliable, accurate. \$1.50 postpaid. Brad Lee Gifts, 26 Bedford St., Waltham 54, Mass.

MEXICAN Gift shop items, Feather cards, pottery, drawwork. Wholesale, retail. Mexican Products, 126 N. Main, Tulsa 3, Okla.

GOVERNMENT Surplus, A thousand bargains. Write for list. Army Navy Surplus Goods, 320 13th St., Richmond, Calif.

FREE—New 42 page book entitled, "How to Become A Successful Direct Salesman," written by salesmen for those who want to become salesmen and earn up to \$100 and more weekly. Send penny postcard. Specialty Salesman Magazine, Dept. PM-10, 307 N. Michigan, Chicago 1, Ill.

LOS Angeles, Your personal questions about Los Angeles answered promptly. \$1.00. Pomeroy Information Service, 11926 Wilshire, Los Angeles 25.

GRADUATE Work in all subjects. Degrees available in one year. Resident and extension classes. Golden State University, Hollywood, Calif.

FREE Catalog, Shop and household gadgets. Lyle Baker, Bismarck, Missouri.

SEEK Buried treasure, Methods, mysteries, devices explained. Circulars free. Century Press, Box 151-B, Glen Ellyn, Ill.

"BIG Mails" moneymaking offers, magazines, samples. Listing 10c. Bentz Jr., Chatawa 4, Mississippi.

HAVE You read "Hi Neighbor", (A fascinating saga of today). Postpaid \$1.10. Money back guarantee if not satisfied. Please print name in full. Write in care of "Hi Neighbor," William A. Horn, P.O. Box 231, Alton, Illinois.

GIGANTIC Mails, magazines, samples. Listing 10c. Lawson, Box 1302-P12, Detroit 31.

FREE! Big new "Book of Values" catalog. Everything for the sport, bicycle and hobby fan at lowest prices. Write Minky's, 3330C Roosevelt Road, Chicago 24, Ill.

DIVER, Scientific toy; all ages; inexpensive. Schiff, 2319 Newton, Milwaukee 11.

BOOKS—All Kinds—Homecraft, Radio, Plastics, Boat Building, Photography, Model Building. Catalog free. Popular Mechanics Press, 200 E. Ontario St., Chicago 11, Ill.

SWISS Music box units, Choice of classical, waltz, popular. All ready to install \$3.25 each. Cash orders postpaid. Information on request. Swiss Novelty Co., Box 1201, Fall River, Mass.

AMAZE Your friends, New Radio Quiz book. Over 1000 unusual questions and answers. \$1.00. Press, 804 Anderson Bldg., Ft. Worth, Texas.

1000 NAMES Opportunity seekers, Mail order aspirants. \$3.00. A. O. Bearden, Route 2, Box 126, Alexander, Ark.

400 YEAR Calendar, Shows actual monthly calendars. 35c. Tracy Newton, Decatur, Georgia.

RECEIVE Free samples, magazines, catalogues, money-making opportunities! Lots of mail from everywhere! Your name in all our "Surefire" mailing directories two years \$1.00. Nine months, 50c; three months, 25c. Stanford, 6220-M 16th, Philadelphia 41.

PENCILS—Individual or firm name. Dozen 60c, two dozen same imprint \$1.00, gross \$4.80 cash. Delivered. Pencil Market, 611 15th Street, Knoxville 16, Tenn.

GOLD—\$70 an ounce possible soon. Free booklet on panning gold, instruction books, supplies. Old Prospector, B-68, Dutch Flat, Calif.

REAL Western belt buckle, Beautiful monel with tip and loops, bronze steer head. \$1.00 postpaid. Aircraft Industries, 411 Wolverton, Ardmore, Okla.

MODERN Luminous house numbers with artistic mounting. Particulars free. W. Thompson, Box 125, Perrysburg, Ohio.

B. B. BALL Point pen \$1.00. Spada, 10 Lexington, Wethersfield 9, Conn.

FIREWORKS: Don't be disappointed. Get famous Banner Fireworks with all newest and startling effects. Giant cannon salutes that rock you like a crash of thunder. Whistling devils with weird unearthly noises. Skyrockets that burst in majestic colorful display. Gasp in amazement as you watch the battle in the clouds. Genuine Chinese firecrackers. Over 200 pieces including sparklers for little tots. Retail value \$11.25 for only \$4.95. Rush order today. Any quantity. Send money order, bank draft or currency. No c.o.d.'s. Big new catalog free. Banner Fireworks Mfg. Co., Inc., Dept. 111, 446 Capistrano, Toledo 12, Ohio.

GOVERNMENT Surplus, A thousand bargains. Write for list. Army Navy Surplus Goods, 320 13th St., Richmond, Calif.

VETERANS Your favorite wallet-size photo or document put in transparent plastic. Free! Send item, we'll return plastic protected. Include former service address. Kovee Plastic Co., 3753 N. Marshfield, Chicago 13, Ill.

BEAUTIFUL Genuine Alligator and snakeskin handbags and shoes \$6.00 upwards. Also belts. Xmas. Catalogue. Alligator Articles, 155 Mason, Havana, Cuba.

EXPERT 14x9" Charcoal drawing of you in thick paper-board. Just send any good sized clear photo of you and \$3.00. Beautiful resemblance or money back guaranteed. Mok's Studio, 617 H St. N.W., Wash. 1, D. C.

CITRUS Fruit cheap, merchandise high. Save money, worry. Send fruit for Christmas. Free folder. Davidson Groves, Box 1118, Edinburg, Texas.

"RECEIVE Mail" Moneymaking offers, opportunities, catalogs. Name listed 10c. Ideal Service, 100, Park Ridge, Ill.

PREVENT Moth damage with one easy application. Permanent mothproofing compound makes one quart solution, 50c postpaid. Money back guarantee. Lee Laboratories, 10108 S. Vermont, Los Angeles 44, Calif.

MEN! Large size shoes, large size sock! We specialize in large sizes 11 1/2 to 16, widths AA-EEE. Oxfords, hitops, work shoes. Guaranteed extra quality. Free catalog. Kingsize, 426, Brockton, Mass.

INDIAN River citrus fruits, Express shipments. List on request. Schuyler Jackson, Wabasso, Florida.

TOPS! Lifetime ballpoint fountain pen \$1.00. Free literature. Novelty Enterprises, Dept. 27, Box 2341 Terminal Annex, Los Angeles 54, California.

FIREWORKS! Wholesale! Lowest prices! Watson Sales Company, P.O. Box 1414, Birmingham 1, Alabama.

TWELVE Alnico magnets, 100 experiments. \$3.00. Experiments, 25c. Disc magnet, \$1.00. Eljay, Box 891, Newark 1, N. J.

M-SCOPE Metal, mineral locators sensational new electronic lightweight models, immediate shipment. Fisher Research Laboratory, Inc., manufactures some of the finest metal locators for the U. S. Army. Built for Arctic, Tropic use. Unsurpassed efficiency, low prices. Time-payment plan available. Send for free 16-page illustrated booklet. Fisher Research Laboratory, Inc., Palo Alto, Calif.

TATTOOING Outfits, supplies, Illustrated list free. Zeis, 728 Lesley, Rockford, Illinois.

TREASURE Hunters! Entirely new Goldak locators. Sensational performance. New light weight model weighs only 11 pounds. Revolutionizes location of gold, silver and minerals. Money-back guaranteed superior any other device. Write The Goldak Co., 1544 W. Glenoaks Blvd., Glendale 1, Calif.

GLADIOLAS—Some newer, better. List. Robinsons Glad Heaven, Sebastopol, Calif.

70 BIBLE Lessons, 25c. Bulletin, Box 87, Cathedral Station, New York 25.

SURPLUS Army mine detectors, complete with batteries. \$26.40. Highbridge, 343 Canal St., New York 13, N. Y.

REWARD—For answering this ad. Valuable free catalog of unusual moneymaking information on: Locksmithing, hunting, mailorder, treasure hunting, formulas, other subjects. National, 378P Hooper Street, Brooklyn 11, New York.

NOW Ready: New, amazing Classified Advertising Record Book—prepared especially for classified advertisers. Here is a book that tells you instantly whether or not your advertising in any publication is paying you real results. You can tell immediately how many inquiries each publication produced—how much cash received from every ad. Spaces are provided for the name and address of the publication, date of issue, space used, rate, cost of ad, key number, etc. You have a complete record of each publication right before your eyes. Plenty of space to keep accurate record of 28 separate publications. You can have a copy by sending only 10c to cover postage and handling. Send for your copy now. W. F. Johnson, Classified Adv. Mgr., Popular Mechanics Magazine, 200 E. Ontario Street, Chicago 11, Illinois.

INVENTORS

Highest

ROYALTIES and CASH

FOR INVENTIONS

When We Market Them

INVENTION MARKETING SERVICE "UNPARALLELED" BY ANY OTHER AGENCY IN THE WORLD

Write for FREE booklet without obligation

UNIVERSAL MARKETING CO., 126 Lexington Ave. (Suite M-12), New York 16, N. Y.



For Men Who are Trained in AUTO BODY & FENDER WORK

Men 18 to 60. Want a future with good pay, perhaps a business of your own later? If you are mechanically inclined, start now to learn to become an auto body mechanic and fender repair man. This fast growing field has great possibilities for trained men with experience. U. E. I. spare time, home-study training combined with actual shop practice gives you sound, basic knowledge of latest, best methods so you may get the experience which may bring you big pay. Capable instructors supervise your studies and actual practice. Course includes acetylene welding, spray painting, use of hand and power tools, etc.

THOROUGH, RELIABLE TRAINING

U. E. I. has trained men for new opportunity fields since 1927 and many students are now making good. Auto body and fender repairing is one of the best profit-makers in any garage or service station. Little capital required. . . . placement service, or we will show you how to start your own shop. Get the facts FREE, without obligation. Write today.

Training approved under G. I. Bill

UTILITIES ENGINEERING INSTITUTE

AUTO-CRAFTS DIVISION

2523 Sheffield Ave., Dept. 1127-X, Chicago 14, Ill.
Gentlemen: — YES! I want to get into profitable Auto Body and Fender Repair Work. Please send me FREE FACTS at once.

Name _____ Age _____

Address _____

City _____ Zone or County _____ State _____

If veteran of World War II check here
Check here for Special Information if under 17.

The Steady Pay Profession Good Times or Bad!

SCIENTIFIC CRIME DETECTION



It Is Easy to Learn!

I will teach you this fascinating science during your spare time at home. It pays to be an expert in Finger Printing, Firearms Identification, Police Photography and Criminal Investigation. I have trained hundreds of men and women now successfully serving in identification bureaus throughout America. You, too, may quickly prepare yourself to become a well-paid valued officer of the law, often sharing in the generous rewards offered for wanted criminals.

FREE! OVER 800

"BLUE BOOK OF CRIME"

This book is full of exciting information on scientific crime detection. It will show how you can get started in a grand career. Now, at amazingly low cost. Clip coupon now... Mail it today.

of all Identification Bureaus in the U. S. employ students and graduates of I. A. S. A majority of these men are heads of Bureaus. Many of them knew nothing about crime detection before training with me. Now they have steady jobs, good salaries and a fine future. Write today for full particulars and free book. Give age.

INSTITUTE OF APPLIED SCIENCE

1920 Sunnyside Ave., Dept. 1359, Chicago 40, Ill.

INSTITUTE OF APPLIED SCIENCE
1920 Sunnyside Ave., Dept. 1359, Chicago 40

Gentlemen: Without any obligation on my part, send me the "Blue Book of Crime," and complete list of Identification Bureaus employing your students or graduates, together with your low prices and Easy Terms Offer. (Literature will be sent ONLY to persons stating their age.)

Name _____ Age _____

Address _____

RFD or Zone _____ State _____

VETERANS Learn WATCHMAKING

A Lifetime Profession

Regardless of Conditions, Age, Sex, or Physical Limitations
Veterans—Civilians!
Your Opportunity—
LEARN WATCHMAKING



Approved G. I. Training

Lift yourself from a futureless job into a position paying better than your present work. Fit yourself for the job that will permit you to establish your own shop, or be employed in a pleasant environment.

Watch Repairing—Jewelry—Engraving will always be in ever greater demand. Our graduates wanted everywhere. Dignified positions \$50-\$75-\$100 per week. Veterans write today for latest FREE enrollment requirements.

Kansas City School of Watchmaking
Largest Horological School in America
617-621 Wyandotte St. Kansas City 6, Mo.

HI-SPEED EQUIPMENT

High Compression Heads—Dual Manifolds
Dual Air Cleaners For V8's

Use these simple conversions to increase horsepower, speed acceleration, and increase top speed of your car. Write today for prices and full information.

SANDEE MUFFLER CO. 7523 S. Western Ave. Los Angeles, Calif.

MUFFLERS

STEELS and ALUMINUMS
with a motorboat tone

SINGLES, Chev, V-8, Plymouth, Steels \$5.50, Aluminum \$6.50. Chry., Olds., Buicks, etc., Steels \$7.50, Aluminum \$8.50. V-8 and MERCURY DUALS, Steel \$17.50, Aluminum \$20.00. Aluminums are guaranteed for life of your car

DEALERS WANTED

SANDEE MUFFLER CO.
7523 S. WESTERN AVE., LOS ANGELES 44, CALIF.

LIQUID MARBLE COLORED POTTERY

Different! Marvelous! Color-glazed. Brush, spray, mold tiles, table-tops, ornaments! **SANITARY COMPOSITION FLOORING!** Dustless, noiseless; put on like plaster, plain or tile designs; yielding as cork, lasting as stone. **RUBBERLASTIC Mold Compound** — For plaster casting, novelties, statuary, toys, plaques, dolls. **TILEX Colored Roofing.** Build Modern **PLASTIC HOMES.** Illustrated literature free. **RAPID MARBLEIZING SERVICE, Dept. 10-A, Edwardsville, Illinois**

SAW YOU SAW IT IN POPULAR MECHANICS

TRIGONOMETRY QUICKLY

SPEED UP YOUR TRIG! LEARN SWIFTLY.

With Josselyn's truly great chart, "TRIGONOMETRY SIMPLIFIED," you get answers speedily, easily. This amazing short-cut to **ACCURACY** can save you hours and days of drudgery. **YOUR OWN TEST** on your problems will quickly convince you of its excellence. If not delighted, 5 day money back guarantee. We mail C.O.D. plus postage fee, or send \$1.00 full price, and we mail postpaid.

EDCO SCIENTIFIC MFG. CO.
Box 531, Hollywood Station Hollywood 28, Calif.

The WORLD'S FINEST SURPLUS BARGAINS



GENERAL ELECTRIC BC 645 TRANSCEIVER

Ideal for two way communication on the new citizens radio band between house and automobile, boats, around ranches, etc. Covers 450-500 megacycles. Cost Gov't over \$400.00 as aircraft unit. Brand new with 15 tubes. (list price tubes alone \$58). Conversion data to ham bands, and 110 V. operation. In original sealed GE cartons. Shipping **\$14.95** 2 for **\$27.00** Wt. 25 lbs.

BRAND NEW ARMY AIR FORCE

ASTROGRAPHS

ORIGINAL COST \$125.

Only \$3.95



Thousands of uses. An ideal navigation instrument for boats, yachts, etc. A wonderful unit for home construction of contact printers, enlarger, strip map holder, etc. A beautiful precision instrument consisting of machined aluminum housing with optical glass view plate, two large ratchet film drive knobs and shafts, one illumination control rheostat, resistor, power plug and film spool, variable light source slide and holder, 11-tools. All housed in beautiful plywood case measuring 14 1/2 x 11 x 10" high. Case has leather handle, steel reinforced corners, hinged lid with stop, lower compartment divided into eight sections. Case is ideal for fishing kit, picnic set case, tool kit, portable radio case, make-up kit, travel case. Case alone worth twice the giveaway price we are asking for both. Shipping weight, 20 lbs.

DYNAMOTORS

Consists of electric motor operating generator on same shaft. Many applications — operating radios from storage battery — using as motor.

Dynamotor A—Input 12 volts, output 1000 volts at 350 MA. Shipping weight, 72 lbs. **\$7.95**

Dynamotor B—Input 6 or 12 volts, output 350 volts, 360 MA. Shipping weight, 30 lbs. **\$5.95**

Dynamotor C—Input 28 volts, output 220 volts at 60 MA. Shipping weight, 6 lbs. **\$1.50**

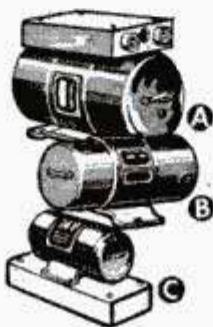

MINIATURE HEADPHONES

Miniature type headphones. Ideal for hearing aids, listening to radio in bed, etc. Complete with headband, cord and two sets rubber ear plugs. Shipping weight, 1 1/2 lbs.

ONLY \$1.00



DIAL ASSEMBLY

This beautiful unit has dozens of parts useful to home builders. Contains gears, cams, clutch and other mechanisms from Army transmitter. Shipping Wt. 2 lbs. **\$1.00**

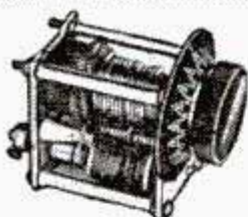

THROAT MICROPHONE

Brand new Army T-30 throat microphones. Used in aircraft, tanks, etc. Broadcast through your radio, use in noisy factories, for home telephone systems, hundreds of applications. Shipping Wt., 1 lb. **\$1.00**



GENERATOR

Makes an excellent home lighting plant and can be operated by wind propeller, waterfall, gas engine, or hand crank. Reduction gear allows full output at very slow speed; supplies 6 volts at 2.45 amp., 425 volts at .115 amp. Brand new, GN-58. Shipping Wt., 28 lbs. **\$7.95**



ELECTRONIC KIT

Experimenter's paradise. Five lbs. of new condensers, transformers, coils, switches, sockets, resistors, selenium rectifier, earphones, etc. Parts for dozens of experiments. Shipping Wt., 6 lbs. **\$1.00**



TUNING UNIT

The heart of the Army Walkie-Talkie. Contains transmitter crystal and tank coil, receiver coil, tuning condenser and crystal; ideal foundation for small set. Shipping Wt., 1 lb. **\$1.00**



Miniature ELECTRIC MOTORS

Ideal for powering all kinds of models. Runs on 24 V. D.C. One of the smallest motors made. 1 1/4" x 1" x 2". Cost Gov't nearly \$20. Shipping Wt. 1 lb. **\$2.95**



Include Postage for Weight Shown

HEATHKIT VACUUM TUBE VOLTMETER KIT

Build yourself this beautiful electronic volt-ohmmeter and save 2/3 of the cost. Measures both AC and DC with ranges 3-30-100-300-1000 volts and ohms .1 to 1,000,000,000 ohms. Every part supplied including printed panel, cabinet, 500 microamp meter, tubes, transformer, blueprints, and instructions. Shipping Wt. 8 lbs. **\$24.50** Complete kit



The **HEATH COMPANY**
DEPT. M . . BENTON HARBOR, MICH.

Learn A Trade NOW! PRACTICAL SHOP TRAINING!

- | | |
|---|--|
| <input type="checkbox"/> AUTO MECHANICS | <input type="checkbox"/> BODY AND FENDER |
| <input type="checkbox"/> DIESEL MECHANICS | <input type="checkbox"/> TOOL AND DIE |
| <input type="checkbox"/> REFRIGERATION | <input type="checkbox"/> MACHINE SHOP |
| <input type="checkbox"/> WELDING | <input type="checkbox"/> PIANO TUNING |

America's Leading School
7 Floors of Fully Equipped Shops
Established 1902 - Day and Evening Classes
Over 45,000 Graduates
Expert Individual Instruction
Learn by Doing - Low Living Expense

YOU HEAR IT EVERYWHERE:

**"GREER SHOP TRAINING
IS THE BEST"**

MAIL THIS AD TO GREER SHOP TRAINING

(Dept. 2127) 460 South State St., Chicago 5, Ill.

Please send without obligation free information regarding trade checked above. (Specify whether you are a Veteran or Civilian)

Name _____ Age _____
Address _____
City _____ State _____

Now for EVERY WORK SHOP!

NEW Invention Electroplates by BRUSH



**Easy to Plate CHROMIUM
GOLD, SILVER, NICKEL, COPPER
... For Pleasure and Profit!**

If you have a workshop—at home or in business—you need this new Warner Electroplater. At the stroke of an electrified brush, you can electroplate models and projects—you can replate worn articles, faucets, tools, fixtures, silverware, etc. with a durable, sparkling coat of metal... Gold, Silver, Chromium, Nickel, Copper or Cadmium. Method is easy, simple, quick. Everything furnished—equipment complete, ready for use. *By doing a bit of work for others, your machine can pay for itself within a week.* So make your shop complete by getting a Warner Electroplater right away. Send today for FREE SAMPLE and illustrated literature. ACT AT ONCE! Mail Coupon.
**WARNER ELECTRIC CO., DEPT. P-3
1512 Jarvis Avenue, Chicago 26, Ill.**

FREE Details & Sample!

WARNER ELECTRIC CO., 1512 Jarvis Avenue, Chicago 26, Dept. P-3

Gentlemen: Send Free Sample and Details to:

Name _____
Address _____
City _____ State _____

Be A MASTER PLUMBER

Earn \$15 To \$50 A Day

DON'T ENVY THE PLUMBER - BE ONE

Every skilled workman will tell you that Plumbers have the best of it. WINTER and SUMMER the Plumber is busy at top wages. No skilled Plumber is ever out of a job—compare his opportunities with any other trade, plus the opportunities of having your own shop. We teach you Plumbing with TOOLS (not books) under Licensed Master PLUMBERS in one of the finest equipped schools in America. We make you a Plumber, every branch is taught thoroughly—Lead Work—Blueprint for plan reading—all other tricks.

LEARN IN 30 WEEKS WITHOUT PREVIOUS EXPERIENCE

If you like to work with tools you owe it to yourself to investigate. No need to ever work as an apprentice. Get free bulletin. Write now! G.I. APPROVED. Our 24th year.

UNIVERSAL PLUMBING SCHOOL

815 HOLMES STREET KANSAS CITY, MO.

60 POWER TELESCOPE \$2.95

VARIABLE EYEPIECE 20X-40X-60X

NEW! Three telescopes in one, 3 different magnifications. 20 power for ultra-bright images with 40 and 60 power for extra long range. Guaranteed to bring distant objects, people, sports events, ships, moon, stars, etc., 60 times as close.



Most powerful for anywhere near the money. 5 sections. Closes to 1 ft. long. Contains 4 ground and polished lenses. Also used as a powerful compound microscope. Directions included. Mass production enables us to offer this high-powered instrument at the amazing price of only \$2.95. We pay the postage. Get yours immediately.

BROWNSCOPE CO. Dept. 12M 24 West 45 St. New York 19, N. Y.

HORSE MASTERY!

A FINE HOBBY - A GREAT VOCATION!

"The EXPERT HORSEMAN"



FREE BOOK—Tells how You can learn to:
BREAK COLTS, GAIT SHOW HORSES, TRAIN RODEO, STOCK and RACE HORSES, BREAK BAD HABITS, HANDLE ANY HORSE, TRAIN CIRCUS TRICK HORSES. WRITE TODAY!

**SUBSCRIBE TODAY
50¢**
One Year

ANIMAL LOVERS ASSOCIATION
BOX KA-111 TARZANA, CALIFORNIA

COLLECT COINS - BE A NUMISMATIST

Learn this fascinating hobby. Get the thrill of having a collection of real value that you can proudly display. Kits for beginners, intermediate, and advanced collectors. **HOBBY HELPERS KITS** are packed full of useful information and material. You may also choose your own items from the descriptive price list. Don't delay—write for price list or send \$1.75 plus 25c handling charge, to get started immediately.

HOBBY HELPERS, Dept. C, Box 665, Washington 4, D. C.

FREE BARGAIN CATALOG of BOOKS

25,000 books of all publishers listed in our 53rd Annual Bargain Catalog of 320 pages. Old-time favorites—latest "best sellers." Reference, Fiction, Juvenile, History, Scientific, etc. Supplying schools, colleges, libraries and thousands of individual customers. Send postcard today for our new 1948 catalog. "Bargains in Books."

**THE BOOK SUPPLY COMPANY, DEPT. 137
564-566 West Monroe St. Chicago 6, Ill.**

ANALYZE HANDWRITING Illustrated Lesson FREE and Grapho Analyst

shows you how to make money at home, full or spare time. Opportunities everywhere. **FREE Analysis Offer** for immediate answer. Must be over 21.
A.I.G.A. Inc., Wilhoit Bldg., Dept. 120-M, Springfield, Mo.

SAY YOU SAW IT IN POPULAR MECHANICS



TRAIN Your VOICE! Results GUARANTEED

We build, strengthen the vocal organs—not with singing lessons—but by sound, scientifically correct silent and vocal exercises and absolutely guarantee complete satisfaction with results. Write for Voice Book, **FREE**. Sent to no one under 17 years old unless signed by parent.
Perfect Voice Studios, Studio 1359, Kimball Hall Bldg., Chicago 4, Ill.

YOU CAN EARN EXTRA MONEY- LEARN NEW SKILLS!

In Your Spare Time!

Do you want to prepare for a career . . . improve your prospects for a better future . . . further yourself professionally and socially in your local community . . . earn more money—now?

Then there's a place for you in the *new* National Guard, where you receive training in a variety of skills while you earn extra pay!

Radio and Electronics . . . Water Chemistry . . . Public Speaking . . . Food Preparation and Distribution . . . Personnel Administration . . . Motor Maintenance and Repair . . . these are but a few of the many specialized skills which you can develop or learn as a member of the *new* National Guard.

You'll train under qualified instructors, work with modern, up-to-date equipment. And, pay for this spare-time training begins at \$1.25 an hour and up!

Don't wait! Start now to help secure your future. Earn while you learn . . . in the *new* National Guard



*Here's how
the National Guard Helps You*

Pay ★ Education
Fellowship ★ Training
Sports ★ Leadership

Write or visit
your community's unit of the

NATIONAL GUARD

of the United States

SEND FOR
FREE
PAMPHLET TODAY!

National Guard Bureau of U. S.
Public Information Office
Room 4C-743, Pentagon Building
Washington, D. C.

Dear Sirs:

Please send me, without obligation, a copy of the pamphlet which tells how I can receive training in technical skills and earn extra pay at the same time as a member of the *new* National Guard.

Name..... Age.....

Address.....

City..... State.....

(Detach and mail this coupon . . . today!)

ELECTRICIANS

Get this Great Book

FREE

Book of 150 Shop Prints, Wiring Diagrams, Full Size 8 1/2" x 11"



For Merely Examining
Coyne's NEW Pay Raising

7 Volume Set APPLIED ELECTRICITY

Here's a brand new set of electrical books to give you the "know how" on all branches of electricity from appliance repairing to D. C. and A. C. equipment, electrical refrigeration, etc. 8,000 subjects, 10,000 facts, latest methods all explained in easy to follow instructions. In order to prove how valuable and Practical this set of electrical books is I'm willing to give you a FREE copy of my book "150 Shop Prints and How to Read Them" just for looking over this set. Written by the Coyne Technical Staff and backed by 47 years' experience, this set has helped many ambitious electrical workers to bigger pay, better jobs & added opportunity.

OFFER LIMITED - ACT NOW! Here's my offer to you - if you act promptly. I'll send you the 7 volume set Applied Practical Electricity for 7 days FREE examination... together with the 150 Shop Print Book. Look the set over 7 days. If you like it send either \$19.75 cash or send \$3.00 after 7 days and \$5.00 per month until \$21 is paid. If you don't want the set, return it and YOU OWE NOTHING. In either event, however, you keep the 150 Shop Print Book absolutely FREE.

SEND NO MONEY! Coupon below is just a request to see the books free and to get my gift book for doing it. ACT - Send coupon Today!



COYNE ELECTRICAL SCHOOL, Dept. 97-R6
500 SOUTH PAULINA STREET, CHICAGO 12, ILLINOIS

E. W. Cooke
Director

O. K., send me, postpaid, Coyne's new 7 volume, "Applied Practical Electricity" for 7 days FREE TRIAL per your offer. Also send, absolutely FREE, the book of 150 Shop Prints as a gift.

NAME _____ AGE _____
ADDRESS _____
TOWN _____ ZONE _____ STATE _____



Auto Library in ONE Book

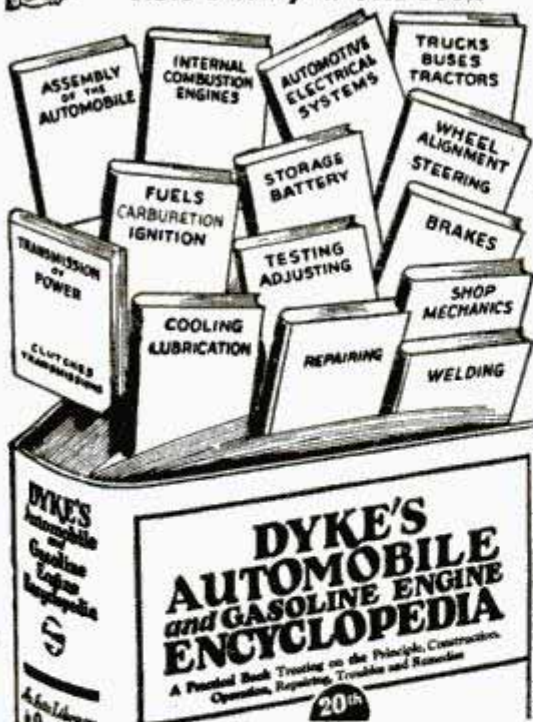

DYKE'S
Leading
Auto
Book
for Over
36 Years

MANY GOT THEIR START with this book.

FOR THE BEGINNER; teaches basic principles.

NEW MATERIAL on trucks, tractors, transmissions in 20th edition.

INCLUDES Ford V8, Chevrolet and other inserts, Diesel and aircraft engines.

DYKE'S AUTOMOBILE and GASOLINE ENGINE ENCYCLOPEDIA
A Pioneering Book Treating on the Principles, Construction, Operation, Repairing, Troubles and Remedies
20th Edition

This book is a wonder. It fairly oozes information. 1,483 Pages; 4,600 Ills., Charts, etc.; 17,000 Lines Index; Size: 9 1/2 x 6 3/4 x 2 3/4; Wt. 6 lbs.; Price \$7.

MAIL COUPON

Goodheart-Willcox Co., Dept. D-9, 2009 S. Michigan Ave., Chicago
Send Dyke's Auto Book at once. C.O.D. \$7.00 Enclosed. Payment refunded in 5 days if not pleased. If remittance accompanies order we will pay all postage charges under same return privilege.

Name _____
Address _____
City _____ State _____

MAKE BIG MONEY IN YOUR OWN YEAR BUSINESS! EASY TO START WITH ONLY A FEW DOLLARS!

Here are 3 amazing, new opportunities to get into your own highly-profitable, dignified business—without previous experience—regardless of your age or sex. 1. **LIQUID Synthetic MARBLE**—Easy to make and install beautiful synthetic Marble Slabs—pouring from liquid state. Big Demand for kitchen and bathroom walls, etc. 2. **FIBRE-TITE FLOORING**—Easy to make and install—in any color or color combination. Many years wear. Dustproof. Soundproof. Verminproof. 3. **FLEXIBLE MOLDS**—for Plaster Casting. \$1.00 in raw materials makes up to \$25 worth finished products. F.B., Iowa, writes: "Am on job that will net me \$150 for 4 days work." Get FREE details. No obligation. Write Today!

Write for FREE DETAILS NOW!

COMPOSITION PRODUCTS CO.

5853 Delmar Blvd., Dept. 121

St. Louis 12, Mo.

GET THE BEST IN MUFFLERS V-8 DUALS & SINGLES



Finest Norman custom-built muffler sets - steel pack - torpedo type - heavy, perforated steel cores - chrome enamel finish - mellow, deep tone (improves with use) - designed to fit - all ways superior - double economy.

DUALS.....\$17.50 SINGLES.....\$7.50
V-8 Ford-Mercury Buick, Olds., Chrys.
SINGLES.....\$5.50 ORDER TODAY! Will outlast three ordinary mufflers.
Chev., Ford, Plym.

Dealers—Write Today for Full Details

NORMAN'S MUSICAL MUFFLERS

Dept. PM-5, 1216 W. Slauson Ave., Los Angeles 44, Calif.

LEARN TO WRITE



FOR BUSINESS AND SOCIAL SUCCESS!

Easy to improve your handwriting at home quickly with my new instruction books just off the press. Master all the secrets of better penmanship. Simple and easy, fully illustrated, highly endorsed. Begin today. Write for: New Free Book, "How to Become a Good Penman," or check books wanted, \$1.00 each. Business Writing Artistic Writing Card Writing Engraving Alphabets Bird and Design Flourishing Complete Set \$4.50 Enclose 10c for your name beautifully written and special penpoint for shaded writing.
S. A. Ziller, President, TAMBLYN SCHOOL OF PENMANSHIP
441 Ridge Bldg. In Business Over 52 Years Kansas City, Mo., U.S.A.

Learn Public Speaking

Learn theory and fundamentals at home—in spare time. Then acquire actual experience and practice. Send for FREE booklet "Power of Effective Speech."

North American School, Dept. 1359
1315 S. Michigan Ave., Chicago 5, Illinois

HAVE YOUR OWN BUSINESS!

Operate pleasant, profitable Silk Screen Printing Shop. NO experience needed. Work at home in spare room or basement. Big demand! Large profits! Few dollars starts you. Start small, grow big. Real future possibilities! Eye-opening literature FREE.

W. E. WOLFF CO., 817 High St., Anderson, Indiana

Enjoy

WORLD'S MOST FASCINATING HOBBY! SEND FOR FULLY ILLUSTRATED BOOK TODAY!



GET THE FACTS on model railroading! Leading authority shows how easily, inexpensively you can join in the absorbing hobby enjoyed by thousands of mechanics, business and professional men. Scale model railroads look, perform like the real thing!

GET STARTED NOW! Send 10¢, coin or stamps, for fully illustrated booklet, "Model Railroading for You".

MODEL RAILROADER MAGAZINE
Dept. 1512 Milwaukee 3, Wisconsin

WAR SURPLUS OPTICAL BARGAINS

ASSEMBLE YOUR OWN BINOCULARS!

Complete Optics! Complete Metal Parts!
Save More Than 1/2 Regular Cost



GOVERNMENT'S 7X 50 BINOCULARS

Complete Optics, new and ready for assembly. We supply full instructions. Limit—1 Set of Metal Parts and 1 Set of Optics to a customer.

METAL PARTS—Set includes all Metal Parts—completely finished—for assembly of 7X 50 Binoculars. No machining required. Bodies have been factory hinged and covered. A sturdy Binocular Carrying Case is optional with each set of Metal Parts.

Stock #842-H.....\$39.40 Postpaid, plus \$4.80 for Case—Total \$44.20

OPTICS—Set includes all Lenses and Prisms you need for assembling 7X 50 Binoculars. These are in excellent condition—perfect or near-perfect—and have new low reflection coating.

Stock #5102-H.....\$25.00 Postpaid
NOTICE! If you buy both Binocular Optics and Binocular Metal Parts, add 20% Federal Excise Tax to above prices.

ARMY'S 6X 30 BINOCULARS

No Carrying Case with any Sets shown below. M-13A1 sets are waterproof model. M-3 sets are not waterproof.

COMPLETE OPTICS & METAL PARTS—Model M-13A1, 6X 30 Binoculars. Everything you need—ready for assembly. When finished will look like a regular factory job costing \$102 to \$120. The Optics are new, in perfect or near-perfect condition. Have new low reflection coating. Metal Parts are new and perfect, all completely finished. No machining required. Bodies factory hinged and covered. Complete assembly instructions included.

Stock #830-H.....\$40.00 Postpaid plus \$8.00 tax—Total—\$48.00

COMPLETE OPTICS & METAL PARTS—Model M-3, 6X 30 Binoculars. The Optics in this set are new, perfect or near-perfect. Prisms have new low reflection coating. Factory mounted Eye Piece and Objective Assemblies not coated. Metal Parts are perfect, new, ready for assembly. When finished, this will look like a regular factory job, except a name has been filed off a cover plate. No machining required. Bodies factory hinged and covered.

Stock #831-H.....\$35.00 Postpaid, plus \$7.00 Tax—Total—\$42.00

METAL PARTS ONLY—Model M-13A1, 6X 30 Binoculars. No Optics. Same Metal Parts as described for Stock #830-H.

Stock #832-H 6X 30 Metal Parts.....\$25.00 Postpaid

OPTICS FOR 6X 30 BINOCULARS (No Metal Parts). Perfect, and low reflection coated.

Stock #5130-H.....\$15.00 Postpaid

SAME OPTICS AS ABOVE (6X 30), Coated—but slight seconds.

Stock #5124-H.....\$12.75 Postpaid

If you buy both the Binocular Optics and the Binocular Metal Parts, your purchase becomes subject to 20% Federal Excise Tax. Be sure to add amount covering tax to your remittance or your order cannot be filled.

Optics and Metal Parts are Available for Monoculars (1/2 a Binocular). For Complete Details, Write for Bulletin #14-H

\$15.00 BUYS A \$500.00 TELESCOPE WITH BIG 3" OBJECTIVE



3 power instrument, brand new with plastic Optics and fixed focus. Objective Lens has F.L. of 14.9". 23" long. Wt. 31 lbs. Wide field of view.

Stock #929-H.....\$15.00 f.o.b. Chicago, Ill. (Shipping Wt. about 70 lbs.)

35 MM. KODACHROME PROJECTING LENS SET—Consists of Achromatic Lens for projecting, plus a Condensing Lens and piece of Heat Absorbing Glass with directions.

Stock #4025-H.....\$1.95 Postpaid

SATISFACTION GUARANTEED

NEVER HAS THERE BEEN SUCH A SENSATIONAL BARGAIN AS THIS!

BUBBLE SEXTANT—TYPE A-10

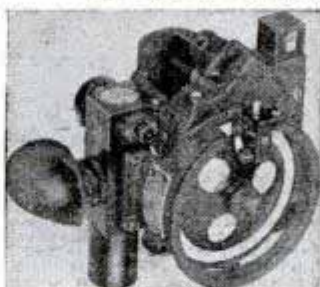

These Army Air Forces Bubble Sextants cost the Govt. about \$125.00 each. A real bargain at our price of \$12.50! Included with Bubble Sextant shipment is wooden Carrying Case, 5 spare waxed paper discs, flashlight with rheostat for night use (uses ordinary flashlight cells—not furnished) aux. 2-power Galilean Telescope, Allen wrench, 1 spare marking point. War-time used, but where necessary completely repaired, collimated and put in good working order.

If not satisfied that Sextant is exactly as represented, return within 10 days and money will be refunded. Full directions for use accompany each shipment.

Stock #924-H.....\$12.50 Postpaid

TYPE A-10A, BRAND NEW! Same SEXTANT as above, but new and with Automatic Electric Averaging Device and Illuminated Averaging Disc for nighttime use. Govt. cost \$217. Though brand new we have re-checked Bubble and Collimation and GUARANTEE perfect working order.

Stock #933-H.....\$22.50 Postpaid

CONDENSING LENSES—Seconds, but suitable for Enlargers and Spotlights.

Stock #1061-H, 6 1/2" dia., 9" F.L.....\$2.50 Postpaid

Stock #1082-H, 4 1/2" dia., 5 1/2" F.L.....70c Postpaid

We have a Limited Quantity of Condensing Lenses—seconds—ranging from 4 1/2" to 8 1/2" in dia. with various focal lengths. Send for Free Bulletin titled "MISCELLANEOUS CONDENSING LENSES—H."

POLARIZING VARIABLE DENSITY ATTACHMENT FOR BINOCULARS

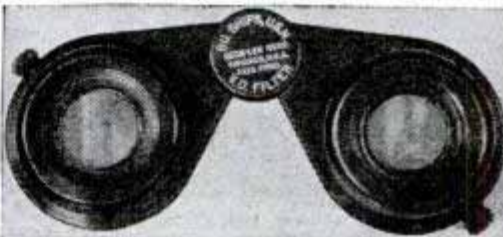

An amazingly effective unit for controlling amount of light reaching your eyes. Cuts down glare in sky and over-water observations. Easily snapped on and off over the eye cups of American-made 7X50 Binoculars. Govt. cost \$8.30 each.

Stock #20,000-H.....\$2.00 Postpaid

Above Polarizing Attachment also adaptable to Govt. 6X30 Binoculars with substitution of special Eye-cups.

Stock #20,010-H, 6X30 Eye-cups.....75c pr. Postpaid



MOUNTED PROJECTING LENS SYSTEM

F.L. 91.44 mm. (just right for 35 mm. Projectors). Speed of F 1.9. Outside dia. of mount at one end 60 mm. Length of mount 64 mm.

Stock #4033-H.....\$3.00 Postpaid

MOUNT FOR ABOVE PROJECTING LENS SYSTEM

Stock #715-H.....\$1.50 Postpaid

LENS CLEANING TISSUE—1st quality, sheet size 11" x 7 1/2". Made to Govt. specs. Won't dust. Free of abrasives and lint.

Stock #721-H, 500 sheets.....\$1.00 Postpaid

SCHMIDT OPTICAL SYSTEM. Black plastic body, size 3-15/16" by 5 1/2". F.L. 2.4" with amazing speed of F.0.9. Used in Navy's Infra-Red Sniperscope and Signalling Units. Govt. cost \$134.

Stock #720-H.....\$6.00 Postpaid

AIR FORCES GUN SIGHT—With Polarizing Variable Density Attachment. (Polarizing attachment alone is worth many times the price of entire unit.)

Stock #908-H.....\$5.00 Postpaid

Same Unit Without Polarizing Attachment

Stock #916-H.....\$2.50 Postpaid

We have literally millions of war surplus lenses and prisms for sale at bargain prices. Write for Catalog "H"—Sent Free!

Order by Stock No.

EDMUND SALVAGE CO.,

P. O. Audubon, New Jersey



"I'M SITTING ON TOP OF THE WORLD"

"I'm sitting on top of the world."

This is the story of hundreds of New York Institute Home Study graduates who tell us of their success in photography. Studying at home in their spare time, these ambitious men and women found profitable work which they really enjoy doing.

The N.Y.I. Home Study Course is prepared by famous authorities. The faculty of America's oldest and largest photographic school gives you constant guidance to speed you to professional perfection in photography. The lessons are crammed with facts in clear, beautifully illustrated, easy to read, easy to understand form.

You need no previous experience — no expensive equipment. "Know-how" will help you earn while you learn. Many students have made enough while studying to pay for the cost of the course and to buy equipment to start their own photographic business.

FREE! Write today for our big colorful book of photos by America's camera aces showing EVERY phase of photography.

NOTE: Resident training is available under the G. I. Bill.

Leadership Since 1910

NEW YORK INSTITUTE OF PHOTOGRAPHY

10 West 33 Street

New York 1, N. Y.

New York Institute of Photography
Dept. 49, 10 West 33 Street
New York 1, New York
Please send me your beautiful four-color catalog illustrating all the different phases of photography and describing the N.Y.I. Home Study Course.

Name _____ (Please Print)
Address _____
City _____ Zone _____ State _____

NOW! Build Your Future On DIESEL Opportunities

LOOK around you. See the way tractors, trucks, buses, railroads, ships, power plants and equipment of many kinds are "going Diesel." Every day new opportunities are opening—in industrial and farming communities — for trained men who can install, maintain, operate and repair Diesel engines. Plan now to build your future in this growing field.

Diesel Knowledge is Earning Power

You don't have to give up your present job. Now, you can begin learning DIESEL in spare time at home. UEI practical training teaches you, step by step, how Diesel engines operate, how fuel systems work, repairs, accessories and auxiliary equipment; a world of Diesel "know how." Includes actual practice on Diesel equipment in our shop under expert guidance. UEI training methods are successful. For 20 years they have helped mechanically inclined men better themselves.

NOW IT'S UP TO YOU!

Coupon below brings you all the facts without cost or obligation. Get going today! MAIL COUPON NOW.

UTILITIES ENGINEERING INSTITUTE Diesel Division
2521 Sheffield Ave.
Dept. 1127-D,
Chicago 14, Ill.



UTILITIES ENGINEERING INSTITUTE, Diesel Division
2521 Sheffield Ave., Dept. 1127-D, Chicago 14, Ill.
Please send me Free Facts about Diesel opportunities and training.

NAME _____ Age _____
ADDRESS _____
CITY _____ Zone or County _____ STATE _____
 Check here for special information if you are under 17.
 Check here if Veteran of World War II.

LEARN the

LETTER SHOP



and DIRECT ADVERTISING Business

You can quickly learn this interesting, profitable business from A to Z via our thorough, easy-to-understand HOME-TRAINING, in your spare time. An ideal business for men or women, or husbands and wives, of all ages.

You can start with very little capital in your own home, or, take a well-paid job, if you prefer. Every business man, firm, club, church, etc., in your community is a prospective customer. Write for our FREE BOOK-LET giving complete details about the opportunities in this wide open field, TODAY.

Write TODAY for our FREE BOOKLET

ARMSTRONG SCHOOLS

7217 SO. BROADWAY, DEPT. P-112
LOS ANGELES 3, CALIF.

5 COURSES TO SUCCESS

CLASSES ENROLLED MONTHLY
Time-saving practical courses—day and evenings. Approved for G.I. Training. Free Placement Service
Write for FREE CATALOG

TOOL and DIE DESIGNING
MECHANICAL DRAFTING
ARCHITECTURAL DRAFTING
INDUSTRIAL PROD. DESIGNING
AUTOMATIC SCREW MACHINE ENGINEERING Cam Design Layout and Estimating

MIDWESTERN TECHNICAL INSTITUTE

431 S. Wabash, Auditorium Bldg., Dept. XB, Chicago 5, Ill.

ONE-MAN SAWMILL LESS THAN \$200.00

Easy To Turn Trees Into Money

Makes lumber, ties, shingles, crates, lath, studding, siding.



Belsaw Models in 10 to 24 foot sawing lengths.

MECHANICAL FEED, accurate set works and positive dogs. Use tractor or old auto engine for low cost power.

Thousands used for commercial sawing. Pays for itself quickly. Send post card today for FREE booklet, "How To Make Lumber" and Catalog of Woodworking Equipment.

BELSAW MACHINERY CO., 2811V Field Bldg., 315 Westport Road Kansas City 2, Mo.

LEARN MEAT CUTTING At Home — In Spare Time



Get into the vital meat industry. Concise, practical Home Training based on 25 years proven instruction methods used at National's famous resident school. Prepares you for bigger pay as Meat Cutter, Supervisor, market manager or more money in your own store. Go as rapidly as your spare time permits. Diploma. Start NOW to turn your spare hours into money. Send for FREE bulletin today. No obligation.

National School of Meat Cutting, Inc., Div. U-88, Toledo 4, Ohio

RACING CAR EQUIPMENT FOR ALL CARS

Engines, Racing Heads, Manifolds, Carburetors, Mufflers, etc. Speed Instructions and literature \$1.00—refunded first order.

LEE MOTORCRAFT CO. 1412 Great Northern Bldg. Chicago, Ill.

ITALIAN ACCORDIONS

Hand Made. Very Best. Lowest Prices. Buy Direct from Factory Representative and Save Money. Send Name and Address for FREE catalog.

ITALIAN ACCORDION MFG. CO. 7600 Cottage Grove Ave., Dept. PM-12, Chicago 19, Ill.

FREE! FREE! FREE! For NEW VIGOR—STRENGTH—VITALITY...

Mail this coupon now

PM-1147

Alan Stephan, Post Office Box 1080, Chicago 90, Ill. Send me, free and without any obligation, your booklet, "Presenting Mr. America . . . Alan Stephan."

NAME _____
ADDRESS _____ CITY _____
STATE _____ DATE OF BIRTH _____

For Greater Income

LEARN A TRADE



- ✓ Auto Mechanics
- ✓ Body-Fender Repair
- ✓ Diesel Engines
- ✓ Refrigeration
- ✓ Air Conditioning
- ✓ Electricity
- ✓ Electronics
- ✓ Radio Servicing
- ✓ Building Construction

The years ahead are going to be big. Grow with them. Prepare now to get into a great, growing industry. Train with C.T.I. — a Nationally Known School. Get the benefits of our efficient Placement Service whether you want a better job or business of your own. You can come directly to our big, well equipped shops, located only a block from the shores of Lake Michigan — or you can begin your training at home by C.T.I.'s SHOP-PROVED HOME TRAINING METHODS. Fill out coupon — mail it today for big, illustrated FREE booklet.

VETERANS!

C.T.I. courses are approved under the G.I. Bill. Just Mail Coupon, we'll handle all details. (Low tuition, easy terms if you are not a veteran.)

FREE BOOKLET



Commercial Trades Institute
Dept. E-212
1400 W. GREENLEAF
CHICAGO 26, ILL.

FILL OUT · CUT OUT · MAIL TODAY!

FACTS FREE FOR MEN WHO WANT TO GET AHEAD

COMMERCIAL TRADES INSTITUTE, Dept. E-212
1400 W. Greenleaf, Chicago 26, Ill.

Send free illustrated Brochures and other information about the field I have checked below.

- | | |
|---|---|
| <input type="checkbox"/> Refrigeration and Air Conditioning | <input type="checkbox"/> Automotive Mechanics |
| <input type="checkbox"/> Electricity | <input type="checkbox"/> Diesel Mechanics |
| <input type="checkbox"/> Radio Servicing | <input type="checkbox"/> Body & Fender Rebuilding |
| | <input type="checkbox"/> Building Construction |

Name _____

Address _____

City _____

State _____

Veteran

Non-Veteran

LEARN MOVIE THEATRE MANAGEMENT

The Motion Picture Theatre Business offers big opportunities for trained men. Get into a fascinating field with a promising future. Train at home in spare time. Free Catalog. Established 20 years.
THEATRE SCHOOL, 370 Washington St., Elmira, New York



HOW'S YOUR PENMANSHIP? If poor, I'll Guarantee to correct it to your satisfaction in 10 days with my definite Hand Controls — No failures. Write, OZMENT, 34-R, St. Louis, Mo.

35¢ CAN MAKE YOU A SUCCESS



Learn the Secrets of Making a Radio Shop Pay

-If you are in business or plan to open a radio shop or store

YOU NEED THIS BOOK

200 pages of practical advice and information, to help you make a go of it. This book was prepared by recognized authorities in cooperation with the Radio Manufacturers Association. Learn from the experience of others.

Get this big, valuable Book **RIGHT NOW**

35¢ POST PAID

CONTENTS: Business For Yourself — Selecting a Location — Building, Equipment, Layout — Buying — Sources of Supply — Receiving and Stocking — Retail Salesmanship — Advertising and Sales Promotion — Window and Interior Display — Repair Services — Record Keeping.

SPECIAL FREE 60-Page "Radio Repairmen's Price Guide" packed with Olson Bargains in parts and equipment. Just check the coupon!

CLIP & MAIL TODAY!



OLSON RADIO WAREHOUSE, inc.
73 E. MILL STREET, Dept. 114, AKRON, O.

- | | |
|--|---|
| <input type="checkbox"/> I have a Service Shop. | <input type="checkbox"/> I am an Amateur or Experimenter. |
| <input type="checkbox"/> Send me the Book on Operating a Shop. I enclose 35c. | |
| <input type="checkbox"/> Send me the FREE Olson "Radio Repairmen's Price Guide." | |

NAME _____ PLEASE PRINT

ADDRESS _____ PLEASE PRINT

CITY _____ STATE _____

RUPTURED?

PAY NO MONEY! \$3.50 FOR THIS TRUSS

To all who try Newer Rupture Relief Method

All you do is try a Doctor's invention for reducible rupture in the privacy of your own home on our trial plan. Easy and comfortable to wear. Has no leg straps—no elastic belts—no leather bands. Holds rupture UP and IN. If for any reason you do not like it, return it within 30 days but keep the special \$3.50 Truss. It's our gift to you for making the trial. Write today for free measurement service and trial offer.
PHYSICIAN'S APPLIANCE CO.
2906 Main Kansas City 8, Mo.



Hands Never Touch the Water—Can be put in Boiling Water. Housewives Like It.

48" Long Handle

Sales QUICK, EASY Every Locality

SALES ARE EVERYWHERE . . . Sells quick to Taverns, Clubs, Hotels, Hospitals, Stores, Restaurants, Large and Small Buildings and the Homes . . . Scores can be sold on a single street . . . Note the Drain Bracket in the illustration . . . This squeezes out the water so thoroughly that HANDS NEVER TOUCH THE WATER . . . Makes no difference what you ever sold, you will like this proposition . . . Your name on a Post Card will bring you FREE PARTICULARS.

CELL-U-MOP CO., Dept.P-12, FREEPORT, Ill.

... Quick Easy Way to BIG PROFITS

Read What Others Are DOING!

"Enclosed you will find 56 orders representing 9 1/2 hours' work on Monday and Tuesday."
 "Enclosed are twelve orders secured after supper this p.m."

Housewives are Enthusiastic

Everyone that sees this outstanding Cell-U-Mop immediately wants one . . . That's the reason why our distributors are so successful . . . You also have the advantage of our other QUICK SELLING PRODUCTS that step up your Volume Sales and Profits.

• We Teach You How •

Gets down under and around for MOPPING, DUSTING or WASHING

DOES THE WORK OF 6 TOOLS IN 1

Get Choice Territory NOW!

Holds 20 times its weight in water.



AIR RIFLES BENJAMIN AIR PISTOLS

PIONEERS - LEADERS

SEND FOR FREE FOLDER OF LATEST MODELS TODAY
 If you want a REAL GUN for PRACTICAL USE inside or outdoors get a SAFE - CLEAN - ECONOMICAL - BENJAMIN with Adjustable Power and Amazing Accuracy. For BEST RESULTS use BENJAMIN H-C PELLETS. WRITE AT ONCE. BENJAMIN AIR RIFLE CO., 812 MARION ST., ST. LOUIS 4, MO.

Raise GOLDEN HAMSTERS

The new wonder animals from Syria. Look like Toy Red Bears. Delightful pets. Everybody wants them. Thousands needed by laboratories. Make money, get started now. Send 10c for illustrated literature, or send \$5 for a pair of hamsters and literature.
GULF HAMSTERY, 1536 BASIL ST., MOBILE 17, ALA.

INVENTORS

The inventor who believes he has a new and useful invention, and finds himself in need of advice, should consult a competent registered patent attorney or agent.

The question as to whether a subject matter is patentable can be substantially determined by a search of the United States Patent records.

Without obligation, write us for information as to what steps an inventor should take to secure a Patent.

RANDOLPH & BEAVERS

Registered Patent Attorneys

11-D Columbian Bldg., Washington 1, D. C.

RANDOLPH & BEAVERS

11-D Columbian Bldg., Washington 1, D. C.

Please send me full information on how to secure Patent Protection.

Name.....
 Street.....
 City.....State.....

PATENTS

TRADE MARKS • COPYRIGHTS
 • **Saulsbury, Russell & Squire** •
 Registered Patent Attorneys
 55 WEST 42nd ST., NEW YORK 18 • WAtkins 9-9194

PATENTS

"Proof of Invention" Folder mailed without obligation.
E. E. VROOMAN, Registered Patent Atty.
 871 Woodward Building, Washington 5, D. C.

PATENTS AND TRADE MARKS

C. A. SNOW & CO.

REGISTERED PATENT ATTORNEYS
 WRITE FOR INFORMATION TO
 428 SNOW BUILDING, WASHINGTON 1, D. C.

SAY YOU SAW IT IN POPULAR MECHANICS

INVENTORS

If you wish to protect your invention, you should take steps to protect it by a U. S. Patent. Write me for "Record of Invention" Form.

CARL MILLER REGISTERED PATENT ATTORNEY

Woolworth Bldg., 35th Floor, Dept. 127A, New York City
 Please send me "Record of Invention" form.

NAME.....
 ADDRESS.....

LEARN TO WRITE

Beautifully

BE AN EXPERT PENMAN — NO TEACHER NECESSARY

RIGHT in your own home you can learn to write a most beautiful hand in an amazingly short time. New, simplified method. It is simply astounding how quickly you can master this new idea in becoming an expert penman. Your friends will be amazed when they see your artistic penmanship. Method originated by J. D. Rice, who for forty-two years was head of Penmanship Dept., Chillicothe, Mo., Business College. Contains same type material as expensive courses yet costs you only \$2.95 postpaid, complete with special pens for shaded writing. Send for your course RIGHT NOW. Money back if not satisfied.

EDUCATIONAL PUBLISHERS

Dept. P-104 7241 Madison St. Kansas City 5, Mo.

MAKE MONEY CASTING AT HOME FREE FACTS SENT



Cast thousands of perfect Plaques, Book Ends, Ash Trays, Etc. Plaster, Liquid Marble, Etc. ENORMOUS PROFITS. Start in basement or garage. LITTLE CAPITAL NEEDED. QUICK, EASY, NO PREVIOUS EXPERIENCE NEEDED. Rubber molds for speed production. MAKE YOUR OWN. Sample Kit \$1.00. Canadian \$1.50. Plastic Arts Studio, Route 5, Dept. 29, Muncie, Ind.

Hollywood Experts Help You Make Good in RADIO-TELEVISION at Home

Direct from Hollywood, nerve-center of broadcasting, Television, Radio and Sound activities, comes R-T-A's time-proven and tested home training. Here at last—easy to learn, home instruction that quickly qualifies you for steady, good-pay jobs or your own Radio business. 10 big kits of radio parts given at no extra charge. Get full details at once! Send postal for FREE BOOK "How to Make Good in Radio-Television." R-T-A APPROVED FOR VETERANS.

RADIO TRAINING ASS'N OF AMERICA, Dept. PM12
5620 Hollywood Blvd. Hollywood 28, Calif.

Be an Investigator!

Our course in scientific crime detection may be studied in the quiet of your own home. Investigation training course written and supervised by former U. S. Government Investigator. Write today for full particulars and free booklet. No obligation whatever. PACIFIC SCHOOLS, INC.

601 S. VERMONT AVE., DEPT. M-1 LOS ANGELES 5, CALIFORNIA

MOTION PICTURE INSTRUCTION
LEARN AT HOME

Professional instruction in Hollywood. Business, Free Lance, and Educational film technique. Personal supervision by authorities. For career or hobby, write today for FREE CATALOG.

MOTION PICTURE INSTITUTE • BIRMINGHAM 14, MICHIGAN
APPROVED FOR VETERANS UNDER G.I. BILL

Stromberg WINTER LAYERS

SILVER LACED WYANDOTTES. Breeders strictly selected, PULLORUM TESTED. Specializing in Large Type, Pedigreed Sired WHITE LEGHORNS and High Production WHITE ROCKS, 22 leading varieties. Also Started Chicks & Ducklings. FREE CATALOG. Stromberg Hatchery, Dept. #13, Ft. Dodge, Iowa



THIS IS THE BUSINESS YOU DREAM ABOUT

QUICK STEADY PROFITS

CORADIO

The Coin Operated Radio

IT'S the new, fast-growing, depression-proof business. Coin operated radios are

placed in hotels, tourist courts, clubs, hospitals, etc. on a commission basis—play 1 or 2 hours for 25c and produce immediate profits. The best coin operated radio is CORADIO

ACT NOW

Start your own lifetime business, full or part time.

Send For Free Catalogue And Complete Information.

WRITE TODAY Dept. P. M.



CORADIO

COIN OPERATED RADIO
108 W. 31st ST. N. Y. 1, N. Y. WISCONSIN 7-5902

HERE'S A NEW AND VITAL BUSINESS!

LEARN ELECTRICAL APPLIANCE REPAIRING

Offers Big Money - Independence

If now employed, start your home appliance repair business NOW in your spare time and be set with a business of your own no matter what happens. Operate from your garage, basement, kitchen, vacant store, etc. Work as many hours as you wish—the home appliance repairman is his own boss. It is a profitable occupation, for on many types of repairs it is not unusual for a repairman to charge on the basis of \$5.00 to \$6.00 per hour! Remember, there are millions of electrical appliances in this country. Appliances such as refrigerators, irons, sewing machines, vacuum cleaners, heaters, toasters, washing machines, motors, etc. To replace them is mighty expensive. That is why the Electrical Appliance Repair Business offers the trained man unlimited earning possibilities.

YOU CAN QUALIFY

All you need to become a successful electrical appliance repairman is ambition plus a little training at home in your spare time. If you are mechanically inclined—that is to say—can hold and use tools, our profusely illustrated course written in simple, easy to understand language will prepare you for the years to come. It does not matter if you have not had a great deal of schooling or have had no previous training along these lines, WE WILL TEACH YOU. Age is no barrier—nor any minor physical handicap.

WE TEACH YOU

Profusely illustrated with photographs and simple drawings we show you what troubles to look for and how to make each repair on an electrical appliance. We give you a good sound working knowledge of electricity, and how to do welding, nickel plating, etc. Our course shows you how to solicit business and keep it coming to you. Not a theory course but an honest to goodness course written by and used by repairmen the country over. Price of course is so low that the savings on your own household appliance repairs will quickly pay for it. Why work for others at the wages they want to pay you? Learn a good trade and operate your own business and determine how long you work each day and the amount of money you make. ACT NOW!

MAIL COUPON TODAY

CHRISTY SUPPLY CO.
2835 N. Central Ave., Dept. D-5203
Chicago 34, Illinois

Please send me free illustrated literature about America's Fastest Growing Industry—ELECTRICAL APPLIANCE REPAIRING.

Name _____

Address _____

City _____ State _____



AUTO BOOKS ON APPROVAL



SEND NO MONEY. Just mail the coupon for a complete set of 4 Big, Thick Auto Books, 20th Edition. Over 2700 Pages! Whether you are a mechanic or helper, expert or apprentice, auto owner or driver, take immediate advantage of this FREE EXAMINATION OFFER.

MAKE GOOD MONEY NOW HOLD A PERMANENT JOB

America wants its automobiles kept in good repair. Men with "know how" are in demand, at big pay. These books will help you get and hold an important job, or give you a chance to go into business for yourself now or later. Any man who half tries to improve himself can learn auto servicing and repairing by this quick reference method. Use the JIFFY INDEX to find easily understood answer to any auto problem. These wonder books prepared by eleven of America's great automobile engineers. Many hundreds of valuable illustrations. Send the coupon TODAY.

A year's consulting privileges with our engineers now given with these books without extra charge.
Vocational Publishers Since 1898

CAN YOU FIX IT?

These wonder books tell step by step HOW to make difficult repairs and adjustments, how to keep a car at maximum efficiency, including latest improvements in car design and operation. Engine troubles and how to correct them well covered.

4 BIG, THICK VOLUMES
Over 2700 Pages, 2000 illustrations, wiring diagrams, etc., including Diesel engines. Beautiful, modernistic, washable cloth binding.

AMERICAN TECHNICAL SOCIETY, Dept. A919
Drexel Ave. at 58th St., Chicago 37, Ill.

I would like to examine your 4-Volume Set of Auto Books. I will pay the delivery charges only, but if I choose I may return them express collect. If after 10 days' use I prefer to keep them, I will send you \$2 and pay the balance at the rate of only \$3 a month until \$24.80 has been paid. Include consulting service as offered above.

Name _____

Address _____

City _____ State _____

Please attach letter stating age, occupation, employer's name and address and name and address of at least one business man as reference. Men in service, also please give home address.

"The Supreme Authority"

in courts, schools, homes, newspapers
and Government offices

The Merriam- WEBSTER

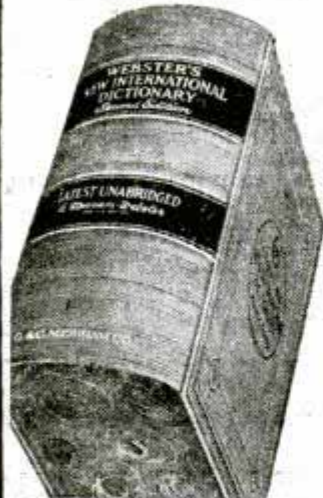

You may have had to wait for a copy of WEBSTER'S NEW INTERNATIONAL DICTIONARY, Second Edition. However, more and more copies are reaching your dealer. See him now. The MERRIAM-Webster contains 3,350 pages, illustrations for 12,000 terms, and a total of 600,000 entries—122,000 more than any other dictionary. It is the only unabridged dictionary completely revised and rewritten in three decades. G. & C. Merriam Co., Springfield 2, Mass.

1847 A CENTURY OF PUBLISHING MERRIAM-WEBSTERS 1947

**WEBSTER'S NEW INTERNATIONAL
DICTIONARY • Second Edition**

MOLDING AND CASTING, ITS TECHNIC AND APPLICATION. 300 pages, 250 illustrations. This book is the outstanding work on the making of molds and casts of every description in various materials. The new edition is completely revised and enlarged. Plaster, Rubber, Agar, Glue, Wax, Liquid Marble, Cement and other substances are described.

METAL CASTING OF SCULPTURE, by Carl D. Clarke, Ph.D. 300 pages, 150 illustrations. A pictorial and written description of step by step processes of producing metal sculpture and ornaments. All necessary formulas are given, including the new vinyl plastic molds. If it's an intricate subject with extensive undercuts, this book tells how to make it in metal.

ILLUSTRATION ITS TECHNIQUE AND APPLICATION TO THE SCIENCES, by Carl D. Clarke, Ph.D. 400 pages, 200 illustrations. This book explains in detail the making of drawings and paintings for scientific text books. New and different techniques are described. It opens new and profitable outlets for the work of the illustrator.

Each book, \$6.50 prepaid. Descriptive circular.

DEPT. A, STANDARD ARTS PRESS
2635 N. CALVERT STREET BALTIMORE 18, MARYLAND

Master Watchmaking

The life-long profitable trade of thousands as taught by the Sweazey System.

"FAMED THE WORLD OVER"

CHICAGO SCHOOL OF WATCHMAKING

Founded in 1908 by Thomas B. Sweazey
1608 N. Milwaukee Ave., Dept. 1127 Chicago 47, Ill.

INVENTIONS

WANTED AT ONCE

Patented or unpatented inventions, all types needed by manufacturers. Write for free booklet "MARKETING YOUR INVENTION" and Protective Disclosure Form. We have a tremendous list of firms who may pay cash or royalties for good inventions. For full particulars, write today.

NATIONAL INVENTION SERVICE
1404 Mitchell Street, Dept. 5 Oakland 1, Calif.

ELECTRICIANS' SCHOOL

HOUSE AND COMMERCIAL WIRING • MOTOR REPAIR
AND REWINDING • ELECTRIC REFRIGERATION

Approved for Veterans Training

PENNSYLVANIA INSTITUTE SCHOOL OF ELECTRICITY

42nd and SPRUCE STS. PHILADELPHIA 4, PENNA.

LAW STUDY AT HOME FOR PERSONAL SUCCESS and LARGER EARNINGS. 39 years expert instruction—over 108,000 students enrolled. LL.B. Degree awarded. All texts furnished. Easy payments. Send for FREE BOOK. G. I. approved.
AMERICAN EXTENSION SCHOOL OF LAW
Dept. 84-M, 646 N. Michigan Ave., Chicago 11, Ill.

RADIO ENGINEERING, Broadcasting, Television, FM, Servicing, Electronics, Aviation, Marine & Police Radio taught thoroughly. Engineering course equivalent to 3 years' college radio work. Approved Veteran Training. Catalog free.
VALPARAISO TECHNICAL INSTITUTE, Dept. D, Valparaiso, Ind.

APTITUDE TESTS discover the kind of work or studies best for your success! You get a personal report—a guide for life—more happiness—more prosperity. For men, women, boys and girls. Write for complete facts.

VOCATIONAL COUNSELING INSTITUTE
956 Maccabees Bldg., Detroit 2, Michigan

LET ANGORA RABBITS GROW YOUR INCOME
Earn up to \$3000.00 a year or more. Wool brings top prices. Plenty markets. Steady cash income. Future prospects bright. Write today for free information, prices and markets.
WHITE'S RABBITRY, Dept. P, Newark, Ohio

RUPTURE!

An amazing Air-Cushion Invention allows body freedom at work or play. Light, neat, cool, sanitary. Durable, cheap. Day and night protection helps Nature support weakened muscles gently but surely. No risk. Sent on Trial! Write NOW for free Booklet and Proof of Results. All correspondence confidential.
Brooks Company, 161-A State St., Marshall, Mich.



BE A PERFUME DISTRIBUTOR

The most sensational profit possibilities in the whole field of selling. 100% year-round demand. Astounding low prices assure you of daily cash profits. Finest perfumes made, exquisite, long lasting fragrances women just can't resist! Men big buyers for gifts—the Christmas trade already starting. Full assortment of beautiful eye-appealing packages!

SELL TO STORES — OR DIRECT

Perfume has no dull season—many millions of dollars' worth sold annually. Get started at once—regular and Christmas profits are waiting for you. **BUT GET STARTED!** Send for free details and samples today!

DUCHESS D'ANDRE

21 W. Illinois St.

Chicago 2, Ill.

ELECTRIC LIGHT JAZZ BOW TIE!

Astonish, amaze your friends. Be the life of the party. Have lots of fun. Easily put on. Flashes on and off by simply pressing battery button hidden in your pocket. Complete with attractive bow tie, cord, two bulbs and battery. Mail your order today. Special prices to dealers.

\$1.95



BERNARD FINE CO., INC.

501 Sixth Ave., Dept. PM7, New York 11, N. Y.

WAR
SURPLUS

BARGAINS

Write for FREE 1947-48 CATALOG

Just Out!

PACIFIC FUR & WOOL CO.

WAR SURPLUS DEPT. Box 926-PM Sacramento, Calif.

RADIO PARTS GRAB BAG!

Over 200 different parts originally valued at \$50.00 including a wide assortment of transformers, coils, condensers, resistors, sockets, controls, etc. A perfect collection for the radio experimenter. Send check or M.O. today.

\$3.98

A
\$50.00
VALUE

MARKO SUPPLY

Dept. P1-R, 2924 Logan Blvd. Chicago 47, Ill.

8MM CINEX MOVIE PROJECTORS

100-150W; Blower; Framer; Precision-Built; \$22.50

BEVERETT CINE CO. • P. O. BOX 675 • CHARLESTON, S. C.

LAWN ORNAMENT-NOVELTY PATTERNS

28 Lawn Ornament Patterns, 25c. Other patterns: 15-20" high; Dutch Girl, Dutch Boy, Pirate, Bull Terrier, Mexican Girl, Mexican Boy, Dwarf, Penguin, Flower Girl, 10c each. 25 Novelty Patterns, 30c. All 62 Full Size Patterns, \$1.00 Postpaid. Strother Pattern Service, Dept. AD-8, Box 383, Belington, W. Va.

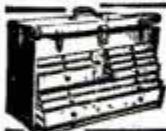

MACHINISTS-TOOLMAKERS

The sturdy structure and the finer finish of Gerstner tool chests always please. Free catalog.

GERSTNER TOOL CHESTS
447-Columbia St., Dayton 7, Ohio.

Say You Saw It in POPULAR MECHANICS

MICROSCOPES SUPPLIES-ACCESSORIES & SCIENTIFIC INSTRUMENTS
B&L SPENCER NEW & USED LEITZ ZEISS
BOUGHT-SOLD-EXCHANGED-REPAIRED
MEDICAL INDUSTRIAL AMATEUR
Send for FREE LIST
NATIONAL SCIENTIFIC INSTRUMENT CO. 119 CHAMBERS ST NY7

It's YOUR future — Make the most of it!



Start now to earn the bigger pay in electrical repair

WAS there ever such an opportunity to get started in electrical maintenance and repair—and at top-notch wages? Are you ready—with experience and ability—to cash in on it? Others are getting just the sort of background needed—quick! practical!—to handle the great variety of electrical maintenance and repair work TODAY—from this well-known electrical library. You can too!

THE LIBRARY OF ELECTRICAL MAINTENANCE AND REPAIR

5 vols., 1826 pages, 1724 illustrations

Gives you the "know-how" to tackle any wiring or motor job. Five books show you HOW—to install all types of motor and generator units—to inspect and repair motor starters and generators—to diagnose motor and generator troubles—to figure new windings for old cores—DC and AC windings—to test armature windings—test induction motors, etc., etc. One book is full of trouble-shooting charts that show quickly symptoms, causes, specific remedies, etc.

Take the first step toward improving YOUR future—Mail this coupon TODAY

No money down—special price—easy payments—FREE trial

McGraw-Hill Book Co., 330 W. 42 St., New York 18, N. Y.

Send me for ten days' free examination the Electrical Maintenance and Repair Library. If satisfactory I will send you \$1.50 in 10 days and \$3.00 monthly until the price of \$16.50 is paid. If not wanted I will return books postpaid. (To insure prompt shipment write plainly and fill in all lines.)

Name.....
Home Address.....
City and State.....
Company.....
Position..... PM-12-47

For MORE MONEY— MORE HAPPINESS

You need this FREE booklet

"HOW TO SUCCEED"

New, fascinating—a tested proven plan to increase your power of leadership—to master obstacles—to make more money—to have more relaxation and contentment.

The result of more than 30 years of research and investigation. Available now for the first time. The author, Eugene J. Bengel, is an outstanding authority on the human problems of business and society. Don't envy a success—Be one.

Fill in coupon now for your FREE copy.

PERSONAL PROGRESS INSTITUTE
Information Division 10-12
20 North Wacker Drive, Chicago 6, Illinois

I want my Free Success booklet.

NAME.....
ADDRESS.....
CITY..... STATE.....



PRACTICAL BOOKS ON HOME PLANNING BUILDING · REPAIRS

MAIL
ORDER
TODAY

Plan Now—Build When You Can
Books Sent C.O.D. Anywhere in U.S.A.

Select from this list of helpful books. In U. S. books sent postpaid if remittance accompanies order. Outside U. S. include 15% extra for shipping charges.

- How to Plan a House. \$5.00
- House Construction Details \$4.00
- Painting, Decorating \$1.75
- Carpentry \$2.50
- Painting, Furniture Finishing and Repairing
Includes floor renewal \$1.50
- How to Remodel a House
Complete, practical. \$5.00
- Building Insulation .. \$4.50
- Concrete Handbook
Do work for yourself, others \$1.50
- Blueprint Reading for Building Trades \$1.50
- Practical Bricklaying. \$2.00
- Simplified Carpentry Estimating \$3.00

FAMOUS PLAN BOOKS

Books contain floor plans, photos, descriptions of homes.

AMERICA'S BEST LOW COST HOMES. 125 designs \$1.00

DE LUXE SMALL HOMES. 210 designs. \$1.00

OUR FUTURE HOME. Wide selection of residences, summer homes, garage apartments. \$1.00

MODERN HOME & GARDENING. 42 popular designs. Improvements, garden short-cuts, etc. \$0.50c

Set of
Four
Books
\$3.50



Stair
Building
\$2.50

POPULAR MECHANICS PRESS

DEPT. 640 • 200 E. ONTARIO STREET, CHICAGO 11

★ ★ ★

MAKE YOUR OWN
POWER TOOLS
at Low Cost
from old Auto Parts, etc.

A New Edition

Featuring TOOLS of WOOD

Now you can have a good lathe, drill press, circular and band saw and other power tools in your home workshop, at a cost of only a few dollars each. Make them yourself from old auto parts, discarded sewing machines and other odds and ends that cost little or nothing. Get this new book—“Forty Power Tools You Can Make.” Costs only \$1.25 postpaid. This book gives every detail in plain language you can understand and follow. Hundreds of pictures and plans show every step to follow in making the power tools you want. Actual photographs of finished machines included. Send \$1.25 today. Money back if not satisfied.



MAKE EVERY POWER TOOL NEEDED IN YOUR HOME WORKSHOP

- Some of the power tools you can make are:
- | | |
|--------------------|------------------------------|
| 2 Band Saws | 2 Drill Presses |
| 9 Sanding Machines | 1 Scroll Saw |
| 2 Circular Saws | 2 Wood Turning Lathes |
| 1 Metal Lathe | 3 Grinders |
| 1 Power Hack Saw | 1 Shaper or Moulding Machine |
| 1 Jig Shears | 1 Vibrating Pencil |
| 1 Cut-Off Wheel | and others |
- Information too, about pulleys, belts, motors and drive methods. Just published. No other book like it. Order today.

POPULAR MECHANICS PRESS

Dept. 621 • 200 E. Ontario Street, Chicago 11

PAY RAISING—EXTRA MONEY BOOKS

Use these books to prepare for a better job—bigger pay—to start a profitable spare time or full time business of your own, improve your home, start a hobby! Popular Mechanics specializes in

supplying outstanding self-help books on many subjects. Send for our FREE catalog.

- Shop Notes for 1948
Now ready. For every man who uses tools \$1.00
- Shop Notes Library
6 Vols.—1948, 47, 46, 45, 44, 42, No Dup. Mat. \$3.50
- Painting, Furniture Finishing and Repairing \$1.50
- Rewinding and Servicing Electric Motors (No. 75) 25c
- Elementary School Subjects for Home Study
Covers high points of grammar, spelling, arithmetic, history, science, geography, etc. 635 pages. \$1.89
- High School Self Taught
Covers 25 subjects with study guide and self-testing quizzes. Completely revised and enlarged edition, 1280 pages, 300 illustrations. \$3.95
- Garden Book
Build own trellises, lawn furniture, fireplaces, ornaments, etc. \$1.00
- Diving, Cutting and Welding in Underwater Salvage Operations
Only book of its kind \$2.00
- Picture Framing
Modern methods for making and painting picture frames. Fully illustrated. \$2.75
- Frog Industry
Breeding, feeding, dressing and marketing \$1.00
- New Fields for the Writer
Television, radio, film, drama \$1.00
- Making Amateur Photography Pay
How and where to sell your pictures \$1.00
- 20 Careers of Tomorrow
Covers plastics, metallurgy, textiles, radio, electronics, television, transportation, chemistry, etc. \$2.50
- Breaking Into Advertising
Into the Freezer and Out
A complete handbook on the home freezing of foods. \$2.50
- Concrete Handbook
New book on using concrete around home, garden, farm \$1.50
- The Vegetable Growing Business \$3.50
- This Way Up
The successful philosophy of practical business men \$2.00
- Welding, Brazing and Soldering
How to build own equipment and how to use it effectively \$1.25
- Modern Refrigeration
Electric, Gas. Be service expert \$5.00
- Dyke's Auto Ency. (includes Diesels, airplane engines)
New 20th Ed. World's greatest book for mechanics \$7.00
- Household Mechanics
The "fix-it" book to end all "fix-it" books. Covers electric appliances, painting, carpentry, etc. \$2.75
- Oil Burner Handbook \$2.50
- Build Your Own Boat
Describes 17 popular boats—rowboats, sailboats, plywood outboard, etc. 192 pages \$1.50
- House Wiring (No. 89) ... 25c
- Turn Scrap Into Money
Convert old auto generators into motors, welders, etc. \$1.00
- Woodworking for Everybody
The first complete book on this subject. Considers tools, explains cutting and shaving of wood, and has 46 useful projects \$2.75

- Sheet Metal Work \$3.00
- Tool and Saw Sharpening (No. 92) 25c
- Forging Practice \$1.50
- Action Toys (No. 66)
Plans for 21 easy-to-make toys 25c
- Foundry Work \$2.25
- Pattern Making
Wood, metal \$2.25
- Forty Power Tools
Build own saw, drill, lathe, sander, etc., from scraps—save money \$1.25
- Carpentry \$2.50
- The Young Craftsman
Over 450 things boys can make \$1.50
- Five Acres and Independence
How to make money on small farm \$2.50
- Your Home and How to Build It
Yours!
Step by step construction of the famous POPULAR MECHANICS house. Wonderfully illustrated \$3.00
- Photo Guide
Construct own equipment, gauges. Make better photos \$1.50
- Knots, Ties and Splices
For everyone who uses rope \$1.25
- Plastics
Latest information on manufacture and use \$5.00
- LeJay Manual of Homemade Electric Equipment
How to construct 100 items that are scarce and valuable \$1.50
- How to Estimate for the Building Trades: Material and labor costs for masonry, plumbing, electricity, carpentry, heating, hardware, painting, etc. 626 pp. \$5.50
- A Small Store and Independence
Guide to successful retailing \$2.50
- Rabbits for Food and Fur \$2.50
- Tool Making \$4.00
- Tool Design \$4.50
- Plumbing Installation & Repair \$2.00
- Ropp's Calculator
Figuring made easy 50c
- Slide Rule Simplified \$2.75
- Drake's Refrigeration Service Manual for Home Builders
All the information you need to know in building a house \$2.50
- How to Remodel A House
Nothing is omitted \$5.00
- Toys You Can Make of Wood \$2.50
- A.B.C. of Poultry Raising \$2.50
- Ice Cream for Small Plants
Some technical formulas for ice cream, ices and frozen desserts on a commercial scale \$2.50
- Furniture Joinery \$2.50
- Essentials of Upholstery \$3.25
- Radio Physics Course
A thorough training in radio fundamentals \$5.00
- Science Digest Reader \$3.00
Fascinating articles on astronomy, atomic energy, psychology, medicine, etc. \$3.00

MAIL THIS COUPON TODAY

Check the books you want, write your name and address below, and mail this advertisement with money order or check. Outside U. S. A. include 15% additional for shipping charges.

Books selected will be mailed promptly on our "money back if you're not entirely satisfied" guarantee.

Name _____

Address _____

City _____ State _____

Mail to POPULAR MECHANICS PRESS

Dept. 650—200 East Ontario St., Chicago 11, Ill.

Learn These 20 DISABLING WAR JUDO BLOWS

—from **BARNEY COSNECK**, War-Time U.S. Coast Guard JUDO Trainer!

These blows work IMMEDIATELY. Protect yourself and loved ones from bullies—even if you're small. WIN RESPECT and ADMIRATION. No practice or training necessary. These blows really work—RIGHT NOW. **BARNEY COSNECK**, U.S. Coast Guard War-Time JUDO INSTRUCTOR, learned restricted JUDO from Japs before the war. Now he offers you his amazing 20 DISABLING WAR JUDO BLOWS (many until recently kept a secret) for only \$1. postpaid. Each clearly explained and illustrated with actual photographs. **MONEY-BACK GUARANTEE!** If not satisfied, return lessons within 5 days, and money will be refunded. Send only \$1 now! **WARNING! DON'T BE CARELESS WITH THESE BLOWS!**

BARNEY COSNECK

208 N. Grand Blvd. Dept. B-1
St. Louis 3, Mo.



FLOYD CLYMER'S unbiased book

"INDEPENDENT TEST REPORT ON KAISER-FRAZER CARS"

Read what 3000 owners now think of their K-F cars. Expert, part-by-part analysis. 100 photos. Tells all. 3000-mile test run, Pike's Peak closed car record, gas mileage. Thousands are buying. Order now. \$1.50 postpaid. \$2.50 deluxe ed. Cash, money-order, or specify C. O. D. Money-back guarantee. Clymer, Publisher, Dept. P.M. 2125 W. Pico, Los Angeles 6, Calif.

Make Up to \$1,000 a Month Own Your Own Business Now!

Make more money the modern way. Send for FREE bulletin No. 10A for details on the Modern Lawn Mower Sharpener.

MODERN MANUFACTURING COMPANY

160 N. FAIR OAKS PASADENA, CAL.

CANVAS COVERS Waterproof tarpaulins, war surplus (Used), perfect condition. Originally made for tents. Approx. 5'x8'. Two buttoned together make approx. 80 sq. ft. Complete with buttons attached. Suitable for use as canvas dams, hay covers, truck covers, machinery and equipment covers, etc. Packed in bales 40 each, priced 40 covers, \$1.00 ea.; 15 covers, \$1.50 ea. Less than 15, \$1.75 ea. All FOB, Kansas City.

AMERICAN SUPPLY CO.

329 W. 5th Dept. P. M. Kansas City, Mo.

SENSATIONAL VALUES IN WATCHES, DIAMONDS, JEWELRY! New and reconditioned ladies and gents **NATIONALLY KNOWN** and **GUARANTEED** wrist and pocket watches.

Prices start from \$7.25

Send for our FREE 1948 WHOLESALE CATALOGUE immediately.

ARPEL JEWELERS, 316 Washington Square Bldg., Dept. M 7th and Chestnut Sts. Philadelphia 6, Pa.



HOW to Make ART OBJECTS with RUBBER MOLDS

NOW READY FOR FIRST TIME Natural Rubber Latex FOR BETTER MOLDS

NEW MOLDING MANUAL 10c

MOLD MAKERS: Get superior natural rubber molding compound at new low prices. Natural Rubber gives you best physical properties; 70% concentration, high elasticity, freedom from permanent set, unusual elongation. Use **FRANCIS** Natural Rubber Red Latex to make longer-lasting molds. At our reduced prices, you can produce more and better casts per mold, at lower cost. New Illustrated Instruction Manual, showing how to mold and produce valuable novelties, gifts, accessories, mailed for only 10c (stamps or coin). Price list free.

FRANCIS SUPPLY COMPANY

Dept. P-2, 1836 East Fulton Street, Columbus 9, Ohio.



GOOD JOB BIG PAY



E. J. SWEENEY 87,675 men have come to E. J. Sweeney Schools—WHY?

nished. YOU LEARN BY DOING — PRACTICALLY. We can prove to you the UNLIMITED OPPORTUNITIES for you NOW in getting into a SPECIALIZED TRADE THAT PAYS TOP MONEY. Your future success depends on proper training — and getting into a business that is NOT overcrowded. Get the FREE PROOF, the full particulars about this most amazing opportunity for a quick, BIG PAY JOB. Do it today — mail coupon below NOW.

APPROVED for VETERANS TRAINING Under P.L. 346 and P.L. 16

SWEENEY AUTO SCHOOL, Inc.
Dept. 16, 2901 East 14th St. Kansas City 1, Mo.

SEND NOW FOR FULL DETAILS!

E. J. Sweeney, President, Sweeney Auto School, Inc.
Dept. 16, 2901 East 14th St., Kansas City 1, Mo.

Name _____
Address or RFD. _____
City _____ State _____
 Veteran Non-Veteran

WAR SURPLUS BARGAIN SPECIAL

BRAND NEW! VACUUM-AIR HYDRAULIC GENERAL PURPOSE PUMP

Original Cost \$45.00

Now Only

\$9.95

Postpaid in U.S.A.

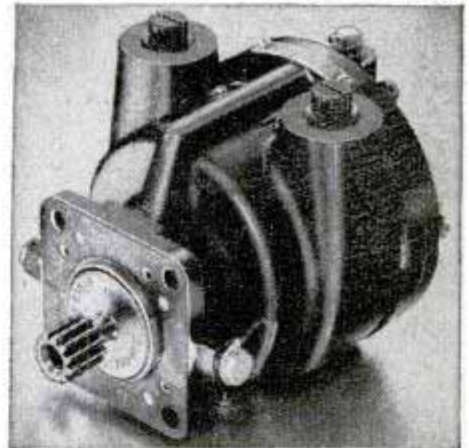

WORTH MANY TIMES THIS LOW SALE PRICE

USE THEM FOR OIL BURNERS

SPRAYING MACHINES

MILKING MACHINES

COMPRESSORS

VACUUM PUMPS

HYDRAULIC SYSTEMS

MANURE LOADERS

PRESSES, etc.

● Originally cost \$45.00. Used by the Air Corps to drive bomber de-icer boots, gyroscopes, automatic pilots, etc. May be used as air or fluid pump—for pressure or vacuum. Standard 3/8 inch pipe thread with interchangeable ports. Will pump 7 1/2 gal. SAE 30 oil per minute at 300 RPM. Builds air pressure of 30 lbs. per sq. in. at 1000 RPM. Vacuum will draw 26 inches of mercury at 1750 RPM. Develops up to 120 lbs. per sq. inch of hydraulic pressure, which in conjunction with a 3 inch hydraulic cylinder, will lift 840 lbs. minimum. Runs forward or reverse. Self-aligning shaft. Die cast aluminum housing 6x4x4 inches. Has stainless alloy steel vanes and impeller. Made by Bendix Avia, Corp. Spline terminal for direct drive—readily replaced with a pulley. Recommend a 1/4 H.P. or stronger electric motor as source of power. Rated capacity 1500 RPM with high overload factor. Special price for quantity users. Complete illustrated report and instruction booklet FREE with every pump. Send check or money order today. Postpaid in U.S.A.

\$9.95

GROBAN SUPPLY CO. 1522 So. Michigan Avenue Dept. PM 12, Chicago 5, Ill.

112 Booklets filled with Money and Time-Saving Helps

Little Library of Useful INFORMATION

5 for \$1.00
12 for \$2.00
25¢ Each

Here at amazingly low cost is the practical help and information you have always wanted. Articles in previous issues of Popular Mechanics have been classified according to subject and are now available in these handy reprint booklets. Check Titles wanted, clip ad and mail today.

* 1947 titles.

WORKSHOP EQUIPMENT

- Power-Driven Saws—74:** Complete details on scrollsaw, two circular saws, sliding cut-off saw, bandsaw.
- Drill Presses, Plane, Grinders—79.**
- Sanders—80:** Complete constructional details on 8 useful machines.
- Wood & Metal-Turning Lathes—81:** Two wood lathes, small metal-turning lathe.
- Filing Machine, Hacksaw, Cutoff Wheel, Shaper—82.**
- Metal Lathe Tools You Can Make—101.**
- Workbenches & Tool Cabinets—47.**
- Spray Painting—94:** Constructing spray guns, compressor, using spray gun.
- From Pattern to Casting—91:** How to make your own patterns and small castings.
- *Handy Farm Implements—114:** Grain elevator, dump truck, spreader and cover.
- *Tractor Attachments—116:** Buckrake, stacker, scoop, auger and spray attachment.
- *How to Build a Concrete Block Machine—110.**

SHARPENING—USING TOOLS

- Correct Measurement—106:** How to use micrometers, gauges, calipers, etc.
- Tool and Saw Sharpening—92.**
- Using & Sharpening Drills & Wood Bits—90.**
- Successful Wood Turning—32:** All the information you need to master this art.
- How to Read Blueprints—71:** Tells you how to understand signs, symbols, and lines.
- Metal Turning Lathe Kinks—99:** Simple homemade tools, time and labor-saving shortcuts you can use.
- Operating a Metal Turning Lathe—100.**
- Heat Treating & Case Hardening—102.**
- Working with Glass—103:** Cutting, drilling, etching, blowing.
- *Using Basic Tools—120:** How to use hammer, files, screwdriver, and cold chisel.

ELECTRICAL BOOKLETS

- Rewinding & Servicing Electric Motors—75:** Repairing and rewinding a.c. and d.c. motors. Locating trouble. Converting auto generators into 110 v. a. c. motors.
- House Wiring—89:** All the information you need to do a complete wiring job or install extra outlets.
- Electromagnets & Solenoids—44:** Designing and building.
- Transformer Construction—41:** Easy-to-understand instructions for all transformers.
- The Boy Electrician—43:** Easy-to-build motors, experiments.
- Soldering & Brazing—17.**
- Arc & Spot Welders—5:** Building and operating 110 v. a. c. arc and spot welders.
- Electroplating with Copper, Nickel, Chromium, Lead, Zinc, Cadmium—86.**
- Plating Leather & Other Non-Metallic Objects—Plating with Gold, Silver, Alloys—87.**
- *How to Fix Electrical Appliances—111:** Repairing clocks, washing machines, vacuum cleaners, electric irons, cords, small motors, etc.

HOME IMPROVEMENT BOOKLETS

- Simple Home Improvements—104:** Modernizing; making storm sash, ironing boards, etc.
- Building Extra Rooms in Attic—23.**
- Attractive Basement Playrooms—24.**
- Lower Your Fuel Cost—31:** Practical kinks that will save you hundreds of dollars.

- Hanging Wallpaper—38:** Tricks of hanging wallpaper, removing old paper, etc.
- Curing Leaky Basements—45:**
- Fitting Home Game Room—55:** Construct own game & tennis tables, shuffleboard court, action game, portable playrooms.
- Ridding the Home of Insect Pests—107:** Exterminating and protecting against moths, flies, termites, mosquitos, etc.
- Built-in Fixtures—78:** Step and space-saving kitchen units, built-in beds, corner cabinets, vanities, linen chest.
- Constructing Indoor & Outdoor Fireplaces—88:** Stone fireplaces, portable mantels, garden fireplaces.
- *Painting Your House Inside and Out—117.**

GARDENING BOOKLETS

- Backyard Gardening—39:** Selecting, planning and getting the best results.
- Lawn & Garden Novelties—72:** Jig-sawed ornaments, parkway numbers, sundials, flower boxes.
- Trellises, Pergolas, Fences—76.**
- Lawn & Garden Furniture—77:** Modern bent-tube furniture, arbor and seat combinations, swings, lawn chairs.
- Playground Equipment—73:** Two playhouses, ferris wheel, roller coaster, treadmill, play store, slide, two merry-go-rounds.
- Colored Concrete Garden Furniture—6:** Garden benches, ottomans, flower boxes, bird baths and sundial pedestals in colored concrete. How to build small concrete mixer.
- Bird Houses—7:** Easy to build homes for all kinds of birds.
- Farm & Garden Tractors—8:** Two tractors you can build from old automobile parts.

CRAFT WORK—HOBBY BOOKLETS

- Working with Plastics—61:** Using brilliant-colored plastics in craftwork.
- Magazine Racks—49:** Ten attractive racks.
- Clock Cases—50:** Large Hall, Colonial wall and mantel, ship's wheel, miniature grandfather, desk, Spanish style banjo.
- Serving Trays for Every Occasion—53:** Fourteen different designs.
- Children's Room Furniture—51:** Twelve attractive pieces.
- Book Ends—52:** Ten designs offer good selection.
- Small Tables—54.**
- Smoking Stands—56:** Seven designs given.
- Jigsawed Novelties—57:** Sewing kits, string holders, place-card holders, plywood kitchenware, plant and flower holders, coin banks.
- Desks—58:** Colonial writing desk, two modern-type desks, student's study desk of plywood, combined chest and writing desk.
- Book Cases—59:** Eight designs.
- Doll House & Doll Furniture—60.**
- 25 Shelves You Can Make—64.**
- Novelties Turned on Lathe—62.**
- Inlay Pictures—Veneering—63.**
- Whittling and Wood & Soap Carving—65.**
- Action Toys—66:** 21 easy-to-make toys.
- High Flying Kites—67.**
- Windmills & Weathervanes—68.**
- Lamps in Wood, Metal, Plastic—69:** Selection of 14 designs.
- Metal Craft—28:** Brass tapping and making of novelties both decorative and useful.
- Small Looms—37:** Building hand looms for weaving rugs, etc.; leather novelties.
- Plain & Novelty Wood Finishing—40.**
- Gem Cutting—42:** How to cut and polish semi-precious stones.

- Rustic Furniture—18:** How to build chairs, benches, tables, gates, summer house, etc.
- *Projects in Plastics—112.**
- *Stows and Crossbows—115.**
- *Marionettes—113:** Designing and operating puppets, how to build stage and backdrops.

BOAT BUILDING BOOKLETS

- Build a boat at home—you can do it**
- 14 Ft. Outboard Runabout—21:** Here is a fast 14 foot V-bottom boat. Suitable for motors of 4 to 24 hp., estimated cost, \$30 to \$40.
- 14 Ft. Sailing Dinghy—26:** This 14-foot boat combines strength and light weight. It carries 140 sq. ft. of canvas and weighs about 350 pounds. Actual photographs and diagrams illustrate every detail.
- 21 Ft. Sloop—46:** Every fact needed by the amateur boat builder to construct this craft which carries eight to ten persons.
- Rowboats, Bicycle Boat, Small Dinghy—83.**
- Small Sail Boats—84:** 12-ft. sailing dinghy, 6-ft. "training ship" for young sailors, how to sail a boat.
- Two Outboard Runabouts—85:** 14-PL. family outboard weighs about 400 lbs. and 12-ft. plywood outboard weighs about 110 lbs. Both are V-bottom type.
- Build Your Own Canoe, Kayak, Surfboard—30:** Complete details on 16-ft. Canadian-type canoe, 17-ft. kayak, and 12-ft. hollow surfboard.
- Fast Class-E Ice Yacht—22:** Build your own Class-E ice yacht.

AUTOMOBILE BOOKLETS

- Automobile Kinks and Shortcuts—10:** Money-saving hints on upkeep, operation.
- Building Trailers—27:** Small streamlined house trailer; several utility trailers.
- Motor-Driven Midget Car & Scooter—34:** Both use gas engine of washing machine type.
- Curing Auto Electrical Troubles—95.**
- *House Trailer—121:** Complete instructions and diagrams for building modern 17 ft. trailer.

PHOTOGRAPHY BOOKLETS

- Photo Enlargers—1:** Condenser lens type; simple vertical; horizontal.
- Photo Printers & Dryer—25:** Describes three practical printers, timer and negative dryer.
- Photo Darkroom Equipment—96:** Cabinets, light-tight box, timer, agitator, washer.
- Picture Projector, Trick & Table Top Photography—97:** Projectors that enlarge magazine illustrations and shop drawings. Tips for table topers, photomontages, tricks.
- Photo Kinks—98:** All time and money-saving ideas you can use.
- *Photo Lighting—119.**
- *Home Movie Equipment—118:** Converting projector to sound, making titles, film cleaner, projector stand.

FORMULA BOOKLETS

- Cleaning Preparations—11:** Easy-to-make cleaners for walls, glass, etc. Removing fabric stains.
- Cosmetic Formulas—12:** Hand lotions, creams, rouge, bath salts, beauty clay, lipsticks, etc.
- Re-Silvering Mirrors—70:** Formulas for silvering and coloring.

MISCELLANEOUS BOOKLETS

- Knots and Ropework—105.**
- Chemical Experiments—93:** Easy-to-perform experiments. Inexpensive lab.
- Taxidermy—9:** How to prepare skins and obtain life-like poses.
- Log Cabins & Tourists Cottages—14:** Year-round log cabins; inexpensive tourists' cabins.
- Magic for Everybody—29:** Simple tricks to muzzle your friends.
- Trapping Small Animals—33:** How to lure fur bearers, prepare bait and traps, dress skins.
- Tricks of Training Your Dog—35.**
- Small Furnaces—36:** Gas or electric.
- Telescopes—20:** Design and construction.
- Poultry Houses—108:** Structures, brooders and incubators.
- Guns and Decoys—109:** Cleaning, shooting; making decoys.

POPULAR MECHANICS PRESS,
200 E. Ontario St., Chicago 11, Ill.

I enclose (U. S. bills may be mailed if carefully wrapped)
for "Little Library" booklets numbers:

.....

.....

Name

Address

City

State

DIESEL

OR

AUTOMOTIVE

TUNE-UP

SPECIALIST

EXPERT



be **ONE** or **BOTH**...the

YOU CAN TRAIN TO BE A DIESEL SPECIALIST or an **AUTOMOTIVE TUNE-UP EXPERT**—or **BOTH**—the famous **HEMPHILL SCHOOLS WAY**. Here are the highlights of these two practical, intensive courses. **READ THIS PAGE**—then **SEND FOR COMPLETE DETAILS!**

HEMPHILL DIESEL TRAINING available to you at home. You can study by means of up-to-date **HOME STUDY COURSE**. Gives theory of Diesel engines, their operation and maintenance. Lessons are simple, easy to understand, fully illustrated by drawings and photographs. Diesels are supplying more and more of the power in transportation, trucking, shipping, power plants, agriculture, logging, construction and other industries. This means greater opportunities for trained Diesel men.

HEMPHILL DIESEL RESIDENT SCHOOL TRAINING available to you in large, well-equipped shops at Los Angeles, California; New York and Memphis, Tennessee. Get the best Diesel training available at America's pioneer Diesel schools under expert instructors.

HEMPHILL AUTO TUNE-UP COURSE available to you in Los Angeles and Memphis. You learn practical modern methods of automotive trouble shooting, ignition and electrical system service and repair, carburetion, etc., on modern equipment. Here is a short, intensive course to quickly qualify you for this well-paid opportunity field. **BE AN AUTOMOTIVE TUNE-UP SPECIALIST!**



This streamliner is "going places" on Diesel power. How about you?

HEMPHILL SCHOOLS HOME STUDY AND RESIDENT COURSES APPROVED FOR VETERANS—AVAILABLE FOR NON-VETERANS ON EASY PAYMENT PLAN

MAIL COUPON TODAY—Get Free Literature

Hemphill Diesel & Automotive Schools
1601 S. Western Ave., Dept. PM-12-7, Los Angeles 6, California

Please send me, without obligation, complete information on your Diesel Courses, Home Study
OR attend school in Los Angeles Memphis New York
Auto Tune-up Course, Los Angeles Memphis

Name.....Veteran Non-Veteran
Street..... Zone.....
City..... State.....

COOK WITH GAS in CAMP OR ANYWHERE!

NEW, SAFE, ALL-ALUMINUM SPORT-O-STOVE

IDEAL FOR A XMAS GIFT!

—Makes and Burns Its Own Gas from Liquefied Petroleum—Obtainable Anywhere!

Next time you go on an outing—take along a SPORT-O-STOVE. Cook your favorite dishes easily and quickly with gas. SPORT-O-STOVE makes and burns its own gas from low-cost, approved liquefied petroleum, known also as Butane, Propane or bottled gas; obtainable practically anywhere. Simply strike a match—turn a knob—and light it instantly, like a kitchen gas stove. NO gathering wood. NO pumping or priming. NO smoke, odor, grease or sooty pots. Has 2 burners. Cooks meal for about one cent. Fuel Cylinder holds about week's supply—refills at cost of approx. only 50c. Weighs only 9 lbs. Compact—only 5"x12"x22" in size. All-Aluminum—easy to keep bright and clean—will not rust or corrode. **10 DAYS TRIAL!**—Try SPORT-O-STOVE 10 days. Then if not satisfied, return in good condition and your money will be refunded under **MONEY-BACK GUARANTEE.** SPORT-O-STOVE, less Fuel Cylinder and Connections, \$16.50, postpaid. SPORT-O-STOVE, complete with Fuel Cylinder and Connections, \$31.75, postpaid. 9-lb. Fuel Cylinder and Connections, alone, \$15.25, postpaid. Extra 9-lb. Cylinder alone, \$9.95, postpaid. 25% deposit required on C.O.D. orders. Order with Coupon at right NOW!

DEALERS WANTED!
Write for liberal Dealer Proposition

INTERNATIONAL METAL PRODUCTS CO.
3550 Vista Ave.; Dept. B-12 St. Louis 4, Mo.



Complies with National Safety Requirements

ONLY \$16.50 Post-paid
Less Fuel Cylinder & Connections

Tastier Outdoor Meals—
Quicker, Easier • At Low Cost!

ORDER WITH THIS COUPON!

International Metal Products Co., Dept. B-12
3550 Vista Ave.; St. Louis 4, Missouri

Dear Sirs: Please send SPORT-O-STOVE and (or) Equipment as indicated below. Enclosed is \$_____ as full payment.
 Enclosed is \$_____ as 25% deposit; send C.O.D. \$31.75, Postpaid.
 SPORT-O-STOVE, less Fuel Cylinder and Connections (\$16.50, Postpaid).
 9-lb. Fuel Cylinder and Connections alone, (\$15.25, Postpaid).
 Extra 9-lb. Cylinder alone (\$9.95, Postpaid).

NAME _____

ADDRESS _____

TOWN _____

STATE _____



Learn modern watch and clock repairing

At home, spare time. Good field now... security and contentment in future. Start part-time business and **EARN** while you learn. Horology is precision instrument work... a great and growing field; sensational opportunities. Easy self-instruction course. Full price, only \$4.95. **SEND NO MONEY.** Just

pay postman, plus C.O.D. postage. Or send \$4.95 with order, we'll ship postpaid. Satisfaction guaranteed or refund.

NELSON-HALL CO.

1139 S. Wabash Ave., Dept. M02

Chicago 5, Ill.

Liquid Plastic PROJECT MANUAL



NOW ONLY 25¢

Now make many swell articles with **CASTO-LITE**, amazing New Liquid Plastic. Embed flowers, butterflies, medals, photos. Make jewelry, figurines, gears, parts, models, toys. Can be sawed, drilled, carved, turned. Use home tools. New home project manual now ready. Shows how to get into fascinating, completely new field. Have fun, earn money. Send 25¢ today for your copy. **THE CASTOLITE COMPANY,** Dept. P-1, Box 211, Kenilworth, Ill.

Say You Saw It in
POPULAR MECHANICS



For the amateur and professional artist and sculptor. Giving detailed study of every part of the body.

"The Book They're Talking About"

Contains over 300 illustrations, charts and notes

ART ANATOMY OF THE HUMAN FIGURE

MALE AND FEMALE, POSED AND IN ACTION

(Sent in plain wrapper.) Outside of U. S. A. Send \$1.25

MAJOR BOOK CO., Dept. 420-A, Lynbrook, New York

ONLY \$1.00

Now a DYNAMIC Industrial Transformer Type Super Charged WELDER

FOR AUTO, HOME APPLIANCE AND FARM REPAIRS

DESIGNED TO DO HIGH GRADE WELDING inexpensively—Maintenance Men, Farmers, Mechanics, Machine Shops, Foundries, Auto, General Repair and Job Welding Shops, all using the DYNAMIC find it so indispensable and useful that they can't afford to be without it. **EASY-TO-OPERATE.** If inexperienced you can easily learn to do a variety of high grade welding jobs by following the practical, *simplified Welding and Operating instructions furnished.* Once you see the DYNAMIC in operation you won't want to be without it. Its simplicity will amaze you. In a year the DYNAMIC only costs you about 7c a day. Comes complete ready to operate with helmet, rods, cable, holder, operating and welding instructions, etc.

AN IDEAL AND PRACTICAL GIFT FOR ANY MAN SAVES YOU VALUABLE TIME AND MONEY

This portable, industrial transformer type *Dynamic Welder* easily carried right to the job can be operated from any convenient properly wired 110 Volt 60 Cycle Line. **WORKS ON IRON, STEEL, BRASS, BRONZE and Other Metals.** Has 8 metallic and carbon arc heat stages. Does work you would think only possible with a larger more expensive machine... Can also be supplied for 220 VOLT 60 CYCLE operation and other voltages and cycles at slight additional cost.

DYNAMIC WELDER CO., 13 East 23rd Street, RR, CHICAGO 16, ILL.

FOR ONLY \$2850 COMPLETE

DO YOUR OWN WELDING

Just a few repair jobs will pay for this machine. A practical and profitable machine tool for any workshop. Make money doing repair work for others.

Write for Particulars Get Details on our 10 day Trial Offer Member Chicago Association of Commerce.



**U. S. SURPLUS BARGAIN
ALL RUBBER SUIT
USE AS A SUIT or CUT APART
FOR WADERS, BOOTS, GLOVES
RAIN CAPE, etc.**



**NOW ONLY
\$4.95**

AMAZING VALUE

Just released by the U. S. NAVY, these heavy duty rubber overboard suits made by Good-year and other famous rubber companies are a sensational buy for sportsmen and all who work in or on the water.

FOR TRAPPERS, FISHERMEN AND ALL WHO WORK IN THE WATER

Trappers with muskrat lines can use these suits "as is" for working on or below the waterline. Also ideal for cassion workers, ditch and trench workers, commercial fishermen, dam workers, etc. Suit may be cut up to make waist or hip waders for surf and river fishing. Suit slips over your regular clothes and shoes. Take-up straps at ankles and wrists provide snug fit. Heavy, solid boots give good traction on stones, etc.

FIRST TIME AT THIS LOW PRICE

These fine rubber suits originally cost many times this low price. They are all brand new and guaranteed in perfect condition. They are a sensational value at this low price.

YOU GET ALL THESE IN ONE SUIT

ARM LENGTH RUBBER GLOVES

You can cut at shoulder for heavy duty arm or elbow length full fingered rubber gloves. These heavy duty gloves alone are worth the price of the complete outfit.



A RAIN CAPE AND PARKA

Just cut off anywhere below the shoulder line and — presto — you have a valuable rain cape and parka. Wear it over your regular rain coat in stormy weather.



HIP HIGH WADERS

Just look at this value. Hip high waders, heavy duty type, too, for only \$4.95. Just cut off as shown, tape the edges and you have as fine a pair of hip high waders as you could find anywhere, and you can wear them right over your regular shoes.



TOP QUALITY WAIST HIGH WADERS

Here is a value for river and surf fishermen that defies competition. Waist high waders—even arm high waders if you want them. Use the suit as is—or cut it up as shown—any way you do it, it's a value you can't afford to pass. Get your order off today.

**Orig. Cost Approx. \$45.00
NOW**

\$4.95

EXPRESS COLLECT



Rush Your Order Today

STARK'S BRING YOU THE BIG VALUES IN SURPLUS and other BARGAINS!

**15 JEWEL—ELGIN MOVEMENT
STOP WATCH**

Built to rigid U. S. Army Air Corps specifications by Elgin Watch Co. Guaranteed 15 jewel movement. Stem wind, stem start, stem stop and stem reset. Graduated in 1/10th seconds—10 seconds to one revolution. Use it for time study work, industrial timing, sporting events, racing—for everything that wants split second timing. Used but guaranteed perfect. Original cost was \$18.75. You save approximately one-half at this special price. Order today. Safe delivery guaranteed. **No. 200 EACH..... \$9.95**



FUR LINED WINTER FLYING BOOTS

Gov't. type A-6. Best buy for fishing, hunting, trapping and outdoor working or driving in the coldest weather. Genuine shearing full fur lining. Rubber outers and zipper closure. Heavy soles for safe traction. They'll give you years of service. State shoe size when ordering. Used but renovated—ready for re-issue. **No. 369 EACH..... \$5.95**

TYPE A2 HORSEHIDE JACKET

The leather coat buy of the year! Brand new Army Air Force Type A2 with full length zipper, shoulder straps, knitted waist band and wrists and full satin lining. Finest horsehide — finest tailoring. Order by chest size. **Shp. wt. 5 lbs. \$19.95**
No. 201 EACH.....



DECORATIVE CHROME STRIPS

For your car, boat, furniture, etc. Highly polished chrome finished strips with clinched edges for flush mounting to any surface. The 3 pound kit provides approx. 15 pieces in lengths from 6 inches to 3 feet and average 3/4 inches wide. Wgt. 4 lbs. **\$2.00**
No. R224 3 lbs. ONLY.....



ROOT COUNTERS

Three wheel type—counts to 999 and repeats. Geared shaft and may be replaced with a pulley to regulate counting speed. Has hundreds of uses. All brand new. A splendid value. Shipping weight 1 lb. **98c**
No. 241 EACH.....



Aviators FLIGHT PANTS

Stay toasty warm in the coldest weather! High pile, heavy nap genuine alpaca lining—heavy twill outer material and pockets everywhere, at knees, thigh, hips and back. All brand new. Use them for skiing, hunting, fishing. Use them for work, driving, farming, etc. Biggest bargain in warmth and comfort you ever bought. Large, medium, small sizes. Cost the Government approximately \$22.50. **\$4.88**
No. 371 PAIR.....

Satisfaction guaranteed. Send cash with order or 25% deposit, balance C.O.D. Include postage to cover. Ask for your copy of the big Stark catalog. A post card will bring it.

**STARK'S 509 So. State Street
Dept. PM 12 CHICAGO 5, ILL.**



R. J. Reynolds Tobacco Co., Winston-Salem, N. C.

You're sure to please with
PRINCE ALBERT
 SMOKING TOBACCO

Look at this colorful, Christmas-wrapped pound tin of crimp cut Prince Albert Smoking Tobacco. It's all ready to say "Merry Christmas" to Dad, to Brother—to any man who enjoys choice tobacco—in his pipe—or in roll-your-own cigarettes. P. A. is rich tasting, mild, and easy on the tongue. Yes, you're *sure* to please with P. A.!

MORE PIPES SMOKE PRINCE ALBERT THAN ANY OTHER TOBACCO



THE NATIONAL JOY SMOKE



How Fast Can Man FLY— and LIVE?

WHEN AN AIRPLANE travels at the speed of sound, what happens to the pilot? Is the shock wave painful to him? What is "supersonic sickness?"

Aviation needs to know the answers to such questions almost at once, for aircraft that may pierce the sound wall are under construction. Pilot safety is one of the unknowns in transsonic flight.

Some people suspect that vibrations from the shock wave, penetrating the cockpit, will sicken and nauseate the pilot. Others theorize that ultrasonic vibrations, such as are employed to homogenize liquids and to kill bacteria, will be set up and that they will disorganize the pilot's senses.

Aeromedical research men don't believe that either of these extremes is likely, but they are trying to anticipate all such possibilities so that preventive measures against harm to the pilot can be taken.

Already some curious things have happened to humans who fly fast. Pilots have landed with swollen

Pilots in the Skystreak, above, wear an energy absorbing helmet, special harness, G-suit and an oxygen mask



By Thomas E. Stimson, Jr.

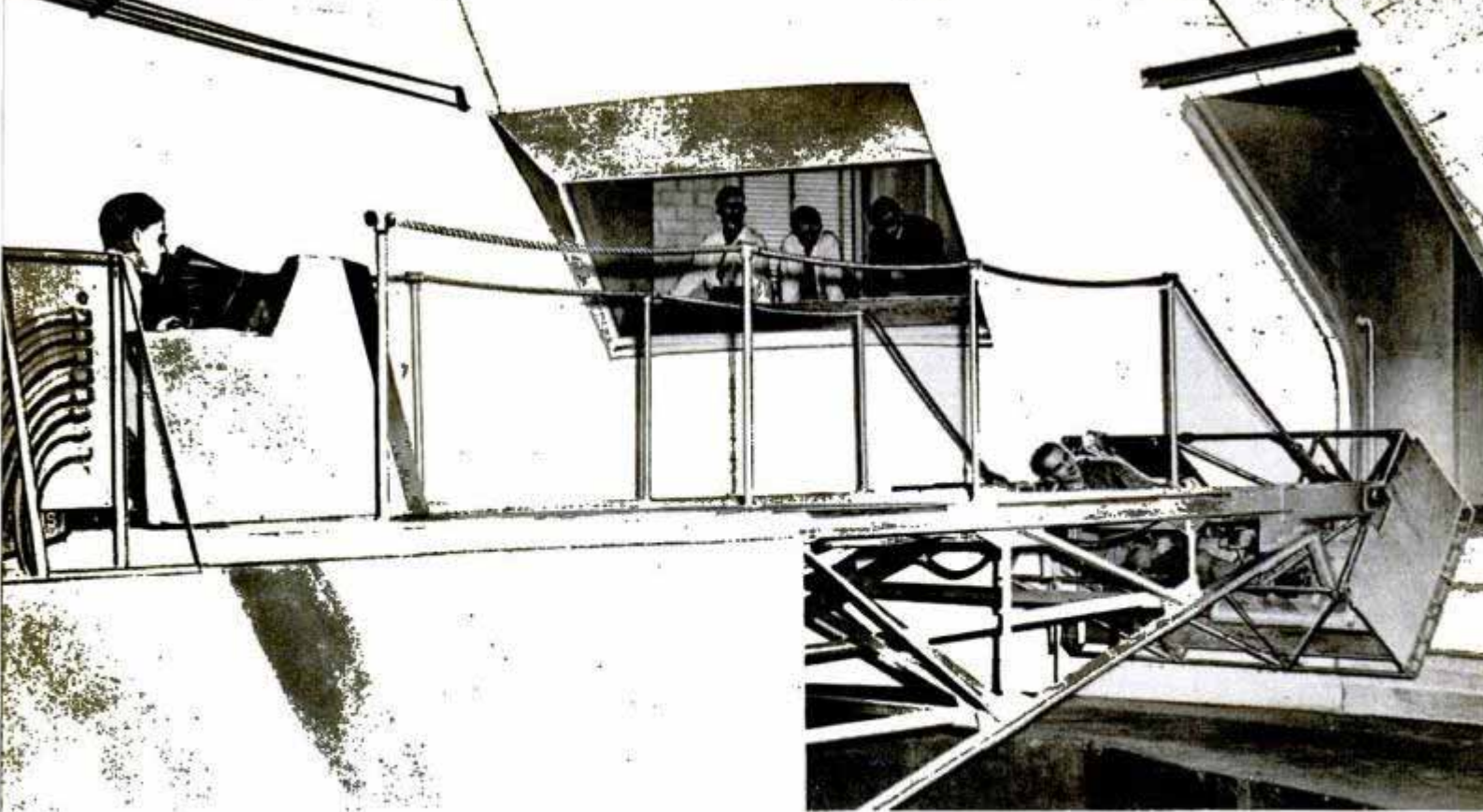

To test their ability to stand high accelerations, pilots are whirled around in this huge human centrifuge

ears and their heads battered black and blue. Some have acquired high fevers in the air, others lost weight from dehydration.

Mysterious as these symptoms appear to be, they are easy to understand and prevent. Swollen ears and black and blue marks come from the pommeling that a pilot receives when he flies through rough air at high speed. A safety belt holds his body to the seat but his head is slammed from side to side and against the rear bulkhead. His ears and skull take a beating.

A new energy-absorbing helmet that contains a thick layer of cellular cellulose acetate is one possible remedy. The acetate crushes under impact of crashes and rebounds during milder impact instead of transmitting the blow. A cup-like depression in the rear bulkhead against which the pilot rests his head is another remedy.

Pilots have had fevers as high as 105 degrees when their cockpits became superheated from friction with the air during speed runs. Similarly, dehydration has occurred in hot, dry weather when the incoming ventilation air sucked too much moisture from a pilot's body. Both conditions are avoided in today's fastest aircraft by means of air conditioners that hold cockpit temperature and humidity to comfortable levels.

Recently a pilot making a low altitude training run in the Navy's record-breaking Douglas Skystreak found his controls had become so hot that he could hardly touch them. The temperature had climbed to 170 degrees because he had accidentally

switched off the air conditioner. Of this heat, 80 degrees were contributed by the temperature of the outside air, 10 degrees by solar radiation, 10 degrees by indirect heat from the jet engine, and 70 degrees by the friction of the plane as it moved through the air.

Science knows that there is nothing harmful to humans in high speed itself; the dangers lie in excessive acceleration and deceleration and in the incidental energies created by the vehicle, mostly in the forms of heat, vibration and noise. A pilot can become incompetent or incapacitated if he absorbs too much of these forces for too long. Lumped together they produce the so-called "supersonic sickness." Even passengers on a medium-speed air liner become nervous and irritable if too much

In actual flight this pilot would be plunging into space instead of onto soft, sponge-rubber padding, as the nose breaks off to facilitate high-speed escape

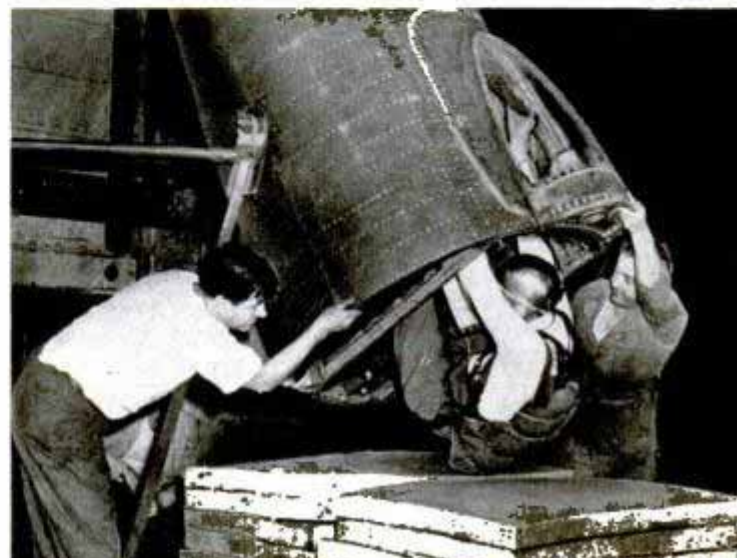



What 6 Gs (six times the force of gravity) does to the pilot. Automatic camera records, right, how his lips and facial muscles are pulled down by the force. Tests were made in giant centrifuge at the University of Southern California

Plate glass replaced original plastic canopy of Skystreak because of frictional heat

noise and vibration are present in flight.

The engineers who design aircraft aren't able to remedy such conditions all by themselves; neither are the men who specialize in aviation medicine. But when the two groups collaborate they can expect to find practical answers to almost any such problems. Douglas Aircraft Company, as one instance of this, now retains Dr. Charles Lombard of the University of Southern California's division of aviation medicine as consultant in "human engineering."

How to protect fighter pilots from injury in a crash, how to avoid "explosive decompression" when a pilot must bail out of his pressurized cockpit at high altitude, how to augment the range of human vision for the high speeds now being anticipated, how to maintain pilot efficiency at extreme and abrupt high Gs—these are some of the most spectacular of the current problems.

In spite of all the research that has been done on acceleration, for instance, much more information is needed. The subject is complex. In addition to take-off acceleration and the deceleration, such as occurs in braking, there are also the so-called positive maneuver acceleration and negative maneuver acceleration. Positive maneuver acceleration is the force exerted on the pilot in such maneuvers as pull-outs and inside loops. These blackout the pilot by draining the blood away from his head.

Negative maneuver acceleration is the opposite, as in an outside loop, and causes the blood to rush toward the head and chest. One of the problems is how to protect a pilot against negative acceleration in the same way that one of the present G-suits guards against positive acceleration.

A pilot seated upright can tolerate considerable positive acceleration but comparatively little of the negative type. Lying

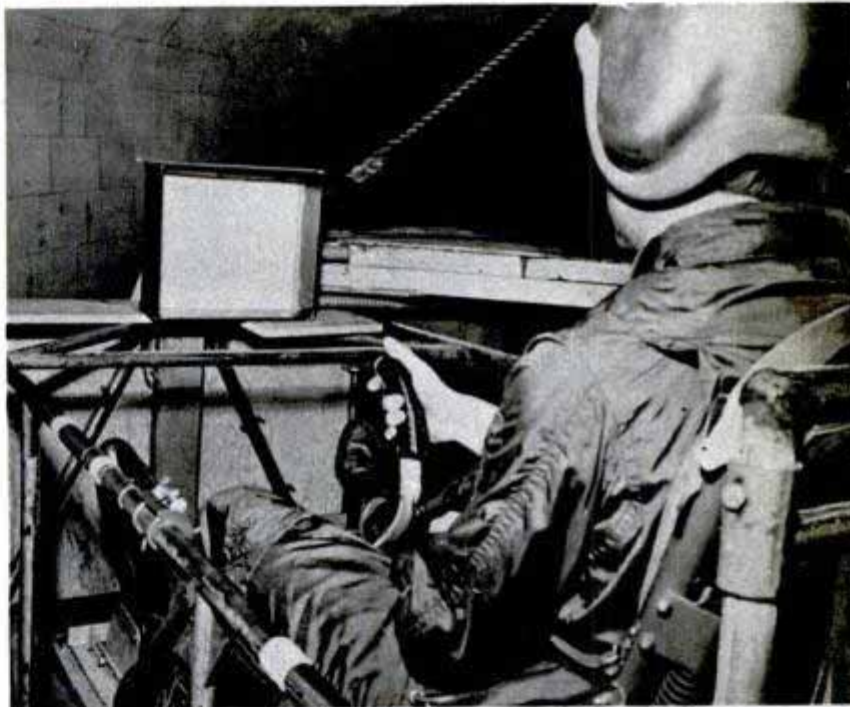

Pilot reaction time under extreme G stress is determined by speed with which he can respond to flight pictures flashed on screen in front of the cockpit

prone, he can tolerate large amounts of both positive and negative G, but has little resistance against the deceleration of slowing down from high speeds or crashes.

These studies are complicated by the time factor. High G that would kill or incapacitate a man when continued over a period of seconds may have little effect on him if it exists only for a fraction of a second. Tremendous deceleration, such as the impact of a crash, may impose a force of 40 or 50 Gs or even more on a pilot. But because this continues only for a few thousandths of a second a pilot who is protected by harness and helmet often is able to walk away from the wreck.

Basic data on all types of G are being



1. TAKE-OFF ACCELERATION



2. POSITIVE ACCELERATION (INSIDE LOOP)
BLOOD DRAINS FROM PILOT'S HEAD



3. NEGATIVE ACCELERATION (OUTSIDE LOOP)
BLOOD RUSHES TO PILOT'S HEAD



4. DECELERATION (BRAKING)

Amounts of acceleration that can be safely tolerated for 10 seconds (by an experienced test pilot wearing protective gear) in various altitudes. The G (gravity) capacities below are keyed to maneuvers shown above



SEATED UPRIGHT

1. 12 Gs
2. 7 "
3. 2½-3 "
4. 12 "



SEMI-SUPINE

1. 3 Gs
2. 8-9 "
3. 3-3½ "
4. 10 "



SUPINE

1. 2 Gs
2. 12 "
3. 12 "
4. 6-7 "



SEMI-PRONE

1. 8-9 Gs
2. 10 "
3. 3+ "
4. 10 "



PRONE

1. 7 Gs
2. 12 "
3. 12 "
4. 2½-3 "

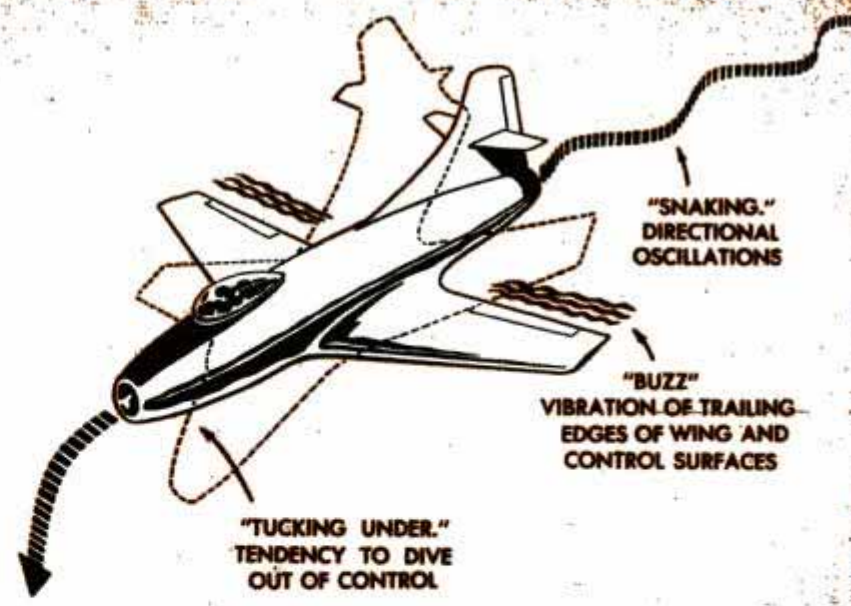

Effects of compressibility on aircraft in the transonic range. These tendencies are believed to disappear at higher speeds

gathered by Dr. Lombard and his associates under contract with the Office of Naval Research, using the \$100,000 human centrifuge that was built at the University of Southern California during the war. Pilots are tested on the huge whirligig at different G levels for different lengths of time, in different positions and under various conditions. Blood pressures, X-rays, reaction time, reflexes and other measurements are automatically recorded during the tests. Included is the testing for new designs of G-suits and other anti-acceleration apparatus.

Some problems of safety and comfort can't be completely solved on the ground. These are to be studied by means of the Skystreak and its two identical sister planes that were built to serve as high-speed laboratories for testing men, materials and design.

When Douglas engineers designed the Skystreak, they incorporated in it all the latest ideas in pilot safety. Projections and protruding knobs in the cockpit were eliminated. The cockpit seat was shaped so that the pilot is close to the semi-supine, with his heels almost level with his hips, allowing him to take positive high G accelerations without blacking out.

Instead of the usual belt, he wears a retaining rig that consists of a combination shoulder harness, safety belt and leg straps. He wears a G-suit and an oxygen mask of the pressure-demand type for flying at altitudes up to 43,000 feet. His cockpit is both air conditioned and pressurized.

No one would be able to bail out of the Skystreak safely at high speed. So, if the pilot finds he must abandon the airplane, he trips a lever that breaks the entire nose section away from the plane. Then, when the nose slows down to a safe speed, he leaves it and descends by parachute.

At extremely high altitude the pilot would be subjected to explosive decompression at the instant that the nose breaks loose, allowing the pressurized atmosphere in the cockpit to escape. To avoid this, the release lever, when pulled, first operates a time-delay relief valve that releases the pressure in the cockpit. The delay is little more than a second in

length, after which the nose section drops off. Even this brief delay protects the pilot.

When the Skystreak set its world record of 650 miles per hour at Muroc Army Air Base in August, parts of its structure actually exceeded the speed of sound. That is, air was flowing over the cambered portions of its wing at about 800 miles per hour. Dangerous compressibility effects were not encountered and the pilot was not subjected to excessive vibration. He was, however, shaken by terrific jolts that were caused by passing through mildly turbulent air at record speed. Hardly rough enough to be noticeable in a low-speed airplane, the turbulence produced shocks of as high as 6 Gs at the speed flown. Spectators on the ground reported that the only noise from the passing of the Skystreak was a blast of sound comparable to the slam of a heavy door.

Setting records is incidental to the Skystreak's job of gathering information for safe high-speed flight, though the plane is expected to continue to set new marks when it is equipped with a more powerful motor and an after burner, and when it is flown wide open at high altitudes. Part of the research program with the plane will

(Continued to page 252)



Layers of cellular cellulose acetate inside new-type helmet absorb the shock instead of transmitting it. The helmet is painted gold to reflect the solar heat

AIRSPED LIMITATIONS DUE TO TEMPERATURE LIMITS OF COMPONENT SYSTEMS

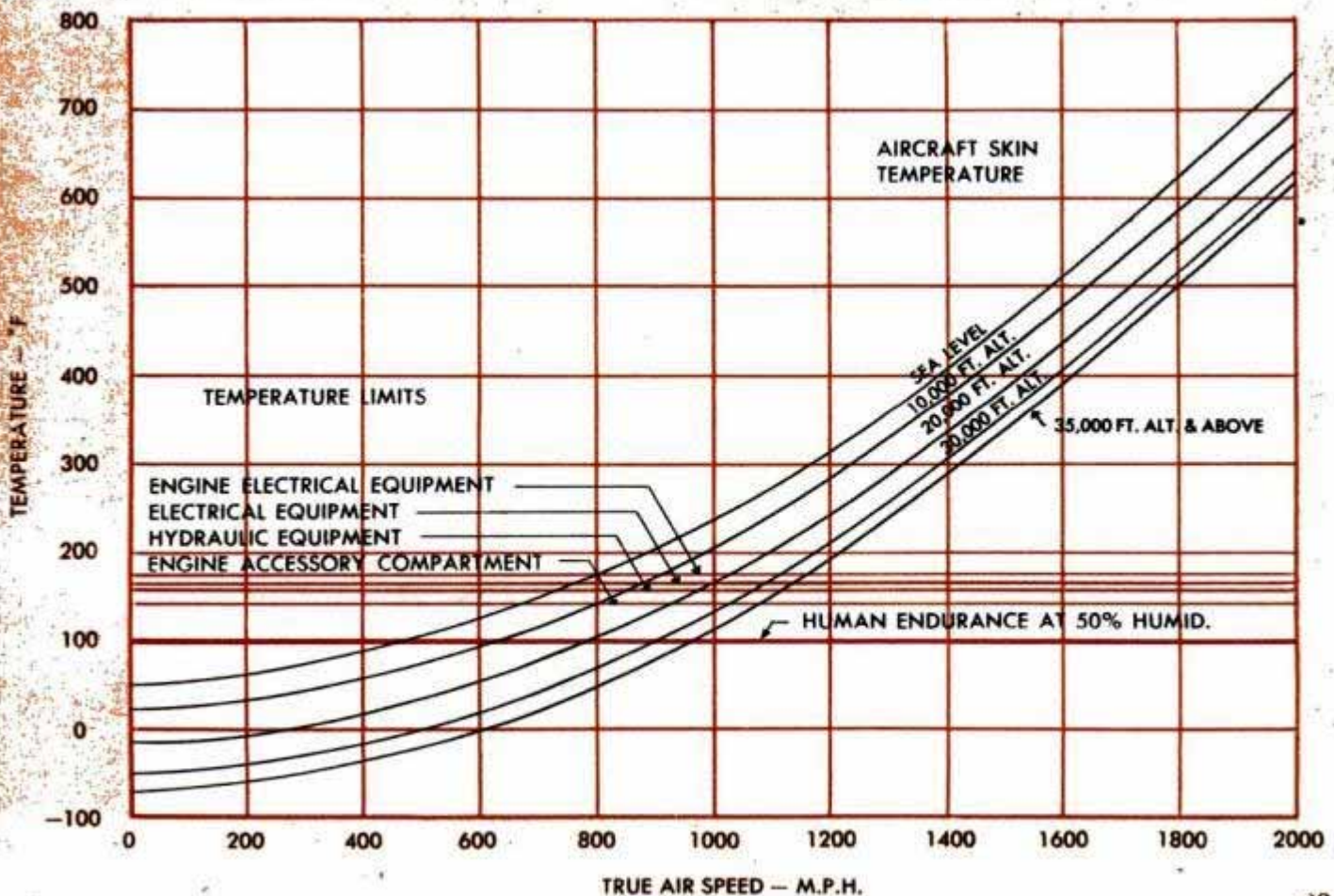



Biggest European Flying Boat Will Carry 46

Biggest of Europe's flying boats, the 46-passenger Latecoere 631 can fly over 3500 miles nonstop. The six-engine French craft

has a wing span of 188 feet, is over 142 feet long and weighs 72 tons. It cruises 185 miles an hour. Ten of them will be built.



Electric Speedboats

Toy speedboats molded of plastic run for several hours on the power of two standard flashlight batteries. A twist of the solid brass steering wheel starts the craft, and plastic flags and a transparent plastic windshield give a realistic appearance. The tiny electric motor requires no lubrication and all parts are plated to prevent rust. The boats are red and white with blue trim. They are demonstrated on a large table with a circular top designed to hold only a few inches of water.

Bicycle Shock Absorber

Bicycle riding is made safer and more comfortable by a front-wheel shock absorber that can be attached to any bicycle or small motor-bike. Two coiled springs cushion the jolts of rough roads that might cause riders to lose control at fast speeds. Easily attached to the front fork, the absorber permits the wheel to move up and down independent of the frame.

Rayon yarn used in hosiery, which formerly took 60 hours to manufacture, now can be turned out in 2 minutes and 15 seconds with an automatic machine developed in Germany.

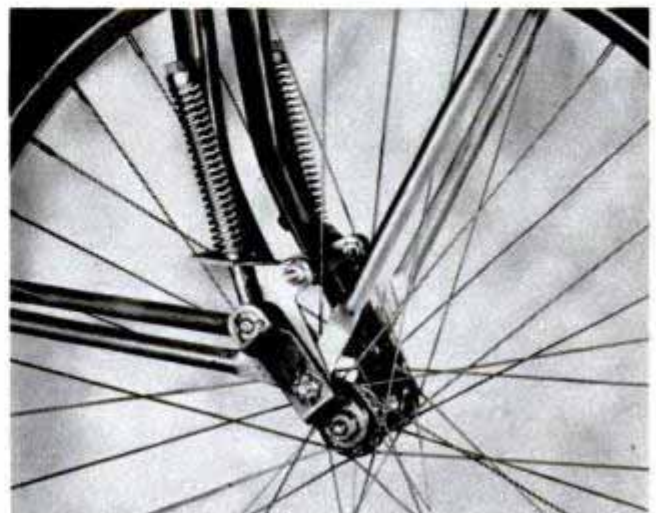

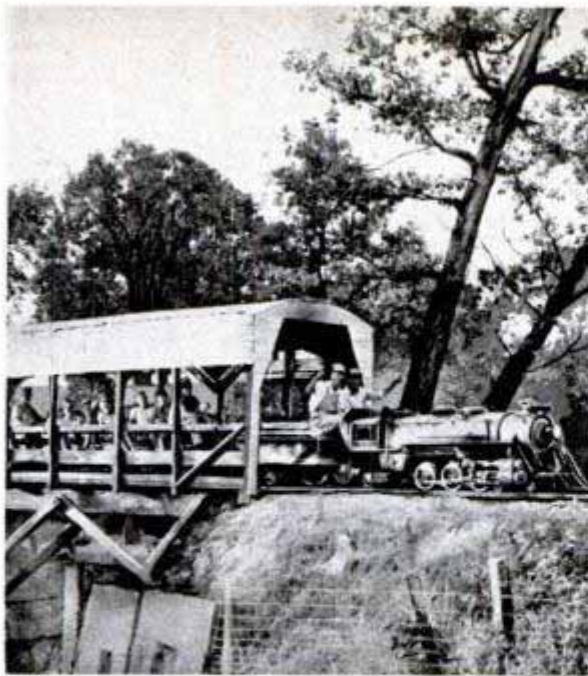

Quarter-Mile Railroad Has Telegraph System

Complete even to the clatter of the telegraph, a Lilliputian railroad system in Texas uses a small-scale version of the Texas and Pacific Railway's Sunshine Special for an engine.

The Pacific-type locomotive, with a 160-pound steam capacity, rolls around the quarter-mile track at speeds up to 30 miles an hour. To make the trip more realistic, there are a 53-foot tunnel, a 22-foot-long trestle and a 40-gallon water tower. One grade crossing gives the engineer a legitimate excuse for tooting the whistle.

Built for Burke Campbell, a retired veteran of 38 years of railroading, the 18-horsepower locomotive cost \$9000. It required more than eight months to build. He uses it as an attraction at his amusement park near Longview, Tex.

The tiny Sunshine Special may show its big brothers something new in locomotive design—a steel cylinder saddle. Rough



Top left, pulling two passenger coaches, the baby Sunshine Special rolls over the 22-foot trestle. Top, a scale model of a Pacific-type locomotive, the tiny engine prepares to roll. Below, owner Campbell acts as system's station agent

roadbeds often crack conventional cast-iron saddles and at least two railroads are watching the experiment with an eye to using steel saddles on their engines.



Cigarette Holder Permits Full Use of Both Hands

Handy for those who like to smoke while they work, a plastic cigarette holder with an attached ring enables the smoker to hold the cigarette without interfering with the use of the hands. After being softened in hot water, the plastic ring can be molded to fit the index finger snugly. The holder is especially useful for mechanics, artists and motorists. For ladies, the holders come in a variety of colors.



Midget Japanese Car

So light it can be carried like a suitcase, a midget automobile built in Japan has a 1/2-horsepower motor. Surplus airplane tail

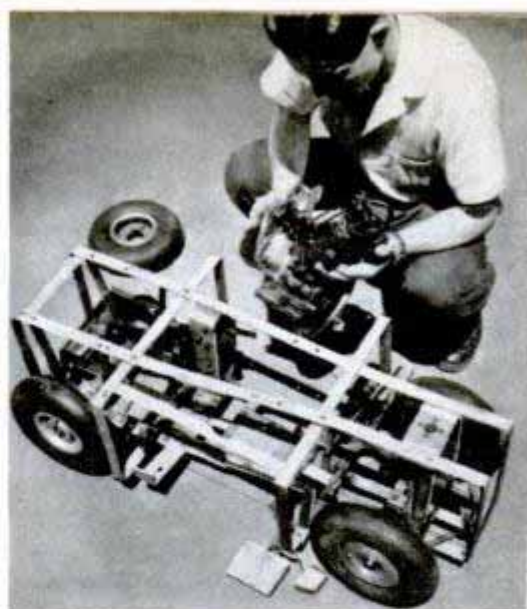

wheels from Japan's wartime factories are used in the car. A tiller steers the front wheels. Only one car has been built, but the inventor hopes to mass-produce them to ease the transportation shortage.

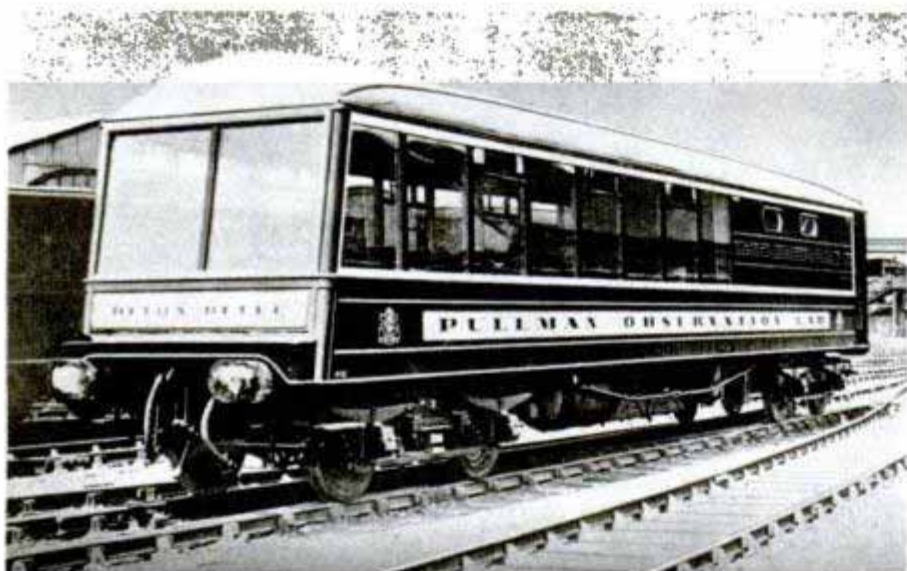

Glass-Enclosed Car Rides British Rails

Glass panels enclose the sides and one end of the observation car on a new English train, giving passengers an excellent view while riding. The car is attached to the Devon Belle, the Southern Railway's crack holiday train made up of 12 sleeping cars. The observation car is equipped with a loud-speaker for broadcasting announcements to passengers.

Sliding Glass Panels Form Cold Frame

Cold frames developed in England have glass panels that can be inserted or detached with changes in the weather. The frames also give special protection where desired. The frame is made of metal and the glass panels slip into grooves.

☐ Fishing lures scented with natural odors to attract fish are being developed by a manufacturing chemist.



Copyright © 1954 FOX PUBLISHING

SEE
HERE-TO-FIND
INDEX



← Powered by a gasoline engine, the test model lifts inventor Bennett to the top of the vertical I-beam

"MECHANICAL FLY"

People trapped in upper floors of burning buildings may soon be rescued by a "Mechanical Fly" invented by Willis J. Bennett of Kansas City, Mo. The rescue elevator, operating on the rack-and-pinion principle, is attached in seven seconds to an I-beam permanently mounted on the building. A two-cylinder gasoline motor drives a gear that engages a toothed rack on the vertical beam and raises the car at speeds up to 75 feet a minute. Descending, the car travels 150 feet a minute. Folding platforms open out to accommodate eight persons plus the operator. Bennett is working on an electric model that will climb and descend 300 feet a minute and will be powered by a generator that will be mounted on a truck built to haul the "Fly"

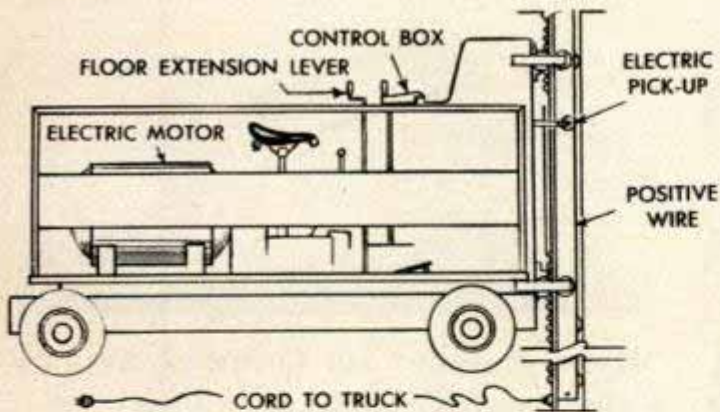

↑ Generator in truck will power fast electric model
 ↓ "Mechanical Fly" goes to fires under its own power



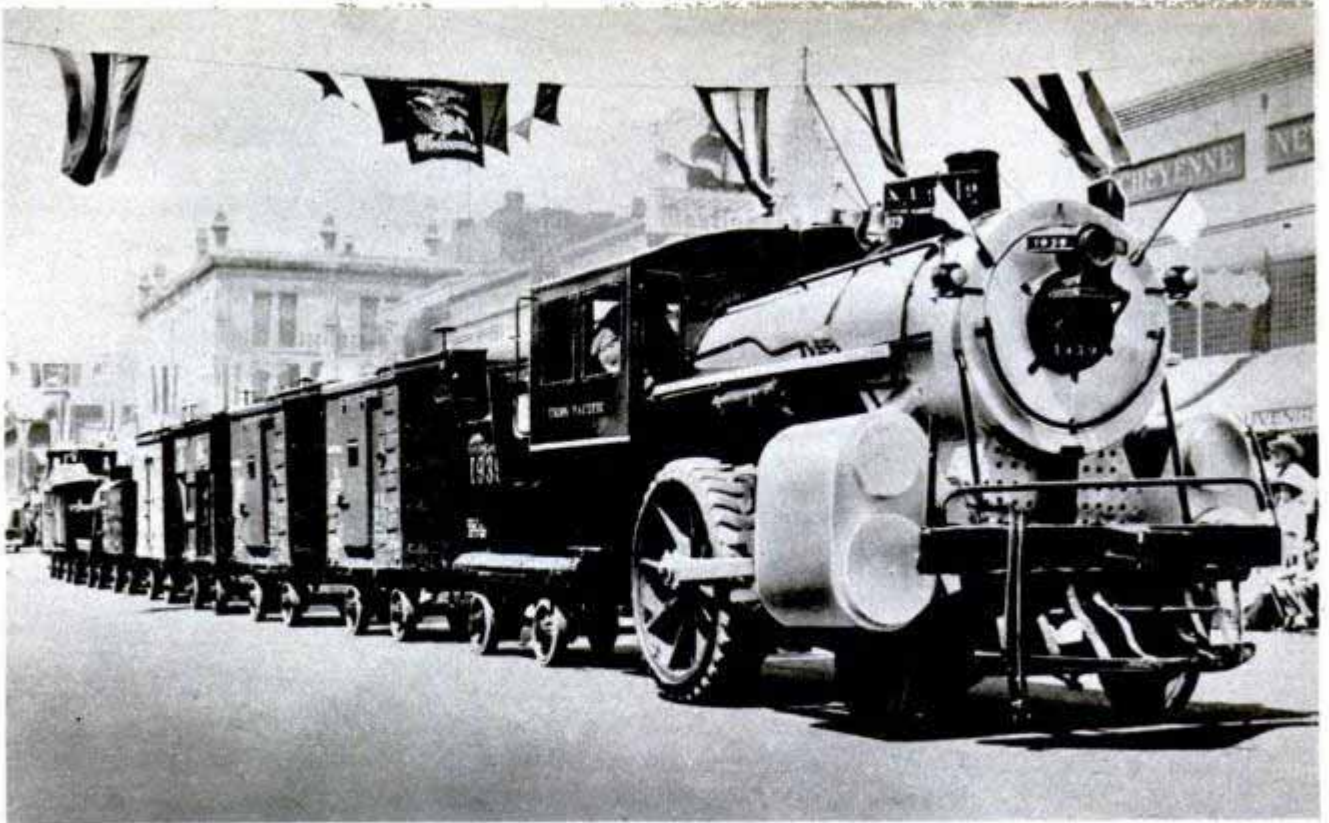

Train Travels 200,000 Miles Without Pay Load

In 25 years, one Union Pacific freight train has never hauled a pound of cargo. It's a miniature train consisting of a locomotive and seven cars. Built for use in parades, rodeos and other celebrations, the

locomotive is mounted on a tractor chassis and stands only six feet high. The train depends upon its big brothers for transportation between parades and has covered more than 200,000 miles in its travels.



Air Hammer Has Multi-Angle Head

Those hard-to-get-at spots are reached easily with an air hammer having a head adjustable through 180 degrees. Weighing less than 3½ pounds, the hammer uses only 5 cubic feet of air per minute at 90 pounds pressure. A needle valve permits choice of either light or heavy hammer action. More than 50 interchangeable tools made from shock-resisting steel, including a hackout chisel, can be used with the hammer.



"Hypo Needle" for Grinding Wheel

Diamond compounds for grinding hard surfaces are applied to the grinding wheel by a dispenser resembling a hypodermic needle which controls the amount of compound ejected. The compounds, of different grain sizes, are available in cartridges which are slipped into the applicator. The stem of the applicator is pushed down to squeeze a portion of the compound onto the wheel. The hermetically sealed cartridges prevent contamination and are convenient to store. The compounds can be used to grind or polish steel, chrome-plate, tungsten carbides, sapphire, ruby and even diamonds. The particles are suspended in a water-soluble vehicle.

Rivermen Use Radar To Steer in Fog

River navigation by radar is being simplified with strip maps made from radar photographs. With them pilots can steer "blind" in bad weather by comparing images on the scope with radar photo-maps for the same section. The system, developed by Colonel Benjamin B. Talley of the Army Engineers, eliminates the need for keying radar images to conventional charts in determining position. Four to six exposures are made each mile with a Fairchild automatic camera and fitted into a mosaic. Engineers add indications of the sailing line, depth figures and short descriptions of important landmarks. The radar has a range up to eight miles, hugging the surface to pick up objects as small as a buoy. The technique has already been used in charting more than 100 miles of the Ohio River.

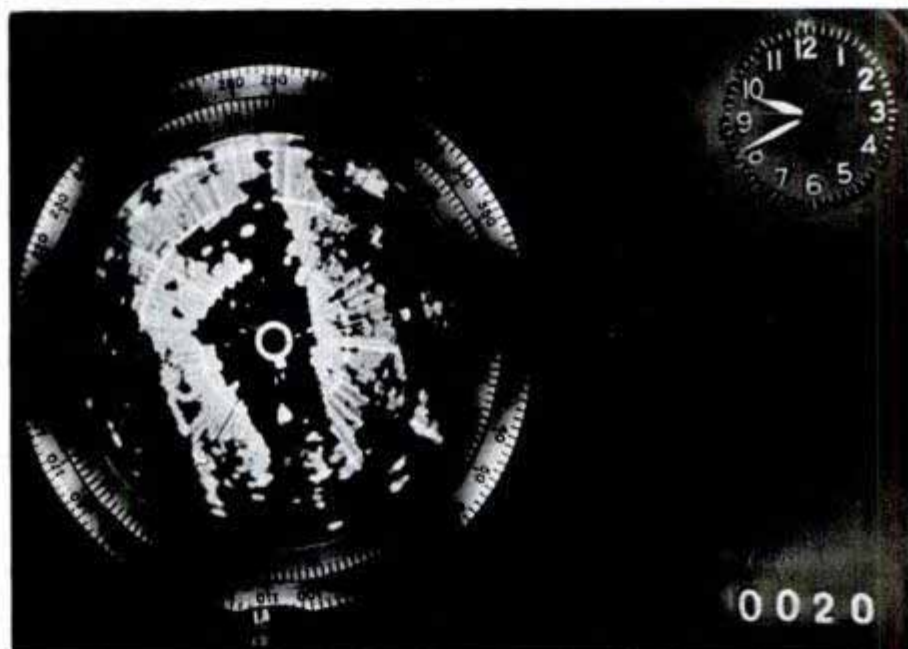
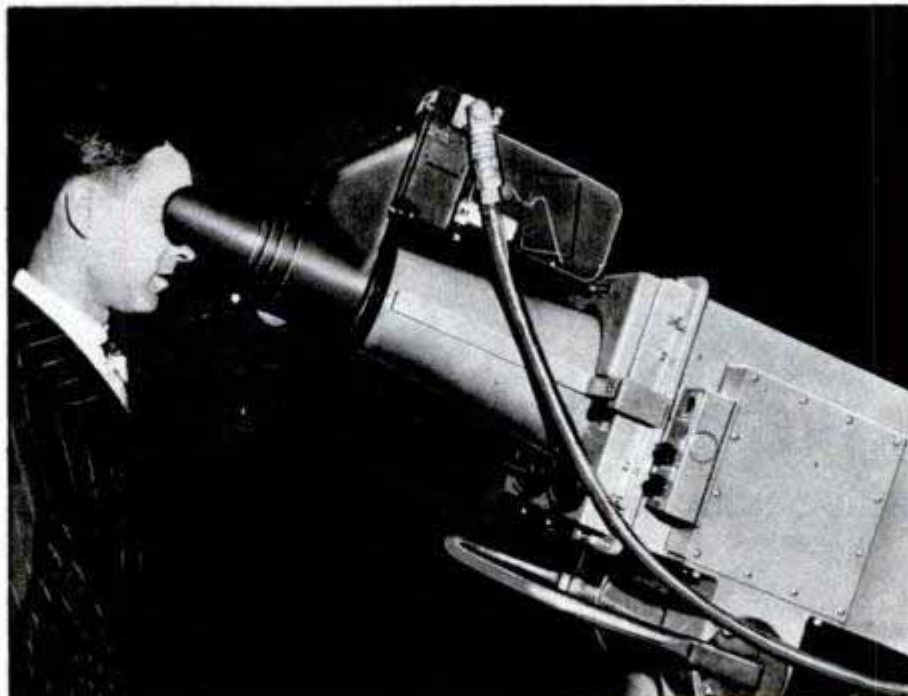

Compact Gas Storage

By converting natural gas into liquid form, chemists at Northwestern University have been able to store 800 cubic feet of gas in a space of one cubic foot. The temperature of the gas is reduced to 260 degrees below zero in the process. Refrigeration equipment and insulated

tanks will permit elimination of present large storage tanks. The liquid gas returns to its gaseous state when the temperature is raised. The process will enable cities to maintain adequate reserves economically.



Jet-Propelled Bicycle

William Tenney and Charles Marks of Dayton, Ohio, believe they have constructed the first jet-propelled bicycle. It is powered by three tiny jet engines developed for model planes. The jets are mounted on the rear fender, with their common fuel tank just below the rider's seat. This bike cruises at 30 to 35 miles an hour.

Names and addresses of manufacturers of new products featured in this issue will be supplied promptly by the Bureau of Information, Popular Mechanics Magazine, 200 E. Ontario, Chicago 11.

AERIAL-NE CO.
DAYTON OHIO
J. W. W.



Used at Battelle to separate very fine particles of ore, each successive cone in the scale blows less air upward

YOUR NEW SMOKELESS coal stove and the ship-bottom paint that created a critical housing problem for barnacles have something in common. And both are related to your watch's new non-rusting, nonmagnetic mainspring and the electronic tuning fork that sings out a sweet and true "A" for the orchestra.

These and a thousand more crystallized ideas, some vitally important during the war and most of them contributing to your peacetime well-being and comfort, are the creations of the same coterie of brains at Columbus, Ohio.

All over America there are research institutions without a product to sell except scientific brains. Perhaps you own a small factory manufacturing a product that performs and sells well enough, but you think it could be improved. Better material, or a shortcut in production, might enhance the profit and the product. But your small company lacks a research organization. There are thousands of small industries like yours, and plenty of large corporations that need specialized assistance, which turn to the research laboratories operated by universities, the government or independent organizations.

By

John R. Kinsey



RESEARCH BRAINS FOR HIRE

Projects at the institute are varied. Here a melt of aluminum alloy is being cast into small test ingots

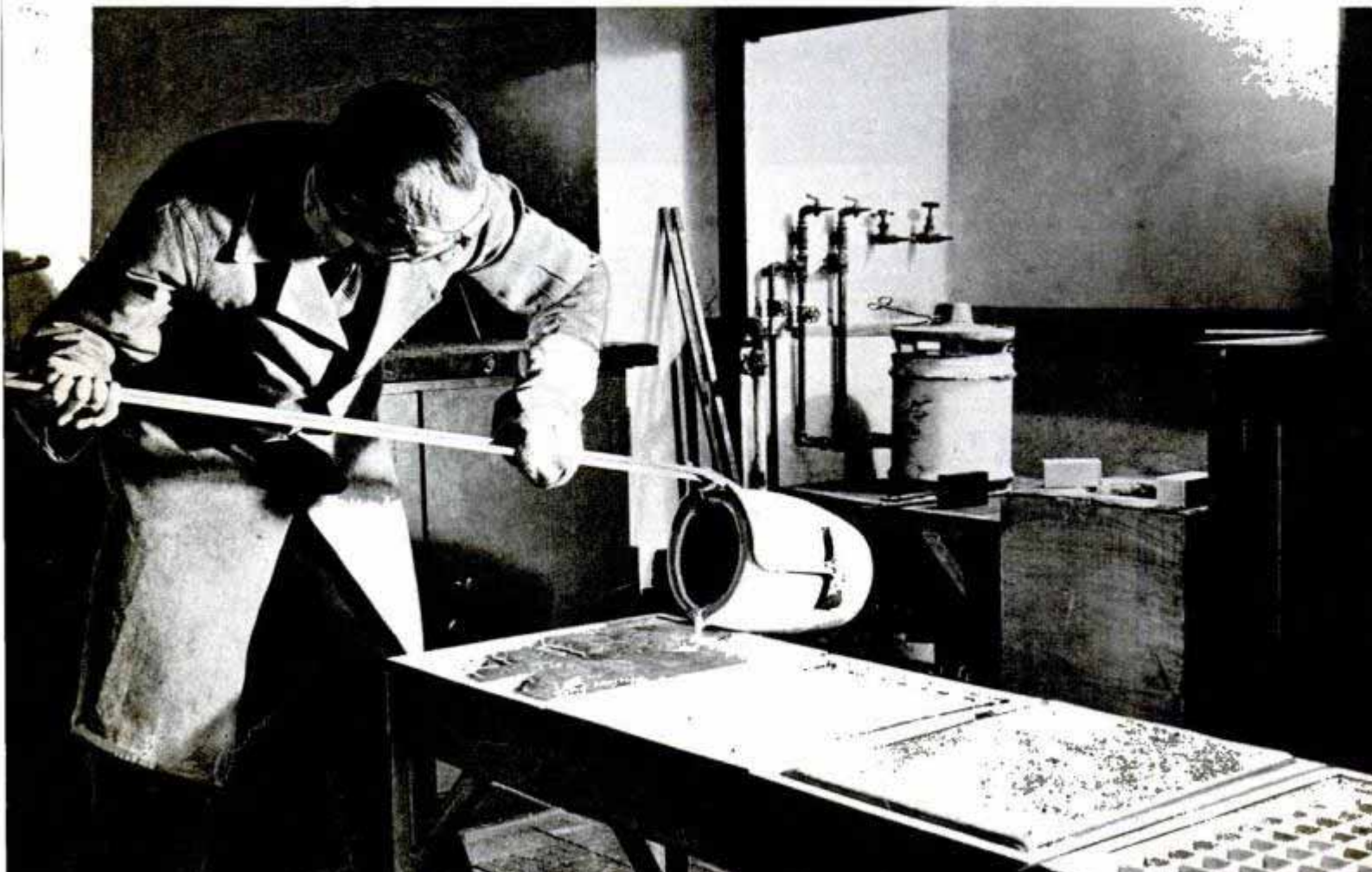

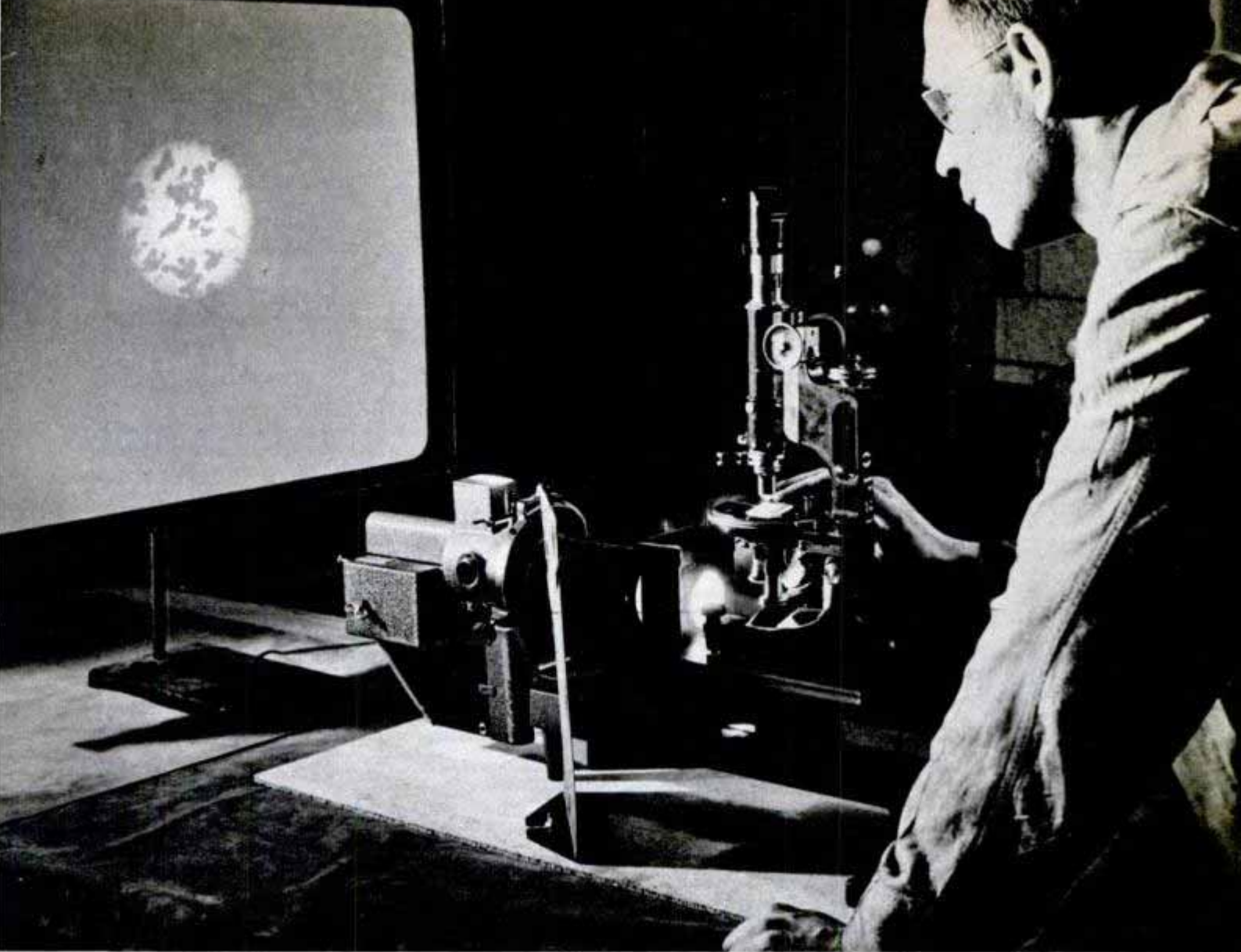

By using a projecting microscope on a thin piece of ore, several experts can see and discuss it simultaneously

Battelle Memorial Institute at Columbus is a typical independent research laboratory. Its 990 scientists today are engaged on such widely different projects as a search for the best possible alloys for tomorrow's supersonic jet planes; for methods of producing dustless and smokeless coal, and for soil chemicals to grow crops and flowers that are disease-free and insect-repellent. Its services to all types of industry are on a nonprofit basis, in accordance with the dictate of the late Gordon Battelle, who left the bulk of his estate to endow the institution to "serve mankind through the making of discoveries and inventions." The laboratories started life in 1929 with 30 scientists. This year their research bill to industry on a strictly cost basis will be over \$4,000,000.

Not long ago announcement was made of a new tough alloy developed for watch mainsprings, hailed by some in the trade as one of the most important improvements in watchmaking for two centuries. This was the "baby" of a Battelle metallurgist, to whom the problem was put by George

Ensign, research director of Elgin National Watch Company. Ensign said the alloy mainspring comes closer to delivering constant power to watches than any previously known metal; it is nonmagnetic, prevents rust formation and is unaffected by humidity.

The revolutionary smokeless stove engineered at Battelle is already on its way to production by a group of stove manufacturers. So efficient is its combustion that the smoke is burned to colorless gas before it enters the flue.

Other Battelle developments from fuel studies include a radiant-tube furnace which burns pulverized coal and is used for heat-treating, annealing and enameling; special treatments to make coal dustless; discovery of causes for corrosion in coal stokers; and the engineering of a mechanical stoker which handles all grades of coal. Under investigation now are problems connected with the use of coal for air conditioning and refrigeration.

One of the strangest devices invented at the Columbus institute is the electronic



When the Columbus Symphony wanted a more accurate pitch standard than the oboe, researchers invented the "obotron," an electrically driven tuning fork

tuning instrument, which they call an "obotron." It is an electrically driven tuning fork with an amplification system which sounds a true "A" note. Battelle developed the obotron for the Columbus Philharmonic Orchestra to provide scientifically the pitch standard to which musical instruments could be tuned. Ordinarily, an oboe player sounds the "A" to which instruments are tuned.

However, of all the instruments in an

Demonstrating the insect-killing ability of sodium selenate; the plant at left had it, the other didn't



orchestra the oboe is the most difficult to tune, according to Izler Solomon, conductor of the Columbus Philharmonic. For that reason, it is customary for the oboe player to tune his instrument first, after which the other instruments are tuned to the oboe "A" note. The fidelity of the entire orchestra's pitch is only as good as the oboe player's reference note.

Mr. Solomon wanted a scientific instrument which would eliminate the human element. The obotron has a tuning fork which is carefully adjusted to a frequency of 440 vibrations per second, which creates a true "A" note.

A few doors away from the birthplace of the obotron, Battelle horticulturists were experimenting with a soil chemical to kill plant insects. Extensive tests showed that sodium selenate added to the soil was absorbed by various plants, making them poisonous to pests which attack them. Successful results were reported for chrysanthemums, carnations and hydrangeas to combat red spider mites, aphids and thrips. In studying the effects of metals and chemicals on soil, Battelle men also found that small amounts of a metal compound introduced into the soil in southern tobacco fields increased the crop yields.

Another Battelle accomplishment in the field of chemistry is the paint that protects a ship bottom against barnacles and eliminates need of dockings to remove barnacles and other marine growth.

Developed after 3½ years of research, the paint owes its effectiveness to metallic copper which, in combination with other ingredients, makes the painted ship hull poisonous to marine-life attack. It has proved effective in preventing barnacle infestation for as long as two years. The paint may be applied to metal or wood surfaces with equal protection.

One of the most important projects at Battelle—and still shrouded in secrecy—is a search for more knowledge about heat-resistant alloys to speed the development of supersonic planes. The Navy, envisioning faster planes requiring higher operating temperatures, wants to learn more about the fundamental science of high-temperature alloys. If the "why" of these alloys can be learned, it may be possible to predict the compositions of new and better alloys that will withstand these higher temperatures.

Battelle aircraft research also has contributed to more efficient hydraulic systems to actuate landing gears, flaps and controls. A new "O-ring" packing to seal fluid in the system is being used in most new aircraft. It has been difficult to find the right material for this packing because of the high pressures of hydraulic systems

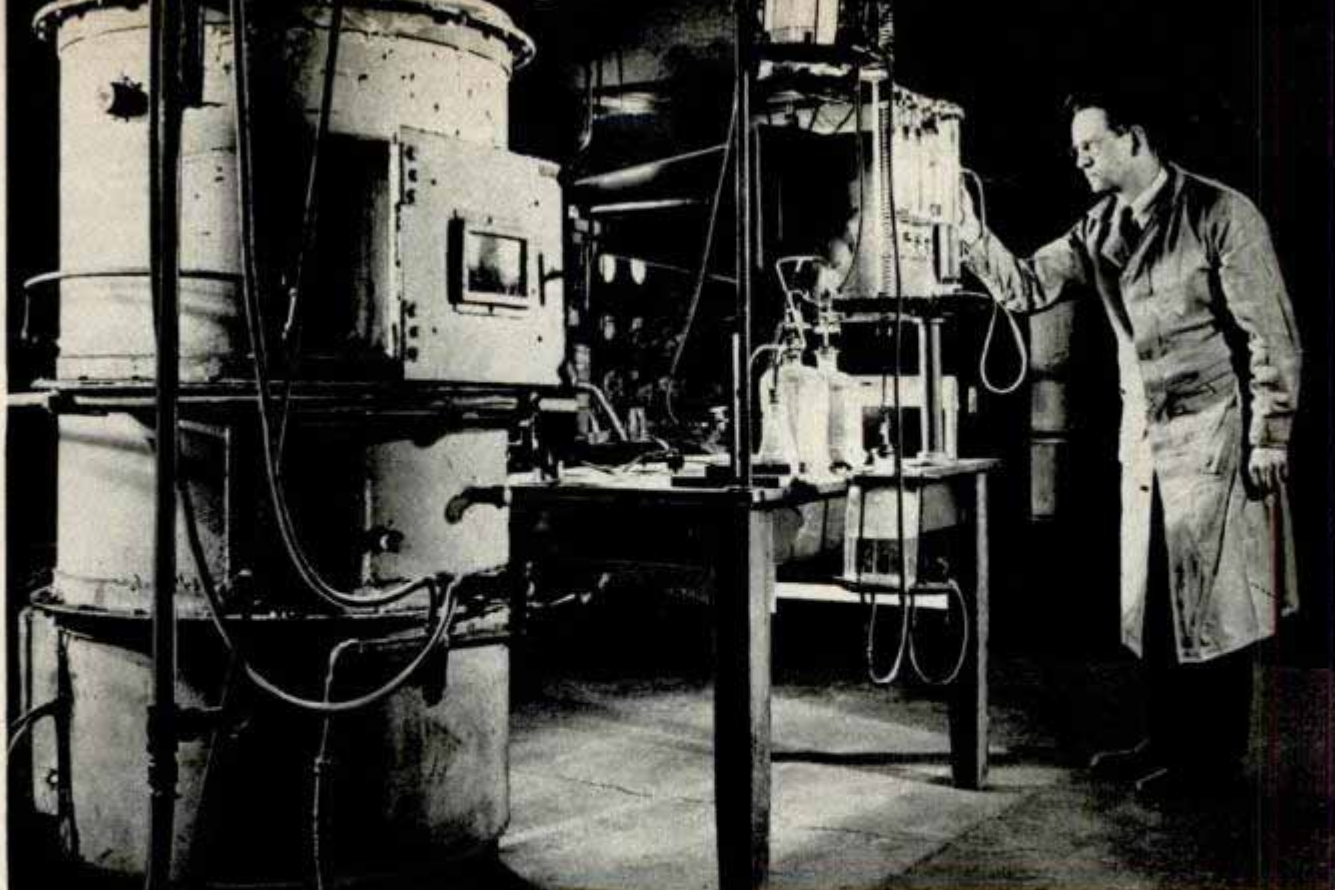

One tool in the program to improve furnaces, this apparatus is used to analyze gaseous combustion products

(up to 3000 pounds per square inch) and the wide range of operating temperatures (from 65 degrees below zero to 160 above). Synthetic rubber is being used rather successfully. Some failures still occur, Battelle reports, and experiments are continuing.

The developments described represent only a small fraction of the accomplishments at Battelle. Thousands of products made by more than 1000 corporations have been improved by Battelle scientists.

Regarding the institute's future, Clyde

Williams, the director, has this to say:

"Pessimists exclaim that technological progress cannot continue at its present rapid rate. To this I point out that technological developments during the past 50 years outweigh in significance those of all preceding history.

"Each succeeding decade has presented an increased rate in the development of new industries and the improvements of the old. Who has the courage to say that the end has come?"

Even old-fashioned heating stoves are studied carefully to learn ways of bettering new designs. Right, the smokeless stove is another Battelle contribution. Smoke is burned to colorless gases before entering the flue

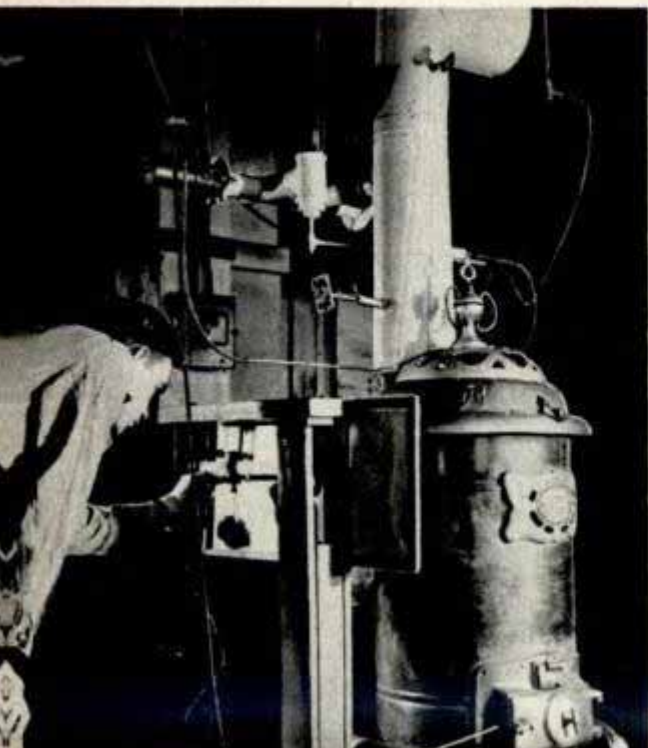



Bomb Debris Made Into Tile for Berlin Roofs

Bomb debris in the American sector of Berlin is tossed into a stone-smashing machine, ground into powder and converted

by hand into tile for roof repair. The work is done by German women who receive relatively high pay, plus increased rations.

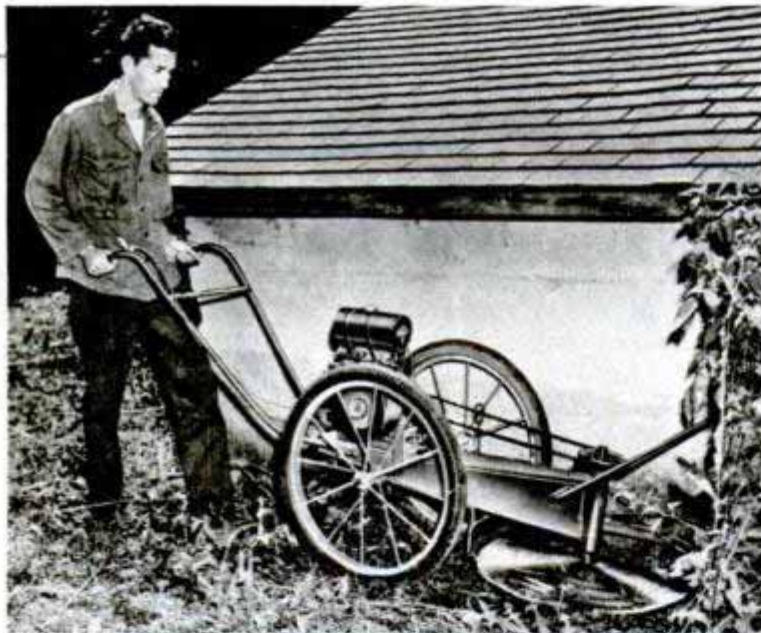

Adjustable Weed Cutter

Adjustable for mowing everything from the front lawn to tall, heavy weeds, a weed cutter has its 1½-horsepower gasoline motor mounted for easy removal for use separately to power emery grinders, feed grinders, pumps and other small equipment. The blade can be set to mow lawns as close as ½ inch from the ground and within ¼ inch of trees and other obstructions. A weed guard on the front of the cutter windrows weeds clear of the blade after cutting. The wheels can be moved up or down and in or out to compensate for uneven ground or to meet special mowing requirements.

"Third Hand" for Solderers Feeds Solder to Tip of Iron

Standard soldering irons are made semi-automatic by a feeding attachment that makes soldering a one-hand operation. By freeing one hand to manipulate parts and other tools, the attachment speeds soldering considerably. A feed lever near the handle of the iron moves the wire solder forward until it touches the tip of the iron. Solder in short lengths, in small coils or fed from spools up to 25 pounds can be handled by the attachment, which can be adjusted to feed up to ⅜ inch per stroke.

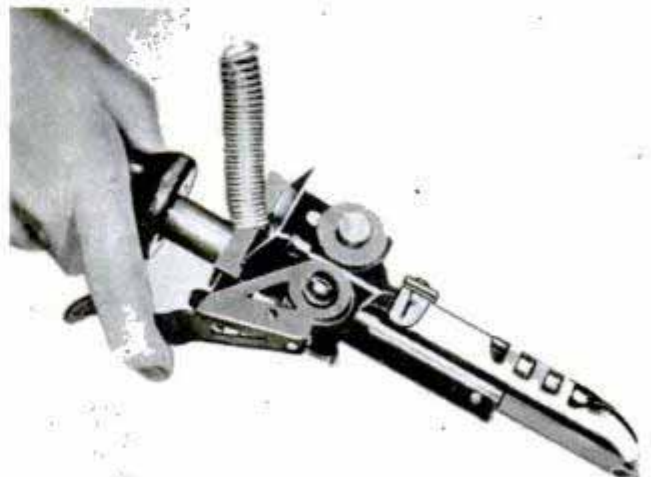

TEST YOUR SCIENCE

By Rex Taylor

SCIENCE tells us that gravity—the attraction of mass to mass—holds us onto the earth's surface. Is this true?

Tie a stone to the end of a string and whirl it in a circle. The stone tries to fly into space. That is centrifugal force.

The earth's circumference is over 24,000 miles and it spins on its axis once every 24 hours.

Therefore, if you stand at any spot on the equator it appears that you would fly through space like the stone on the string, and at a speed of 1000 miles an hour!

i.q.

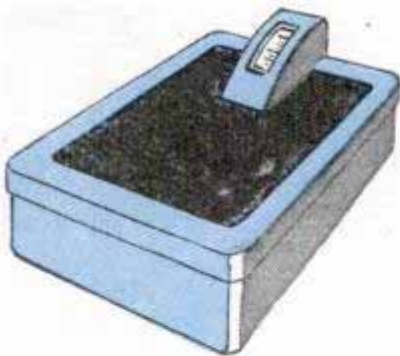
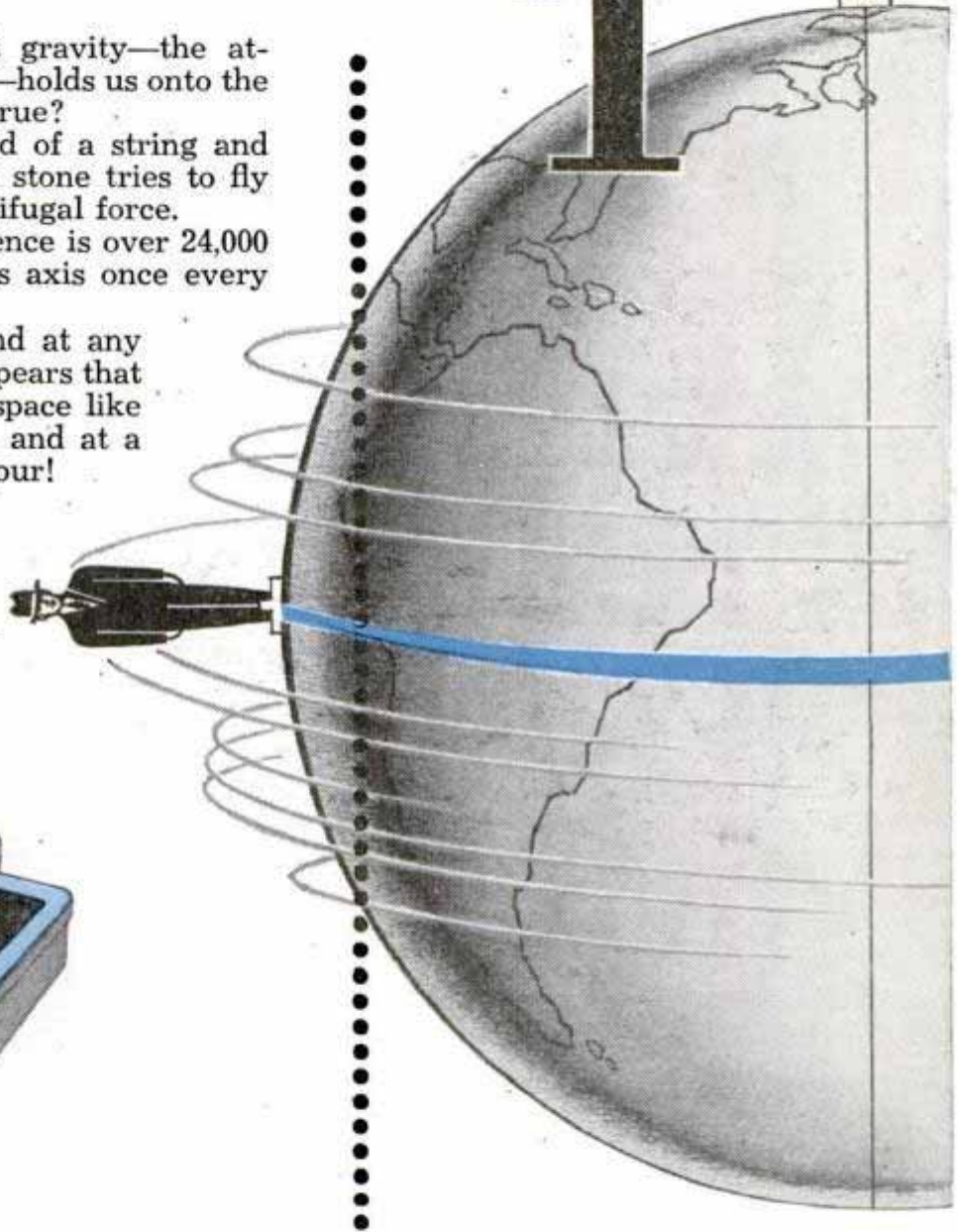

If you weigh yourself at the equator using a spring scale, gravity must be strong enough to overcome that centrifugal force, and in addition make the scale record your normal weight, say 150 pounds.

But if you take your scale to the North Pole you are on the axis and there is no centrifugal force. What do you weigh? Still 150 pounds! What has become of the gravity which was used at the equator to overcome the centrifugal force there? Was Newton wrong?

Answer on page 238



Foolproof Water Softener Has Single Control Lever

Operating a new water softener is made easy by a single control lever that is shifted like automobile gears. The four positions are numbered in the sequence of operation to make the regeneration process virtually foolproof. There are no extra valves to open and close as the control lever makes these unnecessary. The new softener also removes all insoluble sediment.

Deodorant for Garbage Dumps

Odors from garbage dumps, polluted streams and manufacturing plants are destroyed—not just concealed—by a new deodorant containing ammonia. Available in liquid or crystal form, the material is applied by sponging surfaces or spraying. It is effective against garlic, onions and spoiled potatoes. Known as Hyamine 1622, the deodorant also kills germs.

Invisible Christmas Cards

Persons receiving invisible Christmas messages will be puzzled to find a blank card inside the envelope. With the card is a piece of paper toweling with instructions to rub the card with plain water. The water “develops” a seasonal photograph in sepia tones and a greeting signed in invisible ink by the sender. After water has been applied to the card, the photograph and greeting become permanent. There are 12 different cards packed in each box. Invisible ink is supplied with the cards.

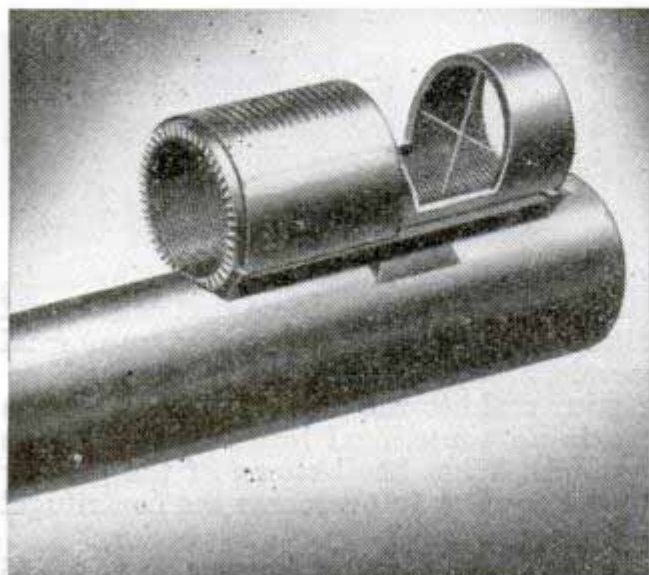

Cross-Wire Rifle Sight

Using the cross-hair feature of the telescopic sight without magnification, a new front sight for rifles consists of two cross-wires fitted into a tubular housing. Designed primarily for game shooting, the sight provides good vision and target definition. An adjustable “window” or cover slides over the opening behind the cross-wires to regulate the amount of light on the wires. The sight can be used with a receiver or open rear sight.

DDT sprayed on a 30-acre test tract killed insect pests, but reduced by 65 percent the five most common bird species, according to U. S. Fish and Wildlife Service.



Train Telephone Service

Making a telephone call from a train speeding between Washington and New York is as simple as using the telephone at home. A soundproof booth in the lounge car provides privacy during the call. The passenger's voice is radioed to one of four relay stations along the route and then transmitted over telephone lines anywhere in the world. The system uses two channels, one for sending and the other for receiving, so conversations may be carried on just as over regular telephones. Incoming calls are received by the stewardess at the switchboard and she pages the person being called. Although installed for the use of passengers, the telephone can be used by train crews when necessary.

Armrest Supports Driver's Right Arm

Drivers relax as they ride with a padded armrest that fits any car. The armrest, designed to support the right arm, is held in place by a base that wedges between the seat and back cushions. It is removed easily and can be used on either front or rear seats.

Names and addresses of manufacturers of new products featured in this issue will be supplied promptly by the Bureau of Information, Popular Mechanics Magazine, 200 E. Ontario St., Chicago 11, Ill.



Slingshot Sharpshooter

Practice makes perfect and after 52 years of practice, Homer H. Parker of Morris, Ill., can fire an ordinary slingshot with accuracy that is the envy of many pistol marksmen. At a distance of 20 feet, he bends pins and breaks cigarettes. Matchboxes and cigarette packages are easy targets at even greater distances. His slingshots are the same as boys have used for years: forked branches and inner tubing. For ammunition, he uses marbles.

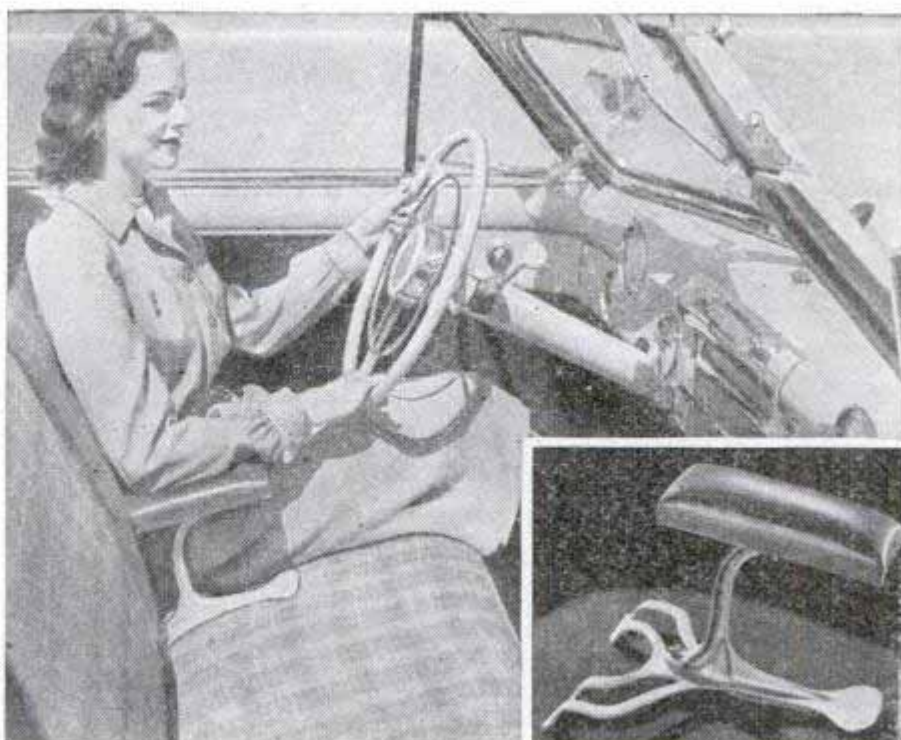



U. S. Air Force photos

Pushing button, above, starts automatic flight. To regain control pilot presses button on wheel, right below. Left, automatic pilot

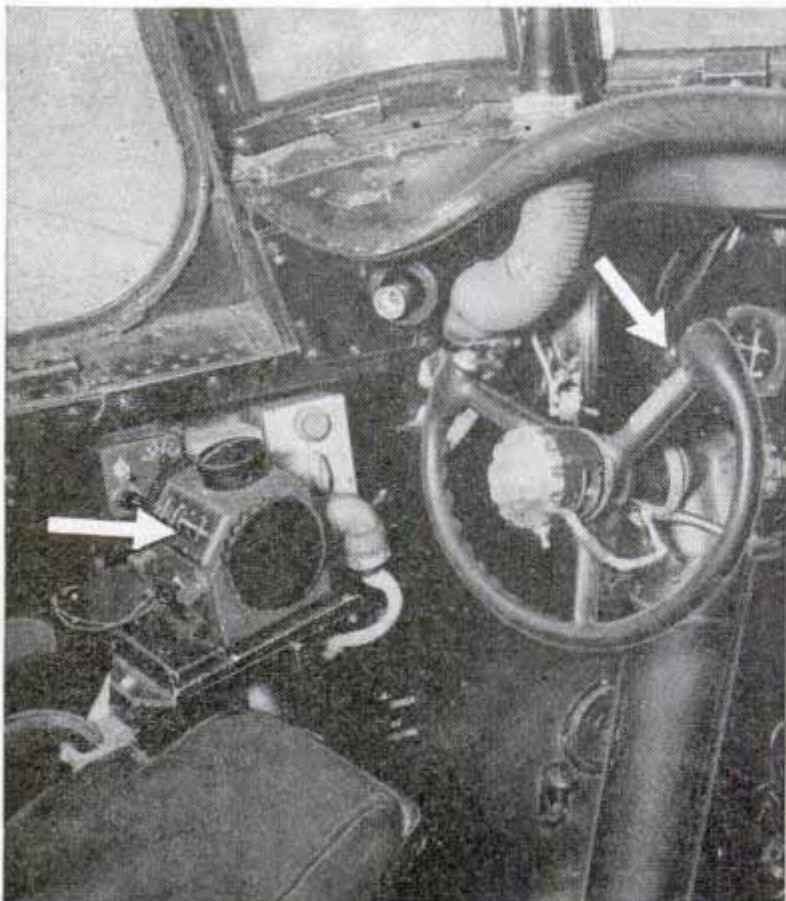

By Aubrey O. Cookman, Jr.

WHEN the push-button Robert E. Lee "kissed" earth at the end of an 8000-mile round trip to England, one of the biggest milestones in man's conquest of the skies was completed. For the plane's 700-pound mechanical "brain," controlling genius of its automatic flight, promises to make flying safer, more precise and less work for human crews.

From take-off at Newfoundland to touch down at Brize Norton, England, not a finger was laid on the controls by Col. James M. Gillespie and 13 other observers. Only on returning to Newfoundland, where no guiding beam was available, was there need for a human aboard. "We were just along for the ride," one of them put it.

The brain's performance points the way to virtual elimination of pilot error, by far the biggest cause of accidents, and brings us closer to all-weather flying on schedule. Though the flight ran through three storm "fronts" and two hours of rain and hail, at no time was the turbulence enough to take it off automatic control.

As planes have grown bigger, faster and more complicated, pilot responsibilities have mushroomed to unwieldy and, many think, dangerous proportions, with their attention scurrying

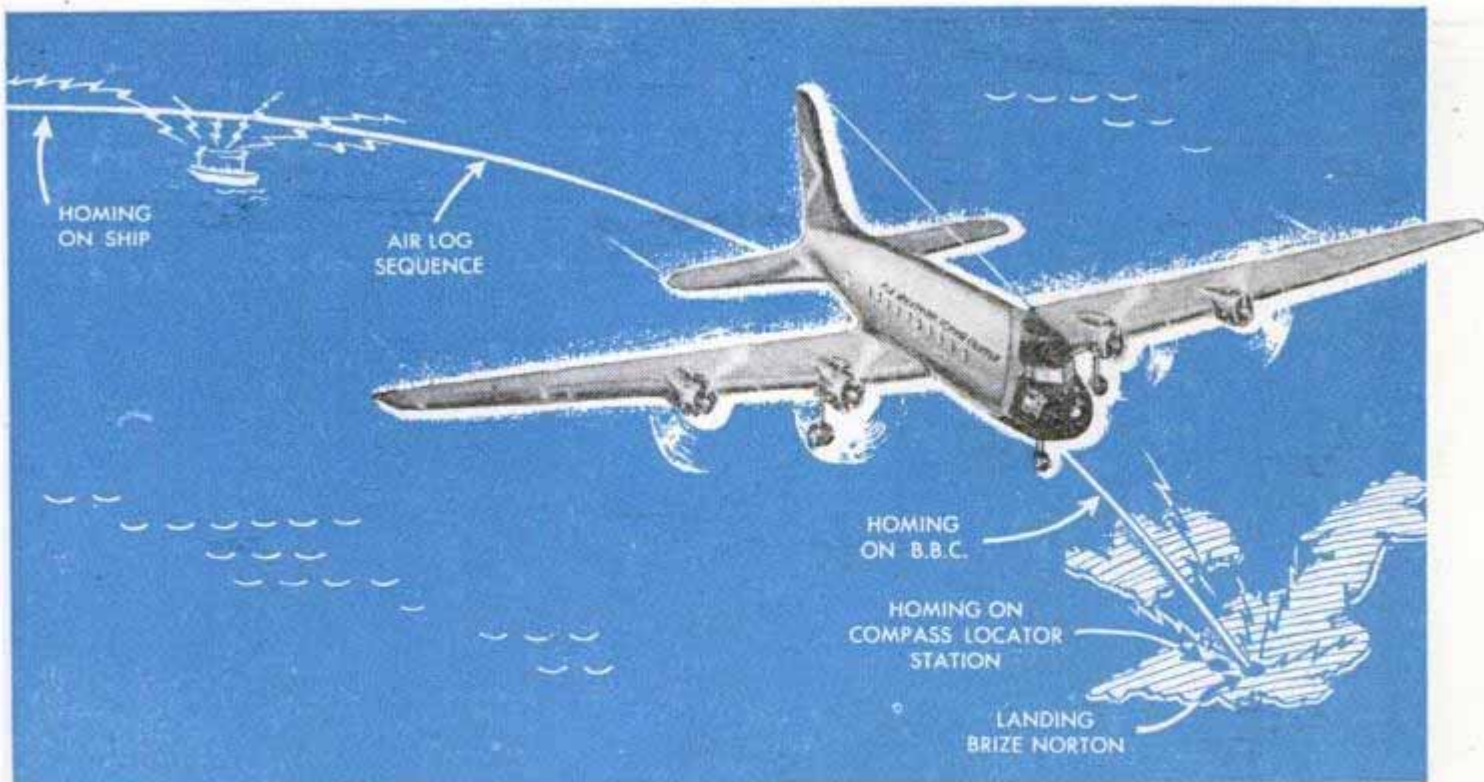

During the 2400 miles from Newfoundland to England, not a hand was laid on the plane's controls

among dozens of vital instruments. Using an automatic system that requires only monitoring, the pilot is free for any decision or emergency arising. All the while the "hands off" plane is rolling up mileage toward the destination.

Air Force leaders are quick to point out that fully automatic flight isn't an overnight phenomenon. There's nothing new in the whole system—except making all the parts work together from start to finish. Some of its elements were used 15 and 20 years ago, when Doolittle and Hegenberger pioneered blind flying, relying entirely on "coaching" from instrument panels. In 1934, at an Air Corps school, 18 pilots made 786 complete instrument flights in 58 days.

But credit for bringing the system to its present state of development belongs to the All-Weather Flying Division at Clinton County (Ohio) Air Base, home field of the Lee and a major element of the Air Materiel Command. Col. Gillespie, the ocean flight's commander, is its chief. Fittingly, one of Doolittle's assistants during the pioneering steps in '29, Col. Ben S. Kelsey, created the automatic flight branch.

The brain itself is a multi-channel, telephone-type rotary switch, the key factor in the Automatic Flight Controller. It is housed in a console the size and shape of an old-fashioned upright piano. In the test C-54 the whole unit is just forward of the cabin's midway point, on the right side.

There are mysterious goings-on in the deserted cockpit during automatic flight. Untouched pedals and levers move back and forth, with instrument needles flicker-

ing in answer, just as they would with a full crew at work. The unseen manipulators are scores of electric motors, responding to the brain's stream of commands.

Before take-off, dials on the controller's panel are fed a series of factors, such as distance, direction, desired cruising altitude and power, and specific en-route radio frequencies. All these factors are predetermined in relation to a particular flight.

As an added gesture to convince skeptics, neither Col. Gillespie nor the pilot was told where the plane was to be landed in England. Only an official observer, who made advance arrangements for the arrival, and the navigator, who "told" the brain before take-off where she'd land, were in on the secret.

Defined by function, the controller has two kinds of instruments. The "sensing" group reports to the brain the air miles flown, altitude and position, as determined by radio beams and bearings, radar and distance-measuring equipment. The others, the "doing" group, are those devices which actually operate the aircraft. In this class are the automatic pilot, engine controls and servos that trim the airplane. The brain gets advice from one group and, in accordance with directions "cranked" into it earlier, tells the other what to do.

Point-to-point flight is divided into 12 phases or positions: (1) pre-take-off, (2) take-off, (3) initial climb, (4) final climb, (5, 6, 7 and 8) navigational sequences, (9) descent, (10) initial approach, (11) final approach and (12) landing. All are indicated on the main panel as well as on a dial

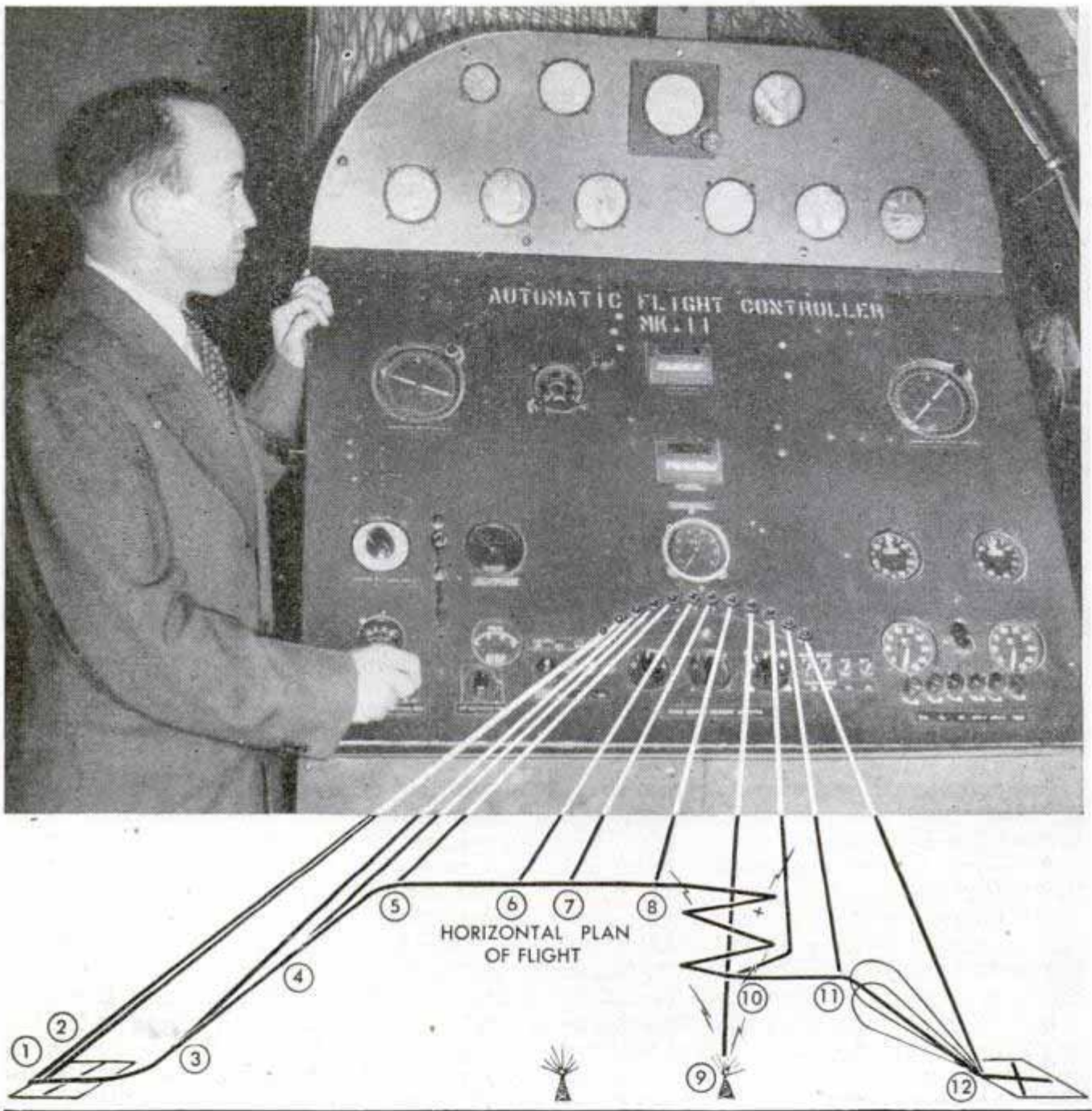

Flashing amber lights show which stage of automatic flight the plane is in. Positions 1 and 2 indicate pre-take-off and take-off; 3, initial climb; 4, final climb; 5, first air-log sequence, with mileage counter clicking off predetermined distance to point where plane will begin to home; position 6, on first preselected radio station. Seven is a second air-log sequence, similar to 5, and 8 is a second homing sequence. At 9 descent begins in preparation for 10, the initial approach, when the landing gear goes down and contact is made with the landing beam. Position 11 is final approach, on the glide path, and 12 is the landing and roll

in the cockpit. As the brain or "sequence selector" steps from one position to another, a flashing light indicates which phase the plane is in. Any time the pilot wants to take control manually, he presses a button on his control wheel, instantly disengaging all automatic operation.

The brain first goes to work when the plane has been taxied to take-off position, brakes locked and engines idling. As soon as traffic clearance is granted the pilot reaches forward and pushes a button on a small, black box.

In response, the throttles are automatically advanced and the brakes unlocked

by the pilot eight seconds later, when the engines have revved up to take-off power. Position two is underway. With the automatic pilot steering more accurately than is humanly possible, the plane races down the runway until flying speed is reached. Veteran pilots can always spot automatic take-offs because they're letter perfect.

Fifty feet off the ground, the brain, advised this time by the absolute altimeter, directs the operation into initial climb, position three. Take-off power is reduced to climbing power and the landing gear retracted. At 1000 feet another altimeter-to-brain message signals the engines to climb

1000 feet a minute to the preselected cruising altitude, perhaps 9000 feet as it was for the Newfoundland-England crossing.

Barometric pressure next causes the selector or brain to readjust the throttles to cruise power, move propellers to proper settings and to trim the craft for increased speed. Preset magnetic control puts the plane on course and the air-mile counter begins clicking off the distance.

Since neither is a real problem to accomplish automatically, in-flight switching of gas tanks and cowl-flap operation are done manually on the experimental plane. No attempt is made to keep a critical balance of the gas load as it is used. Instead, the automatic pilot keeps the control surfaces trimmed to hold the plane in the correct flying attitude.

During position five, the automatic pilot, hooked through the radio, guides the plane to the first preselected transmitter, with barometric control holding it at the proper altitude. At the end of a set number of miles on the counter, the brain's activity is stepped to the next position and the aircraft homes on its first radio point. Flights of 3000 miles can be made with help from only one station.

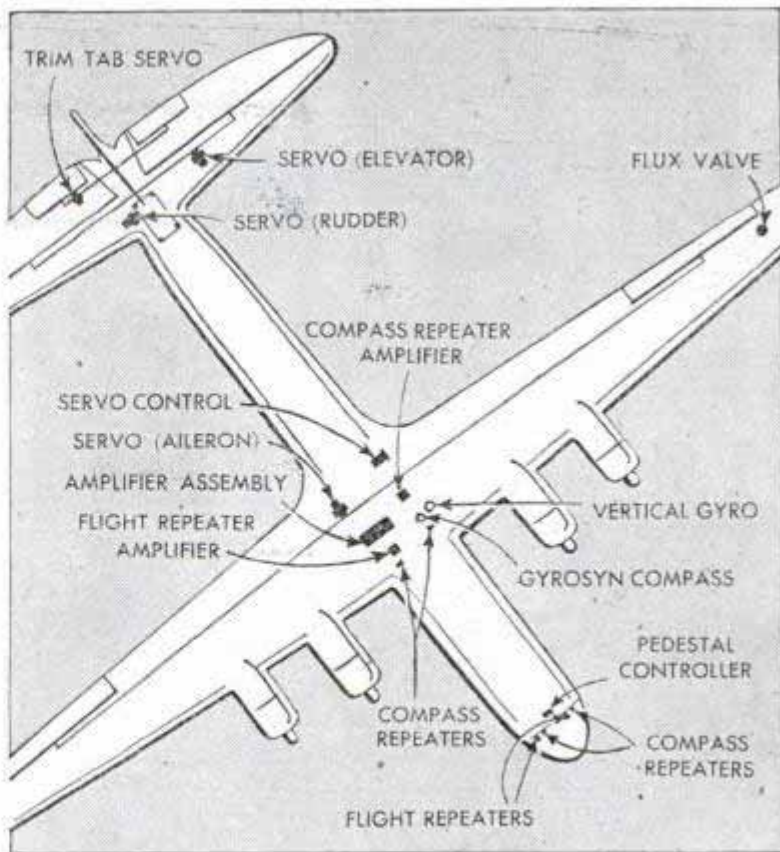

Sperry photo

Probably the most important single element in push-button flight is the Sperry E-4 automatic pilot. At the brain's prompting, it keeps plane straight and level and on the designated course

Where more than one radio check point is used, the landing sequence is fixed so that it can be tripped into action only by the frequency at the final one. As the plane passes through "cones of silence" above

Additional monitoring of the plane's flying attitude comes from the automatic pilot's pedestal controller

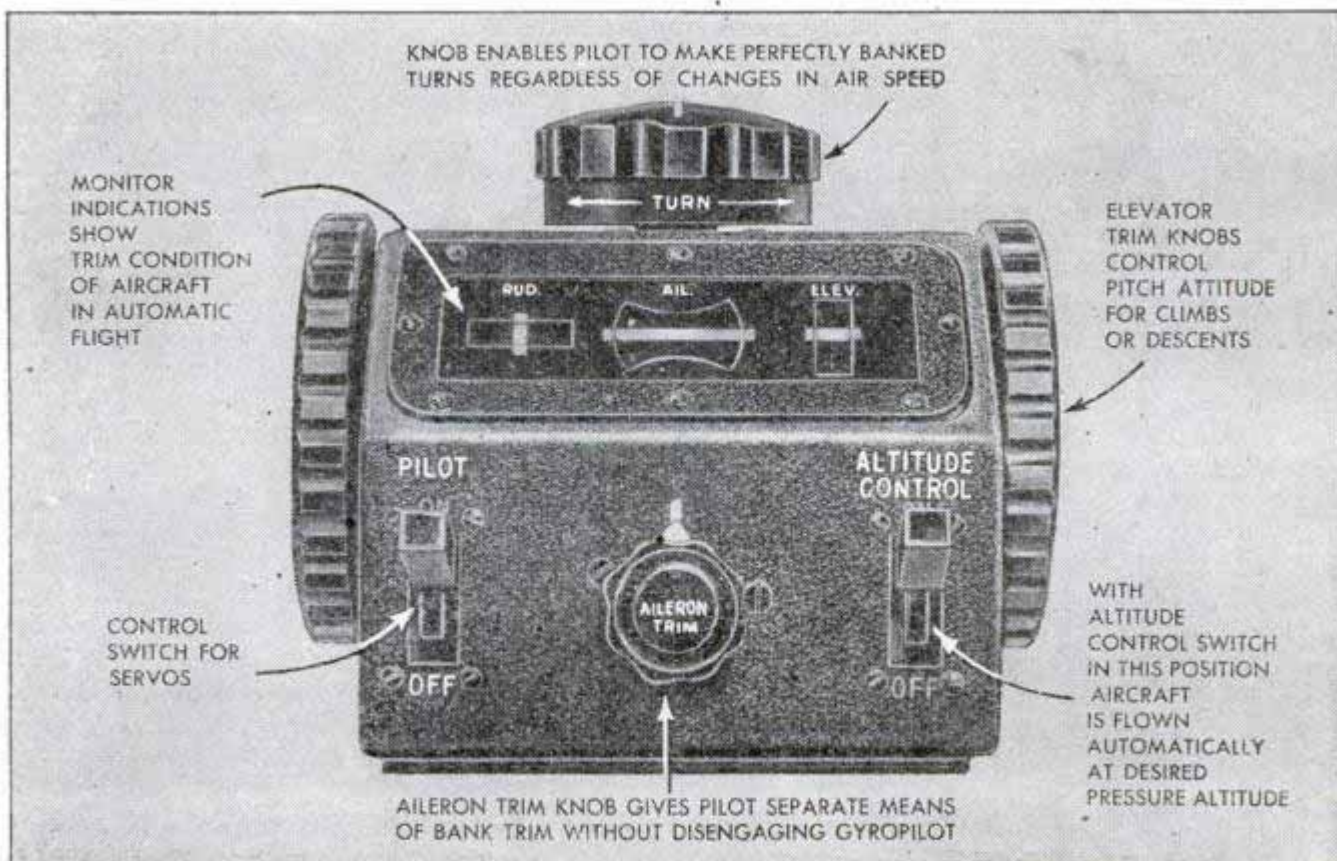

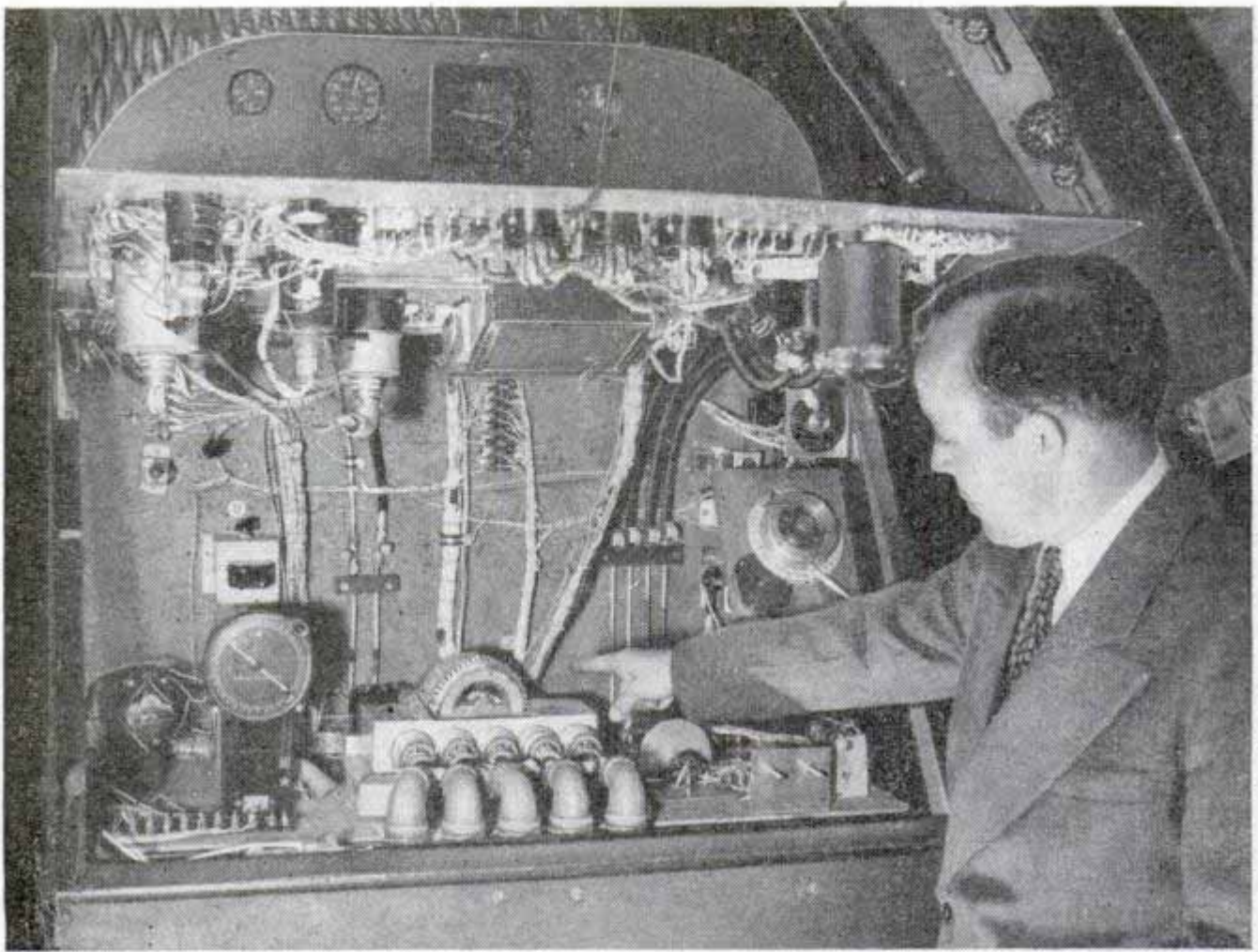

Project engineer points to telephone-type rotary switch, brain of the automatic flight controller

each of the transmitters en route, directional control instantly switches to the next station's frequency.

At position nine, the radio compass needle swings to 180 degrees and trips a brain signal for the plane to be trimmed for descent and power cut for dropping at a 500-foot-a-minute rate. Still directed by radio compass, the aircraft orbits the transmitter at five miles or less until it gets down to 2000 feet. There the altimeter signals the sequence selector to begin the approach, position 10.

Power is stepped up slightly and altitude control reintroduced to hold the plane at 2000 feet. As part of the same response, the landing gear begins to lower and separate motors start adjusting the flaps. Directional control, meanwhile, has switched from radio compass to the localizer beam.

During the eleventh phase the plane is kept in three-point attitude all the way down a radio beam to the runway. Power control flicks on and off to keep air speed at precisely the right landing-approach reading. The brain's teammates respond equally well to either the Air Force's instrument low-approach system, a localizer and glide path combination known as SCS-51, or the Sperry micro-wave landing system, whose four-inch wave lengths offer an even more

stable and concentrated beam. Both are used at the Lee's home field.

On touching down, position 12, a micro-switch on the landing gear is pushed upward, signaling the brain to close the throttles. Automatic landings are on the nose gear and the two main wheels, in contrast to the pilots' technique of making contact with the main wheels first and settling down on the nose wheel during the roll.

All this precise mechanical plotting and execution recalls the time, not so many years ago, when Post and Levine flew the Atlantic with the help of a copy of the New York Times. Levine got to the plane just in time for take-off, jumping aboard with a copy of the Times he'd been reading on the subway still clutched in his hand.

Part way across they were lost, with a lonely ship bobbing along on the waves as their only possible reference point. Levine, in a striking display of ingenuity, simply turned to the Times' listing of ship sailings while Post maneuvered down to where they could read the vessel's identification. Once deciphered and found in the listings, the pair figured out their own position over the vast Atlantic from the ship's destination and its scheduled arrival time.

And now you can fly the whole course by merely pressing a button!

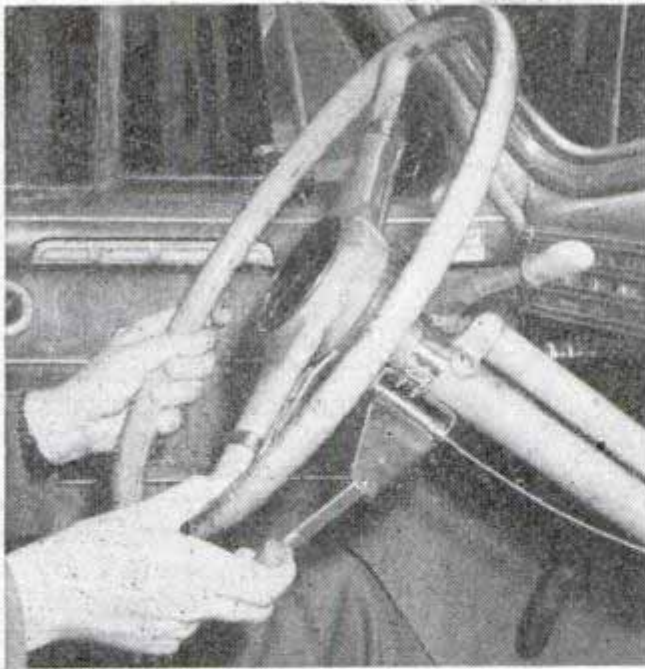

Gas Hand Feed for Cars

For the motorist who tires of holding his foot on the accelerator, a hand-operated gasoline control lever is available which fastens onto the steering column. When the lever is pushed upward, engine speed increases. When released, the engine idles.

Beacon Has Automatic "Spare"

Designed for smaller airports, a rotating beacon has extra sealed-beam lamps that switch on automatically if those in use burn out. Another beam shining at an angle 5 degrees from vertical acts as a locator and ceiling-height indicator.

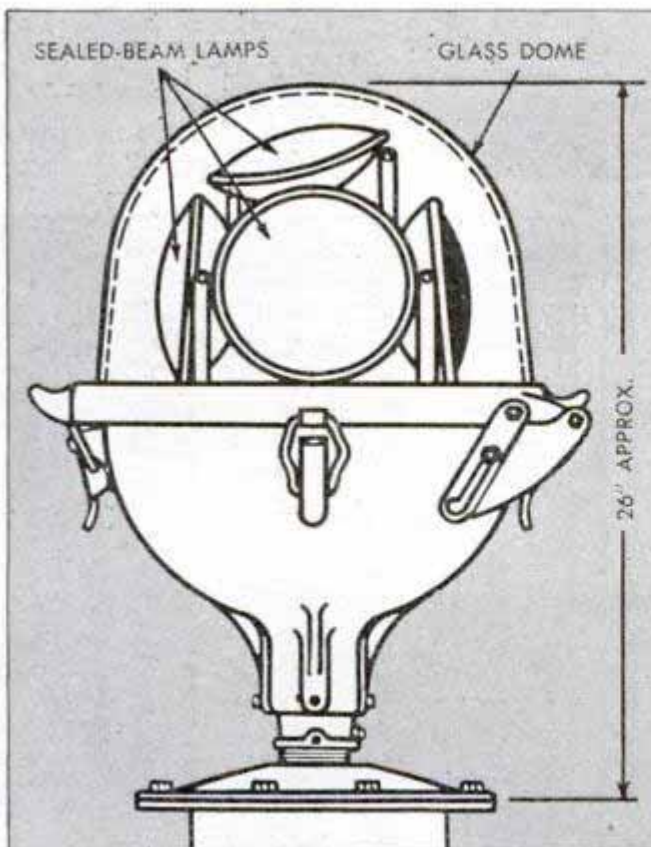

Infrared Lamp Treats Earaches

Infrared rays from a therapeutic lamp provide relief for certain types of earaches and inflammation. The lamp has a small radiant heat source, housed in Beetle plastic, which supplies warmth along the aural canal to the middle ear. An adjustable buckle and headband position and hold the lamp in place.

"Tape" Measures Brake Drums

Brake shoes for trucks can be fitted accurately with a thin steel gauge that measures the inside diameter of the drum. The gauge is coiled inside the drum, the ends pressed to force it against the sides, and a reading taken from a scale which makes possible measurements to $\frac{1}{1000}$ inch. The gauge has a range of 9 to $16\frac{1}{2}$ inches and is read like a vernier. After a measurement, the brake-shoe burnishers are set to duplicate the drum's diameter.



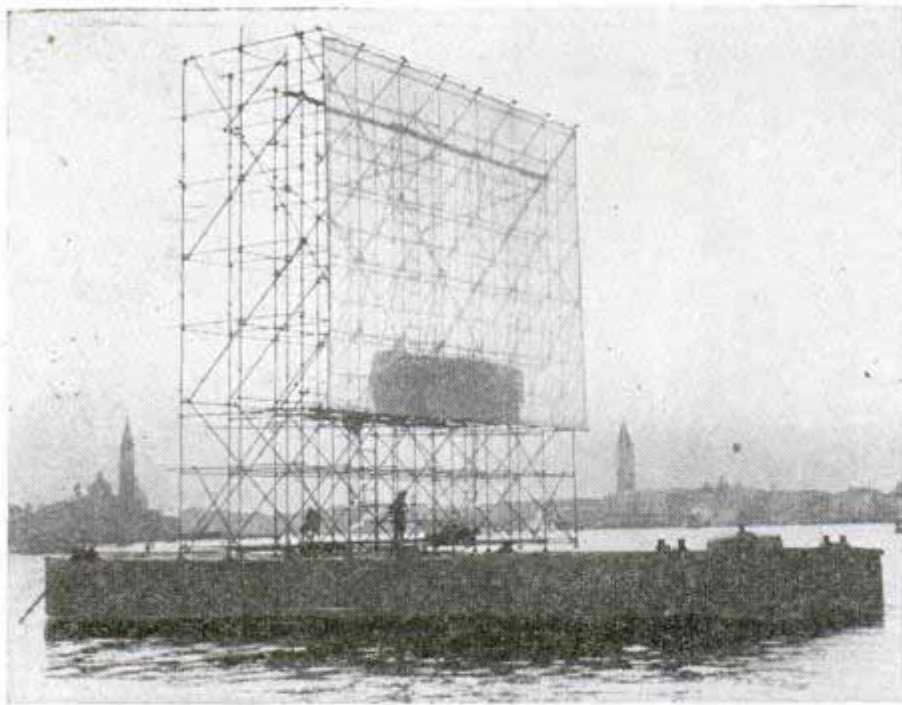

Paddle-In Theater Has Screen on Raft

If ushers were employed in one movie theater in Venice, Italy, they would have to pass a swimming test and their uniforms would be bathing suits. It's a "paddle-in" theater and the movie fans come by boat. The huge screen is mounted upon an anchored raft and boatloads of people see their favorite films in the comfort of their own craft. Supported by a complex framework of metal tubing, the screen is placed high enough so that people in the back rows have an unobstructed view of the movie. The aquatic theater was designed as a feature of the 8th International Film Exhibition held recently in the city of canals.

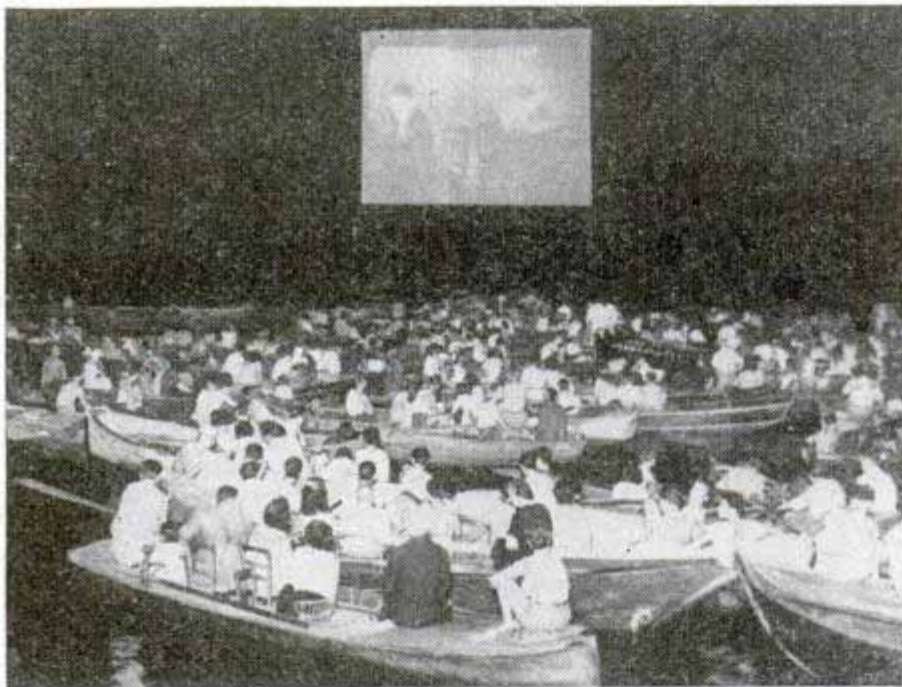

Model Plane Switch Cuts Motor in Dive

By cutting the motor whenever the plane noses over, a small mercury switch prevents model planes from power-diving into the ground. With the motor dead, the plane glides to earth. The switch, connected by wire to the motor, is mounted anywhere on the plane.

Electric "Fence" Safeguards Fish

Electric "fences" steer fish safely past water intakes of irrigation canals, hydroelectric plants and industrial installations. The fences consist of one or more rows of electrodes swinging freely in a stream and suspended by an overhead support. Not only are fish prevented from destroying themselves in man-made water diversions, but they also can be successfully fenced within lakes and private fish preserves.

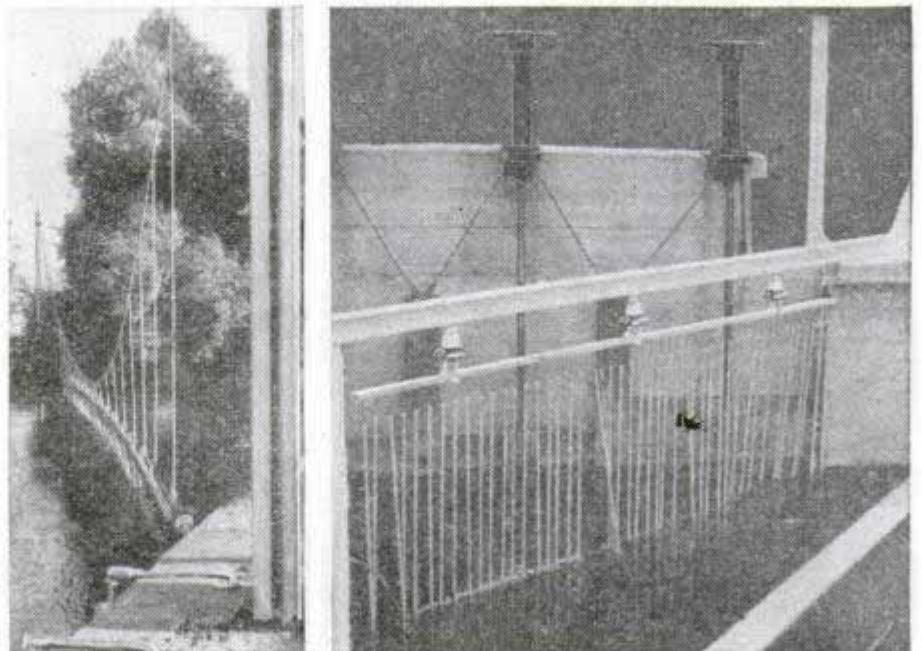



Flying "Semitrailer"

With a detachable freight compartment, the Miles M.68 airplane is expected to become the semitrailer of the air. The British transport flies with or without the freight container which has removable road wheels and a towing bar for quick coupling to an automobile or light truck. The freight compartment is loaded at the factory, towed to the airport

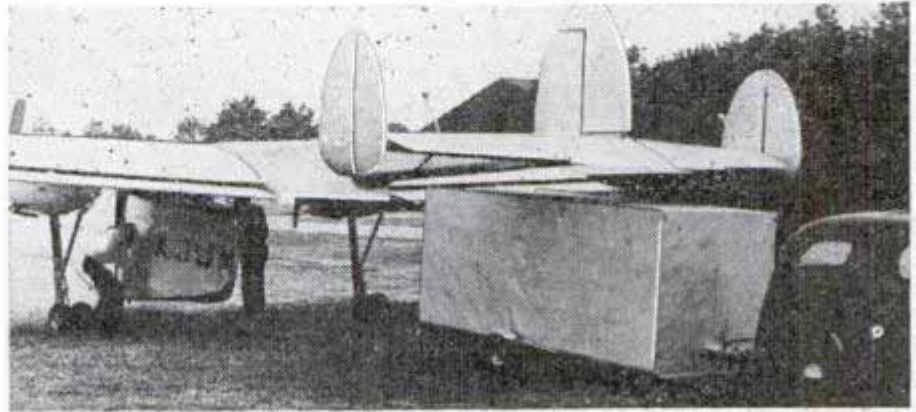

where it is attached to the plane and flown to its destination. Upon arrival, it is detached and towed away by car.

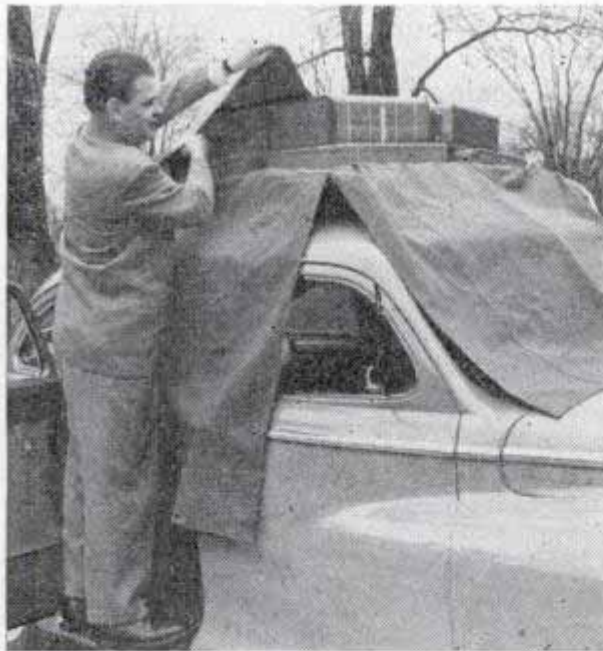

Waterproof Canopy Covers Luggage on Top of Car

For the family that wants a car with large luggage capacity, Chrysler is building the Traveler with a luggage canopy which fits into a luggage rack on the roof. The canopy is held firmly in place by eight elastic straps with swivel snaps. Made of heavy, water-repellent olive-drab duck, 46

inches wide, it folds over from all four sides to cover the luggage and protect it from rain, sun and dust. When not in use, the canopy is carried in a heavy duck bag, specially designed so that it can be stored in the car trunk. The Traveler is built on the regular Windsor chassis.

The '48 CARS Begin to Roll

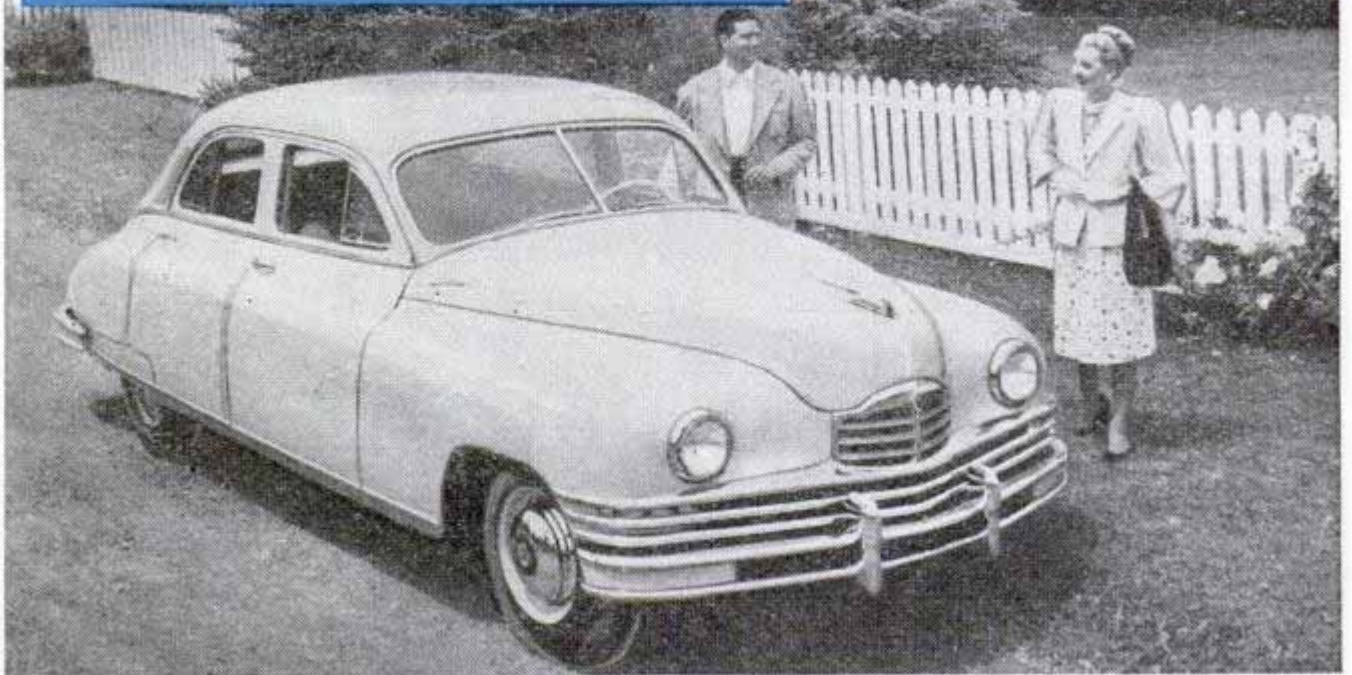

The free-flow styling of the new 1948 Packard Touring Sedan preserves the car's traditional grille lines

WHEN the 1948 passenger cars begin to roll by the thousands from assembly lines, the automotiveminded American public will begin to cash in on a "changeover" investment well in excess of 100 million dollars.

The Packard Motor Car Company spent between 20 and 21 million in bringing out the 17 new body types of its '48 lines. Hud-

By **Wayne Whittaker**

son expended 16 million to bring out its low-slung new models, and over in Dearborn, Mich., the Ford Motor Company is pouring 77 million into an all-out retooling job to produce completely modernized Fords, Mercurys and Lincolns.

That 100 million changeover figure will probably be tripled when General Motors

Don't call this car a wagon—it's Packard's '48 Station Sedan. The body and top are both built of steel

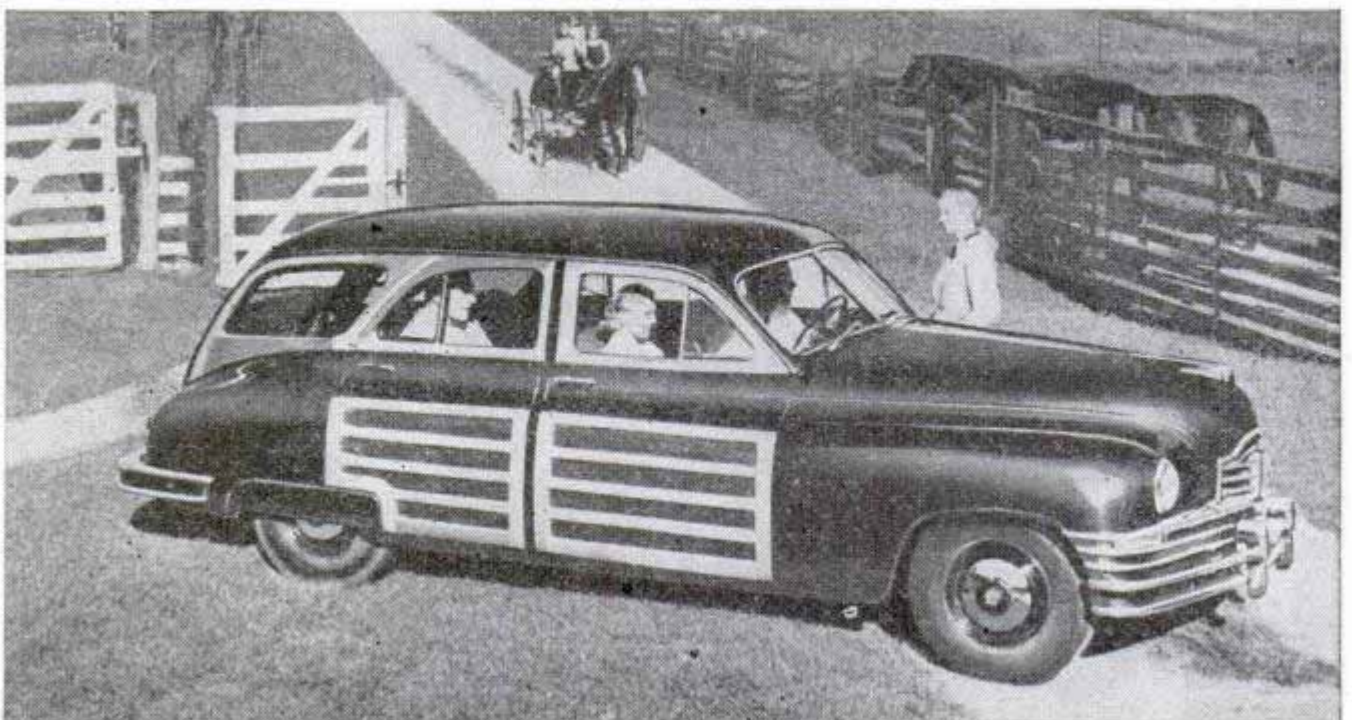



(Cadillac, Buick, Oldsmobile, Pontiac and Chevrolet) and the Chrysler Corporation (Chrysler, DeSoto, Dodge and Plymouth) announce their retooling costs in bringing out new passenger cars. Some of the models, however, are not expected to roll until 1949 or late next year.

Since the war ended, the automobile manufacturers have operated under the every-man-for-himself system. Some have plunged ahead, like Studebaker and Kaiser-Frazer, into the realm of mod-

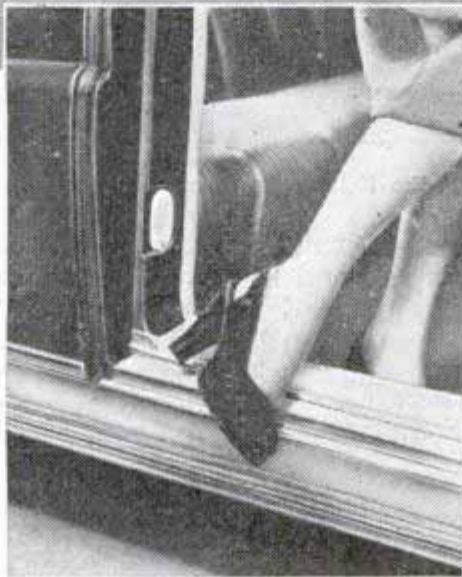

The 1948 Hudson is just five feet from ground to top of car. Passenger (left) steps down into car. Low floor gives extra headroom

ernized styling. Others have held back, like timid youths on the edge of the old swimming hole, and watched the splashes made by the South Bend and Willow Run boys.

The other companies kept telling themselves there was no need to jump into the water when the sun (back orders by

the tens of thousands) was so warm there on the bank. While Studebaker proclaimed its "new look," the others, until

The 1948 jeep convertible has the four-cylinder jeep engine. It's painted a fire-engine red with gray canvas top



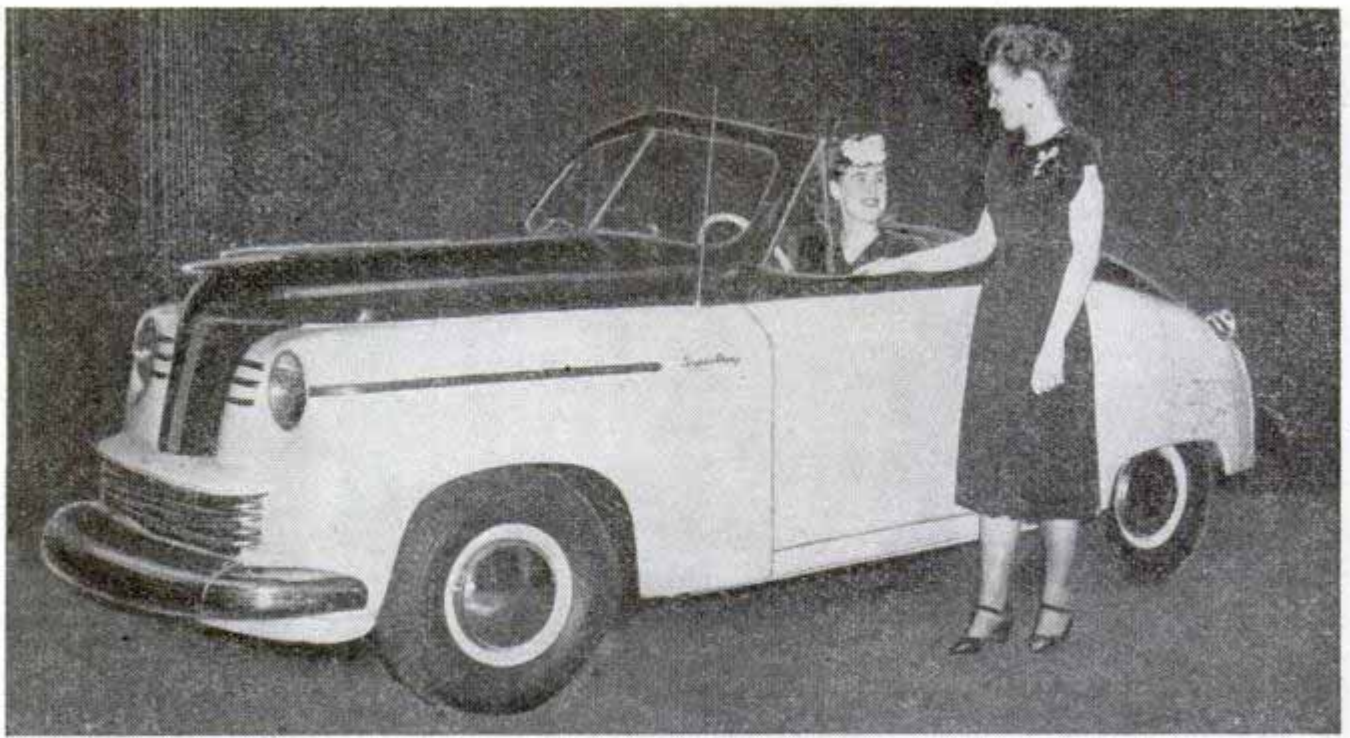

Newcomer in the lightweight class is the Keller. The convertible model has its engine in rear compartment

a few months ago, maintained a rather aloof attitude. That attitude is as dead in Detroit today as a dodo—particularly as far as the Big Three of Motordom (General Motors-Ford-Chrysler) are concerned. Behind a lot of intense activity there's a new spirit of: "We've got to jump sooner or later—maybe it better be sooner."

When several hundred thousand Chicagoans visited the five-day exhibition of the revolutionary rear-engine Tucker automobile, many a motor tycoon sat up and took notice. It did not require an Einstein I.Q. to deduct that the public is far ahead of the conservative automobile manufacturers in its tastes. A couple of years

ago some Detroit engineers regarded automatic transmissions as a lazy man's way of getting from first to third. They now predict with positive emphasis that the entire industry will be turning out fully-automatic transmissions within five years. One official of a company that builds a luxury car said: "We are determined to have an automatic transmission by 1949. If we don't we might as well go out of business."

This new fire in the eye of the automotive industry is already paying off to the public. Exhibit A (first of the '48s) is the new Packard. Its body styles, in "free flow" styling without rear fenders, include club

(Continued to page 252)

Stripped model of the Keller convertible (shown at top) shows engine. Station-wagon model is in background

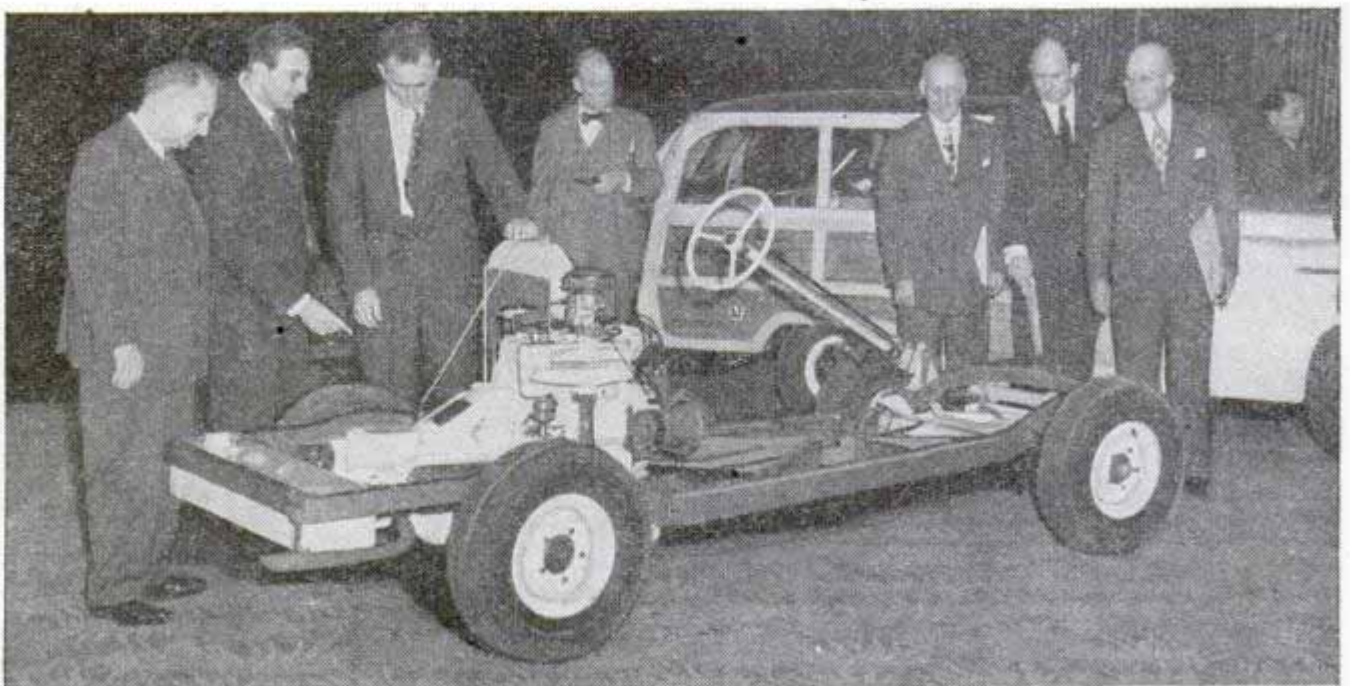

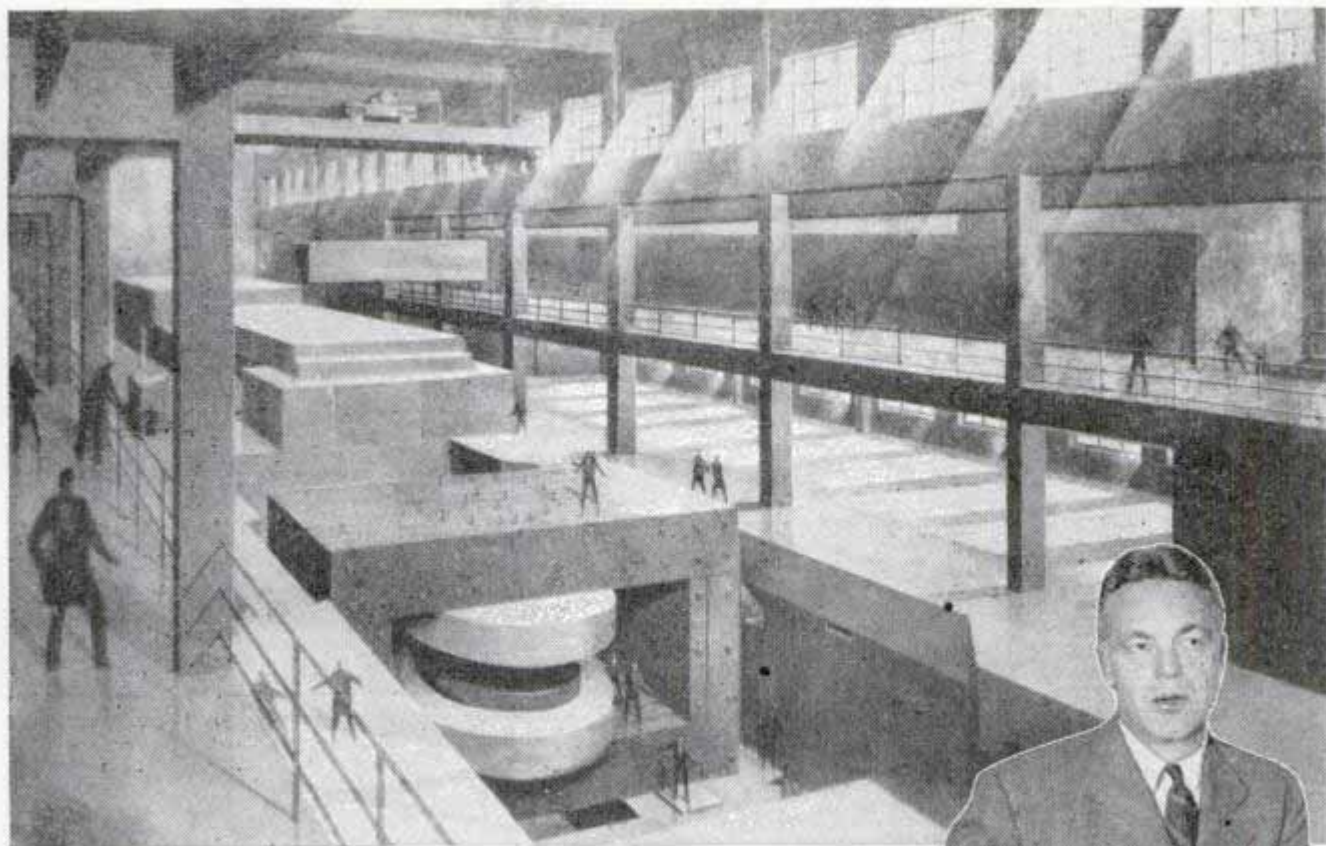

HOUSE OF THE CYCLOTRONS

Under construction at the University of Chicago is a building uniquely constructed to house three powerful instruments that will be used in nuclear research and the treatment of cancer. Called the "ion accelerator building," the structure will contain two cyclotrons and a 100,000,000-volt betatron. A 170-inch cyclotron, not yet completed, will be one of the largest in existence and will include an electromagnet built of 2500 tons of iron. Powerful beams from the cyclotron will be focused on cancerous tissue. University scientists have completed a table model of the machine and have determined the protection required because of the instrument's radioactivity. The cyclotron will be installed in a pit 20 feet below floor level covered by concrete seven feet thick. A feature of the building will be a crane capable of handling 70 tons of heavy equipment.



Top, cyclotron will be installed in a pit 20 feet deep. Overhead crane will run the length of the interior. Above, Chancellor Robert M. Hutchins with model of 170-inch cyclotron to be used in cancer research

High-Speed Spinner Revolves at 187,000 R.P.M.

When he read the report in the September *Popular Mechanics* of a microtome that operates at 123,000 revolutions per minute, O. C. Brewster of Litchfield, Conn., an engineer, regarded it as a challenge. Having been working experimentally with a small laboratory centrifuge doing more than 93,000 r.p.m., he thought the 123,000-r.p.m. mark could be bettered. In two days his assistant, Herman P. Hermenau, built a small air-driven turbine which he reports attained a speed of approximately 187,000 r.p.m. The rotor shaft of the spinner is $\frac{1}{2}$ inch in diameter and about two inches long, running in $\frac{1}{2}$ -inch journal bearings

with special lubricants and means for overcoming bearing whip.

"I am very sure this speed of 187,000 r.p.m. could be greatly exceeded, if there were any need for such speed," says Mr. Brewster, "by giving a little more attention to details. This particular machine serves no purpose other than to demonstrate the possibilities of the type of bearing construction and method of lubrication used."

☐ Motorists in cars equipped with telephones can make and receive calls anywhere between Boston and Washington.

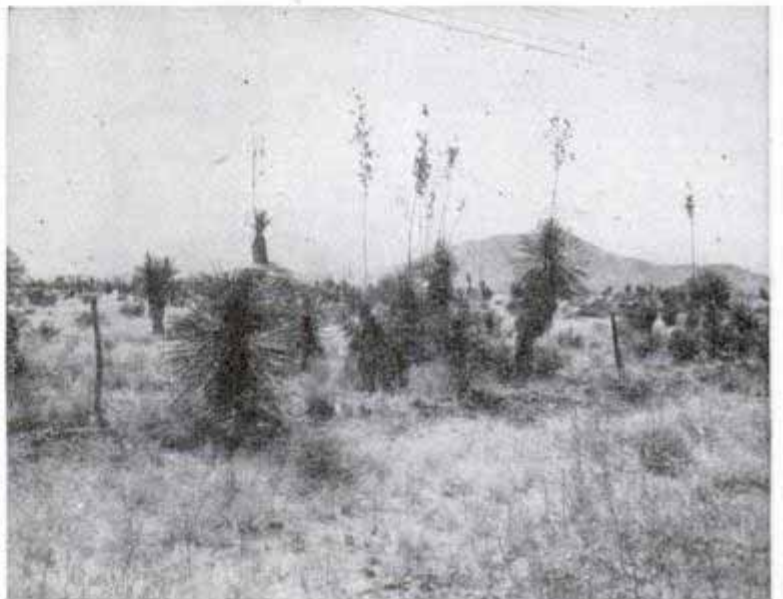
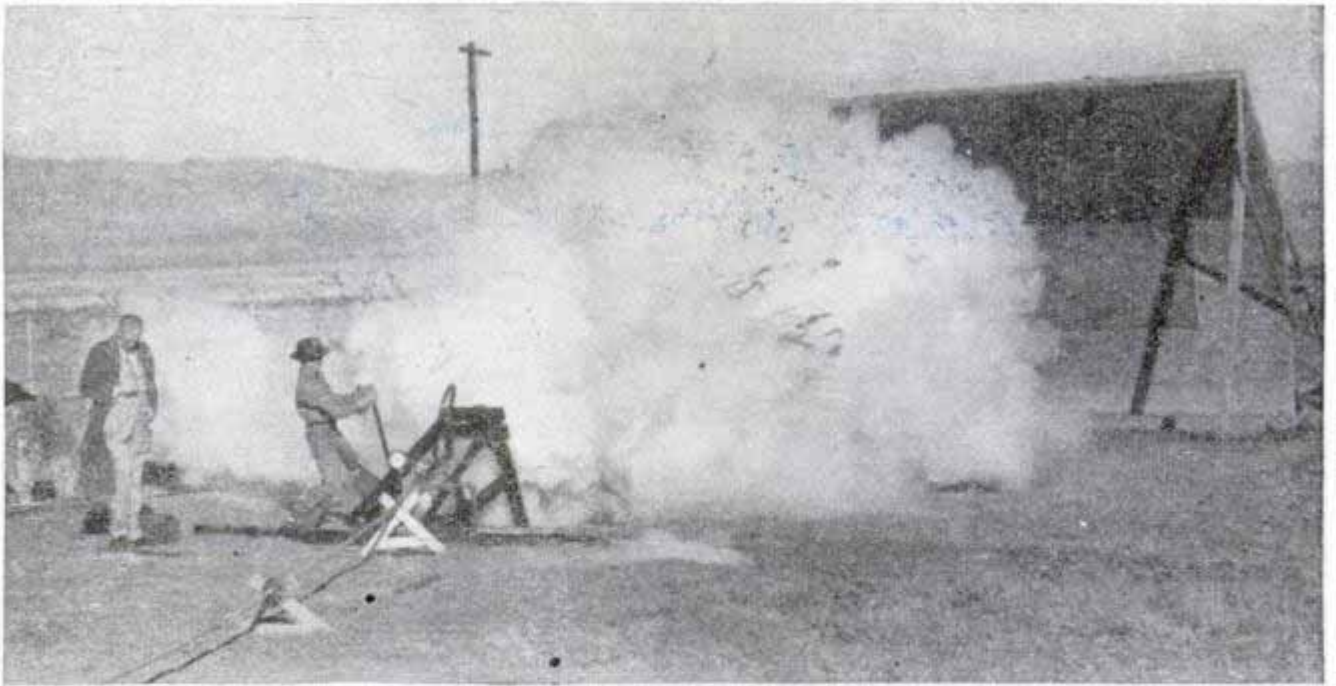

Top, after three minutes under steam pressure, the yucca leaves are shot from the gun. Left, tough and spiny, the leaves have long resisted inexpensive methods of fiber extraction. Right, yucca grows profusely in desert

Steam "Gun" Blasts Upholstery Fiber from Yucca Leaves

Southwestern desert yucca-plant leaves are converted into useful fiber in six minutes by an experimental steam "gun" which shoots the material against a back-

stop. After being washed, the fiber is used in upholstery or for rope. Previous methods of extracting fiber required brushing, boiling, steaming and chemical treatment.

Goodyear Aircraft photo

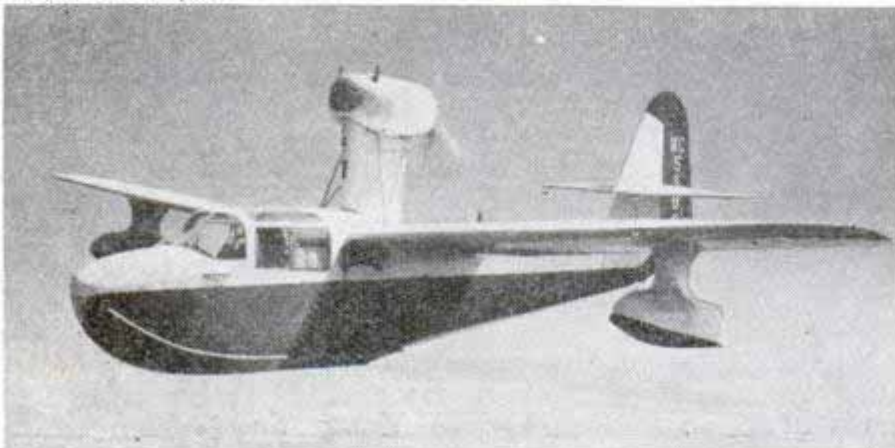

Duck Leaves Water In 1300 Feet

Among the smallest amphibians ever built, three-place Goodyear Ducks make water take-offs in 1300 feet and land at 50 m.p.h. Some models also pioneer a retractable cross-wind landing gear. Water operation is simplified by use of a retractable rudder.



**MUDDING
A SLED**
Eskimo Style

Photos by Ven. Donald B. Marsh, Archdeacon of Aklavik

This Eskimo youth is demonstrating the art of sled mudding which puts an ice-smooth edge on the runners. First he mixes mud with partly decayed moss

Working in below-freezing temperatures, he shapes the mud to the runner from the sides. This method is used on largest Eskimo sleds as well as the small ones



After the mud has frozen solid to the runners it is planed down. Planes were once made from wood or antlers; this young mechanic is using smoothing plane

Preparing to wet the planed surface of runner, boy holds water in mouth and squirts it into piece of bearskin which will not stick to mud as it is applied

With a quick gesture the water-filled bearskin is inverted and rapidly passed along runner from one end to the other. The thin film of water freezes instantly

After many films of ice are applied to the mud surfaces, the slick runners are ready for a tryout. Big sleds often stop along the trail for quick re-icing





SOUND FOR 8-MM. MOVIES

Two synchronous motors operate an 8-mm. projector and a turntable with an electrical transcription to provide sound for home movies. Automatic synchronization is achieved by recording on the beginning of the transcription a short 1000-cycle tone. There is a synchronization mark printed in the beginning leader of the film, and the projector is threaded with this mark just above the aperture gate. The turntable then is started and the needle is set down on the revolving record. When the needle reaches the 1000-cycle tone, this tone operates a relay in the amplifier circuit, which automatically turns on the projector. This starts the picture in synchronization with the sound. The set uses $33\frac{1}{3}$ -revolution-per-minute electrical transcriptions.

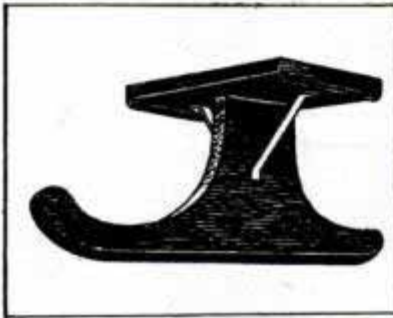

"JUMPER" SLED

Single-runner sleds called "jumpers" provide thrills in winter sports for young people at Petoskey, Mich. Holding onto the handles and with feet extended to the front, the jumper riders balance as they speed down snow-covered slopes, make sharp turns and sail through the air. The jumper base is a piece of 2-inch wood, 24 inches long and 10 inches high, covered with a metal runner $\frac{1}{8}$ inch thick. The seat, attached to the center of the base, is 15 inches long and 9 inches wide and made of $\frac{3}{4}$ -inch wood. Handles are attached at each side to the bottom of the seat.



DISARMING CLOCKWORK FUSE OF BURIED GERMAN BOMB

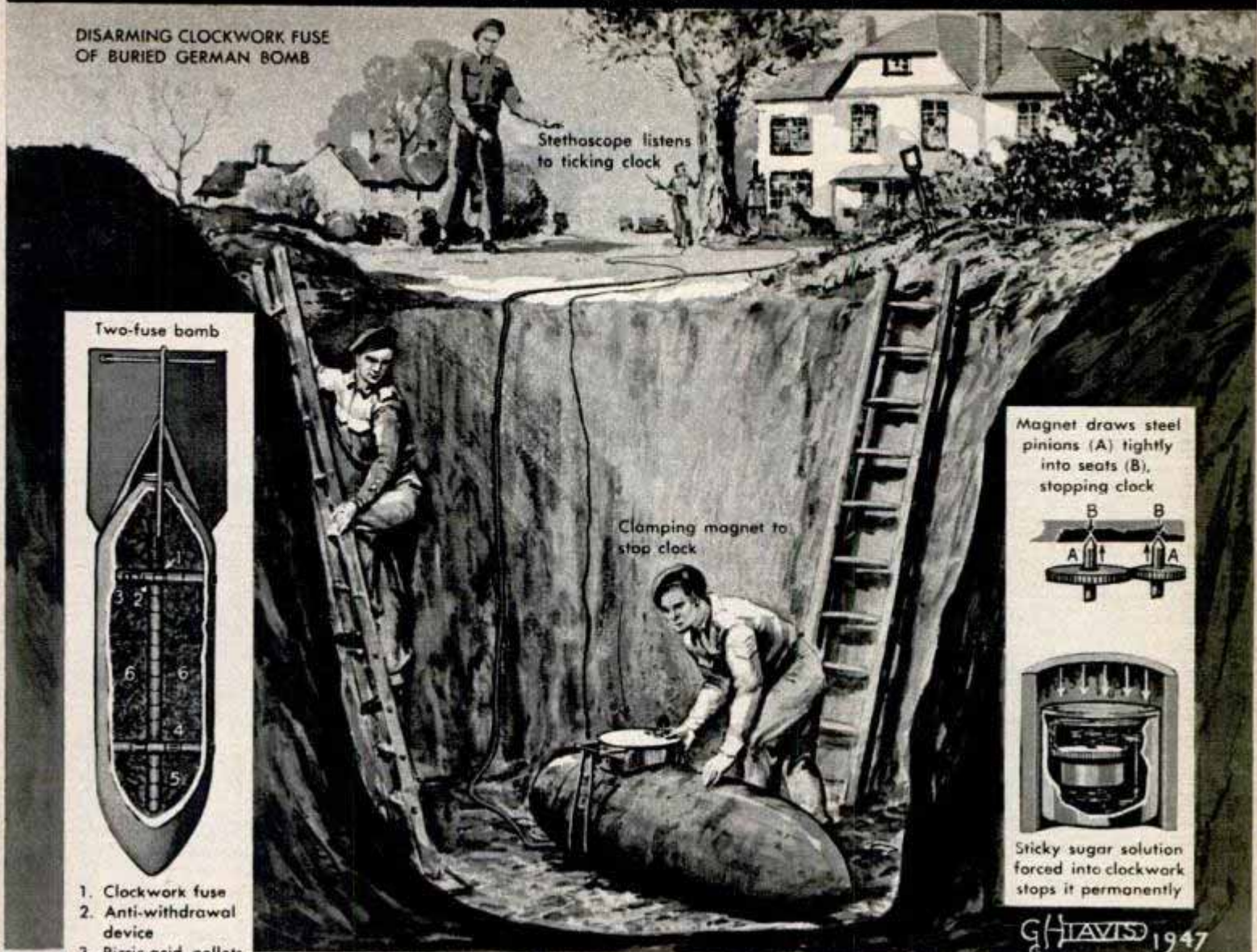

Stethoscope listens to ticking clock

Clamping magnet to stop clock

Magnet draws steel pinions (A) tightly into seats (B), stopping clock

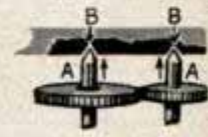

Sticky sugar solution forced into clockwork stops it permanently

G. HAVIS 1947

Two-fuse bomb

1. Clockwork fuse
2. Anti-withdrawal device
3. Picric-acid pellets
4. Sensitive fuse
5. TNT in paper tube
6. Main explosive



Pumping viscous fluid into bomb's clockwork



Pump evacuates air, then lets sugar solution flow into clock

AN UNTOLD CHAPTER of World War II is the Battle of the Bombs waged between British bomb-disposal squads and German technicians. The Germans used great ingenuity in varying the type of fuses used on the bombs and trying to outwit the disposal experts. This cost the lives of many men, but the British succeeded in disposing of more than 50,000

high-explosive bombs during the war years alone. The cleanup operations are still going on. There are four general stages of bomb-disposal work: (1) locating the bomb; (2) identifying the types of fuses used; (3) disarming the fuse pockets; (4) drilling the casing and melting out the main explosive charge. One of the early types of German fuses could be disarmed

HOW FAR BOMBS PENETRATE

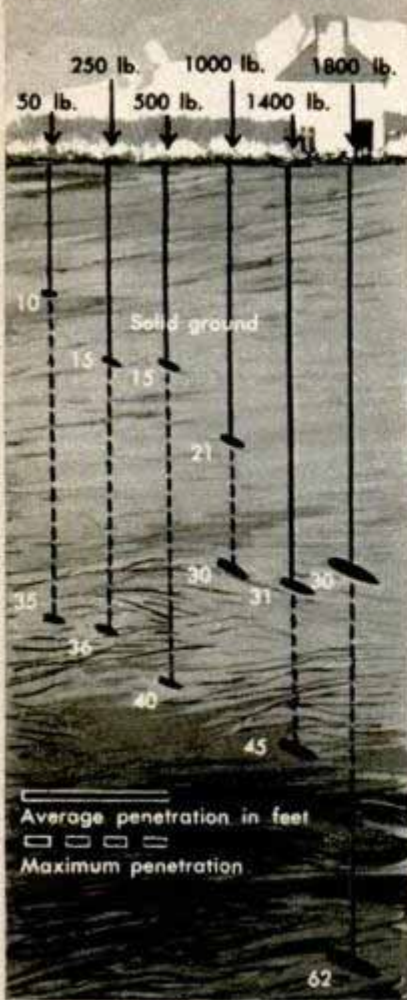

German bombs showing position of fuses

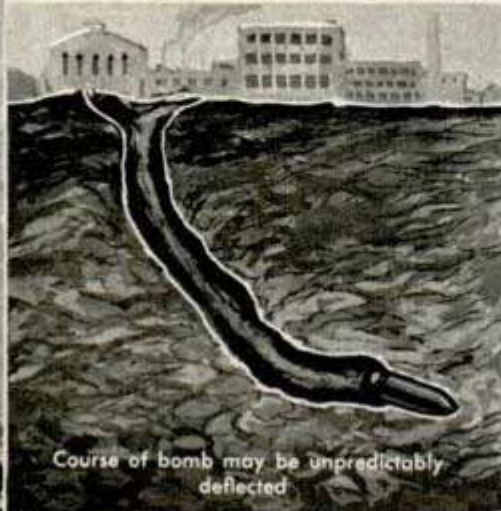
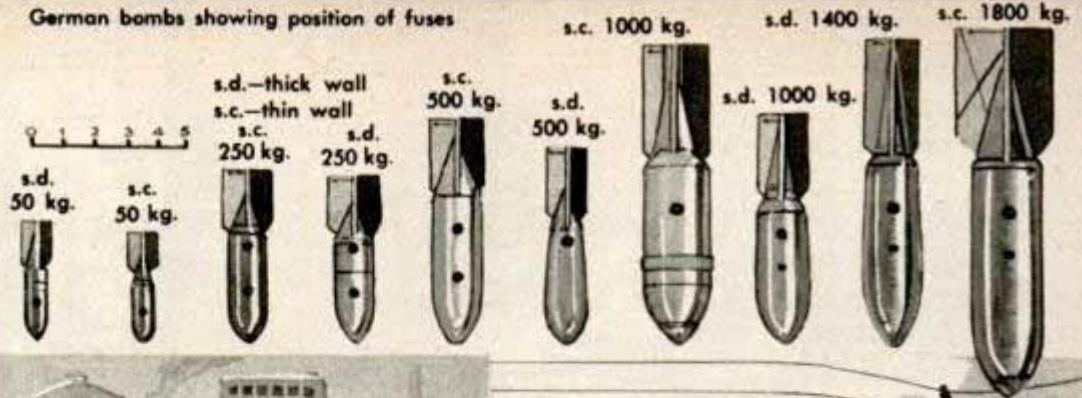

IMMUNIZING FUSE BY STEAM

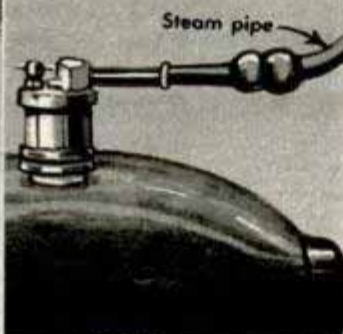

GERMAN FUSE 15

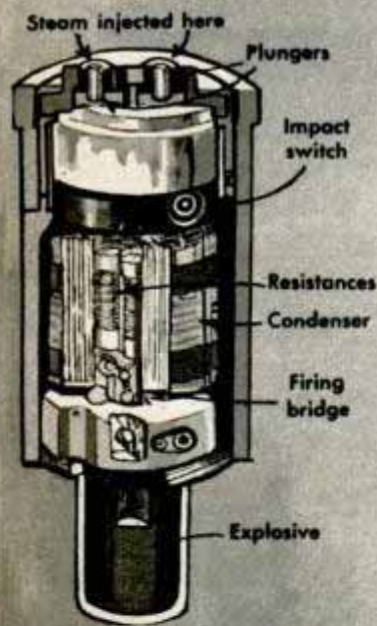

Immunizing fuse 17

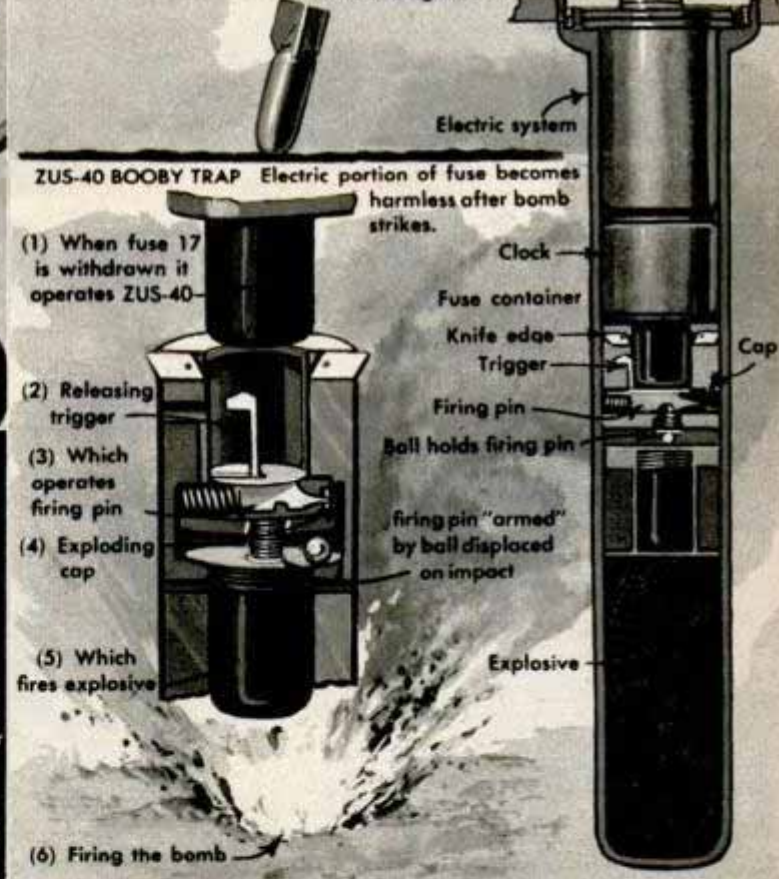

by simply depressing the plungers. Then in 1940, bomb-disposal squads encountered a new fuse with very sensitive inertia switches. This was followed by a delayed-action fuse and an electrical device similar to that on the earlier fuses. Later the Germans introduced a fuse in which the electric gear ceased to function on impact but which had a clockwork fuse arranged to

operate over a period up to several days. Below this mechanism the Germans placed an ingenious booby trap which explodes as the fuse is withdrawn. The experts nullified the electrical device on the early bombs by directing steam into the top of the fuse. This penetrates between the condenser plates and causes the current to discharge slowly and safely. In the clock-

IMMUNIZING Y FUSES

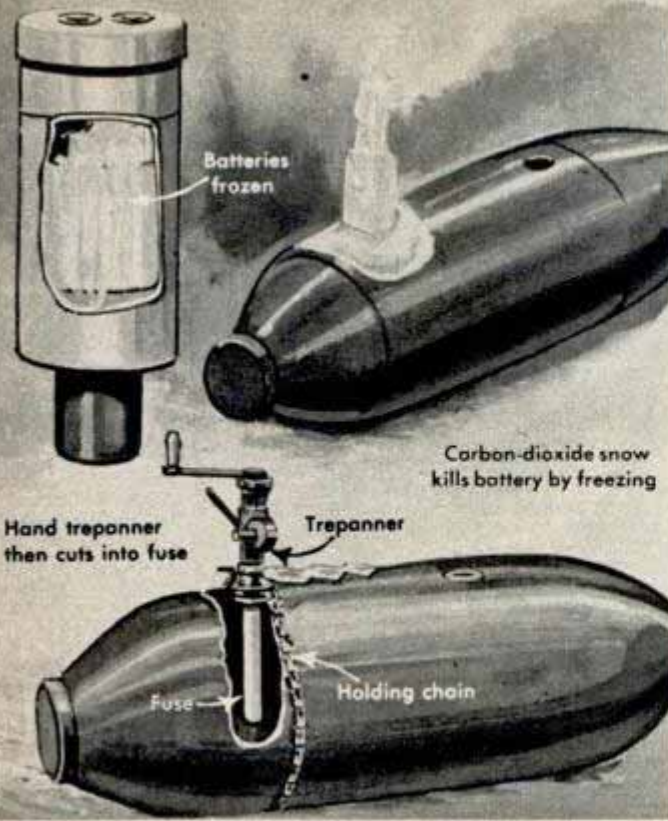

Immunizing the 57 fuse

LIVE 57 FUSE

IMMUNIZED

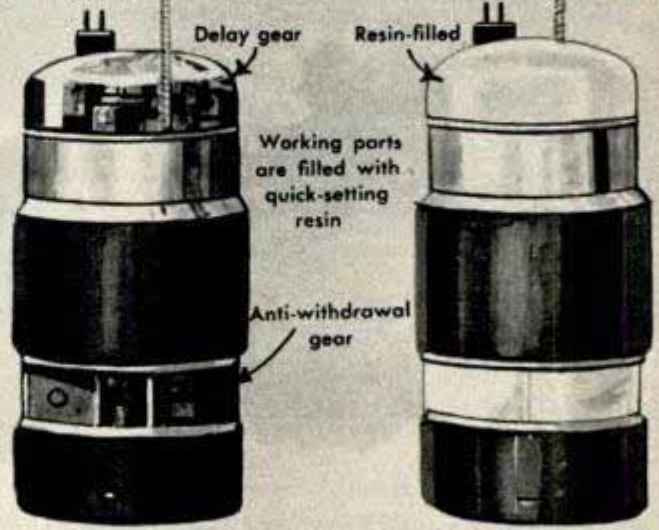

Any attempt to withdraw fuse explodes bomb

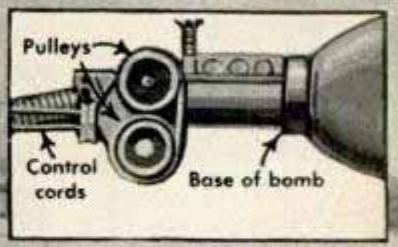
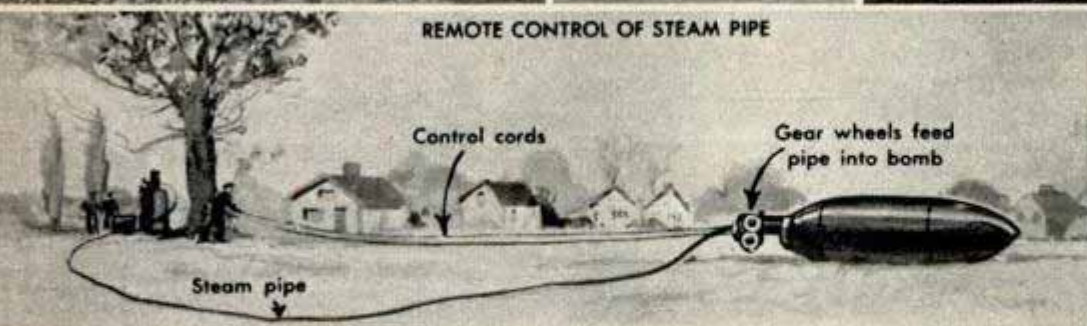
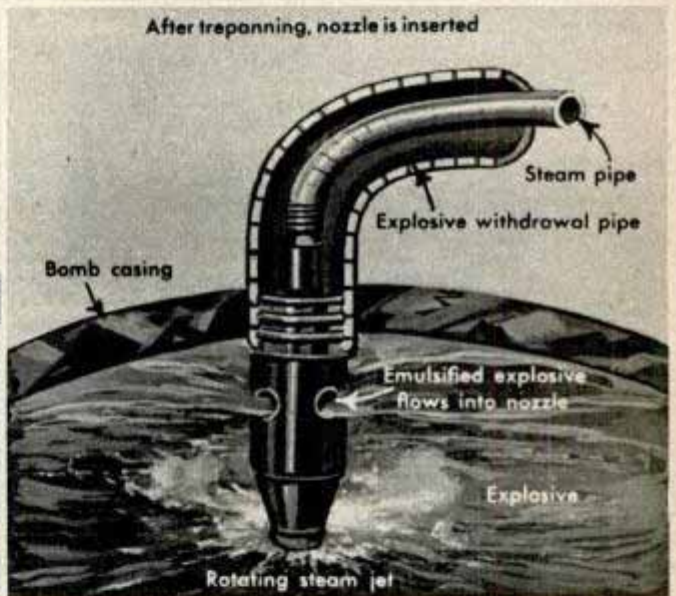
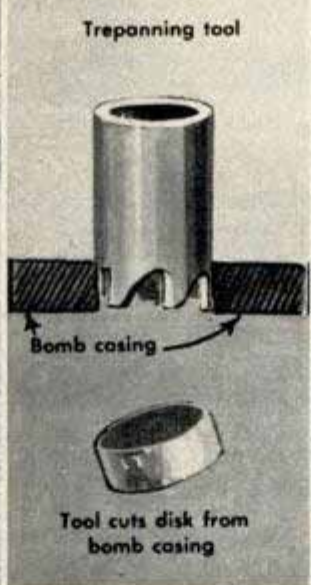

G. HAVIS 1947

work fuse, the bomb-disposal workers have discovered they can draw up the steel pinions into the bearing with a powerful magnet. This stops the mechanism and the next step is to fill the clockwork with a sticky compound. A quick-setting synthetic resin is used for this purpose in one type of fuse. After the clockwork is definitely stopped, the main explosive is

removed from the bombs and the empty casing covered with sandbags and blown up along with the booby-trap attachment. While the disposal work is in progress one member of the crew listens with an electric stethoscope to make sure the clockwork fuse does not start operating again. One type of fuse was immunized by freezing the batteries with dry ice.



Old Railway Car Makes Trestle for Irrigation Flume

Steel beams that once supported the bed of a railroad car now form a trestle to carry an irrigation flume across a stream near La Junta, Colo. The wooden trestle that

formerly crossed the ditch had to be replaced, so concrete piers were poured on both sides to support the new trestle, which was set in place by a portable derrick.



Portable Electroplater Built Into Small Case

Electroplating is simplified by a new plater with a built-in electrical circuit which operates on normal household current. The operator merely clips one wire to the article to be plated and dips it into the ready-made solution. In about 30 seconds, enough metal is deposited on the article for normal plating. Two beakers are equipped with stainless-steel anodes that complete the circuit. Gold, silver and copper plating solutions are available in small quantities for use with the plater.

20-Foot Sprayer Bar Covers Side of Road

Weed-killing solutions are sprayed across highway shoulders by a bar sprayer that covers a strip 20 feet wide. The spray delivers an even concentration of solution at 30 to 40 pounds pressure. The bar, which is spring-mounted, may be raised or lowered when passing mailboxes and trees. Spray jets are spaced at 18-inch intervals along the bar and staggered in an offset of 10 degrees to insure complete cov-



erage of the weeds. A filter in the spray bar prevents foreign matter from collecting in the jets and plugging them.

All-Plastic City

With a pair of scissors and a pot of airplane glue, Clyde H. Johnson of Long Beach, Calif., built himself a city. Using thin sheets of cellulose acetate, he designed and constructed a city complete with apartment houses and department stores for use with his model railroad. Windows and roofs are painted aluminum and shine at night like those of a busy metropolis. Sponge-rubber shrubs "grow" in the parks. Johnson calls his model city, which required about 1000 hours to build, "Silver City."

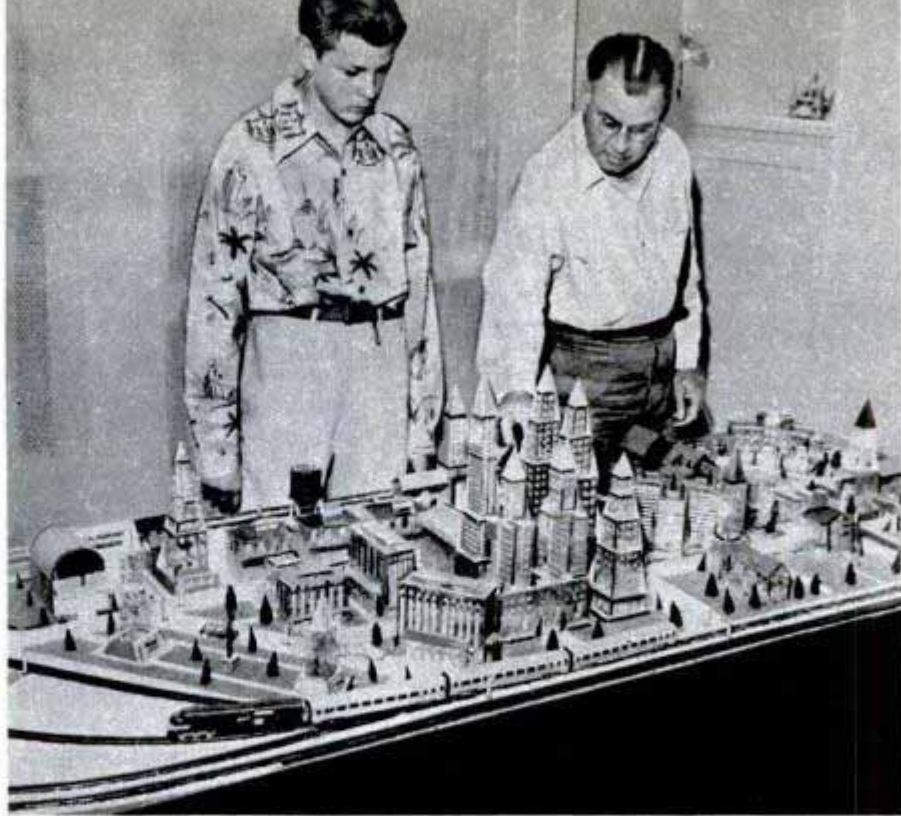

Three-Wheeled Racing Car Has Clamshell Tail

Bumps and vibration at high speeds are reduced as much as 50 percent in a three-wheeled racing car, according to designer Edward J. Shermeister Jr., of Sheboygan, Wis. The front-wheel drive racer was designed for next year's 500-mile racing classic at the Indianapolis Speedway. The hydraulic airfoil tail opens like a clamshell to increase air resistance and prevent skidding on the turns. Opening and closing the tail is controlled from the driver's seat. Before the unusual car can compete in the race, the American Automobile Association contest board must approve the design. At present, the rules of the association define a racing car as "a vehicle of four or more wheels operated in contact with the ground." This definition will have to be changed if the three-wheeler is to compete.

Rolling "Bank" Brings Pay

Workers at the Ford Motor Company's Rouge plant get deluxe service on pay day. Armored "banks" on wheels roll from building to building to speed up the distribution of a payroll that adds up to \$1,500,000 a day. As the workers show their card stubs, the pay clerk slips the envelopes through an opening at the bottom of the bulletproof window.



Robot Rockets Challenge Sonic Barrier

WHAT WILL HAPPEN when planes speed up and slow down on their way through the sonic barrier? To find the answers to one of the most critical problems of supersonic flight, Great Britain has started a six months' test program 14 miles off the Cornish coast. Most authorities are already agreed that aircraft will fly faster than sound successfully, once past the barrier.

Some 80 pilotless rocket models will be flown to probable destruction during the experiments, after brief bursts of blazing speed. They are being launched from beneath bombers flying about 400 miles an hour at 36,000 feet, gliding 15 seconds and losing about 1000 feet before their motors start. After one or two minutes level flying guided by an automatic pilot, the models crash into the sea to avoid danger to shipping.

During the run, batteries of automatic cameras in jet fighters patrolling the course shoot complete records of the test. In addition, each model carries a six-channel telemetering outfit that continuously radioes reports to the ground, where the flight is tracked on radar screens.

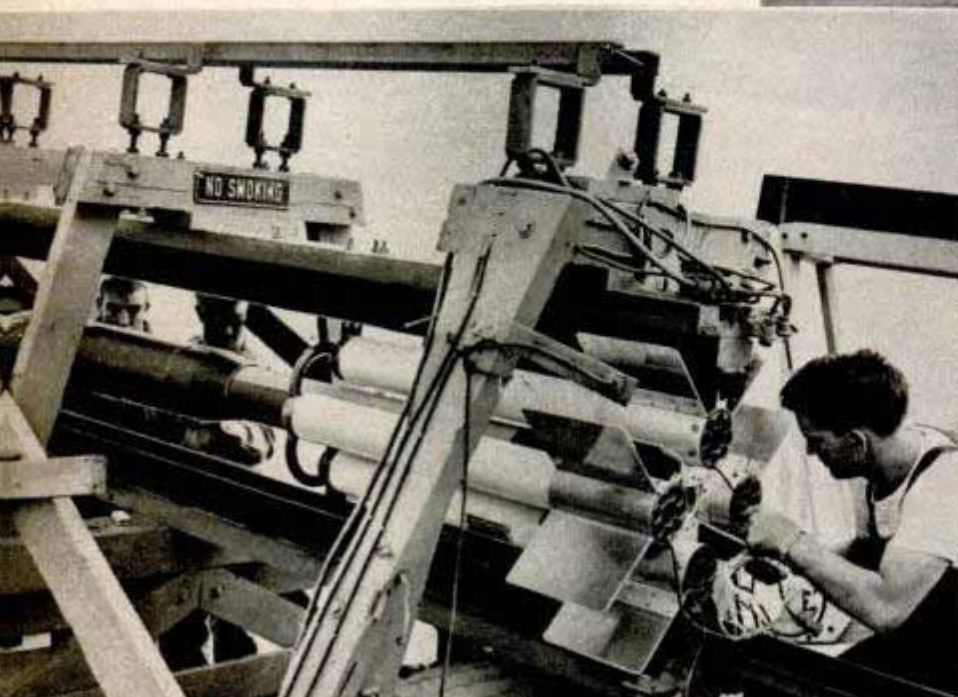
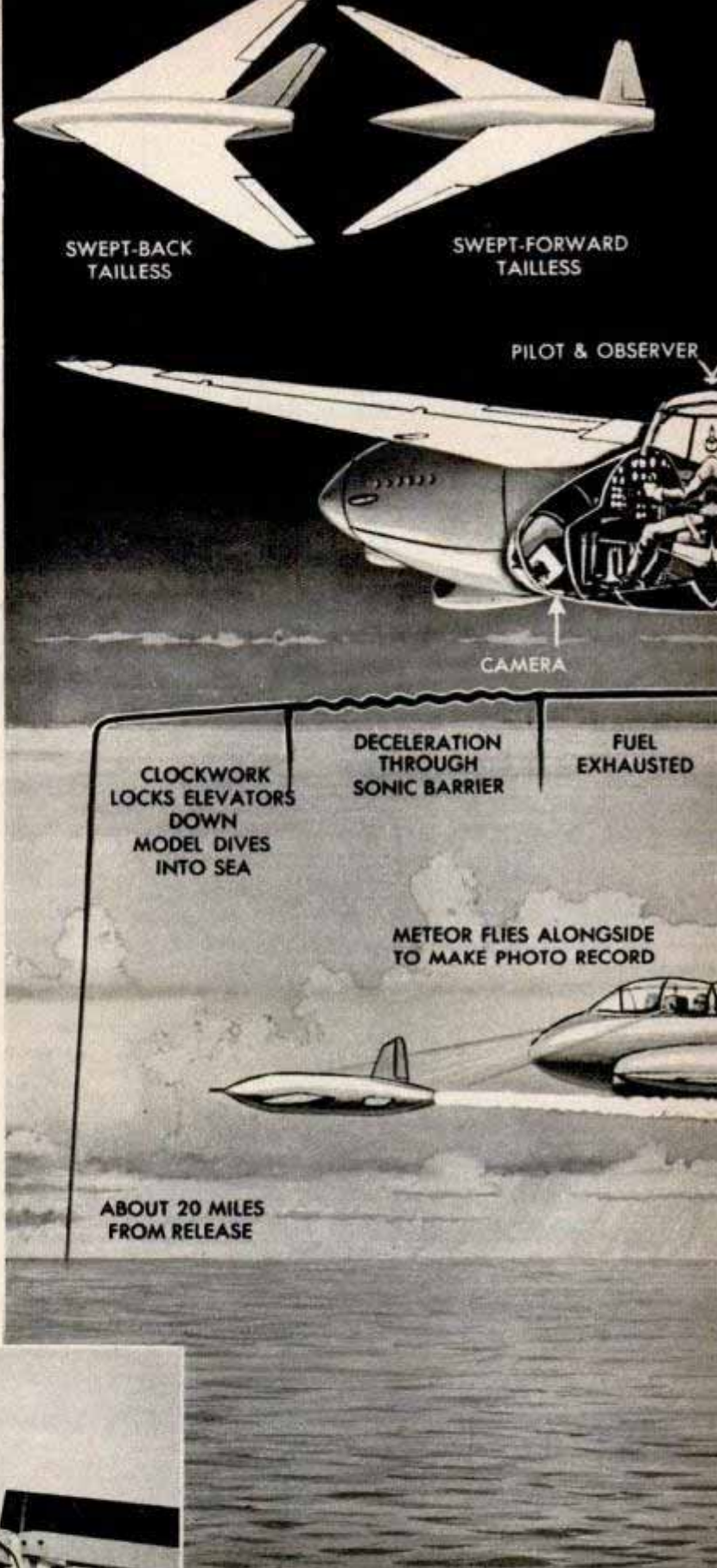

Cutaway diagrams, above, illustrate how the British experiments will be conducted. Speedy Mosquitoes will probably be used for the dropping assignments and 600-mile-an-hour jet Meteors for patrol duties. At the lower right is a typical rocket plane model. Left, in a U. S. test with supersonic projectiles, Navy technician adjusts fuses in rocket chambers of ramjet. One fired at Ft. Miles, Del., reached 1400 miles an hour

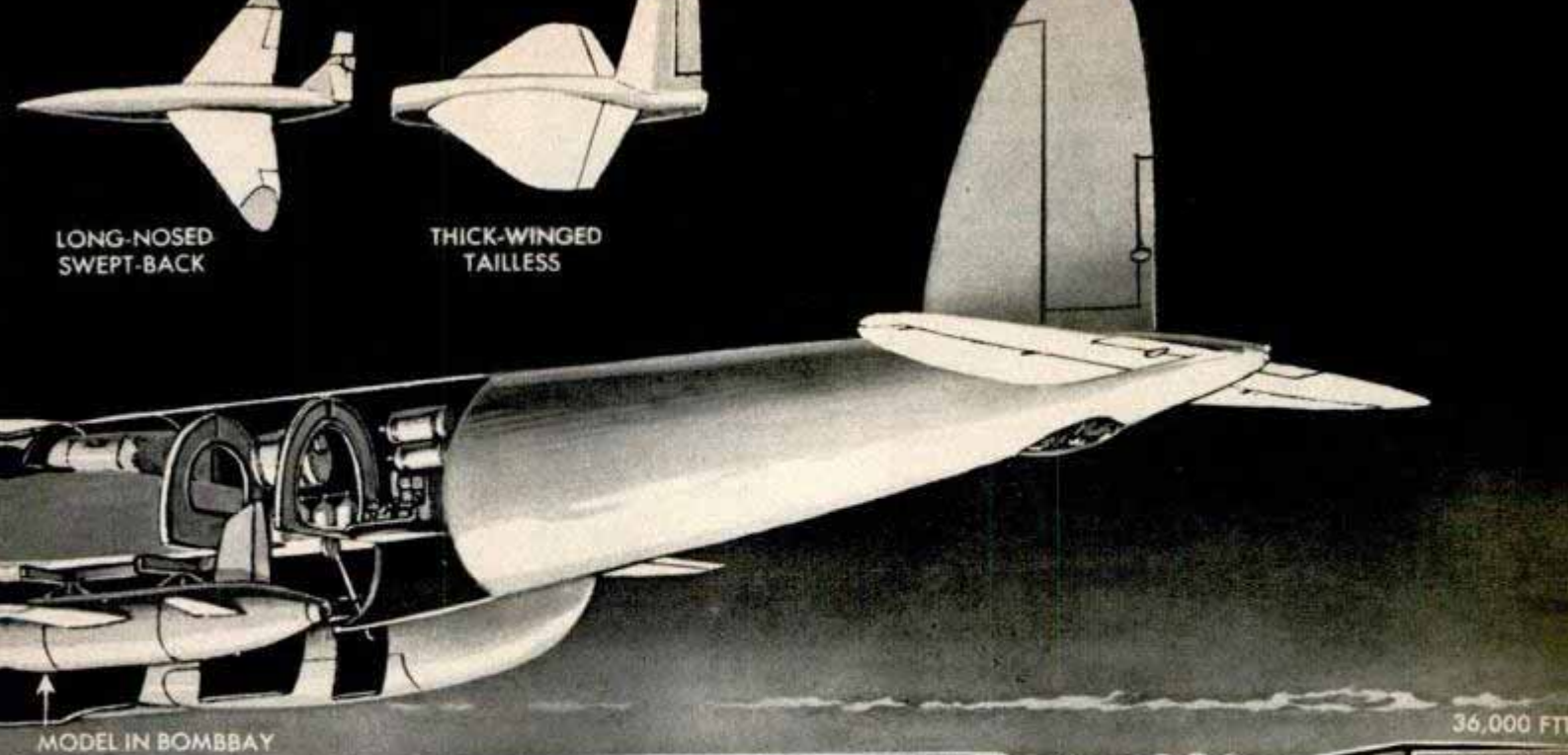

LONG-NOSED SWEEP-BACK

THICK-WINGED TAILLESS

MODEL IN BOMBAY

36,000 FT

35,000 FT

1 MINUTE AT 880 M.P.H.

15 SECS. ACCELERATION THROUGH SONIC BARRIER

ROCKET IGNITES

MODEL RELEASED

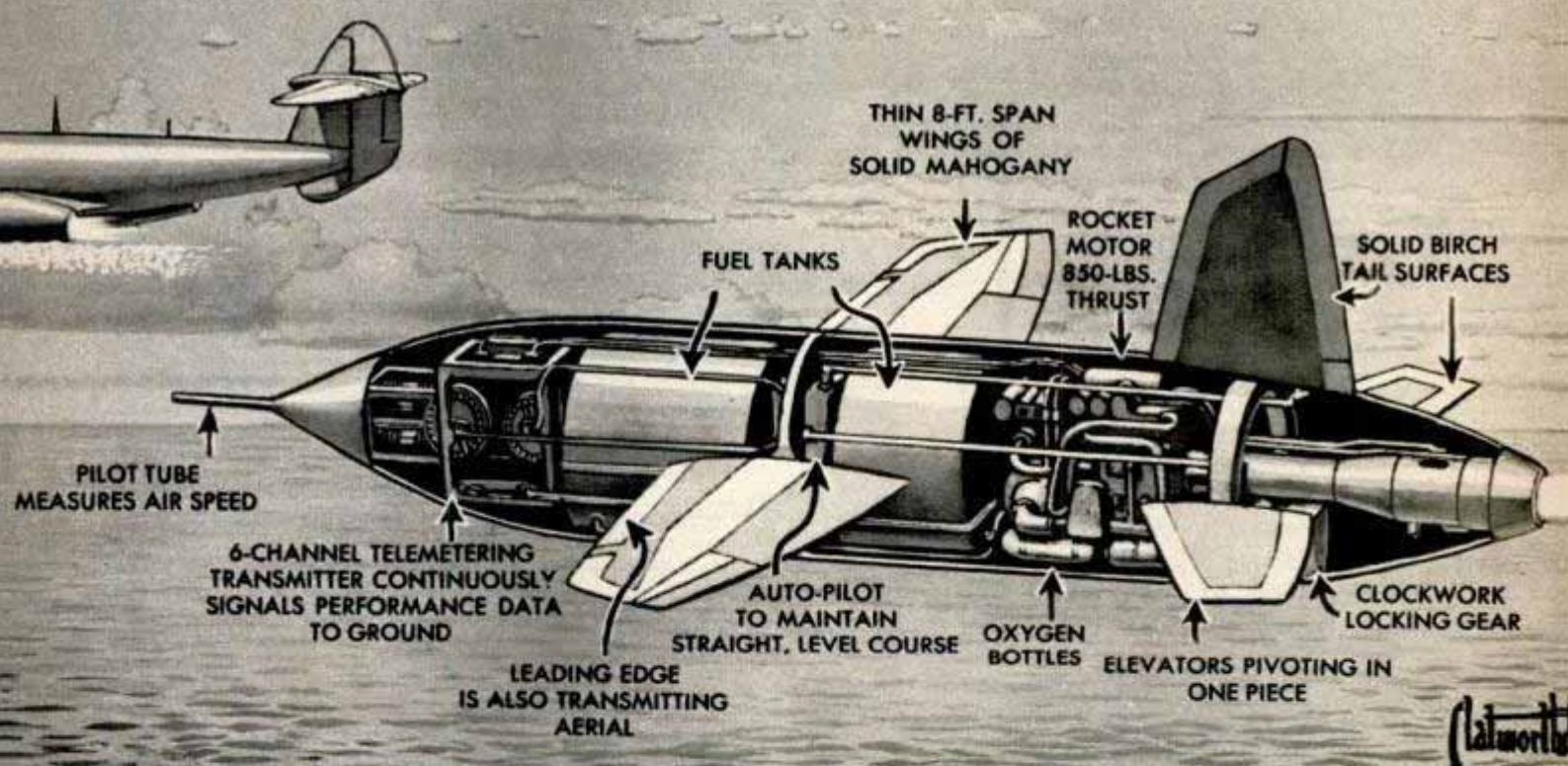

Clatworthy

Copyright by S. W. Clatworthy

The test planes are built to scale. One of the first flown weighed approximately 900 pounds, had a highly polished mahogany skin and a 2000-horsepower alcohol-burning motor. It was close to 12 feet long and had an eight-foot wing span.

Models were decided on, instead of full-size planes, for the experiments because they are quicker and easier to build, permit quicker analysis of results, are simpler

to modify and do not endanger pilots' lives. Flights are necessary because wind-tunnel research is limited at transsonic speeds.

In tunnels, at speeds near sound, shock waves set up by the wing's leading edge are reflected from the walls back onto the rear of the wing, distorting the results. Once the speed of sound is exceeded, the waves move back toward the trailing edge and the reflection no longer affects the wing.

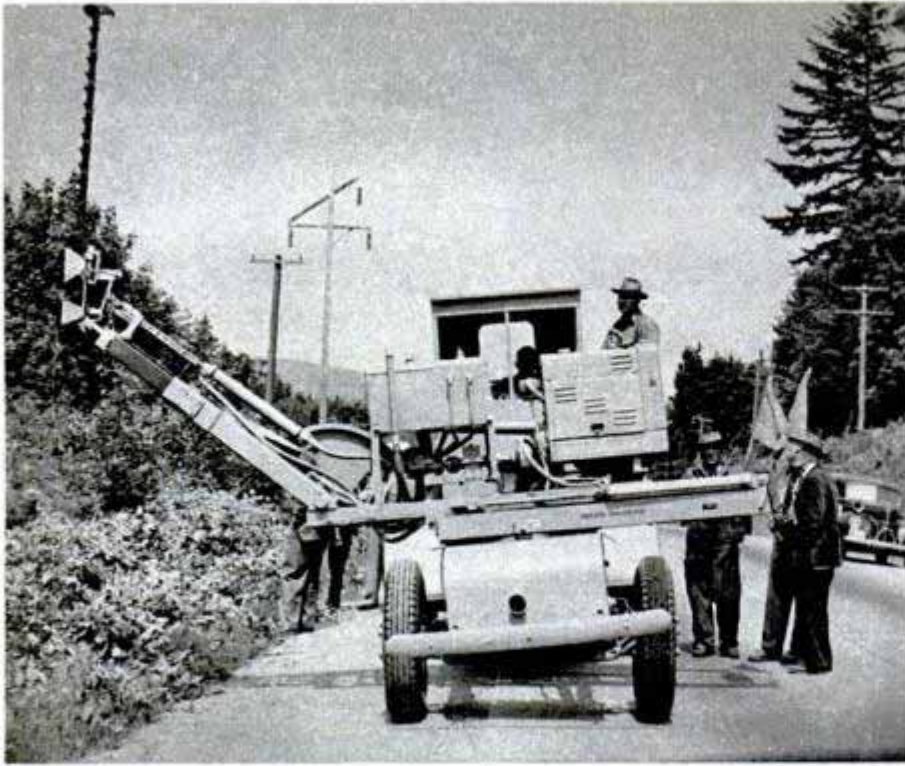

Roadside Trimmer Mows Steep Banks

Capable of cutting at almost any angle, a roadside brush cutter trims gullies and banks easily. Its five-foot blade mounted on a long, adjustable arm, the cutter trims brush and small trees up to four inches thick. In a recent test, the cutter in 15 minutes trimmed a stretch of brush that would have taken three men a full day to cut by hand. A smaller model, designed for use with a tractor, enables farmers to trim brush along irrigation ditches quickly.

Once Barber Chair, Now an X-Ray Table

By using ingenuity and \$25 worth of new materials, shop workmen at Colorado State Hospital in Pueblo converted an old barber chair into a combination X-ray and operating table. The hydraulic unit of the barber chair serves to adjust the height of the table.

ⓂNails in regular production range in size from 15-inch boat spikes, weighing 1 pound 10 ounces each, to the barely visible escutcheon pins, which are only $\frac{3}{16}$ inch long and so light that it takes 95,000 of them to weigh one pound.

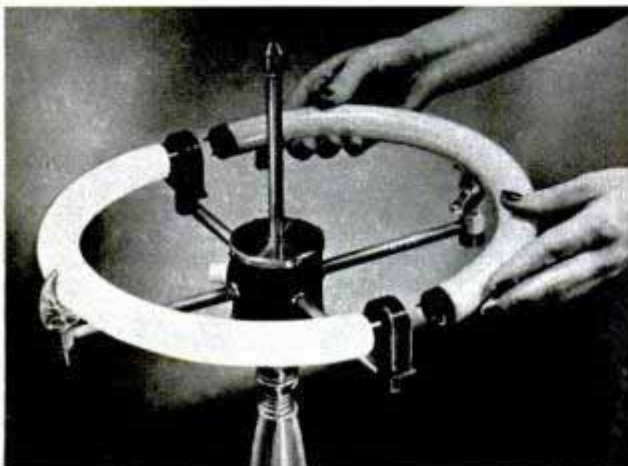

Half-Circle Fluorescent Lamps Can Be Used Singly or in Pairs

Because of its shape, a semicircular fluorescent lamp has greater flexibility of uses than the full-circle fluorescent type. Used in pairs, the lamps provide shadowless light for desk and table lamps. Singly, the crescent-shaped tube fits neatly into bed lamps or wall lamps. It provides more light than a 50-watt incandescent bulb, but consumes only one third the electricity. Two-pin plastic bases at each end of the tube make it easy to replace lamps.

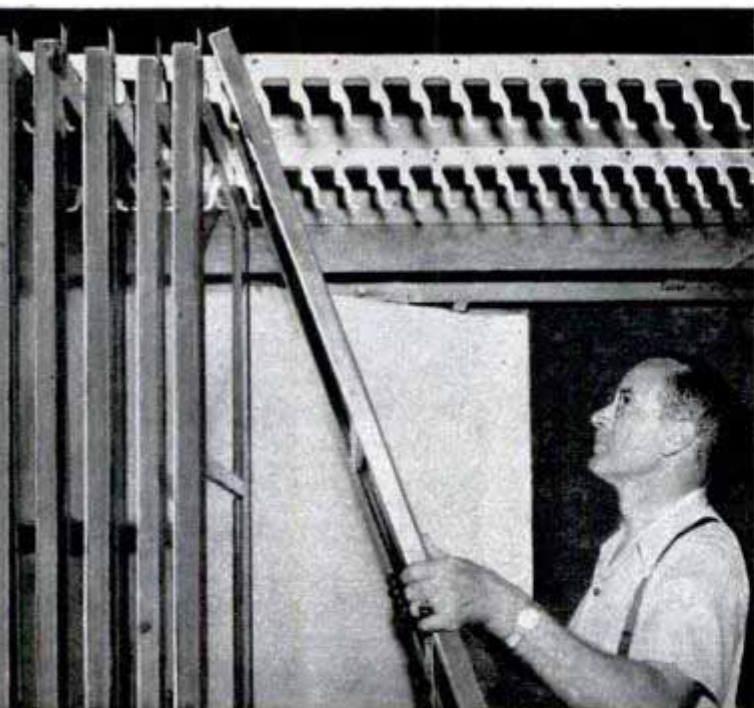

Storm Windows Stored Safely

Storm windows and screens are stored safely with a set of metal brackets attached to the basement ceiling. The sashes are inserted between the fingers of the brackets on an angle and when lowered to a vertical position are held securely. Each set of brackets holds 21 windows or screens. Two or more sets can be arranged in tandem to increase the capacity.

"Disk-Whirler" Tests Metal Alloys

To test the strength of jet-engine alloys, red-hot metal disks are whirled at 35,000 revolutions a minute in a "bombproof" dugout—until they explode. The dugout at Westinghouse Research Laboratories is ringed with heavy sandbags and sunk 10 feet below floor level. Weighing 32 pounds, a foot in diameter and an inch thick, the disks are turned by a shaft from a high-speed motor another 10 feet below the dugout. They are heated to 1400 degrees Fahrenheit by coils. During tests the whirling disks are covered by a thin steel hood from which air has been evacuated to reduce friction. It has purposely been made of very light steel so that flying fragments from the disks penetrate its thin skin undamaged enough to be studied. The disk's increasing diameter is also measured periodically to learn how much the metal "creeps" under stress and temperature.

Popular Mechanics is always ready to supply further information to readers about various products described in any issue. Just write to Bureau of Information, Popular Mechanics, 200 East Ontario Street, Chicago 11, for a prompt reply

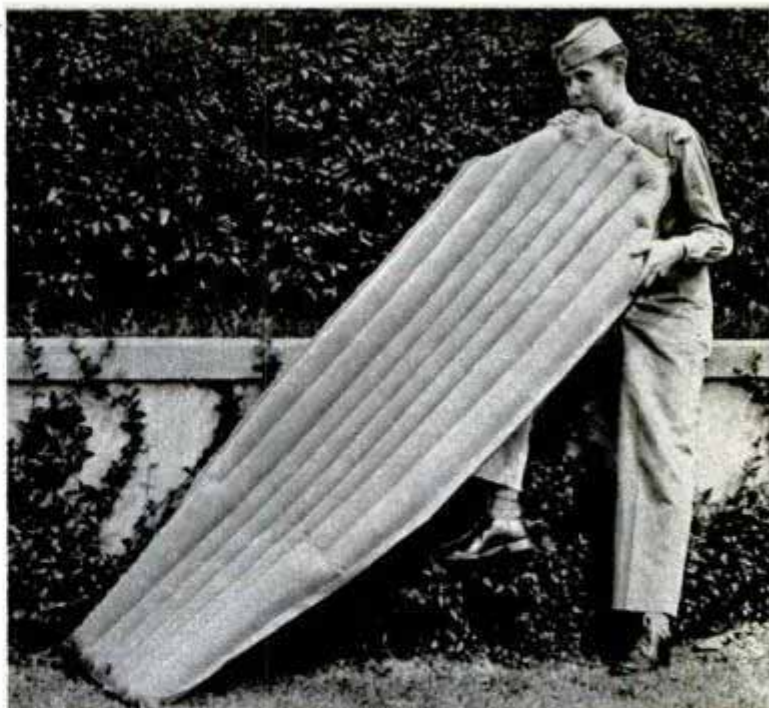

Signal Corps photo

Cradle-Shaped Air Mattress

Soldiers who toss in their sleep won't roll off a new air-filled mattress, according to the Army. The mattress has a concave surface that overcomes the tendency of sleepers to roll off ordinary air mattresses. Weighing less than four pounds, the mattress is designed to fit inside the Army cold-weather sleeping bag. It is made of Nylon cloth coated with butyl rubber.

Westinghouse photo



Caricatures in Wood

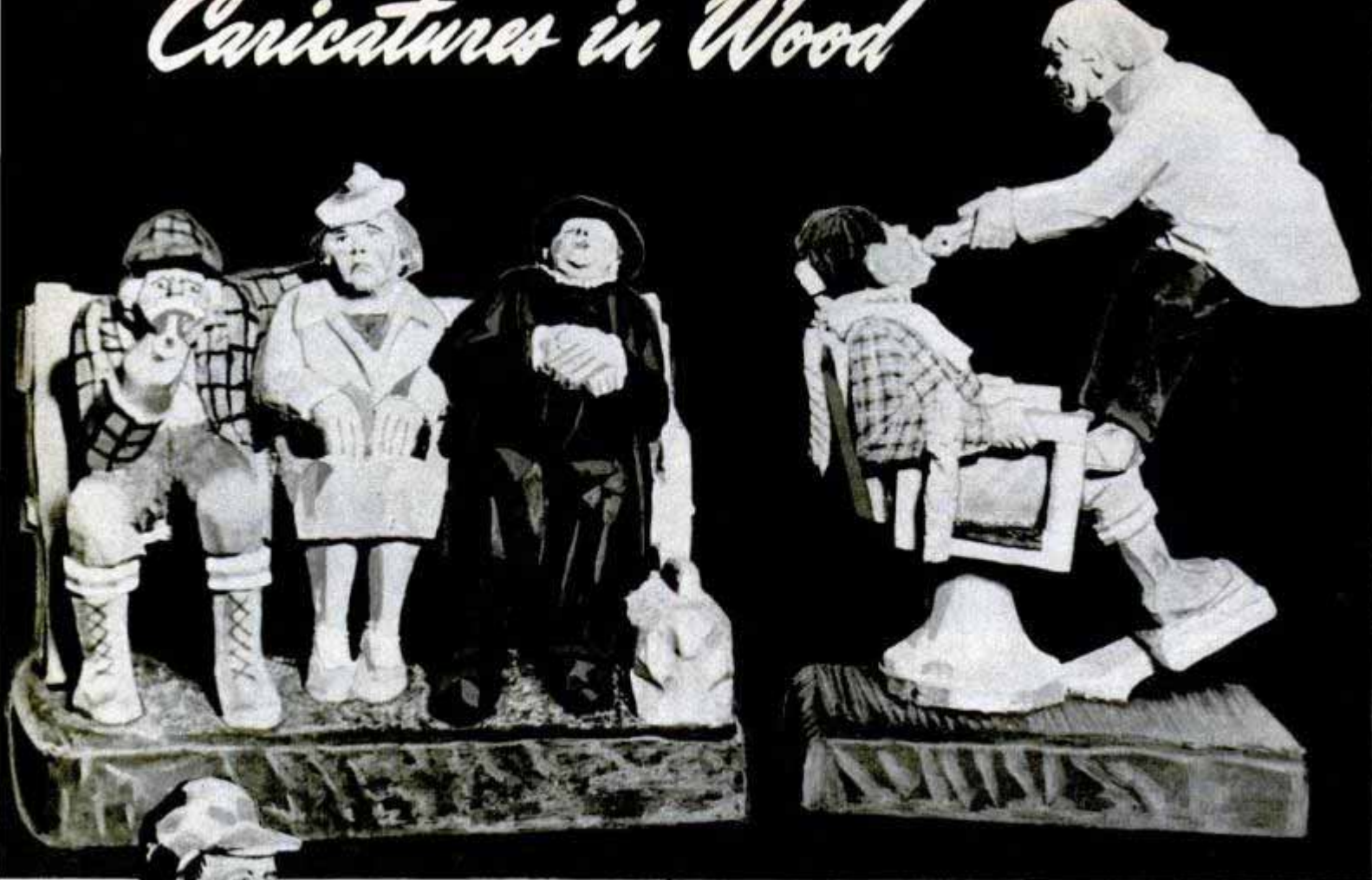

Above left, three weary people waiting for the bus. Right, carving of a dentist yanking a stubborn tooth. Below, Just's friend, the blacksmith

AFTER POUNDING out rough chunks of metal on a huge forge hammer all day, Abel Just of Beloit, Wis., turns to another medium for relaxation when he goes home. Instead of a heavy forge, he uses small wood-carving tools, and instead of pounding metal, he carves caricatures in soft wood.

Wood-carver Just has a photographic memory and he reproduces the features and characteristics of people he meets during the day in wooden caricatures. Once when having some work done on his teeth, he accused the dentist of being too rough on him. That night, after returning home, he carved his impression of the visit.

The caricature shows the dentist standing on the patient's knees and tugging at the stubborn tooth with a pair of huge forceps. The suffering patient is tied to the chair with huge ropes. When Just presented the carving to the dentist, it caused such amusement that the wood carver was besieged with requests from other dentists for copies for their offices.

He doesn't sell his carvings, but gives them away or adds them to his collection of more than 300 figures. He studies the men who work with him at the forge shop and at night carves them from memory. One of his favorite carvings shows an old millwright sitting on a toolbox getting ready to eat his lunch. He's taking a sandwich from the lunch box and holding a Thermos bottle in his other hand. In the box are a banana and an orange.

Although he has never studied art, Just is able to reproduce, in wood, excellent likenesses without any apparent effort. He works without drawings and relies upon his memory for such details as clothing and facial expressions. After the carving is done, he paints the figures in lifelike colors.



Left, the wood carver's version of a pair of teen-agers dressed for an evening date. Right, an old millwright sits on his toolbox eating lunch

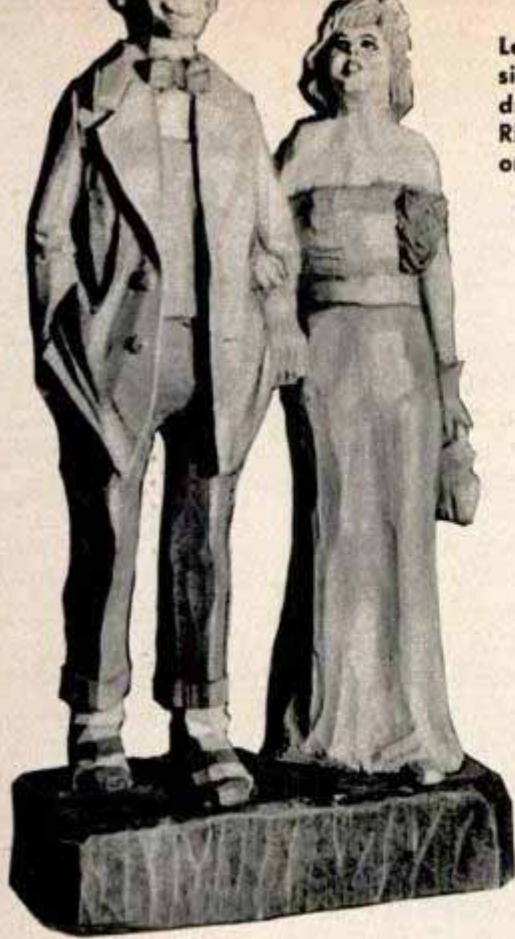

By Frank Reichstein

He has an acute sense of humor and his carvings show the comic side of his characters. He is able to inject humor into the wooden figures by a deft cut or two. Even the most complicated carving requires only a few hours' work. He uses quick, sure strokes and, in a short time, the wood begins to assume the shape of the model.

His tools are the ordinary wood-carving tools used

Below, Just uses his handiest tool an ordinary paring knife on a new carving. Right, another forge worker, the blacksmith's helper

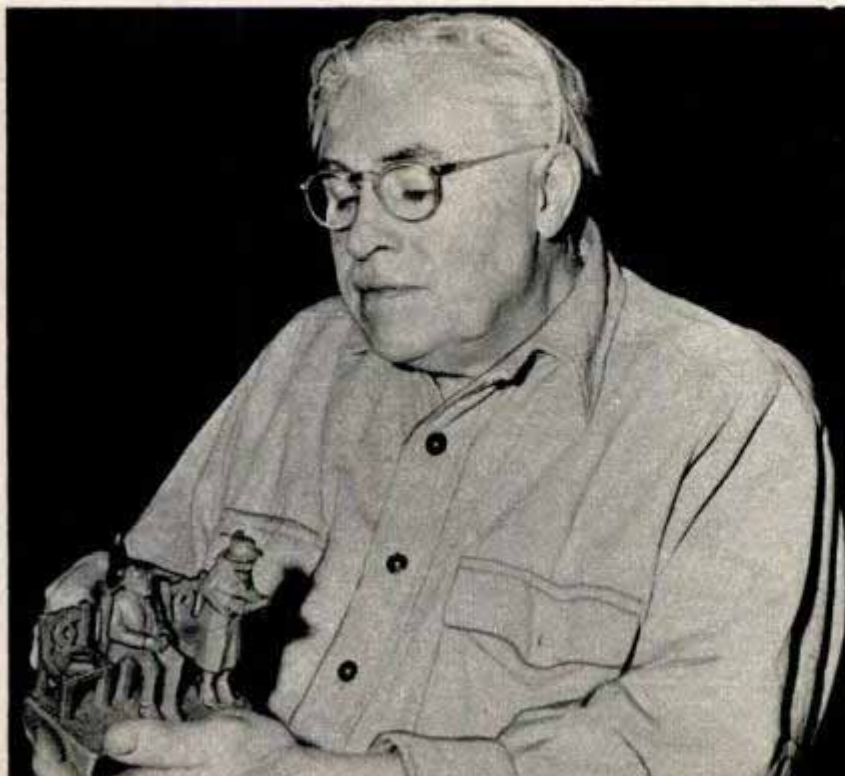

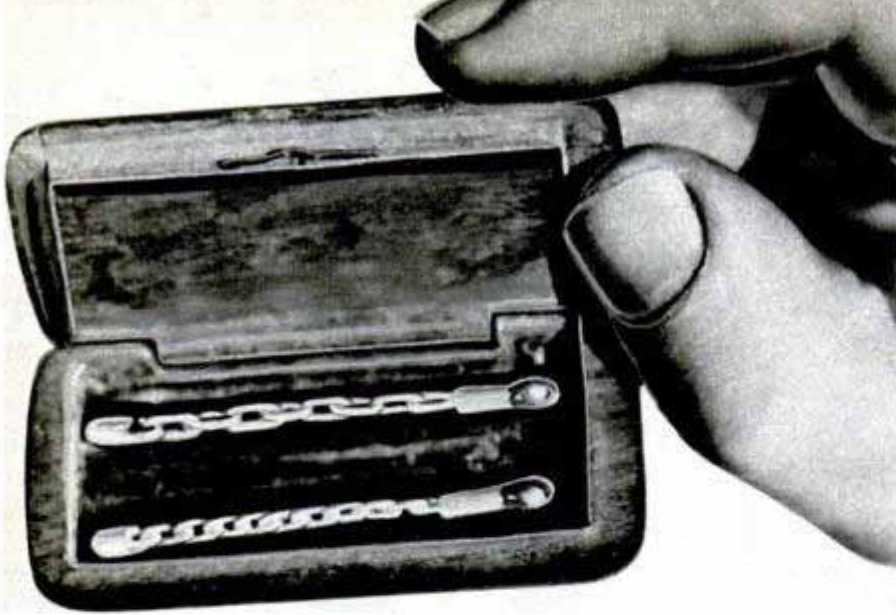

Two chains carved from ordinary household matches. Top chain was Just's first attempt. Bottom is more complex spiral type

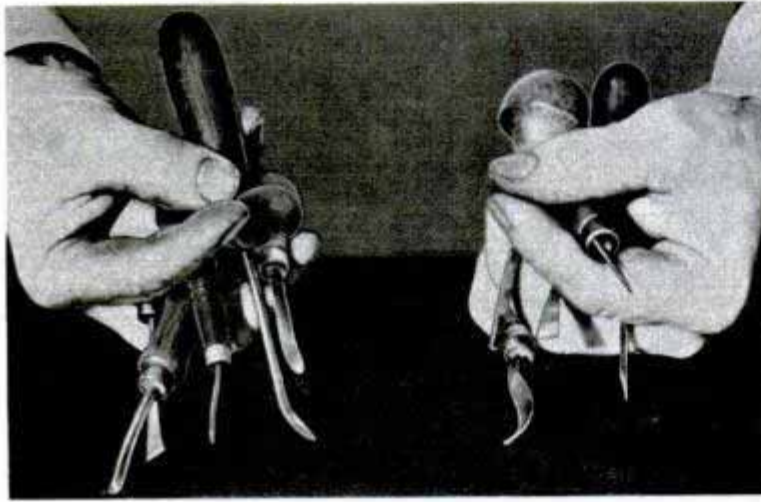

Above, Just holds the tools used in carving his caricatures. Some of these he made himself. Below, western scene shows plenty of action. Cowboy ropes a mustang as another waits with the halter



by furniture makers. They come in sets of six to eight cutters, providing a variety of sizes. He also uses a hand power tool with interchangeable heads for routing. His other power tool is an electric drill used at low speeds only. He also uses it for cutting holes to permit entry of a coping-saw blade when removing large pieces.

For delicate carving such as the tiny chain made from an ordinary match, he grinds down a hacksaw blade to half its original thickness and then sharpens it to a point. Other cutting tools include a shoemaker's tool he sharpened for use in cutting fine lines in facial features and some small chisels he made from discarded machine tools. But, he says, the most important of his tools is an ordinary kitchen paring knife that has been sharpened so many times it is now less than an inch long.

One of the reasons why his carvings are so attractive is that, although they show important details, they also carry the marks of hand carving. The "bites" of the knife blades are plainly visible on every piece, but they don't destroy any of the detail in the likeness.

When asked why he didn't sand his carvings to remove the tool markings, Just answered, "If I sand them down, I'll have something that doesn't look like wood."

His carvings look like wood, and they also look like people—lively folks, with character.

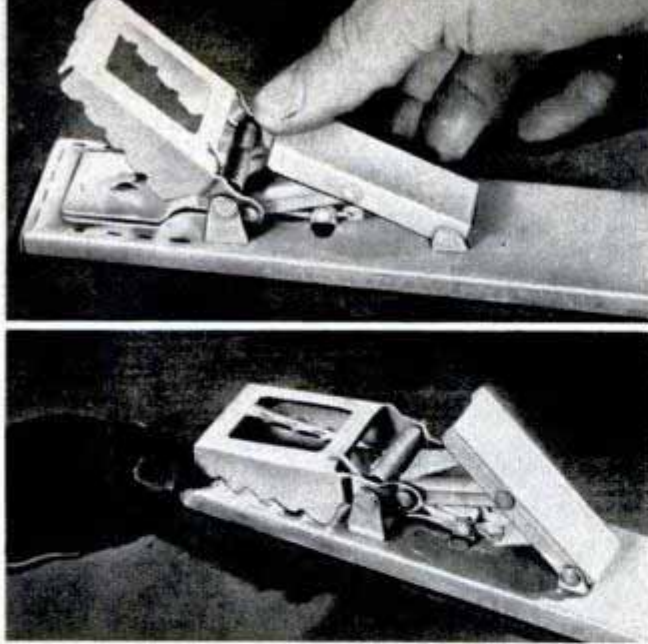

Here's That Better Mousetrap

Bruised fingers are less likely with a safety mousetrap that has an automatic setting bar. Pressing the bar sets the trap or releases the trapped mouse. The tapered jaw, released by a sensitive trigger, kills mice at any angle. Made of aluminum, the safety trap is durable and easy to clean.

Lettering Device for Layouts

To give the layout man a preview of how an advertisement will look when printed, a wheeled lettering device can be used. As easy to use as a ruling pen, the unit consists of a handle and a set of interchangeable wheels for various type faces. The complete alphabet is stamped on each wheel, but the letters are spaced at intervals to resemble words. By rolling the wheel along a straightedge, the layout man can insert letters of the desired type face in the space the copy will occupy in the printed advertisement. The wheel is inked by rolling it on an ink pad.

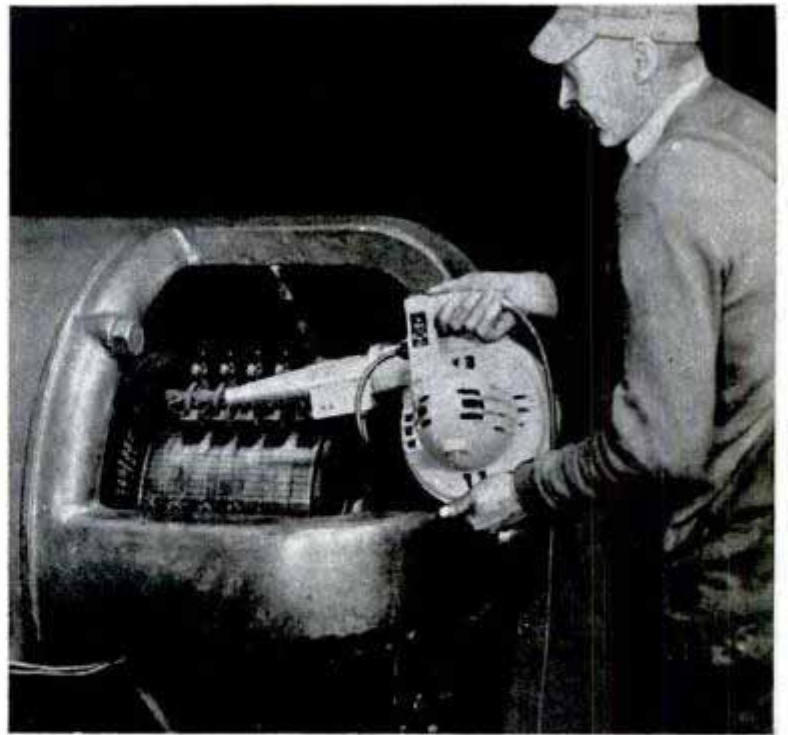
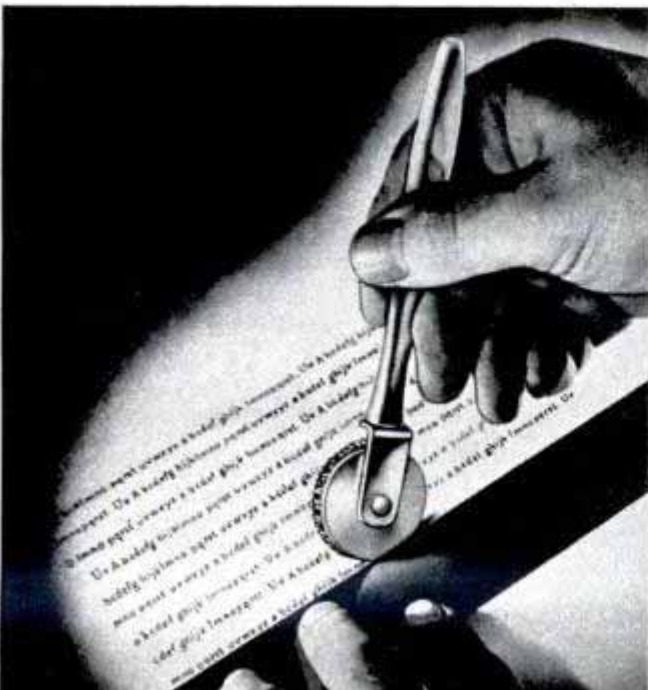

Blower Dries Paint Quickly

Newly painted surfaces are dried quickly by a heating attachment that fits on the end of a portable blower. The element's temperature is regulated by a switch.

Lightweight Japanese Bicycle

Lightweight bicycles made of duralumin are being manufactured at the Mitsubishi airplane factory in Japan. The bicycles can be taken apart easily for storage in a small space. Present production of approximately 600 bicycles a month will be increased as soon as more rubber for the tires is available.





Boeing Stratocruiser Folds Its Tail

With a hinge system that folds the tail, nearly 12 feet is cut from the height of Boeing Stratocruisers, enough to allow them to use standard hangars. After four bolts holding it in place are disconnected, the fin is automatically lowered by a jack hinged at its other end to the tail's horizontal surface. Controls and other installations leading to the tail are extended without being disconnected. The folding system, which is also being installed on Air Force B-50s and C-97s, lowers the fin from 38 feet 3 inches to 26 feet 7 inches. That is lower than any other single-tail four-engine plane and makes it easier to service the tail assembly.

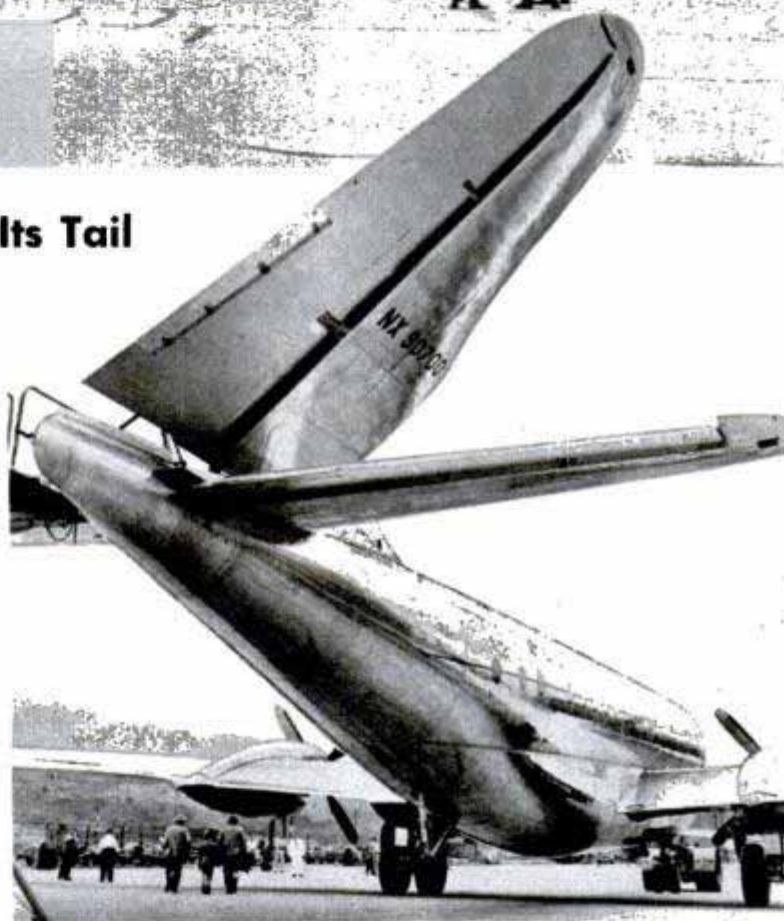

Boeing Aircraft photos

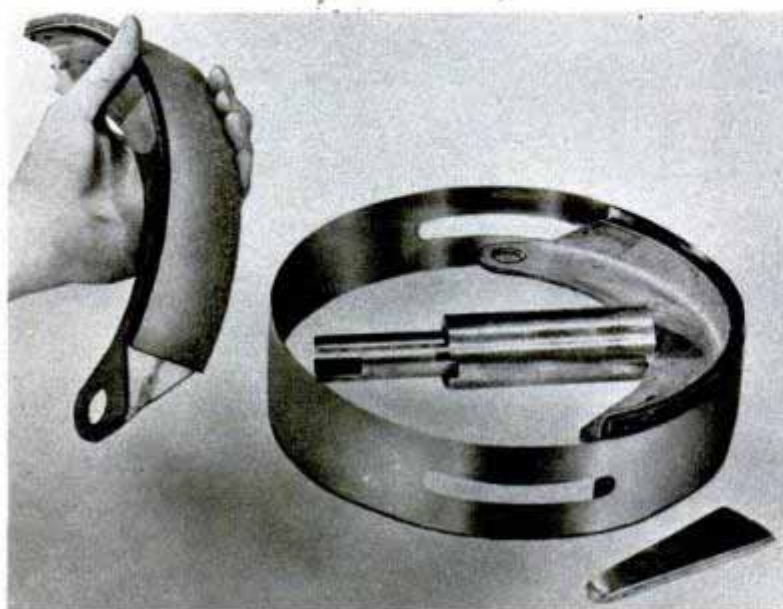

Adhesive Makes Linings Easy to Apply

With its bonding agent applied to the lining at the factory, rivetless brake lining is installed easily by the garage mechanic. Installation is quick and requires no complex machinery. The brake shoes are cleaned and the lining clamped around them with a steel band. The unit is then placed in a curing oven where the bonding is completed.

After removal from the curing oven, the brake shoes are released from the steel clamping band. The smooth lining is now bonded firmly to the shoe without rivets.

Push-Button Panel Sends Telegrams

Push-button switching of telegrams from a tri-state area to any part of the country is accomplished by a complicated switching center installed by Western Union in Philadelphia. The message, typed at the point of origin, is received at the switching center on a machine that prints the message and punches a combination of holes in a paper tape. A clerk then reads the destination from the tape, pushes a button to alert a transmitter and presses another button which sends the message to the proper destination. The transmitter automatically sends the message across the room at 150 words per minute to a circuit transmitter which sends it to its destination in its proper turn. This transmitter prevents telegrams from being sent out in the wrong order. An elaborate monitor system guards against mechanical lapses in the system, which has in its 200 circuits more than 3000 miles of wire. The system replaces a series of manual operations requiring at least four persons.

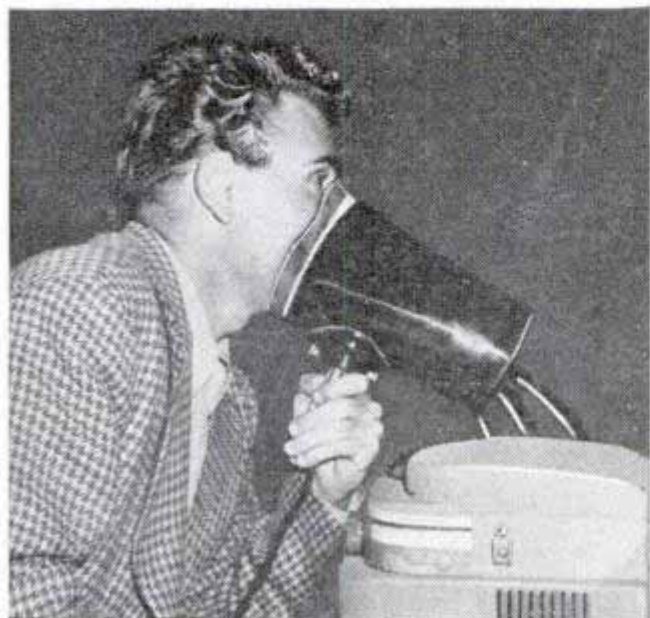
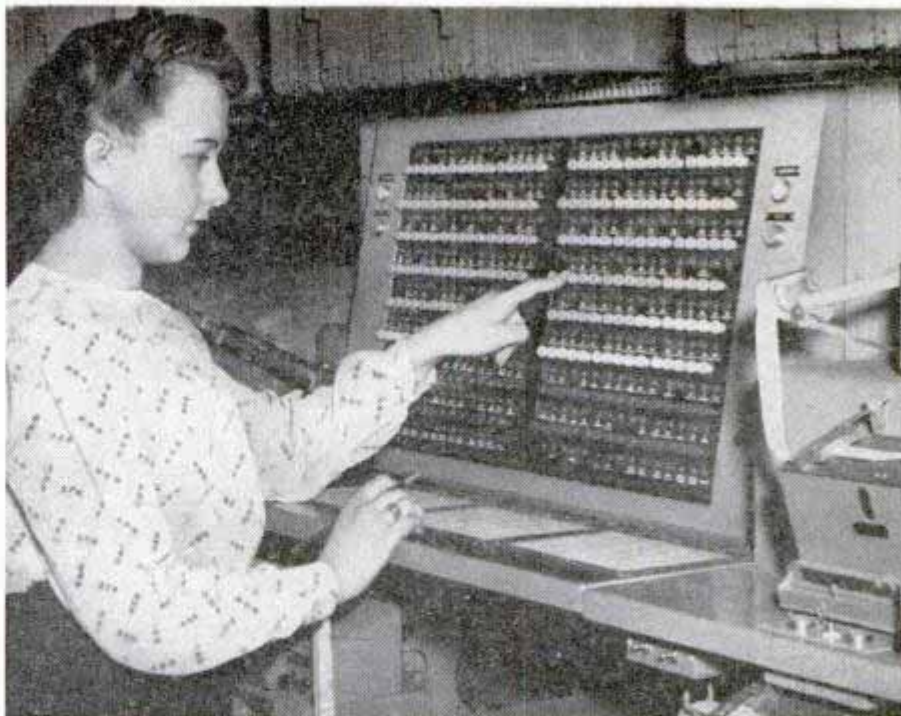

Testimony Recorder

Testimony by witnesses during Senate investigations is being recorded by an instrument with a megaphone-shaped mouthpiece. The machine permits testimony to be played back in case of question. Already in use by the small business committee, it is scheduled to be used by all committees at the next session of Congress.

Plastic-Coated Wallpaper

By means of a war-time technique for weatherproofing maps, wallpaper is now coated with an acetate film only .00088 inch thick. The film is laminated to the paper and protects it from stains. The laminated product has no sheen and cleans easily with soap and water or carbon tetrachloride.

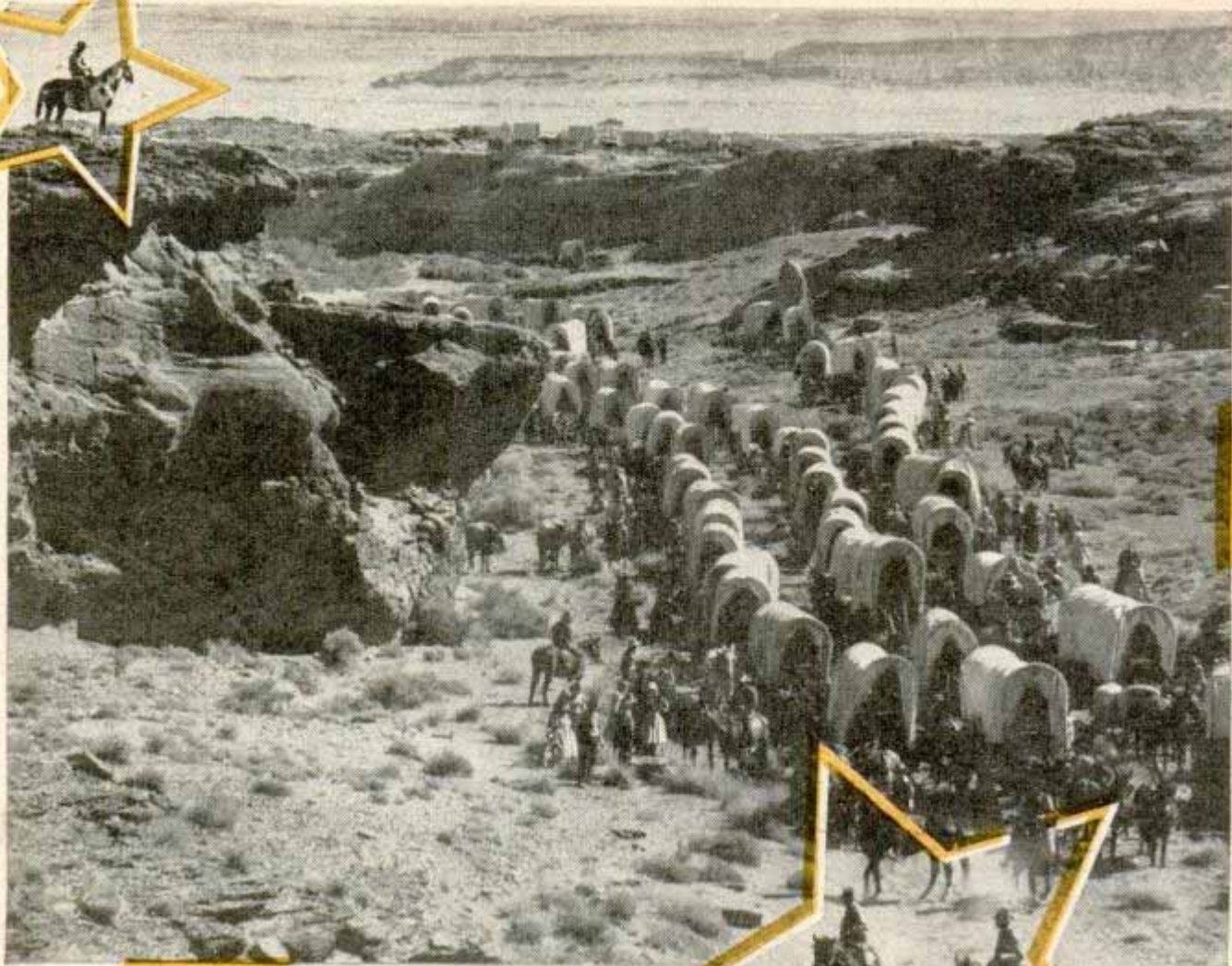

Above, these movie "pioneers" look as though they're roughing it, but at night they sleep in solid comfort. Below, camera, in star at right, is wheeled down the wooden tracks as it films covered wagons on location

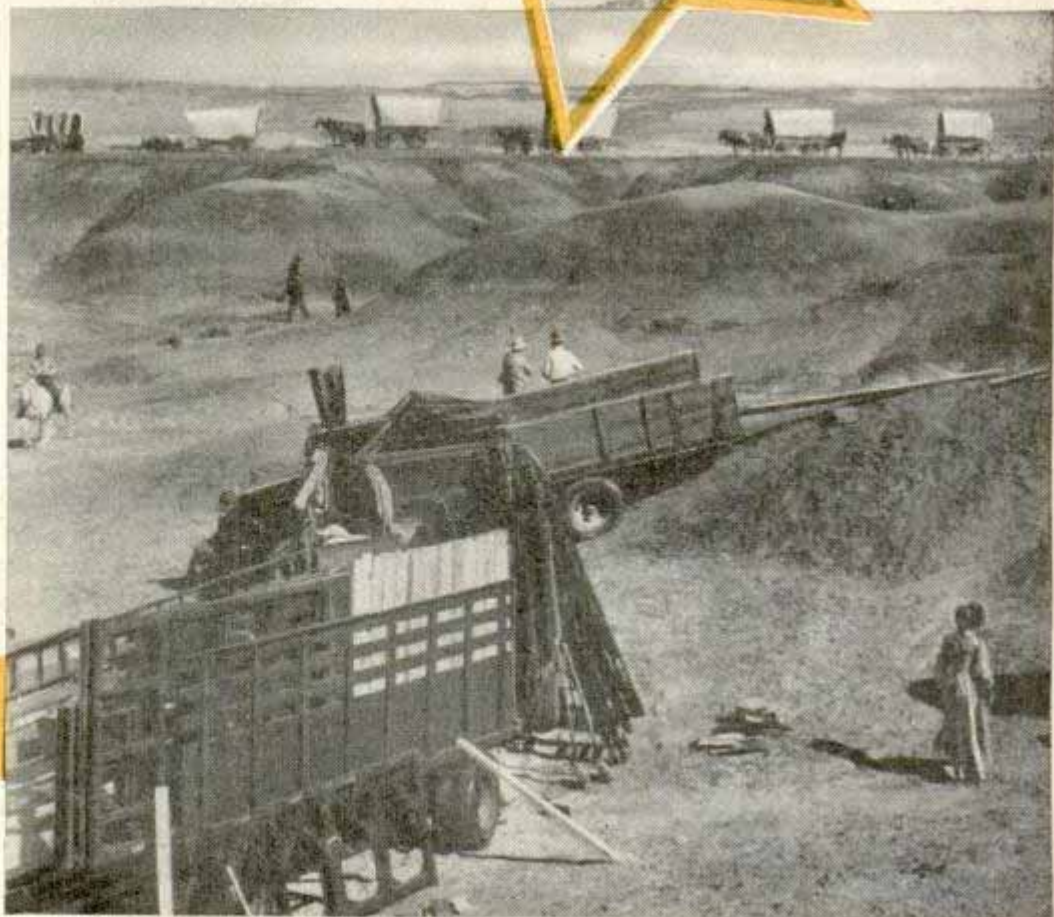

HOLLYWOOD ON THE MOVE

The old and the new join forces as a jeep is used to tow bulky covered wagon into position for movie shot

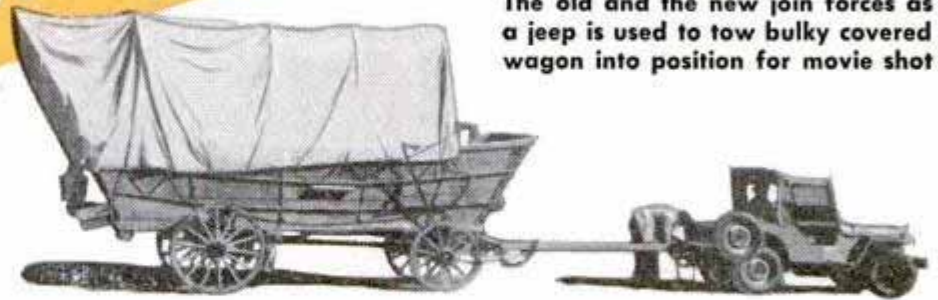

HOLLYWOOD CAMPS OUT in style when it goes on location. Stars and stagehands all expect, and get, hot showers and steak dinners even when working 100 miles beyond the last outpost in some uninhabited part of the West. Clean sheets and electric lights go with them on location even in rugged mountain country.

They enjoy most of the comforts of a first-class hotel no matter whether they camp for a few weeks in an Idaho forest or

spend two months in the sand and sagebrush of a New Mexican desert.

Specialists at producing luxury in the wilderness, Anderson Boarding and Supply Company of Hollywood builds a temporary city in any spot on 10 days' notice, then takes it apart when the shooting is finished, and moves it to another location possibly 1000 miles away.

Big outdoor pictures are a current rage in Hollywood after the long wartime shortage

of spectacular scenic backgrounds. Picture companies go as far as Canada and Mexico to get the scenery they desire.

That means much more than simply transporting the actors to the site that the director selects. Camera crews, sound men, hairdressers, make-up artists, script girls, and set builders who prepare or modify the close-up scenery, all are as necessary as the actors themselves. Radio technicians go along to service the walkie-talkies and for long distance communication with the studio itself. Even an airplane pilot who flies the daily film production to Hollywood for processing and brings back the rushes for the director's viewing may be included in a location group. A big outdoor production may require 200 or 300 people who will be on location from several weeks to several months.

To house and feed such groups, the Anderson subsistence company has its own prefabricated, portable communities that can be erected anywhere trucks can be driven. Where there are no roads the

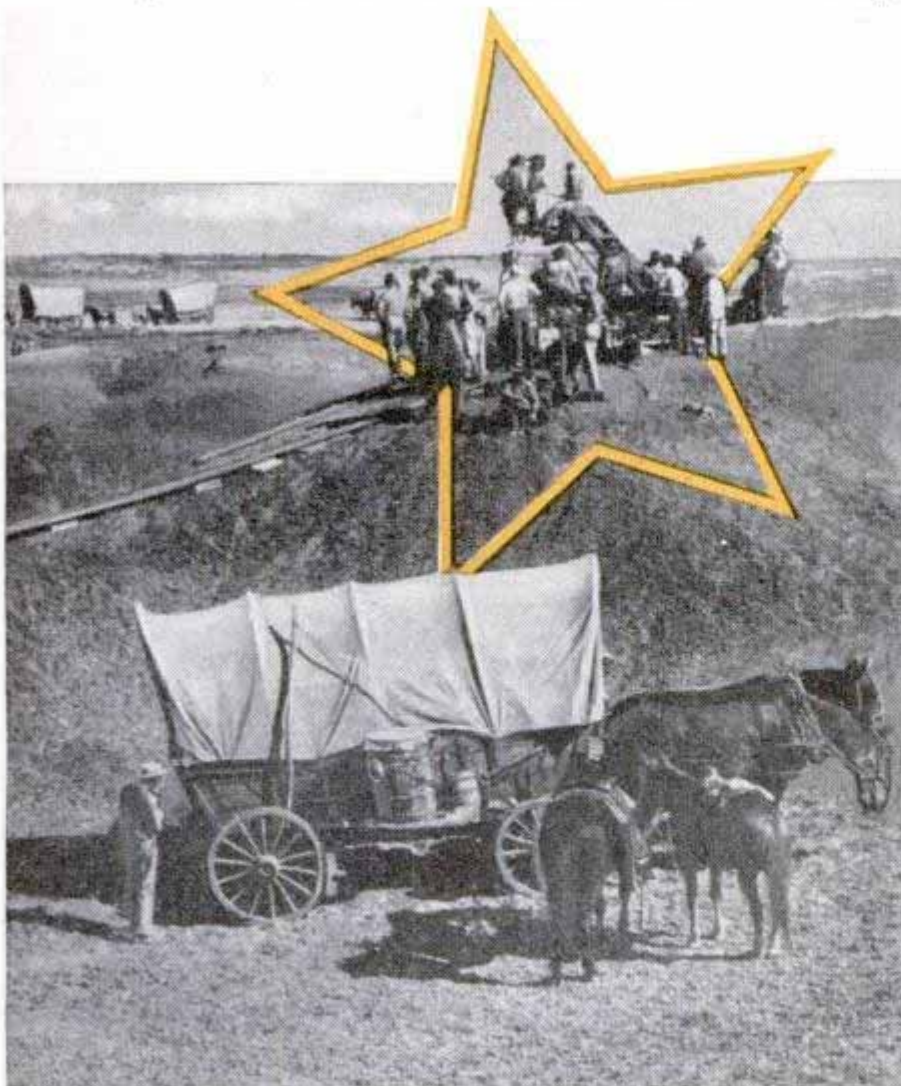



Workman unpacks fireproof canvas roofs for two-room sleeping tents

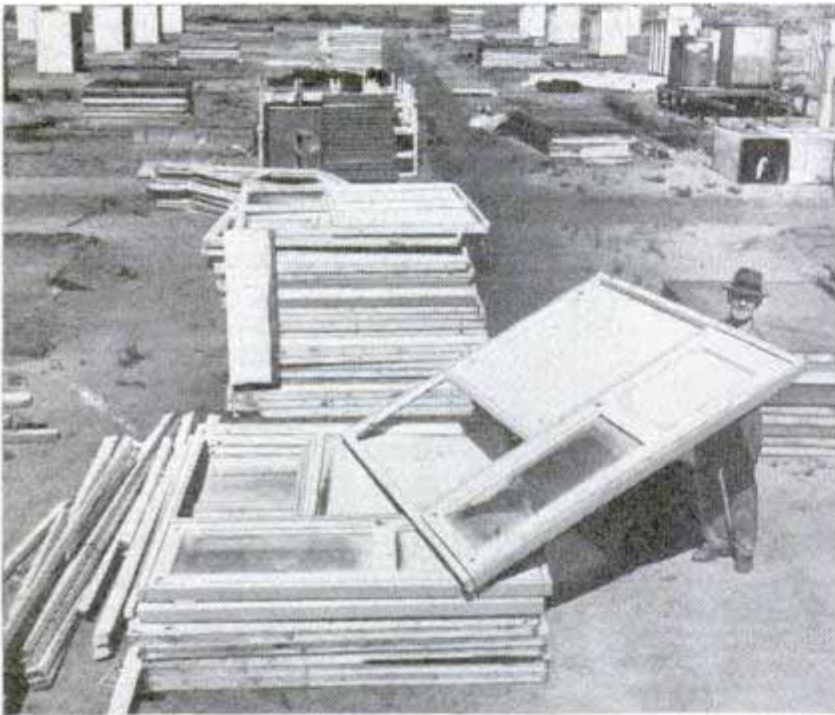

Above, village is torn down for shipment to new location. Bathroom units are still up. Below, sleeping tents with canvas roofs removed



company has to build its own. Two hundred people need about 60 buildings spread over some 15 acres of ground. After the brush has been cleared away and the ground leveled and surveyed the knockdown village arrives on a fleet of trucks.

Interchangeable plywood floor sections of large two-room sleeping tents are assembled on the site. Wall sections are attached and prefabricated bathroom units, complete with showers, are installed. Fireproof canvas roofing is tied over preassembled rafter systems. Beds, chairs, rugs and other furnishings are moved in and the tents are ready for use.

Office tents, make-up tents and other special-purpose units go up just as rapidly. Combination kitchens and mess halls, also prefabricated, are erected in a day.

Water is one of the big problems because a motion-picture camp uses 100 gallons of water per person daily. When there is a stream nearby, water is piped from it through a purifier to an overhead tank. Otherwise tank trucks must haul water from the nearest source.

Huge butane-fired water heaters are installed on concrete foundations. Trenches are dug and preassembled hot and cold water systems and sewer lines are connected to each bathroom unit. Fire hoses are attached to the wa-



Windstorm damaged movie "mountain" revealing its flimsy wood framework covered with burlap and plaster



Stars have their hot showers regardless of location. Huge water heater is fired by butane and provides the entire settlement with a constant supply of hot water

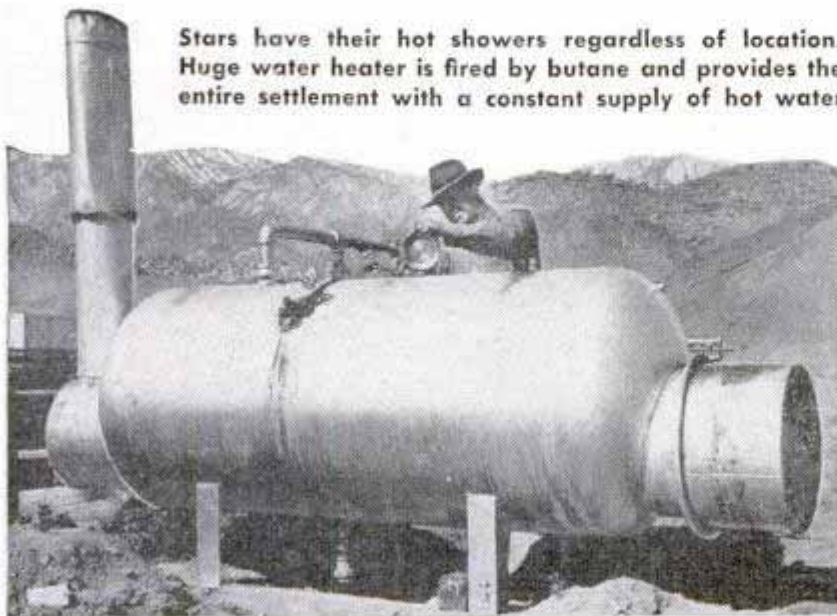

ter system. A lighting plant is placed in operation and wire strung to the buildings. Circulation pumps for the walk-in refrigerators are tested and put to work. There are a thousand details in putting the town together, each done according to plan.

From the first day on, trucks make daily trips to the nearest town to pick up fresh food supplies, clean linen and the constant stream of incidentals the camp needs. Ice cream, trout, fresh fruits and berries, and similar perishables often are flown to the camp. Anderson keeps an airplane under almost continuous charter for this purpose.

In the Monument Valley country of northern Arizona, a movie camp may be plagued by cloudbursts every few days, necessitating constant repair of the roads. On some high-altitude locations, the weather may be so cold that the tanks of liquefied butane



Lunches are the same for all. Stars and "grips" alike line up for hot chow

would freeze solid, requiring a crew to work all night keeping the tanks warm by pouring hot water over them. Humidity is a source of trouble when a movie group is on location in the Bahamas and costumes acquire a coating of mildew overnight. Perishables like motion-picture film and Nylon stockings for the stars must be kept in the iceboxes.

A master at solving these and other problems, Oscar F. Giles, in charge of the location towns for the Anderson concern, has his hands full running as many as three or four towns at a time, usually each in a different state. His inventory of knock-down buildings amounts to 250 units.

A portable city is suitable only for a

large studio group, but frequently the studios have to send small crews to a distant location for only a few days. To house these groups, the Anderson company is now building a village on wheels that travels 50 miles an hour on the highway. Complete living facilities for as many as 80 people are being constructed on a fleet of 35-foot semitrailers that can be towed to almost any location on or off the pavement. One trailer is a kitchen with stoves and refrigerators. Others are for recreation, bathroom units and sleeping.

In use, the four walls of the kitchen trailer are removed and a dining trailer is then backed against each side. Forming a cross, the four dining trailers are served by one kitchen. A similar arrangement allows one bathroom trailer to serve four sleeping units.

In addition to its use by small motion-picture companies, the mobile hamlet may also be used by pipe-line, telephone and power-line crews.

Catering to the movies is a big business but actually this is a mere sideline with the Anderson concern. Largest subsistence firm in the country, Anderson Boarding and Supply Company contracts the housing and feeding of

(Continued to page 234)

Not all location shots are out in the wilderness. Here, a movie outfit takes over the main street of an Arizona town

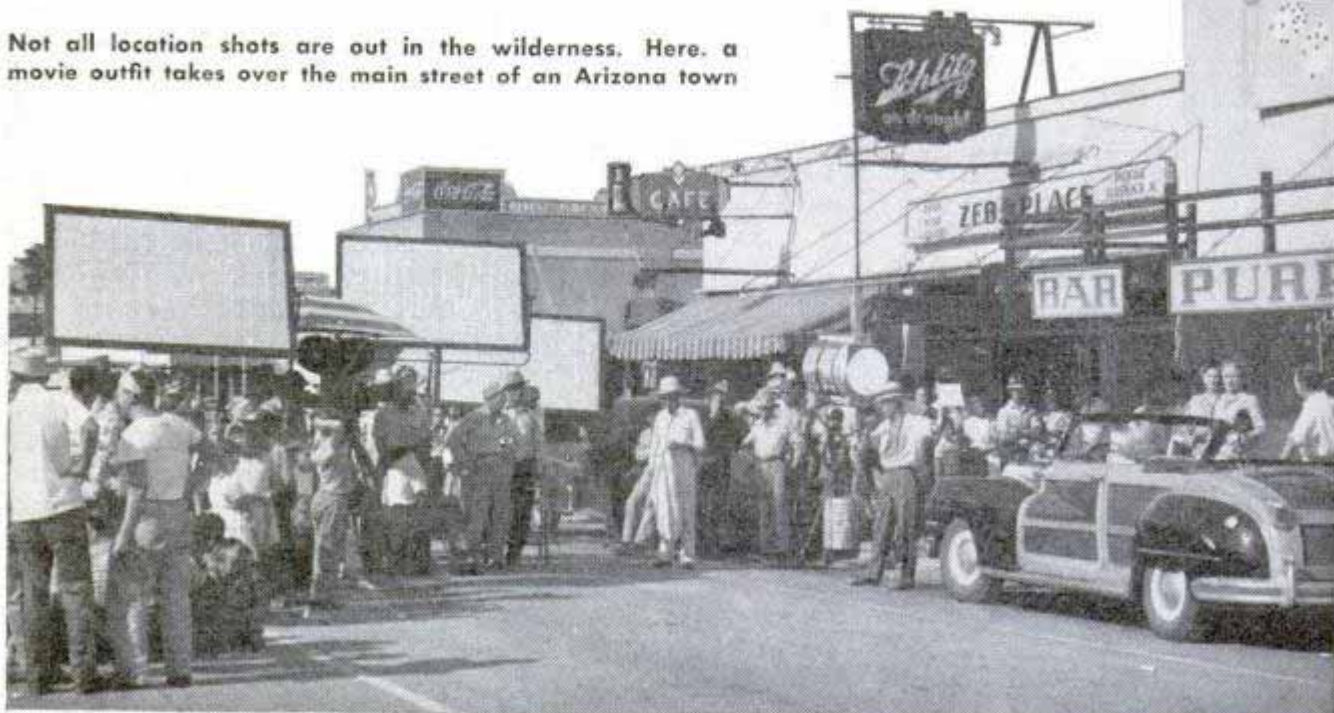

CHINESE TYPEWRITER CAN PRINT 90,000 CHARACTERS



Left, typewriter uses system of combinations. Typist presses keys representing basic parts of word, then selects desired symbol from eight combinations appearing on indicator screen on top of machine (see insert). Right, white rollers flash combinations on screen. The 36 long printing bars in rear contain 8000 symbols

No larger than the conventional size, a Chinese typewriter prints 90,000 characters and will write in an hour what it takes a Chinese copyist a day to do. In addition, the typewriter, called the Mingkwai ("clear and quick"), will type English, Japanese and Russian. As almost all Chinese offices use hand copyists, the machine, invented by Lin Yutang, noted Chinese author, is expected to revolutionize writing in that country. Chinese writing is not made up of letters in an alphabet; instead, each word is an individual symbol. The new typewriter prints every known Chinese word and can be operated at 50 words a minute. To type a word, the typist selects the two basic parts of the symbol by pressing two keys—one for the top part, the other for the bottom. On a screen on the machine are flashed eight Chinese characters using combinations of these two basic parts. The operator then selects the symbol he wants by pressing the corresponding key on the bottom row of the keyboard. Typing is in vertical columns and from right to left. An electric motor performs the printing operation and moves paper and carriage. A spring motor model will be made for places where no electricity is available.

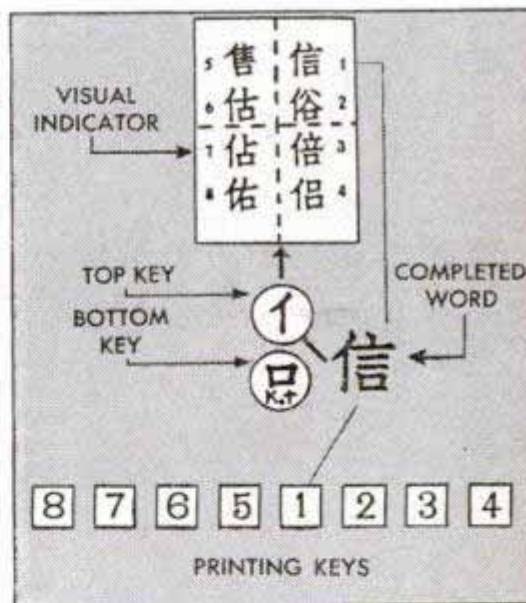

Three steps in typing are (1) typist hits top and bottom keys representing the basic parts of word, (2) eight combinations of these basic parts flash on indicator, (3) typist presses printing key at bottom of keyboard corresponding to desired word

Chemical Capsule Changes Water to Strong Antiseptic Solution

Dissolving secret chemical contents of a capsule in tap water creates a powerful antiseptic which sanitizes eating and cooking utensils, bathroom equipment and floors, telephones, dishwashers, waste food receptacles and other objects exposed to disease germs. Despite its high germicidal power,

the colorless solution is noninjurious to a person's hands. It deodorizes, yet it leaves no odor or taste. The chemical also is used in the manufacture of industrial products which require a preservative, such as casein paints and adhesives, animal glue and starch pastes.

Talking on the

By W. J. Davis



Despite the noise, a derrickman on his lofty perch can use the inter-com system to talk to the driller (below) who is shown flipping switch to give order

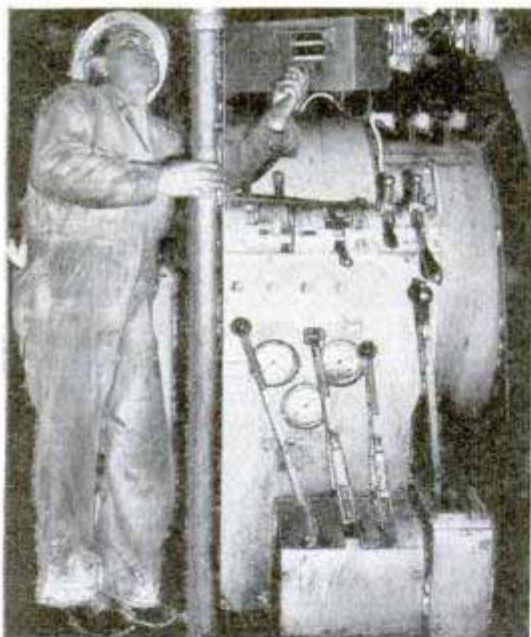

Dotted line on diagram traces inter-com system which links substations

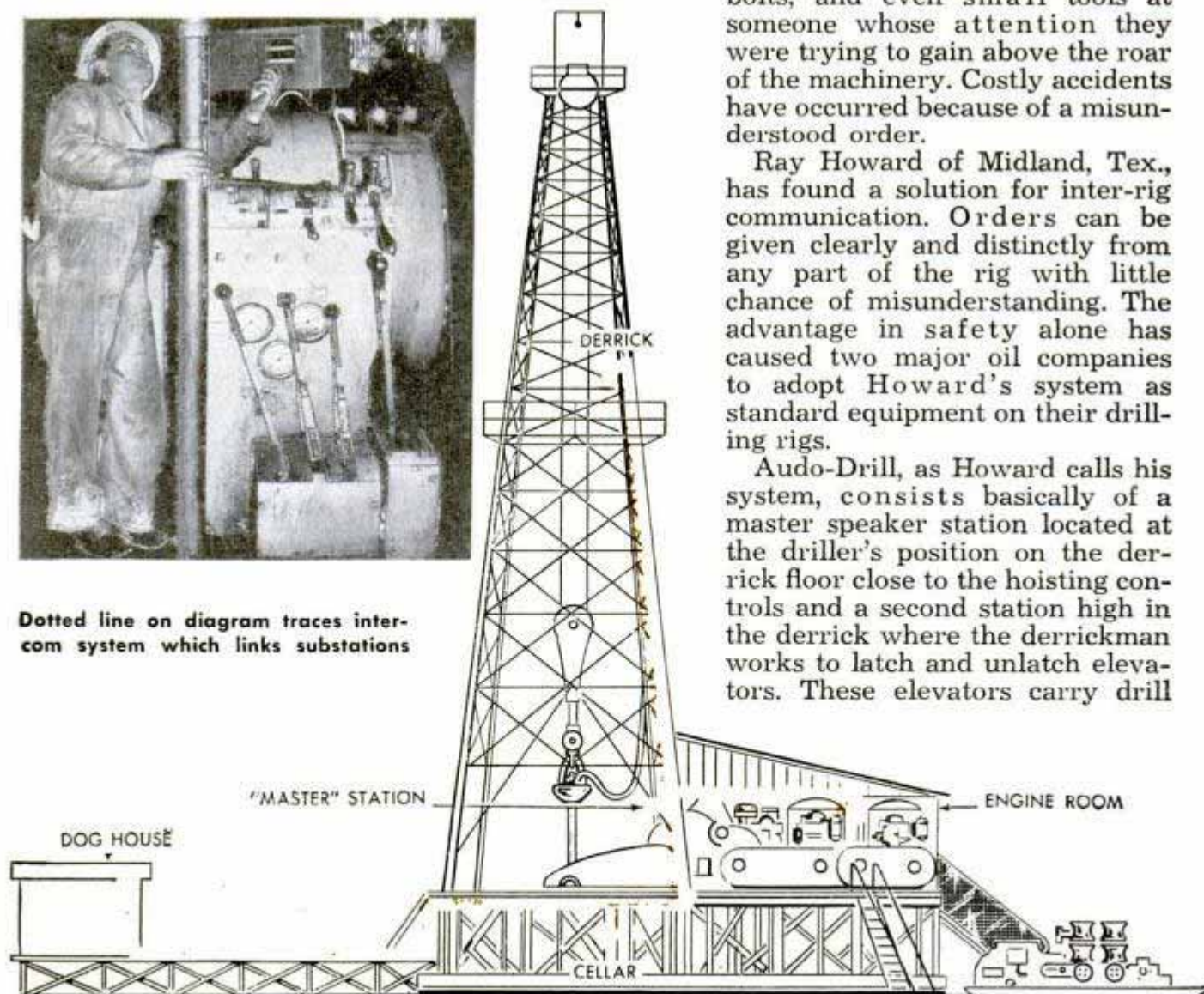

WITH modern-day drilling equipment growing taller, heavier and noisier, the problem of communication between driller and crew members, known to the trade as "roughnecks," has become complicated.

Much of the noise can be traced to the increasing demand for more horsepower to bore deeper and deeper into the earth's surface in search of the liquid that, paradoxically enough, cushions and quiets the wheels of industry and transportation. The resulting increase in the sizes of gears, pinions and chains connected to the sweating Diesels have boosted both efficiency and noise.

In the past, drillers have depended upon shouting, arm signals and pantomime to convey their wishes to old and new roughnecks on the job. Drillers have been known to toss nuts, bolts, and even small tools at someone whose attention they were trying to gain above the roar of the machinery. Costly accidents have occurred because of a misunderstood order.

Ray Howard of Midland, Tex., has found a solution for inter-rig communication. Orders can be given clearly and distinctly from any part of the rig with little chance of misunderstanding. The advantage in safety alone has caused two major oil companies to adopt Howard's system as standard equipment on their drilling rigs.

Audo-Drill, as Howard calls his system, consists basically of a master speaker station located at the driller's position on the derrick floor close to the hoisting controls and a second station high in the derrick where the derrickman works to latch and unlatch elevators. These elevators carry drill

Drill Rig

pipe during a "round trip," the term used when drill pipe is removed and returned to the drill hole, usually to replace a worn bit. Eighty percent of rig communication would normally occur between these two workers, the driller and derrickman.

If the driller wishes to give instructions to the derrickman, he merely pushes the switch for that station on his master set and talks in a normal tone of voice into the speaker. The derrickman gets the message instantly through the speaker located near his working platform. He can reply to the driller through the same speaker without



The engineman's speaker is on a long cord so it can be kept handy to receive driller's instructions. Below, speaker in cellar helps prevent many accidents



opening or closing any switches. However, if he initiates a call to the driller, he must use the switch at his station.

Substations may be added to the two basic stations and located at strategic points about the rig such as the engine room, beneath the derrick floor in the "cellar," and in the "dog house," favorite gathering place of crewmen for eating, keeping records and changing clothes.

Howard found in his early experiments that areas of high noise had to be dealt with along special lines. The result was a micro-substation which filters out the noise from that area when a crewman answers the master station.

For example, in the engine room the driller's remarks issue from a speaker located in that area with sufficient volume to be heard above the roar of the engines. The crewman, rather than compete with the noise at his location by attempting to answer using the speaker as a microphone, can pick up a small directional mike located near the inter-com speaker and converse with the driller in a normal tone of voice over the same line.

Amplification is such that anything said in the rig is clearly audible throughout the rig when all channels are opened by a single switch at the master station. Power for the unit is taken from either utility lines or the rig's own power plant, regardless of whether it is a.c. or d.c.

Crew members and foremen alike have recognized in Audo-Drill many safety possibilities as well as added efficiency and the saving of unnecessary steps in a day's work about the rig.

Spray to Tenderize Meat

Meat is tenderized and "cured" at the same time by spraying with needle-fine jets of edible matter. The spray exerts up to 7000 pounds pressure per square inch and comes from openings as small as .0001 inch. Fluids, like liquid fats or fiber softening milk acids, or solids in liquid suspension can be shot through the jets. The penetration technique makes it possible to salt and pepper meat in advance, if desired.

Daylight Movies

Based on the reflection principle, movies that can be seen clearly in bright sunshine have been invented in Russia. The pictures are projected upon a small screen concealed under a canopy of dark material. Reflected from the screen along a directed channel, the pictures show up clearly in a large mirror even though the room is brightly lighted by the sun or other form of illumination.

DRY-LAND "WARSHIPS" FOR TRAINING NAVAL RESERVISTS



Sailors use model to demonstrate how armories are adjustable in size to meet requirements of the local Naval unit

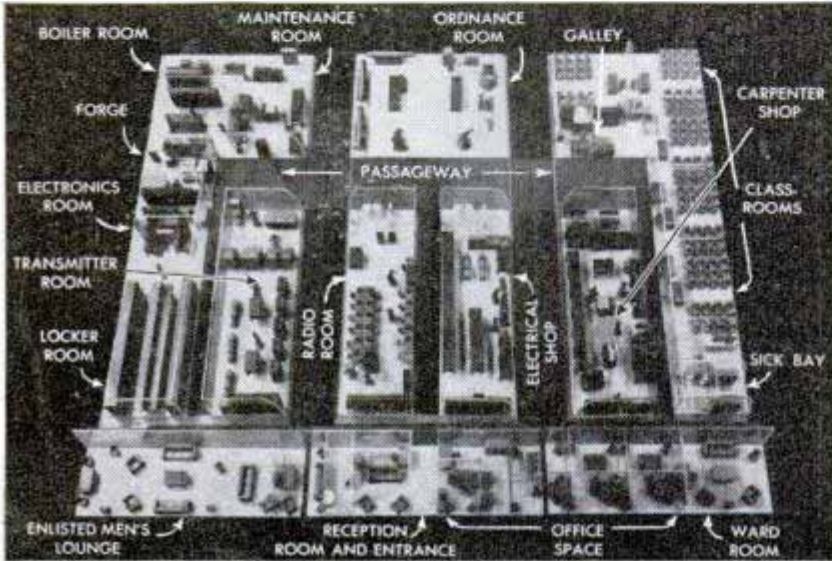

Official U. S. Navy photo

Above, reserve officer removes plastic top of scale model to show layout of "packaged" training center. Left, detailed photograph of the model with each room an interchangeable unit, making it possible for the local group to select the departments in which it will receive its training

"Packaged" training centers for Naval reservists provide everything a ship does except ocean spray and pitching decks. The armories, available to cities requesting them, are designed so facilities can be varied to fit the interests of the local unit without changing the building design. Three Quonset huts, forming the rear of

the armory, contain training rooms designed as separate, interchangeable units. Office and recreational space is provided in a modern-design front section that connects the three Quonsets. Equipment used for training is from surplus seaboard stock. Weekly training periods keep reservists up to date on the latest techniques.

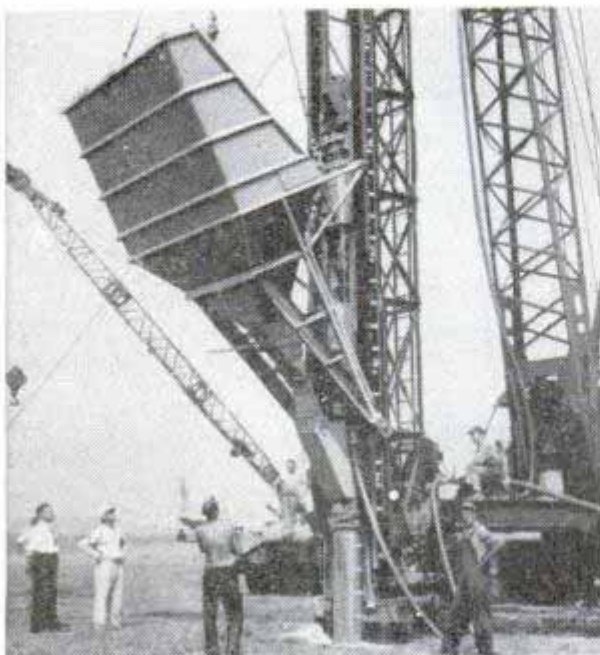

Sand Shafts "Dry Out" Airport

Tons of sand poured down an 18-inch-wide pipe are helping squeeze water from beneath the sinking surface of LaGuardia Field. Fifty-six sand columns are being sunk at intervals 14 feet apart. The hollow pipe, covered at the bottom, is driven down 75 feet by an air hammer before being filled with sand. Compressed air pushes the sand from the pipe and raises the tube out of the ground. The columns, aided by pressure from sand spread several feet thick over the area, act as a "wick" to draw moisture upward for drainage.

Names and addresses of manufacturers of products featured in this issue will be supplied promptly by the Bureau of Information, Popular Mechanics Magazine, 200 East Ontario Street, Chicago 11, Illinois

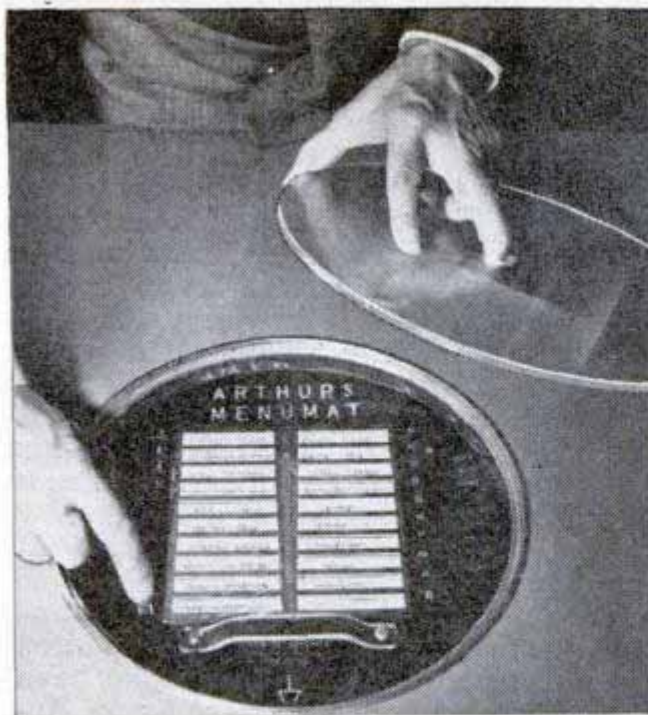

Push-Button Menu

Diners at a Hollywood restaurant can't find fault with the waiter for bringing the wrong order. A push-button menu is set slightly beneath the table surface and protected by a removable plastic cover. Any of four persons seated at the table can order by rotating the menu. He indicates his choice by pushing a button beside each item. As each button is pushed, an illuminated figure lights up on an indicator in the kitchen, where a checker notes the desired dishes and location of table.

Roller Grooves Rims for Safety →

Ordinary automobile wheels are converted into safety wheels by a rolling machine that forces grooves into the rims. The grooves, placed near the outside edges of the wheel, hold the tire bead securely, preventing the tire from being thrown off by a blowout. At high speeds, centrifugal force on the tire gives the effect of air pressure and prevents loss of control. Tests at 65 miles an hour showed the car could be controlled easily after a blowout.

Microscopically Thin Wire

Tungsten wire so thin that a single strand is invisible to the unaided eye is manufactured for use in amplifying tubes. The wire, produced by the Westinghouse Lamp Division, is .00018 inch in diameter. Twenty layers of the wire equal the thickness of a single page from a newspaper. Since the wire is too thin to be measured mechanically, inspectors weigh an eight-inch strip on a scale balance so sensitive it can record the weight of a pencil dot on a piece of paper.



Plastic Balloon Kit

Plastic balloons of many sizes can be blown like bubbles with a kit that contains a tube of Vinylite plastic and a blowing straw. The plastic is molded into a ball on the end of the straw, then the balloon is formed by blowing into the straw. When inflated, the balloon is sealed by pinching the plastic as the straw is removed. Punctures and tears are repaired by the same method. The balloons, which will last for a week or more, can be blown in various shapes and painted, if desired.



AN AUTOMOBILE driven by a wild-eyed young man skidded to a stop at the U. S.-Mexican border in Tijuana.

"Anything from Mexico?" asked the customs inspector.

"For the love of heaven, man, hurry!" gasped the driver. "My wife is going to have a baby. I've got to get her to a doctor in San Diego!"

The inspector looked at the woman in the back seat who apparently was in great distress. He couldn't be sure, but he thought he'd seen the same couple earlier in the day crossing the border in the opposite direction. At that time there were no signs of impending maternity.

The customs man played a hunch.

"We have maternity facilities here," he said. "We'll take care of your wife."

The customs matron found that the woman's voluminous dress contained diamonds, jewelry and watches on which the government collects duty.

OUTSMARTING THE SMUGGLERS

By Andrew Hamilton

of opium inside a religious shrine.

Since the war the smuggling of contraband goods and narcotics into the United States has increased. Federal seizures have almost doubled from a wartime low of 10,215 in 1944 to 20,000 in 1946. This year's figures are expected to be even higher.

Travelers are allowed to bring in \$100 worth of stuff duty-free. Commercial articles valued at \$100 or more are required to have certificates signed by American consuls. All personal luggage is examined

This is just one example of current smuggling. In recent months a traveler at the Canadian border attempted to smuggle \$23,000 in gold into the United States by carrying it in his luggage as buttons. On an incoming plane from Mexico City an entertainer was found to have \$19,000 worth of diamonds sewed into the lining of his clothes. In Los Angeles a member of a ship's crew tried to smuggle a load

Parcel-post packages pass inspectoscope's X-ray eyes. If no irregularities are found they are stamped approved

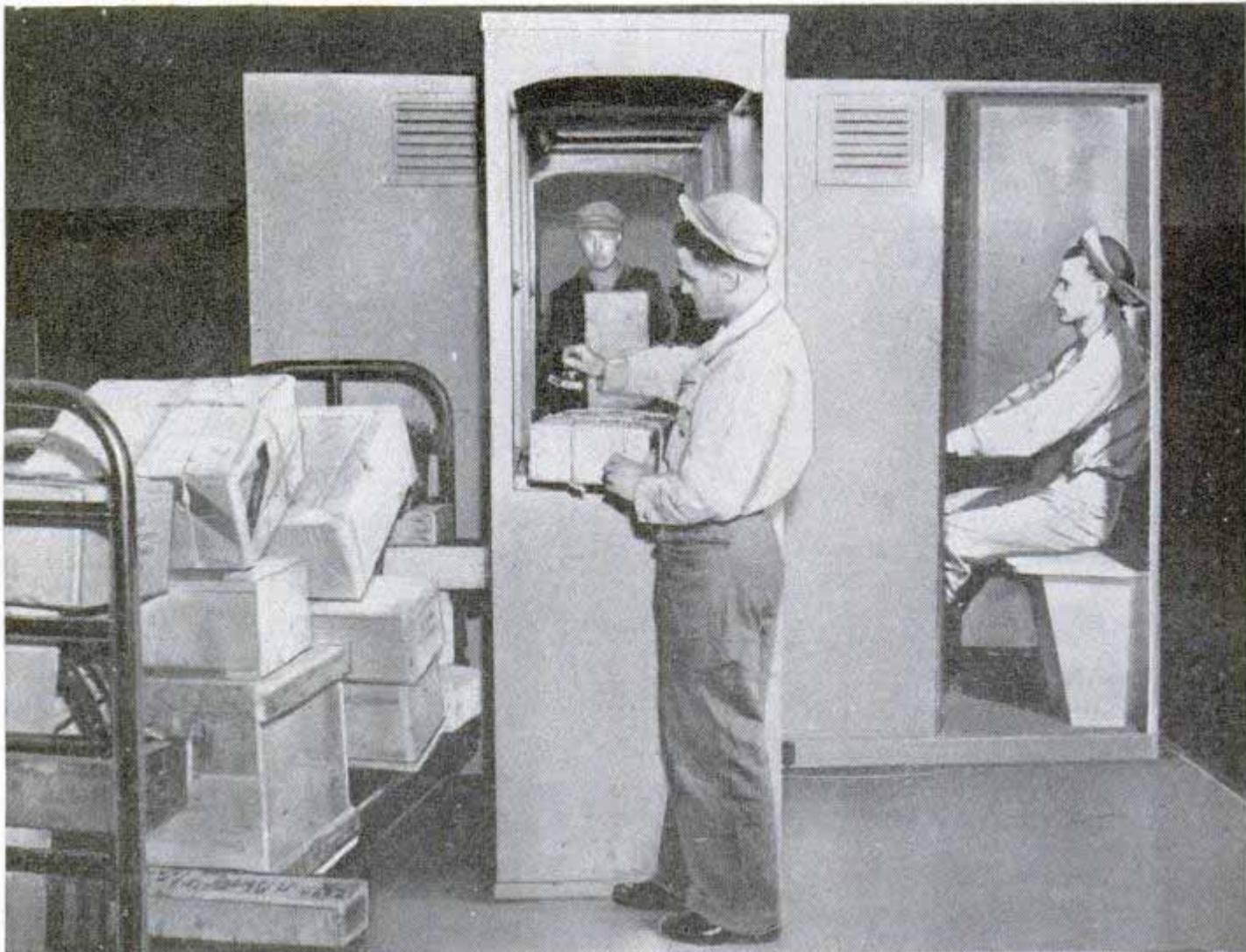



Smugglers' ingenuity is matched by wits of customs men. Diamonds were found in false tops of shoe brushes, behind lid of safety-razor box, in cotton wadding of aspirin bottle and in container buried in cake of soap. Tins of smoking opium were found in built-up heels of shoes



No nook is beyond the prying eyes of an inspector. Here the interior of a tanker's huge valve is checked for narcotics



↑ Homemade snowmobile patrols Canadian-Minnesota border
↓ Inspectors board an incoming ship in search of contraband

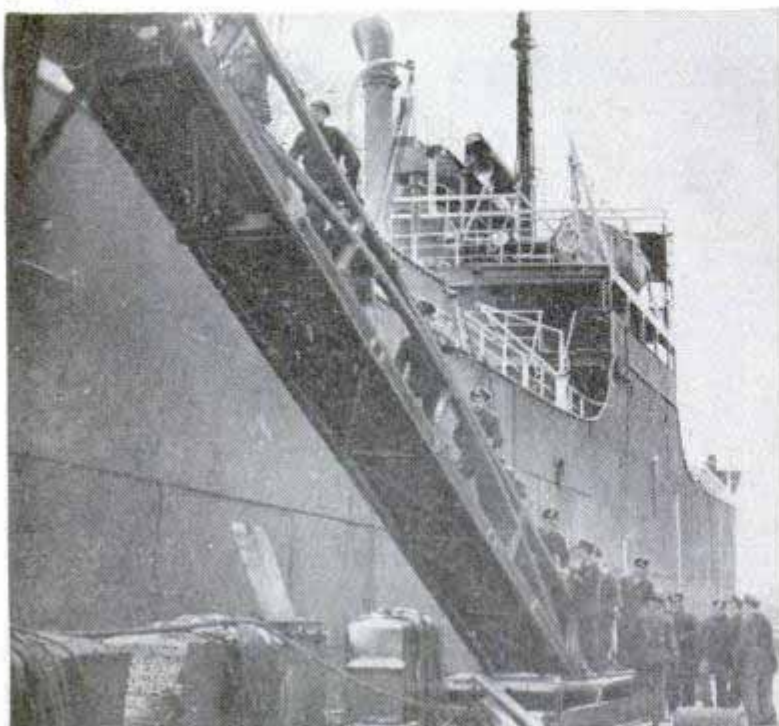

at ports and border stations. A 10 percent sample of all commercial shipments is inspected.

Protecting Uncle Sam against the loss of millions of dollars annually in revenue and guarding the health of American citizens is a small but efficient force of 8900 inspectors, patrolmen, guards and agents of the U. S. Customs Service. They are stationed at ports, railroad stations, highways and airfields; they patrol America's borders with automobiles, airplanes, revenue cutters, speedboats, horses, skis and snowshoes. About 2000 items are taxable and the Customs Service collects more than \$500,000,000 annually.

In general, there are two types of smugglers that customs officials have to cope with: Big-time gangs whose criminal operations are million-dollar enterprises; and petty smugglers—persons who return from a foreign country and fail to declare dutiable articles.

Narcotics smuggling has proved profitable for organized international gangs and before the war was a billion-dollar business on a world-wide basis. Opium and its derivatives, heroin and morphine, are smuggled to the East Coast of the United States from Persia and India, to the West Coast from China and Japan. Cocaine is brought in from South America and Java.

Early this year an electrician re-wiring an old house in San Francisco uncovered a narcotics cache worth \$338,000. Customs men found that the house belonged to the infamous Ezra brothers who were convicted of smuggling 14 years ago and sentenced to McNeil's Island Penitentiary.

Several gangs of alien Japanese were active in narcotics smuggling on the West Coast before World War II. In many cases they were found to have connections with Japanese consuls and shipping officials in Seattle, San Francisco and Los Angeles. Customs men believe that this type of smuggling, apparently carried on with the blessing of the old Japanese government, had a twofold aim: first, to flood the West Coast with narcotics and thus break down the health of U. S. citizens; and second, to extend the Japa-

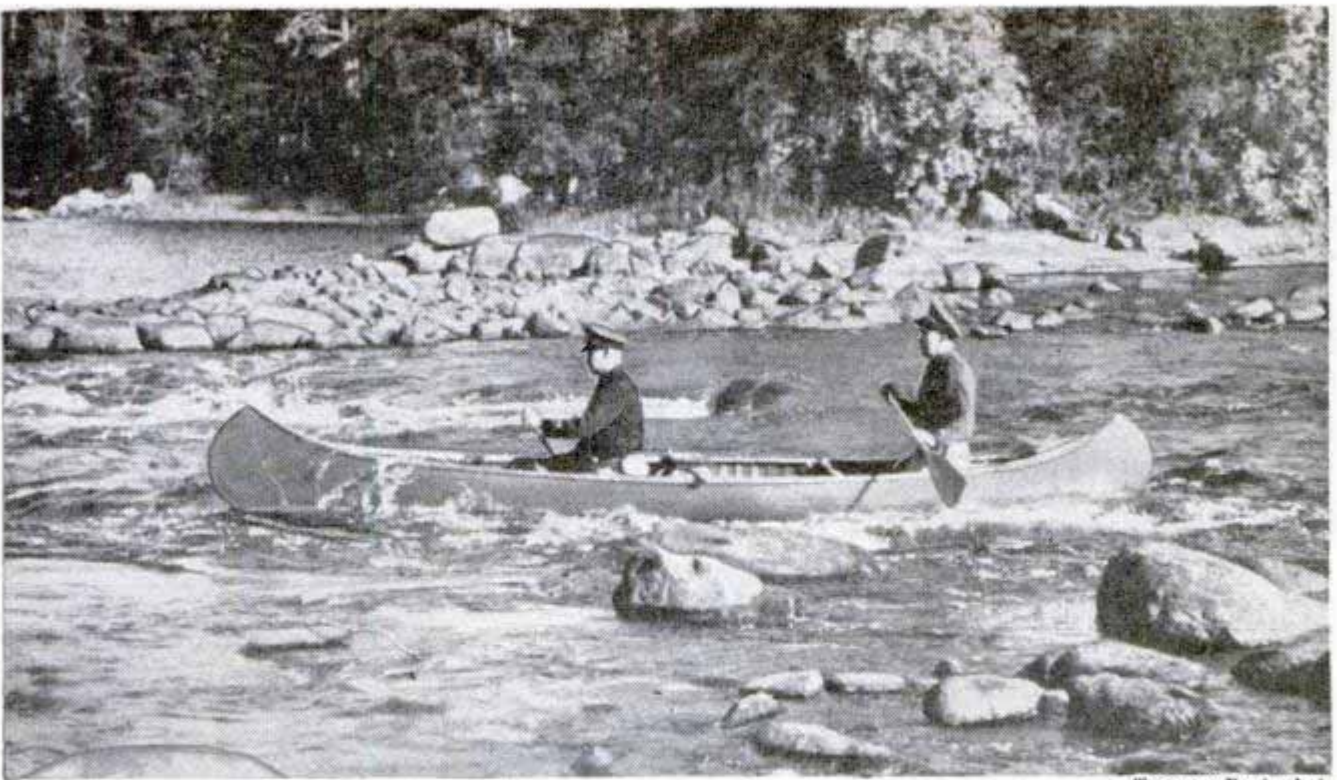

Treasury Dept. photo

Transportation for patrolmen must fit the terrain. Canoes are used for patrols in virtually impassable areas. Horses, airplanes, skis and snowshoes are regular equipment along the border

nese spy network in ports and industries.

As a result of efficient work by the U. S. Customs Service and other law-enforcement agencies most of the gangs were apprehended. Known Japanese spies, smugglers, criminals and other alien suspects were jailed within 48 hours after Pearl Harbor. Because of this quick roundup, no act of sabotage was committed on the West Coast or in the Hawaiian Islands.

Even though the war broke up the large smuggling gangs, the Customs Service is fully aware that they may be reorganized.

Meanwhile, petty smuggling is on the rise now that **passenger-ship traffic has been resumed.**

Before the war this type of **small-time chiseling reached an all-time high.** In the port of New York alone, where 500,000 passengers are inspected annually, 4500 violators were caught. And **customs officials estimate** that many more violators went through undetected.

This type of smuggling is indulged in even by wealthy persons wellable to pay the duty. A few years ago customs agents arrested the widow of a distinguished New York doctor who had brought in \$26,000 worth of Paris

finery without declaring it. In another case, the wife of a New York Supreme Court judge was charged with similar customs violations for bringing in thousands of dollars worth of undeclared jewelry.

During the war when steamship travel was discontinued, smuggling across the Mexican and Canadian borders increased. But hard-to-get items such as automobile tires, steaks, shoes, silk stockings and sugar were favored rather than gold, jewelry and narcotics.

(Continued to page 240)

They're cowhands, too! Customs patrol inspector cuts a bull from a Mexican border roundup. Cattle smuggling can be big business along boundary



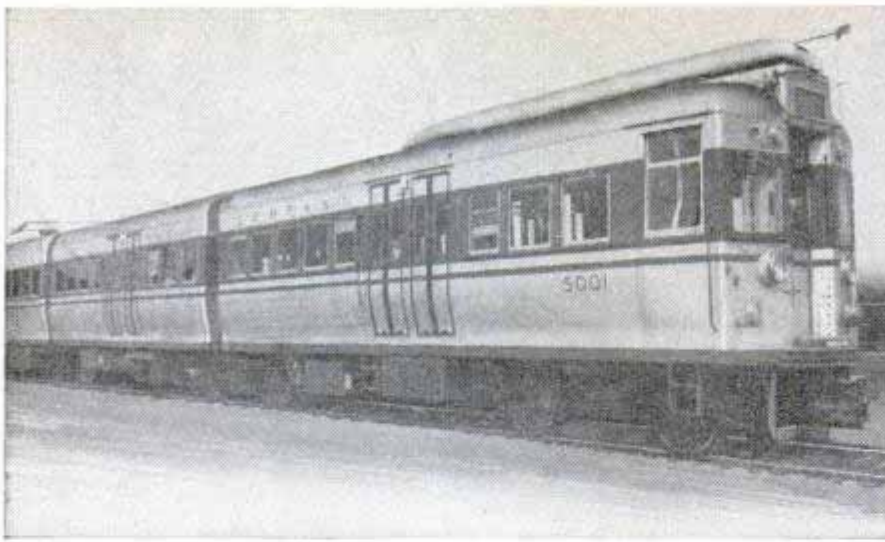

COACH "BENDS" AROUND CURVES

Straphanging commuters ride in luxury on the articulated cars being placed in service by the Chicago Elevated Lines. Nearly twice the length of old cars, the coaches are jointed in two places to permit the sharp turns required on elevated tracks. Seating capacity of 96 passengers is about double that of older cars. Three sets of brakes are provided and any one of them will stop the car quickly. In addition to drum-type wheel brakes and the braking power of the motors when converted to generators, there are powerful magnetic track brakes used for emergency stops. Each car has eight traction motors totaling 400 horsepower and all motors are synchronized for smoother action. Rubber and steel coil springs plus rubber wheel inserts make the ride smooth and quiet. A forced-

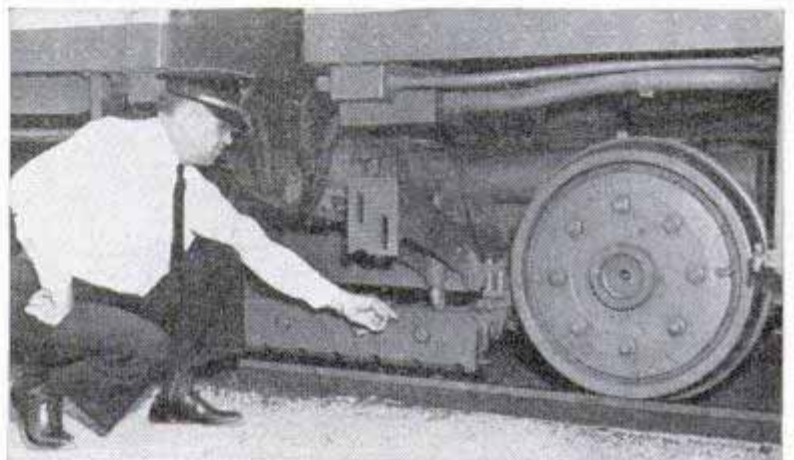

Top left, three-section car is articulated to "bend" around sharp curves. Right, all doors can be operated by master control. Above, flat magnetic brake grips rail for sudden stops

air ventilation system keeps inside air pressure slightly higher than outside to prevent entrance of dirt and dust. The heating system is automatic.

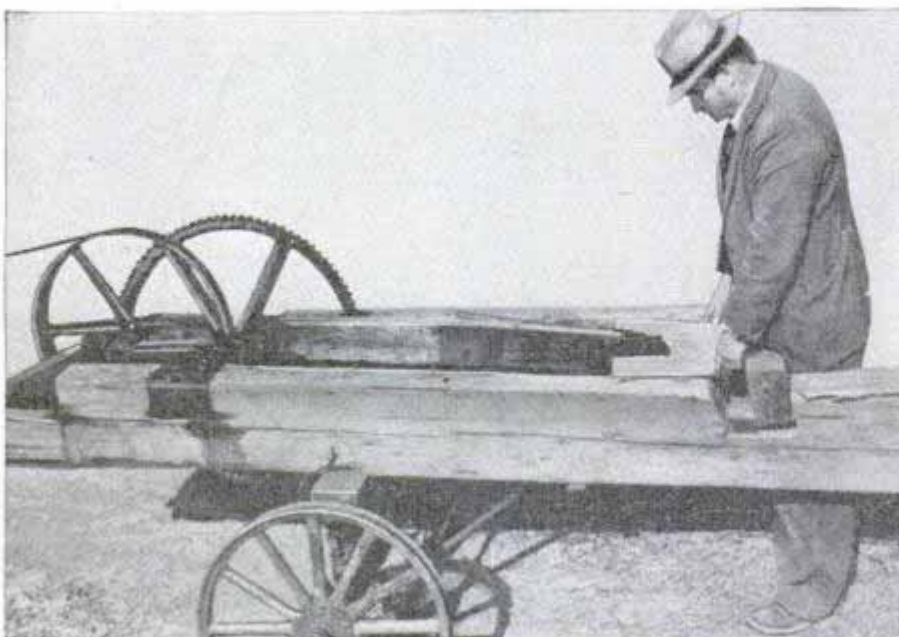

Fast Wood Splitter Made From Scrap

Firewood is cut at the rate of 30 strokes per minute by a homemade wood splitter put together by Carl L. Spearman of Seneca, S. C. The machine is mounted on a model-T Ford front axle assembly and powered by a tractor engine. Wood is split by a road scraper blade, beaten into shape, and attached to the end of a wood shaft mounted eccentrically on a wheel to drive back and forth on a horizontal level.



Land of the Scooter and Cycle

By Thomas E. Stimson, Jr.

IF THE RISING COSTS of driving an automobile are making you stop, look and worry, take a budget-wise look at the handy two and three-wheeled "personal" vehicles that are pouring out of a score of factories.

Lightweight motorcycles, pint-sized motorcycles, powered bicycles and motor scooters make up an important class of transportation that is picking up as fast as a motorcycle on a downhill grade. Not counting the owners of full-sized motorcycles, there are about 250,000 people in this country who ride to work or do their errands on the various kinds of lightweight vehicles. Motor scooters alone today have a registration conservatively estimated at more than 150,000 units. Eight years ago there were fewer than 10,000 such vehicles on the road.

Two reasons explain this tremendous growth—the low initial cost and the low cost of maintenance. You can equip your bicycle with a motor for about \$100 or, for several times that amount, you can buy a motor scooter. Top prices in the motor scooter lines are around \$500.

As for operation and main-

tenance, the costs depend upon the type of vehicle used. Gasoline mileage for motor scooters and motor bikes ranges from 70 to 150 miles per gallon. With one of the personal vehicles you'll have a top speed of 35 miles an hour and hill-climbing performance at least equal to that of a car in high gear. While performance figures vary



Top, a scooter club rides in formation along a western coastal highway. Right, boy rides his scooter to school



With its large package compartment above the front wheels, this scooter is popular with delivery boys

with the type and make of the vehicle, these are conservative averages.

Motor scooters were mass-produced first about 1935 and for several years were turned out in relatively small numbers. To the American automobile owner, the new, midget-sized vehicles were just playthings—something for the children, perhaps, but not for a grown man. The companies manufacturing motor scooters tried unsuccessfully to convince the motoring public that their vehicles were safe and economical

and that there was a place for them in the average family. But the people had to be shown—and it took a war to show them!

The Army and Navy purchased large numbers of these scooters for use in large training camps. They were the answer to the problem of rapid delivery of messages and forms in rambling supply depots. The scooters were drafted into our war plants to deliver small parts between buildings. Sidecars were added to convert them into mobile soda fountains for carrying refreshments to production-line workers. Other sidecar combinations were equipped for ambulance duty and fire-fighting.

Thousands of servicemen saw how practical the tiny vehicles were. They saw them used in training camps and advance bases under all kinds of conditions. They saw how easy it was to load the scooters into transport planes for use in getting from airports to headquarters. One extremely lightweight model, stripped down to the barest essentials, was built for use by paratroopers. The seat and handle bars folded down to make a compact unit that provided airborne fighters with quick transportation when they hit the ground.

Today, the demand for scooters is still increasing. They have become the second "car" in many families. Less expensive to buy and operate than a standard automob-

B

1. Speedometer and light switch
2. Brake pedal
3. Kick starter
4. Automatic clutch and transmission
5. Luggage space
6. Choke
7. Muffler

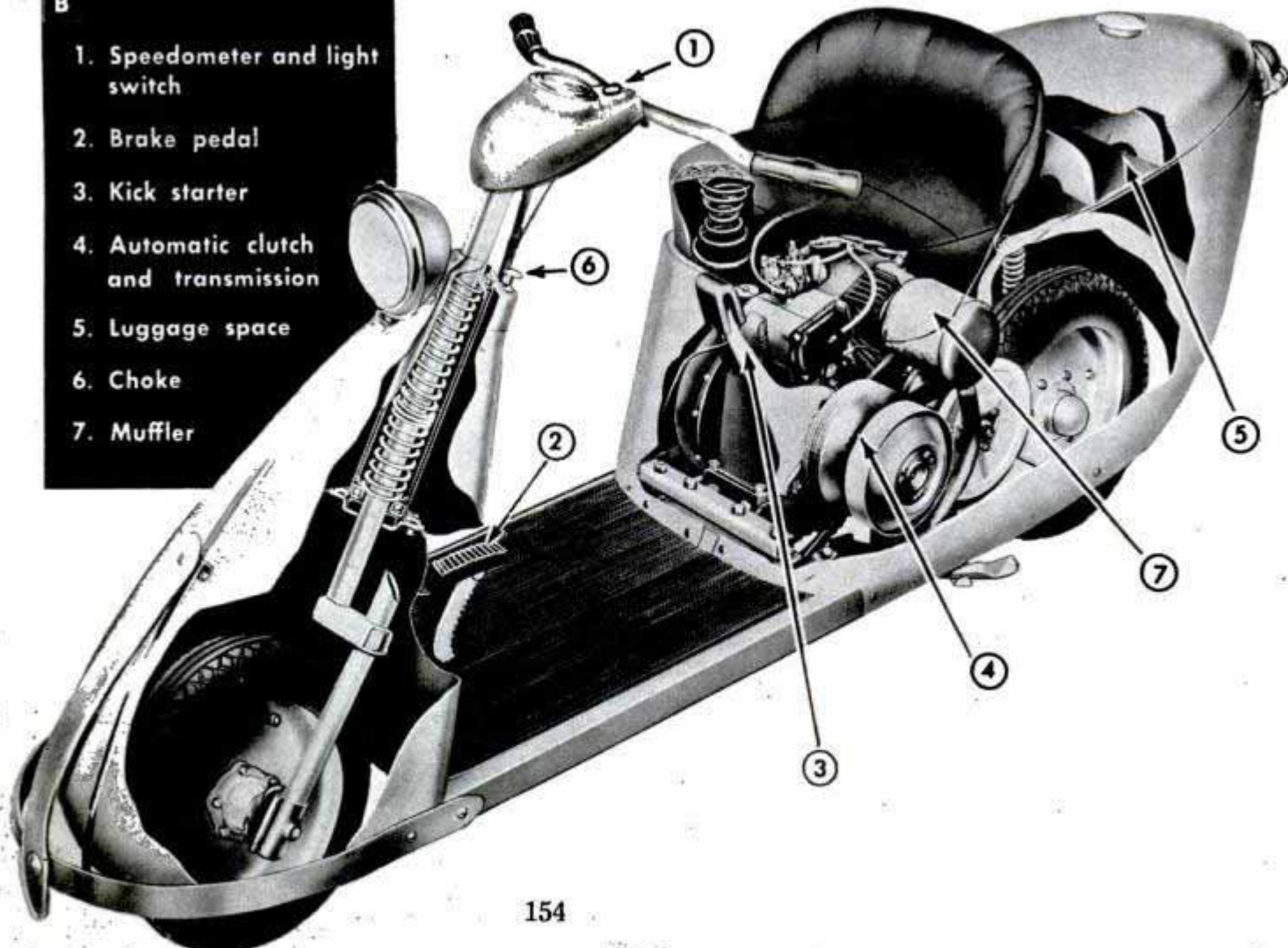

bile, the scooter has the additional advantage of requiring no extra garage space. It can be stored alongside the family automobile in an ordinary one-car garage.

Its ease of parking makes the scooter an ideal vehicle for quick trips to the store. Its low cost of operation means it can be used for commuting to work daily at about the same expense as streetcar riding. Neighborhood stores find the scooter ideal for delivering packages and, in some cities, even the telegram messenger has deserted his bicycle for a motorized scooter. Farmers like them for riding out to the fields; it means that the family car is free for other use. The scooters are comparatively safe and are popular with teen-agers both for fun and for transportation to school.

One Pacific Coast scooter club has 20 members who think nothing of making a 100 or 200-mile excursion in a day. They ride in a neat formation along the highways and stop for lunch alongside the road. A western enthusiast on vacation rode his scooter from California to Florida. Another, who had used his scooter while on police patrol duty, traveled from Glendale, Calif., to New York City via New Orleans. Scooters have invaded the sporting world and "scooter polo" has been played as a stunt to large crowds. Some Americans traveling abroad have taken scooters with them for use as sightseeing vehicles.

Generally, motor scooters are powered by a one-cylinder air-cooled engine that delivers from four to seven horsepower, depending on the weight of the vehicle, and use a chain drive to the rear wheel. Most of them are equipped with a kick-type starter, magneto ignition and a generator that provides current for front and rear lights. Depending upon the size of its motor a scooter can carry from 150 to 300 pounds in addition to the driver. Most of the personal vehicles weigh between 250 and 300 pounds without a load.

Some scooters are equipped with an automatic clutch coupled with a two-speed sliding transmission and a reverse gear (see Photo A). One make combines an automatic clutch with a fully automatic transmission that has a gear ratio varying from 14 to 1 at the low end to 3 to 1 at the high end (see Photo B). With this automatic set-up, clutching and shifting are completely eliminated. The only controls



Motorized bicycle is belt-driven by a 2½-horsepower motor. The small trailer can be used for carrying camping equipment on week-end trips



Above, rear wheel is replaced by the power unit at left to motorize the bicycle. Below, lightweight vehicle gets up to 125 miles on a gallon of gasoline





Above, scooter enthusiast traveled from California to Florida in only two weeks on his economical vehicle

Right, the scooter is useful around the farm. One farmer uses his bike when inspecting irrigation ditches



save space and to reduce weight. Some scooter designs include large luggage compartments behind the seat, roomy enough to hold the spare wheel and tire plus a load of groceries or enough camping equipment for a week end in the woods (see Photo B). Nearly all models can be equipped with a sidecar for an extra passenger or for hauling a load of merchandise. Some scooters have two wheels in front to support a roomy box that holds up to eight cubic feet of supplies. With this extra space, the scooter becomes a bantam-sized delivery truck that can be used to deliver merchandise in crowded city streets quickly and economically.

One manufacturer is producing a sturdy three-wheeled scooter with one wheel in front and two in the rear that is called a

used are the accelerator and brake pedal, both foot operated, plus the steering apparatus. Other designs that use an automatic clutch have a motorcycle-type hand throttle that clears the floor board of all controls except a foot brake.

Many of the latest improvements in automotive and aircraft design have been adapted to scooter construction and the manufacturers are proud of such features as aluminum-alloy crankcases, molybdenum alloy or Stellite-faced valve faces and seats, fuel strainers and sediment traps, sealed wheel bearings, Plexiglas windshields, all-welded steel frames and bodies, knee-action springs and small aircraft-type rubber tires that range from 4.00x8 to 6.00x6 in size.

The power plant is under the seat in most models. In fact, one manufacturer bolts the driver's seat directly to the cylinder head by means of extension rods to

three-wheel ½-ton truck. The flat, two-cylinder motor is an air-cooled valve-in-head model and it develops 8½ horsepower. It has twin carburetors and a built-in cooling fan. This model has a battery and an electric starter similar to those used in automobiles. Another unusual feature is the separate hydraulic drive for each rear wheel that takes the place of a transmission and differential. The entire body can be covered with a lightweight top when the weather requires it. A station-wagon body, capable of carrying six people in addition to the driver, is being tested by the manufacturer.

Motorized bicycles are not new, but recently designers have been busy planning new and more efficient models. One bicycle motor, built to narrow dimensions so it won't interfere with the movement of the driver's legs, is mounted inside the bicycle frame above the sprocket wheel (see Photo

C). Its five-quart fuel tank is attached to the crossbar in front of the seat. The engine has one cylinder, is air-cooled, uses magneto ignition and develops $2\frac{1}{2}$ horsepower. It is rubber-mounted to reduce vibration and noise and drives the rear wheel by means of a rubber belt.

Compression of the tiny motor may be used for braking purposes in addition to the usual coaster brake. When the clutch is released, the bicycle can be pedaled in the usual manner. A miniature generator is friction-driven by the front wheel and provides the current for operating the lights. If desired, a little two-wheeled trailer can be towed behind the bicycle.

Another bike motor that can be used on any type of bicycle is mounted above and on one side of the rear wheel. Complete

with its small fuel tank and controls it weighs only 32 pounds. The inverted one-cylinder engine develops $2\frac{1}{2}$ horsepower at 3000 r.p.m. and drives the rear wheel by means of a roller drive that is "geared" to the edge of the tire. The manufacturer states that tire wear is not increased by the drive wheel.

Still another type of power unit consists of a small engine attached to a special airplane-type wheel and tire (see Photo D). Installation of this motor and drive wheel is easy. You simply remove the rear wheel of the bicycle, substitute the new unit and connect the controls.

Several vehicles are being manufactured that can be classified somewhere between a powered bicycle and an ordinary motorcycle. One of these, actually a full-sized,

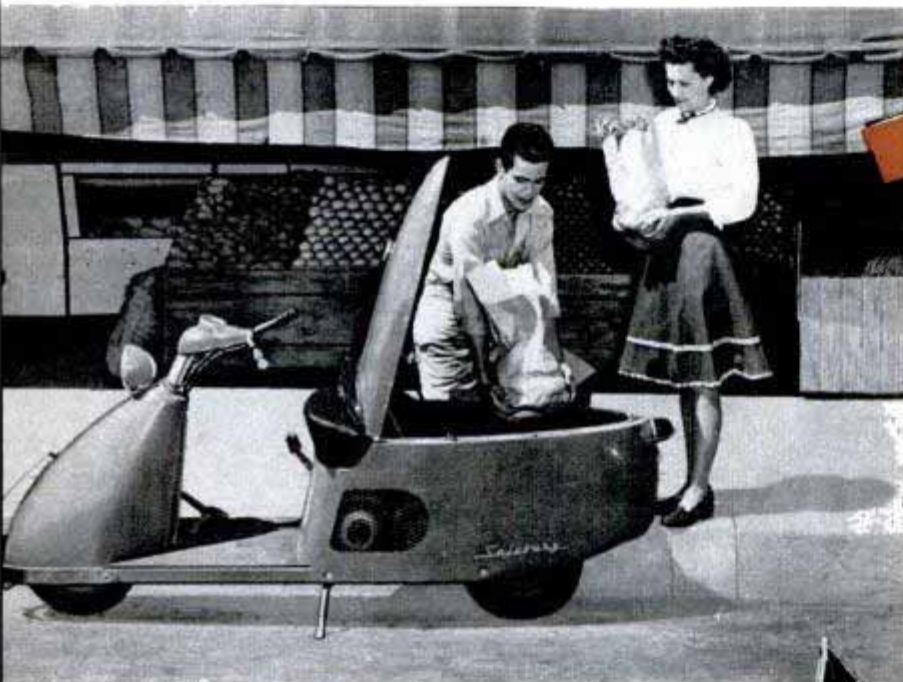

SHOPPER

← As the family's second "car," the scooter makes shopping a pleasure for the housewife. Parking space is no problem and the groceries are piled in the rear

↓ Even the fast-flying airplane has to rely on the lowly scooter when taxiing into a parking area at the airport. The attendant directs the pilot safely along the taxi strip



AIRPORT JOCKEY



Two rear wheels add stability to this motor scooter built for two

had a top speed of 40 miles an hour. Now, this company makes a slightly larger type that hits 70 miles an hour. Low-priced, it has a $9\frac{1}{2}$ -horsepower, one-cylinder motor and weighs only 208 pounds.

Some users build their own cycles. One machinist rebuilt a stock scooter into a small motorcycle-type vehicle. The motor, restroked and rebored, has twice its old power and the bike hits 70 easily.

Another owner, Howard Forrest of Glendale, Calif., designed a powerful motorcycle-type vehicle, about half normal size, that has a four-cylinder, water-cooled engine he built (see Photo G). The 12-horsepower, overhead-valve motor gives the cycle plenty of speed.

So, if you're looking for a cheaper way to get places, follow the lead of the scooter crowd—it may not be so comfortable, but it is less expensive.

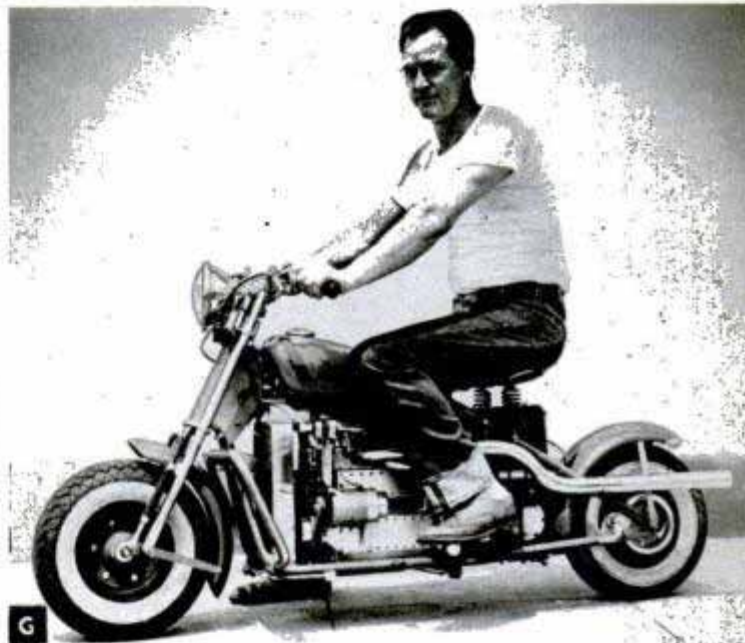

Above left, two small motorcycles are shown beside a full-sized model. Right, built entirely by the owner, this small cycle has a four-cylinder, water-cooled engine. Below, tiny motorcycle used by British paratroops

but extremely lightweight motorcycle, is powered by a one-cylinder air-cooled engine that delivers a top speed of about 35 miles an hour on a gasoline consumption of as low as 125 miles per gallon (see Photo E). The engine is of the two-cycle type and is rated at $2\frac{1}{2}$ horsepower. The rear wheel is driven by a steel-stranded V-belt. The complete machine weighs only 148 pounds.

Another in-between cycle is the miniature motorcycle. One company that makes this type fabricated a small motorcycle fitted with a four-horsepower air-cooled British engine before it designed and built its own power unit (see Photo F). The machine



Sand-Slinger Rides High

Taking the place of hand shoveling, a revolving machine called a sand-slinger deposits sand in molds at the Pittsburgh foundry of the Westinghouse Electric Corp. The operator rides through the air as the device collects sand from an overhead bin and dumps it into molds at the rate of 1000 pounds a minute. The sand feeds through an eight-inch pipe and is hurled out of the machine by the centrifugal force of a 40-horsepower motor.



Air-Line Ticket Vending Machine

Air-line tickets to any destination can be printed, audited and issued in less than five seconds by a mechanical vendor. Introduced by American Airlines, the machine's three-step operation begins when an agent inserts a pencil-like key bearing his personal number and sets a knob indicating the type of sale. Then, from matrices racked alphabetically in nearby cases, the agent selects one, slides it into a slot and the fully printed ticket pops out. Only the time, date and number of the passenger's flight have to be written in. All data on the

transaction is recorded on an auditing tape in the machine. It prints tickets from New York to 65 cities. Another ticket-vending device for high-density routes operates on the meal-check principle. After the prescribed fare is paid, the seller puts a round, slotted disk into the machine, which then issues a preprinted flight coupon with a passenger coupon attached. Space confirmation is written on the latter.



Power Line on Wheels

Functions of electric distribution systems are demonstrated by a mobile power unit now touring the nation. In one stunt (shown in picture), a 15,000-volt disconnect switch on an overhead line is opened to extinguish a flaming arc in a fraction of a second. To show how power lines defend themselves against lightning, the unit is bombarded with 100,000-volt thunderbolts created by a surge generator. Power fuses, line reclosers, fused cutouts and arresters go into action to prevent damage and interruption of service. The "power line on wheels" was designed by Westinghouse for demonstrating modern distribution equipment to utility companies, municipal engineers and rural electrification agencies.



QUICK-TRIGGER FBI AGENTS, aware of the sharpshooter's advantage in a gun duel, demonstrate their firing technique in police training classes held throughout the country every year. Safety, accuracy and rapid firing are the qualities stressed. "Alumni" of the schools are well-trained in the deadly science of shooting quicker and more accurately than the public enemies they may meet. Above, FBI instructor Bill Burke demonstrates how to shoot from the sitting position, elbows braced against knees and revolver gripped vise-like in both hands to provide stability



Right, long-range shooting may be made from cover requiring a left-hand shot. The gun is held against the board and steadied with finger and thumb. Below, crouching low and moving fast, Burke demonstrates rapid-firing at close range. For safety, finger remains clear of trigger guard until revolver is aimed

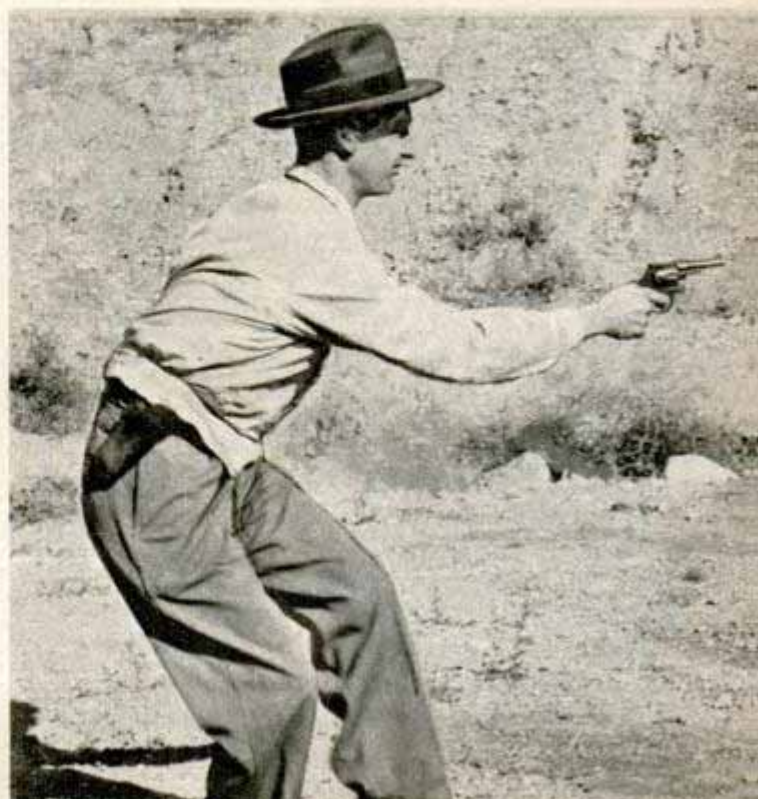



FBI School for Sharpshooters

Above, police officers watch as Burke blasts away with a submachine gun in a demonstration of hip shooting. The gun is held solidly and aimed by pivoting from the hips. Above right, in criticism of his own shooting, Burke says shots are slightly high and indicates target spot where group should be centered. Yet 43 of 50 shots in target would have killed a man

Right, sharpshooter shows how the thumb can be used to steady the revolver. The instructor emphasizes that any weapon always should be held as solidly as possible. "Use a vise if you have one," says Burke

Prone position with feet together and chin almost touching the ground gives maximum stability for long-range shooting while presenting the smallest target to the enemy. The revolver is gripped in both hands with the ground providing a platform for revolver butt



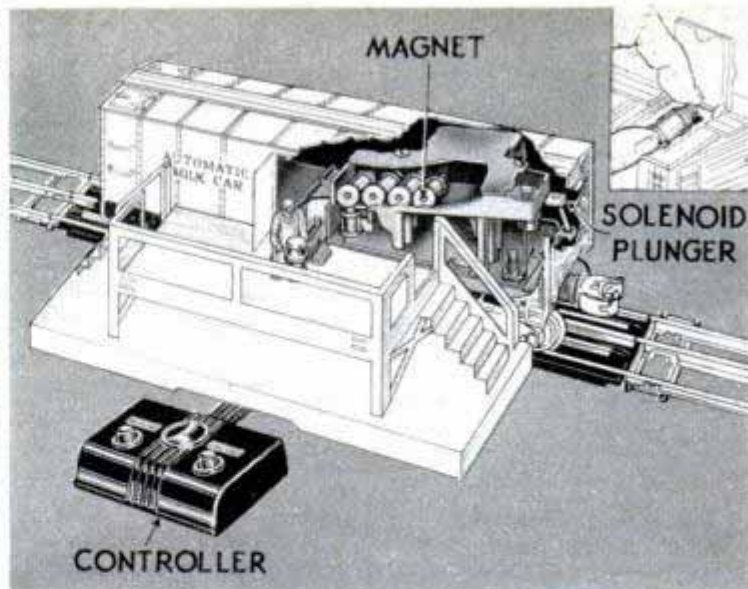
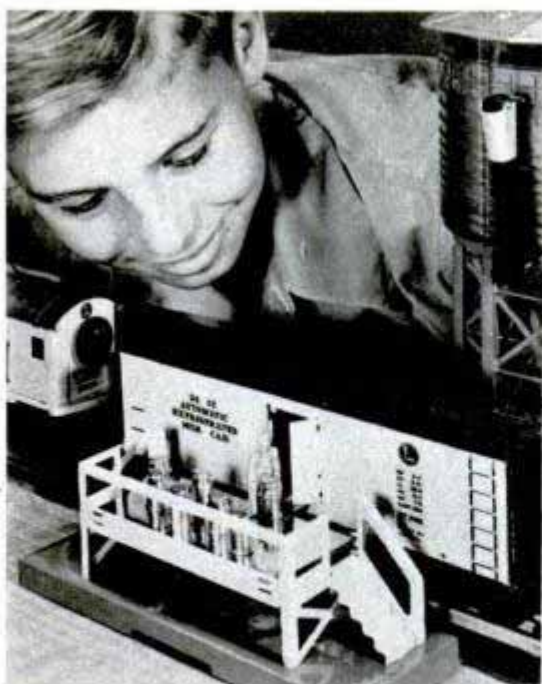

TOY MILK CAR UNLOADS CANS

Electric-train enthusiasts can equip their railroads with a self-unloading milk car. Tiny milk cans are loaded through a door in the car roof and when a remote-control

button is pushed, the car doors open and a workman pushes eight cans, one by one, onto the platform. Magnets on the cans keep them upright during unloading.



"Hot Dog" Roaster for Car

"Hot dogs" can be cooked inside a car with a heater that operates through the automobile battery. The heater is an aluminum tube lined with insulation so that the inside diameter is slightly larger than a wiener. Two hot dogs are placed on a sliding arm which is pushed into the tube. The cooker thoroughly heats two wieners in five minutes. A wire lead is provided for connection with the battery and a plug for installation near the dash. Inserting an electric cord in the plug starts the heater, which is designed to fit into the glove compartment of most automobiles.

Flexible Molds Easy to Make

Flexible molds for the production of plaster-of-paris novelties are produced easily and at little cost with a molding compound that contains natural rubber. To make the mold, the compound, in liquid form, is brushed on the model and permitted to dry. Then, a putty-like form of the same compound is applied. When this is dry, it is peeled off and used as a mold.



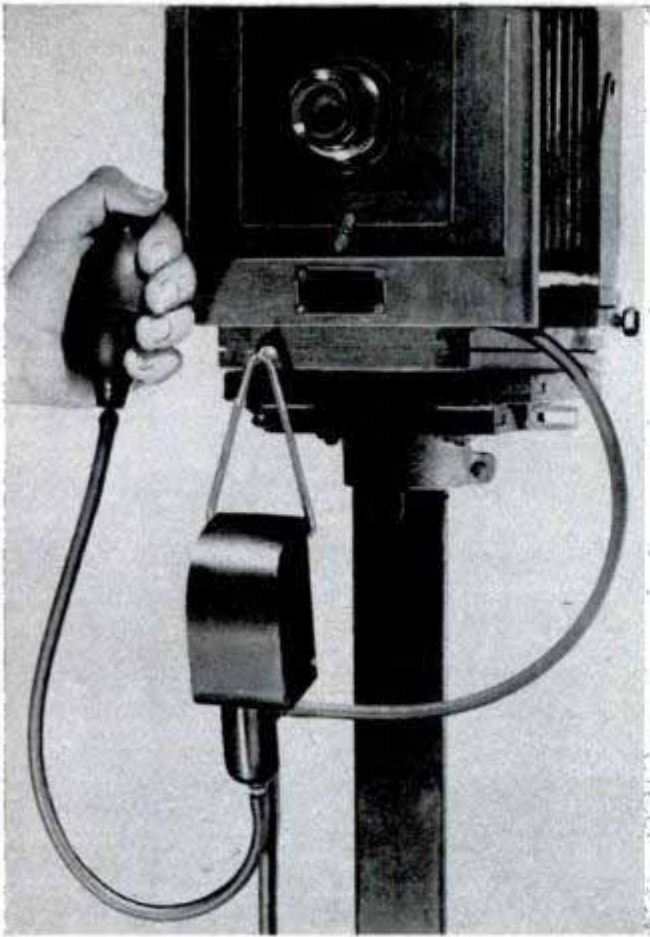

Synchronizer Dims Photofloods

By eliminating the need for posing subjects under bright lights, a photo flood synchronizer makes portrait work less tiring on both the model and the photographer. While the photographer arranges the lights and poses the subject, the lamps burn at a low intensity. Squeezing the bulb operates the synchronizer which turns the lamps on full and releases the shutter. After the exposure, the lamps are dimmed automatically. Any number of photo flood lamps can be used with the synchronizer.

Hangers Hook on Car Door →

Seven loaded clothes hangers can be hung from a metal holder that hooks on the inside rim of an automobile door. Resting on the door frame, it doesn't interfere with the opening and closing of doors and windows. The holder is 7¼ inches long and made of aluminum alloy.

Fire Shutters Seal Escalator

Aluminum shutters that operate automatically seal Escalator openings in case of fire, thus retarding the rapid spread of flame and smoke through the building. Previously, such openings were sealed by hand-cranked shutters. Thermostats and electric eyes are used to actuate the motor-driven fire stops. In case of power failure, the shutters can be closed by hand.



Television on Full-Size Screen Projected by Huge Mirror

Ground to the precision of a fine telescope lens, a huge magnifying mirror has been developed for projecting television programs on large screens. The 42-inch spherical mirror weighs 350 pounds and provides clear-cut magnification. Built by RCA, it will be used by Warner Brothers Studios in a cooperative research program for large-screen television.





Singeing a fowl (left) is only one of a score of jobs that can be performed with the high-temperature heating coil above. It's handy for defrosting the refrigerator, thawing frozen pipes or removing paint

The automatic night light for the bedroom (below) will save many a stubbed toe. It turns on when you get out of bed and off again when the weight of your body depresses the springs. The fixture fits any bed

WHAT'S NEW *For Your Home*

A four-page "shopping section" dedicated to modern homemakers

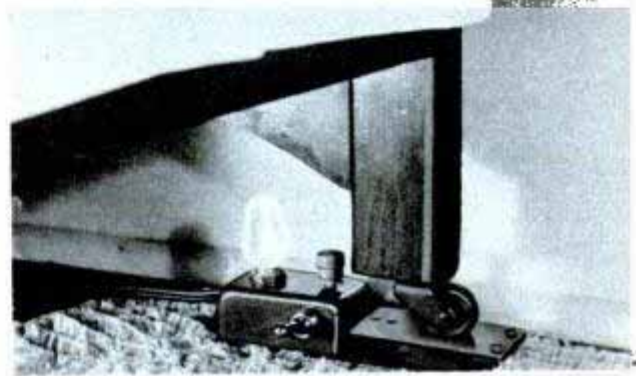

"Picture" lamps hung on the wall below provide light for reading in bed. They are made of panels of decorated glass framed in enameled shadow boxes. Incandescent tubes are at top and bottom of the frame and cast a soft light into the room

The double-fumble of trying to find the right key in the dark and then finding the key hole is eliminated with the small fixture below. It requires no wiring as it contains a long-lasting midget mercury cell. The light is handy in cupboards or over fuse boxes

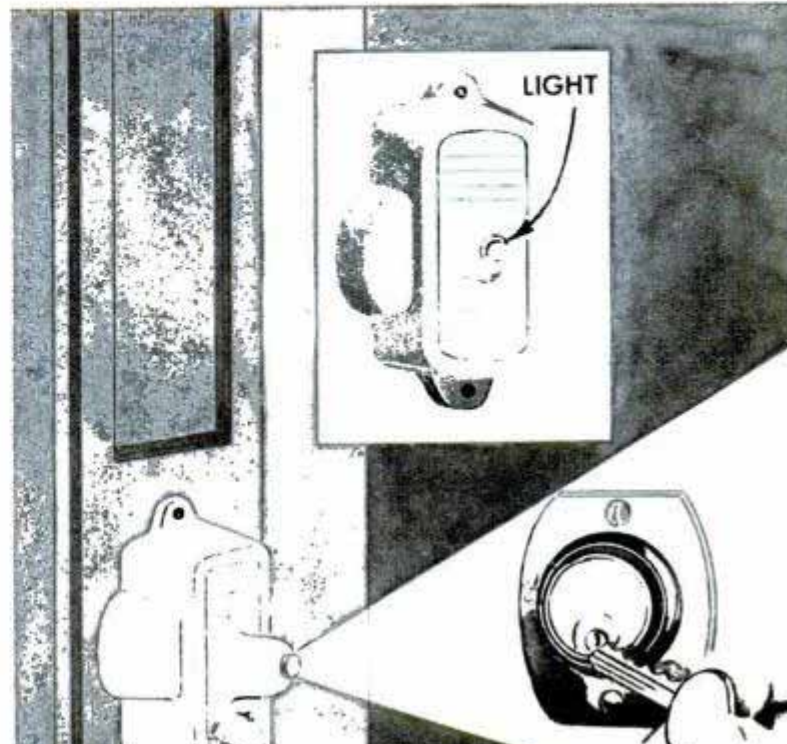
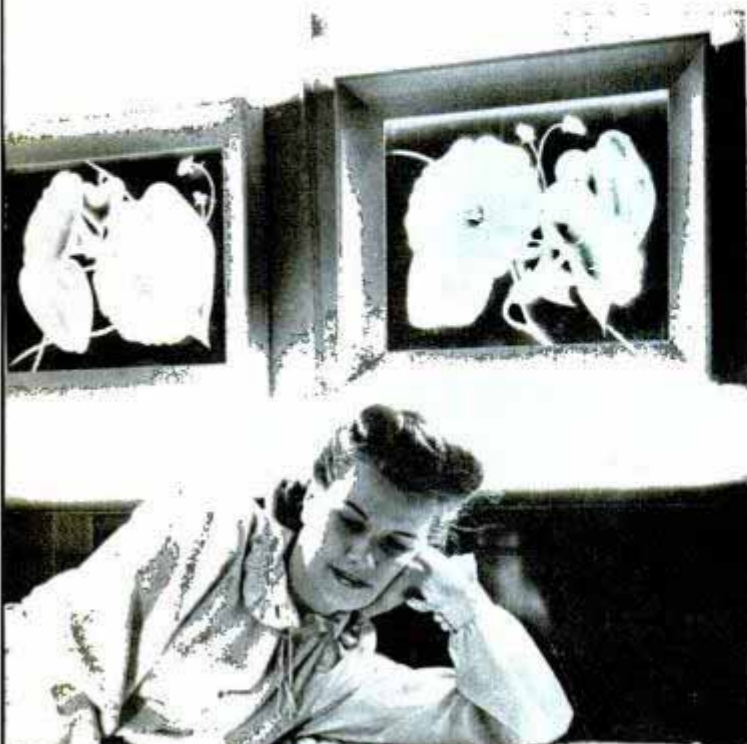

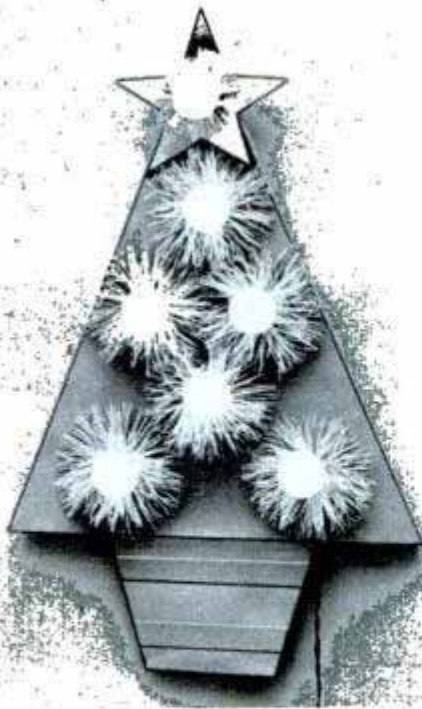

Cool-burning fluorescent bulbs and fringed paper can be used to make this door ornament for Christmas. It is made of heavy paper with holes for the lights

Lazy Susan closet for milady (below) has three hanger rods arranged in a triangle about a center pole that revolves on ball-bearing parts so clothing is within easy reach. Base consists of shoe platform



This serving tray is easily converted into a table by pressing two levers which release its retractable legs. The levers are mounted on top of the table and operated by thumbs of the holder. It is made of plastic and aluminum and weighs 5 pounds

Transparent wall protector below is available in sheets 30 by 40 inches and can be fastened in place with cellulose tape. It is useful in kitchen or bathroom. As a substitute for glass the material can be used for desk tops, dressers and picture frames



WHAT'S NEW *For Your Home*

Continued from preceding page



Made of aluminum foil, the disposable "panette" fits in pie pan or frying pan; it also serves as a plate



Above, sliding removable heating unit into the top section of electric range which plugs into any appliance circuit. Interchangeable unit can be used for either cooking or broiling. The oven is large enough to hold a 22-pound turkey and the range is suitable for use in small apartments or trailers

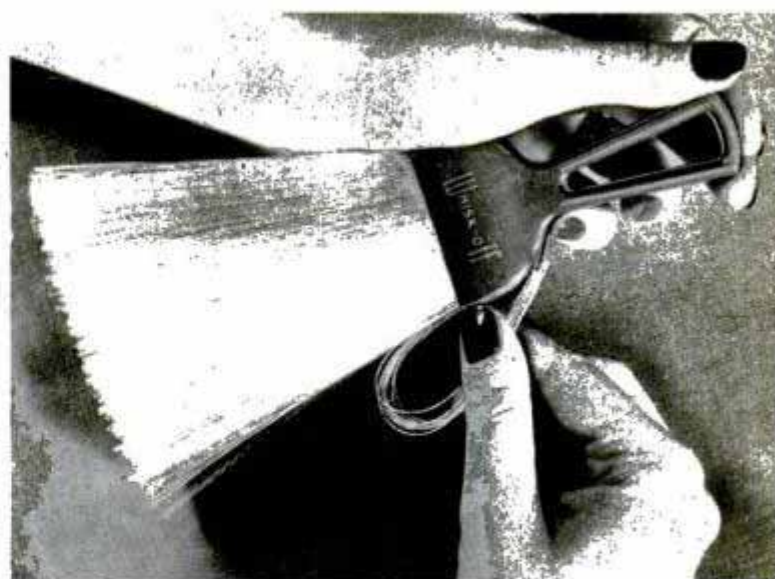

↑ Magnetic reaction in all-plastic whisk broom is used to help draw dirt from minute crevices. This reaction is created from movement of plastic bristles over fabric

Left, browning cover gives just the right crust to fried chicken, fish or other foods. It allows moisture to escape but prevents flying grease; cover serves as colander

POPULAR MECHANICS



Lamb's wool covers Tenite plastic prongs of vacuum-cleaner attachment for dusting venetian blinds. Dust collected by the wool is sucked into slots inside of each prong. This lightweight attachment is easy to hold

Right, new curtain rod with the five tubular forms attached gives the draperies professional-looking cartridge pleats. The material is pinned around forms and adjustable slots are used to slide the draperies



Swirl washer for hosiery, gloves or any delicate material such as fine lace is operated like a cocktail shaker. For washing hose, one teaspoonful of soap flakes is put into shaker and luke warm water added. This miniature plastic washing machine is handy either for travel or in the home

Plastic "greeting" decorations for gift packages, birthday cakes and other items are made in various colors and can be applied with ease. Inscriptions for cakes resemble icing, but are unbreakable and can be washed and used hundreds of times

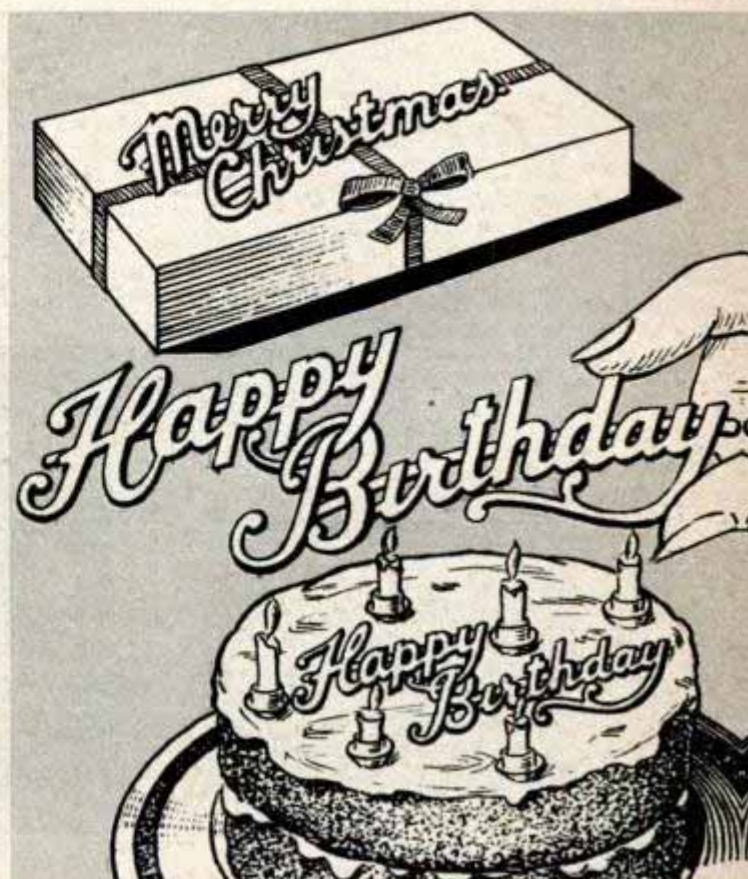

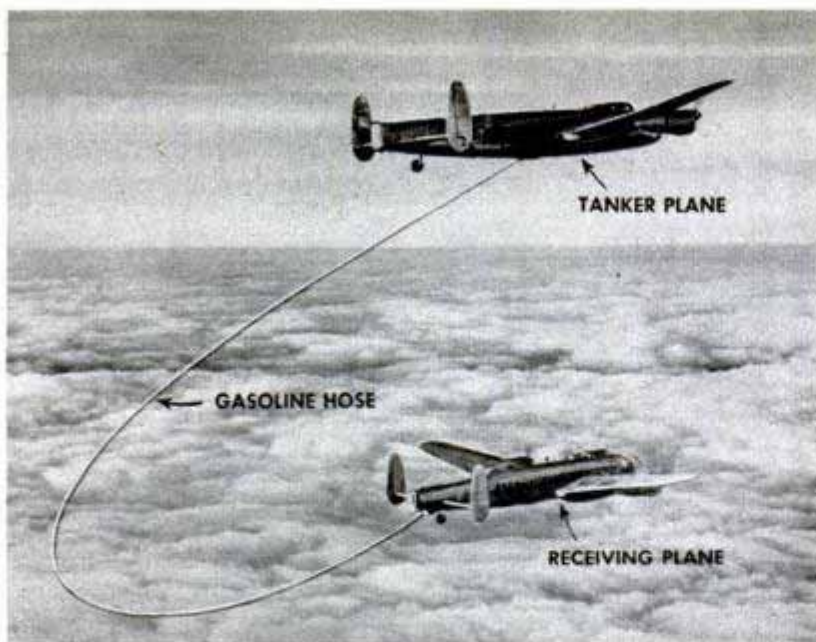

"Tanker" Refuels Planes in Flight

Transocean runs for medium-range planes are the object of refueling experiments conducted by the British government. In one test 3400 gallons of gasoline were piped from a tanker plane to a receiving plane in 20 minutes. Contact is made by firing a claw-tipped projectile, linked to a line, which engages a line trailing from the receiving plane. A gasoline hose attached to the first line is drawn up beneath the receiving plane and a coupling completed to take on the fuel. After transfer, the hose is reeled into the tanker. In one experiment a Lancaster bomber made a non-stop flight from London to Bermuda and back, covering 8000 miles in just over 35 hours. Winter tests are being made over the North Atlantic. Flight refueling eliminates time lost on the ground and in landing, increases pay load and makes possible a lighter and safer take-off.

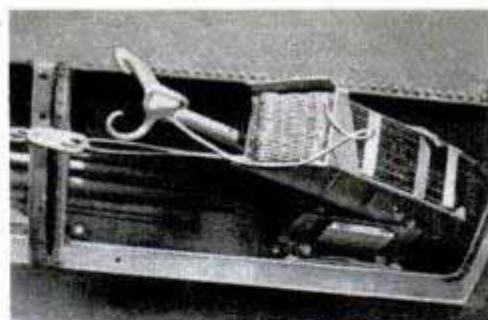

Above, claw-tipped projectile and line fired from tanker to receiving air liner

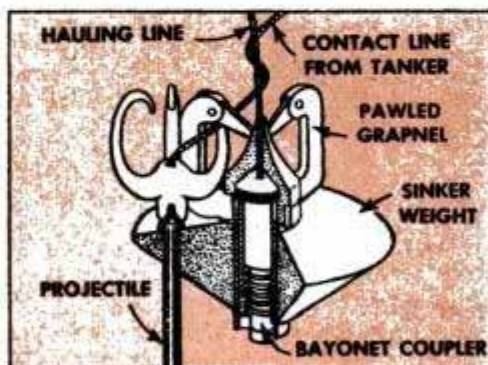

Below, receiving plane's reception coupling, through which trailing line passes

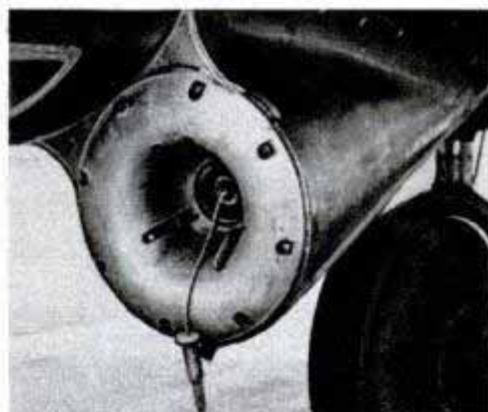

"Drop-Tank" Glider In Midget Class

What was once a P-38 drop tank is now the fuselage of an all-metal glider, believed to be the smallest ever built. It was designed by Irving Prue of Burbank, Calif. The butterfly tail allows the craft to land without becoming entangled in weeds or brush.

Some of the Army's finest antiaircraft artillery is being "packaged" for possible future use in Fiberglas-lined steel tanks resembling those used for gasoline storage.



Two-Car Diner-Kitchen Seats 91 Passengers

Dining car accommodations for 64 railway passengers and lounge seats for 27 are provided in a two-car unit with one car a full-length diner and the other a combined lounge-kitchen. The unit, recently placed in operation by the New York Central System, also has a waiting lounge where passengers may be seated until dining accommodations are available. The dining car, which connects with the kitchen through an electrically operated door, is divided by glass partitions into three compartments. The forward compartment has tables for 22 passengers. In the center section passengers are seated along couches with their backs to the walls. The rear section is sim-



ilar to the forward compartment. The kitchen has stainless-steel fittings which include complete electro-mechanical refrigeration, automatic dishwashers, a double range and a folding washbasin.



Indicators on Portable Lamp Show Need for Recharging

Throwing a 2500-foot beam, a portable rechargeable hand lamp has windows in the side of the case which indicate when each cell of the battery needs recharging. Behind the transparent windows are three specific gravity ball indicators, one green, one white and one red. When the green ball is down, the battery is five percent discharged; when the white ball is down, it is 50 percent discharged; and the red ball indicates it is 95 percent discharged. The shelf life of the battery is about 90 days. The lamp is designed primarily for police and fire departments.

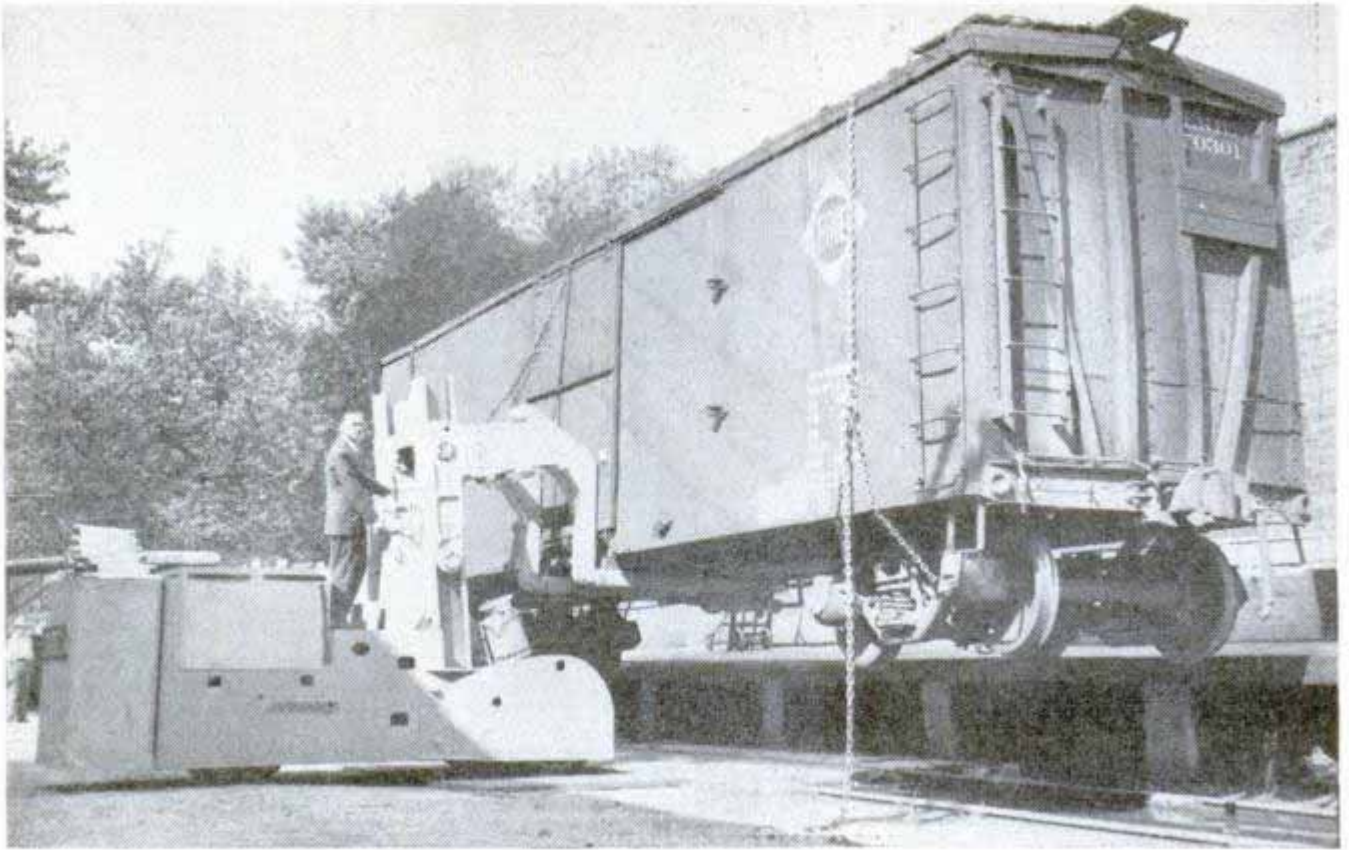

Fork Truck Lifts 45,000-Pound Freight Car

Lifting a 45,000-pound freight car is easy work for a powerful fork truck that was designed for use in steel mills. The truck itself weighs 30,000 pounds and has a capacity of 60,000 pounds. Designed and built by the Automatic Transportation Company of Chicago, the truck is powered by a four-wheel front drive assembly, with twin-

drive units for the two pairs of wheels. The high-pressure hydraulic lift operates through a multiple-action three-cylinder ram which pushes directly against the cantilever. This design eliminates chains and sprockets. Though primarily designed for steel mills, the lift can be used for die-handling in the automotive industry.

U. S. Air Force photo

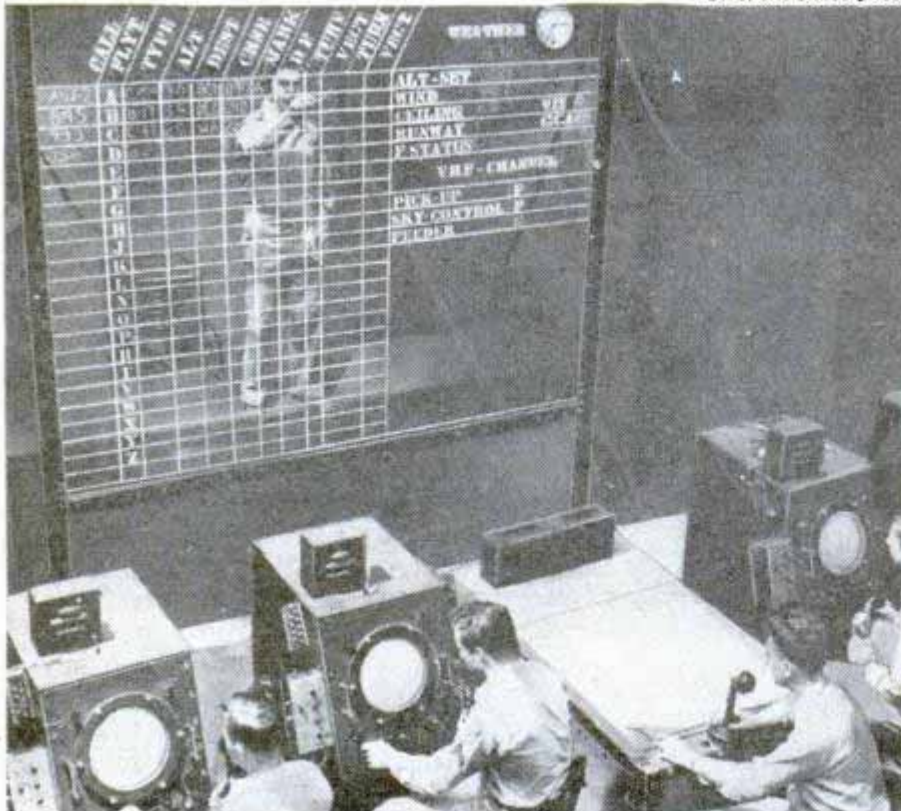

All Planes in Area Show on One 'Scope'

Radar traffic control of all planes within 40 miles of Andrews Field, Md., is centered on a "scope" the size of a kitchen table. Called a Skiatron, it has a white frosted surface and is about twice the size of the usual viewing scope. A controller, watching markers indicating plane positions, "talks" each pilot down to within a few feet of the runway. Smaller radar units follow specific planes. An operator hooked in to all ground-air channels keeps a running account of all landing instructions and information.



HOMEMADE MOWER uses a specially designed tractor to push five ordinary lawn mowers mounted so they cut an eight-foot swath. Mowing unit is easily removed

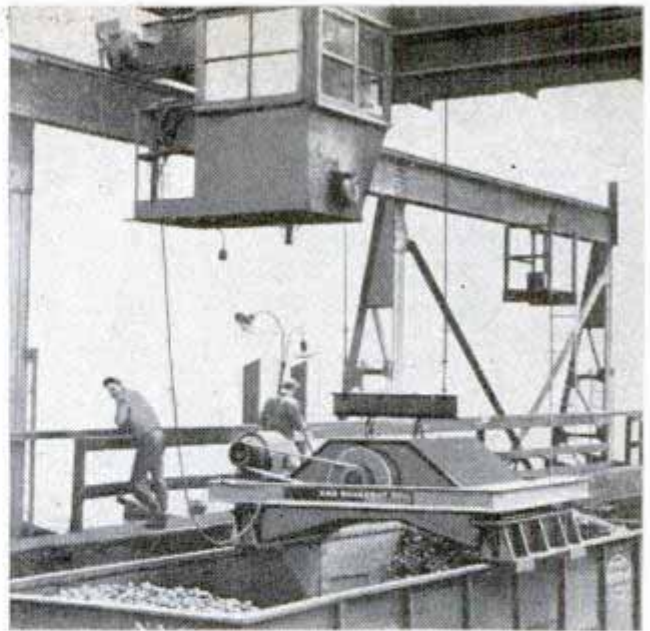

CAR SHAKER, placed on top of hopper-bottom railroad cars, vibrates 1000 times per minute to shake coal loose and cut the unloading time to 90 seconds

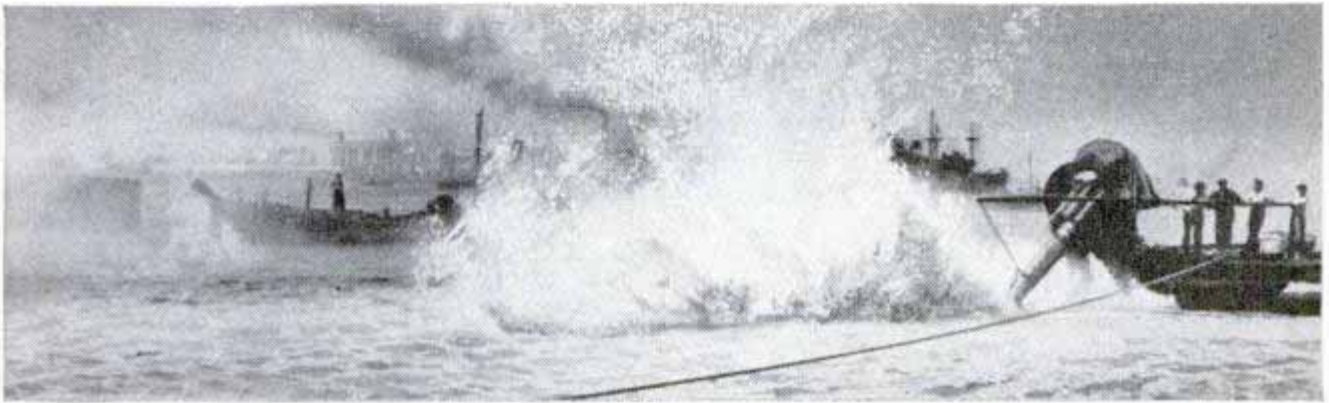

POWER JETS have more uses than just propelling airplanes. A new British adaptation of the jet is used to remove sediment that settles near wharves and obstructs shipping. The jet engine, mounted on a barge, fires a blast of compressed air against the river bottom, stirring up the mud so that it's carried away by the current

AUXILIARY GAS TANKS, mounted on old bomb trailers, are used as drain tanks in changing airplane-engine oil. A flexible tubing carries the old oil from the engine drain cock into the 150-gallon portable tank

SWAYBACK CABIN deliberately violates building principles. With doors hanging askew and stove-pipe slanting, the unusual house was built by a Seattle policeman for use during fishing trips



His Tripod Is a Plane

"YOU JUST CIRCLE around, look down until you find a good angle, then sit back and shoot." That's how Oakley T. Wayman, who makes his living snapping bird's-eye views, sums up the art of aerial photography.

Wayman has been a camera and flying enthusiast for many years. Not long ago he decided to try to make both these avocations pay off, and quit his job at a plant in Linden, N. J., to earn a living with a Fairchild K-20 camera and a Piper Cub.

Factories, private estates, cemeteries, churches, golf courses and even entire cities are all grist for his photographic mill. And customers willingly pay an average of \$75 to have him take a picture of their property from the air.

Although he handles any job that comes along, manufacturing plants and real estate constitute the bulk of his work. Firms use pictures of their factories in house organs, advertising, and in stockholders' reports, to show physical improvements.

Owners of private farms and estates



By Edward J. Linehan

usually frame these photos of their grounds and buildings and sometimes use them for letterheads and greeting cards. The wide range he can cover makes his aerial shots valuable to owners of golf courses and housing developments.

The price depends on the size and number of pictures his customers want, the altitude at which they want them taken, and the distance of the job from Wayman's South Bound Brook, N. J., home. He has ranged as far north as Albany, N. Y., and as far south as Richmond, Va., in his Cub, fulfilling assignments.

Although he has often taken pictures while flying the plane himself, Wayman found that an experienced pilot at the stick is a great asset. His present "asset" is Wilmer H. Atkinson, a veteran. "We work as a team," says Wayman. "Good aerial photographs depend on perfect coordination between pilot and cameraman."

After taking off from Somerset Hills Airport, near Basking Ridge, N. J., where Wayman keeps his plane, the pair flies to the site to be photographed. Once over the



Aerials of sporting events, like this Rutgers-Princeton game, are always in demand by participants

spot, Atkinson levels off at the prescribed altitude (anywhere from treetop level to 11,000 feet), and circles, cutting his speed to about 65 miles per hour.

Wayman folds back the plane's doors and watches the panorama below, waiting for just the right angle, aiming through the cross-hair and bead sight. When he catches the right view he pulls the trigger on the big-bored K-20, taking the picture and automatically winding fresh film into place for another exposure.

Since the Cub's doors are on the pilot's right, Atkinson must fly clockwise. The necessity for this led to tense moments while covering the Rutgers-Princeton football game in 1946. Three or four other pilots, either snapping pictures or taking advantage of a free aerial ticket to the game, insisted on circling in the opposite direction, with relatively few feet difference in altitude. Atkinson had to be constantly alert to prevent a spectacle which would have surpassed that on the grid-iron below.

Wayman said it wasn't easy learning to be a commercial aerial photographer. "I couldn't find a



As Pilot Atkinson flies the ship into position, Wayman sights a target with K-20 aerial camera

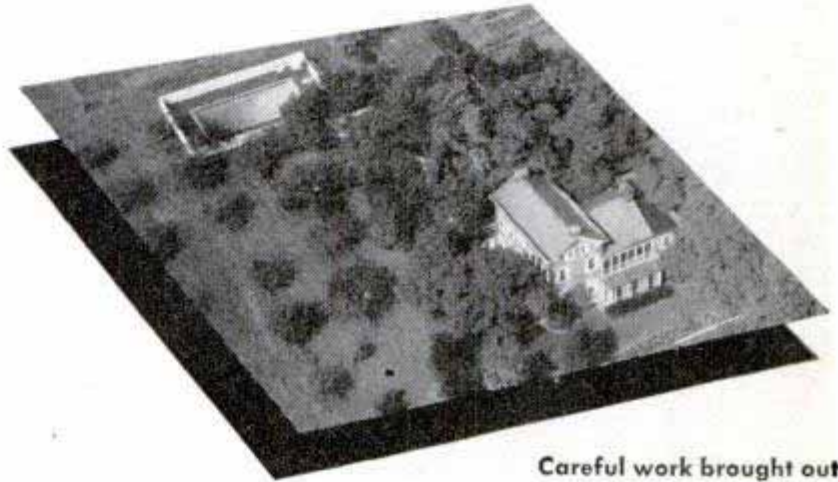

Careful work brought out even fine detail of the foliage on this estate, taken at 1/500th and f:3

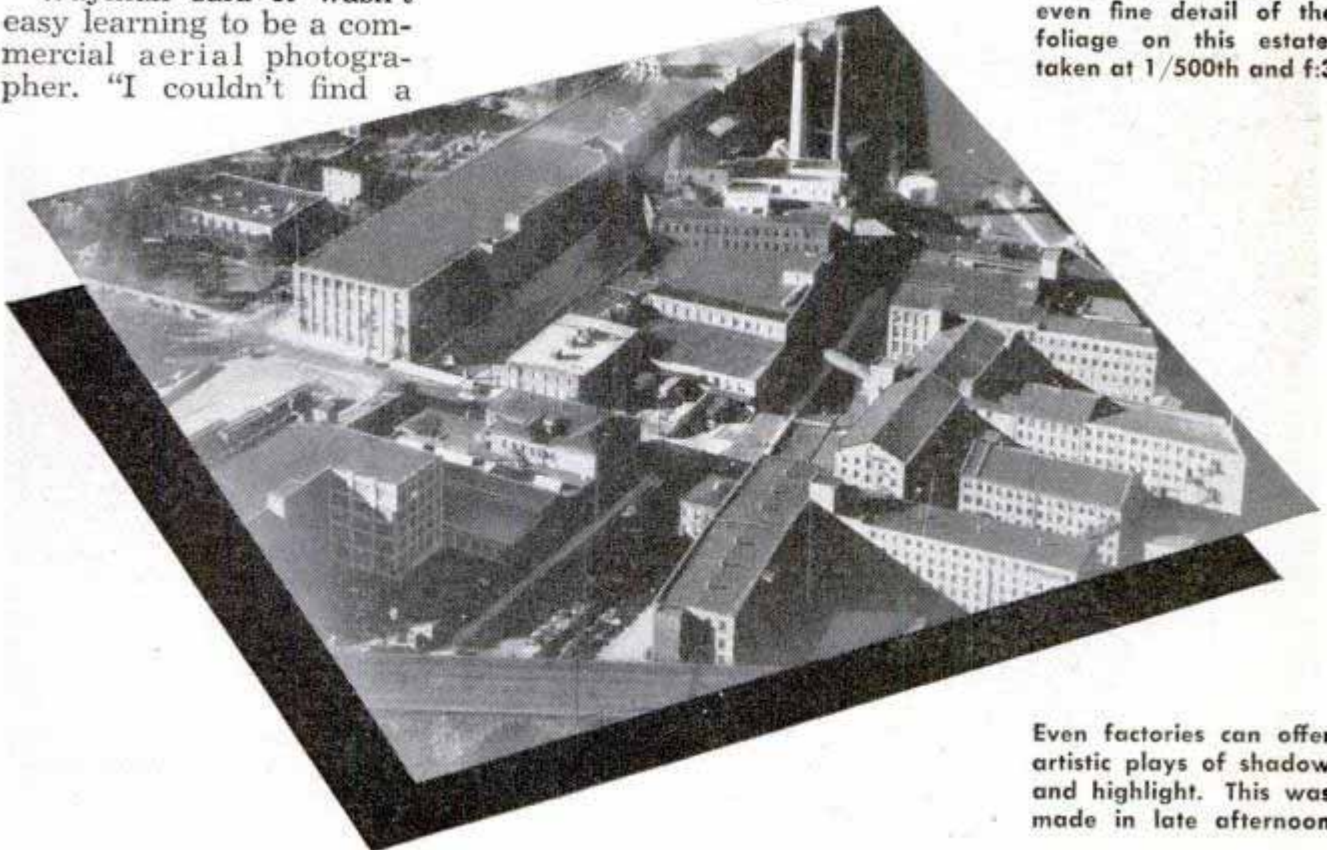

Even factories can offer artistic plays of shadow and highlight. This was made in late afternoon

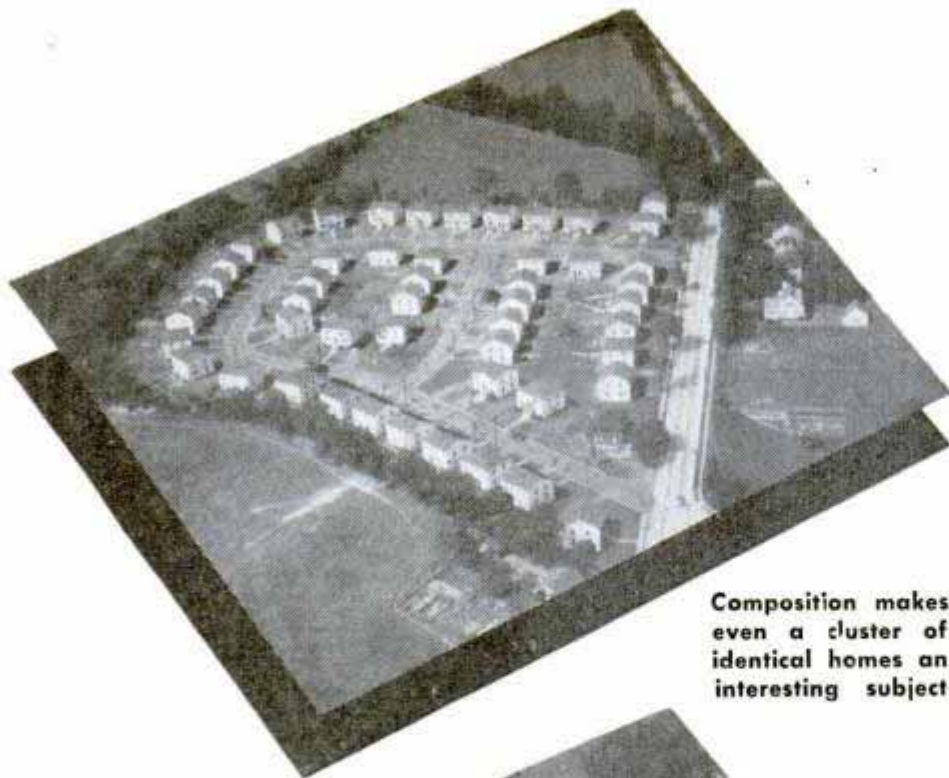

Composition makes even a cluster of identical homes an interesting subject

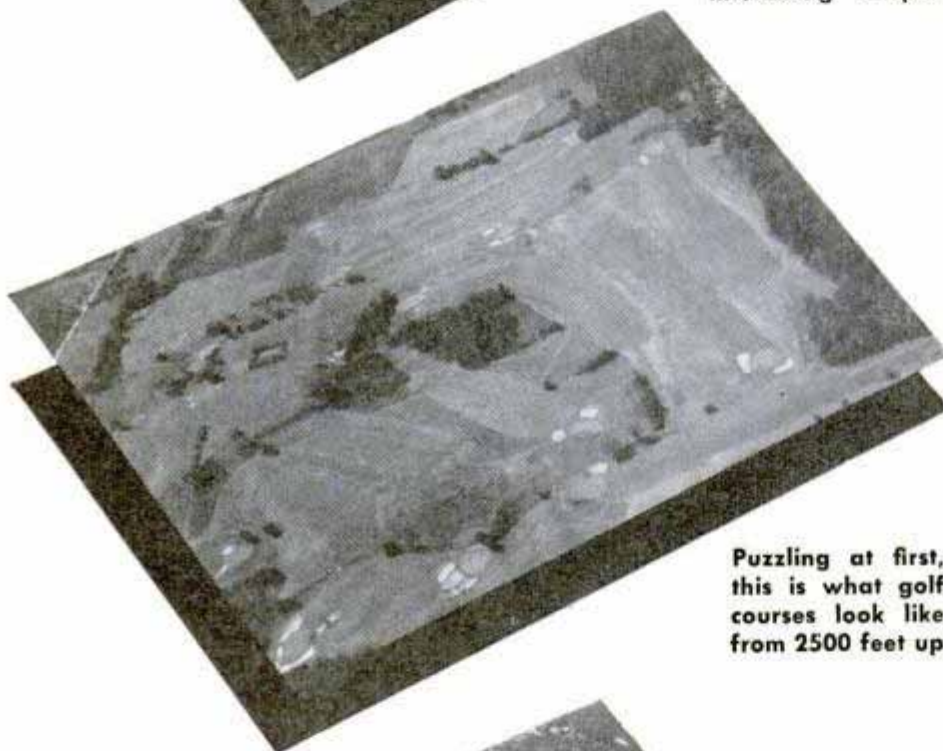

Puzzling at first, this is what golf courses look like from 2500 feet up

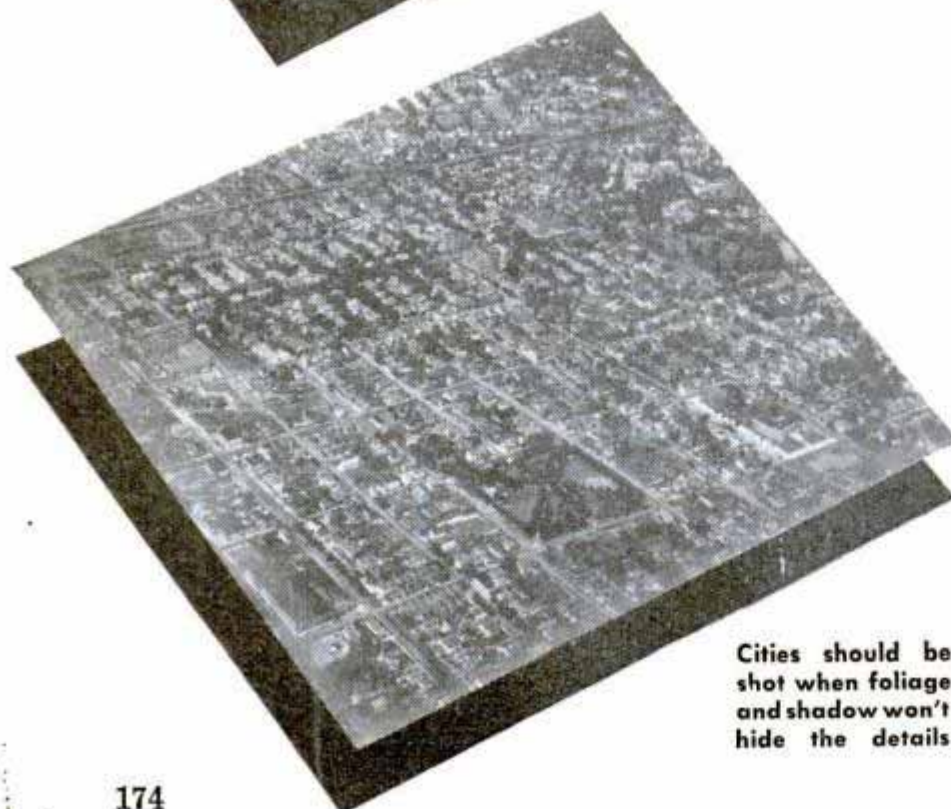

Cities should be shot when foliage and shadow won't hide the details

book explaining all the techniques, so I learned the hard way. It cost me a lot of money through mistakes. I began by snapping pictures hit-or-miss, and then studied the results. It was months before I got anything that satisfied me. You don't learn this business overnight."

Most of his shots are taken at a 45-degree angle. Experience proved that this angle usually gives broad enough coverage for his purposes, still showing something more than just rooftops. Light-streaked negatives taught him that reloading the camera in the air is risky. Now he lands and reloads in a darkroom or closet. "Something else I learned the hard way," he confesses.

Weather, which plagues every outdoor photographer at times, is the bane of Wayman's existence. Sometimes he has to sit on the ground for weeks, awaiting not only good flying weather, but good picture-taking conditions, too.

Wayman says the best shots are made on sunny days after a heavy rainfall. The downpour cuts the atmospheric haze, which, though not obvious to the naked eye, shows up clearly on the negative. He seldom uses a filter to cut the haze because of the sacrifice to camera speed. "I prefer to wait for a bright, clear day," he says.

Although engine failure has never forced him down, darkness has caused Wayman to land in bumpy cow pastures on several of his longer trips. Perhaps the closest call came one day after he and his pilot had been flying seven hours, landing only to refuel.

Circling around a factory, the last job of the day, he was busy snapping pictures from the rear seat of the tandem-control plane. Concentrating all his attention on the camera, he didn't notice that they were spiraling slowly downward. When a scant 250 feet of altitude remained between them and the ground, the pilot suddenly started, looked

(Continued to page 240)

CONTROL FOR MODEL PLANES HAS THUMB-WHEEL OPERATION

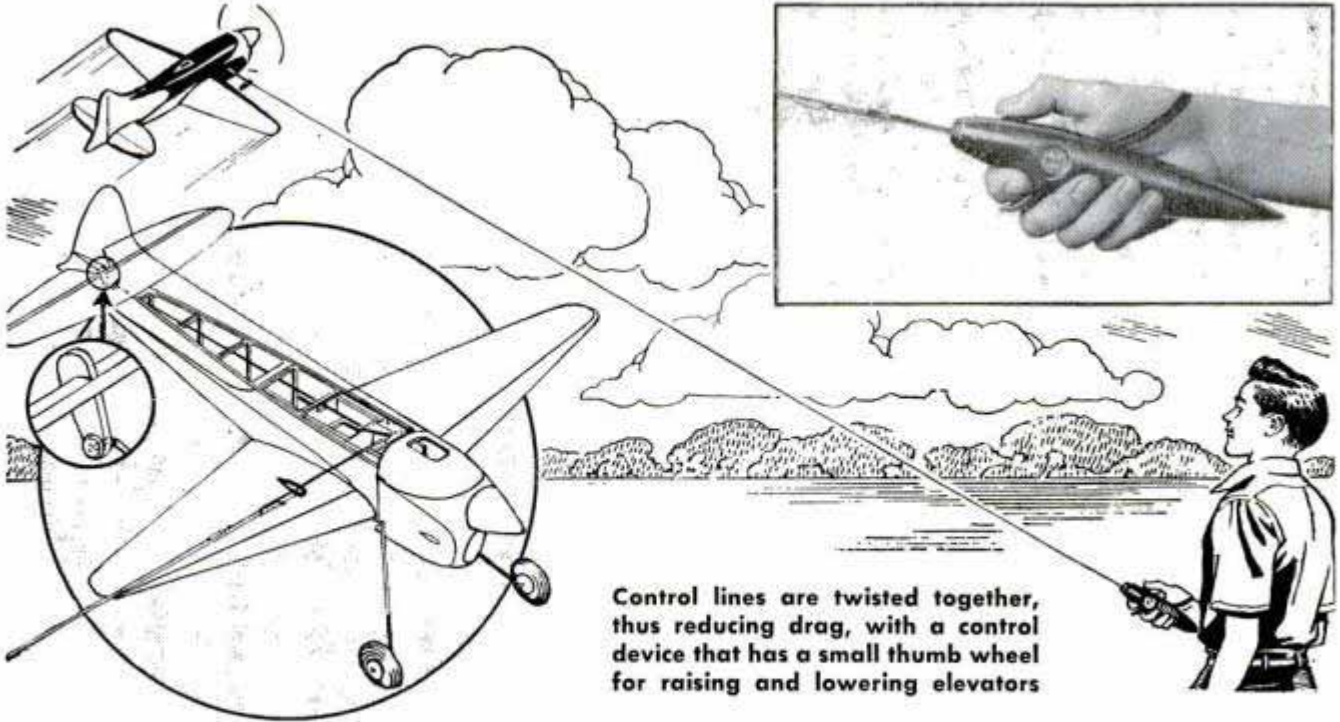

Control lines are twisted together, thus reducing drag, with a control device that has a small thumb wheel for raising and lowering elevators

Twisted control cables do not interfere with the sensitive operation of a new model-plane control unit. In fact, by twisting the two cables, it is possible to reduce line drag enough to increase speed up to 10 per cent without any loss in control. The control consists of a streamlined hand unit and an elevator-control linkage that will fit any

type of model airplane. When using the control, the operator raises or lowers the elevators by turning a knurled thumb wheel on the hand device. It is not necessary to follow plane maneuvers with the hand as with other controls because the elevator position is regulated entirely by the position of the thumb wheel.

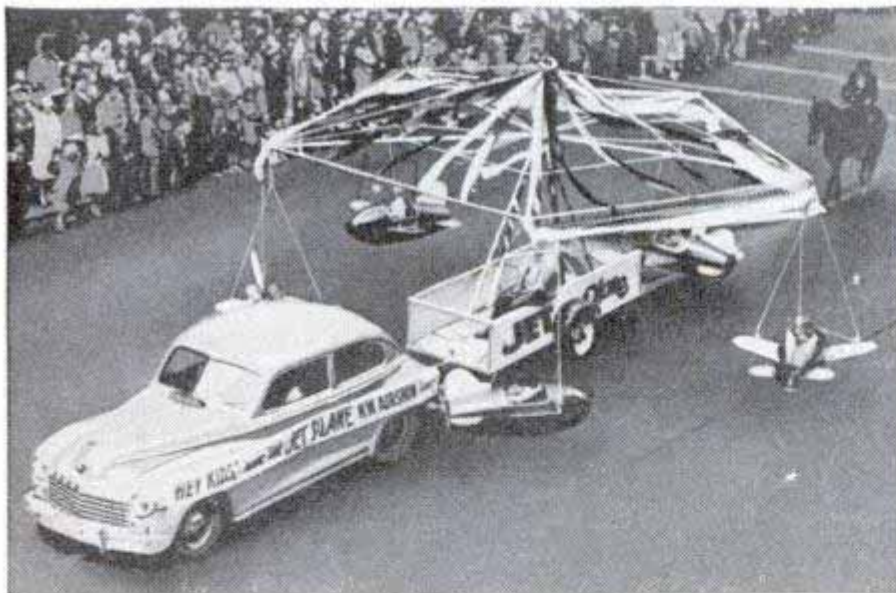

Junior "Jets"

So compactly designed it can be loaded in a two-wheeled automobile trailer, a mobile amusement ride has "jet planes" made of airplane auxiliary gasoline tanks. The trailer forms the base for the rotating device during operation. An electric blower in each plane provides sufficient thrust to revolve the unit at speeds up to 20 miles per hour. The cockpits are roomy enough for children up to 14 years of age. Each plane can be maneuvered by the rider by means of a control stick that lengthens or shortens the supporting cables. Climbs, banks, dives and skids are possible. Assembling and disassembling takes only 30 minutes. The trailer base permits towing the erected unit in parades.

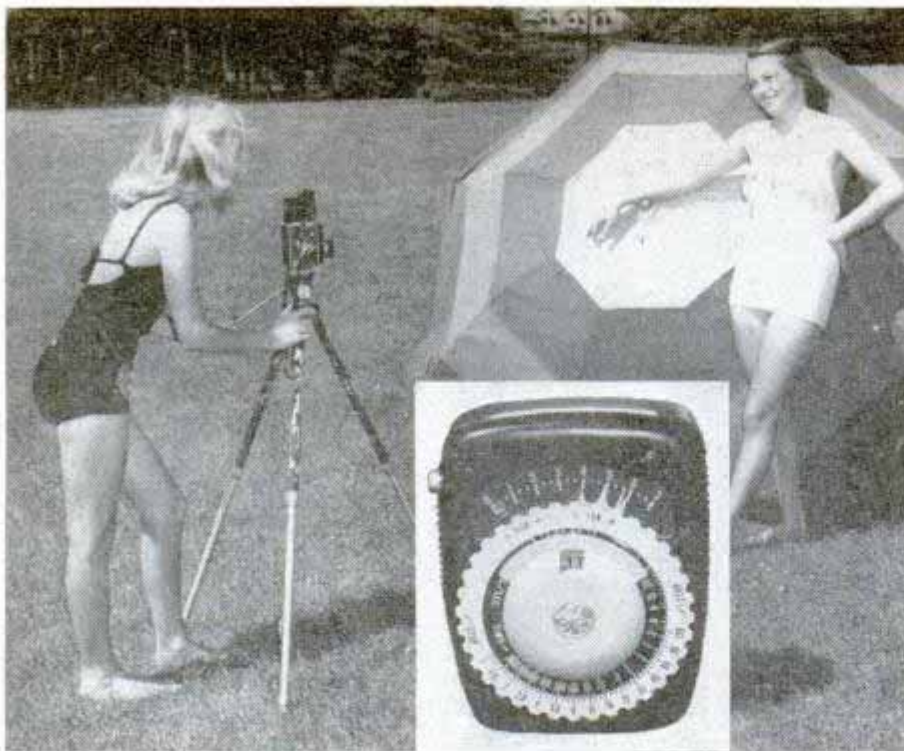

Meter "Remembers" Exposure Reading

By matching pointers on a new photo-electric exposure meter, the photographer reads the proper shutter speed and aperture directly. Called the meter with a "memory," the new device, made by General Electric, has a pointer lock button that holds the needle at the correct reading. The photographer then aligns a second pointer with the light-scale pointer to get the correct exposure. The meter can be used for both still and motion-picture photography.

Rule Totals Hours, Minutes Rapidly

Operated like a slide rule, a time computer converts clock time to work time in one simple operation. The zero arrow on the rule is set opposite the mark representing the time work began, and the elapsed time is read above the point representing the hour work ended. Designed for timekeepers, the computer makes easy work of adding hours.

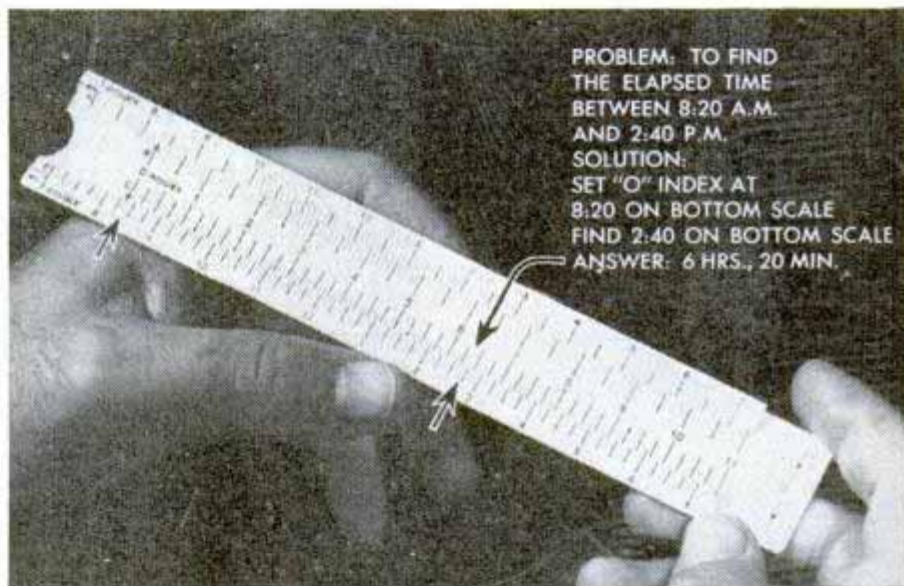

PROBLEM: TO FIND THE ELAPSED TIME BETWEEN 8:20 A.M. AND 2:40 P.M.
SOLUTION:
SET "O" INDEX AT 8:20 ON BOTTOM SCALE
FIND 2:40 ON BOTTOM SCALE
ANSWER: 6 HRS., 20 MIN.



Pistol-Grip Tripod

For use with either movie or still cameras, a dual-purpose accessory provides a pistol grip for hand shooting and a short tripod, which can be set on a rock or log, for use when the conventional tripod is not available. Made of aluminum, it attaches to the tripod socket. The two legs swing up when not in use making it easy to carry in the case or pocket.

You may wish to obtain additional information about new products described each month in Popular Mechanics. If you want to know the name and address of manufacturer or distributor, write to Bureau of Information, Popular Mechanics, 200 E. Ontario, Chicago 11

The CRAFTSMAN

★ Where there's a daughter, there's a dollhouse — or no Christmas is complete. So we've done an architectural job for harassed dads; on page 188 are plans for a big, two-story dollhouse with eight rooms, and electric lights in every room. Construction is simple and easy, for walls and partitions are plywood

★ Home laboratory scientists will find, on page 194, several spectacular experiments to try with common gases—hydrogen and oxygen

★ For bold detail, character and expression, and soft portrait backgrounds, try shooting your album photos close-up. Any focusing camera either with or without a ground glass will do the trick. There's good advice for you on page 204

★ If you like to build your own tools, you'll turn first to the shop story on page 224, telling how to build two sizes of brazing torches that operate on illuminating gas



DOLLHOUSE



HOMEMADE TORCHES



TAKING CLOSE-UP PHOTOS



FUN WITH GASES

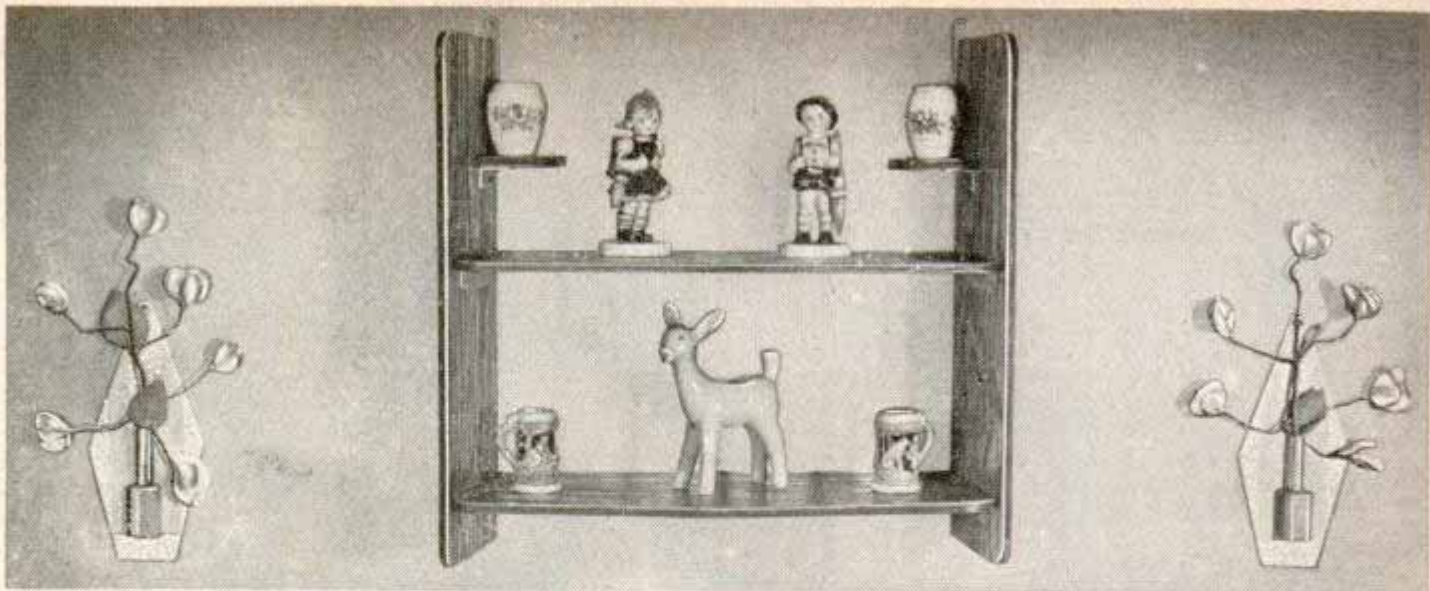

3-piece WALL ENSEMBLE

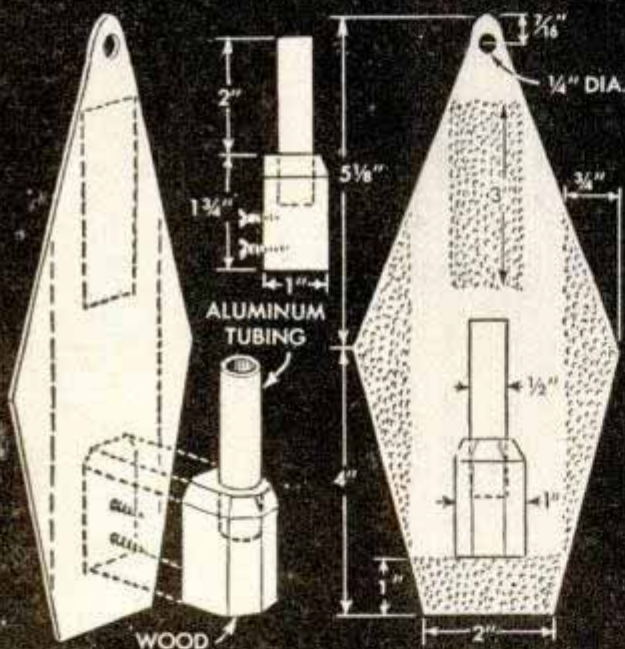

IF YOU WANT something different from mere pictures to break up a bare expanse of wall, then this little wall ensemble may be just the thing. This unusual trio—the knickknack shelf and the hammered-aluminum bud vases—lends a pleasing and balanced treatment if grouped as shown.

To make the vases: The wall plate of the vase is cut from .064-ga. sheet aluminum, following the dimensions and pattern given at the left. Mark the areas which are to have a hammered finish and then peen them lightly with a ball-peen hammer. After this, chamfer the entire edge of the plate slightly by tapping with the face of the hammer as shown in the photo below. Surfaces that are not hammered are given a satin finish by polishing with a wire scratch wheel or rubbing with fine steel wool. A 3-in. length of $\frac{1}{2}$ -in. aluminum tubing serves as a flower holder and is inserted in a wood base attached to the plate.



After hammer-finishing the areas indicated in the drawing, the entire edge of the plate is chamfered by tapping lightly with the flat face of a hammer

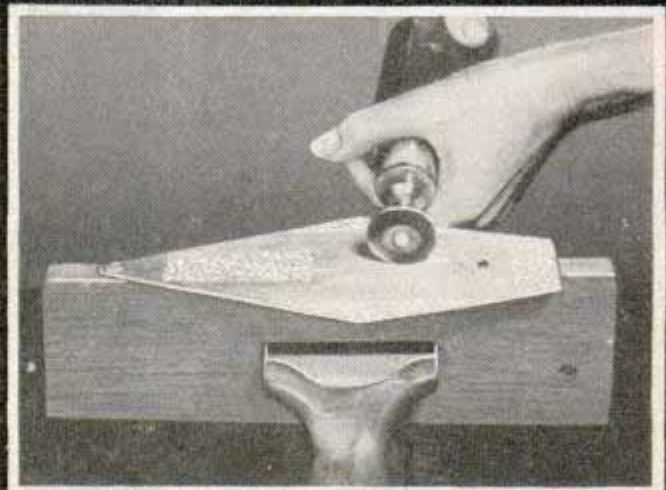

Areas which are not hammered are given a scratch-brush finish by polishing with a fine-wire wheel. This is done with the plate fastened to a board



To make the shelf: The knickknack shelf differs from the usual type of wall shelf in that the sides flare outward. Make two of each part required, cutting them from $\frac{3}{8}$ -in. plywood, according to the patterns given at the right. In the original, pieces of aluminum angle were used to attach the large shelves to the sides, although brass or copper can be combined with light or dark wood. The metal angles are attached to the underside of the shelves first, using short screws so as not to pierce through. Then they are riveted to the side pieces. Note in the sectional detail that a $\frac{1}{2}$ -in. strip of the same metal is used to back the rivet heads on the outside. This method of assembly gives exceptional rigidity. If you prefer a concealed type of fastening instead of the metal angles, the shelves can be set in dados cut in the side pieces and nailed and glued. A piece of fancy molding will cover the nailheads, or the heads can be sunk and puttied. The two little shelves are fastened with angles and screws, and are mounted one on each side, 3 in. above the top shelf. Finally, a metal hanger is recessed at the top of each side.

By R. J. DeCristoforo

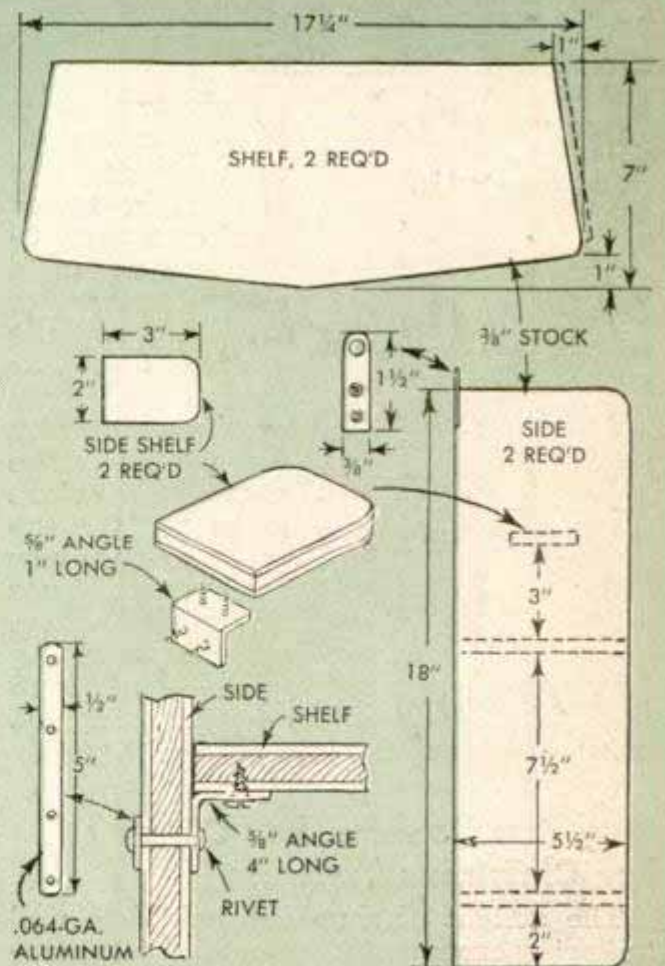

Folded Envelope Corners in Album Keep Records From Falling Out



Many times, when handling a phonograph-record album, a record will slip out of its envelope, drop and break. This will be prevented if the top outside corner of the envelope is creased and pushed inward, as shown in the detail. To keep the paper from tearing along the creases, reinforce them with mending tape.

Mrs. Joyce Tomlinson, Brockton, Mass.

Closet-Door Shoe Rack

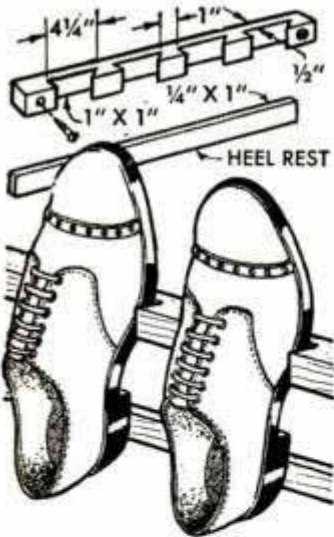

Only two strips of wood are needed to make this shoe rack, which can be fastened to the inside of a closet door. Size of the rack, and the number of shoes that it will hold are determined by the width of the door. Dimensions given for the top piece are for average-size men's shoes. The bottom piece merely

serves as a buffer strip to keep heels from resting against the door and marring the finish.—George M. Singer, Erie, Pa.

Play Pen Doubles As "Corral" For Christmas Tree

The delight of a toddling child to pull glittering ornaments from a Christmas tree is well known to every parent. To prevent

our baby from possibly upsetting the tree, I formed a fence around it by placing the tree in the baby's play pen. This was done the first few years with small trees and was found to save ornament breakage and a lot of worry.

Anthony J. Mueller, St. Louis, Mo.

Costumer Converted to Hold Tools

By adding three round "trays" or shelves to the standard of an old costumer it can be converted into a handy tool rack for your workshop. The top tray is the smallest, the others increasing in size toward the base. Notches are made in the edges of the trays for some

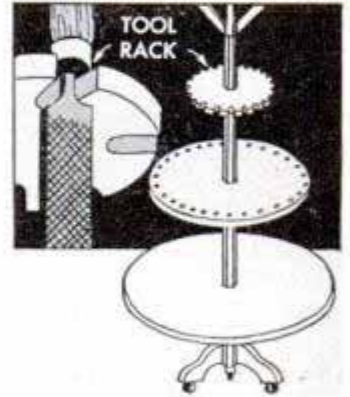

tools and holes are drilled near the edges for others. There's also plenty of space on the shelves to lay tools, such as planes, that can't be hung up conveniently.

Substitute Ornament Hangers

If the hangers on Christmas-tree ornaments become lost, replacements can be made from lightweight cardboard. Cut and fold the material as indicated in the detail and then insert the hanger in the ornament. Pass wire or string through the eye of the hanger to fasten it to the tree. Cardboard with a waxed finish is best for this purpose. Strengthen the eyes with notebook reinforcements.—Benj. Nielsen, Aurora, Nebr.

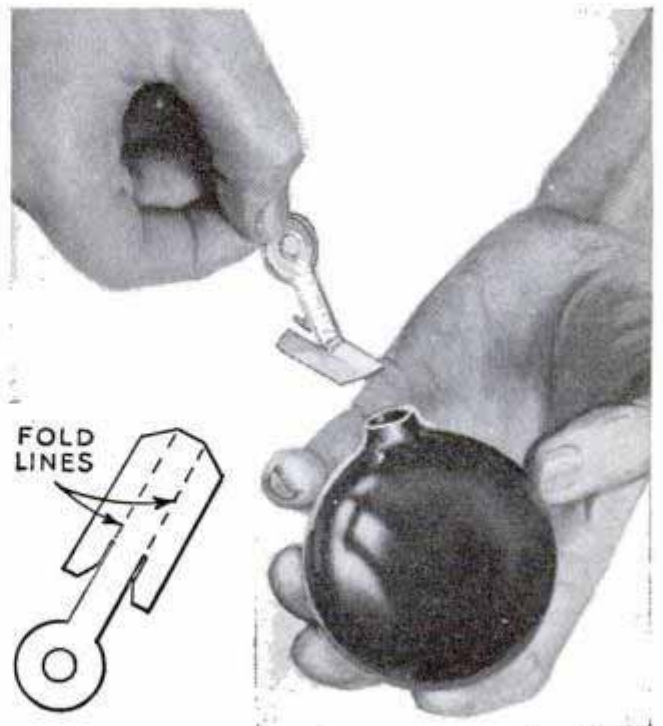

Baby's Swing Doubles As Safe High Chair

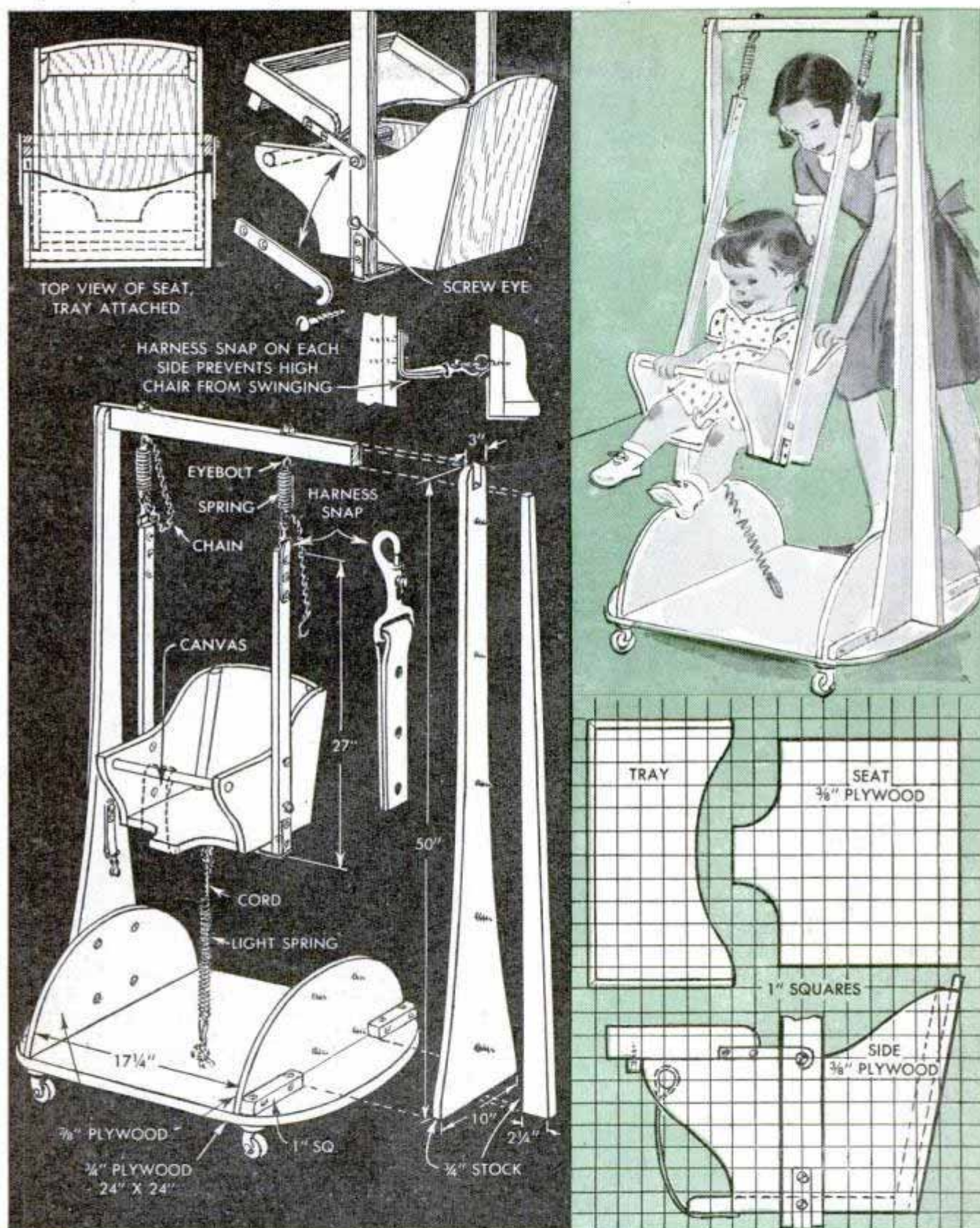

This novel high chair-swing combination is mounted on casters so that it can be rolled from room to room. Harness snaps and leather straps attach the seat to the frame and prevent it from swinging. Add the detachable tray and there's the high chair. To use as a swing, just release the snaps and remove the tray. As a swing the unit has three unusual safety features—

rigid vertical seat hangers, which prevent spinning, a spring-and-cord arrangement connecting the seat to the base, thus limiting the amount of swing. There also are two safety chains which prevent the seat from falling should one of the supporting springs break. Make the frame parts from hardwood and the seat and base from plywood. Finish in the natural-wood color.

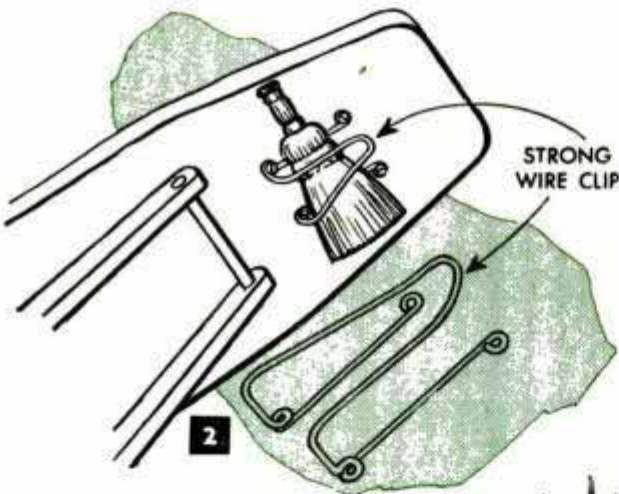
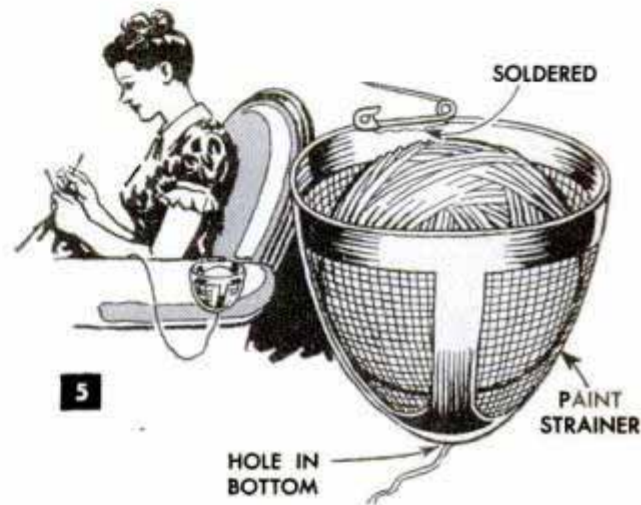
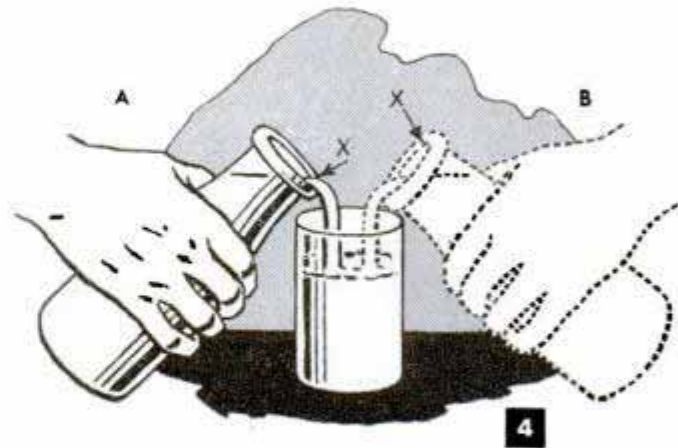

1 Use greased muffin pans as molds when baking stuffed peppers so they will hold their shape. To keep the peppers from drying out, set the muffin pan in another pan containing water and then cover it to retain the moisture

2 When pressing clothes, a whisk broom is convenient for removing lint. To have one always at hand, keep it in a wire clip fastened to the underside of an ironing board. The detail shows how broom clip is made and attached

3 Much of the damage that is caused by youngsters pushing kitchen chairs or other furniture against the walls will be prevented if two or three rubber-headed tacks are driven into the backs of the chairs to act as "bumpers"

4 To pour cream from a bottle of milk, hold the bottle as in detail A-X; then, without rotating it, pour off the rest of the cream by holding the bottle as shown in detail B-X. This prevents the cream from mixing with the milk

5 A metal strainer similar to the one illustrated is handy for holding yarn when knitting. Solder a safety pin to the rim of the strainer so it can be attached to the arm of a chair. Pull yarn out through a small hole drilled in the bottom

HOME PROBLEMS



6

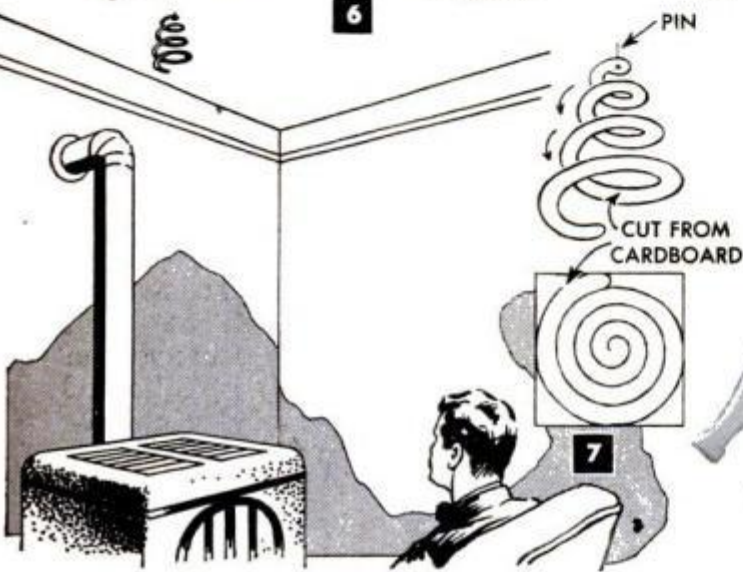

7



8

6 If working from drawings or plans in a magazine, hold it open by clamping a trousers hanger to the top of the pages. Hang the magazine in a convenient location by means of the hanger hook. Any books that are not too bulky will clamp in the hanger also

7 Cut a spiral from a piece of cardboard and fasten it to the ceiling over a stove to serve as a "heat" indicator. The spiral pivots loosely on a pin. Rapidity of motion indicates the degree of heat from the stove

8 This hand truck is used to move radiators over polished floors without marring the surface. Instead of casters, a discarded wringer roll is used. Fasten two L-shaped lengths of flat iron to the bottom cross-piece of the frame to hold the radiators

9 Soldering a large hole in any metal container is easy, and a better job will result if a thumbtack is used as a "patch" to cover the hole. Before soldering the tack in place, cut off the point so that it will not project into the container. Center the head of the tack over the hole and apply solder to both sides



9

Safe "Javelin" for Young Boys Has Padded Head

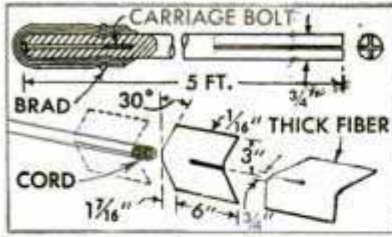

Neatly balanced and provided with a padded head, this javelin is safe for young boys, and it can be thrown accurately at targets some distance away. The shaft is about 5 ft. long and $\frac{3}{4}$ in. in dia. Notch one end for the fiber "feathers" that stabilize flight, and insert a carriage bolt into the other end to provide sufficient weight for the head. The padding covering the bolt is held with brads.

C. L. Meehan, Lakeview, Ont., Can.

Oilcloth Envelopes Behind Seat Make Convenient Carryall

The ledge behind the back seat on many cars often becomes a "catch all" for odds and ends because it is a convenient place to leave papers and other objects. One way to take care of these objects is to make oilcloth envelopes with snap fasteners and

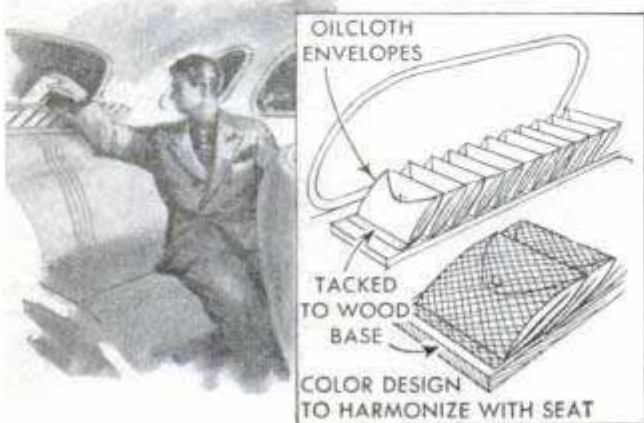

attach them to a board that fits the ledge. The oilcloth should be chosen to harmonize with the upholstery.

Improved Lead-Headed Nails

If only a few lead-headed nails are needed to repair a metal roof and none are available, you can improvise a substitute by using galvanized roofing nails and some wire solder.

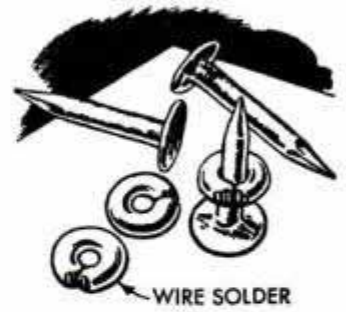

Form rings of the wire to slip snugly over the nails. When driven in place, the nailheads will flatten the solder and seal the nail holes effectively. Do not use an acid-core solder.

Template Guide to Cement Plastics

A template or pattern to position vertical pieces while cementing them to a plastic base will make it unnecessary to scribe locating lines. The template is a sheet of

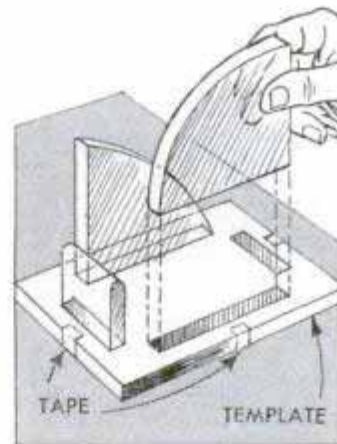

paper the same size as the base, having the outline and the position of the pieces clearly indicated on it. For transparent plastics, the paper is taped to the underside of the base, which makes it a simple matter to see where to cement the uprights. For colored and opaque plastics,

cut out the portions of the pattern where the vertical pieces join the base, tape the pattern to the top of the base and proceed to cement the pieces as before.

Leslie K. Prescott, Newport, N. H.

Nonslip Soles on Wading Boots

To prevent slipping when fishing a stream that has a rocky bottom, cover the soles of rubber boots with thick felt. Typewriter pads, obtainable from a stationery store,

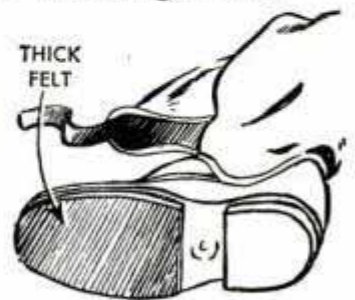

are ideal for this purpose. Outline the sole of the boot on the pad, cut out with a safety-razor blade and cement it to the boot with waterproof adhesive.

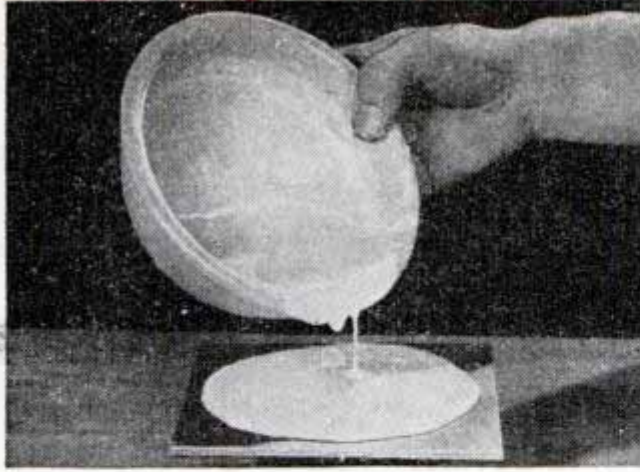

First, mix powdered chalk and water to a consistency of thick cream and pour it onto a sheet of aluminum. Tap edge of metal to level mixture to uniform depth, slightly greater than the desired depth of the design. Use a blotter at the edges to draw off excess water and let the chalk mixture stand until thoroughly hard

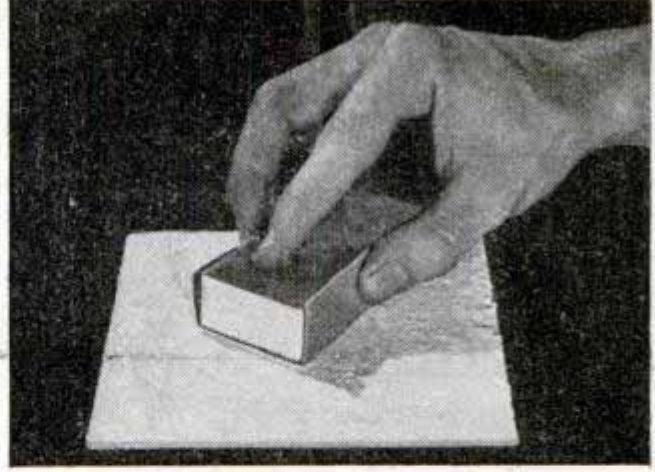

When the chalk is hard, the surface is sanded lightly to remove irregularities and produce a flat surface. This is important. Use fine-grade sandpaper wrapped around a small wooden block. Plaster of paris can be used instead of chalk, although it is somewhat more difficult to tool, and air pockets form in mixture

Matrix casting offers an interesting method of decorating craftwork of sheet metal. By a direct-casting process, you can apply designs in low bas-relief to any flat, metal surface to which stereotype metal or solder will adhere. The design can be a monogram or a simple carving, which is tooled in a chalk-coated aluminum plate and filled with bits of stereotype metal. The metal is heated in the design by placing the matrix on a hot plate. Then the craftwork is placed face down on the matrix. When the casting cools, the work is lifted from the matrix, and the casting will be affixed to it. It is important that the matrix surface be perfectly flat so that the molten metal will contact the work at all points.

The design is traced or drawn directly on the chalk surface. Remember that an initial must be reversed. Tooling is done by scraping the chalk down to the aluminum plate with the point of a pocket knife. The design should not be undercut. Tool it to give a slight draft so that the casting can be withdrawn



MATRIX CASTING

By Kenneth Murray

Stereotype metal and linotype metal are best for casting. Place matrix on a hot plate and fill design with bits of the metal. Add enough to bring it level with surface when molten. Craftwork to receive design is tinned and placed face down on matrix. Upon cooling, work is lifted from matrix with casting affixed

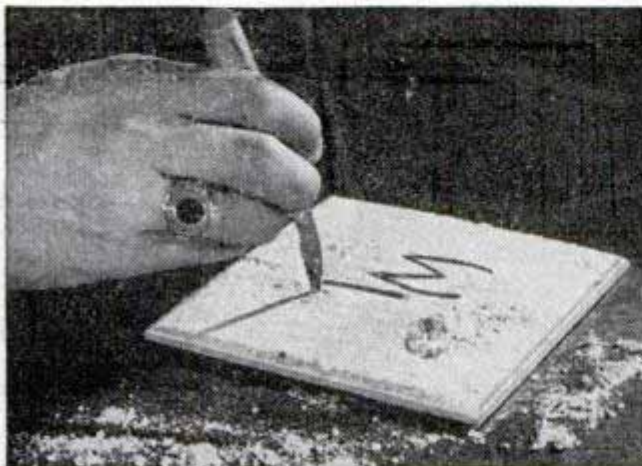

Yarn Dyed With Knitted Garment Assures Match When Mending



When dyeing a knitted garment, dip several yards of yarn in the dye at the same time so that you will have an exact match when it's necessary to mend the garment. When the yarn is dry, wrap it around an empty spool and label it. Thread for sewing on buttons and making buttonholes can be treated in the same manner when dyeing or tinting a garment.

Christmas Tree "Growing" Through Roof Makes Novel Attraction

A Christmas tree that has apparently "grown" through the roof of a house will attract attention during the holiday season. The illusion is created by selecting a tall tree and cutting it into two parts, mounting the lower one inside the house so it will extend to the ceiling and the upper

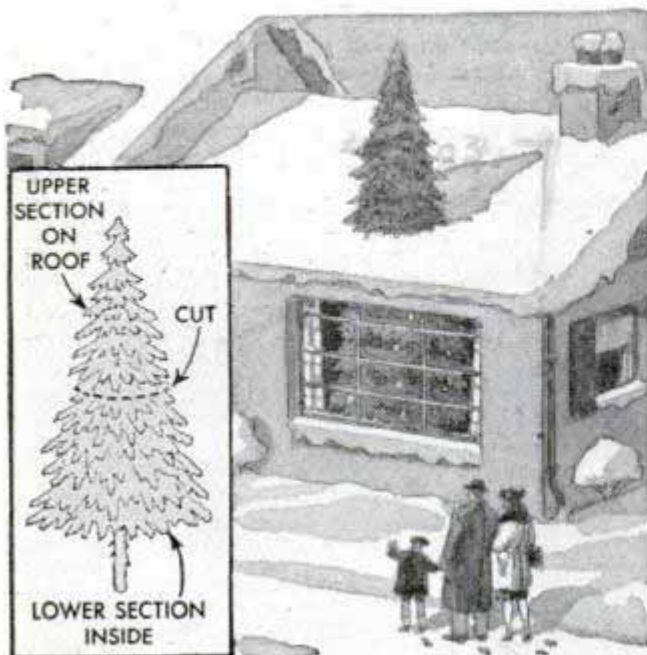

part on top of the roof. The trunk must be kept in line. Place the lower section of the tree in a room where the windows will permit it to be seen from the outside.

Fuses Stored in Light Sockets

Threaded shells removed from discarded electric-light sockets provide ideal receptacles for spare fuses. Fasten several shells to a wooden panel and mount it near the fuse box. Beneath each socket, letter the size of the fuse it contains so proper replacements will be made.—H. D. Hatch, Wollaston, Mass.

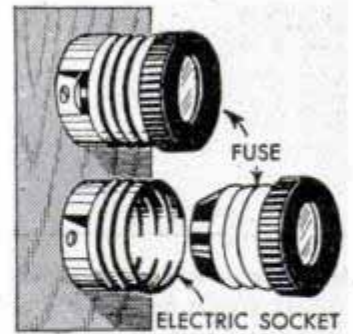

Spring Holds Molding in Miter Box

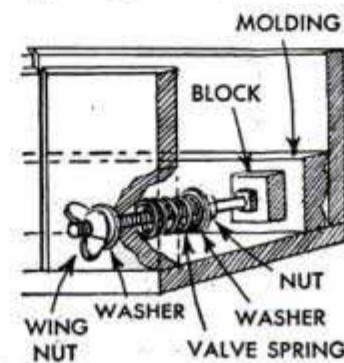

To keep molding from slipping or chattering while cutting it in a miter box, use a spring clamp like this one. The spring, such as one taken from an auto-engine valve, is held in position by washers, nuts

and a bolt. Adjustment of the tension is provided by means of a wing nut, which is located outside the box. A wood block on the end of the bolt serves as a pad to keep the end from marring the molding.

Disk Soldered to Bilge Pump Prevents Marring Boat

Because most bilge pumps used on small boats have bases with sharply projecting feet, they mar the bottom planking when being used. However, if a metal disk with a large hole in the center is soldered to the feet, it will prevent damage, and will not obstruct the flow of water because of the center hole and the space between the feet. A brass disk is preferred as it will not rust, nor will the action of salt water damage it.

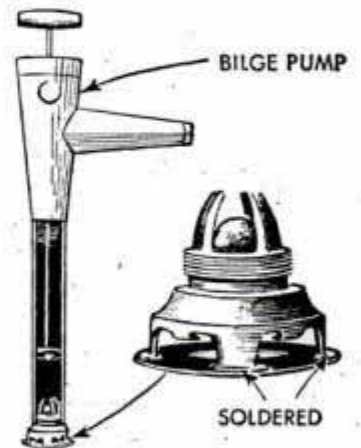

Inexpensive Tree Ornaments Made of Seed Pods

Something novel and distinctly different in tree ornaments are ones made of common seed pods. They're just the thing to supplement ball ornaments, and furthermore, they can be made for practically nothing, except for the cost of a little paint. The three examples shown in the photos below picture what the pods of a trumpet vine, and the spherical seed pods of the sweet gum and sycamore tree look like when gilded with either bronze or silver paint. Gilded, they reflect the light from tree lamps, but they can be painted in bright colors, also. Seed pods of the sweet gum and sycamore, due to their circular shape and rough surface, are decorated easily by spraying. A small insect sprayer will do for this, or the pods can be dipped and hung to dry. Pods of the trumpet vine are painted with a brush. Attach a colored ribbon to each for hanging.

Paul Hadley, Philadelphia, Pa.

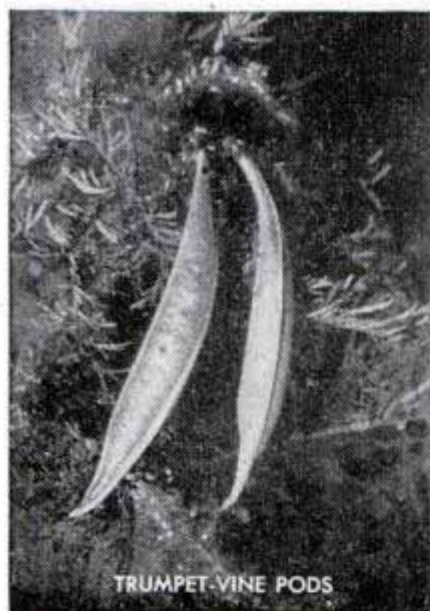

TRUMPET-VINE PODS

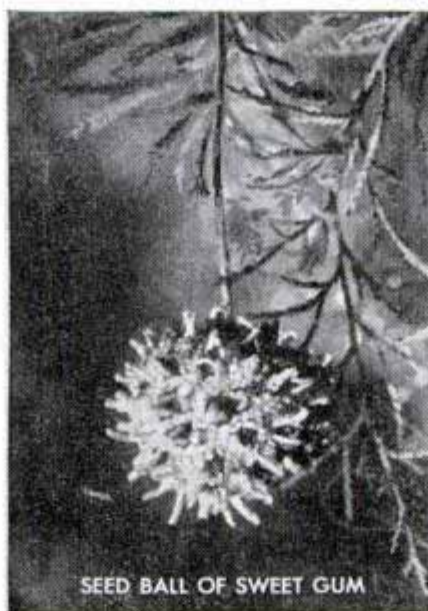

SEED BALL OF SWEET GUM

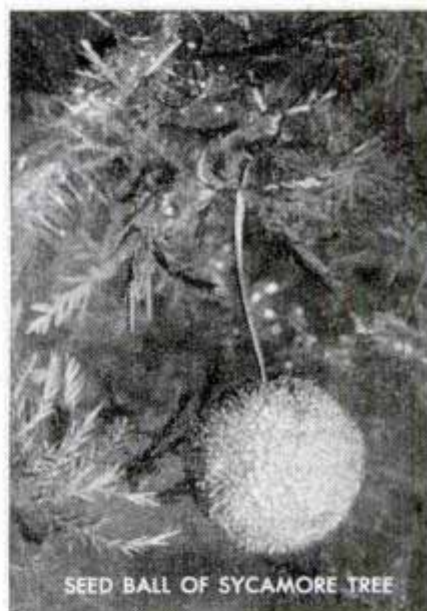

SEED BALL OF SYCAMORE TREE

Postal Card Pasted Inside Cover Assures Return of Book If Lost

Children's school books—if lost—are more apt to be returned if the method devised by one parent is followed. A penny postal card bearing the owner's name and address is taped to the inside front cover. On the card there is a brief note of thanks and a request that the finder mail the card to the owner stating a time and place where the book can be picked up. Of course, the name and address of the finder is requested also.—Jack Wilson, Los Angeles, Calif.

¶If the bottoms of wooden buckets and barrels are covered with several inches of water when not in use, it will keep the wood from drying out and causing cracks.

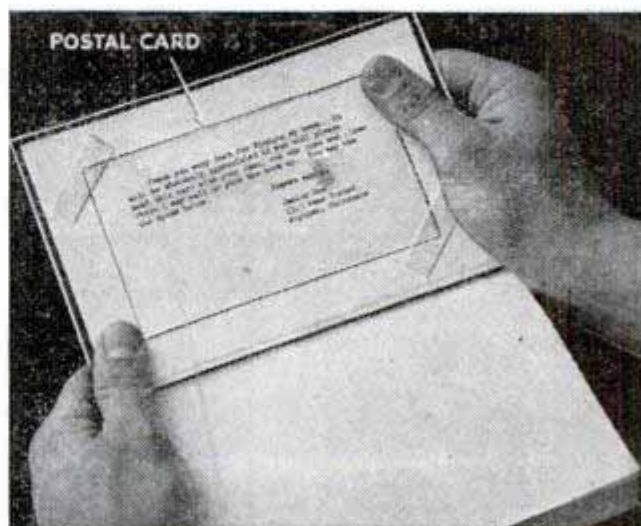



By Adam Trieschmann

MAKE THIS a Christmas some little girl will always remember by giving her this beautiful eight-room dollhouse. It's a replica of a colonial mansion complete with electric lights, fireplace and an open stairway. Both ends swing open for access to rooms upstairs and down as shown in Fig. 1. Made of plywood, the house measures $31\frac{1}{2}$ by $44\frac{3}{4}$ in., exclusive of porches and balcony. The rear stoop and front porch are detachable to permit the house to be carried through a 32-in. opening. If it is to be carried through a doorway of smaller width, the dollhouse must be reduced.

The first step is to make the base framework, Fig. 3. Pieces of solid stock, $\frac{3}{4}$ by $1\frac{3}{4}$ in., are used and are assembled with the pieces set on edge. Then the frame is floored with five pieces of $\frac{1}{4}$ -in. plywood, spaced as shown in Fig. 4 to form $\frac{1}{4}$ -in. grooves into which the interior walls are fitted. The second-floor frame, Fig. 5, is built-up similarly, except that the frame members are placed flatwise, and wider cross members are installed for walls E and F. Both sides of this frame are covered after first installing electrical wires for the

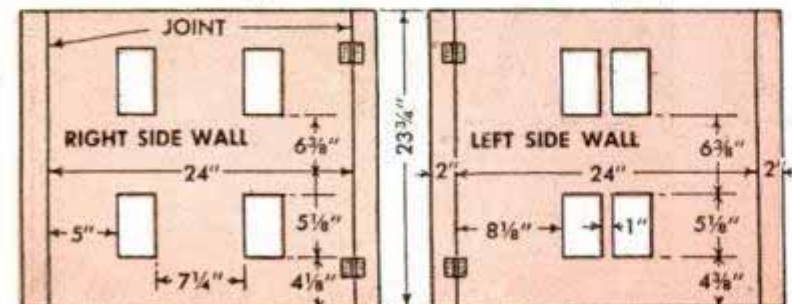
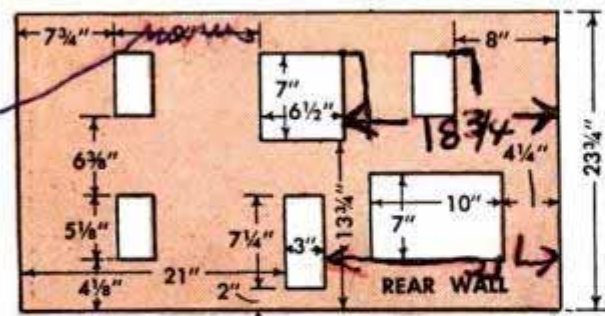
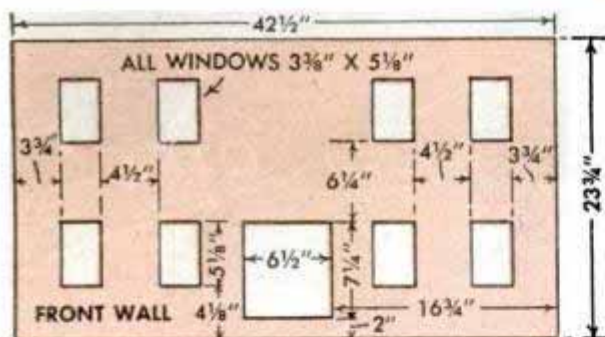

30 3/4

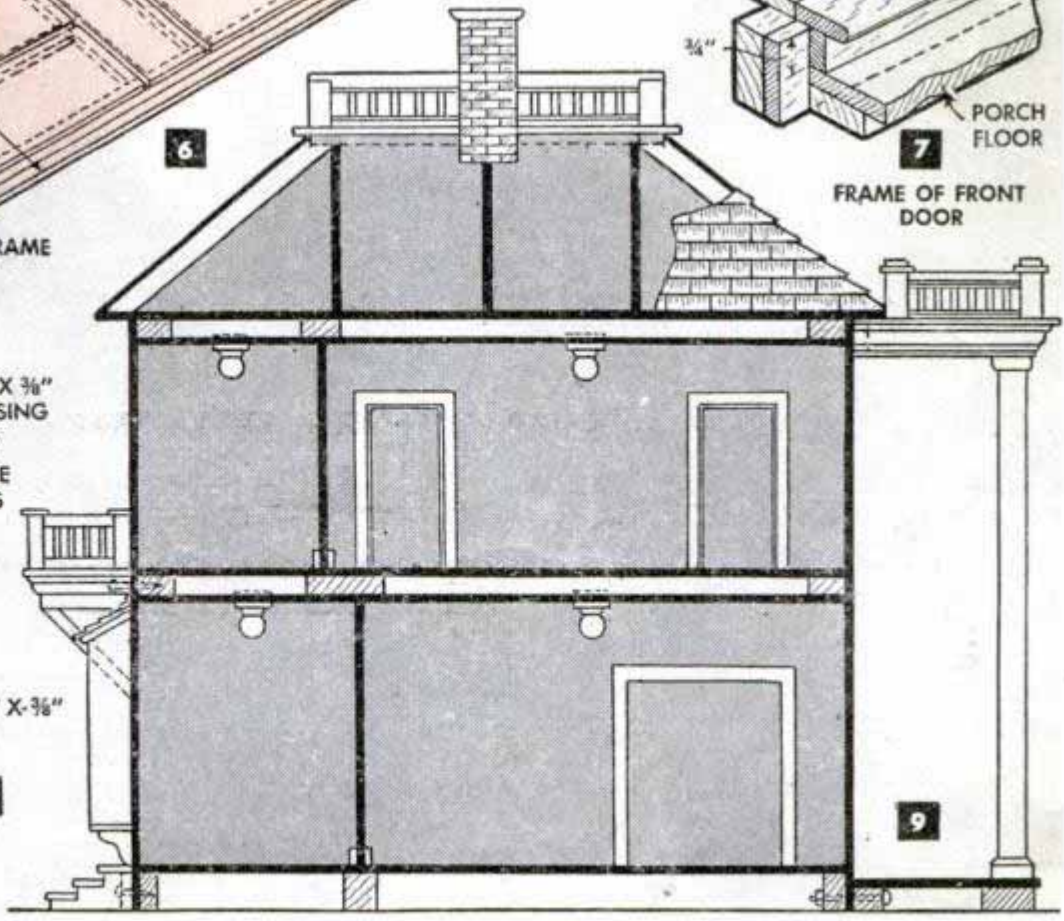
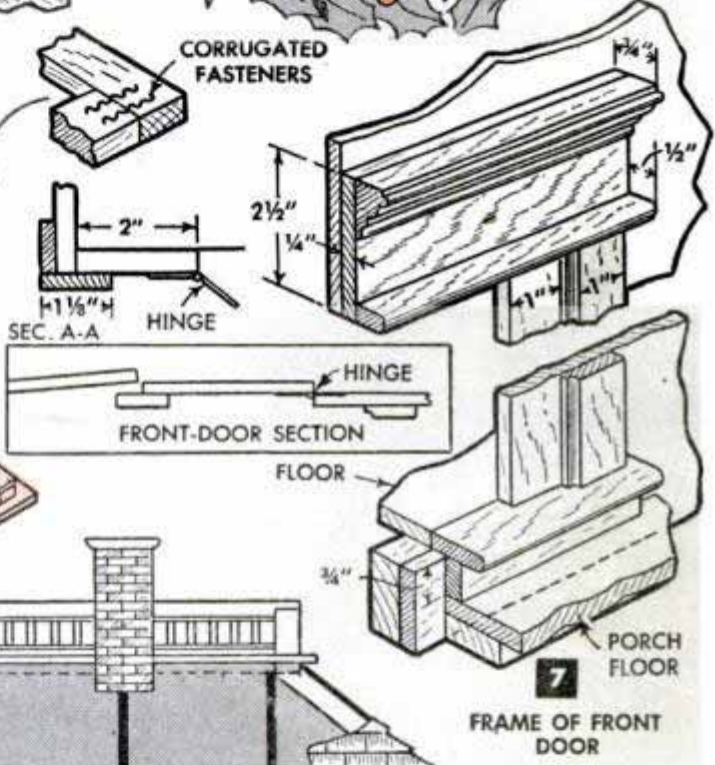
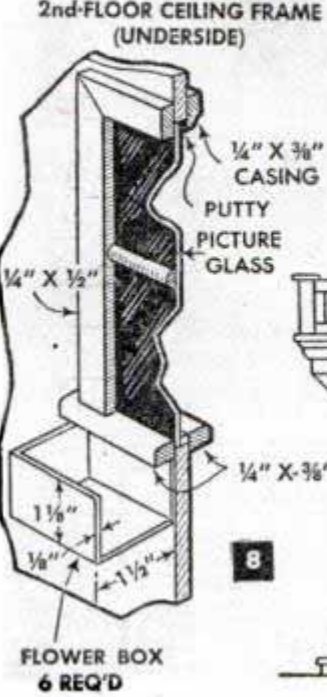
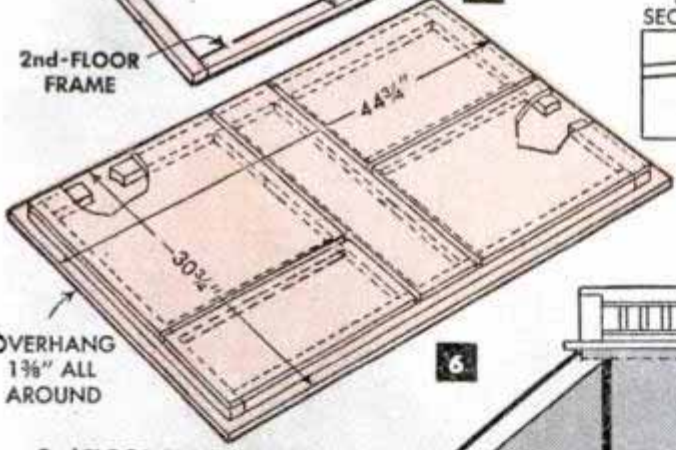
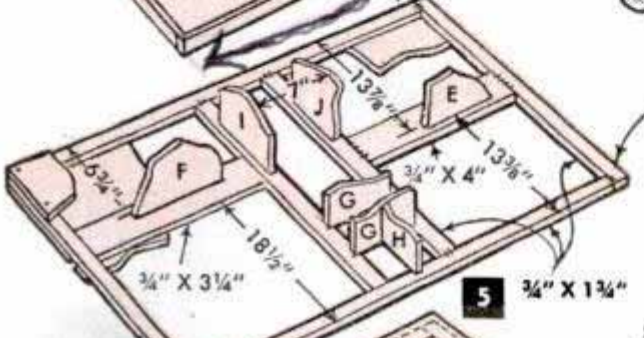
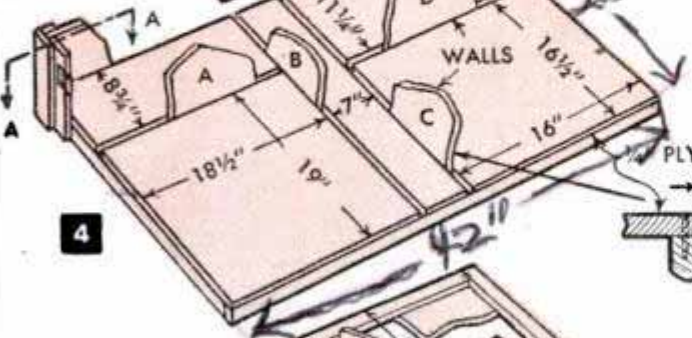
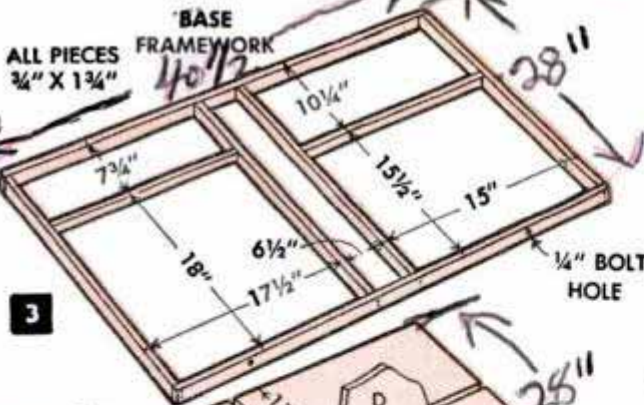

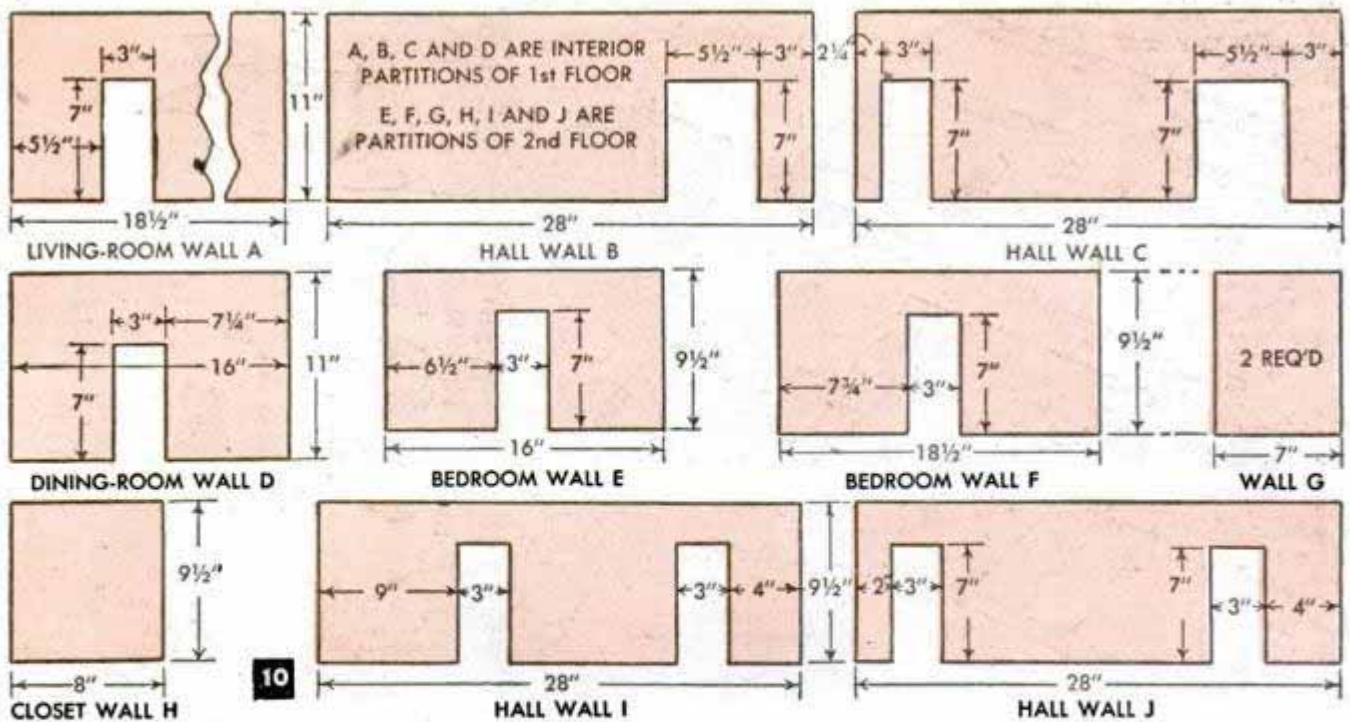

10

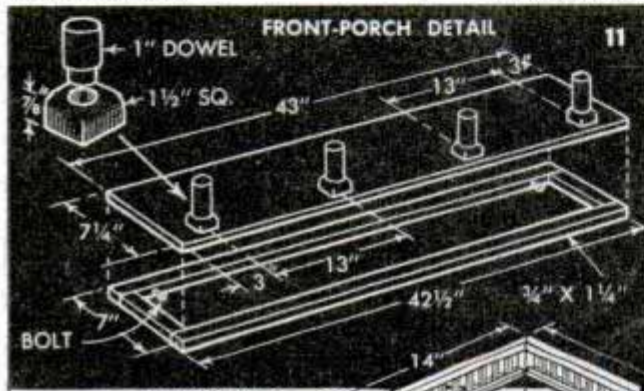

lights. Heavily insulated lamp cord will do for connecting the sockets, and all wiring is brought to a central terminal in the attic. A toy-train or bell-ringing transformer, which can be mounted in the attic or placed remotely from the house, is used to light 6-volt bulbs. Use a well insulated, rubber-covered extension cord from the 110-volt line to the transformer. A toggle switch to control the transformer is mounted in a corner of the bathroom ceiling. The switch should be wired into the extension

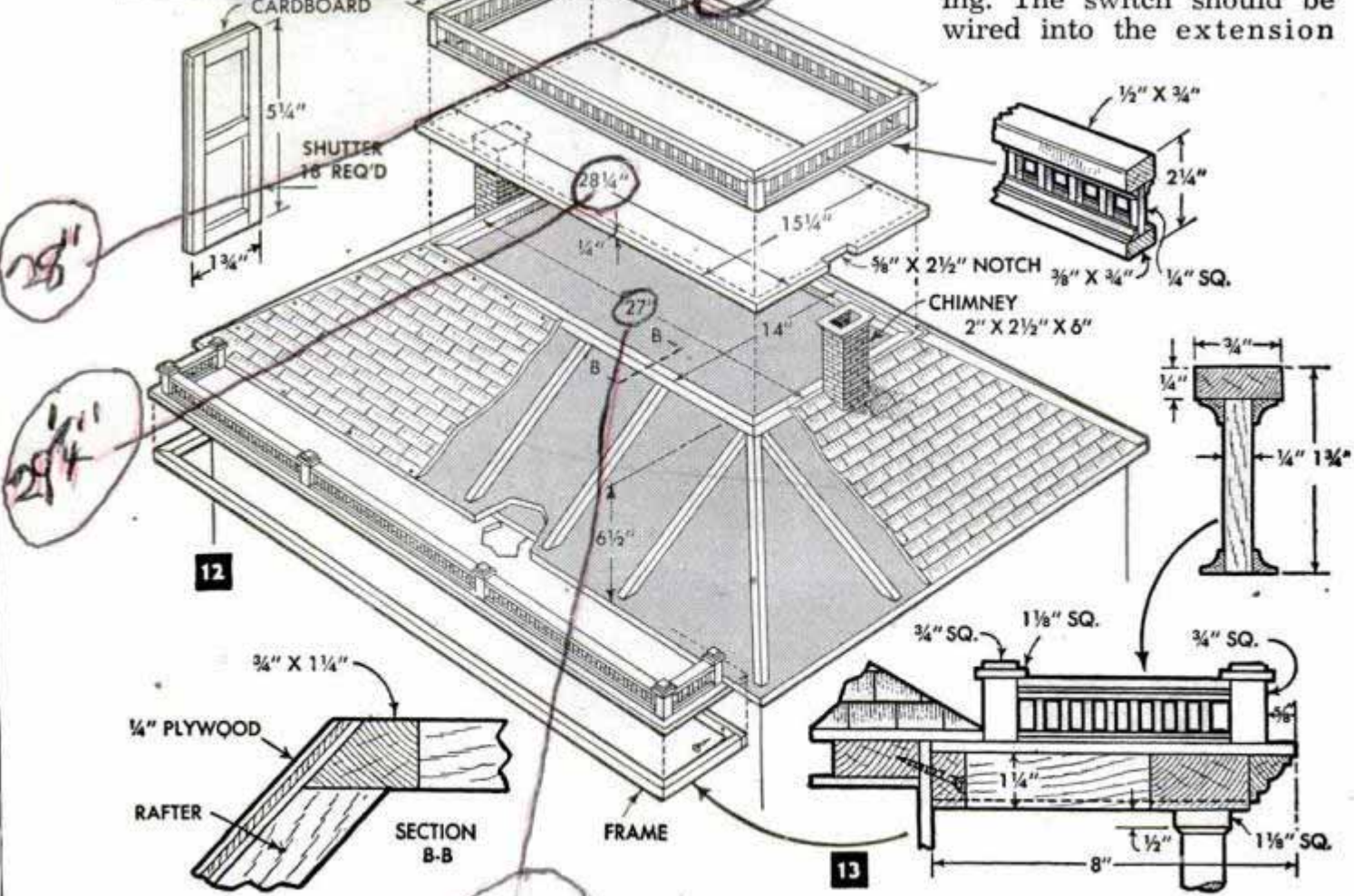

cord ahead of the transformer. Be sure that all connections are soldered and taped. Realistic light fixtures can be made by cutting off the base of 7½-watt frosted bulbs and using the top parts as globes. Or, an indirect lighting effect can be had by covering the hole for the bulb with a piece of frosted glass and mounting the bulb behind it. The ceiling frame for the second floor, Fig. 6, is shown ceiling side up. Note that the partition grooves must be spaced to match those in the top side of the second-floor frame. The top of the ceiling frame is covered with ¼-in. plywood, letting it project 1⅜ in. all around. Remember to include wiring here for second-floor lights.

Cut the partitions, Fig. 10, next. Note that these are keyed with the floor plans to show where each one goes. The waste pieces from the door openings are saved and used as doors. These can be hinged to

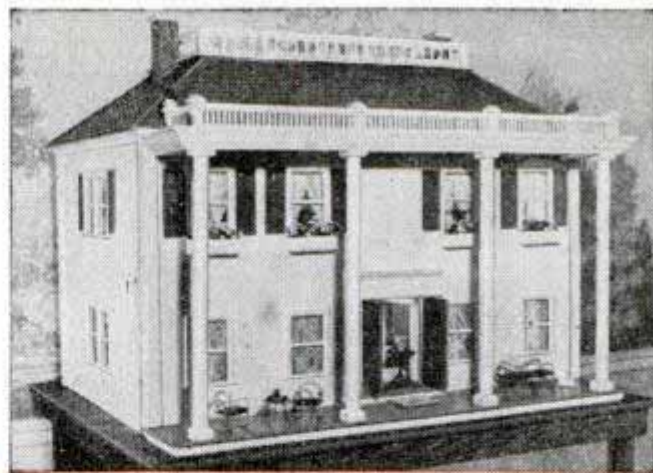
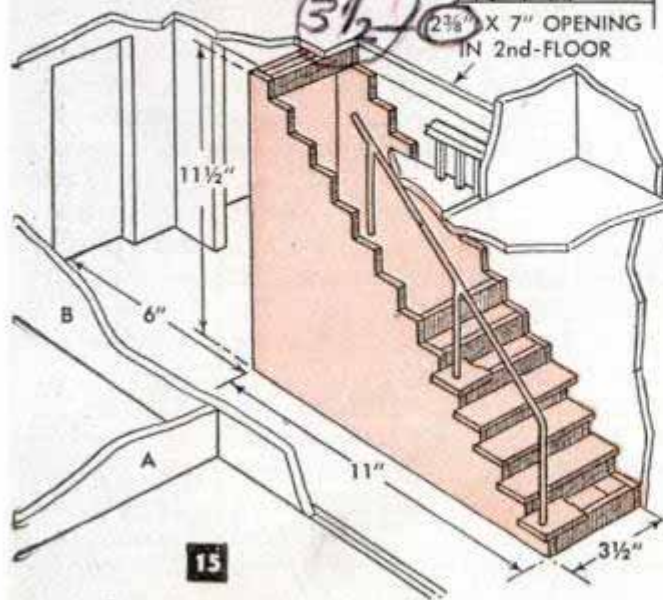
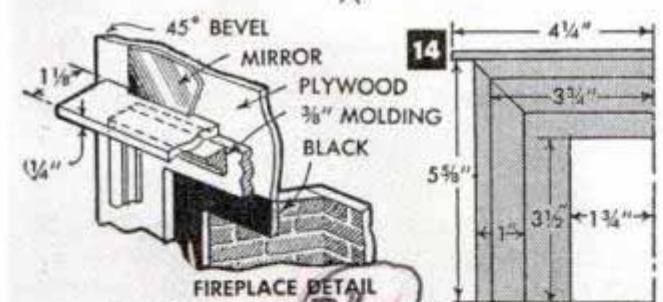
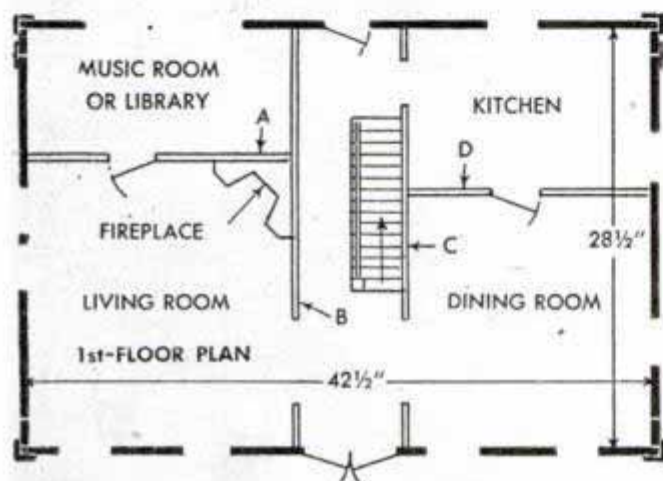

It's patterned after a modified Georgian mansion



Each side gives access to rooms upstairs and down

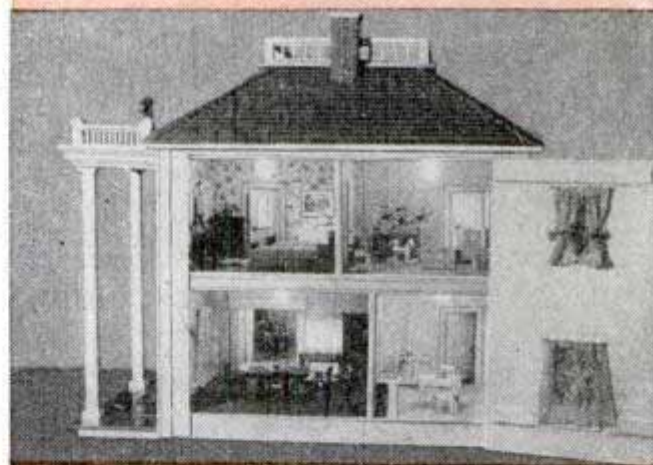

Side walls are hinged to opposite corners of house

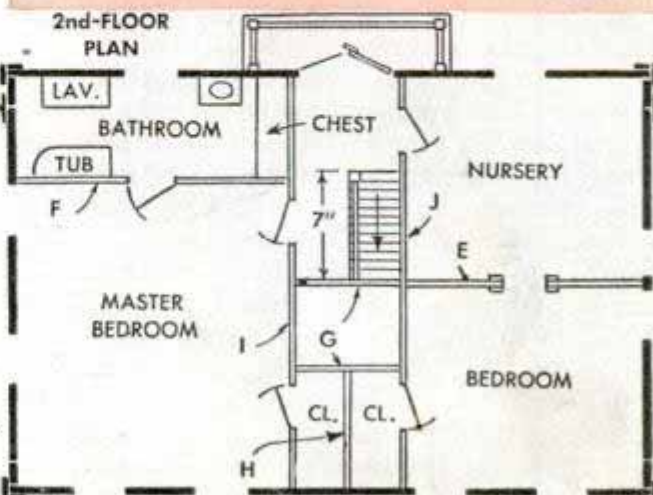

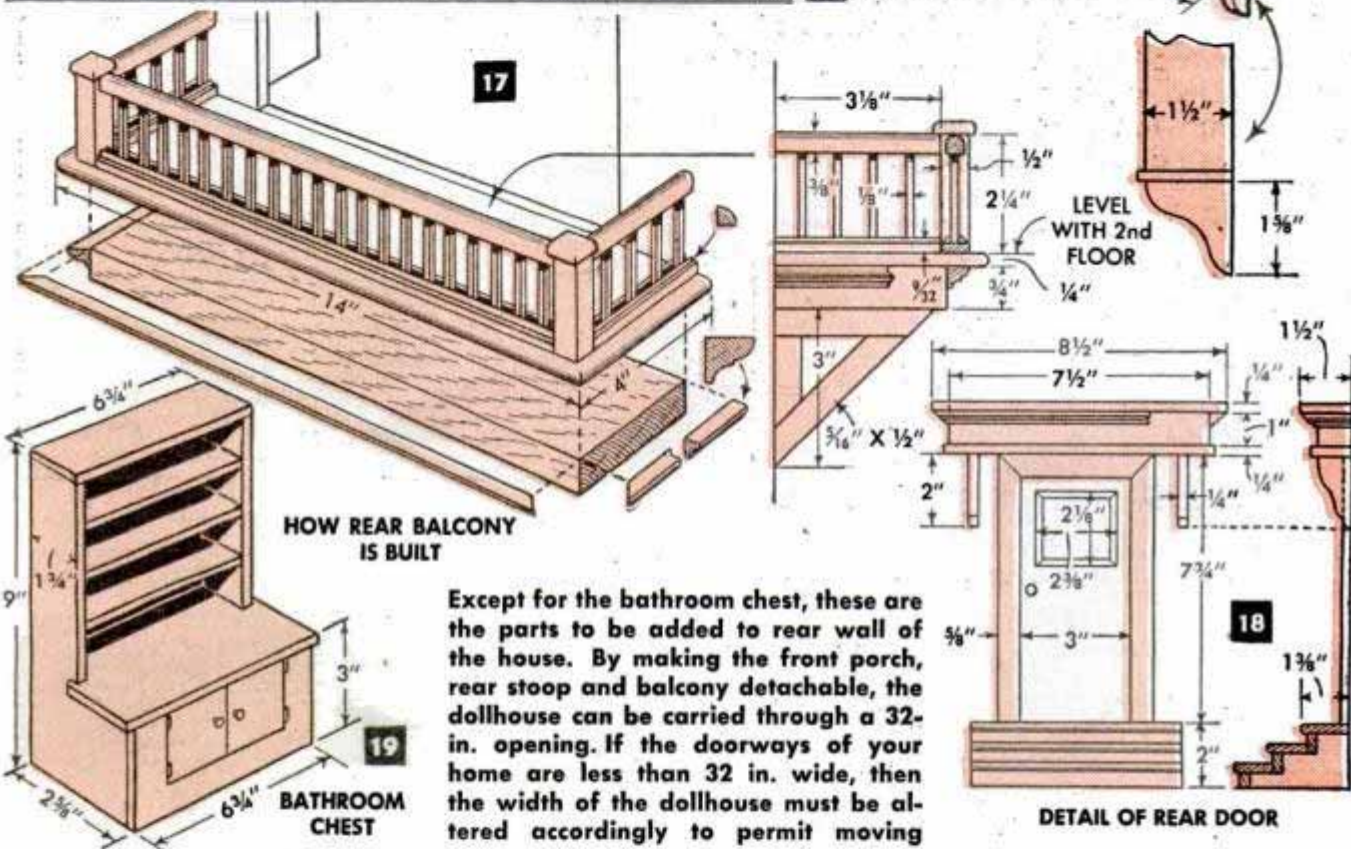
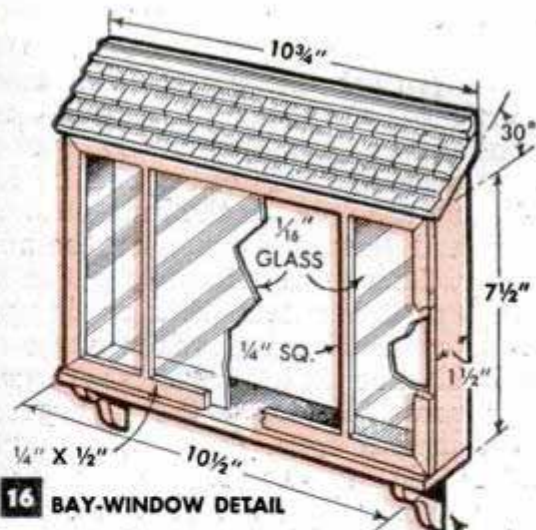

Except for the bathroom chest, these are the parts to be added to rear wall of the house. By making the front porch, rear stoop and balcony detachable, the dollhouse can be carried through a 32-in. opening. If the doorways of your home are less than 32 in. wide, then the width of the dollhouse must be altered accordingly to permit moving

actually swing, or they can be left ajar in a fixed position. Interior casing and baseboard are $\frac{1}{2}$ -in. strips of cigar-box wood. Let the casing on one side of each opening extend $\frac{1}{8}$ in. to form stops for the door, and insert a fill-in piece in the exposed groove. It will be somewhat more convenient to decorate the interior if the partitions are painted or papered before they are glued in place. The open stairway, Fig. 15, must be installed as you go. This fits against wall C and requires cutting away a portion of a cross member in the second-floor framing to make it fit flush. The fireplace, Fig. 14, should be installed at this time, too. A piece of plywood, 10 in. square and having the edges beveled 45 deg., is fitted in a corner of the living room as indicated in the first-floor plan. An opening is cut in it first for a fire pit and then the lower half is faced with a mantel, the upper half with a mirror.

Exterior walls are dimensioned in Fig.

2. These also are of $\frac{1}{4}$ -in. plywood. The front and rear walls are fastened to the edge of the frames with flat-headed screws, letting them extend $\frac{1}{4}$ in. at each end and butting the top edge of the plywood against the roof overhang. A 2-in. strip is added to each corner, to which the side walls are hinged, and then each corner is finished with corner boards. See the sectional view to the right of Fig. 5. Small turn buttons can be used to keep the sidewalls closed. All windows are trimmed, inside and out, according to Fig. 8, and the front door is framed as in Fig. 7. Shutters are added to second-floor windows.

The hip roof is framed next. A 14 by 27-in. beveled frame is supported 6½ in. above the plywood attic floor by $\frac{3}{4}$ -in. rafters and is roofed with plywood as in Fig. 12. Shingles can be of cardboard or wood, laid individually or in strips. Finally, the center of the roof is covered with a removable

panel as shown, the railing fitted and the two chimneys added. Red paper ruled in a brick pattern with white ink can be pasted to the four sides of the chimney. Shingles likewise can be cut from colored cardboard, or painted later to suit. By first coating the shingled roof with a thin application of glue and then sprinkling fine sand on it when the glue is tacky, you can simulate real shingles. Where the shingles meet at the hip line, cover the joint with a strip of cardboard folded in the center as shown.

Figs. 11 and 13 detail the porch and Fig. 9 shows how the porch floor is bolted to the house. This leaves the balcony, bay window and stoop to be added to the rear side of the house. These are detailed in Figs. 16, 17 and 18. The bathroom chest, Fig. 19, is located according to the second-floor plan.

Top "Tab" Saves Book Binding

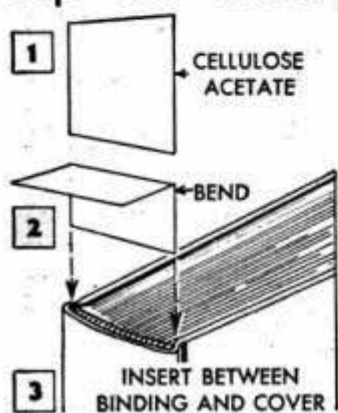

It's a simple matter to protect the top edge of book bindings—which are always being torn when handled—if this "tab" is inserted in the backbone. Fig. 1 shows how a piece of cellulose acetate is cut; Fig. 2 shows the bend

and Fig. 3, the method of insertion. This will keep the binding from being torn and it will help to keep the book clean also.

George Kapitan, Los Angeles, Calif.

Drill-Press Fence Removed Quickly

Less time will be spent attaching or removing the fence on a drill-press table if the sides of the carriage-bolt heads are filed off as indicated in the lower right-hand detail. When the straight sides are turned to parallel the slots in the table, the fence can be removed without screwing off the wing nuts.

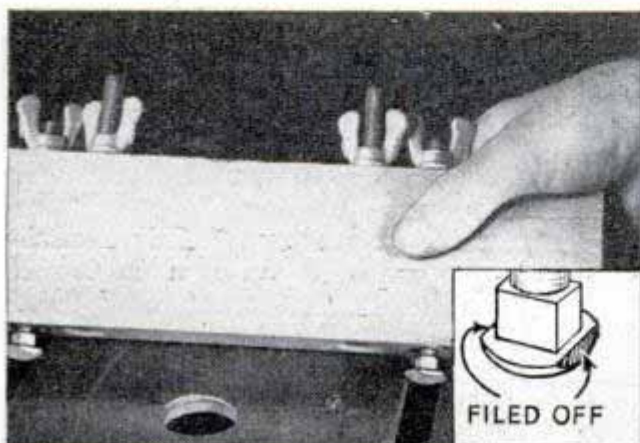

Concealed Switch Foils Car Thief

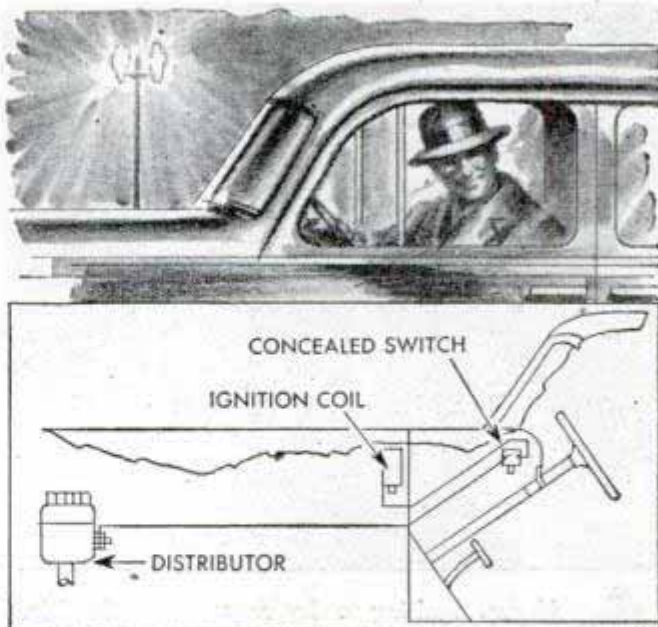

A single-pole toggle switch concealed under the dash and connected into the primary-current wire leading from the coil to the distributor will fool a car thief. The wiring is shown in the diagram. When you leave the car, simply snap the switch to the "off" position. Even though the ignition switch is turned on the engine will not start until the secret switch is closed.

Self-Adjusting Scooter Brakes

This simple brake will solve the problem of adequate braking on homemade motor scooters and midget cars. The brake drum may be made from either metal or hardwood. Usually, the drum is bolted directly to the wheel, but in some cases it may

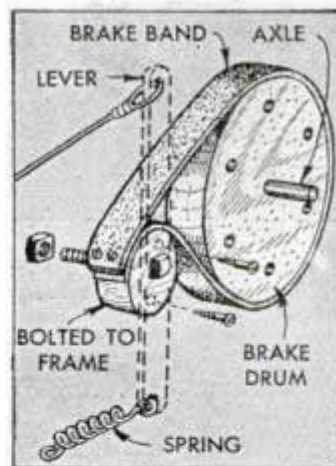

be necessary to bolt it to a flange keyed to the axle of the scooter or car. Turn another disk from hardwood the same thickness as the drum and mount this on the car frame so that it lines up with the drum. Attach a control lever, return spring and brake band as shown. Connect the lever to a pedal with flexible cable. Light pressure on the pedal exerts a powerful braking action on the drum.—Wm. P. Houser, Organ, N. M.

☞ When a felt hat becomes spotted by rain, rub the surface with steel wool until the nap is raised, and you will find that the spots have disappeared.

FUN WITH COMMON GASES

By William A. Hensley



↑ Above, igniting a hydrogen soap bubble. Because hydrogen is lighter than air, the bubbles will rise

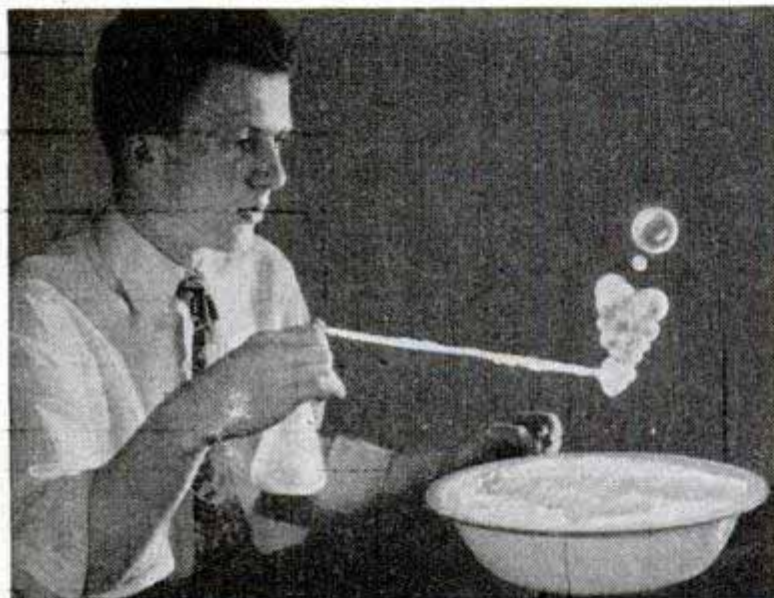

↑ Above, blowing hydrogen bubbles. Below, outlet tube has been immersed in soap solution to make bubbles

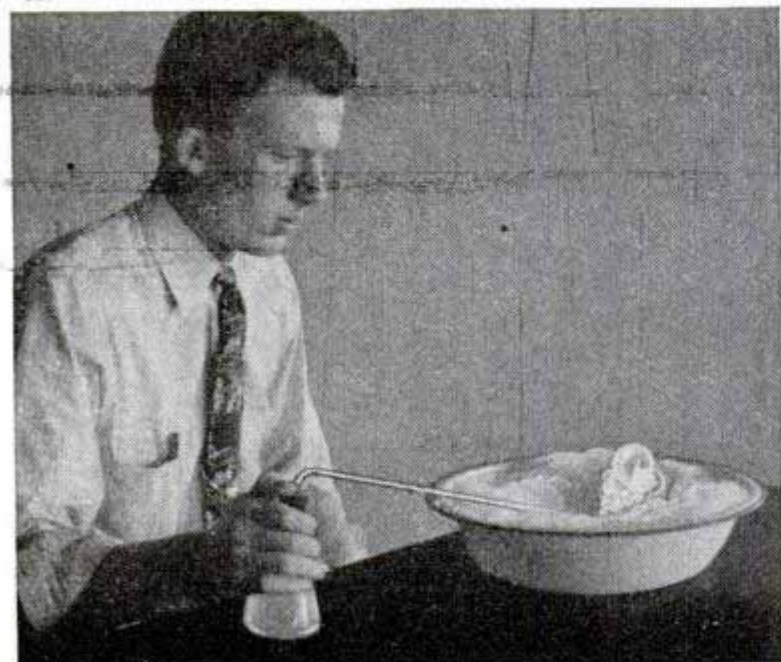

BOTH hydrogen and oxygen are part of the air you breathe and, for that reason, generally are referred to as "common" gases. As a part of the mixture called "air," they exist in abundance and show no unusual properties, but when isolated, these common gases can be used to obtain novel effects.

Flaming soap bubbles: The pictures in the left-hand column show how hydrogen soap bubbles are blown (arrows indicate the progressive steps), the top picture showing one of the bubbles being ignited. To generate hydrogen, place a small amount of zinc in an Erlenmeyer flask or similar container and pour in enough muriatic acid to cover the metal. Insert a one-hole rubber stopper with a glass outlet tube into the flask. This tube should have a short-radius bend in each end as shown. Allow time for air to escape from the container so that only hydrogen is discharging. Then place the open end of the tube in a soapy solution of glycerine, water and granulated soap. The bubbles formed by the hydrogen, being lighter than air, will float upward and, when ignited, produce a sudden flash. When generating hydrogen, always remember that it is a combustible gas and should not be handled in large volume. Also, do not attempt to confine it under pressure.

Phosphorus "sun:" This experiment requires oxygen and red phosphorus. The right-hand page illustrations show the steps to follow in obtaining the sun effect. To make oxygen, prepare a mixture of sodium perborate, 2 table-

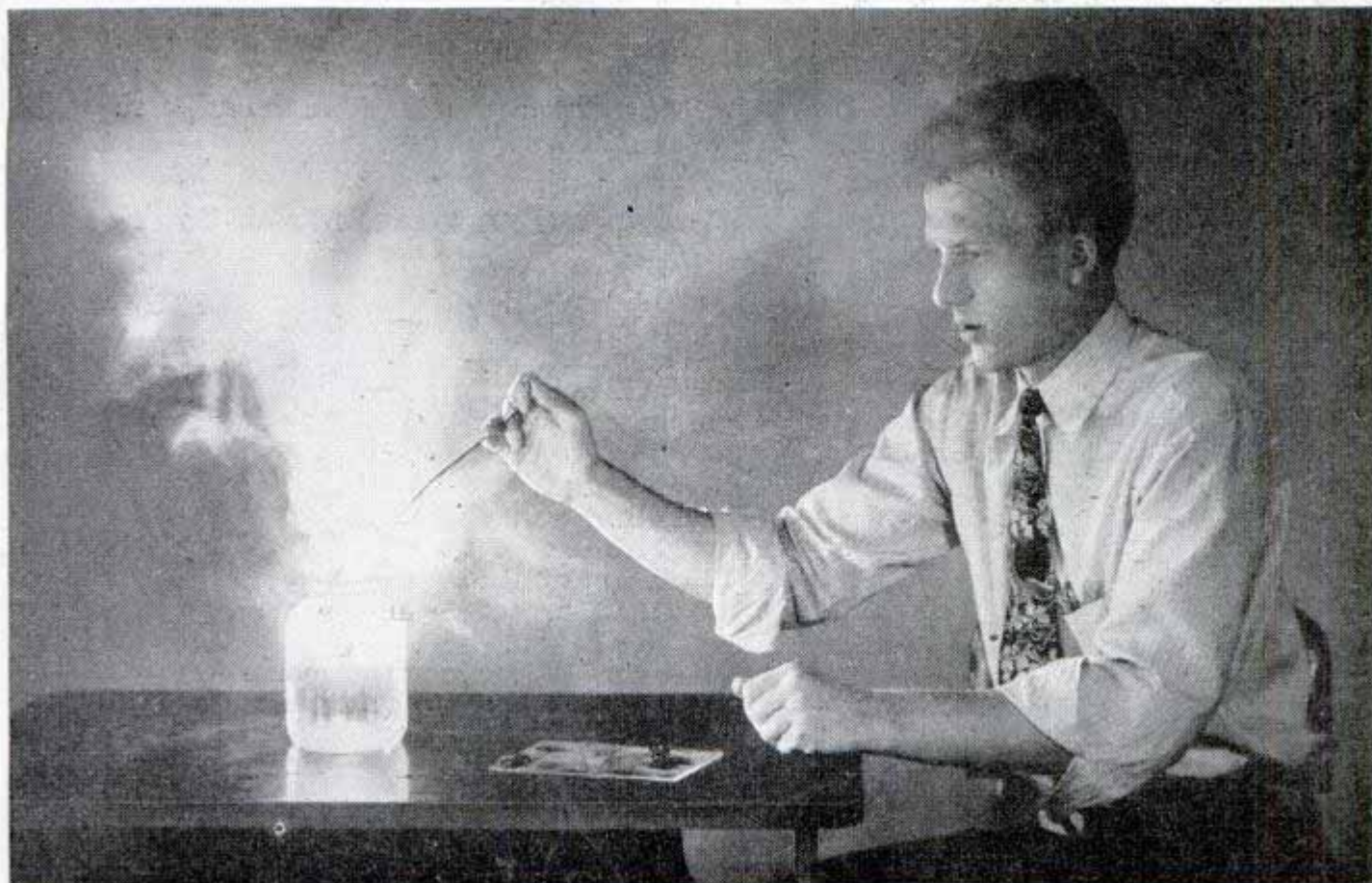

spoonfuls, and manganese dioxide, $\frac{1}{8}$ teaspoonful. Mix these ingredients thoroughly and pour into an Erlenmeyer flask. Add enough vinegar to soak the mixture and heat the contents of the flask over a flame. Then use a stopper and outlet tube to discharge the oxygen into an inverted 2-quart jar that is filled with water. The jar is placed in a wash basin that is partially filled with water. When the oxygen has displaced the water in the jar, slide a glass cover over the mouth and stand it right side up on a table. Then place a small piece of red phosphorus in a spoon, which has a long wire handle. When ignited and burning in air, the phosphorus has a pale yellow flame, but when introduced into the jar of oxygen, it burns vigorously to produce a brilliant "sun." Be careful not to get too close to the burning phosphorus.

Above, "sun" produced by burning phosphorus in oxygen, and below, burning it in air

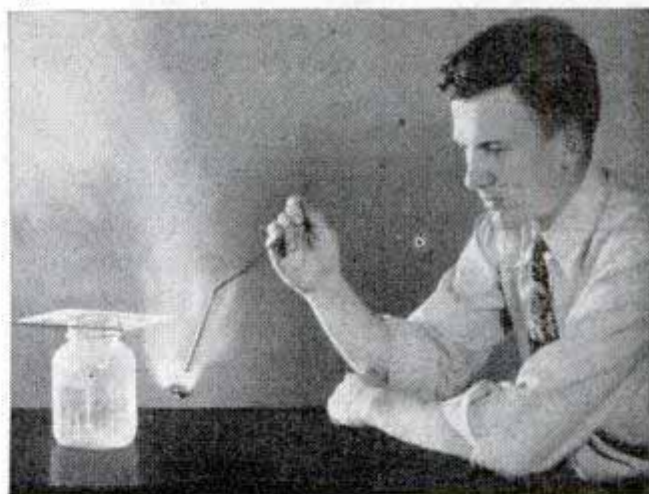

Lower left, generating oxygen and collecting it over water. Below, igniting phosphorus

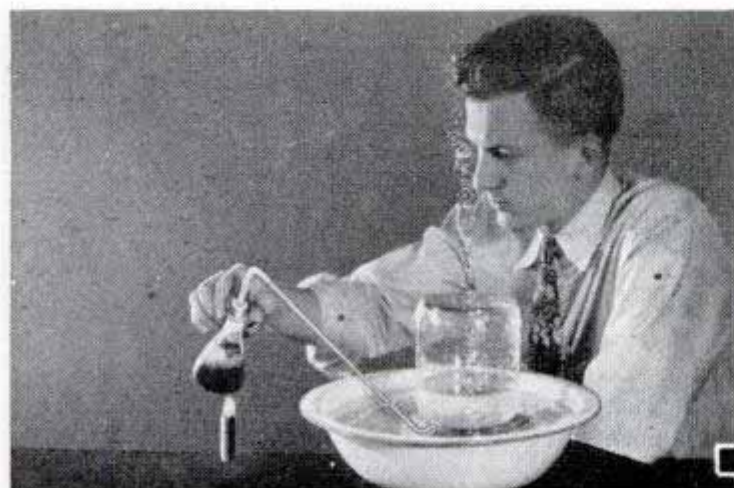

Xylophone Produces Novel Effects When Played With Double Hammer



By altering the frame of a toy xylophone and using a double hammer, professional musical effects can be obtained after a little practice. The circular detail shows construction of the hammer. Two strips of lightweight spring steel are bolted to the handle and wooden balls are attached to the free ends. Bend the steel strips so that, when the hammer is used, one ball strikes the top of the key and the other strikes the bottom. It will only be necessary to alter the frame so that the hammer will slip over the keyboard.

Gaily Decorated Window Shades Add Holiday Touch

Pasted or taped to the outside of window shades, Christmas designs such as are printed on tissue wrapping paper will add a novel holiday touch to the appearance of a house. Since blinds usually are raised during the day, only the lower half will



show, and this must be taken into consideration when pasting the decoration in place. However, if the outside of the house has any illumination at night, the full area of the shade can be used.

Waterproofing Paper Match Book

Here's an easy way to waterproof paper safety-match books. Apply nail polish to the heads, waxed portions of the sticks and the striking surface on the cover. When you want to strike a match, scrape the polish off part of the striking surface, uncovering only a small portion at a time, and use in the regular manner.



Improved Valve for Insect Sprayer

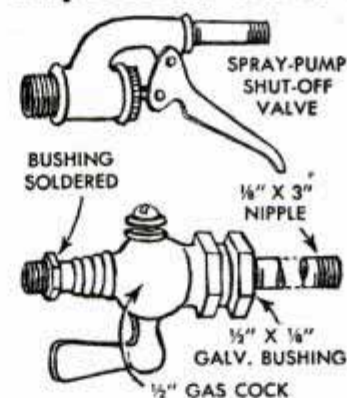

If the shut-off valve, upper detail, on a knapsack-type sprayer doesn't work, a substitute can be made by using a 1/2-in. gas cock and several galvanized pipe fittings. Solder a bushing to the gas-cock outlet that will fit the spray nozzle and screw a reducing bushing and nipple into the inlet for the hose; then clamp the latter in place. A gas cock, being a plug-type valve, will not clog easily.

Miss Helen M. Douglas, Commerce, Tex.

Tripod Supports Boots While Drying

When high-top boots or shoes become soaked after a hike through rain or snow, you can dry them at a campfire by using stick tripods. Cut three sticks for each boot, forming a tripod that will keep the inverted footwear several inches off the ground. Do not place the boots so near the fire that the leather gets hot as this will shrink the "grain" and cause cracking.

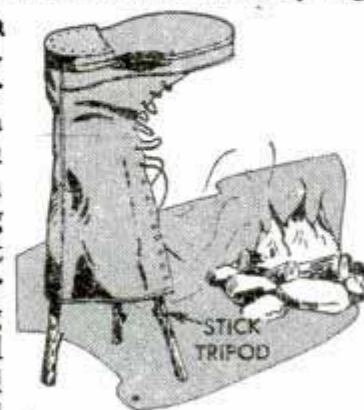



Lack of a stencil duplicator need not prevent you from taking advantage of this simple method of printing. The duplicators shown cover a range from letter size down to one of vest-pocket size.

For the letter-size job in Fig. 2, hinge together with adhesive tape, two 8½ by 11-in. sheets of stiff cardboard or fiber, first cutting a 7 by 9½-in. piece from the center to form a frame. After cutting the stencil, cement it to the underside of the frame, with the face of the stencil up. Inking is done with a roller of the type used for applying wall paints, Fig. 1. Cover the roller with a single thickness of flannel, nap side out, and ink by passing it over a piece of glass on which mimeograph ink has been spread.

Fig. 3 shows a postcard printer which is made from a rocker-type desk blotter. The blotter paper is replaced with two thicknesses of flannel, which are inked with a small brush. A stamp pad, Fig. 4, makes a good printer for address cards. The pad is charged with mimeograph ink and the stencil is held in place with shellac. Turn it upside down and use it as you would a rubber stamp. The printer in Fig. 5 works much like a desk stapler. Two thicknesses of flannel and the stencil are held on the platen or upper jaw with a rubber band.

A handy roller-type duplicator, that will imprint advertising, addresses and similar matter on cartons or other large surfaces, is detailed in Fig. 6. After turning a wooden disk to the required size, cut a dovetail slot in the edge and drill a ⅜-in. hole in the face for a lead weight, which returns the disk to the starting position each time it is lifted. The disk, or roller, is held on the shaft with a washer on each side and a single cotter pin as shown. The stencil and the flannel ink pad are held in place with a dovetail wedge which fits into a groove in the edge of the roller.

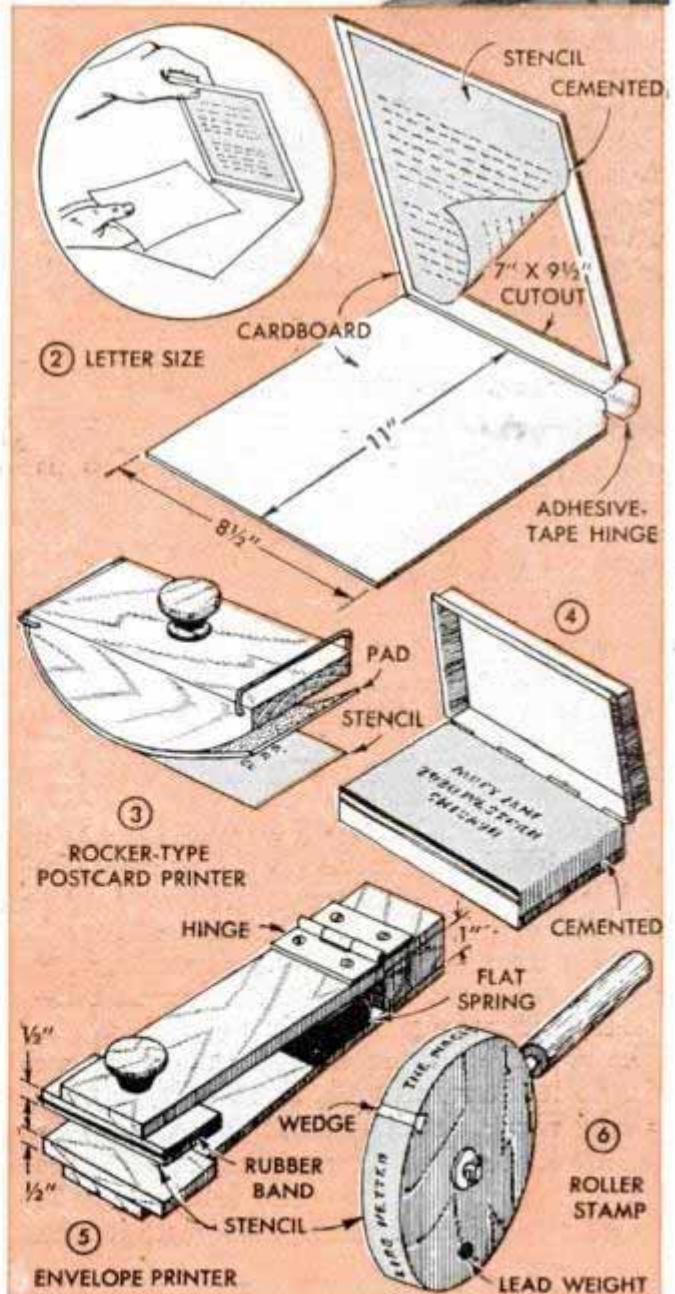

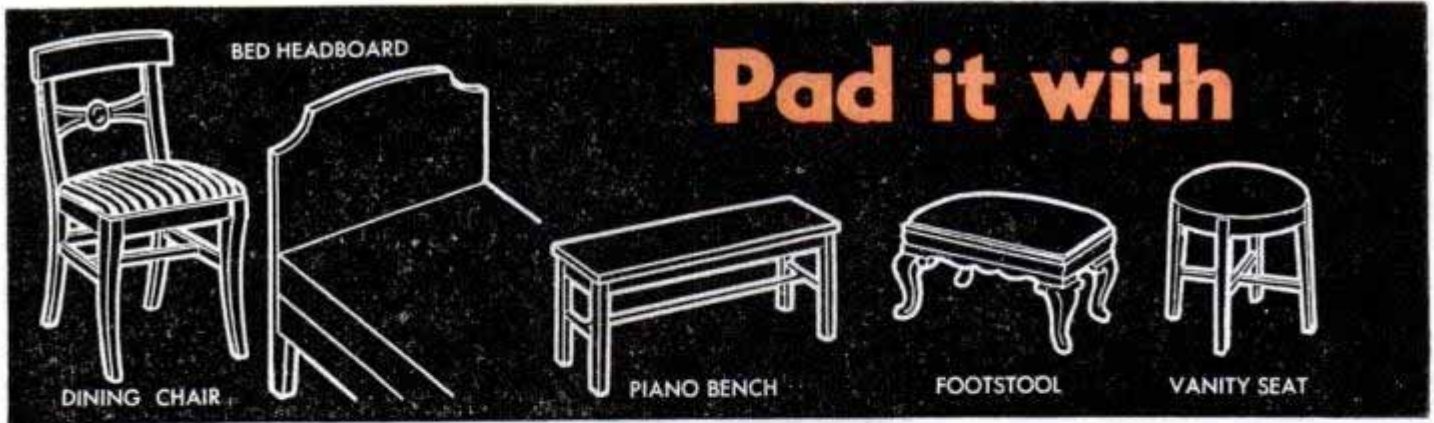

Photos courtesy United States Rubber Co.

First, the old chair seat is removed. Usually a screw on the underside holds each corner. Then seat board is stripped of old padding and all tacks are removed

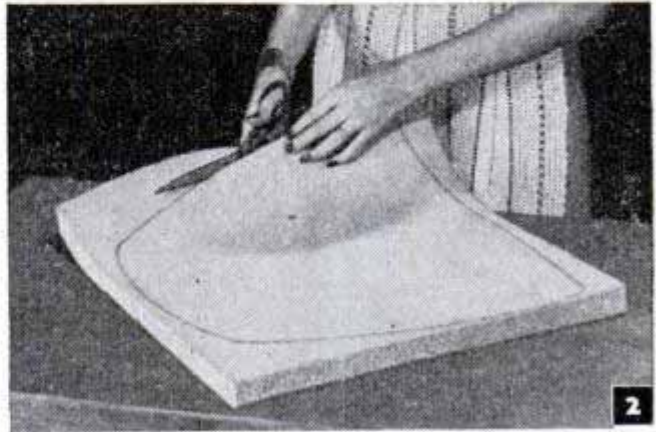

Using the seat board as a pattern, place it on the rubber and mark around it. Then cut with scissors as above. With foam rubber in place, outer fabric is pulled firmly and tacked to seat board as below

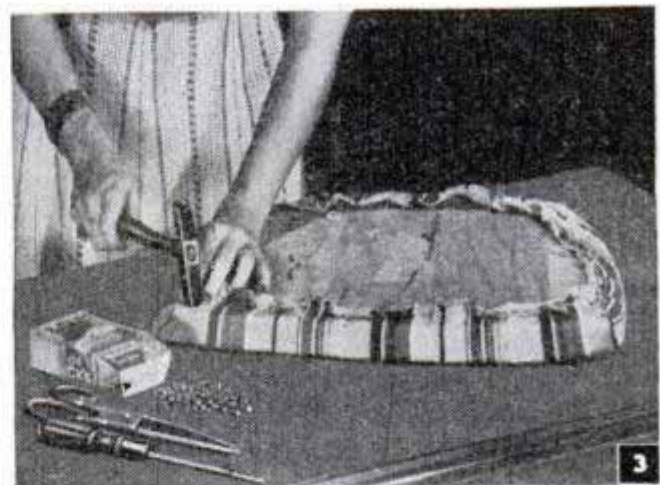

THANKS TO FOAM RUBBER, home upholstery takes on the ultimate in simplicity. This new cushioning material eliminates the use of cotton or other loose-type padding over springs or seat boards—you simply cut the rubber to fit the particular job and cover it with the finish fabric. That's all there is to it. Furthermore, foam-rubber padding retains its shape. It cannot mat or shift like regular loose padding and its resiliency keeps the outer fabric smooth and free from wrinkles, and produces an

exceptionally soft, comfortable cushion. Foam rubber, of pure latex, is marketed in sheet form and is available in the following sizes: 36 by 62 in., 17 by 21 in., and 16 by 16 in., the latter size being suitable for padding the seat of a dining chair. It can be had in $\frac{1}{2}$, $\frac{3}{4}$ and 1-in. thicknesses and three densities, soft, medium and firm. The 36 by 62-in. sheet also is sold in $\frac{1}{4}$ -in. thickness.

Generally used for padding chair seats, foam rubber can be used wherever a cushioned surface is desired. You can use it to pad the headboard of a bed or the bench of

FOAM RUBBER

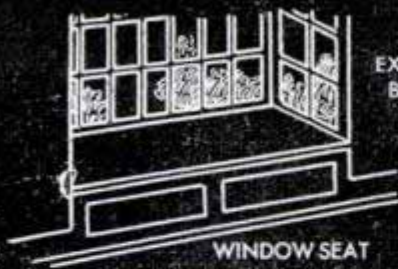

EXERCISE BOARD

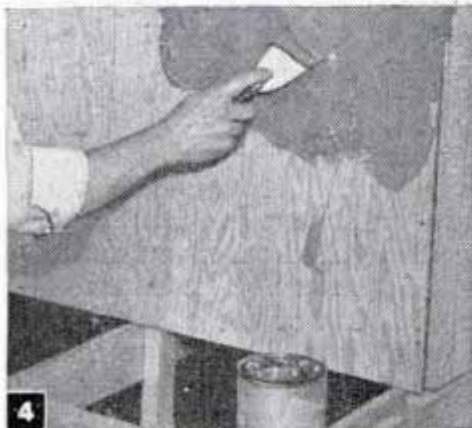
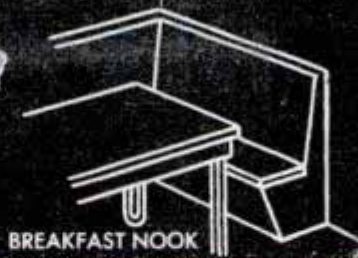

Above, foam rubber is held in place on vertical surfaces with linoleum cement. Abutting edges of sheets are held with 1-in. adhesive tape as shown below. This permits small pieces to be used

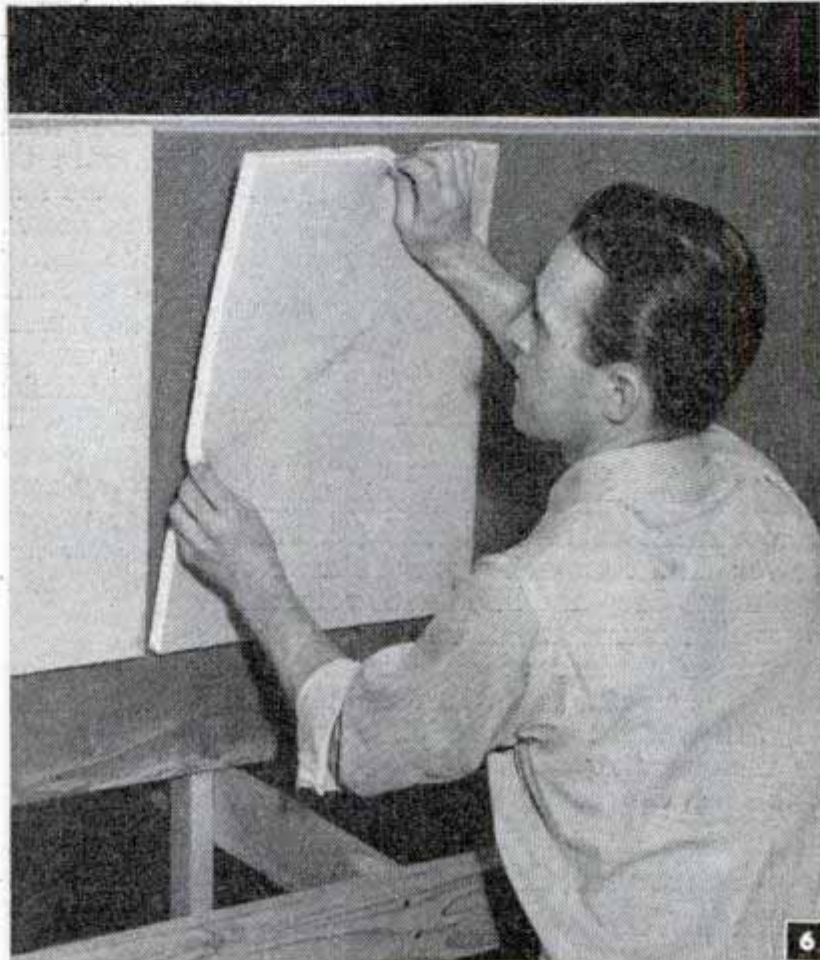

Here foam rubber is being applied to the back board of a breakfast-nook seat. The cement-coated surface is allowed to become tacky, then the individual sheets of rubber are pressed in place, butting the edges. This makes it convenient to apply the covering

a breakfast nook, and to cushion the top of a footstool or vanity bench. It can be used as filling in a removable pad for a piano bench, window seat or lawn furniture. These are just a few of the many practical purposes to which foam rubber can be adapted.

The simplicity of padding a dining chair is pictured in Figs. 1, 2 and 3. First, remove the old seat and strip it of the padding. Then, using the original seat board as a pattern, lay it on the rubber, trace around it and cut to shape with a pair of

By **Wayne C. Lecky**

scissors. Finally, apply the new covering by pulling it over the foam-rubber padding and tacking to the bottom of the seat board. In applying foam rubber to a vertical surface, such as the bench of a breakfast nook, coat the surface with linoleum cement to hold the sheets in position, Fig. 4. Then, when the cement is tacky, press the rubber onto it as in Fig. 6. The joints of all the pieces are held together with adhesive tape as shown in Fig. 5. Taping also permits small pieces to be utilized.

False Bottom for Dresser Drawer Conceals Valuable Articles



Jewelry and other small articles of value will be well concealed if kept in a hidden compartment in the bottom of a dresser drawer. The compartment should be several inches deep and lined with velvet. The lid, which forms the false bottom of the drawer, is a piece of plywood cut to fit closely. A small strap will serve as a handle with which to lift the lid. To complete the illusion that the lid is the real bottom of the drawer, cover it with paper lining.

Ball-Ornament Centerpiece for Yuletide Table

Here's a way of making a novel table centerpiece that is sure to intrigue holiday guests. Representing a miniature Christmas tree, it consists of ball tree ornaments stacked on top of each other, and poses the question of what holds the balls together. The answer is a hidden knitting needle on which the balls are held by their supporting rings. Insert the needle through a wooden base and begin building-up the tree by using large balls at the base



and smaller ones of graduating size from there to the top. For the finial, the metal cap and ring are removed from a ball so that it can be placed over the tip of the needle.

and smaller ones of graduating size from there to the top. For the finial, the metal cap and ring are removed from a ball so that it can be placed over the tip of the needle.

Repairing Cracked Glass Jar

All that's needed to repair a cracked glass jar or other glass container are a saucer, candle, water-color paintbrush and a small quantity of sodium silicate (water glass). Fasten the candle

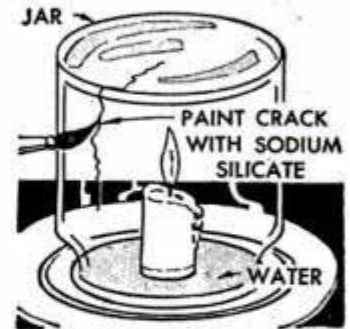

to the saucer by setting it in melted wax, and pour a little water into the dish. Invert the glass over the lighted candle and allow it to burn until it goes out. Then, immediately paint the outside of the crack in the jar with sodium silicate. The vacuum created inside the container as the heated air cools will draw water glass into the crack and make the repair leakproof. Purpose of the water is to keep air from entering the jar through the space between it and the saucer and breaking the vacuum.—S. Leonard Bastin, Christchurch, Hants, Eng.

Decorative Inlay Bands Cast in Gavel

To add a decorative touch to an ornamental wooden gavel, and, at the same time, prevent the wood from splitting, inlay metal rings around the head and handle. Babbitt metal, which is used for the rings, is poured as follows: After the inlay grooves have been turned, wrap heavy paper—not waxed—over them and cut holes in the paper through which the metal can be poured. After pouring, let the babbitt harden, remove the paper and turn or sand the rings flush.—Oscar R. Briggs, Sidney, Ohio.

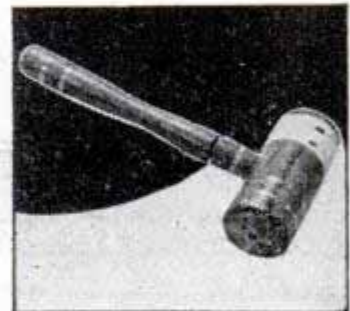

Extending Life of Christmas Bulbs

Christmas-tree bulbs will last much longer if two or more sockets and bulbs are added to each string of lights of the series type. By increasing the number of bulbs from eight to ten, the brilliancy of each bulb will be reduced slightly, but the element will last longer.

"ROW" SLED

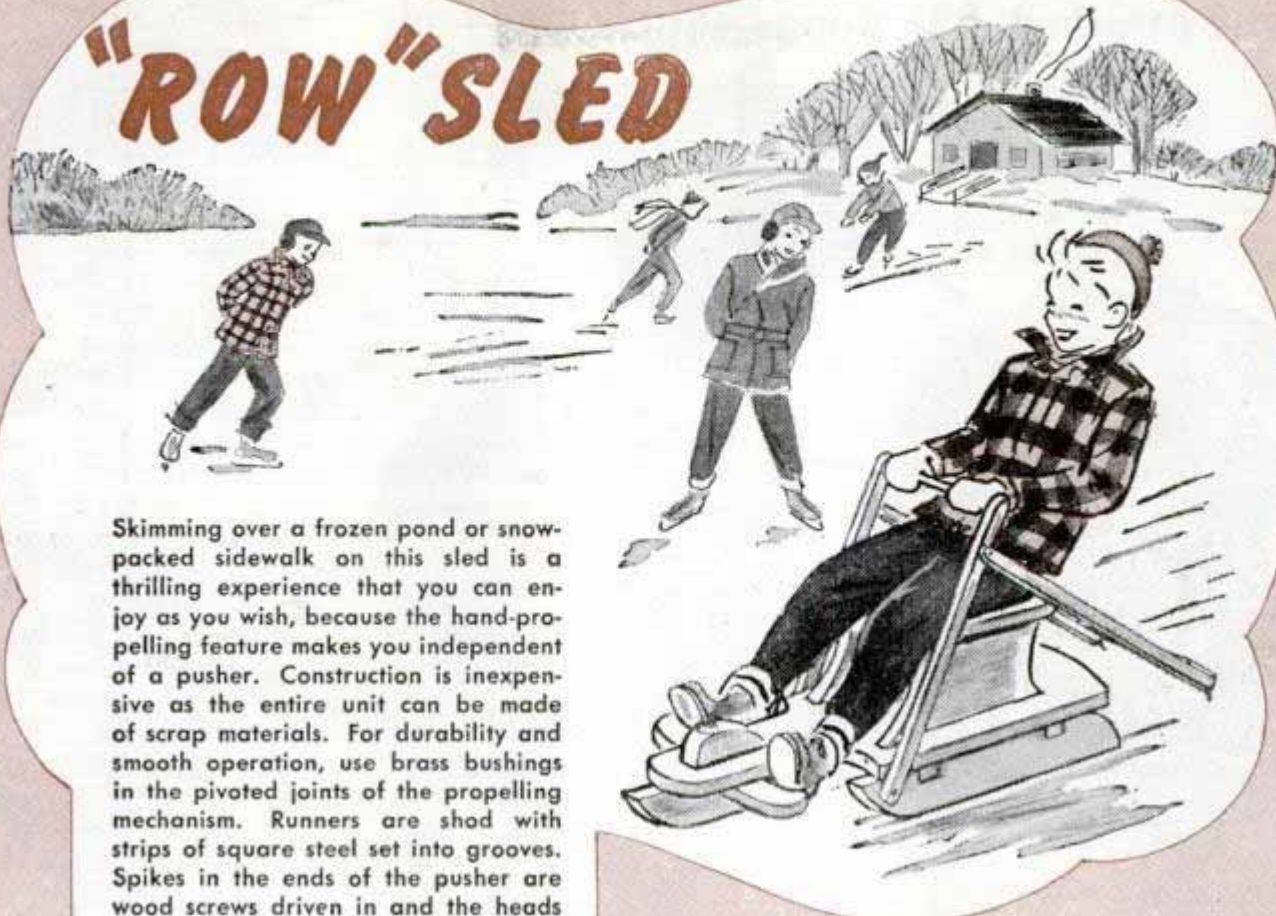

Skimming over a frozen pond or snow-packed sidewalk on this sled is a thrilling experience that you can enjoy as you wish, because the hand-propelling feature makes you independent of a pusher. Construction is inexpensive as the entire unit can be made of scrap materials. For durability and smooth operation, use brass bushings in the pivoted joints of the propelling mechanism. Runners are shod with strips of square steel set into grooves. Spikes in the ends of the pusher are wood screws driven in and the heads cut off, after which the projecting end of each screw is filed down to a stub point that does not wear too rapidly

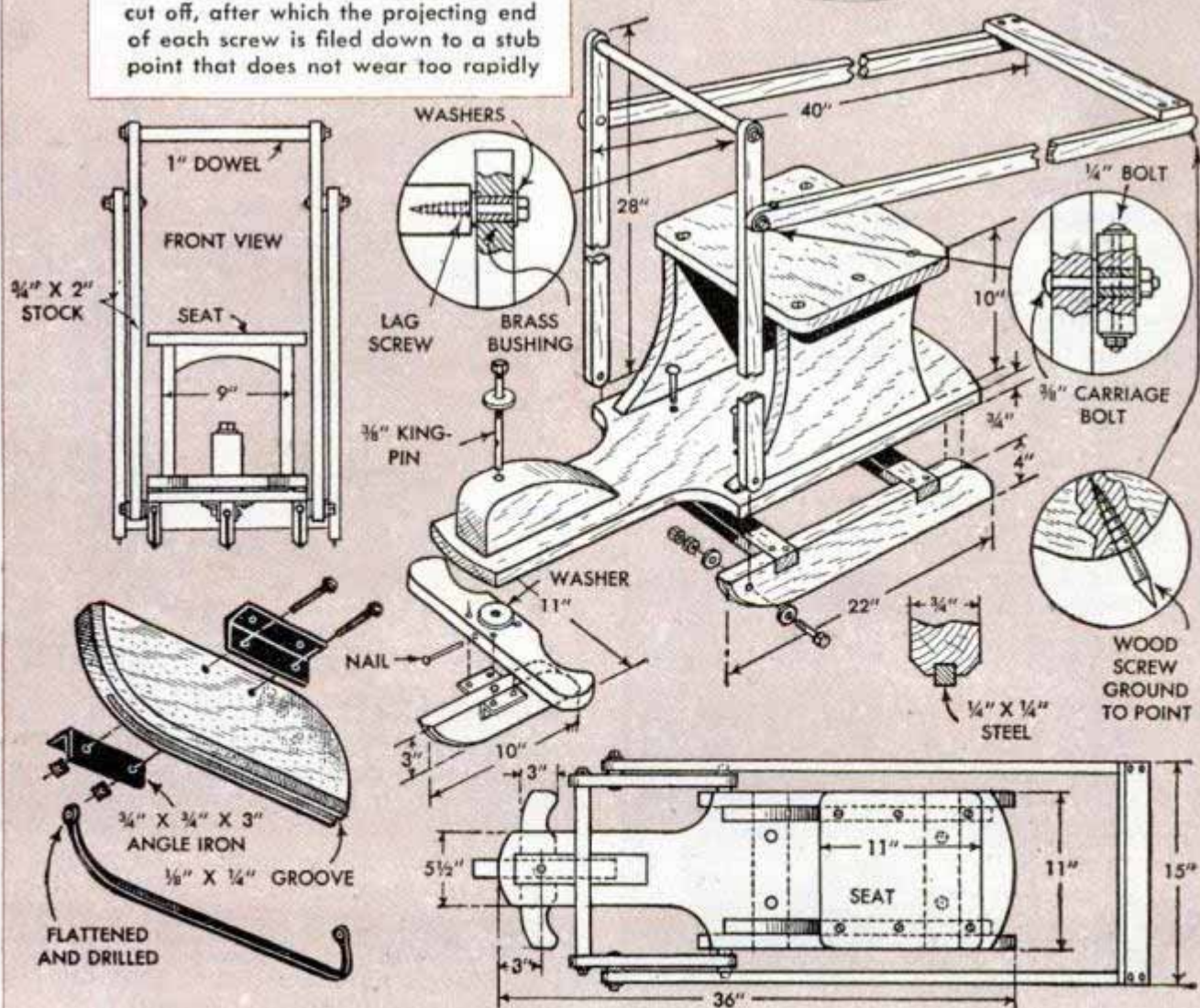

Holder for Assortment of Drawing Pencils Is Attached to Drafting-Board Lamp Shade

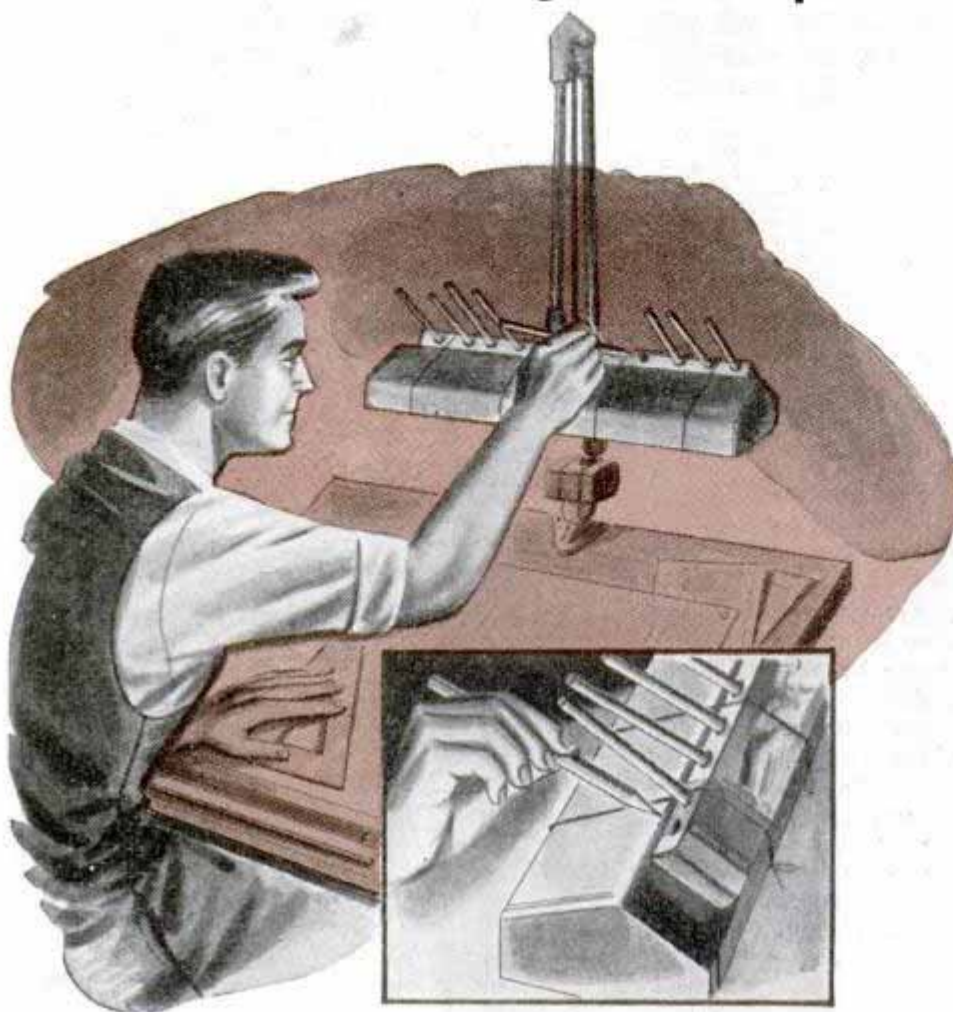

This drawing-pencil holder keeps pencils arranged in an orderly manner off the drawing board, leaving more free space on which to work and, since the holder is shifted with the lamp, the pencils are always within reach. Making the holder is easy; only materials needed are several boxes of the kind that drawing pencils come in and some cord or drafting tape. Holes for the pencils are cut in one side of each box, spacing them about 1 in. on centers. Then the boxes are tied or taped to the rear side of the shade at an angle. If tape is used, do not pass it all the way around the shade as it will obstruct the light. Arrange the pencils according to degree of hardness for easy selection. — H. Drouyn, Ottawa, Ont., Can.

Salt Poured Over Soiled Spot Cleans Baking Oven

When juices from a pie boil over onto the bottom of an oven, pour salt over the soiled spot and keep the heat turned on. In a short time the juices will dry and char without the formation of objectionable odors, and the spot can be brushed away easily by using a brush with stiff bristles. Removing the spot in this manner eliminates time lost scraping and scouring to get the oven clean.

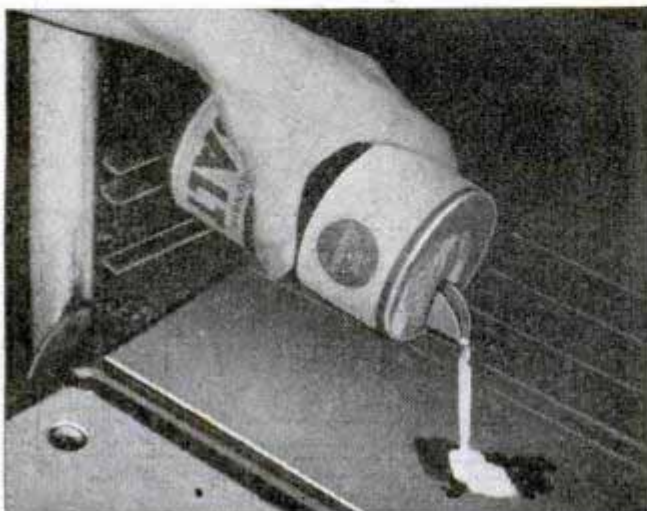

Springboard Fastened Onto Wall Amuses Young Children

Safe for small children, this springboard will provide many hours of entertainment. The board can be of a suitable size, constructed of fairly flexible hardwood. Note that the fixed end is hinged to a garage or other convenient building so that it can be folded up out of the way. Support for the board is provided by a post to which a crosspiece is nailed. Be sure that the post is driven solidly into the ground.

Playroom Furniture Of Bowling Pins

For the bowling enthusiast who likes mementos of the game, this bowling-pin coffee table and floor lamp will lend authentic atmosphere to a playroom or den. Discarded pins serve as legs for both pieces of furniture. However, unless fairly new pins are available, it will be necessary to turn them down in a lathe so the wood will be free from marks and blemishes. As shown, the coffee-table top is of contrasting woods, such as walnut and maple. One way to fasten the legs to the table is to use a wedged tenon joint. This is made by drilling $\frac{3}{4}$ -in. holes, 2 in. deep, in the top of the pins. Drill the same size holes through the table top at a 10-deg. slant. Then insert $\frac{3}{4}$ -in. dowels slotted at the top end and drive wedges into them to make the joints tight. The legs of the lamp are joined to the



"shelf" in the same manner and the column, which is of walnut, is turned on a lathe. Use standard electrical fittings.

Lyle Mussetter, Richmond, Calif.

"Salty Sam" Twine Holder of Plywood Has Handy Razor-Blade Cutter

Sam sits on the ball of twine, which represents rope, and he is always holding the free end of the twine for your convenience. In his duffel bag he keeps a razor blade

handy to cut twine to whatever length you need. Sam and the duffel bag are cutouts, and the cross-hatched detail gives sizes and contours. Plywood, $\frac{1}{2}$ in. thick, is best, but white pine will do. Cut slots in the duffel bag at right angles for a razor blade and the twine, sawing in from the top and bottom as shown. Two brads, fitted in loose holes, hold the razor blade in place. Although a turned base is shown, it can be square or octagonal.

Ralph S. Wilks, Elbridge, N. Y.



Insulation Packed Around Chimney Keeps Fire From Spreading

A source of danger frequently overlooked when fire-proofing a home is the space between a brick chimney and the adjoining floor or ceiling. Fire originating in the basement or first floor will travel through this vent and soon become difficult to control. A good preventive for this is to pack the space with a fill-type insulation. Not only will this stop the draft action of a fire, but it will seal off each floor during the winter and aid in conserving heat.

Francis J. Govoni, Beverly, Mass.

SHOOT 'EM CLOSE-UP

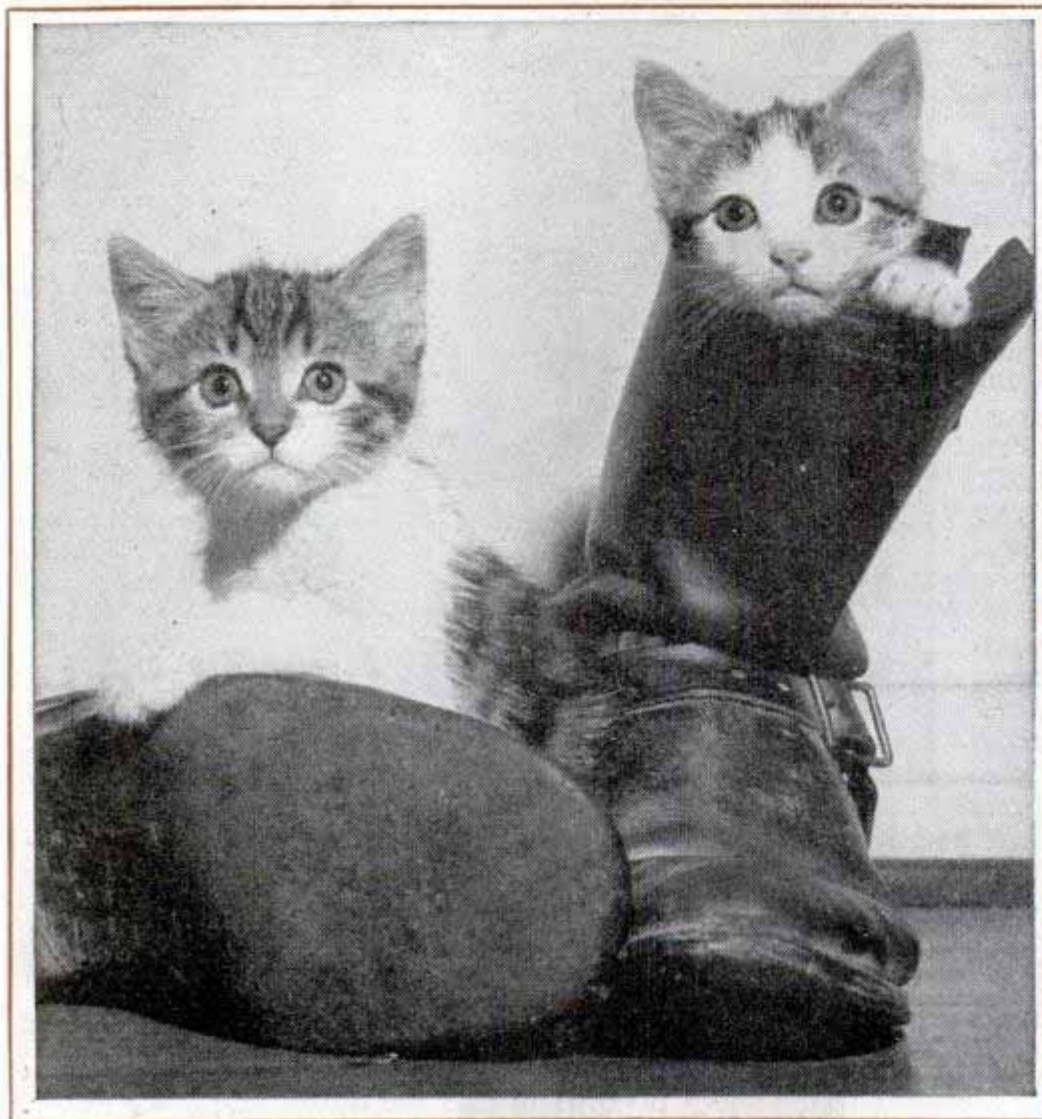

By
Richard W. Emery

Photos by
R. O. Ritchie

LOOK FOR A MOMENT at the close-up above. It's so boldly real that you will feel a sudden impulse to reach out and stroke the kittens. Prints reproduced on the opposite page have the same characteristic—you actually forget for an instant that you are looking at pictures. In each instance, the subject is definitely identified and individually characterized.

Working with the camera close to the subject results in prints having soft, subdued backgrounds and bold, realistic portraiture of the subject. Any good camera will do this work, although a camera not equipped with a double-extension bellows will require an inexpensive supplementary portrait lens. This accessory slips over the barrel of the regular lens and has the effect of shortening its focal length, thereby enabling the photographer to get much closer to his subject. A data table giving lens-to-subject distances is supplied with the portrait lens. As an example in using such a table, set the camera to work at 6 ft. Then, from the table, determine the distance at

which the lens is to work with the supplementary portrait lens in place. This usually will be given as 2 ft., 6 in. Locate the camera exactly 2 ft., 6 in. from the subject, or from that part of it which you want in sharp focus. Measure this distance with a rule just to be sure.

Most folding cameras not fitted with a ground glass are supplied with a reflecting-type view finder which is accurate at distances of about 6 ft. or over. But when you get closer, some displacement of the image occurs because of uncorrected parallax. Also, on many of the older-type cameras, the image will be off-center due to the position of the view finder with relation to the camera lens. In most cases, this is compensated for by sighting over the camera and centering it on the subject.

Combining a supplementary lens with the regular lens has the effect of shortening the depth of focus and changing the speed ratings. The lens must be stopped down to gain maximum depth of field and the exposure must be lengthened correspondingly.



"Immobilize" lively child subjects by giving them something to do. Then pose the hands near the face so that all lie in a plane parallel with the film in the camera. Distance, 4 ft.

In shooting extreme close-ups of persons or animals, focus sharply on the eyes. One flash bulb lighted this close-up of Tabby. Notice the excellent portrait quality. Distance, 2 ft.

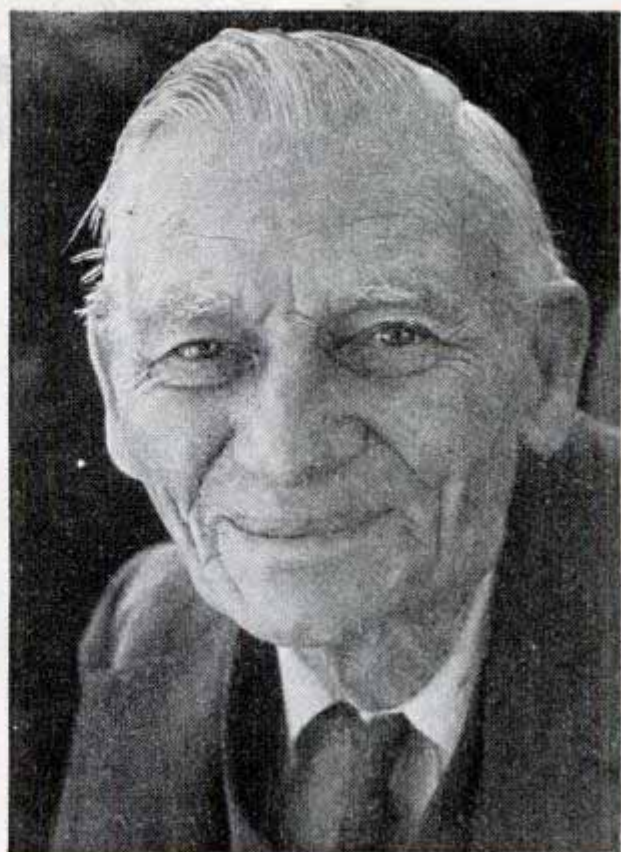
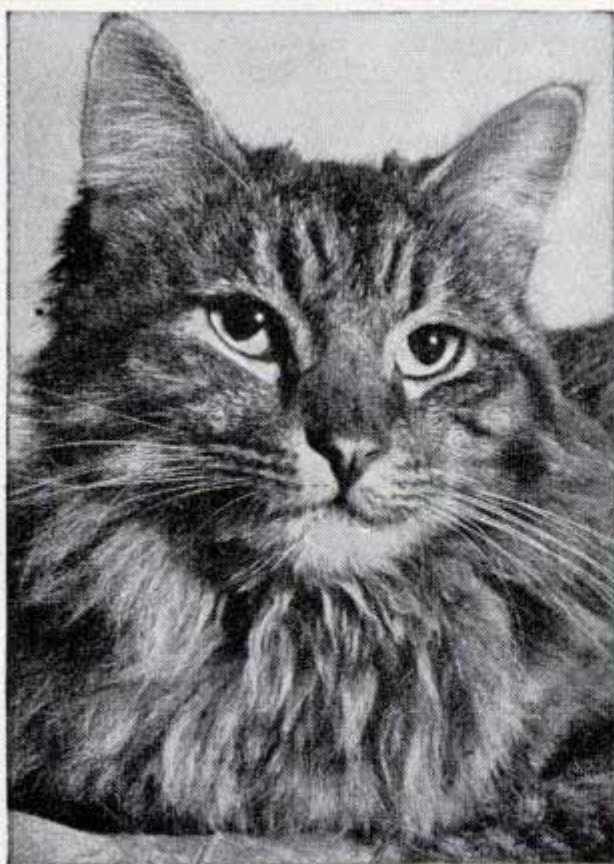

There is no artificial lighting on this informal portrait — only the late-afternoon sunlight. Two reflectors direct fill-in light to the face. Distance, 4 ft.

This shot was taken with prearranged camera and synchronized flash. Nuts were used as bait, and long, patient waiting got this shot of a well-known "park citizen." Distance, 3 ft.





Above, you see Whiskers, the family pet, posing for his picture and doing a very good job of it. Below, the enlarging lens should have a focal length equal to the diagonal of the largest negative the enlarger will take

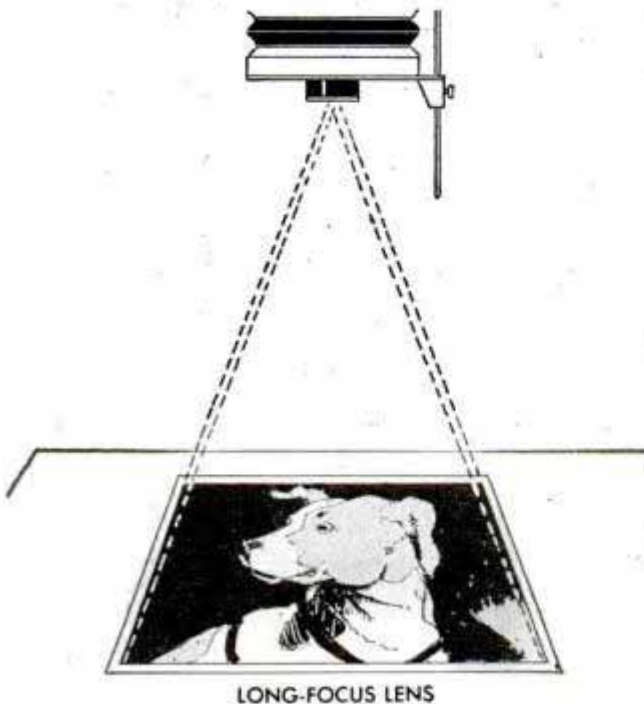
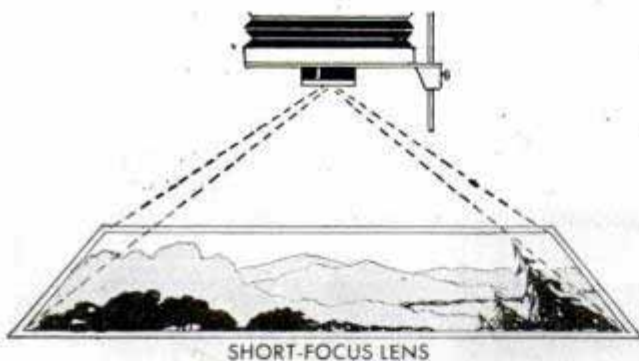

In photographing persons or animals, arrange the subject, or the camera, so that the eyes of the subject will be in sharp focus. Study of the photos on these pages will show that the photographer has focused his lens on the eyes, and that he has chosen subjects with limited depth of field. Also, it will be noted that regardless of the angle from which the picture is taken—three-quarter, front or profile—the main features of the subject and the film are in parallel planes. This is an important point to remember when shooting close-ups. The broadside view of Rover, on the last page, the three-quarter view of the squirrel and the front view of the kittens are examples.

The subject should be brilliantly lighted so that some variation in exposure is permitted. Sometimes it will be necessary to use a shutter speed fast enough to stop action, and where a tripod cannot be used, the shutter speed must be fast enough to minimize slight camera movement. It's a safe rule always to use fast film for extreme close-up work. Use a tripod or a suitable substitute wherever possible. A good rule is to give extreme close-ups about twice the normal exposure. Instead of lengthening the time by opening the lens aperture or reducing shutter speed, simply provide approximately twice the amount of light. On cameras so equipped, synchronized flash lighting, with one of the units



Here is Whisker's portrait, taken as shown at the top of the opposite page. See how intently he was watching the antics of his master in focusing the camera only 2 ft. from his nose. Note also how camera has been focused sharply on the eyes and that area in sharp focus is only a few inches deep



Right, for informal child portraits like that above, use a tripod to hold the camera steady for an indefinite time. As you see here, the photographer waits with flash gun poised while he directs the little lady in the high chair to take just the pose that he wants. Distance, 4 ft.





The enlargement, made from part of the original negative, brings Rover a lot closer

The camera gets close, but usually the enlarger can get even closer. Here's an example. It's what professional photographers call a "grab shot," a quick snap taken when pose, action, lighting and general composition seem to be just right. What resulted from use of this method on Rover, who would not hold a pose, you see in the contact print below. Then the negative was masked to get the projection print reproduced at the left. Also, the original print could be cropped as indicated by the dotted lines

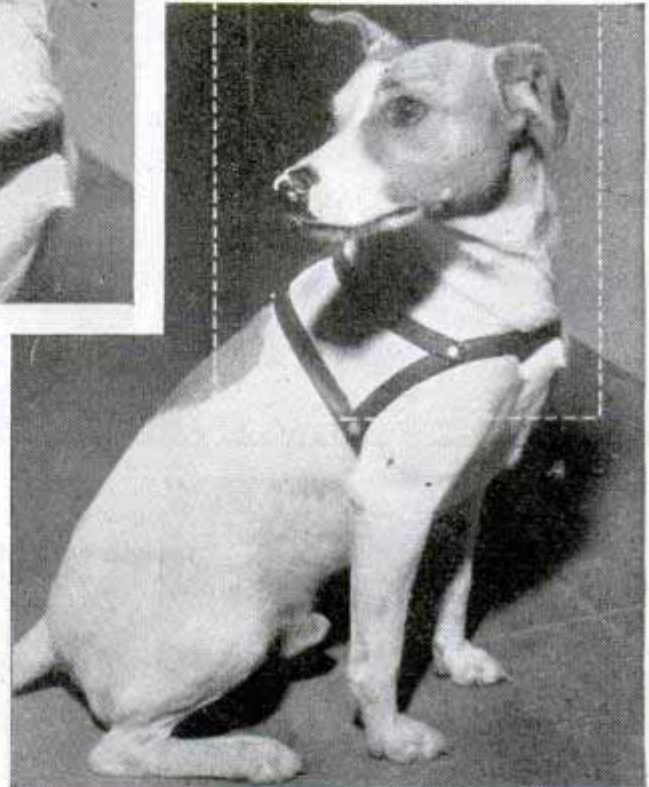

held in the hand, can give quite consistent results on close work. Flood and spotlighting give better control on some subjects and, when shooting outdoors, reflected sunlight is very effective in softening sharp shadows.

Clever scheming often is necessary to induce animal or child subjects to remain still long enough for the exposure. For example, the kittens were temporarily "immobilized" by placing each one in a boot as shown, after which the photographer, by a simple antic, caught and held the close attention of both subjects. In this case the camera was placed on two books on the floor with the lens 30 in. from the subjects. The exposure time was $\frac{1}{200}$ th sec. at f:22. One flash bulb, held above and to the right gave proper lighting.

When shooting close-ups, keep in mind

the possibilities of making enlargements of all or a part of the close-up negative. Rover, already referred to, is a good example of how the enlarger can, in effect, get even closer than the camera. The original full-size close-up of Rover was taken at 4 ft. with synchronized flash, $\frac{1}{200}$ th sec. exposure at f:22, and the enlargement was made from that section of the original enclosed by dotted lines.

Wooden Print Tongs Held by Spring-Type Clothespins to Prevent Warping

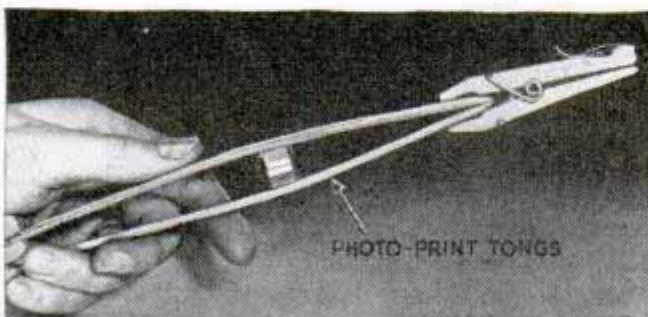

Often photo-print tongs must be discarded because they have become warped and lost their grip. With a little care, however, this can be prevented and tongs can be made to last much longer. After use, insert a spring-type clothespin between the legs of the tongs and use another pin to clip the ends. Leave them this way until they are ready to be used again.

Portrait Lighting for Slender and Stout Subjects

Arrangement of lights, camera angles, composition—these, and many other factors must be considered carefully by the portrait photographer in order to present his subjects in the most complimentary manner. To simplify taking portraits—and produce flattering results—here are two lighting setups, one for slender and one for stout subjects. Neither requires extensive equipment. The top detail suggests an arrangement for lights, camera and subject if the person you are photographing is slender. The bottom detail is for stout persons. When using

the first setup, have the camera above eye level. Use a diffused main front light and have the subject face the camera. The head should be tilted down slightly and the body should be relaxed, sitting in a chair. Generally, a light background is better. To photograph stout persons, have the camera below eye level and use a sharp main side light. Take a three-quarter view with the subject leaning forward slightly. Here a

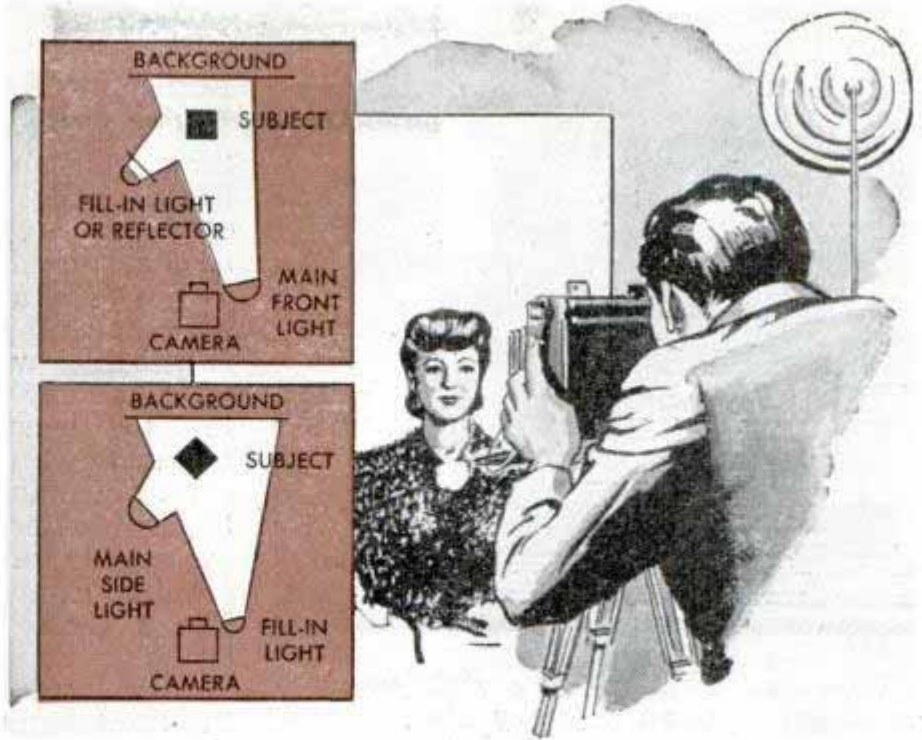

dark background usually produces better results. To modify features, bear in mind the following suggestions: A long nose will photograph better if the head is tilted up and the reverse is true for a person having a short nose. Conspicuous ears are less noticeable if the head is turned slightly. Have the eyes looking in the same direction that the head is turned.

Max Navis, New York City.

Glass "Carrier" Simplifies Centering Prints on Mounting Board

Locating a photograph squarely when mounting it with rubber cement is a simple job if a sheet of glass, somewhat larger

than the print, is used as a "carrier." First, apply cement to the mount and to the back of the print along the top edge in the usual manner. Then place the print, face up, on the glass, letting the cement-coated edge of the print overhang the edge of the glass an inch or so at the top. Next, place glass and print on top of the mounting board and shift it around until the print is centered squarely in the desired position. Then press down the cement-coated edge. This anchors the top of the print after which the glass is removed and the mounting completed. Cleaning the mount of excess cement can be done with an artist's 'pickup,' which consists of a ball of dried rubber cement. This is worked as similar to an eraser and is kneaded as it is used.

R. F. Donovan, Jersey City, N. J.

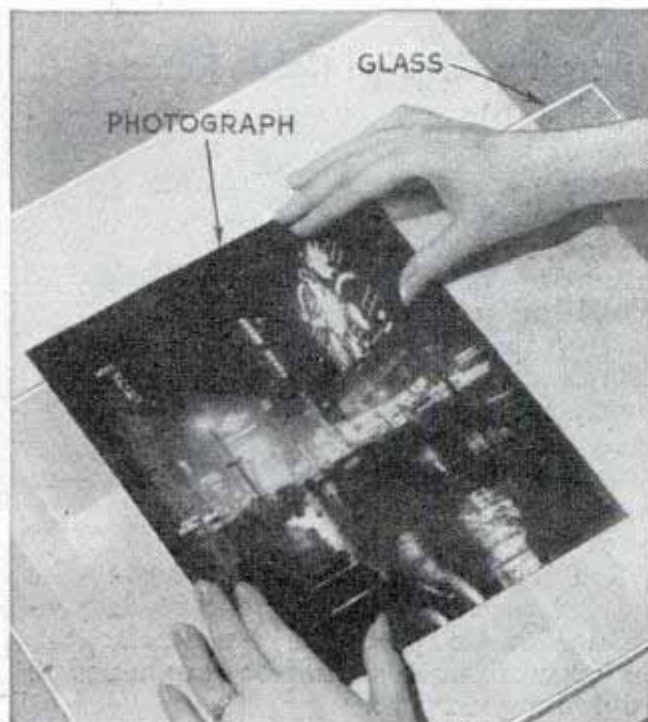

☞ Mechanics who use reference books in the course of their work will find that the pages can be kept clean if a coat of shellac or clear nail polish is applied to the margins. This also keeps the edges of the pages from being torn easily.

Ordinary Thermometer Converted For Use in Darkroom

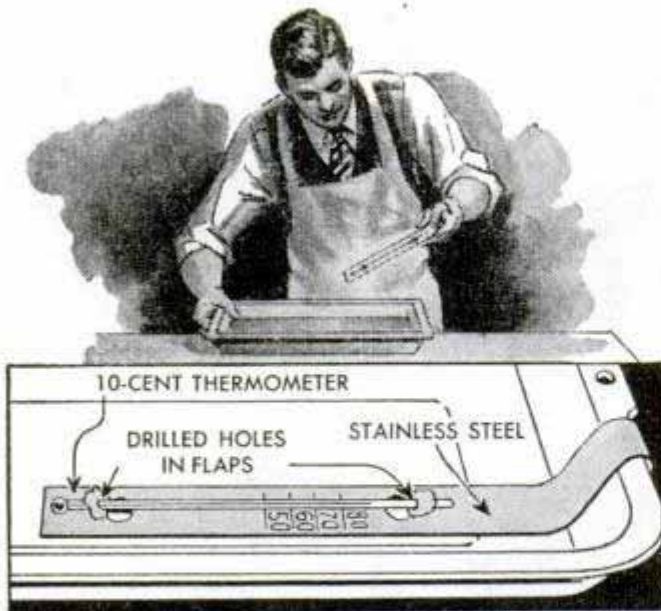

With the addition of a stainless-steel mounting strip, an ordinary 10-cent thermometer can be converted for use in the darkroom. Form the strip to fit the inside of a developing tray, and cut and bend two flaps to hold the thermometer in place. Temperature markings are stamped into the metal strip for easy reading.

H. Klein, Pittsburgh, Pa.

Safe Way to Wash Roll Film

For the photographer who does not have the required tanks or trays, washing roll film often is difficult because the emulsion—at this stage of the processing—is soft and scratches easily. Here's a way I found to safeguard film that does not require special equipment. Clip the ends of the roll together with the emulsion side inward and place it in a wash bowl. Adjust the

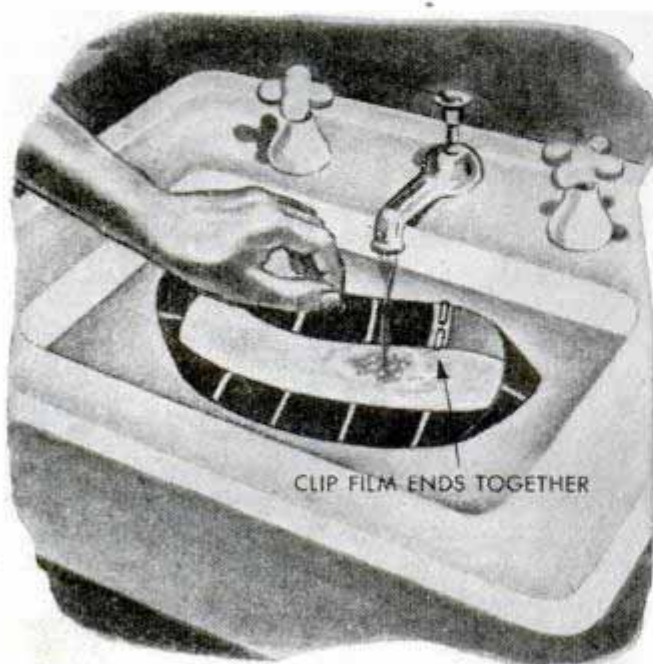

faucet so the water level will remain constant when fresh water is flowing in.

Bob Hurst, Chicago.

Replacing Reflector-Clamp Tubing

If the rubber tubing on photo-flood reflector clamps wears through or dries out, the clamp loses its grip and the bare wire scratches any object the lamp is fastened to. To replace worn tubing,

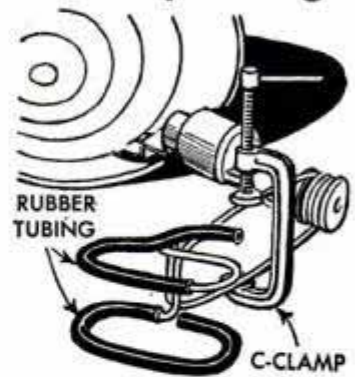

buy several feet of the kind used to connect automobile windshield wipers. Cut it to the required length and slip it over the clamp. Use a C-clamp to spread the reflector clamp while performing this operation. The rubber tubing will go on easier if a little petroleum jelly is applied to the wire.

Locating Tripod Hole in Dim Light

When attaching a camera to a tripod indoors, or wherever the light is dim, it is difficult to see the mounting hole when holding the camera close to the tripod head. If a ring made of luminous paper is pasted around the hole, it will be easy to locate the hole and attach the camera. Also, this will prevent tearing the leather or damaging the tripod screw.

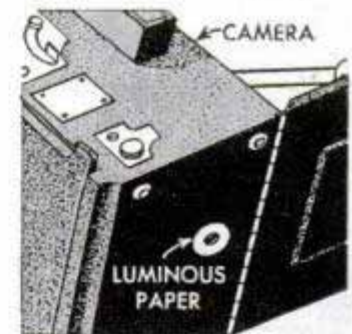

Enlarging Grip on Cable Release

The cable release of a camera can be removed and attached without effort if the threaded end is provided with a fitting that has enough surface so it can be turned easily. The fitting shown is a small piece of $\frac{3}{8}$ -in. wooden dowel drilled through the center to fit over the knurled part and leave the threads projecting. Plastic rod could be used also, but the circumference should be roughened to provide a good grip.



CRAFT QUIZ



1. She is painting with—
 (a) Oil paint (c) Shellac
 (b) Water paint (d) Lacquer

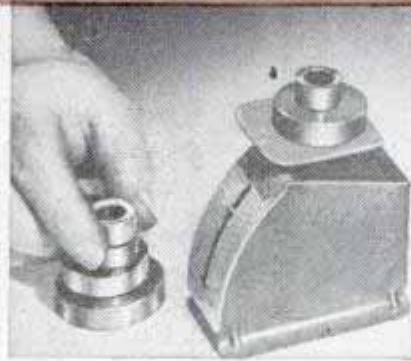

2. Steel is lighter than—
 (a) Brass (c) Aluminum
 (b) Tin (d) Cast iron



3. With these you make—
 (a) Turnings (c) Handles
 (b) Mortises (d) Joints

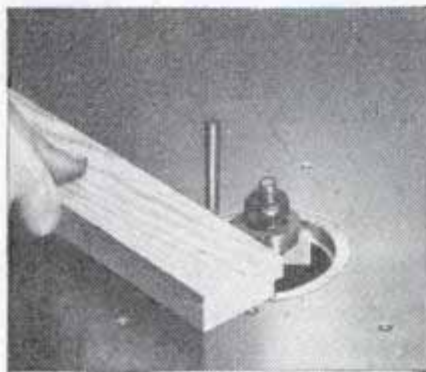

4. It would be safer with a—
 (a) Splitter (c) Fence
 (b) Wheel guard (d) Push block



5. Good work shows no—
 (a) Back-up (c) Cut-off
 (b) Mark-down (d) Mark-off

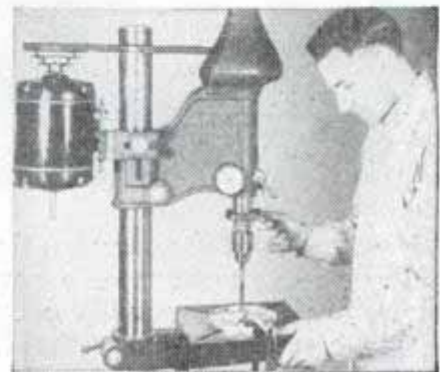

6. Best reaming speed is—
 (a) 1/2 drill speed (c) 1/4 drill speed
 (b) 2/3 drill speed (d) drill speed



7. Heat over 60-w. lamp is—
 (a) 150° (c) 250°
 (b) 200° (d) 400°

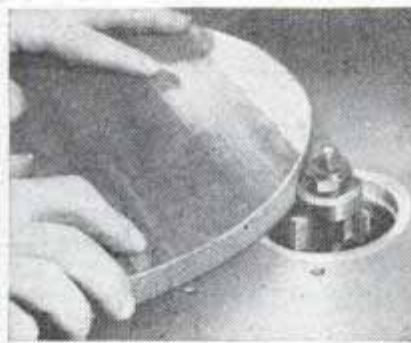

8. Something missing here—
 (a) Fence (c) Starting pin
 (b) Spindle nut (d) Stop

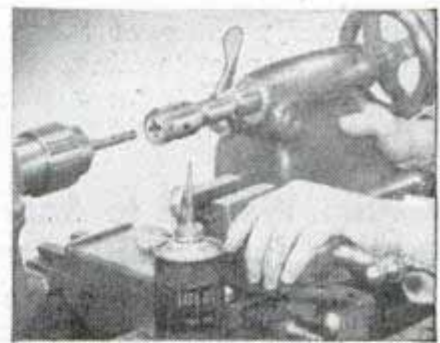

9. Threading die is—
 (a) Acorn (c) Spring
 (b) Button (d) Rethreading

ANSWERS: 1—b (others are not applied with roller); 2—c; 3—d (picture shows dowels); 4—c (straight work, like this, should always be worked with fence); 5—d (pressure marks on plastic); 6—b; 7—c; 8—c (starting pin is always used when shaping curved work); 9—b (button or round); 10—d; 11—c

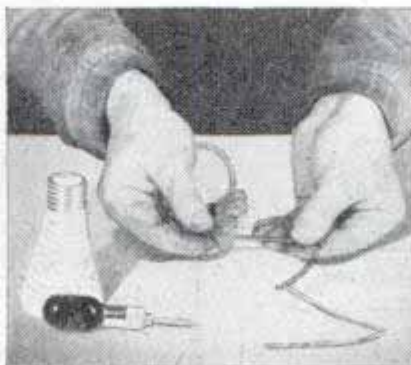

10. This wire is—
 (a) Copper (c) Galvanized
 (b) Piano wire (d) Nichrome



11. Blade for general work is—
 (a) 32 teeth (c) 18 teeth
 (b) 14 teeth (d) 24 teeth

Masking Tape Covers Rusted Holes In Auto Body or Fender



If rusted spots have worn through a door edge or fender seam of a car, and this is where such spots usually occur, a suitable repair can be made with cloth masking tape. First clean the area to be patched, removing dirt and scale from the outside and inside surfaces. Then apply the tape in strips and overlap it like house siding. Finally, brush or spray several coats of waterproof paint over the area. This results in a neat-looking, semipermanent repair that is fairly inconspicuous.

Sherwin Murphy, Chicago.

Handle Welded to Socket Wrench Reaches Inaccessible Parts

Parts of a car that are inaccessible with ordinary wrenches can be reached easily with this tool, which consists of a socket wrench welded to an 18-in. length of flat

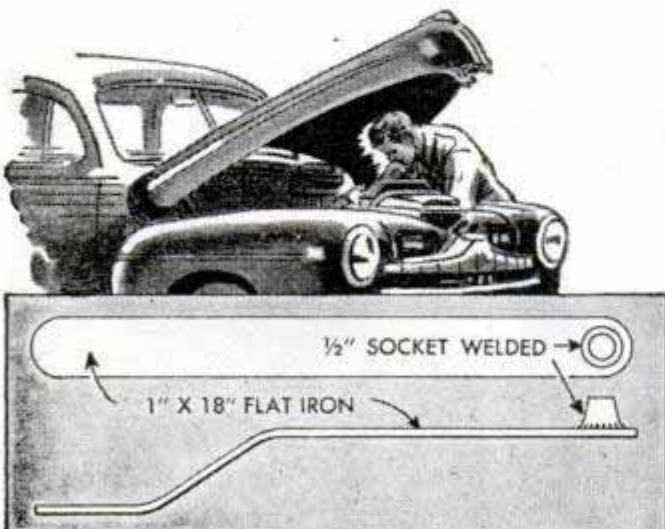

iron that is offset slightly. Since this is a somewhat specialized tool, the size of the socket, length of handle and degree of offset will be determined by the work for which it is intended.

D. W. Brentlinger, Richmond, Calif.

Reversed Guard on Safety Razor Protects Edges of Blade

When a safety razor is kept loose in a medicine cabinet, frequently the edges of the blade become dulled by scraping against the surface of the shelf or against articles in the cabinet. To prevent this, after the razor has been cleaned, reverse

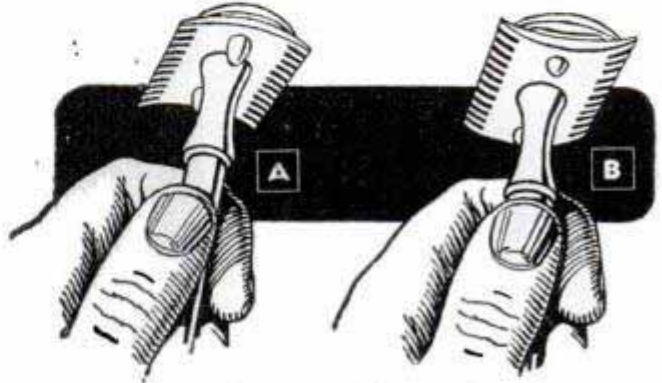

the guard and reassemble as indicated in detail B. Detail A shows the normal assembly of the razor, which leaves blade edges unprotected by the guard.

J. B. Wallace, Armstrong, B. C., Can.

Windshield Wiper Spreads Glue



Should you have a large surface to cover evenly with liquid glue, try using the blade from a windshield wiper as a spreader. No glue is wasted and an even coat is obtained over the entire surface. This method is ideal for cloth, sandpaper, sheet rubber or other materials that are to be mounted on a stiff surface.



ALL-PURPOSE BENCH for light repair work

Ideal for appliance or radio trouble-shooting. Multiple current outlets bring five different voltages within easy reach

By Wm. B. Swindells

THIS sturdy bench can be fitted with a full complement of electrical outlets for testing and repairing meters, telephones and teletype machines, as well as radio equipment. As in the wiring diagram, Fig. 3, outlets are arranged on the back panel to provide 6 and 12-volt d.c., 110 and 220-volt a.c., and 110-volt d.c. The 6 and 12-volt d.c. is supplied to the outlets by storage batteries. One 12-volt battery can be used to supply 12-volt current. When you want 6 volts, simply clamp one lead to the negative terminal post and the other to the connecting strap between the third and fourth cells. Or, use two 6-volt batteries connected in series for 12-volt current, and one for 6-volt current when required.

The heavy bench frame, Figs. 1 and 2, is made from yellow pine in 2 by 4, 4 by 4 and 2 by 6-in. sectional sizes. Side and end rails are joined to the top ends of the 4 by 4-in. legs as in Fig. 1. The bottom rails are mortised into the legs to a depth of one-half the thickness of the rail. Parts are joined with waterproof glue and 3½-in. No. 14 flat-headed screws. A shelf can be provided as shown, with or without a backing board, or arranged in any other manner that suits the needs of the user. Neither the top nor the frame are dimensioned for length and width as the bench can be made any convenient

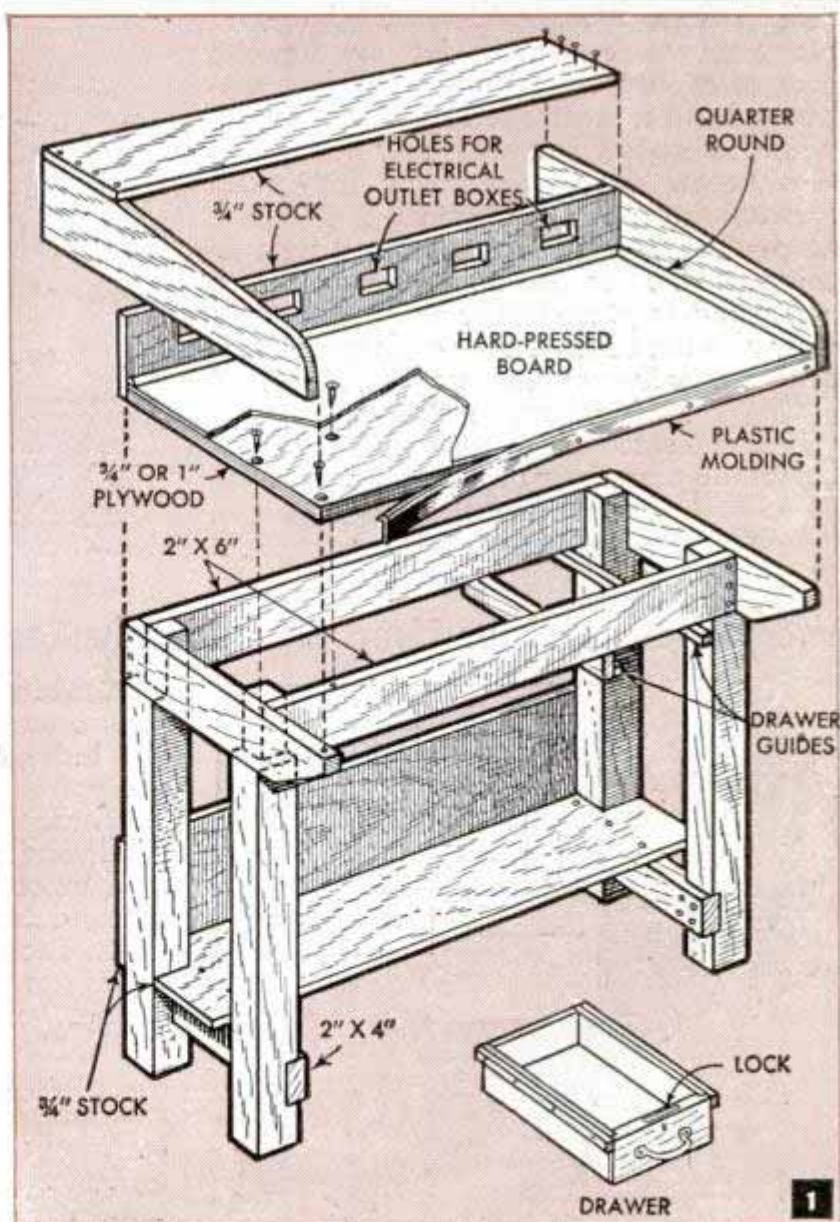
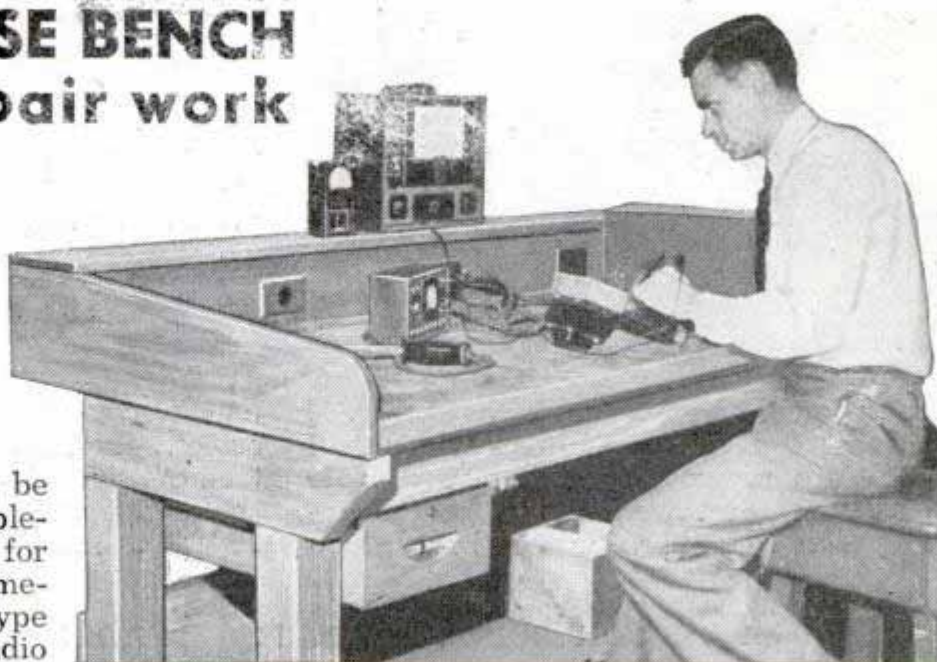

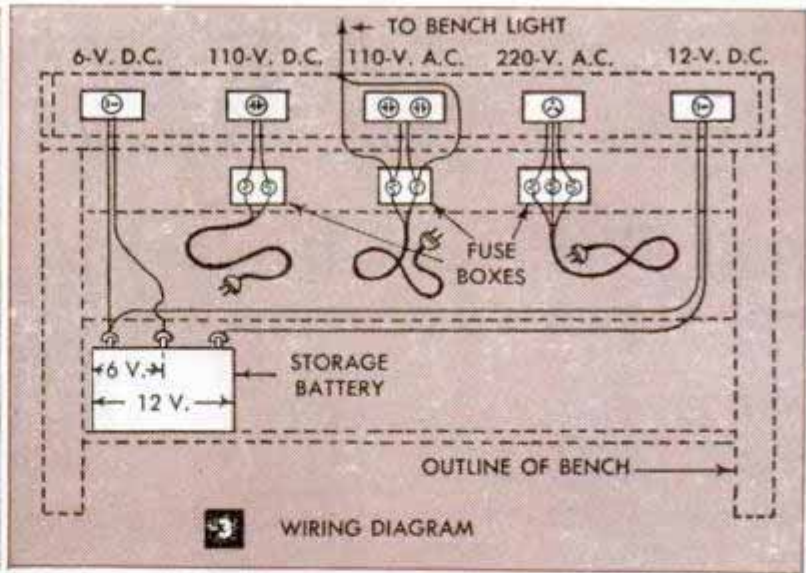
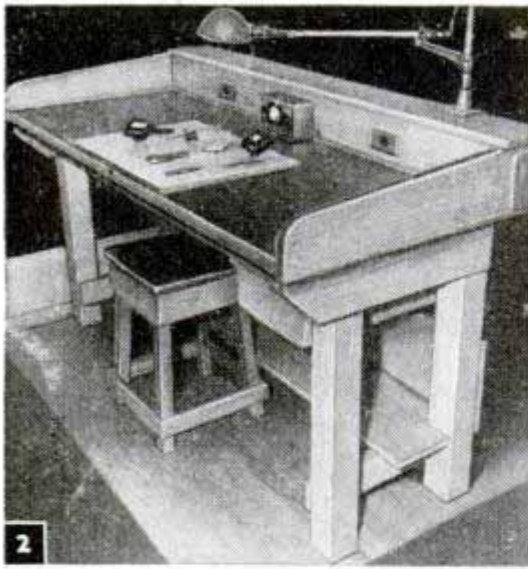

size, using the same plan of assembly. If the top is longer than 60 in. or wider than 24 in., 1-in. plywood should be used. Note that the top is screwed in place before covering with $\frac{1}{4}$ -in. hard-pressed board. Fas-

ten the covering to the top with linoleum cement, then trim the edges square and attach the side wings, the back panel and top shelf. Openings for the outlets are arranged to suit the convenience of the user.

Position of Blind Holes Transferred With Socket-Head Setscrew

Transferring the position of blind stud holes from one piece of work to another can be done accurately with socket-head setscrews. Drill a master hole in the work to be marked to register with any one of the blind holes. Turn a setscrew into each blind hole to the depth indicated at C. Let one project to engage the master hole as shown at B. Then the hole in the piece to be marked is placed over the master setscrew and the surface over each of the other setscrews is struck sharply as shown at A. The blow will cause the cup-shaped head of the setscrew to cut a clear impression on the underside of the work. Spot the center of impression with a prick punch.

Charles E. Pilon, Newport, R. I.

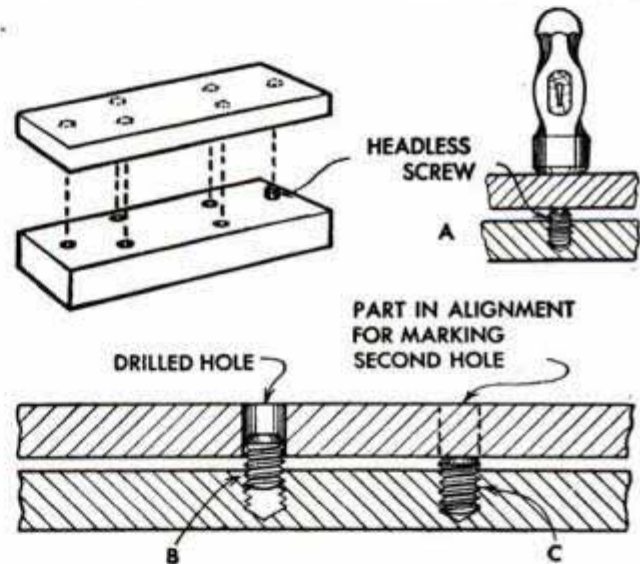

Emery-Cloth Holder Used Like Steady Rest to Polish Turned Work

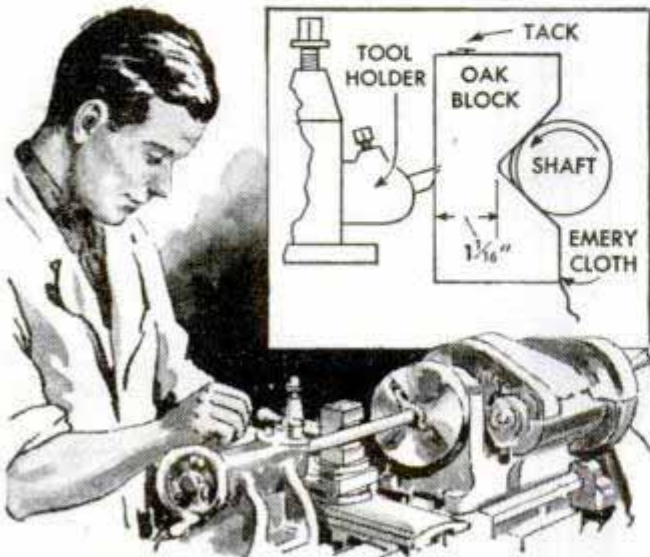

Polishing a shaft with emery cloth is a slow and tedious job when done by hand in a lathe, but with this holder much effort is eliminated and a finished job will result. The holder, which is a block of oak or other hardwood, has a V-notch cut in one side to fit against the shaft, the size of the notch being determined by the diameter of the shaft. Tack the strip of emery cloth to the top of the block only so that it will be loose enough to adjust to the curvature of the work. The block rests on the compound slide and is pressed against the work by the tool and holder. The carriage may be fed by hand or by automatic feed. Some additional hand polishing may be necessary to put the final finish on the shaft.

Wire Chain Produced Quickly With Simple Jig

Custom-made wire chain, suitable for operating small experimental models and other devices equipped with sprockets, is produced in a jiffy with this little bending jig. It consists of a hardwood block, A, grooved and slotted as shown in Fig. 1, and faced with a metal jaw, B. The thickness of the jaw should be slightly greater than the wire. Each link is shaped like a hairpin by bending it over a 1/2-in. rod. Then it is clamped in the jig and the rounded end is flattened as indicated in Fig. 2. After this, the jig is turned upside down and the ends of the wire are bent over the rounded edge of the metal jaw and cut off. In joining the links, the hook ends are closed over the preceding link with pliers. Be careful not to crimp them too tightly, as the completed chain must be flexible.

Fig. 3 shows a simple method of making sprockets. First, a metal disk is turned somewhat larger than the desired sprocket, after which the actual diameter is scribed on the face of the disk. Next, points are located equidistantly around the circumference, spaced to equal the link pitch of the chain, and holes are drilled at these points. Finally, teeth are formed by simply cutting through on the scribed line. The sprocket hub is turned separately and riveted.—T. W. Cleaveland, Weston, W. Va.

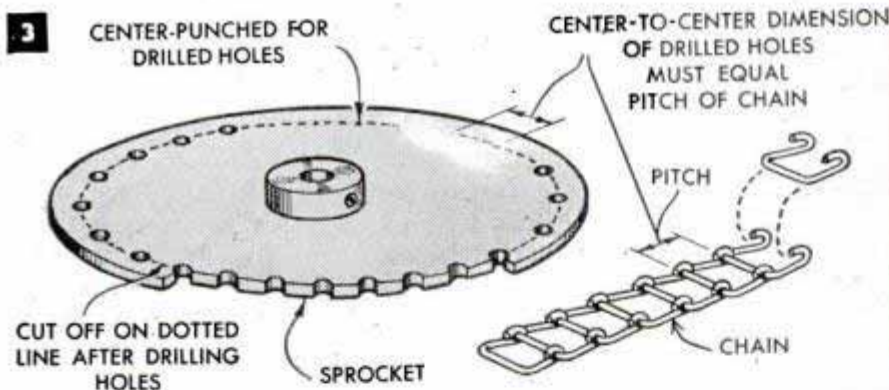
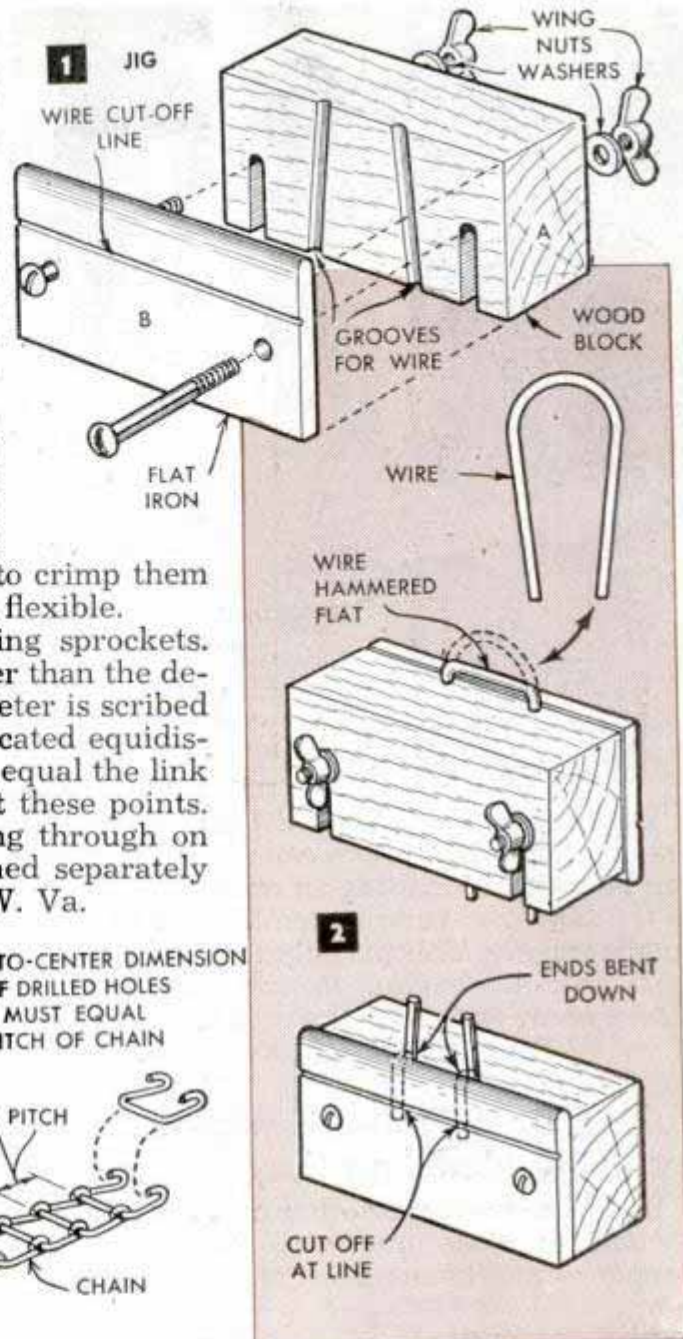

Adjustable Stop Attached to Handsaw Regulates Depth of Sawcut



Handsawing the sides of a dado to uniform depth is a simple operation if the saw is fitted with this adjustable depth stop. Simply set it for the depth you want and keep sawing until the stop contacts the work. The stop is especially handy when cutting dados in wide boards as it assures the cut of being the same depth the entire distance. The stop is made of three pieces of flat iron riveted together for a friction fit, and is attached to the back of the saw with screws and wing nuts. The important thing in fitting the stop to the saw is to see that it is parallel with the cutting edge. To assure this, drill both end links of the stop at one time, and clamp the assembled unit to the saw, even with the teeth, to locate the holes for attaching.

Extra Drift Slot for Taper Sleeve Speeds Removal of Drill

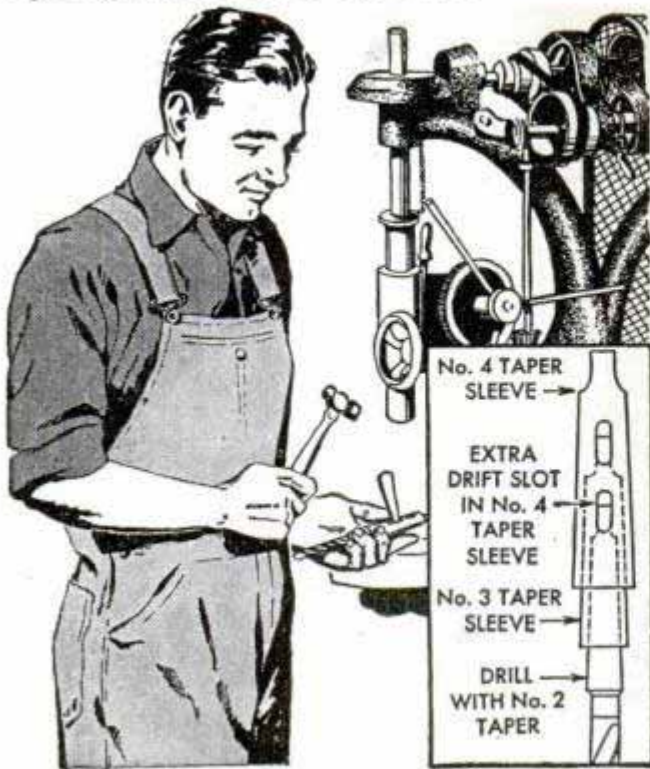

When using small taper drills and reamers in a large drill press, considerable time can be saved by cutting an extra drift hole in the large sleeve to match the one in the smaller sleeve. This permits removal of the drill without having to take the taper sleeve apart each time the drill is changed.

Alvin O. Nelson, Fargo, N. Dak.

Taking Data From Nameplates By Using Modeling Clay

If electric motors or other machinery are located in close quarters, sometimes it happens that nameplates are difficult to

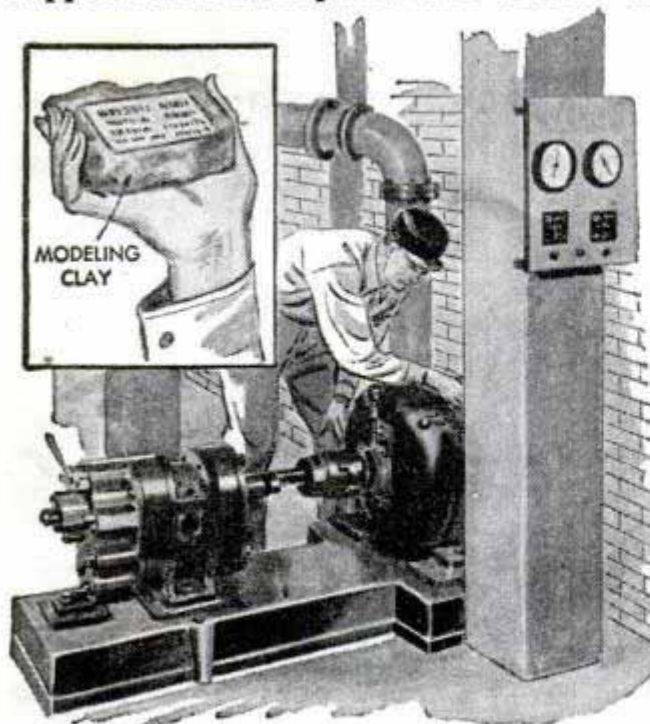

read because they are against a wall or other obstruction. If necessary data, such as current characteristics, horsepower, etc., must be obtained, this can be done by pressing a piece of modeling clay against the nameplate. Although the impression shows the letters in reverse, it can be read by holding the clay up to a mirror.

Better Way to Tap Thin Metal

To obtain greater depth of thread when tapping thin sheet metal, drill an undersize hole and enlarge it to the proper diameter with a tapered punch. A small line scribed around the punch

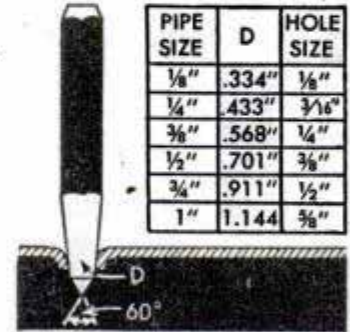

will serve as a guide in determining how far to drive the punch for any particular size of hole. For pipe threads, the taper on the punch should be the same as the taper on the thread. The table shows the size hole to drill, and the enlargement to make with the punch, D, for the pipe sizes indicated in the left-hand column.

Bolt Head Can't Turn in T-Slot If Fitted With Special Washer

Should a T-slot in a machine table be too large for the bolts on hand, so that the heads turn in the slot when being tightened or loosened, a standard washer can be cut and

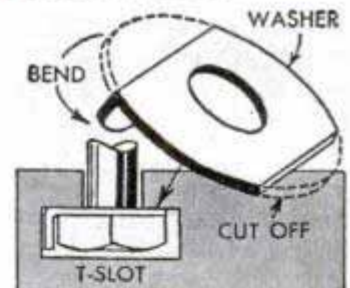

bent to prevent this. The upper detail indicates the method of cutting and bending, and the lower one shows how the washer is placed on the bolt and set in the table.

Earl R. Goddard, Denver, Colo.

Slats Fasten Temporary Fencing

Putting up fencing for temporary use is easy when slats and nails are used instead of staples. The job is done quickly and, when the fence is to be taken down, all that you have to do is remove the slats by pulling out the nails.

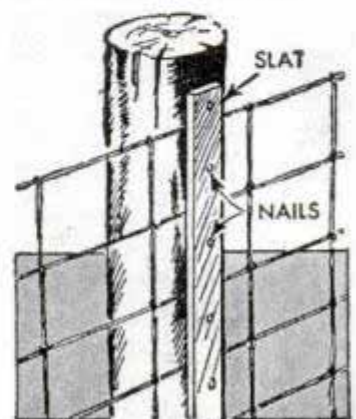

10-in. TABLE SAW HAS TILTING ARBOR

Power Tools

WITH THE SAW completed to the stage described in Part I, the assembly is ready for installation of the arbor-tilting mechanism, Fig. 17. Here the handwheel drives the tilting screw through miter gears which are $1\frac{1}{2}$ pitch diameter, 12 pitch, 18 teeth with a $\frac{7}{16}$ -in. face. A frame, assembled from flat iron, supports the handwheel-shaft housing and the miter-gear drive. As will be seen from Fig. 17-A, this frame consists of two angle brackets and one straight support piece, the latter mortised into the leg of the frame. Both the

Part II



By Elman Wood

larger angle bracket and the flat support are slipped over the ends of the handwheel-shaft housing, bolted temporarily in place and checked for alignment. Then the pipe housings are tack welded to the brackets in the positions shown in the sectional view, Fig. 17-A. Bolts and screws hold these two parts in place when the assembly is made. Notice that the second angle bracket forms a frame for positioning the miter gears and that it pivots on the projecting end of the handwheel-shaft housing, Fig. 17-A. It is held in place by the driving miter gear,

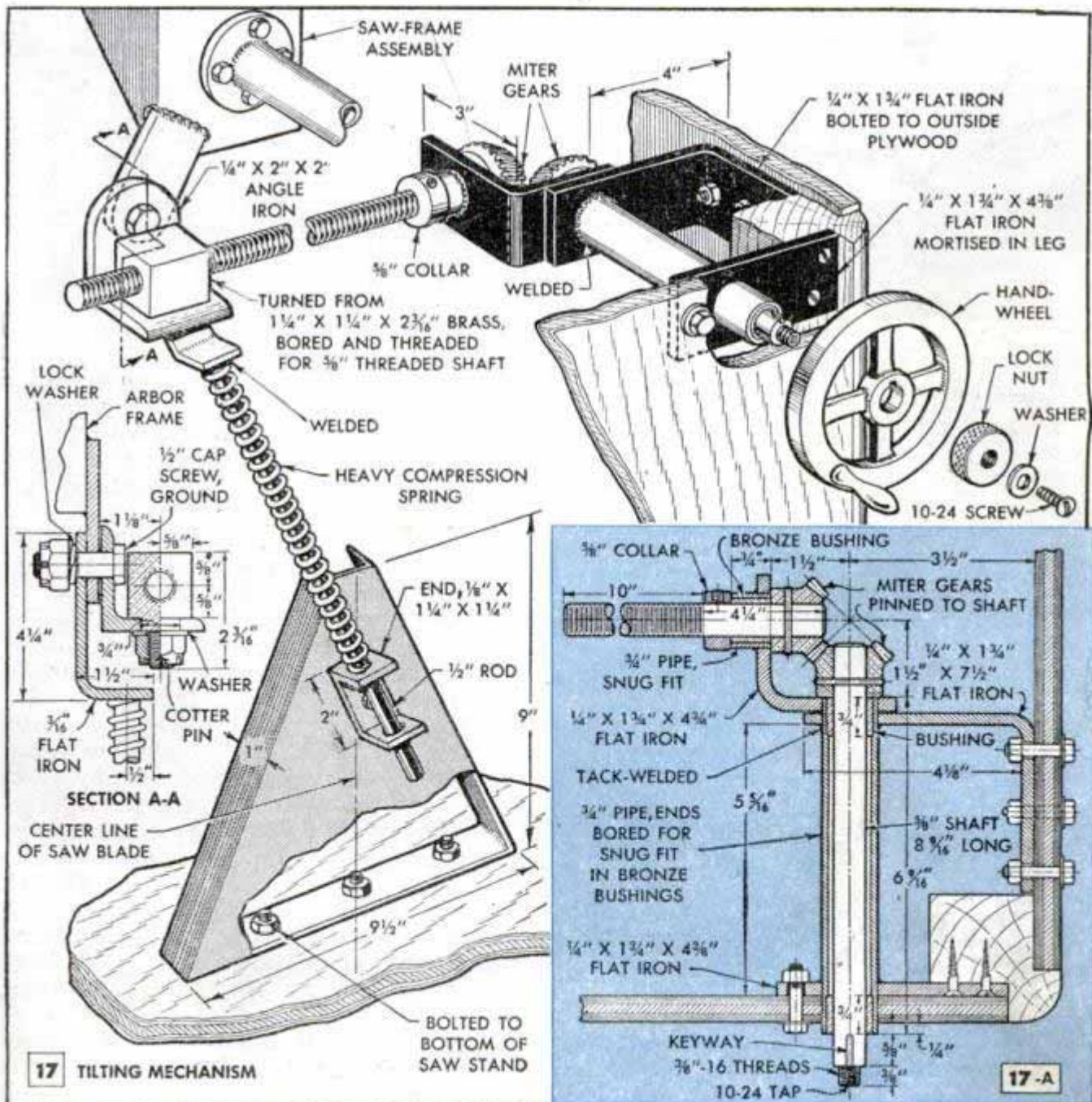

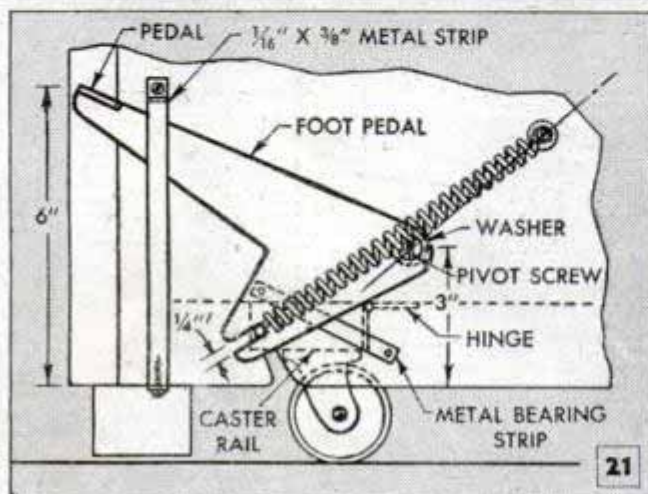
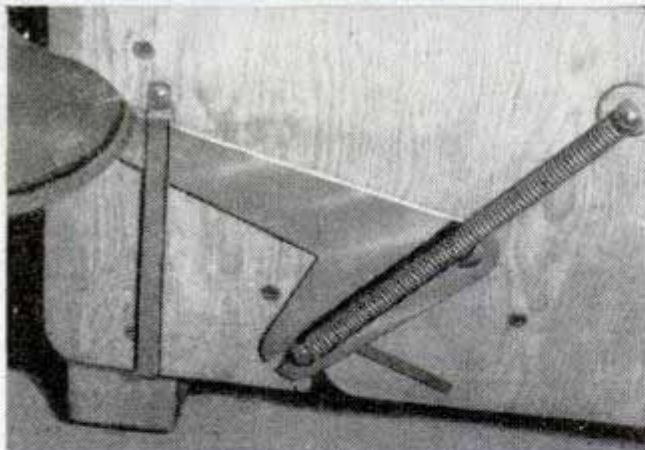
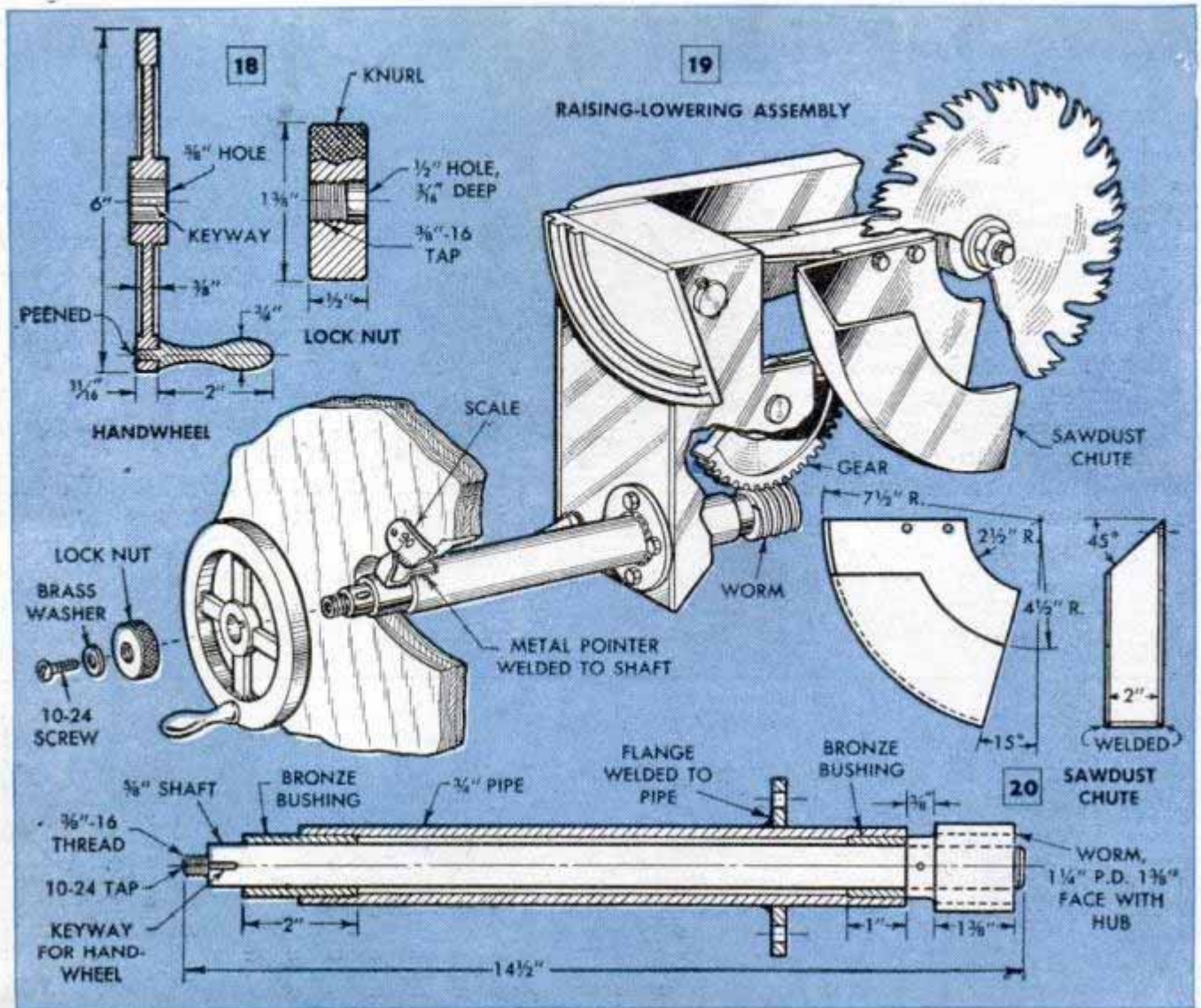

which is pinned to the handwheel shaft. Likewise, the driven gear is pinned to a threaded tilting shaft. Pivoted in this way the shaft and gears can swivel with the arbor frame when it is tilted to any angle up to 45 deg. The tilting shaft is threaded with a 5/8-11 thread.

The tapped block, into which the threaded tilting shaft turns, is bolted to an angle bracket that pivots on the tilting lug welded to the arbor frame. This end of the tilting assembly is carried on a spring-loaded toggle supported by a triangular metal bracket bolted to the bottom of the saw stand as in Fig. 17. The toggle partially supports the weight of the motor and arbor through the 45-deg. tilt and thereby eases the load on the tilting handwheel. The toggle-spring guide rod is welded to an angle bracket bent from flat iron and bolted to the tilting lug as in section A-A, Fig. 17. Handwheels and knurled lock nuts for both the raising-and-lowering and the tilting mechanisms are detailed in Fig. 18. Both are keyed to the shaft in the same way, Figs. 17 and 19.

The worm shaft and housing, not fully described in Part I, is detailed in Fig. 19. It is similar to the tilting-gear shaft and

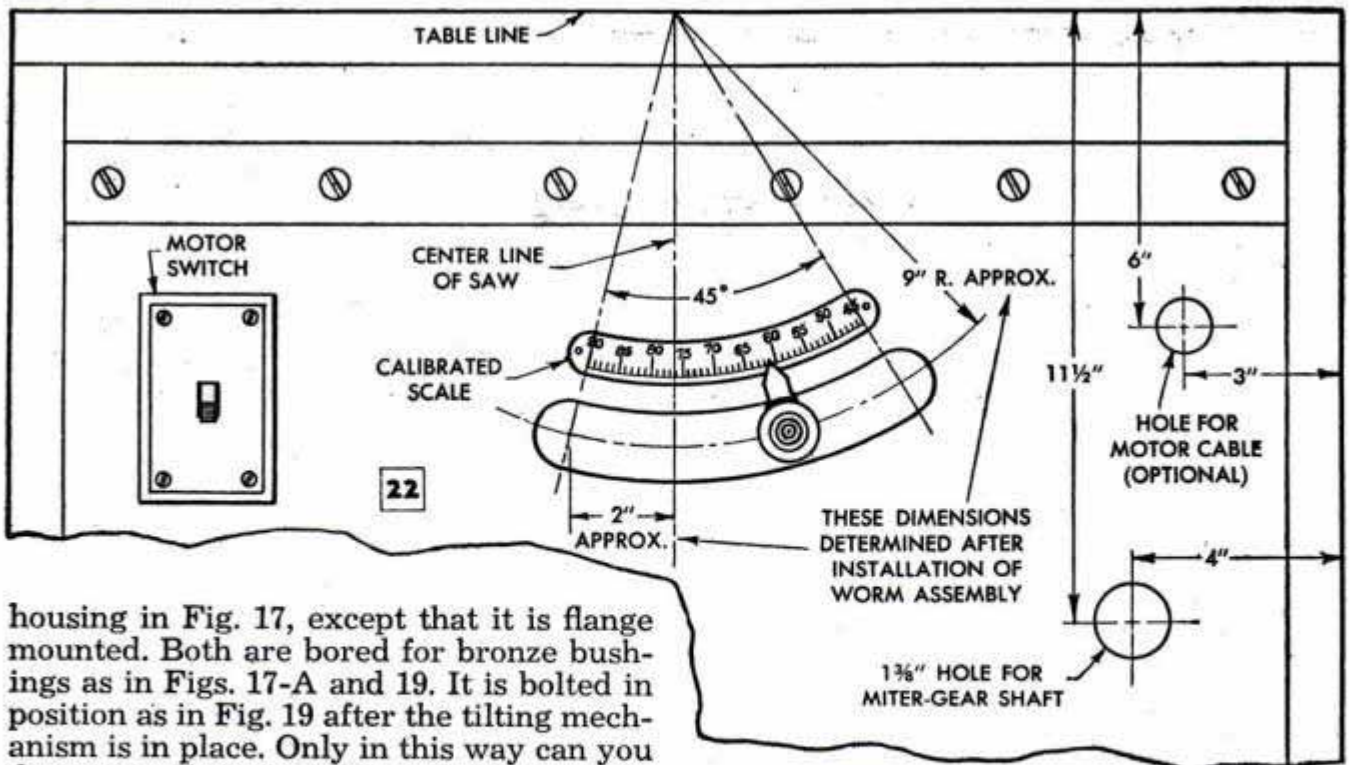

housing in Fig. 17, except that it is flange mounted. Both are bored for bronze bushings as in Figs. 17-A and 19. It is bolted in position as in Fig. 19 after the tilting mechanism is in place. Only in this way can you determine the exact dimensions and location of the curved clearance slot in the front panel of the saw base, Fig. 22.* The best way to determine the exact location of the curved slot and the location of the hole for the miter-gear shaft in the front plywood panel, is first to assemble the tilting mechanism, as in Fig. 17, with the flat support plate attached to the leg with screws, as shown. This will support the completely assembled mechanism in place. Then it is easy to determine the location of these openings in the front panel. After the

slot has been located and cut and the hole for the miter-gear shaft has been bored, the panel is screwed permanently in place.

The calibrated scale, Fig. 22, can be made from thin sheet metal with figures and divisions stamped into the metal by hand with a numeral stamp of the type used for stamping numerals on tools. For stamping the divisions, a 1/4-in. lathe bit ground to a blunt chisel edge will do. The degree scale must be laid out very accurately, and care should be taken when stamping not to cut

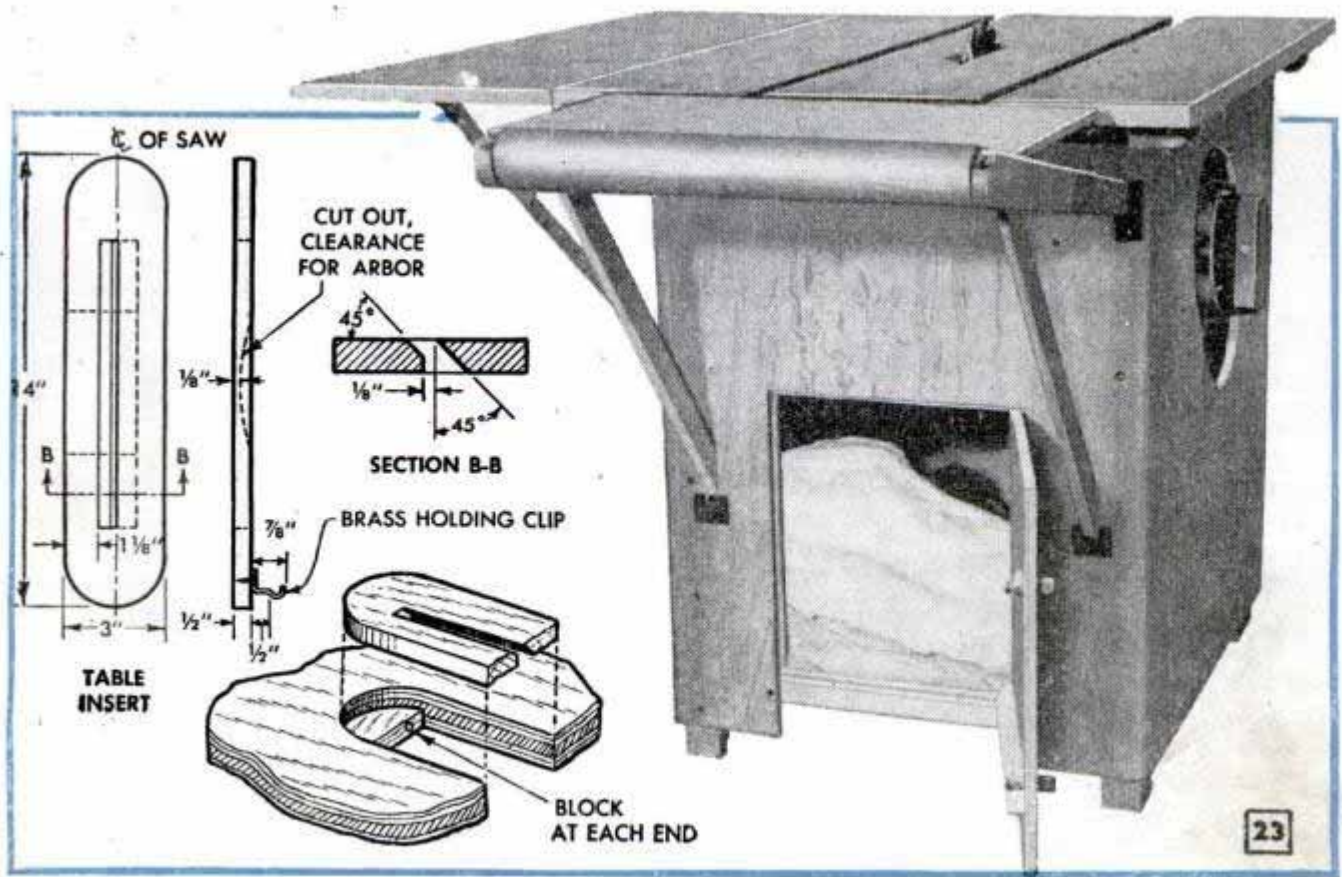

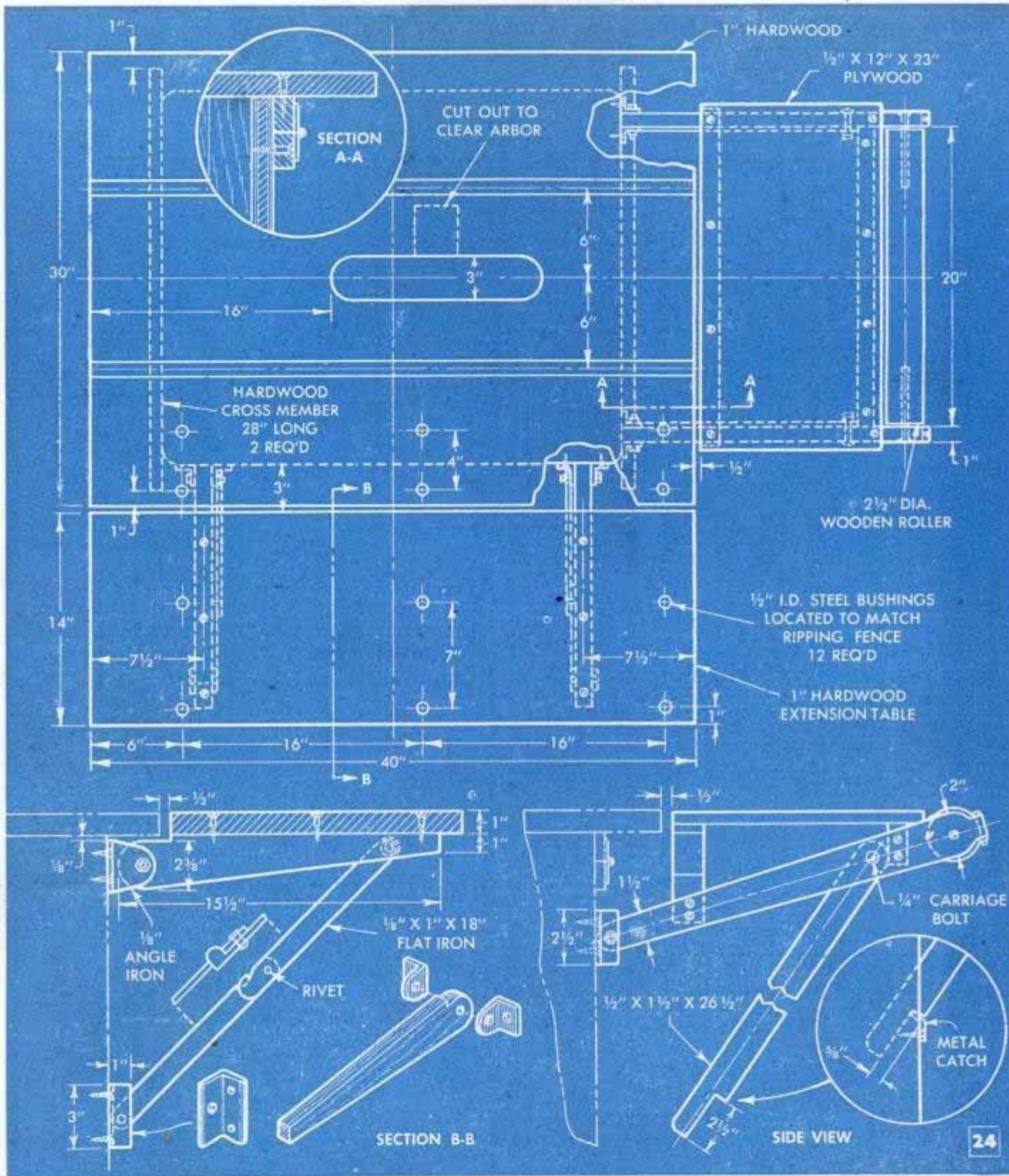

the numerals or divisions through the metal. To make the scale easy to read, coat the face with black enamel and allow to dry. Then follow with a thin coat of white. Wipe this off immediately with a single quick sweep of a dry cloth. This will remove all the white enamel except that in the indentations. After the enamel has dried, locate the 45 and 90-deg. positions of the saw blade and position the scale accordingly. Attach it to the panel with small screws. Cut a pointer from heavy-gauge sheet metal and weld it to the worm-shaft housing as

in Figs. 19 and 22. The sawdust chute, detailed in Fig. 20, is optional, its only purpose being to direct dust and chips to the rear of the enclosed base. If you do include the chute, make it from heavy sheet metal, welding where indicated in Fig. 20. Bolt it to the arbor frame in the position shown in Fig. 19 and be sure to allow for ample clearance when the saw is tilted 45 deg.

The table can be made from 1-in. plywood, but it is better to build it from strips of 1-in. hardwood doweled and glued. The most attractive job is made by gluing up

alternate 1 by 1-in. strips ripped from hardwoods of a contrasting color. Otherwise, using one wood such as maple, dowel and glue together 1-in. strips, each no wider than 2 in., to make the required table width as given in Fig. 24. Make the extension drop leaf in the same way and of the same material. After gluing, run grooves for the crosscut guide and cut an opening for the blade insert as in Fig. 24. Make and fit the insert as detailed in Fig. 23. Attach the table to the base as in Fig. 24, section A-A, checking to assure that the crosscut-guide grooves are aligned with the blade. Fig. 24, section B-B, shows how the side extension is mounted on the saw base. The back extension, Fig. 24, is optional equipment.

Use a regular crosscut guide or make one as in Figs. 25 and 26. Details on the hardwood ripping fence, Fig. 27, are self explanatory. Casters detailed in Fig. 21 also are optional. The lifting mechanism for each set of casters is fitted on diagonal corners of the base.

(The End)

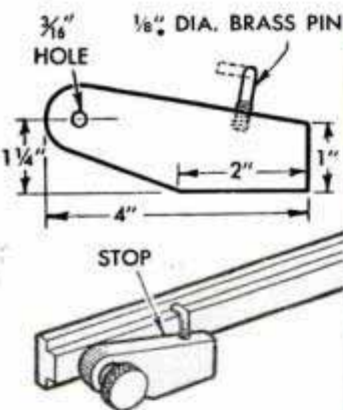

26 CROSSCUT GUIDE WITH STOP

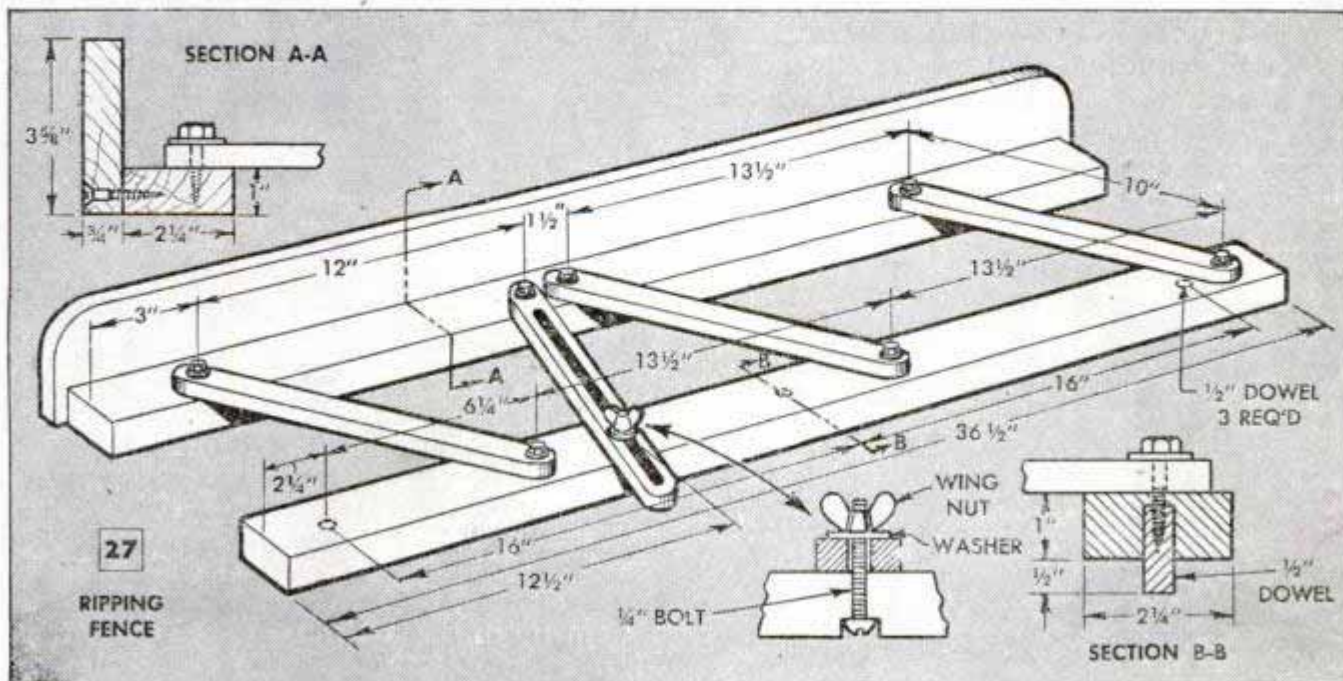
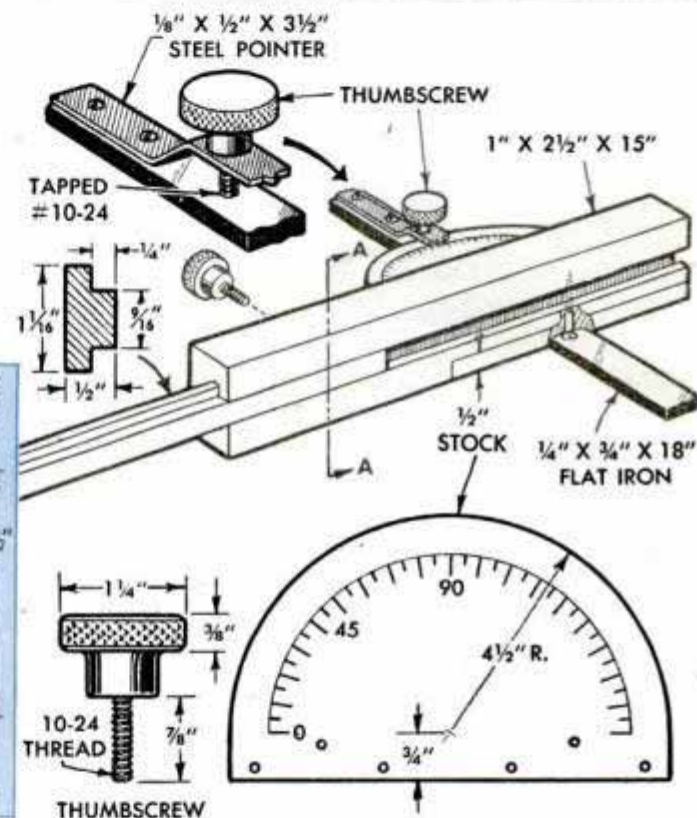
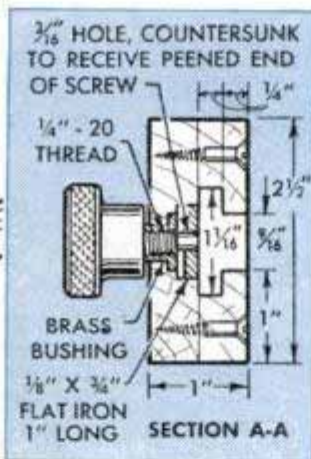

Cattle Guard Eliminates Need for Gate On Road Running Through Pasture

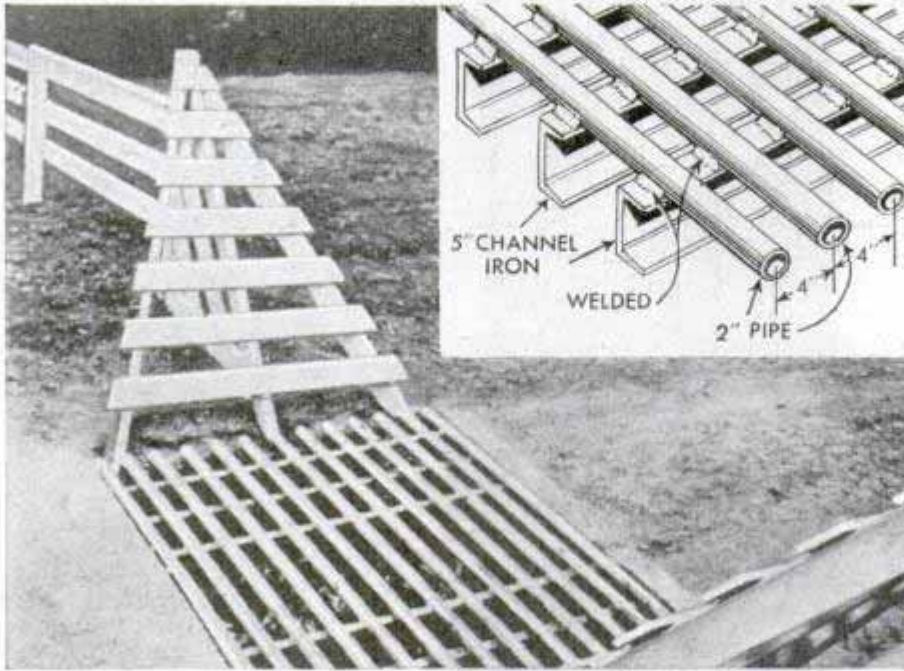

On large farms and ranches, where private roads and little-traveled highways run through pasture or grazing land, this guard will keep cattle confined to fenced-in fields. It will save a lot of time for farmers and ranchers who, otherwise, would have to open and close gates when driving or walking from one field to another. To make and install the guard, dig a trench approximately 6 ft. wide, long enough to extend across the road and several feet deep. Line this with concrete slabs or blocks and embed the ends of six 5-in. channel irons to serve as cross members. Space the channels so they will bear

Locating Cracks in Machinery

Often it's difficult to find small cracks in machinery castings and, although invisible to the naked eye, in time they can cause serious breakdowns or accidents in the shop. To detect minute cracks, a thin mixture of gasoline and red lead will be helpful. Wipe clean the surface to be tested and apply the solution. After the mixture has evaporated, go over the machine with a clean rag. If any cracks are present, they will be marked by a thin line of red lead.

Installation of Porcelain Sockets Speeded With Hole Punch

Having the job of installing a number of 2-piece porcelain sockets in a sheet-metal trough to be used as a lighting fixture, one workman made a punch to cut the holes and speed the job. For these particular sockets, 1¼-in. steel pipe was used for the punch, one end being ground to a sharp cutting edge.—J. Modroch, Danbury, Conn.

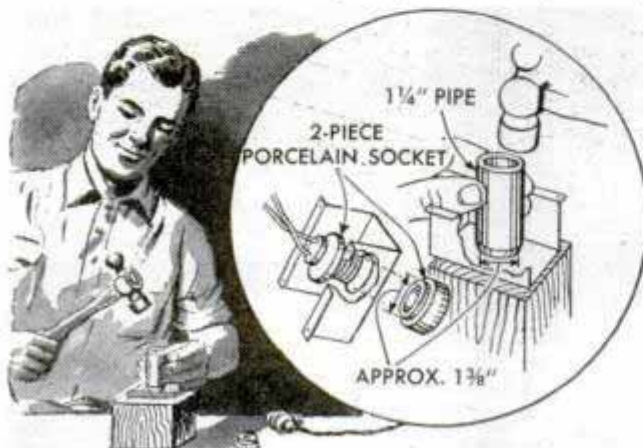

equally the weight of vehicles crossing the guard. Then cut 13 lengths of 2-in. pipe and weld them to the tops of the channels, spacing them on 4-in. centers. The base of the fence should extend to ends of the guard.

Springs at End of Guide Line Serve to Keep it Taut

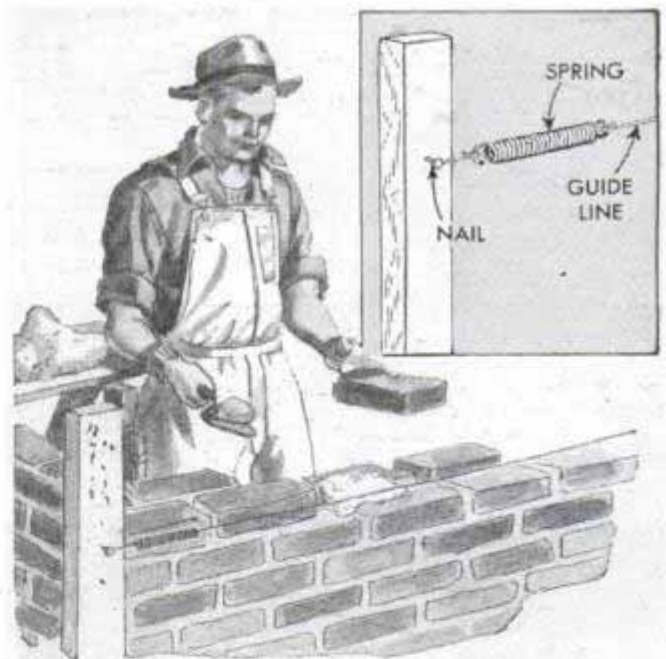

Small coil springs attached to the ends of a guide line and fastened to wooden uprights, will keep the line tight when laying bricks or concrete blocks. Without the springs the line will sag and stretch.

☐ If the tip of a screwdriver is coated with valve-grinding compound, it is less apt to slip when being used.

Feeder for Pullets On Range

Two outstanding features of this range feeder for pullets are the overhanging roof, which will keep feed fairly dry, even in a driving rain, and the base, which supports the hopper off the ground and provides perches from which the birds can feed. Because the feeder comes in several sections, it is easy to dismantle for cleaning. No construction dimensions are given, but the unit shown is 5 ft. long and will hold a day's supply of feed for about fifty growing pullets. Note that the base should be about 3 or 4 in. high to keep the hopper far enough off the ground. Allow sufficient roof overhang, but do not make it so low that it will interfere with feeding. When used with a 9 by 12-ft. shelter, three feeders accommodate 125 to 150 birds. — Norman R. Clizer, Columbia, Mo.

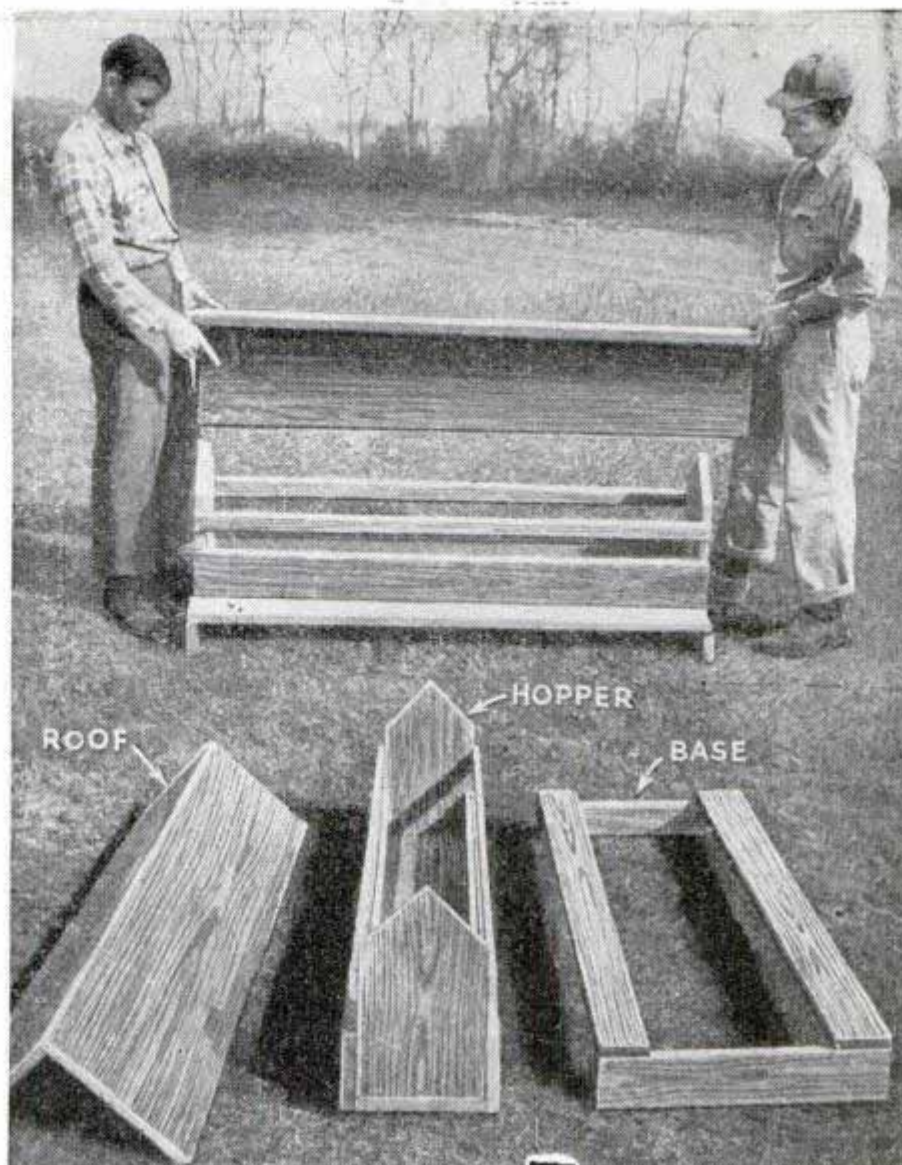

"Hot" Wire Removes Broken Key From Car Lock

If you have ever "fished" unsuccessfully for a broken ignition key, either in the door or the ignition lock, you can appreciate any simple method of removal. Here is the way one mechanic does it in a matter of seconds: Bare the ends of a piece of heavy insulated wire which is long enough to reach from the car battery to the lock. Attach a

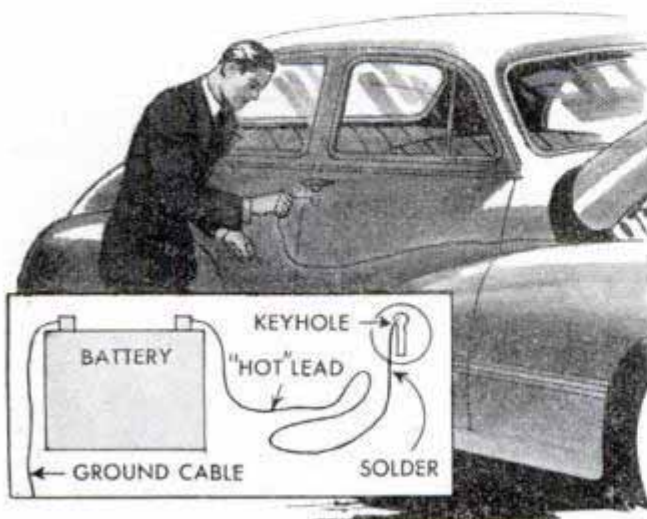

short length of wire solder to one end of the insulated wire. Trim the free end of the solder to a long point and wrap with friction tape, leaving only about $\frac{1}{8}$ in. of the pointed end exposed. Have a helper hold the other end of the wire on the ungrounded post of the battery by pressing it against the post with a piece of wood to make good contact. Then insert the solder tip into the keyhole, being careful not to let it touch any part of the lock. The instant the solder tip touches the end of the broken key, a "dead" short will melt the solder and "tack" it to the key. At the same time the helper must release the wire from the battery post, otherwise heat from the short will continue to melt the solder and may cause it to flow into other parts and "freeze" the operation of the lock. Care must be taken to avoid this possibility.

Frederick W. Jenchen, Englewood, N. J.

☐ To clean and oil a metal straightedge used for trimming wallpaper, use steel wool and petroleum jelly. This is better than using oil, which may stain the paper if the straightedge is not cleaned thoroughly before it is used.

BRAZING TORCHES USE

A vacuum cleaner supplies air for operating these simple gas torches, which are designed in two sizes to cover the widest range of light brazing, silver soldering, soft soldering, annealing and hardening

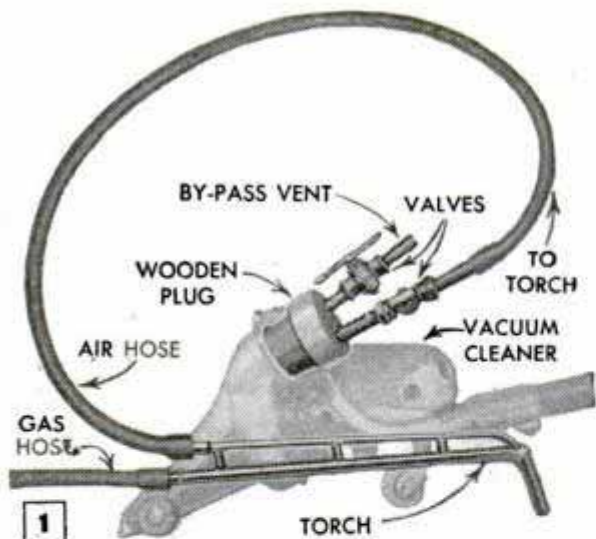

CONNECTED to any source of illuminating gas and supplied with air from a vacuum cleaner, these torches give sufficient heat to handle any ordinary brazing job. Silver soldering, soft soldering, annealing, hardening and tempering also can be done with either size. The torches will not operate on acetylene gas or "bottled" gas.

Both torches are very similar in construction, the only essential difference being in the size of copper tubing used to conduct air and gas to the tips. Figs. 4 and 5 detail the construction. It is impractical to bend tubing to the sharp radius required to form the torch tip, so to save time simply cut an 82-deg. notch in the tube as in Fig. 2. Be careful not to cut into the wall of the tubing at the bottom of the notch. Leave the wall full thickness at this point. Then bend to the position shown by the dotted lines in Fig. 2, and silver solder the joint as in Fig. 3, using a gasoline blowtorch. Place the work on a couple of bricks while heating the joint. The air tubes can be bent by hand to the required radius. Drill a hole just back of the joint in the gas tube for insertion of the air tube. It is important that the air tube project into the tip of the large torch the distance shown in Fig. 5 and that it be exactly centered in the larger gas tube. Wedge it in place before silver soldering the joint at the point where it is inserted

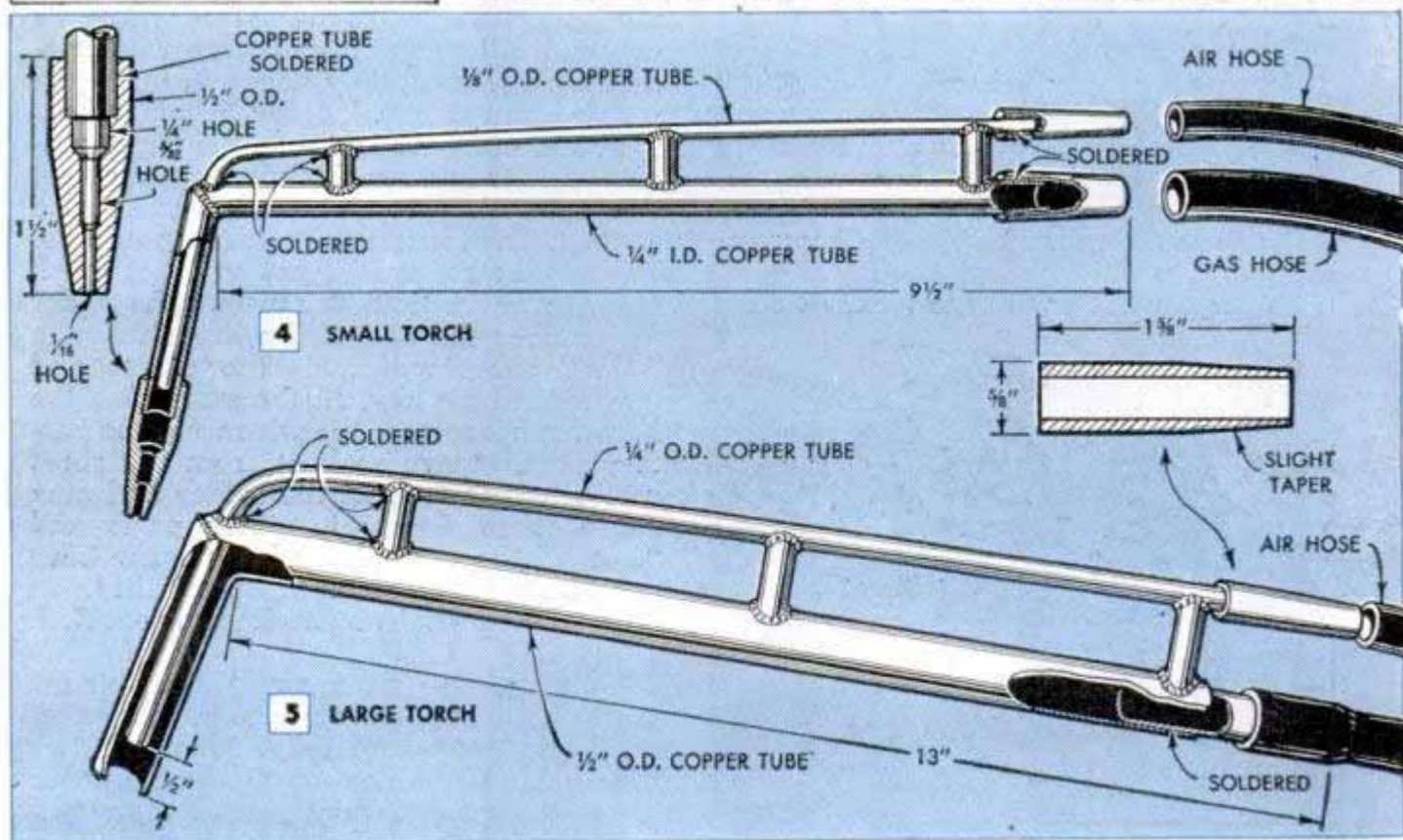
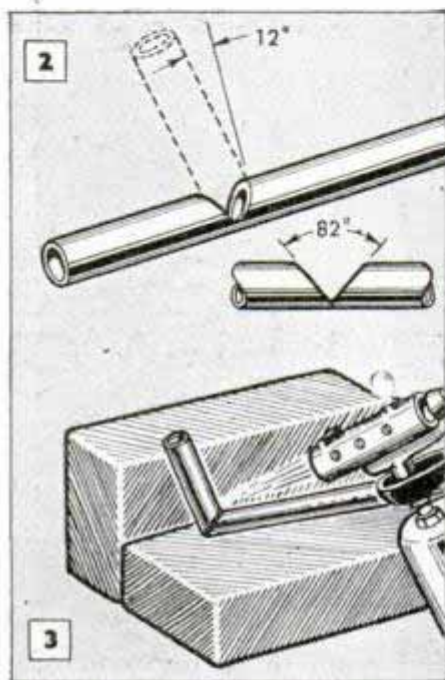

ILLUMINATING GAS

By Edward J. Thatcher

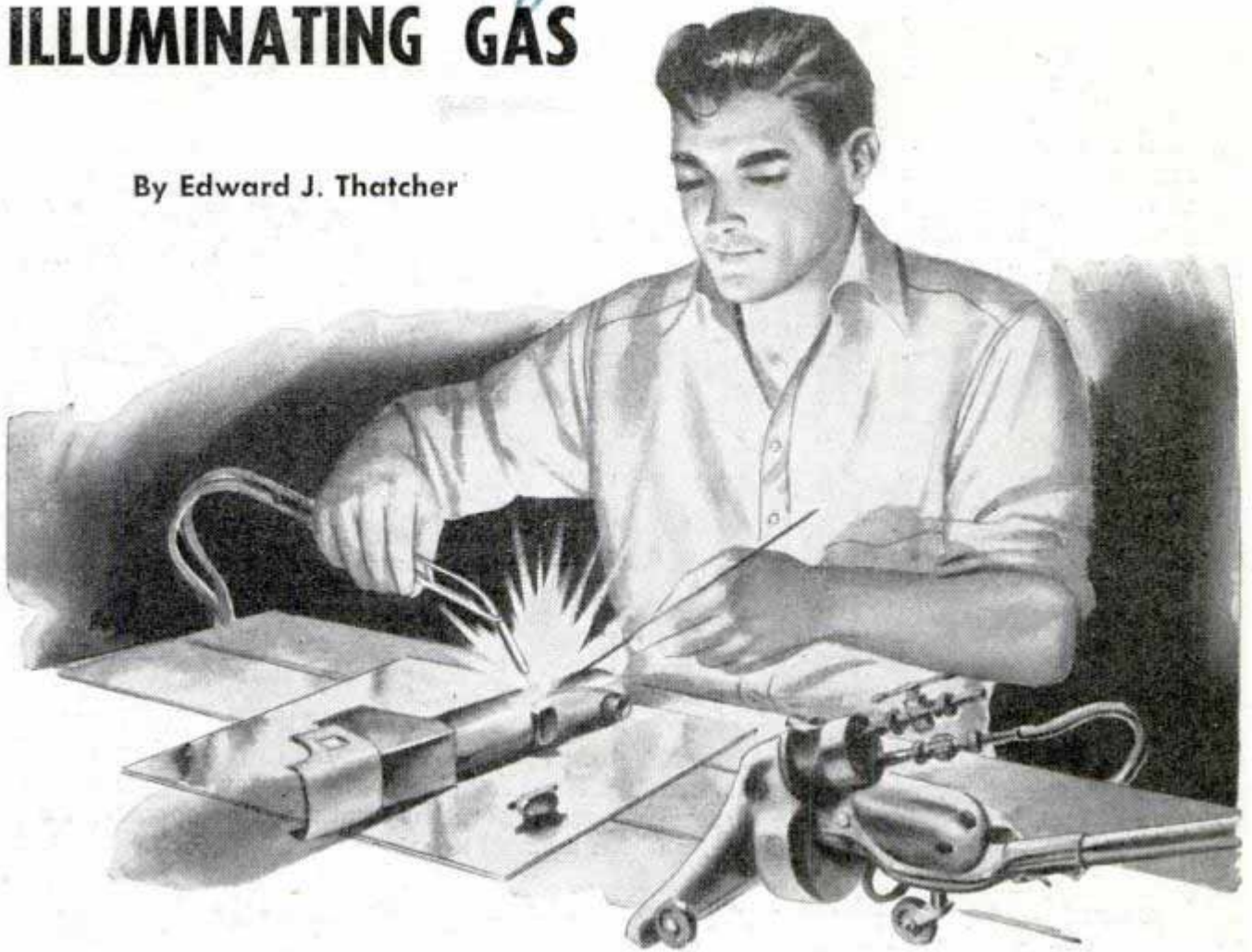

in the gas tube. Joint should be gas-tight.

The three spacers along the length of each torch between the air and gas tubes are short lengths of tubing, silver soldered to both tubes to hold them securely in position. The small torch, Fig. 4, has a separate tip counterbored in four steps as shown in the sectional view. This tip is silver soldered to the gas tube after the latter has been formed.

The air and gas tubes on both the large and small torches are fitted with tapered sleeves turned from thick-walled brass or copper tubing. These are silver soldered to the tubes as in Figs. 4 and 5. Note that one sleeve fits inside the gas tube, Fig. 5. Tapered ends of the sleeves make it easier to connect the lengths of rubber hose which bring gas and air to the torch.

The vacuum cleaner is used without any alteration except for the removal of the dust bag. A wooden plug is turned to fit into the outlet for the dust bag as in Figs. 1 and 8. The tapered end of the plug is covered with felt to prevent air leaks. Two air outlets, each consisting of a pipe nipple, a short length of pipe threaded at one end, and a valve, are turned into holes drilled in the outer end of the plug as in Fig. 8. One serves as a by-pass for excess air. The air hose from the torch is connected to the other. Where more than one torch is to

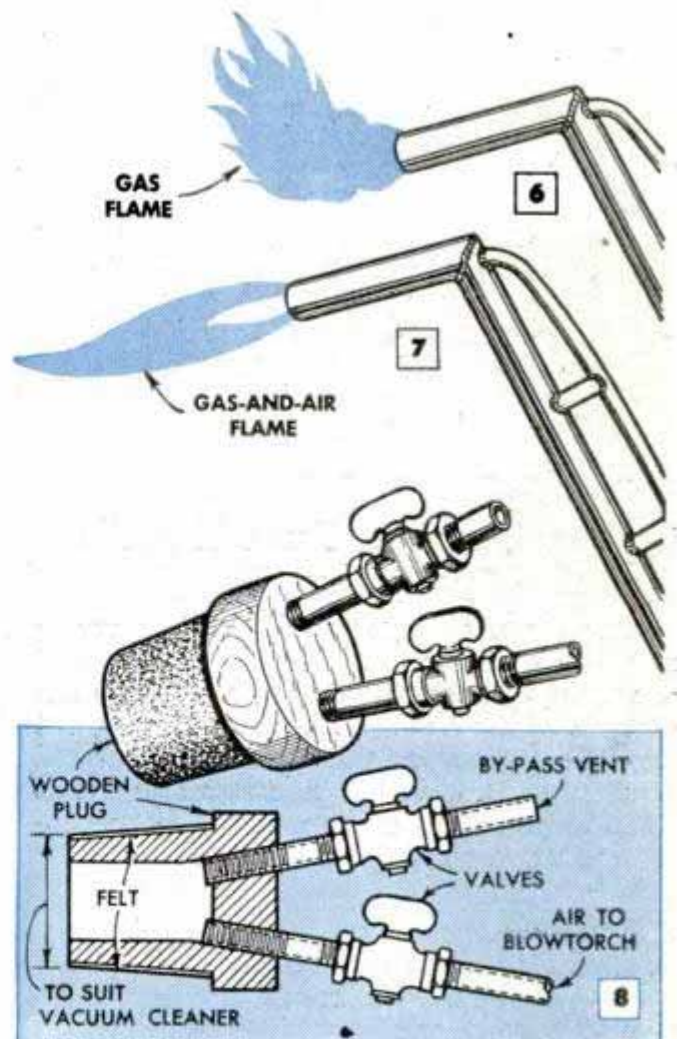

be operated from the same vacuum cleaner, make an air regulator from a gallon can as in Fig. 9. The sliding door in the regulator provides a means of controlling the volume of air supplied to the torches, by-passing the excess through the opening cut in the can.

To use the torches, connect the respective lines to the gas and air, close the air valve at the cleaner and open the by-pass valve. Turn the gas on and light it at the tip, Fig. 6. Turn down until a fairly small flame is produced. Then slowly turn on the air, with the by-pass valve on the cleaner open. Close the by-pass valve slowly, stopping when the pointed flame turns blue as in Fig. 7. Too much air will reduce the heat of the flame and may cause it to "pop" out. It will take some experimenting to produce the proper flame, as

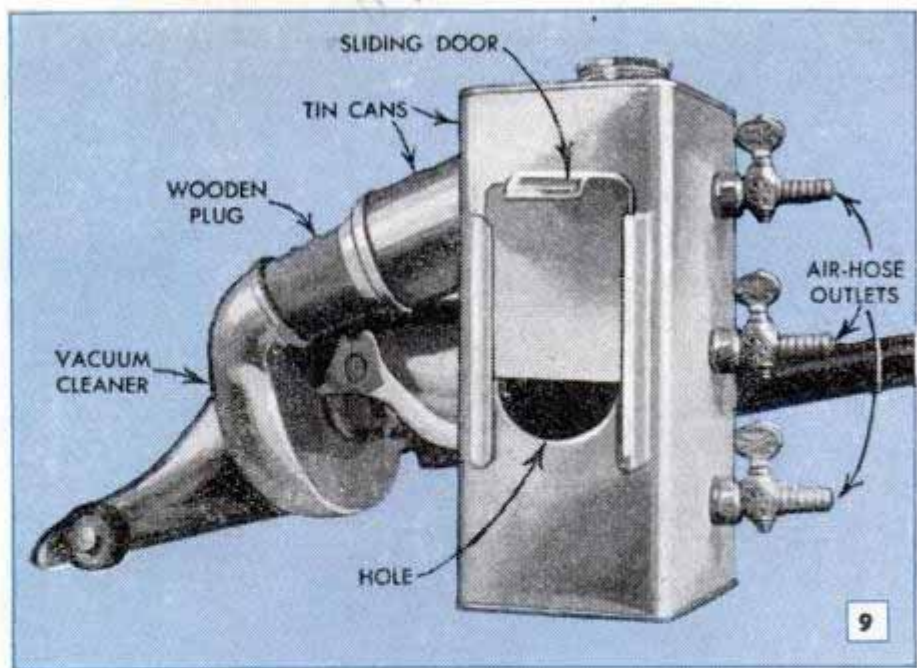

the air pressures are likely to vary with different cleaners.

With proper adjustment, the smaller torch gives a fine, needle-point flame that is ideal for close work on jewelry or model parts where the heat must be concentrated in a small area.



Numbered Strip Pasted on Ruler Helps Check Invoices

Checking invoices or bills can be speeded by using an indicating ruler that will show at a glance the number of items on the bill. Type a vertical row of numbers, 1, 2, 3, etc., on a strip of paper or cloth tape, having them coincide with the spacing of the lines on the invoice to be checked. Then paste the paper on the ruler so that it will not cover the regular markings. Place the ruler as shown in the detail to read the number of items contained in the invoices.

J. G. Schad, Pittsburgh, Pa.

Carbon Removed From Threads By Using Spark Plug

When spark plugs are difficult to screw into the cylinder head and will not seat properly, this may be due to carbon on the threads of the opening. To correct this, cut two V-slots across the threads of an old spark plug, remove the insulator and use as a tap to clean out carbon. It will be necessary to use a wrench on the tap.

☐ If you want to store turpentine for any length of time, keep it in a glass jar. Otherwise, particles of rust from a metal container may become mixed with the turpentine.



Bandsaw Blades Are Brazed By Using Slotted Jig

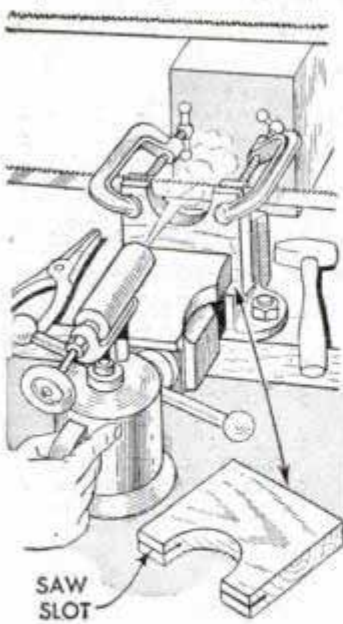

To prevent rapid dissipation of heat, braze bandsaw blades in a wooden jig. Cut a hardwood piece 4 in. wide and about 6 in. long and slot one edge to a depth equal to $1\frac{1}{2}$ times the width of the blade. Then cut a semicircular opening in the grooved edge, centering the opening between the ends of the piece. Bevel the ends of the blade so that they

lap. Place the blade in the jig as shown, centering it in the opening and hold in place with small C-clamps as indicated.

Geo. T. Hewitt, Salem, Ore.

Crochet Hook Handy Tool for Kit

To get at small, intricate parts of an automobile, keep a crochet hook in your tool kit. It will come in handy when removing clips that hold a distributor cap in place or it may be used to "hook" small springs that are part of lightweight rod and lever mechanisms.

Fred R. Brewer, Colorado Springs, Colo.

Carpenter's Steel Square Locates Center of Circle

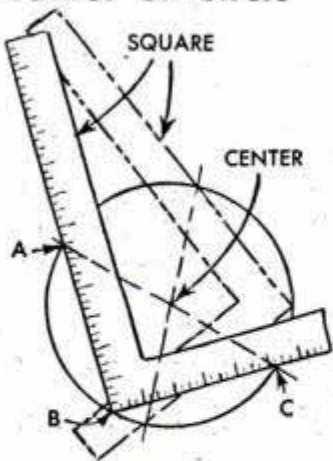

It is easy to locate the center of a circle with a carpenter's square—any circle that the tongue and blade of the square will span. Place the square over the circle in the first position as shown by the solid lines in the detail, with the outside angle or "heel" of the square touching the circle at B. Then mark the points A and C. Turn the square over and place it in the second position shown by the dotted lines. Mark as before and join with pencil lines the points where the tongue and blade of the square bisect the circle. The point where these lines intersect will be the center of the circle.

square touching the circle at B. Then mark the points A and C. Turn the square over and place it in the second position shown by the dotted lines. Mark as before and join with pencil lines the points where the tongue and blade of the square bisect the circle. The point where these lines intersect will be the center of the circle.

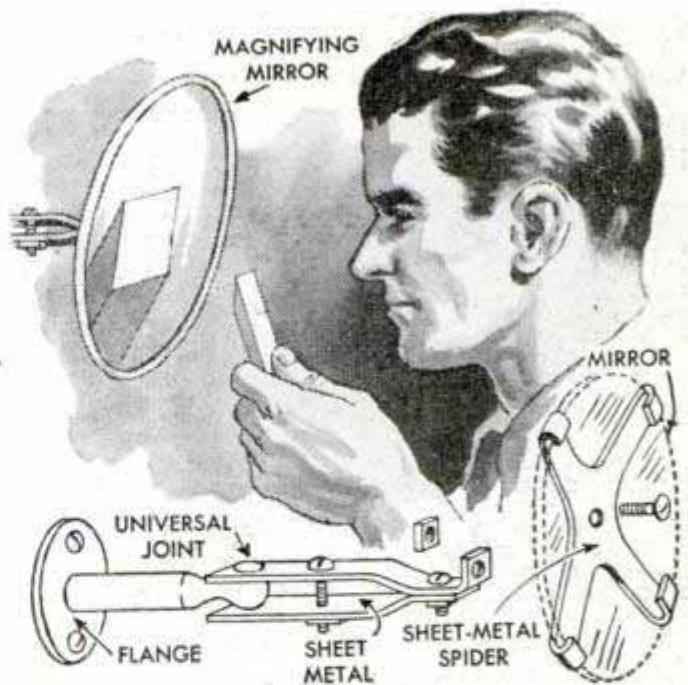

Cutting-Tool Edge Examined With Magnifying Mirror

Determining whether a cutting tool has a fine edge is easier if the tool is examined in a magnifying mirror. In one shop, mirrors are mounted near grinding wheels for the use of machinists. To make the unit adjustable, it is mounted on a bracket having a universal joint and held by a sheet-metal clip.—Jack Bronte, Colfax, Calif.

Barbed Wire Unrolled Safely

Here's a safe and handy method of unrolling barbed wire when working alone. All you need are two 2 by 4-in. handles joined together with an "X" brace and drilled at one end for a pipe axle which passes through the spool of wire. Shaping the ends of the handles for a convenient grip, or fitting a broomstick across the ends, will permit the roll to be pushed or pulled to unroll the wire.



Greeting Cards Displayed Neatly On Plywood Christmas Tree

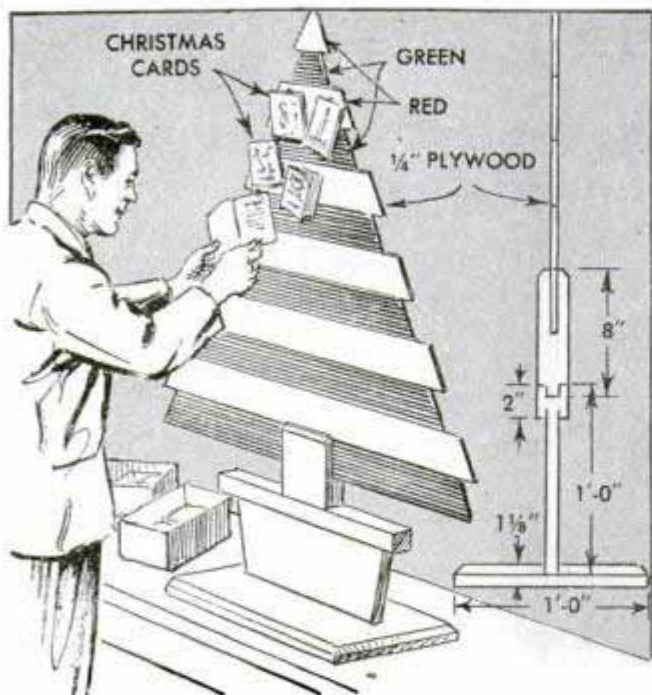

Instead of displaying greeting cards in the usual way, one merchant uses a number of decorative Christmas-tree cutouts on which the cards are mounted attractively as shown. A sample of each card on sale is thumbtacked to the tree so that it can be opened and read easily, and those selected are ordered by number. The trees are of $\frac{1}{4}$ -in. plywood, cut as indicated, and are supported by slotted trunks attached to wooden "flowerpots." Painted red and green, the trees are in keeping with the season and besides providing novel display racks, they add appropriate decoration.

Pointed Dowel Serves as Scriber

If the dimensions aren't too critical, a pointed dowel dipped in red ink can be used to scribe lines on aluminum and light-

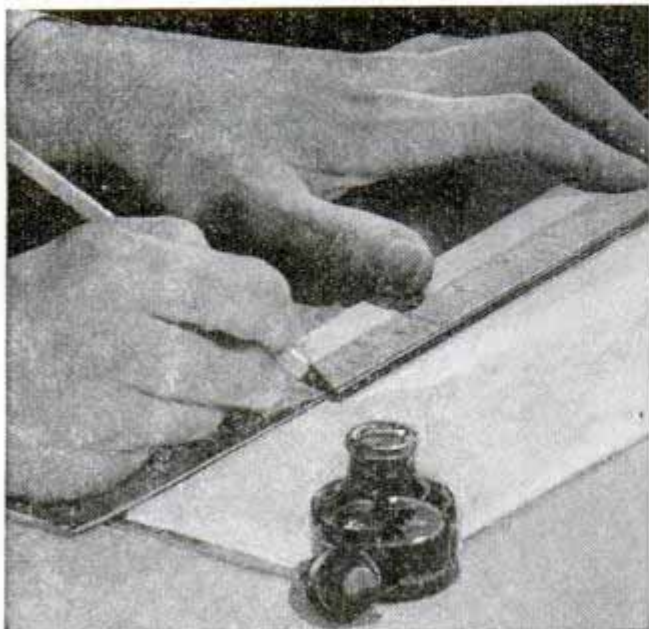

colored alloy sheets. Of course, if the work must be exact, a metal scribe would be required, but once the line is drawn, it cannot be erased.

"Figure-Eight" Trigger Holder Keeps Safety-Can Lids Open

In one large paint department the problem of holding the lids of safety cans open for refilling was solved by using a simple holder bent from $\frac{1}{4}$ -in. steel rod to the rough figure-eight shape shown in the detail. The holder is slipped around one leg of the handle



used to open and close the spring-hinged lid by hand. The holder hook is shaped to keep the lid open when in this position. A slight twist of the holder releases the trigger and allows the safety lid to snap shut.

Sleeves for Muffler Connections Keep Pipes From "Freezing"

A manager of a truck fleet, who had considerable trouble replacing mufflers because of rusted connections at the exhaust and intake ports, found that by using sleeves of copper or other nonferrous metals, this trouble

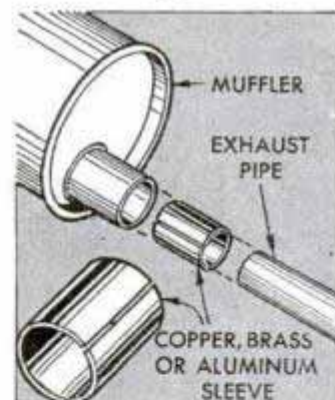

could be avoided. The sleeves, which must be of very thin material, are formed to fit inside the projecting muffler connection at the intake end and outside the connection at the exhaust end. This prevents direct contact of steel to steel so that the parts cannot rust together.

John Krill, Youngstown, Ohio.

Fluid Saves Weather Stripping

To prevent weather stripping on auto doors and trunks from peeling off during cold weather, spread hydraulic brake fluid over the rubber strips with a small paint brush. Repeat the treatment whenever the rubber gives indication of becoming brittle.

Russell L. Card, Tweed, Ont., Can.



FIVE-TUBE A.C.-D.C. RECEIVER KIT FOR STUDENTS

AMONG the special features included in this new superheterodyne kit receiver for students and experimenters, there is an automatic volume control which reduces "blasting" on powerful local broadcast programs, and helps to prevent fading on weak distant stations. It employs a built-in loop antenna, and the illuminated dial is marked in kilocycles. Although the circuit is simple, it includes beam-power output and covers a frequency range of from 535 to 1620 kilocycles. The set is designed to operate efficiently on any 115-volt, 50-60 cycle a.c. line, or d.c. line of the same voltage. The line voltage is not critical and can vary from 100 to 125 volts; the power drain is claimed to be only 27 watts.

With all necessary parts, from plastic cabinet and speaker down to every screw and nut, it offers the student an excellent construction model in complete kit form. Photos A and B show rear and top chassis views of the completed receiver; a front view is shown in the top photo. Construction begins with the mounting of the tuning condenser and dial assembly on the chassis base. In diagram Fig. 1 the method of shock-mounting the tuning condenser is detailed at lower left; a 2 1/4 in. piece of flexible braided wire is soldered to the tuning condenser and to the sheet-metal chassis to provide a good ground. The "exploded" view shows all details for assembling the tuning dial; other circuit and pictorial wiring diagrams are included with the kit. As with all table-model receivers that employ a loop antenna, the loop is directional. If your favorite station is not as loud as desired, turn the receiver slowly until it comes in with maximum volume.

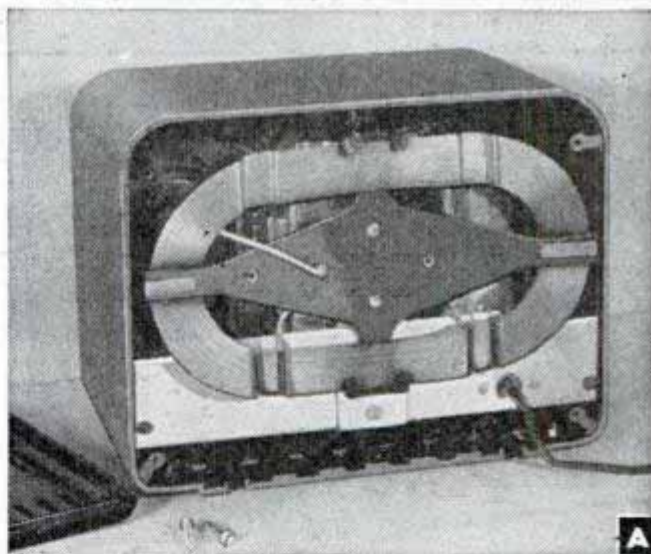

A

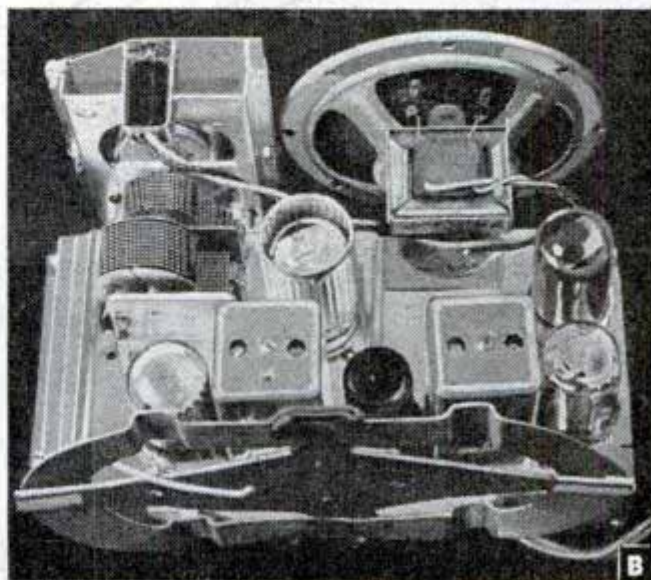

B

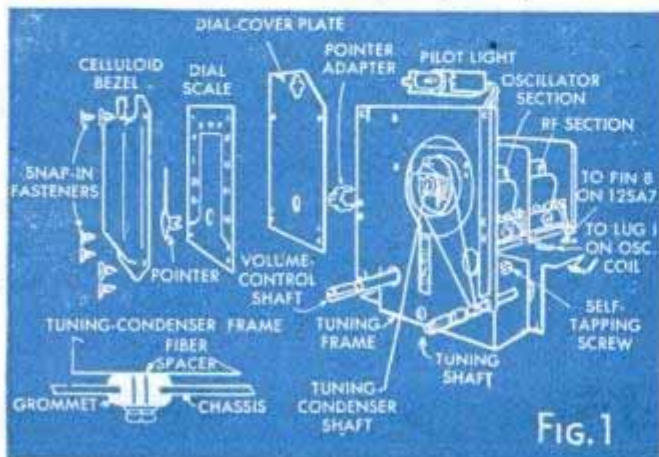
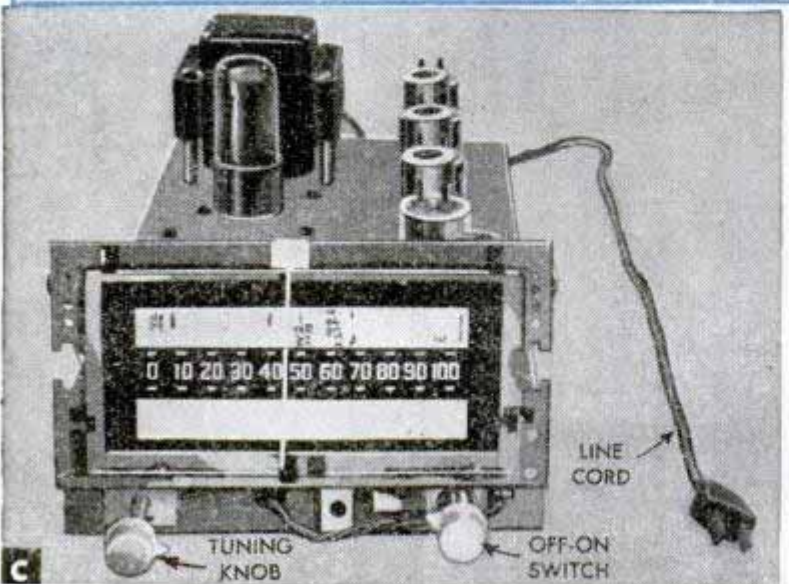
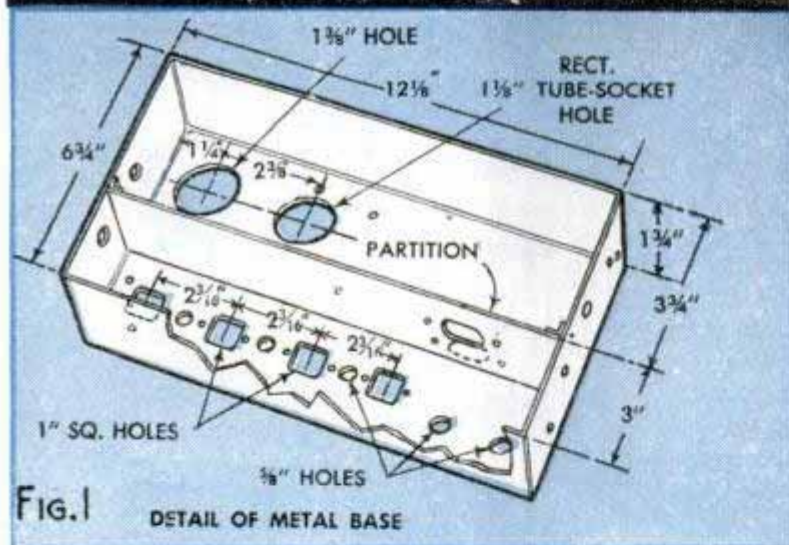
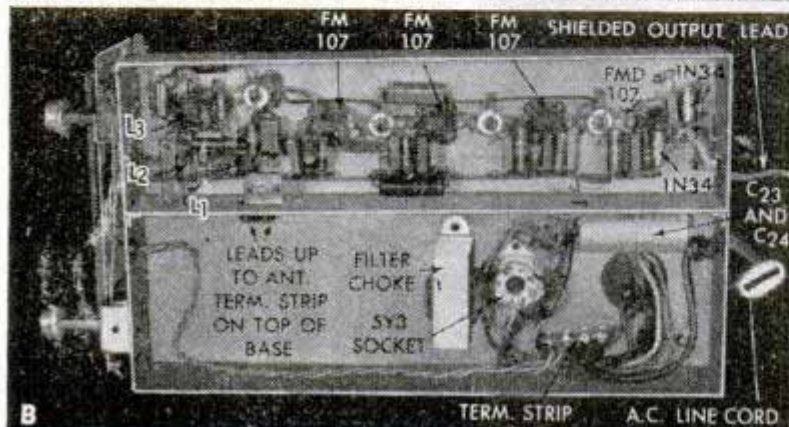
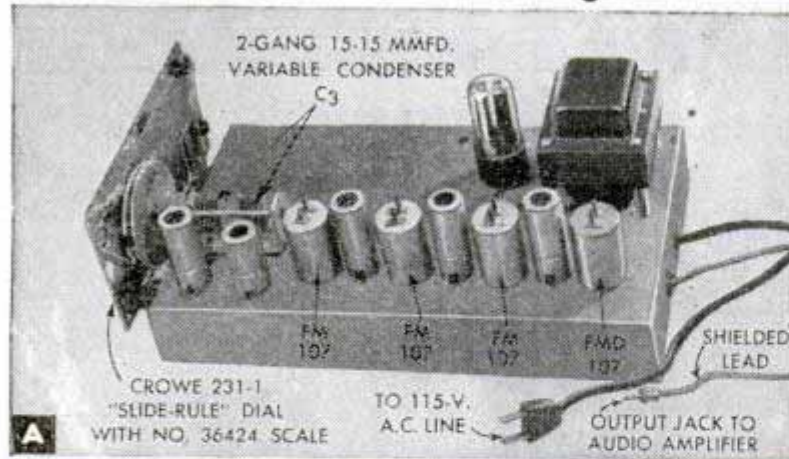

FIG. 1

High-Fidelity Self-Contained

By M. P. Langendorf



MINIATURE transformers designed for the new high-frequency FM band are now available to students and experimenters. Four of these tiny transformers are employed in this self-powered tuner, which provides excellent fidelity and sensitive reception on the new FM band from 88 to 108 megacycles. The completed tuner can be installed in the average console broadcast receiver, or it may be housed in a separate cabinet. It is merely plugged into the phono channel of the broadcast receiver in the same manner as you would use a separate record player.

The small size of the Specoil FM transformers permits the necessary space saving where a number of them are used. The builder can place them close together, thus eliminating undesirable long leads. They are of the double-tuning type and employ adjustable powdered iron cores that tend to eliminate capacity effects when aligning. The frequency of these transformers is 10.7 megacycles. Although definitely not intended for beginners, there is nothing difficult about the circuit except that special care must be taken in winding coils L1 and L2, and the oscillator coil L3. These are hand-wound as follows: The R. F. tuning coil L2 consists of 5 turns of No. 14 copper wire, spaced the diameter of the wire, on a 3/8 by 2-in. polystyrene form, or a form of similar low-loss material; the self-supporting antenna coil L1 consists of one turn of No. 14 copper wire and is 5/8 in. in diameter with the coil ends and leads spaced 1/4 inch apart. Coil L1 is placed over coil L2 at about the center of L2, and the leads continue down the side and through the form near the end. The oscillator coil L3 has 7 turns of No. 14 copper wire; it is 3/8 in. in diameter and the winding is spaced the diameter of the wire. Oscillator coil L3 is wound on a 3/8-in. form and the form is removed as the coil must be self-supporting. Extreme care should be taken in winding these coils. Mount the coils directly under the 2-gang tuning condenser C3 and

Tuner for the New FM Band

the 6C4 tube socket so that the leads will be as short as possible. Photo B shows the coils in position on the underside of the chassis, the top view of which appears in photo A above. Please note that the oscillator coil L3 is mounted at an angle of 90 degrees with respect to coil L2. Photos C and E show other views of the completed FM tuner with the controls, miniature tubes and rectifier tube identified. The sheet-metal chassis base is detailed in Fig. 1 and the complete schematic circuit diagram appears in Fig. 2.

In order to insure absolute static-free reception, the I. F. amplifier has two limiter stages. The R. F. end of the tuner has separate oscillator and converter stages so as to provide stable operation at the ultra-high frequencies used in the new FM band. A Hartley-type circuit is employed with a 6C4 miniature triode tube; the R. F. amplification and mixing is provided by a 6AK5 miniature pentode tube. In the discriminator

(Continued to page 234)

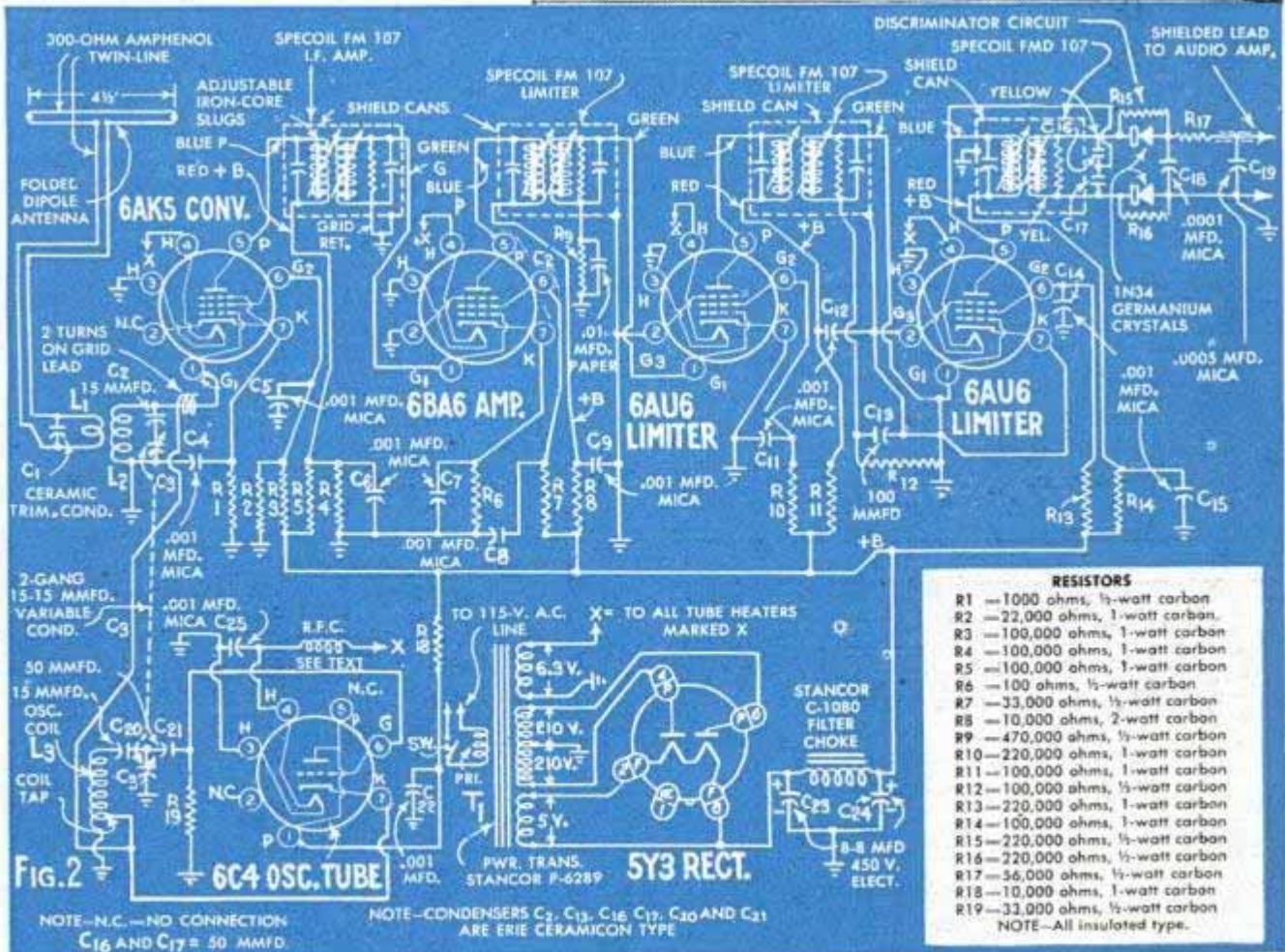
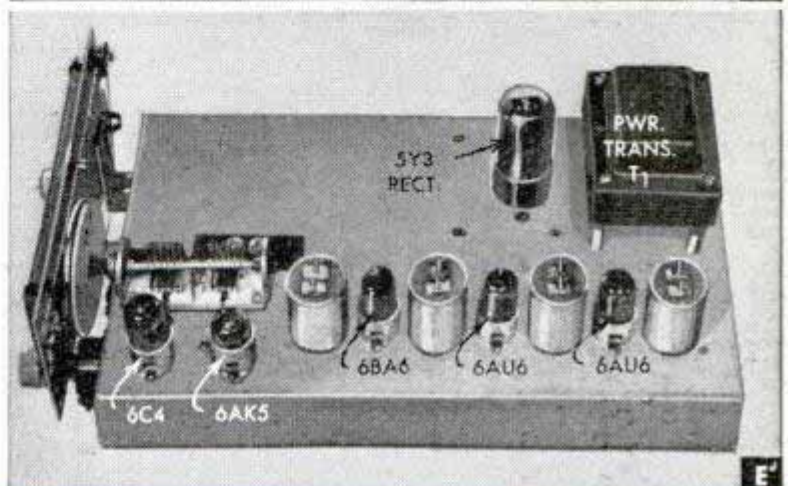

RADIO-ELECTRONIC HINTS

A—Pickup microphone clamps to tail-piece of violin without marring the instrument. It may be used with any audio amplifier; a miniature volume control enables the musician to adjust from light shadings to crescendos. **B**—Low-power inverter for operating a.c. phonographs and other small a.c. devices from d.c. voltage sources; available for various d.c. input voltages, for 110-volt a.c. output at 60 cycles. **C**—Tiny 300-volt dry battery for powering Geiger counters and portable photoflash devices. Six or seven may be connected in series to supply 1800 or 2100 volts. **D**—Frequency standard for mounting in communications-type receivers enables licensed radio amateurs to accurately check their band limits. **E**—Polystyrene stand-off insulators for installing Amphenol 300-ohm transmission lines, and television receiving lead-ins. **F**—Electronic business intercommunication system features visual busy signal and individual push buttons for station selection. **G**—Compact console phonoradio combination; "lift out" radio unit may be removed and used in other rooms.

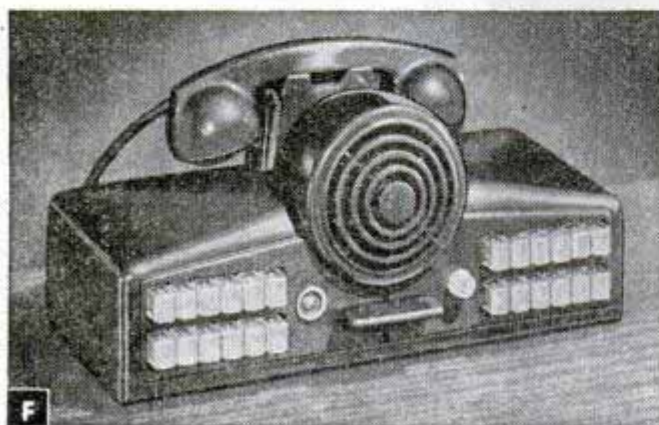
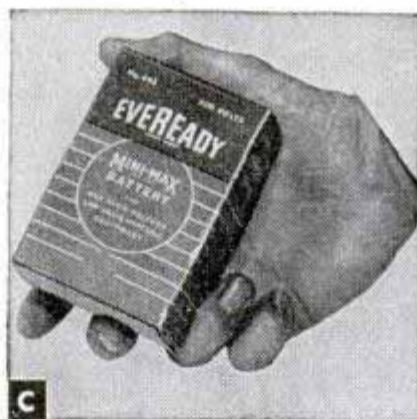
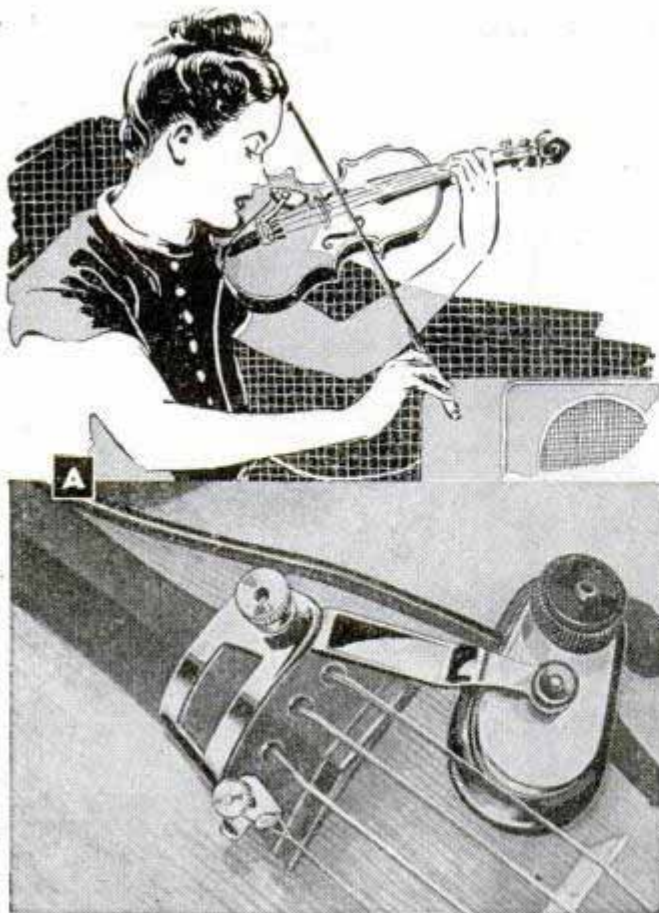

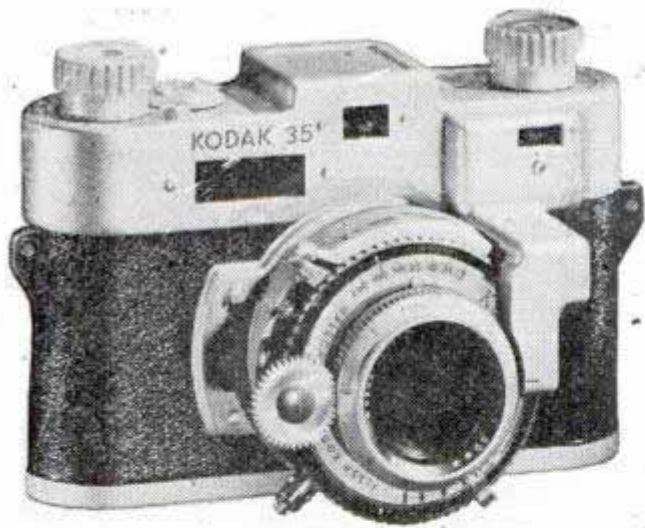

For the miniature fan...

A KODAK 35 CAMERA WITH RANGE FINDER. Brilliant 4-element $f/3.5$ lens, *Lumenized* to block ghost images; 1/200-second Kodamatic Shutter; built-in flash synchronization. Modern refinements include double-exposure prevention, automatic film stop and shutter-setting. Moderately priced.

**One of them is
just right for YOU**

For the artist-photographer...

THE KODAK REFLEX CAMERA. Twin taking and viewing lenses are $f/3.5$'s, *Lumenized* to cut flare. Big, brilliant image makes it easy to study composition; tells you when focus is razor-sharp. 1/200-second Kodamatic Shutter; built-in flash synchronization. Sturdy cast-aluminum body. The most for your money in the fine-reflex field.

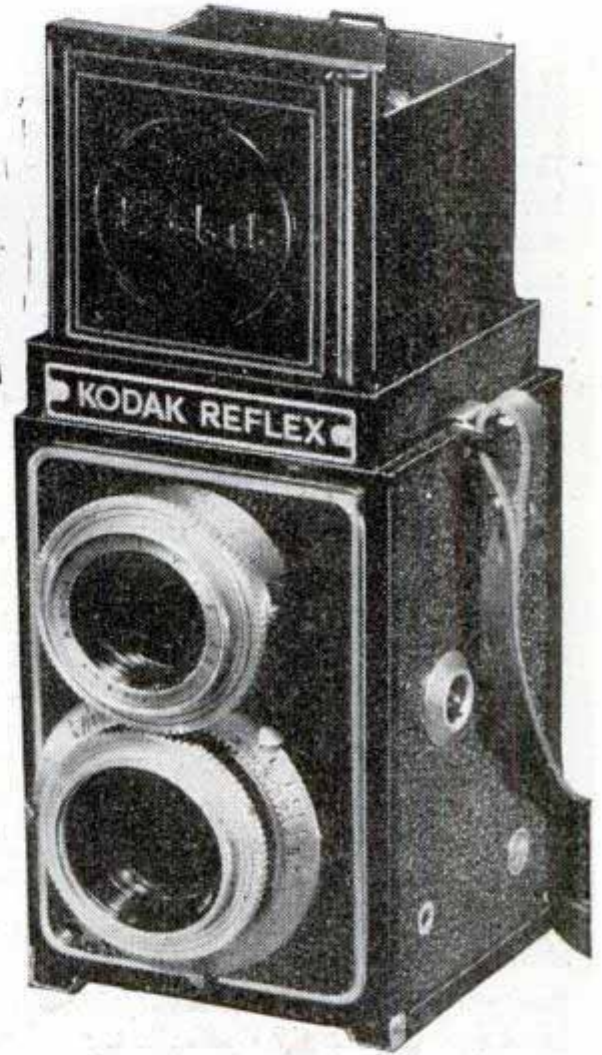

For the critical worker...

KODAK MEDALIST II CAMERA. Kodak Ektar 100mm. $f/3.5$ Lens—*Lumenized*—unsurpassed in correction for definition and color. Supermatic (1/400) Shutter synchronized for flash. Instant focus with coupled split-field range finder. Uses rolls, adapts to packs, sheets, or plates; pictures, $2\frac{1}{4} \times 3\frac{1}{4}$. See your Kodak dealer.
EASTMAN KODAK CO.,
ROCHESTER 4, N. Y.

Kodak

How would you like to build and own the "Sea Pup"?

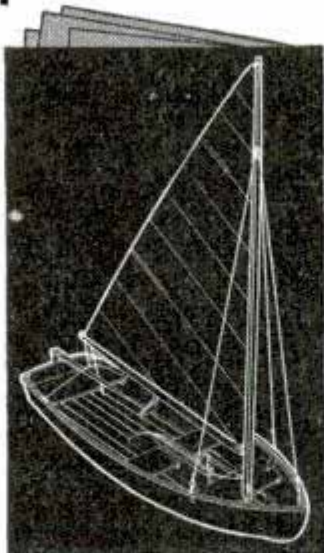

The "Sea Pup" is the first in a new series of boat plans, designed exclusively for Casco-phen by William F. Crosby, creator of the famous "Snipe" and "Seagull."

She can be rowed, sailed, or powered with a light outboard. She's 12' long, 4'5 1/2" beam, seats 2 to 4.

And here's the Pay-off!

Plans for the "Sea Pup" retail at only \$2.50 a set and consist of 5 easy-to-read 24" x 30" blueprints. They include: Complete bill of materials and specifications for hull, hardware, rigging and fasteners... all lines and offsets, profiles and sections, construction plans and detail drawings.

Exclusive of lumber, you can build the "Sea Pup" for about \$50.00 including the price of the hardware, rigging, paint, glue, and equipment.

Start now! Get the "Sea Pup" plans at your local marine supply dealer's. Or mail coupon today.

CASEIN COMPANY OF AMERICA
Dept. PM-27, 350 Madison Ave., N. Y. 17

Please send me a complete set of plans for the "Sea Pup" at the regular retail price of \$2.50.

Attached is my Check _____
Money Order _____ Cash _____

Name _____
Address _____
City _____
Zone _____ State _____

CASCOPHEN

Durable Resin Glues for Boats

High-Fidelity Self-Contained Tuner For the New FM Band

(Continued from page 231)

circuit, two Sylvania 1N34 germanium-crystal diodes have been used instead of the conventional vacuum-tube diode. By using crystals as discriminators, a tube and socket are eliminated; also the possibility of hum pickup from the filaments of a vacuum-tube diode. These crystal diodes are tiny tubular-type units about the size of a small carbon resistor and are provided with pigtailed wire connections. They give superior performance at ultra-high frequencies and were developed for use in radar equipment during the war. All parts specified are available from radio parts houses, with exception of the chassis and hand-wound coils L1, L2 and L3.

The Specoil transformers are all pre-tuned and any slight aligning that might be necessary can be done with the screws on the tops of each transformer. These screws should be moved very slightly and then only after a station is tuned in. Beginning with the I. F. amplifier, adjust each coil for clarity and maximum volume; in most cases this should not be necessary if care has been taken in wiring to keep all grid and plate leads short. All filament leads should be dressed into position and lined down one side of the chassis. Positive B leads should also be dressed into position and lined down the opposite side of the chassis from the filament leads. Cathode bias resistors and by-pass condensers should be grounded as closely as possible to the cathode terminals on the tube sockets. The same precaution should be observed with the screen by-pass condensers, screen-voltage-dropping resistors, and plate-load resistors. If these precautions are taken, very little aligning is necessary. Detailed student material list R-361 is available from Popular Mechanics Radio and Electronics department upon receipt of ordinary letter postage.

Hollywood on the Move

(Continued from page 142)

large groups of people in many industries. During the war it fed the 17,000 employees of Lockheed as well as supplying the meals at five Navy shore establishments. It keeps \$250,000 worth of food on hand in its Hollywood warehouses.

In the past few years Arizona has become a leading location state. The picture "California" was filmed almost entirely within

(Continued to page 236)

Dependable

CHAMPION

AMERICA'S FAVORITE SPARK PLUG



A new set of dependable Champion Spark Plugs is just the thing to make your car start like the proverbial scared rabbit. Quick starts, faster warm-up, and all 'round better engine performance result in substantial gas savings. In addition, they'll reduce excessive drain on the battery, and minimize the danger of crankcase dilution. Now is the time to have your Champion dealer check your spark plugs. Be sure to get dependable Champions if you need new ones. Champion Spark Plug Company, Toledo 1, Ohio.

FOLLOW THE EXPERTS

**DEMAND NEW DEPENDABLE
CHAMPIONS FOR YOUR CAR**

Listen to the CHAMPION ROLL CALL . . . Harry Wismer's fast sportscast every Friday night, over the ABC network

RIDE YOUR WAY TO GOOD TIMES

ON A HARLEY-DAVIDSON

Every strange road challenges you to new adventures! Every high hill brings you breathtaking new panoramas! Every trip on a Harley-Davidson opens new worlds of pleasure, with jolly companions, new things to do and see! So why not swing into the saddle of your own Harley-Davidson and head down some happy highway to good times . . . to thrilling "gypsy tours", exciting race meets, hillclimbs, endurance runs, delightful sightseeing expeditions? There's no sport like motorcycling, no fun like owning a Harley-Davidson. "Owning your own" is easier than you may think. See your Harley-Davidson dealer today. Mail the coupon now.

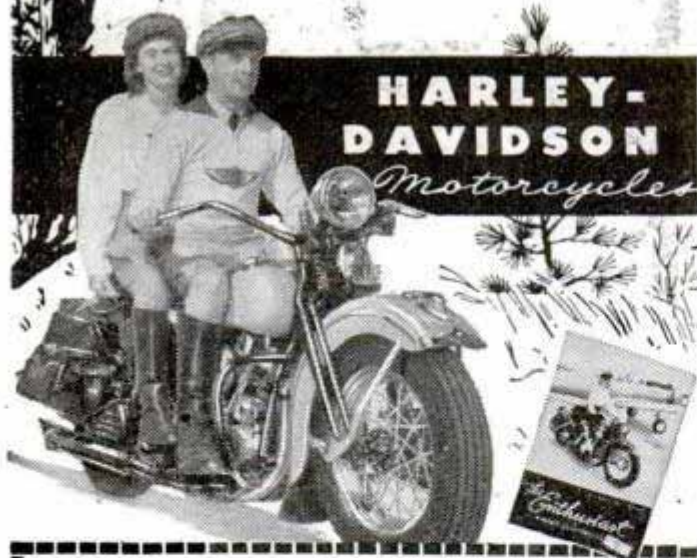

HARLEY-DAVIDSON MOTOR CO.

Department P, Milwaukee 1, Wisconsin

Send FREE copy "ENTHUSIAST" Magazine filled with thrilling motorcycle action pictures and stories; also literature on your 1948 models.

Name.....

Address.....

City.....State.....

its borders. In Arizona, too, practically all of "Red River," a \$2,000,000 picture story of the early Texas cattle drives, was filmed.

The studios do not deliberately choose substitute backgrounds; often it isn't practical to use the real setting of an historical story. For example, Texas didn't have a location suitable for the picture about itself and Arizona did have such a site.

The script called for a river similar to the Red River in Texas, some badlands like those of Texas, and some plains that could double for those of Kansas, and all three must be close together. In addition, a water supply of 80,000 gallons a day was required—20,000 gallons for the picture company and 35,000 gallons for the cattle that appeared in the film. The other 25,000 gallons were needed to settle the dust.

Movie scouts first went to Texas and flew hundreds of miles along the Red River itself, hunting for such a site. Then they tried Oklahoma and New Mexico without success, then portions of Sonora and Chihuahua. Eventually they found the ideal location near Elgin, Ariz., 60 miles south of Tucson. The nearby San Pedro River was a virtual duplicate of the Red, and the other needed backgrounds were less than 50 miles away.

Practically dry, the river was held back by five dams until sufficient water for the flood scenes was in storage, then the water was released to produce the high-flowing river needed for the picture.

The scenery around Sedona, 30 miles south of Flagstaff, in the northern part of Arizona, is so spectacular that one or more picture companies almost always are to be found in the area. The Anderson company kept one of its large portable camps there for a while, then decided to build a permanent motion-picture town in the area.

Normally accommodating up to 350 people, this "little Hollywood" already has housing shortages. Temporary picture populations of up to 450 people have strained its capacity and now the town is being enlarged. Beside pine sleeping cabins, central dining rooms and other facilities, the movie town has its own western trading post and other permanent sets that are modified for different pictures. A sound stage is included in its more than 100 permanent buildings. Parts of "The Angel and the Outlaw," "Desert Fury," "Cheyenne," and other recent western pictures were filmed there.

☐ An Australian scientist has found in edible mushrooms a penicillin-like drug which kills tuberculosis germs in a test tube, and experimental treatment of tuberculosis-infected animals is planned.

HOW TO PAINT

without "holidays" or thin spots

When you paint, do you look at your work when you've finished and say, "Gosh, there's a bad spot!" — or "How did I miss that?"

No matter how good your lighting, reflections and shadows can trick you into leaving "holidays" that *only a moving beam* of light will reveal. Here's how to avoid them:

- 1 With your left hand, point your flashlight at what your right hand is painting so that no shadowy corners can escape.



- 2 When a section is finished—and again after you finish the whole job—inspect the work with your flashlight, powered with "Eveready" batteries (they outlast all other brands)!



Proof! . . . in the laboratory . . . in your own flashlight . . .

"EVEREADY" BATTERIES
OUTLAST ALL OTHER BRANDS!*

Brighter light, longer life! That's what you want in a flashlight battery. And that's what you get with "Eveready" brand batteries. Laboratory tests prove it. And the best "laboratory" of all—*your own flashlight*—proves it! That's why "Eveready" batteries *outsell* any other brand—because they *outlast* any other brand!*

*According to the "General-Purpose 4-Ohm Intermittent Test" of the American Standards Association, which most closely approximates average use.

The registered trade-mark "Eveready" distinguishes products of
NATIONAL CARBON COMPANY, INC.
30 East 42nd Street, New York 17, N. Y.
Unit of Union Carbide  and Carbon Corporation



TEST YOUR SCIENCE

i.q.



PEBBLE

MILE-LONG STRING

Answer to problem on page 105

Of course Newton was not wrong. The centrifugal force at the equator is computed using these factors: Mass of man, 150 pounds; radius, 4000 miles; speed, 1000 miles per hour. Divide each of these factors by 4000. Now picture yourself standing on a little hill with a stone, which weighs just over half an ounce, tied to the end of a string one mile long which you would try to whirl about in a circle at the speed of $\frac{1}{4}$ mile per hour. The centrifugal force at the equator is so slight that it could not be measured on an ordinary spring scale.—By Rex Taylor

To
**FOR A SAFE
CHRISTMAS**



Yes, for holiday and year-round safety from the tragedy and loss of fire, give Pyrene* Fire Extinguishers. What finer present can you give to your family, friends and business associates — to anyone who values his home and possessions?

Pyrene is safe, easy to use, approved by Underwriters' Laboratories, Inc. and Good Housekeeping Institute. Get Pyrene at your local hardware, home or auto supply store.

*T. M. Reg. U. S. Pat. Off.

Pyrene Manufacturing Company

NEWARK 8 • NEW JERSEY

Affiliated with C-O-Two Fire Equipment Company

**A CHRISTMAS
GIFT men
appreciate**



There's thrilling style and luxurious comfort in these all-purpose Concord casual shoes—truly smart informal footwear. Striking "buckle-and-strap" moccasin pattern with bold hand sewn vamp and unique rolled collar. Expertly crafted in rich

Rio brown leather with sturdy leather soles and heels. An ideal Christmas Gift!

ORDER BY MAIL—Immediate Delivery

Quality insured by 45 years of fine shoemaking. Order Model M22 today. State exact shoe size and width. Available NOW in sizes 6 to 12, B, C, D, **\$8.95**. Add 25c for mailing.

Satisfaction or your money back.

CONCORD SHOES, Inc., Milwaukee 1, Wis.

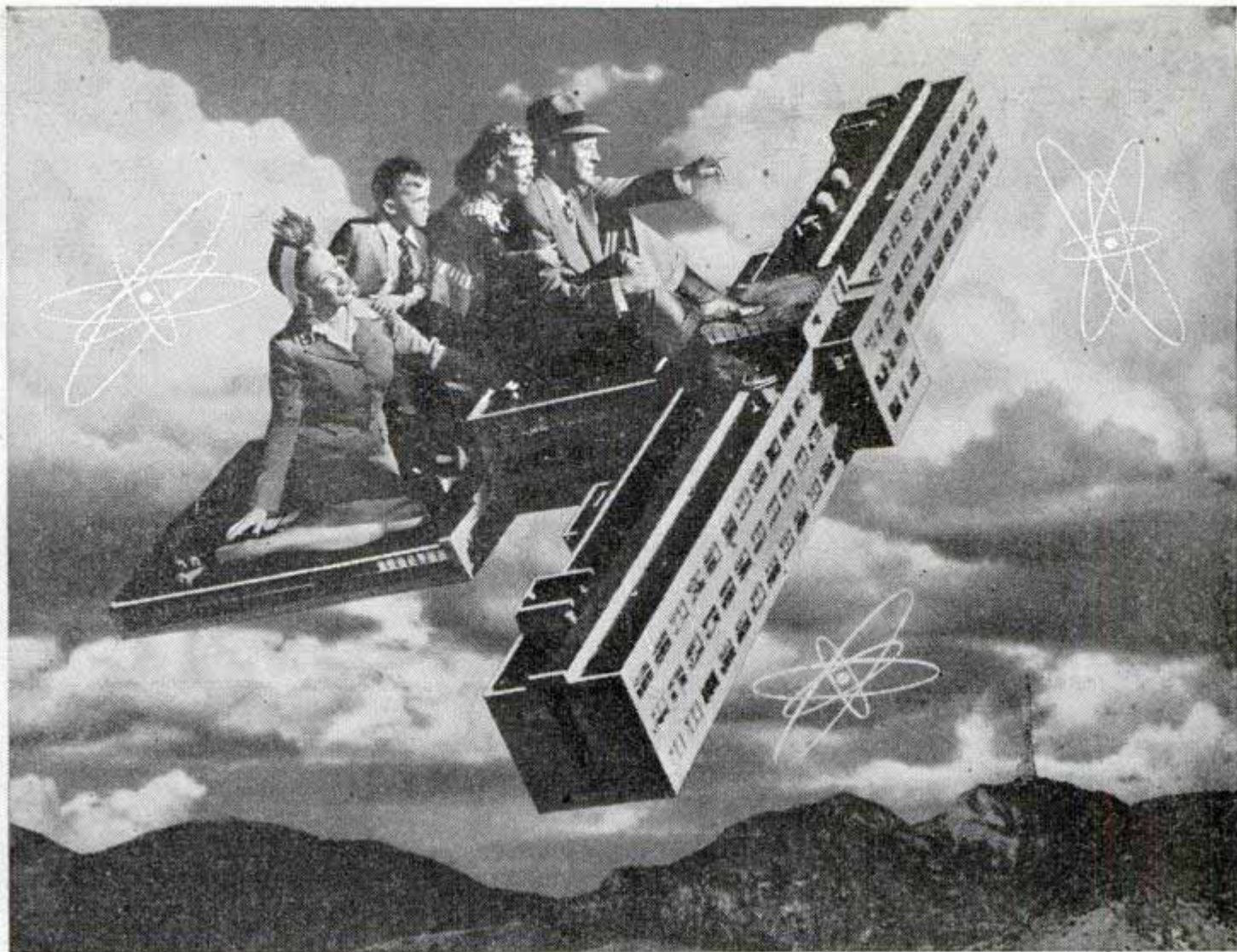

Your enjoyment climbs to new altitudes through radio and television achievements of RCA Laboratories.

RCA LABORATORIES—your "magic carpet"

to new wonders of radio and television

More and more people will go sight-seeing by television as the number of stations and home receivers increases. Eventually, television networks will serve homes from coast to coast . . . bringing you the news as it happens . . . sports events . . . drama . . . vaudeville.

Many of the scientific advances which have made possible these extended services of radio-electronics, in sound and sight, originated in research conducted by RCA Laboratories.

Recent RCA "firsts" include: ultra-sensitive television cameras that give startling clarity to all-electronic television . . . tiny tubes for compact, lightweight portable radios . . . "picture tube" screens for brilliant television reception.

In other fields of radio-electronics, RCA has pioneered major achievements—including development of the electron microscope. Research by RCA Laboratories goes into every product bearing the name RCA or RCA Victor.



RCA Laboratories at Princeton, N. J., one of the world's centers of radio and electronic research. • When in New York City, see the radio-electronic wonders on display at RCA Exhibition Hall, 36 West 49th Street. Free admission. Radio Corporation of America, Radio City, New York 20.



RADIO CORPORATION of AMERICA

NO OTHER TOOL LIKE IT



BURGESS vibro-tool

Trade Mark Reg. U. S. Pat. Off.

- WRITES ON STEEL
- DECORATES GLASS
- ENGRAVES JEWELRY
- CARVES WOOD
- TOOLS LEATHER
- CUTS CARDBOARD

Works by Vibration!

Whether you work with metal, wood, glass, plastics or leather, your shop is not complete without a Burgess Vibro-Tool. Totally unlike anything else on the market! Writes like a pencil on hardest steel! Engraves, carves, hammers and cuts. Only \$7.50 at your dealer. If he cannot supply you, write to us and we will arrange for shipment.

BURGESS

BATTERY COMPANY

Handicraft Division
Lake Zurich, Illinois

ORDER REPLACEMENT ACCESSORIES NOW!

- V 5 Standard Needle...\$0.15
- V 3 Heavy Duty Needle...\$2.00
- V 80 Diamond Point Needle \$5.95
- V 81 Point for Frasting Glass \$0.75
- V 82-87 Leather Tools including punch, liner, deerfoot, spoon, double liner and cupper \$1.50
- V 23 Straight Edge Surgical Steel Knife.....3 for \$0.50
- V 24 Belly Edge Surgical Steel Knife.....3 for \$0.50
- V 101 Foot Gauge for use with knives to regulate cut depth.....\$0.95
- V 51-56 Assorted Carving Chisels.....6 for \$1.50
- V 44-48 Assorted Ball Points 5 for \$0.95
- V 41-43 Assorted Hammer Tips 3 for \$0.25
- V 115 Sharpening Stone \$0.25

DE LUXE KIT only \$16.50

Contains Vibro-Tool and 22 attachments, everything necessary for metal marking, jewelry engraving, leather tooling, wood or linoleum carving, pattern cutting, metal embossing, etc. Includes sharpening stone. Each unit individually packed in handsome, natural finish, wood storage chest. An ideal gift for any hobbyist.



BURGESS BATTERY COMPANY Handicraft Division, Lake Zurich 21, Illinois

Please arrange for a Vibro-Tool dealer to ship the following:

- Vibro-Tool De Luxe Kit Accessories Enclosed find remittance Ship C.O.D.

{ Please list parts wanted by number }

NAME.....

ADDRESS.....

His Tripod Is a Plane

(Continued from page 174)

back and asked blankly: "Are you flying this thing?"

Wayman had been busy with his camera, the pilot had been asleep, and each thought the other was flying the plane.

Wayman sympathizes with private flyers who find themselves lost over unfamiliar territory, having been the victim of such an experience several times himself. As an incentive to better air marking, he has offered to present every factory owner who paints the name of his plant and its location on the roof with a free aerial photograph of the building. So far he has had no takers.

Eventually he expects to fly north in the summer and south in the winter, taking pictures of vacation resorts.

Wayman is already planning for a bigger, faster plane, with a built-in darkroom. "Sometimes, when I come back from a job 300 miles away, my heart is in my mouth all the way home. The way it is now, I never know until I land whether or not the pictures are any good.

"Now if I had a plane that would cruise at 110 miles an hour, with facilities to develop my shots in flight . . ."

Outsmarting the Smugglers

(Continued from page 151)

An important wartime job of the Customs Service was the "security watch" of incoming and outgoing troopships. Working in close conjunction with the Coast Guard, customs men seized a wide variety of objects that could have caused injury and death.

In most cases of wartime smuggling by troops, the confiscated material was turned over to the branch of the service to which the man belonged. Military authorities disposed of the case. Bigger game, however, required special efforts by the Customs Service.

The Chicago office of the Service, for example, helped crack the famous Hesse jewelry case in which several Army officers were charged with bringing into the United States some \$1,500,000 in precious stones and jewelry taken from the Hesse family estate in Germany.

On the West Coast, the San Francisco customs office put the finger on an Army colonel when two diamonds, worth \$10,000, were found in his watch pocket as he disembarked. Further investigation showed that he had brought more than 500 Japanese diamonds, worth \$200,000 into the

(Continued to page 244)



HELLO BOYS!

Erector is the world's greatest toy... crammed with real engineering features.

A.C. Gilbert

Founder, Gilbert Hall of Science

Famous

ERECTOR

BUILT WITH NO. 8 1/2

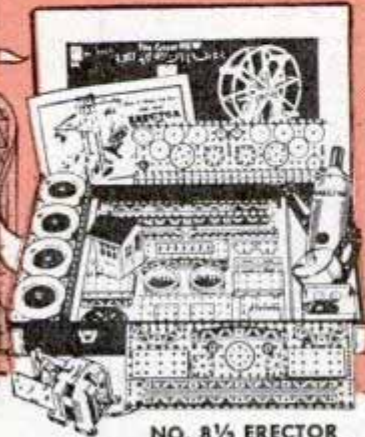

NO. 8 1/2 ERECTOR

THEY WHISTLE

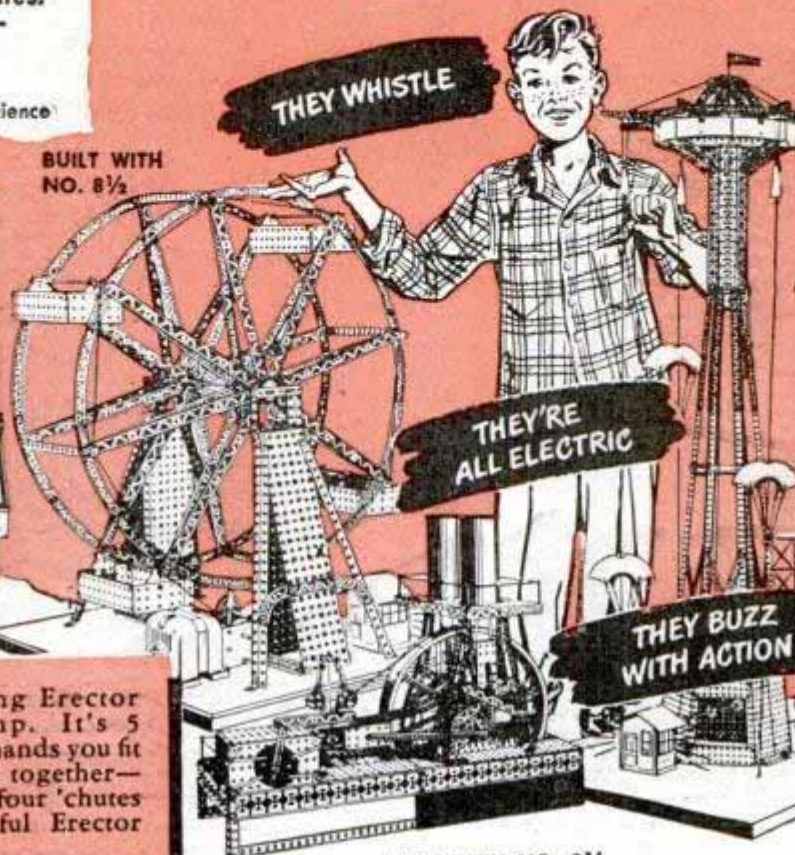

THEY'RE ALL ELECTRIC

Made of STEEL to Build Like REAL

IMPORTANT The U. S. Patent Office has issued over 100 patents covering special Erector features.

BUILT WITH NO. 9 1/2

THEY BUZZ WITH ACTION

BUILT WITH NO. 9 1/2 ERECTOR

LOOK at that towering Erector parachute jump. It's 5 feet high! With your own hands you fit the gleaming steel girders together—attach the rigging for the four 'chutes—and install the powerful Erector reversing engine.

Now for a sensational sight! Throw the engine into gear... and your parachutes are hoisted up and up until they strike the release mechanism. Then, like a flash, they plummet down—unfold—and lazily float to the ground.

Now get a load of that mighty Ferris wheel. It operates in either direction at high or low speed.

Think of the fun of building and running that giant power plant—with boilers, 12-inch flywheel and other parts all made of genuine steel.

You can build hundreds of spectacular mechanical marvels with one Erector set. No other construction set contains so many different parts. And how the Erector reversing engine makes them buzz with action!

FUN with Erector starts the moment you start to assemble girders, wheels, gears and other parts. No blueprints are needed. Erector parts have equi-distant holes, so that you only have to count the holes to put them together.

OTHER GILBERT SCIENTIFIC TOYS

- ★ AMERICAN FLYER TRAINS
Watch 'em puff smoke—hear 'em choo-choo
- ★ GILBERT CHEMISTRY LABORATORIES
The kind that bring boys fame and big awards!
- ★ GILBERT POLARIZING MICROSCOPES
- ★ GILBERT ELECTRICAL SETS
- ★ GILBERT TOOL CHESTS

ONLY ERECTOR HAS ALL THESE FEATURES

- ★ Builds the square girder with interlocking edges
- ★ Erector girder is a structural girder—not just a perforated strip
- ★ Curved, straight and giant structural steel girders for realism
- ★ Equi-distant holes in base plates and girders for fast, precision building
- ★ Metal base plates with every set
- ★ Genuine bolts and nuts patterned after those used in real engineering construction
- ★ Tooth gears, crown gears, mitre gears, worm gears and pinion gears
- ★ Wheels, radiator, axles and other automotive parts
- ★ Engineer's shack
- ★ Steel boiler and giant flywheel parts for building realistic engines
- ★ Electric lights
- ★ Electro magnet
- ★ 110-volt reversing electric engine with gear shift
- ★ 135 different precision engineering parts

When in New York visit the famous Gilbert Hall of Science, Fifth Avenue at 25th Street. Admission Free.



FREE

"Fun and Action with Gilbert Scientific Toys"

The A. C. Gilbert Company
312 Erector Square
New Haven, Conn.

Rush free illustrated broadside describing all Erector sets and other Gilbert Scientific toys.

Name.....
Street.....
City..... State.....

(Offer good only in U. S. A.)

Get Set for the BEST SHOP With These Fine Atlas

Atlas
DRILL PRESSES
\$53.50 and up



Atlas
6"-10" LATHES
\$104.75 and up

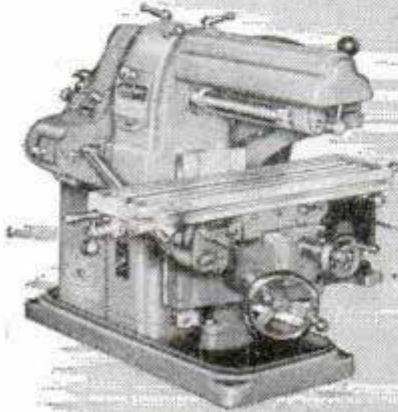
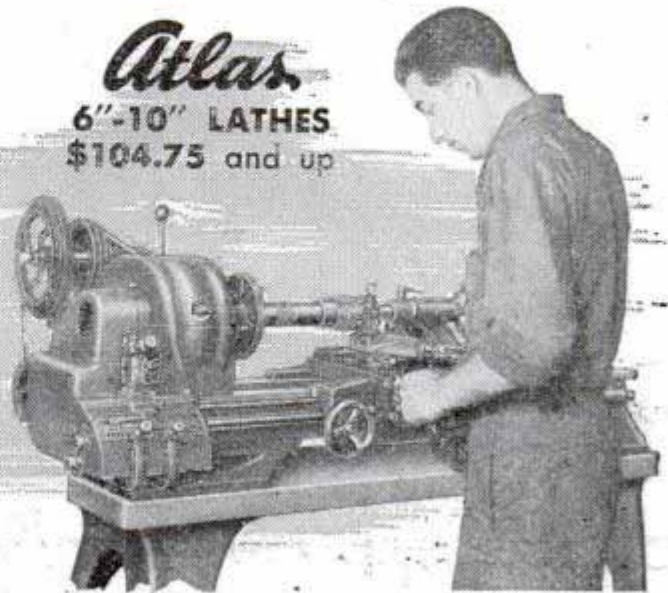

Atlas
MILLING MACHINES
\$285.00 and up

INDUSTRIAL PRECISION for a home hobby shop — that's the goal of many a man. Today, it can be realized. Atlas precision metal working tools, built to industrial quality standards, will add to your shop's usefulness, save on home equipment repairs, and save on many types of home furnishings.

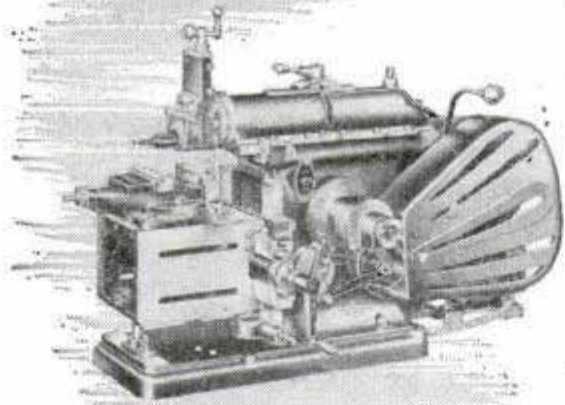

Atlas SHAPER
\$335.00

Tools for YOU, Incorporated

If your shop interest is profit-wise — for business development — Atlas tools provide ideal research and production equipment. Whatever the products or projects you have in mind, these compact, precise tools will handle your work to perfection.

Built for Lifetime Service

Atlas tools are industrially engineered to give you a lifetime of usefulness. See your Atlas distributor today or write for his name. He'll gladly help you start your metal-working shop



ATLAS PRESS CO.
1243 N. Pitcher Street
KALAMAZOO MICHIGAN

LATEST CATALOG FREE

ATLAS PRESS COMPANY
1243 N. Pitcher St., Kalamazoo, Mich.

Kindly send your latest catalog. I am particularly interested in a Lathe Drill Press Milling Machine Shaper 10" Table Saw.

NAME _____

ADDRESS _____

CITY, STATE _____



Atlas
10" SAWS
\$97.50

ALL PRICES F.O.B. KALAMAZOO, LESS MOTOR

YEARS of YOUR LIFE! and POWER KING TOOLS



PK
7"-8" TILT/ARBOR
TABLE SAWS
\$37.75
and up

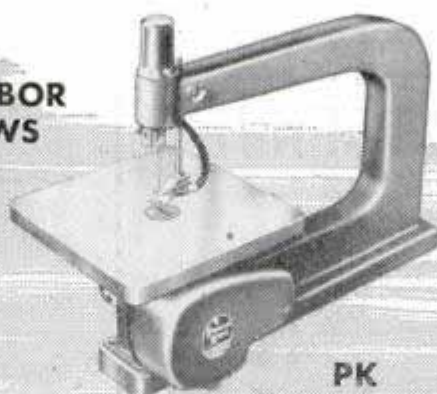

PK
15" JIG SAW
\$29.75



PK
DRILL
PRESS
\$37.75

NOW every home shop owner can afford to equip with power tools. Furniture, cupboards, cabinets, toys, shelves... anything in wood that you want to make... can be handled in short order, at a fraction of the cost when bought outside.

A New Idea for Home Shops

PK tools are designed for men who enjoy their home shop as a hobby... but are practical about it, too. They give you the basic ruggedness, accuracy, and capacity you need for your various projects... yet are priced so you can equip with the full range of Power King tools within the cost formerly required for but two or three machines.

Sensational Values

You'll quickly recognize the quality construction of Power King tools — and be proud to have them in your shop. Ask your nearest Power King dealer (name sent on request) to show you the tools that are ready for you right now.



PK BAND SAW
\$75.00

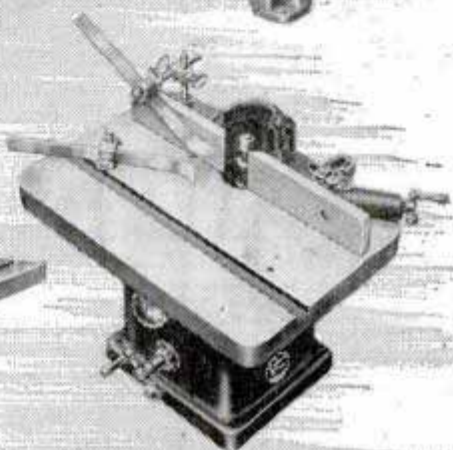

PK SPINDLE
SHAPER
\$42.75

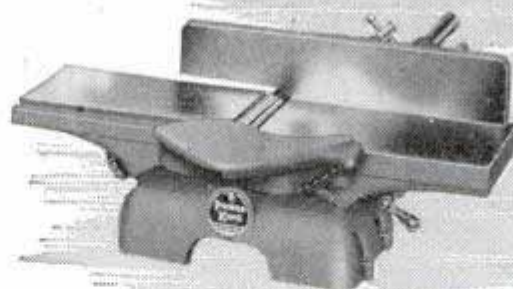

PK
JOINTER
PLANER
\$39.75



POWER KING TOOL CORP.

1220 CLEVELAND ST., WARSAW, IND.
Division of ATLAS PRESS CO.

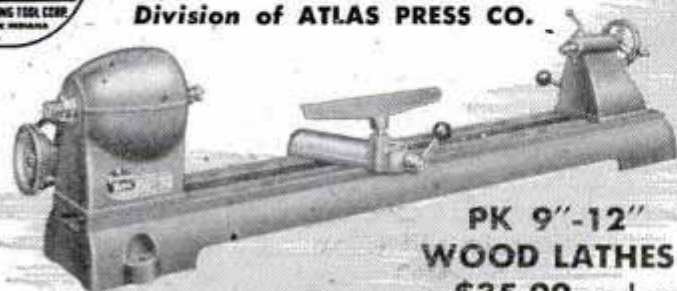

PK 9"-12"
WOOD LATHES
\$35.00 and up

ALL PRICES F.O.B. WARSAW, LESS MOTOR

SEND FOR FREE LITERATURE

POWER KING TOOL CORPORATION
1220 CLEVELAND ST.
WARSAW, INDIANA

Please send me your latest catalog sheets about
 7"-8" Table Saws 15" Jig Saw Drill
 Press 12" Band Saw Spindle Shaper
 Jointer-Planer Wood Lathes.

NAME _____

ADDRESS _____

CITY, STATE _____

Now! YOU CAN INSTALL DUAL WHEELS

On Your Trailer, Pick-up Truck, Farm Wagon or Jeep
with STANDARD WHEELS.

IN LESS THAN 10 MINUTES

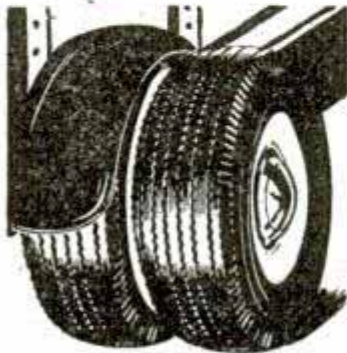

- INCREASE LOAD CAPACITY
- INCREASE TRACTION
- INCREASE TIRE LIFE

Now you can convert your vehicle to dual wheels without the high expenses of changing to truck-type wheels and hubs or changing the entire rear axle. This

new patented converter does the job at a fraction of the old cost. For use on Ford passenger and 1/2-ton truck, 1928 to 1947 (except 1936-39); Chevrolet passenger and 1/2-ton truck, 1927 to 1947; Dodge-Plymouth passenger and 1/2-ton truck, 1933 to 1947; Willys and Ford Jeep vehicles, all models; all trailers and farm wagons equipped with any of the above type wheels.

GUARANTEED TO DO THE JOB OR YOUR MONEY BACK.

NORTHWESTERN AUTO PARTS CO. MINNEAPOLIS 11, MINN.

Only \$28.50

Complete Set



**It's EASY
as A-B-C**

No changing required.
No drilling necessary.
Rim-wrench does the job.

1. Mount the first wheel.
 2. Screw on extension bolts.
 3. Slip on adapter housing.
 4. Mount the second wheel.
- THAT'S ALL!**

CLIP THIS COUPON NOW

Northwestern Auto Parts Co. PM-12
834 N. Seventh Street, Minneapolis 11, Minn.
Please send me.....Dual Wheel Converters at \$28.50 each.
FORD CHEV DODGE-PLYM JEEP
Also Fits Farm Wagons Using Above Type Hubs

Name

Address

City..... Zone..... State.....

Money Order Check

ATTENTION DEALERS: Many fine territories open.

United States on previous trips. He called them souvenirs of war.

The tricks of the smugglers are infinite. False bottoms in trunks and boxes are well known. Contraband has been hidden in false teeth, bars of soap, fountain pens, tooth paste, ear trumpets, beards, nursing bottles, heels of shoes, the tops of hair brushes and in the cotton in aspirin bottles.

A jewel smuggler entered the Port of New York 26 times as a hunchback. On the 27th try, customs men dug into his false hump and removed diamonds, jewelry and watches. A Chinese importer in Seattle was suspected of smuggling opium, but was not caught until customs inspectors found that it was concealed in the tubs of soya sauce which he received from China. Special vests, which can carry several thousand dollars worth of gold or as many as 1000 Swiss-watch movements, are sometimes used. Border smugglers have hidden contraband behind automobile headlights, within the spare tire and inside the gasoline tank.

The Customs Service works in close cooperation with the Federal Bureau of Investigation, the Bureau of Narcotics, the Coast Guard and city and state police. Nine customs laboratories in large cities employ the tools of science to detect law-breaking. In recent years the X-ray, fluoroscope and new detectoscope at ports and border stations have been successful in discovering contraband hidden in clothes, luggage and automobiles.

Because informers receive 25 percent of the duties and penalties of confiscated merchandise, many seizures result from tip-offs—sometimes by acquaintances of the guilty persons. In addition, the Customs Service has contacts overseas which supply them with tips.

But the customs man still depends upon his wits and his judgment of human nature to outsmart smugglers. An evasive, nervous or abusive passenger instantly puts the inspector on the alert.

One successful inspector declares that you always can spot a guilty person by the look in his eyes. Another says: "I figure out where I would hide something I wanted to smuggle in—and then I look in those places."

Along the 6000 miles of U. S. boundary, where narcotics, cattle and wool smuggling are the chief problems, the 351 men of the border patrol rely upon woodsman's lore. A fresh fire or a few blades of grass bent in a certain direction may offer a clue that leads to the smugglers.

In the postwar world the one problem

(Continued to page 248)



AMERICAN FLYER



Developed at the GILBERT HALL OF SCIENCE

SEE 'EM PUFF SMOKE!

HEAR 'EM "CHOO-CHOO"



Lower train—No. 4607 Pennsylvania Freight. 21 pieces. 40 1/4" long. Remote Control. Complete with 14 sections of track, making 140" oval—

\$29.95

Top train—No. 4611 New York Central Freight. 23 pieces. 52 3-16" long. Remote Control. Complete with 14 sections of track, making 140" oval—

\$39.95

THE ONLY SCALE MODEL TRAINS WITH ALL THESE THRILLING FEATURES

- ★ Real smoke synchronized with train speed
- ★ "Choo-choo" sound effects synchronized with train speed
- ★ Realistic 2-rail track—no old-fashioned third rail
- ★ Trains and track built to uniform 3-16" scale
- ★ Spectacular new Electronic Propulsion locomotives
- ★ Billboard whistle—works with any train system

form 3-16" scale, so that your train looks like real—hugs the track like real. Cars have automatic couplers that couple anywhere. Uncouple by remote control. Die-cast locomotives have superpower worm drive that assures smooth, steady pull at all speeds from a crawl to 120 scale miles per hour. See and hear the sensational American Flyers at your nearest department or toy store.

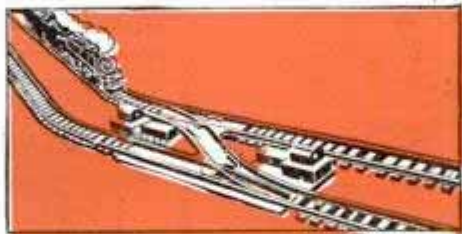

See . . . American Flyer's 2-rail track has no old-fashioned third rail in the middle. "T" design rail. Looks just like the track of a real steam railroad.

The new American Flyers bring you all the wonder and glory of railroading. They puff real smoke. The built-in "choo-choo" reproduces the choo-choo sounds of a real locomotive under full steam. Both smoke and "choo-choos" vary in intensity as you increase or decrease the speed of your train. Locomotives, tenders, cars and track are all built to uni-

When in New York visit the famous Gilbert Hall of Science, Fifth Avenue at 25th Street. Admission free. The A. C. Gilbert Company, New Haven, Conn. Also makers of the famous Erector, Gilbert Chemistry Sets, Microscopes, Tool Chests and other Gilbert Scientific Toys.

HURRY! Send for this Colossal Illustrated Train Book

32 big pages with full color illustrations of all American Flyer trains and spectacular equipment. Advance news on sensational new Electronic Propulsion Locomotives, automatic coal loader, log loader, and other latest developments in scale model railroading. Mail coupon with 10¢.



Gilbert Hall of Science
78 Erector Sq., New Haven, Conn.

I enclose 10¢. Please rush colossal illustrated train book.

Name

Street

City State

This offer good only in U.S.A.

The easy way to paint!

Speedy Sprayer



Favorite of home owners and craftsmen for 20 years! SPEEDY SPRAYER gives your work that professional paint finish everyone admires. Sprays paint, enamel, varnish, lacquer, etc. . . . 4 to 7 times faster than hand brushing! Lightweight, portable, uses any 1/4 H.P. motor. Improved diaphragm principle assures clean, oil-free air. You'll find dozens of time and money saving uses for SPEEDY SPRAYER, including spraying insecticides 2-4-D and DDT. Complete outfit, without motor, only \$26.95.

ONLY \$26.95 LESS MOTOR

At leading hardware, lumber, and auto supply dealers. FREE—write for handy booklet "How to Spray."

W. R. BROWN CORPORATION
5717 Armitage Ave. • Chicago 39, Ill.



THIS BUSINESS IS GOING TO FOLD UP FAST UNLESS YOU HURRY WITH THE WELDWOOD GLUE!

When you want to fix things fast . . . remember Weldwood Glue. It's quick to mix . . . easy to use . . . tremendously strong . . . stain-free . . . rot-proof . . . and permanent. At hardware stores, lumber yards, chain stores, in 10¢, 25¢, 50¢, 85¢ and larger sizes.



WELDWOOD
PLASTIC RESIN
WATERPROOF GLUE

United States Plywood Corporation, New York 18, N. Y.



"YANKEE" VISES
bold work through every step without a misstep

Any job locked in a "Yankee" Vise, is correctly positioned for every operation . . . hand or machine. Lifts on and off swivel base at bench. Machined accurately . . . top, bottom, sides and front end . . . V-grooved block for rounds. Four sizes, with and without swivel base . . . 1 1/2", 2", 2 3/4" and 4" jaw widths. At your dealer's.



Write for "Yankee" Tool Book

NORTH BROS. MFG. CO.
Philadelphia 33, Pa.

STANLEY
THE TOOL BOX OF THE WORLD



handy SPRING kit

Wide assortment of compression, extension and torsion springs—just what you need for a multitude of odd jobs requiring use or replacement of springs.

High quality—same springs that are made for topnotch manufacturers to their rigid specifications. Several dozen springs in kit.

Have the Handy SPRING Kit handy. Send a check or money order right now to Department B

NEW ENGLAND SPRING MFG. CO.
Unionville • Connecticut

ASSORTED SPRINGS FOR REPAIRING AND REPLACING

\$1.10
POSTPAID



FLASH THAT VOLTAGE

Turn that knob. Extinguish the neon glow. Instantly read voltage right off dial. Mini-Volt measures 65 to 660 v. AC. Also DC. Tells whether AC or DC. Virtually burnout-proof. Guaranteed for 10,000 hours' operation. Bakelite case. 12" flexible test leads and test prods. A "must" in electrical and radio work. And only \$2.50 postpaid!

INDUSTRIAL DEVICES, INC., EDGEWATER, N. J.

HI-SPEED HUB & WHEEL ASSEMBLY

FOR TRAILERS TRUCKS-WAGONS

NEW LOW PRICES



Many Implements

HEAVY DUTY 5 STUD 6-00 X 16 WHEEL, EQUIPPED WITH TIMKEN BEARINGS,	1 to 12 . . . \$22.50 pr.
	13 to 25 . . . \$22.00 pr.
	26 to 50 . . . \$21.00 pr.
	51 or more . . . \$20.00 pr.

COMPLETE & ASSEMBLED WITH 1 1/2" x 4 1/2" SPINDLE. SPINDLES MADE TO ORDER AT SLIGHT EXTRA COST.

1000 LB. LOADING PER WHEEL!

GRIFFITH INC.
230 KEELINE BLDG. OMAHA 2, NEBR.

SOLD ONLY IN PAIRS
F.O.B. OMAHA

Whenever you have your headlamps replaced, be sure to insist on

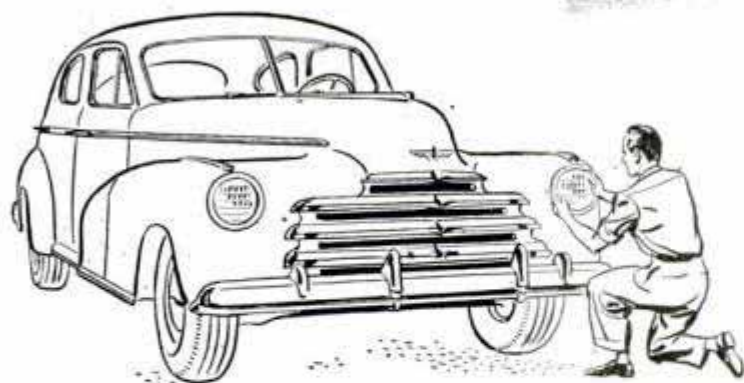

Because G-E sealed beam lamps

DO NOT GROW DIM!

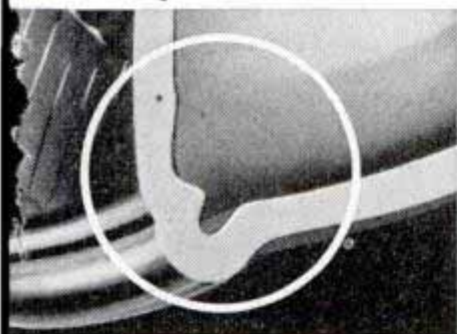

1 ENTIRE HEADLAMP is a one piece "all-glass" unit. Thus, dirt and moisture can't get in to reduce light output.

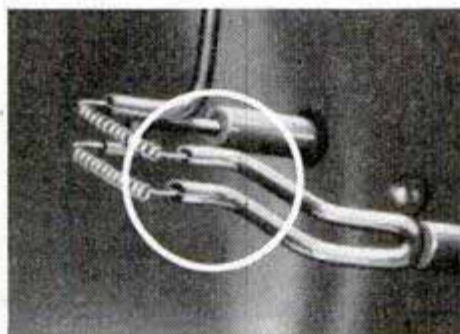

2 THE LIGHT-SOURCE filaments are held in special vise-like grip. Road shock and vibration will not shake them loose and cause light failure.



3 PRECISION LENS of rugged hard-glass construction is designed to put an accurate pattern of light where you need it—on the road.

ROAD and laboratory tests prove that the average General Electric Sealed Beam Headlamp maintains 99% of original light output right up to the end of lamp life. They do not grow dim! You get "new car" lighting always.

12% more light on the road. Now G-E Sealed Beam headlamps give you easier night driving than ever before...12% more light on the road for driving and 16% more light for passing. Just another reason why General Electric Sealed Beam lamps are your best buy!

For every socket,
for every car...

G-E LAMPS

GENERAL  ELECTRIC

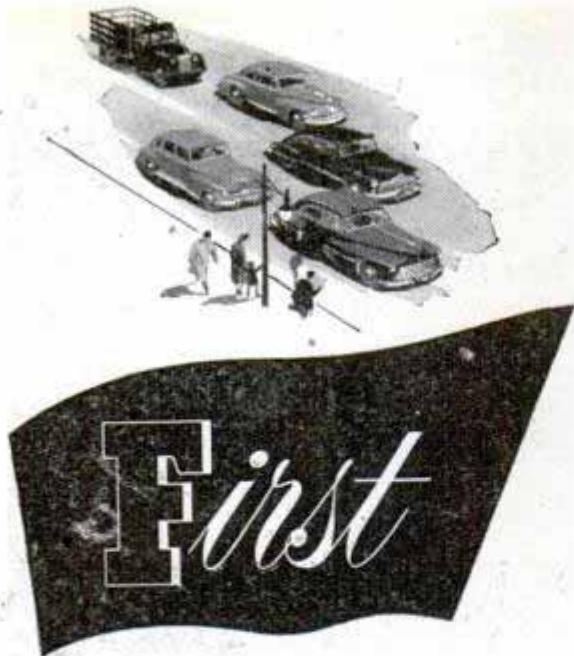

**in Original
Factory-Equipment
Choice**

More than 50% of all cars and trucks built during the past 10 production years have been factory-equipped with AC Spark Plugs. The choice of responsible engineers is your assurance of utmost reliability and top performance.

You can continue to have such reliability and performance by buying AC —the original factory-equipment choice in spark plugs.

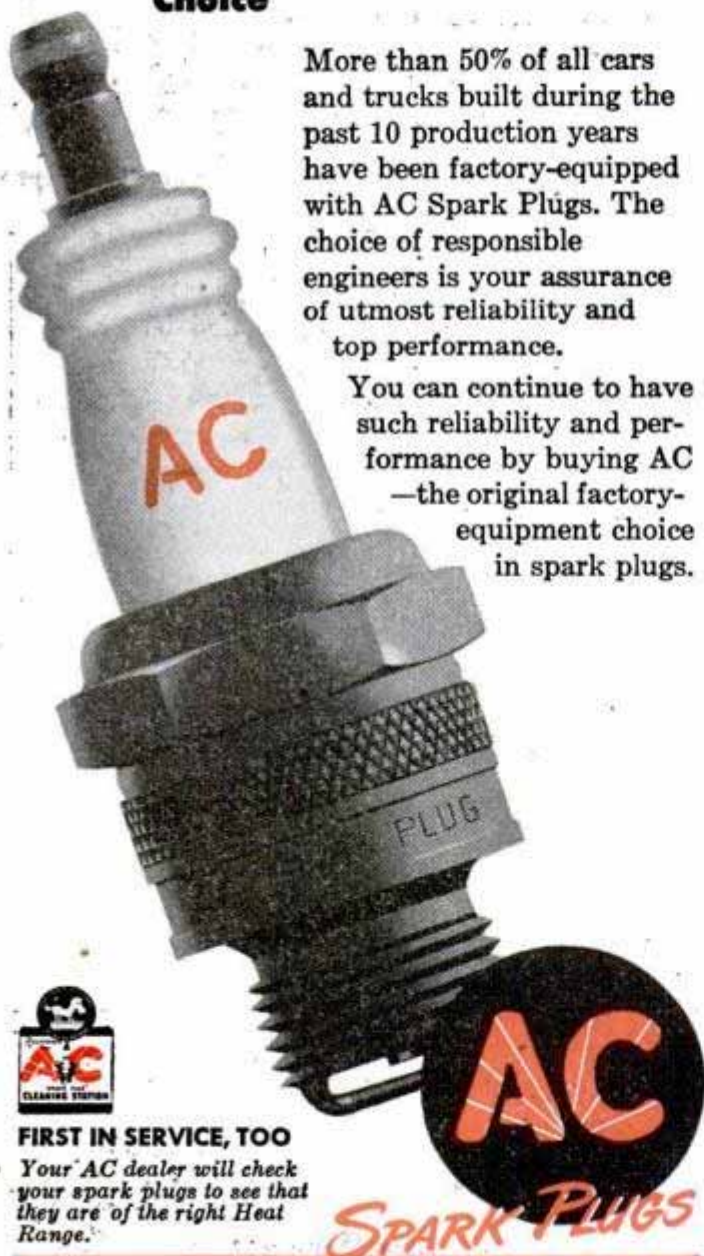

FIRST IN SERVICE, TOO

Your AC dealer will check your spark plugs to see that they are of the right Heat Range.

AC SPARK PLUGS

AC SPARK PLUG DIVISION • GENERAL MOTORS CORPORATION

that worries customs men most is the airplane. Thousands of surplus warplanes are being sold. What is to prevent these planes from being flown across the border, loaded with contraband goods, flown back to the United States and landed on lonely fields?

The penalties for smuggling are stiff—up to two years in jail and \$5000 fine. Members of large smuggling rings or individuals who engage in smuggling with deliberate intent to defraud the U. S. government often pay the full penalty. Where no intent can be shown, the individual pays a fine equal to the value of the smuggled articles, and those articles are confiscated.

Though smuggling may increase for the next few years, the U. S. Customs Service is making it tougher than ever for the lawbreaker. The individual who sees in smuggling a quick road to riches will find that he is wrong and it is more certainly a direct path to the penitentiary.

Hospitals May Establish Vein Banks

Vein banks may some day take their place alongside blood and bone banks. Dr. Charles A. Hufnagel of the Harvard Medical School reports that veins have been transplanted successfully in experiments with animals. He also reveals that a rapid-freezing technique makes it possible to preserve veins. Therefore, he predicts the day will come when human veins are preserved and kept ready for use in persons suffering from vein injury or disease.

Vitamin A Produced Synthetically

Vitamin A, which is essential for proper growth and vision, is now being produced in synthetic form for the first time. Distillation Products, Inc., which developed the process, has not revealed how it is accomplished or what materials are used. The synthetic vitamin A concentrates are light yellow, viscous oils which have no fish odor. Previously, the only commercial source of vitamin A was the oil extracted from the livers of such fish as the cod, dogfish and soup-fin shark.

Electronic "Ear" Detects Gases

Dangerous gases escaping in mines and factories are detected by an electronic "ear" which sets off a signal. Developed at Iowa State College, the instrument consists of a brass tube which collects the gas and an audio frequency oscillator which sends high-frequency sound waves through the gas. A microphone picks up the sound waves and analyzes them to discover type and concentration of the gas.



Blade guide aids close following of a line or pattern.



Steel universal chuck holds all blades, files, and sanding attachments.



Because spring hold-down tilts with table to hold work firmly, you enjoy smooth operation always.



V-jaws of universal chuck hold files with 1/8" or 1/4" shanks.



Using sanding attachment, you finish exterior and interior surfaces easily.

HM-54

Furnished with 4-inch pulley, pulley guard, removable table insert, 3 saw blades, blade guard, dust blower tube, 2 wrenches.



Saws wood up to 2 inches thick — cuts light metals, and plastics. Cuts to center of 32-inch panel.

New! HOMECRAFT® 16" SCROLL SAW built expressly for the hobbyist

Only \$29.95 (Less lamp attachment and motor)

It's now available at your dealer's store, at surprisingly low cost — this good-looking Homecraft 16" Scroll Saw.

With its speed of 1275 cutting strokes per minute, you can do fast, accurate scroll-sawing of all types: fret work, inlay work and marquetry, jig saw puzzles, etc.

Made by a Leading Tool Builder!

Behind the Homecraft 16" Scroll Saw is the engineering skill of the men who make Delta Power Tools. In schools and factories, as well as home shops, Delta tools have long been recognized as outstanding for safety, accuracy, and dependability.

Having a home shop equipped with Delta Power Tools some day is the dream of practically every craftsman who wants the very best!

Worthwhile Features!

With the Homecraft 16" Scroll Saw, Delta answers the demand for a good, popular-priced tool that is adequate for the average limit-



Catalog Sheets! — Show all Homecraft Power Tools and accessories. Sent to you free. Use coupon, for your copies.

ed needs of the hobbyist who "putters around" with woodworking.

Delta engineers have included features that make it a real value for the money — a tool you've every right to be proud to own:

Bearings are constantly lubricated from the splash system in the crankcase. . . . Universal blade chuck fits all types of blades, files, and sanding attachments. . . . Pump in head supplies continuous air flow, to keep cutting line free from sawdust. . . . 11" x 11" table tilts 45 degrees to the right and 15 degrees to the left, for angle-cutting. . . . Guides are fully adjustable. . . . Upper and lower chucks rotate 90 degrees, for unlimited-length side cuts. . . . Accurately-machined one-piece casting forms base and arm. . . . Pulley guard provides safety.

See It At Your Dealer!

Ask your Homecraft dealer to show this scroll saw, and his complete display of Homecraft Power Tools that range in price from \$29.95 to \$39.95.

Visit your Homecraft dealer now!

Tear out coupon and mail today!

DELTA MANUFACTURING DIVISION
Rockwell Manufacturing Company
680N E. Vienna Ave., Milwaukee 1, Wis.
Please send free catalog sheets on Homecraft Power Tools.

Name.....
Address.....
City..... State.....



General Sales Office • Chicago 2, Illinois

"Dave ought to know better than that"



AL: Yeah, I wouldn't take that set of drills if they gave it to me.

PHIL: Just junk—that's all they are. And Dave's bragging about the bargain he got.

AL: You'd think he'd know by this time that you can't save money buying "no-name" tools.

PHIL: Sure, it's plain as day that when a well-known manufacturer puts his name on tools, those tools have *got* to be good. And when you buy tools *without* known brand names, you're just throwing money

away.

AL: Well, I guess we all have to learn it the hard way.

PHIL: Yeah. I made some bad buys before I got wise. Now I stay away from bargain counters and do all my tool buying at the hardware store.

AL: Same here—and the first thing I look for is the brand name.

**Your HARDWARE DEALER sells QUALITY tools
and hardware... Buy from HIM**



POPULAR MECHANICS



Choose EVINRUDE
 for tops in outboard performance — thrilling power for biggest boats and fastest runabout speeds



Choose EVINRUDE
 for matchless 4-cylinder smoothness in 3 great models . . . "Speedifour", "Lightfour" and the famous "Zephyr"



Choose EVINRUDE
 for the right power for every boat . . . with revolutionary new WEEDLESS DRIVE on two popular light models

Choose Evinrude . . . for the certainty of fine performance that means utmost satisfaction and enjoyment for years and years ahead.

See your Evinrude dealer—look for his name in your classified phone directory under "Outboard Motors". For free catalog of the complete Evinrude line write, EVINRUDE MOTORS, 5656 North 27th Street, Milwaukee 9, Wis.

EVINRUDE

FIRST IN OUTBOARDS **38th YEAR**

In Canada: Evinrude Motors, Peterboro, Ontario

Speed Sweep

THE BRUSH WITH
THE STEEL BACK



*Sweeps
cleaner, faster—
Out lasts ordinary
brushes 3 to 1!*

Mail Coupon Today

Milwaukee Dustless Brush Co.
530 N. 22nd St., Milwaukee 3, Wis.

Please send me complete information about
Speed Sweep brushes.

Name _____

Street Address _____

City, State _____

How Fast Can Man Fly — and Live?

(Continued from page 93)

likely determine whether or not transsonic pilots need to be shock-mounted against vibration similar to the way that flight instruments are protected.

Studies in aerodynamic heat already have led to the substitution of strong plate-glass windows for the original transparent plastic canopy on the Skystreak. The plastic, it was found, would heat up and fail even at the speeds already flown. Other materials commonly used in aircraft lose part of their strength from the frictional heat of high speed and present information about this phenomenon will be checked with the aid of the plane.

Instruments on the Skystreak include devices that measure the pressures at 400 different points on the wing and tail surfaces. Temperature-recording instruments are placed at critical points and the plane carries strain gauges that measure total air loads on the wing and tail surfaces. Even from the comparatively few flights that the Skystreak has made enough new information about transsonic flight has been obtained to influence the design of the faster aircraft now under construction. Truly the plane is a test tube.

The '48 Cars Begin to Roll

(Continued from page 118)

sedan, touring sedan, seven-passenger sedan, limousine and convertible. The bodies extend over the rear wheels. Stout bumpers, designed as integral parts of the car, reduce over-all length about four inches without changing wheelbase length. Three new straight-eight engines have 130, 145 and 160 horsepower. Compression ratio of these engines has been stepped up to seven to one compared with 6.58 to one in the '47 engines. Many parts of the new engines are interchangeable which will make for easier servicing. The crankshaft is larger and heavier and a new hardened crankshaft sprocket, combined with a roller-pin timing chain, is said to assure smoother operation and longer life. A ground-level manifold, with no pockets where raw gasoline can accumulate, provides easy starting and good idling. Although the straight-eight will be standard on the passenger cars, Packard will continue to build sixes for taxicabs and for export.

The '48 Packards require 150 pounds more steel than the '47s. Even the new "station sedan"—Packard refuses to call it a wagon—has an all-steel body and top. All

(Continued to page 256)

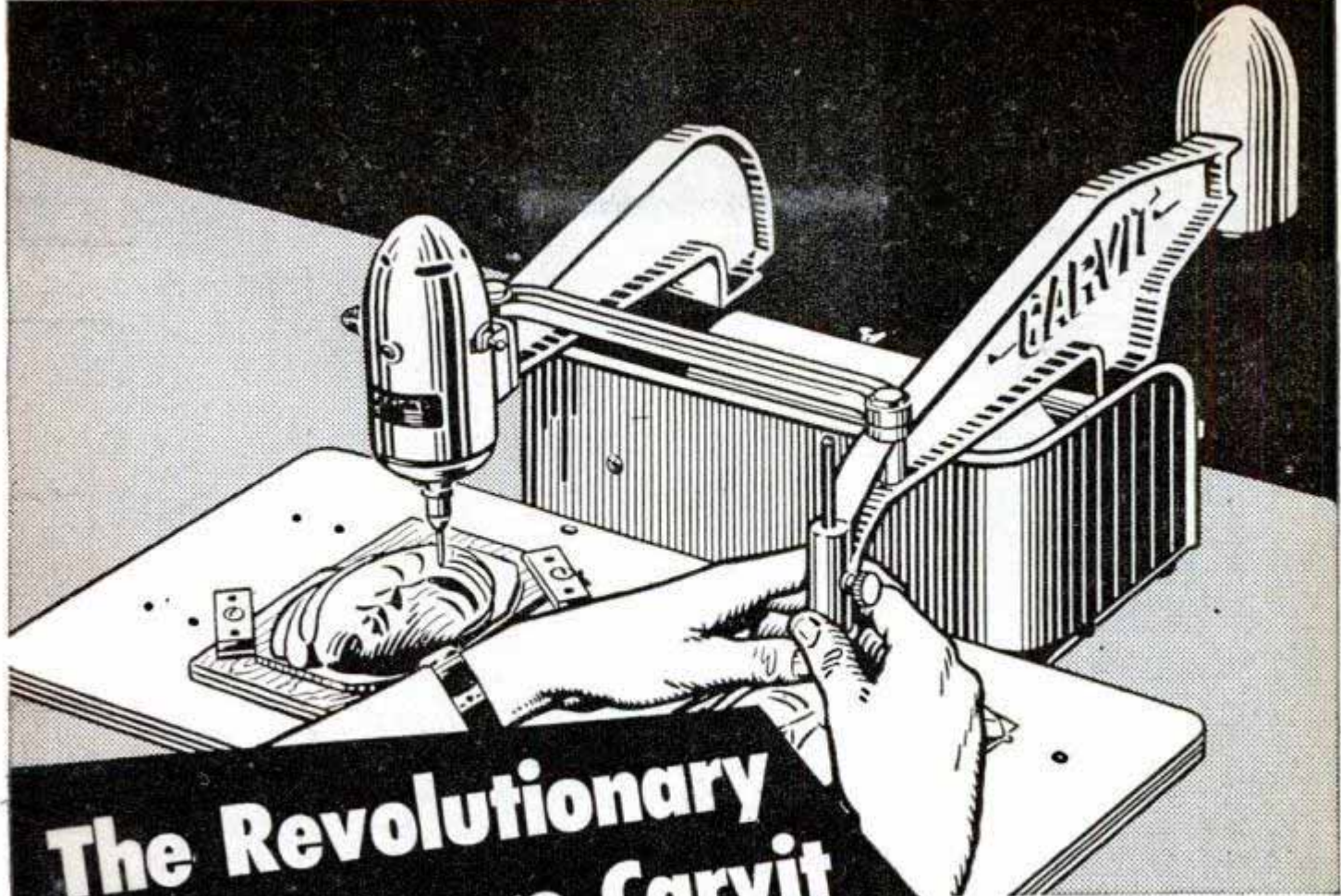

The Revolutionary New Dumore Carvit

makes you a skilled wood-carver in 20 minutes!

Here's a fascinating new hobby — complete in one tool. Making fine wood carvings with the Carvit is so simple a child can do it! The unbelievable perfection of your first carving amazes your friends! Experienced craftsmen use the Carvit to give their woodworking projects that *real* professional touch.

With the Carvit, you make beautiful replicas of inexpensive objects you can find in any dime store or gift shop — reproducing them in mahogany, walnut, and other fine woods. Your carvings are many times more beautiful and valuable than your original models!

You're an expert at once — with a Carvit!

Here's how the easy-to-use Carvit works: You clamp a model to the table below the tracer, and a wood block below the cutter. Then you switch on the motor and guide the tracer over the raised contours of your model. The cutter moves with the tracer to carve an

exact duplicate of the model.

Carving with the Carvit is fascinating fun for everyone. The Carvit is *the ideal gift for your sweetheart, husband, or son!* See the Carvit at your local hardware store today — or mail us the coupon below!



No skill or training needed to do work like this

Carve useful ornaments for the home — distinctive gifts — fine carvings that *sell!*

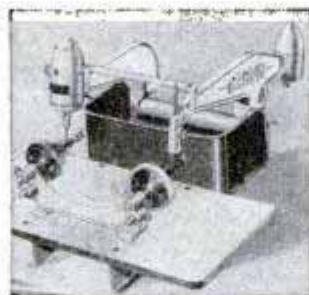

With an index attachment, the Carvit reproduces objects in the round — statuettes, and busts.

**Tear out coupon
and mail today!**

The Dumore Company, Dept. M-51, Racine, Wisconsin

- Please send complete information on the Carvit.
- Please send one Carvit. \$48.50 enclosed.
- Please send one Carvit with index attachment. \$58.25 enclosed. Shipping charges C.O.D.

Name.....

Address.....

City..... (.....) State.....

**Satisfaction
guaranteed or
your money back
in 10 days!**

See the **Amazing Difference**

...the **NEW RADIANT** Screens
make in your pictures

Ordinary projection screen surface... **DULL**, lacking brilliance and contrast



Radiant Glass Beaded Surface... **BRIGHT**, brilliant and contrasty

Your pictures look *twice as bright* when projected on the new 1948 Radiant Projection Screens. They have added brilliance, extra sharpness, more authentic colors. The Special Radiant glass-beaded screen surface with millions of tiny glass beads imbedded in pure white plastic—reflects light instead of absorbing it. Radiant gives you more new features that make for quicker set-up and easier adjustment. These new Radiant Projection Screens make every picture a better picture!

Send for **FREE** Screen Guide Today!

"Secrets of Good Projection," a 32-page booklet, gives proper screen sizes, correct projection lenses, tips for improving projection and many other valuable facts. Mail coupon for your **FREE** copy.



RADIANT MANUFACTURING CORP
1257 S. Tolman Ave., Chicago 8, Ill.
Send me **FREE** Screen Guide—also latest Circular showing complete line of Portable, Wall, Ceiling and Table Screens.

Name _____
Address _____
City _____
State _____

My Dealer Is _____

RADIANT

Reg. U. S. Pat. & TM. Off.

PROJECTION SCREENS

Exclusive New Radiant Screen Features

- 1 Self-Opening Tripod Legs*
- 2 Screen Leveller*
- 3 Shakeproof Safety Catch
- 4 Feather Touch Adjusting Handle (U. S. Patent)
- 5 Fully Automatic Auto-Lock*
- 6 Built-In Shock Absorbers*
- 7 Automatic Leg-Lock
- 8 Rubber-Ball Tripod Feet
- 9 Triangular Steel Tube Construction
- 10 Automatic Leg Adjustment
- 11 Finger Grip Carrying Handle
- 12 Streamlined Design
- 13 Automatic Leg Closing
- 14 Complete Range of Screen Heights
- 15 Unconditional Guarantee

The complete Radiant line includes Wall, Ceiling and Table Models in sizes 22 inches x 30 inches to 20 feet x 20 feet and larger

*Pat Pending



"I've pensioned off my reindeer to ride a **WHIZZER**, too, a Merry **WHIZZER** Christmas to every one of you!"

Complete with all necessary attachments. Fits any man's balloon tire bike. If no Whizzer Dealer in your community yet, send to Whizzer Motor Co., Pontiac, Mich., Dept. 5212, for your Christmas Whizzer.

Ride one and you'll buy one!

\$97⁵⁵

plus tax, F. O. B. Pontiac, Mich.

WHIZZER
AMERICA'S FINEST BIKE MOTOR

SENSATIONALLY PRICED

ELECTRIC TORCH

Now only

\$12

FULLY GUARANTEED

WELDS • BRAZES • CUTS • SOLDERS

Just plug into nearest socket. Arc furnishes up to 10,000 degrees Fahrenheit. Welds metal up to 3/16" thickness, uses up to 3/32" rod. Cuts all steel including hard tungsten. Complete equipment includes unit plus carbon tipped dual copper electrode Cutting Torch and single electrode Welding Torch with attached alligator clip. Generous supply of welding materials. One welding job may more than pay cost of entire unit. Ideal for home workshop. Invaluable for body and fender shops, garages, repair and machine shops, etc. C.O.D. \$12 plus postage (wt. 4 lbs.) or send \$12 and we pay postage. Money back guarantee. Free Folder on request.

CALIFORNIA TECHNICAL PRODUCTS CO.

8510 WARNER DRIVE • CULVER CITY, CALIF. DEPT. A-12

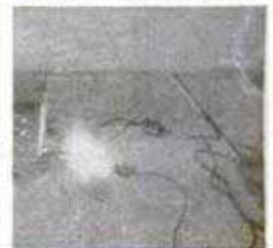

WAR SURPLUS!

New B-24 Aircraft Lighting

GENERATORS

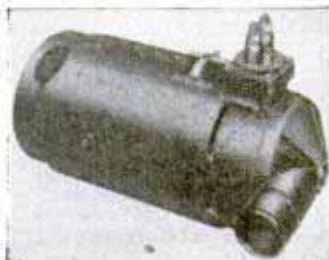

30 Volts
300 Amp. D. C.

\$49⁵⁰

Original cost \$250

MODEL R. 2, BUILT BY JACK & HEINTZ, CLEVELAND, O.

Can be used for lighting or converted for use as welder, electric plater, fast battery charger, auxiliary power unit, etc. Small but mighty. Size 16"x7". Air cooled. Shipping weight 68 lbs. Immediate shipment. Original crates. Send check with order to save time. We also offer new 200 Amp. G.E. and Westinghouse Lighting Generators, 30 Volts D.C. Model P. 1 at \$33.00. (Cost \$150.00.)

GREER CO.

460 S. State St., Dept. 4127
Chicago 5, Ill., Phone Harrison 4075

P
O
R
T
A
B
L
E

Speedy Sprayer SENT DIRECT

P
O
W
E
R
F
U
L



Uses 1/4 Hp. Motor

Ideal Christmas gift! Sprays paint, varnish, lacquer, disinfectants. Paint anything—do it better—five times faster! Generate compressed air, inflate tires, other uses. Delivered (less motor) with sturdy base, compressor, "V" belt, motor pulley, 15 feet high test air hose, trigger-type spray gun, one-quart cup. No. 112—\$24.95.

SPECIAL! No. 414 Master twin-eyl Sprayer (less motor) \$47.50. Handles biggest jobs!

ELECTRIC MOTORS—ball bearing, capacitor, 110/220 V, 1725 rpm, 1/4 HP—\$24.75, 1/2 HP—\$37.50.

IMMEDIATE DELIVERY on above. Add 5% west of Mississippi. Prepaid if check or M. O. enclosed. C.O.D. receipt of 25% deposit. Write for **FREE** Catalog; Power Tools, Radios, Toys. Address:

INDIANA APPLIANCE CO.

20 East Sycamore, Dept. PM-1247 Evansville 9, Ind.

\$6.95

POSTPAID
including
Two Arrows



CROSS-BOW SPORTING GUN

Compact powerful pistol grip gun. 35-lb. bow pull—ideal for small game hunting, frog spearing, target shooting, etc. Non-corrosion construction throughout.

Extra arrows \$3.50 per doz.—45c ea. Special harpoon arrow for underwater goggle fishermen, \$1.40 ea. All C.O.D. orders 30c extra.

JERED ENGINEERING & MFG. COMPANY

1024 S. Washington St. Royal Oak, Mich.

A GIFT SUGGESTION TO FOLLOW FAMOUS HULL COMPASSES



FOR CAR OWNERS (FIELDMASTER) \$5.95



FOR CAR OWNERS (STANDARD) \$3.95

FOR BOAT OWNERS \$2.75



HULL MFG. CO., P. O. Box 246-D11, Warren, Ohio

STAY HOME AND MAKE MONEY!

—Men! Women! Get into profitable, uncrowded profession you can operate from your home or small office after short home training course. No capital required. No goods to buy. No age limit. Others earn \$50.00 to \$100.00 per week making famous Stephenson corrective foot devices to order. Foot sufferers everywhere pay gladly for relief. Send today for **FREE** BOOKLET. **STEPHENSON METHOD**, Established 1894, 12-28 S. Market St., Boston, Mass.

Sand Casting—Forging—Heat Treating—Case Hardening

BRONZE FOUNDRY



is again available in limited quantity without priority. Orders filled in sequence as received. **INVENTORS—SCHOOLS—CRAFTSMEN** use **FOUNDRYETTE** for making castings quickly for new inventions, for instruction, and general purpose. Order now for early delivery. Three sizes are available capable of making bronze castings of 1 1/2, 3, and 6 pounds weight, aluminum, copper, brass, etc. Domestic gas supply and 110 volt AC or DC energy required for operation.

Write for **FREE** circular.
KANSAS CITY SPECIALTIES CO.
Box 6022, Dept. SL-5 Kansas City, Mo.

See These New JACOBS CHUCKS for the HOME SHOP



HEX-KEY Model for drill presses, lathes and motor shafts

★ 4 models, capacities up to 1/2"

★ straight hole design to fit 1/2" or 5/8" shafts

★ fits plain end drill press spindles, motor shafts, and other powered shafts

★ special arbors for Morse Taper spindles



Easily fitted to the shaft, makes a motor tool of many uses.

Holds drills, grinding wheels, sanding drums and other accessories.

For chucking jobs on small work, chuck can be held in lathe spindles.

HAND-TITE Model

for hand drills, flexible shafts, polishing heads.



★ 3 sizes for tools with spindles up to 1/2" dia.

★ 2 diameters to fit 3/8" or 1/2" spindles.

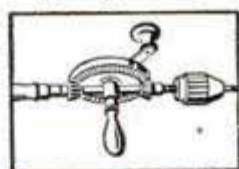

Greater gripping power and dead-center accuracy for drills.

On a bench grinder, this chuck gives a horizontal drilling set-up.

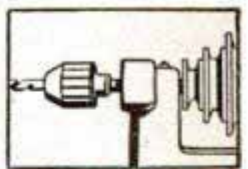

RUBBER-FLEX Jaw Assembly

One-piece construction . . . hardened alloy steel jaws bonded together by oil-proof synthetic rubber . . . no loose jaws or springs. Tremendous gripping power. Accuracy not previously possible in popular priced chuck.



SEE these 2 new Jacobs Chucks at your hardware dealers.

THE JACOBS MANUFACTURING COMPANY, Hartford 2, Conn.

Please send your new illustrated folder on the Jacobs Rubber-Flex Hex-Key and Hand-Tite Chucks.

Name.....

Street.....

City..... State.....

AT LAST!

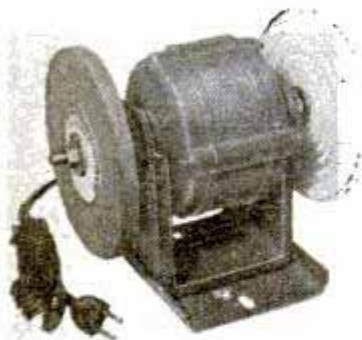

FULL YEAR GUARANTEE

A WORKSHOP GRINDER OF YOUR OWN for only **\$14⁹⁵**

(\$15.95 West of Denver)

Just what you've been waiting for—this sturdy new, grinder-buffer-polisher. Designed and built especially for the home and hobby shop . . . Perfect for small industrial jobs.

HAS COUNTLESS USES

You will need this amazing home workshop grinder to sharpen knives, scissors, screwdrivers, small tools, lathe bits and many other around-the-house items . . . polish silverware, jewelry, golf clubs and keys.

NOTE THESE FEATURES

Safe operating speeds of 1725 rpm—will withstand stalling for 20 minutes without injury to motor. Oversized rubber cushions make it whisper-quiet—a must for home workshops and offices. Low cost operation—uses same current as 100 watt bulb. Will not interfere with radio. It is light enough to be carried to place of work.

NOTHING EXTRA TO BUY

Comes fully equipped—ready to go to work. Includes rugged six foot cord set, dura-hard, silicon carbide grinding wheel, polishing wheel. Has famous Victron motor mounted on resilient, non-vibration base. Finished in gray baked enamel—equipped with oil reservoirs and felt seals to last for the lifetime of the grinder. Weighs approximately 12 pounds. Can be clamped or bolted to table or work bench. Designed specifically for hobbyist, handyman, housewife, mechanic, doctor, dentist, optician, watch maker and jeweler. Send check or money order today. Postpaid in U. S. A.

VICTOR ELECTRIC PRODUCTS, INC.
2950 Robertson Ave. Cincinnati 9, Ohio



models of their line are "luxury finished" throughout with new fabrics, color combinations, trim styles, upholstery with foam-rubber cushions, and even black-light illumination of the instrument panel. This lighting is the same as that used on bombers to relieve air crews of eyestrain on night missions.

Packard does not have an automatic transmission on its '48s, but company officials report they have such a transmission and that its appearance will be delayed from six to nine months by a shortage of materials.

The big surprise of the '48 season so far is the new Hudson. It's as different from its predecessor as was the streamlined Studebaker. This "car of tomorrow," as the '48 Hudson is called by its makers, has a lower center of gravity than any other American automobile. It is only five feet from the ground to its top and when you get in it you step down several inches to the floor level. This unusual feature is said to provide more headroom than any other mass-produced car. Sitting "within the frame of the car" provides the passenger not only with a smoother ride, but with additional protection in case of accident, according to Hudson engineers. Rear-seat passengers are cradled between the axles, and the seat is actually ahead of the rear wheel. This back seat is 63 inches wide while the car itself is only 75 inches wide at the rear wheels. One prewar type of sedan (not a Hudson) had an 80-inch width at the rear wheels and a rear seat only 53 inches wide.

The '48 Hudson has a completely new Super-Six engine and an improved Super-Eight. The Hudson automatic transmission, Drive-Master, is optional equipment at extra cost on all cars.

Studebaker, with a big backlog of orders and a car of postwar design that has won general acceptance by the public and enthusiasm on the part of owners, has elected to coast in 1948 with a program of "still higher standards of style and comfort." There will be a slight face-lifting in the matter of redesigned grilles, front bumpers and bumper guards, black-light instrument illumination, repositioned rear shock absorbers on the Commander, Nylon upholstery in the Land Cruiser, and auxiliary spring coils to insert in the cushions.

Studebaker will continue to turn out its Champion, Commander and Land Cruiser models in increasing numbers and push the smart Champion and Commander convertibles in 1948. Hitherto, only a limited number of convertibles have been made at South Bend. Bidding for major attention

(Continued to page 260)

Christmas Suggestion . . .

for the man who owns, or plans to own a workshop, no gift could bring more pleasure.

Logan

A NAME TO REMEMBER WHEN YOU
THINK OF BETTER LATHES AND SHAPERS

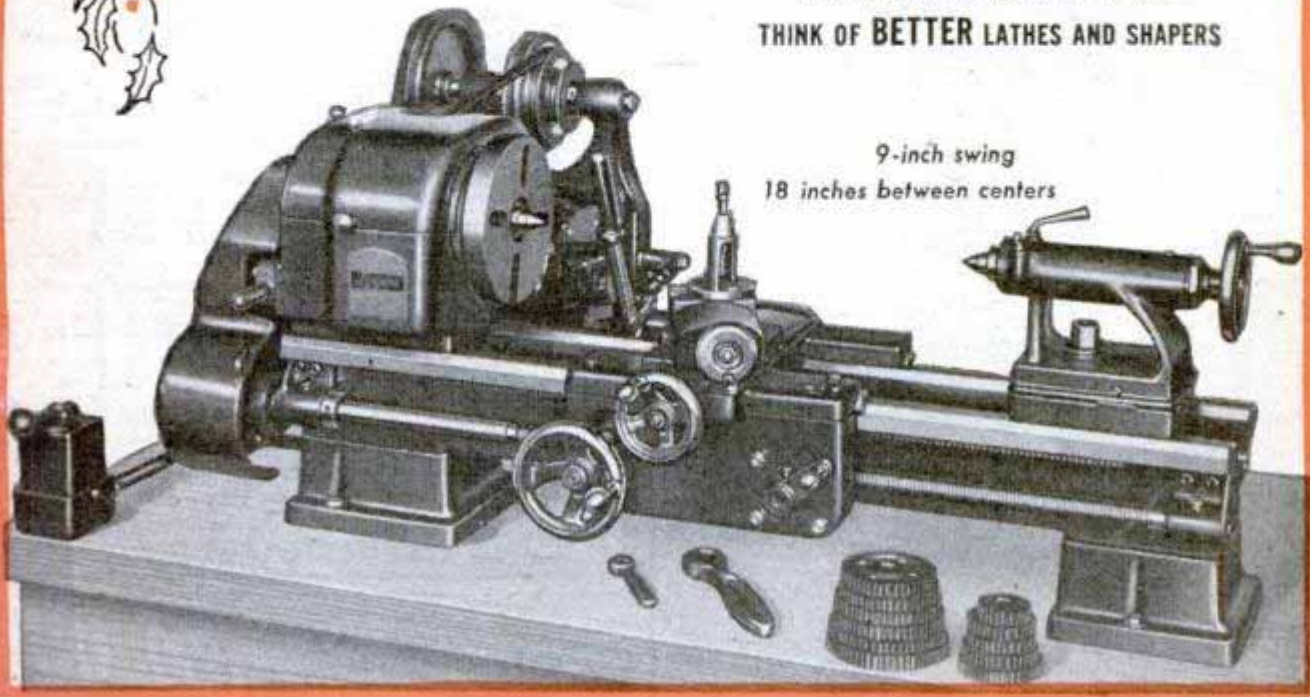

9-inch swing
18 inches between centers

**A LATHE TO
DEPEND ON**

Logan Ruggedness
and Lasting Accuracy
. . . at \$159⁵⁰

This compact Logan 9-inch Lathe handles manufacturing operations with the same speeds and precision that make the larger Logan Lathes outstanding in industry. For general machine shop and tool room work, farm equipment maintenance, and home workshop projects, it is equally effective. The ball bearing spindle mounting, the self-lubricating bronze bearings at other vital points, and the V and flat bed ways precision ground to within .0005" of parallelism are typical of Logan advanced design. Rugged, rigid construction makes it steady on heavy cuts. See this outstanding 9-inch lathe at your Logan Lathe dealer's or write for information.

DISTRICT OFFICES: WOOLWORTH BLDG. 550 W. WASHINGTON BLVD. 1672 MISSION STREET 700 COMMERCE ST.
NEW YORK 7, N. Y. CHICAGO 6, ILLINOIS SAN FRANCISCO, CALIF. DALLAS 2, TEXAS
CORTLAND 7-8024 CENTRAL 1246 UNDERHILL 6682 CENTRAL 4075

LOGAN ENGINEERING CO., Dept. B-12, CHICAGO 30, ILL.

Simoniz Your New Car... From the Start!



Simoniz Keeps Colors from Fading ... Protects and Makes the Finish Last Longer

The sooner you SIMONIZ your new car the better! Your new car needs finish protection now ... to "build up" the beauty ... to give it brilliant beauty from first mile to last. SIMONIZ protects the finish from road grime and grit that scar ... against corrosive airborne chemicals that dull and destroy. SIMONIZ saves car washings, too. Dust and dirt wipe off easily with a cloth. Remember, you can SIMONIZ your car only with genuine SIMONIZ and Simoniz Kleener. Insist on them always!

LIQUID SIMONIZ KLEENER is wonderful for cleaning quickly new cars or those with finishes in average condition. Paste Simoniz Kleener cleans, restores lustre and makes dull cars look new again. Then apply SIMONIZ to make that restored beauty last years longer.

THE SIMONIZ COMPANY, CHICAGO 16, ILLINOIS



Motorists Wise

SIMONIZ

TRADE MARK REG.

KEEPS NEW CARS ... NEW LOOKING

in the open-car field, the '48 Studebaker convertibles feature automatic top control, weatherproof upholstery, full-vision windshields and attractive colors including new iridescent hues.

Although the '48 Studebakers will have the conventional transmissions of the '47s, the company has been conducting extensive tests on several automatic types and is expected to make one of them available as optional equipment on the higher priced models in 1949.

Ford is also intensely interested in automatic transmissions. In fact, 50 test cars were equipped with a new torque-converter type of transmission. This particular transmission has been shelved by the Dearborn engineers, but some form of automatic transmission may make an appearance late in 1948. The new so-called postwar Ford is expected to make its bow sometime next spring. The 1948 car will have a new engine and body, probably low, wide and fenderless. Radical changes in design also are said to be in store for the Mercury and Lincoln. The '48 Mercury is reported to be a larger car intended for competition in a higher price class. Although the Ford Company is making no pre-season announcements, both Mercury and Lincoln are said to have individual suspension of all four wheels, possibly with a torsion-bar springing system using rubber to cushion road shocks. The first '48 models off the assembly lines may not have automatic transmissions, but such equipment may be added during the year and by 1949 at the latest.

The first General Motors division to make a 1948 announcement is Pontiac. This changeover will be made in one day early in the year, indicating that the '48 will be a face-lifting job. The big feature of the '48 Pontiac will be a Hydra-Matic transmission which will be offered as optional equipment. The company expects 50 percent of the buyers to order automatic transmissions. These will be available on both the six and eight-cylinder Torpedo and Streamliner models.

The biggest changes in the General Motors cars will be in the Cadillac, Buick and Oldsmobile divisions. New body lines are reported to be in store for these cars which have always had a basic resemblance. These new '48 lines probably will be in the popular trend of free flow and minus rear fenders. The Buick Roadmaster, largest of that line, is reported coming out with a Buick-developed torque-converter type of automatic transmission. This transmission is said to be more fully automatic than the Hydra-Matic or Fluid Drive. Of course,

(Continued to page 264)



MOTO-TOOL ★ The "Pocket-Size Machine Shop"



PRE-WAR PRICES STILL PREVAIL

Moto-Tool Kit No. 2 about \$30.00; you with 23 accessories (high speed steel cutters, grinding wheels, polishing accessories) and heavy-duty professional Model 2 Moto-Tool in natural-finish, hardwood case... \$23.50 (Items purchased separately would cost

Moto-Tool No. 2 with one emery point \$16.50.

Moto-Tool Kit No. 1 with 34 accessories and Model 1 Moto-Tool in wood case \$17.50

Model 1 Moto-Tool with one wheel point \$9.85.

A TOOL THAT PACKS EXTRA YEARS OF PLEASURE

... LOOK AT THE REST, THEN BUY THE BEST

Here's a tool to please a man's heart... one that holds promise of endless creative hours. Dremel Moto-Tool is a "war-veteran"... used by all branches of the Armed Forces in far-flung repair bases... helped to set production records at General Electric, Westinghouse, Remington Arms, Ford and others. Hobbyist or expert craftsman, first choice is Model 2 Moto-Tool Kit with its handsome felt-lined, highly finished wood case with rows of tools begging to be put to work. Write for FREE catalog of Moto-Tool attachments and accessories.

14 REASONS WHY MOTO-TOOL'S A BETTER BUY

- Housing has "pencil-type" finger grip ● Instant-action, wrenchless chuck ● Oil-less (sealed) trouble-proof bearings
- Patented automatic chuck-lock pin ● Over-size armature shaft, hardened, ground and polished ● 110 volt, universal type (AC-DC) motor ● Easily replaced commutator brushes ● About 27,000 R.P.M. cuts cleaner... saves cutters ● Sliding snap-type switch ● Handy hanger hook;
- Sturdy, shockproof bakelite housing ● Dust filtered, air-cooling system ● Weighs only 13 oz. ... shaped to fit the hand ● Dynamically balanced for vibration-less operation.

MONEY BACK GUARANTEE

Buy Dremel Moto-Tool from your Dealer. If he cannot supply you, order direct from factory on 10 day trial. Shipped postpaid for payment in full (send check or money order); or send only \$2.00, we will ship C.O.D. You pay balance plus postage.

DREMEL MFG. CO. DEPT. 117-M
RACINE, WISCONSIN



Do These Better - Faster

Approx. 27,000 R. P. M.

- Finishing
- Sharpening
- Burnishing
- Engraving
- Touching Up
- Mortising
- Polishing

- Cleaning
- Rasping
- Brushing
- Dressing
- Burring
- Grinding
- Routing
- Sanding
- Drilling
- Inlaying
- Sawing
- Scoring
- Carving
- Cutting



Free Both Hands With Moto-Tool Attachments

Moto-Tool Stand (left) made of heavy cast iron, holds Moto-Tool at any position or angle \$4.50

Moto-Tool Shaping Table \$2.50. (Shown with stand, right). Aids accuracy in routing, grinding.



Get A SEAMAN ROTARY TILLER

Better Yields — Better Crops

Because this farm-size rotary tiller prepares seedbeds most ideally suited to your soil and crop conditions, it helps produce higher yields and better quality crops. Can be adjusted for fine pulverization, coarse or medium tillage... just the way you want it. Mixes fertilizer and humus into the GROWING AREA of seedbed; aerates soil; eliminates air pockets and hard plow soles; conserves moisture; promotes earlier and more complete germination of seed; helps to destroy many crop pests and certain varieties of fungus; provides effective weed control; reduces erosion... all with ONE machine!

SEAMAN ROTARY TILLERS are available in power take-off and motorized models 3 to 7 ft. tillage widths. See your Seaman dealer and write for complete information.

SEAMAN MOTORS, Inc. 364 N. 25th Street Milwaukee 3, Wis.



First Choice

Hand and power grinders to fit all needs. Sold at leading hardware stores.

LUTHER GRINDER & TOOL CO.
Sheboygan, Wis.



Est. 1896



Larson

"MAKE YOUR OWN" FOLDING SAW-HORSE SET



IN USE

A brand new LARSON construction set, with copyrighted instruction sheet for easy assembly. Set makes two complete Folding Saw Horses, that can't be beat for general household use. They are rigid yet light in weight and fold compactly for storage. Can be made to any reasonable height or length. Lumber not included in set.



Prepaid \$2.50 **FOLDED**
CHAS. O. LARSON CO., BOX 358, STERLING, ILLINOIS

MARGIE

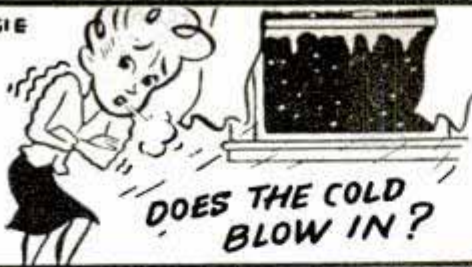

ITS TIME TO
WEATHER-
STRIP
WITH
Mortite



KEEP WARM—SAVE FUEL

Don't put up with dangerous, drafty zones in your home when it's so easy and inexpensive to weatherstrip with Mortite. Simply press pliable Mortite around windows, doors, baseboards, etc. It keeps cold out, keeps heat in, shuts out dust and dirt, too! Mortite adheres to any clean, dry surface. No tools, no tacking needed. Anyone can apply it.

3 Sizes: 29c - 98c - \$1.25

Higher west of the Rockies and Canada

Get at stores or write for free circular



J. W. MORTELL CO., 522 Burch St., Kankakee, Ill.

QUALITY

**8" FLOOR MODEL
TILT-ARBOR SAW**



**UNCONDITIONALLY
GUARANTEED
1 YEAR**

Complete as shown with Trans-axial Ball Bearing Motor Drive, Ball Bearing Saw Arbor, Table including extension 18" x 25", Aluminum Fence & Saw Insert, Complete Mitre Gauge, 3 1/2" steel column and cast iron base, Precision segments on mitre gauge and cradle.

\$79.50 F.O.B.
ROYERSFORD, PA.
**UNUSUAL
VALUE**

BENCH MODEL, \$59.50
Shipping Wt., 118 lbs.

Cast iron table extension bracket furnished. Will support plywood top much larger than 9" x 18". Motor pulley and belt furnished. Blade & Motor NOT included. Overall height 35 1/2", Shipping Wt. 156 lbs.

AMERICAN MACHINE & TOOL CO. Inc.
DEPT. 110 ROYERSFORD, PA.

Write for free illustrated folder.



**TORNADO
GAS TORCH**

The Modern Way of Soldering

Ideal for hard and soft soldering. Will heat quickly; solder will flow freely and smoothly. No compressed air required. Self-adjusting. Safe. Economical. Can be used for annealing small parts and bending metal parts. Generates a heat of 1700° F. Simply connect to any illuminating gas jet with a rubber hose and operate. Tornado Torch No. 119 comes with three tips, (1/8", 1/4", 3/8" blast).

Tornado Gas Torch No. 119—Complete with 2 tips, for Natural Gas or Bottled Gas; with 3 tips for Manufactured Gas. \$2.95 per set. See your dealer or order direct. Send check or money order—post paid.

Robco Corporation, 202 E. 44th Street, New York 17, N. Y.



**SHOCK ABSORBING
Tow Strap**



**FITS ALL
CARS**

Unbelievably strong—fastens to any car or truck bumper like a belt. Attaches in a jiffy. 10" s-t-r-o-t-e-h avoids jerks and car damage when starting and towing. Widely used on farms for pulling stumps, securing heavy loads, etc. Woven linen web—breaking strength 5000 lbs., more than most tow chains. In compact box—fits in corner of glove compartment. Send check (or M.O.) for only \$2.95 and your Motorists' Tow Web will be sent prepaid anywhere in U.S.

Cee-eN Mfg. Co., 7241 N. Hamilton Ave., Chicago 45, Ill.



**NEW U. S.
AIR CORPS A-2 JACKET**

Made of topgrain cowhide on exact G.I. patterns. Silk lined, wool knit sleeves & **\$20.00** bottom.

**A-2 WITH
MOUTON COLLAR \$22.50**

Sizes 36 to 46
Shipped Insured and Postpaid

I. GOLDBERG & CO.
PHILADELPHIA 6, PA.

429 MARKET ST.

Send for Winter Catalog P.M.

LAW

STUDY AT HOME FOR PERSONAL SUCCESS and LARGER EARNINGS. 39 years expert instruction—over 108,000 students enrolled. LL.B. Degree-awarded. All texts furnished. Easy payments. Send for **FREE BOOK.** G. I. approved.
AMERICAN EXTENSION SCHOOL OF LAW
Dept. 84-M, 646 N. Michigan Ave., Chicago 11, Ill.



WOULD you like to buy yourself a nice big chunk of financial security? You can by building a lucrative business of your own NOW with **TRADIO**, the radio functionally-designed for coin-operation in hotels, hospitals, motels, etc. All over the country, individuals like yourself are finding it a natural for big earnings and a steady income. **TRADIO** has pioneered in

this new and flourishing postwar industry. Get in on the ground floor and assure yourself of financial security for life. Phone, wire or write Dept. N-12 for complete information. No routes sold.

TRADIO, Inc. ASBURY PARK
NEW JERSEY

HOBBY CATALOG

NEW, BIG COLLECTION OF MATERIALS

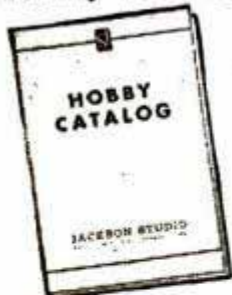

Get this catalog for your shop. It lists and shows a wide variety of tools and materials—some hard-to-get items in addition to a big 20 page section on books and project information. A gold mine of practical help. Shows how we test and approve all materials and tools in our own shop before we offer them to you—your assurance that they are tops in quality—everything fully guaranteed or your money refunded. Hurry to get this catalog, save money with our new Book Dividend Plan. Send 25c today—do it now, to

JACKSON STUDIO, Dept. 38, 5440 N. Shoreland Ave., Milwaukee 11, Wis.

L*AM CARBIDE SCRIBER NON-MAGNETIC

Tungsten Carbide—carefully ground on diamond laps, brazed into stainless steel 6" handle for marking steel and other metals—for etching, marking, cutting glass. In plastic case with pocket clip.



\$2.00
PRICE POST PAID

PRICK PUNCH

Tungsten carbide tip, silver brazed into 3 1/2" heat treated steel body.



with Carbide Tip.... **\$1.50**
Price Post Paid

LUCAS-MILHAUPT ENGINEERING CO. 5053 SOUTH LAKE DRIVE • CUDAHY, WISCONSIN

**FOR SAFER DRIVING IN STORMS AHEAD
ASK YOUR GAS PUMP MAN TO PUT ON FOR YOU**

New "DEAD-LOCKER" Models
ANCO RAIN-MASTER
Windshield Wiper Arms and Blades

Made in U. S. A. by
THE ANDERSON COMPANY GARY, INDIANA



HEAT FURNACES BURNERS GAS-OIL

Circulating Room Heaters. L.P. Gas burners. Floor Furnaces. Cabinets and blowers. Oil Burners. Controls. Card for free literature. Wholesale and Retail. DEALERS WANTED.

Peerless Sales
4318 Sheridan Blvd. Lincoln 6, Nebr.

UTILITY CABINET

36 Roomy Compartments
4-7" Drawers with Removable Partitions

A Thousand Uses For
**HOBBYISTS
MECHANICS
DRAFTSMEN
TECHNICIANS**

For home workshop, factory, laboratory, garage, outdoors, fishing and hunting. Made of heavy gauge aluminum. Strong airplane construction. Sag proof—Rust proof.



\$2.98
plus postage
Shipping Weight 2 lbs., 8 ozs.

Cut out this coupon and send with money

NAME.....
ADDRESS.....
CITY..... STATE.....
Enclosed find check or money order for \$2.98.
THE KNICKERBOCKER CO. ST. CLAIR, MICHIGAN

FREE!



SEND FOR
**ALLIED'S
BIG 164-PAGE
RADIO
CATALOG**

Everything in Radio at Lowest Prices!

Here is *everything* you want in Radio! New home radios and phono-radios, Ham receivers and gear, new kits, thousands of parts, tubes, tools, complete PA equipment, diagrams, latest radio books. The most complete stocks anywhere—in one big book—all at money-saving low prices!

BUILD THIS AMAZING 5 TUBE RADIO



LOW-COST SUPERHET KIT Complete with Plastic Cabinet, Loop Antenna, and Tubes

It's here! The first ultra-modern 5 Tube AC-DC Superhet kit at so low a price! Here's what you get—full broadcast band coverage (550-1600 Kc); built-in loop antenna; latest 5" PM dynamic speaker; handsome walnut plastic cabinet. Unbelievably easy to build; no special tools required. Sockets are riveted in place on chassis base; just assemble, wire and slip into cabinet. Outstanding for power and tone quality. Highest grade components only. Complete with all parts, tubes and full instructions. Nothing like it at the price! Shpg. wt., 10 lbs. **ONLY \$14.95**
No. 83-275. Complete.....

GET THESE VALUABLE ALLIED RADIO BOOKS!



- Radio Formulas & Data No. 37-752 . . . 10c
- Dictionary of Radio Terms No. 37-751 . . . 10c
- Radio Circuit Handbook No. 37-753 . . . 25c
- Radio Builders' Handbook No. 37-750 . . . 15c
- Simplified Radio Servicing No. 37-755 . . . 10c
- Radio Data Handbook No. 37-754 . . . 25c
- ALL 6 BOOKS above No. 37-799 . . . \$1.00
- Parallel Resistance and Series Capacitance Calculator, No. 37-960 . . . 25c
- R-F Resonance and Coil Winding Calculator, No. 37-955 . . . 25c

ALLIED RADIO

ALLIED RADIO CORP.
833 W. Jackson Blvd., Dept. 5-M-7
Chicago 7, Ill.

FREE CATALOG

- Rush FREE 164-page Catalog
 - Send Kit No. 83-275
 - Send 6 Books No. 37-799
 - Send Calculators checked above
- } \$.....enclosed

Name.....
Address.....
City..... Zone..... State.....

AMAZING
New **WAY TO**
PAINT-CUTS
TIME 75%



ELECTRIC PAINTER
 Now you can get professional results in painting, even if you've never painted before! The new Lowell Electric Painter actually gives a fine "factory-finish." Paints rooms, furniture—even your car! At stores, everywhere.



PAINTS BEHIND RADIATORS!

Lowell Electric Painter actually atomizes paint. Covers area in a minute. Directional nozzle sprays paint straight ahead, up, down or sideways.

FURNITURE PAINTING EASY!

Use any kind of paint with the Lowell Electric Painter—enamel, flat paint, or varnish. Holds a quart. Easy to use. Small, efficient AC/DC motor. Weighs 8 lbs.



FASCINATING BOOKLET

Write for fascinating, new booklet: "40 Ways to Beautify Your Home." Send 10c to Lowell, Dept. 72, 589 East Illinois Street, Chicago 11, Illinois.



© 1947 LM. Co.
 Guaranteed

"Thoro-Spray"™
Electric Painter
COMPLETE
No Extras To Buy

\$34.95

Slightly higher in western territories.



*T. M. REG. U. S. PAT. OFF.

LOWELL
Manufacturing Co.
 World's Largest Manufacturer of
 Sprayers and Dusters Exclusively

Cadillac and Oldsmobile will continue with their optional Hydra-Matic systems in the 1948 models. Only the largest Oldsmobile, the "98," will have the new '48 body; changes in the smaller models will be limited to face-lifting.

Chevrolet, biggest seller in the country today, will rest on a backlog of 1,500,000 orders and come out early in 1948 after a slight face-lifting operation. No major change in the Chevrolet is expected until 1949.

The Chrysler Corporation is reported to have dies ready for a quick changeover should sales conditions demand it. This is said to be especially true in the case of the Plymouth. No announcements have been made, but the chances are that if Ford offers an optional automatic transmission the Plymouth will be equipped with Fluid Drive.

The 1948 Kaisers and Frazers will be much like the '47s, according to reports, with the possibility of a slight lowering of the cars (in height). No extreme mechanical changes, such as a rear-engine or front-wheel drive, are predicted. The same applies to the '48 Nash models with some restyling in both the "600" and Ambassador line. There will be no production shut-down during the changeover.

Over in Toledo, known in automotive circles as Jeepville, Willys-Overland is introducing a new jeep "station sedan" this month and a sporty convertible-type car in March. The convertible is mounted on the jeep station wagon chassis with a reinforced frame and has the jeep engine and front end. It will have a gray canvas top. The station sedan has an interior that resembles a conventional passenger car with upholstered seats.

Much has been written about the Tucker '48 (*Popular Mechanics*, September, 1947). Despite many harassments, the company still plans to get into production early in 1948 and hopes to be building 1000 cars a day before the end of the year.

Many U. S. automobile owners, possibly prompted by the rising costs of living, are showing an increasing interest in the mid-gt-car field. They may be able to take a choice of four such U. S.-built cars in 1948. These include the Crosley, most firmly established car in its field with some 700 dealers and a growing organization, the Playboy, Keller and Davis.

The Playboy, which is manufactured in Buffalo, N. Y., features an all-steel disappearing convertible top. The car is powered by a four-cylinder, 40-horsepower engine, has hydraulic brakes, travels 35 miles

(Continued to page 268)

AMERICAN BOYS BILL OF RIGHTS

We... The Boys of America

believe in these OUR RIGHTS: the right to LIBERTY, hard-won by our forefathers & the right to HAPPINESS that comes with the growth of a healthy body and mind & the right to TRAINING, thoughtfully planned by parents, school and church & the right to OPPORTUNITY, to live, learn, play and grow up in the time-honored traditions of a free people & the right to learn to SHOOT SAFELY. We recognize and accept the responsibility imposed by these Rights. But & until we are old enough to vote & we expect YOU & our fathers, mothers and other citizens who elect America's city, county, state and federal officers & to be eternally vigilant that our RIGHTS be not abridged!

"The rights of the people to keep and bear arms shall not be infringed!"
(Quotation from the Second Amendment to the United States Constitution)

PICTURE FOR YOUR ROOM WALL!

A beautiful, large-size, full color reproduction of the American Boy oil painting and Boys Bill of Rights, suitable for sticking or thumb-tacking to your room wall... is yours postpaid for only 15c plus 3c unused stamp.. Order now!



GET YOUR DAISY HANDBOOK

For safer shooting, more fun. Comic strips, jokes, inventions, jet propulsion, cowboy lore, complete Daisy Catalog, etc. Pocket-size. Send 10c, unused 3c stamp, and coupon below!

BIG BARGAIN SPECIAL!

We'll send postpaid both Bill of Rights oil painting reproduction and Handbook... for only 25c in coin... while supply lasts. Hurry!

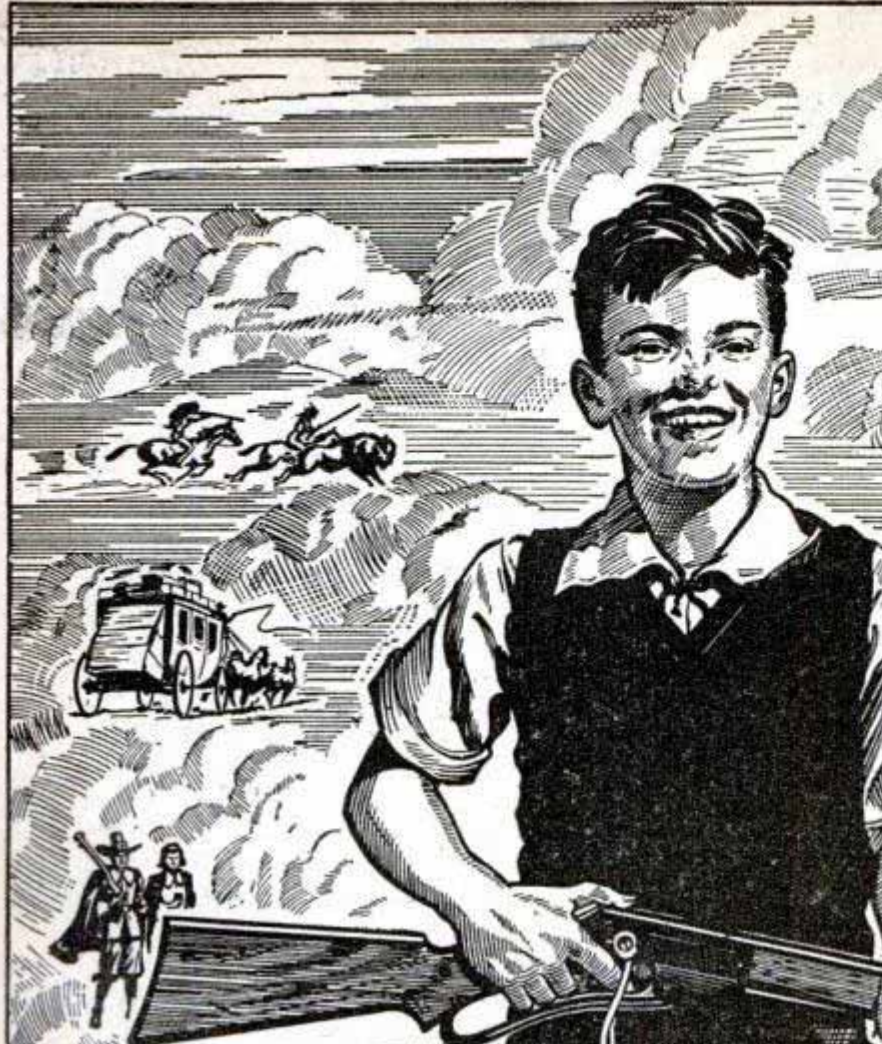

GIVEN! DAISY COMMANDO

with Your Order for



BUCK ROGERS

ATOMIC PISTOL HOLSTER SET!

READY! Surprise GIFT Offer: send only \$1.59 plus 11c for postage-handling and we'll mail postpaid Buck Rogers Atomic Pistol Holster Set—and while supply lasts—INCLUDE the Daisy Commando without extra cost... so hurry! Both guns safe, harmless. Ideal gifts for children 4 to 11. **ATOMIC PISTOL:** 10" long, all metal. Makes loud "ZAP!" noise, flashes harmless red when you pull trigger. **ATOMIC HOLSTER:** Real 2-tone leather belt, straps, nickel-plated buckle, studdings, 25th Century style. **COMMANDO:** full 30" long, gun sling, pump action repeater. Loud "BANG!" each time you pump! Durable wood. Order now—show this to your parents!

\$1.59 Plus 11c Postage

Your Name.....
St. & No..... State.....
City.....

DAISY AIR RIFLES

BULLS EYE SHOT and

DAISY MANUFACTURING COMPANY
6011 Union St., Plymouth, Michigan, U. S. A.

DAISY TARGETEER PISTOL

Safe family fun gun! Air pistol, 500 shot, spinning "birdie" targets, target cards. Ask Dealer.



DAISY MANUFACTURING COMPANY, 5412 UNION ST., PLYMOUTH, MICHIGAN, U. S. A.

Rush to me postpaid your:

- BILL OF RIGHTS PICTURE!
 I enclose 15c coins plus 3c stamp.

Name

St. and No.....

City..... State.....

DAISY HANDBOOK!

- I enclose 10c plus 3c stamp.
 PICTURE & HANDBOOK BARGAIN!
 I enclose 25c. Send me both.

DAISY MANUFACTURING CO., 5412 UNION ST., DEPT. 7, PLYMOUTH, MICHIGAN, U. S. A.

The Flex-O-Shaft TOOL KIT

HANDLES LIKE A PEN*



A new, all-purpose machine for home or shop. Slender, light-weight aluminum hand piece is ideal for grinding, drilling, sawing, buffing, scoring, etching, polishing, etc. No bulky, throbbing, pulling motor in your hand. Light-weight motor can hang on wall. Speed is controlled by foot-operated rheostat, leaving hands free. This precision ball-bearing tool is as easily guided as a pencil. A wonderful, compact power house for making all kinds of objects. Ideal for school shops and factories.

SAVE \$10.00:

- 1/16 H.P. motor, cord and Flex-O-Shaft 27.50
- Foot-operated rheostat, long cord and plug 8.50
- Sixty-six accessories 16.50
- Bought separately 52.50

Complete Tool Kit, only..... \$42.50
Men will appreciate this unique Tool Kit as a Christmas gift

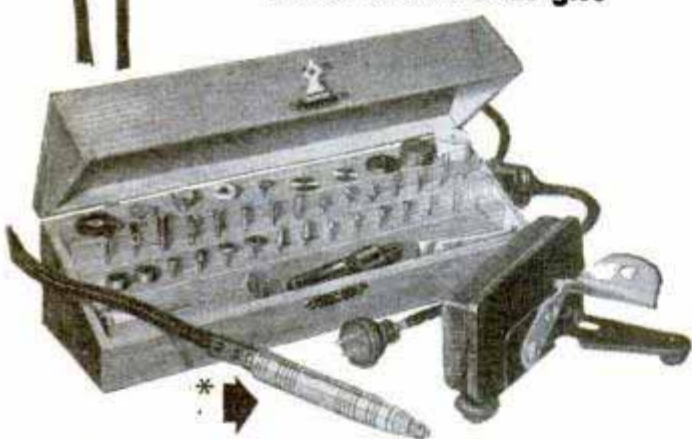

Flex-O-Shaft Sales Co. (Dept. C)
 Prairieview, Illinois

Please send complete information on the Flex-O-Shaft Kit.
 Please send one Flex-O-Shaft Kit. \$42.50 enclosed. Shipping charges C.O.D.

Name _____
 Address _____
 City _____ Zone _____ State _____

SAY YOU SAW IT IN POPULAR MECHANICS



WRITE FOR YOUR FREE COPY OF THE NEW KRW HYDRAULIC PRESS BOOK

Describes all manner of Production and Shop Work on KRW Hydraulic and Bench Type Arbor Presses. 32 pages illustrating the new KRW Hand-operated, Electric-operated and Air-operated Hydraulic Presses. Write for your copy today.



K. R. WILSON, DEPT. 17, 215 MAIN ST., BUFFALO 3, N. Y.
 Builders of Shop Equipment for Ford Dealers Since 1916



CAST ALUMINUM DOUBLE EXHAUST BLOWERS \$15⁸⁵

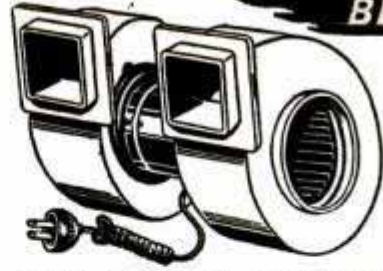

FOR COAL FURNACE BLOWERS (SAVE 31% ON COAL BILL)—AIR CONDITIONERS — HUMIDIFIERS — DARK-ROOM DRIERS — LABORATORIES — WORKSHOPS — HOSPITALS — LAUNDRIES — OFFICES — PRINTERS.

Double intake and exhaust from 2 balanced sirocco type wheels. Will easily solve your forced draft and fresh air problems. Blower designed especially for quick and simple installation. Anyone can do it with ordinary household tools. Blower housing is heavy cast aluminum to last indefinitely. Cont. duty motor is extraordinarily quiet. 110 V., A.C., 50-60 cycles. Cord attached, ready to plug in.

WE GUARANTEE SATISFACTION!

NOW! ONLY \$10.00

While they last! Our famous single exhaust blower DELIVER 100 CU. FT. AIR PER MINUTE. Ready to install yourself with any household tools. It's built for that! 110 V., 50-60 cycles. Cont. duty motor. Send check, money order, No C.O.D.'s. West of Mississippi add \$1.00 for mailing, handling, IMMEDIATE DELIVERY. Service men and dealers: Inquire about quantity discounts.



UNIVERSAL YONKERS CORP.

(Dept. M12) 137 Alexander St. Yonkers 2, N. Y.

JET RACING — New Sport Craze!
 Join the Fun with These New, Fast, Jet Powered Racing Models. Build in One Evening.

JET POWER RACERS



Terra-Jet Deluxe Racer, Kit \$1.25

Kits Only 85c-\$1.25
 Postpaid

You read about these midget racers in LIFE, LOOK and other magazines. Get some yourself for a barrel of fun. Build one easy in an evening. Power it with inexpensive CO₂ cartridge—for sale everywhere. Kits include shaped and bored balsa body, rubber wheels, plastic shields and scoops, instructions and other parts. TERRA-JET, Deluxe, steel axles, etc. \$1.25. HOT SHOT, original jet racer, 85 cents. AQUA-JET, jet power hydroplane, 85c. All three kits, only \$2.75, postpaid. Rush order to



Hot Shot, Original Jet Racer, Kit 85 Cents

MONOGRAM MODELS, Inc., Dept. 19
 2329 S. Michigan Ave., Chicago 16, Ill.



Aqua-Jet, Hydroplane Racer, Kit 85 Cents



EASY PROFIT IN PAINT SPRAYING

Paints walls, ceilings, screens, furniture and machinery faster, better. All complete as shown less motor. Carry anywhere. Fully guaranteed. Could be used with 1/4 H.P. motor or less. Price \$35.00 less motor F.O.B. Chicago. \$5.00 deposit balance C.O.D. or see your dealer. Order #B1-L-M.

IDEAL AUTOMATIC PUMP CO., Dept. P.M. 8
 Chicago 7, Ill.

BIGGEST SAVINGS THAT EVER CAME YOUR WAY!

WAR AND OTHER TYPES OF SURPLUS

Army Air Force FLYER'S GLOVES #1
\$5.95



Gunner's mitt, free index finger. Fully fleeced lined! Heavy grain tan or brown leather. Medium & large.

Army Air Force Type A-2 JACKET #8
\$19.95



Modeled exactly after the finest U.S. flyer's jacket! Genuine top grain horsehide! Knitted elastic cuffs and waist! Full zipper front. Two roomy flap pockets with "snap" fasteners. Rich rayon lining. 2 shoulder straps. Sizes 36 to 44.

Army Air Force Type SUN GLASSES #9
\$2.50



Scientifically ground and polished lenses. True green color. Plastic nose piece and sweat bar. Highly polished metal rims. Complete with imitation leather carrying case.

"Jet Propellent" CO2 CYLINDERS #13
12 FOR \$1



For model plane and racing car builders! To inflate life belts!

Army Air Force FLYER'S HELMET #2
\$2



Heavy duty serge. Fleece lined ear flaps. Removable nose protector. Only eyes and mouth uncovered. Used but perfect. Sizes 6 1/2 to 7 1/8.

Army PX Famous Make BRIAR PIPES #14
3 FOR \$1



Worth far, far more! Choose any or all of the 3 streamlined beauties above!

U. S. Army Pocket WATCH COMPASS
\$1



The most compact compass you ever saw! Letters N E S W & needle painted radium for night use! Highly polished brass "snap-open" case.

U. S. ARMY CARTS
\$19.95



Handy, all-purpose carts! Ideal for farms, gardens and industrial use! Heavy duty construction throughout, steel reinforced at all points of wear, yet easy to handle! To unload, simply drop the back! Support legs fold flat under handles when not in use. Comes to you knocked down, and assembles quickly and easily!

Navy HUNTING KNIVES
\$1



Worth \$5! 6-inch blade. Tempered steel; gun-metal finish. Laminated leather handle. Leather sheath FREE! For hunters, fisherman!
 7-inch blade . . . \$1.25
 8-inch blade . . . \$1.50

U. S. ARMY L-TYPE FLASHLIGHT #4
\$1



Light and durable plastic. Army OD. 7 1/2 in. long. Sturdy built-in metal belt-clip Complete with 2 batteries and flash bulb.

U. S. Navy Emergency SIGNAL MIRROR #16
25¢



Made by General Electric! Reflects sun up to 10 miles! Also a handy shaving mirror for you!

U. S. Army AEROSOL BOMBS #5
\$1



Sprays 1000 cu ft in 4 seconds! Non-toxic. Non-inflammable. Kills mosquitoes, flies, ants, bugs, roaches, spiders! Full 16 ounces!

U. S. Navy Blue TURTLE NECK SWEATER #11
\$5



100% pure wool that gives top warmth and long wear! Pullover model that fits snug all over! Finely knit to meet rigid navy specifications. Sizes 32 to 40.

U. S. Army Desert WATER BOTTLE #12
\$1.50



Rubberized pouch that holds about 1 1/2 gallons water! Plastic dirt protector and screw top! Push-button dispenser nozzle! All built into a big OD pack bag with 2 handles & carrying strap!

U. S. ARMY #5 SASH TOOL BRUSHES #17
\$1



The painter's pal! 12" long. Selected pure bristles. Polished wood handle.

U. S. Army All-Wool BLANKETS #6
\$4



OD, full bed size. Army-used, now sterilized, perfect, ready to use.

U. S. ARMY TWO-EDGED SHARPENING STONE #18
50¢



Puts keen edges on your dull blades! Sharpens and hones! Size 3 1/2" x 1 1/2" x 3/4"

U. S. Army FOLDING RAINCAPE #7
50¢



Slips over head, reaches to knees! Folds into pocket! Excellent cover for your rose bushes & small shrubbery!

Send check or money order, no C.O.D. orders. Orders must total \$1.00 or more. For orders outside United States and its possessions, add 25% for special packaging. Order items by number—specify size where necessary.

Add postage as follows: Items: East of Mississippi River	West of Mississippi River
1,2,3,4,7,9,13,14,15,16,17,18,19.	Add 20c postage
5,11 and 12.	Add 40c postage
6 and 8.	Add 50c postage

BALTIMORE LUMBER COMPANY
War Surplus Division
 418 N. HOWARD ST. • BALTIMORE 1, MD.
ORDER DIRECT FROM THIS AD!

ARMY OD KNIT WOOL STOCKING CAP #19
75¢



Wear it rolled up or pulled down—it keeps you warm all around! For work, school or sports! It fits any head!

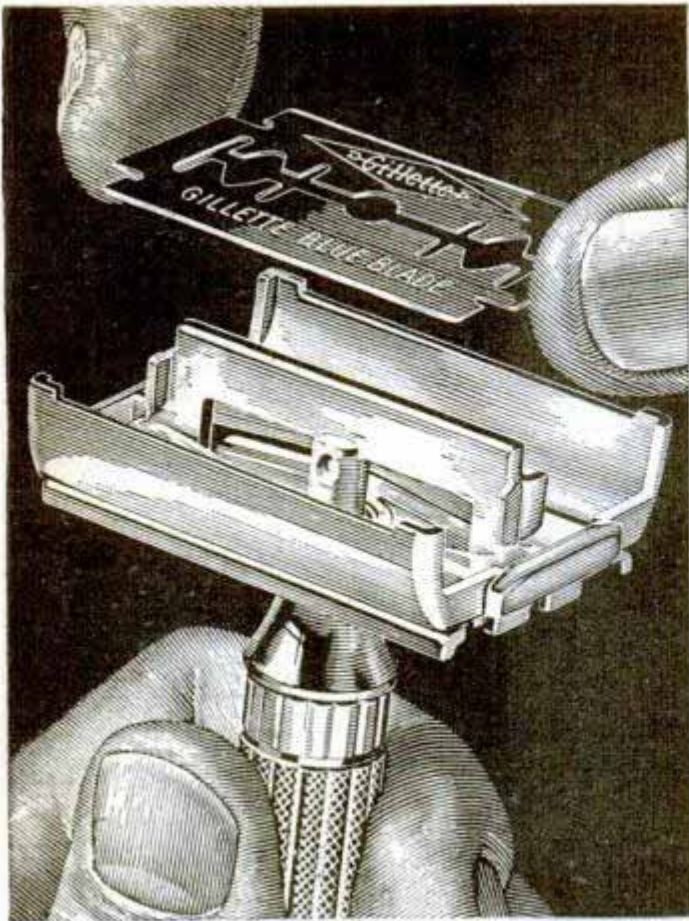

You change blades in a flash with the modern

Gillette

ONE-PIECE RAZOR

SHAVING is mighty quick and easy when you use a modern Gillette One-Piece Razor. There's nothing to take apart or put together. You change blades in jig time. Twist . . . the razor opens. Twist again . . . your blade's locked in position. For cleaning both razor and blade just loosen the holder, rinse and shake.

Enjoy utmost shaving comfort and convenience. Get a Gillette One-Piece Razor. The Gillette Aristocrat, gold-plated, with case and 10 Gillette Blue Blades, \$3.79. The Gillette Milord, gold-plated, with case and five blades, \$2.50. Either will give you years of shaving satisfaction.

Gillette Safety Razor Co.,
Boston 6, Mass.

Copyright, 1947, by Gillette Safety Razor Company

look SHARP! feel SHARP! be SHARP!
use
Gillette Blue Blades

WITH THE SHARPEST EDGES EVER HONED



on a gallon of gasoline, and has a maximum speed of 70 miles an hour. The Playboy is 13 feet from bumper to bumper, 54 inches high and weighs 2035 pounds.

The Keller, the product of Keller Motors in Huntsville, Ala., has a four-cylinder engine that can be located in the front or rear. Three models are planned, a station wagon, convertible (featuring a rear-engine chassis) and a delivery car. The company expects to get into production with the station wagon early in 1948.

Another newcomer to the midget class is the Davis. This is a three-wheel coupe with a removable top now being built at Van Nuys, Calif. The Davis has a wheelbase of 108 inches and is powered by a 68-horsepower engine.

Since the war ended U. S. manufacturers have produced about 5,500,000 cars. The experts figure there is still a deficit of 9,000,000 passenger cars. At that rate it will be 1950 or 1951 at the earliest before you can walk into a showroom and say:

"I'll drive that one home."

Plastic Coating Protects Metal

Metal surfaces are weatherproofed by a special plastic coating less than $\frac{1}{1000}$ inch thick. The coating gives temporary protection before painting, and it makes the paint stick to the surface better. In a test conducted by the Bakelite Corporation, the metal bottom of a boat was coated with the plastic and painted. After six months' service the boat ran aground and some of the paint film was torn off. After 18 months in salt water, there was no corrosion from water getting into the coating despite the break in the paint film. The coating produces effective results in temperatures from below zero to midsummer heat.

Brown Light Prevents Night Blindness

Units of the Swedish Navy are preventing night blindness of lookouts and deck officers with brown light. Formerly, men who had been in lighted rooms were almost blind when they stepped into the dark and nearly a half hour passed before their eyes were satisfactorily adjusted to night vision. On new Swedish ships two systems of lighting are being installed, one that gives ordinary white light and an emergency system that illuminates with tempered brown light. Chart cases and navigation instruments will be lighted by brown lamps equipped with rheostats for adjusting the intensity of the light. Brown is used because other colors remain practically unchanged in such light. Red and blue light both proved unsatisfactory in experiments.

READY for Christmas:



GIVE or GET SYNCRO!

(1) World's safest saw. (2) Portable. (3) No rotating motor needed as self-contained magnetic power unit transmits A.C. magnetic impulses to armature diaphragm—power transferred to blade. (4) No rotating parts to wear out. (5) 14,400 magnetic strokes per minute. (6) Never needs oiling. (7) Large 10"x10" table top. (8) Cross section engraved

lines on top. (9) Big 13 1/2" throat clearance. (10) Finest steel blades. (11) Rubber feet. (12) 5' cable, plug. (13) Varying voltage adjustment nut. (14) Quality materials, workmanship, performance, guaranteed by the famous "SYNCRO" trademark name.

**AMAZING
NEW SAFE
MAGNETIC
SAW!**

Only
\$17.50

**FOB
FACTORY**
Shpg. Wt.,
18 lbs.
Slightly higher in
Foreign Countries.

**NO MOTOR
NEEDED!
JUST PLUG IN!
CUTS CLEAN
AND SMOOTH!**

GET YOURS NOW!

Here's the perfect, lasting family Christmas gift to get or give . . . SYNCRO . . . the remarkable, safe, patented magnetic jig saw . . . ready for immediate shipment! SYNCRO needs no belt, no gears, no oiling. No motor to buy. Just plug in any 50 or 60 cycle (A.C. only) 110-120 volt wall outlet—in kitchen, attic, basement—set on kitchen table, floor, anywhere—and saw! The high-speed, short Magnetic Safety Stroke Action, and freedom from belts, makes SYNCRO so safe small boys and girls may use it. Cuts intricate designs on 5/8" soft wood, 1/2" medium hard plywood and thinner hardwoods, plastics, thin metals. Leaves no ragged undersides on plywood, cardboard. Cuts to center of 27" circle! Get, enjoy this safe, educational, practical quality tool for making models, displays, puzzles, inlays, silhouettes, toys, what-nots, etc. Limited supply—so hurry!

EXPORT ADDRESS: 120 Wall St., N. Y. C.

SYNCRO
SAW CORPORATION
Dept. A-127
Rochester, Michigan

WORLD'S LARGEST MAKERS OF ELECTRIC JIG SAWS

DECEMBER 1947

Complete
with Cord,
3 Blades

No. 2000

HOW TO ORDER!

Mail coupon with Postal Note, Money Order or check for only \$17.50 plus Parcel Post or Express carrying charges . . . or . . . send \$17.50 only and we will ship saw collect for Parcel Post or Express carrying charges only. Specify type of delivery on Coupon. Shipping weight, packed, 18 lbs. Hurry! Act promptly—order—we'll ship same day order is received. (No complete COD orders accepted.) **See your Dealer First!**

**Order With Confidence—Read This
LIBERAL 10-DAY TRIAL OFFER:**

When you receive your SYNCRO, plug it into any 50 or 60 cycle (A. C. only) 110-120 volt wall outlet and saw, according to instructions. THEN . . . if it does not saw cleaner, better than any other jig saw you ever used and with more safety . . . if it does not satisfy YOU . . . return it undamaged, postpaid and postmarked within 10 days of its delivery date . . . and then your \$17.50 will be refunded promptly without question.

SYNCRO Saw Corporation, Dept. A-127
Rochester, Michigan
Export address: 120 Wall St., New York City

Gentlemen: Here's my order for one SYNCRO MAGNETIC JIG SAW, Model 2000, shpg. wt. packed, 18 lbs., \$17.50 FOB Factory. Please send it complete with electric cable and plug, 3 blades, on your 10 Days Money Back Trial Offer.

I enclose \$17.50 as payment. Please ship saw:

Express charges collect or Parcel Post charges collect.

Express, for which I enclose an extra \$.....

Parcel Post, for which I enclose an extra \$.....

Name.....

St. & No.

City..... State.....

I enclose no money — send FREE SYNCRO Circular.



CROSMAN *Silent* RIFLE

Most Amazing Gun Ever Invented for Target and Small Game Shooting

The ideal rifle for year 'round shooting indoors or out. Shoots low-cost SUPER PELLETS without noise, odor or recoil. Requires no cleaning. At your dealer or write direct.



CROSMAN ARMS CO., INC.
3E HENRIETTA ST., ROCHESTER 7, N. Y.

Shoot CROSMAN *SuperPells*

The BETTER Ammunition for ALL .177 and .22 caliber Air Pistols and Rifles.

.177 cal. . . \$2.50 per M
.22 cal. . . \$3.00 per M



POSTAGE PREPAID

At your dealer or order direct

FOR
GREATER
ACCURACY
MAXIMUM
POWER

CROSMAN ARMS CO. HENRIETTA ST., ROCHESTER 7, N. Y.

NOW AVAILABLE

Men's Guaranteed Swiss Wrist Watches

All latest features. Be on time to school and work.



ONLY
\$6.95

plus 70c tax.
We pay postage.
Terms: \$2.00
cash with order
or send cash in full
and save C.O.D. fee.

1. Guaranteed 100 days against defective material and workmanship.
2. Sturdily built.
3. Good timekeeper.
4. Non-breakable crystal.
5. Sweep second hand.
6. Radium dial.

E. F. BERNHOLD, INC.

BOX 128, BROOKFIELD, ILL.

WAP
SURPLUS

110 VOLT - 60 CYCLE - 2500 WATT POWER PLANT GENERATOR

WEIGHT 200 LBS LIST PRICE \$276.00

NEARLY NEW

110-volt single phase 60 cycle A-C generator. Exactly like commercial power. Self-excited. No other equipment required. Fine for ranchers, taverns, sportsmen. Generate your own electricity. Powerful portable plant. (Complete except engine.) Small engines easy to pick up or you can use water or wind power. Fine stand-by power for farms. Contractors use for on-job power saws, drills, etc. Full instr. installing, using. Guaranteed perfect. Order now or write for details.

LECO ENGINEERING CO. Box 908-PM-E, Lincoln, Nebr.



Only
\$89.40
FREIGHT PREPAID
U.S.A. ONLY

IF GLUE WILL FIX IT

FRANKLIN LIQUID HIDE GLUE

will do it better, faster, easier!

Ready-to-use Franklin makes joints stronger than the wood itself. Saves time — no mixing, no heating. Banish unpleasant odors, avoid chilled joints with Franklin Liquid Hide Glue.

The FRANKLIN GLUE CO., COLUMBUS 15, O

AT YOUR HARDWARE DEALER



a
Bigger Income
for You

Be Independent!
Start your own ARC
WELDING business



Hobart arc welders

..... make welding better and more profitable

They're Simplified . . . to give you wide-range current control for superior welding on all sizes and types of jobs. You save time and money with a HOBART Welder.

Small Investment . . . makes it easy for you to start your own business. HOBART Arc Welders are available for every type of work, pay for themselves in no time at all.

"Build Your Own" road type welder . . . using a HOBART Multi-Range Generator and a reconditioned auto engine for the big pay jobs in the field. Save \$300-\$500. Ask us for FREE book also.

HOBART a c Type . . . for single phase 220 Volt lines. Costs you less, yet lets you in on the big profit possibilities of arc welding.

HOBART Arc Welding School — modern building with latest welding equipment and experienced instructors. Operates under G. I. Bill.

Hobart Brothers Company
BOX M-127, TROY, OHIO

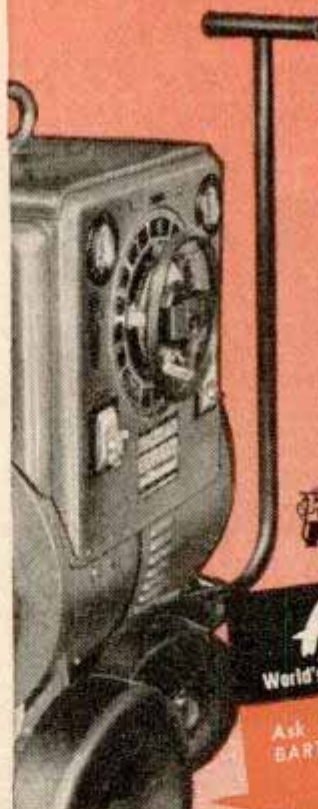

Hobart "One of the
World's Largest Builders of Arc Welders"

Ask for the new catalog on HOBART Arc Welders

Free!

HOBART BROTHERS CO., BOX M-127, TROY, OHIO

YES, I'm interested in how HOBART Arc Welders can start me out in a profitable business of my own, with big earnings. Send me information on items checked below:

- HOBART Electric Drive
- Gas Engine Drive
- "Build Your Own" Arc Welder
- HOBART AC Transformer Welder
 - FREE BOOK "How to Build Your Own."

NAME _____

ADDRESS _____

PRESSURE QUEEN

FOUR CYLINDER
PORTABLE AIR COMPRESSOR
SPRAY PAINTING OUTFIT

- COMPACT
- RUGGED
- POWERFUL!

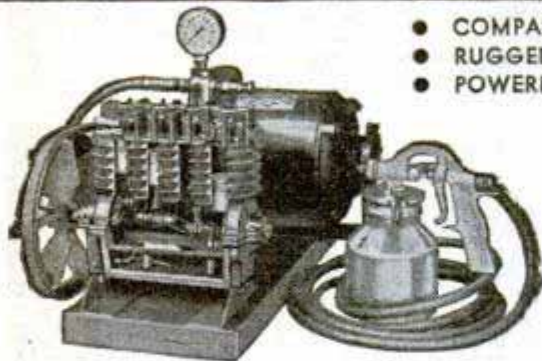

Immediate delivery on compressor with motor

AMAZINGLY LOW PRICED FOR THE ONLY
FOUR CYLINDER UNIT ON THE MARKET

The ideal air supply for home and farm workshop, machine shop, garage and contracting painter; for product finishing, inflating tires, painting automobiles, trucks, machinery, etc.

This 4 cylinder compressor has drop forged crankshaft, stainless steel, heat treated valves; bronze bearings and positive forced feed lubrication. Maximum pressure 50-60 lbs., free from pulsation. Standard equipment includes the compressor mounted on steel base with carrying handle, belt, compressor pulley, air chamber, air gauge, 15-ft. hose, spray gun; 1/2 or 3/4 h.p. motor or gas engine. Immediate delivery.

If your dealer does not sell Pressure Queen write direct
THE CAMPBELL-HAUSFELD CO.
1046 RAILROAD AVE. HARRISON, OHIO

Ready... NEW TOOL

NEW ECONOMY
HOMESHOP MODEL

Ready for shipment again — the famous Mead Bandsander "Economy" only \$14.95! This remarkable machine quickly shapes, sands, carves and polishes wood, metal, plastics! Works equally well on inside cutout openings or irregular outside edges. Gets at places no other can! Tilting table for bevelling, chamfering. Rust-and-sweat proof top. Oilite bearings. Saves time, labor, money on jobs in any home or industrial shop. Invaluable to homecraftsmen, makers of patterns, tools, dies, signs, costume jewelry, castings, forgings, ornaments, radio and electrical parts, stampings, etc. Nothing else like it. Sold on 5 Day Trial, money back guarantee.

Quickly
Shapes,
Sands,
Carves,
Grinds,
Profiles,
Cleans,
Smooths, and
Polishes
Wood! Metal!
Plastics!

CIRCULAR FREE

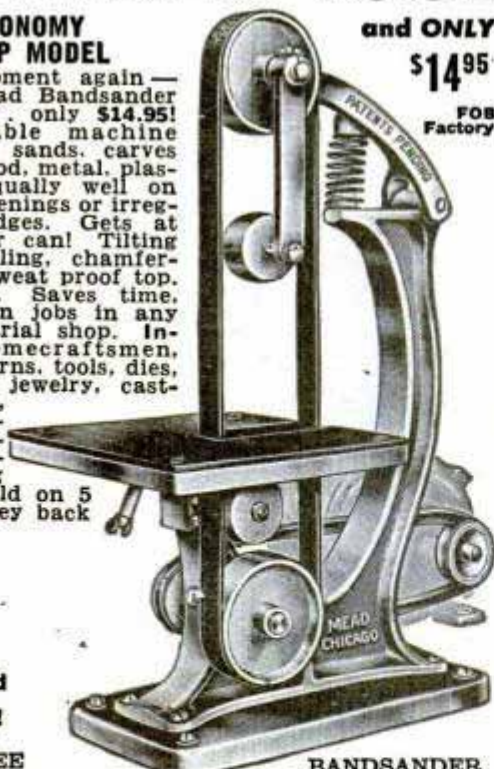

and ONLY

\$14.95

FOB
Factory

BANDSANDER
CUTS FAST AND CLEAN
SAVES FILING, SANDING WORK

Write for FREE Circular

Send for free details on "the machine that amazed the experts!" Rush a postcard today for Circular. Hurry! (Dealers write!)

MEAD SPECIALTIES CO.
Dept. 1127, 4114 N. Knox Ave., Chicago 41, Ill.

The SPEED SAW FILER

Saves You Time, Money

Now you can do expert saw filing at home. Lifetime tool makes precision filing easy for even the most inexperienced. Two simple adjustments make it fit any type hand saw. Keep your saws extra sharp and true-cutting with a Speed Saw Filer. Complete with file, ready to use. Money back guarantee. Cash with order, prepaid (C.O.D. postage extra.)

THE SPEED CO., Dept. PM
2025 N.E. Sandy, Portland 12, Ore.

Now
FILE
Your OWN
SAWS

ORDER
NOW!



\$295

BUILD YOUR OWN TRAILER



Get these Modern
Complete Plans

Select just the model you want—for hunting—travel—camping—or as a home. Each plan is complete with simple, step-by-step instructions and a bill of materials. Easy-to-follow. Three models!

STOCK No. H27 NATIONAL MODEL 27. A sleek 27-foot trailer with 3 rooms, lavatory, etc. Sleeps six. complete plan \$1.00

STOCK No. H20 NATIONAL MODEL 20. A good-looking, easily-built 20-ft. trailer. 3 rooms, sleeps four. complete plan \$1.00

STOCK No. H10 NATIONAL CAMPER. A compact unit for traveling, camping, hunting, fishing. Sleeps two. Complete plan .50

Special—Order all 3 of above plans....\$2.00

FREE! Big parts catalog with any order

NATIONAL TRAILER STORES

Dept. 10 Box 2353 Terminal Annex - Los Angeles 54, Calif.

A "LAB" MAN'S DREAM!

Carry This New Design

"Pen" Microscope

in Your Vest Pocket



- Beautiful satin nickel finish
- Quick adjustment gives you 40, 50, or 60 power self-illuminating magnification
- Perfect for examining minute detail in shop, office, lab, home
- Equivalent of standard lab microscope, yet no larger than a fountain pen. In leather case.

Send Check or Money Order Today for \$18.50
Satisfaction Guaranteed or Money Back in 5 Days

E. W. PIKE & COMPANY 492 NORTH AVE.
ELIZABETH 3, N. J.

DRAIN YOUR CELLAR, POOL, WASH TRAYS, ETC.

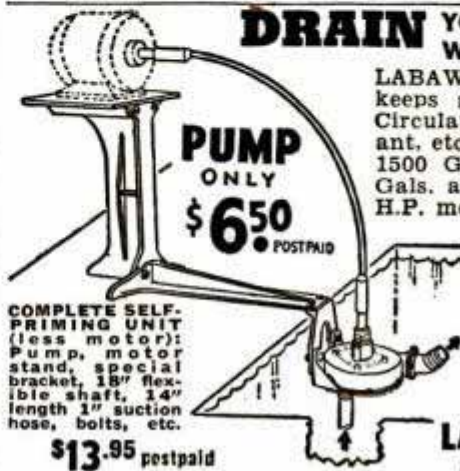

PUMP
ONLY
\$6.50
POSTPAID

LABAWCO Type P Pump keeps garden pools fresh. Circulates oil or refrigerant, etc. DOES NOT CLOG! 1500 Gals. per hr. — 300 Gals. at 30'. Uses 1/4 to 1/2 H.P. motor.

Pump alone \$6.50.
Pump with complete self-priming unit . . . \$13.95

POSTPAID if cash with order. West of Mississippi, add 50c.

SEND ORDER
TODAY

LABAWCO PUMPS
BELLE MEAD 4, N.J.

COMPLETE SELF-PRIMING UNIT (less motor): Pump, motor stand, special bracket, 18" flexible shaft, 14" length 2" suction hose, bolts, etc.

\$13.95 postpaid

TAKE OFF...



NORTHLANDS

As you zoom away on Northlands feel confident that Northland craftsmanship has given you the world's finest skis—first step toward better skiing. Send 15c for Northland Ski Manual edited by H. Schneider. Or write for Free Booklet.

NORTHLAND SKI MFG. CO.

World's Largest Ski Manufacturers

95 MERRIAM PARK • SAINT PAUL 4, MINNESOTA

New MILLING ATTACHMENT



Sizes for 8" to 16" metal lathes

BUILD IT YOURSELF from our sets of semi-machined castings and save 88. Can be finished on your lathe alone. Complete working drawings and step-by-step instructions furnished with castings.

Mill keyways, slots, splines, dovetails, flutes in reamers, taps, hobs, and special cutters; produce spur, bevel, mitre and worm gears, ratchets and racks; mill flat surfaces, square shafts, mill hexes, spot face, drill spaced holes, bore, etc. on your lathe with this precision attachment. It has a T-slotted table, a vise which swivels for angular milling, a gear cutting fixture and dividing centers.

FREE! Illustrated folder and price list. Includes milling cutters, keyway cutters, drill rod, slitting saws and many hard to get shop items. Mention your lathe. Write today. **HURON MACHINE AND TOOL CO.** YALE 4, MICHIGAN

SUPER-MITE RADIO PACKS AMAZING POWER!

Not much larger than a pack of cigarettes and using war-born midget tubes, this powerful little set gets coast-to-coast reception! Power is supplied by midget hearing-aid battery. Brilliant red chassis, black and silver dial, streamlined control knobs. Complete set ready to wire as shown only \$3.99 postpaid. Tubes 95c each. Not available elsewhere at 10 times this price!



\$3.99

ELECTRONIC RESEARCH

1216 Park Row Bldg. New York City 7

WHIPCO HANDY BRACKET CLAMP



the handiest tool you can have around **HOME, HOBBY SHOP OR OFFICE** Attractively finished in light metallic blue.

Slides in holding bracket snugly, holding clamps securely in two positions.

Will lend prestige wherever used. With a Whipco Clamp and a little glue that broken piece of furniture will be back in use.

HOME For many repair jobs, holding quilting frames, curtain frames, flower pots in window, and a thousand other uses.

HOBBY SHOP Holding small parts while shaping, glueing and cutting, holding flies while winding, and many holding jobs in the photography dark room.

OFFICE Holding and hanging bulky papers, clamping various accessories to desk and typewriter stands.

Large clamp opening, 2 1/4"; medium size 1 1/2"; small size, 1 1/4". Order special set today, consisting of 2 large, 2 medium, 2 small and 6 holding brackets —

12 pieces in all, packed in neat box, for only \$4.50 per set post paid in U.S.A. Will make excellent gift.

WHIPPLE MFG. CO.

SPIRIT LAKE, IOWA

STOP RUST and POLISHING OF METAL



Apply

GLIP

New War Tested Coating That **PROTECTS AGAINST RUST OR TARNISH**

PRESERVES the FINISH of gold • silver • chrome • brass • bronze • copper • tin!

One Coat keeps metal sparkling for months



GLIP 2-STEP SYSTEM CLEANS and PRESERVES

Resists Salt Water Mild Acids Gasoline

NOT A VARNISH A LACQUER A PLASTIC

Try Glip without risk — Money back guarantee

DON'T SKIP IT — GLIP IT!

Order Now — Send Coupon Today

METAL PRO-TEK-TIV COMPANY
9219 Dexter Blvd. Detroit 6, Michigan

I am enclosing Money Order Check Cash to the amount of \$_____. Please rush _____ GLIP kits at \$2 each.

NAME _____

ADDRESS _____

CITY _____ ZONE _____ STATE _____

Send Cash or Money Order — No C.O.D.'s



MEDICO FILTERED SMOKING

Frank Medico pipes have the replaceable filter that

- absorbs juices
- collects flakes and slugs
- reduces tongue bite

Only these patented filters have the 66 baffles that whirl smoke cleaner and cooler into your mouth. Replace filter when discolored.

Frank Medico V.F.Q. (Very Fine Quality)

Bowls of rich-grained beauty. Wide variety of shapes. With 10 filters. . . . **\$2**

Frank Medico Standard Quality, still . . . **\$1**



S. M. FRANK & CO., INC., NEW YORK 22

STOPS LEAKS PERMANENTLY

Cut your fixture replacement, water and fuel bills with Economy Renewable Seats. Make economical, permanent repairs quickly and easily with the Junior Kit (illus.). Repair bathroom, kitchen and laundry fixtures. Everything you need included in steel box. This is a natural for the "Fixit" shops—get extra income from making permanent repairs on your customers' faucets.

Senior Master Kit also available—repairs faucets and valves up to 1" pipe. At Better Jobbers and Hardware Stores . . . or Write Direct

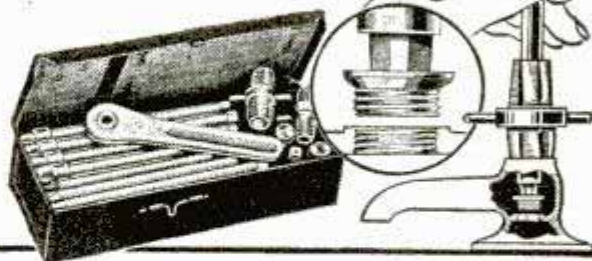

ECONOMY VALVE SEAT CO.
2811 W. Fletcher Street Chicago 18, Ill.

THIMBLE DROME RACER

The Model Racing
SENSATION
Best Xmas Gift for
Yourself or Others



Only
\$3.95
Postpaid

Completely
Finished

Speed! Action! Can be adapted for Class A miniature engine or other power.

4" high. Weighs 18 oz. Order one today—you can't beat this for fun! Rush order for immediate delivery.

HOME-SHOP PRODUCTS CO.

Dept. 19 4821 Sheridan Road Chicago 40

Super Charger Pump



Heavy duty super charger rotary pump designed to efficiently pump water, oil, gasoline, etc. Also used as a vacuum pump. Includes lovejoy coupling for 5/8" shaft, 1" outlet on top, 1" outlet on bottom. Size of pump 7 1/2" W. x 5" D. x 7" H. Compact and sturdy. Four mounting holes in base. Can be used with 1/4, 1/3, or 1/2 H. P. motors. Shpg. Wt. 19 lbs.

No. 8536—Each. **\$15.95**

Send check or money order today plus postage.

FREE CATALOG—Send for new G. & E. APPLIANCE & PARTS CATALOG

Dept. P. M. 9

G & E Equipment Supply Co. OGDEN AVE. AT FULTON CHICAGO 7, ILLINOIS

TRAILER AXLES • HUBS • WHEELS AND SPRINGS

1000 LB. CAPACITY STRAIGHT AXLE

58" Tread—46" Spring Centers
Axle only, \$6.50—With Springs, \$22.00; Axle, wheels and hubs, \$30.50; Axle, wheels, hubs and springs, \$43.70.

1500 LB. CAPACITY STRAIGHT AXLE

58" Tread—46" Spring Centers
Axle only, \$8.25—With Springs, \$24.50; Axle, wheels and hubs, \$32.25; Axle, wheels, hubs and springs, \$46.00; If 4" Drop Axle is wanted, add \$5.25 to above prices.

Wheels take 6.00-16 tires • Hubs equipped with roller bearings • Prices F.O.B. Fenton, Mich. • Remittance with order—No. C.O.D.

Write for Descriptive Literature

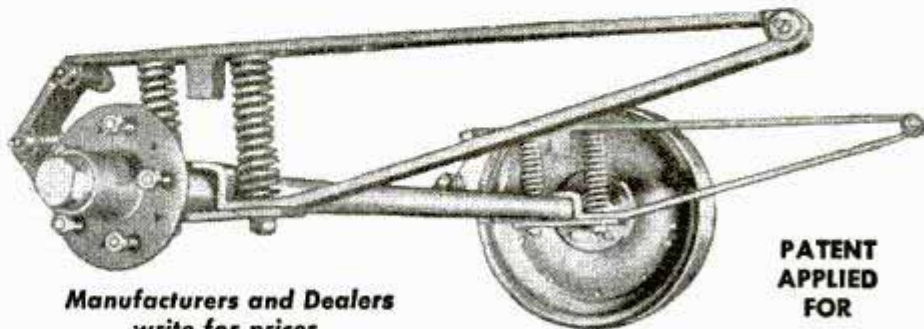

Manufacturers and Dealers
write for prices.

PATENT
APPLIED
FOR

200 S. LEROY ST. INDUSTRIAL MACHINE TOOL CO., INC. FENTON, MICHIGAN

SENSATIONALLY NEW!

YOUR CIRCLE SAW CAN CUT GROOVES LIKE THIS

Easily - - - Quickly - - - Accurately



Yes—This new invention will fit the arbor of any wood power circle saw—and it will saw any groove desired, cleaner, easier, and faster than any dado head on the market today . . . Once mounted, Warren Dado Sawing Washers can be left as a permanent part of your power saw . . . always accessible and quickly adjusted from use as a straight cut off saw to any width groove desired.

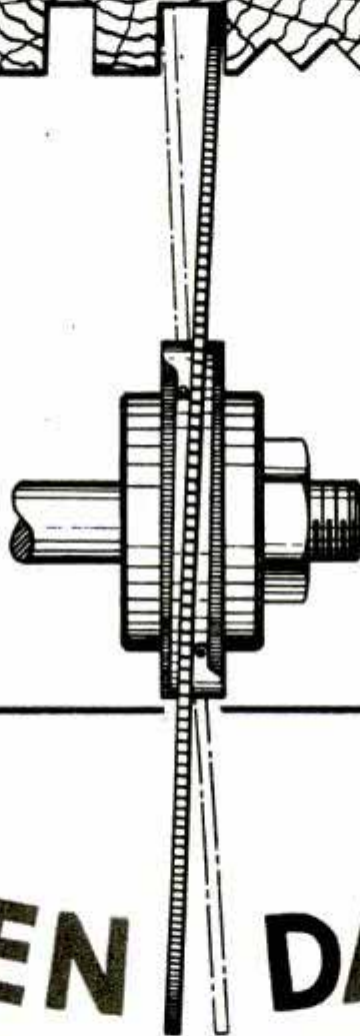

Warren Dado Sawing Washers are precision diecast aluminum alloy. There are four washers to a set—one pair for each side of the saw blade . . . graduated in 32nds and numbered to cut the width groove desired.

Use the coupon below and order your set today at this low mail order price.

\$ 4.95
SET
POSTPAID
INC. TAX

The WARREN SAWING DADO WASHERS

Patent Applied For

— GUARANTEE —

Use Warren Dado Sawing Washers for 10 days. If you are not thoroughly satisfied, send the washers back and your money will be refunded.

WARREN DADO SAWING WASHERS CO.
P. O. Box 98, North End Station Detroit, Mich.

Please send me a set of washers as advertised.

Name.....

Address.....

City.....Zone.....State.....

Arbor Size 1/2 3/8 3/4 1 Circular Only

Enclosed is... Money Order Check

PM

WARREN DADO SAWING WASHERS CO.
P. O. Box 98, North End Station Detroit, Mich.

Carries the Same
**90 DAY
GUARANTEE**
As a New
Motor Assy.

Our Finest Precision REBUILT

MOTOR BLOCK ASSEMBLIES

Sold Outright or Exchange

Rebuilt by skilled mechanics. Assembly has Reborn Block with New Pistons, Pins, Rings, Reground Crankshaft, and all New Bearings. Guaranteed 90 Days.

Allowance on Old Motor
We ship at outright price. Send your motor prepaid, must be suitable for rebuilding. Send in notarized bill of sale showing title number if any. We refund difference when we receive your motor.

DODGE—3 1/4" bore
Year Type Outright Exch.
35-47 6 cyl. \$129.00 \$99.00

Plymouth Outright Exch.
35-47 6 cyl. 129.00 99.00

Specify exact year, make and model when ordering. Send for catalog on motors not listed.

\$5.00
Crating
Charge

FORD BLOCK ASS'Y.			
Year	Type	Outright	Exch.
28-31	4 cyl.	\$ 98.00	\$73.00
32-47	6 & 8	139.00	89.00
Mercury			
Year	Type	Outright	Exch.
39-47	V8	149.00	99.00
Chevrolet			
Year	Type	Outright	Exch.
29-47	6 cyl.	117.50	87.50

POWER TAKE-OFF for JEEP ENGINE

Bolts to clutch housing on the Jeep engine. Has a spline shaft to engage with clutch and extending from rear is a keyed shaft on

which pulley can be mounted. Hand lever controls clutch.
PF4N-23J—
Each.....

\$4250

NEW 5 Gal. CANS

FOR GAS, OIL
OR WATER
Vented for
Safety.
Self-locking
Safety Cap
Extra Heavy
Construction
Will Float
When Full
Size of can,
18" high, 6 1/4"
thick, 13" wide.
PA35U-60—
Lots of 5, ea.
1.15
Lots of 50, ea.
1.05
Lots of 100, Each
98c



60 HP. JEEP Engines

Reconditioned, Tested and Guaranteed in perfect running order and ready to run. Every part is checked to be perfect and carries a 90 Day Guarantee same as a new engine.

COMPLETE with . . . Generator, Starter, Distributor, Coil, Fan and Fan Belt, Water Pump, Fuel Pump, Intake and Exhaust Manifolds, Carburetor, Oil Filter, Spark Plugs, Flywheel, Clutch and Pressure Plate, Wiring.

Outright,
PG58R-003, Each **\$13750**

\$5.00
Crating
Charge

New Willys JEEP Enclosed Power Unit

60 HP. 4 cyl. engine. 134.2 cu. in. displacement. 3 1/4 bore 4 3/8 stroke. Complete with radiator, gas tank, clutch power take-off with 1 1/2" keyed shaft, and all accessories. **READY TO RUN. NEW, COMPLETE, PG60N-002, \$32500**
F.O.B. Chicago.

SEND 25% CASH WITH ORDER, BALANCE C.O.D.

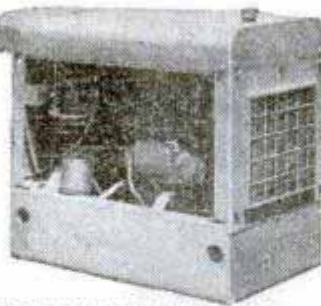

J.C. WHITNEY & Co.
1917 Archer Ave. Chicago 16, Ill.

Order Now for Christmas

(Leave adv. exposed to Santa)

Mows and Trims Lawns

In One Simple
Easy Operation.
8 1/4 Lbs.



Save Time
and Labor with a

MONTAMOWER

New model. New type metal handle has device to adjust cutting height. Drive shaft mounted on free rolling, factory lubricated, sealed ball bearings. No tired backs or aching arms. 8 1/4 lbs. of live precision mechanism that first gathers, then cuts smoothly a clean 16" swath through grass, dandelions, spike grass and weeds. No noise or clatter. As modern and efficient as your electric razor. Cuts right up to walls, fences, trees or posts; leaves no fringes to be trimmed by hand. Cutters are self-sharpening. Built to last many years. Many thousands in use. Sold direct from factory for 25 years. Costs little. Don't risk late delivery in rush Spring season. **ORDERING NOW GUARANTEES** choice of immediate, pre-Christmas or early Spring delivery. Write at once for "TRIAL ON YOUR OWN LAWN" approval offer, guarantee information and literature.

MONTAMOWER DISTRIBUTING CO.

820 Keeler Bldg. GRAND RAPIDS 2, MICHIGAN

YOUR AIR TOOLS WORK BETTER WITH NEW HOSE COUPLING!

Get greater efficiency from your air-operated tools. WIGGINS Quick-Connect Hose Couplings are guaranteed leak-proof—have a larger flow capacity than any other quick couplings. Ideal for Paint Guns, Hand Air Drills, Air Compressor Hand Tools—or any tools and machinery that you are constantly connecting and disconnecting.

MONEY BACK GUARANTEE ON AIR, WATER, FLUID COUPLINGS

WIGGINS Quick-Connect Couplings handle everything—air, steam, oil, water, vacuum, hydraulic, liquids. Withstand higher or lower pressures (even vacuum) than any other quick couplings. Guaranteed not to leak or blow out. Increases flow 1/3 — increases efficiency — saves time. Snaps on and off — no screwing with WIGGINS! Used by Ford, Chrysler, Lockheed, Army, Navy, Westinghouse—many others. Send \$1.50 for sample 3/4" water hose coupling; \$1.90 for 1/2" air hose coupling. Write for information on other uses in home and industry to E. H. WIGGINS OIL TOOL CO., Inc., Dept. PM, 3424 East Olympic Blvd., Los Angeles 23, Calif. Written guarantee of money back unless delighted!





What paper gadgets,
tied with string
Put addresses on
anything?

Dennison

SHIPPING TAGS

At Stationery Departments Everywhere

THERE'S PROFIT in ELECTRICITY—LEARN from PRACTICAL ELECTRICS, \$1.00



Whether you want to enter the electrical field as a profession—or whether you want to know more about fixing electrical gadgets around the house, you will find Practical Electrics a profitable investment. You can find the right answers quickly. It gives you the

fundamentals of electricity, electrical circuits, motors, transformers, electrical symbols, trouble shooting, etc.—all in plain, simple, understandable language. Send \$1.00 today for a copy of Practical Electrics, the ready reference book of electricity.

AUTOPOWER, INC., 2118 PINE STREET, ST. LOUIS 3, MISSOURI

**BUILD REALISTIC
MODELS OF YOUR
INVENTIONS**



Much more than simply "a construction toy," ARKIToy employs perfectly co-ordinated modular dimensions, permitting construction of a great variety of models to approximate scale. In combination with grooved pulleys and wheels, utilizing approximately 350 pieces of material and 150 assorted machine screw bolts with hex nuts, the No. 4 ARKIToy Set provides a handy and practical kit for "visualizing" your ideas in practical form.

At your dealer or order direct \$5.00 postpaid (\$5.50 west of Rockies). No C.O.D.'s please.

CARROM INDUSTRIES, INC.
Dept. A, Ludington, Michigan, U.S.A.

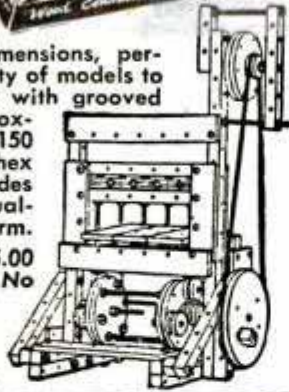

ASSURE EASY WINTER STARTING

ELECTRIC MOTOR HEATER

- Safe—"Black Heat" element can't ignite gas fumes.
- Keeps engine warm. Prevents moisture condensation in carburetor.
- Unconditionally guaranteed.

150 watt heater, wt. 14 oz., 8" long, 2" dia., 8' waterproof cord, 110 v.

FACTORY TO YOU \$3.50
Send money order or request C.O.D. plus postage



W. T. DRIVER, Manufacturer
2646-37th Ave. So., Mpls. 6, Minn.

GOVERNMENT SURPLUS

BRAND NEW

**VICKERS
HYDRAULIC PUMPS**

Hundreds of Practical Uses

BUILD YOUR OWN HYDRAULIC PRESS, ELECTRIC EYE DOOR OPENER, ETC.

\$15.00 F.O.B. DETROIT, MICH.

JAY-BEE SALES CO.

4554 Gd. River Ave. Detroit, Michigan



FREE 8-PAGE FOLDER... Get this
"SOLDERING (easy as A-B-C)"

FOR EVERY HOBBYIST, CRAFTSMAN, AND HANDY MAN AROUND THE HOME. Simple step-by-step illustrations explain how to tin soldering irons, bind and solder wire splices, unite metals, etc. No obligation, just send us your name and address today. We'll mail your soldering folder without charge.

UNGAR Electric Tools, Inc.
P. O. BOX 2255-L, TERMINAL ANNEX
LOS ANGELES 54, CALIF.



SUPER JET BLOW TORCH

ONLY \$1.

100% USES WITH AMAZING NEW DRY FUEL BLOWTORCH

It's Here! The tool that amazed famous science editors! Perfect for soldering, silver soldering, hardening or annealing small parts! Used and praised by model-makers, electricians, jewelers, mechanics, chemists, inventors, schools! 10 minutes intense heat (over 2000°F) with each tablet! Solid brass torch, air cooled handle, clear plastic tube. Guaranteed! Order Yours Today!



MAIL ORDER TODAY!

Send \$1.35 for torch, 12-tablet fuel box, mailing costs. No CODs. Wholesale Areas Open

BIRK MANUFACTURING CO. 552 HILLS STREET
I. HARTFORD, CONN.

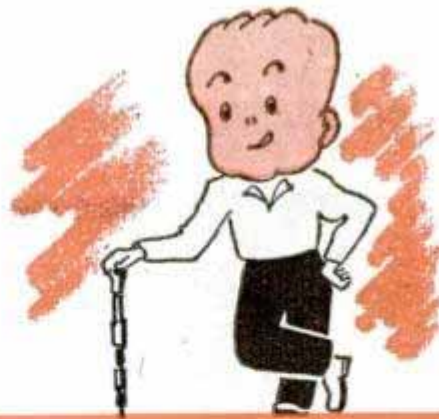

**Save Time
on Routine Jobs**

**with an AUTOMATIC
SCREW DRIVER**

Whether it's light production assembling or a routine home workshop job, you can save a lot of time with a Millers Falls Automatic Screw Driver. This unique spiral ratchet tool can handle any screw driving job quicker and easier. By simply shifting the knurled control sleeve and the spiral lock nut, it can be used either as a regular rigid screw driver, a right or left hand ratchet, or as a complete automatic. Made with or without quick return.

Smooth, powerful action and tested dependability are built right into Millers Falls Automatic Screw Drivers. You can depend on them for long-lasting satisfaction. Ask to see one at your dealers today.

One thing in common—Quality



MILLERS FALLS COMPANY
GREENFIELD • MASSACHUSETTS



Be the Local Manufacturer of this Modern Building Unit

Choice new territories are being opened up for the local manufacturing of Dunbrik and Dunstone—America's finest masonry. Several hundred new local plants are needed to keep pace with the fast-growing consumer demand.

Millions of Dunbrik are used annually for the building of homes, and all types of public and commercial structures. It is outstanding in design, symmetry, and colorful beauty. And has price appeal of tremendous significance. Dunstone—a companion unit broadens the usefulness and market possibilities of Dunbrik.

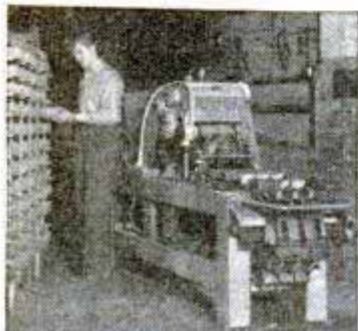

The Lifetime Opportunity for Men of Vision and Enterprise

Dunbrik and Dunstone are vital contributions to the nation's crying demand for low-cost homes. A demand that is only beginning to be supplied. Better yet, they deliver all the advantages of masonry at its best without price penalty. Strength—safety—long life—low depreciation. These factors indicate that market possibilities are almost unlimited.

We supply complete plant equipment for local manufacturing, using local materials and local labor. This explains why selling prices can be low, yet profit margin high. Moderate investment. Franchise-protected territory. Twenty years of consumer acceptance. Wire or write for full information and territorial reservation.

W. E. DUNN MFG. CO.

600 W. 24th Street

Holland, Mich.

DUNBRIK

JEEP POWER UNITS

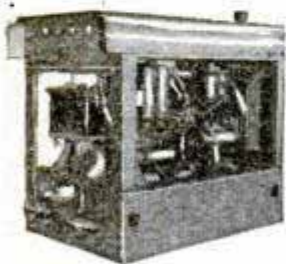

➔ \$200

New—
Gov't. Surplus
54 H.P. at 4000 r.p.m. All units delivered complete as illustrated, with metal covers for all sides AND 12 gal. tank under hood.
ea. f.o.b. Brooklyn

BOYS' EXPRESS CART KIT—only \$9.98—easy to assemble

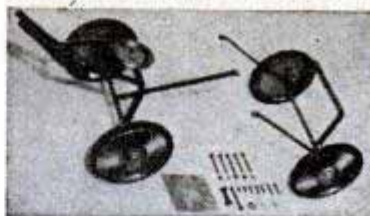

\$5.98 No. 300 Kit includes 4-8" heavy gauge steel, rubber tire wheels with bronze bearings and hubcaps; and ALL metal parts as illustrated, with blueprint for easily making sturdy 15" x 34" wagon.
No. 600 Kit, same as above except wheels equipped with KILLIAN Ball Bearings. \$6.49
ADD 10% TO COVER SHIPPING COSTS. Satisfaction guaranteed. Send money order or check right NOW!
C. W. Young Mfg. Corp.
Burnet Ave. Syracuse, N. Y.



WHEELS

Spotwelded Heavy gauge steel **REDUCED PRICES!**

5"—5 1/2" solid tire, 3/8 bushing, ea. 49c
8" with 1" solid tire—
—with 1 1/2" and 3/8" steel bearing, ea. 99c
—with 7/16" bronze bearing, ea. 99c
—with 7/16" KILLIAN Ball Bearings, ea. 1.19
ADD 10c ea. to all 8" prices for hubcap.
10", bronze hub, 1/2" bearing, 1.75 semi-pneumatic tire, ea. 2.19
10", 1/2" KILLIAN Ball Bearings, 1.75 semi-pneumatic tire, ea. 2.29
Add 10% to ALL prices for P.F., 15% west of Miss. Check or money order only. We guarantee satisfaction. Mail order NOW!

C. W. YOUNG MFG. CORP.
202-4 Burnet Ave. Syracuse, N. Y.

WOODBURNING PEN

with 6 Special Tips

Works on AC or DC

- Woodburning
- Embossing
- Plastic Forming
- Cork Decorating
- Foil Writing
- Leather Burning



With 6 colored foil sheets and Instruction Sheet. Unconditionally Guaranteed.

\$2.95

Postpaid or C.O.D. plus P.O. Charges

S. S. MERCHANDISE CO., Dept. 81
23 Flatbush Ave., Brooklyn 17, N. Y.

Ottawa Self-Propelled Buzz Master

CLEAR LAND FAST! Powerful 7-HP motor with friction clutch for safe operation. Cuts down timber, brush and hedge; turn blade vertically and saw logs to length. Also furnished with post hole diggers. Has clutch pulley for belt work.



OTTAWA MFG. CO., 1-727 Brush Ave., Ottawa, Kansas



LOOK! NEW, FLYING HELICOPTER

Jet model—soars up 100 ft. Aluminum, with 12-inch rotor, only \$1.69. Send \$1 with your name and address. Pay postman balance of 69c plus postage. Order today.

THE ROBERT SALES CO.
727 Hennepin Ave. Minneapolis, Minn.



Print Your Own

Cards, stationery, circulars, tags, labels, photo and movie titles, advertising, etc. Save money. **Print for Others, Good Profit;** easy rules sent. Raised Printing like Engraving, too. Send dime for press samples, supply book, all details and advice on your needs. No obligation. **KELSEY INC., B-37, Meriden, Conn.**

MARLOW PUMPS 2"

NEW!

driven by 3 1/2 H.P. Mercury gasoline engine delivers 55 gal. per min. at 50 foot head
\$110 ea. f.o.b. Brooklyn

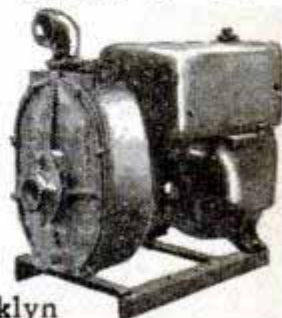

MILL BASIN SHIP REPAIR CO.

2130 Mill Ave., Brooklyn, N. Y. • ES 7-9088

CHEER UP, MISTER!



You Have Just Discovered the
SMOOTH, SWIFT, SWEET SHAVE
YOU'VE BEEN YEARNING FOR!

Yes, siree! And a money-back guarantee so you CAN'T lose! Try ONE blade. If it isn't tops with you . . . return the rest, get your money back. Grand micro-honed blades, regularly 5 for 25c. In this offer . . . 25 and the razor, all for only \$1.00

25 GRAND MICRO-HONED BLADES AND GRAND SELF-LUBRICATING RAZOR

ALL FOR \$1.00

Blades fit any standard Double Edge razor.

This razor holds twice as much water, makes shaves doubly smooth!

WE PAY POSTAGE . . . SEND \$1.00 TO

GRAND RAZOR CO., Dept. A, CLAWSON, MICH.



MUFFLERS
STEELS and ALUMINUMS
with a motorboat tone

SINGLES, Chev, V-8, Plymouth, Steels \$5.50, Aluminum \$6.50. Chry., Olds., Buicks, etc., Steels \$7.50, Aluminum \$8.50. V-8 and MERCURY DUALS, Steel \$17.50, Aluminum \$20.00. Aluminums are guaranteed for life of your car.
DEALERS WANTED

SANDEE MUFFLER CO.
7523 S. WESTERN AVE., LOS ANGELES 44, CALIF.

AUTOMOBILE CIGAR LIGHTER

Universal-Automatic. Fits any car. Precision made. Attractive. Just remove your burned out lighter and insert. Send only \$1.50 postpaid. Complete with bracket for cars without lighter. Send only \$2.50 postpaid.



Money back if not satisfied.
C.O.D. orders filled. You pay postage.

M. G. SALES CO., 1187 Bedford Ave., Brooklyn 16, N. Y.

Do your own professional

FELT FLOCK FINISHING

with complete spray outfit

Now you can apply a professional, colorful, felt flock finish on hobby crafts, novelties, art objects, lamps, furniture, toys, etc. Velvety, durable, easy-to-apply finish. Available in 10 brilliant colors. Complete outfit (as pictured) includes undercoat, brown and ivory flock, solvent, brush, patented spray gun and instructions. Complete price \$9.25 post paid. Write for FREE circular and color sample card



BEROTT-ROSS • DEPT. 12A 411 No. Foothill Road, Beverly Hills, Calif.

Now is the ideal time to Remove Tree Stumps

For As Little As

\$1.00
Or Money
Back!



Remove ugly tree stumps, old or new, roots and all, any season, without digging, chopping, blasting, pulling! Save time, money! Order Magic Stump Remover now by mail. **SEND NO MONEY!** Pay postman only \$1 for 4-Oz. size (for stumps up to 12 in. dia.), \$1.50 for 8-Oz. (for stumps up to 24 in. dia.), \$2.75 for 16-Oz. (for stumps up to 40 in. dia.), plus postage and C.O.D. fee. Or, **SAVE Postage and C.O.D. FEE** by sending cash with order. Also larger quantities at savings. Safe, proven, use anytime, anywhere. Money back if not satisfied.

H. D. CAMPBELL CO., Rochelle 24, Ill.

THE FAITHFUL
HEART
OF YOUR FUEL
SYSTEM



OVER 30,000,000 IN USE TODAY

Pulsing steadily, nearly 100,000 times an hour, your AC Fuel Pump is the strong, reliable heart of your fuel system. It has given you long, faithful service because of its inbuilt quality and scientific design.

You can prolong that faithful service indefinitely, if you insist upon a new AC when you replace your present pump.

There is no satisfactory substitute for quality.



AC SPARK PLUG DIVISION • GENERAL MOTORS CORPORATION

MONEY SAVING BARGAINS

No. 1—FLYING HELICOPTER—Looks and flies like the real article. Has 11" diameter Rotor actuated by a string-and-spool. Works like a top. Flies many feet upward and forward before landing. Sturdily built of aluminum and plastic . . . Only \$2.00.

No. 2—6 POWER TELESCOPE—A pocket size, power aluminum Telescope, with scientifically ground lenses with a 1 3/4" field of vision. Opens into 3 sections, 15 1/2 inches long. Collapses into 8 1/2 inches . . . Only \$1.98.

No. 3—POWER BINOCULARS—High quality lens gives a 3 1/2 power with wide field of vision. Adjustable for inter-pupillary and focal length. Light, sturdy case of aluminum and plastic. Open height 4 3/4". Has neck strap and comes with leatherette Carrying Case . . . \$3.98.

No. 4—ELECTRIC-TAP-A-WAY SET—Contains one electric spring tapper, a 6 volt standard battery and 20 vari-colored metallic plaques of many useful applications . . . \$3.98.

YOUR ORDER shipped C.O.D. plus postage. If you enclose full amount with order we pay postage. Satisfaction or money back. FREE CATALOG.

DOUGLAS SALES CO. 1431 S. Kedzie Ave. Chicago 23, Ill., Dept. PM-1



No. 1

No. 3



No. 2



No. 4

HUGE WAR SURPLUS PURCHASE



- 12" Waterproof Cowhide Uppers!
- Thick Rubber Soles!
- Ideal for Outdoor Men!
- Government Cost \$10

Leather Top • Rubber Sole

SHOE PACS

IDEAL FOR COLD OR SLUSHY WEATHER

Sizes 6 to 14 **\$3.88** FREE with every purchase! A pair of Shoe-Pac Boot Socks.

Keep out icy slush, water and snow! Keep feet toasty warm and dry! Stout leather tops and rubber soles, all waterproof. Boot socks free. When ordering, state size; add 12c for mailing costs. Illinois residents add 2% tax.

Send Check or Money Order (No C.O.D.'s) to

WORLD WAR SURPLUS STORES Dept. PM-12
2450 S. HALSTED STREET • CHICAGO, ILLINOIS



Electrical Wire Assortment

UNBEATABLE VALUE!

INCLUDES: 100 ft. plastic insulating tubing and sleeving—20 ft. each of 5 sizes; 400 ft. plastic insulated stranded flexible wire (insulation highly resistant to acids, water, oil, abrasions, etc.)

—100 ft. each of 22, 20, 18 and 16 gauge; one 10 ft. 18 Ga. 2 conductor heavy duty round rubber extension cord set with male rubber plug and female connector on opposite end (ideal for extending power for portable equip., etc.); one 9 ft. cord set with male rubber plug and 3-way table-top on opposite end; three 6 ft. 18 Ga. 2 conductor cord sets—1 black, 1 brown, 1 ivory (excellent as replacement for lamps, radios, etc.); one 6 ft. 18 Ga. asbestos heater cord set with rubber male plug and heavy duty connector for irons, toasters, etc.; one 100 ft. coil of 7/27 bare copper aerial wire; 3 heavy duty rubber replacement plugs . . . \$10.00 value . . . NOW ONLY . . .

\$5.00

postpaid anywhere in United States when payment accompanies order—1/3 deposit on all C.O.D. orders

PARKSIDE WIRE CO., Parkside and Elston, Chicago 30, Illinois

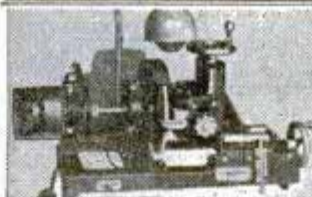

Start a NEW BUSINESS
Sharpen Dull Pipe Wrenches

Or Add to Your Present Repair Business

Write for information.

J. C. MOORE INDUSTRIES P.O. Drawer 276 FREDONIA, PA.

SELF-CONTAINED - COMPLETE SPRAYING OUTFIT

No hose or elec. cords; no pumping

Completely self-contained, portable spray gun—fully guaranteed. Sprays paints, enamels, insecticides. For home, workshop, garden, farm. For pressure uses a CO2 Cartridge available at all drug stores at 10c or less. Complete, ready for use; with one cartridge.

Price, postpaid \$18.50

SULLIVAN-BECKER 6705 14th Ave. Kenosha, Wisconsin



Christmas

FOR THE CRAFTSMAN

1/4" DRILLS FROM THE FAMOUS CLARK FACTORY

ORDERS ACCEPTED NOW FOR IMMEDIATE DELIVERY

\$26.25 ea.
F.O.B. New York

Made to fit your hand with index finger switch



FACTORY & HOME SUPPLIES
243 CANAL STREET, NEW YORK, NEW YORK



AXLE ASSEMBLIES

with a hundred uses

LIMITED
OFFER
•
ORDER
TODAY!

Complete as illustrated, 1 1/2" square, 58" tread. With 6:00 x 16 recap tires \$52.50
Without tires \$45.00

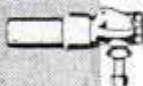

• BULL DOG HITCHES—with tongue-ends for every need.

HAMMER BLOW TOOL COMPANY

DEPT. AB, WAUSAU, WISCONSIN

New PERSONAL RADIO... Pocket Size



This little radio is substantially built and is so constructed that, if dropped, it will not break. It has a beautiful red leatherette case. May be carried in your pocket wherever you go. Reception is guaranteed when used according to instructions.
There is no cost in operating this radio as there are no tubes and no batteries to buy, and no electricity needed. Instead, the new "Crystal diode" rectifier same as used in Army and Navy ultra hi-frequency radar sets is being employed. It is not a toy, but a practical little radio for football or baseball games, news reports, or your favorite program. It is especially good to listen to in bed, or in hospitals, dormitories, barracks, and offices because it is not heard by anyone but yourself.
Send only \$1.00 (check, money order, cash) and pay postman \$3.95 plus delivery fees, or send \$4.95 for postpaid delivery.
SHESS MFG. CO., LAKE GENEVA, WIS.

REAL DIESEL ENGINE

For Model Planes, Boats and Race Cars
Now you can own and run a real miniature diesel engine that operates by the heat of compression. No coil, condenser, wires, or annoying ignition failures. Simply flip the prop or flywheel to start. It's the new DEEZIL—a .125 cu. in. displacement, 5 oz. engine that runs at 8000 RPM. Order today; only \$12.95 p.p., less tank. Every engine fully tested and guaranteed. DEEZIL MIX FUEL \$1.00; PROP 50c.

GOTHAM HOBBY

107 East 126th Street New York 35, N. Y., Dept. "P"

CIRCUIT TESTER

CAN BE USED IN PLACE OF MULTIMETER!

Complete with instruction book! \$3.95
TESTS: Indicates AC and DC Voltages • Fuses • Resistances of Circuits • Capacitors • etc.
Unit in small, strong metal box. Weighs approx. 2 lbs. Test leads provided. Power may be supplied to test unit from 1 1/2 to 130 V. AC or DC. New. Shipped in original Sealed Metal Containers! Shipping Wt. 3 1/4 lbs. F.O.B. Chicago, Ill.

SCHUH'S RADIO PARTS 1253 Lovola Ave. Chicago 26, Ill.



Save Up to 75%

SURPLUS BARGAINS

Precision Bilt MICROMETERS

Chrome finished, made by nationally known manufacturers to give a lifetime of accurate detailed service.

1" Central\$3.50	1" Reed\$3.75
1" Lufkin\$4.25	2" Reed\$5.25
4" Central\$6.25	6" Stocumb\$7.50

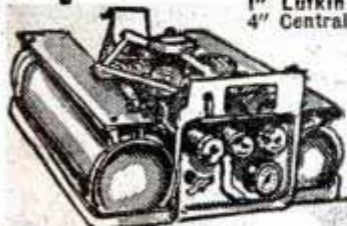

Gasoline Pressure Wickless HEATING STOVES

22" long, 19" wide, 9" high. Ideal for hunting, camping, Bar B Q pits, house trailers, etc. only \$9.95

Order Now — Immed. Shipment, FOB, K.C.

ATLAS SALVAGE & EQUIPMENT CO.

229 S. W. Blvd. Ha 7654 Kansas City, Mo.

EXTRA GIFTS FOR WRENCH USERS



When you get into cramped spots or tough places, try a Billings. It's designed extra thin to get in after the nut and go to work.



An extra measure of strength is built into each Billings wrench to prevent spreading of jaws on even the toughest wrenching job.



Wrenching fatigue on a long job is kept to a minimum with extra light Billings. Means more work in less time, with less effort.



Billings wrenches are finished with sparkling chrome plate and polished heads. Extra beauty... and their finish is rustproof.



You'll get extra pleasure using a Billings on your next job. It fits your grip like a handshake and it's tough on stubborn nuts.

Don't forget to look in your hardware store for Billings balanced line of sockets and parts.

BILLINGS WRENCHES



Buy them at Your Hardware Store



The Billings & Spencer Company, Hartford 1, Conn.

2 BIG SPECIAL BARGAINS at LOW PRICES

BRIGGS & STRATTON LIGHTING PLANTS AND SPERRY S-1 BOMB SIGHTS

110 Volts D.C.



Made For the Government: All NEW . . . Never Used

Cost U.S. Gov't \$4,500

BRIGGS & STRATTON Portable Lighting Plant priced at a fraction of the original cost. Built to rigid Government requirements. Especially built for Field Use or for permanent installation in Cottage, Farm, Trailer, Boat, etc. Complete with 1 3/10 H.P. Gasoline Engine, Hand Starter. Rated 250 Watts will develop 500 Watts. With Spare Parts and Tools. Mounted on permanent base . . . Rubber cushioned . . . Ready for Immediate Use anywhere . . . At this LOW PRICE they won't last long . . . Better Hurry only \$129.50.

SPERRY S-1 BOMB SIGHT—Here is an unusual opportunity to get one of these MARVELOUS Precision Mechanical Instruments . . . Marvellous beyond description. Contains hundreds of parts usable in 1001 ways . . . Regular and Bevel Gears, Shafts, Approx. 100 Roller Bearings, Electrical Parts, Precision Lenses and Prisms, Countless Gears, Dials, Knobs, Switches, Polaroid Filter, Calibrated Dials for Air Speed, Drift Indicator and Illuminated Spirit Level, Gyroscope, etc. . . Excellent for Inventors, Experimenters, Hobbyists. Schools use for Study Demonstration. Only \$49.50.



Complete on Metal Base and Strong Box Container with Lock (can be used for valuables)

ALL FOR— ONLY

\$49.50

COMPLETE WITH POWER PLANT, ONLY **\$129.50**

Cash with order or we will ship C.O.D. if 25% deposit accompanies the order. These prices F.O.B. Chicago.

6 More Big Specials

- BRAND NEW . . . 24 Volt 915-4F . . . AVIATION STARTERS . . . ONLY \$35.00 Each
- BRAND NEW . . . B-11A-EA . . . ECLIPSE AVIATION Vacuum-Air-Hydraulic FUEL PUMP . . . Original cost \$45.00 . . . ONLY \$ 9.50 Each
- BRAND NEW . . . N-9-1 . . . GUN REFLECTOR . . . Ideal for Photo Enlarger. 3 1/2" Lens: Convex and Concave 2" Highly Polished Mirrors . . . ONLY \$ 5.95 Each
- BRAND NEW . . . A-8-B . . . OXYGEN MASKS: can be used for Spraying, Electric Welding, Printing, Grinding, Tree Spraying, etc. Made of Genuine Rubber With Sponge Filters . . . ONLY \$ 2.75 Each
- BRAND NEW . . . B-11 . . . SAFETY BELTS: for many uses . . . On Farms, Homes, Industrial Safety and on Jeeps . . . ONLY \$ 2.75 Each
- BRAND NEW . . . General Electric AIR COMPRESSOR . . . Catalog #T8252882G1 Rated Pressure 1000 pounds to square inch . . . Dual Cylinders . . . Approx. Weight 6 pounds . . . ONLY \$ 9.95 Each

ACE SURPLUS SALES CO., Inc., 1449 West 69th St., Dept. P-12, CHICAGO 36, ILL.

DEALERS: Write For Quantity Prices . . .

The Pipeline

PIPES COAL IN! PIPES ASHES OUT!

WARMTH WITHOUT WORK

All the work of furnace tending is done automatically by *The Pipeline* Coal Burner. Pipes bituminous coal from any bin to your present furnace, burns it smokelessly and efficiently, and even pipes ashes to dust-proof containers! Modulated warmth regulated by automatic controls.

Conversion models and complete winter air conditioners. Field-tested since 1934. Write for free 20-page booklet.

FITS ANY COAL BIN FITS ANY FURNACE DUSTPROOF ASH CONTAINER



POCAHONTAS FUEL COMPANY INCORPORATED
Stoker Division • 344 East 131st Street • Cleveland 8, Ohio

SAY YOU SAW IT IN POPULAR MECHANICS



AAF-B-3 FLYING JACKET

Leather, sheepskin lined, zipper front, reclaimed for reissue like new. The perfect coat for all outdoor sports and outdoor work. Takes the toughest wear. It's warm as toast. All sizes. Army combat field jacket \$3.95. All merchandise reconditioned. Sent C.O.D. Free catalogue of G.I. work clothing.

\$16.95
SURPLUS MERCHANDISE DEALERS, Dept. PM
1214 BROADWAY NEW YORK, N. Y.

BATTERIES!—START

—a factory at home and re-cast junk batteries into new; latest achievement. We supply complete instructions and everything needed. Big Profits!

Battery Laboratories, Dept. PM, Minneapolis 4, Minn.

BUILD YOUR POWER TOOLS

WITH OUR GUARANTEED INDUSTRIAL BALL BEARING ARBORS



New Departure Self Lubricating Bearings



(No extra charge for left hand threads)
B33—\$4.95 PP. C4—1/2x12 1/2 spindle, housing 2x8 \$8.25 PP.
5/8 x 4 1/2 Spindle C5—5/8x12 1/2 spindle, housing 2x8, \$8.25 PP.
B19 Plain Spindle C6—3/4x12 1/2 spindle, housing 2 1/4x8, \$9.25 PP.
\$3.50 PP. D8—1x17 1/2 spindle, housing 2 1/2x11 \$17.00 PP.
1 INCH BETWEEN WASHER AND COLLAR
SHAPER ARBORS 3 inches between collars, C4-1 1/2 \$14.25, C5-5/8 \$14.25, C6-3/4 \$15.25, D8-1 \$23.00, B25—1 1/2x3 1/2 cap. Range mount \$5.50.
SPECIAL SAW ARBOR LENGTHS for 1 1/2, 5/8, 3/4, and 1 1/2.
PILLOW BLOCKS—Ball Bearing, 1 1/2 \$3.50, 5/8 \$3.50, 3/4 \$4.25.
POLY PRODUCTS, 406 S. Chester, Ct. 1a, Pasadena 5, Calif.

The Chief WORK BENCH

Built to Last a Lifetime!

With Bottom Shelf and 18" Sq. Drawer. 2"x6", Solid Plank, Grooved and Dovetailed Top and 1"x8" Back Rail, Shellacked to a Smooth, Satiny Finish.

MOHAWK LUMBER CO. Dept. 32
14525 W. Chicago Blvd. Detroit 27, Mich.
Enclosed Check Money Order for \$
Ship CHIEF WORK BENCHES at
Quantity
\$16.95 each, F.O.B. Detroit, Mich.
 Send C.O.D., \$5 Deposit Enclosed.

NAME _____
ADDRESS _____
CITY _____ STATE _____
No Priority Necessary!

• 6 Ft. Long • 34" High • 26" Deep. Shipped Knock-down, with Bolts, Nuts and Screws and ABC Chart for Quick, Simple Assembly.

Prompt Delivery
MOHAWK LUMBER CO.
14525 W. Chicago Boulevard
DETROIT 27, MICHIGAN

A CHRISTMAS PRESENT HE'D APPRECIATE



\$16.95
F.O.B. DETROIT

Send Check or Money Order, or Will Ship C. O. D. (\$5 Deposit)



STOP LEAKS!

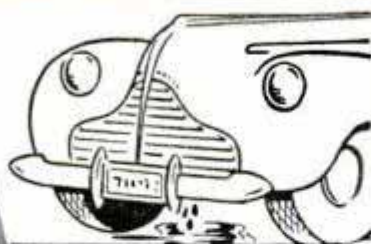

Cooling Systems Made Leak-Proof QUICKLY

WARNER LIQUID SOLDER—Non-Metallic—Deposits Tiny Fibers to Repair Leaks Anywhere in Cooling Systems. Simply pour in! Finds and REPAIRS every crack or hole. Do it yourself—or see your service man.

Warner-Patterson Co., 920 S. Michigan Ave., Chicago 5

SOLID BRASS 12 FT. PORTABLE RADIO ANTENNAS

Real \$15 Value Now Only \$4.95 Postpaid FOR HOMES, BOATS or AUTOS

JUST OUT! Gov't surplus used on Army tanks. These telescopic rustproof antenna have tremendous pickup eliminate dangerous wiring. Solid Brass throughout practically insuring NOISE FREE RECEPTION.



12 Exceptionally Rugged Sections compress into 1 ft. 4 in. Handy for Camping Trips, also Useful for Transmitting, FM & Television sets. Each antenna comes with clamps, nut, lug, and wire. Easy to install anywhere.

QUANTITY LIMITED ORDER TODAY. A real \$15 value for only \$4.95 Postpaid. Mail check or money order now or sent C.O.D. plus postage. Money back in 10 days if not satisfied.

RADIO HOSPITAL 442 East 86th St., Dept. A-12 NEW YORK 28, N. Y.



Please send 10c for Catalog No. 101

MEIER BRASS & COPPER CO. 1155 Bellevue, Detroit 7, Mich.

BRASS For Home Work Shops

Free Cutting Brass Rods Round, Hexagon, Square, 1/2-Oval and Rectangle Naval Brass Rods Round and Hexagon. Brass and Copper Tubing. Brass Sheet.

For Outdoor Pleasure and Transportation

Ride a Royal Enfield



Famous English Lightweight Motorcycle...takes you anywhere

Royal Enfield's popular Model R. E. has everything—Style, Safety, Economy, Flexibility, Performance! Best quality steel tubing; 125 c. c. 2-stroke, single cylinder engine; 3-speed gears. Goes 100 miles per gallon of gas! Folder "C" gives you complete details. Dealer inquiries given prompt attention.

Write Today

WHITEHALL DISTRIBUTORS, Inc. 1385 Commerce Avenue, New York 61, N. Y.

Give USEFUL GIFTS



"Boys" from 6 to 96 love good hand tools...to use on the job or around the home. For gifts that men prize highly, choose tools. And select the best—Plomb Prime-Quality Tools. Your Plomb Dealer has a complete line in a wide range of prices. See him today. Write for catalog to

PLUMB TOOL COMPANY 2255M Santa Fe Avenue Los Angeles 54, Calif.

4769



PLUMB Prime Quality TOOLS

ANCIENT FORMULA
From India
Delights Pipe Smokers



Brings Out the Natural Beauty of Briar

In far off India a pipe receives lifetime magical care. An ancient formula brings out the natural grain pattern of briar and improves it with age. A blending of rare oriental oils (YOGI) conditions the briar and imparts an exquisite finish.

By exclusive arrangement, genuine YOGI is now available to pipe smokers of America. A double-faced Pipe Conditioning Glove is used. One side of this glove is permanently impregnated with YOGI Purifier and the other side with YOGI Magic Sheen.

YOGI is new—not yet in the stores. Simply enclose a \$1 bill and YOGI Pipe Conditioning Glove will be sent postpaid subject to your entire satisfaction. If not pleased return within ten days for refund. An ideal gift. Holiday shipments rushed by return mail.

FREE: We enclose an interesting booklet on YOGI and its amazing uses.

YOUNKER TOWN COMPANY
2231 W. Thomas St. Chicago 22, Ill.

**NOW! A FINE TARGET PISTOL
EVERYONE CAN AFFORD TO
OWN AND SHOOT!**

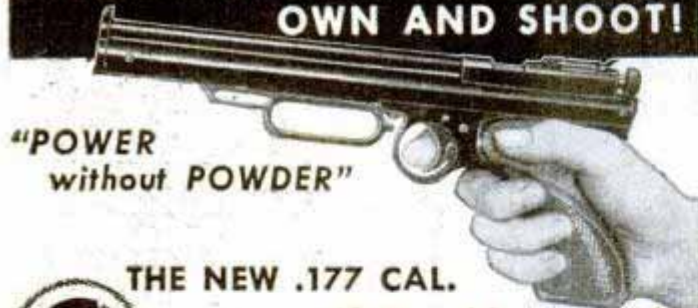

"POWER
without POWDER"

THE NEW .177 CAL.

Crosman "Bullseye"

Now... from the makers of the famous Crosman Silent Rifle, comes the new Crosman "Bullseye"... a single-shot pistol of regulation target type and weight, with the design, quality construction, balance and deadly accuracy demanded by experts. Compare it for performance and thrills. You'll find the Crosman "Bullseye" the outstanding value in small arms today.

SEE YOUR
DEALER OR
WRITE

Using Crosman Super-Pells, the better ammunition for all air-powered pistols and rifles, you can shoot the Crosman "Bullseye" for ONLY 1/4c PER SHOT!

CROSMAN ARMS CO., INC.
DEPT. 3E, ROCHESTER 7, N. Y.

ASK TO SEE CROSMAN DODO AND BELL TARGETS

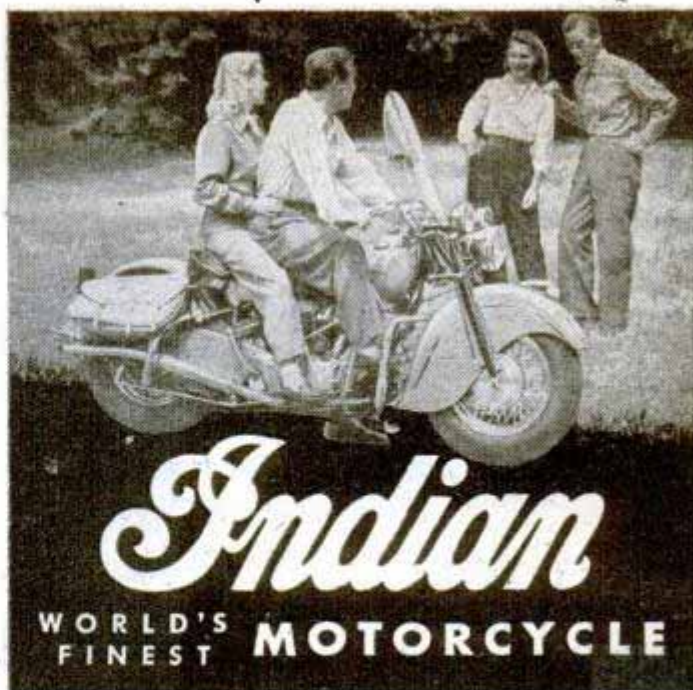

Send for FREE ILLUSTRATED MAGAZINE, "Indian News"
... DEALER INQUIRIES INVITED ...
Dept. 9M, Indian Motorcycle Co., Springfield 9, Mass.

Save Time and Money with this Press

Ten-ton press, ideal for all kinds of pressing, separating, straightening, and bending jobs. Ample capacity for home shops. Easily adjustable table takes work up to 18 inches wide and 11 1/2 inches high. Roller-bearing ram for long life. Send for free bulletin showing press and wide variety of accessories.

UT-10A Press f.o.b. factory \$31.00



DAKE ENGINE COMPANY
624 Seventh Street, Grand Haven, Michigan



CEMENT TILE

**Today's Big
Manufacturing
Opportunity**

The market for drain tile is HUGE. Demand is increasing much faster than supply. Farmers urgently need it to increase soil fertility and crop productivity... and have the money to buy. More cement tile plants are needed—badly—throughout the country. Besides farm drainage, other projects require millions of cement tile. Home building... road construction... sub-division development... and many others.

Manufacturing is easy. Market opportunities are unlimited. Profits are generous. Champion Drain Tile Machine makes the finest tile ever developed—strong, dense, true. Better than clay tile, yet can be sold for less. Made in local plants, of local materials, by local labor, for local market. Requires only a moderate investment. Write for full details.

CONCRETE EQUIPMENT COMPANY, 512 Ottawa Ave., Holland, Mich.





The best *Christmas Present* I ever got
GIVE AN EMRICK — ASK FOR AN EMRICK

HERE'S WHY:  MOST USED
POWER TOOLS IN 1 RUGGED
UNIT FOR ONLY \$34.95

ONLY
\$34⁹⁵

Power tool fun and profit are built into the Emrick Universal Woodworker. Versatile. Rugged. Compact. Big capacity. Heavy—shipping weight 65 pounds. Drill press pulls 1/2" drill in steel. Saw uses 6" to 8" blade. Arbor also takes all standard accessory wheels such as wire brush and cloth buffer. Lathe turns pieces 30" long by 10" dia. Disc sander 8" dia. 5" grinder. Heavy replaceable bronze bearings at all wear points. Only \$34.95 because sold direct from factory to you. MONEY BACK GUARANTEE. Order early for prompt shipment.

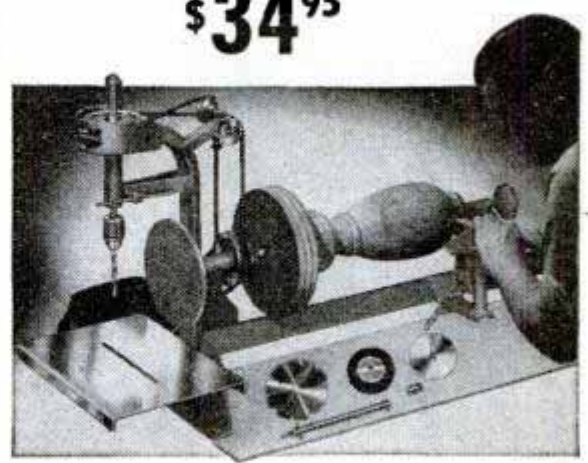

Complete except for motor and saw blade.

SEND THIS COUPON NOW!

EMRICK, Inc. 1742 Clinton Street
Kalamazoo 24, Mich.

Ship on 10 Days Trial.
 I am enclosing \$17.50, balance C.O.D. Send free literature.

Name _____
Address _____
City _____ State _____

LUMINALL
PAINT

makes furnishings
look their best



Redecorate your interiors with Luminall for better lighting and purer color. See the lovely colors at your dealer's.

LUMINALL PAINTS, Chicago 9, Illinois



SAVE MONEY

build your own
SMITH COMPRESSOR

Now, use the world-famous Smith Air Compressor to operate rock drills, paving breakers, spray guns, sandblasting, etc., at low cost! Just order the Smith Compressor Head and Accessories with complete instructions for assembling. All you need is a Ford Motor and shop facilities. Capacity 60 cu. ft.—ample power for most compressor jobs. Pressure up to 100 lbs. per square inch. Head equipped with high speed compressor valves; automatic unloading and idling.

WRITE **GORDON SMITH & CO., Inc.**
TODAY! 410 College Street Bowling Green, Ky.



BRIGHT
STAR

GIVES
MORE
BRIGHT
LIGHT
LONGER



Always Keep a Bright Star Flashlight Handy

"Earn More Easier" with Bayflex!

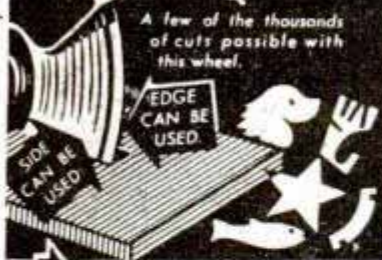

This all-purpose grinding wheel is unexcelled for making Xmas gifts. It is the most popular "fella" in the cellar for thousands of hobbyists. It will saw, file sharpen, cut, form and shape metal or wood . . . will cut BX cable, conduit, copper tubing, transite, celotex, brass, aluminum, steel, plastics, etc. An ideal Xmas gift. Send check or money order. Immediate delivery.

6" — \$1.65 Each 7" — \$2.15 Each 8" — \$2.80 Each

All wheels 3/32" thick with 1" hole. State size of shaft if smaller than 1". Proper bushing will be sent free.

POSTAGE PREPAID Anywhere in U. S. A. by: Bay State Abrasive Products Co., Westboro, Mass.

You can build this Attractive outdoor **BARBECUE** for only \$5.00 worth of materials

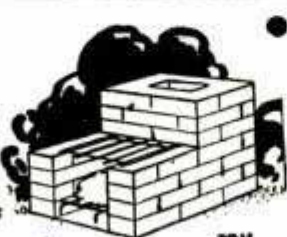

Mold Block Now—Lay Them Next Spring any color

The Kreger Concrete Block Mold . . . makes a block a minute . . . for 3 cents each! This barbecue is made of 40 blocks . . . easily put together.

FOR HOUSES—FOUNDATIONS—GARAGES



You can build or repair anything from a foundation to a complete house with block you make yourself. They meet all building codes.

THIS AMAZING MOLD LASTS A LIFETIME—COSTS ONLY \$15.00

The No. 4816 Kreger Concrete Block Mold, standard block—4" x 8" x 16"—will be shipped prepaid with complete instructions for only \$15.

KREGER PATIO BLOCK MOLD

The No. 4810 Kreger Patio Block Mold for walks or patios makes block 8" x 16" x 2 1/2". Only \$6.50, prepaid.

KREGER DRIVEWAY BLOCK MOLD

The No. 4812 Kreger Driveway Block Mold makes driveway block 16" x 8" x 4", at a cost of 6¢ each (100 linear feet of double track for only \$18.00!). Cost is only \$7.00, prepaid.

Order Your Molds Today or Write for Full Details.

The L. F. Kreger Mfg. Co., 544-B W. 35th Street, Chicago 16, Ill.

New "THERMO-SAW" (CUTS WITH HEAT)

MAKE THINGS FOR THE HOME or FOR SALE

• Any Child Can Use It! • NO NOISE • NO VIBRATION • NO SAWDUST

CUTS RAPIDLY AND CLEANLY THROUGH WOOD AND OTHER MATERIALS . . . AN IDEAL GIFT! Difficult patterns are made QUICK and EASY . . . No turning of work . . . Cuts in every direction . . . Cuts plywood 1/4" or 3/4" . . . Cuts 14"x36" board . . . Special Transformer produces high frequency current in a tough steel wire "blade" from ordinary Alternating (AC) current. No radio interference. **IMMEDIATE DELIVERY!**

NOTE: Operates on 110 volt Alternating Current: 50 to 60 cycle.

Machine Measures 11x4x3 1/2" High, Throat 7" Deep, PATTERN FREE. Postpaid **ONLY \$5.98**

COMPLETE SAW outfit as illustrated with transformer and 12 spare blades. **READY TO USE.**

ORDER \$6.23 in Canada and TODAY Mexico. \$6.48 Elsewhere.

Manufactured by: **THE KING CO., Dept. P-12, 6 No. Batavia Ave., BATAVIA, ILL.**



BRUNO EXPANSIVE BITS NEW DESIGN!

For professional and home use! Cut holes to any depth in wood . . . fast and smooth . . . special lead screw gives faster starts.

No. 200-B2, 3/4" to 1 1/4", \$2.45
No. 201-B2, 1 1/2" to 3 1/2", \$3.45

MONEY BACK GUARANTEE

BRUNO TOOLS, BEVERLY HILLS, CALIF. At dealers everywhere



EXTRA MONEY QUICK

SELL PERSONAL INITIALED BELTS

SEND FOR SPECIAL OUTFIT OFFER

BUCKLES, CAP BADGES, TIE HOLDERS 2000 emblems to choose. Fast profits repeats. Write to-day. Special outfit offer.

HOOKFAST SPECIALTIES, Dept. 51 BOX 1425 PROVIDENCE, R. I.

DEEP TONE DUAL MUFFLERS LONG LIFE

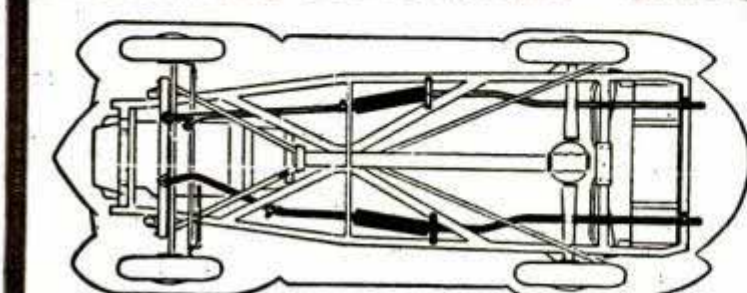

• More Horse Power • Blow-Out Proof
• Better Gas Mileage • Straight Thru Mufflers

FORD & MERCURY DUAL SETS . . . \$20.00
C.O.D. - F.O.B. Los Angeles Order by Year and Model
No Welding, Cutting, Drilling of Holes.
All Fixtures Furnished Rubber Insulated Clamps

DEEP TONED Ford, Chevrolet, Ply. . . \$4.86
SINGLE MUFFLER All others . . . \$5.50
2 1/2" CHROME TAIL PIPE TIPS . . . \$1.75

1935 TO 1947—V-8 FORD AND MERCURY ONLY **Advance Mufflers 6800 SO. VERMONT AVE. LOS ANGELES 44, CALIF.**

Do a Better Job WITH ONE OF THESE EMPIRE LEVELS

EMPIRE TORPEDO LEVEL
Smallest, most handy and accurate Level made. "Cigar-shaped"—no sharp corners to tear pocket. Aluminum stock. Only 3 oz. wgt. 9" long. Has Level, Plumb, 45° Vials.
No. 26\$1.75



ALUMINUM LEVEL — No. 151
Cast and Machined, a Beautiful Tool, with Patented, Removable Level and Vial.
With 2 Plumb, 2 Levels, 2 — 45° Vials. 18"\$6.00
24"\$6.50 28"\$7.00
Order EMPIRE LEVELS from your local dealer.
Write direct for literature.

EMPIRE LEVEL MFG. CO.
717 S. 6th St. Dept. P-249 Milwaukee 4, Wis.

Surplus New War HOIST & WINCH



Eliminates Back Breaking Ordeals

Small But Mighty. Were made to be used on B-29s for lifting bombs. 2,000 lbs. capacity. Weight 16 lbs., perfect for lifting or moving loads in trailers or onto trucks, tractors, or any other movable machinery.

Fine for garages, implement stores, warehouses, assembly lines contractors and many other uses. Original cost, approx. \$100.00.

Sale Price complete with mounting brackets, \$26.30
Cable and hook and Hand Crank, only.....

Send check or money order for immediate delivery

SESCO ENGINEERING & SUPPLY CORP.

15th Ave. and Clay St. Dept. PM No. Kansas City, Mo.

ANALYZE

Auto Exhaust • Furnace Gases

WITH

NAVY TYPE THERMAL CONDUCTIVITY CELL

SIMPLE — QUICK — LOW PRICED

Send money order to:

T.C. SURPLUS SALES CO.

75 Clinton Street
Newark 5, New Jersey

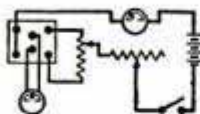

\$995

Post Paid

Full Instructions
Included



BE FAIR
TO YOUR
Hair

WAKE UP YOUR SCALP Want better looking hair? Embarrassed by falling dandruff, itching scalp? Then try VITABRUSH, new electric driven scalp brush that gives your scalp a vigorous and invigorating "workout" in just three minutes of fun. Cleans scalp. Stimulates blood supply. Restful. Pleasant. Write today for complete information and satisfaction-guaranteed offer. Hershey Mfg. Co., 3717 Field Bldg., Chicago 3

Boy Chemist Wins \$100.00 You Can Do The Same

Meet Robert D. Whitaker, 14 year old Tampa, Florida boy, who won \$100 for research on catalysts. More boys have won fame and big awards with Gilbert Chemistry Labs than any other kind. Far more than "toy" sets. Range of chemicals and apparatus based on real laboratory technique. Write messages in invisible ink or fire ink. Make chemical weather flag. Do fingerprinting. Bleach flowers. Make paints, dyes. Hundreds of other spectacular experiments.



No. 6 Senior Laboratory. Big, three-compartment blue metal cabinet crammed with chemicals and apparatus. Puts 389 sensational experiments at your finger tips.

Developed at Gilbert Hall of Science

New GILBERT CHEMISTRY Labs

ALL THESE ADVANCED FEATURES

NEW—All metal cabinet—rugged, easy to carry.

NEW—Each section designed as complete laboratory with trays and racks.

NEW—Tip racks for test tubes, for easier handling.

NEW—Brown, light-proof bottles.

NEW—Rectangular shaped bottles and shelf spaces, holding bottles with label side out.

NEW—Postwar chemistry book. 144 big pages, illustrated, stay-open binding. Edited by Prof. Treat B. Johnson, famous Yale scientist.

\$200.00 IN CASH AWARDS To the boy doing what, in my opinion, is the most important research in Chemistry, Microscopy or Electricity in 1948, I will award \$100.00 in cash. To the ten boys doing the next most important research, I will award \$10.00 each. Applicants must not be over 17 years old and must send me a full description of their experiments by May 1, 1948.

A. C. GILBERT

Founder of the Gilbert Hall of Science

FREE—Illustrated catalog on new Chemistry Sets, Erector, other Gilbert scientific toys. Send name and address on post card. A. C. Gilbert Co., 211 Erector Square, New Haven, Conn. Offer good only in U. S. A.

SAY YOU SAW IT IN POPULAR MECHANICS

DRILL PRESS FILING ATTACHMENT

For Filing, Jig Sawing
Slotting, Cutting Keyways

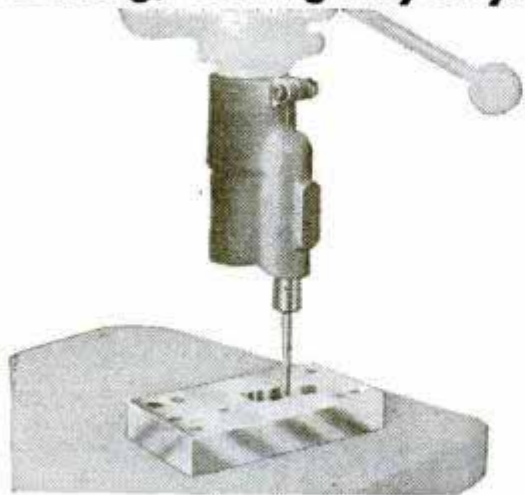

NEW LOW PRICE
\$8.75 prepaid

Order Today — State Make of Drill Press and Taper
HYDRAULIC RESEARCH CO.
1500 W. VERDUGO AVE. BURBANK, CALIFORNIA

Electrically Welded Endless

Paramount

**BAND
SAW
BLADES**



Made in widths from 1/8" to 1-3/4"

Make your band saw do more work for you. The proper width of blade will extend the scope of this important machine. Burrill's Paramount Blades are made from tough Nickel Alloy Steel properly tempered. Teeth accurately set and filed, and all saws carefully straightened. Send order and check today. Delivery will be made as promptly as conditions permit, from a few days to a week or two. You can obtain these saws at the following prices:

1/4"-3/16"-1/4"-3/8" wide, 5'6" long.....\$.90 each
1/4"-3/16"-1/4"-3/8" wide, 6'6" long..... .95 each
1/4"-3/16"-1/4"-3/8" wide, 7'6" long..... 1.10 each

Other sizes at proportional prices

NO C.O.D. SHIPMENTS ACCEPTED

State Make of Machine

Your satisfaction is guaranteed

BURRILL SAW & TOOL WORKS

407 E. Main St., Iliion, N.Y.

PRICES SLASHED! ALUMINUM PIPES

\$4.50 pipe for \$1.50.

Imported briar bowl, hard rubber stem, air cooled aluminum shank. Check or money order, we pay postage. C. O. D. orders filled on request. Write for FREE catalog of pipes and cigars.

SATISFACTION GUARANTEED OR YOUR MONEY BACK

Eddie THE CIGAR MAN

1094 Bedford Ave., Brooklyn 5, N. Y.



\$1.50

\$13.50 Value for Only \$2.49

8000 ohm impedance Head Phones, produced to Air and Signal Corps specs. Extremely sensitive, lightweight (only 9 oz.). With 5 1/2 ft. cord, plug, jack and ear cushions. Every One **BRAND NEW**

No. 17A37, Special Per Pair.....**\$2.49**

Plus 25c each for Postage.

Burstein-Applebee Co. 1012 McGee, Kansas City 6, Mo.



New Cigarette Dispenser for Cars — New Car-Vend

cigarette dispenser eliminates fumbling for a smoke — makes driving safer as you keep your eyes on the road. Comes in beautiful, plastic colors. Fits neatly under the dash. Very simple to install. A practical gift. Sold on money back-guarantee. State color wanted: Blue, Amber, Green, Red. Only \$1.50 postpaid. **DEALERS WANTED.**



Car-Vend 4628-C Hollywood Blvd., Hollywood 27, Calif.

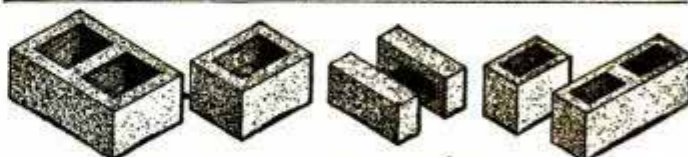

Make Concrete Blocks and Bricks

New superior method makes square, true, easy-to-lay units which will pass any building code. Small investment, high production, big profits. One \$30.00 machine will make four 5"x8"x12" blocks per minute. Pays for itself in a few days. Sell blocks or save 3/4 building cost by making and laying your own.

POST CARD BRINGS FREE FOLDER

Economy Manufacturing Company
Dept. P Stone Mountain, Georgia

POPULAR MECHANICS

**Time & Date
AT A GLANCE**

**BELL
GUARANTEED
CALENDAR
WATCH**

Tells time, name of day and date.
Day name changes automatically.

No. MR 383 — 17 jewels, water-shock resistant, anti-magnetic, radium dial and hands. ALL STAINLESS STEEL CASE.....**\$55.00**

OTHER SPORT WATCHES WATER-SHOCK RESISTANT

Precision tested, 17 jewels, anti-magnetic, radium dial and hands, unbreakable crystal, sweep second hand. No. MR 197—Stainless Steel Back.....**\$29.75**

No. MR 945—ALL STAINLESS STEEL CASE **\$37.50**

Other fine watches from \$12.65 Tax Incl.

ORDER BY MAIL: Send check, money order or pay C.O.D. THESE LOW PRICES INCLUDE FED. TAX & POSTAGE. Write for FREE Booklet "MR".

Repair Service

All types and makes of quality watches repaired expertly and promptly. Free estimate on request.

BELL WATCH COMPANY, INC.

Time and Life Bldg., Rockefeller Center, New York 20, N. Y.

PRE-INVENTORY SURPLUS BARGAINS!

- GOGGLES**, flying, type An6530; clear lens (not plastic) rubber face mask; ideal for cyclists, racers, pilots, etc. \$ 4.95
- BOOTS**, Aviator's leather, type A9, rubber soles, pure sheep shirting lining, 10" high. Fits over shoe size 9 and above. Reclaimed, new zippers \$ 5.95
- CAP-HELMET**, fine for the hunter and outdoorsman! Khaki material, baseball style with ear and neck cover \$ 1.50
- HELMET**, AAF B-6, pure soft leather (brown), shirting lining, chin buckle, each \$1.50. Helmet, AAF A-9, wool gabardine, two for only \$1.00
- GLOVES**, AAF B3A, esquire of soft brown leather, 12" length \$ 2.95
- GLOVES** (gauntlets, 3 finger), pony leather, shirting lined, 12" length, a cold weather glove, reg. \$12.50, now \$ 4.95
- RAINCOATS**, T.I. style, reclaimed, limited this price \$ 1.50
- UTILITY BAGS**, canvas, with shoulder strap (gas mask type), 2 for only \$ 1.00
- AIRPLANE INNER TUBES**, 8.50x10 size, makes fine swim floats, etc. New, each \$ 1.50
- LIGHT ASSEMBLY**, for workbench or desk. Has 36" spring loaded jointed arm for flexibility, movement every direction; uses bayonet double contact lamp, any voltage (not furnished), all new, only \$ 2.49
- SUN GLASSES**, Aviator's, green, ground lens, gold plate, now \$ 3.95
- COMPASSES**, airplane panel mounting type, 3" face, new \$ 7.95
- CLOCKS**, 8 day type (airplane), sweep second, 2" face, reg. \$38.50 value \$19.95
- SAFETY BELTS**, Rusco airplane type, ideal for seat fasteners, any vehicle, new \$ 1.50
- HAND LANTERN**, stainless steel streamlined case, (uses 6V lantern battery) not furnished \$ 2.95
- PROJECTOR SLIDES**, fits all slide projectors, assortment of 50 airplane slides \$ 2.95
- SCREW DRIVERS**, R&P type, one 12" and one 14 1/2", new, both for \$ 1.00
- AIRCRAFT HARDWARE**, assortment nuts, bolts, screws, rivets, clamps, etc. 10 lbs. for \$1.95. 20 lbs. for \$ 3.50
- RADIO HEADPHONES**, good condition \$ 1.95
rubber extension wire for same \$.75
- RADIO MICROPHONES**, hand type T17, new \$ 2.95
- RADIO MICROPHONES**, throat type, good condition, 95c each, 3 for only \$ 2.00
Hand switch and extensions for throat mike, each \$ 1.00
- GENERATOR**, Airplane P-1 type, 200 amps., 21v, 3/4" pulley shaft; makes fine welder; diagrams furnished; wt., 42 lbs. \$22.50
- LEATHER DYE**, for all leather goods, dark brown, per gal. \$ 2.95
- AVIATION BOOK**, copyrighted test-yourself; grade-yourself \$.75

CELESTIAL NAVIGATOR'S SEXTANTS (for boating, sailing, flying)



25. Type A10 (Fairchild), with bubble averaging, wood case, 2 power galian scope. Good used condition, only

\$1250



26. Type A10-A (Fairchild), with famous AUTOMATIC averaging device; original cost nearly double the A10; with wood case, 2 power galian scope. Good used condition

\$1750



27. Type A12 (Link), fine fabric covered carrying case. Good used condition..

\$1750



28. Type A8-A (Bausch & Lomb). One of the finest Sextants built (B&L). You get also the fine wood carrying case, battery holder, etc. Good used condition...

\$3250

(All sextants are furnished with flash light battery holder, attachment for night shots, and free celestial navigation manual)
29. SEXTANT ASSORTMENT (4): 1-A10, 1-A10-A, 1-A12, 1-A8-A; all four for only \$59.50

AERO PARTS SUPPLY

Municipal Airport, Dept. E.

Houston 17, Texas

TRAILER BUILDERS!

Insist on Safety-Engineered

- Bull Dog Hitches and Parking Jacks
- Torq-Less Axles

HAMMER BLOW TOOL COMPANY
Dept. D-117 Wausau, Wisconsin

Send for FREE Catalog

GASOLINE STRAINER



For outboard and other small motors. Fine screen removes damaging dirt and grit. \$1 at Sporting Goods and Marine Dealers, or write direct.

BOWEN MFG. CO., Villa Park, Ill.

TRUCKS • TRACTORS • AUTOS

SAVE WITH CUNO AIRCRAFT TYPE OIL FILTER



Keep oil clean without cartridge replacement...fits all cars, trucks and tractors...No parts to wear out...replaces all popular oil filters...installed at home in a few minutes...one turn of handle removes all dirt from permanent element...drain sludge and dirt from filter sump with each oil change...standard equipment on Airline Army and Navy planes...

Every car owner, farmer, truck or fleet operator will save tremendously with the famous CUNO oil filter...lasts for the life of many cars...save big money by ordering direct from this ad. Sent postage prepaid. Address Dept. 1415.

\$9.00

SHEFRIN SALES COMPANY

1329 W. 9th St.

KANSAS CITY, MO.

ALWAYS TIME FOR GARDEN-ALL

Winter, Summer
Spring or Fall!



Write for Folder.

Utility Scraper—for snow, light grading and terracing jobs.

Garden-All
LAWN and GARDEN TRACTOR

SO STURDY!
SO VERSATILE!
SO EFFICIENT!

RUGGED POWER
in 3 ENGINE
SIZES
1 1/2, 3
and 5
h.p.

See Garden-All before you buy. Garden-All is designed to do every job with speed and efficiency. Easy to handle and economical to operate. All attachments simple to attach and detach. And there's an attachment for every job for every season—Plow, Disc, Cultipacker, Spike Tooth Harrow, Seeder, Cultivator, Sickle Bar, Dump Trailer and Utility Scraper.

Excellent Dealer Territories Open. Write for Details.

GARDEN-ALL TRACTOR, INC.

Dept. P, 100 W. UNION STREET, LIBERTY, INDIANA

SAY YOU SAW IT IN POPULAR MECHANICS

WAR SURPLUS AND OTHER BARGAINS

MOTOR-GENERATOR

Emerson Electric Mfg. Co. 3 HP Motor... AAF Type D50 FD-222-0435, 28 Volts DC, compound, 3800 RPM, 115 Amp, windings glass insulated, blower cooled, shaft dimension $\frac{3}{8}$ ". Wgt. 27 Lbs. As Generator, puts out 115 Amps.

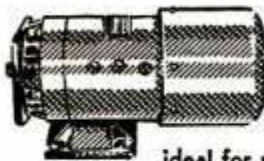

ideal for portable welder, new \$13.95 each

SEND CHECK, MONEY ORDER or CASH

Transformer Automatic Winding

Co. Filament Transformer, up to 250 Volts, step up or step down, 12 points for variation of voltage, can hook into 110 or 220 Volt and 50 or 60 Cycle Current, Wgt. 14 Lbs., all new, will work any 6-12-24-28 Volt aircraft gadget off house current. \$7.95



25% DEPOSIT REQUIRED ON C.O.D. ORDERS

AIRCRAFT WHEEL



12 1/2" x 4 1/2" heavy duty tire and tube; I.D. of shaft 1"; high speed heavy duty bearings; 2 bushings; quick change pull-apart hub suitable for trucks, trailers, small mobile units. Wgt. 11 lbs. New... \$14.50 each.

MICROMETER

Chrome plated, precision engineered and carefully tooled to give long life and highest degree of accuracy... all new. 1" capacity \$1.65 each. 2" capacity \$3.50 each.



ALL PRICES F.O.B. CULVER CITY, CALIF.

CLAMPS: Adel Aluminum Co., Rubber lined, assorted sizes, hundreds of uses in any shop. 500—all new, ass't'd sizes \$5.00

EXPLODING RIVET KIT

A real time saver... rivets in places where ordinary rivets can't be used. DuPont #4 Exploding Rivet Gun (110V., 750W.) with wattage regulator and six tips for 1/8", 5/32", 3/16" brazier and countersunk rivets; Starlette Micrometer for measuring metal thickness from one side only; 5 drills... nos. 40, 29, 17, 6 and 3.5 mm.; 8 Go and No Go Gauges; approximately 10,000 explosive rivets... 1/8", 5/32", 3/16" in proper lengths for metal thickness of .045" to .245" by .02" graduations; long rubber covered extension cord; packed in fitted metal case. Wgt. 41 1/2 lbs. New. \$79.00 each.

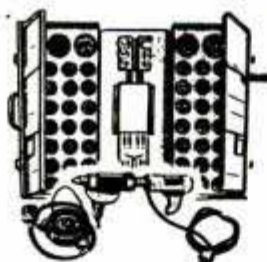

AIRBORNE SALES CO. DEPT. PM 12-7 CULVER CITY, CALIF.

Do You Ride a Bike?

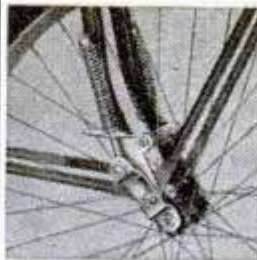

"SHOCKMASTER" for all Bicycles

- LEVELS ROUGH ROADS
- PREVENTS BROKEN SPOKES, WHEELS, FORKS
- MAKES RIDING SMOOTHER, SAFER
- EASY TO INSTALL

"Shockmaster"—the front wheel shock absorber—is ruggedly constructed of nickel plated steel and engineered for years of real service. It'll pay for itself in added pleasure, saves tires and eliminates many costly repair bills. 20,000 satisfied users. Order yours today. Only \$3.50 postpaid. No C.O.D.'s. Complete satisfaction or money back. Dealers Wanted.

H. M. GIBB and COMPANY

1304 PENOBSCOT BLDG.

DETROIT 26, MICH.

HANDY Electric PLUG Connector



No Tools -- No Screws
No Stripping of Wire

Underwriters Listed... Simply screw down cap for strong, positive contact. See your dealer, or 2 will be mailed prepaid on receipt of 20 cents, Waterbury Companies, Inc., 781 So. Main Street, Waterbury, Conn.



48 PLANS

\$100

48 complete plans of toys, ash trays, garden ornaments, Dutch boys and girls, what-not shelves, and many other interesting projects. Finest selection available. Novel method allows you to make finished project any size desired. PLUS FREE Deluxe Plan of corner shelves. Send only \$1 to

Jackson, Dept. 28-5440 N. Shoreland Ave., Milwaukee 11, Wis.

NEWEST OTTAWA LOG SAW

SELF-PROPELLED -- MOVES ANYWHERE on OWN POWER

World's fastest Log Saw. Powerful 6 H-P air-cooled motor. Attachments for sawing down trees, buzzing limbs, post hole digging and pulley for belt jobs. Big demand for wood, pulp, posts. Make big money sawing wood this easy way. Low factory-to-user prices. Nothing like it. FREE details.

OTTAWA MFG. CO., 7-727 Pine St., Ottawa, Kansas



FULLSIZE, CUT-TO-SHAPE BOAT PATTERNS

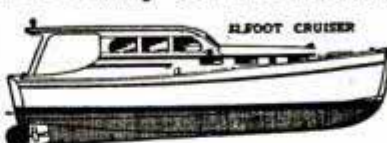

and specifications. Designed by Naval Architect. Cruisers, runabouts, sloops, outboards, sailing canoe, etc. Low prices. Send 10c (coin) for illustrated catalog. SPECIAL: Send \$1.00 for "HOW TO BUILD BOATS" book, postpaid.

Cleveland Boat Blueprint Co. Dept. 666, Cleveland 13, Ohio

WILKEMP ELECTRIC ENGINE

Truly an engine—not a motor. Operates on reciprocating principle like a steam engine, but actually driven by a solenoid electro-magnet. Develops approximately 1/60 horsepower at approximately 800 RPM. Power take-off is miniature V-belt type pulley mounted on flywheel shaft. Chugs realistically. A natural for powering structural toys and models. Plugs into any 110V, 60-cycle AC electric outlet. Size 7" x 5 1/4" x 4". Price, \$6.95. Shipped prepaid, USA, if remittance is enclosed with order; otherwise C. O. D. Orders received by Dec. 19 shipped for Xmas.

Send order to:

WILKEMP INDUSTRIES COMPANY, FISHERS, INDIANA

NO WATER
NO MESS

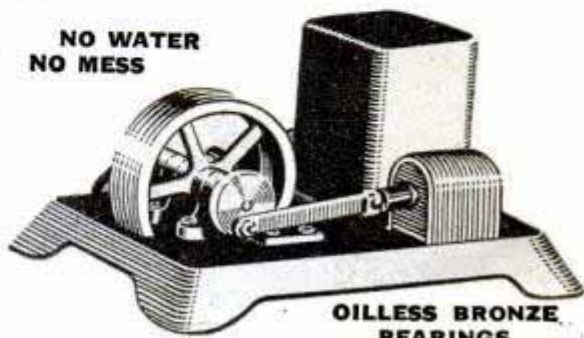

OILLESS BRONZE BEARINGS

New **STEEL ADJUSTABLE BRACKETS & STANDARDS**
For **HEAVY DUTY SHELVING**



LOCKS IN PLACE—EASY TO ADJUST UP OR DOWN

Standards are bolted or screwed into wall vertically. Brackets readily slide into place and are safely locked by patented principles. Can be raised or lowered 14" variation. Rearrangement of shelving requires very few minutes. You can build mass displays for stores in a jiffy. Home-owners will find this the neatest, easiest to install shelving available. Ideal for workshop, garages, filling stations, etc. Finest Shelving Equipment available. Inexpensive — will last a lifetime. No special tools required for installation.

BIG PROFITS FOR SALES AGENTS

Earn big profits installing JIFFY EQUIPMENT in your neighborhood, spare or full time. Write for complete details and prices.

JACKSON MFG. CO. Dept. M3, 622 East Third St. Kansas City 6, Mo.

PRESS-TITE CAULKING AND SEALING CORDS



*Keep cold out!
Seal holes and cracks!*

Soft, rope-like Press-Tite Cords effectively seal windows and doors against cold and dust. Save fuel.

Press-Tite Cords will not harden—they stay soft and seal tight. Use also to fill any cracks or holes in wood, plaster, masonry or brick. Just press into place —no tools needed.

PRESSTITE ENGINEERING CO.

3978 Chouteau Ave., St. Louis 10, Mo.

TURNER VT-73 DESK MICROPHONE

Here's the mike you want for your rig. It's got looks, it's tough, and man, oh man how it performs. It's a TURNER! Ask your dealer or write for Free Literature on other low cost Turner Microphones.



THE TURNER COMPANY
921 17th St., N.E., Cedar Rapids, Iowa

FINE TOOLS NEED FINE OIL!



• Lubricates



• Prevents Rust

• Cleans • Polishes

SOLD EVERYWHERE

3-IN-ONE Oil

STOP WASTEFUL FURNACE LEAKS AND SAVE FUEL

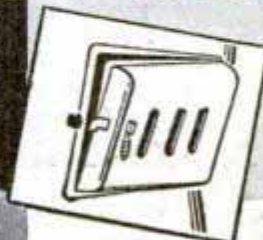

A warped furnace door lets heat escape; build up the frame with Smooth-On No. 1

Use Smooth-On No. 1 to stop draft leaks in heaters

Seal up air leaks in your heating system with Smooth-On No. 1 Iron Cement and your fuel bills will get smaller.

You can apply Smooth-On yourself, like professional repair men have been doing for more than 50 years. You use it like putty — no heat necessary. It hardens like metal and stays tight, because it expands slightly as it sets.

Use Smooth-On to stop leaks and seal cracks in steam, hot water and hot air furnaces, radiators and piping. Tighten loose parts and fixtures with it. Buy Smooth-On No. 1 in economical 1 3/4- or 7-oz. size at your hardware store. If they haven't it, write us.



REPAIR HANDBOOK FREE

40 pages filled with time-saving, money-saving, short-cut repairs on home and shop equipment. Clear, simple directions. 170 illustrations. Thousands of home folks and craftsmen write us for copies each month. Send coupon for YOUR free copy.



— — — — Sign and Send NOW — — — — 80-248

Smooth-On Mfg. Co., Dept. 37M
570 Communipaw Ave., Jersey City 4, N. J.

Please send me my free Smooth-On Handbook

Name

Address

12-47

Do it with **SMOOTH-ON**
THE IRON CEMENT OF 1 000 USES

SEE
Better
SHOOT
Better

with Mossberg
4-power Internal
Adjustment
Scopes



High mount or low mount—your choice with a Mossberg scope. Model #5M4, illustrated, sits right down there, snug to the receiver. For those who require high mounting, there's Model #8M4—either a wonderful value at \$9.95.

NOTE to owners of the new Mossberg Model #151M Automatic Rifle—For you, Internal Adjustment Scope Model #4M4, with new patented mount fitting into dovetail grooves in the receiver. Best ever!

SEE THEM AT YOUR DEALERS

Catalog on request. No sales at factory



76512 St. John Street, New Haven 5, Conn.

WAR SURPLUS BARGAIN SPECIAL

BELT DRIVEN
CENTRIFUGAL
PUMP
READY TO
USE ON ANY
LIQUID
PUMPING NEED
NOW ONLY
\$29.75

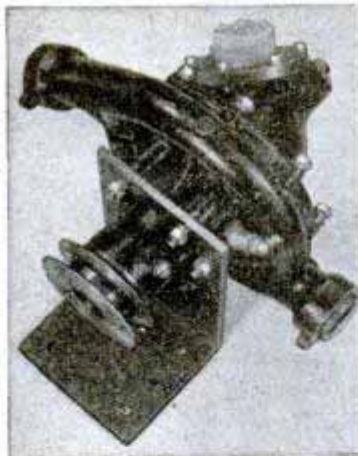

FOR HOME WATER SYSTEMS, IRRIGATION, FIRE PROTECTION, DRAIN BASEMENTS, PONDS, ETC.

● A super value for all types of intermittent service in pumping large volumes of liquid for stock watering, home and shop water systems, irrigation, draining pools, basements, etc. At 1750 RPM on 23 foot head will pump 42 gallons per minute; at 3600 RPM on 52 foot head will move 88 gallons per minute. Cast aluminum housing. Accurately machined bronze impeller vanes. Complete with mounting bracket and 3/4 inch V belt pulley. Run with electric motor, gasoline engine, power take-off on tractor, etc. Shaft rotates on sealed ball bearings with grease gun fitting. Has 1 1/2 inch threaded intake flange, two 1 inch outlets. Use one or both as necessary. Made for Packard Motor Car Co. for use in Rolls-Royce Merlin Aircraft engines. Comes complete with pulley and mounting bracket. Original cost approx. \$147.00. Sold F.O.B. Chicago. Shipping weight 23 pounds. Complete engineering reports and operating instructions free with pump. You can't beat this pump value at anywhere near this price. Satisfaction guaranteed.

ORIGINAL COST APPROX. \$147.00
IMMEDIATE DELIVERY FOB CHICAGO
SPECIAL PRICE, WHILE THEY LAST **\$29.75**

GROBAN SUPPLY CO. 1522 So. MICHIGAN AVENUE
DEPT. PM12, CHICAGO 5, ILL.



NOW! YOU CAN HAVE YOUR OWN ELECTRO-PLATING Business

Plate GOLD - SILVER - CHROMIUM, etc.
It's Profitable - Simple - Pleasant

Do as hundreds of successful men are now doing — start your own business! You can plate on metals and non-metals with the VARI-PLATER. Your cost is low, profits are BIG! Don't let this money-making opportunity go by!



FREE! Write now for descriptive information and complete price list!

The VARI-PLATER — 110 V.A.C., complete **\$5500** Postpaid

LEWIS ELECTRICAL MFG. CO. 1266-A Gun Hill Rd. New York 67, N. Y.

FLASHLIGHT INSPECTION LAMP ASSEMBLY

NEW—Govt. Surplus. Lights up the "Hard-to-get-at" places. Fine for mechanics, electricians, radio repairmen, filling station attendants, in the home, and many other uses. Plastic 12" extension (6" stiff and 6" flexible). Adjustable to any angle. Originally priced over \$4.00. Our price Postpaid..... **\$1.80** Ea.

New Electricians **CABLE REPAIR KIT** contains built-in 1500 watt, 110 Volt AC vulcanizer with complete tools and equipment. Gov't cost over \$200.00. Our price FOB. K. C. **\$3450**

New G. E. **AIR COMPRESSOR** 1/3 HP, 27V-AC-DC. Many uses, paint spraying, etc. 1.000 lb. output. Shipping w/ht. 20#. F.O.B. K. C. **\$1495**
Flight Boots A-6, Sheep Shearling lined, (used—excell. cond.) small, medium, large, postpaid..... **\$575**

MANY OTHER ITEMS — WRITE FOR FREE CIRCULAR
National Surplus Sales Co. 1810 Charlotte, P.M. Kansas City 8, Mo.

HOW TO CUT RAFTERS

New vest pocket book gives lengths, Side cuts, Plumb cuts, Deductions. For all rafters for any building from one inch to forty feet wide. Gives numbers to cut on square. Also degrees for same cuts for Radial Saws. All standard pitches from 1/4 to 3/4. Just open book to pitch page and there are your lengths, side cuts, etc. Anyone who knows what a jack rafter is can frame a roof if he has this great book. Price one dollar pre-paid. **BUILDERS' TOPICS**, Dept. M, Lock Box 828, Seattle, Washington. Original teachers of the square in five easy lessons by mail. SEND FOR FREE LIST OF TECHNICAL BOOKS. Learn to read blueprints etc.

You Can Repair Your Leaking Faucets Easily

SAVE THOSE EXPENSIVE REPAIR BILLS
By using our repair kit with brass renewable seats. No experience required. The first repair job pays for it. You can make money doing repair jobs. Fully rustproof.

See your jobber or write to
GREAT LAKES METAL SPECIALTY MFG. CO.
1450 W. North Ave. Chicago 22, Illinois

Make Your Own Springs at Home or Shop QUICKLY — SIMPLY — EVENLY SPACED

Hobbyists, shop machinists, garage mechanics! This substantial springwinder, hand-operated, makes compression and tension springs 1/16" to 1 inch diameter, using wire up to 45 gauge (3/16"), any length, all coils perfectly spaced.

\$6.50 postage paid anywhere in U.S.A. Send M.O. or C.O.D.
J. V. INDUSTRIES
19300 Waltham Ave., Detroit 5, Mich.

NOW! "CABINET MAKER"

Send Today! **PERFECTION** IN YOUR OWN WORKSHOP!

This TRU-EDGE SANDER will do a perfect job of squaring the edges of wood, plastics, etc., for matching, joining or finishing work of any thickness up to one full inch. YOU WILL FIND IT THE HANDIEST TOOL IN YOUR SHOP!
Send \$1 Today! Free circular on request.
VILLAGE SALES CO. P.O. BOX 305 - OAK PARK, ILL.

COOL STEEL DRILL ROD

\$3.50
POSTPAID
in Continental U.S.
C.O.D.'S ACCEPTED

9 - 18" Bars **SAMPLER KIT** 9 Sizes

GROUND AND POLISHED TO A PERFECT FINISH
1001 uses for CRAFTSMEN, HOBBYISTS, MECHANICS, Etc.

For Making
Punches
Chisels
Engraving
Tools
Shafts, Etc.

Free machining, easily
worked, yet can be made
file hard or hardened to
spring temper. Harden-
ing instructions in-
cluded

FREE
With first order 6" steel
comb. rule & depth gauge
with pocket clip and latest
price list.

FLAT TOOL STEEL

The Precision ground flat tool steel with the anti-smooth finish. Simple to work, easy to harden, ready to use.

SHOP ASSORTMENT - \$4.80
(5 dif. Pieces—1/32" to 1/8" thick; 1/2" wide; 18" long)

BOTH KITS FOR \$7.95
(Include 25c postage on orders under \$5.00.)
We can supply ALL your Tool Steel Needs.

BESSEMER STEEL COMPANY OF AMERICA, Dept. FD-12
Small Shops Division, 1958 W. 59th St. Chicago 36, Illinois

GASOLINE ENGINE

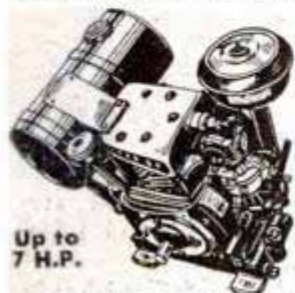

Used Gov't Surplus — Air-
Cooled Briggs - Stratton or
Wisconsin Engine. Our sale
price

F.O.B K.C. **\$74.50**

Also LIGHT PLANTS

3,000 Watt, 110 volt. Sale
Price.

F.O.B., K.C. **\$124.50**

Write for illustrated circular
— Immediate delivery

MIDWEST SURPLUS SALES 1520 Locust St.
Kansas City, Mo.

\$24.95
Full Set



**FREE
FOLDER**

MICROMETERS

Six piece set, in velvet lined leather case.
Special price, only \$24.95.

Precision machined in one thousandths, up to
4" outside and 3 3/4" inside measurements.
Guaranteed accurate, easy to read and ad-
just. Satisfaction or money back. Also
indicators and gauges. Shipped prepaid
on receipt of \$24.95. (Out of U. S.,
\$25.95.) On C.O.D.s send \$2.00 deposit.

MICRO PRODUCTS, 8655 E. Jefferson, Detroit 14, Mich.

BIG SAVINGS HAND TOOLS

Reg. \$1.75 Miller Falls Screw Pitch Gage 30
leaf, 89¢ Add 10¢ P.P. • Wood Chisels, higrade
steel, 1/2" or 3/4" 69¢; 1" - 89¢ + 2" TURNING \$1.39, Add 15¢
P.P. • DEPTH GAGE, adj. angle, Miller Falls, \$1.25, Add 10¢
P.P. • \$5.00 COMB. GAGE Feeler, Thickness & Taper, precision
tool steel \$2.50, 10¢ P.P. No C.O.D.'s please Catalogs 104

METAL MATERIALS CO.
3923 VAN BUREN PL. CULVER CITY, CALIF.

TORQUE-MASTER BACK GEARED PULLEY



for drill presses, band saws, etc.
• Makes a geared head motor out of
any motor.
• Multiplies torque of motor three
times.
• Economical — Increases machine
capacity.

PRICE—Postage pre-paid — **\$16.95**
SEE YOUR MACHINE TOOL SUPPLY
HOUSE — or order from

ROBERTS AIRCRAFT ENGINE COMPANY
203 NO. LAKE STREET — BURBANK, CALIFORNIA

SMALL PRECISION LATHE

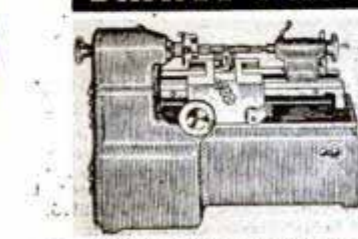

**WITH AUTOMATIC FEED
AND 110 VOLT A. C. MOTOR**

Designed for precision work
where accuracy is essential for
small parts and tools. Ideal for
Home Workshop, Laboratory,
Model Builder, Jeweler, Dentist,
etc.,

\$60.75

SMALL • COMPACT • LOW COST • LIST PRICE
SIZE: 9 3/16" x 3 1/16" x 6 3/4" Wgt. 12 lbs.
110-Volt A.C. Motor Included Without Extra Cost.
Write For Free Pamphlet. Dealer Inquiries Solicited.

OFFENBACH & REIMUS CO. 372 ELLIS STREET
SAN FRANCISCO 2, CALIF.

DECEMBER 1947

\$14.95

**NEVER
BOUGHT
SO MUCH
IN A
POWER
TOOL!**

**New 22-piece CASCO
Power Workshop puts
1001 Skills at your Fingertips**

Here's what every hobbyist, home
craftsman and mechanic has been
waiting for! A high-speed Power
Tool that's actually a complete, port-
able workshop! Each of its 20 pre-
cision made accessories can be instantly
attached—transforming the tool into a
dozen separate tools. Can be used
on wood, metal, glass, plastic or
other materials. Comes complete in
a sturdy leatherette case. Handles
like a pencil—is air-cooled.

The extra powerful, 20,000 RPM
Tool plugs into any AC-DC socket.
Has exclusive finger grip which per-
mits closer work. Shockproof, un-
breakable Tenite case; chrome fit-
tings; on-off switch for one-hand
operation; vibrationless high speed.
Quiet, smooth-running, efficient.

- It Engraves!
- It Cleans!
- It Polishes!
- It Cuts!
- It Grinds!
- It Carves!
- It Saws!
- It Sands!
- It Buffs!
- It Etches!
- It Drills!
- It Brushes!

**POWER TOOL COMPLETE
WITH 20 ACCESSORIES,
KIT AND PROJECT BOOKLET
ONLY \$14.95 — IF BOUGHT
SEPARATELY YOU'D
PAY \$23.45**

**HERE'S
WHAT
YOU
GET**

- 1 Rubber Pol-
ishing Wheel • One
1/16" Speed Drill • One 1/8"
- Ball Cutter • Sturdy Leatherette Case
- Valuable Project Booklet • 3 Bristle
Brushes • 2 Abrasive Separating Discs • 3 Mandrels
- 1 Felt Wheel • 2 Collets • 1 Dressing Stick • 1
Wrench • 4 Emery Wheels • PLUS AC-DC Electric
POWER TOOL. At leading stores everywhere!

CASCO

Another good buy—Casco-Electri-Craft Kit—has 36
accessories and steel storage chest—\$32.95 if purchased
separately—an outstanding value at only \$22.50.

YOU DO BETTER WORK WITH A BETTER TOOL
CASCO PRODUCTS CORPORATION • BRIDGEPORT 2, CONN.

SAY YOU SAW IT IN POPULAR MECHANICS

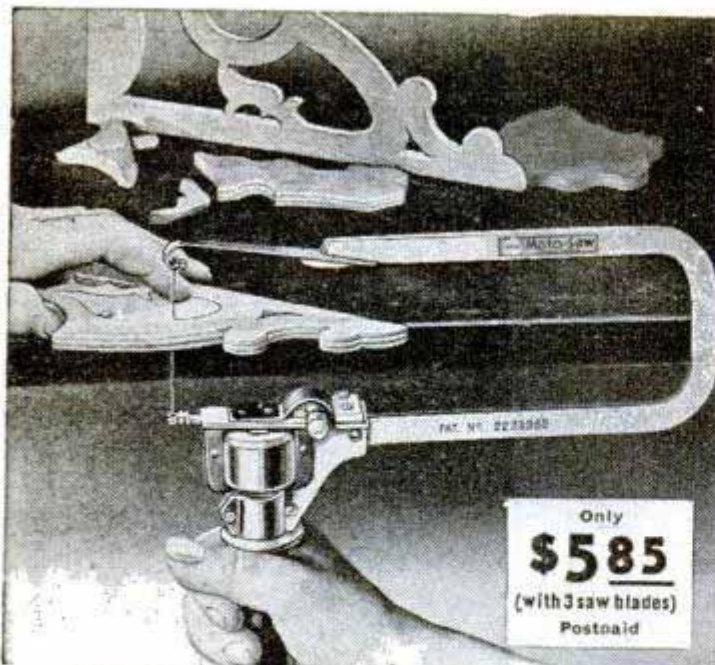

Only
\$5.85

(with 3 saw blades)
Postpaid



MOTO-SAW

THE AMAZING ELECTRIC SCROLL SAW

Boys from 8 to 80 (and girls, too) have fun with a Moto-Saw . . . it works more like magic than any tool you ever saw! It takes no effort to run, no perceptible pressure to feed. Runs 7,200 strokes a minute . . . easily cuts intricate scroll designs in medium hard wood up to 3/4" thick. Blade holder faces blade 4 ways . . . permits you to saw sideways as well as forward and backward. No limit to length of stock it will cut . . . saws to center of 19" widths. Moto-Saw is as safe as a hand saw . . . has only two moving parts . . . never needs oiling. Uses 110-120 V. 50 or 60 cycle A.C. (only). Thousands of satisfied users.

MONEY-BACK GUARANTEE: If your dealer does not yet have Moto-Saw, send only \$5.85 . . . we'll pay postage. Or send \$1, and pay postman balance plus postage. Money back if not delighted after 5 days' trial.

DREMEL MFG. CO., DEPT. 5117-M, RACINE, WIS.

MAKE YOUR OWN



High Speed
**FLEXIBLE
SHAFT TOOL**
with a
Flex-O-Shaft
AND YOUR OWN MOTOR

With our improved coupling, you simply attach this Flex-O-Shaft to any motor that has a 1/4" or 5/16" shaft. The light-weight, aluminum, ball-bearing hand piece weighs only 4 oz. Easy to use as a pen. Only \$12.50 complete.

Flex-O-Shaft Sales Co. (Dept. C)
Prairieview, Illinois
 Please send complete information on the Flex-O-Shaft.
 Please send one Flex-O-Shaft, hand piece, and coupling, \$12.50 enclosed. Shipping charges C.O.D.

Name _____
Address _____
City _____ Zone _____ State _____

SURPLUS JUNGLE FATIGUE



BRAND NEW HERRINGBONE TWILL WEAR SETS TO MATCH. One of the choice Surplus offerings of the day. You'll want these well made, long wearing shirts and pants for work, sports, general wear. Your chance to get **REAL QUALITY** at a **LOW PRICE.** Heavy 8 Oz. Herringbone Twill in Dark Olive Drab shade. Pants have 1 large side patch pocket, one small patch pocket, two regular pants pockets and two hip pockets; Self belt buckles; Plain bottoms. Shirts have Two Breast pockets with flaps; adjustable button-over cuffs. All garments made to gov't specifications; double stitched; washable; fit good, look good, wear, wear, wear. Supply is naturally limited; order promptly. Pant sizes: 30 x 30; 32 x 32; 34 x 31; 34 x 35; 36 x 32; 36 x 34; Give shortest length you can wear; we will ship nearest possible. Shirt sizes: Small (14-14 1/2) Medium (15-15 1/2) Large (16-16 1/2)

PANTS & SHIRT Per set **\$4.88**

If sending cash with order add 35c for postage and handling east of Rockies; 10c Each additional set. West of Rockies add 55c per set, 20c each additional set. Tax in Ohio. OR PAY POSTMAN ON DELIVERY. **SATISFACTION GUARANTEED** or MONEY REFUNDED PROMPTLY.

FREE illustrated circular of SURPLUS and civilian clothing sent with order or Free on request. Send for your copy today.
ADDISON UNIFORM CO. Dept. P-12 CAMBRIDGE, OHIO



WHEELS AT BARGAIN PRICES

- . . . 4" wheel & tire, 5/16" sleeve bearing . . . \$0.45 ea.
- . . . 5" wheel 5/8" solid tire 5/16" shaft hole . . . 0.65 ea.
- . . . 6" wheel 3/4" solid tire 5/16" shaft hole . . . 0.75 ea.
- . . . 7" wheel 3/4" solid tire 3/8" shaft hole . . . 0.85 ea.
- . . . 8" wheel 1" solid tire 1/2" sleeve bearing . . . 1.25 ea.
- . . . 8x2" wheel, semi-pneumatic tire 7/16" ball bearing . . . 2.50 ea.
- . . . 10x1.75 wheel semi-pneumatic tire 7/16" ball bearing . . . 3.25 ea.
- . . . 12x1.75 wheel semi-pneumatic tire 1/2" bronze bearing . . . 4.00 ea.
- . . . 10x2.50 wheel semi-pneumatic 1/2" ball bearing . . . 5.50 ea.
- . . . 8x2" wheel 3/8" ball bearing, solid tires 3.95 ea.

BUILD YOUR OWN Wagons - Scooters - Soap Box Racers - Welding Carts - Baby Pens - Etc. To order above wheels write number wheels wanted in space provided, tear out and mail this ad with check or money order and your name and address. If other sizes are wanted write for **FREE LIST.**
TRULSON MFG. CO., 811 E. 31 St., Dept. P7, Kansas City, Mo.

REAL GAS ENGINE \$6.95



The new THOR "B" - Sensational miniature gasoline engine that really works. Superpower performance. Smooth, velvety power that roars into action with a "twist of the wrist." Over 25,000 already sold. 1/8 H.P. Complete with coil and condenser. Ready to run, only \$9.95. In KIT form, fully machined, 5 minutes to assemble, \$8.95, without coil and condenser. Powers all models. Fully illustrated instructions. Send \$1.00-shipped collect same day C.O.D. **FREE**-Send for 24-page illustrated hobby catalog.

AMERICA'S HOBBY CENTER
Dept. B-127 156 W. 22nd St. N.Y. 11, N.Y.

Best for Reels . . .



LUBRIPLATE

The universal white lubricant reduces friction and wear - Waterproof - Prevents rust - Stays put - Lasts longer

20c at your dealers

in U. S. A.

Ideal for the HOME WORKSHOP

Davis WIZARD TOOLRAK PATENTED

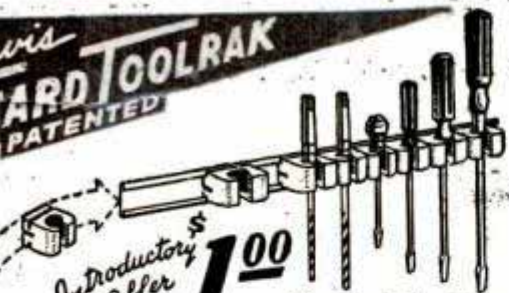

Introductory Offer \$1.00

as illustrated with 8 Basic Block Tool Holders

- KEEPS TOOLS IN ORDER.
- INTERCHANGEABLE HOLDERS MEAN TOOLS CAN BE ARRANGED IN ORDER DESIRED.
- SAVES SPACE • EFFORT.

Your tools can now be arranged in the order you desire. Illustrated folder showing variety of wood block holders and aluminum back strips available is sent with each order.

DEALERS INQUIRIES WELCOMED

Vanco Products Inc. 222 E. CUCHARRAS COLORADO SPRGS. COLORADO



MINIATURE ENGINES

Gasoline—Steam
Air—Locomotive



THE WORLD'S MOST FASCINATING HOBBY

Build them yourself — In your own shop
With your own tools



Send 10 cents for my illustrated catalogue listing the world's largest selection of miniature engine castings and drawings.

McADED MODELS
1313 S. TALMAN AVE.
CHICAGO 8, ILLINOIS

DIE-LESS DUPLICATING

Many small parts can be formed without dies, to duplicated accuracy of .001" with DI-ACRO Precision Machines. — Benders, Brakes, Shears. Save die expense and time delay. Ideal for experimental and research work, making samples, models, etc., as well as regular production runs. Write for descriptive literature.

O'Neil-Irwin Mfg. Company
341 8th Ave.
Lake City, Minnesota



FOR THE SHOP—HOME—FARM—INDUSTRY



Bench Type ROTABIN

15" High, 17" diameter with 3 steel trays, 4 compartments each circular shape. 3/4" pipe extends through center of trays, making them revolving type. Hundreds of uses. Used—good condition. Price at fraction of original cost **\$6.95**



NEW ALL STEEL WORK BENCHES

27" high, 29 1/2" wide, 72" long. Exposed parts rounded, smooth finish, 1/2" steel top. Metal cross bars can be turned to make shelves. Stored outdoors, exposed to weather, slightly rusted. A great value **\$19.95** for only

STEEL ROLLER CONVEYOR

Good condition. Sections 10' long, Ball bearing rollers 4" center, 18" wide, 3 1/2" Channel shaped sides. **\$2.25** Sections can be added on. Per foot.

Send check with order. All Prices FOB, Kansas City
B & G SUPPLY CO. 800 E. 18th St. Kansas City, Mo.

deafened?

TWO NEW ALL-IN-ONE

Western Electric Hearing Aids

OFFER

Better Hearing for Thousands

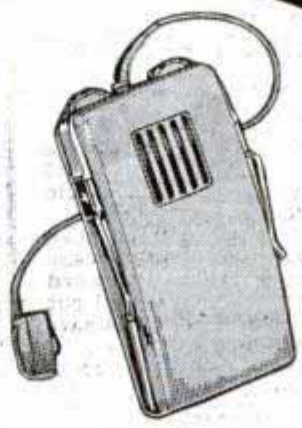

NEW MODEL 65

For the majority of the hard of hearing. Economical, tiny, compact—weighs but 6 ounces, including self-contained batteries.

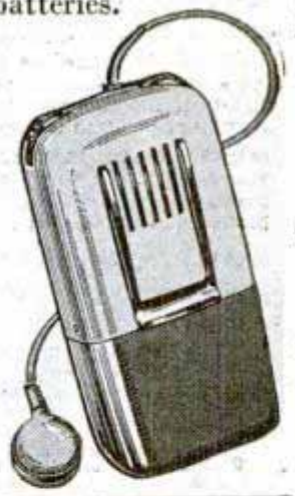

NEW SUPER 66

Ideal for those with severe hearing loss. Tremendous power, superb fidelity, outstanding performance. All-in-one unit.

SEND TODAY FOR TWO FREE BOOKLETS

Western Electric Dept. 380-PM12

195 Broadway, New York 7, N. Y.

Please send my free copy of "Modern Science and Your Hearing." Include the illustrated booklet on two new all-in-one Western Electric Hearing Aids.

Name _____

Address _____

City _____ Zone _____ State _____

Distributed in Canada through Northern Electric Co., Ltd.

\$ MILLION DOLLAR SURPLUS OFFERING \$

Everyday Items For Farmers, Sportsmen, Mechanics and Laborers



NAVY FIELD JACKET (New)
Poplin outer shell with 100% wool knit lining. OD color. Zipper and button front. Has 2 slash pockets. Lightweight for both fall and winter. Sizes 34 and 36. Each... **\$745**



WOOL HOOD
Ideal for anyone working outside, hunters, etc. It has small face opening, completely covers head, neck, and face except eyes and nose. Button down front, extends under jacket to protect neck and chest. Fits anyone up to size 7 1/4 head. Each... **69c**

CHOPPERS MITTS (New)

Heavy, durable, cream colored horsehide leather with wool lining. Dark colored elastic knit wrist. Small size only. Right hand glove has flap in palm for use by hunters. Per **\$298**

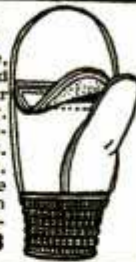

HEAVY OVERALL TROUSERS (New)

N-1 Navy deck all wool flannel lined bib type trousers. Keeps out dampness and are water repellent. Outer shell made of durable jungle cloth. Has 2 front and two hip patch pockets. Sizes small, medium and large. Per pair... **\$495**



VESTS (New)
Sheep Shearling, dark brown, zipper front. One front pocket. Sizes: Small, medium, large. Each... **\$645**

POPLIN FLYING TROUSERS Brand New



Intermediate, type A-9 OD, made of cotton twill cloth lined with an alpaca wool pile fabric. Three leg and two hip pockets. Adjustable suspenders included. Knee pocket and lower end leg inseam fitted with slide fasteners. Asst. sizes ranging from 32-44. Per pair... **\$645**

Sheepskin Flying Trousers



Made of high grade sheepskin, outside color brown, inside color natural. Brand new. Equipped with zipper fly, two full length zippers on each side. Suspenders and front pockets. Asst. sizes 36 to 42. Per pair... **\$795**

SHEEPSKIN LINED MITTENS

Made of recon-verted government flying clothing. A wonderful value and practical garment for protection against cold weather. Brown. New, standard size. Per pair... **\$298**



NEW SHEEPLINED HUNTING JACKETS
Made of recon-verted highest grade sheep shearling. Natural color inside. Brown out. Zipper front. Right hand pocket. Well tailored and a wonderful value. Sizes small, medium, large. Each... **\$2495**

FLYING TROUSERS



Type A-11. Olive Drab cotton twill. Lined throughout with an Alpaca and Wool Pile Fabric. Two hip pockets, two side lower leg pockets, one outside patch thigh pocket, one inside hanging thigh pocket and one built-in oxygen bottle pocket. Entire length slide fastener on each leg. Also suspenders. Each... **\$695**

A-6 FLIGHT BOOTS



Brand NEW, sheepskin lined, with rubber sole. Waterproof, can be used with or without shoes. State size needed, comes small, medium or large. Sale price, per pair **\$1195**

Some Used Boots — Reconditioned and perfect in every sense. Same as above in every respect and size. Per pair... **\$6.95**

Wool Blankets

Army OD, absolutely perfect, full sized. Cleaned and sterilized. Each only **\$498**



B-3A GLOVES (New)

Fine grained light weight capeskin or goat skin leather with double outer stitched seams. Soft cuff gauntlet style, having elastic take-up at wrist. Dark Brown. In sizes 8 1/2 to 10. Ideal Sports- man's or driving glove. Per pair... **\$249**

RIFLE SCABBARD (Used)

Made of Heavy Leather with carrying straps. Each **\$295** only...



IMMEDIATE DELIVERY — Add 10% for Postage and Handling

ROKO, INC. 809 CHERRY ST. KANSAS CITY, MO.



Saves as it Serves
This 2,000 watt Sheppard unit delivers steady, dependable current for about 1¢ per K.W. hour. Powered by an aircooled Sheppard diesel, it operates on low-cost domestic furnace oil. It's the ideal power source for water systems, refrigerators and home-lighting... or wherever economy is important without sacrificing dependability. Write for complete information—see how a Sheppard Diesel Generating set saves as it serves.
R. H. SHEPPARD CO., INC., 48 Middle St., Hanover, Pa.



NOW! ASSEMBLE YOUR ARC WELDER
ALL PURPOSE HEAVY DUTY WELDER
60 LBS. READY-MADE PARTS
TAKES UP TO 1/8" ELECTRODES
Easy to Assemble
PLUG INTO ANY 110 OR 220 A.C. LINE
Only **\$1995**
Immediate Delivery Dept. P12
ATOMIC WELDING CO. 1038 SO. 19 OMAHA, NEBR.

New Bowling Game!
Exciting! Great fun for everyone! Play in teams or alone. Game of skill... you aim, the robot shoots. Keep score like regular bowling.
Heavy, bright aluminum, 30 in. long. Set of 10 pins and ball, alley and robot complete with score pad and instructions. Send check or money order for \$295 today. We pay postage. (With pin setting device \$1.00 extra)
ROBOT TOY CO.
1905 PACIFIC, SAN DIEGO, CALIF. **295**

Quick Starting all Winter..

or Double-Your-Money-Back

Don't sit out in the cold, grinding down your battery and warming up your temper. Start *fast*—with Casite. It retards congealing of oil . . . lets the motor spin over rapidly . . . *guarantees* quick starting no matter how cold the weather. Casite gives you a smoother performance *all the time*, because it improves lubrication and reduces engine wear. Get Casite at your service station, garage or car dealer's today. The Casite Corporation, Hastings, Michigan, and the Casite Division, Hastings Ltd., Toronto.

75¢
A PINT





Color
Photograph
by Wesley Bowman

Gifts that keep on giving!

Beauty that doesn't grow dim . . . Style that never goes out . . . Performance that stays young through the years—all this may be rightfully expected of Sheaffer's ensembles. And for her Christmas this year—Sheaffer's Valiant Tuckaway Threesome—a trio of the finest writing instruments the world affords. To the "TRIUMPH" pen and FINELINE pencil, favorites here and abroad, has been added the STRATOWRITER, the dependable ball-tip instrument—for addressing packages, making carbons, signing stencils—for permanent writing in red, blue or green, on almost any surface, at any altitude, in any climate. Here are all the portable writing instruments she'll ever need . . . And all of Sheaffer's quality. In other words, the best!

VALIANT TUCKAWAY THREESOME—"TRIUMPH" Pen, \$12.50; STRATOWRITER, \$10.00; Non-Jab Pencil, \$5.00; complete set, \$27.50. No Federal Tax.

SHEAFFER'S
Copyright 1947. W. A. Sheaffer Pen Co.
VALIANT TUCKAWAY THREESOME

When it comes to writing, come to Sheaffer's

LISTEN EVERY SUNDAY to SHEAFFER'S PARADE with Eddy Howard—NBC Network: 3 P.M. E.S.T.; 2 P.M. C.T.; 1 P.M. M.T.; 12 Noon P.T.
LISTEN EVERY SATURDAY to SHEAFFER'S ADVENTURERS CLUB—CBS Network: 11:30 A.M. E.S.T.; 10:30 A.M. C.T.; 9:30 A.M. M.T.; 8:30 A.M. P.T.