

NOVEMBER 1947

25 CENTS

ANC



POPULAR MECHANICS

MAGAZINE

WRITTEN SO YOU CAN UNDERSTAND IT

W.C.D. TRADE MARK, G.P.O. REG. IN BRITAIN, NO. 40826

EXD. U.S. PAT. OFF.



NEW ARMY TANK CARRIER
PAGE 89



AUTO-LITE "Plug Tips"

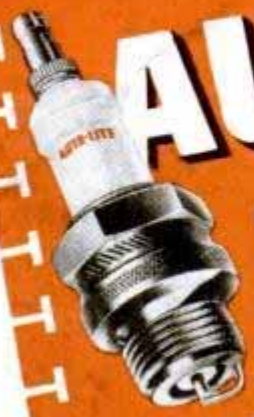

Are your plugs wasting time and money?

The right type of spark plug will save you time and money. Plugs which are faulty and mis-fire waste as high as 10 per cent of your fuel, according to experts. And hard-to-start engines can lose valuable time. Check all your spark plugs regularly to make sure you have the right plugs for your engines.

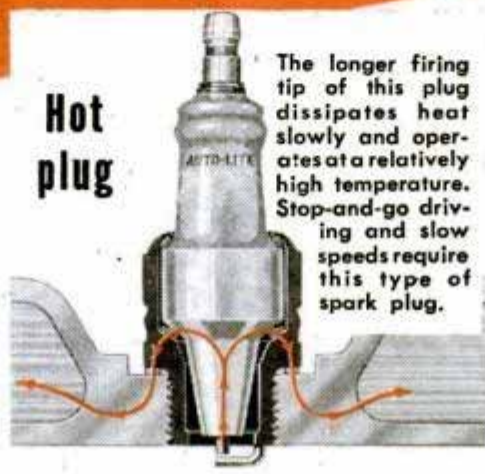

Hot plug

The longer firing tip of this plug dissipates heat slowly and operates at a relatively high temperature. Stop-and-go driving and slow speeds require this type of spark plug.

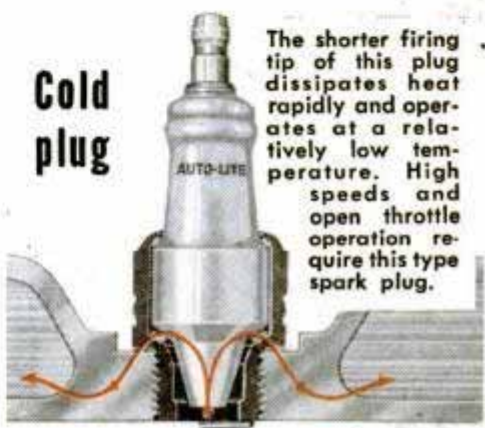

Cold plug

The shorter firing tip of this plug dissipates heat rapidly and operates at a relatively low temperature. High speeds and open throttle operation require this type spark plug.

Send for Auto-Lite "Plug-Chek" kit...only 10¢!



Too Hot *

If spark plug firing tips are fused or blistered, plugs are operating too hot and may be causing loss of power and damaging spark knock.



Normal *

If spark plugs look like this, they are of correct heat range. Get your Auto-Lite "Plug-Chek" Kit right now and check your spark plugs.



Too Cold *

If spark plug firing tips show deposits of carbon or are wet with oil, plugs are too cold, may cause poor starting and waste dollars in costly gas.

This Auto-Lite "Plug-Chek" Kit quickly helps you find spark plugs that are causing trouble. All you do is match plugs with pictures on the "Plug-Chek" Indicator—each example refers to a page in the "Plug-Chek" Data Book that shows you what to do.



* Because these illustrations are not in full color, they do not accurately reproduce the actual firing tip appearance. For accurate, full color reproduction, mail the coupon.

Switch to
AUTO-LITE
SPARK PLUGS

THE ELECTRIC AUTO-LITE COMPANY
Department PM2, Toledo 1, Ohio

Enclosed find ten cents for the Auto-Lite "Plug-Chek" Kit that includes: both the "Plug-Chek" Indicator and Data Book.

Name _____

Address _____

City _____



Now at less than prewar prices—the tire that outwears prewar tires

WHAT BETTER ADS for B. F. Goodrich tires are there than letters from typical B. F. Goodrich Silvertown owners? Here's one from Sheriff Edward Leemkuil of O'Brien County, Iowa, shown pointing to the tire in the picture above.

"I have driven over one million miles, over all types of roads and under adverse conditions, during my twenty-two years' service as sheriff. I have never found any tire that could compare with the new B. F. Goodrich tire. I have driven at extreme high speeds—in sub-zero winter weather over

frozen roads filled with chuck holes—and again over these roads in the extreme heat of summer.

"The B. F. Goodrich tires on my present car have gone over 32,000 trouble-free miles, and they are still good for many more miles of hard driving."

The picture was taken at the time this letter was written.

B. F. Goodrich tires have a wider tread that gives you more mileage because it puts more rubber on the ground—distributes the wear over a wider area. You get better traction on wet roads, quicker stops, greater safety. And

because the body of these tires is made with more cords and stronger cords, you get extra blowout protection.

You can now buy all popular sizes of B. F. Goodrich Silvertown tires for less than you paid before the war. And your B. F. Goodrich dealer will give you an allowance on your old tires if they are still good enough to be used or recapped. *The B. F. Goodrich Company, Akron, Ohio.*

B.F. Goodrich
FIRST IN RUBBER

AMAZE YOURSELF as our "guest"...with this CONTRASTING DEMONSTRATION on your own car

**CLEAR - FLEX
CLEARS!**

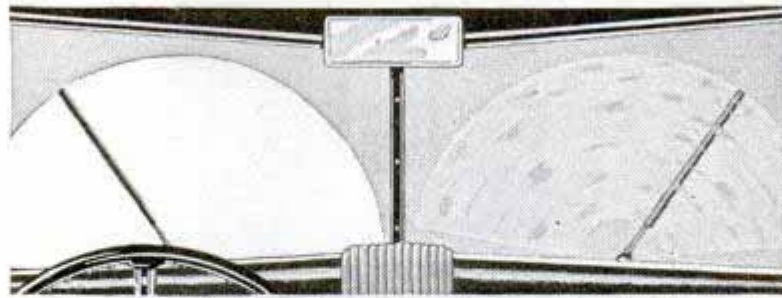

**OLD BLADE
SMEARS?**

Prove that your WINDSHIELD ... like all others ... has LOW SPOTS ... hard to wipe clearly ... using ANYTHING BUT the NEW ...

ANCO† **CLEAR-FLEX**‡ WINDSHIELD WIPER BLADE

END VIEW



FLEXORS

Pats. Pending



DEAD-LOCKER†

**CAN'T FALL OFF—
CAN'T BLOW OFF**

FLEXES TO CLEAR THE LOW SPOTS

Know CLEAR-FLEX ... the first Wiper Blade to conform fully to all windshield surface irregularities. Even wipes uniformly all types of curved windshields. Keeps clear those annoying hard-to-reach low spots common to all FLAT windshield glass. Clears quickly ... WITHOUT HELP ... blinding road muck ... slapped against your windshield ... from sloppy pavements ... by passing cars. CLEAR-FLEX already has engineering approval for original equipment on coming models of high-grade cars.

COSTS LESS TO USE

CLEAR-FLEX ECONOMY REFILLS quickly MAKE LIKE NEW ... at your gas pump ... when rubber finally becomes worn or damaged. Holder **OUTLASTS** your CAR.

YOU WIN THIS WAY

Simply ask your good gas-pump man ... next time you buy gas ... to install for you ... quickly ... out on the driver's half of your windshield ... one ANCO Clear-Flex Wiper Blade.* Deposit with him only the regular price ... printed on its box. Keep your old Blade ... if you like.

THE CONTRAST TELLS

Leave untouched the used Blade and Arm on your OTHER wiper shaft ... until you compare it with CLEAR-FLEX performance ... in the next storm! You are delightfully amazed ... by CLEAR-FLEX. Eye-strain ... jangled nerves ... **FILM FATIGUE** ... **GONE!** You enjoy at last the relaxed comfort ... and added safety ... of crystal-clear driving vision.

YOUR MONEY BACK QUICKLY —IF YOU'LL TAKE IT!

If you then are willing to part with your ANCO Clear-Flex Blade ... the dealer who put it on for you is authorized by us to remove it ... put back your old Blade ... and refund pleasantly every cent you deposited for CLEAR-FLEX. We protect him in that. Show him this ad. You risk no money. Get yours today. Try it. Then make it a PAIR. May save you a costly smashup!

ANCO DEAD-LOCKER WIPER ARMS



*—Use CLEAR-FLEX Blade ONLY with the sturdy ANCO Dead-Locker Arm ... already on millions of cars. ANCO Arm fits quickly any wiper shaft. Suits any good wiper motor. Holds Blade true ... at correct pressure. If not now on your car, ask serviceman to install a PAIR quickly for you. More than 250,000 good gas stations and service stores sell ANCO BETTER Blades and Arms.

Made by the makers of long-famous ANCO RAIN-MASTER† Blades and Arms ... original equipment for years on DeLuxe models of high-grade cars. Your dealer knows ANCO.

†Trade Mark Reg. U. S. Pat. Off.

‡Trade Mark of—The Anderson Company

Quality Protected Under Fair Trade Laws—ANCO Patented Products—Patents Make Jobs

THE ANDERSON COMPANY

Established 1918

GARY, INDIANA

Popular Mechanics Magazine

Registered in U. S. Patent Office and Canada

H. H. WINDSOR, Founder

H. H. WINDSOR, Jr., Editor and Publisher



WHEN one of our editors visited Aberdeen Proving Ground he was concerned at first by abandoned barracks and silent guns. Entering the restricted area where the big guns have their noses pointed out over the Potomac, he expressed this concern to his ordnance escort. The escort grinned and suddenly one of the big guns let go with a mighty roar that shook the earth. "You see the guns still roar at Aberdeen," said the officer. "Thanks for a perfect title," said the editor. You'll find it on our lead-off feature on page 89.

NEXT MONTH our western editor, Tom Stimson, presents a new angle in supersonic research with "How Fast Can Man Fly—And Live?" Another outstanding feature presents one solution to the high cost of buying and driving an automobile. Don't miss "Land of the Scooter and Cycle."

CRAFTSMAN headliners next month include full details on building a two-story, eight-room dollhouse with plywood walls, complete kitchen, bath and electric lights. Another feature gives the home craftsman an interesting slant on the use of foam rubber for upholstery projects. This new material makes it easy to turn out a professional job without extra cost. Photo fans are offered some advice in an article by a well-known authority on shooting close-ups with an ordinary camera.

EXPERIMENTERS will find a high-fidelity tuner for the new FM band in next month's Radio pages.

Volume 88	NOVEMBER 1947	Number 5
Managing Editor.....	Roderick M. Grant	
Assistant Managing Editor.....	Wayne Whittaker	
Shop Notes and Crafts Editor.....	James R. Ward	
Radio and Electronics Editor.....	Frank L. Brittin	
Aviation Editor.....	Aubrey O. Cookman, Jr.	
Associate Editor.....	Clifford B. Hicks	
Eastern Editor.....	Bill Reiche	
Western Editor.....	Thomas E. Stimson, Jr.	
Art Director.....	Frank Beatty	
Assistant Editors		
Donald R. Brooks	Charles D. Emerson	Arthur R. Railton
Assistant Editors, Shop Notes and Crafts		
W. Clyde Lammey	Wayne C. Lecky	John F. Shrock A. E. Youngquist

In This Issue

<u>The Guns Still Roar at Aberdeen</u>	89
<u>Land of Home Workshops</u>	100
<u>"Plane-Dirt" Farmers</u>	108
<u>Daredevils on Two Wheels</u>	115
<u>Colossus of Coal</u>	121
<u>Crystals Grown From Seed</u>	133
<u>New Methods for Plotters</u>	138
<u>Traffic Signals of the Sea</u>	147
<u>Grandpappy Refuses to Die</u>	153
<u>Stained-Glass Artist</u>	165
<u>Harvesting the "Backwoods" Crop</u>	172

For the Craftsman

<u>Rotating Bookcase</u>	178
<u>Christmas Gifts You Can Make</u>	192
<u>How to Wind Springs Yourself</u>	209
<u>Power-Tool Short Cuts</u>	213
<u>Table Saw Has Tilting Arbor</u>	218
<u>Do It Safely</u>	225
<u>Radio and Electronics</u>	229

Table of Contents Continued on Page 8

Published monthly by POPULAR MECHANICS COMPANY, 200 East Ontario Street, Chicago 11, Ill. H. H. Windsor, Jr., president; Paul H. Dunakin, vice president and general manager; D. F. Windsor, vice president and secretary-treasurer; William Harrison Pettridge, vice president and assistant to the publisher; Clover L. Perkins, advertising manager; Alan M. Deyoe, circulation manager. Single copy in the United States and Canada, 25 cents; subscription rates in United States and possessions, Canada, and countries of the Pan-American Postal Union, 1 year, \$2.50; 2 years, \$4.50; 3 years, \$6.00. To all other countries add \$1.00 a year over United States prices for overseas postage. If you plan to move, notify us at least 30 days in advance so you will not miss an issue. Give both old and new addresses. Entered as Second Class Matter, September 15, 1903, at the Post Office at Chicago, Illinois, under Act of March 3, 1879. Entered as Second Class Matter at Post Office Dept., Canada. Copyright 1947 by Popular Mechanics Company, Copyright under International Copyright Union. Copyright in France. All rights reserved under Pan-American Copyright Union. Printed in the United States of America.

Ingenious New Technical Methods

To Help You
Simplify Production



New Automatic Device Provides Up-to-the-Minute Visual Record

The new CHART-O-MATIC provides an instant visual record of all production, shipments, purchases, absenteeism, etc. Avoids inventory surpluses. Guides purchasing department giving constant picture of all parts and supplies on hand. Requisitions can be made direct from chart. Information from all departments transmitted to operator by Telautograph permits instant recording on CHART-O-MATIC. Does away with big wall charts and card-systems and tedious, time-consuming search for data that is often far from current. With the CHART-O-MATIC, the complete activities of the entire plant can be determined in an instant.

The entire unit is easily portable and operates from 110 volts current. Chart rotates in either direction by finger-tip control. Speed may be governed by rheostat.

New devices are proving their worth in saving time and reducing nervous tension on the job. And modern plants throughout America are finding that chewing gum on the job helps relieve monotony and helps to keep workers alert. That is why more plants every day are making Wrigley's Spearmint Gum available to their employees.

Complete details may be obtained from Spiral Mfg. Corporation, 3612 N. Kilbourn Avenue, Chicago 41, Illinois.



The New Chart-O-Matic



AB-78

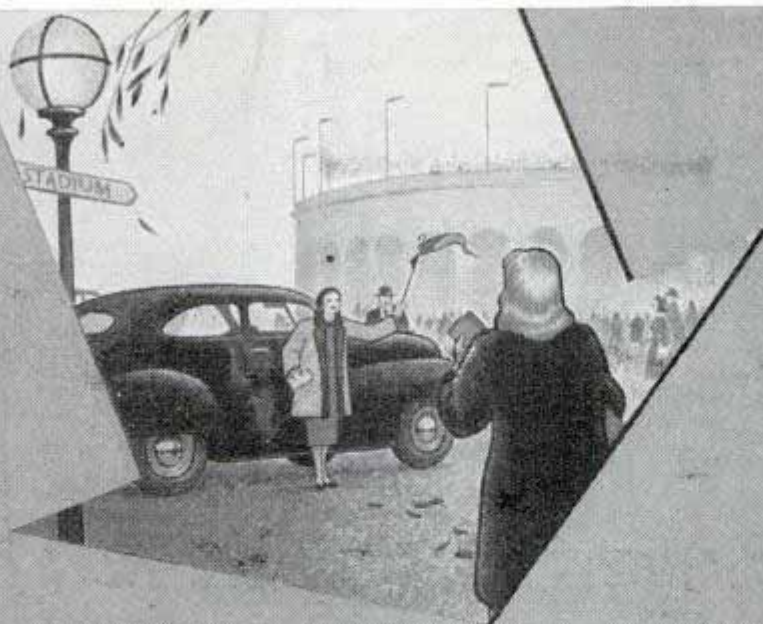

★ WHEN IT'S AN **Exide** YOU START ★

● When you buy a battery, you want to be sure it will start your car—today, tomorrow, this coming winter. Regardless of the age of your car, dependable starting power is your soundest investment. One starting failure can be far more

costly, than the little extra you pay for an Exide Battery.

Play safe—buy starting assurance.

When it's an Exide—you start

THE ELECTRIC STORAGE BATTERY COMPANY
Philadelphia 32
Exide Batteries of Canada, Limited, Toronto

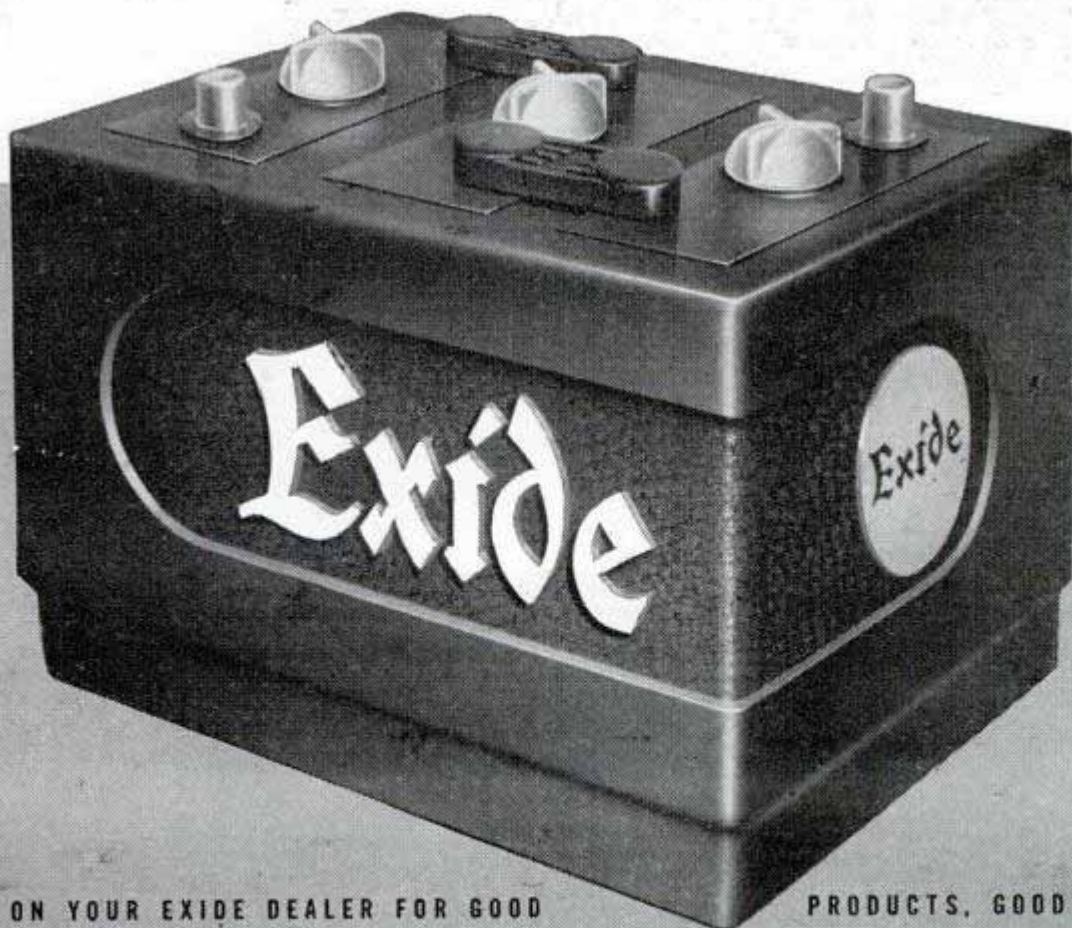

DEPEND ON YOUR EXIDE DEALER FOR GOOD

PRODUCTS, GOOD SERVICE

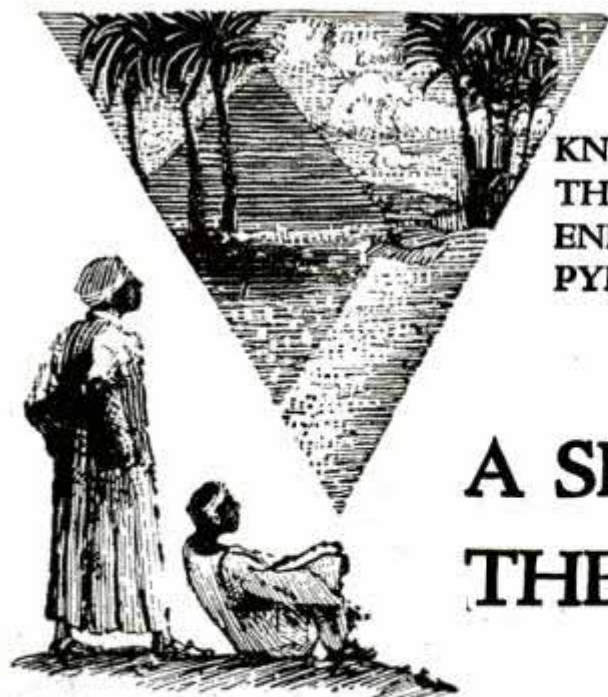

**KNOWLEDGE
THAT HAS
ENDURED WITH THE
PYRAMIDS**

A SECRET METHOD FOR THE MASTERY OF LIFE

WHENCE came the knowledge that built the Pyramids and the mighty Temples of the Pharaohs? Civilization began in the Nile Valley centuries ago. Where did its first builders acquire their astounding wisdom that started man on his upward climb? Beginning with naught they overcame nature's forces and gave the world its first sciences and arts. Did their knowledge come from a race now submerged beneath the sea, or were they touched with Infinite inspiration? From what concealed source came the wisdom that produced such characters as Amenhotep IV, Leonardo da Vinci, Isaac Newton, and a host of others? Today it is known that they discovered and learned to interpret certain *Secret Methods* for the development of their inner power of mind. They learned to command the inner forces within their own beings, and to master life. This secret art of living has been preserved and handed down throughout the ages. Today it is extended to those who dare to use its profound principles to meet and solve the problems of life in these complex times.

This Sealed Book—FREE

Has life brought you that personal satisfaction, the sense of achievement and happiness that you desire? If not, it is your duty to yourself to learn about this rational method of applying natural laws for the mastery of life. To the thoughtful person it is obvious that everyone cannot be entrusted with an intimate knowledge of the mysteries of life, for everyone is not capable of properly using it. But if you are one of those possessed of a true desire to forge ahead and wish to make use of the subtle influences of life, the Rosicrucians (not a religious organization) will send you *A Sealed Book* of explanation without obligation. This *Sealed Book* tells how you, in the privacy of your own home, without interference with your personal affairs or manner of living, may receive these secret teachings. Not weird or strange practices, but a rational application of the basic laws of life. Use the coupon, and obtain your complimentary copy.

The ROSICRUCIANS

SAN JOSE

(AMORC)

CALIFORNIA



AMENHOTEP IV
Founder of Egypt's
Mystery Schools

*Use this
coupon for
FREE
copy of book*

SCRIBE D. Y. S.
The Rosicrucians (AMORC)
San Jose, California

Please send free copy of *Sealed Book*,
which I shall read as directed.

NAME _____

ADDRESS _____

CITY _____

MORE MONEY \$\$\$ a BETTER JOB

Your Competition is Keen



YOU'RE in the biggest competition—yes, the biggest battle in the world—that of making a living. You have to work for a living—so does everyone else.

Competition for promotion is keen—people all around you are looking for more money—a better job—and so are you.

You can get a head start. Other men have—and in a short time you should be able to out-distance those who have no progress plan, make more money—have a better job—a more certain future.

Few people prepare themselves for that promotion—that better job and more money. Not many are making any special effort to learn outside of the time they put in each day on their work. They're taking the long, hard road to success. *How about you?* Are you, too, taking that same old, winding road—with its many disappointments and heartbreaks?

Here at LaSalle we have been training ambitious men and women for success for 40 years—enrolled hundreds of thousands of students—and our files overflow with grateful letters from students who have attained success and earnings far beyond their fondest dreams.

Perhaps we can help you—at any rate it will be well worth a three cent stamp to mail the coupon below. **DO IT NOW!** Just check the field of your choice and

we'll send you full information on that field without obligation. It may be the turning point in your life to a successful career, and more money.



LASALLE EXTENSION UNIVERSITY
A Correspondence Institution

417 SO. DEARBORN ST.

DEPT. 1164-R

CHICAGO 5, ILL.

I am interested in preparing myself for a better job and more money. Please send me your free 48-page booklet on the training course I have checked below.



- | | |
|--|--|
| <input type="checkbox"/> Accounting | <input type="checkbox"/> Industrial Management |
| <input type="checkbox"/> Bookkeeping | <input type="checkbox"/> Business Management |
| <input type="checkbox"/> Business Correspondence | <input type="checkbox"/> Traffic Management |
| <input type="checkbox"/> Sales Training | <input type="checkbox"/> Stenotypy Machine Shorthand |
| <input type="checkbox"/> Law: LL.B. Degree | |
| <input type="checkbox"/> Business Law | |
| <input type="checkbox"/> C. P. A. Coaching | |

Name _____

Age _____

Present Position _____

Street _____

City, _____

This One



HUT2-D38-ZPSZ

CLIP AND MAIL THIS COUPON TODAY!

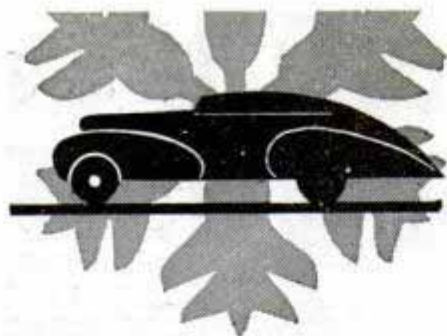

More than ever...
LOW VISCOSITY WINTER OILS NEED PYROIL TO PROTECT YOUR CAR!

The winter oil in your crankcase is a low viscosity oil to help cold weather starting. But, after warming up, your car operates at temperatures practically as high as summer temperatures. For effective lubrication, oil rings and piston rings must operate freely, unhampered by gum and sludge. (Pyroil prevents gum and sludge formation.) When the ignition is turned off, low viscosity oil quickly drains off cylinder walls leaving them dry, subject to corrosion and scoring when making a dry start. (Pyroil gives oil the property of clinging to cylinder walls, protecting them from corrosion and permitting easy safe starting.)

Add miles to your car . . . ask your gas station attendant to add Pyroil.

PYROIL FOR AIRCRAFT ENGINES

Use Aircraft Pyroil B for lubricating oil, Aircraft Pyroil A for gasoline.

Manufactured and Guaranteed by Pyroil Company, 73 Pyroil Bldg., La Crosse, Wisconsin.

Canadian Distributors: Central Purchasing Agency, Ltd. Toronto, Ontario



PYROIL COMPANY

73 Pyroil Bldg., La Crosse, Wisconsin

I want my car to last and run properly. Please tell me more about Pyroil and how it can accomplish this for me.

Name _____

Address _____

City or Town _____ State _____



Jerry, the talking dog, is entertaining hospitalized veterans, by courtesy of the PYROIL Company. Picture of Jerry, sent on request.

TABLE OF CONTENTS (Continued)

AUTOMOTIVE

Windshield protects cyclist..... 98
 Snowplane for two travels 30 m.p.h..... 98
 Bumper guard for parking..... 137
 Sun-porch trailer..... 158
 Plastic fog lens..... 159
 Hollow-handle car cleaner..... 163
 Trailer doorstep becomes shower stall..... 164
 Motor scooter provides transportation for shopping..... 175

AVIATION

Swept-back jet bomber..... 106
 All-weather fighter..... 106
 Flying horses..... 144
 Materiel command tests opposing techniques of helicopter design..... 152
 Midget all-metal racer flies 200 miles an hour..... 162
 Dutch pusher-type air taxi..... 162
 Top of squat transport jets six feet off ground..... 163
 Overhead stick replaces helicopter "wobble plate"..... 163
 Most powerful helicopter..... 169

BOATS AND BOATING

Gas-turbine ferry for the English Channel..... 96
 V-shaped paddles for stern-wheeler..... 132
 Pontoons prevent capsizing boat..... 169
 Foot steering for outboards..... 176

FARM

Motorcycle speeds baled-hay drying..... 120
 Grain unloader..... 132
 Track-laying garden tractor..... 146

HOUSE AND HOME

Mansions from mud..... 107
 Trap clips mouse..... 146
 Ironing-board bracket holds cord..... 146
 Window lock permits ventilation..... 169
 What's new for your home..... 170

INDUSTRY

Stainless-steel salvage..... 98
 European tractor moves freight cars..... 120
 Diving for logs..... 129
 Compact welding unit mounted on trailer uses argon as inert gas..... 144
 They stitch broken ships..... 160
 Cold steel made to "flow" under pressure..... 164
 "Artificial fever"..... 175
 High-voltage box smokes sardines inside the can..... 176

OUTDOOR RECREATION

Sight corrects archer's faults..... 95
 Nonslip clamp for reels..... 99
 Talc pencil marks golf greens..... 99
 Golf-practice device detects hooks..... 128

PHOTOGRAPHY

Adjustment for soft-focus photos..... 99
 Slide viewer gives illusion of depth..... 113
 Side-threaded movie reel..... 145
 Cameras provide "eyes" to study B-17 ditchings..... 171

RADIO AND ELECTRICAL

Practice set uses stylus to sound code symbols..... 120
 Plastic-backed cellulose tape..... 128
 Electronic panel controls lights for theater stages..... 137
 Phonograph on elevator..... 175

STORE AND OFFICE

Pencil-sharpener hone..... 113
 Rotating typewriter eraser..... 128
 Phone holder clamps around neck to leave both hands free..... 145
 Justifier for typewriter evens right margins..... 171

TOOLS

Cylinder gauge checks contour..... 95
 High-speed drill converter..... 99
 Pygmy torque wrench..... 112
 Handles grip heavy sacks..... 145
 Noncrushing wrench for soft metals..... 145

TOYS AND NOVELTIES

Making miniature spinning wheels..... 113
 Musical tree stand plays carols..... 114
 Revolving Christmas tree..... 114
 Coaster wagon steers like an automobile..... 114
 Toy paste-up village..... 146
 Figures molded from bread look and feel like stone..... 152
 Construction set has rivets and grommets instead of bolts..... 175

MISCELLANEOUS

Mobile bandstand..... 95
 Test your science I.Q..... 105
 Paradise for craftsmen—a rental machine shop..... 112
 Keenarik builds an igloo..... 130
 Mobile chair on tank tracks climbs curbs and steps..... 132
 They're always fooling the public..... 136
 Sliding cover in windproof pipe prevents flying ashes..... 137
 X-ray movies record body movements..... 159
 Wheel chair folds to 10-inch width..... 159

Craftsman and Shop Notes Index

AUTOMOTIVE

Mirror fastened to wall of garage aids when parking car..... 184
 Wrench depresses brake pedal when working on auto..... 184
 Fender guide for use with trailer indicates clearance needed..... 200
 Reflector sign on stalled truck warns approaching traffic..... 217
 Mechanic's cleaning tank and rack made from oil drum..... 224
 Replacing flywheel ring gears..... 224
 Route map is pasted to window-shade roller for ready reference..... 227
 Clogged breather tube in auto causes back pressure..... 228

(Continued to page 10)

PRESIDENT
 "Following my graduation from high school, I felt my educational background to be inadequate. It was impossible for me to attend college, so I enrolled with I.C.S. The knowledge I gained from I.C.S. has been invaluable to me through the years."



M. G. ENSINGER
 PRESIDENT
 Union Wire Rope Corporation

SALES DIRECTOR
 "It is with pleasure that I recall my studies with I.C.S. Before that I'd thought I was prepared for a vocation of selling but I found there were a good many things I needed to know. The I.C.S. Course was most helpful to me and continued to be so."

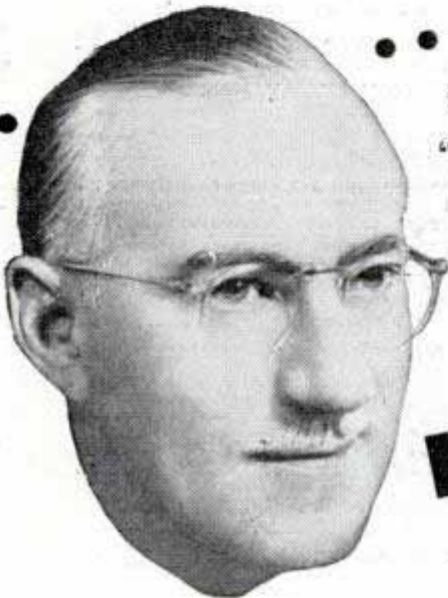

H. C. BONFIG
 VICE PRESIDENT AND DIRECTOR OF SALES
 Zenith Radio Corporation

INTERNATIONAL CORRESPONDENCE SCHOOLS



BOX 5615-K, SCRANTON 9, PENNA.

Without cost or obligation, please send me full particulars about the course BEFORE which I have marked X:

- | | | | |
|--|--|---|--|
| <p>Business and Academic Courses</p> <ul style="list-style-type: none"> <input type="checkbox"/> Accounting <input type="checkbox"/> Arithmetic <input type="checkbox"/> Business Administration <input type="checkbox"/> Business Correspondence <input type="checkbox"/> Certified Public Accounting <input type="checkbox"/> Commercial <input type="checkbox"/> Commercial Art <input type="checkbox"/> Cost Accounting <input type="checkbox"/> Federal Tax <input type="checkbox"/> First Year College <input type="checkbox"/> Foremanship <input type="checkbox"/> Good English <input type="checkbox"/> Higher Mathematics <input type="checkbox"/> Motor Traffic <input type="checkbox"/> Salesmanship <input type="checkbox"/> Sign Lettering <input type="checkbox"/> Spanish <input type="checkbox"/> Traffic Management <p>Air Conditioning and Plumbing Courses</p> <ul style="list-style-type: none"> <input type="checkbox"/> Air Conditioning <input type="checkbox"/> Heating <input type="checkbox"/> Refrigeration | <p>Chemistry Courses</p> <ul style="list-style-type: none"> <input type="checkbox"/> Chemical Engineering <input type="checkbox"/> Chemistry, Analytical <input type="checkbox"/> Chemistry, Industrial <input type="checkbox"/> Chemistry, Mfg. Iron & Steel <input type="checkbox"/> Petroleum Refining <input type="checkbox"/> Pulp and Paper Making <p>Civil Engineering, Architectural and Mining Courses</p> <ul style="list-style-type: none"> <input type="checkbox"/> Architecture <input type="checkbox"/> Architectural Drafting <input type="checkbox"/> Building Estimating <input type="checkbox"/> Civil Engineering <input type="checkbox"/> Contracting and Building <input type="checkbox"/> Highway Engineering <input type="checkbox"/> Lumber Dealer <input type="checkbox"/> Reading Structural Blueprints <input type="checkbox"/> Sanitary Engineering <input type="checkbox"/> Structural Drafting <input type="checkbox"/> Structural Engineering <input type="checkbox"/> Surveying and Mapping <p>Communications Courses</p> <ul style="list-style-type: none"> <input type="checkbox"/> Electronics <input type="checkbox"/> Practical Telephony <input type="checkbox"/> Radio, General <input type="checkbox"/> Radio Operating | <p><input type="checkbox"/> Radio Servicing</p> <p>Electrical Courses</p> <ul style="list-style-type: none"> <input type="checkbox"/> Telegraph Engineering <input type="checkbox"/> Electrical Drafting <input type="checkbox"/> Electrical Engineering <input type="checkbox"/> Electric Light and Power <input type="checkbox"/> Lighting Technician <input type="checkbox"/> Practical Electrician <input type="checkbox"/> Power House Electric <input type="checkbox"/> Ship Electrician <p>Internal Combustion Engines Courses</p> <ul style="list-style-type: none"> <input type="checkbox"/> Auto Technician <input type="checkbox"/> Diesel-Electric <input type="checkbox"/> Diesel Engines <p>Mechanical Courses</p> <ul style="list-style-type: none"> <input type="checkbox"/> Aeronautical Engineer's, Jr. <input type="checkbox"/> Aircraft Drafting <input type="checkbox"/> Flight Engineer <input type="checkbox"/> Forging <input type="checkbox"/> Heat Treatment of Metals <input type="checkbox"/> Industrial Engineering <input type="checkbox"/> Industrial Metallurgy <input type="checkbox"/> Machine Shop <input type="checkbox"/> Machine Shop Inspection | <ul style="list-style-type: none"> <input type="checkbox"/> Mechanical Drafting <input type="checkbox"/> Mechanical Engineering <input type="checkbox"/> Mold-Loft Work <input type="checkbox"/> Pattermaking—Wood, Metal <input type="checkbox"/> Reading Shop Blueprints <input type="checkbox"/> Sheet-Metal Drafting <input type="checkbox"/> Sheet-Metal Worker <input type="checkbox"/> Ship Drafting <input type="checkbox"/> Tool Designing <input type="checkbox"/> Welding—Gas and Electric <p>Railroad Courses</p> <ul style="list-style-type: none"> <input type="checkbox"/> Air Brake <input type="checkbox"/> Diesel Locomotive <input type="checkbox"/> Locomotive Engineer <input type="checkbox"/> Locomotive Fireman <input type="checkbox"/> Railroad Section Foreman <p>Steam Engineering Courses</p> <ul style="list-style-type: none"> <input type="checkbox"/> Boiler making <input type="checkbox"/> Combustion Engineering <input type="checkbox"/> Engine Running <input type="checkbox"/> Marine Engineering <input type="checkbox"/> Steam, Electric <p>Textile Courses</p> <ul style="list-style-type: none"> <input type="checkbox"/> Cotton Manufacturing <input type="checkbox"/> Rayon Weaving <input type="checkbox"/> Woolen Manufacturing |
|--|--|---|--|

Name _____ Home Address _____
 City _____ State _____
 Age _____ Present Position _____ Working Hours _____ A.M. to _____ P.M.

Special tuition rates to members of the Armed Forces.
 Canadian residents send coupon to International Correspondence Schools Canadian, Ltd., Montreal, Canada.

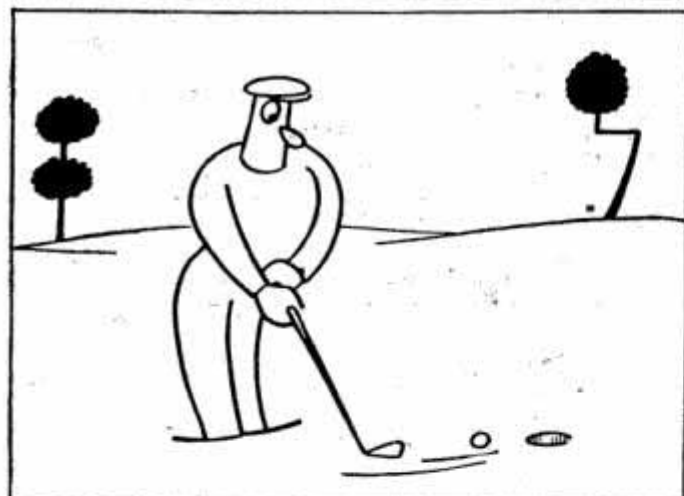
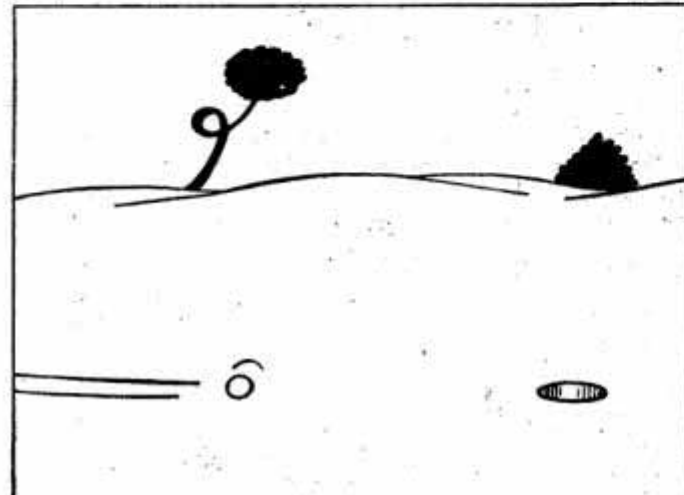
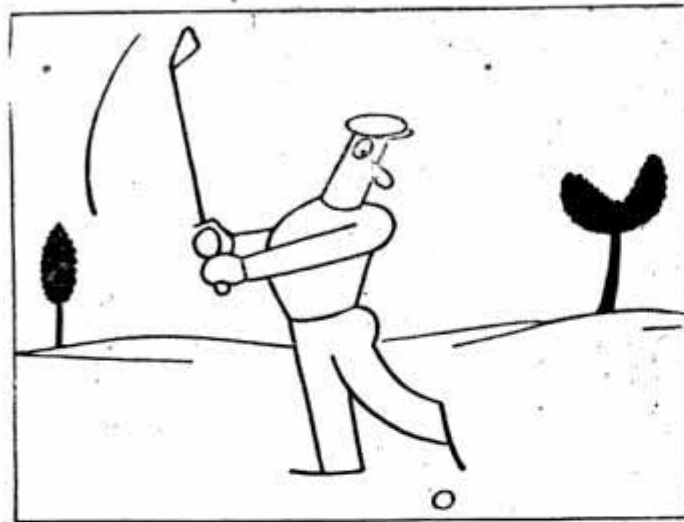

(Continued from page 8)

DRAWING AND DRAFTING

Drawings for illustrated lecture made with tracing wheel.....181
 Compass attachment to T-square aids sign painter.....212
 Plastic scale improves triangle.....217
 Rack tilts drawing board for table-top use.....223
 Adding-machine tape convenient to test artist's pen.....228

FARM

Old horseshoes used as boot racks.....189
 Hinged hoe blade to clean culvert.....191
 Lever-operated "latch" helps keep fence-wire gate stretched tautly.....210
 Drums piled on removable frames.....212
 Watertight fit for cistern covers.....212
 Wheel hub in concrete apron guides barn door.....217
 "Bottled gas" tank mounted on cart makes portable farm heating unit.....223
 Watering-tank faucet is guarded by old horseshoe.....223
 Auto-wheel rim makes creeper for small farm animals.....224

HOUSE AND HOME

Double fold in wall calendar forms a handy pocket for memos 180
 Cardboard-box wastebasket.....181
 Solving home problems.....182
 Filling nail holes in plaster.....184
 Removing feathers from fowl.....184
 How to sharpen food grinders.....185
 Come out of your igloo.....186
 Glycerin lubricates egg beater.....188
 Correcting slip in refrigerator belt.....188
 Thread and lead weight used to pull wire through lamp.....191
 Sagging floors leveled off easily with iron-pipe jacks.....200
 Sponge-rubber balls serve as "gliders" on legs of heavy chairs.....201
 Worn hinges are repaired by using small washers.....204
 Asphalt shingles cemented at edges to prevent loosening by wind.....204
 Clothes rack attached to wall saves floor space.....208
 Molding around kneading board retains excess flour.....208
 Location of hidden outlet boxes determined by using compass 228

METALWORKING

Wire solder fed through tube for close and fine work.....184
 Funnel soldered to top of gas can is always at hand.....188
 Improved bolt-thread cleaner.....200
 Double angle plate for tricky setups.....211
 Locking countersunk screws.....223
 Loosening "frozen" setscrews.....224
 "Gasket" for welding-helmet lens.....227

PHOTOGRAPHY

Copy it candidly.....202
 Darkroom switch box.....205
 Cloth bag tied over bottle neck filters photo solutions.....206
 Way to control water temperature.....206
 Improved photographic spotting.....206
 Camera-cable release reinforced.....206
 Handle on photohood reflector prevents burned fingers.....208
 Reinforcing cap of battery case.....208

RADIO AND ELECTRONICS

General purpose power supply.....229
 Dual-band rotary beam antenna system.....230
 Compact FM converter unit operates on a.c. or d.c.....232

TOOLS

Pipe used as emergency handle for steam or water valve....181
 Slotted wrench for wing nuts.....204
 Craft quiz.....207
 Scoop made with T-shaped handle cleans slots in machine table.....211
 Prick punch has replaceable point made from phonograph needle.....212
 Monkey wrench used on pipe.....217
 Ends of welding hose reversed to obtain longer wear.....217
 Weighted hose keeps torch upright.....224
 Wrench speeds chuck operation.....228
 Oil spread on grease-gun tip keeps it clean.....228

TOYS AND NOVELTIES

"Crossbow" slingshot shoots dart-shaped arrows.....189
 Chessboard folds to form container for "men".....189
 Knee cushion on coaster wagon adds to riding comfort.....200
 Covered wire in plastic lamp has neater appearance.....204
 Drawing a five-pointed star.....208

WOODWORKING

Push pin used as dowel center.....184
 Portable clothes rack hangs on top of door.....185
 Curling iron holds abrasive paper for sanding inside scroll cuts.....185
 Spring-slung runners take the bumps.....190
 Folding "dog house" fits auto rear deck.....191
 Broken golf club is pen holder of novel desk set.....201

MISCELLANEOUS

Corncob "pots" start plants.....181
 Tape protects edges of booklets.....189
 Rubber bands protect dry cells.....201
 Hacksaw blade perforates paper.....204
 Socks protect shoes in suitcase.....204
 Safe shipment of glass jars.....208
 Pipe cleaner used as lighter wick.....208
 "Gripper fingers" hold small forms.....211
 Screen-door spring holds check at parking-lot window.....212
 Publication dates for magazines posted on display rack.....217

IMPORTANT NOTICE—It is the intention of this magazine to provide its readers with information regarding the latest developments in the mechanical arts. We take no responsibility as to whether the disclosures contained in our articles are covered by patents and advise readers to investigate this subject before making, using, or selling any of the products, machines, or processes described in order to avoid possible liability for patent infringements.

AUDELS REFRIGERATION & AIR CONDITIONING GUIDE.....\$4

New from Cover to Cover—1280 Pages, Fully Illus. Covering basic principles, servicing, operation & repair of household, commercial & industrial refrigeration & air conditioning. A gold mine of essential important facts for engineers, servicemen, users.

AUDELS CARPENTERS & BUILDERS GUIDES—4 Vols.\$6

A practical illustrated trade assistant on modern construction for carpenters, joiners, builders, mechanics and all woodworkers. 4 vols., 1600 pages, 3700 illustrations, flexible covers. Pocket size. Each volume sold separately \$1.50 a vol.

AUDELS AUTOMOBILE GUIDE.....\$4

A practical quick ready reference book for auto mechanics, service men, operators & owners. Explains theory, construction & servicing of modern motor cars, trucks, buses & auto type Diesel engines. 1700 pages, fully illustrated. 55 chapters. Indexed. A standard book for mechanics. New fluid drive covered.

AUDELS DIESEL ENGINE MANUAL..\$2

A practical, concise treatise with questions and answers on the theory, operation and maintenance of modern diesel engines including General Motors 2 cycle Diesel. 384 pages, fully illus., flexible binding, pocket size. All details plainly brought out, this book is of extreme value to engineers, operators & students.

AUDELS WIRING DIAGRAMS.....\$1

110 Pages. Illustrated. Gives practical facts on wiring of electrical apparatus. It shows clearly how to wire apparatus for practically all fields of electricity. Each diagram is complete & self-explanatory. Highly Endorsed Pocket Companion.

AUDELS PLUMBERS & STEAMFITTERS GUIDES—4 Vols.\$6

A Practical Trade Assistant & Ready Reference. Explains in plain language & by clear illustrations, diagrams, charts, graphs, pictures principles of modern plumbing practice including Marine Pipe Fitting and Air Conditioning. 4 Vols.—1470 Pages—3642 Diagrams. Pocket size. Each Vol. Sold Separately \$1.50 a Vol.

AUDELS SHEETMETAL WORKERS HANDY BOOK.....\$1

Practical inside information. Fundamentals of Sheet Metal Work. 188 pages. Illustrated. 11 sections. Clearly written. Essential & important facts, figures, pointers in everyday language. Ref. Index.

AUDELS SHEETMETAL PATTERN LAYOUTS.....\$4

Developed by Experts for Sheet Metal Workers, Layout Men & Mechanics. A Practical Encyclopedia in 10 Sections, size 7 x 10 x 2—1125 Pages—350 Layouts—1600 Illustrations. 1001 Key Facts. Fully Indexed for ready reference in answering your layout problems. Covers all phases of sheet metal work including Pattern Cutting, Pattern Development & Shop Procedure.

AUDELS ANSWERS ON BLUE PRINT READING.....\$2

For Mechanics & Builders. Covers all types of blue print reading including ship & airplane. 416 pages, fully illustrated.

AUDELS NEW MACHINIST & TOOLMAKERS HANDY BOOK.....\$4

Covers modern machine shop practice in all its branches. 5 practical books in 1. New from cover to cover. Tells how to set up & operate lathes, screw and milling machines, shapers, drill presses and all other machine tools. 1600 pages, fully illustrated, 5 x 6 1/2 x 2. Indexed. 5 sections. 1—Modern Machine Shop Practice. 2—Blue Print Reading & How to Draw. 3—Calculations & Mathematics for Machinists. 4—Shop Physics. 5—How to Use the Slide Rule. 60 chapters. Easy to read and understand. A shop companion that answers your questions.

AUDELS MATHEMATICS & CALCULATIONS FOR MECHANICS \$2

Mathematics for home study or reference. 700 pages, 550 illus. Practical mathematics from beginning. How to figure correctly. Easy, correct methods covering complete review. Illus. & Indexed.

AUDELS HANDY BOOK OF PRACTICAL ELECTRICITY.....\$4

For maintenance engineers, electricians & all electrical workers. 1440 Pages, 2600 Illus. Covers important electrical information in handy form—including Marine Wiring, Radio Principles, Welding. Indexed. A Key to a practical understanding of electricity.

AUDELS RADIOMANS GUIDE.....\$4

A key to the practical understanding of radio including Frequency Modulation, Television, etc., Aircraft & Marine Radio. For radio engineers, servicemen, amateurs, 914 Pages, 633 Illustrations & Diagrams. Photos. Review Questions & Answers, Reference Index. Authentic, clear, concise.

AUDELS ELECTRONIC DEVICES.....\$2

Tells What You Want to Know About Electric Eye. Easily Understood. Covers photo-electric cells & their applications. Amplifiers, Illumination, frequencies, voltage, photocell, tubes, Ohm's Law, wiring diagrams, etc.

AUDELS WELDERS GUIDE.....\$1

A concise, practical text on operation & maintenance of all welding machines for all mechanics. Over 400 pages, illustrated. Covers all methods of electric and acetylene welding including airplane work.

AUDELS, Publishers, 49 W. 23 St., N. Y. 10

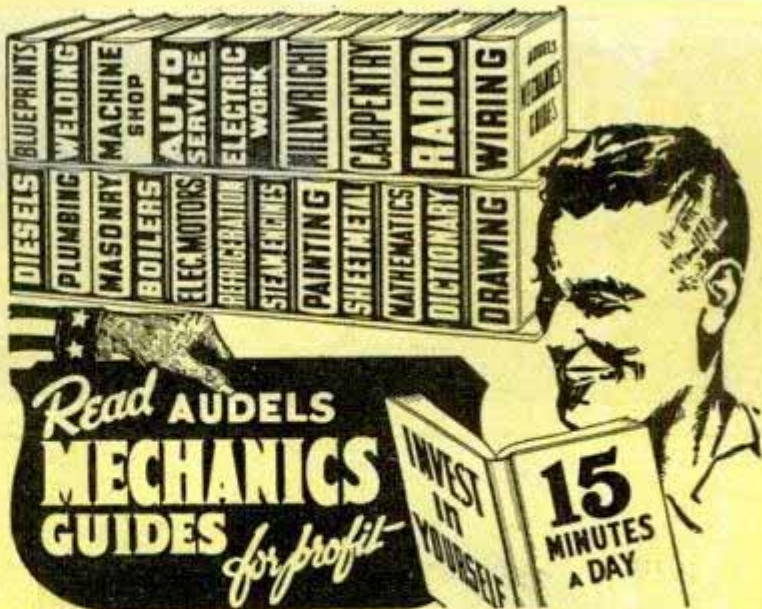

AN AUDEL GUIDE IS A GOOD FRIEND!

Step Up Your Own Skill with the Practical Facts and Figures of Your Trade. Save time and money with right methods, short cuts, labor saving ideas. CHECK NOW! You can look over any Audel Guide in your home. Start the Easy Payments if satisfied.

CUT HERE MAIL ORDER

THEO. AUDEL & CO., 49 W. 23 St., New York 10, N. Y.

Please mail me for 7 days' free examination the books marked (X) below. I agree to mail \$1 in 7 days on each book or set ordered, and to further mail \$1 a month on each book or set ordered until I have paid purchase price. If I am not satisfied with Guides I will return them.

- Audels **ELECTRIC MOTOR GUIDE** \$4.
- Audels **OIL BURNER GUIDE** 1.
- Audels **REFRIGERATION & Air Conditioning Guide** 4.
- Audels **POWER PLANT ENGINEERS GUIDE** 4.
- Audels **PUMPS, HYDRAULICS & AIR COMPRESSORS** 4.
- Audels **WELDERS GUIDE** 1.
- Audels **BLUE PRINT READING** 2.
- Audels **SHEET METAL WORKERS Handy Book** 1.
- Audels **SHEET METAL PATTERN LAYOUTS** 4.
- Audels **AIRCRAFT WORKER** 1.
- Audels **MATHEMATICS AND CALCULATIONS** 2.
- Audels **MACHINISTS & TOOLMAKERS Handy Book** 4.
- Audels **MECHANICAL Dictionary** 4.
- Audels **AUTOMOBILE GUIDE** 4.
- Audels **DIESEL ENGINE MANUAL** 2.
- Audels **MARINE ENGINEERS Handy Book** 4.
- Audels **MECHANICAL DRAWING GUIDE** 1.
- Rogers **MECHANICAL DRAWING and DESIGN** 2.
- Audels **MILLWRIGHTS and Mechanics Guide** 4.
- Audels **CARPENTERS and Builders Guides (4 vols.)** 6.
- Audels **PLUMBERS and Steamfitters Guides (4 vols.)** 6.
- Audels **MASONS and Builders Guides (4 vols.)** 6.
- Master **PAINTER and DECORATOR** 2.
- Audels **GARDENERS & GROWERS GUIDES (4 vols.)** 6.
- Audels **ENGINEERS & FIREMANS EXAMINATIONS** 1.
- Audels **ENGINEERS and Mechanics Guides** 12.
- Nos. 1, 2, 3, 4, 5, 6, 7 and 8 complete 12.
- Audels **Answers on Practical ENGINEERING** 1.
- Audels **ELECTRICIANS EXAMINATIONS** 1.
- Audels **WIRING DIAGRAMS** 1.
- Audels **Handy Book of PRACTICAL ELECTRICITY** 4.
- Audels **ELECTRICAL POWER CALCULATIONS** 2.
- Audels **ELECTRONIC DEVICES** 2.
- Audels **ELECTRIC Dictionary** 2.
- Audels **RADIOMANS GUIDE** 4.
- Audels **NEW ELECTRIC LIBRARY at \$1.50 a Volume** 4.

Name.....
 Address.....
 Occupation.....
 Employed by.....

PM

I Will
Show You
How to

Learn RADIO

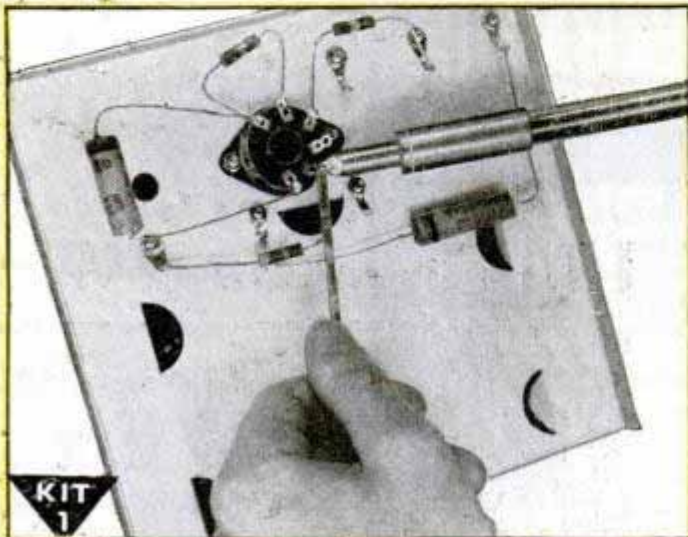

KIT 1

I send you Soldering Equipment and Radio parts; show you how to do Radio soldering; how to mount and connect Radio parts; give you practical experience.



KIT 2

Early in my course I show you how to build this N.R.I. Tester with parts I send. It soon helps you fix neighborhood Radios and earn EXTRA money in spare time.

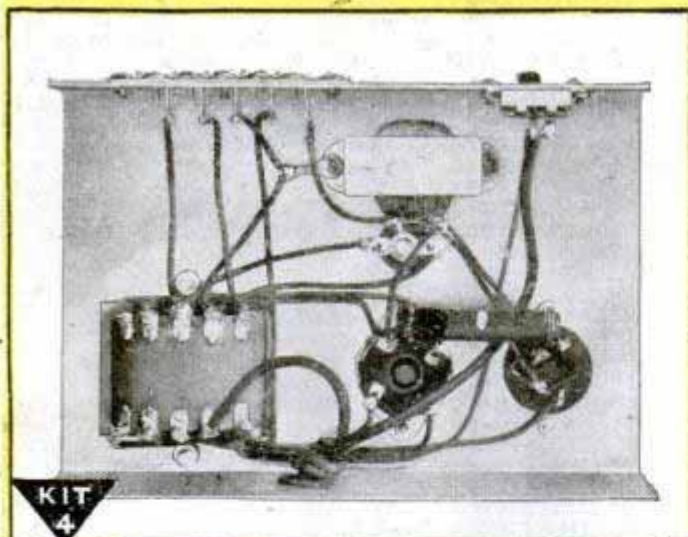

KIT 4

You get parts to build this Vacuum Tube Power Pack; make changes which give you experience with packs of many kinds; learn to correct power pack troubles.

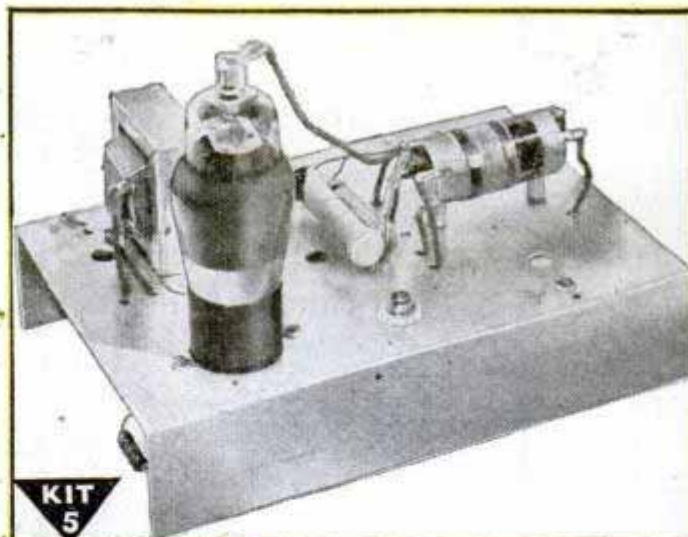

KIT 5

Building this A. M. Signal Generator gives you more valuable experience. It provides amplitude-modulated signals for many tests and experiments.

MEN I TRAIN AT HOME GET GOOD JOBS LIKE THESE

Made \$612, in 12 Months, Spare Time



"Soon after I finished my experimental kits lessons I tackled my first Radio service job. The neighbors were very cooperative. I soon had all the repair jobs I could handle in spare time. I have made \$612 in the past 12 months in spare time."
—J. W. CLARK, Wilmington, N. C.

Minister Makes \$10-\$20 Weekly Spare Time



"I am a minister. I am in a county seat now trying to serve the people in my church, also trying to keep their Radios playing. I have been making from \$10 to \$20 per week in spare time."
—L. H. SMITH, Benton, Tenn.

Knew Nothing About Radio



"I knew nothing about Radio when I enrolled. At present I am doing spare time work. I have more than paid for my Course and I have about \$200 worth of equipment which has paid for itself."
—RAYMOND N. STRICKLAND, Vandalia, Ill.

Doing Good Spare Time Business



"I have been getting receivers to repair right along lately, and by using the methods taught me in the NRI Course, I don't have to spend much time on any of them."
—STANLEY N. STRICKLAND, 191 Dale Homes, Portsmouth, Va.

by Practicing in Spare Time

I Send You
Big Kits
of Radio Parts

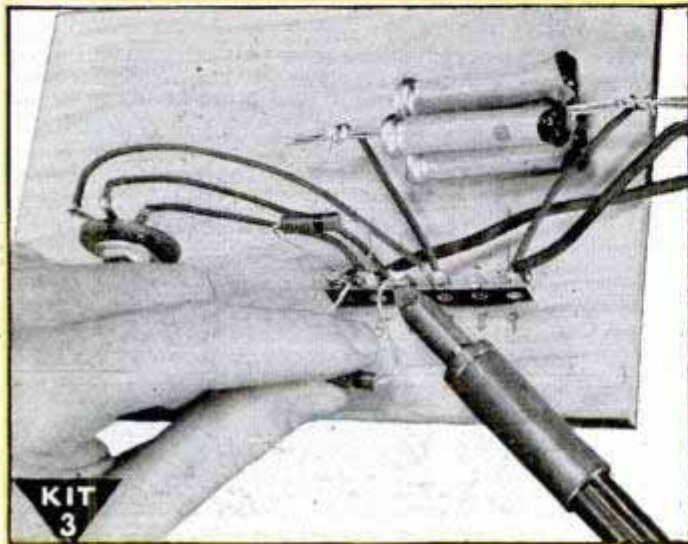

KIT
3

You get parts to build Radio Circuits; then test them; see how they work; learn how to design special circuits; how to locate and repair circuit defects.

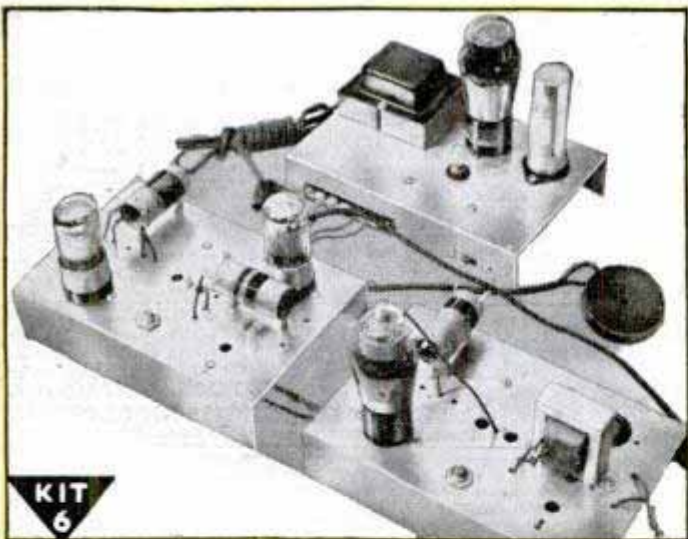

KIT
6

You build this Superheterodyne Receiver which brings in local and distant stations—and gives you more experience to help you win success in Radio.

SAMPLE LESSON

FREE

Gives hints on Receiver Servicing, Locating Defects, Repair of Loud-speaker, I.F. Transformer, Gang Tuner, Condenser, etc. Mail Coupon.



My Radio Course Includes
TELEVISION • ELECTRONICS
FREQUENCY MODULATION

KNOW RADIO *Win Success* I Will Train You at Home

Do you want a good-pay job in the fast-growing Radio Industry—or your own Radio Shop? Mail the Coupon for a Sample Lesson and my 64-page book, "How to Be a Success in RADIO—Television, Electronics," both FREE. See how I will train you at home—how you get practical Radio experience building, testing Radio circuits with **BIG KITS OF PARTS** I send!

Many Beginners Soon Make
Extra Money in Spare Time
While Learning

VETERANS

You can get
this training
in your own
home under
G.I. Bill. Mail
coupon for
full details.

The day you enroll I start sending **EXTRA MONEY** manuals that show how to make **EXTRA** money fixing neighbors' Radios in spare time, while still learning! It's probably easier to get started now than ever before, because the Radio Repair Business is booming. Trained Radio Technicians also find profitable opportunities in Police, Aviation, Marine Radio, Broadcasting, Radio Manufacturing, Public Address work. Think of even *greater* opportunities as Television, FM and Electronic devices become available to the public! Send for **FREE** books now!

Find Out What NRI Can Do For You

Mail Coupon for Sample Lesson and my **FREE** 64-page book. Read the details about my Course; letters from men I trained; see how quickly, easily you can get started. No obligation! Just **MAIL COUPON** NOW in envelope or paste on penny-postal. **J. E. SMITH**, President, Dept. 7MP, National Radio Institute, Pioneer Home Study Radio School, Washington 9, D. C.

Our 33rd Year of Train-
ing Men for Success
in Radio

MAIL NOW!

Mr. J. E. SMITH, President, Dept. 7MP
National Radio Institute,
Washington 9, D. C.
Mail me **FREE**, your sample lesson and
64-page book. (No salesman will call.
Please write plainly.)

Age _____

Name _____

Address _____

City _____ State _____

(Please include Post Office zone number)

Approved for Training under GI Bill

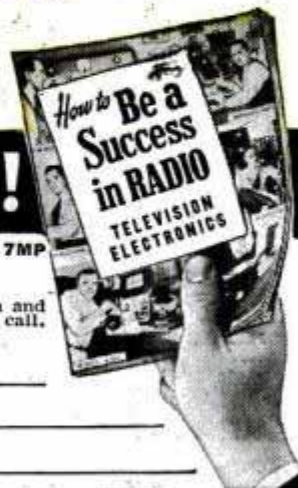



**WORK FOR THE
U.S. GOVERNMENT**

START

\$1,756 to \$3,021 YEAR

Prepare NOW for 1948 Examinations

Railway Postal Clerks

Railway Postal Clerks get \$2,300 the first year of regular employment, being paid on the first and fifteenth of each month. (\$95.84 each pay day.) Their pay is automatically increased yearly to \$3,400 and \$3,600 in larger organizations. Advance may be had to Chief Clerk at \$5,400 a year. (\$225.00 each pay day.) Men, 18 to 35.

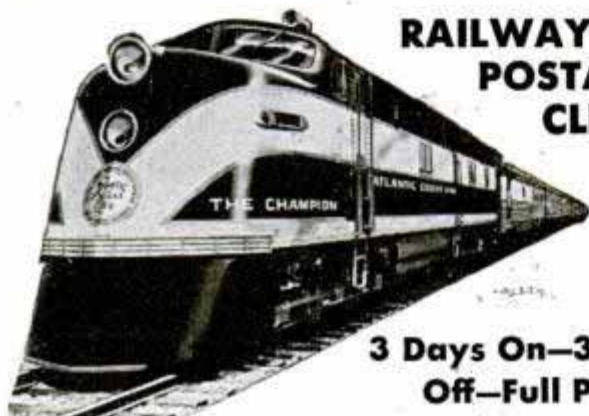

**RAILWAY
POSTAL
CLERKS**

**3 Days On—3 Days
Off—Full Pay**

Railway Postal Clerks on long runs usually work 3 days and have 3 days off duty or in the same proportion. During this off duty their pay continues just as though they were working. They travel on a pass when on business. When they grow old, they are retired with a pension.

City Mail Carriers, Post Office Clerks

Clerks and Carriers now get \$2,100 the first year of regular employment and automatically increase \$100 a year to \$3,100. Open to men—women 18 to 50.



Patrol Inspectors

Men 21 to 35. Entrance salary \$3,021 year. Appointments to positions along the nation's borders are made from this examination.

Many Other Positions

Many other positions are obtainable. Those wishing these positions should prepare at once.

Get Free List of Positions

Fill out the following coupon. Tear it off and mail it today—now, at once.

This small investment can result in your getting a big-paid government job.

FRANKLIN INSTITUTE, Dept. P86, Rochester 4, N. Y.

Rush to me, entirely free of charge (1) a full description of U. S. Government Jobs; (2) Free copy of illustrated 32-page book, "How to Get a U. S. Government Job"; (3) List of U. S. Government Jobs; (4) Tell me what to do to prepare for one.

Name _____

Address _____ Vet.?

Use This Coupon Before You Mislay It. Write or Print Plainly.

NEW!

**HOBBY
HANDBOOK**



A GOLD MINE of INFORMATION on NEWEST EQUIPMENT, TOOLS for HOME CRAFTSMEN & MECHANICS

If you work in metals, wood, plastics or glass you need this Giant NEW Book of equipment, tools, parts and materials... including dozens of hard-to-get items you can't find in stores. Many things you must have for your home hobby or shop.

HELPS YOU GET MORE PLEASURE, MORE PROFIT in

- HOME CRAFTS
- METAL CRAFTS
- WOODWORKING
- PLASTIC CRAFTS
- HOME REPAIRS

A WAREHOUSE of THINGS YOU NEED AND WANT

Over 100 items including Spray Guns; Power Bench Tools; Lathe; Drill Press; Drills; Grinders; Tank and Brush Electroplaters; Telephone System; Tool Chest; Model Tools; "Pin Money" Makers for your sparetime fun and profit! **SEND NAME and ADDRESS and 10c TODAY!** Price of Handbook refunded on first order.

**WARNER ELECTRIC CO., Dept. P-15
1512 JARVIS AVENUE, CHICAGO 26, ILLINOIS**

Learn Penmanship

Good penmanship makes favorable impressions and helps you win success, while poor penmanship will lead you to failure. It makes no difference how poor you now write, you can quickly and easily learn Business Writing, and you can learn Shaded Writing also, right in your own home during spare time by my Simplified Method, without cost of going away to school. Begin Now! Write for my FREE BOOK, "How to Become an Expert Penman," which contains valuable information, many specimens of penmanship, and tells how others learned to write well. If you enclose 10c, I will send you one of my Favorite Pen Points suitable for plain or shaded writing and your name with a beautiful flourish bird written on a card. Write for the FREE BOOK today. HURRY! T. M. TEVIS, Box 25K, Chillicothe, Mo.

LEARN MONEY-MAKING CARTOONING

IN SPARE TIME — by Easy Picture Chart Method
Same Simplified Method that has helped train creators of "Terry & Pirates," "Freckles," "Out Our Way," "Winnie Winkle," "Reg'lar Fellers," "Strange As It Seems," "The Neighbors," and many others. Earn while learning. Send 10c for Picture Chart (to test your ability), and full details. (State age.)



THE LONDON SCHOOL, 4711 Cleve. Transit Bldg., Cleveland, O.

LAW
STUDY AT HOME for PERSONAL SUCCESS and LARGER EARNINGS. 39 years expert instruction—over 108,000 students enrolled. LL.B. Degree awarded. All texts furnished. Easy payments. Send for FREE BOOK. G. I. approved. AMERICAN EXTENSION SCHOOL OF LAW Dept. 83-M, 646 N. Michigan Ave., Chicago 11, Ill.

Learn BAKING At Home

Baking is one of America's high industries in wages. Nearly depression-proof. Thorough basic home course lays sound foundation. If you have aptitude, write for FREE BOOKLET, "Opportunities in Commercial Baking."



National Baking School, 1315 Mich. Ave., Dept. 1358, Chicago 5



NEW CHEMICAL MITT
Sensational! DRY Window Cleaner! Uses no water, no messy liquids. Chemically Treated. Simply glide over windows; leaves glass sparkling clear. No heating water, no heavy buckets to carry. No rags, powders, sponges, chambrays, oils. No mess or muss. No red chapped hands. Dust, dirt, grime, fog disappear like magic. Wonder for auto windows, windshield!
SAMPLES FOR AGENTS Sample offer sent immediately to all who send name at once. A penny postal will do. **SEND NO MONEY—Just your name.** KRISTEE CO., 674 Bar Street, AKRON, OHIO.



INVENTORS



Learn how to protect your invention. The U. S. Patent Laws provide that any new and useful art, machine, article of manufacture, or composition of matter, or any new and useful improvement thereof, may be patented if the act of invention is involved. Therefore, every inventor with a valuable invention should take advantage of the Patent Laws and proceed for patent protection in order to safeguard his rights.

A patent gives the inventor the exclusive right to prevent others from making, using, or selling the invention claimed in the patent for a period of seventeen years.

The Patent Laws were enacted for the benefit of the inventor to give him protection for the features of his invention which are patentable. These features must be properly and concisely set forth and claimed in a formal application for patent, in order to comply with the requirements of the U. S. Patent Office. For that reason, the Patent Office advises the inventor, unless he is familiar with such matters, to engage a competent registered patent attorney or agent to represent him. We maintain a staff of registered patent attorneys ready to serve you in the handling of your patent matters.

A specially prepared booklet entitled "Patent Guide for the Inventor", containing detailed information with respect to patent protection and procedure, together with a "Record of Invention" form will be promptly forwarded to you without obligation upon request.

Patents
Trademarks
Copyrights

Registered Patent Attorneys

CLARENCE A. O'BRIEN
& HARVEY B. JACOBSON

71-L District National Building + Washington 5, D. C.

CLARENCE A. O'BRIEN & HARVEY B. JACOBSON
Registered Patent Attorneys
71-L District National Bldg., Washington 5, D. C.

Please send me copy of "Patent Guide for the Inventor" and also "Record of Invention" form. This request does not obligate me.

Name _____

Address _____

City _____ State _____

(Please write or print plainly.)



**I Put You to Work with Your Hands to LEARN RADIO!
You Build Receivers! You Make Typical Defects Occur
and Make Tests to Prove the Theory!**

**YOU GET
8 BIG KITS OF RADIO
PARTS & EQUIPMENT
including
2-BAND SUPER
RECEIVER!
and 16 RANGE METER
FOR TESTING**

F. L. SPRAYBERRY, PRES-
IDENT of the SPRAYBERRY
ACADEMY OF RADIO. This
is the man who directs
your study. His years of
experience and Radio
"know-how" assure you of
the finest in home Radio
Training!



Set has Long and
Short Wave Tuning.
All Sprayberry Equip.
is yours for **KEEPS**.

SPRAYBERRY HOME TRAINING is PLANNED to MAKE MONEY for you FAST!

I train you with regular professional Radio Equip-
ment. I tell you exactly what to do . . . how to do
it. You handle Radio Parts, see them operate,
learn what they're for. With the fine Kits I supply,
you learn how to build Radio Circuits, construct
your own Test Equipment. I'll show you how to
cause typical Radio defects so you can watch and
see how they act. You learn the latest methods for
trouble-shooting and repair. All this adds up to

the finest kind of "bench" experience. And you get
it right in your own home. In no time at all, you'll
be ready for a business of your own or a good job
in Radio, FM, Television,
Radar, Industrial Elec-
tronics, etc. Now's
the time to get
started!

**READ WHAT
GRADUATE SAYS:**

"One Job Nets About
\$26.00" . . . "Since last
week I fixed 7 radios, all
good-paying jobs, and right
now I am working on an
amplifier system. This job
alone will net me about
\$26.00. As long as my
work keeps coming in this
way, I have only one word
to say and that is "Thanks"
to my Sprayberry training
and I am not afraid to
boast about it." ADRIEN
BENJAMIN, North Groves-
nordale, Conn.

**SEND FOR MY
VALUABLE
FREE BOOKS!**

**VETERANS:
GET SPRAYBERRY TRAINING
WITHOUT COST UNDER G.I.
BILL. CHECK COUPON.**

**LEARN RADIO
to MAKE MONEY!**

LOW COST TRAINING — EASY PAYMENT PLAN!

You Learn at Home How to
Build and Test Dozens and
Dozens of Circuits — Simple
and Complex!

YOU DO
OVER 175
INSTRUCTIVE
EXPERIMENTS



**YOU BUILD
ALL THESE TESTERS
..... AND MORE!**



I give you a fine,
moving-coil type
Meter Instrument on
Jewel Bearings —
with parts for a
complete Analyzer
Circuit Continuity
Tester. You learn
how to check and
correct Receiver
defects with professional speed and
accuracy.

You'll get
valuable ex-
perience and
practice
building this
Signal Gener-
ator and mul-
ti-
purpose
Tester. Makes
a breeze out of fixing Radios and you
don't have to spend money on ready-
made Equipment.

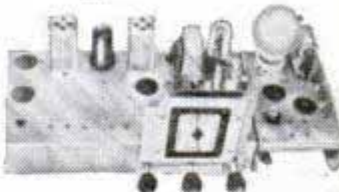

Soldering, wiring, connecting Radio
parts . . . building circuits with your
own hands — you can't beat this
method of learning. When you con-
struct this Rectifier and Filter, Re-
sistor and Condenser Tester, etc., you
get a really practical slant on Radio
that leads to a money-making future.

F. L. Sprayberry, Pres.,
SPRAYBERRY ACADEMY OF RADIO,
10117 Sprayberry Bldg., Pueblo, Colo.

Please rush my FREE copies of "How to MAKE MONEY in
RADIO, ELECTRONICS and TELEVISION" and "How to READ
RADIO DIAGRAMS and SYMBOLS."

Name _____ Age _____
Address _____
City _____ State _____
 Check here if Veteran.

(Mail in envelope or paste on penny postcard)

INVENTORS

Patent Laws Encourage The Development of Inventions

The Rules of Practice of the U. S. Patent Office advises— unless an inventor is familiar with such matters — that he employ a competent registered attorney or registered agent, as the value of patents depends largely upon the skillful preparation of the specifications and claims.

The firm of McMorrow, Berman and Davidson is registered to practice before the U. S. Patent Office. Additionally, it maintains a staff of attorneys able to readily understand inventors' disclosures, to advise concerning patentability, and to prepare appropriate specifications and claims for filing with the Patent Office.

If an inventor believes he has an invention, a search of the most pertinent prior U. S. patents should be made and a report obtained relative to its patentability. Where such report indicates that the invention appears patentable, in order to secure protection, diligence should be exercised in making application for a patent.

McMORROW, BERMAN & DAVIDSON

Registered Patent Attorneys

PATENTS — TRADE-MARKS — COPYRIGHTS

135-B VICTOR BUILDING, WASHINGTON 1, D. C.

McMORROW, BERMAN & DAVIDSON

Registered Patent Attorneys

135-B Victor Building, Washington 1, D. C.

Send me further particulars as to patent protection and procedure and "Invention Record" form at once. I understand that this request does not obligate me.

Name _____

Address _____

City _____ State _____

(WRITE OR PRINT NAME CLEARLY)



Let Them Work for
YOU as They
Have for These
Successful Men!

**Quick, Ready, Low Cost Help
for BETTER JOBS!**

Sent C.O.D. Anywhere
in U. S. Money Back
if Not Satisfied

MAIL
COUPON

To help you on your job — to get a better job — to save money on your own home repairs and improvements — get a low cost, practical Drake Book. Fortieth year of publication and always up to date. Recommended by thousands of users and sold under a strict money-back guarantee. All books are standard library binding—not pamphlets or cheap paper covers. Order on coupon now.

MAKE MONEY
Doing Work You
Will Like
SAVE MONEY
On Your Home
Improvements

Select From This List

Circle Numbers of Books Wanted on Coupon Below

PLUMBING • Installation and Repair
Expert instruction enables inexperienced to plan and install simple plumbing and hot water systems according to good practice without violation of general regulations. 162 illustrations. 256 pages. Book No. 1. \$2.00

Heating • Cooling, Air Conditioning
Specially prepared for those with no experience. Covers computation, planning, selection of equipment, installation and operation. A real how-to-do-it book. 700 pages. 350 illustrations. Book No. 2. \$4.00.



HOUSE WIRING MADE EASY

The ideal book for the home owner and handyman. Covers layout, plans and complete installation. Simplified for quick understanding and easy use. Over 100 illustrations. Book No. 3. \$1.50

PAINTING AND DECORATING

A book for professional painters and home owners. Covers methods, tools and materials for every branch of painting and decorating. No matter what kind of job you want to do it is in this book. 350 pages. 288 illustrations. Book No. 4. \$3.50



CARPENTRY • Practical Procedure

A most practical and usable book that will give you a working knowledge on all building details. Expert's best methods for measuring, cutting, fitting, all materials. 300 pages. 700 illustrations. Book No. 5. \$2.50

ROOF FRAMING — Brand New

Written from a lifetime of practical experience by outstanding authority. Covers every type and phase of roof framing. 175 pages. 400 illustrations. Book No. 6. \$2.00



REFRIGERATION SERVICE MANUAL

Covers all types of household and commercial refrigeration with latest information on maintenance, trouble shooting and repair. Millions of refrigerators must be serviced. Make money with this book. 300 pages. Illustrated. Book No. 7. \$2.00

AUTOMOBILE ENGINE MANUAL

Just the book to keep your own car going or for making money on repair and tune-up jobs for others. 300 pages of vital information. 200 illustrations. Book No. 8. \$3.00

Send No Money



MAIL COUPON NOW

Frederick J. Drake & Co., Dept. 18
600 W. VanBuren St., Chicago 7, Ill.

Send me the books checked below. If not satisfied I will return them in 5 days and money will be refunded.

1 2 3 4 5 6 7 8 (Circle Numbers Wanted)

Check or Money Order enclosed \$ _____ Send books postpaid.
 Send C.O.D. plus postage.

Name _____

Address _____

City _____ State _____

Drake's Books are Sold by Leading Booksellers

Make MORE MONEY

Learn

Screen Process Printing I SHOW YOU HOW This Easy Way at Home!



1 HOW TO START YOUR OWN BUSINESS

—My training shows you how you may start your own business and cash in on the tremendous field open to you in Screen Process—with an investment of a few dollars.

No machinery. Print thru stencil mounted on silk stretched frame.

2 HOW TO GET A GOOD PAY POSITION

—Many of my students earn extra money in spare time at home, while learning. My special "Earn While You Learn" lessons, with the Kit of Supplies I give you—show you how.



Make own stencils. Trace lines on stencil film. No art experience necessary.

3 HOW TO EARN EXTRA MONEY IN SPARE TIME

—If you are in the rut of a low pay, uninteresting job, Screen Process work offers you the opportunity to earn good wages and the better things of life for you and your family.



You can print signs, displays, toys, etc., with this simple equipment.

Send for FREE BOOK

My big free illustrated book, "Opportunities in Screen Process," explains the big demand for Screen Process printed Signs and Displays, Toys and Games, Textiles, Decal Transfers, Plastics and Glass, Pictures and Greeting Cards, Advertising Agencies and other businesses. No art or previous experience required. You Learn While Doing with the 2 BIG KITS of SUPPLIES I give you. Write TODAY. State if veteran.

CALIFORNIA SCHOOL OF SCREEN PROCESS
3740 OVERLAND BLVD., DEPT. PM117, LOS ANGELES 34, CALIF.

AUDELS Carpenters and Builders Guides 4 vols. \$6



Inside Trade Information for Carpenters, Builders, Joiners, Building Mechanics and all Woodworkers. These Guides give you the short-cut instructions that you want—including new methods, ideas, solutions, plans, systems and money saving suggestions. An easy progressive course for the apprentice and student. A practical daily helper and Quick Reference for the master worker. Carpenters everywhere are using these Guides as a Helping Hand to Easier Work, Better Work and Better Pay. To get this assistance for yourself, simply fill in and mail the FREE COUPON below.

Inside Trade Information On:

How to use the steel square—How to file and set saws—How to build furniture—How to use a mitre box—How to use the chalk line—How to use rules and scales—How to make joints—Carpenters arithmetic—Solving mensuration problems—Estimating strength of timbers—How to set girders and sills—How to frame houses and roofs—How to estimate costs—How to build houses, barns, garages, bungalows, etc.—How to read and draw plans—Drawing up specifications—How to excavate—How to use settings 12, 13 and 17 on the steel square—How to build hoists and scaffolds—skylights—How to build stairs—How to put on interior trim—How to hang doors—How to lay-lay floors—How to paint



AUDELS, Publishers, 49 W. 23rd St., New York 10, N. Y.
Mail Audels Carpenters and Builders Guides, 4 vols., on 7 days free trial. If OK I will remit \$1 in 7 days and \$1 monthly until \$6 is paid. Otherwise I will return them. No obligation unless I am satisfied.

Name _____

Address _____

Occupation _____

Employed by _____

PM

Training is essential to advancement in any field—and it's important to have it on record.

International Correspondence Schools' sound and practical training goes on record—and counts in the record. I. C. S. regularly reports the progress of its students to their employers, regularly receives letters expressing appreciation for this service.

A typical employer communication notes: "I have every I. C. S. report on my men filed with their personal records, the records which help to determine any action taken in regard to those men."*

YOU want your record to show you have *trained* for promotion. **YOU** want your employer to know that you have *prepared* yourself for larger responsibilities. Then *act* now to obtain that training. I. C. S. Courses cover more than 400 business and technical subjects. The coupon brings full information.

*Name furnished on request



INTERNATIONAL CORRESPONDENCE SCHOOLS



BOX 5616-K, SCRANTON 9, PENNA.

Without cost or obligation, please send me full particulars about the course BEFORE which I have marked X:

Air Conditioning and Plumbing Courses

- Air Conditioning
- Heating
- Refrigeration
- Plumbing
- Steam Fitting

Chemistry Courses

- Chemical Engineering
- Chemistry, Analytical
- Chemistry, Industrial
- Chemistry, Mfg. Iron & Steel
- Petroleum Refining
- Plastics
- Pulp and Paper Making

Civil Engineering, Architectural and Mining Courses

- Architecture
- Architectural Drafting
- Bridge and Building Foreman
- Building Estimating
- Civil Engineering
- Coal Mining
- Contracting and Building
- Highway Engineering
- Lumber Dealer
- Reading Structural Blueprints
- Sanitary Engineering
- Structural Drafting

- Structural Engineering
- Surveying and Mapping

Communications Courses

- Electronics
- Practical Telephony
- Radio, General
- Radio Operating
- Radio Servicing
- Telegraph Engineering

Electrical Courses

- Electrical Drafting
- Electrical Engineering
- Electric Light and Power
- Lighting Technician
- Practical Electrician

Internal Combustion Engines Courses

- Auto Technician
- Diesel-Electric
- Diesel Engines
- Gas Engines
- Aviation

Mechanical Courses

- Aeronautical Engineer's, Jr.
- Aircraft Drafting
- Flight Engineer
- Forging
- Foundry Work
- Heat Treatment of Metals

- Industrial Engineering
- Industrial Metallurgy
- Machine Shop
- Mechanical Drafting
- Mechanical Engineering
- Mold-Loft Work
- Patternmaking—Wood, Metal
- Reading Shop Blueprints
- Sheet-Metal Drafting
- Sheet-Metal Worker
- Ship Drafting
- Ship Fitting
- Tool Designing
- Toolmaking
- Welding—Gas and Electric

Railroad Courses

- Air Brake
- Diesel Locomotive
- Locomotive Engineer
- Locomotive Fireman
- Railroad Section Foreman
- Car Inspector

Steam Engineering Courses

- Boiler making
- Combustion Engineering
- Engine Running
- Marine Engineering
- Steam Electric
- Steam Engines

Textile Courses

- Cotton Manufacturing
- Rayon Weaving
- Textile Designing
- Woolen Manufacturing

Business and Academic Courses

- Accounting
- Advertising
- Arithmetic
- Bookkeeping
- Business Administration
- Business Correspondence
- Certified Public Accounting
- Commercial
- Commercial Art
- Cost Accounting
- Federal Tax
- First Year College
- Foremanship
- Good English
- Higher Mathematics
- Motor Traffic
- Salesmanship
- Sign Lettering
- Spanish
- Stenography
- Traffic Management

Name _____ Home Address _____

City _____ State _____

Age _____ Present Position _____ Working Hours _____ A.M. to _____ P.M.

Special tuition rates to members of the Armed Forces.
Canadian residents send coupon to International Correspondence Schools Canadian, Ltd., Montreal, Canada.

PATENT PROTECTION *for* INVENTORS

A PATENT IS A VALUABLE RIGHT

On the basis of a constitutional provision Congress has established a system under which inventors may secure the exclusive right to prevent the unauthorized use, manufacture and sale of their inventions for periods of seventeen years. The inventor secures this protection by obtaining a patent from the United States Patent Office.

The United States Patent Office RECOMMENDS

in its Rules of Practice that "an applicant is advised, unless familiar with such matters, to employ a competent registered patent attorney or registered patent agent, as the value of patents depends largely upon the skillful preparation of the specification and claims."

We RECOMMEND

that you authorize us to conduct a search through the U. S. Patents pertinent to your invention and submit a report setting forth our opinion regarding its patentability.

VICTOR J. EVANS & CO. has a staff of experienced registered patent attorneys, available to represent inventors in the preparation and prosecution of their cases before the Patent Office. Detailed information and the steps to be taken in obtaining patent protection will be furnished upon request.

FORM BELOW FOR MAILING CONVENIENCE

**VICTOR J.
EVANS & Co.**

Merlin M. Evans

REGISTERED PATENT ATTORNEY

230-M MERLIN BUILDING, WASHINGTON 6, D. C.

Please forward to me detailed information regarding procedure to obtain Patent Protection, together with your convenient "Evidence of Invention" form.

Name

Address

City and State.....

PATENTS • TRADEMARKS • COPYRIGHTS

Get Training *QUICK* in the Great Shops of **COYNE**



Learn

ELECTRICITY

in a few weeks

NOT a "Home-Study" Course!

Practical training pays! Thousands of successful electricians—men earning good money, with steady jobs and a real future—recommend the COYNE Shops in Chicago. We do not teach by mail. All instruction is given in our own big building in the heart of the World's Electrical Center. You make rapid strides here because it's a shop course.

Work on Full-Size Equipment!

In our great shops you actually operate, test, repair the same kinds of electrical apparatus you'll use later on the job. You do REAL house wiring; rewind REAL armatures; run a REAL switchboard. All this plus needed theory makes it easy to learn Electricity in a few short weeks here at COYNE.

No Experience Necessary

Many Coyne students have never had previous electrical experience. Others have had a smattering of it in one or two branches, but realize their need for "All-Around" training. We not only train you for a good job, we help you get it. Lifetime Free Employment Service to Coyne graduates.

SEND FOR FREE BOOK

Yours for the asking—big 40-page book on Coyne Electrical Training. Filled with fascinating pictures of our great shops and our plans to help you. Get your copy free. No cost or obligation; no salesman will call. Mail the coupon today!

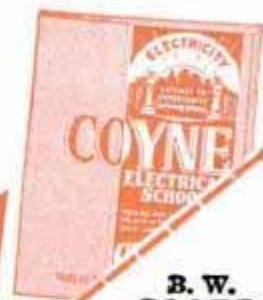

B. W. COOKE,
President,
COYNE ELECTRICAL SCHOOL,
Dept. 87-72,
500 S. Paulina St.,
Chicago 12, Illinois.

Send me your Free Book and tell me about your plans to help me—including Student Finance and added Training in Industrial Electronics and Electric Refrigeration. Mail coupon today.

COYNE Shop Training Includes:

Alarm and Signal Work
D.C. Motors, Generators, Controls
A.C. Motors, Generators, Controls
House Wiring
Armature Winding
Stator Winding

Transformers
Switchboards
Home Appliances
—and many other branches including added training in Industrial Electronics and Electric Refrigeration.

NOW IN OUR 49th SUCCESSFUL YEAR

Since 1899, Coyne has been training men and young men for practical, better-paying jobs. Here in our great Chicago Shops you will find the equipment, the friendly expert instructors, to prepare you for a real future in Electricity. Coyne graduates are in demand by many leading electrical firms. Coyne men are trained to make good in their own electrical shops. Come to COYNE!



B. W. Cooke

NON-VETERANS who are short of cash can finance most of their tuition and pay it in easy monthly payments after graduation. Many students earn while learning. We'll help you get part-time work while here if you need it to help defray living expenses.

ANY MAN WITH A PHYSICAL DISABILITY whether a Veteran or not may qualify for Coyne training at no cost to himself for tuition or subsistence. Send coupon for details.

VETERANS!
Coyne is authorized to accept Veterans for G. I. training. Coupon brings special G. I. Bulletin.

B. W. COOKE, President

COYNE ELECTRICAL SCHOOL
Dept. 87-72
500 S. Paulina St., Chicago 12, Ill.

NAME.....

ADDRESS.....

CITY.....STATE.....

Bigger Opportunities Than Ever in . . .



AUTO BODY AND FENDER REPAIR

●THE FIELD IS STILL GROWING after more than 40 years . . . expanding with the giant auto industry! Millions of new cars are getting to market, millions of old ones are still on the road—THE NEED for MAN-POWER in the service field is INCREASING!

TRAIN NOW . . . FOR THE OPPORTUNITIES AHEAD!

Don't be stuck in a low-pay job! Opportunity here is big enough for thousands to find big-pay work either in a reliable job or in their own shops. UEI teaches Auto Body & Fender Repairing the *easy* way. No special education or experience needed . . . you can start in your spare time, right at home . . . keep your job while you learn. Then, when home study is finished, you continue at the well-equipped UEI shops getting practical experience. Fix and refinish damage, replace panels and tops. Learn up-to-date methods in use of tools, spray painting, welding, metal work—all under expert supervision.

GET THE FACTS . . . FREE!

UEI HAS TRAINED THOUSANDS for opportunity fields, and students are making good. If you want to get ahead, send coupon today for free facts on AUTO BODY AND FENDER REPAIRING. Don't delay!

**AUTOCRAFTS DIVISION
UTILITIES ENGINEERING
INSTITUTE**
2523 Sheffield Ave. Dept. 1117-X
Chicago 14, Illinois

Approved for training under G. I. Bill

Founded 1927



FILL OUT AND MAIL . . . TODAY!

Autocrafts Division
Utilities Engineering Institute, Dept. 1117-X
2523 Sheffield Ave., Chicago 14, Ill.
Yes, I'm interested! Send me those Free Facts about Auto Body and Fender Repairing.

NAME _____ Age _____

ADDRESS _____

CITY _____ Zone or County _____ STATE _____

If veteran of World War II check here
 Check here for Special Information if under 17.

SAY YOU SAW IT IN POPULAR MECHANICS

1847 A CENTURY OF PUBLISHING 1947
MERRIAM-WEBSTERS

The Handy-Sized Merriam-Webster

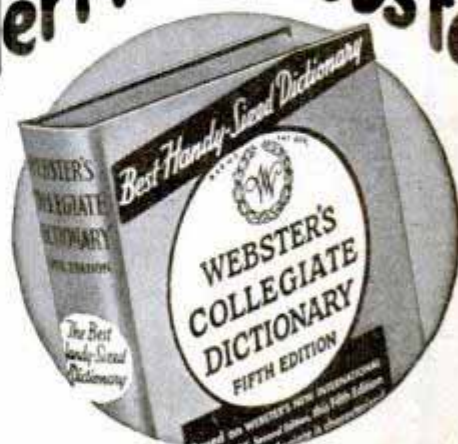

WEBSTER'S COLLEGIATE is the most dependable handy dictionary for home and office because it is a compact abridgment of the famous *Webster's New International Dictionary, Second Edition*—"The Supreme Authority." Defines all the words most commonly used. 1,300 pages; 110,000 entries. \$5 to \$10, depending on binding. Ask your bookdealer.

G. & C. MERRIAM CO., SPRINGFIELD 2, MASS.

ELECTRICAL TRAINING

Intensive 32 weeks residence course in fundamentals of industrial electrical engineering, including radio, electronics. Prepares for technician, engineering aides. Approved for veteran training. 54th year. Catalog.

BLISS ELECTRICAL SCHOOL
7644 Takoma Ave., Wash. 12, D. C.



**LEARN } ACCOUNTING
SALESMANSHIP
SECRETARIAL
WORK**

Assure Your Future Now!

Hill's, one of America's outstanding Business Schools, offers you the opportunity to enter one of the three fields acknowledged to hold substantial earnings and a secure future. Our FREE book, "Through Hill's to Success," tells how and where the best positions are found and how you can qualify for them by study at home or in our resident school. We have thousands of successful graduates and maintain nationwide employment service. G. I. Approved.

**FREE
WRITE
TODAY**

USE THIS HANDY COUPON

**HILL'S EXTENSION SCHOOL
AND BUSINESS UNIVERSITY**
619 W. Main St., Oklahoma City 2, Okla.
Please send me your Free book, "Through Hill's to Success."

NAME _____

ADDRESS _____

CITY _____ STATE _____

WHICH OF THESE *Opportunities* INTERESTS *You* MOST?

Accounting
Air Conditioning
Architecture & Building
Automotive Engineering
Aviation—Practical
Aviation Drafting & Design
Better Foremanship
Bookkeeping
Business Management

Contracting
Diesel Engineering
Drafting & Design
Electrical Engineering
Electricity—Practical
Electronics, Industrial
High School Courses
Machine Shop Operations
Mechanical Engineering

Plastics Engineering
Plumbing—Practical
Private Secretary
Radio Operating & Servicing
Railway Training
Refrigeration
Sheet Metal Pattern Drafting
Shop Management
Tool Making

THINK! LOOK FORWARD!

Business is making big, new plans

Men and Women are preparing for the future

WHAT ARE YOU DOING ABOUT YOUR TOMORROWS?

● *Today*, choose the job you want—and prepare for it. Or if you are already engaged in the work you like best, start training *now* for quicker promotion. Acquire the knowledge that will help you to get ahead faster, make more money and have greater security.

Invest part of your spare time in more rapid progress. Start training now, in spare time in your own home. Be ready to grasp your opportunity and step out ahead of those who lack the ability you have attained.

American School, founded in 1897 as an educational institution *not for profit*, can help you to reach your goal just as it has helped others during the past fifty years. Give serious thought to the list above. Pick one or more subjects that interest you. Then check the coupon at right, add your name and address and mail it at once. The school will send you details on its training plan and outline of study prepared by specialists. There is no charge, no obligation, so send the coupon immediately.

PRACTICAL, EFFECTIVE HOME - STUDY TRAINING SINCE 1897

Take This First Easy Step

CHECK, CLIP AND MAIL COUPON NOW

AMERICAN SCHOOL, Dept. G845, Drexel at 58th, Chicago 37, Ill.
Without obligation. Please send FREE and postpaid, bulletin and details of the Subject checked.

- | | | |
|--|--|--|
| <input type="checkbox"/> PLASTICS ENG'R | <input type="checkbox"/> Accounting | <input type="checkbox"/> Drafting and Design for Men and Women |
| <input type="checkbox"/> Refrigeration | <input type="checkbox"/> Electrical Engr. | <input type="checkbox"/> Radio |
| <input type="checkbox"/> Architecture and Building | <input type="checkbox"/> Electricity-Pract. | <input type="checkbox"/> High School |
| <input type="checkbox"/> Contracting | <input type="checkbox"/> Electronics, Industr. | <input type="checkbox"/> Air Conditioning |
| <input type="checkbox"/> Practical Plumbing | <input type="checkbox"/> Bookkeeping | <input type="checkbox"/> Mechanical Eng. |
| <input type="checkbox"/> Automotive Engineering | <input type="checkbox"/> Private Secretary | <input type="checkbox"/> Shop Management |
| <input type="checkbox"/> Aviation Drafting | <input type="checkbox"/> Diesel Engineering | <input type="checkbox"/> Tool Making |
| <input type="checkbox"/> Aviation | <input type="checkbox"/> Sheet Metal | <input type="checkbox"/> Better Foremanship |
| <input type="checkbox"/> Business Mgmt | <input type="checkbox"/> Pattern Drafting | <input type="checkbox"/> Machine Shop Operations |
| <input type="checkbox"/> Railway Training | | |

Name..... Occupation.....
Address..... Age.....
City..... State.....

AMERICAN SCHOOL

Dept. G845, Drexel at 58th Street, Chicago 37

FREE

SEND FOR

ALLIED'S Big 164 Page RADIO CATALOG!

WRITE TODAY!



SAVE ON EVERYTHING IN RADIO!



NEW HOME RADIOS



SERVICE SUPPLIES
BUILDERS' SUPPLIES



AMATEUR GEAR



SOUND SYSTEMS

164 Value-Packed Pages

Send for your FREE copy of the most complete Buying Guide for Everything in Radio! Here's the Catalog for Servicemen, Dealers, Soundmen, Amateurs, Builders and Experimenters. Features the world's largest and most complete stocks of radio and electronic supplies—quality equipment at lowest prices! Get the speedy service and expert help you want from ALLIED—Radio's Largest Supply House. Depend on ALLIED!

MORE THAN 10,000 ITEMS

Get everything for every radio use: Latest type home radio models, phono-radios, recorders, communications receivers, Ham kits, and gear, code apparatus, radio parts, tubes, tools, test instruments, public address equipment, low-cost easy-to-build radio kits, diagrams and matched parts lists, largest selection of instructive radio books—all at lowest prices!

ALLIED RADIO

ALLIED RADIO CORP.
833 W. Jackson Blvd., Dept. 5-LL-7
Chicago 7, Illinois

Rush FREE 164-Page Catalog

Name.....

Address.....

City..... Zone..... State.....

FREE CATALOG

AVIATION

Aeronautical University Approved Training meets exacting standards of aviation industry, prepares for key positions, big opportunities.

Courses in:

AERONAUTICAL ENGINEERING. B.S. degree.
AERONAUTICAL ENGINEERING DRAFTING
CERTIFIED ENGINE MECHANICS
ADMINISTRATION—including sales

PRE-ENGINEERING: Special refresher courses in math and science for high school graduates and veterans.

Also refresher courses for Gov't Airplane and Engine Mechanics Licenses for those with aviation experience.

Oldest fully approved aviation school. Outstanding faculty, modern equipment, outside employment, placement service. Day, evening. Approved for Veterans. Send today for FREE catalog "Opportunities in Aviation."

AERONAUTICAL UNIVERSITY

Dept. 77, 116 S. Michigan Ave., Chicago 3, Ill.

FOUNDED BY CURTISS-WRIGHT

Bar Bells

Build Lasting Strength

For quickest, best results, use Paramount bar bells, dumb bells and the famous Paramount system. They'll give you a body packed with power and vitality. Don't wait; act today!



Factory Prices
895 UP

Send today for free illustrated catalogue and price list

Save up to 30%

INDEPENDENT IRON WORKS

2416 East 23rd Street, Dept. J
Los Angeles 11, Calif.

ACCOUNTANT

BECOME AN EXPERT

Executive Accountants and C. P. A.'s earn \$2,000 to \$10,000 a year. Thousands of firms need them. We train you thoroughly at home in spare time for C. P. A. examinations or executive accounting positions. Previous experience unnecessary. Personal training under supervision of staff of C. P. A.'s. Placement counsel and help. Write for free book, "Accountancy, the Profession That Pays."

LASALLE Extension University, 417 So. Dearborn St.
A Correspondence Institution Dept. 1164-H Chicago 5, Ill.

"How to Make Money With Simple Cartoons"

A book everyone who likes to draw should have. It is free; no obligations. Simply address

CARTOONISTS' EXCHANGE

Dept. 911D

Pleasant Hill, Ohio

SAY YOU SAW IT IN POPULAR MECHANICS

Enjoy

—WORLD'S MOST FASCINATING HOBBY! SEND FOR FULLY ILLUSTRATED BOOK TODAY!



GET THE FACTS on model railroading! Leading authority shows how easily, inexpensively you can join in the absorbing hobby enjoyed by thousands of mechanics, business and professional men. Scale model railroads look, perform like the real thing!

GET STARTED NOW! Send 10¢ coin or stamps, for fully illustrated booklet, "Model Railroading for You".

MODEL RAILROADER MAGAZINE
Dept. 1511 Milwaukee 3, Wisconsin

Now IN YOUR OWN HOME Learn

RADIO ELECTRONICS

The Practical
"HOME-TESTED"
Modern "A-B-C" Way

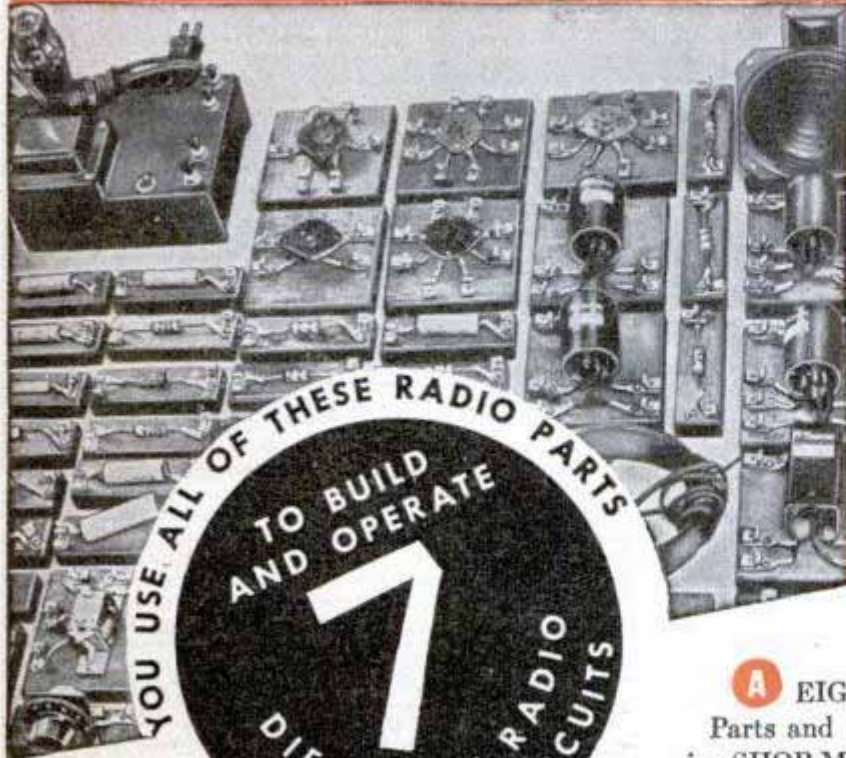

YOU USE ALL OF THESE RADIO PARTS
TO BUILD AND OPERATE
7
DIFFERENT RADIO RECEIVING CIRCUITS

NO PREVIOUS RADIO OR ELECTRICAL EXPERIENCE NECESSARY

DeForest's Training, Inc. provides every major home study aid to help you learn Radio-Electronics rapidly and thoroughly . . . to give you the experience and confidence needed for a responsible, Good-Pay Job, or to Start a Business of Your Own! Here is a REAL opportunity field for YOU . . . when you are a trained Radio-Electronics man! Just think of the tremendously exciting future ahead of FM Radio, Aviation and Broadcast Radio, Sound Motion Picture Equipment, Servicing and Sales of Radio Equipment, etc. Put yourself in this picture . . . See how you can benefit from a PRACTICAL training in this fascinating work! Think, too, of the coming possibilities ahead of Radar, Facsimile and Television. Send TODAY for the interesting, opportunity-revealing book, "Victory for You!" See how others probably no more talented or ambitious than you, have advanced in earning power after this training . . . how YOU can do it too! Mail the coupon NOW!

INCLUDING:

1. Simple Receiver
2. Two Tube Receiver
3. Tuned Radio-Frequency Receiver
4. Short Wave Receiver
5. Aviation Band Receiver
6. 4-Tube Superheterodyne
7. 5-Tube Superheterodyne with Magic Tuning Eye

... PLUS SCORES OF OTHER FASCINATING, INSTRUCTIVE RADIO-ELECTRONIC EXPERIMENTS

WITH THE HELP OF

A EIGHT Big Kits of Actual "Learn-by-Doing" Radio Parts and Assemblies with which you make 133 fascinating SHOP METHOD EXPERIMENTS in your own home! Imagine building 7 different Radio Receivers that operate!

B A 16 mm Home Movie Projector and Twelve Reels of "Learn-by-Seeing" Home Movie Films . . . for picture-clear, fast understanding of Radio Fundamentals!

C Modern, well-illustrated, Loose-leaf Lessons, prepared in clear, simple, understandable language . . . to guide you throughout your training!

THEN GET THE HELP OF OUR EFFECTIVE EMPLOYMENT SERVICE

16 MM MOVIE PROJECTOR YOU USE "LEARN-BY-SEEING" MOVIES



VETERANS!

Big things are happening at DeForest's Training, Inc. for veterans! See how you can prepare yourself WITHOUT COST for a GOOD JOB or a BUSINESS OF YOUR OWN in the vast Radio-Electronic opportunity field.

DEFOREST'S TRAINING, INC. INCLUDES INSTRUCTION IN MOTION PICTURE SOUND EQUIPMENT, FM RADIO AND TELEVISION . . . RESIDENTIAL TRAINING IN OUR MODERN CHICAGO LABORATORIES ALSO AVAILABLE—ASK US FOR INFORMATION!

DeFOREST'S TRAINING, INC.
CHICAGO 14, ILLINOIS



E. B. DEVRY, President
DeFOREST'S TRAINING, INC.
2535-41 North Ashland Ave., Dept. PM-D11
Chicago 14, Illinois, U.S.A.

Send FREE "VICTORY FOR YOU!" BOOK, showing how I may make my start in Radio Electronics.

Name _____ Age _____

Address _____ Apt. _____

City _____ Zone _____ State _____

If under 16, check here for special information.

If a discharged Veteran of World War II, check here.

WARNING! New rates go into effect on policies issued after December 31st. ACT NOW!

\$2000
of Old Line Legal Reserve
LIFE INSURANCE
(at age 21) \$ **78** A MONTH*
ONLY — Other ages in proportion
*One Half Permanent Rate in effect 5th year

Buy as little as \$1500. of this solid protection—or more—at proportionately low rates. But buy your Postal Policy now!

Postal Life of New York has specialized for 40 years in insurance by mail and over the counter. The savings due to this direct dealing are passed on to policy holders. Current dividends 9½%. Further savings are made if premiums are paid quarterly, semi-annually or annually.

POSTAL LIFE OF NEW YORK
operates under the rigid New York State Insurance Laws and has paid out over
\$60,000,000.00

to its Policy Holders and Beneficiaries. Postal issues all Standard Policies to men or women, from ages 10-60, at low cost. Send coupon today for rates on this Modified "4" Policy at your age and other details. *Life Insurance is vital!* CLIP AND MAIL COUPON TODAY

POSTAL LIFE INSURANCE COMPANY
511 Fifth Ave., Dept. M-739
New York 17, N. Y.
Mail me without obligation complete information about your low-cost Modified "4" Policy at my age.

Name

Date of Birth.....

Occupation

Address

(Street and No., Zone, City and State)

ANALYZE HANDWRITING

Qualify for Certified Grapho Analyst Degree at home, spare time. Credit, Employment, Personnel Managers, Business, Professional men, women use **grapho-analysis in their work, earn substantial fees in spare time.** Many study solely for personal benefit, no desire to earn money, find it so fascinating they start using it to add to their incomes. Entertainment field pays well, up to \$100 in a week reported. Others establishing profitable practices as Vocational and Family Problem Counselors, Personality Teachers, and lecturers.

GROWING—UNCROWDED PROFESSION

More and more police use grapho analysis handling suspects and criminals. They understand how criminals think. Their handwriting tells. Men like Hugh Dunlap, university student, Harry Allen, retired preacher, use it in court, win cases, earn fees even before graduation. **Only school in world devoted to teaching grapho analysis** offers thorough training to earnest, ambitious men and women regardless of where you live, small town, farm or city. Send for **GRAPHO ANALYST**, illustrated lesson, personal handwriting analysis offer, **ALL FREE.** Must be 21 or over. Address **A. I. G. A. Inc., 120, Noel, Missouri.**



Learn RADIO TELEVISION ELECTRONICS

Train at home, in spare time, for a good pay job or start a business of your own *without capital*—under our *proven 2-Way* method that helps you get into this money-making field of radio *quicker.* You receive Lessons *plus* Home Shop Practice including 9 kits of radio parts to make hundreds of tests. Many students earn money in spare time while learning. Write for **FREE** book "Your Opportunities in Radio" to Hollywood Radio & Television Institute, (Established 1929), Dept. A-11, 810 W. 6th St., Los Angeles 14, Calif.

LEARN MOVIE PROJECTION THEATRE MANAGEMENT

The Motion Picture Theatre Business offers big opportunities for trained men. Get into a fascinating field with a promising future. Train at home in spare time. Free Catalog. Established 20 years.

THEATRE SCHOOL, 370 Washington St., Elmira, New York

SEND FOR THIS FREE!

Make money. Know how to break and train horses. Write today for this book **FREE**, together with special offer of a course in Animal Breeding. If you are interested in Galting and Riding the saddle horse, check here () Do it today—now.

BEERY SCHOOL OF HORSEMANSHIP
Dept. 11011-D Pleasant Hill, Ohio



Creative Psychology

Transformation through the renewing of the mind. "All things are possible to him that believes." Send for **FREE** booklet.

MENTICULTURE Box 832-F Chicago 90, Ill.

Learn to Write

Begin today. Write now for our Free Book, "How to Become a Good Penman." It contains specimens and tells how others learned to write in spare time. Enclose 10c for your name beautifully written and a pen point suitable for shaded writing. Write today.

THE TAMBLYN SCHOOL OF PENMANSHIP
N-441 Ridge Building, Kansas City, Mo.

SAY YOU SAW IT IN POPULAR MECHANICS

BE A SIGN PAINTER!

Learn by **QUICK METHOD** to paint signs. My artistically true and practical **SYSTEM** is the result of **FORTY YEARS** of experience and study in nationwide display work. Write today—**NOW**—for particulars.

CAHANEY SIGN SYSTEM 1113 SOUTH 3RD ST. DENNISON, OHIO

STAMMER ?

This new 128-page book, "Stammering, Its Cause and Correction," describes the Bogue Unit Method for scientific correction of stammering and stuttering—successful for 46 years. **Benj. N. Bogue, Dept. 7804, Circle Tower, Indianapolis 4, Ind.**

GET THIS FREE BOOK!

LEARN WATCH and CLOCK REPAIRING

Start training now for a better paying job or your own profitable business. Qualified Watch Makers are in demand... Unlimited opportunities. Intensive practical training by experienced watch makers on American and Swiss time pieces. Write for full details.

SCIENTIFIC SCHOOL OF WATCH MAKING, Dept. PM-10
3923 San Fernando Road Glendale 4, Calif.



INDUSTRIAL TRAINING INSTITUTE

AMERICA'S FOREMOST SCHOOL OF *PRACTICAL* TRAINING

**WILL TRAIN YOU FOR A KEY JOB
OR A BUSINESS OF YOUR OWN IN**

REFRIGERATION AND AIR CONDITIONING

A FIELD OF OPPORTUNITY

Here is an industry that offers every opportunity you could ask for. Good jobs—security—plenty of chance for advancement—a business of your own.

And here is a school equipped in every way to train you for Refrigeration and Air Conditioning work—the largest and most completely equipped school of its kind in America—a school that already has trained thousands of men for just such opportunities.

GET READY FOR YOUR BIG CHANCE

Learn Refrigeration and Air Conditioning—now, while the time is ripe. You don't need any advanced schooling or previous experience. If you are at all mechanically inclined and have gone to high school for at least one year or have equivalent education, we can teach you Refrigeration and Air Conditioning. Everything is made simple, fascinating and easy to grasp.

GET THE FACTS **WRITE FOR** **TODAY**
FULL DETAILS

FACTS ABOUT THE INDUSTRIAL TRAINING INSTITUTE . . .

Founded in 1916. Has trained more than 400,000 men for practical work in industrial fields. From 1942 through 1945 trained specialized technicians, exclusively, for the Army, Navy, and Marine Corps. Now training thousands of veterans under the G. I. Bill, both in its Residence Schools and by home-study. Occupies five buildings of its own. Has over \$500,000 invested in training facilities, with an instruction staff of more than 100 men. Known everywhere as America's foremost school of practical training for industry.

**AUTHORIZED TO ACCEPT
VETERANS FOR G. I. TRAINING**



**REGISTRAR, P1L
INDUSTRIAL TRAINING INSTITUTE,
2150 LAWRENCE AVE., CHICAGO 25, ILL.**

Please send me, FREE, your "Camera Visit" booklet and information about the opportunities for trained men in Refrigeration and Air Conditioning. It is understood that I will be under no obligation.

NAME.....

ADDRESS.....

CITY.....STATE.....

ARE YOU A VETERAN:.....

Keep that "TICKING" Car



Every operator and mechanic needs AUDELS AUTO GUIDE.

This book saves time, money and worry. Highly endorsed. It presents the whole subject of auto mechanics:

- 1—Basic principles
 - 2—Construction
 - 3—Operation
 - 4—Service
 - 5—Repair
- Handy Size. Easily understood.

NEW FLUID DRIVE, HYDRAULIC SHIFT AND DIESEL ENGINES FULLY COVERED

Over 1500 pages—1540 illustrations showing inside views of modern cars, trucks and buses with instructions for all service jobs.

ASK TO SEE IT!—To Get This Assistance for Yourself Simply Fill in and Mail Coupon Today.

4 COMPLETE • PAY ONLY \$1. A MONTH ←

AUDEL Publishers, 49 West 23rd St., New York
MAIL AUDELS NEW AUTO GUIDE for free examination. If O.K. I will send you \$1 in 7 days; then remit \$1 monthly until price of \$4 is paid. Otherwise I will return it.

Name.....

Address.....

Occupation.....

Employed by..... PM

8 BIG BUILDING BOOKS

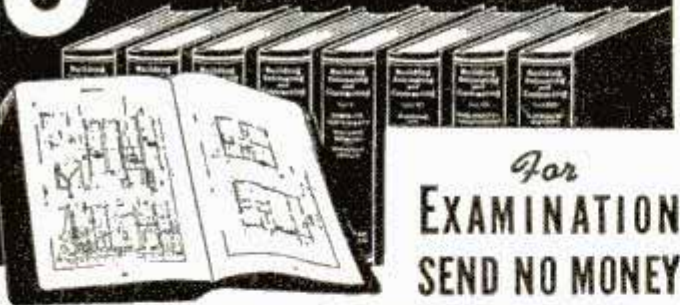

Learn to draw plans, estimate, be a live-wire builder, do remodeling, take contracting jobs. These 8 practical, profusely illustrated books cover subjects that will help you to get more work and make more money. Architectural design and drawing, estimating, steel square, roof framing, construction, painting and decorating, heating, air-conditioning, concrete forms and many other subjects are included.

BETTER JOBS — BETTER PAY

The postwar building boom is in full swing and trained men are needed. Big opportunities are always for MEN WHO KNOW HOW. These books supply quick, easily understood training and handy, permanent reference information that helps solve building problems.

UP-TO-DATE EDITION

These books are the most up-to-date and complete we have ever published on these many subjects.

Coupon Brings Eight Big Books for Examination

AMERICAN TECHNICAL SOCIETY Vocational Publishers since 1898
Dept. G819 Drexel at 58th Street Chicago 37, Ill.

You may ship me the Up-to-Date edition of your eight big books, "Building, Estimating, and Contracting," without any obligation to buy. I will pay the delivery charges only, and if fully satisfied in ten days, I will send you \$2.00, and after that only \$3.00 a month, until the total price of only \$34.80 is paid, I am not obligated in any way unless I keep the books.

Name.....

Address.....

City..... State.....

Please attach a letter stating your age, occupation, employer's name and address, and name and address of at least one business man as a reference. Men in service, also please give home address.

EARN BIG MONEY! METAL TRADES

Courses offered in:

- Machinist-Toolmaking
- Mechanical Drafting
- Tool and Die Designing & Engineering

Practical training in fully equipped shops and drafting rooms by accredited engineers and instructors. Established two decades. Approved for Veterans • Day and Evening Classes Free Employment Service • Dormitory Accommodations Call or write for Free Bulletin



ALLIED SCHOOL OF MECHANICAL TRADES

42 Allied Bldg., 1338 S. Michigan Ave., Harrison 3915, Chicago 5, Ill.

Have an OFFICE of YOUR OWN!

LEARN NEW PROFITABLE PROFESSION At Home in 60 Days, Men & Women, 18 to 70!

Be Your Own Boss and the Boss of Others. Be Respected. Meet Interesting People.

Earnings of men and women in this profession run as high as \$5,000-\$15,000 yearly. Others make good money in spare time. Little money needed to start. A business where your earnings begin sooner. Easy to learn. No selling or goods to buy. No experience necessary. A depression-proof business. A course of action to guide you step by step as you earn. All 53 lessons sent at once to use as operating manuals. Easy terms. Diploma. Money-back agreement. Write for FREE BULLETIN.



FRANKLIN CREDIT SCHOOL
Dept. 75-M ROANOKE 7, VIRGINIA

BY MAIL in Easy Lessons

ANY BOOK IN PRINT

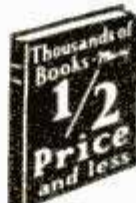

Delivered at your door. We pay postage. Standard authors, new books, popular editions, fiction, reference, medical, mechanical, children's books, etc. Guaranteed savings. Send for Clarkson's 1947 catalog.

FREE Write for our great illustrated book catalog. A short course in literature. The buying guide of 300,000 book lovers. The answer to your Christmas gift problem. Free if you write now—today!

CLARKSON PUBLISHING COMPANY
Dept. PM7, 1257 So. Wabash Ave., Chicago, Ill.

★ **FREE MEMBERSHIP** ★

★ **"STRONG MEN'S CLUB** ★

★ **OF AMERICA"** ★

Send for your personal Membership Card today! Enjoy strength secrets! No dues! No obligations! Send name, address and age on penny postcard.

STRONG MEN'S CLUB OF AMERICA
Joe Bonomo, Director Dept. 1311
1841 Broadway, New York 23, N. Y.

NOW YOU CAN GET ALL THE FAMOUS CORRESPONDENCE COURSES

And Educational Books BELOW COST

Send For FREE CATALOG — We Buy and Sell

Study at home. Realize your ambition for a big paying future in Trades, Professions, Industries, Arts & Sciences, etc., quickly and easily. NO TESTS required. New and used.

COLLEGIATE BOOK CORPORATION
233 W. 42 St., Dept. PM11, New York 18, N. Y.

SAY YOU SAW IT IN POPULAR MECHANICS

LEARN WATCH REPAIRING



AT HOME. By our modern and original system of instruction you can learn every part of the **WATCH REPAIRING TRADE AT HOME.** Prepare yourself for a well-paying position or start in business after completing our course of instruction. Good watch repairers are in demand and generally earn very good salaries. For particulars apply to the **Wisconsin School of Watch Repairing** 759 North Milwaukee St., Milwaukee 2, Wis.

GET INTO

RADIO

TELEVISION
ELECTRONICS
NOW!

Practical shop-type training gives you actual experience with Home Radio Equipment — part of



You build this complete, modern super-heterodyne receiver with the experimental equipment that comes with your National Training. You keep all apparatus sent you.

SHOP METHOD HOME TRAINING

FOR YOU—A REAL HOME LABORATORY IN MODERN RADIO

By National Schools of Los Angeles a Practical Technical Resident Trade School for over 40 years

A permanent faculty of experienced instructors and engineers stands behind all training from National Schools. These men are teaching every day right in our own Television and Broadcasting Studios, Service Shops and Laboratories. From first hand experience with students here at School, our instructors understand the aims and ambitions of men like you. All of our instructors, both home study and resident, have ideal facilities to make your training practical, up-to-the-minute and interesting.

and Electronics—in Aviation, Transportation, Manufacturing, Communications. Good jobs await the trained man, in the production, operation and maintenance of modern Electronic equipment—in Radio stations, in hundreds of industries—in homes, stores, theatres and studios.

Send For Facts Today

You owe it to yourself to investigate how National Schools will prepare you for a CAREER THAT WILL ASSURE YOUR SUCCESS AND SECURITY. Send for the FREE Manual. SEE FOR YOURSELF just how you may readily qualify for opportunities in Radio, Television and Electronics. Read the catalogue we will send you. Then, make up your own mind. For full information, without obligation, send your name and address on the coupon and mail it TODAY!

Fine Opportunities Ahead

Learn how National training can fit you in your spare time for the GREAT FIELD OF RADIO—for the NEW AND RAPIDLY EXPANDING BRANCHES — FREQUENCY MODULATION (F.M.), TELEVISION AND ELECTRONICS. You train right in your own home yet have the ADVANTAGE OF REAL SHOP EXPERIENCE behind you. The man who really knows modern Radio is in greater demand today than ever before—not only in Radio proper but in Television

GET THE DETAILS.
USE THE COUPON!



radio oscillator which you get by building it yourself.

Your National Training Kits include equipment for over a hundred practical electronic experiments in your own home. You get standard radio parts for this audio oscillator which you get to understand by building it yourself.

You learn modulation, beat frequencies, signal generation by actually building this small radio transmitter with your National shop parts.

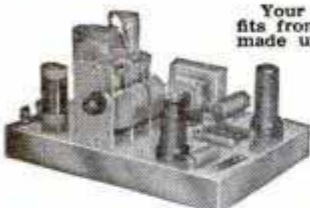
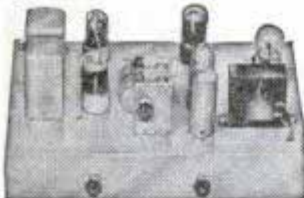

Get the details by mailing the coupon.

Your training outfits from National are made up of the most modern radio equipment—much of it just out of the experimental laboratory. You learn new ways of handling equipment by modern methods.



VETERANS

During the War, National trained enlisted men under contract with the War Department. Now, we are training veterans, both resident and home study. If you are a Veteran qualified for training under the G.I. Bill, check the coupon below for special bulletin.

Here's Just a Few of the Interesting Facts you Learn with the FREE MANUAL

1. Routine for diagnosing Radio Troubles.
2. Preliminary inspection of Receivers.
3. How to Test and Measure Voltages.
4. How to Test Speaker in Audio Stages.
5. How to Trace the Circuit and Prepare Skeleton Diagram.
6. Complete Reference Table for Quickly Locating Receiver Troubles.

FREE GET THESE
2
BIG BOOKS



G.I. APPROVED

NATIONAL SCHOOLS

LOS ANGELES 37, CALIFORNIA EST. 1905

MAIL OPPORTUNITY COUPON FOR QUICK ACTION

National Schools, Dept. 11-PM
4000 South Figueroa Street
Los Angeles 37, California

(Mail in envelope or paste on penny post card)

Mail me FREE the books mentioned in your ad including a sample lesson of your course. I understand no salesman will call on me.

NAME..... AGE.....

ADDRESS.....

CITY..... ZONE..... STATE.....

Check here if veteran of World War II

NATIONAL GRADUATES ARE SUCCESSFUL

NOW MANAGER OF SERVICE DEPARTMENT

"I am really proud to be a National Graduate—it has helped me to hold my present position. Now manager of service department for Valley Music Company. Times have changed since I enrolled for National Training I have an amateur Radio station to keep up on experiments in that field. W7HLP. Plus many, many sound installation problems, I have no time to call it 'spare time' anymore—thanks to National Schools." Dwight J. Albright, Medford, Oregon.

COLLEGE PROFESSOR APPRECIATES COURSE

"I want to take this opportunity to tell you how much I appreciate this Course. Since being here at the College I have been able to put the theory to very good use. I have installed a P.A. system in the students' dining hall; today I am purchasing the required equipment to install a similar system in the large assembly hall; and at all of the large meetings held so far I have been assigned the task of setting up the portable P.A. system. I have also repaired several Radios for the boys and the professors, including car Radios. So once again, thanks for a fine Course. I am looking forward to the rest of the training with pleasure. Brother V. Benedict, Saint Mary's College, Calif.

Do you want

→ ..to go to College?

→ ..or to enter a Profession?

(Such as Accounting, Architecture, Nursing, Dentistry; Teaching, Social Work, Osteopathy, Beauty Culture, Optometry, Embalming, Chiropody, Law, Medicine, etc.)

→ ..or get an Office Position?

To get anywhere, you practically **MUST** finish High School **FIRST**. You can complete our simplified High School Course in **SPARE** time at home, as **FAST** as your time and abilities permit. Equivalent to resident school work—prepares you for college, pre-professional examinations, business, industry. Standard texts furnished. Diploma. Credit for H. S. subjects already completed. Single subjects if desired. Low tuition, easy terms. American School, Chicago, est. 1897—endorsed by educators. Finish your high school education **NOW**. Write **TODAY!**

High School Course at Home

Many Finish in 2 Years

American School, Dept. H845, Drexel Ave. at 58th St., Chicago 37, Ill.

Gentlemen: Send me **FREE** information covering special training in subjects checked below. No obligation on my part.

- | | |
|--|--|
| <input type="checkbox"/> High School Course | <input type="checkbox"/> Diesel Engineering |
| <input type="checkbox"/> Architecture and Building | <input type="checkbox"/> Drafting and Design for Men & Women |
| <input type="checkbox"/> Automotive Engineering | <input type="checkbox"/> Plastics |
| <input type="checkbox"/> Business Management | <input type="checkbox"/> Private Secretary |
| <input type="checkbox"/> Electrical Engineering | <input type="checkbox"/> Mechanical Engineering |
| <input type="checkbox"/> Elec. and Gas Refrigeration | <input type="checkbox"/> Aviation |
| <input type="checkbox"/> Air Conditioning | <input type="checkbox"/> Salesmanship |
| <input type="checkbox"/> Railway Training | <input type="checkbox"/> Radio |
| <input type="checkbox"/> Electronics, Industrial | |

Name.....

Address.....

AVIATION Career

MAXIMUM TRAINING IN MINIMUM TIME

CAL-AERO TECH TRAINING will add dollars to your pay check all the rest of your life. Specializing in **AERONAUTICAL ENGINEERING** and **MASTER AVIATION MECHANICS** since 1929, Cal-Aero Tech training is carefully designed for just one thing—**TO MAKE MORE MONEY FOR YOU**. An alumni of over 6000 successful graduates proves our career training is unsurpassed.

VETERANS —Write us about Aviation Training, as provided under "G.I. Bill of Rights."



CAL-AERO TECHNICAL INSTITUTE
 MAJOR C. C. MOSELEY PRES. SINCE 1929
 FORMERLY CURTIS SWINIGNE TECHNICAL INSTITUTE

GRAND CENTRAL AIR TERMINAL
 GLENDALE 1, CALIFORNIA
 LOS ANGELES COUNTY

MAIL THIS COUPON TODAY!

Cal-Aero Technical Institute, Grand Central Airport, Glendale 1, California
 Please send full information on Aviation Training **FREE**—without obligation. Dept. PM-11

Name..... Birth Date.....
 Street.....
 City..... State.....

"YOU ARE UNDER ARREST!"

There's a Thrill in Bringing a Crook to Justice Through Scientific



CRIME DETECTION!

We have taught thousands this exciting, profitable, pleasant profession. Let us teach you, too, in your **own home**. Learn Finger Printing, Fire Arms Identification, Police Photography and Criminal Investigation thoroughly, quickly and at small cost.

Be A **FINGER PRINT Expert**

Over 800 of All American Bureaus of Identification employ students or graduates of I. A. S. You, too, can fit yourself to fill a responsible crime detection job with good pay and steady employment. But don't delay—get the details now. Let us show you how easily and completely we can prepare you for this fascinating work, during spare time, in your own home. You may pay as you learn. Write today . . . Now . . . Be sure to state age.

FREE!!!
 Send for Thrilling "BLUE BOOK OF CRIME"

INSTITUTE OF APPLIED SCIENCE
 1920 Sunnyside Ave., Dept. 1358, Chicago 40, Ill.

SUCCEED IN THE POULTRY BUSINESS!



You can make a good, comfortable living with poultry. For 26 years our course of Home Study training has been helping thousands. With a little study in spare time—you, too, can obtain the "know how" that means extra profits from the start.

Write today for prospectus describing courses, methods, service.

NATIONAL POULTRY INSTITUTE

Dept. 50

Adams Center, N. Y.



DENTAL TECHNICIANS

Nationwide openings for trained men. Learn by simple home study—with theory and actual practice as a guide. **EASY STEP-BY-STEP TECHNIQUE**

for information write to DEPT. PM-1

DENTAL ARTS INSTITUTE
 1122 MARKET STREET, SAN FRANCISCO 2, CALIF.

CODE SPEED SHORT CUT

Be an expert. Learn to be a Telegraph or Radio Operator. Thousands of men needed. Intensely interesting work—good pay. Learn at home or wherever you are, quickly, easily with the famous Candler Speed System. Book of particulars **Free**. **CANDLER SYSTEM CO.**, Dept. 5-M, Box 928, Denver 1, Colo., U.S.A.

THERE'S MONEY IN CARTOONS!

RAYE BURNS will teach you **HOW** to **CREATE ORIGINAL CARTOONS** at home that you may **SELL!** Course contains **26 lessons** and **over 600 illustrations**. All for **Only... \$2.85**

Send name and address for free details.

RAYE BURNS SCHOOL, Dept. M, Box 3583, CLEVELAND, OHIO

LAW

STUDY AT HOME for **PERSONAL SUCCESS** and **LARGER EARNINGS**. 39 years expert instruction—over 108,000 students enrolled. **LL.B.** Degree awarded. All texts furnished. Easy payments. Send for **FREE BOOK**. **G. I.** approved. **AMERICAN EXTENSION SCHOOL OF LAW**
 Dept. 83-M, 646 N. Michigan Ave., Chicago 11, Ill.

FREE—Big illustrated broadside. Shows 5' Parachute Jump, other action models built with Erector. Gilbert Chemistry sets. Other Gilbert Scientific Toys.

A. C. GILBERT CO., 311 Erector Square, New Haven, Conn.

NEW HELP FOR RUPTURE

is the amazing Treatise which explains simple, inexpensive, easy, proven way for curbing your rupture, right at home. This proven way has helped many rupture sufferers quickly. So don't let your rupture get worse. Send for **FREE** details today. Mailed to you in plain, sealed envelope. No obligation.

BRADNER PUBLISHING CO. (Established 1933)
 Dept. H, Dixon, Ill.

Learn **RADIO**

IN A FEW SHORT WEEKS

IN THE GREAT SHOPS OF COYNE

48 Years of Successful Training

Work on Actual Radio, Sound, Television Equipment! Expert Instructors Train You by Famous **COYNE SHOP METHOD**

Get ready quickly for YOUR FUTURE. Big opportunities are waiting for properly trained men in Radio Manufacturing, Radio Sales and Service, Television, Sound, Public Address. With COYNE "All Around" Training, many branches of Radio are open to you.

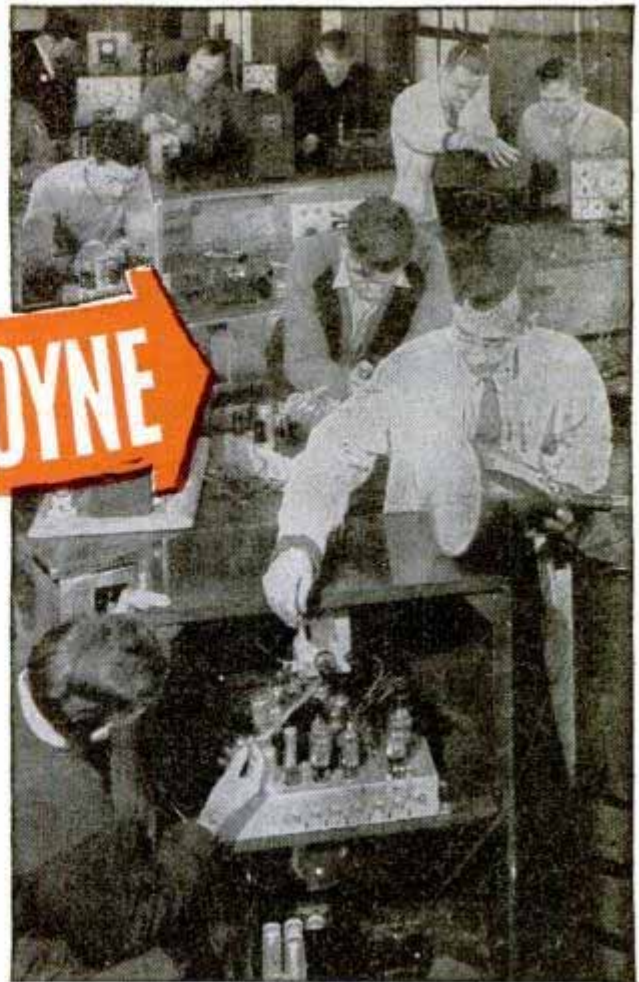

B. W. COOKE

NOT A "HOME-STUDY" COURSE

Learn Radio Fast!

As a Coyne student you work on real equipment in our great shops in Chicago — the Radio Center of the World. We do not teach by mail. All Coyne training is given right here in our big Shops in Chicago. You make rapid progress at Coyne because it's a shop course.

COYNE GRADUATES IN DEMAND

Whether you have had any actual Radio experience or not, we can train you in a few weeks for a better job, steady work and a real future in the Radio field.

First we train you for a good Radio job, then help you get it. Coyne graduates may use our **Lifetime Employment Service** as often as they wish.

Easy to Start Own Shop

If your ambition is to be your own boss, COYNE makes it easy! We include special training in how to start your own Radio Shop, how to get business, keep records, etc., right along with our course. Then we have Free Merchandising Service for graduates to solve many problems.

SEND FOR BIG FREE BOOK!

Our new, fully illustrated Coyne Radio Book tells all about our great Chicago shops and our plans to help you. Packed with facts and pictures. No salesman will call. No obligation.

We'll Finance Your Training

Non-veterans who are short of cash can finance most of their tuition and pay it in easy monthly payments after graduation. You may earn while learning, to help defray living expenses. COYNE works with you to enable you to get the training you need.

VETERANS!

Coyne is authorized to train those who qualify under the G. I. Bill of Rights.

Physical Disabilities

Men with physical disabilities may qualify for training at no cost for tuition and subsistence. Coupon brings details.



ADDED TRAINING

ELECTRIC REFRIGERATION

This valuable training now included with our Radio course.

B. W. COOKE, President, Radio Division

COYNE ELECTRICAL SCHOOL
500 S. Paulina Street
Dept. 87-3H
Chicago 12, Ill.
ESTABLISHED 1899



**B. W. COOKE, Pres., Radio Div.,
COYNE ELECTRICAL SCHOOL
500 S. Paulina St., Dept. 87-3H, Chicago 12, Ill.**

Dear Mr. Cooke: Send me your Big Free Radio Book and all the facts . . . also full details of your "Student Finance" plan.

NAME.....

ADDRESS.....

CITY..... STATE.....

MAIL FOR BIG Free BOOK

"I MADE THE GRADE... THANKS TO N.Y.I."

Says James H. Sparks, Lenoir, North Carolina

Hundreds of New York Institute Home Study graduates write to tell us, "I made the grade, thanks to N.Y.I." Our files bulge with success stories written by ambitious men and women who used part of their spare time to study photography right in their own homes while continuing the job they were doing. You too can find rich rewards and real fun in photography.



The N.Y.I. Home Study Course is crammed with facts presented in clear, beautifully illustrated, easy to understand form. Every late development in this fascinating field is covered. You need no expensive equipment or previous experience. You will be amazed at the many opportunities to make money in photography even while you are learning.

The N.Y.I. Home Study Course is prepared by ace photographers who give you constant, helpful criticism of your work. Our 38 years of teaching experience assures you a speedy road to professional perfection.

FREE! Send today for our colorful book showing all aspects of photography—glamour, action, pets, children, movie-making, color photography, theatrical shots, news, commercial. **IT'S FREE!**

Resident training is available under the G.I. Bill.

NEW YORK INSTITUTE OF PHOTOGRAPHY Leadership Since 1910

New York Institute of Photography
Dept. 49, 10 West 33 Street
New York City 1, N. Y.

Please send me your beautiful four-color catalog illustrating all the different phases of photography and describing N.Y.I. Home Study Course.

38th YEAR

Name _____ (Please Print)
Address _____
City _____ Zone _____ State _____

OIL BURNER INFORMATION IN A HANDY FORM

JUST OUT!



AUDELS OIL BURNER GUIDE
— A new practical, concise treatise, 384 pages—31 Chapters — 321 Diagrams and Illustrations — covering Domestic and Industrial Oil Burners.

New from Cover to Cover, for mechanics interested in Oil Burners. Gives practical inside working knowledge of theory, construction, installation, operation, testing, servicing and repair of all types of oil burners. Includes electrical hook-ups and wiring diagrams of automatic control systems.

PRICE \$1 POSTPAID
Get this information for yourself. Mail coupon today. No obligation unless satisfied.
ASK TO SEE IT

A POCKET COMPANION THAT ANSWERS YOUR QUESTIONS!

AUDEL, Publishers, 49 W. 23rd St., New York 10, N.Y.
Please mail AUDELS OIL BURNER GUIDE (Price \$1). If satisfactory, I will remit \$1 on its safe arrival, otherwise I will return the book.

Name _____
Address _____
Occupation _____
Employed by _____ PM

HOBBY CATALOG

NEW, BIG COLLECTION OF MATERIALS



Get this catalog for your shop. It lists and shows a wide variety of tools and materials—some hard-to-get items in addition to a big 20 page section on books and project information. A gold mine of practical help. Shows how we test and approve all materials and tools in our own shop before we offer them to you—your assurance that they are tops in quality—everything fully guaranteed or your money refunded. Hurry to get this catalog, save money with our new Book Dividend Plan. Send 25c today—do it now, to

JACKSON STUDIO, Dept. 37, 5440 N. Shoreland Ave., Milwaukee 11, Wis.

HORSE MASTERY!

A FINE HOBBY — A GREAT VOCATION!

"The EXPERT HORSEMAN"

SUBSCRIBE TODAY 50¢
One Year



FREE BOOK — Tells how You can learn to: BREAK COLTS, GAIT SHOW HORSES, TRAIN RODEO, STOCK and RACE HORSES, BREAK BAD HABITS, HANDLE ANY HORSE, TRAIN CIRCUS TRICK HORSES. WRITE TODAY!

ANIMAL LOVERS ASSOCIATION
BOX KA-111 TARZANA, CALIFORNIA

ONE-MAN SAWMILL LESS THAN \$200.00

Easy To Turn Trees Into Money

Makes lumber, ties, shingles, crates, lath, studding, siding.



Belsaw Models in 10 to 24 foot sawing lengths. **MECHANICAL FEED**, accurate set works and positive dogs. Use tractor or old auto engine for low cost power.

Thousands used for commercial sawing. Pays for itself quickly. Send post card today for FREE booklet, "How To Make Lumber" and Catalog of Woodworking Equipment. **BELSAW MACHINERY CO., 28117 Field Bldg., 315 Westport Road Kansas City 2, Mo.**



RAISE CHIN-CHINS

No experience needed. Just a few minutes daily and a few feet of backyard, garage or barn space. Several females and a male starts a large, profitable herd. WE FURNISH FREE INSTRUCTIONS. TREMENDOUS DEMAND for breeding and laboratory stock, meat, and world's most beautiful rabbit fur. Brokers, cut off from imported rabbit pelts by world famine. **NEED CHIN-CHIN FURS NOW, and for years to come! Write for free illustrated catalog today.**

WILLOW BROOK FARM • R-36, SELLERSVILLE, PENNA.

FIBRE ARMS AND LEGS!

Light, correctly fitted, strong and comfortable. Natural appearance. Braces for all deformities. Scientific design. Fair Terms.

BUCHSTEIN-MEDCALF 223 S. 6th St., Minneapolis, Minn.

Please Mention Popular Mechanics When Answering Ads

Is Your Rupture HERE?

Why continue to suffer with an uncomfortable truss if we can help you? Relief **GUARANTEED** or it costs you nothing. Send for the facts about my perfected truss invention—the Brooks Appliance for reducible rupture—with the patented **AIR-CUSHION** support that works silently with **Nature** to give protection. Thousands bought by doctors.

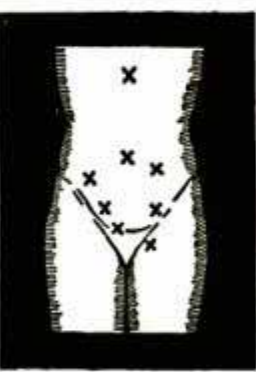

Sent on Trial—Made-to-measure, individual fitting for man, woman or child. Low-priced, sanitary, durable. No obnoxious springs or hard pads; no metal girdle to rust. Light weight, neat and comfortable. Not sold through stores or agents—beware of imitations. Write today for full information sent free in plain sealed envelope.

BROOKS APPLIANCE CO. 161 State St. Marshall, Mich.

Now While these Great Industries Go Forward

AIM HIGH — PICK ONE OF THESE BIG FIELDS

- REFRIGERATION AND AIR CONDITIONING
- AUTOMOTIVE MECHANICS
- BODY, FENDER REBUILDING
- ELECTRICITY ● RADIO
- BUILDING
- DIESEL

Make Your Decision

For a Better Job
or a
BUSINESS of YOUR OWN
NOW'S the TIME

INDUSTRY is rapidly making up for lost time. There may never again be such opportunities for men who want better jobs or business of their own to get in on ground floor and go up fast! Yes — **FOR MEN WHO ACT FAST, THINGS CAN HAPPEN FAST!**

**YOU CAN'T AFFORD to WAIT
YOUR FUTURE DEPENDS
on WHAT YOU DO TODAY.**

A Few Short Weeks Can Make All the Difference

COMMERCIAL TRADES INSTITUTE was only civilian school selected by Army to train service men for refrigeration. In motive trades our institute gained nation wide fame training Auto Mechanics for U.S. Army. Same quality training available to you now. If over 17 and under 60 learn how you can get started. **CONSULTATION AND PLACEMENT SERVICE WHETHER YOU ARE INTERESTED IN WORTHWHILE JOB OR SETTING UP YOUR OWN BUSINESS.**

TRAIN AT HOME
IN SPARE TIME OR IN OUR
WELL EQUIPPED SHOPS



REFRIGERATION and AIR CONDITIONING

Trained men paid well to service, install, maintain, repair, rebuild household and commercial refrigerators. Important new developments such as Frozen Foods, and many new industrial uses. Opportunities for full time, spare time earnings. Begin training at home in spare time, finish in our big modern shops, or come directly to shops.

At home you get C.T.I.'s **SHOP PROVED HOME STUDY** instruction—actual shop experience has gone into the practical lesson assignments. That is why it is easy for mechanically inclined men to learn by our Home-Study training, and start on actual refrigeration work.

AUTOMOTIVE MECHANICS • BODY & FENDER REBUILDING

Progress rapid by our learn-by-doing **SUPERVISED SHOP TRAINING**. Efficient auto mechanics get excellent pay. Learn to overhaul and repair engines, transmissions, differentials and other assemblies.

Body and Fender Rebuilding offers profitable work. Get good, practical "all-around" training—welding, aligning, mixing and matching colors, spray painting, power and hand tools. Values increased when used cars are made to "look like new."

RADIO SERVICING

Vastly increased number of radio receivers, development of FM broadcasting, installation of public address systems, demand services of trained men who can repair receiving sets, install p.a. equipment. Men who can quickly, efficiently service receiving sets earn good pay, have excellent opportunities to start own business. Get practical training in the big C.T.I. shops. Learn Radio Servicing — pay is good!

ELECTRICITY ELECTRICAL SERVICING

Get ready for good job or business of your own. Electricity is the heart of modern industry. Electricians always needed, earn higher pay, work year around. Make rapid progress in step-by-step practical shop training in Electrical Wiring and Circuits; Armature Winding; Electrical Appliance Repairs; Electro Plating and Welding. Rural Electrification, the Building Boom, many new uses of Electricity opening more opportunities in this vast field. Get training under thoroughly experienced instructors, be ready in few short weeks for Job Opportunities in Electricity.

DIESEL

Diesel engines are used to power entire fleets of trucks and buses, to drive tractors and other farm equipment. Diesels have revolutionized the railroads, are employed for passenger and freight trains as well as for switching engines. They are used to power road equipment, and even are being tested for airplanes and passenger cars. A big field that promises even bigger things in the years right ahead. Modern shop training on actual equipment under experienced instructors. Learn Diesel under direction of men who trained Diesel mechanics for U. S. Army.

BUILDING CONSTRUCTION

Do you want to be on the inside in the building boom — where big money is made? Learn about opportunities for building contractors whether or not you have previous experience in this field. Millions of dollars are going to be made in home and farm buildings, in construction of stores, garages, small industrial buildings. Building industry uses men by thousands in construction, supervision, management, sales.

COMMERCIAL TRADES INSTITUTE, Dept. E211
1400 GREENLEAF AVENUE CHICAGO 26, ILLINOIS

FILL OUT • CUT OUT • MAIL TODAY!

FACTS FREE FOR MEN WHO WANT TO GET AHEAD

COMMERCIAL TRADES INSTITUTE, Dept. E211
1400 W. Greenleaf, Chicago 26, Ill.

Send free illustrated Brochures and other information about the field I have checked below.

- | | |
|---|---|
| <input type="checkbox"/> Refrigeration and Air Conditioning | <input type="checkbox"/> Automotive Mechanics |
| <input type="checkbox"/> Electricity | <input type="checkbox"/> Diesel Mechanics |
| <input type="checkbox"/> Radio Servicing | <input type="checkbox"/> Body & Fender Rebuilding |
| | <input type="checkbox"/> Building Construction |

Name _____

Address _____

City _____ State _____

Veteran Non-Veteran

HOME OF
C.T.I.



VETERANS —

Veterans qualifying under "G.I. Bill" have tuition paid by Government plus monthly subsistence allowance while in school. Just mail coupon, we will handle all details. **(LOW TUITION, EASY TERMS if you are not a veteran.)**

YOUR OPPORTUNITY IN WATCHMAKING 4 CAREER FIELDS

Here is a career field which offers opportunity at every "tick" of a watch or a clock. Millions of watches and clocks need fixing—millions more will continue to need repairs. Here is an interesting, top-bracket opportunity to start an independent business of your own, or work for good pay in a factory, repair shop or store. AMERICAN SCHOOL OF WATCHMAKING has trained many men who are now making good. At A. S. W. you get proven, practical training under QUALIFIED, patient instructors who delight in the success of their students and graduates. MAIL THE COUPON BELOW for illustrated booklet. It is FREE — and will give you a fine picture of our complete facilities.

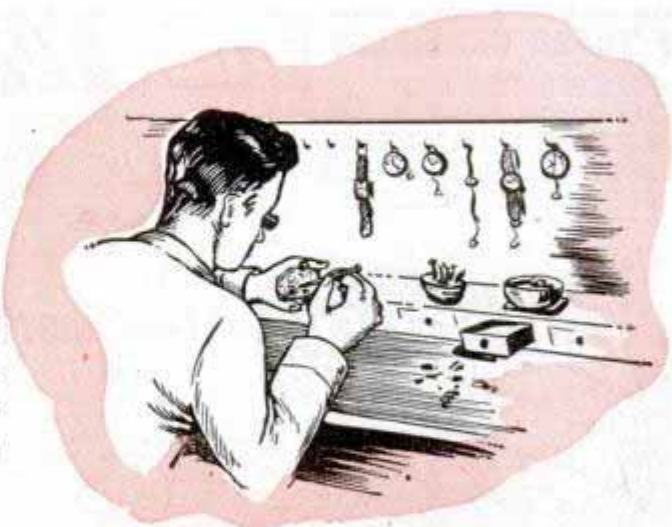

APPROVED FOR VETERANS

American School of Watchmaking
Dept. PM 4-11-7, 5145 W. San Fernando Rd.
Los Angeles 26, Calif.
Gentlemen: Please send me free booklet and information on your training.

Name (Print) _____
Street _____ Age _____
City _____ Zone _____ State _____
Veteran _____ Non-Veteran _____

STUDY IN LOS ANGELES, CALIFORNIA

Enroll at American School of Watchmaking and study in Southern California, the glamor spot of the country. Beach and mountains, Catalina and Hollywood, the Hollywood Bowl and the Rose Bowl—yes, indeed, here is much to interest the student in off hours and over weekends. DECIDE NOW to investigate the field of Watchmaking for your future.

TECHNICAL



TRAINING

YOUR OPPORTUNITY — — — As AN Aircraft

Do you like Aviation? Do you like airplanes? Do you like to take things apart and see what makes them tick? THEN YOU WILL LIKE AIRCRAFT INSTRUMENTS. Here is a vital part of the great aviation industry—and necessary part. As long as planes fly there must be trained men to service, repair, and maintain the instruments that make flight possible. AMERICAN SCHOOLS OF AIRCRAFT INSTRUMENTS teaches men to perform this important, interesting and well-paid work.

INSTRUMENT TECHNICIAN

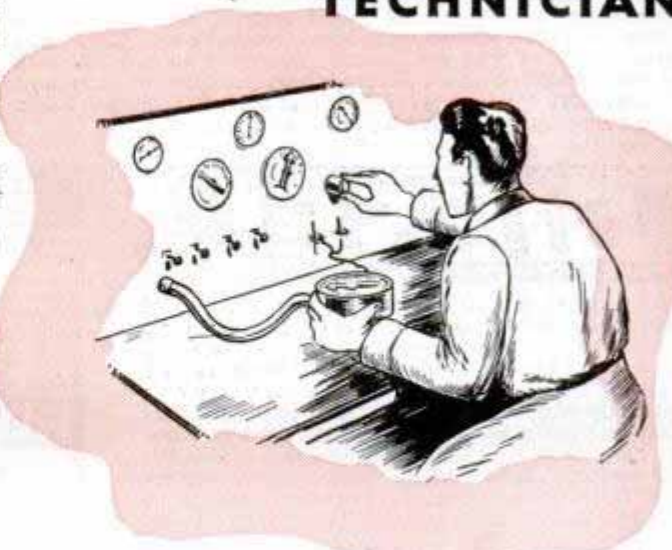

DO YOU WANT A SPECIALIZED CAREER IN AVIATION? Then be an Aircraft Instrument Technician and get your training NOW. 34 Weeks intensive course. Hundreds of A.S.A.I. graduates employed in the industry or have own business. Mail coupon below TODAY for free booklet and complete information.

APPROVED FOR VETERANS

American Schools of Aircraft Instruments
Dept. PM 4-11-7, 5145 W. San Fernando Rd.
Los Angeles 26, Calif.
Gentlemen: Please send me FREE and WITHOUT OBLIGATION, illustrated booklet describing Aircraft Instrument field.

Name (Print) _____
Street _____ Age _____
City _____ Zone _____ State _____
Veteran _____ Non-Veteran _____

INSTRUMENT TRAINING VALUABLE

A sound training in Aircraft Instruments is also applicable to many industrial fields. Many large, important industries use delicate instruments at some point in their operation — and trained instrument men are needed to install, service and maintain them. Here, then is further opportunity for you as an Expert Instrument Technician.

... CHOOSE YOURS

YOUR OPPORTUNITY IN PLASTICS

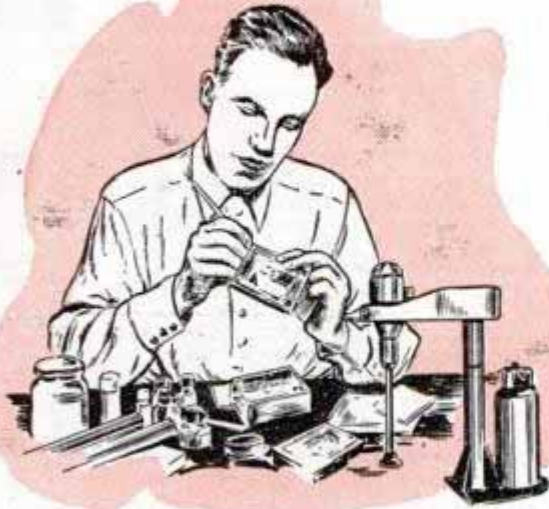

LEARN BY DOING

You get practical experience making useful, attractive articles from plastic materials which we supply. Many students have earned extra money selling articles of their own manufacture.

Consider the growing, important field of Plastics for your future. Many have compared the Plastics Industry with the Radio and the Automobile industries before their great and rapid growth. Today such a comparison seems warranted because more products are being manufactured from various types of plastic materials than ever before—requiring **TRAINED MEN** to develop, design, and fabricate them. Mail the coupon below for complete information and free literature which show, in actual photographs, the many uses of plastics and what trained men must know to get the better paying positions in this field. This literature tells you about Plastics Institute, the oldest and largest exclusively plastics training school in the United States. Read what graduates say about Plastics Institute training and the progress they have made since graduating.

LEARN BY MAIL OR COME TO CALIFORNIA (IMMEDIATE ENROLLMENT)

You can study at home, in your spare time, without interfering with your present employment — or, if you prefer, you can attend Plastics Institute's large, modern school in Los Angeles, the city that "has everything." Please check the coupon to indicate your choice and **MAIL TODAY.**

APPROVED FOR VETERANS

Plastics Industries Technical Institute
Dept. PM 4-11-7, 1601 S. Western Ave., Los Angeles 6, Calif.
Gentlemen: Please send me free literature and information on your practical courses. I am interested in Home Training attending school in Los Angeles .

Name (Print) _____
Street _____ Age _____
City _____ Zone _____ State _____
I am a Veteran _____ Non-Veteran _____

FOR



SUCCESS

YOUR OPPORTUNITY

IN Diesel

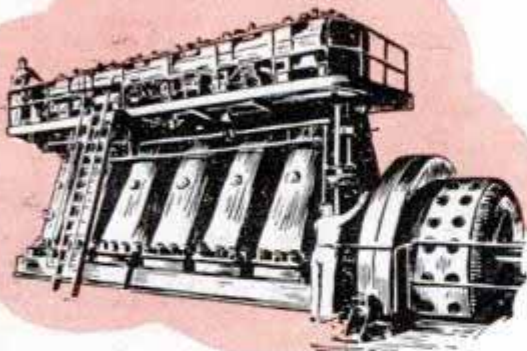

YOU can "go places" in Diesel because Diesel Power is being used more widely than ever before. From tiny Diesel engines in model planes to giant Diesels in locomotives, power generating plants, ships, trucks, drilling rigs, logging machinery and mines, construction machinery and farm equipment—it's Diesel! **DIESEL, DIESEL! PREPARE YOURSELF NOW FOR THIS GREAT SWING TO DIESEL.**

Learn Diesel the famous "Hemphill" way. This school is the oldest training school in the world specializing in Diesel. Graduates are successfully engaged in all branches of the Diesel industry, manufacture, installation, maintenance and operation. Why not take your place beside these Hemphill-trained men.

VETERANS and NON-VETERANS—Ask for detailed information on Home Study and Resident School Courses. CHECK COUPON and MAIL TODAY.

YOU CAN LEARN DIESEL AT HOME in your spare time, without interfering with your present activity—or attend one of the resident training schools listed below:

NEW YORK
31-28 Queens Blvd.
Long Island 1, N. Y.

LOS ANGELES
1601 S. Western Ave.
Los Angeles 6, Calif.

MEMPHIS
311 S. Main St.
Memphis 3, Tenn.

34 weeks practical training. If you would prefer to train at one of these three schools, indicate by check on coupon.

Hemphill Diesel and Automotive Schools
Administrative Office: 1601 South Western Ave.
Dept. PM 4-11-7
Los Angeles 6, California

Gentlemen: Please send me FREE BOOKLET and information on your Diesel Courses. I am interested in Home Study Resident School at New York Memphis Los Angeles (Check school desired.)

Name _____ Age _____
Street _____ Zone _____
City _____ State _____
Veteran _____ Non-Veteran _____

Will You Let Me PROVE I Can Make YOU a New Man?

LET ME START SHOWING RESULTS FOR YOU

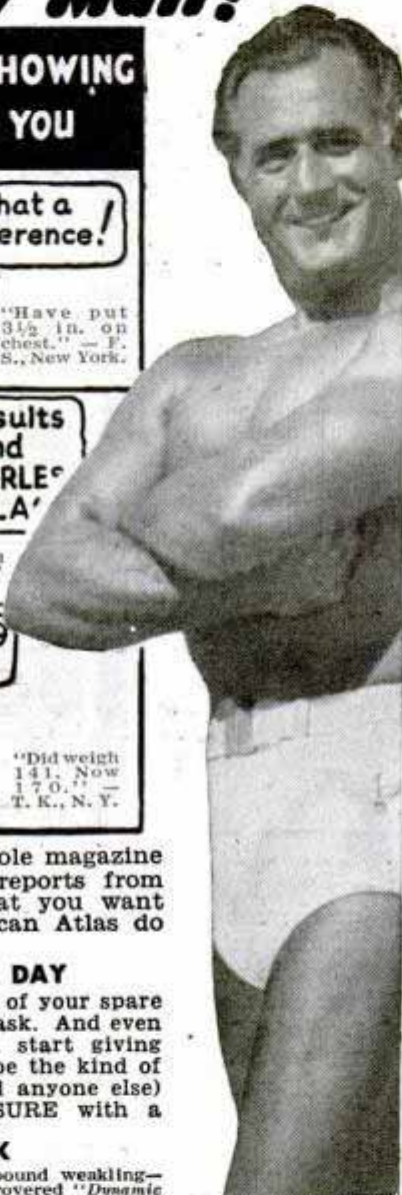

I COULD fill this whole magazine with enthusiastic reports from OTHERS. But what you want to know is—"What can Atlas do for ME?"

15 MINUTES A DAY

Just give me 15 minutes of your spare time daily. That's all I ask. And even in that short time I'll start giving RESULTS. And it will be the kind of RESULTS that you (and anyone else) can SEE, FEEL, MEASURE with a tape.

FREE BOOK

I myself was once a 97-pound weakling—sickly, half-alive. Then I discovered "Dynamic Tension." And I won the title, "The World's Most Perfectly Developed Man!"

"Dynamic Tension" has done so much for other fellows that I simply ask you to let me prove that it can make a New Man of YOU—that it can start new inches of power pushing out your chest—build up your shoulders to champion huskiness—put new, hard, firm muscles on your biceps—make those stomach muscles of yours hard, ridges!

Why not risk a postage stamp? Send coupon for my 48-page illustrated FREE BOOK AT ONCE! Address me personally; Charles Atlas, Dept. 811, 115 East 23rd Street, New York 10, N. Y.



CHARLES ATLAS, Dept. 811
115 East 23rd Street, New York 10, N. Y.

I want the proof that your system of "Dynamic Tension" will help make a New Man of me—give me a healthy, husky body and big muscle development. Send me your free book, "Everlasting Health and Strength."

Name _____ Age _____
(Please print or write plainly)

Address _____

City _____ State _____

MAKE *Extra* MONEY DRAW CARTOONS at HOME!



Learn How! Act NOW! . . . Send only

You'll say it's the best dollar you ever invested! Learn how to draw cartoons in 10 EASY lessons . . . learn where and how to SELL them, rates of pay, how to approach big magazines and syndicates. Many other valuable tips. ALL for one dollar! Act NOW! Address . . . EASY CARTOONS, 4305 Crown St., Indianapolis 8, Ind.

\$1.00

LAW FREE BOOK



Write today for FREE 48-page book, "THE LAW-TRAINED MAN," which shows how to learn law easily in spare time at home through the Blackstone course prepared by 60 well-known law authorities. We furnish all material including 18-volume Modern American Law library. Many successful attorneys among our graduates. LL.B. degree. Moderate cost; easy terms; Money-Back Agreement.

BLACKSTONE COLLEGE OF LAW
225 N. Michigan Ave., Dept. 58, Chicago 1, Ill.
A Correspondence Institution Founded in 1890

TRAIN Your VOICE!

Results GUARANTEED

We build, strengthen the vocal organs—not with singing lessons—but by sound, scientifically correct silent and vocal exercises and absolutely guarantee complete satisfaction with results. Write for Voice Book, FREE. Sent to no one under 17 years old unless signed by parent.

Perfect Voice Studios, Studio 1358, Kimball Hall Bldg., Chicago 4, Ill.

BE A REAL ESTATE BROKER PAYS BIG!

EASY TO LEARN—Start and run your own business quickly. Many graduates report making up to \$1000 a month. Course of study covers Sales, Property Management, Appraising, Loans, Mortgages and hundreds of related subjects. Course offered in home study or residential classrooms.

FREE Big new illustrated catalog from this nationally known school. Send Post Card Today. G. I. Approved.

WEAVER SCHOOL OF REAL ESTATE
Dept. KA-9, 15 E. Pershing Road Kansas City, Mo.

REAL RELIEF FOR RUPTURE



Thousands of wearers tell of real relief. Scientifically shaped, made of strong washable materials, gives the RIGHT support WHERE NEEDED. Satisfaction GUARANTEED. Write for FREE literature NOW.

The WEB Truss Co. Dept. P-8, Hagerstown, Md.

Photography for

PLEASURE or PROFIT

Learn at home. Spare time. Practical basic training. Long-established school. Many have earned while learning. Send coupon below for free booklet, "Opportunities in Modern Photography" and full particulars.

AMERICAN SCHOOL OF PHOTOGRAPHY
1315 Michigan Avenue Dept. 1358 Chicago 5, Illinois
Send booklet, "Opportunities in Modern Photography," full particulars and requirements.

Name _____
Address _____
City _____ Zone _____ State _____

ACE Hollywood Experts will TRAIN
YOU AT HOME to MAKE GOOD in

RADIO

TELEVISION- ELECTRONICS

through practical
EXPERIMENTS
with

**10 BIG
KITS of RADIO
PARTS R.T.A. GIVES YOU!**



**YOU WILL DO
SCORES OF
PRACTICAL JOBS
AND
EXPERIMENTS**

The 10 BIG KITS
RTA GIVES YOU en-
able you to do many
practical jobs. Il-
lustrated above are
only a few of the
many job-exercises
you do. You build
a TRF Receiver, a
High-Frequency
Converter, a com-
plete, powerful 6
Tube A-C-D-C
Superheterodyne
receiver, and per-
form more than a
hundred other fas-
cinating and valu-
able experiments.
These jobs you do
give you ACTUAL
SHOP EXPERIENCE
so vitally neces-
sary to future
success. Thus RTA
methods assure
YOU BALANCED
TRAINING—Theory
PLUS Real Experi-
ence.

**TEAR OUT
COUPON
AND MAIL
TODAY**

MASTER HOLLYWOOD TECHNICIANS Guide You

It was no accident that RTA — RADIO TRAINING ASSOCIATION OF AMERICA — chose HOLLYWOOD as their headquarters. Hollywood has long been recognized as the very heart of America's Broadcasting, Television, Radio and Sound industries. Thus, RTA is right "on-the-spot" where new technical improvements are introduced, and is in the best possible position to bring students ACTUAL METHODS and TECHNIQUES developed BY the RADIO-TELEVISION industry, leading to real money-making opportunities!

OPPORTUNITIES NOW WIDE OPEN for Properly Trained Men

Latest reports estimate 400 MILLION new radio and television sets will be built in the next ten years... and more than 72 million dollars is being spent RIGHT NOW just for radio repairs ALONE! When you are

thoroughly trained by RTA's Hollywood Experts—who have their fingers on the pulse of the Radio-Television industry—you can imagine what undreamed-of opportunities await you in Your Own Radio Sales & Service Business, Television, Aviation, FM, Manufacturing and Communications, etc.

EARN EXTRA MONEY while learning AT HOME

Under RTA's amazingly easy, practical home-training plan there is no need for you to quit your present job. You study in SPARE TIME ONLY and RTA's Hollywood Experts show you how to earn WELCOME EXTRA CASH, even BEFORE FINISHING YOUR TRAINING! In fact, when friends and neighbors know you are studying Radio-Television you may—like many RTA students—actually get MORE REPAIR WORK THAN YOU CAN HANDLE.

25 Year Success Record
Backed by more than 25 years of experience in the home

training field, RTA's practical "learn by doing" methods assure you quick, step-by-step progress. So begin preparing for your future in Radio-Television NOW, while the time is ripe. If you are at all mechanically inclined, and have a grammar school education, RTA can teach you how to MAKE GOOD as a Radio-Television technician.

R. T. A. GRADUATES SAY:

- ★ Thanks to R.T.A. I started my own radio store... am making 220 percent more than when I enrolled.—W. E. Thon, Chicago.
- ★ Truly thankful for the day I enrolled for R.T.A. Course... it fitted me splendidly for my present position.—N. R. Hoffman, Radio Station WCOD, Harrisburg.
- ★... R.T.A. sure opened my eyes to big money... thanks for all you have done for me.—Ernest Lancott, Cleveland.

APPROVED for VETERANS

RADIO TRAINING ASSOC. OF AMERICA, DEPT. PM11
5620 Hollywood Blvd., Hollywood 28, Calif.

Send FREE BOOK showing how to make good in Radio-Television through training by Hollywood experts.

NAME _____ AGE _____

ADDRESS _____

CITY _____ ZONE _____ STATE _____

Check box if VETERAN of World War II

GET FACTS! SEND FOR FREE BOOK!

telling all about RTA's streamlined home-training plan, developed by technicians in the heart of the booming Radio-Television field. Fill out the coupon TODAY and your FREE BOOK, entitled "How To Make Good In Radio-Television" will go out to you AT ONCE! No Obligation, RTA APPROVED FOR VETERANS.





Get into the busiest,
most profitable part
of the electrical
repair business!

Learn to Service and Repair all Kinds of ELECTRIC MOTORS

AN UNCROWDED, BIG-PAY FIELD

ELECTRIC MOTOR REPAIR is a big, 570 page-training course book that can quickly help you learn this important well-paid work at home—for only \$5 for the complete training. Written especially for beginners. Like a good teacher standing by your side, it tells you what to do—exactly how to do it. Everything is explained simply, thoroughly and understandably. Based on what can be learned from this big book alone, you can train for prompt, profitable service on practically every electric motor in common use—from minor adjustments to complete rewinding.

HERE'S REAL OPPORTUNITY!
Think of it! The average small home has 11 motors. Big homes have many more. They're in phonographs, recorders, oil burners, refrigerators, fans, clocks, mixers, washers, cleaners, etc. Millions more in office and industrial equipment. No wonder the motor repair expert is busy and well paid!

LEARN FAST—PRACTICE AT HOME

No previous training required

There are big opportunities for electric motor repair work almost everywhere. Well-trained men are scarce. Even many big appliance shops must send motors back to the factory for repairs or to motor specialists.

ELECTRIC MOTOR REPAIR book teaches you the work from the very beginning. Every step is demonstrated BOTH in text and visually by more than 900 special illustrations. Quick reference guides show how to handle specific jobs. Widely used for training beginners and for daily on-the-job reference in busy motor shops. Covers every modern motor type and both mechanical and electrical motor control systems. Unique Duo-Spiral Binding divides book into 2 sections so that both text and related illustrations can be seen together. You learn fast—and you learn right!



"BORROW" IT FOR
5 FULL DAYS!

Send coupon at once! Practice from ELECTRIC MOTOR REPAIR for 5 full days. See how interesting the work is — how rapidly and completely it can now be learned. Then, if not more than satisfied, return book and your money will be refunded at once! You cannot lose!

YOU CAN'T LOSE ON THIS OFFER!

Dept. PM-117, Murray Hill Books, Inc.,
232 Madison Ave., New York 16, N. Y.

Send me a copy of "ELECTRIC MOTOR REPAIR" for which I enclose \$5 (\$5.50 foreign); or send C.O.D. (no foreign C.O.D.'s) for this amount and I will pay postman \$5 plus postal charge when he delivers it to me. If this book is not what I need, I'll return it within 5 days and you guarantee to refund my \$5.

Name _____

Address _____

City and Zone _____ State _____

SAY YOU SAW IT IN POPULAR MECHANICS

STUDY AT HOME

With An Educational Institution

Men with specialized training win higher positions, insure larger earnings, and are bigger successes in business and public life. Opportunities NOW greater than ever before. Send for our Catalog.

ARTS and SCIENCES

Courses in Philosophy; Education; Letters; Public Health; Medical Jurisprudence; Psychology; Sociology; Physics; Chemistry; Plastics; Geology; Political Science; Theology; Business and Commerce; Accounting; Mathematics; Statistics; Agriculture.

ENGINEERING

Courses in Electrical, Civil, Mechanical, Drafting, Architectural, Steam, Aeronautical, Radio, Structural, Mining, Industrial, Petroleum, Marine, Chemical, Diesel, Automobile, Refrigeration, and Air Conditioning Engineering.

LAW

Complete Professional Law Course includes 18 Hornbook Series college grade textbooks. Courses also in Commercial Law, Patent Law and Medical Jurisprudence.
McKinley-Roosevelt Incorporated, 4610-K, Sheridan Rd., Chicago 40, Ill.

5 - COURSES TO SUCCESS

CLASSES ENROLLED MONTHLY
Time-saving practical courses—day and evenings.
Approved for G.I. Training.
Free Placement Service
Write for FREE CATALOG

TOOL and DIE DESIGNING

MECHANICAL DRAFTING

ARCHITECTURAL DRAFTING

INDUSTRIAL PROD. DESIGNING

AUTOMATIC SCREW MACHINE

ENGINEERING

Cam Design Layout and Estimating

MIDWESTERN TECHNICAL INSTITUTE

431 S. Wabash, Auditorium Bldg., Dept. XB, Chicago 5, Ill.

INVENTING

—FOR PROFIT! If you have an inventive turn of mind, write for free 28-page booklet explaining how the Institute of American Inventors is helping inventors pre-test the profit possibilities of proposed devices to fill today's unprecedented demand for useful new inventions.

INSTITUTE of AMERICAN INVENTORS

Dept. 4, 1926 Eye St., NW, Washington 6, D. C.

SHORTHAND in

6 Weeks at Home

Famous Speedwriting system. No signs or symbols; uses ABC's. Easy to learn; easy to write and transcribe. Fast preparation for a job. Surprisingly low cost. 100,000 taught by mail. Used in leading offices and Civil Service. Write for free booklet.

SPEEDWRITING, Dept. 1511-7, 55 West 42 St., N. Y. 18



CORRESPONDENCE COURSES IN RADIO and ELECTRICAL ENGINEERING

Tuition \$25

ELECTRICAL ENGINEERING. Get good grasp of wide electrical field. Modern. Very understandable. Theory made easy.
RADIO ENGINEERING. Extra fine course in radio, public address, photo-electric work. Trains you to be super-service man, real vacuum tube technician. Tuition ONLY \$25, either course. Deferred payment plan. Servicemen needed badly.
FREE Write for free copies of school catalogs, student magazines, etc.

LINCOLN ENGINEERING SCHOOL, Box 931-P107, Lincoln, Nebr.

GET FRIENDS, PRESTIGE, SUCCESS

How to Publicize Yourself

New nine-page folio "Personal Publicity" tells how to make friends enthusiastic . . . how to become favorably known in your business, profession . . . make others sit up and take notice of YOU. Easy-to-follow instructions. Articles you can write about yourself for papers, radio. Nine kinds of attention-getting letters. Mechanics of preparing material, photographs. Great help for publicity chairmen of clubs, societies.

ONLY \$1.00

PUBLICITY SYSTEMS

Dept. PM11, Box 322

Jacksonville, Illinois

IMAGINE THEIR JOY

WHEN THEY FOUND THEY COULD PLAY

This easy as A.B.C. way!



LEARNED QUICKLY AT HOME

"I didn't dream I could actually learn to play without a teacher. You can imagine my surprise when after 3 or 4 weeks I found I could play real tunes. Now, when I play for people they hardly believe that I learned to play so well in so short a time."
*H. C. S., Calif.

INVESTMENT PAID BACK A THOUSAND FOLD

"Anyone with musical ability should make good with your course. My little investment paid back a thousand fold. I have been playing for 4 years now. Today I play in one of our top bands."
*J. M., San Juan, P. R.



PLAYS AT DANCES

"I have completed your course and your lessons have been most satisfactory. I can play all of the popular songs. I have also earned money playing at dances."
*E. N. J., New York.

PLAYS ON RADIO

"As a proud student I can't keep from telling you that as a result of my course I have a good position playing from KTHS, Hot Springs, Ark., every morning."
*J. S., Okla.



INVITED TO PARTIES

"I enjoyed taking this course and I get a lot of pleasure out of it. I have made much progress and have many invitations to play at parties. I owe you much for making this possible."
*K. U., N. Y.

Thousands Have Learned to Play Quickly, Easily At Home

WHAT instrument would you like to play? We'll show you how you can learn to play it—quickly, easily, in spare time at home for only a FEW CENTS A DAY! Never mind if you don't know one note of music from another—don't worry about our "special talent."

The truth of the matter is that thousands now play who never thought they could! Yes, men and women everywhere are enjoying the thrilling satisfaction of playing the piano, violin, guitar, saxophone or other favorite instrument. Some of them are playing in orchestras and over the radio; others are teaching music, making

money in spare or full time. And thousands are playing for their own enjoyment and the entertainment of their friends.

It all came about when they wrote to the U. S. School of Music for the Free Booklet that shows you how EASY it is to learn music at home this modern way. No tedious scales, no tiresome exercises. You learn to play by playing—start right in almost at once with the melody of a simple tune! It takes only a few minutes a day and the cost is trifling; you save the expense of a private teacher. Mail coupon and get FREE PROOF! (Instruments supplied when needed, cash or credit.) U. S. School of Music, 711 Brunswick Bldg., New York 10, N. Y. (Est. 1898)

NOTICE

Please don't confuse our method with any systems claiming to teach "without music" or "by ear." We teach you easily and quickly to play real music, any music, by standard notes . . . not by any trick or number system.

SEND TODAY → FOR COMPLETE DETAILS

• You'll open your eyes when you find how quickly and easily you can learn to play your favorite instrument. Don't doubt; don't hesitate. Send for the fascinating illustrated booklet that answers all your questions; let the free Print and Picture Sample show you how this method actually works. If interested, mail the coupon NOW.

*Actual pupils' names on request. Pictures by professional models.

FREE! Print and Picture Sample

U. S. SCHOOL OF MUSIC

711 Brunswick Bldg., New York 10, N. Y.

I am interested in music study, particularly in the instrument checked below. Please send me your free illustrated booklet, "How to Learn Music at Home."

Piano	Saxophone	Modern Elementary
Guitar	Trumpet, Cornet	Harmony
Hawaiian Guitar	Reed Organ	Clarinet
Violin	Tenor Banjo	Practical Finger Control
Piano Accordion	Mandolin	Other Instrument

Have you Instrument? _____

Name _____
(Please Print)

Address _____

City _____ State _____

NOTE: If you are under 16 years parent must sign coupon. Save 2c—Stick coupon on penny postcard.

BOYS-IT'S FREE!

Exciting new book on

ATOMIC ENERGY

...and "THE WONDERS OF CHEMISTRY"

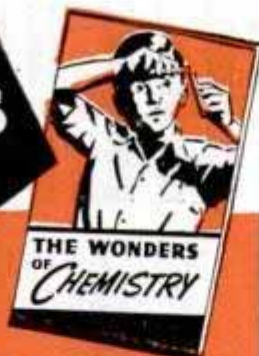

Don't miss it, fellows! Introduces you to the miracles of Atomic Energy . . . and lets you in on secrets of the mysterious Atomic World. Also shows you how to amaze friends and family with Chemical Magic. Describes many fascinating home experiments. Tells about the fun, thrills, adventure and big future opportunities awaiting boys who know chemistry. Send for your **FREE** copy of "THE WONDERS OF CHEMISTRY." Send penny postal or letter to address shown below.

INSIST ON

CHEMCRAFT

America's Leading Chemistry Outfits!



NOW! with SAFE ATOMIC ENERGY EXPERIMENTS!

Now that safe, exciting Atomic Energy experiments have been added to its many other exclusive features, Chemcraft packs more fun than ever before in its 30-year history. So this Xmas, ask Mom and Dad for Chemcraft—America's leading chemistry outfit. Sold by leading stores everywhere. Chemcraft contains no poisons—no explosives, no unpleasant chemicals.

Atomic Energy in Chemcraft \$25, \$15, \$10 outfits only. Other Chemcraft outfits with many exclusive features at \$5, \$3.95, \$2.50 and \$1.25.

Write for free copy of

"THE WONDERS OF CHEMISTRY"

THE PORTER CHEMICAL CO.

65 PROSPECT AVE. HAGERSTOWN, MD.

MAGIC LIQUID CASTS PLASTICS



THE GREATEST THING IN PLASTICS!

A New Liquid Plastic! Pour **PLASTICAST** into any kind of mold (rubber, metal, glass, plaster, etc.) and it hardens in a few minutes into a solid, clear-as-glass plastic! No machinery or tools required. **PLASTICAST** has unlimited possibilities . . . novelties, toys, jewelry, gems, knick-knacks; fascinating, brilliant, clear or colored plastic articles. Being transparent it is ideal for imbedding flowers, butterflies, photos, souvenirs—an endless variety of useful things. Can also be cast into rods, sheets, blocks, **ANY SHAPE!** Make **PLASTICASTING** a thrilling new hobby or a profitable business! No experience required; start casting beautiful articles 10 minutes after you receive your outfit! **MASTER OUTFIT** contains 4 molds, dye, directions, imbedding material, accessories and enough **PLASTICAST** for making about 200 articles. (C.O.D. orders accepted with \$1.00 deposit)

COMPLETE MASTER OUTFIT, (post paid U.S.A. only) . . . \$3.00

FREE Catalog listing hundreds of molds, mold making materials for casting with **PLASTICS, METAL, PLASTER, WAX, RUBBER, WOOD, LIQUID MARBLE, LIQUID IVORY, ETC.**, sent free for 3c stamp.

PLASTICAST CO., (Dept. C)
5961 Madison St. (Send order to nearest office) Chicago 44, Illinois P.O. Box 987 Palo Alto, Calif.

LET ME TEACH YOU



J. D. RICE

Head of Penmanship Dept., Chillocothe, Mo., Business College for 42 years. One of America's finest penmen.



at home in your spare time. Amaze your friends by the skill you can acquire in a short time. Artistic Writing will win you prestige, admiration and respect; help you influence prospective employers.

NO LESSONS TO SEND IN—My new course **ARTISTIC PENMANSHIP** SELF TAUGHT is practical, makes artistic writing easy. No teacher is necessary. Just practice fascinating step-by-step exercises on forms provided and you'll be amazed how quickly you become proficient. Contains same type material as expensive courses yet costs you only \$2.95 postpaid complete with special pens for shaded writing. Send for your course **RIGHT NOW**. (Currency may be mailed if carefully wrapped.) Money Back If Not Satisfied.

EDUCATIONAL PUBLISHERS, DEPT. P-101

7241 Madison St. Kansas City 5, Mo.

FALSE TEETH

KLUTCH holds them tighter

KLUTCH forms a comfort cushion; holds dental plates so much firmer and snuggler that one can eat and talk with greater comfort and security; in many cases almost as well as with natural teeth. **Kutch** lessens the constant fear of a dropping, rocking, chafing plate. 25c and 50c at druggists . . . If your druggist hasn't it, **don't waste money on substitutes**, but send us 10c and we will mail you a generous trial box. © I. P. INC.

KLUTCH CO. Box 4793-K ELMIRA, N. Y.

SAY YOU SAW IT IN POPULAR MECHANICS

START YOUR OWN PHOTO COPY BUSINESS!

SMALL investment . . . BIG profits. No darkroom needed. **EASY** work. Write immediately for **FREE** 4 page folder and price list.

GENERAL PHOTO PRODUCTS COMPANY

15 Summit Avenue Dept. PM-3 Chatham, New Jersey

BE A NAVIGATOR OF SHIPS • OF PLANES

Train at home, in spare time for a fascinating, good pay job in marine or air navigation. **Weems Course** enables you to meet **CAA** requirements for commercial airline navigators—and navigation requirements for Master's or Mate's license in Merchant Marine. Many **Weems** graduates now officers in Navy, Coast Guard, Army-Navy Air Forces and Commercial Airlines. Write today for free descriptive catalog. **G. I. Plan. WEEMS SCHOOL OF NAVIGATION** Dept. 2, Annapolis, Md.



Attend CHICAGO TECH

Approved
for G.I.
Training

•
**TIME-SAVING
COURSES**

•
**DAY and EVENING
CLASSES**

•
**1 YEAR
2 YEAR
3 YEAR
courses**

•
**BUILDING
DRAFTING**

ENGINEERING

AIR CONDITIONING

REFRIGERATION

ELECTRICITY

RADIO

**Learn ENGINEERING
DRAFTING . . . BUILDING
in Chicago, Industrial Hub**

Get your training at Chicago Tech in the Nation's industrial center. Chicago provides unequalled opportunities for part-time employment while training and for permanent positions upon graduation. Many other cultural and recreational advantages described in Catalog, — sent Free!

Practical Time-Saving Courses

Chicago Tech, founded 43 years ago, has trained thousands of men now occupying important places in industry the world over. Training combines theory and practice in 1 year, 2 year, and 3 year (Degree) courses. Saving in time means earlier graduation, — and consequently earlier employment.

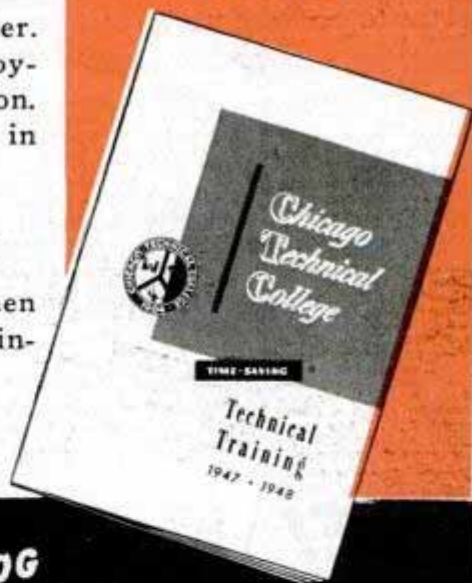

MAIL COUPON TODAY FOR ILLUSTRATED CATALOG

**CHICAGO
TECHNICAL COLLEGE**

TECH BUILDING

**2000 South Michigan Avenue
Chicago 16, Illinois**

CHICAGO TECHNICAL COLLEGE

P-81, Tech Bldg., 2000 So. Michigan Ave.
Chicago 16, Ill.

Please send me without obligation free booklet on Time-Saving Technical Training.

Name _____ Age _____

Address _____

City _____ Zone _____ State _____

Terms start January, April, July and October. Get information now to arrange for early admission and accommodations.

NOW! ALL 5 FAMOUS JOWETT COURSES - 1 COMPLETE MUSCLE BUILDING VOLUME! FOR ONLY **25¢**

LET ME PROVE I can make YOU



AND MY PHOTO BOOK OF FAMOUS STRONG MEN FREE!

COMMANDO-TOUGH OR IT WON'T COST YOU A CENT!

says *George F. Jowett* WORLD'S GREATEST BODY BUILDER

GIVE ME 10 MINUTES A DAY

LEARN MY TIME TESTED SECRETS OF STRENGTH

I'll teach you the "Progressive Power Method" through which I rebuilt myself from a physical wreck the doctors condemned to die at 15, to the holder of more strength records than any other living athlete or teacher! "Progressive Power" has proven its ability to build the strongest, handsomest men in the world. And I stand ready to show you on a money back basis — that no matter how flabby or puny you are I can do the same for you right in your own home. Let me prove I can add inches to your arms, broaden your shoulders, give you a man-sized chest, powerful legs and a Rock-like back—in fact, power pack your whole body so quickly it will amaze you! Through my proven secrets I bring to life new power in you inside and out, until YOU are fully satisfied you are the man you want to be.

PROVE IT TO YOURSELF IN ONE NIGHT

Send only 25c for my 5 easy-to-follow, picture-packed courses now in 1 complete volume "How to Become a Muscular He-Man." Try it for one night! Experience the thrilling strength that surges through your muscles.

10 DAY TRIAL!

Think of it—all five of these famous courses now in one picture-packed volume for only 25c. If you're not delighted with this famous muscle-building guide—if you don't actually FEEL results within ONE WEEK, send it back and your money will be promptly refunded!

Photo Book Of Famous Strong Men!

FREE!

Photos that inspire you to might and muscle. Free with order.



George F. Jowett
Champion of Champions

I am making a drive for thousands of new friends fast—REGARDLESS OF COST!
SO GET NOW MY 5 Muscle Building COURSES
(Valued at \$5 each)
All in 1 Great Complete Volume
Packed With How-To-Do-It Pictures!
Now, this "get-acquainted," extremely low price of only 25c is your chance to build a body you'll be proud of! Follow Jowett's easy method of muscle building NOW!



FREE GIFT COUPON!

Jowett Institute of Physical Culture
230 Fifth Avenue, New York 1, N. Y. Dept. PM-711

George F. Jowett:—Please send by return mail, prepaid, FREE Jowett's Photo Book of Strong Men, along with all 5 Muscle Building Courses, 1. Molding a Mighty Chest, 2. Molding a Mighty Arm, 3. Molding a Mighty Grip, 4. Molding a Mighty Back, 5. Molding Mighty Legs—Now all in one Volume "How to Become a Muscular He-Man." Enclosed find 25c. NO C.O.D.'S.

NAME _____ AGE _____

(Please Print Plainly, Include Zone Number)

ADDRESS _____

LEARN TO SHOOT!

FREE BOOK, 48 pages, pictures and description. Master shooting INDOORS, learn how to shoot OUTDOORS. Famous training method of "Buckshot" Wilson. Edited by Henry E. Bradshaw. Youngsters become amazingly accurate—"hit pennies in the air!" Experts are fascinated. SAFE for entire family.

FREE! SHOOT-RITE MANUAL

BEAUTIFULLY ILLUSTRATED 48 PAGES

Mighty good reading, the simple but thrilling instructions in Parris-Dunn's INDOOR SHOOTING BOOK! Also describes sensationally accurate Parris-Dunn Trainer Gun and realistic whirling Indoor Ro-Target. SEE YOUR DEALER or write for FREE COPY of this great book, 25 cents for mailing expense appreciated. Address: **PARRIS-DUNN • Dept. 65 • CLARINDA, IOWA**

Be A MASTER PLUMBER

Earn \$15 To \$50 A Day
DON'T ENVY THE PLUMBER — BE ONE

Every skilled workman will tell you that Plumbers have the best of it. WINTER and SUMMER the Plumber is busy at top wages. No skilled Plumber is ever out of a job—compare his opportunities with any trade, plus the opportunities of having your own shop. We teach you Plumbing with TOOLS (not books) under Licensed Master PLUMBERS in one of the finest equipped schools in America. We make you a Plumber, every branch is taught thoroughly—Lead Work—Blueprint for plan reading—all other tricks.

LEARN IN 30 WEEKS WITHOUT PREVIOUS EXPERIENCE

If you like to work with tools you owe it to yourself to investigate. No need to ever work as an apprentice. Get free bulletin. Write now! G.I. APPROVED. Our 24th year.

UNIVERSAL PLUMBING SCHOOL

815 HOLMES STREET KANSAS CITY, MO.

BIG PAY IN MANAGEMENT

FREE BOOK — Industrial Engineering. The Management Profession — Write for it Today. Top pay for men who get into Factory Management. Booklet contains valuable information for men who want to advance to bigger jobs in business or industry. Learn how you can train for such opportunities as Methods Engineer, Factory Manager, Time study Engineer, Production Engineer, etc. Now is the time to prepare for management positions while industry is rapidly expanding. **PLACEMENT and CONSULTATION services.** Learn about Resident and Home Study training programs. **APPROVED FOR VETERANS.** Write today—request for Booklet and full information does not obligate you.

INDUSTRIAL ENGINEERING COLLEGE, Dept. 111

3309 Washington Blvd. Chicago, Illinois

MONEY for MEN ALL FREE

THE PLASTEX Industry needs manufacturers on small scale and for big production of Lamp and Clock Stands, Art Goods and Novelties in Plastex and Marble imitation. Experience unnecessary. 1/2c material makes regular 10c store sellers. Rubber moulds furnished for speed production. Small investment brings good returns. Big chain store orders now being placed. Ambitious men have chance for real prosperity. Our Free booklet will interest and benefit you.

PLASTEX INDUSTRIES, Dept. A
3408 Third Ave. New York 56, N. Y.

Make Up to \$1,000 a Month Own Your Own Business Now!

Make more money the modern way. Send for FREE bulletin No. 10A for details on the Modern Lawn Mower Sharpener.

MODERN MANUFACTURING COMPANY
160 N. FAIR OAKS PASADENA, CAL.

MAKE ART MODEL FIGURINES A PROFITABLE HOBBY

Complete rubber molds in a wide variety of subjects now available — 25c and up — ready for your production line. Send 10c for complete 20-page catalog with many illustrations in four colors.

Bersted's Hobby-Craft, Inc. MONMOUTH, ILL., Dept. H6

PRACTICAL TECHNICAL TRAINING

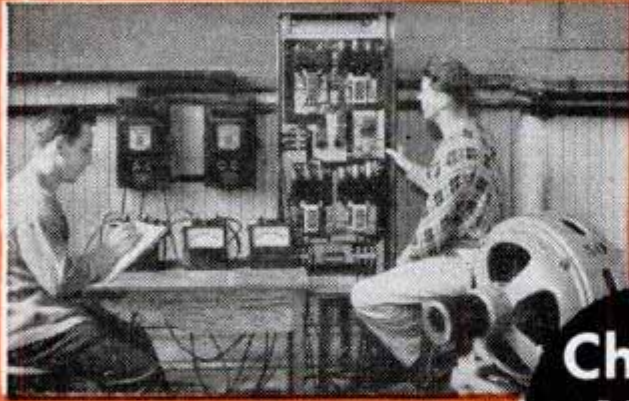

ELECTRICAL ENGINEERING

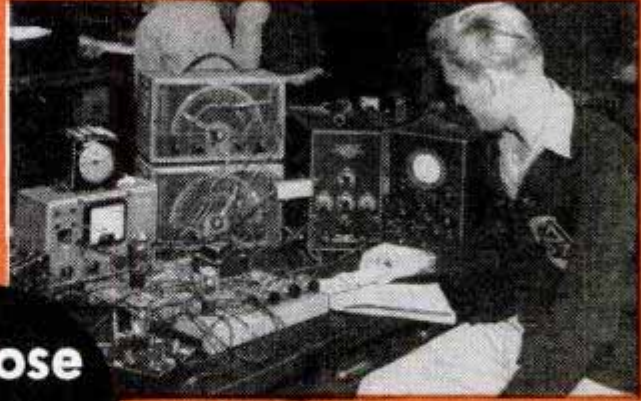

RADIO AND ELECTRONICS

**Choose
Your
Career**

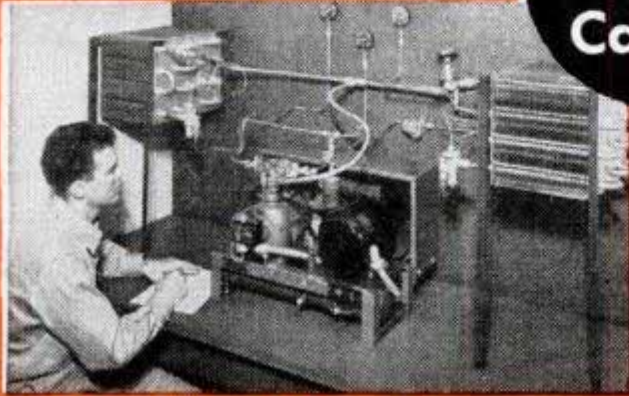

REFRIGERATION & AIR CONDITIONING



GAS AND ARC WELDING

CONCENTRIC CURRICULUM



Our time-tested CONCENTRIC SYSTEM enables you to build your career step by step. Each 6-month course is complete in itself. Stay as long as circumstances permit — until you reach your desired occupational objective.

COURSES

SERVICE . . . 6 to 12 Months

Practical Electricity
Practical Welding
Refrigeration Service
Heating Service

TECHNICIAN . . . 1 to 2 Years

Electro Technician
Radio Technician
Electronics Technician
Refrigeration, Heating, and
Air Conditioning Technician

PROFESSIONAL . . . 3 Years

Electrical Engineering
Bachelor of Science Degree — Major
in Machinery or Electronics

★ SPECIALIZE in 6 months to 3 years

Of utmost importance to anyone considering a technical school, is that school's history, facilities, faculty, and record of successful alumni. The Milwaukee School of Engineering was founded 44 years ago to train men for specific and substantial careers in industry. More than 35,000 former students in industries the world over attest the school's career-building value through its exceptional facilities in laboratories, class rooms, faculty of 92 specialists, and its comprehensive technical courses. 1292 students now enrolled from 48 states and 8 overseas countries. World-wide alumni counselor committee. Terms start January, April, July. SEND COUPON TODAY!

MILWAUKEE
SCHOOL OF ENGINEERING
A Technical Institute

Millwaukee School of Engineering, Dept. PM-1147
N. Broadway and E. State, Milwaukee, Wis.

Without obligation, send me free booklet "Career Building" and more details on course in.....

NameAge

Address

CityState



Put your future
in your own hands

BE AN ARTIST

Here's the Amazing
Way We Teach You
Step-by-Step to Draw
At Home in Spare Time

Draw for money. Prepare yourself now for a fascinating, pleasant and profitable Art career. COMMERCIAL ART, DESIGNING, CARTOONING—all in one complete home study course. No previous art experience necessary. We teach you step-by-step and prepare you for good jobs in advertising, newspaper and magazine publishing, department stores, printers, engravers, or in art studios where you can become your own boss. For 33 years our graduates have been "making good"—WHY NOT YOU?



Trained Artists Are Capable of Earning \$50-\$60-\$75 and MORE a WEEK

Write for FREE BOOK, "Art for Pleasure & Profit"—tells about our course, instruction service, material furnished, what our graduates say, and commercial opportunities for you. TWO ART OUTFITS and other features included with training.

Veterans! Course "G.I." Approved

FREE BOOK gives details!

Washington School of Art, Studio 1211H
1115—15th St., N.W., Washington 5, D. C.

Please send me full information and your Free Book, "Art for Pleasure and Profit."

Name _____ AGE _____

Street _____

City _____ Zone _____ State _____

I am entitled to training under the GI Bill

SAY YOU SAW IT IN POPULAR MECHANICS

NOW YOU TOO CAN BUILD 15 RADIOS COMPLETE KIT \$14.75

Absolutely No Knowledge of Radio Necessary
You Need NO Additional Parts

The PROGRESSIVE RADIO KIT is THE ONLY COMPLETE KIT. Contains everything you need. Instruction Book, Metal Chassis, Tubes, Condensers, Resistors and all Radio parts. The 36-Page Book written by Expert Radio Instructors teaches you to build radios in a Professional Manner. You start with a 1-tube receiver. Before you are done with this kit, you will have built 11 Receivers, 1 Public Address System and 3 Transmitters.

SPECIAL FREE OFFER!
Electrical and Radio Tester sent absolutely FREE with each Progressive Radio Kit. PLUS FREE membership in Progressive Radio Club. Entitles you to free expert advice and consultation service with licensed radio technicians. Write for further information, or ORDER your KIT **\$14.75 NOW!** ONLY. Postage prepaid with check or money order (Postage not prepaid with C.O.D. orders)

PROGRESSIVE ELECTRONICS CO., Dept. PM-4
22 Havemeyer Street Brooklyn 11, N. Y.

LEARN PIANO WITH RECORDS

START PLAYING SONGS 1st LESSON

Low Cost! No Risk! Send No Money!

Amazing . . . so easy . . . so practical. Here's the World's ONLY piano course using this exclusive proven . . . Perfected Record Method. Thousands praise this easier, faster way to learn piano. You too will quickly learn to play any sheet music using real musical notes. No struggling with old-time exercises . . . no "ear" or number systems. Course includes Tracy special teaching records, exact photo guides, other exclusive aids. Costs only a few cents a day complete. Fully guaranteed. Stop wishing! Start playing! Information kit Free . . . no obligation. Send name and address to TRACY INSTITUTE OF MUSIC, Dept. P-7, 54 Holmehurst Ave., Balto.-28, Md.

OPPORTUNITIES AHEAD!
TRAIN FOR A FUTURE IN DIESEL

● Prepare for the big earning power of Diesel Trained Men. Start learning at home, in spare time. UEI's easy, practical training covers all phases of DIESEL engine operation, fuel systems, auxiliary equipment, repairs and maintenance. When home course is completed, you come to Chicago for actual shop practice on DIESEL MOTORS under expert instructors, at UEI's fine, modern school. BEGIN AT ONCE—GET ALL THE FACTS FREE. WRITE TODAY!

DIESEL UTILITIES ENGINEERING INSTITUTE
2521 Sheffield Ave. • Dept. 1117-D • Chicago 14, Illinois

AMAZING DISCOVERY!
Guides hand—Corrects your penmanship in few hours.

Improves Handwriting In 3 Hours

Write, OZMENT, 34-P, St. Louis, Mo.

The GLENWOOD MEMORIAL
Freight Paid Anywhere in U.S.A.

In all its beauty and durability is pictured in our free catalog of genuine Marble and Granite. Write for yours today.
U. S. MARBLE & GRANITE CO., A-18, Oneco, Fla.

TRAVEL - for 'UNCLE SAM'

RAILWAY POSTAL CLERKS
\$2,300 First year regular
MANY OTHER GOVERNMENT JOBS

Postoffice Clerks—Mail Carriers—Stenographers—Typists, Statistical Clerks—Storekeeper—Gaugers, etc. 32 Page Civil Service Book—FREE.

MEN - WOMEN
Veterans Get Preference
Mail Coupon immediately—today sure.

\$1,756 to \$3,021 FIRST YEAR

COUPON
FRANKLIN INST., Dept. P85, Rochester 4, N. Y.
Gentlemen: Rush to me without charge, 32 page book with list of U. S. Government big paid positions. Advise me also regarding salaries, hours, work, vacation, etc. Tell me how to prepare for a position.

Name.....
Address..... Vet?.....



DRAW ME!

TRY FOR A *Free Art Course*

Copy this girl and send us your drawing — perhaps you'll win a **COMPLETE ART COURSE FREE.**

FIVE PRIZES—five complete art courses FREE including Drawing Outfits (Value of each course, \$240.00).

FREE! Each contestant submitting a drawing of sufficient merit will get a grading and our opinion as to whether his or her talent is worth developing.

Vocational Training for talented artistic persons is of tremendous importance. Almost everything must be designed before it can be manufactured.

Only talented persons can be trained as designers and illustrators. Splendid opportunities are available for trained Commercial Artists, Illustrators and Cartoonists. Many of our former students are earning excellent incomes in the profession. Here's an opportunity to test your talent **FREE.**

RULES

Contestants must be amateurs. Our students not eligible. 1. Make copy of girl 5 inches high, on paper 7 inches high. Draw only the girl, not the lettering. 2. Use only pencil or pen. 3. No drawings will be returned. 4. Print your name, address (town, county, state), age, phone number and present occupation on back of drawing. If you live in an apartment give apartment number. 5 All drawings must be received by November 30th, 1947. Prize winning drawings will be selected by our faculty

ART INSTRUCTION INC

Dept. 11137C, 500 S. 4th St., Minneapolis 15, Minn.

Learn this Profitable Profession



IN 90 DAYS AT HOME

Money-Making Career Open to Men and Women, 18 to 50

Hundreds of men and women between 18 and 50 make \$10 to \$20 in a single day giving scientific Swedish Massage and Hydro-Therapy treatments. There is big demand from doctors, hospitals, sanatoriums and clubs. Graduates earn large full time incomes from these or in private practice in their own offices. Others make good money from home treatments given in spare time. Learn this interesting, money-making profession in your own home, through our home study course. Same instructors as in our nationally known resident school. You can win independence and prepare for future security by qualifying for your Diploma. Course can be completed in 3 to 4 months. Many earn while they learn. Begin your training at once.



Anatomy Charts & Booklet FREE

Enroll now and we will include, at no extra cost, many needed supplies. Fit yourself to help meet growing demand for Scientific Swedish Massage. Send the coupon at once for complete details. Anatomy Charts and 32-Page Illustrated Booklet, FREE, postpaid.

THE COLLEGE OF SWEDISH MASSAGE
Dept. 764P, 100 East Ohio St., Chicago 11, Illinois

Please send me FREE and postpaid, Anatomy Charts, 32-page Booklet and complete details on Home Training.

Name _____
Address _____
City _____ State _____

START NOW TOWARD A FUTURE IN REFRIGERATION and AIR CONDITIONING

Refrigeration and Air Conditioning are among the giant industries of America. Such industries need men who KNOW. Many men servicing and installing equipment are making large incomes.

Spare Time Training

If mechanically inclined, get the training you need to qualify for experience installing & servicing Refrigeration and Air Conditioning in stores, offices, homes.

Then you should have no difficulty getting started in these great industries. As experience, tools and a personal following are acquired; you may find it practical, later, to start your own REFRIGERATION and AIR CONDITIONING SHOP.



Approved for training under G.J. Bill

Practical Interesting Training

You'll like our way of training—through capable home-study instruction followed by practice on actual equipment under watchful eyes of seasoned Refrigeration and Air Conditioning men in our shops. You'll get top-rate instructions—the easy way. So get the facts now—FREE of obligation. Write TODAY—SURE!

GET VALUABLE FACTS FREE

UTILITIES ENGINEERING INSTITUTE, Dept. 1117,
2525 Sheffield Ave., Chicago 14, Ill.

Please send me the Free FACTS about opportunities in Air Conditioning and Mechanical Refrigeration. I marked the one that interests me most.

Air Conditioning Mechanical Refrigeration

NAME _____ Age _____
ADDRESS _____
CITY _____ Zone _____ STATE _____

MAKE BIG MONEY IN YOUR OWN YEAR BUSINESS! EASY TO START WITH ONLY A FEW DOLLARS!

Here are 3 amazing, new opportunities to get into your own highly-profitable, dignified business—without previous experience—regardless of your age or sex. 1. **LIQUID Synthetic MARBLE**—Easy to make and install beautiful synthetic Marble Slabs—pouring from liquid state. Big Demand for kitchen and bathroom walls, etc. 2. **FIBRE-TITE FLOORING**—Easy to make and install—in any color or color combination. Many years wear. Dustproof. Soundproof. Verminproof. 3. **FLEXIBLE MOLDS**—for Plaster Casting. \$1.00 in raw materials makes up to \$25 worth finished products. F.B., Iowa, writes: "Am on job that will net me \$150 for 4 days work." Get FREE details. No obligation. Write today!

Write for FREE DETAILS NOW!

COMPOSITION PRODUCTS CO.
5853 Delmar Blvd., Dept. 111 St. Louis 12, Mo.

HOW TO DO WONDERS ON AN ACRE!

MY WIFE and I would like to send you our FREE BOOK about our "HAVE-MORE" PLAN for "a little land—a lot of living." Tells how to do wonders with a garden, fruits, berries, poultry, livestock, etc.—all on small scale—in spare time. Many new devices, scientific methods. Special house plans and layouts for small acreages. It's a whole wonderful NEW SCIENCE of living—a healthier, happier, more independent life—on the little place you've always dreamed of having. Just drop us a post card today for our FREE BOOK—32 pages—50 illustrations.

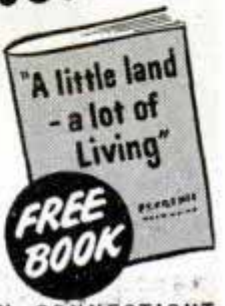

ED ROBINSON • BOX 2711 • NOROTON, CONNECTICUT

ARTISTS MAKE MONEY

Do you like to draw? Send name, address, age and occupation for FREE ART TEST, to find out your ability.

ART INSTRUCTION, Inc.
11137 ART INSTRUCTION BLDG., MINNEAPOLIS 15, MINN.

INVENTORS! LET US DEVELOP YOUR INVENTION

Our offices are staffed by experienced engineer designers and draftsmen fully qualified to detail the structure and design of your idea for manufacturing and patent drawings. All work confidential. Write today for information. **QUALITY DESIGN AND DRAFTING SERVICE, 613 Atlantic Building, 930 F Street, N. W., Washington, D. C.**

RUPTURED?

Get Relief This Proven Way

Why try to worry along with trusses that gouge your flesh—press heavily on hips and spine—enlarge opening—fail to hold rupture? You need the Cluthe. No leg-straps or cutting belts. Automatic adjustable pad holds at real opening—follows every body movement with instant increased support in case of strain. Cannot slip whether at work or play. Light. Waterproof. Can be worn in bath. Send for amazing FREE book, "Advice To Ruptured," and details of liberal truthful 60-day trial offer. Also endorsements from grateful users in your neighborhood. Write: **CLUTHE SONS, Dept. 31, Bloomfield, New Jersey**

FREE! FREE! FREE!
For NEW VIGOR—STRENGTH—VITALITY...
PM-1147

Mail this coupon now

Alan Stephan, Post Office Box 1080, Chicago 90, Ill. Send me, free and without any obligation, your booklet, "Presenting Mr. America . . . Alan Stephan."

NAME _____
ADDRESS _____ CITY _____
STATE _____ DATE OF BIRTH _____

DO ACTUAL ELECTRICAL WORK DAILY IN OUR LARGE SHOPS



HOUSEWIRING



MOTOR WINDING



GENERATORS

INSTALLATION

GET INTO BIG-PAY



ELECTRICITY

**NATION'S
LARGEST
EXCLUSIVE
ELECTRICAL
SCHOOL**

QUICK, THOROUGH, EASY-TO-LEARN-TRADE

Steady job, good pay, clean work! . . . That's your future in this lifetime trade. Learn-by-doing in a few months on actual equipment . . . not "home study"—not "mail"—not "spare time"—**YOU GET PRACTICAL "A TO Z" EXPERIENCE** in our modern resident shops. Get ready fast for many electrical jobs now open everywhere! New classes start every few weeks. Living quarters arranged.

NO COST TO VETERANS Train at Gov't. expense. Receive \$65 to \$90 month while learning. Coupon brings details.



**MAIL TODAY FOR
QUICK ACTION**

MICHIGAN TECHNICAL INSTITUTE, Dept. PM-11
2281 W Fort St., Detroit 16, Michigan

- Send me catalog and complete information.
 I am a GI. Send special information.
 Married. Single.

NAME _____

ADDRESS _____

CITY _____ ZONE _____ STATE _____

MICHIGAN TECHNICAL INSTITUTE

Department PM-11, 2281 West Fort Street, Detroit 16, Michigan

INDIANA TECHNICAL COLLEGE

ENGINEERING B. S. DEGREE IN 27 MONTHS. Aeronautical, Chemical, Civil, Electrical, Mechanical and Radio Engineering (inc. television). Drafting, 1-yr. Gov't approved for G.I.'s. Low rate. Earn board. Large industrial center. Students from 48 states, 18 countries. Demand for graduates. Enter December, March, June, September. Catalogue, 5117 E. Washington Blvd., Fort Wayne 2, Ind.

Thrilling Work COLORING PHOTOS

Facinating vocation learned at home by those with aptitude. Thrilling pastime. National method brings out life-like colors. Free booklet.
NATIONAL PHOTO COLORING SCHOOL
 1315 S. Michigan, Dept. 1358, Chicago 5

EASY TO LEARN

Here Is a Way YOU Can Get Ready for the BUILDING BOOM

Learn about Earning Opportunities in BUILDING CONTRACTING

FREE FACTS



Do you want to be on the inside in the building boom—where big money is made? Learn about opportunities for Building Contractors whether or not you have previous experience in this field. Millions of dollars are going to be made in home and farm buildings, in construction of stores, garages, small industrial buildings. The building industry uses men with organizing ability by thousands in construction, supervision, management, sales. Properly trained men needed in production, distribution, finance, installation, and marketing.

Easy to Learn in Nationally Known School

Government estimates housing demand at 40 billion dollars! Others are preparing to get in now! Act immediately—get the facts!

HOME BUILDERS TRAINING INSTITUTE, Dept. D-211
 DIVISION COMMERCIAL TRADES INSTITUTE
 1400 W. Greenleaf, Chicago 26, Ill.

USE OUR TRAINING PLAN TO LEARN AT HOME IN YOUR SPARE TIME

Fill Out, Cut Out, Mail Today

FACTS FREE for Men Who Want to Get Ahead
 HOME BUILDERS TRAINING INSTITUTE, Dept. D-211
 1400 Greenleaf, Chicago 26, Illinois

I am interested in the opportunities in the Building Industry. Please send me free information about getting a start as a building contractor.

Name _____

Address _____

City _____ State _____

SAY YOU SAW IT IN POPULAR MECHANICS

THOUSANDS OF SUFFERERS USE
BREATH EASY
 FOR
ASTHMA

CARRY IT WITH YOU
 USE IT ANYWHERE

Sold on Money-Back Guarantee

Write To Dept. PM

BREATH EASY DISTRIBUTORS, INC.
 65 CEDAR STREET
 SEATTLE 1 WASHINGTON

HUNDREDS OF THOUSANDS OF MEN



Appear

SLIMMER..

FEEL BETTER, LOOK YOUNGER
with **COMMANDER**

The Amazing **NEW** Abdominal Supporter

Yes, instantly, you, too, can begin to feel ALIVE . . . ON TOP OF THE WORLD by joining the Parade of Men who are marching up the highway of happier living with the COMMANDER, the amazing new Men's Abdominal Supporter.

**GET "IN SHAPE" INSTANTLY
AND ENJOY A HAPPY STREAMLINED APPEARANCE**

The COMMANDER presents the exclusively designed "INTERLOCKING HANDS" principle for extra support where you need it most. It flattens the burdensome sagging "corporation" and restores to the body the zestful invigorating feeling that comes with firm, sure "bay window" control. Order this new belt today and begin enjoying the pleasure of feeling "in shape" at once.

BREATHE EASIER — TAKE WEIGHT OFF TIRED FEET

The helpful uplifting EXTRA SUPPORTING power of the COMMANDER firmly supports abdominal sag. The instant you pull on the belt you breathe easier . . . your wind is longer . . . you feel better!

**YOUR BACK IS BRACED —
YOUR CLOTHES FIT BETTER — YOU APPEAR TALLER**

The COMMANDER braces your figure . . . you look and feel slimmer . . . your clothes fit you better. Your friends will notice the improvement immediately.

COMMANDER IS NEW AND MODERN!

The absence of gouging steel ribs, dangling buckles and bothersome laces will prove a joy. COMMANDER has a real man's jock type pouch. IT GIVES GENUINE MALE PROTECTION. Try this amazing new belt with full confidence . . . and at our risk. SEND FOR IT NOW!



Make
This
Test

with your own hands
and feel what we mean

The Secret of the
"Interlocking Hands"

Only COMMANDER contains this New principle. A porous non-stretch material is built into the special stretchy body of the COMMANDER . . . In the outline of two interlocking hands for EXTRA DOUBLE SUPPORT where you need it most. NO BUCKLES, LACES or STRAPS.

Commander Wearers All Over America Say—

"I am sure you will be pleased to know that it is by far the best and most practical supporter I have ever had. I have been pleased to show it to several of my friends and they are likewise impressed with it. You shall probably hear from some of them in the future."
—Dr. A. M. S. Standish, Mich.

"Enclosed find order for another belt. I wouldn't be without this

Above are just a few of the many unsolicited testimonials for the Commander that we receive regularly. Originals of these and others are on file.

supporter for ten times what it costs."
—Dr. G. C. S. St. Charles, Ill.

"I recommend the Commander for what it is made for. It sure has been a great help to me. I want to thank you for what it has done. I might add it has helped me more than anything I have ever tried."
P. N., Fort Knox, Ky.

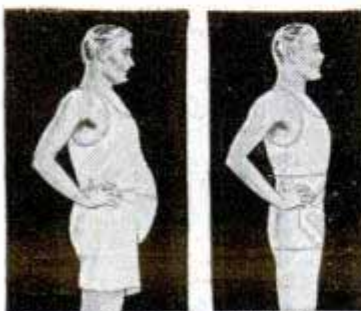

BEFORE

AFTER

**FREE
10 DAY TRIAL!**

If it fails to do all we say, send it back and the purchase price will be promptly refunded.

ONLY \$2.98

Special Large Sizes, 48 to 60, \$3.98 **SIZES 28 to 47**

MAIL THIS COUPON TODAY

INTRODUCTORY TEN-DAY TRIAL OFFER

**WARD GREEN CO., DEPT. T-1311
113 WEST 57TH STREET, NEW YORK 19, N. Y.**

Send me the "COMMANDER" for ten days Trial. I will pay postman the special price of \$2.98 plus postage. If not satisfied after wearing it ten days, I may return it and the purchase price will be promptly refunded.

My waist measure is _____ My height is _____

NAME _____

ADDRESS _____

CITY _____ STATE _____

Check here if you enclose \$2.98 with this order and we will pay postage charges. The same refund offer holds.

**WORLD'S
BEST
WANT AD
MEDIUM**

CLASSIFIED Advertisements



Advertisements in this section 60 cents per word, each insertion, minimum 10 words, payable in advance
To be inserted under proper classification, copy must be in our office the 25th of the
second month preceding date of issue

F. W. Johnson, Manager, Classified Advertising
Popular Mechanics Magazine, 200 East Ontario Street, Chicago 11, Illinois

1470 CLASSIFIED ADVERTISEMENTS 1470 OPPORTUNITIES FOR YOU

AUTOMOBILES, MIDGET CARS

FROM Speedway to roadway! Track-proved hi-speed heads and manifolds now available for passenger cars! No special tools needed! Increase horsepower 25%! Astounding getaway! Free illustrated catalog. Speedsport 5747A Waveland, Chicago 34.

"BURN Water"—Quickly convert any automobile (or truck, tractor, motorcycle) to amazing "Water Injection" (like late war planes)—only \$1.00! Saves gas, greatly increases power, more pickup, speed, cooler, smoother motor. Up to 33 miles per gallon! Easily assemble your own injector. Copyrighted installation manual, including comprehensive diagrams, detailed instructions, etc. \$1.00 complete. Newhouse Industries, 5941-R Hereford, Los Angeles 22, Calif.

WATER Injection for your car. More power, smoother performance. Wrench installs in half hour. \$14.65 complete. Free booklet sent on request. Spee-Dee Products, 2409 South Tenth Street, Tacoma 6, Wash.

CLYMERTONE. Twin muffler sets, beautiful sound, complete with necessary welded pipes, E-Z installation. Ford V-8, \$20.00. Chevrolet set with split manifolds, \$37.50. Specify car model. Clymer, Dept. A114, 2125 W. Pico, Los Angeles 6, Calif.

"1948" CUSTOM Styling manual. Easily make car look Hollywoodized, custombuilt, ultra-beautiful! New simplified customizing, restyling, streamlining methods. Instructions, photographs. Plans for accessories, refinishing, mufflers, model changes. Custom, sport, Hollywood, etc. \$2. Almqvist Engineering, Box 660-R, Brooklyn 1.

HIGH Compression heads. V-8. More speed, acceleration, power. Offenhauser or Edlebrock \$75.00 complete set. Dual manifolds complete with throttle kit, fuel lines. Edlebrock \$49.00. Offenhauser \$55.00. Give make, model V-8. Catalog 10c. Clymer Motors, Dept. A113, 2125 W. Pico, Los Angeles 6, Calif.

CUSTOMIZE Your automobile! Revised, enlarged book, latest restyling, complete, sharp. 50 photographs! \$1 pp. Post Publications, Box 723-SE, Arcadia, California.

"STREAMLINED Three-wheeled car"—Build your own for \$75! Speedy, two passenger roadster. Unbelievably simple construction. Racer body; small motor. Also, two-passenger "motor-ette" plans. Working diagrams, instructions, for both \$1.98. EA Engineering, Box 660-R, Brooklyn 1.

AUTO Racing magazine subscriptions. Pacific Speedway News, \$6.00 yearly. National Speed Sport, \$4.00. Illustrated Speedway News, \$4.00. All give complete data midget, big car race results. Sample copy each 50c. Specify publication wanted. Clymer, Dept. A112, 2125 W. Pico, Los Angeles 6, Calif.

NOW Available, after two years of post-war engineering, world's most practical midget auto. Suitable for both highway driving and small track use! Acclaimed finest by many small car technicians. Four precision models from which to choose. Available ready-to-run or in kit form. Send 25c for illustrated literature. Saxon Midget Engineering, Dept. H, Sacramento, Calif.

CUSTOM-CAR Photograph album. Fascinating automobile style classics. Coachcraft, Summers, Independents, photo-packed! \$1 pp. Post Publications, Box 723-AE, Arcadia, California.

KAISER-FRAZER. Floyd Clymer's new book (no connection with K-F factory) gives complete uncensored, impartial report 3000-mile test run with Kaiser. 100 photographs; describes new Pike's Peak closed car record. Kansas City-Denver record run, economy test. Opinions of 3000 K-F owners. Complete breakdown of equipment, units used. Read good and bad about K-F cars. No punches pulled. \$1.50 postpaid. Deluxe edition \$2.50. Clymer, Dept. A111, 2125 W. Pico, Los Angeles 6, Calif.

SEE Our ad under Motorscooters for midget car bargains. Midget Motors Directory, Athens, Ohio.

JEEP Body plans \$5.00. Dime brings snapshot and information. Southern Plan Service, Box 151, Charleston, S. C.

PHOTOGRAPHS. World's finest automobiles. List 10c. Box 1028, Minneapolis, Minnesota.

SPEED And Mileage Manual—Obtain greater speed, mileage, racing performance from any automobile! Includes simplified methods, speed tuning, gas saving secrets. Instructions on building economizers, speed equipment, duals, mufflers, superchargers, racing fuels, fast conversions, "hot-rods," parts lists. \$1.98. Almqvist Engineering, Box 660-R, Brooklyn 1.

CLYMER'S Historical Motor Scrapbook No. 4, latest Clymer book old cars and motorcycles. Postpaid \$1.50; de luxe edition, \$2.50. Clymer, Dept. A118, 2125 W. Pico, Los Angeles 6, Calif.

USED-CAR Buyer's Handbook. Save dollars, grief. Photographs, dealers' tricks, complete tests. \$1 pp. Post Publications, Box 723-TE, Arcadia, California.

JEEP Station Wagon Body Manual \$1.00. Jeep Trailer Coach Manual \$1.00. Jeep Semi-diesel Conversion Manual \$1.00. Circular illustrating all three 20c. Craftsman Books, Box 1153-PJ, Milwaukee 1, Wis.

BRITISH Sports cars. New book, 96 makes described. Fine illustrations, specifications. \$3.00 postpaid. Clymer, Dept. A117, 2125 W. Pico, Los Angeles 6, Calif.

FORD-MERCURY Owners 1941-47, operate your dome lights from both front doors. Easily installed, no drilling. Door light switches with wiring \$2.50 per pair postpaid. Danby Manufacturing Company, Portland, Michigan.

HYDRAULIC Speed transmission. Consists of 1250 PSI hydraulic pump and variable speed, reversible hydraulic motor, both encased in reservoir. Transmits 2 hp. Manufactured by Vickers for Air Corps. Ideal for small automobile drive, hoists, winches, presses, etc. Special \$28.75. Delta Sales, 738 Kirby Shreveport, Louisiana.

BE A used car dealer. Tested plan \$1, or details from E. H. Smith, 17A Rockland Ave., Yonkers, N. Y.

CLYMER-LITE Aluminum pistons for Chevrolet. More speed, power, acceleration. Less vibration, heat. Complete with pin, rings. \$5.00 each. Semi or finished. State size. Clymer, Dept. A118, 2125 W. Pico, Los Angeles 6, Calif.

MIDGET Racing car blueprint. 1948 professional design \$1.98. Sawin, Box 31b, Seekonk, Mass.

BUILD Automatic clutch, scooters, midget autos, tractors, shop machines. Catalog free. Nichols Equipment Co., Dept. 411, Purvis, Miss.

RECOVER Auto door panels yourself with leatherette. Send size, color required. \$6.50 per set of two. Shined C.O.D. Bardeen's Upholstery Shop, 534 Liberty Street, Penn Yan, New York.

FORD And Mercury owners. Attention! Give your car that knee-action ride. Restore arch to flat springs. Eliminate side-sway. Free literature. Supertone Mufflers, 2470 E. Slauson, Huntington Park 3, Calif.

DUALTONE Chrustalline packed, California mufflers, single or twin for all automobiles. Carburetor velocity stacks. Compression cylinder heads. Dual manifolds. Large double or single chromed tailpipe extensions. Chromed station wagon stacks. Fender skirts. Request catalogue. Dualtone Mufflers, 2636C India Street, San Diego 1, California.

1947 INDIANAPOLIS "500" Race History Book. Complete details every car, driver competing. 100 photos, charts, drawings. \$1.00 postpaid. Large complete Indianapolis Race History Book, 352 pages, 1100 illustrations, all data 1909 to 1946 inclusive. Postpaid \$3.50; de luxe edition fabrikoid binding, gold lettering, \$5.00. Clymer, Dept. A110, 2125 W. Pico, Los Angeles 6, Calif.

HOLLYWOOD Hot-Rod manual, plans photos, instructions, fast Fords. \$1.50 p.p. Racing parts list 25c p.p. Hollywood Hot-Rod, Box 9626P, Los Feliz Sta., Hollywood 27, Calif.

AUTO Repair manuals, by Victor Page. Complete non-technical data all mechanical features, operation, repair, Ford V-8 cars, trucks, 823 pages. 369 illustrations. \$3.50 postpaid. Chevrolet six and truck, 896 pages, 363 illustrations. \$3.50 postpaid. Clymer, Dept. FC-1, 2125 W. Pico, Los Angeles 6, Calif.

TACHOMETER Kits for V8's 0-5000 or 0-8000 r.p.m. \$27.00, tachometer alone \$12.00, 130 m.p.h. speedometer \$10.00. Zakarian Engineering, Box 416, East San Diego, Calif.

MAKE Your Model "A" do 100 m.p.h. Lightning acceleration, breath-taking top speed. Complete details, photographs. \$1 postpaid. Four Barrel, Box L-1, Eaglerock, Los Angeles 41, Calif.

INSTALL V-8 engine in your Model A for extreme acceleration, more top speed, smoother performance. Complete details, photographs. \$1 postpaid. A-V-8, Box L-1, Eaglerock, Los Angeles 41, Calif.

BUILD Speedy midget track racer from castoff parts! Plans, specifications, construction information, \$1.00. Motor Supply, Box CS-1682, Toledo, Ohio.

PROFESSIONAL Midget racer, motor-scooter, midget roadster, and midget motorcycle. Plans, specifications for all four contained in illustrated handbook, 25c. Big list bargain priced used motors, motor-scooters, servicycles, etc., included free! Midwest, 3839 Drummond, Toledo, Ohio.

R & R Mfg. Co., marine and auto division. Anderson, Indiana. Robert M. Roof. \$1.00 for our new 1947 speed and power equipment catalogue with price sheet—showing racing cars, midgets, speed boats with recommendations how to rebuild your motors for racing. Dual ignition racing cylinder heads for V-60-100 and Mercury Ford engines. Dual intake manifolds, racing pistons, camshafts, compound valve springs, Lynite flywheels, quick change gear boxes and numerous other supplies.

MAKE Your Ford fast! Complete details, photographs. How to construct 120 m.p.h. Hotrod. \$1 postpaid. California Bill, Box L-1, Eaglerock, Los Angeles 41, Calif.

AUTO SUPPLIES AND EQUIPMENT

ATOMIC Condenser for all cars, quick starting, more power, smoother motor, better mileage. Order yours now. \$3.00 prepaid. State make and year of car. Improved Automotive Products, 154 Lenox Street, Rochester 11, N.Y.

OIL Pumping motors. Details, Mullner Co., Box 3102, St. Paul 1, Minn.

NEW Discovery for all gasoline engines. Deadly carbon monoxide gas exploded. Increases power and mileage, prolongs life of motor and maybe yours! Send \$1.00 for valuable information. Olson Motor Breather Co., 3609 Motor Ave., Los Angeles 34, Calif.

AUTO Mechanics, remote control for push button type auto starters makes adjusting valves, points, timing, bearings, compression testing, easy. \$1.00 postpaid. W. Nickerson, 162 Hazelton Ave., Jamestown, N.Y.

PATENTED Gasoline saving vacuum supercharger, uses gasoline motors waste. \$12.50. Self addressed stamped envelope for pamphlet. McDowell Co., 2000 NE Union, Portland 12, Oregon.

CAR Owners, mechanics, hydraulic brake kinks and information, also safe repair of gasoline tank by welding or brazing. Both \$1.00 postpaid. W. Nickerson, 162 Hazelton Ave., Jamestown, N.Y.

WATER Injection manual—Easily make own system (for less than \$1). "Vaper injection" increases speed, power; 30% gas saving! Better performance! Eliminates ping, carbon. Reduces wear, sludge, oil pumping. Booklet includes "tuneup tips" \$1.00. Alquist Engineering, Box 660-R, Brooklyn 1.

NEW Auto thief alarm protects car, tires and accessories. Amazing invention blasts loud alarm instant thief tampers with any part of car or truck. Write for descriptive circular and prices. Joyce Distributing Co., 30 W. Washington St., Room 940, Chicago 2, Illinois.

RECONDITION Engines and cure oil pumping without overhaul! Simplified procedure includes "tuneup" and economy tips for better performance! Manual \$2. EA Engineering, Box 660-R, Brooklyn 1.

PARTS For autos and trucks guaranteed from 1916 on. Describe part when ordering. Bill's Auto Parts, Valley Falls, R. I.

AUTO Glass, shock absorbers, rubber floor mats at factory prices! State requirements for quotations. Shipment immediately. Cooper Automotive Services, 3135 Lawrence, Chicago 25, Illinois.

WELDING Bodies, repairing fenders, pays good profits using Hobart's a.c. arc welder. Catalog free. Write Hobart Welders, Box M-1072, Troy, Ohio.

WELDERS For all requirements. Free catalog. Write Hobartweld, Box M-1073, Troy, Ohio.

HEAT Booster. Raises temperature of water entering your hot water heater. Aluminum casting bolts to exhaust manifold. Cuts down warm-up time, increases heat, solves problem for sluggish heaters. Russell Machine Co., 416 Scribner, Grand Rapids, Mich.

STOP Automatic choke troubles with easily attached hand choke adapters. \$3.00 postpaid guaranteed. Details free. Redex Co., 1301 Ridgeway, Rochester 13, New York.

CHROME Grilles for all cars. Wagner Grille Co., Route 2, Bernville, Penna.

NEED Auto parts? We have them. New and rebuilt. Prompt shipment. Write requirements. Save money. Buy direct. (See our display advertisement page 266). Factory warehouse. Mechanics Auto Parts, 3807-PM-11 North Ashland, Chicago 13.

HAVING Car trouble? New, used, guaranteed auto, truck parts save money. Transmission specialists. Describe needs; immediate reply. Victory, 2930ZN North Western, Chicago 18.

PLAID Fiber seat covers, to 1933; leatherette trim; full sets \$6.95; fronts \$3.95. Cover Co., 1911-N, Lubbock, Texas.

CARBURETOR Repair kits, miscellaneous parts for most popular carburetors. State requirements. Carburetor Service, 600 LaPrairie Ave., Ferndale 20, Mich.

SPRAY Paint your automobile. Complete professional instructions, \$1.00. 155 Tasso, Palo Alto, California.

TIRES—Firestone. Retail, wholesale. C. Page, Franklinville, N.Y.

AUTO Parts for all autos and trucks. Trans., motors, differentials, fenders, carburetors. Also body parts. Security Auto and Truck Parts, 1923 BJ Grace, Chicago 13.

GRILLES For all cars. Meyers Auto Parts, 820 Dryades, New Orleans, La.

NEW And used automobile and truck parts. Lowest prices. Complete stock. Prompt reply. Babbitt Auto Parts, 2833 W. Chicago Ave., Chicago 22.

PLATING Outfits for auto parts. Connect to a battery. No tanks used. Free particulars and proofs. Gunmetal Co., Ave. J, Decatur, Ill.

BURN Water in your car. Costs less than gas. More power, cleaner motor. Mail card for data on \$17.50 octa-gane water injecting carburetor. Ralph A. Shade, 563 Lake Road, Webster, N.Y.

FILTERMASTER'S Flo-meter tells when to change oil filters and crankcase oil. This instrument eliminates guessing from engine lubrication. Increases useful engine life, pays for itself quickly. \$2.80 at automotive stores or \$2.00 postpaid with return this ad. Get yours now. Fully guaranteed. Information on request. Filtermaster, Dept. PM-5, 440 E. Schantz, Dayton 9, Ohio.

AUTO TRAILERS

BUILD \$300 Streamline camp or baggage trailer in three evenings for under \$65. Plans and instructions \$2. Barton Enterprises, Box 351, Atascadero, California.

STREAMLINER 17 Ft. coach, large manual, drawings, parts list \$1.00. Circulars illustrating design 14 ft. to 28 ft. 20c. Craftsman Books, Box 1153-PT, Milwaukee 1, Wis.

TRAILERCOACHES—Learn about all types; sports, living or travel. Approximately 100 pages monthly; magazine tells all. Special rate, \$1 the year in U.S., \$1.50 to Canada, \$2.00 foreign. Trail-R-News, Box 431-A, Glendale, California.

COMPLETE Foundation for your trailer home. Chassis frames, Tor-Q-Les axle, spring and wheel assemblies, hitches, tires and tubes. Order a complete unit or specify items desired. Literature on request. General Trailer Company, 412 South Barstow Street, Eau Claire, Wisconsin.

BUILD Your own trailer! Save money! Have every feature you want! Plans for house, sport, camp and utility trailers. Catalog describing 9 models 10c. 15c in Canada and overseas. Jim Dandy, Box 125-A, Wausau, Wisconsin.

MOTORCYCLES, BICYCLES, MOTOR-SCOOTERS AND SUPPLIES

SCHWINN Bicycles for Christmas. Send dime for list. Wholesale. Retail. Century Cycle, 3447 Lawrence, Chicago 25, Illinois.

BOYS, Repair your own bike. "Bicycle Repair Manual" teaches brake repairing, rebuilding wheels, etc. 65c. Robert Klausner, Shelbyville, Ill.

MOTOR Scooter tires, guaranteed nationally known make, first quality. Size 3.50 x 6, 4-ply, with inner tube, \$7.54. Size 4.00 x 8, 4-ply, with tube, \$8.15. Size 6.00 x 6, 4-ply, with tube, \$15.00. Prices f.o.b. Akron. Check or money order. Also have sizes to 18" diameter. Jahant Company, 626 E. Exchange Street, Akron 6, Ohio.

BICYCLE Repairing. Begin at once. Manual explains everything. Make money from start. Postpaid, one dollar. Cahill Cycle Shop, Centerville, Maryland.

MOTOR Scooters, bicycle engines. 120 miles gallon. Dime for catalog. Clymer, Dept. A115, 2125 W. Pico, Los Angeles 6, Calif.

MIDGET Racer less motor \$25; midget car complete \$58; factory built motor-scooters \$50 up complete; others \$25 up; German Sachs motorcycle \$50; 74 Harley \$25; Henderson motor \$5; plenty of brand new two horsepower gasoline engines in original crates; plenty new midget highway racers; plenty brand new motorscooters; over 5,400 small tires \$1 up. (Mail order only), send 25c for big war-bargain catalogue number 22, just out, listing the above and hundreds of other bargains in motorscooters, midget cars, motorcycles, engines, parts, plans, etc. (35c by first class mail). Midget Motors Directory, Athens, Ohio.

JUST Out. Bulletin containing bargains in race cars, motorbikes, motorcycles and motors. Send 25c. Behnke's, 5721 Leland, Chicago 30, Ill.

PROPELLERS For ice-snow sleds, air boats. Catalog 10c. Banks-Maxwell, R.F.D. 12, Ft. Worth, Texas.

MOTORCYCLE Parts for all English and American makes, tires, batteries, pistons, valves, bearings and carburetors. Catalog on request. Nicholson Brothers, Saskatoon, Canada.

BICYCLE Supplies—wholesale, retail. Metal disc wheels, List 10c. Universal, 4713 Virginia, St. Louis, Missouri.

MOTORCYCLE News—monthly. Yearly subscription \$1.00. Introductory copy 10c. Motorcycle News, 5424-A Sawyer, Chicago 25.

NEW British motorcycles, unequalled for design, performance and operating economy. Immediate deliveries available. Catalog on request. Nicholson Brothers, Saskatoon, Canada.

HARLEY-DAVIDSON Parts, accessories, batteries, and tires, 24 hour service. Authorized factory dealer. Philadelphia Harley-Davidson Company, 857 North Broad Street, Philadelphia 23, Penna.

CUSHMAN Motorscooter \$15. Shaw bicycle motor \$15. Harley-Davidson motorcycle, \$35! Send 25c for bargain catalog #8 packed with money saving buys in motor-scooters, motorbikes, midget cars, motors, wheels, tires and parts. Gail and Company, 538 Erie, Toledo, Ohio.

WHEELS! Build wagons, scooters, mowers, trailers, wheelbarrows, grocery carts, baby carts, play pens, baby carriages. 4" to 16". Free list. Trulsen Mfg. Co., 811 E. 31, Kansas City, Mo.

TIRES And industrial wheels, suitable for scooters, wheelbarrows, farm equipment, etc. All sizes. Bicycles and accessories. Largest assortment in America. Send dime for list. Cycle Transport Company, 1241 So. Michigan Ave., Chicago 5, Illinois.

BUILD America's lowest priced motor-scooter speedster! Complete plans, specifications, \$1.00. Big list bargain priced used motors, etc., included free! Motor Supply, Box 1682-CS, Toledo, Ohio.

LARGE Stock Indian parts. Expert motor rebuilding. New and rebuilt Chief motorcycle, motors only. Indian Motorcycle Sales, Kansas City 1, Mo.

HARLEY-DAVIDSON—New and used 45" motors, service, parts, accessories, tires. Send \$2.25 for army motorcycle manual, 10c for bulletins. Knuth's (Harley-Davidson factory dealer), 2491 Fondulac, Milwaukee, Wis.

CUSHMAN Motorscooter \$20 (includes motor and extra tires). Midget racer \$15! Send 25c for big catalog #938 listing these and scores of other sensational bargains in motors, wheels, motorscooters, motorbikes, servicers, tires, etc. Associated, Box CS-1764, Toledo, Ohio.

AVIATION

FLIGHT Engineers Manual just published by Charles A. Zweng. Prepares for flight engineer rating. 420 pages, illustrated \$4.00 postpaid or C.O.D. Free aeronautical catalog. Pan American Navigation Service, 12021 Ventura Blvd., North Hollywood, Calif.

FREE Catalog describes world's most complete line of navigation instruments and texts. Includes famous Weems Mark II Plotters, Dalton E6B and Mark VII Computers, protractors, star charts, plotting boards, watches, celestial coordinators, charts, sextants, navigation notebooks, many more. Weems equipment standard with Army-Navy air forces, commercial airlines. Write Dept. 2, Weems System of Navigation, Annapolis, Md.

JET Propulsion experiments. New design. Drive bicycle. Circular on plans. Rush name. Maupin, Tipp City 3, Ohio.

PROPELLERS—2 And 3 blade, designed for ice-snow sleds, boats. Literature. Standard Aircraft, Box 387, Ft. Worth, Texas.

WOOD Propellers, all types duplicated. Universal Aircraft Co., Box 2256, Fort Worth, Texas.

FOR Sale—Aeronca 30 hp., two cylinder, excellent shape and complete, \$175.00; Aeromarine 55 hp., 3 cylinder, excellent shape and complete, \$200.00; Franklin 90 hp., 4 cylinder, good condition, complete \$200.00. Prices quoted include pusher or tractor propeller. Excellent engine for snow or ice sleds. Curtiss Conqueror, 600 hp., 12 cylinder, complete \$200.00. Airplane propellers for fire place or den \$9.95 each. Sensenich Corporation, Dept. PM, Lancaster, Penna.

B-29 COMPUTERS, 400 Cycle dynamometers, 60VDC amplitudes and servo amplifiers, turret drives, bomb releases, starter solenoids, collector rings, etc. List. Erec, 2912 Hewitt, Everett 1, Washington.

SKI-TOWS, Portable, auto-powered, 500 ft. long. Pulls you both ways. Up, level or downhill. Set up in 20 minutes. Only \$125. Send card for particulars. Great-Northern Mart, North Adams, Mass.

VETERANS: Flight training under the G. I. Bill. Tuition paid. Private, commercial, flight instruction, instrument and multi-engine ratings. Opportunities to work for living expenses or tuition, if not a veteran. Write Gottschalk School of Aeronautics, Adrian, Mich.

4" 6" PUSHER Propellers. Three blade pusher propeller. Finest birch laminated construction, brass tipping. 50 to 85 h.p. for boats, sleds, etc. \$75.00. Same type as used on the famous CallAir SnowCar. Call-Air, Afton, Wyoming.

GIANT Glider kites. Double. 14x10 ft. Lifts 100 lbs., tows car, etc. Cost government \$108. Yours for \$20. Satisfaction guaranteed. Great Northern Mart, North Adams, Mass.

BATTERIES, GENERATORS

\$150.00 NEW Generators, only \$33.00. See Greer advertisement under "Welding."

EDISON Non-acid lifetime storage batteries for home lighting, motors, radios, etc. Free complete interesting literature. T. Hawley Smith Company, Croton Falls, N. Y.

ELECTRICAL SUPPLIES, EQUIPMENT

CHRISTMAS Tree light sets and bulbs. Jeannette Electric, 159 West 23rd St., New York 11, N.Y.

BLOWERS, Motors, gas burners, gas furnaces, controls, oil burners, oil furnaces, oil circulators, water heaters, exhaust fans, pumps, "Superior's," 120 El-nido, Monrovia, Calif.

DIRECT Factory agents for fast-selling, fine commercial popcorn machines. Nationally advertised. Sales leads furnished. Excellent profit. Viking Popcorn Machines, Inc., 114 W. 18th, Kansas City, Mo.

VOLTMETERS 3 1/2" Burlington or Supreme, 0-10 d.c. plus special battery charging scale. Easily converted to other ranges. Instructions included. \$1.39 each, five for \$5.00 p.p. Boutwell Electric, 203 Gilbert, Kirkwood 22, Mo.

GENERATOR Flashlight. No batteries to wear out! Easily make your own from simple household materials and tools. Complete guaranteed copyrighted instructions. 50c (cash, check or money order). Reiss, 3017-M Ocean Parkway, Brooklyn 24, N. Y.

\$150.00 NEW Generators, only \$33.00. See Greer advertisement under "Welding."

MAGNET, "Ainico" 4 oz. horseshoe, powerful (lifts about 5 lb.) \$1.00, 8 oz. (lifts 10 lb.) \$1.50, 3 lb. (lifts 20 lb.) \$6.00; all postpaid. Ross, C68 West Broadway, New York, N. Y.

VOLTAGE Regulators. Autolite, silver contacts and large radio filter. Like new condition. Original cost \$140.90. Price \$5.95 prepaid. Also new Delco Remy regulators. Platinum contacts. \$3.95 prepaid. Both 24 volt, 50 amp. State Ignition, 2521 Indiana, Chicago 16, Ill.

FREE Catalog of welders, welding supplies, generators, fences, electric lawn mowers, freezers, and other electrical items. LeJay Company, Minneapolis, Minn.

LAMPS—All parts to build or repair. Harps, sockets, vase caps, bases, hard to get items. Illustrated catalog 10c. Gyro Lamps, 5416 Clark, Chicago 40.

LAMPS—Build your own, all parts furnished at wholesale prices. Write for free photos. Brown Lamp Company, Box 501, Welston, St. Louis 12, Mo.

NEW Surplus wire and cable. 200 sizes and types. Armored, Tirez, lead. Free list. Ercco, 2912 Hewitt, Everett 1, Washington.

WANTED Ex. G.I. electricians to start motor repair shops. Write Electrical Engineering Consultation Service, 3013 East 6th St., Long Beach 4, California.

TATTOOING Machines, outfits. Free catalogue, Jensen, 120 West 83rd Street, Los Angeles 3.

ELECTRIC Pencil—Writes, engraves all metals. Battery model \$1.00—110 volt model \$3.00. Complete. C.O.D.'s accepted. Reb Industries, Dept. 265-CC, Elmhurst, Illinois.

BUILD Your own lamps. Save half. Be different. Write for free photos, also lamp parts. Buddy Products Mfg. Co., Dept. 30, 1123 W. Belmont, Chicago, Ill.

ELECTRIC Pencil: Writes, engraves all metals. \$1.00 postpaid. Beyer Mfg., 229-H Dixon Blvd., Uniontown, Penna.

LITTLE Library of Useful Information. 102 different books. Catalog free. Popular Mechanics Press, 200 E. Ontario St., Chicago 11, Ill.

WELDING, SOLDERING, PLATING

ERGOLYTE Welding kit—Industrial type, junior model, glass insulation, both flame and metallic arc. Compact carrying case. Ideal home and shop use. 110 volt, \$44.85 complete. Ergolyte Mfg. Company, 3627 N. Lawrence St., Philadelphia 40, Penna.

A.C. Welders, 110v. Welds 1/2" steel, \$29. Guaranteed. Morris Welding Service, 1850A State St., Schenectady 4, N. Y.

NEW Model electric welder, 110 volt a.c.-d.c.; will weld all metals; easy to use; full directions. Complete with power unit, flame and metallic arc attachments, carbons, fluxes, rods, mask; all for \$19.95. Used by the navy. Magic Welder Mfg. Co., 239 MP11 Canal St., New York City.

WELDERS—Govt. surplus tested gasoline driven. Save up to 50%. Iowa Machinery Co., Des Moines.

WELD, Cut, braze with gasoline! Amazing discovery shatters costs. Range jewelry to railroad steel. For farm, factory, shop. New opportunities. New wealth. Important! Investigate. Matthews Mfg. Co., Calgary 21, Canada.

ACETYLENE Welding outfit approved by Underwriters and oxygen and acetylene cylinders I.C.C. inspected. All for \$75.00 complete. Best's Service, M8215 S. Honore St., Chicago 20, Ill.

OXY-ACETYLENE Welding and cutting outfit complete with cylinders and carrying case. Designed especially for hobby-shops, small repair shops, refrigeration and electrical service men. You own the cylinders. Free literature. A-A Welding Supply Co., C9228 S. Ada St., Chicago 20, Ill.

CLOSEOUT—While 250 last. Nine page pamphlet "Electroplating" including formulas and plating instruction for gold, silver, nickel, copper, chrome, etc. 25c. F. D. Hyde, 432 "F" St., San Diego, California.

WELDERS (Acetylene) become expert on white metal. Use own inexpensive rod made from scrap. LaCombe, Oakland 6-M, California.

NEW Aircraft lighting generators. War surplus. Only \$49.50. Original cost \$250.00. Can be used for lighting or converted for use as welder, electric plater, fast battery charger, auxiliary power unit, etc. Model R.2, manufactured by Jack & Heintz, 30 volts, 300 amp. d.c., shipping weight 68 lbs. Size 16"x7". Also new G.E. and Westinghouse P.1 generators, d.c., 200 amp., 28 1/2 volts, cost \$150.00, price \$33.00 each. Immediate shipment. Check with order. Greer, 460 South State Street, Chicago, Illinois.

PORTABLE Arc welder, "build your own." Your engine plus Hobart welding generator saves \$350. Starts paying business. Free instruction book. Write Hobart Welders, Box M-1074, Troy, Ohio.

WELDERS For all requirements. Free catalog. Write Hobartweld, Box M-1075, Troy, Ohio.

BUY Direct from factory. Welding outfit \$48.36; soldering outfits \$12.70 to \$9.70 complete prepaid. Box 331, Hamilton, Ohio.

NEW Portable champion special; transformer welder; 110/120 volt a.c.; 8 heat stages. Welds, brazes, solders, cuts all metals. Complete with electro holder, mask, rods, carbons, fluxes, cables, also special flame weld torch. Full directions, easy to use. Splendid for shop, farm and home repairs. Guaranteed 1 year. Only \$27.50. Magic Welder Mfg. Co., 241 NW Canal St., New York City.

BUILD Heavy duty industrial transformer type welder. Primary, secondary separate. Operates 110 or 220 volts. Alternating current. Complete detailed plans \$1.00. Atomic Welder, 1038 So. 19th St., Omaha, Nebr.

30 AMP. Selenium plating rectifiers with Powerstat control, \$85.00. Lead lined tanks, geared motors for agitation. Complete line of bronzed baby shoe mounts. Hollywood Bronze Supply, 1770 N. Vermont, Hollywood 27, Calif.

MACHINERY, TOOLS AND SUPPLIES

FOUNDRY Castings, blueprints, materials for woodworking and metalworking machine tools. Suitable for commercial or home shop production. 23 items, catalog 10c. Lewis Machine Tool Co., 3217 Union Pacific Avenue, Dept. M, Los Angeles 23, California.

BENDIX Compass—Magnetic, aircraft liquid filled type. Used, good condition, guaranteed, \$7.95. Other big values in surplus motors, switches, flexible shafts, gears, speed reducers, etc. Delta Sales, 738 Kirby, Shreveport, Louisiana.

"WAR Surplus" bargains! All new! Flexible drive cables! Three sizes, 10", 25", 72". Over \$5.00 value. Combination offer of all 3 sizes, \$1.75. Precision built right angle drives. Complete with flexible drive cables. Only \$3.50. Magnet wire 1/2 lb. coils No. 22, 10 rolls for \$3. Dual drive assembly. Geared 7 to 1 reduction, driven by powerful 1/5 hp. a.c. or d.c. motor. Operated on 6-27- or 110 volts with transformer. Standard attachments convert this unit into a dual, hand or table drill, polisher, buffer, router, sander, etc. May be used as individual drill, sander, etc., by detaching flexible drive shaft. Comes set-up as drill equipped with 3 flexible drive cables and mounting bracket. Original cost to govt. over \$300.00. Now \$15.00. Splendid values! Order today. No c.o.d. "Amazing Bachman's," 23 Herman Street, Rochester 5, N. Y.

CONCRETE Building block machines and molds. Catalog free. Concrete Machine Co., 5466 Gravois, St. Louis, Mo.

WOODWORKING Machine knives. Low prices. Also precision sharpening service. Free circular. Colman Tools, 204 North Buchanan, Amarillo, Texas.

DAYTON "V" belts and pulleys. All sizes for every need; prompt shipments. Free circular and prices. Hydraulic Products Co., East Main Street, Southold, N. Y., Box 206.

LATHE Milling attachment. Photograph for dime. Depoy Model Shop, Muncie, Ind.

HARDWARE, Tools, drills, taps, dies, pattern, model supplies, electrical equipment, steel, brass, drill rod. Catalog 10c. Terek, 6304 Patterson, Chicago 34.

12" BAND Saw, tilting table, Oillite bearings, \$35.00. 6" jointer, ball bearing, 43" long, \$59.50. Spindle shaper, ball bearing, 15x20 table, interchangeable spindles, \$49.50. 8" bench saw, large tilting table, ball bearing, complete, \$29.50. Immediate delivery. Dealers wanted. Write for catalog. Backus Machine Co., Boyd, Wis.

ELECTRIC Foot switch—For power tools. Leaves both hands free. Just plug it in. \$3.95 postpaid. C.O.D.'s accepted. Reb Industries, Dept. 265-CB, Elmhurst, Illinois.

VALVE Guide inserter and extractor. Self-centering and machined to assure proper alignment of tool and guide. Available two sizes. Chev. \$1.00. Buick \$1.25. Luson Enterprises, 1333 So. 6th St., Minneapolis 4, Minn.

ASSORTED Scissor screws, saw supplies, list 10c. Overland Saw Service, Independence, Iowa.

WOOD Shaper assembly with 1/2" ball bearing spindle, fence, table plate and plans for floor model stand. \$14.75. Woodcraft Tool and Supply Co., Sylacauga, Ala.

GEAR Reductions! Values ranging from \$500 to \$1100 each. All new! Complete with 1/2 h.p. motor a.c. or d.c. 110 volt. 25 or 60 cy. Single phase. Variable speeds. Bearing assembly with machined gears. Absolutely the thing for sanders, polishers, winches, hoist, conveyors. Adaptable for many uses. Special \$39.50. No c.o.d. "Amazing Bachman's," 23 Herman Street, Rochester 5, N. Y.

ARC Welders, A.C. or D.C. 150-600 ampere. Portable, stationary. Prompt delivery. Reasonable terms. Also electrodes and accessories. Free catalogs. Write Hobart Welders, Box M-1076, Troy, Ohio.

BENCH, Jig saws, drills, mandrels, sanders, etc. Circulars 3c. Sunshine, Berkshire Heights, Penna.

DRILLS, High speed, 1-60 \$10.95. Send dime for sample and list. V-B Sales, Roselle, Illinois.

UNIVERSAL Angle plate, 4"x3"x3", rib is handle, precision ground 6 sides. \$4.45. Tool catalog. Model Tool Service, Rock Falls, Ill.

DRILL Grinder for twist drills \$2.95. See ad on page 266.

NEW Band saw for home workshop or factory use, ideal for hobbyists. Special \$14.95. Circular free. Woodcraft Tools, 147 E. Lake, Minneapolis, Minn.

SOCKET-SCREW Key handles (Aluminum). Free trial. Wittle Manufacturing, 1041 Lititz Avenue, Lancaster, Penna.

MAKE Easy money with our drain tile machines. Bird bath, flower pot and other miscellaneous molds. Concrete Machinery Company, Hickory 22, N. C.

DECIMAL Equivalents, tap drill sizes, and temperature color charts for wall or tool chest lid. 50c each or all three \$1.00. Northcott, Box 486, Hays, Kans.

ELECTRIC Sander low as \$7.65. Circular. Handy Tools, 255PM Charles, Grand Rapids 6, Michigan.

WE Offer 60 tons of new war surplus bolts, nuts, washers, screws, etc. All popular sizes. A good mixture for hobby shops, garages, machine shops and farms. A big 40 lb. box for only \$6.85. War Surplus Co., Morris and John Sts., New Brunswick, N. J.

SHEBEL Saw Filer files all saws. Circular. A. P. Shebel, 730B So. 2nd St., Milwaukee 4, Wis.

BALL Bearings one-fourth list price; gears, switches, rheostats. Free list. Burgess, Box 168, Ferguson, Mo.

V-BLOCKS At low prices. 10 sizes for all purposes. Free literature. Miles Products, 2532 Wabash, Chicago 16.

HOME Shop owners attention.—Send for actual photograph and sample of the work our attachments will do. The photograph and sample speak for themselves. Have fun in your home shop. Cut gears, sprockets, ratchets, lay out holes accurately, cut keyways, build complete clocks and other interesting jobs. Build these attachments yourself from our reasonably priced blue prints. Don't limit your lathe to round work only. The Home Shop, 415 Raymond Avenue, Glendale 1, California.

DRILL Grinder—Grinds drills to factory accuracy. Calipers with direct reading scales. Circle cutters. New Tool grinder. Lowest prices. Free literature. Factory, 811-B East 31st, Kansas City 3, Mo.

MACHINE Shop tools released for private industry; small bench lathe \$90. Logan loose change \$250. Quick change \$350. 14" screw cutting engine lathe \$150. 16"-180. 15" quick change \$440. 16"-17" \$510. 17" and 32"x10" gap lathe \$650. 22"x17" \$550. Hand miller \$100. 20"-30" upright drills. \$100-\$300. Amco bench shaper \$350. Gasoline driven 200 amp. welder \$315. Electric motors 30"-36" band saws \$140-\$275. Money back guarantee. Conversion Parts Co., 278 Adams St., Boston 22, Mass.

ENGINES, MOTORS, DYNAMOS

MIDGET Motors—4 r.p.m., 110 volts, 60 cycle a.c. Perfect for timing machines, displays, models. Price delivered \$5.00 each. McLaren Products Co., P.O. Box 1021, Riverside, California.

MOTORS, Water, air, steam driven. 3" novelty, \$3.50. 4" novelty, \$5.50. 6" novelty, \$9.50. 8" novelty, \$12.50. Heavy duty, 1/4 hp. \$5.50. 1/2 hp. \$7.50. 3/4 hp. \$12.50. 1 hp. \$20.00. Cash with order. Prepaid, Duplex Motors, Burlington, Ia.

"**BUILD Your own**" portable arc welder. Your engine plus Hobart welding generator saves \$350. Starts paying business. Free instruction book. Write Hobart Welders, Box M-1077, Troy, Ohio.

WELDERS For all requirements. Free catalog. Write Hobartweld, Box M-1078, Troy, Ohio.

\$150.00 **NEW Generators**, only \$33.00. See Greer advertisement under "Welding."

MOTORS! 1/2 HP. d.c. converted to a.c. All new. High speed 110 volt. 25 or 60 cycle, ball-bearing motors with forward and reverse switches. Actual cost about \$100.00. Now \$19.50, three for \$50, or same motor without reverse switch \$15. Three for \$40. Countless uses for home mechanics. Order today! No c.o.d. orders. "Amazing Bachman's," 23 Herman Street, Rochester 5, N. Y.

AC MOTOR Winder, winds concentric coils for electric motors, adjustable 1/2 to 2 h.p. Send for bulletin. Motor Industries, Quincy, Illinois.

WELDING Generator, 150 ampere, \$47.50. Other bargains. Butler, 1885 Milwaukee, Chicago.

WINDING Data, listing 225 motors, single and three phase, \$1.00. Motor Data Co., Box 7631, Kansas City 3, Mo.

BOATS, OUTBOARD MOTORS, ETC.

FREE Catalog describes famous Weems line of navigation instruments and texts. Write Dept. 2, Weems System of Navigation, Annapolis, Md.

SKATE, Iceboat sails, canvas all widths, wingdope, boat builders' equipment, Everdure screws, marine hardware, fitted boat covers, etc. Alan-Clarke, 96 Chambers, New York City.

P-38 BELLY Tank speed boat. Complete plans, instructions \$1.00. Twintank Boat Company, 1032 62nd Street, Oakland, Calif.

DUCK And rowboats, kayaks, Weldwood ready cut kits. Booklet, E. J. Croot Co., 103-D, Basking Ridge, N. J.

CATALOGUE—Over 30 world's best plywood designs sent with Wm. Deed's book "Plywood Boats." Send \$1.00. Marine Mart, Buffalo 7, N. Y.

BUILD Your own boat by the Welch system with knock down kits. Save 2/3 cost. Rowboats to cruisers. Send 10c for illustrated catalog. Midwest Boat Company, Menomonee Falls, Wisconsin.

TWENTY Plywood boat plans \$1.00. 6 to 20 feet, sail, power. The Rudder, 15 Murray Street, New York.

MOLDED And sheet plywood boat kits, ready to assemble, 8 to 14 ft. \$40.00 up. Genuine weldwood marine type plywood in various thicknesses and lengths. Send 25c for literature. Marine Mart, Buffalo 7, N. Y.

KAYAK Blueprints, deluxe models—catalogue 10c. Viking Canoes, Merrick, N. Y.

MARINE Catalogue—15,000 deliverable items pictured that should be pictured at price. Send \$1.00. Marine Mart, Buffalo 7, N. Y.

\$35 SEA SHELL Pre-fabricated 8' plywood rowboat. Free illustrated folder. Hagerty, Cohasset, Massachusetts.

AIRPLANE Jettison tanks—Streamlined. 10 1/2 foot, tear drop shaped. 165 gallon. Of light weight lead coated steel, weighs 75 pounds. Floats over 1200 pounds. Ideal for making trim, inexpensive boats, canoes, kayaks, dinghys, duck boats, powered catamarans and runabouts. Prices \$12.50 complete. \$9.75 each for three or more. U. S. freight prepaid. General Sales, 205 Market, Grand Rapids 3, Michigan.

NEPTUNE Outboard motor parts, complete stock. Limited supply new motors, 1 1/2 to 9 1/2 h.p. Citizens Supply Co., P.O. Box 1241 M, Muncie, Indiana.

MARINE Power—Easily convert any Jeep or Ford motor (domestic or foreign) with Convo parts and kits. Complete catalog 25c (coin). Osco Motors Corporation, 2020B East Orleans Street, Philadelphia 34, Penna.

P-38 BELLY Tanks, new, steel. 10 ft. 2 in. 165 gallon \$9.95. Anzio Boat Co., Box 89, Merced, California.

OUTBOARD Motor parts, new and used, for all makes. New pistons, standard and oversize. Cylinders rebored. Outboard Motor Mart, Inc., 309 Atlantic Ave., Boston 10, Mass.

NEW, Used, rebuilt marine motors. Marine conversions, fittings. Free catalog. Stokes Marine Supply, Dept. 24, Coldwater, Michigan.

ALL Copper water jacketed exhaust manifolds for marine conversions of automobile and aviation engines and marine engine replacements; any make, model or age. Joseph Van Bierck & Son, 391 Woodcleft Ave., Freeport, N. Y.

MARINE Conversions for Ford and Jeep engines. Catalog 10c. Lehman Manufacturing Company, Department D, Newark 2, New Jersey.

BOATS And all about them. How to select, build, repair and operate. For 40 years the leading practical boating magazine. Half price trial subscription. 12 issues for \$1.00. Motor Boat, 62 Gold Street, New York 7.

BOAT Designers are highly paid professionals. Complete course by mail. Catalog. Westlawn, Montville, N. J.

ATHLETIC EQUIPMENT, BODY BUILDING COURSES

BARBELLS! Catalog! Bur Barbell Co., 319 Orient Way, Lyndhurst, N. J.

DEADLY Judo—Fiercest fighting technique. Trick knockouts. (200 photographs plus illustrations). Expert instructions. Three volumes. Complete \$2.25. Variety House, Box 46-BX, Wall Station, New York 5.

MUSCLES—Power bulging muscles with "Herculex Crusher Grip Outfit" \$3.00. Includes course plus big pictured list of equipment and free booklet on weightlifting. Nat Berent, 1090 W. 43rd, Norfolk 8, Va.

HANDBALANCING—Acrobatics easily learned. Write. Power, 923a W. Vine, Kalamazoo, Michigan.

HEALTH—Build perfectly developed body. Fast and easy. World's greatest system. Literature free. Todd Foundation, Springfield 9, Massachusetts.

BARBELLS \$11.00 up. Stamp for folders. Jackson International Barbells, Springfield, N. J.

BARBELLS, Exercise equipment. Courses. Free booklet. Good Barbell Co., Reading, Penna.

SPORTING GOODS, GUNS, FISHING TACKLE, ARCHERY, TRAPPING

COMMANDO Sheath knife, 6 inch, extra heavy, blood grooved blade; built to last lifetime with rough leather washer handle; per Army specifications. Excellent for hunters, trappers, fishermen. Guaranteed brand new. \$3.00. C. Strickler, Kleinfeltersville, Penna.

GUN Grips, Pearl, Wholesale, Miracle Product, 44 North Albany, Chicago.

GUARANTEED tapered leaders, 3 times stronger. Santa Fe Products, Santa Fe, N. Mex.

FREE! Klein's big, new complete all-sports catalog. Features 1000 guns, gun-trading information, \$800 prize contest entry blank. Write Klein's, 227 West Washington Street, Dept. CTM, Chicago 6. (Send \$1.25 for new gun encyclopedia "The Gun Digest.")

SHOTGUNS, Rifles, revolvers. Over 500 modern, obsolete. Also cartridges. List 10c coin. Ed Howe, 52 Main, Coopers Mills, Maine.

GOLF. Improve your game immediately. \$1.00 brings amazing results from our book. Golf Instruction Book Co., 6943 Saybrook Ave., Philadelphia 42, Penna. Wholesale rates to dealers.

GUN Stock blanks \$1.50 up. Information. Banks-Maxwell, R.F.D. 12, Ft. Worth, Texas.

AUTOMATIC Lure—Positively weedless. Greatest invention in ages. Nothing like it. Circular free. Babcock Reel Co., Oak Harbor, Ohio.

CARTRIDGES, Firearms, ammunition complete list 25c. Frank Parish, Vicksburg, Mississippi.

TEAM Uniforms, equipment, trophies, awards. Craig Dare Company, 670 East 42, Brooklyn 3, N. Y.

5000 BARGAINS, Firearms, binoculars, war relics. Catalog 40c. Smith Firearms, Rummene, New Jersey.

BOWS-Arrows. Write headquarters for archery equipment. Quality products. Popular prices. Catalog 10c. Large illustrated hand book instructions, making and shooting, 50c. Archery, 617-B So. State, Chicago 5.

AMMUNITION—New and used shotguns, rifles, handarms, fishing tackle. List 10c. Rudolph's, Atchison, Kansas.

TAXIDERMISTRY

"**MODERN Taxidermist Magazine.**" Greenfield Center, N. Y. Devoted exclusively to taxidermy. Two sample copies 25c.

FINEST Glass eyes; taxidermy supplies. Catalog free. Elwood Company, Department 234, Omaha 2, Nebr.

FIELD GLASSES, TELESCOPES, MICROSCOPES, MAGNIFIERS

BINOCULARS, Cameras, telescopes hard coated, repaired and collimated. Prompt service, all work guaranteed. Optical Coating Laboratory, Route #1, Clinton, Maryland.

TELESCOPES, Microscopes, binoculars, cameras, books. Buy, sell, repair. We guarantee. List 10c. Rasmussen & Reece, Amsterdam, N. Y.

SAVE Money, build your own reflecting telescope from complete kit of finished optical parts: 3" diameter, 39" focal length, mirror and diagonal both hard aluminized, plus 3 lenses for high power eyepieces. All \$6.00. Ross, C68 West Broadway, New York 7, N. Y.

MICROSCOPES For professionals, hobbyists, students. Big money saving values. Testa "S" 65x200X, \$29.50. "G-3" 75X-400X, \$52.50. Enclose remittance; free delivery. Laboratory Supply, 424 So. Broadway, R706, Los Angeles, Calif.

SEE It closer! 3X field glasses, \$6.60. 3X binoculars, \$5.10. 5X spy glass, \$1.25. 50X microscope kit, \$2.98. Guaranteed. Literature. W. Wardell, 2509-A Clarendon Road, Brooklyn 26, New York.

TELESCOPES, Binoculars, microscopes, big bargain catalog free. Brownscope Company, 24 West 45th Street, New York.

REFLECTING Telescopes, complete. 3 1/2" diameter, equatorially mounted. View planets, stars. \$19.75. Write Sky-scope Company, 475-P 5th Ave., New York.

BINOCULARS, Telescopes, watches. Buy, sell, trade. Paul Schweer, Donnellson, Iowa.

DOGS, PETS, BIRDS, RABBITS

DOBERMAN Pinscher puppies, AKC registered, easy terms. Wilfocal Kennels, East Berlin, Penna.

FOR That puppy you want, write today to "Royal," Chazy, N. Y.

RAISE Guinea pigs. Profitable, low-cost feeding, small space required, small investment. Complete details 25c. Guinea Pig Farms, 234 So. Muscatel Ave., San Gabriel, California.

RAISE Guinea pigs. Make money at home. Big demand. Booklet free. Taylor, Box 426A, Hapeville, Georgia.

INCREASE Your income by raising domestic rabbits. Small space needed. Ready market for delicious meat, fur and wool. Largest magazine in the industry tells you how. \$1.50 per year. Sample 15 cents. No stamps. Small Stock Magazine, Lamoni 50, Iowa.

AIREDALES, Chesapeakes; puppies. Registered. Watchdog, hunting strains. "Suchan," Jackson, Minnesota.

PUPPIES—Registered beagles, bassets, cockers. Robinson Kennels, Sebastopol, Calif.

RAISING Canaries pays good profits. Valuable bird book—"Its Care, Breeding and Training," Price \$1.00. American Canary, 2839 N. Halsted, Chicago.

ST. Bernard Xmas pups! Descriptions, prices and 12 delightful pictures, free upon request. Manitou Kennels, Watrous, Sask., Canada.

BEAUTIFUL, Useful collie, shepherds, pups. \$14. Paul Schultetus, New Liberty, Illinois.

ANGORA, Giant chinchillas. Finest pedigree! World's most profitable rabbits. Literature free. Grinsteads, Edwardsville, Illinois.

SUPERIOR Chinchilla giants—Other varieties. Breeding stock supplied credit terms. Beautiful picturesque catalogue. Complete instructions, 25c. Behrens Farms, Pearl River 4, New York.

MONEY In New Zealand Whites and Chinchillas. Increasing demand for breeders, meat, fur. Particulars free. Loughman's Sandamar Farm, Newark, Ohio.

RAISE Hamsters. New wonder animals from Syria. Delightful pets. Laboratories, need thousands. Profitable. Free information. Hamstery, 1519 Basil, Mobile, Ala.

\$2000 PER Year raising Angora rabbits. We buy your output. Contract particulars free. Wilsons, 1065 Shryer, St. Paul 8, Minn.

\$50.00 WEEKLY Raising Angoras for us. Free literature. Angoraville, 1215-34th Northeast, Cedar Rapids, Iowa.

\$250.00 MONTHLY Raising angora rabbits. Particulars free. White's Rabbitry, Newark, Ohio.

ST. BERNARD Pups: Champion sired beauties. Franklin Young, R4, Riverhead, Long Island, New York.

70 VARIETIES—Pigeons, rabbits, pheasant, peafowls. Catalogue 10c. Jim Houck, Tiffin, Ohio.

GUARANTEED Chin-Chin giant Chinchilla rabbits. Greatest amount of delicious meat. Largest, finest, most valuable furs. Tremendous demand for breeding stock. We buy youngsters. Contact world's largest breeder. Willow Brook Farm, R15, Sellersville, Penna.

ZOOLOGICAL And pet animals for sale. Illustrated catalogue, literature, 25c. Trails End Zoo-5, St. Stephen, S. C.

RAISING Rabbits, Cavies, Hamsters, Chinchillas is a growing and profitable industry. Magazine 10c. Descriptive book and magazine 25c. Book and magazine (monthly) one year \$1.00. Address Small Stock Farmer, Pearl River 15, N. Y.

SEEDS, PLANTS, NURSERY STOCK

ORCHID Seed 50 for \$1. Red sunflower 100-\$1. Nice Christmas presents. Robinson Nurseries, Sebastopol, Calif.

FARMS, FARM LAND, REAL ESTATE

STROUT'S Big farm catalog—mailed free. Describes over 2800 outstanding bargains. Coast to coast. Time-money saver. Write today. Strout Realty, 255-P 4th Ave., New York 10, N.Y.; 20 W. 9th St., Kansas City 6, Mo.; 453 S. Spring, Los Angeles 13, Calif.

HOMESITES \$450—Convenient payments. California's finest garden section. On Morro Bay's scenic shores. Wonderful fishing, hunting, boating, bathing. Fertile soil, softest water, temperate climate, congenial community. Free literature. Richard Otto, Department M, San Luis Obispo, California.

CALIFORNIA Farmers have highest per capita income of any state. Free bargain catalog. Allied Farm Agency, 1938G E. Colorado, Pasadena 8, California.

FIVE Acres joining Inverness, \$500.00. \$10.00 down, \$10.00 monthly. R. W. Stewart, Inverness, Florida.

NEW Free winter catalog of farm bargains, 20 states, many equipped, many illustrated. Write today! United Farm Agency, 220-PM South State St., Chicago 4, Illinois.

FARMS, Ranches. All kinds, sizes. Choice of location, climate, production. Information on irrigation projects Columbia and Missouri River Basins. Resorts, summer houses. Milwaukee Railroad territory: Washington, Idaho, Montana, Dakotas, Wisconsin, Upper Michigan, Central Corn Belt. Free folders, price lists. R. W. Reynolds, 604, Union Station, Chicago 6, Illinois.

CANADA—For full details regarding any phase of agriculture, such as general farming, ranching and fruit lands, write H. S. Williams, Department of Immigration & Colonization, Canadian Pacific Railway, Vancouver, B. C.

WEST'S Latest catalogue: Over 1000 farm and business bargains, 160 agents, 16 states; free. Write West's Farm Agency, Inc., HE-9, Pittsburgh 17, Penna.

\$5.00 MONTHLY Buys 40 acres near town; price \$200.00. Free list. Box 425-P, Carthage, Mo.

GOVERNMENT Lands \$2.00 acre up. Information all states twenty-five cents. National Tax Service, 834-A Majestic Bldg., Detroit.

GOOD Farms—Ranches. Washington, Minnesota, Montana, Idaho, Oregon, North Dakota. Dependable crops, favorable climate. Write for literature, lists describing typical postwar farm opportunities. Specify which state. J. W. Haw, 119 Northern Pacific Ry., St. Paul 1, Minn.

OZARK Lands for all purposes. Actual river frontages. 5 acres \$90.00 and upwards. Free list and literature. Hubbard, 424-I, Minnesota Ave., Kansas City 4, Kansas.

POULTRY, FARM SUPPLIES

RAISE Turkeys for profit! America's only all-turkey magazine tells how. Unlimited money making possibilities. Mail \$1.00 for six month bargain trial order today. Turkey World, Dept. 20, Mount Morris, Ill.

MAKE More money with poultry. Magazine with experimental farm explains how. 24 months for only \$1.00. Order today! Poultry Tribune, Dept. S, Mount Morris, Ill.

RAISE Turkeys the new way. Write for free information explaining how to make up to \$3000.00 in your own backyard. Address National Turkey Institute, Dept. 3, Columbus, Kansas.

HONEY Bee care, instruction. Cost insignificant. Mary Struble, Cupertino, Calif.

KNOW How to raise poultry for profit. Read Northeastern Poultryman. Every issue packed with helpful hints and practical suggestions. Latest articles on breeding, feeding and management. Subscribe now. 1 year 65c. 2 years one dollar, foreign subscriptions \$1.00 a year. Northeastern Poultryman, Dept. P.M., 376 Boylston St., Boston 16, Mass.

PROFITABLE OCCUPATIONS

DIRECT Factory agents for fast-selling, fine commercial popcorn machines. Nationally advertised. Sales leads furnished. Excellent profit. Viking Popcorn Machines, Inc., 114 W. 18th, Kansas City, Mo.

PROFITABLE Exciting advertising profession open to you. Progressive Ads Studio, 3679 Baldwin, Detroit 14, Michigan.

INCOME From local information. No selling. Schenet, 12161-P East Camille, Route #3, Santa Ana, Calif.

TECHNIGLO Makes everything visible in the dark! Just paint it on! Like regular white paint in daylight. Stores up light, shines clear, sky-blue for hours in darkness. Creates novel effects, starlike beauty, safety, convenience in home. Luminize camp, auto, boat, photo darkroom, fishing, theatre equipment. War time research guarantees amazing results. Marvelous to demonstrate; make easy profits selling or decorating. Kits, 4 oz. \$2.75, 8 oz. \$4.25, 16 oz. \$7.00, prepaid, including brushes, Plastikote protective, instructions. United Technical Laboratories, Morristown 1, N.J.

START Your own business at home, spare time. Pleasant work. Write Gantz, 1778 Crawford Rd., Cleveland 6, Ohio.

LEARN Gagwriting. Profitable diversion. Particulars and comic gagster. 10c. Frankel, 1508 South Homan, Chicago 23.

"FROG Raising"—New book tells how! Marlboro, 1035 Marlborough, Detroit 15, Michigan.

"EVERYBODY Likes candy"—Learn to manufacture in a professional manner. (Our 37th year). Ragdsdale Candies, #107, East Orange, N. J.

PERMA-FLEX Molds, made from B. F. Goodrich Company's Koroseal flexible molding compound. Stock or custom built molds. Send 25c for catalog and sample mold. The Perma-Flex Mold Company, Columbus 15, Ohio.

HOME Manufacturing business. Manufacture novelty ladies' lapel pins, materials penny dozen. Sensational profits, no experience, no expensive equipment needed. Few dollars starts you. Plastex Products, 1025 Prague St., San Francisco 12, Calif.

SCRAP Metal costing 5c pound brings dollars in finished castings. Literature. Fritz Foundry, 622 N. Fulton, Allentown, Penna.

BE A Weed control expert. Unlimited opportunity. New field. Send \$1 for newest book on 2,4-D weed control. Willamette Weed Chemical Company, Eugene, Oregon.

MAKE Beautiful mirrors from ordinary window glass. No special equipment required. Details free. Tesco, Box 189-MP, Wilkes Barre, Penna.

AMAZE Your friends with colors that glow in the dark. Paint signs and pictures for profit and pleasure! Write today for full information about black light and luminescent material. Baldwin-Smith Specialties, Te. 3-3797, 4829 Woodward Ave., Detroit 1, Mich.

"INTERESTED In Latin American and foreign employment?" \$1 brings 1947 copyrighted foreign service directory listing firms with interests in construction, oil, mining, aviation, manufacturing by personnel expert. Hot list of companies hiring. Global Reports, 6417 Homewood, Dept. PM, Hollywood 28, Calif.

RAISE Earthworms. Instructions \$1.00. Huffman's Worm Ranch, R.R., Rives Junction, Michigan.

WEAR, Sell metallized plastic lapel pins. Enormous profit. Gorgeous sample three dollars. Details free. E. O. Wells, 1325 Wilson, Chicago 40.

"ALASKA—The last frontier" offers thousands of opportunities. \$1 brings 1947 official government map and copyrighted report with authentic listing: Fishing, construction, mining, aviation, lumber concerns. Current information on homestead lands, prospecting and business enterprises. Listing of firms hiring. Alaska Opportunist, 6417 Homewood, Dept. PM, Hollywood 28, Calif.

1947-1948 LEATHERCRAFT Supply catalog 10c. Art Craft Supply, 1205 Throckmorton, Fort Worth, Texas.

TYPISTS—Profitable business at home. Complete copyrighted information, 50c. Gaunt, 3521A Broadway, Chicago 13, Ill.

ANNOUNCING Home study course in commercial baking. Practical basic training. Good field for those with aptitude. Nearly depression proof. Send for free booklet, "Opportunities in the Baking Industry," National Baking School, 1315 Michigan Ave., Dept. 3431, Chicago 5, Ill.

YOU Can make real money raising Golden Hamsters, the new amazing tiny animal. Food costs less than 10c month per animal. Breeds in 16 days! Easily raised in basement, attic, garage, barn, or shed. Write for convincing details. Hudson Hamstery, Box 78-P, Palisades Park, N. J.

WOULD You pay 3%—first \$350 made? Color-illustrated book "505 Odd, Successful Enterprises" free! Some offer occasional "day off." Work home. Expect something odd! Pacific, Oceanside, Calif.

NO Selling, operate vendors, amazing profits, details free. Silver-King, 622 Diversey, Chicago 14, Ill.

"THERE'S Big money in junk" and repairing batteries. Write, Batteryman, Grand Junction 5, Colorado.

HOW To set up and run a mirror shop! Resilver mirrors. For price write, John Sprinkle V50, Marion, Indiana.

LOCKSMITHING—Profitable business or hobby! New course teaches you lock secrets, how to fit keys, de-code, masterkey, etc. Easy self-instruction lessons. Bargain price. Fascinating 100-page illustrated catalog free! Write Nelson Company, Dept. 2-02, Chicago 5.

MEDICAL Laboratory technicians in great demand. We train you in your spare time, in your own home. You can practice while studying. Write for free catalogue. Imperial Technical Institute, Box 973-T, Austin, Texas.

MUSHROOMS Grown. Boxes. Barrels. Illustrated instructions 50c. Spawn \$1.00. Gordons, 553 William, Winnipeg, Manitoba.

TYPEWRITER Repairing instructions, standard typewriters. Webbers', Box 1008, Canton, Ohio.

\$40.00 WEEKLY Made growing mushrooms, fresh, dried. Dominion patent 331583. Free spawn. North American, 169P Yonge, Toronto, Canada.

TYPEWRITER Repairmen urgently needed. Earn \$40 to \$50 weekly spare time. Our easy to learn home study course teaches how to repair typewriters. Write for free information. Houston Typewriter Repair Service, P.O. Box 5357A, Houston 12, Texas.

ELECTRIC Clocks are every where you go, buildings, homes, parking lots, factories. Repairs increasing. Our easy to learn course with pictures and drawings teach you how to repair these clocks. Electronic Supply Co., P.O. Box 2350A, Houston 1, Texas.

BOOKS, PERIODICALS, PICTURES, POSTCARDS

ALL Pocket books. Wholesale, retail. Catalog free. Gordon's, 2613 Crenshaw, Los Angeles 16.

FREE Particulars for book bargains. Rosenthal, 200 Ross, Brooklyn 11, N. Y.

COLORED Lithographs for framing. Lists free. Curtis Specialties, Box 1916-B, Denver 1, Colorado.

TRADE And class magazines. Current copies. All fields. Free price list. Commercial Engraving Publishing Co., 34C North Ritter, Indianapolis 19, Indiana.

VIEWS Of the hereafter. For copy of the remarkable book by Emanuel Swedenborg "Heaven and Its Wonders and Hell," send 5c to cover mailing. Swedenborg Foundation, Room 1649, 51 East 42nd St., New York 17, N. Y.

WHAT Every Mason wants. We have Masonic books for Blue Lodge, Chapter, Commandery, Scottish Rite and Shrine. Our rituals are used the world over. Send for free catalog of books and rituals for Masons, Odd Fellows, Knight of Columbus, etc. Ezra A. Cook, Publisher, P.O. Box 796-PN, Chicago 90, Ill.

ART And craft books. Send for free catalog of 500 titles of leading art and craft books selected from the stocks of all publishers. Painting, drawing and sketching, printmaking, advertising and commercial art, cartoons and caricatures, costume and fashion, architecture, sculpture, leathercraft, pottery, jewelry, metal-craft, plastics, woodcraft, puppets and dolls, masks, weaving, home decoration, etc. Watson-Guptill Publications, Inc., 341 Hudson Street, New York, N. Y.

NAVY Diver's manual \$2.00. Jack's Diving Service, 402 Allegheny, Vallejo, Calif.

HISTORICAL Postcards. Twenty-five, one dollar. Hill, 1208 Church, Flint 3, Mich.

CHINA India photos. George Clayton, 8469 1/2 Cypress Ave., South Gate, Calif.

POSTCARDS Your hobby? Samples 25c. Wilkins, 417 Hill, London, Canada.

BOOKFINDERS! (Scarce, out-of-print, unusual books). Quickly supplied. Send wants. Clifton, Box 1377pm, Beverly Hills, Calif.

EXTRAORDINARY Books. Free catalogue. Abbott-Dunhill, 752-C Northwest 66th, Miami 38, Florida.

ART Of drawing women \$1.00; art of pencil drawing \$1.00. Also free catalogue of interesting books. A. Faller Company, 201 Dewey Street, Newark 8, New Jersey.

UNIQUE Book plan will save you money. Send for free details. Royal Sales Co., Box 1452, Waterbury, Conn.

BACK-DATE Magazines, books. Specific issues—years. Arkell's, Tarzana, Calif.

NEW, Modern, "How to Drive an Automobile" complete, illustrated training course in book form. Approved by driving schools. \$1.00. A. Szafarz, P. O. Box 705, Pawtucket, R. I.

FREE Bargain catalogue. Correspondence courses. All books. Baker, 5509-B Winthrop, Chicago 40.

EARN Extra money handling magazine subscriptions, books, greeting cards. Excellent commissions. Cassell Publishers, Westfield, New Jersey.

NEW, "The Keys" 10c. Inspirational Books, Box 106, Old Chelsea Station, New York 11, N. Y.

GOOD "Used" self-instruction educational books on all subjects bought, sold, rented, exchanged. Satisfaction guaranteed. Complete information and 100-page illustrated bargain catalog free! Write—Nelson Company, Chicago 5.

MAGAZINES (Back dated)—foreign, domestic, arts. Books, booklets, subscriptions, etc. Catalog 10c (refunded). Cleerone's, 863 First Ave., New York 17, N. Y.

BOOKS Found free! All subjects. Send wants! Jaher Book Service, 620-P East 178 Street, New York 57.

BIG Profits taking subscriptions for all magazines. Agents' confidential catalog listing over 2500 periodicals and complete starting supplies free. Pines Subscription Agency, Flushing, New York.

GAMES AND ENTERTAINMENT

TEN-PING. New, different game. Fun for all. Two, four players. 50c postpaid. Send coins. Ludecke Co., 5809A Franklin Ave., Hollywood, California.

EXCITING Baseball game—Regulations only 25c. Joustra, Box 365, Grand Rapids, Mich.

BUY This game today for fun. Combination one man game and checker board puzzle, keeps you working hours to solve, tricky and provoking, greatest fun maker ever invented 25c. Parris, 1364 N. Sedgwick, Chicago 10, Ill.

PLAY The races with original magic photo-finish. It's fascinating fun for parties, clubs. 20 exciting races \$1.00. Free samples. B. and R. Duplicating Service, Park Market Building, Stroudsburg, Penna.

MAGIC TRICKS, PUZZLES, JOKER NOVELTIES

ENTERTAIN! Mystify! 64 page book, magic and party stunts, 50c. Catalog included. Herbert, P-192 N. Clark, Chicago 1.

MYSTIFY Your friends. New illustrated, narrated card trick, copyrighted, \$1.00. Box 691A, Atlantic City, N. J.

"**MAGIC** As a Hobby," book of 108 simple, mystifying tricks, 50c. Ernest Byrn, Bertrand 2, Missouri.

FREE! Large catalog of magical apparatus if you remit 25c for "Magic Is Fun" magazine. Robbins Co., 152-F West 42nd Street, New York.

MAGICIANS' Headquarters. 400-page professional catalogue, latest pocket, parlor, stage tricks. World's finest magic. Send \$1.00 (refunded first \$5.00 order). Kanter's, M-1311 Walnut, Philadelphia 7, Penna.

TRICKS Of Guerilla self-defense make you a superman! Free particulars. Inspiration, 3108 Hillside Road, Harrisburg, Penna.

NEW Magic monthly, year 25c. Sample copy and new magic catalogue free. Magic Factory, Minneapolis 2, Minn.

FAMOUS Slip block puzzle—Postpaid \$1.00. Ketko, Box 2N, Cincinnati 24, Ohio.

WOW "Em with DeLand's spectacular "Card Locator"! Locate any card in ordinary deck! Deal straight royal flush! 25c, catalog of magic, rare courses and books, included. Ar-Ges Company, 790 Broad St., M12, Newark 2, N. J.

VANISHING Key or card 15c. 3c stamp for list. Nick's Fun Shop, 450 Elizabeth Ave., Elizabeth, N. J.

LARGE Catalogue of the best magic for professionals and amateurs. Send 25c. Mazda Magic Co., 1135 Westgate Ave., Oak Park, Ill.

BIG Magic magazine, trick and price lists—25c. Lloyd M. Jones, 4064 39th Avenue, Oakland 2, California.

MYSTIC Squared circles. Object vanishes before your eyes. Entirely new. One dollar. H. and H. Sales, Box 575, Savanna, Ill.

200 ELECTRIC Stunts, 110 volts. \$1. Kutting Sons, Campbell, Calif.

"**MAGIC** Vanishing card." Throw it into air, it completely disappears, reproduce it later from spectators pocket. Easy to do. Complete, 25c with magic catalog. The Magician, 2463-C Kensington Ave., Philadelphia 25, Penna.

500 TRICKS. Send only 10c for Douglas' famous 112-page catalog 500 tricks. New magic for amateur, professional. America's fastest service for 25 years. Douglas Magician, Dept. 1, Dallas, Texas.

TRUE Secret of ventriloquism. Send for booklet. Quackenbus, Big Flats, N. Y.

BE A magician. Large professional magic catalog of latest tricks, 25c. Ireland, C-109 North Dearborn, Chicago 2.

VENTRILLOQUISM Taught. 3c stamp bring particulars. Smith, 801 Bigelow, Peoria 5, Ill.

VANISHING Half dollar trick and catalog 25c. Sterling Magic Co., Royal Oak, Mich.

WORLD'S Largest professional magic shop, keeps you in touch with latest tricks. To receive mailings, send 35c for new catalog. Holden's, M220 West 42nd St., New York.

EARN Money in any crowd. Call names of strangers, tell unspoken questions. Professional course mind reading, faked spiritualism, etc., \$1. Henderson, Box 341, San Bernardino, Calif.

MAGIC Tricks, puzzles, books, cards, punch boards. Catalog 10c. Specialty, Box 671, St. Louis 1, Mo.

OLD STAMPS WANTED

I WILL Pay \$100.00 each for 1924 1c green Franklin stamps, rotary perforated eleven (up to \$1,000.00 each unused). Send 6c today for large illustrated folder showing amazing prices paid for old stamps and coins. Vernon Baker, PM-710, Elyria, Ohio.

STAMP COLLECTING

GIVEN! 55 Different Scandinavia, Netherlands, Italy, Latin America, etc., with approvals, Enclose 3c postage. H. P. Wisehart, 301 Second, Frankfurt, Ohio.

25 DIFFERENT Russia 10c to approval applicants. Reasonable prices. Personal service. Teichmann, 3912 Fitler, Philadelphia 14, Penna.

55 DIFFERENT United States, 10c to approval applicants. Standard, 3817 Sackett, Cleveland 9, Ohio.

ICELAND 40 Different \$1.00. Six beautiful new airmails \$1.00. Sverrir Sigmondsson, Oldugotu 21, Hafnarfirdi, Iceland.

FREE—U. S. stamp mixture, Seconds. Send postage. Howard Smith, 36 Alcott, East Hartford 8, Conn.

1c POSTCARD Brings you latest monthly bulletin. Trusty Stamps, 1106 Concord, Detroit 7, Mich.

SURPRISE Beginner's assortment—25c! Packet pricelist free! Neptune Stamps, Neptune 4, N. J.

FREE Exchange! Send any quantity stamps, covers, postcards! Receive equal number different! Postage please! Smith, Route Two, Fayetteville, Arkansas.

101 DIFFERENT Foreign cataloguing over \$2.00, 10c. Approvals. Ramsay, Brainard 2, N. Y.

HONDURAS Roosevelt mint airmail, 20 different India 5c with approvals. Robert Ompaceh, 1312 West Washington, Fort Wayne 2, Ind.

1000 WORLDWIDE \$1.00; 200 for 27c. Pacific, P.O. Box 5704, Los Angeles, Calif.

EARLY United States approvals. Scarce stamp 10c. Pomeroy, Minnetonka Beach, Minnesota.

50 STAMPS From 50 countries 50c. Mendelsohn Stamp Co., 1900 West 25, Cleveland, Ohio.

FREE—Worldwide stamps with first approvals. U. S. want lists solicited. Peter Nerger, Palisade, New Jersey.

FREE, Adults. Monthly illustrated price list. Neundorf, 22-A West Florida, Evansville 11, Ind.

112 DIFFERENT World-wide from 20 different countries, 10 cents to approval applicants. Daniel W. Menge, 827 North Lime Street, Lancaster, Penna.

PERSONAL U. S. and foreign approval service. Reference please. Gobrecht, 205 Anderson, Joliet, Ill.

FREE Wonder packet to approval applicants. Detroit Postage Stamp Co., Box 56, Detroit 23, Mich.

ITALY: Mussolini "hate" stamps and victory liberation issues only 15c to serious approval applicants. A. Evensen, 1625 N. Moody Ave., Chicago 39, Illinois.

FRANCE: 250 different, mostly semi-postals, \$2.00. Cubells, 2 Graviers, Soissons, France.

CHINESE And Manchukuo mint sets, packets. Reasonable prices. List 3c mint large commemorative. Dakiang Stamp Co., 1340 Chungcheng Road East, Shanghai 9.

POSITIVELY Greatest free offer—latest Scott's International \$6.00 stamp album—covering entire world, contains 36,000 illustrated descriptive spaces; Scott's 1948 Standard \$7.00 catalogues "Philately's Encyclopedia"—absolutely free to applicants for foreign approvals becoming customers. "Approval Service," Box 1700, San Francisco, California.

ABSOLUTELY Free! 25 different valuable mint Chinese new issues with approvals. Barton, Box 321, Elizabeth, N. J.

72 DIFFERENT U.S., 10c with approvals. Album Service, Box 2006, Soledad, Calif.

STRANGE Lands airmails. Liberia, Mozambique, Venezia Giulia, Morocco, Bolivia. Everything 5c with approvals. Raymax, 123-Z William St., New York City 7.

FAMOUS Chinese "Sun" set of five, catalog 40c, huge Antarctica and 100 different 10c. Kalumet Stamps, 523 Detroit, Hammond, Ind.

\$27.00 STAMP-33 Different Hungary! 3c with approvals. "Jim," 319 Eye Northeast, Washington 2, D. C.

REQUEST 1c To 5c approvals. G. Gregoire, 507 Montgomery, Manchester, N. H.

200 DIFFERENT Foreign stamps from over 20 countries 30c. Jem Stamps, Port Jefferson, N. Y.

1000 U. S. Presidential set, complete. Every commemorative railroad to Pulitzer, many others, flags, famous Americans, blocks, airs—Over 150 varieties, maximum 25 any variety \$3.00 postpaid. R. Lehr, Somerton, Philadelphia 16, Penna.

AIRMAILS, Hitler heads free, approvals. Lee, Box 1455, Greenwich, Connecticut.

BREAKING Up large foreign collection. Approvals by countries. Lion, 200 W. 81 Street, New York 24.

GIBRALTAR Packet free—Nice collection Gibraltar, New Zealand Centennial, British Uganda, French Colonials, early British Colonial, West Indies, South American, war stamps plus Philatopic Monthly Magazine. All for 5c postage. Empire Stamp Company, Dept. PM, Toronto 5, Canada.

FREE—United States Columbian set—8 values, retailing \$3—absolutely free to customers for our unusual approvals. Send 3c postage for selection plus full particulars. S. C. Engel, 38 Park Row, New York.

EXCHANGE Stamps universe. Particulars free. "Exchangers," Bry 126, Seine, France.

TONGS, Gauge, mint set 5c. Foreign approvals. Oedamer's, 1738 Arlington, Corpus Christi, Texas.

UNITED States \$5.00 stamp with inverted surcharge, also set of twelve different unused confederate states, plus complete set of United States occupation stamps for Germany. Entire lot 25c approval applicants only. "Stamps," Box 87, Albany 1, N. Y.

50 DIFFERENT Argentina plus Argentina Roosevelt. Five cents with approvals. Sadler Stamp Service, 611 Carolina Ave., Norfolk, Va.

WHOLESALE Bargain list, dealers only. Borkman, 3414 10 Street, Tampa, Florida.

120 DIFFERENT Stamps only 3c with approvals. Appelman, Ida, Mich.

LARGE Egyptian set 5c. Approvals. Herman, 539A East 54th, Brooklyn 3, N. Y.

100 STAMPS 5c And approvals. Gotardo, 1226 Rossell, Oak Park, Ill.

FIFTY Canadian and Newfoundland, 10c. Approvals. Reede, 696 Gerrard, Toronto.

MINT Black Harding 10c to approval applicants. Louis Merrill, 1623 5th, Portsmouth, Ohio.

GENEROUS Assortment world mint stamps \$1.00. Ritter, Box 1245, Corpus Christi, Texas.

FINE Approvals. Fast, personal service. What countries do you prefer? I'll send their stamps. Skinner, 438 Locust, Long Beach 12, California.

ARMY Navy set 10c. United States foreign approvals. Yokum's, Box 1327, San Antonio 6, Texas.

"UNITED States collection," 37 different mint commemoratives before 1943 including Columbians, aeronautics, bicentennials. Price \$1.03 approval applicant only. "Stamps," Box 87, Albany 1, New York.

U. S. Price list free. Sikes, 1831 E. Allegheny, Philadelphia 34, Penna.

NICARAGUA Roosevelt set of three 10c with approvals. Murray, 2152 Vogel Road, Evansville 14, Indiana.

MONACO Roosevelts including triangle to approval applicants for 3c postage. GeeKay Stamp Co., 13 Overlea Ave., Baltimore 6, Md.

THREE Sets 5c with approvals. Veteran's Stamp Service, 8238 N. Olcott, Chicago 31, Illinois.

1/2c UP U. S. or foreign approvals by countries. Hurt & Posse, Blue Ridge, Va.

25 IRAQ Abyssinia, etc. 3c. Approvals. O. Burgett, Lima, Ohio.

1000 WELL Mixed U. S. 25c. Monjar, 1750 Fairmount, Cincinnati 14, Ohio.

UNITED States approvals. Swell arrangements, low prices. Panther, Box 76X, Dorchester 24, Mass.

50 COUNTRIES, One stamp from each, including Egypt, Malta, Salvador, Siam, 10c with approvals. Paul Bauer, 31 Wilkshire, Lancaster, N. Y.

FREE, Two Aden sets for 5c, and good approvals. Edward Hefflon, St. Albans, Vermont.

FOREIGN Mint approvals, that satisfy. Premiums with purchases. B/L Stamps, 4530 Magnolia, Chicago 40.

100 DIFFERENT. Oriental countries. 10c. Northeast, Box 6618, Kansas City, Mo.

FREE! 20 South America. Approvals. Super Stamp Shop, 2 Madison, Greencastle, Indiana.

BRAZIL Diamond shaped set, 10c with approvals. Vargo Stamps, 6044 South Fairfield, Chicago 29, Illinois.

BRITISH Empire stamp cat. \$1.35 (1947) 25c. Steeple, County Line, British Columbia.

100 DIFFERENT U. S. commemoratives, \$1.25. 200 different Belgium, 75c. Approval applicants only. Cripe Bros., 1922 Ohio, Anderson, Ind.

FREE—16 Different presidentials—Approvals included. Frontier Stamps, 1280(B) Ocean Ave., Brooklyn 30, N. Y.

WRITE Today for our better U. S. approvals. Box 488, Minneapolis.

FREE Greek Occupations to approval applicants. Seiden, 1331-M Intervale, New York City 59.

FREE! 25 different Canada. Approvals. Postage. Victor Logsdon, Hyndman, Pennsylvania.

FREE Beautiful pictorials, commemoratives, airmails, seven countries, with approvals. Green and Company, Norwood 12, Ohio.

300 DIFFERENT Hungary, 75c. Free list. Bosland, 322 North Eight Street, Paterson 2, New Jersey.

WORLDWIDE Mixture! 500 stamps, 25c. Garrow, 84-M Montevista, Chula Vista, California.

LOW Priced United States approvals. N. E. Whitlow, 302-B South Barnett, Dallas 11, Texas.

FREE 25 Different Canada. Approvals. Knight, Box 3770, Portland 8, Oregon.

SELLING Large collection, 50% catalogue. Minimum sale \$5.00. Kinnear, Box #4, Seabold, Wash.

30 BEAUTIFUL Airmails 10c. Selected approvals. Louis Morrison, Milmont Park, Penna.

RARE Iraq set, 9 values 10c and approvals. Spencer Stamp Company, Honeoye Falls, N. Y.

FREE! Negro Triangle: Turks Islands "Caetus"; Dakar; Guinea; Palestine; "Fairy Tale." Pirate Chart, Map, Ship, Sea Lion and Snake stamps; French, British, Portuguese Colonies, etc. Free for 3c postage. Approvals. Potomac Stamps, Washington 10, D. C.

UNPICKED: 5000 U. S. \$2.00; 3000 foreign \$2.00; 2500 British Empire \$2.00. Satisfaction guaranteed. Kuhn, 3315 80th, Jackson Heights, N. Y.

STAMPENDOUS! United States approvals that please plus unique premiums to customers. Get them from Jarr, Box 217-X, Madison Square, New York 10.

RECENT And new issues. Illustrated booklet free. Stamps, 5805 Delmar, St. Louis 12, Mo.

50 DIFFERENT Finland 10c with 1/4-1/2c approvals. Carroll's, 4357A S. Hoover, Los Angeles 37, Calif.

BRITISH Guiana, West Indies, Surinam, Curacao, etc. 70 different \$1.00. 110 different \$2.00. 1000 mixed \$5.00. Alexander Stamp Service, Georgetown-P, British Guiana.

ELEVEN Rare philatelic envelopes from this part of the world \$1.00 (American banknote or mint stamps). Edward Basry, Bagdad 8, Iraq.

SAN Marino Roosevelts—Mint set of six only 5c to approval applicants. Clayton Doll, 85 Audubon Ave, New York 32, N. Y.

BOY! Oh! Boy! Dandy collection. Monaco Roosevelt triangle, U.S. commemorative stamp over 50 years old, Hitler-Mussolini stamp, many others—only 5c to new approval applicants. Modern Stamp Service, Box 12, Wakefield Station, N. Y.

50 DIFFERENT Denmark 5c. Approvals. Elcerrito, 5611 Meade, San Diego 5, California.

FREE Fifty different worldwide. Approvals. Jack Dudak, Streator 2, Illinois.

ALL Different. 25 Canada, 25 Denmark, 25 Finland, 25 U.S. free with approvals. Alatalo, Maynard 14, Massachusetts.

NEW Brazilian commemorative honoring presidential visit free with approvals. Granada, 4891 Southwest Fifth Street, Miami 34, Florida.

ERITREA, Ethiopia, huge Roosevelt, free-approvals. Logan Stamps, Box 4, New Lots Station, Brooklyn 8, New York.

FREE! Rare Cape Juby airmails cataloging \$1.00, 3c. Postage for bargain approvals. Criterion Stamps, No. Hackensack 2, New Jersey.

WORLD Collections: 500 different, \$1.00; 1,000, \$2.50; 2,000, \$7.50; 3,000, \$13.75; 5,000, \$32.50; 10,000, \$100.00. Long Beach Stamp Company, Long Beach, New York.

FREE! Siam, Tanganyika, Philippines pictorials! Approvals. Keating, 637-P Bergen, Jersey City, N. J.

POPULAR Approvals 1/2c up. Stampdealers Exchange, 2616 Cortez, Chicago 22.

FREE. Five San Marino airmails. Ten Siam. Approvals. Newton, 1511 Portage Road, Niagara Falls, Canada.

SEND \$1.00 for fine selection U. S. stamps. Herman Jacot, Greenwich, Conn.

FREE! Canadian sets, royal visit. George VI, George V, coronation, jubilee, others, to approval applicants. Ensign, Box 118-M, South Orange, N. J.

WORLD Wide 100 different 10c. No approvals. Arthur Terreson, Box 479, Bellmore, N. Y.

25c SENT With your request entitles you to \$1 worth of stamps, your choice, from our gigantic first approval selection. Cosmopolitan Stamp Co., 1457 Bway, N. Y.

200 DIFFERENT Stamps cataloging up to 50c each; only 3c to approval applicants! Littleton Stamp Co., Littleton 42, N. H.

\$27.00 CHINA Airmail, 10 different Egypt and 50 others 10c to approval applicants. Burmaster, Box 1910L, Los Angeles 53, Calif.

FREE—Hitler heads, airmails, French Coat of Arms, Vatican with approvals. Gulfstream, Box 103, Teaneck, New Jersey.

FOREIGN—Complete mint sets and new issues on approval. Woodco, 5719 Wabash, Kansas City 4, Missouri.

AMERICA'S Friendliest stamp magazine! Next 3 issues, 10c! "Valuable tips" included! "Stamp Post," Station A, Pasadena 15, Calif.

BEAUTIFUL Monaco, Argentine, and Cuba Roosevelt sets, and nine other sets. Everything 10c with approvals. Inland Stamps, Wurtland, Ky.

25 BEAUTIFUL Stamps from 25 French Colonies and our price lists. One silver dime. Stampsales, Box 1649-P, Oakland 4, California.

WORLD Mixture, variety countries. 25c. MacDonald, 30-M Seaman Ave., New York 34.

FLAG Stamp free with U. S. approvals. Wenigman, 929 Oakdale, Chicago.

ROUMANIA—New "athletes" 25c with approvals. Esslinger, 5260 Montgomery Rd., Norwood, Ohio.

GOYA Nude (2) 5c. Approvals. Hanan's, 310 Quail, Albany 3, N. Y.

CANADA Peace set 10c with attractive approvals. Rheume, 8949 Routhier, Montreal 12, Canada.

BIG Value—12 sets, 12 countries. Triangle, maps, animals. With approvals, only 25c. Wirth, Norwichtown, Conn.

START Your own stamp business. Write for free circular. Donald Shepard, Security Building, Chicago 2.

WORLDWIDE, Different 200, 25c; 500, 60c; 1000, \$1.50; 2000, \$4.25. Beacon Sales, Maynard 2, Mass.

HISTORICAL Collection! Cavalry charge! Bulgaria, Flaming Sword! Ireland, Big She-wolf! Italy, Fort! Dominican Republic, Field Marshall! New Zealand, Pitcairn Mutiny Island! Commemoratives! Pictorials! Only 3c. Approvals. Star Stamps, Lakewood, New York.

NICE Clean U. S. approvals, numbered and classified; mounted with peelable hinges; postpaid both ways. Jess T. Green, Bonita Ave., Route 2, Box 111, Mountain View, California.

FREE! Crystal-mount samples! Har-risco! 202 Transit Bldg., Boston.

UNITED States approvals complete coverage, fine quality, attractive prices. Seminole Stamps, Box 1138-P, Coral Gables, Florida.

PHILATELIC Printing. Stock forms. Samples for postage. Acmeprint-6, R-#5, Hendersonville, No. Car.

UNITED States stamps on ten days approval! Lowest prices! Finest quality! Fast personal service! Thrifty Stamps, 727 Silver, Silver Spring, Maryland.

OLD Stamps wanted. Send 30c for catalogue. Stamp Market, 356-P Clinton, Columbus 2, Ohio.

10 FINE Mint U. S. stamps \$1.00. No junk. Brahm's, 1540 Bedford St., Los Angeles, California.

FREE Handy pocket stamp wallet. Worldwide approvals 1c up. Free gift plan. Crown, 412 Maple, Holyoke, Mass., Dept. 6.

FREE! St. Helena and 37 other countries to approval applicants. Pioneer, Box 414A, Pasadena 18, California.

BEGINNERS, 100 Different stamps 5c. General approvals. Return postage paid. Burton, 413 C SW, Ardmore, Oklahoma.

29 FRENCH Colonies, all mint, 10c with foreign approvals. Adlez, South River 2, New Jersey.

FREE! Six Greek wind airmails with approvals. El Rey Stamps, 5170 Sunset Blvd., Hollywood, California.

IMMEDIATE Cash for stamp collections, accumulations. Brooks, 270 Burkhardt, Cincinnati 15, Ohio.

GENUINE "Goya Nude" set, cataloging \$1.05, complete 35c. Approvals. Royal Stamp Company, Tamaqua, Penna.

1000 MIXED U. S. old and new—25c; 2 lb. \$1.25. Weatherby, Medina, Ohio.

MINT Pictorials free to approval applicants. Surf Stamp Co., Box 1016, Wilmington, N. C.

YOUR Money's worth! Seychelles, Djibouti, Angola, Chinese hunger stamps and over 100 different other stamps. Everything 10c to approval applicants. Atlas Stamps, 4220 West 16th, Dep't L, Little Rock, Ark.

SCARCE United States stamps nearly 100 years old; Roosevelt set complete; \$5.00, \$10.00 stamps; Army, Navy, Marines, Coast Guard, Columbian Exposition commemoratives; 19th century revenues. Everything 5c to buyers U. S. approvals. Metropolitan, 140-B Nassau, New York City 7.

\$10.00 FOR \$1.00. Box full stamps valued Scott's \$10.00 and stamp album. Everything \$1.00. Longacre Shop, 108k West 42nd, New York City 18.

THE Stamp World, 12 copies 25c. The Stamp Mart, Box 2078Q, Akron 11, Ohio.

AROUND The world—30 different countries; Basutoland, Nyassaland, Tangier, Cyprus, St. Helena, 10c with approvals. Exello Stamps, P.O. Box #95, Hackensack, N. J.

CHIANG KAI-SHEK! Catalogues \$2.30. (4) mint, victory, commemoratives 496-99. 10c to approval applicants. Eliot Stamps, 86-31 Eliot Ave., Rego Park, N. Y.

WHOOPIE! Wow! 25c worth of U. S. stamps free! No obligations! Write M & N Co., 742A Sheffield Ave., Brooklyn 7, N. Y.

FREE—Beautiful and unusual set of the Italian Social Republic, with introductory foreign approvals. Home Hobby-Craft, 3322 Decatur, Philadelphia 36, Pa.

ROOSEVELT—Three new beautiful large bicolor stamps in packet of 50 different airmails, commemoratives, etc. 5c with approvals. Chesapeake Stamps, 748 Overbrook, Baltimore 12, Maryland.

CANADIAN Collection—From 1870 to date. 80 face different stamps including many pictorial; just about 1/3 of all stamps issued. A \$1 value for only 25c if you request approvals. Fields of Cleveland, 9328 Amesbury Ave., Cleveland, Ohio.

55 DIFFERENT United States, 5c. Approvals. Utechts, 1143-C North Keeler, Chicago 51.

128-PAGE United States catalog—1000 illustrations, 10c. Harris & Co., 202 Transit Bldg., Boston.

FREE! Ten mints: Ethiopia Red Cross plus Free French. With approvals. Florida Stamp Company, Box 807, Miami 5, Fla.

100 DIFFERENT including scarce diamond-shaped airmail 3c to approval service applicants. Avalon Stamp Co., Dept. M, Springfield 8, Mass.

100 U. S. Commemoratives, etc.—10c, 300—25c. Kellermann, Box 457, Newark 1, New Jersey.

WOW! 10.00 Worth of fun—only 10c! What a treasure hunt! Big package 500 foreign stamps just as received from foreign missions, other sources. Includes stamps from Africa, South America, Free French, Cape Juby, Palestine, etc. Includes airmails, commemoratives and stamps worth up to 50c. This offer sent for 10c to serious approval applicants only—one to a customer. Jamestown Stamp Co., Dept. 22, Jamestown, N. Y.

FREE—The Stamp Finder. Big new edition—32 pages profusely illustrated! Tells at a glance the country to which any stamp belongs and so where to place it in your album! Also: 25 different stamps from Vatican City, Palestine, Cyprus, San Marino, etc. All sent to approval applicants enclosing 3c postage. Garcelon Stamp Co., Box 900, Calais, Maine.

UNITED States approvals. Low prices! Gordon Davison, Box 1019X, Manchester, N. H.

FIRST Day covers on approval. Knobel, 1918 S.W. 12th St., Miami, Florida.

50 DIFFERENT Stamps, triangle, airmails, etc., 5c with approvals. Carlton's, 10243 Silverton, Tujunga, California.

EGYPT—15 Different, 5c to approval applicants. Bohemia Stamp Service—1, Bohemia, N. Y.

ILLUSTRATED Stamp Magazine, 26 weeks 25c. Stamp Journal, Kalamazoo, Michigan.

ROOSEVELT, Churchill, Stalin, Hitler, Vatican City stamps free, to approval applicants. Flamingo Stamps, Box 517, Miami Beach, Florida.

200 DIFFERENT Stamps, 6c, to approval service applicants. Tatham Stamp Company, Springfield 30, Mass.

BRITISH, Spanish and French Colonies, Vatican, Hitler heads, and airmail packet, free with approvals. Pan-American Stamp-co, Box 145, New York 33, N. Y.

DANDY U. S. approvals; write immediately. Sullivan, Endicott Building, St. Paul, Minnesota.

BERLIN Bears, complete set of eight and 100 different stamps only 10c to approval applicants. Reich Stamp Co., 4647 Kenmore, Chicago 40, Ill. Dept. M11.

STAMP Collections wanted. Complete collections, duplicate lots, surplus stock, mint and used. Prefer trade for printing or other items, buy outright if priced right. What have you, what's wanted? Vanroy Shirk, Lebanon, Penna.

U. S. Price list. Send postage. State Stamp Service, 1225 Park Building, Pittsburgh 22, Penna.

OLD Scarce U. S. seconds on approval. Slightly defective, nice appearance, bargain prices. Hernfield, 551 Clinton, Newark 8, N. J.

ZOWIE-E! A barrel of fun for only a dime. 500 United States stamps—absolutely unpicked and unsorted—just as received from church missions. Many varieties, including large commemoratives, airmails, high denominations up to \$5.00! Stampdom's biggest package of fun—and you might find something really valuable! Price only 10c to serious approval service applicants. Money back if not delighted. Illustrated bargain lists with each order. Mystic Stamp Company, Dept. 80, Camden, New York.

U. S. Price list. Send postage. Stanley Gibbons, 38-P Park Row, New York.

PENNY Approvals, that satisfy. Neil Gronberg, Box 5441-P, Philadelphia 43, Penna.

50 DIFFERENT United States, 10c. Price-list free. Seidenberg, Cassopolis, Mich.

FREE U. S. price list. Postage 3c. Mark Hanna, 335 - 5th Avenue, Pittsburgh 22, Penna.

WORLD'S Largest diamond and triangle stamps, free stamp magazine, stamps from fighting Free French, 20 stamps from 20 different countries, pictorials, airmails, big bargain 5c with approvals. Capital Stamps, Dept. 2, Little Rock, Ark.

DEALERS—Wholesale list. Postage 3c. Frank, 5031 Queensberry, Baltimore 15, Md.

STAMPS From 40 countries, including Fiji 10c. No approvals. Elsea, Bowling Green, Ohio.

COINS, TOKENS, CURRENCY

START A collection, twenty different dated Indian head cents \$1.00. E. Walton, 7 Water, Boston 9, Mass.

U. S. Large cent, 2c piece, 3c piece, Nickel cent, price list, all for \$1.00. U. S. half dime and 15 different Indian cents \$1.00. A. C. Overton, P.O. Box 893, Pueblo, Colo.

COINS Bought and sold. Catalog 10c. Brunks Coins, 3530 Osceola, Chicago 34, Ill.

OLD Money wanted. Do you know that coin collectors pay up to \$100.00 for certain U. S. cents? And high premiums for all rare coins? We buy all kinds. Send 4c for large coin folder. May mean much profit to you. Numismatic Co., Dept 20, Fort Worth, Texas.

BARGAINS! Rare collection contains United States large cent over 90 years old, flying eagle cent, white Indian cent, 1890 cent, 1909 V.D.B. cent, 2c piece, 3c silver, 3c nickel, half dime, shield nickel, 1883 nickel, Liberty seated dime, Civil War cent, confederate bill, foreign coin, foreign bill and our complete buying and selling catalogue all for \$3.00. Catalogue alone 25c. 30 different foreign coins \$1.00. 28 dates Indian cents \$1.00. Following coins over 100 years old: Half cent 75c. 1802 cent 50c. 5c piece 75c. dime 50c. quarter \$1.00. half \$1.25. Colonial coin 75c. Worthy Coin Corporation, 152-C Washington, Boston, Mass.

NEW Coin buying list 10c. 209 South Church, Rockford 27, Ill.

U. S. Coins bought—sold. Send now new list. Coins, Box 77, Alameda, Calif.

INDIANHEAD 3c. Mexico bills, 10 different \$1.00. Finest United States coin book \$1.00. Maurice D. Scharlack, Corpus Christi, Texas.

WE Pay \$2 to \$200 each for hundreds of old or odd coins. Indianhead, Lincoln and foreign coins wanted. You may have valuable coins. Keep all until posted. Send 20c for new Ill's Coin Value Book. 4x6. Buying and selling prices. 40 years in business. Coin Exchange, (7), LeRoy, N. Y.

FREE! Banknote, coin with bargain list, 10c. 4 Whitman folding albums, \$1.00. Olson Company, 434 North Menard, Chicago 44.

50 DIFFERENT Coins and bills, \$1.00. 100 different bills, \$1.00. Oddehon, Box 482, St. Louis, Mo.

32 DIFFERENT Coins \$1.00. Bischof, 714 East 8th, Kansas City, Mo.

COINS For collectors, reasonable prices. Free lists. Hutchinson, 3463 "T" Street, Philadelphia 34, Penna.

100 FOREIGN Coins \$4.00 postpaid. Parker, 1122 Market, San Francisco 2, Calif.

COMMEMORATIVE \$1/2, Oregon, Texas, Kentucky, Cleveland, Long Island, \$2.00 ea. Illustrated catalogue 25c. Norman Shultz, Salt Lake 9, Utah.

LINCOLN Cent collectors; scarce 1922 D 15c. Complete list free. Reynolds, 1118 Mathews, Flint 3, Michigan.

WORLD Coins—30 different \$1.00. Harry Elsholz, Box 9014, Pittsburgh 24, Penna.

COINS Wanted, will pay up to \$2000 for certain coins, send 25c for catalogue. Burton's, 111 So. Third, Columbus, Ohio.

GET Profit and pleasure in collecting old coins. Send 10c for 56 page illustrated coin catalog. You'll be delighted with it. Send for it now. B. Max Mehl, 370 Mehl Bldg., Fort Worth, Texas. Largest rare coin establishment in U.S. Established 47 years.

FREE! Foreign coin, banknote and coin collectors illustrated catalog to approval service applicants. Send 3c postage. Tatham Coinco, Springfield-125, Mass.

HOBBIES AND COLLECTIONS

MILLIONS Of dollars in prize contests being given away. Contest Magazine will help you win. Send \$1.00 today for the next four issues and learn how it's done. Contest Magazine, Drawer 259, Upland, Indiana.

WANTED: Old cigarette cards. Write Charles Bray, East Bangor, Penna.

WOOD And ivory carvings made to order. Hermania Anslinger, 918 West 4th Ave., Spokane, Wash.

MOVIE Star photos—newest 1947 poses. List free. Midwest's authorized distributors. American Features Syndicate, 1990 Como Ave., St. Paul 8, Minnesota.

CIRCUS Photos. List and sample 10c. Box 1028, Minneapolis, Minnesota.

MEN, Boys—Worldwide hobbyists' contacting service. Hobby Directory, Box 91, South Orange, N. J.

FOREIGN Campaign ribbon packet, and illustrated book \$1.00. Insigniacrafts, 236 28th Avenue N.W., Calgary, Canada.

SWAPPERS, Collectors, hobbyists. National bulletin 25c. Royal Oak, 128, Michigan.

KLONDIKE! For hobby jewelry makers! Novelty jewelry findings swept from tables of large manufacturers—parts for bracelets, pins, earrings, etc.—unfinished chains, rings, pins, stones, clips, beads—many other items. 1 lb. bags—\$3.00 sample bag—\$2.00 per bag in 5 bag lots. Prepaid only. Mdse. Distributing Co., 19 E. 16 St., New York 3, Dept. P.S.

100 UNUSED Canadian book match covers, all different. \$1.00. Post Office Box No. 8, Toronto, Canada.

UNUSED Match book covers, 100 all different \$1.00. 35 Royal Flash covers \$1.00. Free catalog. Charles Edelman, 1311C East 84, Cleveland 3, Ohio.

INVENTING Can be an interesting and profitable hobby. Write for complete particulars. Institute of American Inventors, Dept. 40-E, 1926-Eye St. N. W., Washington 6, D. C.

CAMPAIGN Ribbons—Beginner's pack-age. Introductory price 50c. Contains 15 assorted ribbons. L.H.G. Company, 19 E. 16 St., New York 3.

BOOKS—All Kinds—Homecraft, Radio, Plastics, Boat Building, Photography, Model Building. Catalog free. Popular Mechanics Press, 200 E. Ontario St., Chicago 11, Ill.

ANTIQUES, RELICS, INDIAN GOODS, CURIOS

WANTED—Weight driven banjo clocks, movements, any condition, give description and price first letter. I'll pay c.o.d. Carleton Hutchins, Colby Street, Brockton, Mass.

600 ANTIQUE Gun bargains, Catalogue 25c. Gil Hebard, Knoxville, Illinois.

10 ANCIENT Indian arrowheads \$1.00. List free. Lear's, Box 569, Galveston, Texas.

6 PERFECT Birdpoints \$1.00, list free. H. L. Talburt, Calico Rock, Ark.

SWORDS, Rapiers, daggers, pistols, armor. Illustrated catalog 50c. Robert Abels, 860-A Lexington Ave., New York.

PRECIOUS STONES, MINERALS

ZIRCONS. Mined and mastercraftsman cut in Siam. Flash fire, sparkle of diamonds. Reputed to bring good luck. Sample \$2.00. Two \$3.50. Wholesale \$1.50 carat. Imhuxep P.M., 336 West St., White Plains, N. Y.

GEM Cutters! Genuine topaz; aquamarines; amethyst; tourmaline; crysoteryl, etc. All the natural semi-precious stones of Brazil. Information, Lapidacao Ebinezer, Caixa Postal 5748, Sao Paulo, Brazil.

GENUINE Zircons sent on approval. Write for selection of zircons to choose from. Make selection and return to us for mounting. Send no money. Special: 3 genuine zircons, unset, approximately total 3-kts. \$6.00. Make big money selling genuine zircons. Send order or write for details today. Lowe's, Dept. PM-10, Holland Bldg., St. Louis, Mo.

"GENUINE" Deep red Arizona rubies (garnets). Send quarter for packet. Mineral Specimens Company, Box 2651, Phoenix, Arizona.

PETRIFIED Woods. Rare. Beautifully grained. Twelve cubic inches \$2. Jesse Teer, Roosevelt 1, Oklahoma.

METAL Detectors. The very latest circuit. Free literature. Hedden Metal Detectors, 538 N. Homewood Ave., Pittsburgh 8, Penna.

CAMERAS AND PHOTO SUPPLIES

STROBE-FLASH Kits. Free plans. Reed, 120 So. Glasgow, Inglewood, Calif.

CAMERAS, photographic supplies. Free catalog. Lynchburg Camera Shop, Lynchburg, Va.

PANCHROMATIC Film. Superior to ordinary "chrome type" film. This fine grain indoor and outdoor film gives excellent results due to wide range of latitude. Dated November 1948. Guaranteed. Shipped postpaid: #127, 5 for \$1.00; #120 and 620, 4 for \$1.00; #116 and 616, 3 for \$1.00. No stamps. Hudson Distributing Co., 509 Boulevard, Bayonne 1, N. J.

CAMERAS Repaired, all makes, all size bellows installed. Camera Repair Service, 121 Broadway, San Diego 1, Calif.

THIRD Dimensional pictures possible with new Tri-Vision camera. Double matched lens. Dual synco-shutters. Inexpensive. Free literature. Wishing Well, 2019 So. 39th, St. Louis 10, Mo.

AMATEUR Photographers! Save money. Make your own enlarger. Plans \$1.00. State negative size. Photo Lab., Salina Star Route, Boulder, Colorado.

COLOR Your own photographs. Kit \$1.00. Goynes, Lock Drawer 1784-D, Orange, Texas.

DEVELOPING And printing kit, complete \$4.95. Kit #1: Three 4x6 trays, one set of printing masks, one safe-light, four Universal M-Q developer, one qt. acid fixing powder, one pkg. (24 sheets) print paper, one graduate, one 4x6 all-metal print frame, one thermometer, two film clips, one instruction booklet. Kit #2: Same as above but includes a candid type camera that takes 16 pictures on each roll of film, complete \$7.95. We can supply all items needed for replacement listed in above kits. Send money order or check today and include 75c to cover handling and postage. Sorry, no C.O.D. orders. Simon Bros., 144 Elmora Avenue, Elizabeth, N. J.

MAGIC Photos—Make your own. Stamp brings literature. Photo Specialties, 812-A No. 18th, St. Louis, Mo.

BASS Says! At the sign of the old "Horse Trader," 37th year. Thousands of satisfied customers everywhere! Finest brands including Kodak, Bell & Howell, Argus, Zeiss, Leitz, etc. Satisfaction always guaranteed, or your money back! Bass buys 'em, sells 'em, trades 'em. Write or wire. Bass Camera Company, Dept. AG, 179 W. Madison St., Chicago 2.

CAMERA Prices slashed! Free list. Seymour's, 101-M Sherman Avenue, New York 34.

CAMERAS, Enlargers, projectors. Lowest prices. Free catalog. Cavalier Camera, 1822 Center, Pittsburgh 19, Penna.

PHOTOGRAPHY For pleasure or profit. Learn at home. Practical basic training. Long established school. Write for booklet. American School of Photography, 1315 Michigan, Dept. 3431, Chicago 5.

HAVE You a camera? Improve your hobby of photography and learn how to make better pictures. Write today for our latest book catalog and sample copy of American Photography, containing articles and pictures by the world's foremost writers and photographers. Camera House, 601, 353 Newbury St., Boston 15, Mass.

OIL Coloring photographs can be a fascinating hobby or profitable sideline for those with artistic talent. Learn at home. Easy simplified method. Send for free booklet. National Photo Coloring School, 1315 Michigan, Dept. 3431, Chicago 5, Ill.

FREE Premiums choice Christmas gifts free catalog. Westwood Company, 635 Victoria Street, San Francisco, Calif.

PRINT Your own pictures. Kit \$1.00. Spada, 10 Lexington, Wethersfield 9, Conn.

BUILD Your own enlarger. Takes negatives up to 4"x5". Detailed plans one dollar. Emby Co., Birmingham, Michigan.

PHOTO FINISHING

PHOTO Enlargements and specialists. 5x7, 15c; 8x10, 25c. Glossy or dull. Gorgeously oil colored 50c extra. Negatives made 50c. Special developing. Painting prices on request. L. & R., P.O. Box 1476, Milwaukee, Wisconsin.

SENSATIONAL Introductory offer! Send snapshot or negative, this ad and 10c. We'll send you a beautiful 7x5" enlargement! Or, Kodak roll developed and printed (with free coupon) only 25c; or 8 giant prints from roll, 30c. Reprints from negatives, any quantity, regular size, 3c; Giant size, 4c. Candid rolls—36 exp. 35mm. developed, vaporated, enlarged to 3x4, \$1.00, 18 exp. 50c. Free mailers. Free premium offers sent on request. American Studios, Dept. 364, La Crosse, Wisconsin.

ENLARGEMENTS Postcard size, 6 for 25c. Robert Renshaw, Jr., P.O. Box 478, Chester, Penna.

PHOTOGRAPHIC Christmas card 5c. Send negative for sample and illustrated price list. 50 cards \$3.25. Superior Finishers, Box 5610, Dallas 2, Texas.

SEND Me your pet negative; I will make you a beautiful 5x7 picture for only 50c. John Henley, Brooksville, Miss.

8 PRINTS From roll 23c; 16, 35c; 24, 50c. Reprints 2 1/2c. Enlarged prints; 16, 3x4 50c. Eight 4x6s, 40c. 20 premiums; Greeting cards, aprons, rings, fountain pens. Wholesale Camera, Albany 8, Wis.

PERSONALIZED Photo Christmas greeting cards made from your negatives 7c including envelopes. Send negative and 5c for sample. Young Photo Service, 405-H Albany 2, N. Y.

PERSONALIZED Photographic Christmas cards with envelopes, 10c each. Send negative. Minimum 25 cards. Raleigh Photo Service, Box 88, Seattle 11, Wash.

ENLARGEMENTS. 1 8x10 \$1.00. Oil colored \$2.00. Prepaid. Leon's Studio, 215 Carl Building, Independence, Missouri.

8 HR. Service. Xmas cards from your favorite negatives. 20 for \$1.00, 10 for 60c. Send up to 4 negatives. Roll developed and printed 3c each, giant size 4c. 5x7 enlargements, 2 for 25c. La Salle Photo Service, 1034 No. LaSalle, Chicago, Ill.

HAVE You photo finishing worries? Forget them. Newly invented camera snaps, develops and prints finished pictures. Write today for our free illustrated folder. Complete details and copy of photo. Pittsburgh Photo Shop, Dept. A-3, 1618 Westmont Avenue, Pittsburgh, 10, Penna.

EVERY Photographic service! Free lists! Phototron, Musgrove Building, Andover, Mass.

EMBOSSED Christmas cards from your own negative. For samples, send negatives and 25c. Film Capital Service, 818 Dewey Avenue, Rochester 13, N. Y.

PERSONALIZED Photocards. This year send Christmas cards made from your favorite snapshot. Relatives and friends will love them. See before you buy; send negative plus 3c postage for sample card and full details. Franklin Photofinishing, Box PM 11, Framingham, Mass.

50 VELOX Reprints \$1. Suburban Studio, 1410-M Bond, Rockford, Ill.

16 DECKLEDGE Prints from any standard 8 exposure roll 25c. Quick service. Professional work. Skrudland, Lake Geneva, Wis.

18 CHRISTMAS Cards and envelopes \$1.00, 60-\$3.00, send negative. Three prints each 8 exposure roll 40c. Two each 35c. One each 25c. Reprints 3c. Fred D. Eastman, Bode, Iowa.

BARGAIN—8 Exposures, with art borders and prize coupon, 25c. "Aircastles" Studios, 7050 Van Buren, Hammond, Indiana.

8 HOUR Service. Your 8 exposure roll printed jumbo or regular size, 25c; 12 exposures, 35c; 16 exposures, 50c; 36 exposures, \$1.00. Reprints, jumbo or regular, 3c. Regular prints deckled. Fine grain developing. Send for free mailers. Quality Photo Service, Box 468, San Francisco 1, Calif.

FREE Price list on quality developing, printing, enlarging. Write for it today. Bryan's Photo Shop, Dept. M, Panama City, Florida.

2c—VELOX Reprints. Roll developed 16 prints 25c. Photographer, Lake Geneva, Wis.

16 FOR 25c—Velox deckled prints with roll developed. Velox reprints 2c. Deckletone, Lake Geneva, Wis.

8 PRINTS All enlarged to nearly postcard size from your roll or negatives 25c; 16-50c. (Trial offer). Willard Studios, Box 3535A, Cleveland, Ohio.

TWO Beautiful prints from each picture on roll 25c. Twenty-six years of satisfied customers. Quick service. Lens Photos, Dept. J4, Janesville, Wis.

16 VELOX Deckledge prints with roll developed 25c. Studio, River Grove, Ill.

BEAUTIFUL Enlargement from each picture on roll 25c. Cut Rate Photos, Dept. B4, Janesville, Wis.

8 BEAUTIFUL Double size pictures and roll developed 30c. 8 hour service. Free mailers. Pacific Photo Service, Box 666, San Francisco, Calif.

2 BEAUTIFUL Hi-Gloss prints each good negative and enlarging coupon with each 6 or 8 exposure roll developed 28c. Owlphoto Co., Weatherford, Oklahoma.

PHOTOGRAPHY For pleasure or profit. Learn at home. Practical basic training. Long established school. Write for booklet. American School of Photography, 1315 Michigan, Dept. 3452, Chicago 5.

MOTION PICTURES AND SOUND EQUIPMENT

SAVE! Movies, cameras, projectors! Catalogue, sample, 10c. Poorman, Schuylkill Haven, Penna.

35 MM. Sound-silent; features, comedies, shorts. Victor Cromwell, Darien, Connecticut.

HOME Movies 8-16mm. silent sound. Free list. Ultra Pictures, Box 319, No. Hollywood, Calif.

BARGAINS In 16mm. sound projectors, films, reels, splicers. Harris, 303 West 42nd Street, New York 18.

MAGAZINE 16MM. 50' E. K. Super X panchromatic. Guaranteed. Processing included. \$1.99 postpaid. Fischer Photo, 1727 N. Mobile, Chicago 39, Illinois.

FILM—Free processing 100 ft. 16mm. Weston 12 \$3.25, Weston 24 \$4.90, Weston 64 \$4.95, 25 ft. double 8mm. Weston 12 \$1.50, Weston 24 \$1.89, Weston 64 \$1.99. Free circulars. Promader Genera, Davenport 4, Iowa.

PROJECTORS—16MM., 35 mm. silent-sound. Nusslock, 4614 Green-Tree, Milwaukee 9, Wis.

LISTINGS—200 free movies! Enclose 25c. Box 1, Ida Grove, Iowa.

ESTABLISHED School, teaching 35mm. sound motion picture projectionists for ten years, now offer correspondence course. Hollywood Sound Institute, Hollywood 37, Calif.

FINEST Movie screens, inexpensive, make them yourself. Free literature. Snow White Screen Company, Danville, Illinois.

16MM., 8MM. sound-silent films, projectors, screens. New, used, Bargain lists free. Osborn Films, Lebanon, Ohio.

WE BUY, Sell, rent, exchange home movies. Details for dime. Midland, Box 429, Oak Park 4, Ill.

8 AND 16 MM. movie film, fast machine processing service, bulk film, free circular. Atlantic Films, 28F N. 4th St., Reading, Penna.

SOUND Films. Special discount. Eastern Film Supply Co., Baldwin, New York.

SEND Stamp for list of 16mm., 8mm. movies, projectors, etc. Sterling's, 679 Northampton, Easton, Pennsylvania.

GUARANTEED Film—Weston 50! 100 ft. 16mm. \$3.45; 25 ft. (8-8) \$1.45 processed free! MK Photo, 451 Continental, Detroit 14, Michigan.

DISCOUNTS! 8MM., 16mm. films, equipment. Catalogue 3c. Towers, 935 North 40th, Philadelphia 4.

RENT 16MM. sound films 50c reel. Large selection; free catalog. Film Service, 128 Chestnut St., Roselle Park, N. J.

LEARN Movie projection, management. Free catalog. Theatre Institute, Elmira, N. Y.

PROCESS Your own 8mm.-16mm. movie film. Literature. Duro Movie Products, 1519 Eggert, Eggertsville 21, N. Y.

16 AND 35MM. films, projectors (sound). Savarese, Woodcliff Lake, N. J.

EXCLUSIVE Home movies. Select films. Write for free list. Home Pix, 1674 Broadway, New York 19, N. Y.

8-16MM. Silent-sound films. Complete rental library. All latest subjects. Free catalogue, (sample film 10c). Garden Film, 317 West 50th, New York 19.

COMPLETE Stocks always of Castle, Official, Pictorial films, 8mm., 16mm., sound, Musicals, soundies, free catalogs. We exchange your films and equipment, or buy them for cash. Frank Lane, 5 Little Bldg., Boston, Mass.

PROJECTORS \$16.00 Up. Cameras, film available. Selco Products, Danvers, Mass.

RARE 8-16MM. silent-sound films. International, 2120 Straus, Brooklyn, N. Y.

BASS Says! 37 years of leadership means satisfaction to you! Finest equipment, 8 and 16 mm., sound cameras, sound projectors. Bass buys 'em, sells 'em, trades 'em. Satisfaction always guaranteed, or your money back! Bass Camera Company, Dept. A, 179 W. Madison St., Chicago 2.

BEAUTIFUL Kodachrome slide and lists 25c. Slide Supply Service, 3111 West Tuscarawas, Canton, Ohio.

GUARANTEED Fresh anti-halo outdoor movie film! Weston 12! Daylight loading! Processing free! Three spools double 8mm. \$3.45! Six single 8mm. for Univex, \$4.60! Postpaid! Catalog. Eso-S, 828-B West 39th, Kansas City 2, Missouri.

"THE World's Greatest Passion Play," all sizes sound and silent. Write Hemenway Film, 33-F Melrose St., Boston 16, Mass.

I BUY. Exchange, swap movie films. Harvey Iris, Box 539, Brockton, Mass.

NEW Medical film* listing available to doctors, groups and responsible individuals. 8mm. and 16mm. Kodachrome and B & W. Medical Research Film Library, Dept. J, 1569 Broadway, Brooklyn 7, N. Y.

MUSIC AND MUSICAL INSTRUMENTS

BACK Popular music. List 10c. Forbe's, M3151 High, Denver 5, Colorado.

PIANO—Play by ear. Easy. Bodine, 10353 Peoria, Chicago, Ill.

WESTERN. Popular records—Late numbers 29c, catalog 3c. F-L Shop, Box 19-L, New York 35, N. Y.

ACCORDIONS. Streamline, wholesale. Request circular. Metro Accordion, 44 North Albany, Chicago.

PLAY Piano by ear. Book and "Mayberry" Chord-Slide (pocket size keyboard) \$2.00 postpaid. Chord-Slide, P3122 Lawrence Drive, Corpus Christi, Texas.

MUSIC Written to poems, \$3.00. Willams, Box 5030, San Francisco, Calif.

REAL Composer of music will co-operate with lyric writers in song production. Fine publication proposition. Nationwide distribution of publications. Recordings made. Copyrights secured. Write now. C. Isabel Mayer, Box 3896, Portland 8, Ore.

PHONOGRAPH Records. All makes. Catalogs 10c. Wack, 3131-W, North, Milwaukee 8, Wis.

SONGWRITERS! Music composed, arranged reasonable. Billy Hannon, 6703 Oshkosh, Chicago 31.

SONGWRITERS. Publication, collaboration. Newark Publications, GPO Box 1226, Syracuse, N. Y.

PLAY Piano by ear in one week. Amazing new system very simple. English, French. Write The Little System Reg'd., Ancienne-Lorette, Quebec, Canada.

MUSIC Arranged. Songs printed. Frank Wildt, Music Publisher, Lancaster, Penna.

PHONOGRAPH Records cheap. Catalogue. Paramount, MK-313 East Market, Wilkes-Barre, Penna.

SONG Writers! Collaborate with professional composer-arrangers, Radio Music Studios, Dept. D, Box 942, Chicago 90, Ill.

SONGWRITERS—Send for new special offer. Jas. Crane, Box 154, Providence, R. I.

BRAND New records. Distributor's surplus, Columbia and other major labels, \$3.50 per dozen, \$25.00 per 100. Indicate hillbilly, race, or popular selections. F.O.B. Cleveland. Record Rack, 7909 St. Clair Ave., Cleveland, Ohio.

MUSICAL Instruments, hundreds new and rebuilt, 5-day trial. Free bargain list. Meyer's Musical Exchange, 454-A Michigan, Detroit 26, Michigan.

SONGWRITERS—Protect your songs. Get the facts first. Free booklet, attractive offer. Song Service, 331-C West 46th, New York.

PIANISTS Acquire professional technique quickly! Wehner, 25 Fulda, Roxbury 19, Mass.

SONGWRITERS: Outstanding, honest music writing offer. Dick Reynolds, Leonard, Texas.

POEMS Wanted for musical setting. Send poems for free examination. Five Star Music Masters, 630 Beacon Bldg., Boston, Mass.

PIANISTS: Master popular music chord charts show names, symbols, readings, notation, indexes; 648 treble, 180 bass positions. Terrific! For you! \$1.00. Carol Music Chart Co., P.O. Box 21 P.M. Lefterts, Brooklyn 25, N. Y.

FREE Accordion pickup with each accordion purchased. New or used accordions for sale. Cash or terms, wholesale or retail. Write for bargain list. Del Principe, 307 So. Wabash, Chicago.

DUO-FLEX Reeds, for clarinets and saxophones. Eliminate your reed troubles. Circular free. Duo-Flex Reeds, 1204 First Ave., Evansville, Ind.

AMPLIFY Your accordion with our new Del Principe pickup, \$22.50. Install it yourself in one minute. Makes any accordion sound like an organ. Works with any amplifier. Special Del Principe amplifier and pickup only \$72.50. Write for details. Del Principe, 307 So. Wabash Ave., Chicago.

POEMS Wanted for musical setting! Send poem for immediate consideration. Hamann Service, 614 Manhattan Building, Milwaukee, Wisconsin.

POEMS Wanted to be set to music. Free examination. Send poems. McNeil, Master of Music, 510-PM S. Alexandria, Los Angeles, California.

BEFORE Sending your poem to be set to music, know your composer. Free folder. Al. Moquin, 5333 La Cresta Court, Hollywood 38, Calif.

SONGWRITERS! Outstanding ethical offer. Hibbler, C5, 2157 N. Avers, Chicago.

SONGWRITERS: Send poems for free examination and outstanding offer. United Music Service, 150, Salem, Indiana.

WRITE Songs. Big money and reputation. Write for information. J. Gordon Pub Co., 201 N. Hoyne Ave., Chicago.

SONG Writer's attention! The amazing demand for phonograph records, accelerated by more than 300,000 juke boxes and the hits popularized warrants your immediate consideration. We are offering song-poem writers the rare opportunity of having established composers collaborate on appealing material received this month. Recola Records, Box 987P, Hollywood 28, Calif.

RADIOS, SUPPLIES, INSTRUCTIONS

RADIO Tubes, parts, below list price. Quick delivery. Belltone Radio, 167-04 111th Ave., Jamaica 5, Long Island, N. Y.

BUILD "Loudest" crystal radio. Instructions and crystal, 25c. Amorose Radio, Route Four, Richmond, Virginia.

RADIO And television catalog—free! Money saving prices on radios, hard-to-get parts, record changers, wire and disc recorders, amplifier systems, tubes, books, amateur and test equipment. Write today! Radionic Equipment Co., Dept. 2011, 170 Nassau Street, New York 7, N. Y.

ACT Now for Xmas 1948 radios, 110 volt a.c. or d.c. superhet. Famous make. Manufacturers guarantee enclosed. \$19.95. Check or money order prepaid or c.o.d. Rated established company. We ship at once. Belmont Radio & Appl. Co., 440 Common Street, Belmont 78, Mass.

MAKE Selective, distance getting, crystal radios, also one tube radios. Improved designs. Complete instructions and crystal 25c. Radio Leader, LaVerne, California.

AMAZING Resistor kit values! \$20.00 value for only \$2.50. Specially selected resistors for radio, amplifier and experimental uses. 25 resistors \$1.00; 100-\$2.50; 150-\$3.00. Rush your order today. Cash-check or money order. Northern Electronic Development Co., 2544 S. 77th St., Milwaukee 14, Wisconsin.

NOW in kit form or wired: phono-oscillator kit, complete \$5.90, wired \$6.90. Code practice oscillator kit, complete \$4.80, wired \$5.80. Army key, 75c; speaker \$1.90. All postpaid. R J S Products, 925 Concord, Akron 6, Ohio.

TINY Crystal 2-way wrist radios. Receives, transmits. Marvelous gift, \$4.00. Goleblewski, 5103 Wyoming, Dearborn, Michigan.

BOOKS On radio electronics supplied by mail. Servicing, home study, math, electricity, operating, television, etc. Send stamp for catalog and details of free offer to new customers. Nephews Publishing Company, Dept. M11, 300 Pacific Street, Brooklyn 2, N. Y.

AMERICA'S Best buys. Radio tubes 29c up. Free bargain lists. Potter, 1314-P McGee, Kansas City 6, Mo.

FM Television antennas, ham parts, bargain list. Wholesale Supply, 347 Lunenburg St., Fitchburg, Mass.

MAKE Simple, tubeless, batteryless, distance-getting crystal radios. Crystal and illustrated instructions 25c postpaid. Allen, 427-P, Clinton, Missouri.

24 PAGE Plans "18 Long Distance Crystal Sets," including "Radiobuilder," catalog 25c. Laboratories, Eye-c, San Carlos, California.

BUILD A portable radio tube tester; improved design, checks all type radio receiving tubes; complete kit with easy to follow assembly blueprints; saves you \$20. Brand new factory parts; Standard Appliance Co., 1438 West Third Street, Dayton, Ohio.

25 YEARS Experience radio repairing at your fingertips. I've repaired 45,000 radios and have perfected system you can follow step by step. My methods are far simpler than any course published. Requires no calculations. Total price \$1.00 postpaid or c.o.d. Moneyback guarantee. Ross Radio Company, 14615A Grandriver, Detroit 27, Michigan.

\$1.00 RADIO Service. Write Wholesale Service, 780 E. 214 St., New York, N. Y.

U. S. SIGNAL Corps featherweight earphones \$1.00. Radio service men and experimenters send stamp for our giant radio catalogue. Save dollars. United Radio Co., (100-V) Newark 1, N. J.

RADIOMEN. Servicemen, beginners—make more money, easily, \$250 weekly possible. We show you. Information free. Merit, 216-32A 132nd Avenue, Springfield Gardens 13, New York, N. Y.

RADIO Technician and radio service courses. Training for federal licenses. American Radio Institute, 101 W. 63 St., New York City. Approved under G. I. Bill of Rights.

BUSINESS OPPORTUNITIES

METALLIZING Baby shoes makes you money! Learn this simple, profitable business from nationally recognized authority. Get professional results with professional "know-how"! Free particulars. Joseph B. Kushner, Metal Finishing Consultant, Stroudsburg 3, Pennsylvania.

OPERATE Profitable home mail order business on \$5 capital. Details free. Note, 2718 W. Cambridge Street, Philadelphia 36, Penna.

"HOW To work your way through college." Excellent book, \$1.00 postpaid. 26 North 11th Street, Toledo, Ohio.

GET In on big Christmas trade. Start magazine subscription service now. Liberal commissions. Supplies furnished. Rush request for free catalog and starting information. McGregor Magazine Agency, Dept. PM-10, Mount Morris, Ill.

YOUR Own plastic business at home. Produce costume jewelry, novelties, statuettes. Liquid plastic, liquid marble. Flexible molds. Write for free book. American Trades, Box 89-A, Cincinnati 29, Ohio.

RUBBER Molds. Make your own. Manufacture gifts, novelties. "Aircure," mold making liquid. Free model. Directions, Quart \$2.95. Plasticwood, concentrated "Plaster Hardener," quart \$2.50. Rubbercoat, 3873A California Street, San Diego 1, California.

ADDRESSES Of hard-to-get items. Mailing lists. Q Service, 422 S. Dearborn, Chicago 5, Ill.

YOU Too can start profitable home business with \$5.00 capital. Details free. B. E. Leveque, 823 Howard St., San Antonio.

A HIGHLY Profitable factory in your own home or garage! Amazing waterless hand cleaner. Formula and instructions free. Western Aircraft, Dept. D, Los Angeles 6.

A SHIP In a bottle sells for as much as \$50.00, materials cost less than \$1.00. Particulars free. Box 2095, Wichita, Kansas.

MECHANICALLY Inclined men — Own and operate general appliance repair shop. Complete, illustrated course shows you how. Welding, refrigeration, motor repair, how to get business, etc., all phases covered. Free literature. Christy Supply, Dept. T-177, 2835 N. Central Ave., Chicago.

YOU Need "Mail Order World Magazine." Sample 25c. Bentz Jr., Chatawa 4, Mississippi.

OPERATE Profitable business on small capital. For details write, Crest Service, 906 Silvercrest Ave., Akron 14, Ohio.

RUBBER Moulds for casting novelties. Latex for making moulds. Use thoroughly tested and approved products. Eastern Latex Laboratories, Box 153, Mattapan 26, Mass.

UNPAINTED Plaques, figurines. Emerson, 142 Bay 14 St., Brooklyn 14, N. Y.

RED Hot; slickest, legitimate way to make money quick. Amazing book, "How to Build Your Own Mail Business." (Rare information). Book with other pointers 25c postpaid. Literature free. Piant Mail Order, Duenweg, Mo.

BOOKKEEPERS — Operate your own bookkeeping and tax service. Part or full time. Free course, "How to Operate a Contract Bookkeeping Service." A. J. Hawthorne, Public Accountant, Decatur, Ala.

FREE Details, operate home mail order business. Margaret Hantzis, 315 N. Walcott, Indianapolis, Indiana.

DOLLARS Daily! Cleared \$1,900 in two months by mail! Write immediately! Loeb, A-11, Silverton, Cincinnati 13.

TRADE And class magazines. Current copies. All fields. Free price list. Commercial Engraving Publishing Co., 34BF North Ritter, Indianapolis 19, Indiana.

COMPOSITION Flooring—Made in most colors. Lifelong, soundproof, resilient. Flexible molds. Cast novelties, plaques, statuary. Big money—your own business. Catalog free. Write Bing Products, 88-A3U Broad Street, Boston 10, Mass.

OPERATE Profitable mail order business. Splendid opportunity. For details write C. S. Coleman, 29 Lippitt Street, Providence 6, R. I.

BUYERS Wanted for plaster novelties. Painted — unpainted. Retail — wholesale. Write today for free information. Bing Products, 88-X6A Broad, Boston 10, Mass.

OPERATE Profitable mail order business. Splendid opportunity. For details write, Annefred Service, 1227 Princeton Ave., Philadelphia 11, Penna.

MAKE Liquid marble, flexible molds, statuary, art goods, novelties, artificial marble flooring. Literature free. Kemico, Park Ridge 50, Ill.

START Home manufacturing business making Cleaning Compounds, Soaps, Insecticides, Cosmetics, Polishes, Food Flavors. No machinery. Literature free. Kemix, Park Ridge, Ill.

DIRECT Factory agents for fast-selling, fine commercial popcorn machines. Nationally advertised. Sales leads furnished. Excellent profit. Viking Popcorn Machines, Inc., 114 W. 18th, Kansas City, Mo.

READ—"From Nothing To Independence." Descriptive literature free. Maciolek, 7738-A Dayton St., Detroit 10, Mich.

PLASTIC Tablecloth covers, curtains, drapes, baby pants, bowl covers and other plastic articles selling like wildfire! Make big money now! Free details. Write Plastics, Dept. 58-M, 206 N. Fourth, St. Louis, Mo.

PROFITABLE Spare time business. Details free. Big mail 10c. Hobby News, 3910N North 24th Street, Tacoma 7, Wash.

MAKE Money selling by mail from your own home, no stock to carry, start on \$15. Write to Walter H. Neece, Wakenva, Va.

OPPORTUNITIES And profits unlimited. "Success For You" tells how. Write Otto Stuempe, 238 McCormick, Cincinnati 19, Ohio.

BABY Shoes bronzing supplies wholesale. 15 styles onyx and plasticized mountings, special hardening solutions, shoes metalsealed for \$1.00. Box 2095, Wichita, Kansas.

BE A tax consultant. Bookkeepers, etc. can qualify quickly. Details free. Edw. H. Smith, 17 Rockland Ave., Yonkers, N. Y.

ELECTRICALLY Inclined men. Amazing illustrated literature free, proving \$100-\$250 weekly possible installing, maintaining fluorescent lighting. Rebuild fixtures for excellent profits. Make beautiful lights for 50c each and less. Free sample materials. Write Willis Fluorescent Service, 101 York Street, Brooklyn 1, New York, Dept. C.

WOODWORKERS, Craftsmen, mechanics. Earn up to \$30.00 daily with or without shop. Tremendous demand. Amazing particulars free. Stafford, 708-E Rawlings, Carbondale, Ill.

PARTY-CAT Noisemaker balloons \$5.90 gross. Retail 10c to 20c. Balloons, balls, rubber specialties, add to your business; factory prices; profit plenty. Ellsworth Balloon Headquarters, LaJunta, Colorado.

SEA Shells, plastics, metal findings, free catalog. "Secors," 238 Bradenton Beach, Florida.

OPERATE Profitable mail order business. Splendid opportunity. For details write P.O. Box 835, Philadelphia 5, Penna.

DEALERS! Get our prices on silver and gold plated ear screws. The Marcraft Co., Skokie, Illinois.

BOOKKEEPING Service by mail. Comprehensive, nation-wide survey shows why and how of phenomenal growth. Free details. Management Engineers, Box 33, Forest Hills, N. Y.

WINDSHIELD Wiper rebuilding brings big profits. Free particulars. H & H Products, Box 430, East Akron 5, Ohio.

PLAQUES, Novelties, painted, unpainted. Free sample and list. Assortment \$1.00. Ward Plaster Craft, 82 Seward Lane, Green Ridge, Aston Township, Penna.

MIDGET, Deformed two year old calf. Suitable show purposes. Percentage or sell. Picture and details to interested parties sending 25c. Don Christoffer, Spirit Lake, Iowa.

CONVERT Hand mowers to power mowers. Sell the handy-dandy lawn mower conversion kits. Easily installed on any make mower in 3 hours. Used with any small gasoline or electric motor (Maytag, Power Products engines) in stock. Quick delivery. Kits can be purchased with or without engines. Fits 16 to 20 inch mower. Dealers wanted. Write for details. Le Claire Manufacturing Co., Le Claire, Iowa.

EARN Money at home by mail. Information free. Goodrich, Edgewood Terrace, Longmeadow 6, Mass.

SAVE! Million articles wholesale. Directory 10c. Publishers, Box 1302-P11, Detroit 31.

SIMPLE Method of Guerilla self-defense makes you the master! Free particulars. Inspiration House, 3108 Hillside, Harrisburg, Penna.

NO Limit to the money you can earn in mail order operation. If you are ambitious and have \$10.00 write the Brown Company, Dept. AA, Box 1412, Wichita, Kansas.

PROFITABLE Manufacturing business. Capital unnecessary. Write Box 263, Far Rockaway, New York.

1001 MONEYMAKING Ideas! Free details. Neuway Institute, Box 5463-M, Chicago 80.

SELL Merchandise wholesale. Make unusual profits. Develop your own business. Particulars free. Young's, Kent 4, Ohio.

500% PROFIT! Manufacturing and selling your own guaranteed furniture and silver polishes. Simple mixing! Manufacturers "plan of operation" shows how! \$2.00. Hy-Polish Factory, Rowan, Iowa.

LATEX For making flexible rubber moulds. Thoroughly tested. No shrinkage. Complete instructions with each order. Stoneham Rubber Co., Box 244, Stoneham 80, Mass.

SPECIAL Molding Latex. Free samples. Universal, Box 1076-A, Peoria, Ill.

MANUFACTURE Paints, your garage a factory, free information. Industrial Chemist, 525 Donnelly, Kansas City, Missouri.

TWELVE 10c Pocket combs on display card. 3 cards \$1.00 postpaid. Buford's, Box 54, Dallas, Texas.

SHORTEST Complete bookkeeping and income tax system. Copyrighted, merchant's time saver; big money to bookkeepers, whole or part time. Complete system, \$1. Tax bulletin free. Mixon, Box 2048, Los Angeles, 53.

\$100.00 A Week possible. Your own mail-order business. Newest mailorder business and agency plans, stamp. Three leading trade magazines, dime, postage, packing only. Norman Spm. Rorick, 217 Strader, Cincinnati 26, Ohio.

METALLIZE Baby shoes. Excellent profits. New system assures success. Free details. Treasures Forever, 89 Henry Ave., Lynn, Mass.

EXCLUSIVE Distributor. Plasticized beauty-protection for auto finishes. Used like polish. Must fin. own stock. Plasticize, 2254 NW 62nd St., Miami, Fla.

VARIETY Store business, large profits. I tell you how to start. Fred Carpenter, Hamlin, Texas.

LIFETIME Business. Work locally and or mail. Fast moving, profitable repeat item. New plan. Einert Sales, 150-23 115 Ave., Jamaica 4, N. Y.

GENUINE Natural Latex for rubber molds. Only two coats necessary for thick mold. Make money reproducing statuary, plaques, novelties. Low cost. Write: Major Chemical Company, 131 Inman Street, Cambridge, Mass.

BIG Money in vending machines. Smallest capital start brings immediate profits that build permanent profitable business. Instruction booklet free. Becker Vendors, 105-A Dewey, Brillion, Wisconsin.

FLASH. Beat competition. Be first. New products bulletin published monthly. Fastest money making items from factory to you. Sample \$1.00. Free details. Business Plans Co., 1243 Park, San Jose 11, Calif.

"MAILORDER Fundamentals" for mail-order beginners. \$1.00. Mecca, 30 West Washington, Chicago 2.

NEW Low prices—Super X molding Latex. Liquid sample 25c. Literature and sample free. W. Wooley, 115-A Donald, Peoria, Ill.

\$46 FROM Square foot plywood. Jigsaw necessary. Write, Woodarts, X-38, Bridge-water, Mass.

WHOLESALE New women's item. A "natural" for mail dealers also. Write manufacturer, Renee of Boston, Dept. One, 618 Little Bldg., Boston, Mass.

\$5000 Yearly possible operating national chain office, your own business. "Write Hunt," Box 308, Burlingame, California.

METALLIZE Baby shoes. Latest method. Easy instructions, \$1.00. Reed Plating, 120 So. Glasgow, Inglewood, Calif.

300% PROFIT Selling fast-selling item by mail, local. Dade Products, Box 1720H, Cleveland, Ohio.

MAKE Rubber stamps, plaster novelties, metallize baby shoes, silver mirrors. Catalogue of "20 ideas" free. Universal, Box 1076-A, Peoria, Ill.

DOUBLE Your money back, if not delighted with "Opportunities Preferred"—big, 8 1/2 x 11 magazine, handsomely printed on slick paper, Money-making ideas; Opportunities galore! One man got \$5,000 idea! Dollar brings nine big numbers. B. W. Coates, Publisher, 33 Vassar, Dorchester 24, Mass.

12,000,000 COLLECTORS Your market! Become successful postage stamp dealer. Large profits. Proven method. Write Largentiere Company, 6462 83rd Place, Forest Hills, New York.

HOME Workers wanted to hand-spin Angora wool. Either sex. House of Angora, M-11, Springfield, Illinois.

OWN A mail-order paper products business. Sell envelopes, tags, bags, boxes, by mail, wholesale. Tremendous demand. Steady profits. No capital necessary. Write Omaha Envelope Service, Dept. 224, 4721 California, Omaha 3, Nebraska.

HOMEWORKERS — \$50.00, \$75.00, \$100.00! weekly "Castwood Plastic" gifts, plaques novelties; material, molds, instructions furnished (sample outfit) rubber scottle mold, woodcut ashtray, 1-pound castwood plastic; with big list supplies, \$1.00 postpaid. Standard Art Products, 1416-R2 Fletcher, Chicago.

MOLD Plastics. Easy, profitable methods. Free instructive literature. Plastics Digest, 2917B Michigan, Kansas City 3, Mo.

BE Your own boss. Metallize baby shoes at home, spare time. Your own business. H. Schwiager, 8404 W. Chestnut, Wauwatosa 13, Wis.

LACQUERS, Spray outfits, flocking kits, natural rubber, molds. Creative Specialties, 3356 Cullom, Chicago 18.

EXPANDING Research requires higher production at fancy profits. Start at home. Small capital. Experience not essential. Free startling facts. Vigilant Sales, 6432 Cass, Detroit 2, Mich.

BOOKS—All Kinds—Homecraft, Radio, Plastics, Boat Building, Photography, Model Building. Catalog free. Popular Mechanics Press, 200 E. Ontario St., Chicago 11, Ill.

OPERATE Profitable mail order business. Splendid opportunity. For details write J. Kavas, 54 Seigel Street, Brooklyn 6, New York.

SAWDUST. Turn it into cash. Six methods. Instructions 25c. Charles, 12-AX, Norwood, Ohio.

BIG Mail 6 months 25c. Roth, 1455B Cornelia, Chicago 13, Ill.

FORMULAS—Private brand products. Opportunities catalog. Farrand Chemical, Tyrone, Penna.

LOOKING For something to sell? Then you need our new products bulletin. Brings advance notice about 100 newest and fastest selling items for local or mail order selling. Red hot items. Latest confidential release \$1.00. Details free. H. R. Barlett, 1011 W. 2nd St., Flint 3, Michigan.

COMPOSITION Flooring—Money-making business! Waterproofing, Tile roofing, plastic homes. Flexible molds—cast statuary, costume jewelry, bookends, colored pottery, liquid plastic, liquid marble. Particulars free. Marbleizing Service, Edwardsville, Illinois

OPERATE Profitable mail order business. Free details. Miller, 75 S. Fulton Court, Hazleton, Penna.

MAKE Profits in mail order business. Astounding plans describing method sent free. Jimton Service, Lock Box 1373-A, Mobile 8, Alabama.

YOUR Own business. Something new; something different. Easy to make and sell. Big demand. Particulars free. Belmont, Garrett, Indiana.

START Profitable mail order business. Run ads, forward orders, keep big cash commissions, everything furnished. Free details. McKittrick Publications, Box 58, Mt. Vernon 4, Ill.

UNPAINTED Plaster ornaments made from new, wonderful loxite. Beautiful designs easily decorated with water colors or oil paints. For profit or hobby. Illustrated list free. Midwest Novelty Mfg. Co., 108A Cedar St., Anaconda, Montana.

UPHOLSTERING. Start your own shop. Complete instructions \$1.00. Wynn and Graf, 5117 Charlotte, Nashville, Tenn.

WANT To sell your brains? Publish and sell your own knowledge for money. Publisher tells how. Free details. Write today. Royal Publishers, Auburn 3, Alabama.

TREMENDOUS Profits selling real estate. Authorative new manual shows how to start full or part time business of your own. Complete only \$2.00. Details free. Schultz House, 3116 Seminary, Chicago 13.

GOLD, Silver plating at home. New, amazing outfit. Does marvelous work and so simple. Just plug into electric socket and in a jiffy you begin to plate. Not a toy. No experience needed. Everything furnished. Absolutely guaranteed. Make money plating for others. Write immediately for full details. Louric Mfg. Co., 1809-W Callowhill Street, Philadelphia 30, Penna.

MAIL Order businesses, franchises, distributorships, bought and sold. Write for free bulletin of exclusive opportunities. Turnipseed, Inc., Box 681, St. Louis, Mo.

REMNANTS—Amazing values. Housewives buy on sight. Good profit. Write B & M Textiles, 415 East 26th Street, Paterson 4, N. J.

RAISE Fishworms, everything revealed; extensive method. \$5.00. Details, free. Stoner's, Chattanooga 6, Tenn.

RUBBER Molds, liquid rubber, statuary plaster, kits for beginners. Complete "Plastercraft" course free on request. Blue Rapids Supply, Blue Rapids, Kansas.

COLOR Concrete with chemicals. Formulas, instruction. Sample 10c. Hollywood Cementcraft, 8527-A Wonderland, Hollywood 46, Calif.

DO It with sea shells. Beautiful jewelry, novelties. Big profit spare time. Free lesson. Werts (F.), 1429 56th Avenue, Oakland 3, Calif.

UNPAINTED Plaques, statues. Variety of designs, free list. ArBo Products, A 195 E. 7th St., St. Paul, Minn.

EXCLUSIVE Distributorships available. New sensational home labor saving device ready October first. Wonderful money making opportunity. Write Sherwood Products, Erie, Penna.

LEARN Piano tuning, repairing, at home. Tremendous field! Piano parts, tools furnished. Established 1935. Empire School of Piano Tuning, 606-B East University Ave., Champaign, Ill.

SECURITY, Happiness, independence. Selling by mail. Free details. W. Young, Box 1477, Portland 7, Ore.

AGENT Or exclusive distributor for cigarette lighter mfg. MacGregor, Tahoe Valley 16, Calif.

YOU Too can start profitable home business with \$5.00 capital. Details free. B. E. Leveque, 823 Howard Street, San Antonio 1, Texas.

MEN—Women—"Everybody likes candy." Learn to manufacture professionally at home. (Our 37th year). Ragsdale Candies, Dept. 4, East Orange, N. J.

LIQUID Rubber for making flexible molds. Sample bottle 25c. Plaster hardener, quart \$2.00. Free literature. Chaney, 1130 East 16th Street, Jacksonville 6, Fla.

START Home business making statuettes, plaques, artificial marble flooring, liquid marble, flexible molds, metalizing baby shoes. Amazing profits. Folder free. Creative, 236-L, Winnetka, Illinois.

UNPAINTED Bookends, plaques, statues, figurines. List. Haverty Products, 1219 8th Ave., Altoona, Penna.

FELLOW Workers, no bosses. National opportunity to become independent with business of your own. Details free. P. Padney, 307 York St., Jersey City 2, N. J.

BABY Shoes preserved. Formulas, instructions \$1.00. Novelty Bronzing, Box 56, Hyde Park 36, Mass.

RE-NEW Leather and leatherette—Make cloth into imitation leather with plastic discovery called Leather-New. Opportunity to make real profits taking care of sales resulting from national advertising. Write for free sample of Leather-New covered material and complete deal. 701 Land Bank, Kansas City, Missouri.

BRONZED Baby shoe mountings and supplies. All metal bronze bookends, picture frames, ash trays, etc. Onyx ash trays, desk sets, plaques. Hardening solution. 30 amp. plating rectifiers with powerstat control, \$85.00. Geared motors for agitation, \$15.00. Lead lined tanks. Write for list. Hollywood Bronze Supply, 1770 N. Vermont, Hollywood 27, Calif.

BIG Money selling "Bobby-Jo" baby shoes. Everything furnished. Tested successful mail plan free. No-Co-Ro, Oakland, 6-M, Calif.

FREE Literature describing many money making plans. Albert Pearson, Box 1182, Milwaukee, Wisconsin.

LEARN To metalize baby shoes! Complete instructions \$1.00. Don Brady, 1618 Gage St., Topeka, Kan.

ELEVEN Formulas, also diagram of electroplating outfit for \$1.00. (coin). Emery, 482-40th Street, Oakland 9, California.

READ "Advance"—The Voice of Mail Order. Offers money-making opportunities, sources of supply, personal guidance, etc. Issued monthly. Sample copy 25c. Yearly subscription \$2.00. American Mail Trade Association, 313 East 21st Street, Suite 45, New York 10, N. Y.

MAILING List! 10,000 women mailorder buyers, \$45.00, 5000, \$25.00, 1000, \$6.00. Guaranteed accurate. Try them! Woods Remnants, Bedford, Penna.

MERCHANDISE At half the standard advertised price and catalog 10c, none free. Ken Solomon Company, 813 Broadway, New York 3, N. Y.

MOTHPROOFING And cleaning business pays well. I'll show you how to start on amazingly small capital. Write today for details on eight practical plans. Howard Robinson, Ph.G., Box A, South Ohio Street, Sedalia, Missouri.

GET Into a billion-dollar industry, unlimited possibilities, large demand, small capital. Details free. Becroft, 15 Park Row, New York 7, New York.

IF You'd like your own, high income but easily learned office business, write for free details today. Cole Associates, Syracuse 2, N. Y.

PROFITABLE Letter shop operation. Details free. Wollard, Box 268-E, Newark, Ohio.

UP To \$1500 yearly selling by mail in spare time interest you? New ideas and plans every month. Details free. Idea of Month Club, Box 118-A, Baltimore 18, Md.

BECOME A finance man. Particulars free. George Lenhoff, Lincoln 8, Nebr.

METALLIZE Baby shoes, new ideas, particulars free. Krall, Box 8087, Pittsburgh 16, Penna.

FLASH 3 Classie novelties. Large profits. Gold mine for agents, salesmen. Hurry. 25c coin, not stamps. Martin, PM 57 Hart, New Britain, Connecticut.

\$5 COMMISSION On booked distant moving jobs you recommend. Upited, 243 West 60th Street, New York, N. Y.

POPCORN Machines. Potato chip outfits. Long Eakins Co., 4760 Hi St., Springfield, Ohio.

GET It for them wholesale. Be community buyer nationally-known merchandise; radios, refrigerators, washers, sweepers, typewriters, etc. Savings up to 50%. This pleasant, easy work can earn up to \$5000 year. Get details today. Kraft, Aurora 8, Missouri.

WHITE Liquid rubber for making flexible molds! Quick drying! Safe! For home, classroom, or industry! Quart \$2.00. Gallon \$5.95. Full instructions! Beginner's booklet on molding and plaster casting 25c. Free with order! Plastercraft Supply Company, 1406 East 43rd Street, Cleveland 3, Ohio.

INVESTIGATE Mail order or home business. 140 new ideas. Write Marshall, Box 655, Centralia 13, Washington.

MAILING Postcards selling repeat merchandise is profitable. Everything supplied. Details free. Gordan Publishers, Box 23, Pawtucket, R. I.

WOULD You pay 3%—first \$350 made? Color-illustrated book "505 Odd, Successful Enterprises" free! Some offer occasional "day off." Work home. Expect something odd! Pacific, Oceanside, Calif.

\$40 WEEKLY, Spare time, your own home business. Many plans. Literature free. Carroll Service Company, 521-A North Pine St., Little Rock, Ark.

TWO Amazing new typing opportunities. Earn up to several dollars hour, right at home. New, exclusive, different. Write Schroder, 221 E. Bush, Covington, Ky.

SELL Books by mail. Large profits! Free! Literature. Cline-Porter, Box 6346 PB, Pittsburgh 12, Penna.

BIG Profits and your own business casting latest 1947 metal toy autos, airplanes, ashtrays, savings banks, etc. Enormous wholesale and chain store demand keeps manufacturers busy. Spare or full time. No experience or special place needed. For full information write Metal Cast Products Co., Dept. A, 1696 Boston Road, New York 60, N. Y.

COLORGLAZED Concrete pottery made without molds. New, low cost, patented method. Cemetery products, novelties, tiles, floors, etc. Basement leaksealing. Other money-making projects. Booklet, details free. Men only. National Pottery Company, Grand Rapids, Minnesota.

UNPAINTED Plaques, bookends, ash trays. List. Bava, 3655 E. Canfield, Detroit 7, Michigan.

COIN Machines earn big money! Machines are now available at \$11.75 that can earn as high as \$7 weekly profit. Place machines in stores, hotels, filling stations, etc., and your income starts immediately. Routes can be operated in spare or full time with no experience needed. We'll tell you how and send you a catalogue describing our nut, candy, gum, and postage vendors, also scales, amusement games, etc. Write immediately to Parkway Machine Corp., Dept. P, 623 W. North Ave., Baltimore 17, Md.

CO-PUBLISH And advertise in The Central Mail Advertiser. Sample copy for stamp. Low rates. Large circulation. Bagby Printing Co., Georgetown, Ohio.

HOW To set up and run a mirror shop! Resilver mirrors. For price write—John Sprinkle V60, Marion, Indiana.

OPERATE Profitable mail order business. Write Walter Service, 4159-A East 112th, Cleveland 5, Ohio.

RECAST Old batteries into new. Latest achievements. Battery Laboratories, Minneapolis.

BIG Mail income. Free particulars. Murray's, 196 Circle, Forestville, Conn.

PARATOL—Amazing new rubber latex moulding compound for perfect detail castings of all kinds tested and approved in long service. No worries—easy to apply, quick drying, maximum strength and long life. Why pay more—buy direct! Quarts—\$1.60, 1 gal.—\$4.90, 5 gals. \$4.45 gal. 4 oz. samples on request. Send 25c to cover mailing and handling charges. Full instructions sent with each order. Testworth Laboratories, Inc., Manufacturers of coating and adhesive products of all kinds. 407 S. Dearborn Street, Chicago 5, Illinois.

OUR Unique service will help sell your idea or invention. Literature free. Ellis Martz, Representative, Muncy, Penna.

START A home business in spare time. Make extra money. Experience unnecessary. Literature free. Ellmar Services, Muncy, Penna.

MAKE Perfumes. Profitable business. Free book tells how. Walter Lawson, 21 Joiner, St. Augustine, Florida.

MAIL Order opportunities. Full or spare time. Hundreds of chances. No charge. Postal brings copy. Blackstone Press, Somerville, New Jersey.

MAIL Order business course shows you how to make money, spare or fulltime. Teaches professional mail order technique—not penny-snatching schemes. Fascinating 100-page illustrated success-catalog free! Write: Nelson Company, Dept. 4-02, Chicago 5.

GREAT Opportunities and profits in mail order business at home. Free literature. F. Webster, Box 1972C, Hollywood, Calif.

BOOKKEEPERS—Operate your own simplified "Dollar-A-Week" bookkeeping and tax service. Full or spare time. Details free. Ellis, Box 200, Cedar Grove, North Carolina.

ELITE Collection contains 137 practical money-making plans; local and mail order. New edition. Particulars free. Elite Co., 220 Grand St., New York 13.

QUICK Money! "Repairing car batteries." At home! Easy too! Write: Batteryman, Grand Junction 5, Colorado.

SELL By mail!—Books and novelties! 35 different items! Large profits! Catalog free! Elfoo, 432 N. Wells, Chicago 10.

OPERATE Profitable home business selling merchandise by mail. Fast sellers. Large profits. Powell Service, 5713 Euclid, Cleveland 3, Ohio.

COPUBLISH Leading m.o. paper. Latest copy Mail Sale Advertiser and proposition, commemorative stamp. Vanroy Shirk, Lebanon, Penna.

START Profitable mail order business. **PMT** lists new propositions available; products, sources, accurate methods. Covers ad writing, letter logic, trade information. Send 10c for copy and get free instruction folio offer. Progressive Magazine, Sheboygan, Wisconsin.

START A clock shop. Fascinating, easily learned profitable business requiring little capital. We teach you how to repair all kinds of clocks. Information free. Houston Clock Shop, P.O. Box 5086A, Houston 12, Texas.

HOW And where to obtain capital. Fully explained. Particulars free. Star Service, Wapakoneta, Ohio.

SPECIALTY Manufacturing, the big money business that can be operated anywhere, start on a very small capital; we supply dependable formulas and complete instructions; get interesting free booklet, "Money-making Opportunities in Specialty Manufacturing." Howard Robinson, Ph.G., 1300-A South Ohio Street, Sedalia, Mo.

START Mailorder bookshop—Everything furnished; publisher cooperation. 25c brings booklet, exclusive setup, samples, exciting ideas. General Publications, Ossining, N. Y.

\$25 WEEKLY Working two hours daily. No canvassing. No manufacturing. Lycke, Box 2471, Cleveland 12, Ohio.

137 WAYS To make money, in home or office, business of your own. Full particulars free. Elite Co., 220 Grand St., New York 13.

BRUSH Plating outfits connect to a battery. No tanks necessary. Good paying business at home plating autoparts, bathroom fixtures, bicycles, reflectors, silvering mirrors. No shop or experience required. Outfits furnished. Free booklet. Gunmetal Co., Ave. H, Decatur, Ill.

MONEYMAKING OPPORTUNITIES

SHELLCRAFT Supplies. A fascinating and profitable hobby for homeworkers. Free illustrated design sheets, wholesale and retail catalogue. Rice's Handicraft Supplies, Dept. B, 141 S. Court St., Orlando, Florida.

MONEY Making opportunities by the hundreds! Details free. American Success Aids, Bellmore, N. Y.

SELL Watches and jewelry. Illustrated booklet free. The Jewelbox, W-2 Stone St., New York 4.

A HIGHLY Profitable factory in your own home or garage! Amazing waterless hand cleaner. Formula and instructions free. Western Aircraft, Dept. E, Los Angeles 6.

HOME Workers, casters, rubber mold makers; 10 ornamental Plastex models for \$1.00. 25c to \$3.00 sellers. Edw. Bishop, 616 N. Second St., Milwaukee 3, Wis.

THOUSANDS Articles wholesale. "Supply Source Directory" 10c. Ideal Service, Park Ridge 40, Illinois.

MECHANICALLY Inclined men—Own and operate general appliance repair shop. Complete, illustrated course shows you how. Welding, refrigeration, motor repair, how to get business, etc., all phases covered. Free literature. Christy Supply, Dept. 1174, 2835 N. Central Ave., Chicago.

METALLIZE Flowers for profit! It's new, easy, sure fire! Free details. Joseph B. Kushner, Metal Finishing Consultant, Stroudsburg 3, Pennsylvania.

SEWING Machine repairs make big money lifetime. Start neighborhood shop. Complete repair manual, covering all makes, \$1.98 postpaid. Money back guarantee. Sewmachine Serviceman, Hamilton 9-G, Ohio.

WIN Contest money. General Contest Magazine gives hundreds of tips. Lists current contests and rules. Sample 25c. General Contests, 1609½ East 5th, Duluth, Minn.

LUCRATIVE Profits! In a mail order business. Details free. Apostle, Clayton, N. J.

BUTTERFLIES! World assortment, 20 for \$2.00. Make pictures, trays, brooches. Materials supplied. Free price list. American Butterfly Co., 3457 Park Heights Ave., Baltimore 15, Maryland.

START Your own business! Big money manufacturing novelties, plaques, statuary. Free catalog. Write Bing Products, 88-A3W Broad Street, Boston 10, Mass.

DIRECT Factory agents for fast-selling, fine commercial popcorn machines. Nationally advertised. Sales leads furnished. Excellent profit. Viking Popcorn Machines, Inc., 114 W. 18th, Kansas City, Mo.

RESILVER Mirrors at home. Formula 25c. Ideal Service, Park Ridge 6, Illinois.

DOUBLE Your income! Mail order or direct salesmen. Amazing new plan. Be first with newest merchandise. Details free. Albert Peek, 1514 Driscoll, Houston 6, Texas.

PROFITS From spare time! Cash in on your hobby. Make and sell beautiful authentic wood carvings, easily made from inexpensive models. No experience necessary with new, amazing "Carvit" duplicating machine. Start your own business now! Dumore Co., Dept. L-58, Racine, Wis.

WHOLESALE Catalog free. Retail 10c. Curios, Mexican novelties, old bills, animals. Quivira Specialties, Topeka 1, Kansas.

START Mail forwarding. Details 10c. Instructions \$1.00. Banas, Box 285, Syracuse 1, N. Y.

NEW Lawn mower sharpeners. Details for stamp. Anton Wellert, 142 Gaylord Street, Binghamton, N. Y.

EARN Money evenings, copying and duplicating comic cartoons for advertisers. Adservice, Argyle 1, Wisconsin.

MR. MAIL Order man, start right, start today, that business of your own with the 100 newest products. Monthly "New Products Bulletin." Sample copy \$1.00. The 49 successful way new book "From Nothing to Independence" \$2.00. The "Twenty Ad" tested plans \$2.00. All three sure fire big money plans for \$4.50. Details free, satisfaction guaranteed. Educational Book Co., 2907 Berwick Ave., Baltimore 14, Maryland.

EARN Up to \$480 month part or full time keeping books for small firms. Simplified system. Write Tax-Saver System, Dept. L, Ft. Worth, Texas.

CAPITALIZE Your spare time. Make shell jewelry. Special \$5.00 introductory kit \$3.25. The Marcraft Co., Skokie, Illinois.

OPPORTUNITIES In mailorder. Sample magazine 10c. Adam Palmer, Blacklick, Penna.

VIRGIN—Mail money-makers. Part-time—full time. Opportunities galore. Unusual! Particulars free. Frank Coffey, 62A East Hillcrest, Dayton 5, Ohio.

"KNOCK 'Em Cold" teaches secrets everyone should know. Free particulars. Mileson, 1818A Tyler Parkway, Louisville, Ky.

100% PROFIT Beautiful line fishscale and shell costume jewelry and novelties. \$2.00 brings 5 samples, returnable. Wonderland Studio Inc., Box 709, St. Petersburg, Fla.

144 GLASS Ash tray liners \$2.00. 5-gallon drum liquid latex \$21.00. Vallance Art Products, 1873 E. 70 St., Cleveland 3, Ohio.

"315 GOLDEN Opportunities" to make money. Details 3c stamp. Thorn, Box 2842, Paterson, New Jersey.

METALLIZE Baby shoes. Further information free. Metal Crafts, Box 356-R5, Tampa 4, Fla.

HONEST Discounts appliances, gifts, toys. "Quality," Box 1301, Peoria, Ill.

MAKE Money right from home. Mitla, Box 207-P, Mena, Arkansas.

WHOLESALE Directory, business plans, opportunities. Holm Sales, 12A, Oaklandon, Indiana.

WANT Profitable home mail business? Write, Leon Moreau, 86 Myrtle Street, Somerville 45, Mass.

"TUNE IN" To profits from everywhere! Details free! Write today! Elliott, 177 Columbia, Edgewood 5, R. I.

ATTENTION! Send today for beautiful raised letter writing outfit. Engrave your stationery and cards. Make money writing for others. Price \$1.00. J. E. Hampton, 601½ N. Main, P. O. Box 1838, Wichita, Kans.

36 PAGE Catalogs. Imprint circular plan. Sample, treatise \$1.00. Lynch, 402-4 Hazlett, Baltimore 29, Md.

FEW Distributorships open. Dealers buy on sight; rodents/leides; over 10,000,000 packets sold. Write for samples. Piper Company, Inc., St. Louis 17, Mo.

WHOLESALE Anything imaginable. New guaranteed list 25c. Refundable. L-salle Novelties, Box 2188, Waterloo, Iowa.

ANIMAL Breeding dial calculator \$1.00 postpaid. Excellent gift. Farmers purchase immediately. Agents wanted. Handy Charts, 406 Greer, Memphis, Tenn.

SOAPMAKING. 25 Pages of easy instructions. 40 formulas. No machinery needed. \$1.00. U.S. or foreign. C. Brown, 9111 Hoyne, Chicago 20.

CUT Living costs! Make extra money! Enjoy life! New book gives many profitable backyard opportunities. Literature free. G. Hopp, 1216-PM Park Row Building, New York 7, New York.

EARN Money spare time, mailing circulars for mail dealers. Pioneer, P-404, Yonkers 1, N. Y.

SHELL Jewelry kits \$2.60, also \$1.00 postpaid. All materials furnished with instructions. Most distinctive and complete kits ever offered. Order today. Earn while you learn. Catalog free. Shell-O-Craft Co., Box 365, Station A, St. Petersburg, Fla.

"NAMES" Directory. Free listing. Sample copy free. Fowl Printing, Muncie, Indiana.

NEW Invention. Opportunity exclusive selling rights. Ingram, 6774 Taft, Detroit 8, Michigan.

1947 GIGANTIC Directory of opportunities, advertiser's supplies, sources, trade information, mail order ideas, products, wholesalers, valuable tips—just published! Descriptive literature free. Wilkin & Co., Hillsboro, Ohio.

GET Dollar orders by mail! You keep 90c! Easy, pleasant, home business. Just a few dollars starts you! "Interesting details" free. Holmes Service, Cornell, California.

FREE Booklet! Biggest opportunity quick money! Collection 137 sure-fire plans. Stamp. Twin Parks, Box 4696-Z, Dallas 6.

BUILD Knockabout sport shoes for yourself, friends. Great fun. Send foot outlines, size. Patterns, easy directions \$5.00 prepaid. Each additional size \$1.00 set. (3-12½). American Shoebuilding Course, 668-S, Hollywood 28, California.

BIG Profits. Sensationally new. Every home, office, store prospective buyers. No competition. Exclusive dealerships. Sherwood Products, Erie, Penna.

INCOME Tax experts earn good money. Send \$2.00 for instructions telling how to start this fascinating business. Townsend, 119 East Main, Rochester 4, New York.

UNBELIEVABLE. But true!—100 money-making ideas free. 10,000 word instruction treatise on mail order, free. Membership in Opportunity Club, free. Barrows, 28 Stebbins, Worcester 7, Mass.

FREE—Magazines, publishers offers. 5c stamp. Ritz, 939-P Fteley, Bronx 61.

SCHOOL Seniors—Sell classmates America's most beautiful graduation name cards. Largest selection. 40% commission. Outsell all others. Send for free sample kit. Printcraft, 1425 E. Elm St., Scranton 5, Penna.

WOODSCRAFT Is profitable. Beautiful fan with over 40 petals, carved from one piece of wood, shows how. \$3.00 cash or money order. Woodcraft, Lock Box 322, Seattle 11, Wash.

LEARN To make seashell jewelry, pins, earrings, hair ornaments, novelties. Book of instructions and designs free with \$2.00 and \$5.00 kits, postpaid. Herbert Diamond Co., Box 4619, Miami 31, Florida.

EARN Money with colorful handmade jewelry. Free circular tells how! Nothing complicated. Dollar starts you! Plastic Works, 712 Kimball, Danville 3, Illinois.

EARN Up to \$2,000 year, inventing simple items. Special cash markets. Hendrickson, Argyle 7, Wisconsin.

I MAKE Big money in the mail-order business. You can do the same at home with my copyrighted system. Write me. I'll tell you how. F. Little, R.D. #1, Glen-shaw, Penna.

WOULD You pay 3%—first \$350 made? Color-illustrated book "505 Odd Successful Enterprises" free! Proven! Work at home, office. Expect something odd! Pacific, Oceanside, Calif.

MAKE Big money. Build your own lamps and sell. Write for free factory photos. Buddy Products Mfg. Co., Dept. 25, 1123 West Belmont, Chicago, Ill.

THERE'S Big money in junk, and re-paring batteries. Write, Batteryman, Grand Junction 5, Colorado.

\$246.50 MAKING Unusual secret device without skill, machinery, from former war material costing \$1.50! Simple, baffling invention, unbelievably profitable! Illustrated proofs free. Rolis Enterprises, 115-D West 16th, New York 11.

FORTIFY The future! Start own business; home, office. Booklet describing "Collection of 137 Tested Plans" free. Elite Co., 220-A Grand St., New York 13.

PUBLISH Your own magazine. Hand-some 52 page format, well edited, illus-trated. Cost low as \$1.00 month. Brings you prestige, profits. 25c brings sample. details. National, Ord. Nebr.

FORMULAS, PLANS, ETC.

A HIGHLY Profitable factory in your own home or garage! Amazing waterless hand cleaner. Formula and instructions free. Western Aircraft, Dept. F, Los Angeles 6.

MANUFACTURE Cleaners, soaps, pol-ishes, flavors, cosmetics. Literature free. Kemico, Park Ridge 16, Illinois.

NEED Chemists? Products duplicated? Formulas? Analyses? Consulting Scien-tific Company, Swarthmore, Pennsylvania.

PUBLIC Service Testing Lab., Inc., 381 Fourth Ave., N. Y. 16. Save money, make your own toilet articles and cosmetics. These and other formulas and trade se-crets available as low as \$1.00.

NONPOISONOUS Rat exterminator and insecticide base. Start good business with little capital. "Small Business Services," 711 Alamo National Building, San Anto-nio, Texas. Inclose one dollar.

100 SINGLE Ingredient formulas, 25c. Tes-Co, Box 189-MG, Wilkes Barre, Penna.

10,000 FORMULAS And trade secrets. Free literature. Stillman, 555 Kingston Ave., Brooklyn 3, N. Y.

REAL Manufacturing formulas. Lists free. Cummings, Chemist, Gordon Ave., Syracuse 4, N. Y.

PLASTICS

METALLIZE Plastics for profit! Free particulars. Joseph B. Kushner, Metal Finishing Consultant, Stroudsburg 3, Pennsylvania.

PLASTICS. "Experimental Casting Plastics," practical, well illustrated in-struction, formula book. New. Postpaid \$2.00. Plastic Research Bureau, 3873A California Street, San Diego 1, California.

POLISH Plastics with flame. Complete kit and instructions. Nothing additional needed. \$2.00 postpaid. Barnett Specialty Co., 5104 Hollywood Blvd., Hollywood 27, Calif.

NEW Liquid plastic. Clear, colors. Cast without heat. Embed flowers, insects, coins. Saw, drill, carve. Manual tells how. Send \$3.50 for complete 20 project kit including one pound liquid Castolite. Castolite, Dept. M-21, Box 211, Kenil-worth, Ill.

NEW, Self-adhering, transparent plas-tic film. Lifetime protection for maps, charts, sketches, drawings, blueprints, valuable papers, sheet music, book covers, index cards and hundreds of other uses. Easy to use. Waterproof, dirtproof, germ-proof, washable. One dollar for 5 foot by 12 inch roll. R. E. Heyman, 123 Center Terrace, Newark, New Jersey.

LEARN Internal carving of plastics for pleasure and profit. It's easy, exciting to carve flowers, animals, landscapes of color-ful, thrilling beauty in solid Plexiglas plaques and cubes. Send 10c for complete instruction folder, jewelry findings cata-log and big plastics price list. Plastic Parts, Dept. H-2117, 1157 S. Kingshigh-way, St. Louis 10, Mo.

WONDERFUL New thermoplastic. Lit-erature free. Sample 25c. Jalco, 161 Dille, Memphis, Tenn.

FORMALIN Plastic casting supplies. Free descriptive literature. Sample kit \$3.00 f.o.b. Formalin, Romeo, Michigan.

ELECTRIC Pencil—Writes, engraves all metals. Battery model \$1.00—110 volt model \$3.00. Complete. C.O.D.'s accepted. Reb Industries, Dept. 265-CC, Elmhurst, Illinois.

LUCITE, Rods, sheets, tubing, catalog dime. Mid-West Plastic Supply, 1717 No. 66, Omaha 4, Nebraska.

EMBED Shells, flowers, etc. in Dixie Klearkast Plastic. Kits \$3.95. Shell kits dollar up. Catalogue stamp. Dixie Shell Service, Lakeland, Fla.

PRESERVE Those cards! Identification card holders 3 for 25c. Permanent Plastic Sealing Service—business cards 10 for \$1.00, photographs, miscellaneous cards (3"x4") 25c, (4"x5") 50c. Plastic cellulose sheets; 20"x50"x.010" \$1.00. Send money order, check. Postpaid. Plastex Company, 942 Fifth Avenue, Coraopolis, Penna.

PLASTICS, Supplies. Free list. Kits \$3.00 and \$5.00 f.o.b. Plas-met Sales and Engineering, 4648 Shirley Pl., St. Louis 15, Mo.

PLASTIC Injection machines, tenite, plexiglas, dyes, polystyrene rods, jewelry findings, etc. Special get acquainted shell-craft kit—big assortment \$2.50. Free list. G. Baker Company, River Edge, New Jersey.

INJECTION Molding presses, \$30.00 complete! Molded Lucite pocket pillbox, bulletins 15c. Technicraft, 1156 Common-wealth, Boston 34, Mass.

PLASTIC Supplies! Kits. Lowest prices. Catalog 10c (Refundable). Plastic Prod-ucts, 211 7th Street, Canton 2, Ohio.

INTERNAL Carved roses costume jew-elry sets, \$1.50 less findings. 2" cubes with roses, \$2.00. Crystal Floral Novelty Co., Dept. M, Somerville, N. J.

PLASTICS—Sheets, rods, tubes, all col-ors; dyes, supplies; findings. Illustrated fabricating manual, prices, 10c. Lucite sample, 35c. Gem-O'-Lite, Box 686F, North Hollywood, Calif.

PLASTICS—Eight colors. Sheets and rods. Stamp brings price list. Hanson Plastics, 7625 South Parkway, Chicago 19, Ill., Dept. 100.

INTERNAL Carvings, drills, dyes, jewel-ry findings, tools. Plexiglas masked sheets, 12"x12", 1/16" \$1.00, 1/8" \$1.25, 3/16" \$1.55, 1/4" \$1.85. Include 10% postage. Rods, tubes, dyes, cements, buffing compounds. Free listings. Craft Plastics, Somerville, New Jersey.

PLEXIGLAS Aircraft gun fairing win-dow assembly 2 1/2 x 3 1/2. Duplate shatter-proof windows. Free list. Ercco, 2912 Hewitt, Everett 1, Washington.

RENEW Leather and leatherette—Make cloth into imitation leather with plastic discovery called Leather-New. Opportunity to make real profits taking care of sales resulting from national advertising. Write for free sample of Leather-New covered material and complete deal. 704 Land Bank, Kansas City, Missouri.

PLASTIC—Sheets, rods, tubes, etc. Free list. Plastic Supply Co., 2618 St. Louis Ave., St. Louis 6, Mo.

TEN Fascinating detailed Plexiglas proj-ects, \$1. Original Plasticplans, Box 181, Cincinnati 1, Ohio.

PLASTIC Costume jewelry, beautiful designs. Free catalogue. Howard Schultz, 115-83 229 St., St. Albans 11, N. Y.

MAKE Money assembling our pre-fabri-cated plastic kits. Sample kit 50c. Cata-log free. Fabros, Box 156, Station F-1, Buffalo 12, N. Y.

CHEMISTRY

CHEMICAL Magic: Interesting, educa-tional, mystifying. Complete set 50c. Wholesale \$3.00 per dozen. 10 dozen \$25.00. Make money selling your friends. Dytex Chemical Co., Dept. M, 145 Cray St., Providence 3, R. I.

RESEARCH Chemistry. Synthesize or-ganic chemical compounds in your own laboratory. The Chemist's Note Book, 830 Market St., San Francisco, California.

CHEMICALS, Formulas, apparatus, any quantity. Catalog 5c. Helett Products, 141-42 78 Road, Flushing, N. Y.

LABORATORY Supplies, chemicals, glassware, etc., low prices. Large catalogue 15c. Microscopic stain catalogue 20c. Both for 25c. National Scientific Company, Es-tablished 1908, 2204 W. North Ave., Chi-cago 47, Ill.

HANDBOOK For chemical experimen-ters, illustrated, hundreds of experiments, 50c. Experiment booklet 15c. Supply cat-alog 5c. Reading Scientific Company, Reading, Penna.

BOOK, Chemical catalog, 10c. Pilgrim Chemical, 348L Edith, Salt Lake City 4, Utah.

LEARN Chemistry at home, from the house of Winn. Home of supplies for stu-dent chemists. New idea chemical and apparatus outfits for home experimenting. Semi-professional microscopes and acces-sories. Send 10c for retail catalogue. Es-tablished 1931. John H. Winn, Dept. 511, 124 West 23 Street, New York 11, N. Y.

FREE Catalog Chemistry, mineralogy, physics. Tracey Laboratories, 1907 Harri-son, Evanston, Illinois.

APPARATUS, Chemicals, ounce quanti-ties, catalog 10c. Fleischer's Laboratories, Everett 49, Mass.

CHEMICALS Of all kinds. Special at-tention to small orders. Write for free catalogue. Lab Chemical Co., Box 206, Oak Park, Ill.

SPECTROSCOPE For quick chemical analysis \$3.00. Cutting Co., Box 457, Camp-bell 1, Calif.

NEW Laboratory supply catalog of chem-icals and apparatus, contains over 5000 items with illustrations, 212 pages. Send 50c. Standard Science Supply Co., 1232 No. Paulina Street, Chicago 22, Ill.

CHEMICALS—LAB. Supplies. New cata-log 10c. Mel-Glo Chemical Co., 258 Fourth Avenue, Brooklyn 15, N. Y.

CHEMICALS And apparatus for indus-trial, analytical, and private laboratories. Complete supply service for correspond-ence school students. Send 3c for catalog. Dept. M-43, Biological Supply Co., 1176 Mt. Hope Ave., Rochester 7, New York.

HELP WANTED

FREE Sample. Nameplates—homes, offices, honor rolls. Whitney Signs, Box 41, Waterbury, Conn.

SAVE Coal, demonstrate: Samples, 100 free test circulars, obtains profitable re-turns, 90c prepaid. Refundable guarantee. Coalaid, Waterloo 4, Iowa.

MIRACLE Arch supports, sell \$3.95. Send shoe size, get sample pair \$1.95. Masten's, Box 702, Winston-Salem, N. C.

EXTRA Money—Quick profits: selling personalized buckles, belts, cap-badges, tie clasps, 2000 emblems, caps, shirts, ties. Write, Hook-Fast Products, Dept. A, Columbus 6, Ohio.

SELL Christmas Cards, stationery, gift wraps. Gold imprinting free. Samples on approval. Carleton, 25a W. 17th, Bayonne, N. J.

AGENTS WANTED

STRANGE "Dry" window cleaner. Sells like wild. Replaces messy rags, liquids. Simply glide over glass. Samples sent on trial. Kristee, 115, Akron, Ohio.

AGENTS—Wagon jobbers, direct sales-men, choice territories open for house-hold product of merit. Good profit. De-tails free. Plastic Sales, 34-A Davenport, Detroit 1, Mich.

MAKE Money at home like I do! Write immediately. Duffy, Covington, Ky.

\$1 STARTS You in business. Sell De-Luxe ties, 100% wool interlining. Costs you only \$7 per dozen, you make \$5.00 dozen. Send \$1.00 for special introductory offer two DeLuxe ties. Catalog complete line free. Philip's Neckwear, 20 West 22nd St., Dept. K-17, New York 10.

"27" AGENTS—Salesmen wanted! Lib-eral territory allotted. Demonstrate amaz-ing "27 Second" eye glass cleaner. Whirl-wind seller. Year's supply in compact only 59c. 2 for \$1.00. \$40.00 per gross—110% profit. 27 Second Cleaner Co., Dept. 49-P, 6337 N. Talman, Chicago 45.

DISTRIBUTORS—28% To 75% profit selling Reflex spark plugs (guaranteed) to garages, service stations, fleets, along with other lines, steady repeat business. Exclusive territory. Reflex Spark Plug Co., 10902 Madison Ave., Cleveland 2, Ohio.

RADIOS, Plastic specialties, gloves, toys; buy wholesale, sell retail. Big prof-its. Catalogue free. Diverso, 510 Water, Milwaukee, Wis.

AGENTS! Earn up to \$300 a week. Take orders now for Xmas cards from stores. \$15 profit every sale. Free rack, free in-structions, free kit. No investment. Hur-ry. Write. Stores want in November. Castlecraft Cards (Mrs.), Dept. C, 175 Fifth Ave., New York, N. Y.

DISTRIBUTORS Wanted for unusual household products. Levine's, 15-X Boule-vard Station, New York 59, N. Y.

400% PROFIT—Sensationally successful upholstery cleaner. Weber Cleaners, Al-lentown 45, Pennsylvania.

BIG Commissions. Boost income quickly. Sell stores, restaurants, bars. Plastic tickets, shelf moulding, menu covers, signs. Write today. Pricing Press, 124 White St., Dept. P.K., New York 13, N. Y.

FREE Water and our concentrates, makes flavors, lotions, shampoos, 72 products, labels, bottles furnished. Qualco, E-20030 Russell, Detroit.

DIRECT Factory agents for fast-selling, fine commercial popcorn machines. Nationally advertised. Sales leads furnished. Excellent profit. Viking Popcorn Machines, Inc., 114 W. 18th, Kansas City, Mo.

EARN Christmas money taking magazine renewals in spare time. Need no capital. Big commissions. Supplies—helps furnished. Free book tells how. Write today. McGregor Magazine Agency, Dept. PM-4, Mount Morris, Ill.

SILVER Plating liquid. Apply with cloth. Renews silverplated ware. Cleans, silverplates, polishes, one rubbing. Genuine silverplate. Lasting finish by occasionally going over again. Won't wash, boil, brush off. Also silverplates on brass and copper. Female and male selling representatives wanted. Part time or full. Any age, wonderful profits. Exclusive territory. Sells by showing and demonstrating. Retail and wholesale. NuProcess Products, Aurora, Illinois.

MAKE Money fast selling Christmas cards. 75 popular assortments. Big profits. Request \$1.00 Christmas assortment on approval. Free samples 50 for \$1.00 cards. Hedenkamp, 343 Broadway, Dept. N-21, New York.

CHRISTMAS Greeting cards, gift wrappings, personalized papeteries, novelties. Raum, 4154 5th Street, Philadelphia 40.

200% PROFIT Selling beautiful latest design artificial Christmas corsages, guaranteed durable. Samples 3 for \$1.00. Retail for \$1.00 each. Floral Art Studio, 169 William Street, Springfield, Massachusetts.

AGENTS—Stop! Never buy plastic aprons, tablecloths, etc., until you get our new low prices. They're amazing. Riddell Sales Co., 1313-P East 62nd Street, Chicago 37.

AMAZINGLY Quick profits selling new, gorgeous satin, velvet-embossed, gold-trimmed Christmas banners to business firms, homes, etc. Write for details now. Samples \$1.00. Velva-Sheen Mfg. Co., Cincinnati 14, Ohio.

THE Most irresistible gift ever created. Economy Distributing Co., 308A West Superior, Cleveland 13, Ohio.

SELL Ultra blue stock signs to stores, 1000 slogans, comedy, general, religious. 7x11, cost 6c, sells 35c. Make money. Sample free. Lowy, 8 West Broadway, Dept. 345, New York City 7.

CHOOSE Your own future with importing-exporting. Sell, buy abroad; make 1,000% profit. Master world trade principles quickly, easily. Send \$1 for two bulletins supplying addresses of hundreds overseas firms seeking connections. Money refunded if unsatisfied. Benko, 246-P Fifth Ave., New York 1.

AGENTS Make big profits selling sensational new diapers which require no folding. Every new mother a prospect. Rush name for free sample. Fred Dexter and Staff, 234 West 17th, Houston 8, Texas.

SELL Enchanting French perfumes for Christmas and build up all year 'round trade! Pricelist and sample dozen, retailing \$3.00 postpaid \$1.00. Act quick. Reserve territory. Willingmyre, Merchantsville 2, N. J.

EXTRA Money. Send for new plan. Inspirational Books, Box 106 Old Chelsea Station, New York 11, N. Y.

AGENTS—Big money for men, women, boys, girls—selling gorgeous night-glowing orchids, gardenias; perfect imitation real flowers, last for years, all the rage for wear on hair or clothes. Write for wholesale prices. Marney's, Dept. M-7, P.O. Box 581, Ogden, Utah.

NEW Sensational seat covers. Mono. 6545 Santa Monica Blvd., Hollywood 38, Calif.

NEW Moneymaker. Sell amazing aluminum brush pen. Every store prospect. Marx, Ampere 54, New Jersey.

WHITE Shirts, pajamas, nylon slips, liberal commission. Sales kit. Jarod Mfg. Corp., Rockville Centre 4, N. Y.

AMAZING: Fast, easy, money maker. New patent rubber stamp ink. Sells everywhere. Big profits. Hudson, 934K Lakeside, Chicago.

SELL Xmas signs. Send \$1.00 for 10 samples. Sample money refunded if not satisfied. Deduct your \$1.00 from first order. Novelty Sign Co., 133 Thatford Ave., Brooklyn 12, N. Y.

SELL Jewelry. Dollar brings samples. Guaranteed value, \$4.00. George Sassen, 154 Nassau Street, New York 7.

AGENTS. Sell finest food products direct to homes. Successfully sold for 25 years. Big profits. Powerful combination sale plans make sales easy. Permanent repeat business. Samples furnished. Live territories open to distributors. Mother Hubbard Products Co., 4139 Grand, Dept. P.M., Chicago.

WE Pay you \$25 for selling 50 boxes Xmas cards, 21 for \$1. Also 50 and 25 for \$1. Costs nothing to try, samples free. Victory Studios, Mt. Vernon, N. Y.

AGENTS—Make big money from now on, selling the sensational new low priced transparent plastic table cloth cover. Saves on laundry bills. Every woman a prospect. Sample swatches free. Carwell Products, 330DZ South Wells, Chicago 6.

SELL "Glass-Sure-Shine." Retail 50c. Your price 25c, postpaid. Tested and proven repeater. Cash profits daily! Paragon Products (Manufacturer), P.O. Box 142, Oil City 2, Penna.

CHRISTMAS Cards. Earn \$5.00 with every ten 21 card \$1.00 boxes you sell. Also new plastic cards, wrappings, imprint cards. Write for samples today. Howard P. Ellis, Dept. PM-12, Pitman, N. J.

MARVEL Wax, world's fastest 25c seller, agents profit 150%. Write Marvel Belt Wax Co., Batavia, N. Y.

A NATURAL! Big money, selling new line one piece, lace plastic tablecloths! Sizes to 54x108. Also women's aprons; novel, embroidered cotton pillow cases. Free, "interesting details." Royalty, Box 748-K, Passaic, N. J.

AGENTS Make big money selling the "Sure Heat" oil conversion burner units. Converts wood or coal cook stoves, heaters, brooder houses, small steam boilers, syrup mills, potato curing houses, tobacco barns, most any type of furnace from wood and coal to a cheap grade of fuel oil. Clean, economical, cheap, safe. Immediate delivery. Write for descriptive literature and prices. Standard Manufacturing Co., P.O. Box 427, Wallace, N. C.

FOOT-MASTER Tablets. Amazing seller to those afflicted with foot trouble. Proven seller 45 years. Good profit. Repeats fast. Write Master Products Co., 6 East Oak Avenue, Moorestown, New Jersey.

BIG Money for Xmas. Sell beautiful plastic lace table covers, raincoats. Twenty other terrific gift items. Free swatches. Star, 261 Fifth Avenue, New York.

HOUSE-TO-HOUSE Salesmen. make 85c on the dollar. 25c for sample. Austin Mail Service, 5538 Lexington, Chicago 44, Illinois.

INFORMATION — Wholesale supply sources, Money-making plans, Increase your income! Write Reynard Service, Smithfield 3, Ohio.

AMAZING Discovery. Miracle glaze puts brilliant glass-like surface on cars. Free sample, information. Big profits. Miracle Glaze Company, 9714 S. Austin Ave., Oaklawn, Illinois.

WANT Pleasant outdoor work in a business of your own? Good profits selling over 200 widely advertised Rawleigh home-farm necessities. Pays better than most occupations. Hundreds in business 5 to 20 years or more! Products-equipment on credit. No experience needed to start, we teach you how. Write today for full particulars. Rawleigh's, Dept. K-145-PPM, Freeport, Ill.

CHRISTMAS Gift item. Agents wanted for sensational new camera that snaps, develops and prints finished pictures. Free folder and wholesale price list. Pittsburgh Photo Shop, Dept. 33, 1618 Westmont Avenue, Pittsburgh 10, Penna.

PLASTONE: Amazing new polishes for floor, furniture, autos. Beautifully packaged. Low priced. Whirlwind seller to stores, gas stations, homes. Fast repeater. Big profits. Unconditional moneyback guarantee. Write for "free sample offer" now. Plastone Company, 2014-PM11 Wabansia Ave., Chicago 47, Ill.

AGENTS: Sensational new name plates 50c to \$1.00. Big profits. George Cross, 1187 East Grand St., Elizabeth, N. J.

JUST Take orders. We deliver. "Gadgets," 210 5th Ave., New York City.

CHRISTMAS Cards. 100% profit. 21-25-50 \$1.00. Free literature. 2 boxes samples \$1.00. Torres Company, 8F St. Francis Place, Brooklyn 16, N. Y.

DISTRIBUTE Extra large flower bulbs— Guaranteed to grow indoors. Different bulbs every month. All grow easily in pots or bowls in office and living room the year around. Pleasant-refined-cultural business. 100% profit. Write today—see if your territory is still open. Algonquin Flower Farm, Algonquin, Illinois.

LEATHER Goods. Fast selling line. Boxed and carded. Particulars from Artin Leather, 411 Joseph Ave., Rochester 5, N. Y.

TAKE Orders. We deliver! Glamorous reproductions of any picture on beautiful plastic hardwood plaques. Immediate big profits! Gotham Products, Dept. A, Box 5427, Philadelphia 43, Penna.

QUICK Sure money. Selling Annie Blain flavors. New Brunswick, New Jersey.

BIG Profits selling used clothing. Operate from home, auto or store. Men's suits \$4.00. Overcoats \$4.00. Field jackets \$2.00. Ladies' coats \$1.50. Army shirts \$1.50. Other big bargains. Catalog free. Kadetsky & Son, 702 Barber Street, Dept. 14, Chicago 7, Ill.

SELL Handkerchiefs. Xmas boxed and bulk. Stanchief, 491 Broadway, New York 12, N. Y.

HAN-KOTE—New amazing cream. Protects hands against grease, grime, paint, printers' ink. Sells fast. Excellent repeater. Good profit. Sample free. Guerrieri, 952 Addison, Chicago 13.

SELL Personalized gifts. Hildebrands, 4554 North Uber Street, Philadelphia 40, Penna.

AGENTS: All ages, earn \$30 to \$50 weekly selling for yourself, fibre brooms, mops, and floor dusters, start now. Write Burtz Fibre Broom Co., Columbia, Penna., Dept. A.

\$1.00 INVESTED Brings \$29.00. Nothing else to buy. In great demand. Write for details. Kohen, 506 W. 45th, Chicago 9.

AGENTS—Big line including food products. Fast selling premium and bargain deals. Low prices. Send card for big outfit offer with gift. Ho-Ro-Co, 2725 Dodier, St. Louis 7, Mo.

AMAZING New Glow in the dark house numbers, switch plates, decals, pictures, religious articles, etc. Factory representative wanted. Wonderful opportunity. Free samples. Madison Mills, 303 Fourth Avenue, New York, N. Y.

SCHOOL Seniors—Earn 40% commission selling classmates America's most beautiful graduation name cards. Largest selection. Outsell all others. Send for free sample kit. Printcraft, 1425 E. Elm St., Scranton 5, Penna.

PROFITS To 100%, selling Xmas and everyday greeting card assortments. Details and assortment on approval. Glorian, (Dept. 10) 515 East 45th St., Brooklyn 3, N. Y.

MAKE UP to \$50 a week in spare time selling greatly in demand oil burners for kitchen stoves. Oil Burner Supply, Box 327, Cambridge, Mass.

SCHOOL Seniors! Your postal will bring our wonder, Kwick-Sell Cardalog of popular graduation name cards. Biggest profits! Only firm giving free souvenir chest and card case. Don't miss out! Hurry that postal! Craftcards, Box 235(L), Pittsburgh 30, Pennsylvania.

SCHOOL Seniors: Sell classmates superb Craftcards for super profits. Write Craftcards, Box 235(AK), Pittsburgh 30, Pennsylvania.

100% PROFIT With new electric gas lighter, eliminates matches, pilot. Write Optical Research Products, Fairview, N. J.

LARGE Variety fast selling items from \$1. Manufacturers, 264—5th Ave., New York.

MAGIC Cleaner and laundry soap deal. Hotter than a firecracker. Big profits. Sample free. Bestco, 5007 Irving Park, Chicago.

AMBITIOUS. Sell Xmas cards, stationery, big profits, colored catalog free. Beacon Hill Greetings, 115 Chauncey M, Boston, Mass.

EXCELLENT Sideline for printing and advertising salesmen. Decalomania name plates in small quantities. Great demand. Also, make money with our line of automobile initials and sign letters. Free samples. "Ralco" XL-Roxbury, Boston 19, Mass.

JUST Out! History of World War II. Huge volume. Popular price. Authentic text. Official photographs. Big profits. Riverside Book Company, Iowa Falls, Iowa.

BIG Bargains for big profits. Over 100 sensational values. Men's used suits \$2.00, pants 35c, topcoats \$1.25, overcoats \$2.00, shoes 20c. Experience unnecessary. Free wholesale catalog. Superior, 1250-B Jefferson, Chicago 7.

GREETING Card agents, "line up" with "Pines" for bigger, better, quicker profits. Rush name, address on postcard today. Box 32, Flushing 5, New York.

AGENTS: Stamping names on pocket-protectors. Sample check with your name, address, 25c. Stamping outfits. Emblem checks, check-fobs, name plates. Hart Mfg. Co., 303 Degraw St., Brooklyn, N. Y.

137 COMPLETE Plans for starting own business: local—mail order. Particulars free. Elite Co., 220 Grand St., New York 13.

AGENTS—300 % Profit selling genuine gold window letters; stores and offices. Free samples. Metallic Letter Co., 438-B North Clark, Chicago.

GOLD Lacquered window sign letters. Large sizes penny each. New foils. Absolutely beautiful. Free samples. Atlas, 544 W. 79th, Chicago 20.

SELL Personalized soap. Name on every cake. Ideal for gifts. Get sample offer. Dunbar Soap, New Brunswick, N. J.

HIGH GRADE SALESMEN

BONUS Commissions selling photographic creations. Samples. Creative Photography, Box 315M, Cooper Station, New York City 3.

AMAZING New zipper shoe sells on sight. Big profits for salesmen. Leads line 200 splendid styles. Territories open. Get free sample outfit. Write. Consolidated Shoe, Dept. S-802, Chippewa Falls, Wis.

MAKE Money selling genuine leather jackets. Prospects everywhere. Top quality, full cut, exclusive features. Big cash commissions. Also 250 styles fine shoes. Sample outfit free. Victor Thomas, Dept. V-817, 610 W. Van Buren St., Chicago 7.

STOP Hunting! Become a distributor for Mono-Rub and make easy money. Details. Hew Chemical Co., Cedar Grove, New Jersey.

ADVERTISING Book matches—Cash in on political campaigns. Sell union label matches. Cuts for all businesses and political parties. Free powerhouse selling kit. Low prices. Protection guaranteed on repeat orders. Cash commissions. Superior Match Co., Dept. M117, 7530 Greenwood, Chicago.

BRAND New! "Circline" fluorescent sweeping country! Fabulous profits selling stores, offices, homes. Also exclusive fluorescent table lamp. Complete line modern fixtures. Rush name for free sales kit, sample offer. Rose Co., 529LB South Franklin, Chicago.

START Your own business on our capital. Always your own boss. Hundreds average \$6,000 to \$25,000 annual sales. We supply stocks, equipment on credit. 200 home necessities. Selling experience unnecessary to start. Wonderful opportunity to own pleasant, profitable business backed by world-wide industry. Write Rawleigh's, Dept. K-U-PPM, Freeport, Ill.

AMAZING Daily profits. steady repeat business selling Colt's famous foot-balance shoes direct. Exclusive features make selling easy. 216 styles! Experience unnecessary. Patented Foot-O-Graph assures accurate fitting. Free selling outfit. Colt Shoes, 601D-11 Atlantic, Boston 10, Mass.

SALESMEN Sell new, fast-moving advertising item—a combination leather key case and flashlight. Earn large commissions. Every business a potential customer. Write Hal-Hen Co., 1066B College Ave., New York City 56.

DEALER Franchises. Gas power lawn mower, \$99.50. Drop shipments. Rotacut, M-2007, Excelsior Springs, Mo.

PLASTIC Tablecloths, aprons, new nationally advertised fast selling Firestone Velon kitchen ensemble. K & D Products Co., Room 104-A, 4955 Delmar, St. Louis 8, Mo.

AUTOMATIC Fire extinguishers. Red Ball Co., Box 1552, Salt Lake City, Utah.

SALESMEN Wanted by factory for original keyhole light. Handled by all stores. Buyers Products Co., 18994 Fairfield, Detroit 21, Mich.

ADVERTISING Deals. key cases and specialties. 25% commission. Catalog, samples free. Adv. Novelty Service, Dept. PM, Kenhorst, Reading, Penna.

ADVERTISING Specialty salesmen. Commission. Bonus. Joy Specialty Company, 1719A West Chicago Avenue, Chicago 22.

NEW Auto accessory. \$8.50 seller. Big profits. Write Aero, 4836-M Joy, Detroit 4.

SELL Direct or mail orders, manufacturer's line of famous advertised perfumes in bulk, or assorted size packages. Large profits, details and information free. Lustre Products Company, 1 Union Square, New York.

\$221.90 IN One week—Unusual? Not at all! Just look at one week's earnings of these representatives. SWB \$247.84, JRS \$252.80, HMT \$242.75, HC \$252.93, HET \$319.38, OP \$442.40. Direct mail campaign brings hot leads right into your home. Remarkable product does part of 10 men's work—a "natural" during these labor problem days. Has perfect sales story—sells year 'round. As modern as radar! Free equipment offer! We extend credit, deliver and collect. No capital required—no experience necessary. You make big profit on first sale and full credit on repeat business. Every business, store, home, factory, etc. are prospects. Write John Porter, 2433 Indiana, Dept. 301, Chicago 16, Ill.

FACTORY-SALESMEN: Profitable line of electrical supplies is your chance for good, steady income. Only go-getter wanted. Starco, 235 Canal St., New York, N. Y.

ADVERTISING Book matches—World's largest direct selling manufacturer of advertising book matches offers opportunity for profitable year 'round selling; every business a prospect. No experience needed to start; full or part time. Factory service. Low prices for high quality; repeats; sales kit furnished. Match Corp. of America, 3433-43 West 48th Place, Dept. E-12, Chicago 32, Illinois.

SALESMEN "Her Majesty's" high class nerve soothing beauty bubble bath Christmas item and reorders. Samples \$1.00. J. Landauer, 190 West 170th Street, Bronx 52, N. Y.

FOR Rugs, nylons, plastic garments, cleaners, household specialties. Consumers Products, Tiffin, Ohio.

MONEY in your pocket, \$1.00 brings two plans telling how to sell by long distance telephone. Larger sales. Bigger commissions. R. L. Mackin, 1512 Roblyn, St. Paul 4, Minnesota.

SELL Delicious candies, nuts, gum. Immediate delivery. Write Casterline, 2031-PA Sunnyside, Chicago 25, Illinois.

FREE! Latest issue Opportunity Magazine. Salesman's Guide. Inspiring, constructive. Shows how to earn money selling for others or in your own business. Hundreds postwar opportunities. Send name and describe what you have sold or are selling. Illustrated copy sent free. Opportunity Magazine, 28 E. Jackson Blvd., Dept. 17, Chicago 4, Ill.

PHOTO-Salesmen-Agents. Sell beautiful hand colored plastic enlargements. Collect deposit, we deliver. Profitable sideline. Send card, for free sample kit. Novel Portrait, 3329 North Ave., Chicago, Ill.

POCKET Pal: The all-purpose cutting tool, wagon jobbers, salesmen. Sell to retailers and jobbers. 50c seller. Steady repeat item. Exceptional profit. Sample 25c. Nelson Manufacturing Company, 222 W. Kellogg, St. Paul 2, Minnesota.

AMAZING Profits selling personal initialed individualized buckles, belts, cap badges, tie holders, flexible cap bands, 2000 emblems to choose from. Repeats. Write today special outfit offer. Hook-Fast Company, Box 480-PM, Roanoke, Virginia.

WAGON Salesmen—Fast moving carded goods and 10c line. Long profits. Free facts. Peerless, 2720 Dodier, St. Louis 7, Mo.

EDUCATIONAL AND INSTRUCTION

"HOW To Break and Train Horses"—A book every farmer and horseman should have. It is free, no obligation. Simply address Beery School of Horsemanship, Dept. 11011C, Pleasant Hill, Ohio.

NOW You can have an office. Learn credit-collection business by new home study course. Many earn up to \$5000-\$15,000 annually. Free bulletin. Franklin Credit School, Dept. 202M, Roanoke 7, Va.

BECOME A Doctor of Psychology or Metaphysics. Teach secret of contentment, happiness. Win degree of Ps.D. or Ms.D. Solve mental worries. Free book. College of Universal Truth, 5153-C North Clark, Chicago.

LEARN Simplified shorthand. Complete course 50c. Typing course included. Rainier Co., Box 112, Selah, Washington.

PAINT Beautiful pictures quickly, easily, inexpensively. Free literature. Art Book Shop, Arnold, Mo.

MAGIC Shorthand and typewriting course. Home study. 4800 So. Laramie Ave., Chicago, Ill.

SUCCESSFUL Men are good at figures—add, divide, subtract, multiply easily, with lightning-like rapidity and always be right! Make your associates envious; astound your boss. Increase your efficiency; become a "quick-at-figures" top-flight executive. Write for free literature. Parnell, P.O. Box 412, Van Nuys, Calif.

GOOD Jobs and a sound substantial future await you in hotel and institutional field. Men and women—all ages—needed for well-paid positions that offer color, excitement, ever-new and fascinating duties. Record-breaking travel means even greater opportunities for trained men and women in hotels, clubs and institutions. Lewis School receiving calls for managers, assistant managers, stewards, hostesses, purchasing agents and 55 other types of important positions! From coast to coast there are important positions that offer splendid opportunities for advancement in a business where you are not dropped because you are over 40. Previous experience proved unnecessary! No need to leave your job to qualify. A good grade school education, plus Lewis Training qualifies you at home, in spare time. Our National Placement Bureau helps to place you—and our amazing Certified Job Plan—actually certifies you will "make good" when placed. Write today for Free book! Course approved for Veteran's training. Lewis Hotel Training School, Room LW-368, Washington 7, D. C. (First and only School of its kind—now in its 32nd year).

ADDING Machine no bigger than a watch, comes free with the Addograp-System, the modern method which enables you to add, divide, subtract and multiply like lightning. Easy to learn—simple to operate. Will help you gain executive rank quickly. Send for free literature. Addograp, MC-1209 South Garfield Ave. Alhambra, Calif.

BOOKS Astrological; sold, rented. Write for catalog A-P. Library Astrolyte, 6531 West Blvd, Inglewood, Calif.

"UNCLE SAM" Jobs! \$1756-\$3021 year. Men-women. Prepare for next examinations. Vets get preference. 32-page book on Civil Service free. Write, Franklin Institute, Dept. P24, Rochester, N. Y.

GAGWRITERS Institute comedy course digest \$1.00. National Laugh Week Foundation, 347 Madison Ave., New York City.

LEARN Cardwriting. Free details. O'Rourke, 1534 W. Valley, Alhambra, California.

NATIONAL School of foot correction. Extension. Box 2894, Juneau, Alaska.

LEARN Paint, Estimating, blue print reading at home. Approved easy system, prepared by expert. Write for interesting facts. Fred T. Schuttler, 5017 No. Wolcott, Chicago 40, Ill.

HOME Study course in Psychology of Personal Adjustment. Learn to mobilize your mind for more happiness, health, success. Write today for free personality check-up and details of course. School of Modern Psychology, 134 E. Second Street, Dayton 2, Ohio.

BECOME Sanitation supervisor. Seven easy lessons. Certificate, profits, promotion. Institute, 2385-A Edgewater, Los Angeles 26.

LEARN Piano tuning and repairing at home. Course by Dr. William Braid White. Write Karl Barten Bach, 1001-H Wells Street, Lafayette, Indiana.

MACHINIST'S Specialized shop information. Write Machine Shop Technical Service, 1616 W. 12th, Vancouver, Can.

RAPID Calculation course worth \$50.00; limited introductory offer, \$2.00. Osborne College, San Bernardino, California.

USED Correspondence courses and educational books bought, sold, rented. Free catalog. Educational Exchange, Henagar, Alabama.

PRACTICAL Mathematics. Details free. Math Tutor, Box 1214, Indianapolis 6, Indiana.

WELDING—Best training in U. S. Complete modern equipment. Non-profit. GI approved. Write for free booklet. Hobart Welding School, Box M-1079, Troy, Ohio.

AMAZE Others. Add faster than adding machine. Free details. Math Institute, Box 633, Mobile 4, Ala.

NO Special training needed to make \$1,000.00. If you like working with figures, you can make this much or more in three months spare time. Write without obligation to James A. Sherrod, Pavo, Ga.

PRACTICAL Course—Automobile radiators, repairing, recoring, cleaning. Ralph Hendry, Galt, Canada.

EDUCATION in a nutshell helps you think and talk intelligently on most subjects. Thousands have used these ideas. Send \$1 to Dad-P, 1310 Sanborn Ave., Hollywood 27, Calif. Information free.

ENGRAVING. Learn latest internal plastic carving, lettering, trophies, etc. Details free. Renzelman, 611 S.W. 23rd Road, Miami 36, Fla.

HOME Study course, drugless therapy. Free literature. Institute of Drugless Therapy, Tama, Iowa.

GOOD "Used" self-instruction educational books on all subjects bought, sold, rented, exchanged. Satisfaction guaranteed. Complete information and 100-page illustrated bargain catalog free! Write—Nelson Company, Chicago 5.

USED Educational books on all subjects sold, rented, also bought and exchanged. Moneyback guarantee. Write today for free catalog and details. Lee Mountain, Pisgah, Alabama.

INVESTIGATOR Training, Phillips Secret Service, 1917B North Kenneth, Chicago 39, Ill.

29 LANGUAGES By Linguaphone. Russian, Spanish, Portuguese—Direct conversational method for mastering any language quickly, easily, correctly at home. Available under G.I. Bill of Rights. Send for free book. Linguaphone Institute, 83 RCA Bldg., New York 20.

MEDICAL Laboratory technicians in great demand. We train you in your spare time, in your own home. You can practice while studying. Write for free catalogue. Imperial Technical Institute, Box 973-E, Austin, Texas.

SECRET Investigation. Experience unnecessary. Investigators particulars free. George Wagner, M 125 West 86th, New York.

PLAYS, STORIES, MANUSCRIPTS

NEW Writers needed. Nonfiction material demand is booming. Many magazine editors buy features and "fillers" from new writers. Our earn as you learn lessons prepare you to meet their requirements. Experience unnecessary. Reasonable price, unexcelled service. Details, sample lesson free on request. Use postcard. No obligation. Comfort Writer's Service, 200-PN S. 7th St., St. Louis 2, Mo.

PLANS AND BLUEPRINTS

TOOLMAKERS, Machinists, hobbyists, build your own toolmakers vise. Plans \$1.00. Design Service, Box 451, Ansonia, Conn.

I WANT New writers to cash hundreds of checks for \$1 to \$100, offered each month. The easiest way to write for pay. No previous experience necessary. Send for free details. No obligation. Saunders M. Cummings, 467-M Independence Bldg., Colorado Springs, Colo.

BUSINESS SERVICE

BUY For less. Enjoy buying advantages of huge corporations. Any item. Details free. Kelly & Co., 9544-Q Whitcomb, Detroit 27, Michigan.

NEW York office address. Your mail received, forwarded. Confidential. Free details. Arlington, 131-H West 42nd, New York 18.

ADDING Machines, \$21.50 new. Write, Brown, Box 1412, Wichita, Kansas.

CONFIDENTIAL New York mail-address disclosed. Information. Levitt, 330 East 19th, New York City.

INCREASE Business with your own monthly magazine. 500 copies complete with your own full page advertisement, only \$3.50 per month. Particulars free. D'Yarmett Printing, Newark, Ohio.

REPRESENTATION—New York, principal cities, business, personal. Copen, 2030 Valentine, New York 57.

CALIFORNIA Office. Mail forwarded daily, \$2.00 monthly. Certified. 1232 Loew's State Building, Los Angeles 14.

TO Whom it may concern. We will represent you in all principal cities of the world. Representatives wanted. Will send you assignments immediately. James W. Farley, Citizens Bldg., Cleveland 14, Ohio.

SPECIAL SERVICES

MAIL Forwarded. 25c each letter. Monthly \$2.00. Banas, Box 285-C, Syracuse 1, N. Y.

HOLLYWOOD Postcards surprise your friends. Picture postcards with your signature and message. I'll mail you blank cards. You fill in and return to me in pre-paid envelope for mailing in Hollywood. 8, 50c; 20, \$1.00. G. King, 6131 1/2 A Glen Oak, Hollywood 28, Calif.

WASHINGTON, D.C., remail address. Your business, personal letters received, reforwarded, 10c each. Complete service, \$3.00 monthly. "Hawkins," 1300-a Taylor N.W.

NIAGARA Falls or Buffalo N. Y. mail forwarding and representative services. Confidential; Mail 25c each or \$1.00 per week unlimited. Blain's Services, 29 Coe Place, Buffalo 8, N. Y.

LOCATE Any article made \$1.00. Business Service, 1101 Kings Highway, Shreveport, Louisiana.

GOOD "Used" self-instructional books on all subjects bought, sold, rented, exchanged. Satisfaction guaranteed. Complete information and 100-page illustrated bargain catalog free! Write—Nelson Company, Chicago 5.

CARTOONING, COMMERCIAL ART, SHOWCARD WRITING, SIGN PAINTING

KOPYKIT—Amazing new plastic discovery makes drawing for fun or profit easy. Details free. Vane Co., Box 98, Bergenfield, N. J.

DRAWING, Painting, lettering taught by professional. Unique, personal mail courses. Information free. Joseph Bolger, 148 Concord, River Edge, New Jersey.

"HOW To Make Money With Simple Cartoons"—a book everyone who likes to draw should have. It is free; no obligation. Simply address Cartoonists' Exchange, Dept. 911C, Pleasant Hill, Ohio.

130 ALPHABETS Plus many numerals. Less than penny each. New book. New ideas. Saves sign men, artists, students time. Durable, compact, flat. Only \$1.50 postpaid. Gray Associates, 30 West Washington, Chicago 2.

LEARN Showcard writing! Fascinating lifetime business of your own. Free beginner's outfit. Write for full details. Sherwood Publishing Co., 11-J, Irvington, N.J.

ENJOY Independence, security. Learn sign painting! Signways, 4933 Erie, Chicago 44.

MAKE Up to \$100 weekly cartooning and illustrating at home. No experience necessary. Big, new, simplified method shows you how. Rush name for free trial offer. National Artists Bureau, Box 4248-A, Dallas 8, Texas.

WINDOW Sign letters; look like sign artist work. Easily applied. Free samples. Artistic, 74 Edmund Pl., Detroit.

SIGN Painting taught at home by an old master. Ben Kerns, Box 812, Greenville, S.C.

TALENT Test free. American School Commercial Art, Box 8066, Dallas 5, Texas.

MAKE Signs. 9 complete alphabet pattern sets. 3 complete numeral pattern sets and catalog \$1.00. Sign Letter Distributors, P.O. Box 101, Mineola, N. Y.

CHALK Talks. Laugh producing program, \$1.00. Catalog 10c. Balda The Cartoonist, Oshkosh, Wisconsin.

ADVERTISING AGENCIES, LETTER WRITERS, FOR ADVERTISERS

MAIL Order "Monitor," leading mail trade magazine for mail order business operators, beginners. Read it regularly with profit. Copy 25c, none free. No stamps. "Monitor," 10029 85th Ave., Edmonton, Alberta, Canada.

INCH Display advertisement Mailorder World, year \$24. Wood's Popular Services, Atlantic City, New Jersey.

1,000 OPPORTUNITY Seekers' correct names, 25c. Brass, 1065-A Madison, Chicago 7.

FREE:—Advertisers rate and data bulletin covering the southern states. Alabama Advertising Agency, Exchange Building, Birmingham 3, Alabama.

LATE Mailing lists! Teachers, births, automobile owners, etc. Business Service, 1101 Kings Highway, Shreveport, Louisiana.

ADVERTISE: 24 Words, 77 weekly newspapers \$5.00. Write for free rate directory. A. Burton Carnes Advertising Agency, 410 South Michigan Ave., Chicago 5.

ADVERTISERS! Reach nearly 18,000,000 readers. 25 Sunday national key newspapers, 18 words, \$42.25. "Terrific pullers." 20 popular newspapers, \$8.50. "Free booklet." Special—One inch display 2,821,198 circulation, \$42.00. Newmark's Advertising Agency, (Established 1893) 217-7th Ave., New York 11.

MAIL Order ads, circulars, letters, by leading advertising agency in mail order field. Low prices. Moran Advertising Agency, Box 104, Wilkes-Barre 3, Pennsylvania.

ADVERTISERS: Mail order ad covering United States—2,200,000 circulation—\$28.00 inch. Classified ad, 24 words, 20 metropolitan Sunday newspapers—\$25. Magazine, newspaper, mailing-list ratebook, advertising assistance—free. Chicago Advertising Agency, 20-PM West Jackson, Chicago 4.

ADVERTISE: 24 Words, 40 newspapers \$3.50. Lists free. Advertising Bureau, 229-C Dixon Blvd., Uniontown, Penna.

FREE! 1947 Advertisers Rate and Data Directory. 52 pages! E. H. Brown Advertising Agency, 20 N. Wacker, Chicago 6.

ADS Placed in out of town newspapers and magazines. Low rates. Catalogue free. Ideas that pay. Baker Advertising Agency, Successors Ankrum Agency, 189 W. Madison, Chicago 2.

MAILING Lists, certified, productive, inexpensive, \$5.00 1000. Homeworkers, agents, buyers, etc. Write Dixie Service, King, N. C.

24 WORDS in 64 weeklies \$4.96. H. J. Darnell, 730 Hays, Jackson, Tenn.

TYPEWRITERS, DUPLICATORS, OFFICE DEVICES

TYPEWRITERS, All makes \$17.50 up; new duplicators with supplies \$13.50; new portable adds \$12.95. Ship anywhere. Typewriter Service, 118 Spruce, Wichita, Kansas.

DUPLICATORS \$9.95 Up. (New.) Immediate delivery. "Free circular." Rucker, 2836-PM Slevin, Louisville 12, Ky.

"PRINTOMATIC" Selffeeding post card stencil printing duplicators \$9.50 up. Office size duplicators, Speedoprints, Hiltos, Excellographs \$33.41 up. Literature free. Pittsburgh Typewriter Supply, 336-WK Fourth Avenue, Pittsburgh 22, Penna.

RECONDITIONED Typewriters, mimeograph, multigraph printing devices, appliances, supplies. Catalog. Dixiegraph Service, King, N. Carolina.

RUBBER STAMPS AND OFFICE SUPPLIES

RUBBER Stamps, printing. Literature, samples free! Lee-Vall Press, 1208 Edgemont, Indianapolis 23, Indiana.

RUBBER Stamps, all kinds. Catalogue 10c. Print & Stamp Co., Box 172, Boston 1, Mass.

LINE 20c; 2-35c; 3-50c. Stamp Works, Auburn, Nebraska.

PRINTING, MULTIGRAPHING, MIMEOGRAPHING, GUMMED LABELS

STATIONERY—Name and address in blue. Box 100 sheets, 60 envelopes, \$1.49 postpaid. Sprague's Plastex Arts, Berlin, Wisconsin.

1000 EMBOSSED Business cards \$2.95. Ortiz, 700 West 180 Street, New York.

VARI-TYPING. Mimeographing, offset printing. Postal brings samples and prices. Compare. Vari-Typing Service, Box 33, Forest Hills, N. Y.

FINE Raised-letter embossed personal cards. Only \$2.99 thousand. Geren, 403 South Oakhurst, Beverly Hills, California.

HAMMERMILL, Letterheads, envelopes or cards; 100 \$1.00 postpaid. Benneville Printing, Box 1931, Pittsburgh 30, Penna.

PRINTING? Lowest prices, samples free. Basil Churchill, West Medway, Mass.

MIMEOGRAPHING—Designs; letters, booklets composed. Free samples. Topical Emprise Corporation, 1527 Highland, Box 42P, Louisville 4, Kentucky.

SPECIAL! 250 two color letterheads \$1.50 postpaid. Howard's, St. Johnsbury 2, Vt.

100 PRINTED Informals, envelopes. Excellent Xmas gift. \$1.89. Wood, 249 Sisson, Hartford, Conn.

BLUE Ink mimeographing. Fast service, reasonable. Ritter Sales, Sioux Falls, S. Dak.

BETTER Printing at reasonable prices. Send requirements. Free samples sent upon request. Mills Press, Highland, North Abington, Mass.

PERSONAL Stationery: 100 sheets 100 envelopes fine quality Hammermill bond paper printed three lines \$2.00. Mills Press, Highland, North Abington, Mass.

1000 BUSINESS Cards \$2.45. 1000 6 3/4 envelopes \$4.95 (prepaid). Quick, Madison, Ohio.

NEED Printing? Send copy for estimate. Modern Print, Box 34, Hyattsville, Maryland.

QUALITY Printing: Business, personal stationery. State requirements. Samples. Mero Products, 100 Morrison, Punxsutawney, Penna.

100 8 1/2 x 11 HAMMERMILL Letterheads \$1.00 postpaid. Envelopes same. Herbert Hudson, 261 Woonasquatucket, Centredale, R. I.

ENVELOPES Our specialty, free price list. Doerr Printing, Lewiston, New York.

GET Our printing prices first. Crane, Box 7625-D, Kansas City 3, Missouri.

MIMEOGRAPHING Specialists—Any copy. Reasonable. Mailers Service, Box 606-A, Chicago 90, Ill.

MIMEOGRAPHING Experts. Samples free. Martin Mimeographing, 3212 Harper, Saint Louis 7, Missouri.

MIMEOGRAPHING—Forms, letters, lists, etc. Top quality. Salem Print, 4720 Salem, Dayton 6, Ohio.

ENVELOPES, Letterheads, card printing. Samples free. Gehling, 1834 Fuller, Philadelphia 15, Penna.

150 LETTERHEADS \$1.00. Envelopes, business cards, same. Race Printing, Hudson, New York.

QUALITY Printing by Mail Distributors, 730 West Gift, Peoria 5, Illinois.

PRINTING—Quick, careful, reasonable. Ad-Man Press, 305½ Liberty Bldg., Indianapolis, Indiana.

1000 BUSINESS Cards prepaid \$2.50. Samples free. Reliable Print Shop, 901 E. Jefferson St., Louisville 6, Ky.

PRINTING Reasonable. Mail copy. Free estimates. Berliner, 3581 Milwaukee, Chicago 41.

500 6¾ ENVELOPES \$2.35. Mango, 555-A South 20th, Newark 3, N. J.

MIMEOGRAPHING—24 Hour service. Reasonable rates. Free samples. Jay Service, 1028m East 63rd, Chicago 37.

BUY Your printing at wholesale! Sell others. Details free. Adams-PM, 30 West Washington, Chicago 2.

POSTCARD Brings our samples, prices. Valley Print Shop, St. Elmo, Tenn.

100 VISITING, Business cards, 65c. printed, prepaid. W. Davis, 935 Maxwell St., Chicago, Ill.

QUALITY Mimeographing, accurate, reasonable. Riddle, 360 S. Hill, Los Angeles, 13.

BETTER Grade printing reasonable. Estimates on anything. Economic Press, Leonia, N. J.

QUALITY Printing—Reasonable prices. Fast service on catalogs, folders, publications. Write for prices. Bagby Printing Co., Georgetown, Ohio.

500 ¾x2¼ FOUR Line gummed stickers, 35c. Moritz Printery, Saginaw, Mich.

SEND 10c Now, for our 36-page 1947 pricelist—refunded first order. McCall Press, 1326 South 27th, Omaha, Nebraska.

MIMEOGRAPHING—Letters, pricelists, formulas, instructions. Lowest prices. Lem's Letter Shop, 5710 Stanton, Detroit 8.

PRINTING OUTFITS AND SUPPLIES

EXPAND Or start printing; excellent field. Fully equipped. Multigraphs, multiliths, streamlined floor model mimeographs. Folders, cutters, addressographs. Sacrifice rebuilt. International Machines Company, 1515 Larimer, Denver 2, Colo.

BARGAINS—Presses, type, supplies, stereo-casters, catalogs. Customprint, 211, Springfield, Missouri.

MAKE Your own Plastoplate printing cuts. Simple, easy process. Plastoservice, Argyle 1, Wisconsin.

TYPE Printing and multigraph. Fonts, composition. Ace Printing, Brentwood, Maryland.

CUTS—Make real halftones, linecuts yourself! Sample 25c. Particulars free. Chemical Service, Edwardsville, Illinois.

PRINTING Presses, type, supplies. Lists 3c. Turnbaugh Service, Loysville, Penna.

PRINTING Presses, type, supplies. Send dime for complete illustrated printer's supply book, details and press samples. Kelsey, Inc., A-11, Meriden, Connecticut.

HOME Made presses. Write Riegel, 1111 Harrison, Philadelphia 24, Penna.

INEXPENSIVE Home-made printing press. Details free. Novelty Shop, Downsville, Louisiana.

PATENT ATTORNEYS

INVENTORS—Patent laws encourage the development of inventions. The Rules of Practice of the U. S. Patent Office advises—unless an inventor is familiar with such matters—that he employ a competent registered attorney or registered agent, as the value of patents depends largely upon the skillful preparation of the specifications and claims. Write for further particulars as to patent protection and procedure and "Invention Record" form at once. No obligation. McMorrow, Berman & Davidson, Registered Patent Attorneys, 134-Z Victor Building, Washington 1, D. C.

INVENTORS—A patent is a valuable right. Detailed information and the preliminary steps to take to obtain patent protection will be sent to you upon request. Victor J. Evans & Co., 231-M Merilin Building, Washington 6, D. C.

INVENTORS: Learn how to protect your invention. The United States Patent Office advises the inventor, unless familiar with such matters, to engage a competent, registered patent attorney or agent to represent him. We maintain a staff of registered patent attorneys ready to serve you in the handling of your patent matters. Special booklet "Patent Guide for the Inventor" containing detailed information concerning patent procedure with "Record of Invention" form will be forwarded upon request—without obligation. Clarence A. O'Brien & Harvey Jacobson, Registered Patent Attorneys, 71B-K District National Building, Washington, D. C.

C. A. SNOW & Co.—M-427, Snow Building, Washington 1, D. C. Registered Patent Attorneys. Write for information.

INVENTORS. For "Record of Invention" form, contact Carl Miller, Registered Patent Attorney, Woolworth Building, New York.

"INVENTOR'S Guide" free on request. Frank Ledermann, Registered Patent Attorney, 154 Nassau St., New York 7, N. Y.

PATENTS. "Proof of Invention" folder mailed without obligation. E. E. Vrooman, Registered Patent Attorney, 871 Woodward Building, Washington 5, D. C.

INVENTORS: Without obligation, write us for information as to what steps an inventor should take to secure a patent. Randolph & Beavers, Registered Patent Attorneys, 21-C Columbian Bldg., Washington 1, D. C.

INVENTORS: Write for free brochure "Evidence of Invention." Labiner, World Building, New York 7.

PATENTS—Trade marks. Irving L. McCathran, 315 McLachlen Bldg., Washington 1, D. C. Registered Patent Attorney.

PATENT And Trade-Mark Practice before U. S. Patent Office. Validity and infringement investigations and opinions. Booklet and form "Evidence of Conception" forwarded upon request. Lancaster, Allwine & Rommel, Registered Patent Attorneys, Suite 411, 815-15th Street, N.W., Washington 5, D. C.

FOR INVENTORS

PATENT Protection—The U. S. Patent Office recommends—"an applicant is advised, unless familiar with such matters, to employ a competent registered Patent Attorney or registered Patent Agent, as the value of patents depends largely upon the skillful preparation of the specification and claims." Preliminary steps to take to obtain patent protection will be sent upon request. Victor J. Evans & Co., 232-M Merilin Building, Washington 6, D. C.

MAKE Your ideas earn money. Grayland Engineering, 5312 Grace, Chicago 41.

ARE Your ideas sound? Send details. Our expert opinion \$2.00. James Engineering Service, Box 648, Zanesville, Ohio.

INVENTIONS Appraised: Send details and \$1 to Will Price, Box 2313, Sheridan Park, Bremerton, Washington.

HOW To sell unpatented inventions. Charles Dimmick, 477A Adair St., Longbeach, California.

I'D Like to show you how I've sold my inventions. Write for free literature. George Pearce, 47-0 Bartholomew St., Peabody, Mass.

PATENT Development engineering service converts rough sketches into finished designs. Patent search included. Free estimate. Associated Research Engineers, 2627 Adams Mill Rd., Washington 9, D. C.

INVENTORS—Patent laws encourage the development of inventions. The Rules of Practice of the U. S. Patent Office advises—unless an inventor is familiar with such matters—that he employ a competent registered attorney or registered agent, as the value of patents depends largely upon the skillful preparation of the specifications and claims. Write for further particulars as to patent protection and procedure and "Invention Record" form at once. No obligation. McMorrow, Berman & Davidson, Registered Patent Attorneys, 134-Y Victor Building, Washington 1, D. C.

FREE—Our illustrated booklet, "Industrial Design and the Inventor." Learn how modern industrial styling and a professional presentation helps sell your invention. Etel Industrial Design, Room 416, 112 South 106th Street, Seattle 88, Washington.

HIGHEST Royalties and cash for inventions when we market them. Free booklet without obligation. Universal Marketing Co., 126 Lexington Ave., New York 16, N. Y.

INVENTORS—Free service. Descriptions of your invention sent free to 1,000 mfrs. No charge unless invention placed. National Industrial Chamber, 82 Beaver St., New York City.

PRELIMINARY Search reported 2 days, excepting Saturdays, etc., copies included \$7. Fee sensible because search made painstakingly. Attorneys and Inventors Central Search Bureau, consolidated with Patent Engineer Nicholas Aabberly, 305 Woodward Building, Washington.

INVENTORS: Knowledge produces results! Learn practical needed facts. Benefit from methods used by successful inventor. Progressive booklet 50c postpaid. Details free. Write Charles Klug, 1549 Hood Ave., Chicago 26.

INVENTORS: Learn how to protect your invention. The United States Patent Office advises the inventor, unless familiar with such matters, to engage a competent, registered patent attorney or agent to represent him. We maintain a staff of registered patent attorneys ready to serve you in the handling of your patent matters. Special booklet "Patent Guide for the Inventor" containing detailed information concerning patent procedure with "Record of Invention" form will be forwarded upon request—without obligation. Clarence A. O'Brien & Harvey Jacobson, Registered Patent Attorneys, 71A-K District National Building, Washington, D. C.

INVENTORS: Your ideas developed into manufacturing and patent drawings by engineer designers and draftsmen. Write today. Quality Design and Drafting Service, 613 Atlantic Building, 930 F Street, N.W., Washington, D. C.

FREE Pamphlet! How to develop your inventions. Elo Development Company, Department P, Chatham Phoenix Building, Long Island City 1, New York.

RELIABLE Patent searches complete with patent copies \$6.00. Protection forms free. Write Raymond L. Smith, Patent Searcher, 703-M Albee Building, Washington 5, D. C.

INVENTORS: Avoid unnecessary expense. Write for free booklet explaining how our consulting and advisory service can assist you in deriving greatest profit from inventing. Institute of American Inventors, Dept. 40-A, 1926-Eye St. N.W., Washington 6, D. C.

"INVENTOR'S Guide" free on request. Frank Ledermann, Registered Patent Attorney, 154 Nassau St., New York 7, N. Y.

THE Inventor who believes he has a new and useful invention, and needs advice, should consult a competent registered patent attorney. Without obligation, write for full information on how to secure patents and trademarks. Randolph & Beavers, Registered Patent Attorneys, 11-E-Columbian Bldg., Washington 1, D. C.

INVENTIONS WANTED

INVENTORS — Booklet "Self-Testing Your Patent or Invention" free on request. Avoid costly mistakes, wrong markets. Direct Contacts, 11106-A2 Longwood, Chicago 43.

WANTED: Products utilizing Western raw materials in large scale manufacturing. Address Industrial Development Division, P.O. Box 1703, Helena, Montana.

MANUFACTURERS Want patented or patent pending inventions! Write, Universal Guaranty Company, Lakewood, New York.

CASH Or royalty paid for acceptable inventions by the manufacturers. Write, John D. & Son, Box 3213, PM11, 285 Howard, Bridgeport 5, Conn.

INVENTIONS Wanted—Your invention should be legally protected by a filed patent office application before offering for sale. Use my complete patent office application service and I will help sell your invention. Commission basis. Buyers waiting. Issued patents may kill value of your invention. Have patent office search made cost \$6.00 for report and copies of patents nearest yours. Protection forms free. Charles Morton, Patent Broker, Established 1919, 11 West 42nd Street, New York.

INVENTORS: Hundreds of manufacturers have requested our assistance in locating marketable new products. Complete information, free. Institute of American Inventors, Dept. 40-D, 1926-Eye St. N.W., Washington 6, D. C.

SMALL Inventions wanted by manufacturers. I'll help you sell your invention. Write for circular. Stanley Hull, 7829 Euclid, Cleveland, Ohio.

INVENTORS. Write for our sales plan. Complete service for inventors. Visioneering Inc. Security Building, West Bend, Wis.

PATENTED. Unpatented inventions wanted. We have tremendous lists of manufacturers who may pay cash royalties. Descriptive booklet free. National Invention Service, 1404-T Mitchell St., Oakland 1, Calif.

PATENTS FOR SALE

MOTOR Mural Patent 2,419,802. Particulars, Mark Van Horne, 135 Barrington, Rochester, N. Y.

PATENT For excellent motor vehicle advertising device. Delivery truck, Van, Mark Van Horne, 135 Barrington, Rochester, N. Y.

OUTRIGHT Or royalty, automatic mop. H. Prillwitz, Waupaca, Wis.

INVENTORS: Test the commercial value of your patented or unpatented inventions, quickly and inexpensively. Write for free information. Institute of American Inventors, Dept. 40-B, 1926-Eye St. N.W., Washington 6, D. C.

MANUFACTURING

WOOD Turnings, hand, automatic, copy lathe work. Banks-Maxwell, R.F.D. 12, Ft. Worth, Texas.

MODELS, Dies, molds made to your drawings. Short run stampings, specialties manufactured. National Machine & Tool Co., 249 Stanton Ave., Akron 1, Ohio.

SMALL Lot production wanted. Aluminum castings; stampings; screw machine. J and M Company, Burlington, Kentucky.

EXPERIMENTAL Work, models. Reasonable. Nelson Manufacturing, 948 First, Woodburn, Oregon.

MODELS—Small lot manufacturing. Metals, plastics, etc. Milburn, Burlington, Kentucky.

MODELS AND MODEL SUPPLIES

MODEL Railroads exclusively. Complete stock. HO Scale, Lionel, American Flyer. Send for catalog. Eric Fuchs, 28 Brattle Street, Boston 8, Mass.

BUILD Miniature plastic city, three kits \$1. Johnson, 366 Freeman, Long Beach 4, Calif.

MINIJET Engine kit now \$9.95 pp. U.S.A. Assemble real pulse-jet at home. Send n.o. today. No c.o.d.'s. Minijet Motors Sales Company, Box 406, Pasadena, California.

FOUR Large 1/4" scale houses. Kit contains 72 wood and cardboard pieces. 16-page instruction booklet. Infinite variety possible. Only \$1.50 postpaid. Peck Publication, 372 Bloomfield Avenue, Verona, New Jersey.

STEAM Boiler for model engines, withstands 300 lb. pressure. Complete with pressure gauge and all fittings. Postpaid \$22.50. Ross, C68 West Broadway, New York, N. Y.

DETAILED Instructions for casting lovely "ming trees" dish-gardens. Material sources given. Sources for experts' techniques in making trees, shrubbery, etc. For model builders, \$1.00. Linde, 1361 Grove St., San Francisco 17, Calif.

LIONEL Railroaders—Our ad, on page 266, has hot news for you! See it! Madison Hardware Co., N. Y.

STEAM Engine, precision made to scale from brass and bronze. A practical working model that performs like its full size brother. Complete, fully assembled—ready for steam. Overall size 6"x3"; weight 2 1/4 lb. \$17.50 postpaid. Ross, C68 West Broadway, New York, N. Y.

POWER Models—Steam and gasoline engines, steam traction engine, metals, tools. Catalog 35c. Chas. Cole, Ventura, Calif.

SPEED King steam engine for boats and other models. Engines, casting kits, water tube boilers. Literature 5c. H & P Machine Co., 1617 Fulton St., Kalamazoo 25, Mich.

SHIP Model kits and fittings, most complete stock in New England. Boucher, Fisher, Marine Model and Model Shipways fittings, blueprints and model yacht equipment at standard prices. Send 25c for new illustrated 1947 catalog and price list. Dept. M, James Bliss & Co., Inc., 220 State Street, Boston, Mass.

RAILWAY Models, complete informative catalog HO and O gauge. 128 pages, 35c. Walthers, 247 Erie, Milwaukee, Wisconsin.

LANDLOCKED Sailors! Here's a beautiful, richly illustrated, fully descriptive catalogue of famous model ships—whalers, slavers, corvettes, etc., authentic in every detail. Send for it today. Only 10c. Halesite Yacht Service, Inc., Halesite, Huntington, N. Y.

SHIP Models and yacht supplies complete. Large 64 page catalogue 30c. Bill Wild's, 510 East 11 St., New York City 9.

SHIP and Yacht model fittings; blueprints. Send 25c for illustrated catalog No. 20—listing hundreds of items. A. J. Fisher, 1002-1 Etowah Ave., Royal Oak, Mich.

MINIATURE Steam locomotives, 1/4", 1/2", 3/4" scales. Castings, parts, rail! Thorough drawings with instructions. Catalog 25c. Little Engines, Wilmington, Cal.

"SHIP Models of Lasting Beauty." Copper sails. Construction sets, assembled models. Folder free. Trade Wind Models, P.O. Box 171-B, Lakewood, N. J.

TINY Power steam engines, boilers, locomotives finished ready-to-run. Also castings, prints. New catalog 25c. Chas. V. Arnold, Philomath, Oregon.

SHIP Model supplies, catalog 25c coin. R. E. Hancock, 323 Douglas Ave., Portsmouth, Virginia.

STEAM Engines, boilers, castings. Catalog 25c. Anton Bohaboy, 2297 Price, Rahway, New Jersey.

FREE Estimates on patent models. Wood, metal, plastic. Rogay Industrial Models, 3818 Beecher Street, N.W., Washington 7, D. C.

HOME CRAFTSMEN

SHELLCRAFT Supplies. Make money! Illustrated instructions catalogue, 10c. Beginners kit \$1.69 postpaid. Shell-Art Novelty Company, 5th and Moore, Philadelphia, Penna.

HUNDREDS Patterns: Plywood novelty furniture, lawn ornaments, silhouettes, weathervanes, letters, numerals, 200 craftsmen's books and booklets, hundreds decal transfer decorations. Other lines. Large illustrated catalog. Write Wo-Met Shop, Ashburn, Georgia.

SENSATIONAL Full size cutout patterns eliminates tracing, squares. Free picture demonstration. Winkler, 2822 Harney, Omaha, Nebraska.

OREGON Myrtlewood lumber and turning squares for sale. M. Weaver, 3923 SE Tibbetts, Portland 2, Oregon.

MAKE Beautiful dolls of sea shells. Kit complete with instructions \$1.50 c.o.d. Mrs. H. Gibson, Cortez, Fla.

ALUMINUM Rods, tubing, sheet, extruded shapes, any alloy, any amount. Free engineering service. Dunsmuir, Keyport, N. J.

GORGEOUS Plastic jewels. Samples and booklet of exciting ideas 50c. Peoria Crafts, 609 Bradley, Peoria, Illinois.

SPRINGS 50 Assorted bronze and stainless 25c. A work shop must. Hurry, limited supply. Springs, 147 Dogwood Lane, Manhasset, Long Island, N. Y.

PAINT Beautiful pictures quickly, easily, inexpensively. Free literature. Art Book Shop, Arnold, Mo.

MUSICAL Piano box kit easily assembled. Everything needed to make a beautiful music box \$4.75. Swiss music movements for your creations \$3.50. Roger Gift Shop, 31-14 Broadway, Long Island City 2, N. Y.

ELECTRIC Ceramic kiln 110v. 2000°F. Build yourself. Plans \$2.00. Allen, 245 South 1st, Montrose, Colorado.

CELLULOID—New beautifully colored assortment. Mottles, opaques, onyx, pearls. Used by ring makers everywhere. One pound assortment; pieces approximately 30 sq. in. each. Price \$1.00. Please add 10c for postage. Craft Service, 337 University Avenue, Rochester 7, New York.

WAR Surplus for camping or hobbies. 100% down sleeping bags, clothing, tools, machines, skis, and thousands of other articles. We buy direct—Government to consumer. Save half regular retail price. Send now for money saving catalog 10c. Coast Distributor Corp., Dept. T-D, 9025 Bothell Way, Seattle 5, Washington.

LEATHERCRAFTERS—Saddle stamps and tools. High quality, reasonable prices. The Marcraft Co., Skokie, Illinois.

LEATHER Designs for tooling or carving. Ten handbags \$1.00; twenty billfolds, \$1.00; fifty belts, \$1.00. All three, \$2.50. Lampkin Artcrafts, Box 641-M, Culver City, Calif.

ANTIQUE Reproductions metal pulls, knobs, escutcheons. Kiln dried mahogany, walnut, other woods. Highly figured veneers. Sedlo Company, P.O. Box 7161, New Orleans, Louisiana.

WOODCRAFTERS—40 Pictures of new woodworking projects. Folder 10c. Joanes Patterns, P.O. Box 141, Omaha 7, Nebr.

MAKE Beautiful seashell jewelry. Scores of beautiful things you can make at home. No experience needed. Earn money selling what you make. (Buy wholesale.) Large illustrated catalogue including instructions 10c. Pace's, Box 279-T, Bradenton, Florida.

BAMBOO—Newest vogue. Build for business or hobby; lamps, furniture, novelties. Free price list, complete instructions. Trial, eight 4-ft. pieces assorted cane \$1. Rogers Bamboo, 1660 Berkeley, Santa Monica, Calif.

CHRISTMAS Toys, animals. Easy to make. 10 new, action designs \$1. Engineering Development, Box 37, Sta. C, Lincoln, Nebraska.

HOBBYISTS! Join the "Allcraft Club." Free. Fun! Profits galore! We are America's lowest priced hobby supply house. 24 hour service on orders. Send for free price lists and full details of the club. Write immediately to: Allcraft Products, Dept. M, Hempstead, N. Y.

BAND And jig saw owners, let your machine and hobby bring you profits, fun. Free details, Nu-Art Designers, 33 Rosemont Rd., No. Weymouth, Mass.

DESIGN And specification prints of 6 wood earthmoving toys including power shovel, dump truck and loader. \$1.50 postpaid. Earthmover Toys, E. Lansing, Mich.

OUTDOOR Furniture—Lawn chairs, table and benches, 5 different plans \$1.00. 10—\$2.00. Summercraft Studio, 42 Vernon Street, Newton 58, Mass.

50 FLORAL And fruit patterns for painting or needlework. Four large sheets—\$1.00. Color guide included. Design-Prints, Box 669, Madison, Wis.

ARBORS, Wheels, pulleys, sanders for home workshop. Make your own with Nordco hub. \$2.00. Free literature. Northwest Die Casting, Box 1266, Station A, Bremerton, Washington.

METALCRAFTERS! Send for catalog listing copper, brass, aluminum tools and supplies. Kit Kraft, 3203 W. Washington Blvd., Los Angeles 16, California.

FREE—5 1/2" Cold chisel with purchase of 12 tungsten hacksaw blades \$1.00. Maxlon, Box 9 Highbridge P.O., New York 52, N. Y.

RHINESTONES, Pearls, earwires. Introductory assortment 25c. 1360-F Hicks Street, New York 67.

START Flocking. Spray beautiful plush finish on everything. Supplies, equipment, instructions. Easy, inexpensive. Coast Industries, 1507 W. Manchester, Los Angeles 44.

20 CHRISTMAS Tree decorations from plywood scraps. Children love them. Patterns and instructions \$1.00. Southern Plan Service, Box 151, Charleston, S. C.

LEATHERCRAFTERS! Belt kits, projects, leather, supplies. Write for catalog. Art Leather, 411 Joseph Ave., Rochester 5, N. Y.

DO It with leather. Profitable hobby. Send card for free booklet. Artcraft Leather of California, Dept. PM-11, 271 Twelfth Street, Oakland 7, California.

GENUINE Leather scraps for leathercraft items, assorted colors, 6 pounds, \$2.00. Send 10c for sample. International Cushion Co., 515-AA North Halsted, Chicago 22, Illinois.

UNIQUE 1948 Two-in-one lawn ornament pattern, full size, 12 1/2" high. Complete with color schemes \$1.00. Morris, 3437 E. 108th St., Cleveland 4, Ohio.

LEATHER, Retail, mail orders, catalog, tools, lacing, supplies. National Handcraft Co., 30 Frankfort St., New York City 7.

TEXAS Ebony, America's most beautiful lathe turning wood. Large piece, \$1 prepaid. Sample, dime. Information on southern woods, stamp. Starcraft 1, Edinburg, Texas.

MAKE Your own jewelry! Findings in metal and plastics; earwires, pinbacks, cameos, stones, beads, clasps, sprays, combs, hairbars, plastic and metal chains. Hobby Art Corp., Dept. 7, P.O.B. 276, New York 18, N. Y.

PLYWOOD Cabinet kitchen plans 25c. Playne Cabinets, 4617 Johnson Avenue, Western Springs, Illinois.

PLASTIC Jewelry supplies. Free catalog. J & M Novelties, Box 464P, Griffith, Indiana.

HOW To set up and run a mirror shop! Resilver mirrors. For price write—John Sprinkle V55, Marion, Indiana.

SHELLCRAFT Supplies. C. A. Werts, 1429-56th Avenue, Oakland 3, Calif.

BUILD And sell lawn chairs. Plans \$1.00. We tell you how and where we sell. The Woodcraft Shop, Danby, Vermont.

SHELLCRAFT Supplies. Beginner's kit with instruction book \$3.00. Price list free. Stelle Shellcraft Industries, 230 Randall Avenue, Trenton 10, New Jersey.

KNOCKDOWN Cedar chests. Lumber and veneers. Free price list. Giles & Kendall Company, Huntsville, Ala.

SPECIAL 77 Full sized patterns. Lawn ornaments, toys and novelties \$1.00. Modern Woodcraft, Saginaw, Michigan.

FREE Price list, 34 pages of tools and supplies showing hundreds of items for the leather crafter. A complete selection of leather stock. Yours for the asking. Russo Handicrafts Supplies, 239 S. Spring St., Dept. A, Los Angeles, Calif.

SPECIAL Offer: 80 full size toy, novelty, and lawn ornament patterns only \$1.00. Lynds, Medway, Mass.

LEATHERCRAFTERS: Ready made leather projects simple to complete are fully illustrated in our 1947 catalog of projects, tools, hides and accessories. Write for free catalog. Ester Leather Company, 145 St. Paul St., Rochester 4, N. Y.

LEARN Sea-Shell jewelry and novelty manufacturing. No tools or experience needed. Learn—earn within a week! Complete, beautifully photographed home instruction course, shows you how to make 110 designs of pins, earrings, brooches, hair ornaments, necklaces, bracelets, plaques, ash trays, dolls, animals, miniatures, etc. Explains pearlizing, tinseling, gilding, dyeing, luminous processes. Illustrates 65 species sea shells. Lists 200 raw materials with wholesale prices. Complete course \$1 postpaid. Beginner's kit, \$3 (\$3.50 in Canada). House of Gifts, Box 4550FR, Coral Gables, Fla.

CERAMIC Jewelry supplies, bar pins, ear screws, for ceramic and woodworkers; also glass and seashell assemblers. Free catalog. Philadelphia Badge Co., Dept. B-1, 1007 Filbert St., Philadelphia, Penna.

35 PATTERNS Of action pull toys, trucks, carts, toy furniture, etc. \$1.00. Continental Homecrafters, 907 Birch, Eau Claire 3, Wisconsin.

LEATHERCRAFTERS! Send for free catalog listing leathers, tools, supplies. Kit Kraft, 3203 W. Washington Blvd., Los Angeles 16, Calif.

WHITTLES'S Supplies, Redicut blanks, special woods, tools. Catalog 10c. Old Whittler, 1402 Charles, La Crosse, Wis.

SHELLS, Plastics, findings. Lowest prices. Free catalog. Frances Jones, Box 251, Sarasota, Fla.

EXPERIMENTERS! Interested in electrical, mechanical devices from war surplus? List free. F. Siefke, Box 18, Station E, Buffalo 11, N. Y.

MAKE IT YOURSELF

OPEN And close garage doors (swing out type) with air, plans \$1.00. W. Hughes, Box 465, Port Jefferson Sta., N. Y.

BUILD Concrete block machine. Vibrator or hand. Easy. Inexpensive. 125 blocks per hour. Build house, shop, garage or other buildings. Save half. Sell blocks. Make money. Free details. Clyde Lee, Dept. A, Mountain View, Oklahoma.

SPECIAL. Full size patterns make over 100 toys, \$1.00. Complete plan for over 20 modern kitchen cabinets \$1.00. Free list. Masterprint, White Building, Buffalo 2, N. Y.

BUILD Concrete block machines, portable sawmills. Shop, farm, home machines. 70 plans. Catalog-handbook free. Nichols Equipment Co., Dept. 410, Purvis, Miss.

BUILD Better tilting table circular saw. Details 10c, refundable. Ward Manufacturing Co., Walsenburg, Colo.

"MODERN Homes"—Over 40 surprisingly unusual construction ideas from California! Book of money-saving, labor saving suggestions; for remodeling or building new. Valuable! Practical! Concise! \$1.00 complete. Newhouse Industries, 5941-A2 Hereford, Los Angeles 22, California.

HOT Water free—From sunlight. System efficient any locality year 'round. Standard materials, easily built, low cost, facts free. Solar Water Co., Box 175, Dept. U, Coral Gables, Florida.

MAKE Shell pin, earrings. Instructions, material, 25c. Oceanshell, Route 1, Box 249A, Rochester, Michigan.

"CONCRETE Block homes." 32 page booklet: drawings, instructions on how to build. \$1.00. H. C. Lightfoot, Civil Engineer, Richboro 1, Penna.

GRANDFATHER Clock building system, \$1. Simple, shoptested, thousands built, with pictured prices fine Westminster weight movements. Kuempe Clock Plant, Minneapolis 16, Minn.

WATCHES, OLD GOLD, JEWELRY

EXPERT Repairing, chronographs a specialty. One week service. All work guaranteed. Send your trial order. Estimates submitted before we proceed. Royal Watch Co., 29 Forsyth St., New York 2, N. Y.

GENUINE Diamonds at out-of-pawn low prices from unredeemed loans and cash buys. We offer beautiful gems at far less than original cost. Shipped free for inspection, appraisal. Write for free list showing fine diamonds at amazing low prices. Lloyd J. Butler, President, Prudential Loan Association, 133 North Clark, Dept. J-117, Chicago 2.

JEWELRY, Gem cutting. Big profits in leisure time. Huge instruction book and catalog 35c. Tools, equipment, materials. \$1 for rough African tiger eye and catalog. \$2.50 value guaranteed. Grieger's, Dept. HC, 1633 Walnut, Pasadena 4, California.

STUN Your friends with genuine, sparkling, brilliant-white zircons. Cut, polished, mounted just like diamonds. Amazing diamond-like appearance. Top-quality. Hard for even experts to tell the difference. Beautiful settings 14K gold. Over 100 gorgeous latest-style rings to choose from. Attractive low prices. Send for big free catalog. U. S. Zircon Syndicate, 139 N. Clark, Dept. ZG-117, Chicago 2.

RELIABLE Repairing—Cleaning, oiling, complete overhauling, \$3.75; cleaning, mainspring, overhauling, \$4.75; cleaning, balance staff, overhauling, \$5.00; worn parts replaced, 14 day service. Literature free, or send watch. Brookins, B-E1975, Little Rock, Ark.

WHOLESALE—Bulova, Elgin, Waltham, Hamilton rebuilt like new watches; 7 jewel \$12.65; 15 jewel \$13.80; 17 jewel \$14.95; minimum, 2 watches; samples \$1.00 extra. Catalogue free. Brookins, B-1975E, Little Rock, Ark.

ZIRCONS, Mystic, genuine Siamese gems. Brilliance of diamonds. Treasured by ancient Egyptian kings as good luck charms. Stand diamond acid test. Diamond facet cut, unmounted. Wholesale \$1.50 carat. Sample \$2.00, two for \$3.00. Will mount in good rings at popular prices. B. Lowe, Dept. PM-10, Holland Bldg., St. Louis, Mo.

LEARN Watchmaking. Complete instruction course, \$3.50. Tools, materials. Catalog free. Stewart's, 727 Market St., St. Louis, Mo.

GOLD \$35.00 Ounce—Mail old gold teeth, diamonds, jewelry, watches—receive cash by return mail. Satisfaction guaranteed. Free information. Dr. Welsberg's Gold Refining Company, 1500-Q Hennepin, Minneapolis, Minn.

WATCH Repairing easy learned by our home study course. Watch repairers are in demand and are among the highest paid craftsmen today. Write for free information. Houston Chronometer & Watch Co., P. O. Box 1140A, Houston 1, Texas.

WATCHMAKERS Don't be without B&M hairspring straightening vise. Price \$4.50. Meyer Mfg. Co., 3911 N. Figueroa St., Los Angeles 31, Calif.

CASH For old, broken jewelry. Highest prices paid immediately. Mail gold teeth, watches, rings, silverware, diamonds, spectacles. Satisfaction guaranteed. Information free. Rose Smelting Co., 29-A East Madison, Chicago.

GEMS, Precious and semi-precious, all genuine, from world wide sources. Deal direct, no overhead, save money. Catalog 10c. Hill Co., Route 7, Salem, Oregon.

WATCH And clock repairing—Complete practical course in modern horology. 66 illustrated self-instruction lessons. Just out! Low price. Fascinating 100-page illustrated catalog free! Write—Nelson Company, Dept. 3-02, Chicago 5.

TOBACCO, SMOKERS' SUPPLIES

CIGARETTES. Prompt delivery on all popular brands. Minimum order 3 cartons \$4.35. We pay postage within 300 miles New York City; if beyond, add 2c per carton postage. Send check or money order. Write for free price list, including cigars. Durham's Mail Order Co., Dept. M, North Branch, N. J.

VESTPOCKET Pipe imported briar. Perfect for short smoke. Hard rubber bit turns to cover bowl, light goes out, no ashes in pocket, new and different. \$1 satisfaction guaranteed or your money back. Remit now to American Mail Order, 60 Park Place, Newark 1, N. J.

PIPES. Imported briar, slight seconds, smoking qualities unimpaired, 69c each, 2 for \$1. Satisfaction guaranteed or your money back. Name shapes desired. Remit now to American Mail Order, 60 Park Pl., Newark 1, N. J.

MAKE A pipe. Manual of instructions \$1.00. Briar blocks, stems, rough pipes. Free list. Harold Mangus, R.D. 3, Alliance, Ohio.

CIGARS, Trial package, \$1.65 postpaid. Prices on request. S. & E. Co., Dept. PM, Red Lion, Penna.

PIPE Carving kits \$1.00. Seconds \$5.00 pipes 65c. Literature free. Carvapipe, 2829-X Dixie, Hamilton, Ohio.

CIGARS—Factory-fresh by mail. Andrew Tapia, 1903 Nebraska, Tampa 3, Florida.

PIPE Lovers magazine! Pictures, articles, gadgets, ideas. 532P Pine, Long Beach 12, Calif.

CIGARS, Tobaccos. Write for particulars regarding better smokes for less money, mentioning your favorite brands. Pete Moberly, Box 999, Owensboro, Kentucky.

RAZORS, BLADES, SHARPENING

DRY Shaver, no electricity, no lather. Fits neatly into vestpocket. Shave anywhere, anytime. Important men use it. You look neat always. Satisfaction guaranteed or your money back. \$3 postpaid. Remit now to American Mail Order, 60 Park Pl., Newark 1, N. J.

FOR SALE—MISCELLANEOUS

HULL Automobile compass, for accurate road direction, brand new, \$2.50. Prisms for 6x30 or 8x30 binoculars, brand new, \$1.50 each. Offset prisms to be attached to 7x50 B. & L. binoculars, gives double the field of the ordinary 7x50 binoculars. Cost \$98.00, special \$25.00. Green sunshades for binoculars, size 6x30 and 7x50 snap on type, value \$7.50, special \$1.25 per pair. Forward money order. No c.o.d. shipments. Send coin \$1.25 for Third Annual Edition of Gun Digest together with our complete catalog of new and used guns, ammunition, rifles, binoculars and powder flasks. Our separate catalog 25c. Public Sport Shops, 13 S. 16th Street, Philadelphia, Penna.

A-2 FLIGHT Jacket, AAF regulation style! First-quality, dark brown leather—windproof, rainproof, lightweight but extra warm. Features solid brass zipper, two big snap pockets, water-repellent lining, pure wool cuffs and waistband. Every jacket new, perfect; no "seconds." Money-back guarantee. Now only \$19.95, postpaid! Send check or money order today, with your height and suit size, to Perry Sales Co., Dept. PM-11, 37-47 82nd St., Jackson Heights, N. Y.

FORD Bus—1937 25-passenger, \$1,995. Burnside, Phone Ev. 1663, 14915 Telegraph, Detroit.

SEA Shells from 7 seas for collectors, curios, manufacturers. Retail, wholesale. Skipper Naylor, 3616 Curlew, San Diego, California.

U. S. Surplus clothing bargains for men, women. Free catalogue. New York Clothing Co., Dept. P, 2079 Second Ave., New York 29.

SOFTEN Efficient portable water softener. Rechargeable. \$8.95 prepaid. Lewis Mercantile Co., Box 383, Scottsdale, Ariz.

FOR SALE—One Greenwald, 90 h.p. steam engine with water pump and all connections. One 100 h.p. steam boiler complete. Jas. S. Wilson & Sons, Paris, Kentucky.

USED Army raincoats—good serviceable condition. Send no money, pay when received. Satisfaction guaranteed. Light weight \$1.50, heavier weight \$2.00. Buford Butts, Sharon, Tennessee.

WANTED—MISCELLANEOUS

ANYTHING Bought-sold-traded. Send for free list opportunities. Buyers Bulletin, P. O. Box 415, Evansville, Indiana.

MERCURY (Quicksilver). Write for quotation stating quantity. Metallurgical Products Co., 35th and Moore Sts., Philadelphia, Penna.

FOR THE HOME

"AIRGUIDE" Indoor-outdoor thermometer. Handsome scientific instrument shows outside temperature indoors. Ideal gift. \$6.00 postpaid. Circular free. Trade Winds, Dept. M, 727 30th Street, Rock Island, Illinois.

"REPLACEMENTS"—Stoves, furnaces, Grates, firepots, linings. Magic, Royal Oak 128, Mich.

WHY Worry about gas shut off time for water heaters. Use FW Safety Alarm \$1. Circular free. Wackenhuth, 18 Burnett St., Newark 2, N. J.

PERSONAL

IT'S Lots of fun! Pretend visiting Hollywood! 3 cards 35c. You address, return. We remail. Kards, P.O. Box 84, Wilmington, California.

"INSURANCE Man" entertaining, informative novel 27,000 words. Humorous, factual. Special edition 35c postpaid. Underwriter Supply, College Park, Georgia.

PERSONALIZED Christmas cards and stationery. J & M Novelties, Box 464, Griffith, Indiana.

TEN Ranch postcards, you address, return. We remail. Box 712, Corsicana, Tex.

25 AMERICAN Cities. Picture postcards mailed from 25 cities to you. Personal message. Send \$1.00. Retail Register, 106 Market Street, Portland, Maine.

MEXICAN Address. Mail received and forwarded. Photographic postcards 15c. Remaild free. Mexican articles. Questions answered about Mexico 50c. Tillotson, Aptdo. 1405, Guadalajara, Jalisco, Mexico.

"SIGHT Without Glasses," a complete book by Dr. Peppard, enables many to see normally without glasses. Only \$1.25 postpaid. Laura Dickson, 808 Elizabeth St., Anderson, S. C.

GREETINGS From Switzerland welcomed by your friends. Send dollar bill, for 4 postcards, or letters. Beautiful photographs. You write, return. I mail them. Fontana, P.O. Box 80, Zurich, Switzerland.

ST. PETERSBURG, Fla. Tropical view cards 5-25c remaild. Craig, 1401 12th St. So.

BUYING Agency. List your needs. Spada Enterprises, 10 Lexington, Wethersfield 9, Conn.

PRETEND Visiting Rochester. 3 postcards 25c. Address, return. I remail. Mail forwarded 10c. Balch, Sodus Pt., N. Y.

THICKER, Lovelier hair for men and women. All about latest secrets, discoveries free. Write immediately. Bruns, 3307-D Fremont, Madison 4, Wis.

RUPTURED? Improved appliance holds easily. Free trial. Earles Company, Flint, Michigan.

SURPRISE Friends, letters forwarded. Los Angeles, 25c, 3-50c, monthly rates on request. "Best," Box 607, Los Angeles 43.

SWAP! Trade! Anything, everything. Free information. "Swappers' Gazette-PM" Louisville 12, Kentucky.

RUPTURED? Positive comfort, no understraps, no steel, no elastic. Write Smith Manufacturing Company, Preston, Ontario.

HAIR Falling? Dandruff? Write Trichologist, 137 Lewis St., Phillipsburg, N. J.

HOW You can find out! Information discreetly developed, any matter, person, problem, anywhere. Personal-business assignments, representations, undertaken. Nation-wide. Officially licensed and bonded service established 1922. Reasonable. All inquiries confidential. William Herman, 170 Broadway, New York.

MISCELLANEOUS

"RECEIVE Mail." Moneymaking offers, opportunities, catalogs. Name listed 10c. Ideal Service, 100, Park Ridge, Ill.

WIND-UP Trains complete \$4.95 and other scarce toys. List free! Pekay's, Box 594-P, Monroe, Michigan.

CITRUS Fruit cheap, merchandise high. Save money, worry. Send fruit for Christmas. Free folder. Davidson Groves, Box 1118, Edinburg, Texas.

PREVENT Moth damage with one easy application. Permanent mothproofing compound makes one quart solution, 50c postpaid. Money back guarantee. Lee Laboratories, 10108 S. Vermont, Los Angeles 44, Calif.

BALLOONS, Army targets inflate 3 1/2 feet in diameter. Flies better than a kite. 29c postpaid. Harry Freedman, Box 68B Revere, Massachusetts.

FREE—New 42 page book entitled, "How to Become a Successful Direct Salesman," written by salesmen for those who want to become salesmen and earn up to \$100 and more weekly. Send penny postcard. Specialty Salesman Magazine, Dept. PM-9, 307 N. Michigan, Chicago 1, Ill.

GOLD Decal letters and numbers 1/4", 1/2", 1"; 325 assorted \$1.00. Other decals made to order. Photo-Cal Decal, P.O. Box 2044, San Diego, California.

KEY, Pet, luggage, milk can tags. Request illustration. Rasco, 413 Pedretti Road, Cincinnati, Ohio.

FIREWORKS: Don't be disappointed. Get famous Banner Fireworks with all newest and startling effects. Giant cannon salutes that rock you like a crash of thunder. Whistling devils with weird unearthly noises. Skyrockets that burst in majestic colorful display. Gasp in amazement as you watch the battle in the clouds. Genuine Chinese firecrackers. Over 200 pieces including sparklers for little tots. Retail value over \$10.00 for only \$4.95. Rush order today. Any quantity. Send money order, bank draft or currency. No c.o.d.'s. Big new catalog free. Banner Fireworks Mfg. Co., Inc., Dept. 111, 446 Capistrano, Toledo 12, Ohio.

MEN! Large size shoes, large size socks. We specialize in large sizes 11 1/2 to 16, widths AA-EEE. Oxfords, hipops, work shoes. Guaranteed extra quality. Free catalog. Kingsize, 426, Brockton, Mass.

18 PENCILS \$1.00. Your name printed in gold. Write L. M. Alken, Route 25P, Riverside, N. J.

RED, White and blue airmail rubber stamp, ink pad, and paper weight. All in one. New invention that prints red arrow and blue airmail on a white envelope. It is also an attractive paper weight. Mailed complete, prepaid. Rubber stamp and ink pad for only \$2.00. Dealers write for prices. Multi-Color Stamp Co., Box 96, Keene, Texas.

WORLDS Best Christmas card bargain. 25 beautifully colored boxed. Bible verse each card and envelopes. \$1.00 per box, two boxes \$1.90, three boxes \$2.70, four boxes \$3.60, five boxes \$4.25, ten boxes \$7.50. Fredericks', Box 1810, Houston 1, Texas.

GIGANTIC Mails, magazines, samples. Listing 10c. Lawson, Box 1302-P11, Detroit 31.

LAY Brick! Build it yourself and save money. New invention assures good job. Requires no previous experience. Send for information. Bricklayer, Box 260C R. 7, Dayton 9, Ohio.

INDIAN River citrus fruits. Express shipments. List on request. Schuyler Jackson, Wabasso, Florida.

PANNING Gold. Free instruction booklet. Old Prospector, B-60, Dutch Flat, Calif.

TOPS! Lifetime ballpoint fountain pen \$1.00. Free literature. Novelty Enterprises, Dept. 27, Box 2341 Terminal Annex, Los Angeles 54, California.

FIREWORKS! Wholesale! Lowest prices! Watson Sales Company, P.O. Box 1414, Birmingham 1, Alabama.

"BIBLE Confirmed by Archaeology," 40c. Christian Evidence League, Malverne, N. Y.

"JITTERBUGGING Is Easy." Popular new illustrated course teaches everything. Readable, understandable, guaranteed. Only \$1.00. Sorry, no C.O.D.'s. The Peters Co., Dept. TP, 328 Adams St. N.E., Washington 2, D.C.

AMAZING Chemical. One application keeps trousers creased entire month. Gives sharp crease. Package sufficient for twelve applications. Price 50c. Sta-Rite Products, 355 Imperial Street, Youngstown 9, Ohio.

TWELVE Alnico magnets, 100 experiments. \$3.00. Experiments, 25c. Disc magnet. \$1.00. Eljay, Box 891, Newark 1, N. J.

FREE! Big new "Book of Values" catalog. Everything for the sport, bicycle and hobby fan at lowest prices. Write Minky's, 3330B Roosevelt Road, Chicago 24, Ill.

400 YEAR Calendar. Shows actual monthly calendars. 35c. Tracy Newton, Decatur, Georgia.

BEAUTIFUL Fluorescent table lamp. Wonderful Christmas gift. Free illustrated literature. Salesmen needed. Harold Amspacker, 307 Electric Ave., Lewistown, Penna.

SWISS Music box units. Choice of classical, waltz, popular. All ready to install. \$3.25 each. Cash orders postpaid. Information on request. Swiss Novelty Co., Box 1201, Fall River, Mass.

M-SCOPE Metal, mineral locators sensational new electronic lightweight models, immediate shipment. Fisher Research Laboratory, Inc., manufactures some of the finest metal locators for the U. S. Army. Built for Arctic, Tropic use. Unsurpassed efficiency, low prices. Time-payment plan available. Send for free 16-page illustrated booklet. Fisher Research Laboratory, Inc., Palo Alto, Calif.

PINE Cones 3 to 4 1/2 inches; 100, \$2.00. All kinds. Write for prices, samples postpaid \$2.00. Maryland Nursery, Hyattsville, Md.

CHRISTMAS Cards; assortment of 21 attractive multi-colored greetings with envelopes. Worth \$3.15, send only \$1.00. Bernard Fertel, 1014 East 179 Street, Bronx 60, New York.

BAKERS Secret for good bread. Recipes \$2.00. Martin Lee, 100 Nuckols, Red Oak, Iowa.

MEXICAN-AZTEC Featherwork tropical bird picture cards. Samples 25c. Mexican Products, 126 N. Main, Tulsa 3, Okla.

PROTECT Your good hat, as your raincoat protects your clothing, with a new plastic hat cover! Only \$1 postpaid. Satisfaction guaranteed. Bestyet Distributors, 545-HA Fifth Avenue, New York 17.

"WATERBUG." New water toy. Propeller driven. 9"x15". \$1.00. Satisfaction guaranteed. Hare Products, Whitinsville, Mass.

B. B. Ball point pen \$1.00. Spada Enterprises, 10 Lexington, Wethersfield 9, Conn.

COMPLETE Listing of our nationally advertised "war surplus" bargains free. Write, "Amazing Bachman's," 23 Herman Street, Rochester 5, N. Y.

FORTY Square dance instructions, \$1.00. Rader, Box #237, Denver, Colo.

JIFFY One cup coffee maker. Brews tea or coffee in 3 minutes right on the table. 30c postpaid. Austin Specialties, 818 Waller, Chicago 51, Ill.

SWISS Musical units \$3.25. Music Boxes, 131 West 42nd, New York 18, N. Y.

ATOMIC Laboratory. For few cents, in few hours make and operate remarkable atomic energy devices. Absolutely harmless. Easily made. Intensely fascinating. Flash chamber. See vivid, frenzied flashes caused by released atomic energy. Instructions 50c. Electroscope; test minerals, rocks, earth, etc. for atomic activity. Instructions 50c. Wilson chamber; phenomenal display of ionized particles in violent action. Instructions 50c. Easily understood scientific explanations. All three above with captivating booklet "Essential Atomic Theory," list of easily obtainable material, other valuable information, \$1.00 complete. Alpha-Atom Products Co., 475-A Fifth Ave., New York 17.

STAMPS Wanted by thousands of our readers. Your ad in this space will bring you some nice orders. One advertiser sold 150,000 stamps. Write for positive proof. F. W. Johnson, Classified Advertising Manager, Room 301, 200 East Ontario St., Chicago 11.

TATTOOING Outfits, supplies. Illustrated list free. Zeis, 728 Lesley, Rockford, Illinois.

NEW "Easy-to-See" thermometer, 3 1/2" transparent dial with glass cover. Attaches firmly anywhere on outside of window pane. Big figures easily read 10 ft. away. Weatherproof, reliable, accurate. \$1.50 postpaid. Brad Lee Gifts, 28 Bedford St., Waltham 54, Mass.

TREASURE Hunters! Entirely new Goldak locators. Sensational performance. New light weight model weighs only 11 pounds. Revolutionizes location of gold, silver and minerals. Money-back guaranteed superior any other device. Write The Goldak Co., 1544 W. Glenoaks Blvd., Glendale 1, Calif.

THE Lord's coming! Get plenty free proofs you unbelievers. International, Box 263-X, Duluth, Minnesota.

GOOD "Used" self-instruction educational books on all subjects bought, sold, rented, exchanged. Satisfaction guaranteed. Complete information and 100-page illustrated bargain catalog free! Write—Nelson Company, Chicago 5.

GLADIOLAS—Some newer, better. List. Robinsons Glad Heaven, Sebastopol, Calif.

GOVERNMENT Surplus. A thousand bargains. Write for list. A card will do. Army, Navy Surplus Goods, 320 13th St., Richmond, Calif.

SEEK Buried treasure. Methods, mysteries, devices explained. Circulars free. Century Press, Box 151-B, Glen Ellyn, Ill.

70 BIBLE Lessons, 25c. Bulletin, Box 87, Cathedral Station, New York 25.

PENCILS—Individual or firm name. Dozen 60c, two dozen same imprint \$1.00, gross \$4.80 cash. Delivered. Pencil Market, 611 15th Street, Knoxville 16, Tenn.

RECEIVE Free samples, magazines, catalogues, moneymaking offers! Mail galore! Your name in all our "surefire" mailing lists two years, \$1.00. Four months, 25c. Stanford, 6220-M 16th, Philadelphia 41.

FREE—"Amazing New Book"—"Profits From Classified Advertising." Tells how and what to advertise. Be sure to read this book before you invest one cent in advertising. Remember—it's free! Write for your copy now. F. W. Johnson, Classified Advertising Manager, 200 East Ontario Street, Chicago 11, Illinois.

PAIN'T YOUR CAR WITH WYPE[®] for \$3.95

Amazing NEW AUTO ENAMEL

You WIPE ON Instead of Brushing & Spraying

Get Beautiful Mirror-Like Finish That Looks Like Spray Job!

At last! Practically anyone can now paint his car with WYPE and get a beautiful high-gloss job that gives you an expensive finish such as is sprayed on by Professional Auto Painters—at a fraction of regular cost! With WYPE you need NO BRUSH, NO SPRAY, NO MASKING! Just WIPE ON with Powder Puff—which we furnish at no extra charge. You get a brilliant, glossy finish that is truly "factory-like." No streaks. No lap-marks. Guaranteed for TWO years not to crack, peel, chip or fade, if simple directions are followed. Takes about an hour to apply. Dries dust-free in an hour. WYPE comes in eight most popular shades including those on newest model cars. Goes over any other color, lacquer or enamel.

NEW MONEY-MAKING BUSINESS!
WYPE 2 CARS DAILY for \$25.00 each—
Gross Up to \$260.00 Weekly Profit!

Start making BIG MONEY Now! Sell WYPE in cans or go into business painting cars yourself (or hire others to do work). Send for FREE details of powerful money-making plan. Why wait! Start now by ordering one quart or more of WYPE!

2-YR Guarantee
NO MASKING NEEDED
NO STREAKS or LAP-MARKS
looks like SPRAY JOB



ANYONE CAN DO BEAUTIFUL JOB

SEND NO MONEY! ORDER WYPE TODAY!

Color	Price Per Quart
BLACK	\$3.95
GREEN (Brewster-Dark or Jewel-Light)	3.95
BLUE (Washington-Dark or Monticello-Light)	3.95
GRAY	3.95
RED or MAROON	3.95

Order one quart or more today! SEND NO MONEY! Mail penny postcard. Then pay your mailman for WYPE plus postal charges. Or, if you send money with order, WE pay postage. See your dealer or order direct.

WYPE CORP.

Dept. 49-M, 2214 Dolman St.

ST. LOUIS, MO.

ONE QUART DOES ENTIRE JOB! DRIES TO GLISTENING PROFESSIONAL FINISH!

WYPE is a new Miracle Enamel for Autos. It is NOT a wax or polish but a hard high lustre ENAMEL finish! With WYPE, ANYONE can do a beautiful job! Order a quart to paint your car or to get started in this BIG-MONEY Business!

Learn Public Speaking

Learn theory and fundamentals at home—in spare time. Then acquire actual experience and practice. Send for FREE booklet "Power of Effective Speech."

North American School, Dept. 1358
1315 S. Michigan Ave., Chicago 5, Illinois

SAY YOU SAW IT IN POPULAR MECHANICS

IS YOUR CAR CRAWLING LIKE A TURTLE?



If your car is listless . . . has no pep and power . . . do as race drivers do—install a set of quick-seating Burd "Graf-Flox" Piston Rings. You'll save on gas and oil, too!

Send today for free, handy booklets for car-owners. Write name and address in margin, clip and mail ad today.

BURD PISTON RING CO., DEPT. PM, ROCKFORD, ILL.



WANTED

DISTRICT PURCHASING AGENTS

No experience or money required. Exceptional opportunity for those who want to establish themselves in a steady, year 'round, well paying business.

For details: Write

PURCHASING MANAGER, DEPT. C

2719 LAWRENCE AVE.

CHICAGO 25, ILL.

ARTIFICIAL ARMS

WRITE FOR FREE BOOK showing how CARNES ARTIFICIAL arms have PUT THOUSANDS BACK ON THE PAYROLL. Every appliance made to fit individual amputation. World-wide recognition of merit since 1904. BOOK SENT FREE—no obligation, send for it now.

CARNES ARTIFICIAL LIMB CORP.

Dealers and Representatives Everywhere
906 East 12th Dept. B Kansas City 6, Mo.



NOW READY! Floyd Clymer's Newest and Best Motor

Scrapbook of Historical Cars . . . No. 4 Illustrates, describes 200 early cars, motorcycles. Entirely different from books 1, 2, 3 (also available), \$1.50 each postpaid; \$2.50 for De Luxe edition.



CLYMER

Dept. A-11, 2125 W. Pico
Los Angeles 6, Calif.



COMB-A-TRIM The New Quick Trimmer

Something New! Trim your hair without any experience. It's easy! The excess hair comes off smoothly and easily by just pulling trimmer through hair like an ordinary comb. Save on hair-cut bills. . . . Trim your own hair or the whole family's. Send 59c and your Comb-A-Trim will be sent at once, postpaid.

SPECIAL OFFER Send \$1.00 for 2 Comb-A-Trim Trims. Save 18c **2 for \$1** 5 Extra Blades (Year's Supply) **25c**
COMB-A-TRIM CO., CAREW TOWER, Dept. R-23, Cincinnati, Ohio

DO ANY JOB .. EASIER .. QUICKER
MAKE MORE MONEY *in the*
BIG OPPORTUNITY
FIELDS

Here's the Help You Need
For Best Paying Jobs
Right NOW!

FREE TRIAL
IN YOUR OWN HOME

Used by Army, Navy, Other Government
 Depts., 200 Schools and Industrial Firms.

SEND NO MONEY
 Select the Books
YOU Need Now!
 We Ship **C.O.D.**
 Anywhere in U. S.
 and Will Refund
 Amount Paid if
 Not Satisfactory.

Do it now! Get the better pay that goes to men with specialized knowledge. Get into one of these big opportunity fields. Big money and many other advantages await you if you prepare now. Here is the help you need—EASY—QUICK—AT LOW COST. Thousands of men have already used these famous books. Beginners and experienced men alike have doubled and tripled their earnings with this help. You too, can now get the special knowledge you need for top pay, better jobs, or a business of your own. This is your **GOLDEN OPPORTUNITY.**

AIR CONDITIONING

Big air conditioning boom interrupted by war now bigger than ever and alive with new opportunities! Get this non-technical book by international authority and be ready for your share of millions to be spent. Covers whole field. 450 pages. Illustrated. \$4.00.

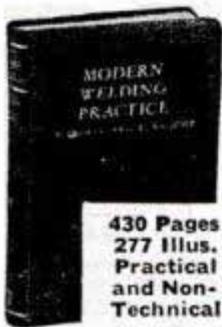

MODERN WELDING PRACTICE

Newest book on all types of welding and heat treatment of metals. Written by recognized specialists in training men for production jobs. Practical and Non-Technical.

430 Pages
 277 Illus.
 Practical and Non-Technical

Covers everything you need to know. Prepare for best pay jobs now. Price \$4.00.

SHEET METAL LAYOUT

Makes sheet metal layout work so simple that anyone can learn. Get this new instructor and get into the easiest, cleanest and best paying part of all sheet metal work. 143 jobs worked out in drawings and carefully explained. Gives standard for all sheet metal fittings. \$3.50.

HOUSE WIRING
LATEST EDITION

Get this sixth edition of this standard and practical electrical wiring book. It gives complete practical instruction on every phase of house wiring in one handy volume. Goes further than most books on subject. Hand-book style. Gives National Electric Code, 400 pages, 669 illustrations. Electrical work will reach a new high with millions of new homes to be built. Get started now. \$3.00.

DYKE'S FAMOUS CARBURETOR BOOK

This famous book has been the standard guide in the best paying auto work for a generation. It has helped thousands of men make money. New edition covers engine tune-up, compression, ignition, carburetion, fuel pump valves, etc. Use this book to specialize in this big field. 244 pages, 549 illustrations. \$3.50.

AUTO BODY and FENDER REPAIR

Owners will spend big money to keep their good older cars looking like the new ones coming out. This is a practical money-making guide, ideal for shop owners and every man who wants a share of the millions to be spent in keeping old cars looking new. Tells how to get a good job or start business of your own with small capital. 325 pages, 232 illustrations. \$3.50.

15 Million Refrigerators
 Need Service and Repairs

REFRIGERATION—Book of the Hour!
Biggest Opportunity in Many Years!

NEW PRINTING—ALMOST 1000 PAGES

408 Pictures—17 Diagrams in Colors Makes All Refrigerator Service Maintenance, Repairs Simple as A. B. C.

Thousands of Refrigerators need repairs! Owners will pay big for competent service which will be needed more and more. Get **MODERN GAS AND ELECTRIC REFRIGERATION**, the non-technical guide to all types of refrigerators and get your share of this new profit. Get a job or start your own service business. This book will help you make money anywhere. Price \$5.00.

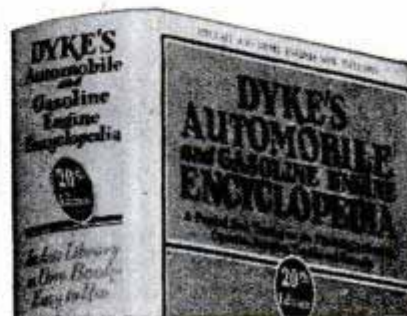

BIG 20th EDITION
Leading Auto Book for Over 36 Years

World's Greatest AUTO BOOK

New Material on Transmissions, Trucks, Tractors, Diesels, Aircraft and Auto Engines

Now with millions of cars needing repairs and thousands of men needed to do the work, you need the famous DYKE Auto Book more than ever before. This big 20th edition covers all principles, construction, repair, adjustments, testing, troubles and remedies of all cars. Over a half million copies of 20 editions of Dyke's have been sold. Gives specifications of old and newer cars. World's biggest book value. \$7.00. This big book, a complete auto library in one volume, has 1483 pages—4600 illustrations and diagrams—weighs 6 lbs.—equal to 4 ordinary books.

BAILEY'S HANDBOOK
For Engineers and Firemen

World famous handbook of universal questions and answers for Stationary, Marine and DIESEL engineers and firemen. Prepares for any license examination. This is the one book that men should have if they want to reach the top in installation, maintenance and operation of Diesel and steam plants. Pocket size, \$2.00.

Goodheart-Willcox Co., Inc.
 2099 S. Michigan Ave., Dept. 19, Chicago 16, Ill.

SEND NO MONEY! Mail Coupon

GOODHEART-WILCOX CO.,

2099 S. Michigan Ave., Dept. 19, Chicago 16, Ill.

Send books checked, C.O.D. I will pay postman, plus few cents charges. If not satisfactory I will return books in 5 days and you will refund money paid. (Outside U.S. or possessions remit with order.)

- | | | | |
|---|--------|---|--------|
| <input type="checkbox"/> Gas & Electric Refrigeration | \$5.00 | <input type="checkbox"/> Air Conditioning | \$4.00 |
| <input type="checkbox"/> Dyke's Auto Book | \$7.00 | <input type="checkbox"/> Engineers Handbook | \$2.00 |
| <input type="checkbox"/> Dyke's Carburetor Book | \$3.50 | <input type="checkbox"/> Body and Fender Repair | \$3.50 |
| <input type="checkbox"/> Modern Welding | \$4.00 | <input type="checkbox"/> Shop Math. (2 vols.) | \$3.00 |
| <input type="checkbox"/> Airplane Welding | \$3.50 | <input type="checkbox"/> House Wiring | \$3.00 |
| <input type="checkbox"/> Sheet Metal Layout | \$3.50 | <input type="checkbox"/> A.C. Power Wiring | \$4.00 |
| | | <input type="checkbox"/> D.C. Power Wiring | \$4.00 |

If remittance accompanies order we will pay all postage charges under same return privilege.

Name _____
 Address _____
 City _____ State _____

VETERANS *Learn* WATCHMAKING

A Lifetime Profession

Regardless of Conditions, Age, Sex, or Physical Limitations
Veterans—Civilians!
Your Opportunity—
LEARN WATCHMAKING



Lift yourself from a futureless job into a position paying better than your present work. Fit yourself for the job that will permit you to establish your own shop, or be employed in a pleasant environment.

Watch Repairing—Jewelry—Engraving will always be in ever greater demand. Our graduates wanted everywhere. Dignified positions \$50-\$75-\$100 per week. Veterans write today for latest FREE enrollment requirements.

Kansas City School of Watchmaking
Largest Horological School in America
617-621 Wyandotte St. Kansas City 6, Mo.

INVENTORS

The inventor who believes he has a new and useful invention, and finds himself in need of advice, should consult a competent registered patent attorney.

The question as to whether a subject matter is patentable can be substantially determined by a search of the United States Patent records.

Without obligation, write us for information as to what steps an inventor should take to secure a Patent.

RANDOLPH & BEAVERS

Registered Patent Attorneys

11-D Columbian Bldg., Washington 1, D. C.

RANDOLPH & BEAVERS

11-D Columbian Bldg., Washington 1, D. C.

Please send me full information on how to secure Patents & Trademarks.

Name.....

Street.....

City.....State.....

BE A GOVERNMENT LICENSED AIRPLANE AND ENGINE MECHANIC

Train Now at **LINCOLN**



EARN BIG PAY IN AVIATION

Our new enlarged school now offers these courses:
MASTER AVIATION MECHANICS, CAA Approved 1 Yr. Airplane & Engine Mechanics Course, **REFRESHER AIRPLANE & ENGINE MECHANICS**. Designed for veterans with aviation mechanics experience. Either course is available to veterans under the G. I. Bill of Rights. Write today for complete information.

LINCOLN AVIATION INSTITUTE

UNION AIR TERMINAL DEPT. 11 LINCOLN, NEBRASKA

• PROFESSIONAL TRAINING IN A MINIMUM OF TIME

RADIO BROADCAST & TELEVISION ENGINEERING

An Accredited Technical Institute; preparing high school graduates for technical careers. CREI graduates are in demand—in every branch of radio. Classes start every Monday. Comprehensive courses in Radio-Electronics Engineering, Broadcast and Television Engineering or Servicing; 2,100 hours classroom and laboratory study.

Write for FREE booklet, "Radio Engineering as a Career."

CAPITOL RADIO ENGINEERING INSTITUTE

Dept. P-11, 16th & Park Road, N.W., Washington 10, D. C.

PATENTS

TRADE MARKS • COPYRIGHTS

• **Saulsbury, Russell & Squire** •

Registered Patent Attorneys

55 WEST 42nd ST., NEW YORK 18 • WAtkins 9-9194

PATENTS

AND TRADE MARKS

C. A. SNOW & CO.

REGISTERED PATENT ATTORNEYS

WRITE FOR INFORMATION TO

428 SNOW BUILDING, WASHINGTON 1, D. C.

BROKEN JEWELRY WANTED

All kinds. Highest prices paid for jewelry, rings, spectacles, gold teeth, diamonds, broken and usable watches, etc. Cash mailed promptly. Write for FREE shipping container.

LOWE'S, Dept. PM, Holland Bldg., St. Louis 1, Missouri

PATENTS

"Proof of Invention"
Folder mailed without obligation.

E. E. VROOMAN, Registered Patent Atty.

871 Woodward Building, Washington 5, D.C.

INVENTORS

If you wish to protect your invention, you should take steps to protect it by a U. S. Patent. Write me for "Record of Invention" Form.

CARL MILLER

REGISTERED PATENT ATTORNEY

Woolworth Bldg., 35th Floor, Dept. 117A, New York City
Please send me "Record of Invention" form.

NAME.....

ADDRESS.....



Now ANY **AUTO REPAIR JOB** Can Be "Duck Soup" For You!

**MoToR's New AUTO REPAIR MANUAL
 Shows You How to Service and Repair
 ANY Part of ANY Car!**

**FREE 7-DAY
 OFFER!**

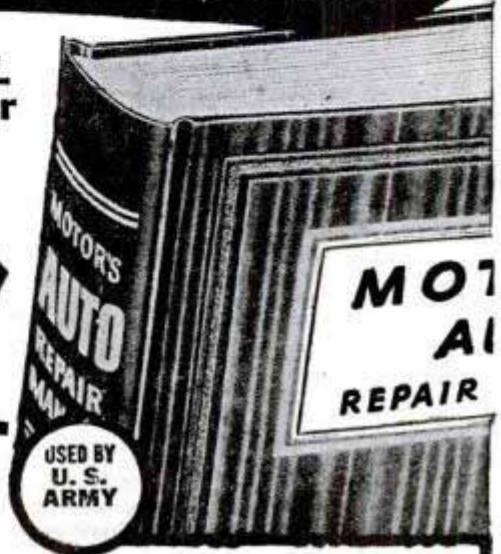

NOW you can "polish off" the **HARDEST** jobs the **EASIEST** way! MoToR's **AUTO REPAIR MANUAL** is ready to show you how to repair anything from carburetor to rear end—with the *least* possible amount of time and effort!

Suppose plain-talking car engineers from every auto plant in America got together and showed you all the things you needed to know about repairing and servicing the cars they had designed and manufactured! That's really what you get in this big manual! Right at your fingertips, the main "dope"

from *150 Official Factory Shop Manuals*, covering every make car built since 1935!

Easy to use, too! Quick-index leads you to right page in jiffy! Just follow simple instructions step-by-step.

SEE HOW MUCH YOU GET!

856 pages, 8½x11 inches, bound in sturdy covers. 200,000 service, repair, adjustment, replacement, tune-up facts on all makes and models, 1935 through 1946. More than 1000 cut-away photos, diagrams, drawings show you exactly **WHAT** to do and **HOW** to do it. Used by U. S. Army, trade and technical schools everywhere, thousands of auto servicemen.

Now **YOU**—without cost—can see for yourself what a wonderbook MoToR's Auto Repair Manual really is. **TRY** it—**FREE** for 7 days! Learn first-hand how it can pay for itself the first few times you use it.

SEND NO MONEY 7-Day Free Examination

Just mail coupon at right, without money! When the postman brings your book, pay him nothing. First make it show you what it's got! Unless you agree this is the greatest time-saver and work-saver you've ever seen—return book in 7 days and pay nothing. Mail coupon today! Address: MoToR Book Dept., Desk 1N, 572 Madison Ave., New York 22, N. Y.

Published by MoToR, The Leading Automotive Business Magazine. MoToR's manuals assure high standards of repairwork.

Covers All These Makes!

- | | |
|-----------|------------|
| American | Lincoln |
| Bantam | Lincoln |
| Auburn | Zephyr |
| Austin | Mercury |
| Buick | Nash |
| Cadillac | Overland |
| Chevrolet | Oldsmobile |
| Chrysler | Packard |
| Cord | Pierce |
| Crosley | Arrow |
| De Soto | Plymouth |
| Dodge | Pontiac |
| Ford | Reo |
| Graham | Studebaker |
| Hudson | Terraplane |
| Hupmobile | Willys |
| Lafayette | |
| La Salle | |

**USED BY
 U. S.
 ARMY**

Clear, Pictured Facts on Every Job on Every Car Built Since 1935!

Nearly 200,000 service and repair facts on all 31 makes. 856 big pages; including 50 pages of carburetor text, charts, illustrations, covering all models. Over 500 charts, tables; Tune-up Chart; Valve Measurements; Compression Pressure; Torque Wrench Reading; Starting Motor; Engine Clearances; Generator; Clutch & Brake Specifications; Front End Measurements, etc., Engines; Electric, Fuel, Cooling, Lubricating Systems; Transmissions; Universals; Front Ends; Wheels; Rear Ends, etc.

Same FREE 7-Day Offer Applies on MoToR's TRUCK REPAIR MANUAL

For mechanics, truck specialists, service stations, fleet owners. Covers **EVERY** job on **EVERY** truck made since 1936! 1400 pictures, 952 pages, 300,000 facts. Used by Armed Forces.

All types Gasoline Engines, Diesels, Hesselman, Fuel Systems, Governors, Lubrication Systems, Ignition Systems, Starters, Generators, Clutches, Transmissions, Axles, Torque Dividers, Transfer Cases, Brakes, Steering, etc.

ALSO SERVICES buses, farm and industrial tractors, contractor and road building equipment, stationary power machinery, etc. (on all parts described in Manual.) Check box in coupon at right.



MAIL COUPON NOW FOR 7-DAY FREE TRIAL

MoToR Book Dept., Desk 1N, 572 Madison Ave., New York 22, N. Y. Rush to me at once: (check box opposite book you want).

- MoToR's **AUTO REPAIR MANUAL**. If O.K. I will remit \$1 in 7 days, (plus 35c delivery charge), then \$2 monthly for 2 months with a final payment of 95c one month later. (Book's price \$5.95.) Otherwise I will return book postpaid in 7 days. (Foreign price, remit \$8 cash with order.)
- MoToR's **TRUCK REPAIR MANUAL**. (Described at left.) If O.K., I will remit \$2 in 7 days, and \$2 monthly for 3 months, plus 35c delivery charges with final payment (\$8.35 in all). Otherwise I will return book postpaid in 7 days. (Foreign price, remit \$10 cash with order.)

Print Name.....Age.....

Print Address.....

City..... Zone No. State.....
 (if any)

Occupation.....

SAVE 35c! Check here if enclosing full pay. (check, m.o., postal note) WITH coupon. We pay 35c shipping cost. Same 7-day return-refund privilege.

LEARN A TRADE NOW in Sunny CALIFORNIA

- REFRIGERATION, RADIO, ELECTRICAL APPLIANCE Service and Repair... a Combination Course in three opportunity fields.
- PLASTERING—a busy field these days!
- UPHOLSTERING—available, Los Angeles or Chicago.

Here are three career fields offering many opportunities to trained men, either in good paying positions or through a business of your own. GENERAL TRADE SCHOOLS' courses are PRACTICAL, INTENSIVE. Instructors are master craftsmen who know the practical side of each job.

School hours are concentrated so that time is available for taking part-time employment if desired.

Immediate Enrollment. Courses Approved for Veterans Available for Non-Veterans

MAIL THE COUPON NOW FOR COMPLETE INFORMATION

General Trades Schools
1601 S. Western, Dept. PM-11, Los Angeles 6, Calif.

Please send me FREE information on your courses as checked below:

Refrig., Radio, Elect. Appl. _____ Plastering _____ Upholstering _____

Name _____ Age _____

Street _____

City _____ Zone _____ State _____

Veteran _____ Non-Veteran _____

ELECTRICIANS Get this Great Book **FREE**

Book of 150 Shop Prints, Wiring Diagrams, Full Size 8 1/2" x 11"



For Merely Examining
Coyne's NEW Pay Raising

7 Volume Set APPLIED ELECTRICITY

Here's a brand new set of electrical books to give you the "know how" on all branches of electricity from appliance repairing to D. C. and A. C. equipment, electrical refrigeration, etc. 3,000 subjects, 10,000 facts, latest methods all explained in easy to follow instructions. In order to prove how valuable and Practical this set of electrical books is I'm willing to give you a FREE copy of my book "150 Shop Prints and How to Read Them" just for looking over this set. Written by the Coyne Technical Staff and backed by 47 years' experience, this set has helped many ambitious electrical workers to bigger pay, better jobs & added opportunity.

OFFER LIMITED - ACT NOW! Here's my offer to you - if you act promptly, I'll send you the 7 volume set Applied Practical Electricity for 7 days FREE examination... together with the 150 Shop Print Book. Look the set over 7 days. If you like it send either \$19.75 cash or send \$3.00 after 7 days and \$3.00 per month until \$21 is paid. If you don't want the set, return it and YOU OWE NOTHING. In either event, however, you keep the 150 Shop Print Book absolutely FREE.

SEND NO MONEY! Coupon below is just a request to see the books free and to get my gift book for doing it. ACT—Send coupon Today!

**FREE BOOK
Coupon**



**COYNE ELECTRICAL SCHOOL, Dept. 87-R7
500 SOUTH PAULINA STREET, CHICAGO 12, ILLINOIS**

Send me that 7 volume set APPLIED PRACTICAL ELECTRICITY and your FREE gift of a copy of "150 Shop Prints and How to Read Them". I'll either return the set in 7 days and owe nothing or send you either \$3 in 7 days and \$3 a month until \$21 is paid or \$19.75 cash. Regardless of whether or not I keep the 7 Volume Set the 150 Shop Prints is mine FREE as a Gift.

NAME _____ AGE _____

ADDRESS _____

TOWN _____ ZONE _____ STATE _____

Learn WATCH REPAIRING

From An
Approved School
The Largest of Its Kind

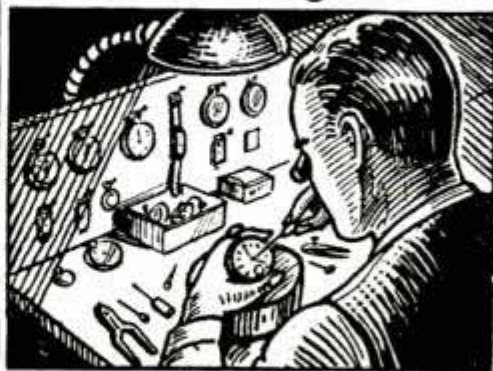

**EARN
WHILE
LEARNING**

Spare Time Home Training
Prepares You For Big Pay

FREE WATCH working tools and watch included as part of our Watch Repairing Course

The demand for skilled watch repairers—men and women—is increasing with the step-up in the manufacture of watches. Now is the time to prepare yourself in this fascinating profession with the aid of our highly practical HOME TRAINING COURSE—in your spare time at home. Start your own business or accept a big pay position.

WRITE TODAY FOR FREE DETAILS
Earn while you learn with an "approved" school.
Get the facts—then judge.

ILLINOIS SCHOOL OF WATCH REPAIRING
2870 Elston Ave., Dept. PM-11 Chicago 18, Illinois

FREE TO ALL WHO ARE D-I-S-S-A-T-I-S-F-I-E-D

Are you dissatisfied with your income, job, progress, recognition, with yourself?

The difference between a Success and Failure is that the Success acts to get what he wants; the Failure just wishes and pities himself. If you are dissatisfied get a FREE copy of the NEW "Advance-You Words" booklet. It gives you words most frequently used by successful, once-dissatisfied men and tells how to make them work for you. It also gives you the AMAZING story of the "TWENTY-FOUR STEPS TO SUCCESS."

**MAIL this coupon today for
your FREE copy.**

PERSONAL PROGRESS INSTITUTE
Information Division 10-11
20 North Wacker Drive, Chicago 6, Illinois

I want my Free copy of "Advance-You" Words booklet.

NAME.....

ADDRESS.....

CITY.....STATE.....

LEARN TO MOUNT BIRDS and ANIMALS



SPORTSMEN • MEN, BOYS -

Here is something **NEW** — something **MARVELOUS**. Act **NOW**.
Learn **TAXIDERM**Y at home. Save your wild-game trophies.

HAVE A HOME MUSEUM

Here is the **GRANDEST HOBBY** in the world for **hunters, anglers, sportsmen**. **DOUBLE** your interest in hunting and fishing. Save your marvelous trophies. Mount **Birds, Animals, Heads, Fish**, all kinds of beautiful specimens, wild or tame. Tan leathers and fine furs. It is grand to be a **TAXIDERMIST**. You become well known and famous.



WILD-GAME NOT NEEDED

Mount common specimens, squirrels, crows, fish, frogs, pigeons. Make useful and humorous groups. A highly interesting hobby. You will be **amazed and delighted**.

TAN SKINS

Learn easily, fine **KROME-TAN METHODS**. Make sole, rawhide, harness leather, and **TAN** skins and furs. Create beautiful rugs. Decorate your home, and **MAKE FINE PROFITS** doing work for others.

CRAFT-TAXIDERM

Y!

Make wild-game and domestic specimens into alluring **CRAFT-ART**, like the lamp shown above. You can devise a vast variety of alluring creations, **Easily learned**. Decorate with mounted specimens, **book-ends, door-stops, hat-racks, match and pen-holders**, and scores of delightful and **USEFUL** home articles and gifts. We teach you so easily, both wild-game and also craft Taxidermy. Investigate **NOW**.

Rush Coupon TODAY!

The beautiful book will go to you by **RETURN MAIL**. Nothing like its strange and amazing art ever seen before. It is **FOR SPORTSMEN and NATURE-LOVERS**, and it is **FREE** if you send the **COUPON NOW**. Hunters, Men, Boys. Mail the coupon this **MINUTE**. You will **WIN**, new interests.

NORTHWESTERN SCHOOL OF TAXIDERM
3378 Elwood Bldg., Omaha 2, Nebr.

FUN • PROFITS

THINK of the fun and joy of mounting and saving your own hunting trophies. Right in your home, will be the prizes of your fine hunting and outing trips. It's simply great!

SPARE-TIME PROFITS

All of your sportsmen friends will be proud of you and your work. **THEY WILL URGE YOU TO MOUNT THEIR SPECIMENS**. They will be delighted to pay you liberally. Many students earn splendid profits while learning. **YOU can now be a Taxidermist, for pleasure and profits.**

300,000 Students

Many of our vast number of students are employed in the **BIGGEST AND FINEST MUSEUMS**, which endorse our school. No higher recommendation can be had in America. **WE CAN TEACH TAXIDERM**Y TO YOU, men, boys, and women. Yes, more than 300,000 are members of this fine school, and endorse it enthusiastically. Here is your opportunity, long awaited. Send the **COUPON** without fail.

GET THE FREE BOOK

This new, strange, unique **FREE BOOK** will open a new world of fine pleasure to you. Write for it **NOW**. **IT TELLS THE WHOLE STORY**. 44 pages, over 100 photos of wild-game, and stories of success that will thrill you. Shoot fewer specimens, double your fun, and help conserve the wild-game.

Send the **COUPON THIS MINUTE**. State your **AGE**.

Send
for
Free
Book

Mail Coupon Now

Northwestern School of Taxidermy,
3378 Elwood Building, Omaha 2, Nebr.

Please Rush the FREEBOOK to Me. I am interested. Please send the **FREE BOOK ON TAXIDERM**Y and tell me about how I can **BECOME A FINE TAXIDERMIST**.

Without obligation on my part, explain how I can **double my interest** and fun in hunting, outdoor life.

Name.....

Address..... Age.....

LINGUAPHONE



is your *Passport*
to the World

In your own home, alone or in a group, you
can now learn to speak

**SPANISH • PORTUGUESE
FRENCH • RUSSIAN**

or any of 25 other languages by the
world-famous

LINGUAPHONE Conversational METHOD

You learn the new language by listening to voices of native teachers. It is amazingly simple; thousands have succeeded. Educators hail Linguaphone as a notable advance in simplifying the mastery of languages. That is why so many Linguaphone Sets are used in schools, colleges, universities, as an aid to *fluent* speaking.

Available to Veterans under
G I BILL OF RIGHTS

SEND FOR FREE BOOK

LINGUAPHONE INSTITUTE
98 RCA BUILDING, NEW YORK 20, N. Y.

LINGUAPHONE INSTITUTE
98 RCA Bldg., New York 20, N. Y.

Send me the FREE Linguaphone Book.

Name

Address..... City.....

Language Interested.....

State if G I.....

SUPER YOUR GREATEST ASSET!

MEMORY

Facts, figures, faces **STICK LIKE BURRS**, are remembered when needed, with new dynamic **SUPERMEMORY** Course. Est. 1938. Send postcard for FREE details.

THOR BOOKS, M-11 Box 1210, Chicago

TODAY'S BIG PAY FIELD . . .

CRIME DETECTION!!!

Now you can earn important money, by learning Crime Detection by methods similar to those taught to, and used by famous G-Men. There's never a dull moment in this uncrowded field, the work is always interesting, and operatives taught by the AMERICAN method always command the best jobs, and get the highest pay.

Trained men always get the best jobs, and the most money. When you enroll with the A.I.C. you get your training from men who have been on the firing line, men who have worked in the F.B.I. — men with extensive experience in government intelligence work — Men who know from actual experience what it is all about. You learn at home. There's no need to give up your present job — you learn while earning.

Thousands of jobs are open for men thoroughly trained in Crime Detection. Jobs in stores, in industry, and in municipal and Federal departments are waiting for capable men — and these jobs all pay well too! Or you can start your own, well paying business!

If you are interested in this BIG PAY FIELD,
write today. There is no obligation.

AMERICAN INSTITUTE OF CRIMINOLOGY

30 North LaSalle Street

Chicago, Illinois

RADIO ENGINEERING, Broadcasting, Television, FM, Servicing, Electronics, Aviation, Marine & Police Radio taught thoroughly. Engineering course equivalent to 3 years' college radio work. Approved Veteran Training. Catalog free.
VALPARAISO TECHNICAL INSTITUTE, Dept. D, Valparaiso, Ind.

WANTED - Ambitious Men

who would like to go to this famous school. Stream-lined courses in Diesel, Diesel Electric, Electricity, Radio Mechanics, Refrigeration, Air Conditioning. Write for FREE catalog.

BAILEY TECHNICAL SCHOOLS ST. LOUIS, MO.
1650 SO. GRAND BLVD.

LEARN MEAT CUTTING EASILY-QUICKLY At Home - In Spare Time



The steady, dependable trade of Meat Cutting taught easily, quickly by improved HOME METHOD. National School, established over 25 years, has organized its famous "Learn By Doing" Classroom, Cutting room and Retail Market training system into sound, practical HOME STUDY form.

Now, by the miracle of this EXTENSION TRAINING you can prepare in Your Spare Time At Home, for a better job, bigger responsibilities or success and security in a store of your own. Remember, **PEOPLE MUST EAT!**

Buying, cutting, percentage, pricing, advertising, selling — a complete meat education. For beginner or men with ex-

perience. Thousands of successful graduates. Send coupon for FREE Bulletin NOW!

MAIL THIS COUPON TODAY FOR FREE BULLETIN

National School of Meat Cutting Div. U87, Toledo 4, Ohio

Send me your FREE Bulletin on Meat Cutting and Meat Merchandising. No obligation. No Salesman will call.

Name

Street.....

City..... State.....

WAR SURPLUS OPTICAL BARGAINS

ASSEMBLE YOUR OWN BINOCULARS!

Complete Optics! Complete Metal Parts!
Save More Than 1/2 Regular Cost

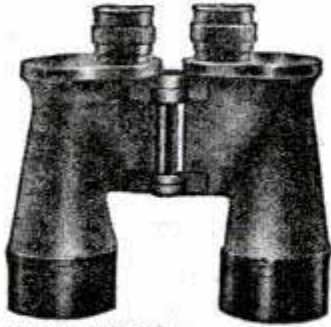

GOVERNMENT'S 7X 50 BINOCULARS

Complete Optics, new and ready for assembly. We supply full instructions. Limit—1 Set of Metal Parts and 1 Set of Optics to a customer.

METAL PARTS—Set includes all Metal Parts—completely finished—for assembly of 7X 50 Binoculars. No machining required. Bodies have been factory hinged and covered. A sturdy Binocular Carrying Case is optional with each set of Metal Parts.

Stock #842-H.....\$39.40 Postpaid, plus \$4.80 for Case—Total \$44.20

OPTICS—Set includes all Lenses and Prisms you need for assembling 7X 50 Binoculars. These are in excellent condition—perfect or near-perfect—and have new low reflection coating.

Stock #5102-H.....\$25.00 Postpaid

NOTICE! If you buy both Binocular Optics and Binocular Metal Parts, add 20% Federal Excise Tax to above prices.

ARMY'S 6X 30 BINOCULARS

No Carrying Case with any Sets shown below. (None yet available in Surplus Market.) M-13A1 sets are waterproof model. M-3 sets are not waterproof. Limit—1 Set to a Customer on all Sets shown below.

COMPLETE OPTICS & METAL PARTS—Model M-13A1, 6X 30 Binoculars. Everything you need—ready for assembly. When finished will look like a regular factory job costing \$102 to \$120. The Optics are new, in perfect or near-perfect condition. Have new low reflection coating. Metal Parts are new and perfect, all completely finished. No machining required. Bodies factory hinged and covered. Complete assembly instructions included.

Stock #830-H.....\$40.00 Postpaid plus \$8.00 tax—Total—\$48.00

COMPLETE OPTICS & METAL PARTS—Model M-3, 6X 30 Binoculars. The Optics in this set are new, perfect or near-perfect. Prisms have new low reflection coating. Factory mounted Eye Piece and Objective Assemblies not coated. Metal Parts are perfect, new, ready for assembly. When finished, this will look like a regular factory job, except a name has been filed off a cover plate. No machining required. Bodies factory hinged and covered.

Stock #831-H.....\$35.00 Postpaid, plus \$7.00 Tax—Total—\$42.00

METAL PARTS ONLY—Model M-13A1, 6X 30 Binoculars. No Optics. Same Metal Parts as described for Stock #830-H.

Stock #832-H 6X 30 Metal Parts.....\$25.00 Postpaid

OPTICS FOR 6X 30 BINOCULARS (No Metal Parts). Perfect, and low reflection coated.

Stock #5130-H.....\$15.00 Postpaid

SAME OPTICS AS ABOVE (6X 30), Coated—but slight seconds.

Stock #5124-H.....\$12.75 Postpaid

If you buy both the Binocular Optics and the Binocular Metal Parts, your purchase becomes subject to 20% Federal Excise Tax. Be sure to add amount covering tax to your remittance or your order cannot be filled.

Optics and Metal Parts are Available for Monoculars (1/2 a Binocular). For Complete Details, Write for Bulletin #14-H

\$15.00 BUYS A \$500.00 TELESCOPE WITH BIG 3" OBJECTIVE

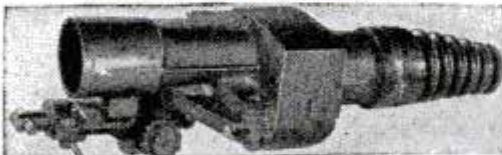

3 power instrument, brand new with plastic Optics and fixed focus. 23" long. Wt. 31 lbs. Wide field of view.

Stock #929-H.....\$15.00 f.o.b. Chicago, Ill.

(Shipping Wt. about 70 lbs.)

35 MM. KODACHROME PROJECTING LENS SET—Consists of Achromatic Lens for projecting, plus a Condensing Lens and piece of Heat Absorbing Glass with directions.

Stock #4025-H.....\$1.95 Postpaid

SATISFACTION GUARANTEED

EDMUND SALVAGE CO.,

NEVER HAS THERE BEEN SUCH A SENSATIONAL BARGAIN AS THIS!

BUBBLE SEXTANT—TYPE A-10

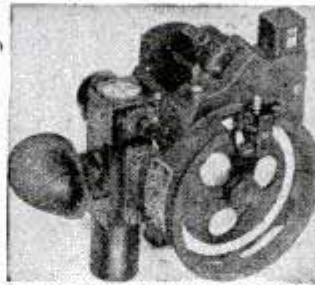

These Army Air Forces Bubble Sextants cost the Govt. about \$125.00 each. A real bargain at our price of \$12.50! Included with Bubble Sextant shipment is wooden Carrying Case, 5 spare waxed paper discs, flashlight with rheostat for night use (uses ordinary flashlight cells—not furnished) aux. 2-power Galilean Telescope, Allen wrench, 1 spare marking point. War-time used, but where necessary completely repaired, collimated and put in good working order.

If not satisfied that Sextant is exactly as represented, return within 10 days and money will be refunded. Full directions for use accompany each shipment.

Stock #924-H.....\$12.50 Postpaid

Same SEXTANT as above, but new and with Automatic Electric Averaging Device and illuminated Averaging Disc for nighttime use. Govt. cost \$217. We have checked Bubble and Collimation and guarantee perfect working order.

Stock #933-H.....\$22.50 Postpaid

CONDENSING LENSES—Seconds, but suitable for Enlargers and Spotlights.

Stock #1061-H, 6 1/2" dia., 9" F.L. \$2.50 Postpaid

Stock #1082-H, 4 1/2" dia., 6 1/2" F.L. 70c Postpaid

We have a Limited Quantity of Condensing Lenses—seconds—ranging from 4 1/2" to 8 1/2" in dia. with various focal lengths. Send for Free Bulletin titled "MISCELLANEOUS CONDENSING LENSES—H."

POLARIZING VARIABLE DENSITY ATTACHMENT FOR BINOCULARS

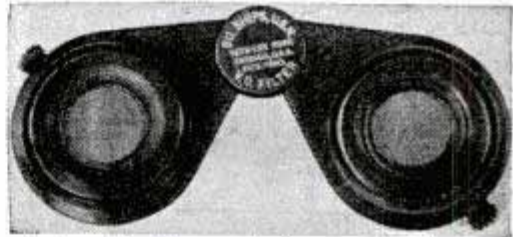

An amazingly effective unit for controlling amount of light reaching your eyes. Cuts down glare in sky and over-water observations. Easily snapped on and off over the eye cups of American-made 7X50 Binoculars. Govt. cost \$8.30 each.

Stock #20,000-H.....\$2.00 Postpaid

Above Polarizing Attachment also adaptable to Govt. 6X30 Binoculars with substitution of special Eye-cups.

Stock #20,010-H, 6X30 Eye-cups.....75c pr. Postpaid



MOUNTED PROJECTING LENS SYSTEM

F.L. 91.44 mm. (Just right for 35 mm. Projectors). Speed of F 1.9. Outside dia. of mount at one end 60 mm. Length of mount 64 mm.

Stock #4033-H.....\$3.00 Postpaid

MOUNT FOR ABOVE PROJECTING LENS SYSTEM

Stock #715-H.....\$1.50 Postpaid

LENS CLEANING TISSUE—1st quality, sheet size 11" x 7 1/2". Made to Govt. specs. Won't dust. Free of abrasives and lint.

Stock #721-H, 500 sheets.....\$1.00 Postpaid

SCHMIDT OPTICAL SYSTEM, Black plastic body, size 3-15/16" by 5 1/2", F.L. 2.4" with amazing speed of F.0.9. Used in Navy's Infra-Red Sniperscope and Signaling Units. Govt. cost \$134. Limit—1 to a customer.

Stock #720-H.....\$6.00 Postpaid

AIR FORCES GUN SIGHT—With Polarizing Variable Density Attachment. (Polarizing attachment alone is worth many times the price of entire unit.)

Stock #908-H.....\$5.00 Postpaid

Same Unit Without Polarizing Attachment

Stock #916-H.....\$2.50 Postpaid

We have literally millions of war surplus lenses and prisms for sale at bargain prices. Write for Catalog "H"—Sent Free!

Order by Stock No.

P. O. Audubon, New Jersey

Increasing your hold on your job and giving yourself a chance for advancement

Few men deliberately plan to work persistently on self-improvement. If progress comes naturally, they're happy; if it doesn't, they worry or ignore the situation. Yet it is possible to pay attention to self-improvement with considerable hope of success. A noticeable degree of advancement is practically assured any one who will make an intelligent and persistent effort. Thousands of men have proved this for themselves, with:



The Croft Library of Practical Electricity

The Croft Library is a complete electrical educator. It is founded on practice—on 20 years of shirt-sleeve experience—on work as it is actually done. It is jammed from cover to cover with the kind of hard-headed facts you want. Written so that the beginner can easily understand it, yet so sound, so thorough, that it is the daily guide of 50,000 highly paid electrical workers and engineers. Croft tells you the things you need to know about motors, generators, armatures, commutators, transformers, circuits, switchboards, distribution systems—electrical machinery of every type—wiring for light and power—wiring of finished buildings—underwriters and municipal requirements—illumination in its every phase—the most improved methods of lighting lamps—and lamp effects, etc.—how to do a complete job, from planning it, to completion.

No money down—easy payments

Fill in and mail the coupon attached and we will send you the entire set of seven volumes for ten days' examination on approval. We take all the risk—you assume no obligation. If you decide to keep the books, send \$3.50 in ten days and the balance at the rate of \$4.00 a month. Send the coupon NOW and see the books for yourself.

McGRAW-HILL BOOK CO., 330 W. 42nd St., New York 18, N. Y.
Send me for ten days' examination on approval the Croft Library of Practical Electricity, 7 vols. If satisfactory I will send you \$3.50 in 10 days and \$4.00 monthly until the price of \$19.50 is paid. If not wanted, I will return the books postpaid. (To insure prompt shipment write plainly and fill in all lines.)

Name _____
Home Address _____
City and State _____
Company _____
Position _____

PM-11-47

MACHINE SHOP MEN

Needed Now!

Learn to set up and run ANY kind of machine; MAKE MORE MONEY NOW by learning quickly HOW TO DO THINGS which usually take years of study and practice. The demand for SKILLED men offers excellent opportunities for men with "know how."

Bigger Pay Don't miss this chance to qualify for promotion, don't miss this Big Opportunity which is yours almost for the asking. Eight Big Books, 14th Edition, chockful of important mechanical facts told simply and clearly. Over 3000 pages, nearly 3000 illustrations cover every subject fully, including Tool Making, Pattern Making, Foundry Work, Mechanical Drawing, Forging, Machine Shop Practice and Management, and hundreds of other subjects. A big help to G. I. trainees and other ambitious men.

8 BIG BOOKS ON APPROVAL

With them we send a Big Binder of nearly 900 pages with 293 shop tickets and over 1300 illustrations. These show, step by step, how to set up and run almost any kind of job and are in addition to the 8 books. Note their great MONEY MAKING value, then, if you want to keep them, pay on the easiest kind of payments. A year's consulting privileges with our engineers now given with these books without extra charge.

American Technical Society, Vocational Publishers since 1898

American Technical Society, Dept. 5819, Drexel at 58th St., Chicago 37
You may send me the 8 big books and binder of shop tickets on approval. I will pay the delivery charges only, unless I decide to keep them in which case I will send \$2.00 in ten days and \$3.00 per month until the total price of only \$34.80 is paid. If I return them in 10 days I will owe you nothing. You also agree to send me a certificate entitling me to consulting privileges with your experts for one year without extra charge.

Name _____
Address _____
Please attach a letter stating age, occupation, employer's name and address and name and address of at least one business man as reference. Men in service, also please give home address.

10,000 HELPS TO BE YOUR OWN BOSS IN THIS BIG BOOK!



IF IT'S RESULTS YOU WANT—GET ACTION QUICKLY WITH THESE PRACTICAL IDEAS

Never before has a more helpful book been printed for those planning a business of their own. Gathered in this large illustrated volume are the formulas, recipes, facts and secrets that have contributed so largely to America's great industrial progress. Capitalize on this information for making most any conceivable product without experience, special equipment or previous knowledge of chemistry or manufacturing. The experts who compiled this book are authorities, and present this information in simple, understandable language. They also give you wholesale supply sources for needed materials, short cuts and methods for the most profitable results.

START AT HOME—Expand out of profits.

Hundreds of good paying businesses have been built on a product made from a simple recipe. Choose from any of the 102,000 facts and 10,000 formulas of which the following are only a very few: Adhesives, Antifreeze Solutions, Cosmetics, Beverages and Liquors, Candy, Gum, Casein, Celluloid, Ceramics, Cheese, Cleaning Preparations, Concrete, Copper, Cotton, Dentifrices, Depilatories, Dyes, Embalming Fluids, Enameling, Glass, Glazes, Household Formulas, Inks, Insecticides, Iron, Jewelers' Formulas, Lacquers, Laundry Preparations, Leather, Linoleum, Lubricants, Manicure Preparations, Marble (artificial), Metals, Mirrors, Paints and Ointments, Papers, Paper, Perfumes, Photography, Polishes, Powders, Remedies for Man, Beast or Fowl, Rubber Products, Refrigerants, Soaps, Solder and Soldering, Tooth Cements, Transfers, Transparencies, Varnishes and Thousands of others for making all sorts of profitable and practical things.

—BE FREE!

Work when you wish. Avoid clock-punching, forced lay-offs, payroll deductions. Enjoy life. Be independent.

MANY FORTUNES MADE FROM A SINGLE IDEA!

This comprehensive book is an accepted authority by chemists, schools, industry, etc., and is the largest and most comprehensive book of its kind ever issued. Nothing else like it in existence. A single formula has been worth a thousand times this book's cost to countless owners. Crammed with money-making ideas. Invaluable for reference. Ideal for Factory, Home, Farm, Office or Workshop. As necessary as the dictionary and more useful for manufacturers, chemists and salesmen who put up products for profit.

POSTPAID
\$3.98
ANYWHERE IN THE WORLD

\$3.98 U. S. Funds. Postpaid anywhere in the world. (C.O.D. in U.S.A. only). Immediate shipment. Safe Delivery Guaranteed.
ADAMS BROWN COMPANY BOOKS OF APPLIED SCIENCE
Dept. 711, Chestnut Hill 67, Massachusetts, U. S. A.

Now for EVERY WORK SHOP! NEW Invention Electroplates by BRUSH



Easy to Plate CHROMIUM GOLD, SILVER, NICKEL, COPPER . . . For Pleasure and Profit!

If you have a workshop—at home or in business—you need this new Warner Electroplater. At the stroke of an electrified brush, you can electroplate models and projects—you can replating worn articles, faucets, tools, fixtures, silverware, etc. with a durable, sparkling coat of metal . . . Gold, Silver, Chromium, Nickel, Copper or Cadmium. Method is easy, simple, quick. Everything furnished—equipment complete, ready for use. By doing a bit of work for others, your machine can pay for itself within a week. So make your shop complete by getting a Warner Electroplater right away. Send today for FREE SAMPLE and illustrated literature. ACT AT ONCE! Mail Coupon.
WARNER ELECTRIC CO., DEPT. P-2
1512 Jarvis Avenue, Chicago 26, Ill.

FREE Details & Sample!

WARNER ELECTRIC CO., 1512 Jarvis Avenue, Chicago 26, Dept. P-2
Gentlemen: Send Free Sample and Details to:
Name _____
Address _____
City _____ State _____

THESE 5 TRADES ASSURE YOU HIGH PAY • Future Security

- **PLUMBING** Every phase of plumbing Pipe-Cutting and Installations, Completed Installations of entire plumbing systems, Threading, Lead-Wiping, Rough-in Projects on Blueprint reading, Estimating
- **DRAFTING** College-level courses in General Machine and Architectural Drafting, with fundamentals in Drafting Mathematics—all under graduate engineers.
- **SHOE REPAIRING** From simplest repairs on boots and shoes to the finest details of reconditioning and rebuilding, under expert craftsmen.
- **ELECTRICAL** Technical and shop training include Basic Electricity, Residential Wiring, Industrial Wiring, General Testing and Trouble Shooting, and Appliance Repair
- **AUTOMOTIVE & TRACTOR** Applied training on latest model automobiles and tractors, including engine overhaul, transmission and differentials, carburetion, generator and ignition systems, engine tune up, Hydramatic and Vacumatic Transmissions, and general service

"There's Always a Demand for the Man who KNOWS!"

CHOOSE ONE OF THESE 5 LEADING TRADES

Get Out of that Rut... Be a Skilled Tradesman! Have a Lifetime Career... Own Your Own Business and Be Secure in Your Old Age

NOW while Enrollment is still open, send for FREE information.

THE 5 DIVISIONS OF

NATIONAL TRADE SCHOOL

2610 Grand Ave., Kansas City 8, Mo.

- Plumbing Drafting
 Shoe Repairing Electrical
 Automotive & Tractor

NAME _____

ADDRESS _____

CITY _____ STATE _____

VETERAN _____ OCCUPATION _____

Choose One of these 5 Essential Trades

Our complete courses of thorough training prepare you to go right into the field as a Qualified Tradesman at High Pay in only 34 weeks (39 in Shoe Repair). All courses under especially trained instructors with practical experience. 6 Hour Classes 5 Days a Week. Our Employment Department helps you.

VETERANS "Approved for veterans' training by the State Department of Education under Public Law 346."
"Approved for veterans' training by the Veterans Administration under Law 16."

Send Coupon for Free Information Now



LIKE TO WORK WITH YOUR HANDS? THEN GET INTO ELECTRIC APPLIANCE Repair & Service

OPEN YOUR OWN SHOP Be Independent!

Here's a great growing field that's getting bigger every day as more houses are wired for electricity. You can start small—even in your spare time—with the tools we send you. In your basement or garage and **GROW AS BIG AS YOU LIKE**, with NO FEAR OF LOSING YOUR JOB in a depression. Or, you can take a well paid job, to start... as there is a big need for service mechanics. Let's talk it over by mail.

New Book "HOW TO START YOUR OWN BUSINESS"

Sent if you act promptly

This valuable book covers locating your shop, contains drawings of how to build and wire work-benches, where and how to advertise, what to charge, how to hire solicitors, etc. Sent without charge to students who enroll promptly.

Recent University Discoveries prove that one of three major classifications of men are only thoroughly happy when working with their hands. This doesn't mean they don't use their heads, too. But it does mean that nature intended A BIG GROUP of men to be the builders, makers, fixers and servicers of life. If you are in this group—not completely happy in your present work—seeking increased income and handy with tools—A SUGGESTION: Get into electrical appliance service and repair.

LEARN AT HOME In Your Spare Time...

Our practical, thorough course teaches you this interesting, good paying business AT HOME—During Your Spare Time. A Grade School education is all you need. We teach repairing washing machines, vacuum cleaners, electric ranges, lamps, irons, motors, etc., REFRIGERATION and HOUSE WIRING. Our lessons are understandable and easy to grasp. You'll enjoy every minute of them. And you'll enjoy the work itself when you get into it.

I include A BIG KIT of Special APPLIANCE TOOLS at NO EXTRA COST



H. T. Armstrong, General Manager
PACIFIC TRAINING SCHOOL - Dept. P-111
7217 So. Broadway, Los Angeles 3, Calif.
Please send me your FREE BOOKLET:
"Today's Big Opportunity - Appliance Servicing"

NAME _____ AGE _____

ADDRESS _____

CITY _____ STATE _____

MAIL COUPON for FREE BOOKLET



AUTO BOOKS ON APPROVAL



CAN YOU FIX IT?
These wonder books tell step by step HOW to make difficult repairs and adjustments, how to keep a car at maximum efficiency, including latest improvements in car design and operation. Engine troubles and how to correct them well covered.
4 BIG, THICK VOLUMES
Over 2700 Pages, 2000 illustrations, wiring diagrams, etc., including Diesel engines. Beautiful modernistic, washable cloth binding.

SEND NO MONEY. Just mail the coupon for a complete set of 4 Big, Thick Auto Books. 20th Edition. Over 2700 Pages! Whether you are a mechanic or helper, expert or apprentice, auto owner or driver, take immediate advantage of this **FREE EXAMINATION OFFER.**

MAKE GOOD MONEY NOW HOLD A PERMANENT JOB

America wants its automobiles kept in good repair. Men with "know how" are in demand, at big pay. These books will help you get and hold an important job, or give you a chance to go into business for yourself now or later. Any man who half tries to improve himself can learn auto servicing and repairing by this quick reference method. Use the **JIFFY INDEX** to find easily understood answer to any auto problem. These wonder books prepared by eleven of America's great automobile engineers. Many hundreds of valuable illustrations. Send the coupon **TODAY.**

A year's consulting privileges with our engineers now given with these books without extra charge.
Vocational Publishers Since 1898

AMERICAN TECHNICAL SOCIETY, Dept. A819
Drexel Ave. at 58th St., Chicago 37, Ill.

I would like to examine your 4-Volume Set of Auto Books. I will pay the delivery charges only, but if I choose I may return them express collect. If after 10 days' use I prefer to keep them, I will send you \$2 and pay the balance at the rate of only \$3 a month until \$24.80 has been paid. Include consulting service as offered above.

Name _____
Address _____
City _____ State _____
Please attach letter stating age, occupation, employer's name and address and name and address of at least one business man as reference. Men in service, also please give home address.

FREE TO the MAN INTERESTED IN LAW

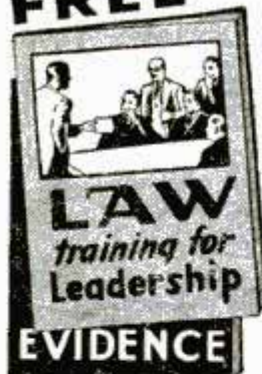

Every question about Law and its value to you is answered in LaSalle's 48-page booklet, "Law Training for Leadership." And the question of *how* you can master Law is answered in the companion booklet, "Evidence"—in which

scores of our students tell how they have advanced through LaSalle Law Training in spare hours at home. Legal training gives you what the business and professional world prizes highly and rewards liberally—a keen, analytical mind, the ability to judge shrewdly, talk convincingly, and act with confidence. LaSalle's "Problem Method" of personalized instruction by lawyer-instructors gives you practice in handling legal problems... you *learn by doing*, not by memorizing rules. We guide you step-by-step, furnish all texts, including remarkable 14-volume Law Library prepared by leading law professors and lawyers, and used as reference in many Law libraries and offices. Degree of LL.B. conferred. Low cost, easy terms. Investigate your opportunities in Law. Mail coupon today for free booklets described—without obligation.

LA SALLE EXTENSION UNIVERSITY A Correspondence Institution

417 S. Dearborn St. Dept. 1164-L Chicago 5, Ill.

Send me "Law Training for Leadership" and "Evidence"—without obligation.

Name _____ Age _____

Street _____

City, Zone & State _____

MAKE MONEY CASTING AT HOME FREE FACTS SENT



Cast thousands of perfect Plaques, Book Ends, Ash Trays, Etc. Plaster, Liquid Marble, Etc. **ENORMOUS PROFITS.** Start in basement or garage. **LITTLE CAPITAL NEEDED. QUICK, EASY, NO PREVIOUS EXPERIENCE NEEDED.** Rubber molds for speed production. **MAKE YOUR OWN.** Sample Kit \$1.00. Canadian \$1.50. Plastic Arts Studio, Route 5, Dept. 29, Muncie, Ind.

Master Watchmaking

The life-long profitable trade of thousands as taught by the Sweazey System.

"FAMED THE WORLD OVER"

CHICAGO SCHOOL OF WATCHMAKING

Founded in 1908 by Thomas B. Sweazey
1608 N. Milwaukee Ave., Dept. 1117 Chicago 47, Ill.

What Every Mason Wants

We have important Masonic books for Blue Lodge, Chapter, Commandery, Scottish Rite, and Shrine.

Our Rituals Are Used the World Over. Send for free catalog of books and rituals for Masons, Odd Fellows, Knights of Pythias, Knights of Columbus, etc.

EZRA A. COOK, Publisher, P. O. Box 796, PN, Chicago 90, Ill.

FREE BARGAIN CATALOG of BOOKS

25,000 books of all publishers listed in our 53rd Annual Bargain Catalog of 320 pages. Old-time favorites—latest "best sellers." Reference, Fiction, Juvenile, History, Scientific, etc. Supplying schools, colleges, libraries and thousands of individual customers. Send postcard today for our new 1948 catalog, "Bargains in Books."

THE BOOK SUPPLY COMPANY, DEPT. 136
564-566 West Monroe St. Chicago 6, Ill.

Learn LANDSCAPE GARDENING

A thorough, interesting, home study course for those who wish to become LANDSCAPERS, GARDENERS, DESIGNERS, etc., for profit or pleasure. Write today for FREE BOOK to

APPROVED NATIONAL LANDSCAPE INSTITUTE
FOR VETERANS Dept. P-01, 310 So. Robertson, Los Angeles 36

STATEMENT OF THE OWNERSHIP, MANAGEMENT, CIRCULATION, ETC., REQUIRED BY THE ACT OF CONGRESS OF AUGUST 24, 1912, AS AMENDED BY THE ACTS OF MARCH 3, 1933, AND JULY 2, 1946, of Popular Mechanics Magazine, published monthly at Chicago, Illinois, for October 1, 1947.

State of Illinois, County of Cook, ss.
Before me, a Notary Public in and for the State and county aforesaid, personally appeared H. H. Windsor, Jr., who, having been duly sworn according to law, deposes and says that he is the Editor of the Popular Mechanics Magazine, and that the following is, to the best of his knowledge and belief, a true statement of the ownership, management and if a daily, weekly, semiweekly or triweekly newspaper, the circulation, etc., of the aforesaid publication for the date shown in the above caption, required by the Act of August 24, 1912, as amended by the acts of March 3, 1933, and July 2, 1946 (section 537, Postal Laws and Regulations), printed on the reverse of this form, to wit: First. That the names and addresses of the publisher, editor, managing editor, and business managers are: Publisher, Popular Mechanics Company, 200 E. Ontario St., Chicago, Ill.; Editor, H. H. Windsor, Jr., 200 E. Ontario St., Chicago, Ill.; Managing Editor, R. M. Grant, 200 E. Ontario St., Chicago, Ill.; Business Manager, J. H. Dunlap, 200 E. Ontario St., Chicago, Ill. Second. That the owner is: (If owned by a corporation its name and address must be stated and also immediately thereunder the names and addresses of stockholders owning or holding one percent or more of total amount of stock. If not owned by a corporation, the names and addresses of the individual owners must be given. If owned by a firm, company, or other unincorporated concern, its name and address, as well as those of each individual member, must be given.) Popular Mechanics Company, 200 E. Ontario St., Chicago, Ill., H. H. Windsor, Jr., 200 E. Ontario St., Chicago, Ill., H. H. Windsor, Jr., Trustee for H. H. Windsor III and Wm. T. Windsor, 200 E. Ontario St., Chicago, Ill. Third. That the known bondholders, mortgagees, and other security holders owning or holding 1 percent or more of total amount of bonds, mortgages, or other securities are: (If there are none, so state.) The Equitable Life Assurance Society of the United States, 29 S. LaSalle St., Chicago, Ill. Fourth. That the two paragraphs next above, giving the names of the owners, stockholders, and security holders, if any, contain not only the list of stockholders and security holders as they appear upon the books of the company but also, in cases where the stockholder or security holder appears upon the books of the company as trustee or in any other fiduciary relation, the name of the person or corporation for whom such trustee is acting, is given; also that the said two paragraphs contain statements embracing affiant's full knowledge and belief as to the circumstances and conditions under which stockholders and security holders who do not appear upon the books of the company as trustees, hold stock and securities in a capacity other than that of a bona fide owner; and this affiant has no reason to believe that any other person, association, or corporation has any interest direct or indirect in the said stock, bonds, or other securities than as so stated by him. Fifth. That the average number of copies of each issue of this publication sold or distributed, through the mails or otherwise, to paid subscribers during the twelve months preceding the date shown above is (not daily publication). (This information is required from daily, weekly, semiweekly, and triweekly newspapers only.) H. H. Windsor, Jr., Editor. Sworn to and subscribed before me this 19th day of September, 1947. N. E. Toole, Notary Public. (My commission expires March 23, 1948.)



**BIG MONEY
INDEPENDENCE**

*A PROFITABLE
LIFETIME
BUSINESS
OF
YOUR OWN!*

LEARN ELECTRICAL APPLIANCE REPAIRING

PREPARE NOW FOR THE FUTURE

If now employed, start your home appliance repair business NOW in your spare time and be set with a business of your own no matter what happens. You don't need elaborate fixtures or expensive equipment to be a successful repairman. Operate from your garage, basement, vacant store, etc. Work as many hours as you wish—the home appliance repairman is his own boss. It is a profitable occupation for on many types of repairs it is not unusual for a repairman to charge on the basis of \$5.00 to \$6.00 per hour. Don't gamble with your future—learn a trade that will always support you. Remember, as long as electrical appliances are used, there will be a need for electrical appliance repairmen.

If you are at all mechanically inclined—can hold and use tools—then you have all of the qualifications required for becoming a big money earning home appliance repairman. It does not matter if you have not had a great deal of schooling or had previous experience along these lines—**WE WILL TEACH YOU.** Age should be no barrier—nor should any minor physical handicap.

New Course Tells All

Profusely illustrated, our new course shows you in simple, easy to understand language and drawings how to make each repair on refrigerators, vacuum cleaners, washing machines, motors, etc. Explains and gives you a working knowledge of electricity, welding, nickel plating, etc. Shows you how to build the power tools you need and how to solicit and keep business coming to you. Not a theory course but an honest to goodness course written by and used by repairmen the country over. Price of course is so low that the savings on your own household appliance repairs will quickly pay for it. Act now! Mail the handy coupon below today.

— — — Read What Our Students Say About Course — — —

I really believe your course the best investment a mechanically minded man can make.—Claude E. Allen, Indianapolis, Ind.

I have received your Course in Appliance Repairing and I must say I am well pleased with same. I am only sorry I did not have said Course some years ago. I have learned so much more through this course I would not part with it.—Charles Schwarz, Hamilton, Ohio.

The Course in Appliance Servicing arrived a few days ago. Want to take out a few minutes of my valuable time to let you know that this is just what I have been looking for ever since I opened up my Fix-It shop. I must admit that you told the truth when you said that it contains quite a bit more information than I bargained for.—P. J. Bretl, Sebring, Ohio.

I am a mechanic for the Western Union Telegraph Co. Three days after receiving the lessons in refrigeration I earned the exact cost of the course.—Henry S. Lee, Washington, D. C.

I work day times at the shipyard and after 4:00 P.M. I operate from my cellar and garage. I average \$10.00 to \$15.00 clear every day.—Walter Hanhy, Brockton, Mass.

GET STARTED TODAY — MAIL THIS COUPON

CHRISTY SUPPLY CO.
2835 N. Central Ave., Dept. D-5103
Chicago 34, Illinois

Please send me free illustrated literature about America's Fastest Growing Industry—**ELECTRICAL APPLIANCE REPAIRING.**

Name.....

Address.....

City.....State.....

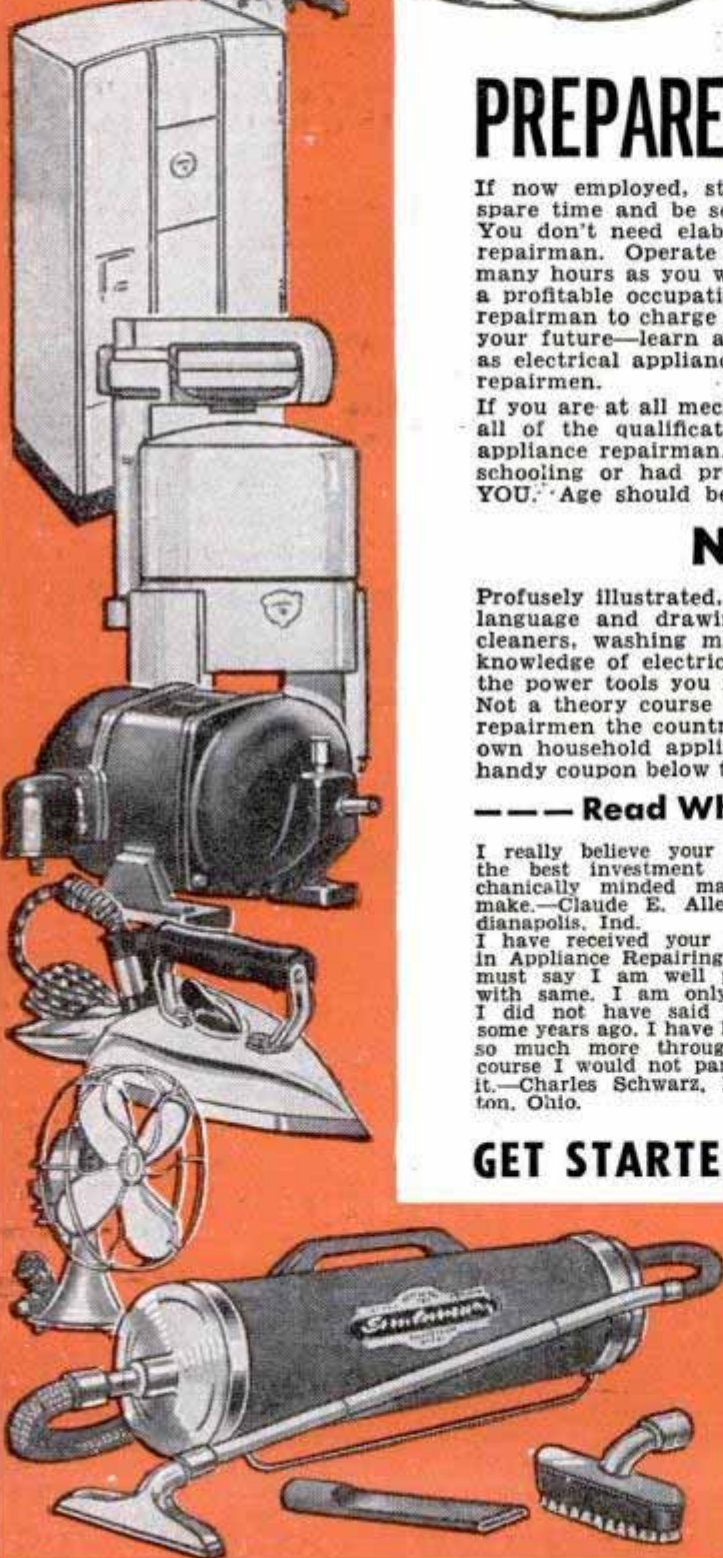

LOW-PRICED LARGE-IMAGE TELEVISION IS HERE!

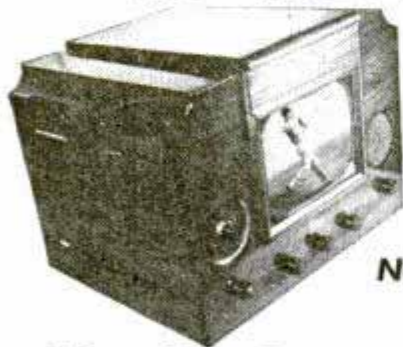

ONLY
\$289.50

Transvision's
New 12" Tube Kit

**Gives You Larger Image Than
Sets Selling at \$500**

● Here is your chance to get low-priced, large-image television with an easy-to-assemble Transvision Television Kit. After only 20 working hours you'll have a ringside seat at fights and ball games with a "big-as-life" television set.

Nothing extra to buy! Price includes specially designed folded dipole antenna, 22 tubes, R. F. unit pre-assembled and pre-tuned for all stations, true F. M. sound (besides 12" picture tube large enough for 60 people!). Even solder is supplied!

If you can read a road map you can put a Transvision kit together! Complete novices have done it by following the simple step-by-step directions. All you need is a screwdriver and soldering iron to finish off the assembly. Factory guarantees high quality, clear, sharp reproduction as good as sets selling at twice the price.

So, join over 12,000 satisfied people who have saved money by putting an easy-to-assemble Transvision Television Kit together. *Beat high-priced finished set costs!* Order today. A \$25 deposit will assure early delivery. (Beautifully turned walnut cabinet available, for those who wish it, at low cost.) (Also a limited number of 7" tube kits still available at \$169.50.)

MAIL THIS FOR FREE DETAILS

Beacon Television, Inc., Dept. PM11-B
143 E. 49th Street, New York 17, N. Y.

Gentlemen:

Please send me more information about Transvision's new easy-to-assemble television kits:

- 12" tube set (75 sq. in. image)
 7" tube set (25 sq. in. image)

Name _____

Address _____

City _____

State _____

TRI-STATE COLLEGE

B. S. Degree in 27 months in Civil, Electrical, Mechanical, Chemical, Aeronautical, Radio Engineering; Bus. Adm'n., Acct' and Sec. Science. Graduates successful. 64th year. Enter Jan., March, June, Sept. Catalog. 4117 College Ave., Angola, Ind.

Learn NOVELTY MANUFACTURING!!



Today's best bet for a business of your own starting with little money is the Casting of Wall Plaques, Book Ends and other Novelties. Large orders and profits waiting. Start in garage or basement, quickly learned. **NO EXPENSIVE MOLDS TO BUY.** Our system has started many on the road to a splendid financial future. Write today for free particulars.

**PLASTEX PRODUCTS, 711 Laguna St.
San Francisco 2, Calif.**

LEARN WATCH REPAIRING



IN YOUR OWN HOME!

THERE'S BIG MONEY and a secure future for YOU in watch repairing even if you're just a beginner. Get **PRACTICAL SELF-TRAINING** through our new and complete book, "MODERN WATCH REPAIRING & ADJUSTING," Easy to understand. Every step in repair, adjustment, construction. Theory, operation. Covers all needed tools and their use. Fully illustrated. Only **\$2.75** Post Paid

C.O.D. plus charges.) **MONEY BACK GUARANTEE**

MODERN TECHNICAL BOOK & TOOL CO.

Dept. MMC, 55 W. 42nd Street, New York 18, N. Y.

JUST OUT! NEW ALL INCLUSIVE TOOL CATALOG

OVER 450 ILLUSTRATIONS. Contains all tools, materials, complete sets for STUDENTS, Watchmakers, Jewelers & Handicrafters, and list of Books. Send 25c - FREE with above book order.

HI-SPEED EQUIPMENT

High Compression Heads—Dual Manifolds
Dual Air Cleaners For V8's

Use these simple conversions to increase horsepower, speed acceleration, and increase top speed of your car. Write today for prices and full information.

SANDEE MUFFLER CO. 7523 S. Western Ave. Los Angeles, Calif.



MUFFLERS

STEELS and ALUMINUMS
with a motorboat tone

SINGLES, Chev, V-8, Plymouth, Steels \$5.50, Aluminum \$6.50. Chry., Olds., Buicks, etc., Steels \$7.50, Aluminum \$8.50. V-8 and MERCURY DUALS, Steel \$17.50, Aluminum \$20.00. Aluminums are guaranteed for life of your car.

DEALERS WANTED

SANDEE MUFFLER CO.
7523 S. WESTERN AVE., LOS ANGELES 44, CALIF.



CARTOON TO SUCCESS!

Learn cartooning from a PROFESSIONAL! Let me show you how to create ORIGINAL cartoons and IDEAS. Send for FREE details about course.

Also **CARTOONIST'S MAGAZINE**—Lessons, plans and hints. Send 25c coin for copy.

CARTOONIST HARTMAN, 2776 California Court, LINCOLN 8, NEB.

INVENTIONS

WANTED AT ONCE

Patented or unpatented inventions, all types needed by manufacturers. Write for free booklet "MARKETING YOUR INVENTION" and Protective Disclosure Form. We have a tremendous list of firms who may pay cash or royalties for good inventions. For full particulars, write today.

NATIONAL INVENTION SERVICE

1404 Mitchell Street, Dept. 5 Oakland 1, Calif.



MAKE MAGIC YOUR HOBBY

BE A MAGICIAN FOR FUN OR PROFIT!

Hurry 25c for a sample copy of "MAGIC IS FUN," magazine that teaches how to do tricks with coins, cards, ropes, etc. PRICE with order, large catalog of magical apparatus. D. Robbins & Co., Dept. M-126, 152 W. 42 St., N. Y. 18, N. Y.

The American Institute of Specialized Watch Repair
270-276 East Building GRAND RAPIDS 6, MICHIGAN

A Fully Accredited School

You can learn the highly fascinating and profitable trade through this Institute, either at home by correspondence... or at the modern school.
Earn While You Learn

Write for
Free
Circular



Learn WATCH REPAIRING

APTITUDE TESTS discover the kind of work or studies best for your success! You get a personal report—a guide for life—more happiness—more prosperity. For men, women, boys and girls. Write for complete facts.

VOCATIONAL COUNSELING INSTITUTE

956 Maccabees Bldg., Detroit 2, Michigan

Welding for Fun and Profit!

See our ad Page 341

DYNAMIC WELDER CO. 13 E. 23rd St., RA, CHICAGO 16, ILL.

WAR SURPLUS AS MADE FOR U. S. NAVY

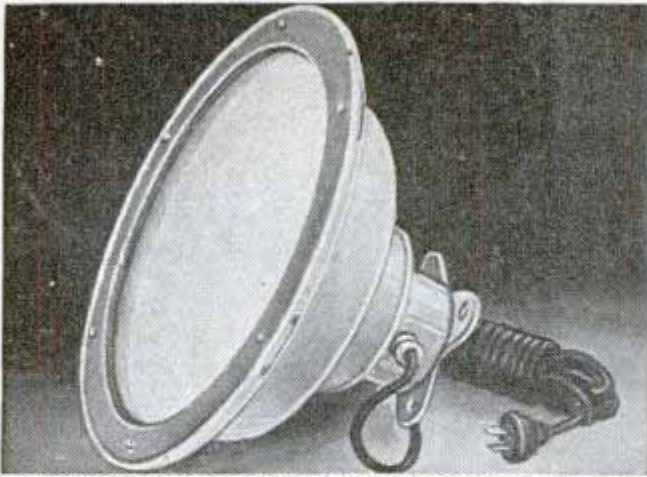

PROTECT YOUR HOME AGAINST BURGLARS AND PROWLERS WITH

ONLY \$15
BRAND NEW
THIS PRICE BELOW FORMER OPA CEILING. ONLY FRACTION OF WHAT IT COST GOVERNMENT.

GIANT FLOOD LIGHT

FOR Industrial Uses of Photography • Athletic Fields • Estates • Farms • Tennis • Churches • Libraries • Gifts • Parking Areas • Ships • Yards • Docks • Beaches • Soft Ball • Foot Ball • Parks • Golf Driving Ranges • Construction Work • Schools • Driveways • Protection.

ILLUMINATES LARGE AREA. Easily installed. lamp bored for quick mounting. Base plate on Has 14 ft. of heavy rubber cord; takes AC or DC current; frosted heavy convex lens; rugged construction; made to Navy specifications.

GIANT (Navy Surplus — Brand New) 14" in diameter; includes 150-watt standard bulb. Wt. 8 lbs. **ONLY \$15**

JUMBO: 12 1/2" Lens; wt. 9 lbs. Built-in swivel to adjust to any position; adjustment for far or near lighting; includes 500-watt bulb. **\$35**

ONLY MONEY BACK GUARANTEE. Terms: Cash with order. Mail order today with money order or check. Shipped Express Charges Collect. **CARNEY'S, 29 Central Ave., Dept. MM-4, Tarrytown, New York**

SUPER GIANT (Navy Surplus — Brand New) 17" in diameter; includes 300-watt standard bulb; wt. **\$25**

15 lbs. **15 1/2" Pyrex Lens; MASTER:** wt. 13 lbs.; built-in swivel to adjust to any position; adjustment for far or near lighting; includes 1500-watt **\$45**

bulb. **ONLY \$45** bulb. Mail order today with money order or check. Shipped Express Charges Collect.

Carry 5000 ELECTRICAL FACTS in Your Pocket!



ELECTRICIANS HANDBOOK

Helps You on the Job!

Handiest electrical reference book on the market. A "library" of 5,000 facts, wiring diagrams, formulas, charts, tables, rules—condensed into one pocket-size, 4 1/2" x 7" volume. Weighs little more than your steel rule. Take it with you on the job—have the answers to daily problems always on hand without figuring. Saves you time and money. Flexible leatherette cover for hard usage.

Use This Book for 7 Days FREE

Try it on the job—use it for 7 days. You must be satisfied that it is worth at least the \$2.75 price to you, or we'll refund in full on return of book. **ACT AT ONCE** and also get Home Wiring Booklet FREE. Send coupon today. **Book Division, COYNE Electrical School 500 S. Paulina St., Dept. 87-R6, Chicago 12, Ill.**

ALSO FREE!

EXTRA! Brand New 24-page booklet—"Residential Wiring Design" FREE for prompt action. You keep it even if Handbook is returned for refund. Rush this coupon.

7 DAY TRIAL—FREE BOOKLET COUPON

Technical Book Division, COYNE Electrical School, Dept. 87-R6 500 S. PAULINA STREET, CHICAGO 12, ILL.

Please send me, postpaid, Electricians Handbook on No-Risk 7-Days' Trial. Include FREE: "Residential Wiring Design". I am enclosing \$2.75. If not satisfied, I may return Electricians Handbook in 7 days for my money back.

NAME _____ Age _____

ADDRESS _____

CITY _____ Zone _____ STATE _____

() Send C.O.D. I'll pay postman \$2.75 plus postage on same offer.



Seagram's illuminated display near Michigan Blvd., Chicago. Said to be one of world's most beautiful neon displays.

Neon Signs for \$\$. \$\$. \$

And I show you how to make plenty of them!



C. S. Blakely Executive Director

Smart men—ambitious, foresighted, practical men—are getting into Neon Sign Construction, fastest growing branch of advertising. Learn a profession, trade and art all in one. Fascinating, exciting, and highly paid. Acme trained men make \$1.50 an hour and up to start. Experienced Neon Experts get \$100, \$150 a week and MORE. At Acme, America's foremost school in neon, you learn Neon Tube Bending; Neon Glass Blowing, Color Gassing, Cold Cathode Lighting, Bombarding, other important branches of the neon art.

People are like Buttons
Says Acme Student Thanes: "People are like buttons. Their value is not apparent until they are attached to something useful." Get attached to Neon. Put your head and hands to maximum use.

JOBS FROM COAST TO COAST

Almost everyday, we get calls for Acme Trained men from coast to coast, like this wire from a big Montana firm saying: "Opening for Neon Tube Bender—union scale plus bonus—prefer married vet." Acme Grads step into big pay jobs or start businesses of their own. Demand is large and growing all the time. Pick your career in the uncrowded field of Neon. Then qualify quickly as an expert, by Acme's intensive 500 hour job-training-plan. In another few weeks, you, too, can be a highly paid Neon Expert. Get complete facts by return mail.

APPROVED FOR G.I. TRAINING

FREE FACTS

Acme Neon Institute
Dept. P-3, 1648 West Van Buren St.
Chicago 12, Ill.

Send at once for FREE folder, "Your Big Opportunity," plus facts about your intensive 500 hour job-training course in Neon Sign Construction.

Name _____

Address _____

City _____ State _____

SAY YOU SAW IT IN POPULAR MECHANICS





A Big Field for Your Future

Auto Body and Fender Rebuilding

Body and Fender Rebuilding is one of the best paid branches of the automobile industry. Good jobs for trained men—fine opportunities for those who want their own business. Now is the best time to get ready—cash in on big money—C.T.I. methods prepare you quickly, easily.

**FREE
BIG ILLUSTRATED
PICTURE BOOKLET**

BEGIN TRAINING AT HOME OR COME DIRECTLY TO SHOPS

Begin your training at home in spare time, finish in our big modern shops—or come directly to shops. Right in your own home you get C.T.I.'s SHOP PROVED HOME STUDY instruction—actual shop experience has gone into the practical lesson assignments. That is why it is easy for mechanically inclined men to learn by our Home Training methods and start on actual Body and Fender work. CONSULTATION AND PLACEMENT SERVICE WHETHER YOU ARE INTERESTED IN WORTHWHILE JOB OR SETTING UP YOUR OWN BUSINESS. OPPORTUNITIES FOR FULL AND PART TIME EARNINGS.

VETERANS have all expenses paid by Government plus monthly subsistence while in school. Just mail coupon, we will handle all details. (LOW TUITION, EASY TERMS if you are not a veteran.)

A NATIONALLY KNOWN INSTITUTION
Chicago Motive Trades Institute, Dept. F-211
(Division Commercial Trades Institute)
1400 W. Greenleaf, Chicago 26, Ill.



Fill Out, Cut Out, Mail Today

FACTS FREE For Men Who Want to Get Ahead

CHICAGO MOTIVE TRADES INSTITUTE, Dept. F-211
(Division Commercial Trades Institute)
1400 W. Greenleaf, Chicago 26, Ill.
Send FREE Illustrated Picture Book and other information about Body and Fender Rebuilding.

Veteran Non Veteran

Name _____
Address _____
City _____ State _____

Learn Welding • Spare Time!

See our ad Page 341

DYNAMIC WELDER CO. 13 E. 23rd St., RB, CHICAGO 16, ILL.



Learn modern watch and clock repairing

At home, spare time. Good field now... security and contentment in future. Start part-time business and **EARN** while you learn. Horology is precision instrument work... a great and growing field, sensational opportunities. Easy self-instruction course. Full price, only \$4.95. **SEND NO MONEY.** Just pay postman, plus C.O.D. postage. Or send \$4.95 with order, we'll ship postpaid. Satisfaction guaranteed or refund. **NELSON-HALL CO.,** 1139 S. Wabash Ave., Dept. LO2, Chicago 5, Ill.

WRITERS WANTED!

Business firms now paying writers \$10 to \$100 for writing letters. Wonderful opportunity for people who like to write. Inexpensive new course teaches you all you need to know and where to get the business. Write today.

C. F. ROEHR

936 Van Houten

Clifton, N. J.



CARTOONING

HAVE FUN! MAKE MONEY! Cash in on your sense of humor AT HOME—BY MAIL. No experience needed to start. Write today FOR FREE TRIAL LESSON and full particulars.
MOON Gag Cartoon School, Dept. B, Fall Creek, Wis.

Giant Astronomical Telescope

100 diameters magnification (10,000 area magnification) Steel main tube 3 inches diameter, 50 inches long. Brass focusing tube. Tripod 6 feet tall. Equatorial mounting. Ready to set up and use. Full power and clear vision guaranteed. Price \$15.00. 25% deposit on C.O.D. orders.

No Export Orders

SUFFOLK SCIENCE SERVICE, Dept. CT, MANORVILLE, N.Y.

LEARN JAZZ FROM JAZZ STARS

TEDDY WILSON
piano
CHARLIE VENTURA
saxophone
OSCAR MOORE
guitar
BOBBY HACKETT
trumpet
HERBIE FIELDS
clarinet

Now America's Jazz Masters Will Teach You at home, by correspondence courses. Send coupon now for information.

WESCO SCHOOL OF MUSIC, INC. pm10
657 High Street, Newark, N. J.

Name _____
Address _____

SAY YOU SAW IT IN POPULAR MECHANICS

Do You Make These Mistakes in English?

MANY persons say "between you and I" instead of "between you and me"—or use "who" for "whom"—or don't know whether to spell certain words with one or two "e's" or "m's" or "r's," or with "ig" or "ei," etc. Mistakes in English reveal lack of education, refinement. Lack of language power prevents you from presenting your thoughts in the strongest way. Real command of English will help you reach ANY goal. Stop making mistakes in spelling, punctuation, pronunciation, grammar. Increase your vocabulary.



Sherwin Cody

WONDERFUL INVENTION

Only 15 minutes a day with Sherwin Cody's new invention—and you can actually SEE your English improve. It teaches by **HABIT**—makes it easier to do the **RIGHT** way. Wonderful self-correcting lessons.

FREE BOOK ON ENGLISH Lack of language power may be costing you friendships, income, every year. See what Mr. Cody can do for you: it costs nothing to find out. Write this very minute for free book, "How You Can Master Good English in 15 Minutes a Day." It will prove a revelation. **WRITE NOW, SHERWIN CODY SCHOOL OF ENGLISH, 511 B & O Bldg., Rochester 4, N. Y.**

LOWEST PRICE IN HISTORY!

Sensationally New **WELDRITE** Electric Welding-Cutting Torch

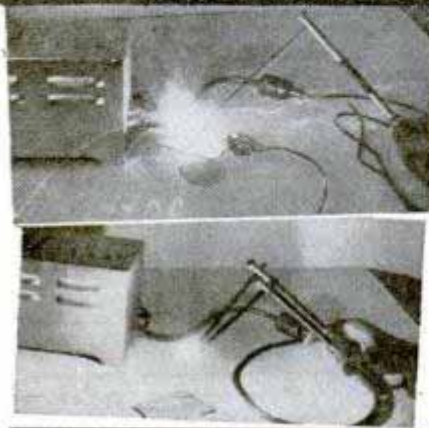

Plugs into any convenient AC-DC Socket
WELDS - BRAZES - CUTS - MELTS - SOLDERS - HEAT TREATS

The **WELDRITE** Torch—tested and proven by countless commercial and amateur users, is now offered direct to you at the amazingly low price of only \$12.00. No Gas—No Gauges—No Spark Lighter needed. Always ready for immediate use—Just plug **WELDRITE** into any 110 AC or DC outlet. Uses standard welding and brazing materials available at all welding supply stores. **WELDRITE** furnished complete with Converter Unit. Single Holder with attached Alligator clip, for Welding metal up to 3/16" thickness, using up to 3/32" rod, and Double Holder with Carbon-Tipped Dual Copper Electrodes for Cutting, Brazing, Heat Treating,

Soldering, etc. Supply of welding materials included free.

Ideal for home workshop. Invaluable for body and fender shops, garages, repair and machine shops, manufacturers, etc. **SEND NO MONEY.** Order your **WELDRITE** Electric Welding-Cutting Torch today. Pay postman \$12 plus postage charges (wt. 4 lbs.) or send \$12 and we pay postage. Either way, if not satisfied, return **WELDRITE** in 5 days, and money will be refunded. California orders please add sales tax.

CALIFORNIA TECHNICAL PRODUCTS COMPANY
8510 Warner Drive • Culver City, California • Dept. A-11

**NOW ONLY
\$12
FULLY GUARANTEED**

A Book That Shows You

3000 ILLUSTRATIONS and DESIGNS OF MECHANICAL MOVEMENTS, DEVICES, CONTRIVANCES & DETAILS!



Every conceivable kind of mechanical motion and work is briefly explained and illustrated in this unusually helpful book. As far as known, the only work in existence which aims to provide side by side suggested sketches of the various methods in use for accomplishing any particular mechanical movement or work, in a form easily referred to. Every engineer, inventor or mechanic finds the need of devising, simplifying or improving some mechanical process or method. In doing this he has to rely on memory or experience. Here is a reference book of nearly 3000 MEANS AND METHODS for producing any kind of movement or work, classified and arranged for easy reference! SUCH AS: Accumulators, Anti-friction, Ball and Socket, Bearings, Blowing, Bakes, Cams, Chain Gear, Chopping,

Chucks, Circular Motions, Clutches, Conveying, Cranes, Cranks, Cutting Doors, Drilling, Eccentrics, Engines, Expanding, Filtering, Gears, Governors, Grips, Grinds, Heating, Hinges, Hydraulics, Indicators, Journals, Levers, Links, Lowerings, Lubricators, Measuring and Weighing, Mixing, Nozzles, Parallel Motions, Pipes, Pivots, Power Propulsion, Raising, Ratchets, Rotary Engines, Safety Appliances, Shafting, Signals, Slides, Sounds, Speed, Spindles, Springs, Starting, Striking, Swivels, Tanks, Traps, Turbines, Valves, Water Wheels, Winding, Wipers, etc. If you work with machinery of any kind, you need this ENGINEER'S SKETCH BOOK by Thomas W. Barber—355 pages, durably printed and bound in cloth. Price

\$2.98

A Book With Over

2000 DRAWINGS and ILLUSTRATIONS OF DESIGNS, ORNAMENTS AND FORMS



Almost every conceivable kind of adornment and artistic decoration is listed and ILLUSTRATED in this unusually helpful and encyclopedic reference and idea book. This BRAND NEW WORK with 109 Black and White Full Pages and 13 in Color of illustrations shows the entire range of ornament in all its different styles and manifestations from the dawn of civilization down to the present. Design and form in every phase of art, craft, or trade is included and classified. The multitudinous examples are arranged and classified according to origin and use. There are Ornaments, Designs, Devices, Forms, Shapes, Symbols; wreaths, festoons, silhouettes, borders, monograms, alphabets, frames, columns, crests, patterns, zigzags, flowers, leaves, haws, feathers, plumes, chains, brooches, finery, geometric forms, animals, religious symbols, fraternal signs, rules, patriotic symbols, etc., etc. Most of the designs shown are FULL SIZE and Complete, and easy to trace, copy or re-

produce. Printed in black and white, they can be enlarged or reduced to fit every size or need. They will prove to be a gold mine of ideas, inspiration and suggestion for developing appropriate, original and unusual designs for CREATING and DECORATING your ART or CRAFT or COMMERCIAL PRODUCTS.

The book is a most valuable reference source for artists, craftsmen, designers, decorators, printers, painters, sculptors, wood carvers, chasers, modelers, hobbyists, ceramists, jewelers, architects, textile workers, scenic designers, display creators, engravers, metal workers, plastic workers, leather workers, embroidery, rug craftsmen, etc., etc.

If you work with designs of any kind, you need this "2000 DESIGNS, ORNAMENTS and FORMS" by M. Estrin—a beautifully printed and spiral-bound volume. Price

\$2.95



A Book That Tells You

The Working Procedure of 14 Handicrafts AND INCLUDES OVER 200 MAKE-IT-YOURSELF PROJECTS

A gold mine of fun and craft instructions for both the beginner hobbyists and the expert. Here are more things to make and do than have ever before been crammed into a single volume at this low price. From an ash-tray to a breakfast-table-and-bench set, over 200 projects are explained, with tools and equipment needed, simplified working drawings, pictures and step by step directions that make it easy to turn out finished handicrafts that everyone will admire. Each craft and each project COMPLETELY EXPLAINED in this BRAND NEW book—"A TREASURY OF HOBBIES AND CRAFTS" edited by Michael Estrin. There is a unique enjoyment in making something with your own hands. If you have made it yourself, it will give you more pleasure than anything like it that you can buy.

- | | | | | |
|---------------------|---------------------|-------------------|------------------------------------|------------|
| Costume Jewelry | Metal Vases | Plastic Craft | Wooden Toys | Book-Cases |
| Book Ends | Miniature Furniture | Portrait Drawing | Rings and many, many, more things. | |
| Soap Sculpture | Candy Dish | Whittling | Earrings | |
| Leather Accessories | Basketry | Metal Craft | Pendants | |
| Albums | Photography | Model Railroading | Trays | |
| Letter Openers | Indoor Gardening | Magic | Wallets | |
| | | Stuffed Dolls | Dog Leashes | |

PRICE \$1.98



CAR OWNER'S GUIDE To Care and Repair

By Walter Altschuler

A master mechanic tells you how to get the best performance out of your car, prolong its useful life and save money on repair bills. He explains what makes your car run and how to keep it running. It is written so that anybody who can read can understand it, and it is illustrated with 143 photos and drawings, diagrams and cut-away illustrations. This guide-book is the first of its kind ever written by a mechanic independent of any automobile manufacturer or service corporation. It tells you how to repair your own car (every job on every car, no matter what the make, is explained and covered)—or if you have your repair

man do your work you will know what the job needs doing and approximately what it should cost you! It tells you everything you need know about the generator, battery, starter, fuel system, oil consumption, play in the clutch pedal, grinding noises, squeaks and "chatter," how to eliminate gear troubles, when to replace shock absorbers, the why of front wheel shimmy, and a thousand other facts to help you get the best performance from your car.

Brand New Book—and only \$3.00

HERE'S HOW IT'S DONE!

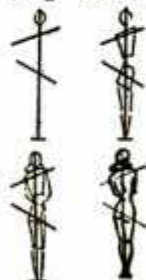

"IT'S FUN TO DRAW"

A Complete Self-Instruction Course and Reference Book with Over 1000 "How-to-do-it" Drawings in 9 Divisions of Art. Anyone who has learned to write, can learn to draw! "It's Fun to Draw" removes the mysticism that has surrounded art for years. By reducing the elements of drawing to its essence, it teaches THE BEGINNER—to draw, and to advance into more and more difficult subjects. For the practiced artist, it is a source book and veritable mine of information. This book guides you from the first stroke on paper to selling the finished art work. Includes specific instruction, advice, tricks, timesavers, special effects on—Still Life, Animals, Human Figure, Portraits, Lettering, Layouts, Color work, etc., etc. Includes glossary of Art Terms, Supplies, Use of Such Guides, Types of Work, Mediums, etc., etc. Completely illustrated.

SPECIAL \$1.00

for Amateur Artists Also for Professionals

HOW TO ORDER: Fill out the convenient coupon, check the titles of the books you want and mail the order. If you send payment with order we pay all delivery charges—If C.O.D., plus few cents postage.
MONEY BACK GUARANTEE: All books full library size, beautifully printed and hard cover bound. If, for any reason, not completely satisfied return books and get money back at once.

HOBBY BOOK MART

20 Greenwich St. Dept. PM-11 New York 6, N. Y.

HOBBY BOOK MART, Dept. PM-11
120 Greenwich St., New York 6, N. Y.

Please send me the book or books I have checked below. If not satisfied, I can return for full refund.

Engineer's Sketch Book \$2.98 Treasury of Hobbies and Crafts 1.98

2000 Drawings, Ornaments and Forms... 2.95 Car Owner's Guide to Care and Repair..... 3.00

I enclose \$_____ in full payment. Send books postpaid.

Send C.O.D. for \$_____ plus postage.

NAME _____

ADDRESS _____

CITY & ZONE _____ STATE _____

**MEET TODAY'S OPPORTUNITIES!
GET STARTED QUICK in**

Tools and Working Outfit Furnished

NOTHING FOR YOU TO BUY

Immediately when you start, I will furnish you with a complete set of drawing instruments, adjustable drafting table and other equipment you will need. Nothing for you to buy. You start right out doing professional type drafting with real professional equipment.



Real Professional Type Instruments



DRAFTING

I Will Train You at Home Until You Get a GOOD PAY JOB!



Engineer Dobe

Act Now! Get ready for a better job, advancement, more pay and security. Drafting is the field of big opportunities, and now bigger than ever before. Thousands of draftsmen and designers must come first—before any kind of production can begin. Get into Drafting.

You Get Experience As You Learn

I will train you at home in your spare time, and give you actual experience on actual work—the same kind of jobs you will do for the best paying firms. You will be trained until you are competent, experienced, and are actually holding a position that will bring advancement and pay raises as deserved.

Recommended for Job When You Are Ready

A careful record of your progress and experience will be kept. These I will give as a reference to employers when you become competent. Lack of previous experience or higher education won't hold you back.

ACT NOW!

Mail the coupon for all details and illustrated book. No obligation. No salesman will call. Give your age to insure reply.

Mail Coupon to ENGINEER DOBE, Libertyville, Ill.

Engineer Dobe, Div. 19, Libertyville, Ill. Send me the Vital Facts on Drafting and Industrial Designing, your FREE BOOK and advertised list of positions for Draftsmen and Designers wanted.

Name.....Age.....

Address.....

City.....Zone.....State.....

PRACTICAL SHOP TRAINING! LEARN A TRADE NOW!

- | | |
|---|--|
| <input type="checkbox"/> AUTO MECHANICS | <input type="checkbox"/> BODY AND FENDER |
| <input type="checkbox"/> DIESEL | <input type="checkbox"/> TOOL AND DIE |
| <input type="checkbox"/> REFRIGERATION | <input type="checkbox"/> MACHINE SHOP |
| <input type="checkbox"/> WELDING | <input type="checkbox"/> PIANO TUNING |

**America's Leading School
7 Floors of Fully Equipped Shops
Established 1902
Over 45,000 Graduates
Expert Individual Instruction
Learn by Doing**

You hear it everywhere:

"GREER SHOP TRAINING IS THE BEST"

**MAIL THIS AD TO
GREER SHOP TRAINING**

(Dept. 2117) 460 South State St., Chicago 5, Ill.

Please send without obligation free information regarding trade checked above. (Specify whether you are a Veteran or Civillian)

Name.....Age.....

Address.....

City.....State.....

Learn MASONRY CARPENTRY



BUILDING TRADES NEED MEN NOW PAY IS BIG — OPPORTUNITY UNLIMITED

The Construction Industry offers unlimited opportunities to men prepared to handle building trade jobs. You can get in on the biggest building boom in history by obtaining actual shop training in Carpentry or Masonry under our expert instructors. If you are a veteran, Midwest School of Building Trades is fully approved for "G.I. Bill of Rights" training. You will receive subsistence allowance while in school. Part time work is also available. Write for free catalog today.

MIDWEST SCHOOL OF BUILDING TRADES
Dept. A-111, 411 No. Center St., Bloomington, Ill.

Fill Out, Cut Out, Mail Today

MIDWEST SCHOOL OF BUILDING TRADES
Dept. A-111, 411 N. Center St. Date.....
Bloomington, Illinois

Please send me your free catalog telling about the excellent career opportunities in the building industry.

I am interested in MASONRY CARPENTRY
 VETERAN NON VETERAN

NAME.....

ADDRESS.....

CITY.....STATE.....



AIR CORP GUN SIGHT

Worth many times this low price. Consists of a polaroid filter, top surfaced prism mirror, actuating motors, compensating adjustments, calibrated dials for air speed, drift, straining range, etc. Inventors and experimenters will find many valuable parts in this assembly. All brand new in original export packing. Weight 7 lbs. No. 215. Each only..... **\$4.95**

WAR SURPLUS AND HUNDREDS OF OTHER BARGAINS

7 LB. EXPERIMENTER PARTS ASSORT. KIT



A "gold mine" for the radio serviceman. Hundreds of valuable radio parts, new radar and electronic parts and sub-assemblies, coils, resistors, trimming condensers—worth many times this low price. A130R -7 lbs. **\$1.79**

VEEDER-ROOT COUNTERS



Three wheel type—counts to 999 and repeats. Geared shaft end may be replaced with a pulley to regulate counting speed. Has hundreds of uses. All brand new. A splendid value. Shipping weight 1 lb. No. 241. Each..... **98c**

HUNTING KNIFE



Has 5 inch blade with keen cutting edge, 9 1/2 inches overall. Dressed leather handle with plastic insets and guard. Sheath included. Wgt. 1 1/2 lbs. No. 197. Each..... **\$1.65**



TRAINING RIFLE

Regulation size and weight. Looks like the real thing. Fitted with adjustable sights and full size leather sling. Bolt action sets and individually packed. Shipping weight 8 pounds. Stock No. 192. Price, Each..... **\$4.50**

B-29 BOMB SIGHT

Combination range finder, bomb sight and computer made by Sperry Gyroscope Co. Approx. cost to gov't. \$21,000.00. Combines a fine optical system with one 22 and one 68 inch prism periscopes. Has no less than 8 DC motors, a self contained precision sextant, heat and temperature control units and hundreds of ball bearing mounted gears, switches, controls, elaborate electronic assemblies, etc. Unit less periscope measures 35 x 25 x 14 lbs. Experimenters, technical schools in electronics, mechanical engineering and optics will find endless use for parts and sub-assemblies. Shipping wgt. 250 lbs. Orig. cost approx. \$21,000.00. No. 276—Each **\$150.00**



FISHING KIT 18 Pcs. BRAND NEW

Here is a war surplus special that every fisherman will appreciate. It consists of hundreds of feet of line with lures, hooks, sinkers, etc. Fishing knife and gloves, all packed in a cloth roll up kit that also serves as an apron. Entire assembly of 18 pieces comes packed in a hermetically sealed can. Brand new! A real value. Shp. wgt. 4 lbs. Stock No. 413. Each only..... **\$2.95**

SATCHEL POUCH

Heavy canvas pouch. Ideal for toting lunches, shopping, books, etc. Has 11x12 inch pocket. Brand new. Guaranteed perfect. Has oversize flap with single strap fasteners. A113—Each **\$1.69**

15 JEWEL STOP WATCH U. S. AIR CORPS SURPLUS



Genuine Egin 15 Jewel movement. Ideal for split second timing in racing, sports, time study, etc. Full sweep split second hand graduated in 1/10th seconds. Stem wind, start, stop and reset. Used but guaranteed perfect. A splendid value. Shp. wgt. 1 lb. No. 200—Each..... **\$9.95**

BAYONET BLADE

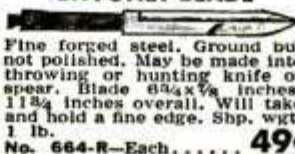

Fine forged steel. Ground but not polished. May be made into throwing or hunting knife or spear. Blade 6 3/4 x 1/2 inches, 11 3/4 inches overall. Will take and hold a fine edge. Shp. wgt. 1 lb. No. 664-R—Each..... **49c**

FLEXIBLE NECK FLASH LIGHT

Ideal trouble shooter's flash light. Flexible neck lets you direct light around corners and inaccessible spots. Brand new! Plastic case with BX type neck. Uses 2 standard flash light batteries (less batteries). Shp. wgt. 2 lbs. No. 205—Each..... **\$1.69**

FISHING REEL



Full 100 ft. line capacity. Free acting brass bearings. Ratchet drag. Catalin handles. A real value at this low price. All metal Shp. wgt. 1 lb. No. F412, Each **98c**

2 Man Mountain Tent



Regulation Army type two man mountain tent, complete with poles, guy ropes, etc. Of durable nylon with reinforced seams. Ideal for outdoorsmen, campers, etc. Shp. wgt. 10 lbs. A splendid value. Stock No. 202—Each.... **\$9.95**

HORSEHIDE JACKET

The leather coat buy of the year! Brand new Army Air Force Type A2 with full length zipper, shoulder straps, knitted waist band and wrists and full satin lining. Finest horsehide—finest tailoring. Order by chest size. Shp. wt. 5 lbs. No. 201—Each..... **\$19.95**

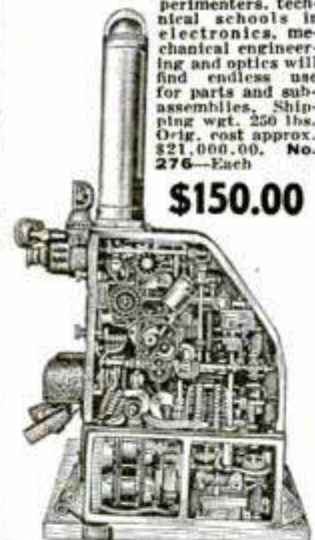

TANK TELESCOPE

Std. model M44 made by Bell & Howell for use as tank scope. Has 17 degree field of view at 39 feet. Highly polished and finely ground optics of 2X power. Rubber eye shield. Measures 22 1/2 in. long, 1 3/4 in. diam. Used but perfect. Wgt. 6 1/2 lbs. No. 522—Each..... **\$6.95**



SHIP BELL

Purchased from U. S. Maritime Comm. Measures 10 inches high, 9 3/4 inch flare. Big 6 inch clapper. Weight 15 lbs. Fine for farms, clubs, estates, etc. All new A-541, ONLY **\$9.85**

RUBBER OVERBOARD SUIT



Here is a buy! All rubber suit with parka. Fits over your regular clothes and shoes. Can be cut apart for waist high waders, hip high or knee high boots, also arm length rubber gloves. Heavy gum rubber over fabric. Fine for those who work in the water, commercial fishermen, sewer diggers, etc. Use it as is or cut it up for waders. All brand new! Wgt. 14 lbs. No. 183, Each... **\$4.95**

MEDICAL STERILIZER



Consists of alcohol burner and sterilizing tray in hinged metal case 13x11x2 1/2 inches. Burner may be used separately. Bright nickel finish. All brand new, A125—Ea. **98c**

DECORATIVE CHROME STRIPS



For your car, boat furniture, etc. Highly polished chrome finished strips with clinched edges for flush mounting to any surface. The 3 pound kit provides approx. 15 pieces in lengths from 6 inches to 3 feet and average 3/4 inches wide. Wgt. 4 lbs. No. R224, 3 lb. Assort. **\$2.00** only.....

ORDER DIRECT FROM THIS AD

Values galore! Hundreds of hard-to-find items for home, shop and outdoors. Make remittances by money-order, bank draft or personal check. Send 25% deposit on C.O.D. orders. No C.O.D.'s on orders for less than \$5.00. Include sufficient postage on parcel-post orders—any overage will be promptly refunded. All quotations F.O.B. Chicago. Used items and materials are guaranteed serviceable and as described. Your money back if not more than satisfied.

BIG ILLUSTRATED CATALOG FREE

STARK'S

Dept. PM1147
509 So. State St.
CHICAGO 5, ILL.

Officers Watch Compass



Brand new gov't. surplus. Army-Navy model. Single jewel mounted needle. Silver colored dial. A splendid value. Shp. wgt. 1 lb. A174—Each... **98c**

BERNARD WIRE PLIERS



Parallel acting jaws. Wire cutter at top. Brand new. Wgt. 2 lbs. No. 168. Each..... **\$1.29**

Now

YOU CAN HAVE IMPROVED No-DRIFT FM in the Sensational New 1948 **FM** **MIDWEST RADIOS**

NEW SERIES
16*
SUPER DELUXE
AM-FM
CHASSIS

Here is the finest radio Midwest has ever produced in its 28 years of manufacturing—a world-ranging, 5-band radio with improved Midwest No-Drift FM . . . plus Standard Broadcast and 3 short wave bands, Television Audio Switch-over, and Color-Ray Tone Selection. The Series 16* Super De Luxe Chassis is a powerful, magnificently-toned radio that challenges comparison for performance, sensitivity, selectivity, and advanced engineering features. Supplied with satin stripe copper finish panel—ready to mount in your present cabinet. Send today for the FREE 1948 Midwest Radio Catalog. Buy your radio direct from the manufacturer on Easy Terms and 30 Days Trial and SAVE!



14 1/2"
PANASONIC
SPEAKER

5
WAVE
BANDS

*Series 16
CHASSIS USES ALL THESE
LATEST TYPE TUBES,
RECTIFIER AND TUNING INDICATOR

30
DAYS
TRIAL

LOW
FACTORY-
TO-YOU
PRICES

EASY
TERMS

A COMPLETE LINE OF FINE RADIOS AND RADIO-PHONOGRAPHS . . . Available in Separate Chassis Like the Powerful Series 16* AM-FM Model above, or in beautiful Radio-Phonograph Consoles like this:

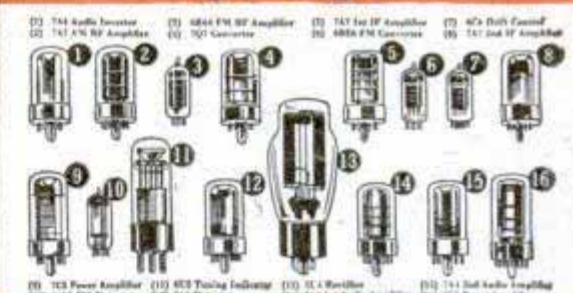

Scores of NEW Features such as the Exclusive MIDWEST TRI-MAGNADYNE COIL SYSTEM and COLOR-RAY TONE SELECTION



SYMPHONY GRAND AM-FM **RADIO-PHONOGRAPH CONSOLE** with NEW Intermix **AUTOMATIC** **RECORD CHANGER**

Our Finest! A superbly beautiful musical instrument . . . a masterpiece of furniture design and radio engineering that offers the sensational Midwest NO-DRIFT FM, Automatic Intermix Record-Changer, Exclusive Color-Ray Tone Selection, World-ranging 5-Band Reception, Television Audio Switch-Over, and many more new and exclusive features.

Rush for Free Catalog!
FILL IN COUPON AND MAIL TODAY OR JUST SEND YOUR NAME AND ADDRESS ON 1c POSTCARD

MIDWEST RADIO CORP.
Dept. 25-M, 909 Broadway
Cincinnati 2, Ohio

Gentlemen: Please send me your new FREE catalog and details of your liberal 30 Days Trial.

Name _____
Address _____
City _____ Zone _____ State _____

MIDWEST RADIO CORP.
Dept. 25-M • 909 BROADWAY • CINCINNATI 2, OHIO

POPULAR MECHANICS

WRITTEN SO YOU CAN UNDERSTAND IT
VOL. 88 NO. 5

The Guns Still Roar AT ABERDEEN



U. S. Army Signal Corps photo

The Army's new tank transporter (also pictured in the cover painting) has an engine at either end

STARTLED Philadelphians along Broad Street recently stared in wonder at a giant olive-drab vehicle that rolled by while patrol cars chased traffic to side streets. The steel giant—all of 60 feet long and under Army escort—seemed to have two “heads.” Engine cabs mounted on four huge rubber-tired wheels were at either end and suspended between these cabs was a low carrier deck.

The vehicle, known to Army Ordnance as the T8 tank transporter, was on its way from a manufacturing plant at Allentown, Pa., to Aberdeen Proving Ground at the top of Chesapeake Bay in Maryland. It is designed to transport tanks across country and to maneuver sharp turns in narrow city streets. Atop each cab is an anti-aircraft gun mount. The crews in either cab com-

municate by using the interphone system.

If the amazed onlookers along the route of the tank transporter could have followed it all the way to Aberdeen their wonder and respect for the Army's Ordnance Department in time of peace would have been increased a hundredfold. The new tank carrier is only one of scores of developments that have moved ahead at a swift pace since the end of World War II. For at Aberdeen Proving Ground, largest military installation of its kind, the big guns still roar and some of the best scientific brains are working night and day.

“The nation learned a lesson during World War II,” said an officer at Aberdeen, “that any inventor knows. The development of new and better tools, whether for war or peace, is a continuing process. You

By Wayne Whittaker

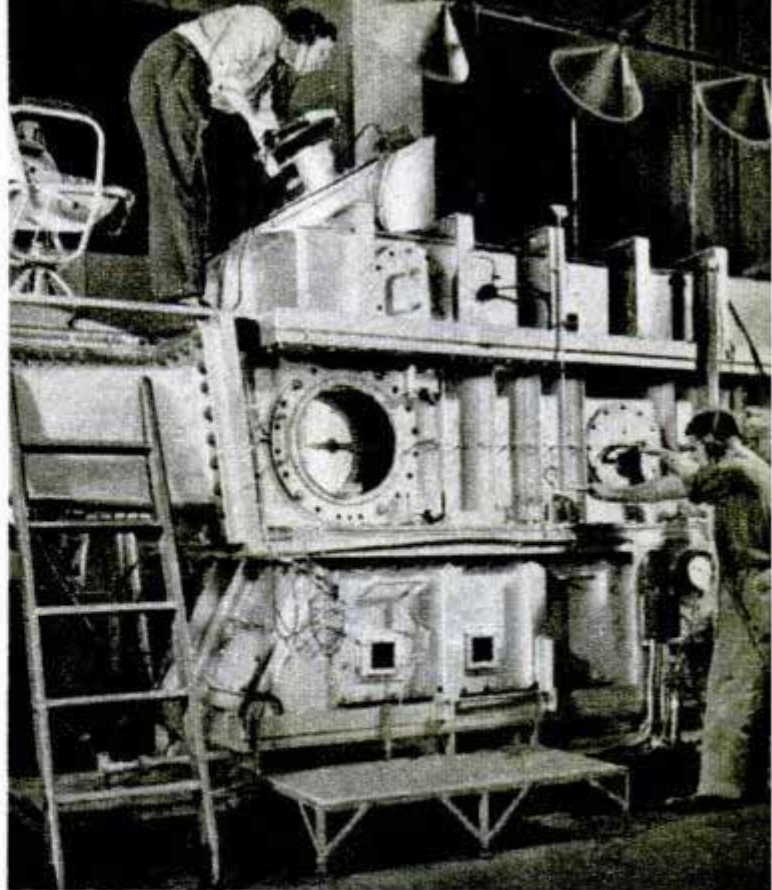

A large array of switches (left) control compressors and 24 valves of \$2,000,000 supersonic wind tunnel at Aberdeen. Engineers at right are adjusting test missile in the model-working section of the big tunnel

can't go to sleep on the job and then when faced with an emergency produce overnight a better rocket or recoilless rifle than the other fellow. Much that is going on here today will be obsolete in a short time, but that is the only way we can keep abreast of modern military improvements vital to our welfare."

Some indication of the War Department's regard for the work being carried on at Aberdeen today is evidenced by the difficulty in obtaining a pass to the industrial area of the proving ground. Special passes into this area, where new tools of war are being tested and much research conducted, must be cleared by the Office of the Chief of Ordnance in Washington.

A visitor to peacetime Aberdeen gets a false impression of the place during the first few miles after entering the grounds. These grounds, incidentally, cover 74,000 acres of land and water and the big guns in permanent mounts at the head of the bay can shoot over more than 20 miles of water within the reservation. Military personnel has been reduced from 21,000 during war-time to less than 2500, and empty barracks and abandoned buildings of all types line the roads. Even Aberdeen's own railroad, about 45 miles of track known as the "Shuttle" or the "Back and Forth," seems semi-deserted.

A different picture greets the visitor at A. P. G. Headquarters in the offices surrounding those of Brig. Gen. A. B. Quin-

ton, commander of the proving ground. The general explains that although thousands of men are trained in the ordnance school at Aberdeen in time of war the basic personnel of the ground is civilian experts—engineers, scientists, mechanics and others. An outstanding exception is Colonel Leslie E. Simon, graduate of West Point and Massachusetts Institute of Technology, who is director of the Ballistic Research Laboratories and one of the top men in his field in the world; other exceptions are Colonel W. E. Becker, director of Development and Proof Services, and a veteran of the North African and Pacific campaigns, and Colonel R. K. Haskell, command officer of the Ordnance School which sends officers and enlisted men into the field with a special knowledge of ammunition, artillery, fire control, and the maintenance of all motorized equipment.

During the early part of World War II all transport vehicles were under the Quartermaster. In 1942 automotive vehicles were transferred to ordnance, part of a general move to make the army more close-knit and streamlined.

"This program of modernizing the Army did not stop with the end of the war," explains C. F. Waters, director of the automotive division. "One thing we learned was that the Germans were far ahead of us in standardizing their motorized equipment. Right now one of our big goals here is the standardization of engines for all

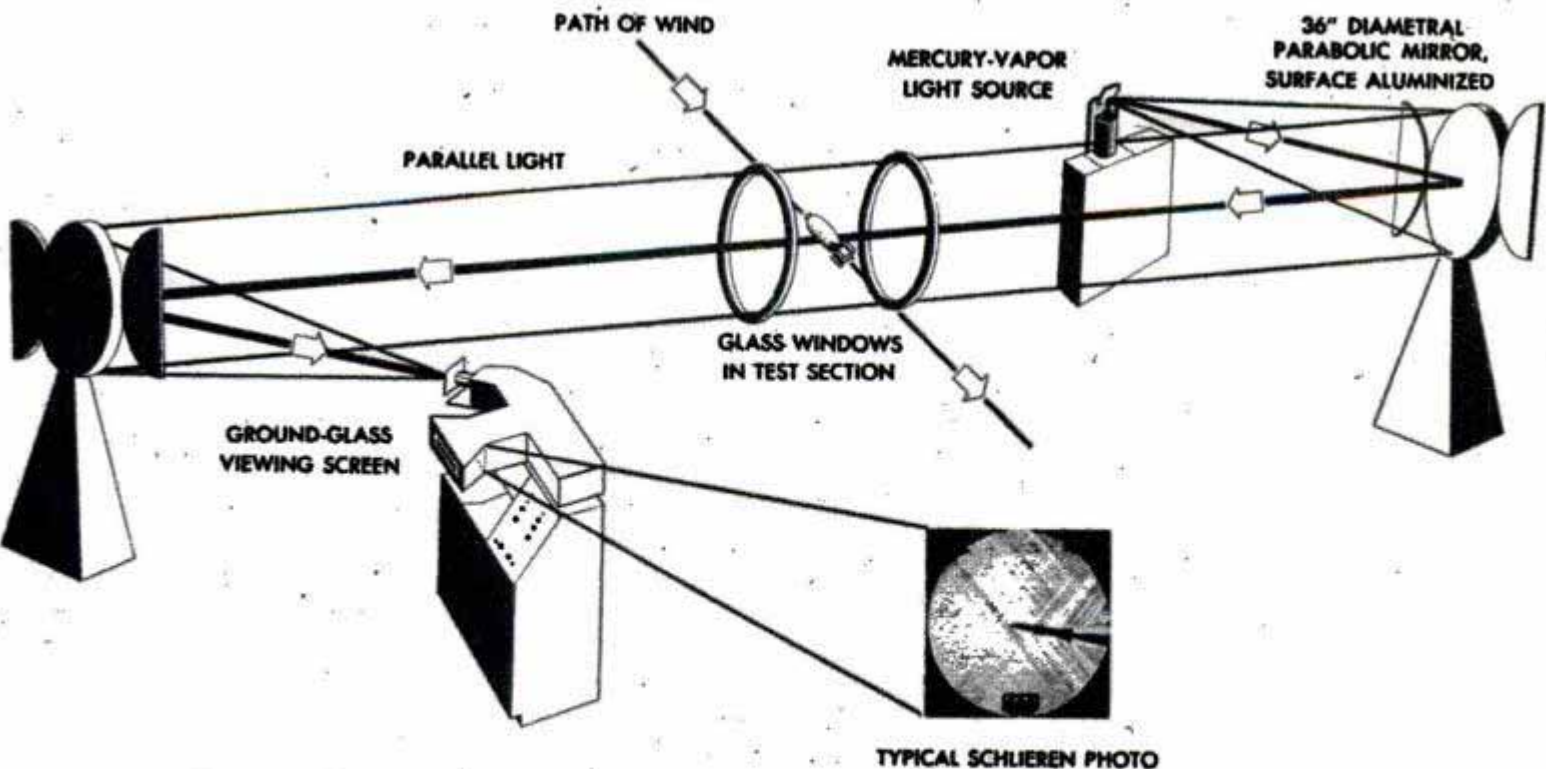

TYPICAL SCHLIEREN PHOTO

WIND TUNNEL SCHLIEREN SYSTEM

Want a photograph of the wind? The amazing Schlieren camera shows how supersonic missiles "shatter" air

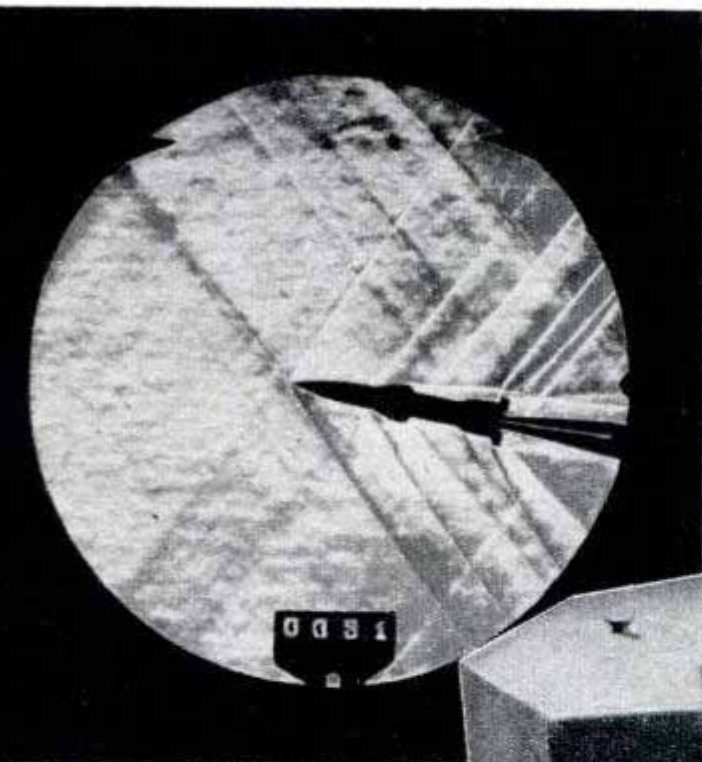

types of military vehicles. The advantage of this can be readily seen; in the field, tank engines could be repaired with truck engine parts, and vice versa. This standardization could be extended beyond the engines to a score of other automotive parts. Tires are another example."

The experts at Aberdeen are more concerned with practical weapons now in a state of near-perfection than they are with talk about atomic missiles of the future. The most exciting weapons which can be

The photo above is what you see when you look at viewing screen of the Schlieren camera (right). As in an ordinary camera, the flick of a switch takes the picture. This camera used in conjunction with the wind tunnel saves thousands of dollars by revealing defects in models at an early stage in development

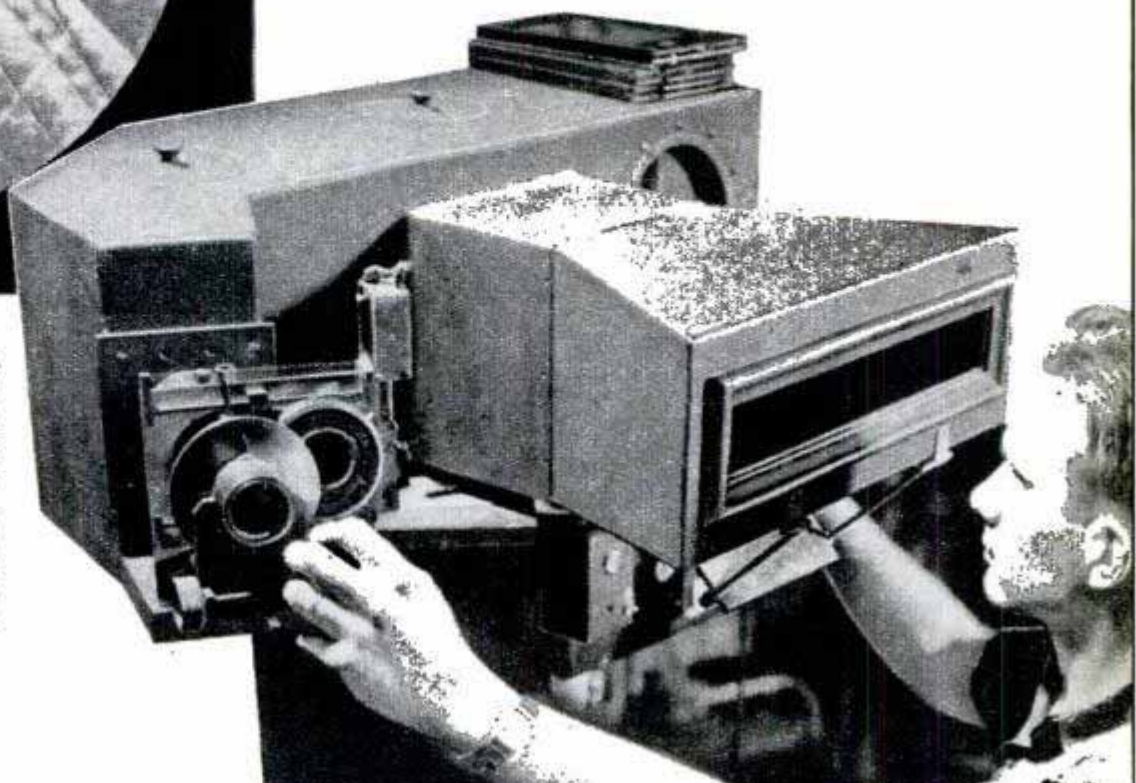



The 57-mm. recoilless rifle (above) and heavier 75-mm. (below) give the infantry the potent firepower of an artillery unit



Below, new superheavy tank weighs 95 tons and mounts 105-mm. high-velocity gun; it has 12-in. armor in front

talked about at Aberdeen are the recoilless rifles—57-mm. and 75-mm. This type of rifle, according to Captain C. V. Gandy of the arms and ammunition division, will create as great an effect on the conduct of warfare as the invention of gunpowder. These powerful recoilless weapons give the all-important infantry the striking force of an artillery unit.

The recoilless rifle was tested briefly in combat toward the end of the war with highly satisfactory results. The shoulder-fired 57 resembles the bazooka in appearance, but is not to be confused with rocket weapons, the projectiles of which carry their own propellants. In the recoilless rifle only the shell goes through the air. Its ammunition is easily recognized by the perforations in the cartridge case which permit the hot propellant gases to escape to the rear through a breech provided with escape vents. More potent than the shoulder-fired 57 is the 75-mm. portable recoilless rifle, which is mounted and fired from a machine-gun tripod. The 75 fires a 14-pound projectile approximately 7200 yards with the speed and accuracy of a rifle bullet. It weighs only 105 pounds compared with 1200 pounds for the pack howitzer, smallest of the 75-mm. artillery pieces. This rifle can be carried into action by four men and fired from terrain which is inaccessible to conventional artillery.

Despite the general tendency, obvious in equipment being tested at Aberdeen, to decrease weight for greater mobility, there is one department where there is no substitute for tons of thick armor. Tank experts



Graphic record at right shows flight of big V-2 rocket which rises to height of 70 miles in air. Points A, B, C, D and E show variations of speed during six-minute flight. Figures at bottom show the range scale in miles

have developed the Army Ordnance Department's heaviest tank—the 95-ton T28. This low-slung behemoth has 12-inch armor across the front. Instead of a turret mounting, as in conventional tanks, a new 105-mm. high-velocity tank gun is in a gimbal-type mount near the front and has but limited traverse. This mounting reduces silhouette, an extremely important factor. Another new feature of the tank is dual tracks and suspensions, the outer tracks being removable. This provides greater mobility over rough terrain for such a heavy vehicle and still permits movement by train and across narrow bridges. The tracks can be replaced by four men in two hours.

The development of the tank transporter was inspired by the difficulty in getting tank transporters around corners in the narrow streets of European cities. It was frequently necessary to knock down part of a building to move tanks to the front. The transporter, which created something of a sensation on its maiden trip from the Mack Manufacturing Company plant to Aberdeen, must be steered from both ends and has enough power from either of its two engines to roll along at 30 miles per hour. The cargo deck, suspended between the power units, can be lowered to the ground at the rear end to permit loading of vehicles. Each engine is supplied with fuel from individual 100-gallon gasoline tanks and the T8's cruising range is about 150 miles.

Another machine which would startle motorists if it ever ventured on a cross-

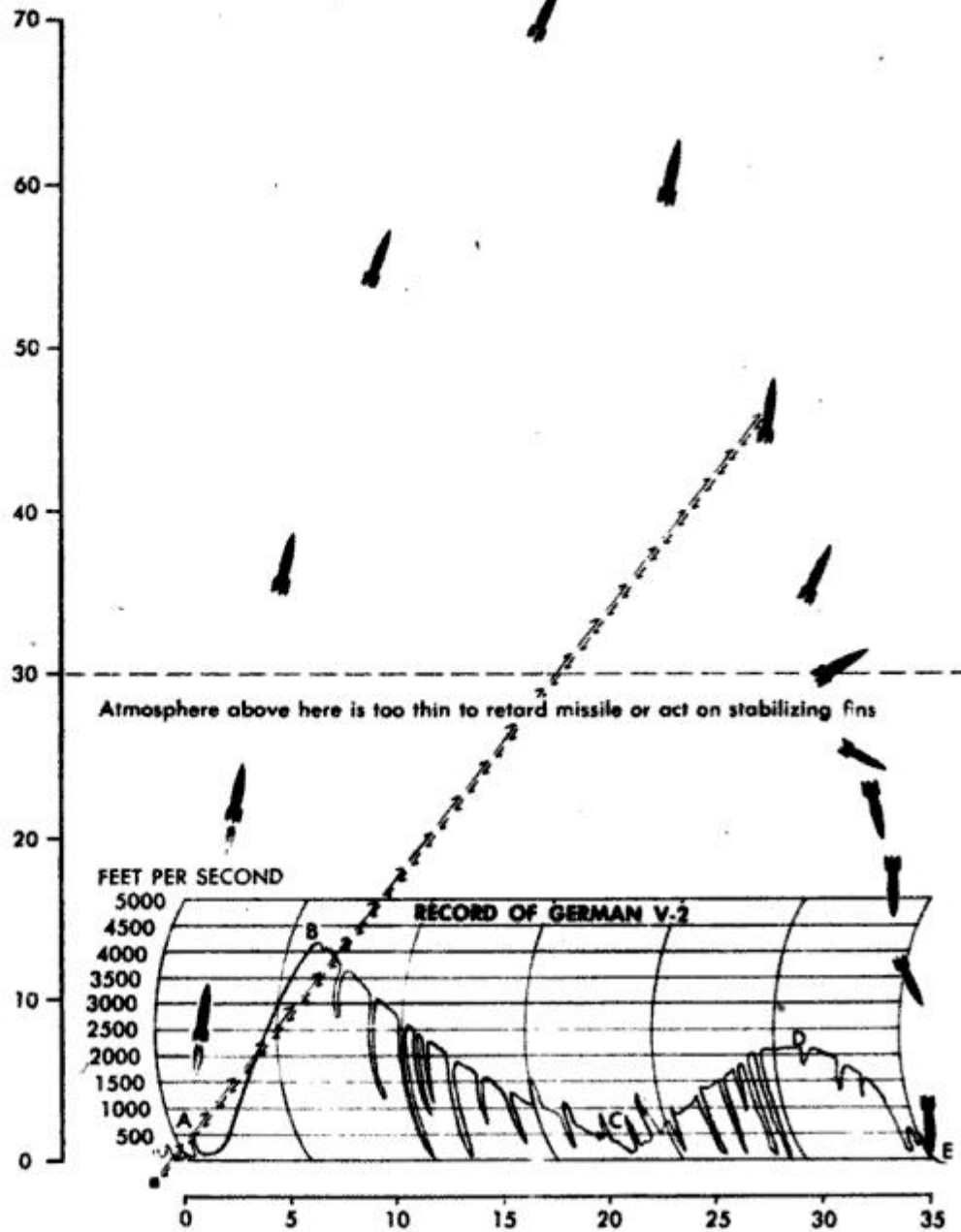

HOW TO MEASURE PATH OF A LONG-RANGE MISSILE BY RADIO

A radio doppler station, located two miles behind the launching site broadcasts a frequency of 38.5 million cycles per second. A station in the missile receives the signal; doubles it and rebroadcasts at 77 million cycles. The doppler station receives the missile's signal, and beats it against the first harmonic of its own signal. The beat difference is the doppler frequency; and each doppler beat means a change of radio path of one wave length, or about 6.4 feet, from which the change in position of the missile can be inferred. Thus, from the sum of the beats one determines the length of path; from the beat frequency, the velocity; and from the slant of the frequency curve, one determines the acceleration. For precise work, three such stations are used, the results recorded photographically, and reductions made accurately by special machines. This is the most precise system the world has known for getting exact ballistic data and was developed by Army Ordnance

country trip is the disk-type mine exploder. It consists of two sets of five 96-inch disks which are pushed over mined areas to detonate the mines with its weight of 4600 pounds. These exploders can operate in 18 inches of mud and across broken terrain. They clear a path 33¾ inches wide in front of each track.



Mine exploder pushed by tank clears path 33 $\frac{3}{4}$ inches wide before each disk section. Disks weigh 4600 lbs.

Man at right and 500-lb. bomb, left, are dwarfed by 42,000-lb. super-bomb developed by Army Ordnance



On a tour through the proving ground one sees the "hog wallow" where mud tests are conducted on all types of equipment. Aberdeen has facilities for tests on every type of terrain known to man. There are smooth strips of concrete, coarse and fine gravel roads, rough Belgian block pavements, several varieties of "corduroy" concrete, a snake-like frame-twisting course which pulls the frame of a vehicle four different ways at the same time, a climbing course with hills rising at 10-percent increases from a gentle 20-percent angle to a sharp 60 percent, and sharp curves and inclines of all types. Over this course are tested all the tanks, trucks, jeeps, gun transporters and everything built for the Army that moves on wheels. After a test, the experts know exactly how much a vehicle can or cannot take—vital information either to an engineer bent on improving the vehicle or a general planning a tactical move in the field.

Along the miles of roads through Aberdeen Proving Ground is a virtual "world's fair" of military equipment, past and present. A vast outdoor museum contains almost every type of tank, truck and gun of every nation from World War I to the present time. These range from the lofty and antiquated-looking early British tanks of 1918 to the pink-camouflaged tanks used by the Nazis in the African desert during World War II. Another more formal museum, this one boasting four walls and a roof, is devoted entirely to equipment used in World War II. This collection, the only one of its kind in the world, is the pride of the Ordnance Department. Here are all the Jap tanks and guns, German (47-ton Panther, 60-ton Tiger and 75-ton King Tiger), and Russian tanks carefully cut away to reveal equipment inside, the Nazi V-1 and the deadly V-2 rockets.

Farther along the road one passes what seem like miles of artillery pieces carefully protected from the elements with special preservatives; some of the guns are "canned" in experimental aluminum containers. Maintenance crews work over this equipment constantly; even the

(Continued to page 252)



Sight Corrects Archer's Faults

Adding a further mechanical twist to an ancient sport, G. T. Bradley of Los Angeles has developed an adjustable bow sight that corrects common archery faults and simplifies shooting technique. Bradley's sight is light in weight, with front and rear sighting elements that assure proper alignment of the arrow. Length of draw is controlled by a check mirror which reflects the arrow tip directly on the line of vision. There is a graduated dial which allows the archer to correct for windage variations, and a single rear-aperture lens. It has dual prismatic lenses, calibrated for elevation and windage, which are separately adjustable. The sight can be used by either right or left-hand archers. With the sight, Bradley doubled his score in six months.

Mobile Bandstand

With the help of a large lift truck, a Shrine band from Cleveland provides its own mobile bandstand for parades. A platform was built on the truck's lift and a canvas canopy erected over the platform. Band members ride on the mobile bandstand while one man drives the truck.

Every day new products for homes and workshops, farms and factories, are appearing on the nation's markets, and every month you'll find them described in *Popular Mechanics*. For additional information about the products featured in this issue, write to Bureau of Information, *Popular Mechanics Magazine*, 200 E. Ontario St., Chicago 11, Ill.

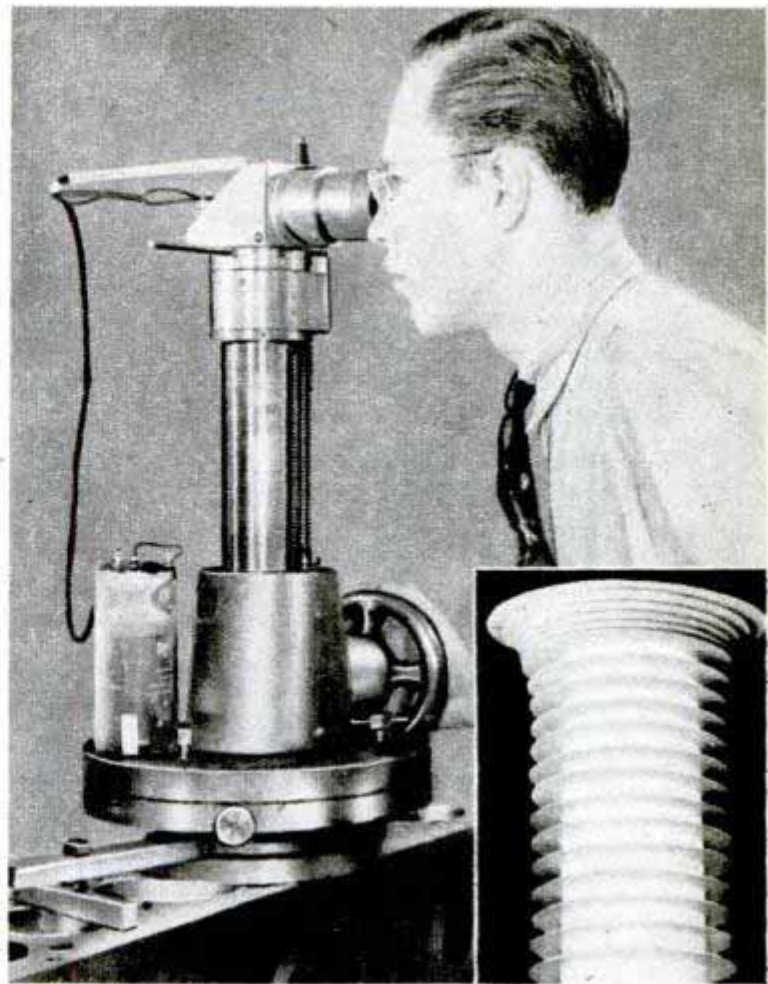

Cylinder Gauge Checks Contour

Cylinder wear and distortion are measured by a contour gauge which makes radial instead of diametric measurements. The measurements are reproduced in scale models and for easy visualization, the deviations from the original cylinder diameter are magnified 300 times.



GAS-TURBINE FERRY FOR THE ENGLISH CHANNEL

PASSENGERS BOUND for France from England soon will be ferried across the channel on a ship powered by a closed-cycle gas turbine. Because of its relatively high efficiency the turbine-type power plant is expected to compete economically with older types of marine propulsion. The ferry will have two 6000-shaft-horsepower turbines burning a heavy grade of fuel oil. The closed-cycle type is particularly suitable for large engines and the two now under construction may be followed by others generating 50,000 shaft-horsepower. To start the cycle of the turbine, compressed

air enters an air heater where it passes through closed coils, emerging at a temperature of 1200 degrees Fahrenheit. It then drives a high-pressure turbine and the exhaust air is carried off to a low-pressure turbine. This turbine in turn powers a variable-pitch propeller through reduction gears. Exhaust from the low-pressure turbine passes through a heat exchanger, where it raises the temperature of more compressed air about to enter the turbine. In the pre-cooler the temperature is lowered by sea water. The air then enters the compressors where the pressure is raised

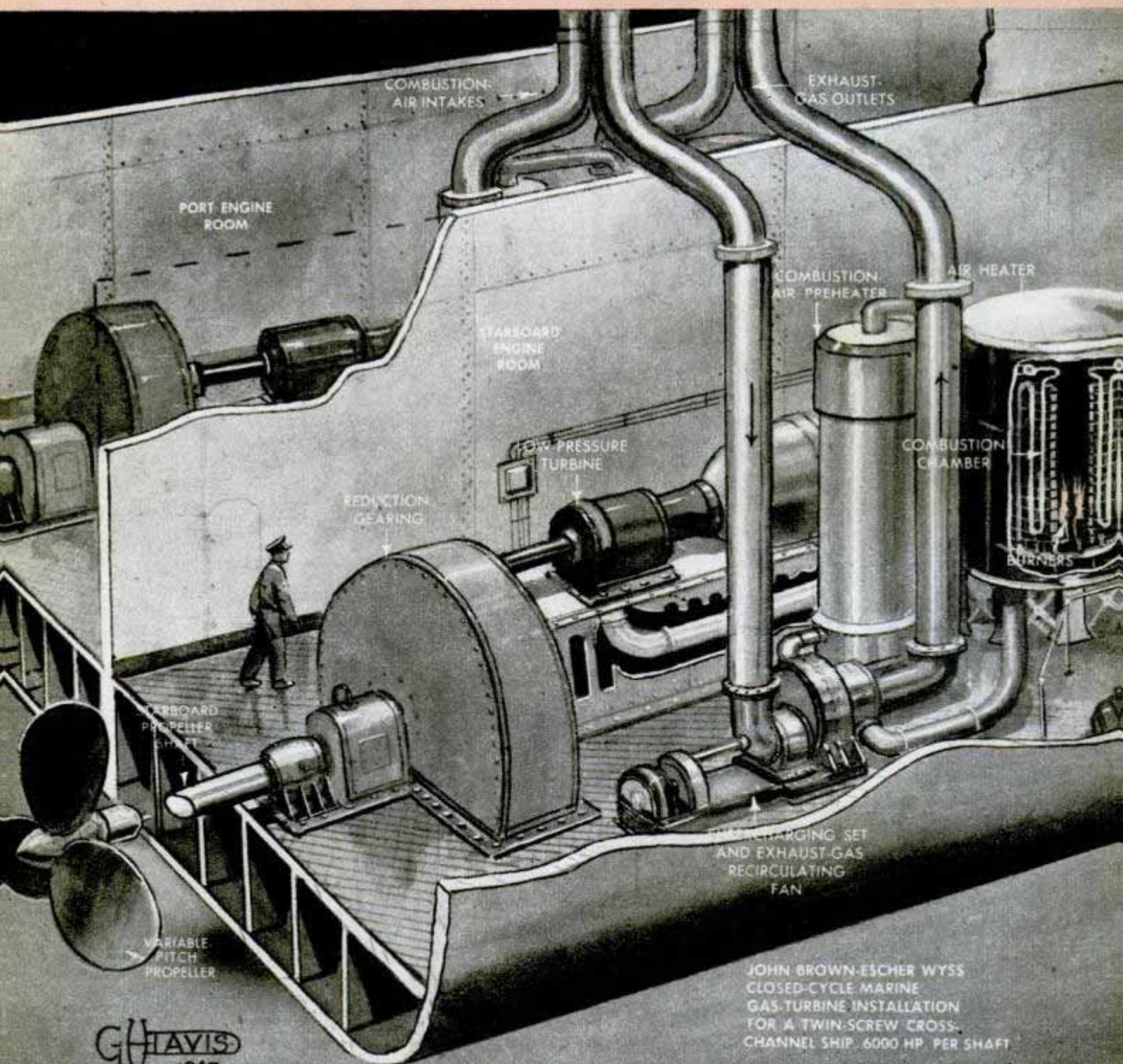

JOHN BROWN-ESCHER WYSS
CLOSED-CYCLE MARINE
GAS-TURBINE INSTALLATION
FOR A TWIN-SCREW CROSS-
CHANNEL SHIP. 6000 HP PER SHAFT

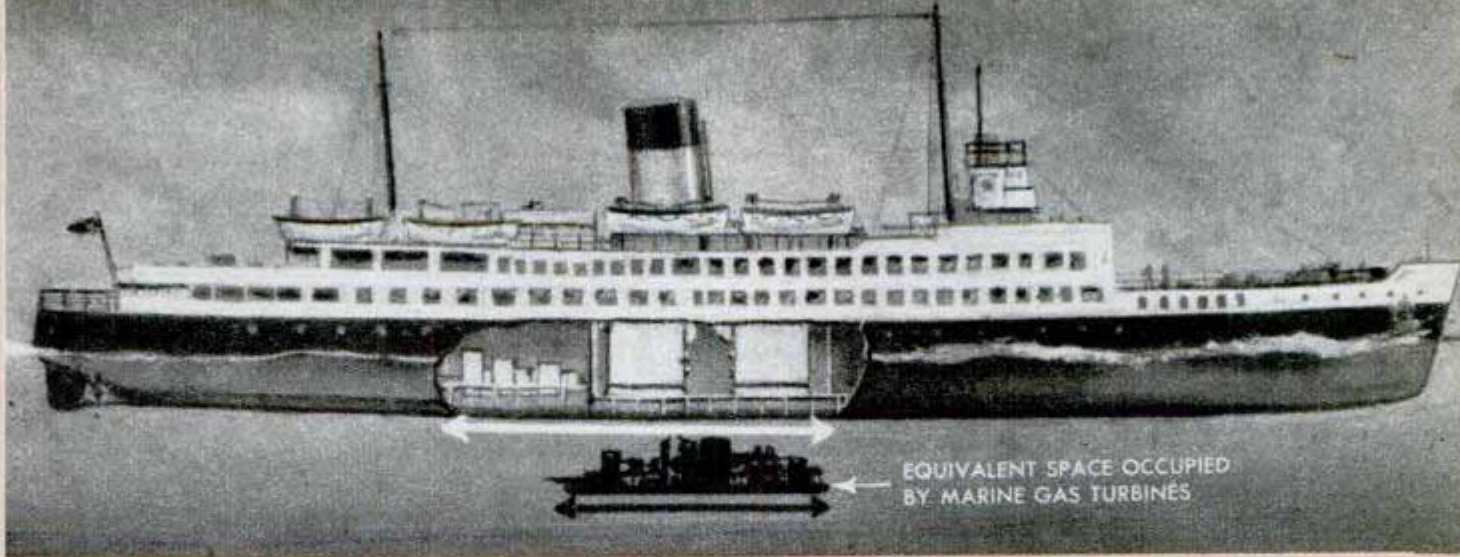

Long arrow shows the size of the engine room of a conventional cross-channel steamer fitted with a standard steam engine. Below it is shown the space required for a closed-cycle gas turbine of equivalent power

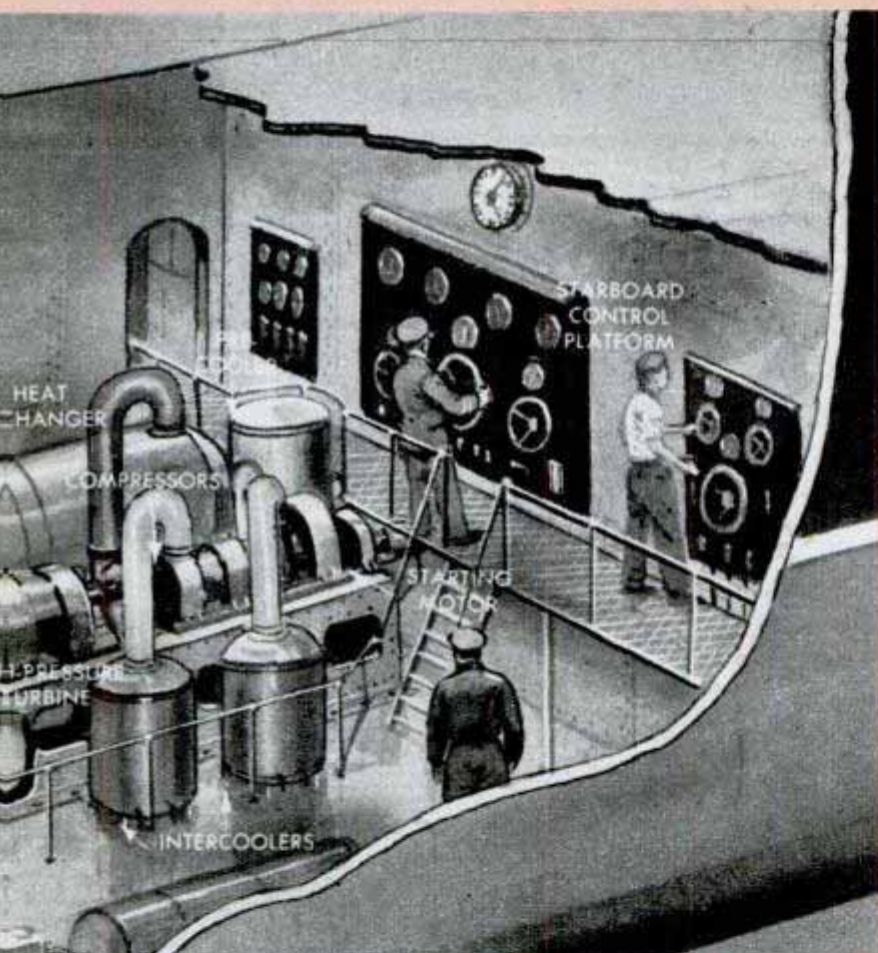

from 90 to 340 pounds per square inch. It passes through the heat exchanger again, this time in fine tubes, and enters the air heater to complete the cycle. As a result of the fine tubing throughout the engine, the closed-cycle turbine uses only pure air, unpolluted by combustion gases, preventing the parts from being fouled by deposits of ash and soot. The ferry in which the turbines are installed will be equipped with variable-pitch propellers eliminating the need for reversing gears. According to estimates, the efficiency of the completed engine will be about 31 percent but will vary depending on the quality of the fuel oil. The engine, operating at a maximum temperature of 1200 degrees Fahrenheit, will have an estimated life of 100,000 hours.

↓ Diagram shows the major parts of the gas turbine. Trace the path of the air after it enters the air heater to the completion of a full cycle of the turbine's operation

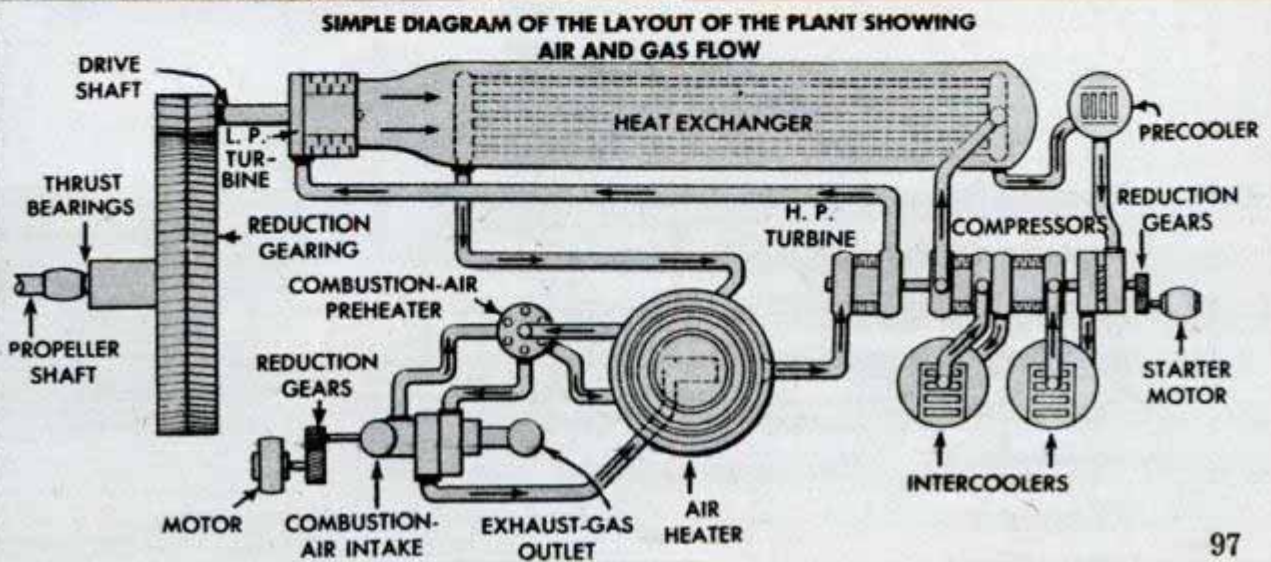



A.F.P. photo

Windshield Protects Cyclist

Cyclists are protected from the rain by a combination wind-breaker and umbrella that attaches in front of the handle bars. Designed in Italy, the plaid shield is complete with windows for good visibility. The transportation shortage in that country makes bicycle-riding a necessity and this new item of rainwear protects madame's clothes as she pedals to and from the office.

Stainless-Steel Salvage

Chemical recovery of valuable nickel and chromium alloys increases the value of stainless-steel scrap such as waste lathe turnings. In small machine shops, where stainless is made into a variety of articles, the stainless scrap is usually mixed with ordinary carbon steel, lessening its value. In a process developed by Virginia Polytechnic Institute, the stainless scrap is dissolved in a hydrochloric-acid solution. The addition of other chemicals separates the nickel and chromium from the iron.

Snowplane for Two Travels 30 M.P.H.

Transportation across the snow and ice of Canadian prairies is no problem for Richard Sunter of Beechy, Saskatchewan, who built a snowplane from salvaged and homemade parts. The skis and propeller of the streamlined vehicle are made of laminated wood. A single ski on the front is used for steering and two other runners support the rear end. The cockpit is glass-enclosed for all-around vision. A direct-drive model A motor at the rear powers the vehicle at speeds up to 30 miles an hour. In order to save weight, Sunter uses a motorcycle battery with a special control on the generator.

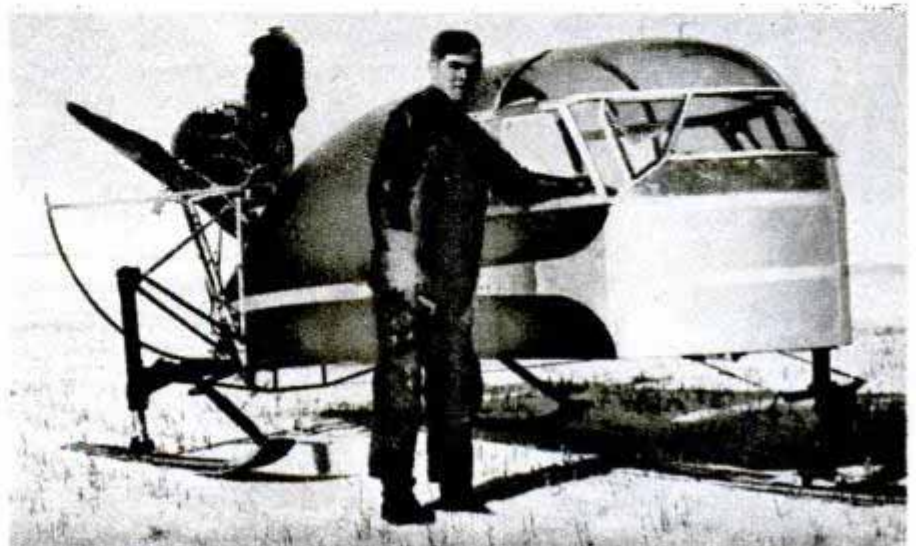



High-Speed Drill Converter

Standard drill presses can be converted into high-speed drills by adding a self-contained electric drill which fits any chuck of $\frac{3}{8}$ -inch capacity, or larger. The tool supplies its own power— $\frac{1}{18}$ horsepower—and 17,000 revolutions per minute for drills up to $\frac{1}{8}$ -inch diameter. The drill also will fit the chuck of any standard lathe, milling machine or specially designed machine and fixture. It provides a quick method of setting up for small production drilling jobs at minimum cost.

Nonslip Clamp for Reels

Reels are held securely on fishing rods by a nonslip clamp which is tightened with a thumbscrew. A "worm" that engages slots in the band of the clamp prevents the reel from wobbling or slipping.

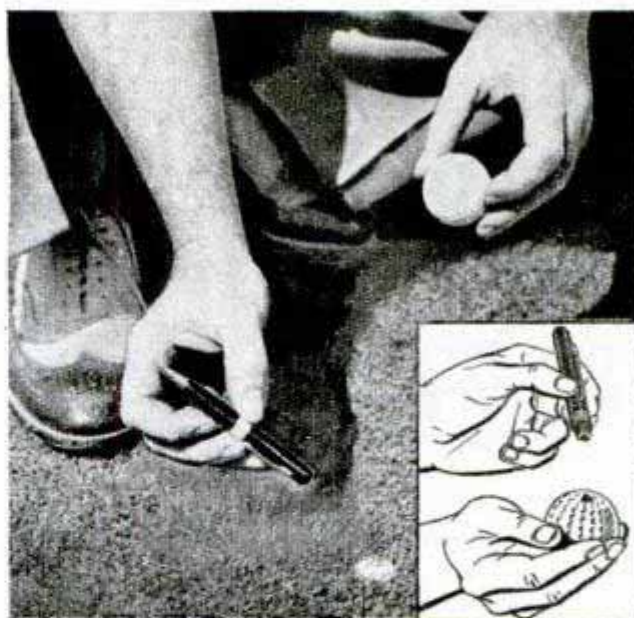
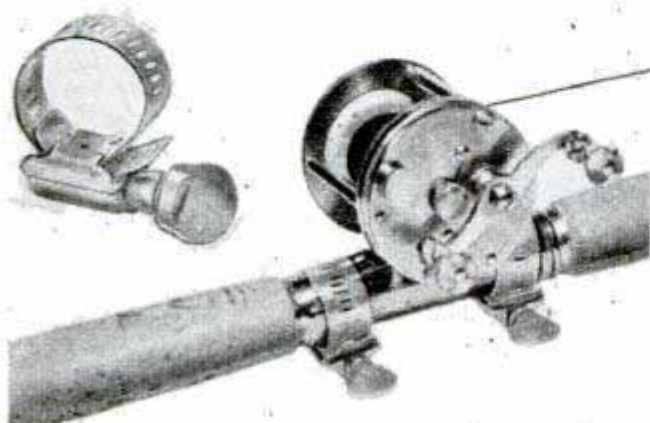

Talc Pencil Marks Golf Greens

White talc powder carried in the top of a golfer's pencil marks the position of a ball on the green when it is in line with another player's ball. The pencil also has a die to mark golf balls with a personal identification mark. A third feature is a knurled section to rough up the leather grip of a club handle to provide a better grip for the hands.

Adjustment For Soft-Focus Photos

Any lens can be made to take soft-focus photographs by attaching a new control device. It is a calibrated ring that can be adjusted for desired diffusions from razor sharp to misty soft. No increase in exposure time is necessary. The attachment also can be used on enlargers.





There are 22 million people in Mexico and 16 million depend on their home workshops to produce thousands of items needed for their everyday life

Typical Mexican potter still uses primitive wheel powered by foot to make beautiful ceramics ware



LAND OF THE HOME WORKSHOP



Left, Diego Rivera, noted artist, at work on mural in the National Palace, Mexico City. Right, Mexican craftsman uses a hand roller to apply ink to a lithograph stone





Many Mexican cities are famous for a particular type of craftsmanship. The intricate silver jewelry at the left was made by Taxco artisans; at right are carved wax figures from the studio of Luis Hidalgo in Mexico City

IN 1519 Hernando Cortes landed at Vera Cruz as Mexico's first tourist. Like the thousands who later discovered the charm of this south-of-the-border country, Cortes sent back home gifts of filigreed gold and silver, jade and obsidian ornaments, capes of bright-colored feathers and other examples of what he termed "workmanship of exceeding exquisiteness and rare design . . ."

Today, 428 years later, approximately 272,000 United States tourists visit Mexico each year and spend something like \$80,000,000. A whopping chunk of it goes to buy Mexico's amazing variety of arts and crafts—multi-hued pottery, gay serapes and other textiles, glassware, lacquer ware, finely woven baskets, hand-tooled leather, beautiful silver jewelry, furniture and toys.

This is not surprising. The average American tourist, in spite of some of his gringo faults, is descended from a long line of Yankee inventors and tinkerers. As such, he finds a special kinship with his neighbors below the Rio Grande. After all,

Colorful serape (shawl) weaver warps his yarn in preparation for the actual weaving process

it is not such a far cry from the home workshop where you build a hanging shelf or repair a radio to a mud-walled hut where a Mexican craftsman turns a potter's wheel or works a serape loom.

Mexico is one of the three great craft centers of the world, along with Russia and China. The Aztecs, Toltecs and other ancient peoples who built flourishing civilizations in the land that we now call



Broad-brimmed sombreros, always popular with tourists from north of the Rio Grande, are decorated with gay colors by this young señorita:



Mexico were essentially agricultural people. These farmers had settled down in one spot and between harvests had plenty of time to fashion household implements, fancy costumes, jewelry and objects of sacred worship.

In the arts and crafts of Mexico today it is easy to pick out the three major influences:

First and most prominent is the native Indian influence. In many craft objects, especially household items like pottery, serapes and baskets, many designs and techniques have come down almost unchanged from the days when the great Aztec emperor, Montezuma, ruled a mighty nation in the Valley of Mexico.

Second is the Spanish influence which crossed the Atlantic with Cortes and his followers. You see it in glasswork (the Indians didn't know about glass), in the glazed surfaces on pottery (Indian pottery is rough), and in wrought ironwork (a metal that was unknown to the natives). The Spaniards also encouraged wood-carving and tile-making which was put to use in Mexico's churches.

Third—and this may surprise you—China has influenced certain Mexican arts and crafts. Mexican lacquer ware, for example, follows the designs and techniques brought from China in 16th-century Spanish galleons that sailed the Pacific.

Left, hand-tooled saddle of intricate design. Right, artist prepares linoleum block for printing fabrics

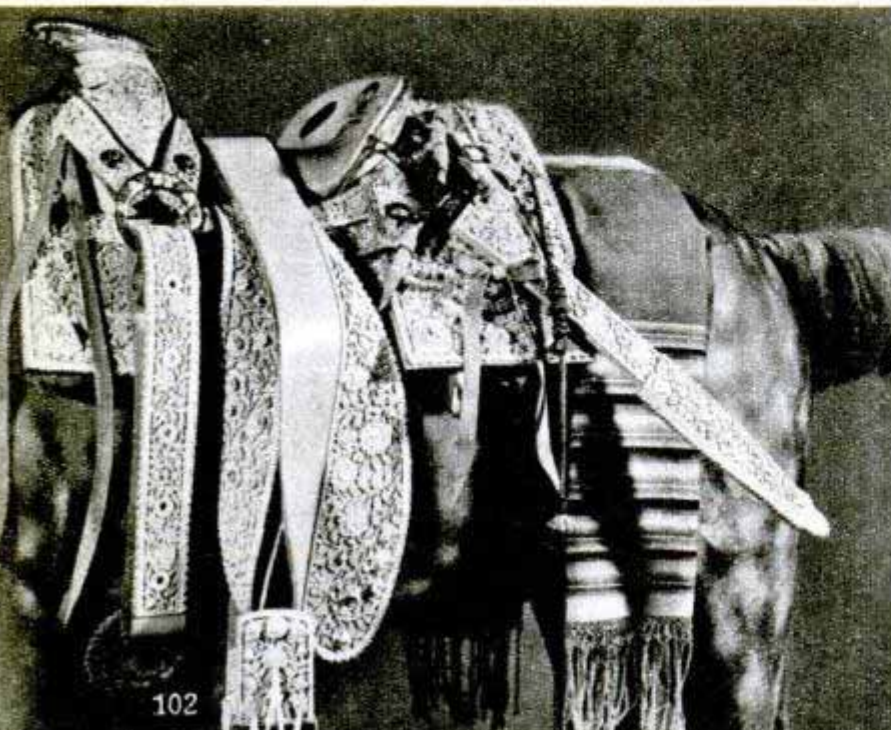

The typical Mexican native costume—the red and green sequined skirt and the white embroidered blouse—was also influenced by China. According to legend, a Chinese princess was carried back to Mexico by Spanish sailors as a slave and was Christianized by a pious Mexican couple in Puebla. Because of the princess' good works, she was much beloved, and the dress she adopted is the national woman's costume today, the China Poblana.

Mexican arts and crafts are still in what might be called the "cottage industry" stage. A whole family, for example, may join in making a piece of pottery. The mother grinds the clay, the father shapes the bowl on his potter's wheel, the children bake it in the oven. They all collaborate on the decoration: mama paints the flowers, papa the animals, the kids put on the dots.

Often whole villages specialize in making one certain product. Tlaquepaque, near Guadalajara, for example, is famous for its fine pottery; Taxco, south of Mexico City, is known throughout the world for its beautiful silver jewelry and plateware; and Saltillo is synonymous with beautiful wool serapes. We follow the same practice in the United States: Detroit for automobiles, Pittsburgh for steel, Los Angeles for sports clothes.

The difference is that we turn out a standardized product on the assembly line. Mexico produces a wide variety of useful goods, no two of which are exactly alike. From huaraches to sombreros, flowerpots to rugs, jewelry to saddles; each is an unsigned piece of art by a Mexican craftsman.

Most of Mexico's arts and crafts are sold in the market—an institution which combines some of the features of a state fair, a town meeting and a box social. The farmer brings his tomatoes, corn and avocados;

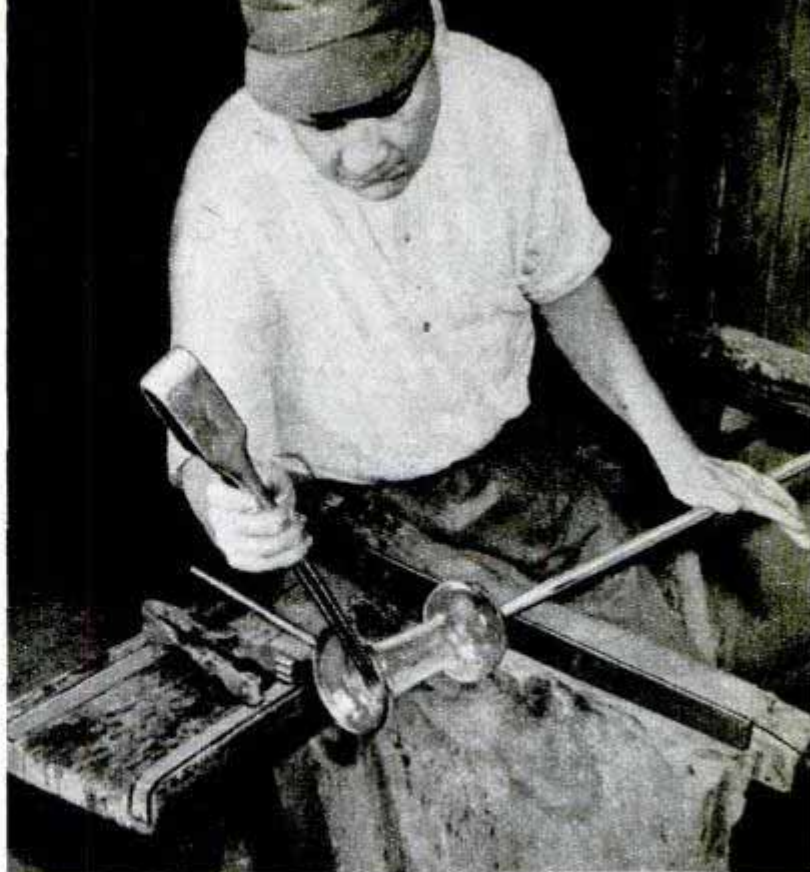

Brought to Mexico by the Spaniards, glass-blowing has become a highly skilled craft in that country

the wood carver has for sale images of Guadalupe, or delicately-carved swizzle sticks for Mexican chocolate; the basket weaver displays an amazing variety of colors and designs in his products.

Wherever it may be—in the public square of some small village, along the Pan-American highway, or in the throbbing metropolis of Mexico City—the market is not devoted entirely to the serious pursuits of business and commerce. It is a place where one may chat about the crops, borrow a peso or two from a friend, discuss the latest in politics, or drowse in the sun.

Left, tiny glass figures made by Mexican glass blowers. Right, artist paints design on an earthenware jug

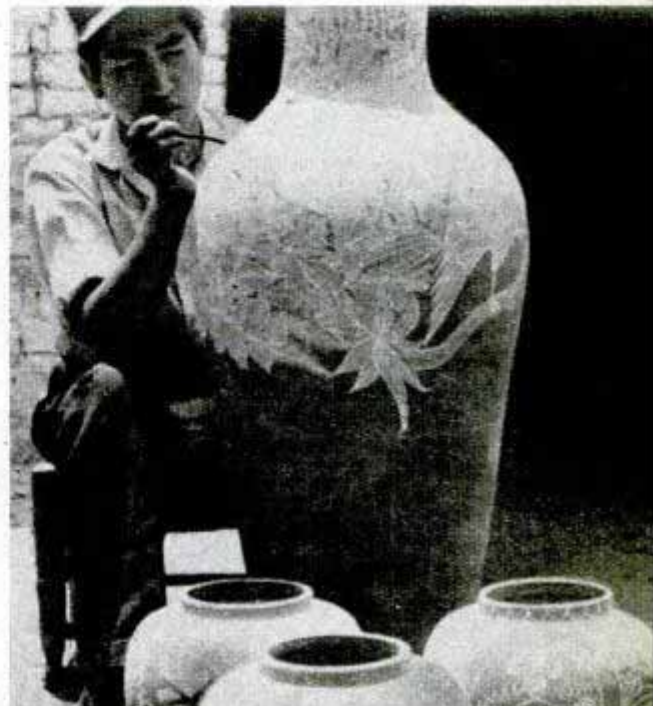



Senoritas from Michoacan hold samples of the lacquer work for which that part of Mexico is famous. These designs show the Chinese influence on Mexican art



Above, fine lacquer work from the Patzcuaro region. Below, these examples of Mexican basket weaving are made of lightweight bamboo and are extremely sturdy



Unfortunately, it's true that some Mexican arts and crafts are rapidly becoming commercialized and stylized. Old Aztec designs have been cheapened, and some curios and trinkets are as useless as those on sale at Coney Island or Niagara Falls. One author describes tiny whips in a Mexico City store "so small they couldn't be used for anything but to beat the canary."

In general, Mexican artisans turn their craftsmanship into three channels: (1) Making objects of utilitarian value for the village in which they live, (2) providing curios for the tourist trade, and (3) making objects to swap with other villages. Among items in the latter category, artistry and craftsmanship reach their peak.

Basic in Mexico, pottery is one of the oldest and most widely distributed of human crafts. The most typical Indian pottery is made of unglazed earthenware, plain or decorated. If the jug is a little lopsided or the bowl has thumb marks on it, it's merely a sign of an individual piece of art.

Glazed pottery, made also in many parts of Mexico, is the Spanish introduction. Dominican friars who helped found Puebla in 1532 sent to their monastery at Talavera de la Reina, near Toledo, Spain, for glazers among the brotherhood to come and teach the Indians how to make glazed pottery and tiles. The Mexicans quickly learned the art and improved upon it.

In Mexican lacquer work you can see most distinctly the Chinese influence. Gourds, calabashes and sweet-smelling linaloa wood are used as a base for this art. There are many styles and designs, depending on the region in which the work is done, and each has its distinctive beauty.

There are two techniques for lacquer work. In one, the design is inlaid in various-colored lacquers on a solid base. In the other, a series of solid colors is applied to an object and then a fine point is used to cut through to the underlying layers which consist of all the colors appearing in the final product.

Each coat is highly polished by endless rubbing and a final coat of clear lacquer is applied to the final product—and then rubbed and polished again. The secret of genuine lacquer work can be told by touching the surface; it looks and feels like engraving.

Textiles are as fundamental as pottery and many Mexican families still weave their own cloth as they did in Aztec days. As with pottery, different sections of Mexico produce various patterns and it is said that you can guess an Indian's town from the color, weave and design of his serape.

For peasant men, the serape is the basic unit of clothing. It serves as a blanket at

(Continued to page 260)

TEST YOUR SCIENCE

By Rex Taylor



CAN ENERGY BE DESTROYED?
One of the fundamental laws of physics is that energy, like matter, can never be created or destroyed. Here's an experiment that appears to destroy energy:

Take a small brass or steel spring—compress it—tie it down with impregnated catgut. The energy placed in the spring by compression is now imprisoned there. Drop it into a beaker of dilute sulphuric acid. Acid soon dissolves spring and the catgut holds fast. The spring did not expand—nor can it ever!



i. q.



WHAT BECAME OF THE ENERGY?

Logic says it was destroyed.
Was it?

(Answer on page 250)

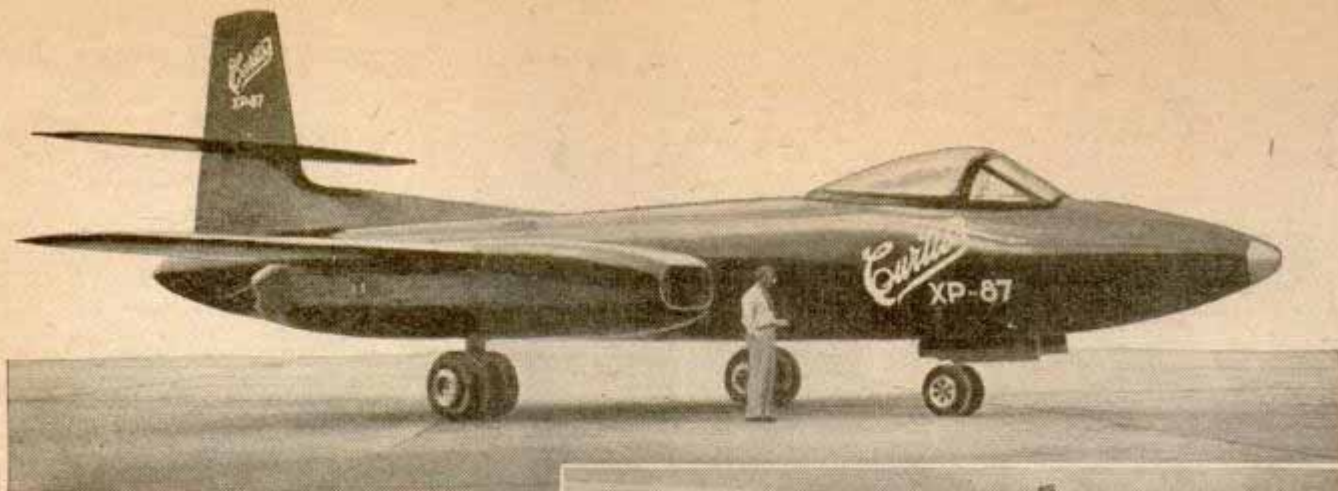

Curtiss-Wright photos

All-Weather Fighter

Elaborate radar and de-icing equipment are featured in the Curtiss XP-87, first of the U. S. Air Force's all-weather jet fighters. A two-man crew sits tandem fashion on ejection seats for high-speed emergency escape. The plane has four engines which are 24 inches in diameter, permitting pairs to be installed in the long, thin nacelles to give the plane a 620-mile-an-hour top speed. Armament, concentrated in the nose, consists of six fixed 50-caliber machine guns and a four-gun radar-controlled turret. The pressurized XP-87 weighs 15 tons



Long, flat nacelles and a sharp nose are distinguishing marks of the XP-87. It is 65 feet long and has a 60-foot wing span



Boeing Aircraft photos



Nearly as large as a Superfortress, the six-jet XB-47 is the first of the heavyweights to employ swept-back wings and tail surfaces. It is 108 feet long, with a span of nearly 116 feet

Swept-Back Jet

Sharply swept-back wings and tail surfaces make their first big-plane appearance in the Boeing XB-47, which is nearly as large as a Superfortress. Six jet engines hang from the ultra-thin wings, a pair of them in each of the double inboard nacelles. The main landing gear is tandem type, aided by a pair of small outrigger wheels during operation on the ground



← Mud solves New Zealand's housing muddle: Farmers are building homes of mud bricks in a local process 70 years old. The field is plowed, watered. Then horses are ridden across it for two hours making a dough which (below) is molded into bricks

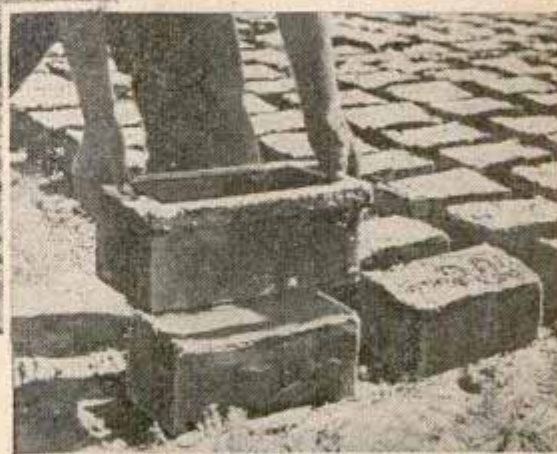

Mansions From Mud



↑ Farmers construct the interior walls of a house, laying mud brick in the same way the outside walls are built. A mortar made of both lime and cement is used. Tough grass sprinkled into the mud dough strengthens the bricks and completed walls. The homes are built on conventional foundations. The house at right is completed except for a rough stucco-like finish that will be applied to the walls to give them a more attractive appearance. The result is a durable house, easily heated in winter and cool throughout the summer



MOVE OVER, DOBBIN, and make room for the sturdy little planes that are fast taking over your traditional farm chores. The men whose lives and hopes are entwined in the soil are becoming the most air-minded of all.

Manufacturers estimate about 60 percent of the new personal aircraft will go to farmers, who are already a sizable bloc of the flying public. With their products bringing good prices and help hard to get, farmers have both the means and the reasons to use "air jeeps" for more and more odd jobs. Time is a precious commodity to them and the air offers many opportunities to do the work quicker. And, when there's a lull for family relaxation, the plane can assume transportation duties that used to fall to buggies and autos.

Years ago a few hundred miles' travel represented a full day's work loss to the farmer. With planes, little time is wasted now when those emergency trips come up for urgently needed farm-ma-

"Plane-Dirt" Farmers

By Aubrey O. Cookman, Jr.

Like most farmers, Orville Brown is curious about the potentialities of helicopters. Here he's learning how a Bell model flies



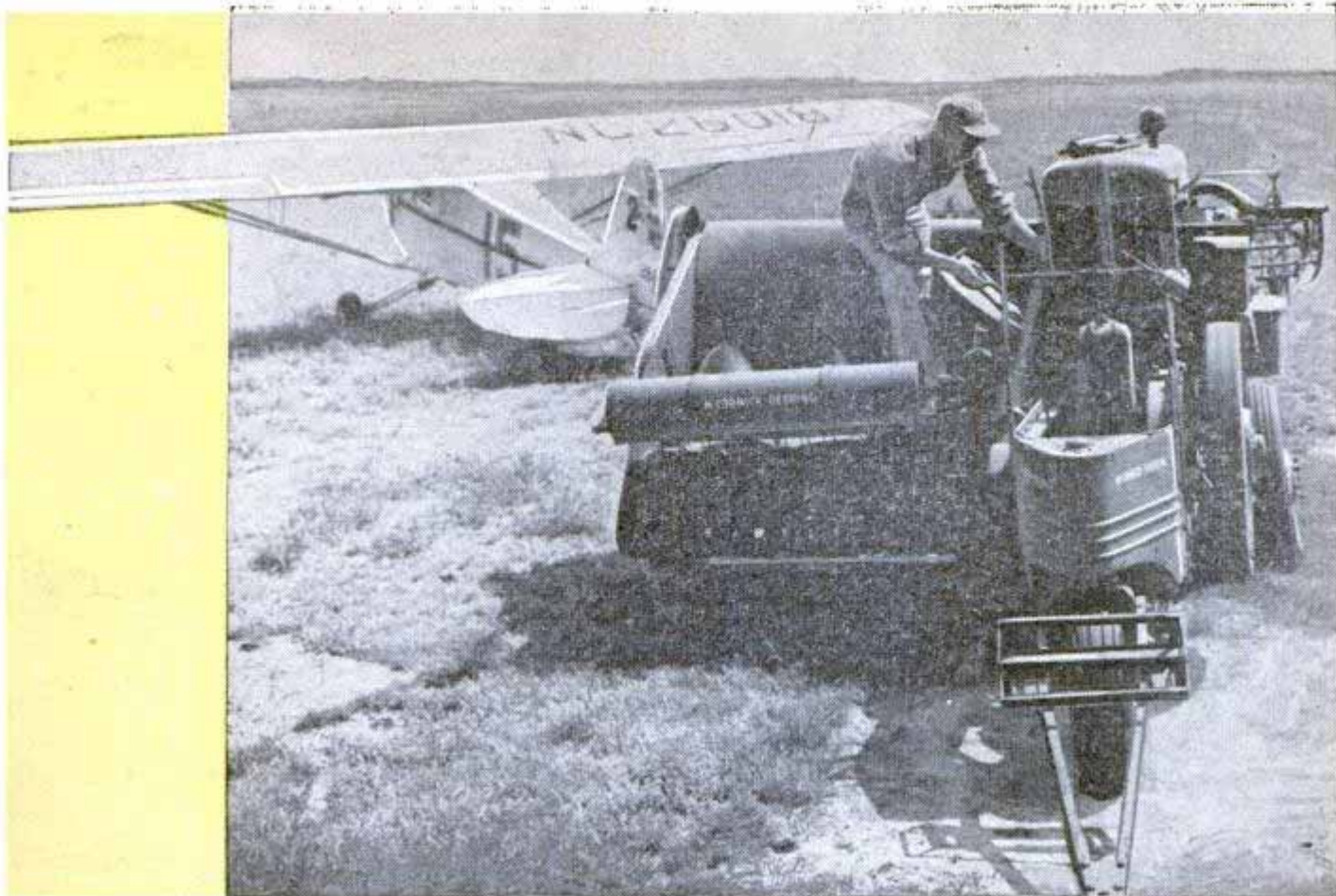

For speeding repair of badly needed farm equipment, planes can't be beaten. Parts can be picked up at the nearest town and flown back to machinery, like this baler, in a few hours

chine parts, for seed or supplies. And rural communities are beginning to cooperate by bringing the landing field closer to Main Street. In one Kansas town a street from the airport to the business section has been made a taxi strip, along which planes roll directly to an aircraft parking section.

Flying farmers refute the assumption that it's a "young man's game." Most of them are in their late thirties and forties and many learn to fly at fifty and more. Among the reasons for this are that the ships aren't "hot" and difficult to handle and, more important, few young fellows have cash and land to justify the expense.

As a group they're among the most careful, with only a single fatality chalked up against them in nearly two million air miles. About three-fourths regularly provide shelter for their plane and have landing strips on their own property. Less than two years old, the National Flying Farmers Association already has nearly 3000 rural pilot members.

The airplane helps them keep abreast of the latest in agricultural methods and equipment. More than 900 planes flew into the University of Illinois airport recently for a two-day meeting of farmers from four states. Lined up alongside the runway for their inspection was the newest farm machinery, everything from grain driers and

electric silo unloaders to septic tanks.

Instructors from the university's agricultural college were on hand to discuss farm problems, or the visitors watched demonstrations of agricultural and aviation equipment. At night, about 2000 gathered for a fish fry served by the Famous Jonah Club of Akron, Ind., a farmers' fun group dedicated to "avenging Jonah" by offering up thousands of the whale's small descendants at banquets and outings.

Among those at the Illinois meeting was a typical flying farmer who is "sold" on the advantages of a plane. Orville Brown, 36 years old, operates 460 acres near Gessie, Ind., raising corn, wheat, clover, soy beans and alfalfa. During the four years he has flown, Brown has logged approximately 450 hours. His plane, a Piper Super-Cruiser, was \$3295 new and operating costs have come to about \$300 yearly.

His land is split between two farms only four miles apart, too close to justify flying, but he says the time saved by using a plane for many required business trips and errands gives him many extra working hours on the farm, where he is shorthanded. Without it he'd have to cut down his farming or try to get another hand, at considerably more than it costs to operate the plane.

Brown has made a sod strip 70 by 1800 feet at one edge of his "home field" and,



Some of the 900 planes flown to the University of Illinois for a demonstration of the latest agricultural equipment and techniques. Families like the Browns came for combined "shopping tour" and brief holiday

Prairie Farmer photo

by rotating crops and always having one in clover, he has an additional east-west clover runway at right angles to the main strip. He built a 28 by 40-foot hangar of sheet metal and railway ties, storing farm machines in the extra space on both sides of the plane. As an indication of how deeply the flying bug hit the Browns, his wife is taking lessons and Johnny, 11, already handles the controls with a little help. But they've never lost sight of the fact that they're first of all a farm family, as three gold metals for agricultural achievements testify. Brown has worked up one of the state's top averages in corn competition.

Planes are finding an ever-widening utility on the farm. They're invaluable on

inspections to check soil erosion; in locating wind, storm and insect damage; surveying water supplies and broken fences; and for running miscellaneous errands. In 20 minutes aloft a rancher can inspect as much as he would during a full day in the saddle. Oklahomans, especially, have found that they're by far the most effective means of hunting coyotes, bagging hundreds during a three-day shoot last year.

One of numerous state agricultural officials who has complimentary things to say about the air age on the farm is New Jersey's state secretary, W. H. Allen. According to him: "There is greater use for a plane on the farm than in any business, with the exception of transportation."

Landing at the campus air field, the Brown youngsters are the first to alight and head for the exhibit area

Brown and son look over an all-crop drier at the exhibit. It blows hot air over wet hay and grains

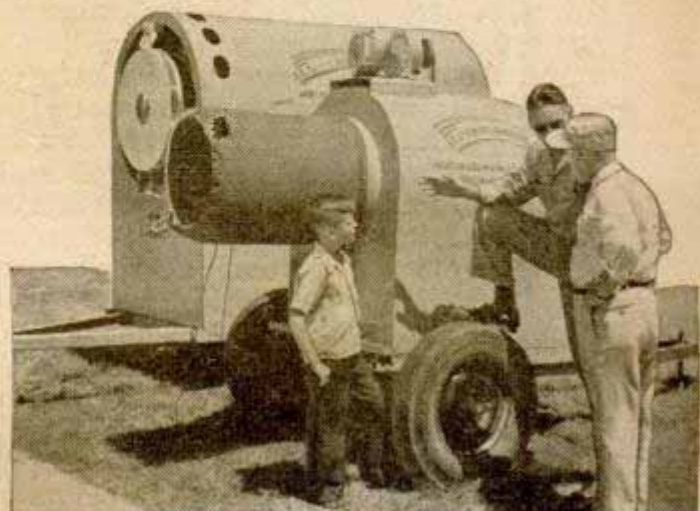

Someone else called the plane the farmer's "key to the city."

Among the bigger operators there is Paul Thompson of Terre Haute, Ind., with cattle-feeding operations in Kentucky and Mississippi, as well as the Hoosier state. Thompson uses two single-engine craft, as well as a twin-engine Cessna, putting in close to 75,000 miles a year on strictly business travel. As a small illustration of mileage saving, it is 250 road miles from Terre Haute to Lexington, Ky., one of his most regular trips, and only 170 by air. In the Cessna, that takes little more than an hour.

Since its beginnings in the 20s and 30s as a crop-dusting agent and seed layer, the airplane has come a long way in its fight for recognition as a farm machine. Though still in the experimental stage in many of its agricultural uses, farmers are learning by trial and error how to get the most out of their sky buggies.

Most promising of all, the farmer is "up in the air" now—and he likes it!

Since he'll be piloting one soon, Johnny Brown tests the "feel" of a new tractor



Farmers check their planes carefully. Below, Browns see unit that makes round bales, which resist weather better than square type

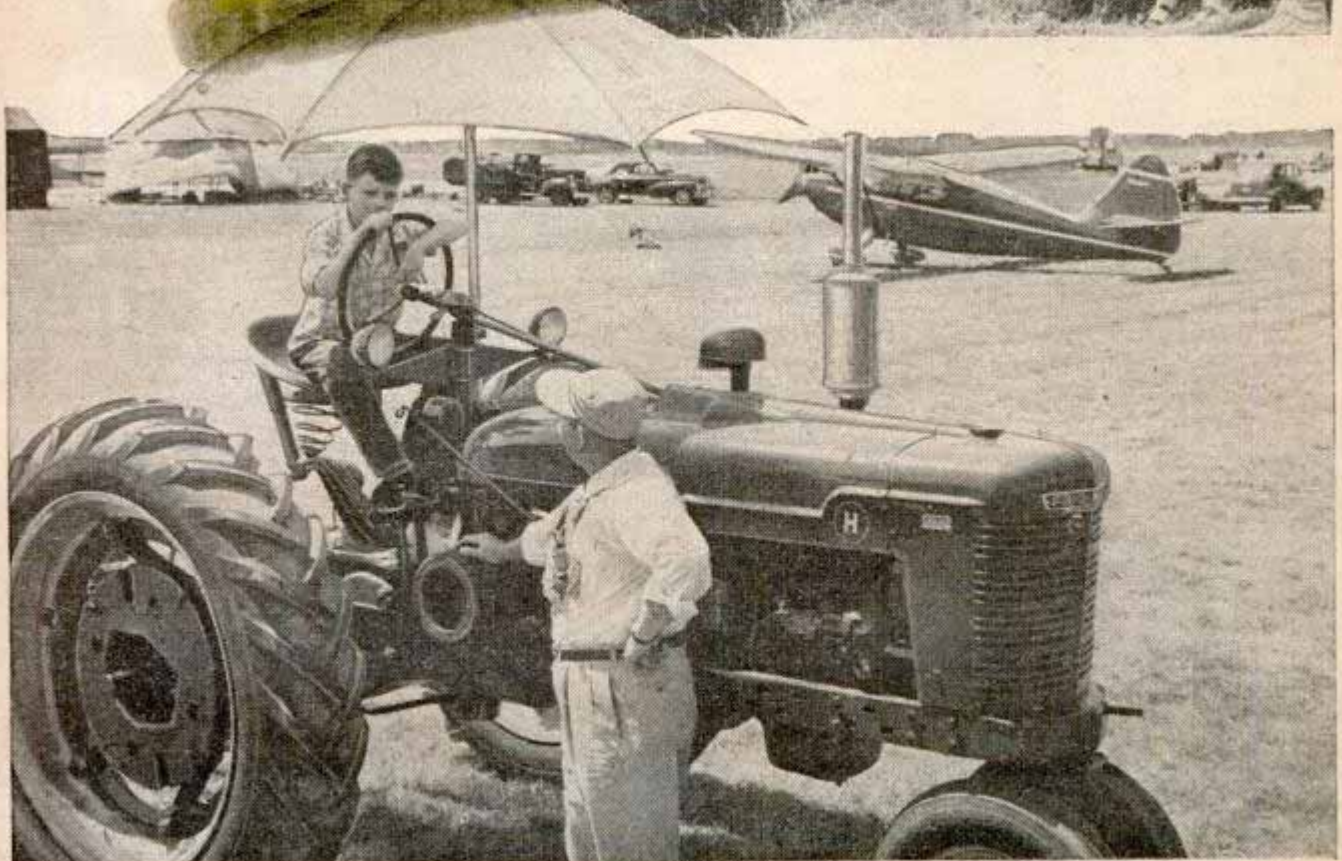
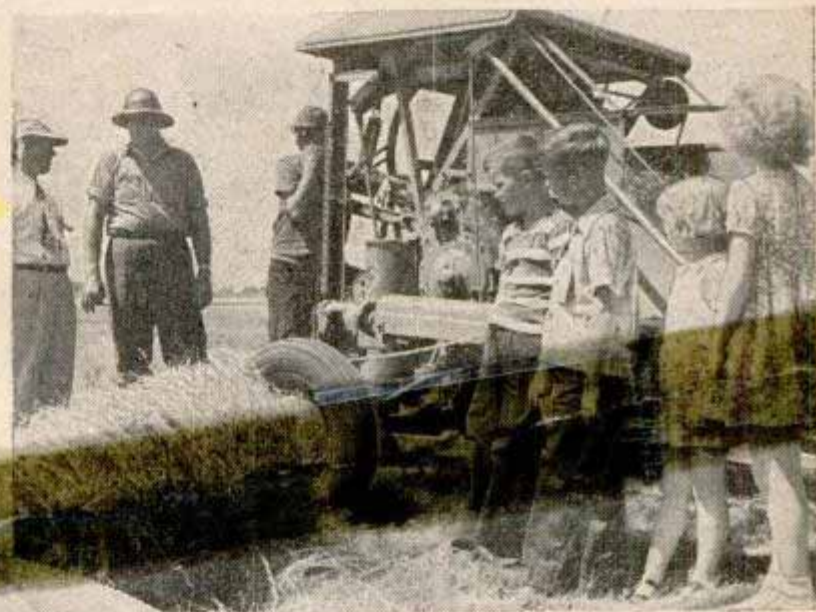

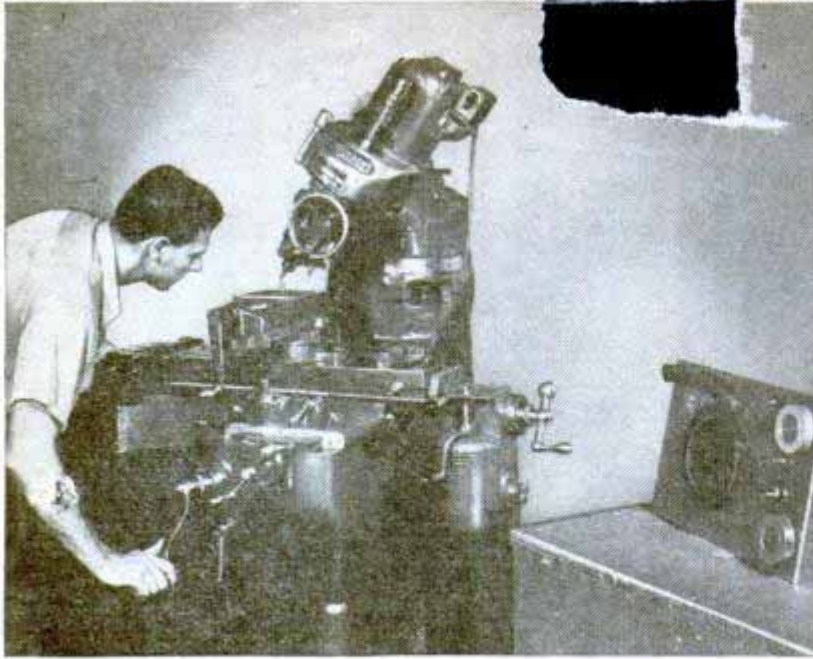

Above, inventor works on a shaft for recorder of his own design shown at right of photo. Right, girl runs a rented lathe. Below, view of machine shop on a busy evening with owner, Xelphin Dugal, standing at right

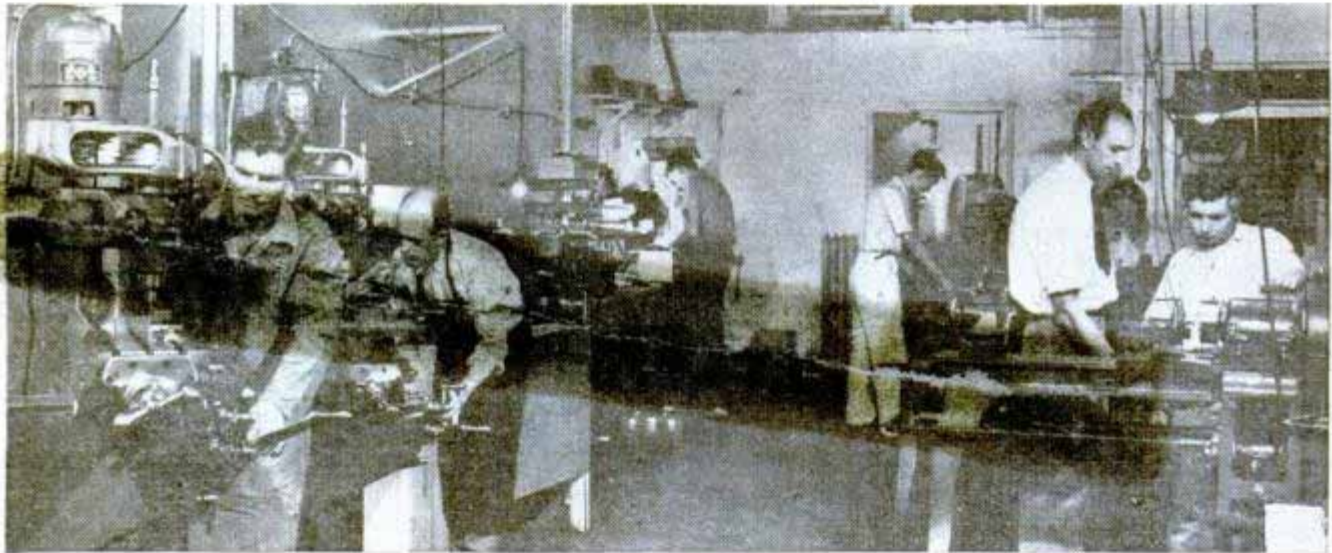

Craftsmen and inventors rent power tools by the hour in a rental machine shop recently opened in New York City. A variety of precision equipment including milling machines, drill presses, lathes, sur-

face grinder, metal-cutting planer and pantograph engraver can be rented at rates averaging about 75 cents an hour. The operator is a machinist of many years experience and he acts as teacher and adviser.

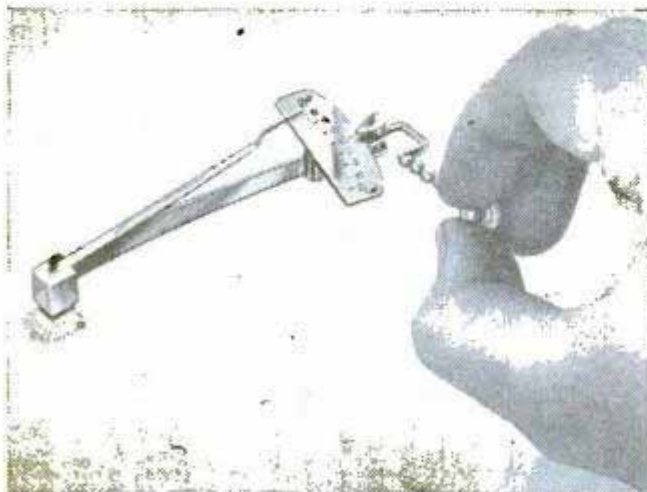

Pygmy Torque Wrench

Delicate measurements of the tightness of small screws in gauges and instruments are recorded by a pygmy torque wrench measuring only $3\frac{7}{8}$ inches in length. Furnished with a $\frac{1}{4}$ -inch drive square, the little wrench has a scale from zero to eight inch ounces. This extreme range of the wrench is equivalent in measurement to only $\frac{1}{24}$ th of a foot pound.

Ⓞ Gasoline is stored and handled like a solid when packaged in a transparent, cellulose film that is almost completely nonflammable.



Making Miniature Spinning Wheels

Fifteen years ago Henri Legault of Montreal, Canada, read an article in *Popular Mechanics* explaining how to make miniature spinning wheels. He decided to make one according to the instructions and enjoyed the work and result so much that he established his own business of making tiny spinning wheels for souvenirs. Today, Legault, his wife, 11-year-old daughter and 10-year-old son work as a team, producing about 400 models a month. Each little spinning wheel consists of 30 pieces of solid maple, scaled $\frac{1}{8}$ inch to one inch.

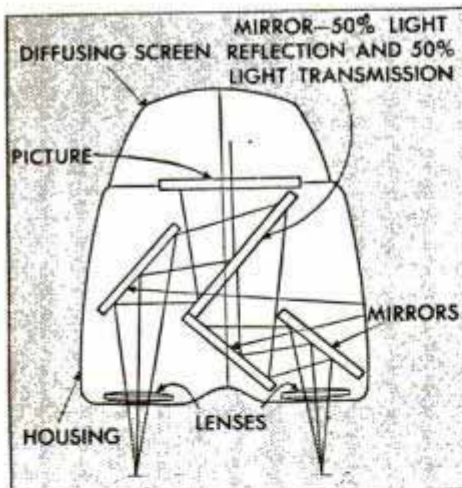

Slide Viewer Gives Illusion of Depth

With two lenses, a transparency viewer achieves a three-dimensional effect from a single slide, according to the manufacturer. A mirror that reflects half the light and transmits the rest is a feature of the unusual optical system that gives each eye a separate view of the transparency.

Pencil-Sharpener Hone

Dull pencil sharpeners are sharpened quickly with a pencil-shaped hone that is easy to use. The hone is placed in the sharpener, the handle turned backwards several times and the blades are like new. The hone comes equipped with a leather carrying case.

Information, including manufacturers' names, concerning products described in this issue may be obtained by writing Bureau of Information, *Popular Mechanics Magazine*, 200 E. Ontario, Chicago

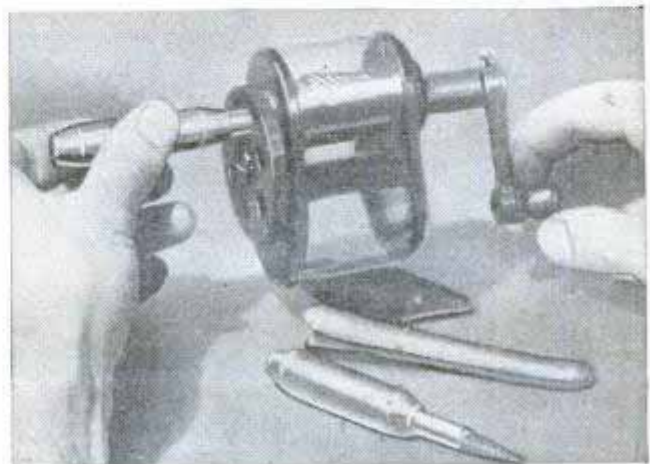

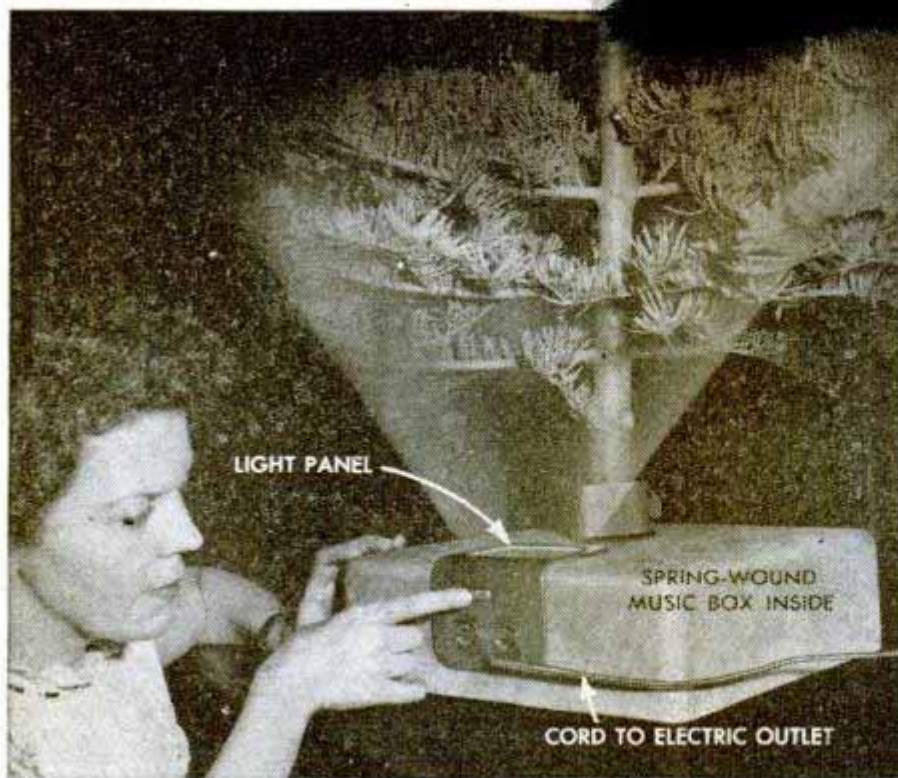

Musical Tree Stand Plays Carols

Concealed in an aluminum stand for Christmas trees, a spring-wound music box plays carols. The stand has an electrical connection into which the tree lights may be plugged. A frosted glass window on the stand covers a light bulb which adds illumination. Tree trunks fit into a tube which may be filled with water to prevent the tree from drying out, or with a fireproofing liquid that makes the tree fire-resistant. The stand is made of aluminum coated with green flocking. Setscrews hold the tree securely.

Revolving Christmas Tree →

Christmas decorations for the home can be made refreshingly novel with a motor-driven stand that slowly revolves the tree. The tree turner is adjustable to fit almost any tree and will hold 200 pounds safely. A built-in two-way outlet rotates with the tree to provide for tree lighting. The cast-aluminum holder makes three revolutions a minute.



Coaster Wagon Steers Like an Automobile

With its front wheels mounted on caster supports, a new coaster wagon steers like an automobile. A tie rod connects the wheels to a vertical steering column. The pulling handle, attached to the steering column near the right side of the wagon, serves as a tiller. So that sharp turns can be made without tipping, the rear wheels are farther apart than the front pair. The wagon is assembled with nuts and bolts requiring special tools to keep curious boys from tearing it apart. Because of the welded frame chassis, the hardwood body is strong enough to support 900 pounds.

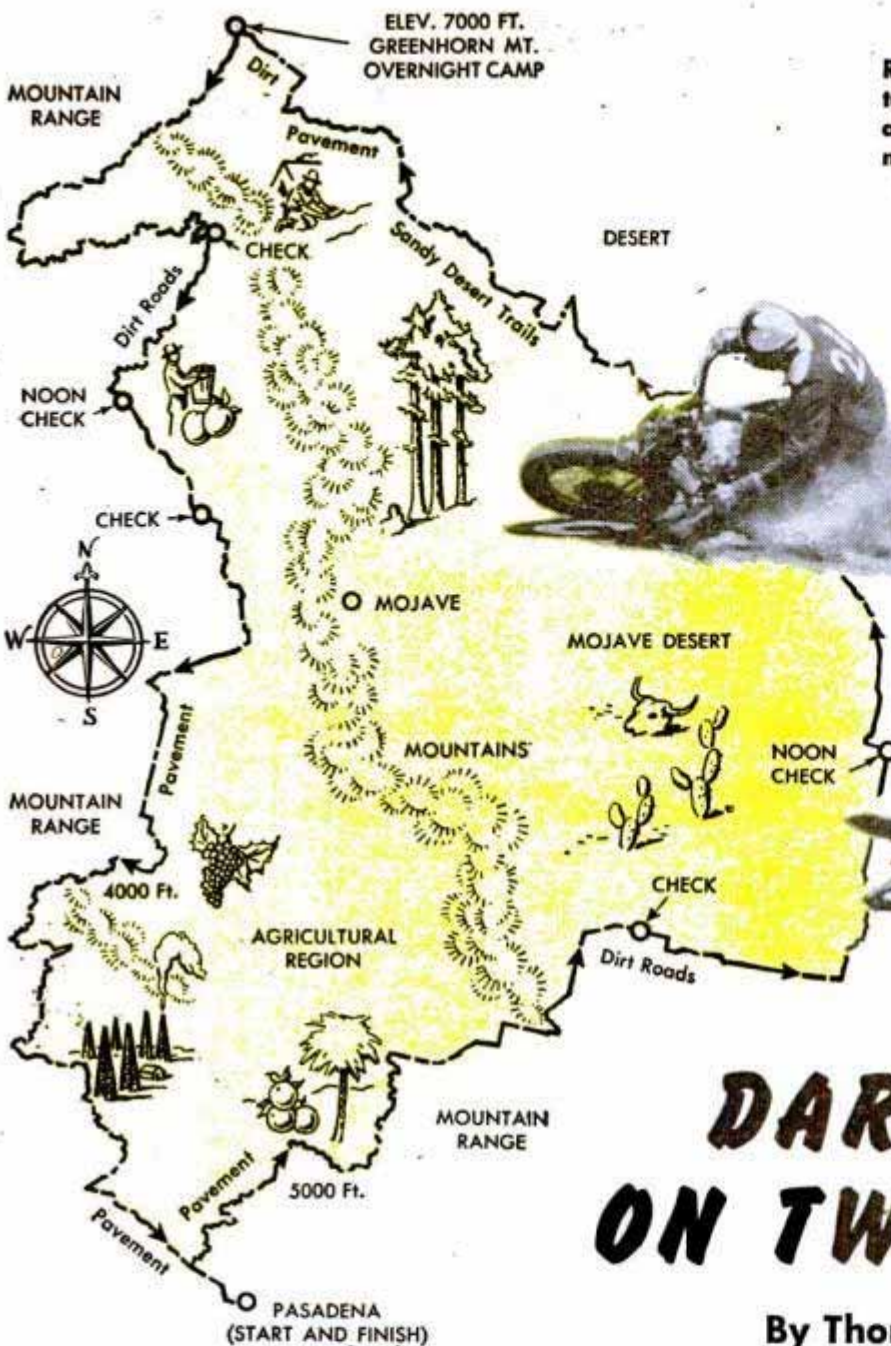

Riders below take a sharp turn on the tough 500-mile endurance course shown at left. This course crosses several big mountains and 100 miles of desert

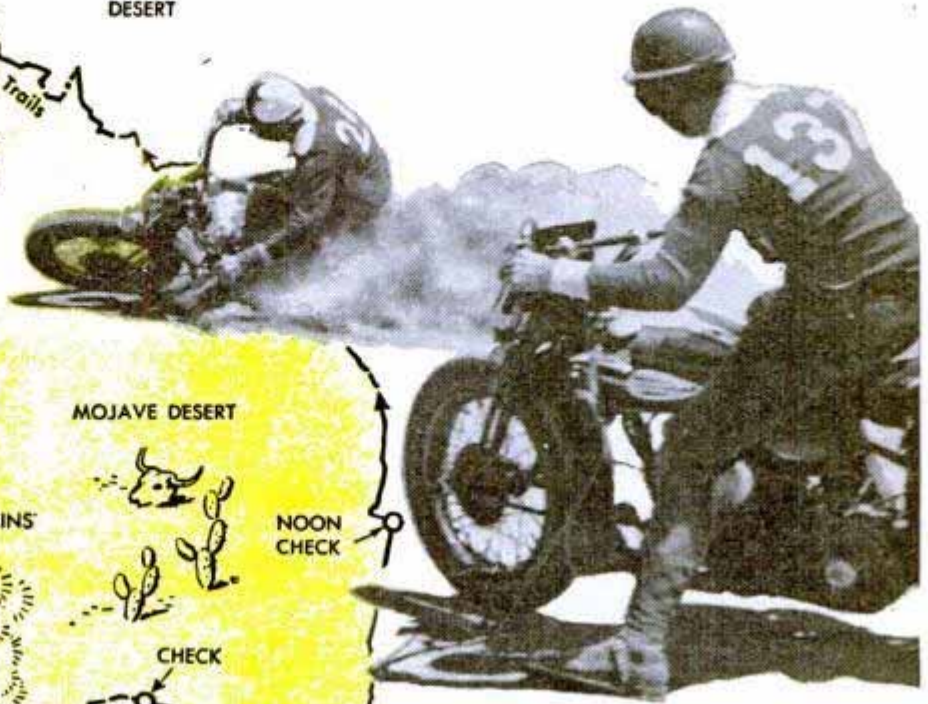

DAREDEVILS ON TWO WHEELS

By Thomas E. Stimson, Jr.

ONLY THE HARDEST-RIDING motorcycle pilots stand much chance of winning the grueling endurance contests that motorbike clubs hold every year. The pace may average no more than 24 miles per hour and yet two thirds of the contestants are apt to fall out before the contest is over.

The thing that breaks the riders' hearts and punishes their machines is the course over which a run is held. Picked for trouble, it is the roughest 500 or 600 miles of roads, trails, and cross-country terrain that a club can find in its vicinity.

Part of one western endurance course is a four-mile downhill stretch of slick clay. The trail is like grease and the contestants slip and slide most of the way to the bottom. A three-mile stretch on the same course is through deep adobe. During the wet season a cyclist needs almost an hour to ride and push his machine from one end to the other. The famous Jack Pines course

in Michigan, through timber and along old logging trails, is a slippery, rough and treacherous course on which no one has ever made a perfect score.

In California the Greenhorn Mountain run, starting from Pasadena, climbs across the summits of three mountain ranges of up to 7000 feet altitude and includes 100 miles or so of blistering desert. Old abandoned dirt roads and forestry trails are followed across the mountains; most of the run across the desert is simply in the tracks of a motorcycle that had been through the region a week before to chart the route. Only 90 miles of the 500 is on pavement. Contestants carry maps with them and although all the turns are marked with signs many of the riders lose precious minutes or hours when they make wrong turns and become lost.

Another famous course is the Sandy Lane that starts at Camden, N. J. Scene of

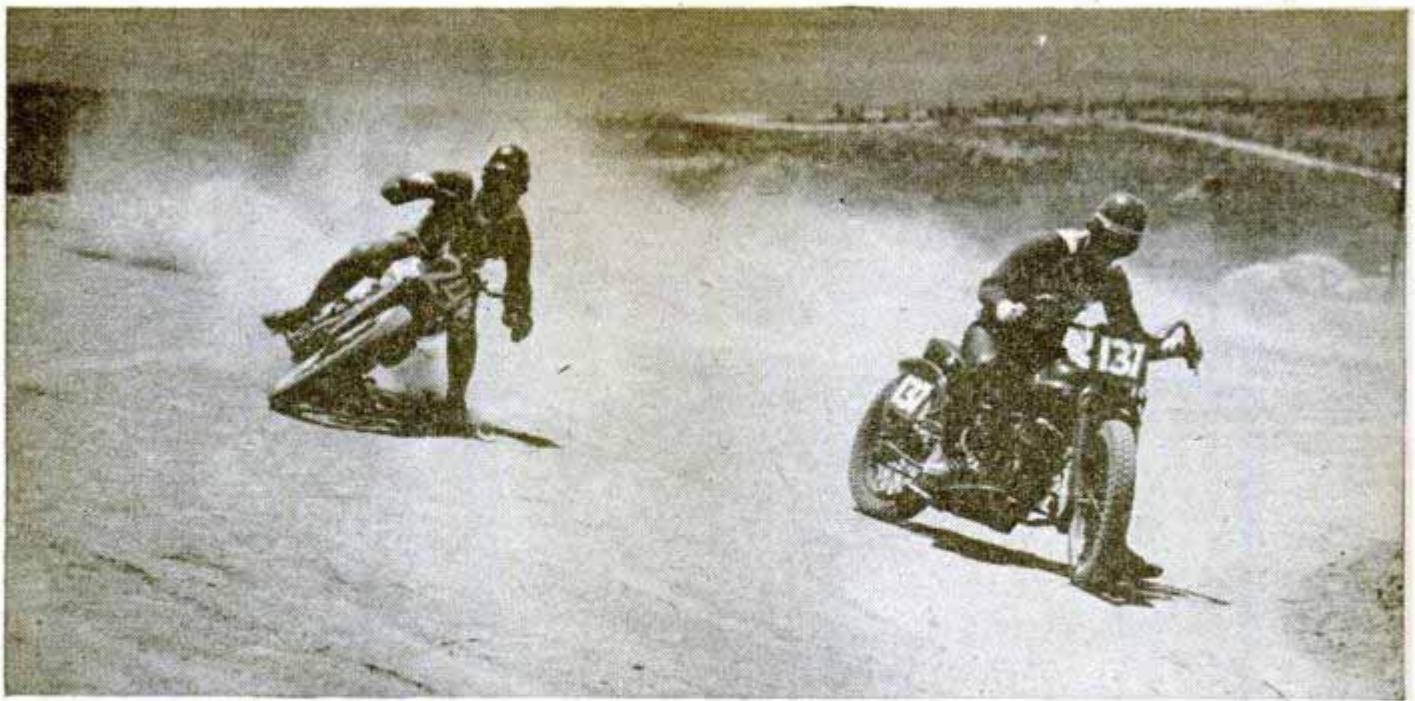

Skidding wide on a turn, rider uses his steel-plated left shoe to keep his balance and avoid spill. These riders wear sturdy crash helmets, leather pants and knee boots. The cyclist below could use bathing suit

the 1947 championship endurance run, Sandy Lane is 500 miles of deep sand, rough country roads, and narrow twisting trails. Contestants grind along in the low gears a good part of the way.

An endurance run is not a race. It is a contest in which each rider tries to adhere to a certain schedule so that he arrives at the numerous check points on time. He knows the location of a number of the check points and in addition there are secret checks that he encounters unexpectedly along the route. One point is knocked off his score for every minute behind schedule at any of the checking points. He can arrive 29 minutes early, but if he arrives 30 minutes or more ahead of schedule he is disqualified.

From 50 to 100 riders participate in the numerous endurance runs that American motorcycle clubs hold during the year. All the big runs are two-day affairs and the riders cover some 250 miles during the first day. Sleeping bags and food arrive by truck at their camp site. The return to the starting point, over a different route, is made on the second day.

Some of the riders are eliminated long



before the first day ends. Utterly exhausted, they've had all they can take. Most of the men who stay in the contest will have fallen off their motorcycles once or twice before they make camp that night. Some of the machines will break down and be eliminated and few of them finish without some mechanical trouble. The riders carry a handful of spare chain links, a spare timer, tools, an extra inner tube, and a boot.

Endurance runs are open competitions and the riders may use any kind of machine they desire, modified in any way. Mufflers and headlights must be retained if any part of the course is over public roads. To

provide greater clearance for rough stretches it is a common practice to lengthen the forks or to use wheels of greater diameter. The new "hydraulic" front forks that contain a built-in shock absorber and the new rubber-mounted handle bars are popular accessories among endurance riders. The hydraulic forks iron out much of the usual pounding on rough ground and the rubber-mounted bars absorb most of the vibration on any kind of surface.

Motorcycles plus sidecars make up a

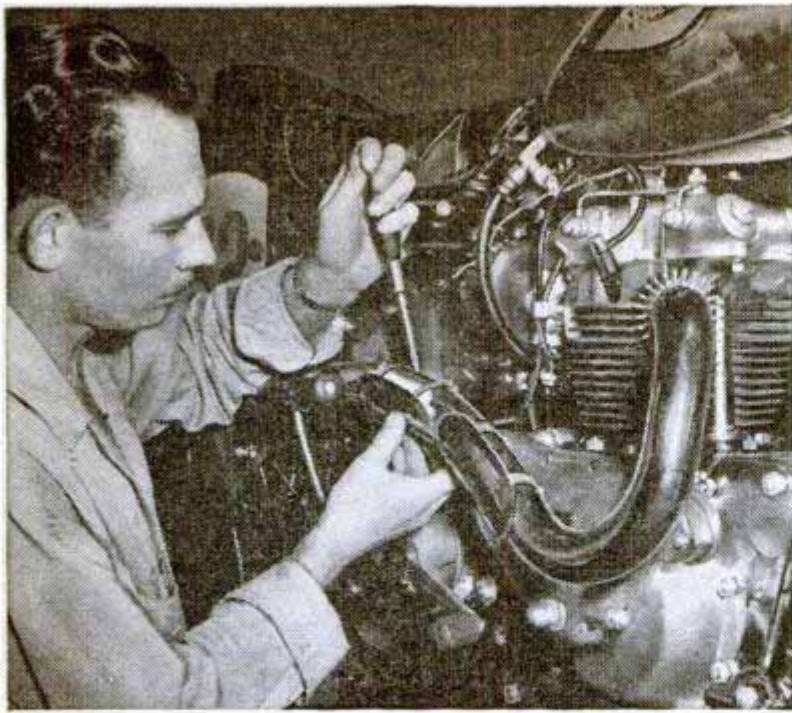

special class in many endurance runs. Usually the sidecar has a rear entrance so that the passenger can jump out and push without loss of time when a steep grade or deep sand is encountered. The passenger rides mostly in a kneeling position, ready to lean far to the left or right to help the vehicle around sharp turns. Some sidecar combinations use a long axle so that both rear wheels are powered.

Many competitors rework their engines to deliver as much as 50 percent greater power. A higher compression ratio, longer stroke, and a faster cam action are among the usual changes that give more power. Combustion

Above left, rider attaches shield over asbestos pad that protects leg from hot exhaust stacks. Right, machine leaps in air as rider tops short, steep hill. Below, racer relaxes during pause in pits where mechanic changes his carburetor





Left, ready and "raring to go," rider awaits start of endurance race. The motorcycle tires above are for use on pavement (left), pavement and dirt (two in center), hills and endurance contests (knobby tire at right)

chambers often are reshaped and the weight of the intake valves may be reduced by grinding and polishing metal from their flat tops. All moving parts are balanced. Everything with which the lubricating oil comes in contact, including the inside surface of the crankcase and the flywheel, is given a high polish to reduce friction.

A stock 45-cubic-inch motor with an original top speed of around 85 miles per hour can be made to deliver as much as 115 miles per hour by such changes. High speed is rarely a factor in an endurance run, but a reworked engine also produces additional power in the lower gears. This is important in deep sand and in climbing steep hills.

Motorcycle riders compete in more different kinds of contests than do the owners of other types of vehicles; for one thing because their machines are so adaptable to sport. For this reason, too, membership in

the different motorcycle clubs is high. Clubs that are affiliated with the American Motorcycle Association sponsor a wide variety of events that include short-track racing, hill climbs, and reliability trials that last one or two days and that are comparable with the endurance runs. Short-track racing is virtually for experts only although special races are held for riders of the novice class.

Field meets in which club members compete in different events are a popular sport, as are the so-called English trials in which the emphasis is on good riding over a short, tough course and in which penalties are called for touching the ground with a foot, stalling the engine, and for other mistakes. Hare-and-hound races, in which one rider is given a long start over a cross-country course before the other riders start out and attempt to overtake him, are other popular club events.

Signs along race course from left to right mean: Right Turn, Wrong Turn, Straight Ahead and Left Turn



Contests of this kind culminate in the TT races, the abbreviation for "tourist trophy." To the riders the real meaning of TT is "tough track," they declare. Most TT tracks consist of a closed course half a mile or so long, containing all the obstacles and difficult situations, except water hazards, that might be encountered during an ordinary cross-country tour by motorcycle. Sharp left and right-hand turns, rough spots, unexpected dips, steep climbs, and short stretches of sidehill are all built into a TT track.

Such a course is a hard test of riding ability when one rider alone tries to get around it at high speed. In a race there may be 20 or 30 machines pounding around the short track. Spills and collisions are frequent. For self protection the riders wear goggles, crash helmets, heavy sweaters, leather pants, knee boots, and long gauntlets. The left shoe is protected by a metal plate that curls up over the toe, allowing a rider to use his foot to help balance and pivot the machine around sharp left turns.

Worst, or best of the TT courses, depending on the point of view, is the treacherous Box Springs track at Riverside, Calif., scene of the 1947 national championship TT race. Skip Fordyce, one of the sponsors of the event, spent a month seeking a satisfactory location for the race before the Box Springs course was chosen. Then the dirt road was scraped and graded to make it harder than before. Almost every foot of it is a challenge to a good rider. Six tenths of a mile long, it is possible to get around the course in 50 seconds, equal to about 43 miles per hour. Even this speed is reduced before the race is over for the 100 mile TT championship race calls for 168 laps around the course.

"Sugar-Coating"

Table sugar can be converted into a durable, transparent coating for wood. Highly resistant to wear, hot oils and heat, the film is insoluble in organic solvents, according to chemists in the Department of Agriculture. The coating has a high gloss finish. Being transparent, it may be used as an adhesive for glass.



Thrilling moments in a hill-climbing contest—rider above is struggling to maintain control of machine on steep grade, and below both wheels are off ground during race to the top



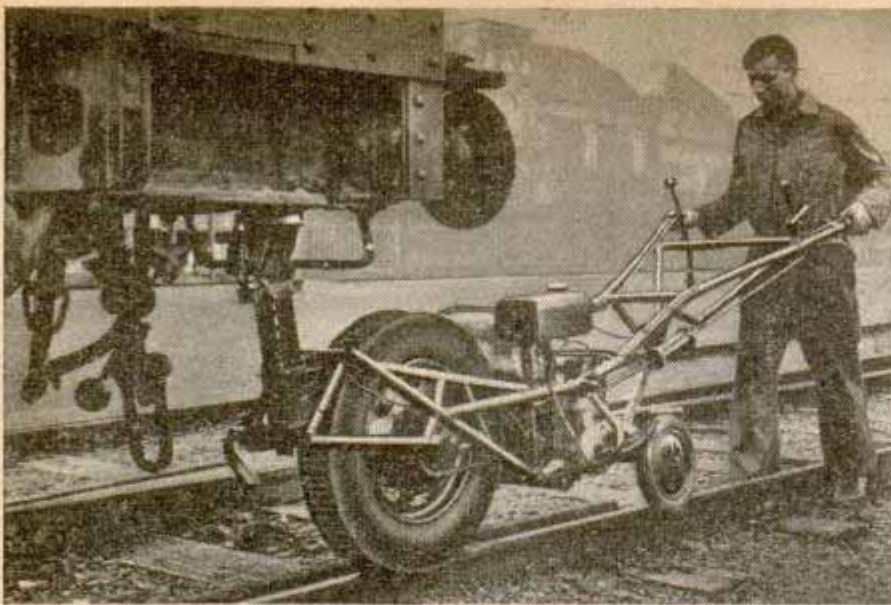

European Tractor Moves Freight Cars

Freight cars in Europe are moved with a small tractor powered by a one-cylinder gasoline motor. Used in freight yards for making up trains, the machine is called a Locopulseur. Traction is provided by a pneumatic tire with a treaded groove to fit the rail. The driving wheel forces its way in a wedge-like manner between the car and the rail and can push an entire freight train.

Motorcycle Speeds Baled-Hay Drying

Bunting hay bales with a motorcycle is a technique recently tested near Elm Grove, Wis. Harley-Davidson is checking this means of expediting the drying of hay bales. The round bales roll out of the baler onto the ground. Later, the cyclist rides across the field, bunting each bale with the safety guard to expose the damp side to the sun. Over 1000 bales have been turned in 38 minutes in tests.



Practice Set Uses Stylus To Sound Code Symbols

Telegraphic code is learned quickly with a device on which the student sounds code letters by sliding a stylus across a contact plate. The code symbols are sounded on the buzzer in the proper rhythm regardless of whether the stylus is moved slowly or rapidly. By repeating the code on the hand key after hearing it sounded by the stylus, the student learns proper timing of dots and dashes. Power is provided by flashlight batteries. Two sets can be connected for practice transmissions.

By crossing cultivated potatoes with a wild species from South America, Dr. D. K. Reddick of Cornell University has produced a potato that is immune to blight.

Mechanical cutter at Robena slices nine feet deep into bituminous coal vein in the first step of mining operation. Miner adjusts a water spray to minimize coal dust



COLOSSUS OF COAL

Robena is a sort of infant prodigy among coal mines. When it really gets going, its underground caverns will discharge 24,000 tons a day—but not a pound for your furnace

A FEW hundred yards from the bank of the lazy Monongahela River in southwestern Pennsylvania you enter a rather unprepossessing hole in the ground and descend a moderate grade as a conveyor belt rumbles upward with a softly gleaming load of black stuff.

To the most inexperienced observer what he is entering is obviously a coal mine—but a few vital statistics about this particular hole in the ground are enough to make a mining expert whistle.

This is Robena—the atom age grandpappy of the world's coal mines—the biggest and the most completely mechanized. Mines which produce from 5000 to 10,000 tons a day are considered big; Robena, when completely developed, will mine a whopping 24,000 tons daily.

A single day's shipment would be enough to heat 2000 average homes for

By Bill Reiche

Power drill cuts into face of vein making it ready for charging with blasting powder. Machine runs on tracks and gets its power through the trailing electric cable

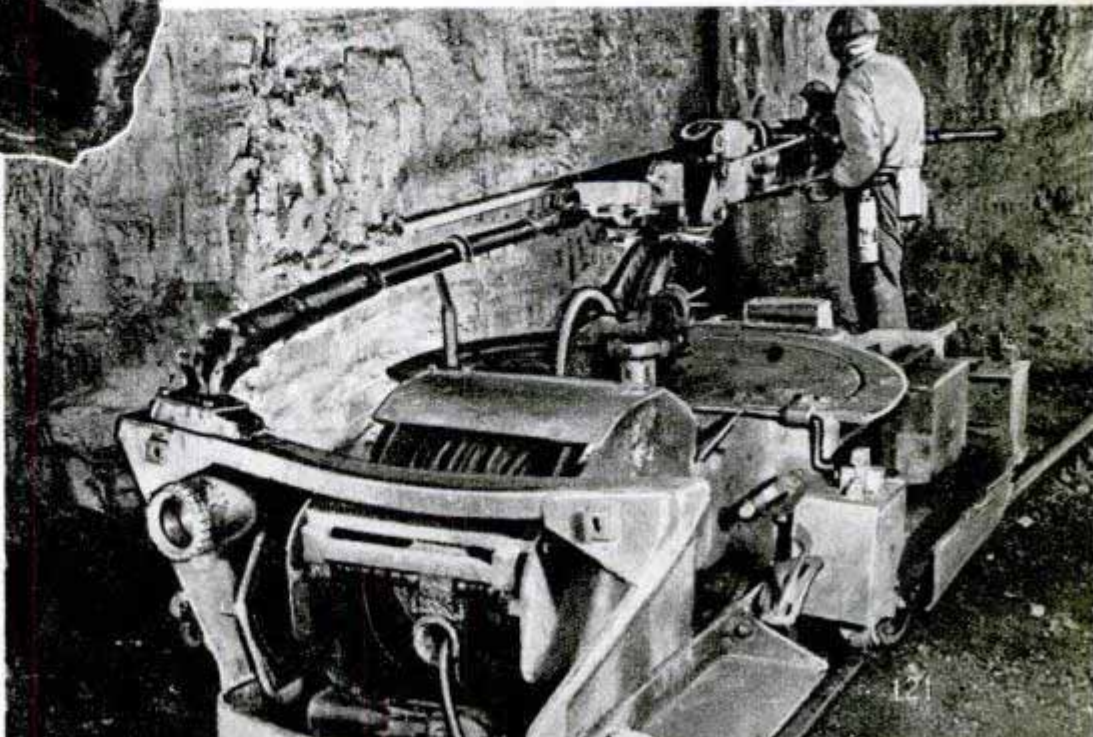

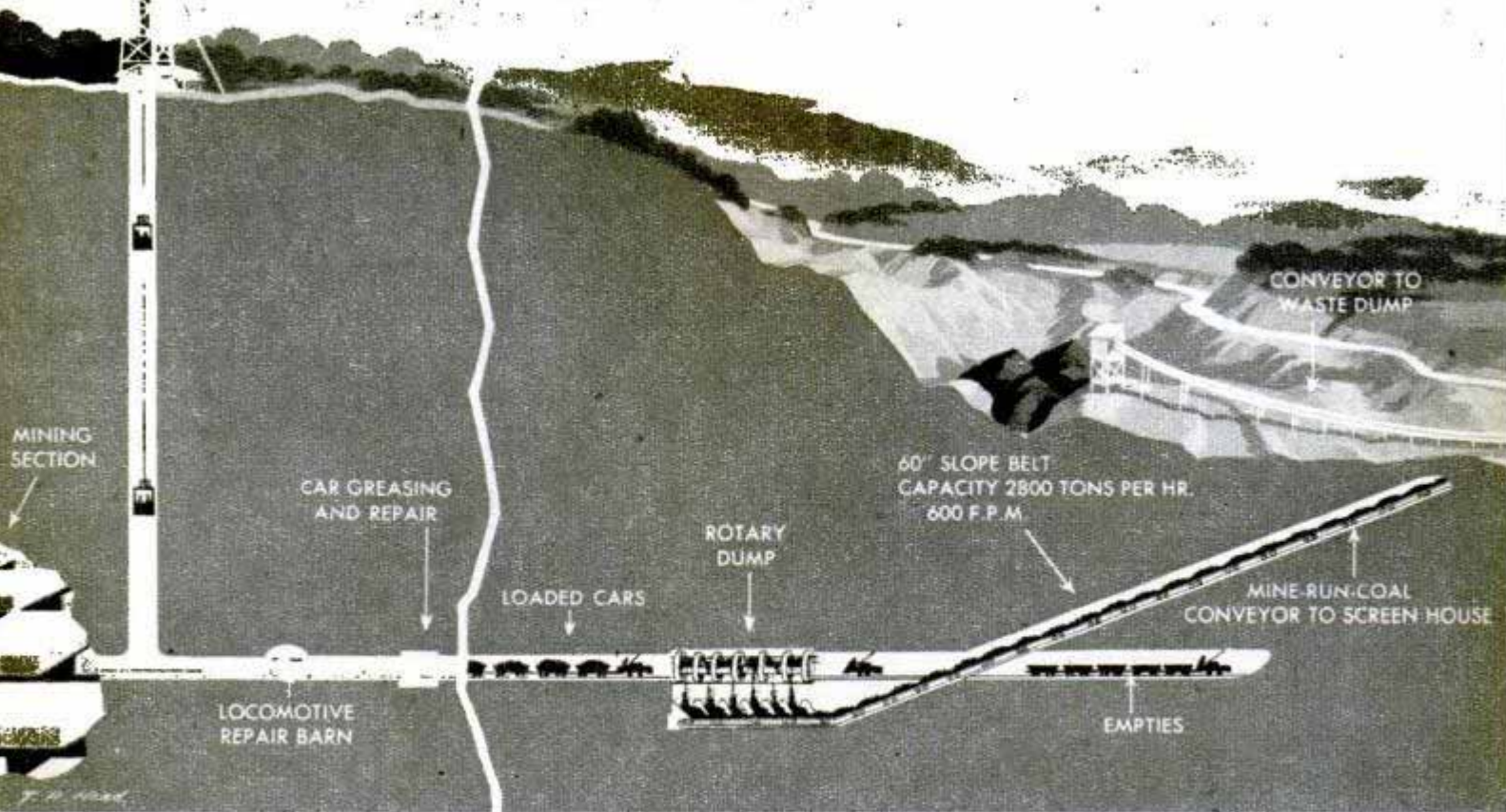

an entire winter—but not a ton of Robena's black diamonds will warm a home or a factory or drive a locomotive. This coal has a rendezvous with iron ore and limestone; it will make steel.

The mine is a property of the H. C. Frick Coke Co., fuel producing subsidiary of the United States Steel Corporation. It is a captive mine whose owner has an insatiable appetite for metallurgical coke—an appetite which demands the gaudy total of 31,000 tons of coking coal a day.

This is used by three of Big Steel's subsidiaries—Carnegie Illinois, National Tube and American Steel and Wire—in the Pittsburgh-Youngstown area alone. The mills in this area of these three companies have an annual capacity of 12,500,000 tons of ingots and steel for castings—more than 13 percent of the national output.

Heavy wartime steel production put a heavy drain on reserves of first class coking coal, such as is found in Fayette County, Pa. A new source of satisfactory—if slightly inferior—coking coal had to be provided or the companies would be in trouble. There are three prime factors in steel making: ore, coal and customers, and two of them must be within a reasonable distance of the mills. Since the ore comes from the western Great Lakes region that meant that the bituminous and the buyers had to be kept handy.

Samples were taken from the Pittsburgh No. 8 seam in Greene County, where Frick had a 69,000-acre reserve—approximately 100 square miles of coal in a vein eight feet thick. It was of generally higher sulphur and ash content than the coal then being used, but the sulphur content ranged from low to high.

This geological inconsistency made it possible for the Frick people to blend high sulphur and low

Explosive expert inserts blasting cap in final powder stick to be packed in hole. Blast sets off charge, loosening the coal



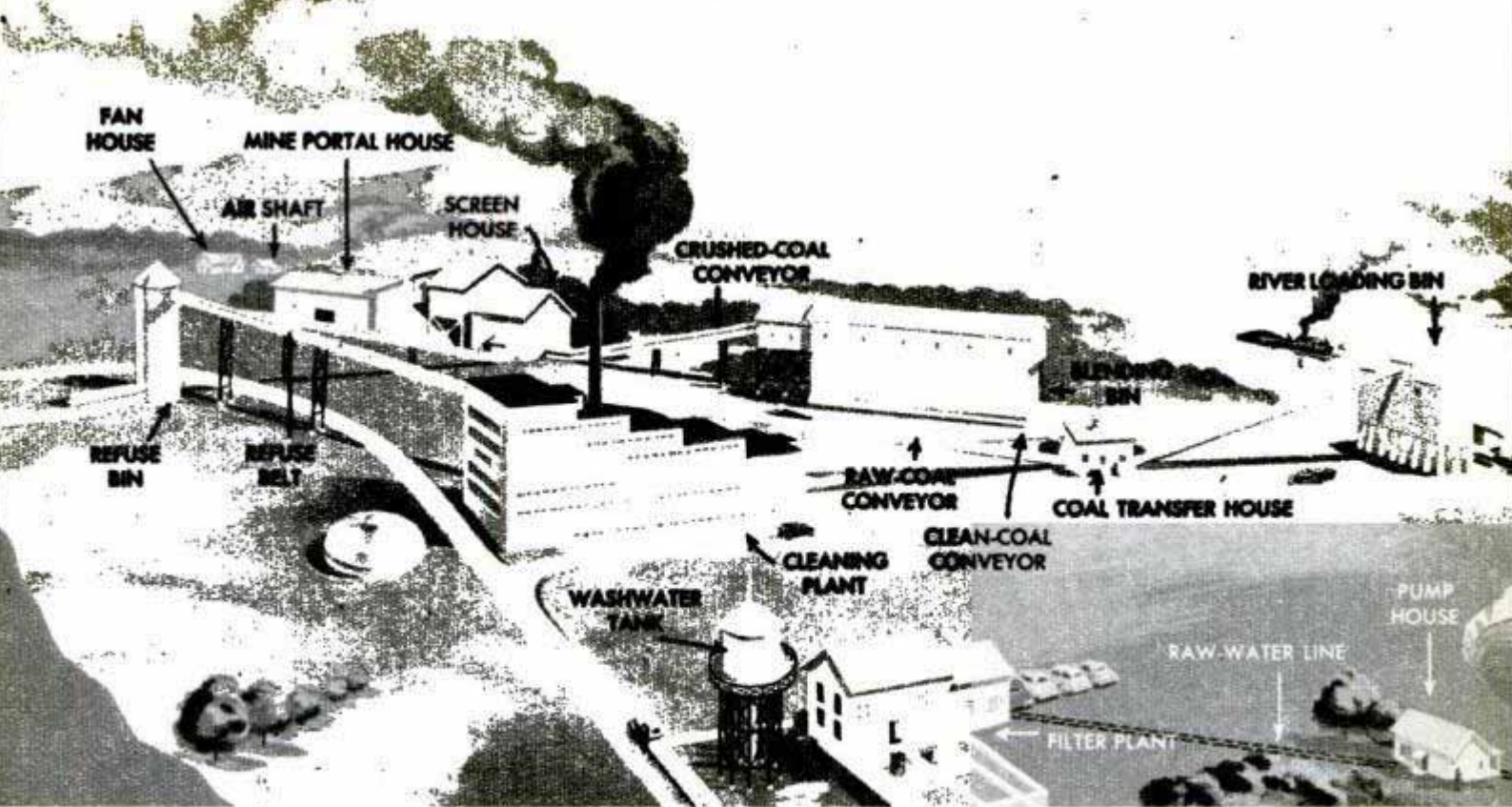

sulphur coals before they leave the vein level; by the time the coal reaches the coking ovens at Clairton, 61 miles down the river, it has been blended seven times. In addition to this mixing process the Robena output will soon be beneficiated — washed and cleaned to reduce the sulphur and ash content—at a new and efficient washing plant at the mine.

The main service shaft of the Robena mine is 454 feet deep and is 38 feet 10 inches by 15 feet 9 inches. It is lined with concrete ranging in thickness from 12 inches at the top to 18 inches at the base. This shaft is divided into four compartments, two for hoisting, one for a stairway, and a fourth for up-cast ventilation. The latter is connected to the main exhaust fan and the other three serve as air intakes.

The big exhaust fan plays a vital part in the Robena ventilation system. This unit is housed in a 24 by 40-foot brick building adjoining the shaft and the variable-pitch eight-blade fan is 96 inches in diameter. It removes 300,000 cubic feet of air a minute.

Another nearby structure is the lamp and bathhouse which provides accommodations for 1345 miners and 45 foremen. This building has two huge dressing rooms

Above, cutaway drawing shows the mechanized transport of coal from the mining sections to the above-ground processing plant. Carried on long conveyor belts, the processed coal is loaded on river barges at right. Below, power loader in mine scoops up the coal and drops it into cars



with overhead clothes-drying facilities. It also contains the first-aid room and offices for the superintendent, mine foreman, cost clerk, and a payroll office with a fireproof vault. The lamp room has facilities for maintaining 2500 cap lamps and the necessary flame safety lamps.

Let's start our tour of inspection at the mine face, where the coal starts its streamlined journey from vein to steel mill, noting what's done to fit it for its exacting role in the making of the basic material of

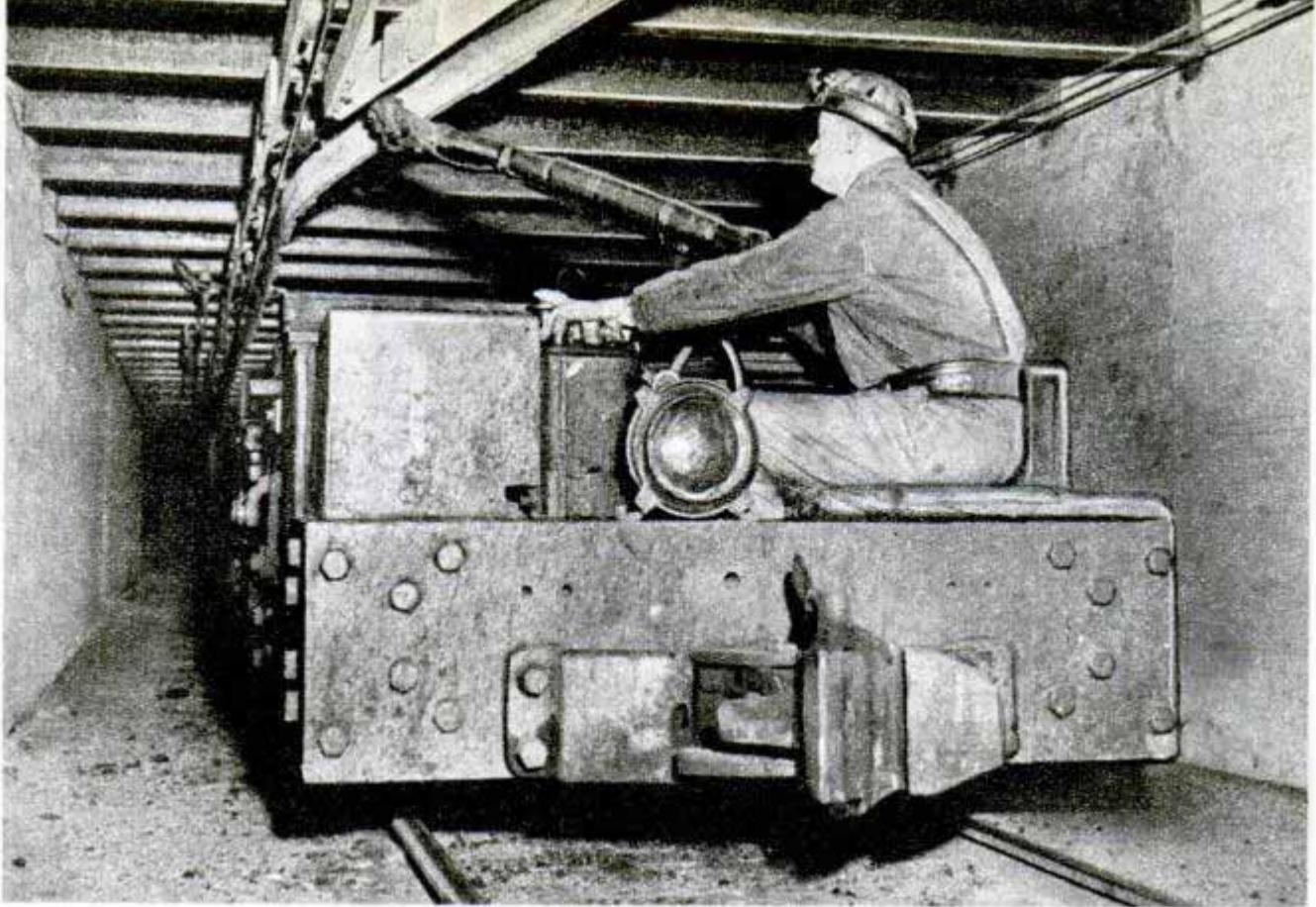

Electric trolleys haul 35 loaded cars up to 12 miles an hour along the ten miles of mine tunnels

our country's industrial production, steel.

Traveling on the Robena underground railroad system, a visitor is struck with its resemblance to a city subway. In the main haulage way tunnels there are practically no posts used as roof supports, but steel beams with four-inch flanges, are firmly anchored into the coal or rock on either side of the tunnel. In the temporary entry tunnels, leading to the sections where the productive mining is done, cross timbers are installed in the same manner and only near the working faces are the older-type roof supports employed.

A smooth ride is provided by 60-pound track set on slate ballast throughout the more than 22 miles of main haulage ways. Two and a half feet of clearance are re-

quired on the wide side—between car and wall—for the protection of persons on foot, and wall niches are cut at frequent intervals to shelter personnel from the possible derailment of a fast-moving train.

A brisk, fresh breeze, moved by three ventilating fans with a combined capacity of 750,000 cubic feet per minute, keeps the air fresher underground than it is in many cities. Water pipes with drinking fountains are a mine innovation and account in part for the necessity of having a million-gallon-a-day water filtering system. Even the rolling stock is cared for underground, a completely equipped repair shop at mine level taking care of all but major repair and overhaul jobs.

At Robena, the open-end system of mining is used, a technique pioneered by Frick 20 years ago—which permits maximum output per section developed, operation at a high degree of safety, low maintenance when operations are curtailed or suspended—and which lends itself to a high degree of mechanization.

The development of a mine is something like that of a community except that the purpose is to remove rather than to create something. The ways are the streets and avenues, pushed through the coal seam to bring men, machines, electricity, air and water to the place where the job's to be done. In an eight-foot vein such as this, the burrowing can be done entirely within

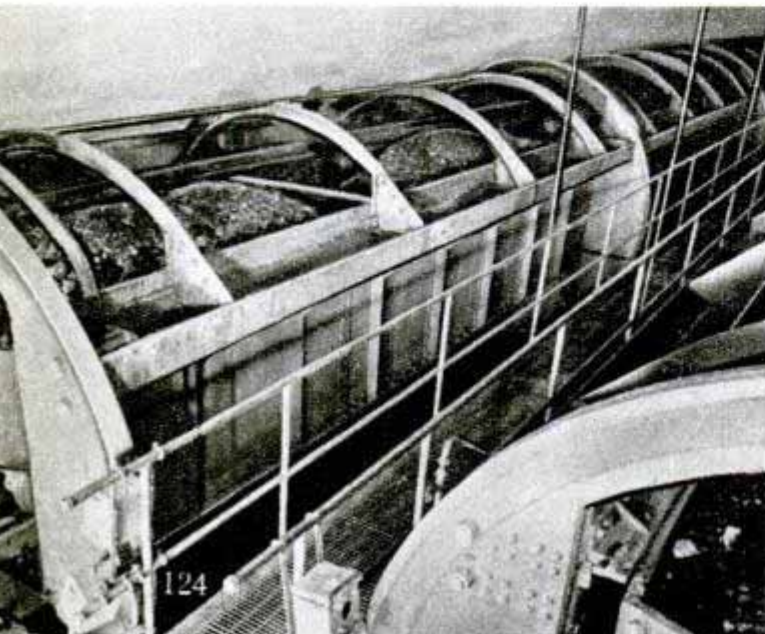

Cars are unloaded by rotary dumps which turn them upside down. Coal is mixed before moving to surface

the coal seam and 25 percent of the coal recovered comes from the development work.

The sections might be compared to rectangular communities, with regular rows of houses and streets. The mining is begun at one end or corner of the section and proceeds, row by row, to the opposite end—leaving a sort of collapsed emptiness behind it. This latter results from the fact that as a lane is emptied of coal the timbers are pulled out and the roof permitted to fall in. This reduces pressure on the adjacent working area and eliminates what would eventually be a vast shored-up area which would invite accidents.

In each working place the extraction of coal is carried on with the efficiency of a well-drilled backfield driving the length of a football field, but probably with less expenditure of human energy.

Up to the working face of the coal seam rolls a track-mounted cutting machine. The saw teeth of its oblong revolving cutter swiftly make an incision 8 feet deep extending across the top of the working face. Water is constantly played on the cutting area to lay the coal dust and to reduce sparking when the teeth hit shale.

A drilling machine then moves in and bores three to six holes in the face. The man doing the blasting places explosives, detonator cap, and tamping in each hole and then detonates them one hole at a time. This method is slower than blasting them simultaneously, but it is safer since an unexploded charge is immediately detected and does not turn up as a gruesome surprise when the coal is being loaded.

When the face has been shot, 25 to 45 tons of coal have been jolted loose from their ancestral home and the mechanical loader moves into the scene. Its long nose with its endless chain conveyor is shoved into the pile of loose coal and the black chunks are whisked over the loader into the eight-wheeled steel cars, each of which has a 6½-ton capacity. However, before the loading is done the face is inspected for gas and soundness of the roof.

Cutters, drillers and loaders are all electrified and track-mounted. Shuttle locomotives pull the loaded cars to a main haulage way where they are made up into trains of 35 to 40 cars. Fifteen-ton locomotives, operating on 500 volts of direct current, haul the trains to the rotary dump at a maximum speed of 12 miles an hour. En route the trains pass a check point at which every car is weighed and the initial check on

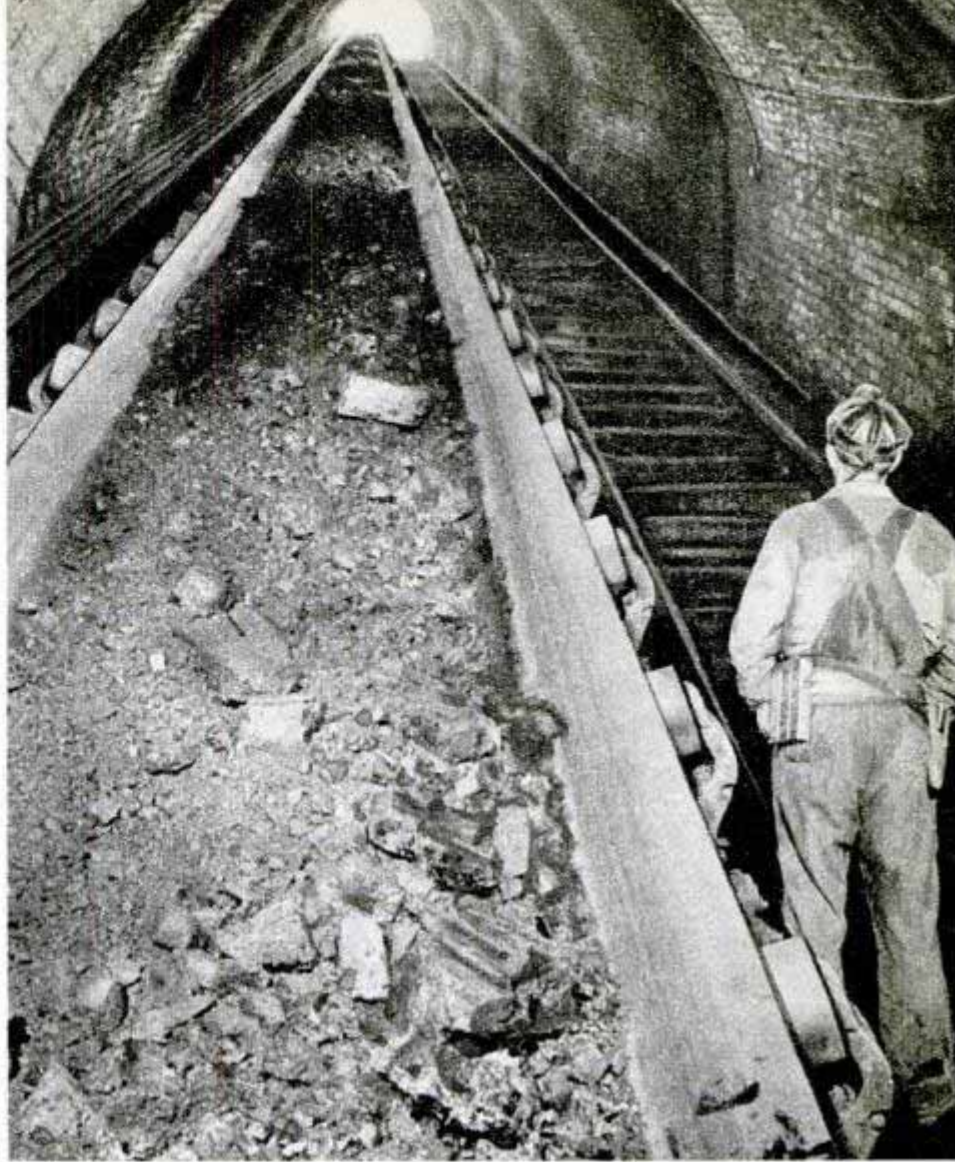

At a rate of 2800 tons an hour, Robena coal is carried from the rotary dump to the surface on this long conveyor belt

Below, a strong electromagnet, hanging over the top end of the conveyor, removes broken tools and equipment from the coal

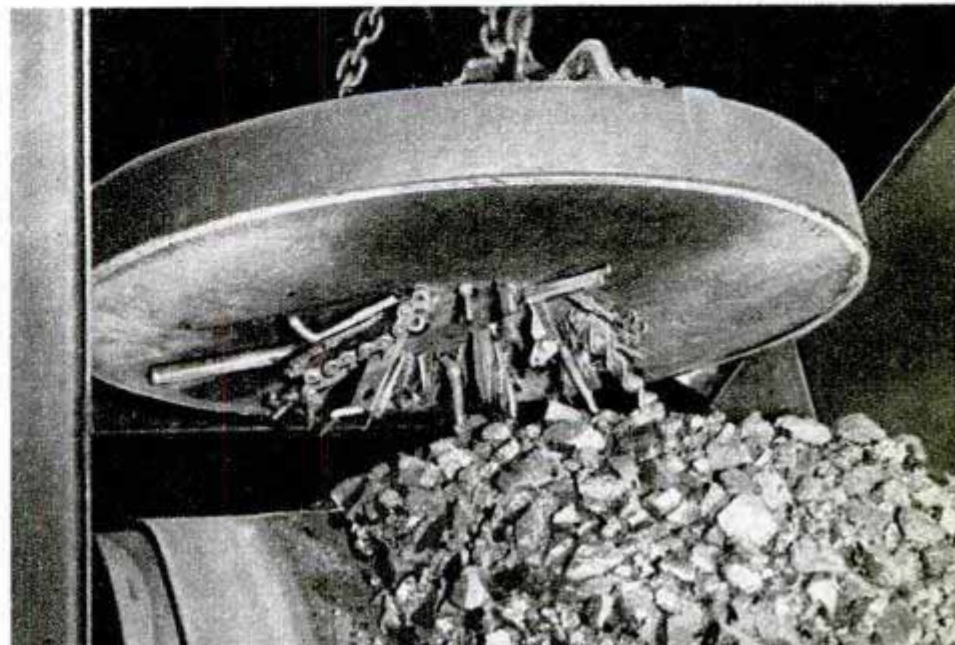



Above, workmen remove slate and other refuse from the coal as it moves on to the screen breakers where it is reduced to three inches or less in size. Below, conveyor belts distribute the coal into blending bins which mix it to insure the chemical uniformity needed for producing metallurgical coke

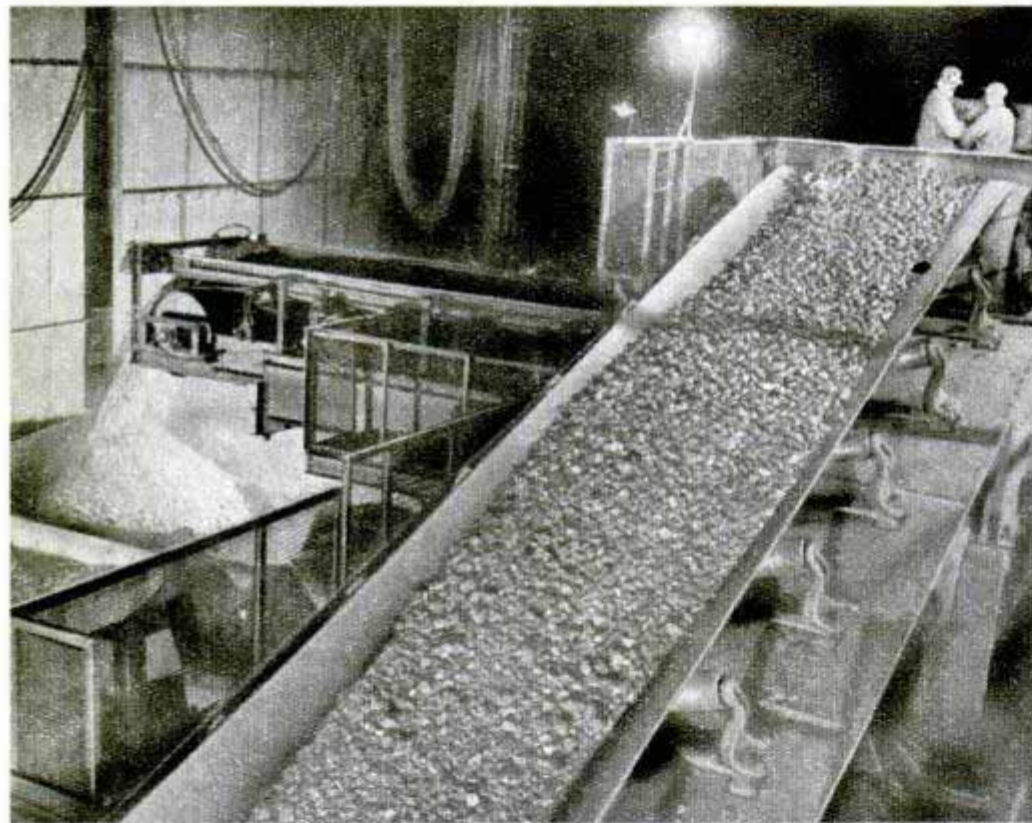

the tremendous output of the mine is made.

The cars are left in a classification yard near the car dumper; separated according to the sulphur content of the coal. Two ten-car rotary dumps are loaded with high and low sulphur coal, which is dumped simultaneously into a 700-ton bin. This is the first step in the blending.

Ten apron feeders move the coal onto the slope belt—five feet wide and more than 1600 feet long—which can carry 2800 tons an hour to ground level, 171 feet above. From ground level it goes higher and higher until it reaches the great tippie, from which it will be loaded into barges;

it gets cleaner, and it gets smaller.

Its first step above ground is in the screen house and breaker where it goes over two 12 by 25-foot shaking screens with three-inch perforations, then two more smaller screens similarly perforated. This removes all the minus three-inch pieces—the size which it must all eventually reach. From here the remaining large-size chunks are fed onto brightly illuminated picking tables where slate and other refuse is removed by hand—one of the few manual operations at the mine—and dropped into chutes which load it on the main refuse belt.

The coal then passes to the Bradford breakers, consisting of two revolving cylinders, 12 feet in diameter and 17 feet long, which again have three-inch perforations. The breakers reduce the coal to the desired size and the freed unbroken slate and sulphur balls are carried off to the main refuse belt. This belt has a capacity of 7200 tons a day, more than the total output of many large mines. After the reject material is crushed it is conveyed to a concrete bin six stories high, from which it is loaded on trucks for disposal.

As the coal passes from the screen house to the blending bins on a conveyor belt it passes beneath a 65-inch electromagnet which removes tramp iron in a wide variety of forms, including tools, personal effects, etc. Here also is an automatic sampler which removes 350 pounds of coal from each 1000 tons for laboratory analysis and reduces it to pass through a $\frac{1}{4}$ -inch screen.

It is in the blending bin that the mixing process really reaches its zenith. The bins consist of 168 pockets, each holding more than 100 tons and arranged in six rows of 28 each. Over this elaborate filing system runs an electrically operated flying bridge

which can distribute the incoming coal to each bin in succession or in any order that is desired. The coal is then withdrawn from a set of 56 bins simultaneously via undercut gates and represents a blended average of 6000 tons of production from the mine. It is conveyed to the tipple on a belt from which another automatic sampler takes coal for analysis.

In the huge tipple, two five-foot conveyor belts take the coal from the main belt and "layer-load" it into a 14-pocket bin. Thus some part of every 100 tons of coal which reaches the tipple goes into each pocket. Undercut gates and feeder belts connected with seven adjustable telescopic chutes then convey the product from the bin, loading 800 tons on a barge in $4\frac{1}{2}$ minutes.

Sixty-one miles down the river the cargo reaches Big Steel's Clairton By-Product Coke Plant where it is unloaded, washed, and placed horizontally into bins with the rich Fayette and Westmoreland County coal. When it is withdrawn in vertical slices to go into the coking ovens it has received its final blending.

In the coke ovens, under tremendous heat and pressure, the volatile matter burns off and $20\frac{1}{2}$ tons of coal becomes 14 tons of metallurgical coke—a super-tough variety that will stand up under tons of iron ore and limestone in the blast furnace. As by-products each ton of coal produces, along with about $\frac{2}{3}$ ton of coke, 11,000 cubic feet of gas, 11 gallons of tar, 25 pounds of ammonium sulphate and 3.4 pounds of benzol products.

The whole steel process depends on the quality of the resultant coke, which in turn is established by the coal which fathers it. Badly blended coal makes a weak coke, which cannot support the ore and limestone in the furnace. High sulphur and ash content results in too much slag, requiring a large amount of limestone to neutralize it. An excess of sulphur or silicon carries through into the iron and requires a longer period for refine-

ment during the open hearth steel process.

Design engineers are confident that the washery now being constructed at Robena will, when completed, produce coking coal that will require a minimum of upgrading for satisfactory performance.

The portion of this coal reserve earmarked for Robena comprises 22,000 acres and assays 10,000 tons per acre—enough coal to last more than 24 years, mining 20,000 tons a day 365 days a year. The total reserve is 69,000 acres—a 78-year supply.

The art of mining coal has come a long way since the days of the donkey cart. Maybe the highly mechanized Robena mine forecasts a future day when coal will be delivered "untouched by human hands."

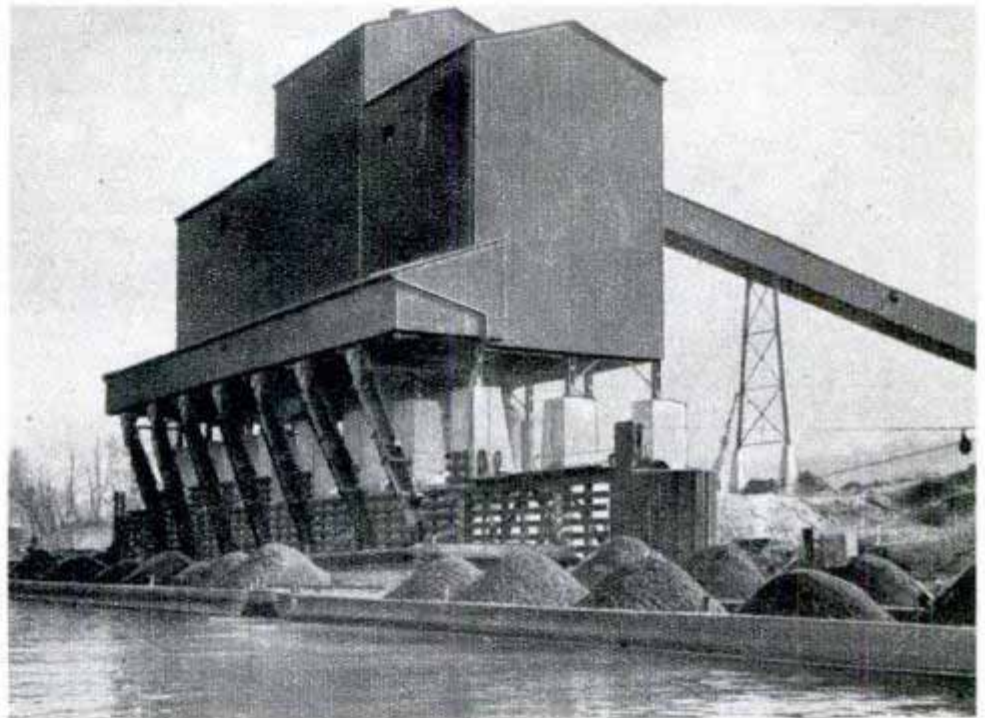

Above, enclosed in elevated passageway at the right, the conveyor belt pours coal into this 2000-ton tipple. A complex conveyor system inside the tipple carries the coal to the seven barge-loading chutes. Below, loading chutes fill barge with 900 tons of coal in about five minutes



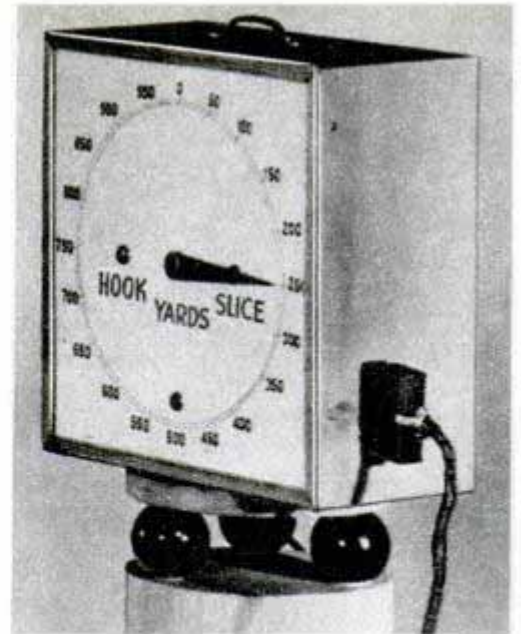
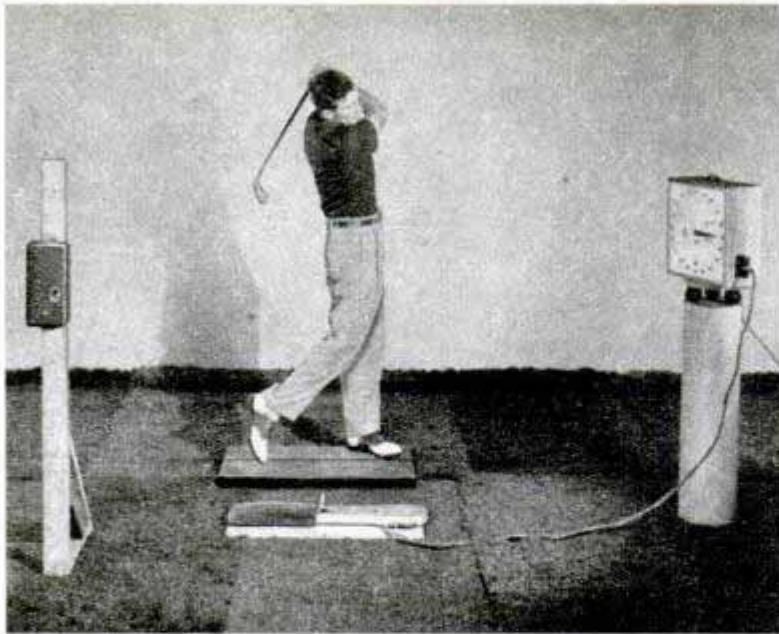

Golf-Practice Device Detects Hooks, Slices

In addition to registering yardage, a new golf-practice recorder flashes a light if the swing would produce a hook or slice. The player, using either a wood or iron, hits a rubber-and-canvas target just as he would hit a golf ball. If his swing is to the left, which would cause a slice, a light flashes on the meter above "slice." If the

swing is to the right, the "hook" light flashes. The machine is designed for coin operation—five shots for a nickel. Yardage on the meter extends to 1000, so that players know total "distance" for several shots. Or, games can be played by setting the distance for a hole and then hitting the target with the force considered necessary.

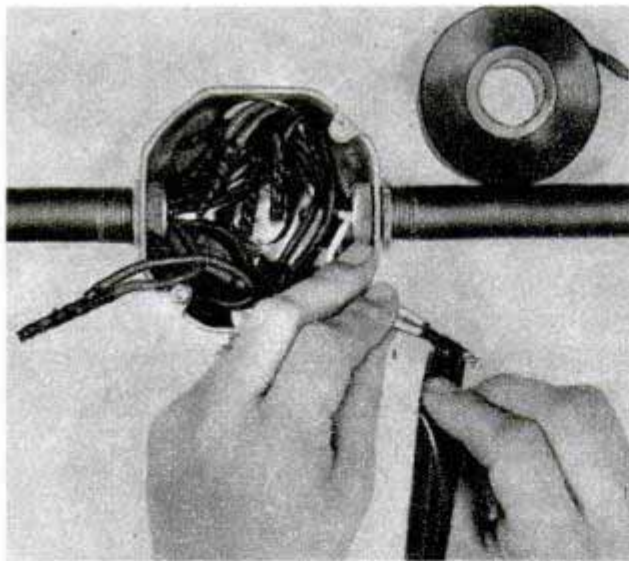

Rotating Typewriter Eraser

With the action of an automatic push drill, a mechanical typewriter eraser removes typing errors by the revolving motion of its rubber tip. The operator fits the adjustable guide in the V-slot type guide of the typewriter. Then as she pushes on the handle of the pencil-shaped eraser, the rubber tip spins clockwise against the paper. As pressure is released, the handle springs back and the rubber tip revolves counterclockwise. The rubber eraser is removable and can be replaced.

Plastic-Backed Cellulose Tape

Designed to make the wrapping of wire splices a one-tape operation, a special cellulose tape with plastic backing provides the electrical insulation of rubber tape and the physical strength of friction tape. The tape is weather-resistant and has a dielectric strength of 1000 volts per mil. Also resistant to oils, acids and water, the tape is being used for automotive and aviation ignition systems and for exposed wiring in manufacturing plants. It comes in thicknesses from 7 to 12 mils and in yellow, white and black.





Above, water-soaked log breaks water between pontoons of raft. Below, underwater lumberjack begins a 75-foot descent to bottom

DIVING FOR LOGS

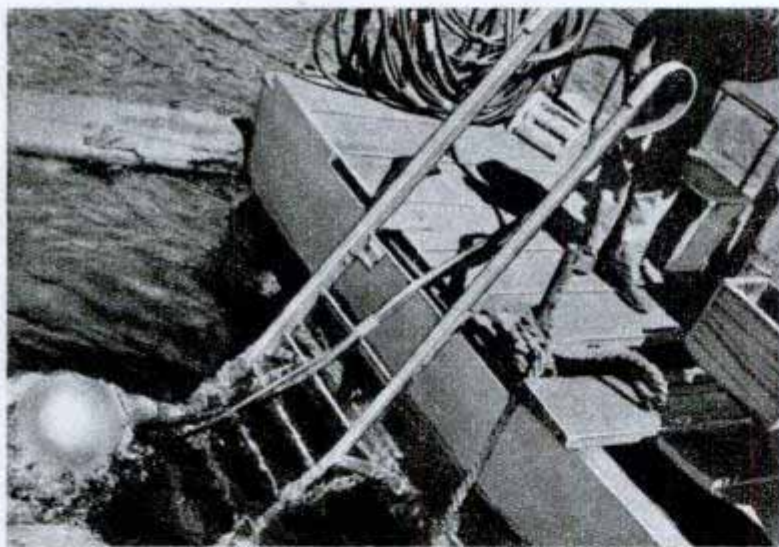

Underwater lumberjacks in northern Idaho have no use for axes and saws. Their tools are diving suits and the logs they are after are already cut. River bottoms in that timber country hide thousands of sunken logs that were kept from floating downstream by rocks until they became waterlogged. These water-soaked logs sank to the bottom and never reached the sawmill. Three veterans, former Navy divers, are now salvaging this valuable timber which, when properly dried, still holds marketable quality.

Below, left, the three veterans take turns diving. The other two help the diver into his war-surplus outfit. Right, no danger of falling timber here. The soakers have to be pulled up from the bottom by a hand winch

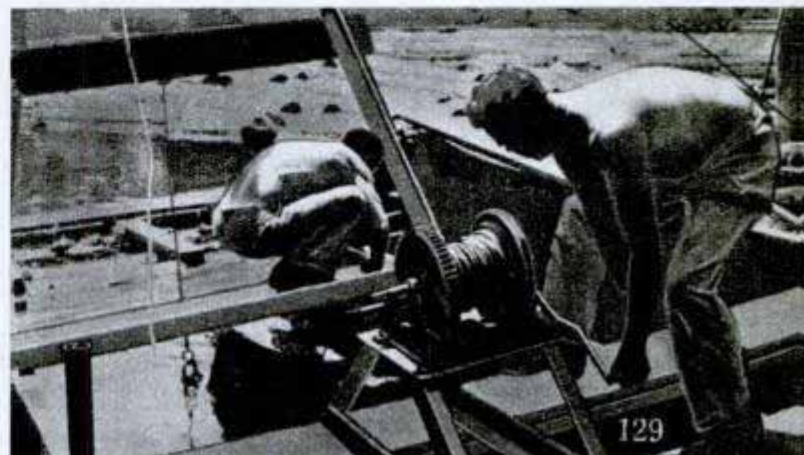

Keenarlik Builds an Igloo

Housing problem? Keenarlik, a 12-year-old Eskimo girl, demonstrates an age-old technique in building herself an igloo. Photos were taken with the temperature at 42 degrees below zero. 1. Snow is scored into blocks with a butcher knife, then each block is cut free with a final undercut. 2. As Keenarlik cuts each block she erects it to form the base of the igloo wall. Thus the hole in the snow increases the height of the finished igloo. 3. She tilts each block slightly inward to start shaping the walls. 4. The knife is passed beneath the blocks several times to make the edges match. Slight holes and cracks then are filled with cut snow. 5. As the second row is built up, the tilt of the walls can be plainly seen. 6. Blocks in the top rows

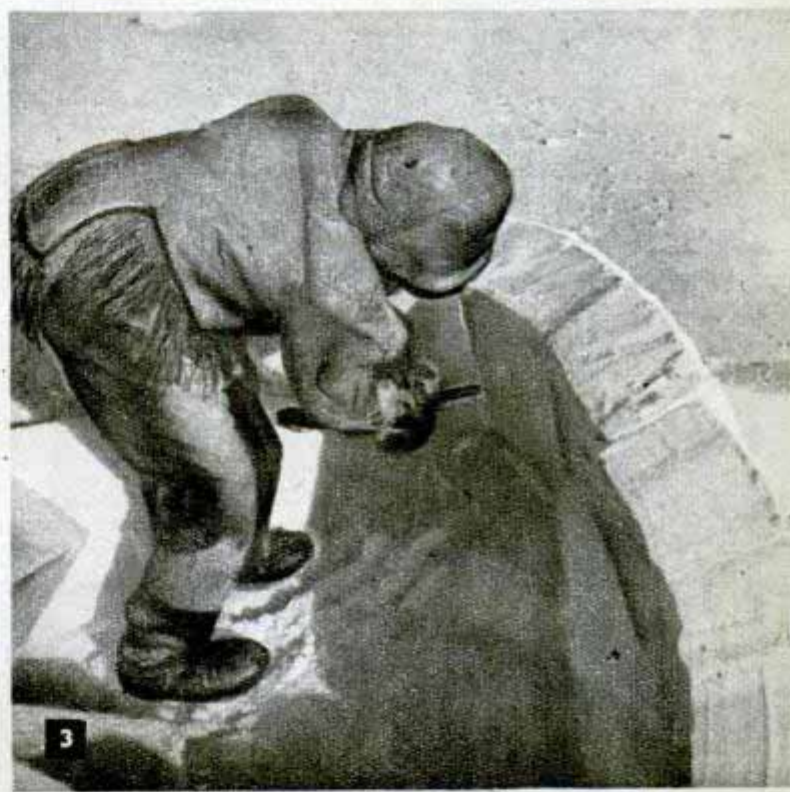

Photos by Ven. Donald B. Marsh Archdeacon of Aklavik, N.W.T.

are almost flat and are held in place by contact with the last block that was set. The snow is heavy, and in a full-size igloo each block would weigh about 60 pounds. 7. With the igloo almost completed, Keenarlik barely can be seen. 8. She now is sealed in the igloo and must push away one of the blocks before she can crawl out. This loose block will be used as the door when the igloo is finished. 9. Rough edges are pared away and the cracks and holes filled with powdered snow. The extremely low temperature freezes it almost instantly. 10. Keenarlik makes the finishing touches on her home. When heated inside, the igloo will settle into a solid mass of snow to make it completely windproof. However, igloos built of the wrong kind of snow may be demolished by a high wind. A grown man can stand on top of the igloo.

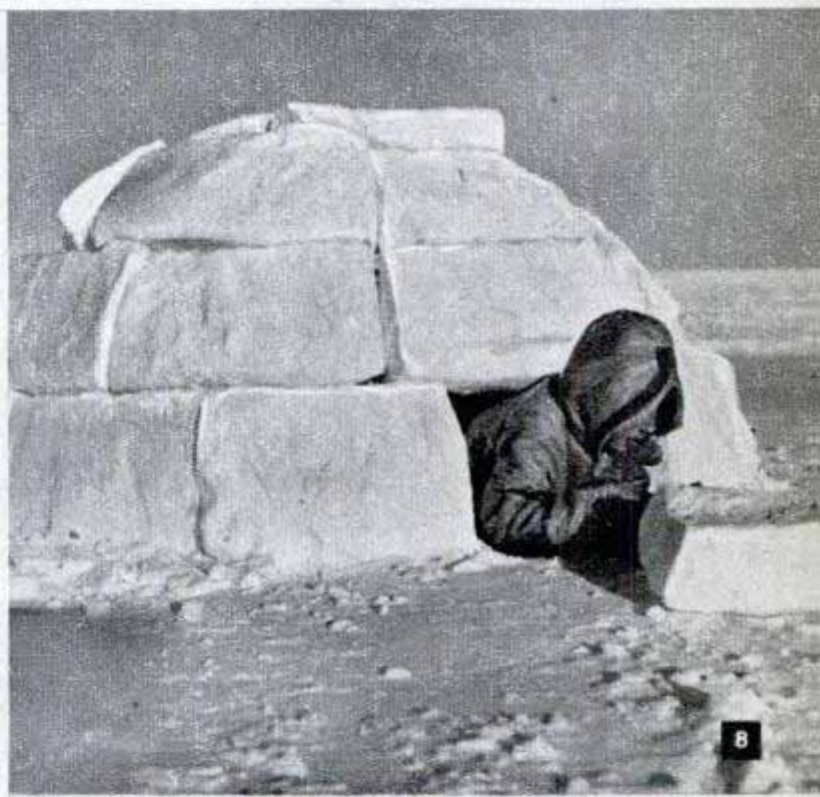



Mobile Chair on Tank Tracks Climbs Curbs and Steps

Miniature tank-type tracks drive a mobile chair designed for disabled veterans, invalids and the aged. The hard-rubber tracks make it possible for the chair to climb steps, mount curbs and travel over rough terrain. The chair is 27 inches wide and can pass through ordinary doorways. Powered by an electric motor run from a storage battery, it travels faster than the normal walking speed. Two steering levers control the tracks and the chair can turn in its own length—50 inches. It was invented by E. C. Gleason of Everett, Wash., while he was stationed with the Navy in the Aleutians. He calls it a "gleep."

V-Shaped Paddles For Stern-Wheeler

By using V-shaped paddles instead of the usual parallel arrangement, stern-wheel steamboats may be operated more economically and with less strain on the engines. With parallel paddles the drive shaft and engine are subjected to great strain as the paddles dig into the water at regular intervals. The new design, tried out successfully on the river steamer *George M. Verity*, provides a continuous thrust in the water and results in smoother operation. In backing, the V-paddles deliver water to the sides instead of pouring it over the stern as do the parallel paddles. Nine percent saving in



fuel and 10 percent slower wheel speed for the same tow tonnage at the same boat speed were reported from the tests.



Grain Unloader

Farmers save time and cut grain waste in livestock feeding with an unloader designed for 38-inch wagon boxes. Two augers, driven by the tractor's power take-off, transport the grain up a tube which swings over feeder boxes. Unloading speed is 20 bushels a minute. The unit is easily removed.

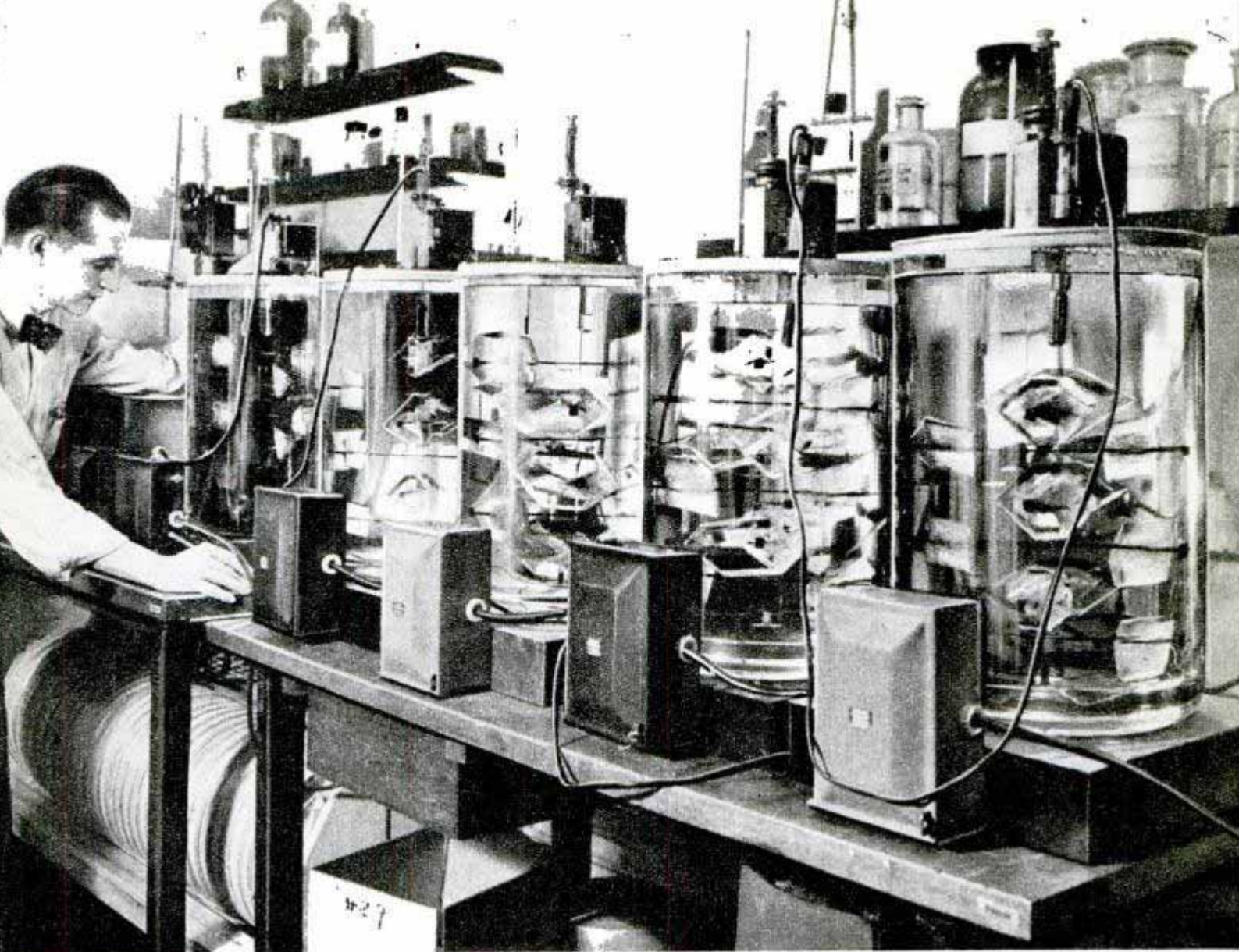

Grown from seeds, these artificial crystals, in final stage of growth, are ready for harvesting

CRYSTALS GROWN FROM SEED

SCIENTISTS have taken a leaf from the rock-candy makers' cook book. They are using a similar technique to produce artificial crystals now used in long-distance telephone circuits.

Prior to the discovery of a way to grow crystals artificially, the telephone companies relied on scarce natural quartz. When wartime demands for that material in the production of sonar equipment threatened to exhaust the supply, scientists went to work on production of artificial crystals.

Engineers now predict that within a few years, artificial crystals will replace as much as 90 percent of the natural quartz used in long-distance telephone systems—and it will do as efficient a job as its natural brother. Already, some New York City to St. Louis circuits are operating with the synthetic crystal units.

The new crystals, ethylene diamine tartrate, are familiarly known in the laboratory as EDT. Different from natural quartz

in chemical composition, the artificial crystals react electrically in the same way as their natural brothers. Both can convert mechanical energy to electrical energy and both can reverse the process. To demonstrate this unusual characteristic, the scientists at the Bell Telephone Laboratories use a 110-volt glow lamp of the gas-filled type. Properly wired to the lamp, the crystal, when struck a sharp blow with a padded hammer, will cause the lamp to light up momentarily.

A small slice of the crystal vibrates with unvarying frequency when electric current is applied to it. Telephone engineers use this characteristic to send many telephone conversations over the same wire simultaneously, but at different frequencies. The crystals filter each conversation into its proper channel so there is no interference. In effect, the filtering process does the same thing a radio listener does when he tunes his dial to select a station.

Similar in basic outline to the process used to make rock candy, the crystal-growing technique is much more refined than that used by the candy makers. Since it must produce single crystals rather than a haphazard growth of many crystals, the entire growing process has to be controlled precisely. For example, temperature variations are kept within a tenth of one degree during the growing period.

The original seeds to which millions of artificial crystals could trace their ancestry were only a third of an inch wide. They were produced by evaporating a saturated solution of the chemical in a shallow dish, just as ocean water can be evaporated to obtain salt. The chemical used was nothing more complicated than a pulverized chemical salt, commonly used as fertilizer, dissolved in water.

Today, the seeds used in the production-line growing process are small slices of the transparent crystal material harvested from a previous batch, but rejected for electronic use because of flaws. Strangely enough, though the seeds are imperfect, the crystal bars that grow from them are not. From these imperfect seeds, perfect crystals result.

Several dozen seeds, each about a half

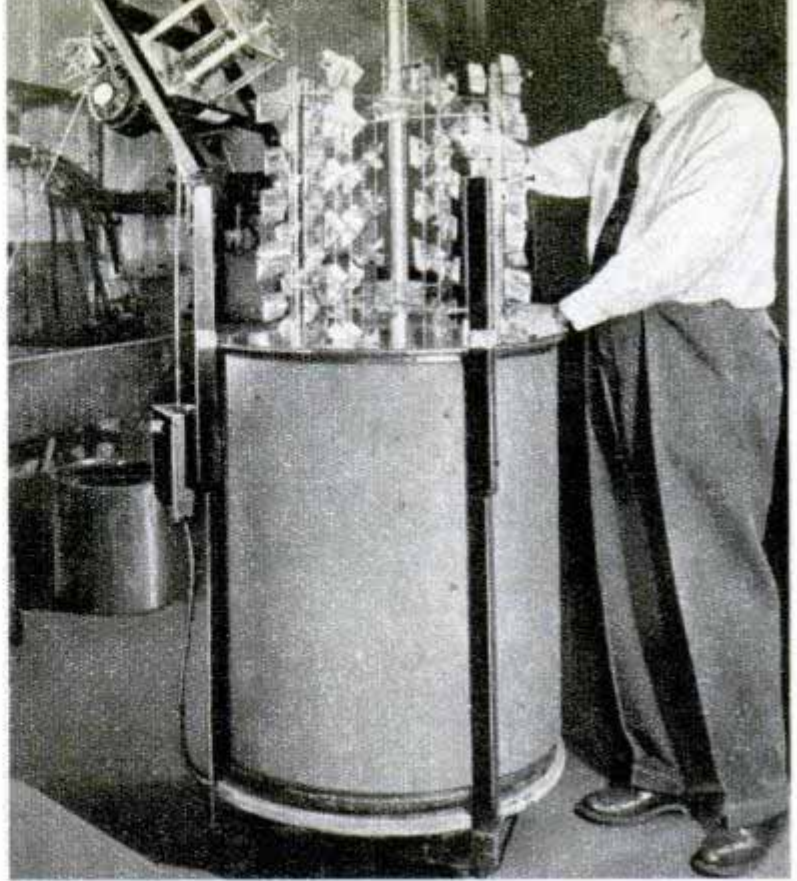

Crystal seeds, mounted on frames, being placed in growing bath

inch thick and one to two inches square, are mounted on a framework of metal bars and placed in the saturated chemical solution. The seeds are rocked slowly back and forth in the solution for several days while its temperature is lowered from 135 degrees Fahrenheit to room temperature.

As the temperature of the solution drops,

Left, crystal plates are polished before being gold-plated. Right, test unit measures crystal's frequency



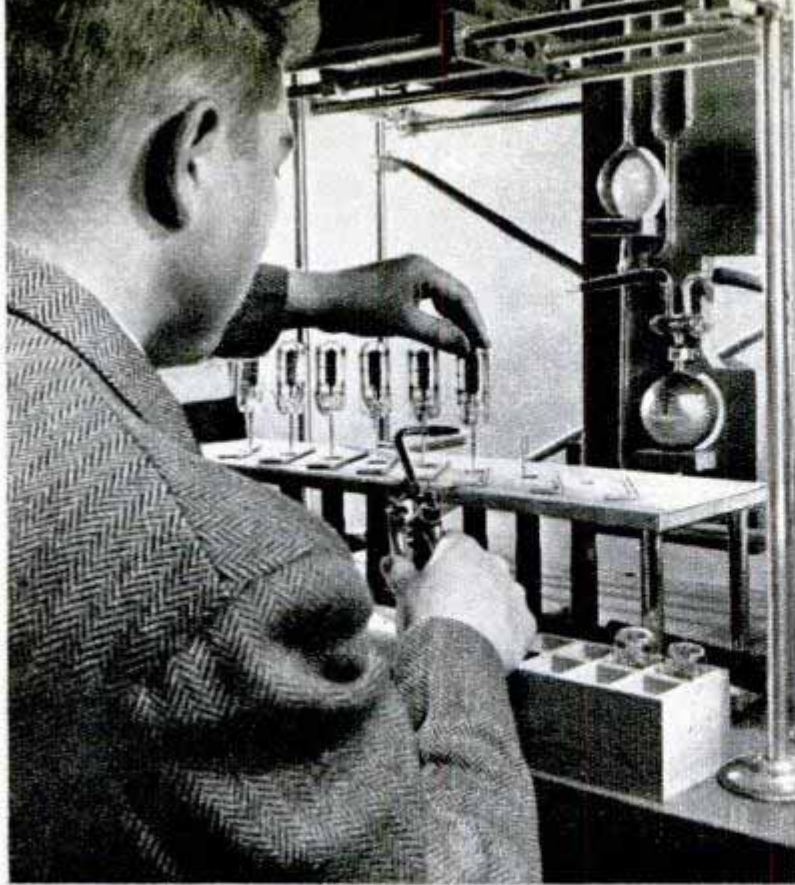

Glass envelope containing crystal is sealed tight by blowtorch

the salt crystallizes and is deposited on each face of the seed, forming a four-sided pyramid on each end.

After they have been removed from the first bath, the crystals are inspected and placed in glass jars where the process is repeated. For 45 to 60 days, the growing seeds are rocked continuously in the solu-

tion. Gradually, the crystals increase in size as the salt is deposited on them. When harvested, they have grown to transparent bars six inches or more in length and weighing about a pound each. Seeds are cut from the imperfect portions of the full-grown crystals for use in planting a new growth.

The full-grown crystals are then cut into plates about an eighth of an inch thick, an inch and a half long and a half inch wide. These plates are coated with a film of gold a millionth of an inch thick. This gold-plating serves as an electrical connection when the crystals are installed in the electronic equipment. The crystals are then mounted in a glass envelope to form a crystal unit, the selective element for separating phone conversations.

Bell Telephone engineers will never get around to doing it, but if all the crystals they have grown with the "rock-candy"

process were piled in one spot, it probably would rival the famous Big Rock Candy Mountain in size. By mass production methods, they produced 20,000,000 crystals during the war for use in sonar equipment. Today, however, engineers are too busy filling the demand for these crystals to think about the hill made famous in song.

Artificial crystal in sealed envelope is mounted in tube base for use as selector in long-distance circuit

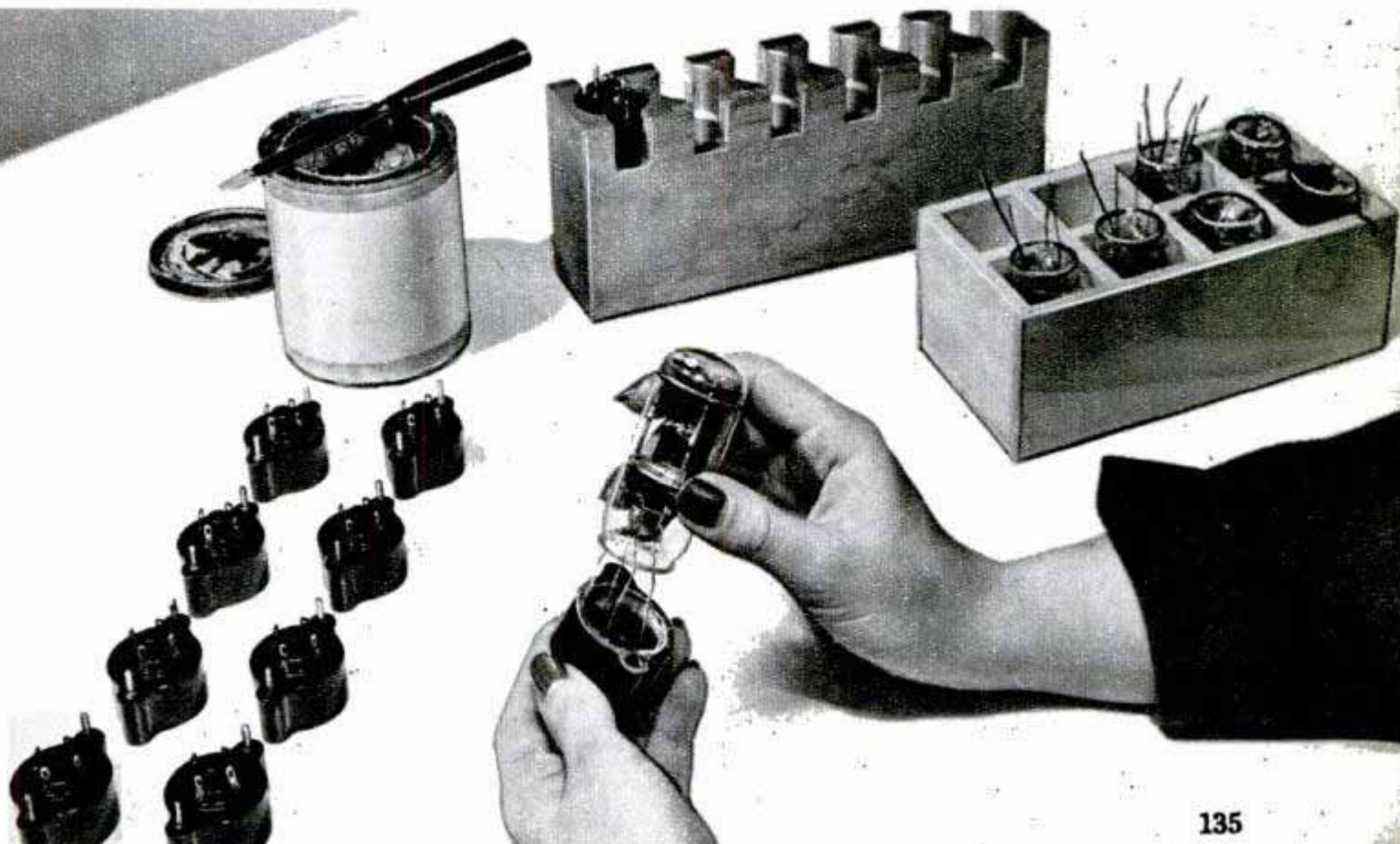

They're Always Fooling the Public



You can't always believe your ears. In every major broadcasting studio there's a man whose principal duty is to fool you. He's the sound-effects man, and each has his own bag of tricks—some of which are illustrated here. On one program not long ago you could hear thunder rolling, horses' hoofs click-clacking on the pavement, the patter of rain (shown above), a door slammed, the splash of a waterfall, monkeys chattering, a ship's whistle and the screech of auto brakes. But the sounds were all made to order—there wasn't a monkey or a steamer or a storm within miles



Squeak box (above) makes a noise like a creaking door or prying open a crate

Studio version of a kiss is achieved by disengaging rubber disks shown at left

Sound equipment at right makes noise of falling junk in Fibber McGee's closet



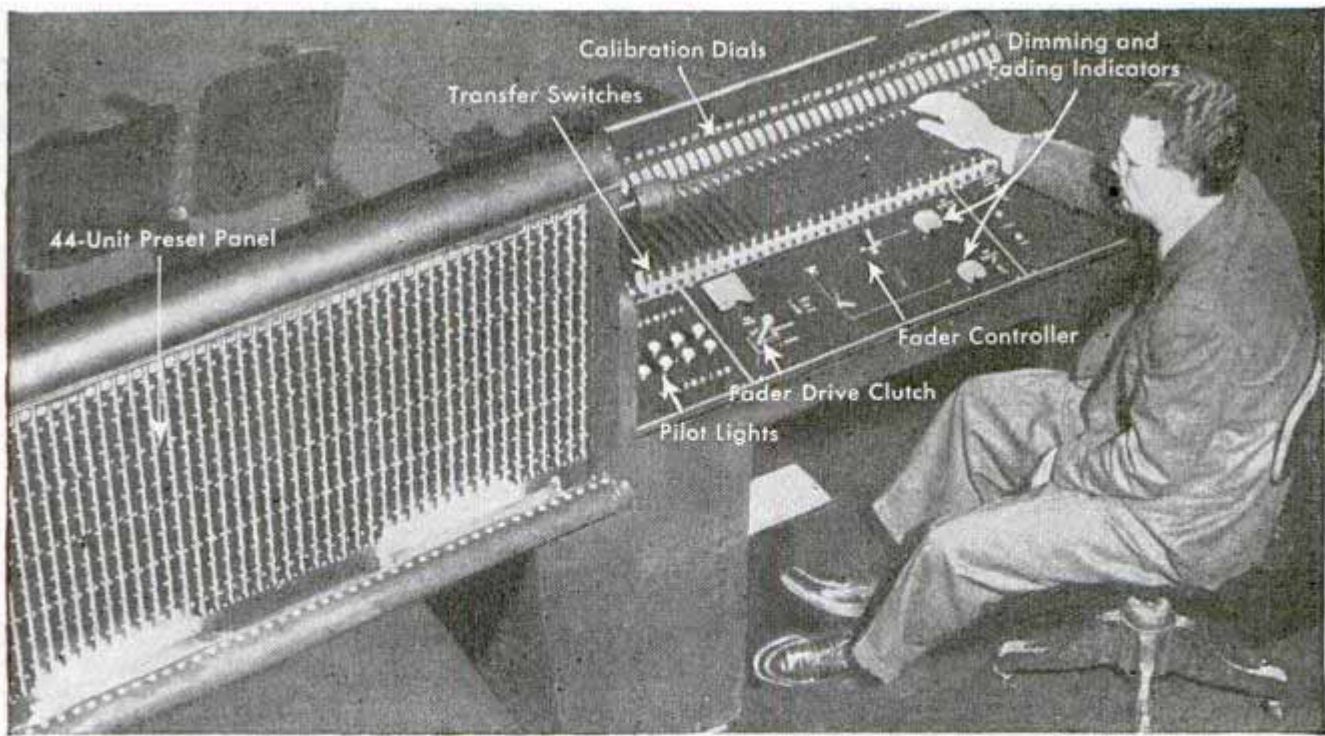

Electronic Panel Controls Lights for Theater Stages

Complicated operations in controlling stage lights are simplified by an electronic system developed by Prof. George C. Izenour of Yale University. The unit makes

it possible to set the controls so that one operation, involving change of intensity of all lights, becomes a single manual or automatic movement. With old-style stage switchboards, 44 manual adjustments would be required to accomplish the same results. Professor Izenour's system enables the operator to switch and dim lights from one electronic control network.

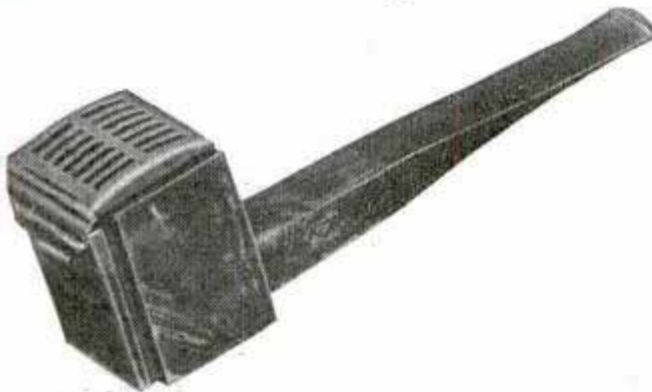

Sliding Cover on Windproof Pipe Prevents Flying Ashes

No hot ashes or burning tobacco can blow from a windproof pipe equipped with a sliding metal cover. A flick of the thumb moves the cover out of the way so the pipe can be cleaned and filled. Available in natural, walnut and plum finishes, it has a bowl of imported briar.

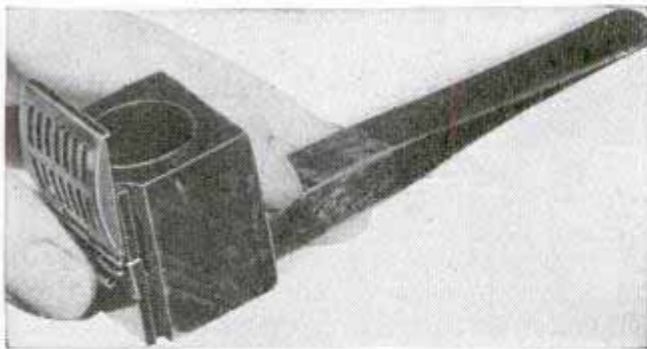

Bumper Guard for Parking →

Room to drive out of a parking space is guaranteed by a combination bumper, grille guard and luggage rack that attaches to the front bumper. Inventor Guy Kibbee, Hollywood actor, demonstrates how the guard is let down to prevent bumper-to-bumper parking. Used as a luggage rack, it will support 300 pounds. When not in use, it folds back to protect the grille.



New Methods for Plotters



Bausch & Lomb Optical Co. photo

By making a mosaic map from aerial photographs these modern map makers save hundreds of hours of work

G. Washington, surveyor, would envy his modern counterpart the tools of his trade. Today's surveyor can measure one ten-millionth of a circle

THE SURVEYOR today still climbs the high mountains, slogs through the jungles, and crosses the deserts—but he doesn't toil painfully through the land. He uses modern instruments which measure easily and accurately, and he climbs into an airplane to map, in a matter of minutes, what formerly took months. His equipment is improving so rapidly that what he learned to use last year can easily be obsolete today.

There are instruments that will measure distances for the highway surveyor without his touching a measuring tape. He can have levels that are fantastically accurate and transits that will measure one ten-millionth of a circle. He can work more accurately and rapidly but, even so, the greatest improvements are not his—they are for the surveyors of huge land areas, the explorers, the map-

pers of states, the city planners, and the surveyors of large government projects.

The war brought many advancements to these men and the greatest and most radical is aerial photography. It is the key to inexpensive yet accurate surveys of large areas—soon to map the entire United States, a great portion of which is not yet mapped with any accuracy. And "measuring" photography has been made a really accurate method because of the war research in three things: the improvement of cameras, the use of the compact optical theodolite, and the Multiplex.

During the war, many complicated aerial cameras were developed for reconnaissance and mapping. They did a good job for the invasion mappers but every one of them is now obsolete for precise aerial surveying. They

By Thomas E. Riley

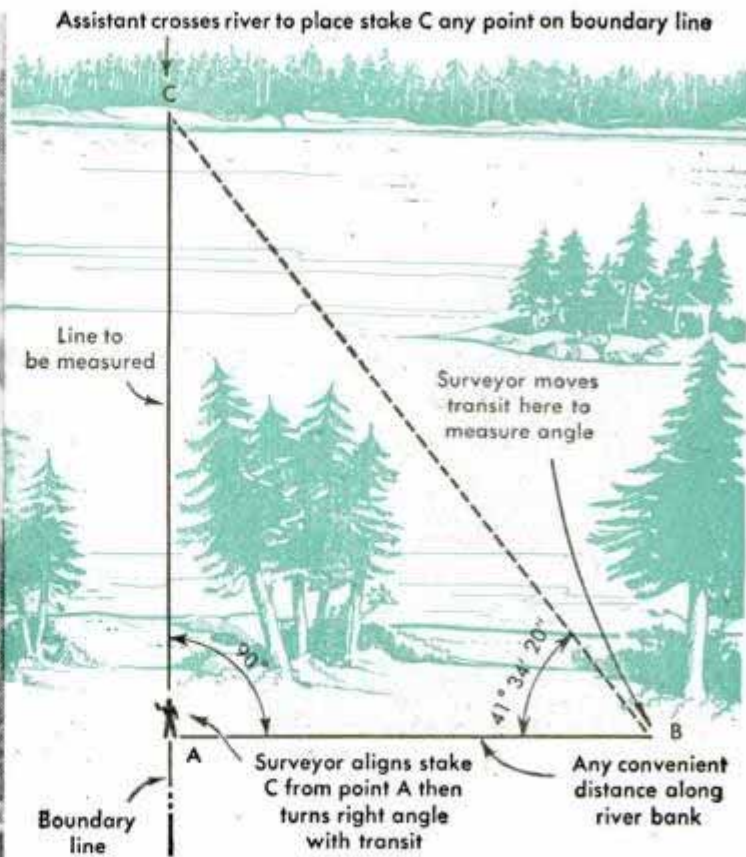

Photo at left shows the surveyor standing at point A shown in sketch above. Line AB is 2000 feet. After reading angle ABC, surveyor uses mathematics to compute line AC across river. Distance is 1773.9 feet

are simply not accurate enough. Today's aerial cameras are basically similar, but are greatly improved models made to more rigid specifications. They have eliminated the Rube Goldberg gadgets, such as the horizon recorder and the time counter that blossomed on the earlier models. Finely machined, permanently adjusted, these cameras have to be perfect—their photos are to give the height and position of valuable lands. They can measure the height of trees from an altitude of 20,000 feet.

Of course, the lenses must be perfect. For modern aerial surveying an extremely wide-angle lens is needed. The Metrogon lens used in these aerial cameras has so wide an angle it resembles half an orange or a door knob. Its four, deep-curved lens elements represent the lens maker's highest skill, two elements being ground paper-thin at the center and two paper-thin at the edges. The lens is so free from distortion that all parts of the negatives, even the corners, can be accurately scaled to represent equal distances on the ground.

But the aerial camera does not eliminate surveyors—not even for aerial mapping. No accurate map can be made from photographs or anything else without control points. Men can compute the elevations and distances and types of terrain from the photos, but they must have accurate positions to start with and from which to check their work. Surveyors must locate—with what is called second-order accuracy—these control points on the ground; control points that can be identified on the photos,



Surveyor on western prairie is reading off angles to his assistant who records and computes them as fast as he can to prevent any expansion of metal or settling of tripod from affecting accuracy





Survey ship, the U.S.S. Garbage Box, used by government surveyors to make survey of river for dam site

such as the top rock on a mountain or the center of a road junction. And to do this phase of aerial mapping efficiently, they need super-accurate transits (theodolites) light and sturdy enough to be carried easily over any terrain.

Until just recently, even the Coast and Geodetic Survey, foremost surveyors in the United States, believed the ultimate in a lightweight theodolite was one reading angles to one second ($1/1,290,000$ of a circle) and even these were too bulky and slow in operation. But the Wild theodolites had been developed in Switzerland; highly advanced, compact little instruments that read to $1/10$ of a second—and do it faster! The U. S. Army bought quite a few of these instruments shortly before the war, and they stood the abuse of surveying in Alaska and later in the jungles of New Guinea. The engineers called them optical theodolites, and during the war developed a similar model in the U. S. and in England.

The heart of these Wild instruments is two 5.5-inch-diameter, circular plates, made of optical glass on which superfine graduations are etched. The most important of these plates is the horizontal circle, located in the cone-shaped base of the instrument. Above it are ingenious micrometers that further divide the graduations by means of the movement of light rays through a combination of prisms. The resulting answer is read by the surveyor as simply as the speedometer on your car and his reading is automatically the average of two readings on opposite sides of the glass circle. The surveyor does not have to step around his theodolite as he once did to take his readings—with the constant danger of jarring it. He merely looks through a small tube alongside the telescope and by means of another series of prisms views the micrometer and the circle in the base of the instrument.

Some of these modern optical theodolites

Five Multiplex projectors above map maker's head (left) recreate line of flight of five aerial photos. Close-up of operator's tracing table (right) shows him tracing in a contour line on map. He gets stereoscopic view

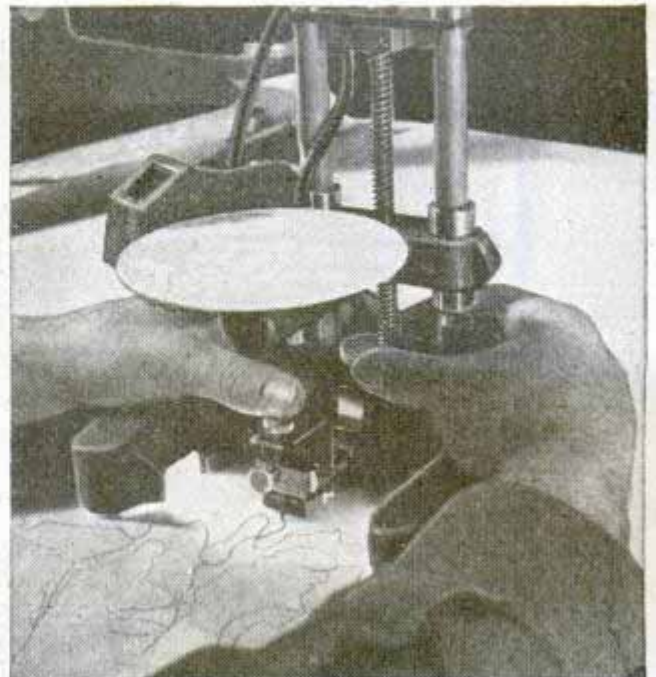

do not use plumb bobs, a great advantage on a windy mountaintop. The surveyor simply sights through still another lens and prism to adjust a cross-hair that centers his instrument. At night, he plugs in a wire from a small battery and everything on the instrument, including the telescope cross-hairs, is illuminated.

With these compact, accurate theodolites, the surveyor can now move rapidly over the wildest regions, placing the few control points necessary for the Multiplex. Then with the aid of the aerial photos of the region, the Multiplex will grind out accurate maps cheaply and quickly.

The Multiplex, itself, is a group of projectors mounted on a rigid bar above a heavy metal table, usually set in immovable concrete. The projectors are ingeniously built so that each can reproduce the exact position of the aerial camera at the spot in the air each photo was taken. This is done by alignment with the field surveyor's control points. The projectors have similar lens and other characteristics of the aerial cameras—actually, they are miniature reproductions of the aerial camera.

The operator sits there in the dark pro-

jection room, his only light the alternate red and green beams from the Multiplex projectors. Wearing peculiar glasses—one lens red, one green—he moves his small tracing table across his unfinished map. What he sees is a three dimensional view of the area. Above his tracing table, he also sees a bobbing dot or "V" that seems to float in the air. By moving and adjusting the little table, he moves the dot through the air until it seems to touch one of the mountainsides that protrude up towards him. There! He has an exact elevation and he pushes a lever and slides the dot around the mountainside to trace in that contour on the map.

The whole procedure is based on the simple principle of the old-fashioned scenic stereoscope. The most remarkable thing is that the operator—with just a few points that the surveyor has positioned on the photos—can accurately map a whole mountain range in a few weeks, more than field surveyors alone can do in years.

The Army used this system for its best maps; Admiral Byrd recently surveyed the Antarctic with it, and now the civilian agencies will have their chance.

SURVEYING IN MOUNTAINS

AS ALL THREE ANGLES AND ONE SIDE OF THIS TRIANGLE ARE KNOWN, THE HEIGHT OF THE MOUNTAIN IS DETERMINED BY A SIMPLE GEOMETRY PROBLEM

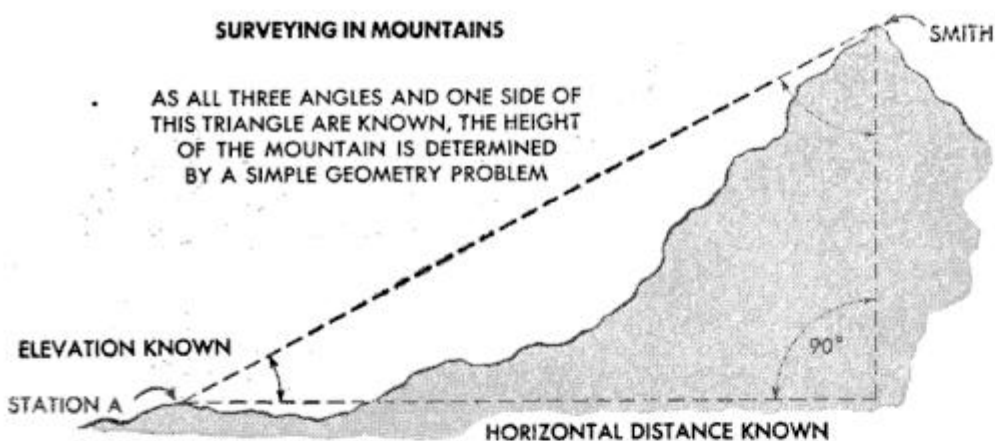

Here is the surveyor's answer to: How high is a mountain? Note the locations of Station A and mountain Smith shown at left and in the triangulation network below. In the mountainous region shown in the network only two distances (see base lines) were measured by tape. The theodolite was moved rapidly from station to station reading angles at each point. With vertical angles and horizontal distance between mountains known, height is accurately determined

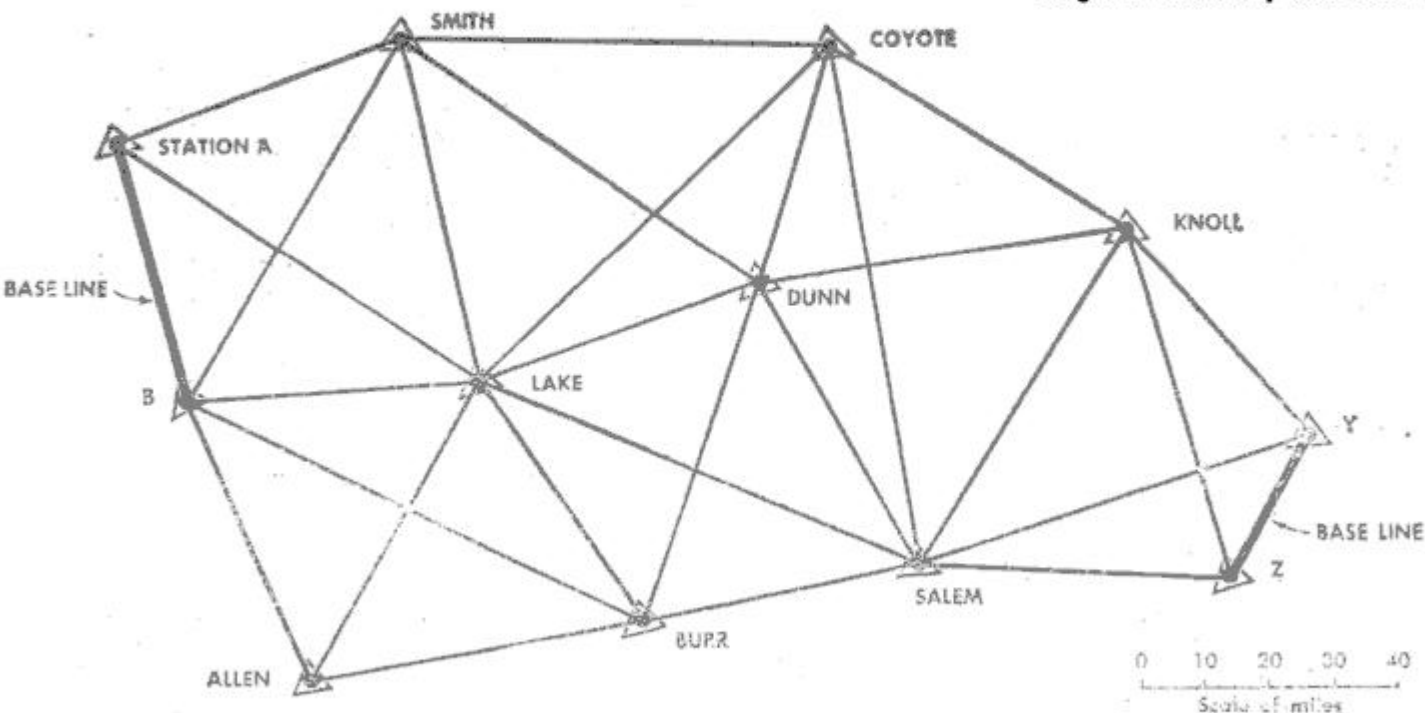

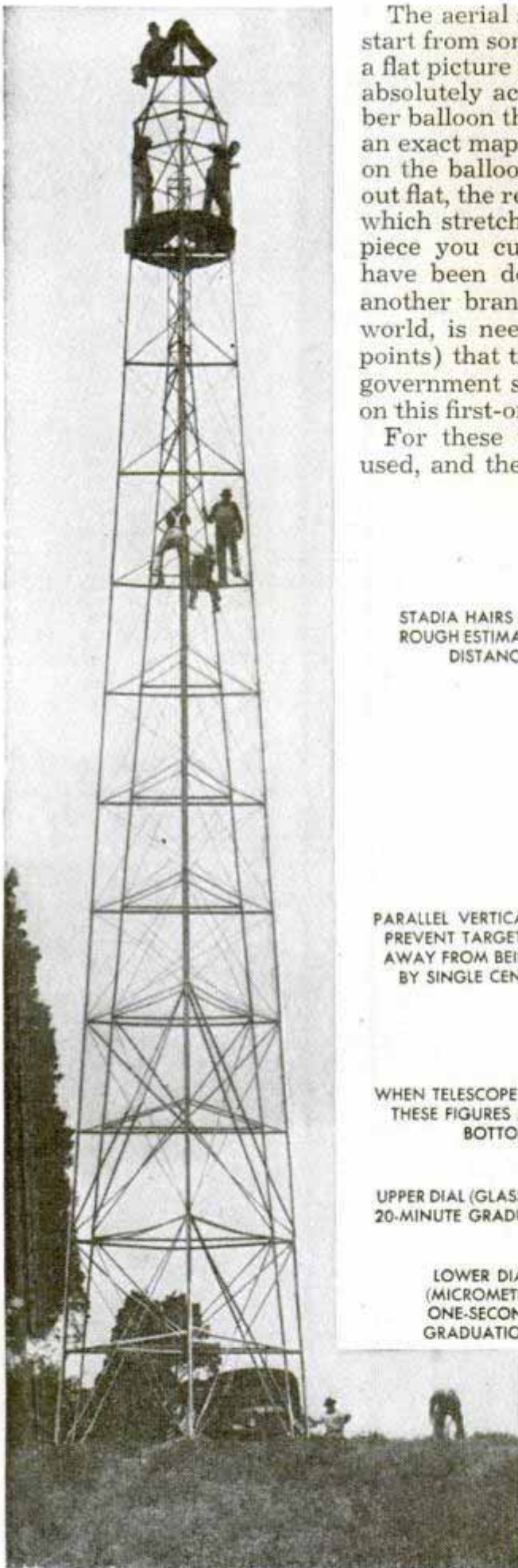
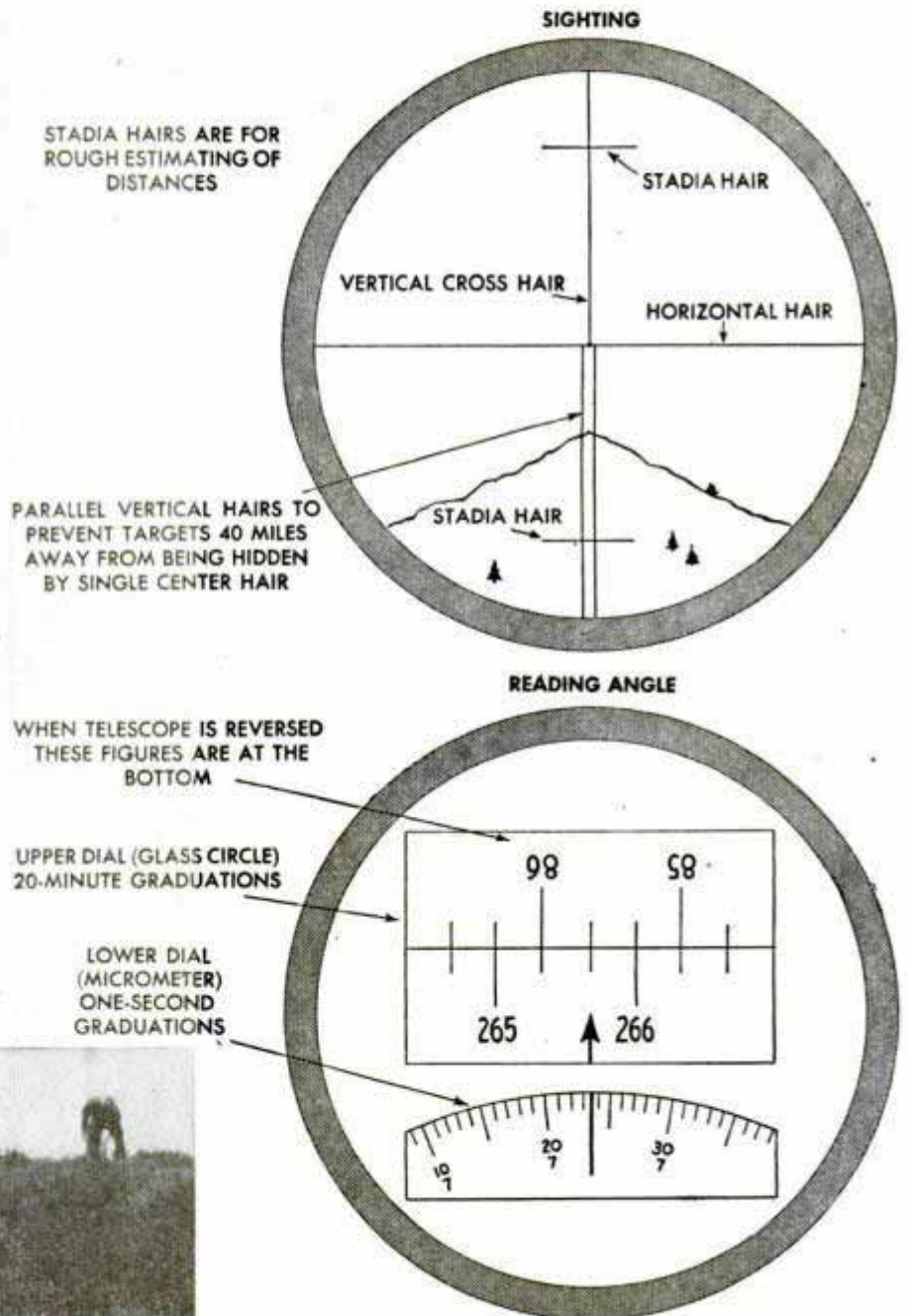

Photo courtesy of The Military Engineer

Portable Bilby tower raises theodolite above forests and earth's curvature. Inner tower supports theodolite; outer one is for surveyor's platform

The aerial surveys are large projects, but even they must start from somewhere. And a map of any part of the world is a flat picture of a round surface and, therefore, can never be absolutely accurate. For instance, suppose you have a rubber balloon that is a replica of the world. Any portion of it is an exact map of that portion of the world as long as it is left on the balloon. But, if you cut out a portion and stretch it out flat, the resulting map will be distorted. And the corners, which stretch the most, will not match at all with the next piece you cut. Many complicated and ingenious methods have been devised to overcome this—none is perfect. So another branch of surveying, figured on the shape of the world, is needed to place monuments (permanent control points) that tie together the flat maps. In the United States, government surveyors still have a tremendous job to finish on this first-order geodetic triangulation.

For these triangulation networks, huge theodolites are used, and the most accurate of the new optical theodolites



In sighting (top), telescope is lowered until horizontal hair touches mountain. Then a knob is flipped to read vertical angle through micrometer

are also coming into use as they are much speedier in operation.

First-order level networks are important, too, for such work as keeping a state-wide irrigation system from draining backwards. For these, the surveyors have special levels with 40-or-more-power telescopes and extremely sensitive bubbles. The rods on which these levels are aimed are made of invar steel, a metal with practically no expansion in heat or cold—its temperature coefficient is 0.000001 per degree Centigrade. Even so, these metal rods have thermometers which are read constantly to compute minute changes in length from expansion. Also, flattening of the earth towards its poles must be considered.

Surveying needs many grades and types of instruments. Besides the precise control instruments, there are the American transits and levels, the all-around workers in construction. For a tall office building or a dam, there are none better. These transits and levels are rugged and tough and accurate enough for this work. They have been constantly improved and today are foolproof instruments for construction, subdividing, and the like.

The transits in the past used the delicate strands from spider webs for their cross-hairs. Now they use a platinum wire, drawn to the same fineness, which will not break when jarred and which never sags in damp weather. The transits have many ingenious attachments, such as the extra telescope that enables a mine surveyor to map the position of a vertical shaft at the same time his other telescope is sighted

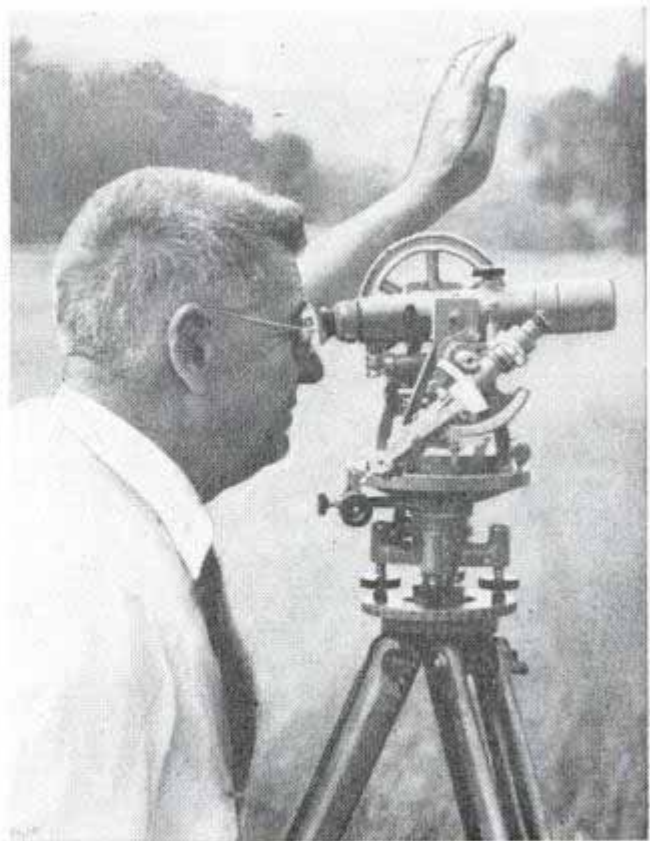

Photo courtesy of Gurley Instrument Co.

Government engineer determines latitude and longitude with aid of the sun, the correct time and a solar attachment on transit. He is signalling helper

down a horizontal tunnel. There are attachments for determining the longitude and latitude from the sun or the stars—much more accurately than with the sextant a mariner uses.

The third common instrument used by the construction or county surveyor is the

(Continued to page 234)

With the optical theodolite (left) surveyor can use subtense bar shown at right to measure distances up to 1000 feet. Surveyor simply reads angle between two markers on bar and refers to table to get the measurement

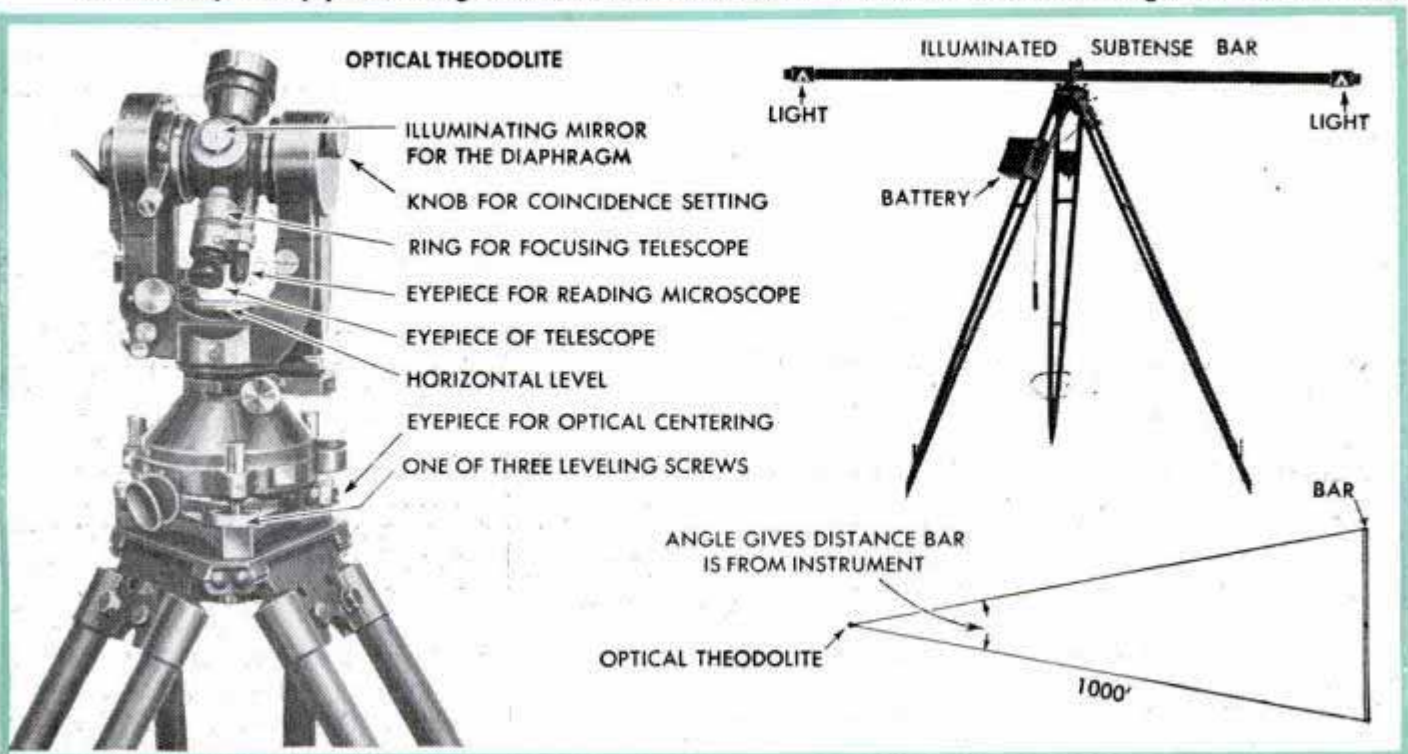

FLYING HORSES



Bristol Aeroplane Company photos

Air movement of valuable horses has been simplified by a British-designed stall box and loading ramp. The box remains level as the horse is hoisted up the ramp, which operates on the principle of a funicular railway. A canvas screen in the rear prevents the horse from injuring his hind legs. The box was used in shipping Attley, champion Australian miler, on a seven-hour flight from Melbourne to Brisbane for an important race. After loading, the 250-pound ramp is dismantled and stowed inside the plane for use at the destination. It eliminates the hydraulic-lift trucks or long ramps too heavy or too large to be flown.

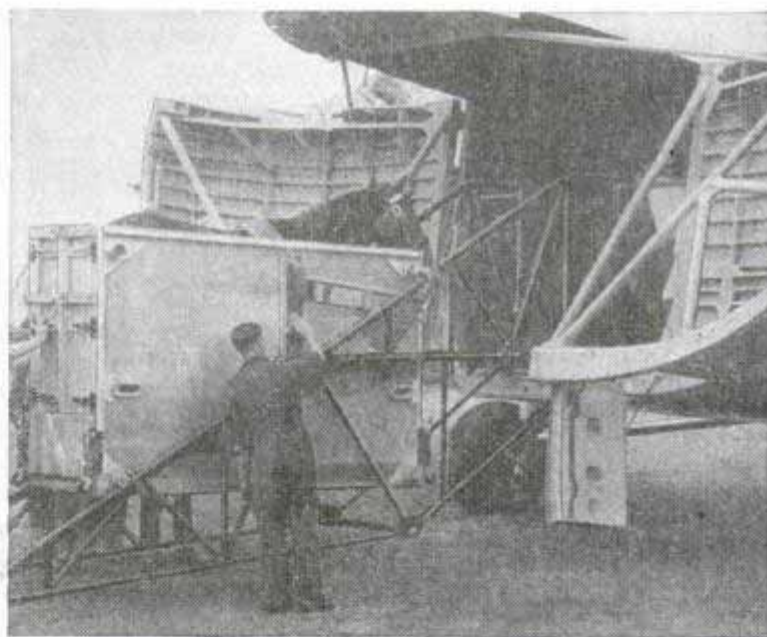

Compact Welding Unit Mounted on Trailer Uses Argon as Inert Gas

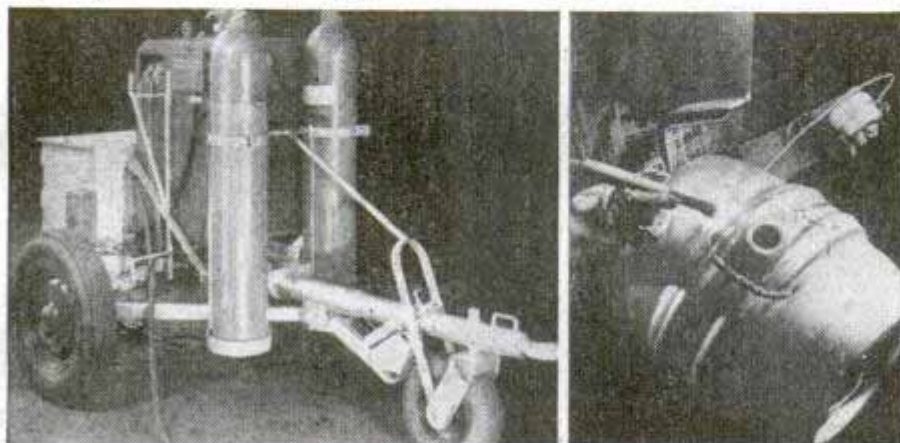

Argon is used as the inert gas in a compact aluminum arc-welding unit mounted on a road-type trailer. The unit's inert-gas process requires no welding flux. Both the welding torch and the power cable are water-cooled. The trailer carries the cylinders of gas, and has 75-foot torch leads permitting a large radius of operation.

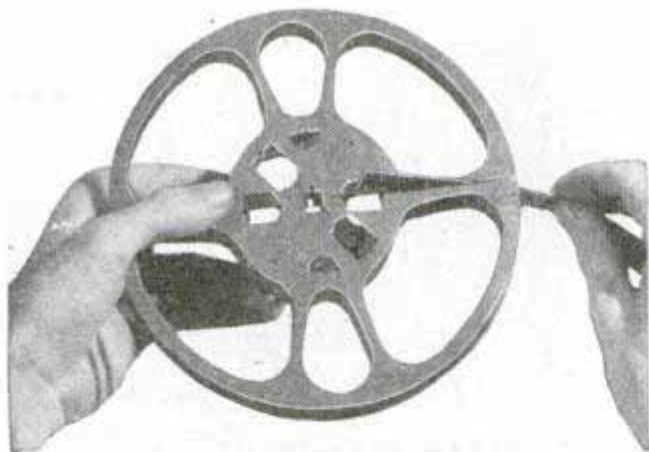

Side-Threaded Movie Reel

Movie film is threaded through a slot in the side of a quick-loading projection reel to minimize bending and breaking. The film is pushed into the slot where tiny jaws grip it for projection. When the film is re-wound the end is released automatically without snagging or pulling. The reels are available in 200 and 400-foot sizes for 16-mm. projectors and a 200-foot size for 8-mm. films.

Handles Grip Heavy Sacks

Sacks of grain and feed that are awkward to move can be lifted more easily with handles that grip them with hundreds of tiny hooks. The handles are made of curved stainless-steel plates in which triangular hooks have been stamped and bent inward. When the handles are slapped against the sack the hooks penetrate the cloth to distribute the weight over a relatively large area.



Phone Holder Clamps Around Neck To Leave Both Hands Free

Both hands are left free by a neck clamp for handset telephones that holds the phone in the correct position. The clamp remains fastened to the phone at all times and is slipped around the neck when in use. The neckband is padded for comfort and does not interfere with normal use of the phone. The device was exhibited at an exposition of inventions at Chicago.

Noncrushing Wrench For Soft Metals

Because of its three-sided grip, a trigger-operated wrench handles tubular fittings and nuts made of soft metal without crushing them. It is nonslipping and adjustable for nuts from $\frac{3}{8}$ to $\frac{9}{16}$ inch. A ratchet on the trigger holds the self-equalizing jaws snugly against the nut.

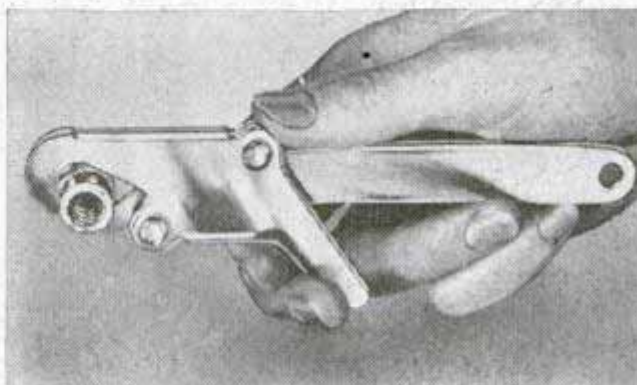

SEE INDEX IN FRONT OF BOOK FOR MFR.

WRENCH ON PAGE 142
SEE INDEX IN FRONT OF BOOK FOR MFR.



Track-Laying Garden Tractor

Instead of the conventional wheel, a new garden tractor has a cleat-type, continuous track. Weighing only 100 pounds, the tractor is powered by a 1½-horsepower gasoline motor. All controls are on the handle bar. Attachments are available to convert it into a mower, seeder, snowplow and other tools. A power take-off permits its use as a stationary power unit.

Ironing-Board Bracket Holds Cord

Tangled electric-iron cords are eliminated by a bracket that clamps on the end of the ironing board. The cord is held off the board by a roller at the top of the bracket. A weight, tied to the cord between the wall socket and the board, takes up the slack cord during use.

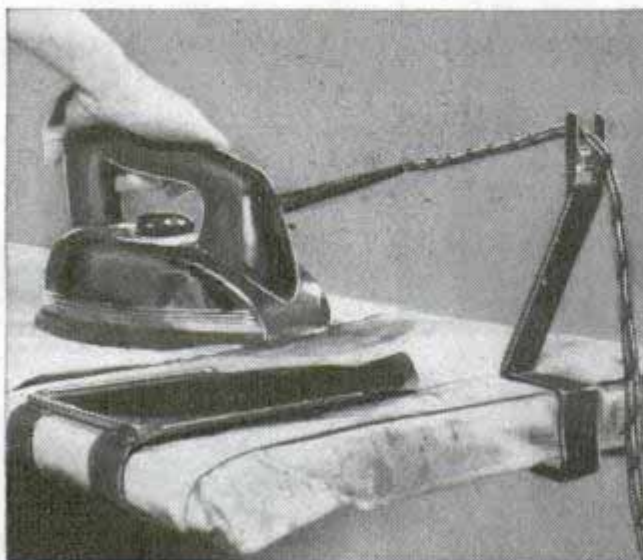

SEE WHERE-TO-FIND-IT IN FRONT OF MAG.

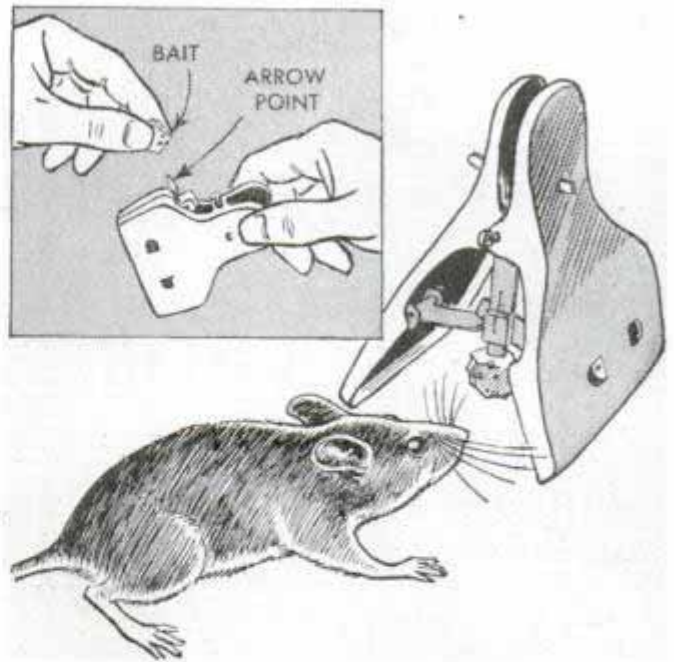

Trap Clips Mouse

Resembling a giant spring clip, an all-metal trap catches mice between two jaws that are sprung by an inside mechanism. Bait is placed on an arrow point while the jaws are closed, and swings inward when the trap is set. The protected location of the trap mechanism reduces the danger of injury to children and pets.

Toy Paste-Up Village (SEE WHERE-TO-FIND-IT)

Toy bricks, timbers, windows and doors included in a model building set are pasted together by youngsters to form stores in a miniature village. To disassemble a structure, it is placed in warm water which dissolves the paste.



CAPTAIN JOSHUA JAMES, American coastal pilot of the last century who saved several hundred lives in storms along the Atlantic coast, had a canny sense of direction. No matter where he was on the sea—in darkness or high noon, in fog or clear weather—he always had his bearings. When asked about this extraordinary sixth sense, he said:

"I can hear the land talk."

Today's skippers rely upon

Traffic Signals OF THE SEA

By Andrew Hamilton

scientific devices. It is the U. S. Coast Guard's job to maintain the 35,000 aids to navigation along 40,000 miles of coastline in the United States, Puerto Rico, Panama, the Hawaiian Islands and Alaska.

During the war many lighthouses, buoys and lightships in harbors and river mouths were blacked out—lest they silhouette Allied vessels and provide landmarks for enemy planes and submarines. By now all aids to navigation have been reconditioned and re-lit. New cutters and lighthouse tenders have been acquired by the coast guard. And several thousand new navigational aids have been installed.

All traffic signals of the sea serve the same general purpose whether they be small buoys or an expensive lighthouse: to help the mariner know at all times his exact position. Through navigational aids, ship captains are assisted in making landfalls when approaching from overseas, warned of isolated dangers, aided in following natural and improved channels, and provided with a continuous chain of charted marks for coast piloting.

Here are a few of the more



Official Coast Guard photos

New and old: helicopter for sea rescues flies by 231-year-old Boston lighthouse. Below, emergency kerosene lighthouse lamp



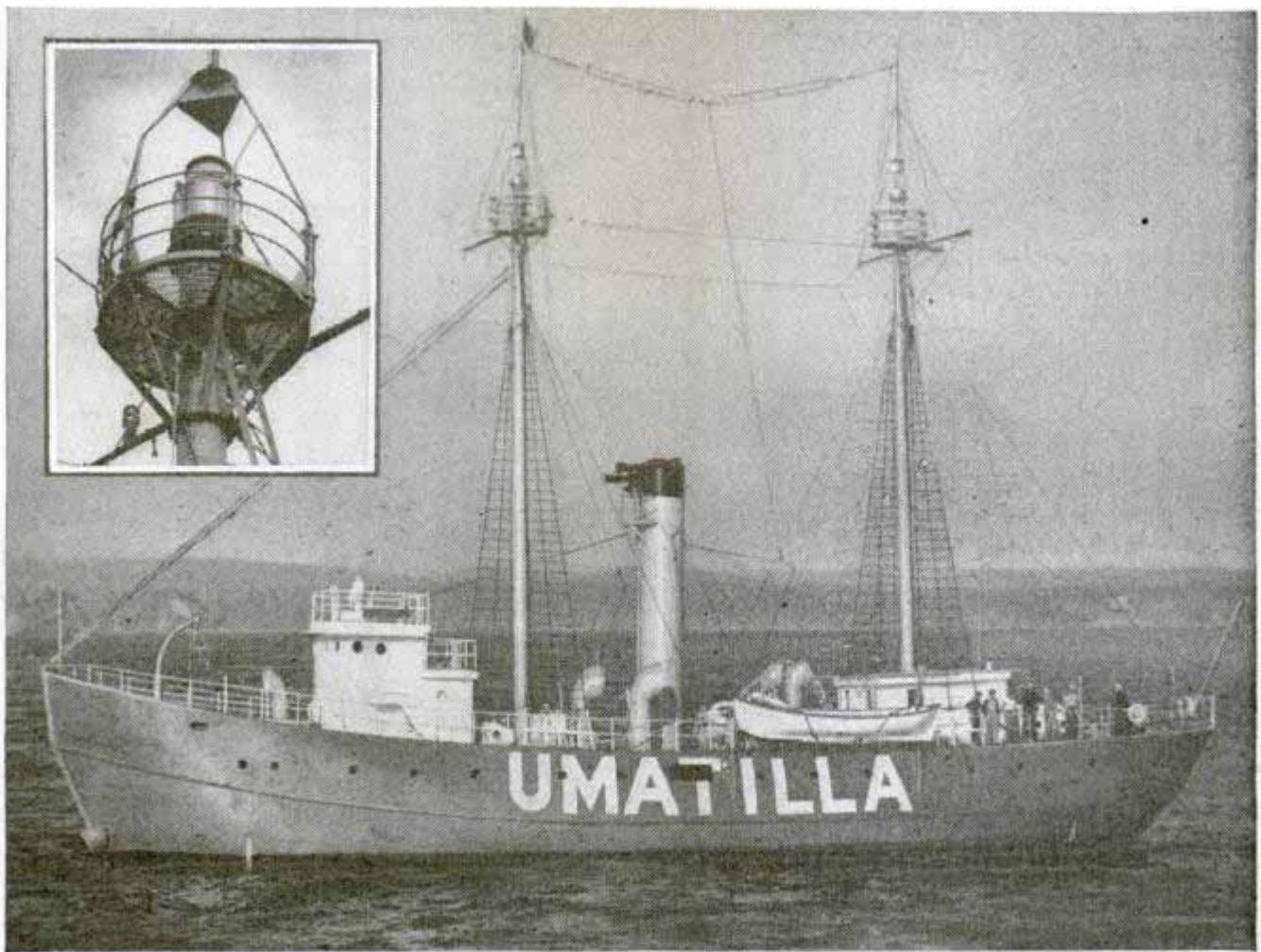

Ocean traffic off Washington coast is guided by light beacons (one shown in inset) on this lightship

important types of aids to navigation:

1. Lighthouses. Still standing as a sentinel of safety at the entrance to Massachusetts Bay is the first lighthouse erected in North America. Known as the Boston Light, it was built in 1716 and remains a monument to the early settlers and their regard for shipping.

Types of light towers vary, each adapted to the coast and climate where it is located. On the Pacific coast, where there are many high bluffs, lighthouses may be low, since the lights are elevated sufficiently for visibility at great distances. The generally low-lying Atlantic coast requires tall towers.

In a century and a half, extraordinary developments in lighting methods have marked the progress of navigational aids. Up to 1877, lighthouses were illuminated with whale, colza and lard oils. Then kerosene became the chief fuel until 1916, when it was supplanted by electricity. The Sandy Hook, N. J., light was electrified as early as 1888. In the larger lighthouses of today, electric incandescent lamps inside lenses produce beams up to 9,000,000 candlepower.

The flashing characteristics which distinguish many lighthouses are produced by revolving the entire lens. In earlier days, lightkeepers wound heavy weights attached to a clockwork device to turn the

light. Now most modern lighthouses are equipped with electric motors to perform the work. Larger light stations also are fitted with fog signals and radio beacons. Many lighthouses originally cared for by resident keepers are operated automatically. Most automatic lights are powered by compressed acetylene gas or by battery.

Highest marine light maintained by the coast guard is Lehua Rock Light, an automatic light on Lehua Island, northwest of the Hawaiian Islands. It rises 709 feet above sea level. Tallest lighthouse tower is at Hog Island on the coast of Virginia. This structure, of skeleton iron, is 191 feet in height. Two feet higher but no longer in use is the old Cape Hatteras lighthouse. The Pensacola lighthouse, Fla., 171 feet, is the tallest brick structure in use.

Most powerful light in the United States used as an aid to marine navigation—9,000,000 candlepower—is at the Navesink lighthouse, N. J., marking the approaches to the harbor of New York.

2. Lightships. Earliest lightships were small boats anchored at harbor entrances or at dangerous shoals—with lights displayed at mast or tower. They had no crews, but were visited daily, when possible, by attendants to refuel the lights and pump out the hulls. Later, small vessels

were rigged as lightships, in most cases small sailing ships manned by crews when on station.

America's 29 present-day lightships are equipped with lights, fog signals and radio beacons. They take the form of ships only because they are placed in waters where it would be impractical to build lighthouses. They mark entrances to harbors, estuaries and shoals, and serve as leading marks for transoceanic and coastwise traffic.

While on station, a lightship shows only the masthead light and a less brilliant light on the forestay, the latter serving to indicate the direction in which the ship is heading. As lightships ride to a single anchor, the light on the forestay also indicates the direction of the current.

3. Range lights. Range lights are established at bay entrances and in rivers as markers to enable sailors to obtain bearings. Two lights are located at some distance apart and visible in one direction only. They are so placed that to the mariner, when his ship is brought into line, the lights will appear one over the other and guide his ship to the axis of the channel. If a captain steers his ship so that the lights remain continuously in line, he will remain within the confines of the channel.

The lights of ranges may be of any of



Installing antenna (above) and batteries (below) on radio-equipped buoy which aids navigation in fog

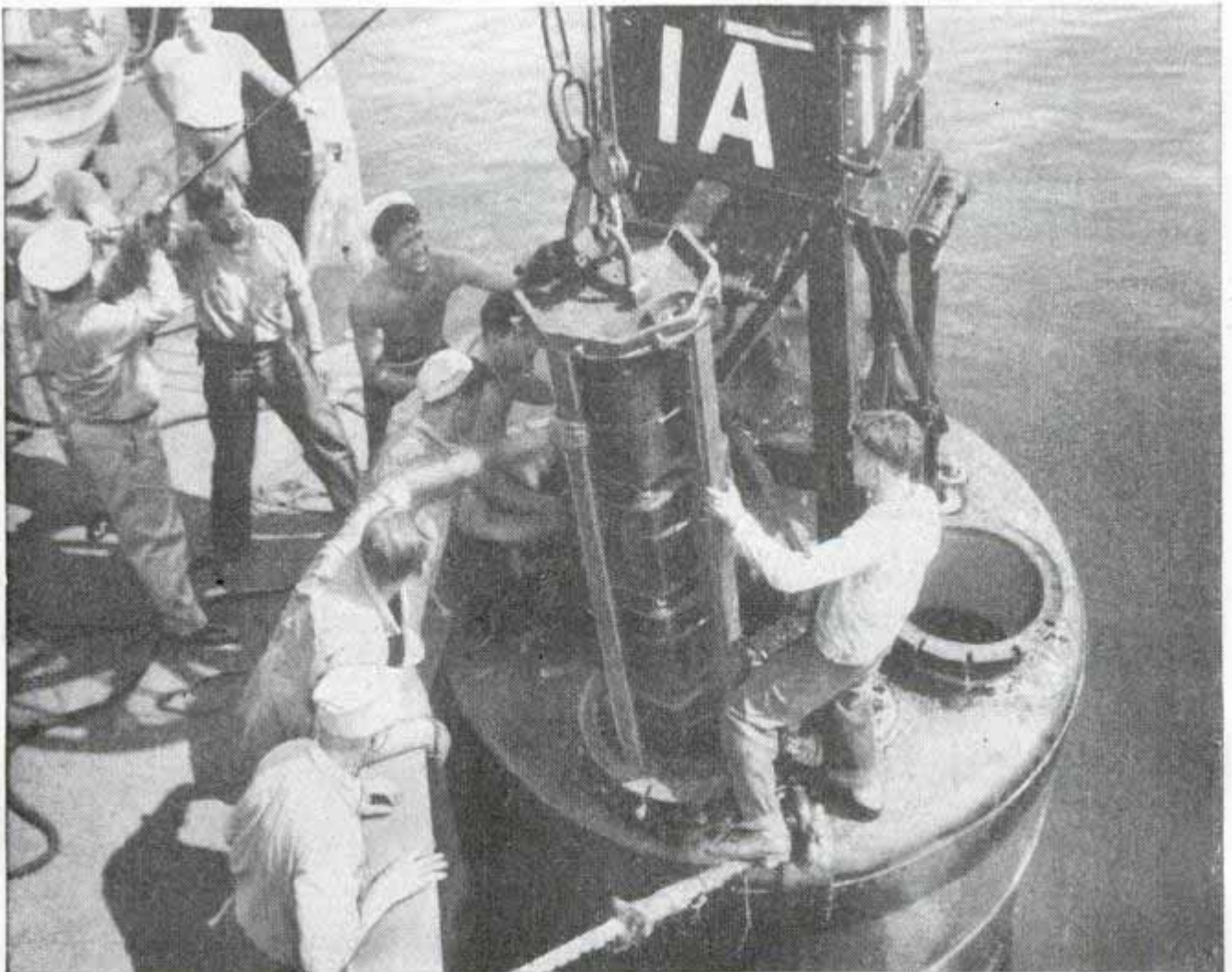

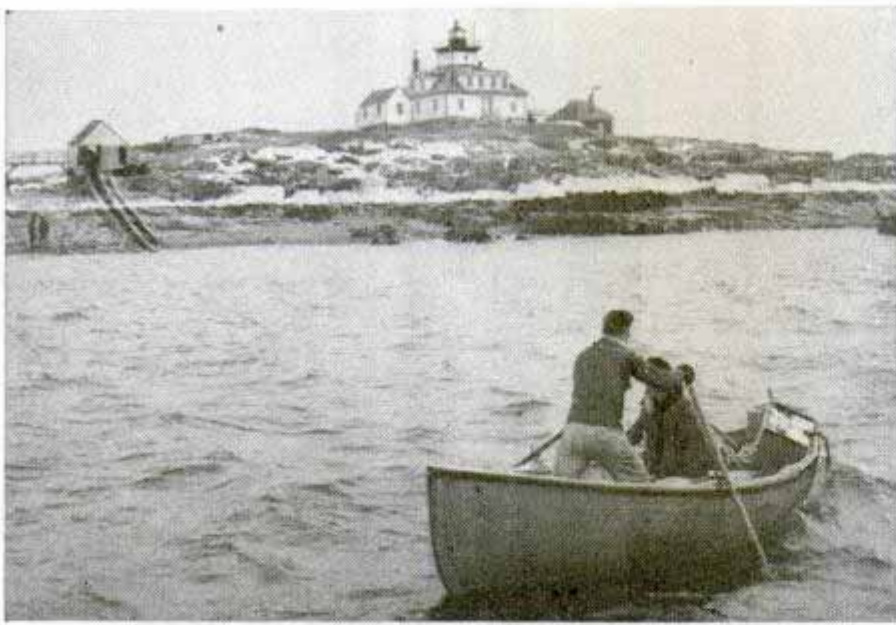

After five-day shore leave, Maine lighthouse keeper returns to his post

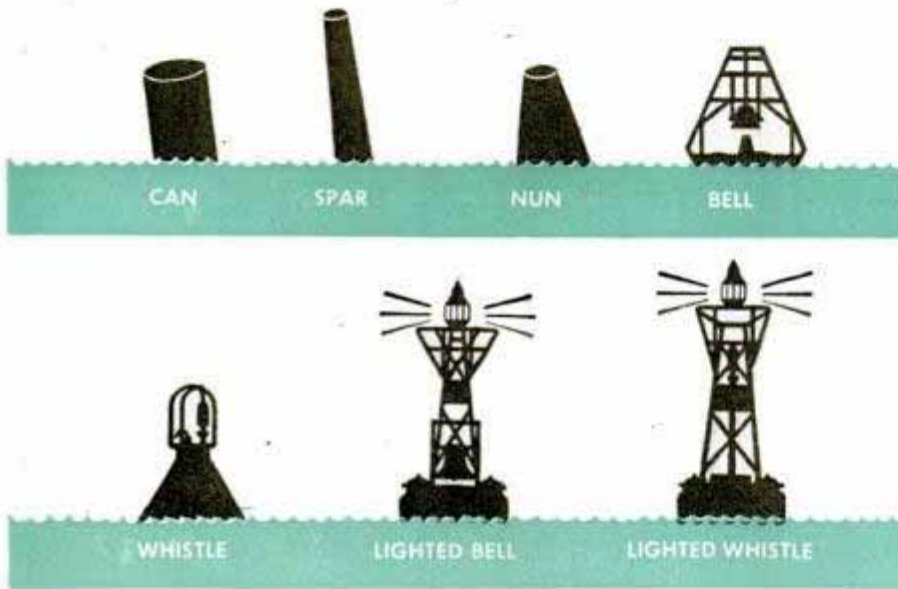

Various types of buoys are represented by drawings. Below, each man has a particular duty as coastguardmen go through regular lifeboat drills



three standard colors—white, red or green—and may be fixed, flashing or eclipsing. Principal requirement is that they stand out distinctly from their surroundings. Most range lights lose brilliance rapidly as a ship diverges from the range line.

4. Fog signals. Since the placing of a cannon at Boston Light in 1719 to warn ships in fog, many types of sound signals have been developed to overcome poor visibility. Hot-air engines, forerunners of today's internal-combustion engines, were once used to produce the power for sounding horns and trumpets. Steam fog signals were employed for many years. In recent times, powerful fog signals are operated by compressed air or electricity.

The various types of apparatus used for sounding the coast guard's 2159 fog signals produce distinctive sounds, composed of blasts and silent periods. A definite time is required for each signal to perform a complete cycle of changes. Differing in tone, their sound may aid in recognition of various stations.

Equipment for sounding signals includes diaphones, diaphragm horns, reed horns and sirens. Simpler signals are bells and whistles on buoys, and bells struck by hand at a lighthouse.

5. Buoys. Primary function of buoys is to warn of some danger, obstruction, or change in the contours of the sea bottom, and to sketch the channels leading to various harbors.

In the early days, buoys were haphazardly marked, if at all, and were made of wood. A standardized system of buoy markings was

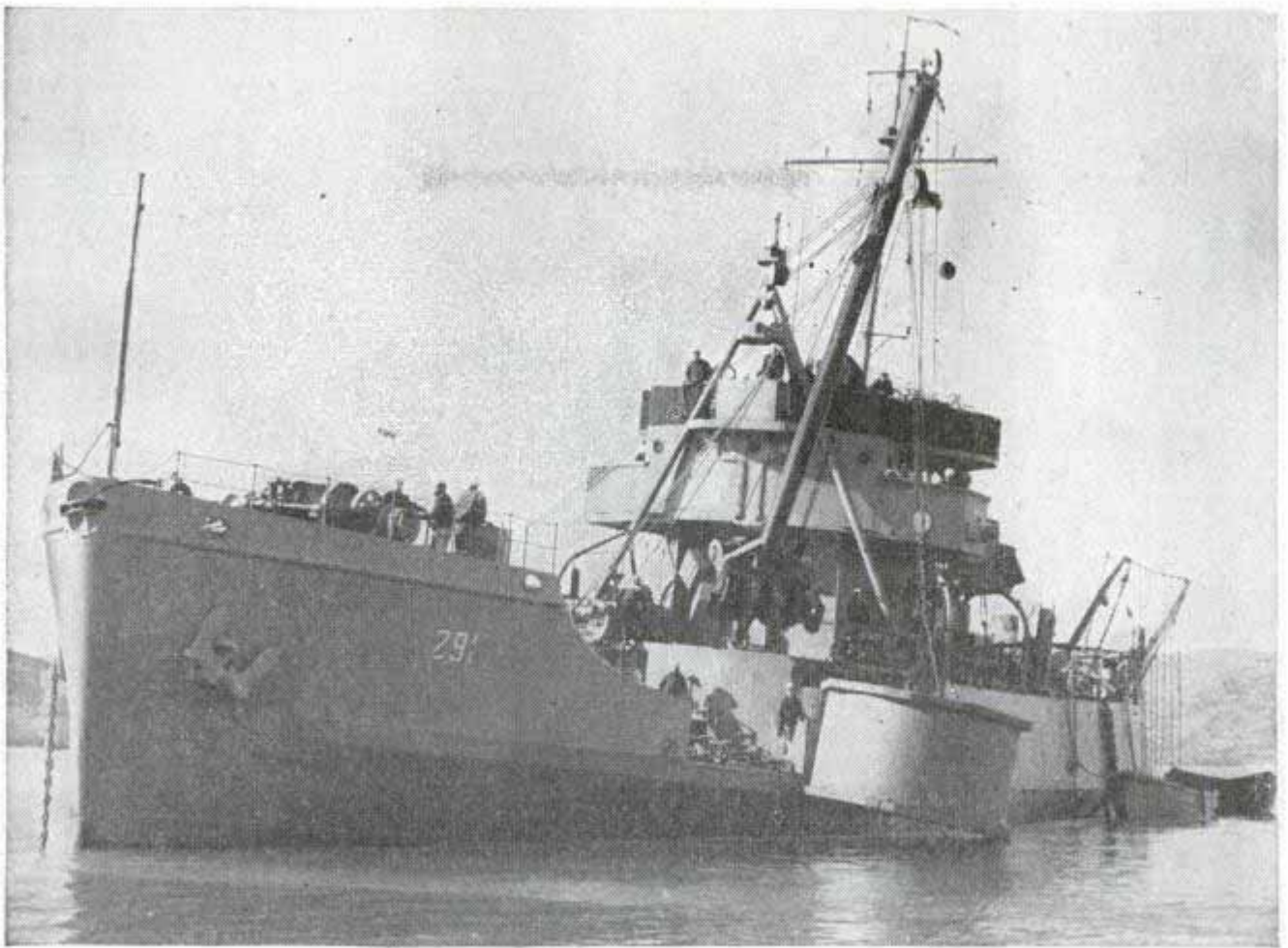

adopted in the 1850s, along with the introduction of iron buoys. The great majority of buoys today are metal. The larger are, in fact, miniature lighthouses—and some are equipped both with light and sound signals.

Utmost advantage is obtained from buoys when they mark definitely identified spots. If the skipper of a ship knows his precise location of the moment and is properly equipped with charts, he can plot a safe course. Such features as size, shape, coloring, number and signaling equipment are important means to warn, guide and orient the mariner.

Principal types of the 18,096 buoys operated by the coast guard are: spar buoys, large logs trimmed, shaped and painted; can and nun buoys, usually of steel; bell buoys, steel floats on which bells are fixed; gong buoys, similar to bell buoys; whistle buoys, the mechanism operated by wave motion; lighted buoys, metal floats with lights operated by acetylene gas or battery, and combination buoys, in which lights and sound are combined.

(Continued to page 240)

Ship lists as 20-ton mooring buoy is lowered by boom over her side in a Greenland fjord. Below, lowering a 10-ton anchor which is to hold a mooring buoy and the ship tied up to it. When the anchor reaches bottom, the lowering hawser is returned to deck



FIGURES MOLDED FROM BREAD LOOK AND FEEL LIKE STONE

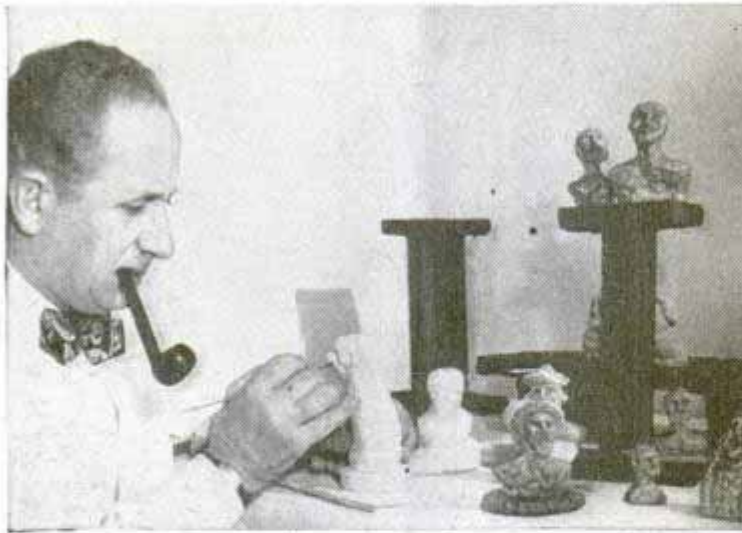

Above, the soft inside of the loaf is dampened before molding. Left, Mr. Podell adds facial expression to a rye-bread statuette

Obtaining material for his sculpturing is easy for Maurice Podell of Long Branch, N. J. He simply stops in at a bakery and buys a loaf of rye bread. Podell tears out the inside of the loaf, dampens it and molds it into artistic shapes and realistic busts of

famous persons. The only tool he uses is a slender stick for the final touches. After the figure is completed, it is dried thoroughly and looks and feels like stone. The figures are about three inches high and take approximately three hours to make.

Materiel Command Tests Opposing Techniques of Helicopter Design



U. S. Air Force photos

German-designed Flettner 282, above, counteracts torque with intermeshing rotors, tilted so axis of each is at 24-degree angle to the other. Five-place Bell XR-12, below, achieves same result with rotor on the tail boom



Opposing techniques of helicopter design are being tested by the Air Materiel Command in the big Bell XR-12 and the Flettner 282. The former, a five-seater, employs a two-bladed main rotor system with a gyroscopic stabilizer bar. Weighted at both ends, the bar is attached to the blades at right angles to decrease vibration. Torque is eliminated by a rotor on the tail boom. The German-designed Flettner attacks the torque problem with two intermeshing, contrarotating, twin-bladed rotors, mounted so that the axis of each is at a 24-degree angle to the other. While the right-hand rotor is revolving clockwise the other spins in the opposite direction.

If you would like the names and addresses of the manufacturers of the new products described in this issue, write to the Bureau of Information, Popular Mechanics, 200 East Ontario St., Chicago 11, Ill.

Grandpappy Refuses to Die

Ancient locomotives still chug over the famous old Virginia & Truckee Railroad, whose silver spike was driven in 1869. But the line never did get to Truckee

By Thomas E. Stimson, Jr.

PASSENGERS on the crack streamliners that pause at Reno sometimes see on an adjacent track a steam train so ancient that they walk over to it in surprise.

"What's this?" they ask, surveying the 40-year-old locomotive and its wooden open-end coaches. "Historical exhibit?"

"No sir," some native answers, "that's the daily train of the Virginia & Truckee. It's a famous old railroad that refuses to die."

The Virginia & Truckee no longer goes to Virginia City and it never did get to Truckee. Its present line is only 46 miles long, from Reno through Carson City to Minden, Nev.

Seventy-five years ago the V & T owned 24 wood-burning locomotives and operated as many as 52 trains a day between Carson City and Virginia City. There were plenty of sidings on the single track and the engineers watched for the smoke of oncoming trains to decide when to move into the sidings.

That was in the days when frenzied mining activity along the vast Comstock silver lode transformed a sage-brush desert into a region of bustling cities. Now one mixed train that makes a leisurely round trip over the

Narrow-gauge engine of the V & T line takes on water in the desert from tank which is kept full by the old windmill

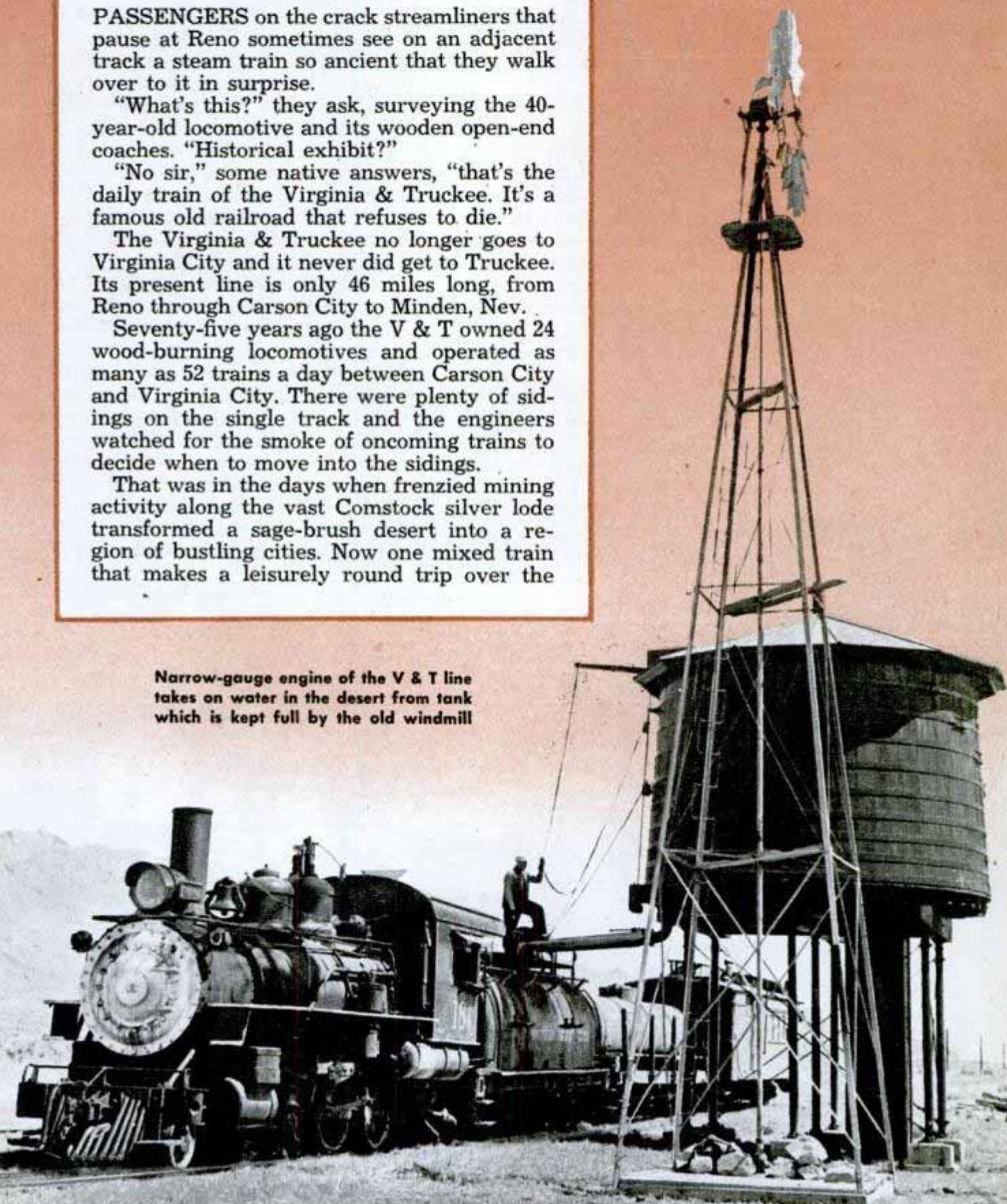

railroad six days a week handles all the passengers, mail and freight.

In today's modern high-speed transportation picture the old fashioned "bonanza railway" furnishes a living picture of the early days of western railroading. Once the line paid \$100,000 a month in dividends; now years have passed since the stockholders received a cent. Unable to afford up-to-date equipment, the little line struggles along with the rolling stock and equipment it has inherited from the past.

Its wooden passenger coaches were all built in the last century. Painted canary yellow with light green trim, they still preserve their early color scheme. Some are equipped with their original kerosene lamps and wood-burning heat stoves. Switchmen along the line use ancient "harp" switch stands for throwing the stub switches that were installed when the road was built.

The vast shops, built in the '70s and once the largest and best equipped west of Omaha, are now a virtual museum of early-day machinery. Much of the original shop equipment is still in use and a new machinist spends hours learning the tolerances of the old belt-driven lathes and mills.

The Virginia & Truckee's first silver spike was driven in 1869 and early the next year the line was completed from Carson City to Virginia City, 21 miles away. Rails were 50 and 60-pound, brought by boat from Liverpool to San Francisco and thence overland. The first five locomotives were hauled across the desert from Reno by 10 yoke of oxen each, broad tires pro-

tecting the flanges of the engine wheels. The railroad was one of the first standard-gauge lines in the West.

The V & T's volume business consisted of carrying silver ore down the mountain from Virginia City to the mills located on a river and in hauling mine timbers and supplies back uphill. Most trains were double or triple-headers. The line climbed 1600 feet in 15 miles and had a curvature equaling 17 full circles.

In 1872 the tiny railroad built its present line from Carson City to Reno, connecting there with the Central Pacific that later became the Southern Pacific. Business boomed. In a typical six-month period, beside thousands of passengers, the V & T hauled a tonnage that was tremendous for those days, amounting to a quarter of a million tons of wood, coal, ore, livestock and merchandise, including 80 tons of silver bullion. The tradition is that during its early history the line moved its entire weight in sterling silver, including all its rolling stock and ties and rails.

Supplying timbers for the Comstock mines was a problem in transportation that the pioneers solved in a unique way. The nearest trees in sufficient quantities were on the shores of Lake Tahoe on the Nevada-California border. There the trees were cut, towed by steamer to a sawmill on the lake, and the timbers were then carried by a narrow-gauge railroad to the summit of the Sierra Nevada mountains. From here they were dropped by means of a V-shaped water flume to a point near Carson City and were loaded on V & T

This early V & T wood-burning locomotive has been retired to the plush pastures of a Hollywood movie set

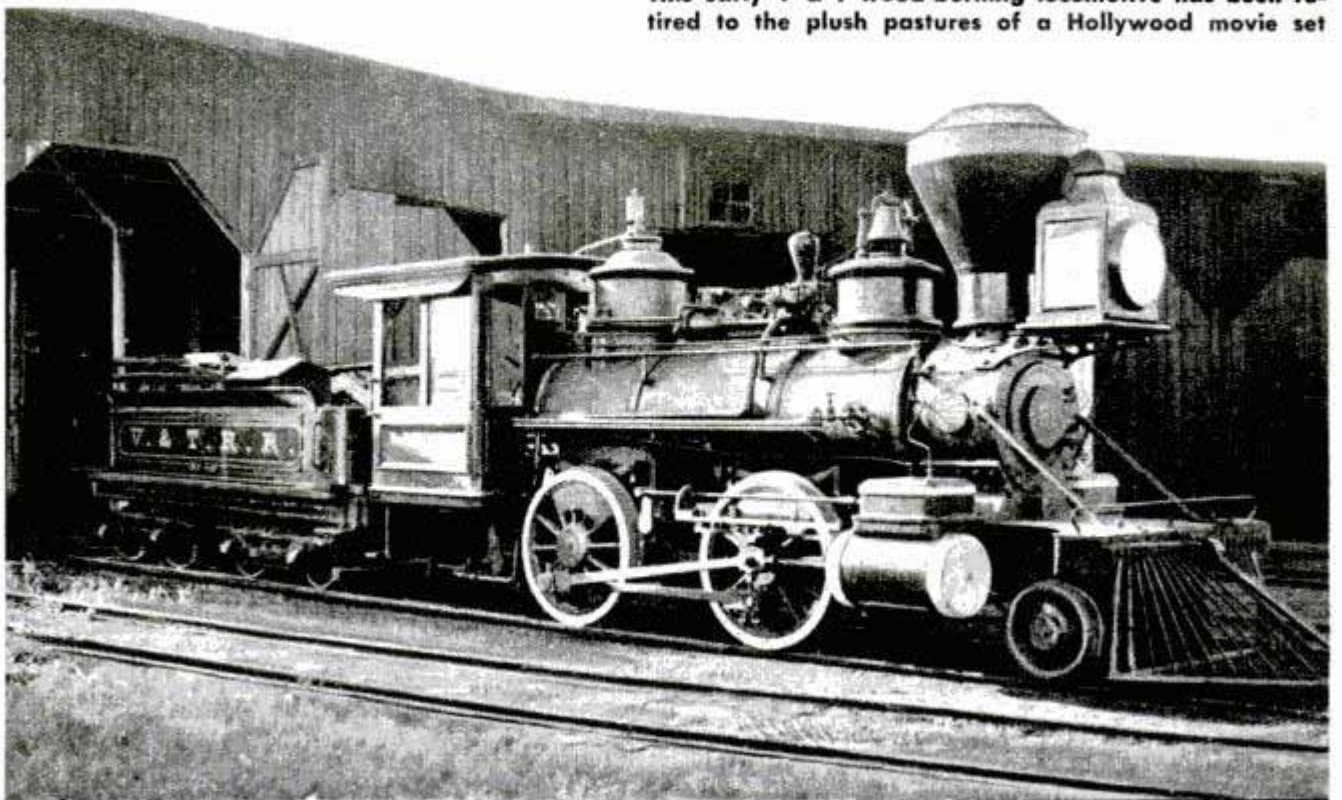



Dressed up with an old funnel, a V & T special carries state officials on an inspection trip over the line

flatcars for the final haul up to the Virginia City mines.

With the decline of the mines in the late '70s the railroad built a subsidiary narrow-gauge railroad from just east of Carson City to Keeler, Calif., 300 miles to the south. Called the Carson & Colorado, the narrow gauge traversed barren desert that had no mines, no agriculture, no industry. There was practically no traffic. Then the line was bought by the Southern Pacific and renamed the Nevada & California. Later the V & T and the N & C both flourished when Tonopah became a mining center. Traffic became so heavy, in fact, that freight was delayed for weeks.

One gambler who had a freight car full of roulette wheels at Reno, destined for Tonopah, was faced with a month's delay until he had a bright idea. Cars containing livestock had an immediate priority, he learned, and so he made room in his carload of gambling paraphernalia for one cow. That constituted livestock and he demanded shipment at once. The cow and the roulette wheels were en route to Tonopah the next day.

In 1906 V & T built a branch line from Carson City to Minden. When the road abandoned its Virginia City run in 1938 the Reno-to-Minden route became its main line.

Old passenger coaches built in the V & T shops retain original kerosene lamps in addition to electric lights

The history of the V & T reads like a wild-west thriller. It has had its share of wrecks, derailments and express robberies. The timbers in the tunnels along its line have been burned out, it has had runaway locomotives, and its train crews have fought snowstorms that created drifts as high as the stacks of their locomotives.

In recent years the old railroad has been at death's door a dozen times and each time it has pulled itself out of the hole. On several occasions when the outlook was dark it sold some of its aged rolling stock to Hollywood for use in motion pictures, other times it rented part of its roadbed and equipment to motion-picture companies on location.



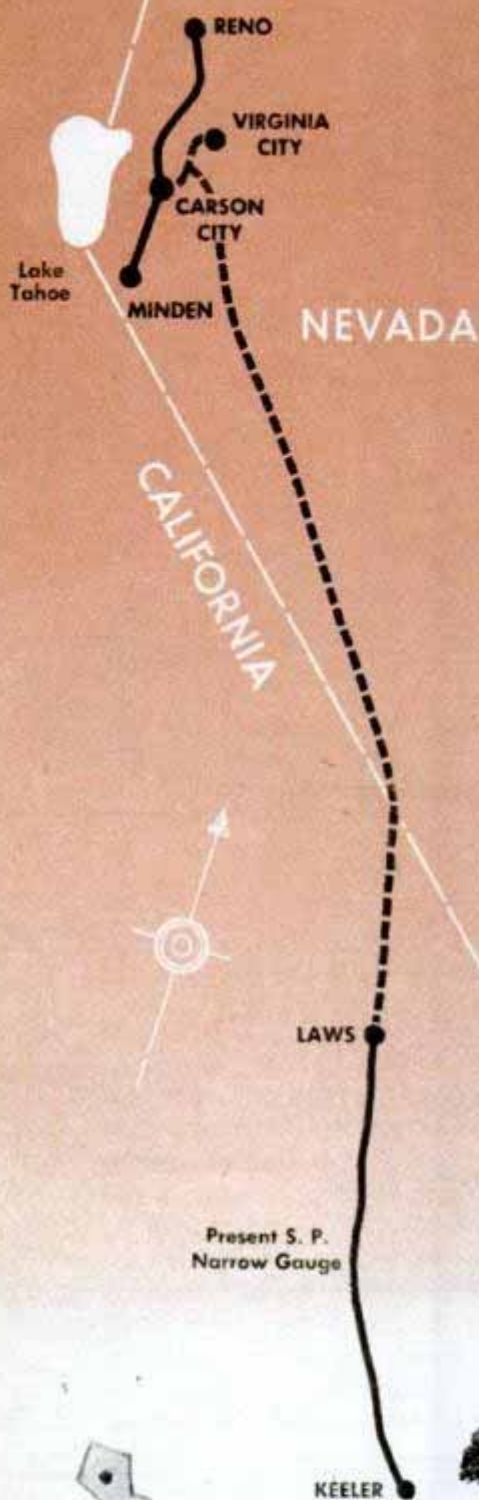

In Hollywood today, on the Paramount lot, two early V & T locomotives are working in a railroad picture called "Whispering Smith." Converted from wood to oil burners for convenience and with their big diamond stacks replaced by the stacks of a later period, the engines have been rebuilt as good as new.

Each has had its boiler reflued, each carries a standard inspection card, and each is equipped with forced-feed lubrication, monitor injectors, electric generators, and air brakes and air sanders. In all, Paramount owns 25 pieces of old rolling stock, including a wrecker, blacksmith car, passenger coaches, and assorted box, flat, and livestock cars, nearly all of which was purchased from the V & T.

On some occasions, too, when the V & T seemed doomed, its officials have been able to sell enough scrap and old trackage to keep it out of the red for another year. Still other times its shops have picked up enough outside work to meet part of its deficit. Again, promotion and publicity campaigns among its poten-

Switchman below checks clearance of an ancient stub switch. At bottom, after switch is thrown the engineer of oncoming train is waved through



tial customers have brought in enough business to carry the railroad over a financial hump. G. A. Sampson, vice president and general manager of the line, never knows what kind of crisis will occur next nor how he will solve it.

The V & T owns less than 25 pieces of rolling stock and the road is operated by less than 50 people. Last year it moved 1277 carloads of inbound freight, mostly petroleum products and livestock, and originated 239 carloads of outbound freight.

Right now the old line is in the midst of a modernization program. There isn't enough money to burn all the weeds from its right of way or to keep its signs and buildings gleaming under fresh paint, but section crews are maintaining the roadbed in adequate condition and are keeping the bridges in good enough shape for the traffic.

During the next few years the ancient stub switches are to be replaced and other early equipment is to be retired from use. In the shops a big electric motor has replaced the steam plant that formerly powered the overhead system of leather belts that drives lathes and other power tools.

A few months ago the V & T splurged

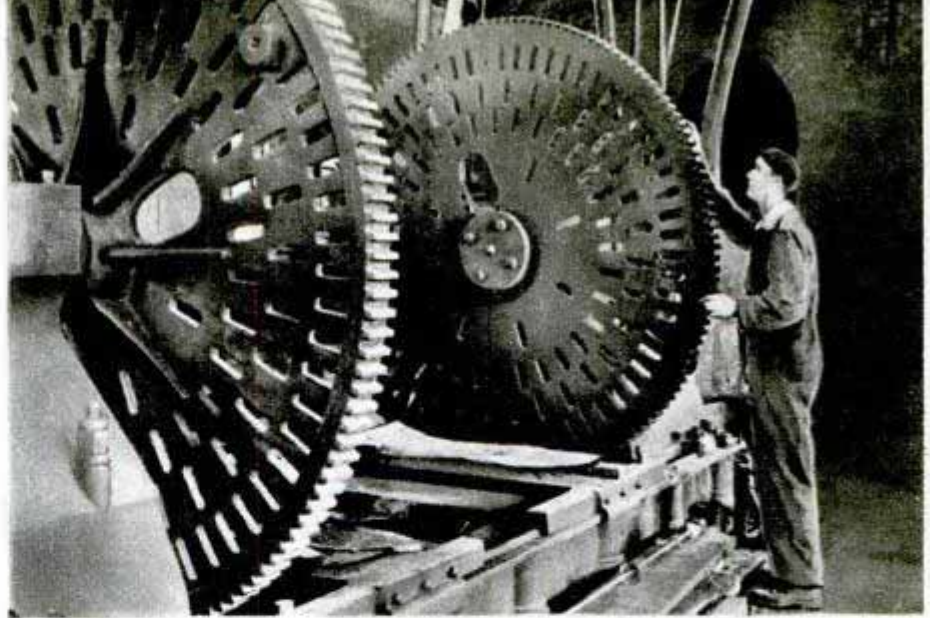

Wheel lathe used in the V & T shops to turn flanges of car wheels

and bought its newest engine, a 1925 locomotive that can outpull both of its other two remaining engines. These are a pair of 4-6-0 Baldwins, one of which was built in 1913 and the other in 1907. The new engine can pull the hill north of Carson City all by itself and it's no longer necessary to send out a helper engine with the daily train. All of the V & T's rolling stock is maintained to the safety standards of the I.C.C.

Down in California, a portion of the narrow gauge that was built by the V & T is

(Continued to page 252)

V & T shop equipment includes (left) steam plant kept in stand-by status in case of electric power failure, and (right) 75-year-old hand-operated wooden crane still in use; only base of the crane is shown in the photo

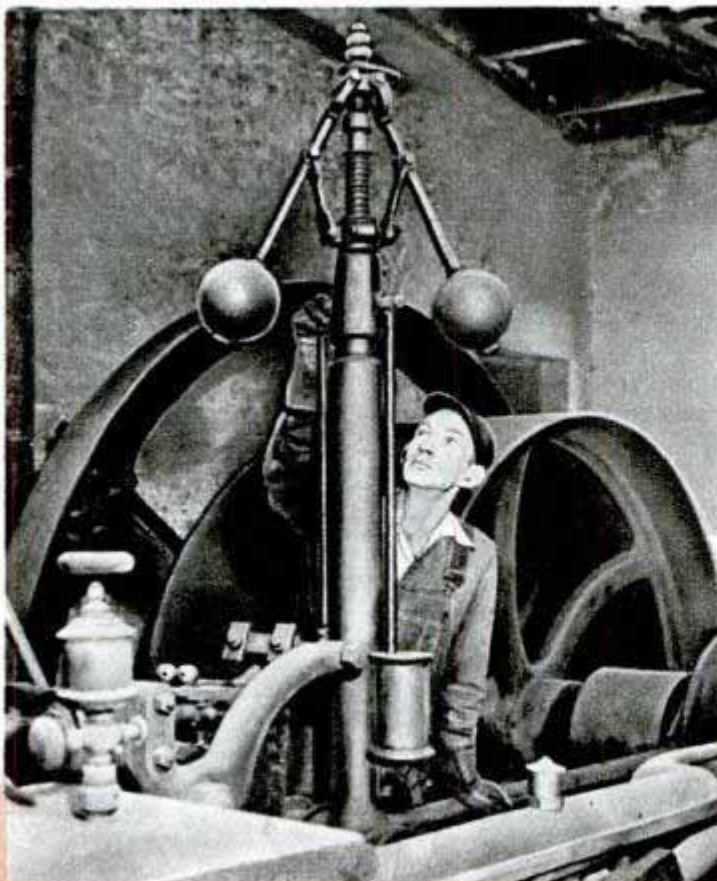

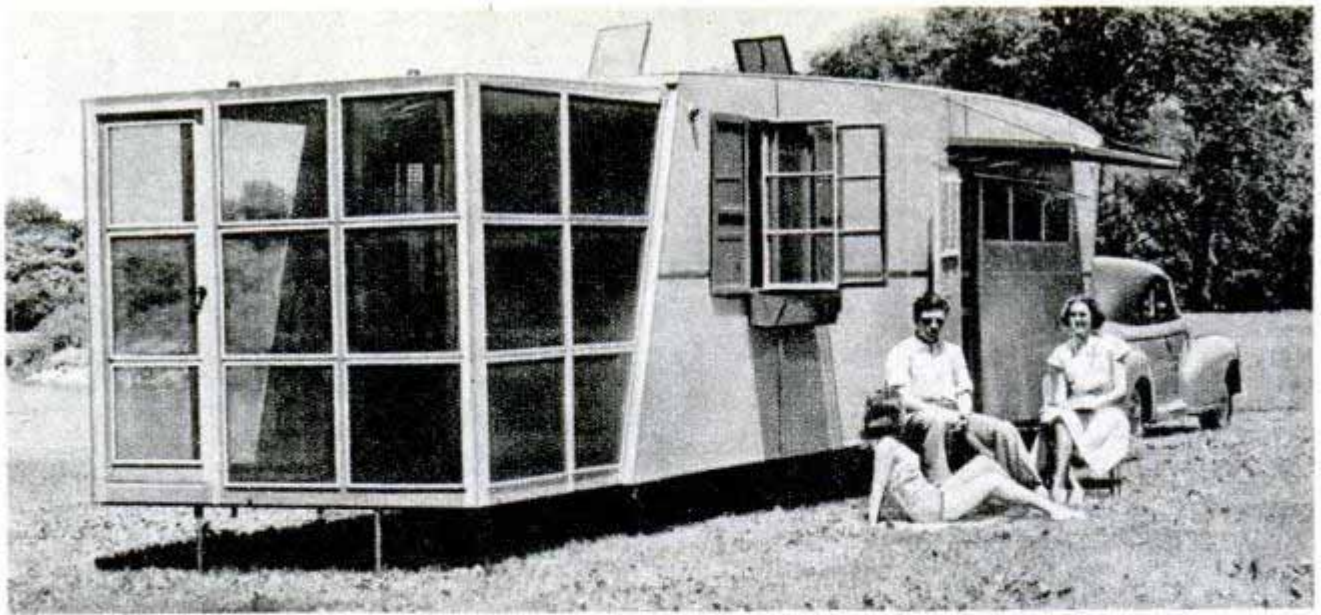

SUN-PORCH TRAILER

With a screened porch that folds into the rear of the coach for traveling, a new trailer provides a roomy home on wheels. Above, the seven-foot-long porch comes equipped with screens that bolt into place easily. Left, porch interior is separated from living room by a glass wall. Below, floor plan shows large living area. Folding partition converts space into two bedrooms. Modern kitchen has an electric refrigerator. Electric heater provides hot water for sink and built-in shower. Bottom, ready for travel, the coach is 28 feet 8 inches long. Folding porch forms screen-storage space in rear of trailer. Partholed sun shields for windows and door fold against body. Its tandem wheels have electric brakes.

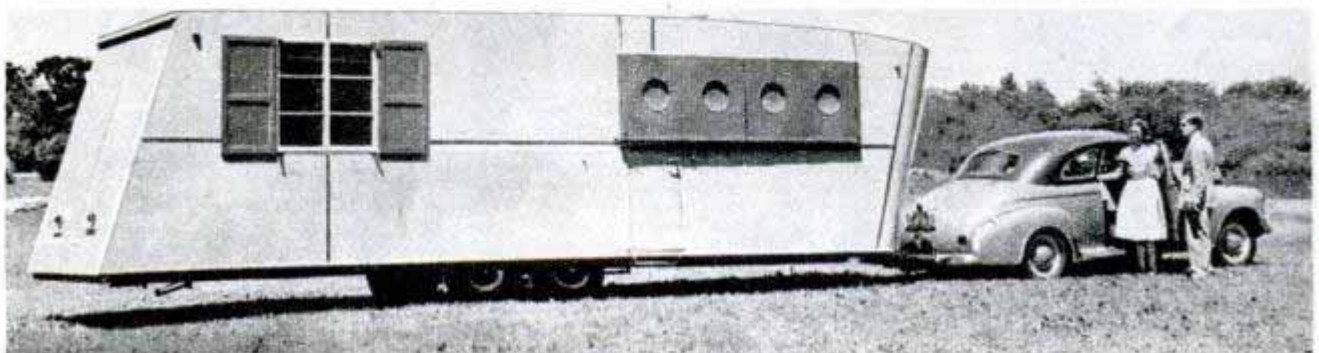
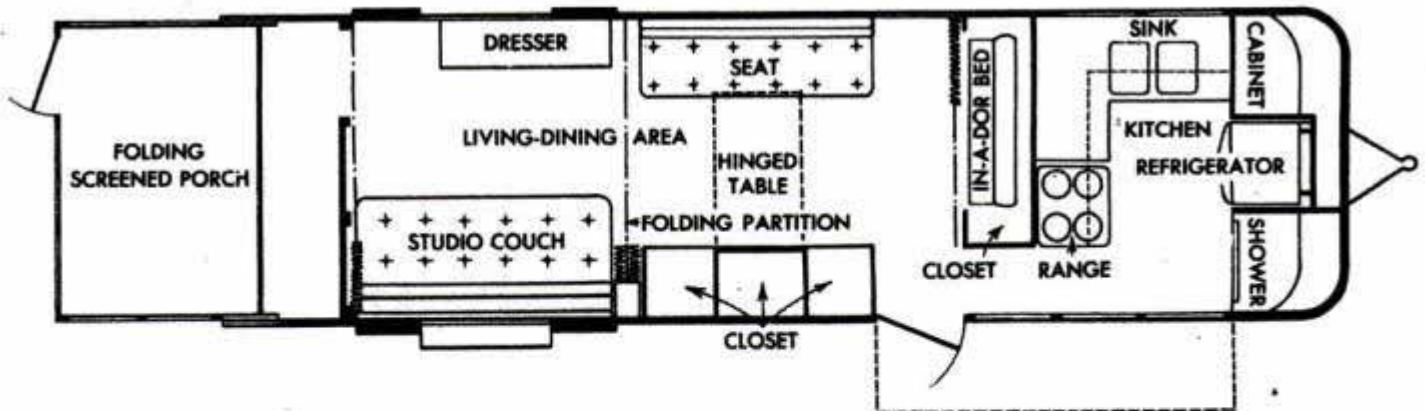



Movie camera is bolted to the X-ray machine prior to photographing bone movement in hand and wrist. Vertical strip shows completed pictures. Right, doctors adjust camera for filming heart's pumping action

X-Ray Movies Record Body Movements

By synchronizing a 16-mm. camera with an X-ray machine, medical researchers take movies of the inner movements of the body and its organs. This technique, developed by the University of Southern Cali-

fornia and Northrop Aircraft, Inc., is expected to result in better artificial limbs, more effective treatment of infantile paralysis, and greater knowledge of circulatory and respiratory functions.



Wheel Chair Folds To 10-Inch Width

Weighing only 35 pounds, a wheel chair folds to a 10-inch width to fit easily in an automobile, plane or train. The chairs maneuver so easily that users play basketball while seated. On women's chairs, stainless-steel skirt guards are provided. For persons who have lost an arm, a special chair is operated from one side.

Plastic Fog Lens

Eliminating the need for special fog lamps, clip-on fog lenses made of amber plastic quickly equip a car's headlights for foggy-weather driving. The lenses fit any standard sealed-beam unit and are held in place by three metal clips. The specially developed plastic is water repellent, heat resistant and has excellent light-transmission qualities. The clips are formed of non-corrodible Monel metal.



Information, including manufacturers' and distributors' names and addresses, concerning products described in this issue may be obtained by writing to Bureau of Information, Popular Mechanics Magazine, 200 East Ontario Street, Chicago 11

Savered bow of oil tanker is towed into Todd shipyards after a storm ripped the vessel asunder amidship



They Stitch Broken Ships

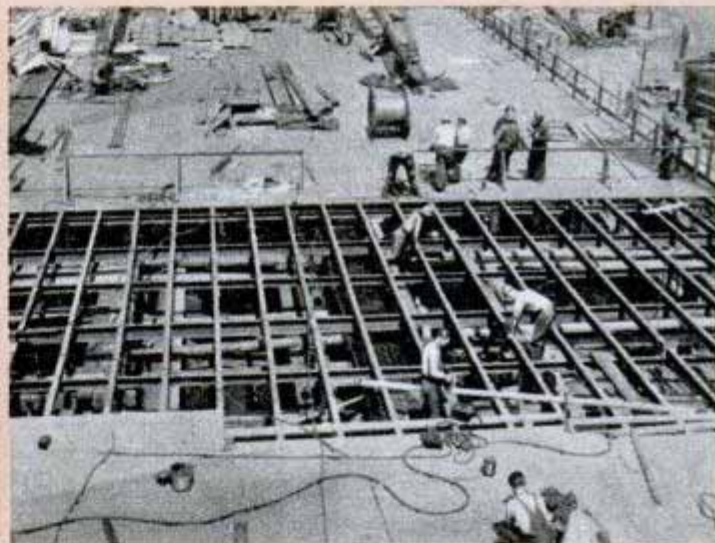
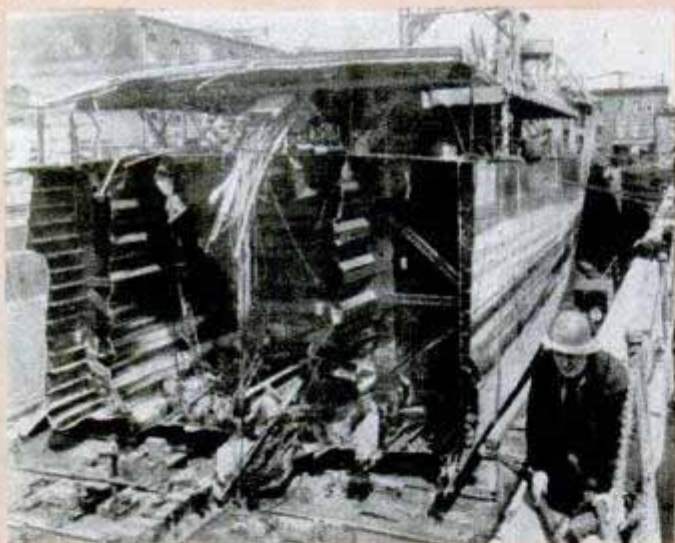

Mangled stern half (left) awaits repairs before being "sewed" together with bow. The two halves are re-joined (right) by strong iron beams. After only 63 days in the ship "hospital" at Brooklyn, the reunited sections leave as a complete tanker, staunch and seaworthy. The ship has an entirely new midships section



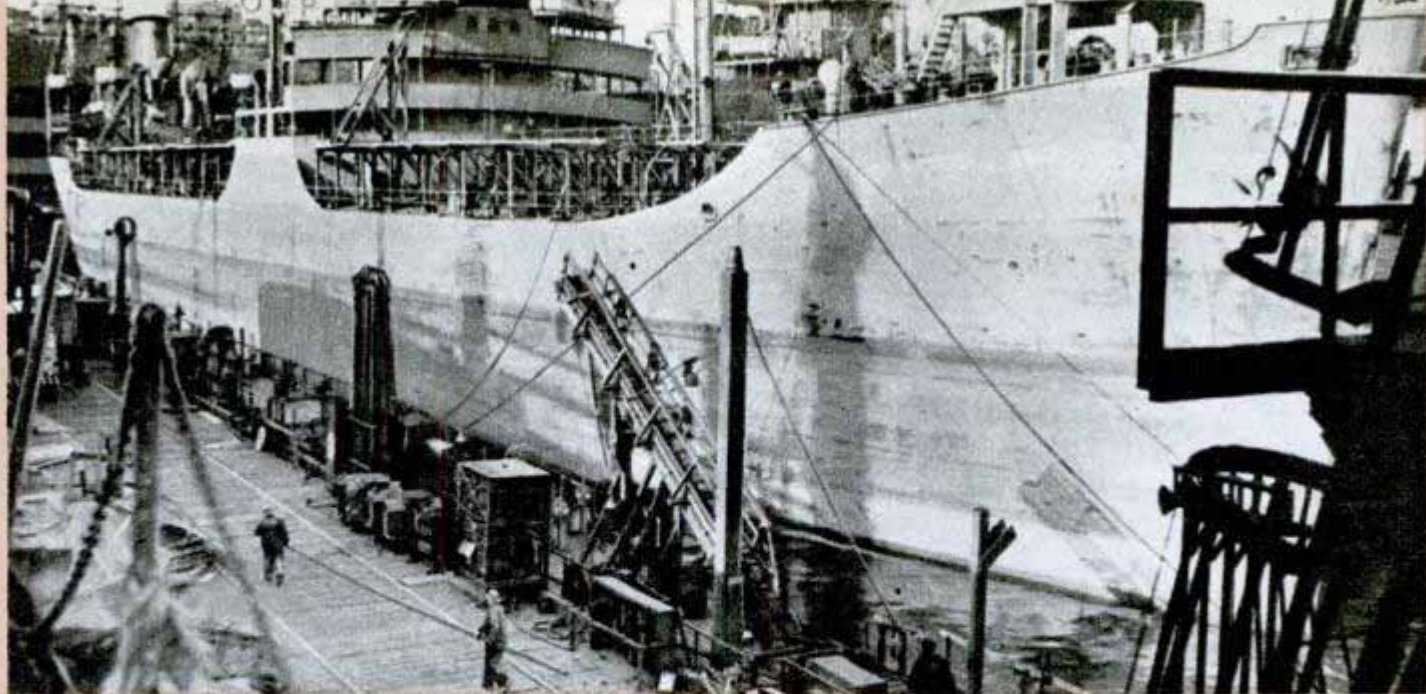

The tanker, Gold Creek, comes to the shipyard to be shortened to negotiate turns in South American rivers

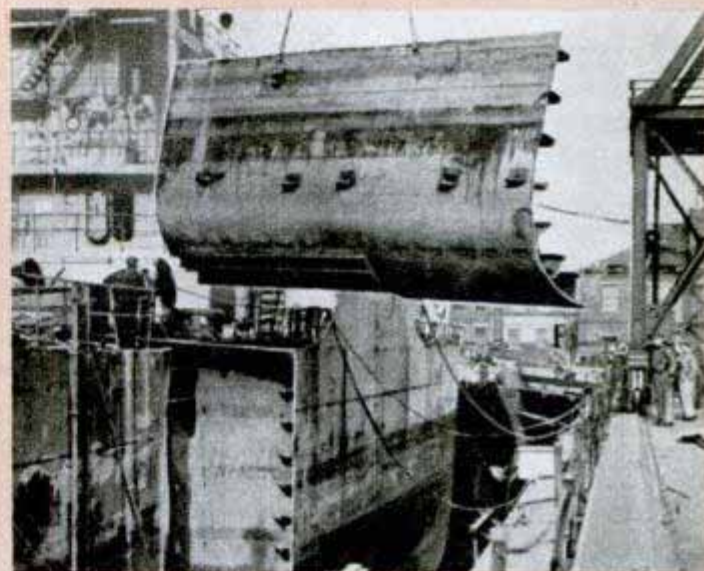

After a ship "can opener" (left) sears its way through the tough hull, a crane (right) removes the last severed section. Then the two halves are floated together (below, left), and the sections are welded together

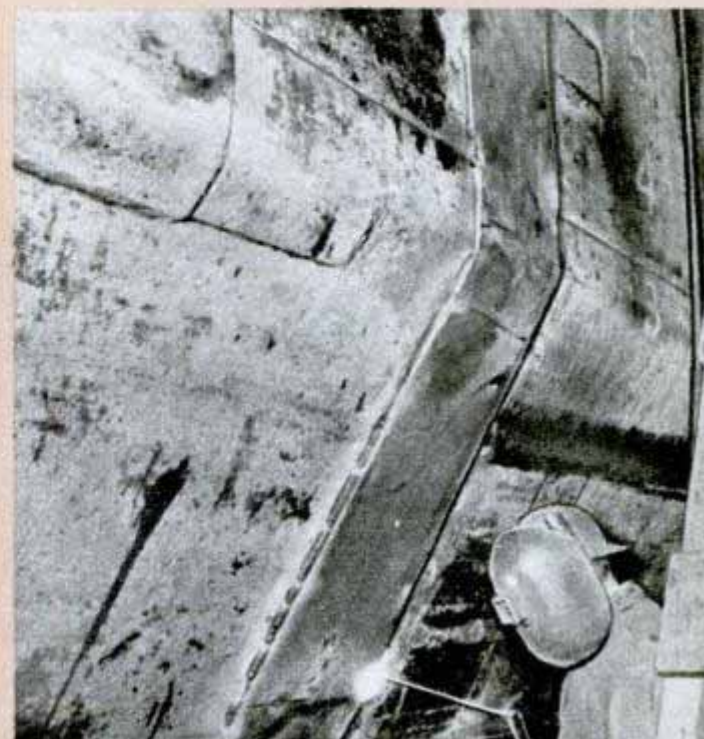
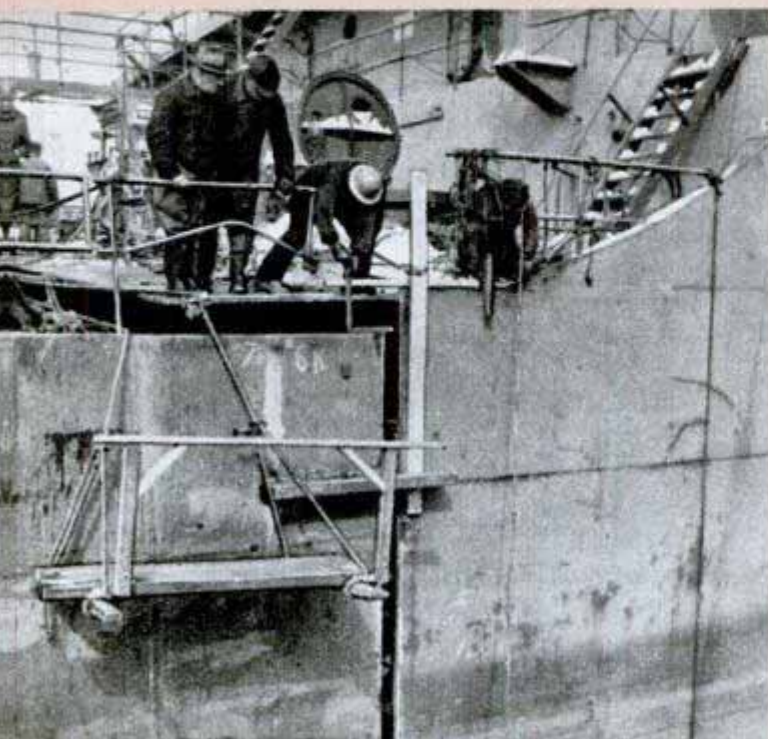

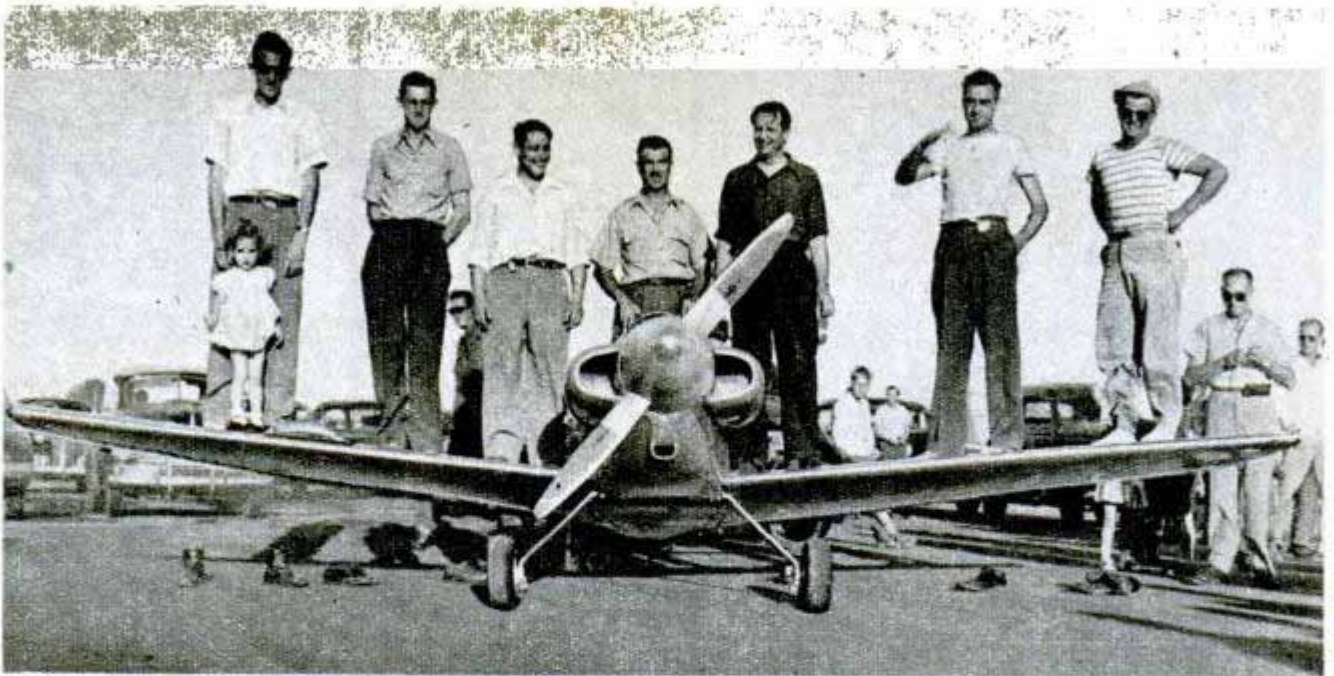

Nineteen-foot wing span of midget racer supports seven men and a child. Built by Tony Levier, Lockheed test pilot, it has a top speed of 200 miles an hour. With pilot and three hours' fuel, the craft weighs 800 pounds



Midget All-Metal Racer Flies 200 Miles An Hour

Midget-plane racing is a new week-end sport envisioned by Tony Levier, Lockheed test pilot, and a group of friends who are building five identical racers with 85-horsepower engines. One of the smallest all-metal planes ever built, the first of the

class is 16 feet long, has a 19-foot span and stands 4½ feet off the ground. It has a fixed-pitch propeller, fixed landing gear and weighs 800 pounds, including pilot and a three-hour fuel supply. Its top speed is estimated near 200 miles an hour.

British Combine photo



Dutch Pusher-Type Air Taxi

Judged best among small taxi or feeder planes at an international show in Paris was a pusher-type Fokker. Seating four, it cruises between 130 and 140 miles an hour. The plane was built by the Fokker Aircraft Company, Ltd., in Amsterdam, Holland.

POPULAR MECHANICS



Top of Squat Transport Just Six Feet Off Ground

Mechanics don't need ladders or stands to work on the Brigadier, a twin-engine pusher transport whose cabin top is only six feet off the ground. It is low enough to allow the five occupants to enter without using a step. Slightly more than 27 feet long and with a 41-foot wing span, two 125-horsepower engines are expected to give it a 150-mile-an-hour cruising speed. It weighs 3200 pounds fully loaded, climbs 300 feet per minute, lands at less than 60 miles an hour.

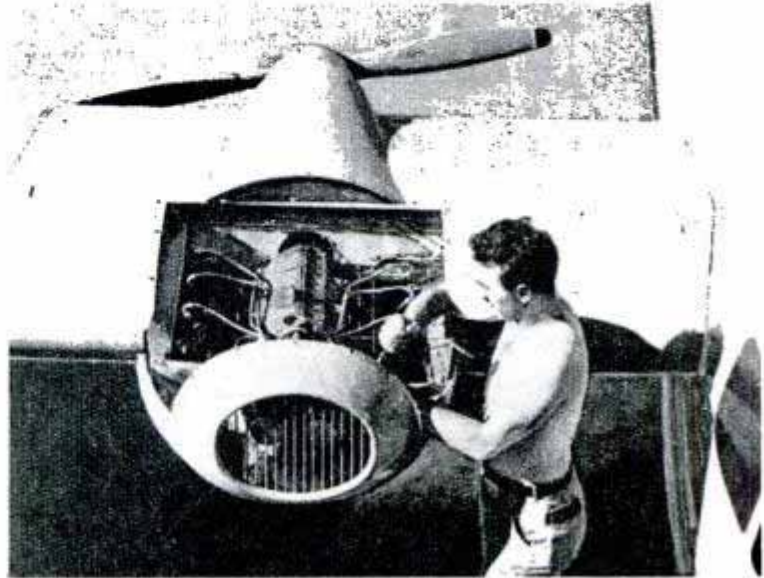

Overhead Stick Replaces Helicopter "Wobble Plate"

Helicopter control is simplified by an overhead stick that directly rolls the rotor head to get the desired direction, replacing the conventional "wobble plate." Since the rotor blades are mounted rigidly one to the other, the rolling increases the pitch of one blade and decreases that of the other. The test model has been flying for more than a year. Eliminating cables, pulleys, rods, cams and levers required by the universally mounted head saves weight and increases carrying capacity.



United Helicopters photo

Hollow-Handle Car Cleaner

By using a long, hollow-handle brush, motorists can wash their cars without getting wet. The handle attaches to a garden hose and water pours out of the soft brush to dislodge dirt and grime from the car surface.

Freight cars built of concrete except for wheels, springs and drawbars are under construction in Germany.



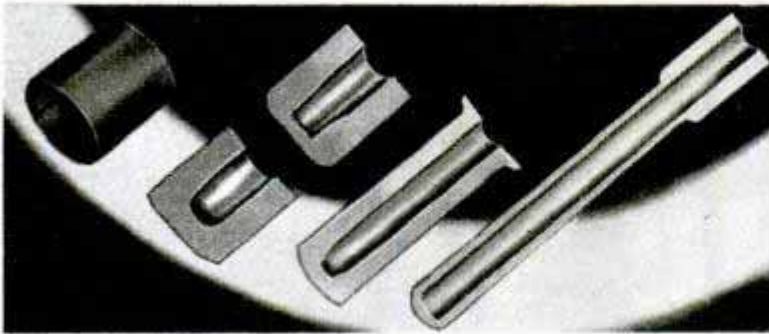
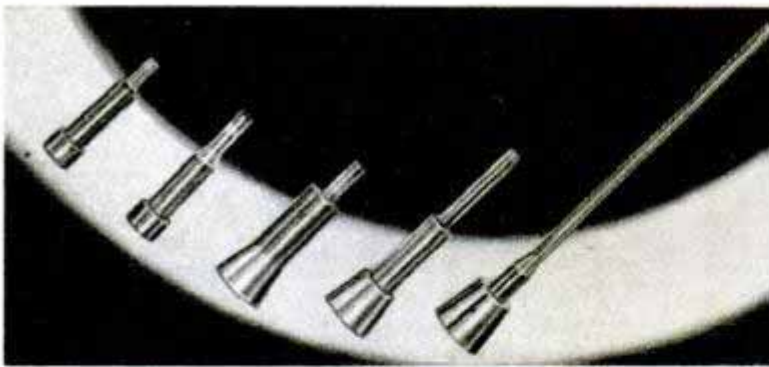

Cold Steel Made to "Flow" Under Pressure

Tests are being made of a German method for making cold steel "flow" under tremendous pressure to produce extruded steel parts and shapes. An advancement on techniques used for shaping softer metals, such as copper, brass and lead, it can greatly simplify production of many com-

mon steel objects since only a small number of working operations and little or no machining are required. One secret of the German method appears to be coating the steel with a thin layer of phosphate. This holds lubricants so well that friction between steel and die is greatly reduced.

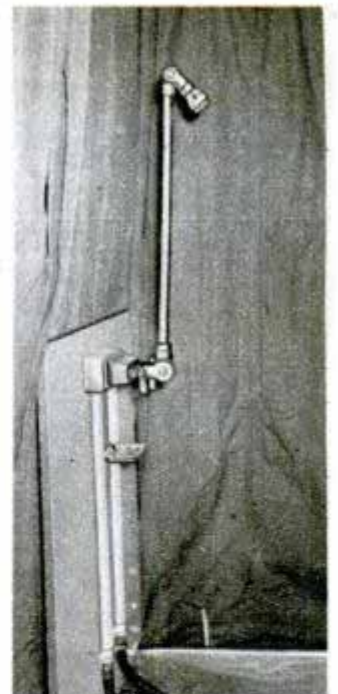
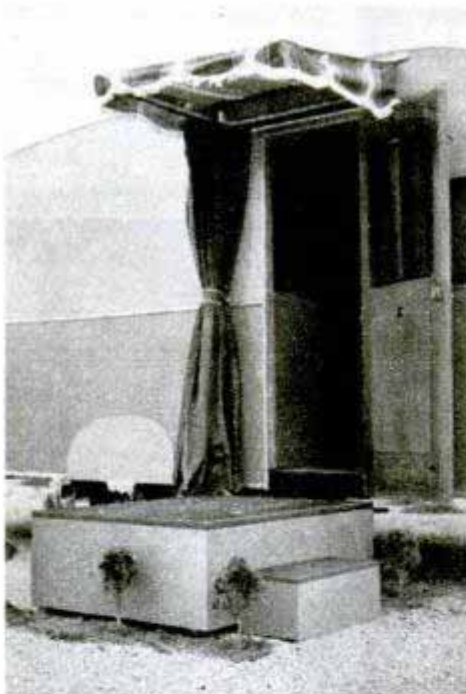

Trailer Doorstep Becomes Shower Stall

Shower baths for trailers are provided with a doorstep—that can be converted in a few minutes into a stall with hot and cold running water. The shower pipe and head are hinged to the underside of the step top and swing into place when it is raised upright. A canopy and a curtain with fas-

teners give the bather privacy. Water is supplied through hose connections and heated by an electric unit with a five-gallon-an-hour capacity. The tub portion is nearly 3 feet square and 14 inches deep. Drain water can be either piped away or disposed of in a seepage pit.

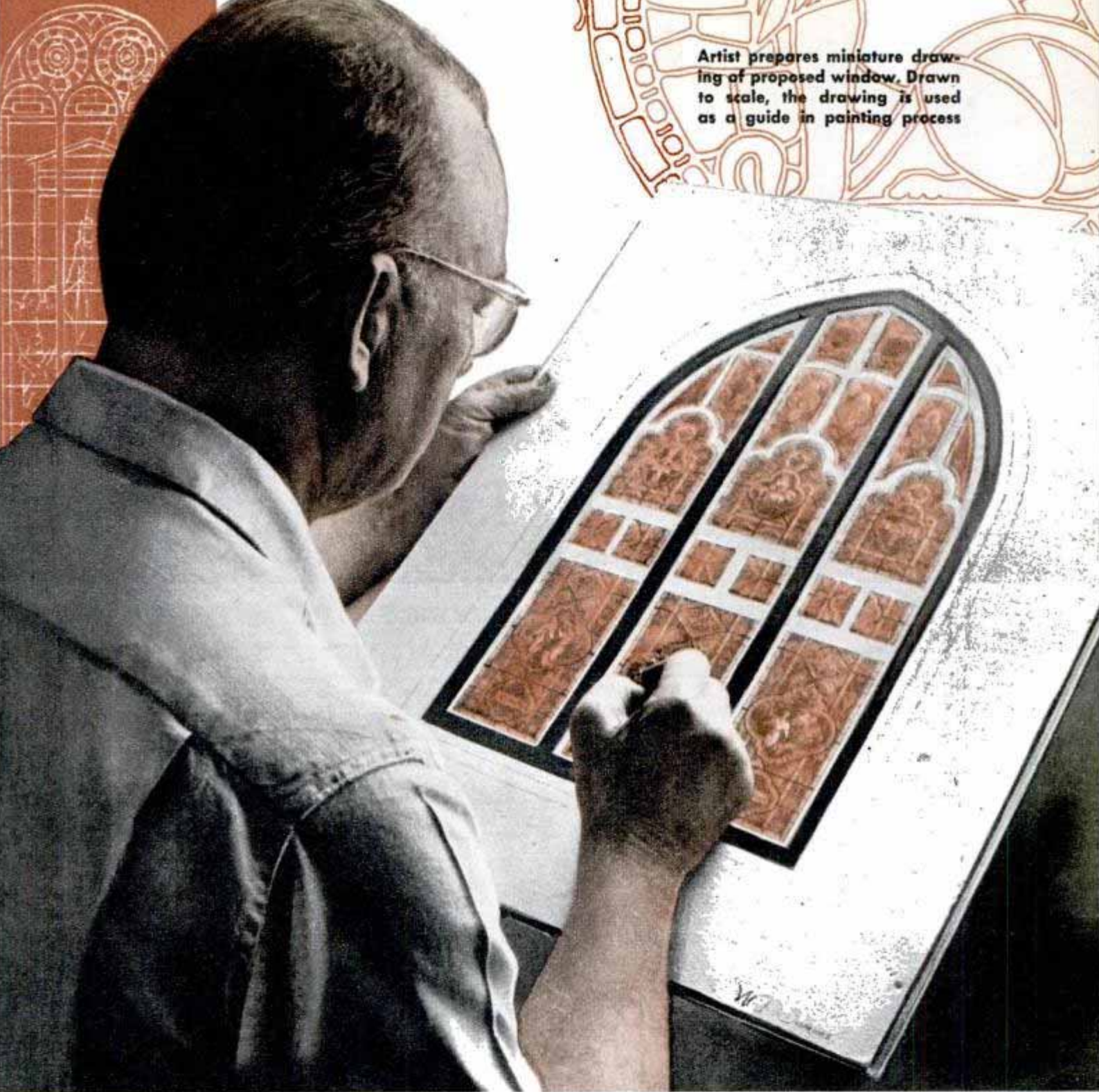

Artist prepares miniature drawing of proposed window. Drawn to scale, the drawing is used as a guide in painting process

STAINED-GLASS ARTIST

PICTURE windows are an old story to William D. Somers. He's been making them for 50 years. But his picture windows are not merely transparent areas of glass disclosing a pretty view, they're the beautiful, stained-glass windows seen in churches, colleges and other buildings.

Somers not only paints on glass, but he is one of the few men in his profession who does the entire job. He starts at the very beginning by making the original design,

By Stanley J. Dreyfuss

then he selects and colors the glass, assembles the window and finally mounts it in the building.

With more than 5000 windows of all shapes and sizes already to his credit, the 65-year-old artist is swamped with more orders than he can possibly handle.

"There are perhaps fewer than 75 recognized glass painters at work in the world today," he points out, stressing the need for courses on stained-glass painting in college art schools. "With no apparent effort

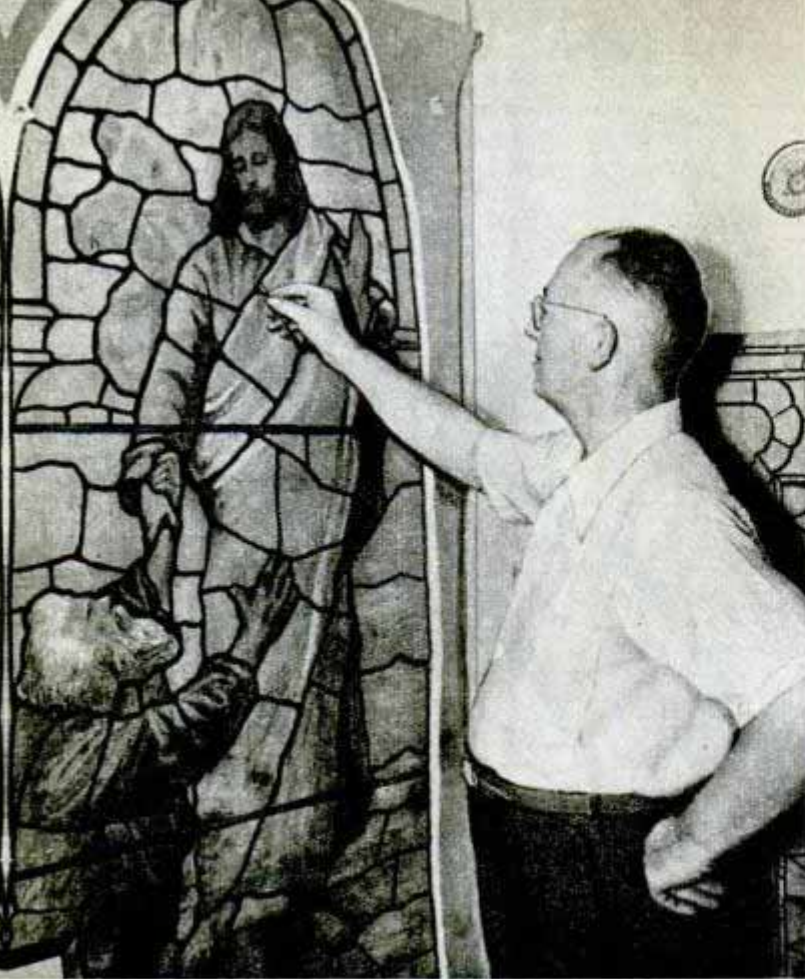

Charcoal drawing of design is divided into sections that are used as patterns for cutting glass (below)

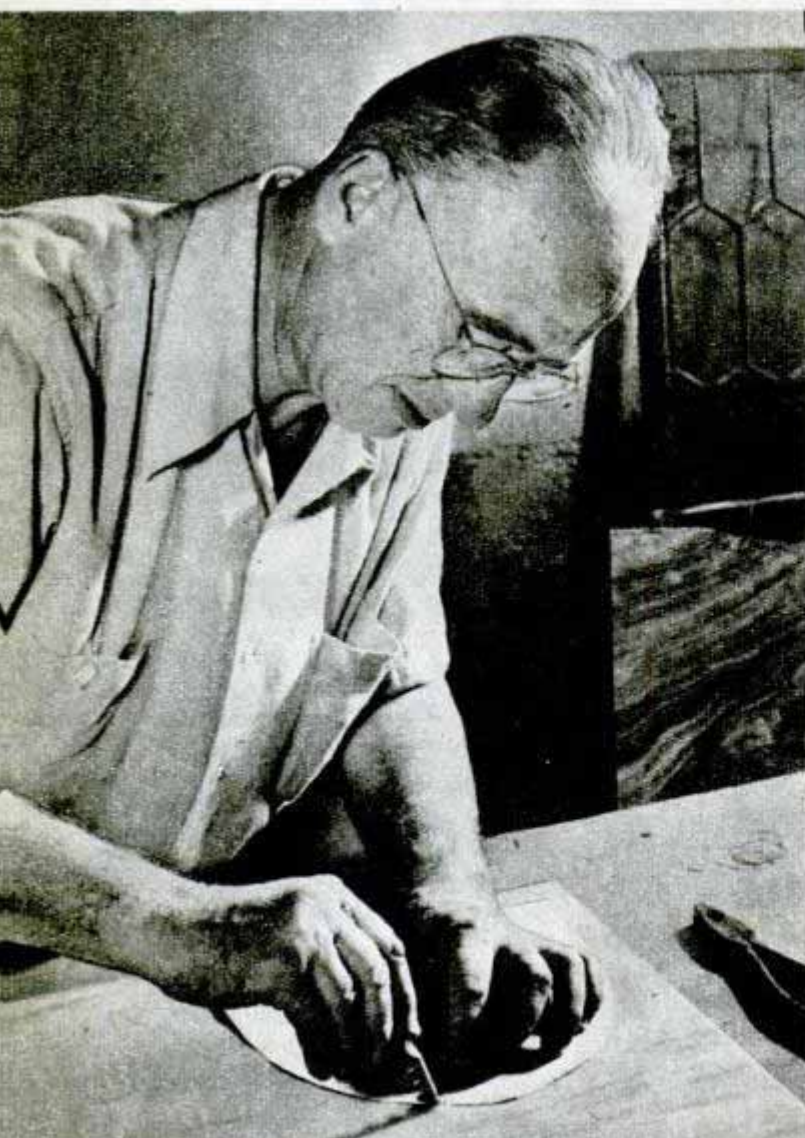

When stained-glass sections are cut, they're assembled on a clear-glass plate prior to being painted

being made to train apprentices to replace us as we die off, one of the most ancient crafts seems doomed to become a lost art."

Of Dutch descent, Somers is the first of his family to take up any phase of art work. He began working for a Brooklyn firm that made stained windows for churches, cathedrals and theaters when he was only fifteen. He wanted to learn more about the art so he attended night school, first at Cooper Union, then Pratt Institute where he studied under several European stained-glass painters and majored in the related subjects of the trade: architecture, literature, history and anatomy. On his twentieth birthday he decided to go into business for himself.

Today, his ten-room, three-story home on the outskirts of New York City serves as his workshop. In a large attic below the building's pitched roof is the studio where he does his designing and colored-glass assembling. A room on the second floor is used for the meticulous work of painting stained-glass sections. Another room on the same floor contains the equipment used for glass cutting and baking. The garage houses a store of antique and plate glass and a large, flat-topped bench in the basement, is used for cutting down the large glass sections and for the messy task of soldering and cementing.

The tastes and the budgets of the people who order the window, plus its location, are considered before the initial step of laying out the design is begun. The design and the subject must harmonize with the window's surroundings. A thorough study of the architecture and contours of the building is made by the artist.

After this research, Somers sits down at his easel and makes a rough sketch of the design. When the sketch has been approved, Somers starts work on the detailed drawing of the window, carried out in every particular of color and characters as well as design. Some drawings take only a few days to complete, while others are so complex they require as long as several months. Next, a full-scale charcoal drawing on heavy wrapping paper is made for a pattern. This is sprayed with shellac to prevent the charcoal from smudging or rubbing off when handled.

After the full-scale drawing has been traced on pattern paper, special shears, imported from Germany before the war, are used to cut out the many sections. The shears have a forked blade to allow for spaces in which lead strips are to be inserted.

Using the master drawing as a guide for color and the paper patterns for dimensions, the artist selects various colored glass to be cut with a "wheel" or glass cutter. Antique glass in striking reds, blues, greens and hundreds of other bright and handsome colors, shades and hues are used to obtain the proper background effect for the painted design. Some of Mr. Somers' glass was produced in the United States, but more than two thirds came from England, which has excelled in that industry since World War I.

When the stained-glass pieces have been cut to shape they are

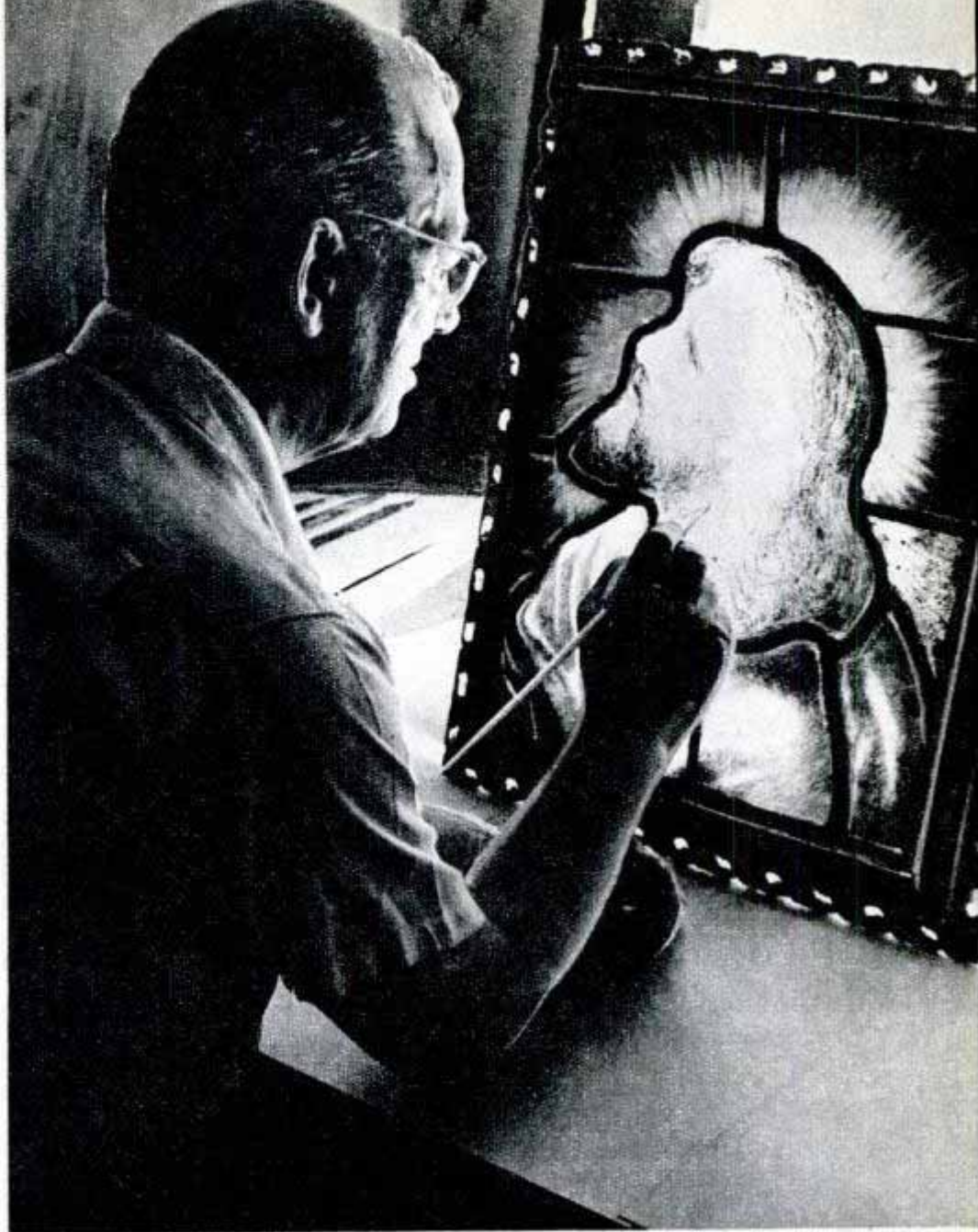

Placed in front of a light, the assembled sections are painted by Somers. Any mistake is costly as the pigment cannot be painted over. Below, after paint is baked, the sections are fixed in place with strips of came lead





Came-lead strips are soldered to insure permanence. Below, the artist cleans a \$10,000 window before re-painting part of the design. Window is 50 years old

ready for painting. Using a clear-glass plate as a base and working from one section of his drawing at a time, the artist assembles the pieces into the proper design, leaving spaces between them. Hot beeswax mixed with rosin is dropped in these spaces to hold the sections temporarily.

Somers then places the assembled plate on an easel in front of a window or a strong light. Using imported, fusible-glass paint pigments, he adds the many details of figures, faces, clothing and backgrounds. As soon as the paint has dried, he applies a murky brown stipple to the glass and with a dry brush removes some of the stipple to produce artistic highlights.

The wax is removed from the glass sections before they are placed in a gas kiln where they are baked from 20 minutes to three quarters of an hour. When the glass is heated to a cherry red, the jets are turned off and the glass allowed to cool for 24 hours.

Then, the sections are reassembled on the full-scale drawing. The artist uses came lead, a pliable compound that comes in six-foot lengths and many thicknesses, to bind together the glass sections. The arrangement of the lead was planned in advance to fit into the design effectively, helping to form important lines, such as folds of drapery. It is soldered and then weatherproofed. Stained-glass windows, no matter how beautiful, are impractical if

they cannot withstand weather. Cement, mixed so that it is fairly stiff, is spread over the exterior surface of the window with a scrubbing brush and pressed into the cracks. Excess cement is removed at once and the window is set out to dry for a week or ten days, after which it is ready to install.

Some windows, like those in Great Britain's noted cathedrals and St. Peter's Church, adjoining the Vatican in Rome, cost as much as \$25,000 each. The most inexpensive are the opal type. Opalescent windows are less costly because they represent the least amount of labor. Somers has made stained-glass windows priced from \$100 to \$5000.

With orders coming in faster than he can fill them, Somers is worried that the stained-glass art may be lost in the future. And, he says, the windows are much too beautiful for that.

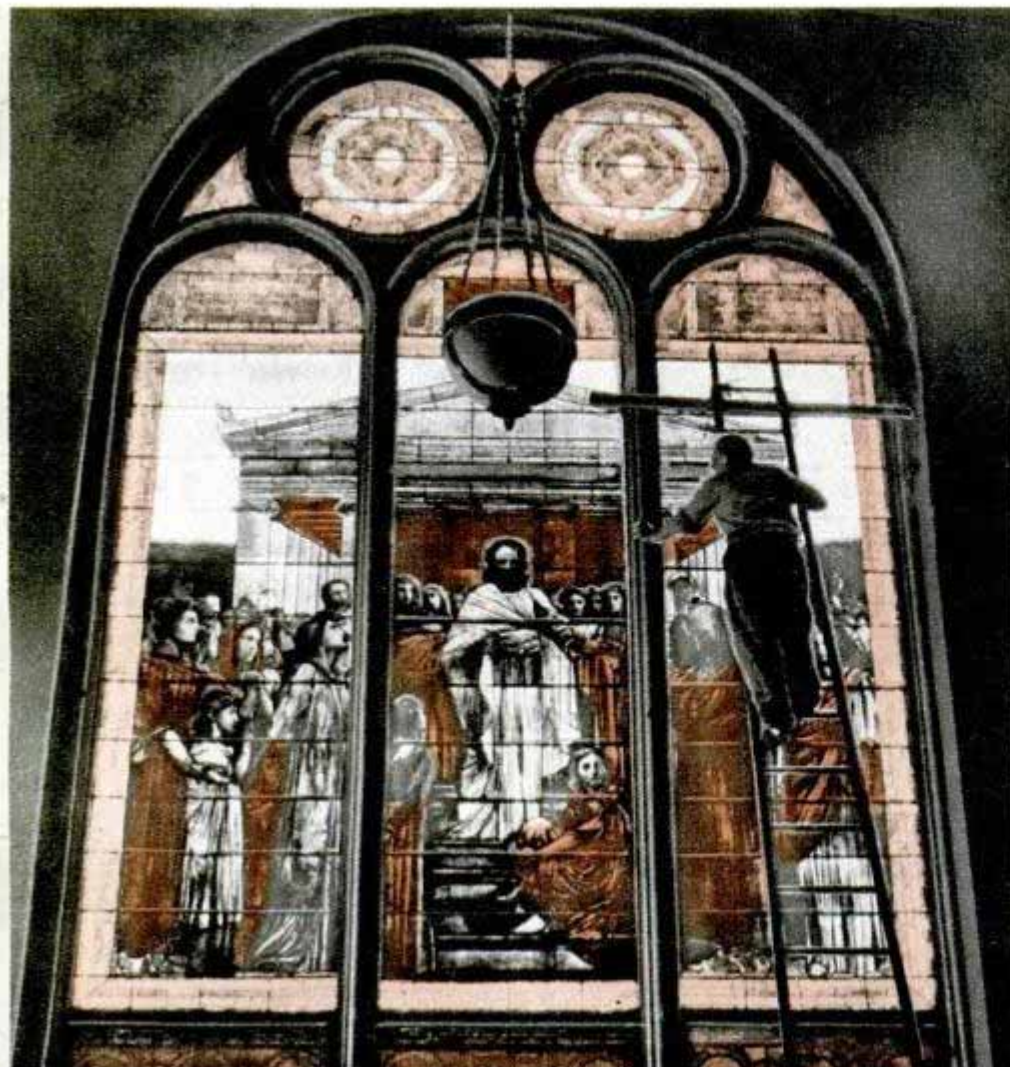

Most Powerful Helicopter

Most powerful and first all-metal helicopter, the XR-10 flies well over 100 miles an hour and climbs to a near-record altitude of 18,800 feet. It carries pilot, co-pilot and 10 passengers. The U. S. Air Force plans to use it for transport and air-ambulance assignments. It has a hoist and a 33 by 52-inch hatch through which litter patients and cargo can be loaded from otherwise inaccessible places. Two 525-horsepower engines drive contrarotating rotors, placed close together so that the three blades of each intermesh as they turn. Each rotor is 65 feet in diameter. Both engines are outside the fuselage, allowing added cabin space, but faired against the side so that no extra structure is needed.



U. S. Air Force photo

The craft has a gross weight of 11,000 pounds, lifts 2000 pounds and has a 350-mile range at 90 miles an hour.

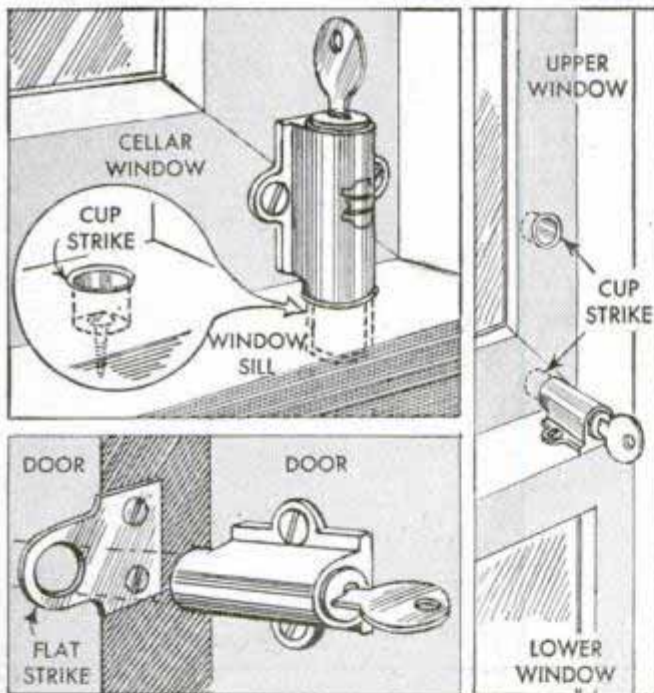

Window Lock Permits Ventilation

Windows can be locked fully closed or partially open for ventilation with a cylinder sash lock that has two sockets. Turning the key moves the striker in or out of the socket and the key can be removed in either locked or unlocked positions. One of the sockets is installed so the window can be locked shut and the other is fastened a few inches away so the window can be locked partially open. When the window frame is moved, the second socket comes opposite the lock. Special screws that can be turned in one direction only are used to fasten the lock in place.

Of the 300,000 known organic chemicals only about 9000 are currently useful while the other 291,000 await development, according to Hoyt M. Corley of Armour and Company's chemical research department.

Pontoons Prevent Capsizing Boat

Rubberized pontoons, inflated by mouth and attached to both sides of a canoe or small boat, help prevent the vessel from capsizing. They can be used on any boat up to 42 inches in width. A clamp is fastened to each side of the boat and a telescoping arm of square steel tubing, which carries a pontoon at its outer end, is fastened to the clamp. An additional sliding part on each arm extends inward from the clamp to the center of the boat where the two ends are locked together.





JAR TOP OPENER is adjustable to fit any size lid and works on either screw or pry-off caps. Right, shopping list that requires no pencil is made up by punching holes in printed sheet. Transparent cover over sheets has openings for punch

WHAT'S NEW For Your Home

FLEXIBLE MOP HEAD that will bend in any direction reaches hard-to-get spots. The coiled spring keeps the long cotton strands pressed evenly against the surface being cleaned. The washable head can be used dry, with soap or with oil

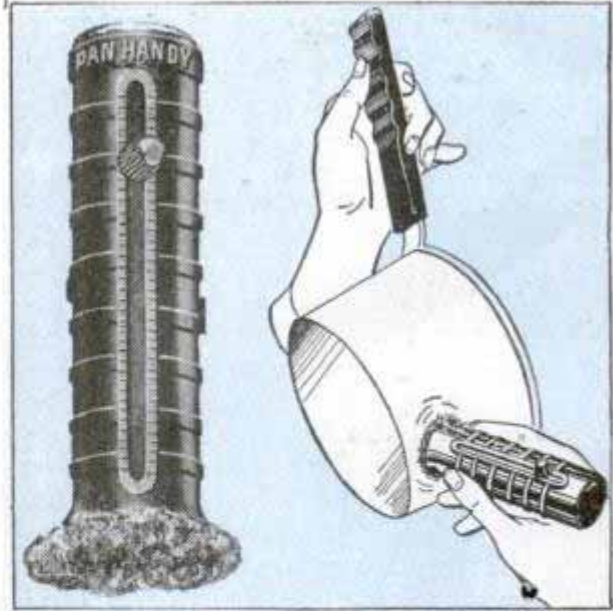
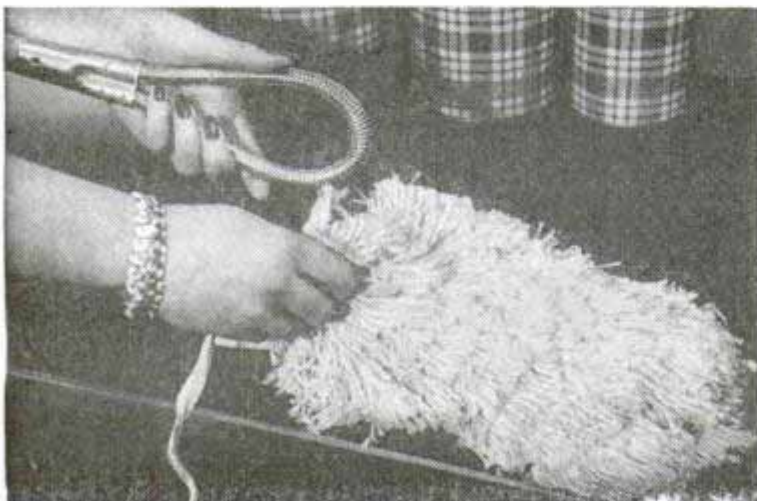

↑ **STEEL WOOL HOLDER** is shatterproof and holds a tube of steel wool that is coated with soap for quick suds. Wool refills are easily inserted in the handy plastic case



↓ **SKIRT HANGER** holds garment straight, smooth, making it unnecessary to press the skirt before wearing. Pressure of spring on waist line tends to smooth out creases

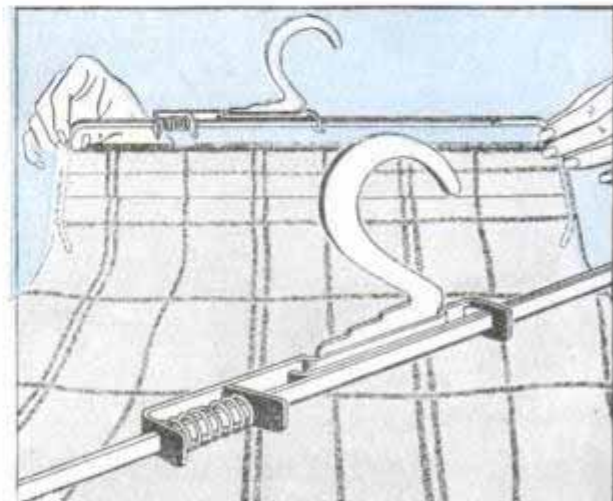



Curtiss-Weight photo



Air Materiel Command photo

Left, adjusting lens before sealing camera in watertight box. Shielded flood lamps are above and below case. Above, ditched "Fort" settling into Gulf of Mexico. Tray load of television and photo equipment, below, being installed in bomber's nose

Cameras Provide "Eyes" To Study B-17 Ditchings

Automatic cameras sealed in waterproof boxes are the "eyes" through which the U. S. Air Force is studying what happens when big land planes are ditched. Ten crewless B-17s, controlled by radio, are being dunked in the Gulf of Mexico during the two-year program. The results will be used in future airframe design and in training crews for emergency water landings. Eight cameras peer from strategic points to record structural damage, while television transmits instrument readings to a receiver in the "mother" plane. Floodlights with a Plexiglas and canvas shield illuminate the interior when the instruments begin recording. To aid divers recovering them, the aluminum-alloy cam-

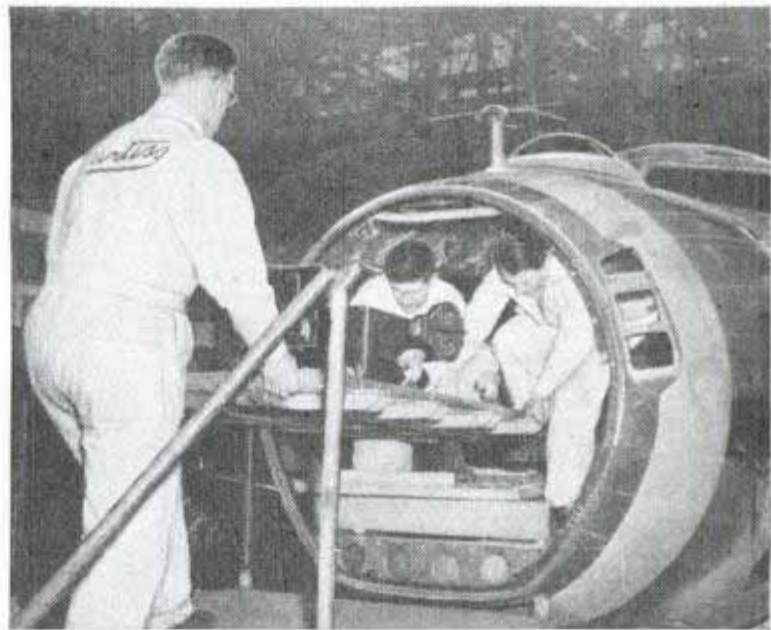

era boxes are striped black and white. The weak signals from water-pressure pickups are amplified and picked up by a highly sensitive recording oscillograph.

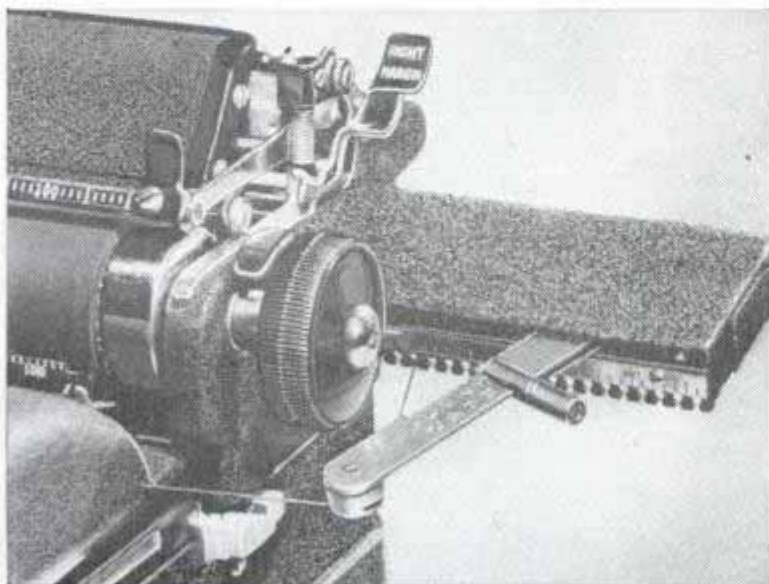

Justifier for Typewriter Evens Right Margins

Uneven right-hand margins of typewritten material can be aligned perfectly with a spacing device which fits any typewriter. The justifier has nine different settings to expand or condense the typewritten line as needed. It also has a neutral position which permits regular typing when justification is not desired. Typewritten copy prepared with the spacing justifier is suitable for mimeograph sheets, catalogues, price lists, sales manuals, booklets or narrow-column papers.

Harvesting The "Backwoods" Crop

"TURPENTINING," the backwoods industry of Florida, Georgia and the Carolinas, is going to town. Antiquated rosin stills and uneconomical collecting methods have given way to a number of revolutionary improvements.

For almost 200 years, rosin, tars and gum turpentine, commonly called "naval stores," have been made from the sap or gum of southern pine trees in crude stills in the woods.

Slowly, the naval-stores industry changed from its original purpose of producing pitch and pine tar for calking ships to supplying turpentine and rosin for everyday use. Turpentine is a basic mate-



By John L. Kent

rial in the paint industry, for insecticides, polishes and medicinal ointments. Rosin is used in soap, paper, plastics, varnish, cements, waxes and soldering flux.

Collection methods have changed little. Several times a month during the spring and summer, chipping crews go from tree to tree cutting through the inner bark of each tree with a sharp cutting tool. Each chip wound is known as a streak, and each new streak is made just above the last one. The combined streaks are known as a "face."

The operator cuts about 32 streaks in each face being worked during the gum-flowing season. Ten thousand faces consti-

In tests by the Department of Agriculture, rosin flows from the "flash" chamber of a continuous-process still

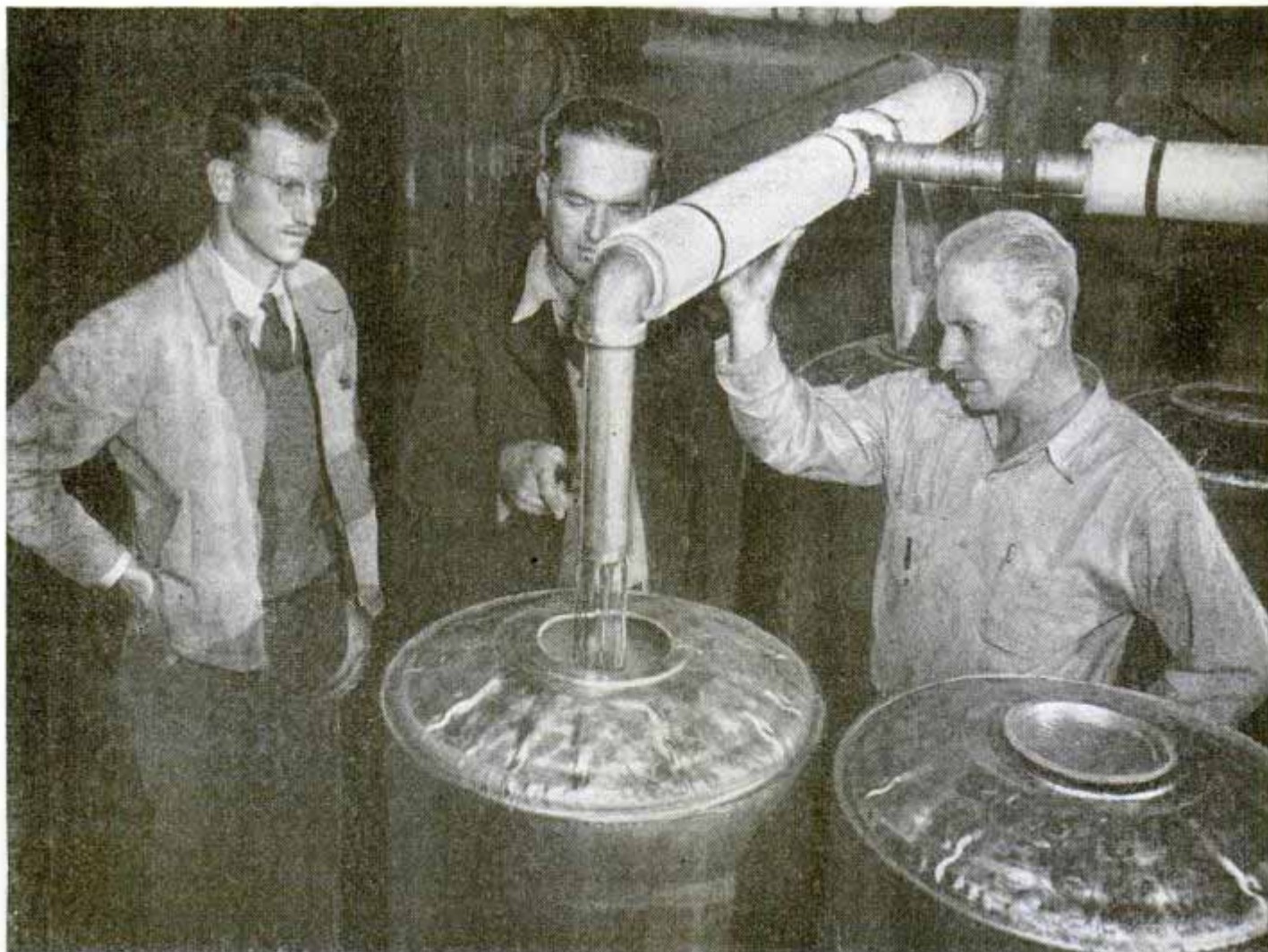

tute a "crop," the working unit of the industry.

A clean cut through the inner bark allows the clear oleoresin to flow over a sheet-metal apron or gutter which guides the gum into a collecting cup. These cups fill up about once a month; the contents are collected in buckets, transferred to wooden barrels and hauled to the distillery.

Pine gum usually has been processed, without preliminary cleaning, in copper pot stills heated directly by wood fires. To help distill off the spirits, water was added to the gum in the pot. These stills were easy to operate and to move to new virgin timber. Distillation was controlled partly by guess. Contamination and scorching resulted in poor grades of rosin, with the thick residue remaining.

Recently, a new method was tried on a semicommercial scale by U. S. Department of Agriculture naval stores' scientists. They developed a new-type continuous-steam still with a "flash" chamber.

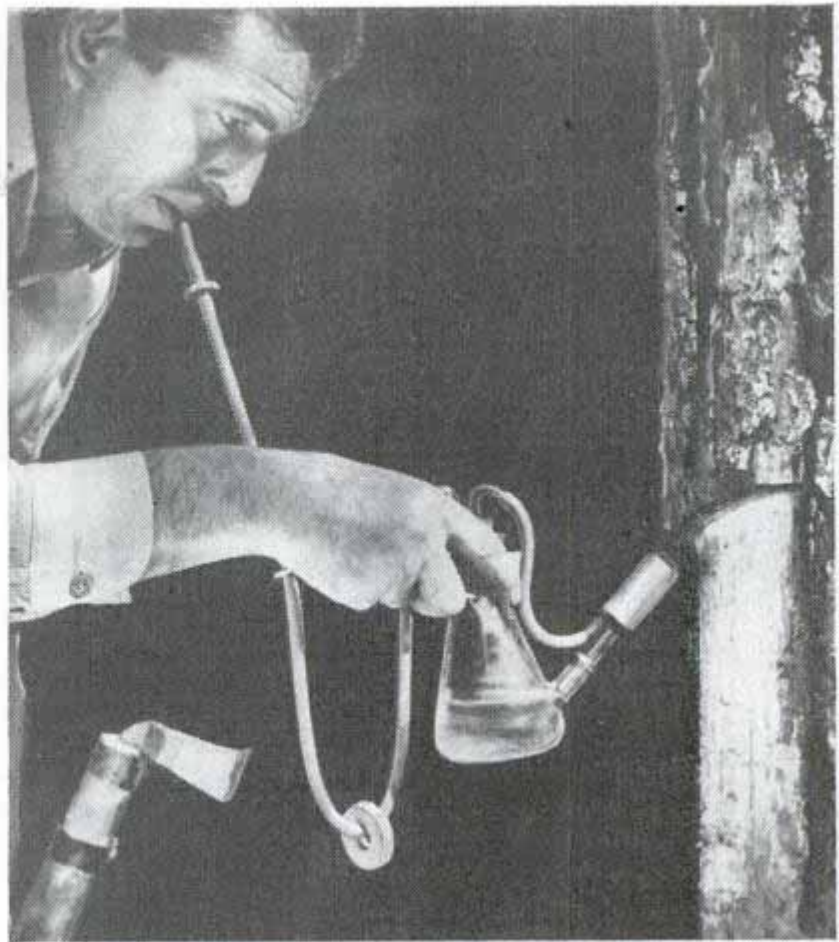

U. S. Forest Service photo

Applying sulphuric acid to turpentine tree to stimulate flow of oleoresin. Below, turpentine distillery depends for its operation on the condenser, flash chamber, stripping column. Note product outlets

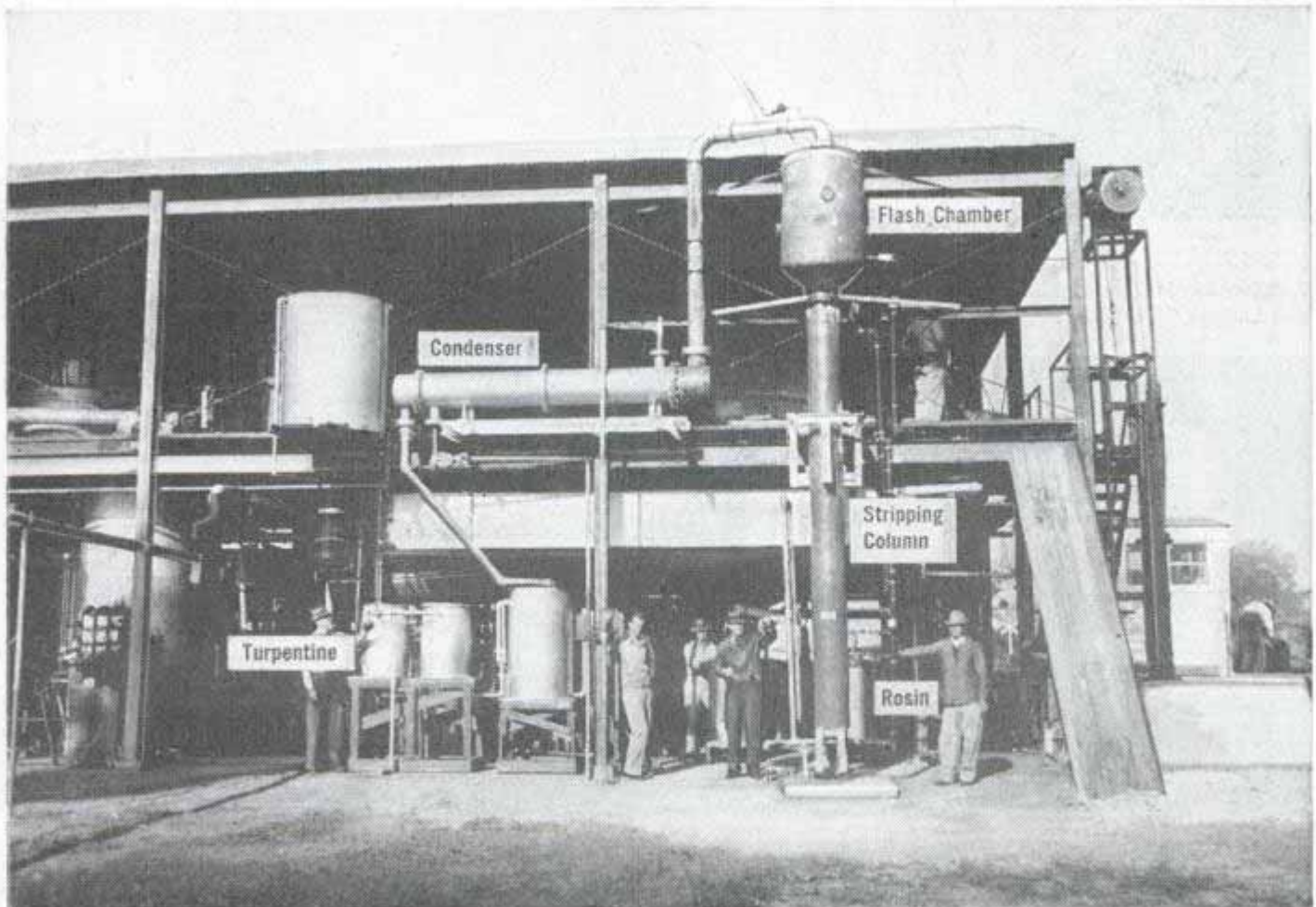

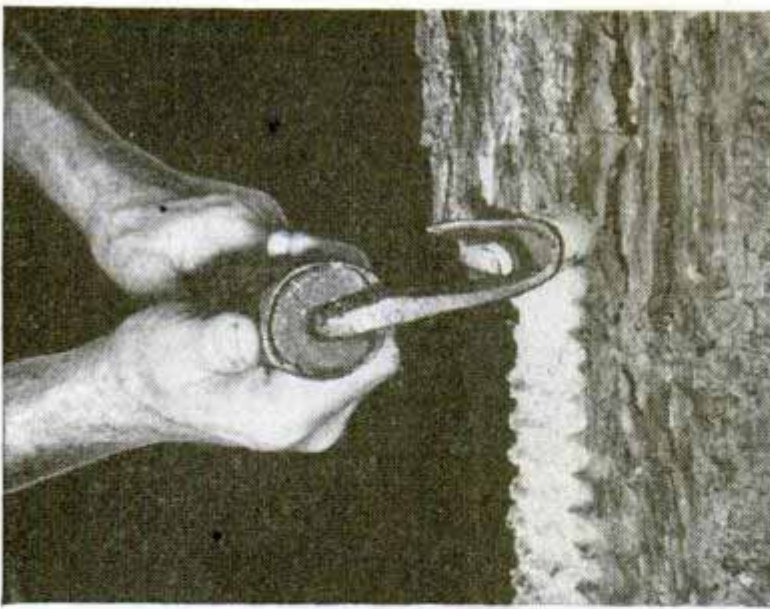

Close-up of conventional wood-chipping hack in use, showing a worker cutting through the inner bark of a tree to reach the gum



New bark-chipping hack was devised by Keith Dorman at the Olustee Experimental Forest in Baker County, Fla. Below, glass cup shaped like flowerpot catches oleoresin, or gum, from tree



Gum is fed into one end, and turpentine and rosin flow out through separate holes at the other end.

The cleaned gum is first preheated to a temperature of 350 degrees, and then pumped through a spray nozzle into the flash chamber atop a 20-foot column. The flash chamber is so named because approximately 80 percent of the turpentine in the gum vaporizes instantly at this point. Turpentine vapors leave the chamber and are conducted through a condensing tank and then, as a liquid, to storage.

The rosin, not being volatile, flows toward the bottom of the upright "stripping" column, which is surrounded by a steam jacket carrying steam under pressure of 125 pounds. As the rosin flows down this stripping column, it meets an ascending current of live steam which drives out the last of the turpentine. The remaining residue—the rosin—leaves at the bottom of the column and is piped into containers. The still turns out over a ton of liquid rosin per hour.

The continuous still uses less than two thirds as much steam and half as much labor as the old process. One man can manage the new still and package the rosin it produces. Its cost is less than that of the batch still.

Dr. L. B. Howard, Chief of the Bureau of Agricultural and Industrial Chemistry, says the new still was developed to increase the income of 50,000 people who "turpentine" over 100,000,000 slash and long-leaf pine trees in the southeastern states. The trees produce a "crop" valued at \$40,000,000 a year.

The new still is in operation near Lake City, Fla., where it is running in competition with a modern steam batch still. Both stills take their cleaned gum from the same tank and both are producing about the same quality rosin and turpentine.

Several improvements have been made in collection of the gum. One is the acid-spray treatment. By treating the streaks, or cuts, on the tree with a sulphuric-acid solution, more gum is made to flow. The gum also flows longer—often for as long as three weeks. With

(Continued to page 244)

PHONOGRAPH ON ELEVATOR rises when a knob is → turned, providing easy access to the turntable. Another turn of the knob sends it back into the recess. A lamp atop the section will not be disturbed by the action



↑ **CONSTRUCTION SET** for seven to 15-year-olds has rivets and rubber grommets instead of bolts and nuts to hold the pieces together. Miniature traveling cranes, derricks, dump trucks and other toys can be built with the set. Individual pieces are made of square aluminum tubing and some sets include motors

↓ **MOTOR SCOOTER** provides the transportation when 71-year-old Mrs. Mary R. Spoor of Danville, Illinois, goes shopping or visiting. Sometimes her 74-year-old husband rides the back seat of the open-air vehicle

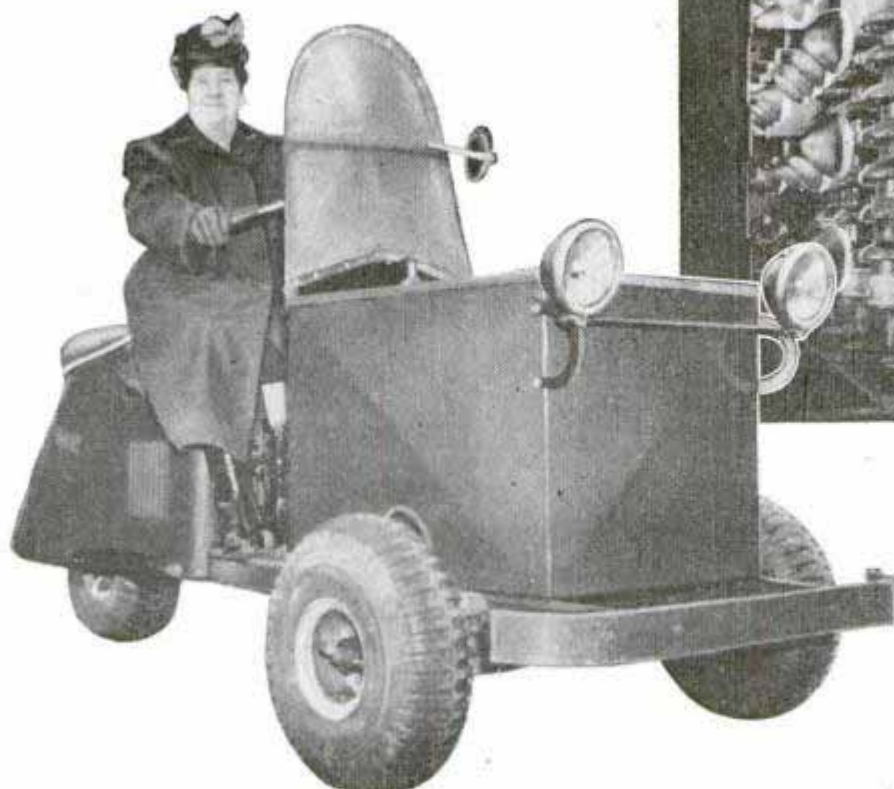

↑ **'ARTIFICIAL FEVER'** is induced into porcelain condenser bushings by Westinghouse engineers to prevent them from cracking when they are filled with hot insulating plastic. The bushings, used in circuit breakers and transformers, are heated to 266 degrees Fahrenheit by battery of 120 infrared lamps in the process

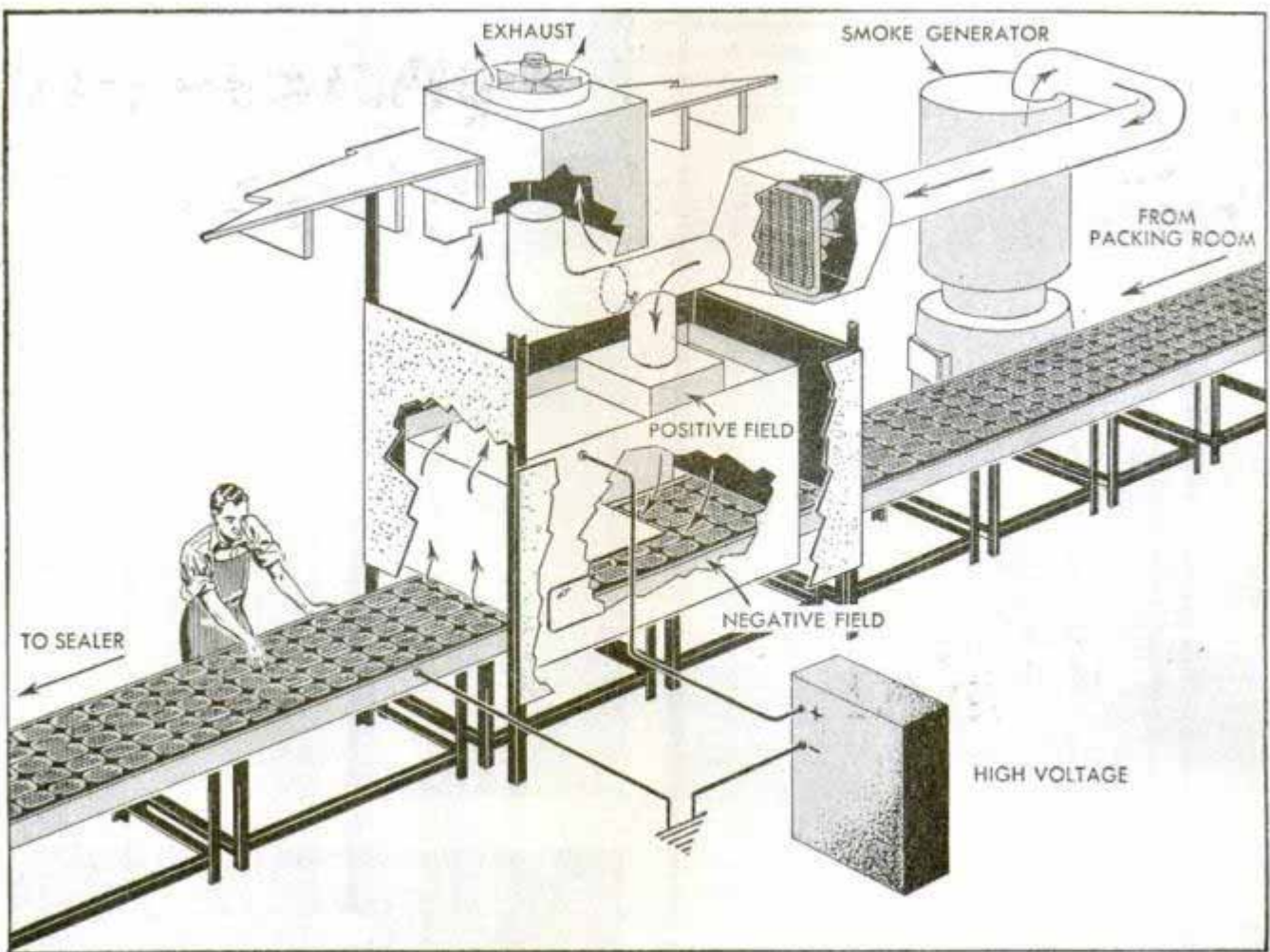

Drawing from Fish and Wildlife Service

High-Voltage Box Smokes Sardines Inside The Can

Sardines are being smoked right in the cans by a new method of smoke precipitation used by Maine fish packers. The process smokes the sardines in one sixth the time formerly required. The little fish, packed in open cans, are carried on a moving metal belt through a closed six-foot box. Along the top of the box, high-voltage tungsten wires form a positive field, while

the metal belt and cans are charged to form a negative electrode. Birch smoke blown into the top of the box is charged by the positive field and attracted downward by the negative field. The smoke particles penetrate through the sardine layers in the few seconds that the cans move through the box, flavoring the fish. The new process can be used on meats and cheeses.



Foot Steering for Outboards

Fishermen who use outboard motors have both hands free for casting, trolling or changing bait when they use the foot-control steering attachment. By pressing down on the pedal, the fisherman turns the boat to the right; by lifting up, to the left. A simple linkage system made of rustproof metal runs along the gunwale to the motor. The attachment can be adjusted for operation from the stern or center seat.

Names and addresses of manufacturers of new products described in this issue may be obtained by writing to Bureau of Information, Popular Mechanics Magazine, 200 E. Ontario St., Chicago 11



CHRISTMAS TOYS

TILTING-ARBOR SAW



The CRAFTSMAN

★ Selected from Santa's advance showing, 14 home-made gifts described in a feature beginning on page 192 get you off to an early start on your Christmas "workshopping." There are toys, games and furniture to please every member of your family

★ You asked for it and here it is—a tilting-arbor table saw that has everything, a 10-in. blade, scaled handwheel adjustment, and drop-leaf extensions that make the table large enough to handle a 4 by 8-ft. panel. Starting on page 218 a two-part story gives complete constructional details

★ Tailor-made springs, tension or compression type, are easy to wind with the tool detailed on page 209

★ And on page 178 there is a rotating bookcase for students and others who live in small quarters

ROTATING BOOKCASE



SPRING-WINDING TOOL

ROTATING BOOKCASE

TAKING little space in comparison to its large capacity, this rotating bookcase is made to order for the limited study quarters of a high school or college student. It features a novel "ball bearing" base on which the bookcase itself rotates on five wooden balls which roll in a track turned in the surface of the base. With the balls spaced to distribute the load uniformly, the upper part can be rotated very easily for quick selection of books from either side.

The book section is constructed first, preferably of hardwood, such as maple, birch, walnut or mahogany. Fig. 4 gives

By Norbert Engels

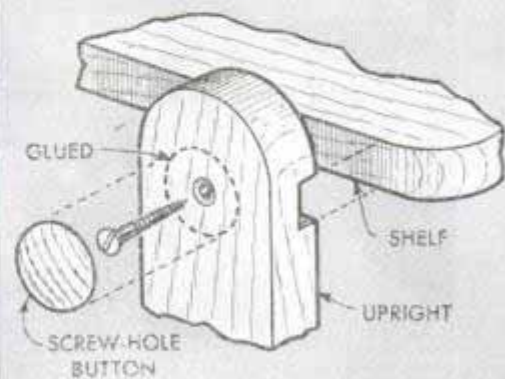
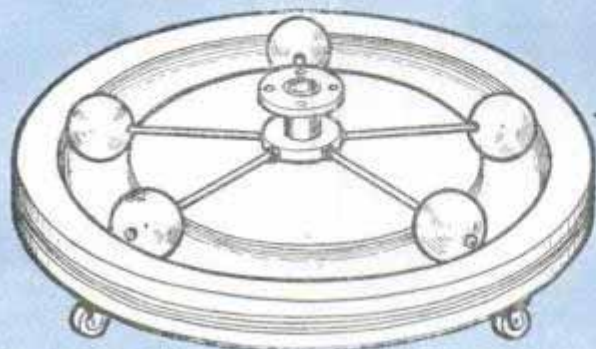
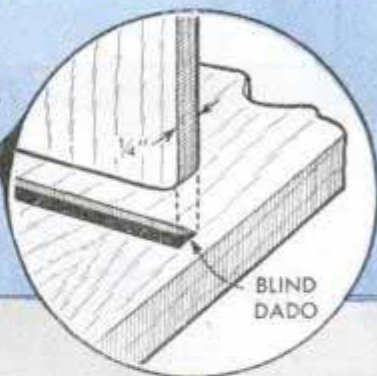
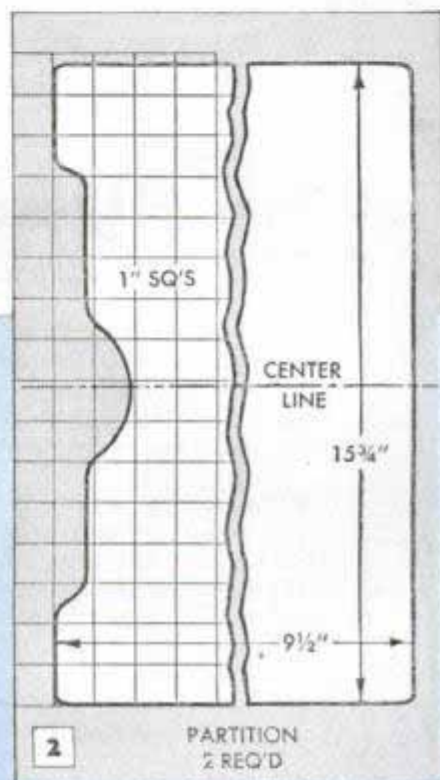
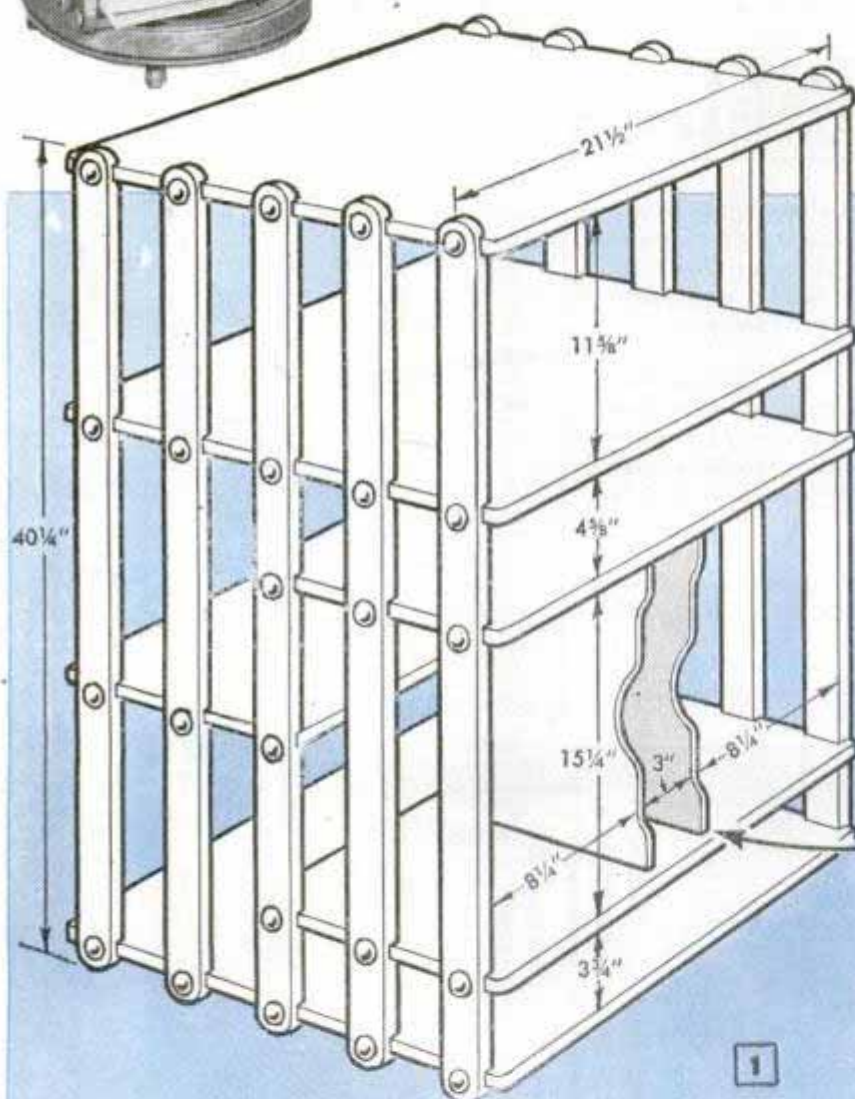
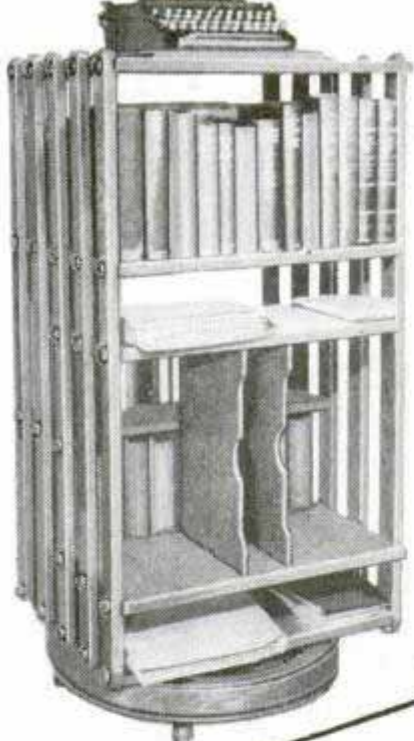



the size and shape of the 10 side members and indicates where each one is notched to receive the shelves. Each member is keyed with the assembly drawing in Fig. 3 to show just where it goes. The wide shelves can be made of plywood, or of solid stock by gluing edgewise several pieces of random widths. Note that between two of the shelves there are two scrolled partitions, Fig. 2, which form a compartment for magazines and newspapers. These are glued vertically in blind dados, 3 in. apart. Top surfaces of the shelves, and all other parts, should be sanded smooth before assembling. Holes for flathead screws are bored through each side member, at the notch, and then countersunk slightly so that the screwheads will be flush. Use glue in addition to screws in assembling the parts, and check the whole unit for squareness. Each screwhead is covered by a wood screw-hole button, which is made for the purpose. Wood dress buttons will do also, as well as metal furniture glides. The wooden buttons are simply glued over the screwheads. In the case of the bottom shelf, it will be necessary to stain or paint it before it is screwed in place.

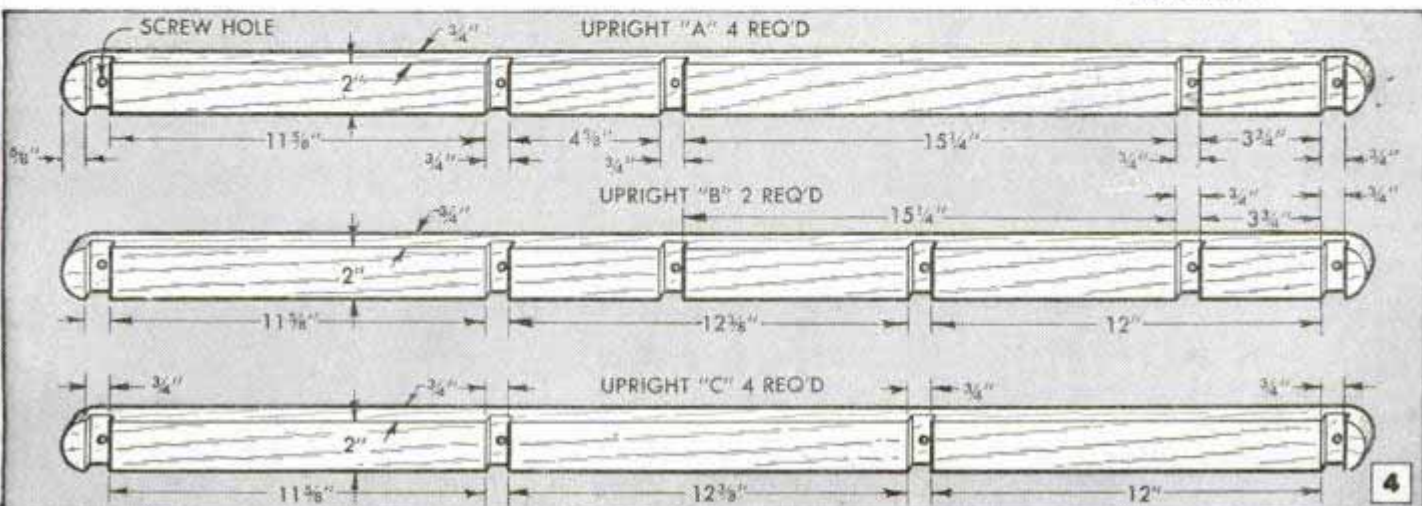
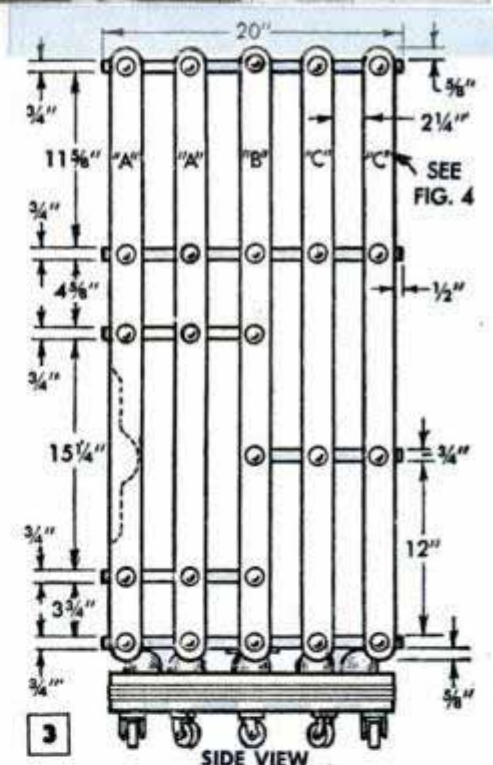

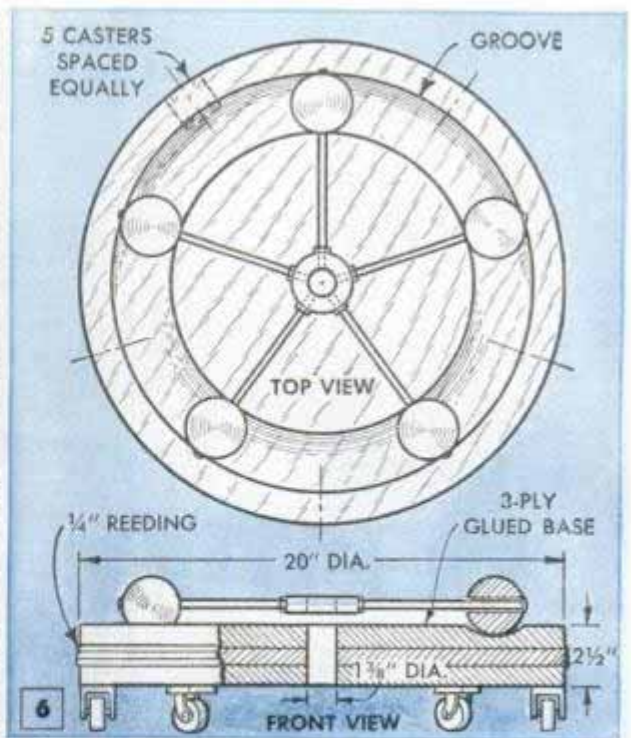
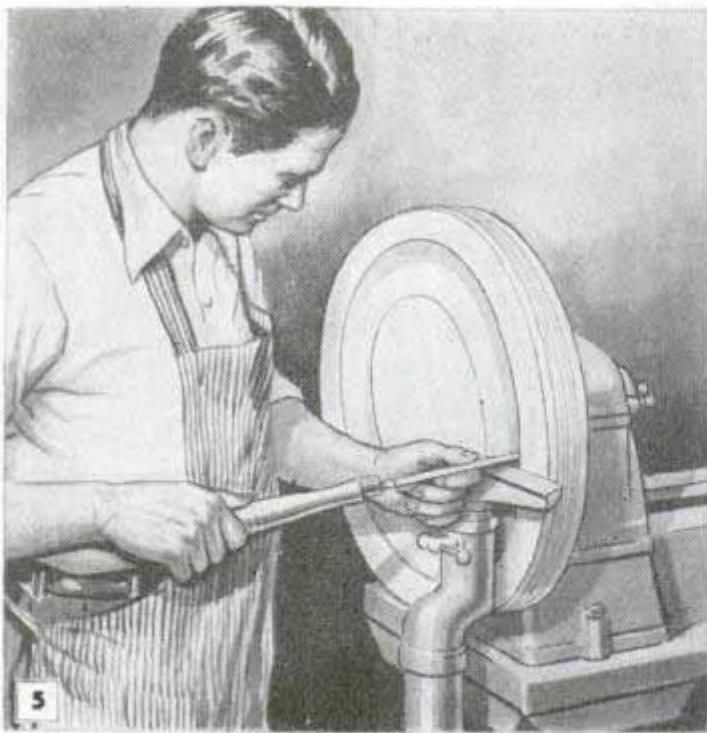

The base is built up of three wood disks totaling 2½ in. in thickness. Cut each slightly oversize and glue all three together with the grain at right angles, one to the other. To turn work of this size, it is necessary to mount it on the left-hand end of the lathe headstock as shown in Fig. 5. The ball track in the face of the base is made 1¾ in. wide and ½ in. deep and ¼-in. reeding is turned in the edge as shown in Fig. 6.

The rotating device is detailed in Fig. 7. It consists of a threaded length of 1-in. pipe, which turns freely in a hole bored through the base at the center, and has a floor flange at one end for fastening the pipe to the bottom of the bookcase. The axles or spokes on which the five wooden balls rotate, are ¼-in. bolts turned into tapped holes equidistantly

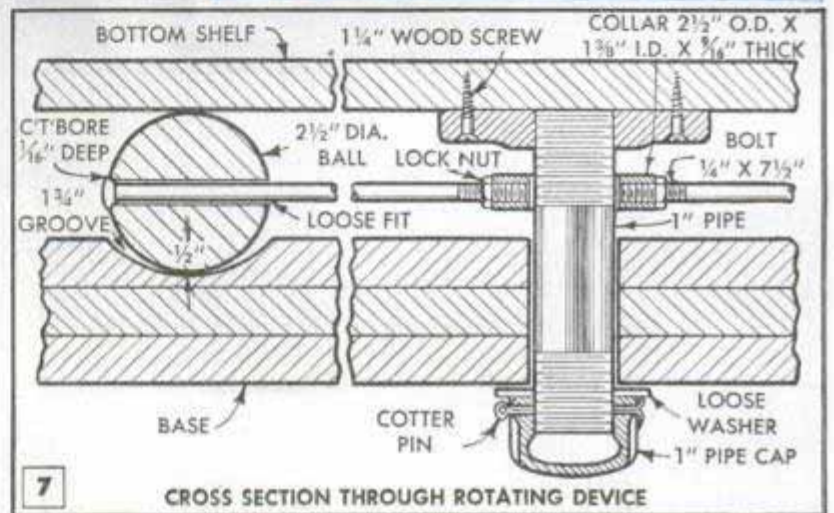

spaced in the edge of a metal collar. This collar slips over the pipe kingpin like a wheel, after which the base is locked in place by a pipe cap as shown. Five swivel plate casters are screwed to the base. You can use balls from an indoor croquet set and turn the ball race in the base to suit.

Double Fold in Wall Calendar Forms a Handy Pocket for Memos

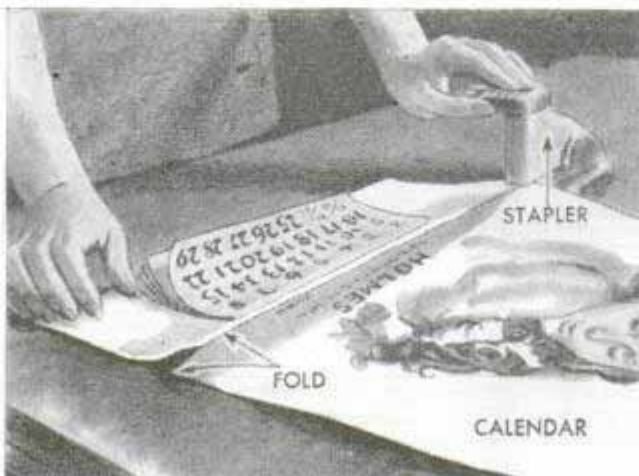

To provide a handy pocket on a wall for holding current memos and notes, double-fold a calendar—as indicated by arrows on the drawing—and staple the edges to close the sides. Strengthen the sides and top edge of the pocket, by reinforcing them with gummed tape. If you want to keep memos and notes separated, divide the pocket into several compartments, using staples to make the divisions.

Louis Hochman, New York, N. Y.

Crayon marks can be erased from parchment-type lamp shades if a ball of soft bread is rubbed over the spots.

Cardboard-Box Wastebasket

Simple and easy to make, this wastebasket will add color to almost any room where it is used. The sides and bottom are cut from corrugated cardboard to the dimensions given in the two upper details, and laced together with ribbon. It's best to lace from the bottom up and finish with bows at each corner. Then cover with a glazed-surface wallpaper and decorate with decals that harmonize with the color scheme.—Eileen M. Briggs, North Rose, N. Y.

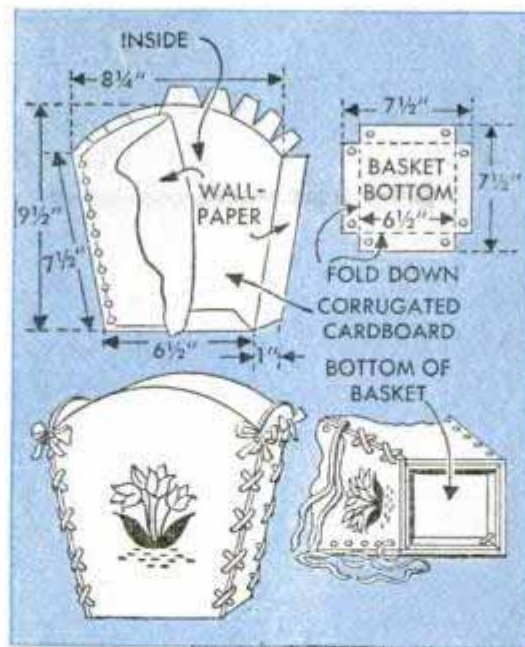

Corncob "Pots" Start Plants

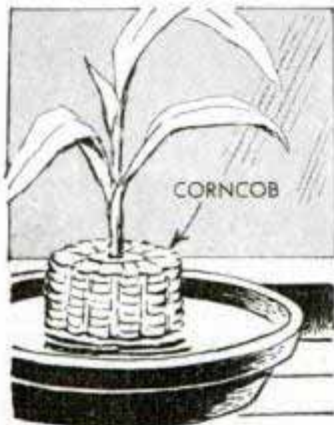

Small "pots" for starting plants without soil may be made from sections of dried corn-cobs. The seed is embedded in the center of the cob and moisture is supplied by setting the cob in a shallow bowl of water. If desired, suitable chemicals

can be added to the water to stimulate growth. The improvised pots are transplanted in the garden, just as they are.

Pipe Used as Emergency Handle For Steam or Water Valve

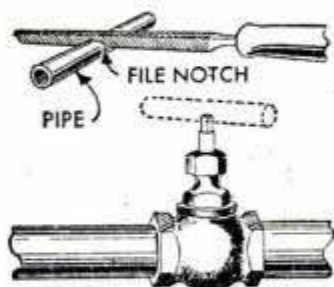

If the hand-wheel on a steam or water valve is lost or broken, an emergency one can be made, using a short piece of small-diameter pipe. With a triangular file, cut a V-notch in the pipe. This will form a square hole that fits over the valve stem.

G. E. Hendrickson, Argyle, Wis.

Instead of cutting one paper for the bird cage each morning, cut six or eight papers, place them in the cage and then remove the top one as required.

Drawings for Illustrated Lecture Made With Tracing Wheel

Those who, from time to time, have occasion to give talks or lectures that are illustrated with drawings made on the stage can employ an old trick of the chalk-talk artist and prepare the drawings beforehand. One way to do this so the audience will not be able to detect the prepared drawings is to outline them with a dress-maker's tracing wheel. Then the perforations are followed when making the sketch on the stage.



Solving HOME PROBLEMS

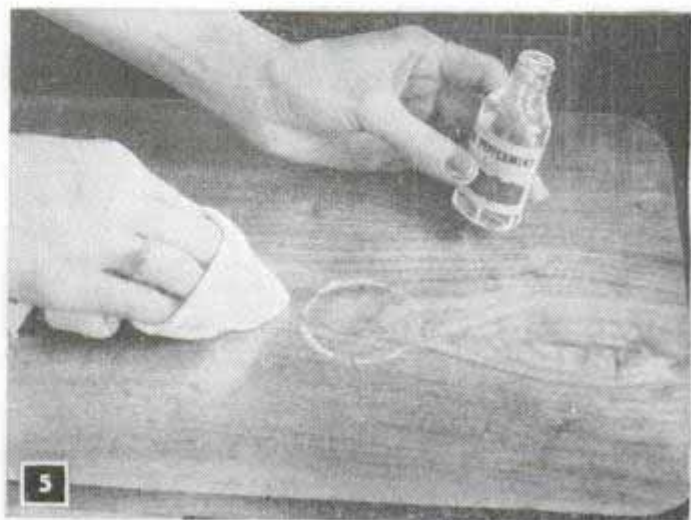
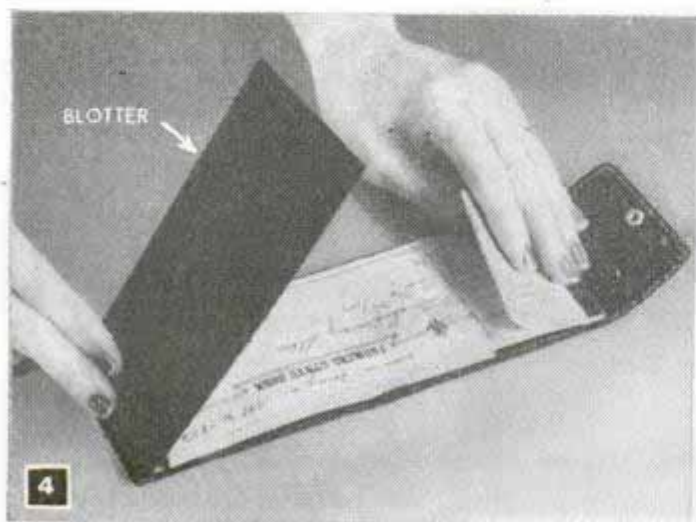
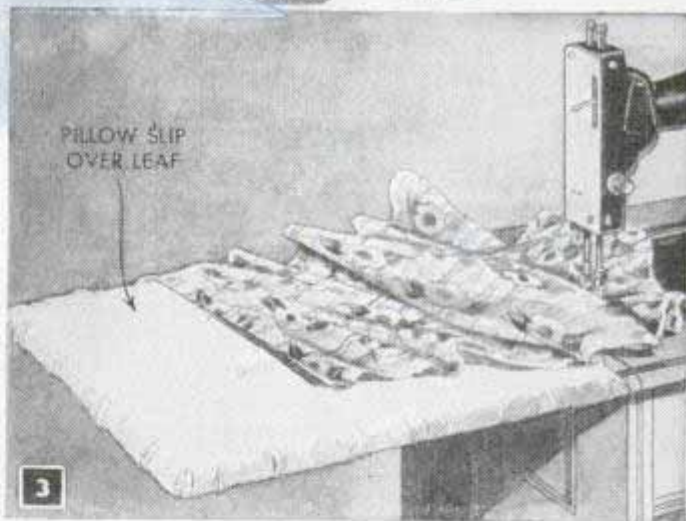
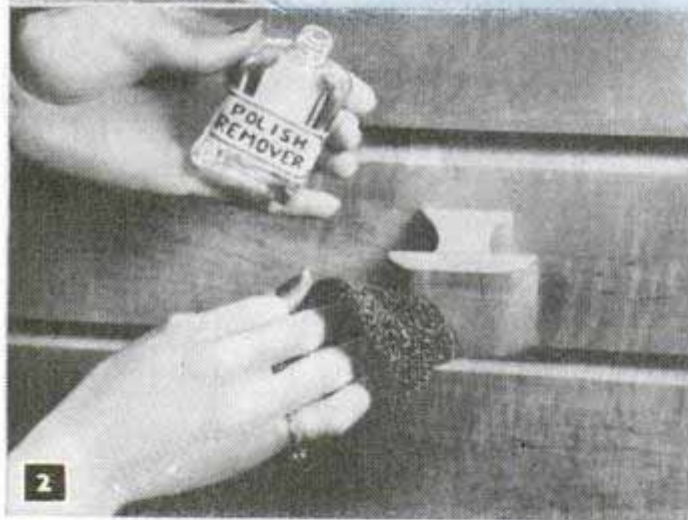

Measuring the amount of bluing to be added to rinse water is much easier and more exact when it is dispensed from a beverage bottle or similar container that has been fitted with a clothes-sprinkler head

It's no trick to remove scuff marks from blond-finish furniture if you rub over them with a pad moistened with furniture-polish remover or cleaner

When the edge of the table-top leaf on your sewing machine becomes worn and roughened it will catch and snag cloth that is being sewed. A pillow slip placed over the leaf when sewing will prevent this

Glue a strip of blotting paper inside the cover of a checkbook as a convenience when writing checks. Then it won't be necessary to wait for the ink to dry and a blotter will always be at hand when needed

White heat marks on a walnut surface are removed by rubbing a cloth dampened with essence of peppermint over the spots. When dry, apply polish sparingly; let stand for about 20 min. and rub with a dry cloth

Installing cords in venetian blinds is difficult because the ends unravel, making it hard to thread the cord through the slats. To prevent fraying, cover the end of the cord with one half a gelatin capsule, which can be removed when the job is done

Periodically clean the drain of a washing machine by using a force cup. This removes accumulations of thread and lint that retard the flow of water

Glue a square of sandpaper on the outside of your notebook cover to clean pencil erasers. Then papers in the book won't become smudged when erased

Lawn chairs and other pieces of furniture that fold flat can be stored in paper garment bags when not in use. This will protect the chairs from dust and scratches. Hang the bags from the hooks provided

If rubber-head tacks are driven into the top of a closet clothes pole to serve as garment spacers, they will help keep coat hangers from bunching

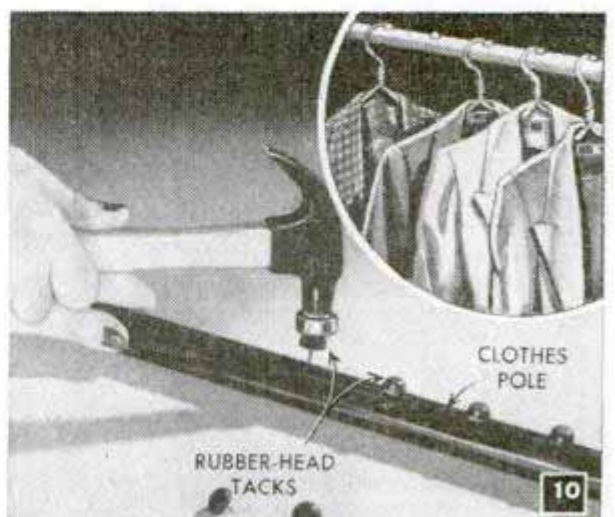
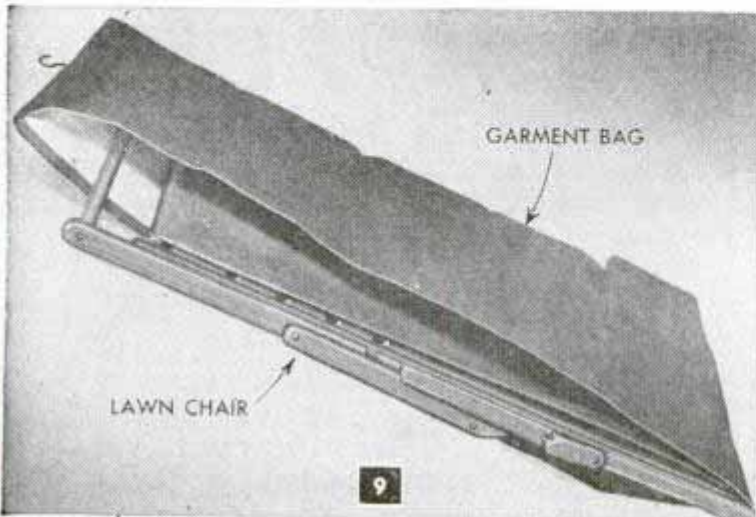
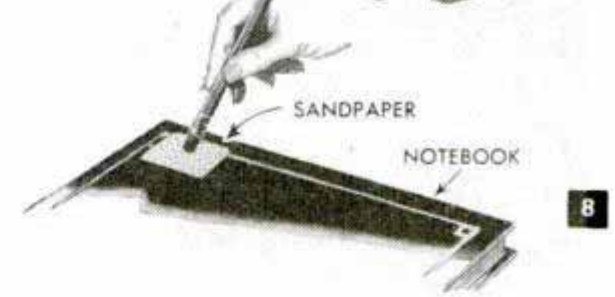
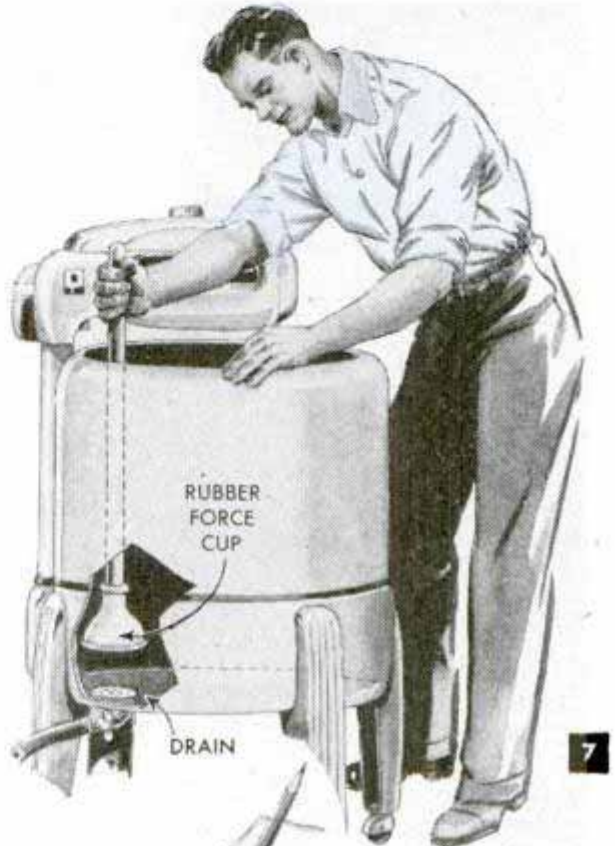
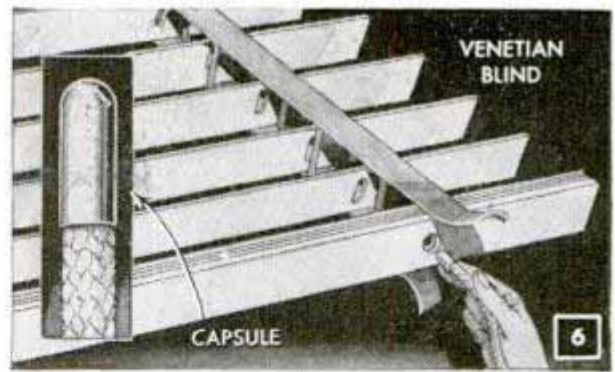

Wire Solder Fed Through Tube For Close and Fine Work



Handy for all kinds of soldering, but especially when working in close quarters or on fine work, this tube-and-spool holder is easy to make and will be a help when you want to do a neat job. Parts required and the method of assembly are given in the detail. Dimensions of the parts are optional and can be made to fit whatever size adhesive-tape spool is on hand. The tube can be of any suitable length.

E. J. Murawski, Baltimore, Md.

Mirror Fastened to Wall of Garage Aids When Parking Car

Set at a 45-deg. angle on the rear wall of a garage, a mirror will enable the driver to see how far the bumper of the car is from the wall and thus prevent damage to

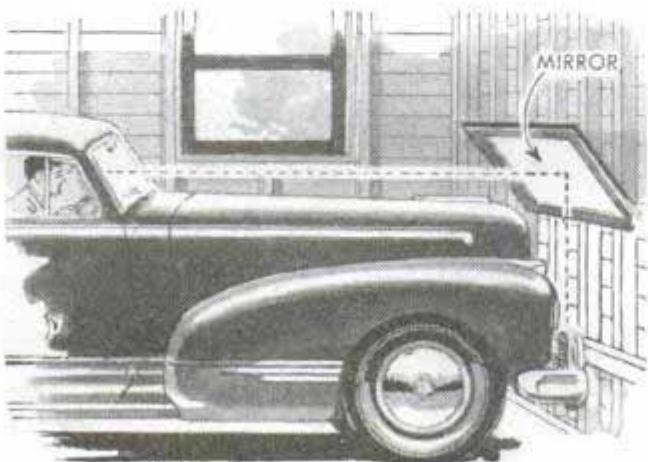

either the building or the car. The mirror should be mounted at about the height of the windshield. On cars with long hoods and projecting bumpers, this device will prove especially helpful.

Filling Nail Holes in Plaster

To fill a nail hole in plaster so it will be invisible, carve a cone-shaped plug from a piece of chalk. Insert the plug in the hole and rub the part that extends with a cloth until it is flush with the surface of the plaster. Chalk dust will fill any small cracks around the hole.



Wrench Depresses Brake Pedal While Working on Auto

When working on a car, either clutch or brake pedal may be held down by using an adjustable wrench that has a handle long enough to reach from one pedal to the pad of the adjoining pedal. Hold the clutch or brake down and tighten the jaws of the wrench around the other pedal.

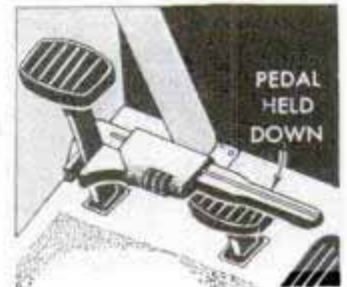

Push Pin Used as Dowel Center

If you do not have a set of dowel centers, substitutes for most sizes can be had by using ordinary push pins. These can be purchased in several sizes. To use them, press the head into the dowel hole, letting the pin point project so that it will mark the center of the hole to be drilled in the joining member when both pieces are placed on a flat surface.



Removing Feathers From Fowl

One of the most difficult tasks when picking wild—or tame—waterfowl is the removal of the downy feathers. However, with a gum-type eraser, this is the easiest part of the job. After plucking the feathers, use the eraser to remove the down.

Portable Clothes Rack Hangs on Top of Door

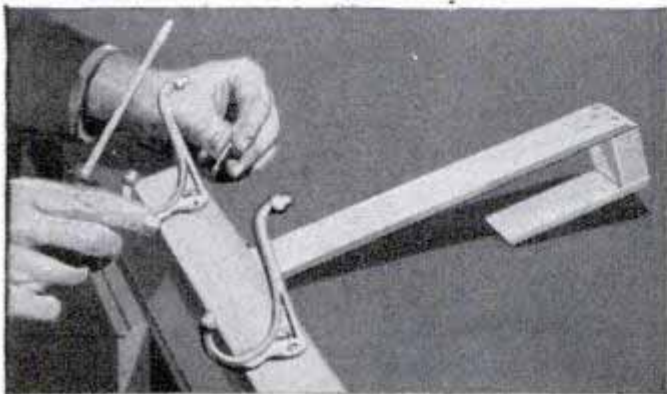
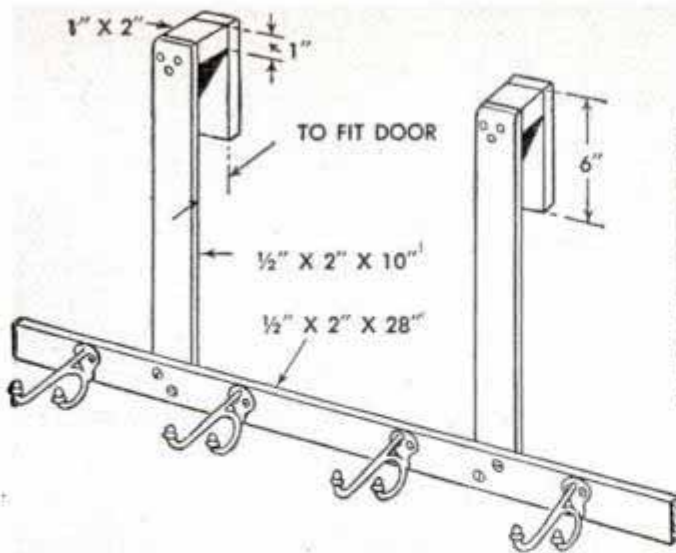

This clothes rack was designed primarily to take care of the overflow from the average clothes closet, but in an emergency it provides additional hanger space for the coats and hats of guests on party nights and also serves as a special rack for choice garments on ironing days. When not in use, it takes very little storage space. All parts

except the spacer blocks at the top of the hanger hooks are cut from 1/2 by 2-in. hardwood. Join the parts with flathead screws and glue. Sand the wood smooth and round all corners and ends. Finish in the natural color of the wood or with enamel. Then attach the metal coat hooks with screws, spacing them on 7-in. centers.

Curling Iron Holds Abrasive Paper for Sanding Inside Scroll Cuts

As a sandpaper holder when smoothing curves or irregularly shaped surfaces, spread the jaws of an ordinary curling iron and wrap a small strip of abrasive paper on the round jaw. When the iron is closed, the curved jaw will hold the strip in a tight

grip and make the sanding operation easy. If the spring that holds the jaws shut is weak and the sandpaper tends to slip, use rubber cement to hold it in place. Spread cement over the smooth side of the paper and also on the round jaw; allow it to dry until slightly tacky and then wrap the paper around the jaw.

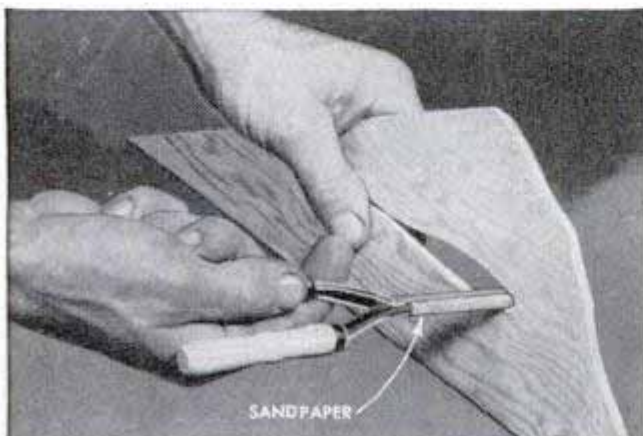

How to Sharpen Food Grinders

One way to sharpen dull knives of food and sausage grinders is to use a small amount of valve-grinding compound. Take the grinder apart and spread compound over the edge of each knife and the inside of the body. Then assemble and turn the blade for a few minutes. Finally, clean all parts thoroughly in soap and hot water so the compound cannot contaminate food.

H. W. Swope, Danville, Pa.

COME OUT OF YOUR IGLOO

DOES IT TAKE more fuel than it should to keep your home comfortably warm? Then, now is the time to come out of your igloo and plug the cracks that are letting the heat escape. Heat loss from the average house can be figured in approximately equal proportions: 25 percent through the glass of windows and doors and 25 percent through openings around them. Another 25 percent is lost through uninsulated side walls and 25 percent more through the

roof. These figures will vary, of course, with each type of house, but they offer a basis for weighing the value of storm sash, weather stripping, caulking and insulation. Insulation, besides reducing fuel costs, adds healthful comfort both winter and summer; for just as it keeps the heat in, it also keeps the heat out. Rooms will be 8 to 15 percent cooler in summer. Below are things you can do to help keep the heat at home and money in your pocket.



Storm sash can save you 15 percent or more on winter fuel bills by reducing heat loss through windows. It pays to put them on every window of the house, including basement windows, and especially on those with a north and west exposure



Like windows, exterior doors let heat escape, too, if they are left unprotected. The best storm door to use here is the popular combination type which has an interchangeable sash-and-screen unit. For best results the storm door should fit snugly



Closing off unused rooms during the winter months is another way of saving the heat and promoting greater comfort. If the opening is large, French doors are both practical and smart looking. A heavy drape can be used to close off a doorway



Cracks around doors and window sash provide another exit for heat and an entrance for drafts, but you can seal them effectively with a metal weather stripping which is simply tacked to the casing. Being flexible, it bears against the door



By Wayne C. Leckey



Lining an unfinished attic with wallboard will help keep the heat in and provide useful rooms at the same time. Standard-width sheets permit direct application to studs and rafters. Joints can be covered neatly with plain wooden battens

Up to 25-percent saving in fuel can be had by insulating your home. Not only will you have a warmer home in winter, but a cooler one in summer. Blanket and batt-type insulation are ideal for new construction and fill insulation for old



Sealing cracks due to shrinkage that develop around window frames of brick homes can be done with caulking compound. You can use either a mastic-type compound, or one marketed in rope form which is pressed into the joint with a knife



Cold and drafty floors of homes constructed without foundations can be eliminated by banking straw and leaves around the outside. Asphalt roofing felt is first tacked to building as shown, and boards weighted with stones anchor the straw

'Crossbow' Slingshot Shoots Dart-Shaped Arrows

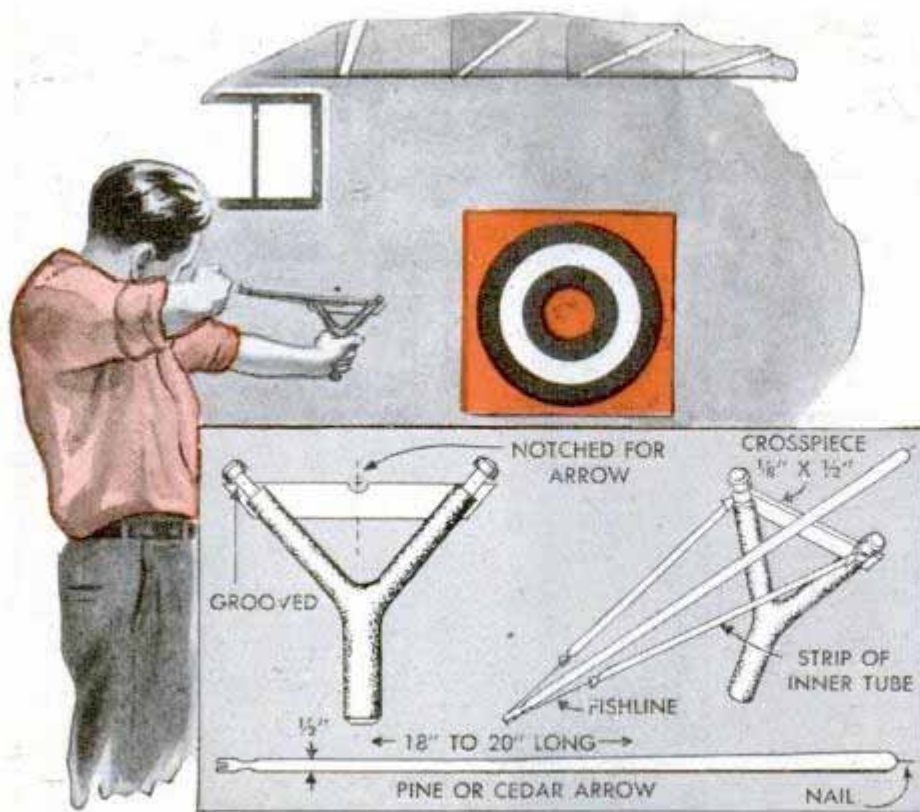

Indoor target practice with a slingshot becomes real competitive sport when the sling is equipped to shoot arrows. Converting a regular slingshot into one to shoot arrows is a simple job. A notched crosspiece is fastened to the crotch of the handle and the regular rubber sling bands are replaced with longer ones as shown in the detail. Note that the arrow, which should be made of light wood, is tapered and has a pointed nail at the tip. A saw cut forms a nock at the opposite end of the arrow to engage a length of fishline tied securely to the sling bands.

Funnel Soldered to Cap of Gas Can Is Always at Hand

To assure always having a funnel at hand when filling the tank on a gasoline engine or other small container, solder a small funnel to the cap of the gasoline can. In use, simply unscrew the cap and place the funnel in the filler opening. Remove the cap from the can when soldering the funnel in place to avoid any possibility of explosion.

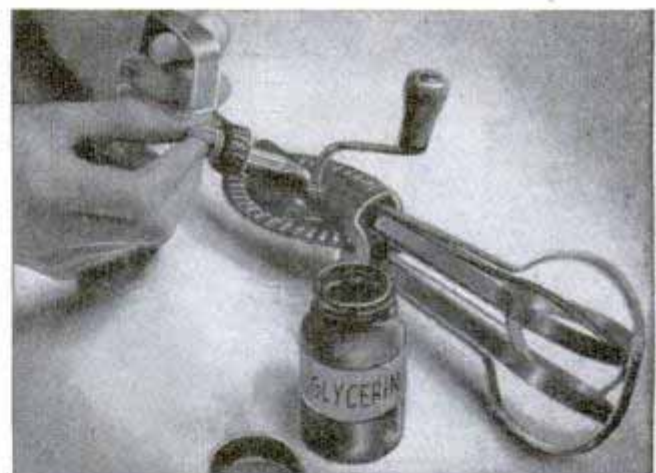

Glycerin Lubricates Egg Beater

For egg beaters or other kitchen utensils having moving parts, glycerin makes an excellent lubricant. Unlike oil, it will not spoil the taste of food if mixed with it by accident. The glycerin can be applied with a medicine dropper.

Benj. Nielsen, Aurora, Nebr.

Correcting Slip in Refrigerator Belt

If the V-belt on a refrigerator unit is slipping or making noise, the trouble can be corrected in some cases by rubbing a little naphtha laundry soap on the sides of the belt while the unit is running. When working around a unit in operation, be careful to avoid catching your tie or loose clothing in the machinery.

Charles F. Smith, Chicago.

Chessboard Folds to Form Container for "Men"

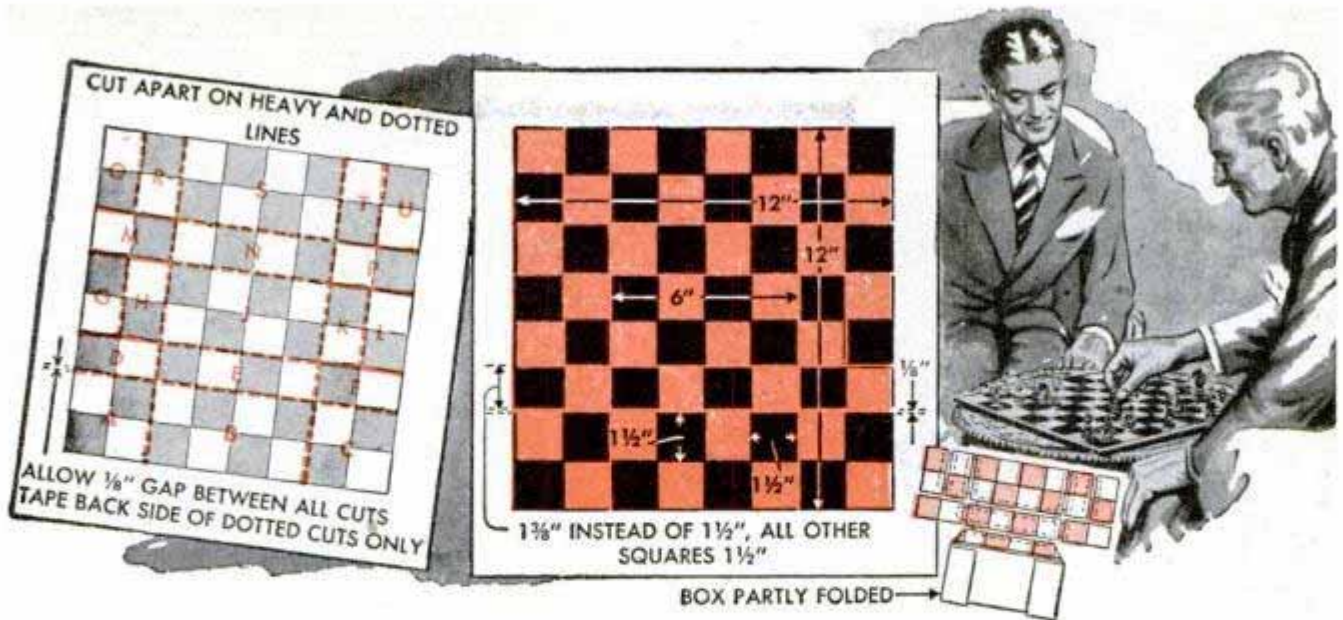

With a checker or chessboard that can be folded to form a compact little box for storing the "men," you can easily carry the game anywhere. To make such a board, first rule a 12 by 12-in. piece of heavy cardboard into 64 squares as shown above. The size to make the squares is dependent upon the amount of storage space that the set at hand requires. If the men are small, $1\frac{1}{4}$ or 1-in. squares may do. Note that row D-E-F is ruled $1\frac{3}{8}$ in. wide instead of $1\frac{1}{2}$ in. This is necessary as some pieces fold under others. After ruling the cardboard, cut it apart where indicated in the drawing by the solid and dotted red lines and then reassemble the pieces by hinging them together

with adhesive tape along the dotted lines only. In taping the pieces, space them $\frac{1}{8}$ in. apart to permit folding.

Now to fold the board: First, fold lines A-D and C-F on top of B-E. Next, fold line A-B-C at right angles to D-E-F, then, D-E-F at right angles to J. Follow this by folding lines G-H and K-L at right angles to J. At this stage, the box should look like the one shown in the small detail. To complete the box, line N is folded downward to close the open side, and then line M is folded against H, and P against K. A rubber band can be used to keep the box folded.—Philippe St. Gelais, Jonquiere, Quebec, Can.

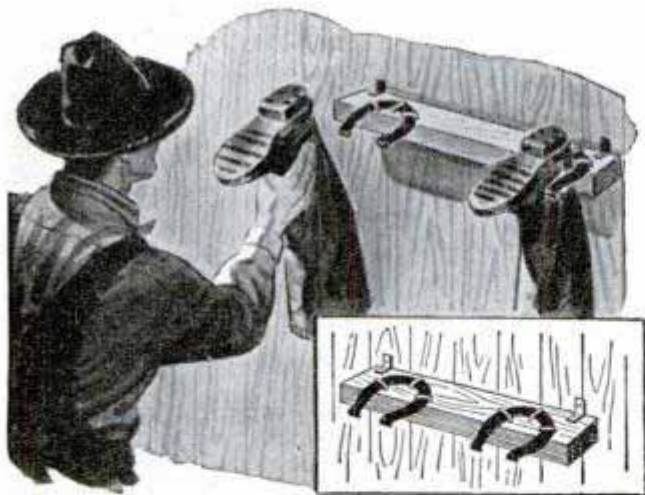

Old Horseshoes Used as Boot Racks

To hold rubber boots upside down for drying them out, one farmer nailed a pair of horseshoes to a 2 by 4-in. wood block and hinged this to a convenient wall. The open ends of the shoes extend outward so the ankles of the boots will slip between them. When not in use, the rack is swung up out of the way.

Tape Protects Edges of Booklet

After a certain amount of wear and tear, the edges of paper-bound booklets become worn, and in time, the entire book will be damaged. To prevent this, bind the edges of the covers with cellulose tape. This will prevent them from bending and tearing, and the cost is small compared to the replacement value of most books.



Spring-Slung Runners Take the Bumps



Anyone who has experienced a spine-jarring ride down a rough hill on an ordinary bobsled will appreciate a sled equipped with spring-suspended runners. On this one runners are sprung to the frame with the main leaves of light auto springs, which can be picked up at a wrecking yard. The rear runners oscillate on a pipe sleeve to which the spring leaves are clamped at each end with U-bolts. At the front, the leaves are bolted to a hardwood block in which the kingpin pivots. The eyes of the spring leaves slip over tie rods inserted crosswise in the frame, and snubbers of leather belting are looped around the block and the pipe sleeve on rear runners to control the rebound

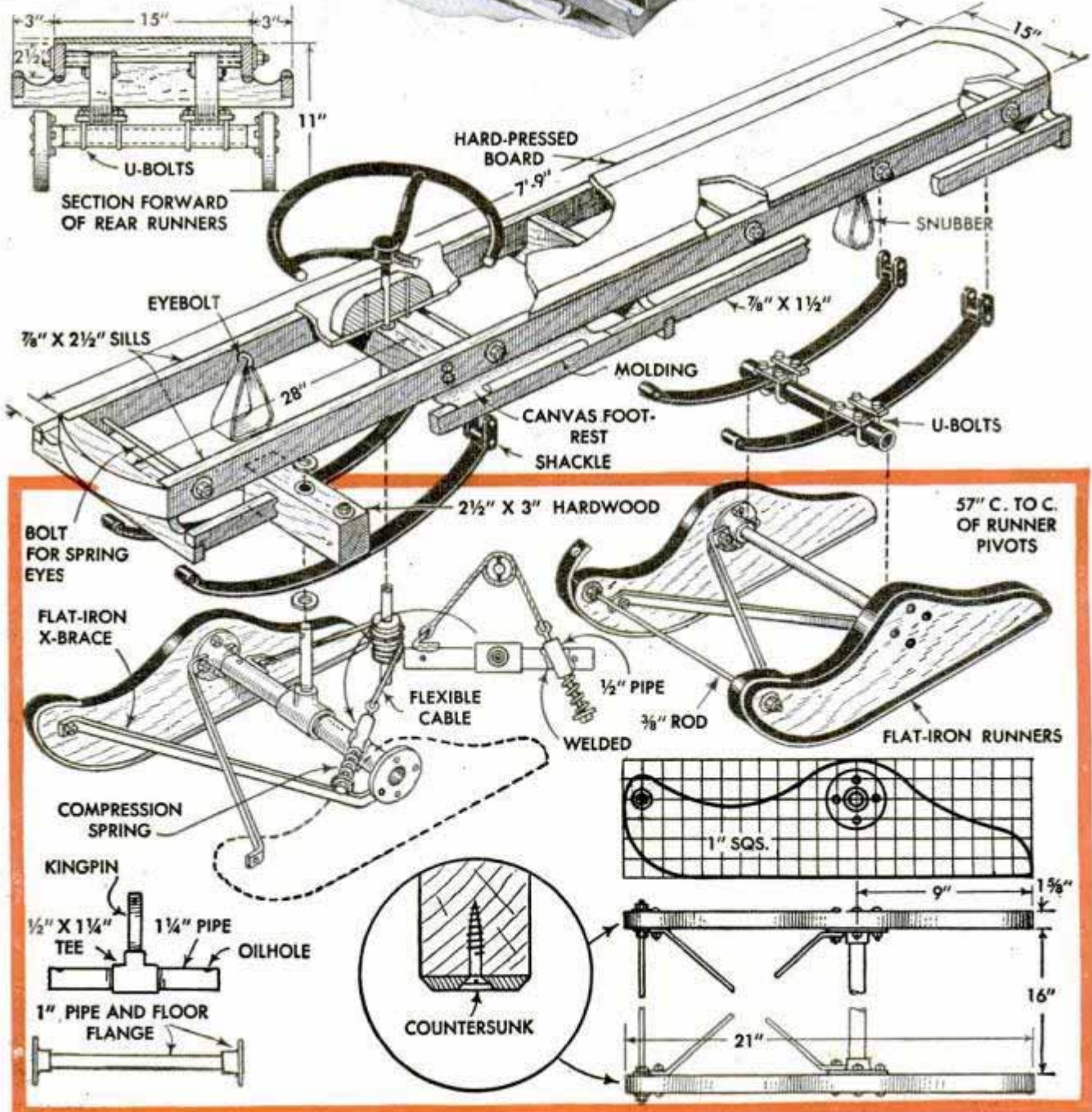

Taking the family dog along on a trip in a car, especially in a coupe, usually happens only once—the next time he is left at home. This was our experience until I converted the rear deck of the car into a separate compartment in which the pet could ride without disturbing others. I shaped the three pieces as shown to match the contour of the deck door, which forms the roof of the compartment, and hinged the three together so that the whole unit would fold compactly. Screen-door springs placed across the openings prevent the dog from jumping out and a large box provides a bed.—P. Gowland, Los Angeles, Calif.

Folding "Dog House" Fits Auto Rear Deck To Keep Your Dog Happy on Long Trips

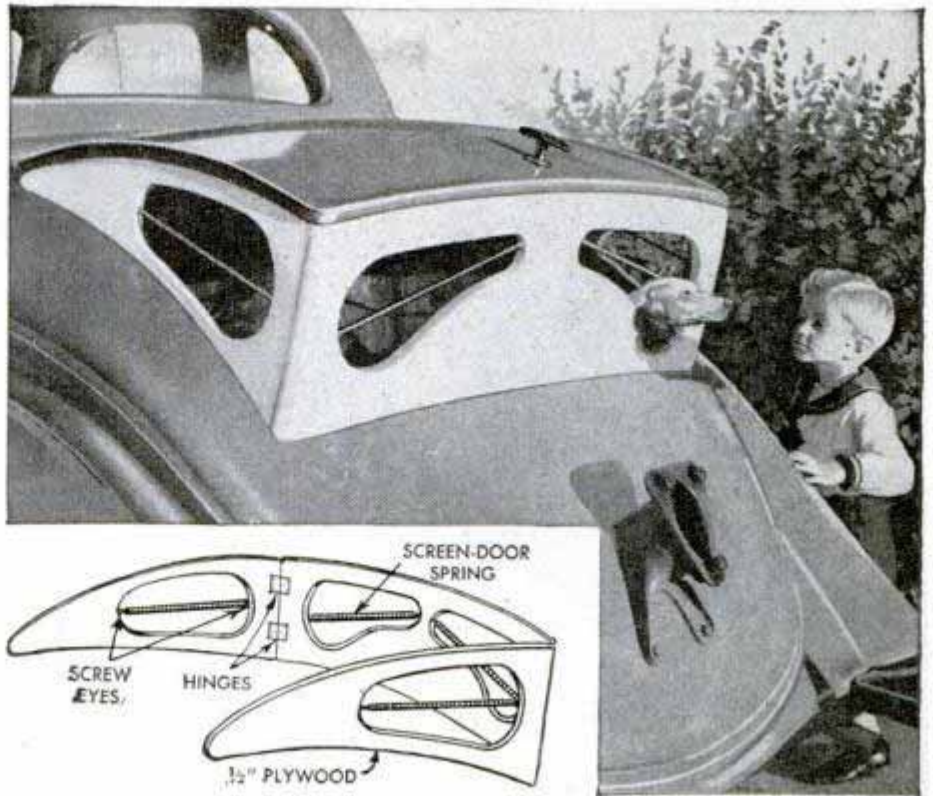

Thread and Lead Weight Are Used To Pull Wire Through Lamp

Difficulty sometimes experienced in threading new wire through the standard of a floor lamp when rewiring it, can be avoided by using a lead weight, such as a lead shot or round fishline sinker, and a length of heavy thread or cord to pull the wire into place. This trick is especially handy if the lamp is fitted with an arm, or the surface of the hollow interior of the standard is rough. After removing the old

wire, tie the weight to one end of the cord, turn the lamp upside down and feed the weight and cord through the standard from the base end and out the socket end. Then tie the new wire to the free end of the cord and pull the wire into position. If the position of the socket permits, you can do the job still easier. Disconnect the old wire from the socket, connect the end of the new wire to it and simply pull the new wire into place from the socket end of the lamp as you pull out the old wire.

David B. Clapp, Livingston, N. J.

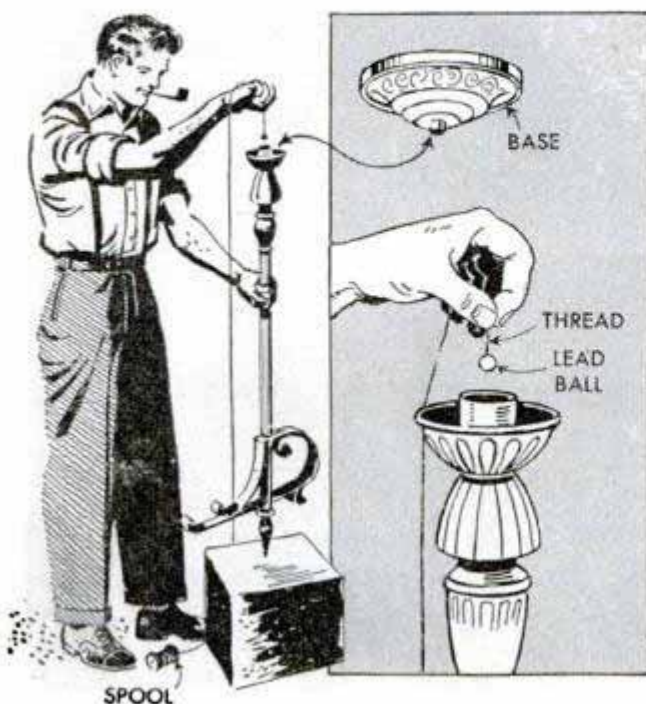

Hinged Hoe Blade to Clean Culvert

With the hinged blade on this hoe, it's a simple matter to clean debris and dirt from a culvert or covered drain. When the hoe is inserted in the drain, the blade folds against the handle so it is out of the way, and when withdrawn, the blade opens out to catch and remove dirt. Construction is simple: Use 16-ga. steel for the blade and cut it to a size best suited for your purpose leaving two projections which are bent into offset eyes for the hinge bolt. A bolt pivots the blade to the pipe handle. Flat washers keep the bolt from binding.

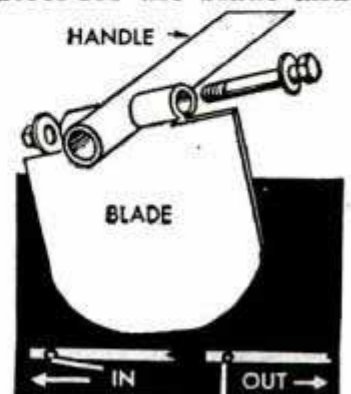



14 HOMEMADE CHRISTMAS

MERRY CHRISTMAS

from Your Workshop

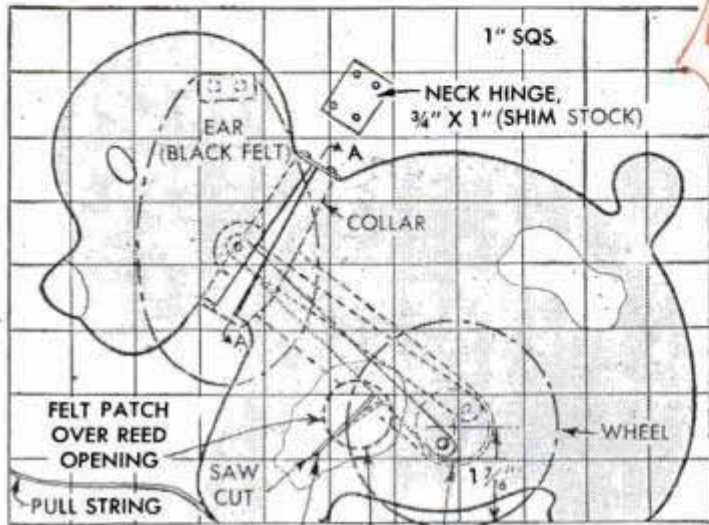

REED (SHIM STOCK)
7/8" X 1 3/8"

1" DIA. 1 1/8" DIA., LOOSE FIT

Barking Dog

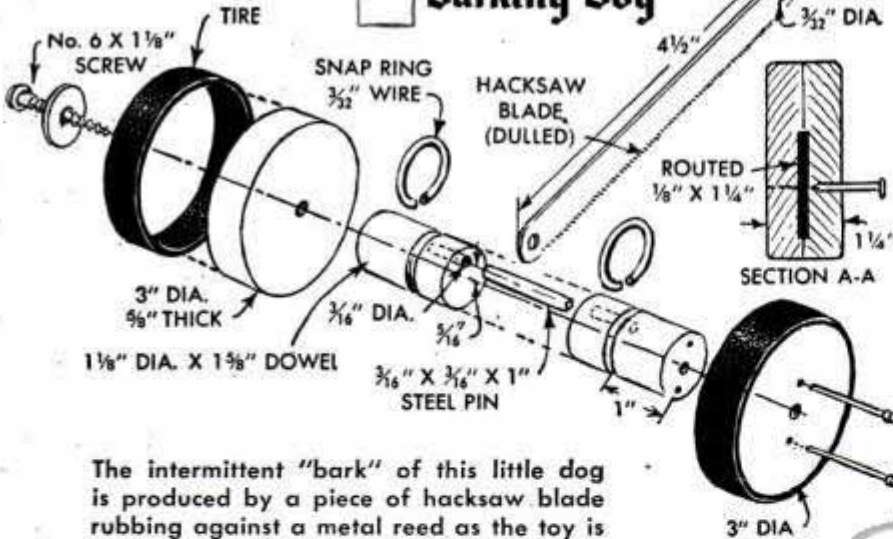

The intermittent "bark" of this little dog is produced by a piece of hacksaw blade rubbing against a metal reed as the toy is pulled. The saw blade, pivoted off-center in a dowel axle held in place by snap rings, lifts the dog's head realistically on each upward stroke. Body consists of two parts with both parts routed to provide space for the saw blade. The head hinges on shim stock; a felt patch conceals the reed

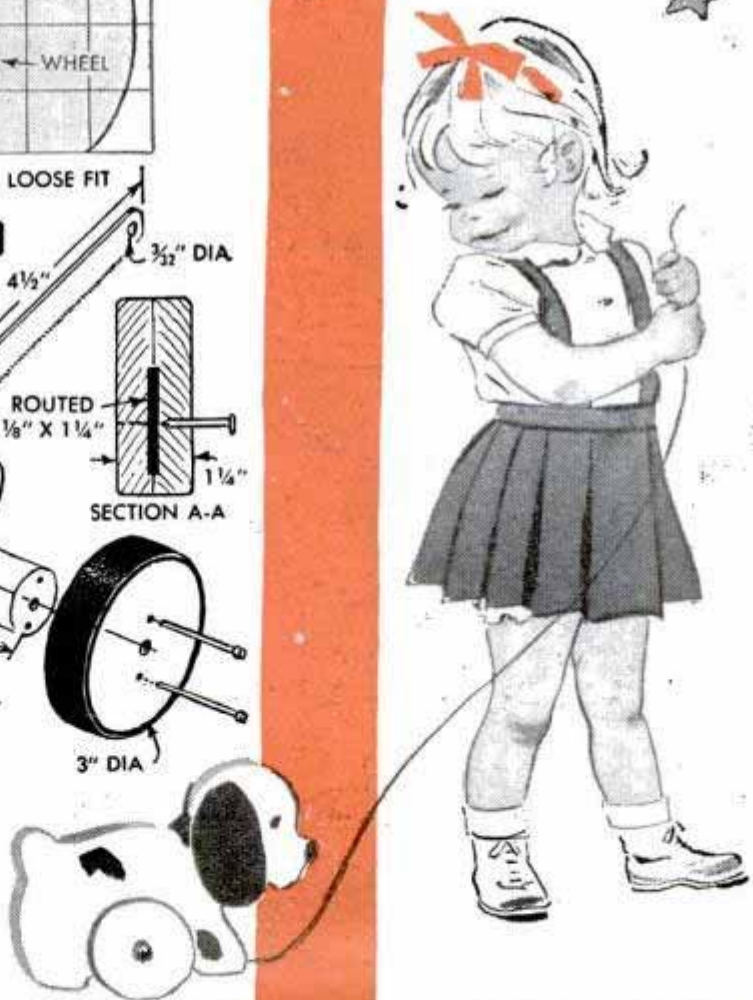

GIFTS YOU CAN MAKE...

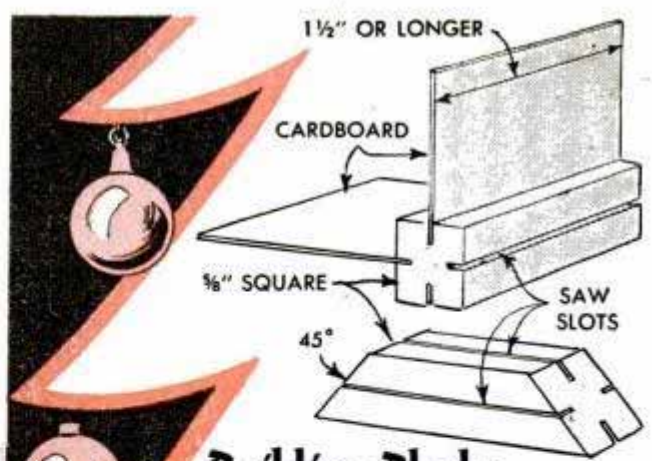

Building Blocks

Something new in building toys combines cardboard with grooved blocks. The blocks—some are cut at an angle—can be produced on a power saw

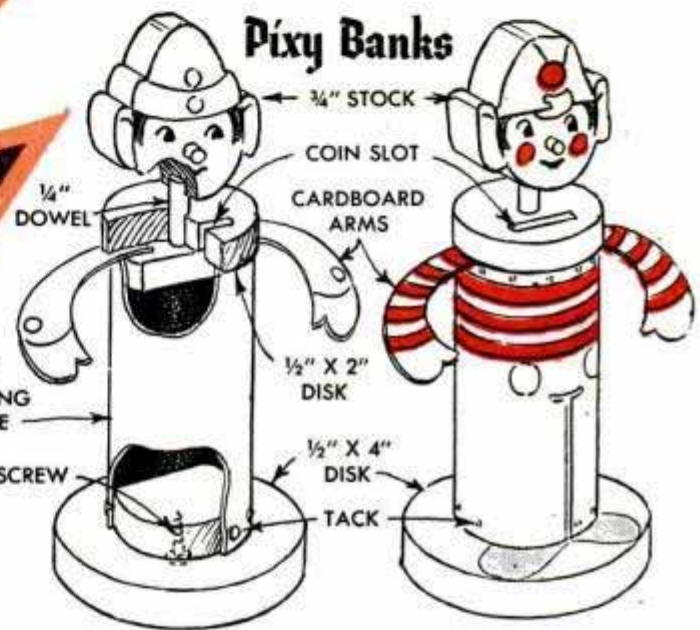
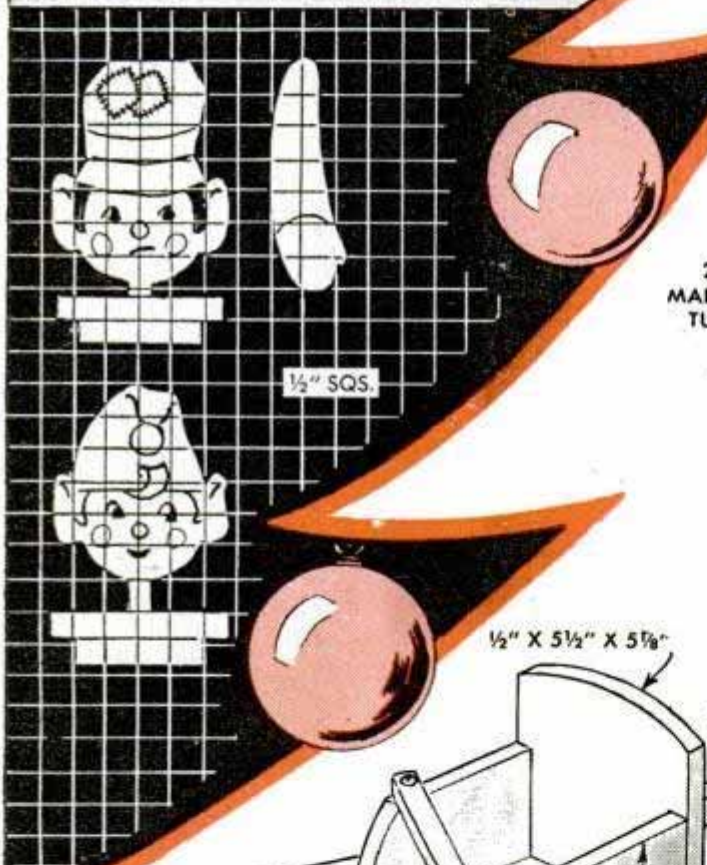

Pixy Banks

Sections of mailing tube form the bodies of these little pixy banks, which can be made short or tall. Scraps of pine will do for the wooden parts. The squared drawing gives two different head patterns

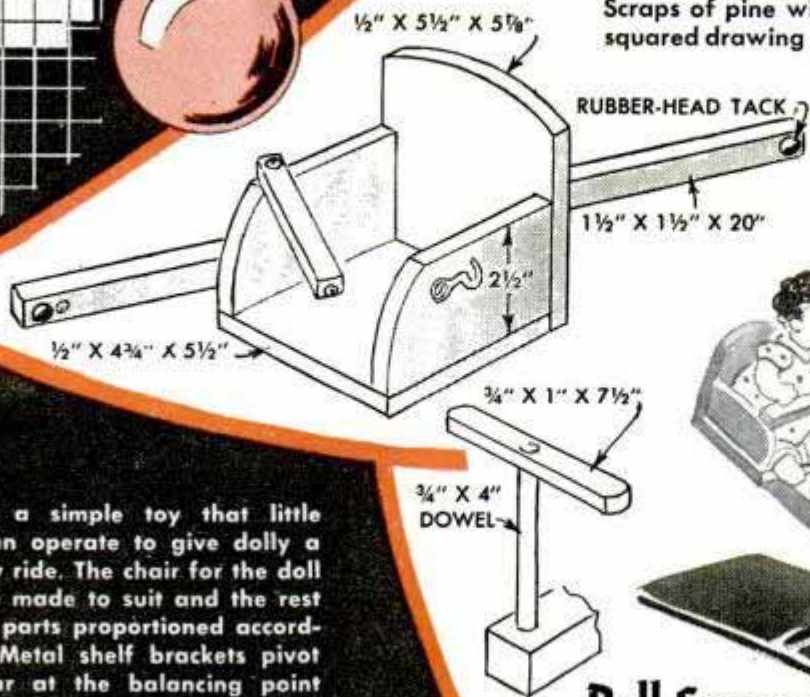

Here's a simple toy that little tots can operate to give dolly a seesaw ride. The chair for the doll can be made to suit and the rest of the parts proportioned accordingly. Metal shelf brackets pivot the bar at the balancing point



Doll Seesaw

Stern-Wheeler

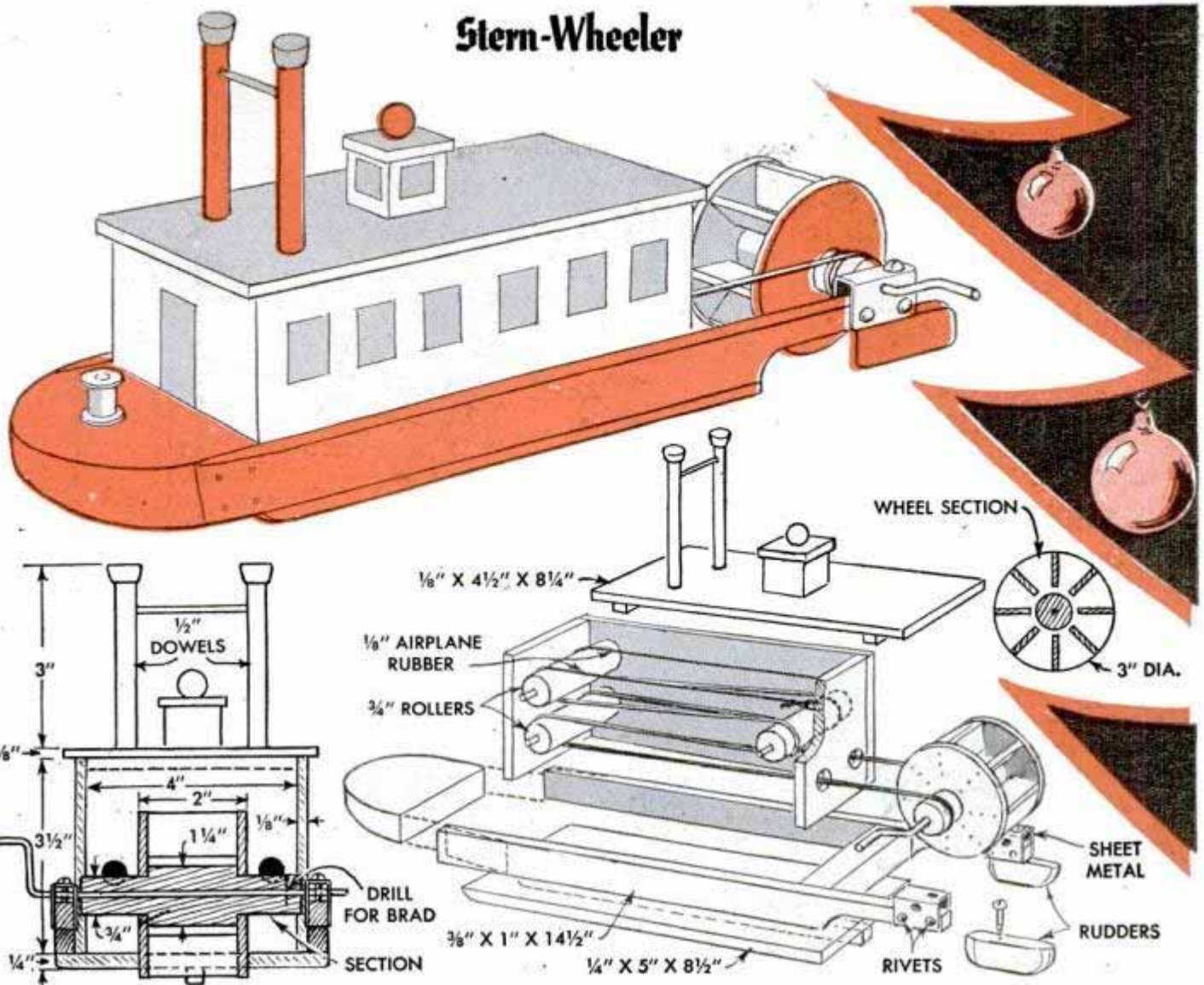

Above: Propelled by a rubber-band "engine," this stern-wheeler will travel a considerable distance on one winding. Twin rudders can be set for a straight or circular course. Below: Mother-Goose rhymes pictured on the legs and backs of the chairs of this table-and-chair set will delight little folks. The table, about 26 in. high, is divided into two storage compartments having hinged covers. Plywood, 1/2 or 3/4 in., is best for the chairs

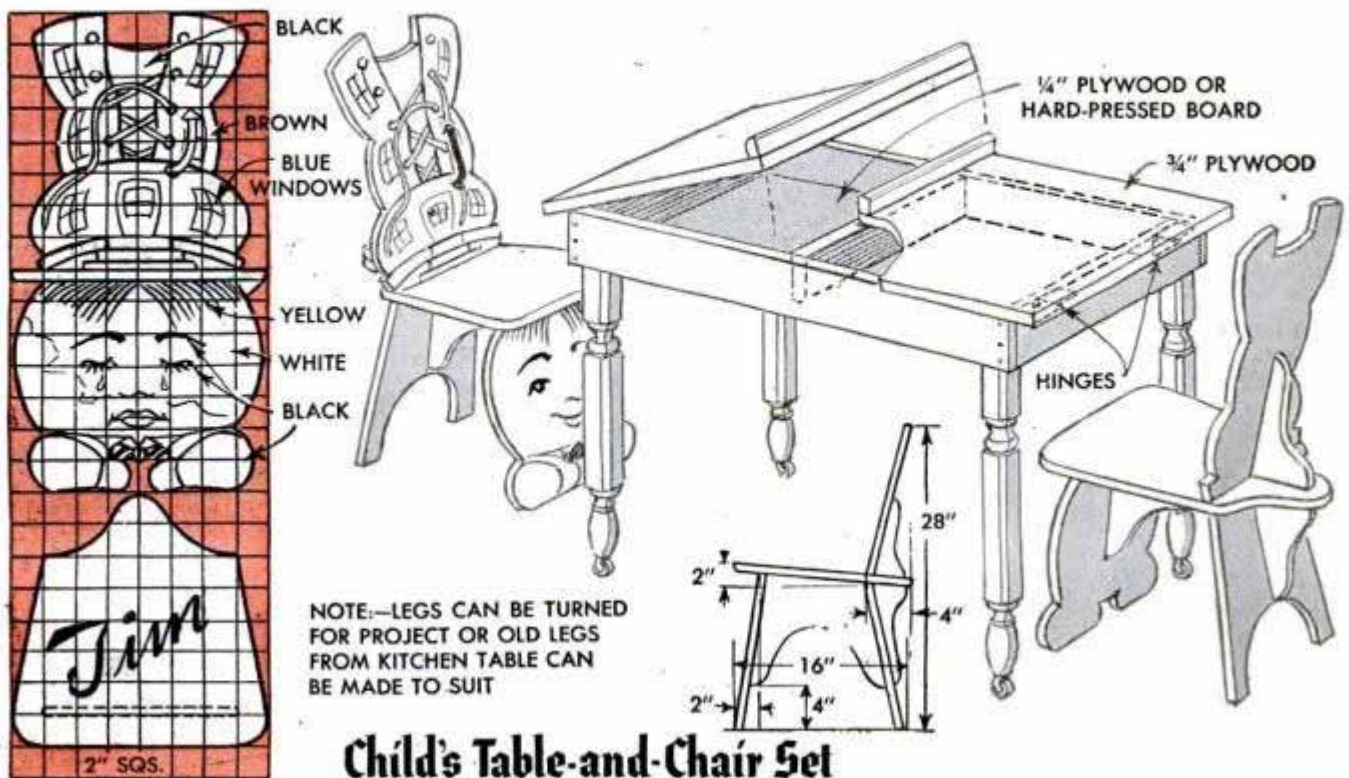

Child's Table-and-Chair Set

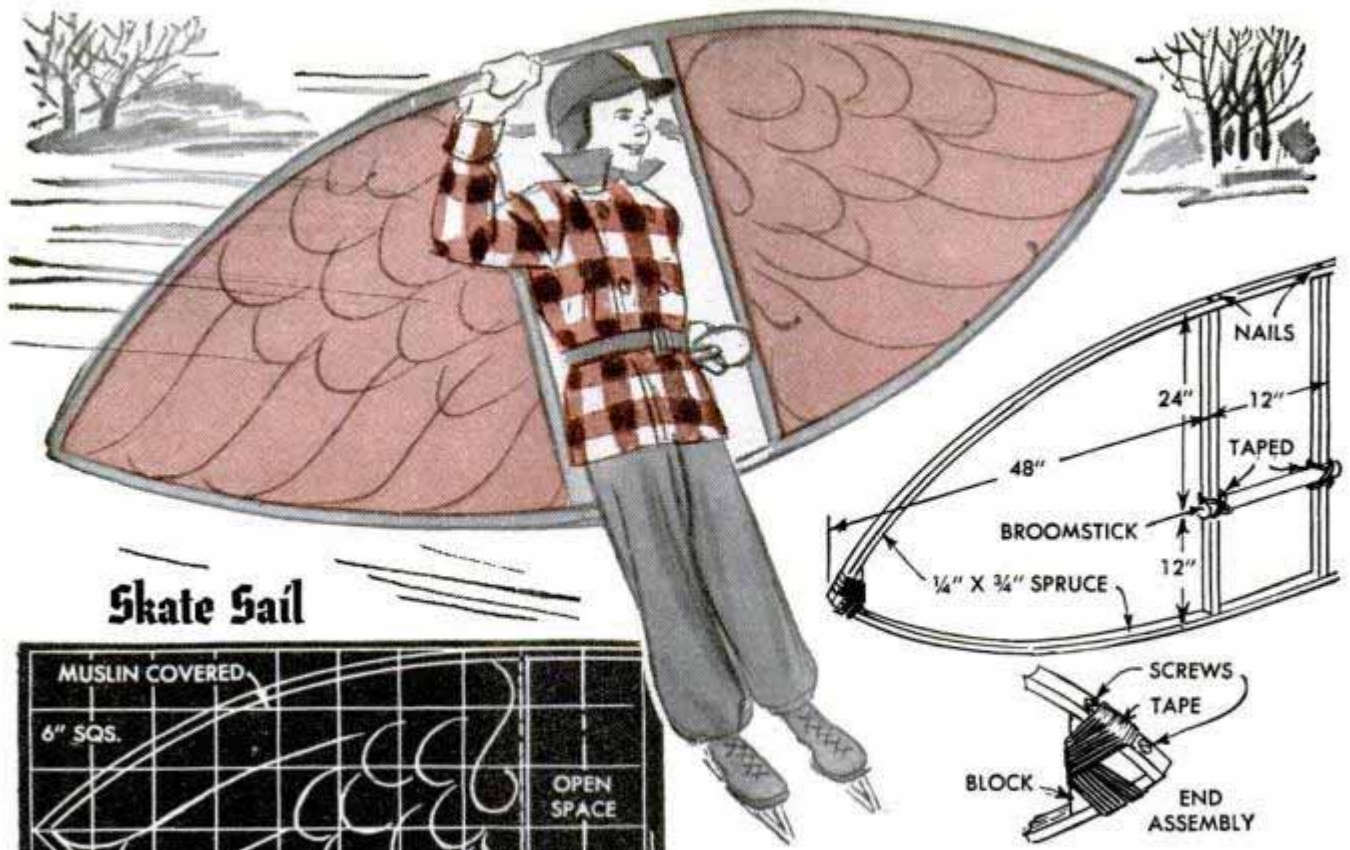

Skate Sail

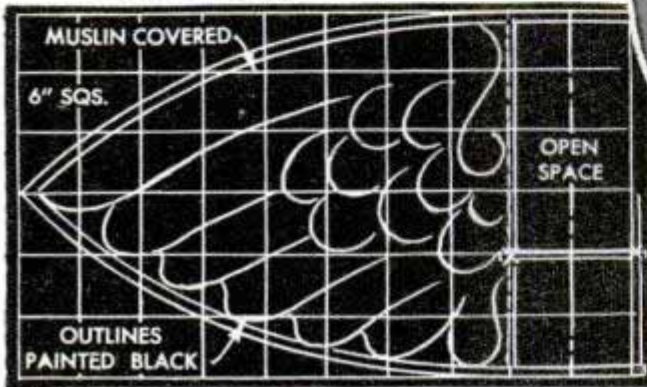

Gliding swiftly across the ice with a skate sail is thrilling sport and lots of fun. The sail shown here consists of a wooden frame covered with muslin and decorated to represent the wings of a bird. Spruce is best for the framework, although it can be of pine



An electric dart game, which flashes a light or rings a bell when a dart pierces certain bull's-eyes, will entertain both young and old. The two parts of the game, the scoreboard and the target, are mounted on a sheet of soft wallboard. Seven holes are cut through the wallboard to align with seven holes in a cardboard target. Then the holes in each are backed with copper screen wire which is wired to scoreboard, bell and dry cells. Bell rings only when center hole is hit

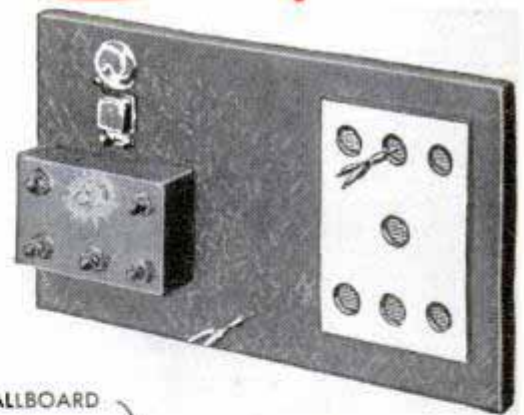

Dart Game *Book for Boys*

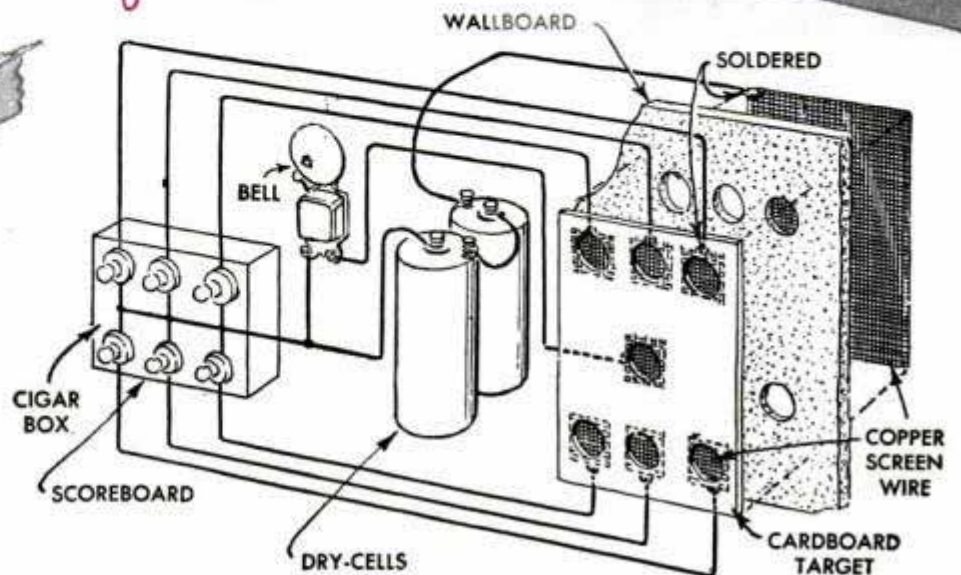

Below: Mom, sister or sweetheart will be pleased with this little earring bar. The base is $\frac{1}{4}$ -in. plywood; all other parts are $\frac{1}{8}$ in. Rail tenons projecting through slots in the side pieces are pegged with short dowels; the base is glued. Right: The crumb tray features a nesting scraper which locks itself within the tray when not in use. It is jigsawed from $\frac{1}{4}$ -in. stock and glued together

Earring Bar

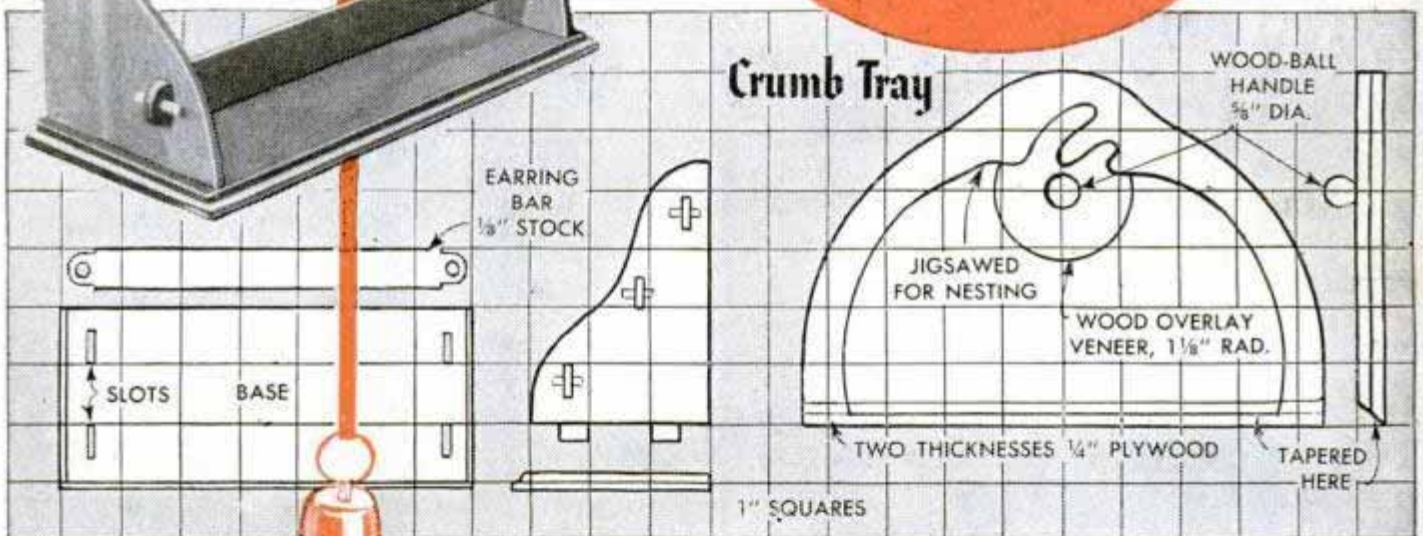
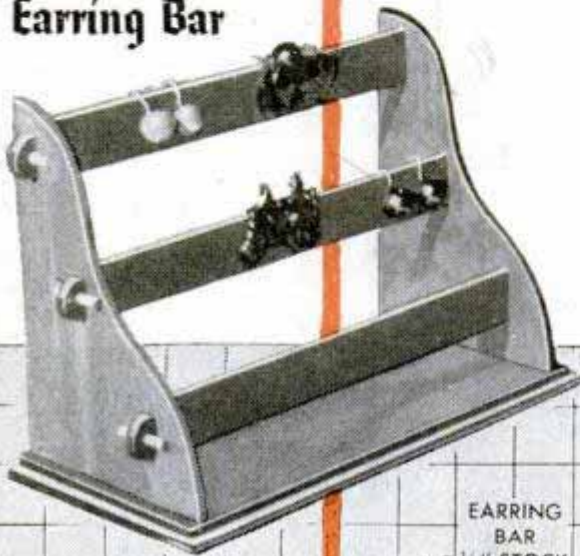

Crumb Tray

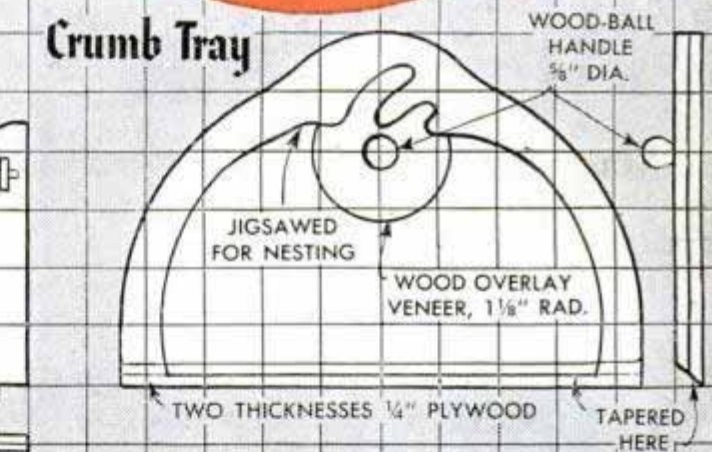

Dad will go for this novel cigarette dispenser. It ejects a cigarette on end with each turn of a knob. The bottom of the hopper is slanted toward a narrow slot through which cigarettes feed to the ejector unit

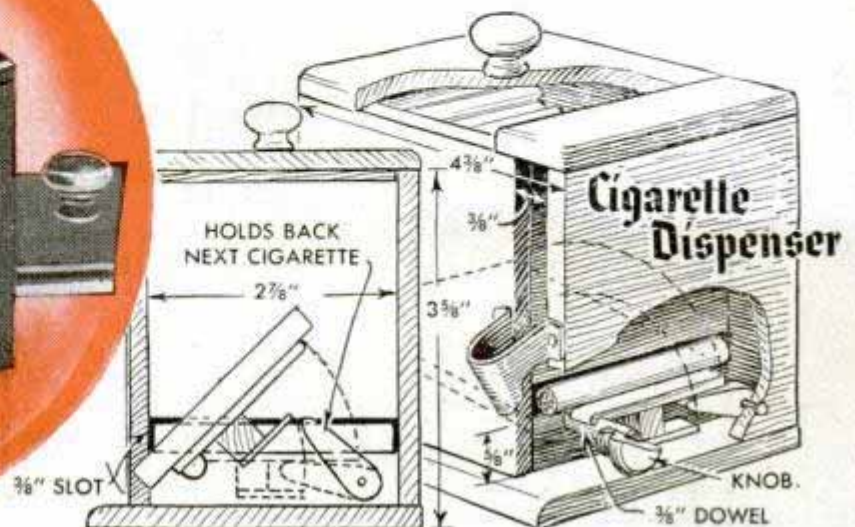

The gifts on these pages are appropriate for adults, and most of them are simple enough for the boy craftsman to make for Mom or Dad. With the exception of the magazine rack, which requires a lathe, all the projects can be duplicated with ordinary hand tools. Finish can be paint or varnish



Magazine Rack

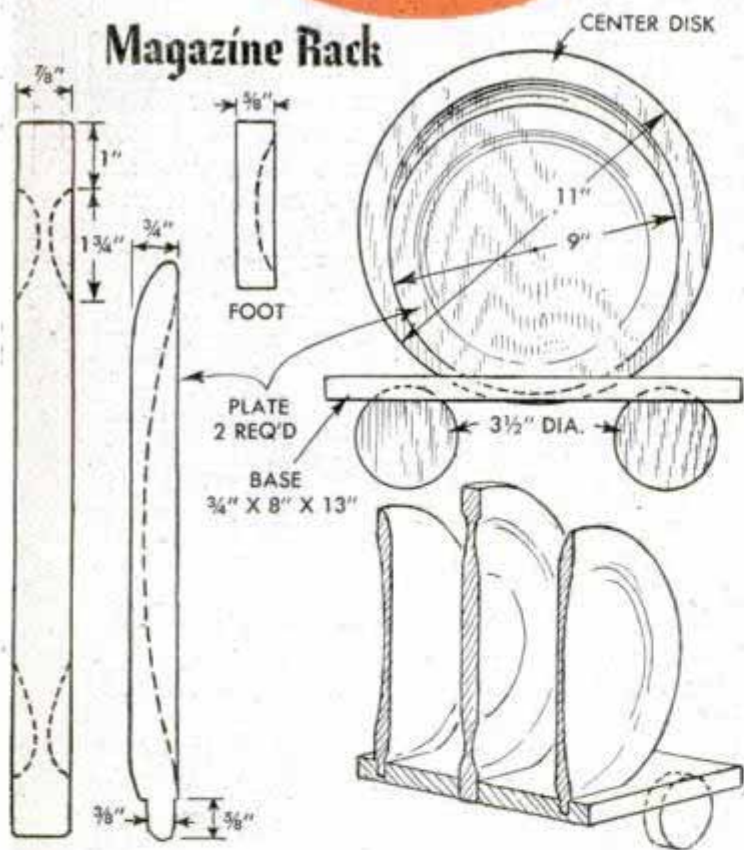

Resembling a little wagon, this unusual magazine rack has disk partitions which are dished like saucers. It's almost entirely a lathe job, except for the base which is grooved top and bottom to hold the disks and the "wheel" feet. Grooves for the two outer disks are spaced about 2 1/2 in. from the center one, the latter one being cut completely through the base

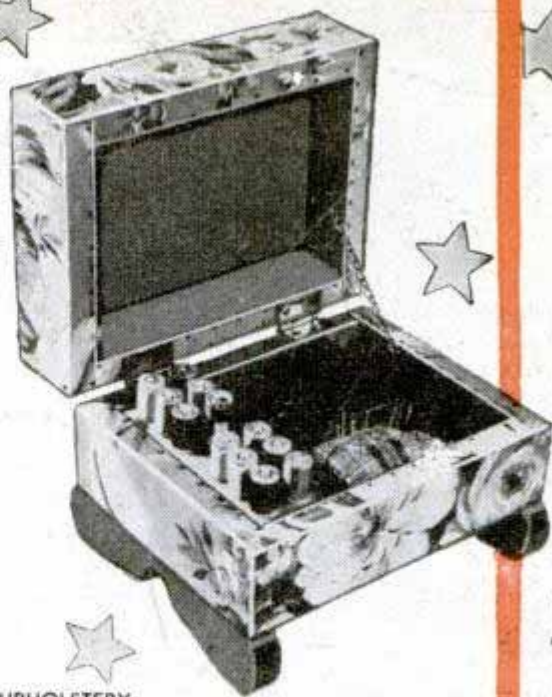

UPHOLSTERY MATERIAL

COTTON BATTING

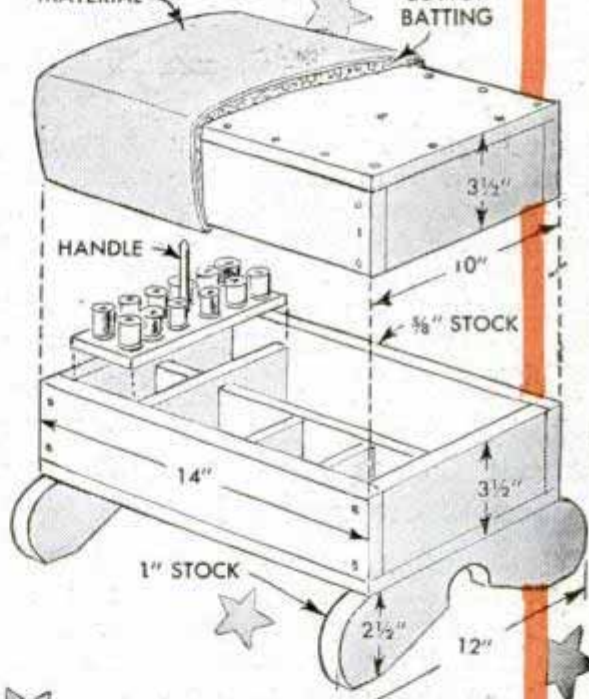

Footstool Sewing Kit

It's not just a footstool but a sewing kit, too. Raise the lid and you have a divided compartment for thread, pin-cushion, etc. Make a box with a top and bottom and saw it in half, length-wise, to form the two parts. Pad and upholster both; hinge the lid and attach feet with screws in counterbored holes. The spool rack is made removable so that the space under it can be used

Knee Cushion on Coaster Wagon Adds to Riding Comfort

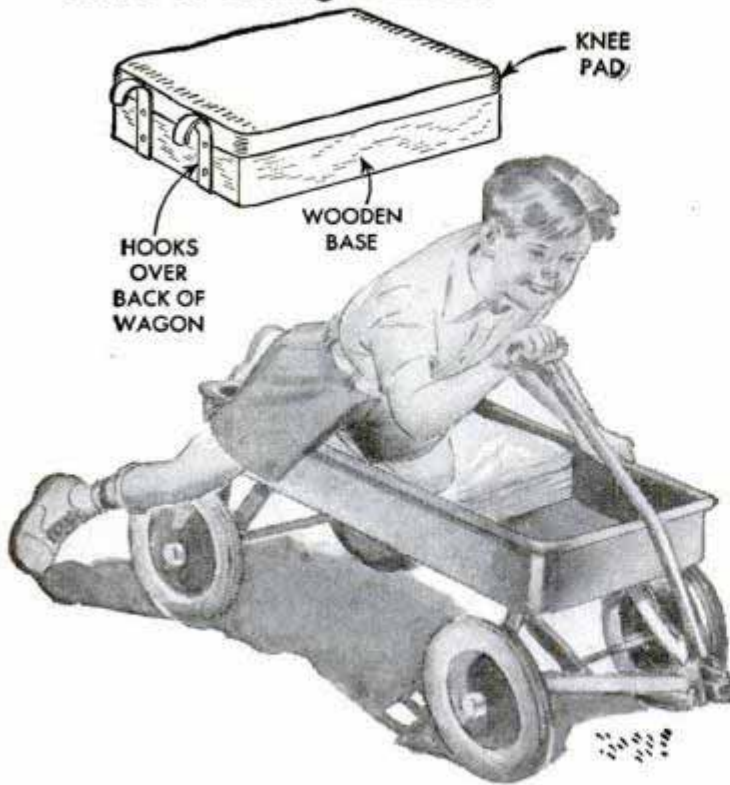

Chafed and sore knees can be avoided if this knee pad is used on a coaster wagon. The base is made of wood and covered with padding material. Two flat-iron hooks are screwed to the back of the cushion to hold it in place when being used. Size of the base is governed by the inside dimensions of the wagon.

Fender Guide for Use With Trailer Indicates Clearance Needed

When pulling a trailer, often it's difficult to judge the clearance required when parking or driving in congested traffic. But with this fender guide to aid you, maneuvering is a lot easier. An ordinary fender guide is adapted for this purpose by sol-

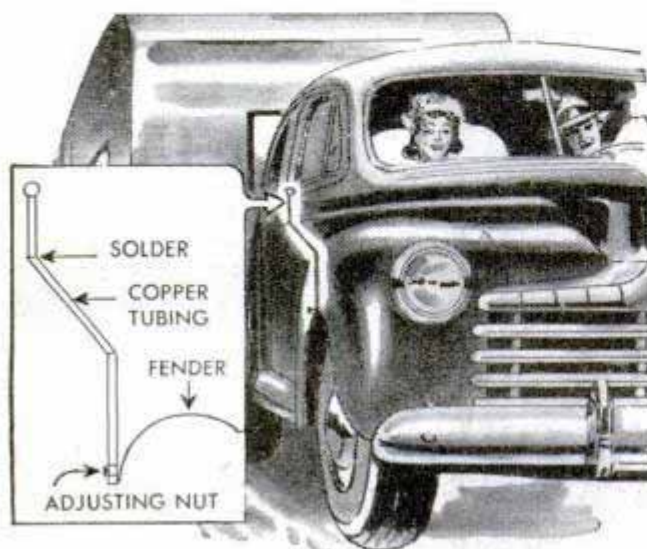

dering it to an offset piece of copper tubing. When not towing the trailer, loosen the adjusting nut and set the guide parallel with the fender.

Harold J. Reine, Tucson, Ariz.

Improved Bolt-Thread Cleaner

Rusted or dirty threads on bolts and pipe can be cleaned with this improvised tool, which consists of a collar cut from a length of pipe and four pointed screws that have knurled heads. The collar is drilled and tapped for the screws which are spaced equidistantly around the circumference. To use the device, slip the collar over the bolt and adjust the screws to fit in the bottom of the threads. Then use it like a threading die.

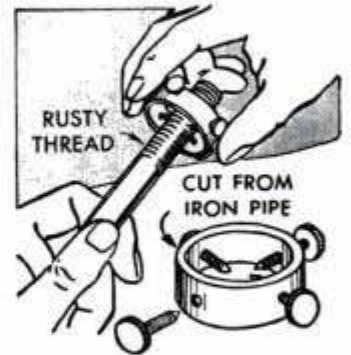

Sagging Floors Levelled Easily With Iron-Pipe Jack

It is a simple matter to level sagged floors with this inexpensive jack, which may be left in place as a permanent support. The jack is nothing more than a length of heavy pipe having a steel plate welded to the lower end, and a screw assembly fitted at the upper end. The screw assembly consists of a nut large enough to rest on the end of the pipe and a stud bolt. A plate is welded to the bolt after turning on the nut. Holes through the plate take screws for attaching it to the joist or beam to be raised. In use, the jack is set in place, the screw plate attached to the joist or beam, and the nut backed off the bolt. This forces the latter upward, raising the floor. If the jack is to be left in place only temporarily, a brick under it will provide sufficient bearing surface. On a permanent installation, a concrete block or a poured concrete footing should be used. If you pour a footing it should be above 12 in. square and 12 in. deep for the average load. For a heavy load increase the size.

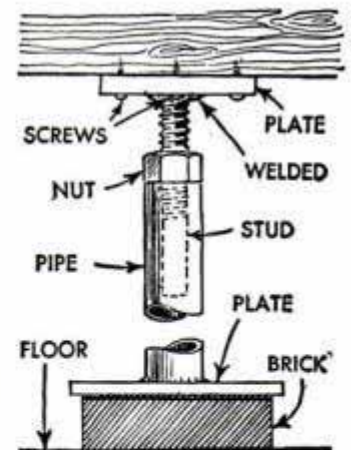

Joseph Roth, Chicago.

Broken Golf Club Is Pen Holder of Novel Desk Set

Don't throw away that broken driver. You can use it to make a novel desk set, which will suit any golf enthusiast to a "tee." The golf-club head, which can be a driver, brassie or spoon, provides the pen holder of the set, while two golf-ball tees form a letter rack. A groove in the base is is for a pencil. First, saw off the broken shaft at the head and smooth the cut with a fine file; then bore a hole into the shank. This hole should be made to fit the desk pen to be used and should be drilled deep enough to prevent the pen point from touching the bottom. A generous application of shellac to the hole will keep the wood from absorbing ink.

If the club head is scarred badly, remove the old finish, fill any nicks with plastic wood and rescore the original grooving in the face of the head. Then stain the whole thing, except the face, and apply two coats of shellac or clear lacquer. Attach the head to a $\frac{3}{4}$ -in. walnut or mahogany base in the position shown, using two flat-

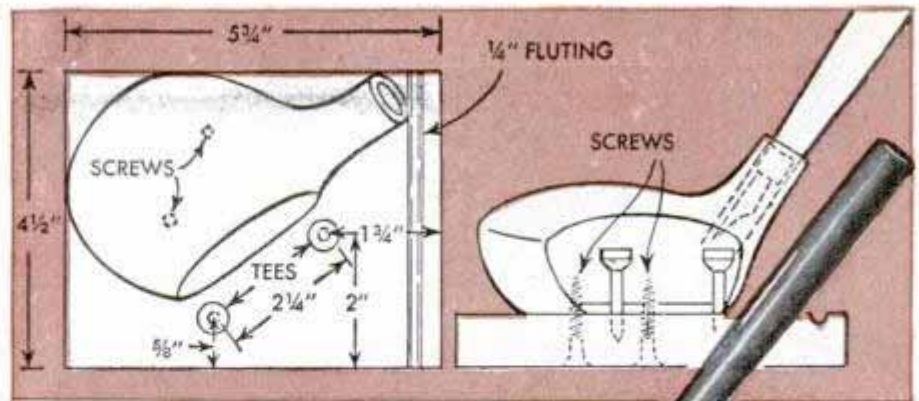

head screws, driven from the underside. The tees are forced into undersize holes, and the bottom of the completed set is covered with a piece of felt.

Walter Burton, Akron, Ohio.

Non-Slip Glides of Sponge Rubber Keep Chairs Away From Wall

To prevent chairs and other pieces of heavy furniture from sliding on bare floors around rugs, casters can be made of

sponge-rubber balls that will hold the furniture in place. Remove any metal domes or casters from the chairs and fasten half of a ball to each leg with a wood screw and washer. Sink the screwheads deeply into the rubber so they will not mar the floor.

Joseph B. Moses, Blacksburg, Va.

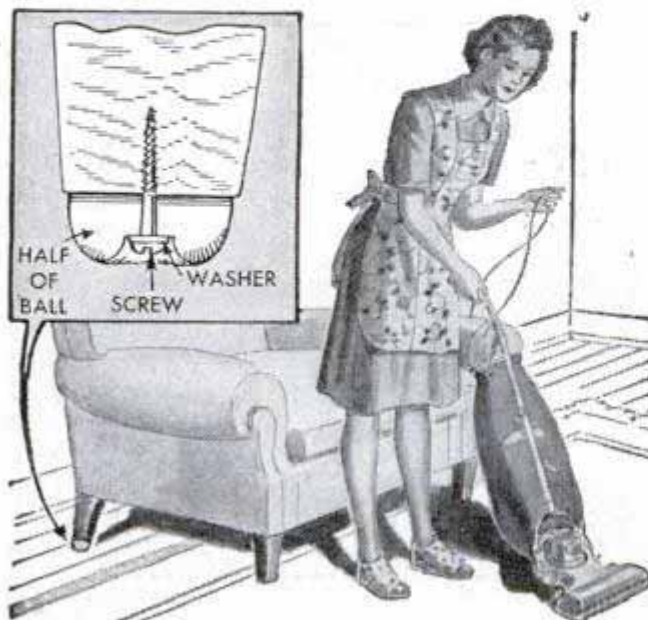

Rubber Bands Protect Dry Cells

When flashlight dry cells are placed in a drawer or stored elsewhere, there's always the chance that they may become short circuited by touching metal articles in the same compartment. As a precaution, stretch a wide rubber band over the contacts or ends of each cell as indicated to prevent "shorts."

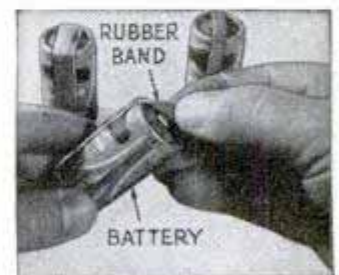

COPY IT "CANDIDLY"

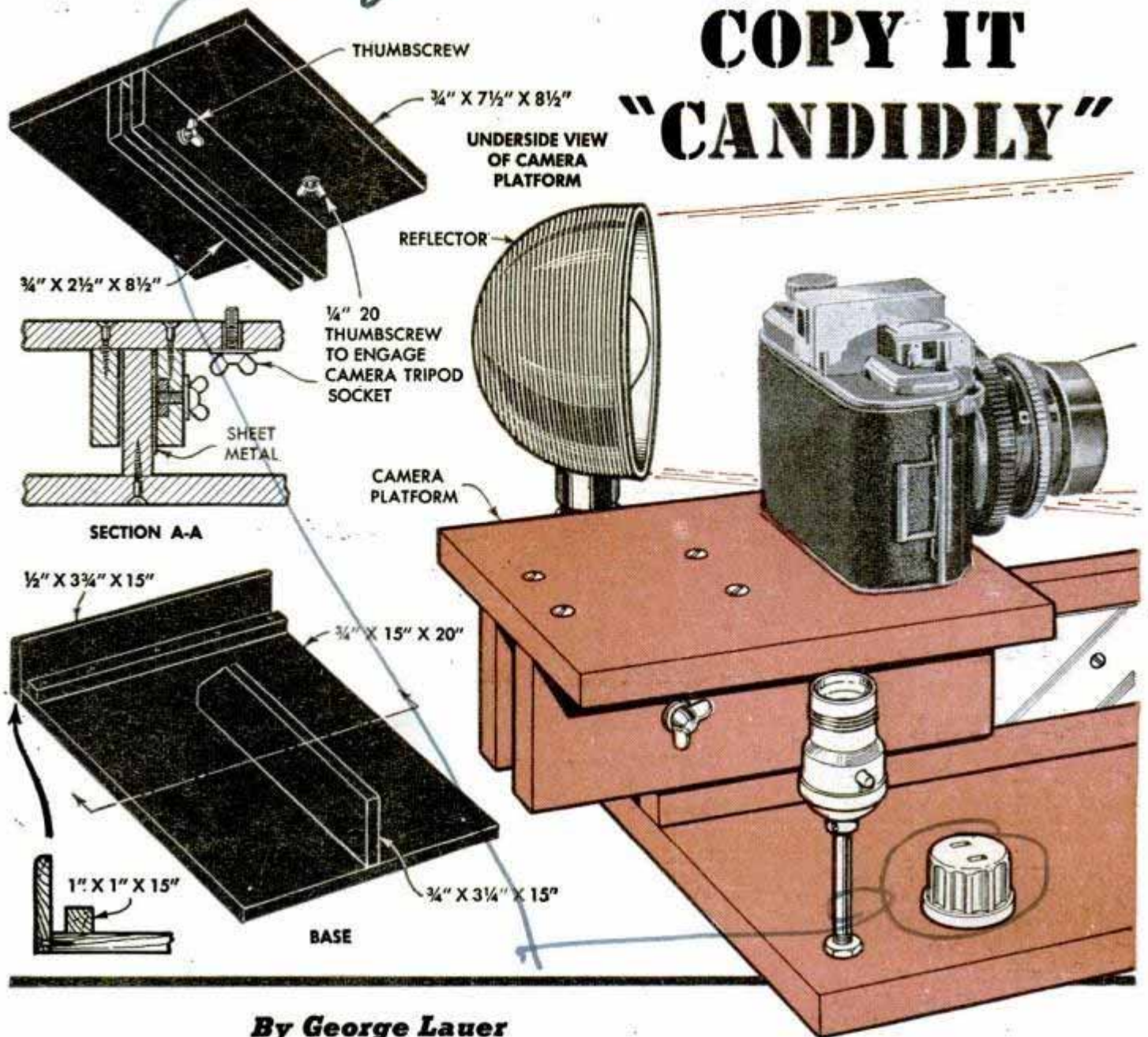

By George Lauer

SUBJECT DISTANCE AND APPROXIMATE PICTURE SIZE FOR ROLL-FILM CAMERAS WITH SUPPLEMENTARY LENSES

Distance in inches between subject and lens

Approx. size of negative	Average focal length	2+ portrait lens (focal length: 19 $\frac{3}{4}$ in.)		3+ portrait lens (focal length: 13 $\frac{3}{8}$ in.)	
		Camera focused at inf. Subject distance 19 $\frac{1}{2}$ in.	Camera focused at 3 $\frac{1}{2}$ ft. Subject distance 13 $\frac{3}{8}$ in.	Camera focused at inf. Subject distance 13 in.	Camera focused at 3 $\frac{1}{2}$ ft. Subject distance 10 in.
1 x 1 $\frac{1}{2}$ inches 24 x 36 mm.	50 mm.	9 $\frac{3}{8}$ x 14	6 $\frac{1}{8}$ x 9 $\frac{1}{4}$	6 $\frac{1}{4}$ x 9 $\frac{3}{8}$	4 $\frac{1}{2}$ x 6 $\frac{7}{8}$
1 $\frac{1}{8}$ x 1 $\frac{9}{10}$ inches 28 x 40 mm.	50 mm.	10 $\frac{7}{8}$ x 15 $\frac{1}{8}$	7 $\frac{1}{8}$ x 10 $\frac{1}{8}$	7 $\frac{1}{4}$ x 10 $\frac{3}{8}$	5 $\frac{1}{4}$ x 7 $\frac{1}{2}$
1 $\frac{1}{2}$ x 2 $\frac{1}{4}$ inches 4.5 x 6.0 cm.	75 mm.	10 $\frac{5}{8}$ x 14 $\frac{3}{4}$	6 $\frac{3}{8}$ x 8 $\frac{7}{8}$	7 $\frac{1}{8}$ x 9 $\frac{7}{8}$	5 x 7
2 $\frac{1}{4}$ x 2 $\frac{1}{4}$ inches 6.0 x 6.0 cm.	75 mm.	14 $\frac{3}{4}$ x 14 $\frac{3}{4}$	8 $\frac{7}{8}$ x 8 $\frac{7}{8}$	9 $\frac{7}{8}$ x 9 $\frac{7}{8}$	7 x 7
2 $\frac{1}{4}$ x 3 $\frac{3}{4}$ inches 6.0 x 9.0 cm.	100 mm.	11 $\frac{1}{8}$ x 16 $\frac{1}{8}$	6 $\frac{7}{8}$ x 10	7 $\frac{1}{2}$ x 10 $\frac{3}{4}$	5 $\frac{1}{4}$ x 7 $\frac{1}{2}$

Eastman Kodak Co.

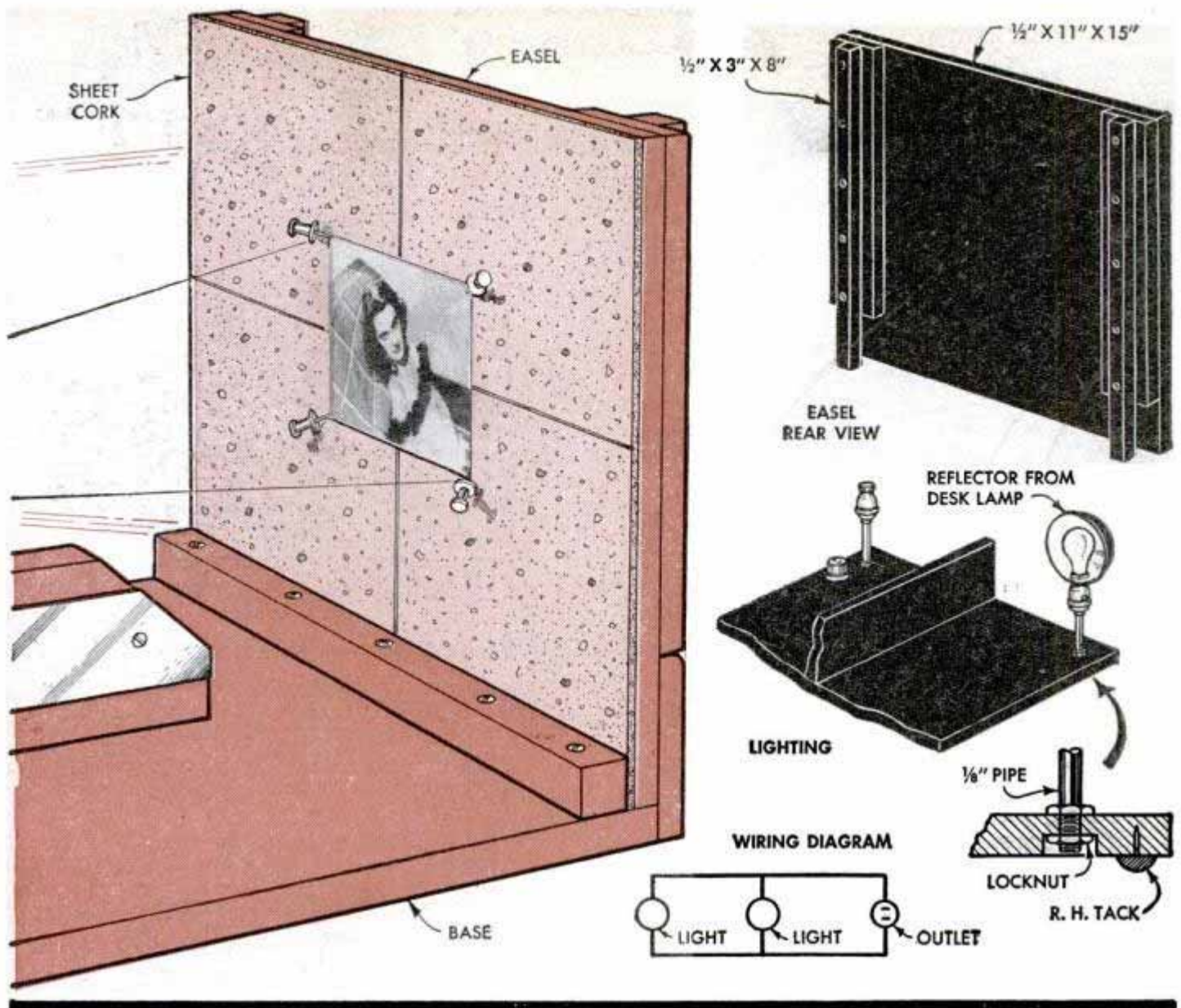

A SMALL CAMERA of the folding or candid type not fitted with a ground glass can be used for copying by mounting the camera on a firm support and fitting it with a supplementary lens. For this work the support should be a self-contained unit consisting of lights, camera platform and easel mounted on a rigid base. As in the details left to right above, the platform, base and easel should be cut from plywood to the size and thickness given. All other wood parts, platform guides, cleats and spacers are of straight-grained solid stock. The center member of the platform guide, section A-A, is glued and screwed to the base, and is fitted with a sheet-metal bearing plate, as shown, to take the end of a thumbscrew.

The easel is made so it can be removed. It has $\frac{1}{8}$ -in. sheet cork glued to the face side for mounting the print to be copied. Horizontal and vertical pencil lines aid in centering the print. Lighting units are duplicates, each consisting of a short length of $\frac{1}{8}$ -in. pipe, threaded at both ends, a con-

ventional light socket and a desk-lamp reflector of the screw-on type. The lamps are wired as detailed in the wiring diagram. Use an extension cord with a feed-through switch to control the lights, or operate each at the socket.

A data table supplied with the supplementary portrait lens gives the relative picture size in inches covered by the lens at given distances. If you know the focal length of your camera and the size of the negative, it's easy to determine the distance from the supplementary lens to the subject, as well as the size of the area in inches covered by the lens at that distance. For example, reading from the sample table at the left, if the negative size is 1 by $1\frac{1}{2}$ in. and focal length of the camera lens is 50 mm., then, with a 2+ portrait lens attached and the camera focused at $3\frac{1}{2}$ ft., the distance from lens to subject (photo or other copy mounted on the easel) will be $13\frac{3}{8}$ in. and the area covered at that distance $6\frac{1}{8}$ by $9\frac{1}{4}$ in. Distance from lens to subject must be measured carefully.

Worn Door Hinges Are Repaired By Using Small Washers

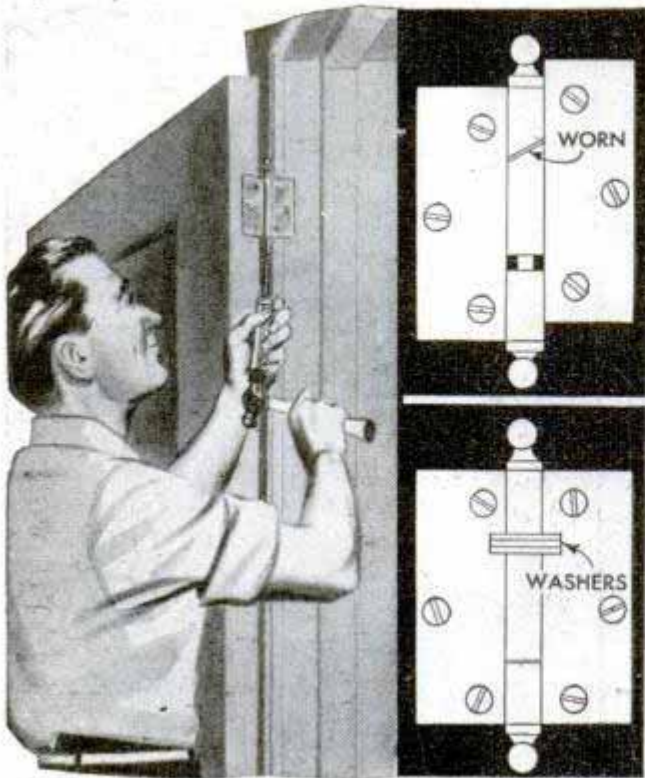

On door hinges carrying a heavy load the pin sleeves eventually become worn something like those shown in the exaggerated upper detail. To repair, remove the hinge, separate the halves and file the ends of the sleeves square. When replacing, shim the parts with small washers as shown in the lower detail.

Hacksaw Blade Perforates Paper



Here is an easy way to perforate paper so that it can be torn from a pad. Place the pad on a hard surface, such as a wooden cutting board, and set a hacksaw along the line to be scored. Then strike the blade with a hammer to produce the perforations. Only a few sheets can be scored at a time.

Slotted Wrench for Wing Nuts

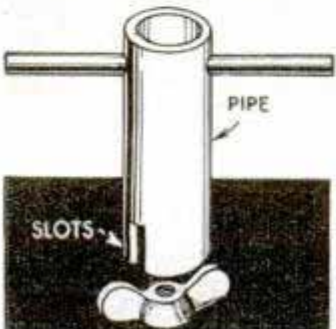

A slotted-end wrench like this one will take care of tight wing nuts in inaccessible places. The body is made from a section of $\frac{3}{4}$ -in. pipe slotted at one end and drilled at

the other end for a $\frac{5}{16}$ -in. handle, 6 in. long. The slots should be about 1 in. deep to fit over the wing nut.

Asphalt Shingles Cemented at Edge To Prevent Loosening by Wind

Should the wind loosen asphalt shingles at the ends of gables, the individual shingles can be anchored securely with roofing cement applied to the underside of the exposed portions. This can be done when laying a new roof or on shingles already laid. In the latter case apply the cement only along the lower edge.

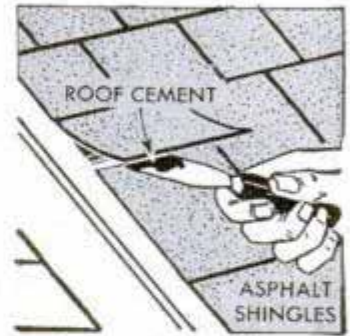

Socks Protect Shoes in Suitcase

If traveling on a vacation or for business, you'll find it handy to have an extra pair of socks for covering shoes carried in the suitcase. This will protect clothing and do away with the necessity of wrapping the shoes in a bulky parcel.

Robert S. Martin, Iowa City, Iowa.

Covered Wire in Plastic Lamp Has Neater Appearance

When making electric lamps that have transparent standards, a better looking job will result if the wire is covered in some manner. One way to do this is to slip white plastic covering over the wire and then run this through the standard. The covering keeps the wire straight.

Leslie K. Prescott, Newport, N. H.



DARKROOM SWITCH BOX

By Henry Hanscom

This unit groups all darkroom lighting switches on one panel and speeds up both darkroom and photographic work by supplying finger-tip control to all lighting circuits. The unit is designed for table use or wall mounting, and is easily portable for photoflood lighting as well. Outlet mounting brackets are inverted to allow each outlet to fit flush with the top of the box. Brackets are placed at an angle to conserve space. Three different kinds of switches are used so that each can be readily identified.

Wiring is done according to the diagram before the box is completely assembled. The line wire is brought into the box through a flexible-conduit connector, which is fitted with a wood reducing plug made by drilling and slotting a length of dowel. A porcelain or rubber bushing also can be used. Solder and tape all connections.

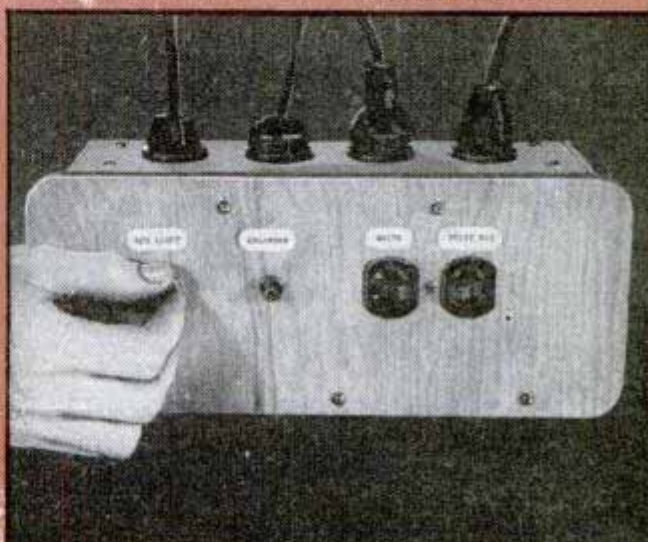
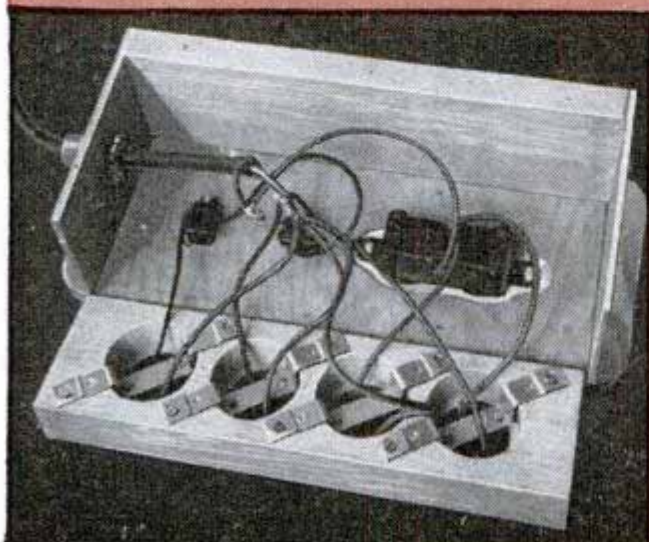
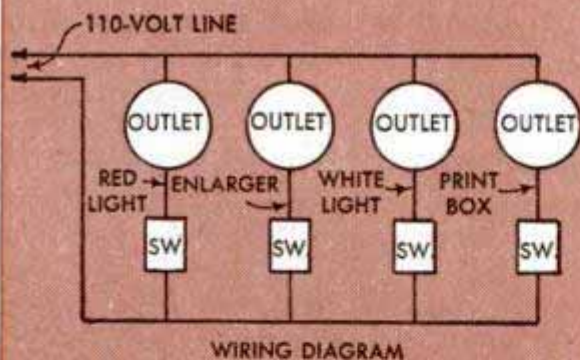
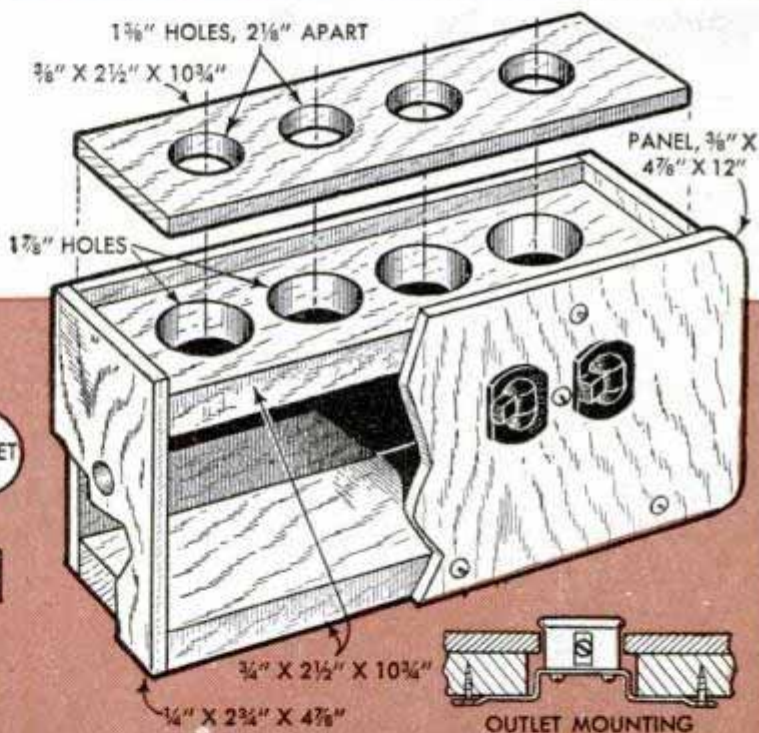

Cloth Bag Tied Over Bottle Neck Filters Photo Solutions



Large bottles of hypo solution or similar photographic chemicals can be filtered as they are poured by simply tying a cloth mailing bag or a clean tobacco sack over the mouth of the bottle. The drawstring provided with the bag will serve to tie it. When enough solution has been poured, empty the chemical that has been filtered into a clean bottle and wash the bag.

Way to Control Water Temperature



If you have a mixing faucet in your darkroom, you can control water temperatures within close limits by inserting a dial thermometer in the faucet. Drill a hole near the end so that the rod element will slip through and be covered with water for a distance of about 2 in. when the faucet is turned on. A rubber grommet on the rod will hold the thermometer in place. Because this type of thermometer changes quickly, regulation of water temperature can be fairly exact.

Leonard Hart, Chicago.

Improved Photographic Spotting

Because of the relatively high surface tension of enlarging paper, it is difficult for spotting colors to penetrate the emulsion. Instead, the color gathers in globules

and is not deposited uniformly. To correct this condition, mix a few drops of commercial wetting agent with the color to reduce surface tension and it will spread more evenly.—Henry Zave, Chicago.

Camera-Cable Release Reinforced

Sharp bends will be less likely to "kink" a camera-cable release if the part next to the operating button is given one or two coats of fingernail polish. This reinforces the cable housing at the point where there is the most strain. On cloth-covered releases, the polish also will prevent wear caused by rubbing and twisting.



Handle on Photoflood Reflector Prevents Burned Fingers

A wooden handle from a coffee percolator can be attached to a photoflood reflector and thus make it safe to adjust the reflector when hot. Usually

the handle can be purchased with mounting screws so that it's necessary only to drill two small holes near the rim of the reflector to fasten the handle in place.—H. Leeper, Canton, Ohio.

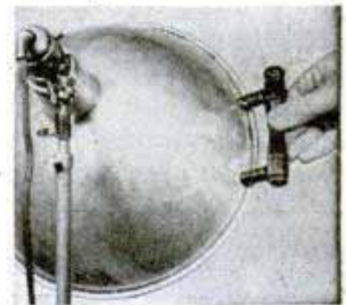

Reinforcing Cap of Battery Case

Battery cases for many synchronized flash units are supported by means of a bracket bolt that passes through the cap at the bottom of the case, and often the latter becomes bent out of shape. To reinforce the cap and prevent this, solder an iron or brass washer to the inside. Then the case may be screwed tightly to the supporting bracket and will not get out of line.

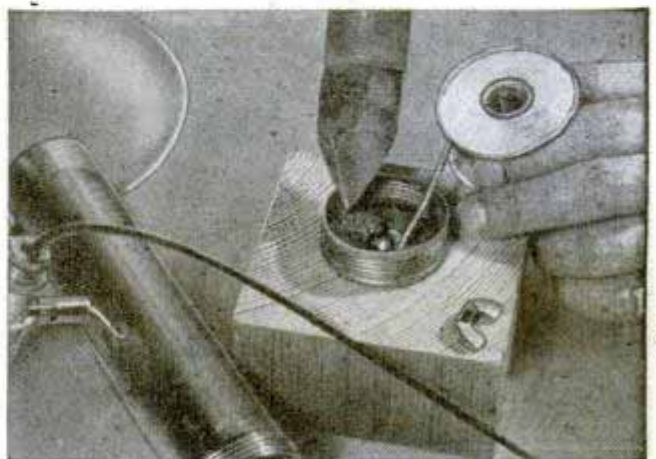

CRAFT QUIZ



1. When this is necessary, you—
 (a) Remove faucets (c) Plug overflow
 (b) Turn off water (d) Look at meter



2. This dado-head cutter is—
 (a) Swage set (c) Hollow ground
 (b) Rabbeted (d) Spring set

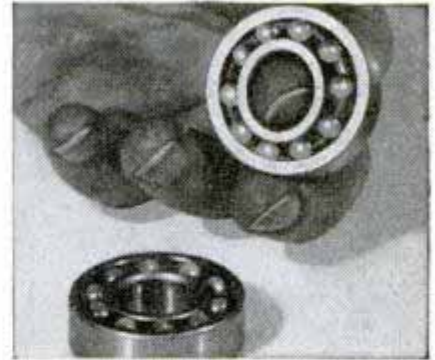

3. Bearing shown here is—
 (a) Radial (c) Thrust
 (b) Self-sealed (d) Roller



4. Novelty coaster set uses—
 (a) Multiple thread (c) Split turning
 (b) Flutes (d) Splines

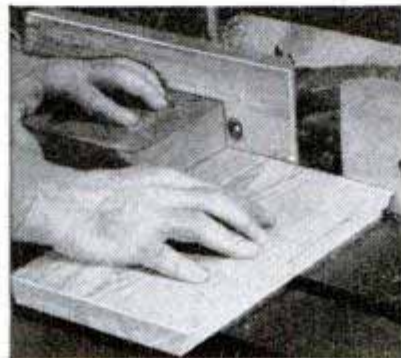

5. Wrong in this job is—
 (a) Order of cuts (c) Hands
 (b) Fence (d) Push block



6. This saw has a—
 (a) Swing splitter (c) Offset center
 (b) Depth stop (d) Fixed splitter



7. He is using a—
 (a) Strike board (c) Spiling board
 (b) Kingpin (d) Edger

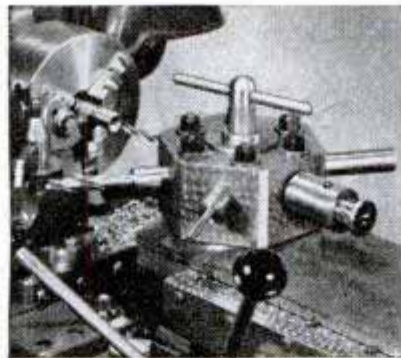

8. Lathe setup shows a—
 (a) Milling table (c) Die head
 (b) Tailstock turret (d) Bed turret

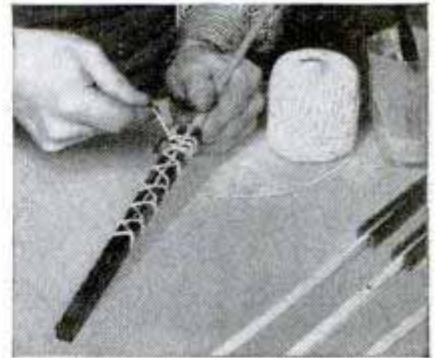

9. He knows his—
 (a) Veneers (c) Beefwood
 (b) Rudders (d) Acrylics

ANSWERS: 1—c (force cup is not effective unless water overflow is plugged with rags); 2—a; 3—a; 4—c; 5—a (end grain cut will splinter side cut previously made); 6—a; 7—a; 8—d; 9—c (wood used in arrow-making); 10—c; 11—d (thread chasing with hand tool)



10. Stain maker is using—
 (a) Litmus paper (c) Filter paper
 (b) Wax paper (d) Tracing paper



11. He is all set to do—
 (a) Firing (c) Reeding
 (b) Shaping (d) Chasing

Clothes Rack Attached to Wall Saves Floor Space

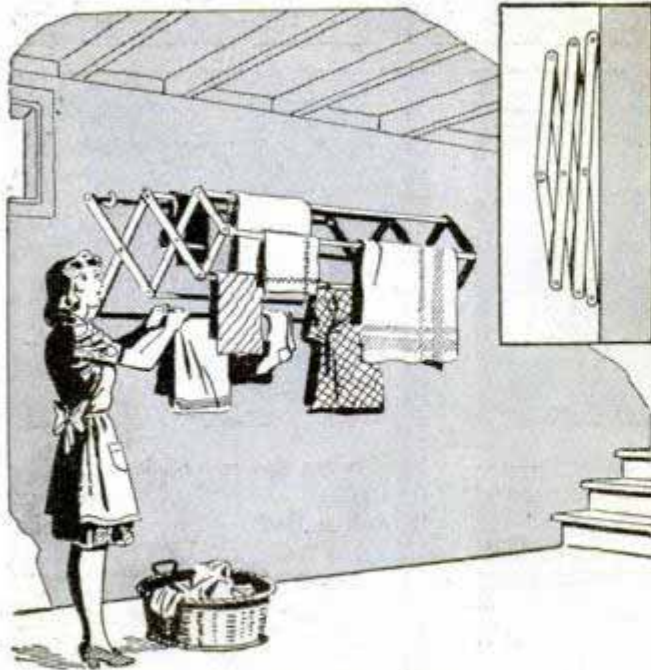

Ordinarily set on the floor, a folding-type clothes rack can be mounted on a kitchen or basement wall so that, when in use, it's difficult for small children to reach the clothes and, when folded, it takes little space. One lower bar of the rack fastens to screw hooks that are set in the wall. Locate the rack as high as conveniently possible to take full advantage of the warmer air near the ceiling.

Nicholas Cappella, Waterbury, Conn.

Drawing a Five-Pointed Star

In laying out a five-pointed star, first draw a straight line to represent the width of the star and divide it into eight equal parts as in step 1. Then strike intersecting arcs from each end of the line with a compass, step 2. Next, adjust the compass to strike an arc through the fifth division

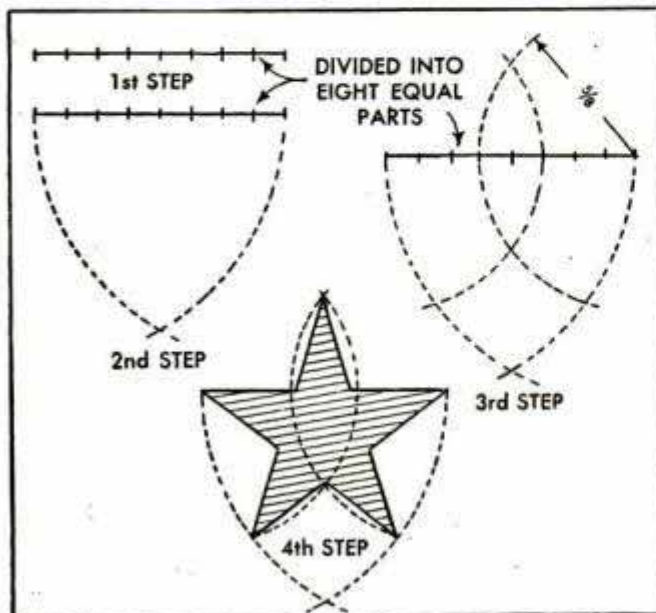

mark from each end, step 3. This establishes the five points of the star. Connect these with straight lines, step 4.

Molding Around Kneading Board Retains Excess Flour

To keep flour from being brushed or otherwise worked off the kneading board onto the table or floor when making bread or pastry, attach strips of molding around the edges of the board. The molding is glued and screwed to the board in such a manner that it will form a trough. It's best to use a waterproof glue because the board will have to be washed often.



Safe Shipment of Glass Jars



Often people find that glass jars of food which they thought were well packed have been broken in shipment. One way to protect such containers is to place them in tin cans that are several

inches larger and pack paper around the jars. Handled in this way, the glass will not be broken easily.

Jack Dempsey, Seattle, Wash.

Pipe Cleaner Used as Lighter Wick

As a substitute for a standard wick, a pipe cleaner can be used in some cigarette lighters. Coil the cleaner inside the windshield and insert the end in the wick hole. It will be necessary to shorten the cleaner. Be sure not to obstruct the small holes in the shield when coiling the wick.—Eugene S. Darlington, New Orleans, La.

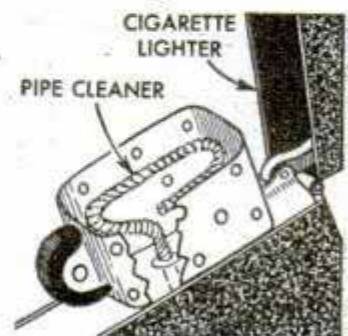

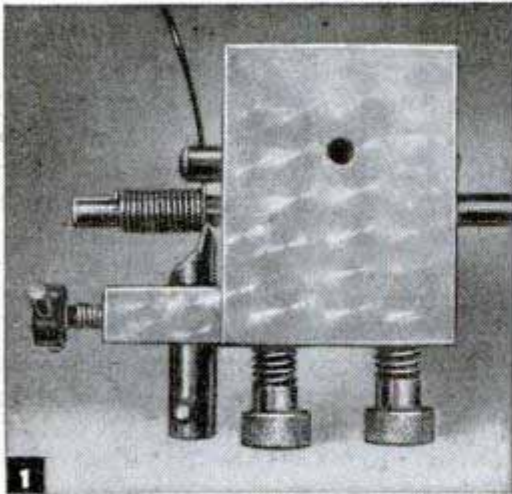

1 Above: Relative position of pitch guide and wire when winding a tension spring, and below, setup for compression spring

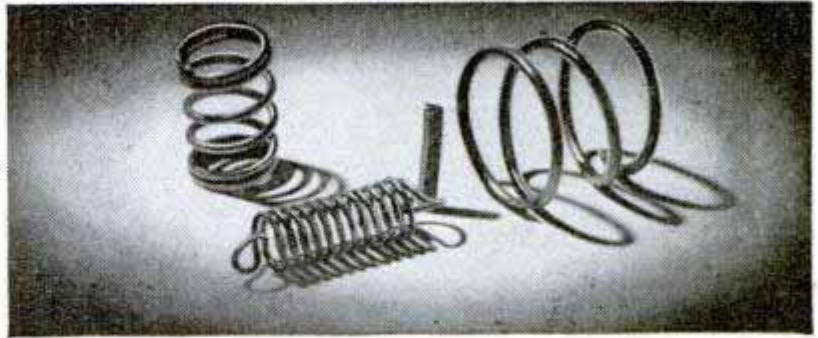

SPRINGS

Wind Them Yourself

By E. F. Bowley

Ranging in size from approximately $\frac{1}{8}$ to $\frac{3}{4}$ -in. outside dia., tension or compression springs of almost any pitch can be made with this winder. Construction of the tool is simple and requires only two pieces of steel bar stock for the body, some rods and several cap screws. Fig. 3 gives the necessary dimensions for the body, which is composed of a main block and a smaller one for the pitch guide. When drilling and tapping the two pieces, note that the hole for the spring arbor is made large enough to accommodate rods up to about $\frac{3}{8}$ in. in dia. Two

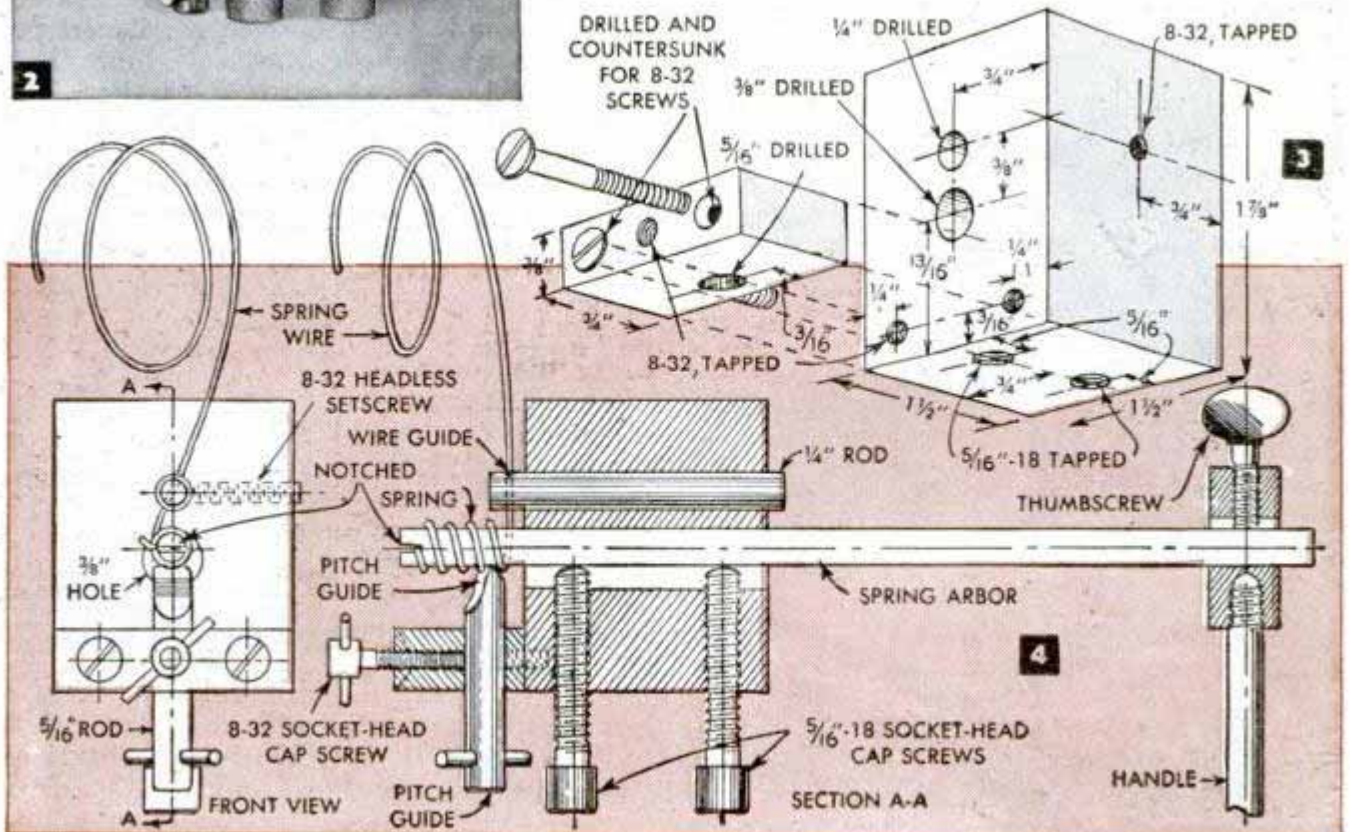
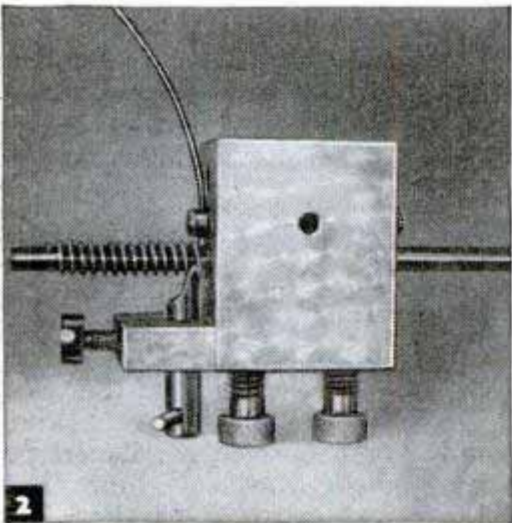

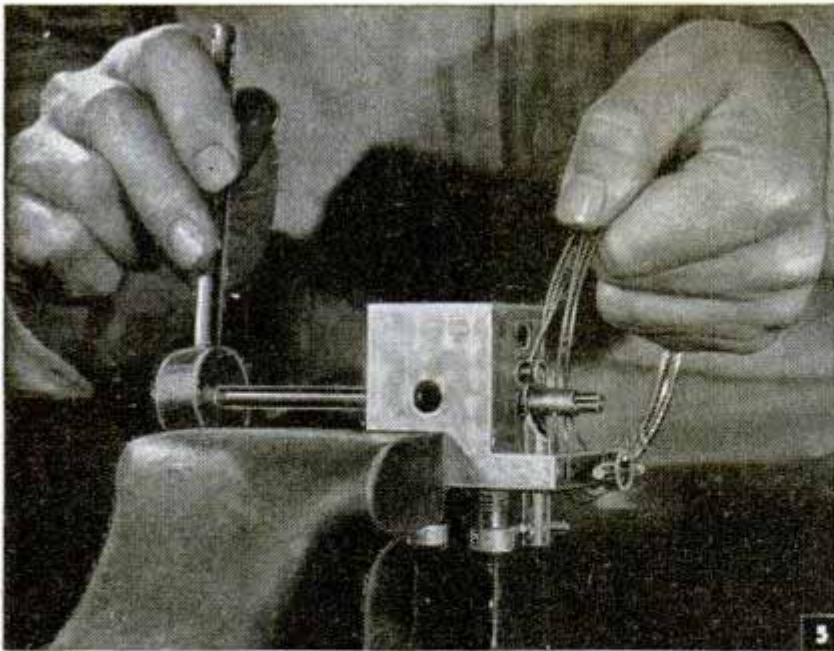

cap screws in the bottom of the body serve to position the arbors. Although the body of the tool is spot finished for appearance, this is not necessary. Lengths of the rods for the pitch guide and wire guide are made to suit. Both rods are locked in position by means of setscrews after being adjusted. The locking screw for the pitch guide is a cap screw fitted with a small pin that serves as a handle to permit easier

adjustment. The end of the pitch guide is ground to the shape indicated in Fig. 4 and it, also, is provided with an adjusting handle. Complete assembly of the tool is indicated in Fig. 4. While no dimensions are given for the spring-arbor handle, it should provide sufficient leverage to turn the arbor against the tension produced by the spring, Fig. 5. Diameters and lengths of the arbors are determined by individual requirements. Some practice in the use of the winder will be necessary before you can produce springs of the exact size you wish to obtain. This is due in part to the fact that the spring will increase in diameter when removed from the arbor, the amount of expansion depending on the type and diameter of wire used to wind them. Fig. 1 shows how the pitch guide presses against the wire for a tension spring and Fig. 2 shows the way the guide is set to wind a compression spring. Pitch of the coils in a compression spring is controlled by twisting the guide to space them as desired.

Lever-Operated "Latch" Helps Keep Fence-Wire Gate Stretched Tautly

If you have a gate made of fencing wire, here's a locking device that will keep it stretched tightly. A U-shaped piece of flat iron is pivoted to the end post of the gate and two holes for the wire loop are drilled

about 4 in. from the pivot holes. A length of wire is passed through these holes and looped over the stationary fence post. The flat iron acts as a lever to tighten the gate when pulled over as shown. If, after a time, the gate tends to become loose, it can be tightened by making the wire loop that slips over the stationary post smaller.

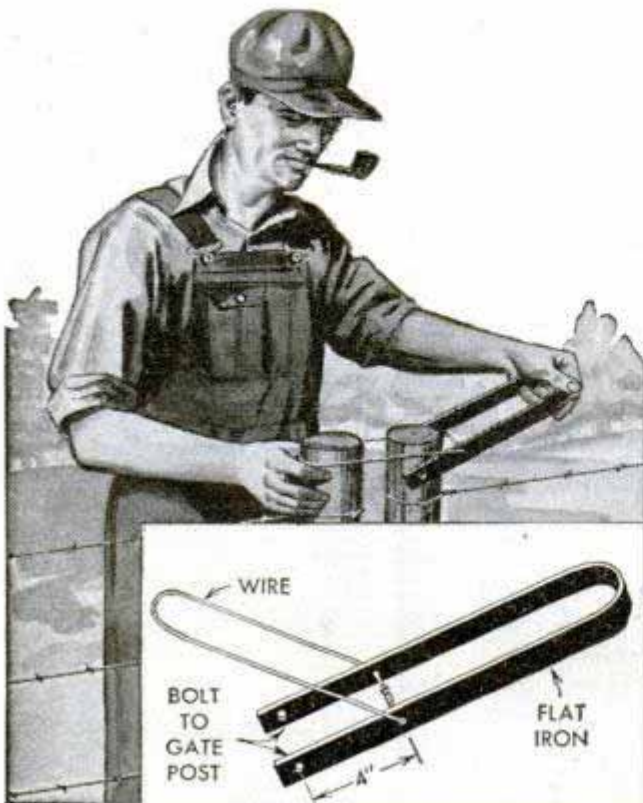

Nail Holds Brush off Commutator When Working on Generator

When working on an auto generator, either to dress the commutator or get at other parts for removal, it's difficult to keep the commutator brushes out of the way, but by slipping a bent nail under the brush holder, it's no trick at all. Although the brush-holding device varies with different types of generators, a nail bent somewhat as shown will be suitable in most cases.

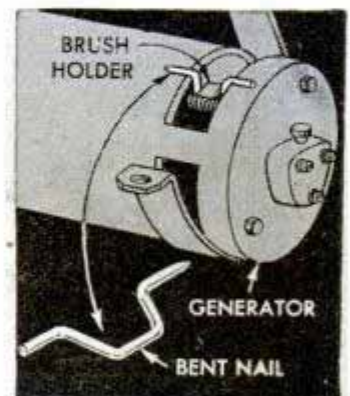

G. H. Enyart, Jackson, Mich.

Double Angle Plate For Tricky Setups

This angle plate has all the advantages of the regular plate plus an additional surface and precision angle, which is parallel with the axis of the lathe when mounted on the faceplate. It's small, as you will see from the dimensions, and can be cast in gray iron from a simple wood pattern, or milled from a block of steel. Any number of clamps for holding the work can be made, but those shown proved satisfactory for a wide range of small work. Pattern of the drilled and tapped holes on the flat surfaces may be made to suit your requirements. After machining, drilling and tapping, the plate is hardened and ground on all flat surfaces.—Edmund L. Johnson, Pittsburgh, Pa.

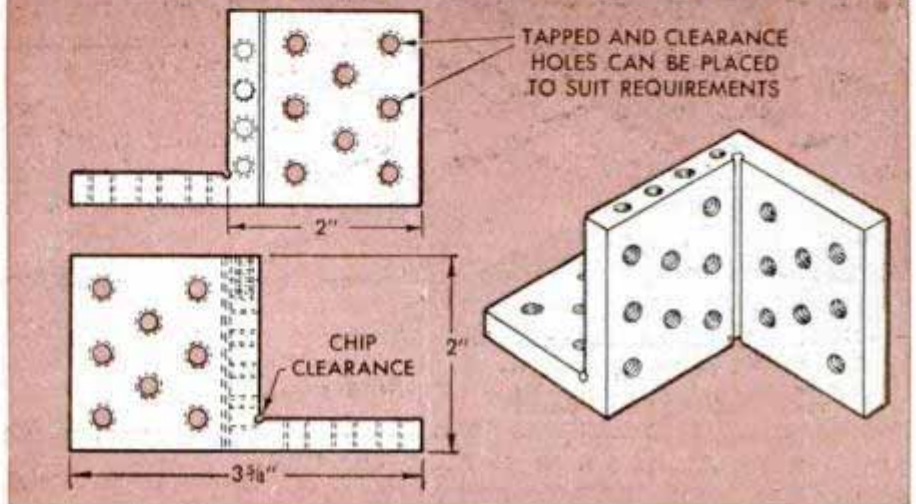
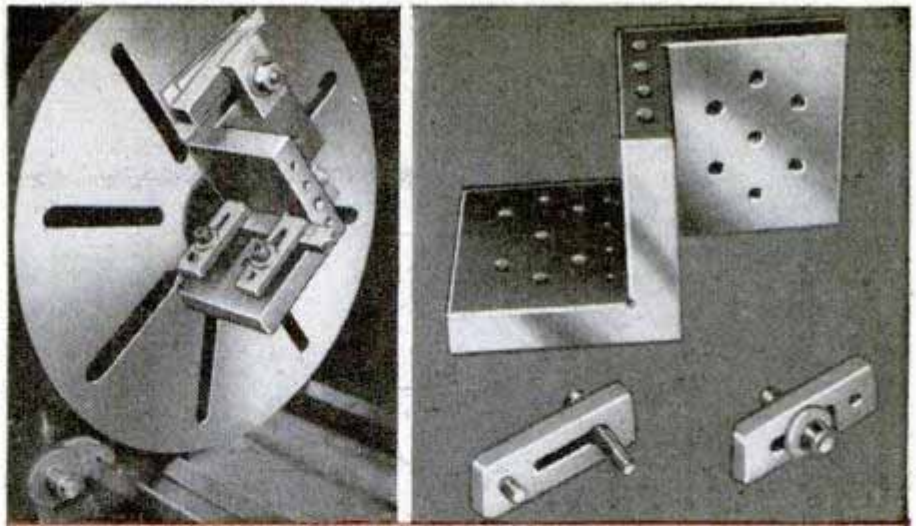

Scoop Made With T-Shaped Handle Cleans Slots In Machine Table

It's difficult to clean chips from T-slots on milling-machine tables and do a clean job, but with this special scoop, the work

can be done in a short time. The detail gives dimensions for the scoop, but these may have to be altered to fit a specific machine; especially the handle, which must be a loose fit in the table slots. To use the device, clean the chips from the slots by using the handle and then pick them up with the scoop. This handy tool can be used on many types of machines.

Harold B. Eastman, Cleveland, Ohio.

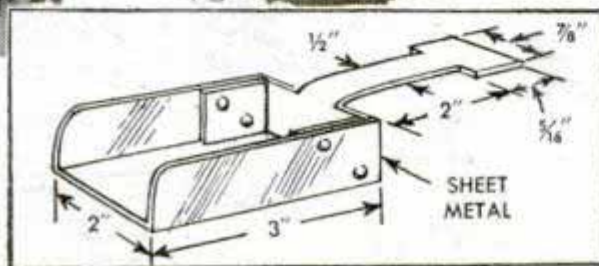
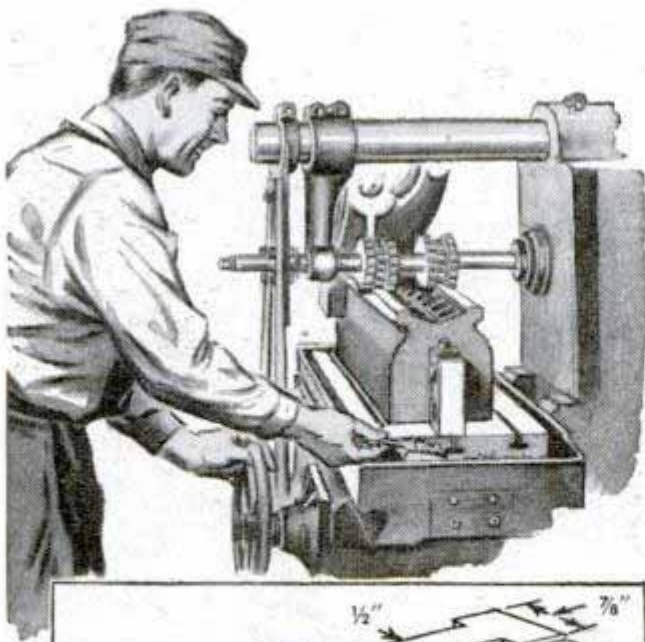

"Gripper Fingers" Hold Small Forms

Printed forms that are too small to be held by the regular grippers on a job press will stay in position when these gripper fingers are used.

They can be formed from light sheet metal cut and bent as shown in the circular detail. Dimensions are governed by the size of the grippers and the size of the forms.—George T. Clayton, Los Angeles, Calif.

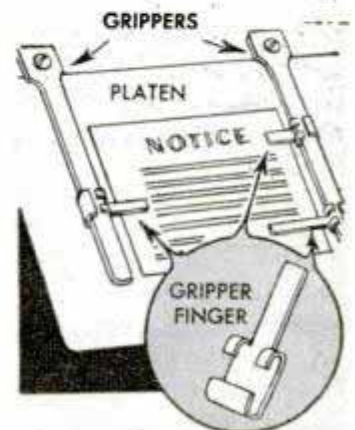

Compass Attachment to T-Square Aids Sign Painter

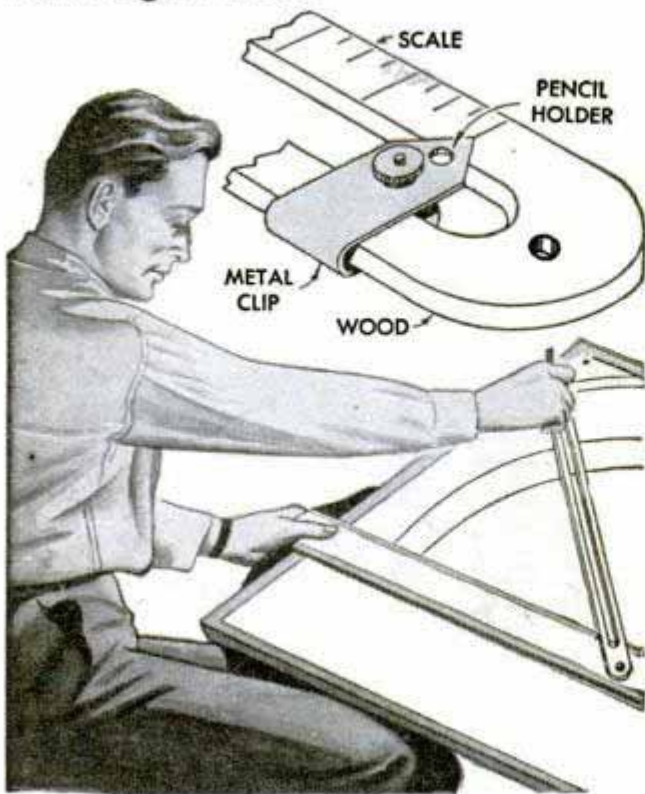

Useful when drawing curved guide lines for lettering, this compass attachment will speed the work of a sign painter. The unit is made of wood and attached to the right-hand end of a T-square. An adjustable pencil holder is used to set different radii on the scale. When not in use, the arm of the compass swings over the T-square out of the way.

Drums Piled on Removable Frames

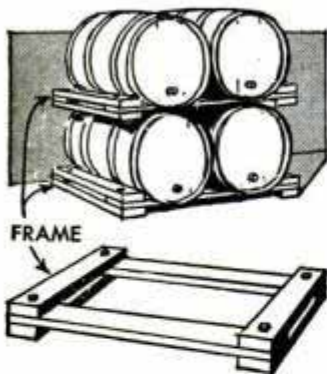

Good use of storage space can be made by using wooden frames on which to stack oil or gasoline drums. The frames are built as indicated in the lower detail and the containers are placed in pairs, piled one on top of the other. Handling drums stored in this manner is comparatively easy. If the dimensions of the frames are altered to fit, any barrel-shaped containers can be stored similarly.

Watertight Fit for Cistern Covers

If it's a tight fit, a concrete cover for a cistern will keep out insects and surface water. One way to insure the proper fit between the cistern and the cover is to spread mortar or cement on top of the cis-

tern wall, lay waxed or waterproof paper on the mortar and set the cover on this. The cover will seat itself in the soft mortar and the paper will prevent sticking until the cement sets.

Paul Criton, Jr., Kayville, Sask., Can.

Prick Punch Has Replaceable Point Made From Phonograph Needle

For fine layout on sheet metal having an easily marked surface, a punch with a replaceable phonograph needle will do excellent work. Take a small punch or scriber and grind down the point, then drill a hole in the end for the needle. The latter should be a tight fit so that it will not drop out. Needles too dull for use on a phonograph will do.

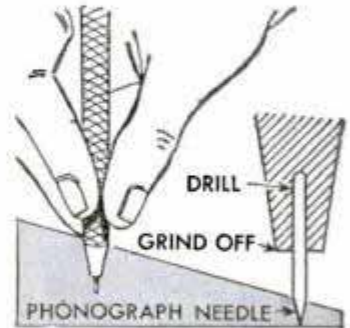

Clarence Klumb, Rockfield, Wis.

Screen-Door Spring Holds Check At Parking-Lot Window

To prevent claim checks from being blown away at the cashier's window, a parking-lot attendant fastened a screen-door spring to the outside of the window ledge. The spring is extended slightly to open the coils for inserting the check. Held in this manner, the check also is easy to reach from the car.

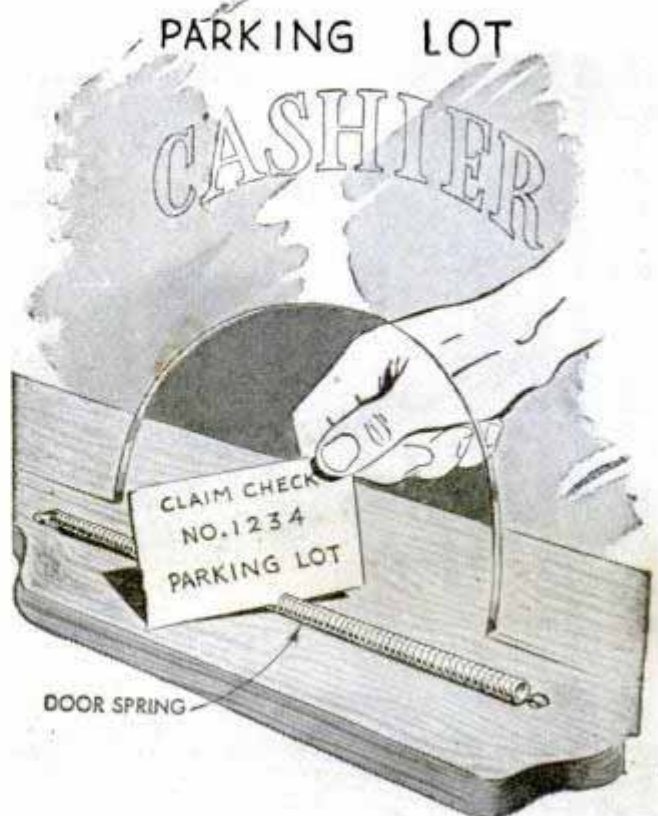

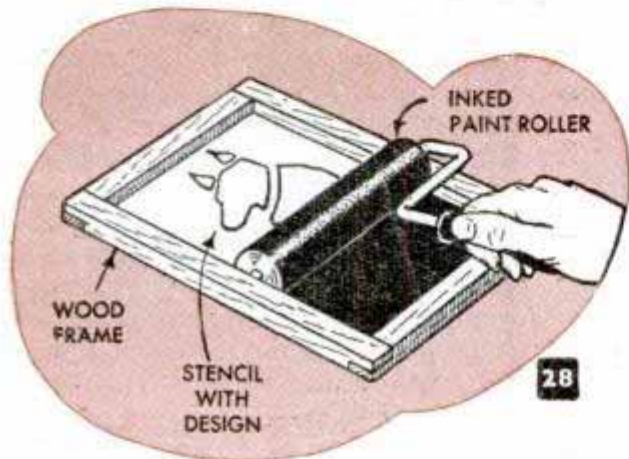
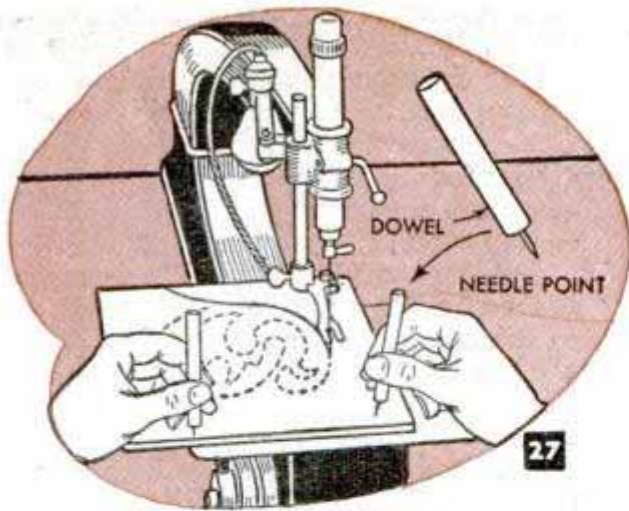

POWER-TOOL SHORT CUTS

Part II

By Kenneth Murray

AS EXPLAINED last month in Part I of this story, simple jigs and fixtures for power tools enable owners of small job shops and home workshops to adapt their machines to a variety of uses. Also, by using suitable jigs, it is possible to do production work on machines not originally intended for such work.

Jigsaw: The crosscut gauge for use on a jigsaw in Fig. 26, and the pivot fixture in Fig. 29 for cutting disks are two good examples. The gauge is one from a circular saw and is turned upside down and used on a jigsaw table as pictured. The pivot fixture is merely a length of flat iron having a point at one end and a slot at the other to straddle a machine screw on the blade-guide assembly. The slot also permits adjustment of the pivot to cut disks of various radii. A pointed stove bolt serves as the pivot. It is important that the pivot be at right angles to the blade teeth so that the latter will not draw to one side.

When cutting intricate scrolls in thin stock, the needle-pointed jigs shown in Fig. 27 will aid in maneuvering the work over a jigsaw table. When duplicating a design on several pieces of work, time can be saved by making a mimeograph stencil of the design, then cementing it to the underside of a light wood frame and using it as a means of transferring the design out-

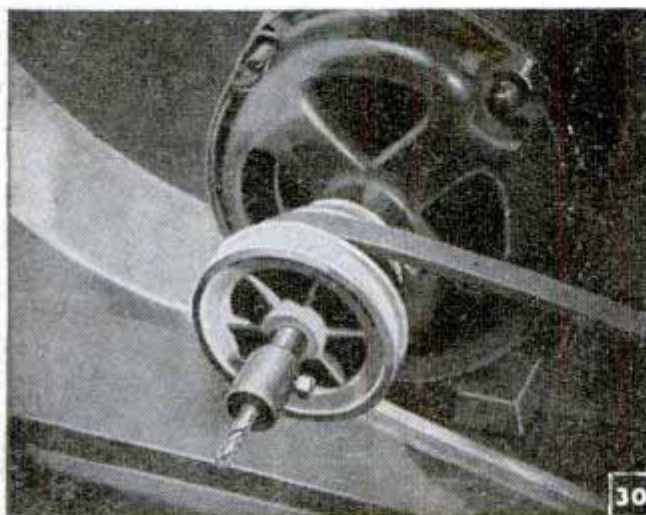
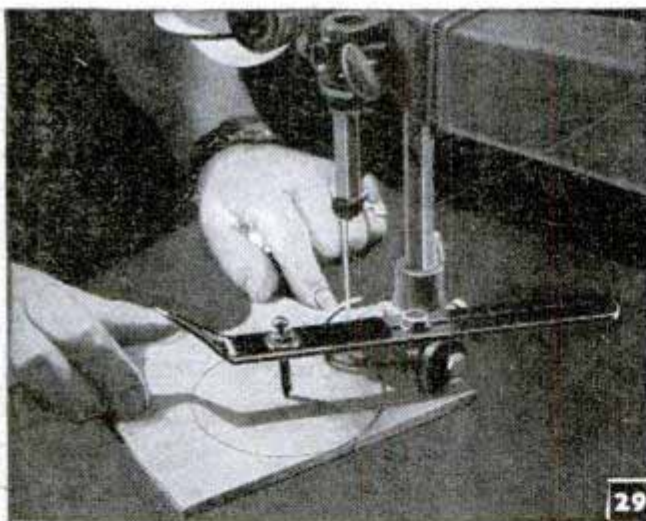

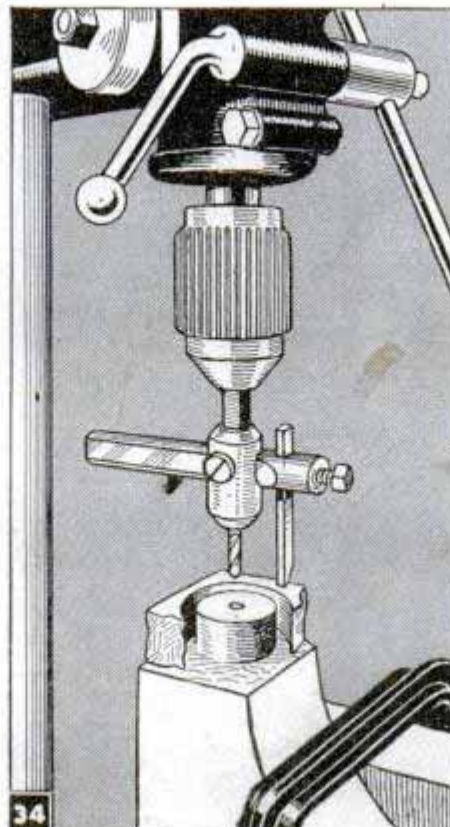
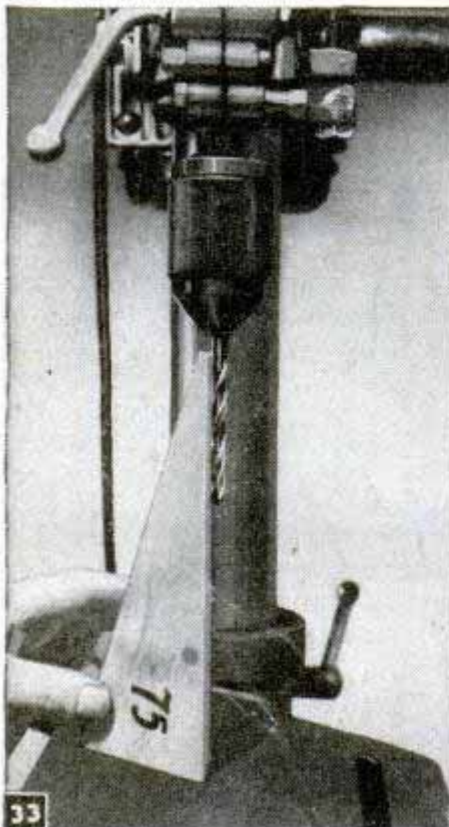
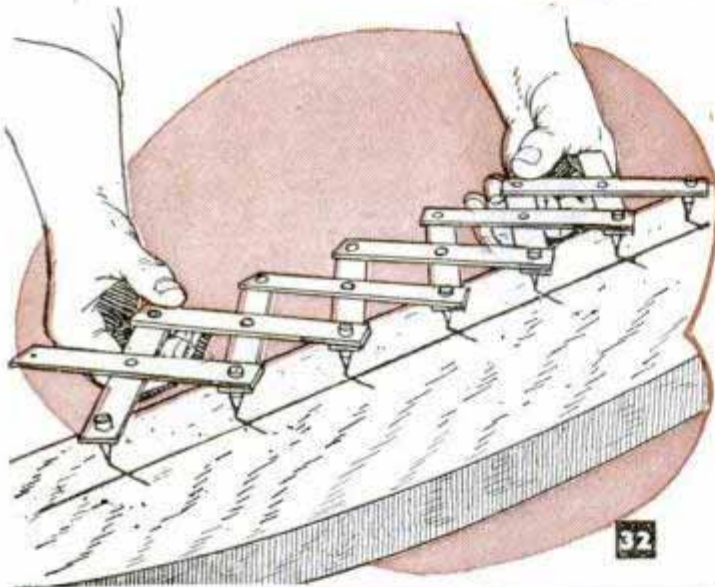
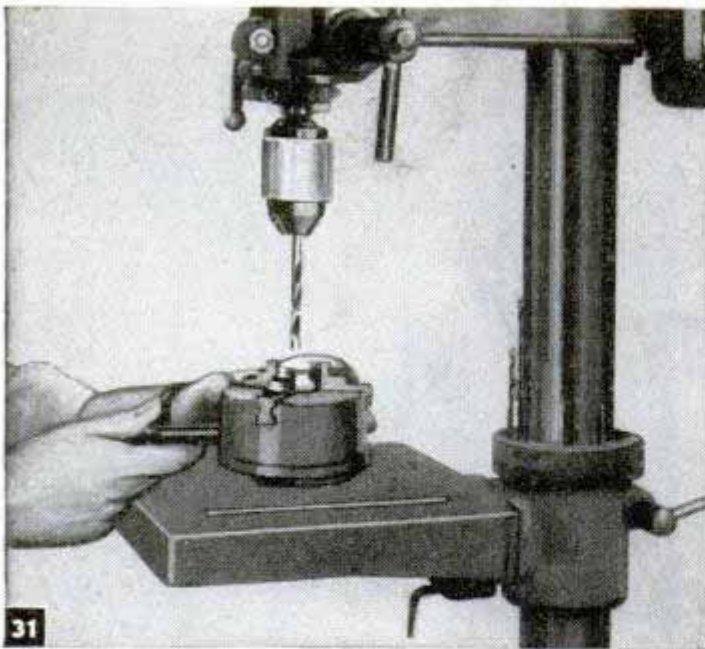

line to the work as indicated in Fig. 28.

Fig. 30 shows a fixture on a jigsaw motor for making starting holes when cutting inside designs. In this case, the fixture was made from a hole cutter by removing the cutter arm and then inserting the cutter-arm holder tightly in the cone pulley on the motor.

Drill press: Likely, few inexperienced operators realize the versatility of this machine when jigs and fixtures are used in connection with it. As an example, lack of a drill-press vise need not be a handicap if a lathe chuck is at hand. It makes a good substitute as shown in Fig. 31, and can be bolted to the table when used on special setups. As a timesaver when laying out equally spaced holes to be drilled, the jig shown in Fig. 32 is hard to beat. It is nothing more than a "lazy tong" having the pivot holes along one side enlarged to take short pencils. A drill press not having a tilting scale can be set accurately by using angle blocks as shown in Fig. 33.

The problem of cutting round tenons on irregularly shaped work is solved by using a hole cutter in a drill press as shown in Fig. 34. Shoulders are cut after the tenon has been formed. If you have experienced difficulty in holding small round work to drill the end, a cam-locking vise like the one shown in Fig. 35 will help. Pulling the handle causes the wood cam to wedge the work tightly against two blocks screwed to a base.

In Fig. 36 the operator, lacking an indexing head for drilling, moved the drill press up to his lathe and used the indexing head on the latter. The jig pictured in Fig. 37 takes all the worry out of drilling holes in mitered frames for starting nails or screws. If you have a job that requires sanding the inner surfaces of rings it can be done quickly on a drill press using a strip of abrasive cloth held in a split dowel, Fig. 38. A wide strip cut from inner tube and snapped around the drill-press table, Fig. 39, provides a non-slip surface for flat work. A mandrel for a variety of cleaning and polishing operations is shown in Fig. 40. It consists of a wood cylinder wrapped with steel wool in the roll form. The cylinder is mounted on a steel arbor and is grooved lengthwise to hold one end of the steel-wool roll, which then is wound onto the cylinder in a direction opposite to that of rotation. No other fastening is required as the wool will quickly mat itself together in use. Always wear goggles when operating this polisher.

Bandsaws: Although bandsaws usually are limited to sawing irregular outside shapes in wood and metal, there are several simple jigs and fixtures that can be made to increase the versatility of these saws. The jig for splitting a dowel, Fig. 41, is just one of many. It is merely a straightedge to which the dowel to be split is nailed at one end. In use, the straightedge is pushed along a fence. Such a jig is

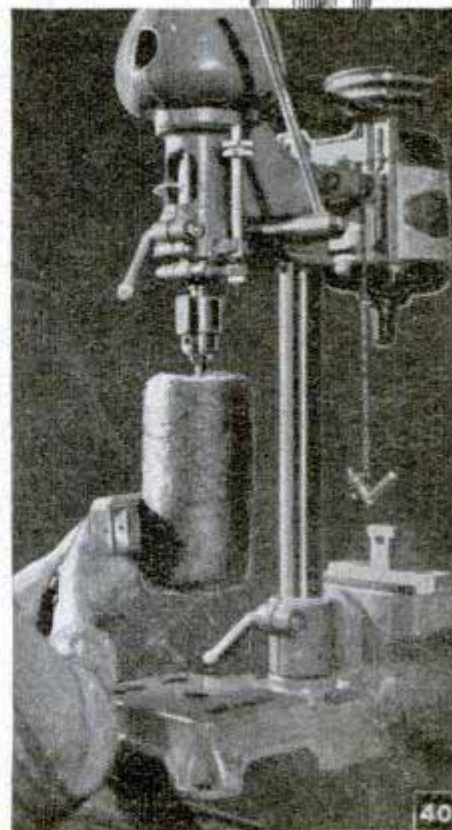
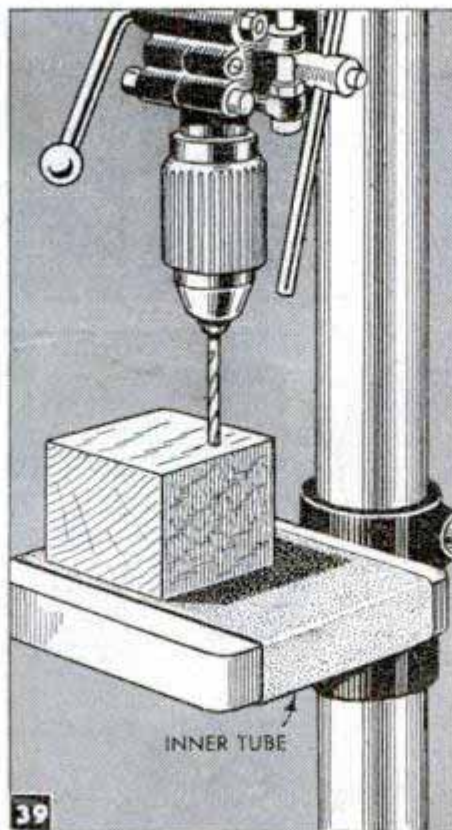
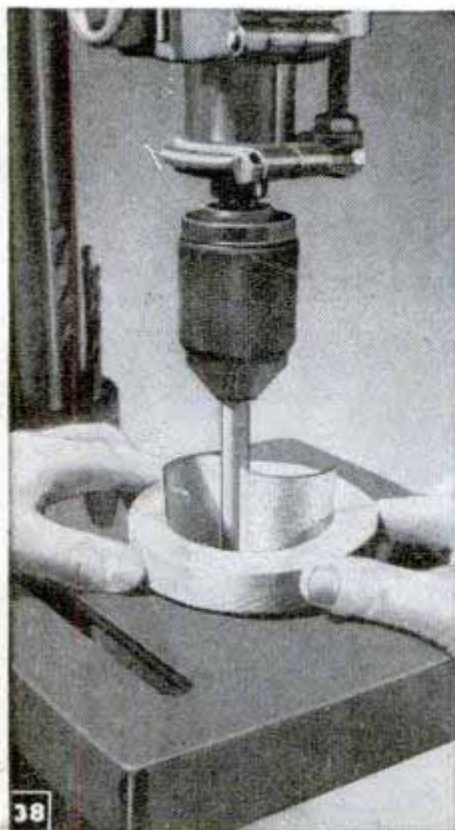
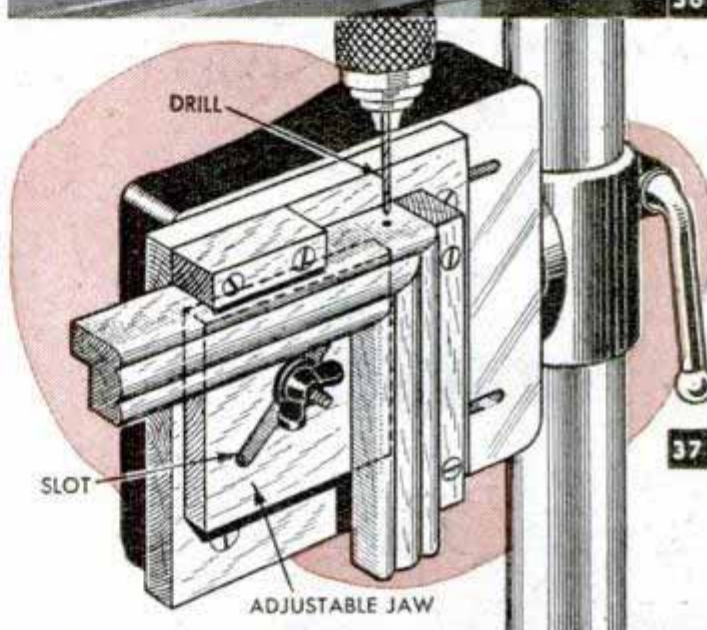
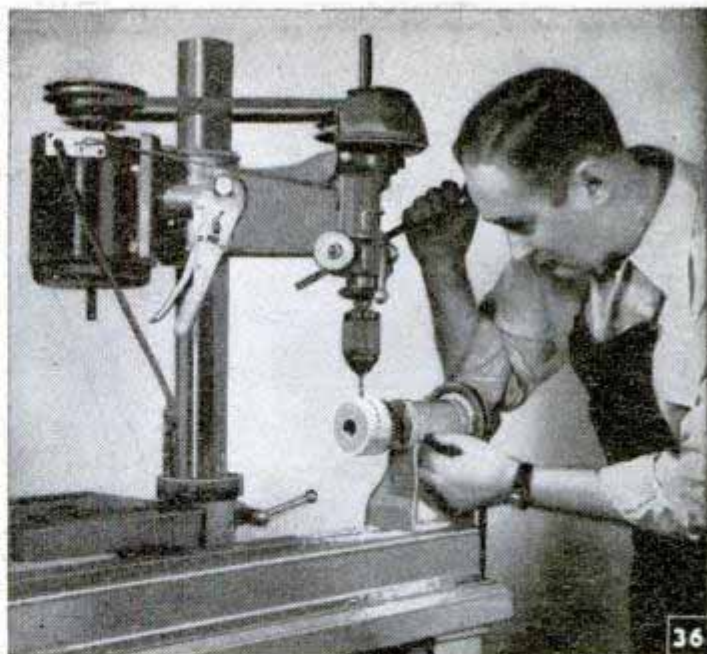

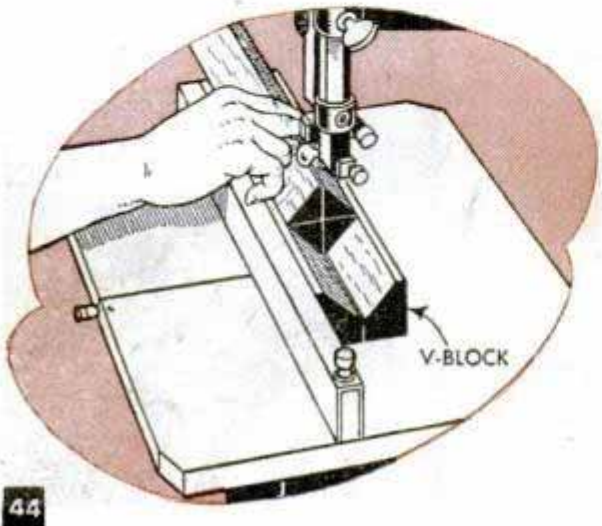
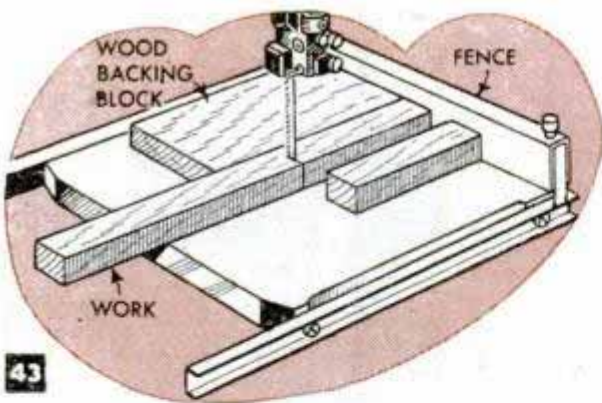
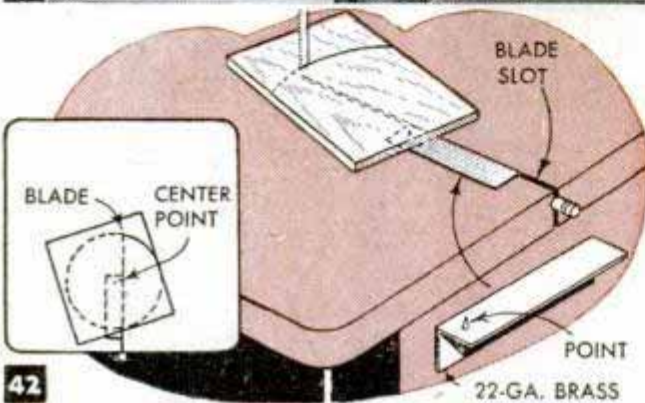
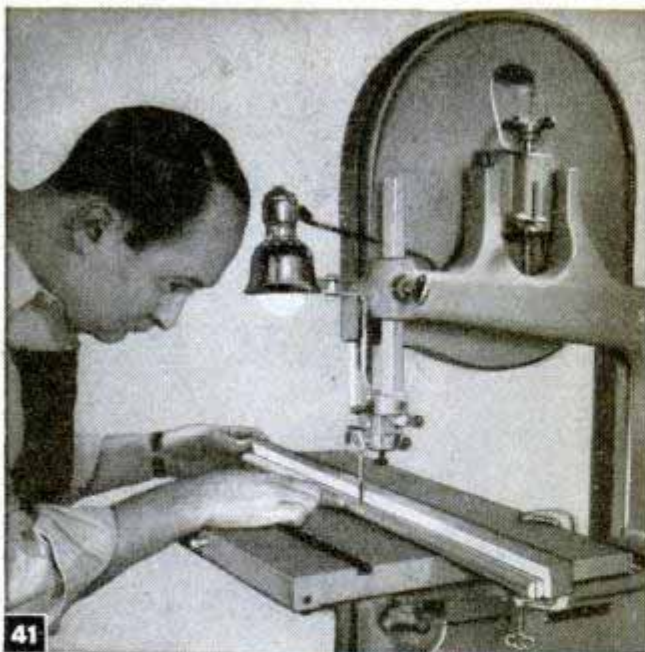

handy for flattening one side of long dowels, which later are cut into short lengths for making doweled-and-glued joints.

The pivot point shown in Fig. 42 simplifies the job of cutting true disks on a bandsaw. The point is soldered near one end of a piece of brass, which is bent at right angles to slip into the blade slot in the table. A wedge holds the brass piece in place. For cutting duplicate pieces to length, a setup like the one shown in Fig. 43 makes a production machine of your bandsaw. The backing block serves as a crosscut guide. If your bandsaw is equipped with a ripping fence, it can be used to center turning squares quickly and accurately. Make a long V-block to slide along the fence and run the saw blade in from one end as shown in Fig. 44. Then place the work in the block and push the assembly against the blade just enough to score the work.

If a bandsaw does not have a ripping fence, one can be improvised for some kinds of work by simply turning the crosscut gauge upside down and using it as shown in Fig. 45. A C-clamp will keep the gauge in position. The step gauge in Fig. 46 is handy when you have varied short lengths of work to cut off. It also is useful in cutting dowels to short lengths when using them in assembly work.

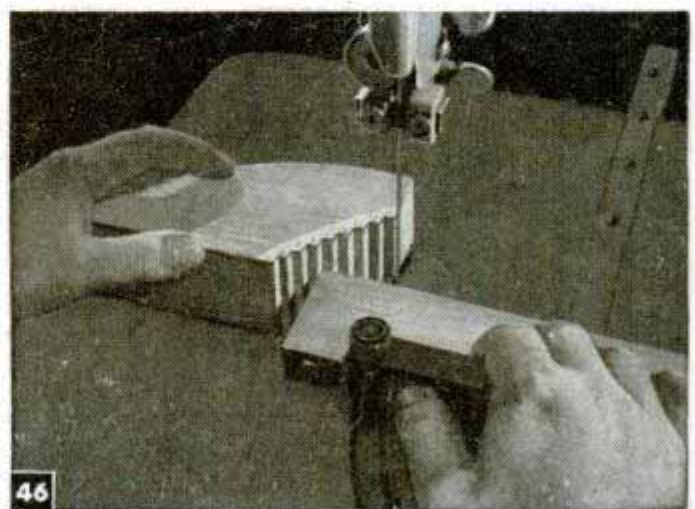
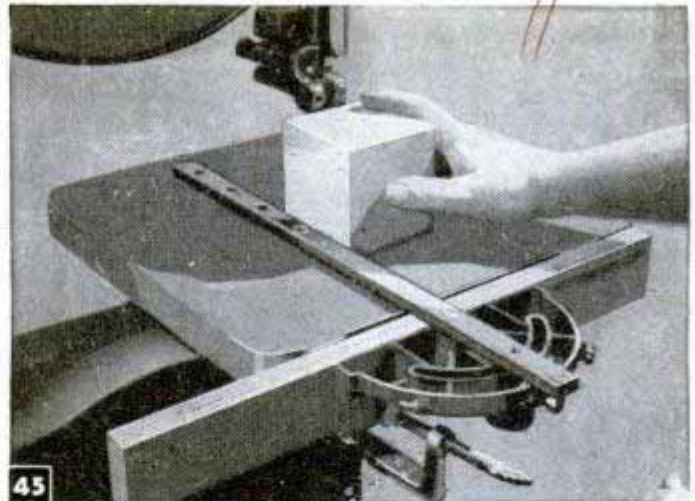

Monkey Wrench Used on Pipe

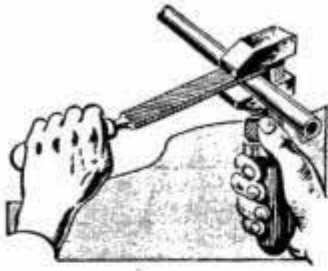

If you want to tighten or loosen pipe and a pipe wrench is not at hand, a monkey wrench and a coarse file can be used. Hold the file against the fixed

jaw and tighten the wrench so that the file and the movable jaw clamp the pipe. Apply leverage with both tools. Also, a monkey wrench can be used in close quarters where the handle of a pipe wrench will not clear obstructions.

Plastic Scale Improves Triangle

By cementing a transparent plastic scale or rule to one side of a triangle, I found that the instrument would serve a twofold

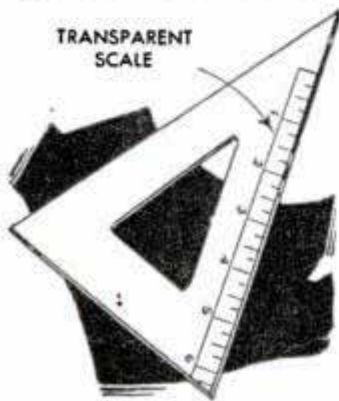

purpose and save time that is wasted ordinarily in picking up one instrument and laying down the other. A transparent rule is used so that lines on the drawing can be seen through it.—John Krill, Youngstown, Ohio.

Wheel Hub in Concrete Apron Guides Barn Door

Barn doors hung from tracks are inclined to swing outward when being opened or closed, making them difficult to manage. However, if one or more wooden wagon-wheel hubs are mounted on spindles and set in the concrete apron outside the door, they will serve as guides so that handling the door is easy.—Ray Harrison, Fort Qu'Appelle, Sask., Can.

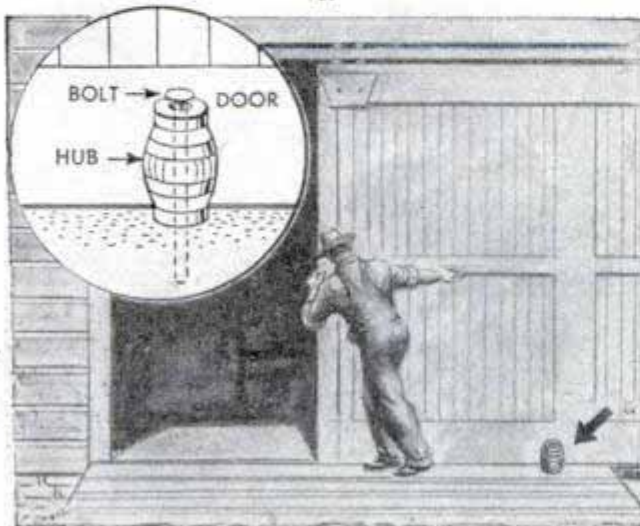

Reflector Sign on Stalled Truck Warns Approaching Traffic

In addition to the required flares, one trucker has a warning sign made of bicycle reflectors which he hangs on the back of his truck when stopping for repairs on the road at night. The letters of the word "Slow" are sufficiently large to be seen easily by any approaching motorist. Hooks are provided to hang the sign.

Ends of Welding Hose Reversed To Obtain Longer Wear

Due to continual handling, the hose of an oxyacetylene outfit gets the most wear at the end nearest the torch, and leaks and breaks develop here first. Instead of cutting off the worn section, thereby shortening the hose, reverse it and connect the worn part to the tank end.

Publication Dates for Magazines Posted on Display Rack

To inform regular customers when the next issue of their favorite magazine is due to appear on the newsstands, a dealer prints a list of publication dates, along with the names of the magazines, on a large panel which is fastened to one side of the display rack. Thus, if the magazine is not on the stand, the reader can tell when the next issue is due by reference to the list.

DATE MAGAZINES ARE ISSUED

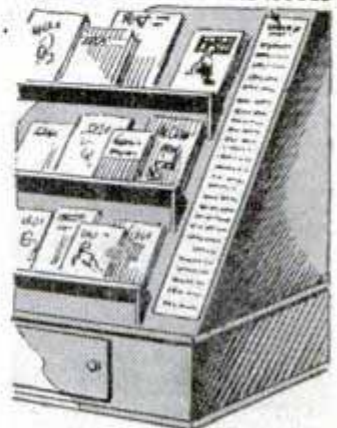

Features

Takes a 10-in. blade,
which raises, lowers, tilts
Has built-in sawdust chute
Large 30 by 40-in. table
Cuts 2½ in. deep with
a 10-in. blade

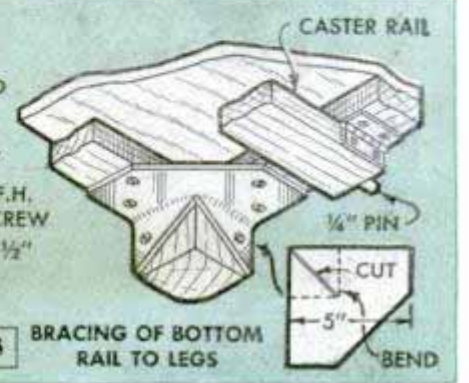
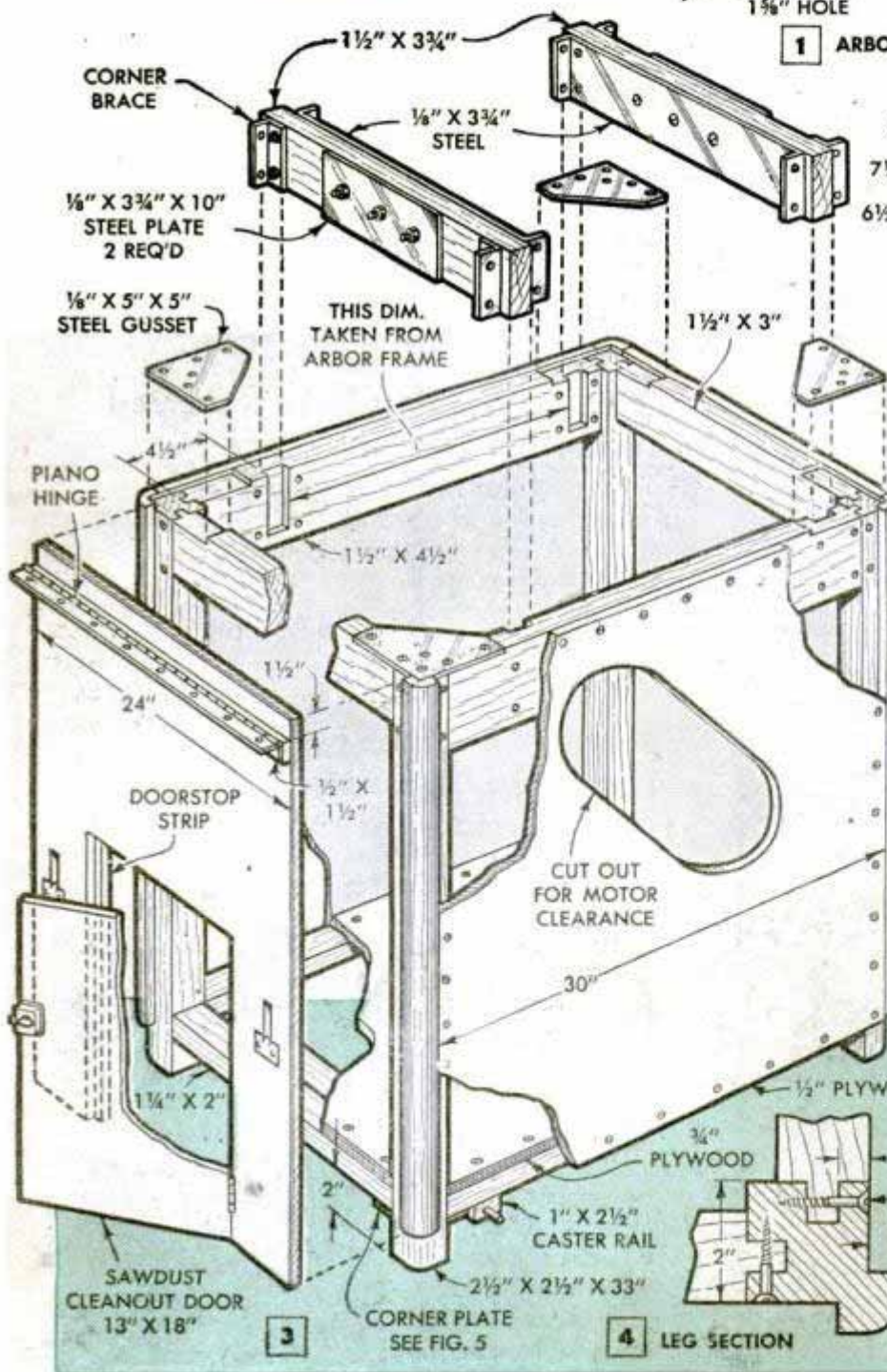
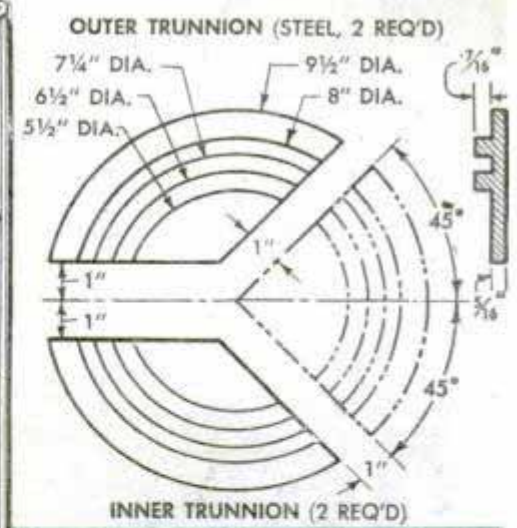
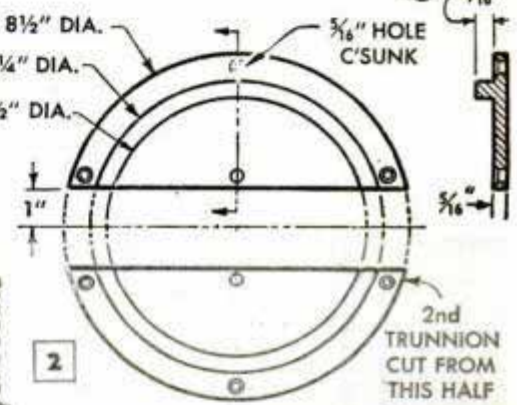
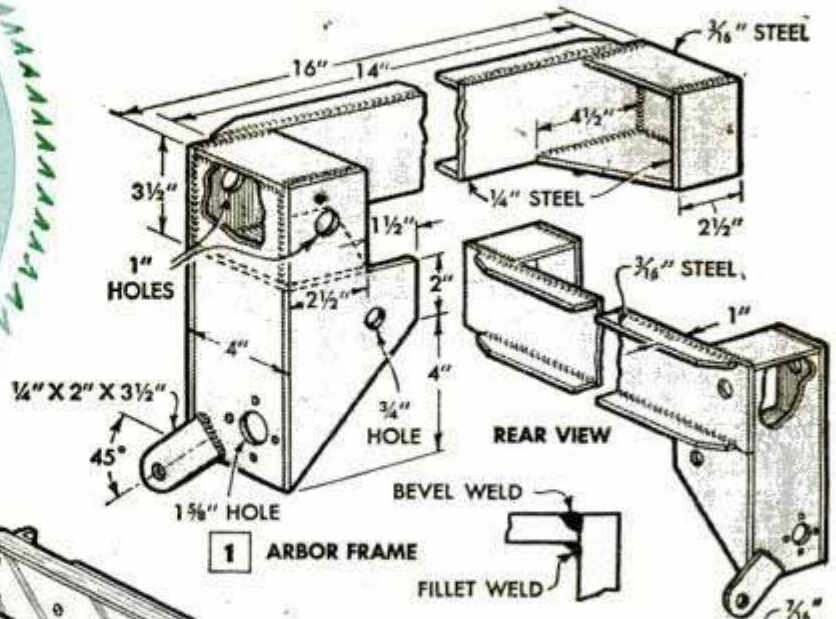

HAS TILTING-ARBOR

By Elman Wood

Part I

Hinged side and back extensions increase the size of the table so that the ripping fence can be set 25 in. from the saw blade. Rips to the center of 48-in. plywood panel

WOODWORKING craftsmen will rate this tilting-arbor table saw "tops" because of its versatility, speed and accuracy. By turning one handwheel the blade is raised or lowered for any depth setting within its capacity. A few turns of another handwheel tilt the blade for any angle cut up to 45 deg., the settings being indicated by a degree scale and pointer. The saw table remains always in a horizontal position; only the saw arbor tilts. The hardwood table with hinged extensions is plenty large enough to handle a 4 by 8-ft. plywood panel. An enclosed base catches all the sawdust, and swivel casters fitted to built-in foot lifts enable the operator to roll the saw to any part of the shop.

Construction should begin with the saw-base frame, Fig. 3. Building the base requires care in cutting and fitting as it must be strong and rigid to support the motor and arbor assembly. Use well-seasoned, selected oak for legs and rails. Rabbet the legs on adjacent sides as in Fig. 4 to take side and end panels flush. Both top and bottom rails are mortised into the legs, but note that the upper side rails are 4½ in. wide and that the end ones are 3 in. The tenons are glued and keyed with screws, and after the joining is completed, steel gussets are mortised into the

top rails across the four corners, and the bottom rails are braced to the legs with steel corner plates cut, bent and attached as in Fig. 5. Caster rails, one across each end, are hinged to the underside of the

An accurate scale with pointer shows all angles from 0 to 45 deg. Here blade is tilted to full 45-deg. angle

Saw frame and arbor assembly completed ready for the table. Base is painted before table is installed

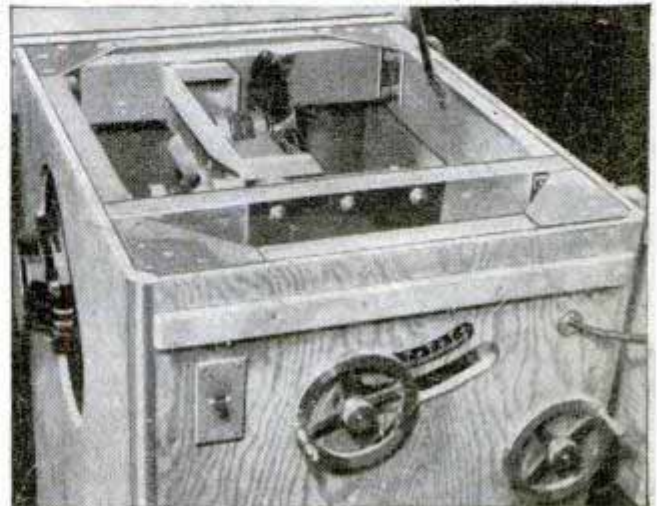
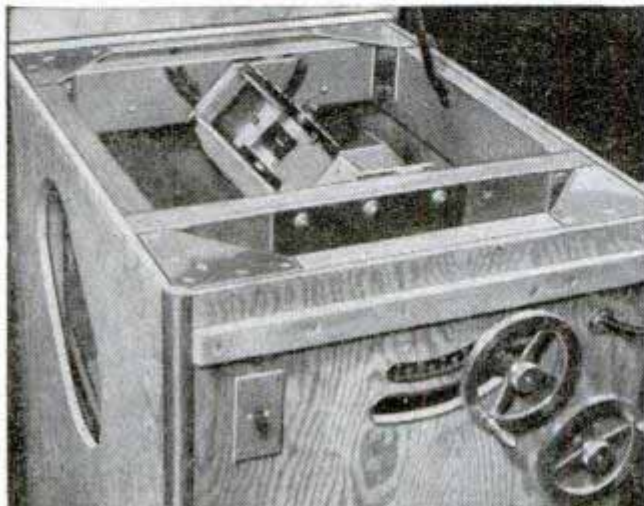
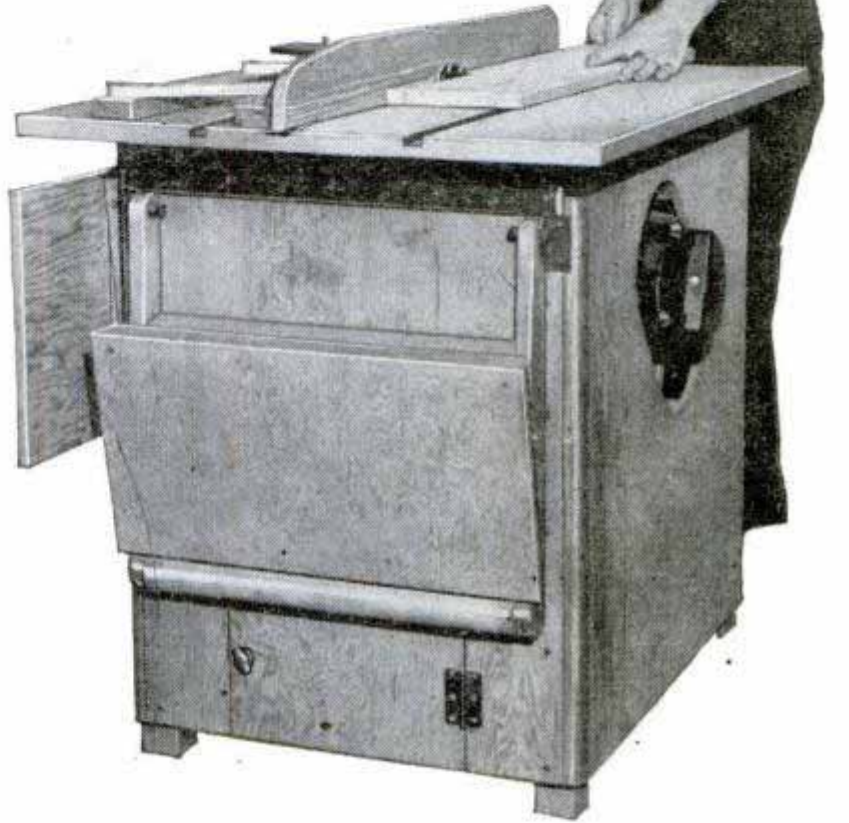

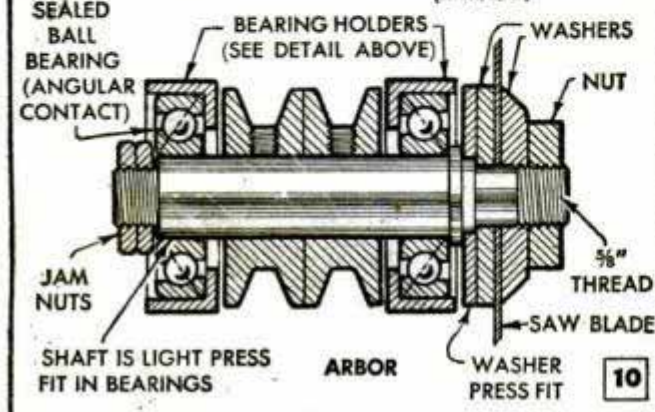
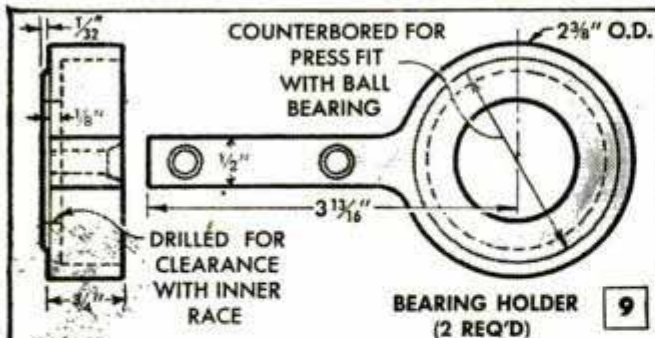
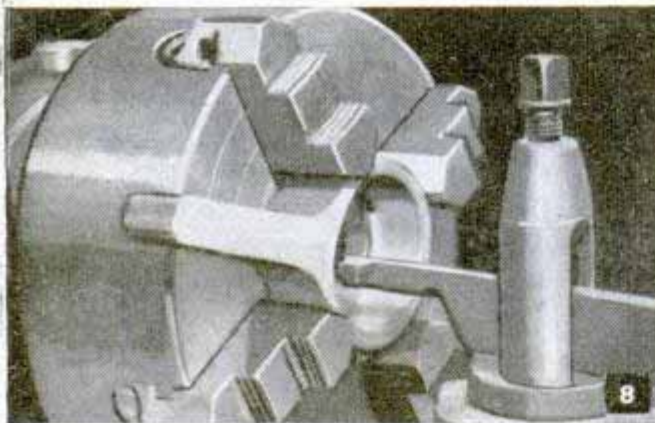
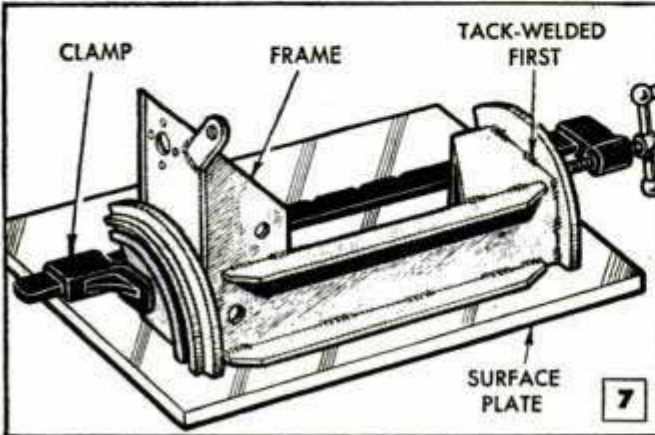
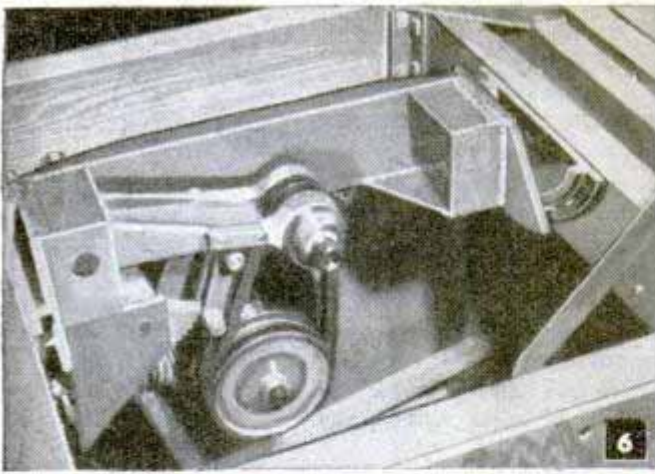

frame rails as in Figs. 3 and 5. The plywood bottom and the rear and right-side panels can now be installed, but the front and left-side panels are omitted at this stage as it is necessary to determine later the location of the handwheels and the size of the opening for the motor.

The arbor frame, shown in front and rear views in Fig. 1, comes next. This consists of a number of parts cut from steel plate and welded together to form the unit shown. This frame swings on trunnions made as detailed in Fig. 2. Each trunnion consists of an inner and outer segment, the two trunnions requiring four segments in all. These four segments are obtained from 3/4-in. mild-steel plate turned first to the form of disks, which are then cut into segments as indicated in Fig. 2. Inner segments are welded to the arbor frame while the outer ones are attached to the steel-faced cross members in Fig. 3. In installing a trunnion-mounted saw arbor there are two precise requirements: The center line of the blade must coincide exactly with the center line of the outer trunnion segments and the center of rotation of the trunnions must be at that point where the plane of the blade intersects that of the saw-table top. Fig. 6 shows the arbor and arbor frame in position and Fig. 7 shows the first step in positioning the inner trunnion segments on the arbor frame. Use a surface plate or other flat surface and make sure that the parts are exactly in line before welding. This done, measure the length of the arbor frame, plus the four trunnion segments. This gives you the distance between the two trunnion-support members, Fig. 1. Face the members with steel plates as

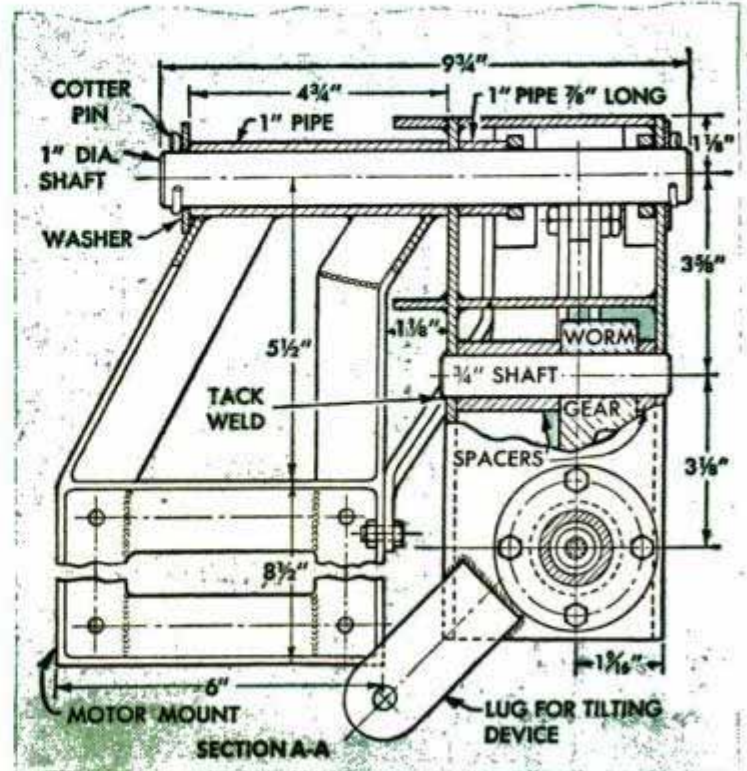

shown and drill the bolt holes. While the members are temporarily in position determine the center line of the saw base and scribe it on both members for guidance in locating the trunnions. Then slip the arbor frame and trunnions between the supports. The arbor frame should fit snugly but should swing on the trunnions with only a slight frictional drag. With all parts located on the center line of the saw base, clamp the outer trunnion segments to the cross members and lift out the whole assembly. Using each trunnion segment as a drilling jig, drill holes and bolt the segments to the cross members.

Next, come the arbor-bearing holders shown in detail in Fig. 9, and in section in Fig. 10, with the arbor, pulley and bearings in place. Holders are rough-cut from $\frac{3}{4}$ -in. steel plate with a cutting torch or metal-cutting bandsaw and are recessed and bored through to suit the bearings as in Fig. 8. Bearings should be a fairly tight press fit in the recesses. The arbor or spindle is machined from steel and finish-ground to final dimensions. Note that it is flanged at the saw-blade end to form a seat for the press-fitted spacing washer. The spindle is shouldered and threaded at the left-hand end for jam nuts for pre-loading the bearings. Pulleys are locked on the spindle with socket-head setscrews, the ends of the setscrews seating on a flat, milled or filed on the saw spindle. Dimensions of the spindle through the bearings, Fig. 9, and also the bearing-recess diameter in Fig. 10, have been

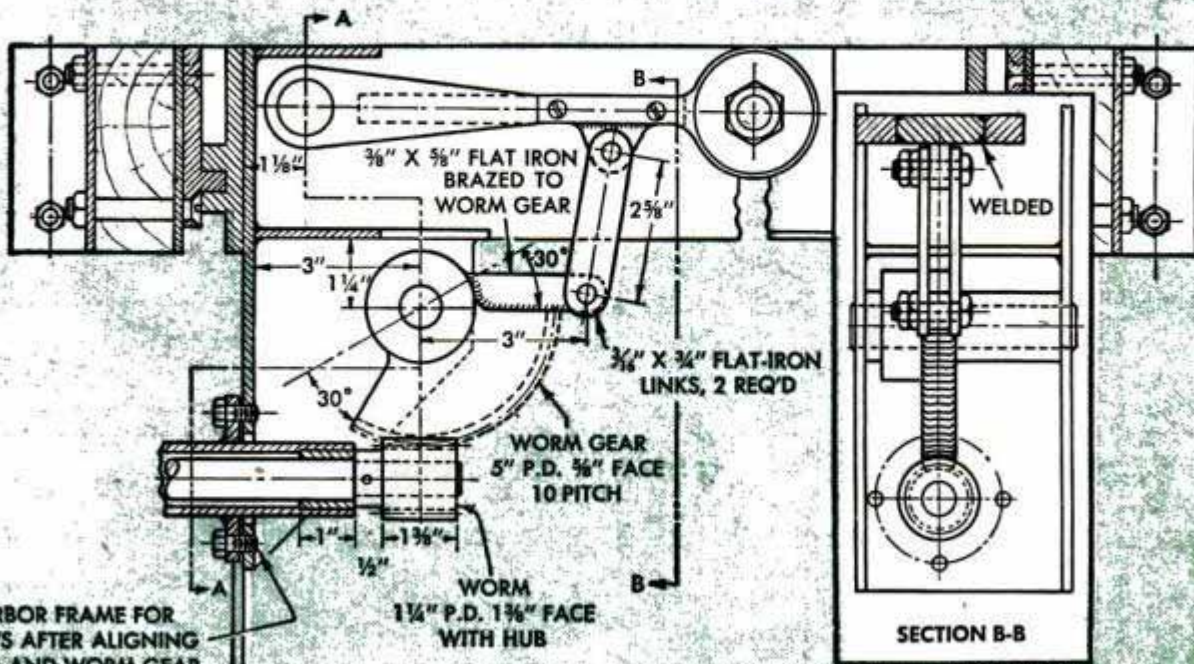
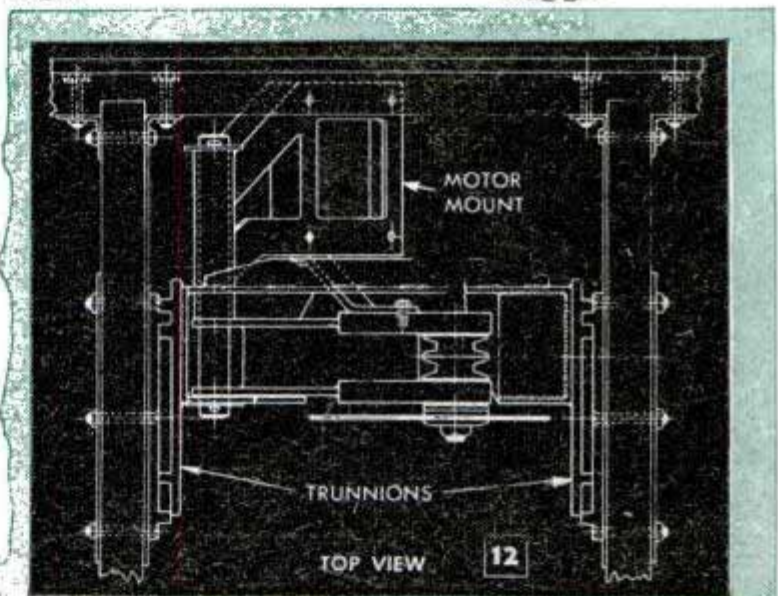
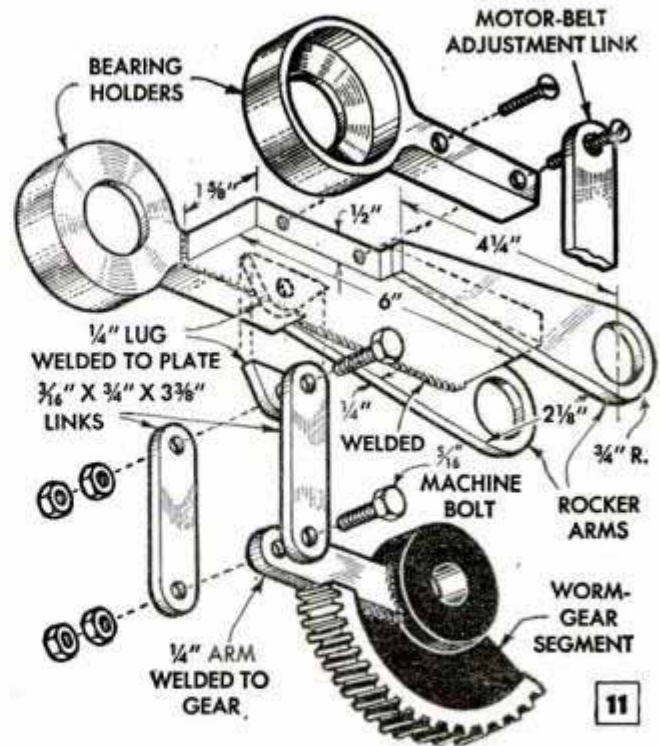

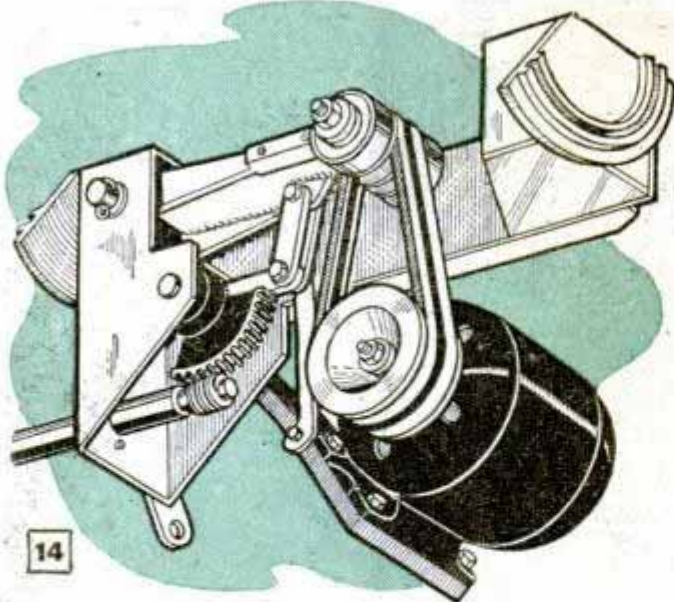

14

purposely omitted. These measurements must be taken from the bearings at hand.

Now, before going farther, study carefully sections A-A and B-B in Fig. 13, also the perspective and top views in Figs. 11 and 12. From Fig. 11 you will see that a 1/2-in. steel plate forms the mounting base for the saw-arbor assembly. Notches milled in opposite edges take the ends of the bearing holders, and rocker arms welded to the mounting base allow it to pivot on a rocker shaft for raising and lowering the saw blade and motor as a unit. When this assembly is complete, the saw spindle should turn freely in the bearings. Check this before finally welding the bearing holders in place. The motor mount, a separate assembly built up by welding together steel angles and flats, is welded to a length of 1-in. pipe which telescopes over the rocker shaft and fits snugly against the rocker arms. See Fig. 13, section A-A, and also the top view, Fig. 12. Shaft, pipe sleeve and arbor mounting are held in place in the arbor frame by washers and cotter keys. When assembled, the parts should move freely but without any end play. The motor mount is not fully dimensioned as it must be made to fit the base of the motor you are to use. Final unit in this assembly is the belt-adjustment link, Figs. 15 and 16. It's made from flat iron, bent to approximately a 2-in. offset and drilled and slotted as indicated. Upper end is bolted to the left bearing holder, Fig. 12, and the lower end to the motor mount. Loosening the lower bolt allows the motor to be moved up or down to obtain correct belt tension.

The raising-and-lowering mechanism consists of a worm and worm-gear segment, the latter made from an ordinary gear by simply cutting away all but a 120-deg. segment. An arm made from 1/4-in. flat iron is welded or brazed to the segment as in Figs. 11 and 13. This arm is connected to

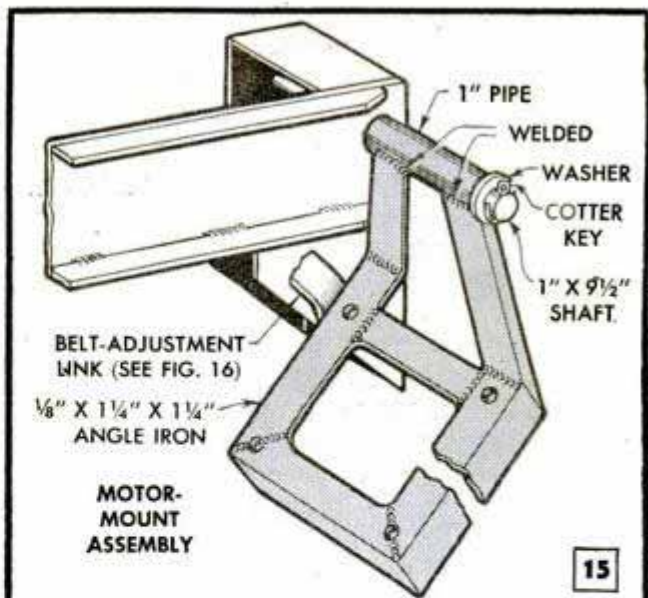

15

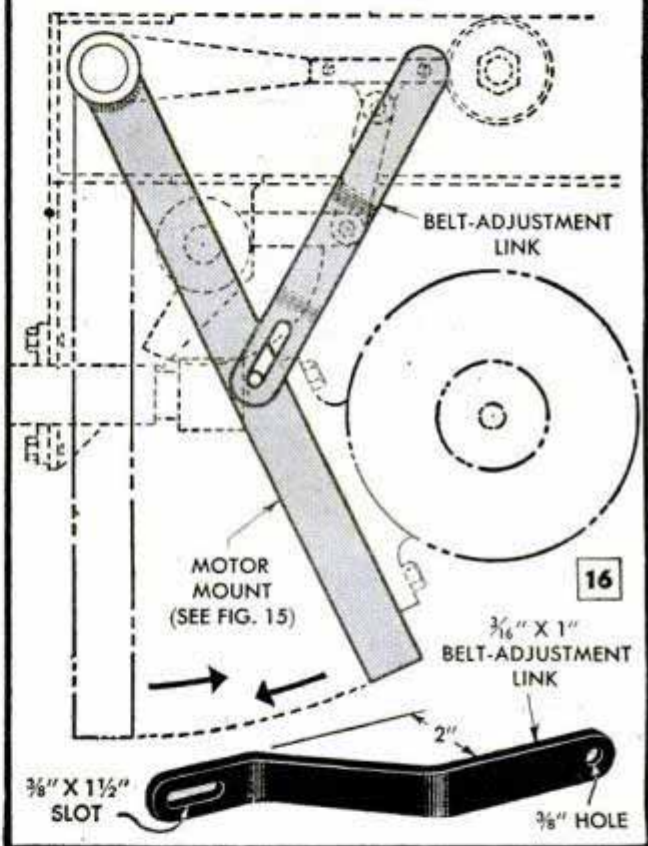

16

a lug welded to the underside of the arbor plate by two links as shown. The gear segment turns on a shaft passing through the sides of the boxed end of the arbor frame as in Fig. 14. The shaft is made a drive fit in the holes drilled in the frame. Spacers cut from pipe position the worm-gear segment on the shaft, as shown in Fig. 13, section A-A. Although not detailed, the raising mechanism will operate more smoothly if the gear segment is fitted with a bronze bushing. If this is done, the bushing should be a tight drive fit in a reamed hole. Fig. 13 shows worm and worm shaft in position.

(To be continued)

☐ A set of socket wrenches can be made by using the heads of hexagon socket screws and welding handles to them.

For cooking feed mixtures in an open kettle, heating water at butchering time and for other purposes requiring quick, concentrated heat, one farmer uses a tank of bottled gas mounted on a cart so that it can be moved about as needed. Large-diameter wheels on the cart make the unit easy to push over rough ground. The tank carriage consists of stub axles welded to a heavy metal band which is drawn tightly around the tank with clamping bolts. Although wood wheels from an old buggy are shown, any metal implement wheels will do very well. Gas from the tank feeds through a copper tube, 5 to 7 ft. long. The flame is controlled by the outlet valve on the tank and the tubing can be bent to direct the flame to any point desired.

"Bottled Gas" Tank Mounted on Cart Makes a Portable Farm Heating Unit

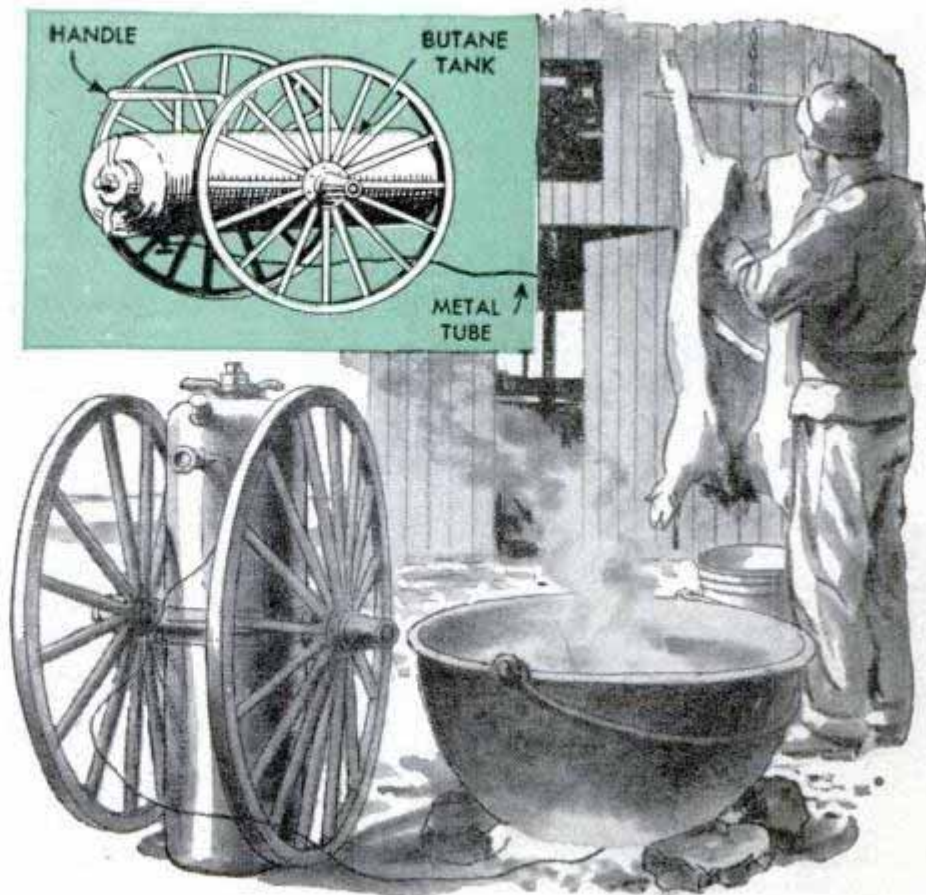

Locking Countersunk Screws

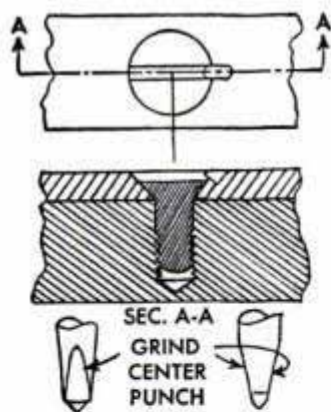

Locking countersunk screws can be done by punching the metal at the edge of the countersunk hole to force the metal into the screw slot. Flats are ground on two sides of the punch, to make a better "lock."

Watering-Tank Faucet Is Guarded By Old Horseshoe

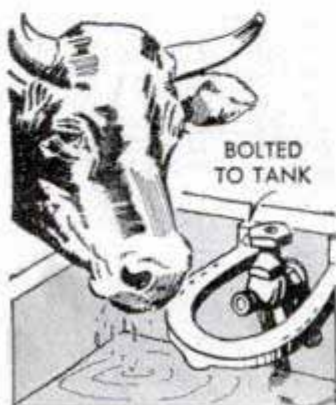

If a horseshoe is bolted to the side of a watering tank to serve as a guard for the faucet, it will keep cattle from bending or breaking the pipe connection. This may occur when a number of cattle crowd around the

tank. The guard should be bolted firmly in place by means of bolts extending through the shoe calks and the end of the tank.

Rack Tilts Drawing Board For Table-Top Use

Although this little rack holds a drawing board at a fixed angle, it also tilts the board so that it is more convenient to use than in a flat position on a desk or table. Each half of the rack is a right-angle brace, consisting of two parts which are assembled with a metal angle bracket as shown. Each brace is attached to the drawing board with flat-head screws, and the bottom surfaces of both are padded with felt to prevent marring the table on which the rack is used. Note that the braces are attached to the upper half of the board to allow it to extend over the edge of the table.

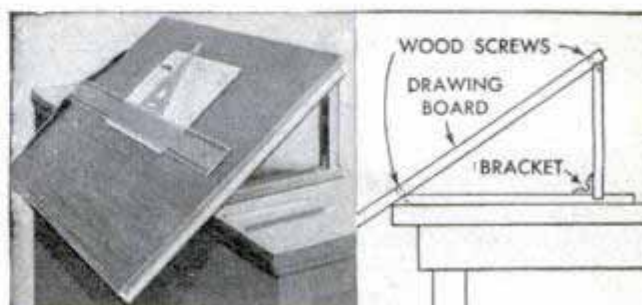

Mechanics' Cleaning Tank and Rack Made From Oil Drum



Inexpensive to make, this cleaning tank and racks require only an oil drum and a few odds and ends of lumber. The drum is cut lengthwise and then halfway around the ends so the sides can be bent back to form the racks. The ends are cut to be level. When cutting and forming, be sure to lay out the work so the drain plug will be at the bottom. A wooden cradle holds the tank at the proper working level.

Wilford Leach, Williamsburg, Va.

Auto-Wheel Rim Makes Creep For Farm Animals

Small animals, such as hogs and sheep will be able to pass through this auto-rim creep while larger animals are confined to

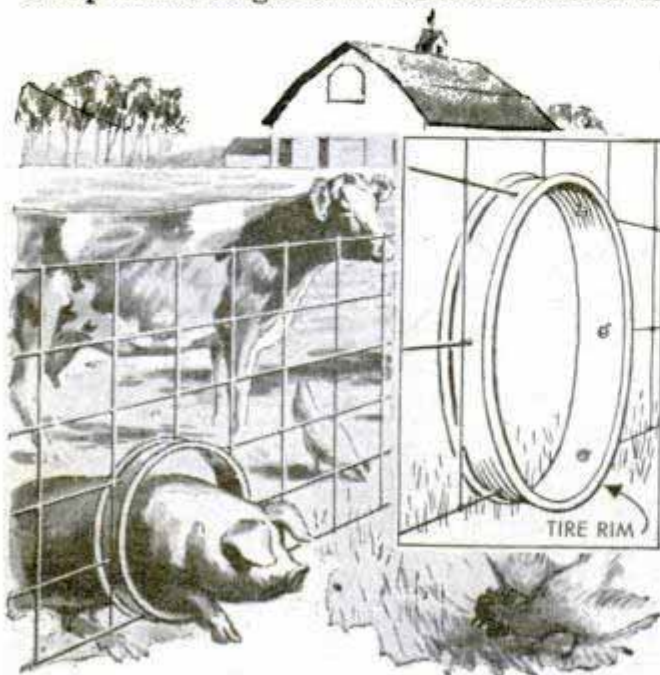

one field. The rim is held in place by means of holes to which the wires of the fence are attached.—Wm. P. Houser, Organ, N. Mex.

Loosening "Frozen" Setscrews

Socket-head setscrews, which are "frozen" or rusted in, can be loosened and removed by the following method: Grip the setscrew wrench with an end wrench as shown and tap the former lightly with a hammer as tension is applied. The hammering plus the tension of the end wrench helps break the threads loose. Square-head setscrews are loosened by a similar method.

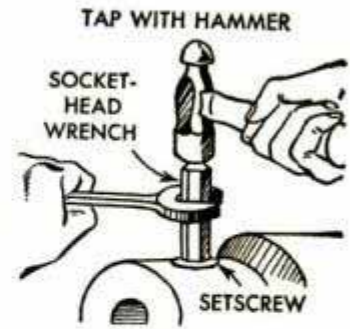

Replacing Flywheel Ring Gears

Since ring gears on flywheels are a shrink fit, it's necessary to heat them before they can be installed and this calls for the use of an acetylene torch or some similar source of heat. However, if such equipment is not at hand, the gear can be heated as follows: After removing the old ring, lay the new one on several bricks to support it 3 or 4 in. above the ground. Then place some old rags in a circle beneath it and saturate them with gasoline. Ignite the rags and allow them to burn down. Then lift the gear with two pairs of pliers and slip it in place. Adjust the gear by tapping it with a punch as the metal cools.

D. W. Brentlinger, Richmond, Calif.

Weighted Hose Keeps Torch Upright

One plumber who had trouble keeping his blowtorch from tipping over fitted a piece of garden hose filled with lead shot around the base. This adds enough weight to the bottom of the torch to prevent it being top heavy. A piece of wire is inserted in the hose and the ends are twisted tightly to keep the shot from spilling out. As a further precaution, wrap tape around the hose where the ends join.

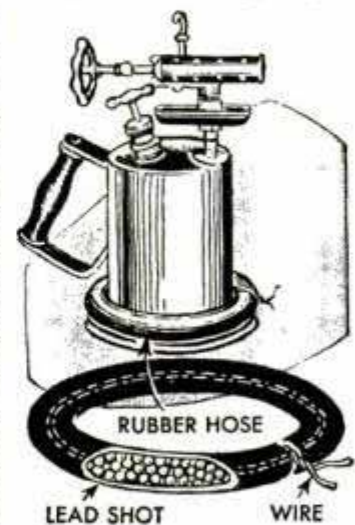

Edgar Barnhart, Whittier, Calif.

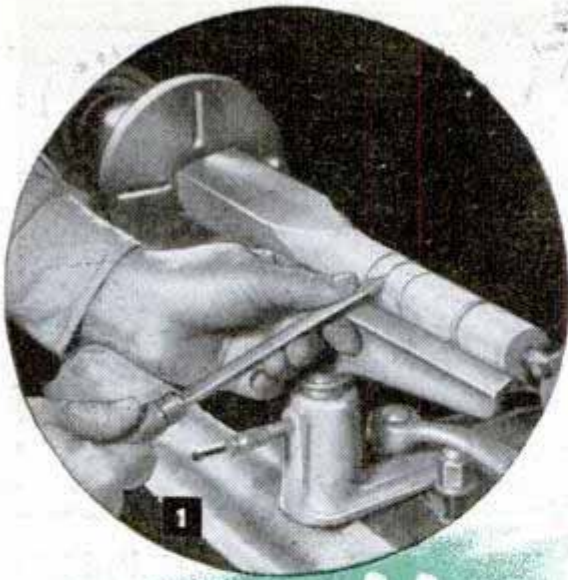

Do it Safely

By Edward R. Lucas



HOME WORKSHOP power machines can be operated safely if you make a habit of always observing simple safety precautions. As an example, take the wood lathe, Figs. 1 and 2. With the exception of the jigsaw it is one of the safest machines to operate provided the work is properly mounted, correctly centered and securely fastened, either between the centers or on the faceplate or screw chuck. When rough-turning a square into a spindle, Fig. 1, spindle speed as a rule should not exceed 500 to 700 r.p.m., depending on the size of the stock. After the square has been turned round, the turning tools do better work at higher speeds, ranging up to 3000 r.p.m. on turnings of small diameter. Unless you regularly wear glasses, goggles are a good eye protection when doing any wood-lathe work, Fig. 2. Clip a necktie to your shirt or remove it entirely and avoid reaching over the rotating work with a dangling shirt sleeve. Keep the tool rest close to the work and hold the turning tool firmly with both hands as in Fig. 2.

A careful operator uses a push stick, Fig. 3, when ripping narrow strips from thin stock on the circular saw. The stick also serves as a hold-down. The saw blade is lowered, or the table raised, so that the teeth just cut through the thickness of the stock, exposing as little of the blade as possible. When crosscutting long pieces, wide boards, or in any operation where one setting is made for the duplication of parts, it's a good idea to use the blade guard, Fig. 4. Most late-model machines are equipped with a combination guard and splitter, also an anti-kickback device which is a part of

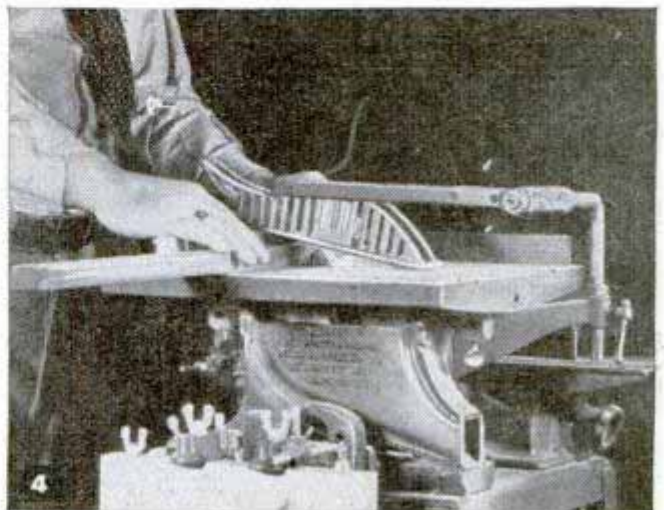
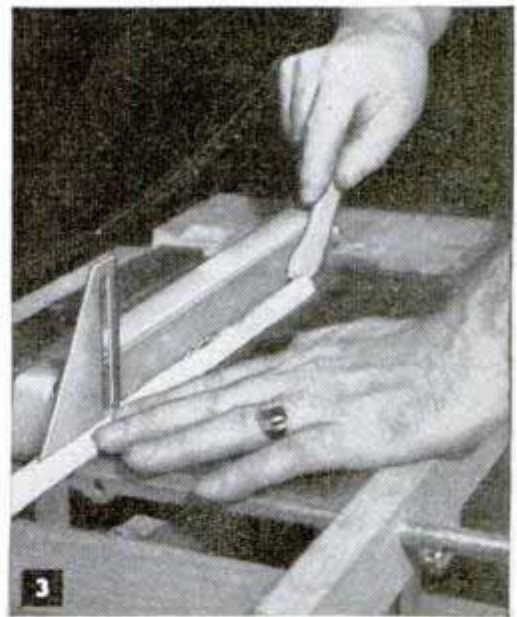

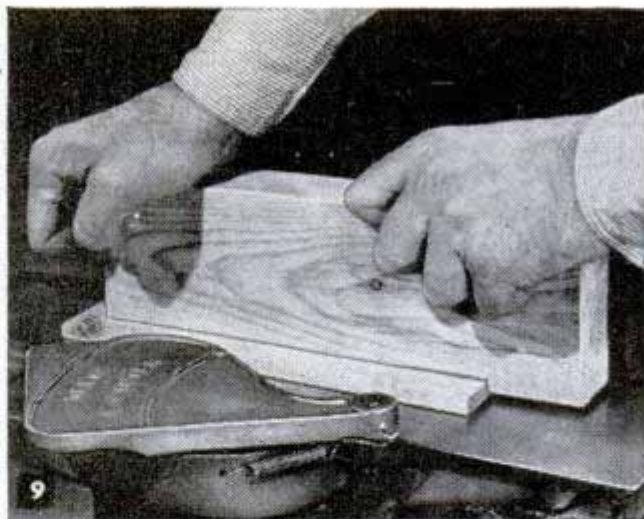
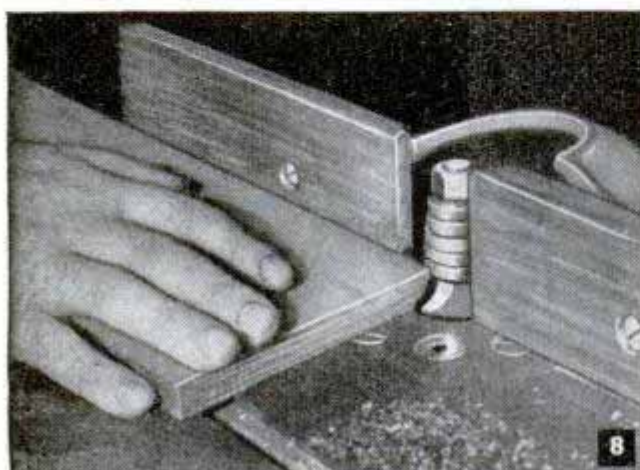
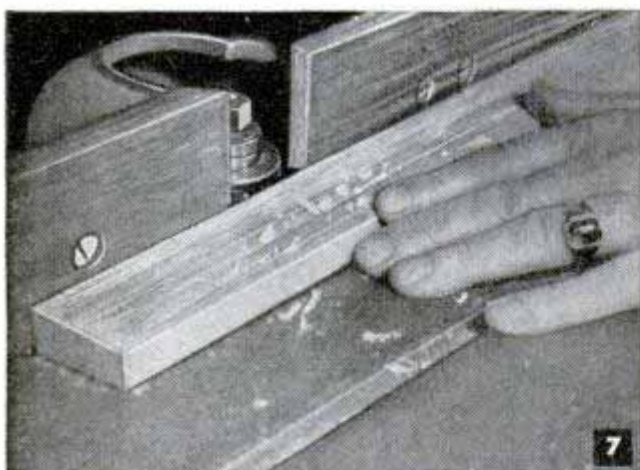
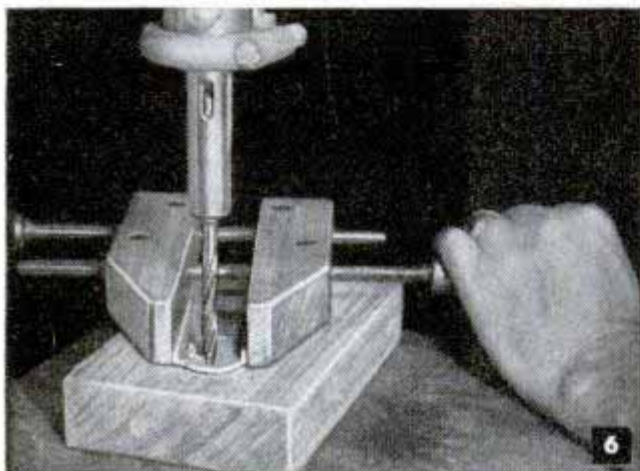
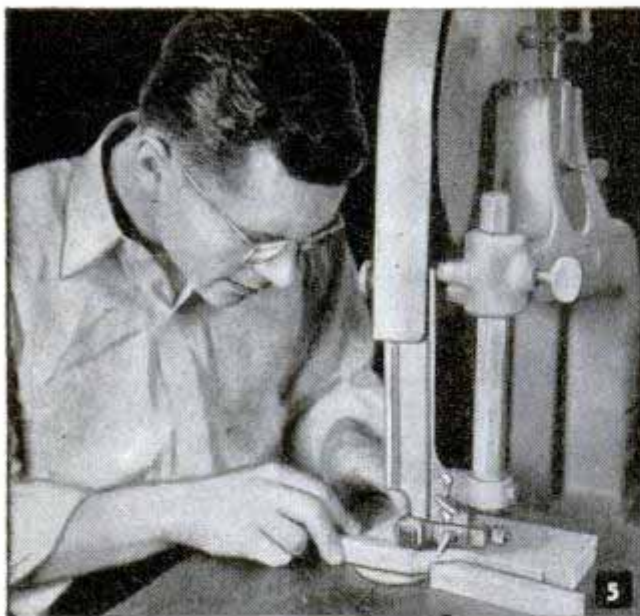

the unit. This unit is so arranged that you can use the guard and splitter in combination, the guard alone as in Fig. 4, or the splitter separately as in Fig. 3. It's a good safety device and should be used on all sawing operations except, of course, when grooving or tenoning with the dado head or in any sawing operation where the blade does not cut through the stock.

The bandsaw, Fig. 5, is another of the comparatively safe workshop power tools because all moving parts are well guarded and during almost all common operations the entire cutting area of the blade is in the wood. The important thing about safe bandsaw operation is adjusting the upper blade guide so that the stock just clears under it. Adjust the blade tension according to manufacturer's directions. If you're working on small pieces of stock, as in Fig. 5, be very cautious as the blade breaks through at the finish of the cut. That's the time it might nip your fingers unless you are careful to have a part of each hand resting firmly on the machine table. Note position of the operator's hands in Fig. 5.

Small metal parts to be drilled should always be held with a clamp, Fig. 6, or in a drill vise. Otherwise you're really asking for it as the work may "pick up" at the instant the hole breaks through and rotate with the bit. If your hands happen to be in the way you may get a serious injury. Make it a rule always to clamp small work securely before drilling.

In all straight shaper work a fence is used to guide the stock, Figs. 7 and 8, and the adjustable fixture which supports the fence usually has a housing or cover that partially encloses the spindle and cutters. When molding curved work the stock is held against a pin inserted into the machine table near the spindle. The pin serves as a guide to start the cut. After the cut has been started, uncut portions of the edge being molded ride on depth collars which keep the stock the same distance from the spindle, resulting in a molding cut of uni-

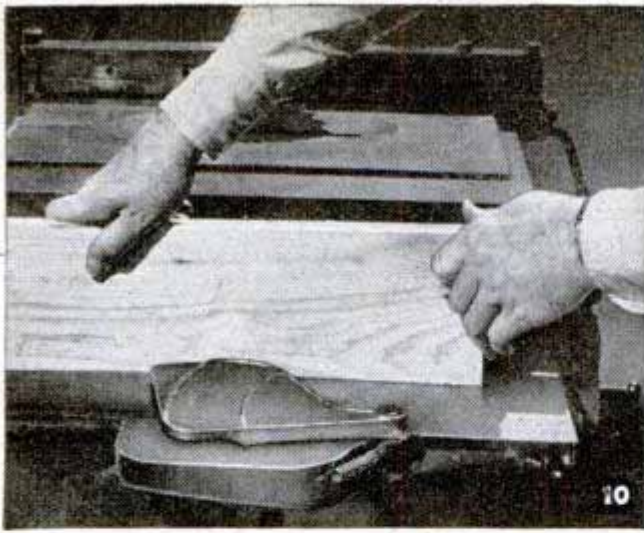

form depth. In this operation the cutters are covered by a large flat disk which rotates with the spindle. The essential thing in safe shaper operation is to keep a firm hold on the stock, more especially when shaping curved work. Press the stock into close contact with the table and shift the hands alternately when feeding the work, either freehand or along the fence. When cutting a deep molded shape, start with a light cut and make several passes, adjusting the spindle and shaper head to take a slightly deeper cut at each pass of the work. Mount the cutter to work on the lower corner of the stock, Fig. 8, as in this position the cutting edges are not exposed above the surface. Be sure that the spindle nut, fence and spindle-adjusting device are

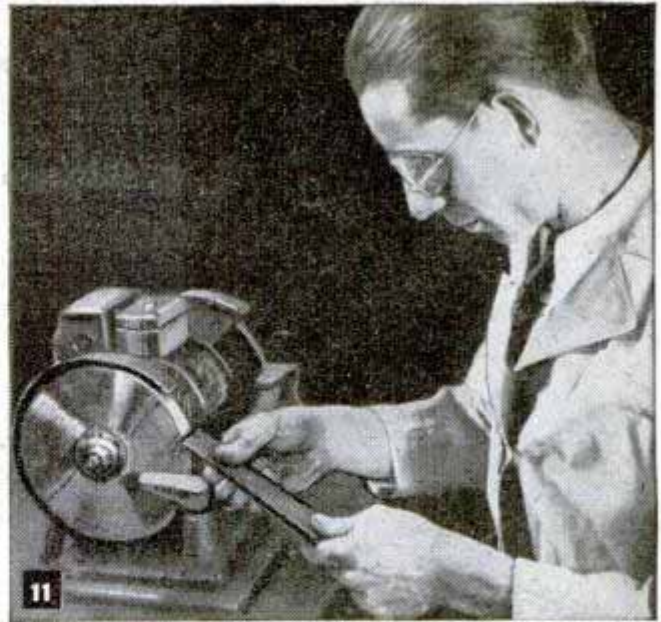

tightened securely into place before you start the machine.

To be safe when planing thin stock on the jointer, use a notched hold-down as in Fig. 9. This is made from a length of 2 by 4-in. stock, notched, or fitted with a small block which catches the end of the stock and prevents the material from being thrown backward by the action of the cutter head. When edging stock, plane with the grain as in Fig. 10. This gives a smoother cut and it's safer because there's no danger of the stock being kicked back by the knives. If you sharpen tools on a high-speed grinder, Fig. 11, not equipped with eye shields, it's safer to wear goggles.

Route Map Is Pasted to Window-Shade Roller for Ready Reference

Salesmen, truck drivers and others whose work carries them over unfamiliar highways and streets will find that a road



or city map pasted to a window-shade roller and attached to the car above the windshield is handy for quick reference. The roller is shortened to fit the width of the map and is held by regular shade brackets screwed to the car.

"Gasket" for Welding-Helmet Lens

Frequently the gaskets that are used on welding-helmet lenses are lost or damaged so that light from the electric arc leaks through, resulting in severe eyestrain. To overcome this, one welder wraps friction tape around the edges of the dark glass only, allowing it to overlap slightly. This serves as an efficient gasket that will not become lost or leak light.—G. J. Davis, New York City.

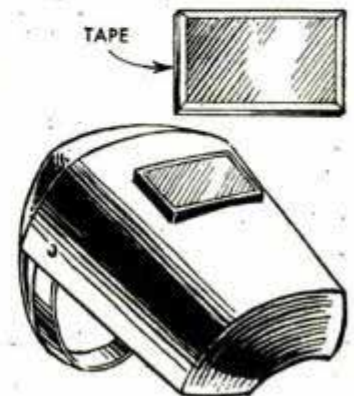

Location of Hidden Outlet Boxes Determined by Using Compass

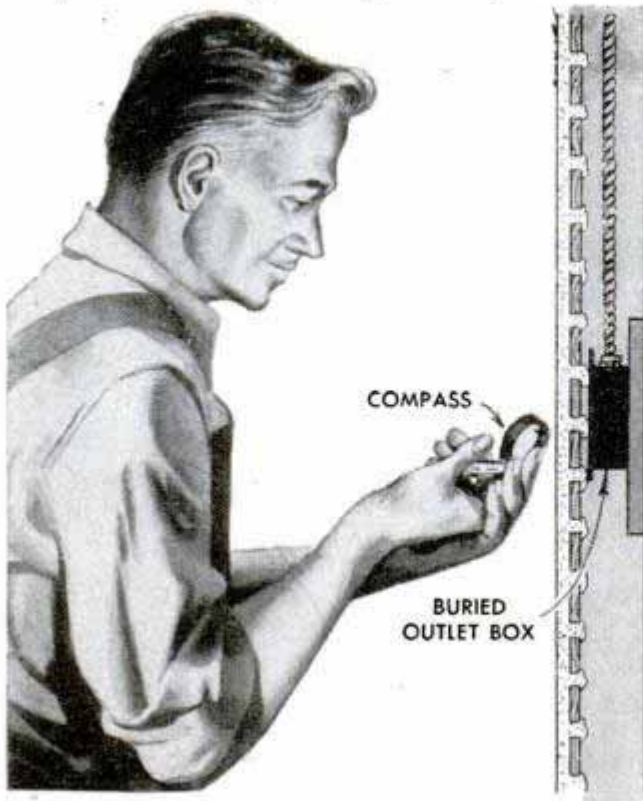

Electrical outlet boxes for wall plugs often become "lost" when covered by mistake during plastering. To locate the buried box, use a magnetic compass instead of marring the wall by tapping and exploratory digging. Hold the compass in the normal, horizontal position and slide it up and down the wall. When near any large piece of metal, such as an outlet box, a marked deflection of the needle will occur.

H. A. Highstone, Santa Rosa, Calif.

Wrench Speeds Chuck Operation

Time is saved when opening or closing the jaws of a universal chuck if one arm of the wrench is fitted with a round knob or handle so that it can be spun rapidly. Drill a hole in the end of one arm and attach the metal or wooden handle with a bolt, washer and nut.—Kenneth Murray, Colon, Mich.



Clogged Breather Tube in Auto Causes Back Pressure

Back pressure in an automobile crankcase, caused by a clogged breather tube, sometimes has misleading symptoms that cause one to look elsewhere for the trouble. The car may be using excessive amounts of oil, or it may be noticed that

a few drops are coming from the rear end of the crankcase or flywheel pan, ordinarily indicating worn bearings. But before replacing the rear main bearing, check to see that the breather tube is clear. It may be that the loss is due to back pressure caused by the reciprocating action of the pistons, which would act like an air compressor; then the air, instead of going out the breather, is forced through the bearings, taking oil with it. To remedy the condition, remove the breather cap and tube and clean with gasoline.

Oil Spread on Grease-Gun Tip Keeps It Clean

Light oil spread over the tip of a grease gun will prevent grease from sticking to the tip. If grease adheres to the tip, it will collect dirt, which may eventually be worked into the lubricating system where it can damage bearings or other equipment. An oilcan is used to apply the oil. Of course, fittings and other parts of the gun should be cleaned occasionally.



Adding-Machine Tape Convenient To Test Artists' Pens

One artist solved the problem of keeping paper on hand to test his pens by attaching a holder and roll of adding-machine tape to his drawing board. The holder was formed of wire and stapled to the board. Masking tape was used to prevent the sides of the holder from spreading.

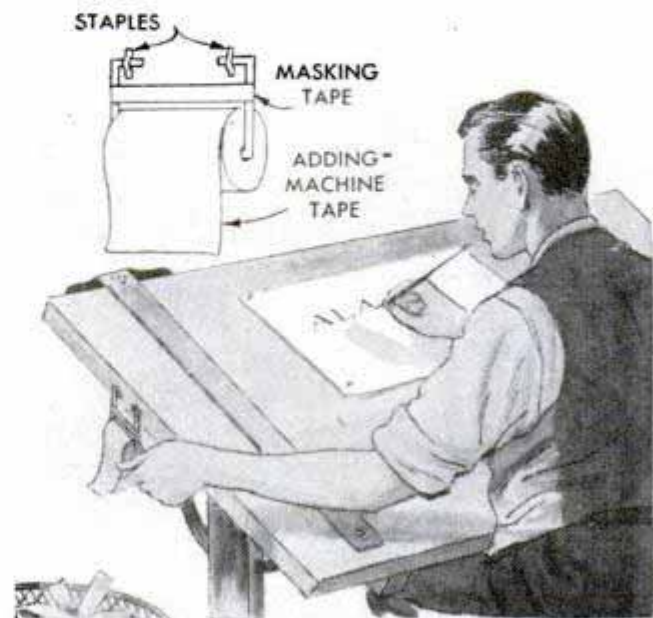



GENERAL PURPOSE POWER SUPPLY

By George D. Hansen

PERHAPS the most useful unit on the radio experimenter's workbench is a utility power supply. These usually consist of odds and ends of power units salvaged from discarded receivers, and the output voltages are seldom the values needed. The compact general-purpose unit illustrated is flexible as to voltage output and it has good regulation. It is capable of delivering about 450 volts d.c., with less than 2 percent ripple, at approximately 125 milliamperes. There are also two 6.3-volt a.c. filament supplies at different load capabilities.

By means of the combination bleeder voltage-divider resistor (R1), this unit adapts itself to various voltages necessary for testing or operating receivers and amplifiers. It is also ideal for powering a small CW transmitter. Adjustable sliding terminal contacts on R1 can be set to the voltage values desired by checking with a suitable voltmeter. Photos A, B and C show bottom, back and front views. All parts values are given in Fig. 1, and a standard 2 by 7 by 11-in. sheet-metal base is employed. A red jewel pilot light is included and large "dime" store drawer pulls provide handles for moving the unit to convenient positions on the experimenter's workbench.

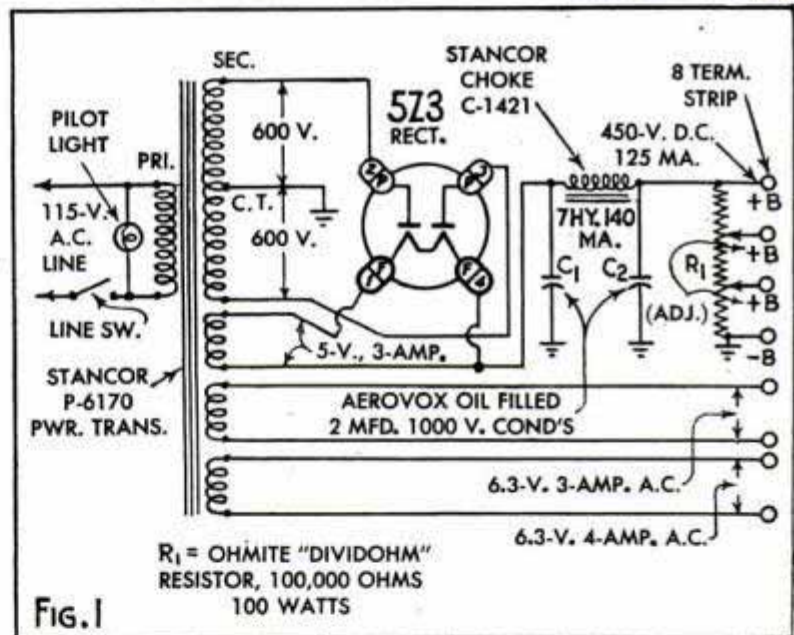
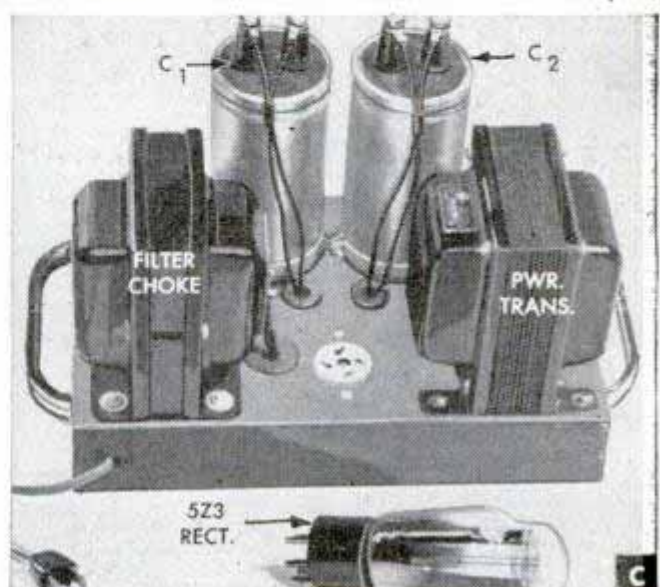
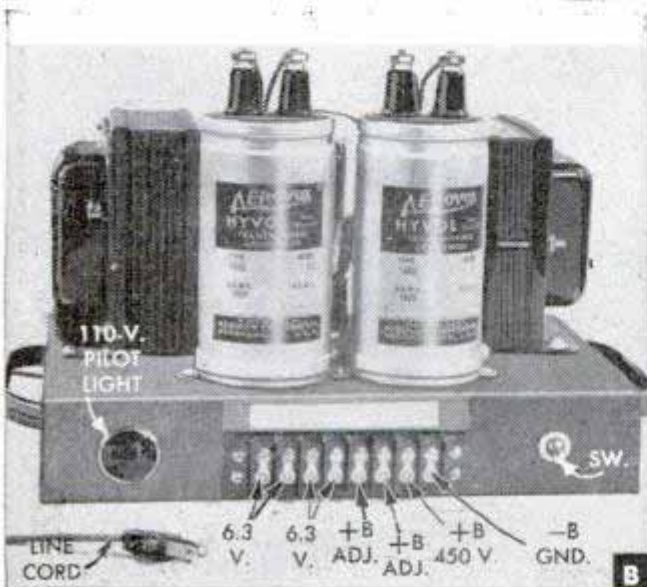

FIG. 1





DUAL-BAND ROTARY



WITH present-day conditions of crowding in the 10 and 20-meter bands, a rotary beam system that combines antennas for both of these bands on the same supporting framework is one of the most desirable pieces of amateur equipment imaginable. It operates by confining all of the radiated energy to a fairly narrow beam, and the effect is equal to an increase of several times in the power from the transmitter. For receiving, it improves reception to the same degree. Original experiments conducted by M. P. Mims, W5BDB, of Texarkana, Ark., several years before the war, were highly successful and the signal strength delivered into receivers all over the world by his "signal squirter" made the Mims name one of the best-known in the amateur-radio fraternity. Since the war, certain refinements have been made in the rotator unit and indicator system by the American Phenolic Corporation in Chicago. Selsyn motors in the indicator system now replace the stepping relay and ratchet of the original indicator which operated in steps of about 6 degrees. With the new, smooth-running system

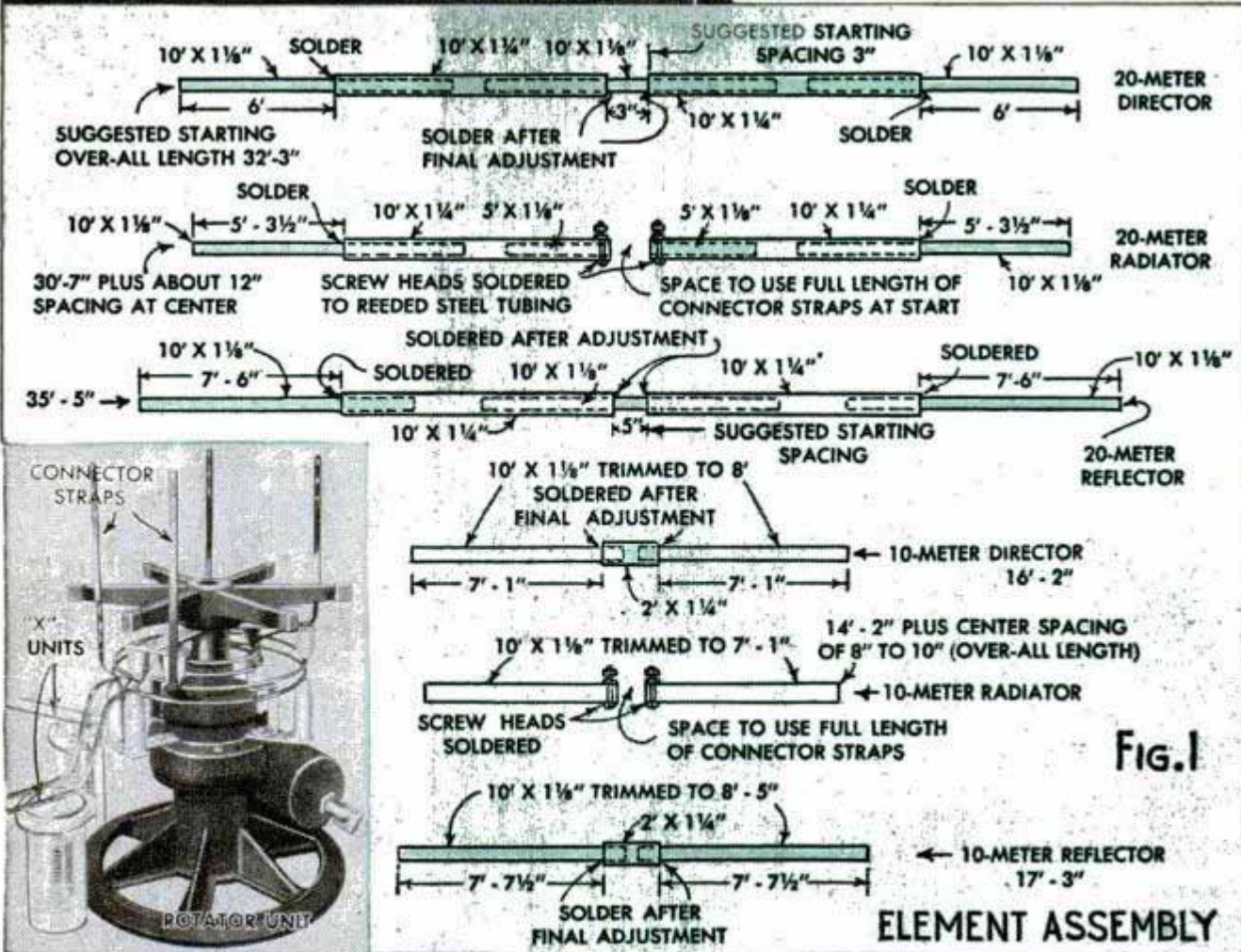

BEAM ANTENNA SYSTEM



the selsyn direction-indicator unit shown in photo C is synchronized with the antenna array, photo A, indicating the direction of the beam at all times.

The rotator unit supports the wooden boom and crossarms on which the telescoping brass-plated reeded steel elements are mounted; the dimensions of the elements for both the 10 and 20-meter bands are given in Fig. 1. Both radiators, or driven elements, receive power direct from the transmitter; the reflector and director elements are adjusted for length and spaced to reflect and direct the transmitted signal for maximum forward gain. Reception off the ends of the antenna, and signals coming from the reflector side are reduced to a point of non-interference. Installation may be made on any supporting mast or tower which should be from 35 to 50 ft. high. Telephone poles, Sky-Lane and similar wooden towers can be used. The homemade one shown in photo A is a simple type with a suitable platform so that the element centers can be reached for adjustments after the antenna is in place.

Rugged insulators of special design are employed to mount the elements on the crossarms as indicated in photo B. The open-wire feed lines are spaced with low-loss Amphenol polystyrene line spreaders as shown in photos A and D. A single transmission line may be used for both bands if a suitable relay is installed at the rotator, or, individual lines may be employed. Perhaps the most interesting feature of this dual-band rotary beam antenna system is the method of coupling the transmission

(Continued to page 234)

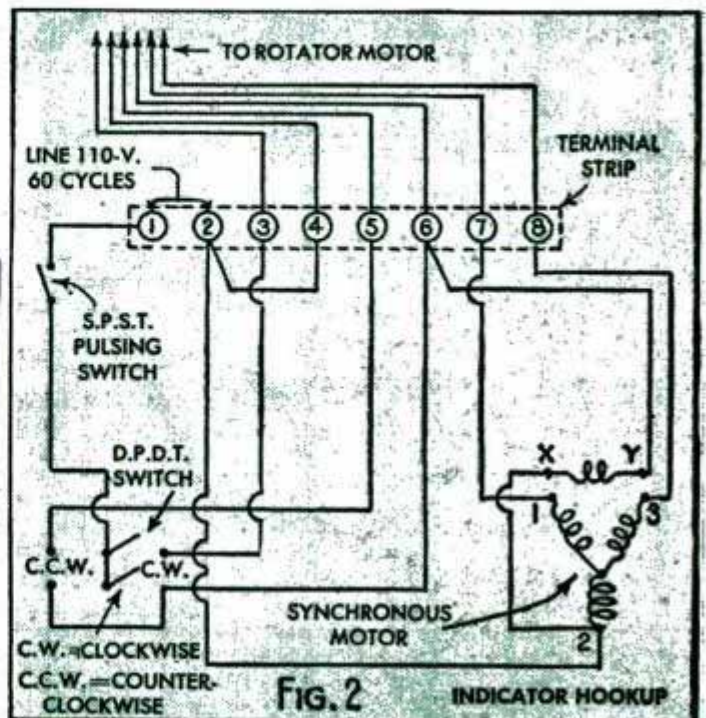
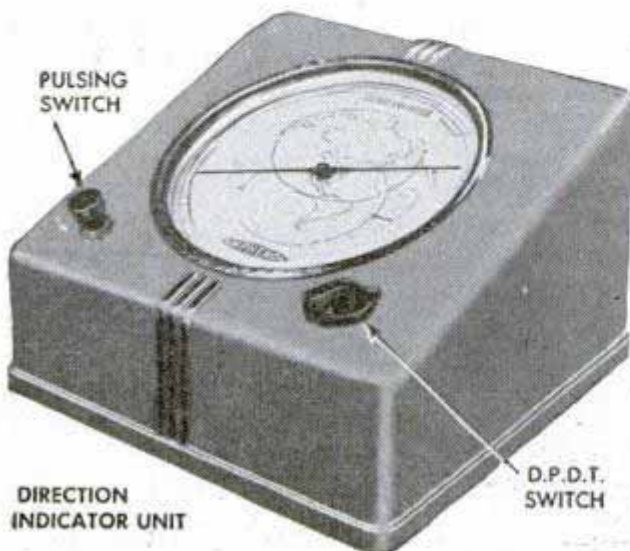
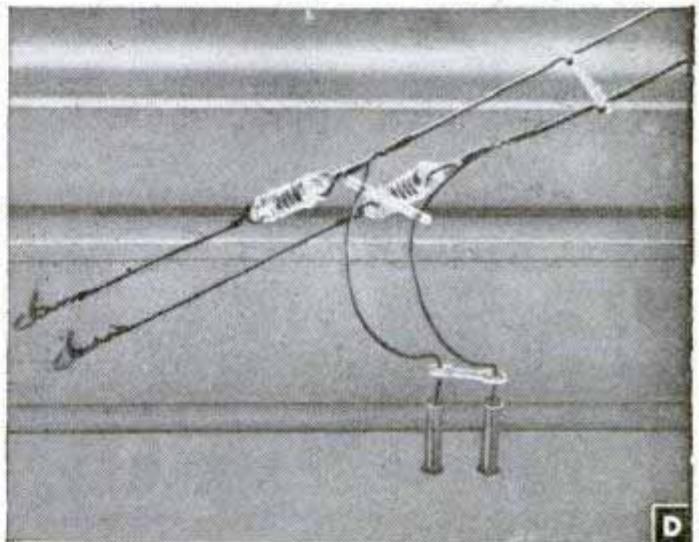
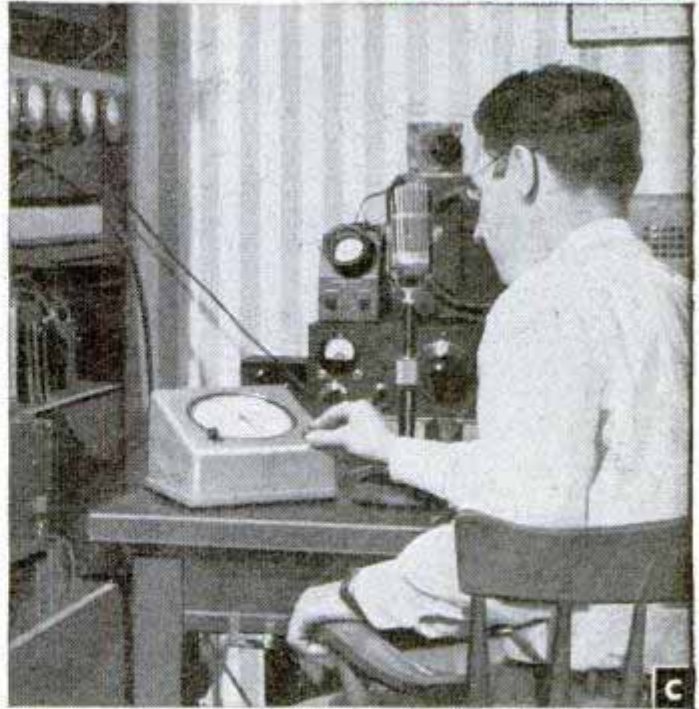

Compact FM Converter Unit Operates on A.C. or D.C.

Any standard broadcast receiver can now be converted to receive FM programs on the new FM band from 88 to 108 megacycles just as easily as you can connect a crystal phono pickup to your radio receiver or audio amplifier. Receivers that do not have phono attachments are simply adapted by the installation of a phono input jack and switch. The converter merely uses the audio stages in the AM broadcast receiver. If your present set has quality output on standard broadcast programs you can expect excellent FM reproduction.

The unit is a superheterodyne converter operating on an intermediate frequency of 21.75 megacycles. It includes a self-contained power supply and operates on any 117-volt a.c. or d.c. line with a current drain of only a little more than that required for a 25-watt lamp. Recently demonstrated in Chicago by the Meck Industries, of Plymouth, Ind., this tiny receiver is claimed to employ a new regenerative circuit and a special tube adapted from wartime radar equipment. The circuit was worked out by Meck engineers in cooperation with the Hazeltine Laboratories. It is housed in a neat plastic case, available in several colors to match the AM broadcast receiver with which it is to be used; a front view of the converter unit, which looks like a tiny table model receiver, appears in photo A; the unit measures 9½ in. by 7 in. The lower knob is the off-on switch, and the upper knob is the tuning control; the radio set that is being converted to receive FM is turned on in the usual manner and switched to prepare for FM reception, in the same way you would switch to use a record player. The tuning control on the converter is rotated to tune in the FM station selected and the volume control on your broadcast receiver is set for the desired volume. A view of the chassis base is shown in photo B.

A short length of wire is usually sufficient for local FM reception. Improved results in locations unfavorable to FM reception can be had by using an inside or outside dipole or folded dipole antenna which can be installed by your local radio serviceman. In areas where FM transmissions are available this unit makes it possible for the listener to hear excellent static-free, FM programs at comparatively low cost. With thousands of new FM listeners, a new listening audience is being created, and, like television, it opens new fields of entertainment and commercial possibilities. Photo C shows the FM converter unit connected to a small table model receiver.

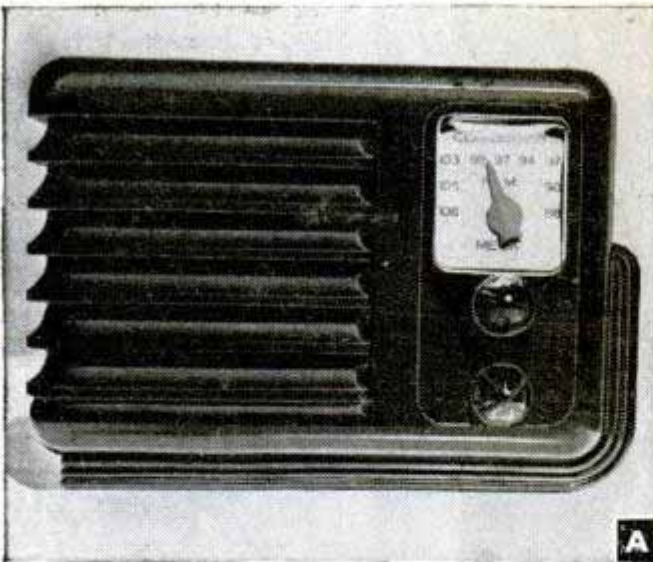

A

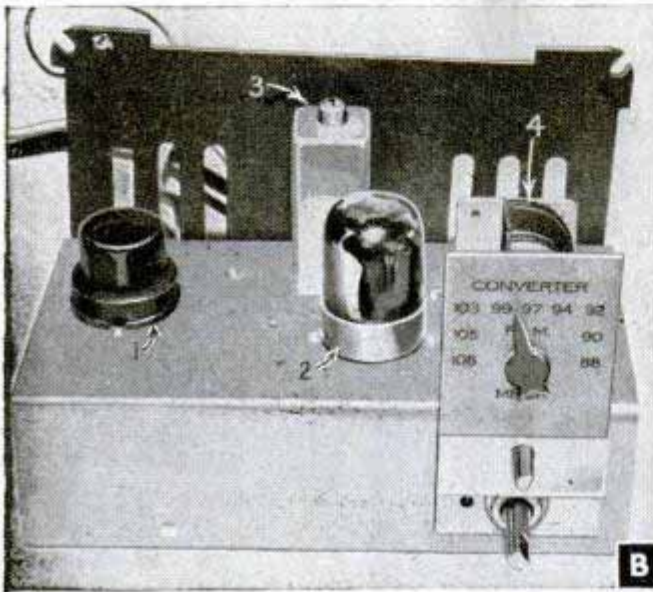

B

Above: No. 1, type 6H6 tube; No. 2, 7F8; No. 3, 21.75 mc. I.F. transformer; No. 4, tuning condenser



C

**It projects
bright images**

up to 40 inches wide



**and it
costs
only
\$27.50**

THE NEW KODASLIDE PROJECTOR, MODEL 1A



It's simple to operate, easy to store. *Lumenized Optical System*—boosts screen brilliance 50%; *Kodak Projection Ektanon Lens* 4-inch $f/3.5$ —easily focused, needle-sharp; *Heat-absorbing Glass*—protects transparencies from overheating; *150-Watt Lamp*—throws plenty of light across average-size room.

For that "professional touch" use the **KODASLIDE CHANGER**, illustrated above. One slide follows smoothly right after another. The changer does the work...you just push the plunger for the next slide. The screen is darkened while slides are being changed. One loading shows up to 46 cardboard slides.



Visit your nearest Kodak dealer for a demonstration
Eastman Kodak Company, Rochester 4, N. Y.

Kodak

**"You can't get laughs
when you've got
ACID
INDIGESTION
so Tums for me!"**

Says WILLIAM BENDIX
Famous Screen and Radio Star



"On the air or before the camera," says Bill, "I always have a roll of Tums handy in my pocket — ready to relieve acid indigestion fast. Believe me, you can't get laughs if you've got acid upset!"

When you want relief from acid indigestion, there's nothing *faster*—nothing *surer*—nothing *handier* than Tums. Just slip one or two Tums in your mouth, as you would candy mints. Tums not only neutralize excess acid almost instantly—Tums also coat the stomach with protective medication, so relief is more prolonged. Tums sweeten sour stomach, relieve gas, heartburn and that bloated feeling. No soda in Tums—no raw, harsh alkali to irritate your delicate stomach. And when acid upset comes at bedtime, don't count sheep—count on Tums for a refreshing night's rest. Get Tums today—then, *never* overalkalize, always *neutralize* excess acidity with Tums for the tummy!

**Night and day, at home or
away, always carry Tums!**

10¢
Handy Roll

3-roll package, a
quarter—everywhere



TUMS ARE ANTACID — not a laxative. For a laxative, use mild, dependable, all-vegetable **NR** (Nature's Remedy).
Caution: Take only as directed. Get a 25c box today.

Dual-Band Antenna System

(Continued from page 231)

line to the radiator elements of both antennas. Coupling is obtained through single "inducto" rings thus making it possible to operate with no mechanical connection between the antenna and feed lines so that continuous rotation in either direction is provided. One pair of rings is used for 20, and a second, smaller pair for 10 meters, as will be noted in the photo of the rotator unit. The "X" units are tuning condensers which raise the impedance of the primary rings to 465 ohms at the point where the transmission line attaches to the copper primary strips. No complicated element adjustments are necessary. A long 6-wire cable is employed to connect the indicator and rotator units; the circuit connections for the direction indicator are shown in Fig. 2. A solenoid brake in the rotator unit automatically locks the beam in any desired position. The direction indicator is furnished with a compass-card dial. Azimuth map cards centered on the East Coast, Middle West or West Coast of the United States may be used if preferred.

New Methods for Plotters

(Continued from page 143)

plane-table and its alidade. This is a complicated sketching board that makes accurate maps in the field. Its use for the mapping of large areas is now made obsolete by the faster and cheaper aerial mapping, but it is still needed for small detailed maps of industrial sites or subdivisions. It is also used for maps of areas not quite big enough to be worth the expense of aerial photography.

But here another postwar instrument can now do the job. It is the camera-transit—exactly what it is called, a combination camera and transit. The camera contains a Goertz Aerotar lens, is as carefully calibrated as the latest aerial cameras, and its photographs are taken on glass plates to prevent any error from shrinkage of the film. The photo-surveying is done by snapping photos at different angles and by tying them together with a simple triangulation and leveling procedure with the transit part of the instrument. Everything else is done in the office, making the system rapid and efficient. This "ground measuring" photography was used in the planning of Hoover Dam and the instrument is now being used by the Navy to survey rugged coast lines.

Even the plain, old measuring tape is

(Continued to page 236)

**FIGHTS 5-FOOT DRIFTS
IN EMERGENCY CALL**
Stork arrives in year's worst blizzard

*When safety's a must
... it's "Prestone!"*

ANTI-FREEZE



"Driving an ambulance is always 'emergency.' I can't take chances on freeze-ups—I always use 'Prestone' anti-freeze!"

Chester Raffia

*In your
car too!*

**NO RUST...
NO FOAM...
NO FREEZE...
NO FAILURE...**

One shot lasts all winter!

IF YOU drove an ambulance...if lives depended on you...you wouldn't have to be reminded that "Prestone" is the anti-freeze for your radiator.

The weather can shoot up or plunge down—"Prestone" anti-freeze won't boil away...you're safe and you know it! Give your car the protection it needs. One shot of "Prestone" brand anti-freeze!

NATIONAL CARBON COMPANY, INC.
30 East 42nd Street, New York 17, N. Y.
Unit of Union Carbide and Carbon Corporation



SAME PREWAR PRICE

1926...\$6.90	1933...\$2.95
1929...\$5.90	1935...\$2.70
1932...\$4.95	1939...\$2.65

1947...\$2.65 PER GALLON

The registered trade-marks "Eveready" and "Prestone" distinguish products of National Carbon Company, Inc.



PRESTONE

TRADE-MARK

Anti-Freeze

PICTOREEL HOME MOVIE HITS YOU CAN OWN!

GOOD NEWS FOR PROJECTOR OWNERS!

DEVIL DRIVERS



Auto-racing thrills of ten films in one! Swerving juggernauts...fearless drivers...in roaring races over world-famed tracks. Smash thrills of the Indianapolis meet! (No. 123)



BUCK CHEEZER

Whiz out to the moon in Buck Cheezer's 25th Century rocket-plane.

Chuckle-filled comedy amid the planets! (No. 116)

UNDERWATER

Revealing show of underwater beauty and sport! See archery, exploring, spear-fishing, water polo thrills filmed so perfectly you'll marvel at miracles of photography! (No. 130)



FREE!

Your de-luxe new PICTOREEL catalog of sound and silent home movies is ready. Send for it!

Please send the home-movies checked below.
I enclose remittance Send C O D

	COMPLETE			STREAMLINER	
	16 snd	16 sil	8mm	16mm	8mm
DEVIL DRIVERS	\$17.50	\$8.75	\$5.50	\$2.75	\$1.75
UNDERWATER					
BUCK CHEEZER	STREAMLINER ONLY				

Name _____

Address _____

City _____ State _____

PICTORIAL FILMS, Inc.
625 MADISON AVE., NEW YORK 22, N. Y.

now being replaced by other methods. For first-order measuring of long distances, triangulation has always been used. To measure with a tape—say, a thousand miles across country—is not only difficult, but the expansion of the steel tape (even the invar tapes) and the errors of marking off every tape length make it too inaccurate. But for ordinary measuring along a highway the steel tape has been "king."

Today, the subtense bar method from Europe is gradually being recognized. With one model of the compact Wild theodolites, a subtense bar can be set up over a point and the distance to it read accurately and quickly by a simplified, miniature form of triangulation. The same theodolite can be used for most general surveying. The bar is simply a two-meter-long rod that rests horizontally across another tripod.

But the steel tape will still be used in the construction of buildings and the like—and the timber-cruiser doesn't give a hang for any precise instrument. He needs only a good compass and an ability to judge timber with the bark still on it. Today, he can have several different compasses that will read angles and elevations and still go in his shirt pocket.

Altogether, so many intricate and superior instruments are appearing that the old-time, jack-of-all-trades surveyor is fast becoming a specialist. He and his fellow surveyors follow one another throughout the land, each an expert in his own field and with his own particular instrument. With the value of the land increasing every year, with the air lines scheduling flights throughout the world, with all the myriad demands of the postwar world for his work—the surveyor has needed these better instruments, as much as a doctor needs the X-ray.

Longest stretch of straight track in this country is a 78.86-mile stretch on the Seaboard Air Line Railway between Wilmington and Hamlet, N. C.

Model Builders Attention!



	V	V-2	V-3
Hex	1/2"	3/8"	5/16"
Thread	3/8"-24	1/4"-32	1/4"-32
Thread Length	7/32	7/32	5/32
Weight, Grams	8	3 1/2	2 1/2

Actual Size V-Plug

Champion Spark Plugs for model gas engines give the same dependable performance as regular Champions. Champion Ceramic insulation—Sillment sealed. Alloy needlepoint electrodes for easy starting. One piece construction.

CHAMPION

SPARK PLUG COMPANY • TOLEDO 1, OHIO

Dependable

CHAMPION

AMERICA'S FAVORITE SPARK PLUG

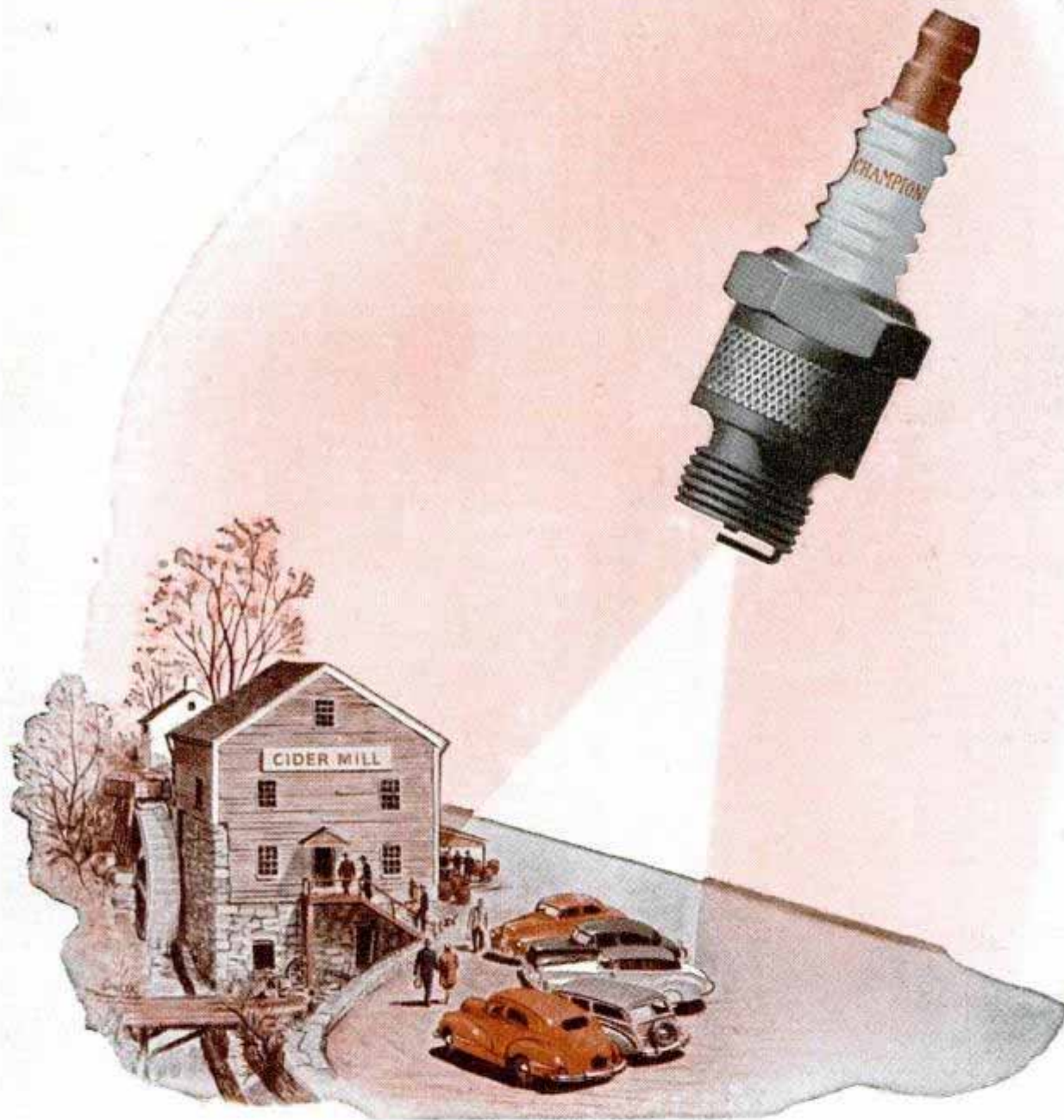

Dependable Champion Spark Plugs will give you sparkling performance in cider season as in every season. But the first few crisp days of Fall should be a reminder to you that your spark plugs should be serviced. If you find that new ones are needed, be sure to ask for dependable Champions—America's Favorite Spark Plug for every engine.

Champion Spark Plug Company, Toledo 1, Ohio.

FOLLOW THE EXPERTS

**DEMAND NEW DEPENDABLE
CHAMPIONS FOR YOUR CAR**

Listen to the CHAMPION ROLL CALL . . . Harry Wismer's fast sportscast every Friday night, over the ABC network

Where "The Good Earth" is H₂O

Crisp lettuce, loaded with sliced tomatoes and garnished with green peppers—sounds like a wartime combat soldier's dream, doesn't it—a luxury so many wanted to come home to. But it's no dream today to Regular Army men—even those in far off Iwo Jima, Japan and Korea—where garden soil is too scarce or starved for vegetables' growth. Right in their own backyards, the Quartermaster Corps grows vine-ripened, garden-fresh salad vegetables in *water*—instead of soil.

Of course, the whole plant doesn't grow under this nutritious water—just the root system. And it gets fed only during specified periods of the day. Simply, hydroponic gardening is *water culture* in beds of gravel or cinders which hold plants in place. Every day the beds are flooded with chemically fortified water until the plants are virtually swimming in fertilizer. The yield is high, the cost far lower than flying soil-grown fresh vegetables from the U. S.

Hydroponics is an exacting science. Its research has drawn upon the scientific genius of the Air Force, the Quartermaster Corps and civilian specialists.

Through this type of continuing research, the Army and the Air Force are making life more pleasant and healthful. And it is symbolic of the research which makes hundreds of interesting jobs for young men. It's one of many reasons why an Army or Air Force career is more attractive than ever before. Visit your nearest U. S. Army and Air Force Recruiting Station for further details.

U. S. ARMY AND AIR FORCE RECRUITING SERVICE

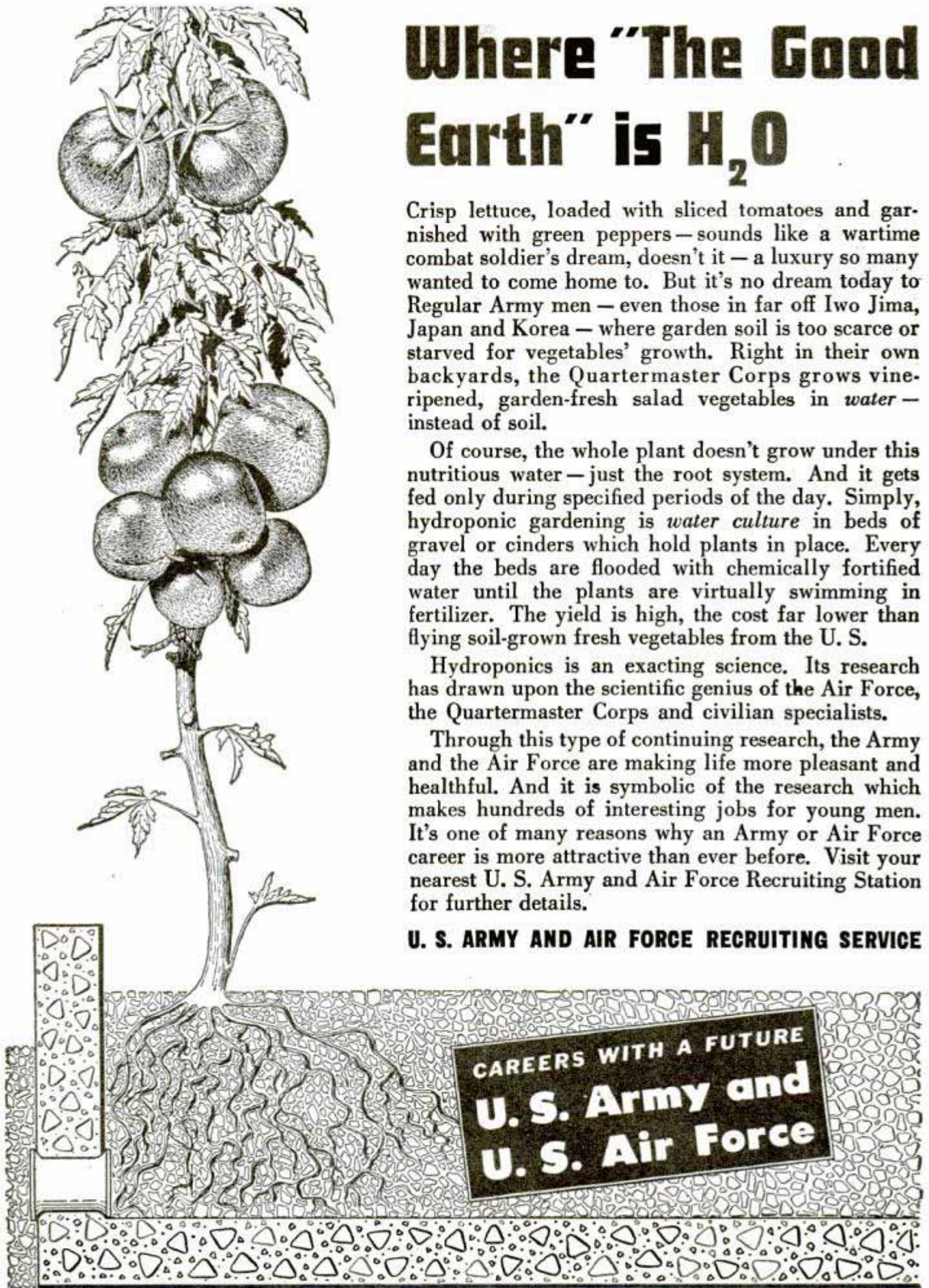

Your Army and Air Force Serve the Nation and Mankind in War and Peace



*Here's how to
get out of bed!*

... into a warm, comfortable room!
Perfection keeps your home
automatically warm throughout
the night. Just a turn of the dial
assures summer comfort for winter
mornings ... all over the house!

There's "Winter-Morning" Warmth
with **PERFECTION** Oil Burning Heaters!

—plus these other advantages—

Uniform Heat — quick radiating and circulating warmth, always there, day or night, when and where you want it.

Automatic Control — you can have fully automatic operation with an outside fuel supply tank and Accessory No. 12.

Clean Burning — soot-free, smoke-free, odor-free, result of advanced Perfection engineering over the years.

Blower — addition of Blower No. 24 will carry heat to far corners and other rooms.

Quiet Operation — a silent servant producing the quick, clean comfort of better living.

and — no coal to carry, no fires to build, no ashes to empty, no soot-streaked walls to clean!

PERFECTION

The World's Largest Manufacturers of Oil Burning Appliances for the Home

PERFECTION STOVE COMPANY • 7897-C PLATT AVENUE • CLEVELAND 4, OHIO
Atlanta • Cleveland • Chicago • Jersey City • Kansas City • Oakland • St. Paul

*Ivanhoe Model
2205 Space
Heater, other
sizes available.*



*Firelight Portable
Model 750 for
"spot" heating
anywhere.*

Outstanding!

**THROUGH FIVE GENERATIONS
OF FINE TOOL-MAKING**



There's a reason why men who know fine tools have, for over ninety years, chosen Plumb.

Plumb tools have outstanding features of quality—the one-piece steel head, the comfortable shock-absorbing handle made from tested second-growth hickory, the perfect "hang" and fine appearance. Plumb's constant research, engineering and design in fine tool-making have made Plumb tools the outstanding choice of five generations of craftsmen. Fayette R. Plumb, Inc., Phila. 37, Pa.

The red handle with the black head—exclusively Plumb.

Quality Comes FIRST

PLUMB

is FIRST in quality

PLUMB

HAMMERS • HATCHETS • AXES • FILES

Traffic Signals of the Sea

(Continued from page 151)

7. Radio aids. Comparable in its effect to the introduction of the high-powered prismatic lens in 1859, the radio-beacon system first used in 1941 ranks as the outstanding achievement in the coast guard's aid-to-navigation program.

Radio beacons are radio stations installed in lighthouses, lightships or other points known to mariners for sending out signals in all directions to guide vessels equipped with radio direction finders. Each radio beacon has a distinguishing signal and is marked on marine charts. On a ship, the direction finder enables the navigation officer to obtain bearings without delay and to get a "fix" through a series of cross bearings by tuning on two or more radio beacons.

Many radio-beacon stations are also equipped to send out synchronized radio and sound fog signals for distance-finding purposes. Distance-finding signals are based on the fact that radio signals are transmitted practically instantaneously, while sound signals travel through air at the rate of about one mile every five seconds. Distance thus may be calculated by the difference in time between receiving the two sets of signals. Normally, radio beacons operate continuously only during fog or low visibility, and on fixed schedules in clear weather.

Similar in purpose to the radio beacons—but differing markedly in method of operation—are radio direction finders. Radio direction finders are shore stations which supply ships at sea with their locations through a series of bearings taken on radio transmissions from the vessel. These bearings are then transmitted by radio to ships requesting the information. Greatest usefulness is in locating vessels in distress from their SOS signals.

Wartime development of radar is fast being put to peacetime uses—and one of the greatest of these is expected to be applicable to peacetime shipping. Radar "eyes" are fast being installed on many types of ships.

Mechanics and science have joined in developing modern navigation aids. These traffic signals of the sea mean greater safety for ships traveling in American waters. Captain Joshua James would be amazed to hear the land "talk" today.

☐ Watery waste from breweries known as "slurry" can be converted to a superior poultry feed by treating it with ultraviolet rays, according to tests conducted at St. Joseph's College, Collegeville, Ind.

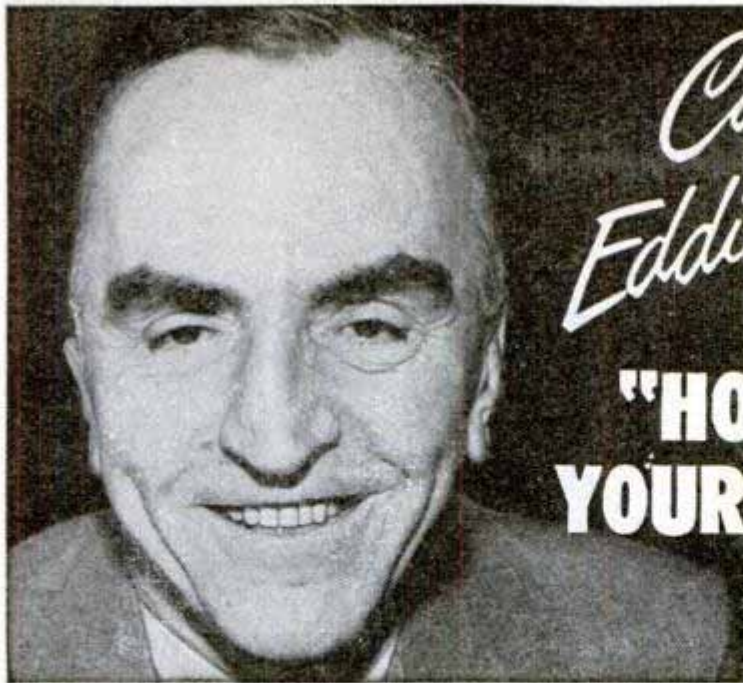

Capt. Eddie Rickenbacker
tells you
"HOW TO IMPROVE YOUR OPPORTUNITIES!"

Send for book "How to Get More Out of Life"
ONLY 10 CENTS with purchase of a package of POSTUM

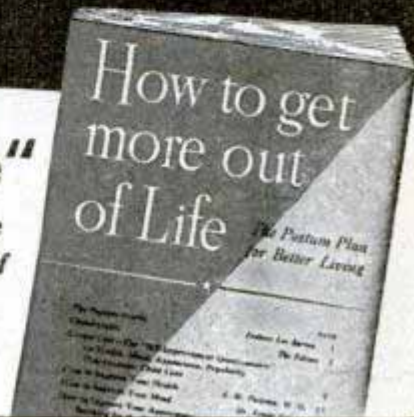

HERE'S your *big opportunity* to get the help of top-notchers like Eddie Rickenbacker, Dale Carnegie, Gene Tunney, and others in a *Private Edition**—yours for only 10c!

Simply go to your grocer today, buy a package of Postum, and fill in the coupon below. Mail with 10c in coin... This sensational offer is made solely to introduce you to POSTUM—and to the chance for a better, more successful life...

You see, for so many, POSTUM is more than a beverage. It has become a key to both health and happiness.

Scientific Facts About Mealtime Beverages

Both coffee and tea contain caffeine. It is a drug—a nerve stimulant! While many people can drink coffee or tea without ill-effect, others suffer nervousness, indigestion, and sleepless nights.

POSTUM contains no caffeine or other drug! Drink POSTUM *exclusively* for 30 days—see if you don't *sleep better—feel better—look better!*... And write today for this helpful book!

* NOTE: This wonderful book is not for sale through any other source. It is intended solely for the help and inspiration of America's huge and growing Postum family.

POSTUM
Plan for Better Living

Let these Famous People Help You to SUCCESS!

64 pages—handsomely printed—illustrated with 48 photos from real life.

In addition to **Captain Eddie Rickenbacker**—famous aviator, successful businessman, Eastern Air Lines president—this inspiring book brings you the counsel of such top-notchers as:

Gene Tunney... with priceless tips on "How to Improve Your Appearance"!

Dr. Ernest Dichter... telling you "How to Improve Your Mind"!

Dale Carnegie... giving you his latest popularity secrets!

A. M. Palermo, M.D.... with a simple, easy health program!

Plus Other Big Features!

MAIL THIS COUPON TODAY



POSTUM PLAN,
Dept. 42, Battle Creek, Mich.

I have purchased a package of POSTUM. Please send me the book "HOW TO GET MORE OUT OF LIFE," for which I enclose 10 cents in coin.

Name _____

Street _____

City _____ State _____

"That brand name means plenty, Mister"



JONES: Sure it does—to you hardware dealers. Tools with advertised names get you higher prices. But how about me? I want the most I can get for my money.

DEALER: Well, sir, let me ask you this. Do you think you get more for your money when you buy unknown tools at bargain counter prices?

JONES: Not necessarily. But I know this much—you can't change a poor tool into a good one just by putting a well-known name on it.

DEALER: Of course not. But don't forget that when a reliable manufacturer puts his advertised brand name on a tool—or

any other piece of hardware—it's got to be good.

JONES: How do you figure that?

DEALER: The manufacturer has a reputation to protect. Thousands of men *believe* in that brand name... *depend* on it... and he can't afford to let them down. It's the same way with me and my hardware store. I've got to keep *my* reputation for quality merchandise or I couldn't even stay in business.

Your **HARDWARE DEALER** sells **QUALITY tools**
and hardware... Buy from HIM



POPULAR MECHANICS

Motorcycling

world's
greatest
sport ~



Ever zip over a hill with the fresh morning air in your face, a companion clinging tight and happy laughter ringing in your ears? Ever feel the thrill of swinging down a beautiful country road on a swift, sleek Harley-Davidson that seems alive with power and anxious to go places? Ever hear the roar of races, hillclimbs and other spine-tingling events that only motorcycling provides? Ever join a jolly caravan of riders on a sight-seeing tour of scenic wonderlands, out-of-way places, distant cities? If you haven't, you're missing the world's greatest sport—motorcycling! And it's so *easy* to enjoy . . . easier to own a Harley-Davidson than you think. See your dealer today. Mail coupon now!

HARLEY-DAVIDSON
Motorcycles

HARLEY-DAVIDSON MOTOR CO.
Dept. P, Milwaukee 1, Wis.

Send free copy of ENTHUSIAST Magazine, filled with thrilling motorcycle action pictures and stories; also literature on 1948 models.

Name.....

Address.....

State.....

City.....



FOR *Building* AND *Repairing* CHRISTMAS TOYS



use **PLASTIC WOOD**

You can get a professional finish on those jobs for the kids! For a slick, smooth finish that takes paint, lacquer or varnish perfectly, use Plastic Wood as your filler. Repairs such as cracks, gouges or loose joints are quickly mended and the toy is back in apple-pie order! *Handles like putty—hardens into wood!*

... dozens of other uses

FOR FILLING ... **FOR REPAIRING ...**

- Countersunk screws
- Chipped furniture
- Nail and screw holes
- Loose casters
- Broken balusters
- Broken furniture

- *You'll want Plastic Wood SOLVENT, too.* Get both at one time. It is made especially to control the consistency of Plastic Wood ... useful also in removing dried Plastic Wood from tools and fingers.

T. M. Reg. U. S. Pat. Off.

At all Hardware,
Paint and 10c Stores



PLASTIC WOOD

Tube or Can

A CELLULOSE FIBRE FILLER

Harvesting the "Backwoods" Crop

(Continued from page 174)

the regular chipping process and no acid treatment, the flow of gum dwindles after the first two or three days.

It pays the turpentine farmer to apply acid. Chipping only and applying no acid, a man can handle about 5000 tree faces each week. By chipping and spraying, he can tend about 4000 faces a week. That means he can take care of 8000 faces by using two-week intervals and 12,000 faces by using three-week intervals. By chipping and treating at two or three-week intervals, a man can obtain from one and one half to two times the amount of gum per season normally produced by weekly chipping without acid treatment.

The acid solution, 40-percent strength for slash pine and 60-percent strength for long-leaf pine, is obtainable ready-mixed. It is sprayed on the freshly cut streak with a lung-powered spray gun.

The acid-spray treatment has resulted in the development of a new slashing method called "bark chipping." In this method, only the bark is removed, and the usual incision into the wood is omitted. Ordinarily, it is necessary to chip into the wood to get a normal gum yield, but when acid is applied the gum flows freely without the tree being cut.

Pine gum is providing an income for nearly 400,000 people who depend largely upon the naval-stores industry for their living. With the advent of central gum-distilling plants and the continuous-process method, many owners of land on which there are small stands of southern yellow pine are finding a new source of cash income in the sale of crude oleoresin.

Aluminum from Clay

Aluminum can be produced from clay in a process developed by Dr. James I. Hoffman, government chemist. In the past, bauxite ore has served as the raw material but according to wartime estimates, only a six-year supply of bauxite remains in this country. In the Hoffman process, clay is heated, treated with dilute hydrochloric acid, and filtered. The aluminum is obtained as hydrated chloride by adding hydrochloric-acid gas. The rest of the process consists of separating and washing the aluminum-chloride crystals, heating them to drive off the chloride and then recovering the hydrochloric acid for re-use. This process costs about twice as much as the bauxite process.

Logan

A NAME TO REMEMBER WHEN YOU
THINK OF BETTER LATHES AND SHAPERS

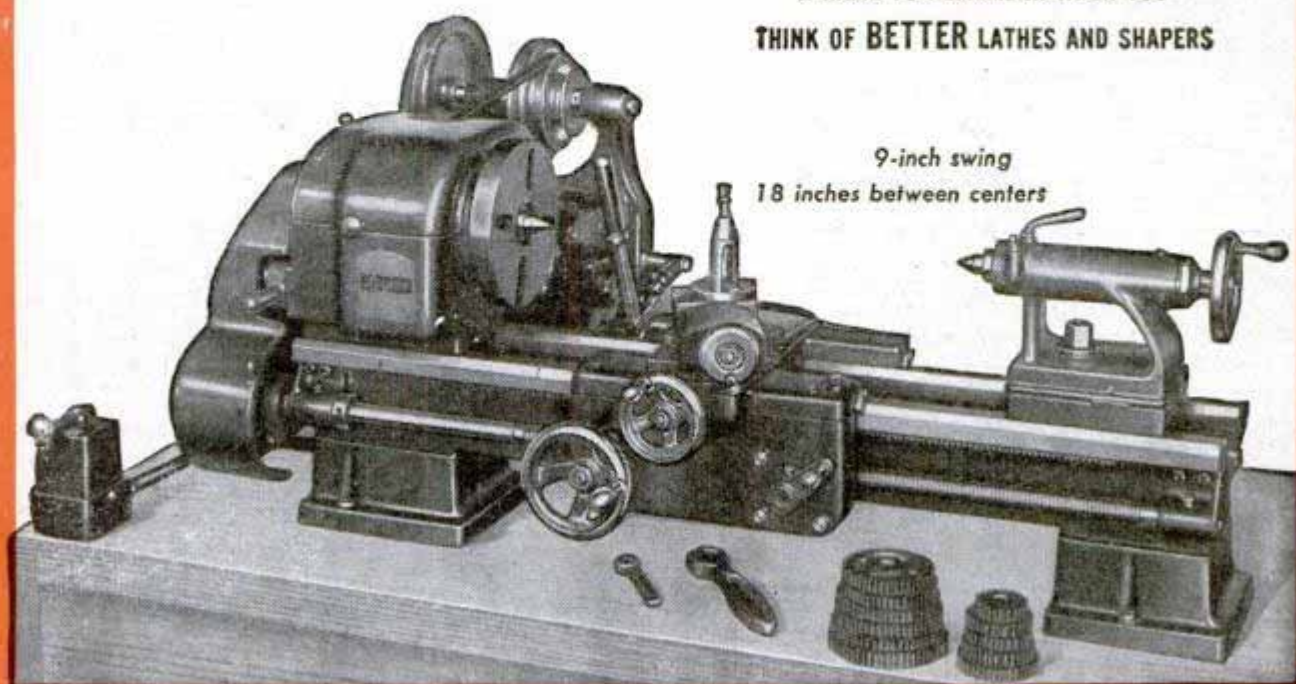

\$159⁵⁰

A New Low Price for *Logan* Performance In a New 9-Inch Lathe

The Logan 9-inch Lathe is as accurately, ruggedly built as larger Logan Lathes. Whether you use this new 9-inch lathe for precision manufacturing operations, general machine shop and tool room work, maintenance, or as the key tool of a home or farm work shop, it gives you big lathe accuracy and dependability. Its bed ways are machined to within .0005" of parallelism. Its ball bearing mounted spindle is inherently well adapted to high speed work. Its rugged, rigid construction assures steadiness on heavy cuts. In brief, here is a truly fine small lathe, at a low price that only the most efficient methods of lathe construction could make possible. Complete information at your Logan Lathe dealer's, or on written request.

DISTRICT OFFICES:

WOOLWORTH BLDG.
NEW YORK 7, N. Y.
CORTLAND 7-8024

550 W. WASHINGTON BLVD.
CHICAGO 6, ILLINOIS
CENTRAL 1246

1672 MISSION STREET
SAN FRANCISCO, CALIF.
UNDERHILL 6682

700 COMMERCE ST.
DALLAS 2, TEXAS
CENTRAL 4075

LOGAN ENGINEERING CO., Dept. B-11 CHICAGO 30, ILL.

FREE!



SEND FOR
ALLIED'S
BIG 164-PAGE
RADIO
CATALOG

Everything in Radio at Lowest Prices!

Here is *everything* you want in Radio! New home radios and phono-radios, Ham receivers and gear, new kits, thousands of parts, tubes, tools, complete PA equipment, diagrams, latest radio books. The most complete stocks anywhere—in one *big* book—all at money-saving low prices!

**BUILD THIS
AMAZING
5 TUBE RADIO**



LOW-COST SUPERHET KIT
Complete with Plastic Cabinet,
Loop Antenna, and Tubes



It's here! The first ultra-modern 5 Tube AC-DC Superhet kit at so low a price! Here's what you get—full broadcast band coverage (550-1600 Kc); built-in loop antenna;

latest 5" PM dynamic speaker; handsome walnut plastic cabinet. Unbelievably easy to build; no special tools required. Sockets are riveted in place on chassis base; just assemble, wire and slip into cabinet. Outstanding for power and tone quality. Highest grade components only. Complete with all parts, tubes and full instructions. **ONLY \$14.95**
Nothing like it at the price! Shpg. wt., 10 lbs. No. 83-275, Complete.....

GET THESE VALUABLE ALLIED RADIO BOOKS!



- Radio Formulas & Data No. 37-752... 10c
- Dictionary of Radio Terms No. 37-751... 15c
- Radio Circuit Handbook No. 37-753... 25c
- Radio Builders' Handbook No. 37-750... 15c
- Simplified Radio Servicing No. 37-755... 10c
- Radio Data Handbook No. 37-754... 25c
- ALL 6 BOOKS above No. 37-799... \$1.00
- Parallel Resistance and Series Capacitance Calculator, No. 37-980... 25c
- R-F Resonance and Coil Winding Calculator, No. 37-955... 25c

ALLIED RADIO

ALLIED RADIO CORP.
833 W. Jackson Blvd., Dept. 5-L-7
Chicago 7, Ill.

**FREE
CATALOG**

- Rush FREE 164-page Catalog
 - Send Kit No. 83-275
 - Send 6 Books No. 37-799
 - Send Calculators checked above
- } \$.....enclosed

Name.....
Address.....
City.....Zone.....State.....

Larson

"MAKE YOUR OWN" CARPENTER'S SAW-HORSE SET

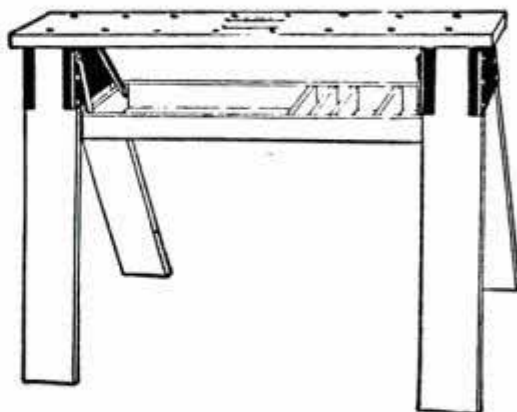

Makes a rigid saw horse that is actually a **PORTABLE HOME WORK BENCH** with many uses. Has a novel **SWINGING TOOL TRAY**. Complete hardware and copyrighted instruction sheet for easy assembly. Lumber is not included.

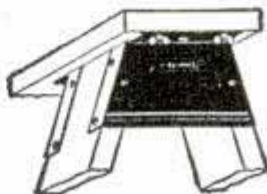

Prepaid \$1.35

CHAS. O. LARSON CO., BOX 358, STERLING, ILLINOIS

IMMEDIATE DELIVERY!

Complete as shown

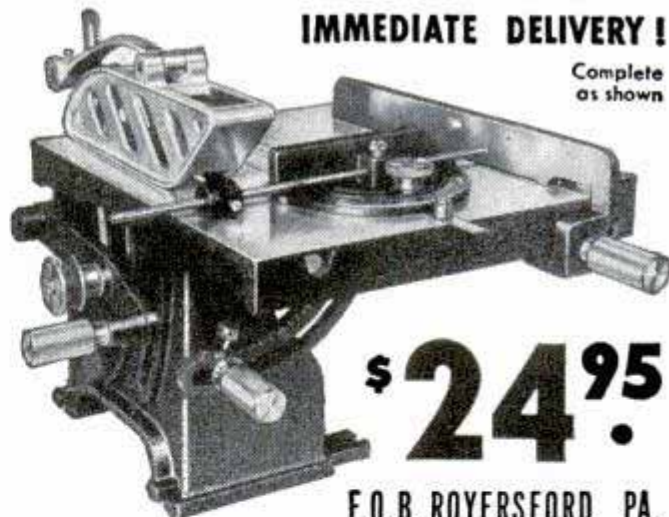

\$24.95

F.O.B. ROYERSFORD, PA.

QUALITY 8" BENCH SAW CUTS THROUGH 2⁵/₁₆"

UNCONDITIONALLY GUARANTEED ONE YEAR

(Write for Free Booklet and Guarantee Bond)

Comes complete with Floating motor mount—miter gauge with adjustable stop—aluminum guard—soft aluminum insert—spring steel splitter—heavy gray iron fence—(no motor—no blade). Table 12" x 14". Tilts to 45°—Oilite bearings. Shipping Wt. 50 lbs.

AMERICAN MACHINE & TOOL CO. Inc.

DEPT. 100

ROYERSFORD, PA.

Here's an Auto Headlamp that Does Not Grow Dim!

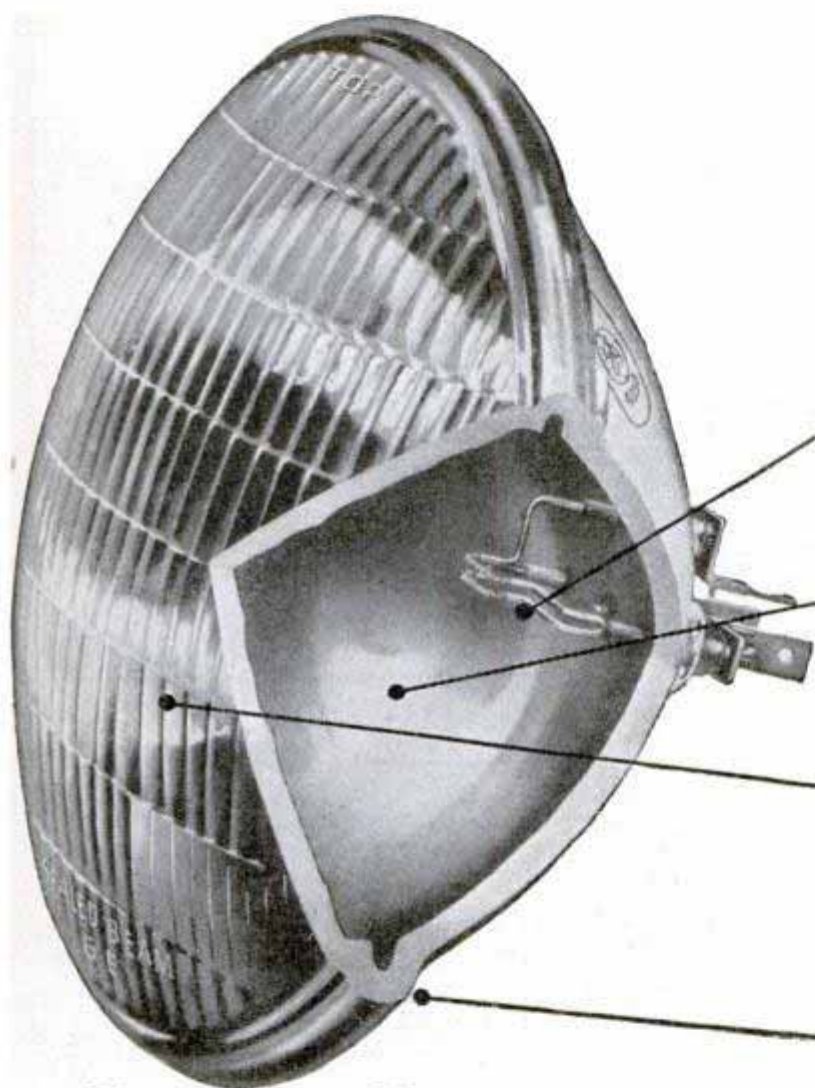

GENERAL ELECTRIC Sealed Beam Headlamps Do Not Grow Dim! Road and laboratory tests prove that the average G-E Sealed Beam Headlamp maintains 99% of original light output right up to the end of lamp life! Here's why the "all-glass" construction is the biggest value in headlamps today:

1. FIXED-FOCUS FILAMENTS HELD IN VISE-LIKE GRIP. Filaments are securely placed in the lamp. Firmly held so that road shock and vibration will not shake them loose.

2. MIRROR-LIKE, BUILT-IN REFLECTOR. Hard-glass, scientifically designed. Since dirt and moisture can't get in the bulb, the reflector can't tarnish . . . another reason why G-E Sealed Beam Headlamps do not grow dim!

3. RUGGED, HARD-GLASS PRECISION LENS. The special hard-glass used for G-E Sealed Beam Headlamps and the one-piece construction give maximum strength and ruggedness. And the lens is designed to put an accurate pattern of light where you need it . . . *on the road.*

4. ONE-PIECE, "ALL-GLASS" CONSTRUCTION. The whole thing is a bulb! Dirt and moisture cannot get in to reduce light output. Another reason why the average G-E Sealed Beam Headlamp maintains 99% of original light output right up to the end of lamp life!



G-E FOG LAMP. Same "all-glass" construction as G-E Sealed Beam Headlamps.



G-E SPOT LAMP Clear, penetrating beam you'll find useful on dozens of occasions.



INSTRUMENT Indicator bulb. Typical of the many efficient G-E miniature automotive bulbs.

NOW! *More light than ever before. Today's G-E Sealed Beam Headlamps give you 12% more light on the road for driving, 16% more light for passing!*

FOR EVERY SOCKET...FOR EVERY CAR

G-E LAMPS

GENERAL  ELECTRIC

Be sure your headlamps are aimed properly, and whatever lamps you need for your car be sure to insist on...



USE AC's FOR
**UTMOST
RELIABILITY**

"The mail must go through"—and does, with the help of today's AC's in thousands of mail cars and trucks. You can enjoy utmost reliability in spark plug performance by having your spark plugs checked to be sure they are right for today's driving and fuels.



Look for this sign



Spark Plugs cleaned and adjusted "By the AC Method" may save as much gas as 1 gallon in 10



SPARK PLUGS

AC SPARK PLUG DIVISION • GENERAL MOTORS CORPORATION

G.A. SPANGLER
Box 193, WILLIAMSVILLE, N.Y.
Blade-Tip Lights for Helicopters

Automatic signaling lights in the blade tips of helicopters are designed to distinguish them in flight from conventional aircraft. Both now use the same system despite their radically different flight characteristics. The lights also act as an automatic distress signal. In the new system the tips of a three-bladed helicopter are fitted with three different-colored lights—red, green and white. As the blades revolve the red light flashes on when the tip

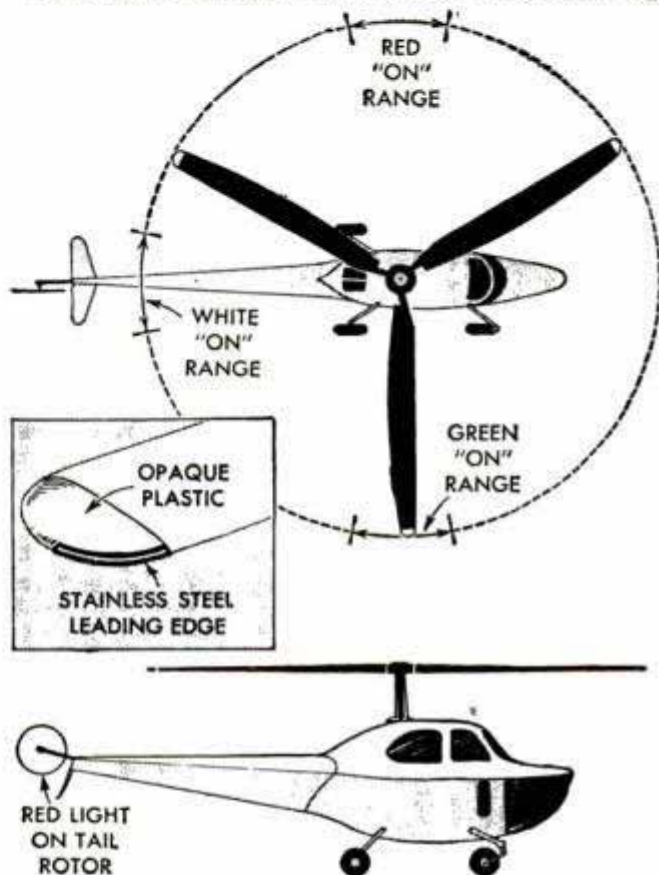

in which it is mounted is at the port (left) side; the green light flashes when its blade is at the starboard (right) side; the white light goes on when the third blade points aft. The relatively low revolutions per minute produces a distinctive pulsating signal. As a hovering signal all three lights stay on through complete rotation. As a distress signal, only the red light stays on. If a tail rotor is used it constantly displays a red light for safety. The system, developed by Gervase A. Spangler of Universal Helicopter Corporation, can be used on helicopters with various combinations of rotor blades.

Lard Kept Fresh By Adding Chemical

By adding a small amount of chemical called propyl gallate, lard and all types of edible animal fats and oils are kept fresh for a longer period of time. The chemical retards or prevents auto-oxidation, which creates a rancid odor and unpleasant taste.

NO WORKSHOP IS COMPLETELY EQUIPPED WITHOUT
BOTH THESE TOOLS



**IT'S BACK
MOTO-SAW**

THE AMAZING ELECTRIC SCROLL SAW



7,200 Strokes Per Minute
JUST GUIDE IT

Only
\$5.85

COMPLETE
With 3 Saw Blades
POSTPAID

**AVERAGE CUTTING SPEED
ONE FOOT PER MINUTE**

Boys from 8 to 80 (and girls, too) have fun with a Moto-Saw . . . it works more like magic than any tool you ever saw! Takes no effort to run, no perceptible pressure to feed . . . only a trifle heavier than a hand scroll saw, and better balanced in your hand. Runs 7,200 strokes a minute . . . leaves no rough edges . . . easily cuts intricate scroll designs in medium-hard wood up to 3/4" thick. Blade holder faces blade 4 ways . . . permits sawing sideways as well as forward and backward. No limit to length of stock it will cut . . . saws to center of 19" widths. Plug into any 110-120 Volt, 50 or 60 cycle alternating current outlet (does not operate on direct current). See Dremel Moto-Saw at your dealer's. If he cannot supply you, use coupon below to order on 10 day, money-back trial.

AS SAFE AS A HAND SAW

The versatile Moto-Saw is as safe as a hand saw . . . a touch of the trigger switch sets it going . . . releasing stops it instantly. A thrill awaits you when you first feel the hang of Moto-Saw in your hand and sense its surge of precision power. Sturdily constructed . . . only two moving parts . . . never needs oiling . . . requires no bench room or floor space. Thousands of satisfied users.

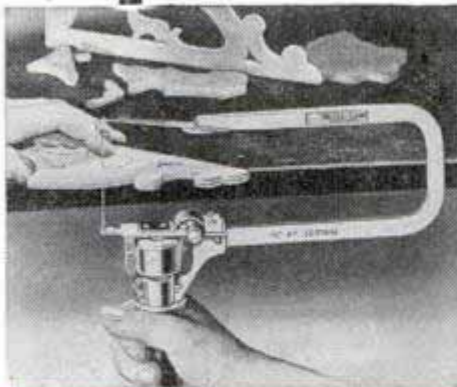

**IMPROVED
MOTO-TOOL**

**"THE POCKET-SIZE
MACHINE SHOP"**

Look at the rest . . . then buy the best! Only Moto-Tool offers about 27,000 R.P.M. (the speed necessary to conserve cutters, do fine work). Owners declare Moto-Tool the handiest tool in the home or shop . . . find new uses for it daily.



Approx.
27,000
R.P.M.

14 REASONS WHY MOTO-TOOL IS A BETTER BUY

- Housing has "pencil-type" finger grip.
- Instant-action, wrench-less chuck.
- Patented automatic chuck-lock pin.
- 110 Volt universal type (A.C.-D.C.) motor.
- Oversize armature shaft; hardened, ground and polished.
- Easily replaced commutator brushes.
- Oil-less, (sealed) trouble-proof bearings.
- About 27,000 R.P.M.
- Cuts cleaner . . . saves cutters.
- Dust-filtered air-cooling system.
- Dynamically balanced for vibrationless operation.
- Sturdy, shockproof bakelite housing.
- Sliding, snap-type switch.
- Handy hanger hook; cord protector.
- Weighs only 13 oz. . . shaped to fit the hand.

MODERN CRAFTSMEN'S KITS

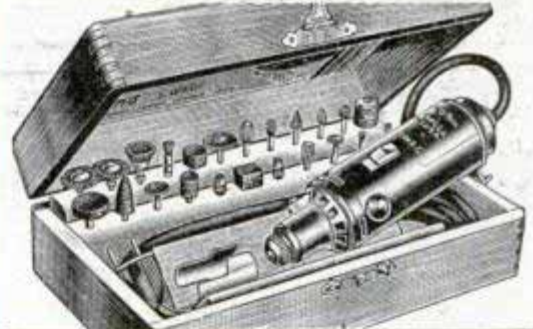

PRE-WAR PRICES STILL PREVAIL

Moto-Tool Kit No. 2, with 23 accessories (high-speed steel cutters, grinding wheels, polishing accessories) and heavy-duty professional Model 2 Moto-Tool in natural-finish, hardwood case . . . \$23.50 (Items purchased separately would cost about \$30.00; you save \$6.50).
Model 2 Moto-Tool, with one emery point, \$16.50
Moto-Tool Kit No. 1, with 34 accessories and Model 1 Moto-Tool in wood case . . . \$17.50
Model 1 Moto-Tool, with one wheel point, \$9.85

MONEY-BACK GUARANTEE; Buy Dremel Moto-Tool from your dealer. If he cannot supply you, order direct from the factory on 10 day trial. Shipped postpaid for payment in full (send check or money order); or send only \$2.00, we will ship C.O.D. You pay balance plus postage.

DREMEL MFG. CO. • DEPT. 117-L • RACINE, WIS.

IF YOUR DEALER CANNOT SUPPLY YOU, USE THIS COUPON TO ORDER

DREMEL MANUFACTURING CO. • DEPT. 117-L • RACINE, WISCONSIN

- Enclosed find \$_____ (Check or money order). Ship items checked below at once Postpaid.
 Enclosed find \$2.00 as part payment on items checked. I will pay postman balance plus postage upon COD delivery.
 Moto-Saw, with 3 blades, \$5.85 Model 1 Moto-Tool, \$9.85 Universal Stand, \$4.50
 _____dozen blades (60c per doz.) Moto-Tool Kit No. 2, \$23.50 Shaping Table, \$2.50
 Moto-Tool Kit No. 1, \$17.50 Model 2 Moto-Tool, \$16.50 Free catalog of Dremel Tools and Equipment

NAME _____ ADDRESS _____

CITY _____ ZONE _____ STATE _____

i.q.

Answer to problem on page 105

The energy is not destroyed, but released in the form of HEAT. To prove this, repeat the experiment with two identical springs, two beakers of acid and two sensitive thermometers. Compress one spring and tie it with catgut before dropping into the acid; leave the other free. The temperature of both beakers will rise during the dissolving, but that in the beaker containing the spring under compression will rise higher.

By Rex Taylor.

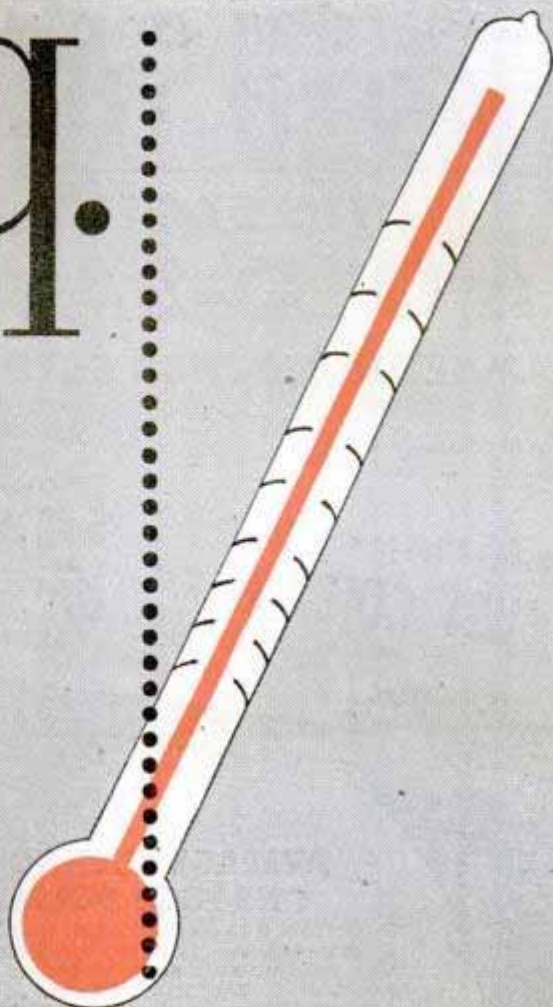

Honeys for warm comfort on the job

Test Yank-er-Jac's full-cut comfort—roomy shoulders, bloused body. Warm as only wool can be, handsome as black and red plaid always is. And Big Yank cotton plaid shirts have features like storm cuffs, elbow-action sleeves, large flap pockets, tailored collars. Get a Big Yank cold weather work-and-play favorite today at better stores . . . also corduroy or moleskin pants.



BIG YANK

SHIRTS · PANTS

OUTER WEAR

Reliance Manufacturing Co., 212 West Monroe Street, Chicago 6



HAND TRUCKS for every job!



REFRIGERATOR TRUCKS—Heavy 1½" tubular steel construction. Ball-bearing rubber tired wheels. Height 60½", Width 27", Weight 67 lbs.\$27.95

BARREL TRUCKS—D-2200, M-205 1 Handle, 10" Rubber tires\$17.45
D-2200, M-201 1 Handle, 5" Steel Wheels 8.95
No. 5503—Bar construction 5" Rubber Wheels, No. 2203 Tubular construction 5" Rubber Wheels\$8.95
D-3300, M-205 2 Handles, 10" Rubber tires\$17.95

CYLINDER TRUCKS—Heavy steel base 12"x24", 10" Rubber, puncture-proof tires\$24.45

MILK TRUCKS—8" Dual wheels, Ball bearing\$13.95

BATTERY TRUCKS—5x1½ Ball bearing solid rubber wheels...\$6.95

GARBAGE TRUCKS—5x1½ Ball bearing solid rubber wheels \$10.95

WHEELBARROW WHEELS

Ball bearing, steel or aluminum, 4-ply rubber tires and tube 4.00 x 8...\$13.95

RUBBER WHEELS

5 x 1½ \$1.50 6 x 2 \$4.50
8 x 2 \$2.25 10 x 2:75 \$6.84

10 x 1:75 \$2.95

Heavy duty, double-dual wheel, ball bearing 8 x 1¼ \$3.50

No C. O. D.'s — Send Money with Order.

Jobbers wanted. write for particulars.



UNITED SUPPLY CO. 420 WEST JUNEAU AVE. MILWAUKEE 3, WIS.

WHIPCO HANDY BRACKET CLAMP

the handiest tool you can have around
HOME, HOBBY SHOP OR OFFICE
Attractively finished in light metallic blue.

Slides in holding bracket snugly, holding clamps securely in two positions.



Will lend prestige wherever used. With a Whipco Clamp and a little glue that broken piece of furniture will be back in use.

HOME For many repair jobs, holding quilting frames, curtain frames, flower pots in window, and a thousand other uses.

HOBBY SHOP Holding small parts while shaping, gluing and cutting, holding files while winding, and many holding jobs in the photography dark room.

OFFICE Holding and hanging bulky papers, clamping various accessories to desk and typewriter stands.

Large clamp opening, 2½"; medium size 1½"; small size, ¾". Order special set today, consisting of 2 large, 2 medium, 2 small and 6 holding brackets — 12 pieces in all, packed in neat box, for only \$4.50 per set post paid in U.S.A. Will make excellent gift.

WHIPPLE MFG. CO.

SPIRIT LAKE, IOWA

Masonry Spraying

... Today's Outstanding Business Opportunity



Beauty and protection are sprayed on old and new buildings... exterior and interior surfaces... by COLORCRETE. It's a plastic, water-resistant material, spread evenly over surfaces and forced into cracks by air pressure. Fuses to masonry with enduring tenacity. Many textures. Range of 30 smart colors. Fully proven by 20 years of actual use under all conditions.

BIG EARNINGS FOR COLORCRETERS

Colorcrete ties in with today's huge building program. Renews old buildings. Makes new construction more attractive and enduring. Large waiting market, because building owners get long lasting beauty and protective values at low price. Yet your selling price can be several times your basic cost. Machine is easy to operate. Moderate investment. Write or wire for complete information.

COLORCRETE INDUSTRIES, INC.
570 Ottawa Avenue Holland, Mich.

COLORCRETE

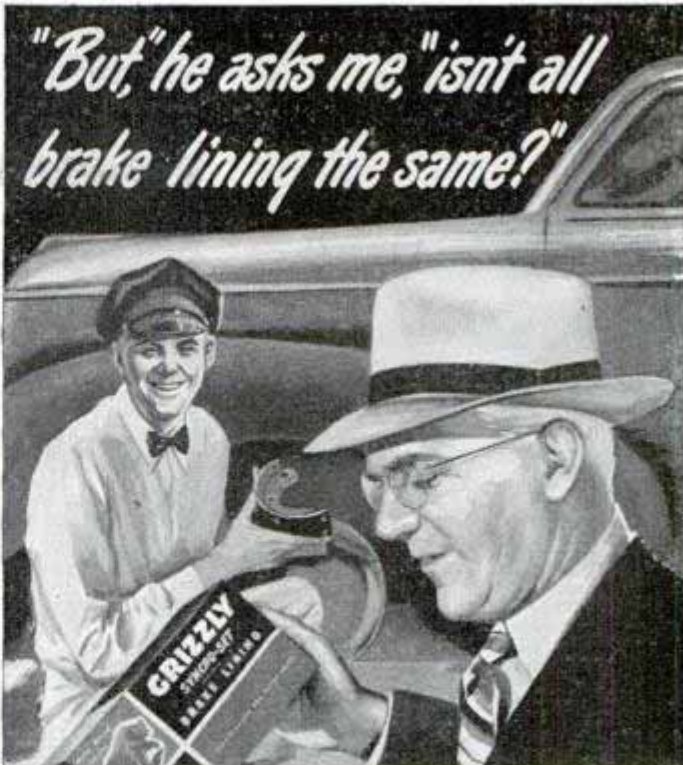
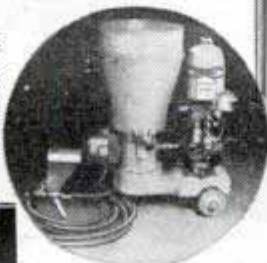

"But, he asks me, 'isn't all brake lining the same?'"

"Look, Joe," he says, as he watches me reline his brakes. "Isn't all brake lining the same?"

"Not quite," I answer. "For example, Grizzly Brake Lining is an exclusive, asbestos-friction compound, molded on a strong wire grid back. There are plenty of other features too, but what's most important is the way Grizzly gives better braking action to both 'Big Foot' and 'Little Foot' drivers."

"How's that?" he asks.

"Just this," I reply. "The many fine Grizzly features assure superior brake performance in the largest trucks down to the smallest passenger cars. Women, as well as men, find Grizzly gives them quick, smooth, sure stops with a 'soft' pedal."

"Well," he grins, "if the quality of your work equals Grizzly's quality, I'll be satisfied."

"Don't worry," I assure him. "Grizzly and I make a combination that satisfies every time!"

BIG FOOT... LITTLE FOOT

both share equally in Grizzly's superior all-around performance. Remember — for smooth, easy stops and amazing freedom from adjustment, reline with Grizzly. Grizzly Manufacturing Company, Pauldine, Ohio.



"Bear in Mind"... ask for

GRIZZLY
BRAKE LINING

WHEREVER BRAKES ARE SERVICED

There's more
pleasure in
working—
with an

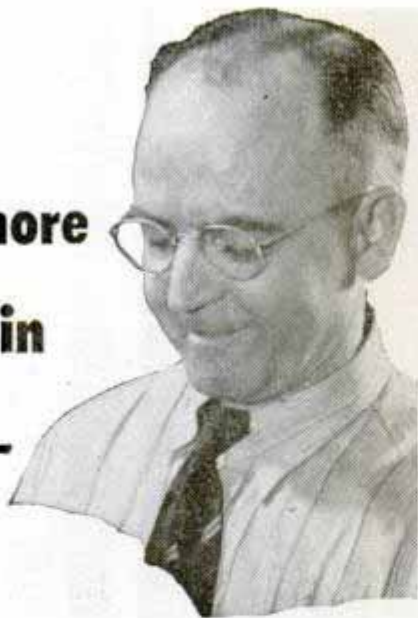

ATKINS



Equip your home workshop with a "Silver Steel" Handsaw and you'll promptly discover what genuine pleasure there can be in working with a saw. To feel the "rightness" of an Atkins in your hand is to realize what a top-quality saw can do to make shop work simple and enjoyable. Those extra-sharp teeth go slicing straight and true—and so fast and easy—through the wood. And the fine work you can turn out . . . that's one more reason for using Atkins saws. Remember, too, that Atkins "Silver Steel" Saws hold that keen cutting edge much longer.



E. C. ATKINS AND COMPANY
Indianapolis 9, Indiana

ALWAYS ASK FOR "Silver Steel"

Grandpappy Refuses to Die

(Continued from page 157)

still being operated by the Southern Pacific as a branch of its desert line that serves the Owens Valley region. There, too, there is just enough traffic to keep the line in business. Nonmetallic minerals such as clays, pumice, sulphur, and diatomaceous earth are the principal commodities hauled. One freight train is operated three times a week over the 71-mile portion that remains of the original line. There are no passenger accommodations and the occasional visitor who makes the trip needs no ticket to ride the caboose.

Parts of the roadbed on the narrow gauge are so rough that the bell on the small engine rings all by itself when the speed creeps up past 23 miles per hour, but there is no hurry and the engineer slows down when he hears this warning. Some of the original 35-pound rail is still in use.

Much of the rolling stock, built by the V & T in the '80s, is still at work and most of the wheels under the diminutive boxcars were cast in the V & T foundry. When one of the aged boxcars or flats is no longer safe it is tipped off the end of a spur track and burned.

Automobile tourists in Nevada who spot a V & T train and tourists in California who see one of the narrow-gauge freights usually stop their cars and grin while the old equipment rattles by. The engineers wave an arm and grin right back at them, for operating the old trains is fun.

The Guns Still Roar at Aberdeen

(Continued from page 94)

pressure of tires on the big mounts is checked regularly.

Here and there are guns that made history during World War II. Parked peacefully alongside our own giant artillery pieces are the German "Leopold" and "Anzio Annie," the latter being a 15-inch railroad gun used with devastating effect against our soldiers on the Italian beach. Our own giant 914-mm. mortar, the famous "Little David," is also on display.

Anchored near the shore where the big guns points out over Chesapeake Bay is the Aberdeen fleet. It consists of small boats that patrol the water areas during tests. Despite the daily thunder of the guns at Aberdeen it is necessary to remind some fishermen that those big shells are deadly.

The modern machine shops in the industrial section are equipped to modify almost any weapon or vehicle. These shops are

(Continued to page 256)

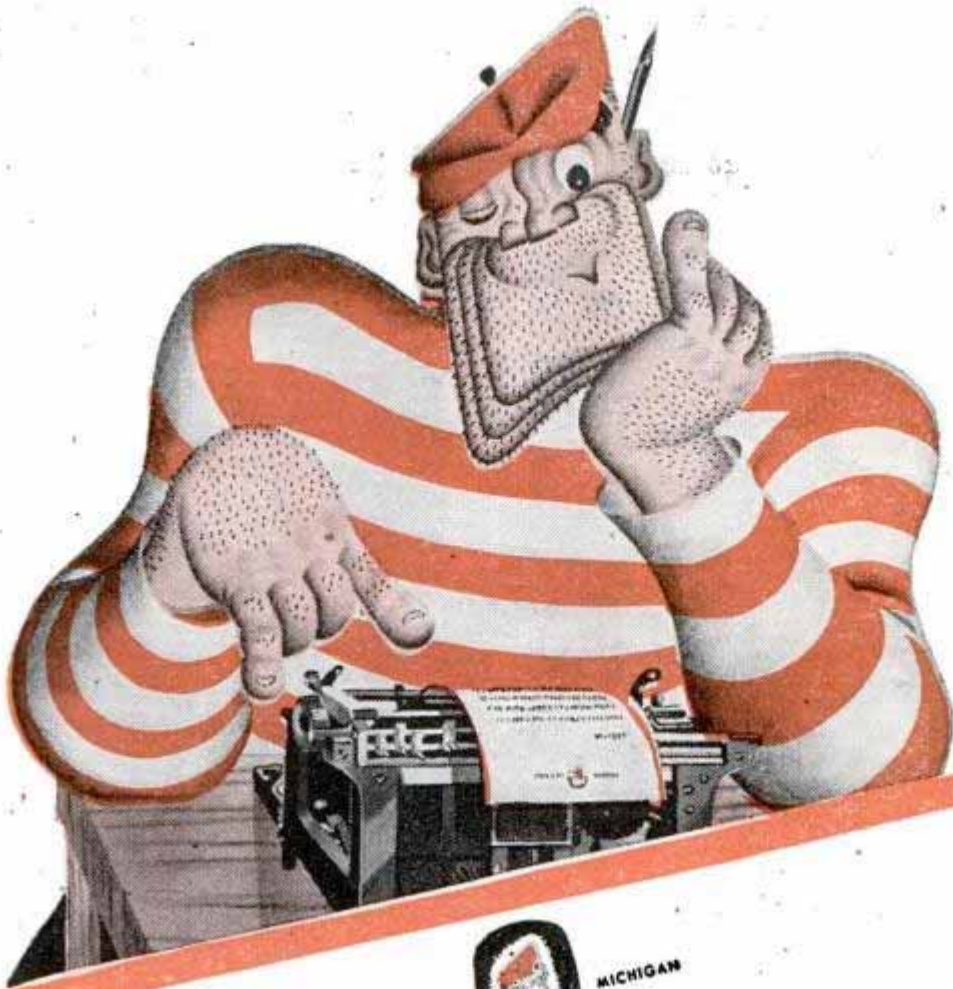

Dear Joe:

You're ~~right~~ right, oil-pumping is the first sign of worn-out piston rings. And the only sensible ~~thing~~ thing to do is hurry to a good mechanic and get them replaced.

Naterally I'd recommend Hastings rings. Cause I KNOW from experience they DO stop ~~put~~ oil-pumping, engine restore/performance and check cylinder wear.

Tough Guy

p.s. My boss says, "They'RE the best money you can spend on your car."

TOUGH BUT OH SO GENTLE



HASTINGS

STEEL-VENT PISTON RINGS

TOUGH on Oil-pumping
GENTLE on Cylinder Walls

HASTINGS MANUFACTURING CO.
HASTINGS, MICHIGAN
Hastings Ltd., Toronto



It shouldn't happen to a dog!

"I've been feeling as low as a dog-catcher, lately. I've got worms—and they shouldn't happen to any dog!"

"Sergeant's SURE SHOT Capsules are what I need. They clean out worms fast, surely, and safely. For pups, and small dogs weighing less than 10 pounds, use Sergeant's Puppy Capsules. They're specially made for worming the little fellows."

Sergeant's 73 years of clinical research have developed 19 dependable dog care products. Each one helps you to give your dog the care he deserves.



• You can keep your dog happy and healthy with just a little attention. Sergeant's new FREE Dog Book contains many interesting dog care hints. Ask for it at any drug or pet store, or write Sergeant's, Richmond 20, Virginia.

Sergeant's DOG CARE PRODUCTS

SAY YOU SAW IT IN POPULAR MECHANICS

SAFE HANDS

WORK FASTER

with Steel-Grip Gloves



The best opportunity for lower costs lies in speeding production. Keep materials moving with Steel-Grip Reinforced Gloves. They handle rough, heavy, jagged materials at breathless pace. Chrome tanned cowhide. Steel ribbon reinforced palm and fingers. Steel thread sewed. Protect against cuts, bruises. Or what's your need? Over 4,300 proved Steel-Grip Safeguards may give immediate answer. Used by big industrials since 1910. Write for catalog or state your need today.

INDUSTRIAL GLOVES CO.
647 Garfield Blvd., Danville, Ill.
In Canada: Safety Supply Co., Toronto



SHOCK ABSORBING

Tow Strap



FITS ALL CARS

Unbelievably strong—fastens to any car or truck bumper like a belt. Attaches in a jiffy. 10" s-t-r-e-t-c-h avoids jerks and car damage when starting and towing. Widely used on farms for pulling stumps, securing heavy loads, etc. Woven linen web—breaking strength 5000 lbs., more than most tow chains. In compact box—fits in corner of glove compartment. Send check (or M.O.) for only \$2.95 and your Motorists' Tow Web will be sent prepaid anywhere in U.S.

Cee-eN Mfg. Co., 7241 N. Hamilton Ave., Chicago 45, Ill.

GOODBYE to BURGLARS

Protect your belongings and the lives of your family. Send \$1.50 (or 7/8) by International Money Order for complete plans for combined burglar alarm and automatic locking device (electrical). It's unique. You make it from scrap.

SAFETY INVENTIONS, 110 Cranbourne Ave., Benoni, South Africa

ACE LATHE TOOL SET

Be permanently tooled-up for every operation on your Metal Cutting Lathe



The ACE Set is complete—there's nothing more to buy. Drop forged by the manufacturers of cutting tools used by 96 per cent of the plants and shops in industry they are correctly designed, are of special steel, are finely finished, are stronger—will last a lifetime. You can cut easier, faster and more accurately with ACE TOOLS.

At your Hardware Store—

ARMSTRONG BROS. TOOL CO.

"The Tool Holder People"
368 N. Francisco Ave., Chicago 12, U.S.A.

3 Turning Tools, 2 Cutting Tools, 2 Grinding Tools, 2 Boring Tools, 2 Threading Tools, 2 High Speed Steel Cutters and Blades, and 2 Wrenches in Fitted Steel Case.

The Chief's WORK BENCH

Built to Last a Lifetime!

With Bottom Shelf and 18" Sq. Drawer. 2"x6", Solid Plank, Grooved and Dovetailed Top and 1"x8" Back Rail, Shellacked to a Smooth, Satiny Finish.

MOHAWK LUMBER CO. Dept. 32
14525 W. Chicago Blvd. Detroit 27, Mich.
Enclosed Check Money Order for \$
Ship Quantity CHIEF WORK BENCHES at
\$16.95 each, F.O.B. Detroit, Mich.
 Send C.O.D., \$5 Deposit Enclosed.

NAME

ADDRESS

CITY STATE

No Priority Necessary!

• 6 Ft. Long • 34" High • 26" Deep. Shipped Knock-down, with Bolts, Nuts and Screws and ABC Chart for Quick, Simple Assembly.

Prompt Delivery
MOHAWK LUMBER CO.
14525 W. Chicago Boulevard
DETROIT 27, MICHIGAN



A CHRISTMAS PRESENT HE'D APPRECIATE

\$16.95
F.O.B. DETROIT

Send Check or Money Order, or Will Ship C. O. D. (\$5 Deposit)

POPULAR MECHANICS

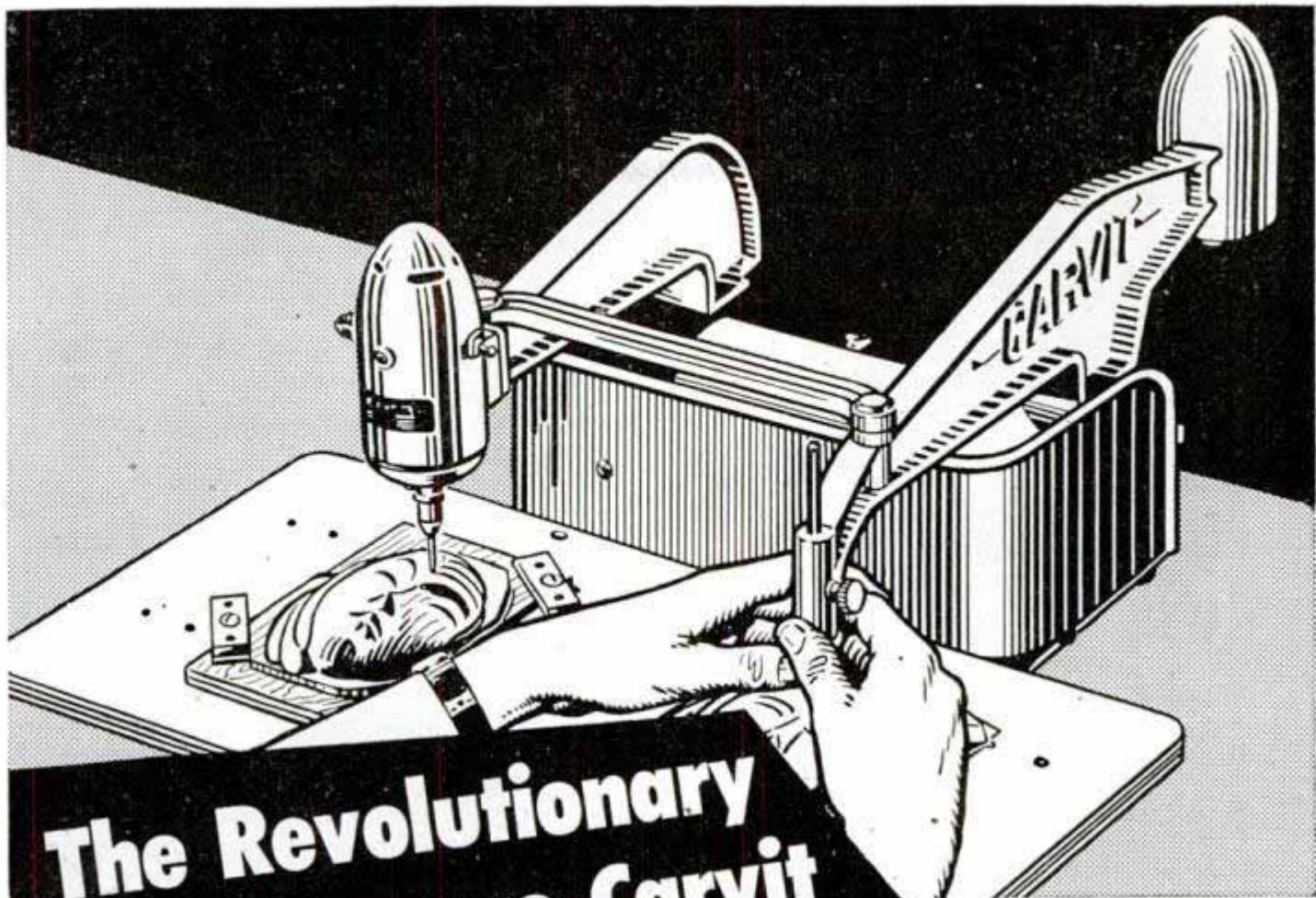

The Revolutionary New Dumore Carvit

makes you a skilled wood-carver in 20 minutes!

Here's a fascinating new hobby — complete in one tool. Making fine wood carvings with the Carvit is so simple a child can do it! The unbelievable perfection of your first carving amazes your friends! Experienced craftsmen use the Carvit to give their woodworking projects that *real* professional touch.

With the Carvit, you make beautiful replicas of inexpensive objects you can find in any dime store or gift shop — reproducing them in mahogany, walnut, and other fine woods. Your carvings are many times more beautiful and valuable than your original models!

You're an expert at once — with a Carvit!

Here's how the easy-to-use Carvit works: You clamp a model to the table below the tracer, and a wood block below the cutter. Then you switch on the motor and guide the tracer over the raised contours of your model. The cutter moves with the tracer to carve an

exact duplicate of the model.

Carving with the Carvit is fascinating fun for everyone. The Carvit is *the ideal gift for your sweetheart, husband, or son!* See the Carvit at your local hardware store today — or mail us the coupon below!



No skill or training needed to do work like this

Carve useful ornaments for the home — distinctive gifts — fine carvings that *sell!*

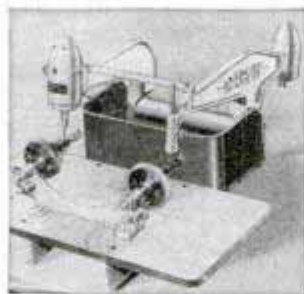

With an index attachment, the Carvit reproduces objects in the round — statuettes, and busts.

The Dumore Company, Dept. L-51, Racine, Wisconsin

- Please send complete information on the Carvit.
- Please send one Carvit. \$48.50 enclosed.
- Please send one Carvit with index attachment. \$58.25 enclosed. Shipping charges C.O.D.

Name.....

Address.....

City..... (.....) State.....

H-8

**Satisfaction
guaranteed or
your money back
in 10 days!**

**Tear out coupon
and mail today!**

AT LAST!

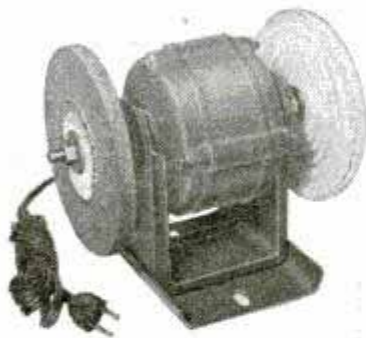

A WORKSHOP GRINDER OF YOUR OWN for only **\$14.95**

(\$15.95 West of Denver)

FULL YEAR GUARANTEE

Just what you've been waiting for—this sturdy new, grinder-buffer-polisher. Designed and built especially for the home and hobby shop . . . Perfect for small industrial jobs.

HAS COUNTLESS USES

You will need this amazing home workshop grinder to sharpen knives, scissors, screwdrivers, small tools, lathe bits and many other around-the-house items . . . polish silverware, jewelry, golf clubs and keys.

NOTE THESE FEATURES

Safe operating speeds of 1725 rpm—will withstand stalling for 20 minutes without injury to motor. Oversized rubber cushions make it whisper-quiet—a must for home workshops and offices. Low cost operation—uses same current as 100 watt bulb. Will not interfere with radio. It is light enough to be carried to place of work.

NOTHING EXTRA TO BUY

Comes fully equipped—ready to go to work. Includes rugged six foot cord set, dura-hard, silicon carbide grinding wheel, polishing wheel. Has famous Victron motor mounted on resilient, non-vibration base. Finished in gray baked enamel—equipped with oil reservoirs and felt seals to last for the lifetime of the grinder. Weighs approximately 12 pounds. Can be clamped or bolted to table or work bench. Designed specifically for hobbyist, handyman, housewife, mechanic, doctor, dentist, optician, watch maker and jeweler. Send check or money order today. Postpaid in U. S. A.



good evidence of some of the \$50,000,000 spent for construction at Aberdeen during the war. One building houses a 1,000,000-volt X-ray machine and has facilities for examining entire units, such as gun tubes.

All roads at Aberdeen lead eventually to the Ballistic Research Laboratories and the office of Colonel Simon.

"Our laboratories here are responsible for all the Army's ballistic measurements," said Colonel Simon, "including the rocket and guided-missile tests at White Sands. Things around here actually move with the speed of light. The measurements for guided objects are largely electronic and all electromagnetic radiation moves with the speed of light. The instruments we use in this work change and improve so swiftly that we scarcely bother to write research reports because they would be obsolete before they could be printed."

To measure the flight of a single guided missile, the laboratory normally uses ordinary radar, pulse radar, the radar plotting board, several unique ballistic cameras, including a new one which can take a picture of a V-2 at 30 miles which occupies only one-third of a moving-picture frame, a specially built Knapp-Bowen camera, and Mitchell and German theodolites. The radio doppler system (see illustration) is used to measure and record the position, velocity, and acceleration of a guided missile hurtling through space at many times the speed of sound. Intensive research, both at White Sands and in the \$2,000,000 supersonic wind tunnel at Aberdeen, is causing rapid changes in the design of rockets and guided objects. The wind tunnel, which was completed before the war ended, saved the country millions of dollars by revealing a fault in a heavy bomb before it went into production.

In regard to guided objects, the colonel points out that no one has yet guided a supersonic missile in the accepted meaning of the term except for a few test models of a German flak rocket. Guidance of a German V-2 functions only when the rocket is burning and therefore it is actually guided much as an artillery shell is aimed. Despite the many factors to be overcome in perfecting guided missiles, Colonel Simon says: "It is reasonable to expect that long-range rockets and guided missiles will largely replace the tactical and long-range bombing planes, the long-range gun, and the large antiaircraft gun."

How soon? The answer to that question is buried deep at Aberdeen Proving Ground where the roar of guns in time of peace assures a nation that its best military minds are very much on the alert.

VICTOR ELECTRIC PRODUCTS, INC.
2950 Robertson Ave. Cincinnati 9, Ohio

**CREATING DESIGNS IN
PLASTIC
IS A GRAND FEELING**



**IT'S A
GRAND
FEELING,
TOO...**

**WHEN YOUR CAR IS
CUSHIONED WITH MARFAK
CHASSIS LUBRICATION**

THAT CUSHIONY FEELING LASTS LONGER WITH MARFAK!

It's a grand feeling to watch those artistic plastic designs take form. It's the same feeling of satisfaction you get when you drive your smooth-riding *Marfak* lubricated car.

Cushiony driving and handling ease is a sure sign that *Marfak* sticks to its work, with bearing surfaces scientifically protected against wear . . . for a thousand miles and more. *Marfak* is designed to resist wash-out, jar-out and squeeze-out. Applied by chart, never by chance. Ask your Texaco Man to give your car that "*Marfak* feeling" today.



THE TEXAS COMPANY

TEXACO DEALERS IN ALL 48 STATES

Tune in: TEXACO STAR THEATER presents the TONY MARTIN show every Sunday night. See newspaper for time and station.

YOU CAN'T BEAT AN *American*

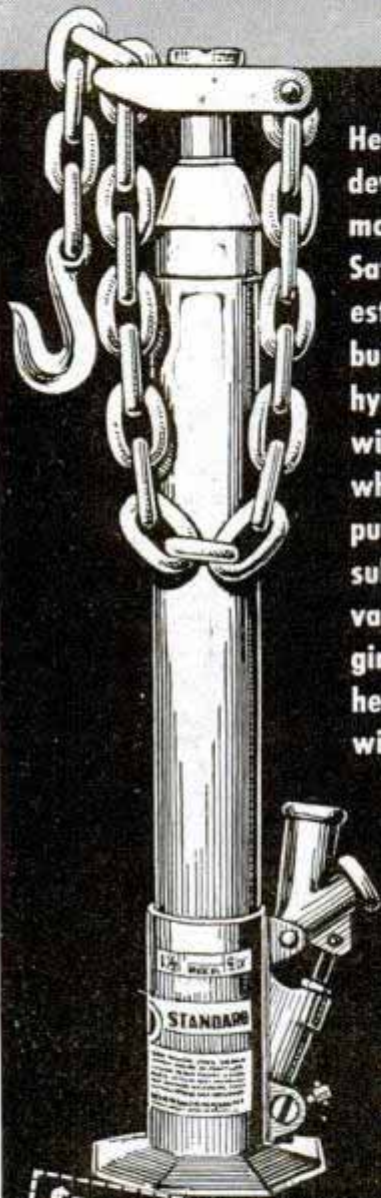

Here it is—the greatest development in automobile bumper jacks! Safest, quickest, easiest to use on any car built. Also an all-around hydraulic utility jack with hundreds of uses where easy lifting or pulling is required. Result of 15 years of advanced precision engineering. Extra long, heavy duty steel chain with forged steel grab hook picks up loads from 4" BELOW bottom of jack to 22" ABOVE. Base, handle socket, head and chain plate are all tough malleable iron castings. 17" hydraulic lift, 3000 lb. capacity.

\$14.50 Complete with chain, hook and handle

Order now at your dealer or write to

*American
Hydraulics*
Inc.
SHEBOYGAN, WISCONSIN

© 1947 AH, Inc.

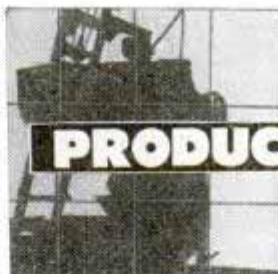

**We'll Start You
Complete in this**

PRODUCTS BUSINESS

**And Help You
Put It Over**

The great building industry is your profitable market for masonry products. Low investment . . . high returns . . . wide-open opportunity to establish a lifetime business.

The biggest building years in the nation's history are just beginning. New construction, involving billions of dollars, means huge demands for block, drain tile, and other masonry products which YOU can manufacture locally, from local materials, with local labor for local consumption. Remember, MASONRY products are in mesh with today's building preference!

Use our modern machines and equipment to insure the finest quality products at pared-to-the-bone manufacturing costs. Sold direct from factory to you. Backed by 40 years of pioneering and manufacturing. Write for new catalog. Describes complete line of equipment with prices plainly marked. Tells how we help you in manufacturing and merchandising. Write TODAY.



**CONCRETE
EQUIPMENT COMPANY**

512 Ottawa Avenue
Holland, Mich.



Sand Casting—Forging—Heat Treating—Case Hardening **BRONZE FOUNDRY**



is again available in limited quantity without priority. Orders filled in sequence as received. INVENTORS—SCHOOLS—CRAFTSMEN use FOUNDRYETTE for making castings quickly for new inventions, for instruction, and general purpose. Order now for early delivery. Three sizes are available capable of making bronze castings of 1½, 3, and 6 pounds weight, aluminum, copper, brass, etc. Domestic gas supply and 110 volt AC or DC energy required for operation.

Write for FREE circular.

KANSAS CITY SPECIALTIES CO.

Box 6022, Dept. PK-4

Kansas City, Mo.

NEWEST OTTAWA LOG SAW

**SELF-PROPELLED — MOVES
ANYWHERE on OWN POWER**

World's fastest Log Saw. Powerful 6 H-P air-cooled motor. Attachments for sawing down trees, buzzing limbs, post hole digging and pulley for belt jobs. Big demand for wood, pulp, posts. Make big money sawing wood this easy way. Low factory-to-user prices. Nothing like it. FREE details. **OTTAWA MFG. CO., 7-727 Pine St., Ottawa, Kansas**



BUILD YOUR OWN FAST FREEZER

**PLANS
\$1**

It's easy to build this household appliance with LeJay Plans. Made from new or used parts. Save up to 75%. No expert knowledge needed. Plans show 5 sizes and are easy to follow. All details clearly explained. Enjoy making one of these freezers. Mail \$1 for set of plans and catalog. **LEJAY MFG. CO., 447 LeJay Bldg., Minneapolis 8, Minnesota**



5 sizes
8 to 40 cu.ft.

Now CHEAP OIL BURNER FOR HEATING AND COOKING STOVES—FURNACES

**HEAT YOUR HOME, COOK YOUR MEALS
WITH CHEAP FURNACE OIL**

NO MORE SHOVELING COAL OR ASHES. Sensational Fuelizer Starter Vaporizing System turns Cheap No. 1 Furnace Oil, also Range, Heater, Tractor Distillate, Kerosene and like oils into oil heat—one of the quickest, hottest fires known. **LIFETIME GUARANTEE. \$1.00 Bonus Offer for Testing.** We will let you try it in your own stove or furnace for one month. Get yours for introducing. Big profits QUICK. Be first. Send in your name today for details and cash in on the tremendous demand for this Amazing Invention.

NORTHWEST MFG. CO., 608-N. Mitchell, S. Dak.



OWN THIS

Threadwell

TAP AND DIE KIT

\$19.95 Complete with Case

THREAD THESE SIZES
(NATIONAL COARSE SERIES)

1/4", 3/8", 1/2", 5/8", 3/4"

Tap holes, cut threads quickly, easily, accurately in any material! Threadwell 50-S SCREW PLATE SET contains Die Stock, Tap Wrench, seven 1 1/2" O. D. Round Dies and seven Hand Taps for cutting National Coarse Series threads. Each die adjustable for standard, over or under-size cut. Steel guide for each die insures straight, accurate threads. All in handsome, sturdy, fitted box with complete instructions. Order through your dealer or send \$19.95 for prepaid, same-day shipment (C. O. D. \$19.95 — you pay charges). Money-back guarantee if returned in 5 days.



THREADWELL TAP & DIE COMPANY
120 ARCH STREET, GREENFIELD, MASS., U.S.A.



LUMINALL, in lovely new colors, brightens your home at low cost. At your dealer's.

LUMINALL
Paint does more for rooms and furnishings

Its purer colors give better lighting



LUMINALL PAINTS, Chicago 9, Illinois



ASSORTED SPRINGS
FOR REPAIRING AND REPLACING

\$7.10
POSTPAID

handy SPRING kit

Wide assortment of compression, extension and torsion springs—just what you need for a multitude of odd jobs requiring use or replacement of springs.

High quality—same springs that are made for topnotch manufacturers to their rigid specifications. Several dozen springs in kit.

Have the Handy SPRING Kit handy. Send a check or money order right now to Department B

NEW ENGLAND SPRING MFG. CO.
Unionville • Connecticut

PRINT YOUR OWN

- CARDS
- LETTERS
- POSTCARDS

25% Deposit Required **\$3.95** COMPLETE
Dealers send for Discounts

COASTAL DISTRIBUTORS

553 MARKET STREET

NEWARK 5, N.J.

NOVEMBER 1947

NOW TRY

Dustless SWEEPING



Reduce Germ Laden Dust
Eliminate Sweeping Compound

Dustless brushes used with Arbitrin sweep fluid eliminate up to 97% of germ laden dust and reduce sweeping costs 20%. Arbitrin fluid, poured into a metal reservoir in the brush back, filters through the tufts and keeps dust down as you sweep. Dustless brushes are used in thousands of schools, factories, offices, stores, and institutions. There is a Dustless brush to fit your needs. Write for sizes, styles and prices today.



Milwaukee Dustless Brush Co.
530 N. 22nd St., Milwaukee 3, Wis.
Please send complete facts about Dustless Brushes.

Name _____

Street Address _____

City, State _____

SAY YOU SAW IT IN POPULAR MECHANICS

NO OTHER TOOL LIKE IT



BURGESS vibro-tool

Trade Mark Reg. U. S. Pat. Off.

- WRITES ON STEEL
- CARVES WOOD
- DECORATES GLASS
- TOOLS LEATHER
- ENGRAVES JEWELRY
- CUTS CARDBOARD

Works by Vibration!

Whether you work with metal, wood, glass, plastics or leather, your shop is not complete without a Burgess Vibro-Tool. Totally unlike anything else on the market! Writes like a pencil on hardest steel! Engraves, carves, hammers and cuts. Only \$7.50 at your dealer. If he cannot supply you, write to us and we will arrange for shipment.

**BURGESS
BATTERY COMPANY**
Handicraft Division
Lake Zurich, Illinois

ORDER REPLACEMENT ACCESSORIES NOW!

- V 5 Standard Needle...\$0.15
- V 3 Heavy Duty Needle...\$2.00
- V 80 Diamond Point Needle \$5.95
- V 81 Point for Frosting Glass \$0.75
- V 82-87 Leather Tools including punch, liner, deerfoot, spoon, double liner and cupper \$1.50
- V 23 Straight Edge Surgical Steel Knife...3 for \$0.50
- V 24 Belly Edge Surgical Steel Knife...3 for \$0.50
- V 101 Foot Gauge for use with knives to regulate cut depth...\$0.95
- V 51-56 Assorted Carving Chisels...6 for \$1.50
- V 44-48 Assorted Ball Points 5 for \$0.95
- V 41-43 Assorted Hammer Tips 3 for \$0.25
- V 115 Sharpening Stone \$0.25

DE LUXE KIT only \$16.50

Contains Vibro-Tool and 22 attachments, everything necessary for metal marking, jewelry engraving, leather tooling, wood or linoleum carving, pattern cutting, metal embossing, etc. Includes sharpening stone. Each unit individually packed in handsome, natural finish, wood storage chest. An ideal gift for any hobbyist.



BURGESS BATTERY COMPANY
Handicraft Division, Lake Zurich 11, Illinois

Please arrange for a Vibro-Tool dealer to ship the following:

- Vibro-Tool De Luxe Kit Accessories Enclosed find remittance Ship C.O.D. } Please list parts wanted by number

NAME.....

ADDRESS.....

.....

Land of Home Workshops

(Continued from page 104)

night, a raincoat during thundershowers, and as a display for wares in the market place. For women, the rebozo or shawl worn around the head is almost as versatile. It keeps out the morning chill, serves as a cradle in which to carry a baby and becomes a market basket in which to bring home food.

Mexicans do some amazing things with their basket weaving. The materials that go into these products include the maguey fiber (the plant that also produces pulque, the poor man's drink), grass, fine bamboo, henequen and horsehair. A great variety of techniques are used to produce a wide range of colorful articles—sleeping mats, hammocks, earrings, sandals, toys, hats and baskets of all sizes and shapes.

One of the interesting sights in Mexico City is a man born without arms who cheerfully weaves with his feet. All day long he sits on Juarez Avenue, Mexico's Broadway, using his toes as cleverly as most persons use their fingers.

Since Mexico is the world's No. 1 producer of silver, it is only natural that her craftsmen should be highly skilled in fashioning jewelry and platework of a purity higher than Sterling. In Aztec days, much filigree work was produced, but today simpler designs for rings, bracelets, necklaces, earrings, pins and other jewelry are favored. Many designs are set with coral, amethyst, opal, jade, onyx, obsidian and other semiprecious stones.

Glass working was brought to Mexico by the Spaniards. It is an art whose secrets are jealously guarded and handed down from father to son. In Mexico City, the Avalos family have been glass blowers for several hundred years, producing everything from tiny, colored glass animals to stained-glass windows for churches.

There are a number of other crafts which flourish and which produce objects of real art. Fine leather work—belts, pocketbooks, wallets, boxes—are produced in Mexico City. The ancient craft of tinworking has been revived and exists side by side with silver in Taxco. Toys of all kinds for Mexico's many fiestas and saint's days are fashioned in Tlaquepaque and Celaya. Wrought-iron work flourishes in Mexico City, Puebla and Amozoc. Furniture is turned out in Mexico City, Cuernavaca, Toluca and Guadalajara.

Mural painting, one of the great arts of Mexico's ancient peoples, has come to life again under the brushes of Diego Rivera,

(Continued to page 264)

They Puff SMOKE!
They WHISTLE!

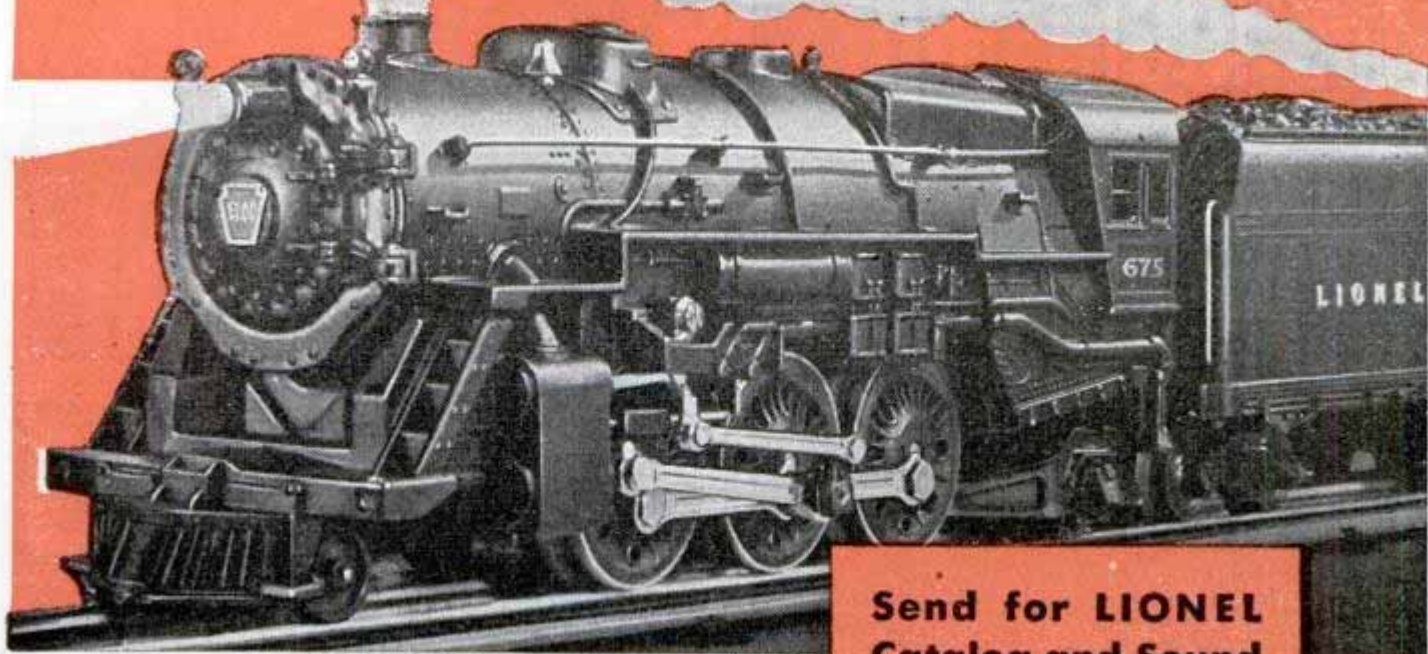

Send for **LIONEL**
Catalog and Sound
Effects Record

Here's one of the most unusual offers ever made. Now you can SEE and then HEAR the new LIONEL TRAINS in action! Not only are we providing a magnificent 32-page, full color catalog, but we have also created a remarkable Sound Effects record so that you HEAR Lionel Trains whistle and thrill to the excitement of model railroading—the LIONEL way. The 1947 Lionel Trains are the most extraordinary ever made. SEE them! HEAR them!

SPECIAL OFFER

For only 25c we'll send you the 32-page, full color catalog, the Sound Effects record with narration by Bill Stern, famous sports commentator, PLUS a 32-page "Fun with Lionel Model Railroading" book, a R. R. Guide Wall Chart and a model layout blue print. It's a great package!

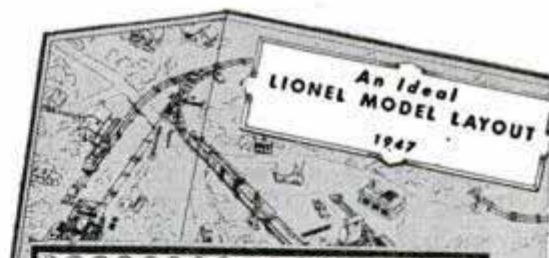

SEE THEM—



HEAR THEM—

4-inch Sound Effects Record narrated by Bill Stern, famous sports commentator. Official R.R. whistle signals on reverse.



LIONEL TRAINS, Box No. 418
 Madison Square Station, New York 10, N. Y.

Please send me offer checked below. Complete special offer of Catalog, Sound Effects Record, Fun Book, Wall Chart, and Ideal Layout — all for 25c.

I enclose 25c for Special Offer.

I enclose 10c for catalog only.

NAME _____

ADDRESS _____

CITY _____ ZONE _____ STATE _____

LIONEL

"Half the fun and twice the success" come from having

the RIGHT TOOLS for the JOB



NICHOLSON strives to make fun and success a certainty so far as working with files is concerned. For there are more than 3000 kinds, cuts and sizes in the Nicholson and Black Diamond lines—their uses ranging from battleship building to watchmaking.

Of course, you don't have to have them all. A kit of Nicholson X.F. Swiss Pattern Files; a few well-chosen Special Purpose Files (some being of exclusive, patented Nicholson design); and a modest assortment of Regular Purpose types . . . such a variety constitutes a well-balanced complement of files for the average home workshop. Good hardware houses can advise you and supply you with the right files for your needs. Send for "File Philosophy," famous Nicholson 48-page book on kinds, use and care of files.

NICHOLSON U.S.A. **NICHOLSON FILE CO.** 22 Acorn St., Providence 1, R. I. (In Canada, Port Hope, Ont.)

NICHOLSON FILES FOR EVERY PURPOSE

EARN BIG MONEY IN YOUR OWN BUSINESS Sharpening Lawn Mowers

"THE UNIVERSAL WAY"

Here's one of the best and quickest ways we know for you to become your own boss in a profitable year 'round business of your own. Mr. Hardy of Mississippi writes: "Received my Universal Grinder the first part of May and by August 18th had sharpened over 1000 mowers." Mr. Bacon of California writes: "The lawn mower business with the use of my Universal Grinder has been a gold mine in the last two years."

Investigate this opportunity yourself without cost or obligation.

WRITE TODAY

ROGERS MFG. CO.
DEPT. M117 LINDSEY, OHIO



FREE

Full details on the exclusive advantages of the Universal Grinders which have made hundreds successful.

Get A SEAMAN ROTARY TILLER

Better Yields — Better Crops



Because this farm-size rotary tiller prepares seedbeds most ideally suited to your soil and crop conditions, it helps produce higher yields and better quality crops. Can be adjusted for fine pulverization, coarse or medium tillage . . . just the way you want it. Mixes fertilizer and humus into the GROWING AREA of seedbed; aerates soil; eliminates air pockets and hard plow soles; conserves moisture; promotes earlier and more complete germination of seed; helps to destroy many crop pests and certain varieties of fungus; provides effective weed control; reduces erosion . . . all with ONE machine!

SEAMAN ROTARY TILLERS are available in power take-off and motorized models 3 to 7 ft. tillage widths. See your Seaman dealer and write for complete information.

SEAMAN MOTORS, Inc. 364 N. 25th Street Milwaukee 3, Wis.

WALKIE SIREN

Formerly \$15.00 - Now Only \$3.95

GOV'T SURPLUS. A precision instrument. Easy turn of crank produces CLEAR, FULL SIREN TONE. Can be heard for great distance. Ideal for Boats, Autos, Schools, Sporting Events, etc. Dimensions 7" x 8" x 5". Wt. 4 1/2 lbs. Includes shoulder strap and waterproof cover. SEND NO MONEY. Just name and address. We'll ship C.O.D. for \$3.95 plus postage, or send money in advance, we'll ship prepaid. Canadian price \$4.50. ILLINOIS MERCHANTISE MART, Dept. 400-D, 1227 Loyola Ave., Chicago 26, Ill.

BUILD YOUR OWN POWER LAWN MOWER

WHY BREAK YOUR BACK MOWING FIELD OR LAWN?

WRITE FOR
FREE
LITERATURE
The Rite-Way
Mower
Attachment
Ball Bearing



SAVE MONEY
SAVE TIME

Now anyone can save time and effort mowing field or lawn by building their own whirl type power mower. Build according to your own ideas and needs at small cost. Cut close to fences, walks, buildings, etc. Build in short time with parts and instructions we furnish. Save hours of time and back breaking labor. Write today for FREE information.



T & H MFG. CO., Dept. S6
811 E. 31, Kan. City 3, Mo.

Keep Brushes like New

BEFORE

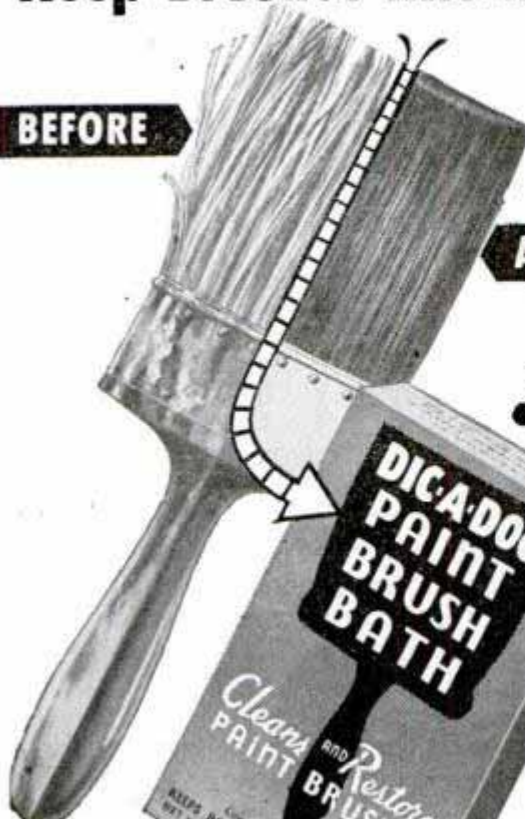

AFTER



**DICA-DOO
PAINT
BRUSH
BATH**

Cleans and Restores
PAINT BRUSHES

5c
10c
25c

At Paint, Hardware, Dept., and 5 & 10c Stores
Patent Cereals Co. Geneva, N. Y.

PRESS-TITE CAULKING AND SEALING CORDS



Keep cold out!
Seal holes and cracks!

Soft, rope-like Press-Tite Cords effectively seal windows and doors against cold and dust. Save fuel.

Press-Tite Cords will not harden—they stay soft and seal tight. Use also to fill any cracks or holes in wood, plaster, masonry or brick. Just press into place—no tools needed.

PRESSTITE ENGINEERING CO.

3978 Chouteau Ave., St. Louis 10, Mo.

For Outdoor Pleasure and Transportation

Ride a Royal Enfield



Famous English Lightweight
Motorcycle...takes you anywhere

Royal Enfield's popular Model R. E. has everything—Style, Safety, Economy, Flexibility, Performance! Best quality steel tubing; 125 c. c. 2-stroke, single cylinder engine; 3-speed gears. Goes 100 miles per gallon of gas! Folder "C" gives you complete details.

Write Today:

Dealer inquiries given prompt attention.

WHITEHALL DISTRIBUTORS, Inc.

1385 Commerce Avenue, New York 61, N. Y.

Never so much for so little!

- ✓ coupled range finder combined with optical view-finder
- ✓ compose and focus in one eyepiece
- ✓ extinction exposure meter
- ✓ precision flash synchronizer
- ✓ automatic shutter release lock; no double exposures
- ✓ automatic film transport
- ✓ filminder
- ✓ automatic film-wind stop
- ✓ retractable lens mount; locks against accidental exposure
- ✓ coated f3.5 lens for black and white or color
- ✓ body shutter-release with cable release socket
- ✓ versatile shutter speeds; time, bulb, 1/10 to 1/300
- ✓ fingertip focusing with twin focus knobs
- ✓ tripod socket
- ✓ balanced streamlined case
- ✓ uses standard 35mm. film cartridge



Inc. Fed. excise tax **\$65** RETAIL

You've never seen so much for so little . . . and what a camera! It's Universal's new 35 mm. double-frame Buccaneer—the minicamera that gives you everything! All those wonderful features you see listed above point the way to better pictures every time . . . and it's so easy. Because everything you need is built RIGHT IN! See the new leader in precision photography yourself . . . the BUCCANEER . . . at your dealer's today.

UNIVERSAL CAMERA CORPORATION
NEW YORK CHICAGO HOLLYWOOD

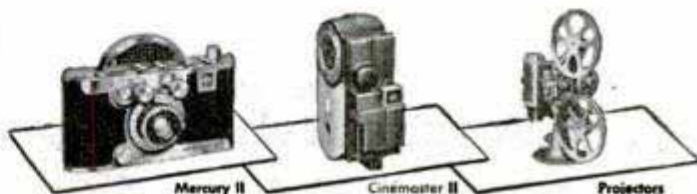

SAY YOU SAW IT IN POPULAR MECHANICS



When worn engine bearings
cause oil pumping in your car...

Performance goes up in smoke...



**Replace with Federal-Mogul
Bearings to restore Clean
Power, Pep and Economy!**

Smoky exhaust means that worn engine bearings are passing excess oil into combustion chambers, where it burns to carbon on spark plugs, valves, pistons and piston rings. Performance goes up in smoke! To correct oil pumping, replace worn engine bearings with genuine Federal-Mogul, the bearings engineered for the job of oil control. Ask your mechanic!

FEDERAL-MOGUL SERVICE,
COLDWATER, MICHIGAN
DIVISION OF FEDERAL-MOGUL CORPORATION



Replace in sets with Genuine
FEDERAL-MOGUL
Oil-Control Bearings

David Alfaro Siqueiros, and Jose Clemente Orozco. In its libraries, schools and government buildings, Mexico City has perhaps the greatest collection of mural paintings of any city in the world. Mural painting combines the craftsmanship of a house painter with the artistry of an expert in oils.

It is estimated that 16,000,000 of Mexico's 22,000,000 people make and use exclusively the products of their own home workshops. These are the peasants who cannot afford to purchase factory-made goods. Why, for example, pay 5 pesos (\$1) for an iron skillet when you can purchase a terra-cotta cooking pot in the market place for 25 centavos (5 cents)?

But Mexico is on the march under her young, dynamic president, Miguel Aleman. He is trying to spread the benefits of a mass-production, industrial economy to all his people—not just the few millions that live in Mexico City and some of the larger cities.

This means that Mexico, the workshop of the western world, is threatened by the spinning machines, the stamp presses and the machine lathes of the United States. It is a safe wager, however, that when Mexico's millions begin to wear factory-made shoes, hats and shirts, the artisans and craftsmen will continue to make many objects for their own enjoyment and amusement. The average American handicraft hobbyist understands that.

Self-Closing Electrical Outlet



With a new-type electrical safety outlet, it is impossible for a child to get shocked by inserting a hairpin or wire. The outlet makes contact only when a plug is inserted, turned to the right and pushed in slightly.

Backward Plane Seating Safer

Plane passengers seated backward get more protection and a better view, tests indicate. With the head and spine supported throughout its length, a body can take terrific jolts in forced landings. Passengers "flying backward" at 200 miles an hour can be brought to a stop in nine feet without injury. Since nothing goes past the window except at take-off and landing, it doesn't interfere with sightseeing.

Snap-on Basic ELECTRONIC CONTROL SERVICE TOOL KIT

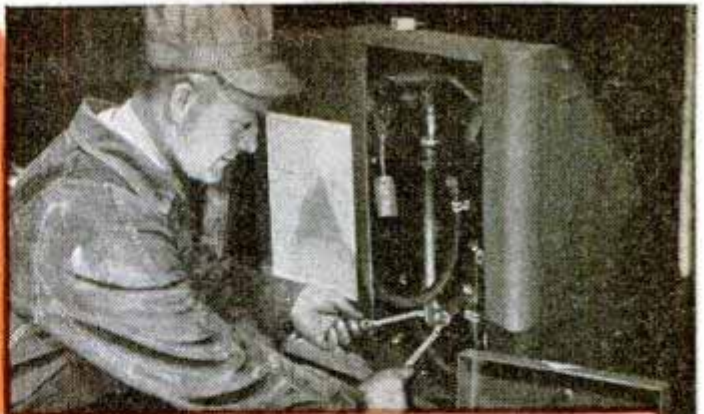

▶ A made-to-order, "tested-on-the-job" kit to service Electronic Controls, Panels, Relays . . . Heat Control Panels . . . Spot Welding Timers . . . Small Hoist Controls . . . and Welding Machine Starters.



▶ . . . cuts "down-time" to a minimum
▶ speeds maintenance . . . because
you always have the right tool
at the right time



This complete 51-pc. kit
with Handy Hold-all Box
for only

\$48⁴⁷

Actually tested in the shops where "down-time" must be held at an absolute minimum, this kit has proved its value over and over again. It contains all the basic tools you will need . . . and they're Snap-on tools, built and sized to precision tolerances with the feel and balance that gives you fast nut-turning efficiency. Check the complete list at the right . . . tear out coupon and mail today.

SNAP-ON TOOLS CORPORATION
8062-K 28th AVENUE • KENOSHA, WISCONSIN
International Division: Kenosha, Wisconsin, U. S. A.

- Including . . . Ratchet, Sliding Tee Nut Spinner, Flexitation Plastic Grip Handle Universal Joint 2" and 6" extension
8 Hex. Sockets $\frac{1}{8}$ " to $\frac{1}{2}$ "
8 Deep Hex. Sockets $\frac{1}{8}$ " to $\frac{1}{2}$ "
3 Square Sockets, $\frac{1}{4}$ ", $\frac{5}{8}$ ", $\frac{3}{8}$ "
4 Dwarf Boxsockets $\frac{1}{8}$ " to $\frac{3}{4}$ "
8 Ignition Wrenches $\frac{3}{8}$ " to $\frac{3}{8}$ "
1 $9\frac{1}{4}$ " Screw Starter
Tungsten Ignition File
6" Mill Bastard File
5" Gripper Pliers

- 6" Diag. Cutter Pliers
6" Needle Nose Pliers
3 Screw Drivers
4" Offset, $1\frac{1}{2}$ " and $2\frac{1}{2}$ " Stubby, plus a 3" and 4" blade.
1 Red Hold-all Box

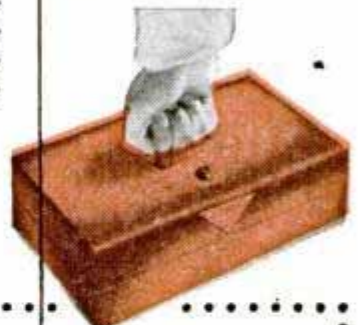

8060-L

Please send me the \$48.47 Electronic Control Service Kit, No. TM-151. I am enclosing . . .

Check Money Order Company Purchase Order

Name.....

Company.....

Address.....

City..... Zone..... State.....

IF IT'S MADE BY LIONEL, YOU CAN GET IT AT MADISON HARDWARE



**NEW LIONEL
GG-1 PENN.
Electric Type LOCO**
\$29.95



No. 2332

A masterpiece of scale detailing! Designed for third-rail operation; can easily be adjusted for pantograph current from overhead wires. The 2 pantographs can be raised or lowered. 20-wheel drive, realistic horn.

Madison has been World Lionel Headquarters for since 1909. We offer a complete line of Lionel Train Sets, Cars, and Accessories. Write for big Train folder—it's FREE

AUTOMATIC SEMAPHORE

No. 151... \$4.95

Another new touch for your Lionel system! Semaphore arm automatically operates when train passes.

PENNSYLVANIA STEAM-TYPE LOCO WITH SMOKE AND WHISTLE TENDER

No. 675LTS



"0" gauge \$25.00, "027" gauge \$24.50

SEND US YOUR LIONEL REPAIRS

Here's realism. Rugged, powerful! Smoke synchronized with driving mechanism; puffs when in motion. 10 wheels.

We pay postage on cash orders. C. O. D.'s accepted.

MADISON HARDWARE CO., 103 E. 23rd St., New York 10

Please ship
Quantity: GG-1 Penn. Loco @ \$29.95 ea.
Automatic Semaphore @ \$4.95 ea.
675LTS Loco "0" gauge @ \$25.00 ea.
"027" gauge @ \$24.50 ea.
 FREE Big Train Folder.

Name _____
Address _____
City _____ Zone _____ State _____
 Cash M. O. Check C. O. D.

MADISON HARDWARE CO., 103 EAST 23rd ST., N. Y. 10, N. Y.

U.S. NAVY 7 X 50 PRISM BINOCULARS WITH COATED OPTICS

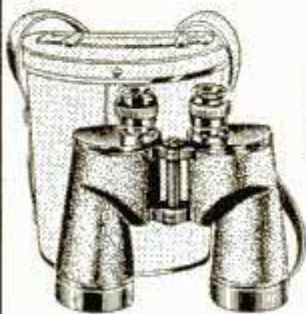

Used but in Excellent Condition

\$139.50
Tax Included

Complete with leather carrying case and sling

Engineers All Metal Army Type Hand-Sighting

LEVELS

\$2.00 PRECISION QUALITY



Send \$1.25 for 3rd Annual Edition of Gun Digest with our complete catalog of new and used guns, etc. Our separate catalog 25c.

PUBLIC SPORT SHOPS

13 S. 16th St., Phila. 2, Pa.

No COD's

SAY YOU SAW IT IN POPULAR MECHANICS

AUTO PARTS NEW - REBUILT We Have Them!

Mechanics! Car Owners! We make prompt shipment of new parts.

Grills Axle and Motor Parts
Radiators Transmissions
Clutches Knees and Shocks

REBUILT UNITS FOR EXCHANGE

Carburetors Fuel and Water
Starters Pumps
Generators Differentials
Transmissions Clutches Knees and Shocks

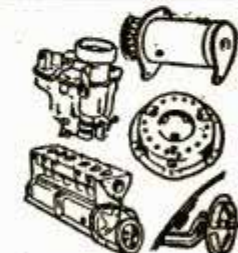

**Save Money
Buy Direct**

Write today for our new price list of standard replacement parts.

RUSH ORDERS FOR PROMPT SHIPMENT

MECHANICS AUTO PARTS - Factory Warehouse

3807 N. Ashland Ave.

Chicago 13, Ill.

NONE BETTER! SUPER DRILL GRINDER



Sharpens round shank drills from 3/32" to 1-1/16" in diameter, up to 11" long. Grinds old drills like new in 4 different point angles, using hand or power grinding wheels. Money-back guarantee.

Price only \$2.95

At Dealers or Postpaid

CRANDALL MFG. CO. 1512 W. Slauson, Dept. FA-23, Los Angeles 44, Calif.



Hands Never Touch the Water—Can be put in Boiling Water. Housewives Like It.

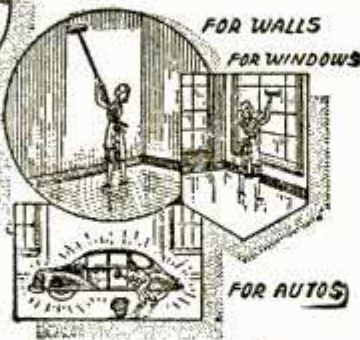

48" Long Handle

Sales QUICK, EASY Every Locality

SALES ARE EVERYWHERE . . . Sells quick to Taverns, Clubs, Hotels, Hospitals, Stores, Restaurants, Large and Small Buildings and the Homes . . . Scores can be sold on a single street . . . Note the Drain Bracket in the illustration . . . This squeezes out the water so thoroughly that HANDS NEVER TOUCH THE WATER . . . Makes no difference what you ever sold, you will like this proposition . . . Your name on a Post Card will bring you FREE PARTICULARS.

CELL-U-MOP CO., Dept. P-11, FREEPORT, Ill.

... Quick Easy Way to BIG PROFITS

Read What Others Are DOING!

"Enclosed you will find 56 orders representing 9 1/2 hours' work on Monday and Tuesday."
"Enclosed are twelve orders secured after supper this p.m."

Housewives are Enthusiastic

Everyone that sees this outstanding Cell-U-Mop immediately wants one . . . That's the reason why our distributors are so successful . . . You also have the advantage of our other QUICK SELLING PRODUCTS that step up your Volume Sales and Profits.

• We Teach You How •

Gets down under and around for MOPPING, DUSTING or WASHING

DOES THE WORK OF 6 TOOLS IN 1

Get Choice Territory NOW!

Holds 20 times its weight in water.





With an Evinrude, you enjoy trouble-free performance that's known and respected everywhere.

It's an Evinrude "plus"
for your greater
boating enjoyment

But run any motor long enough and hard enough and *you'll want service...* and no nonsense about it!

When that time comes, it's mighty satisfying to own an Evinrude. Because, in just about every boating center and popular fishing spot in America, Evinrude Service is close at hand... where you want it when you need it! Friendly, capable, it is ready to help you — on a quick troubleshooting job, a major repair or a complete overhaul.

Evinrude service mechanics are experts; many are factory trained. Factory parts are used, precision made and *right!* Every step is an efficient, proved factory procedure.

Own a motor that "stays young"! With an Evinrude you can *keep on running* your motor as many years as you like.

You can bank on Evinrude Service to maintain "performance like new" in your motor's 5th



year — or its 10th — and for years after.

Higher resale value, too! Used Evinrudes are always in demand, bring

favorable trade-in allowance, sell at good prices. Buyers know that their investment in an Evinrude is protected by this *established, continuing, nation-wide service.*

If you own an outboard motor (any make) you can benefit by Evinrude Service right now. Take your motor to an Evinrude Service Dealer for seasonal check up, needed repairs, safe winter storage. If you have considered trading in your old motor on a sparkling new Evinrude, *this is the most favorable time*, with assurance of early delivery. Look for your dealer's name in your classified phone directory. For complete catalog, write EVINRUDE MOTORS, 5631 N. 27th Street, Milwaukee 9; Wis.



In Canada: Evinrude Motors, Peterboro, Ontario.

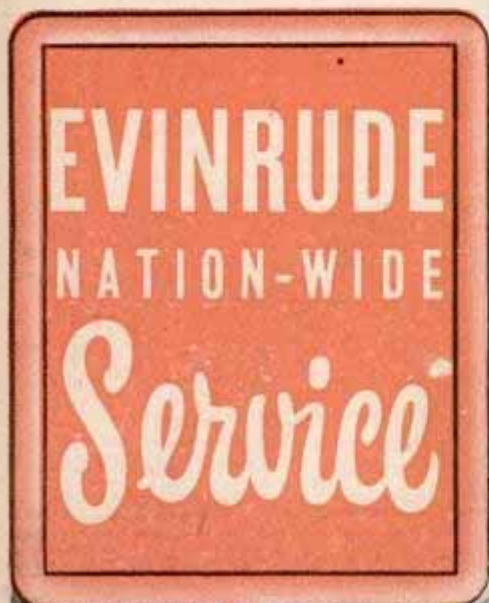

Evinrude and Evinrude dealers have been perfecting Evinrude Service since the earliest years of the industry. Many Evinrude service departments were established 20 and 30 years ago. The service department pictured here has been delivering satisfying service to Evinrude owners for 36 years.

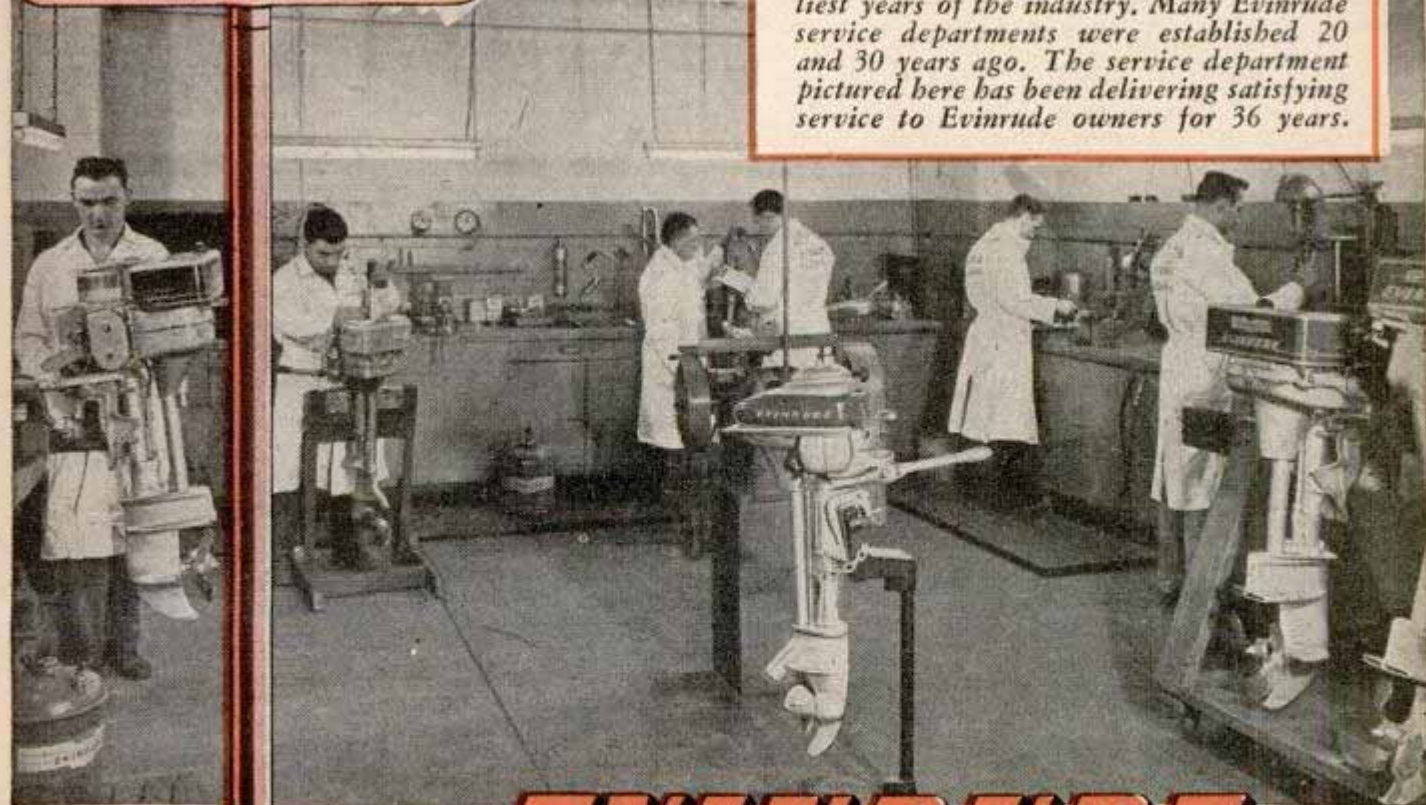

EVINRUDE

FIRST IN OUTBOARDS • 38TH YEAR

Order by Mail NOW

FOR WINTER COMFORT AND PROTECTION

GABARDINE COVERALLS



Genuine AAF 100% wool gabardine with zipper. Sizes 36 to 48 New **\$6.95** postpaid. Slightly used, but dry-cleaned and in excellent condition - sizes 36, 40, 42 and 44 **\$4.25** postpaid

NEW! ELGIN STOP WATCHES

Genuine Navy surplus. **\$9.95** postpaid plus 10% federal tax.

NEW! MEN'S SWISS WRIST WATCHES

Sweep-second hand, serviceable, handsome, excellent timekeeper ... **\$11.50** postpaid plus 10% federal tax.

NEW! NAVY WATER-PROOF COVERS

67"x87" grommeted. Makes excellent small tarpaulin **\$3.45** postpaid



NEW! CANVAS TARPULINS

Grommeted. 8-1/2'x10'...**\$7.95** FOB Sacramento. 9'x15'...**\$12.75** FOB Sacramento. 15'x20'...**\$29.50** FOB Sacramento.

NEW! WALL TENTS Fireproof, water-proof and mildew proof; no poles. 16'x32' **\$45.00** FOB Sacramento. 9'x9' complete with poles ... **\$27.50** FOB Sacramento.

NEW! NAVY ELECTRIC LANTERNS

Throw brilliant light. Complete with two dry cells **\$5.25** postpaid.



ARMY DRAW-STRING JACKETS

...Slightly used, water repellent, four pockets **\$3.95** postpaid

ARMY O.D. BLANKETS - 100% WOOL ...

NEW, 67"x84" **\$6.75** postpaid - USED, excellent condition **\$4.25** postpaid - NEW! WHITE, either Army or Navy **\$11.95** postpaid.

SEND CHECK or MONEY ORDER for Prompt Delivery by Mail

BUY NOW for Christmas

PACIFIC FUR & WOOL CO.

War Surplus Dept. Box 926-PM Sacramento, Calif.

WRITE FOR FREE WAR SURPLUS CATALOG!

NEW! 100% DOWN-FILLED SLEEPING BAGS ... 76"x39" with pocket for air mattress. Warm and serviceable, with zipper down one side and one end. Complete with water-proof carrying bag



MUMMY-TYPE

Water repellent case - DOWN-FILLED, slightly used but sterilized, excellent condition **\$12.95** postpaid
WOOL BLANKET LINED, new **\$6.95** postpaid.
Slightly used **\$4.50** postpaid.

NAVY FOUL-WEATHER JACKETS

Water-repellent, with alpaca lining and collar. Slightly used, sizes 36 through 42 **\$8.45** postpaid



LEATHER FLYING TROUSERS

Sheepskin lined. Sizes 36, 38 & 40. NEW...**\$8.95** postpaid
NEW! O.D. WOOL TROUSERS Sizes 29 to 34 ... **\$6.50** postpaid. Slightly used ... **\$3.50** postpaid.



NEW! AAF FLIGHT BOOTS

Sheepskin lined, rubber soles, large, medium and small. NEW ... **\$9.95** postpaid. Slightly used, excellent condition. Large and medium only **\$6.00** postpaid

NEW! AAF B-7 Sheepskin PARKA

Natural color sheepskin, attractively trimmed in brown leather. Wolverine-trimmed hood. Zipper front is made weather-proof by heavy buttoned flap. Two zippered pockets and two patch pockets. Buckled throat strap & drawcord in hood afford perfect protection. Medium and large sizes only. **\$25.00** postpaid



A NEW SHELDON

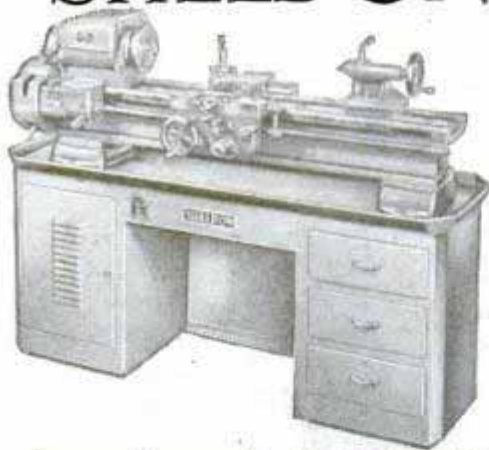

TRB-S56

For the home craftsman who can afford the best, or for those who use lathes in their business, the new SHELDON TRB-S56 is today's most sensational lathe value.

With 11 1/4" swing, 1" collet capacity and a 56" bed, it has capacity. With "Zero Precision" Taper Roller bearings (heretofore available on large and costly lathes) it has extreme accuracy. Mounted on a modern 3-drawer steel bench with enclosed 8 spindle speed, double V-belt underneath motor drive it has convenience, extra power and speeds for both today's and tomorrow's machining, and, frankly, class, not found in ordinary shops.

\$1000.00, as illustrated, less motor f.o.b. Chicago.

Write for TRB-S56 Bulletin

SHELDON MACHINE CO. Inc.

Manufacturers of Sheldon Precision Lathes • Milling Machines • Shapers
4206 N. KNOX AVENUE • CHICAGO 41, ILLINOIS, U. S. A.

HAWAIIAN WIGGLERS

Get Bass!

Write for free catalog on all my baits.



No. 2 Shallow Running - \$1.10

FRED ARBOGAST & CO., 1621 North St., Akron, Ohio

BEST OUTFIT

of Grinding, Polishing Wheels and Abrasives EVER OFFERED



We've "Murdered" Prices on abrasive tools. Think! This 560 piece grinding, polishing and abrasive assortment for only \$9.75—less than 1 1/2¢ per piece. Talk about knocking the props out from under inflation! This does it!

- 15 grinding wheels from 3" to 10" in dia.
- 2 cut off wheels
- 1 roll aluminum oxide cloth, 50 Yds. long
- 10 mounted wheels, 1/2" and 3/4" shanks
- 2 rotary files H.S.S. 1/4" shank
- 12 abrasive belts, Asst. grits and sizes
- 100 abrasive cartridge rolls, Asst. grits
- 1 mandrel for rolls
- 400 sanding discs from 1" to 9" dia.
- 2 sharpening stones
- 1 drum sander, 3/4" dia.

A Regular \$50.00 Value

Now only **\$9.75**

F.O.B. Chicago Send \$2.00 Deposit on C.O.D. orders

- 15 bands for sander
- 1 wheel brush, 8" dia.
- 1 canvas polishing wheel, 6" dia.

AND MANY MORE ITEMS FOR HOME OR SHOP.

Order today from

D. SCHUPACK,

Dept. PM-11, 7331 Cottage Grove Avenue, Chicago 19, Ill.

GIFT OF A LIFETIME!



The Handee Tool, famous "TOOLSHOP IN YOUR HAND" is packed with power and speed, designed for extreme accuracy, absolute dependability! It's the first and finest tool of this type for the skilled craftsman or the eager beginner. Handee grinds, drills, cuts, engraves, routs, polishes, carves, sands, saws, etc. And it works on any material—wood, metal, plastic, alloy, glass, leather, linoleum, horn, stone, bone, etc.

WHAT A THRILL! Smooth, steady power at the fingertips—a tool quick and sure, easy to guide as a pencil! Hundreds of useful articles can be made with Handee: ship, train and plane models, puppets, costume jewelry, initialed tumblers, wood carvings, etc.

EASY TO USE—Lightweight (only 12 oz.) and perfectly balanced, the easy to handle HANDEE runs at a cool 25,000 r.p.m., plugs into any AC or DC socket.

THE HANDEE KIT—Here is the very finest of all equipment—a practical combination that every craftsman will welcome. The Handee Tool, acclaimed the world over for its remarkable speed, power and long life . . . plus a complete assortment of 40 accessories including drills, steel cutters, saws, brushes, drum sander and bands, mounted wheels, etc. . . . all packed in a handsome steel carrying case. At Stores, or sent Postpaid. . . . \$27.50 Handee with 7 accessories (not in case) \$20.50.

**SHIPMENT in TIME
for CHRISTMAS
ORDER NOW
SATISFACTION GUARANTEED**

**GET THIS HANDEE KIT
FOR A FRIEND
AND YOURSELF**

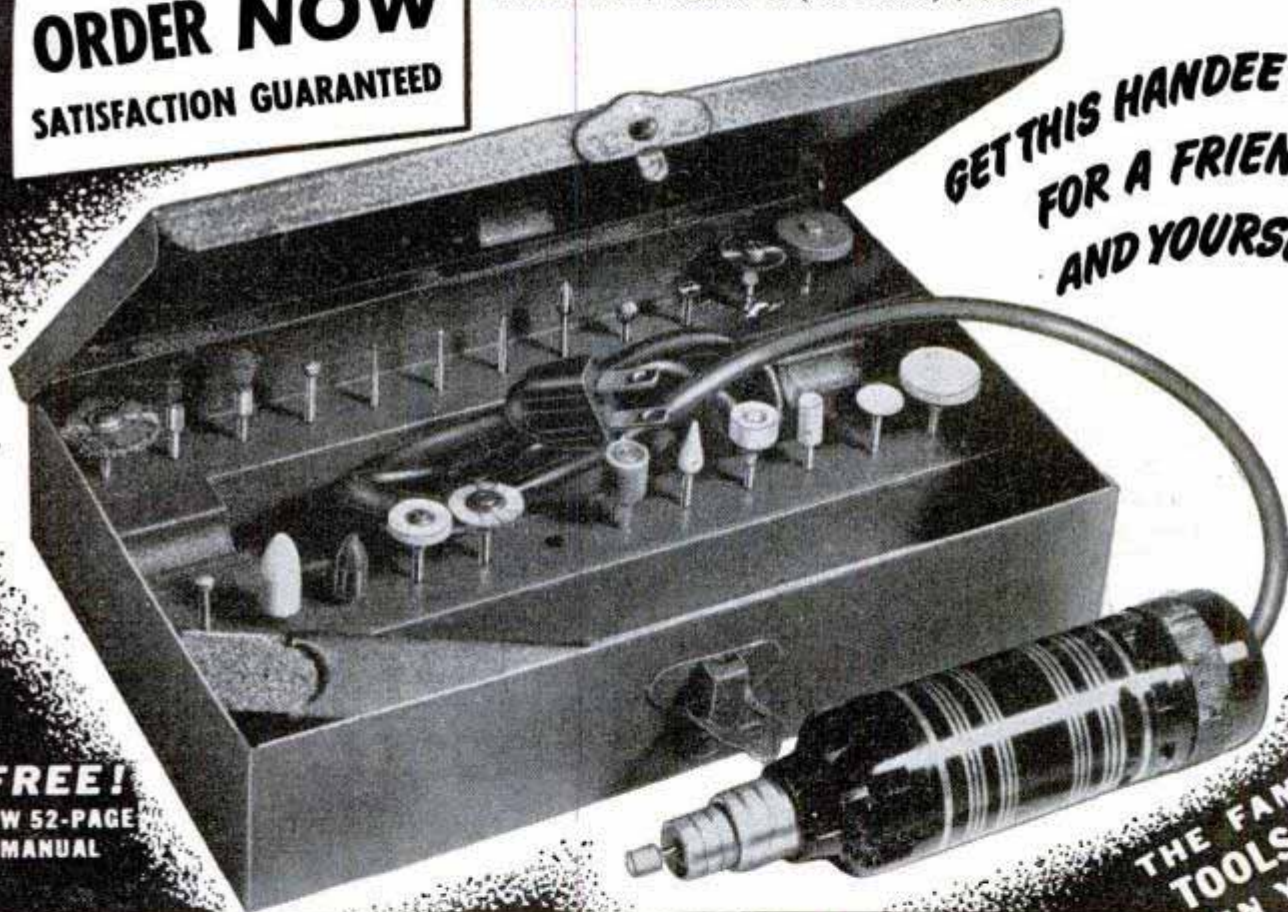

**FREE!
NEW 52-PAGE
MANUAL**

**THE FAMOUS
TOOLSHOP
IN YOUR
HAND**

* HANDEE

TOOL OF 1001 USES

NEW PLASTIC-CRAFT KIT

For internal carving. Contains special plastic cutters, buffers, sanding discs, buffing compounds, a liberal supply of clear plastic, dyes, cement and instructions. At stores or postpaid. . . . \$6.95

*Reg. U. S. Pat. Off.

CHICAGO WHEEL & MFG. CO.
1101 W. Monroe St., Dept. PM, Chicago 7, Ill.

Rush the Handee Kit Handee Tool
 Plastic-Craft Kit Remittance Enclosed
 Send C.O.D. Send Manual.

Name _____

Address _____

**A SURE CURE
FOR
Home-
Budget
HEADACHES...**

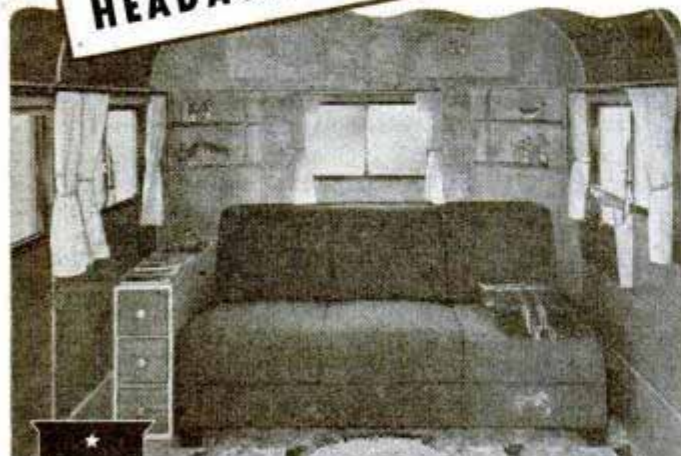

SCHULT

own a SCHULT!

Move into a Schult and you have an equipped, 3-room home wherever you go. Your investment in this quality product is backed by a decade of preference... for design, performance, and high trade-in value. **WRITE TODAY** for illustrated catalog and the name of the Schult dealer nearest you.



SCHULT CORPORATION
Dept. 3211, Elkhart, Indiana
In Canada: John Inglis Co., Ltd., Toronto



SCHULT Trailer Coaches

SAY YOU SAW IT IN POPULAR MECHANICS



\$2.45

1/2" Wing Nipple-guide (above) or Wing Pipe-chuck (in vise) 1/8" thru 1". Handy spring carriers; display carton. Hardened—Electroplated.

**Fast
Simple
Accurate**

Or drop card for information:
WING S. LABORATORY
129 Water St., Grass Lake, Michigan
Salesmen... In piping products,
Wing means speed.

Wing Nipple Tools utilize waste in a hurry! An' easy too! With your threader you can thread: ● Long or Short pipe ● Chrome pipe ● Next a wall AND



● Up to 15° angle per pair of threads

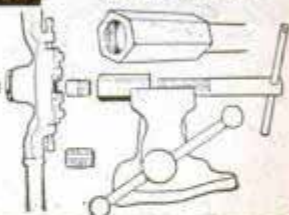

IF GLUE WILL FIX IT

FRANKLIN LIQUID HIDE GLUE

will do it better, faster, easier!

Ready-to-use Franklin makes joints stronger than the wood itself. Saves time — no mixing, no heating. Banish unpleasant odors, avoid chilled joints with Franklin Liquid Hide Glue.

The FRANKLIN GLUE CO., COLUMBUS 15, O

AT YOUR HARDWARE DEALER



Men's Fully Guaranteed NEW \$13.95 PLUS TAX
15-JEWEL WRIST WATCH

ORIGINALLY sold up to \$55

Sacrificed because they're post-war surplus

LOOK AT THESE FEATURES:

Luminous dial... sweep second hand... waterproof... shockproof... anti-magnetic... imported Swiss precision movement and case. You get them now for a small fraction of original prices. Don't delay! Order now... while they last. Send only \$1 down payment with order. Pay balance to postman on arrival, plus postage. Or we pay postage if you enclose \$13.95 plus \$1.39 Fed. Tax.

Receive Reg. 52 expansion band FREE with prepaid order. Money back in 5 days if not delighted. Order now.



MARYLAND DISTRIBUTORS, Dept. P-2

501 E. Balto. St.

Balto. 2, Md.



Aladdin's Tool
THE "GENI" OF
A THOUSAND AND ONE USES !!!

Complete With 6 Ground Blades — And New Adaptor

Makes 12 Different Cuts

Makes any cut wood shaping tools costing up to \$300.00 can make—more too. Sturdily built, lasts a lifetime. Complete—makes 12 standard cuts and over 100 variation shapes. See your dealer or if he does not stock, send \$7.95 for immediate delivery to your door. All other orders C. O. D. plus postage.

\$7.95

Dealers Write for Information



The Design Co., 531 Scarritt Bldg., Dept. N11, Kansas City 6, Mo.

**All Types Of
Wood Shaping**

POPULAR MECHANICS



The best Christmas Present I ever got

GIVE AN EMRICK — ASK FOR AN EMRICK

HERE'S WHY: **5** MOST USED
POWER TOOLS IN 1 RUGGED
UNIT FOR ONLY \$34.95

ONLY
\$34⁹⁵

Power tool fun and profit are built into the Emrick Universal Woodworker. Versatile. Rugged. Compact. Big capacity. Heavy—shipping weight 65 pounds. Drill press pulls 1/2" drill in steel. Saw uses 6" to 8" blade. Arbor also takes all standard accessory wheels such as wire brush and cloth buffer. Lathe turns pieces 30" long by 10" dia. Disc sander 8" dia. 5" grinder. Heavy replaceable bronze bearings at all wear points. Only \$34.95 because sold direct from factory to you. **MONEY BACK GUARANTEE.** Order early for prompt shipment.

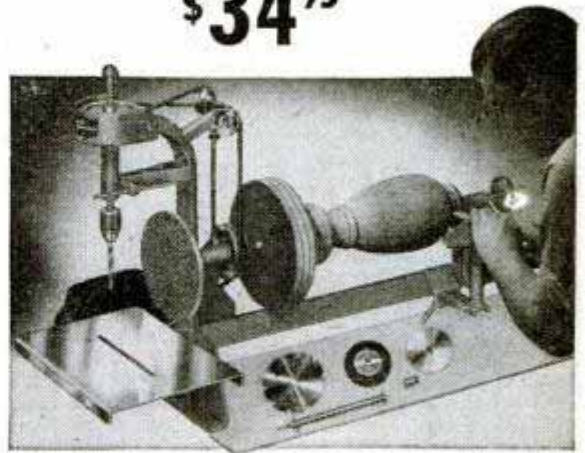

SEND THIS COUPON NOW!

EMRICK, Inc. 1741 Clinton Street
Kalamazoo 24, Mich.

Ship on 10 Days Trial.
 I am enclosing \$17.50, balance C.O.D. Send free literature.

Name _____
Address _____
City _____ State _____



Complete except for motor and saw blade.

New STEEL ADJUSTABLE BRACKETS & STANDARDS For HEAVY DUTY SHELVING



LOCKS IN PLACE—EASY TO ADJUST UP OR DOWN

Standards are bolted or screwed into wall vertically. Brackets readily slide into place and are safely locked by patented principles. Can be raised or lowered 1 1/2" variation. Rearrangement of shelving requires very few minutes. You can build mass displays for stores in a jiffy. Home-owners will find this the neatest, easiest to install shelving available. Ideal for workshop, garages, filling stations, etc. Finest Shelving Equipment available. Inexpensive—will last a lifetime. No special tools required for installation.

BIG PROFITS FOR SALES AGENTS

Earn big profits installing JIFFY EQUIPMENT in your neighborhood, spare or full time. Write for complete details and prices.

JACKSON MFG. CO. Dept. M2, 622 East Third St. Kansas City 6, Mo.

New Bowling Game!



Exciting! Great fun for everyone! Play in teams or alone. Game of skill... you aim, the robot shoots. Keep score like regular bowling.

Heavy, bright aluminum, 30 in. long. Set of 10 pins and ball, alley and robot complete with score pad and instructions. **Send check or money order for \$2⁹⁵ today. We pay postage.** (With pin setting device \$1.00 extra)

ROBOT TOY CO.
1905 PACIFIC; SAN DIEGO, CALIF.

SNOW CLEARANCE made easy with a BOLENS HUSKI 2-WHEEL TRACTOR!



CLEAR AWAY SNOW — fast and clean, from your drives, lanes, walks, roadways, with this sturdy 42"-Blade Snowplow Attachment for Bolens HUSKI Power-Ho or Gardener Tractors. Saves you time and labor. Amazingly low first cost and operation. Easily attached to Tractor.

See Your Bolens Dealer Now!

BOLENS PRODUCTS DIVISION

Food Machinery Corporation

265-B Park Street, Port Washington, Wis.



THE STANDARD FOR OVER 40 YEARS



the BEACON that never fails



EVEREADY CASE. Simulated brown leather, beautifully styled. **\$250**

Ever-faithful, the BEACON camera will always bring you top precision, miniature camera performance at low cost. The 46mm Whitlar coated lens — color corrected, gives you sharp, sparkling snapshots. **\$995** incl. tax

Safety lock shutter — no accidental snaps • Speeds 1/50, or time • Uses No. 127 film • Optically ground lenses, fluoride coated



Whitehouse Products, Inc.
360 Furman St., Brooklyn, N. Y.



HERE'S *Fun* AT YOUR FINGERTIPS

Now EVERYONE can enjoy RAILROADING IN MINIATURE!

Build true reproductions of famous trains that are actual working models! Our "00" Gauge kits are especially scaled for home use where layout space and time are limited. Yet these kits are as accurate in detail as our larger model, the "0" Gauge. Kits contain every part needed to build the model with only common tools. Made of fine materials, rugged, realistic . . . Scale-Craft Model Railroading kits provide a challenging, thrilling hobby. The Scale-Craft Catalogue and Data Book fully describes layouts, types of kits and model railroad practice, with room to add supplemental information, and costs only 25c postpaid.

Send stamp TODAY for your How to Begin folder. Address Dept. M2



SCALE-CRAFT & CO. 1731 N. HIGHLAND AVE. HOLLYWOOD 28, CALIF.

The Pipeline

PIPES COAL IN! PIPES ASHES OUT!

WARMTH WITHOUT WORK

All the work of furnace tending is done automatically by The Pipeline Coal Burner. Pipes bituminous coal from any bin to your present furnace, burns it smokelessly and efficiently, and even pipes ashes to dust-proof containers! Modulated warmth regulated by automatic controls.

Conversion models and complete winter air conditioners. Field-tested since 1934. Write for free 20-page booklet.

FITS ANY COAL BIN

FITS ANY FURNACE

DUSTPROOF ASH CONTAINER



POCAHONTAS FUEL COMPANY INCORPORATED
Stoker Division • 344 East 131st Street • Cleveland 8, Ohio

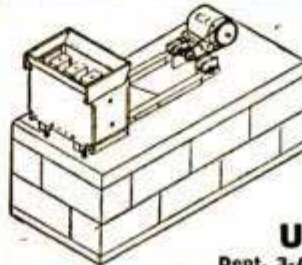

BUILD THIS CONCRETE BLOCK MACHINE

Sell blocks; or build your home, garage, barn at 1/2 cost by making and laying your own blocks.

This simple machine which you can build yourself at a cost of about \$15 (excluding motor) will make a block in 30 seconds using only one form. 2 to 4 forms can be used on each vibrator.

Power driven concrete mixer plans also. Send dime for details and "How to Make and Lay Blocks."

U-BUILD-IT SERVICE

Dept. 3-A, 206 West Wilder Ave., Tampa 3, Fla.

REAL GAS ENGINE \$6.95



The new THOR "B" — Sensational miniature gasoline engine that really works. Super-power performance. Smooth, velvet power that roars into action with a "twist of the wrist." Over 25,000 already sold. 1/8 H.P. Complete with coil, condenser, and fully illustrated instructions, ready to run, only \$9.95. In KIT form, fully machined, 5 minutes to assemble, \$6.95, without coil and condenser. Powers all models. Send \$1.00—shipped collect same day C.O.D. Free. Send for 24-page illustrated hobby catalog.

AMERICA'S HOBBY CENTER
Dept. 8-117, 156 West 22nd Street
New York 11, New York

SAY YOU SAW IT IN POPULAR MECHANICS

FASTEST PLANER in the WORLD at this Low Price... \$195.00

Belsaw Multi-Duty Planer



Needed by every saw mill owner and woodworking shop to Speed Up Production — Increase Profits. Belsaw high speed thickness planer provided for single surfacing stock up to 12" wide by 6" thick at the high speed rate of 24 lineal feet per minute for HIGH PRODUCTION. Planes GREEN or DRY sawed lumber into higher priced, valuable smooth and worked forms. Machine has welded all STEEL frame . . . nothing to break. Safety-type all Steel cutterhead runs in heavy duty ball bearings. Three HIGH SPEED Steel knives make 42 cuts per inch for smooth finish. Belsaw Multi-Duty Planer is REALLY ECONOMICAL . . . adequately powered by any motor developing 2 horsepower — REALLY PROFITABLE . . . lowest in investment and operating costs; and takes inexpensive attachments for all common planing mill operations: Jointing, Rabbeting, Grooving, Matching. Produces S4S Finish (surfaced four sides) without the great investment required for S4S Surfacers. Simple accessories provide for SHARPENING and JOINTING its own knives. You get BIG VALUE in Belsaw, and provide for your progressive growth. Write for FREE specifications, illustrations and low prices.



BELSAW MACHINERY CO., 1012 Field Building
315 Westport Rd. Kansas City 2, Mo.
World's largest manufacturer of light sawmill and woodworking equipment.

The BEST in SURPLUS

BRAND NEW ARMY AIR FORCE ASTROGRAPHS

ORIGINAL COST \$125. **Only \$3.95**

Thousands of uses. An ideal navigation instrument for boats, yachts, etc. A wonderful unit for home construction of contact printers, enlarger, strip map holder, etc. A beautiful precision instrument consisting of machined aluminum housing with optical glass view plate, two large ratchet film drive knobs and shafts, one film spool, variable light source slide and holder, illumination control rheostat, resistor, power plug and tools. All housed in beautiful plywood case measuring 14 1/2 x 11 x 10" high. Case has leather handle, steel reinforced corners, hinged lid with stop, lower compartment divided into eight sections. Case is ideal for fishing kit, picnic set case, tool kit, portable radio case, make-up kit, travel case. Case alone worth twice the giveaway price we are asking for both. Shipping weight, 20 lbs.



BC223 TRANSMITTER

One of the Army's best. Ideal for amateur use, covers 80 meter band, 25 watt, crystal controlled, supplied brand new with meters, tuning unit, speech amplifier, and modulator. Less tubes. Shipping weight, 80 lbs.



\$12.95

DYNAMOTORS

Consists of electric motor operating generator on same shaft. Many applications — operating radios from storage battery — using as motor.

Dynamotor A—Input 12 volts, output 1000 volts at 350 MA. Shipping weight, 72 lbs. ... **\$7.95**

Dynamotor B—Input 6 or 12 volts, output 350 volts, 160 MA. Shipping weight, 30 lbs. ... **\$5.95**

Dynamotor C—Input 28 volts, output 220 volts at 60 MA. Shipping weight, 6 lbs. **\$1.50**

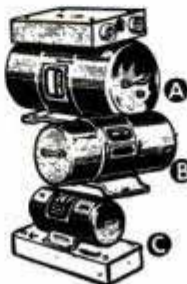

GENERATOR

Makes an excellent home lighting plant and can be operated by wind propeller, waterfall, gas engine, or hand crank. Reduction gear allows full output at very slow speed; supplies 6 volts at 2.45 amp., 425 volts at .115 amp. Brand new, GN-58. Ship. wght., 28 lbs. **\$7.95**



INTERPHONE AMPLIFIER

The famous tank communication set. Makes excellent communicating system, public address system, phonograph amplifier. Comes complete with two tubes, volume control, pilot light, has circuit diagram. These units are in used condition as removed from tanks. Shipping weight, 31 lbs. **\$2.95**



TUNING UNIT

The heart of the Army Walkie-Talkie. Contains transmitter crystal and tank coil, receiver crystal, tuning condenser and small set; ideal foundation for crystal set. Shipping weight, 1 lb. **\$1.00**

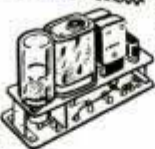

ELECTRONIC KIT

Experimenter's paradise. Five lbs. of new condensers, transformers, coils, switches, sockets, resistors, selenium rectifier, earphones, etc. Parts for dozens of experiments. Shipping weight, 6 lbs. **\$1.00**



MINIATURE HEADPHONES

Miniature type headphones. Ideal for hearing aids, listening to radio in bed, etc. Complete with headband, cord and two sets rubber ear plugs. Shipping weight, 1 1/2 lbs. **ONLY \$1.00**

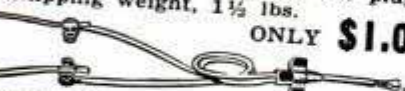

BC455B AIRCRAFT RECEIVER

Brand new 6-tube superheterodyne aircraft radios, 3-gang cond., RF stage, 2 IF stages, tunes 6 to 9.1 Mc; built by West. Electric. Complete with tubes in original carton. Easily converted. Shipping weight, 8 lbs. **\$4.95**

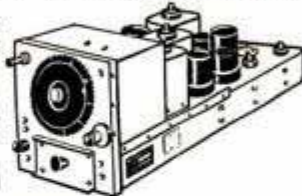

PUSH BUTTON TUNER

This beautifully constructed unit was used on an Army FM receiver. A ten push-button assembly operating four gang silver plated tuning condenser drum dial manual tuning. Brand new. Shipping weight, 10 lbs. **\$2.50**



THROAT MICROPHONE

Brand new Army T-30 throat microphones. Used in aircraft, tanks, etc. Broadcast through your radio, use in noisy factories, for home telephone systems, hundreds of applications. Shipping weight, 1 lb. **\$1.00**



Include
POSTAGE
FOR
WEIGHT
SHOWN



The HEATH COMPANY

DEPT. M . . BENTON HARBOR, MICH.



CONGRESS PULLEYS

America's finest pulleys—diamond-bored—tested for true-running—in all popular sizes, at your hardware store. Insist on Congress—your best buy in pulleys.



Sign of an Authorized Congress Dealer

CONGRESS *DIAMOND BORED* **DRIVES**
3750 EAST OUTER DRIVE DETROIT 12, MICHIGAN

SAY YOU SAW IT IN POPULAR MECHANICS

NOW! EXTRAORDINARY New GOV'T RELEASE!

Shoots A High Pressure Stream Of 30 Feet!

ALL PURPOSE STIRRUP

PUMP

ONLY **\$149**
EACH

The Tool of 100 Uses!

Just the thing for

- FIRE FIGHTING. A very handy tool to have in your workshop in case of fire.
- Spraying Garden
- Washing Cars
- Bailing Boats and Basements

Finest quality all purpose pump on the market! Never before offered at this ridiculously low price. There are dozens of uses for this versatile sprayer. Approximate height 27" overall. Complete with 10 feet of flexible hose, ready for assembly. **SEND NO MONEY:** Simply send name and address and number of pumps desired and we will promptly mail your order C.O.D. plus 25c for postage. If you prefer send \$1.49 plus 25c for postage with order and save C.O.D. charges.

S & B SURPLUS SALES CO., Dept. P-50

2905 W. Madison St.

Chicago 12, Ill.



A TOOL... NOT A BRUSH

\$1.00 POST PAID

NOW! PAINT STRIPING MADE EASY!

PAINTERS' STRIPING TOOL

Easy to use as a pencil! Draws parallel lines, straights, curves, circles with paint, enamel, lacquer, etc. Do your own striping on autos, furniture, toys, bikes, model planes, signs, linoleum... make wall board look like tile. Painters—craftsmen, order today! Type "M" Master Painters' Striping Tool complete with tip for 1/16" stripe, \$1.00. Extra tips 1/64", 1/32", 3/64", 1/16", 5/64", 3/32", 1/8" - 75c each. Tool with complete set of 7 tips \$5.00. (C.O.D. orders 25c extra.) Dealers write!

WENDELL MFG. CO.
4234-B Lincoln Ave., Chicago 18, Illinois

Have Your Own ELECTRO-PLATING Business

Profitable - Simple - Pleasant

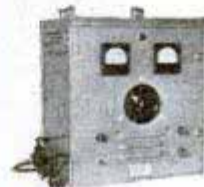

The VARI-PLATER—110 V. A.C.—plus a glass or rubber tank and chemicals, which are always available, and accompanying handbook, that is illustrated and easy to understand, will give you many money making opportunities.

You can PLATE Gold—Silver—Chromium—Nickel—Copper—Cadmium, etc. on metals and non-metals with the VARI-PLATER.

FREE Write today for descriptive literature and price list.

LEWIS ELECTRICAL MFG. CO. 1266A Gun Hill Rd. New York 67, N. Y.

AMPLIFIER

For Call System
or Phono. Amplifier

\$1.95



COMPACT-WIRED
READY TO OPERATE
USES 35Z5-50L6

25% Deposit Required

N. J. INDUSTRIAL CO., 309 Elm St., Newark 5, N. J.

FINE TOOLS NEED FINE OIL!



• Lubricates



• Prevents Rust

• Cleans • Polishes

SOLD EVERYWHERE

3-IN-ONE Oil

A New COMPLETE power driven workshop . . .

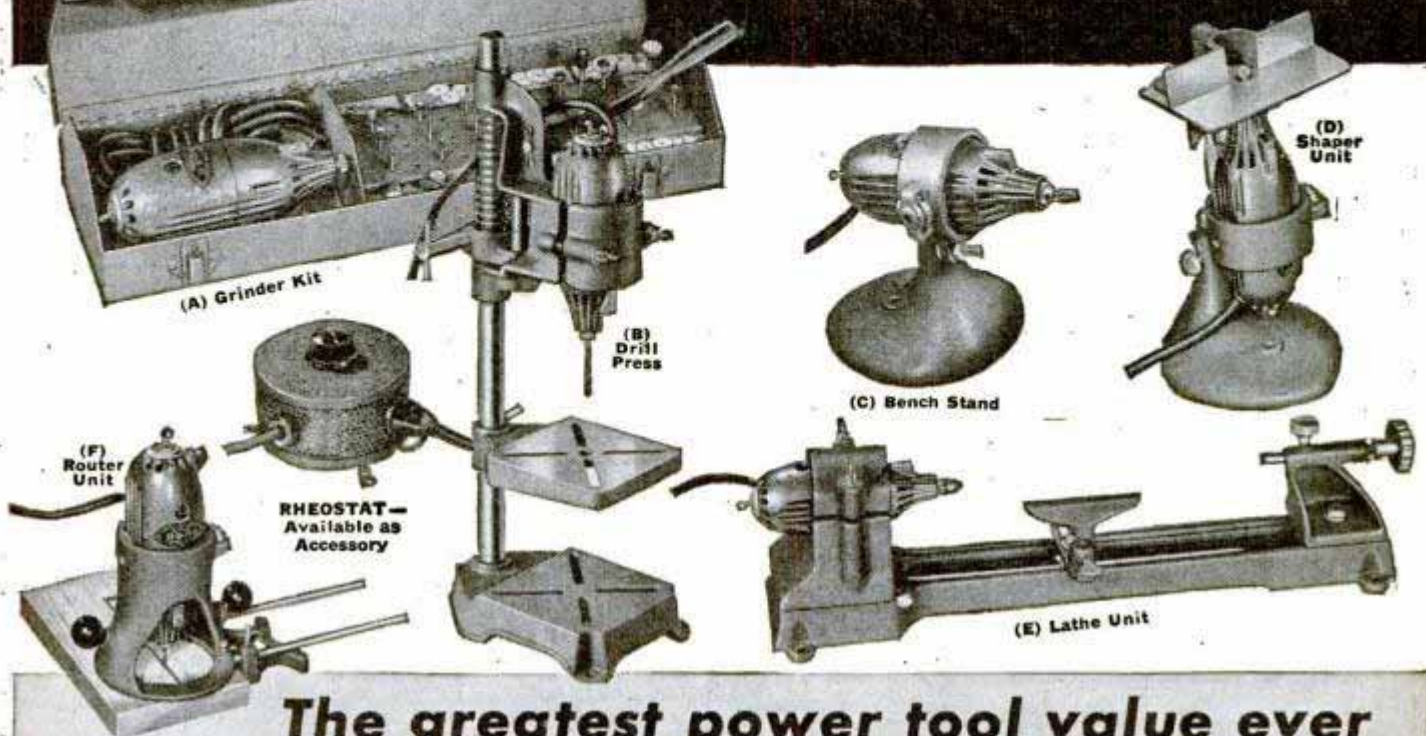

The greatest power tool value ever offered to American craftsmen

6 Major Power Tools
Complete with Motor
and Full Assortment of Accessories

COMPLETE SHOP
\$69.50
COMPLETE GRINDER KIT
(Including Motor)
\$29.95

Handles Scores of Operations

Designed primarily for light work in wood, plastics and light metals—this remarkable shop can be used in many ways by home craftsmen and model builders for—routing, shaping, engraving, grinding, polishing, carving, cleaning, buffing, de-burring, sanding, drilling, turning, etc. Here is the greatest value in power tools ever offered to the American craftsman. Consider this: You get a Power-driven Drill Press, Lathe, Shaper, Router, Bench Grinder, Hand Grinder—complete with AC.-DC motor, all ready to operate—with a compact accessories kit containing 50 sanding, grinding, drilling, polishing accessories—all for only \$69.50.

- A. Grinder Kit (Including Motor, Grinder, 50 accessories and case) \$29.95
Grinder alone 24.95
- B. Drill Press (less motor) 12.85
- C. Bench Stand (less motor) 5.45
- D. Shaper Unit (less motor) 8.95
- E. Lathe Unit (less motor) 11.25
- F. Router Unit (less motor) 8.45

(Many useful accessories also available)

Send for FREE Circular

giving complete description, specifications, and showing photographs of many unusual jobs that you can do with this shop. Also names of nearest dealers where you can see the shop on display. Mail coupon today!

DURO METAL PRODUCTS CO.
2688 North Kildare Avenue, Chicago 39, Illinois
Gentlemen:

Please rush me your free illustrated circular giving complete specifications and photos of the New Duro Workshop . . . plus a list of dealers where I can see the shop on display.

Name _____
Street Address _____
City _____ State _____

DURO METAL PRODUCTS CO.
2688 N. KILDARE AVE., CHICAGO 39, ILL.

**RIDE IT...
AND
YOU'LL
BUY IT!**

HERE'S WHY! A Whizzer Bike Motor takes you 125 miles on a gallon of gas! It's precision-engineered! Fits any man's balloon tire bike! Complete with all attachments necessary to motorize your bike! See your local Whizzer Dealer!



\$97⁵⁵ PLUS TAX

F. O. B. Pontiac, Michigan

WHIZZER

Whizzer Motor Company, Dept. 5211, Pontiac, Michigan.

I enclose \$99.97, which includes \$2.42 Federal Excise Tax () check or () money order. Send me one Whizzer Motor complete, ready for installation. If descriptive literature only is desired, check here ().

Name _____ City _____
Street _____ State _____

YOU CAN MAKE \$50 A DAY!

Be **INDEPENDENT** in your own business



with our
**15
TRADE
SECRETS**

START your own business in your spare time with **our 15 private manufacturing processes—like DECOR DYE.**

In your own home—garage, basement, kitchen, fill the demand for a tested cement floor and pavement coloring—and 14 other wanted products.

We tell you **ALL!** How to **MAKE.** Where to **BUY** simple inexpensive materials. How to **Package.** Promote, **SELL.** If you can follow simple directions, here are 15 roads to success. We give you full details on all 15 processes!

The public **NEEDS** these 15 products. You, yes you, can make them. And you can have **OTHERS SELL THEM** for you, too.

Lose no time! Write for details!

CHEMICAL RESEARCH CO.

214 West 42nd St. New York 18, N. Y.

SENSATIONAL SURPLUS PACKAGE

- 2 ea. A.A.F. FLYING HELMETS
 - 1 ea. A.A.F. OXYGEN MASK
 - 2 ea. Pliofilm Envelopes
 - 1 ea. Alphabetical Index File
 - 1 ea. Leather Buckle & Strap Set
 - 6 ea. Adjustable Hose Clamps
 - 6 ea. Assorted Gaskets
 - 6 ea. Assorted Spacers & Shims
 - 1 ea. Battery Ground Cable
 - 1 ea. Faucet or Utility Handle
- Assorted bolts and screws, bit scabbard, generator brush, seal caps, etc. Everything **BRAND NEW.**

All Items Listed Above for Only \$2.00

Send bills, check or money order. Big 5 lb. package sent immediately postage collect.

FORTUNE & SHAW

2250 McKinley Fresno, Calif.

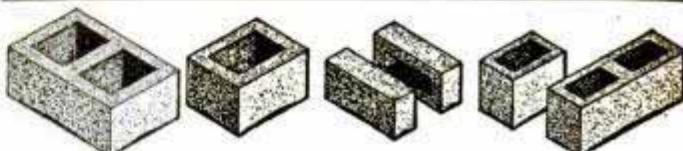

Make Concrete Blocks and Bricks

New superior method makes square, true, easy-to-lay units which will pass any building code. Small investment, high production, big profits. One \$30.00 machine will make four 5"x8"x12" blocks per minute. Pays for itself in a few days. Sell blocks or save 2/3 building cost by making and laying your own.

POST CARD BRINGS FREE FOLDER

**Economy Manufacturing Company
Dept. P Stone Mountain, Georgia**

**BURIED TREASURE, MINERALS
AMAZING NEW GOLDAK LOCATORS**

SENSATIONAL NEW MODEL. ONLY 11 POUNDS WEIGHT! One Hand Operation! Money-back Guarantee of Superiority. Write for full details, to World's largest Manufacturer.

THE GOLDAK CO.
1544 WEST GLENOAKS BLVD.
GLENDALE 1, CALIFORNIA



Learn LANDSCAPE GARDENING

A thorough, interesting, home study course for those who wish to become **LANDSCAPERS, GARDENERS, DESIGNERS, etc.,** for profit or pleasure. Write today for **FREE BOOK** to

APPROVED NATIONAL LANDSCAPE INSTITUTE
FOR VETERANS Dept. P-01, 310 So. Robertson, Los Angeles 36

**CARPENTERS...
CRAFTSMEN ...** *All Aluminum*
4" BARTON JOINTER

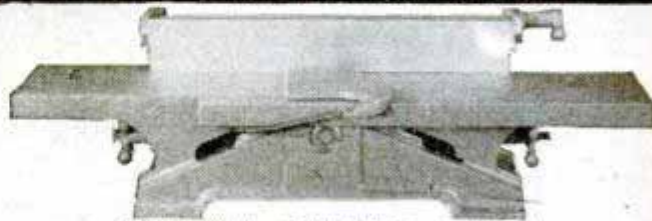

TABLE—23 1/4" x 5 1/2" BEARINGS—Sealed Ball
HEAD—Round 2 7/16", 3 Knives, RABBIT—Full 3/8"

\$57 F.O.B. PORTLAND (With 1/2 H.P. Motor \$90)

IMMEDIATE DELIVERY

PALMER D. WEEKS

401 S. W. 1st AVE. • PORTLAND, OREGON • DEPT. 032

\$65,000 IN AWARDS FOR BOYS

More than 700 awards—8 university scholarships, \$1,000 to \$4,000 each, cash awards, trips—in the Fisher Body Craftsman's Guild 1948 model-building competition



Michael Welther
Detroit, Mich.
First award,
\$5,000 Scholarship



Douglas C. Brown
Hatboro, Pa.
Second award,
\$3,000 Scholarship



Donald F. Schonoltz
Hutchinson, Kans.
Duplicate first award,
\$5,000 Scholarship



Charles Jordan
Cambridge, Mass.
First award,
\$4,000 Scholarship



Wm. Bowman
Bell, Calif.
Second award,
\$3,000 Scholarship



Donald A. Stumpf
Buffalo N. Y.
Second award,
\$2,000 Scholarship



Robert Welther
Detroit, Mich.
First award,
\$5,000 Scholarship



James Mariol
Canton, Ohio
First award,
\$4,000 Scholarship



John R. Chadma
Cedar Rapids, Iowa
Duplicate first award,
\$5,000 Scholarship



Philip Rauth
York, Nebr.
Second award,
\$2,000 Scholarship

Major Award Winners 1947 Competitions

Any boy 12 years old or over and not yet 20 on September 1, 1947, may enter the competition to design and build a model car. Junior and Senior Divisions with identical awards let you compete with boys your own age. There are no dues or entrance fees, and awards include Model Builders' Tool Chests, cash, all-expense trips to the Guild convention, and 8 university scholarships worth \$1,000 to \$4,000 each. (Duplicate awards are given if sons of General Motors employes win.)

Judges include deans or presidents of 10 leading technical schools and universities.

Write for free membership. Each new member receives a membership card and button, a full set of plans and instructions, *all free*. Competition closes July 1, 1948. You can win one of these awards! Mail the coupon NOW and get started.

FISHER BODY CRAFTSMAN'S GUILD

Sponsored by: Fisher Body Division of General Motors
General Motors Bldg., Detroit 2, Michigan

Gentlemen: Enroll me in the Fisher Body Craftsman's Guild 1948 Model Car Competition. Send me full instructions without charge.

Name _____
Address _____
City _____ Zone _____ State _____
I was born on the _____ day of _____ 19____
Parent or guardian _____
Name of school _____
City _____ State _____ Dept. 9 _____

DON'T THROW IT AWAY • FIX IT!
with this complete
ELECTRIC SOLDERING SET

\$2.25
POSTPAID

Set No. 207 includes:

- Underwriters Approved Pencil Iron
- 8-page Folder Soldering Instructions
- Two sizes of Copper Tips
- Flux & Brush
- Core Solder
- Emery Cloth



HEATING UNIT
Guaranteed
Forever!

COMPLETE
No Extras Needed

For soldering tin, brass, copper, etc. A necessity for every home workshop. Ideal for general repair, model, hobby, electronic, radio work, and other hard-to-reach jobs requiring exactness and speed. New 20-watt design gives 100-watt performance.

10-DAY MONEY-BACK GUARANTEE

See your dealer or send \$2.25 direct to

UNGAR Electric Tools

Box 2255-M, Terminal Annex, Los Angeles 54, Calif

DISSTON
The saw most
carpenters use



A Favorite
with Crafts-
workers, too

LIKED FOR MANY GOOD REASONS

Disston Saws are made of Disston Steel to assure highest quality and uniformity. True taper ground for faster, easier sawing. Being scientifically hardened and tempered throughout, they require less frequent setting and filing, stay sharp longer... last longer, too. Disston makes a complete line of...

SAWS FOR EVERY HOME WORKSHOP NEED

Ask your Hardware Retailer for Disston Hand Saws and Back Saws, Compass and Coping Saws, Band and Circular Saws. All are described in the Disston Saw, Tool and File Manual, which contains valuable home workshop data. Write for a FREE Copy.

HENRY DISSTON & SONS, INC.
1111 Tacony, Philadelphia 35, Pa., U.S.A.



Makes Exposure
Simple and Sure



For sparkling, brilliant pictures, use a WESTON with your still or movie camera. Tells you the correct camera settings to use for any scene. Ideal for black-and-white film . . . a "must" for color. Ask your photographic dealer for a demonstration . . . Weston Electrical Instrument Corp., 622 Frelinghuysen Ave., Newark 5, New Jersey.

WESTON

Master II

EXPOSURE METER

"the meter most photographers use!"



A few of the thousands of cuts possible with this wheel.

EDGE CAN BE USED

SIDE CAN BE USED

MAKE DAD GLAD . . . buy him a BAYFLEX All-Purpose Wheel

These amazing wheels are a craftsman's "Must" for those thousands of easy, as well as "tricky", bench grinder and table saw jobs. They saw, file, sharpen, cut, form and shape metal or wood. They are faster, safer, easier . . . will cut BX cable, conduit, copper tubing, transite, celotex, brass, aluminum, steel, plastics, etc. Excellent for making Xmas toys. Send check or money order to-day. Immediate delivery

6" — \$1.65 Each 7" — \$2.15 Each 8" — \$2.80 Each

All wheels 3/32" thick with 1" hole. State size of shaft if smaller than 1". Proper bushing will be sent free.

POSTAGE PREPAID Anywhere in U. S. A. by: Bay State Abrasive Products Co., Westboro, Mass.

TRUCKS • TRACTORS • AUTOS

A TWIST OF THE WRIST AND YOU

SAVE WITH CUNO AIRCRAFT TYPE OIL FILTER

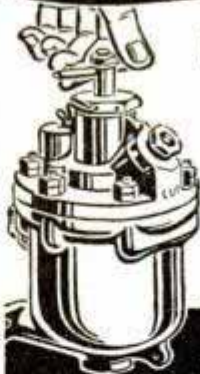

Keep oil clean without cartridge replacement...fits all cars, trucks and tractors...No parts to wear out...replaces all popular oil filters...installed at home in a few minutes...one turn of handle removes all dirt from permanent element...drain sludge and dirt from filter sump with each oil change...standard equipment on Airline, Army and Navy planes...

Every car owner, farmer, truck or fleet operator will save tremendously with the famous CUNO oil filter...lasts for the life of many cars...save big money by ordering direct from this ad. Sent postage prepaid. Address Dept. 1414.

SHEFRIN SALES COMPANY

1329 W. 9th St.

KANSAS CITY, MO.



U. S. SURPLUS BARGAIN

POLAROID GOGGLES

Brand new! In original packing. Each with three interchangeable lenses.

SHOCK PROOF FRAME — SHATTERPROOF LENSES

Use them for all outdoors sports, beach, motor-ing, boating—anything. Heavy windproof sponge rubber ventilated frame with snap button! Adj. elastic head band. Red, green, amber flexible shatterproof lenses, all instantly interchangeable. They won't last long at this price—it's smart to buy an extra. Post paid in U. S. A.

\$1.00
POST PAID

GROBAN SUPPLY CO., Dept. PM 11
1522 S. Michigan Ave. Chicago 5, Ill.

SOLID BRASS 12 FT. PORTABLE

RADIO ANTENNAS

Real \$15 Value Now Only \$4.95 Postpaid FOR HOMES, BOATS or AUTOS

JUST OUT! Gov't surplus used on Army tanks. These telescopic rustproof antenna have tremendous pickup eliminate dangerous wiring. Solid Brass throughout practically insuring NOISE FREE RECEPTION.

12 Exceptionally Rugged Sections compress into 1 ft. 4 in. Handy for Camping Trips, also Useful for Transmitting, FM & Television sets. Each antenna comes with clamps, nut, lug, and wire. Easy to install anywhere.

QUANTITY LIMITED

ORDER TODAY. A real \$15 value for only \$4.95 Postpaid. Mail check or money order now or sent C.O.D. plus postage. Money back in 10 days if not satisfied.

RADIO HOSPITAL 442 East 86th St., Dept. A11 NEW YORK 28, N. Y.





The cop took a ticket from me!

"I think I'd make a good cop," I told Officer Riley, "because every Doctor of Motors has to do some sleuthin' now and then.

"Take your car, f'rinstance. An open and shut piston ring case. There were plenty of clues—gray-blue smoke, high oil consumption, dirty plugs, and no pickup. Fortunately, it was an easy case to solve!"

As he took the job ticket from me, I said, "You're getting off easy this time. If you'd driven much further you might have burned out the bearings and scored the cylinders—that's real trouble. However, Perfect Circle Piston Rings solved this case completely. I know that you and your car are all set for thousands of trouble-free miles."

WARNING TO CAR OWNERS—Your car needs good, regular care. So see your Doctor of Motors soon. Let him prevent as well as cure its ills. Your favorite mechanic—your Doctor of Motors—recommends Perfect Circle Piston Rings, available at any automotive repair shop. Perfect Circle Corporation, Hagerstown, Indiana, U.S.A. The Perfect Circle Company, Ltd., Toronto, Ontario, Canada.

Your Doctor of Motors
restores power . . . saves gas
. . . saves oil with . . .

**PERFECT
CIRCLE** PISTON RINGS

LOOK!



WAR SURPLUS

FIELD JACKETS

Ideal for
Farmers • Lumbermen
Truck Drivers • Laborers
and for
Plain and Fancy Loafing

ONLY
\$1.98
EACH

Nothing like it has ever been offered at this low price!

This full-zipper front, bi-swing back, fine poplin Army FIELD JACKET is the favorite of G.I.s all over the world. Although used EVERY jacket is guaranteed to be in perfect condition. Sizes 34 to 40. Send name, address and size and on delivery pay postman \$1.98 plus C.O.D. charges. Add 15c for postage. Or send \$1.98 plus 15c for postage with your order and save C.O.D. charges. Order yours today!

S & B SURPLUS SALES CO., Dept. P41
2905 W. Madison St. Chicago 12, Ill.

Sheppard

AIRCOOLED DIESEL POWERED GENERATING SET...



Generating sets to 36 K.W.

Power units to 62 H.P.

Saves as it Serves

This 2,000 watt Sheppard unit delivers steady, dependable current for about 1¢ per K.W. hour. Powered by an aircooled Sheppard diesel, it operates on low-cost domestic furnace oil.

It's the ideal power source for water systems, refrigerators and home-lighting... or wherever economy is important without sacrificing dependability. Write for complete information—see how a Sheppard Diesel Generating set saves as it serves.

R. H. SHEPPARD CO., INC., 48 Middle St., Hanover, Pa.



DIESEL'S THE POWER...

Sheppard's the Diesel.

YOUR AIR TOOLS WORK BETTER WITH NEW HOSE COUPLING!

Get greater efficiency from your air-operated tools. WIGGINS Quick-Connect Hose Couplings are guaranteed leakproof—have a larger flow capacity than any other quick couplings. Ideal for Paint Guns, Hand Air Drills, Air Compressor Hand Tools—or any tools and machinery that you are constantly connecting and disconnecting.



MONEY BACK GUARANTEE ON AIR, WATER, FLUID COUPLINGS

WIGGINS Quick-Connect Couplings handle everything—air, steam, oil, water, vacuum, hydraulic, liquids. Withstand higher or lower pressures (even vacuum) than any other quick couplings. Guaranteed not to leak or blow out. Increases flow 1/2 — increases efficiency — saves time. Snaps on and off — no screwing with WIGGINS! Used by Ford, Chrysler, Lockheed, Army, Navy, Westinghouse—many others. Send \$1.50 for sample 3/4" water hose coupling; \$1.00 for 1/2" air hose coupling. Write for information on other uses in home and industry to E. B. WIGGINS OIL TOOL CO., Inc., Dept. PM, 3424 East Olympic Blvd., Los Angeles 23, Calif. Written guarantee of money back unless delighted!

OTTAWA TRACTOR SAW



THOUSANDS IN USE

Falls trees quick—no lifting, pulled by tractor—easily swung into position. Saws large and small logs. Safety Friction Clutch. The most useful, low-priced tractor saw ever built. Thousands in use—NEW improvements making more useful than ever. Saw your wood lot, into Cash while prices are high. Make your tractor pay bigger dividends. Lowest direct-to-user prices. Fully guaranteed. Send for Free details.

Costs Too Little To Do Without

OTTAWA MFG. CO., 4-727 Forest Ave., Ottawa, Kansas

SUPER JET BLOW TORCH

ONLY \$1.

1000 USES WITH AMAZING NEW DRY FUEL BLOWTORCH

It's Here! The tool that amazed famous science editors! Perfect for soldering, silver soldering, hardening or annealing small parts! Used and praised by model-makers, electricians, jewelers, mechanics, chemists, inventors, schools! 10 minutes intense heat (over 2000°F) with each tablet! Solid brass torch, air cooled handle, clear plastic tube. Guaranteed! Order Yours Today!



MAIL ORDER TODAY!
Send \$1.35 for torch, 12-tablet fuel box, mailing costs. No CODs. Wholesale Areas Open

BIRK MANUFACTURING CO. 552 HILLS STREET, HARTFORD, CONN.

SAY YOU SAW IT IN POPULAR MECHANICS

AIR COMPRESSORS

Gasoline powered—3 to 5 cu. ft. Immediate delivery. DeVilbiss, Curtis or Kellog. Thoroughly re-conditioned. F.O.B. K. C. \$95.00

Supply limited — write for illustrated circular.

MIDWEST SURPLUS SALES
1520 Locust Kansas City, Mo.

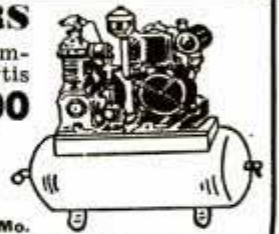

SURPLUS BRAND NEW 5 TON

Hydraulic Jacks



Nationally Known — Limited Supply. Regular List Price \$19.50. Our Sale Price, only... **\$8.95**

Prices FOB, K.C. Send money order or check.

We Have The Parts You Need

Tell us your needs. Get our prices on all Army Built Truck Parts. Dodge—Chev.—G.M.C.—Studebaker—Intl. 6x6—4x4—6x4 and other items.

AMERICAN AUTO PARTS CO.

1830 LOCUST—DEPT. P. M. KANSAS CITY, MO.

ADD TO YOUR INCOME

Profit by Increasing Demand
for Belts, Purses, Gloves
Woolskin Toys —

with **LARSON**
Leathercraft

No Experience Necessary

Sell popular, useful, easy-to-assemble items from Leathercraft Headquarters. Complete stock. All tools and accessories. Instructions come with materials. Immediate delivery.



101 Ideas
Send ten cents at once for catalog of money-making ideas.

For new, 16-page catalog, write to J. C. LARSON COMPANY
176 N. Wacker Dr., Chicago 6, Ill.

New "THERMO-SAW" (CUTS WITH HEAT)

MAKE THINGS FOR THE HOME or FOR SALE

• Any Child Can Use It!

- NO NOISE
- NO VIBRATION
- NO SAWDUST

CUTS RAPIDLY AND CLEANLY THROUGH WOOD AND OTHER MATERIALS... AN IDEAL GIFT! Difficult patterns are made QUICK and EASY... No turning of work... Cuts in every direction... Cuts plywood 1/8" or 1/4"... Cuts 14"x36" board... Special Transformer produces high frequency current in a tough steel wire "blade" from ordinary Alternating (AC) current. No radio interference. IMMEDIATE DELIVERY!



Machine Measures 11x4 1/2" High. Throat 7" 3/4" Deep. PATTERN FREE. Postpaid ONLY \$5.98. COMPLETE SAW outfit as illustrated with transformer and 12 spare blades. READY TO USE.

\$1 Deposit on C.O.D. orders.
ORDER \$6.23 in Canada and TODAY Mexico. \$6.48 Elsewhere.
Manufactured by:
THE KING CO., Dept. P-11, 6 No. Batavia Ave., BATAVIA, ILL.



A PENNY POSTCARD MAY CHANGE YOUR FUTURE . . .

Get full information on the coin-operated vending machine industry. Start with a few machines and build to a wonderful future. We'll give you complete advantage of our "know-how."
Send For Free Booklet Today—No Routes Sold!

PIONEER VENDING SERVICE

Address all mail to Dept. PM
461 SACKMAN ST. • BROOKLYN 12, N. Y.

DRAIN YOUR CELLAR, POOL, WASH TRAYS, ETC.

LABAWCO Type P Pump keeps garden pools fresh. Circulates oil or refrigerant, etc. DOES NOT CLOG! 1500 Gals. per hr. — 300 Gals. at 30'. Uses 1/8 to 1/2 H.P. motor.

Pump alone \$6.50. Pump with complete self-priming unit . . . \$13.95

POSTPAID if cash with order. West of Mississippi, add 50c.

SEND ORDER TODAY

LABAWCO PUMPS
BELLE MEAD 4, N.J.

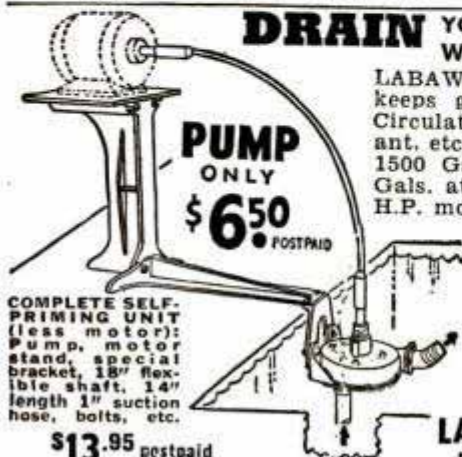

PUMP ONLY
\$6.50 POSTPAID

COMPLETE SELF-PRIMING UNIT (less motor): Pump, motor stand, special bracket, 18" flexible shaft, 14" length 1" suction hose, bolts, etc.

\$13.95 postpaid

NOW
A motor with the name you know

The New HOOVER Fractional Horsepower Motors



1/4 horsepower and up

You know what you are buying when you see "Hoover" on the name plates of these new fractional horsepower motors.

You know Hoover is the "great name" in electric cleaners; you know its reputation for fine products.

FEATURES OF THE HOOVER MOTOR

Induction run . . . single phase . . . 60 cycles . . . 1725 R.P.M. . . heavy duty . . . built for continuous operation.

Capacitor start . . . more than 300% full load starting torque with minimum current flow.

No vibration or "shift" . . . integral feet, carefully machined to give solid mounting and quiet operation.

Low temperature . . . electrical and mechanical design for low-temperature operation. Ventilated open type. 40° C. Rise.

Laminated steel rotor . . . carefully ground and balanced for maximum efficiency.

Centrifugal starting switch . . . built for years of trouble-free operation.

High-grade ball bearings . . . sealed against dust and grit, give smooth performance and long wear.

Rotation . . . clock or counterclockwise.

POPULAR USES OF HOOVER MOTORS

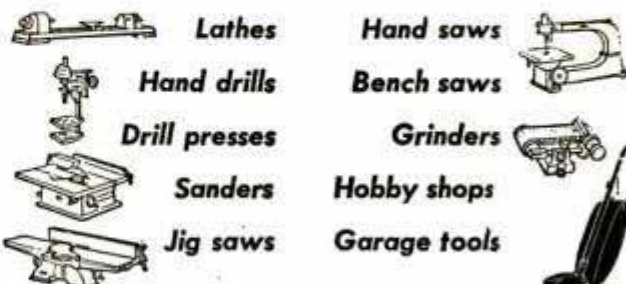

See your authorized Hoover motor dealer. If unable to locate, write:

THE HOOVER COMPANY
Electric Motor Division
North Canton, Ohio; Hamilton, Ontario, Canada

Makers of the World-Famous
HOOVER
CLEANERS

Be the Local Manufacturer of this Modern Building Unit

Choice new territories are being opened up for the local manufacturing of Dunbrik and Dunstone—America's finest masonry. Several hundred new local plants are needed to keep pace with the fast-growing consumer demand.

Millions of Dunbrik are used annually for the building of homes, and all types of public and commercial structures. It is outstanding in design, symmetry, and colorful beauty. And has price appeal of tremendous significance. Dunstone—a companion unit broadens the usefulness and market possibilities of Dunbrik.

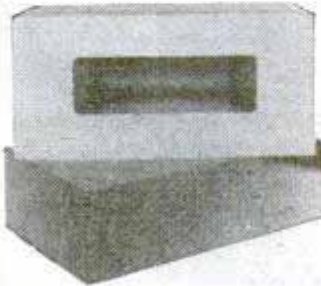

The Lifetime Opportunity for Men of Vision and Enterprise

Dunbrik and Dunstone are vital contributions to the nation's crying demand for low-cost homes. A demand that is only beginning to be supplied. Better yet, they deliver all the advantages of masonry at its best without price penalty. Strength—safety—long life—low depreciation. These factors indicate that market possibilities are almost unlimited.

We supply complete plant equipment for local manufacturing, using local materials and local labor. This explains why selling prices can be low, yet profit margin high. Moderate investment. Franchise-protected territory. Twenty years of consumer acceptance. Wire or write for full information and territorial reservation.

W. E. DUNN MFG. CO.

600 W. 24th Street

Holland, Mich.

DUNBRIK

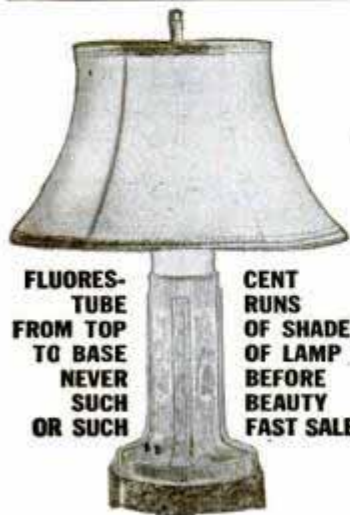

FLUORESCENT TUBE FROM TOP TO BASE NEVER SUCH OR SUCH

CENT RUNS OF SHADE OF LAMP BEFORE BEAUTY FAST SALES

Agents

For the First Time— FLUORESCENT All-Lite TABLE LAMP!

FIRST to utilize the exclusive feature of UPRIGHT fluorescent illumination, the ALL-LITE gives off a soft, even distribution of light without glare—from shade top to bottom of base.

Selling like mad. Men order sample, show it and reorder in gross lots. Instant appeal. Plug it in and watch them buy. Comes complete with tube and plastic shade.

MAXILUME COMPANY

Send name for **FREE SAMPLE OFFER**

DON'T send a penny. Sample offer is free—Rush name for selling outfit and make money from the day it arrives. We will show you how to sell to hundreds of homes, restaurants and public places and to stores by the dozens for resale. Also immediate delivery on standard fluorescent fixtures. Get going with the MAXILUME line. It's a winner for others—it can bring big, fast profits to you. Rush name on penny postcard.

125 W. HUBBARD STREET, Dept. 811
CHICAGO 10, ILL.

WHEELS & AXLES

Precision-made steel wheels, red enamel finish.

WHEELS WITH SEMI-PNEUMATIC TIRES

6" X 1.50 with 3/8" Oilite bearing.....\$1.75
8" X 1.75 with 3/8" or 1/2" Oilite bearing..... 2.25
10" X 1.75 with 1/2" Oilite bearing..... 2.75

WHEELS WITH SOLID RUBBER TIRES

4" X 1 1/2" tire, 1/4" steel bushing......65
6" X 2 1/4" tire, 3/8" steel bushing..... 1.00

INDUSTRIAL & AGRICULTURAL WHEELS

PAINTED BLACK

10 X 2.75 with Semi-solid lug tire, load cap. 400 lbs. Ballbearings 1 1/2", 5/8" or 3/4". Hub length 3"..... 7.00
3.00 X 5 with 2-ply Pneumatic tire and tube. Ballbearings 1 1/2", 5/8" or 3/4". Hub length 3"..... 9.75
4.00 X 8 with 4-ply Pneumatic tire and tube. Ballbearings 1 1/2", 5/8" or 3/4". Hub length 4" or 6"..... 13.95
Roller Bearings in 3/8", 3/4" or 1" supplied at \$1.00 extra



AXLES, COLD ROLLED STEEL

THREADED, NICKEL CAP NUTS

1/2" x 14" long..... .40 1/2" x 18" long..... .80
3/8" x 16" long..... .60 1/2" x 24" long..... 1.00
3/8" axle with washers and cotter pins, per ft..... .75
3/4" axle with washers and cotter pins, per ft..... 1.00

Shipped postpaid in U. S. on receipt of price. Other wheel sizes available. Send stamp for catalog.

CIRCLE METAL MANUFACTURING COMPANY

4266 E. Pacific Way

Los Angeles 23, Calif.

THIMBLE DROME RACER

The Model Racing SENSATION

Completely Finished



Only \$3.95 Postpaid

New, accurate scale model of midget racer, the classiest thing you ever laid eyes on. Die cast malleable aluminum body, turned aluminum rubber-tired wheels, Chrome exhaust stacks, Wobble pump. Simulated leather seat and back. Instrument panel and numbers. Equipped with bridle lugs for cable track racing. Car is 9 3/8" long, 4" high. Weighs 18 oz. Order one today—you can't beat this for fun!

Speed! Action! Can be adapted for Class A miniature engine or other power.

4" high. Weighs 18 oz. Order one today—you can't beat this for fun!

HOME-SHOP PRODUCTS CO.

Dept. 18

4821 Sheridan Rd.

Chicago 40



The Modern PLASTIC for lasting Home Repairs

PERMANENTLY mends cracks or holes in wood, tile, stone or plaster. Sticks and stays put—Does not chip, shrink or fall out. Easy to use. Economical Mold it, chisel it, polish or paint it. If unobtainable from your lumber, paint or hardware dealer, the big 4-lb. can will be sent you postpaid (in U.S.) for only \$1. Full money-back guarantee, order now.

DONALD DURHAM CO.

Box 804-K, Des Moines, Iowa

SAY YOU SAW IT IN POPULAR MECHANICS

SpeedWay

No. 117 PORTABLE BENCH GRINDER \$1495



A new type air cooled motor that has 3 times the power of the pre-war model. Protected self-aligning, oil impregnated bronze bearings. A new 1-piece die cast aluminum housing with integral wheel guards and tool rests. Built in switch, rubber covered cord and plug. 1 coarse wheel, 1 fine wheel (4 1/2" x 3/8" x 3/8"). You can never appreciate the sweet running balance and grinding efficiency of this grinder until you test it. Ask your SpeedWay dealer to demonstrate.

"Blue Line" Tools

SpeedWay Blue Line Tools are built for use. Each operates at the correct speed for its capacity and operation: Grinders grind at the proper speed to give efficient f.p.m. without excessive wheel wear; drills drill at speeds that cut rapidly thru work but won't burn drill bits . . . or with one of the stands illustrated, quickly convert into a sturdy, inexpensive, lever-operated drill press.

Each has its own specially wound, high torque, long life, air cooled SpeedWay tool motor, and all embody the quality features and "tool sense" developed thru SpeedWay's 35 years of specialization in the design and manufacture of portable electric tools.

Standardize on SpeedWay Tools. You will not only have better tools but in each case more tool for the money.

Sold by hardware, farm implement tool dealers, and tool departments everywhere . . . by many household appliance outlets and electrical stores.



No. 129 GRINDER
\$825



GA KIT
\$1395



No. 209
Drill Stand
(Less Drill)
\$1295



No. 89
1/2" ELECTRIC
DRILL \$2995



No. 69
1/4" DRILL \$1180

No. 229 DRILL STAND
(Less Drill) \$525



SPEEDWAY MFG. CO.
1863 South 52nd Avenue, Cicero, Ill.

COMPLETELY *New* MOWER POWER UNIT

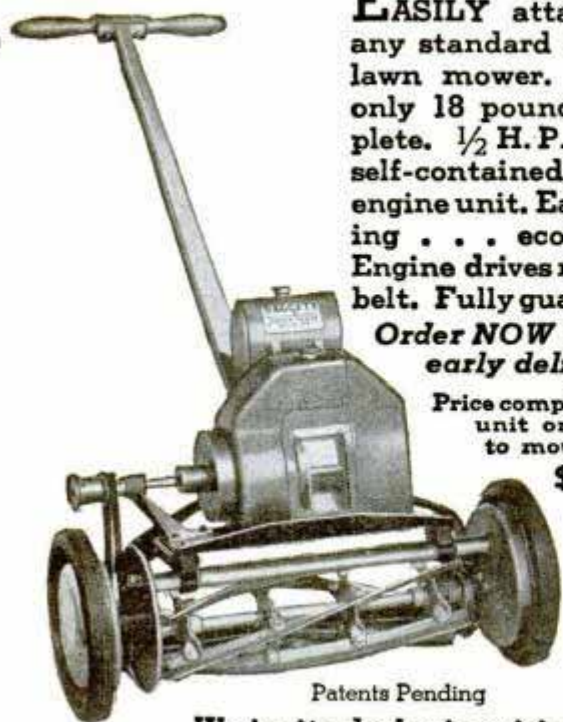

EASILY attached to any standard make of lawn mower. Weighs only 18 pounds, complete. $\frac{1}{2}$ H. P., 2 cycle, self-contained gasoline engine unit. Easy starting . . . economical. Engine drives reel by V-belt. Fully guaranteed.

Order NOW to insure early delivery.

Price complete (power unit only), ready to mount . . .

\$49.50
F. O. B. plus tax.

Patents Pending

We invite dealer inquiries.

Daggett Engineering
MEADVILLE, PA.



NOW Install your own LOW COST 2-WAY TELEPHONE

Talk from house to barn, warehouse office to shop, etc.

Easy to use! Just hook up terminals to any 2-strand wire; several phones on same line if desired.

Operates on standard flashlight batteries. Compact, rugged . . . portable. Performance equals best present day commercial telephones . . . GOOD UP TO 17 MILES!

NEW - per pair, complete with heavy canvas case . . . \$29.50; leather \$32.50.
USED - per pair complete with either case . . \$19.50

Extra wire, new 500 ft. \$3.50.
1/2 mile reel \$10.50. 1-mile reel \$16.00. FOB Sacramento. No COD



FREE
With every order - 50 ft. sample new Army field wire.

Write for **FREE** Illustrated Catalog

MAKES IDEAL CHRISTMAS GIFT



SEND CHECK or MONEY ORDER **LORIS SALES**

P. O. Box 2414, Dept. B Sacramento, California

Best Boat Buy—\$35



HAGERTY
SeaShell

Assemble it Yourself!

The Hagerty SEA SHELL is a complete kit of precision cut wood and waterproof plywood parts. Write for illustrated folder today.

REG. U.S. PAT. OFF.

HAGERTY
Cohasset, Mass.

TiK FOR KiTs—Look at these Values

Mica Condensers, Assorted, 100 for \$3.49
Allen Bradley etc. volume controls 50 ohm to 1 meg.; 12 for . \$2.59
Carbon Resistors, color coded, $\frac{1}{2}$, 1 and 2 watt; 100 for . . . \$2.50
Wire wound Resistors, Ward Leonard etc. 5 to 75 watt; 20 for . \$2.98
FUSES—Buss and Littlefuse; 100 for \$1.89
Assorted Oil filled Condensers, tubular and bath tub type;
400v.-600v.-1000 volts; 12 for \$2.49
Octal and 4 prong Ceramic Sockets (without rings); 100 for . \$3.98
Condensers .05 mfd. 2000 v. to .25 mfd. 3000WVDC; 6 for . \$3.59
Precision Wire Wound Resistors, Shallcross, Mepeco, etc.
 $\frac{1}{4}$, $\frac{1}{2}$ and 1 watt; 15 for \$2.98

SPECIAL COMBO KIT

Our Introductory Offer—Excellent Assortment—Big Value—Tremendous Savings. This kit includes a quantity of items listed in the above kits, PLUS many others. It's our New **\$10.98** Customer Special

25% DEPOSIT REQUIRED ON ALL C.O.D. ORDERS.

MINIMUM ORDER \$2.00—ADD POSTAGE—WRITE DEPT. PM11

TiK - 55 WALKER STREET New York City 13
Tel. CAnal 6-7585

BUILD YOUR POWER TOOLS

WITH OUR GUARANTEED INDUSTRIAL BALL BEARING ARBORS



New Departure
Self Lubricating
Bearings



10,000 R.P.M.

(No extra charge for left hand threads) CS- $\frac{5}{8}$ Pictured

B33—\$4.95 PP. C4— $\frac{1}{2}$ x12 $\frac{1}{2}$ spindle, housing 2x8 \$8.25 PP.
 $\frac{5}{8}$ x 4 $\frac{1}{2}$ Spindle C5— $\frac{3}{8}$ x12 $\frac{1}{2}$ spindle, housing 2x8 \$8.25 PP.
C6— $\frac{3}{4}$ x12 $\frac{1}{2}$ spindle, housing 2 $\frac{1}{2}$ x8 \$9.25 PP.
B15 Plain Spindle D8—1x17 $\frac{1}{2}$ spindle, housing 2 $\frac{1}{2}$ x11 \$17.00 PP.
\$3.50 PP. 1 INCH BETWEEN WASHER AND COLLAR
SHAPER ARBORS 3 inches between collars, C4- $\frac{1}{2}$ \$14.25, C5- $\frac{5}{8}$ \$14.25, C6- $\frac{3}{4}$ \$15.25, D8-1 \$23.00. All P.P.
SPECIAL SAW ARBORS with 4 in., 5 in., 6 in., 7 in., housing length, add \$1.40, $\frac{1}{2}$, $\frac{5}{8}$, $\frac{3}{4}$ models. Ask about other designs.
POLY PRODUCTS, 406 S. Chester, Ct. 1a. Pasadena 5, Calif.

$\frac{1}{4}$, $\frac{1}{3}$ H.P. MOTORS

NEW, LIFETIME, GREASE-SEALED, BALL-BEARING, BASE-MOUNTED; Unconditionally guar. by OHIO ELECTRIC MFG. CO., mfrs.

$\frac{1}{4}$ H.P. \$19.95 $\frac{1}{3}$ H.P. \$26.50

Freight prepaid CHECK or MONEY ORDER. Freight collect C.O.D.

BENTONE Appliance Co., 11 W. 42, New York, N. Y.

SAY YOU SAW IT IN POPULAR MECHANICS

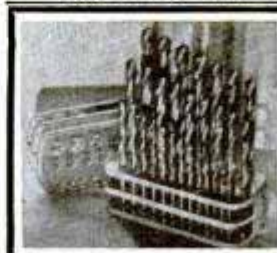

Why Hunt for Drills?

These Complete High Speed Drill Sets Now Available at Low Prices

#1 to 60 Drills \$12.95 Per Set
1/16-1/2 by 64ths \$16.95 Per Set
Drill Sets A-Z \$15.50 Per Set
(Drill Stands Free)

Send For Free Circular

SID TOOL CO.

MACHINE SHOP SUPPLIES
183 Grand St., New York 13, N. Y.

Berkroy...

sheet metal equipment

Something New
in Metal Working

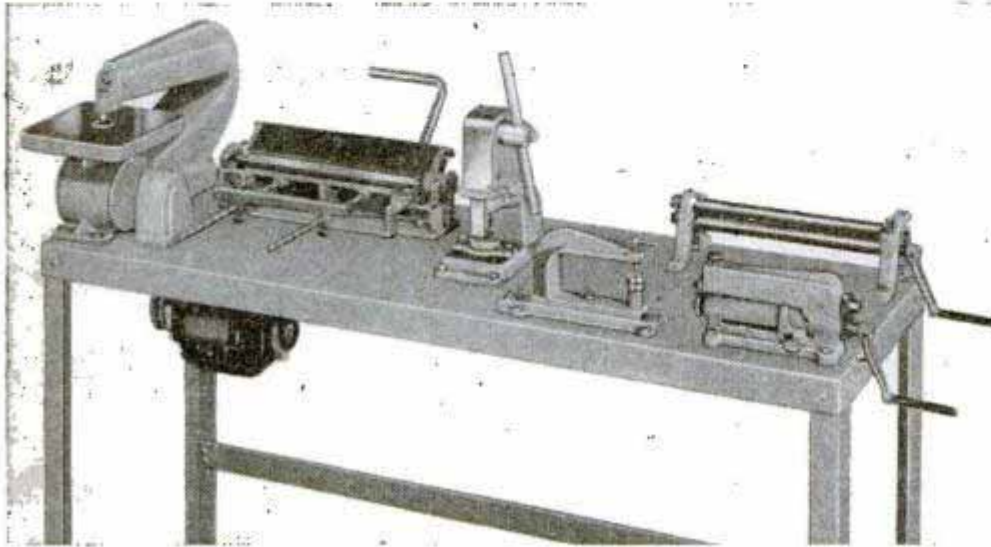

The compact Berkroy Unit completely equips your workshop for fascinating projects in sheet metal working. Mounted on the steel stand nearly 6 feet long, are five versatile metal working tools, that within their capacity, compare in performance to larger, far more expensive equipment. Each tool processes up to 16 gauge sheet steel with the exception of the Nibbler which will handle 20 gauge steel. Heavier gauges of aluminum, zinc, pewter, copper, plastics and other softer materials can be worked. The Berkroy Unit also has wide uses in industrial shops handling medium and small work at reduced costs and increased profits.

Complete set, stand and five tools, **\$217.50**
less motor No. 150

F. O. B. Factory



Write for free Berkroy Folder

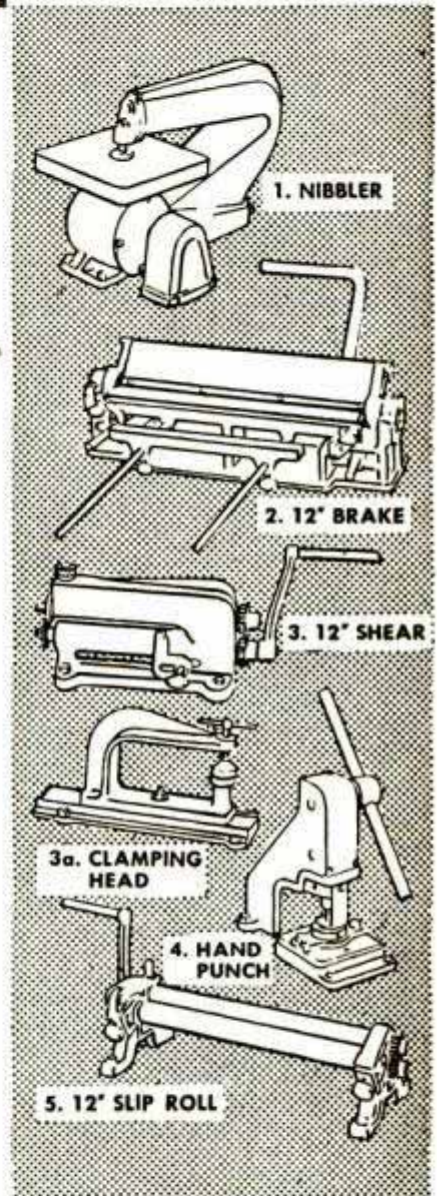

BERKROY TOOLS Sold in Sets or Single Units

1. NIBBLER ...
For cutting odd shapes, straight or scroll work. 8" square cast table, less motor.

No. 50 **\$49.50**

2. 12" BRAKE ...
For square or rectangular work and simple types of trim. Forms flanges, boxes, tabs, etc.

No. 40 **\$43.95**

3. 12" SHEAR ...
Hardened and tempered cutters for straight line cutting, trimming, etc. No. 30

\$19.75

3a. CLAMPING HEAD ...
For cutting inside or outside circles. No. 3001

\$7.50

4. HAND PUNCH ...
Used to punch sheet metal and to install pressed fits into small work. (Die sets and shear blades extra.)

No. 20 **\$27.50**

5. 12" SLIP ROLL ...
For forming cylinders, scrolls, reverse curves, etc. Simple, easy adjustment on rollers.

No. 10 **\$27.50**

BERKROY PRODUCTS, INC.

336 MAGNOLIA STREET
OAKLAND 7, CALIFORNIA

DISTRICT OFFICES:

WOOLWORTH BLDG.
NEW YORK 7, N. Y.
CORTLAND 7-8024

550 W. WASHINGTON BLVD.
CHICAGO 6, ILLINOIS
CENTRAL 1246

1672 MISSION STREET
SAN FRANCISCO, CALIF.
UNDERHILL 6682

700 COMMERCE STREET
DALLAS 2, TEXAS
CENTRAL 4075

Write Berkroy Office Nearest You

\$ MILLION DOLLAR SURPLUS OFFERING \$

Everyday Items For Farmers, Sportsmen, Mechanics and Laborers



NAVY FIELD JACKET (New)
Poplin outer shell with 100% wool knit lining. OD color. Zipper and button front. Has 2 slash pockets. Lightweight for both fall and winter. Sizes 34 and 36. Each... **\$6.95**

FACE AND NECK PROTECTOR

Navy blue wool felt (NEW) snug fit adjustable head bands. Button down mouth flap with bib collar (buttons in back). Finest of tailoring. Perfect cold weather protector. Each... **\$1.29**



CHOPPERS MITTS (New)

Heavy, durable, cream colored horsehide leather with wool lining. Dark colored elastic knit wrist. Small size only. Right hand glove has flap in palm for use by hunters. Per pair... **\$2.98**



HEAVY OVERALL TROUSERS (New)
N-1 Navy deck all wool flannel lined bib type trousers. Keeps out dampness and are water repellent. Outer shell made of durable jungle cloth. Has 2 front and two hip patch pockets. Sizes small, medium and large. Per pair... **\$4.95**



CANVAS BUCKETS

2 Gal. capacity. New, collapsible. For use when motoring, fishing, in a trailer camp, or as a clothespin bag. Made of double canvas lining, heavy web belting handle, reinforced bottom, metal band top and bottom. A handy item for any use. Each only... **79c**



POPLIN FLYING TROUSERS Brand New

Intermediate, type A-9 OD, made of cotton twill cloth lined with an alpaca wool pile fabric. Three leg and two hip pockets. Adjustable suspenders included. Knee pocket and lower end leg inseam fitted with slide fasteners. Asst. sizes ranging from 32-44. Per pair... **\$5.95**



Sheepskin Flying Trousers

Made of high grade sheepskin, outside color brown, inside color natural. Brand new. Equipped with zipper fly, two full length zippers on each side. Suspenders and front pockets. Asst. sizes, 36 to 48. Per pair... **\$7.95**



SHEEPSKIN LINED MITTENS

Made of converted government flying clothing. A wonderful value and practical garment for protection against cold weather. Brown. New, standard size. Per pair... **\$2.98**



NEW SHEEPLINED HUNTING JACKETS

Made of recon-verted highest grade sheep shearing. Natural color inside. Brown out. Zipper front. Right hand pocket. Well tailored and a wonderful value. Sizes small, medium, large. Each... **\$24.95**



FELT FACE MASK

Brand new - Made of 100% OD wool felt, double layer reinforced. Used to prevent outdoor rash and chaps. Also wonderful buffer against cold weather. Plenty of room for eyes and nose; held in place by small elastic band. Each... **89c**



A-6 FLIGHT BOOTS

Brand NEW, sheepskin lined, with rubber sole. Waterproof, can be used with or without shoes. State size needed, comes small, medium or large. Sale price, per pair **\$11.95**
Some Used Boots - Reconditioned and perfect in every sense. Same as above in every respect and size. Per pair... **\$6.95**



Wool Blankets

Army OD, absolutely perfect, full sized. Cleaned and sterilized. Each only **\$4.98**
New Wool gray blankets, full sized. Only **\$7.95** ea.



RIFLE SCABBARD (Used)

Made of Heavy Leather with carrying straps. Each **\$2.95** only



IMMEDIATE DELIVERY - Add 10% for Postage and Handling

ROKO, INC. 809 CHERRY ST. KANSAS CITY, MO.

CRANDALL TILTING TABLE SAW

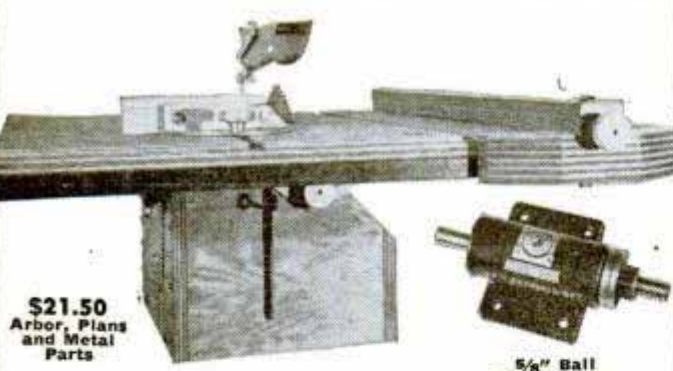

\$21.50
Arbor, Plans and Metal Parts

5/8" Ball Bearing Arbor

BUILD IT YOURSELF

In your own shop - with our Ball Bearing Arbor, Plans and Metal Parts. Here's the saw you've been wanting for your shop! With our easy to follow step-by-step plans and instructions, you can build it with ordinary hand tools for a fraction the cost of all metal saws of comparable size and capacity. Sturdy wood, steel and aluminum construction.

Features-
Big roomy top 27" x 32" with 13 1/2" clearance ahead of saw. Tilts to 45°. Precision built ball bearing arbor lubricated and sealed. No further lubrication required. Self aligning, full length rip fence. Indexed mitre gauge. Indexed table tilting quadrant. Adjustable saw arm - cuts from 0" to 2 1/4".

Complete Kit- In California add 2 1/2% sales tax
Includes Ball Bearing Arbor with Saw Plans and instructions, and all metal parts, bolts, washers and screws **\$21.50** (less saw blade)
5/8" Ball Bearing Arbor only - with Saw Plans and instructions **\$6.95**
Metal Parts only - **\$14.95** less Arbor

If your dealer cannot supply you, send check or money order - we will ship promptly postpaid in U.S.A. or possessions. DEALER INQUIRIES INVITED

WILLIAM H. CRANDALL COMPANY
1009 Fruitvale Avenue Dept. M Oakland 1, California

SAY YOU SAW IT IN POPULAR MECHANICS

The SPEED SAW FILER

Saves You Time, Money



Now you can do expert saw filing at home. Lifetime tool makes precision filing easy for even the most inexperienced. Two simple adjustments make it fit any type hand saw. Keep your saws extra sharp and true-cutting with a Speed Saw Filer. Complete with file, ready to use. Money back guarantee. Cash with order, prepaid (C.O.D. postage extra.)

THE SPEED CO., Dept. PM
2025 N.E. Sandy, Portland 12, Ore.



\$2.95

WAR SURPLUS!

New B-24 Aircraft Lighting **GENERATORS**



30 Volts
300 Amp. D. C.

\$49.50

Original cost \$250
MODEL R. 2, BUILT BY JACK & HEINTZ, CLEVELAND, O.

Can be used for lighting or converted for use as welder, electric plater, fast battery charger, auxiliary power unit, etc. Small but mighty. Size 16"x7". Air cooled. Shipping weight 68 lbs. Immediate shipment. Original crates. Send check with order to save time. We also offer new 200 Amp. G.E. and Westinghouse Lighting Generators, 30 Volts D.C. Model P. 1 at \$39.50.

GREER CO. 460 S. State St., Dept. 4117 Chicago 5, Ill., Phone Harrison 4075

POPULAR MECHANICS

A BONANZA for the HOME WORKSHOP
ACTUALLY \$50.00 WORTH OF

Grinding Wheels

Abrasive discs, felt and buffing wheels, mandrels, rotary files, sheets, etc.

327 PIECES
ASS'T. SIZES
FOB CHICAGO
ALL FOR ONLY **\$6.95**

The buy of a lifetime! 327 pieces including 35 ass't. Grinding and Cut-off wheels up to 10 inches diameter, 1/16 to 1 1/4 in. face, 1/8 to 3 in. holes. Assorted grits—all brand new—made by Norton, Carborundum, Macklin, Bay State, etc. Also included are 100 slotted disc cloths; 100 paper discs; 3 round wire brushes on handles; 2 felt bobs; 2 felt wheels; 1 4" rag buff; 3 honing stones; 10 abrasive sleeves; 10 mounted stones, 1/8 and 1/4 shank; 2 mandrels; 2 rotary files, 1/4 shank; 50 abrasive discs; 2 7/2" abrasive belts; 5 9x11 abrasive sheets. Satisfaction guaranteed. Order today. It's better than **\$6.95** a \$50.00 value for only



GROBAN SUPPLY CO. 1522 SO. MICHIGAN AVENUE
DEPT. PM-11, CHICAGO 5, ILL.

TOOL STEEL DRILL ROD

\$1.95
POSTPAID
in Continental U.S.
C.O.D.'S ACCEPTED

25 RODS SAMPLER KIT 25 SIZES
1001 Uses for Craftsmen, Hobbyists, Mechanics, etc.

For Making
Punches
Chisels
Engraving
Tools
Shafts, Etc.

Free machining, easily worked, yet can be made file hard. Hardening instructions included!

ORDER TODAY

FREE

With Every Kit or first order 6" Steel comb. rule and depth gage with pocket clip.

FLAT TOOL STEEL

The Precision ground flat tool steel with the satin-smooth finish. Simple to work, easy to harden, ready to use.

SHOP ASSORTMENT \$4.80

5 dif. Pieces—1 1/32" to 1 7/8" thick 1 1/2" wide; 18" long. Include 25¢ postage on orders under \$5.00.

We can supply ALL your Tool Steel Needs.

BESSEMER STEEL COMPANY OF AMERICA, Dept. FC-11
Small Shops Division Chicago 36, Illinois
1958 W. 59th St.

STATION WAGON BODIES AND CABS FOR ALL CARS, JEEPS SMART MAPLE - OAK WOODS



Year around comfort for Jeep owners. Kiln dried hardwoods, safety glass. Finest hardware, varnishes, top materials. Full opening rear door, locks. Send 25¢ with order balance **\$165** COD. FOB Cleveland plus tax, complete, semi-assembled.

STATION WAGONS, INC. (PM)
1760 Lakeview Rd. Cleveland, O.

OTHER CARS converted to station wagons. Write for details.

**STURDY!
VERSATILE!
EFFICIENT!**

Garden-All

LAWN and GARDEN TRACTOR

There's nothing at all like Garden-All! Instant Tool Attachment, Exclusive Depth Control, A Tool for Every Need. Write for folder.

GARDEN-ALL TRACTOR, INC.
Dept. P, 100 W. UNION STREET, LIBERTY, INDIANA

EXTRA POINTS COUNT IN WRENCHES, TOO!

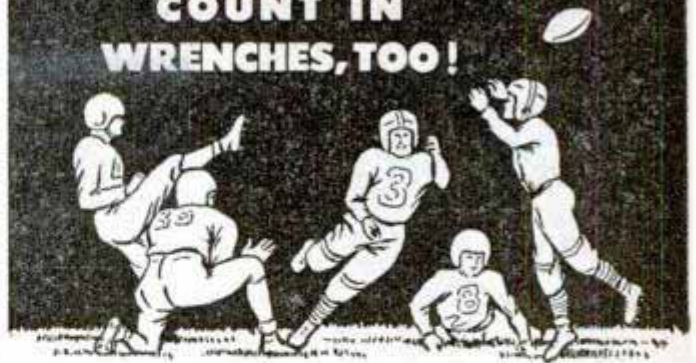

EXTRA THINNESS

Billings' thinness gets them in and out of close quarters like a broken field runner. You can really save time with Billings.

EXTRA LIGHTNESS

Billings are so light and easy to use they save your strength for the job and let you finish with plenty of time to spare.

EXTRA TOUGH HEADS

Good wrench heads must be able to take a beating. That's why Billings' extra tough heads are made to take it for years.

EXTRA SNUG FIT

There's no slipping when you put a Billings on a nut or bolt. It hangs on like a tackle and runs 'em off or sets 'em down surely.

EXTRA PLEASURE

The extra points all add up to that wonderful feeling you get when the tough job's well done in short order with great ease.

And remember, Billings has a balanced line of wrenches for complete farm use. Buy them at your Hardware Store.

BILLINGS WRENCHES



Buy them at Your Hardware Store



The Billings & Spencer Company, Hartford 1, Conn.

Carries the Same 90 DAY GUARANTEE As a New Motor Assy.

Our Finest Precision REBUILT MOTOR BLOCK ASSEMBLIES

Sold Outright or Exchange

Rebuilt by skilled mechanics. Assembly has Reborn Block with New Pistons, Pins, Rings, Reground Crankshaft, and all New Bearings. Guaranteed 90 Days.

Allowance on Old Motor
We ship at outright price. Send your motor prepaid, must be suitable for rebuilding. Send in notarized bill of sale showing title number if any. We refund difference when we receive your motor.

DODGE—3 1/4" bore
Year Type Outright Exch.
35-47 6 cyl. \$129.00 \$99.00

Plymouth Outright Exch.
35-47 6 cyl. 129.00 99.00

Specify exact year, make and model when ordering. Send for catalog on motors not listed.

\$5.00 Crating Charge

FORD BLOCK ASS'Y.
Year Type Outright Exch.
28-31 4 cyl. \$ 98.00 \$73.00
32-47 6 & 8 139.00 89.00

Mercury Outright Exch.
39-47 V8 149.00 99.00

Chevrolet Outright Exch.
29-47 6 cyl. 117.50 87.50

POWER TAKE-OFF for JEEP ENGINE

Bolts to clutch housing on the Jeep engine. Has a spline shaft to engage with clutch and extending from rear is a keyed shaft on

which pulley can be mounted. Hand lever controls clutch. PF4N-23J—Each.....

\$4250

NEW 5 Gal. CANS



FOR GAS, OIL OR WATER Vented for Safety. Self-locking Safety Cap Extra Heavy Construction Will Float When Full Size of can, 18" high, 6 1/4" thick, 13" wide. PA35U-60—Lots of 5, ea. 1.15 Lots of 50, ea. 1.05 Lots of 100, Each 98c

60 HP. JEEP Engines

Reconditioned, Tested and Guaranteed in perfect running order and ready to run. Every part is checked to be perfect and carries a 90 Day Guarantee same as a new engine.

COMPLETE with . . . Generator, Starter, Distributor, Coil, Fan and Fan Belt, Water Pump, Fuel Pump, Intake and Exhaust Manifolds, Carburetor, Oil Filter, Spark Plugs, Flywheel, Clutch and Pressure Plate, Wiring.

Outright, PG58R-003, Each \$13750

\$5.00 Crating Charge

New Willys JEEP Enclosed Power Unit

60 HP. 4 cyl. engine. 134.2 cu. in. displacement. 3 1/8 bore 4 3/8 stroke. Complete with radiator, gas tank, governor, clutch power take-off with 1 1/2" keyed shaft, and all accessories. **READY TO RUN. NEW, COMPLETE.** PG60N-002. \$32500 F.O.B. Chicago. SEND 25% CASH WITH ORDER, BALANCE C.O.D.

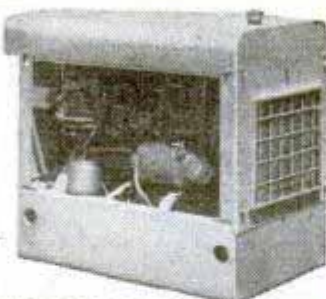

J.C. WHITNEY & Co.
1917 Archer Ave. Chicago 16, Ill.

STAY HOME AND MAKE MONEY!

—Men! Women! Get into profitable, uncrowded profession you can operate from your home or small office after short home training course. No capital required. No goods to buy. No age limit. Others earn \$50.00 to \$100.00 per week making famous Stephenson corrective foot devices to order. Foot sufferers everywhere pay gladly for relief. Send today for FREE BOOKLET. STEPHENSON METHOD, Established 1894, 12-28 S. Market St., Boston, Mass.

SAY YOU SAW IT IN POPULAR MECHANICS

SMALL EFFICIENT SPEED REDUCER



\$18.56

NET — POSTPAID

Just the thing for the Home Work Shop, Hobby Shop, Bench Work, Animated Displays, Light Production work. Used daily in thousands of homes and shops. Sturdy, compact, (see dimensions). Case of aluminum. Gears, SAE 65 (British) Gear Bronze. Worm of case hardened steel. Timken Bearings throughout. Torque capacity 100 inch pounds. Available in 4 different assemblies (shown below) and in these standard ratios:

4-1	25-1	64-1	200-1
8-1	30-1	75-1	300-1
10-1	40-1	80-1	400-1
16-1	50-1	100-1	600-1
20-1	60-1	150-1	800-1

When ordering be sure to specify assembly and ratio required. Shipping weight in carton, 8 lbs. Full money back guarantee. Prompt deliveries.

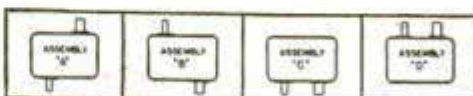

THE OHIO GEAR CO.
1407 EAST 179th ST. · CLEVELAND 10, OHIO

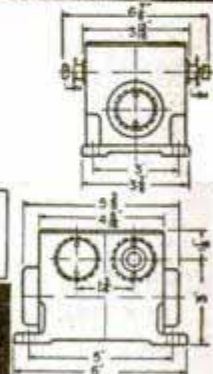

NEW — A PERFECT GIFT



WHALE Pli-rench
SUPER POWER LOCKING

it's all in the SELF ALIGNING RED JAW

Every farmer, home owner, mechanic needs this miracle, all-purpose hand tool.

- Use as pliers, wrench, clamp, vise.
- Self-aligning jaw gives full length grip on straight or tang objects.
- Locks work with tons of pressure . . . hands free.

If not yet at Dealer's order direct and please send us his name. Send for free circular.

WHALE TOOL CORP., DEPT. M
1767 Broadway, New York 19, N.Y.

\$1.95

10" SIZE FULLY GUARANTEED



WIND ELECTRIC PLANT

Build Your Own — From Auto Generator
Easy to have lights and power. Dime brings complete PLANS and catalog of Electrical Bargains. Send 10c today to LEJAY MFG. COMPANY, 547 LeJay Building, Minneapolis 8, Minn.

GET THE BEST IN MUFFLERS V-8 DUALS & SINGLES



Finest Norman custom-built muffler sets — steel pack — torpedo type — heavy, perforated steel cores — chrome enamel finish — mellow, deep tone (improves with use) — designed to fit — all ways superior — double economy.

DUALS \$17.50 SINGLES \$7.50
V-8 Ford-Mercury Buick, Olds., Chrys.
SINGLES \$5.50 ORDER TODAY! Will outlast three ordinary mufflers.
Chev., Ford, Plym.
Dealers—Write Today for Full Details

NORMAN'S MUSICAL MUFFLERS
Dept. PM-5, 1216 W. Slauson Ave., Los Angeles 44, Calif.

A FRACTION OF WHAT
THEY COST UNCLE SAM!

WAR SURPLUS

SAVE ON XMAS GIFTS!
THE BEST—FOR LEAST!

ANY 1
of these for
\$1.00

Army WOOL TOQUE



Keeps your head, ears, cheeks, chin warm as toast! Reg. Army of OD knitted wool... the finest! It fits any head! New stock! Great for winter sports.

\$1.00

Army SUN HELMET PARATROOPER'S HELMET



For year 'round sun protection! Adjusts to any head! Water-repellent! Chin strap, air vents.

\$1.00



How its wool lining warms you up! Fine new OD heavyweight drill with chin strap. Small, med., lg.

\$1.00

Army DRIVER'S HAT



Transport men! Pleasure drivers! Note the blanket-lined ear flaps extra large visor firm chin strap! Green heavy drill. Small, med., lg.

\$1.00

ANY 2
of these for
\$1.00

Navy FACE MASK



A "masked marvel" of winter warmth! Navy blue heavy felt; eye slits; reinforced nose guard, mouth flap. It fits any head! For outdoorsmen!

2 for \$1

Navy GOB HAT



Dad, Sis, Junior you all want this snappy, crisp USN headgear! Gray heavy drill. Small, medium, & large sizes

2 for \$1

Army WOOL HOOD



For Mom's shopping trips! For kids at school or at play! For farm workers & snow shovelers! New OD knit wool; 3 neck buttons; it fits any head!

2 for \$1

Navy HUNTING KNIVES



Worth \$5! 6-inch blade. Tempered steel, gunmetal finish; laminated leather handle. Leather sheath **FREE!**

7-in. blade..... \$1.25
8-in. blade..... \$1.50

SLEEPING BAG

Army Officer's Type

For campers, outdoorsmen. Warmer than any blanket! Kapok-filled. New OD poplin. 6 1/2 ft. long. 106-in. zipper.

\$15

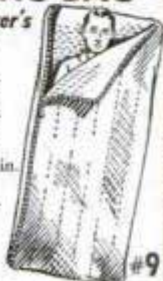

100% Wool BLANKET



OD, full bed size. Army-used now sterilized, perfect and ready to use!

\$4

RADIO HEADPHONES

Special for 'hams' & repairmen! Amazingly sensitive! Brand new Army make!

\$1.00



B-15 JACKET

Army Air Corps

The same jacket our flyers wear! Thick pile lining. Big mouton collar. New water repellent OD fabric. Full zipper front. Snap fastener pockets. Sizes 34-44.

\$15



ORDER DIRECT FROM THIS AD!

1. Send check or money order - no C.O.D. orders accepted.
2. Orders limited to the United States and possessions.
3. Order items by number. Specify size where necessary.
4. On items #1,2,3,4,5,6,7,8,11, add 10¢ postage east of Mississippi River; add 20¢ west of Miss. On items #9,10,12, add 20¢ postage east of Mississippi; 40¢ west of Mississippi.

BALTIMORE LUMBER Company

War Surplus Division
418 N. HOWARD ST., BALTIMORE 1, MD.

2 Full Reels

16 mm SILENT \$16.00
8 mm SILENT 8.00

Deluxe Comedies

6 of Each

- WINNIE WINKLE
- "COCKEYED" BEN TURPIN
- HAIRBREADTH HARRY
- JUNGLE LAND - CHIMPS & ANIMALS
- POODLES HANNEFORD
- SNUB POLLARD
- BARNYARD ANIMALS

Silent Complete

200 ft. 16 mm . . . \$4.00
100 ft. 8 mm 2.00
Follow the Bouncing Ball
14 Cartoon Song Parodies

EXCLUSIVE! ARTCLASS VARIETIES MEAN BETTER MOVIES

16 and 8 M. M., Sound or Silent

OUR PRICES FOR EXCLUSIVE QUALITY PRODUCTS
ARE THE LOWEST IN THE WORLD!

WE WILL NOT BE UNDERSOLD!

Black & White Complete

16 mm SOUND \$3.33
16 mm SILENT 2.00
8 mm SILENT 1.17

Kodachrome Complete

16 mm SOUND . . . \$10.00
16 mm SILENT 8.00
8 mm SILENT 4.00

Cartoon Nursery Rhymes

- HUMPTY DUMPTY
- LITTLE MISS MUFFET
- JACK AND JILL
- HEY DIDDLE DIDDLE
- THIS LITTLE PIG
- THREE BLIND MICE

16

Novelty Musicals

100 ft. 16 mm SOUND
\$5.00

The Drunkard

4 Reels SOUND
Complete Production

16 mm SOUND
\$11.67

16 mm SILENT
\$5.83

8 mm SILENT
\$3.67

Complete Subjects

- 9 WALT DISNEY "Alice" Cartoons
- 4 KRAZY KID Cartoons
- 6 Wrestling Bouts

100 ft. 16 mm SILENT
\$2.00

50 ft. 8 mm SILENT
\$1.17

6 of EACH

- WILD BEASTS of the Jungle
- Western Featurettes
- "Cockeyed" Ben Turpin
- Poodles Hannaford
- Winnie Winkle
- Snub Pollard

9
Walt Disney
Cartoons

6
Nursery
Rhymes

10 2-Reel Sound Chapters
\$60.00 Each Chapter
The Holy Bible
From THE CREATION to
THE SONGS OF SOLOMON



MAIL SAMPLE ORDER AND RECEIVE OUR COMPLETE CATALOG

SHIP FILMS AS INDICATED:

- Money Order or Check Enclosed . . .
- Enclosed 25% Deposit, Balance C.O.D.
- Mail Deluxe Catalog
- Please add 2 1/2% California State Sales Tax if you live within the State. Add 3% State and City Tax if you live in Los Angeles.

FILM TITLE	8 mm	16 mm	PRICE

NAME _____ ADDRESS _____
CITY _____ ZONE _____ STATE _____

ARTCLASS VARIETIES · LOUIS WEISS & CO. · 4336 SUNSET BLVD. · HOLLYWOOD 27, CALIFORNIA

MAGNETIC UTILITY LIGHT

STICKS TO CAR BODY CHASSIS OR MOTOR



Plugs Into Car Lighter

MAGNALITE \$3.85 postpaid

AN IDEAL GIFT The amazing Magnalite base is made of "Alnico," the war-born miracle metal that stays magnetized permanently! Holds light securely in any position leaving both hands free to service car. Plugs into car lighter, uses very little current, yet provides headlight brilliance. Very light in weight. Beautifully streamlined, durable black case with red guard that shields light from user's eyes; also acts as strong red warning light, even in fog. Long 15 ft. cord reaches all around car. Fits into glove compartment. You will be pleased or your money refunded. If your dealer does not have the genuine "Magnalite," order direct from factory. Enclose \$3.85. We ship prepaid. Big demand. Do not delay.

DEALERS: Magnalites are fast sellers. Stock them for Christmas!

GIBBS MANUFACTURING & RESEARCH CORP.
450 N. Main St. Dept. 1117 Janesville, Wis.

Special! BUILD YOUR OWN "Personal Radio" NEW MEISSNER RADIO KITS



2-TUBE \$5.65
AC-DC Model

3-TUBE \$6.30
AC-DC Model

Have your own "Personal Radio" at home. These fine new Meissner kits are not toys, but real radio sets that receive signals from great distances. Supplied with plug-in coils for broadcast bands. Two controls. Pictorial diagram makes assembly very simple with screwdriver, pliers and soldering iron. All parts and material supplied, except tubes, phones, aerial. For 110 volts AC or DC. 5 lbs. No. A-10998 2-Tube, No. A-10999 3-Tube Kit.

Kit of 2-Type 76 Tubes for above.....\$1.48
Kit of 3-Type 76 Tubes.....\$2.22
Set of Head Phones.....\$1.95

T-17B MICROPHONE
All Brand New — Perfect Carbon Hand Mikes. Light Weight, 200 ohms. Single button, press-to-talk switch. 5 ft. rubber cord, plug, dust cover. Terrific at 99¢ F.O.B. N. Y. or Chicago • Send for Bargain Bulletins

NEW YORK Offices & Warehouse 242 W. 55th St., N.Y. 19
NEWARK
ELECTRIC COMPANY, INC.
CHICAGO 323 W. Madison St. Chicago 6, Ill.

New York City Stores: 115-17 W. 45th St & 212 Fulton St.

L&M CARBIDE SCRIBER NON-MAGNETIC

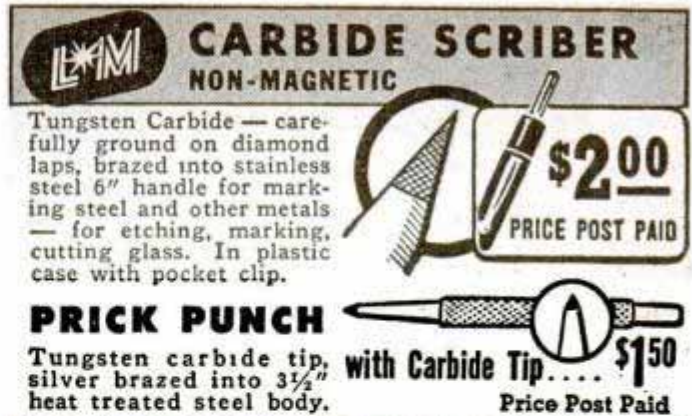

Tungsten Carbide — carefully ground on diamond laps, brazed into stainless steel 6" handle for marking steel and other metals — for etching, marking, cutting glass. In plastic case with pocket clip.

\$2.00
PRICE POST PAID

PRICK PUNCH with Carbide Tip.....\$1.50
Tungsten carbide tip, silver brazed into 3 1/2" heat treated steel body.
Price Post Paid

LUCAS-MILHAUPT ENGINEERING CO.
5053 SOUTH LAKE DRIVE • CUDAHY, WISCONSIN

MINIATURE ENGINES

Gasoline—Steam
Air—Locomotive



THE WORLD'S MOST FASCINATING HOBBY
Build them yourself — In your own shop
With your own tools

Send 10 cents for my illustrated catalogue listing the world's largest selection of miniature engine castings and drawings.

McADED MODELS
1313 S. TALMAN AVE.
CHICAGO 8, ILLINOIS

A GREAT SURPLUS BARGAIN REDUCING GAUGE



The buy of a lifetime in a standard make air pressure regulator. Used on liquid carbonic tanks and air pressure tanks of all kinds to regulate the pressure. Fitted with standard 1/2 inch pipe thread. Dial calibrated 0 to 200 lbs. Made by U. S. Gauge, Air Reduction Co., Waller Kiddie—all famous makers. Used by artists for air brush work, sign painters, retouchers, welders, etc. Used by soda fountains and taverns. All units are brand new. Satisfaction guaranteed.

A \$15 VALUE \$5.95
Send check or money order. Ship same day.

GROBAN SUPPLY CO.
1522 S. Michigan Ave., Dept. PM11, Chicago, Ill.

Fully Guaranteed
All Brand New and in Perfect Condition

UTICA TOOLS FOR MORE TOOL MILEAGE



UTICA

WRENCH No. 91—4"—6"—8"—10"—12"

UTICA DROP FORGE & TOOL CORPORATION
UTICA 4, NEW YORK

Acidproof glass-cloth-covered collector tube.

BE SAFE!

WHEN YOU BUY AN OIL FILTER ELEMENT

Glass cloth trap will not deteriorate when attacked by engine oil acids.—an exclusive AC advantage.

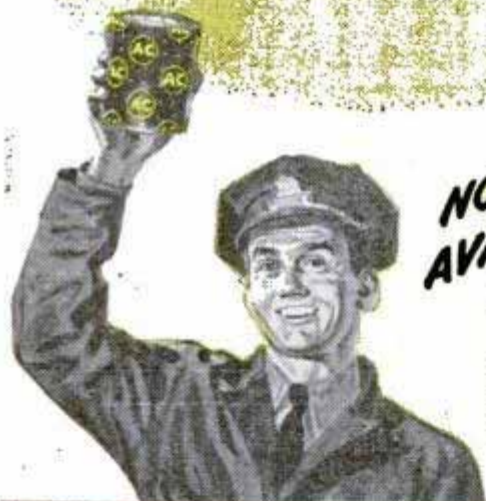

**NOW AVAILABLE
AT YOUR
AC
SERVICE
STATION**

Only the new "5-Star Quality" AC Oil Filter and Element has an acidproof glass cloth collector tube trap which prevents pollution of the oil stream and assures a free flow of clean engine oil.

You can't afford to take a chance. This glass cloth trap actually means that your oil is filtered *twice*—for your protection.

AC SPARK PLUG DIVISION • GENERAL MOTORS CORPORATION

WHEN YOU WANT A NEW OIL FILTER, GET A NEW AC "5-STAR QUALITY" OIL FILTER . . . and get these additional advantages

- POSITIVE END SEALS
- EXTRA STURDY BAIL
- MACHINED GASKET SEAT
- HIGH OUTLET RESTRICTOR POSITION
- EVEN DISTRIBUTION OF FLOW
- OUTSIDE-IN FLOW
- LONG FIBRE VIRGIN COTTON, RAM-PACKED
- EXTRA HEAVY METAL CASE
- EXTRA LARGE HEX HEAD DRAIN PLUG



HY-ARC "4-PURPOSE" WELDER

IT WELDS • IT BRAZES • IT SOLDERS • IT HEATS
AT A SENSATIONALLY LOW PRICE OF ONLY

Ideal for Home • Shop • Farm • Machinists • Auto • General Repair • Plumbers • Electricians, Etc. **\$19.95**

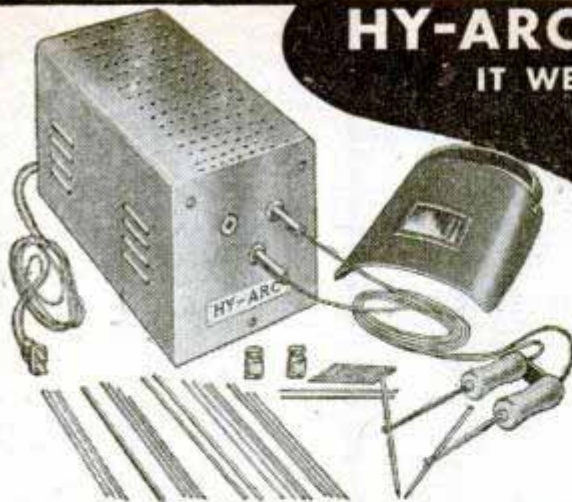

Radical in construction and design. Successfully used on ships... in the field... and shops. Works on AC or DC 110 volts. Sold on money-back guarantee. Return set if dissatisfied in 10 days. Send check, money order or \$5 deposit. Pay postman \$14.95 balance plus small postage charge. Welder sent postpaid if you send check or money order for \$19.95 with order.

HERE'S WHAT YOU GET WITH THIS OUTFIT!

Set consists of power unit; all metal case; heavy duty carbon arc torch (also to be used as metallic arc electrode holder and ground); also Extra Special welding helmet with unbreakable lens; 1 asbestos block; brazing flux; cast iron flux; ample supply of metallic arc rods; aluminum rods; brazing rods; cast iron rods; copper coated carbons; 6 ft. primary cable; 2 secondary cables with plugs and insulators; complete instruction book. Send in order today.

**HY-ARC MFG. CO., Dept. P11, Suite 528
333 N. Michigan Avenue, Chicago, Illinois**

A Real Sensation!

Here's something needed in every shop

the *New*

L-W Medium Duty 4-Jaw Independent CHUCKS for Small Lathes

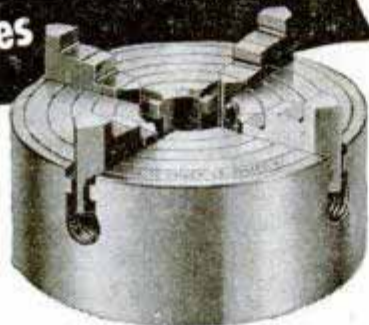

They will save you a lot of time and labor and permit much more accurate work.

PRICED WITHIN THE REACH OF ALL!

Semi-steel bodies. Face and outer edge surfaces ground. Steel jaws. Hardened and ground steps. Heat-treated steel screws. Complete with wrench.

Finished adapter back plates are suitable for some models of Atlas, Clausing, South Bend and Logan lathes.

ORDER TODAY or write for complete catalog

INFGS. UNIVERSAL AND INDEPENDENT LATHE CHUCKS • MILLING MACHINE VISES • POWER BACK SAWS • DIVIDING HEADS • MAGNETIC CHUCKS • RECTIFIERS • DEMAGNETIZERS

L. W. CHUCK CO., 31 So. St. Clair St., Toledo 4, Ohio

6" HEAVY DUTY \$16.95

Semi-finished, ready to mount adapter back plate, 1½" — 8 thread \$3.00. Rough adapter back plate casting, \$1.25.

RUGGED 8" MEDIUM DUTY \$21.

Semi-finished, ready to mount adapter back plates, 1½" — 8 thread \$3.60. Rough adapter back plate casting, \$1.50.

Speedy Paint Sprayers

S
P
R
A
Y
G
U
N
S

L
E
S
S
M
O
T
O
R
C
O
M
P
R
E
S
S
O
R
S



Uses ¼ Hp. Motor

No. 890 Complete as illustrated, less motor... \$26.95
No. 444 Outfit, twin cyl. complete less motor... \$47.50

NEW BLACK & DECKER DRILLS—110V AC-DC
Jacobs hex-key chuck

¼" 2250 rpm. Drill \$18.95

½" 375 rpm. Drill 35.95

POWER TOOLS,
RADIOS, TOYS

Special—Closing Out All Hobbycraft Supplies.

Send for Bargain List.

IMMEDIATE DELIVERY — Check or M.O. with order, shipped prepaid. West of Mississippi add 5%. Or we will ship C.O.D., plus charges. Write for FREE Catalog today!

INDIANA APPLIANCE CO.

20 E. Sycamore Dept. PM-125 Evansville, Indiana



Army Corps. of Engineers COMPASS. Jewelled movement, brass hunting-type watch case. A precision compass at a tiny price, only

\$1.39



PUMPS for 5 and 7 man life rafts. Pumps 2 chambers at same time — quickly and evenly. Brand New.

Enclose check or Money order—items sent post paid.

SURPLUS VALUE CENTER

4602 ST. CLAIR

CLEVELAND 3, OHIO

WRITE FOR YOUR FREE COPY OF THE NEW KRW HYDRAULIC PRESS BOOK

Describes all manner of Production and Shop Work on KRW Hydraulic and Bench Type Arbor Presses. 32 pages illustrating the new KRW Hand-operated, Electric-operated and Air-operated Hydraulic Presses. Write for your copy today.

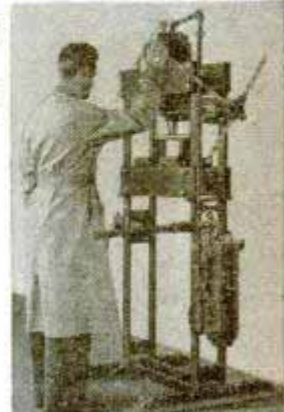

K. R. WILSON, DEPT. 17, 215 MAIN ST., BUFFALO 3, N. Y.
Builders of Shop Equipment for Ford Dealers Since 1916

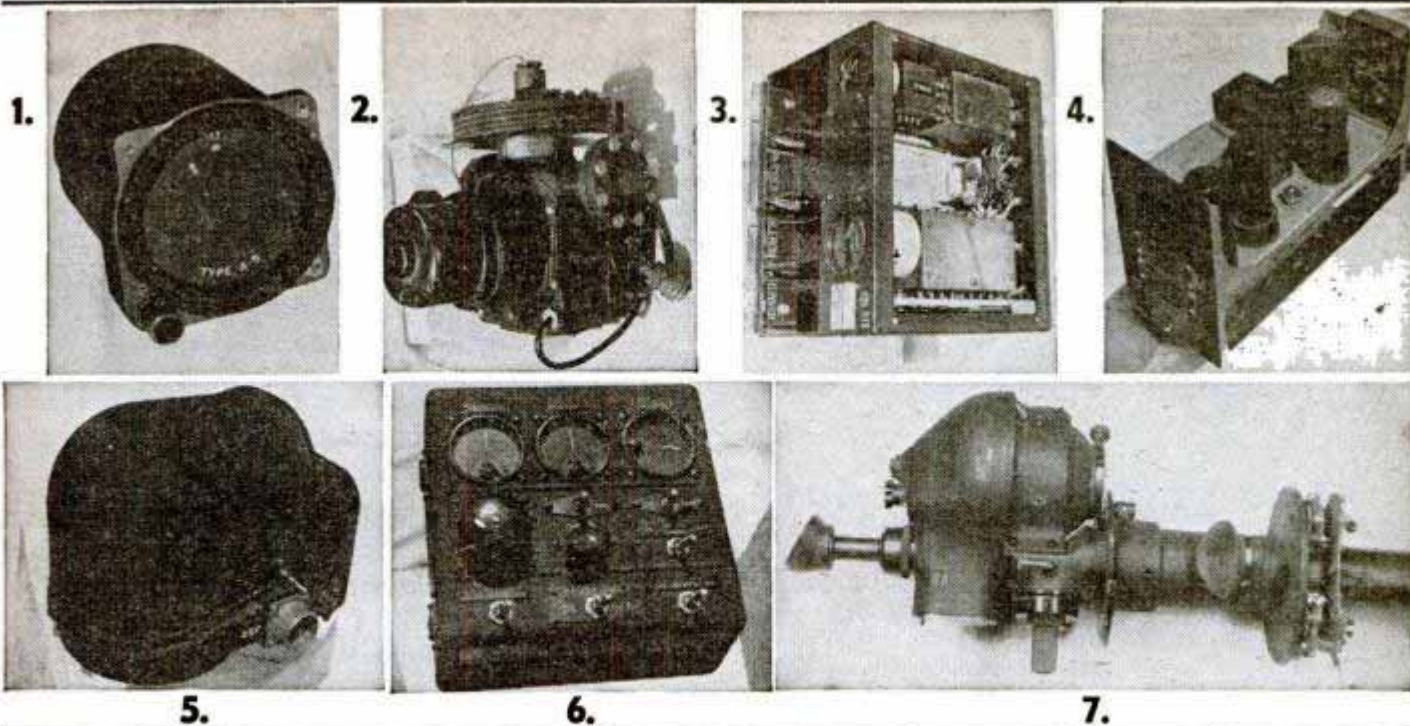

1. INDICATOR, Pilot Director, Sperry. Includes autosyn motor, indicator face, etc. Shipping weight app. **\$0.95**
2 lbs.

2. SERVO UNIT, a combination hydraulic and electric actuating unit. Includes 1/10 hp 24V DC motor (6000 rpm), gears, etc. Shipping weight app. **\$4.95**
25 lbs.

3. AMPLIFIER RACK assembly, Auto-Pilot A-5 Sperry. Electronic device for amplifiers. A complicated assembly that is filled with gadgets such as: 2 1/4" size dial AC volt meter, 0 to 120; Freq. meter 350 to 450, dial size 3 1/4"; relays, capacitors, resistors, condensers, plugs, etc. Size 14"x10"x12". App. shipping **\$5.95**
weight, 30 lbs.

4. AMPLIFIER, (not audio). Includes 4 tubes: 1632, 1633, 1634; condensers, transformers, switches, resistors, terminals, sockets, chassis, etc. For radio, experimenters, etc. Shipping **\$1.45**
weight app. 5 lbs.

5. GYROSCOPE, Directional. Has fine electric motor, gyro in brackets, autosyn transmitter, 11 electro-magnets, bearings, gears, plugs, etc. App. **\$4.95**
shipping weight 17 lbs.

6. CONTROL UNIT AND PANEL, Sperry. Used to control the units of auto-pilot, by electronics! Size 7 1/2"x8"x4 1/2". Includes 6 toggle switches, 2 three way switches, 3 indicators, plugs, resistors, etc. App. shipping weight **\$3.95**
8 lbs.

7. AIRFORCE DRIFT METER, Type B-3. Overall length 47", tube length 27". Used to navigate Bombers during war! Faceting value for lenses, prisms, electric gyro and many more valuable parts. Cost hundreds of dollars. App. shipping **\$9.95**
weight, 40 lbs. Used condition.

(All Auto-pilot items 1 through 6 are new, operate on 115-volts AC, 3 phase, 400 cycles and are War Surplus.) We pay no shipping charges!

8. GENERATOR, aircraft P-1 type, 200 amps, for welders, (not pictured) \$22.50

AERO INSTRUMENT COMPANY
8102 Lockheed, Houston 12, Texas

**Make Your Car or Truck
A PORTABLE POWER PLANT
This Easy, Economical Way!**

ASPEN DRIVE-ALL gives power when you want it . . . where you want it! Just line up with rear wheel, drive on to unit, and you're set for work! No jacking up or demounting! Use the rugged DRIVE-ALL for all belt-driven operations requiring up to ten h.p.!

**LOW-COST
ACCESSORIES—**
Generator; Grinder
Centrifugal Pump.

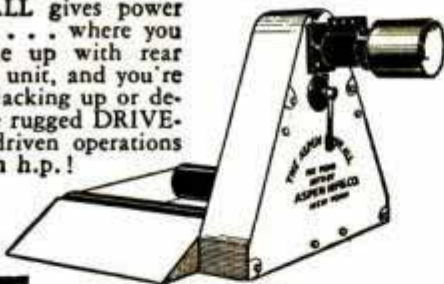

**Aspen
DRIVE-ALL**

FREE! Write today for illustrated folder and full information to: Aspegren Mfg. Co., Inc., 1612-D Webster Avenue, Bronx 57, N. Y.

Special Offer 17 JEWEL WATCHES
MEN AND WOMEN'S SWISS



Just received — Precision made, cased in Yellow rolled gold plated top with stainless steel back. Clear easy to read dials have rhinestone numerals, (look like diamonds). Unusual value at \$28.50 Postpaid including handsome long wearing wrist band. Ideal as Gift. Mail Check or Money Order now. Quantity limited. Sent C.O.D. plus postage.

HARCO DISTRIBUTORS
622M Pennfield Bldg., Philadelphia 7, Pa.

**FIRE WORRIED
PEOPLE**

**WAITING FOR A RANDOLPH
FIRE EXTINGUISHER**

**A SELLING OPPORTUNITY
FOR YOU!**

Every building holds a prospect. Homes, Boats, Cars, Garages, Gas Stations, Shops, Laundries, Farms, Hotels, Stores, Factories.

THEY WANT A RANDOLPH with its panic-proof trigger action that smothers the fire instantly in a snowy blanket of carbon dioxide. No mess, no water, no damage, even to food. It evaporates without a trace.

YOU CAN QUALIFY for exclusive territory to sell the famous, nationally advertised Randolph used by leading industrial concerns everywhere. Approved by Underwriters' Laboratories.

Quick profits await those who act at once. Two sales a day net \$84.00 a week. Write today for full or part-time plan, territories, demonstration kit, etc. Don't delay.

Randolph Laboratories, Inc.
6 EAST KINZIE ST. CHICAGO 11, ILLINOIS, U. S. A.

PRESSURE QUEEN

FOUR CYLINDER
PORTABLE AIR COMPRESSOR
SPRAY PAINTING OUTFIT

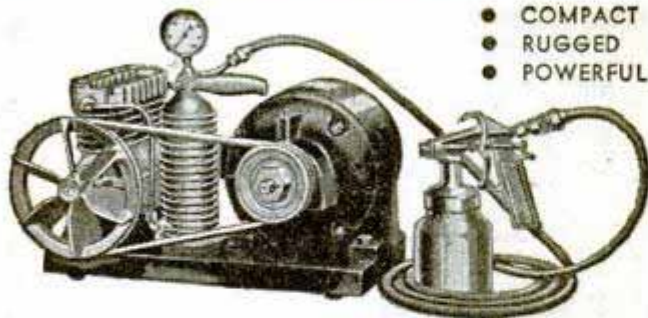

- COMPACT
- RUGGED
- POWERFUL

Immediate delivery on compressor with motor

AMAZINGLY LOW PRICED FOR THE ONLY
FOUR CYLINDER UNIT ON THE MARKET

The ideal air supply for home and farm workshop, machine shop, garage and contracting painter; for product finishing, inflating tires, painting automobiles, trucks, machinery, etc.

This 4 cylinder compressor has drop forged crankshaft, stainless steel, heat treated valves; bronze bearings and positive forced feed lubrication. Maximum pressure 50-60 lbs., free from pulsation. Standard equipment includes the compressor mounted on steel base with carrying handle, belt, compressor pulley, air chamber, air gauge, 15-ft. hose, spray gun; 1/2 or 1/3 h.p. motor or gas engine. Immediate delivery.

If your dealer does not sell Pressure Queen write direct

THE CAMPBELL-HAUSFELD CO.
1046 RAILROAD AVE. HARRISON, OHIO

**A GIANT IN
YOUR HAND!**

NEW!



1,000's
of
Uses

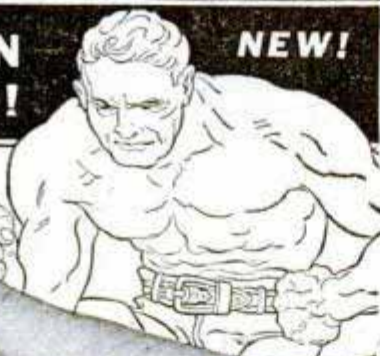

"Snap-Lock"
PLIER-
WRENCH

Pat. App. For



Serves as a plier or wrench—or jaws can be quickly locked tight, so that hand pressure can be released and tool used as a hand vise or clamp. PARALLEL-UNIVERSAL JAWS afford full grip on either straight or angular objects. Terrific grip; any object held in jaws can not slip or be twisted loose! Pressed steel body, hardened (replaceable) jaws. Guaranteed. 10" size, \$2.25; 7", \$1.75. If not yet at dealer's, order from us but give his name.

Send for free circular

SEYMOUR SMITH & SON INC.
900M Main Street, Oakville, Conn.

TWO SURE WAYS TO KILL RATS!

K-R-O BIS-KITS come ready to use. No muss, no fuss, no bother. Containing *red squill*, K-R-O BIS-KITS are relatively harmless to farm animals. Economical! Only 35c and \$1.00.

K-R-O POWDER also contains *red squill*, is easy to mix with meat, fish, or grain. A real value. Two-ounce package at 75c will make 200 quick-killing baits.

• If not available at your drug, feed, or seed store, order K-R-O direct. Add 15c for mailing and handling. *The K-R-O Company, Springfield, Ohio.*

MONEY-BACK GUARANTEE!

→ **K-R-O**

ARC WELDING
FOR PROFIT OR PLEASURE

60 LBS. OF READY MADE PARTS *Only \$195*

**BUILD YOUR OWN
HEAVY DUTY WELDER!**

All parts are Ready-Made and easy to assemble in a few hours. Be prepared to do all around welding on Steel, Cast Iron, and many other metals. **FREE** Fully illustrated pamphlet. **WRITE TODAY P11**

ATOMIC WELDER
1038 SO. 19TH ST. OMAHA, NEBR.

Gives 100% penetration. Welds are stronger than original metal. Operates on 110 or 220 AC

MYSTERY RADIO No Tubes — No Batteries No Electricity

Electronic mystery marvel of the century! Get radio reception anywhere from strongest nearby station—at home, at the beach, in the woods or camping, fishing or hunting trips. Complete with ground and ear phone. Weighs only few ounces. Carry in pocket or purse. Fascinate and mystify friends. Lasts forever; permanent crystal. Rush order with only \$2.99 before limited supply is exhausted. Send NO MONEY just name and address and you pay postman \$2.99 plus few cents postage. Write TODAY



CLAIREE DISTRIBUTORS Dept. PM-2, P.O. Box 747, North Hollywood, Calif. **ONLY \$2.99 POSTPAID**

BE YOUR OWN BOSS! LEARN ELECTROPLATING HIGHLY PAID FIELD



UNCROWDED, interesting business. Part or full time. Common school education sufficient. Chromium, Nickel, Silver, Gold, etc., money making secrets. Processes. (Approved for Veterans.) Send postcard today, **FREE** electroplating booklet and proof.

PLATER HYDE

432 F Street Room 520
San Diego 1, California

AMAZING NEW PEN

writes in
3 colors

A FLICK OF THE FINGER CHANGES THE COLOR

World's most sensational pen . . . the Color King. Writes in any of 3 colors—blue, green or red. Writes dry, smoothly, easily, on any material—no blotter required. Each color writes for months and months without refilling. Ideal for students, business men, housewives—for anyone who keeps records. Makes several carbon copies.

REALLY 3 PENS IN ONE—FULLY GUARANTEED—

Color King is a jewel-like, precision pen, finished in gleaming everlasting gold color—made and guaranteed by one of this country's oldest established manufacturers. Lightweight—less than 1/2 oz.—makes it a pleasure to use. Refills of each color available—can be inserted in a few seconds.

SEND NO MONEY

Just fill out and mail coupon. When Color King arrives, pay postman only \$5.95 plus small postage and C.O.D. charge. Give Color King a thorough workout for a week—if you do not agree it is the greatest pen value you have ever seen—you can return it, and your money will be refunded immediately—without question. (Or if you prefer—you send check or money order for \$5.95 with order—and we will pay postage. Either way, satisfaction or money back is fully guaranteed.) Mail coupon today!



COLOR KING PEN

Just ONE Pen

writes

RED, BLUE or GREEN

Beautifully Gift Packaged!

COLOR KING

110 E. 18th Street, Chicago 16, Ill.

Please send me Color King Pen:

I will pay postman \$5.95 plus postage on arrival.

I enclose \$5.95. Send pen, postage prepaid. It is understood that either way, if I am not fully satisfied within a week after receipt, I can return pen for complete refund.

(Please print)

Name _____

Address _____

City _____ State _____

EXHAUST BLOWERS

\$15⁸⁵



FOR PHOTOGRAPHERS
HOSPITALS • LABORATORIES • WORK SHOPS
LAUNDRIES • OFFICES
RESTAURANTS • PRINTERS
PLAYROOMS

100 CU. FT. FRESH AIR EVERY MINUTE!

Solve your ventilation problems with this NEW rugged, built-for-service blower and exhaust. Quick and simple to install. Anyone can do it with ordinary household tools.

110 Volt, A.C., 50-60 cycles. Continuous duty, BALL BEARING motor assures quiet, trouble free operation. Durable Housing Insures Long Life. Send Check, Money Order. No C.O.D.'s. West of Mississippi add \$1.00 for mailing, handling. Immediate delivery.

UNIVERSAL YONKERS CORP. (Dept. M-11) 41 Locust St., Yonkers 2, N.Y.

AAF-B-3 FLYING JACKET

Leather, sheepskin lined, zipper front, reclaimed for reissue \$16.95 like new. The perfect coat for all outdoor sports and outdoor work. Takes the toughest wear. It's warm as toast. All sizes. Army combat field jacket \$3.95. All merchandise reconditioned. Sent C.O.D. Free catalogue of G.I. work clothing.

SURPLUS MERCHANDISE DEALERS, Dept. PM
1214 BROADWAY NEW YORK, N. Y.



Just Out! New CONCORD RADIO Catalog



The ONLY Complete

Up-to-the-minute Catalog of
RADIO PARTS • RADIO SETS
KITS • HAM GEAR • TESTERS

The greatest, latest complete presentation of radio, electronic and television equipment and supplies in Concord history! Packed from cover to cover with thousands of items—160 pages of everything in Radio and Electronics. Special bargain

section of hundreds of money-saving values. Scores of new items from famous makers. Parts, blueprints for famous Popular Mechanic and many other kits. Write for your FREE copy. Please address Dept. P-117.

CONCORD RADIO CORP.

LAFAYETTE RADIO CORPORATION

CHICAGO 7

901 W. Jackson Blvd.

ATLANTA 3

265 Peachtree Street

BALL BEARING STEEL WHEELS

Complete with GOODYEAR, GATES or OSBORN PUNCTUREPROOF Semi-Pneumatic Tires . . . Also Solid and Pneumatic Tires . . . FUN . . . SPEED GALORE . . . BUILD YOUR OWN RACER, ETC.

SIZE	TIRE	BEARINGS	LOAD	ONE	TWO	FOUR
12" x 2 1/2"	Semi-Pneumatic	Ball 1/2" or 3/8"	150 Lbs.	\$ 5.50	\$10.00	\$18.00
10" x 1 3/4"	Semi-Pneumatic	Ball 1/2" or 3/8"	125 Lbs.	\$ 3.00	\$ 5.50	\$10.00
10" x 2 1/2"	Semi-Pneumatic	Ball 5/8"	250 Lbs.	\$ 5.50	\$10.00	\$18.00
20" x 1 3/4"	Semi-Pneumatic	Ball 7/16"	60 Lbs.	\$ 5.00	\$ 9.50	\$18.00
(the above 20" is Bike type 20 Spokes)						
6" x 1 1/4"	Solid	Ball 3/4"	480 Lbs.	\$ 7.85	—	—
6" x 1 3/8"	Solid	Ball 3/4"	640 Lbs.	\$10.35	—	—
4.00" x 8"	Pneumatic	T.R. 1"	700 Lbs.	\$13.50	\$26.00	\$50.00
(the above 4.00 x 8 is 4 Ply Goodyear with Tube and Taper Roller Bearings for 1 inch diameter straight axle.)						

Add 10% For Prepaid Shipment in U.S.A.

Send 10c For Circular on—Racers—Electric Wheel Chair—Steering Wheel Assemblies—Auto Type Axles—Carts—Electric and Gas Power—Trucks—Pulleys—Belts—and many other interesting items.

OSBORN WHEEL COMPANY, 115 So. Main St., Dept. P-11, Doylestown, Penn.

Made To Outwear
Other Type Wheels



—NEW—
1948 MODEL "B" RACER

REAL THRILL FOR ANY BOY!

76" Long x 30" Wide, 12" Steering Wheel; Left Side Steering, Two Passenger, 12" Wheels, Foot Pedals, Internal Brakes, 1-H.P. Gasoline Engine, Transmission, Etc., as shown READY-TO-RIDE . . . ONLY \$175.00.

Add 10% for Prepaid Shipment in U.S.A.

CHASSIS as shown less power plant. ONLY \$56.00
Add 15% For Prepaid Shipment in U.S.A.

ORDER
NOW

Time & Date AT A GLANCE

BELL
GUARANTEED
CALENDAR WATCH

Tells time, name of day and date. Day name changes automatically.

No. LM 383 — 17 jewels, water-shock resistant, anti-magnetic, radium dial and hands. ALL STAINLESS STEEL CASE..... **\$55.00**

OTHER SPORT WATCHES WATER-SHOCK RESISTANT

Precision tested, 17 jewels, anti-magnetic, radium dial and hands, unbreakable crystal, sweep second hand. No. LM 197—Stainless Steel Back..... **\$29.75**

No. LM 945—ALL STAINLESS STEEL CASE **\$37.50**

Other fine watches from **\$12.65** Tax Incl.

ORDER BY MAIL: Send check, money order or pay C.O.D. THESE LOW PRICES INCLUDE FED. TAX & POSTAGE. Write for FREE Booklet "LM".

Repair Service All types and makes of quality watches repaired expertly and promptly. Free estimate on request.

BELL WATCH COMPANY, INC.
 Time and Life Bldg., Rockefeller Center, New York 20, N. Y.

Ball-Bearing **SPEED WHEELS**

Juvenile wheels, solid tire—No Bearings

7" wheels.....	60c
6" wheels.....	50c
4" wheels.....	30c

Semi-pneumatic tired wheels

12 x 1.75".....	\$3.25
10 x 1.75".....	\$2.75
10 x 1.25".....	\$2.00
8 x 2".....	\$2.00

Industrial wheels for heavy loads

Semi-Pneumatic

400 x 8, 2 ply tire and tube.....	\$15.00
10 x 2.75".....	\$6.75
10 x 2.75" Single Tube.....	\$7.25
8 x 1".....	\$4.90
6 x 2".....	\$2.80

DEALERS WANTED

Free blueprints with all wheel orders. Send check with order. Shipments f.o.b. Akron.

JIM BROWN TOY COMPANY
 1097 Home Ave. Akron 10, Ohio

AMAZING SAVINGS JUST **OUT OF PAWN!**

GENUINE HIGH QUALITY DIAMONDS

UNREDEEMED DIAMOND PLEDGES DIRECT TO YOU AT AMAZING SAVINGS

Full cut genuine diamonds, expertly reset in beautiful modern mountings of 14 Kt. Yellow or White Gold, ladies' or men's, priced at a small fraction of retail value. Over 100,000 satisfied customers. Iron-clad guarantee. Wear your diamond 7 days. Your money refunded immediately if not delighted. Order from this ad. Also write us for FREE CIRCULAR of other Unredeemed Diamond Pledges from \$5.00 to \$5000. Small deposit holds any diamond until wanted. Write us today. References: Equitable Trust Company, Baltimore, Md., or your own bank.

BERMAN'S COLLATERAL LOAN BANK
 Dept. P-4, 636-38 W. Balto. St. Balto.-1, Md.

1/5 Ct. (\$125 Value)
\$49.00
 Tax included.

Please Mention Popular Mechanics When Answering Ads

WALKIE-TALKIES!

Complete Army Sets Ready to Operate

Portable radio telephone sends and receives 10 to 15 miles! Used by the Army with great success. Ideal for amateurs, police, explorers, airports, utilities, boat owners, Government services, etc. Operates anywhere in the 28 to 52 MC band. Renewed by the Government and guaranteed. Shipped, ready to operate, complete with tubes, microphone, telescope antenna and new batteries. Price—only **\$45.00** each. F.O.B. Chicago

Extra batteries (80 hours continuous service) **\$4.75** each

Radio-Telegraph Sending Keys

Real S-37 Signal Corps keys for your radio or telegraph set or for code practice. They have coin silver contacts and full adjustments. Valued at 3 times our low price. Send \$1.00 plus 20c for postage anywhere in U. S. Guaranteed.

WELLS SALES, INC.
 320 N. La Salle St., Dept. P-11
 Chicago 10, Illinois

STAINLESS STEEL AIR TANK WITH 100 USES

Perfect pressure tank for Paint Spraying, Moth Proofing, Insecticide, Tree, Shrub, and Garden spraying.

Makes ideal portable Air Tank to carry in car. Will completely inflate four tires from one filling. Wonderful for Buoys and many other uses.

Sold in U.S. only. No foreign orders accepted.

Non-corrosive, non-shatterable. Tank tested for 450 pound pressure. Volume, 2100 cu. in. Size, 12 1/2" x 24" with 1/4" female pipe thread opening at each end.

\$3.95
 F.O.B. Kansas City

W. F. TEAGUE & COMPANY
 714 CENTRAL, KANSAS CITY 6, KANSAS

SEALED POWER PISTON RINGS
 save oil, save gas, restore original power

Send postal for free booklet on oil-saving.

SEALED POWER CORP., DEPT. 65, MUSKEGON, MICH.

GLOWS in the DARK **FREE Sample!**

Be the first to sell luminous house numbers, light switch plates, wall protectors, pull cords. Also luminous pictures, statues, decals, and a host of religious, nursery and other objects that glow in the dark. Get into this new and growing industry. Enormous demand... no competition... sensational demonstration... big profits. Represent a large manufacturer, established over 34 years. Write today for liberal money-making offer and free sample to show how they glow in the dark.

MADISON MILLS 303 Fourth Ave., New York 10, N. Y.

NOW YOU CAN PAINT WITH PLASTICS

The brilliant glistening beauty of pure phenolic plastics is now yours for as large a surface as you want, at an infinitesimal fraction of the cost of solid plastics. A block of the cheapest wood or other material can be made as beautiful, as durable, as chemical-proof, as brilliantly polished, as a block of pure plastic, for PHENOPLAST is nothing but 100% phenolic resin which due to new scientific compounding methods, can now be made to actually "set" or "polymerize" ON YOUR WORK, instead of requiring huge ovens or gigantic molding-presses. ALL THE ADVANTAGES OF SOLID PLASTICS ARE RETAINED—yet you just BRUSH IT ON, WIPE IT ON, SPRAY IT ON, or DIP IT.

COAT ANYTHING WITH PHENOPLAST—and you have an object that looks, feels, shines, lasts and acts like solid plastic. You can turn burlap or cotton batting into strong shock-proof automobile bodies, you can carve small objects in pine and make them look like ruby or jade, you can put down a floor finish that never needs waxing, you can paint a boat-hull that resists fungi, teredos and barnacles and cannot peel, you can turn linoleum into "tile," you can put a permanent finish, with a permanent polish, on ANYTHING with PHENOPLAST—it sets with the highest gloss and the hardest surface of ANY finish.

PHENOPLAST the new cold-setting liquid phenolic resin was developed by A. J. Lockrey, plastics expert and author of "PLASTICS," the text book used in most vocational schools.

SEND FOR TRIAL PACKAGE—a quart of clear transparent PHENOPLAST, three bottles of ruby, jade and amber dyes and complete instructions for dozens of fascinating uses, only **\$3.95**

Per Gallon (without dyes) \$12.00 F.O.B. New York
LOCKREY PLASTIC PRODUCTS COMPANY
40-16 150TH ST. FLUSHING 2, N. Y.

LIGHT PLANTS

Used Gov't Surplus—Lowest Price Ever Offered—3,000 watt, 110 volts.

Powered by Briggs-Stratton or Wisconsin 6 H.P. air-cooled engine. For stationary or portable use. Our sale price, F. O. B. **\$124.50**

SPECIAL: 6 to 7½ H.P. Aircooled engine, a real bargain... Only **\$74.50**

Limited Supply — Immediate Delivery — Order Now
Write for Illustrated Circular

MIDWEST SURPLUS SALES 1520 LOCUST ST. KANSAS CITY, MO.



PHONO AMPLIFIER KITS

- 3 Tube Phono Amplifier Kit.....\$2.35 completely wired and tested..... 2.85
- Kit of 3 tubes for above
- 12SK7, 50L6, 35Z5..... 1.95
- 5" Alnico Permanent Magnetic Speaker and Transformer..... 2.00
- Astatic Crystal Pickup Model L-70 1.95
- Shure Glider Crystal pickup.... 1.95
- Alliance Phono Motor..... 3.25

All prices F.O.B. our warehouse New York
25% with order, Balance C.O.D.

RAYTONE ELECTRONIC COMPANY

25 Frankfort Street New York 7, N. Y.

WASHING MACHINE PARTS

ALL MAKES

Wringer gears, Agitators, Rolls, Pumps, Gear cases, Shafts, etc. 10,000 parts.

NORTHEAST BURNER, 1358-M H St. N.E., Washington, D. C.

148 PAGE WOODWORKERS CATALOG

ONLY 15 CENTS-REBATED ON FIRST ORDER

SHOWS IN NATURAL COLOR

22 inlay and overlay insets
32 veneer bandings—matched woods
30 kinds of world's finest woods in character grains and color

31 moulding, rosettes, ornaments and home wood working labor-saving tools and hard-to-find hardware

CRAFTSMAN WOOD SERVICE CO.

2729 S. Mary St., Dept. A-87, Chicago 8, Ill.

LISTS OVER 300
PIECES OF ARTISTIC
FURNITURE SHOWN

including cost of plans, lumber, hardware and finishing material, choice of MAHOGANY, WALNUT, BIRCH or MAPLE, LUMBER-PLYWOOD- VENEERS UNEQUALLED BARGAINS

Make beautiful furniture at only 20% store prices.

A Home Workshop at Bargain Price

BUFFALO RADIO SUPPLY (sole export agents)

219 Genesee, Buffalo 3, N. Y.

Accurate and precise 2 speed guaranteed hobby lathe, the essential machine for the home workshop, sturdy enough for light production work or factory standby service. Supplied with 56 inches of belting for connecting to any available electric motor or power take-off, such as on a jeep or tractor. Also included in this unbelievable offer, are such accessories as a one-half inch drill chuck with specially hardened tool steel jaws, a four inch electric furnace high speed grinding wheel, a cotton buffing wheel with a large supply of buffing compound and a steel wire scratch brush. Distributor inquiries invited. Special at \$6.00, postage prepaid.

It's EASY to USE the ELECTRIC PEN...

BURN YOUR OWN DESIGNS AND MANY OTHER GIFTS

BURN-RITE Detachable PEN



Underwriters' Approved

is the only pen on the market. Use like a wall plug. Electrical and receptacle with interchangeable heating units. Safe. Underwriters' Approved.

PRICE, postpaid **\$1.50**

A XMAS SUGGESTION BURN-RITE SET



Deluxe-4-craft combination kit complete. Contains plaques, foil, leather, water colors, brushes, Burn-Rite pen, colored silicate sand, glue and full instructions. PRICE, postpaid **\$5.00**

A Miniature Home Foundry in Cast-Rite CASTING SET



Combination electric and gas complete metal casting outfit. Comprises 3 figure mold, handles, electric stove, ladle, vise, jars of paints, brush, and 12 bars antimonial metal.

PRICE, postpaid **\$4.00**

Our entire line available at leading stores. If they can't supply you, mail remittance with order direct. Catalog PM11 of complete line available on request.

RAPAPORT BROS. INC.
1830 S. WASHTENAW AVE., CHICAGO 8, ILL.

Announcing



**WORLD'S
BEST
HAND
TOOL!**

New

**THIN-NOSE
VISE-GRIP**
with WIRE-CUTTER

Possesses all the features of the world-famed VISE-GRIP Toggle Wrench including Ton Grip, plus:

THIN TAPERED NOSE - Reaches down into extremely tight places to grip bolt-heads, screw-heads, rod-ends, etc.

NEW INVOLUTE JAW CURVE - New scientific design puts tremendous pressure on 4 points of any size nut. Increases tooth-contact on round work — work can't slip out of jaws. Holds round work up to 1 7/8" diameter. Holds anything, any shape, with a non-slip grip.

WIRE CUTTER - Ton-pressure cuts wire and small bolts. Actually cuts 1/4" bolts by taking progressive bites.

KNURLED JAW TIPS - Holds work at the very tip with powerful non-slip grip.

Never before was so much usefulness packed into a single hand tool! Easy to open from locked position. Made of fine alloy steel. Nickel plated. 2 sizes: 7" and 10" — both with or without wire-cutter.

SEE YOUR DEALER! If he hasn't it, order direct. With Cutter, 7", \$2.25, 10", \$2.50. Without Cutter, 7", \$1.85, 10", \$2.25. Get yours at once.

PETERSEN MFG. CO., Dept. 31, DeWitt, Nebr.

MAGNETS OF ALL TYPES—10c UP
AMAZINGLY POWERFUL!
4 oz. Alnico Magnet, lifts 10 lbs. \$1.00. Our Leader, Cat. No. 510, lifts 40 lbs. \$1.95. New alloy—will not weaken! Useful for lifting valuables from tanks, lakes, or rivers easily! 7 small magnets, \$1.00 with list of many shop and home uses. Satisfaction guaranteed.
R. EYRICH, 2566 N. 49TH ST., MILWAUKEE 10, WIS.



**DRIVING
A SNAIL?**

Take the sluggishness out of your car . . . save on gas and oil, too, by installing a set of quick-seating Burd "Graf-Flox" Piston Rings!

Two free, handy booklets for car-owners, mailed on request. Just print your name and address in the margin, alongside this ad, clip and mail.



BURD PISTON RING CO., DEPT. PM, ROCKFORD, ILL.

ARMY SURPLUS BARGAINS

Every Item BRAND NEW except Blankets

100% Wool Army Serge Pants, size 28 x 28 only, a real buy. \$2.98
100% Wool Army Serge Pants, size 28 to 36 W., 28-34 lgths. 6.98
100% Wool Army Covert Pants, 30 to 36 W., 28 to 33 lgths. 6.98
AIR FORCE SHEEPSKIN LEATHER JACKETS—
Sheep collar, zipper front, 40 to 46. 22.95

WHIPCORD WORK PANTS—DARK OXFORD GRAY—HEAVY 11 oz. wt. All sizes. SANFORIZED SHRUNK. Reg. \$3.49 Value. Direct from this ad.	2.98
NAVY SURPLUS GRAY SLICKERS, WATER-PROOF, sizes 36 to 42.	4.98
AIRFORCE COVERALLS, 100% wool O.D. GABARDINE, 36 to 42.	6.95
100% Wool Army Blankets, used, small repairs required.	2.98
BOY'S O.D. Herringbone Twill Dungarees, 4 to 16.97
100% WOOL ARMY BLANKETS, select grade, absolutely perfect.	4.98
ARMY BLACK MECHANICS Socks, mercerized cotton, 10 to 11 1/2.69
GRAY CHINO TROUSERS, 32-34-36 waist; 28 to 36 lgths.	2.98

If sending cash with order add 25c for one garment, 5c Ea. add'l. garment: west of Miss. and Canada 45c one Gar., 20c Ea. add'l. postage and handling chgs.; tax in Ohio. **OR PAY POSTMAN ON DELIVERY. SATISFACTION GUARANTEED OR MONEY REFUNDED PROMPTLY.**

FREE Illustrated circular of SURPLUS and civilian clothing sent with order, or free on request. Send for your copy today.

ADDISON UNIFORM CO., Dept. P-11, CAMBRIDGE, OHIO

NOW—IT'S EASY TO DRILL CONCRETE!

Slip a Carboloy Masonry Drill into your Rotary Drill, Hand Brace or Drill Press — and drill holes



4 TIMES FASTER!

Here's the "secret" — super-hard tip of Carboloy Cemented Carbide (developed to cut hardest steel) "breezes through" softer masonry!

- Stays Sharp Up To 50 Times Longer!
- Drills Clean-edged Circular Holes!
- Eliminates Costly Breakage!

ALL MASONRY—BRICK, SLATE, ASPHALT, PLASTER, ETC.

Goodbye to back-breaking masonry drilling! Here's the easy way!—the precision way!—the speedy, professional way! Drill holes 1/8" apart without breakthrough! Drill any masonry. 15 popular drill sizes—ask about Handy 6-Drill Set (sturdy canvas case, free)! See your dealer, or write today for FREE LEAFLET SA-225.

CARBOLY COMPANY, INC., 11185 E. 8 Mile Rd., Detroit 32, Mich.

PISTON TYPE COMPRESSOR



EASY PROFIT IN PAINT SPRAYING

Paints walls, ceilings, screens, furniture and machinery faster, better. All complete as shown less motor. Carry anywhere. Fully guaranteed. Could be used with 1/4 H.P. motor or less. Price \$35.00 less motor F.O.B. Chicago. \$5.00 deposit balance C.O.D. or see your dealer.

IDEAL AUTOMATIC PUMP CO., Dept. P.M. 8

801 W. Washington Blvd.

Chicago 7, Ill.

\$13.50 Value for Only \$2.49

8000 ohm impedance Head Phones, produced to Air and Signal Corps specs. Extremely sensitive, lightweight (only 9 oz.). With 5 1/2 ft. cord, plug, jack and ear cushions. Every One **BRAND NEW**

No. 17A37, Special Per Pair. **\$2.49**

Plus 25c each for Postage.

Burstein-Applebee Co. 1012 McGee, Kansas City 6, Mo.



★★★ MACHINERY ★★★

LATHE—DRILL PRESS—SAW—Now Ready—Others On The Way—All Metal—All Machining Completed—Assemble Yourself and Save—Folder 947M on Above 10c. Refunded on First Order. Catalog 1046 on Tools—Aluminum—Plastics—Supplies—Equipment, etc. 15c.

METPLAS SUPPLY CO., 1420 So. 16th Ave., Maywood, Ill.

THE LITTLE GIANT

DIAMOND Grinding Wheel Truing Tool!

1/4 ct diamond insert removable for machine dressing The ideal tool for home craftsmen and modern machine shops

\$5.00
Postpaid

CASTGEM 226 N. WESTERN AVE. LOS ANGELES 4, CALIF.

C.O.D. ORDERS ACCEPTED

WORLD'S BIGGEST, MOST POWERFUL, SAFEST

MAGNETIC JIG SAW

READY for Christmas Delivery!



Number 2000

SYNGRO

For Hobbyists

Craftsmen, Light Production
GREATEST CLEARANCE, LARGEST TABLE TOP
OF ANY MAGNETIC SAW MADE!

ONLY
\$17.50
 FOB FACTORY

Shpg. Wt., 18 Lbs.
 Slightly higher in foreign countries.

NO MOTOR NEEDED..JUST PLUG IN!
PORTABLE! SAFE! CUTS CLEAN!

Here's the perfect, lasting family Christmas gift to get or give . . . SYNCRO . . . the remarkable, safe, patented magnetic jig saw . . . ready for immediate shipment! SYNCRO needs no belt, no gears, no oiling. No motor to buy. Just plug in any 50 or 60 cycle (A.C. only) 110-120 volt wall outlet—in kitchen, attic, basement—set on kitchen table, floor, anywhere—and saw! The high-speed, short Magnetic Safety Stroke Action, and freedom from belts, makes SYNCRO so safe small boys and girls may use it. Cuts intricate designs on $\frac{3}{8}$ " soft wood, $\frac{1}{2}$ " medium hard plywood and thinner hardwoods, plastics, thin metals. Leaves no ragged undersides on plywood, cardboard. Cuts to center of 27" circle! Get, enjoy this safe, educational, practical quality tool for making models, displays, puzzles, inlays, silhouettes, toys, what-nots, etc. Limited supply—so hurry!

WHY SYNCRO IS SAFEST!

SYNCRO has NO continuous cutting blade nor "Long stroke" blade to pull fingers into teeth—instead there are 14,400 strokes per minute—7,200 short cutting strokes plus 7,200 upward NON-CUTTING, REPELLING strokes! (Fig. 1) SYNCRO will not even CUT wood unless piece is pushed FIRMLY DOWNWARD AGAINST blade and FIRMLY FORWARD — both actions at SAME time! SYNCRO blade teeth cut ONLY on DOWN stroke. (Fig. 2) Teeth raise, repel, push away any object on UP stroke. (Fig. 3) When blade moves UP it KICKS finger away free. On down stroke, blade does not move far enough to accidentally cut finger unless finger is intentionally, deliberately fed into blade like wood is fed in Figure 1. No wonder SYNCRO is the world's SAFEST saw . . . a feature old and young users acclaim!

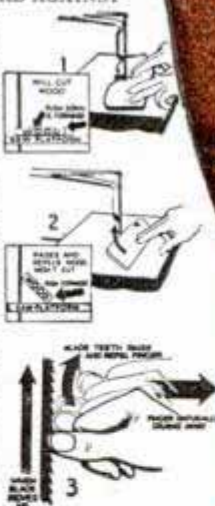

"Family Saw"

"The SYNCRO POWER SAW ordered from you in 1940 is still saving merrily away. My son (then 8) has used it in the attic, kitchen, his room, and basement shop. I use it too. We never worry about accidents due to its MAGNETIC SAFETY STROKE feature. It's truly a family saw."—Mr. B. H. Smith, Rexburg, Idaho.

Complete with Cord,
 3 Blades

ORDER NOW on
10 DAY TRIAL!

Order with complete confidence on this liberal Trial Offer: When you get your SYNCRO, plug it in and saw, as per directions. Then, if it does not saw cleaner, better than any other jig saw you ever used, and with more safety . . . if it does not satisfy YOU . . . return it undamaged, postpaid and post-marked within 10 days of its delivery date . . . and we will refund the saw price promptly without question!

SEE YOUR DEALER FIRST!

15 OUTSTANDING SYNCRO FEATURES:

(1) World's safest saw. (2) Portable. (3) No rotating magnetic motor needed as self-contained magnetic power unit transmits A.C. magnetic impulses to armature diaphragm — power transferred to blade. (4) No rotating parts to wear out. (5) 14,400 magnetic strokes per minute. (6) never needs oiling. (7) Large 10"x10" table top. (8) Cross section en-

graved lines on top. (9) Big 13 1/2" throat clearance. (10) Finest steel blades. (11) Rubber feet. (12) 5' cable, plug. (13) Varying voltage adjustment nut. (14) Lifetime durability. (15) Quality materials, workmanship, performance, guaranteed by the famous "SYNCRO" trademark name.

EXPORT ADDRESS:
 120 Wall St., N. Y. C.



SAW CORPORATION
 Dept. A-117,
 ROCHESTER, MICHIGAN

WORLD'S LARGEST MAKERS OF ELECTRIC JIG SAWS

SYNGRO SAW CORPORATION, Dept. A-117
 ROCHESTER, MICHIGAN
 Export address: 120 Wall St.
 New York City

Gentlemen: Here's my order for one SYNCRO MAGNETIC JIG SAW, Model No. 2000, shpg. wt. packed, 18 lbs., \$17.50 FOB Factory. Please send it complete with electric cable and plug, 3 blades, on your 10 Days Money Back Trial Offer. I enclose \$17.50 as payment. Please ship saw:

Express charges collect or Parcel Post charges collect.
 Express, for which I enclose an extra \$_____
 Parcel Post, for which I enclose an extra \$_____

NAME _____
 ST. & NO. _____
 CITY _____ STATE _____
 I enclose no money—send FREE SYNCRO Circular.

Amazing **NEW!**
 ● SHAPER
 ● PLANER
 ● SANDER



at a **NEW LOW PRICE**

Precision Built
PORTABLE
 Multiple Purpose
TOOL

**for THE HOME WORKSHOP
 or ON THE JOB**

Here is THE precision tool that every man who works with wood just can't afford to be without. The REDFORD is a shaper, planer, sander — all in one — at a price never before thought possible. It is portable (weighs only 12½ pounds) takes any standard cutter, planer or sander that fits a ½-inch spindle. Power-driven from a ½ H.P. electric motor (not furnished) or it may be bolted to a drill press table and driven direct from drill press chuck.

Illustrated folder explains in detail ALL of the many NEW FEATURES and advantages. Nothing else compares with its versatility—or LOW COST.

Send for
FREE
 Illustrated
FOLDER

**DON'T WAIT - WRITE
 TODAY**

REDFORD SPECIALTIES INC.
 18437 Salem • Detroit 19, Mich.

**MAKE \$ MORE
 MONEY**

Applying or Selling
CORKSTONE
 A General Purpose Magnesium Oxychloride Flooring
THE MODERN PLASTIC FLOORING

EASY TO APPLY
 Here's your opportunity to get into business for yourself applying or selling Corkstone, the economical, top-grade plastic flooring. Plenty of profit. Act without delay!



Dealers & Agents Wanted
 WRITE FOR DETAILS
LASTING PRODUCTS COMPANY
 Franklinton Road Plant, Baltimore 23, Md.



Iron Repair Kit
 Contains a complete assortment of terminals, pins, porcelain insulators, mica, etc. that will fit most flat irons and appliances. Practically every part necessary in the ordinary repairing of flat irons in one handy kit. Additional supplies obtainable so that your kit can be replenished.

Entire kit sent postpaid for only \$3.10 plus 18c postage.

Electrical Appliance Repair Parts

Lead wire, Asbestos covered heater hook-up wire, 10 ft.	\$1.00
Heating element wire, 10 ft. coiled 3/4" O.D. #20	2.55
Heating element wire 10 ft. coiled 3/16" O.D. #22	1.77
Ribbon element heating wire Std. size 100 ft.75
Christy Electric Heating Element Welding FLUX for repairing flat irons, toasters, electric stoves, etc. Enough for 50 elements	1.00
Hot plate bricks 5 3/4" diameter, 6 for	1.62
Element cement. Withstand 3000° F. 1 lb. package	1.00
Carbon brush set. Assorted. 104 brushes, 15 Springs. Complete	3.00

REPAIR ELEMENTS FOR ELECTRICAL APPLIANCES

Renualt iron element. Guar. 1 year. Package of 6	3.12
Irons. Porcelain shoes for 500-600 watt. Set of 4	1.00
Percolator elements. Universal flat type. 1 Yr. guar. 2 for ..	1.20
Percolator Element. Porcelain for new glass types. 2 for ..	1.80

Here is your opportunity to save on repairing your own appliances and to earn extra money repairing appliances for friends and neighbors.

CHRISTY SUPPLY CO.
 2835 N. Central Ave. Dept. T-1150 Chicago 34, Ill.

BECOME A PISTOL EXPERT WITH A HY-SCORE AIR PISTOL



- No Pumping
- Powerful, Fast
- Single Shot
- Precision-Made
- 30½ oz.;
- 10 1/4" long

HY-SCORE PELLETS FIT ALL PISTOLS
 Cal. 177 2.50
 Cal. 22 3.90
 per 1000

SEE YOUR DEALER
 Send For Free Circular Dept. M-11

HY-SCORE ARMS CORP. • BROOKLYN 1, N. Y.

SURPLUS HARDWARE SPECIALS

High Speed Hacksaw Blades, Hand Type, Molybdenum, 10 in. 32 teeth	\$1.30 doz.
3 Phillips Screwdrivers #2, 3 & 495 set
5 Common Screwdrivers, 1 1/2"-2"-4"-6"-8"	1.25 set
6 Cold Chisels, Hand Type 4" to 8"	1.80 set
Carton of 10 GE 110 Volt 2 1/2 Watt Argon Glow Lamp Standard socket listed at \$5.50 ea.	2.00 cart.
Tool Roll, Brown Duck, 26"x52"-49 Pockets	1.25 ea.
Hack Saw Frames, Adjustable, Mfgd. by Union Hdwe.60 ea.
12 Assorted Amer. Std. Files 6" to 14"	2.25 set
24 Assorted Files 4 to 14"	4.00 set
4 rasps 8 and 14" Cabinet, 14" Half Round, 12" Flat ..	2.10 set

All orders \$5.00 and over sent postpaid.
 All orders less than \$5.00 add 10% for postage.
 Write for complete list.

INDUSTRIAL SUPPLY CO., 312 E. 33 St., New York City 16, N. Y.



DUAL TAIL PIPE EXTENSION FOR YOUR CAR. \$2.95
DEEP TONE, PRODUCED BY 2 1/2 IN. OUTLETS
 Chrome Plated -- Fits All Cars
 Postage Free on Money Order, Check or Cash
PAT. PEND. LYONS PRODUCTS Co. 2319 Ridgeley Dr. Los Angeles 16, Cal.

BUILD THESE PROJECTS

For garden or lawn. Easy to build. Easy to sell. Detailed Blueprints Model B-25 Dutch Windmill 50c; Model OM-60 Old Mill, 85c. Lawn Figure Patterns—Sunbonnet Girl, Dutch Boy, Tulip Girl, Holland Pair, 35c each, all 4—\$1. Catalog illustrating many models, send 10c, today.

CRAFTSMAN'S MODEL CO., Dept. P-109, 2030 N. 41st St., Milwaukee, Wis.

MARCOT KEY MACHINE

Immediate Delivery

Marcot No. 8 Key Machine Mounted on Cabinet	\$ 82.50
Book on Modern Locksmithing	3.95
Auto Code Book and Auto Depth Keys	12.50
162 Doz. Popular Key Blanks ..	77.76
Set Key Files, Tools, Pins, Springs, Thimble	10.50

\$187.21

A. J. MARCOTTE CO., 1200 N. KEDZIE AVE., DEPT. PM, CHICAGO 51, ILL.

"CHIEF" Portable Electric Welder



A
Complete
Welding
Shop
All In
One Case

CARRY IT
ANYWHERE

VERY
SIMPLE
TO
OPERATE

America's greatest welder value! Does high grade welding, brazing, soldering, preheating. Works on light and medium gauge steel, iron, aluminum, brass, etc. Not a gadget, not a toy heater, but an amazingly efficient portable welder that achieves expert results. Simple to operate. Quality made. Completely equipped as illustrated. 110 or 220 volt models. Low cost. Send for FREE details, NOW!

CHICAGO PRECISION MACHINE CO.

926 South Michigan Avenue

Chicago 5, Illinois

RACER POLISHED CAST ALUMINUM

SPEEDY RACER . . . Streamlined . . .
Heavy Unbreakable Aluminum 9½ inches long with 4½ inch Axles . . . Fully mounted with smooth running Rubber Tire Wheels that can't come off . . . Can't rust . . . Looks like models selling Up to \$13.00.

Dealers
Wanted
Everywhere

SEND
\$2.79

JODEL PRODUCTS

756 W. 69th St., Dept. P-11, Chicago 21

Postpaid in U.S.A.



NEW OTTAWA Wood Saw

FOR TRACTORS Makes wood sawing fast; easy. Cuts enough wood to pay for itself quickly. Easily moved while attached. Big blade; send for FREE details

LOW
PRICE

OTTAWA MFG. CO., 1-727 Oak Ave., Ottawa, Kans.

*New
Advertising
Machine*



Prints & Illustrates 1¢ Post Cards

FREE! Learn how thousands of merchants and business men are boosting sales in spite of product shortages with 1¢ messages—printed in a few minutes on gov't postcards—with amazing new, patented **CARDMASTER**. Your "todays" ideas for specials, read by prospects next morning. Not a toy, but a sturdy, advertising machine, built to last many years. Low price, sold direct. Guaranteed, five years.

SEND NAME We'll send free illustrated book of money-making ideas for your business and complete, unique advertising plans. Rush your name today.

CARDMASTER COMPANY
4546 Ravenswood Dept. 1311, Chicago 40, Ill.

Build a successful arc welding business quickly

*with only a small
investment*



**HOBART
arc welders
are
"Simplified"**

That's why it's easier to learn arc welding with Hobarts—to get into big profits now.

Build Your Own

With the Hobart welding generator only, used auto engine and chassis, you can "build your own" portable arc welder at home and earn bigger pay by going right to welding job.



Build Your Own
Generator Only

New A. C. Heavy Duty

arc welder is just right for shop use if you start your own welding business. No job too large or small for the Hobart heavy duty A.C.

The Hobart Arc Welding School

is open to everyone interested in arc welding. Learn in a hurry so you can start on a big pay welding job. Return coupon today for information. G. I. Approved.



New Industrial
A. C. Welder

Hobart Bros. Co., Box M 117, Troy, Ohio

"One of the world's largest builders of arc welders"

**MAIL
this coupon
Today!**

Hobart

HOBART BROS. CO., BOX M 117, TROY, OHIO

Without obligation send me information on items checked

- Build Your Own A. C. Welder
 Electric Drive Welder Hobart Trade School

PHONE NO. _____

NAME _____

ADDRESS _____

JET The Sensational NEW
Combination ROLLER-ICE SKATES

FASTER—SMOOTHER—EASIER SKATING

Skating
Clubs are
Enthusiastic
Users . . .

YOU will like the NEW "JET" Roller Skate . . . Study the THREE-IN-LINE-ROLLERS . . . Goes over cracks and irregular surfaces with a new smoothness . . . The "JET" Skate is the ONLY SKATE WITH BRAKES to STOP QUICK . . . Another feature: you can quickly change to Ice Skates by replacing the rollers with the "JET" Ice Skate Attachment . . . A new experience awaits you in Roller Skating . . . Get a pair TODAY . . . Three Sizes: Large, Small, and Medium for CHILDREN and ADULTS . . . In ordering simply GIVE SIZE OF SHOE.

Local Agents Wanted . . . RUSH ORDER

AFCO PRODUCTS, INC., 4547 No. Clark St., Dept. P-11, CHICAGO 40, ILL.

• **ICE SKATERS**
ROLLER SKATES

50% Lighter Than Ordinary Skates

Streamlined



PAT. NO.
2113862

The
Ideal
Gift

Be
First
In Your
Locality

Only **\$4.95**
A PAIR

Postpaid in U.S.A.
Ice Skate Attachment
\$2.25 Extra

3 Ball Bearing Wheels
in line gives
MORE SPEED with
LESS EFFORT . . .

Note the BRAKE!
to STOP QUICK
simply RAISE THE TOE

• We Ship C. O. D.
Plus Postage

Mail Your Order
Direct To Factory

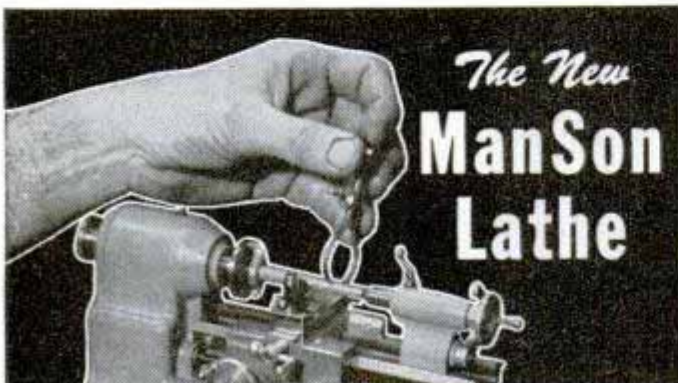

The New
**ManSon
Lathe**

Pat. Pend.

Price "ready to run," including
electric motor built into base, \$60.75

For mechanics,
hobbyists, model
makers, radio and
appliance repair.

Here is a small metal turning lathe to machine a wide variety of jobs quickly, accurately and economically. This is the ideal machine for the home workshop. Carefully engineered and precision built of steel, cast iron and aluminum. Fully adjustable for wear, with porous bronze self-oiling bearings, machined gears, longitudinal power feed, quick clamping tailstock. Send for circular. Time payments available. See your local dealer; if he cannot supply you, write us direct.

Overall dimensions 9-3/16" long, 3 11/16" wide, 6 3/4" high. Shpg. wt. 10 pounds. Work capacity 3" between centers, 3/4" swing over carriage, 2" swing over bed, 1/8" collet capacity.

SMALL MACHINES, Inc.

2010 S. Sepulveda Blvd., West Los Angeles 25, Calif.

New! BLACK & DECKER



1/4 inch

ELECTRIC DRILL

This portable electric drill handles hundreds of "odd jobs" in homes, hobby shops, farms, repair kits. Only 7 7/8" long, weighs 3 1/4 lbs. Will drill to 1/4" in steel. Has fast-operating Jacobs hex-key chuck and an instant-release trigger switch. Operates from any 110 volt A.C. or D.C. circuit at 2250 RPMs. Order today **\$18.95** for immediate delivery.

Postpaid upon receipt of check or M.O.; C.O.D. you pay postage. For General "all-purpose" drilling from 1/8" to 1/2" order the Black & Decker 1/2 inch Electric Drill. \$35.95

ASTORIA REFRIGERATOR EXCHANGE

25-57 STEINWAY ST. LONG ISLAND CITY 3, N. Y.

LIVE CENTER \$12.95 POST PAID

Double Ball Bearings
Hardened Point

No. 1 or 2 Morse Taper

Slip-on Wood Working

Attachment \$1.50 Extra

FULLY GUARANTEED—SEND CHECK OR MONEY ORDER

G-K MFG. & SUPPLY 5907 Catalina
Mission, Kansas

Lathe Owners Attention

If your present metal lathe is without power cross-feed, you can now build your own. All parts available from your nearest mill supplier or jobber and scrap box. Positive non-slip performance—no belts used. Adaptable to all metal screwcutting lathes. Make the most of this winter in your shop. Detailed pictorial drawing and complete instructions sent postpaid \$2.95. Send Money Order today to;

JAMES B. WATERS, Jr.

4412 Georgia Ave., N.W. Washington 11, D. C.

TRAILER AXLES • HUBS • WHEELS AND SPRINGS

1000 LB. CAPACITY STRAIGHT AXLE

58" Tread—46" Spring Centers

Axle only, \$6.50—With Springs, \$22.00; Axle, wheels and hubs, \$30.50; Axle, wheels, hubs and springs, \$43.70.

1500 LB. CAPACITY STRAIGHT AXLE

58" Tread—46" Spring Centers

Axle only, \$8.25—With Springs, \$24.50; Axle, wheels and hubs, \$32.25; Axle, wheels, hubs and springs, \$46.00; If 4" Drop Axle is wanted, add \$5.25 to above prices.

Wheels take 6.00-16 tires • Hubs equipped with roller bearings • Prices F.O.B. Fenton, Mich. • Remittance with order—No. C.O.D.

Write for Descriptive Literature

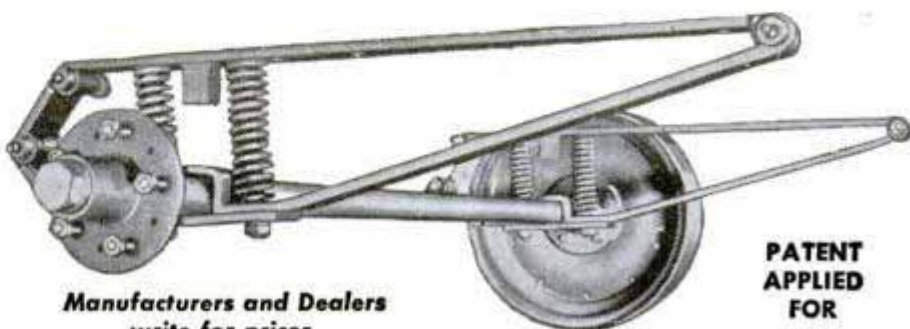

Manufacturers and Dealers
write for prices.

PATENT
APPLIED
FOR

200 S. LEROY ST. INDUSTRIAL MACHINE TOOL CO., INC. FENTON, MICHIGAN

WAR SURPLUS BARGAIN SPECIAL CENTRIFUGAL PUMP READY FOR USE ON ANY LIQUID PUMPING NEED

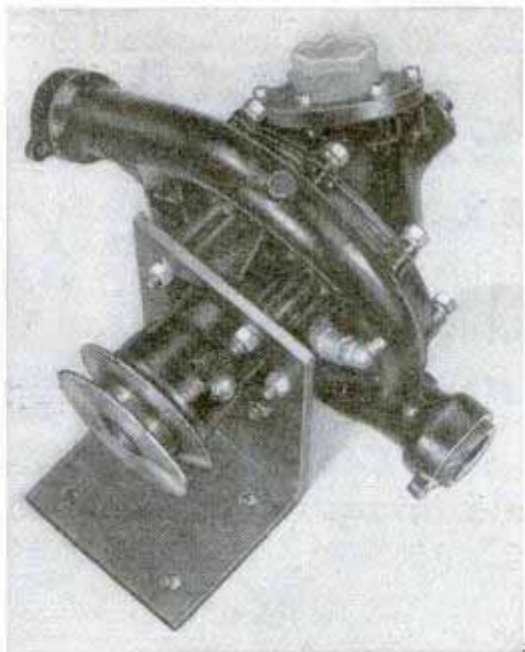

USE IT FOR
HOME
WATER
SYSTEMS

IRRIGATION

STOCK
WATERING

FIRE
PROTECTION

DRAIN
BASEMENTS,
PONDS,
TANKS, etc.

INDUSTRIAL
PUMPING

A super value for all types of intermittent service in pumping large volumes of liquid in home, farm and industrial service. Ideal for home water systems, draining basements, fire protection, etc. On the farm for watering stock, draining ponds, sprinkling, etc. In shops and factories for all types of pumping service.

MOVE LARGE VOLUME QUICKLY

When operated at 1750 RPM, will pump 42 gallons per minute on a 23 foot head; at 3600 RPM on 52 foot head will pump 88 gallons per minute. May be run with electric motor, gas engine or power take-off on tractor.

COMPLETE WITH PULLEY AND MOUNTING BRACKET — READY TO INSTALL

Pump has cast aluminum housing—accurately machined bronze impeller vanes. Complete with mounting bracket and 3½ inch V belt pulley. Shaft rotates on sealed ball bearings with grease gun fitting. Has 1½ inch threaded intake flange, two 1 inch outlets. Use one or both as necessary. Made for Packard Motor Car Co. for use in Rolls-Royce Merlin Aircraft engines. Comes complete with pulley and mounting bracket.

GREATEST PUMP VALUE IN YEARS

Original cost approx. \$147.00. Sold F.O.B. Chicago. Shipping weight 23 pounds. Complete engineering reports and operating instructions free with pump. You can't beat this pump value at anywhere near this price. Satisfaction guaranteed.

Original Cost Approx. \$147.00

COMPLETE
WITH
PULLEY
AND
MOUNTING
BRACKET—
READY
FOR USE

\$29.75

F. O. B.
Chicago

GROBAN SUPPLY CO. Dept. PM11 1522 So. Michigan Ave., Chicago 5, Ill.

Now is the ideal time to Remove Tree Stumps

For As Little As

\$1.00
Or Money
Back!



Remove ugly tree stumps, old or new, roots and all, any season, without digging, chopping, blasting, pulling! Save time, money! Order Magic Stump Remover now by mail. SEND NO MONEY! Pay postman only \$1 for 4-Oz. size (for 1 average stump), \$1.50 for 8-Oz., \$2.75 for 16-Oz., plus postage and C.O.D. fee. Or, SAVE Postage and C.O.D. FEE by sending cash with order. Also larger quantities at savings. Safe, proven, use anytime, anywhere. Money back if not satisfied.

H. D. CAMPBELL CO. :: ROCHELLE 24, ILL.

**ARC
WELDER**

BUILD YOUR OWN!

Light or heavy. No rewinding. 16 Heats. Use old auto generator coils. Complete plans and catalog, 35c. LEJAY MFG. CO., 3347 LeJay Bldg., Minneapolis 8, Minn.

HOLD-E-ZEE Automatic Grip



SCREWDRIVERS

... not only tools of finest quality, with chrome-vanadium blades, hand-ground bits, insulating, unbreakable handles ... but possessing the exclusive Gripper which holds, starts, and sets up screws in unhandy places. At leading dealers everywhere. Upson Bros., Inc., 86 Exchange St., Rochester, N.Y.

QUALITY UNSURPASSED • CONVENIENCE UNEQUALLED

Could Be Yours

The Spratts are looking for a furnished room now. They lost everything in their fire. And to think—a Pyrene® Fire Extinguisher would have put it out at the start and saved everything.

Be safe with Pyrene. It's quick and easy to use, approved by Underwriters' Laboratories, Inc. and Good Housekeeping Institute. Get your Pyrene at your hardware, home or auto supply store.



PYRENE MANUFACTURING COMPANY

NEWARK 8 • NEW JERSEY

Affiliated with C-O-Two Fire Equipment Company

SURPLUS SALE!

L I K O BINOCULARS

45 X 3.5

BRAND
NEW



Only
\$6⁹⁸

Immediate
Delivery

with **COATED OPTICS**
and Interpupillary Adjustment

First Time in America! Now you can have a close-up of all events with these all-purpose heavy duty binoculars. Precision lenses. Coated lenses. interpupillary adjustment and other features found only in high priced binoculars. Carrying case and shoulder straps included. **SEND NO MONEY.** 10 day no risk money back guarantee. Order today! Ideal Gift.

VETERAN'S EMPORIUM, Dept. B-4
1148 W. Chicago Ave. Chicago 22, Ill.

VETERAN'S EMPORIUM, Dept. B-4
1148 W. Chicago Ave., Chicago, Ill.

Send me _____ Liko Binoculars.

Send C.O.D. plus charges.

I enclose \$ _____ Send postpaid.

Name _____

Address _____

City _____ State _____

Be sure to add 20% Fed. Tax (\$1.40)



Capacity
0" to 2 1/4"

Write for
Literature
and Prices

Long recognized for high quality tools by Home Craftsmen and Hobbyists, Blue Star now makes this 8" Table Saw again available. It handles a wide variety of sawing jobs easily, quickly, economically. The 3/8" ball-bearing Arbor tilts 45° to right and 5° to left keeping work flat for all cuts. Large Table 20" x 26" with milled grooves for miter and fence. Large Base 18" in diam. holds unit firm for accurate operation. 24" adjustable Aluminum Fence with steel guide. 8" Rip Blade raises or lowers for various thicknesses. Two 10 1/2" Miter Gauges accurately graduated in degrees. Shipping Weight 185 lbs. complete with 1/2 H.P. motor. Write at once for literature and prices.

BLUE STAR PRODUCTS

617 W. Kirkwood Street, FAIRFIELD, IOWA

Established in 1921

A Division of St. Paul Foundry & Mfg. Co.

• MOHAWK CHIEF •



TRUE AIRCRAFT CYLINDER
NOT CAST IRON OR ALUMINUM
WITHOUT LINER

One-piece steel cylinder
Deep cylinder fins
One-piece crankshaft
Aluminum crankcase
One-piece steel piston
Bakelite fuel tank
Easily adjustable timer
Precision needle valve
Aluminum connecting rod
Champion spark plug
SPITFIRE COIL with high
tension lead — \$1.95

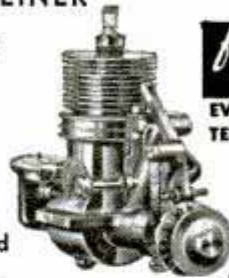

for only \$8⁹⁵

EVERY ENGINE BLOCK
TESTED & GUARANTEED

Specs. — 29 Disp. 'B'
2-10,000 RPM
Weight — 7 oz.

See local dealer or
order from factory
... adding 25c for
handling. If you prefer,
send \$1 and we will ship C. O. D.
for the balance.

MOHAWK ENGINEERING CO., MOHAWK, N. Y.



MIKE Jr.

NOW ONLY \$169

SING—TALK—AMUSE YOUR FRIENDS—
through your own radio set. Practice to become an an-
nouncer. Simple to install—Not a Toy.

SEND NO MONEY—WRITE TODAY

Just send your name and address and when your MIKE
Jr. arrives, pay postman \$1.69 plus few cents post-
age. Sent postpaid if check or money order accom-
panies your order. No stamps.

MART DISTRIBUTORS, Dept. P-18, Box 3472 Merchandise Mart, Chicago 54, Ill.

NEW! LOW COST! RESPIRATOR

Wear when sanding, grinding, paint spraying,
sweeping, dusting, furnace cleaning, etc. Handy as
a pair of glasses. Just keep mouth closed and
breathe through nose is all you do to operate. Pro-
tects against nuisance dusts, lint, coal, cement,
grain dust, hay fever pollen. Has 9 sq. in. filter.
For EYE protection against paint spray, dusts,
gases, fumes, smoke, order our Fog-Proof Rubber
GOGGLES \$2.00 p.p.



Order Today \$1⁰⁰
POST PAID

JERRY BRYANT, Dept. PM
919 N. Michigan Ave. Chicago 11, Ill.

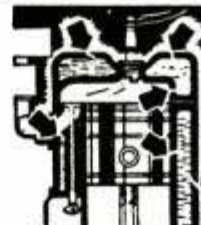

REPAIR CRACKED BLOCKS AND HEADS—

External and internal leaks in blocks,
cylinders and valve ports quickly and
easily with LUSCO PLASTIC SEAL.
90 day Service Guaranteed or your money
back. Send money order or
check for full pint—more than \$3.00
sufficient for average repair. . . Postpaid

C. F. LUSK CO., 5924 BONNA AVE., CLEVELAND 3, OHIO

New Scientific "GUZZLIN CHARLIE"



MYSTERY DRINKING BIRD WITH
ROLY POLY EYES

\$1⁹⁵ Complete with stand. No
springs, no gadgets, no
wires, not mechanical. Amaz-
ing "Guzzlin Charlie" drinks
and drinks; he is always
thirsty. You won't believe your eyes.
Young and old go wild over him.
Mail your order today.

ELECTRIC LIGHT JAZZ BOW TIE!

Astonish, amaze your friends.
Be the life of the party. Have
lots of fun. Easily put on.
Flashes on and off by simply
pressing battery button hidden
in your pocket. Complete with attractive
bow tie, cord, two bulbs and battery. 2
Unique Xmas Gifts. Mail your order today.
Special prices on all articles to dealers.

\$1⁹⁵



BERNARD FINE CO., INC.

501 Sixth Ave. Dept. PM6 N. Y. 11, N. Y.

WHAT'S YOUR NAME?

PERSONALIZED LIGHTERS . . . JUST FOR YOU!



We've Got It!

Inscribed in Clear Script on the famous

STRIKALITE POCKET LIGHTERS

Yes — we've got over 2500 names in stock! That's why we can offer you these fine personalized Strikalite Pocket Lighters at the incredibly low price of only 3 for \$1.00.

Over 18,000,000 Strikalites sold. Attractive, dependable lighters in a variety of gay colors with lustrous Pearl-Glo finish. 2 1/4" in length. Unsurpassed in mechanical perfection—we guarantee it for life!

You'll want one for yourself and several for your friends. You'll use them for social gifts and business gifts. It's the new way to win friends and influence people—a sure-fire gift that every smoker will appreciate.

NO WAITING — PROMPT DELIVERY

Enclose check or money order for quantity desired. Print names you wish inscribed clearly. Money back within 5 days if not completely satisfied.

JACK AVEDON PRODUCTS CORP., 10 W. 33rd STREET, NEW YORK 1, N. Y.

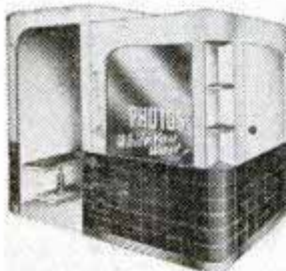

UP TO \$600 WEEKLY

with new 5 min. photo equipment.

No experience necessary.

Booth models—for your own small store location, arcades, department, variety, other stores, lobbies, depots, carnivals, parks, beaches, etc. Portable models for street corners, parks, near schools, picnics — anywhere.

Send 3c stamp for **BIG PROFITS Plan.**

FEDERAL IDENTIFICATION CO.
Dept. A-3, 1012 N.W. 17th
Oklahoma City, Oklahoma

THE Improved 16 mm Battery Drive - Magazine Load LEKTRO Jr. MOVIE CAMERA



Simple to Operate. Easy to Load—standard Kodak film magazine. Economical. Complete — Battery, Cord, Tripod Socket. Original Value over \$200. Never needs winding or film threading. Kodak Super-X 50 ft. Magazine — 16 MM. Gov't stock. Panchromatic. Weston 32. Tested, Guaranteed. Price **\$59.50** case add! includes processing

Special! FOTOSHOP

Dept. 1-PC, 18 E. 42nd St.
136 W. 32nd St., N.Y.C.

SAY YOU SAW IT IN POPULAR MECHANICS

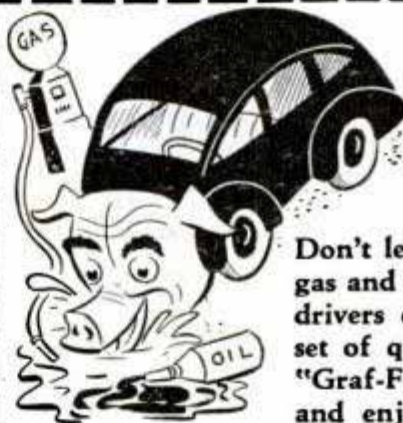

IS YOUR CAR A HOG?

Don't let your car "hog" gas and oil! Do what race drivers do . . . install a set of quick-seating Burd "Graf-Flox" Piston Rings and enjoy fuel economy plus pep and power!

Two free, handy booklets for car-owners are yours for the asking. Just print your name and address in the margin, alongside this ad, clip and mail today.



BURD PISTON RING CO., DEPT. 'PM, ROCKFORD, ILL.

AMERICA'S BIGGEST TOOL VALUE \$17.95 27-PIECE WRENCH SET—only

"IT'S FUN TO FIX" Here's the wrench set that everybody wants — for home, store, garage, farm, or shop—a set made to sell for \$30.00! Just think—22 socket wrenches and handles for hex nuts up to 1", a 14" pipe wrench for all pipes and fittings up to 1 1/2", a 7 1/2" gripping plier for small rods and countless ordinary uses, an 8" adjustable wrench to fit square nuts up to 1"—and two deluxe steel carrying cases!

MADE FOR MECHANICS!

The Perfect Gift For Any Man

These are hard-to-get tools, manufactured of finest alloy tool steel, hot forged for greater strength and wear. Of modern design. Inspected 13 times during manufacture, assuring top quality and finish! Chrome plated—guaranteed to satisfy, or money back! With this set, you'll have the right wrench for every use. The supply of these sets is limited. **SO ORDER YOURS TODAY!** Sent postpaid for only \$17.95.

TODD TOOL COMPANY



HIGHLAND PARK, ILLINOIS

2 BIG SPECIAL BARGAINS at LOW PRICES

BRIGGS & STRATTON LIGHTING PLANTS AND SPERRY S-1 BOMB SIGHTS

110 Volts D.C.



Made For the Government: All NEW . . . Never Used

BRIGGS & STRATTON Portable Lighting Plant priced at a fraction of the original cost. Built to rigid Government requirements. Especially built for Field Use or for permanent installation in Cottage, Farm, Trailer, Boat, etc. Complete with 1 3/10 H.P. Gasoline Engine, Hand Starter, Rated 250 Watts will develop 500 Watts. With Spare Parts and Tools. Mounted on permanent base . . . Rubber cushioned . . . Ready for Immediate Use anywhere . . . At this LOW PRICE they won't last long . . . Better Hurry only \$129.50.

SPERRY S-1 BOMB SIGHT—Here is an unusual opportunity to get one of these MARVELOUS Precision Mechanical Instruments . . . Marvelous beyond description. Contains hundreds of parts usable in 1001 ways . . . Regular and Bevel Gears, Shafts, Approx. 100 Roller Bearings, Electrical Parts, Precision Lenses and Prisms, Countless Gears, Dials, Knobs, Switches, Polaroid Filter, Calibrated Dials for Air Speed, Drift Indicator and Illuminated Spirit Level, Gyroscope, etc. . . . Excellent for Inventors, Experimenters, Hobbyists. Schools use for Study Demonstration.

Cost U.S. Gov't \$4,500



Complete on Metal Base and Strong Box Container with Lock (can be used for valuables)

ALL FOR— ONLY

\$49⁵⁰

COMPLETE WITH POWER PLANT. ONLY **\$129.50**

Cash with order or we will ship C.O.D. if 25% deposit accompanies the order. These prices F.O.B. Chicago.

5 More Big Specials

- BRAND NEW . . . 24 Volt 915-4F . . . AVIATION STARTERS . . . ONLY \$35.00 Each
- BRAND NEW . . . B-11A-EA . . . ECLIPSE AVIATION Vacuum-Air-Hydraulic FUEL PUMP . . . Original cost \$45.00 . . . ONLY \$ 9.50 Each
- BRAND NEW . . . N-9-1 . . . GUN REFLECTOR . . . Ideal for Photo Enlarger. 3 1/2" Lens: Convex and Concave 2" Highly Polished Mirrors . . . ONLY \$ 5.95 Each
- BRAND NEW . . . A-8-B . . . OXYGEN MASKS: can be used for Spraying, Electric Welding, Printing, Grinding, Tree Spraying, etc. Made of Genuine Rubber With Sponge Filters . . . ONLY \$ 2.75 Each
- BRAND NEW . . . B-11 . . . SAFETY BELTS: for many uses . . . On Farms, Homes, Industrial Safety and on Jeeps . . . ONLY \$ 2.75 Each

ACE SURPLUS SALES CO., Inc., 1449 West 69th St., Dept. P-11, CHICAGO 36, ILL.

DEALERS: Write For Quantity Prices . . .

Amazing!

Yes, amazing the value and features you get in this 15-shot repeater—sleek streamlining, latest Mossberg sighting equipment, famous Mossberg "Master" action.



Model 46M—.22 cal.
15-shot, bolt action
tubular repeater \$27.95
(\$28.60 west of Rockies)

SEE IT
AT YOUR
DEALERS

No sales at factory.
Free catalog on request.

O.F. Mossberg
& SONS, INC.

76511 St. John St., New Haven 5, Conn.

New MILLING ATTACHMENT

Sizes for 8" to 16" metal lathes

BUILD IT YOURSELF from our sets of semi-machined castings and save \$8. Can be finished on your lathe alone. Complete working drawings and step-by-step instructions furnished with castings.

Mill keyways, slots, splines, dovetails, flutes in reamers, taps, hobs, and special cutters: produce spur, bevel, mitre and worm gears, ratchets and racks; mill flat surfaces, square shafts, mill hexes, spot face, drill spaced holes, bore, etc. on your lathe with this precision attachment. It has a T-slotted table, a vise which swivels for angular milling, a gear cutting fixture and dividing centers.

FREE! Illustrated folder and price list. Includes milling cutters, keyway cutters, drill rod, slitting saws and many hard to get shop items. Mention your lathe. Write today.

HURON MACHINE AND TOOL CO.
YALE 4, MICHIGAN

Breaks the GRIP of RUST!

When corroded threads refuse to let go . . . that's the time to apply KROIL the amazing new chemical that creeps into millionth inch spaces, dissolves rust and dried grease and supplies lubrication.

KROIL LOOSENS FROZEN PARTS

Rusty nuts, bolts, shafts, bearings, bushings, pipe threads, all yield to this new chemical tool—or your money back!

At your dealers, or send \$1 for a pint in 2 spout cans, post paid. (Send dealers name.)

(Dealers, write for discounts)

KANO LABS.
3021 Lincoln Tower Chicago 1, Ill.

THERE'S PROFIT in ELECTRICITY—LEARN from PRACTICAL ELECTRICS, \$1.00



Whether you want to enter the electrical field as a profession—or whether you want to know more about fixing electrical gadgets around the house, you will find Practical Electrics a profitable investment. You can find the right answers quickly. It gives you the

fundamentals of electricity, electrical circuits, motors, transformers, electrical symbols, trouble shooting, etc. —all in plain, simple, understandable language. Send \$1.00 today for a copy of Practical Electrics, the ready reference book of electricity.

AUTOPOWER, INC., 2118 PINE STREET, ST. LOUIS 3, MISSOURI

Does More Grinding Operations

FASTER!

because it's an
Abrasive Belt
Grinder CN-2
by
PORTER-CABLE



The CN-2 increases output over ordinary bench grinder by 200%... because it eliminates wheel loading, wheel digging, wheel dressing. Cutting element—the abrasive belt—keeps sharper longer. Reduces operator fatigue. Maintains high production all day.

Grinds on contact wheel, platen or free belt. Use the CN-2 for deburring, bevelling, chamfering, clean-up, knocking-off corners... and for many other operations in assembling and machining departments, tool rooms, job shops, service stations, home shops.

Easily adjusted for vertical or horizontal use within 90° arc. Weighs only 60 lbs. Furnished with or without motor. Model for connecting your bench grinder also available. Write today for full information. Ask for demonstration by local Porter-Cable distributor.

PORTER-CABLE MACHINE CO.
2050-11 N. Salina Street Syracuse 8, N. Y.

The **Flex-O-Shaft TOOL KIT**
HANDLES LIKE A PEN*



A new improved, all-purpose machine for use in home or shop. The slender, light-weight aluminum hand piece is ideal for grinding, drilling, sawing, buffing, scoring, etching, polishing, and scores of other uses. No bulky, throbbing, pulling motor in your hand. Light-weight motor can be hung on wall. Speed is controlled by a foot-operated rheostat, leaving your hands free. This precision, ball-bearing tool is as easily guided as a pen or pencil. A wonderful, compact power house for making all kinds of objects. So easy to move around, it is handy for school shops and factories.

SAVE \$10.00:

1/16 H.P. Motor—6-ft.
cord and switch \$27.50
Foot-operated rheostat
with long cord and
plug \$ 8.50
Sixty-six accessories . . \$16.50
\$52.50

All for only
\$42.50
when you buy
the complete
FLEX-O-SHAFT
Tool Kit

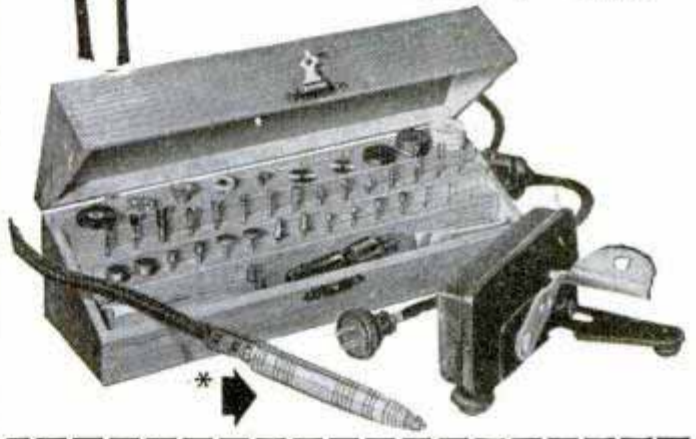

Flex-O-Shaft Sales Co. (Dept. C)
Prairieview, Illinois

Please send complete information on the Flex-O-Shaft Kit.
 Please send one Flex-O-Shaft Kit. \$42.50 enclosed. Shipping charges C.O.D.

Name _____
Address _____
CITY _____ Zone _____ State _____

SAY YOU SAW IT IN POPULAR MECHANICS

LAW

STUDY AT HOME for PERSONAL SUCCESS and LARGER EARNINGS. 39 years expert instruction—over 108,000 students enrolled. LL.B. Degree awarded. All texts furnished. Easy payments. Send for FREE BOOK. G. I. approved. **AMERICAN EXTENSION SCHOOL OF LAW** Dept. 83-M, 646 N. Michigan Ave., Chicago 11, Ill.

BUILD YOUR OWN TRAILER



Get these Modern Complete Plans

Select just the model you want—for hunting—travel—camping—or as a home. Each plan is complete with simple, step-by-step instructions and a bill of materials. Easy to follow. Three models!

STOCK No. H27 NATIONAL MODEL 27. A sleek 27-foot trailer with 3 rooms, lavatory, etc. Sleeps six. complete plan \$1.00
STOCK No. H20 NATIONAL MODEL 20. A good-looking, easily-built 20-ft. trailer. 3 rooms, sleeps four. complete plan \$1.00
STOCK No. H10 NATIONAL CAMPER. A compact unit for traveling, camping, hunting, fishing. Sleeps two. Complete plan .50
Special—Order all 3 of above plans....\$2.00

FREE! Big parts catalog with any order

NATIONAL TRAILER STORES

Dept. 10 Box 2353 Terminal Annex — Los Angeles 54, Calif.

SURPLUS BARGAIN SPECIALS

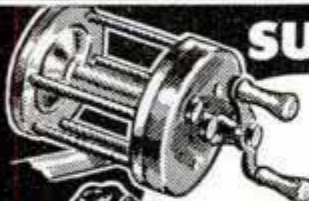

MAR-100 **Marquette LEVEL WIND REEL**

Rugged, free casting, precision built, anti-backlash reel for better casting. Positive built-in clutch eliminates spinning of crank lever while casting. Line cap—12 lb. Test. 100 yards—Wt. 8 oz. In Xmas Gift Box. \$20.50 value. **\$10.65**



CA-20 **Leather CAPESKIN JACKET**

Made of tough, long-wearing tanned capeskin—warm lining. Belted back, adjustable side straps—2 side pockets, 1 chest pocket. Zipper front. **\$15.95**
\$24.95 value.

WJ-682 **RAIN JACKETS** Reg. Navy— **\$1.49**
Water-repellent. Non-rust metal snaps.

FREE bulletin listing many Amazing Bargains. Send for your copy TODAY!

Protexit **FLYROD CASES**

Durable, waterproof, light-weight aluminum with satin finish. Cork padded lining in ends for protection of rod. 36", 38", 40", 42", 44" lengths.

RC-100 \$4.45 • RC-200 \$5.45
Dia. 1 1/2" Dia. 2 1/2"

SAVE at these LOW PRICES

Order direct by catalog number from this ad. Send check or money order. Add 10% for postage—any overage will be promptly refunded. All prices FOB L.A. Send 25% deposit on COD orders. No COD less than \$5.00. Money back if not satisfied.



WB-352 **WET STORAGE BATTERY**

4 3/4" x 4 3/4" x 6 3/4" — 6 volts, 3 cell, 15 Amp. Ideal Battery for Midget Racers... for miniature trains, laboratories, home workshops. Terrific **\$4.95** value.

UNITED SURPLUS

1665 N. SYCAMORE, DEPT. 11-M
LOS ANGELES 28 • CALIFORNIA

NEW FOUNTNBRUSH

Flo-master

**WRITES, MARKS, DRAWS
ON ANY SURFACE!**

For home, office, plant, farm!

Ideal for marking all kinds of things—freight, parcel post, express, children's clothing, price tags, display signs, sketches, drawings, graphs, charts, laundry, canning jars, frozen foods, etc.

The instant-dry ink gives a clean, legible impression on wet or dry surface, smooth or rough, hot or cold. Permanent and waterproof. Black and 7 brilliant colors.

Special felt nibs give fine, medium or broad line (up to $\frac{3}{8}$ inch). Automatic valve controls ink flow by writing touch; prevents leaking, flooding or sweating. Carry in pocket like fountain pen. Satin finished aluminum.

Saves you as much as 50% out of every dollar you'd spend for costly crayons, chalk, pencils. Lifetime guarantee.

At leading stationery, art supply and hardware stores. Or send check to Cushman & Denison Mfg. Co., 135 West 23rd St., New York 11, N. Y. Write for illustrated folder.

*Pat. Applied For

**ONLY
\$3.00**

Flo-Master
Fountnbrush
 $\frac{1}{2}$ oz. ink
3 asstd. nibs
\$3.25 in West.



a small investment

will establish you in . . .

Your OWN Business

We are NOW enlarging our organization of U.S.A. and Canadian DURACLEAN dealers, in territories still open. Here is an opportunity to **BE YOUR OWN BOSS . . .** to become financially independent with a business of your own!

You become a fabric specialist, providing the proper cleaning and moth protection for upholstery and floor coverings. You use the proven, successful methods of established dealers. Service is rendered right in the home, office or institution without removing furnishings.

DURACLEAN Service was established 17 years ago as an improved method for cleaning and revitalizing rugs and furniture. No brush machine rubbing, soaking or shrinking. No inconvenience for the customer.

DURAPROOF makes fabrics and rugs repellent to moths, carpet beetles and mildew.

These services have a waiting market . . . a big repeat business. Write today! A letter and 16 page illustrated booklet will explain everything.

- No Overhead Expense
- No Shop Necessary
- No Experience Needed
- You Learn Quickly, Easily
- Short Hours . . . Large Profits
- Service Nationally Advertised

Don't delay! Territories are limited. Remember, just a moderate payment, easy terms, and the opportunity to become financially independent in **YOUR OWN BUSINESS!**

DURACLEAN CO., 16 N St., Deerfield, Illinois



Patented

Write for
**FREE
Booklet**

• Test ALL Home Outlets
• Find Open Circuits

STAR TEST-PLIERS

• Locate Blown Fuses
• Remove Fuses SAFELY

A must tool for electricians, maintenance men, home owners. Replaceable lamp inside Plier tests 110 to 250 Volts. Plier pulls fuses from 10 to 100 Amperes. Shockproof. Requires the use of only one hand. Can be obtained from General Electric or Westinghouse stores, or from local electric dealers.

Order one TODAY

Price \$2.75 without Leads, \$1.50 additional for Leads

STAR FUSE CO., 233 Canal St., New York 13, N. Y.

GET A GENUINE DELTA REDDYLite ELECTRIC LANTERN

6-volt. Shoots beam 800-ft. Light revolves in a circle—"stays put" at any angle you set. Dozens of uses. Buy at hardware, sport, and electrical stores.

\$2.98
less battery



Delta ELECTRIC CO.
Marion, Indiana

\$2.95

TORNADO GAS TORCH

The Modern Way of Soldering

Ideal for hard and soft soldering. Will heat quickly; solder will flow freely and smoothly. No compressed air required. Self-adjusting. Safe. Economical. Can be used for annealing small parts and bending metal parts. Generates a heat of 1700° F. Simply connect to any illuminating gas jet with a rubber hose and operate. Tornado Torch No. 119 comes with three tips, ($\frac{1}{8}$ ", $\frac{1}{4}$ ", $\frac{3}{8}$ " blast).

Tornado Gas Torch No. 119 — Complete with 2 tips, for Natural Gas or Bottled Gas; with 3 tips for Manufactured Gas. \$2.95 per set. See your dealer or order direct. Send check or money order — post paid.

Robco Corporation, 202 E. 44th Street, New York 17, N. Y.

New PERSONAL RADIO... Pocket Size



This little radio is substantially built and is so constructed that, if dropped, it will not break. It has a beautiful red leatherette case. May be carried in your pocket wherever you go. Reception is guaranteed when used according to instructions.

There is no cost in operating this radio as there are no tubes and no batteries to buy, and no electricity needed. Instead, the new "Crystal diode" rectifier same as used in Army and Navy ultra hi-frequency radar sets is being employed. It is not a toy, but a practical little radio for football or baseball games, news reports, or your favorite program. It is especially good to listen to in bed, or in hospitals, dormitories, barracks, and offices because it is not heard by anyone but yourself.

Send only **\$1.00** (check, money order, cash) and pay postman **\$3.95** plus delivery fees, or send **\$4.95** for postpaid delivery.
SHESS MFG. CO., LAKE GENEVA, WIS.

ELECTRIFY

Your Sewing Machine With a
"SEWING MACHINE MOTOR KIT"
 The IDEAL GIFT for Mother... Wife... Sister!

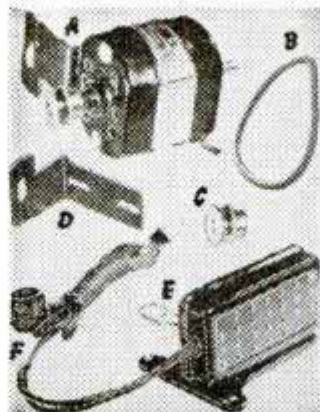
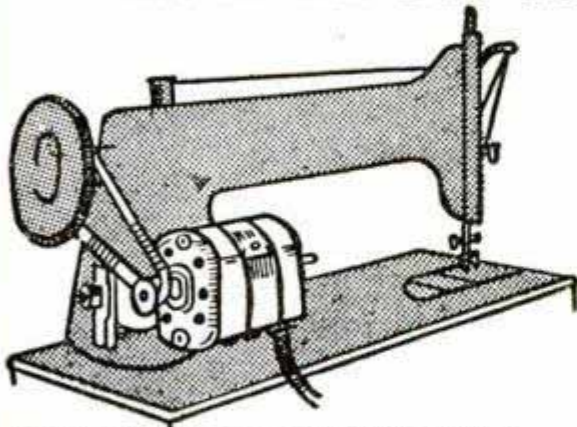

\$17⁷⁵
COMPLETE

ADJUSTABLE FOR USE WITH ANY TYPE OF SEWING MACHINE

ANYBODY CAN INSTALL IT!

Takes but a few seconds

COMPLETE SET CONSISTS OF:

(A) MOTOR & BRACKET—Universal AC or DC, 60 cycle, 115 Volts. (B) BELT—Long Wearing Rubber Belt. (C) PULLEY—Single Grooved Steel Hubbed Pulley. (D) BRACKET—New and Improved. (E) FOOT CONTROL—7 Step Rheostat. (F) CORD SET—Extension Cord fitted with plug and socket. (G) Installation Instruction Sheet.

SPECIAL NOTE: This 1/20 H.P. motor with double end shaft and rheostat can be used in all hobby workshops for flexible shaft attachments, grinding, drilling etc.

Special Offering to DEALERS!

MAIL THIS COUPON

Dept. M

BROWNELL DISTRIBUTORS, INC.

308 Canal St., New York 13, N. Y.

Please rush _____ motor kits at \$17.75 each (postage pre-paid) in:

money order or check
 send C.O.D.—and I'll pay postman \$17.75 plus C.O.D. fees.

Name _____

Address _____

City _____

Zone _____

State _____

BIG MONEY and YOUR OWN BUSINESS

in

LIQUID IVORY



FREE INFORMATION ON A GREAT NEW MONEY MAKING OPPORTUNITY

SEND FOR
FREE
 DETAILS

Regardless of your age, sex, previous experience, we will send you astonishing free facts about the great possibilities—in your own business—with amazing LIQUID REPLICATED IVORY. To secure this information, absolutely free, fill in coupon below or send a letter or postcard. No salesman will call on you now or ever. Write TODAY! Offer limited!

LIQUID IVORY is one of the most marvelous synthetics developed in years. With it you can easily and simply produce a wide variety of wonderful items that almost defy detection from genuine ivory. No expensive equipment is needed. You can work in a corner of your basement or garage with a few hours of work producing handsome profits. Here is unexcelled opportunity for all ambitious people that want a profitable business of their own.

GREAT OPPORTUNITIES NOW!

Stop being a slave to a time clock! Stop worrying about layoffs and depressions stealing your livelihood. NOW is the time to line up your own money-making business. We offer this great opportunity to aggressive people. Get into your own profitable business with LIQUID IVORY. Get the FREE FACTS today!

Copyright 1947

A MONEY-MAKING BUSINESS FOR THE LITTLE MAN! NO EXTENSIVE CAPITAL NEEDED!

Forget big investment worries. We tell you how to get your own fast-moving business going with very little money. We feature only one sound business course. You will never find us confusing this successful vocation with other diverting business ideas. We tell you all about one great business and how you can make money in it exclusively. Write for full FREE information today!

FREE INFORMATION COUPON

EMPIRE TRADES & HANDICRAFTS, BOX 1340-PM-11, ST. LOUIS, MO.

Please send me free details about your BIG money making LIQUID IVORY. I am anxious to get started in a profitable business of my own. Please rush!

Name _____

Address _____

City _____

State _____

EMPIRE TRADES and HANDICRAFTS
 Box 1340 PM11 St. Louis, Mo.

112 Booklets filled with Money and Time-Saving Helps

Little Library of Useful INFORMATION

5 for \$1.00
12 for \$2.00
25¢ Each

Here at amazingly low cost is the practical help and information you have always wanted. Articles in previous issues of Popular Mechanics have been classified according to subject and are now available in these handy reprint booklets. Check Titles wanted, clip ad and mail today.

* 1947 titles.

WORKSHOP EQUIPMENT

Power-Driven Saws—74: Complete details on scrollsaw, two circular saws, sliding cut-off saw, bandsaw.
Drill Presses, Plane, Grinders—79.
Sanders—80: Complete constructional details on 8 useful machines.
Wood & Metal-Turning Lathes—81: Two wood lathes, small metal-turning lathe.
Filing Machine, Hacksaw, Cutoff Wheel, Shaper—82.
Metal Lathe Tools You Can Make—101.
Workbenches & Tool Cabinets—47.
Spray Painting—94: Constructing spray guns, compressor, using spray gun.
From Pattern to Casting—91: How to make your own patterns and small castings.
***Handy Farm Implements—114:** Grain elevator, dump truck, spreader and cover.
***Tractor Attachments—116:** Buckrake, stacker, scoop, auger and spray attachment.
***How to Build a Concrete Block Machine—110.**

SHARPENING—USING TOOLS

Correct Measurement—106: How to use micrometers, gauges, calipers, etc.
Tool and Saw Sharpening—92.
Using & Sharpening Drills & Wood Bits—90.
Successful Wood Turning—32: All the information you need to master this art.
How to Read Blueprints—71: Tells you how to understand signs, symbols, and lines.
Metal Turning Lathe Kinks—99: Simple homemade tools, time and labor-saving shortcuts you can use.
Operating a Metal Turning Lathe—100.
Heat Treating & Case Hardening—102.
Working with Glass—103: Cutting, drilling, etching, blowing.
***Using Basic Tools—120:** How to use hammer, files, screwdriver, and cold chisel.

ELECTRICAL BOOKLETS

Rewinding & Servicing Electric Motors—75: Repairing and rewinding a.c. and d.c. motors. Locating trouble. Converting auto generators into 110 v. a. c. converters.
House Wiring—89: All the information you need to do a complete wiring job or install extra outlets.
Electromagnets & Solenoids—44: Designing and building.
Transformer Construction—41: Easy-to-understand instructions for all transformers.
The Boy Electrician—43: Easy-to-build motors, experiments.
Soldering & Brazing—17.
Arc & Spot Welders—5: Building and operating 110 v. a. c. arc and spot welders.
Electroplating with Copper, Nickel, Chromium, Lead, Zinc, Cadmium—86.
Plating Leather & Other Non-Metallic Objects—Plating with Gold, Silver, Alloys—87.
***How to Fix Electrical Appliances—111:** Repairing clocks, washing machines, vacuum cleaners, electric irons, cords, small motors, etc.

HOME IMPROVEMENT BOOKLETS

Simple Home Improvements—104: Modernizing; making storm sash, ironing boards, etc.
Building Extra Rooms in Attic—23.
Attractive Basement Playrooms—24.
Lower Your Fuel Cost—31: Practical kinks that will save you hundreds of dollars.

Hanging Wallpaper—38: Tricks of hanging wallpaper, removing old paper, etc.
Curing Leaky Basements—45.
Fitting Home Game Room—55: Construct own game & tennis tables, shuffleboard court, action game, portable playrooms.
Ridding the Home of Insect Pests—107: Exterminating and protecting against moths, flies, termites, mosquitos, etc.
Built-In Fixtures—78: Step and space-saving kitchen units, built-in beds, corner cabinets, vanities, linen chest.
Constructing Indoor & Outdoor Fireplaces—88: Stone fireplaces, portable mantels, garden fireplaces.
***Painting Your House Inside and Out—117.**

GARDENING BOOKLETS

Backyard Gardening—39: Selecting, planning and getting the best results.
Lawn & Garden Novelties—72: Jig-sawed ornaments, parkway numbers, sundials, flower boxes.
Trellises, Pergolas, Fences—76.
Lawn & Garden Furniture—77: Modern bent-tube furniture, arbor and seat combinations, swings, lawn chairs.
Playground Equipment—73: Two playhouses, ferris wheel, roller coaster, treadmill, play store, slide, two merry-go-rounds.
Colored Concrete Garden Furniture—6: Garden benches, pottery, flower boxes, bird baths and sundial pedestals in colored concrete. How to build small concrete mixer.
Bird Houses—7: Easy to build homes for all kinds of birds.
Farm & Garden Tractors—8: Two tractors you can build from old automobile parts.

CRAFT WORK—HOBBY BOOKLETS

Working with Plastics—61: Using brilliant-by-colored plastics in craftwork.
Magazine Racks—49: Ten attractive racks.
Clock Cases—50: Large Hall, Colonial wall and mantel, ship's wheel, miniature grandfather, desk, Spanish style banjo.
Serving Trays for Every Occasion—53: Fourteen different designs.
Children's Room Furniture—51: Twelve attractive pieces.
Book Ends—52: Ten designs offer good selection.
Small Tables—54.
Smoking Stands—56: Seven designs given.
Jigsawed Novelties—57: Sewing kits, string holders, place-card holders, plywood kitchenware, plant and flower holders, coin banks.
Desks—58: Colonial writing desk, two modern-type desks, student's study desk of plywood, combined chest and writing desk.
Book Cases—59: Eight designs.
Doll House & Doll Furniture—60.
25 Shelves You Can Make—64.
Novelties Turned on Lathe—62.
Inlay Pictures—Veneering—63.
Whittling and Wood & Soap Carving—65.
Action Toys—66: 21 easy-to-make toys.
High Flying Kites—67.
Windmills & Weathervanes—68.
Lamps in Wood, Metal, Plastic—69: Selection of 14 designs.
Metal Craft—28: Brass tapping and making of novelties both decorative and useful.
Small Looms—37: Building hand looms for weaving rugs, etc.; leather novelties.
Plain & Novelty Wood Finishing—40.
Gem Cutting—42: How to cut and polish semi-precious stones.

Rustic Furniture—18: How to build chairs, benches, tables, gates, summer house, etc.
***Projects in Plastics—112.**
***Bows and Crossbows—115.**
***Marionettes—113:** Designing and operating puppets, how to build stage and backdrops.

BOAT BUILDING BOOKLETS

Build a boat at home—you can do it
14 Ft. Outboard Runabout—2: Here is a fast 14 foot V-bottom boat. Suitable for motors of 4 to 24 hp., estimated cost, \$30 to \$40.
14 Ft. Sailing Dinghy—26: This 14-foot boat combines strength and light weight. It carries 140 sq. ft. of canvas and weighs about 350 pounds. Actual photographs and diagrams illustrate every detail.
21 Ft. Sloop—46: Every fact needed by the amateur boat builder to construct this craft which carries eight to ten persons.
Rowboats, Bicycle Boat, Small Dinghy—83.
Small Sail Boats—84: 12-ft. sailing dinghy, 6-ft. "training ship" for young sailors, how to sail a boat.
Two Outboard Runabouts—85: 14-Ft. family outboard weighs about 400 lbs. and 12-ft. plywood outboard weighs about 110 lbs. Both are V-bottom type.
Build Your Own Canoe, Kayak, Surfboard—30: Complete details on 16-ft. Canadian-type canoe, 17-ft. kayak, and 12-ft. hollow surfboard.
Fast Class-E Ice Yacht—22: Build your own Class-E ice yacht.

AUTOMOBILE BOOKLETS

Automobile Kinks and Shortcuts—10: Money-saving hints on upkeep, operation.
Building Trailers—27: Small streamlined house trailer; several utility trailers.
Motor-Driven Midget Car & Scooter—34: Both use gas engine of washing machine type.
Curing Auto Electrical Troubles—95.
***House Trailer—121:** Complete instructions and diagrams for building modern 17 ft. trailer.

PHOTOGRAPHY BOOKLETS

Photo Enlargers—1: Condenser lens type; simple vertical; horizontal.
Photo Printers and Dryer—25: Describes three practical printers, timer and negative dryer.
Photo Darkroom Equipment—96: Cabinets, light-tight box, timer, agitator, washer.
Picture Projector, Trick & Table Top Photography—97: Projectors that enlarge magazine illustrations and shop drawings. Tips for table toppers, photomontages, tricks.
Photo Kinks—98: 63 time and money-saving ideas you can use.
***Photo Lighting—119.**
***Home Movie Equipment—118:** Converting projector to sound, making titter, film cleaner, projector stand.

FORMULA BOOKLETS

Cleaning Preparations—11: Easy-to-make cleaners for walls, glass, etc. Removing fabric stains.
Cosmetic Formulas—12: Hand lotions, creams, rouge, bath salts, beauty clay, lipsticks, etc.
Re-Silvering Mirrors—70: Formulas for silvering and coloring.

MISCELLANEOUS BOOKLETS

Knots and Ropework—105.
Chemical Experiments—93: Easy-to-perform experiments. Inexpensive lab.
Taxidermy—9: How to prepare skins and obtain life-like poses.
Log Cabins & Tourists Cottages—14: Year-round log cabins; inexpensive tourists' cabin.
Magic for Everybody—29: Simple tricks to puzzle your friends.
Trapping Small Animals—33: How to lure fur bearers, prepare bait and traps, dress skins.
Tricks of Training Your Dog—35.
Small Furnaces—36: Gas or electric.
Telescopes—20: Design and construction.
Poultry Houses—108: Structures, brooders and incubators.
Guns and Decoys—109: Cleaning, shooting; making decoys.

POPULAR MECHANICS PRESS,
200 E. Ontario St., Chicago 11, Ill.

I enclose (U. S. bills may be mailed if carefully wrapped)
for "Little Library" booklets numbers:

.....
.....
.....
Name Zone
Address
City State

WINTER CLOTHING

1. **BOOTS**, Aviator's leather, rubber soles, pure 1/2" thick shearing lining. 10" high. Fits over shoe size 9 and above. Reclaimed, new zippers! \$ 5.95
2. **JACKET**, Aviator's leather, genuine shearing lining, full collar, zippered front. Reclaimed, redyed, has some patches: world's cheapest price..... \$ 4.95
3. **CAP**, Aviator's baseball style, Khaki, long bill; has ear and chin flaps for winter..... \$ 1.50
4. **CAP**, leather, shearing lining, AAF B-2 type, square visor, ear flaps \$ 2.50
5. **HELMET**, AAF A9, wool gabardine, OD color. Keeps head and ears warm! 2 for..... \$ 1.00
6. **HELMET**, AAF B-6, pure soft leather (brown), rich shearing lining \$ 1.50
7. **GLOVES**, AAF B3A, pure soft leather (brown), 12" length, light weight \$ 2.95
8. **GLOVES**, gauntlets, soft pony leather, shearing lined, 3 fingered type, 12" length..... \$ 5.95
9. **RAINCOATS**, G.I. style, reclaimed..... \$ 1.50
10. **UTILITY BAGS**, canvas, with shoulder strap, (gas mask type), 2 for \$ 1.00

SURPLUS BARGAINS

11. **SUN GLASSES**, Pilot's type, green ground lense, 14k plated frames, reg. \$10, now..... \$ 4.95
12. **GOGGLES**, flying, type An6530: clear lense (not plastic), rubber face mask, elastic head bands; ideal for cyclists, race cars, pilots, etc..... \$ 4.95
13. **CLOCKS**, 8 day type (airplane), with sweep second hand, 2" face size. Either Elgin or Longines, state which. Reg. \$38.50, now \$20.00
14. **COMPASSES**, Airplane Airpath type, magnetic, 3" mounting face, now \$ 7.95
15. **SAFETY BELTS**, Rusco airplane type, 2 1/2" width, with safety locks; ideal for seat fasteners for air boats, snow boats, race cars, etc..... \$ 1.50
16. **HAND LANTERN**, stainless steel streamlined case, plastic lense, 2 bulbs, has toggle switch (uses regular dry battery 6V, not furnished) \$ 2.95
17. **AVIATION BOOK**, "Bart's Aero-Quiz Book," over 1200 test yourself questions with answer blanks and answer keys. Test yourself! 75c, 2 for..... \$ 1.00
18. **PROJECTOR SLIDES**, fits all slide projectors, assortment of 50 airplanes \$ 2.95
19. **AIRCRAFT HARDWARE**, assortment nuts, bolts, screws, rivets, clamps, etc. 10 lbs..... \$ 1.95
20. **RADIO HEADPHONES**, used, good condition..... \$ 1.95
21. **RADIO MICROPHONES**, hand type T17, brand new..... \$ 2.95
22. **RADIO MICROPHONES**, throat type, good condition, 95c each, 3 for only..... \$ 2.00
23. **GENERATOR**, Airplane P-1 type, 200 amps, 24 volt, 2500-3500 rpm, glass wound. Has 5/8" shaft for pulley. Makes fine welder. Diagrams furnished..... \$22.50

CELESTIAL NAVIGATOR'S SEXTANTS (for boating, sailing, flying)



24. Type A10 (Fairchild), with bubble averaging, wood case, 2 power galian scope. Good used condition, only

\$1250



25. Type A10-A (Fairchild), with famous AUTOMATIC averaging device: original cost nearly double the A10: with wood case, 2 power galian scope. Used

\$1750



26. Type A12 (Link), fine fabric covered carrying case, extra bubble. Good used

\$1750



27. Type A8-A (Bausch & Lomb). One of the finest Sextants built (B&L). You get also the fine wood carrying case, battery holder, etc. Good used condition...

\$3250

(All sextants are furnished with flash light battery holder, attachment for night shots, and free celestial navigation manual)

28. **SEXTANT ASSORTMENT (4)**, 1-A10, 1-A10-A, 1-A12, 1-A8-A: all four for only..... \$59.50

AERO PARTS SUPPLY

Municipal Airport, Dept. 5

Houston 12, Texas

CAST BRONZE

Size 5 1/2" x 2 1/4", 1/2" Block letters brightly polished.

Complete with small nail for mounting on office doors or desks, door bells, mail boxes, chests or tool boxes, etc. Makes an ideal gift. Print initials and name wanted.

Special mail order price \$1.00 postpaid.

W. W. THUMANN • 3220 State St. • Salem, Oregon



NAME PLATE

One or two initials, and name not more than 10 letters.

make your own Gems 29.50 F.O.B.

All necessary lapidary equipment is furnished, including a super-charged diamond blade for sawing, and all wheels for grinding, shaping and polishing also complete instructions. The complete equipment as shown, less motor and belt, for only \$29.50, f.o.b., Burlington, Wisconsin. Write today for information and literature.



B&I MANUFACTURING CO.
Dept. S Burlington, Wis.

TEEHO-TOOL Makes saw sharpening easy! New tool gets teeth uniform! Only 50c Postpaid. Details.

TEEHO-TOOLS, 316 North 2, Maywood, Ill.

WOODWORKERS ... Get this

CONSTANTINE MASTER MANUAL

Get the Most Fun From Your Hobby

Indispensable to woodworkers. Newest, biggest edition, more pages, more color, helpful how-to-do-it articles, pre-war and new items, more bargains. Send 25c today and we will include **FREE! FULL YRS. SUBSCRIPTION** to Chips and Chats, published bi-monthly. Keeps you up-to-date on everything in woodworking, offers big money-saving bargains. Send now.

ALBERT CONSTANTINE & SON, Inc.
791-L, 135th Street, New York 54, N. Y.



Please Mention Popular Mechanics When Answering Ads



NO TUBES!
NO BATTERIES!
NO ELECTRICITY!

Just Pick up Receiver... Dial a Station—and Listen!



• it's like the magic of tomorrow! A real crystal RADIO SET built in a standard size "telephone." All you do is attach ground wire to radiator or water pipe, etc. and antenna wire to fire escape, etc.—and you're "all set"! Pretuned. Picks up stations in 50 mile radius on all wave lengths. Just dial the station you want! A thrill for young and old!

• **SEND NO MONEY! YOURS ON FREE TRIAL!**

Try this amazing new "Radiophone" on Free Trial and see for yourself! Full price, if you keep it, is only \$5.98! Just mail your name and address. Then deposit \$5.98 (plus postage) with postman when package arrives. (For better reception use our special expansion type indoor antenna only \$9.98 additional.) If not thrilled upon examination, return it and your purchase price will be refunded at once. **SAVE MONEY!** Send \$5.98 now and we'll pay postage. Same **FREE TRIAL** and refund privilege. Hurry! Send for your "Radiophone" today! **SUPPLY IS LIMITED!**

• **ELECTRONIC PRODUCTS, Dept. B**
141 Broadway
New York 6, N. Y.

AUDELS ELECTRIC MOTOR GUIDE

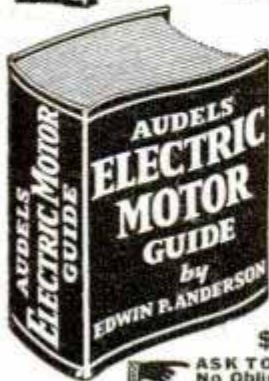

**1000 PAGES OF PRACTICAL
MOTOR INFORMATION**

JUST OUT! Audels Electric Motor Guide covering the construction, hook-ups, control, maintenance and trouble shooting of all types of motors including armature winding. Explains entire subject in every detail. 31 Chapters, 617 Illustrations and Diagrams. A Handy Guide Fully Indexed for Electricians and all Electrical Workers.

\$4 COMPLETE • PAY \$1 A MO.

ASK TO SEE IT!—Get This Information for Yourself
No Obligation Unless Satisfied.

----- **MAIL ORDER** -----

AUDEL, Publishers, 49 W. 23rd St., New York 10, N. Y.
MAIL AUDELS ELECTRIC MOTOR GUIDE for free examination. If O. K. I will send you \$1 in 7 days; then remit \$1 monthly until price of \$4 is paid. Otherwise, I will return it.

Name.....

Address.....

Occupation.....

Employed by..... PM

Super Charger Pump



Heavy duty super charger rotary pump designed to efficiently pump water, oil, gasoline, etc. Also used as a vacuum pump. Includes lovejoy coupling for $\frac{3}{8}$ " shaft. 1" outlet on top, 1" outlet on bottom. Size of pump $7\frac{1}{2}$ " W. x 5" D. x 7" H. Compact and sturdy. Four mounting holes in base. Can be used with $\frac{1}{4}$, $\frac{1}{5}$, or $\frac{1}{2}$ H. P. motors. Shpg. Wt. 19 lbs.

\$15.95

Send check or money order today plus postage.
FREE CATALOG—Send for new G. & E. APPLIANCE & PARTS CATALOG
Dept. P. M. 9

G & E Equipment Supply Co. OGDEN AVE. AT FULTON
CHICAGO 7, ILLINOIS

PILOTS' JACKETS

(Left) NEW AIR-CORPS SURPLUS. B-15 Style. Green poplin. Warm alpaca lining. Genuine Mouton fur collar. 4 Pockets. 36-46. . . \$14.75
(Right) SHEEPSKIN LINED JACKET. Brown leather. Army B-3 style. 34-46. \$15.95
Sheepskin Leather Pants. \$5.95
PILOT'S CAP (illus.) Brown leather. Lamb's fleece lining and ear flaps. \$2.50
Write for FREE illus. List Army Surplus. Orders sent postpaid except C.O.D.



Satisfaction or Money Back
CONSUMER CLOTHING CO., Box 3-P, 26 Greene St., New York 13, N. Y.

NEW QUIK CHANGE SANDER

For sanding wood, plastic and metal. Use it in bench grinder, or direct on motor. No cement needed. Simply clamp sanding cloth in place. \$2.95 postpaid with $\frac{1}{2}$ doz. cloths. Order direct or send for literature.
WASCO MFG. CO., P. O. Box 111, Dept. P-3, Blue Island, Ill.



AIR RIFLES BENJAMIN AIR PISTOLS

PIONEERS - LEADERS

SEND FOR FREE FOLDER OF LATEST MODELS TODAY
If you want a REAL GUN for PRACTICAL USE inside or outdoors get a SAFE - CLEAN - ECONOMICAL - BENJAMIN with Adjustable Power and Amazing Accuracy. For BEST RESULTS use BENJAMIN H-C PELLETS. WRITE AT ONCE.
BENJAMIN AIR RIFLE CO., 812 MARION ST., ST. LOUIS 4, MO.



Toy Gun Shoots Air "Pellets"

Cardboard targets 20 feet away can be knocked down by a stream of air from a toy gun patterned after a gas gun developed for war use. A rubber diaphragm inside the toy gun expels the air stream with surprising accuracy when the trigger is pulled. The gun weighs $12\frac{1}{2}$ ounces, is 7 inches high and 10 inches long. There is not sufficient force from the air stream to hurt a person, even if the gun is aimed in his face, according to the manufacturer.

Microscope Shows Finer Detail

Finer detail in tiny organisms can be observed through a German phase contrast microscope than was hitherto possible. So clear and sharp is the detail that live, moving organisms can be viewed without the use of stains which usually kill the specimens. Data on the microscope, developed by the Carl Zeiss plant in Germany, will be released soon by the U. S. Air Force's Technical Intelligence Unit to American industries and scientists.

Quick-Freeze Used in Oil Tests

Quick-freezing is increasing oil production by helping petroleum engineers estimate underground reserves. Analysis of core samples cut from a well gives experts the information needed. Because exposure to the air changes the sample, engineers formerly could study only one well at a time. This they did by analyzing cores as soon as they were brought to the surface. Now the samples are quick-frozen to stabilize rock and oil structures so that they can be shipped to a laboratory for intensive study at any future time.

• BE A MONEY MAKING DISTRIBUTOR
of CARBON BLAST

SENSATIONAL MOTOR RECONDITIONER

Proven chemical motor reconditioner creating sensation with service stations, garages, truck fleet owners, tractor operators, and motorists. One can of CARBON BLAST poured into crankcase or carburetor cuts gum, sludge, carbon from valves, rings and pistons. Stops oil burning due to sticking motor parts; steps up gas mileage, saves overhaul costs, peeps up sluggish motors. Our smart merchandising plan and selling aids make your success quick and permanent. Write for details.

E. T. BARRON & CO.

Dept. PM117 Minneapolis 8, Minn.



AROUND THE WORLD FOR 10¢

NEW, INTERESTING, EDUCATIONAL HOBBY. Collect beautifully colored official EMBLEM STICKERS of world famous airlines, railroads, steamships, major league ball clubs, hotels, etc. Be the first among your friends to start a collection, form a club. Send 10c for big bargain package, illustrated catalog, and Honorary Membership card in TRAVELERS CLUB with your name in gold.

TRAVELERS CLUB 491 Carnegie Hall, Dept. P11, Cleveland, Ohio

Air Cooled — GASOLINE ENGINES
BRIGGS-STRATTON Model N

1½ Hp. Perfect size for Power Lawn Mowers, Garden Tractors, Grain Augers, Scooters, etc. (Used) thoroughly reconditioned. Guaranteed.

IMMEDIATE SHIPMENT
 Sale Price — FOB, K.C. **\$54.50**

MIDWEST SURPLUS SALES CO. 1520 Locust St. Kansas City, Mo.



**BUILD YOUR OWN ZEOLITE
 WATER SOFTENER**

Troubled by water hardness? Build a LAR water softener for as little as \$40.00. Requires only a wrench. Quickly pays for itself by savings in soap and clothing alone. Send \$1.00 for complete plans and operating instructions. Money back if not satisfied. LAKE REGION MFG. CO., Box 2732-P, Minneapolis 7, Minn.

LEATHER PANTS

U. S. AIR CORPS **\$1200**
 SHEEPSKIN LINED POSTPAID

Soft, brown leather, finest quality shearing. Lightweight, wind and rainproof, full length zipper on each leg, zipper fly and pockets, attached wide adjustable suspenders. IDEAL FOR HUNTERS, FISHERMEN, CYCLISTS, Etc.

SEND FOR CATALOGUE.

H. O. NEBRICH

1641 W. WOLFRAM CHICAGO 13, ILL.

Do Your Own Welding & Save!

See our ad Page 341

DYNAMIC WELDER CO. 13 E. 23rd St., RL, CHICAGO 16, ILL.

MAKE MONEY AT HOME

RUBBER MOLDS Low as **6¢** EA.

Amazing rubber mold-making outfit makes perfect flexible molds of plaques, ash trays, bookends, etc. Molds cost 6c to 25c each. Each mold makes hundreds of novelties and gifts to sell for \$1.00 apiece and more! No experience necessary. Everything furnished. Quick and easy. Start profitable business in your home—sell to stores, gift shops, friends, resorts, road stands, by mail. Full or spare time. Write for complete FREE details and easy instructions.

SO-LO WORKS, Inc., Dept. C-803, Loveland, Ohio



Amazing New Tool—
 For Internal or External Carving
 and Cutting in
Plastics



PORT-O-TOOL

With a PORT-O-TOOL you can make many attractive, useful articles from plastics: earrings, pendants, brooches, buttons, decorative plaques...and many other items.

PORT-O-TOOL will also do a variety of things such as engraving—stamping—embossing—welding—heat sealing—soldering—etching—wood burning and sawing on plastics, wood, leather and metal.

PORT-O-TOOL is easy to operate—anyone can learn to use this tool in less than an hour. No skill is required.

PORT-O-TOOL is a natural for hobbyists, home craftsmen or for commercial use. Manufactured in two sizes: Master Model, large heavy duty, \$22.50...Junior Model, small, compact, \$15.75.

Buy PORT-O-TOOL from your dealer today. If he can't supply you order direct. Here are a few dealers who stock PORT-O-TOOL:

- PALACE HARDWARE CO. . . . 581 Market Street . . . San Francisco, California
- PALACE HARDWARE CO. . . . Lakeside Village . . . San Francisco, California
- PLASTIC PRODUCTS CO. . . . 371 South Main Street . . . Salt Lake City, Utah
- PLASTIC MART 2443 East 14th Street Oakland, California
- PLASTIC PARTS AND SALES . . . 1157 South Kingshighway, St. Louis, Missouri
- THE MAY COMPANY STORES Los Angeles, California
- POLKS MODEL CRAFT HOBBIES, 225 South Wabash Avenue, Chicago, Illinois
- POLKS MODEL CRAFT HOBBIES, 314 Fifth Avenue, New York City, New York
- ALLISON ERWIN COMPANY, 216 East 6th Street, Charlotte, North Carolina

See the PORT-O-TOOL display at

National Hobby Crafts and Science Show — New York City — November 23 to 30

We also carry a complete line of plastic supplies and materials for the plastic-craft hobbyist. Send for free catalog.

BARNETT SPECIALTY CO. 5104 HOLLYWOOD BLVD. HOLLYWOOD 27, CALIF.

"MAKES ARITHMETIC INTERESTING"



PATENT PENDING

The AMAZING CHINESE ABACUS which a Japanese contestant used in Tokyo to outspeed the Electric Calculator! Now made in the U. S. A. with complete instructions. Naturally! LOY'S IMPROVED ABACUS is easier to use and more accurate to calculate than the old Chinese Abacus. Easy to add, subtract, multiply, and divide without using paper and pencil.

Use it at the store for all calculations . . . adding, checking bills and bookkeeping. Use it at home to make arithmetic more interesting for your children. The beautifully finished abacus and specially illustrated book all for \$8.50.

Send for yours today with money order or C.O.D.

LOY'S CHINESE CALCULATOR

1317 Rhode Island Ave., N.E. Washington 13, D. C.

Attention retailers: be the first in your community to sell this sensational item.



NEW LIQUID PLASTIC

**MAKES SWELL GIFTS,
NOVELTIES, THINGS
TO SELL!**

Thousands are having fun, making big extra money, using CASTOLITE, the wonder Liquid Plastic that pours without heat or pressure. Use crystal clear or with brilliant colors. Embed real flowers, butterflies, coins, medals, photos, for plaques, paper weights, novelties. Make useful objects like book ends, trays, picture frames, coasters, jewelry, toys. Also make gears, parts, models. Can be sawed, carved, drilled, turned.

20 - PROJECT KIT \$3.50
(West Coast, Canada & Mexico \$3.75)

Special Casto-Kit now ready. Contains materials and instructions to make useful objects at once. Get into this fascinating new field now, and have unusual distinctive gifts or make fine sales before Christmas. Send \$3.50 (West Coast, Canada and Mexico, \$3.75) for your Casto-Kit, postpaid. Or order C.O.D. For instruction manual alone, send 25c. The Castolite Company, Dept. M-1, Box 211, Kenilworth, Ill.



Very adaptable, the plastic with 1001 uses. **DEALERS**—Write for literature and prices.



MIDGET 5 in 1 SLIDE RULE

Will instantly add, subtract, divide, multiply and solve proportion. Used in thousands of offices, schools, shops. Profit, percentage, freight rates and interest problems easily solved with this rule. Accurately-divided scales. Will give years of accurate service. 4" diameter—easily carried in pocket. Price \$2.50 in fabricoid case or \$3.25 in Leather case.

BINARY SLIDE RULE—Desk model, 8" diameter—has two additional log-log scales.

Price \$7.25 in Fabricoid Case or \$9.25 in Leather Case. We pay postage on prepaid orders, or C.O.D. plus postage and charges. Money-back guarantee either way.

TAVELLA SALES, Dept. 216, 25 W. B'way, New York 7



Gator Grip lamps clamp and stand to eliminate troubles of ordinary lamps. Stand by themselves, hang on walls, clamps securely to almost anything. Spring loaded ball joint automatically holds in position. For use with reflector type bulbs, heat lamps, screw on photographic reflectors. Ideal for stage, display and general use. \$2.75 no reflector; \$4.75 reflector; \$4.95 reflector and heavy duty cord 12' long. Bulbs, extra. Dealer and agent inquiries invited. **WIL' MAILORDER HOUSE, P. O. Box 389, Greenwood Lake, N. Y.**

A Wonderful Gift . . . Easy to Assemble

3 in 1 STEAM ENGINE

**with electric-heat
safety boiler**

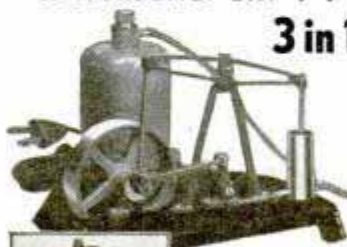

Here's the most fascinating father-and-son toy of 1947! A real steam engine that runs like a whiz! Available either set up, or as a knock-down kit. Either way, its 99 precision parts can be assembled into 3 different engines, as shown. A real deal for safe, educational fun. Shipped postpaid. Assembled as a walking-beam model—\$9.95.

\$8.95
Knocked down
Send check or money order. Or \$1 deposit on CODs. Money back if not delighted.

YOUTHCRAFT Dept. A, 338 N. Michigan
Chicago 11, Ill.

Miniature Violin Has 59 Parts

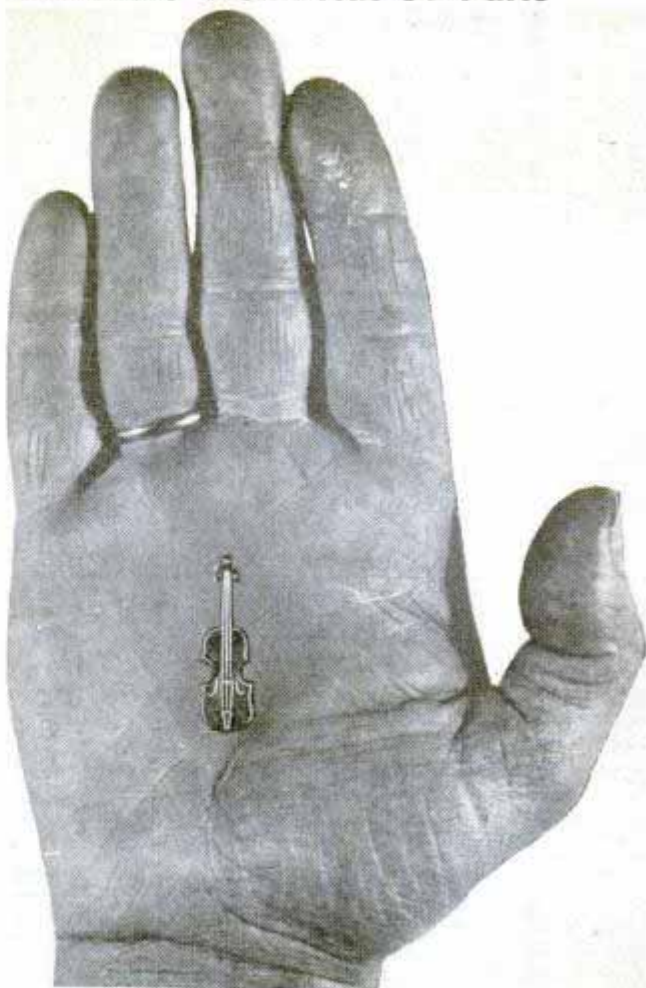

Barely 1¼ inches long, a tiny violin made by a French craftsman contains 59 separate parts, including strings much finer than human hair. Maurice Bruyas, violin maker of Saint-Etienne, Loire, France, spent 10 years of his spare time to complete the miniature reproduction of a Stradivarius. One of his tools was a bit the size of a needle to bore holes in the tailpiece for the strings. Each carving of the bridge, which is three millimeters high, is reproduced, as are the scrolls. Bruyas is now making an even smaller violin.

Sulfa Drugs Check Grain Mold

Molds that feed on stored grain are checked by the same sulfa drugs that kill germs in human beings, according to recent experiments at the University of Minnesota. When stored grain becomes damp the molds multiply rapidly and often spoil the grain for use as seed or food. Fumigants and preservatives have been used to check the mold but they often give the grain disagreeable tastes or make it poisonous. Dr. Max Milner discovered that one part of powdered sulfanilamide to 250 parts of damp grain held mold growth in check. Other sulfa drugs which were tested also gave encouraging results.



Keep Up With the
Changing World

Understand How Science
is Changing the World
and the Habits of its
Peoples!

Look Behind the
Fascinating Scenes
of Science at
Work!

Fortify Yourself with
Science News And Facts
—More Interesting
than Fiction!

Today...
Get the
**SCIENCE DIGEST
READER**

Bring yourself up to date in the world wide drama of science at work. The Science Digest Reader gives the "whys" and "wherefores" of what is going on and what the vast changes being made mean to you. Don't feel that progress is passing you by; leaving you in an old-fashioned past. Read the Science Digest Reader and get the best of the thousands of volumes of scholarly books and magazine articles pouring from scientific pens.

**Fascinating, Intriguing, Informative—
Drawn from Hundreds of Authoritative Sources**

The editors of Science Digest scan hundreds of books, scientific journals and popular periodicals every month for articles on subjects that hold interest for every thinking person. They select the cream—the finest—in subject matter, in writing, and sheer interest, and speed them up for quick reading by fact-hungry people. The Science Digest Reader, with over 300 pages, contains 72 of these articles—the very best of the best—published in the last ten years, on such subjects as aviation, medicine, weather, animals, building, speech, crime, astronomy and others.

SOME TYPICAL SUBJECTS

- | | |
|---------------------------------|---------------------------------|
| What Atomic War Will Be Like | Helping the Deaf to Hear |
| What Happens When People Starve | We're All a Little Crazy |
| Building Tomorrow's House Today | Eat and Grow Thin |
| Farming Fish for Food | Your Mental Age |
| | How to Develop Ideas Profitably |
| | Jet Planes—Almost Too Simple |

72 Articles in all

**A STOREHOUSE OF
KNOWLEDGE**

Science Digest Reader gives you, at your finger tips, hundreds of facts you will want to know for your own personal satisfaction or to make you outstanding in conversations or group discussions.

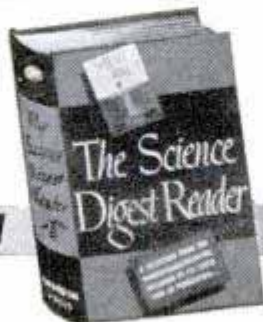

MAIL COUPON

WINDSOR PRESS
A Division of Popular Mechanics Co.
200 E. Ontario Street, Chicago 11

Send me _____ copies of Science Digest Reader at \$3.00 each. Remittance enclosed.

Name _____

Address _____

City _____ Zone _____ State _____

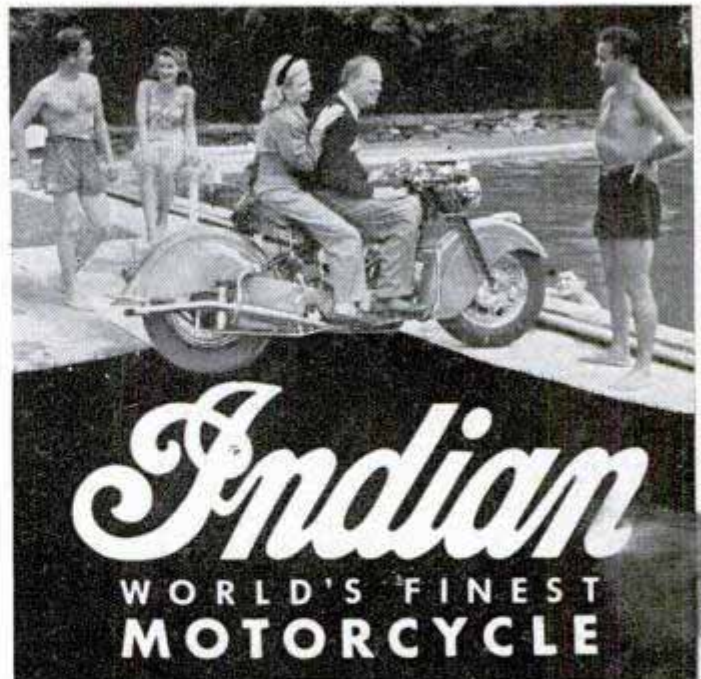

Indian
WORLD'S FINEST
MOTORCYCLE

Send for FREE ILLUSTRATED MAGAZINE, "Indian News"
• • • DEALER INQUIRIES INVITED • • •
Dept. 6M, Indian Motorcycle Co., Springfield 9, Mass.



"LITTLE WONDER" Crystal Radio

NO ELECTRIC—NO BATTERIES—NO TUBES
One of the smallest genuine crystal radio sets in the world. Slider-contact tuning, binding posts for aerial and ground. Extra long range. **SEND NO MONEY.** Just send your name and address and when your "Little Wonder" arrives simply pay the postman \$1.99 plus a few cents postage. Sent prepaid if you include check or money order with your order.

MART DISTRIBUTORS

Box 3472 Merchandise Mart, Chicago 54, Illinois, Dept. P-17



KEEP YOUR WINDSHIELD CLEAR!

STA-CLEAR WINDOW FILMS . . . for autos, busses, trucks! Prevents fogging and frosting on inside of every window of your car during cold, snowy, or rainy weather. Easy to apply, easy to remove. Kit contains 12 films and all materials for application. Complete kit sent prepaid for \$1.

RUBY PRODUCTS CO.

430 N. Water St., Milwaukee, Wis.

**LEARN TRIG
QUICKLY — EASILY**

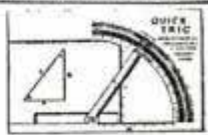

WITH QUICK TRIG, by competitive tests, it was found that QUICK TRIG gave answers faster to one with a slight knowledge of trig than to an expert on trig with a slide rule. Let it solve your trig problems. You need no previous training. Entirely automatic. Easy instructions included FREE. We mail C.O.D. plus postage or send \$1.00, the full price, and we will mail postpaid.

REED MFG. CO. 11350-B BURBANK BLVD. N. HOLLYWOOD, CALIF.

UTILITY CABINET

36 Roomy Compartments
4-7" Drawers with Removable Partitions

A Thousand Uses For

**HOBBYISTS
MECHANICS
DRAFTSMEN
TECHNICIANS**

For home workshop, factory, laboratory, garage, outdoors, fishing and hunting. Made of heavy gauge aluminum. Strong airplane construction. Sag proof—Rust proof.



\$2.98
plus postage
Shipping Weight 2 lbs., 8 ozs.

Cut out this coupon and send with money

NAME.....
ADDRESS.....
CITY.....STATE.....
Enclosed find check or money order for \$2.98.
THE KNICKBOCKER CO. ST. CLAIR, MICHIGAN

New

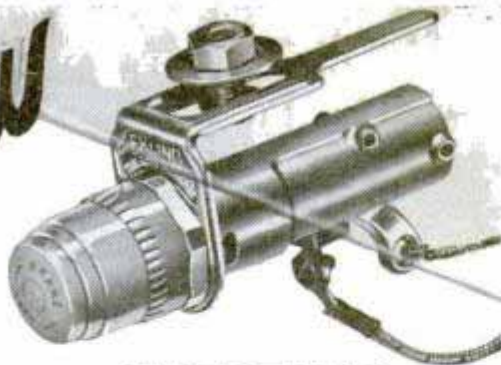

A PRACTICAL CHRISTMAS GIFT

A Must For Every Car Owner



EMERGENCY BRAKE SIGNAL LITE

AUTOMATIC SIGNAL WARNS DRIVER TO RELEASE HAND BRAKE

- Reduces wear on brake lining . . . Eliminates scored brake drums
- Will serve as a handy light for night reading of notes and road maps
- Cuts down on repair bills . . . makes driving safer

ONLY
\$2.00
P. P.

The moment your ignition goes on, your EKLIND EMERGENCY BRAKE SIGNAL-LITE flashes a brilliant red light to warn you that your emergency brake is ON. Most drivers know the hot, smoky smell of dragging brakes—the "too-late" warning that the emergency brake is on—EASILY INSTALLED—complete instruction sheet with each lite. FITS ANY CAR OR TRUCK. Order now from your dealer. If he cannot supply you, send us \$2.00 (M.O. pref.) and we will ship postpaid promptly.

EKLIND TOOL & MFG. CO.

2627 N. Western Avenue

Chicago 47, Ill.

Sherman's Tip
each cigar
individually tipped



Guaranteed to be the finest, lightest hand-made, individually tipped cigar. Every leaf selected Havana. Custom rolled for us exclusively. Really different! \$6.25 for box of 25. INTRODUCTORY OFFER: Trial package of 5 at \$1.25 postpaid. Send for yours today!

Now taking Xmas Orders.
For the Finest in cigars it's

nat sherman
THE HOUSE OF FINE CIGARS
1400-G Broadway, N. Y. 18, N. Y.



GENUINE CRYSTAL RADIO \$1.89

Receives regular programs. Not a toy. Uses no tubes, batteries, or electricity. Guaranteed. Long range. Lasts for years. A fascinating midjet radio. Send 25c (no stamps) with C.O.D. orders. Postpaid for \$1.89, (\$3.00 in foreign countries.) Send to:

K-C SALES, Radio Dept. PM-1
1943 Central St. Evanston, Illinois

Win or Lose, TEST YOUR WITS!

ERNO PUZZO GAMES

Baffling — Challenging — Provoking

Aggravating puzzlers that help improve your mind and provide a worthwhile pastime. Exciting fun! Beautiful 6-color panels. IDEAL GIFTS. Send \$1 for 5, all different. Solutions included. \$1.25 outside U.S.A. **ERNO SALES CO., Box 1146-Q, Cleveland 3, Ohio**

Raise GOLDEN HAMSTERS

The new wonder animals from Syria. Look like Toy Red Bears. Delightful pets. Everybody wants them. Thousands needed by laboratories. Make money, get started now. Send 10c for illustrated literature, or send \$5 for a pair of hamsters and literature.



GULF HAMSTERY,

1536 BASIL ST.,

MOBILE 17, ALA.

Steel Brace With Flanged Ends Adds Strength to Floor Joists



Steel braces equipped with patented flanged-grip ends add strength to floor joists. The 7/8-inch flanged ends penetrate wooden joists when driven by a hammer, thus adding to the hold supplied by nails. If the joists shrink, the wedged ends of the steel braces tighten their grip instead of becoming loose, as sometimes happens with braces which rely entirely on nails for support. These special braces also reduce the number of nails used for installation, saving about 200 nails per house.

Brass Collar Around Electrode Prevents Spark Plug Fouling

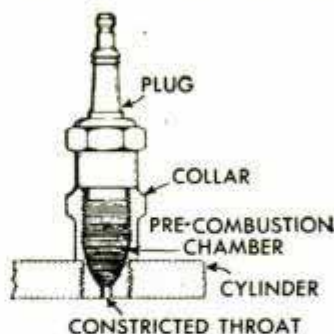

Spark plug fouling is prevented by a brass collar that shields the electrode from carbon accumulation. Instead of being exposed in the cylinder and collecting carbon during firing, the electrode is in a precombustion chamber created by the collar. The collar screws onto the lower threads of the plug, then the combined unit is screwed into the plug's normal location. One model makes it possible to use 14-mm. plugs in place of 10-mm. without boring, tapping and re-threading the engine head to the larger size.

TALK-SING thru your own radio
with
RADIO MICROPHONE



Be the life of the party. Put on your own broadcasts at home. Talk-Sing make announcements from any room. Wonderful voice practice. Microphone easily attached to any radio. Follow enclosed instructions. SEND NO MONEY—pay postman \$1.98 plus postage. Send Money Order or check and save postage.

EMPIRE RADIO & TELEVISION CO. (Dept. R2) 1521 Bedford Ave. Brooklyn 16, N. Y.

AIR or LIQUID TANKS

Airplane oxygen tanks (used) good condition, holds up to 400 lbs. pressure: non-rusting stainless steel, weighs 18 lbs., 10 1/2 gal. capacity, 24" long x 12" diam., \$4.98. Same specifications 24" long x 6" diam., weighs 5 lbs., 3 gal. capacity, \$2.98. Ends tapped for 1/4" standard pipe thread. Air check-valve to fit tanks, \$5.00 value, 98c. Ideal for compressed air tanks, some bottled gas, or liquids, water supply for home trailers, compressors, floating rafts, buoys, net floats, air horns, air brakes, etc.

Prices FOB, Kansas City — No COD orders

MIDWEST BUY ANYTHING CO.

1520 Locust St. Kansas City, Mo.
Hundreds of other bargains — Write for Circular

SELL MERCHANDISE by Mail

OPERATE Profitable Lifetime Business Selling Merchandise by Mail. Large Profits on Fast Selling \$1.00 Items. **WRITE TODAY!**

POWELL CO. DEPT. A SAMPLER BLDG., CLEVELAND 3, OHIO

Beautiful Modern **SIGN LETTERS**

Signs anywhere, quickly, easily... Write for money making-saving plan... Samples

PINNACLE SIGN LETTERS, Mound City, Ill.

END ACHING FEET NOW!

Let me analyze your particular foot trouble, then show you how and why I can prescribe amazing relief, with my **BASO PATENTED SHOES**, 30 years experience. **SEND NO MONEY!** but write today for **FREE** Booklet and Foot Chart.

DR. C. P. LEYDECKER
Dept. 101-M, 705 Olive St. St. Louis 1, Mo.

LAWN ORNAMENT-NOVELTY PATTERNS

28 Lawn Ornament Patterns, 25c. Other patterns; 15-20" high; Dutch Girl, Dutch Boy, Pirate, Bull Terrier, Mexican Girl, Mexican Boy, Dwarf, Penguin, Flower Girl, 10c each. 25 Novelty Patterns, 30c. All 62 Full Size Patterns, \$1.00 Postpaid. Strother Pattern Service. Dept. AC-8, Box 383, Belington, W. Va.

OLD GOLD JEWELRY WANTED

Dental gold teeth, plates and bridges with metal attached. Any broken pieces of gold jewelry. Immediate payment and free mailing container to you or your friends upon request.

LOWES, DEPT PM Holland Bldg., St. Louis 1, Mo.

NAMEPLATE for your HOUSEDOOR

Your name handsomely engraved on plastics, white letters on blue background or black letters on gold background. For mailbox or doorbell, size 3"x1 1/2" \$1.00—for house-door, size 6"x1 1/2" \$1.75—for office desk with metal base, size 6"x1 1/2"x2" \$3.00—Send check or M.O. we will ship promptly postpaid.

KENDAR ENGRAVING • 46 Linden Street • ROCHESTER 7, N. Y.

YOU CAN EASILY GET ANY BOOK IN PRINT

Get hard-to-find books the easy way... any Book in print can be sent to your door—we pay postage. New—old—fiction—biography—reference—technical—hobbies—whatever you want—write to us.

FREE. Write for free Catalog listing hundreds of books and texts immediately available. Write today!

HARD-TO-FIND BOOK DEPT.
Popular Mechanics Co.
200 EAST ONTARIO STREET
Chicago 11, Illinois

DELIVERED TO YOU
WE PAY POSTAGE IN U.S.A. EXCEPT ON C.O.D.'S

Say You Saw It In **POPULAR MECHANICS**

NEW! METAL FORMING TOOLS



INVENTORS HOBBYISTS SHOP OWNERS

Form difficult cylinders, crimps, angles, channels, boxes, etc. . . . without costly dies . . . in sheet or strap metal, rod, wire, or plastic.

12" BRAKE. Fits in vise or bolts down. Forms angles, etc. \$14.50 PP.

30" BRAKE. All steel, two handles. Weight, 40 lbs. \$24.50 PP.

VISE IRON BENDER. Bends 1/2" square or round; 1/4" to 2" wide. Forms hooks, rings, etc. \$10.00 PP. USA.

SHEET METAL PLIERS. Forms angles, straightens radiator fins, etc. \$2.

CURVE FORMING TOOL. Makes ovals, cylinders, round corners, etc. 18" wide. Price \$10.00 PP. USA.

IMMEDIATE DELIVERY . . . ALL ITEMS GUARANTEED . . . ORDER DIRECT OR SEND FOR DETAILS.

WISE BRAKE MFG. CO., 1318 So. 30th Ave., Omaha 5, Nebr.

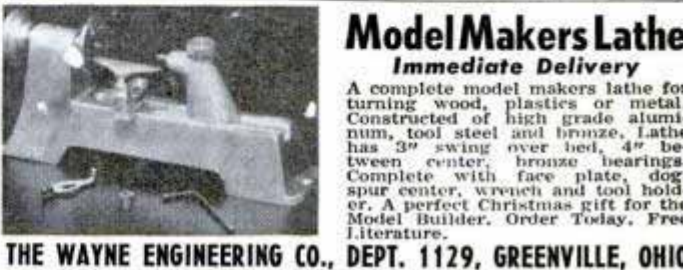

Model Makers Lathe
Immediate Delivery

A complete model makers lathe for turning wood, plastics or metal. Constructed of high grade aluminum, tool steel and bronze. Lathe has 3" swing over bed, 4" between center, bronze bearings. Complete with face plate, dog, spur center, wrench and tool holder. A perfect Christmas gift for the Model Builder. Order Today. Free Literature.

THE WAYNE ENGINEERING CO., DEPT. 1129, GREENVILLE, OHIO

25c The Original **MOORE'S** Educational **TOY MOTOR**

Postage Paid in U.S.A.

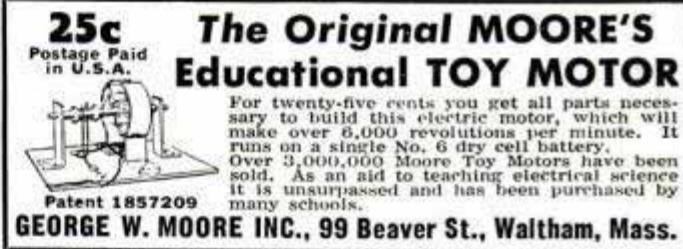

For twenty-five cents you get all parts necessary to build this electric motor, which will make over 6,000 revolutions per minute. It runs on a single No. 6 dry cell battery. Over 3,000,000 Moore Toy Motors have been sold. As an aid to teaching electrical science it is unsurpassed and has been purchased by many schools.

Patent 1857209

GEORGE W. MOORE INC., 99 Beaver St., Waltham, Mass.

FINECRAFTERS

PREPARE YOUR CHRISTMAS GIFTS IN LEATHERCRAFT. WE HAVE A FULL SUPPLY OF CRAFT MATERIALS. SEND FOR OUR LATEST PRICE LIST AND DESCRIPTIVE CIRCULARS.

227-229 NORTH MAIN STREET, PROVIDENCE, R. I.

HAVE YOUR OWN BUSINESS!

Operate pleasant, profitable Silk Screen Printing Shop. NO experience needed. Work at home in spare room or basement. Big demand! Large profits! Few dollars starts you. Start small, grow big. Real future possibilities! Eye-opening literature **FREE**.

W. E. WOLFF CO., 817 High St., Anderson, Indiana

Are You Manufacturing A New Product?

Our automatic screw machines may cut your production costs. Send us drawings of your round and hexagon metal parts for a quotation of our low rates.

ZETCO PRODUCTS COMPANY, Bellefontaine, Ohio

BATTERIES!—START

—a factory at home and re-cast junk batteries into new; latest achievement. We supply complete instructions and everything needed. Big Profits!

Battery Laboratories, Dept. PM, Minneapolis 4, Minn.

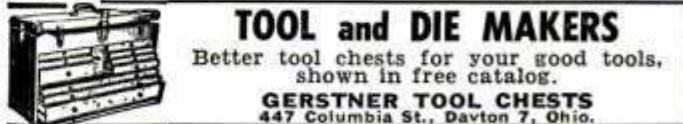

TOOL and DIE MAKERS

Better tool chests for your good tools, shown in free catalog.

GERSTNER TOOL CHESTS
447 Columbia St., Dayton 7, Ohio.

CRESCENT TOOLS
Give Wings to Work

ASK YOUR **HARDWARE DEALER**

AT LAST! A HOBBY THAT OFFERS YOU PROFIT AS WELL AS PLEASURE!

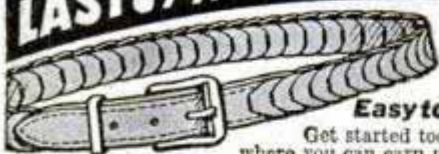

**GENUINE LEATHER
Hand Crafted
LINK BELT**

Easy to Make—Easy to Sell

Get started today on a fascinating hobby where you can earn up to \$10 or \$15 a week in spare time! Send for your complete profit-producing Handicraft Kit with all the material needed to make 6 genuine leather link belts. Sell all you make at \$2 each to people expecting to pay far more for genuine hand-made belts. Kit for 6 belts costs you only \$3.50—can easily be sold for \$12—leaving you a profit of \$8.50. Send \$3.50 for your Kit today, or mail only a dollar for sample Kit! Or C.O.D., you pay postage. Money back if not delighted.

FREE

WITH YOUR ORDER

... IF YOU ACT NOW!

Beautiful Plastic Identification Card Case, Value 25c. Yours to keep, even if you return belt kit. Also, on request, big new 40-page CRAFT CATALOG FREE with or without order.

DWINNELL CRAFT SHOP, Dept. P711, Elm Grove, Wheeling, W. Va.

60 POWER TELESCOPE \$2.95

VARIABLE EYEPIECE 20X-40X-60X

NEW! Three telescopes in one, 3 different magnifications. 20 power for ultra-bright images with 40 and 60 power for extra long range. Guaranteed to bring distant objects, people, sports events, ships, moon, stars, etc., 60 times as close.



Most powerful for anywhere near the money. 5 sections. Closes to 1 ft. long. Contains 4 ground and polished lenses. Also used as a powerful compound microscope. Directions included. Mass production enables us to offer this high-powered instrument at the amazing price of only \$2.95. We pay the postage. Get yours immediately.

BROWSCOPE CO. Dept. 11M 24 West 45 St. New York 19, N. Y.

COLLECT COINS — BE A NUMISMATIST

Learn this fascinating hobby. Get the thrill of having a collection of real value that you can proudly display.

Kits for beginners, intermediate, and advanced collectors. **HOBBY HELPERS KITS** are packed full of useful information and material. You may also choose your own items from the descriptive price list. Don't delay—write for price list or send \$1.75 plus 25c handling charge, to get started immediately.

HOBBY HELPERS, Dept. B, Box 665, Washington 4, D.C.

BUILD YOUR OWN MACHINE TOOLS!

Blueprints \$1.00—Catalog FREE

Make your own Milling Machines, Shapers, Drill Presses, 8" Circular Saws, 6" Jointers and similar tools with Lewis ready-to-machine castings. Save up to 80% of finished machine cost. \$1.00 brings complete blueprint specifications for above 6 tools. Catalog describing Lewis line sent free with blueprint order.

WRITE TODAY!

LEWIS MACHINE TOOL CO.
P. O. Box 7446, Sta. L, Dept. M, Los Angeles 23, Calif.



Take TURNS with a HULL AUTOMOBILE COMPASS

Drive right, without a moment's doubt, with Hull instrument quality. **BEACONLITE** illuminated for night driving. \$5.95; **STREAMLINE** standard, \$3.95. Ideal gifts. At your dealer's. Write for circular.

HULL MFG. CO., P. O. Box 246-D10, Warren, Ohio



SAY YOU SAW IT IN POPULAR MECHANICS

PLASTIC BIKE SPOKES

Boys! Here is the latest from Hollywood. Beautiful plastic bike spokes that slip over your present ones in a few minutes. Your choice: bright Red—Yellow—Orange—White—Blue—Green. Set of 36 for \$2.00 or 18 for \$1.25. Order yours today. Be first in your neighborhood.

CLAIREE DISTRIBUTORS, P.O. Box 747, North Hollywood, Calif.



FIX SEWING MACHINES

BIG MONEY. Spare or full time. Open your own neighborhood shop. Thousands need repairs. Send for complete Repair Manual—only \$1.98 postpaid. Money back guarantee.

SEWING MACHINE SERVICE CO., Hamilton 25, Ohio

Safety "Shield" for Air Gun



Streams of air shoot out from the nozzle of a safety air gun to form an umbrella-shaped shield to prevent flying particles from striking the operator. The air shield surrounds the concentrated air jet which dislodges tiny chunks of various materials in cleaning

operations. The safety device was designed particularly to prevent eye accidents. The gun is made in several sizes.

Sawdust Molded Into Trays, Boxes

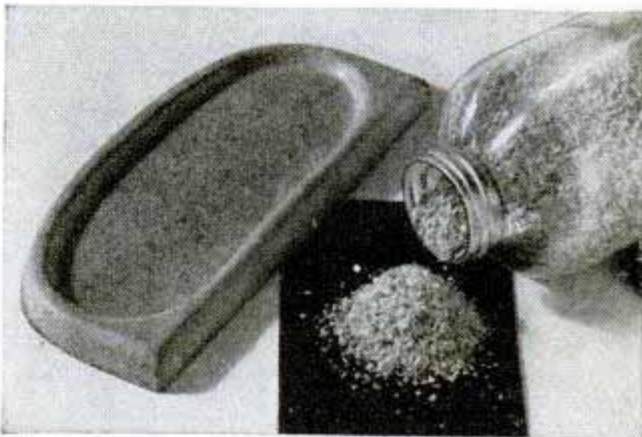

Trays for babies' high chairs, cutlery cases and small tool containers are molded from sawdust treated with a resin binder. The low cost of materials makes it possible to produce such items cheaply. The molded product takes lacquer readily. Boxes made of the material, dropped cornerwise on concrete from 10 feet, were undamaged.

Fishing Reel With Adjustable Brake

Plugs of different weights can be cast accurately with a reel that has an adjustable brake. By setting the brake according to the plug's weight, the angler reduces backlash in casting. The line is wound on "Y" prongs and



need not be unwound for drying because the reel's open construction permits free circulation of air through the line.

thinking of
building a
home?

Then you
need . . .



**PRIMER
for
HOME
BUILDERS**

The New Book by 12
Leading Home Build-
ing Authorities That can so
Easily Save You Hundreds of Dollars!

**Answers These and Other
Perplexing Questions**



- Can I Afford to Build a Home?
- What Should I Know About Financing?
- What to Look for When Buying a Lot.
- What Community is Most Suitable for My Family?
- How to Go About Definite Planning.
- What is Most Suitable Inside Arrangement of Working and Living Space?
- Should I Employ an Architect?
- What Should Be My Guide When Buying an Older House?
- Legal Rights and How to Protect Them.
- How to Work with Contractors and Builders.

Whether you are actually planning to build a home or just hoping that some day you can, Primer for Home Builders is the most important book you can own. It's the combined work of twelve leading authorities and contains real down-to-earth facts on every phase of planning, contracting, building and financing a home, plus typical legal documents used in all real estate transactions. You can read it in a few hours but it can save you hundreds of dollars and a lot of time, trouble and tears.

**A Book for Beginners — That
Makes You Feel Experienced!**

You'll like the way this book goes right into the business of building a new home, or buying an old one. Right from the start of "just dreaming," through whether or not to employ an architect and how to select an architect and work with him and contractors, how to plan the house, how to finance it, how to avoid legal difficulties, up to the time you take possession. You'll learn a hundred things you ought to know and probably don't know now.

Get Primer for Home Builders Now!

Don't wait until you are ready to start building. Before you do another day of thinking or planning or dreaming, get this most practical 184-page book to help you save time, worry and money.

MAIL COUPON TODAY

WINDSOR PRESS
A Division of Popular Mechanics Co.
200 E. Ontario St., Chicago

Rush _____ copies of Primer for Home Builders at \$2.50 each. Remittance enclosed.

Name _____

Address _____

City _____ Zone _____ State _____

WHEN YOU WANT THE BEST, RISCO HAS IT...

New G. E.
"CIRCLINE"
Fluorescent
Overhead
Fixture

**YOUR COST
\$10**

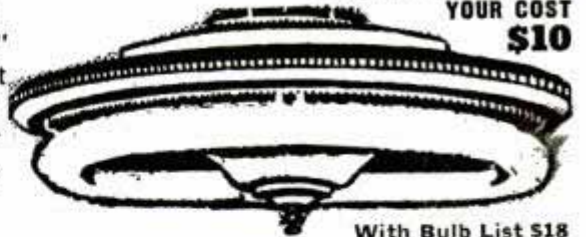

All White
Baked
Enamel

With Bulb List \$18

The newest, fastest selling Overhead Fixture in America today. The new G.E. 32 watt "CIRCLINE" lamp gives the SAME AMOUNT of light as the ordinary 150-watt incandescent bulb.

For Kitchens, Basements, Halls, Workshops, etc. Comes with 4" cup or for Flush Mounting.

Remit in Full and we pay postage. West of Mississippi 50c extra for postage.



PORTABLE PHONO—ALL ELECTRIC

Plays 10" and 12" records. Self-starting motor. 5" P.M. spk.—High output. Brown, Red or Blue, 2-tone leatherette. May we substitute color?

Diagrams for Any Radio 50c Prepaid
For best buys in record changers
SEE OCTOBER ISSUE

25% on COD orders—BE-3-8554—FREE CATALOG—ORDER FROM THIS AD

Wholesale Distributors—RISCO ELECTRONICS, 22 Warren St., N.Y. 7

SPECIALTY MEN!

Clean Up with
"LATHER LEAVES"
SOAP BOOKS!

SAGE IS READ 24 TIMES.

original business as well as for all repeat orders. Write for details and free sample today!

GENERAL SOAP CO.

2215-25 Ford Ave., Dept. PM-1

Chicago 16, Ill.

Advertising specialty and book match men earn fabulous profits selling instant-appeal LATHER LEAVES, (soap in paper form) to firms, stores, taverns, lodges, clubs, business houses, etc. ADVERTISER'S COVER MESSAGE

Very fine commissions paid for all repeat orders. Write for details and free sample today!

**AUTO ENGINE SPEED CONTROL
GOVERNORS**



Agents Wanted

In Montreal, 7546 Wiseman; in Skaneateles, N. Y., Horie Welding Supply.

CANDEE, Los Angeles 7



**A BUSINESS
OF YOUR OWN**

Use simple home-made equipment. Make HOLLYWOOD STYLE cement pottery, birdbaths, benches, mantels, coffee tables, miniature castles. Also rustic garden walks, steps, stucco-rock walls, imitation marble. Chemical coloring, formulas & instructions. 10c brings pictures, sample, details.

HOLLYWOOD CEMENTCRAFT
8529 Wonderland Ave., Hollywood 46, Calif.

**QUICK! "REPAIRING CAR BATTERIES"
MONEY! At Home! Easy Too!**

Write, BATTERYMAN, Dept. 5, Grand Junction, Colorado

AUTOMATIC IRON TESTER

Pilot Light Flashes on and off with thermostat.

For checking temperatures and re-setting thermostats. Graduated for RAYON, SILK, WOOL, COTTON, LINEN—Also in degrees from 200° to 700° F. Has a specially designed precision thermometer. Unsurpassed in quality. ONLY \$18.50 postpaid — MONEY BACK GUARANTEE.

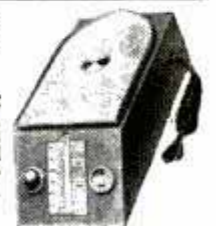

Write for circular.

HANLAN CO., 1419-A, W. Jefferson, LOS ANGELES 7, CALIF.

SAY YOU SAW IT IN POPULAR MECHANICS

VINCO Automatic CENTER PUNCH

NO HAMMER NEEDED

JUST PRESS



The one-hand punch for precision work on any metal or wood, or for staking nuts and bolts. Adjustable from 8 to 20 pounds. Has "shock absorber action" for extremely fine work (watches, jewelry, dies) 4 in. long, 1 1/2 oz. with unbreakable plastic handle. Metal parts nickel plated. *Guaranteed 1 year.*

C15 Punch \$2.75
C12 Punch (non-adjustable) \$1.70
C2 "Carboloy" Tungsten-Carbide Point For Marking Hard Metals, Glass \$1.15

MASTER KIT contains No. C15 punch . . . Self-Centering Attachment for precision-mounting all size hinges . . . "Carboloy" Tungsten-Carbide Point for marking hard metals and glass . . . 2 Hole-Cutting Points (.045" and .080") . . . Chisel-Point for tooling all metals . . . Nail-Set Point for delicate setting and riveting. *Makes an ideal gift.*

MASTER KIT Complete With Wood Case \$8.25

Authorized Manufacturer of "CARBOLOY" Tipped Products

VINCO PRODUCTS, Asbury Park, N. J.
All Prices Postpaid, except C. O. D. Write for Free Descriptive Literature. Dealers Solicited.



IMPORTED DECORATIVE DECALCOMANIA

TRANSFERS of all Sizes and Types — Flowers, Fruits, Birds, Figures, Ships, Juvenile, Oriental, Peasant, Patriotic, Gold, Inlay, Borders, Initials, etc.—for Furniture, Doors, Walls, Trays, and what not.

Catalog with 800 illustrations in Color—25c
Pre-war. Limited Stocks.

L. C. WELLS, Dept. PM-711, 25 E. 26th St., N.Y. 10



New Sensational 7" Television Kit

Free Booklet — Write Today

High Performance Low cost Television is here. Easily assembled. 26 sq. in. picture. Complete kit ready to assemble **\$159.50** including leatherette cabinet. . . Mahogany, Walnut or Birch cabinet **\$174.50**, Dumont—7" cathode ray tube, new advanced true FM sound; non-flicker pictures.

NOW available 10" unit complete panel **\$229.50** — Cabinet **\$262.50**.

Distributors for Dynamic Television Assoc. Inc.

assembled ready to play **\$205**

KENRAD TELEVISION CO., 509P-5th AVE., N. Y. 17

Ball Bearing All Purpose Mandrell, \$5.95



P. P. Anywhere in U.S.
Send Certified Check or Money Order
Length overall 11 1/2"
Shaft size 3/8" or 1/2" (Optional)

THE CARTER CO. Box 195 Lexington (73), Mass.

NOW! You can use carbide tools.

1/4" CARBIDE TOOLS \$1.00 EACH POSTPAID

HOLDER FOR 1/4" TOOL BITS 50c EACH POSTPAID

IRWIN PRODUCTS CO.
200 WASHINGTON AVE. NO. MINNEAPOLIS 1, MINN.

Fits tool post of Atlas, Logan, etc. L.H., R.H. Point & Sq. Nose & 60° threading tools. State style and if for steel, cast iron, brass or plastics when ordering. No C.O.D.

Learn to MOLD NOVELTIES

Cast plaques, book ends, ash trays, art goods and novelties in Plaster and Imitation Marble. 5c material makes \$1.00 sellers. Composition floors, Tilex roofing, Colored Pottery, Plastic Homes, Waterproofing — easily learned. We teach you at home. Start in garage or basement. Particulars free.

RAPID MARBLEIZING SERVICE, Dept. 10-C, Edwardsville, Illinois

SIGNS AND SHOWCARDS

EASILY AND EXPERTLY PAINTED WITH LETTER PATTERNS

MANY SIZES & STYLES. WRITE FOR FOLDER!

JOHN F. RAHN
1230-31 N. Central Ave.
CHICAGO 51, ILL.

RACING CAR EQUIPMENT FOR ALL CARS

Engines, Racing Heads, Manifolds, Carburetors, Mufflers, etc. Speed Instructions and literature \$1.00—refunded first order.

LEE MOTORCRAFT CO.
1412 Great Northern Bldg. Chicago, Ill.

Wave Measurer Reports by Radio

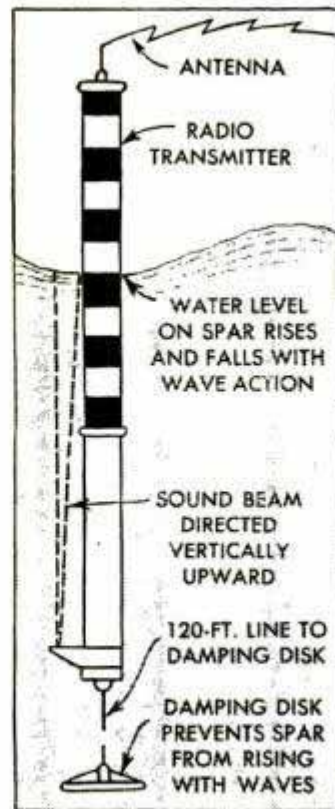

Measurements of the height and speed of waves in deep ocean waters are recorded by a spar buoy that automatically sends the data by radio to a remote observer. The buoy is a 35-foot length of four-inch pipe capped at each end and weighted to float upright with one-third of its length above water. A radio transmitter is housed in the upper end with a whip antenna rising a few feet above the spar. In the lower part of the buoy is an

echo-ranging set which transmits "pings" upward and receives echoes thrown back from the surface of the water. Measurements of the time elapsing between the ping and its echo are transmitted to the observer who then can calculate the height and frequency of the waves. In order to prevent the buoy from rising and falling with the waves, a horizontal disk is suspended from the lower end of the spar on a 120-foot line. The disk tends to hold the buoy at a uniform distance from the ocean floor.

Blade Attaches to Hammer Head

By attaching a steel cutting plate to any standard hammer, the craftsman can provide himself with a handy carpenter's adz. The slightly curved blade is tightened to the hammer head by a setscrew. A slot which engages the hammer head and two projections at the butt of the blade keep the adapter from loosening during use.

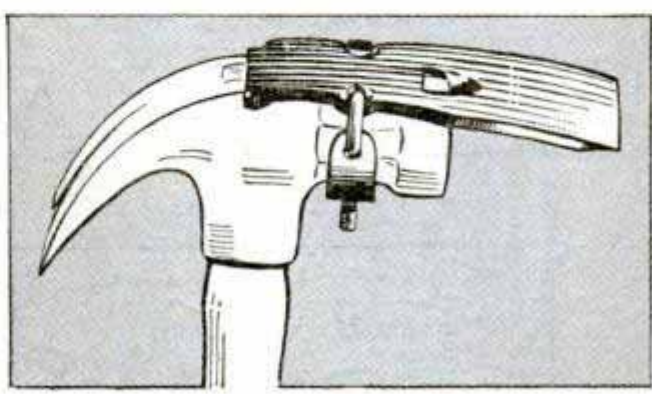

Electric WONDER PEN

Burns Beautiful Designs in Wood

DECORATE Leather, Cork, etc.

Works like Magic for Lining, Etching, Shading!

Learn in One
FREE
Easy Lesson

Amaze your friends with this exciting new craftsmanship. Enjoy this magical art for pleasure or profitable income. Make gifts or sell your work direct or to gift shops. With this great electric pen you quickly learn to burn, etch or shade thousands of articles in gorgeous varied tones of rich sepia brown. Also apply colors or varnish finishes, etc. We supply everything in one big Special Gift Offer. You get the only Electric Wonder Pen guaranteed for 800 working hours and 25 accessories. All materials, Tools, 9 Plaques, Book Ends, Brushes, colors, varnish, nails, sandpaper—everything you need—ready for etching plus your FREE easy lesson. A thoughtful gift to any adult or youngster. If your dealer does not have the genuine "Wonder Pen," mail coupon below to us at once.

SPECIAL GIFT OFFER
only \$3.00 postpaid



GIRLS, BOYS—You'll Enjoy

Painting With Colored Sand!

Miraculous Sand Pen does amazing works of art. Easy to do. Get this handsome Gift Box 19 x 11 containing complete set with 5 tubes and 12 boxes of colored sand, a bottle of special adhesive, brush and 12 outline pictures ready for "Sand Painting." If your dealer can't supply, mail coupon.

Complete only \$2.25 postpaid



Get our General Catalog of other interesting items, mark the coupon.

AMERICAN TOY & FURNITURE CO.
6130 N. Clark, Dept. 1117 Chicago 26, Ill.

17 QUALITY TOOLS

with DeLUXE
CHEST



Complete Set
only \$5.50 postpaid

All at a fraction of
the cost if pur-
chased by the piece

Has tempered spring steel saw, claw type hammer, screw driver, chisel, all with hardwood handles, steel square 8" long, semi-steel pliers, wood level, hardwood clamp, triangle, semi-steel plane, 12" ruler, two steel punches, carpenter pencil, plumb bob, depth gauge, wood miter box. All tools are packed in beautiful Wood Chest with push button lock, hinged lid, end carrying handles of plated steel. Has wood tray 15 1/8" long, 3 1/4" wide. Size of chest 16" long, 6 3/8" wide, 3 3/8" high. Beautifully lacquered in natural finish. An ideal gift for man or boy. If your dealer does not have this "American DeLuxe Tool Chest," mail coupon below to us.

AMERICAN TOY & FURNITURE CO.
6130 N. Clark, Dept. 1117, Chicago 26, Ill.

Enclosed is \$_____ Please send me the items checked, postpaid.

- Electric Wonder Pen, \$3 American Tool Chest, \$5.50
 Sand Pen Outfit, \$2.25 Send catalog of other gifts

Name _____

Address _____

City _____ Zone _____ State _____

(If west of Rockies or in Canada, add 25c to each item)

FIND UNDERGROUND MINERALS and METALS with M-SCOPE

New sensational lightweight models, unsurpassed efficiency. Low prices. Time-payment plan. Write for free 16 page booklet.



FISHER RESEARCH LABORATORY, INC.
PALO ALTO CALIFORNIA

Surplus
New
War

HOIST & WINCH

Eliminates Back Breaking Ordeals

Small But Mighty. Were made to be used on B-29s for lifting bombs. 2,000 lbs. capacity. Weight 16 lbs., perfect for lifting or moving loads in trailers or onto trucks, tractors, or any other movable machinery.

Fine for garages, implement stores, warehouses, assembly lines contractors and many other uses. Original cost, approx. \$100.00.



Sale Price complete with mounting brackets, \$26.30
Cable and hook and Hand Crank, only.....

Send check or money order for immediate delivery

SESCO ENGINEERING & SUPPLY CORP.

15th Ave. and Clay St. Dept. PM No. Kansas City, Mo.

\$1.00

PLAY SAFE
THIS WINTER
... YOU CAN
REPLACE
BROKEN TIRE
CHAIN LINKS
QUICKLY
AND EASILY!

HERSHEY
TIRE CHAIN REPAIR
PLIERS

Hershey Tire Chain Repair Pliers replaces broken chain links quickly and easily . . . WITH ONE HAND OPERATION. Any one can use it. Made of tough, hardened steel, every one is guaranteed against any defects in workmanship and material. Send \$1.00 for yours today!

HERSHEY METAL PRODUCTS COMPANY

DERBY, CONNECTICUT

DISTRIBUTED BY GEARY & CO., Inc.
1518 WALNUT ST., PHILADELPHIA 2, PA.

Foredom PRESTO-FLEX

←YOUR MOTOR

**NOW! For Only \$5.95 You
can have an Amazing New
FLEXIBLE SHAFT TOOL**

with **PENCIL-SIZE HANDPIECE**
**Grinds, Polishes, Sharpens, Cleans, Mills, Carves,
Engraves, Etches on Metal, Wood, Glass, and Plastic**

Now you can turn your old motor, drill press, or electric drill into a Flexible Shaft Tool. Amazing new Presto-flex, latest addition to the Foredom flexible shaft family. Simply attach to your electric drill, drill press or motor. Presto—a flexible shaft machine! Off again in a jiffy! Pencil size handpiece gives you finger-tip control. Gets into tight places you can't reach with any other tool! Handy 35" overall length. And—only \$5.95 complete! Order NOW.

—SEND NO MONEY—

Just send your name and address. We will rush your Presto-flex COD. Pay postman \$5.95 plus postage or send \$5.95 now and WE pay postage. Money back if not delighted! If you order Presto-flex for use on motor, specify motor shaft diameter. Add 50c for special motor coupling. (Available for 1/4", 5/16", 3/8" and 1/2" shafts.) 50 piece accessory set available \$1.50 extra. Order TODAY from

FOREDOM ELECTRIC CO. Dept. 134

Manufacturers of Flexible Shaft Equipment for Home and Industry for a Quarter-Century.

27 PARK PLACE • NEW YORK 7, N. Y.

SAY YOU SAW IT IN POPULAR MECHANICS

WAR SURPLUS BARGAIN SPECIAL

**BRAND NEW!
VACUUM-AIR
HYDRAULIC**

FUEL PUMP

Original Cost
\$45.00

Now Only
\$9.95

Postpaid in U.S.A.

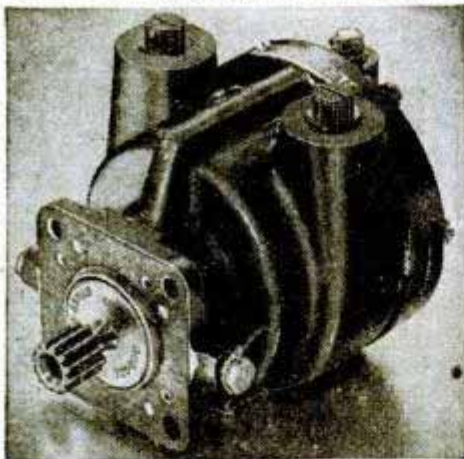

WORTH MANY TIMES THIS LOW SALE PRICE

**USE THEM FOR
OIL BURNERS**

**SPRAYING
MACHINES**

**MILKING
MACHINES**

COMPRESSORS

VACUUM PUMPS

**HYDRAULIC
SYSTEMS**

**MANURE
LOADERS**

PRESSES, etc.

Originally cost \$45.00. Used by the Air Corps to drive bomber de-icer boots, gyroscopes, automatic pilots, etc. May be used as air or fluid pump—for pressure or vacuum. Standard 3/8 inch pipe thread with interchangeable ports. Will pump 7 1/2 gal. SAE 30 oil per minute at 300 RPM. Builds air pressure of 30 lbs. per sq. in. at 1000 RPM. Vacuum will draw 26 inches of mercury at 1750 RPM. Develops up to 120 lbs. per sq. inch of hydraulic pressure, which in conjunction with a 3 inch hydraulic cylinder, will lift 840 lbs. minimum. Runs forward or reverse. Self-aligning shaft. Die cast aluminum housing 6x4x4 inches. Has stainless alloy steel vanes and impeller. Made by Bendix Avia, Corp. Spline terminal for direct drive—readily replaced with a pulley. Recommend a 1/4 H.P. or stronger electric motor as source of power. Rated capacity 1500 RPM with high overload factor. Special price for quantity users. Complete illustrated report and instruction booklet FREE with every pump. Send check or money order today. Postpaid in U.S.A.

\$9.95

**GROBAN SUPPLY CO. 1522 So. Michigan Avenue
Dept. PM11, Chicago 5, Ill.**

Mows and Trims Lawns



**In One Simple
Easy Operation**

8 1/4 Lbs.



**Save Time
and Labor with a
MONTAMOWER**

New model. New type metal handle has special device to adjust cutting height. Drive shaft now mounted on free rolling, factory lubricated, and sealed ball bearings. No tired backs or aching arms. 8 1/4 lbs. of live precision made mechanism that first gathers, then cuts smoothly a clean 16" swath through grass, dandelions, spike grass and weeds. No noise or clatter. As modern and efficient as your electric razor. Cuts right up to walls, fences, trees or posts; leaves no fringes to be trimmed by hand. Cutters are self-sharpening. Built to last many years. Many thousands in use. Sold direct from factory. Costs little. Write at once for guarantee information and literature.

**MONTAMOWER DISTRIBUTING CO.
820 Keeler Bldg. GRAND RAPIDS 2, MICHIGAN**

WORLD'S FASTEST VISE



The new Heinrich "Grip-Master" is a SCREWLESS vise. Operates effortlessly... avoids tiresome winding... saves time. Movable jaw adjusted in a jiffy... locked securely by easy press on locking lever. Design permits drilling clear thru work. Jaws have built-in parallels... extra loading capacity. Bars and locking mechanism hardened and ground. The "Grip-Master" is the most revolutionary advancement in 100 years of vise manufacture.

HEINRICH

Grip-Master
SCREWLESS VISE

NATIONAL MACHINE TOOL CO. • Dept. 157-L • RACINE, WIS.

Money Back Guarantee

If your dealer does not have the "Grip-Master," we will ship express prepaid for cash with order. Model 3-SV (3" jaw), \$16.50; 4-SV (4" jaw), \$27.50. Larger sizes also available. Folder on request.

ONE-MAN SAWMILL LESS THAN \$200.00

Easy To Turn Trees Into Money

Makes lumber, ties, shingles, crates, lath, studding, siding.



Belsaw Models
in 10 to 24 foot sawing lengths.

MECHANICAL FEED, accurate set works and positive dogs. Use tractor or old auto engine for low cost power.

Thousands used for commercial sawing. Pays for itself quickly. Send post card today for FREE booklet, "How to Make Lumber" and Catalog of Woodworking Equipment.

**BELSAW MACHINERY CO., 2811-U Field Bldg.
315 Westport Road Kansas City 2, Mo.**

LOW PRICED

STEAM CLEANER

Jenz Super Chief

Portable—No moving parts—Cleans anything—Motors—Chassis—Machinery—Floors—Buildings—Remove wallpaper—Dairy & Creamery—Oil Rigs etc. Oil fired—Economical—fully tested and warranted. 75# Steam in less than 10 min. Complete as illustrated. **\$276.00**

F.O.B. factory.

**HI-PURE LABORATORIES
EVANSVILLE, IND.**

\$300



**AUTOMOTIVE
FLASHER**

Simple to
install

For use on all privately owned Motor Cars, Buses, Trucks, Highway Patrol Cars, Ambulances, Cabs, State & City Motor Transportation. Remarkably effective. If your dealer can't supply send check or M. O. for \$3.00. We pay postage. Dealers and Agents wanted.

MACCHI and COMPANY

927 Larkin Street • San Francisco 9, California

POPULAR MECHANICS

**PROVEN POWER TOOLS FOR A VALUE
AND QUALITY CONSCIOUS MARKET**



DRILL PRESS \$17



HC SAW \$12.50



LINE SHAFT & HANGER ASSEMBLY \$7.48

"The Searjeant Line is the result of my 20-year experience as a user, designer, and manufacturer of power tools. Acceptance proves that it is just what craftsmen want." (Signed) Will Searjeant.

**A 6" BENCH
SAW THAT
CUTS 2" STOCK
\$19.00**



Delivered
C.O.D. or outside
U.S.A. add 25c

A husky, durable saw heavily built of grey iron and steel. TORRINGTON NEEDLE BEARINGS for long life and friction-free operation. 12" x 14" table tilts to 45° angle; adjustable guide; adjustable, removable guard; miter gauge; hardened and ground shaft. Arbor adjustable for depth of cut. Uses standard 6" blade (available at extra cost of \$4.00). A great saw at a really low price.

Send for literature describing entire line
Satisfaction Guaranteed or Money Back

Searjeant Metal Products, Inc. 89-90 Allen St. Rochester 6, N. Y.

Sterling Silver SADDLE RING



Authentic replica of championship rodeo saddle! Handsomely formed from solid Sterling Silver, by expert silver craftsmen. Men's, Women's, Children's styles. Sent on approval.

SEND NO MONEY! Just clip ad and mail with name, address, ring style and size. Pay postman only \$4.95 (includes tax) plus postage, wear 5 days. If not delighted, return for full refund. 1904 Farnam St.

Western Craftsmen Dept. 672-E Omaha 2, Nebr.

CRAFTSMEN . . .

We offer you hundreds of craft materials, supplies and accessories:

- PLASTICS • POWER TOOLS • PLYWOODS
- PLASTIC LEATHERS • JEWELRY FINDINGS
- MARINE PLYWOOD • BOAT KITS
- PLASTIC KITS • SHOP SUPPLIES

Send 10c for latest big 64-page illustrated catalog.

CARMEN-BRONSON CORP.

162 So. Fulton Ave., Dept. DS-1, Mount Vernon, N. Y.

AMAZING NEW MOTOR KIT



Here's the new electric motor bargain you've been waiting for—you and your friends will be amazed at the clever design of this rugged little motor.

- Complete kit—finest materials
- Easily constructed with simple hand tools
- Connect it to toys, shafts, etc.

SEND NO MONEY

Just send your name and address and when your motor kit arrives merely pay postman \$1.00 plus a few cents postage—or enclose \$1.00 bill, check or money order for post-paid delivery.

HOBBY MOTOR CO. Dept. 101, Box 252, Greenville, Michigan

NAVY STANDARD BATTERY (Brand) (New)

Made by Gould Storage Battery Corp. 6 volt 15 amp. hour. Excellent for motors, motorcycles, amateurs, experimenters, radio servicemen, etc. Shipped dry, with complete instructions for charging. 4 1/2" wide, 4 3/4" deep, 6 3/4" high. Shipping weight 12 lbs. While they last. . . .

\$4.95



MICHAEL STAHL, Inc.

39 Vesey Street

New York 7, N.Y. Dept. P.M.11

NOVEMBER 1947

**STOP LEAKS
In Concrete, Brick or Stone
WALLS and FLOORS**



Apply Smooth-On No. 7 Iron Cement to cracks, holes, seams and porous spots, using a trowel or stiff brush. The surface to which you apply it may be either wet or dry. In about 24 hours the Smooth-On will have set hard, sealing the leaks. It will stay in place, because it expands slightly as it sets.

Use Smooth-On No. 7 also to line cisterns, swimming pools, troughs, fountains, septic tanks, etc. Use it to seal openings where piping passes through walls.

Buy Smooth-On No. 7 in 1-, 5-, 25-lb. or larger size at your hardware store; if they haven't it, write us.

FREE REPAIR HANDBOOK

40 pages. 170 illustrations. Clear, simple directions for stopping leaks, sealing cracks, tightening loose parts in household equipment and autos. Every home needs this useful repair guide. Just mail the coupon for YOUR free copy.



—Sign and Send NOW—

**SMOOTH-ON MFG. CO., Dept. 37L,
570 Communipaw Ave., Jersey City 4, N.J.**

Please send me a Smooth-On Handbook.

Name _____

Address _____

11-47 _____

Do it with **SMOOTH-ON**
THE IRON CEMENT OF 1 000 USES

SAY YOU SAW IT IN POPULAR MECHANICS

BUILD YOUR OWN *Modernistic* SPORTS TRAILER

COMPLETE PRE-FABRICATED KIT, READY TO ASSEMBLE

DIRECT-FROM-FACTORY-TO-YOU SAVES 50%

Sleeps 2 adults comfortably, roomy galley, plenty of stowage space. Lustrous all-aluminum exterior; overall length 12'7", width 6', height 5'. Total weight only 400 lbs., easy to take anywhere for delightful trips. Eye-appealing airflow design created by aircraft engineers, with distinctive comfort features found only in most expensive custom-built jobs. Features: torque-type spring and SAE 10-40 Steel axle; Timken high-speed bearings; Ford 16" disk wheels; tail and clearance lights that pass state laws; heavy-gauge Kaiser Aluminum thruout. Precision fitted, comes complete with all parts needed, less tires and tubes.

2 Days of Your Time Assembling the Modernistic Saves You Over \$200.00

Easy-to-follow instructions make your assembling real fun. If factory assembled or sold to you by a dealer, this de luxe sports trailer would cost over \$500.00. Factory-to-you price only \$279.50, F.O.B. Los Angeles. When ordering, enclose full amount or, if you desire speedy C.O.D. shipment, send \$50 deposit.

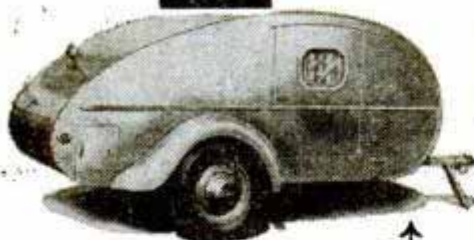

Actual View of Trailer Assembled



View of Galley, Stowage Compartment and Roomy Interior



Remove Body in 10 Minutes and You Have Flat Bed Utility Trailer for Year-'Round Use

ALTERNATE CONVENIENT PURCHASE PLAN: Can be bought in 2 sections: Section 1, containing chassis and outer shell units, only \$157.50; Section 2, containing balance of trailer, when you're ready for it, \$139.00; deposit of \$50, if ordering C.O.D. (Materials alone, without pre-fabrication, would cost you more if you bought locally.)

Specify COMPLETE KIT or SECTION 1, when ordering. Fit and quality of every unit unconditionally guaranteed. You'll be pleased—ORDER TODAY. Write for free folder.

MODERNISTIC TRAILER MFG. CO.
Dept. M1, 1230 E. 109th St.
Los Angeles 2, Calif.

MARGIE



DOES THE COLD BLOW IN?

IT'S TIME TO WEATHER-STRIP WITH *Mortite*



KEEP WARM—SAVE FUEL

Don't put up with dangerous, drafty zones in your home when it's so easy and inexpensive to weatherstrip with Mortite. Simply press pliable Mortite around windows, doors, baseboards, etc. It keeps cold out, keeps heat in, shuts out dust and dirt, too! Mortite adheres to any clean, dry surface. No tools, no tacking needed. Anyone can apply it.

3 Sizes: 29c - 98c - \$1.25

Higher west of the Rockies and Canada
Get at stores or write for free circular



J. W. MORTELL CO., 522 Burch St., Kankakee, Ill.

PRECISION JEWELERS SCREW DRIVERS

Complete Set of 8 for Every "Hobbyist"



At last—a complete set of precision screw drivers to meet the needs of every model builder. Not a miniature but the same type set used by U. S. Navy for precision instruments and watches during the war. Brass knurled handles, hexagon heads, finest tempered steel blades. Sizes 2-9. Never before a set of this quality and precision at such a low price. Your money back if not satisfied. C.O.D. \$2.00 plus postage or send \$2.00 and we pay postage.

PINE WATCH CO., Rm. 24A, 29 Eldridge St., New York 2, N. Y.

JEWELRY HOBBYISTS

This BEAUTIFULLY ILLUSTRATED CRAFTSMAN'S CATALOG NO. 7 is NEW, DIFFERENT! Contains such items as rosary kits, plastic gems, findings, chains, beads—everything for the serious hobbyist. SEND 25¢ (REFUNDED ON FIRST ORDER) TODAY!

P. O. BOX 90

PITTSHIRE • PITTSFIELD, MASS.

The CRAFTSMAN'S Catalog

JEWELRY WITH THE TOUCH OF DISTINCTION

PRICED FOR PLEASURE OR PROFIT!

NOW... THE IDEAL CHRISTMAS GIFT.

For Sportsmen, Boy Scouts - Anyone Who Travels.



3-way Combination HUNTING KNIFE, FORK AND BOTTLE OPENER

Sale... Easily Carried... Durable. High Quality Product. Made of stainless steel with heavy duty gleaming plastic, combined case and handles.

Perfect for picnics, camping, lunch boxes, fishing, hunting, traveling, hiking.

Only \$1.98

Free Delivery On Prepaid Orders

SECURITY CO.

Suite 216

229 No. Broadway

Los Angeles 12, Calif.

"I'LL TAKE THE WHITE ONE EVERY TIME!"



WYTEFACE
TRADE MARK
STEEL MEASURING TAPES



KEUFFEL & ESSER CO.

CROSMAN Silent RIFLE



POWER without POWDER

You'll like a Crosman because there is no recoil to spoil your aim... no noise... no odor... no cleaning! Rifled barrel for greater accuracy... adjustable power, too, for short or long range shooting indoors or out. Available in .177 and .22 cal. models.

AT YOUR DEALER OR WRITE DIRECT

CROSMAN ARMS CO., INC.
3D HENRIETTA ST., ROCHESTER 7, N. Y.

Shoot CROSMAN SuperPells

The BETTER Ammunition for ALL .177 and .22 caliber Air Pistols and Rifles.

.177 cal... \$2.50 per M
.22 cal... \$3.00 per M

FOR GREATER ACCURACY MAXIMUM POWER

POSTAGE PREPAID
At your dealer or order direct

CROSMAN ARMS CO. HENRIETTA ST., ROCHESTER 7, N. Y.

CHUPP ROTOR-FLYER CAPTIVE AUTOGIRO



Here's something really new, an amazing, scientific model, covered by the same basic patents as full size passenger-carrying autogiros. Designed by an experienced aeronautical engineer, the ROTOR-FLYER is sturdily constructed of spruce, white cedar and balsa wood. Carefully machined fittings are rust-proof, heated steel, brass and aluminum. Precision manufacturing assures easy replacement of parts. Spares available.

BUILD IT YOURSELF - SEE IT FLY

Dimensions of the ROTOR-FLYER—length, 40"; span, 41"; height, 10"; weight approx. 10 oz.

The ROTOR-FLYER IS EASY TO ASSEMBLE, EASY to fly. It needs only the power of a ten mile wind. Owners report flights over 2000 feet. GET YOURS FOR CHRISTMAS!

4.95

POST-PAID U.S.A. ONLY

GEORGE W. MOORE INC., 99 Beaver St., Waltham, Mass.

V-8 DUALS & SINGLES

MUFFLERS

STEELS and ALUMINUMS with a motorboat tone

SINGLES, Chev, V-8, Plymouth, Steels \$5.50, Aluminum \$6.50. Chry., Olds., Buicks, etc., Steels \$7.50, Aluminum \$8.50. V-8 and MERCURY DUALS, Steel \$17.50, Aluminum \$20.00. Aluminums are guaranteed for life of your car.

DEALERS WANTED

SANDEE MUFFLER CO.
7523 S. WESTERN AVE., LOS ANGELES 44, CALIF.

Surplus Patches

50 EVERY ONE DIFFERENT FOR ONLY \$1

Army Shoulder Patches—Officers Collar Insignia—Large Flying Squadrons in multi-colors—all in this BIG bargain pack of 50 all different sent Post-paid on receipt of only \$1.00. Some factory rejects—most however perfect. Complete catalog with every order. Biggest bargain ever. Money back if not satisfied. No C.O.D.'s. Best Assortment to early buyers. Visit our store when in N. Y. (near Wanamakers).

THE INSIGNIA MART
703 Broadway, Dept. C2, New York 3, N. Y.

Now! YOU CAN INSTALL DUAL WHEELS

On Your Car, Trailer, Pick-up Truck, Farm Wagon or Jeep with DROP CENTER DISC WHEELS

IN LESS THAN 10 MINUTES



- INCREASE LOAD CAPACITY
 - INCREASE TRACTION
 - INCREASE TIRE LIFE
- Now you can convert your vehicle to dual wheels without the high expenses of changing to truck-type wheels and hubs or changing the entire rear axle. This

new patented converter does the job at a fraction of the old cost. For use on Ford passenger and 1/2-ton truck, 1928 to 1947 (except 1936-39); Chevrolet passenger and 1/2-ton truck, 1927 to 1947; Dodge-Plymouth passenger and 1/2-ton truck, 1933 to 1947; Willys and Ford Jeep vehicles, all models; all trailers and farm wagons equipped with any of the above type wheels.

GUARANTEED TO DO THE JOB OR YOUR MONEY BACK.

NORTHWESTERN AUTO PARTS CO. MINNEAPOLIS 11, MINN.

Only \$2850

Complete Set

It's EASY as A-B-C

No changing required. No drilling necessary. Rim-wrench does the job.

1. Mount the first wheel.
2. Screw on extension bolts.
3. Slip on adapter housing.
4. Mount the second wheel.

THAT'S ALL!



CLIP THIS COUPON NOW

Northwestern Auto Parts Co. PM-11
834 N. Seventh Street, Minneapolis 11, Minn.

Please send me.....Dual Wheel Converters at \$28.50 each.

FORD CHEV DODGE-PLYM JEEP

Also Fits Farm Wagons Using Above Type Hubs

Name

Address

City..... Zone..... State.....

Money Order Check

ATTENTION DEALERS: Many fine territories open.

With this New *Minute Man* Tool Kit

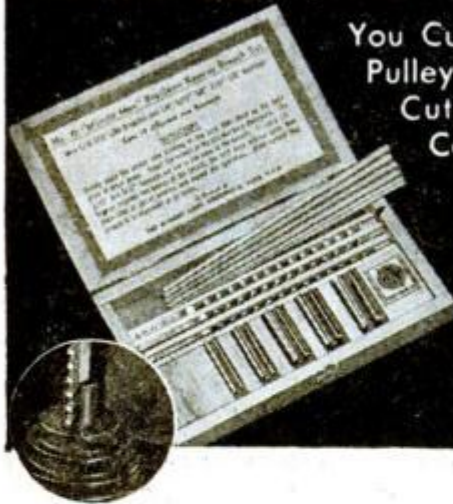

You Cut Keyways in
Pulley Hubs, Gears,
Cutters, Collars,
Couplings, Etc.
**BY HAND,
IN
ONE MINUTE**

Kit contains precision broaches, slotted bushings, shims, keyway stock — everything you need to cut clean, accurate keyways any standard width, any depth.

Kit illustrated is ideal for home workshop — cuts 12 different size keyways in small bores.

Complete in handsome hardwood case, only \$25.00.

Write for Folder "PM", illustrating and describing, with prices, full range of Minute Man Keyway Broach Kits for machine shop, industrial and home workshop use. Cut a few keyways and the Kit has paid for itself.



Santa Rides Again!



SEND FOR THIS NEW

FREE

SUPPLEMENT & GIFT GUIDE

SUPER VALUES FOR YOUR LIST—FOR YOURSELF



- ★ save money!—new low-cost offerings in P. A., "ham" equipment and wanted radio parts.
- ★ miracle Lafayette FM tuner, sensational buy!
- ★ rich console radio with automatic record player, under \$100.
- ★ selection of small home electrical appliances.

... and lots more.

Lafayette Radio

RADIO WIRE TELEVISION, INC.

100 Sixth Ave., N. Y. 13 • 542 E. Fordham Rd., Bronx 58
110 Federal St., Boston 10 • 24 Central Ave., Newark 2, N. J.

LAFAYETTE RADIO, Dept. LK-7
100 Sixth Ave., New York 13, N. Y.
Rush new Supplement & Gift Guide #885.

Name.....
Address.....
City.....Zone.....State.....



USE OUR CAPITAL

NO SALES EXPERIENCE NEEDED

The biggest opportunity ever, to quickly establish a money-making, lifetime business, now awaits you as a McNess Dealer. Sell things farmers need and use up. Serve same families year after year. Pleasant work--no bosses--easy to do. We supply capital to work on. Also provide offers--advertising--premiums and trade secrets that bring sales.

First to apply get best trading areas. Don't wait--write us today for McNess proposition. Tell us county and state you want to serve. Ask for free McNess Book.

The McNESS CO., 481 Adams St., Freeport, Ill.



BE FAIR TO YOUR HAIR Want better-looking hair? Embarrassed by falling dandruff, itching scalp? Then try VITABRUSH, new electric driven scalp brush that gives your scalp a vigorous and invigorating "workout" in just three minutes of fun. Cleans scalp. Stimulates blood supply. Restful. Pleasant. Write today for complete information and satisfaction-guaranteed offer.

Hershey Mfg. Co., 157 S. La Salle, Chicago 3

CANVAS COVERS Waterproof tarpaulins, war surplus (Used), perfect condition. Originally made for tents. Approx. 5'x8'. Two buttoned together make approx. 80 sq. ft. Complete with buttons attached. Suitable for use as canvas dams, hay covers, truck covers, machinery and equipment covers, etc. Packed in bales 40 each, priced 40 covers, \$1.00 ea.; 15 covers, \$1.50 ea. Less than 15, \$1.75 ea. All FOB, Kansas City.

AMERICAN SUPPLY CO.

329 W. 5th Dept. P. M. Kansas City, Mo.

AMERICA'S LOWEST PRICED BAND SAW



ENGINEERING FEATURES FOUND ONLY IN HIGHEST PRICED MACHINES

Practical, modern design; new improved model. Accurate, smooth operation. Cuts to center of large 14" circle, 2 1/2" thick. Genuine "Oillite" bearings; adjustable ball-bearing blade guide. Upper wheel blade-tension adjustment; safe, fully enclosed mechanism. Thoroughly proved construction, ruggedly designed with sturdy laminated plywood. Stands 24" overall. As illustrated--blade included. **Immediate Delivery!** Ask your dealer or send only \$16.95, and we'll pay shipping charges. Or, if you prefer, will forward C.O.D. Absolute Money-Back Guarantee.

Now

\$16.95

Postpaid

SEE YOUR DEALER or write Dept. 102

SERRO MFG. CO. 1933 Olive St. St. Louis 3, Mo.

ONLY \$9.95

ADJUSTABLE GOOSENECK FLOOR LAMP

PUTS LIGHT WHERE IT IS NEEDED MOST

INDUSTRIAL USES: Over power sewing machines; precision work; fine close work.

PROFESSIONAL USES: Hospitals for patients; operating rooms; doctor's and dentist's offices.

BUSINESS: Drawing boards; filing; typing, typesetting.

IN THE HOME: Sewing; writing; reading in bed.

GIFTS

KEEPS GLARE OUT OF EYES

Overall height 60 inches. Adjustable to 73 inches. Chrome socket, extension and neck. 11 feet of rubber cord. Approved by underwriters. Heavily weighted base. White or Bronze. Give preference. Includes 100-watt standard bulb. Reflector can be removed and a standard heating therapeutic bulb inserted.

MONEY BACK GUARANTEE Send check or Money Order Today.

Shipped Express Charges Collect.

CARNAGEY'S, 29 Central Ave., Dept. GG-1, Tarrytown, N.Y.

AIR COMPRESSORS

BENDIX-WESTINGHOUSE 4 CU. FT.

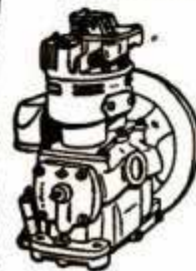

2 Cylinder BUS and Truck Piston type ball bearing. Pressure feed oil system. Positively one of the finest and most accurately built air compressors on the market. Each Compressor completely checked and in good operating condition.

Ideal for home work shop; garage; filling stations; paint spraying; farms; factories, etc.

Original List Price \$160.00

Our NEW Low Price **\$29⁵⁰** FOB, K. C.

MIDWEST SURPLUS SALES CO. 1520 Locust St. Kansas City, Mo.

Ugly BLACKHEADS OUT IN SECONDS



Keep your complexion free of Blackheads this new way — look attractive instantly!



Try VACUTEX Blackhead-Remover.

The amazingly effective Vacutex extracts Blackheads automatically — WITHOUT squeezing the skin or injuring tissues. Easy to use with three fingers. It reaches Blackheads anywhere. Try it 10 days and if not delighted, return VACUTEX and your money will be refunded.

\$700



AT YOUR DEALER OR USE COUPON

10 DAY TRIAL COUPON

BALLCO PRODUCTS CO., Dept. A-3211
19 West 44th St., New York 18, N. Y.

- Enclosed find \$1. Send postpaid.
- Send C.O.D. I will pay postman \$1 plus postage; \$1 refund if not delighted.

SORRY. NO C. O. D.'s OUTSIDE U. S. A.

SAY YOU SAW IT IN POPULAR MECHANICS



CONVERTIBLE

2800 MILES FOR \$16

Weighing about 1/3 as much and operating for about 1/2 as much as other so-called light cars, the new fine CROSLLEY reverses the trend toward heavy, cumbersome, expensive automobiles—and delivers amazing performance.

For example: George Kachaylo, 3452 Childs Court, Baltimore, made five trips to Sharon, Pa. (2800 miles) and spent less than \$16 for gasoline.

And the Crosley is a FINE car. In the convertible or sedan, you get ample room for 4 husky people plus luggage. You get a smooth, care-free ride.

In the 1/4 ton CROSLLEY PICKUP, you get true economy for service calls, light deliveries, etc.



In every CROSLLEY you get the startling COBRA (Copper BRAZed) steel engine with 7 1/2 to 1 ratio; delivers 35 to 50 miles per gallon and smooth cruising at 50 miles an hour.

Sedan lists \$888 at factory. Taxes extra.

CROSLLEY

a FINE car

For information and literature, write: Crosley Motors, 2532-HF Spring Grove Ave., Cincinnati 14, Ohio.



STOP LEAKS!



Cooling Systems Made Leak-Proof QUICKLY

WARNER LIQUID SOLDER—Non-Metallic—Deposits Tiny Fibers to Repair Leaks Anywhere in Cooling Systems. Simply pour in! Finds and REPAIRS every crack or hole. Do it yourself—or see your service man.

Warner-Patterson Co., 920 S. Michigan Ave., Chicago 5

QUALITY**8" FLOOR MODEL
TILT-ARBOR SAW**

**SAW
TILTS
TABLE
STAYS
LEVEL**

**UNCONDITIONALLY
GUARANTEED
1 YEAR**

Complete as shown with Trans-axial Ball Bearing Motor Drive, Ball Bearing Saw Arbor, Table including extension 18" x 25", Aluminum Fence & Saw Insert, Complete Mitre Gauge, 3 1/2" steel column and cast iron base, Precision segments on mitre gauge and cradle.

\$79.50 F.O.B.
ROYERSFORD, PA.
**UNUSUAL
VALUE**

BENCH MODEL, \$59.50
Shipping Wt., 118 lbs.

Cast iron table extension bracket furnished. Will support plywood top much larger than 9" x 18". Motor pulley and belt furnished. Blade & Motor NOT included. Overall height 35 1/2", Shipping Wt. 156 lbs.

AMERICAN MACHINE & TOOL CO. Inc.
DEPT. 110 ROYERSFORD, PA.

Write for free illustrated folder.

**SHOVELS SNOW, SAWS WOOD
PLOWS and CULTIVATES**

SHAW DU-ALL and



'PEPPY PAL' TRACTORS

These rugged walking and riding tractors pay their way the year 'round. Plows, discs, harrows, hauls, operates lawn mower, cutter bar, spray, bulldozes, plows snow, runs wood saw and other belt machinery.

Ideal for small farms, orchards, truck gardens, poultry farms, golf courses and estates.

Easy to change attachments with improved Jiffy Hitch. Patented tool control allows quick adjustment for wide hills or crooked rows. Sturdy, extra-strength construction means low upkeep cost. Operates for only a few cents an hour.



LOW FACTORY PRICES

Buy direct and save. Mass production holds prices down—quality up. Anyone who has a garden can afford a "Peppy Pal". Write for FREE folders and price list.

**SHAW
MFG. CO.**

4511 FRONT ST., GALESBURG, KAN.
6686 NORTH 4th ST., COLUMBUS, OHIO

**LOOK
TALLER
INSTANTLY!**



**WEAR
HITE-BUILDERS
IN YOUR
OWN SHOES**



Want more respect? ... more opportunities? Then increase your height INSTANTLY with Davis Hite-Builders. Slip them inside your own shoes. Invisible ... comfortable ... easy to wear. Made to last for years. Amazingly low-priced!

SEND NO MONEY

Rush name, address, and shoe size today. Pay postman only \$1.95 plus few cents postage for your pair of Hite-Builders, mailed in plain package. If not delighted with immediate result, just return them and we'll refund your money at once. Or send \$1.95 now and save postage. Same guarantee ... of course. Order today, look TALLER next week!

DAVIS MFG. CO.
DEPT. C-338 LOVELAND, OHIO

**Only
\$1.95
A PAIR**

FLASHLIGHT LAMP ASSEMBLY
NEW—Govt. Surplus. Lights up the "Hard-to-get-at" places. Fine for mechanics, electricians, radio repairmen, filling station attendants, in the home, and many other uses. Plastic 12" extension (6" stiff and 6" flexible). Adjustable to any angle. Originally priced over \$4.00. Our price Postpaid..... **\$1.80** Ea.

New Electricians CABLE REPAIR KIT contains built-in 1500 watt, 110 Volt AC vulcanizer with complete tools and equipment. Gov't cost over \$200.00. Our price FOB. K. C. **\$34.50**

New G. E. AIR COMPRESSOR 1/2 HP, 27V-AC-DC. Many uses, paint spraying, etc. 1,000 lb. output. Shipping wht. 20#. F.O.B. K. C. **\$14.95**
COVERALLS (Flight) New, Gabardine, size 38 **\$57.50** postpaid
Flight Boots A-6, Sheep Shearling lined, (used—excell. cond.) small, medium, large, postpaid..... \$57.50

Hundreds other items—WRITE FOR CIRCULAR

National Surplus Sales Co. 1810 Charlotte, P.M. Kansas City 8, Mo.

SAY YOU SAW IT IN POPULAR MECHANICS

Signal-Powered Radio
(No electricity, no batteries)

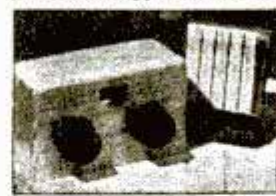

GET YOUR MONEY'S WORTH ... Custom-designed to outperform all others of its type. Novelty appeal secondary, a real radio. Tiny cabinet 2 1/2 x 1 1/2 x 1 1/2. Two inductively-coupled circuits var. cond. tuned. Single station tuning anywhere. Frequency-dividing switch, all broadcast, some police bands. Radar's Germanium diode detector for strongest reception. Alternate antenna circuit. Jacks for two headsets. Plexiglass back panel, works visible! Never wears out. Complete with sensitive phone. \$6.95 postpaid in U.S. **Caring—Box 1308—Chicago 90**

MACHINE SHOP EQUIPMENT



Just off the press!—Every man who owns a workshop should have a copy of the new, up-to-the-minute, 200 page catalog of Machine Shop Equipment—the latest tools made by the biggest manufacturers in the U. S. Replete with illustrations, descriptions, prices. Prompt delivery on most tools listed in this book. Available at cost of printing—50c a copy—get yours today! **Price of Catalog Refunded on First Order over \$5.00.** Send check or Money Order to

CENTER TOOL CO., 153 Centre St., Dept. C, New York 13

POWERFUL WAR-TESTED

PUTT-PUTT

GIVES YOU APPROX. 4 H.P.

GASOLINE MOTOR

plus 24-28 volt 70 amp 2000 watt

D. C. GENERATOR

For only \$69.50 complete

Here's one of the most useful items to come out of war surplus! Known throughout the Air Corps as the Putt-Putt, it's a combination gasoline motor-generator that packs a wallop as a universal power-source and generator of DC current. Each unit is slightly used, in excellent condition and guaranteed operative. Substantially crated for domestic shipment, they arrive complete, ready to operate. Generator is removed by detaching only 4 bolts. Cost to govt.: several hundred dollars. Cost to you: \$69.50. Order now. Save C.O.D. charges by remitting in full—or send 25% deposit (bal. C.O.D.)

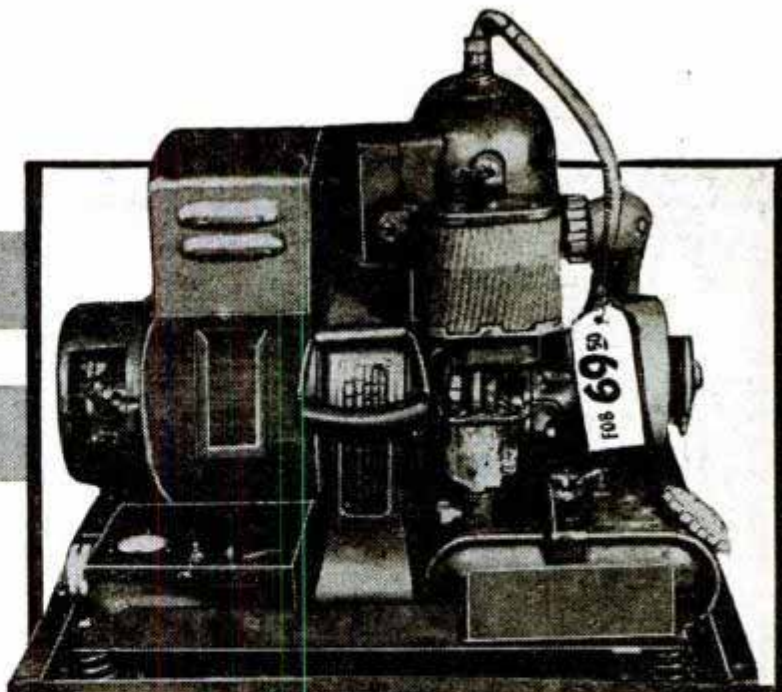

SPECIFICATIONS

- Govt. designated HRU-28, Commercial C-10A
- Removable generator (reduces weight by half)
- 3/4" power-take-off shaft (2 1/2" extension)
- 1 cyl.-2 cycle gasoline motor
- Height—21 1/2"
- Voltage regulator—12 to 35 volts
- Total weight—115 lbs.
- Length—24 1/4"
- Width—17 1/2"

USES:

- Amateur Radio power supply
- Battery Charging
- Power source for war-surplus radio equipment (24v.)
- Powering farm equipment
- Starting airplane engines
- Generator for boat or farm (auxiliary) lighting
- Powering mowers & buzz saws
- Welders

R & M RADIO COMPANY

Dept. P-11, 1426 N. QUINCY ST., ARLINGTON, VIRGINIA



WOULD you like to buy yourself a nice big chunk of financial security? You can by building a lucrative business of your own NOW with TRADIO, the radio functionally-designed for coin-operation in hotels, hospitals, motels, etc. All over the country, individuals like yourself are finding it a natural for big earnings and a steady income. TRADIO has pioneered in

this new and flourishing postwar industry. Get in on the ground floor and assure yourself of financial security for life. Phone, wire or write Dept. N-11 for complete information. No routes sold.

TRADIO, Inc. ASBURY PARK NEW JERSEY

BUILD YOUR OWN OIL BURNER!!

**PLANS \$1.00
COMPLETE KIT \$19.75**

Be Comfortable next winter at **LOW COST!**

Genuine Breese pot provides clean fire.

Genuine Detroit Lubricator float valve, regulates from four pints a day to half gallon per hour.

Six inch Field draft control goes in standard smoke pipe.

Everything you need except 2 used 50-gallon oil drums.

Just enclose a dollar bill for plans to be applied on Kit price when you order.

HUGH MANUFACTURING COMPANY

Heating Division

Hartley Box 145 Iowa



IT'S SING SING FOR SUPPER UNLESS YOU FIX THAT DOOR WITH WELDWOOD GLUE



When you want to fix things fast... remember Weldwood Glue. It's quick to mix... easy to use... tremendously strong... stain-free... rot-proof... and permanent. At hardware stores, lumber yards, chain stores.



WELDWOOD
PLASTIC RESIN
WATERPROOF GLUE

United States Plywood Corporation, New York 18, N. Y.

"Funster"

The New Amazing 20 way-play HOME GYM SET
FOR INDOORS OR OUTDOORS **BUILD IT YOURSELF** OF WOOD

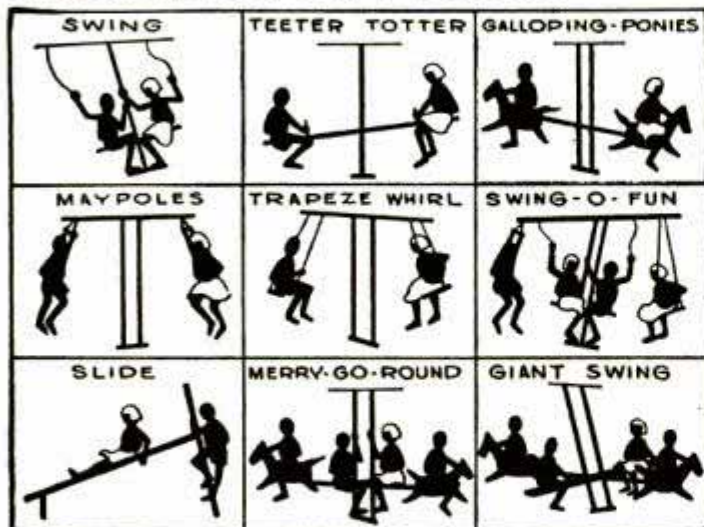

The unit includes, besides these illustrations, a chair-plane scoot-a-round, gym bar and various combinations of play thrills. **ALL PARTS ARE INTERLOCKING AND REQUIRE ONLY FROM 10 TO 50 SECONDS TO CONVERT FROM ONE PLAYTHRILLER TO ANOTHER.**

An Ideal Xmas Gift For All The Children

INSTRUCTIONS FOR ALL 20 WAYS

ONLY \$2.00 SEND FOR YOURS NOW

THE HIGHLAND MFG. CO., 2848 Garfield St., Highland, Indiana

Start a SAW REPAIR BUSINESS!

MAKE A GOOD LIVING IN YOUR OWN BUSINESS—sharpening saws with the Foley Automatic Saw Filer. It makes old saws cut like new again. All hand saws, also band saws and cross-cut circular saws can be filed on this ONE machine.

THERE ARE HUNDREDS OF SAWS TO BE FILED in your own neighborhood, used by farmers, carpenters, homes, schools, factories, etc. W. L. Tarrant writes: "I left my old job last September and in 10 months have filed 2,159 saws. We have a lovely business worked up and cannot keep up with the work."

SEND FOR FREE PLAN—Shows how to start this steady cash business. No experience needed, no eyestrain, no canvassing. Send coupon today.



FOLEY Automatic SAW FILER

FOLEY MANUFACTURING CO.
1116-7 Foley Bldg., Minneapolis 18, Minnesota
Send Free Plan on Saw Filing business, no obligation

Name _____

Address _____

Do You Ride a Bike?

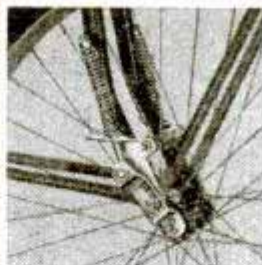

"SHOCKMASTER" for all Bicycles

- LEVELS ROUGH ROADS
- PREVENTS BROKEN SPOKES, WHEELS, FORKS
- MAKES RIDING SMOOTHER, SAFER
- EASY TO INSTALL

"Shockmaster"—the front wheel shock absorber—is ruggedly constructed of nickel plated steel and engineered for years of real service. It'll pay for itself in added pleasure, saves tires and eliminates many costly repair bills. 20,000 satisfied users. Order yours today. Only \$3.50 postpaid. No C.O.D.'s. Complete satisfaction or money back. Dealers Wanted.

H. M. GIBB and COMPANY

1304 PENOBSCOT BLDG.

DETROIT 26, MICH.



BOATS for Home Assembly

"U-MAK-IT"

KAYAKS, ROWBOATS, DINGHIES, INBOARDS, OUTBOARDS, RUNABOUTS
Cut-To-Fit for Quick Assembly. Everything Complete plus Illustrated Instructions. No Experience Necessary. Simple as A. B. C.

SEND 25c POSTAGE (COIN) TODAY FOR 3 MONEY SAVING ILLUS. CATALOGS Showing all '47 Models (marine plywood) and construction details.

25¢ COIN FOR ALL THREE

AQUAMOBILE V-18

Designed for Auto Engines. Open or with cab. Length 18 ft.
Fast VEE Bottom Hull



KAYAK BOAT CO., 703P-WHITTIER ST., NEW YORK 69, N.Y.

HOW TO CUT RAFTERS

New vest pocket book gives lengths, Side cuts, Plumb cuts, Deductions. For all rafters for any building from one inch to forty feet wide. Gives numbers to cut on square. Also degrees for same cuts for Radial Saws. All standard pitches from 1/4 to 3/4. Just open book to pitch page and there are your lengths, side cuts, etc. Anyone who knows what a jack rafter is can frame a roof if he has this great book. Price one dollar pre-paid. BUILDERS' TOPICS, Dept. M, Lock Box 828, Seattle, Washington. Original teachers of the square in five easy lessons by mail. SEND FOR FREE LIST OF TECHNICAL BOOKS. Learn to read blueprints etc.



CARBOLOY-TIPPED

Tools for Wood, Metal, Plastic

Same high quality as used by the big factories. Long-life, high production—a pleasure to use. Performs perfectly on wood, metal, and plastic. In pairs as shown—either 1/4 or 5/16". Cash with order, postpaid. Ask for free catalog.

SCHMARJE TOOL & ENGINEERING CO., MUSCATINE, IOWA FULLSIZE, CUT-TO-SHAPE BOAT PATTERNS

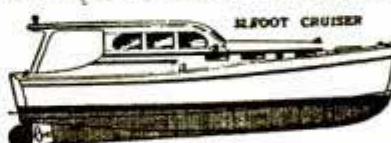

and specifications. Designed by Naval Architect. Cruisers, runabouts, sloops, outboards, sailing canoe, etc. Low prices. Send 10c (coin) for illustrated catalog. SPECIAL: Send \$1.00 for "HOW TO BUILD BOATS" book, postpaid.

Cleveland Boat Blueprint Co. Dept. 666, Cleveland 13, Ohio

New Designs in FRANZITE GRIPS

Modernize Your Gun! Improve Your Score!

Most durable grips made. Positively unbreakable! For Colt, Smith & Wesson, Hi-Standard, Ortigs, Luger & Mausers in a wide choice of beautiful designs in ivory, pearl, walnut, onyx, etc. Low prices. FREE CATALOG. Dealers Wanted.

SPORTS, INC. (Mrs.) 5501 Broadway, Dept. P-11, Chicago 40, ILL.



FACTORY SURPLUS OUTSTANDING BARGAINS



MILLIAMMETERS
No. 5066
High grade instruments. Special dial, 6" dia. Flush mounting—5 milliamperes, full scale—50 M.V. drop. Handsomely finished.
Price \$7.50



ELECTRIC TIME CLOCKS
No. 5419
Handy for photographic dark rooms—turning out lights in garages, shops, etc. 110 volt, 60 cycle, 29 amp. capacity. 1 to 100 minutes duration.
Price \$4.80



CIRCUIT BREAKERS
No. 8992
This overload switch is ideal for automatically breaking circuit when load is excessive. 15 AMP. capacity, 110 volts, AC.
Price \$2.50



COPPER SULPHATE RECTIFIERS
No. 8991
Ideal for fast battery chargers, electro-plating, moving picture projectors—many other uses. 100 AMP. input, 17 VAC; output, 8 1/2 VDC.
Price \$9.90



SOLENOID SWITCHES
No. 9465
Used for variety of purposes. Can be adapted to Fords for under-hood starter switch.
Price \$1.50



V-GROOVE PULLEYS
No. 8655
Sturdy pressed steel construction, steel hubs. Single groove.
3.6 in. dia., 1/2 in. bore \$0.65
4 in. dia., 1 in. bore . \$0.65
8 in. dia., 1 in. bore . \$1.25



ELECTRIC MOTORS
No. 5418
Quality built, 1/50 HP., motor. A real bargain. Wide application. Accommodates No. 8990 fan, below. 1500 RPM., 110-volt, 60-cycle. Shaft, 1/4 in.
Price \$4.75



TWO BLADE FANS
No. 8990
Strongly constructed. 1/4 in. bore. Fits shaft of No. 5418 motor. Combination makes excellent cooling unit.
\$0.55



ELECTRIC MOTORS
Variable speed, reversible, brush-shifting, intermittent duty types. Operate on any phase of 2 or 3-phase circuit.
No. 5496 1/2 HP. 500-2500 r.p.m. \$45.00
No. 8589 1 1/2 HP. 750-6000 r.p.m. \$79.00
No. 8517 3 HP. 750-6000 r.p.m. \$129.00

ALSO AVAILABLE
Red or green bull's eye signal lamps, \$0.95 ea.
No. 4226 Special, high grade vacuum gage. Mount it on steering column of your car. \$2.00
.001 Mfd. 10,000 V tubular condensers.
.2, .5, .25 and 1.0 Mfd. 400 V. tubular condensers.
10, 100, 350 ohm fan-type resistors.
Vitreous resistors, fixed.
Carbon resistors.
Many other types and capacities.

All items listed are new. Outstanding quality. Act quickly to take advantage of this offer backed by a manufacturing experience of over 30 years.
SPECIAL PRICES WHEN ORDERING QUANTITIES
(All prices F.O.B. Chicago, Ill.)
Send today for complete list of available items.
JOSEPH WEIDENHOFF, INC.
4344-58 W. ROOSEVELT RD. CHICAGO 24, ILL.

Ottawa Self-Propelled Buzz Master
CLEARS LAND FAST! Powerful 7-HP motor with friction clutch for safe operation. Cuts down timber, brush and hedge; turn blade vertically and saw logs to length. Also furnished with post hole diggers. Has clutch pulley for belt work.
OTTAWA MFG. CO., 1-727 Brush Ave., Ottawa, Kansas

THE MACHINE THAT AMAZED THE EXPERTS!

STOP CHANGING MOTOR OIL!

End this needless waste and expense forever with . . . "RECLAIMO"
Today's Most Advanced Oil Re-Refining Filter!
Continuously cleans and RE-REFINES motor oil as you drive (by utilizing motor heat)—keeps oil in high grade lubricating quality at all times—reduces motor wear to an absolute minimum! Proves conclusively that "Oil Does Not Wear Out Mechanically" as stated in U. S. Bureau of Standards, Bulletin 86.

"RECLAIMO"
REMOVES SOLIDS (by filtration) PREVENTS Excess Fuel Dilution
REMOVES WATER (by distillation) PREVENTS Acid & Sludge Formation
MAINTAINS Stable Viscosity ELIMINATES All Oil Changes!
CAR — TRUCK — TRACTOR OWNERS!
You'll want to know more about Reclaimo's Oil, Motor and Money Saving Features. FREE 40-PAGE BOOK "OIL FACTS" gives you the complete "Reclaimo" story plus details about our NEW 90-DAY NO RISK—NO COST TRIAL OFFER! Write for your copy today!

RECLAIMO MFG. CO.
5083 Elston Ave. Dept. 58 Chicago 30, Ill.

BANDSANDER IS BACK AGAIN!

ONLY \$14.95. FOB FACTORY

The remarkable, economical home-shop Bandsander is again available for immediate shipment! Quickly shapes, sands, carves and polishes wood, metal, plastics! Works equally well on inside cut-out opening or irregular outside edges, on intricate scrolls, curves. Gets at places no other can! Patented. Tilting table for bevelling, chamfering. Rust-and-sweat proof top. Self-oiling sleeve bearings. Saves time, labor, money, invaluable to homecraftsmen, hobbyists, model-makers, etc. Normal band speed 1600 ft. per min. gives fast, smooth, clean cuts. 1/4 hp 1725 rpm motor recommended. Rush only \$14.95 with order — or \$5, balance COD. 5 Days Trial, Money Back Guarantee. Prompt shipment. Limited supply—so hurry! Dealers write! (Or send postcard for Free details.)

MEAD SPECIALTIES CO.,
4114 N. Knox Ave., Dept. 1117, Chicago 41, Illinois.

**Now! PAINT YOUR CAR
LIKE NEW WITH**

Wipe-On
CARONIZE

**NO BRUSHING!
NO SPRAYING!
JUST WIPE
IT ON!**



\$4.95
Postpaid

**PAINTS TWO FULL COATS
ON AN AVERAGE AUTO**

No brushing...spraying...
masking! Almost anyone can
now paint his car the
smoothest, brightest colors
with just a few simple
arm strokes. Just spread
Caronize over the surface
of your car and it looks
fresh from a professional
paint shop. No streaks...
no lap marks...just follow
the simple instructions.

Caronize is not a polish or wax,
but a glowing, hard enamel finish. For
a lasting, brighter "paint-shop" finish on
your car, use Caronize. It's easy to do!
Guaranteed!

CHOICE OF 6 LUSTROUS COLORS

- | | |
|------------------------------|---------------|
| 1. Fiery Red | 2. Brewster |
| 3. Washington
(Dark) Blue | (Dark) Green |
| 5. Maroon | 4. Black |
| | 6. Cloud Gray |

ORDER CARONIZE TODAY

Mail postcard. Then pay postman for
Caronize plus postal charges. If you send
money with order, we pay postage.

DEALERS write for quantity prices and full information.

CARONIZE, INC.
828 S. 18th St.

Dept. PM-11
St. Louis, Mo.

**SEND
NO
MONEY!**

**QUICKLY DRIES
TO A GLEAMING
"FACTORY-NEW"
FINISH**

**LOOKS LIKE
AN EXPENSIVE
SPRAY JOB**

**How to Start
YOUR OWN BUSINESS
And Reap BIG Profits!**

Plastics, one of the most revolutionizing and rapidly expanding industries, offers a great opportunity to all enterprising men and women. This is one of the few industries in which home manufacturers thrive and prosper. You can start even on a spare time basis in your own home, and expand rapidly into a full time business, paying good profits.

LIQUID MARBLE
Make LIQUID MARBLE the amazing Plastic, with a thousand uses. LIQUID MARBLE can be poured into FLEXIBLE MOLDS for casting all kinds of artistic and serviceable articles such as: ornaments, novelties, desk sets, paper weights, book-ends, souvenirs, statuary, toys, etc.

FLEXIBLE MOLDS
Make your own FLEXIBLE MOLDS. The cost is low—in fact, a large sized mold costs but a few cents. Hundreds of casts can be taken from a single mold.

NO EXPERIENCE NEEDED!
No skill, or previous knowledge is necessary. All you do is follow our easy-to-understand instructions.

UNLIMITED MARKET
The market is literally unlimited. You will find steady year-round demand in your own community. Your problem will not be in selling but in supplying the huge pent-up demand. Moreover, we supply you with names of buyers for your finished products.

WRITE TODAY
Bing Products will show you how to start with a small investment and build a permanent, independent, profitable business! Don't fail to grasp this opportunity! Write today for FREE CATALOG.

BING PRODUCTS

Dept. A-24, 88 Broad Street Boston 10, Mass.

**PRESS YOUR OWN
PANTS • TIES • LAPELS**

SAVE TIME AND MONEY. Plug in AC or DC socket and you're ready to go—no wet cloth, no board, no bother. Two nickel-plated pressing sides do the job. Use at home, office, when traveling. Women like it for skirts, slacks. A fine gift. Free circular.

Presser opens with a flick of the thumb.



Empire Products, Inc., 817 Main St., Dept. PM, Cincinnati 2, Ohio

Empire PRESSER

\$2.49 at stores or send check or money order. C.O.D. accepted. Satisfaction Guaranteed.



**Quick!
Easy!**



**GUARANTEED
LIFE TIME**

Guaranteed not to rust, corrode, stain or tarnish.

**CHRISTMAS SPECIAL
STAINLESS STEEL WRIST WATCH BANDS**

The most comfortable and wearable band. \$1.00 For Single Orders. 4 sizes—Large for about 7 1/2" wrist, Medium 6 7/8", Small 6 1/4", Ex. Small 5 1/2". Bands are 1/2" or 3/8" wide to fit watch.

SEND PENNY POST CARD
INDICATE SIZE AND WIDTH
\$1.00 plus c.o.d. charge

**AGENTS & DEALERS WANTED
BANDS, INC.** 1491 Ruge Street West Salem, Oregon



Balance 4" x 9" Base. With either Metric or Avoirdupois Weights .. **\$7.00**

Catalog with 3000 Illustrations of laboratory apparatus, and over 10,000 prices sent for \$1.00.

LABORATORY MATERIALS CO. 7321 Vincennes Ave. Chicago 21, Ill.

**SELF-CONTAINED - COMPLETE SPRAYING
OUTFIT**

No hose or elec. cords; no pumping

Completely self-contained, portable spray gun—fully guaranteed. Sprays paints, enamels, insecticides. For home, workshop, garden, farm. For pressure uses a CO2 Cartridge available at all drug stores at 10c or less. Complete, ready for use; with one cartridge.

Price, postpaid **\$18.50**

SULLIVAN-BECKER 6705 14th Ave. Kenosha, Wisconsin

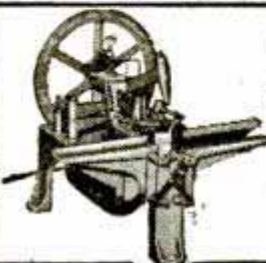

**AUTOMATIC
SAW SET**

Set saw teeth automatically on hand or band saws — 400 per minute without effort. Perfect hammer and anvil action sets teeth uniformly—No tooth breakage.

BURR MFG. COMPANY 8933-K Venice Blvd. Los Angeles 34, Calif.



**IMMEDIATE
DELIVERY**
Write Today

**AUTOMATIC
RETOOTHER**

Cuts new saw teeth in 50 seconds—any size 4 to 16 points. Old teeth fall off as chips. Easy to operate. A perfect job.

**FOR HAND
SAWS**



ATOMIC BALL POINT PEN

No. R360. Styled after one of the most expensive pens. You will like the balance, ease in writing and smooth performance. Writes on cloth, paper, wood or cardboard. Can be used for carbon copy work. The lacquered gold colored cap and clip has the wearing qualities of stainless steel. They are ideal for personal use and make a welcome birthday or Christmas gift.

20 Year Service Guarantee

A 20 year service guarantee stands back of every pen. You may try the pen 10 days and if you are not satisfied 100% you may return it for full refund.

1 FOR \$1.00 3 FOR \$2.00



MYSTIC WEATHER WIZARD

No. H1180. Molded of plastic. Predicts weather 8 to 24 hours in advance. Fair weather brings out the Dutch boy and girl, foul weather is preceded by the witch. It's 5 1/4" high 4" wide.

PRICE ONLY \$1.00

SPORS CO., 9-47 Main, Le Center, Minn.

TURNER

VT-73

DESK MICROPHONE

Here's the mike you want for your rig. It's got looks, it's tough, and man, oh man how it performs. It's a TURNER! Ask your dealer or write for Free Literature on other low cost Turner Microphones.



THE TURNER COMPANY

921 17th St., N.E., Cedar Rapids, Iowa

Assemble KING MIDGET

Practical highway racer runabout. We supply all parts. Just bolt together. Low cost. Ready for delivery NOW. One or two cylinder 40 m.p.h., 45 to 50 on ice or snow with skis, up to 100 miles per gallon. Send 25c for complete literature with large picture, 4-view drawings, price of parts, or send \$1 (refunded with first order) for the above, plus 24-page assembly book with 42 photographs and drawings; blueprints for converting for use on ice and snow, etc.

MIDGET MOTORS, Athens, Ohio



AMAZING DENTAL DISCOVERY

Griplate

REFITS and
TIGHTENS
LOOSE
FALSE PLATES



Don't suffer from loose false plates that wobble, drop, click or cause soreness. Use **GRIPLATE**—the amazing, patented, plastic lining that *actually re-fits and tightens* loose false plates instantly. **GRIPLATE** permanently hardens to the plate, is odorless, tasteless, requires no heat and is *easy to apply* for quick results. Enjoy eating, talking, chewing without embarrassment. Order **GRIPLATE** today for Both plates—only \$2.00 plus postage. For upper or lower plate—only \$1 plus postage. Sent postpaid when remittance accompanies order. **SATISFACTION GUARANTEED or Money Back!**

**SEND NO
MONEY!**

THE GRIPLATE CO., Dept. P-11
6754 Sheridan Road • Chicago 26, Ill.

Give USEFUL GIFTS



"Boys" from 6 to 96 love good hand tools... to use on the job or around the home. For gifts that men prize highly, choose tools. And select the best—Plomb Prime-Quality Tools. Your Plomb Dealer has a complete line in a wide range of prices. See him today. Write for catalog to

PLOMB
TOOL COMPANY
2255M Santa Fe Avenue
Los Angeles 54, Calif.

4769



PLOMB Prime Quality TOOLS

NOW! A FINE TARGET PISTOL EVERYONE CAN AFFORD TO OWN AND SHOOT!



"POWER without POWDER"

THE NEW .177 CAL.

Crosman "Bullseye"

Now ... from the makers of the famous Crosman *Silent Rifle*, comes the new Crosman "Bullseye" ... a single-shot pistol of regulation target type and weight, with the design, quality construction, balance and deadly accuracy demanded by experts. Compare it for performance and thrills. You'll find the Crosman "Bullseye" the outstanding value in small arms today.

SEE YOUR DEALER OR WRITE

• Using Crosman *Super-Pells*, the better ammunition for all air-powered pistols and rifles, you can shoot the Crosman "Bullseye" for ONLY 1/4c PER SHOT!

CROSMAN ARMS CO., INC.
DEPT. 3D, ROCHESTER 7, N. Y.

ASK TO SEE CROSMAN DODO AND BELL TARGETS

HOME CRAFTSMEN! BUILDERS!

DRAW ANYTHING. ANYTIME. ANYWHERE
NEW PORTABLE FOLDING • SELF-CONTAINED



STERLING DRAFT KIT

Builders, Contractors, Craftsmen, Home Work-shop Owners, Artists, Students, Engineers, Architects, and Executives!

Save 50% of your time and effort with the **STERLING DRAFT KIT**. Just one "L"-square and One Triangle pivots and lays out any line or angle.

Fast. Easy to use. Accurate. Compact. Self-contained. Fold and carry where you need. Always ready for instant use! In time saved and greater convenience **STERLING DRAFT KIT** pays for itself over and over again!

No. 12 for 8 1/2 x 11" paper. No. 18 for 11 x 17" paper.

SEND TODAY FOR ILLUSTRATED CIRCULAR

STERLING DRAFT KIT

DIV. OF STERLING-FREELAND INDUSTRIES, INC.
8th Floor — 122 S. Michigan Ave., Chicago 3, Ill.
(Patented. Patents Pendg. U. S. & Foreign Countries)

HANG THAT DOOR THE PROFESSIONAL WAY!

USE THE TIME SAVING —LABOR SAVING . . .

E-Z Mark Butt Gauge

YOU DO THIS



AND GET THIS

- Hang more doors better.
- No adjustments • No errors.
- Used and approved by Master mechanics.
- Comes in 3 1/2" and 4" (standard) sizes.
- Precision made.

Cost ONLY \$1.75 each or \$3.50 a set at your hardware store. If your Dealer can't supply, send only \$1.00 with order and pay Postman balance, plus postage C.O.D. \$3.75 in Canada (No C.O.D.)

You get a clean cut deeply etched profile. Remove chips. Repeat this operation on the jamb and hang the door. THAT'S ALL—NO MORE!

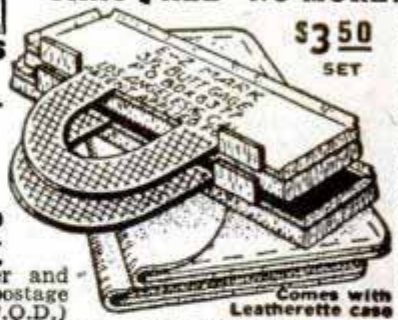

\$3.50 SET

Comes with Leatherette case

E-Z MARK TOOLS • P. O. BOX 8377 • LOS ANGELES 16, CALIF.

GARDEN TRACTORS

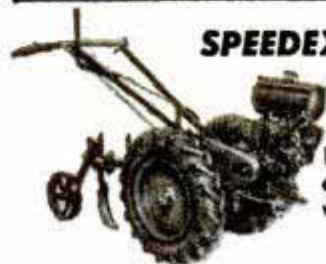

SPEEDEX

SAVE UP TO \$100.00 OR MORE BY PURCHASING NOW

Immediate delivery in limited quantities. For full information write for free circular.

P-1247-53

POND GARDEN TRACTOR COMPANY
BOX 216 RAVENNA, OHIO

SELF LUBRICATING BEARINGS



Over 2 million in stock in 500 sizes of plain, flanged and spherical types in Bronze or Iron. Big savings.

Send for Free Catalogue
THE ARRANDALE COMPANY
SHREWSBURY, NEW JERSEY



"BILD-A-FONE" SET

\$2.95 set of 2, 50' cable

A Perfect Gift for the youngster! No batteries needed. Point to point communication. Set of 2 includes 50 ft. cable and instructions. **SCHUH'S RADIO PARTS**
1253-A LOYOLA AVENUE CHICAGO 26, ILLINOIS

METALS

sold in small quantities for the home workshop. Steel, Brass, Copper, Aluminum, etc. In Bars, Shapes, Tubes and Sheets. Write for free price list.

CASHMETALS CO., 2720 California Ave., Pitts., 12, Pa.

Big Money for Workers In Home or Shop



Licensed Concrete Specialists wanted. No experience needed. Make Colorglazed concrete pottery without molds. New, low cost, patented method. Cemetery products, novelties, tiles, etc. Basement leaksealing. Other big pay projects. Booklet, details free. Men only.

NATIONAL POTTERIES COMPANY
415 Third Avenue, W., Grand Rapids, Minnesota

Get in on the ground floor! Be first in your area to enter this

profitable NEW business!

**YOU'RE CERTAIN TO SUCCEED
BECAUSE DRYEX SUCCEEDS
WHERE EVERYTHING ELSE HAS FAILED!**

DRYEX

**makes wet walls DRY
... and keeps them DRY!**

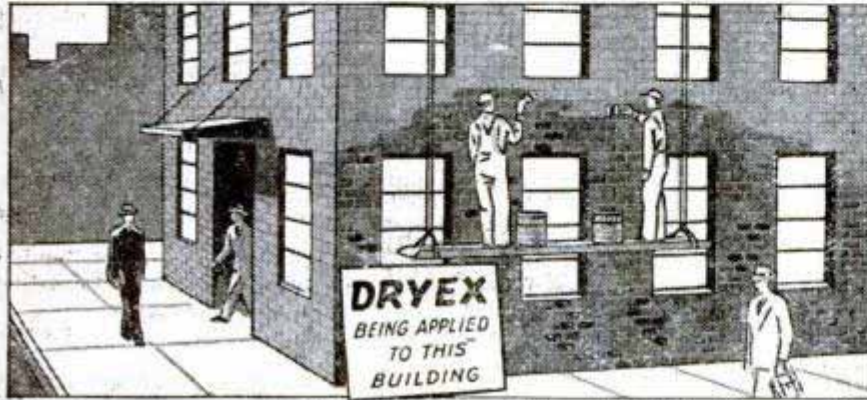

SELL OR APPLY DRYEX ...
the great wartime discovery that will make big money for you!

Easy to brush on, easy to sell, DRYEX spells "opportunity" for you. Every owner of a leaky wall is your prospect, and there are thousands of them! Amazingly effective, DRYEX is the miracle plastic that seals leaky exterior walls definitely and enduringly. Stays tough, flexible and waterproof in all weather, all climates.

Your Territory May Still Be Open. Write Today for Details.

LASTING PRODUCTS COMPANY

Franklinton Road Plant, BALTIMORE 23, MD.

IMPORTED SWISS WRIST WATCH

Precision Made With Hands and Numbers that GLOW

Stream-lined chrome case. Smart dial with sweep second hand. Precision movement. With metal stretch band. Order today! Supply limited.

\$5.95

Plus 20% Fed. Tax

SEND NO MONEY

We mail COD plus postage or send remittance, save postage.

VOGUE JEWELERS, Dept. PM11
1003 Locust St. Louis, Mo.



WAR SURPLUS 110 VOLT - 60 CYCLE - 2500 WATT POWER PLANT GENERATOR

NEARLY NEW 110-volt single phase 60 cycle A-C generator. Exactly like commercial power. Self-excited. No other equipment required. Fine for ranchers, taverns, sportsmen. Generate your own electricity. Powerful portable plant. (Complete except engine.) Small engines easy to pick up or you can use water or wind power. Fine stand-by power for farms. Contractors use for on-job power saws, drills, etc. Full instr. installing, using. Guaranteed perfect. Order now or write for details.

LECO ENGINEERING CO. Box 908-PM-D, Lincoln, Nebr.

Only **\$89.40**
FREIGHT PREPAID U.S.A. ONLY

STERLING SILVER LADY LUCK HORSE SHOE RING

Stylusque Horse's head, horse shoe and 4-Leaf Clover design. Handsomely formed from solid Sterling Silver. Oxidized, hand-buffed finish.

SEND NO MONEY! Just clip ad and mail with name, address and ring size. Pay postman only \$3.98 (tax included) plus postage. Wear for 5 days. If not delighted, return for full refund.



Styled for men or women.
WESTERN CRAFTSMEN Dept. 572A 1904 Farnam St. OMAHA, NEBR.

WAR SURPLUS BARGAINS

<p>FIELD JACKETS, M1939, zipper & buttons in front. 2 slash plets, adjusting straps at wrists. Letter P on back can be removed. Used, in good condition, small, med. & lge. Sh. wt. 3 lb. post-paid. \$1.75 ea.</p>	<p>SUPERCHARGERS, used, in good con., aircraft surplus turbo type, comp. Can be converted into blowers, turbines, etc. Cost Gov't. approx. \$1,000. Sh. wt. 175 lb. \$15.00 ea. Lab. Harrisburg, Pa.</p> 
<p>Oxygen Cylinders, new, high pressure, 2000-lb. capacity, 1 1/4 dia., 10" long, 3000-lb. gauge & release valve. Ideal for tire inflators, fire extinguishers, small air tanks, etc. Sh. wt. 2 1/2 lb. \$4.50 ea.</p> 	<p>SYNCOVAL ENGINE MOUNTS, new, ball bearing & rubber suspension mount. Ideal for all types of machinery, engines & shop equip., etc. Ruggedly constructed forged arm & base. Mtg. bolts bonded in rubber for max. vibration absorption. Sh. wt. 5 lb. \$2.85 ea.</p> 
<p>BOOSTER MOTORS, new, high r.p.m. reversible motor comp. with removable reduction gear train. Mtg. brackets & feed guides incl. For small high-power motor applications requiring high efficiency & small space, conveyors, feed mechanisms, grinders, etc. Sh. wt. 4 lb. & oz. \$5.75 ea.</p> 	<p>Trim Tab Motors, new, reversible, high r.p.m. 24V. For use wherever small highly efficient rotating power is req'd. Sh. wt. 14 oz. \$2.85 ea.</p> 
<p>GUN HEATERS, new, designed to heat machine guns from as low as 80° below 0. Adaptable for auto engine heaters, bottle warmers, plastic molding ovens, etc. Sh. wt. 2 lb 10 oz. \$4.75 ea.</p> 	<p>Oxygen Manifolds, new, handy where several outlets are desired from one source of supply. For liquids or gases. Machined from solid block of metal, 6 plugs & 2 connector fittings. Sh. wt. 14 oz. \$1.50 ea.</p> 

NO C.O.D. SEND CHECK OR MONEY ORDER TO
MICHEHL INDUSTRIES
930 F St., N. W., Washington, D. C., Phone Executive 5687

BUILD YOUR OWN TILTING TABLE SAW!

A few evenings work will put this sturdy saw in your workshop at a fraction of the cost of manufactured saws of comparable capacity and performance. Does all ripping, beveling, mitering, grooving, and other circular saw operations with speed and accuracy. Tested and proven design.

SAVE
\$50
OR MORE

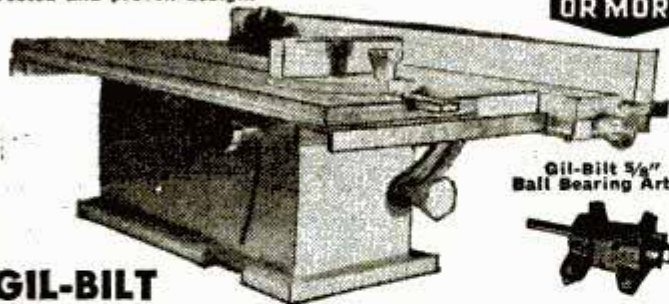

Gil-Bilt 5/8" Ball Bearing Arbor

GIL-BILT TILTING TABLE SAW FEATURES:

- 21 x 27 in. table, 13" capacity in front of blade, tilts full 45 degrees with positive lock in any position.
- 8 in. blade cuts from 0 to 2 1/2 inches.
- Specially designed precision 5/8" ball bearing arbor.
- Self-aligning and calibrated rip fence and miter gauge.
- Sturdy wood, steel, and aluminum construction engineered for rigidity and warp resistance.
- No machining — Build easily with hand tools.
- No blueprint reading — simplified step-by-step plans illustrated with actual photographs, full scale patterns.
- Use any 1/4 to 1/2 h.p. motor or gas engine.
- All metal parts in kits as low as \$9.65 — lowest prices in field.

GIL-BILT BALL BEARING ARBOR—cast aluminum housing, lubricated and sealed precision ball bearings, press fit precision faced collar, specifically designed for saws. **\$7.50**

GIL-BILT SPECIAL PARTS KIT—Includes Gil-Bilt Ball-bearing Arbor, Step-by-step Plans, aluminum channel and bar, cast aluminum hand-wheels, V-pulley and all other metal parts (less blade) including screws and bolts. **\$14.95**

No dealers—low price! Prices include postage up to 600 miles. Send cash, check or money order for complete kit, or send \$1.00 for Step-by-Step Plans and order kit later less cost of plans. Plans sent postpaid anywhere in the world.

COMPLETE
PLANS
only
\$1.00

GILLIOM POWER TOOLS

Box 1-B, Lambert Field St. Louis 21, Missouri

"Mr. Walker"

THE FASCINATING ACTION TOY FOR YOUNGSTERS AND ADULTS.

WALKS DOWNSTAIRS!

America's greatest post-war Action Toy. An ideal Xmas gift. It walks down a flight of stairs! Fascinating and exciting. Nothing to get out of order. No winding, no motor. Just set it on the top step, flip it and plop, plop, plop, it goes downstairs automatically like a giant night-crawler. Be the first to amaze your friends with this toy sensation. Fun galore! Sent anywhere in the U. S. Postpaid for **\$1**

An unusual Christmas gift, for adults and children. Order several now!

Travis Products Co.
224 W. Huron St.
Dept. 49-P, Chicago 10, Ill.

"PROFITABLE KEY DUPLICATING"

WITH THE

HOUK KEY MACHINE

IS FULLY EXPLAINED IN OUR **FREE** ILLUSTRATED CIRCULAR... send for it today!

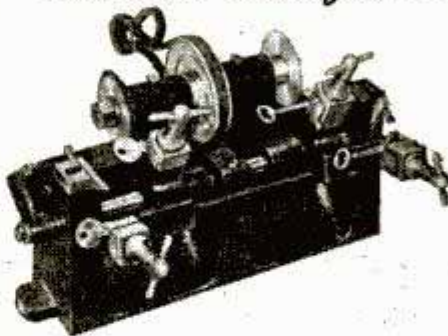

only
\$82.50
EACH FOB NY
IMMEDIATE
DELIVERY

WHITLOCK CORP. 17 WARREN ST. NEW YORK 7

HAND REAMER SETS



A Complete Set of 33 Hand Reamers—1/4" to 1 1/4" by 32nds —All in a Well-Built Oak Box!

REGULAR \$90.00 VALUE!

OUR PRICE—
\$30.00

GUARANTEED!

Send for Our Complete Catalog of Machine Shop Tools and Equipment — Only 40c — Refunded on First Order over \$10.00.

VETERAN TOOL & SUPPLY CO.

88 Baxter St.

New York 13, N. Y.

GOVERNMENT SURPLUS

GRAND NEW



VICKERS HYDRAULIC PUMPS

Hundreds of Practical Uses

BUILD YOUR OWN HYDRAULIC PRESS, ELECTRIC EYE DOOR OPENER, ETC.

\$15.00 F.O.B. DETROIT, MICH.

JAY-BEE SALES CO.

4554 Gd. River Ave.

Detroit, Michigan



MINE DETECTOR SCR-625

Locates buried pipes, cables, ore bearing rocks, metal in wood. Screens personnel in plants. Will detect over 2 feet deep. All components in wooden chest. Operating weight 15 lbs. Reconditioned. **\$39.50** Originally sold for \$166.00. Only... Complete with batteries.

SCHUH'S RADIO PARTS

12538 Loyola Ave.

Chicago 26, Ill.



ELECTRIC WELDER

AC or DC 110 Volts

Pre-war type—All metal—No chemical—5 year written guarantee. Welds 1/4" thick metal or money back. Repairs tanks, tools, fenders, machine parts, etc. Comes complete with rods, unit directions and eye shield. We also manufacture a set you can

learn with for only \$3.95 complete. On C.O.D. mailing charges extra.

ESSAY MFG. CO., INC., Dept. P.M., Quincy 69, Mass.

\$6.45

Complete



VENETIAN BLIND MACHINERY and EQUIPMENT

Write us for our Catalog

WRIGHT SALES CO., INC.

9600 Carr Ave. • Cleveland 8, Ohio

It's Self Tying

MAKE BIG MONEY!

The Self-Tying Tie Has Been Discovered
 Sell this sensational SELF-TYING NECK-TIE. Tailored in fine fabric, gracefully draped and fashioned. In today's smart patterns such as Foulards, Pearlots, Romaines, Burells, Orientals, etc. Each Tie 100% Wool Interlined. Guaranteed Wrinkle Proof.

BE A TY-SELF AGENT

Special Introductory Offer

Nationally advertised \$1 and \$1.50 Ties. We will send you one \$1 and one \$1.50 Tie... Both for \$1. State Color Desired. Please order one set only. Customer satisfaction or money refunded. Sorry—no C.O.D.'s.

TY-SELF CO. FULTON 2, ILLINOIS

Millions Already Wearing Ty-Self Ties

41 PIECE ASSORTMENT HAND GRINDER ACCESSORIES

Here's good news for owners of hand grinders. A 41 piece assortment of "wanted" parts and accessories for an endless variety of jobs. You'd pay well over \$15.00 if you bought these parts separately.

ALL THESE PARTS ARE INCLUDED

Outfit includes 20 mounted grinding wheels with 1/8 inch shank; 10 mounted grinding wheels with 3/32 inch shank; 10 rubber and resin wheels 1x1 1/4 x 1/4 inches—all assorted grits; and one mandrel with 1/4 x 1/4 inch screw.

A GUARANTEED VALUE

All parts are new—all are guaranteed. All in an attractive set-up box as illustrated. Postpaid in U.S.A. Order today.

GROBAN SUPPLY CO.

1522 S. Michigan Ave., Dept. PM11, Chicago 5, Ill.



**41
PIECES
•
THIS
\$15.00
VALUE
ONLY
\$4.95**

\$4.95

Sensationally New Low THERMOSETTING PLASTIC Cost in POWDER FORM { self casting MIX

NOW ANY-ONE CAN MOLD QUICK AND EASY
 "Kalon" is a NEW TYPE CASTING MIX... Does not require expensive equipment or presses to handle... Simply mix "Kalon" with water, stir and pour into mold... THAT'S ALL... "Kalon" remains liquid about 15 minutes after mixing, after which time "hardening" process begins and lasts from 20 to 30 minutes to permit removing the cast from the mold. JUST THAT SIMPLE. Pins, Clasps, Hooks, etc. can be inserted for Costume Jewelry, Plaques and other ornaments, while it is hardening.

We can supply KOROSEAL STOCK MOLDS to produce saleable products... Catalog showing these molds mailed prepaid for 15c. A Novelty Koroseal Mold is available at the Special LOW COST of ONLY \$2.00.

Start Molding Many Things
CLARENDON MFG. CO.

176 West Adams St. • Dept. P-11 • CHICAGO 3, ILL.

• **INTRODUCTORY OFFER** •
 A Trial Kit contains a 16-oz. supply of "KALON"... A pkg. of Mold Dressing... Set of Instructions **READY TO USE**... Sell the articles at a PROFIT. KALON can be cast in Rubber Molds. **\$1.49**
RUSH ORDER ONLY Postpaid

**CASTING MIX
STRONG,
TOUGH,
HARD**

NEW EASY WAY TO MAKE MONEY at HOME

Your cost only 5c

You get \$5.00.

Full or spare time.

It's easy to Bronze Baby Shoes. Business still in infancy. Get in on ground floor and skim cream of profit from rich and never-ending market. No experience needed. Learn in one week. Income up to \$1,000 a month full time—\$50 to \$75 weekly in spare time. We furnish complete kit and full instructions. So easy to understand that a 12 year old can become expert.

FREE FACTS. Write today. Don't send a penny. Just name and address in letter or post card. Be the first in your territory to reap rewards waiting. Costs only 5c to bronze shoes. Sell for \$5.00! This is too good to miss. Get facts today. Write to

KIKTAVI COMPANY
 Dept. 11, 8620 So. Ruthelen Los Angeles 44, California



AMERICA'S MOST USEFUL ENGINE The CLINTON

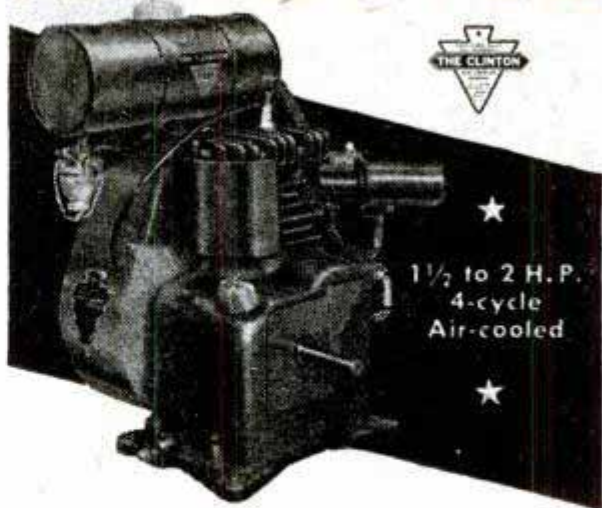

1 1/2 to 2 H.P.
4-cycle
Air-cooled

DEPENDABLE POWER

The engine preferred for powering lawn mowers—scooters—tractors—bikes—boats—concrete mixers, etc. Built by the world's largest manufacturer specializing in 1 1/2 to 2 H. P. Gasoline Engines.

Write for information Box 101 PM

CLINTON MACHINE CO.
 CLINTON, MICHIGAN

Auto Repair & Fix-It Shops Extra Profits for You!

See our ad Page 341
DYNAMIC WELDER CO. 13 E. 23rd St., RP, CHICAGO 16, ILL.

War Surplus Bargains

SLEEPING BAG
 Perfect all wool Olive Drab
 Comes in handy for fishing trips, hunting, camping, boating, just roughing it or use as auto robe and many other purposes. Has warmth of 2 blankets; zipper slide fastener. Tie-strap on bottom; approx. Gov't cost \$12.90, our price Ea. \$3.95
 Outside Cover for Sleeping Bag—Water repellent.....\$2.39

PUP TENTS Perfect—2 Man Size for Scouting, Camping, etc. Without Pole. \$2.95

NEW GOGGLES Set comes complete. Kit with 1 extra interchangeable shatter-proof, flexible, cellulose acetate lens. Green and white colors. A rubber flexible goggle frame. Back adjustment head strap. Made for A.A.F. Cost Gov't approx. \$4.50. Ea. 98c

BLANKETS All Wool... O. D. Excellent condition \$4.89
 #2 Grade Comforters, can be used for moving vans as padding, etc.....\$2.25

NEW BENCH LAMPS Adj. type for work benches and many other uses. Cost Gov't approx. \$15.00. Only \$3.95

HYDRAULIC JACKS FOR HEAVY DUTY WORK
 (Perfect) 8 ton \$10.95—20 ton.....\$44.50

WATER PURIFIERS "Sunstill" New, used by Air forces and Navy to distill salt water into fresh drinking water. Complete—nothing else to buy. Our price.....\$4.95

NEW PARACHUTES (Green Rayon) Approx. 36 sq. ft. Cloth good for making into ties, handkerchiefs, lining, etc. complete with canis. \$2.95
 ter, wght. approx. 10 lb.

AMERICAN SUPPLY CO. Dept. P.M., 5th & Broadway Kansas City, Mo.



NAMECHAIN

Personalized
Spells KEY
CHAIN
YOUR NAME
in full

DURABLY
CONSTRUCTED
The Perfect Gift

Each NAMECHAIN made to your order—up to 14 letters allowed. Packed in gift box. Orders shipped in 48 hours. We pay tax and postage.

★ GOLD \$3.50
★ PLATED \$2.00
★ STERLING \$7.00
★ SILVER \$7.00

NAMECHAIN MFG. CO.
19 East Pearson Street
Dept. 63, CHICAGO 11

STENCIL SETS

BRAND
NEW

ALL LETTERS A to Z
NUMERALS 0 to 9

A bargain sensation! Complete stenciling outfit—with interchangeable letters, numerals and punctuation. Complete with stencil brush and stencil paste—all in a fine, natural finish wooden box—all brand new.

HAS HUNDREDS OF USES

In factories, stores, home work shops, farms—there are hundreds of uses for a stencil outfit. Put your name, address, identifying numbers, etc. on all your personal belongings—boats, ladders, shipping cases, etc. These sets are brand new. Only because they're surplus can you buy them at so low a price. Send your order today! Postpaid in U. S. A.

GROBAN SUPPLY CO., Dept. PM 11
1522 S. Michigan Ave. CHICAGO 5, ILL.



Set in 1 in. Size
Complete, Only

\$2.50

Set in 2 in. Size
Complete, Only

\$3.95



FIRE FIGHTER PUMP SHOOTS 30 ft. STREAM!

Wash cars, windows, spray lawns, gardens, fight fires, etc. Just dip in pail of any liquid. A few strokes builds up pressure. Pump with one hand, guide hose with other. War Surplus U. S. Army Fire fighting equipment converted to every day use. All metal. Intake filter. Compact. 27" high. 10 ft. rubber-lined hose. Only \$2.98. Limited supply. Write Today.

SEND NO MONEY. Just send name and address . . . pay postman \$2.98 plus C.O.D. postage. Use 10 days, if not completely satisfied money back. Cash orders sent prepaid. M.P.K., Dept. 49-P, 179 N. Michigan Ave., Chicago 1, Ill.

SAY YOU SAW IT IN POPULAR MECHANICS



WE WILL GET YOU ANY BOOK YOU WANT

- Save Your Time!
- Save Searching!
- Save Money!

You can send to us for any book in print. We quickly get the book and send it directly to your door. We pay the postage when remittance accompanies orders. On C.O.D.'s there are extra charges.

Take advantage of our expanded book department and our new book counselling service. If you need a book on a certain subject let us help and advise you.

Fiction, biography, reference, art, science, technical, mechanical, children's books, etc., or any hard-to-locate book.

FREE Write for free catalog listing hundreds of books, and texts available.

We Pay Postage

Outside U.S.A. please allow 15% for wrapping and shipping.

HARD-TO-FIND BOOK DEPT.
Popular Mechanics Co.
200 EAST ONTARIO STREET
Chicago 11, Illinois

Write today!



- Row Boat—12 Foot
- Dinghy—8 Foot
- Dinghy—14 Foot Sailing
- Training Ship—4 Foot
- Sea Sled—9 Foot
- Outboard—12 Foot
- Cruiser—18 Foot
- Bicycle Boat—Kayak
- Row Boat—Sectional
- Dinghy—Sailing
- Canoe—16 Foot
- Sailing—12 Foot
- Outboard—12 Foot
- Penton—Runabout
- Ice Yacht

FOR PLEASURE OR PROFIT DESCRIBES 17 LOW COST BOATS Get this outstanding book and build a boat at home for your own use or to sell at a profit. You can do it. Just the boat you've always wanted—power, sail or row boat—17 different kinds and sizes.

Order BUILD A BOAT on postal card and pay only \$1.50 plus postage on delivery. Return in 5 days if not pleased and get money back. Or send \$1.50 with order and we'll pay postage. (Outside U. S. \$1.70 with order.) Order today.

POPULAR MECHANICS PRESS
Dept. 598, 200 E. Ontario, Chicago 11

DEEP
TONE

DUAL MUFFLERS

LONG
LIFE

1935 TO 1947—V-8 FORD
AND MERCURY

- More Horse Power
- Better Gas Mileage
- Less Back Pressure
- Blow-Out Proof
- Straight Thru Mufflers

FORD & MERCURY
DUAL SETS

\$20.00 C.O.D.
F.O.B. LOS ANGELES

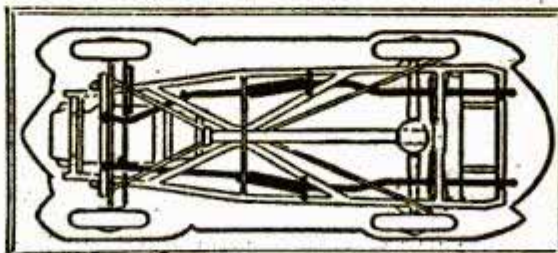

ORDER BY YEAR AND MODEL

- SIMPLIFIED INSTALLATION
No Welding, Cutting, Drilling
of Holes.
All Fixtures Furnished
Rubber Insulated Clamps

DEEP TONED SINGLE MUFFLER
Ford, Chevrolet, Ply. \$4.86
All others \$5.50
2 1/2" CHROME TAIL PIPE TIPS . . \$1.75

ADVANCE MUFFLERS DEPT. 3 ● 6800 So. Vermont Ave. ● Los Angeles 44, Calif.

PAY RAISING—EXTRA MONEY BOOKS

Use these books to prepare for a better job—bigger pay—to start a profitable spare time or full time business of your own, improve your home, start a hobby. Popular Mechanics specializes in supplying outstanding self-help books on many subjects. Send for our FREE catalog.

- Shop Notes for 1947**
Now ready. For every man who uses tools 60c
- Shop Notes Library**
5 Vols.—1946, 45, 44, 42, 41 (No Dup. Mat.) \$3.00
- Painting, Furniture Finishing and Repairing** \$1.50
- Rewinding and Servicing Electric Motors (No. 75)** 25c
- Elementary School Subjects for Home Study**
Covers high points of grammar, spelling, arithmetic, history, science, geography, etc. 635 pages, \$2.89
- High School Self Taught**
Covers 25 subjects with study guide and self-testing quizzes. Completely revised and enlarged edition, 1280 pages, 300 illustrations, ... \$3.95
- Garden Book**
Build own trellises, lawn furniture, fireplaces, ornaments, etc. \$1.00
- Diving, Cutting and Welding in Underwater Salvage Operations**
Only book of its kind .. \$2.00
- Picture Framing**
Modern methods for making and painting picture frames. Fully illustrated, \$2.75
- Frog Industry**
Breeding, feeding, dressing and marketing \$1.00
- New Fields for the Writer**
Television, radio, film, drama \$1.00
- Making Amateur Photography Pay**
How and where to sell your pictures \$1.00
- 20 Careers of Tomorrow**
Covers plastics, metallurgy, textiles, radio, electronics, television, transportation, chemistry, etc. \$2.50
- Breaking into Advertising** \$1.00
- Into the Freezer and Out**
A complete handbook on the home freezing of foods. \$2.50
- Concrete Handbook**
New book on using concrete around home, garden, farm \$1.50
- The Vegetable Growing Business** \$3.50
- This Way Up**
The successful philosophy of practical business men \$2.00
- Welding, Brazing and Soldering**
How to build own equipment and how to use it effectively \$1.25
- Modern Refrigeration**
Electric, Gas. Be service expert \$5.00
- Dyke's Auto Ency. (includes Diesels, airplane engines)**
New 20th Ed. World's greatest book for mechanics \$7.00
- Household Mechanics**
The "fix-it" book to end all "fix-it" books. Covers electric appliances, painting, carpentry, etc. \$2.75
- Oil Burner Handbook** \$2.50
- Build Your Own Boat**
Describes 17 popular boats—rowboats, sailboats, plywood outboard, etc. 192 pages \$1.50
- House Wiring (No. 89)** ... 25c
- Turn Scrap into Money**
Convert old auto generators into motors, welders, etc. \$1.00
- Woodworking for Everybody**
The first complete book on this subject. Considers tools, explains cutting and shaping of wood, and has 48 useful projects \$2.75

- Sheet Metal Work** \$3.00
- Tool and Saw Sharpening (No. 92)** 25c
- Forging Practice** \$1.50
- Action Toys (No. 66)**
Plans for 21 easy-to-make toys 25c
- Foundry Work** \$2.25
- Pattern Making**
Wood, metal \$2.25
- Forty Power Tools**
Build own saw, drill, lathe, sander, etc., from scraps—save money \$1.25
- Carpentry** \$2.50
- The Young Craftsman**
Over 450 things boys can make \$1.50
- Five Acres and Independence**
How to make money on small farm \$2.50
- Your Home and How to Build It Yourself**
Step by step construction of the famous POPULAR MECHANICS house. Wonderfully illustrated \$3.00
- Photo Guide**
Construct own equipment, gadgets. Make better photos \$1.50
- Knots, Ties and Splices**
For everyone who uses rope \$1.25
- Plastics**
Latest information on manufacture and use \$5.00
- LeJay Manual of Homemade Electric Equipment**
How to construct 100 items that are scarce and valuable \$1.50
- How to Estimate for the Building Trades: Material and labor costs for masonry, plumbing, electricity, carpentry, heating, hardware, painting, etc. 629 pp** \$5.50
- A Small Store and Independence**
Guide to successful retailing \$2.50
- Rabbits for Food and Fur** \$2.50
- Tool Making** \$4.00
- Tool Design** \$4.50
- Plumbing Installation & Repair** \$2.00
- Ropp's Calculator**
Figuring made easy .. 50c
- Slide Rule Simplified** ... \$2.75
- Drake's Refrigeration Service Manual** \$2.00
- Primer for Home Builders**
All the information you need to know in building a house \$2.50
- How to Remodel A House**
Nothing is omitted ... \$5.00
- Toys You Can Make of Wood** \$2.50
- A.B.C. of Poultry Raising** \$2.50
- Ice Cream for Small Plants**
Some technical formulas for ice cream, ices and frozen desserts on a commercial scale \$2.50
- Furniture Joinery** \$2.50
- Essentials of Upholstery** \$3.25
- Radio Physics Course**
A thorough training in radio fundamentals \$5.00
- Science Digest Reader**
Fascinating articles on astronomy, atomic energy, psychology, medicine, etc. \$3.00



25-Year Club—

... folks who have been doing a good job for a long time! And Inkograph's right up among 'em! Been working for 33 years, is hard to wear out! Inkograph's point is like a pencil's—one-piece, rounded, cylindrical, made of extra hard 14kt. gold—can't bend or spread. Writes easily on any kind of paper. Fits any hand or writing style. Makes carbon copies, rules lines. In five smart colors, and black. At all good stores And ...

only \$2

INKOGRAPH

Inkograph Co., Inc., 200 Hudson St., New York City 13, N. Y.

MODERNIZE Mother's SEWING MACHINE

MAKES SEWING A PLEASURE! **ELECTRIFY IT!**

A COMPLETE SEWING MACHINE MOTOR KIT that is adjustable for use with any type of Sewing Machine. Anyone can install it in a few seconds. The complete set consists of Universal AC or DC, 60 Cycle, 115 Volt Motor and Bracket; Long wearing Belt; Single Grooved Steel Hubbed Pulley; New, Improved Bracket; Foot Control (7 Step Rheostat); Extension Cord Set with Plug and Socket.

OUTFIT CAN ALSO BE USED TO MOTORIZED MANY OTHER APPLIANCES WHERE CONTROL IS NEEDED.

PASAAK'S DEPT. M-11
BOX 153, CANAL ST. STATION
NEW YORK 13, N. Y.

\$18⁹⁵
COMPLETE



MAIL THIS COUPON TODAY

Check the books you want, write your name and address below, and mail this advertisement with money order or check. Outside U. S. A. include 15% additional for shipping charges. Books selected will be mailed promptly on our "money back if you're not entirely satisfied" guarantee.

Name _____
Address _____
City _____ State _____

Mail to **POPULAR MECHANICS PRESS**
Dept. 650-200 East Ontario St., Chicago 11, Ill.

YOU CAN NOW BECOME A PROSPECTOR!

HERE IS ONE OF THE WAR'S TOP SECRETS

BRAND (NEW) ARMY MINE DETECTORS!

Portable: Will Detect METALLIC and NON-METALLIC objects; Very Sensitive; using 955 Tube in detecting head; two tube amplifier using two 1N5gt; headset; or microphone; also 150 micro meter; Power supply; 3-45v.; one 6-v.; or 2 3-v. batteries. Complete with instr. Less Batteries; packed in original cases; shpg. wgt. 108 Lbs.



FOB,
From N. Y.
No C.O.D.'s

SPECIAL
\$1750

With Batteries
\$26.40
F.O.B. N. Y.

Send order to

COLUMBO TRADING CO., INC.

304 CANAL ST. DEPT. M NEW YORK 13, N. Y.

BARGAIN 3X ARMY TELESCOPE

Original Cost \$150.00 — Our Price \$7.50

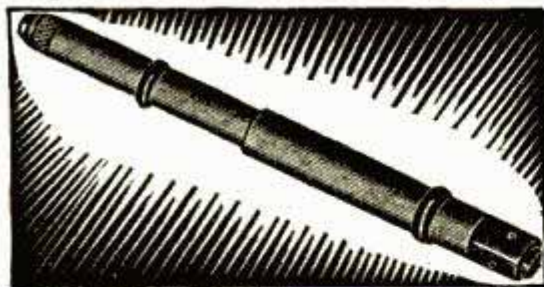

ALL COATED LENSES — BRAND NEW

An ideal gift for viewing objects, landscapes, seashores, etc. The high resolving power of the six coated lenses, five of them achromats will bring out great details. For the experimenter it can be dismantled and used for hundreds of projects. Length 22½ inches. 36° Field. Postpaid \$7.50.

500,000 Lenses and Prisms. Send 3c stamp for "Bargain" List

A. JAEGER'S

123-26P ROCKAWAY BLVD., SO. OZONE PARK 20, N. Y.

Second-Selling
WRIST WATCH



AIR & MARINE
NAVIGATION
TYPE

Beautifully designed as personal timepieces. Can be set to exact second desired. Worn and relied upon by Army-Navy Air Force, Commercial Airline and Shipping personnel. Made for Weems by Longines-Wittnauer. Stainless Steel Case. 15 Jewel movement. Easily read. Guaranteed. If not satisfied, return within 10 days and money back. Send check or money order for prompt postpaid shipment. Same watch in gold plated case \$49.75. State whether stainless steel or gold plate desired.

ONLY
\$43.75

Inc. Fed. Tax

WEEMS SYSTEM OF NAVIGATION, Dept. 2, Annapolis, Md.



True-Turn

New tool, with built-in micrometer, converts your drill press, grinder stand, wood lathe into a precision lathe to turn or cut-off steel, brass, aluminum. Send check or money order, or write for information to:

MILLHOLLAND SCREW PRODUCTS CORPORATION
134 West 13th Street, Indianapolis 2, Indiana

\$24.95
Full Set

MICROMETERS



FREE
FOLDER

Six piece set, in velvet lined leather case. Special price, only \$24.95. Precision machined in one thousandths, up to 4" outside and 3¼" inside measurements. Guaranteed accurate, easy to read and adjust. Satisfaction or money back. Also indicators and gauges. Shipped prepaid on receipt of \$24.95. (Out of U. S., \$25.95.) On C.O.D.s send \$2.00 deposit.

MICRO PRODUCTS, 8655 E. Jefferson, Detroit 14, Mich.

Do your own professional

FELT FLOCK FINISHING

with complete spray outfit

Now you can apply a professional, colorful, felt flock finish on hobby crafts, novelties, art objects, lamps, furniture, toys, etc. Velvety, durable, easy-to-apply finish. Available in 10 brilliant colors. Complete outfit (as pictured) includes undercoat, brown and ivory flock, solvent, brush, patented spray gun and instructions. Complete price \$9.25 post paid. Write for FREE circular and color sample card



BEROTT-ROSS • DEPT. 11A 411 No. Foothill Road, Beverly Hills, Calif.

LAW

STUDY AT HOME FOR PERSONAL SUCCESS and LARGER EARNINGS. 39 years expert instruction—over 108,000 students enrolled. LL.B. Degree awarded. All texts furnished. Easy payments. Send for FREE BOOK. G. I. approved. AMERICAN EXTENSION SCHOOL OF LAW Dept. 83-M, 646 N. Michigan Ave., Chicago 11, Ill.



MAKE BIG MONEY!

Be a floor surfacing contractor and sand both new and old floors. Sanders are easy to operate and better still, you're your own boss. Write for latest "sell-all" booklet entitled "Opportunities in Floor Surfacing", enclosing 25 cents in coin or stamps to cover handling.

AMERICAN
FLOOR SURFACING MACHINE CO.
235 So. St. Clair Street • Toledo 3, Ohio

HOLIDAY BEST SELLER!!

NEW "SUPER" DRINKING BIRD—Gorgeously created, 7¼" tall, rolling eyes, ass't colors with brilliant feathers, individually boxed, guaranteed working order. SELLS-ON-SIGHT. Trial Order \$8.00 doz., \$8.20 doz. in 6 doz. lots, \$7.20 doz. in gross lots.

FREE!! Catalogue, chock full of Quick-Selling Specials on Request.

ERNIE'S ENTERPRISES

725 PINE STREET

ST. LOUIS 1, MISSOURI

SAY YOU SAW IT IN POPULAR MECHANICS



HEAT BURNERS FURNACES GAS-OIL

L. P. PROPANE Gas Burners, Floor furnaces, Blowers, Oil Burners, Exhaust Fans, Controls. Card for free literature. Wholesale and Retail. DEALERS WANTED.

Peerless Sales

4318 Sheridan Lincoln 6, Nebr.



MACHINISTS' TELESCOPE GAUGE Something new! A REAL 20th CENTURY TOOL. These compact instruments measure by tens of thousandths the exact size of holes and slots using outside caliper or micrometer to determine measurement, and making shrink or loose fit. A screw adjustment is its great advantage. All contact points are carefully hardened and ground to radius of hole. Four measuring rods with lock adjustment measuring from 5/8" to 2¼". Guaranteed accurate and durable. One set packed in box. Order direct from your dealer or factory; postage prepaid, C.O.D. Send for booklet. Patent applied for. Price \$7.50

SEABOARD TOOL COMPANY
P.O. Box No. 514 Baltimore 3, Md.

Learn EXPORT!

BIG MONEY IN FOREIGN TRADE BOOM



Here is your opportunity to enter a respected vocation that may take you to far distant lands—acquaint you with interesting people the world over—make you a high paid executive.

No matter where you live, near a large city or small town—you can start your own export business with headquarters at home—on practically no investment. Or you can be an export specialist for a steamship line, airline or railroad. Or work for an exporting firm, or as export sales manager for one of many manufacturers who want foreign markets.

MANY EXPORT MANAGERS MAKE \$10,000 A YEAR

Owners of active, well-managed export companies go far beyond that in earnings. Truly there is a world of wealth open to the export man or woman.

WE TEACH YOU

If you can read and learn and use what you learn, export offers you financial success and a position of importance. Extensive education unnecessary. Many highly paid export men have only public schooling.

Our streamlined course in the practical essentials of export is built on our actual experience. We have exported hundreds of thousands of dollars worth of auto supplies, building materials, electrical goods, foods, machinery, jewelry, toys, paints, household goods, etc.

The QUICK Way to Learn Export

We send you a kit of the actual documents used in foreign trade and give you step by step guidance. We show you how to do business by mail with customers all over the world. We even provide you with a list of 150 of our own preferred foreign representatives. Free consultation. Expansion of foreign trade is at fever heat. The low price of this course will surprise you. Mail coupon quick! Air Mail reaches us over night. (No salesman will call.)

the MELLINGER CO. Exporters - Importers

DEPT. A, LOS ANGELES 24, CALIFORNIA

Please send FREE LITERATURE explaining how I may establish myself in a highly paid lifetime career in export.

NAME _____

ADDRESS _____

CITY OR TOWN _____

START TODAY-GET FREE DETAILS

REALISTIC MODEL KITS



Spend enjoyable winter evenings building these super-realistic scale models. Authentic miniature mementos of the old West and of World War II that you'll be proud to own and display! Miniature 2 1/2 Ton U. S. Army Truck and lifelike Jeep in 1/4" scale; Western Ranch Buckboard Wagon and Wells Fargo Stage Coach in 1/4" scale. Precision parts die-cut from white pine and plywood for easy, accurate assembly. Free-rolling wheels, real metal parts, O. D. canvas, formed ribs, leather springs, etc., full size plans. Order now—save at "combination" prices. Add 15c per set for postage and wrapping costs.

Buckboard Kit . \$1.00
Stage Coach Kit \$1.50 **\$2.00**

BOTH FOR..... Plus 15c postage

HOLLYWOOD MODELS POST OFFICE BOX 389 BURBANK, CALIFORNIA

2 1/2 Ton Army Truck \$1.25
U. S. Army Jeep. \$.60 **\$1.25**

BOTH FOR..... Plus 15c postage

151 Piece ASSORTMENT HAND GRINDER Access.

A bonanza of valuable parts and accessories for owners of hand grinders! Everything you could want is included in this great lifetime assortment.

GREATEST GRINDER ASS'T. EVER OFFERED

Just look what you get: 1 roughing stone; 8 mounted stones with 1/2 inch shank; 2 buffers; 6 cut-off wheels; 1 circular saw; 2 rubber abrasive wheels; 100 abrasive paper discs; 3 felt wheels; 1 felt cone; 3 mtd. bristle brushes; 2 mtd. stones; 1 mtd. wire brush; 1 mtd. drum sander; 6 sander sleeves; 7 steel cutters, all with 1/8 or 3/32 in. shank; 7 mandrels with 1/2 in. shaft, 1/16" screw. Everything you could want is there.

ALL NEW - GUARANTEED

Every piece in this great assortment is new—it gives you the right tool for every job. All in an attractive set-up box, handy to keep on the work bench. Postpaid in U.S.A. Order today!

GROBAN SUPPLY CO. 1522 So. Michigan Ave. Dept. PM11, Chicago 5

\$8.95

New BRUSH Electroplater

ESPECIALLY BUILT FOR MECHANICS, MODEL MAKERS HOME CRAFTSMEN



Easy to Plate GOLD, SILVER, NICKEL, COPPER, etc... For Pleasure and Profit!

If you have a workshop—at home or in business—you need this new Warner Electroplater. At the stroke of an electrified brush, you can electroplate models and projects—you can replate worn articles, faucets, tools, fixtures, silverware, etc., with a durable, sparkling coat of metal... Gold, Silver, Nickel, Copper, Cadmium, and after a bit of practice, even Chromium! Everything furnished—equipment complete, ready for use. By doing a bit of work for others, your machine can soon pay for itself. So make your shop complete by getting a Warner Electroplater right away. Send today for FREE PLATING SAMPLE and illustrated literature. ACT AT ONCE.

WARNER ELECTRIC CO., Inc., Dept. P-75
1512 Jarvis Ave., Chicago 26, Illinois

FREE Details & Sample!

WARNER ELECTRIC CO., Inc., 1512 Jarvis Ave., Chicago 26, Ill., Dept. P-75
Gentlemen: Send Free Sample and Details to:

Name _____
Address _____
City _____ State _____

Gift Suggestions FOR HOBBYISTS



MULTI-PURPOSE WOOD PLANER

Fits any drill press. Exclusive hi-speed blade design performs precision surface planing, rabbeting, tenoning, paneling, grooving, routing, beading. Thousands now in home workshops, schools, cabinet and pattern shops. An indispensable lifetime tool for wood and plastic workers. Complete **\$750**



NEW STYLE DRUM SANDER

Fits any 1/2" drill press chuck. Used for sanding curves, contours, straight edges. Has many essential workshop applications. Complete with 5 spiral sanding sleeves..... **\$395**



4" ROTARY SURFACE SANDER

An exclusive type sander for drill presses, flexible shafts, motors, hand drills. Instantly sands woods, plastics and metals to agate smoothness. No waves, ripples, striations. Discs immediately interchangeable. With 20 discs... **\$595**



ALL METAL SHAPER FENCE

Precision built of hard alloy aluminum and steel. Nothing to rust. No wooden parts to warp. For moulding, jointing, shaping, rabbeting, tenoning. Fits all standard drill presses—shapers. Complete with two hold down springs. A real buy at **\$795**



AT YOUR DEALER—OR ORDER DIRECT
FREE Workshop Catalog →
BARRON TOOL COMPANY, INC.
269 Architects Bldg., Detroit 1, Mich.

BARRON PRECISION WORK SHOP TOOLS

It's New! Unsurpassed!

DIRECT READING

BEAM-COMPASS and adjustable rule

Pat. No. 2349670



\$295 cash with order.

No C.O.D.'s. Postage prepaid.

Here is a complete Beam Compass and Measuring Device, all in one. Strong, compact, accurate, direct-reading. Has genuine 72" Lufkin Steel Rule Nickel Plated.

For architects, draftsmen, carpenters, woodworkers, sheet metal men, stone cutters, millwrights, pattern makers.

- 1—Easy, accurate to use.
- 2—Sets by direct-reading scale.
- 3—Locks in position.
- 4—Has reversible pivot, a hard metal point for drafting table and soft surfaces—a blunt point for scribing on metal and other hard surfaces.
- 5—Uses lead or stylus. (Both included.)
- 6—Draws circles up to 12 ft. diameter.
- 7—Complete, no accessories needed.
- 8—Beautifully designed. In brown variegated, non-rusting plastic case.

AMERLINE

1753 NORTH HONORE STREET, CHICAGO 22, ILLINOIS

PRESENTING THE NEW
Dual Caliber



Super Power

BIG
.250
CAL.

APACHE AIR RIFLE

ACTUAL SIZE

Here's the BIG .250 Cal. air rifle you've waited for. Shoots .250 or .175 Cal. in separate barrels with smashing accuracy. All steel and brass. Rifled barrel, safety, adjustable sights. Apache .250 Ball Shot available. At your dealers or SEND FOR FREE BOOKLET.

NATIONAL CART CORPORATION

234 East Colorado • Pasadena 1, California



Start a NEW BUSINESS

Sharpen Dull Pipe Wrenches

Or Add to Your Present Repair Business

Write for information.

J. C. MOORE INDUSTRIES P. O. Drawer 276 FREDONIA, PA.

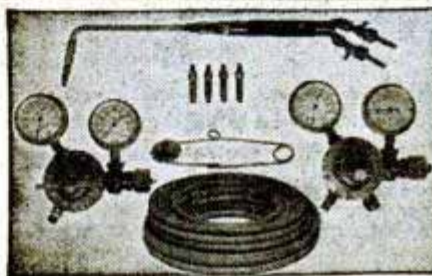

New Welding Outfit

Complete like picture **\$54.50**

Electric Welding Outfits from \$39.00 up. (Welders Manual \$1.75) 400 pages.

Distributors Wanted
EAGLE WELDING EQUIP. CO.

Dept. 40
5085 Broadway, Chicago

A TIP FOR THE HOME WORKSHOP

Keep micrometers factory-new, tools keen-cutting, motors and pulleys supple, with

FIENDOIL

FOR HOME • SHOP • SPORTS



3 oz. spout can 40c

MAGIC LIQUID MAKES PHOTOS APPEAR

Amazing discovery permits you to print pictures from any of your snapshot negatives on wood, cloth, leather or paper. Like magic your pictures will show on ties, handkerchiefs, purses, Christmas cards and letterheads. Takes only a few minutes in broad daylight. Won't rub off or harm negative. An attractive set with enough material for over 100 pictures. ORDER TODAY. Send \$1.00 postpaid. C. O. D. pay postman a few cents more in addition. (Foreign \$1.50 money order only.)



STYLE-ARTS, Inc., Dept. PM-10, 2427 Cortland, Chicago 47, Ill.

Please Mention Popular Mechanics When Answering Ads

OWN A Printing Business

Cards, Tickets, Stationery, etc. Good profit in spare time. PRINT YOUR OWN greeting cards, movie titles, church work, etc. Save money. Easy rules supplied. Raised printing like engraving too. Have home shop. Sold direct from factory only. Send dime for supply book, suggested outfits, all details and advice on your needs. No obligation. **KELSEY, INC. C-37, MERIDEN, CONN.**

INSTALL-SERVICE OWN OIL BURNER \$1

Save up to \$150! Send for the famous DELTA PHOTO-INSTALLATION MANUAL. Simple, easy step-by-step photos of a complete oil burner installation. Complete with all necessary plans, drawings and easy-to-follow directions. Published under exclusive copyright at \$5.00. SPECIAL OFFER—CLIP \$1 to this ad and mail today!

DELTA HEATING CORPORATION
85-05 NORTHERN BLVD., JACKSON HEIGHTS, NEW YORK CITY

ANNOUNCING THE NEW Atlas "QUICK- CHANGE" 10" LATHE

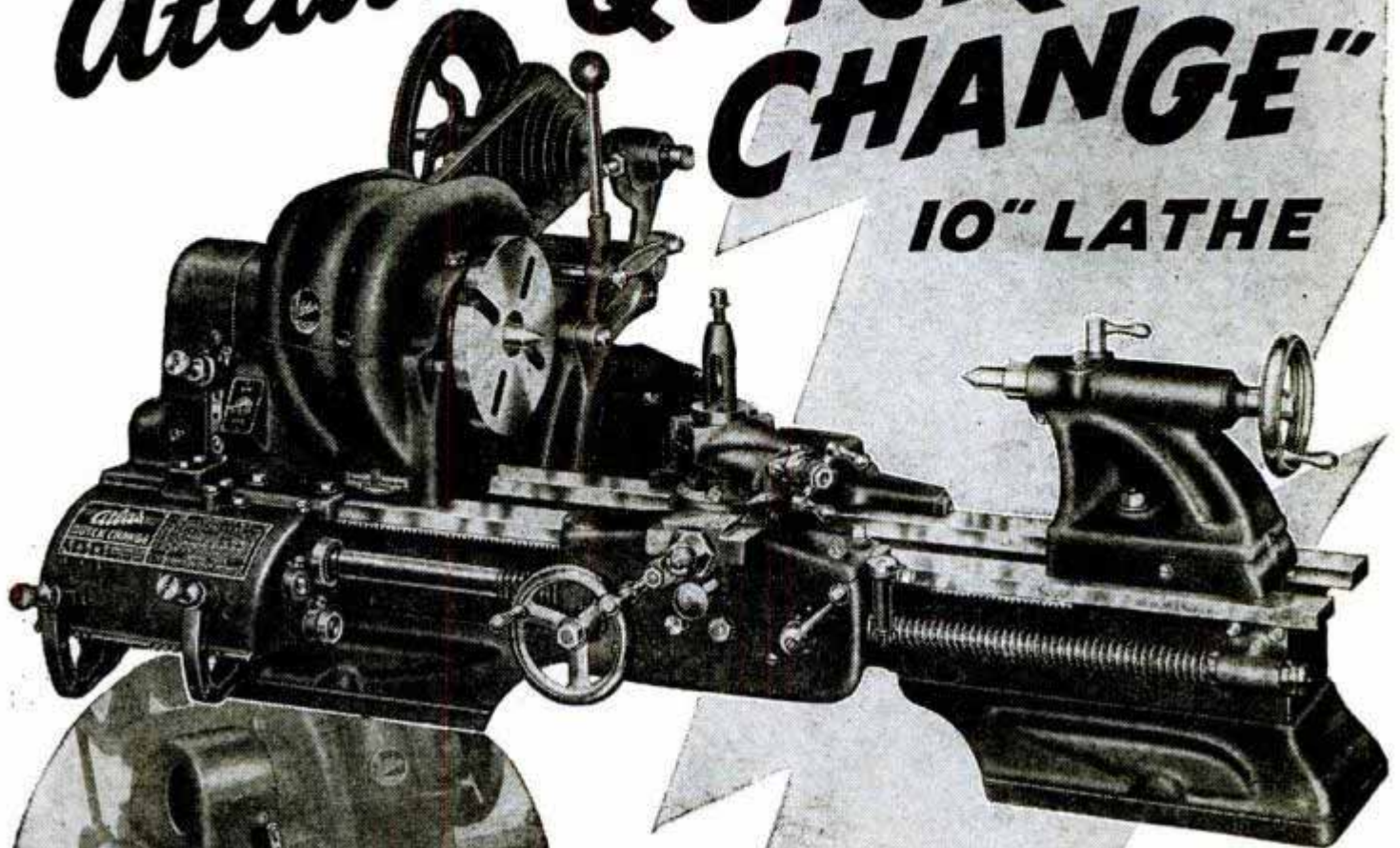

SPEEDS UP PRACTICALLY EVERY LATHE JOB (QUICK-CHANGE UNIT ADAPTABLE TO ANY ATLAS 10" LATHE)

Model QC 42 (above) 24"
between centers \$250.00

Also QC 54 — 36" be-
tween centers . . . \$280.00

Prices less motor F.O.B.
Kalamazoo

Here's new lathe efficiency for your home or commercial shop! The new Atlas Quick-Change gives you instant fingertip selection of 54 threads or feeds . . . speeds every turning operation requiring the use of power feed . . . saves you many hours of set-up time. Quick-Change does not limit the odd thread and feed capacity of the Atlas lathe. Hundreds of additional threads and feeds are obtained with standard Atlas change gears, extra — for metric threading, special tooling, coil and wire winding, etc. Other outstanding Atlas features include 16 spindle speeds; precision ground bed; Timken tapered roller bearings; back gears; complete V-belt drive; reversible automatic power cross and longitudinal feeds. New illustrated Quick-Change bulletin gives you full details. Send a postcard for your copy.

FREE
SEND FOR YOUR
COPY TODAY



ATLAS PRESS COMPANY
1143 N. PITCHER ST. • KALAMAZOO, MICHIGAN

Now Your
Dream Home
Comes True!

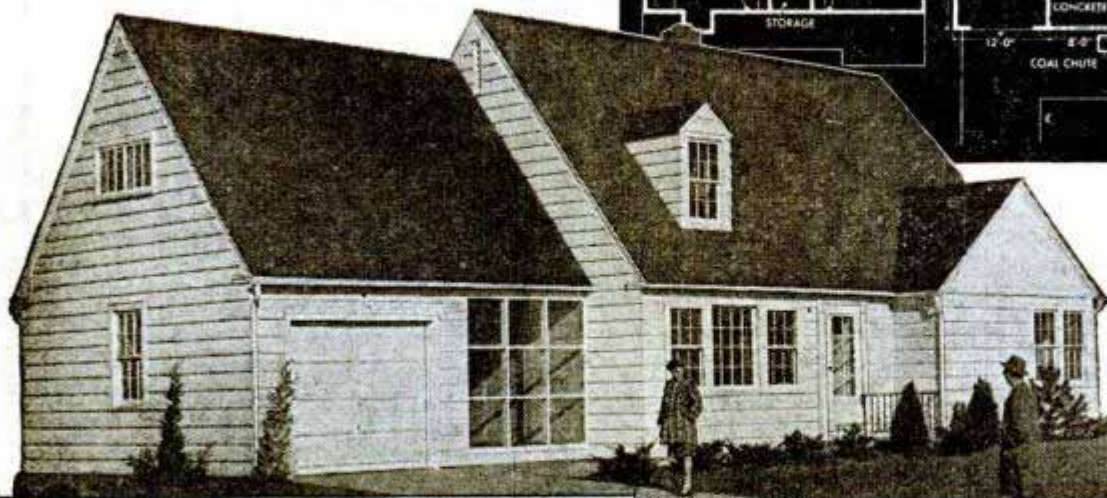

The House That Jack Built

From actual photograph of Build-It-Yourself House with breezeway and garage as built by Jack Brownson, Aurora, Illinois, a twenty-three-year-old veteran.

YOU CAN BUILD THIS HOUSE YOURSELF!

GET THE BOOK NOW! STUDY THE PLANS NOW!

Start Building When You Can

You can get "Your Home and How to Build It Yourself" and complete plans by mailing the coupon below. Book is plastic bound and contains 100 pages, size 8½ x 11 inches. Three-fifths of the book consists of photographs and drawings. Several sections are printed in extra colors and a four-page, four-color insert shows just how your own house will look in actual colors. Every detail of the house and its construction are discussed in this book with minute details of Build-It-Yourself instruction that will guide you in every step.

PLANS YOU CAN READ AND FOLLOW

Plans consist of eight working size blueprints, giving floor plans, elevations, notes on construction, framing, lumber list, millwork list, specifications, plumbing and wiring diagrams. Every measurement is marked, every detail made as clear as A-B-C. With the book to guide you and the plans to follow, any handyman who can use simple tools can build this remarkable house and enjoy every minute of the work while saving thousands of dollars.

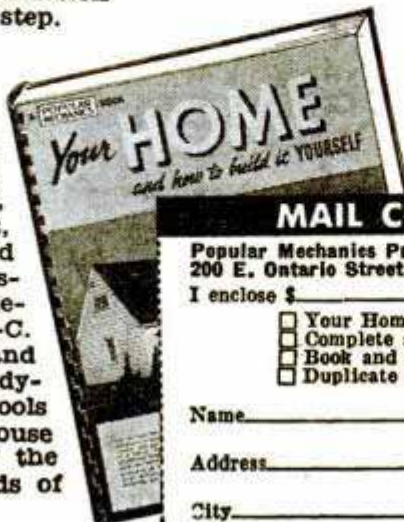

MAIL COUPON FOR BIG NEW BOOK AND PLANS • BUILD IT YOURSELF OR HAVE IT BUILT AT A BIG SAVING!

Can you use a hammer—saw a board straight—use common, everyday tools as well as the average *Popular Mechanics* reader? Then, startling as it may at first seem, you too, can build this modern house in any of its five designs, and do it easily and quickly, at a tremendous saving. *Popular Mechanics* and a famous firm of architects have designed it and worked out every detail so you can do every part of the job yourself, even though you have no experience whatever.

SPACE FOR LIVING AND FAMILY GROWTH

Illustrated is the *Popular Mechanics* "build-it-yourself" house Jack Brownson built from our plans, in Aurora, Illinois, with one inexperienced helper. This beautiful, modern house is 1½ stories, with basement, living room, kitchen, dining nook, two bedrooms, bath, plenty of closets and space for 2 additional bedrooms on the second floor. The house itself is 35'-9" x 28'-11"; breezeway 20'-10" x 8'; garage 20'-10" x 12 feet.

THE HOUSE THAT HAS EVERYTHING

The big, basic idea behind the design is ease of construction and the most living space and the most useful space, at the least cost, considering attractiveness and suitability for any neighborhood and most income groups. On top of this is its adaptability to other types of architecture, such as modified Dutch Colonial, modified Cape Cod, plain gable roof house without dormer windows, or the house as pictured, but without garage and breezeway.

USE CONVENIENT ORDER COUPON

You may never have thought about actually building your own house, but you can do it. And now that building restrictions have been lifted, it's easier than you think. So send for the big new book—Your Home and How to Build It Yourself, and set of construction plans, today. Even if you engage a contractor or builder to build this house for you, you will need the plans. Then too, you will certainly want the book, which can easily save you countless hundreds of dollars whether you build this house or any other house of your choosing.

100 Pages
52 in Color
60% illus.
8½"x11"

MAIL COUPON FOR BOOK AND PLANS

Popular Mechanics Press,
200 E. Ontario Street, Chicago 11.

I enclose \$_____ Send me the items checked at once.

- | | |
|---|---------|
| <input type="checkbox"/> Your Home and How to Build It Yourself | \$ 3.00 |
| <input type="checkbox"/> Complete set of plans for Popular Mechanics Home | 12.50 |
| <input type="checkbox"/> Book and Plans at reduced price | 14.00 |
| <input type="checkbox"/> Duplicate set of plans | 5.00 |

Name _____

Address _____ Zone _____

City _____ State _____

Paint Your Own Car in One Hour with the NEW AUTO ENAMEL

YOU WIPE ON Like Magic with only a POWDER PUFF

2 YEAR Guarantee LUSTR-WIPE

TRADE MARK

in about one
hour to smooth,
mirror-like
professional
finish.
GUARANTEED
FOR 2 YEARS
to crack,
peel or
fade, if simple
instructions are
followed. Lustr-
wipe is NOT a
primer or a polish
but a marvelous
new Auto
Enamel.



NO Brushing
NO Spraying
NO Masking
NO Streaks

Just follow the simple instructions and LUSTR-WIPE will give your car that new "factory-look." No Streaks! No Lap-marks! Dries dust-free in about an hour! Goes over any other color, enamel or lacquer.

**ONE QUART PAINTS YOUR ENTIRE CAR
ANYONE CAN DO A BEAUTIFUL JOB**

LUSTR-WIPE is the easy, speedy, economical, yet most successful way you've ever seen to PAINT YOUR OWN CAR. It's different-works most like magic! All you need is ONE QUART of LUSTR-WIPE, the Miracle Auto Enamel, and the powder puff we send you AT NO EXTRA COST. Almost ANYONE, can do a magnificent job in about ONE SHORT HOUR. It seems unbelievable but true. JUST WIPE IT ON. No brush needed. No spray required. No masking of any kind. LUSTR-WIPE dries dust-free in about an hour. You'll be amazed—beyond words with the results! Your friends will think you spent \$125 for a professional paint job. YOUR CAR WILL LOOK LIKE NEW". Rush your order for a quart of LUSTR-WIPE TODAY.

WHICH OF THESE 10 COLORS DO YOU LIKE?

- BLACK\$3.95 Qt. Brewster GREEN (dark) \$3.95 Qt.
- CRIMSON\$3.95 Qt. Jewel GREEN (light) \$3.95 Qt.
- Washington BLUE (dark) \$3.95 Qt. Gunmetal GREY (dark) \$3.95 Qt.
- Anticello BLUE (light) \$3.95 Qt. Air Wing Grey (light) \$3.95 Qt.
-\$3.95 Qt. Sun BEIGE (tan) ...\$3.95 Qt.

This Price for Immediate Delivery
SAVE by
Ordering
NOW! \$ **3.95**
PER
QUART
Applicator
Furnished

MAIL COUPON TODAY! SEND NO MONEY!

AGENTS WANTED FOR NEW MONEY-MAKING BUSINESS!
MAKE GROSS PROFITS UP TO \$275.00 IN ONE WEEK.
Go into business for yourself selling LUSTR-WIPE in cans, or painting cars yourself or having others to do the work. Owners of old cars everywhere (who can't get new cars) are easy prospects. Send now for our MONEY-MAKING PLAN.

DISTRIBUTORS WANTED: A few wonderful territories now available. Write at once for our SPECIAL OFFER.
LUSTR-WIPE CORP. 166 W. Washington St. Dept. M Chicago 2 ILL.

LUSTR-WIPE CORP. 166 W. Washington Dept. M Chicago 2, Ill.
Please send me _____ quarts of LUSTR-WIPE AUTO ENAMEL at the special price of \$3.95 per quart.

COLOR _____

Send Postpaid. Full Payment \$ _____ enclosed.

Send C.O.D. plus Postal charges.

NAME _____

ADDRESS _____

CITY _____ ZONE _____ STATE _____

Send information regarding AGENT PLAN.

Send information regarding DISTRIBUTORSHIP.

POLISHES! SANDS! GRINDS! CURVED & FLAT

SURFACES - FASTER -
EASIER! Works with any
1/4" Electric
Power Drill,
Flexible Shaft.

You Can Use It To:
Fix Bodies, Fenders;
Wax, Polish
Cars, Floors, Lino-
leum; Refinish Furni-
ture, Wood, Metal
Surfaces; Smooth,
Reduce Welds; etc.



Bends
To Take
Curved
Surfaces

On Flat Surface

On Curved Surface

NEW FLEX Sander - Polisher

Works with your electric drill, flexible shaft or chuck equipped motor. Speeds up all grinding, sanding and polishing jobs - fits any 1/4 inch chuck. Rubber face plate flexes into curves for fast, smooth, clean work. Outfit includes 6 1/2 inch rubber disc, with metal flange and shank, fibre backed sanding disc, and heavy sheep's wool polisher. Makes your drill the equal of any \$75.00 grinding or polishing outfit. Satisfaction guaranteed. **\$4.95**
Order today. F.O.B. Chicago. Only.....



3 1/2 IN. VISE

Greatest vise value in years! Swivel base. Anvil back. 3 1/2 inch replaceable steel jaws, auxiliary copper jaws and auxiliary pipe jaws. Jaws open to 3 1/2 inches. Shp. wgt. 16 lbs. F.O.B. Chicago. Regular retail \$8.00.

\$5.85



SURFACE PLATE

For the home work shop, for tool and pattern makers. Has hand scraped surface accurate to .0005 inch. Has full 8x12 inch surface. Heavy cast ribbed base with metal inset handles and protective wooden cover. Indispensable for all types of precision work in machine, tool making, etc. Original cost to Gov't. was \$21.85. Only because it's surplus can we offer it at so low a price. Wgt. 22 lbs. **\$12.85**
F.O.B. Chicago. Each

DEALERS WRITE

PREHLER PROVED PRODUCTS

Division Norbert Prehler & Co.

Dept. PM11, 1623-5 Milwaukee Ave. Chicago 47, Ill.

BRUSH PLATING OUTFITS

for re-plating articles in the home and shop. No tanks necessary. Free particulars.

GUNMETAL CO., AVE. M, DECATUR, ILLINOIS



Please send 10c
for Catalog No. 101

MEIER BRASS & COPPER CO.
1155 Bellevue, Detroit 7, Mich.

BRASS

For Home Work Shops

Free Cutting Brass Rods
Round, Hexagon, Square,
1/2-Oval and Rectangle
Naval Brass Rods
Round and Hexagon.
Brass and Copper Tubing.
Brass Sheet.



IT'S EASY TO
Trim-it-Yourself
with
CHROMTRIM
METAL MOULDINGS

The perfected metal trim for wall or floor linoleum and building materials. 6' lengths, 8 shapes, easy to cut and apply.



Send 10c for "Trim Ideas" 16 page booklet. Over 30 projects and remodeling suggestions on where and how to use CHROMTRIM. Hints on lino-laying.

REMODEL
KITCHEN
BATH - ATTIC



MAKE METAL
PROJECTS
with
CHROMTRIM



R. D. Werner Co., 291 Fifth Ave., N.Y. 16

Enclosed is 10c for CHROMTRIM "Trim Ideas" booklet

Name _____
Address _____
City _____ Zone _____ State _____

ELECTRICITY *Anywhere*

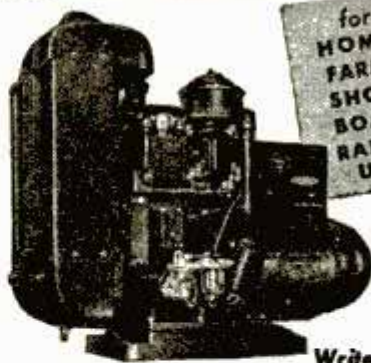

for
HOMES
FARMS
SHOPS
BOATS
RADIO
USE

Onan gasoline engine-driven electric plants supply reliable, economic electric service for any use. Portable, stationary or stand by models. Water-cooled, compact and rugged.

A.C.: 350 to 35,000 watts, all standard voltages and frequencies. D.C.: 600 to 10,000 watts, 115 and 24 volts. BATTERY CHARGERS: 500 to 3,500 watts; 12, 24, 32 volts.

Write for folder

D. W. ONAN & SONS INC.

2535 Royalston Ave., Minneapolis 5, Minn.

WOO-WEE AUTO HORN

Reproduces "Wolf Whistle" better than any sailor. Screeches, barks, whistles, imitates siren, moves any "road hog" off the highway in "double quick plus." Attract more attention than by driving a yellow Cadillac. Operates from manifold. Installed on any car in 15 minutes. Sturdily constructed. Cleverest novelty since the use of the auto. Be the first user in your neighborhood. Dealers wanted. Absolute money back guarantee. 6 dollars each. Order today. Ohio orders add 3% tax. THE PROTECTUOD COMPANY - Dept. 101 4033 Windsor Road - Youngstown 7 Ohio



AMAZING MYSTERY BUTTON



Startles Everybody. With this Electronic Button you can make your own Telephone Amplifier-Detectophone. Attach this button to piece of cardboard-transmit conversation to another room. Music also transmitted to distant places. Most interesting electrical apparatus ever discovered. Enables you perform hundreds of experiments. So tiny it can be concealed in dozens of places. A Pre-War Product. Electronic Button including 5000 word instruction booklet with 50 illustrated experiments, postpaid, only..... **\$10**
Electronic Products Company, Saint Charles 4, Mo.

TRAILER BUILDERS!

Insist on Safety-Engineered.

- Bull Dog Hitches and Parking Jacks
- Torq-Less Axles

HAMMER BLOW TOOL COMPANY

Dept. D-116 Wausau, Wisconsin

Send for FREE Catalog



48 PLANS

\$100

48 complete plans of toys, ash trays, garden ornaments, Dutch boys and girls, what-not shelves, and many other interesting projects. Finest selection available. Novel method allows you to make finished project any size desired. PLUS FREE De-Luxe Plan of corner shelves. Send only \$1 to Jackson, Dept. 27-5440 N. Shoreland Ave., Milwaukee 11, WI

KNOW

about

COLGRA

SUPERFILM

Moneyback

GUARANTEE

CAR OWNERS! MECHANICS

There's NOTHING like it! Positive "plated lubrication" to all metal surfaces. Dissolves carbon. Details on request. \$1.50 per can (18 oz.). Postpaid.

Dealers wanted

COLGRA COMPANY

11624 W. Pico, Los Angeles 34, Calif.

AGENTS 300% Profit SIGN LETTERS

For Store Fronts and Office Windows. Anyone can put them on. Free Samples. Liberal Offer to General Agents.

METALLIC LETTER CO., 430 N. Clark, Chicago

New Plastic Discovery

MAKES LEATHER and LEATHERETTE ITEMS - LIKE NEW!

Make Cloth Into An Imitation Leather

A new plastic discovery has recently been put on the market which is called Leather-New. This amazing plastic coats Leather, Leatherette and Cloths and gives them a new leather-like finish in just five seconds. Quickly and easily spread over any material with a brush or spray gun it dries quickly. One quart of Leather-New covers approximately 60 square feet. Even inexperienced hands can spread it on smoothly as it leaves no brush marks. Costs only a fraction of the cost of new leather goods. With this amazing discovery old leather and leatherette covered items can be made to look like new. Cloth covered Gliders, Deck Chairs, Porch Furniture, Tarpaulins and many other items can be given a water and weatherproof, coating—making them much more valuable than they were with ordinary cloth coverings.

GIVES LEATHER and LEATHERETTE NEW FINISH and COLOR

Does Not Crack, Peel or Scuff

The color of leather and leatherette items can be quickly changed by coating them with this new plastic discovery. Leather-New does not crack, peel or scuff in coldest weather. Does not get sticky in hottest weather. Get a FREE sample of Leather-New covered material—see for yourself just what this amazing plastic does—simply fill out coupon and mail it on a 1c postcard today.

Alcohol, Simple Acids or Caustics Do Not Harm This Finish

A Leather-New coated job is easily cleaned and will stand repeated washings with strongest soaps—soot, dust or dirt wash away like magic with a damp cloth. Simple Acids, Alcohol or Caustics do not stain its finish. It will remain clean and new looking as long as real leather. Leather-New will save many dollars on leather goods that otherwise would have to be thrown away. Act quick—mail 1c postcard today for FREE sample of Leather-New coated material.

Save Cost of Re-Covering With New Leather



Leather Covered Furniture



Luggage and Handbags

Hassocks



Cafe-Bar Restaurant and Kitchen Furniture

Auto Seat Covers
Golf Bags - Shoes
Any Leather or Leatherette Item

FREE SAMPLE

Of Leather - New Coated Material

NOT A PAINT BUT PLASTIC

SAVE MONEY

JUST SPREAD IT ON WITH A PAINT BRUSH - LEAVES NO BRUSH MARKS

Get Into This MONEY-MAKING BUSINESS

I'll Show You How to "Cash In" On Big Jobs Such as Coating The Leather Furniture Of Bars - Grills - Restaurants

\$5000 to \$50000 Possible on a Single Job

This business offers tremendous profits to men who can see its possibilities. Let me give you an exclusive territory in which to handle Leather-New Sales and Service—Let me help you build your own profitable business in your exclusive territory. You do not risk one penny—simply send me your name and address on a 1c postcard—I'll do the rest.

Jack Edwards, Sales Mgr.

LEATHER-NEW PRODUCTS

701 LAND BANK BLDG., Dept. PM1, KANSAS CITY 6, MO.

JUST MAIL COUPON

LEATHER-NEW PRODUCTS

701 Land Bank Bldg., Dept. PM1, Kansas City 6, Mo.

Mr. Edwards, rush me FREE sample and complete details about Leather-New. I understand this does not obligate me in any way.

Name _____

Address _____

City _____

State _____

(Fill out—Tear out—Paste on 1c Postcard—Mail Today)

WORLD'S

LOWEST PRICED ADDING MACHINE

VEST POCKET SIZE

NEW!

Fits vest pocket or purse. Guaranteed accurate. Operated as easily, and as reliable, as machines costing many times as much. **NOT A TOY OR GADGET.** Precision made—very durable. Guaranteed for life against defects in construction. Beautiful looking, modernized design. Finished in silver with black numbers and red slides. You positively can't buy a Calculator of equal quality for as little money. **ACCEPTED AS THE FINEST LOW PRICED CALCULATOR FOR OVER 35 YEARS!** Now completely redesigned and improved. **BETTER THAN EVER BEFORE!** Operates with a flick of your finger. Adds, subtracts, multiplies, divides—counts up to one billion. Pays for itself over and over in mistakes avoided and time saved.

MAKES IDEAL GIFT

Baby Calculator makes an ideal gift—for every Gift occasion. Birthday—Graduation—Christmas—Anniversaries. For men, women, children, teachers, business people, home or shop use. **COMES PACKED READY FOR GIFT WRAPPING.**

TEN DAY TRIAL

Money Back Guarantee

Because we know that our machine is the very best Calculator to be obtained at this low price, we make this 10 Day Trial Offer, on a positive money back guarantee! Don't buy ANY Calculator without this guarantee! Send only name and address, pay postman \$2.95 plus postage (if cash is sent, we pay postage—you save up to 40c). (Send full cash if outside U.S.) Money back within 10 days if not delighted.



IDEAL XMAS GIFT

FREE TRIAL

ONLY

\$2.95

SEND NO MONEY

AGENTS WANTED

TOTAL COST

FREE!!

Each Baby Calculator enclosed in beautiful, rich-looking simulated Leather Case—at no extra cost.



CALCULATOR Machine Co. (Mfrs.)

Dept. 196, P. O. Box 248, GLENVIEW, ILL.

USE COUPON

CALCULATOR MACHINE CO. (Mfrs.)
P. O. Box 248, Dept. 196, Glenview, Ill.

Your Calculator is just what I've been looking for. Send one at once (C.O.D.) or (I am enclosing \$2.95).

Name _____

Address _____

City _____ State _____

MACHINISTS — HOBBYISTS — MECHANICS — HOME CRAFTSMEN

DO MORE WORK WITH LESS EFFORT . . . FASTER

WITH THE

CUMMINS POWER DRILL



2200 RPM—110-115 Volts
60 cycles or less, AC-DC

CAPACITY 3/4 INCH

Model 120 **\$17.95**

With Keyless Chuck

Model 110 **\$18.95**

With Jacobs Hex Key Chuck (Illustrated)

Model 130 **\$20.95**

With Jacobs Geared Chuck

Compare and try . . . before you buy!
For Wood, Metals, Plastics, Cement, and other Material.

No matter what the material, you get a better job faster and easier with less effort when you use the Cummins Power Drill. Try it at your favorite dealer. Check its rugged construction. Flip the switch and feel the instant surge of power. See how the saw-grip handle fits your hand to give a perfect balance. Then note its price! You'll agree with the many thousands of Cummins drill users . . . there is none better in the same price range. See the Cummins drill at your favorite dealer TODAY! . . . Or write for further information.

CUMMINS PORTABLE TOOLS

DIV. CUMMINS BUSINESS MACHINES CORP.
4764 RAVENSWOOD AVENUE, CHICAGO 40, ILLINOIS

MAKE UP TO \$5.00 AN HOUR

In Your Own YEAR 'ROUND Business!

ONLY A FEW DOLLARS PUTS YOU IN BUSINESS!

Many Clearing as High as \$20 to \$30 a Day NET Renewing Rugs, Carpets, Upholstery. New Method Now Used for Auto Upholstery. Write for Facts About Quick, Easy Way to Get Started

Here is the chance you've been looking for to step into a pleasant, dignified, big-pay business of your own that offers you a steady, year 'round income. Start on "a shoestring," full or spare time, right from your own home. Equal opportunities for men and women, young or old, in small towns or big cities. No experience needed. Many making big money with new Americlean System just cleaning auto upholstery. Easy to learn. We send you complete instructions and quick-cleaning supplies so you can start making money the very first day! Quick method cleans upholstery, rugs and carpets like new without taking off floor! Tremendous demand in homes, apartments, hotels, stores, office and public buildings. Steady repeat business. Territories going fast. Write today for full FREE facts. No cost or obligation. Rush letter or postcard now to AMERICLEAN CO., Inc.; Dept. G-11; 211 North 7 St.; St. Louis 1, Mo.

WRITE FOR FREE DETAILS NOW!

TOYS COMPLETE PLANS FOR JUST 10¢

STANLEY

PLAN SET No 16



Happy evenings for you . . . joyous days for your children . . . holiday gifts for all. Detailed plans for easy to make, hard to buy toys . . . wheelbarrow, rocking horse, kiddie push car, scooter and toy wagon. Send just 10¢ and ask for free list of all the Stanley Plan Sets. **STANLEY TOOLS, 111 Elm St., New Britain, Conn.**

An Ideal and Practical Gift For Any Man!

Now A DYNAMIC Industrial Transformer Type Supercharged WELDER

Ideal for Auto, Home Appliance & Farm Repairs!

DESIGNED TO DO HIGH-GRADE WELDING INEXPENSIVELY

... Maintenance Men, Farmers, Mechanics, Machine Shops, Foundries, Auto, General Repair and Job Welding Shops, all using the DYNAMIC find it so indispensable and useful that they can't afford to be without it.

Saves You Valuable Time and Money!

This portable, industrial transformer type Welder easily carried right to the job can be OPERATED FROM ANY CONVENIENT PROPERLY WIRED 110 VOLT 60 CYCLE LINE.

Works on Iron, Steel, Brass, Bronze and Other Metals

Has 8 metallic arc and carbon arc welding heat stages. Does work you would think only possible with a larger, more expensive machine. CAN ALSO BE SUPPLIED for 220 volt 60 cycle operation and other voltages and cycles at slight additional cost.

Read What Users Say ...

Repair Shop Owner says "It will do more than you say"

"I want to say I operate a repair garage and am more than satisfied with the welder. It will do more than you say." *C. P., Butler, Ohio.*

IT'S THE GREATEST PORTABLE OUTFIT "Now I am equipped for all kinds of welding and I must say it's the greatest portable outfit for welding any man could wish to own.

I wouldn't sell mine for the cost of plenty welders I have seen which were very high in cost but not in convenience. You may put me on file as a booster of your wonderful welding product."

W. J. B., St. John, N. B. Canada.

BETTER THAN I EXPECTED "I have done quite a little welding with my welder and will say it is better than I expected. The price, convenience and variety of work that can be done with the Dynamic are the attractive points." *W. R. P., Portland, Ore.*

FOR ONLY
\$28.50

COMPLETE

Do Your Own Welding and SAVE!

AMAZINGLY SIMPLE TO OPERATE!

Just a few repair jobs will pay for this machine. A practical and profitable machine tool for any workshop. **MAKE MONEY DOING REPAIR WORK FOR OTHERS.**

Write Today for Particulars

GET DETAILS on our 10 day Trial Offer



FARM IMPLEMENTS

BICYCLE REPAIRS

HOME APPLIANCES

SHOP MAINTENANCE

AUTOMOBILE REPAIRS

EASY TO OPERATE!

DYNAMIC SUPERCHARGED WELDER

If inexperienced, you can easily learn to do a variety of high-grade welding jobs by following the practical SIMPLIFIED WELDING AND OPERATING INSTRUCTIONS FURNISHED. Once you see a DYNAMIC WELDER in operation you won't want to be without it. Its simplicity will amaze you. In a year the DYNAMIC only costs you about 7c a day. Comes complete ready to operate with helmet, rods, cable, holder and operating and welding instructions, etc. *Nothing else to buy.* Write today for Free Particulars. Get details now on our amazingly low-priced Dynamic Welder on 10-Day Trial Offer.

DYNAMIC WELDER CO., 13 E. 23rd St., RN, Chicago 16, Ill.

MAIL COUPON FOR FREE DETAILS

10-DAY TRIAL OFFER

DYNAMIC WELDER CO.

13 EAST 23rd STREET, RN, CHICAGO 16, ILL.

Send me FREE DETAILS of your 10-DAY TRIAL OFFER.

NAME _____

ADDRESS _____

CITY _____ ZONE _____ STATE _____



New!

A practical, economy-priced drill press built specifically for the hobbyist . . .

Only **\$39⁹⁵**
for this
HOME-CRAFT®
11-inch
Drill Press
(Motor extra)

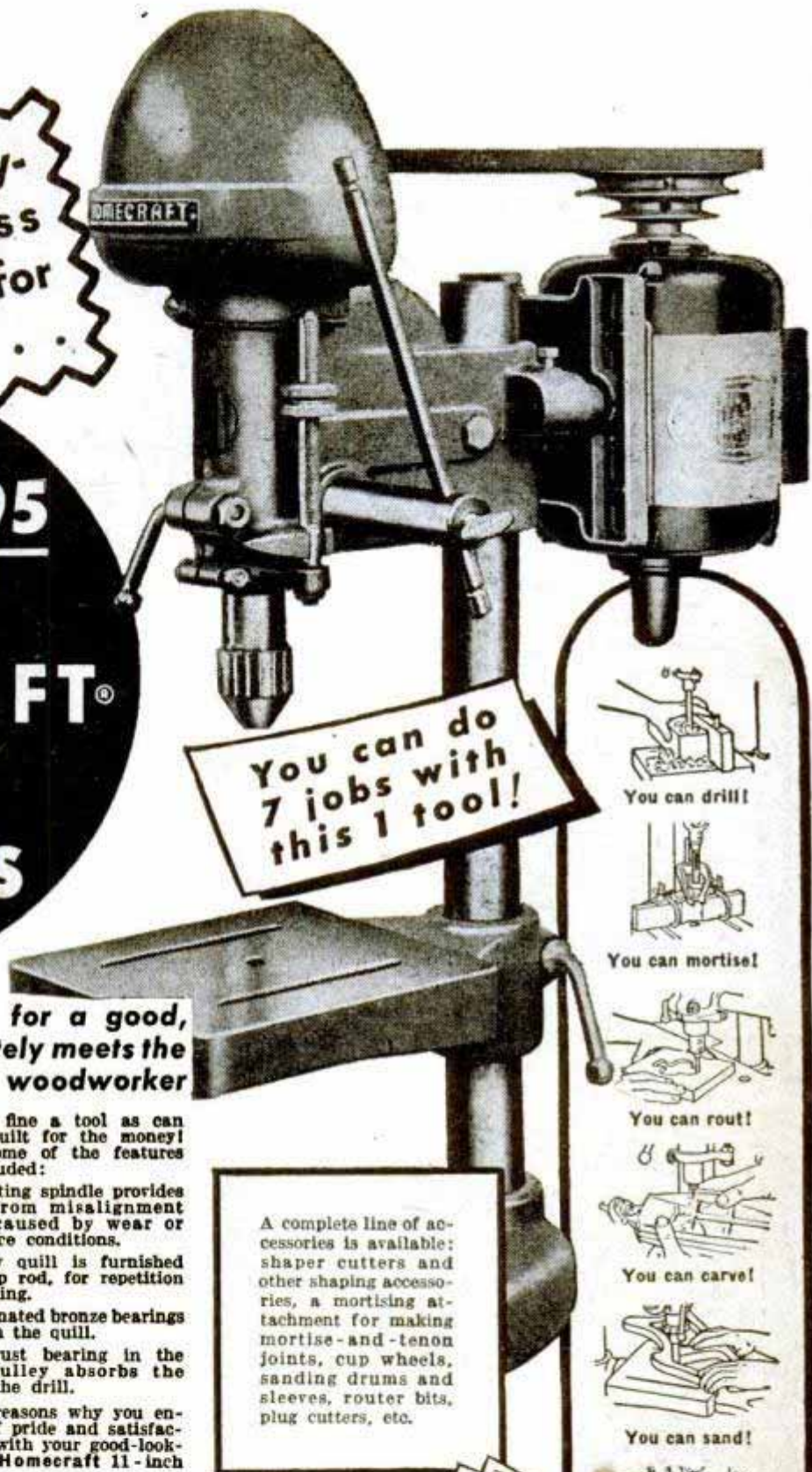

Fulfills the long-standing need for a good, popular-priced tool that adequately meets the basic requirements of the home woodworker

You get a bigger kick out of "tinkering" with wood and light metal projects, when you have a Homecraft 11-inch Drill Press to help ease your work.

With this versatile tool, you do many jobs safely, accurately, and inexpensively. You can even drill 1/2-inch holes in cast iron. Four speeds provide a wide range from 700 r.p.m. to 4700 r.p.m.

Skillfully Designed and Built

Behind the Homecraft 11-inch Drill Press is the engineering "know-how" of Delta, the leading builder of home shop tools.

The accuracy, safety and dependability of Delta quality tools for home shops, schools, and industrial plants have led to their widespread use all over the country. Having a home shop equipped with Delta Power Tools some day is the dream of practically every craftsman who wants the very best!

A Real Value

In the moderate-priced Homecraft 11-inch Drill Press — intended solely for the hobby shop — Delta

gives you as fine a tool as can possibly be built for the money! Look at some of the features that are included:

- A free-floating spindle provides freedom from misalignment troubles caused by wear or other service conditions.
- The sturdy quill is furnished with a stop rod, for repetition depth drilling.
- Oil-impregnated bronze bearings are used in the quill.
- A ball-thrust bearing in the spindle pulley absorbs the thrust of the drill.

These are reasons why you enjoy a sense of pride and satisfaction working with your good-looking, efficient Homecraft 11-inch Drill Press.

See It At Your Dealer!

Ask your Homecraft dealer to show you this new drill press, and his complete display of Homecraft Power Tools that range in price from \$29.95 to \$39.95. Visit your Homecraft dealer now!

A complete line of accessories is available: shaper cutters and other shaping accessories, a mortising attachment for making mortise-and-tenon joints, cup wheels, sanding drums and sleeves, router bits, plug cutters, etc.

Catalog Sheets! Show all Homecraft Power Tools and accessories. Sent to you free. Use coupon, for your copies.



You can drill!



You can mortise!



You can rout!



You can carve!



You can sand!



You can shape!



You can grind!

HM-53

Tear out coupon and mail today!

DELTA MANUFACTURING DIVISION
Rockwell Manufacturing Company
680M E. Vienna Ave., Milwaukee 1, Wis.
Please send free catalog sheets on
Homecraft Power Tools.

Name.....
Address.....
City..... () State.....



HOME-CRAFT®
POWER TOOLS

General Sales Office • Chicago 2, Illinois

SAVE UP TO 85% in WAR SURPLUS... SENSATIONAL VALUES

at "GADGETEER'S HEAVEN" IN MANY ITEMS WE HAVE THE WORLD'S LARGEST SUPPLY

MESS TRAY 6 COMPARTMENTS
 Rustless, Stainless Steel. Can be used for cooking as well ideal for restaurants. The perfect companion for that vacation trip, barbecues, picnics. Saves dishwashing.



#311 NEW 79c ea.

CANTEEN
 GL 1 qt. aluminum. Porcelain lined & covered. Plastic screw top chained to body. For campers, hikers, fishermen, etc.



Slightly used but perfect 45c
 Cup (fits around canteen and snaps onto belt) — 19c.

CANTEEN COVERS
 Heavy felt lined, shoulder type with adjustable strap — 29c. Belt snap-on type 19c.

COMPASSES

- #151 Marching, lensite, with luminous dial \$1.69
- #152 Matchbox, both jewel & liquid floating dial 39c
- #153 Jeweled Pocket Watch Compass \$1.19
- #154 Wrist strap Compass 69c



AIRCRAFT CABLE
 Alloyed steel, rust resistant, 3/16" diam., 21' ft. long, with turnbuckle ends 99c each

On Reels
 1/8", in any length 4c per ft.
 3/16", in any length 5c per ft.

STOP WATCH
 Elgin 15 jewel Waltham. Pocket style. Shatterproof crystal. Split seconds (1/10ths). Waterproof. In stainless steel, spring suspension case.



#200 A few left \$9.00

NEW SIGNAL CORPS TUNING UNIT
 In heavy alum. case with black crackle finish 16" x 10" x 8". Valve vernier dial knob, calibration 0-100, with locking assembly. Switch — 5 position with knob. 4 1/2" diam. coil with three others inside, and movable induction tuning coil. Worth many times — \$1.89 ea.

NEW TRANSMITTER TUNING UNIT
 Heavy crackle finish alum. case 17" x 8" x 5". Master unit & power amplifier parts: Valve vernier dial knob, calibrated 0-100 (plus lock), master oscillator tuning dial, wave gear driven (plus lock), 4-1 to 4-4 u 1 to 6 switch. Also variable and mica condensers, R.F. Chokes, tapped coils, etc. \$2.95 ea.



RADIO HEAD SETS
 EXCELLENT CONDITION. LOW IMPEDENCE.

AN-BH-1. WITH LEATHER SPONGE RUBBER PADS \$1.75 ea.
 Throat mikes \$1.00 ea.
 Voice Filters, FL-8-B. Noise eliminator. \$1.50 ea.



PLEXIGLASS DOMES
 15" x 19 1/4" x 6" deep. 1/4" thick. Can be used for home bathhouse, fish bowl, wash-bowl, ornamental light. Can be flattened in oven and will make flat sheets, 15" x 19 1/4" x 1/4". Weight 3 1/4 lbs.



#700 \$1.69
 Also 200,000 lbs. of other plexiglass sizes and shapes.

TEAR SHAPED PLEXI DOME
 Overall length 21" width at widest point 11" at base 4" 6" deep.



\$1.39 ea. #70-1-A

#148 Used, but in Good Condition #149
 2,000 P. S. I. Capacity. Up to 450 P. S. I.

#148 \$12.45 #149 \$10.95

#148 AIRCO and VICTOR OXYGEN WELDING GAUGE AND REGULATOR
 Regulation up to 400 P. S. I.

#148 VICTOR ACETYLENE WELDING GAUGE AND REGULATOR
 Regulation up to 50 P. S. I.

#155 VICTOR CUTTING TORCH \$15.75
 Type #40055. Used, but in good Condition.



MICARTA TUBE
 M-1
 Ideal for insulation or Bushing Stock, 36" x 1/4" wall x 1" O. D. Original use was for trailing antenna - F 10. Use for towel rack, souvenir displays, shafting spacers, etc.
 In original carton. 59c ea.



PILLOWS
CURLED CHICKEN FEATHERS
 28" x 17" 99c ea.
 Blue & white ticking. New, but still Renovated and Sterilized, in accordance with Laws of California.



NEW TARPS HEAVY CANVAS MILDEW RESISTANCE

- 5' x 7' \$3.95
- 8 1/2' x 10' \$7.95
- 5' x 14' \$9.95
- 14' x 21' \$24.50

NEW HUNTING KNIFE #307
 6" chrome vanadium blade 4" handle, leather grip. In leather sheath.
 \$5.98 Value For Only \$1.69



#313 BOAT FENDER—21 in. long 5 in. diam. Protection against docks for small boats.
 \$6.50 VALUE A STEAL AT \$1.95

- 3/16" JUTE ROPE 3 Thread Strand, Right Lay, 50 Ft. 75c
- 7/8 SISAL ROPE 50 Ft. \$3.99
- 5 lb. Ball 2 1/2" Heavy Twine Treated. \$1.45



ORDER DIRECT FROM THIS AD
 All sales final. Make remittances by money-order, bank draft or personal check. Purchase orders acceptable from D & B firms. All quotations F. O. B. Los Angeles. BIG ILLUSTRATED CATALOGUE AVAILABLE. Send 1/2 deposit with C. O. D. orders. Also Aircraft Supply Catalogue

ANOTHER "SCOOP" NEW, K-21 AIRCRAFT CAMERA
 (5" by 7")
 Eastman Kodak Lens. F 2.5, 7 in., 176 mm., 5x5, E. M. 1215.



With filters for haze, and night operation. 24V motor and all drives for operating this amazing camera. Graflex Mfg.
 A \$500 Value for \$75.00 Ea.

Air Force Pilots Brief Case
 Ideal for Business Men and Students. Long-wearing, genuine leather. Two full width compartments and three smaller pockets. Holder for identification card. Full zipper on three sides, 16 3/4" by 12" USED but reconditioned \$15.00 VALUE Only \$2.95! #188



FLYING HELMET
 #407 - Fleece-lined winter — \$1.59
 #407 A — Summer weight 69c
 Ideal for cycle drivers, racers, sportsmen. Used, but in excellent condition.



OXYGEN MASK
 A-14 Demand type. Slightly used, but perfect \$1.95 ea.
 A terrific deal with "mike." — \$2.50 ea.



NEW AIRCRAFT ALUMINUM BUCKET SEAT
 Use for boats, jeeps, tractor seats, etc. 17" x 18" seat, 18" x 24" back. Rib reinforced. Adjustable height tube mounting. Wide, high back gives excellent support. Easily installed. Shipped in original carton. You'll appreciate the buy at \$4.95 ea.



CUSHIONS
 New leather cushions of finest nickskin color, yellow. Filled with kapok. Will float for tractors, jeeps, boats, cars, as well as home use.
 Size - 22 1/2" x 17" x 1 1/2" thick. At fraction of Gov't. cost. \$2.95 ea.



FOR THE FREEZE THAT'S COMING!

AIR CORPS FLEECE LINED LEATHER JACKET



1/3 to 1/5 Gov't Cost! (approx.)

- Made to last.
- Full sheepskin felt.
- Fleece-lined collar.
- Leather taped seams.
- Full length zipper.
- 2 zippered, deep, slash pockets.
- Adjustable strap & buckle at throat.
- Type D-1, styled for easy, hind free action.
- Soft, pliant, "aviation tan" leather.

Thousands of Satisfied Customers

Made to U. S. Gov't. specifications — "nut sed!"
 Sizes: #401, small; #402, medium; #403 large.
 You've never seen them at these prices. Reconditioned, cleaned and brushed

\$8.95 While They Last!

SLEEPING BAG
 NEW! 100% wool. Mummy type. Heavy duty 30" zipper. Gov't. cost \$22.00 \$1 extra for used water repellent cover. \$4.95 (#283)



LEATHER FLEECE-LINED BOOT INSERTS
 For hunting or around house as slipper. sizes medium. \$7.00 Value \$1.89 pr. #312



NEW 100% ALL WOOL BLANKET
 7 x 7 ft. Extra heavy. Also Double warmth. Fits Wood's Robe sleeping bag. \$4.65 #414



STA-CLOSE DOOR CLOSER
 New-Adjustable

- Simple Construction
- Easy to Disengage if Necessary.
- Off center rod to permit opening of door more than 90 degrees. Will control Screen Doors, Communicating Doors.

#DC1 \$1.69 each



HORSEHIDE WORK GLOVES
 ALL LEATHER GAUNTLET TYPE REINFORCED PALMS & FINGER STITCHING.
 LENGTH 13 1/2" \$2.95 \$1.95 pr.
 ALL LEATHER WRIST Length 10 1/2" \$2.95 \$1.55 pr.
 Reinforced wrist, welding, all purpose work gloves.
 A Steal... Gov't. cost many, many times more.



SAFETY BELT
 New, in original box. Type B-14 Lap Safety Belt. Adjustable - full length 48", width 3". Forged steel, fool proof safety catch. Ideal for planes, jeeps, fun rides, farm equipment, etc. Try to beat this at 99c



PALLEY SUPPLY CO. THE LARGEST FIRM OF ITS TYPE IN THE WORLD DEPT. P.M. 117 — 6321 SAN FERNANDO RD. GLENDALE 1, CALIFORNIA

SOUTH BEND LATHES

PRECISION-BUILT FOR PRECISION WORK

The precision with which South Bend Lathes are built insures precision machining under all conditions. Regardless of the type of machining—between-centers, collet, fixture, or chucking—a high degree of accuracy can be maintained. The precision of South Bend Lathes will give you better results on any kind of work.

There is a South Bend Lathe for every size and type of shop. They are made with 9", 10", 13", 14½", 16", and 16/24" swings.



SOUTH BEND LATHE WORKS

Building Better Lathes Since 1906

455 EAST MADISON STREET • SOUTH BEND 22, INDIANA

PROMPT DELIVERY

See your South Bend Lathe distributor. You will find his name under "Machine Tools" in classified telephone directory.

PRICES

Prices of South Bend Lathes start at \$145.00, f. o. b. factory.

TIME PAYMENTS

25% down payment, 12 months to pay balance. Moderate finance charge.



SOUTH BEND 16" X 6'
TOOLROOM LATHE

SOUTH BEND LATHE WORKS

455 East Madison Street, South Bend 22, Indiana

Please send catalog of lathes with _____ swing for the following types of work _____. Also send Time Payment Plan information

NAME _____

STREET _____

CITY _____ STATE _____

Printed by Popular Mechanics Company, Chicago, Ill., U. S. A.

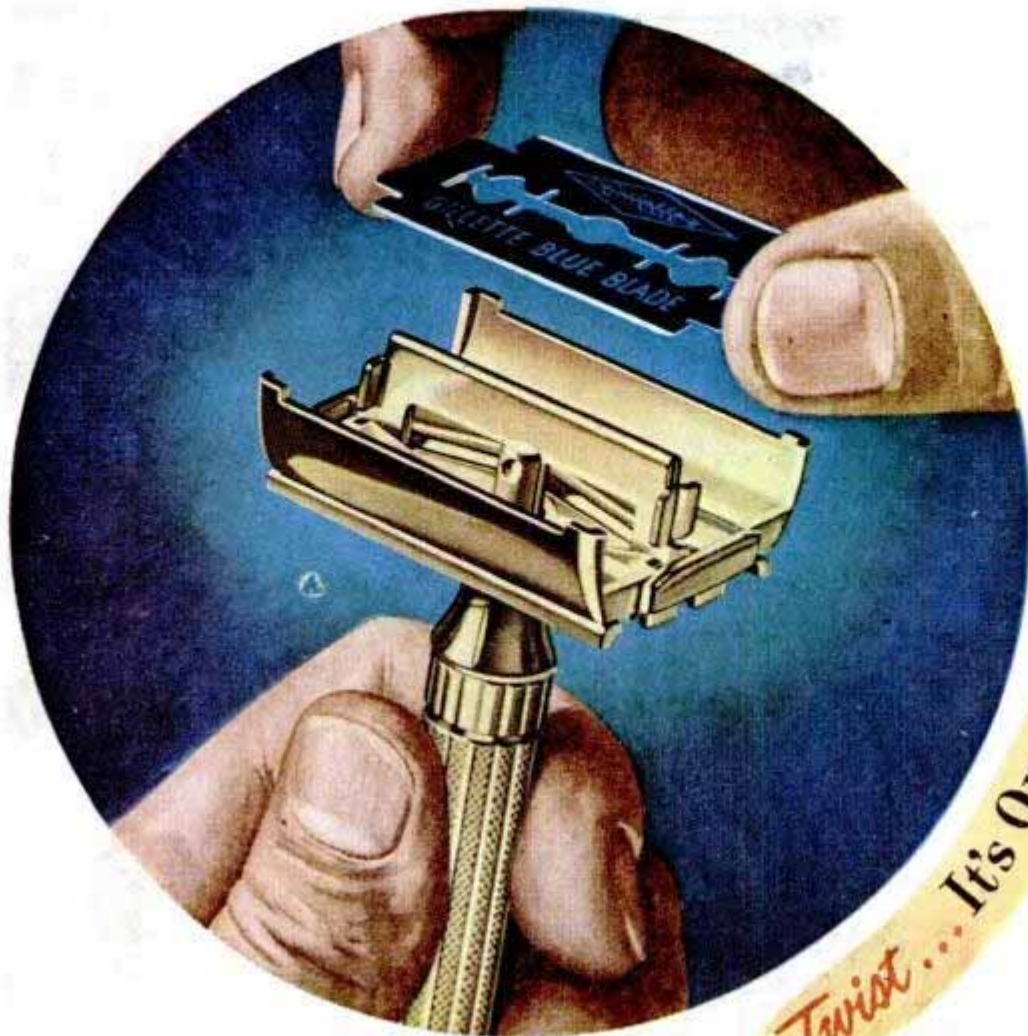

Twist... It's Open

You enjoy extra shaving speed and ease with the modern..

Gillette One-Piece Razor!



Gillette Aristocrat One-Piece Razor, gold-plated, with case and ten Gillette Blue Blades... **\$3⁷⁹**



Gillette Milord One-Piece Razor, gold-plated, with case and five Gillette Blue Blades... **\$2⁵⁰**

TO save time and shave with utmost comfort and convenience, get a Gillette One-Piece Razor. There's nothing to take apart or put together. You change blades in a jiffy. Twist . . . the razor opens. Twist again . . . your blade is locked in shaving position. To clean both razor and blade just loosen the holder, rinse and shake. See the Gillette Aristocrat and Gillette Milord One-Piece Razors. They're the finest shaving instruments money can buy. Either will give you years of satisfaction.

Gillette Safety Razor Company • Boston 6, Mass.



Twist... It's Closed

look SHARP! feel SHARP! be SHARP!

use Gillette Blue Blades
with the *SHARPEST* edges ever honed

Copyright, 1947, by Gillette Safety Razor Co.

**"EXPERIENCE IS THE
BEST TEACHER!**

*... in bowling and in
choosing a cigarette,"*

says

Ned Day

5-Time National
Bowling Champion



I KNOW
FROM **EXPERIENCE**
THERE'S NO
OTHER CIGARETTE
LIKE A **CAMEL!**

**More people are smoking CAMELS
than ever before**

R. J. Reynolds Tob. Co., Winston-Salem, N. C.

"**G**REATEST Match Game Bowler of All Time" is the title bowling authorities have given Ned Day. He's had years of *experience* as a bowler. His most enlightening experience as a smoker dates to the wartime cigarette shortage.

"Those were the days," says Ned, "when I smoked whatever brand I could get. I found no other cigarette suits my 'T-Zone' like a Camel!" Millions had that same experience. With smoker after smoker who tried and compared, Camels are the "choice of experience."

According to a Nationwide survey:

MORE DOCTORS SMOKE CAMELS
than any other cigarette

When 113,597 doctors were asked by three leading independent research organizations to name the cigarette they smoked, more doctors named Camel than any other brand!



**YOUR "T-ZONE"
WILL TELL YOU ...**

T for Taste ... T for Throat...
that's your proving ground for any
cigarette. See if Camels don't suit
your "T-Zone" to a "T."

