

POPULAR MECHANICS

MAGAZINE

WRITTEN SO YOU CAN UNDERSTAND IT

ESTABLISHED 1872

REG. U.S. PAT. OFF.



**WATER BOMB
FOR FOREST FIRES
PAGE 126**

*Enjoy extra
shaving speed and
convenience with a*
Gillette
One-Piece Razor

TO whisk off tough beard with perfect ease—save time and bother—get a gold-plated Gillette Aristocrat or Gillette Milord *one-piece razor*. These are the finest and most convenient shaving instruments money can buy. There's nothing to take apart or put together. You change blades in a flash. Twist . . . the razor opens. Twist again . . . your blade's locked in shaving position. For cleaning both razor and blade just loosen the holder, rinse and shake. Every man wants a fine razor. Ask to see the superb Gillette Aristocrat and Gillette Milord *one-piece razors*.

**Gillette Safety Razor Company
Boston 6, Mass.**



**Gillette
Aristocrat
One-Piece Razor**

in a beautiful case with ten Gillette Blue Blades . . . **\$3⁷⁹**



**Gillette
Milord
One-Piece Razor**

with handsome case and five Gillette Blue Blades . . . **\$2⁵⁰**



look SHARP! feel SHARP! be SHARP!

use Gillette Blue Blades WITH THE SHARPEST EDGES EVER HONED



Now at less than prewar prices—the tire that outwears prewar tires

B. F. Goodrich Silvertowns in all popular sizes now cost less than before the war. And yet they outwear prewar tires. For several months, issues of this magazine have shown, on this same page, pictures of car owners who have kept actual records of tire mileages. Others are shown above.

Typical example No. 74: 42,375 miles in taxi service! Paul A. Howell, manager of the City Cab Co. of Orlando, Fla., writes:

"We have thirty cabs in operation and several sets of B. F. Goodrich Silvertowns in service. To date we have not had a single tire failure. The mileage record on one set shows 42,375 miles, and we believe this set will go at least

50,000 before recapping. No other tire in our experience has given us better service."

Typical example No. 69: 23,304 miles in hospital service—tires still look new! Orrie Ewart, of Port Huron, Mich., is employed by St. Clair County, and his duties consist of transporting hospital patients. He says: "B.F. Goodrich Silvertowns don't skid on wet roads like others. I've driven the set you see in the picture 23,304 miles since last December, and they appear as if they were newly purchased."

Typical example No. 57: Best tires she ever had in thirty-three years! Says Mrs. Eugene Guest of Lithonia, Georgia: "I purchased three B. F.

Goodrich tires last year. When these tires were put on, the speedometer reading was 21,246. It is now 51,636, and there is a lot of good wear left in them. They are the best tires I have ever had, and I have been driving thirty-three years."

Not only do these tires cost less than before the war, but your B. F. Goodrich dealer will give you a good allowance on your old tires if they're still good enough to be used or recapped.

The B. F. Goodrich Company, Akron, Ohio.

B.F. Goodrich
FIRST IN RUBBER

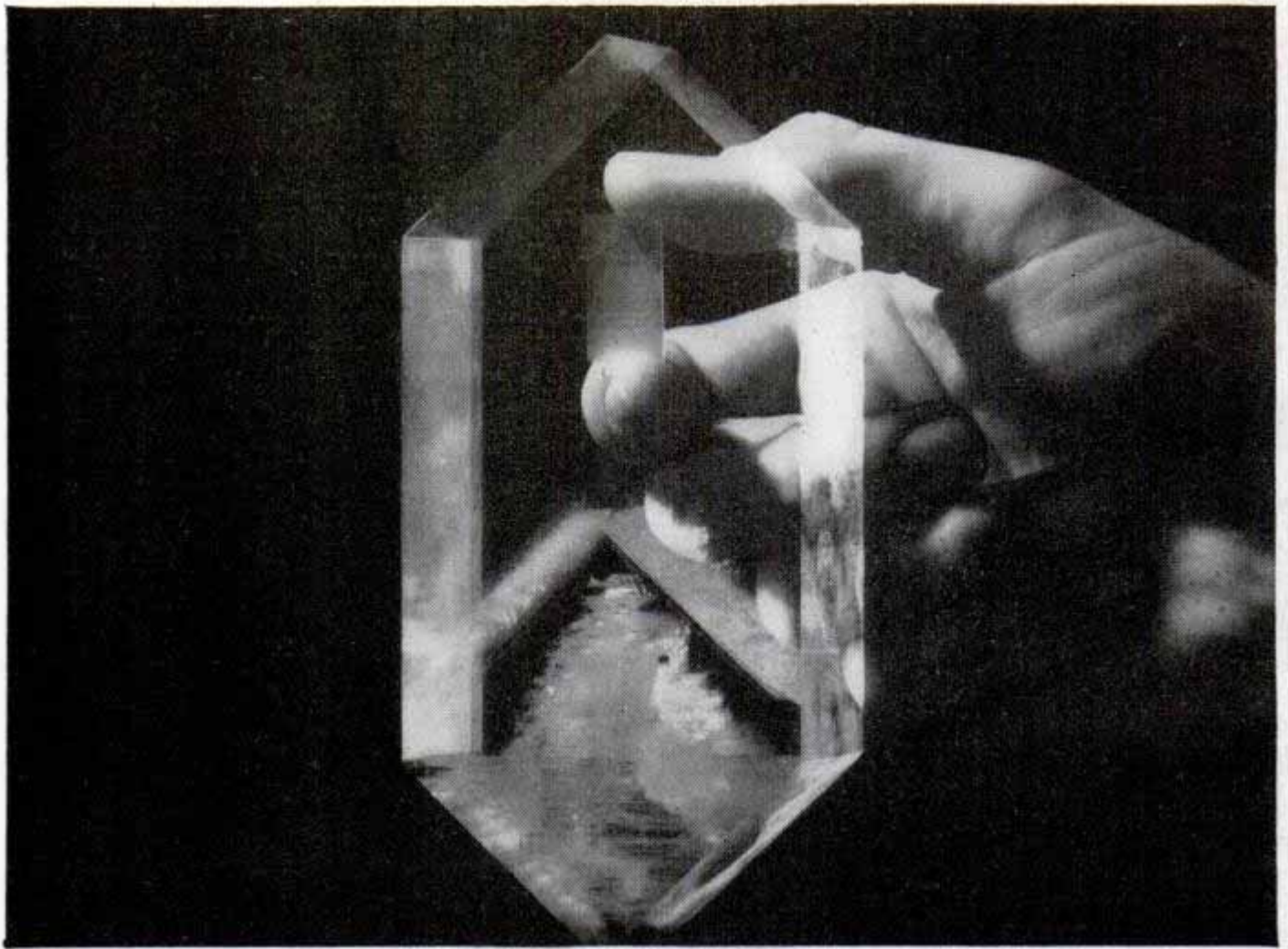

A CRYSTAL THAT GREW FROM A SEED . . . *The large crystal in the foreground is an EDT (Ethylene Diamine Tartrate) crystal. It started from a seed (a piece of mother crystal) and in three months grew in a slowly cooling solution to the size shown. The small plate is cut from a large crystal, then gold-plated for electrical connection and mounted in vacuum. Cultivated EDT crystals can do the same job as quartz in separating the nearly 500 conversations carried by a coaxial circuit.*

Crystals for Conversations

AT WAR'S END, the Bell System began to build many more Long Distance coaxial circuits. Hundreds of telephone calls can be carried by each of these because of electric wave filters, which guide each conversation along its assigned frequency channel. Key to these filters was their frequency-sensitive plates of quartz.

But there was not enough suitable quartz available to build all the filters needed. Bell Telephone Laboratories scientists met the emergency with cultivated

crystals. Years of research enabled them to write the prescription at once — a crystal which is grown in a laboratory, and which replaces quartz in these filters.

Now Western Electric, manufacturing unit of the Bell System, is growing crystals by the thousands. Many more Long Distance telephone circuits, in urgent demand, can be built, because the scientists of Bell Telephone Laboratories had studied the physics and chemistry of artificial crystals.



BELL TELEPHONE LABORATORIES

EXPLORING AND INVENTING, DEVISING AND PERFECTING, FOR CONTINUED IMPROVEMENTS AND ECONOMIES IN TELEPHONE SERVICE

Popular Mechanics Magazine

Registered in U. S. Patent Office and Canada

H. H. WINDSOR, Founder

H. H. WINDSOR, Jr., Editor and Publisher

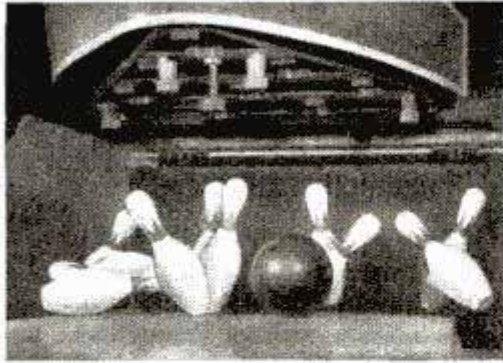

BOWLING PINS toppled by the country's 18,000,000 fans are clattering across the alleys in full volume again this fall. We asked Joe Wilman, voted 1946's "Bowler of the Year" by sports writers, for a few tips on knocking over strikes and picking up spares. "Control and 'stuff' on the ball are most important," he says. He explains this bowling lingo in a story on page 106.

NEXT MONTH'S ISSUE features a trip underground to the "Colossus of Coal," a mechanized tunnel that pours forth enough fuel in a single day to heat 2000 homes for the winter. Another fast-moving yarn describes the thrills and spills of motorcycle racing—over a course rough enough to shake the confidence of any rider. The latest surveying instruments are given a close inspection in "New Methods for Plotters."

STRAIGHT from Santa's workshop come the detailed plans in next month's Craftsman section. This pre-Christmas feature tells how to build toys, games, gift items and children's furniture. Also, for the man who builds his own machines there's the first installment of a two-part article detailing the construction of a table saw with a tilting arbor. The home workshop can be a dangerous place—and a November feature tells how to operate shop equipment safely.

RECEIVERS, amplifiers and transmitters can be operated with the compact power unit described in next month's Radio section.

Volume 88

OCTOBER 1947

Number 4

Managing Editor.....	Roderick M. Grant
Assistant Managing Editor.....	Wayne Whittaker
Shop Notes and Crafts Editor.....	James R. Ward
Radio and Electronics Editor.....	Frank L. Britton
Aviation Editor.....	Aubrey O. Cookman, Jr.
Associate Editor.....	John R. Kinsey
Associate Editor.....	Clifford B. Hicks
Eastern Editor.....	Bill Reiche
Western Editor.....	Thomas E. Stimson, Jr.
Art Director.....	Frank Beatty

Assistant Editors

Donald R. Brooks

Charles D. Emerson

Arthur R. Railton

Assistant Editors, Shop Notes and Crafts

W. Clyde Lamme Wayne C. Leckey John F. Shrock A. E. Youngquist

In This Issue

Science HQ of the Navy - - - -	89
Fancy Freighters Ride Ol' Man River	100
First Aid for Bowlers - - - -	106
Flying Trouble Spotters - - - -	117
Policing the Bering Sea - - - -	129
There's Magic Up Your Sleeve - - -	137
Industry Has a Million Eyes - - -	148
Paradise for Sidewalk Superintendents - - - -	153
Bombing the Desert With Seed - - -	165
Ducks by the Acre - - - -	171

For the Craftsman

Inexpensive Ski Tow - - - -	186
Winter Bouquets From Your Garden	192
Shotgun Chokes and Gauges - - -	196
"Jet"—Iceboat for Boys - - - -	202
Hints on Buying Used Motorcycles	214
Power-Tool Short Cuts - - - -	218
Radio and Electronics - - - -	229

Table of Contents Continued on Page 8

Published monthly by POPULAR MECHANICS COMPANY, 200 East Ontario Street, Chicago 11, Ill. H. H. Windsor, Jr., president; Paul H. Dunakin, vice president and general manager; D. F. Windsor, vice president and secretary-treasurer; William Harrison Fetrick, vice president and assistant to the publisher; Clover L. Perkins, advertising manager; Alan M. Deyoe, circulation manager. Single copy in the United States and Canada, 25 cents; subscription rates in United States and possessions, Canada, and countries of the Pan-American Postal Union, 1 year, \$2.50; 2 years, \$4.50; 3 years, \$6.00. To all other countries add \$1.00 a year over United States prices for overseas postage. If you plan to move, notify us at least 60 days in advance so you will not miss an issue. Give both old and new addresses. Entered as Second Class Matter, September 15, 1903, at the Post Office at Chicago, Illinois, under Act of March 3, 1879. Entered as Second Class Matter at Post Office Dept., Canada. Copyright 1947 by Popular Mechanics Company. Copyright under International Copyright Union. Copyright in France. All rights reserved under Pan-American Copyright Union. Printed in the United States of America.

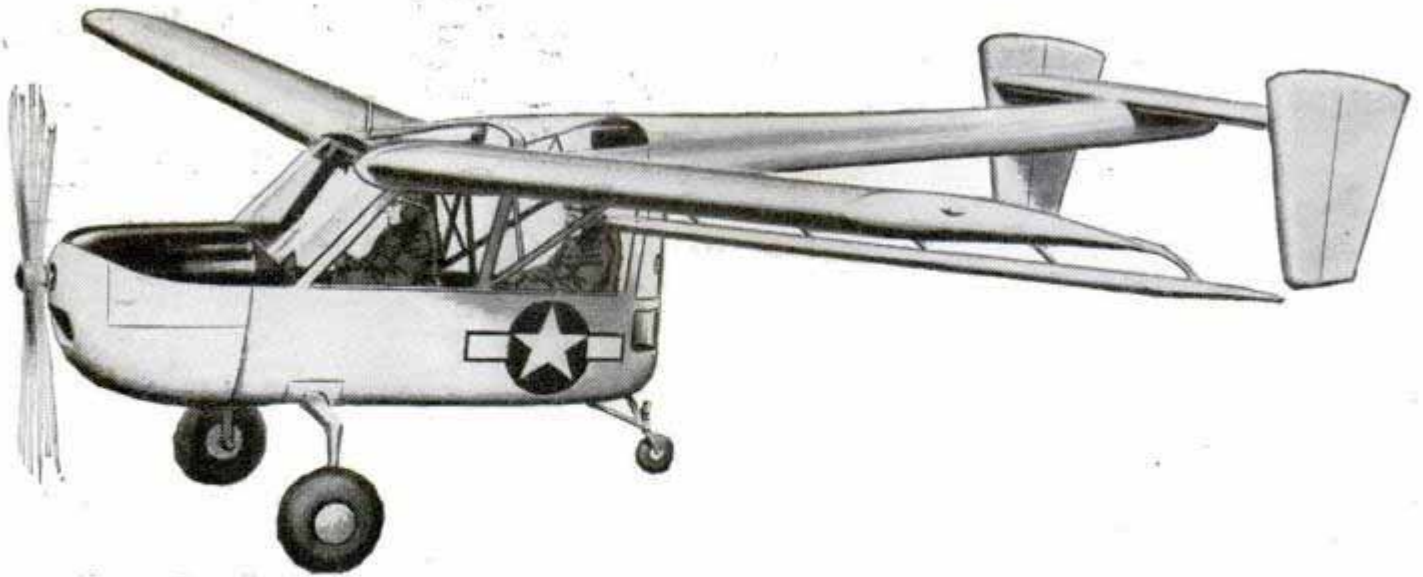

New "eyes" for the Army Ground Forces

YOU might guess this little aircraft belonged to the Air Forces, but you'd be wrong. It's strictly a Ground Forces gadget — the latest development in liaison and spotting planes.

It's the 125-hp. L-15, built to do the almost unbelievable things required by the Infantry, Artillery and Armored Cavalry.

This plane can cruise at a top speed of 112 mph., and dive safely at 200, yet it can hover at 36 mph. without stalling! On a field where there are no obstacles it can take off or land in less than 250 feet — or take off and clear 50-foot trees in 600 feet.

One of the L-15's most outstanding features is full visibility in all directions. Pilot and observer have a sweeping, all-round view, including straight down and straight aft, made possible by the unique cockpit design and elevated tail spar.

The role of small observation planes in World War II was vitally important to

victory. Spotting enemy installations, they enabled our firepower to strike with deadly accuracy. This new plane will give the Ground Forces still more dependable "eyes."

All through the peacetime Regular Army you'll find new scientific advances being tested and perfected. It's a great career for young men of mechanical skill who want to get ahead. There's good pay while learning; food, clothing, shelter and medical care; travel and splendid educational opportunities. A 3-year enlistment permits you to choose your branch of service from those still open. Ask for full details at your nearest U. S. Army Recruiting Station.

• Listen to "Sound Off," "Voice of the Army," "Proudly We Hail," and "Front and Center" on your radio.

A GOOD JOB FOR YOU
U. S. Army
CHOOSE THIS
FINE PROFESSION NOW!

YOUR REGULAR ARMY SERVES THE NATION AND MANKIND IN WAR AND PEACE

*Plant roses where the
woodpile used to be!*

Modernize your home with a Perfection Oil Heater and you'll be able to have a garden where the woodpile was! This is a symbol of the greater comfort and freedom that can be yours with *quality* Perfection heat. You can look to Perfection, as so many others have, for better living!

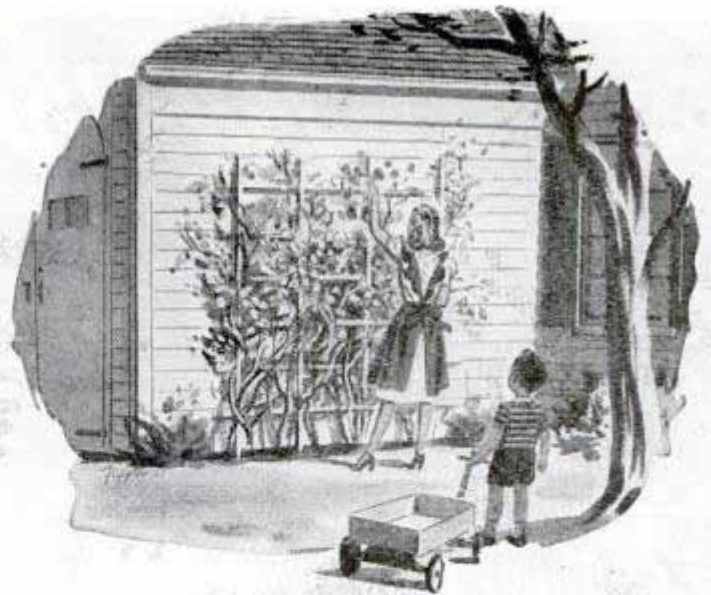

Switch to Modern, Economical PERFECTION Oil Heat!

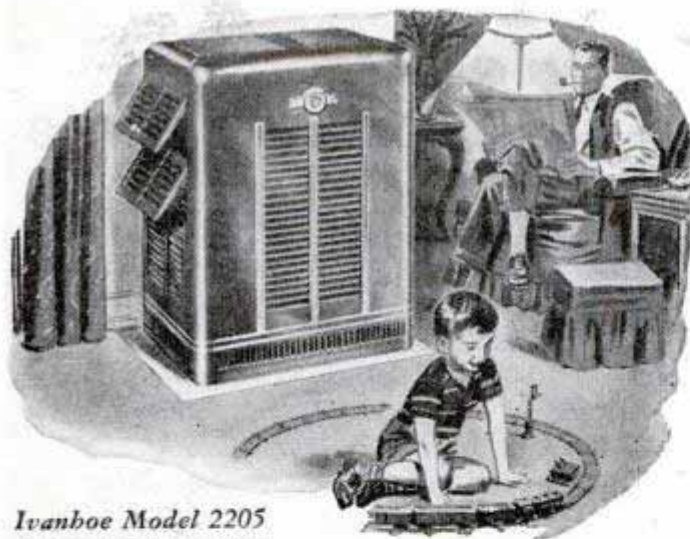

*Ivanhoe Model 2205
Space Heater, other
sizes available*

*Firelight Portable
Model 750 for "spot"
heating anywhere*



The Mark of Quality



Uniform Heat—quick radiating and circulating warmth, always there, day or night, when and where you want it.

Automatic Control—you can have fully automatic operation with an outside fuel supply tank and Accessory No. 12.

Clean Burning—soot-free, smoke-free, odor-free, result of advanced Perfection engineering over the years.

Blower—addition of Blower No. 24 will carry heat to far corners and other rooms.

Quiet Operation—a silent servant producing the quick, clean comfort of better living.

and—no coal to carry, no fires to build, no ashes to empty, no soot-streaked walls to clean!

PERFECTION

*Manufacturers of
Oil Cookstoves, Oil Heaters, Oil Water Heaters,
Oil and Gas Air-Conditioning Furnaces*

PERFECTION STOVE COMPANY
7897-B PLATT AVENUE • CLEVELAND 4, OHIO

Atlanta • Cleveland • Chicago • Jersey City • Kansas City • Oakland • St. Paul

By These Signs -----

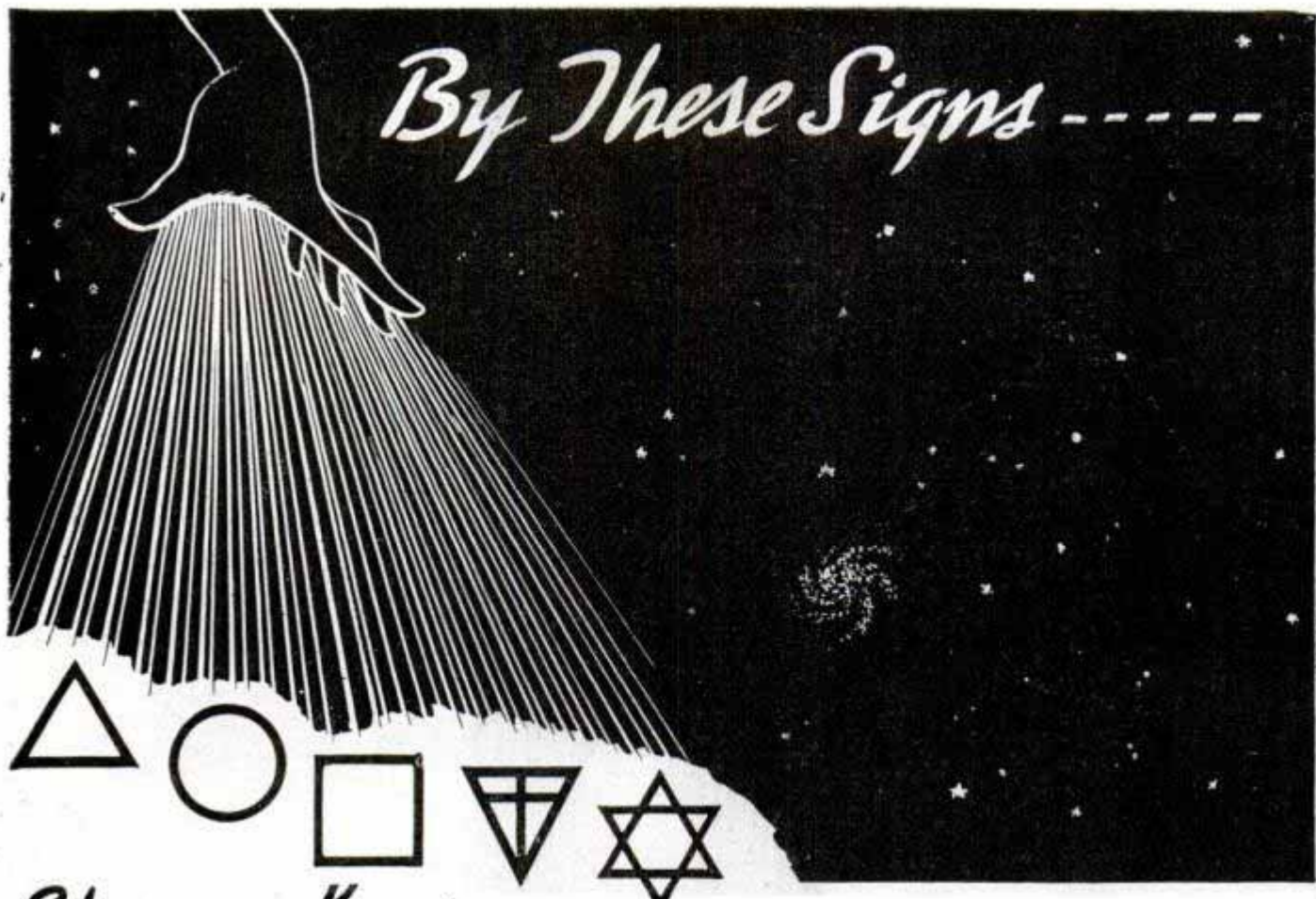

Strange Keys

to the Powers of the Universe

"GOD GEOMETRIZES," said an ancient sage. Within the straight line, curve, and angle—and their combinations—exist the forces of creation. These *secret symbols* contain the mysterious laws of the universe. Upon their right use—or the neglect of them—the success or failure of every *human enterprise* depends.

Have you a desire, *something you wish to accomplish* in life? Put your finger on a dot. In whatever direction you move your finger from the dot, you have made a beginning. Thus a dot is the symbol of *one*—or a beginning. Your desire then is also symbolized by *one*. If you follow the *proper method* or way to accomplish what you want, you have arrived at point *two*. Whenever these two symbols are brought together—the idea and the right way—you produce point *three*—the success of your plan. Success, therefore, is symbolized by the three equal sides of a *triangle*.

In planning your personal affairs—business, domestic, or the welfare of your family—do you use a *Cosmic formula*? Do you determine whether your acts are in accord with Divine truths eternally expressed in symbols? Why does the circle represent completion? Why is it said that a man is on the square? These

symbols are used by astronomers and scientists to prove the physical laws of the universe—why don't you apply them to the problems of your everyday world? Learn what symbols, as powers and forces of nature, you can simply and intelligently use in directing the course of your life.

Let the Rosicrucians (not a religious organization), a world-wide brotherhood of learning, reveal to you *the symbolism of successful living*.

Let this GIFT BOOK Explain

If you want to prepare yourself through understanding for the greater rewards of life, write for the fascinating *free Sealed Book*. It explains how you may receive this age-old wisdom. Use the coupon below.

Scribe W.F.Y.
THE ROSICRUCIANS, AMORC
San Jose, California, U. S. A.

Please send me the Free, Sealed Book. I am interested in knowing how I may obtain the masterful Rosicrucian teachings.

Name.....

Address.....

.....



THE ROSICRUCIANS, AMORC - SAN JOSE, CALIFORNIA, U. S. A.

**"What's he got
that I haven't got?"**

LOOK at the successful men you know. "What have they got" that you haven't?

Very little, probably. In most ways these men are no brighter or naturally more capable than average. Many of them probably have no more formal education or better natural aptitudes than you.

But that little extra they have is important. They have the special knowledge and ability for which business is glad to pay well—they know the what, why and how of business. They have also the confidence and aggressiveness which come from knowing that they know and can apply their knowledge.

You may add that extra—may get that same profitable knowledge and ability—that same confidence and aggressiveness—if you are willing to pay the price in earnest, necessary study. For LaSalle has spent 38 years developing, testing and proving, with over a million student members, spare-time success training in certain specialized business fields. What scores of thousands of men and women—many just like you—have done, you should be able to do.

You need not leave your home or interrupt your job; you need pay comparatively little money. But you must be ambitious and willing to study seriously. And soon after you start training, the results will begin to show up in your own confidence and in your work. For what you learn at home tonight is so practical that often you can apply it on the job tomorrow.

How much do you want success—more money, a promotion or a new job, prestige and responsibility? If you really want it, you will use the coupon below to find out what LaSalle training can do for you. It costs only a postage stamp, but a coupon like it has been the starting point to real success for scores of thousands—and can be for you.



LA SALLE Extension University
A Correspondence Institution

Dept. 1064-R • 417 S. Dearborn • Chicago 5, Ill.

I want to know how LaSalle can help me win success in the field I have checked below. Please send me your free 48-page booklet about that field and your success training in it.

- | | |
|--|--|
| <input type="checkbox"/> Accountancy | <input type="checkbox"/> Salesmanship |
| <input type="checkbox"/> Bookkeeping | <input type="checkbox"/> Effective Speaking |
| <input type="checkbox"/> C.P.A. Coaching | <input type="checkbox"/> Business Management |
| <input type="checkbox"/> Business English | <input type="checkbox"/> Industrial Management |
| <input type="checkbox"/> Law: LL.B. degree | <input type="checkbox"/> Traffic Management |
| <input type="checkbox"/> Foremanship | <input type="checkbox"/> Stenotypy (Machine Shorthand) |

Name.....Age.....

Position.....

Address.....

City, **This One**



WKEU-C7B-CHHZ

LA SALLE EXTENSION UNIVERSITY
A Correspondence Institution

So little Pyroil gives so much Protection

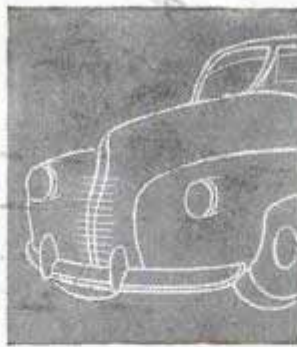

A pint of Pyroil in the crankcase — and a few ounces in the gas tank will add miles to your car. Pyroil gives oil the property of clinging to cylinder walls—thus preventing excess wear and corrosion. Pyroil prevents the accumulation of sludge, gum and other contamination in the crankcase and on cylinder walls. A little PYROIL does so much. Be sure to ask your gas station attendant to add PYROIL.

PYROIL FOR AIRCRAFT ENGINES

Use Aircraft Pyroil B for lubricating oil, Aircraft Pyroil A for gasoline.

Manufactured and Guaranteed by Pyroil Company, 72 Pyroil Bldg., La Crosse, Wisconsin.

Canadian Distributors:
Central Purchasing Agency, Ltd.
Toronto, Ontario



PYROIL COMPANY

72 Pyroil Bldg., La Crosse, Wisconsin

I want my car to last and run properly. Please tell me more about Pyroil and how it can accomplish this for me.

Name _____

Address _____

City or Town _____

State _____



Jerry, the talking dog, is entertaining hospitalized veterans, by courtesy of the PYROIL Company. Picture of Jerry, sent on request.

TABLE OF CONTENTS (Continued)

AUTOMOTIVE	
Here's relief for accelerator pushers.....	94
Half-size bus for youngsters made from scrap parts.....	98
Magnetized oil dipstick.....	120
Four-wheel steering guides British truck.....	128
Wrench with heavy handle shocks lug nuts loose.....	143
Foot-operated tire spreader leaves both hands free.....	158
Test simulates tire wear.....	170
Roller prevents doors from jamming on curbs.....	175
Motorcycle car.....	176
AVIATION	
Mapping planes fly aerial "chalk line".....	113
Track-type landing gear.....	124
Helicopter dusts crops.....	147
"Crackup Charlie".....	152
Airplane seat-bed has foldaway table.....	164
BOATS AND BOATING	
Shallow-draft hydroplane.....	124
Paddle-boat from war barges.....	134
Floating refrigerator.....	142
Locking device prevents theft of outboard motor.....	146
Hinged boat folds to form trailer.....	163
FARM	
Electric-fence gate handle.....	93
Scoop-scale for cattle feed.....	113
Beans by the mile.....	114
Old auto parts plus spare time equal tractor.....	134
Machine-made check rows.....	163
HOUSE AND HOME	
Glider cottage.....	134
"Plug-in" oil burner.....	152
What's new for your home.....	160
Aluminum baseboard "radiators".....	162
INDUSTRY	
Coal-mine tractor "hugs" the ground.....	93
Scale model of giant magnet.....	95
Peacetime proximity fuse.....	98
Hand truck moves wire coils.....	98
"Belt line" for gravel.....	99
Navy tests frozen-food container.....	120
X-raying oil fields.....	121
Atomic-ray counter.....	121
Salt-water railroad.....	122
Transparent models expose works.....	125
Steam cooks "spuds" by the truckload.....	128
Whole oranges handled by automatic juicer.....	128
Railway school has "course" 10,000 miles long.....	136
Shock absorbers for trains.....	136
Shrimp cleaner.....	142
Steam heated "lake" reclaims used oil.....	143
An old craftsman preserves the wheelwright's trade.....	144
Insecticide atomizer.....	159
Fuel atomizer for gas turbine.....	163
Brightly colored crane safer.....	169
Tractor-powered unloading platform dumps trucks.....	170
OUTDOOR RECREATION	
Down marker for night football.....	112
Three-piece trailer for small boats.....	143
Tent-trailer sleeps four persons and folds for storing.....	158
TOOLS	
Cordless soldering iron.....	95
Device adds extra uses to drill.....	95
Drilling 385 holes at once.....	112
Rotary planer has 100 teeth.....	116
Vise with fingers holds odd shapes.....	120
Instrument used with drill to locate center of holes.....	146
Drill press doubles as wood lathe.....	152
Rods cut by multiple leverage.....	162
Shearing jig.....	164
Woodworking height gauge.....	169
TOYS AND NOVELTIES	
Heirlooms made to order.....	96
Tiny Diesel engine drives toy car.....	121
Clock has wooden parts.....	146
Glass miniatures.....	159
Indoor wingshooting.....	159
Remote radio "stick-box" controls model planes.....	175
Furnished matchbox-rooms fashioned from household materials.....	176
MISCELLANEOUS	
Bowler's stop light.....	93
DDT kills crawfish.....	93
Underground New York.....	94
Line marker has finger-tip control.....	94
Fast-drying lacquer in artist's pen.....	95
Test your science I.Q.....	105
Floating cafeteria.....	112
Indoor indicator shows wind conditions.....	116
Pipe has bowl made of quartz.....	116
Collapsible copyholder.....	124
Plastic instrument draws ellipses.....	125
Stereoscopic camera moves during exposure.....	135
Hydraulic hoist lifts patients.....	136
Sea lion hums and talks.....	147
Braille wrist watch for blind.....	158
Football-shaped street lamp.....	162
Three guesses—what are they?.....	162
Pedal taxis.....	163
Air-driven hammer clears remains of blitzed buildings.....	169

Craftsman and Shop Notes Index

AUTOMOTIVE	
Trousers hanger holds floor mat while battery is serviced.....	184
Making oil gauge easy to read.....	184
Truck tail-gate-chain adjustment.....	190
Tool table from oil drum holds mechanic's equipment.....	223
Hole in muffler drains moisture.....	225
Making loop in ignition wire.....	228

(Continued to page 10)

DON'T read another word of this advertisement unless you're interested in a better job, a larger salary, greater responsibility! I. C. S. messages are not addressed to the idly curious — they're for the man who is curious with a purpose.

If you want to know how to start achieving advancement and success, we have important information for you.

We want to tell you that I. C. S. Courses covering more than 400 commercial and technical subjects are available for spare-time study at surprisingly low cost.

We want you to know that pay increases and job betterments are consistently reported to us by I. C. S. students in a volume as high as 600 and more letters a month.

Note, too, that successful I. C. S. graduates are numbered in the thousands and include presidents, board chairmen, production and research heads, superintendents, foremen in almost every branch of industry.

If you're truly curious, you'll want to know the details of what I. C. S. did for these men — and what it can do for you. The coupon brings you this full information. Mark and mail it *right now!*

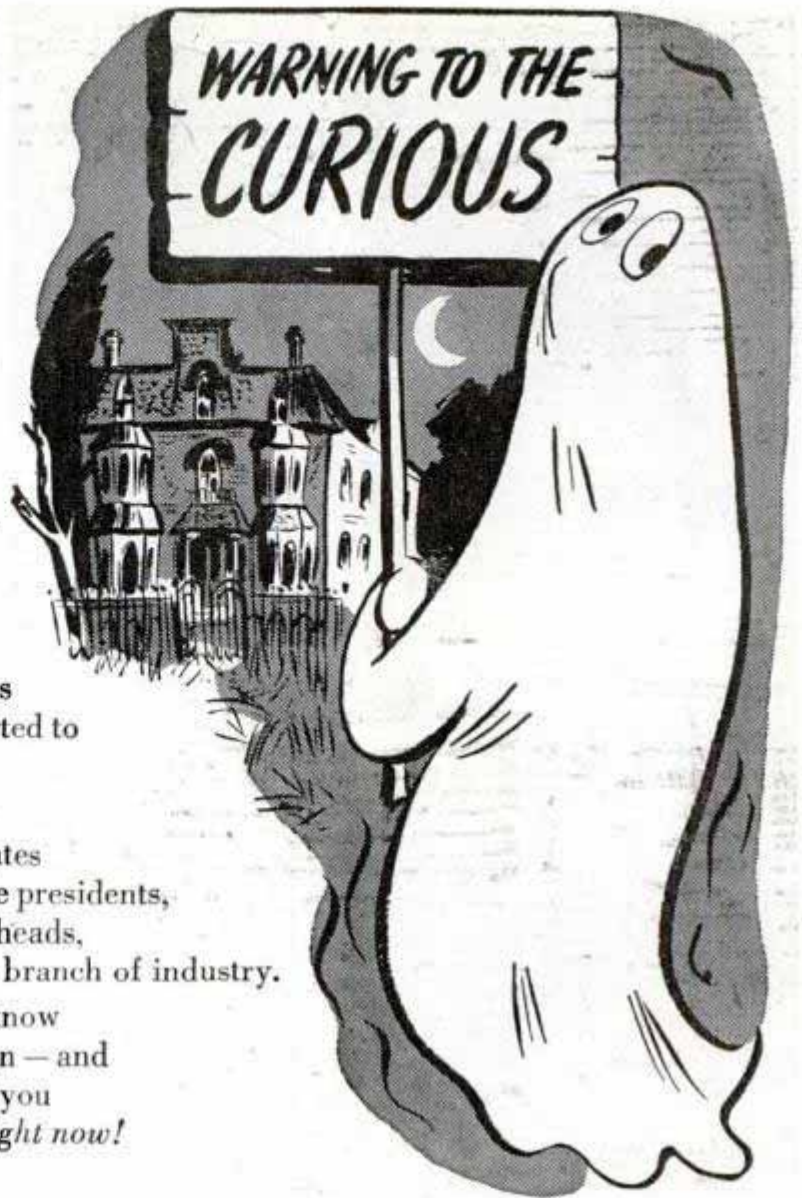

INTERNATIONAL CORRESPONDENCE SCHOOLS



BOX 5613-K, SCRANTON 9, PENNA.

Without cost or obligation, please send me full particulars about the course BEFORE which I have marked X:

Air Conditioning and Plumbing Courses

- Air Conditioning
- Heating
- Refrigeration
- Plumbing
- Steam Fitting

Chemistry Courses

- Chemical Engineering
- Chemistry, Analytical
- Chemistry, Industrial
- Chemistry, Mfg. Iron & Steel
- Petroleum Refining
- Plastics
- Pulp and Paper Making

Civil Engineering, Architectural and Mining Courses

- Architecture
- Architectural Drafting
- Bridge and Building Foreman
- Building Estimating
- Civil Engineering
- Coal Mining
- Contracting and Building
- Highway Engineering
- Lumber Dealer
- Reading Structural Blueprints
- Sanitary Engineering
- Structural Drafting

Structural Engineering

- Surveying and Mapping

Communications Courses

- Electronics
- Practical Telephony
- Radio, General
- Radio Operating
- Radio Servicing
- Telegraph Engineering

Electrical Courses

- Electrical Drafting
- Electrical Engineering
- Electric Light and Power
- Lighting Technician
- Practical Electrician

Internal Combustion Engines Courses

- Auto Technician
- Diesel-Electric
- Diesel Engines
- Gas Engines
- Aviation

Mechanical Courses

- Aeronautical Engineer's, Jr.
- Aircraft Drafting
- Flight Engineer
- Forging
- Foundry Work
- Heat Treatment of Metals

Industrial Engineering

- Industrial Metallurgy
- Machine Shop
- Mechanical Drafting
- Mechanical Engineering
- Mold-Loft Work
- Patternmaking—Wood, Metal
- Reading Shop Blueprints
- Sheet-Metal Drafting
- Sheet-Metal Worker
- Ship Drafting
- Ship Fitting
- Tool Designing
- Toolmaking
- Welding—Gas and Electric

Railroad Courses

- Air Brake
- Car Inspector
- Diesel Locomotive
- Locomotive Engineer
- Locomotive Fireman
- Railroad Section Foreman

Steam Engineering Courses

- Boilermaking
- Combustion Engineering
- Engine Running
- Marine Engineering
- Steam Electric
- Steam Engines

Textile Courses

- Cotton Manufacturing
- Rayon Weaving
- Textile Designing
- Woolen Manufacturing

Business and Academic Courses

- Accounting
- Advertising
- Arithmetic
- Bookkeeping
- Business Administration
- Business Correspondence
- Certified Public Accounting
- Commercial
- Commercial Art
- Cost Accounting
- Federal Tax
- First Year College
- Foremanship
- Good English
- Higher Mathematics
- Motor Traffic
- Postal Service
- Secretarial
- Sign Lettering
- Spanish
- Stenography
- Traffic Management

Name _____ Home Address _____

City _____ State _____

Age _____ Present Position _____ Working Hours _____ A.M. to _____ P.M.

Special tuition rates to members of the Armed Forces
Canadian residents send coupon to International Correspondence Schools Canadian, Ltd., Montreal, Canada

(Continued from page 8)

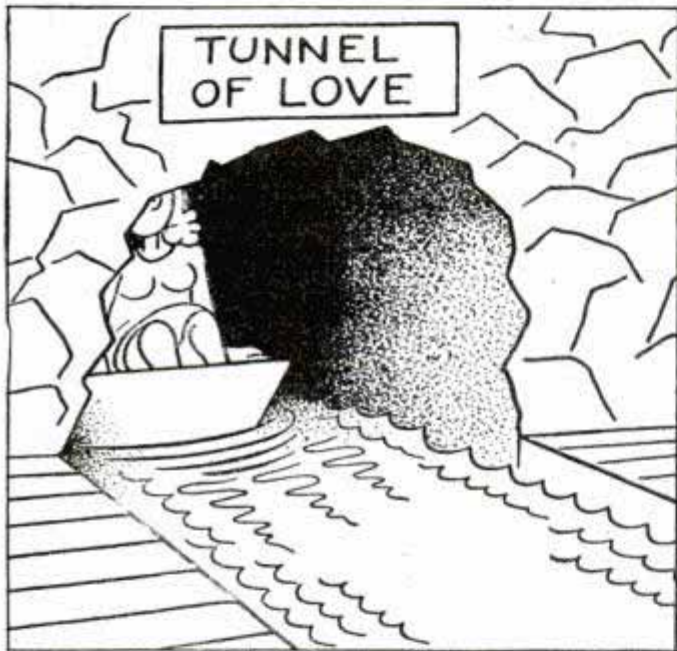
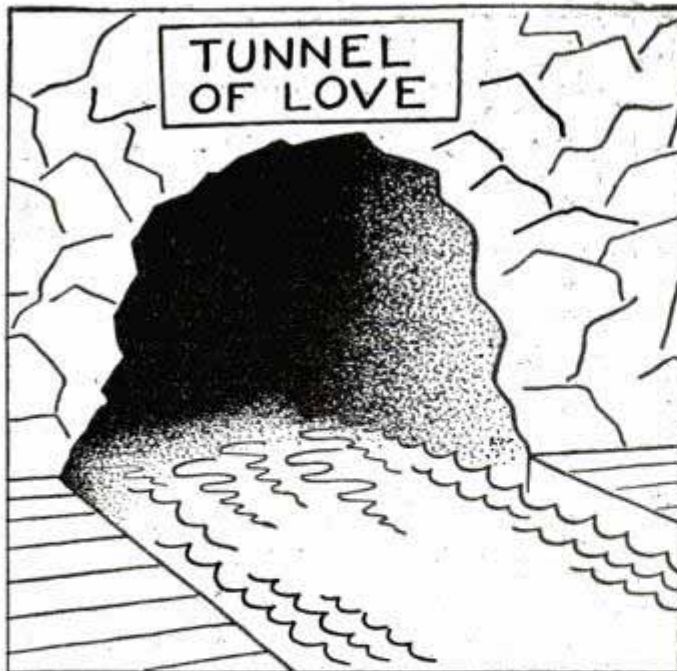

FARM

Oil drum supports rural mailbox and serves as package holder 201
 Pipe and straps make gate latch 213
 Lantern fount packed with cotton reduces fire hazard 213
 Combination cutter and bale hook 224
 Durable farm gate formed from single pipe 228

HOUSE AND HOME

Upper half of window operated from sash pulley 180
 Solving home problems 182
 Rosin removes cold-water paint 184
 Fine finish on interior woodwork 185
 Secret drawer in buffet 189
 Memo card gives correct sizes to stretch curtains 189
 Improved lock for bathroom door 190
 Paintbrush applies shoe polish 190
 How to recondition jar covers 201
 Handle aids in emptying basket 201
 Fastening rain gutters securely 201
 Hammering pin on shade roller 204
 Gauge glass on boiler cleaned without being removed 224

LAWN AND GARDEN

Mold cut in ground simplifies casting flagstones 194
 Implement seat for garden 204
 Depth gauge on garden trowel 210
 Leaf guard for broom-rake teeth makes cleaning easier 210
 Bottled tags identify trees 228

METALWORKING

Oilcan makes shellac container 180
 Gilt finish for metal surfaces 180
 Two ways to lock nuts on bolts 190
 Pewter bonbon dish typifies homespun craft 191
 How to solder small copper tubing 217

OUTDOOR RECREATION

Shower curtain pins are used to carry small game 184
 Focus mark filed on binoculars permits quick adjustment 201
 Sleeve quiets oarlock squeak 204
 Handy tool when fishing 210

PHOTOGRAPHY

Three simple reels for developing movie film 205
 Spigot in roll-film developing tank speeds draining of liquid 206
 Constant-flow print washer 207
 Pad serves as built-in "lens cap" on folding camera 208
 Protective cover fits flash gun 208
 Determining number of exposures 208
 Safe connection for photoflood 208
 Typewriter stand holds enlarger in small apartment 208

RADIO & ELECTRONICS

Twelve-tube receiver covers nine bands 229
 Signal "booster" increases sensitivity of short-wave receivers 230
 Proposed combination phone-television system 232

STORE & OFFICE

Sorted file cards racked in spring 213
 Approximate weights on scoop speed measuring 213
 Window-shade "blackboard" aids stock clerk 217

TOOLS

Notches in side-cutting pliers strip insulation 180
 Sliding bolts secure ladder 184
 Metal holder for hand tools fastened on workbench 194
 Cutting strips of leather evenly 204
 Lubricating high-speed drill 204
 Craft quiz 209
 Altered stovepipe serves as rack to keep miscellaneous parts 210
 Power drag saw 211
 Gauge marks electrical outlets 213
 Small dots of solder on square make it easy to pick up 217
 Paint scraper used as tack puller 222
 Settings for adjustable wrench marked on fixed jaw 222
 Accessory clamps polished rod 222
 Handy kinks for hand grinders 223
 Ovals of various sizes drawn by using simple tools 224
 Tray holds mechanic's tools close at hand 224
 Accurate circles are cut with jigsaw fixture 225
 Combination tool for surveyors increases efficiency of workers 225
 File it faster 226

TOYS AND NOVELTIES

Jar lid used as picture frame 180
 Toy glider shot from hand-operated catapult 185
 Acetone used to repair table-tennis balls 185
 Drawing silhouettes from models 189

WOODWORKING

Easy-to-make vanity stool 178
 Demountable four-piece picture frame 179
 Two-way shelf 181
 Mixture for filling holes in wood 189
 Sawdust absorbs paint remover 194
 Safety razor serves as scraper 194
 Screws hard to remove from hinge when "locked" with nail 194
 Turn this novel thread holder 195
 "Jet"—iceboat for boys 202

MISCELLANEOUS

Heated brick keeps putty warm in winter 190
 Winter bouquets from your summer garden 192
 Electric shaver used as eraser 204
 Money concealed in pocket flap 204
 Lifting chipped fingernail polish 210
 Ends of molding are colored to indicate length 222
 Weight tied to sandpaper block keeps it out of the way 228
 Extension tip on mechanical pencil is an aid when drafting 228

IMPORTANT NOTICE—It is the intention of this magazine to provide its readers with information regarding the latest developments in the mechanical arts. We take no responsibility as to whether the disclosures contained in our articles are covered by patents and advise readers to investigate this subject before making, using, or selling any of the products, machines, or processes described in order to avoid possible liability for patent infringements.

AUDELS REFRIGERATION & AIR CONDITIONING GUIDE.....\$4

New from Cover to Cover—1280 Pages, Fully Illus. Covering basic principles, servicing, operation & repair of household, commercial & industrial refrigeration & air conditioning. A gold mine of essential important facts for engineers, servicemen, users.

AUDELS CARPENTERS & BUILDERS GUIDES—4 Vols.\$6

A practical illustrated trade assistant on modern construction for carpenters, joiners, builders, mechanics and all woodworkers. 4 vols., 1600 pages, 3700 illustrations, flexible covers. Pocket size. Each volume sold separately \$1.50 a vol.

AUDELS AUTOMOBILE GUIDE.....\$4

A practical quick ready reference book for auto mechanics, service men, operators & owners. Explains theory, construction & servicing of modern motor cars, trucks, buses & auto type Diesel engines. 1700 pages, fully illustrated. 55 chapters. Indexed. A standard book for mechanics. New fluid drive covered.

AUDELS DIESEL ENGINE MANUAL..\$2

A practical, concise treatise with questions and answers on the theory, operation and maintenance of modern diesel engines including General Motors 2 cycle Diesel. 384 pages, fully illus., flexible binding, pocket size. All details plainly brought out, this book is of extreme value to engineers, operators & students.

AUDELS WIRING DIAGRAMS.....\$1

210 Pages. Illustrated. Gives practical facts on wiring of electrical apparatus. It shows clearly how to wire apparatus for practically all fields of electricity. Each diagram is complete & self-explanatory. Highly Endorsed Pocket Companion.

AUDELS PLUMBERS & STEAMFITTERS GUIDES—4 Vols.\$6

A Practical Trade Assistant & Ready Reference. Explains in plain language & by clear illustrations, diagrams, charts, graphs, pictures principles of modern plumbing practice including Marine Pipe Fitting and Air Conditioning. 4 Vols.—1670 Pages—3642 Diagrams. Pocket size. Each Vol. Sold Separately \$1.50 a Vol.

AUDELS SHEETMETAL WORKERS HANDY BOOK.....\$1

Practical inside information. Fundamentals of Sheet Metal Work. 388 pages. Illustrated. 11 sections. Clearly written. Essential & important facts, figures, pointers in everyday language. Ref. Index.

AUDELS SHEETMETAL PATTERN LAYOUTS.....\$4

Developed by Experts for Sheet Metal Workers, Layout Men & Mechanics. A Practical Encyclopedia in 10 Sections, size 7 x 10 x 2—1125 Pages—350 Layouts—1600 Illustrations. 1001 Key Facts. Fully indexed for ready reference in answering your layout problems. Covers all phases of sheet metal work including Pattern Cutting, Pattern Development & Shop Procedure.

AUDELS ANSWERS ON BLUE PRINT READING.....\$2

For Mechanics & Builders. Covers all types of blue print reading including ship & airplane. 416 pages, fully illustrated.

AUDELS NEW MACHINIST & TOOLMAKERS HANDY BOOK.....\$4

Covers modern machine shop practice in all its branches. 5 practical books in 1. New from cover to cover. Tells how to set up & operate lathes, screw and milling machines, shapers, drill presses and all other machine tools. 1600 pages, fully illustrated, 5 x 6 1/2 x 2. Indexed. 5 sections. 1—Modern Machine Shop Practice. 2—Blue Print Reading & How to Draw. 3—Calculations & Mathematics for Machinists. 4—Shop Physics. 5—How to Use the Slide Rule. 60 chapters. Easy to read and understand. A shop companion that answers your questions.

AUDELS MATHEMATICS & CALCULATIONS FOR MECHANICS \$2

Mathematics for home study or reference. 700 pages, 550 illus. Practical mathematics from beginning. How to figure correctly. Easy, correct methods covering complete review. Illus. & Indexed.

AUDELS HANDY BOOK OF PRACTICAL ELECTRICITY.....\$4

For maintenance engineers, electricians & all electrical workers. 1440 Pages, 2600 Illus. Covers important electrical information in handy form—including Marine Wiring, Radio Principles, Welding. Indexed. A Key to a practical understanding of electricity.

AUDELS RADIOMANS GUIDE.....\$4

A key to the practical understanding of radio including Frequency Modulation, Television, etc., Aircraft & Marine Radio. For radio engineers, servicemen, amateurs, 914 Pages, 633 Illustrations & Diagrams. Photos. Review Questions & Answers, Reference Index. Authentic, clear, concise.

AUDELS ELECTRONIC DEVICES.....\$2

Tells What You Want to Know About Electric Eye. Easily Understood. Covers photo-electric cells & their applications. Amplifiers, illumination, frequencies, voltage, photocell, tubes, Ohm's Law, wiring diagrams, etc.

AUDELS WELDERS GUIDE.....\$1

A concise, practical text on operation & maintenance of all welding machines for all mechanics. Over 400 pages, illustrated. Covers all methods of electric and acetylene welding including airplane work.

AUDEL, Publishers, 49 W. 23 St., N. Y. 10

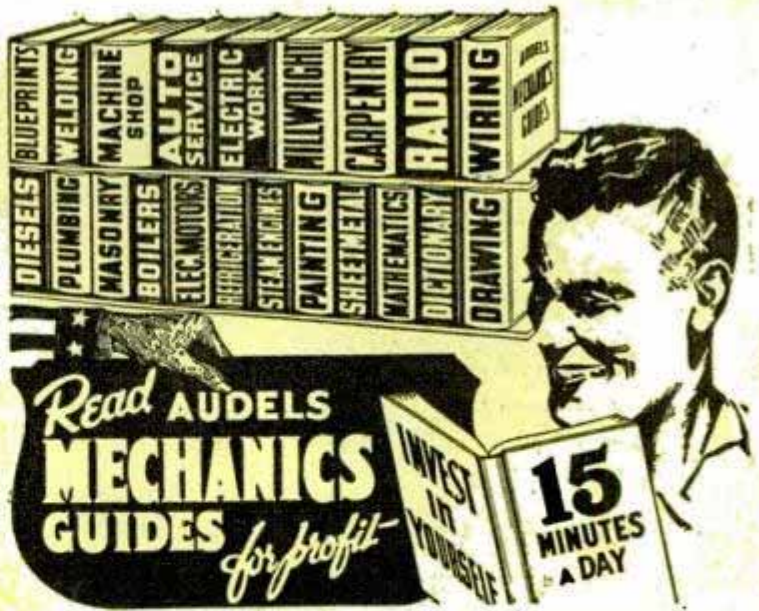

AN AUDEL GUIDE IS A GOOD FRIEND!

Step Up Your Own Skill with the Practical Facts and Figures of Your Trade. Save time and money with right methods, short cuts, labor saving ideas. CHECK NOW! You can look over any Audel Guide in your home. Start the Easy Payments if satisfied.

CUT HERE MAIL ORDER

THEO. AUDEL & CO., 49 W. 23 St., New York 10, N. Y.

Please mail me for 7 days' free examination the books marked (X) below. I agree to mail \$1 in 7 days on each book or set ordered, and to further mail \$1 a month on each book or set ordered until I have paid purchase price.

If I am not satisfied with Guides I will return them.

- Audels **ELECTRIC MOTOR GUIDE** \$4.
- Audels **OIL BURNER GUIDE** 1.
- Audels **REFRIGERATION & Air Conditioning Guide** 4.
- Audels **POWER PLANT ENGINEERS GUIDE** 4.
- Audels **PUMPS, HYDRAULICS & AIR COMPRESSORS** 4.
- Audels **WELDERS GUIDE** 1.
- Audels **BLUE PRINT READING** 2.
- Audels **SHEET METAL WORKERS Handy Book** 1.
- Audels **SHEET METAL PATTERN LAYOUTS** 4.
- Audels **AIRCRAFT WORKER** 1.
- Audels **MATHEMATICS and CALCULATIONS** 2.
- Audels **MACHINISTS & TOOLMAKERS Handy Book** 4.
- Audels **MECHANICAL Dictionary** 4.
- Audels **AUTOMOBILE GUIDE** 4.
- Audels **DIESEL ENGINE MANUAL** 2.
- Audels **MARINE ENGINEERS Handy Book** 4.
- Audels **MECHANICAL DRAWING GUIDE** 1.
- Rogers **MECHANICAL DRAWING and DESIGN** 2.
- Audels **MILLWRIGHTS and Mechanics Guide** 4.
- Audels **CARPENTERS and Builders Guides (4 vols.)** 6.
- Audels **PLUMBERS and Steamfitters Guides (4 vols.)** 6.
- Audels **MASONS and Builders Guides (4 vols.)** 6.
- Master **PAINTER and DECORATOR** 2.
- Audels **GARDENERS & GROWERS GUIDES (4 vols.)** 6.
- Audels **ENGINEERS & FIREMANS EXAMINATIONS** 1.
- Audels **ENGINEERS and Mechanics Guides Nos. 1, 2, 3, 4, 5, 6, 7 and 8 complete** 12.
- Audels **Answers on Practical ENGINEERING** 1.
- Audels **ELECTRICIANS EXAMINATIONS** 1.
- Audels **WIRING DIAGRAMS** 1.
- Audels **Handy Book of PRACTICAL ELECTRICITY** 4.
- Audels **ELECTRICAL POWER CALCULATIONS** 2.
- Audels **ELECTRONIC DEVICES** 2.
- Audels **ELECTRIC Dictionary** 2.
- Audels **RADIOMANS GUIDE** 4.
- Audels **NEW ELECTRIC LIBRARY at \$1.50 a Volume Vols. I, II, III, IV, V, VI, VII, VIII, IX, X, XI, XII**

Name _____

Address _____

Occupation _____

Employed by _____

I Will
Show You
How to

Learn RADIO

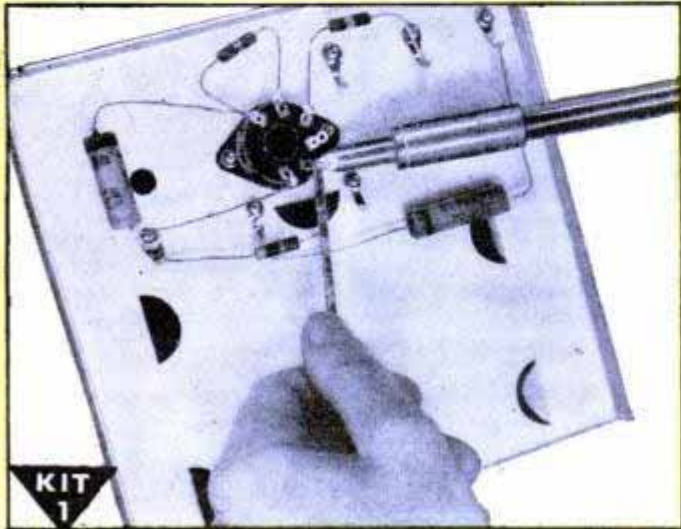

KIT 1

I send you Soldering Equipment and Radio parts; show you how to do Radio soldering; how to mount and connect Radio parts; give you practical experience.

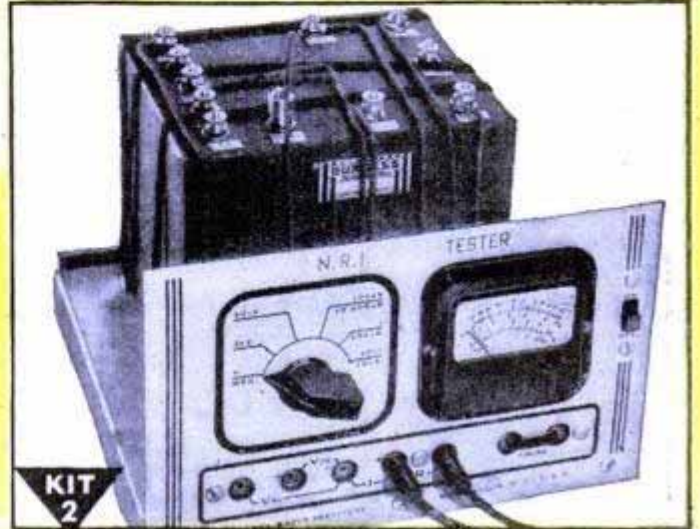

KIT 2

Early in my course I show you how to build this N.R.I. Tester with parts I send. It soon helps you fix neighborhood Radios and earn EXTRA money in spare time.

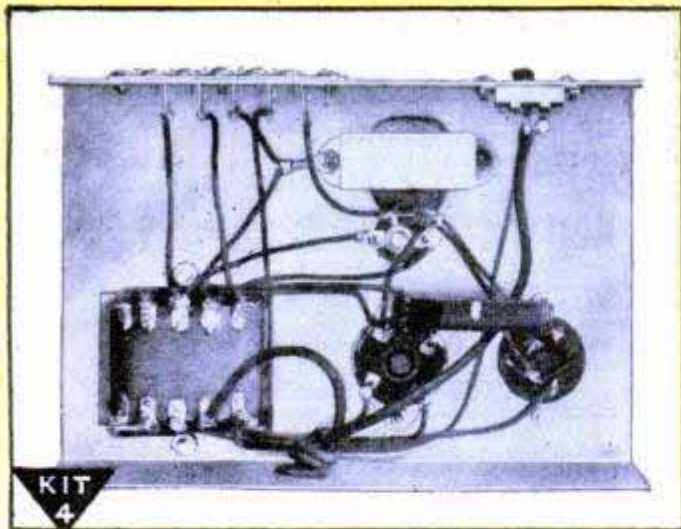

KIT 4

You get parts to build this Vacuum Tube Power Pack; make changes which give you experience with packs of many kinds; learn to correct power pack troubles.

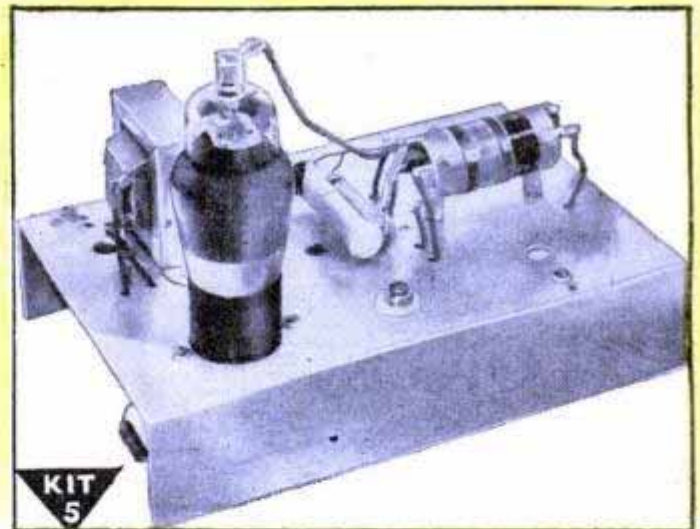

KIT 5

Building this A. M. Signal Generator gives you more valuable experience. It provides amplitude-modulated signals for many tests and experiments.

MEN I TRAIN AT HOME GET GOOD JOBS LIKE THESE

Made \$612, in 12 Months, Spare Time



"Soon after I finished my experimental kits lessons I tackled my first Radio service job. The neighbors were very cooperative. I soon had all the repair jobs I could handle in spare time. I have made \$612 in the past 12 months in spare time."
—J. W. CLARK, Wilmington, N. C.

Minister Makes \$10-\$20 Weekly Spare Time



"I am a minister. I am in a county seat now trying to serve the people in my church, also trying to keep their Radios playing. I have been making from \$10 to \$20 per week in spare time."
—L. H. SMITH, Benton, Tenn.

Knew Nothing About Radio



"I knew nothing about Radio when I enrolled. At present I am doing spare time work. I have more than paid for my course and I have about \$200 worth of equipment which has paid for itself."
—RAYMOND HOLT CAMP, Vandalia, IN.

Doing Good Spare Time Business



"I have been getting receivers to repair right along lately, and by using the methods taught me in the NRI Course, I don't have to spend much time on any of them."
—STANLEY N. STRICKLAND, 191 Dale Homes, Portsmouth, Va.

by Practicing in Spare Time

I Send You
Big Kits
of Radio Parts

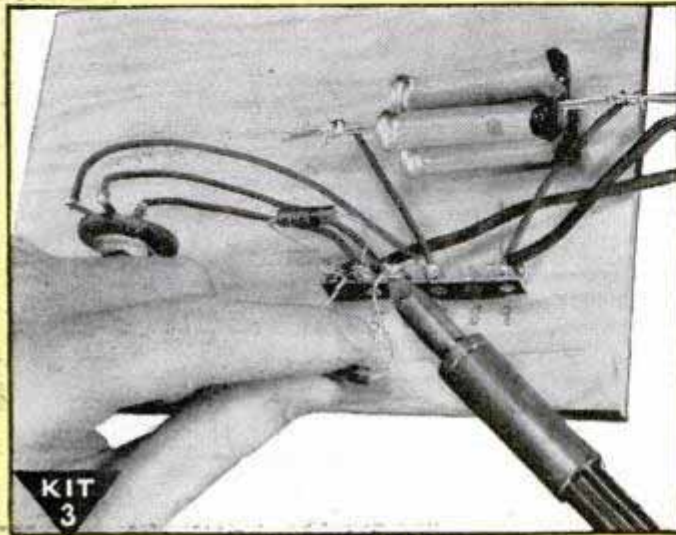

KIT
3

You get parts to build Radio Circuits; then test them; see how they work; learn how to design special circuits; how to locate and repair circuit defects.

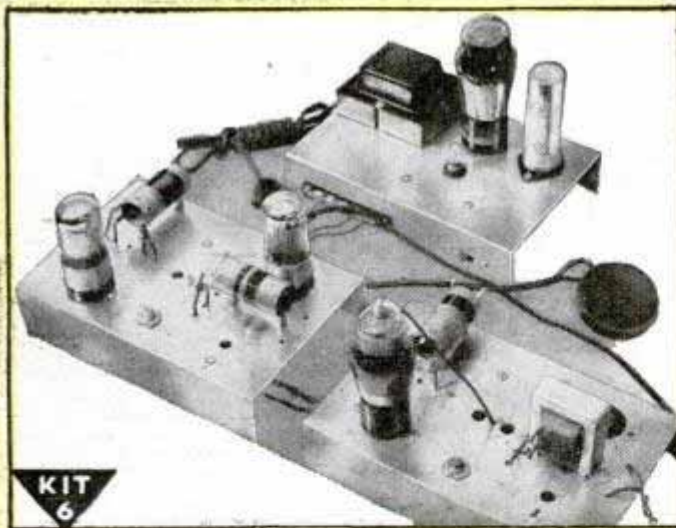

KIT
6

You build this Superheterodyne Receiver which brings in local and distant stations—and gives you more experience to help you win success in Radio.

SAMPLE LESSON FREE

Gives hints on Receiver Servicing, Locating Defects, Repair of Loud-speaker, I.F. Transformer, Gang Tuner, Condenser, etc. Mail Coupon.

GETTING ACQUAINTED WITH
RECEIVER SERVICING

My Radio Course Includes
TELEVISION • ELECTRONICS
FREQUENCY MODULATION

KNOW RADIO Win Success I Will Train You at Home

Do you want a good-pay job in the fast-growing Radio Industry—or your own Radio Shop? Mail the Coupon for a Sample Lesson and my 64-page book, "How to Be a Success in RADIO—Television, Electronics," both FREE. See how I will train you at home—how you get practical Radio experience building; testing Radio circuits with BIG KITS OF PARTS I send!

VETERANS
You can get
this training
in your own
home under
G.I. Bill. Mail
coupon for
full details.

Many Beginners Soon Make
Extra Money in Spare Time
While Learning

The day you enroll I start sending EXTRA MONEY manuals that show how to make EXTRA money fixing neighbors' Radios in spare time, while still learning! It's probably easier to get started now than ever before, because the Radio Repair Business is booming. Trained Radio Technicians also find profitable opportunities in Police, Aviation, Marine Radio, Broadcasting, Radio Manufacturing, Public Address work. Think of even greater opportunities as Television, FM and Electronic devices become available to the public! Send for FREE books now!

Find Out What NRI Can Do For You

Mail Coupon for Sample Lesson and my FREE 64-page book. Read the details about my Course; letters from men I trained; see how quickly, easily you can get started. No obligation! Just MAIL COUPON NOW in envelope or paste on penny postal. J. E. SMITH, President, Dept. 7KP, National Radio Institute, Pioneer Home Study Radio School, Washington 9, D. C.

Our 33rd Year of Train-
ing Men for Success
in Radio

MAIL NOW!

Mr. J. E. SMITH, President, Dept. 7KP,
National Radio Institute,
Washington 9, D. C.

Mail me FREE, your sample lesson and
64-page book. (No salesman will call.
Please write plainly.)

Age _____

Name _____

Address _____

City _____

State _____

(Please include Post Office zone number)

Approved for Training under GI Bill



Accountancy Home-Study

made interesting and practical thru problem method

YOU know as well as we do that Accountancy fits many men for positions that pay three and five and ten thousand dollars a year—gives many other men unusual opportunity to start a profitable growing business of their own.

You probably realize also that the accounting profession faces the greatest opportunity it has ever had.

The only question is—just how practical is it for *you* to train yourself adequately in Accountancy through home study?

And the answer lies in the LaSalle Problem Method.

For this modern plan of training not only makes Accountancy study at home thoroughly practical but makes it interesting as well.

And here's how:

You Learn by Doing

Suppose it were your privilege every day to sit in conference with the auditor of your company or the head of a successful accounting firm. Suppose every day he were to lay before you in systematic order the various problems he is compelled to solve, and were to explain to you the principles by which he solves them. Suppose that one by one you were to work those problems out—returning to him every day for counsel and assistance—

Granted that privilege, surely your advancement would be far faster than that of the man who is compelled to pick up his knowledge by study of theory alone.

Under the LaSalle Problem Method you pursue, to all intents and purposes, that identical

plan. You advance by solving problems.

Only—instead of having at your command the counsel of a single individual—one accountant—you have back of you the organized experience of a great business training institution, the authoritative findings of scores of able accounting specialists, the actual procedure of the most successful accountants.

Thus—instead of fumbling and blundering—you are coached in the solving of the very problems you must face in the higher accounting positions or in an accounting practice of your own. Step by step, you work them out for yourself—until, at the end of your training, you have the kind of ability and experience for which business is willing and glad to pay real money.

One-Tenth of All C. P. A.'s Are LaSalle Trained

If you want still more proof, remember that over 2300 C.P.A.'s—approximately one-tenth of all those in the United States who have passed the difficult examination for this coveted degree—are LaSalle alumni.

And knowing these facts, ask yourself if there can be any further question about the practicability of this training for you—ask rather if the real question is not about the size of your own ambition and the quality of your determination.

For Accountancy is no magic wand for the lazy or the fearful or the quitter—it offers success only to the alert adult who has the courage to face the facts and the will to carry on till the job is done.

If you are that individual, the coupon below, filled out and mailed, will bring you free the information that may open up to you the future of which you have dreamed—ability and income and success. Is it not worth getting that information?

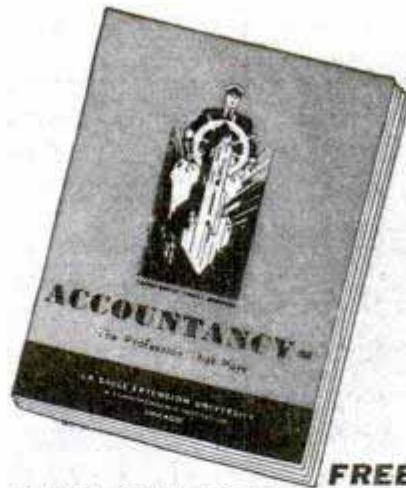

**FREE
SEND FOR THIS...BOOK**

LaSalle Extension University

A Correspondence Institution

Dept. 1064-H 417 S. Dearborn St., Chicago 5, Ill.

Please send me, free of all cost or obligation, your 48-page illustrated book "Accountancy, the Profession That Pays," telling about the profession of accountancy and your training for success in that field.

Name.....

Address.....City & Zone.....

Position.....Age.....





INVENTORS



Learn how to protect your invention. The U. S. Patent Laws provide that any new and useful art, machine, article of manufacture, or composition of matter, or any new and useful improvement thereof, may be patented if the act of invention is involved. Therefore, every inventor with a valuable invention should take advantage of the Patent Laws and proceed for patent protection in order to safeguard his rights.

A patent gives the inventor the exclusive right to prevent others from making, using, or selling the invention claimed in the patent for a period of seventeen years.

The Patent Laws were enacted for the benefit of the inventor to give him protection for the features of his invention which are patentable. These features must be properly and concisely set forth and claimed in a formal application for patent, in order to comply with the requirements of the U. S. Patent Office. For that reason, the Patent Office advises the inventor, unless he is familiar with such matters, to engage a competent registered patent attorney or agent to represent him. We maintain a staff of registered patent attorneys ready to serve you in the handling of your patent matters.

A specially prepared booklet entitled "Patent Guide for the Inventor", containing detailed information with respect to patent protection and procedure, together with a "Record of Invention" form will be promptly forwarded to you without obligation upon request.

Patents
Trademarks
Copyrights

Registered Patent Attorneys

CLARENCE A. O'BRIEN
& HARVEY B. JACOBSON

71-K District National Building + Washington 5, D. C.

CLARENCE A. O'BRIEN & HARVEY B. JACOBSON
Registered Patent Attorneys

71-K District National Bldg., Washington 5, D. C.

Please send me copy of "Patent Guide for the Inventor" and also "Record of Invention" form. This request does not obligate me.

Name _____

Address _____

City _____ State _____

(Please write or print plainly.)



I'll Send You 8 Big Kits of Training Equipment including
TWO-BAND 6 TUBE SUPER RECEIVER
AND 16 RANGE METER SET-UP
for Testing

Learn Fast . . . Earn Fast
HOME TRAINING
Planned For Your Needs
You Build All These
TESTERS . . . and MORE!



Practice Does It!
 Soldering, wiring, connecting Radio Parts . . . building circuits with your own hands — you can't beat this method of learning. When you construct this Rectifier and Filter Resistor and Condenser Tester, etc., you get a really practical slant on Radio that leads to a money-making future.

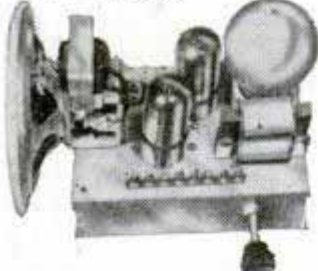

Building this Signal Generator and multi-purpose Tester will give you the kind of valuable experience and practice that is so important as a foundation for making good money in Radio. It makes a-breeze out of fixing Radios, and you don't have to spend money on ready-made Equipment.

VETERANS
 You can get Sprayberry training at home under G.I. Bill. Mail coupon for full details.



PRACTICE WITH YOUR OWN HANDS!
 Mind training through hand practice, that's the only way to LEARN and REMEMBER Radio. It's the most successful of Home Training methods.



OVER 175 PRACTICAL EXPERIMENTS
 You'll find out how to build countless Radio Circuits. You'll learn a new, fast way to test Radio Sets without mfg. Equipment.

LOW COST HOME RADIO TRAINING!
Easy Monthly Payments!

The answer to the PRACTICAL results, I show my Students lies in the way I train you. Not books and lessons alone. But "sight demonstrations" with real Radio Parts worked out with your own hands. You LEARN! You UNDERSTAND! You REMEMBER! Pay special attention to the quality and completeness of the Equipment which comes with the Sprayberry Course. You get a big 6 Tube Super Receiver and a 16 Range Meter Set-up for testing. When I put you to work with the 8 big Kits of Radio Parts I send you, you'll really LEARN Radio and learn it RIGHT! You'll get the practical experience

and pre-conditioning you need to be useful in Radio, and that's what it takes to make money. You don't need any previous experience. The Sprayberry Course starts right at the beginning of Radio — you can't get lost!
 Soon after you begin your Sprayberry Course, I'll send you my sensational BUSINESS BUILDERS. You'll learn how to get and do neighborhood Radio repair jobs for nice profits and rich experience. With the kind of Training I give you, you will be able to set up your own Business, or step into a good-pay job in Radio, Television, FM, Radar, Industrial Electronics. Don't waste time! Make your start NOW!

MAIL COUPON FOR THESE 2 BOOKS!



"How to Read Radio Diagrams and Symbols" and "How to Make Money in Radio, Electronics and Television." Immense, practical value to you — and they're yours FREE!

SPRAYBERRY ACADEMY OF RADIO
 F. L. Sprayberry, President
 Room 10107, Pueblo, Colorado

Please rush my FREE copies of "How to MAKE MONEY in RADIO, ELECTRONICS and TELEVISION" and "How to READ RADIO DIAGRAMS and SYMBOLS."

Name _____ Age _____
 Address _____
 City _____ State _____

(Mail in envelope or paste on penny postcard)

HOW "JACK THE WEAKLING" SLAUGHTERED THE "DANCE-FLOOR HOG"!

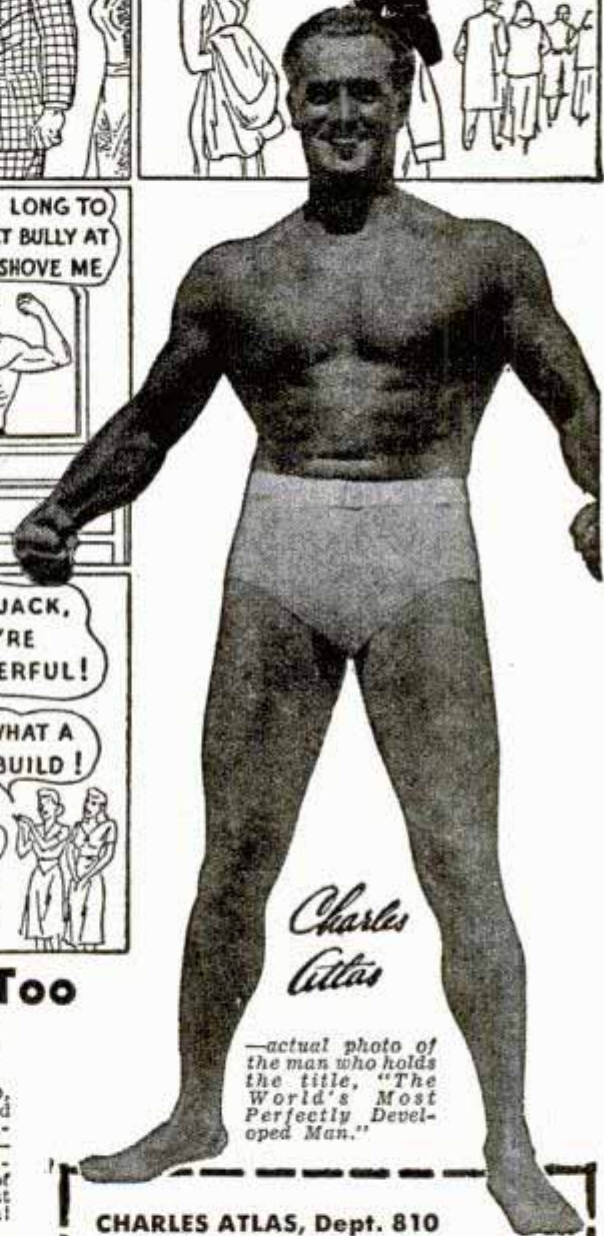

Charles Atlas

—actual photo of the man who holds the title, "The World's Most Perfectly Developed Man."

I Can Make YOU a New Man, Too —in Only 15 Minutes a Day!

HAVE YOU ever felt like Jack—absolutely fed up with having bigger, huskier fellows "push you around"? If you have, then give me just 15 minutes a day! I'll PROVE you can have a body you'll be proud of, packed with red-blooded vitality!

"Dynamic Tension." That's the secret! That's how I changed myself from a scrawny, 97-pound weakling to winner of the title, "World's Most Perfectly Developed Man."

"Dynamic Tension" Does It!

Using "Dynamic Tension" only 15 minutes a day, in the privacy of your own room, you quickly begin to put on muscle, increase your chest measurements, broaden your back, fill out your arms and legs. This easy, NATURAL method will make you a finer specimen of REAL MANHOOD than you ever dreamed you could be!

You Get Results FAST

Almost before you realize it, you will notice a general "toning up" of your en-

tire system! You will have more pep, bright eyes, clear head, real spring and zip in your step! You get sledge-hammer fists, a battering-ram punch—chest and back muscles so big they almost split your coat seams—ridges of gold stomach muscle—mighty legs that never get tired. You're a New Man!

FREE BOOK

Thousands of fellows have used my marvelous system. Read what they say—see how they looked before and after—in my book, "Everlasting Health and Strength."

Send NOW for this book—FREE. It tells all about "Dynamic Tension," shows you actual photos of men I've turned from puny weaklings into Atlas Champions. It tells how I can do the same for YOU. Don't put it off! Address me personally:

Charles Atlas, Dept. 810,
115 East 23rd St., New York 10, N. Y.



CHARLES ATLAS, Dept. 810
115 East 23rd St., New York 10, N. Y.

I want the proof that your system of "Dynamic Tension" will help make a New Man of me—give me a healthy, husky body and big muscular development. Send me your free book, "Everlasting Health and Strength."

Name.....Age....
(Please print or write plainly)

Address.....

City.....State.....

INVENTORS

Patent Laws Encourage The Development of Inventions

The Rules of Practice of the U. S. Patent Office advises— unless an inventor is familiar with such matters — that he employ a competent registered attorney or registered agent, as the value of patents depends largely upon the skillful preparation of the specifications and claims.

The firm of McMorro, Berman and Davidson is registered to practice before the U. S. Patent Office. Additionally, it maintains a staff of attorneys able to readily understand inventors' disclosures, to advise concerning patentability, and to prepare appropriate specifications and claims for filing with the Patent Office.

If an inventor believes he has an invention, a search of the most pertinent prior U. S. patents should be made and a report obtained relative to its patentability. Where such report indicates that the invention appears patentable, in order to secure protection, diligence should be exercised in making application for a patent.

McMORROW, BERMAN & DAVIDSON

Registered Patent Attorneys

PATENTS — TRADE-MARKS — COPYRIGHTS

135-A VICTOR BUILDING, WASHINGTON 1, D. C.

McMORROW, BERMAN & DAVIDSON

Registered Patent Attorneys

135-A Victor Building, Washington 1, D. C.

Send me further particulars as to patent protection and procedure and "Invention Record" form at once. I understand that this request does not obligate me.

Name _____

Address _____

City _____ State _____

(WRITE OR PRINT NAME CLEARLY)

WHY THE CIRCLE IN THE GRASS?

You don't have to be a farmer to recognize this circular patch. A horse or cow tethered to a stake leaves a perfect circle of closely cropped, heavily trampled grass.

Here's the point: in many fields of business and industry you can go only as far as your education and training permit — *and no farther*. Most things beyond are out of reach. Only additional training can enable you to get away from the tether, can give you an unlimited area of opportunity.

During the past 56 years, the International Correspondence Schools have helped to broaden the vocational scope for more than 5,000,000 men like yourself.

INTERNATIONAL CORRESPONDENCE SCHOOLS



BOX 5614-K, SCRANTON 9, PENNA.

Without cost or obligation, please send me full particulars about the course BEFORE which I have marked X:

- Air Conditioning and Plumbing Courses
- Air Conditioning
- Heating
- Refrigeration
- Plumbing
- Steam Fitting
- Chemistry Courses**
- Chemical Engineering
- Chemistry, Analytical
- Chemistry, Industrial
- Chemistry, Mfg. Iron & Steel
- Petroleum Refining
- Plastics
- Pulp and Paper Making
- Civil Engineering, Architectural and Mining Courses**
- Architecture
- Architectural Drafting
- Bridge and Building Foreman
- Building Estimating
- Civil Engineering
- Coal Mining
- Contracting and Building
- Highway Engineering
- Lumber Dealer
- Reading Structural Blueprints
- Sanitary Engineering
- Structural Drafting

- Structural Engineering
- Surveying and Mapping
- Communications Courses**
- Electronics
- Practical Telephony
- Radio, General
- Radio Operating
- Radio Servicing
- Telegraph Engineering
- Electrical Courses**
- Electrical Drafting
- Electrical Engineering
- Electric Light and Power
- Lighting Technician
- Practical Electrician
- Internal Combustion Engines Courses**
- Auto Technician
- Diesel-Electric
- Diesel Engines
- Aviation
- Gas Engines
- Mechanical Courses**
- Aeronautical Engineer's, Jr.
- Aircraft Drafting
- Flight Engineer
- Forging
- Foundry Work
- Heat Treatment of Metals

- Industrial Engineering
- Industrial Metallurgy
- Machine Shop
- Mechanical Drafting
- Mechanical Engineering
- Mold-Loft Work
- Patternmaking—Wood, Metal
- Reading Shop Blueprints
- Sheet-Metal Drafting
- Sheet-Metal Worker
- Ship Drafting
- Ship Fitting
- Tool Designing
- Toolmaking
- Welding—Gas and Electric
- Railroad Courses**
- Air Brake
- Car Inspector
- Diesel Locomotive
- Locomotive Engineer
- Locomotive Fireman
- Railroad Section Foreman
- Steam Engineering Courses**
- Boilermaking
- Combustion Engineering
- Engine Running
- Marine Engineering
- Steam Electric
- Steam Engines

- Textile Courses**
- Cotton Manufacturing
- Rayon Weaving
- Textile Designing
- Woolen Manufacturing
- Business and Academic Courses**
- Accounting
- Arithmetic
- Business Administration
- Business Correspondence
- Certified Public Accounting
- Commercial
- Commercial Art
- Cost Accounting
- Federal Tax
- First Year College
- Foremanship
- Good English
- Higher Mathematics
- Motor Traffic
- Salesmanship
- Sign Lettering
- Spanish
- Traffic Management
- Advertising
- Bookkeeping
- French
- High School
- Postal Service
- Secretarial
- Stenography

Name _____ Home Address _____

City _____ State _____

Age _____ Present Position _____ Working Hours _____ A.M. to _____ P.M.

Special tuition rates to members of the Armed Forces
Canadian residents send coupon to International Correspondence Schools Canadian, Ltd., Montreal, Canada

ADVICE for the INVENTOR

The United States Patent Office advises the inventor, unless he is familiar with such matters, to employ a competent, registered patent attorney or agent as the value of patents depends largely upon the skillful preparation of the specification and claims.

PRELIMINARY STEPS *toward* PATENT PROTECTION

The Evidence of Invention form mentioned below is offered as a convenience to the inventor in making his disclosure of invention. The inventor should date and sign his disclosure and have it witnessed by two or more persons who are capable of understanding his invention. The disclosure should then be mailed to the registered patent attorney or agent whom he selects to assist him. The disclosure should be accom-

panied by a letter authorizing the patent attorney or agent to conduct a preliminary search at the U. S. Patent Office among previously granted U. S. Patents for similar types of invention. The patent attorney or agent then prepares a report of the probable patentability of the invention and recommends the further course the inventor should take, provided the report indicates possible patentability.

Victor J. Evans & Company has a staff of experienced registered patent attorneys available to assist inventors in the preparation and prosecution of their cases before the Patent Office.

The **COUPON BELOW** is suggested as a convenience to the inventor in starting action on his invention.

**VICTOR J.
EVANS & Co.**

Merlin M. Evans
REGISTERED PATENT ATTORNEY

230-L Merlin Building, Washington 6, D. C.

PLEASE SEND DETAILED PATENT INFORMATION TOGETHER WITH CONVENIENT "EVIDENCE OF INVENTION" FORM.

Name.....

Address.....

City and State.....

Learn **RADIO** in a Few Weeks

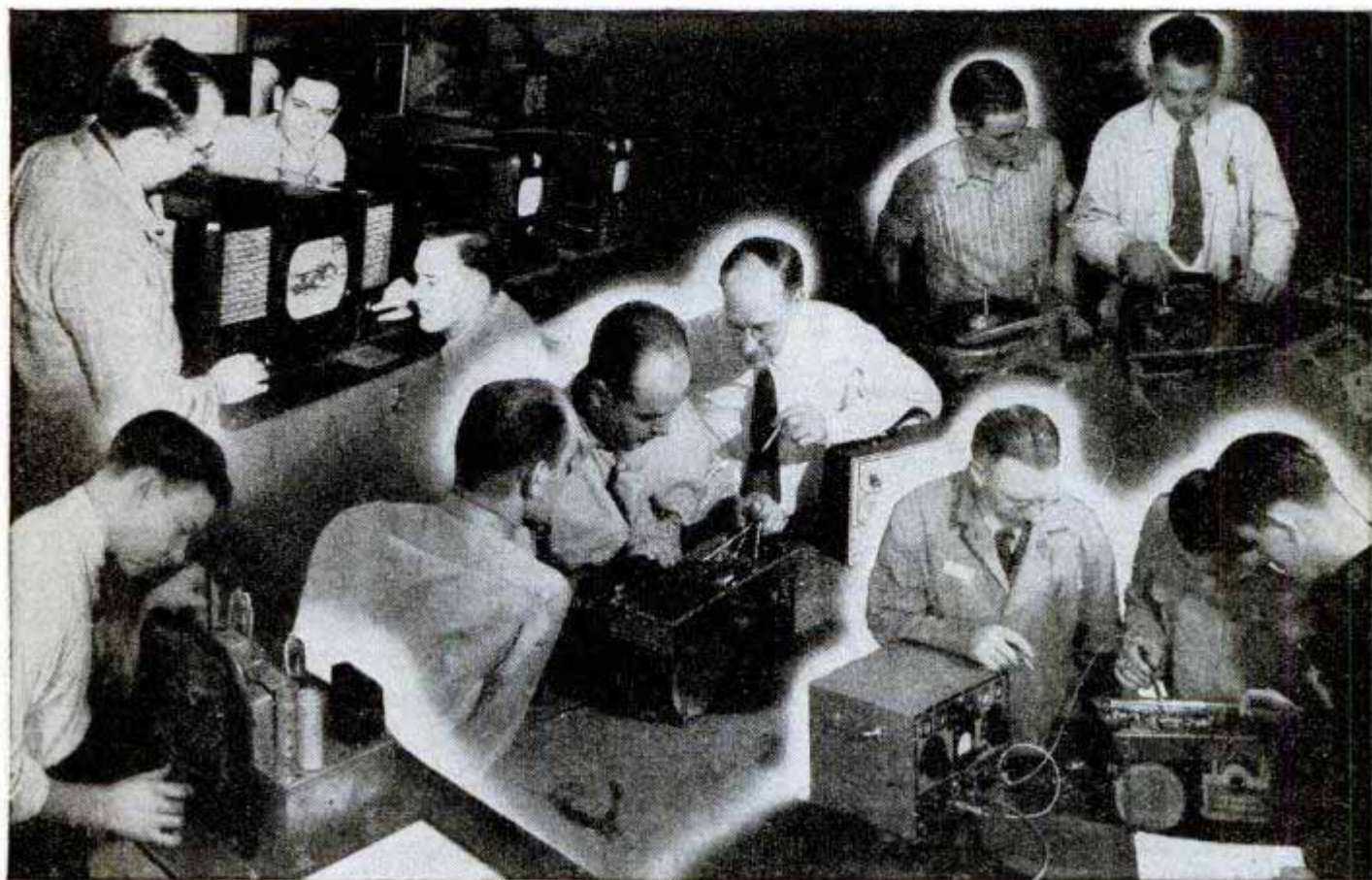

In the **GREAT SHOPS** of **COYNE**

NOT A "HOME-STUDY" COURSE!



B. W. Cooke

Men, here's the quick, easy way to learn Radio—with practical training in the Great Shops of COYNE. All training given on full-size equipment under friendly, helpful instructors, plus necessary theory. We do not teach by mail. At Coyne you learn Radio Set-building and Trouble-shooting, Public Address and Sound Systems, Television, Electronics, how to start your own shop. Prepare NOW for better jobs, bigger pay. Mail coupon today!

At Coyne you learn Radio Set-building and Trouble-shooting, Public Address and Sound Systems, Television, Electronics, how to start your own shop. Prepare NOW for better jobs, bigger pay. Mail coupon today!

ATTENTION, NON-VETERANS!

Don't let lack of money hold you back. Our Student Finance Plan has helped thousands. Pay most of tuition after you graduate. We also help you get part-time work while here, if you wish. Lifetime Job Service FREE to Coyne-trained men.

INCLUDED!

Added training in Electric Refrigeration Now Included with Radio Course.



VETERANS!

COYNE is authorized to train men who qualify under the G. I. Bill. Coupon brings special G. I. Bulletin.

SEND NOW FOR BIG FREE BOOK

Dozens of actual photos taken in the Great Shops of Coyne—also vital facts about YOUR opportunities in Radio-Electronics and Television. Coyne gives you ALL-AROUND Training, to prepare for many branches of the vast Radio field. Send for this book today. No obligation, and no salesman will call on you. Rush the coupon—new class starting soon!



Founded 1899

B. W. COOKE, President, Radio Division

COYNE ELECTRICAL SCHOOL
500 S. PAULINA ST. Dept. 77-3H, CHICAGO 12

FREE BOOK COUPON

B. W. COOKE, President
COYNE ELECTRICAL SCHOOL, Radio Division
500 S. Paulina St., Dept. 77-3H, Chicago 12, Ill.

I want to build a REAL FUTURE for myself. Send your big FREE BOOK on RADIO, also details of Student Finance Plan and Lifetime Employment Service. This does not obligate me in any way, and no salesman will call.

NAME.....
ADDRESS.....
CITY.....STATE.....

...MAIL THIS TODAY!

WORK FOR THE



GOVERNMENT START

\$1,756 to \$3,021 YEAR

VETERANS GET SPECIAL PREFERENCE

MEN—WOMEN

Postoffice Clerks, Carriers
Railway Postal Clerks
Patrol Inspectors
Stenographers-Typists
Many Other Jobs

PREPARE IMMEDIATELY
Common Education Often Sufficient

Mail Coupon TODAY



COUPON

Name.....

Address..... Vet?.....

Franklin Institute
Dept. N86
ROCHESTER 4, N. Y.

Gentlemen: Rush to me FREE of charge, list of U. S. Government big pay jobs. Send FREE 32-page book describing salaries, vacations, hours, work. Tell me how to prepare for one of these jobs.

AUDELS Carpenters and Builders Guides 4 vols. \$6



Inside Trade Information for Carpenters, Builders, Joiners, Building Mechanics and all Woodworkers. These Guides give you the short-cut instructions that you want—including new methods, ideas, solutions, plans, systems and money saving suggestions. An easy progressive course for the apprentice and student. A practical daily helper and Quick Reference for the master worker. Carpenters everywhere are using these Guides as a Helping Hand to Easier Work, Better Work and Better Pay. To get this assistance for yourself, simply fill in and mail the FREE COUPON below.

Inside Trade Information On:

How to use the steel square—How to file and set saws—How to build furniture—How to use a mitre box—How to use the chalk line—How to use rules and scales—How to make joints—Carpenters arithmetic—Solving mensuration problems—Estimating strength of timbers—How to set girders and sills—How to frame houses and roofs—How to estimate costs—How to build houses, barns, garages, bungalows, etc.—How to read and draw plans—Drawing up specifications—How to excavate—How to use settings 12, 13 and 17 on the steel square—How to build hoists and scaffolds—skylights—How to build stairs—How to put on interior trim—How to hang doors—How to lath-lay floors—How to paint



THEO. AUDEL & CO., 49 W. 23rd St., New York City

Mail Audels Carpenters and Builders Guides, 4 vols., on 7 days' free trial. If O.K. I will remit \$1 in 7 days, and \$1 monthly until \$6 is paid. Otherwise I will return them. No obligation unless I am satisfied.

Name.....

Address.....

Occupation.....

Reference..... PM

AVIATION

Aeronautical University Approved Training meets exacting standards of aviation industry, prepares for key positions, big opportunities.

Courses in:

AERONAUTICAL ENGINEERING, B.S. degree.
AERONAUTICAL ENGINEERING DRAFTING
CERTIFIED ENGINE MECHANICS
ADMINISTRATION—including sales
PRE-ENGINEERING: Special course for high school graduates and veterans deficient in math and science.

Also refresher courses for Gov't Airplane and Engine Mechanics Licenses for those with aviation experience.

Oldest fully approved aviation school. Outstanding faculty, modern equipment, outside employment, placement service. Day, evening. Approved for Veterans. Send today for FREE catalog "Opportunities in Aviation."

AERONAUTICAL UNIVERSITY

Dept. 77, 116 S. Michigan Ave., Chicago 3, Ill.

FOUNDED BY CURTISS-WRIGHT

MEN ARE NEEDED FOR ENGINEERING RADIO TELEVISION ELECTRONICS

Thorough training in radio, including fundamentals, math, repair, sales, broadcasting, communications, with modern laboratory facilities and experienced faculty.

APPROVED FOR VETERANS TRAINING

Moderate tuition and living costs
New Classes Start Each Month

Dept. 3

Albuquerque, New Mexico

EGGERT RADIO INSTITUTE

HORSE MASTERY!

A FINE HOBBY — A GREAT VOCATION!

"The EXPERT HORSEMAN"



FREE BOOK — Tell how you can learn to: BREAK COLTS, GAIT SHOW HORSES, TRAIN RODEO, STOCK and RACE HORSES, BREAK BAD HABITS, HANDLE ANY HORSE, TRAIN CIRCUS TRICK HORSES. WRITE TODAY!

ANIMAL LOVERS ASSOCIATION
BOX KA-111 TARZANA, CALIFORNIA

SUBSCRIBE TODAY 50¢
One Year

WHY DON'T YOU WRITE?

Writing short stories, articles on business, homemaking, travel, hobbies, shop crafts, local and club activities, etc., will enable you to earn extra money. In your own home, on your own time, the New York Copy Desk Method teaches you how to write, the way newspaper men learn—by writing. Our unique "Writing Aptitude Test" tells whether you possess the fundamental qualities essential to successful writing. You'll enjoy this test. Write for it, without cost or obligation.

Veterans: This course approved for Veterans' Training.

NEWSPAPER INSTITUTE OF AMERICA

SUITE 359-S ONE PARK AVENUE NEW YORK 16, N. Y.

LEARN MONEY-MAKING CARTOONING

IN SPARE TIME — by Easy Picture Chart Method

Same Simplified Method that has helped train creators of "Terry & Pirates," "Freckles," "Out Our Way," "Win-nie Winkle," "Reg'lar Fellers," "Strange As It Seems," "The Neighbors," and many others. Earn while learning. Send 10c for Picture Chart (to test your ability), and full details. (State age.)

THE LANDON SCHOOL, 4710 Cleve. Transit Bldg., Cleveland, O.



LAW

STUDY AT HOME for PERSONAL SUCCESS and LARGER EARNINGS. 39 years expert instruction—over 108,000 students enrolled. LL.B. Degree awarded. All texts furnished. Easy payments. Send for FREE BOOK, G. I. approved. **AMERICAN EXTENSION SCHOOL OF LAW** Dept. 82-M, 646 N. Michigan Ave., Chicago 11, Ill.

LEARN WATCH REPAIRING



AT HOME. By our modern and original system of instruction you can learn every part of the **WATCH REPAIRING TRADE AT HOME.** Prepare yourself for a well-paying position or start in business after completing our course of instruction. Good watch repairers are in demand and generally earn very good salaries. For particulars apply to the **Wisconsin School of Watch Repairing** 759 North Milwaukee St., Milwaukee 2, Wis.

WHICH OF THESE *Opportunities* INTERESTS *You* MOST?

Accounting
Air Conditioning
Architecture & Building
Automotive Engineering
Aviation—Practical
Aviation Drafting & Design
Better Foremanship
Bookkeeping
Business Management

Contracting
Diesel Engineering
Drafting & Design
Electrical Engineering
Electricity—Practical
Electronics, Industrial
High School Courses
Machine Shop Operations
Mechanical Engineering

Plastics Engineering
Plumbing—Practical
Private Secretary
Radio Operating & Servicing
Railway Training
Refrigeration
Sheet Metal Pattern Drafting
Shop Management
Tool Making

THINK! LOOK FORWARD!

Business is making big, new plans

Men and Women are preparing for the future

WHAT ARE YOU DOING ABOUT YOUR TOMORROWS?

● *Today*, choose the job you want—and prepare for it. Or if you are already engaged in the work you like best, start training *now* for quicker promotion. Acquire the knowledge that will help you to get ahead faster, make more money and have greater security.

Invest part of your spare time in more rapid progress. Start training now, in spare time in your own home. Be ready to grasp your opportunity and step out ahead of those who lack the ability you have attained.

American School, founded in 1897 as an educational institution *not for profit*, can help you to reach your goal just as it has helped others during the past fifty years. Give serious thought to the list above. Pick one or more subjects that interest you. Then check the coupon at right, add your name and address and mail it at once. The school will send you details on its training plan and outline of study prepared by specialists. There is no charge, no obligation, so send the coupon immediately.

PRACTICAL, EFFECTIVE HOME - STUDY TRAINING SINCE 1897

Take This First Easy Step

CHECK, CLIP AND MAIL COUPON NOW

AMERICAN SCHOOL, Dept. G745, Drexel at 58th, Chicago 37, Ill.
Without obligation, Please send FREE and postpaid, bulletin and details of the Subject checked.

- | | | |
|--|--|--|
| <input type="checkbox"/> PLASTICS ENG'R | <input type="checkbox"/> Accounting | <input type="checkbox"/> Drafting and Design for Men and Women |
| <input type="checkbox"/> Refrigeration | <input type="checkbox"/> Electrical Engr. | <input type="checkbox"/> Radio |
| <input type="checkbox"/> Architecture and Building | <input type="checkbox"/> Electricity-Pract. | <input type="checkbox"/> High School |
| <input type="checkbox"/> Contracting | <input type="checkbox"/> Electronics, Industr. | <input type="checkbox"/> Air Conditioning |
| <input type="checkbox"/> Practical Plumbing | <input type="checkbox"/> Bookkeeping | <input type="checkbox"/> Mechanical Eng. |
| <input type="checkbox"/> Automotive Engineering | <input type="checkbox"/> Private Secretary | <input type="checkbox"/> Shop Management |
| <input type="checkbox"/> Aviation Drafting | <input type="checkbox"/> Diesel Engineering | <input type="checkbox"/> Tool Making |
| <input type="checkbox"/> Aviation | <input type="checkbox"/> Sheet Metal | <input type="checkbox"/> Better Foremanship |
| <input type="checkbox"/> Business Mgmt | <input type="checkbox"/> Pattern Drafting | <input type="checkbox"/> Machine Shop Operations |
| <input type="checkbox"/> Railway Training | | |

Name.....Occupation.....

Address.....Age.....

City.....State.....

AMERICAN SCHOOL

Dept. G745, Drexel at 58th Street, Chicago 37

FREE

SEND FOR

ALLIED'S Big 164 Page RADIO CATALOG!

WRITE TODAY!

SAVE ON EVERYTHING IN RADIO!



NEW HOME RADIOS



SERVICE SUPPLIES BUILDERS' SUPPLIES



AMATEUR GEAR



SOUND SYSTEMS



164 Value-Packed Pages

Send for your FREE copy of the most complete Buying Guide for Everything in Radio! Here's the Catalog for Servicemen, Dealers, Soundmen, Amateurs, Builders and Experimenters. Features the world's largest and most complete stocks of radio and electronic supplies—quality equipment at lowest prices! Get the speedy service and expert help you want from ALLIED—Radio's Largest Supply House. Depend on ALLIED!

MORE THAN 10,000 ITEMS

Get everything for every radio use: Latest type home radio models, phono-radios, recorders, communications receivers, Ham kits, and gear, code apparatus, radio parts, tubes, tools, test instruments, public address equipment, low-cost easy-to-build radio kits, diagrams and matched parts lists, largest selection of instructive radio books—all at lowest prices!

ALLIED RADIO

ALLIED RADIO CORP.
833 W. Jackson Blvd., Dept. 5-KK-7
Chicago 7, Illinois

FREE CATALOG

Rush FREE 164-Page Catalog

Name.....

Address.....

City.....Zone.....State.....

SAY YOU SAW IT IN POPULAR MECHANICS

Make MORE MONEY

Learn

Screen Process Printing I SHOW YOU HOW This Easy Way at Home!



1 HOW TO START YOUR OWN BUSINESS
—My training shows you how you may start your own business and cash in on the tremendous field open to you in Screen Process—with an investment of a few dollars.

No machinery. Print thru stencil mounted on silk stretched frame.

2 HOW TO GET A GOOD PAY POSITION
—Many of my students earn extra money in spare time at home, while learning. My special "Earn While You Learn" lessons, with the Kit of Supplies I give you—show you how.



Make own stencils. Trace lines on stencil film. No art experience necessary.

3 HOW TO EARN EXTRA MONEY IN SPARE TIME—If you are in the rut of a low pay, uninteresting job, Screen Process work offers you the opportunity to earn good wages and the better things of life for you and your family.

Send for FREE BOOK

My big free illustrated book, "Opportunities in Screen Process," explains the big demand for Screen Process printed Signs and Displays, Toys and Games, Textiles, Decal Transfers, Plastics and Glass, Pictures and Greeting Cards, Advertising Agencies and other businesses. No art or previous experience required. You Learn While Doing with the 2 BIG KITS of SUPPLIES I give you. Write TODAY. State if veteran.



You can print signs, displays, toys, etc., with the simple equipment.

CALIFORNIA SCHOOL OF SCREEN PROCESS

3740 OVERLAND BLVD., DEPT. PM107, LOS ANGELES 34, CALIF.

Enjoy

—WORLD'S MOST FASCINATING HOBBY! SEND FOR FULLY ILLUSTRATED BOOK TODAY!



GET THE FACTS on model railroading! Leading authority shows how easily, inexpensively you can join in the absorbing hobby enjoyed by thousands of mechanics, business and professional men. Scale model railroads look, perform like the real thing!

GET STARTED NOW! Send 10¢ coin or stamps, for fully illustrated booklet, "Model Railroad for You".

MODEL RAILROADER MAGAZINE
Dept. 1510 Milwaukee 3, Wisconsin

Become a Doctor of PSYCHOLOGY

Win the degree of Ps.D. Teach the secret of contentment, happiness. Solve mental worries. Experience the revelation of truth. Chartered college. Individual help. Write for FREE book. COLLEGE OF UNIVERSAL TRUTH, 5153-B North Clark St., Chicago.

Photography



for

PLEASURE or PROFIT

Learn at home. Spare time. Practical basic training. Long-established school. Many have earned while learning. Send coupon below for free booklet, "Opportunities in Modern Photography" and full particulars.

AMERICAN SCHOOL OF PHOTOGRAPHY
1315 Michigan Avenue Dept. 1357 Chicago 5, Illinois
Send booklet, "Opportunities in Modern Photography," full particulars and requirements.

Name..... Age.....

Address.....

City.....Zone.....State.....

POPULAR MECHANICS

LEARN RADIO ELECTRONICS

at HOME

In Your SPARE TIME . . .
PREPARE For a Profitable Job
Or a Business of YOUR OWN!



ABOVE: You work out 133 intriguing experiments from this equipment to get valuable, practical experience AT HOME.

You certainly are interested in a better job, more money and a real future. We can train you for such opportunities in the privacy of your own home during your spare time. Fill in coupon below and see how you, too, can prepare for a substantial career in the thrilling, fascinating and highly profitable fields of RADIO and ELECTRONICS.

You get a tested, proved combination of Home Study advantages — plus the assistance of our effective EMPLOYMENT SERVICE to help you get started.

No previous RADIO or ELECTRONIC experience necessary. Our effective A-B-C Home Study Method includes (A) "Learn-By-Doing" Home Laboratory of many Radio parts enabling you to work out 133 fascinating experiments at home, including 7 different Radio Receiving Circuits; (B) a 16 mm. Movie Projector and 12 reels of "Learn-By-Seeing" Movie Film to speed your progress; and (C) well-illustrated lessons. Mail coupon below for complete details.

VETERANS!

Both our (1) Chicago Laboratory and (2) Home Study Course are accepted under the "G. I. Law." If you qualify, the Government will pay cost of either Course you select.

at SCHOOL

A New Building — Modern Equipment — TELEVISION STUDIO

36 Weeks — That's all the time you need to get one of today's finest, practical trainings in TELEVISION, RADIO and ELECTRONICS. Now you can enjoy outstanding training advantages in the large, entirely NEW postwar laboratories of DeForest's Training, Inc. in Chicago. We secure comfortable living quarters for you.

You get your instruction amid a large staff of skilled instructors and an extraordinary amount of modern, costly, commercial RADIO-ELECTRONIC and TELEVISION equipment. After you complete your training, our effective EMPLOYMENT SERVICE helps you get started. Mail Coupon below for complete details.



In our modern Chicago training laboratories, you will find some of the finest Television equipment available for training purposes.

MOVIES HELP YOU LEARN FASTER

D.T.I.'s Home Study Course includes the use of a 16 mm. Motion picture projector and Movie Film to help you learn important fundamentals FASTER . . . EASIER. Get vivid — LASTING impressions by means of the modern MOVIE-WAY method of instruction.



DeFOREST'S TRAINING, INC.

Associated with the De VRY CORPORATION
 CHICAGO, ILLINOIS

E. B. DeVry, President
 DeForest's Training, Inc.
 2533 N. Ashland Ave., Dept. PM-D10
 Chicago 14, Ill.

Please send me information about the Radio-Electronic Course I have checked:

HOME STUDY CHICAGO LABORATORY BOTH

Name..... Age....

Address..... Apt....

City.....Zone.... State.....

If under 16, check here If a discharged Veteran of World War II, check here.



Photography is a delightful hobby which can easily be turned into a profitable career. All you need is the "know-how" and you can get it right in your own home.

Every N.Y.I. Home Study lesson has been prepared by an outstanding authority. You get the complete facts in clear, beautifully illustrated, easy to understand, up-to-the minute instructions in every branch of photography.

No matter how scanty your photographic experience may be, N.Y.I. Home Study training will make you skillful. You don't need expensive equipment. An expert with a simple box camera makes better pictures than amateurs with fancy equipment. Earn while you learn to pay for any additional equipment you may want.

Join the many thousands who say, "Thanks for the wonderful New York Institute's Home Study training that made my success possible."

Resident training is available under the G.I. bill.

FREE! Write today for our big colorful book of photos by America's camera axes showing EVERY phase of photography.

Leadership Since 1910

NEW YORK INSTITUTE of PHOTOGRAPHY

10 West 33 Street, New York 1, N. Y.

New York Institute of Photography
Dep't. 49, 10 West 33 Street
New York 1, New York

Please send me your beautiful four-color catalog illustrating all the different phases of photography and describing N.Y.I. Home Study Courses.

Name _____
(Please Print)

Address _____

City _____ Zone _____ State _____

8 BIG BUILDING BOOKS

For EXAMINATION SEND NO MONEY

Learn to draw plans, estimate, be a live-wire builder, do remodeling, take contracting jobs. These 8 practical, profusely illustrated books cover subjects that will help you to get more work and make more money. Architectural design and drawing, estimating, steel square, roof framing, construction, painting and decorating, heating, air-conditioning, concrete forms and many other subjects are included.

BETTER JOBS — BETTER PAY UP-TO-DATE EDITION

The postwar building boom is in full swing and trained men are needed. Big opportunities are always for MEN WHO KNOW HOW. These books supply quick, easily understood training and handy, permanent reference information that helps solve building problems.

These books are the most up-to-date and complete we have ever published on these many subjects.

Coupon Brings Eight Big Books for Examination

AMERICAN TECHNICAL SOCIETY Vocational Publishers since 1898
Dept. G719 Drexel at 58th Street Chicago 37, Ill.

You may ship me the Up-to-Date edition of your eight big books, "Building, Estimating and Contracting," without any obligation to buy. I will pay the delivery charges only, and if fully satisfied in ten days, I will send you \$2.00, and after that only \$3.00 a month, until the total price of only \$34.80 is paid. I am not obligated in any way unless I keep the books.

Name _____

Address _____

City _____ State _____

Please attach a letter stating your age, occupation, employer's name and address, and name and address of at least one business man as a reference. Men in service, also please give home address.

ANALYZE HANDWRITING

Qualify for Certified Grapho Analyst Degree at home, spare time. Credit, Employment, Personnel Managers, Business, Professional men, women use grapho-analysis in their work, earn substantial fees in spare time. Many study solely for personal benefit, no desire to earn money, find it so fascinating they start using it to add to their incomes. Entertainment field pays well, up to \$100 in a week reported. Others establishing profitable practices as Vocational and Family Problem Counselors, Personality Teachers, and lecturers.



GROWING—UNCROWDED PROFESSION

More and more police use grapho analysis handling suspects and criminals. They understand how criminals think. Their handwriting tells. Men like Hugh Dunlap, university student, Harry Allen, retired preacher, use it in court, win cases, earn fees even before graduation. Only school in world devoted to teaching grapho analysis offers thorough training to earnest, ambitious men and women regardless of where you live, small town, farm or city. Send for GRAPHO ANALYST, illustrated lesson, personal handwriting analysis offer, ALL FREE. Must be 21 or over. Address A. I. G. A. Inc., 120, Noel, Missouri.



EARN BIG MONEY! METAL TRADES

Courses offered in:

- Machinist-Toolmaking
- Mechanical Drafting
- Tool and Die Designing & Engineering

Practical training in fully equipped shops and drafting rooms by accredited engineers and instructors. Established two decades. Approved for Veterans • Day and Evening Classes Free Employment Service-Dormitory Accommodations Call or write for Free Bulletin

ALLIED SCHOOL OF MECHANICAL TRADES

42 Allied Bldg., 1338 S. Michigan Ave., Harrison 3915, Chicago 5, Ill.

LEARN PIANO WITH RECORDS

IN ONLY 6 EASY LESSONS

\$2.00 STARTS YOU PLAYING

America's original piano teaching course with Records... tested, proven. This sensationally successful Tracy method quickly teaches even those who thought they could never learn piano. Receive Piano Teaching Records plus other EXCLUSIVE AIDS NEVER BEFORE AVAILABLE. No exercises... no number systems. You learn real notes; play popular music. Order now. You get all lessons, photo guides, Records at one time. Never before priced under \$40. Amazing introductory price now only \$16.90. Send only \$2.00 with name and address. When course arrives, deposit \$14.90 balance plus postage with postman, or send \$16.90 and we pay postage. Results guaranteed or money refunded. You take no risk. Send \$2.00 today to TRACY INSTITUTE OF MUSIC, Studio P-6, 54 Holmehurst Ave., Baltimore-28, Md.

THERE'S MONEY IN CARTOONS!

RAYE BURNS will teach you HOW to CREATE ORIGINAL CARTOONS at home that you may SELL! Course contains 26 lessons and over 600 illustrations. All for Only... **\$2.85**

Send name and address for free details.

RAYE BURNS SCHOOL, Dept. M, Box 3583, CLEVELAND, OHIO

RADIO ENGINEERING

Broadcasting, Television, FM, Servicing, Electronics, Aviation, Marine & Police Radio taught thoroughly. Engineering course equivalent to 3 years' college radio work. Approved Veteran Training. Catalog free.

VALPARAISO TECHNICAL INSTITUTE, Dept. D, Valparaiso, Ind.



RAISE CHIN-CHINS

No experience needed. Just a few minutes daily and a few feet of backyard, garage or barn space. Several females and a male starts a large, profitable herd. WE FURNISH FREE INSTRUCTIONS. TREMENDOUS DEMAND for breeding and laboratory stock, meat, and world's most beautiful rabbit fur. Brokers, cut off from imported rabbit pets by world famine, NEED CHIN-CHIN FURS NOW, and for years to come! Write for free illustrated catalog today.

WILLOW BROOK FARM • R-36, SELLERSVILLE, PENNA.

GET INTO THE NEW FIELD OF

INDUSTRIAL

Electronics



THRILLING NEW FRONTIER OF OPPORTUNITY



AMERICA'S FOREMOST SCHOOL OF PRACTICAL TRAINING

Here is a **NEW** Industry—one that points the way to a vast new field of opportunity—Opportunities that beckon alike to men looking for new fields, and to experienced electrical men seeking a way to bigger earnings and a more secure future.

Industrial Electronics is *not* Radio. It has nothing to do with radio transmitters and receivers. It is a totally new application of electric power, applied to modern production by means of the magic of the vacuum tube. Everywhere industrial electronic devices are replacing the old-time electrical controls, and processes. Industrial Electronics is *Modern Industrial Electricity*.

GET READY NOW!

Now is the time to get into Industrial Electronics, while the field is in its infancy . . . and while it is rapidly developing a need for thousands of trained experts. Tomorrow's leaders are training today.

And here is a School equipped in every way to train you for Industrial Electronics work—one of the largest and most completely equipped, and one of the few of its kind in America—a School that already has trained thousands of men for industrial opportunities.

LEARN AT HOME OR COME TO OUR SCHOOL

Learn Industrial Electronics—now, while the time is ripe. You don't need any advanced schooling or previous experience. If you are at all mechanically inclined and have gone to highschool for at least one year or have an equivalent education, we can teach you Industrial Electronics.

You can take most of your training at home, in your spare time—or you can come to Chicago and take your entire training in our completely equipped shops and laboratories. Either way you quickly acquire the fine points, practical skill, and broad, technical "know how" that makes the expert Industrial Electronics Technician.

"Every electrician should know — must know — Industrial Electronics." That's what many Union leaders are telling their members today. They know that the use of Industrial Electronics devices is growing by leaps and bounds. They know that to install and service this equipment, even the best of present-day electricians must first have had special

FACTS ABOUT THE I. T. I.

Founded in 1916. Has trained more than 400,000 men for practical work in industrial fields. From 1942 through 1945 trained specialized technicians, exclusively, for the Army, Navy, and Marine Corps. Now training thousands of veterans under the G. I. Bill, both in its Residence Schools and by home-study. Occupies five buildings of its own. Has over \$500,000 invested in training facilities, with an instruction staff of more than 100 men. Known everywhere as America's foremost school of practical training for industry.

training.

Get all the facts about the opportunities in this interesting field of work and about the I.T.I. system of training that has helped so many men into key jobs in industry. Fill out the information, coupon below and mail it TODAY. You will be under no obligation whatsoever.

AUTHORIZED TO ACCEPT VETERANS FOR G. I. TRAINING



GET THE FACTS ABOUT AMERICA'S FOREMOST SCHOOL OF PRACTICAL TRAINING

REGISTRAR, PIK

**INDUSTRIAL TRAINING INSTITUTE,
2150 LAWRENCE AVE., CHICAGO 25, ILL.**

Please send me, **FREE**, your "Camera Visit" booklet and information about the opportunities for trained men in **INDUSTRIAL ELECTRONICS**. It is understood that I will be under no obligation.

NAME.....

ADDRESS.....

CITY.....STATE.....

ARE YOU A VETERAN?.....

Give yourself the Backing of a
GREAT GROWING INDUSTRY



REFRIGERATION AIR CONDITIONING

Refrigeration and Air Conditioning have leading place in fast growing fields of our time. Trained men paid well to service, install, maintain, repair, rebuild household and commercial refrigerators. Important new developments such as Frozen Foods and many new industrial uses. Demand for commercial installations in restaurants, butcher shops, taverns, florists, bakeries, etc. — air conditioning in homes, offices, shops.



START NOW—Full and Part Time Earnings

There may never again be such opportunities for men who want better jobs or business of their own to get in on ground floor and go up fast! Many started with small investment who built good, growing business. If over 17 and under 60 learn how you can get started. **CONSULTATION AND PLACEMENT SERVICE WHETHER YOU ARE INTERESTED IN WORTHWHILE JOB OR SETTING UP YOUR OWN BUSINESS.**



Begin Training at Home or Come Directly to Shops

Begin your training at home in spare time, finish in our big, modern shops, or come directly to shops. At home you get C.T.I.'s SHOP PROVED HOME STUDY instruction—actual shop experience has gone into the practical lesson assignments. That is why it is easy for mechanically inclined men to learn by our Home Study training and start on actual refrigeration work.



A NATIONALLY KNOWN INSTITUTION

C.T.I. was only civilian school selected by Army to train service men for refrigeration. Same quality training available to you now. The method that has made rapid progress possible, Commercial Trades Institute has established its place in Air Conditioning and Refrigeration industries, and that is important to you in making your start.

VETERANS

Veterans qualifying under "G.I. Bill" have tuition paid by Government plus monthly subsistence allowance while in school. Just mail coupon, we will handle all details. (LOW TUITION, EASY TERMS if you are not a veteran.)

COMMERCIAL TRADES INSTITUTE
Dept. A210

1400 W. Greenleaf Ave., Chicago 26, Ill.

FREE — Important Information Telling How to Get Started

CUT OUT COUPON BELOW

Fill Out, Cut Out, Mail Today

FACTS FREE for Men Who Want to Get Ahead
COMMERCIAL TRADES INSTITUTE, Dept A210
1400 W. Greenleaf, Chicago 26, Ill.

Send free Illustrated Brochures and other information about Refrigeration and Air Conditioning.

Veteran Non Veteran

Name.....
Address.....
City.....State.....

*Amazing New Books
Reveal Secrets of Success*

AT HOME WITH ARTISTIC PENWORK—Copyrighted Now you can be at home with Artistic Penmanship for fun and profit. These new authoritative books just off the press give you most modern, streamlined methods for perfecting your skill as a penman. Written by S. A. Ziller, President, Tamblin School of Penmanship. Acclaimed by leading authorities as the finest books on penmanship ever written.

Order Today—\$1.00 Each

These books are sensationally new and different. Each covers its subject fully and completely. You can select one or more—or get the whole series of five at the special introductory price of only \$4.50. Money on set of books deducted in full from tuition on signing up for professional course of school instruction.

- | | | | |
|--------|--------------------------------------|---|--------------------------|
| BOOK 1 | <i>Business Writing</i> | Write legibly—Be recognized because of Your Writing. | <input type="checkbox"/> |
| BOOK 2 | <i>Artistic Writing</i> | Earn Money—Amuse Your Friends. | <input type="checkbox"/> |
| BOOK 3 | <i>Card Writing</i> | For Fun and Profit. Write cards, invitations. | <input type="checkbox"/> |
| BOOK 4 | <i>Engrossing Alphabets</i> | Letter diplomas, complete Alphabets Given. | <input type="checkbox"/> |
| BOOK 5 | <i>Print and Cursive Flourishing</i> | A good outlet for your artistic interest. Fascinating designs, birds, quills. | <input type="checkbox"/> |

Complete Set of All Five Books—Special Introductory offer. Prepaid, \$4.50. Money Back Guarantee.

FREE BOOK—How to become a good penman. Tells how others learned in spare time. Imitate the professional, avoid mistakes, earn extra money—be a popular friend.

Enclose 10¢ for a pinpoint suitable for shaded writing and your name beautifully written.

Write today, check the squares—attach to your name and address, enclose remittance, and send to

Stephen A. Ziller, Pres., The Tamblin School of Penmanship
A441 Ridge Bldg., Kansas City, Mo., U.S.A. In business over 52 years

Have an OFFICE of YOUR OWN!

LEARN NEW PROFITABLE PROFESSION
At Home in 60 Days, Men & Women, 18 to 70!

Be Your Own Boss and the Boss of Others. Be Respected. Meet Interesting People.

Earnings of men and women in this profession run as high as \$5,000-\$15,000 yearly. Others make good money in spare time. Little money needed to start. A business where your earnings begin sooner. Easy to learn. No selling or goods to buy. No experience necessary. A depression-proof business. A course of action to guide you step by step as you earn. All 53 lessons sent at once to use as operating manuals. Easy terms. Diploma. Money-back agreement. Write for FREE BULLETIN.



FRANKLIN CREDIT SCHOOL
Dept. 75-K ROANOKE 7, VIRGINIA

BY MAIL in
Easy Lessons

SHORTHAND in 6 Weeks at Home

Famous Speedwriting system. No signs or symbols; uses ABC's. Easy to learn; easy to write and transcribe. Fast preparation for a job. Surprisingly low cost. 100,000 taught by mail. Used in leading offices and Civil Service. Write for free booklet.
SPEEDWRITING, Dept. 1510-7, 55 W. 42 St., N. Y. 18

★ FREE MEMBERSHIP ★
★ "STRONG MEN'S CLUB" ★
★ OF AMERICA ★

Send for your personal Membership Card today! Enjoy strength secrets! No dues! No obligations! Send name, address and age on penny postcard.

★ STRONG MEN'S CLUB OF AMERICA ★
★ Joe Bonomo, Director Dept. 1310 ★
★ 1841 Broadway, New York 23, N. Y. ★

TRI-STATE COLLEGE

B. S. Degree in 27 months in Engineering (7 branches); Bus. Admin., Acct and Sec. Science. Graduates successful. 64th year. Enter Sept., Jan., March, June. Write for catalog.
4107 College Ave., Angola, Ind.

Learn **CARTOONING**

HAVE FUN! MAKE MONEY! Cash in on your sense of humor at HOME—BY MAIL. No experience needed to start. Write today FOR FREE TRIAL LESSON and full particulars.
Moon Gag Cartoon School, Dept. P, Fall Creek, Wis.

GET INTO RADIO

TELEVISION ELECTRONICS NOW!

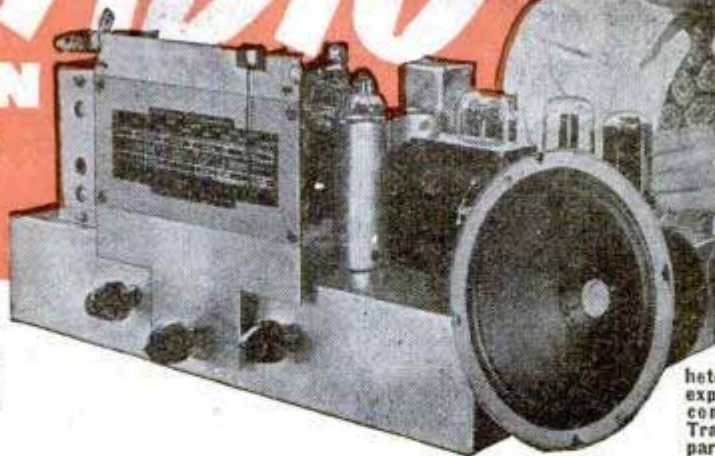

You build this complete, modern super-heterodyne receiver with the experimental equipment that comes with your National Training. You keep all apparatus sent you.

Practical shop-type training gives you actual experience with Home Radio Equipment — part of

SHOP METHOD HOME TRAINING

By National Schools of Los Angeles a Practical Technical Resident Trade School for over 40 years

FOR YOU—A REAL HOME LABORATORY IN MODERN RADIO



Your National Training Kits include equipment for over a hundred practical electronic experiments in your own home. You get standard radio parts for this audio oscillator which you get to understand by building it yourself.

You learn modulation, beat frequencies, signal generation by a **actually** building this small radio transmitter with your National shop parts.



Get the details by mailing the coupon.

Your training outfits from National are made up of the most modern radio equipment — much of it just out of the experimental laboratory. You learn new ways of handling equipment by modern methods.

A permanent faculty of experienced instructors and engineers stands behind all training from National Schools. These men are teaching every day right in our own Television and Broadcasting Studios, Service Shops and Laboratories. From first hand experience with students here at School, our instructors understand the aims and ambitions of men like you. All of our instructors, both home study and resident, have ideal facilities to make your training practical, up-to-the-minute and interesting.

Fine Opportunities Ahead

Learn how National training can fit you in your spare time for the **GREAT FIELD OF RADIO**—for the **NEW AND RAPIDLY EXPANDING BRANCHES — FREQUENCY MODULATION (F.M.), TELEVISION AND ELECTRONICS**. You train right in your own home yet have the **ADVANTAGE OF REAL SHOP EXPERIENCE** behind you. The man who really knows modern Radio is in greater demand today than ever before—not only in Radio proper but in Television

and Electronics—in Aviation, Transportation, Manufacturing, Communications. **Good jobs** await the trained man, in the production, operation and maintenance of modern Electronic equipment—in Radio stations, in hundreds of industries—in homes, stores, theatres and studios.

Send For Facts Today

You owe it to yourself to investigate how National Schools will prepare you for a **CAREER THAT WILL ASSURE YOUR SUCCESS AND SECURITY**. Send for the **FREE Manual. SEE FOR YOURSELF** just how you may readily qualify for opportunities in Radio, Television and Electronics. Read the catalogue we will send you. Then, make up your own mind. For full information, without obligation, send your name and address on the coupon and mail it **TODAY!**

GET THE DETAILS. USE THE COUPON!



VETERANS

During the War, National trained enlisted men under contract with the War Department. Now, we are training veterans, both resident and home study. If you are a Veteran qualified for training under the G.I. Bill, check the coupon below for special bulletin.

Here's Just a Few of the Interesting Facts you Learn with the **FREE MANUAL**

1. Routine for diagnosing Radio Troubles.
2. Preliminary inspection of Receivers.
3. How to Test and Measure Voltages.
4. How to Test Speaker in Audio Stages.
5. How to Trace the Circuit and Prepare Skeleton Diagram.
6. Complete Reference Table for Quickly Locating Receiver Troubles.

FREE GET THESE 2 **BIG BOOKS**



G.I. APPROVED

NATIONAL SCHOOLS

LOS ANGELES 37, CALIFORNIA EST. 1905

MAIL OPPORTUNITY COUPON FOR QUICK ACTION

National Schools, Dept. 10-PM
4000 South Figueroa Street
Los Angeles 37, California

(Mail in envelope or paste on penny post card)

Mail me **FREE** the books mentioned in your ad including a sample lesson of your course. I understand no salesman will call on me.

NAME..... AGE.....

ADDRESS.....

CITY..... ZONE..... STATE.....

Check here if veteran of World War II

NATIONAL GRADUATES ARE SUCCESSFUL

NOW MANAGER OF SERVICE DEPARTMENT

"I am really proud to be a National Graduate—it has helped me to hold my present position. Now manager of service department for Valley Music Company. Times have changed since I enrolled for National Training I have an amateur Radio station to keep up on experiments in that field. W7HLP. Plus many, many sound installation problems. I have no time to call it 'spare time' anymore—thanks to National Schools." Dwight J. Albright, Medford, Oregon.

COLLEGE PROFESSOR APPRECIATES COURSE

"I want to take this opportunity to tell you how much I appreciate this Course. Since being here at the College I have been able to put the theory to very good use. I have installed a P.A. system in the students' dining hall; today I am purchasing the required equipment to install a similar system in the large assembly hall; and at all of the large meetings held so far I have been assigned the task of setting up the portable P.A. system. I have also repaired several Radios for the boys and the professors, including car Radios. So once again, thanks for a fine Course. I am looking forward to the rest of the training with pleasure. Brother V. Benedict, Saint Mary's College, Calif.

AUDELS ELECTRIC MOTOR GUIDE

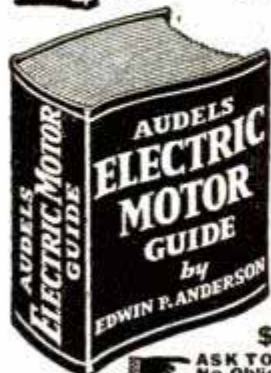

**1000 PAGES OF PRACTICAL
MOTOR INFORMATION**

JUST OUT! Audels Electric Motor Guide covering the construction, hook-ups, control, maintenance and trouble shooting of all types of motors including armature winding. Explains entire subject in every detail. 31 Chapters, 617 Illustrations and Diagrams. A Handy Guide Fully Indexed for Electricians and all Electrical Workers.

\$4 COMPLETE • PAY \$1 A MO.

ASK TO SEE IT!—Get This Information for Yourself No Obligation Unless Satisfied.

MAIL ORDER

AUDEL, Publishers, 49 W. 23rd St., New York 10, N. Y.
MAIL AUDELS ELECTRIC MOTOR GUIDE for free examination. If O. K. I will send you \$1 in 7 days; then remit \$1 monthly until price of \$4 is paid. Otherwise, I will return it.

Name _____
Address _____
Occupation _____
Employed by _____ PM



AUTO BOOKS ON APPROVAL

SEND NO MONEY. Just mail the coupon for a complete set of 4 Big, Thick Auto Books. 20th Edition. 2800 Pages! Whether you are a mechanic or helper, expert or apprentice, auto owner or driver, take immediate advantage of this FREE EXAMINATION OFFER.

**MAKE GOOD MONEY NOW
HOLD A PERMANENT JOB**

America wants its automobiles kept in good repair. Men with "know how" are in demand, at big pay. These books will help you get and hold an important job, or give you a chance to go into business for yourself now or later. Any man who half tries to improve himself can learn auto servicing and repairing by this quick reference method. Use the JIFFY INDEX to find easily understood answer to any auto problem. These wonder books prepared by eleven of America's great automobile engineers. Many hundreds of valuable illustrations. Send the coupon TODAY.

A year's consulting privileges with our engineers now given with these books without extra charge.
Vocational Publishers Since 1898

CAN YOU FIX IT?
These wonder books tell step by step HOW to make difficult repairs and adjustments, how to keep a car at maximum efficiency, including latest improvements in car design and operation. Engine troubles and how to correct them well covered.

4 BIG, THICK VOLUMES
2800 pages, 2000 illustrations, wiring diagrams, etc., including Diesel engines. Beautiful modernistic, washable cloth binding.

AMERICAN TECHNICAL SOCIETY, Dept. A719
Drexel Ave. at 58th St., Chicago 37, Ill.

I would like to examine your 4-Volume Set of Auto Books. I will pay the delivery charges only, but if I choose I may return them express collect. If after 10 days' use I prefer to keep them, I will send you \$2 and pay the balance at the rate of only \$3 a month until \$24.80 has been paid. Include consulting service as offered above.

Name _____
Address _____
City _____ State _____

Please attach letter stating age, occupation, employer's name and address and name and address of at least one business man as reference. Men in service, also please give home address.

CAUGHT BY THEIR FINGER PRINTS



YOU

Can Become a
**CRIMINAL INVESTIGATION
and FINGER PRINT
EXPERT AT HOME!**

During the past 30 years the I. A. S. has trained hundreds of men at home to fill positions of responsibility and steady pay as finger print experts. This fascinating, profitable profession can be learned at home during spare time. More than 800 American Identification Bureaus employ I. A. S. graduates or students. Write today for complete list of these Bureaus.

Send Now for "BLUE BOOK OF CRIME"

Thrilling, inspiring, helpful. Be sure to state your age when sending for book. **FREE!**

INSTITUTE OF APPLIED SCIENCE
Dept. 1357, 1920 Sunnyside Ave., Chicago 40, Ill.

Learn Penmanship

Good penmanship makes favorable impressions and will help you win success, while poor penmanship will lead you to failure. It makes no difference how poor you now write, you can quickly and easily learn Business Writing, and you can learn Shaded Writing also, right in your own home during spare time by our Simplified Method, without cost of going away to school. If you are dissatisfied with your present handwriting and wish to become a good writer, write for my FREE BOOK, "How to Become an Expert Penman," which contains specimens of penmanship and shows what others have learned by taking my courses. If you enclose 10c, I will send you one of my Favorite Pen Points suitable for plain or shaded writing and your name with a beautiful flourished bird written on a card. Begin Now. Write for the FREE BOOK today, T. M. TEVIS, BOX 25K, CHILLICOTHE, MO.

LAW...

STUDY AT HOME Legally trained men win higher positions and bigger success in business and public life. Greater opportunities now than ever before.

More Ability: More Prestige: More Money We guide you step by step. You can train at home during spare time. Degree of LL.B. We furnish all text material, including 14-volume Law Library. Low cost, easy terms. Get our valuable 48-page "Law Training for Leadership" and "Evidence" books FREE. Send NOW.
LASALLE EXTENSION UNIVERSITY, 417 South Dearborn Street
A Correspondence Institution Dept. 1064-L Chicago 5, Ill.

Learn LANDSCAPE GARDENING

A thorough, interesting, home study course for those who wish to become LANDSCAPERS, GARDENERS, DESIGNERS, etc., for profit or pleasure. Write today for FREE BOOK to

APPROVED NATIONAL LANDSCAPE INSTITUTE
FOR VETERANS Dept. P-O, 310 So. Robertson, Los Angeles 36

LEARN MEAT CUTTING At Home—In Spare Time



Get into the vital meat industry. Concise, practical Home Training based on 25 years proven instruction methods used at National's famous resident school. Prepares you for bigger pay as Meat Cutter, Supervisor, market manager or more money in your own store. Go as rapidly as your spare time permits. Diploma. Start NOW to turn your spare hours into money. Send for FREE bulletin today. No obligation.

National School of Meat Cutting, Inc., Dept. U-86, Toledo 4, Ohio

MAGIC LIQUID MAKES PHOTOS APPEAR

Amazing discovery permits you to print pictures from any of your snapshot negatives on wood, cloth, leather or paper. Like magic your pictures will show on ties, handkerchiefs, purses, cards and letterheads. Takes only a few minutes in broad daylight. Won't rub off or harm negative. An attractive set with enough material for over 100 pictures. **ORDER TODAY.** Send \$1.00 postpaid. C.O.D. pay postman a few cents more in addition. (Foreign \$1.50 money order only.)

STYLE-ARTS, Inc., Dept. 1-E, 2427 Cortland, Chicago 47

Learn

ELECTRICITY

in the
GREAT SHOPS OF COYNE

ACTUAL SHOP
SCENES AT
COYNE



MOTORS



ARMATURES



REFRIGERATION



LIGHTING

NOT A "HOME-STUDY COURSE"

For nearly 50 years, the Great Shops of COYNE in Chicago have been training men to step into the better-paying jobs in ELECTRICITY. Here in just a few short weeks YOU can quickly prepare for amazing opportunities.



B. W. COOKE

As a Coyne student you work on real equipment—just like you'll use later on the job. We do not teach by mail. You get actual shop work plus necessary theory. Coyne training is practical. You make rapid progress at COYNE because it's a shop course.

GET ALL-AROUND TRAINING in a Few Short Weeks

Why be satisfied with a "one-operation" job? At Coyne you learn Motors, Armature Winding, House and Factory Wiring, Appliances, Power Plant Work, Illumination, Electrical Maintenance—plus the fast-growing branch of Industrial Electronics. Whether you're experienced or not, we train you for a good job, then help you get it! Coyne graduates may use our Lifetime Employment Service as often as they wish.

INDUSTRIAL ELECTRONICS and REFRIGERATION Included

Added training in Electric Refrigeration—principles, testing, repairing—is included with this course. Industrial Electronics given as part of our "all-around" Electrical Training.

VETERANS! Coyne is authorized to accept veterans for G. I. Training. Coupon brings special G. I. Bulletin.

NON-VETERANS who are short of cash can finance most of their tuition and pay it in easy monthly payments after graduation.

ANY MAN WITH A PHYSICAL DISABILITY whether a Veteran or not may qualify for Coyne training at no cost to himself for tuition or subsistence. Mail coupon for details.

MAIL COUPON for Big FREE Book

Find out NOW what Coyne offers in training for your future. Coupon brings big book filled with fascinating pictures of our great shops and our plans to help YOU. Get your copy FREE. No cost or obligation, and no salesman will call. Rush the coupon. TODAY.



B. W. Cooke, President,
COYNE ELECTRICAL SCHOOL, Dept. 77-72,
500 S. Paulina St., Chicago 12, Ill.

Send me your Free Book and tell me about your plans to help me—including Student Finance and added Training in Industrial Electronics and Electric Refrigeration.

NAME.....

ADDRESS.....

CITY.....STATE.....

COYNE

ELECTRICAL SCHOOL
500 S. Paulina St.,
Dept. 77-72,
Chicago 12, Illinois



ESTABLISHED 1899

PRACTICAL SHOP TRAINING!

LEARN A TRADE!

- | | |
|--|---|
| <input type="checkbox"/> AUTO MECHANICS | <input type="checkbox"/> BODY AND FENDER |
| <input type="checkbox"/> DIESEL | <input type="checkbox"/> TOOL AND DIE |
| <input type="checkbox"/> REFRIGERATION | <input type="checkbox"/> MACHINIST |
| <input type="checkbox"/> WELDING | <input type="checkbox"/> MACHINE DRAFTING |
| <input type="checkbox"/> PIANOFORTE TECHNOLOGY | |

America's Leading School
7 Floors of Fully Equipped Shops
Established 1902
Over 45,000 Graduates
Expert Individual Instruction
Learn by Doing

You hear it everywhere:
"GREER SHOP TRAINING IS THE BEST"

MAIL THIS AD TO

GREER SHOP TRAINING

(Dept. 2107) 460 South State St., Chicago 5, Ill.

Please send without obligation free information regarding trade checked above. (Specify whether you are a Veteran or Civilian)

Name _____ Age _____

Address _____

City _____ State _____

OIL BURNER

INFORMATION IN A HANDY FORM

JUST OUT!

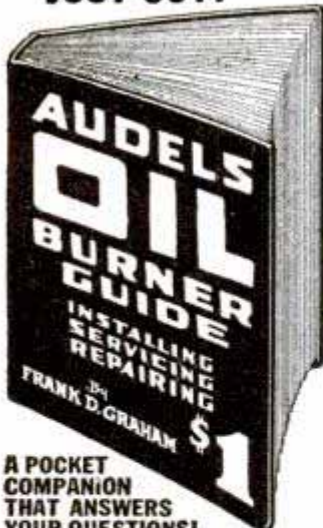

A POCKET COMPANION THAT ANSWERS YOUR QUESTIONS!

AUDELS OIL BURNER GUIDE
 - A new practical, concise treatise, 384 pages-31 Chapters - 321 Diagrams and Illustrations - covering Domestic and Industrial Oil Burners.

New from Cover to Cover, for mechanics interested in Oil Burners. Gives practical inside working knowledge of theory, construction, installation, operation, testing, servicing and repair of all types of oil burners. Includes electrical hook-ups and wiring diagrams of automatic control systems.

PRICE \$1 POSTPAID

Get this information for yourself. Mail coupon today. No obligation unless satisfied.

ASK TO SEE IT

AUDEL, Publishers, 49 W. 23rd St., New York 10, N.Y.

Please mail AUDELS OIL BURNER GUIDE (Price \$1). If satisfactory, I will remit \$1 on its safe arrival, otherwise I will return the book.

Name _____

Address _____

Occupation _____

Employed by _____ PM

Be A MASTER PLUMBER

Earn \$15 To \$50 A Day

DON'T ENVY THE PLUMBER - BE ONE

Every skilled workman will tell you that Plumbers have the best of it. WINTER and SUMMER the Plumber is busy at top wages. No skilled Plumber is ever out of a job—compare his opportunities with any trade, plus the opportunities of having your own shop. We teach you Plumbing with TOOLS (not books) under Licensed Master PLUMBERS in one of the finest equipped schools in America. We make you a Plumber, every branch is taught thoroughly—Lead Work—Blueprint for plan reading—all other tricks.

LEARN IN 30 WEEKS WITHOUT PREVIOUS EXPERIENCE

If you like to work with tools you owe it to yourself to investigate. No need to ever work as an apprentice. Get free bulletin. Write now! G.I. APPROVED. Our 24th year.

UNIVERSAL PLUMBING SCHOOL
 815 HOLMES STREET KANSAS CITY, MO.

SEND FOR THIS

HOW to
BREAK
and
TRAIN
HORSES

FREE!

Make money with horses. Every farmer, every lover of horseflesh should have a copy of this booklet. If you want to know how to break, train and make money with horses, write today for full information FREE, together with my special offer of a course in Animal Breeding. If you are interested in Gaiting and Riding the saddle horse check here. Do it today—now. You'll never regret it.

BEERY SCHOOL OF HORSEMANSHIP
 Dept. 11010 Pleasant Hill, Ohio

ELECTRICIANS' SCHOOL

HOUSE AND COMMERCIAL WIRING • MOTOR REPAIR
 AND REWINDING • ELECTRIC REFRIGERATION

Approved for Veterans Training

PENNSYLVANIA INSTITUTE SCHOOL OF ELECTRICITY
 42nd and SPRUCE STS. PHILADELPHIA 4, PENNA.

"How to Make Money With Simple Cartoons"

A book everyone who likes to draw should have. It is free; no obligations. Simply address
CARTOONISTS' EXCHANGE

Dept. 910D Pleasant Hill, Ohio

BE A REAL ESTATE BROKER PAYS BIG!

EASY TO LEARN—Start and run your own business quickly. Many graduates report making up to \$1000 a month. Course of study covers Sales, Property Management, Appraising, Loans, Mortgages and hundreds of related subjects. Course offered in home study or residential classrooms.

FREE Big new illustrated catalog from this nationally known school. Send Post Card Today. G. I. Approved.

WEAVER SCHOOL OF REAL ESTATE

Dept. KA-8, 15 E. Pershing Road Kansas City, Mo.

SAY YOU SAW IT IN POPULAR MECHANICS

STAMMER?

This new 128-page book, "Stammering, Its Cause and Correction," describes the Bogue Unit Method for scientific correction of stammering and stuttering—successful for 46 years. Benj. N. Bogue, Dept. 7803, Circle Tower, Indianapolis 4, Ind.



APTITUDE TESTS

discover the kind of work or studies best for your success! You get a personal report—a guide for life—more happiness—more prosperity. For men, women, boys and girls. Write for complete facts.

VOCATIONAL COUNSELING INSTITUTE
 956 Maccabees Bldg., Detroit 2, Michigan

They Never Knew It Was SO EASY To Play

Thousands Now Play Popular Songs
Who Didn't Know a Note of Music Before

You, too, can learn your favorite instrument at home, without a teacher, this quick, easy, money-saving way

THINK of the fun YOU are missing! The popularity, friendship, good times! Why? Because you think it's *hard* to learn music. You have an idea that it's a slow, tedious task, with lots of boring drills and exercises.

That's not the twentieth-century way! Surely you've heard the news! How people all over the world have learned to play by a method so simple a child can understand it—so fascinating that it's like playing a game. Imagine! You learn without a teacher—in your spare time at home—at a cost of only a few cents a day! You learn by the famous print-and-picture method—every position, every move before your eyes in big, clear illustrations. You **CAN'T** go wrong! And best of all, you start playing real tunes almost at once, from the very first lesson.

No needless, old-fashioned "scales" and exercises. No confused, perplexing study. You learn to play by playing. It's thrilling, exciting, inspiring! No wonder hundreds of thousands of people have taken up music this easy way. No wonder enthusiastic letters like those reproduced here pour in from all over the world.

Sound interesting? Well, just name the instrument you'd like to play and we'll prove you **CAN!** If interested, mail the coupon or write. Do it now!

U. S. SCHOOL OF MUSIC
710 Brunswick Bldg.
New York 10, N. Y.



Learned Quickly at Home. "I didn't dream I could actually learn to play without a teacher. Now when I play for people they hardly believe that I learned to play so well in so short a time." *H. C. S., Calif.

Music is the magic key to friendship, fun, romance. The person who can play a musical instrument is always sure of a welcome. Why not let music open up a new world for you. Thousands have discovered unexpected pleasure and profit in music, thanks to the unique method that makes it amazingly easy to learn.

Send for FREE Booklet and Print and Picture Sample

See for yourself how this wonderful self-instruction method works. Sit down, in the privacy of your own home, with the interesting illustrated booklet, "How to Learn Music at Home." No salesman will call—decide for yourself whether you want to play this easy way.



Invited to Parties. "Before I took your course I didn't know one note of music. Then three months later I started to play for dances. I've been invited to many parties. The course is easy and interesting." *R. M., Vancouver, B. C.



Well Worth Money. "The course is fully self explanatory. When one is finished with it there is little one need learn. It is well worth the money and I fully believe you have the finest course on the market today." *R. E. G., Clarksburg, W. Va.



Surprised Friends. "People who hear me play don't understand how I do it. They ask if I haven't had lessons from a teacher. To their surprise they find I haven't. I'm glad to be a student of your School." *M. H., Athol, Kans.

U. S. SCHOOL OF MUSIC
710 Brunswick Bldg., New York 10, N. Y.

I am interested in music study, particularly in the instrument indicated below. Please send me your free booklet, "How to Learn Music at Home" and the free Print & Picture Sample.

Piano
Guitar
Hawaiian Guitar
Violin
Piano Accordion
Saxophone
Trumpet, Cornet

Reed Organ,
Tenor Banjo
Ukulele
Clarinet
Trombone
Flute
Piccolo

Modern
Elementary
Harmony
Mandolin
Practical Finger
Control

Name _____ Have You
(PLEASE PRINT) This Instru. ? _____

Address _____

City _____ State _____

Note: If you are under 16 yrs. of age, parent must sign coupon.

*Actual pupils' names on request. Pictures by Professional models.

SAVE 2c—Stick coupon on penny postcard.

NOW!
ALL 5 FAMOUS JOWETT COURSES—1 COMPLETE MUSCLE BUILDING VOLUME!
FOR ONLY 25¢

LET ME PROVE I can make YOU

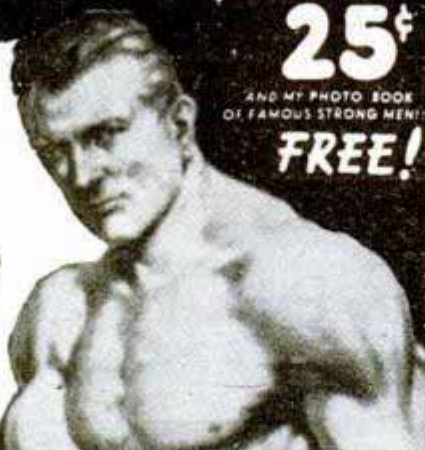

FREE!
 AND MY PHOTO BOOK OF FAMOUS STRONG MEN!

COMMANDO-TOUGH OR IT WON'T COST YOU A CENT!

says George F. Jowett **WORLD'S GREATEST BODY BUILDER**

GIVE ME 10 MINUTES A DAY

LEARN MY TIME TESTED SECRETS OF STRENGTH

I'll teach you the "Progressive Power Method" through which I rebuilt myself from a physical wreck the doctors condemned to die at 15, to the holder of more strength records than any other living athlete or teacher! "Progressive Power" has proven its ability to build the strongest, handsomest men in the world. And I stand ready to show you on a money back basis—that no matter how flabby or puny you are I can do the same for you right in your own home. Let me prove I can add inches to your arms, broaden your shoulders, give you a man-sized chest, powerful legs and a Rock-like back—in fact, power pack your whole body so quickly it will amaze you! Through my proven secrets I bring to life new power in you inside and out, until YOU are fully satisfied you are the man you want to be.

PROVE IT TO YOURSELF IN ONE NIGHT

Send only 25¢ for my 5 easy-to-follow, picture-packed courses now in 1 complete volume "How to Become a Muscular He-Man." Try it for one night! Experience the thrilling strength that surges through your muscles.

10 DAY TRIAL!

Think of it—all five of these famous courses now in one picture-packed volume for only 25¢. If you're not delighted with this famous muscle-building guide—if you don't actually FEEL results within ONE WEEK, send it back and your money will be promptly refunded!

Photo Book of Famous Strong Men!

I am making a drive for thousands of new friends fast—REGARDLESS OF COST!
SO GET NOW MY 5 Muscle Building COURSES
 (Valued at \$5 each)
All in 1 Great Complete Volume Packed With How-To-Do-it Pictures!
 Now, this "get-acquainted," extremely low price of only 25¢ is your chance to build a body you'll be proud of! Follow Jowett's easy method of muscle building NOW!



FREE!

Photos that inspire you to might and muscle. Free with order.

FREE GIFT COUPON!

Jowett Institute of Physical Culture Dept. PM-710
 230 Fifth Avenue, New York 1, N. Y.

George F. Jowett:—Please send by return mail, prepaid, **FREE** Jowett's Photo Book of Strong Men, along with all 5 Muscle Building Courses. 1. Molding a Mighty Chest, 2. Molding a Mighty Arm, 3. Molding a Mighty Grip, 4. Molding a Mighty Back, 5. Molding Mighty Legs—Now all in One Volume "How to Become a Muscular He-Man." Enclosed find 25¢. NO C.O.D.'S.

George F. Jowett
 Champion of Champions

NAME _____ AGE _____
 (Please Print Plainly, Include Zone Number)

ADDRESS _____

Learn NOVELTY MANUFACTURING!!



EASY TO MAKE Profitable to Sell!

Become a manufacturer of Novelties! Enjoy continuous business filling orders from chain stores, gift shops, etc. Regular orders amounting to thousands of dollars come from these customers. A business easy to get into. You need no experience. Make merchandise that has sold steadily and profitably for years. Now, the demand for it is amazingly increasing. Gives you opportunity to enjoy splendid business right now.

START YOUR OWN THRIVING BUSINESS ON LITTLE MONEY

Successful manufacturer shows you how. Start in garage, basement, etc. No machinery needed, no priority on materials. You make large profits. Surprisingly easy and quick to learn. And, it doesn't matter what your age may be or what kind of work you have previously done, you'll find this a business made to order for you. Why not write at once for **FREE**, full particulars?

PLASTEX PRODUCTS

711-M Laguna St.,

San Francisco 2, Calif.

ACTION RACING PHOTOS

Indianapolis, Gilmore, Garden, Coliseum, etc. Midg-ets, big cars. Thundering speeds, spectacular action. Famous drivers; Maxs. Horn, Rose, Cole, Hanks, Naion, etc. ASPAR, AAA. Official action photos, genuine ORIGINALS. Finest photo kit ever offered. Kit #51. Sensational introductory offer ONLY \$1.00 postpaid. Cash, or money order.



PHOTO ACTION CO.
 Box 1965, Hollywood, Calif.

INVENTIONS

WANTED AT ONCE

Patented or unpatented inventions, all types needed by manufacturers. Write for free booklet "MARKETING YOUR INVENTION" and Protective Disclosure Form. We have a tremendous list of firms who may pay cash or royalties for good inventions. For full particulars, write today.

NATIONAL INVENTION SERVICE

1404 Mitchell Street, Dept. 5

Oakland 1, Calif.



Bar Bells

Buy Direct From Factory

Write for free booklet and price list

\$8.95
 up

INDEPENDENT IRON WORKS
 2416 East 23rd Street, Dept. B
 Los Angeles 11, Calif.

Veterans Veterans
LATEST G. I. LOAN FACTS

Now you can not only provide for a home of your own but also use your loan credit for **INCOME** and **PROFIT!** **FREE** literature.

H. B. SMITH

Box 747

Dept. 102

Youngstown, Ohio

Creative Psychology

Transformation through the renewing of the mind. "All things are possible to him that believes." Send for **FREE** booklet.

MENTICULTURE

Box 832-F

Chicago 90, Ill.

NOW READY!

Floyd Clymer's Newest and Best Motor Scrapbook of Historical Cars . . . No. 4



Illustrates, describes 200 early cars, motorcycles. Entirely different from books 1, 2, 3 (also available). \$1.50 each postpaid; \$2.50 for Do Luxe edition.

CLYMER

Dept. A-10, 2125 W. Pico^(rd)
 Los Angeles 6, Calif.

Now! NO AUTO REPAIR JOB IS TOO TOUGH FOR YOU!

Let this New Short-Cut Save You Time and Work!

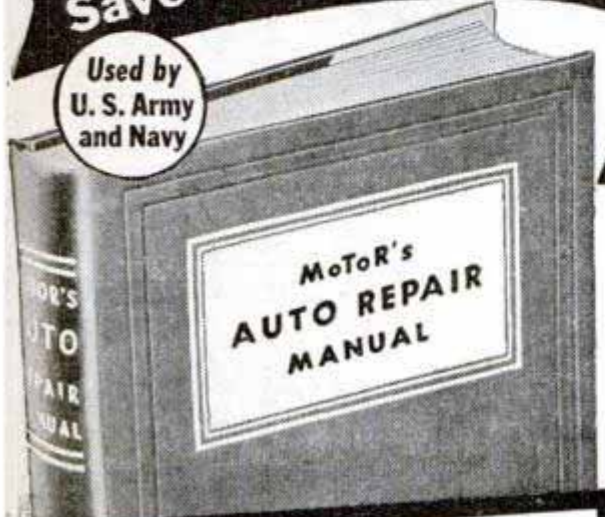

Whether you do auto repairs either as full-time or as part-time work, no service or repair job can "throw" you when you've got MoToR's AUTO REPAIR MANUAL! Just look up make, model, and the job in the streamlined index—and you're ready to lick ANY job from carburetor to rear end, faster, easier, better!

Try it FREE for 7 Days!

MoToR's AUTO REPAIR MANUAL Shows You How to Service and Repair ANY Part of ANY Car Built Since 1935!

Nearly 200,000 service and repair facts on all 31 makes. 856 big pages; including 50 pages of carburetor text, charts, illustrations, covering all models. Over 500 charts, tables; Tune-up Chart; Valve Measurements; Compression Pressure; Torque Wrench Reading; Starting Motor; Engine Clearances; Generator; Clutch & Brake Specifications; Front End Measurements, etc.; Engines; Electric; Fuel, Cooling, Lubricating Systems; Transmissions; Universals, Front Ends; Wheels; Rear Ends, etc.

Covers All These Makes!

American	Cord	La Salle	Packard
Bantam	Cresley	Lincoln	Pierce Arrow
Auburn	De Soto	Lincoln	Plymouth
Austin	Dodge	Zephyr	Pontiac
Buick	Ford	Mercury	Reo
Cadillac	Graham	Nash	Studebaker
Chevrolet	Hudson	Overland	Terraplane
Chrysler	Hupmobile	Oldsmobile	Willys
	Lafayette		

Try this great book for 7 days FREE! It's "headquarters" for 200,000 facts about service, repair, adjustment, replacement, and tune-up — on every car built from 1935 through 1946. The engineer-editors of MoToR Magazine built this Manual for YOU, by collecting and organizing all the vital information from 150 official factory shop manuals. Then they put ALL the facts into this ONE amazing workbook.

More Than 1,000 Pictures!

MoToR's AUTO REPAIR MANUAL not only TELLS you clearly what to do. It SHOWS you, too! — in over 1,000 cut-away photos, diagrams, drawings. 856 BIG pages (8½x11 inches) put the complete "know-how" right at your fingertips! And the fabric binding is strong, built for years of day-in-day-out service!

No wonder it is used by the U. S.

Army, Navy, trade and technical schools, thousands of auto servicemen and handymen everywhere! No wonder we're willing to have YOU try it, FREE, for 7 days! Once you use it—and see for yourself how much valuable time and hard work it saves—you'll never again want to be without it!

SEND NO MONEY 7-Day Free Examination

Don't send any cash — unless you wish to do so in order to save postage charges! Simply mail coupon NOW. When postman brings your book, pay him nothing. First make the book show you what it does for you! Unless convinced it's the greatest time-saver and work-saver you've ever seen—return book in 7 days, pay nothing. Mail coupon NOW! Address: MoToR Book Dept., Desk 1M, 572 Madison Avenue, New York 22, N. Y.

Same FREE 7-Day Offer Applies on MoToR's TRUCK REPAIR MANUAL

For mechanics, truck specialists, service stations, fleet owners. Covers EVERY job on EVERY truck made since 1936! 1400 pictures, 952 pages, 300,000 facts. Used by Armed Forces.

All types Gasoline Engines, Diesels, Hesselman, Fuel Systems, Governors, Lubrication Systems, Ignition Systems, Starters, Generators, Clutches, Transmissions, Axles, Torque Dividers, Transfer Cases, Brakes, Steering, etc.

ALSO SERVICES many buses, farm and industrial tractors, contractor and road building equipment, stationary power machinery, etc. (on all parts described in Manual.) Check box in coupon at right.



Published by MoToR, The Leading Automotive Business Magazine. MoToR's manuals assure high standards of repair work.

MAIL COUPON NOW FOR 7-DAY FREE TRIAL

MoToR Book Dept., Desk 1M, 572 Madison Ave., New York 22, N. Y. Rush to me at once: (check box opposite book you want).

- MoToR's AUTO REPAIR MANUAL. If O.K. I will remit \$1 in 7 days, (plus 35c delivery charge), then \$2 monthly for 2 months, and a final payment of 95c a month later. (Book's price \$5.95). Otherwise I will return book postpaid in 7 days. (Foreign price, remit \$8 cash with order).
- MoToR's TRUCK REPAIR MANUAL. (Described at left.) If O.K., I will remit \$2 in 7 days, and \$2 monthly for 3 months, plus 35c delivery charges with final payment (\$8.35 in all). Otherwise I will return book postpaid in 7 days. (Foreign price, remit \$10 cash with order).

Print Name Age

Print Address

City Zone No. (If any)

State Occupation

Save 35c! WE pay postage if you ENCLOSE full payment. (Check, M. O., postal note.) Same 7-day return-refund privilege.



HERE'S A NEW AND VITAL BUSINESS!

LEARN ELECTRICAL APPLIANCE REPAIRING

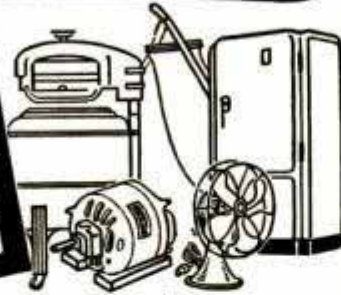

Offers Big Money -Independence

If now employed, start your home appliance repair business NOW in your spare time and be set with a business of your own no matter what happens. Operate from your garage, basement, kitchen, vacant store, etc. Work as many hours as you wish—the home appliance repairman is his own boss. It is a profitable occupation, for on many types of repairs it is not unusual for a repairman to charge on the basis of \$5.00 to \$6.00 per hour! Remember, there are millions of electrical appliances in this country. Appliances such as refrigerators, irons, sewing machines, vacuum cleaners, heaters, toasters, washing machines, motors, etc. To replace them is mighty expensive. That is why the Electrical Appliance Repair Business offers the trained man unlimited earning possibilities.

YOU CAN QUALIFY

All you need to become a successful electrical appliance repairman is ambition plus a little training at home in your spare time. If you are mechanically inclined—that is to say—can hold and use tools, our profusely illustrated course written in simple, easy to understand language will prepare you for the years to come. It does not matter if you have not had a great deal of schooling or have had no previous training along these lines, WE WILL TEACH YOU. Age is no barrier—nor any minor physical handicap.

WE TEACH YOU

Profusely illustrated with photographs and simple drawings we show you what troubles to look for and how to make each repair on an electrical appliance. We give you a good sound working knowledge of electricity, and how to do welding, nickel plating, etc. Our course shows you how to solicit business and keep it coming to you. Not a theory course but an honest to goodness course written by and used by repairmen the country over. Price of course is so low that the savings on your own household appliance repairs will quickly pay for it. Why work for others at the wages they want to pay you? Learn a good trade and operate your own business and determine how long you work each day and the amount of money you make. ACT NOW!

MAIL COUPON TODAY

CHRISTY SUPPLY CO.
2835 N. Central Ave., Dept. D-5003
Chicago 34, Illinois

Please send me free illustrated literature about America's Fastest Growing Industry—ELECTRICAL APPLIANCE REPAIRING.

Name _____

Address _____

City _____ State _____

SAY YOU SAW IT IN POPULAR MECHANICS

THE ONLY GENUINE WEBSTER IS THE

Merriam
WEBSTER

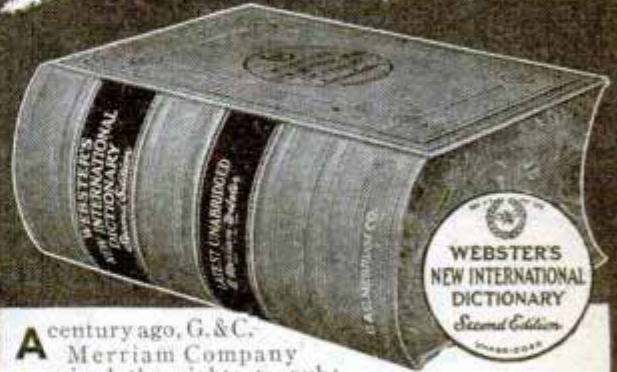

A century ago, G. & C. Merriam Company acquired the rights to publish Webster's Dictionary. Through the years, with each new edition, Merriam has constantly enlarged the scope and usefulness of Noah Webster's original work, until today the names MERRIAM and WEBSTER are equally important in identifying "The Supreme Authority." Ask for WEBSTER'S NEW INTERNATIONAL DICTIONARY, Second Edition—the great unabridged Merriam-Webster.

G. & C. MERRIAM Co., Springfield 2, Mass.

1847 A CENTURY OF PUBLISHING **1947**
MERRIAM-WEBSTERS

"THE SUPREME AUTHORITY"



WATCH & CLOCK REPAIRING

LEARN AT HOME IN YOUR SPARE TIME! ... Prepare for a happy future, with security—and qualify for a good job NOW. A fascinating and thorough self-instruction training in American and Swiss watches and clocks. Special section on alarm clock repairs. Fast-growing field. Satisfaction is guaranteed. Success-Catalog Free. NELSON CO., 1139 S. Wabash, Dept. K-02, Chicago 5, Ill.



Thrilling Work COLORING PHOTOS

Fascinating vocation learned at home by those with aptitude. Thrilling pastime. National method brings out life-like colors. Free booklet.

NATIONAL PHOTO COLORING SCHOOL
1315 S. Michigan, Dept. 1357, Chicago 5

INDIANA TECHNICAL COLLEGE

ENGINEERING B. S. DEGREE IN 27 MONTHS. Aeronautical, Chemical, Civil, Electrical, Mechanical and Radio Engineering, Inc. television, Drafting, 1-yr. Gov't approved for G.I.'s. Low rate. Earn board. Large industrial center. Students from 48 states, 18 countries. Demand for graduates. Enter December, March, June, September. Catalogue. 5107 E. Washington Blvd., Fort Wayne 2, Ind.

MAKE UP TO \$5.00 AN HOUR
In Your Own YEAR ROUND Business!

ONLY A FEW DOLLARS PUTS YOU IN BUSINESS!

Many Clearing as High as \$20 to \$30 a Day NET Renewing Rugs, Carpets, Upholstery. New Method Now Used for Auto Upholstery. Write for Facts About Quick, Easy Way to Get Started

Here is the chance you've been looking for to step into a pleasant, dignified, big-pay business of your own that offers you a steady, year 'round income. Start on "a shoestring," full or spare time, right from your own home. Equal opportunities for men and women, young or old, in small towns or big cities. No experience needed. Many making big money with new Americlean System just cleaning auto upholstery. Easy to learn. We send you complete instructions and quick-cleaning supplies so you can start making money the very first day! Quick method cleans upholstery, rugs and carpets like new without taking off floor! Tremendous demand in homes, apartments, hotels, stores, office and public buildings. Steady repeat business. Territories going fast. Write today for full FREE facts. No cost or obligation. Rush letter or postcard now to **AMERICLEAN CO., Inc.**, Dept. G-10; 211 North 7 St.; St. Louis 1, Mo.

WRITE FOR FREE DETAILS NOW!

Now

YOU CAN HAVE IMPROVED NO-DRIFT FM in the Sensational New 1948 **FM** **MIDWEST RADIOS**

NEW SERIES
16*
SUPER DE LUXE
AM-FM
CHASSIS



14 1/2"
PANASONIC
SPEAKER

5
WAVE
BANDS

Here is the finest radio Midwest has ever produced in its 28 years of manufacturing—a world-ranging, 5-band radio with improved Midwest No-Drift FM . . . plus Standard Broadcast and 3 short wave bands, Television Audio Switch-over, and Color-Ray Tone Selection. The Series 16* Super De Luxe Chassis is a powerful, magnificently-toned radio that challenges comparison for performance, sensitivity, selectivity, and advanced engineering features. Supplied with satin stripe copper finish panel—ready to mount in your present cabinet. Send today for the FREE 1948 Midwest Radio Catalog. Buy your radio direct from the manufacturer on Easy Terms and 30 Days Trial and SAVE!

*SERIES
16 CHASSIS USES ALL
THESE LATEST-TYPE TUBES

30
DAYS
TRIAL

LOW
FACTORY-
TO-YOU
PRICES

EASY
TERMS

A COMPLETE LINE OF FINE RADIOS AND RADIO-PHONOGRAPHS . . . Available in Separate Chassis Like the Powerful Series 16* AM-FM Model above, or in beautiful Radio-Phonograph Consoles like this:



Scores of NEW Features such as the Exclusive MIDWEST TRI-MAGNADYNE COIL SYSTEM and COLOR-RAY TONE SELECTION



SYMPHONY GRAND AM-FM **RADIO-PHONOGRAPH CONSOLE** with NEW Intermix **AUTOMATIC** **RECORD CHANGER**

Our Finest! A superbly beautiful musical instrument . . . a masterpiece of furniture design and radio engineering that offers the sensational Midwest NO-DRIFT FM, Automatic Intermix Record-Changer, Exclusive Color-Ray Tone Selection, World-ranging 5-Band Reception, Television Audio Switch-Over, and many more new and exclusive features.

Rush for Free Catalog!
FILL IN COUPON AND MAIL TODAY OR JUST SEND YOUR NAME AND ADDRESS ON 1c POSTCARD

MIDWEST RADIO CORP.
Dept. 25-L, 909 Broadway
Cincinnati 2, Ohio

Gentlemen: Please send me your new FREE catalog and details of your liberal 30 Days Trial.

Name _____
Address _____
City _____ Zone _____ State _____

MIDWEST RADIO CORP.
Dept. 25-L • 909 BROADWAY • CINCINNATI 2, OHIO

Makes Any Auto Engine Job Easy!

New Book—Makes Money Saves Money in Hundreds of Ways

Get Drake's Auto Engine Manual to keep your own car going good. Use it to help you earn big money on repair and tune up jobs for others. Car owners now pay big for this work. Learn how to service all types of auto engines, ignition, carburetors, etc., easy and quick.

Thousands of Manuals in Use Money Back if Not Satisfied

Contains 300 pages of vital information and practical instruction plus over 200 illustrations that you can use to make money in one of the best opportunity fields of the day. Order now—No. 1 on coupon below.

Covers Engine Tune-Up, Carburetors, Hi-Speed Ignition, Starters, Etc.



- ALSO GET**
- No. 2. Diesel Engines and Diesel Electric Power. 308 pages. \$3.00.
 - No. 3. House Wiring Made Easy. Over 100 illus. \$1.50.
 - No. 4. Refrigeration Service Manual. 317 pages. \$2.00.
 - No. 5. Heating, Cooling and Air Conditioning. 700 pages. \$4.00.

MAIL COUPON NOW

FREDERICK J. DRAKE & CO., Dept. 17
600 W. VanBuren St., Chicago 7, Ill.

Send me the books checked below. If not satisfied I will return them in 5 days and money will be refunded.

1 2 3 4 5 (Circle Numbers Wanted)
 Check or Money Order enclosed \$_____ Send books postpaid.
 Send C.O.D. plus postage.

Name _____
Address _____
City _____ State _____
Drake's Books are Sold by Leading Booksellers

HERE'S Fun

AT YOUR FINGERTIPS



Now EVERYONE can enjoy RAILROADING IN MINIATURE!

Build true reproductions of famous trains that are actual working models! Our "00" Gauge kits are especially scaled for home use where layout space and time are limited. Yet these kits are as accurate in detail as our larger model, the "0" Gauge. Kits contain every part needed to build the model with only common tools. Made of fine materials, rugged, realistic . . . Scale-Craft Model Railroad kits provide a challenging, thrilling hobby. The Scale-Craft Catalogue and Data Book fully describes layouts, types of kits and model railroad practice, with room to add supplemental information, and costs only 25c postpaid.

Send stamp TODAY for your How to Begin folder. Address Dept. M1



SCALE-CRAFT & CO. 1731 N. HIGHLAND AVE. HOLLYWOOD 28, CALIF.

How to Start YOUR OWN BUSINESS And Reap BIG Profits!

Plastics, one of the most revolutionizing and rapidly expanding industries, offers a great opportunity to all enterprising men and women. This is one of the few industries in which home manufacturers thrive and prosper. You can start even on a spare time basis in your own home, and expand rapidly into a full time business, paying good profits.

LIQUID MARBLE

Make LIQUID MARBLE the amazing Plastic, with a thousand uses. LIQUID MARBLE can be poured into FLEXIBLE MOLDS for casting all kinds of artistic and serviceable articles such as: ornaments, novelties, desk sets, paper weights, book-ends, souvenirs, statuary, toys, etc.

FLEXIBLE MOLDS

Make your own FLEXIBLE MOLDS. The cost is low—in fact, a large sized mold costs but a few cents. Hundreds of casts can be taken from a single mold.

NO EXPERIENCE NEEDED!

No skill, or previous knowledge is necessary. All you do is follow our easy-to-understand instructions.

UNLIMITED MARKET

The market is literally unlimited. You will find steady year-round demand in your own community. Your problem will not be in selling but in supplying the huge pent-up demand. Moreover, we supply you with names of buyers for your finished products.

WRITE TODAY

Bing Products will show you how to start with a small investment and build a permanent, independent, profitable business! Don't fail to grasp this opportunity! Write today for FREE CATALOG.

BING PRODUCTS

Dept. A-23, 88 Broad Street Boston, 10, Mass.

HI-SPEED EQUIPMENT

High Compression Heads—Dual Manifolds

Dual Air Cleaners For V8's

Use these simple conversions to increase horsepower, speed acceleration, and increase top speed of your car. Write today for prices and full information.

SANDEE MUFFLER CO. 7523 S. Western Ave. Los Angeles, Calif.



MUFFLERS

STEELS and ALUMINUMS with a motorboat tone

SINGLES, Chev, V-8, Plymouth, Steels \$5.50, Aluminum \$6.50. Chry., Olds., Buicks, etc., Steels \$7.50, Aluminum \$8.50. V-8 and MERCURY DUALS, Steel \$17.50, Aluminum \$20.00. Aluminums are guaranteed for life of your car.

DEALERS WANTED

SANDEE MUFFLER CO.
7523 S. WESTERN AVE., LOS ANGELES 44, CALIF.

WANTED DISTRICT PURCHASING AGENTS

No experience or money required. Exceptional opportunity for those who want to establish themselves in a steady, year 'round, well paying business.

For details: Write

PURCHASING MANAGER, DEPT. C
2719 LAWRENCE AVE. CHICAGO 25, ILL.

FREE 5 INCH GENUINE LEATHER Jolly Rogers Patch



Join the JOLLY ROGERS CLUB of INSIGNIA COLLECTORS. Send only \$1.00 and get this Genuine Leather Jolly Roger Breast Patch Free with 25 all different Air Force Wings and Officers Collar Insignia. (List Price \$7.00.) Colored insignia book FREE with order.

THE INSIGNIA MART, DEPT. P.P.
703 Broadway New York 3, N. Y.



COMB-A-TRIM The New Quick Trimmer

Something New! Trim your hair without any experience. It's easy! The excess hair comes off smoothly and easily by just pulling trimmer through hair like an ordinary comb. Save on hair-cut bills. . . Trim your own hair or the whole family's. Send 59c and your Comb-A-Trim will be sent at once, postpaid.

SPECIAL OFFER Send \$1.00 for 2 Comb-A-Trim. Save 18c **2 for \$1** 5 Extra Blades (Year's Supply) **25c**
COMB-A-TRIM CO., CAREW TOWER, Dept. R-22, Cincinnati, Ohio

Sensationally New Low THERMOSETTING PLASTIC in POWDER FORM { self curing

Cost CASTING MIX STRONG, TOUGH, HARD

NOW ANY-ONE CAN MOLD QUICK AND EASY

"Kalon" is a NEW TYPE CASTING MIX . . . Does not require expensive equipment or presses to handle . . . Simply mix "Kalon" with water, stir and pour into mold . . . THAT'S ALL . . . "Kalon" remains liquid about 15 minutes after mixing, after which time 'hardening' process begins and lasts from 20 to 30 minutes to permit removing the cast from the mold. JUST THAT SIMPLE. Pins, Clasps, Hooks, etc. can be inserted for Costume Jewelry, Plaques and other ornaments, while it is hardening. We can supply KOROSAL STOCK MOLDS to produce saleable products . . . Catalog showing these molds mailed prepaid for 15c. A Novelty Korosal Mold is available at the Special LOW COST of ONLY \$2.00. Start Molding Many Things

CLARENDON MFG. CO.
176 West Adams St. • Dept. P-10 • CHICAGO 3, ILL.

• **INTRODUCTORY OFFER** •
A Trial Kit contains a 10-oz. supply of "KALON". A pkg. of Mold Dressing . . . Set of Instructions READY TO USE . . . Sell the articles at a PROFIT. KALON can be cast in Rubber Molds. **\$1.49**

RUSH ORDER ONLY Postpaid

Learn MASONRY CARPENTRY

Write for "Free" Catalog

In a few short weeks you can be making big money in the building trades. Learn now while opportunities are greatest. Prepare for the future. You receive your training in our completely equipped shops under expert instructors. Fully approved for G.I. Training.

MIDWEST SCHOOL OF BUILDING TRADES
Dept. A110, 411 N. Center Street, Bloomington, Ill.

LEARN TRIG QUICKLY - EASILY

WITH QUICK TRIG, by competitive tests, it was found that QUICK TRIG gave answers faster to one with a slight knowledge of trig than to an expert on trig with a slide rule. Let it solve your trig problems. You need no previous training. Entirely automatic. Easy instructions included. We mail C.O.D. plus postare or enclose \$1.00, the full price, and we will mail postpaid.

REED MFG. CO. 11350-A BURBANK CALIF. N. HOLLYWOOD, CALIF.

BOYS' EXPRESS CART KIT—only \$5.98—easy to assemble

87.98 No. 300 Kit includes 4-8" heavy gauge steel, rubber tire wheels with bronze bearings and hubs; and ALL metal parts as illustrated, with blueprint for easily making sturdy 15" x 34" wagon. No. 600 Kit, same as above except wheels equipped with FULIAN Ball Bearings. \$8.98. ADD 10% TO COVER SHIPPING COSTS. Satisfaction guaranteed. Send money order or check right NOW!

C. W. Young Mfg. Corp.
Burnet Ave. Syracuse, N. Y.

HOUSE PLAN TEMPLATE

Made of clear sheet plastic, with accurate cut-outs for drawing door-swings, plumbing and electric fixtures, fireplace, stairs, moldings, roof-pitch, etc. Standard 3/4" equals 1'-0" scale.

AT YOUR DEALER \$1.50 or mailed postpaid

Send card for list of templates

TIMELY PRODUCTS CO.
Box 206C, Columbus 9, Ohio

INVENTORS! LET US DEVELOP YOUR INVENTION

Our offices are staffed by experienced engineer designers and draftsmen fully qualified to detail the structure and design of your idea for manufacturing and patent drawings. All work confidential. Write today for information. **QUALITY DESIGN AND DRAFTING SERVICE**, 613 Atlantic Building, 930 F Street, N. W., Washington, D. C.

SAY YOU SAW IT IN POPULAR MECHANICS

CARTOON TO SUCCESS!
Learn cartooning from a PROFESSIONAL! Let me show you how to create ORIGINAL cartoons and IDEAS. Send for FREE details about course.
Also **CARTOONIST'S MAGAZINE**—Lessons, plans and hints. Send 25c coin for copy.

CARTOONIST HARTMAN, 2776 California Court, LINCOLN 8, NEB.

ENSHRINE THEIR MEMORIES WITH U. S. MONUMENTS \$14. UP

Freight Paid

There is none better. Our free catalog is ready for you. Write today. A-18 U. S. Marble & Granite Co., Oneco, Fla.

Make \$100 TO \$300 a week with any of these

101 WAYS to be YOUR OWN BOSS
By MICHAEL GORE



Why knock yourself out as somebody else's "wage slave" when you can be sitting pretty in an easy-to-start, big-money business of your own? If you're fed up with begging for raises, lay-offs, shut-downs and catering to company "big shots," get a copy of the book that has put thousands into money-lifetime businesses of their own—101 WAYS TO BE YOUR OWN BOSS, by Michael Gore.



COMPLETE "INSIDE INFORMATION" helps you succeed in these and other **PROFITABLE BUSINESSES**

(Partial Contents)
RETAILING: Sport Goods Store; Electrical Appliances; Filling Stations; Men's Dress Shops; Men's Clothing; Boys' Wear; Beauty Shops; Florist; Book Store; Rental Library; Gift & Art Shop; Meat Market; Restaurants; Bakeries, etc.
MAIL ORDER BUSINESSES — Full-time and spare-time.
SERVICE BUSINESSES: Laundries; Retail Dry-Cleaning; Diaper Supply; Linen Supply; Coin Machines; Employment Agencies; Country Newspaper; Trucking; Export & Import; Auto Repair; Photography; Junk & Scrap; Exterminating; Radio Repair; Metal Service Shops, etc.
MANUFACTURING: Ceramics; Precision Casting; Metal Working, etc.
FARMING: Small Commercial Farms; Specialty Farms; Poultry Farming.
REAL ESTATE: Management; Buying and Selling, etc.

Send No Money!

You Don't Need Much Money or Experience

With really small capital, with little or no experience, but with this gold mine of a book to guide you, you can start from scratch and build yourself a big-money future with **REAL SECURITY**. Many of the opportunities revealed by Mr. Gore are in little-known, uncrowded, easy-to-enter fields. Many have the perfect set-up for 1-man, partnership or husband-and-wife operation. All are fully explained, with step-by-step instructions for making the smallest possible investment pay you a good living from the very beginning.

101 WAYS TO BE YOUR OWN BOSS puts at your fingertips the wealth of actual experience so hard for the newcomer to get. In it, 200 successful businessmen have crammed a million dollars' worth of "know how" to help the new boss make a real success of his enterprise. They show you what businesses hold today's biggest opportunities, how to get started fast and grow fast, how to make a little capital go a long way, get fixtures and merchandise on time, pick the just-right location, keep down overhead, bring in all the business you can handle.

Time Is Precious! Don't Waste It!

Experts agree the time is ripe for thousands of more new businesses. But whether you're quite ready or not, take the first step toward \$100 to \$300 a week in a business of your own by getting your copy of **101 WAYS TO BE YOUR OWN BOSS**. We're so sure you will find it the gold mine of opportunity we say it is, that **WE'LL LOAN YOU THE BOOK FOR 7 DAYS FREE EXAMINATION**. Your copy will be rushed to you immediately upon receipt of the coupon below.

FREE FOR 7 DAYS

SUCCESS BOOKS, Dept. 35, 206 Division St., New York 2, N. Y.
Please rush, for 7 DAYS' FREE EXAMINATION, a copy of **101 WAYS TO BE YOUR OWN BOSS**. I will deposit with postman only \$2.00, plus C.O.D. charges. If I am not fully satisfied that it is worth many times the price to me, I may return it within 7 days for immediate refund.

Name.....
Address.....
City.....Zone.....State.....
 CHECK HERE if you prefer to enclose \$2.00 and we will pay all delivery charges. Same Free-Trial Money-Back Guarantee!

LOW-PRICED LARGE-IMAGE TELEVISION IS HERE!

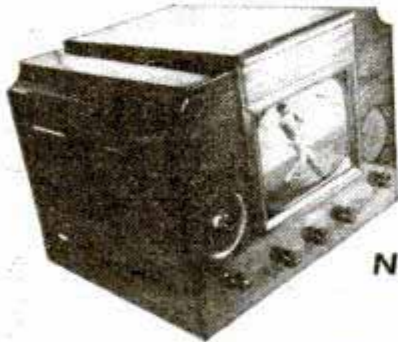

ONLY
\$289.50

Transvision's
New 12" Tube Kit

**Gives You Larger Image Than
Sets Selling at \$500**

● Here is your chance to get low-priced, large-image television with an easy-to-assemble Transvision Television Kit. After only 20 working hours you'll have a ringside seat at fights and ball games with a "big-as-life" television set.

Nothing extra to buy! Price includes specially designed folded dipole antenna, 22 tubes, R. F. unit pre-assembled and pre-tuned for all stations, true F. M. sound (besides 12" picture tube large enough for 60 people!). Even solder is supplied!

If you can read a road map you can put a Transvision kit together! Complete novices have done it by following the simple step-by-step directions. All you need is a screwdriver and soldering iron to finish off the assembly. Factory guarantees high quality, clear, sharp reproduction as good as sets selling at twice the price.

So, join over 10,000 satisfied people who have saved money by putting an easy-to-assemble Transvision Television Kit together. *Beat high-priced finished set costs!* Order today. A \$25 deposit will assure early delivery. (Beautifully turned walnut cabinet available, for those who wish it, at low cost.)

MAIL THIS FOR FREE DETAILS

Beacon Television, Inc., Dept. M-107
143 E. 49th Street, New York 17, N. Y.

Gentlemen:

Please send me more information about Transvision's new easy-to-assemble, large image 12" tube television kit.

Name _____

Address _____ City _____ State _____

SAY YOU SAW IT IN POPULAR MECHANICS

**AT LAST! A HOBBY THAT OFFERS YOU
PROFIT AS WELL AS PLEASURE!**

**GENUINE LEATHER
Hand Crafted
LINK BELT**

Easy to Make—Easy to Sell

Get started today on a fascinating hobby where you can earn up to \$10 or \$15 a week in spare time! Send for your complete profit-producing handcraft kit with all the material needed to make 6 genuine leather link belts. Sell all you make at \$2 each to people experting to pay far more for genuine hand-made belts. Kit for 6 belts costs you only \$3.50—can easily be sold for \$12—leaving you a profit of \$8.50. Send \$3.50 for your Kit today, or mail only a dollar for sample Kit! Or C.O.D., you pay postage. Money back if not delighted.

FREE WITH YOUR ORDER

... IF YOU ACT NOW!

Beautiful Plastic Identification Card Case. Value 25c. Yours to keep, even if you return belt kit. Also, on request, big new 40-page CRAFT CATALOG FREE with or without order.

DWINNELL CRAFT SHOP, Dept. P710, Elm Grove, Wheeling, W. Va.

5 COURSES TO SUCCESS

CLASSES ENROLLED MONTHLY

Time-saving practical courses—day and evenings. Approved for G.I. Training. Free Placement Service. Write for FREE CATALOG

TOOL and DIE DESIGNING

MECHANICAL DRAFTING

ARCHITECTURAL DRAFTING

INDUSTRIAL PROD. DESIGNING

AUTOMATIC SCREW MACHINE ENGINEERING Cam Design Layout and Estimating

MIDWESTERN TECHNICAL INSTITUTE
431 S. Wabash, Auditorium Bldg., Dept. XA, Chicago 5, Ill.

**SONG WRITERS
PROTECT YOUR SONGS**

What every song writer should know—must know. This book "HOW TO PROTECT AND COPYRIGHT YOUR SONGS IN THE UNITED STATES AND THROUGHOUT THE WORLD" by a world famous copyright attorney — answers these and other fundamental questions in language you can understand. This is a highly informative and interesting book for every writer of original lyrics and music. Sent prepaid for 50c. No COD's.

CHECKERBOARD PRODUCTS, INC.
Dept. PM. 1 East 42nd Street New York 17, N. Y.

**TALK-SING thru your own radio
with
RADIO MICROPHONE**

Be the life of the party. Put on your own broadcasts at home. Talk-Sing make announcements from any room. Wonderful voice practice. Microphone easily attached to any radio. Follow enclosed instructions. **SEND NO MONEY**—pay postman \$1.08 plus postage. Send Money Order or check and save postage.

EMPIRE RADIO & TELEVISION CO. (Dept. R2) 1521 Bedford Ave. Brooklyn 16, N. Y.

LIQUID MARBLE COLORED POTTERY

Different! Marvelous! Color-glazed. Brush, spray, mold tiles, table-tops, ornaments! **SANITARY COMPOSITION FLOORING**—Dustless, noiseless; put on the plaster, plain or tile designs; yielding as cork, lasting as stone. **RUBBERLASTIC Mold Compound**—For plaster casting, novelties, statuary, toys, plaques, dolls. **TILEX Colored Roofing**. Build Modern **PLASTIC HOMES**. Illustrated literature free.

RAPID MARBLEIZING SERVICE, Dept. 10-A, Edwardsville, Illinois

YOU MAY BE ABLE TO TRIPLE YOUR INCOME IN YOUR SPARE TIME

MAKE BIG MONEY at HOME

FULL OR PART TIME IN A CORNER OF YOUR GARAGE OR BASEMENT

LEARN TO METALIZE BABY SHOES Heirlooms, Jewelry, Bookends, Novelty Items, Flowers, etc. . . Processing in Bronze, Gold, Silver, Pearl . . . Start a Profitable Business Of Your Own With A Real Future! No other business gives you such LARGE RETURNS for so LITTLE INVESTED! Synthetically processed baby shoes retail at approximately \$5.00 per pair. Cost of materials is 5c to 10c per pair. Think—a profit of \$4.90 for your labor! It's easy to learn (you can learn in your spare time in a few weeks). . . EASY WORK (Your equipment does most of the work for you). . . EASY TO SELL! . . . A NEW FIELD WITH UNLIMITED POSSIBILITIES! Every parent cherishes the first little shoes of their baby and wants them preserved permanently in this beautiful way. All the "Tricks Of The Trade" and Special Secret Formulas Now Available To You. **WRITE FOR FREE LITERATURE**

COMPLETE KIT OF SUPPLIES INCLUDED

Dept. PM-107, KIKTAVI School of Metallic Arts, 8620 S. Ruthelen Ave., Los Angeles 44, Calif.

LEARN **DIESEL** THE QUICK, EASY WAY



THE FAMOUS HEMPHILL WAY!

Wherever Diesels are used, the name "HEMPHILL" is famous. It stands for TRAINED MEN—men who *know* Diesel. Many trained Diesel graduates of Hemphill Schools are successfully engaged in work where their Diesel training is "paying off." Perhaps they are assembling Caterpillar Tractors, or servicing Cummins-powered trucks, or installing and maintaining General Motors' Diesels. Perhaps they are working with these and other makes of Diesel engines in trains, ships, drilling rigs, sawmills or construction equipment—but no matter what the Diesel job, Hemphill trained men

have the "know how" to handle it.

Prepare YOURSELF for the great industrial swing to Diesel power which is now here. Get complete details of Hemphill Diesel training now!

STUDY AT HOME—Learn Diesel AT HOME in your spare time, without interfering with your present activities. Prepare for a bigger future this quick, easy way. Mail the coupon below for complete details and free literature. Or attend 34 weeks resident classes at schools listed below.

Home Training approved for Veterans under G.I. Bill

VETERANS and NON-VETERANS—Ask about our Home Study and Resident courses available in New York, Memphis and Los Angeles.

RESIDENT SCHOOLS LOCATED AT:

NEW YORK 31-28 Queens Blvd. Long Island I, N. Y.	LOS ANGELES 1601 S. Western Ave. Los Angeles 6, Calif.	MEMPHIS 311 S. Main St. Memphis 3, Tenn.
---	---	---

34 weeks practical training. If you would prefer to train at one of these three schools, indicate by check on coupon.

HEMPHILL DIESEL AND AUTOMOTIVE SCHOOLS

Administrative Office: 1601 South Western Ave., Dept. PM-10
Los Angeles 6, California

Gentlemen. Please send me FREE BOOKLET and information on your Diesel Courses. I am interested in Home Study Resident School at New York Memphis Los Angeles (Check school desired.)

Name _____ Age _____
Street _____ Zone _____
City _____ State _____
Veteran _____ Non-Veteran _____

MAIL COUPON NOW!

GET EXPERIENCE ON EQUIPMENT LIKE THIS—GET INTO—



DO ACTUAL WORK ON ACTUAL EQUIPMENT!—STUDENT WORKING ON ELECTRONIC HIGH-FREQUENCY INDUCTION FURNACE

ELECTRICITY

NATION'S
LARGEST
EXCLUSIVE
ELECTRICAL
SCHOOL

NOT A
HOME STUDY
COURSE

"LEARN
BY
DOING"



Get ready fast! . . . Get ready right! . . . Train to step into any of the *better paying jobs* in **ELECTRICITY**. Train with on-the-job equipment and methods in the large shops of M.T.I. . . . Learn housewiring, motors, armature winding, power plant work, etc. *New classes start every few weeks*. Living arrangements made.

NO COST TO VETERANS. Train at Gov't expense. Receive monthly subsistence pay while learning. Work part time if necessary. Coupon brings details.

MICHIGAN TECHNICAL INSTITUTE

Department PM-10 2281 West Fort Street, Detroit 16, Michigan

MAIL TODAY—FOR QUICK ACTION

MICHIGAN TECHNICAL INSTITUTE, Dept. PM-10
2281 W. Fort St., Detroit 16, Michigan

- Send me catalog and complete information.
- I am a GI. Send special information.
- Married. Single.

NAME _____

ADDRESS _____

CITY _____ ZONE _____ STATE _____

PAIN'T YOUR CAR WITH WYPE[®] for \$3.95

Amazing NEW AUTO ENAMEL

You WIPE ON Instead of Brushing & Spraying

Get Beautiful Mirror-Like Finish That Looks Like Spray Job!

At last! Practically anyone can now paint his car with WYPE and get a beautiful high-gloss job that gives you an expensive finish such as is sprayed on by Professional Auto Painters—at a fraction of regular cost! With WYPE you need NO BRUSH, NO SPRAY, NO MASKING! Just WIPE ON with Powder Puff—which we furnish at no extra charge. You get a brilliant, glossy finish that is truly "factory-like." No streaks. No lap-marks. Guaranteed for TWO years not to crack, peel, chip or fade, if simple directions are followed. Takes about an hour to apply. Dries dust-free in an hour. WYPE comes in eight most popular shades including those on newest model cars. Goes over any other color, lacquer or enamel.

NEW MONEY-MAKING BUSINESS!
WYPE 2 CARS DAILY for \$25.00 each—
Gross Up to \$260.00 Weekly Profit!

Start making BIG MONEY Now! Sell WYPE in cans or go into business painting cars yourself (or hire others to do work). Send for FREE details of powerful money-making plan. Why wait! Start now by ordering one quart or more of WYPE!

SEND NO MONEY! ORDER WYPE TODAY!

Color	Price Per Quart
BLACK	\$3.95
GREEN (Brewster-Dark or Jewel-Light)	3.95
BLUE (Washington-Dark or Monticello-Light)	3.95
GRAY	3.95
RED or MAROON	3.95

Order one quart or more today! SEND NO MONEY! Mail penny postcard. Then pay your mailman for WYPE plus postal charges. Or, if you send money with order, WE pay postage. See your dealer or order direct.

WYPE CORP.

Dept. 49-K, 2214 Dolman St.

ST. LOUIS, MO.

2-YR Guarantee
NO MASKING NEEDED
NO STREAKS or LAP-MARKS
looks like SPRAY JOB



ANYONE CAN DO BEAUTIFUL JOB

ONE QUART DOES ENTIRE JOB! DRIES TO GLISTENING PROFESSIONAL FINISH!

WYPE is a new Miracle Enamel for Autos. It is NOT a wax or polish but a hard high lustre ENAMEL finish! With WYPE, ANYONE can do a beautiful job! Order a quart to paint your car or to get started in this BIG-MONEY Business!



IMPORTED SWISS WATCH

7 DAY MONEY BACK GUARANTEE NOW ONLY **\$4.98** PLUS 50c Fed. Tax

A beauty—for dress, sports, outdoor wear. Precision made. Streamlined, chrome-plated case. Smart modern dial (glows in dark), handsome watchband. Supply limited. Order now!

SEND NO MONEY! We mail C.O.D. plus postage or send money order. Save postage.

THE JEWELBOX, 2-B Stone St., N. Y. 4, N.Y.

SAY YOU SAW IT IN POPULAR MECHANICS

MAKE BIG MONEY IN YOUR OWN YEAR ROUND BUSINESS!

EASY TO START WITH ONLY A FEW DOLLARS!

Here are 3 amazing, new opportunities to get into your own highly-profitable, dignified business—without previous experience—regardless of your age or sex. 1. **LIQUID Synthetic MARBLE**—Easy to make and install beautiful synthetic Marble Slabs—pouring from liquid state. Big Demand for kitchen and bathroom walls, etc. 2. **FIBRE-TITE FLOORING**—Easy to make and install—in any color or color combination. Many years wear. Dustproof. Soundproof. Verminproof. 3. **FLEXIBLE MOLDS**—for Plaster Casting. \$1.00 in raw materials makes up to \$25 worth finished products. F.B. Iowa, writes: "Am on job that will net me \$150 for 4 days work." Get FREE details. No obligation. Write today!

COMPOSITION PRODUCTS CO.
5853 Delmar Blvd., Dept. 101

Write for FREE DETAILS NOW!

St. Louis 12, Mo.

FULLSIZE, CUT-TO-SHAPE BOAT PATTERNS



and specifications. Designed by Naval Architect. Cruisers, runabouts, sloops, outboards, sailing canoe, etc. Low prices. Send 10c (coin) for illustrated catalog. SPECIAL: Send \$1.00 for "HOW TO BUILD BOATS" book, postpaid.

Cleveland Boat Blueprint Co. Dept. 666, Cleveland 17, Ohio



FIBRE ARMS AND LEGS!

Light, correctly fitted, strong and comfortable. Natural appearance. Braces for all deformities. Scientific design. Fair Terms.

BUCHSTEIN-MEDCALF

223 S. 6th St., Minneapolis, Minn.

YOU CAN EASILY GET ANY BOOK IN PRINT



Get hard-to-find books the easy way... any Book in print can be sent to your door—we pay postage. New—old—fiction—biography—reference—technical—hobbies—whatever you want—write to us.

FREE. Write for free Catalog listing hundreds of books and texts immediately available. Write today!

HARD-TO-FIND BOOK DEPT.
Popular Mechanics Co.
200 EAST ONTARIO STREET
Chicago 11, Illinois

DELIVERED TO YOU
WE PAY POSTAGE IN U.S.A. EXCEPT ON C.O.D.'S



Learn ENGINEERING DRAFTING... BUILDING in Chicago, Industrial Hub

Approved for G.I. Training Time-Saving Courses Day & Evening Classes

Get your training at Chicago Tech in the Nation's industrial center. Chicago provides unequalled opportunities for part-time employment while training and for permanent positions upon graduation. Many other cultural and recreational advantages described in Catalog. — sent Free!

Chicago-Tech, founded 43 years ago, has trained thousands of men now occupying important places in industry the world over. Training combines theory and practice in 1 year, 2 year, and 3 year (Degree) courses. Saving in time means earlier graduation. — and consequently earlier employment.

Terms start January, April, July and October. Get information now to arrange for early admission and accommodations.

**CHICAGO
TECHNICAL COLLEGE**
N-81 Tech Bldg.
2000 So. Michigan Ave.
Chicago 16, Ill.



**1 YEAR • 2 YEAR
3-YEAR COURSES**

**BUILDING
DRAFTING
ENGINEERING
AIR CONDITIONING
REFRIGERATION
ELECTRICITY
RADIO**

MAIL COUPON TODAY

CHICAGO TECHNICAL COLLEGE
N-81 Tech Bldg., 2000 So. Michigan Ave.
Chicago 16, Ill.

Please send me without obligation free booklet on Time-Saving Technical Training.

Name _____ Age _____

Address _____

City _____ Zone _____ State _____



**NOW! ... Build
Your Future on**

DIESEL OPPORTUNITIES

Compact Diesel Truck Engine

6 cylinders, 5-1/8" bore and 6" stroke, maximum horse power rating 200 H.P. at 2100 RPM.

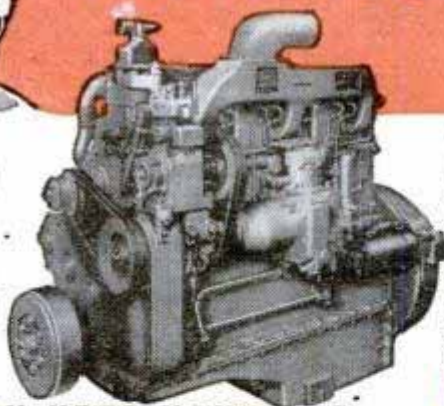

Prepare Now

WHILE YOU KEEP YOUR JOB...

If you are between 17 and 60 and mechanically inclined, you can get thorough, individual instruction at home. With U.E.I. balanced training, you learn first through home study the fundamentals of Diesel in all its phases, in practical, easy to understand lessons. We show you how Diesel Engines operate, how fuel systems work, repairs, latest accessories & auxiliary equipment.

ACTUAL SHOP PRACTICE Then you get valuable practice in our big shop, working on costly equipment under expert Diesel men. This course is new, up to the minute, includes latest techniques. UEI offers placement service for graduates and numerous other features. Now in our 21st year. Coupon brings complete information.

DO IT NOW! It costs you nothing to get all the facts about Diesel opportunities and training. But time is important—send coupon today!

Diesel Power is Going Places

You don't have to look far to see Diesel Power in action these days. Trucks, buses, tractors, railroads, ships, power plants, farm and road equipment—more and more depend on Diesel each day. On the farm, in factories, in communities, large and small—Diesel is growing as it proves to be efficient, economical, dependable, streamlined power.



ON LAND



ON WATER



IN INDUSTRY

DIESEL KNOWLEDGE is Earning Power

THE NEW AND INCREASING USES OF DIESEL open a broad field for trained men who can install, maintain, operate and repair DIESEL EQUIPMENT. Now is the time to prepare for these opportunities.



UTILITIES ENGINEERING INSTITUTE, Dept. 1107D
Diesel Division, 2521 N. Sheffield Ave., Chicago 14, Ill.
Please send me FREE facts about U.E.I. training and opportunities in the field checked below.

Diesel Refrigeration Welding
 Auto Body & Fender Repair Air Conditioning

NAME _____ Age _____

ADDRESS _____

CITY _____ Zone or County _____ STATE _____

If World War II veteran give length of service.
 Check here for special information if you are under 17.



UTILITIES ENGINEERING INSTITUTE

2521 N. Sheffield Ave.
Dept. 1107D
Chicago 14, Ill.



Pay Is Good

for Trained mechanics in both these Big Industries

LEARN IN A FEW WEEKS IN OUR BIG MODERN TRAINING SHOPS

AUTOMOTIVE MECHANICS

DIESEL MECHANICS

NOW IS THE TIME TO PREPARE FOR YOUR PLACE IN A GIANT INDUSTRY

Automobile and Diesel Industries making up for lost time! There may never again be such opportunities for men who want better jobs or business of their own to get in on ground floor and go up fast! Yes—FOR MEN WHO ACT FAST, THINGS CAN HAPPEN FAST!

TRAIN ON ACTUAL EQUIPMENT

Chicago Motive Trades Institute makes rapid progress possible by Learn-By-Doing SUPERVISED SHOP TRAINING. In motive trades our institute gained nation wide fame training Auto Mechanics for U.S. Army. Same quality training available to you now. CONSULTATION AND PLACEMENT SERVICE WHETHER YOU ARE INTERESTED IN WORTHWHILE JOB OR SETTING UP YOUR OWN BUSINESS.

AUTOMOTIVE MECHANICS

Practical shop training on all types of equipment. Automotive mechanics needed to keep millions of cars, busses, trucks rolling. Efficient auto mechanics get fine pay. Can service, repair, install all mechanical and electrical parts of a car. Learn to overhaul and repair engines, transmissions, differentials, and other assemblies. Good pay, steady work, excellent opportunities for increased earnings for properly trained auto mechanics.



DIESEL MECHANICS

Diesel engines are used in locomotives, ships, trucks, busses, power plants, tractors, farm equipment. Trained men needed to repair, rebuild, install, maintain, operate equipment. A big field that promises even bigger things in the years right ahead.

A NATIONALLY KNOWN INSTITUTION

Rapid progress possible by supervised learn-by-doing SHOP TRAINING. C.T.I. is an old established school, backed by years of experience—with trained instructors—with completely equipped shops.

VETERANS qualifying under "G.I. Bill" have tuition paid by Government plus monthly subsistence allowance. Just mail coupon, we will handle all details. LOW TUITION, EASY TERMS if you are not a veteran.

CHICAGO MOTIVE TRADES INSTITUTE

Div. of Commercial Trades Inst.
1400 W. Greenleaf Ave. Dept. B210
Chicago 26, Ill.

- FREE -

Important Information
Telling How to Get Started



CUT COUPON ALONG THIS LINE

Fill Out, Cut Out, Mail Today

FACTS FREE for Men Who Want to Get Ahead

CHICAGO MOTIVE TRADES INSTITUTE, Dept. B210
1400 W. Greenleaf, Chicago 26, Ill.

Send free illustrated Brochures and other information about the field I have checked below.

Automotive Mechanics Diesel Mechanics Body and Fender
 Veteran Non Veteran

NAME _____

ADDRESS _____

CITY _____

STATE _____

SAY YOU SAW IT IN POPULAR MECHANICS

HOW to Make ART OBJECTS with RUBBER MOLDS

NEW MOLDING MANUAL 10c

NOW READY FOR FIRST TIME

Natural Rubber Latex FOR BETTER MOLDS

MOLD MAKERS: Now for the first time since the war, you can get superior natural rubber molding compound at new low prices. Natural Rubber gives you best physical properties; 70% concentration, high elasticity, freedom from permanent set, unusual elongation. Use FRANCIS Natural Rubber Red Latex to make longer-lasting molds. At our reduced prices, you can produce more and better casts per mold, at lower cost. New Illustrated Instruction Manual, showing how to mold and produce valuable novelties, gifts, accessories, mailed for only 10c (stamps or coin). Price list free. Francis Supply Company, Dept. K-2, 1836 East Fulton Street, Columbus 9, Ohio.



EASY WINDOW WASHER

Sensational new invention enables you to clean home windows like a professional. MITY-MIST uses water; no costly preparation necessary. Simply spray on window and wipe clean with blade. One-hand operation.

At all hardware, department, and specialty stores or order direct **\$1.00** post-paid

COLUMBIA INDUSTRIES

19th Ave. & 36th St. Long Island City 5, N. Y.

WOO-WEE AUTO HORN

wolf whistle



Reproduces "Wolf Whistle" better than any siren. Screeches, barks, whistles, imitates siren, moves any "road hog" off the highway in "double quick plus". Attract more attention than by driving a yellow Cadillac. Operates from manifold. Installed on any car in 15 minutes. Sturdily constructed. Cleverest novelty since the use of the auto. Be the first user in your neighborhood. Dealers wanted. Absolute money back guarantee. \$6.00 each. Order today. Ohio orders add 3% tax.

THE PROTECTUROD COMPANY - Dept 101
4033 Windsor Road - Youngstown 7, Ohio

THE GEM MAKER



Amateurs or professionals... hobbyists or jewelers... Polish your own gems with a B&I Gem Maker. You will find this a profitable adventure. All necessary lapidary equipment is furnished, including a super-charged diamond blade for sawing, and all wheels for grinding, shaping and polishing, also complete instructions. The complete equipment as shown, less motor and belt, for only \$29.50, f.o.b., Burlington, Wis. Write today for information and literature on the Gem Maker and accessories.

B&I MFG. CO., Dept. S, Burlington, Wis.



A BUSINESS OF YOUR OWN

Use simple home-made equipment. Make HOLLYWOOD STYLE cement pottery, birdbaths, benches, mantels, coffee tables, miniature castles. Also rustic garden walks, steps, stucco-rock walls, imitation marble. Chemical coloring, formulas & instructions, 10c brings pictures, sample, details.

HOLLYWOOD CEMENTCRAFT
8529 Wonderland Ave., Hollywood, Calif.

QUICK! "REPAIRING CAR BATTERIES" MONEY! At Home! Easy Too!

Write, BATTERYMAN, Dept. 5, Grand Junction, Colorado

BECOME A MANUFACTURER'S AGENT

Be your own boss and earn big profits with little or no capital investment. Send today for the VIMAR PLAN which provides you in detail with soundly-tested methods on how to become a representative for prominent manufacturers. Learn how to contact concerns, select products and build a successful business for yourself. \$2.00 postpaid.

VIMAR CO. 210 LOES ARCADE, Dept. A-13
MINNEAPOLIS 2, MINN.

CONCRETE BLOCK OPPORTUNITY

Immediate delivery on concrete block equipment.

Now's your chance. Contact

CONCRETE BLOCK EQUIPMENT, INC.

920 Central St., Dept. 419 Kansas City, Missouri

DO ANY JOB.. EASIER.. QUICKER
MAKE MORE MONEY *in the*
BIG OPPORTUNITY
FIELDS

Here's the Help You Need
For Best Paying Jobs
Right NOW!

FREE TRIAL
IN YOUR OWN HOME

Used by Army, Navy, Other Government
Depts., 200 Schools and Industrial Firms.

SEND NO MONEY
 Select the Books
YOU Need Now!
 We Ship **C.O.D.**
 Anywhere in U. S.
 and Will Refund
 Amount Paid if
 Not Satisfactory.

Do it now! Get the better pay that goes to men with specialized knowledge. Get into one of these big opportunity fields. Big money and many other advantages await you if you prepare now. Here is the help you need—**EASY—QUICK—AT LOW COST.** Thousands of men have already used these famous books. Beginners and experienced men alike have doubled and tripled their earnings with this help. You too, can now get the special knowledge you need for top pay, better jobs, or a business of your own. This is your **GOLDEN OPPORTUNITY.**

AIR CONDITIONING

Big air conditioning boom interrupted by war will be bigger than ever. It's ready to GO now! Get this non-technical book by international authority and be ready for your share of millions to be spent. Covers whole field. 450 pages. Illustrated. \$4.00.

AIRPLANE WELDING

All metal airplane building offers big peacetime opportunities. New 2nd edition of this famous book by J. B. Johnson, Materials Division, Wright Field. The authoritative and practical book on Airplane welding and materials brought right up to date. 420 pages, 193 pictures. \$3.50.

BODY & FENDER REPAIR

Owners will spend big money to keep their good older cars looking like the new ones coming out. This is a practical money-making guide, ideal for shop owners and every man who wants a share of the millions to be spent in keeping old cars looking new. Tells how to get a good job or start business of your own with small capital. 325 pages, 232 illustrations. \$3.50.

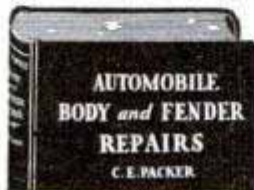

DYKE'S FAMOUS
CARBURETOR BOOK

This famous book has been the standard guide in the best paying auto work for a generation. It has helped thousands of men make money. New edition covers engine tune-up, compression, ignition, carburetion, fuel pump valves, etc. Use this book to specialize in this big field. 244 pages, 549 illustrations. \$3.50.

HOUSE WIRING
LATEST EDITION

Get this new sixth edition of this standard and practical electrical wiring book. It gives complete practical instruction on every phase of house wiring in one handy volume. Goes further than most books on subject. Hand-book style. Gives National Electric Code, 400 pages, 669 illustrations. Electrical work will reach a new high with millions of new homes to be built. Get started now. \$3.00.

15 Million Refrigerators
Need Service and
Repairs

REFRIGERATION—Book of the Hour!
Biggest Opportunity in Many Years!

NEW PRINTING—ALMOST 1000 PAGES

408 Pictures—17 Diagrams in Colors Makes All Refrigerator Service Maintenance, Repairs Simple as A. B. C.

Thousands of Refrigerators need repairs! Owners will pay big for competent service which will be needed more and more. Get **MODERN GAS AND ELECTRIC REFRIGERATION**, the non-technical guide to all types of refrigerators and get your share of this new profit. Get a job or start your own service business. This book will help you make money anywhere. Price \$5.00.

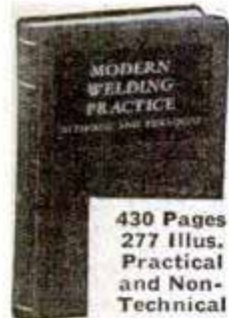

MODERN
WELDING
PRACTICE

Newest book on all types of welding and heat treatment of metals. Written by recognized specialists in training men for production jobs. Practical and Non-Technical.

430 Pages
 277 Illus.
 Practical and Non-Technical

Covers everything you need to know. Prepare for best pay jobs now. Price \$4.00.

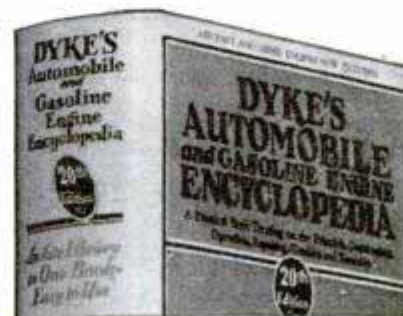

NEW
20th
 EDITION
Leading
Auto
Book
for Over
32 Years

World's GREATEST AUTO BOOK

New Material on Transmissions, Trucks, Tractors, Diesels, Aircraft and Auto Engines

Now with millions of cars needing repairs and thousands of men needed to do the work, you need the famous DYKE Auto Book more than ever before. Brand new 20th Edition covers all principles, construction, repair, adjustments, testing, troubles and remedies of all cars. Over a half million copies of 20 editions of Dyke's have been sold. Gives specifications of old and newer cars. World's biggest book value. \$7.00. This big book, a complete auto library in one volume, has 1483 pages—4600 illustrations and diagrams—weighs 6 lbs.—equal to 4 ordinary books.

ENGINEERS HANDBOOK

World famous Bailey's handbook of universal questions and answers for Stationary, Marine and DIESEL engineers and firemen. Prepares for any license examination. This is the one book that men should have if they want to reach the top in installation, maintenance and operation of Diesel and steam plants. Pocket size, \$2.00.

Goodheart-Willcox Co., Inc.
 2009 S. Michigan Ave., Dept. 18, Chicago 16, Ill.

SEND NO MONEY! Mail Coupon

GOODHEART-WILLCOX CO.,
 2009 S. Michigan Ave., Dept. 18, Chicago 16, Ill.
 Send books checked. C.O.D. I will pay postman, plus few cents charges. If not satisfactory I will return books in 5 days and you will refund money paid. (Outside U.S. or possessions remit with order.)

- Gas & Electric Refrigeration \$5.00
- Dyke's Auto Book \$7.00
- Dyke's Carburetor Book \$3.50
- Modern Welding \$4.00
- Airplane Welding \$3.50
- Sheet Metal Layout \$3.50
- Air Conditioning \$4.00
- Engineers Handbook \$2.00
- Body and Fender Repair \$3.50
- House Wiring \$3.00
- Shop Math. (2 vols.) \$3.00
- A.C. Power Wiring \$4.00
- D.C. Power Wiring \$4.00

If remittance accompanies order we will pay all postage charges under same return privilege.

Name
 Address
 City State

WAR SURPLUS OPTICAL BARGAINS

ASSEMBLE YOUR OWN BINOCULARS!

Complete Optics! Complete Metal Parts!
Save More Than 1/2 Regular Cost



GOVERNMENT'S 7X 50 BINOCULARS

Complete Optics, new and ready for assembly. We supply full instructions. Limit—1 Set of Metal Parts and 1 Set of Optics to a customer.

METAL PARTS—Set includes all Metal Parts—completely finished—for assembly of 7X 50 Binoculars. No machining required. Bodies have been factory hinged and covered. A sturdy Binocular Carrying Case is optional with each set of Metal Parts.

Stock #842-H.....\$39.40 Postpaid, plus \$4.80 for Case—Total \$44.20

OPTICS—Set includes all Lenses and Prisms you need for assembling 7X 50 Binoculars. These are in excellent condition—perfect or near-perfect—and have new low reflection coating.

Stock #5102-H.....\$25.00 Postpaid

NOTICE! If you buy both Binocular Optics and Binocular Metal Parts, add 20% Federal Excise Tax to above prices.

ARMY'S 6X 30 BINOCULARS

No Carrying Case with any Sets shown below. (None yet available in Surplus Market.) M-13A1 sets are waterproof model. M-3 sets are not waterproof. Limit—1 Set to a Customer on all Sets shown below.

COMPLETE OPTICS & METAL PARTS—Model M-13A1, 6X 30 Binoculars. Everything you need—ready for assembly. When finished will look like a regular factory job costing \$102 to \$120. The Optics are new, in perfect or near-perfect condition. Have new low reflection coating. Metal Parts are new and perfect, all completely finished. No machining required. Bodies factory hinged and covered. Complete assembly instructions included.

Stock #830-H.....\$40.00 Postpaid plus \$8.00 tax—Total—\$48.00

COMPLETE OPTICS & METAL PARTS—Model M-3, 6X 30 Binoculars. The Optics in this set are new, perfect or near-perfect. Prisms have new low reflection coating. Factory mounted Eye Piece and Objective Assemblies not coated. Metal Parts are perfect, new, ready for assembly. When finished, this will look like a regular factory job, except a name has been filed off a cover plate. No machining required. Bodies factory hinged and covered.

Stock #831-H.....\$35.00 Postpaid, plus \$7.00 Tax—Total—\$42.00

METAL PARTS ONLY—Model M-13A1, 6X 30 Binoculars. No Optics. Same Metal Parts as described for Stock #830-H.

Stock #832-H 6X 30 Metal Parts.....\$25.00 Postpaid

OPTICS FOR 6X 30 BINOCULARS (No Metal Parts). Perfect and low reflection coated.

Stock #5130-H.....\$15.00 Postpaid

SAME OPTICS AS ABOVE (6X 30), Coated—but slight seconds.

Stock #5124-H.....\$12.75 Postpaid

If you buy both the Binocular Optics and the Binocular Metal Parts, your purchase becomes subject to 20% Federal Excise Tax. Be sure to add amount covering tax to your remittance or your order cannot be filled.

Optics and Metal Parts are Available for Monoculars (1/2 a Binocular). For Complete Details, Write for Bulletin #14-H

\$15.00 BUYS A \$500.00 TELESCOPE WITH BIG 3" OBJECTIVE



3 power instrument, brand new with plastic Optics and fixed focus. 23" long. Wt. 31 lbs. Wide field of view. Stock #929-H.....\$15.00 f.o.b. Chicago, Ill. (Shipping Wt. about 70 lbs.)

35 MM. KODACHROME PROJECTING LENS SET—Consists of Achromatic Lens for projecting, plus a Condensing Lens and piece of Heat Absorbing Glass with directions. Stock #4025-H.....\$1.95 Postpaid

SATISFACTION GUARANTEED

EDMUND SALVAGE CO.,

NEVER HAS THERE BEEN SUCH A SENSATIONAL BARGAIN AS THIS!

BUBBLE SEXTANT—TYPE A-10

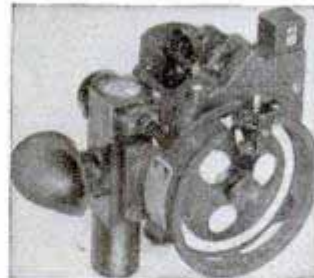

These Army Air Forces Bubble Sextants cost the Govt. about \$125.00 each. A real bargain at our price of \$12.50! Included with Bubble Sextant shipment is wooden Carrying Case, 5 spare waxed paper discs, flashlight with rheostat for night use (uses ordinary flashlight cells—not furnished) aux. 2-power Galilean Telescope, Allen wrench, 1 spare marking point. Wartime used, but where necessary completely repaired, collimated and put in good working order.

If not satisfied that Sextant is exactly as represented, return within 10 days and money will be refunded. Full directions for use accompany each shipment.

Stock #924-H.....\$12.50 Postpaid

Same SEXTANT as above, but new and with Automatic Electric Averaging Device and illuminated Averaging Disc for nighttime use. Govt. cost \$217.

Stock #933-H.....\$22.50 Postpaid

CONDENSING LENSES—Seconds, but suitable for Enlargers and Spotlights.

Stock #1061-H, 6 1/2" dia., 9" F.L.....\$2.50 Postpaid

Stock #1082-H, 4 1/2" dia., 6 1/2" F.L.....70c Postpaid

We have a Limited Quantity of Condensing Lenses—seconds—ranging from 4 1/2" to 8 1/2" in dia. with various focal lengths. Send for Free Bulletin titled "MISCELLANEOUS CONDENSING LENSES—H."

POLARIZING VARIABLE DENSITY ATTACHMENT FOR BINOCULARS



An amazingly effective unit for controlling amount of light reaching your eyes. Cuts down glare in sky and over-water observations. Easily snapped on and off over the eye cups of American-made 7X50 Binoculars. Govt. cost \$8.30 each.

Stock #20,000-H.....\$2.00 Postpaid

Above Polarizing Attachment also adaptable to Govt. 6X30 Binoculars with substitution of special Eye-cups.

Stock #20,010-H, 6X30 Eye-cups.....75c pr. Postpaid



MOUNTED PROJECTING LENS SYSTEM

F.L. 91.44 mm. (just right for 35 mm. Projectors). Speed of F 1.9. Outside dia. of mount at one end 60 mm. Length of mount 64 mm.

Stock #4033-H.....\$3.00 Postpaid

MOUNT FOR ABOVE PROJECTING LENS SYSTEM

Stock #715-H.....\$1.50 Postpaid

LENS CLEANING TISSUE—1st quality, sheet size 11" x 7 1/2". Made to Govt. specs. Won't dust. Free of abrasives and lint.

Stock #721-H, 500 sheets.....\$1.00 Postpaid

SCHMIDT OPTICAL SYSTEM. Black plastic body, size 3-15/16" by 5 1/2". F.L. 2.4" with amazing speed of F.0.9. Used in Navy's Infra-Red Sniperscope and Signalling Units. Govt. cost \$134. Limit—1 to a customer.

Stock #720-H.....\$6.00 Postpaid

AIR FORCES GUN SIGHT—With Polarizing Variable Density Attachment. (Polarizing attachment alone is worth many times the price of entire unit.)

Stock #908-H.....\$5.00 Postpaid

Same Unit Without Polarizing Attachment

Stock #916-H.....\$2.50 Postpaid

We have literally millions of war surplus lenses and prisms for sale at bargain prices. Write for Catalog "N"—Sent Free!

Order by Stock No.

P. O. Audubon, New Jersey

HERE'S YOUR FUTURE—

These McGraw-Hill Books

can mean a BETTER JOB . . . more MONEY



ELECTRONICS

1. Chute's **ELECTRONICS IN INDUSTRY**. Shows you in simplified diagrams and non-technical terms how electronics circuits and equipment are applied in all types of industry. Explains the theory of various types of electronic tubes and takes you step-by-step to a full understanding of the more complex circuits used for controlling motors, speeds, currents, temperatures, etc. Over 300 illustrations. 292 pages \$5.00

AUTO REPAIR

2. Crouse's **AUTOMOTIVE MECHANICS**. A complete, practical guide-book for automotive maintenance. Tells you how your engine operates, explains ignition circuits, power transmission principles, and construction of your automobile. It shows you how to trace every squeak or cough to its source, keep your car operating at peak efficiency, and avert costly repairs. 617 pages \$4.50

WOODCARVING

3. Tangerman's **WHITTLING AND WOODCARVING**. Clearly explains and illustrates all techniques. Goes from simple whittling through rustic, chain and fan carving, to caricatures, ship-in-bottle, chip carving and surface decoration. Takes you successfully from choice of a knife and the right piece of wood to the completed article. Hundreds of things to make—easy and intricate. 293 pages . . . \$3.75

CARPENTRY

4. Lair's **CARPENTRY FOR THE BUILDING TRADES**. Gives all the expert instruction you need on how to plan and do carpentry work for house building or remodeling—from planning and selecting materials to smoothing on the last trowel of plaster. Covers the latest FHA-approved methods for framing, roofing, floor-laying, finishing, etc. This is your key to better, quicker construction. 188 pages. \$2.50

SOLDERING

5. Taylor's **SUCCESSFUL SOLDERING**. Shows fully how to obtain the best results in all types of soldering—black iron, zinc, stainless steel, copper, aluminum, etc. Covers fundamentals of the process, materials and methods to save you hours of time, and help you turn out a stronger, better job. 76 pages \$1.00

MATHEMATICS

6. Palmer and Bibb's **PRACTICAL MATHEMATICS FOR HOME STUDY**. The essentials of arithmetic, geometry, algebra and trigonometry explained in easy-to-understand terms. Hundreds of practical problems show you how to apply mathematics to every-day situations. Covers fractions, percentages, ratio, equations, logarithms, trigonometric functions, etc. 697 pages \$4.00

MICROSCOPY

7. Corrington's **WORKING WITH THE MICROSCOPE**. The best methods for using the microscope and preparing slides for study. It tells how to fix, stain, section and mount all types of organic and inorganic material from the simplest mounts to the highly technical. 418 pages \$3.50

PLASTICS

8. Sasso's **PLASTICS HANDBOOK FOR PRODUCT ENGINEERS**. Up-to-the-minute facts on plastics and synthetic rubbers. Tells you which material is best suited for the job—how to process, machine and finish plastic parts—what faults are common to certain plastics and how to remedy them. All the latest techniques and materials are included with a thorough discussion on recent developments in synthetic rubbers. 465 pages \$6.00

AIR CONDITIONING

9. Allen, Walker and James' **HEATING AND AIR CONDITIONING**. A comprehensive treatment of heating and air conditioning systems for residences, factories, office buildings, theatres, etc. Discusses fully the theory underlying heat conservation and air conditioning engineering and covers the numerous post-war developments in this rapidly expanding field. 330 illustrations, charts and tables, 667 pages \$5.50

ELECTRICITY

10. Abbott's **NATIONAL ELECTRICAL CODE HANDBOOK**. Tells how to handle all kinds of wiring and installation jobs in strict accordance with the 1947 Code. Practical direction, simple language, and diagrams make clear the meaning of the rules and help you avoid costly errors. All rules pertaining to a job are grouped for easy reference, saving time and preventing oversight. 633 pages . . . \$4.00

SCIENCE

11. White's **PRACTICAL PHYSICS**. Here is a handbook of the laws of mechanics, heat, light, sound and electricity for the industrial and technical worker, with emphasis on practical application. 365 pages \$3.25

HOUSE REPAIRS

12. Whitman's **FIRST AID FOR THE AILING HOUSE**. A big, money-saving guide to all kinds of house repairs. Enables you to be your own repairman and to deal more economically and intelligently with mechanics. 349 pages. \$2.50

SEND NO MONEY—MAIL COUPON

McGraw-Hill Book Co., 330 W. 42d St., N.Y.C. 18

Send me the books corresponding to the numbers circled below for 10 days' examination on approval. In 10 days I will remit for the books I select to keep, plus a few cents postage, and return those I do not want to you postpaid. (Postage paid on cash orders.)

1 2 3 4 5 6 7 8 9 10 11 12

Name _____

Address _____

City and State _____

Position _____

Company _____ PM-10-47

(For Canadian prices, write McGraw-Hill Co. of Canada Ltd., 12 Richmond Street E., Toronto 1.)

SEE THESE BOOKS FREE!

Just send coupon for books you'd like to inspect. See for yourself how much they give for your money. No advance payment, no obligation. After 10 days' examination, return any unwanted books, and remit for those you decide to keep. Here's your key to a better future—Mail coupon today.

"OWN a Business" Coupon

DURACLEAN CO.
Division of HOME SERVICE CO.
160 St., Deerfield, Illinois

With no obligation to me, send booklet and letter giving full details. Tell me how I may OWN a growing business of my own built upon satisfied customers.

Name _____
Address _____
City _____ State _____



Are You The Man?

If you are dependable, honest and willing to work to own a large-profit, lifetime business and become financially independent, we invite you to mail the above coupon for full details. We are now enlarging this 17-year-old, nation-wide chain of individually-owned CERTIFIED Service businesses. We'll establish you in

YOUR OWN business and help finance you. You use successful methods of established Duraclean dealers. This is a sound, steady, lifetime business. Dealer gross profits (above materials and labor) are up to \$20 for a day's service on EACH of his service men. Easy to learn . . . quickly established.

Revive, Clean and Protect Upholstery and Rugs!

This remarkable service restores the natural fibre lubrication of wool and other animal fibers. Resiliency returns to the pile. It rises again. Brilliant colors revive. Results in many instances are almost unbelievable.

This service banishes the need of cleaning upholstery, rugs and carpeting by harsh machine scrubbing and soaking. It eliminates harmful solvents and strong soaps.

The aerated foam, created by the patented electric Foamovator, cleans by ABSORPTION—not by scrubbing. Dirt, grease and many unsightly spots vanish. Your service is recommended nationally by America's foremost furniture and department stores.

Immunizes Against Moths, Beetles, Mildew

The patent protected immunizing service not only kills moths and carpet-beetles but is WARRANTED to make fabrics non-eatable to both. The U. S. Government says, "Moths are present in practically every household . . . No section of the country seems free from such infestations." Damage to household goods and wearing apparel is greater from moths than from fire. This modern treatment DEFINITELY PROTECTS rugs, carpets, upholstery, furs, clothing, blankets, pianofelts, auto interiors, etc.

Dealer Comments:

- R. Kimbrough: "Finished First White House of Confederacy and am to Duraclean the Governor's Mansion."
- P. Wilson: "My business comes from recommendations of satisfied customers."
- O. D. Heffelbower: "People who have seen the work have expressed amazement."
- Q. Corbett (Canada): "Several hundred dollars in jobs lined up from canvassing."
- S. Edsall: "Have 5 women's clubs interested in the work."
- H. T. Satterfield: "We Duracleaned a chair for the largest department store and got an order for 60 to 75 chairs, couches and davenportes."
- E. Schalehlin: "Have on hand 5 orders totaling over \$500.00 . . . obtained from recommendations of customers."
- F. R. Jones: "Your offer is the best and most amazing I've ever had."

No Shop Needed—EASY to Learn

No overhead expense. Service may be rendered in homes, offices, hotels, theaters, institutions, etc., by your service men. Auto dealers have upholstery revived in used cars. Foamovator converts to carrying case. Some establish shops or an office—others operate from their homes.

Start Part or Full Time

No experience needed. We show you 18 ways to get customers. Almost every building in your territory houses a potential customer. There is a waiting market in small and large towns alike. These are year-around services for which there is always a constant need. Free booklet and our first letter explain everything. Just mail coupon.

EASY TERMS:

A moderate payment establishes your own business—pay balance from profits. We furnish electric machines, folders, store-cards, introduction slips, sales portfolio, demonstrators and enough materials to return your TOTAL investment. You can have your business operating in a very few days. Just mail the coupon. No obligation.

Copyright 1947 by

DURACLEAN CO., 160 St., Deerfield, Illinois

Repeat & Voluntary Orders

Demonstrations win new customers. Men in this business find REPEAT and VOLUNTARY orders become a major source of income. Customers are not merely satisfied—many are enthused at results and tell friends and neighbors.

Double Profits

You enjoy large profits on both materials and labor, after paying service-men and salesmen. At the start, you may want to render service yourself. You have national prestige and cooperation of a national organization interested in YOUR success.



FREE Booklet

Our first letter and 16 page illustrated booklet will explain everything—these modern urgently needed services, the waiting market, how business grows, your large profits, easy terms and protected territory.

Send for It—Mail Coupon



PATENTED

Mail Coupon TODAY—While Territory is Open!

**WORLD'S
BEST
WANT AD
MEDIUM**

CLASSIFIED Advertisements



Advertisements in this section 60 cents per word, each insertion, minimum 10 words, payable in advance
To be inserted under proper classification, copy must be in our office the 25th of the
second month preceding date of issue

F. W. Johnson, Manager, Classified Advertising
Popular Mechanics Magazine, 200 East Ontario Street, Chicago 11, Illinois

1507 CLASSIFIED ADVERTISEMENTS 1507 OPPORTUNITIES FOR YOU

AUTOMOBILES, MIDGET CARS

DON'T Underestimate "Water Injection." Army fighter planes conserve fuel, gain hundreds of horsepower! Easily convert any automobile, tractor, or private plane to burn water—only \$1.00 cost. Much less gas, less oil, much more power, speed, smoother, cooler engine. Includes copy-righted installation manual, diagrams, complete instructions, etc. \$1.00 postpaid. Newhouse Industries, 5941-A Hereford, Los Angeles 22, Calif.

SEE Our ad under Motorcycles for midget car bargains. Midget Motors Directory, Athens, Ohio.

WATER Injection for your car. More power, smoother performance. Wrench installs in half hour. \$14.65. Free booklet sent on request. Speed-Dee Products, 2409 South 10th Street, Tacoma 6, Washington.

HOLLYWOOD Hot-Rod manual, plans photos, instructions, fast Fords. \$1.50 p.p. Racing parts list 25c p.p. Hollywood Hot-Rod, Box 9626P, Los Feliz Sta., Hollywood 27, Calif.

BUILD Automatic clutch, scooters, midget autos, tractors, shop machines. Catalog free. Nichols Equipment Co., Dept. 311, Purvis, Miss.

KAISER-FRAZER. Floyd Clymer's new book (no connection with K-F factory) gives complete uncensored, impartial report 3000-mile test run with Kaiser. 100 photographs; describes new Pike's Peak closed car record, Kansas City-Denver record run, economy test. Opinions of 3000 K-F owners. Complete breakdown of equipment, units used. Read good and bad about K-F cars. No punches pulled. \$1.50 postpaid. Deluxe edition \$2.50. Clymer, Dept. A-101, 2125 W. Pico, Los Angeles 6, Calif.

1947 SUPERIGNITIONER. Atomic pep, starting, mileage. \$5.50. 12 improvements. 75c. EG Mfg., 355A East 149th, New York 55.

HIGH Compression heads, V-8. More speed, acceleration, power. Offenhauser or Edelbrock \$75.00 complete set. Dual manifolds complete with throttle kit, fuel lines. Edelbrock \$49.00. Offenhauser \$55.00. Give make, model V-8. Catalog 10c. Clymer Motors, Dept. A-103, 2125 W. Pico, Los Angeles 6, Calif.

PHOTOGRAPHS. World's finest automobiles. List 10c. Box 1028, Minneapolis, Minnesota.

AUTO Repair manuals, by Victor Page. Complete non-technical data all mechanical features, operation, repair. Ford V-8 cars, trucks, 823 pages, 369 illustrations, \$3.50 postpaid. Chevrolet six and truck, 896 pages, 363 illustrations, \$3.50 postpaid. Clymer, Dept. FC-1, 2125 W. Pico, Los Angeles 6, Calif.

TWIN-TONE Mufflers for V-8 and Mercurys 35 to 47 models. Gives more mileage, without back pressure. Mufflers are straight through-type and produce deep mellow tone. \$20.00 a set. Single through-type mufflers for all cars \$6.50 ea. Chrome tail pipe extension 2 1/2" dia. \$1.85 ea. Satisfaction guaranteed. Elmer's Muffler Shop, 139 East Manchester Ave., Los Angeles 3, Calif.

AUTO Racing magazine subscriptions. Pacific Speedway News, \$6.00 yearly. National Speed Sport, \$4.00. Illustrated Speedway News, \$4.00. All give complete data midget, big car race results. Sample copy each 50c. Specify publication wanted. Clymer, Dept. A-102, 2125 W. Pico, Los Angeles 6, Calif.

1947 INDIANAPOLIS '500' Race History Book. Complete details every car, driver competing. 100 photos, charts, drawings. \$1.00 postpaid. Large complete Indianapolis Race History Book, 352 pages, 1100 illustrations, all data 1909 to 1946 inclusive. Postpaid \$3.50; de luxe edition fabrikoid binding, gold lettering, \$5.00. Clymer, Dept. A-100, 2125 W. Pico, Los Angeles 6, Calif.

JEEP Station wagon body plans \$1.00. Jeep special design house trailer plans \$1.00. Jeep semi-diesel conversion plans \$1.00. Three manuals for \$2.00. Craftsman Books, Box 1153-PJ, Milwaukee 1, Wisconsin.

TACHOMETER Kits for V8's 0-5000 or 0-8000 r.p.m. \$27.00, tachometer alone \$12.00, 130 m.p.h. speedometer \$10.00. Zakarian Engineering, Box 416, East San Diego, Calif.

CLYMERTONE, Twin muffler sets, beautiful sound, complete with necessary welded pipes, E-Z installation. Ford V-8, \$20.00. Chevrolet set with split manifolds, \$37.50. Specify car model. Clymer, Dept. A-104, 2125 W. Pico, Los Angeles 6, Calif.

ATTENTION, Pistons, cast, Lynite. Std. os, semi. 1916 to 1946 cars, trucks and tractors. Also rings. Zrubek Tractor and Supply, 509-11 So. Main St., Pratt, Kansas.

CLYMER'S Historical Motor Scrapbook No. 4, latest Clymer book old cars and motorcycles. Postpaid \$1.50; de luxe edition, \$2.50. Clymer, Dept. A-108, 2125 W. Pico, Los Angeles 6, Calif.

MAKE Your Model "A" do 100 m.p.h. Lightning acceleration, breath-taking top speed. Complete details, photographs. \$1 postpaid. Four Barrel, Box L-1, Eaglerock, Los Angeles 41, Calif.

INSTALL V-8 engine in your Model A for extreme acceleration, more top speed, smoother performance. Complete details, photographs. \$1 postpaid. A-V-8, Box L-1, Eaglerock, Los Angeles 41, Calif.

BRITISH Sports cars. New book. 96 makes described. Fine illustrations, specifications. \$3.00 postpaid. Clymer, Dept. A-107, 2125 W. Pico, Los Angeles 6, Calif.

"STREAMLINED Roadster"—America's lowest priced car! Small, speedy, two passenger sportster! Amazingly easy to build from inexpensive material, small motor. Complete instructions, drawings, \$1.98. Alquist Engineering, Bx. 660, Brooklyn 1.

CLYMER-LITE Aluminum pistons for Chevrolet. More speed, power, acceleration. Less vibration, heat. Complete with pin, rings. \$5.00 each. Semi or finished. State size. Clymer, Dept. A-106, 2125 W. Pico, Los Angeles 6, Calif.

"REX May's Racer," 1/16 scale model of 1947 Indianapolis Speedway Classic, six rich colors. Heavy duty motor, long runs from 150 to 175 feet at speeds up to 15 miles per hour, then free-wheeling. Aluminum fin brake drums. Custom built rubber tires. Radiator grill design. Off-set cockpit. Flared headpiece. Steering-wheel that turns. \$3.00 postpaid. (Agents wanted.) Moore Mechanical Laboratory, Dept. #1, 1371 Elizabeth St., Pasadena, California.

CUSTOMIZE Your automobile. Over 50 photographs, up-to-minute book intelligently presents numerous restyling ideas, instructions, specific changes, etc., postpaid \$1. Post Publications, Box 723-SE, Arcadia, California.

BUILD Speedy midget track racer from castoff parts! Plans, specifications, construction information, \$1.00. Motor Supply, Box CS-1682, Toledo, Ohio.

CUSTOM-STYLING Manual. Easily make car look Hollywoodized. Custom built, ultra-beautiful! New, simplified customizing, restyling, streamlining methods. Instructions, illustrations. Plans for accessories, refinishing, mufflers, model changes—Custom, sport, continentals, "town and country," etc. \$2. Alquist Engineering, Box 660-W, Brooklyn 1.

AUTOMOBILE Racing book, fifth edition, well illustrated. Instructions on building bodies, frames, engines, Ford A and B conversions. Plans. AAA rules, specifications. Roadster racing, Indianapolis cars. \$1.00 postpaid, \$1.30 C.O.D. Ray Kuns, Dept. 47, Madisonville, Cincinnati 27, Ohio.

AUTOMOBILE Racing, Sixth Edition, 100 illustrations. Working drawings with building instructions for Ford-60 midget, California roadster, Offenhauser racer. Details on racer parts. Sample entrance blank. World's record 158.5 m.p.h. rear engine four-wheel drive car. Interesting information for fans, drivers, mechanics. \$2.00 postpaid; \$2.25 c.o.d. Ray Kuns, Department 63, Cincinnati 27, Ohio.

SPEED And Mileage Manual—Obtain greater speed, mileage, racing performance from any automobile! Includes simplified methods, speed tuning, gas saving secrets. Instructions on building economizers, speed equipment, duals, mufflers, superchargers, racing fuels, fast conversions. "hot-rods," parts lists. \$1.98. Alquist Engineering, Box 660-W, Brooklyn 1.

DUALTONE Crystalline packed mufflers. Single or twin mufflers for all cars. Duals, priced complete, V8's \$23.00, six cylinders \$33.00, eight cylinders \$36.00. Large chromed tailpipe extensions \$3.30. Small curved \$1.70. Carburetor velocity stacks \$1.30. Chromed station wagon stacks \$15.00. Fender skirts—Torpedo, streamline, teardrop, square \$19.95. Request catalogue. Dualtone Mufflers, 2636C India Street, San Diego 1, California.

USED-CAR Handbook, saves you dollars, grief. Photographs, complete comprehensive tests, dealers' tricks exposed. "Judging the Used Car," postpaid \$1. Post Publications, Box 723-TE, Arcadia, California.

MUFFLER Manual. Convert your own! Hollywood mellotone construction details; duals on Vee, straight engines; diagrams, postpaid \$1. Post Publications, Box 723-ME, Arcadia, California.

PROFESSIONAL Midget racer, motor-scooter, midget roadster, and midget motorcycle. Plans, specifications for all four contained in illustrated handbook, 25c. Big list bargain priced used motors, motorscooters, servicecycles, etc., included free! Midwest, 3839 Drummond, Toledo, Ohio.

R & R Mfg. Co., marine and auto division, Anderson, Indiana, Robert M. Roof, \$1.00 for our new 1947 speed and power equipment catalogue with price sheet—showing racing cars, midgets, speed boats with recommendations how to rebuild your motors for racing. Dual ignition racing cylinder heads for V-60-100 and Mercury Ford engines. Dual intake manifolds, racing pistons, camshafts, compound valve springs, Lynite flywheels, quick change gear boxes and numerous other supplies.

MAKE Your Ford fast! Complete details, photographs. How to construct 120 m.p.h. Hotrod. \$1 postpaid. California Bill, Box L-1, Eaglerock, Los Angeles 41, Calif.

AUTO SUPPLIES AND EQUIPMENT

GUARANTEED Winter starting ignition on two volts. Eliminate burned points. Unit \$16. Plans for making your own \$2. Give car make, model. Ignition Engineering Co., 3344-A Beard Ave., Robbinsdale, Minn.

BODY And fender repairs easy, profitable with new Hobart a.c. welder. Ranges for sheet metal to heavy frame work. Write for free catalog. Hobart Welders, Box M-1072, Troy, Ohio.

PATENTED Gasoline saving vacuum supercharger, uses gasoline motor's waste, more power, speed, smoother motor, price \$12.50, send self-addressed stamped envelope for pamphlet. McDowell Co., 2000 NE Union, Portland 12, Oregon.

PLAID Fiber seat covers, to 1933; leatherette trim; full sets \$6.95; fronts \$3.95. Cover Co., 1911-N, Lubbock, Texas.

NEED Auto parts? We have them. New and rebuilt. Prompt shipment. Write requirements. Save money. Buy direct. (See our display advertisement page 258). Factory warehouse. Mechanics Auto Parts, 3807-PM-10 North Ashland, Chicago 13.

CHROME Plated grilles for all cars. Wagner Grille Company, Route 2, Bernville, Penna.

BIG Money in auto parts, accessories, radios, guns, ammunition, home supplies. 50% discount catalog available. Main Supply, Fairfield, Illinois.

WANT To save gas? Free literature on simple carburetor part installed in one minute. Write Albert Peek, 1514 Driscoll, Houston 6, Texas.

"MOTORISTS"—If your car burns oil, lacks power, fix it in 30 minutes for \$3.50. Write Burger's Formula Service, 1734 Meldrum, Detroit 7, Mich.

CARBURETOR Repair kits, miscellaneous parts for most popular carburetors. State requirements. Carburetor Service, 600 LaPrairie Ave., Ferndale 20, Mich.

SPRAY Paint your automobile. Complete professional instructions, \$1.00, 155 Tasso, Palo Alto, California.

USED Parts; Chevrolet 1930, 1932, 1934, Plymouth 1932. H. Christian, Wilmington, Mass.

TIRES—Firestone. Retail, wholesale. C. Page, Franklinville, N. Y.

AUTO Parts for all autos and trucks. Trans., motors, differentials, fenders, carburetors. Also body parts. Security Auto and Truck Parts, 1923 BJ Grace, Chicago 13.

GRILLES For all cars. Meyers Auto Parts, 820 Dryades, New Orleans, La.

NEW And used automobile and truck parts. Lowest prices. Complete stock. Prompt reply. Babbitt Auto Parts, 2833 W. Chicago Ave., Chicago 22.

HAVING Car trouble? New, used, guaranteed auto, truck parts save money. Transmission specialists. Describe needs; immediate reply. Victory, 2930½ North-western, Chicago 18.

PLATING Outfits for auto parts. Connect to a battery. No tanks used. Free particulars and proofs. Gunmetal Co., Ave. J, Decatur, Ill.

BURN Water in your car. Costs less than gas. More power, cleaner motor. Mail card for data on \$17.50 octa-gane water injecting carburetor. Ralph A. Shade, 563 Lake Road, Webster, N. Y.

AUTO TRAILERS

COMPLETE Foundation for your trailer home. Chassis frames, Tor-Q-Les axle, spring and wheel assemblies, hitches, tires and tubes. Order a complete unit or specify items desired. Literature on request. General Trailer Company, 412 South Barstow Street, Eau Claire, Wisconsin.

HOUSE Trailer expertly prepared. Easily read plans, every part illustrated, numbered, parts list, instructions, 32 sheets, \$2.00. Huron Engineering, Box 114 Monroe Blvd. Station, Dearborn, Michigan.

BUILD Your own trailer! Save money! Have every feature you want! Plans for house, sport, camp and utility trailers. Catalog describing 9 models 10c. 15c in Canada and overseas. Jim Dandy, Box 125-A, Wausau, Wisconsin.

HOUSE-TRAILER. Complete housekeeping facilities built into this beautiful trailer. Size 7½x17 by 6 ft. 4" inside measurements. Sleeps 4 comfortably. All steel chassis. Our plans make it easy to build. Complete plans \$1.50. Popular Mechanics Press, 200 East Ontario St., Chicago 11, Ill.

STREAMLINER 17 Ft. trailer. Plans, manual, parts list \$1.00. Circulars 10c. Craftsman Books, Box 1153-P3, Milwaukee 1, Wisconsin.

ATTENTION Trailer builders: Complete chassis assembly including box type steel frame, axles, springs, wheels and tires. Ready to roll. Wausau Trailer Company, Box 351, Wausau, Wis.

MOTORCYCLES, BICYCLES, MOTOR-SCOOTERS AND SUPPLIES

MIDGET Racer with three speed transmission \$35; Briggs motorscooter \$25; three wheeled motorscooter \$45; English motorcycle \$100; gasoline motors \$5 up; outboards \$25 up; plenty brand new 2 horsepower motors in factory crates; plenty midget racers for highway use; over 6200 small balloon tires for motorscooters and small cars. (Mail order only). Send 25c for Big War-Bargain catalogue Number Twenty-One, just out, listing the above and hundreds of other bargains in new and used motorscooters, motorcycles, midget cars, motors, transmissions, automatic clutches, parts, plans, etc. (35c by first class mail). Midget Motors Directory, Athens, Ohio.

MOTORCYCLE Parts for all English and American makes, tires, batteries, pistons, valves, bearings and carburetors. Catalog on request. Nicholson Brothers, Saskatoon, Canada.

MOTORCYCLE Parts, new and used. Harley, Indian, Henderson, Super-X. List 10c. Ballak, 811 N. 9th, St. Louis 1, Mo.

BICYCLE Supplies—wholesale, retail. Metal disc wheels. List 10c. Universal, 4713 Virginia, St. Louis, Missouri.

MOTORCYCLE News—monthly. Yearly subscription \$1.00. Introductory copy 10c. Motorcycle News, 5424-A Sawyer, Chicago 25.

NEW British motorcycles, unequalled for design, performance and operating economy. Immediate deliveries available. Catalog on request. Nicholson Brothers, Saskatoon, Canada.

NOW "Water Injection" for your motorcycle! Easily convert any motorscooter, motorcycle, automobile, or private airplane to burn water (like army warplanes). Greatly increases horsepower, getaway, speed; saves gasoline; cleaner, cooler, smoother engine! Copyrighted quick-installation manual, diagrams, operating instructions, etc.; only \$1.00 postpaid. Newhouse Industries, 5941 Hereford Street, Los Angeles 22, California.

MOTOR Scooters, bicycle engines. 120 miles gallon. Dime for catalog. Clymer, Dept. A-105, 2125 W. Pico, Los Angeles 6, Calif.

TIRES, Tubes, wheels, highest quality, 8" to 18" diameter, for power scooters, farm equipment, wheelbarrows, carts, etc. Special offer short time only, size 10x3.50, 2-ply casing, inner tube, wheel, mounted complete, \$6.90 f.o.b. Akron, check or money order. Write for circular. Jahant Company, 626 East Exchange Street, Akron 6, Ohio.

BEAUTIFUL Bicycles, all sizes. Send dime for list. Wholesale. Retail. Century Cycle, 3447 Lawrence, Chicago 25, Illinois.

BICYCLES, Tricycles for export. Atlas Cycle Co., 3002 Broadway, Chicago 14, Ill.

HARLEY-DAVIDSON Parts, accessories, batteries, and tires. 24 hour service. Authorized factory dealer. Philadelphia Harley-Davidson Company, 857 North Broad Street, Philadelphia 23, Penna.

CUSHMAN Motorscooter \$15, Shaw bicycle motor \$15, Harley-Davidson motorcycle, \$35! Send 25c for bargain catalog #8 packed with money saving buys in motorscooters, motorbikes, midget cars, motors, wheels, tires and parts. Gail and Company, 538 Erie, Toledo, Ohio.

WHEELS! Build wagons, scooters, mowers, trailers, wheelbarrows, grocery carts, baby carts, play pens, baby carriages. 4" to 16". Free list. Trulsen Mfg. Co., 811 E. 31, Kansas City, Mo.

BICYCLE Book, how to buy, rebuild, sell used bicycles 50c. John Collett, Handley, Texas.

TIRES And industrial wheels, suitable for scooters, wheelbarrows, farm equipment, etc. All sizes. Bicycles and accessories. Largest assortment in America. Send dime for list. Cycle Transport Company, 1241 So. Michigan Ave., Chicago 5, Illinois.

BUILD America's lowest priced motorscooter speedster! Complete plans, specifications, \$1.00. Big list bargain priced used motors, etc., included free! Motor Supply, Box 1682-CS, Toledo, Ohio.

LARGE Stock Indian parts. Expert motor rebuilding. New and rebuilt Chief motorcycle, motors only. Indian Motorcycle Sales, Kansas City 1, Mo.

HARLEY-DAVIDSON—New and used 45" motors, service, parts, accessories, tires. Send \$2.25 for army motorcycle manual, 10c for bulletins, Knuth's (Harley-Davidson factory dealer), 2491 Fondulac, Milwaukee, Wis.

CUSHMAN Motorscooter \$20 (includes motor and extra tires), Midget racer \$15! Send 25c for big catalog #938 listing these and scores of other sensational bargains in motors, wheels, motorscooters, motorbikes, servicycles, tires, etc. Associated, Box CS-1764, Toledo, Ohio.

MOTORIZE Your bike. Easy, economical, proven method. No cutting or welding of frame. Plans, instructions, photos and diagrams all for \$1. Dunakin Shops, 819 Golf Lane, Wheaton, Ill.

AVIATION

AAF Bubble sextants (octant), for marine or aircraft navigation. Good condition, with case, etc. Approximately 5% of original cost! Fairchild A10, \$17.50; Fairchild A10A, \$22.50; Link A12, \$17.50; B&L A8A, \$32.50. Cash, check, money order. Aero Parts Supply, Municipal Airport, Houston, Texas.

B-29 COMPUTERS, 400 Cycle dynamometers, 60VDC amplidyne and servo amplifiers, turret drives, bomb releases, starter solenoids, collector rings, etc. List. Erec, 2912 Hewitt, Everett 1, Washington.

PROPELLERS—Especially designed 3 blade, 2 blade, for ice-snow sleds, boats. Literature. Standard Aircraft, Box 387, Ft. Worth, Texas.

PROPELLERS For ice-snow sleds, air boats, catalog 10c. Banks Propellers, R.F.D. 12, Ft. Worth, Texas.

SKI-TOWS Portable, auto-powered, 500 ft. long. Pulls you both ways. Up, level or downhill. Set up in 20 minutes. Only \$125. Send card for particulars. Great-Northern Mart, North Adams, Mass.

VETERANS: Flight training under the G. I. Bill. Tuition paid. Private, commercial, flight instruction, instrument and multi-engine ratings. Opportunities to work for living expenses or tuition, if not a veteran. Write Gottschalk School of Aeronautics, Adrian, Mich.

4' 6" PUSHER Propellers, Three blade pusher propeller. Finest birch laminated construction, brass tipping. 50 to 85 h.p. for boats, sleds, etc. \$75.00. Same type as used on the famous CallAir SnowCar. CallAir, Afton, Wyoming.

GIANT Glider kites. Double. 14x10 ft. Lifts 100 lbs., tows car, etc. Cost government \$108. Yours for \$20. Satisfaction guaranteed. Great Northern Mart, North Adams, Mass.

BATTERIES, GENERATORS

EDISON Non-acid lifetime storage batteries for home lighting, motors, radios, etc. Free complete interesting literature. T. Hawley Smith Company, Croton Falls, N. Y.

ELECTRICAL SUPPLIES, EQUIPMENT

FLUORESCENT Lights: Make your own, ideal for home and shop. Complete electrical parts for 20-watt fixture with detailed instructions. Postpaid only \$2.00. Write Fluorokit, 332 E. Reservoir, Milwaukee, Wis.

SAVE On haircuts—guaranteed electric clippers \$9.75. Free circular. Kerr, 2461-PM North Clark, Chicago-14.

MICRO Switches! All new! Type Z. \$2.00 value. Special \$1 or 12 for \$10; large micro switch, catalog No. WZ-TRQ9TN, \$4.00 value. Now \$1.50; GE midget precision micro switches, \$1.25 value, 50c each. Combination assortment, variety of 6 micro switches—only \$5. Real buy! "Amazing Bachman's," 23 Herman Street, Rochester 5, New York.

LAMPS—All parts to build or repair. Harps, sockets, vase caps, bases, hard to get items. Illustrated catalog 10c. Gyro Lamps, 5416 Clark, Chicago 40.

MAGNET "Alnico" 4 oz. horseshoe, powerful (lifts about 5 lbs.) \$1.00. 8 oz., (lifts 10 lbs.) \$1.50. 3 lbs. (lifts 20 lbs.) \$6.00 postpaid. Ross, C68 West Broadway, New York, N. Y.

BUILD Your own or electrify old clocks for fun and profit. Genuine, self-starting Synchron movement complete with hands. \$4.95 prepaid. Scott Industries, 306 E. McMillan, Cincinnati 19, Ohio.

SOLENOID Assembly. All new! Contains over 1 pound magnet wire. Over \$30 value. Special \$1.50 each. Four for \$5 No c.o.d. "Amazing Bachman's," 23 Herman Street, Rochester 5, N. Y.

LAMPS—Build your own, all parts furnished at wholesale prices. Write for free photos. Brown Lamp Company, Box 501, Wellston, St. Louis 12, Mo.

NEW Surplus wire and cable. 200 sizes and types. Armored, Tlrex, lead. Free list. Eresco, 2912 Hewitt, Everett 1, Washington.

GUN Charger assembly—All new! Contains 27 volt d.c. motor geared for 120 r.p.m. Miniature brass precision-built clutch assembly, 2, type Z, micro switches. Solenoid assembly that contains over 1 pound magnet wire. Many valuable parts. Original cost to government over \$150.00. Now! \$9.95 each. Three for \$25. Real buy! No c.o.d. "Amazing Bachman's," 23 Herman Street, Rochester 5, N. Y.

FLUORESCENT Parts kits and instructions for making your own lights for home and workshop. Double 20 watt \$3.50, double 40 watt hipower factor \$6.50, postpaid. Other kits available. Anderson Engineering, Box 1031D, St. Paul, Minn.

GENERATOR Flashlight. No batteries! Make your own from simple household materials. Easily made; no machining. Complete instructions, 50c coin. Guaranteed. Reiss, 3017-B Ocean Parkway, Brooklyn 24, N.Y.

ELECTRIC Motors 1/30 h.p. a.c. 60 cycle 115 v. 1550 r.p.m. \$9.95 each. 1/4 h.p. motors \$24.50 each. Jeannette Electric, 159 West 23rd Street, New York 11, N. Y.

WANTED Ex. G.I. electricians to start motor repair shops. Write Electrical Engineering Consultation Service, 3013 East 6th St., Long Beach 4, California.

FREE Catalog of welders, welding supplies, generators, fencers, and other electrical items. Write LeJay Company, Minneapolis 8, Minn.

MANUFACTURE High grade electrical appliances. We supply parts and instructions. Write Southern Electric, 97A, Radford, Virginia.

MAGNET Wire—1/2 lb. coils No. 22. All new! Special! 10 rolls for \$3. No c.o.d. "Amazing Bachman's," 23 Herman Street, Rochester 5, New York.

GATOR Grip all purpose clamp on lamps. Ideal for garages, the photographer's dream. Spot or flood. Clamp anywhere. Heavy duty \$4.95, light duty \$4.75, for sun lamps \$3.75. 1/2 down, balance c.o.d. Wil's Mailorder House, Greenwood Lake, N. Y.

MOTORS, Blowers, Exhaust fans, Oil burners, oil furnaces, gas burners, gas furnaces, Circulating heaters, Automatic water heaters, Pumps, "Superior's," 120 Elnido, Monrovia, Calif.

MAGNET Wire—1 1/2 lbs., #20, \$1.00. John Weeks, 527 Worden, Grand Rapids 7, Mich.

ELECTRIC Motors!—5,000 revolutions per minute. Easy put together, guaranteed to work! Complete kit with all necessary parts for building two complete motors only \$1.00. American Stamp Company, Wilmington-P, Delaware.

ALUMINUM Fan blades, correctly balanced, 1/2" bore \$2.25 each. All welded 18" guard \$2.50. Ted Riseman, 207 North Fifth, Springfield, Illinois.

TATTOOING Machines, outfits. Free catalogue. Jensen, 120 West 83rd Street, Los Angeles 3.

ELECTRIC Pencil—Writes, engraves all metals. Battery model \$1.00—110 volt model \$3.00. Complete. C.O.D.'s accepted. Reb Industries, Dept. 265-CC, Elmhurst, Illinois.

LAMP Sockets, brass shell. Also Mogul sockets. Three way switches, cord sets, electrical repair parts, lamp parts, wires, etc. Catalog 10c. The Gearon Company, 6405 North Oakley, Chicago.

BUILD Your own lamps. Save half. Be different. Write for free photos, also lamp parts. Buddy Products Mfg. Co., Dept. 30, 1123 W. Belmont, Chicago, Ill.

ELECTRIC Pencil: Writes, engraves all metals. \$1.00 postpaid. Beyer Mfg., 229-H Dixon Blvd., Uniontown, Penna.

WELDING, SOLDERING, PLATING

NEW Aircraft generators—War surplus. Only \$49.50. Original cost \$250.00. Can be converted for use as welder, electric plater, fast battery charger, auxiliary power unit, etc. Model R. 2, volts 25 to 30, 300 amp. d.c., shipping weight 68 lbs. Size 16"x7". Air cooled. Immediate shipment. Original crates. Check with order to save time. Greer, 460 South State Street, Dept. 1007, Chicago 5, Illinois.

BUILD Heavy duty industrial transformer type welder. Primary, secondary separate. Operates 110 or 220 volts. Alternating current. Complete detailed plans \$1.00. Atomic Welder, 1038 So. 19th St., Omaha, Nebr.

NEW Model electric welder 110 volt a.c.-d.c.; will weld all metals; easy to use; full directions. Complete with power unit, flame and metallic arc attachments, carbons, fluxes, rods, mask; all for \$19.95. Used by the navy. Magic Welder Mfg. Co., 239 MP10 Canal St., New York City.

"BUILD-UR-OWN" Portable arc welder. Save \$300. Easy with Hobart generator plus auto engine. Write for free book. Hobart Welders, Box M-1073, Troy, Ohio.

FAMOUS ABC welding compound. Weld near glass, rubber, cloth. No break or burn. Stop buckle when cutting metal. Limit spoil area on paint and chrome. Save time buffing, grinding and ledging. Full instructions. Price \$3.00 box. Sunset Laboratories, Box 625, National City, California.

A.C. Welders, 110v. Welds 1/2" steel, \$29. Guaranteed. Free information. Morris Welding Service, 1850A State St., Schenectady 4, N. Y.

WELDERS: New 200 ampere aircraft generators \$25.00. Blackhawk Distributors, Box 89, Olathe, Kansas.

30 AMP. Selenium plating rectifiers with Powerstat control, \$85.00. Lead lined tanks, geared motors for agitation. Complete line of bronzed baby shoe mounts. Hollywood Bronze Supply, 1770 N. Vermont, Hollywood 27, Calif.

FREE Samples sensational electrode. Specify diameter. For any make 110, 220 volt welder. Plymouth Equipment, 3920 East 155th, Cleveland 20, Ohio.

A.C. Welders, torches, helmets. Bargains. Free literature. Holger's Service, Canton, Kans.

JOHNSON Jiffy-Kit, portable welding and cutting outfit complete with cylinders and carrying case designed especially for hobby shops, small repair shops, refrigeration and electrical service men. You own the cylinders! No rental charges! Free literature! A-A Welding Supply Co., E-9228 S. Ada St., Chicago 20, Illinois.

ACETYLENE Welding outfits, new, consisting of 2 gauge regulators, torch, 3 tips, hose, connections, clamps, lighter, \$54.50. Eagle Welding, Dept. PM, 5085 Broadway, Chicago 40, Illinois.

OXY-ACETYLENE Welding outfit including: Full oxygen and acetylene cylinders, \$72.95 complete, f.o.b. Cleveland, Ohio. New, supply limited. Check or deposit with order, balance c.o.d. Cylinders can be refilled anywhere. Ideal for hobbyists, garages, repair shops, etc., includes supply of rod. The Burdett Oxy-Weld Equip. Co., 3399 Lakeside Avenue, Cleveland 14, Ohio.

WELDING, Cutting, aircraft welding and soldering equipment. Electric arc welders. Superior Oxy-Acetylene Co., Hamilton, Ohio.

MACHINERY, TOOLS AND SUPPLIES

NEW Band saw for home workshop or factory use, ideal for hobbyists. Special \$14.95. Circular free Woodcraft Tools, 147 E. Lake, Minneapolis, Minn.

MACHINE Tool castings for woodworking and metalworking tools. Machine them yourself, save up to 80%. Catalog describing 23 Lewis tools and projects sent for 10c. Lewis Machine Tool Co., 3217 Union Pacific Avenue, Dept. M, Los Angeles 23, California.

WELDERS, Electric arc. Models and sizes for all requirements. D.c., a.c. 150-600 amp. Portable, stationary. Prompt delivery. Reasonable terms. Write for free catalog. Hobart Welders, Box M-1074, Troy, Ohio.

(24) 10c HACK Saw blades, \$1.03. Trading Post, 109 Atlantic, Stamford, Conn.

SOCKET-SCREW Key handles (Aluminum). Free trial. Wittle Manufacturing, 1041 Litz Avenue, Lancaster, Penna.

MECHANICS, Machinists, hobbyists, note! Amazing dual-drive assembly, geared 7 to 1 reduction, is driven by powerful 1/5 h.p. a.c. or d.c. motor. Operates on 6, 27 or 110 volts with transformer. Simple standard attachments convert this amazing unit into a dual-hand or table-drill, polisher, buffer, router, sander, countless other uses. May be used as individual drill, sander, etc., by detaching flexible drive shaft. This wonder machine shop all in one comes set-up as drill equipped with 3 flexible drive cables and mounting bracket. Original cost to government over \$300.00. Now! While they last, \$19.50. No c.o.d. "Amazing Bachman's," 23 Herman Street, Rochester 5, New York.

MAKE Easy money with our drain tile machines. Bird bath, flower pot and other miscellaneous molds. Concrete Machinery Company, Hickory 22, N. C.

MACHINE Tools for wood and metal. We specialize in small machinery. Tell us your needs, we will quote. Kandler, Kalamazoo 12, Michigan.

DECIMAL Equivalents, tap drill sizes, and temperature color charts for wall or tool chest lid. 50c each or all three \$1.00. Northcott, Box 486, Hays, Kans.

FLEXIBLE Drive cables. All new! Three sizes. 10", 25", 72". Adaptable for many uses. Over \$5.00 value. Combination offer of all 3 sizes, while they last \$1.75. No c.o.d. "Amazing Bachman's," 23 Herman Street, Rochester 5, New York.

BANDSAWS (Narrow) repaired, welded, set, filed. Lowest prices, prompt service. John F. Cushman, 106 No. Frankfort St., Frankfort, New York.

ELECTRIC Sander low as \$7.65. Circular. Handy Tools, 255PM Charles, Grand Rapids 6, Michigan.

LONG'S Index head for the lathe, milling-machine, drill-press, etc. Write for folders. Satisfaction guaranteed. Long's Index Head, Box 537, Torrington, Wyoming.

WORK Wanted for hand turret lathes. Glenbern Machine Co., Youngwood, Penna.

DRILL Grinder for twist drills \$2.95. See ad on page 266.

LATHE Milling attachments, drawings, 25c. Catalog of tool castings. Model Tool Service, Rock Falls, Ill.

WOOD Screw bargain—War surplus 2 1/4"x#8 round head steel wood screws, (#8 is about 3/32") 5 gross for \$1.00. These screws cost Uncle Sam 70 cents a gross. Send coin, check, stamps, money order or c.o.d. Money back if you are not satisfied. Conversion Parts Co., 278 Adams Street, Boston 22, Mass.

HI-SPEED Drills, 25 for \$2.00. A carefully selected assortment of number and fractional sizes. Free decimal chart with all orders. Lampke Surplus Tools, 11607 Linwood, Detroit 6, Mich.

METAL Shaper attachment for lathes. Free circular. Corona Tool Co., Dept. M, 107-15 51st Avenue, Corona, N. Y.

MACHINISTS, Hobbyists, experimentalists, note! Precision built right angle drives. Excellent for home workshop. Complete with flexible drive cable. Only \$3.50. No c.o.d. "Amazing Bachman's," 23 Herman Street, Rochester 5, New York.

WE Offer 60 tons of new war surplus bolts, nuts, washers, screws, etc. All popular sizes. A good mixture for hobby shops, garages, machine shops and farms. A big 40 lb. box for only \$6.85. War Surplus Co., Morris and John Sts., New Brunswick, N. J.

GEAR Reductions! Values ranging from \$500 to \$1100 each. All new! Complete with 1/2 h.p. motor a.c. or d.c. 110 volt. 25 or 60 cy. Single phase. Variable speeds. Bearing assembly with machined gears. Absolutely the thing for sanders, polishers, winches, hoist conveyors. Adaptable for many uses. Special \$39.50. No c.o.d. "Amazing Bachman's," Dept. AU, 23 Herman Street, Rochester 5, N. Y.

SHEBEL Saw Filer files all saws. Circular. A. P. Shebel, 730B So. 2nd St., Milwaukee 4, Wis.

12" BAND Saw, tilting table, Oilite bearings, all grey iron castings, \$35.00. Backus Machine Co., Boyd, Wisc. Write for circular.

ALUMINUM Compressor tanks. All new! Welded throughout. 3 1/2 gallon: just the thing for portable units; at fraction of original cost. Now! \$6 each. 10 gallon size: suitable for storage or marine uses. special only \$7.50. No c.o.d. "Amazing Bachman's," 23 Herman Street, Rochester 5, N. Y.

ANYONE Can sharpen saws with a Teeho-Tool, 25c. Free details. Teeho, 316 North 2, Maywood, Illinois.

BUSHINGS—Spacers. All new! Made of aluminum and steel. 25-variety assortment 5 pounds for \$5. No c.o.d. "Amazing Bachman's," 23 Herman Street, Rochester 5, N. Y.

NEW 12" Bandsaw; anti-friction bearings; tilting table; Write for circular. Sterling, 2310 W. Warren, Detroit 8, Mich.

BUILD Quickchange gear box without castings for \$10.00 Craftsman, Atlas, adaptable other lathes. Complete drawings \$3.75. Stevens, 2604 Military, Los Angeles 34.

BALL Bearings one-fourth list price; gears, switches, rheostats. Free list. Burgess, Box 168, Ferguson, Mo.

V-BLOCKS At low prices. 10 sizes for all purposes. Free literature. Miles Products, 2532 Wabash, Chicago 16.

BOLT And screw assortment. All new! Guaranteed over 50 varieties. Special! Minimum order. 5 pounds for \$4.95. 10 pounds for \$8.95. No c.o.d. "Amazing Bachman's," 23 Herman Street, Rochester 5, N. Y.

HARDWARE, Tools, drills, taps, dies, reamers, belts, pulleys, pattern, model supplies, saw mandrels, jeweler saws, electrical equipment, brass, steel, drill rod. Catalog 10c. Terek, 6304 Patterson, Chicago 34.

SAFETY Goggles. For your workshop, machine shop, etc. \$2.00 to \$3.00 values. Special! Assortment of 3 for \$2. No c.o.d. "Amazing Bachman's," 23 Herman Street, Rochester 5, N. Y.

HOME Shop owners attention.—Send for actual photograph and sample of the work our attachments will do. The photograph and sample speak for themselves. Have fun in your home shop. Cut gears, sprockets, ratchets, lay out holes accurately, cut keyways, build complete clocks and other interesting jobs. Build these attachments yourself from our reasonably priced blue prints. Don't limit your lathe to round work only. The Home Shop, 415 Raymond Avenue, Glendale 1, California.

DRILL Grinder—Grinds drills to factory accuracy. Calipers with direct reading scales. Circle cutters. New Tool grinder. Lowest prices. Free literature. Factory, 811-B East 31st, Kansas City 3, Mo.

RIVETS. All new! Made of aluminum, copper, steel. Guaranteed assortment of over 50 varieties. Special. 5 pound assortment \$3.50. 10 pound \$5.95. No c.o.d. "Amazing Bachman's," 23 Herman Street, Rochester 5, N. Y.

ENGINES, MOTORS, DYNAMOS

GAS Drive arc welders. "Build Your Own." Portable, goes everywhere after profitable jobs. Save \$300 with Hobart generator plus auto engine. Write for free instruction book. Hobart Welders, Box M-1075, Troy, Ohio.

A.C. Rebuilt motors. 1/2 h.p., \$14.50. Other sizes; prompt shipment. Emsco, 85 Reynolds, Rochester 8, New York.

MOTORS! 1/2 HP—DC converted to AC. All new. High speed 110 volt, 25 or 60 cycle, ball-bearing motors with forward and reverse switches. Actual cost about \$100.00. Now \$19.50, three for \$50. Or same motor without reverse switch \$15. Three for \$40. Countless uses for home mechanics. Order today! No C.O.D. orders. "Amazing Bachman's," 23 Herman Street, Rochester 5, N. Y.

WELDING Generator. 150 ampere. \$47.50. Other bargains. Butler, 1885 Milwaukee, Chicago.

SELSYNS—All new! Transformers, GE Model 2J1G1, 57.5-57.5V 400 cy.; generators, GE Model 2J1F1, 115-57.5V 400 cy. With gears. Sensational offer! \$1.50 each. Quantity lots \$15 dozen. Order now! No c.o.d. "Amazing Bachman's," 23 Herman Street, Rochester 5, N. Y.

DYNAMOTORS. All new! 400-cycle, GE5D21N3A, 27 v.d.c. to 110 v.a.c. 485 watts. Sensational offer! \$8.95 each. Three for \$25. Order today! No c.o.d. "Amazing Bachman's," 23 Herman Street, Rochester 5, N. Y.

WINDING Data, listing 225 motors, single and three phase, \$1.00. Motor Data Co., Box 7631, Kansas City 3, Mo.

SUPERCHARGERS—Aircraft. All new! Contains carburetors, many valuable gears, parts. Can be used as cooling unit with aircraft motors. Original cost over \$5,000.00. Now! \$50 each. No c.o.d. "Amazing Bachman's," 23 Herman Street, Rochester 5, N. Y.

RANGER Engine-Aircraft—All new in original case. 570 h.p., 12 cyl. V type. Engine Spec. No. 177. Complete with spark plugs. Original government cost over \$12,000.00 each. Special offer \$200. Crated weight 1200 lbs. No c.o.d. Write for complete description. "Amazing Bachman's," 23 Herman Street, Rochester 5, N. Y.

AMPLIDYNE Motor - generators. All packed—new! GE5AM 31N/9A. Output 60 v.d.c. input 27 v.d.c. 530 watts. Original cost \$120.00. Now! \$7.95 each. Three for \$20. Order today! No c.o.d. "Amazing Bachman's," 23 Herman Street, Rochester 5, N. Y.

BOATS, OUTBOARD MOTORS, ETC.

MOULDED Hull kits ready to assemble; plywood building kits \$35.00 up; marine type sheet plywood. Send \$1.00 for literature plus Wm. Deed's book—"Plywood Boats." Marine Mart, Buffalo 7, N. Y.

DUCK And rowboats, kayaks. Weld-wound ready cut kits. Booklet, E. J. Croot Co., 103-D, Basking Ridge, N. J.

MARINE Clearance lights. All new! Gov't surplus. Made for use on landing craft. Operates on all currents. Original value over \$10.00 each. Special! Minimum order 3 for \$5. No c.o.d. "Amazing Bachman's," 23 Herman Street, Rochester 5, N. Y.

TWENTY Plywood boat plans \$1.00. 6 to 20 feet, sail, power. The Rudder, 15 Murray Street, New York.

MARINE Catalogue 15,000 deliverable items, pictures and prices. Send \$1.00. Marine Mart, Buffalo 7, N. Y.

ANK-ROD Anchor your boat from the bow without leaving cockpit. \$3.00 postpaid. Progressive Ads Studio, 3679 Baldwin, Detroit 14, Michigan.

CATALOGUE—Over 30 world's best plywood designs sent with Wm. Deed's book, "Plywood Boats." Send \$1.00. Marine Mart, Buffalo 7, N. Y.

35 SEA SHELL Pre-fabricated 8' plywood rowboat. Free illustrated folder. Hagerty, Cohasset, Massachusetts.

AIRPLANE Jettison tanks—Streamlined. 10 1/2 foot, tear drop shaped, 165 gallon. Of light weight lead coated steel, weighs 75 pounds. Floats over 1200 pounds. Ideal for making trim, inexpensive boats, canoes, kayaks, dinghys, duck boats, powered catamarans and runabouts. Prices \$12.50 complete. \$9.75 each for three or more. U. S. freight prepaid. General Sales, 205 Market, Grand Rapids 3, Michigan.

NEPTUNE Outboard motor parts, complete stock. Limited supply new motors, 1 1/2 to 9 1/2 h.p. Citizens Supply Co., P.O. Box 1241 M, Muncie, Indiana.

MARINE Power—Easily convert any Jeep or Ford motor (domestic or foreign) with Convo parts and kits. Complete catalog 25c (coin). Osco Motors Corporation, 2020B East Orleans Street, Philadelphia 34, Penna.

P-38 BELLY Tanks, new, steel, 10 ft. 2 in. 165 gallon \$9.95. Anzio Boat Co., Box 89, Merced, California.

OUTBOARD Motor parts, new and used, for all makes. New pistons, standard and oversize. Cylinders rebored. Outboard Motor Mart, Inc., 309 Atlantic Ave., Boston 10, Mass.

NEW, Used, rebuilt marine motors. Marine conversions, fittings. Free catalog. Stokes Marine Supply, Dept. 24, Coldwater, Michigan.

ALL Copper water jacketed exhaust manifolds for marine conversions of automobile and aviation engines and marine engine replacements; any make, model or age. Joseph Van Blerck & Son, 391 Woodcleft Ave., Freeport, N. Y.

MARINE Conversions for Ford and Jeep engines. Catalog 10c. Lehman Manufacturing Company, Department D, Newark 2, New Jersey.

BOATS And all about them. How to select, build, repair and operate. For 40 years the leading practical boating magazine. Half price trial subscription. 12 issues for \$1.00. Motor Boat, 62 Gold Street, New York 7.

BOAT Designers are highly paid professionals. Complete course by mail. Catalog. Westlawn, Montville, N. J.

ATHLETIC EQUIPMENT, BODY BUILDING COURSES

MUSCLE-BUILDING Equipment. Free big pictured list. Milo barbells, grippers, cables, ropes, also York barbell equipment, etc. Nat Berent, 1090 W. 43rd, Norfolk 8, Va.

HEALTH—Build perfectly developed body. Enjoy youth, power, success—fast and easy. World's greatest system. Literature free. Todd Foundation, 210 Fifth Avenue, New York 10.

DEADLY Judo—Fiercest fighting technique. Trick knockouts. (200 photographs—plus illustrations). Expert instructions. Three volumes. Complete \$2.25. Variety House, Box 46-BW, Wall Station, New York 5.

SECRETS Of guerilla self-defense. Free particulars. Inspiration, 3108 Hillside, Harrisburg, Penna.

HAND Balancing—Tumbling, self-taught. Write. Power, 923a W. Vine, Kalamazoo, Michigan.

TRAINING Bags, to develop punch and body speed. List 10c. Andre's Gym, 3466 Mt. Elliott, Detroit 7, Michigan.

BARBELLS \$11.00 up. Stamp for folders. Jackson International Barbells, Springfield, N. J.

BARBELLS, Exercise equipment. Courses. Free booklet. Good Barbell Co., Reading, Penna.

SPORTING GOODS, GUNS, FISHING TACKLE, ARCHERY, TRAPPING

AUTOMATIC Lure—Positively weedless. Greatest invention in ages. Nothing like it. Circular free. Babcock Reel Co., Oak Harbor, Ohio.

CARTRIDGES, Firearms, ammunition complete list 25c. Frank Farish, Vicksburg, Mississippi.

TEAM Uniforms, equipment, trophies, awards. Craig Dare Company, 670 East 42, Brooklyn 3, N. Y.

FISHERMAN'S Cast aluminum multiple cavity sinker molds. Hinged and handled. Dealers wanted. E. L. Sweet & Son, Tonawanda, N. Y.

PLY Tying materials and tools. Professional grade only. We have imported hooks. Materials catalog 6c. Sierra Tackle Co., 4083 Mission Road, Los Angeles 32, Calif.

5000 BARGAINS, Firearms, binoculars, war relics. Catalog 40c. Smith Firearms, Runnemed, New Jersey.

BOWS—Arrows. Write headquarters for archery equipment. Quality products. Popular prices. Catalog 10c. Large illustrated hand book instructions, making and shooting, 50c. Archery, 617-B So. State, Chicago 5.

AMMUNITION—New and used shotguns, rifles, handarms, fishing tackle. List 10c. Rudolph's, Atchison, Kansas.

DISPOSING Large collection guns, list 20 cents. Levitt, 307 Sterling St., Brooklyn, N. Y.

TAXIDERMY

FINEST Glass eyes; taxidermy supplies. Catalog free. Elwood Company, Department 234, Omaha 2, Nebr.

FIELD GLASSES, TELESCOPES, MICROSCOPES, MAGNIFIERS

SALE Of brand new 16-power spyglass telescope built to government specifications for the U. S. navy by leading optical makers. Telescope has microfocusing eyepiece adjustment, 2 1/2" diameter coated lens, rubber lens guard. Length 30 1/2". Complete in fitted oak case, \$150.00 value. Special, while they last, only \$49.95. Your money refunded in full if not satisfied after ten day trial. Complete catalog of photographic equipment and supplies free on request. Central Camera Co., Photographic Headquarters since 1899, 230 S. Wabash Avenue, Chicago 4, Ill.

MICROSCOPE—50 Power, 7 1/2" high, fully adjustable. Unbreakable light reflector. \$2.00 postpaid, including manual and slides. Lynn Products Co., Dept. C, Box 896, Pittsburgh, Penna.

NAVIGATOR'S Sextants, Type A10-A. Ideal for boats, planes, hobbyists. Complete with case, etc. Slightly used. Regular \$300 value. Now \$17.50. Aero Parts Supply, Municipal Airport, Houston, Texas.

REFLECTING Telescope kit, complete optical parts, fully finished; 3" diameter, 39" f.l., mirror and diagonal both hard aluminized, plus 3 lenses for high power eyepieces. Never again a bargain like this. All \$6.00 postpaid. Ross, C68 West Broadway, New York, N. Y.

TELESCOPES, Microscopes, cameras, binoculars, barometers, books; buy, sell, repair. Lists 10c. Rasmussen-Reece, Amsterdam, N. Y.

GENUINE Polaroid glass—2 1/8" (72 mm.) diameter. \$1.25 each, 2 for \$2.00. Ross, C68 West Broadway, New York, N. Y.

MICROSCOPES For professionals, hobbyists, students. Amazing money saving values. Tests "S" 65X-200X, \$29.50. "G-3" 75X-400X, \$52.50. Remit with order for free delivery. Laboratory Supply, 424 S. Broadway, Los Angeles, Calif.

NAVY Binoculars, 7x50mm., coated optics, excellent condition, case, \$90, prepaid. Hugh DeFrance, 986 Woodlawn Ave., Newark, Ohio.

SAVE Money—Make own Galilean telescope. 5, 8, 15 powers. Achromatic, coated objective. 7 1/2 inch focal length, 1 1/4 inch diameter; 3 eye lenses; complete with instructions \$2.00 postpaid. Ross, C68 West Broadway, New York, N. Y.

GENUINE Army tank periscope. Used to see things above your level, around corners, etc. 1,001 uses! Very powerful! Only \$4.98. Send no money! Pay on delivery! American Stamp Company, Wilmington-P, Delaware.

SEE It closer! 3X field glasses, \$6.60. 3X binoculars, \$5.10. 5X spy glass, \$1.25. 50X microscope kit, \$2.98. Guaranteed. Literature. W. Wardell, 2509-A Clarendon Road, Brooklyn 26, New York.

INFRA-RED Filters, glass, 1 1/4 inch (40 mm.) diameter, mounted. Snap on binocular or camera, \$1.00 per set. Ross, 688 West Broadway, New York, N. Y.

GUN Sights. All new! A buy for lens value alone. Excellent for spotlights, experimental work, etc. Over \$40.00 value. Special \$5 each. No c.o.d. "Amazing Bachman's," 23 Herman Street, Rochester 5, N. Y.

ULTRA Powerful compound microscope easily made. Perfect lenses and detailed instructions for making microscope that gives 50, 200 and 400 diameters magnification. See the digestive processes of a mosquito. \$3.00. Instructions alone 10c. Suffolk Science Service, Manorville, N. Y.

TELESCOPES, Binoculars, microscopes, big bargain catalog free. Brownscope Company, 24 West 45th Street, New York.

POWERFUL Astronomical telescopes easily made. Perfect lenses and instructions. 100 power \$2.50. 100 and 200 power \$3.50. 100, 200 and 400 power \$5.50. Clear vision and full power guaranteed. Instructions alone 10c. Suffolk Science Service, Manorville, N. Y.

REFLECTING Telescopes, complete. 3 1/2" diameter, equatorially mounted. View planets, stars. \$19.75. Write Sky-scope Company, 475-P 5th Ave., New York.

BINOCULARS, Telescopes, watches. Buy, sell, trade. Paul Schweer, Donnellson, Iowa.

DOGS, PETS, BIRDS, RABBITS

RAISE Guinea pigs. Profitable, low-cost feeding, small space required, small investment. Complete details 25c. Guinea Pig Farms, 234 So. Muscatel, San Gabriel, California.

RAISE Diamond Seal rabbits. We pay \$30 to \$60 each. Booklet on raising rabbits for profit 25c, with hutch plans \$1. Hansen's Rabbit Institute, 1347 Miller Avenue, Salt Lake City 6, Utah.

RAISE Rabbits commercially. We teach you. Good markets, large profits. Angora Federation, 200 Burrell Bldg., San Jose, Calif.

ANGORAS, Giant chinchillas—Finest, pedigreed! World's most profitable rabbits. Literature free. Grinsteeds, Edwardsville, Illinois.

SUPERIOR Chinchilla giants—Other varieties. Breeding stock supplied credit terms. Beautiful picturesque catalogue. Complete instructions, 25c. Behrens Farms, Pearl River 4, New York.

MONEY In New Zealand Whites and Chinchillas. Increasing demand for breeders, meat, fur. Particulars free. Loughman's Sandamar Farm, Newark, Ohio.

RAISE Hamsters. New wonder animals from Syria. Delightful pets. Laboratories need thousands. Profitable. Free information. Hamstery, 1519 Basil, Mobile, Ala.

\$2000 PER Year raising Angora rabbits. We buy your output. Contract particulars free. Wilsons, 1065 Shryer, St. Paul 8, Minn.

\$50.00 WEEKLY Raising Angoras for us. Free literature. Angoraville, 1215-34th Northeast, Cedar Rapids, Iowa.

\$250.00 MONTHLY Raising angora rabbits. Particulars free. White's Rabbitry, Newark, Ohio.

ST. BERNARD Pups: Champion sired beauties. Franklin Young, R4, Riverhead, Long Island, New York.

INCREASE Your income by raising domestic rabbits. Small space needed. Ready market for delicious meat, fur and wool. Largest magazine in the industry tells you how. \$1 per year. Send dime for sample. No stamps. Small Stock Magazine, Lamoni 50, Iowa.

STANDARD Rabbit Journal, Milton, Pa. 3 years \$1.00, sample dime.

70 VARIETIES—Pigeons, rabbits, pheasant, peafowls. Catalogue 10c. Jim Houck, Tiffin, Ohio.

GUARANTEED Chin-Chin giant Chinchilla rabbits. Greatest amount of delicious meat. Largest, finest, most valuable furs. Tremendous demand for breeding stock. We buy youngsters. Contact world's largest breeder. Willow Brook Farm, R15, Sellersville, Penna.

ZOOLOGICAL And pet animals for sale. Illustrated catalogue, literature, 25c. Trails End Zoo-5, St. Stephen, S. C.

RAISING Rabbits, Cavies, Hamsters, Chinchillas is a growing and profitable industry. Magazine 10c. Descriptive book and magazine 25c. Book and magazine (monthly) one year \$1.00. Address Small Stock Farmer, Pearl River 15, N. Y.

FARMS, FARM LAND, REAL ESTATE

FARMS, Ranches. All kinds, sizes. Reasonable prices, terms. Wide variety locations, climates, recreational facilities. Free descriptive folders, price lists, Milwaukee Railroad territory: Washington, Idaho, Montana, the Dakotas, Minnesota, Iowa, Missouri, Indiana, Illinois, Wisconsin, Upper Michigan. R. W. Reynolds, 604, Union Station, Chicago 6, Illinois.

80 ACRES Virgin Ozark land, \$295. Free details. Write J. T. Armstrong, Shook, Mo.

FIVE Acres joining Inverness, \$500.00. \$10.00 down, \$10.00 monthly. R. W. Stewart, Inverness, Florida.

JUST Out—Strout's new red fall farm catalog! Contains over 2800 outstanding bargains, 34 states—coast to coast. Time-money saver. Write today. Strout Realty, 255-P 4th Ave., New York 10, N. Y.; 20 W. 9th St., Kansas City 6, Mo.; 453 S. Spring, Los Angeles 13, Calif.

OZARK Magazine, Eureka Springs, Arkansas. For Homeseekers, tourists. Year, \$1.50.

WEST'S Latest catalogue: Over 1000 farm and business bargains, 160 agents, 16 states; free. Write West's Farm Agency, Inc., HE-9, Pittsburgh 17, Penna.

\$5.00 MONTHLY Buys 40 acres near town; price \$200.00. Free list. Box 425-P, Carthage, Mo.

GOVERNMENT Lands \$2.00 acre up. Information all states twenty-five cents. National Tax Service, 834-A Majestic Bldg., Detroit.

HOMESITES \$450—Convenient payments. California's finest garden section. On Morro Bay's scenic shores. Wonderful fishing, hunting, boating, bathing. Fertile soil, softest water, temperate climate, congenial community. Free literature. Richard Motto, 6560 Hollywood Blvd., Hollywood 28, California.

GOOD Farms—Ranches. Washington, Minnesota, Montana, Idaho, Oregon, North Dakota. Dependable crops, favorable climate. Write for literature, lists describing typical postwar farm opportunities. Specify which state. J. W. Haw, 119 Northern Pacific Ry., St. Paul 1, Minn.

OZARK Lands for all purposes. Actual river frontages, 5 acres \$90.00 and upwards. Free list and literature. Hubbard, 424-I, Minnesota Ave., Kansas City 4, Kansas.

HERE'S A plan for your future! Write today for complete information on farming opportunities in Canada. Farms of all types, sizes, at low prices. Favorable terms. Be sure in indicate kind of farm and what province you are interested in. Address H. S. Cresswell, Canadian Pacific, Montreal.

NEW Free fall catalog of farm bargains 20 states, many equipped, many illustrated. Write today! United Farm Agency, 220-PM South State St., Chicago 4, Ill.

POULTRY, FARM SUPPLIES

RAISE Fryers new easy way. One-man home plant earns \$500 monthly. Booklet free. Poultry Guild, 1046-A So. Olive, Los Angeles 15, California.

HONEY Bee care, instruction. Cost insignificant. Mary Struble, Cupertino, Calif.

KNOW How to raise poultry for profit. Read Northeastern Poultryman. Every issue packed with helpful hints and practical suggestions. Latest articles on breeding, feeding and management. Subscribe now. 1 year 65c. 2 years one dollar. Foreign subscriptions \$1.00 a year. Northeastern Poultryman, Dept. P.M., 376 Boylston St., Boston 16, Mass.

PROFITABLE OCCUPATIONS

HOME Manufacturing business. Manufacture novelty ladies' lapel pins, materials penny dozen. Sensational profits, no experience, no expensive equipment needed. Few dollars starts you. Plastex Products, 1025 Prague St., San Francisco 12, Calif.

WRITE Features! For newspapers, magazines, markets, requirements. Rates, \$1.00 tells how. E. MacEntee, 7114 Freret St., New Orleans 18, La.

"INTERESTED In Latin American and foreign employment?" \$1 brings 1947 copyrighted foreign service directory listing firms with interests in construction, oil, mining, aviation, manufacturing by personnel expert. Hot list of companies hiring. Global Reports, 6417 Homewood, Dept. PM, Hollywood 28, Calif.

RAISE Earthworms. Instructions \$1.00. Huffman's Worm Ranch, R.R., River Junction, Michigan.

WEAR, Sell metallized plastic lapel pins. Enormous profit. Gorgeous sample three dollars. Details free. E. O. Wells, 1325 Wilson, Chicago 40.

LAMP Repairing—Big profits, little competition. We have all parts. Illustrated catalog 10c. Gyro Lamps, 5416 Clark, Chicago 40.

MAKE Flexible molds! Few cents each! Cast plaques, novelties, bookends! Free sample! H. Tooker, Hamilton 9, Ohio.

"ALASKA—The last frontier" offers thousands of opportunities. \$1 brings 1947 official government map and copyrighted report with authentic listing: Fishing, construction, mining, aviation, lumber concerns. Current information on homestead lands, prospecting and business enterprises. Listing of firms hiring. Alaska Opportunist, 6417 Homewood, Dept. PM, Hollywood 28, Calif.

UP To \$100 weekly in spare time representing us in your community. No selling. Write immediately for details. Moss Bros, 1634 Coventry Road, Cleveland 18, Ohio.

ATTENTION! Like big money? Permanent future? Security? "Dynamic Detroit Service Directory" lists names, addresses, phone numbers, of world's greatest automobile, automobile parts, airplane and other factories, employing hundreds of thousands of men, women at highest wages. Contact them direct. Lists many new and used auto parts companies, used car lots. Buy direct, save money. Large "help wanted" classified section given free with this issue only \$1.00. "Service Directory," 2707 S. Telegraph, Dearborn, Mich.

MAKE Rubber stamps, metalize baby shoes, silver mirrors, raise earthworms. Free booklet. Universal, Box 1076-A, Peoria, Ill.

BUY Unpainted plaques, decorate and sell locally. Good profits. Small cost. List free. Samples \$3.00. Instruction books, paints, brushes available. Pioneer Art, Austin, Minnesota.

MAKE Beautiful mirrors from inexpensive window glass. No special equipment required. Details free. Tes-Co, Box 189-MP, Wilkes-Barre, Penna.

METALIZE Baby shoes for big profits. Several methods \$1.00. Tes-Co, Box 189-MC, Wilkes-Barre, Penna.

1947-1948 LEATHERCRAFT Supply catalog 10c. Art Craft Supply, 1205 Throckmorton, Fort Worth, Texas.

TYPISTS—Profitable business at home. Complete copyrighted information, 50c. Gaunt, 3521A Broadway, Chicago 13, Ill.

CASH In on television, now! Amazing opportunity to start profitable business. Technical knowledge unnecessary. Write for free details. Marlowe Television, 10 Rockefeller Center, New York City.

START Lamp and shade factory. Profitable, fascinating. Easy to learn. Illustrated course teaches you. Complete instructions and wholesale catalog \$1.00. The Gearon Company, 6405 North Oakley, Chicago.

ANNOUNCING Home study course in commercial baking. Practical basic training. Good field for those with aptitude. Nearly depression proof. Send for free booklet, "Opportunities in the Baking Industry." National Baking School, 131f Michigan Ave., Dept. 3431, Chicago 5, Ill.

YOU Can make real money raising Golden Hamsters, the new amazing tiny animal. Food costs less than 10c month per animal. Breeds in 16 days! Easily raised in basement, attic, garage, barn, or shed. Write for convincing details. Hudson Hamstery, Box 78-P, Palisades Park, N. J.

WOULD You pay 3%—first \$350 made? Color-illustrated book "505 Odd, Successful Enterprises" free! Some offer occasional "day off." Work home. Expect something odd! Pacific, Oceanside, Calif.

NO Selling, operate vendors, amazing profits, details free. Silver-King, 622 Diversey, Chicago 14, Ill.

"THERE'S Big money in junk," and repairing batteries. Write, Batteryman, Grand Junction 5, Colorado.

HOW To set up and run a mirror shop! Resilver mirrors. For price write, John Sprinkle V50, Marion, Indiana.

LOCKSMITHING—Profitable business or hobby! New course teaches you lock secrets, how to fit keys, de-code, masterkey, etc. Easy self-instruction lessons. Bargain price. Fascinating 100-page illustrated catalog free! Write Nelson Company, Dept. 2-02, Chicago 5.

MEDICAL Laboratory technicians in great demand. We train you in your spare time, in your own home. You can practice while studying. Write for free catalogue. Imperial Technical Institute, Box 973-T, Austin, Texas.

MUSHROOMS Grown. Boxes. Barrels. Illustrated instructions 50c. Spawn \$1.00. Gordons, 553 William, Winnipeg, Manitoba.

TYPEWRITER Repairing instructions, standard typewriters. Webers', Box 1008, Canton, Ohio.

\$40.00 WEEKLY Made growing mushrooms, fresh, dried. Dominion patent 331583. Free spawn. North American, 169P Yonge, Toronto, Canada.

TYPEWRITER Repairmen urgently needed. Earn \$40 to \$50 weekly spare time. Our easy to learn home study course teaches how to repair typewriters. Write for free information. Houston Typewriter Repair Service, P.O. Box 5357A, Houston 12, Texas.

ELECTRIC Clocks are every where you go, buildings, homes, parking lots, factories. Repairs increasing. Our easy to learn course with pictures and drawings teach you how to repair these clocks. Electronic Supply Co., P.O. Box 2350A, Houston 1, Texas.

BOOKS, PERIODICALS, PICTURES, POSTCARDS

WESTERN Story fans! Try Zane Grey's Western Magazine, 192 pages each issue containing every month magazine abridgment of Zane Grey novel, unusual stories and articles featuring Old West, color pictures on front and back covers—trial subscription eight issues \$2.00 (foreign \$2.50). Zane Grey's Magazine, Desk 1, Poughkeepsie, N. Y.

WAR Battle photos of you and your outfit in action! Official, unretouched. Send for yours today! Specify battle, landing, etc.; division, unit, fleet; Army, Navy, Marines, Air Corps, Coast Guard. Not a book—twenty 4"x5" genuine, glossy, action photos only \$2.00 postpaid. Money-back guarantee. Official War Pictures, C93, Forest Hills, New York.

UNIQUE Book plan will save you money. Send for free details. Royal Sales Co., Box 1452, Waterbury, Conn.

WHAT Every Mason wants. We have Masonic books for Blue Lodge, Chapter, Commandery, Scottish Rite and Shrine. Our rituals are used the world over. Send for free catalog of books and rituals for Masons, Odd Fellows, Knight of Columbus, etc. Ezra A. Cook, Publisher, P.O. Box 796-PO, Chicago 90, Ill.

BOOK Bargains! Variety. Unusual. Free catalogue. Robotti Service, 422-PM, 1133 Broadway, New York City.

BACK-DATE Magazines, books. Specific issues—years. Arkell's, Tarzana, Calif.

MONEY? "Pocket Millionaire." 112 pages, 1269 basic money-getting secrets of the rich. \$1 postpaid. Order now! Satisfaction guaranteed. Free circular. Stanley Service, 544 E. Jersey St., Elizabeth 1, N. J.

BACK Issues magazines, reasonable. Reedmore, 240 East 9th, New York 3, N. Y.

MAGAZINES—Trade, business, vocational. Current copies. All fields. Free price list. Commercial Engraving Publishing Co., 34C North Ritter, Indianapolis 19, Indiana.

BOOKS Out-of-print, hard-to-find our specialty. Any book. Banker Book Co., Dept. O, 13518 Contour Dr., Sherman Oaks, Calif.

ALL Pocket books. Catalog free. Gordon's, 2613 Crenshaw, Los Angeles 16, Calif.

WONDERING Why others accumulate wealth and you can't? "Seven Cures For A Lean Purse" shows you how. Request brings descriptive literature of this and other wisdom-crammed dollar books. Pencil mark this ad as a reminder. Greene's Nation-Wide Service, Harrison Z3, Arkansas.

NEW, Modern, "How to Drive an Automobile" complete, illustrated training course in book form. Approved by driving schools, \$1.00. A. Szafarz, P. O. Box 705, Pawtucket, R. I.

2 BOOKMARKS 10c. Good luck, friendship, birthday cards, 10c each. Mathematical short-cuts 25c. Slide rule, 25c. Postpaid. Figurology, Box 222, Chicago 90.

BOOKS—Home building, decorating, handicrafts. Catalog 10 cents. Artcraft, 6827, Baltimore 4, Maryland.

AVIATION Books—New catalogue free! Aeronautical Book Company, Box 2641, Detroit 31, Michigan.

SELF-EXPLAINING Bible: Illustrated circular free. Box 446-P, Minneapolis, Minn.

ART Of pencil drawing \$1.00. Also free catalogue of interesting books. A. Fallor Company, 201 Dewey Street, Newark 8, New Jersey.

HOW To drive safely. Copyrighted, 25c postpaid. Safety, Box 41, Forsyth, Ga.

NATIONAL Geographic Magazine, 1888-1945, any issue. Periodical Service, Dept. PM, Swarthmore, Penna.

MIDGET Bible—World's tiniest. Amaze your friends. Send today. 15c. Austin Specialties, 818 Waller, Chicago 51, Ill.

FREE Bargain catalogue. Correspondence courses. All books. Baker, 5509-B Winthrop, Chicago 40.

EARN Extra money handling magazine subscriptions, books, greeting cards. Excellent commissions. Cassell Publishers, Westfield, New Jersey.

BEAUTIFUL Colored pictures. Lists free. Curtis' Specialties, Box 1916A, Denver 1, Colorado.

NEW. "The Keys" 10c. Inspirational Books, Box 106, Old Chelsea Station, New York 11, N. Y.

AUTOGRAPHED First edition: ninety page book of "Memory Tuned" Poems, by Olvey, the Postmaster Poet. Send 50c. Cascadden Bros., Lapel, Ind.

BOOK Club supervisors wanted. We train you for fascinating, spare-time secretarial duties. Receive outstanding book benefits and exciting library privileges. Write Library-Builders Guild, 1212 Park Ave., Utica 3, N. Y.

100 BOOKPLATES (Gummed backs) with your name printed, \$1.00 postpaid. Further information. Write Square Deal Printers, 4640 Prospect Ave., Hollywood 27, California.

TECHNICAL Books rented. Free list. Rodgers, Box 5286, Chicago.

BOOKS Found free! All subjects. Send wants! Jaher Book Service, 620-F East 178 Street, New York 57.

GOOD "Used" self-instruction educational books on all subjects bought, sold, rented, exchanged. Satisfaction guaranteed. Complete information and 100-page illustrated bargain catalog free! Write—Nelson Company, Chicago 8.

BIG Profits taking subscriptions for all magazines. Agents' confidential catalog listing over 2500 periodicals and complete starting supplies free. Pines Subscription Agency, Flushing, New York.

MAGAZINES (Back dated)—foreign, domestic, arts. Books, booklets, subscriptions, etc. Catalog 10c (refunded). Cicero's, 863 First Ave., New York 17, N. Y.

MAGIC TRICKS, PUZZLES, JOKER NOVELTIES

LARGE Catalogue of the best magic for professionals and amateurs. Send 25c. Mazda Magic Co., 1135 Westgate Ave., Oak Park, Ill.

FREE Catalogue remarkably inexpensive pocket tricks! Postways, Box 5325-A, Philadelphia 42.

BIG Magic magazine, trick and price lists—25c. Lloyd M. Jones, 4064 39th Avenue, Oakland 2, California.

AMAZING New trick and catalog of clever, amusing, mystifying tricks 10c. Weck's Magic Supply House, Box 54, Algonquin, Ill.

GUARANTEED Magic tricks! Amateur, professional. Big 8 1/2 x 11 illustrated catalog. 10c. Newton's, Box 202-A, Bonham, Texas.

MYSTIC Card vanishes coins. Trick and large catalog 25c. Steiners, 316 East 61, New York.

VANISHING Card 15c. Send 3c stamp for list. Nick's Fun Shop, 450 Elizabeth Ave., Elizabeth, N. J.

PALMING, Shuffling, forcing cards. Instructions illustrated. \$1.00. Bowman, 5341 Winona, Chicago 30.

COMPLETE Instructions for twelve professional card tricks, "and" my big mails for one year. All for \$1.00. Clarence Wells, 1444 N. Prospect, Milwaukee 2, Wis.

MAGIC! Most thrilling hobby. Entertain others. Have fun yourself. Interesting magic literature free. The Baron, Prescott, Arizona.

MYSTIC Squared circles. Object vanishes before your eyes. Entirely new. One dollar. H. and H. Sales, Box 575, Savanna, Ill.

WOW "Em with DeLand's spectacular "Card Locator"! Name exact location any card in ordinary deck! Deal straight royal flush! Only 25c, magic catalog, starting free offer details included. Ar-Ges Company, 790 Broad St., Newark 2, N. J.

ILLUSTRATED "Easy-do" magic catalog, 3c. Lee's, 2231-M McKinley, Berkeley 3, Calif.

200 ELECTRIC Stunts, 110 volts. \$1. Kutting Sons, Campbell, Calif.

"MAGIC Vanishing card." Throw it into air, it completely disappears, reproduce it later from spectators pocket. Easy to do. Complete, 25c with magic catalog. The Magician, 2463-C Kensington Ave., Philadelphia 25, Penna.

500 TRICKS. Send only 10c for Douglas' famous 112-page catalog 500 tricks. New magic for amateur, professional. America's fastest service for 25 years. Douglas Magician, Dept. 1, Dallas, Texas.

TRUE Secret of ventriloquism. Send for booklet. Quackenbus, Big Flats, N. Y.

MAGICIAN'S Pin, ghost illusion, Houdini escapes, giant catalogue. Everything, complete 25c. Magic Wand-M, 9W Colorado, Pasadena, California.

BE A magician. Large professional magic catalog of latest tricks, 25c. Ireland, C-109 North Dearborn, Chicago 2.

VENTRILLOQUISM Taught. 3c stamp bring particulars. Smith, 801 Bigelow, Peoria 5, Ill.

VANISHING Half dollar trick and catalog 25c. Sterling Magic Co., Royal Oak, Mich.

WORLD'S Largest professional magic shop, keeps you in touch with latest tricks. To receive mailings, send 35c for new catalog. Holden's, M220 West 42nd St., New York.

EARN Money in any crowd. Call names of strangers, tell unspoken questions. Professional course mind reading, faked spiritualism, etc., \$1. Henderson, Box 341, San Bernardino, Calif.

MAGIC Tricks, puzzles, books, cards, punch boards. Catalog 10c. Specialty, Box 671, St. Louis 1, Mo.

COINS, TOKENS, CURRENCY

OLD Money wanted. Will pay fifty dollars for nickel of 1913 with Liberty head (no buffalo). We pay cash premiums for all rare coins. Send 4c for large coin folder. May mean much profit to you. Numismatic Co., Dept. 20, Fort Worth, Texas.

100 FOREIGN Coins \$4.00 postpaid. Parker, 1122 Market, San Francisco 2, Calif.

PRICE Lists, foreign coins and bill 10c. Oliver Arnold, Macon, Mo.

COMMEMORATIVE 1/2, Oregon, Texas, Kentucky, Cleveland, Long Island, \$2.00 ea. Illustrated catalogue 25c. Norman Shultz, Salt Lake 9, Utah.

4 WHITMAN Folders \$1.00. Bargain list 10c. Olson, 434 North Menard, Chicago 44.

LINCOLN Cent collectors; scarce 1922 D 15c. Complete list free. Reynolds, 1118 Mathews, Flint 3, Michigan.

COINS For collectors, reasonable prices. Free lists. Hutchinson, 3463 "T" Street, Philadelphia 34, Penna.

CASH For old coins and war relics. 48-page coin value guide, 50c. 25 different foreign coins, \$1.00. Royal Coin, 3 School St., Boston.

WORLD Coins—30 different \$1.00. Harry Elsholz, Box 9014, Pittsburgh 24, Penna.

COINS Wanted, will pay up to \$2000 for certain coins, send 25c for catalogue. Burton's, 111 So. Third, Columbus, Ohio.

FOR Sale: 1893 Columbian World's Fair half dollar, 75c; U. S. 2-cent pieces or 3-cent pieces, 25c each; 50 assorted Indian head cents, \$1.25; large 50 page U.S. coin catalog, listing thousands of coins for sale at reasonable prices, 25c; Giant 72 page foreign copper-silver-gold catalog listing over 10,000 coins for sale, 25c. Ben's Coin Company, 72 West Washington, Chicago 2, Illinois.

GET Profit and pleasure in collecting old coins. Send 10c for 56 page illustrated coin catalog. You'll be delighted with it. Send for it now. B. Max Mehl, 370 Mehl Bldg., Fort Worth, Texas. Largest rare coin establishment in U.S. Established 47 years.

FREE! Foreign coin, banknote and coin collectors illustrated catalog to approval service applicants. Send 3c postage. Tatham Coinco, Springfield-125, Mass.

OLD STAMPS WANTED

I WILL Pay \$100.00 each for 1924 1c green Franklin stamps, rotary perforated eleven (up to \$1,000.00 each unused). Send 6c today for large illustrated folder showing amazing prices paid for old stamps and collections. Vernon Baker, PM-710, Elyria, Ohio.

STAMP COLLECTING

BET You haven't these! South Georgia, South Orkneys, Grahamland, South Shetlands. Shortlived Falkland Dependencies. Everything 3c with approvals. Vikings, 13023 Clinton St., Brooklyn, N. Y.

STAMPS 100 Years old. Every collector should have at least a few stamps nearly 100 years old. Although hard to get, we offer a wonderful selection of ten old 19th century foreign stamps and also the blue re-issue of the 100 year old first U. S. stamp, the famous 5c Franklin. All for only 10c. Kindly state whether approvals shall consist of U. S. or foreign stamps or both. Globus Stamp Company, 268 Fourth Avenue, Dept. 212, New York 10, N. Y.

FREE! 19th Century U. S., commems., Civil War revenues, battleships, a total of 30 stamps to serious approval applicants. Equal value in foreign stamps given to applicants for foreign approvals. Enclose 5c postage with request. Cosmopolitan Stamp Co., 1457 Broadway, Dept. 10-E, New York.

FREE—Famous Americans set, plus Flag Set, plus the National Parks Set, plus the Presidential Set to the \$5. A total of 90 stamps absolutely free to customers for our unsurpassed U. S. or foreign selections. Send 3c postage for 15 of the above mentioned stamps and full particulars. Triboro Stamp Company, 145 Nassau St., Dept. 110, New York.

VICTORY Packet free—Includes stamps from Tanganyika, British Cayman Islands, animal, scarce babyhead, Coronation, early Victorian, airmail, map stamps. Including big illustrated catalogue. Send 5c for postage. Gray Stamp Company, Dept. PM, Toronto, Canada.

"SCARCE" United States stamps with inverted surcharge, also complete set of United States stamps issued for occupation of Germany, also twelve different unused Confederate states (reprints). Entire listing twenty-five cents to approval applicants only. Stamp Company, Albany 1, New York.

POSITIVELY Greatest free offer—Latest Scott's International \$6.00 stamp album—covering entire world, contains 36,000 illustrated descriptive spaces; Scott's 1948 standard \$7.00 catalogues "Philately's Encyclopedia"—absolutely free to applicants for foreign approvals becoming customers. Plymouth Specialty Company, Dept. A9, Bell, California.

300 DIFFERENT Given free with approvals. Postage 3c. Windsor Stamps, 1435 East 67th Place, Chicago 37.

STRANGE Land airmails, Liberia, Mozambique, Venezia Giulia, Morocco, Bolivia. Everything 5c with approvals. Raymax, 123-Z William St., New York City 7.

FREE! Tiny Chinese "midget" war set. Approvals. Seminole, Elliston, Virginia.

FREE 30 Ethiopia, Morocco, Turkey, etc. Whisenant Approvals, 1709 Texas, San Antonio 1, Texas.

TRY My fine approvals one cent and up. L. M. Erickson, 1516 South Cushman, Tacoma, Washington.

GREENLAND #1-#7 (9 Varieties) 60c. Catalogue \$2.29. Approvals. Millhiser, 7724 Abbott, Pittsburgh 21, Penna.

FREE—Hitler heads, airmails, French Coat of Arms, Vatican with approvals. Gulfstream, Box 103, Teaneck, New Jersey.

UNITED States collection. Thirty-seven different mint commemoratives, including Columbians, bicentennials, national parks, famous Americans. Price \$1.03 to approval applicants only. Stampco, Box Eighty-seven, Albany 1, New York.

100 DIFFERENT 10c. Approvals 1/2c up. Kingman, Highbridge Box 42, New York 52.

ALL Different—25 Egypt 20c; 100 Germany 45c; 50 Hungary 15c; 25 Russia 20c. Elsa, Bowling Green, Ohio.

FREE 100 Different with approvals. Kloster, 3883C 47th St., San Diego 5, Calif.

FREE, Fifty different worldwide, approvals. Jack Dudak, Streator 1, Illinois.

FREE 50 Different with approvals. R. Miller, Station P, Box 89, Brooklyn, N. Y.

BREAKING Up large foreign collection. Approvals by countries. Lion, 200 W. 81 Street, New York 24.

FOLD-O-HINGES Free. Regular 10c package to approval applicants who enclose 3c postage. Baker Stamps, Evansdale Street, Lake Mary, Fla.

FREE! Complete Balkan aviation set with approvals. Beaman, Elliston, Virginia.

25 DIFFERENT India—3c with approvals. Premiums with purchases. Brandwein Stamp Co., Box 92-H, Bayonne, N. J.

NORWAY Queen Maud mint set catalogs 75c, 10c to approval applicants. We sell only complete mint sets. Philatelic Corner, 175 Stratford Rd., Buffalo 16, N. Y.

FOREIGN—Complete mint sets and new issues on approval. Woodco, 5719 Wabash, Kansas City 4, Missouri.

AMERICA'S Friendliest stamp magazine! Next 3 issues, 10c! "Valuable tips" included! "Stamp Post," Station A, Pasadena 15, Calif.

BEAUTIFUL Monaco, Argentine, and Cuba Roosevelt sets, and nine other sets. Everything 10c with approvals. Inland Stamps, Wurtland, Ky.

25 BEAUTIFUL Stamps from 25 French Colonies and our price lists. One silver dime. Stamp sales, Box 1649-P, Oakland 4, California.

LESS Than penny approvals. Also better. Fellemans, 320 East 167th, New York 56.

FREE Bargain list quality stamp packets! Write Neptune Stamp Co., Neptune 7, N. J.

WORLD Mixture, variety countries. 25c. MacDonald, 30-M Seaman Ave., New York 34.

ANNOUNCING An approval service especially devised for foreign buyers. Literature describing this "modern" service free. K. Archibald, 40 Railroad Avenue, Taunton, Massachusetts.

BIG Packet Scandinavian government and mission mixture 30c with approvals. John Lindblom, 422 Marshall Street, Gary, Indiana.

FIFTY British Empire 10c. Approvals. Arcadiac, Box 21, Station J, Toronto.

FLAG Stamp free with U. S. approvals. Wenigman, 929 Oakdale, Chicago.

1000 WELL Mixed U. S. 25c. Monjai, 1750 Fairmount, Cincinnati 14, Ohio.

FOREIGN Packets 1,000 diff. \$2.75, 2,000 diff. \$6.00. 200 U. S. \$1.50. Mendelsohn Stamp Co., 1900 W. 25 St., Cleveland, Ohio.

6 HITLER Heads, ship set, everything 2c. Approvals. Amberg, 537W 35th, Union City, N. J.

FREE Philippines mint booklet pane cataloging \$2.50 with surprise packet. Everything 10c only to approval applicants. Criterion Stamp Company, North Hackensack 7, New Jersey.

1933 VATICAN Set, 25c with approvals. Vargo Stamps, 6044 South Fairfield, Chicago 29, Illinois.

GIVEN 55 Scandinavia, Netherlands, Italy, Latin America, etc. with approvals. Enclose 3c postage. H. P. Wisheart, 300 Second, Frankfort, Ohio.

45 DIFFERENT Foreign 20c. U. S. or foreign approvals. Rebeck, 5614 East 3rd Place, Gary, Ind.

ROUMANIA—New "athletes" 25c with approvals. Esslinger, 5260 Montgomery Rd., Norwood, Ohio.

VALUABLE Scarce Luxembourg Centennial (cataloging fifty cents!) and nineteen beautiful, scarce pictorials—two dollars catalog value for ten cents! Introducing our guaranteed low price approvals, free duplicate exchange, extra premiums with purchases; many other unusual services. Charles Ernest, 64 Wayne Terrace, Staten Island 10, New York.

GOYA Nude (2) 5c. Approvals. Han-nay's, 310 Quail, Albany 3, N. Y.

188 U. S. Commemoratives, etc. 10c. Dorenbusch, 501 Ridgeway, Cincinnati 29, Ohio.

FREE 10 Odd U. S. mint for stamped addressed envelope. Michalicka, 89 Wallace St., Newark 3, N. J.

CANADA Peace set 10c with attractive approvals. Rheume, 8949 Routhier, Montreal 12, Canada.

300 DIFFERENT Worldwide 30c with approvals. Schaeffer, Box 825, Alhambra, California.

950 DIFFERENT Commemoratives, airmails, pictorials, etc., \$1.50 (value \$20.00). Lists free. Approvals, 15,000 different, 1c up. Premiums. Alatalo, Maynard 14, Massachusetts.

BIG Value—12 sets, 12 countries. Triangle, maps, animals. With approvals, only 25c. Wirth, Norwichtown, Conn.

MANCHUKUO Including map, high value Canadian, large Peru "El Chasqui" post runner, Ceylon pictorials, French, British colonials, others. 10c to approvals applicants. Meagher, 2040 Spencer, Philadelphia 38, Penna.

SEND Lot precancels. Equal value foreign. Peck, 2231 18th, Tulsa, Okla.

START Your own stamp business. Write for free circular. Donald Shepard, Security Building, Chicago 2.

WORLDWIDE, Different 200, 25c; 500, 60c; 1000, \$1.50; 2000, \$4.25. Beacon Sales, Maynard 2, Mass.

HISTORICAL Collection! Cavalry charge! Bulgaria, Flaming Sword! Ireland, Big She-wolf! Italy, Fort! Dominican Republic, Field Marshall! New Zealand, Pitcairn Mutiny Island! Commemoratives! Pictorials! Only 3c. Approvals. Star Stamps, Lakewood, New York.

FREE Surprise packet, request approvals. Schmidie, Box 2551, Portland 3, Oregon.

\$1.00 WILSON, 4c Bell, 2 flags, 10c. Approvals. O. Burgett, Lima, Ohio.

NICE Clean U. S. approvals, numbered and classified; mounted with peelable hinges; postpaid both ways. Jess T. Green, Bonita Ave., Route 2, Box 111, Mountain View, California.

FREE! 20 Portuguese colonies. Approvals. Super Stamp Shop, 2 Madison, Greencastle, Indiana.

\$1.00 CATALOG Value for 30c. Schultz, 1304 19th, Two Rivers, Wisconsin.

U. S. Approvals. Large selections, fast personal service. Panther, Box 76A, Dorchester 24, Mass.

COMPLETE Outfit; only 5c, consisting of hinges, perforation gauge, book for 100 stamps, 75 different stamps and approvals. Mounblow, 740 Hegney, Bronx 56.

SEE Them first! United States approvals plus unique premiums. Jarr, Box 217-N, Madison Square, New York 10.

GIANT Roosevelt triangle; beautiful set from world's smallest country, catalog value 90c; and 25 different worldwide. Only 10c. Approvals included. Rostamps, 1921 Shiller, Little Rock, Arkansas.

WORLDWIDE Mixture! 500 stamps 25c. Garrow, 84-M Montevista, Chula Vista, California.

300 U. S. Free. Subscribe "Sastco Post" 50c. Sanguinet, 4019 Dunnica, St. Louis 16, Missouri.

FREE! Crystal-mount samples! Har-risco; 202 Transit Bldg., Boston.

UNITED States fine mint bargains, 5c each. 498, 499, 598, 658, 670, 690, 702, 707, 717, 720, 728, 730a, 732, 741, 752, 772, 773, 774, 776, 783, 785, 787, 791, 792, 795, 860, 864, 870. List 101-PX free. David Chassy, 38 Park Row, New York.

20 COLORFUL Pictorials 10c. Approvals. Budwitz, Box 108, Meriden, Connecticut.

FREE Colorful San Marino airmails, 3 values to new applicants requesting approvals. Wesken Stamp Co., Box 66, Queens Village, N. Y.

UNITED States approvals complete coverage, fine quality, attractive prices. Seminole Stamps, Box 1138-P, Coral Gables, Florida.

WE Have them. Stamps from those "where the heck is that" countries. Send 3c for surprise packet and approvals. Pikes Peak Stamps, 117 Nevada, Colorado Springs, Colorado.

PHILATELIC Printing. Stock forms. Samples for postage. Acmeprint-6, R-#5, Hendersonville, No. Car.

FREE! 25 Different Canada. Approvals. Postage. Victor Logsdon, Hyndman, Pennsylvania.

UNITED States stamps on ten days approval! Lowest prices! Finest quality! Fast personal service! Thrifty Stamps, 727 Silver, Silver Spring, Maryland.

SURPRISE Packet 100 stamps from many countries 10c with approvals. Prince Georges Stamp Co., Box 95, Mt. Rainier, Maryland.

OLD Stamps wanted. Send 30c for catalogue. Stamp Market, 356-P Clinton, Columbus 2, Ohio.

APPROVALS—Inexpensive sets. Discounts. Philately Exchange, 823 1/2 Maple, Santa Monica, California.

10 FINE Mint U. S. stamps \$1.00. No junk. Brahms, 1540 Bedford St., Los Angeles, California.

SAN Marino, Turkey given approval applicants. Edward Carter, 918 Lakeside Pl., Chicago 40, Ill.

100 U. S. Oblong commemoratives, \$1.00; no junk. Minkin's, 1166 Beachwood, Pittsburgh 6, Penna.

KNOW Your stamps. Read stamp magazines. List free. Seelye, Box 968, Whittier, California.

FREE Handy pocket stamp wallet. Worldwide approvals 1c up. Free gift plan. Crown, 412 Maple, Holyoke, Mass., Dept. 6.

FREE! St. Helena and 37 other countries to approval applicants. Pioneer, Box 414A, Pasadena 18, California.

72 DIFFERENT U. S. 10c with approvals. Album Service, Box 2006, Soledad, Calif.

\$100 Chinese Victory bicolor cataloguing \$1.00 free. Approvals. Granada, 4891 Southwest 5th Street, Miami 34, Florida.

MONACO Roosevelts, 4 beautiful pictorials to approval applicant 10c. G. A. Hegenbarth, 1545 Ardmore Ave., Chicago 26, Ill.

UNRIVALED Bargain! Includes set Seychelles, set Cyprus, assortment Libia, assortment Uruguay, also Bolivia, Albania, Angola, etc. Everything 10c to approval applicants. Wollastin Stamps, Wollaston 70, Mass.

LOOK! Ceylon, Geo. VI, to 2Rs \$1.00. List alone 10c (returnable). Steeple, County Line, B. C., Canada.

OWN Profitable stamp business at home. Our proven method explains fully. Information free. Argentiere Company, 6462 83rd Place, Forest Hills, New York.

1,000 NEW Customers wanted! San Marino (Roosevelt) French Colonies, San Marino airmails, Italy mint set, Hitler heads, Monaco Roosevelt (triangle) all given to approval applicants enclosing 10c. Shoaps, (The Square Dealer), 5010 Hillsboro Ave., Detroit 4, Michigan.

U. S. Airmail imperforate, #771, mint, \$1.00. Block, \$4.00. Molesworth, Soldiers Field, Boston 63.

BEGINNERS, 100 Different stamps 5c. General approvals. Return postage paid. Burton, 413 C SW, Ardmore, Oklahoma.

100 DIFFERENT U. S., Canada, Newfoundland—20c with approvals. Windsor, 26 Wigglesworth, Malden 48, Massachusetts.

THREE Rare Vatican City, cataloguing seven dollars, only 35 cents with approvals. Trailer Stamps, 4035 Temescal, Corona, Calif.

FREE! Five San Marino airmails, ten Egypt. Approvals. Newton, 1511 Portage Road, Niagara Falls, Canada.

SAN Marino Roosevelts 5c. Approvals. Kataja, Whiting Rd., East Hartford, Conn.

29 FRENCH Colonies, all mint, 10c with foreign approvals, Adlez, South River 2, New Jersey.

MONACO Roosevelts free (three, including triangle), to approval applicants. R. J. Boyle, 2339 Manning, W. Los Angeles, Calif.

FREE! Sudanese, Egyptian, Philippines pictorials! Approvals, Keating, 637 Bergen, Jersey City, N. J.

NO Junk. Good stamps only on our honestly priced foreign approvals. Inter-Continental Stamps, Englewood 2, Florida.

GENUINE Confederate 10c approvals. Stamping Grounds, Whiting Road, East Hartford 8, Conn.

KING Farouk set (45) 5c. Approvals. Schneider Stamp Co., 60 Clarkwood Street, Mattapan, Mass.

FAMOUS Americans! 21 different, 20c to approval applicants. Midwest Approvals, Box 6823, Cleveland 1, Ohio.

FROM Strange remote lands—17 Siam, 18 Morocco, 17 St. Pierre, 14 Dominica, 20 Vatican, quarter each. All five plus Sudan Camel for dollar bill. All different. Stuart Stamps, Box 72, Bowling Green Station, New York 4, N. Y.

100 DIFFERENT Foreign stamps free with approval. Canisius Kevilus, 933 West 34th Place, Chicago 8, Illinois.

ITALY Polish Corps, 10 different Vatican, 10 different San Marino. All 10c with approvals. Aldee, Tremont Station, Box 38, Bronx 57, N. Y.

COMPLETE Stamp dealers outfit \$1.10 postpaid. Details free. Wholesale. Palmer Company, Berkeley-Norfolk 6, Virginia.

IMMEDIATE Cash for stamp collections, accumulations. Brooks, 270 Burkhart, Cincinnati 15, Ohio.

GENUINE "Goya Nude" set, cataloguing \$1.05, complete 35c. Approvals. Royal Stamp Company, Tamaqua, Penna.

300 MIXED British 25c. Approvals. Mantle Stamp Company, London, Canada.

GENUINE 1863 Saxony—Plus amazing "queer countries" packet—only 3c with approvals! Saxon, Walden, New York.

NUDE Duchess set (two values) 5c to approval applicants. Masters, Box 7027D, Baltimore 16, Maryland.

BOY! Oh boy! Dandy collection, Monaco Roosevelt triangle, U. S. commemorative stamp over 50 years old, Hitler-Mussolini stamp, many others. Only 5c to new approval applicants. Modern Stamp Service, Box 12, Wakefield Station, N. Y.

WORLD Wide 100 different 10c. No approvals. Arthur Terreson, Box 479, Bellmore, N. Y.

COMPLETE U. S. Roosevelt set 5c. United States-foreign approvals. Yokums, Box 1327, San Antonio 6, Texas.

CHINA—300 Different \$1.50 with approvals. Jewell's "Stamps," Tamaqua, Penna.

FALKLAND Islands map stamps. Three values mint 5c to approval applicants. Middleton Stamp Company, 78-14 Woodside Avenue, Elmhurst, N. Y.

FREE! Six Greek wind airmails with approvals. El Rey Stamps, 5170 Sunset Blvd., Hollywood, California.

ERITREA, Ethiopia, huge Roosevelt stamp, free with approvals. Logan Stamps, Box 4, New Lots Station, Brooklyn, N. Y.

MIXTURES. Worldwide accumulations 1,500 \$1.00. Missions Outlet, Reverend Marshall, Paterson 1, New Jersey.

AUSTRALIAN Commemorative and State issues. Used or mint \$3.00 U. S. (or equiv. other currency) brings bargain selection. McNear, Longford, Tasmania.

FREE Introductory offer! Pick 30c worth of stamps from our first selection of approvals. Send postcard. Same day service. Jayson Stamps, 1295 Amsterdam, New York City.

NEW Zealand triangle set (2) 5c. Approvals. Philip Mandel, 1912 N. Kimball, Chicago 47.

1000 MIXED U. S. old and new—25c; 2 lb. \$1.25. Weatherby, Medina, Ohio.

FREE—Write for details of complete outfit for beginner and small stamp dealer. Starts you in business at extremely low cost. Halay, 132 West 63rd, New York 23.

1000 MIXED United States 18c. Two pounds \$1.25. Halay, 132 West 63rd, New York 23.

MINT Pictorials free to approval applicants. Surf Stamp Co., Box 1016, Wilmington, N. C.

BRITISH Colonies and South America on approval. Theo. Stevens, Box 3706, Kercheval Station, Detroit 15, Mich.

YOUR Money's worth! Seychelles, Djibouti, Angola, Chinese hunger stamps and over 100 different other stamps. Everything 10c to approval applicants. Atlas Stamps, 4220 West 16th, Dep't L, Little Rock, Ark.

DOLLAR Each: 1200 U. S.; 2000 Canada; 400 Ireland. Seiden, 1331-M Intervale, New York 59.

SCARCE United States stamps nearly 100 years old; Roosevelt set complete; \$5.00, \$10.00 stamps; Army, Navy, Marines, Coast Guard, Columbian Exposition commemoratives; 19th century revenues. Everything 5c to buyers U. S. approvals. Metropolitan, 140-B Nassau, New York City 7.

\$10.00 FOR \$1.00. Box full stamps valued Scott's \$10.00 and stamp album. Everything \$1.00. Longacre Shop, 108k West 42nd, New York City 18.

THE Stamp World, 12 copies 25c. The Stamp Mart, Box 2078Q, Akron 11, Ohio.

AROUND The world—30 different countries; Basutoland, Nyassaland, Tangier, Cyprus, St. Helena, 10c with approvals. Exello Stamps, P.O. Box #95, Hackensack, N. J.

FREE Hitler head, French colonial, air mail, Vatican City packet to approval applicants. Nitta Yuma Stamp Co., Harrods Creek, Kentucky.

PONY Express stamp and 99 different 10c to approval applicants. Tippet, 1118 Clay, Pelham Manor, N. Y.

CHIANG KAI-SHEK! Catalogues \$2.30. (4) mint, victory, commemoratives 496-99. 10c to approval applicants. Eliot Stamps, 86-31 Eliot Ave., Rego Park, N. Y.

WHOOPIE! Wow! 25c worth of U. S. stamps free! No obligations! Write M & N Co., 742A Sheffield Ave., Brooklyn 7, N. Y.

CANADA Mixture containing hundreds of fine used commemoratives, airmails, specials, blocks, coils, high values, etc. Off paper, 1000 stamps, \$3.00; 2000 stamps, \$5.00; 5000 stamps, \$10.00, postpaid. Money-back guarantee. J. D. Guevremont, Valleyfield, Que., Canada.

POWERFUL Magnifying glass! 5c. Approvals. Buchanan, 307 East 23rd, New York 10.

FREE—Beautiful and unusual set of the Italian Social Republic, with introductory foreign approvals. Home Hobby-Craft, 3322 Decatur, Philadelphia 36, Pa.

ROOSEVELT—Three new beautiful large bicolored stamps in packet of 50 different airmails, commemoratives, etc. 5c with approvals. Chesapeake Stamps, 748 Overbrook, Baltimore 12, Maryland.

THREE Hitler heads. Overprinted by Russia. Mint. With approvals. Marvin Green, Box 287, Hollywood 28, Calif.

EXOTIC Pictorial collection: Tahiti spearfishing, Melanesian idol, Ingavi battle, Reunion, Madagascar, St. Pierre Miquelon, Djibouti, Wurttemberg, Dutch Indies, Newfoundland, many others. This outstanding offer only 5c. Imperial, Box 1491, Tampa, Florida.

CANADIAN Collection—From 1870 to date, 80 face different stamps including many pictorial; just about 1/3 of all stamps issued. A \$1 value for only 25c if you request approvals. Fields of Cleveland, 9328 Amesbury Ave., Cleveland, Ohio.

55 DIFFERENT United States, 5c. Approvals. Utechts, 1143-C North Keeler, Chicago 51.

128-PAGE United States catalog—1000 illustrations, 10c. Harris & Co., 202 Transit Bldg., Boston.

\$27.00 CHINESE Airmail and 50 others 10c to approval applicants. Burmaster, Box 1910-C, Los Angeles 53.

U. S. 1909 Alaska commemorative. This scarce stamp 5c with approvals. Willett Stamp Co., Box 507, Port Chester, N. Y.

FREE! Ten mints: Ethiopia Red Cross plus Free French. With approvals. Florida Stamp Company, Box 807, Miami 5, Fla.

100 DIFFERENT Including scarce diamond-shaped airmail 3c to approval service applicants. Avalon Stamp Co., Dept. M, Springfield 8, Mass.

6 DIFF. San Marino Roosevelts, 10c with 1/4-1/2-1c approvals. Carroll's, 4357A S. Hoover, Los Angeles 37, Calif.

FREE Attractive airmails, commemoratives, pictorials, eight countries, with approvals. Green and Company, Norwood 12, Ohio.

100 U. S. Commemoratives, etc.—10c, 300—25c. Kellermann, Box 457, Newark 1, New Jersey.

ZANZIBAR, Palestine, Manchukuo, Azerbaijan, Haiti, Iraq, Cayman, Siam, Roosevelt, Hitler, 5c. Approvals. Postzegel, Windham, N. Y.

WOW! 10.00 Worth of fun—only 10c! What a treasure hunt! Big package 500 foreign stamps just as received from foreign missions, other sources. Includes stamps from Africa, South America, Free French, Cape Juby, Palestine, etc. Includes airmails, commemoratives and stamps worth up to 50c. This offer sent for 10c to serious approval applicants only—one to a customer. Jamestown Stamp Co., Dept. 22, Jamestown, N. Y.

CUBA Roosevelt stamp and 25 different Switzerland only 1c to approval service applicants! Littleton Stamp Company, Littleton 42, New Hampshire.

FREE! Airmail packet with approvals. Deane Stamps, Box 87, Miami 35, Florida.

FREE—The Stamp Finder. Big new edition—32 pages profusely illustrated! Tells at a glance the country to which any stamp belongs and so where to place it in your album! Also: 25 different stamps from Vatican City, Palestine, Cyprus, San Marino, etc. All sent to approval applicants enclosing 3c postage. Garelson Stamp Co., Box 900, Calais, Maine.

50 DIFFERENT Stamps, triangle, airmails, etc., 5c with approvals. Carlton's, 10243 Silverton, Tujunga, California.

UNITED States approvals. Low prices! Gordon Davison, Box 1019X, Manchester, N. H.

FIRST Day covers on approval. Knobel, 1918 S.W. 12th St., Miami, Florida.

ANIMAL, Map and triangle stamps, included in 50 different for 3c to approval buyers. Paul Bauer, 31 Wilkshire, Lancaster, N. Y.

ROOSEVELT, Churchill, Stalin, Hitler, Vatican City stamps free, to approval applicants. Flamingo Stamps, Box 517, Miami Beach, Florida.

EGYPT—15 Different, 5c to approval applicants. Bohemia Stamp Service—1, Bohemia, N. Y.

ILLUSTRATED Stamp Magazine, 26 weeks 25c. Stamp Journal, Kalamazoo, Michigan.

CANADA—75 Diff. 25c. Approvals, Lists. Victoria Stamp Co., London 4, Canada.

FINE Approvals, freshly mounted. Fast, personal service. Tell me what countries you prefer and I'll send them stamps. Skinner, 438 Locust, Long Beach 12, Calif.

200 DIFFERENT Stamps, 6c. to approval service applicants. Tatham Stamp Company, Springfield 30, Mass.

BRITISH, Spanish and French Colonies, Vatican, Hitler heads, and airmail packet, free with approvals. Pan-American Stamp-co, Box 145, New York 33, N. Y.

DANDY U. S. approvals; write immediately. Sullivan, Endicott Building, St. Paul, Minnesota.

BERLIN Bears, complete set of eight and 100 different stamps only 10c to approval applicants. Reich Stamp Co., 4647 Kenmore, Chicago 40, Ill. Dept. M11.

STAMP Collections wanted. Complete collections, duplicate lots, surplus stock, mint and used. Prefer trade for printing or other items, buy outright if priced right. What have you, what's wanted? Vanroy Shirk, Lebanon, Penna.

U. S. Price list. Send postage. State Stamp Service, 1225 Park Building, Pittsburgh 22, Penna.

OLD Scarce U. S. seconds on approval. Slightly defective, nice appearance, bargain prices. Hernfield, 551 Clinton, Newark 8, N. J.

ZOWIE-E! A barrel of fun for only a dime. 500 United States stamps—absolutely unpicked and unsorted—just as received from church missions. Many varieties, including large commemoratives, airmails, high denominations up to \$5.00! Stampdom's biggest package of fun—and you might find something really valuable! Price only 10c to serious approval service applicants. Money back if not delighted. Illustrated bargain lists with each order. Mystic Stamp Company, Dept. 80, Camden, New York.

U. S. Price list. Send postage. Stanley Gibbons, 38-P Park Row, New York.

PENNY Approvals, that satisfy. Neil Gronberg, Box 5441-P, Philadelphia 43, Penna.

50 DIFFERENT United States, 10c. Price-list free. Seidenberg, Cassopolis, Mich.

FREE U. S. price list. Postage 3c. Mark Hanna, 335 - 5th Avenue, Pittsburgh 22, Penna.

WORLD'S Largest diamond and triangle stamps, free stamp magazine, stamps from fighting Free French, 20 stamps from 20 different countries, pictorials, airmails, big bargain 5c with approvals. Capital Stamps, Dept. 2, Little Rock, Ark.

DEALERS—Wholesale list. Postage 3c. Frank, 5031 Queensberry, Baltimore 15, Md.

FREE 10 stamps from first selection. Quality Stamp Service, Waverly, N. Y.

PERSIA And China packet free to approval applicants. Write "Everglades," Box 3222-M, Atlanta, Georgia.

HOBBIES AND COLLECTIONS

FOREIGN Campaign ribbon packet, and illustrated book \$1.00. InsigniCrafts, 236 28th Avenue N.W., Calgary, Canada.

NEW Magazine of hobbies—collections to be published soon. If interested send your name, address and hobby to Hobby Hill Trading Post, Dept. 295, Forest Hills, New York.

SWAPPERS, Collectors, hobbyists. National bulletin 25c. Royal Oak, 128, Michigan.

WORLDWIDE Hobby magazine, twelve issues \$1.00; sample 10c. Klings', Blue Island, Illinois.

KLONDIKE! For hobby jewelry makers! Novelty jewelry findings swept from tables of large manufacturers—parts for bracelets, pins, earrings, etc.—unfinished chains, rings, pins, stones, clips, beads—many other items. 1 lb. bags—\$3.00 sample bag—\$2.00 per bag in 5 bag lots. Prepaid only. Mdse. Distributing Co., 19 E. 16 St., New York 3, Dept. F.S.

100 UNUSED Canadian book match covers, all different. \$1.00. Post Office Box No. 8, Toronto, Canada.

50 DIFFERENT Army patches postpaid for only \$1.00 (factory rejects). Catalog free with order. Insignia Mart, 703 Broadway, New York.

FIRST Again: United Nations insignia 30c; military emblems 2c up. Send 10c for price lists. Hobbyguild, P-35 West 32nd St., New York.

UNUSED Match book covers, 100 all different \$1.00. 35 Royal Flash covers \$1.00. Free catalog. Charles Edelman, 1311C East 84, Cleveland 3, Ohio.

INVENTING Can be an interesting and profitable hobby. Write for complete particulars. Institute of American Inventors, Dept. 40-E, 1926-Eye St. N. W., Washington 6, D. C.

CAMPAIGN Ribbons—Beginner's package. Introductory price 50c. Contains 15 assorted ribbons. L.H.G. Company, 19 E. 16 St., New York 3.

ANTIQUES, RELICS, INDIAN GOODS, CURIOS

10 FINE Arrowheads \$1.00. Catalog free. Nirscher, 27 South 10th, Belleville, Illinois.

HITCHING Posts. Beautiful horsehead design. Made of enduring cast iron. Send for free folder. Grafton Metal Products, Grafton, Wisconsin.

6 PERFECT Birdpoints \$1.00, list free. H. L. Talburt, Calico Rock, Ark.

4 FINE Ancient arrowheads \$1.00. Stone tomahawk \$1.00. List free. Lear's, Box 569, Galveston, Texas.

SWORDS, Rapiers, daggers, pistols, armor. Illustrated catalog 50c. Robert Abels, 860-A Lexington Ave., New York.

PRECIOUS STONES, MINERALS

GENUINE Zircons sent on approval. Write for selection of zircons to choose from. Make selection and return to us for mounting. Send no money. Special: 3 genuine zircons, unset, approximately total 3-kts. \$6.00. Make big money selling genuine zircons. Send order or write for details today. Lowe's, Dept. PM-10, Holland Bldg., St. Louis, Mo.

"GENUINE" Deep red Arizona rubies (garnets). Send quarter for packet. Mineral Specimens Company, Box 2651, Phoenix, Arizona.

MINERAL Specimens, rough gems from around the world. Rough sapphire with list 10c. Plummer's, 5068 Brighton, San Diego 7, Calif.

ZIRCONS Genuine Siamese exotic gems. Flash, fire, sparkle of diamonds. Ancient Egyptian queens treasured their good luck bearing charms. Mastercraftman diamond cut, unmounted. Wholesale \$1.50 carat. Sample \$2.00, two \$3.00. Ten small glistening zircons \$5.00. Imhusex PM, 336 West Street, White Plains, N. Y.

PETRIFIED Woods. Rare. Beautifully grained. Twelve cubic inches \$2. Jesse Teer, Roosevelt 1, Oklahoma.

METAL Detectors. The very latest circuit. Free literature. Hedden Metal Detectors, 538 N. Homewood Ave., Pittsburgh 8, Penna.

KING Jade—Not Nephrite or Jadeite, bluish green. Gem quality cutting material available to professionals and amateurs. Send 50c for cut sample. King Gems, Inc., Dept. PM, Box 1579, Colorado Springs, Colorado.

CAMERAS AND PHOTO SUPPLIES

REDUCED 25%! Brand new General Electric photo-electric exposure meter, current model Type DW58 with new A.S.A. exposure index numbers. Three meters in one: 1. An exposure meter for perfect picture taking. 2. A darkroom meter for easier printing and enlarging. 3. A light meter for illumination control. Regularly \$26.95. Special \$19.95. Genuine leather case \$2.20. Your money refunded in full if not satisfied after ten day trial. Complete catalog of photographic equipment and supplies free on request. Central Camera Co., Photographic Headquarters Since 1890, 230 S. Wabash Ave., Chicago 4, Ill.

AUXILIARY Lenses to fit your filter ring for ultra close-ups. Literature for stamp. Crown Lens Company, Box 536, Peoria, Illinois.

SPEED-O-COPY; Groundglass focusing attachment for Leica, Contax, Perflex, Argus C-2 & C-3. Send for literature. D. Paul Shull, Dept. PM-10, 240 S. Union Avenue, Los Angeles, Calif.

FREE 2x2 Color slide and fine grain negative! Send self addressed stamped envelope for samples and catalog. Slidecraft, 5855 Hollywood Blvd., Hollywood 28, Calif.

FREE Premiums choice Christmas gifts free catalog. Westwood Company, 635 Victoria Street, San Francisco, Calif.

PRINT Your own pictures. Kit \$1.00. Spada, 10 Lexington, Wethersfield 9, Conn.

CAMERA "Specials" for P.M. readers. Argus, Revere, etc. Buy, sell, just write Charles Wolfe, 167 Canal St., New York 13, N. Y.

WARPLANE Photo slides, fit any slide projector! Mixed types, 25 for \$1.95, 100 for \$4.95, 500 for \$17.95, 1000 for \$29.95. Postpaid. Our choice. Aero Parts, Municipal Airport, Houston, Texas.

EARN Spare cash with camera. Tested plans, 25c. Esaki's Photo Service, 608 Pearl Street, Monterey, Calif.

PHOTOGRAPHIC Equipment: representatives wanted. Manufacturer, 1619 Glendale Blvd., Los Angeles 26, Calif.

BUILD Your own enlarger. Takes negatives up to 4"x5". Detailed plans one dollar. Emby Co., Birmingham, Michigan.

COLOR Your own photographs. Kit \$1.00. Goynes, Lock Drawer 1784-C, Orange, Texas.

THREE Photographic filters—Red, green, yellow, solid glass. Sizes range from 25 to 42 mm. Approximate sizes only. Value \$5.00. Special for only \$1.00. Ross, 668 West Broadway, New York, N. Y.

MAGIC Photos—Make your own. Stamp brings literature. Photo Specialties, 812-A No. 18th, St. Louis, Mo.

CAMERA Prices slashed! Free list. Seymour's, 101-M Sherman Avenue, New York 34.

NEW Cameras cheap. Write Sneriff Specialty, Box 3278, San Francisco, Calif.

PHOTO Album—70 heavy pages, 10"x14", screw metal post, simulated leather covers, red, blue and brown, \$5.00 value, prepaid \$2.95. Dept. 7, Symons Associates, 345 Hudson Street, New York City 14.

CAMERAS, Enlargers, projectors. Lowest prices. Free catalog. Cavalier Camera, 1822 Center, Pittsburgh 19, Penna.

BASS Says! At the sign of the old "Horse Trader," 37th year. Thousands of satisfied customers everywhere! Finest brands including Kodak, Bell & Howell, Argus, Zeiss, Leitz, etc. Satisfaction always guaranteed, or your money back! Bass buys 'em, sells 'em, trades 'em. Write or wire. Bass Camera Company, Dept. AG, 179 W. Madison St., Chicago 2.

PHOTOGRAPHY For pleasure or profit. Learn at home. Practical basic training. Long established school. Write for booklet. American School of Photography, 1315 Michigan, Dept. 3431, Chicago 5.

HAVE You a camera? Improve your hobby of photography and learn how to make better pictures. Write today for our latest book catalog and sample copy of American Photography, containing articles and pictures by the world's foremost writers and photographers. Camera House, 601, 353 Newbury St., Boston 15, Mass.

OIL Coloring photographs can be a fascinating hobby or profitable sideline for those with artistic talent. Learn at home. Easy simplified method. Send for free booklet. National Photo Coloring School, 1315 Michigan, Dept. 3431, Chicago 5, Ill.

PHOTO FINISHING

FREE 4x6 Enlargement with every ten reprints only 30c. Rolls developed 30c. Globe Photo Service, Dept. 312, La Crosse, Wis.

POSTCARD Size enlargements 5c, 5x7, 2 for 25c. Kobylak, 50 Downs, Binghamton, N. Y.

SATISFACTION. Roll developed and 8 professional double weight enlarged prints 35c. Modern photographic Christmas card sample, 5c. Superior Finishers, Box 5610, Dallas 2, Texas.

DELUXE Deckle edged prints no extra cost. Roll developed and 8 prints 30c or 8 doublesize enlargements 35c. Extra prints 3c; extra enlargements 4c. Candid rolls, superfine development, 3x4 prints 12 exposures 45c; 16 or 18 exposures 65c; 36 exposures \$1.25. Fast service, satisfaction guaranteed. Robinson Photo Service, 3610 Konkle, Kalamazoo, Mich.

HAVE You photo finishing worries? Forget them. Newly invented camera snaps, develops and prints finished pictures. Write today for our free illustrated folder. Complete details and copy of photo. Pittsburgh Photo Shop, Dept. A-2, 1618 Westmont Avenue, Pittsburgh 10, Penna.

PERSONALIZED Photographic Christmas cards with envelopes, 10c each. Send negative. Minimum 25 cards. Raleigh Photo Service, Box 88, Seattle 11, Wash.

18 CHRISTMAS Cards and envelopes \$1.00, 60-\$3.00, send negative. Three prints each 8 exposure roll 40c. Two each 35c. One each 25c. Reprints 3c. Fred D. Eastman, Bode, Iowa.

PERSONALIZED Photo Xmas cards—12 for 85c. Send negative and 10c for sample card and list of styles. Smith Photo Studios, 8 Saint John Street, Plains, Pennsylvania.

BARGAIN—8 Exposures, with art borders and prize coupon, 25c. "Aircastles" Studios, 7050 Van Buren, Hammond, Indiana.

PRINT Your own photographs! 1c each! Easy to do! Saves money! Takes only few minutes! Complete outfit ready to print 100 professional-like photographs only \$1.00! American Stamp Company, Wilmington-P, Delaware.

25c ROLL Developed with 16 Velox deckledge prints. Quick service. L. Skrudland, Lake Geneva, Wisc.

50 VELOX Reprints \$1. Suburban Studio, 1410-M Bond, Rockford, Ill.

8 HOUR Service. Your 8 exposure roll printed jumbo or regular size. 25c; 12 exposures, 35c; 16 exposures, 50c; 36 exposures, \$1.00. Reprints, jumbo or regular, 3c. Regular prints deckled. Fine grain developing. Send for free mailers. Quality Photo Service, Box 468, San Francisco 1, Calif.

PHOTOS, Documents, etc. photocopied to wallet size and permanently sealed in plastic. \$1.00. Originals returned. Solifis, Box 1942Y, Boston 5, Mass.

FREE Price list on quality developing, printing, enlarging. Write for it today. Bryan's Photo Shop, Dept. M, Panama City, Florida.

2c-VELOX Reprints. Roll developed 16 prints 25c. Photographer, Lake Geneva, Wis.

16 FOR 25c-Velox deckled prints with roll developed. Velox reprints 2c. Deckle-tone, Lake Geneva, Wis.

8 PRINTS All enlarged to nearly post-card size from your roll or negatives 25c; 16-50c. (Trial offer). Willard Studios, Box 3535A, Cleveland, Ohio.

EVERY Picture an enlargement. Bigger and better snapshots than you have ever seen before. New electronic developments give you improved lifetime deckled-edge enlargements at our same low prices. Any 8 exposure roll developed and printed enlarge size 25c; reprints 3c each. Fast, accurate service guaranteed! Send for free mailers. today! Enlarge Photo Service, Box 791D, Boston, Mass.

LARGA-PIC-We have only one offer, but it's an outstanding one! Your roll developed and 8 prints made into brilliant Larga-Pic photos for 30c. Reprints from your negatives 4c each. Write for free mailers. Larga-Pic, Box 22, Brookline 46, Mass.

TWO Beautiful prints from each picture on roll 25c. Twenty-six years of satisfied customers. Quick service. Lens Photos, Dept. J4, Janesville, Wis.

16 VELOX Deckledge prints with roll developed 25c. Studio, River Grove, Ill.

BEAUTIFUL Enlargement from each picture on roll 25c. Cut Rate Photos, Dept. B4, Janesville, Wis.

8 BEAUTIFUL Double size pictures and roll developed 30c. 8 hour service. Free mailers. Pacific Photo Service, Box 666, San Francisco, Calif.

2 BEAUTIFUL Hi-Gloss prints each good negative and enlarging coupon with each 6 or 8 exposure roll developed 28c. Owlphoto Co., Weatherford, Oklahoma.

PHOTOGRAPHY For pleasure or profit. Learn at home. Practical basic training. Long established school. Write for booklet. American School of Photography, 1315 Michigan, Dept. 3452, Chicago 5.

ROLL Developed and 8 prints 30c. Overnight service. Free mailers. Tri-Plex Photo Service, Box 375, San Francisco, Calif.

GLOSS Finish enlargements. 4 5x7 from negative 50c. 3 5x7 from photo 50c. Robert Renshaw, Jr., P.O. Box 478, Chester, Penna.

MOTION PICTURES AND SOUND EQUIPMENT

"PROFITS In Home Movies." Read and study this excellent book. \$2.00. General Films, 4249-C Barnett St., Philadelphia, Penna.

SOUND Films. Special discount. Eastern Film Supply Co., Baldwin, New York.

MOVIE Camera films 100' 16mm. \$2.25. 3 rolls \$6.00. 100' high speed \$2.75. 25' double eight \$1.25. Ambassador, 479-A Quincy Street, Brooklyn 21, N. Y.

PROJECTOR Owners—Large selection 8mm-16mm. movie subjects—exchange. Send complete edition plus \$1.00. The Camera Shop, St. Johns, Michigan.

SEND Stamp for list of 16mm., 8mm. movies, projectors, etc. Sterling's, 679 Northampton, Easton, Pennsylvania.

JIU Jitsu movies, free sample. Stone, Box 171-B, Canal Sta., New York 13, N. Y.

FLORIDA In Kodachrome. 5,000 slide subjects. Send 50c for two samples and catalog. Pasco Roberts Studios, Box 728, St. Petersburg, Fla.

UNUSUAL Home movies. Free list. Loja, Box 74B, Station B, Brooklyn 16.

DISTRIBUTORS Wanted. Make big money selling our new sensational movies. Send for sample today 16mm. Snd. \$10.00. 16mm. Sil. \$7.50. 8mm. \$2.50. and receive free our wholesale price list. Standard Pictures Corporation, Dept. A, Universal City, Calif.

8MM. Sound—Movie Sound 8 projector \$304.00 prepaid, including tax. Also Castle 8mm. sound films, \$8.75. Kaw Photographic Products Company, Box 26, North Topeka, Kansas.

FILM—Movetone is back. It's Weston 12 nonhalation. Free processing 100 ft. 16 mm. \$3.25. 25 ft. double 8mm. \$1.50. Bulk film without processing 100 ft. 16mm. \$2.25. double 8mm. \$2.45. Free circulars. Fromader Genera, Davenport 4, Iowa.

ESTABLISHED School, teaching 35mm. sound motion picture projectionists for ten years, now offer correspondence course. Hollywood Sound Institute, Hollywood 27.

JUST Released! Miss "America of 1947." See America's most beautiful girl! 8mm., 50 ft., \$2.00; in Kodachrome, \$7.50. 16mm., 100 ft., \$4.00; in Kodachrome, \$14.75. Catalog of 66 dazzling subjects. 25c. Hurry! Hurry! World In Color Productions, Dept. PM, Elmira, N. Y.

DEALERS And wholesale users: Fresh Anso 16mm. 100' movie film—black and white, \$5.25; color, \$7.00—minimum order, six rolls. Fresh Anso 20 exposure 35mm. color film, 3 rolls for \$4.50. F.O.B. Baltimore. Gamerman's, 3808-E Eastern Avenue, Baltimore 24, Maryland.

FRESH Movie film 100' 16mm. \$2.25. three rolls \$6.00. 25' double 8mm. \$1.25. Ambassador, 479-A Quincy Street, Brooklyn 21, N. Y.

16-35MM. Silent, sound films. Bedner, 5300 So. Talman, Chicago, Ill.

FREE, 16MM. Sound films. Also bargains in used films. List free. Charles Crank, 2403 Elsinor Avenue, Baltimore 16, Maryland.

MOVIE Cameras! New Lektro Junior 16mm. electric, magazine-loading F3.5 anastigmat lens, viewfinder, battery, cord, tripod socket. Complete, ready-to-operate only \$59.50. Money back guaranteed! Free booklet. Magazine film, panchromatic for this camera, \$2.50. Free processing. Photo-shop Inc., Room 53, 18 E. 42 St., New York City.

MOVIE Film at tremendous savings! Kodak Super X. Gov't stock, tested—guaranteed! 16mm. 100 ft. \$2.95; 50 ft. magazine \$2.50; double 8mm. 25 ft. \$1.65. Super XX, 50c add'l. each roll. Free processing. Fast service. Photo Surplus Sales, Box J4, 12 Duane St., New York City.

GUARANTEED Film—Weston 50! 100 ft. 16mm. \$3.45; 25 ft. (8-8) \$1.45 processed free! MK Photo, 451 Continental, Detroit 14, Michigan.

SOUND Projectors: Used 16mm. standard brands, from \$195.00. Free catalog of 8 and 16mm. art films. Gamerman's, 3808-E Eastern Avenue, Baltimore 24, Md.

DISCOUNTS! 8MM., 16mm. films, equipment. Catalogue 3c. Towers, 935 North 40th, Philadelphia 4.

RENT 16MM. sound films 50c reel. Large selection; free catalog. Film Service, 128 Chestnut St., Roselle Park, N. J.

LEARN Movie projection, management. Free catalog. Theatre Institute, Elmira, N. Y.

PROCESS Your own 8mm.-16mm. movie film. Literature. Duro Movie Products, 1519 Eggert, Eggertsville 21, N. Y.

16 AND 35MM. films, projectors (sound). Savarese, Woodcliff Lake, N. J.

EXCLUSIVE Home movies. Select films. Write for free list. Home Pix, 1674 Broadway, New York 19, N. Y.

EARN \$8.00 To \$10.00 daily with your movie projector. Details free. Metcalf, 10806 Glenroy, Chicago, Ill.

JOIN World's largest cinematographic society. Details free. International Cine Society, Suite 118, 6770 Hollywood Blvd., Hollywood 28, Calif.

EXCHANGES: 8/16mm. silent, \$1.00 per reel. Rentals, sales at money-saving rates. Details for dime. Midland, Box 429, Oak Park 4, Illinois.

8-16MM. Silent-sound films. Complete rental library. All latest subjects. Free catalogue, (sample film 10c). Garden Film, 317 West 50th, New York 19.

COMPLETE Stocks always of Castle, Official, Pictorial films, 8mm., 16mm., sound. Musicals, soundies, free catalogs. We exchange your films and equipment, or buy them for cash. Frank Lane, 5 Little Bldg., Boston, Mass.

PROJECTORS \$16.00 Up. Cameras, film available. Selco Products, Danvers, Mass.

RARE 8-16MM. silent-sound films. International, 2120 Strauss, Brooklyn, N. Y.

BASS Says! 37 years of leadership means satisfaction to you! Finest equipment, 8 and 16 mm., sound cameras, sound projectors. Bass buys 'em, sells 'em, trades 'em. Satisfaction always guaranteed, or your money back! Bass Camera Company, Dept. A, 179 W. Madison St., Chicago 2.

BEAUTIFUL Kodachrome slide and lists 25c. Slide Supply Service, 3111 West Tuscarawas, Canton, Ohio.

GUARANTEED Fresh anti-halo outdoor movie film! Weston 12! Daylight loading! Processing free! Three spools double 8mm. \$3.45! Six single 8mm. for Univex, \$4.60! Postpaid! Catalog, Eso-S, 828-B West 39th, Kansas City 2, Missouri.

"THE World's Greatest Passion Play," all sizes sound and silent. Write Hemenway Film, 33-F Melrose St., Boston 16, Mass.

I BUY, Exchange, swap movie films. Harvey Iris, Box 539, Brockton, Mass.

MUSIC AND MUSICAL INSTRUMENTS

LEARN Piano! Play songs, read notes, in only 1 easy lesson. New sensationally successful method includes exclusive aids never before available. Send \$2.00 today for complete course. Or order c.o.d. Self-Teaching School of Music, Studio PC, Box 3155, Catonsville, Maryland.

USED Records \$1.95 per dozen, \$15.00 per hundred, good selection. Send no money, pay postman i.o.b. Cleveland. Record Rack, 7909 St. Clair Ave., Cleveland, Ohio.

SONGWRITERS—Protect your songs. Get the facts first. Free booklet, attractive offer. Song Service, 331-C West 46th, New York.

NEW Italian accordions, all sizes. Wholesale prices. Free catalog. American Accordion Center, 39 So. Kedzie Ave., Chicago 12, Illinois.

RECORD Albums. "Tip-Loc" safety holder prevents loss. Simulated leather. \$1.00 each, 3 for \$2.75. Prepaid. Symons Associates, Dept. 8, 345 Hudson Street, New York City 14.

SONGWRITERS! Music composed, arranged reasonable. Billy Hannon, 6703 Oshkosh, Chicago 31.

PIANISTS Acquire professional technique quickly! Wehner, 25 Fulda, Roxbury 19, Mass.

SONGWRITERS: Outstanding, honest music writing offer. Dick Reynolds, Leonard, Texas.

SWISS Music boxes repaired. Swiss musical units for hobbyists, \$3.00. Old music boxes bought (any condition). Assembly & Repair Company, 582A Third Avenue, New York 16.

PHONOGRAPH Records cheap. Catalogue, Paramount, MJ-313 East Market, Wilkes-Barre, Penna.

SONGWRITERS! "The Music Game." Newest creation assisting songwriters. Sample copy, 25c plus 6c postage. Paschall, Box 287, Hollywood 28.

POEMS Wanted for musical setting. Send poems for free examination. Five Star Music Masters, 630 Beacon Bldg., Boston, Mass.

PIANISTS: Master popular music chord charts show names, symbols, readings, notation, indexes; 648 treble, 180 bass positions. Terrific! For you! \$1.00. Carol Music Chart Co., P.O. Box 21 P.M. Lefters, Brooklyn 25, N. Y.

MUSICAL Instruments, hundreds new and rebuilt like new. 5-day trial. Free bargain list. Meyer's Musical Exchange, 454-A Michigan, Detroit 26, Michigan.

ACCORDIONS, Wholesale prices. Request circular. New streamline accordions. All sizes and makes. Metro Accordion Co., 44 N. Albany Ave., Chicago, Ill.

PIANO—Play without notes or teacher. System sent free, includes chart and directions. Enclose 10c for handling and mailing. Latom Music, 2147B 86th Street, Brooklyn 14, N. Y.

FREE Accordion pickup with each accordion purchased. New or used accordions for sale. Cash or terms, wholesale or retail. Write for bargain list. Del Principe, 307 So. Wabash, Chicago.

SONGWRITERS—Send your song poem at once for immediate examination and free rhyming dictionary. Richard Brothers, 24 Woods Building, Chicago.

WESTERN Records—Latest numbers 29c. Catalog 3c. F-L Shop, Box 19-L, New York City 35, N. Y.

DUO-FLEX Reeds, for clarinets and saxophones. Eliminate your reed troubles. Circular free. Duo-Flex Reeds, 1204 First Ave., Evansville, Ind.

AMPLIFY Your accordion with our new Del Principe pickup, \$22.50. Install it yourself in one minute. Makes any accordion sound like an organ. Works with any amplifier. Special Del Principe amplifier and pickup only \$72.50. Write for details. Del Principe, 307 So. Wabash Ave., Chicago.

POEMS Wanted for musical setting! Send poem for immediate consideration. Hamann Service, 614 Manhattan Building, Milwaukee, Wisconsin.

POEMS Wanted to be set to music. Free examination. Send poems. McNeil, Master of Music, 510-PM S. Alexandria, Los Angeles, California.

BEFORE Sending your poem to be set to music, know your composer. Free folder. Al. Moquin, 5333 La Cresta Court, Hollywood 38, Calif.

SONGWRITERS! Outstanding ethical offer. Hibbler, C5, 2157 N. Avers, Chicago.

POEMS Wanted for new songs. Send poem for free examination. Eliot Wright, Master Composer, 207 Rivoli Theater Building, Portland, Oregon.

SONGWRITERS: Send poems for free examination and outstanding offer. United Music Service, 150, Salem, Indiana.

WRITE Songs. Big money and reputation. Write for information. J. Gordon Pub Co., 201 N. Hoyne Ave., Chicago.

SONG Writer's attention! The amazing demand for phonograph records, accelerated by more than 300,000 juke boxes and the hits popularized warrants your immediate consideration. We are offering song-poem writers the rare opportunity of having established composers collaborate on appealing material received this month. Recola Records, Box 987P, Hollywood 28, Calif.

RADIOS, SUPPLIES, INSTRUCTIONS

WIRELESS Oscillator for your phonograph! Completely wired, with tubes, instructions. \$6.90 postpaid. C.O.D. accepted. R J S Products, 925 Concord Ave., Akron 6, Ohio.

BUILD "Loudest" crystal radio. Instructions and crystal, 25c. Amoroso Radio, Route Four, Richmond, Virginia.

EXPERIMENTERS Look, uncased, new genuine, radiosonde C-W transmitters complete with tube, less battery and mike, \$2.50 ppd. No. c.o.d. Dunlap, 219 S. 17th, Philadelphia 3, Penna.

BUILD Modern console type radio cabinet with sliding free-panel, doors of natural wood. Simple, easy-to-read blueprints. Order number 1100. 25c. Popular Mechanics Press, 200 E. Ontario, Chicago 11, Ill.

BRAND New army throat microphones, used in tanks, airplanes, etc. Ideal for home communicating sets, announcing through your radio, hearing aids, etc. \$1.00 prepaid. Heath Co., Dept. M, Benton Harbor, Mich.

FIX Any radio. Amazing new instrument locates radio troubles double quick. Simple instructions show you how. Thousands in use. Write today for Folder "PM". Free. Feiler Engineering Company, 422 S. Dearborn St., Chicago 5, Ill.

RADIO Kits complete, five tubes, instructions, \$15.95. Aerials 95c; volt ohmmeters \$5.25. Three tube amplifier, less tubes and speaker, \$1.95. Army headphones with rubber cushions \$1.50. Radio Parts Sales Company, 5220 South Vermont Avenue, Los Angeles 37, California.

WESTERN Electric fixed crystal, no adjusting, new war product. Excellent for crystal sets—sensitive, cost government \$5.00, prepaid \$1.29 with holder. Special release. Famous paratroop metal folding antenna expands 128 inches. Very scarce. Worth \$10.00, only \$1.49 plus postage, two pounds. Free list #4. Radio City Lab., 30 Church St., New York 7, N. Y.

NEW Fall list #17. Kits, television phones. War surplus. John Barron, Box 128, Ft. Hamilton Sta., Brooklyn 9, N. Y.

6 ASSORTED Crystals, catwhiskers, instructions. "Radiobuilder," catalog—all 25c. Laboratories, Eye-c, San Carlos, California.

BUILD A portable radio tube tester; improved design, checks all type radio receiving tubes; complete kit with easy to follow assembly blueprints; saves you \$20. Brand new factory parts; Standard Appliance Co., 1438 West Third Street, Dayton, Ohio.

KIVER'S "Television Simplified" theory, repair, servicing. Practical 375 pages illustrated. Only \$6.00 complete. Center Book Club, 243 Market, Newark 2, N. J.

BUILD Your own television. 7" television receiver kit, complete less tubes \$89.95, all tubes included \$129.95. Metropolitan Electronics, 42 Warren, New York, N. Y.

MOULDED Bakelite condensers—.0001 to .2 mfd, 200-600 wv. Standard brands; capacities clearly marked in figures. Kit of 50 asstd. \$2.95. Write for radio parts bulletins. Leotone Radio, 65 Dey St., New York City 7, N. Y.

25 YEARS Experience radio repairing at your fingertips. I've repaired 45,000 radios and have perfected system you can follow step by step. My methods are far simpler than any course published. Requires no calculations. Total price \$1.00 postpaid or c.o.d. Moneyback guarantee. Ross Radio Company, 14615A Grandriver, Detroit 27, Michigan.

BUILD One tube cigarette case radio. Easy to build. Plans 50c. Complete kit and plans less batteries \$5.00. Special miniature batteries \$1.75. Extra tube \$2.20. Money order or c.o.d. Electronic Manufacturers Co., Fifteenth and Greene, Augusta, Georgia.

RADIO And television catalog—free! Money saving prices on radios, hard-to-get parts, record changers, wire and disc recorders, amplifier systems, tubes, books, amateur and test equipment. Write today! Radionic Equipment Co., Dept. 2010, 170 Nassau Street, New York 7, N. Y.

\$1.00 RADIO Service. Write Wholesale Service, 780 E. 214 St., New York, N. Y.

U. S. SIGNAL Corps featherweight earphones \$1.00. Radio service men and experimenters send stamp for our giant radio catalogue. Save dollars. United Radio Co., (100-V) Newark 1, N. J.

BROADCAST Through your radio with the "Tiny-Tone" Little Mike. Complete instructions included. 50c postpaid. Money back guarantee. Tiny-Tone, 1216 Park Row Building, New York 7, N. Y.

TELEVISION Opportunity knocks now. See Marlowe Ad under Profitable Occupations.

RADIOMEN, Servicemen, beginners—make more money, easily. \$250 weekly possible. We show you. Information free. Merit, 216-32A 132nd Avenue, Springfield Gardens 13, New York, N. Y.

MAKE Simple, tubeless, batteryless, distance-getting crystal radios. Crystal and illustrated instructions 25c postpaid. Allen, 427-P, Clinton, Missouri.

RADIO Technician and radio service courses. Training for federal licenses. American Radio Institute, 101 W. 63 St., New York City. Approved under G. I. Bill of Rights.

BUSINESS OPPORTUNITIES

TOP Profit. No investment. Handle superior quality photo stamps. Amazing portrait photographs in gummed back stamp form. Steady business. Free samples and particulars. American Photo Stamp Co., 103 East 125th Street, Dept. 509, New York 35, N. Y.

START Home manufacturing business making Cleaning Compounds, Soaps, Insecticides, Cosmetics, Polishes, Food Flavors. No machinery. Literature free. Kemix, Park Ridge, Ill.

DISTRIBUTORS, All territories, new simplified bookkeeping system, includes preparation income and estimated tax returns. \$16.25 profit each sale. Repeats. Leads furnished. Permanent. National Accounting Service, Dept. M-10, Lynbrook, New York.

MAKE Profits in mail order business. Astounding plans describing method sent free. Jimton Service, Lock Box 1373, Mobile 8, Alabama.

SIGNS Made easily. Instructions and ten sets modern alphabets, numerals, patterns. Sizes up to eight inches. All for \$1.00. Co-operative Business, 7 West Madison, Chicago, (2).

STUFFED Toys. Make and sell sawdust stuffed toys. Spare or full time. Instructions and five patterns, postpaid, \$1.00. Sawdust, Dept. 113, Lock Box 586, Old San Diego Station, San Diego 10, California.

WANT To sell your brains? Publish and sell your own knowledge for money. Publisher tells how. Free details. Write today. Royal Publishers, Auburn 3, Alabama.

TREMENDOUS Profits selling real estate. Authoritative new manual shows how to start full or part time business of your own. Complete only \$2.00. Details free. Schultz House, 3116 Seminary, Chicago 13.

GOLD, Silver plating at home. New, amazing outfit. Does marvelous work and so simple. Just plug into electric socket and in a jiffy you begin to plate. Not a toy. No experience needed. Everything furnished. Absolutely guaranteed. Make money plating for others. Write immediately for full details. Louric Mfg. Co., 1809-W Callowhill Street, Philadelphia 30, Penna.

OPPORTUNITY Knocks for those sending for our successful business enterprises. Manning, 3259 Decatur, New York 67, N. Y.

MAIL Order businesses, franchises, distributorships, bought and sold. Write for free bulletin of exclusive opportunities. Turnipseed, Inc., Box 681, St. Louis, Mo.

BUYERS Wanted for plaster novelties. Painted—unpainted. Retail—wholesale. Write today for free information. Bing Products, 88-X5A Broad, Boston 10, Mass.

REMNANTS—Amazing values. Housewives buy on sight. Good profit. Write B & M Textiles, 415 East 26th Street, Paterson 4, N. J.

NEW Invention. Opportunity exclusive selling rights. Ingram, 6774 Taft, Detroit 8, Michigan.

FOR Best prices on silver plated and gold plated earscrews, write The Marcraft Co., Skokie, Illinois.

START Home business in spare time. No experience needed. Unusual opportunity. Literature free. Bailey Service, 1710 Portland Avenue, Nashville, Tennessee.

HOME Moneymakers. Business information directory \$1.00. Reimer, N-1119 Chestnut, Saginaw, Michigan.

GROW, Sell plants, flowers. Details—Geranium seed 10c. Bowers, Loyaltown, Penna.

MAKE Liquid marble, flexible molds, statuary, art goods, novelties, artificial marble flooring. Literature free. Kemico, Park Ridge 50, Ill.

OPERATE America's most popular low priced precision penny vending machine. Big profits. Be independent. Write for bulletin and prices. Stock shipments. Fielding Mfg. Co., Desk 1047PM, Jackson, Michigan.

MAILORDER Beginners! Save money by getting started right! Our new booklet may save you dollars. Only 10c, postpaid. Mail Order Mecca, 30 West Washington Street, Chicago 2, Illinois.

RAISE Fishworms, everything revealed; extensive method, \$5.00. Details, free. Stoner's, Chattanooga 6, Tenn.

DOLLARS Daily! Cleared \$1,900 in two months by mail! Write immediately! Loeb, A-10, Silverton, Cincinnati 13.

MAKE Own products, keep all profits! 500 formulas, rush 25c. Wilde, Z-10, Rossmoyne, Ohio.

RUBBER Molds, liquid rubber, statuary plaster, kits for beginners. Complete "Plastercraft" course free on request. Blue Rapids Supply, Blue Rapids, Kansas.

ONE Minute portable studios. No negatives. Photos cost about 1½c each. Ideal for pleasure or profit. Complete camera \$60.00. Glossick Mfg. Co., 544B Monson Street, East Peoria, Illinois.

GOODYEAR—Has natural Malaya liquid rubber, for mold making, fast drying, air-curing, quart \$3.00, gal. \$10.50, trial pints, \$1.50. Write for full particulars. Goodyear, Lake Geneva, Wis.

OPERATE Profitable mail order business. Write Gallagher Publications, Box 691C, Kingsport, Tenn.

\$100.00 WEEKLY In local or mail order business. Exclusive set up free. J. Molus, 2146 N. Campbell Ave., Chicago 47, Illinois.

PLASTER Paris gets hard as stone. Just mix in "ROC," amazing new chemical—air bubbles come to surface, disappear. Finished casts hard, ring like a bell. Enough for 2,000 casts only \$1.00 postpaid. Money back guarantee. So-Lo Works, Dept. A-200, Loveland, Ohio.

INSIDE Secrets, quick cash folder free. Jenkins Enterprises, 4831 Hatfield St., Pittsburgh 1, Penna.

USE Your home as magazine subscription station. Represent all magazines. Liberal commissions—we supply everything. Big Christmas business ahead. Catalog, full details, free. McGregor Magazine Agency, Dept. PM-9, Mount Morris, Ill.

COMPOSITION Flooring—Made in most colors. Lifelong, soundproof, resilient. Flexible molds. Cast novelties, plaques, statuary. Big money—your own business. Catalog free. Write Bing Products, 88-A3E Broad Street, Boston 10, Mass.

OPERATE Profitable home mail order business on \$5 capital. Details free. Notte, 2718 West Cambridge, Philadelphia 30, Penna.

COLOR Concrete with chemicals. Formulas, instruction. Sample 10c. Hollywood Cementcraft, 8527-A Wonderland, Hollywood 46, Calif.

OPERATE Profitable home business. Levine's, 15-X Boulevard Station, New York 59, N. Y.

ATTENTION, Agents or gift and novelty shops. Make 100% profit, buy direct from manufacturer beautiful line fish-scale and shell costume jewelry and novelties. \$2.00 brings 3 samples returnable. Free illustrated folder on request. Wonderland Studio, P.O. Box 709-P, St. Petersburg, Fla.

REBUILT Champion-A.C. spark plugs, 11c each. Finished, boxed like new! Guaranteed. Big profits selling dealers. Exclusive territory. Standard Parts, 3033 Main, Kansas City, Mo.

SEND \$1.00 For quart earthworm stock. Complete instructions. Earthworm Farms, Lamoni, Iowa.

AT Home—Your own manufacturing business; making popular \$1.00 novelties. Cost you 3c to 15c. Everything supplied. Write So-Lo Works, Dept. B-600, Loveland, Ohio.

PROFITABLE Mail order business. Write Beiers, 837-A Hoffer, Bethlehem, Penna.

MOLD Easily-sold articles from plastic, plasters, compositions. Free circular describes designs, methods, opportunities. Digest, 2917B Michigan, Kansas City, Mo.

PLASTICIZE—Lasting beauty-protection for autos. Used like polish, entirely new. Opp. exclusive distributors earn \$15,000 annually. Plasticize, 2254 N.W. 62nd St., Miami, Fla.

METALLIZE Baby shoes. Excellent profits. New system insures success. Free details. "Treasures Forever" Metallizers, 89 Henry Ave., Lynn, Mass.

300% PROFIT Selling fast repeat item by mail, local. Dade Products, Box 1720H, Cleveland, Ohio.

NUPLAMOLD Molds are permanent, will not shrink or deteriorate. Made to order. Own your own business, start spare time. Make big money duplicating hundreds of decorative ornaments or industrial items. Start now—Get our price list. Write the Shop Technician, 314 Westport Road, Kansas City, Mo.

DO IT with sea shells. Beautiful jewelry, novelties. Big profit spare time. Free lesson. Werts (P.), 1429 56th Avenue, Oakland 3, Calif.

UNPAINTED Plaques, statues. Variety of designs, free list. ArBo Products, A 195 E. 7th St., St. Paul, Minn.

EXCLUSIVE Distributorships available. New sensational home labor saving device ready October first: Wonderful money making opportunity. Write Sherwood Products, Erie, Penna.

BABY Shoes bronzing supplies, lowest prices, onyx and plasticide mountings, special hardening solutions. Box 2095, Wichita, Kansas.

MAKE 90c profit, every \$1.00. Operate profitable mail order business. Lane, 548-B 61st St., West New York, New Jersey.

SECURITY, Happiness, Independence. Selling by mail. Free details. W. Young, Box 1477, Portland 7, Ore.

AGENT Or exclusive distributor for cigarette lighter mfg. MacGregor, Tahoe Valley 16, Calif.

START Your own mail order business, anywhere on small capital. Interesting, fascinating, profitable. Details free. Artz, 1060A Harding Drive, Toledo 9, Ohio.

OPERATE Profitable mail order business. Splendid opportunity. For details write, E. C. Oliver, P.O. Box 1030, Newburgh, N. Y.

YOU Too can start profitable home business with \$5.00 capital. Details free. B. E. Leveque, 823 Howard Street, San Antonio 1, Texas.

MEN—Women—"Everybody likes candy." Learn to manufacture professionally at home. (Our 37th year). Ragsdale Candies, Dept. 4, East Orange, N. J.

DOES \$1,500 Yearly in spare time by mail interest you? Free details. Lawson, Box 1302-P10, Detroit 31.

PERFUME Manufacturing business. Little capital. Big profits. Particulars free. Bob Celaya, Brownsville, Texas.

MEN, \$100-\$250 weekly possible installing, maintaining fluorescent lighting. Rebuild fixtures for 100% profit. Make beautiful lights (including ballast and lamps) for 50c each and less. Free sample materials. Write Willis Service, 101 York St., Brooklyn 1, N. Y.

LOOK Mail order service business everybody wants. No manufactured stock to carry. Operate from home for many extra dollars. Complete detailed instructions 25c. Particulars free. Brady, 323 S. Mulberry, Albuquerque, N. M.

HOME "How to Sell by Mail" business. Complete instructions 25c. Martin, 2454-OM Wilson, Chicago 25, Illinois.

NEWEST Idea in finishes. Flok-Kraft Synthetic Plush sprayed on all shapes, surfaces. Beautiful soft texture covers mended radios, furniture, figurines, lamps. Profitable, entertaining. Supplies, equipment, free instructions. Coast Ind., 1509 W. Manchester, Los Angeles 44.

LIQUID Rubber for making flexible molds. Sample bottle 25c. Plaster hardener, quart \$2.00. Free literature. Chaney, 1130 East 16th Street, Jacksonville 6, Fla.

MAKE Flexible molds! Few cents each! Cast plaques, novelties, bookends! Free sample! H. Tooker, Hamilton 44, Ohio.

QUIT Wasting dollars trying to start a mail order business. Get and read the truth and save losses. Send quarter for ideal free booklet of facts not promises. Send for "How to Build Your Own Mail Order Business" and get "in right" for profits. Douglas Service, 3231-M 40 Ave., S. W. Seattle 6, Washington.

SAWDUST. Turn it into cash. Six methods. Instructions 25c. Charles, 12-AV, Norwood, Ohio.

LEARN Piano tuning, repairing, at home. Tremendous field! Piano parts, tools furnished. Established 1935. Empire School of Piano Tuning, 606-B East University Ave., Champaign, Ill.

FACTORY Representatives. Gas-electric lawn mowers, 1948 models. Lowest priced. Rotacut, M-2006, Excelsior Springs, Mo.

GET Hundreds of money-making deals, business ideas, plans and manufacturing formulas. Amazing folio free. Austin Mail Service, 5538 Lexington St., Chicago 44, Ill.

OWN A mail-order paper products business. Sell envelopes, tags, bags, boxes, by mail, wholesale. Tremendous demand. Steady profits. No capital necessary. Write Omaha Envelope Service, Dept. 219, 4721 California, Omaha 3, Nebraska.

CONSULT—Mitchell Engineering, 6430 Evans, Chicago 37, Ill. Electrical; mechanical; product design; patent engineers.

NEW Help for bona fide mail order beginners! To get going right contact Pes, 10226X 11th SW, Seattle.

\$6,000 YEARLY Possible operating branch office in cities of 5,000 and up population. Write for full details, proof. "D. Hunt," President, Box 308, Burlington, Calif.

UPHOLSTERING—Start your own shop. Beginners kit, complete instructions \$12.95. Wynn and Graff, 5114 Charlotte, Nashville, Tenn.

START Home business making statuettes, plaques, artificial marble flooring, liquid marble, flexible molds, metalizing baby shoes. Amazing profits. Folder free. Creative, 236-L, Winnetka, Illinois.

UNPAINTED Bookends, plaques, statues, figurines. List. Haverty Products, 1219 8th Ave., Altoona, Penna.

WORKERS—Apply Reflect-O-Lite to signs, readable 500 ft. at nite. Sample with instructions \$2.00. Reflect-O-Lite Signs, P.O. Box 18, Mentor, Ohio.

GET Money by mail—Keep all or half. Samples 10c. "Faucher," P.O. Box 381, Fall River, Mass.

"22 REASONS For Mail Order Failure" and "So, You Want to Sell by Mail?" Both regularly 50c, now 20c. Basura, 425 East Garvey, El Monte, Calif.

MOBIL "Popcorn Candy Business" 100% profit. Complete course \$1.00. "La-Plant," Menominee, Michigan.

FREE—Magazines, publishers offers. 5c stamp. Ritz, 939-P Fteley, Bronx 61.

FELLOW Workers, no bosses. National opportunity to become independent with business of your own. Details free. P. Padney, 307 York St., Jersey City 2, N. J.

BABY Shoes preserved. Formulas, instructions \$1.00. Novelty Bronzing, Box 56, Hyde Park 38, Mass.

METAL Awnings built cheaply from standard materials. Complete bldg. plans \$1.00. Information only 10c, refundable. Lohme, 825 Lima, Burbank, Calif.

ABALONE Pearl sea shell rings, sterling silver, ladies \$6.75 and \$12.00 dozen. Joseph Fleischman, 1535 Broadway, Tampa, Florida.

HANDYMAN—Earn up to \$30.00 daily in America's most uncrowded mechanical field. Write Stafford, 708-A Rawlings, Carbondale, Ill.

RE-NEW Leather and leatherette—Make cloth into imitation leather with plastic discovery called Leather-New. Opportunity to make real profits taking care of sales resulting from national advertising. Write for free sample of Leather-New covered material and complete deal. 701 Land Bank, Kansas City, Missouri.

CO-PUBLISH For profit, details 3c stamp. "RBCO," 542P Fifth Ave., New York 19.

BRONZED Baby shoe mountings and supplies. All metal bronze bookends, picture frames, ash trays, etc. Onyx ash trays, desk sets, plaques. Hardening solution. 30 amp. plating rectifiers with powerstat control, \$85.00. Geared motors for agitation, \$15.00. Lead lined tanks. Write for list. Hollywood Bronze Supply, 1770 N. Vermont, Hollywood 27, Calif.

PLASTIC Novelties—Cast statuary, costume jewelry, bookends, colored pottery, liquid plastic, liquid marble. Flexible molds, composition flooring, tile roofing, waterproofing, plastic homes. Particulars free. Marbleizing Service, Edwardsville, Illinois.

MAIL Order beginner? Write Dunlop, 915X 30th South, Seattle 44, Wash.

OPERATE Vending machine route. 10 new Atlas Ace or Silver King ball gum machines and 14,750 balls bubble gum \$147.50. Sell gum, machines paid for. Subsequent orders of gum \$12.50 per case of 3500 balls. Only one offer to customer. T. O. Thomas Co., 1572 Jeff., Paducah, Ky.

TOYS. Make, sell, sawdust filled. Spare, full time. Instructions, five patterns, postpaid \$1.00. Sawdust, Dept. A, Box 586, Old San Diego Station, San Diego 10, California.

RUBBER Molds. Make your own. "Air-cure," mold making liquid. Free model. Directions. Quart \$2.95. Plasticwood, "Plaster Hardener," quart \$2.50. Luster-glaze, quart \$2.50. Rubbercoat, 3873A, California Street, San Diego 1, California.

OPERATE Profitable mail order business. Splendid opportunity. For details write Clara S. Coleman, 29 Lippitt Street, Providence 6, Rhode Island.

\$10,000 YEARLY With topnotch sellers. Catalog sent free. Salesman's Service, 1412A Chase, Chicago 26, Ill.

HALLOWEEN Cats! Inflate 12 inches high, noisemakers attached. Balloon novelty sensation! \$5.90 gross. Retail to 20c. Merchants move these fast. Sell profitable balloon specialties. Ellswood Balloon Headquarters, La Junta, Colorado.

GENUINE Natural latex for rubber molds. Only two coats necessary for a thick mold. Make money reproducing hundreds of objects. Write, Major Chemical Co., 131 Inman Street, Cambridge 39, Mass.

BIG Money selling "Bobby-Jo" baby shoes. Everything furnished. Tested successful mail plan free. No-Co-Ro, Oakland, 6-M, Calif.

NEW Low prices on Super X Molding Latex. Liquid sample 25c. Literature and sample free. W. Wooley, 115-A Donald, Peoria, Ill.

SPECIAL Rubber for making molds. Literature and sample free. Universal, Box 1076-A, Peoria, Ill.

HOME Workers wanted to hand-spin Angora wool. Either sex. House of Angora, M10, Springfield, Illinois.

FREE Literature describing many money making plans. Albert Pearson, Box 1182, Milwaukee, Wisconsin.

SALT Peanuts in the shell! Year round business. Start in kitchen grow to factory. Instructions include buying, salting, selling. \$1.00. E. H. Pease, Grover Hill, Ohio.

\$46 FROM Square foot plywood. Jigsaw necessary. Write Woodarts, X-38, Bridgewater, Mass.

LEARN To metalize baby shoes! Complete instructions \$1.00. Don Brady, 1618 Gage St., Topeka, Kan.

EXCEPTIONAL. Permanent weekly income for man or woman to own and operate route of new small coin machines made especially to sell "Hershey's" world famous 5c chocolate bars. Machines cost \$26.50. You can start with ten or more. Amazing earnings. Be first. Send money order for sample. Full particulars free. Address "Star," 635 South Kenmore Ave., Los Angeles 5, Calif.

DOUBLE Your money back, if not delighted with "Opportunities Preferred"—Big, 8½x11 magazine, handsomely printed on slick paper. Money-making ideas and opportunities galore. One man got \$5,000 ideal! Dollar brings nine big numbers. B. W. Coates, Publisher, 33 Vassar, Dorchester 24, Mass.

MAKE Big money building ship in bottle. See page 74.

MANUFACTURE Paints, your garage a factory, no equipment, capital necessary. Industrial Chemist, 525 Donnelly, Kansas City 32, Mo.

METAL-COTE—Metalizes "baby shoes," plaster casts, etc. old silver, copper, gun metal. Pint \$1.95, gallon \$8.00. Plastic Products, 3151-NE Southport, Chicago.

PLASTIC—Liquid glass, china glazes plaster, protects wood etc. Pint \$1.00, gallon \$4.00. Plastic Products, 3151-NE Southport, Chicago.

RUBBER—Airflex, makes molds overnight "A coat or two will do." Pint \$1.50, quart \$2.50, gallon \$7.00. Plastic Products, 3151-NE Southport, Chicago.

ATTENTION Ambitious men. Get into business for yourselves, using our proven and dependable methods. Free details. Stratton Business Service, Chicago Stock Exchange Building, Chicago 3.

ELEVEN Formulas, also diagram of electroplating outfit for \$1.00, (coin). Emery, 482-40th Street, Oakland 9, California.

MAKE—Sell new amazing auto paint you simply wipe on. Complete formula \$1.00. Ideal Service, Park Ridge 8, Ill.

DISTRIBUTORS Wanted for nationally advertised, guaranteed, high-quality brushless, Wipe-on Auto Paint and 1-coat Auto Spray Paint. Protected territory. No price competition, full profit margin. Easily make \$200 per week selling to jobbers and dealers. Requires \$500 to handle stock. Address Gold Seal Brands, 673 So. Coronado, Los Angeles 5, Calif.

READ "Advance"—The Voice of Mail Order. Offers money-making opportunities, sources of supply, personal guidance, etc. Issued monthly. Sample copy 25c. Yearly subscription \$2.00. American Mail Trade Association, 313 East 21st Street, Suite 45, New York 10, N. Y.

NEW Auto thief alarm protects car, tires and accessories. Amazing invention blasts loud alarm instant thief tampers with any part of car or truck. Write for descriptive circular and prices. Joyce Distributing Co., 30 W. Washington St., Room 940, Chicago 2, Illinois.

JOIN The New Inventors Club. We work together to protect, discuss, improve, model, and manufacture your ideas. Suite 4-45, 5511 Euclid Ave., Cleveland 3, Ohio.

BUILD Your own independent, fascinating and very profitable business at home, spare or full time. \$75.00 and upwards weekly easily possible making beautiful, brilliant, sparkling novelties, religious figures and popular sports souvenirs. Fast sellers through you, salesmen, stores. Quickly learned and few dollars starts you making real money. Successful manufacturer can tell you how and furnish everything. Start small, grow big. Write for full information and "Amazing story of my success" at once. Inghram Company, 2845 Sixth Street, Detroit 1, Michigan.

"PLANNED And profitable" mail order selling. New work book of ideas and instructions for beginners, aspirants, established dealers. Send quarter for copy of "Mail Order Business Monitor" magazine and details. Free subscription offer. P. Kaufman Agency, 2629 78th Ave., Chicago 35, Illinois.

MAILING List! 10,000 women mailorder buyers, \$45.00, 5000, \$25.00, 1000, \$6.00. Guaranteed accurate. Try them! Woods Remnants, Bedford, Penna.

FREE Sample copy national mail order publication. Other opportunities. Write Post-Age, 909 E. 20th, Indianapolis 2, Ind.

PROFITABLE Home sparetime business, making wallets, belts, other fast-selling leather novelties. Simple to make. Tools not necessary. Amazing opportunity. Send for free catalog. Gold Leathercraft, 632 Desplaines, Forest Park, Ill.

LEARN To metallize baby's first shoes at home. Big profits in spare time. Secrets, free gift. Send card. Schoettle, Friendship, Ohio.

MERCHANDISE At half the standard advertised price and catalog 10c, none free. Ken Solomon Company, 813 Broadway, New York 3, N. Y.

MOTHPROOFING And cleaning business pays well. I'll show you how to start on amazingly small capital. Write today for details on eight practical plans. Howard Robinson, Ph.G., Box A, South Ohio Street, Sedalia, Missouri.

GET Into a billion-dollar industry, unlimited possibilities, large demand, small capital. Details free. Beecroft, 15 Park Row, New York 7, New York.

START Your own electroplating business, highly paid, uncrowded field. Learn at home. G.I. approved. Send postcard for free electroplating booklet and proof. Plater-Hyde, Room 521, 432 "F" Street, San Diego 1, California.

IF You'd like your own, high income but easily learned office business, write for free details today. Cole Associates, Syracuse 2, N. Y.

PROFITABLE Letter shop operation. Details free. Wollard, Box 268-E, Newark, Ohio.

UP To \$1500 yearly selling by mail in spare time interest you? New ideas and plans every month. Details free. Idea of Month Club, Box 118-A, Baltimore 18, Md.

SWAP! Successfully! Instruction book 25c. "Swappers," 2836-PB Slevin, Louisville 12, Kentucky.

BECOME A finance man. Particulars free. George Lenhoff, Lincoln 8, Nebr.

METALLIZE Baby shoes, new ideas, particulars free. Krall, Box 8087, Pittsburgh 16, Penna.

50 GOLDEN Opportunities for profitable mail order operation. Free literature. Star Publications, Dept. S, 207 Investment Bldg., Pittsburgh 22, Penna.

FLASH. 3 Classic novelties. Large profits. Gold mine for agents, salesmen. Hurry. 25c coin, not stamps. Martin, PM 57 Hart, New Britain, Connecticut.

CAPITAL Raising made easy; millions available; send for Financing Your Business; large 250 page volume; complete details, only \$2.00. Seminole Publishing Company, Room 9, 317 W. Forsyth St., Jacksonville, Florida.

\$5 COMMISSION On booked distant moving jobs you recommend. United, 243 West 60th Street, New York, N. Y.

POPCORN Machines. Potato chip outfits. Long Eakins Co., 4760 Hi St., Springfield, Ohio.

BE Your own boss! Let us show you how to make big money right at home! Free details! Kiktavi, 8620 South Ruthelen, Los Angeles 44, California.

START Profitable mail order business on \$5. Write Duncan, Ortega Station, Jacksonville, Florida.

HOW To make profits in mail order 25c. Mail Order Monitor, 356 South Broadway, Suite 706-PM, Los Angeles 13, Calif.

GET It for them wholesale. Be community buyer nationally-known merchandise; radios, refrigerators, washers, sweepers, typewriters, etc. Savings up to 50%. This pleasant, easy work can earn up to \$5000 year. Get details today. Kraft, Aurora 8, Missouri.

WHITE Liquid rubber for making flexible molds! Quick drying! Safe! For home, classroom, or industry! Quart \$2.00. Gallon \$5.95. Full instructions! Beginner's booklet on molding and plaster casting 25c. Free with order! Plastercraft Supply Company, 1406 East 43rd Street, Cleveland 3, Ohio.

INVESTIGATE Mail order or home business. 140 new ideas. Write Marshall, Box 655, Centralia 13, Washington.

WHOLESALE Lists, business plans, home profits. Free. Holm Sales, Box 12A, Oaklandon, Indiana.

AMAZE Others. Add faster than adding machine. Free details. Math Institute, Box 633, Mobile 4, Ala.

LEARN Import—Export! Represent manufacturers! Study at home. Uncrowded fields, unlimited opportunities. ITP trains you in a few weeks. Five years free information service. Folder free! International Trade, 246-P Fifth Ave., New York 1.

OPPORTUNITY Mail 6 months 25c. Roth, 1455B Cornelia, Chicago 13, Ill.

MAILING Postcards selling repeat merchandise is profitable. Everything supplied. Details free. Gordan Publishers, Box 23, Pawtucket, R. I.

WOULD You pay 3%—first \$350 made? Color-illustrated book "505 Odd, Successful Enterprises" free! Some offer occasional "day off." Work home. Expect something odd! Pacific, Oceanside, Calif.

OPERATE Home mail order business. Small capital. Write. Browning Service, Box 4001, Miami 25, Fla.

\$40 WEEKLY, Spare time, your own home business. Many plans. Literature free. Carroll Service Company, 521-A North Pine St., Little Rock, Ark.

FREE Water and our concentrates, makes flavors, lotions, shampoos. 72 products, labels, bottles furnished. Qualco, E-20030 Russell, Detroit.

TWO Amazing new typing opportunities. Earn up to several dollars hour, right at home. New, exclusive, different. Write Schroder, 221 E. Bush, Covington, Ky.

TATTOOING And engraving pays big profits. Experience unnecessary. Literature free. William Moore, 412M South Green, Chicago 7, Illinois.

SELL Books by mail. Large profits! Free! Literature. Cline-Porter, Box 6346 PB, Pittsburgh 12, Penna.

BABY Shoes metallized the durable method. Complete instructions \$1.00. St. Albans Plating Industries, 135-17 135 Ave., So. Ozone, L. I., New York.

BIG Profits and your own business casting latest 1947 metal toy autos, airplanes, ashtrays, savings banks, etc. Enormous wholesale and chain store demand keeps manufacturers busy. Spare or full time. No experience or special place needed. For full information write Metal Cast Products Co., Dept. A, 1696 Boston Road, New York 60, N. Y.

COLORGLAZED Concrete pottery made without molds. New, low cost, patented method. Cemetery products, novelties, tiles, floors, etc. Basement leaksealing. Other money-making projects. Booklet, details free. Men only. National Pottery Company, Grand Rapids, Minnesota.

UNPAINTED Plaques, bookends, ash trays. List. Bava, 3855 E. Canfield, Detroit 7, Michigan.

COIN Machines earn big money! Machines are now available at \$11.75 that can earn as high as \$7 weekly profit. Place machines in stores, hotels, filling stations, etc., and your income starts immediately. Routes can be operated in spare or full time with no experience needed. We'll tell you how and send you a catalogue describing our nut, candy, gum, and postage vendors, also scales, amusement games, etc. Write immediately to Parkway Machine Corp., Dept. P, 623 W. North Ave., Baltimore 17, Md.

CO-PUBLISH And advertise in The Central Mail Advertiser. Sample copy for stamp. Low rates. Large circulation. Bagby Printing Co., Georgetown, Ohio.

HOW To set up and run a mirror shop! Resilver mirrors. For price write—John Sprinkle V60, Marion, Indiana.

GOT \$24,500 Using "schemes" from "Schemer" magazine, Alliance, Ohio. 49th year. \$1.00. Three samples 25c.

RAISING Canaries pays good profits. Valuable bird book—"Its Care, Breeding and Training." Price \$1.00. American Canary, 2839 N. Halsted, Chicago.

OPERATE Profitable mail order business. Write Walter Service, 4159-A East 112th, Cleveland 5, Ohio.

MAKE Strange plastic—1c pound. Makes durable, attractive floors, walls. Build with waste. Save half. Bays Laboratory, Oklahoma City 9.

INCORPORATE Your business. Delaware laws. Many advantages, free details. Tax Research Bureau, Inc., Delaware Trust Building, Wilmington, Delaware.

RECAST Old batteries into new. Latest achievements. Battery Laboratories, Minneapolis.

BIG Mail income. Free particulars. Murray's, 196 Circle, Forestville, Conn.

PARATOL—Amazing new rubber latex moulding compound for perfect detail castings of all kinds tested and approved in long service. No worries—easy to apply, quick drying, maximum strength and long life. Why pay more—buy direct! Quarts—\$1.60, 1 gal.—\$4.90, 5 gals. \$4.45 gal. 4 oz. samples on request. Send 25c to cover mailing and handling charges. Full instructions sent with each order. Testworth Laboratories, Inc., Manufacturers of coating and adhesive products of all kinds. 407 S. Dearborn Street, Chicago 5, Illinois.

OUR Unique service will help sell your idea or invention. Literature free. Ellis Martz, Representative, Muncy, Penna.

START A home business in spare time. Make extra money. Experience unnecessary. Literature free. Elmar Services, Muncy, Penna.

BIG Money in vending machines. Smallest capital start brings immediate profits that build permanent profitable business. Starting instructions free. Becker Vendors, 105-A Dewey, Brillion, Wisconsin.

MAKE Perfumes. Profitable business. Free book tells how. Walter Lawson, 21 Joiner, St. Augustine, Florida.

BELTS! Make 'em and make money. No tools! Sample 50c. Artnic Leather, 411 Joseph Ave., Rochester 5, N. Y.

WINDSHIELD Wiper and fuel pump rebuilding bring big profits. Free particulars. H. & H. Products, P.O. Box 430, East Akron Station, Akron 1, Ohio.

MAIL Order opportunities. Full or spare time. Hundreds of chances. No charge. Postal brings copy. Blackstone Press, Somerville, New Jersey.

MAIL Order business course shows you how to make money, spare or fulltime. Teaches professional mail order technique—not penny-snatching schemes. Fascinating 100-page illustrated success-catalog free! Write, Nelson Company, Dept. 4-02, Chicago 5.

GREAT Opportunities and profits in mail order business at home. Free literature. F. Webster, Box 1972C, Hollywood, Calif.

BOOKKEEPERS—Operate your own simplified "Dollar-A-Week", bookkeeping and tax service. Full or spare time. Details free. Ellis, Box 200, Cedar Grove, North Carolina.

PLASTIC Discs, shapes, metal findings, wholesale, free catalog. "Secors," Bradenton Beach, Florida.

ELITE Collection contains 137 practical money-making plans; local and mail order. New edition. Particulars free. Elite Co., 220 Grand St., New York 13.

QUICK Money! "Repairing car batteries." At home! Easy tool! Write. Batteryman, Grand Junction 5, Colorado.

SELL By mail!—Books and novelties! 35 different items! Large profits! Catalog free! Elfo, 432 N. Wells, Chicago 10.

OPERATE Profitable home business selling merchandise by mail. Fast sellers. Large profits. Powell Service, 5713 Euclid, Cleveland 3, Ohio.

COPUBLISH Leading m.o. paper. Latest copy Mail Sale Advertiser and proposition, commemorative stamp. Vanroy Shirk, Lebanon, Penna.

START Profitable mail order business. PMT lists new propositions available; products, sources, accurate methods. Covers ad writing, letter logic, trade information. Send 10c for copy and get free instruction folio offer. Progressive Magazine, Sheboygan, Wisconsin.

START A clock shop. Fascinating, easily learned profitable business requiring little capital. We teach you how to repair all kinds of clocks. Information free. Houston Clock Shop, P.O. Box 5086A, Houston 12, Texas.

HOW And where to obtain capital. Fully explained. Particulars free. Star Service, Wapakoneta, Ohio.

SPECIALTY Manufacturing, the big money business that can be operated anywhere, start on a very small capital; we supply dependable formulas and complete instructions; get interesting free booklet, "Money-making Opportunities in Specialty Manufacturing," Howard Robinson, Ph.G., 1300-A South Ohio Street, Sedalia, Mo.

START Mailorder bookshop—Everything furnished; publisher cooperation. 25c brings booklet, exclusive setup, samples, exciting ideas. General Publications, Ossining, N. Y.

\$25 WEEKLY Working two hours daily. No canvassing. No manufacturing. Lycke, Box 2471, Cleveland 12, Ohio.

137 WAYS To make money, in home or office, business of your own. Full particulars free. Elite Co., 220 Grand St., New York 13.

BRUSH Plating outfits connect to a battery. No tanks necessary. Good paying business at home plating autoparts, bathroom fixtures, bicycles, reflectors, silvering mirrors. No shop or experience required. Outfits furnished. Free booklet. Gunmetal Co., Ave. H, Decatur, Ill.

MONEYMAKING OPPORTUNITIES

BUSINESS Or hobby. Make shell jewelry and novelties. Kits \$1.00 up. Instruction book 50c. Free catalogue. Daytona Shell Store, Box 3236, Daytona Beach, Fla.

CHRISTMAS Cards: America's outstanding lines. Free literature tells all Evers, Elmhurst, N. Y.

CAPITALIZE Your spare time. Make shell jewelry. Special \$5.00 introductory kit \$3.25. Postpaid when cash accompanies order. Marcraft Co., Skokie, Illinois.

SEWING Machine repairs make big money lifetime. Start neighborhood shop. Complete repair manual, covering all makes, \$1.98 postpaid. Money back guarantee. Sewmachine Serviceman, Hamilton 9-F, Ohio.

EARN Up to \$480 month part or full time keeping books for small firms. Simplified system. Write Tax-Saver System, Dept. J, Ft. Worth, Texas.

RESILVER Mirrors at home. Formula 25c. Ideal Service, Park Ridge 6, Illinois.

START Your own business! Big money manufacturing novelties, plaques, statuary. Free catalog. Write Bing Products, 88-A3S Broad Street, Boston 10, Mass.

NOVELTY Manufacturing—If you have garage or basement write for interesting, money making story, our system has given many financial independence. Plastex Products, 711 Laguna St., San Francisco.

METALLIZE Baby shoes. Further information free. Metal Crafts, 5501 Suwanee, Tampa 3, Florida.

WHOLESALE Catalogue free. Curios, scientific equipment, Mexican novelties, old bills. Quivira Specialties, Topeka 1, Kansas.

BIG Profits—Manufacture at home under own name; ask how. Kimia Testing Laboratory, South Bend 24, Indiana.

HOBBYISTS, Homeworkers—Profitable business clipping pictures. Details 25c. Box 100, Gracie Sta. (P.M.), New York 28, N. Y.

FREE Booklet! Biggest opportunity quick money! Collection 137 sure-fire plans. Stamp. Twin Parks, Box 4696-Z, Dallas 6.

WIN Money on contests advertised in magazines and on radio. General Contest magazine, published monthly, gives hundreds of tips. Lists current contests and rules. Sample 25c. General Contests, 1609 1/2 East 5th, Duluth, Minn.

PROFITABLE Businesses. Ideas, wholesale sources. Sample 30c. Wallen, 215 N. 28th, Camden 5, N. J.

THOUSANDS Articles wholesale. "Supply Source Directory" 10c. Ideal Service, Park Ridge 40, Illinois.

BUILD Knockabout sport shoes for yourself, friends. Great fun. Send foot outlines, size. Patterns, easy directions \$5.00 prepaid. Each additional size \$1.00 set. (3-12 1/2). American Shoebuilding Course, 668-S, Hollywood 28, California.

ECUADOREAN Native handwork brings fantastic profit. Precious sample collection \$2.00. "Estrella," Box 53F, Quito, Ecuador.

BIG Profits. Sensationally new. Every home, office, store prospective buyers. No competition. Exclusive dealerships. Sherwood Products, Erie, Penna.

INCOME Tax experts earn good money. Send \$2.00 for instructions telling how to start this fascinating business. Townsend, 119 East Main, Rochester 4, New York.

MAKE Big profits from honeybees. Interesting, fascinating hobby. Literature free. F. T. Hawkins, 906 Howard Ave., Palestine, Texas.

START Profitable mail order business. Plans—Ideas, 25c. Jackson, Newfoundland, Kentucky.

SHELL Jewelry kits \$2.60, also \$1.00 postpaid. All materials furnished with instructions. Most distinctive and complete kits ever offered. Order today. Earn while you learn. Catalogue free. Shell-O-Craft, Box 365 Station A, St. Petersburg, Fla.

TIN-CANS. Turn them into cash. Four methods. Instructions 25c. Charles, 12-AW, Norwood, Ohio.

WIN Contest money. We'll show you how. Information free. Write: Townsend Contest Service, 604-W Elm, Urbana, Illinois.

UNBELIEVABLE, But true! — 100 money-making ideas free. 10,000 word instruction treatise on mail order, free. Membership in Opportunity Club, free. Barrows, 28 Stebbins, Worcester 7, Mass.

BIG Money making shellcraft kits! \$1-\$3.50. Wholesale supplies. Shelart, 3202 6th St., So., St. Petersburg, Fla.

"NAMES" Directory. Free listing, Sample copy free. Fowl Printing, Muncie, Indiana.

FREE—Magazines, publishers offers. 5c stamp. Ritz, 939-P Fteley, Bronx 61.

HAVE You read How to Run Mail Order Business Profitably? Send postal card for information. Lock Box C, Yellowlake, Wisconsin.

EARN Money at home! Several mail order propositions. Write: Apostle, Clayton 1, N. J.

MAKE Money statulizing baby shoes. Inexpensive process. Free details. Schauder's, Department "F," Shawano, Wisconsin.

15 RED Hot slickest, legitimate ways to make money quick. This is rare information. Written by a man who was broke 3 years ago and now is sitting atop the world. Tells how you may make a fortune with little or no investment. This valuable information not sold elsewhere. Limited edition! Only \$1.00. American Stamp Company, Wilmington-P, Delaware.

SCHOOL Seniors—Sell classmates America's most beautiful graduation name cards. Largest selection. 40% commission. Outsells all others. Send for free sample kit. Printercraft, 1425 E. Elm St., Scranton 5, Penna.

WOODSCRAFT Is profitable. Beautiful fan with over 40 petals, carved from one piece of wood, shows how. \$3.00 cash or money order. Woodcraft, Lock Box 322, Seattle 11, Wash.

SPARE Time home work plans. Write Business Plans Company, 1242 Park, San Jose, California.

WHOLESALE Catalog 10c (illustrated). Bargains galore. Stafford, Box 5211-A, Indianapolis 1, Ind.

LEARN To make seashell jewelry, pins, earrings, hair ornaments, novelties. Book of instructions and designs free with \$2.00 and \$5.00 kits, postpaid. Herbert Diamond Co., Box 4619, Miami 31, Florida.

BIG Mail including mail order magazines 10c. Mallo, 767-PM Leith, Flint 5, Mich.

GIGANTIC Mails, trade magazines, opportunities galore 15c. Jackson, Newfoundland, Kentucky.

EARN Money with colorful handmade jewelry. Free circular tells how! Nothing complicated. Dollar starts you! Plastic Works, 712 Kimball, Danville 3, Illinois.

EARN Money evenings, copying and duplicating comic cartoons for advertisers. Adservice, Argyle 1, Wisconsin.

EARN Up to \$2,000 year, inventing simple items. Special cash markets. Hendrickson, Argyle 7, Wisconsin.

I MAKE Big money in the mail-order business. You can do the same at home with my copyrighted system. Write me. I'll tell you how. F. Little, R.D. #1, Glen-shaw, Penna.

1947 GIGANTIC Directory of opportunities, advertisers' supplies, sources, trade information, mail order ideas, products, wholesalers, valuable tips—just published! Descriptive literature free. Wilkin & Co., Hillsboro, Ohio.

REVOLUTIONARY Mail order plan! This isn't guess work but a newly-tested practical idea that can help you put extra dollars into your pocket every day. Quick action necessary. Send for convincing details today. Kutz, National Mail Sales Service, P.O. Box 2001, Natural Bridge, St. Louis, Mo.

EXTRA Money. Send for new plan. Free. Inspirational Books, Box 106, Old Chelsea Station, New York 11, N. Y.

WOULD You pay 3%—first \$350 made? Color-illustrated book "505 Odd Successful Enterprises" free! Proven! Work at home, office. Expect something odd! Pacific, Oceanside, Calif.

MAKE Big money. Build your own lamps and sell. Write for free factory photos. Buddy Products Mfg. Co., Dept. 25, 1123 West Belmont, Chicago, Ill.

WHY Earn profits for somebody else? Build your own business, spare or full time. Small capital start, grow big! Be your own boss! Start today! Details free! Elliott, 177 Columbia, Edgewood 5, R. I.

EARN Money at home! Thousands do! Free details. Sizemore, Box 7, 4917 Kostner, Chicago 30.

THERE'S Big money in junk," and repairing batteries. Write. Batteryman, Grand Junction 5, Colorado.

\$246.50 MAKING Unusual secret device without skill, machinery, from former war material costing \$1.50! Simple, baffling invention, unbelievably profitable! Illustrated proofs free. Rolis Enterprises, 115-D West 16th, New York 11.

PORTIFY The future! Start own business; home, office. Booklet describing "Collection of 137 Tested Plans" free. Elite Co., 220-A Grand St., New York 13.

PUBLISH Your own magazine. Handsome 52 page format, well edited, illustrated. Cost low as \$1.00 month. Brings you prestige, profits. 25c brings sample. details. National. Ord. Nebr.

FORMULAS, PLANS, ETC.

MANUFACTURE Cleaners, soaps, polishes, flavors, cosmetics. Literature free. Kemico, Park Ridge 16, Illinois.

HORSERADISH And beet relish. Delicious, appetizing, make it at home. Send 50c in coin for recipe. John Bock, 1108 East 35th Street, Tacoma 4, Wash.

NEED Chemists? Formulas? Analyses? Products duplicated? Consulting Scientific Company, Swarthmore, Penna.

ROOFING, 100% Fireproof, low cost, lasts indefinitely; make yourself; formula with instructions, \$1.00. Rav Roofing Co., P.O. Box 255 Petersburg, N. Y.

21 POPCORN, Candy apple, etc. formulas. All money-makers. \$1.00. We can supply equipment. Concession Supply Co., Dept. "A," Box 133 Sta. "B," Toledo, O.

10,000 FORMULAS And trade secrets. Free literature. Stillman, 555 Kingston Ave., Brooklyn 3, N. Y.

REAL Manufacturing formulas. Lists free. Cummings, Chemist, Gordon Ave., Syracuse 4, N. Y.

PLASTICS

LUCITE, Plexiglas, masked sheets cut to size. Cost per square foot (12"x12") 1/16" 85c; 1/8" \$1.10; 3/16" \$1.30; 1/4" \$1.60. Also Lucite rod, tubing, include 10% postage. Almac Plastics, 230 Fifth Avenue, New York 1, N. Y.

PLASTICS—Sheets, rods, tubes, all colors; dyes, supplies; findings. Illustrated fabricating manual, prices, 10c. Lucite sample, 35c. Gem-O-Lite, Box 686F, North Hollywood, Calif.

PLASTICS—Eight colors. Sheets and rods. Stamp brings price list. Hanson Plastics, 7625 South Parkway, Chicago 19, Ill., Dept. 100.

PLEXIGLAS Sheets 1/10" x 12" x 12" 78c; 12" x 15" 96c; 1/8" x 11 1/2" x 12" 98c; 13" x 17" \$1.60; 6" dia. x 12" length x 1/8" wall clear cylinders \$1.60. Include postage. Julian Rhodes Muench Co., 1527 W. Alabama, Houston 6, Texas.

PLASTIC Injection machines, tenite, plexiglas, dyes, polystyrene rods, jewelry findings, etc. Special get acquainted shell-craft kit—big assortment \$2.50. Free list. G. Baker Company, River Edge, New Jersey.

LEARN Internal carving of plastics for pleasure and profit. It's easy, exciting to carve flowers, animals, landscapes of colorful, thrilling beauty in solid Plexiglas plaques and cubes. Send 10c for complete instruction folder, jewelry findings catalog and big plastics price list. Plastic Parts, Dept. H-2107, 1157 S. Kingshighway, St. Louis 10, Mo.

PLASTIC Experiment supplies list and fabricating instructions 10c. Kidder Manufacturing Company, 76 Duke, Toronto, Canada.

PLASTIC Materials and supplies. Lowest prices, highest quality. Send for free price list. Plastex Products, Curtis and Filbert St., Baltimore 28, Md.

LUCITE—Sheets, rods, tubing, catalog dime. Mid-West Plastic Supply, 1717 No. 66th, Omaha 4, Nebraska.

INTERNAL Carvings, drills, dyes, jewelry findings, tools. Plexiglas masked sheets, 12"x12", 1/16" \$1.00, 1/8" \$1.25, 3/16" \$1.55, 1/4" \$1.85. Include 10% postage. Rods, tubes, dyes, cements, buffing compounds. Free listings. Craft Plastics, Somerville, New Jersey.

PLASTIC Supplies, free list. Kits \$3.00 and \$5.00 f.o.b. Plas-Met Sales and Engineering, 4648 Shirley Place, St. Louis 15, Missouri.

INTERNAL Carved roses costume jewelry sets; \$1.50 postpaid, less findings. Crystal Floral Novelty Co., Dept. M, Somerville, N. J.

PLEXIGLAS Aircraft gun fairing window assembly 2 1/2"x3 1/2". Duplate shatter-proof windows. Free list. Eresco, 2912 Hewitt, Everett 1, Washington.

GOLD Imprinter \$3.25. Samples 10c. GE, 8 Walden, Cambridge 40, Mass.

PLASTICS—Flexiglas, Lucite, Bakelite, etc. in sheets, rods, tubes—dyes, cements, compounds, 10c brings big 64-page illustrated catalog listing hundreds other craft materials, supplies, tools, accessories. Carmen-Bronson, Dept. CA-1, Mount Vernon, N. Y.

RENEW Leather and leatherette—Make cloth into imitation leather with plastic discovery called Leather-New. Opportunity to make real profits taking care of sales resulting from national advertising. Write for free sample of Leather-New covered material and complete deal. 704 Land Bank, Kansas City, Missouri.

PLASTIC—Sheets, rods, tubes, etc. Free list. Plastic Supply Co., 2618 St. Louis Ave., St. Louis 6, Mo.

TEN Fascinating detailed Plexiglas projects, \$1. Original Plasticplans, Box 181, Cincinnati 1, Ohio.

PLASTIC Costume jewelry, beautiful designs. Free catalogue. Howard Schultz, 115-83 229 St., St. Albans 11, N. Y.

WONDERFUL New thermoplastic. Literature free. Sample 25c. Jalco, 161 Dille, Memphis, Tenn.

EDUCATIONAL Offer! Learn by doing! Sample kit containing odorless resin, accelerator, rubber mold, dye, lubricant plus all equipment necessary to make quick castings in lustrous Formalin! Complete with instructions and price lists for quantity orders of these excellent plastics casting materials: \$3.00 f.o.b. Formalin, Romeo, Michigan.

MAKE Money assembling our pre-fabricated plastic kits. Sample kit 50c. Catalog free. Fabros, Box 156, Station F-1, Buffalo 12, N. Y.

CHEMISTRY

LEARN Chemistry at home from The House of Winn, home of supplies for amateur chemists. See Winn's New Idea Chemical kits and apparatus outfits for home experimenting. Send 10c for retail catalog. Established 1931. John H. Winn, Dept. 510, 124 W. 23rd St., New York 11, New York.

FREE Catalog. Chemistry, mineralogy, physics. Tracey Laboratories, 1907 Harrison, Evanston, Illinois.

GET "Planning Your Laboratory," 25c. Catalog, 10c. Pilgrim Chemical, 348F Edith Avenue, Salt Lake City 4, Utah.

AMATEUR Chemistry magazines. Write Lankton Chem-Research Bureau, Lansing 15, Michigan.

LABORATORY Supplies, chemicals, low prices. Glassware, etc. Large catalogue 15c. Microscopic stain catalogue 20c. Both for 25c. National Scientific Company, Established 1908, 2204 W. North Ave., Chicago 47, Ill.

APPARATUS, Chemicals, ounce quantities, catalog 10c. Fleischer's Laboratories, Everett 49, Mass.

CHEMICALS Of all kinds. Special attention to small orders. Write for free catalogue. Lab Chemical Co., Box 206, Oak Park, Ill.

SPECTROSCOPE For quick chemical analysis \$3.00. Cutting Co., Box 457, Campbell 1, Calif.

NEW Laboratory supply catalog of chemicals and apparatus, contains over 5000 items with illustrations, 212 pages. Send 50c. Standard Science Supply Co., 1232 No. Paulina Street, Chicago 22, Ill.

CHEMICALS-LAB Supplies. New catalog 10c. Mel-Glo Chemical Co., 258 Fourth Avenue, Brooklyn 15, N. Y.

CHEMICALS And apparatus for industrial, analytical, and private laboratories. Complete supply service for correspondence school students. Send 3c for catalog. Dept. M-43, Biological Supply Co., 1176 Mt. Hope Ave., Rochester 7, New York.

HELP WANTED

BOYS Wanted. Over \$50 a week! Sell name plates for front doors. Write National, 214 Summer, Boston, Mass.

EXTRA Money—Quick profits: selling personalized buckles, belts, cap-badges, tie clasps, 2000 emblems, caps, shirts, ties. Write, Hook-Fast Products, Dept. A, Columbus 6, Ohio.

"SAVE \$20.00 To \$50.00 on your coal." Demonstrate, free compounds. Write for yours. Coalaid, Waterloo 4, Iowa.

SELL Christmas Cards, stationery, gift wraps. Gold imprinting free. Samples on approval. Carleton, 25a W. 17th, Bayonne, N. J.

AGENTS WANTED

RUBERLYKE Plastic Foneholder. New, novel, fast-selling. Retail, 60c fair traded. Everybody a prospect. You also sell retail outlets. Fits all phones. Phone rests on shoulder, leaves hands free. It's hot—fast selling. Reyam Plastic Products Co., 1525-Z E. 53rd Street, Chicago 15, Ill.

BIG Profits selling friends famous Wear Wright nylon hosiery, lingerie, blouses, sweaters, sportswear. Free sample display cards. Complete line Christmas cards. Samples on approval. Special offers. Wear Wright Company, 1709 Arch Street, Dept. B, Philadelphia, Penna.

"27" AGENTS—Salesmen wanted! Liberal territory allotted. Demonstrate amazing "27 Second" eye glass cleaner. Whirlwind seller. Year's supply in compact only 59c. 2 for \$1.00. \$40.00 per gross—110% profit. 27 Second Cleaner Co., Dept. 49-M, 6337 N. Talman, Chicago 45.

CHRISTMAS Cards. Earn big money. Take orders galore from friends. 25 exquisite folders with name, \$1.25. Free samples 10 designs. America's fastest selling 21 Christmas folder box, costs 50c, sells \$1. Request samples today. Sunshine Art, Dept. E-10, 115 Fulton St., New York 8, N. Y.

PLASTIC Tablecloth covers, curtains, drapes, baby pants, bowl covers and other plastic articles selling like wildfire! Make big money now! Free details. Write Plastics, Dept. 58K, 266 N. Fourth, St. Louis, Mo.

\$1 STARTS You in business. Sell deluxe ties, 100% wool interlining. Costs you only \$7 per dozen, you make \$5.00 dozen. Send \$1.00 for special introductory offer two deluxe ties. Catalog complete line free. Philip's Neckwear, 20 West 22nd St., Dept. K-16, New York 10.

SALESMEN: Sell Pre-Eze, "King of penetrating solvent." Tunes, desludges, breaks-in-motors; loosens rusty parts. Nationally advertised. Exclusive or sideline. Profitable. Pre-Eze Chemical Corporation, 1019 Virginia Ave. N.E., Atlanta, Georgia.

SILVER Plating liquid. Apply with cloth. Renews silverplated ware. Cleans, silverplates, polishes, one rubbing. Genuine silverplate. Lasting finish. Won't wash, boil, brush off. Also silverplates brass and copper. Female and male selling representatives wanted. Part or full time. Any age. Big profits. Exclusive territory. Sells by demonstrating. Retail and wholesale. NuProcess Products, Aurora, Illinois.

\$50 CASH For selling 100 assortments of 21 Christmas cards at \$1.00. Complete line. Free samples 50 for \$1.00 cards. Special offers. Write today. Hedenkamp, 343 Broadway, Dept. O-21, New York 13.

CHRISTMAS Card salespeople—Special offers. Imprints big variety lovely cards. Ruthanna Studios, 825 Arch St., Philadelphia 7, Penna.

SELL Ultra blue stock signs to stores, 1000 slogans, comedy, general, religious. 7x11, cost 6c, sells 35c. Make money. Sample free. Lowy, 8 West Broadway, Dept. 340, New York City 7.

TAKE Orders. We deliver! Glamorous reproductions of any picture on beautiful plastic hardwood plaques. Immediate big profits! Gotham Products, Dept. A, Box 5427, Philadelphia 43, Penna.

QUICK Sure money. Selling Annie Blain flavors. New Brunswick, New Jersey.

SELL Candid type cameras. Ideal Christmas gift. Price, details free. Interstate Distributors, Box 732, Evanston, Ill.

YOU Make \$25 for selling fifty \$1.00 boxes. 50 beautiful assorted Christmas cards sell for only \$1.00, your profit 50c. Write today for free samples 50 and 25 for \$1.00 and other boxes on approval. It costs nothing to try. Cheerful Card Co., 184, White Plains, N. Y.

BIG Profits selling used clothing. Operate from home, auto or store. Men's suits \$4.00. Overcoats \$4.00. Field jackets \$2.00. Ladies' coats \$1.50. Army shirts \$1.50. Other big bargains. Catalog free. Kadetsky & Son, 702 Barber Street, Dept. 14, Chicago 7, Ill.

MEXICAN Feather pictures. Unusual novelty. \$1.00 (stamps) brings \$2.00 worth samples, details. Refunded if unsatisfied. Aztec Art-P, Apartado 762, Mexico City.

USED Book agents—Boys and girls! Sell friends and relatives. Books withdrawn from chain libraries. Sells easily. Catalog, samples. Large commission. Bookland, Box 95, College Point, N. Y.

MAKE Christmas money at home running magazine subscription service. No capital needed. We supply everything. Renewals come automatically. Write for free starting kit. McGregor Magazine Agency, Dept. PM-3, Mount Morris, Ill.

DOUBLE Duty shopping bag. Zips open. Instantly changes from small to large size. Lightning seller. Samples sent on trial. Kristee 114, Akron, Ohio.

GET Free folio on 200 money making deals. Success plans. Rare formulas. Write Reynard, 108 Maple, Smithfield, Ohio.

MEN, Women, your opportunity for success. Small investment. Business surprise. Write. Dysart's Gift Service, 2352 Hawthorne Ave., Louisville 5, Ky.

AVAILABLE For the first time. Profit making Xmas game. Sensational new magnetic action. A simple demonstration makes a fast sale. Every man, woman and child gets a box full of fun playing with the "Wise Old Owl." Our local men sold up to 1 dz. per hr. in recent sales test. Cash in now on the tremendous profits selling the "Wise Old Owl" magnetic quiz. Retail price \$1.75. Sample \$1 postpaid, money back guarantee. Stock delivered costs you \$12 per dz. Same day shipment. Novel Toy Co., 161 West 25th St., New York 1, N. Y.

IT'S New, it's hot, sells for 35c. Big profit. National Sales & Service, Greenville, Penna.

SELL Oil burners for kitchen ranges. Great demand—terrific profits. Oil Burner Supply, Box 327, Cambridge, Mass.

SELL Luminous paint. Big profits. Sample \$1.00 (refundable). Price list. Willis Distributors, B-61 Hayes, Wilkes-Barre, Penna.

MAKE More money selling personal initialed individualized belts, buckles, cap badges, tie holders. 2000 emblems to choose. Big profits, whole or part time. Write today special outfit offer. Hookfast Specialties, Box 1425, Dept. 6, Providence, R. I.

NEW Artistic kitchen novelties and luminous pictures. Big profits. Sample \$1.00. Literature free. Hillside Studios, Milwaukee 5, Wis.

AGENTS: Sensational new rubber stamp ink — patent self-feeding no reinking. Sells quick, easy everywhere. Big cash profits. Hudson, 934D Lakeside, Chicago 40.

SELL Handkerchiefs. Xmas boxed and bulk. Stanchief, 491 Broadway, New York 12, N. Y.

SELL World's finest bronzed baby shoes. 100 years guarantee. Real Bronze Co., Los Angeles 42, Calif.

HAN-KOTE—New amazing cream. Protects hands against grease, grime, paint, printers' ink. Sells fast. Excellent repeater. Good profit. Sample free. Guerrieri, 952 Addison, Chicago 13.

WE Buy old type Singer sewing machines. Your profit up to \$25.00 on each. Write for literature. Essex Shop, 172 Washington St., Newark 2, N. J.

FREE 7 Day trial. Sparetime money-maker. "Gadgets." Box 28W, Jackson Heights, N. Y.

SELL Personalized match packs, 100 for \$1.75. Huge market, big steady profits. Write Personalized Products Company, 4426 N. Richmond, Chicago 25, Ill.

CHRISTMAS Tree lights available. Liberal commission. Write, Cartre's, 97A, Radford, Virginia.

MAKE Money at home, like I do. Write immediately. Duffy, Covington, Ky.

SELL Personalized gifts. Hildebrands, 4554 North Uber Street, Philadelphia 40, Penna.

EASY Cash. Sell Christmas store signs. Huge profits. Any merchant will buy. Artistically designed with sparkling tinsel. Request free catalog or send \$1.00 for samples that can net \$4.00. Silverglo, 4824 Barry, Chicago 41, Illinois.

SELL Tighestest woven 100% Jersey cotton rugs to hotels, homes, institutions. Reversible. Real thick heavy rugs, 2½ lbs. Size 24x48. Sample rug, wholesale prices, \$3; or 3 for \$7.50. Money back guarantee. M. Pescatori Co., 1123 Broadway, New York 10, N. Y.

MEXICAN Silver, leather, wooden, strawpalm, textiles, items. Miniatures, oil, featherbird, cloth pictures. Wonderful collection for \$20.00, worth double. Gieda, Lucerna 63-8, Mexico City.

CHRISTMAS Cards 50, 25 \$1.00 name imprinted, 17 other assortments. 100% profit. Bonus. Free samples. Richar, 16 East 18th Street, New York 3.

AGENTS—Make big money from now on, selling the sensational new low priced transparent plastic table cloth cover. Saves on laundry bills. Every woman a prospect. Sample swatches free. Carwell Products, 330D South Wells, Chicago 6.

CHRISTMAS Cards. Earn \$5.00 with every ten 21 card \$1.00 boxes you sell. Also new plastic cards, wrappings, imprint cards. Write for samples today. Howard P. Ellis, Dept. PM-11, Pitman, N. J.

SELL Jewelry. Dollar brings samples. Guaranteed value, \$4.00. George Sassen, 154 Nassau Street, New York 7.

MAKE Big profits — fast sales with "Quick" self sticking gauze bandage. Get supply at nearest agents supply store or write us. Quick Bandage Company, 2010 Wabansia Ave., Dept. PM-1, Chicago.

EARN Easy money. 100% profit. Sell to friends luxurious Christmas — Everyday cards, 21-25-50 for \$1.00. Terrific appeal. Sell on sight. Samples on approval. Torres Company, 8F St. Francis Place, Brooklyn 16, N. Y.

MAKE Big money daily, taking orders for splendid line of books. No experience needed! Good commissions! "Interesting" details free. John's Variety House, Box 106, York 14, Penna.

AT Last! Something new and sensational in Christmas cards. Amazing "Oilette" cards. Like costly oil paintings. Designs never before offered. Quick orders. Beautiful 50 for \$1 cards, name imprinted. Big profits. 20 other assortments 60c to \$1. Samples on approval. Puro Co., 2801 Locust, Dept. 740M, St. Louis, Mo.

AGENTS: All ages, earn \$30 to \$50 weekly selling for yourself, fibre brooms, mops, and floor dusters, start now. Write Burtz Fibre Broom Co., Columbia, Penna., Dept. A.

AGENTS For fast selling products in demand everywhere! Big money! Send dime for sample, wholesale prices, full particulars, and 10c refund certificate. Copper Hill Sales Service, Copper Hill, Va.

WELDING Outfit—New portable model makes welding easy as A-B-C! Anyone can operate it and save expensive repair bills; or cash in on welding repair work. Sells on sight. Pays you \$8.00 on every sale. Comes complete in fibre carrying case with instructions and accessories for all types of welding on all metals. Indispensable to maintenance shops, factories, garages, farmers, home owners, mechanics, etc. A real money maker. Sells at the sensational low price of only \$19.95; costs you only \$13.95. Write for full details and tested selling plans or start earning at once; send \$13.95 check or money order; save c.o.d. and shipping charges. Universal Equipment Co., 24 West 25th St., New York 10, N. Y.

FREE Nylons given your customers if Kendex hosiery runs or snags within guarantee period! Sensational written guarantee amazes everybody. Three magic words: "Guaranteed Against Everything" enough to make sales. Earn wonderful income writing orders. We deliver and collect. Spare or full time. No money or experience needed. Liberal advance cash profit plus big cash bonus. Your names and address brings you complete free money-making sales outfit prepaid. Write today; start earnings next week! Kendex Co., Dept. 107, Babylon, N. Y.

A NATURAL! Big money, selling new line one piece, lace plastic tablecloths! Sizes to 54x108. Also women's aprons; novel, embroidered cotton pillow cases. Free, "interesting" details. Royalty, Box 748-K, Passaic, N. J.

REMNANTS—Amazing values. Housewives buy on sight. Good profit. Write B & M Textiles, 415 East 26th Street, Paterson 4, N. J.

EXCLUSIVE Territories now available for agents to sell beautiful aluminum ware, prewar silverware and sensational pressure cookers. Big profits on guaranteed merchandise. No investment necessary. Write for catalogue. Continental Products Corp., Dept. P, Box 210, Providence, R. I.

28% TO 75% Profit selling Reflex spark plugs (guaranteed) to garages, service stations, fleets along with other lines steady repeat business. Free catalogue. Reflex Spark Plug Co., 10902 Madison Ave., Cleveland 2, Ohio.

LEATHER Goods and advertising specialties. Fast selling items. Big profits, low prices. Everyone is buying now. Send for particulars. Star Craft, 5023a Broadway, Chicago 40, Ill.

\$1.00 INVESTED Brings \$29.00. Nothing else to buy. In great demand. Write for details. Kohen, 508 W. 45th, Chicago 9.

SHOW Quality greeting cards also. Reese, 915Y 30th South, Seattle 44.

AMAZING Daily profits. Big repeat business. Sell top-quality, lowest-priced men's dress, work hosiery, full, part-time. Experience unnecessary. Take orders. We deliver. Outfit free. Write Colt Shoe Company, 242-D9 Purchase, Boston 10, Mass.

AGENTS—Big line including food products. Fast selling premium and bargain deals. Low prices. Send card for big outfit offer with gift. Ho-Ro-Co, 2725 Dodier, St. Louis 7, Mo.

AMAZING New Glow in the dark house numbers, switch plates, decals, pictures, religious articles, etc. Factory representative wanted. Wonderful opportunity. Free samples. Madison Mills, 303 Fourth Avenue, New York, N. Y.

SELL 10 Boxes of personalized Xmas cards, and we'll pay you \$8.50. Also 7 other beautiful assortments, 50 and 25 for \$1.00 with name. Free samples. Ed-Brite Co., Dept. C, Mount Vernon, N. Y.

SCHOOL Seniors—Earn 40% commission selling classmates America's most beautiful graduation name cards. Largest selection. Outsells all others. Send for free sample kit. Printcraft, 1425 E. Elm St., Scranton 5, Penna.

PROFITS TO 100%, selling Xmas and everyday greeting card assortments. Details and assortment on approval. Glorian, (Dept. 10) 515 East 45th St., Brooklyn 3, N. Y.

WHITE Shirts, pajamas. Sell direct from manufacturer. Free sales kit. Jarod Mfg. Corp., Rockville Centre 4, New York.

MAKE UP to \$50 a week in spare time selling greatly in demand oil burners for kitchen stoves. Oil Burner Supply, Box 327, Cambridge, Mass.

AMAZING Daily profits, steady repeat business selling Colt's 216 shoe styles. Featuring Whippets — miracle post-war super-flexible, super-durable quality shoes at \$6.95. Exclusive features make selling easy. Experience unnecessary. Free outfit. Colt Shoes, 601-D9 Atlantic, Boston 10, Mass.

SELL Delicious candies, nuts, gum. Immediate delivery. Write Casterline, 2031-R Sunnyside, Chicago 25, Illinois.

CHRISTMAS Cards — Earn big money selling personals, boxed assortments. Samples. Lincoln Press, X220 Hartwell, Fall River, Mass.

SCHOOL Seniors! Your postal will bring our wonder, Kwick-Sell Cardalog of popular graduation name cards. Biggest profits! Only firm giving free souvenir chest and card case. Don't miss out! Hurry that postal! Craftcards, Box 235(L), Pittsburgh 30, Pennsylvania.

DISTRIBUTORS. Fast selling item. 100% profit. Repeats. Details free. Morrison's, Box 9312-N, Station S, Los Angeles 5, Calif.

DISTRIBUTORS. Unusual \$2.98 photograph product. Fine profits. Repeats. Morrison's, Box 9312-N, Station S., Los Angeles 5, Calif.

NO Money or experience needed. Spare or full time. Steady income writing orders guaranteed men's hose. Variety 20 styles. We deliver and collect. Liberal advance profit. 33% cash bonus. Write today for complete free sales outfit. Kentcraft, Dept. SM, 44 Court St., Brooklyn 2, N. Y.

SCHOOL Seniors: Sell classmates superb Craftcards for super profits. Write Craftcards, Box 235(AK), Pittsburgh 30, Pennsylvania.

\$50 UP. Spare time. Magic money making opportunity. Sell beautiful personalized Xmas cards, 25 and 50 for \$1. Costs nothing to try. Samples free. Victory Studios, Mt. Vernon, N. Y.

AGENTS-DISTRIBUTORS; \$28.00 daily possible. Flo-Glo Plastic wood-linoleum finishes. Acme, Box 404, Mount Vernon, N. Y. Puerto Rican Distributor, A. R. Torres & Associates, San Juan, Puerto Rico.

100% PROFIT With new electric gas lighter, eliminates matches, pilot. Write Optical Research Products, Fairview, N. J.

LARGE Variety fast selling items from \$1. Manufacturers, 264—5th Ave., New York.

MAGIC Cleaner and laundry soap deal. Hotter than a firecracker. Big profits. Sample free. Bestco, 5007 Irving Park, Chicago.

CHRISTMAS Card agents! New, exclusive, patented children's linenette books. Four books in attractive packet. Retail 50c. Sample on approval. Also cut-out valentine assortment. Elmcraft Card Co., 5928 South Western, Chicago 36, Illinois.

AMBITIOUS. Sell Xmas cards, stationery, big profits, colored catalog free. Beacon Hill Greetings, 115 Chauncey M, Boston, Mass.

EXCELLENT Sideline for printing and advertising salesmen. Decalomania name plates in small quantities. Great demand. Also, make money with our line of automobile initials and sign letters. Free samples. "Ralco" XL-Roxbury, Boston 19, Mass.

JUST Out! History of World War II. Huge volume. Popular price. Authentic text. Official photographs. Big profits. Riverside Book Company, Iowa Falls, Iowa.

BIG Bargains for big profits. Over 100 sensational values. Men's used suits \$2.00, pants 35c, topcoats \$1.25, overcoats \$2.00, shoes 20c. Experience unnecessary. Free wholesale catalog. Superior, 1250-B Jefferson, Chicago 7.

90c PROFIT Each \$1 sale. Sell positive mothproofing solution to housewives, stores, agents. Experience unnecessary. Postal brings details. Kinford, Wayne 3, Penna.

GREETING Card agents. "line up" with "Pines" for bigger, better, quicker profits. Rush name, address on postcard today. Box 32, Flushing 5, New York.

AGENTS: Stamping names on pocket-key protectors. Sample check with your name, address, 25c. Stamping outfits. Emblem checks, check-fobs, name plates. Hart Mfg. Co., 303 Degraw St., Brooklyn, N. Y.

137 COMPLETE Plans for starting own business: local—mail order. Particulars free. Elite Co., 220 Grand St., New York 13.

AGENTS—300 % Profit selling genuine gold window letters; stores and offices. Free samples. Metallic Letter Co., 438-B North Clark, Chicago.

\$3 FIRE Extinguisher; quick sales, wholesale or direct; liberal profits. "Fire-Killer." 109 N. Franklin, Syracuse 1, N. Y.

PLATING Outfits for autoparts, reflectors. Connect to a battery. No tanks necessary. Free booklet and particulars. Gunmetal Co., Ave. N. Decatur, Ill.

GOLD Lacquered window sign letters. Large sizes penny each. New foils. Absolutely beautiful. Free samples. Atlas, 544 W. 79th, Chicago 20.

SELL Personalized soap. Name on every cake. Ideal for gifts. Get sample offer. Dunbar Soap, New Brunswick, N. J.

HIGH-GRADE SALESMEN

PHOTO—Salesmen—Agents. Sell beautiful hand colored plastic enlargements. Collect deposit, we deliver. Profitable sideline. Send card, for free sample kit. Novel Portrait, 3329 North Ave., Chicago, Ill.

SELL Advertising on our new farm account books. Astounding sales and profits. Sell to merchants only. Average town means \$20-\$30 commission daily. Write: Ampubco, 321 Jackson, Topeka, Kansas.

SELL Writewell specialties! Big profits! Huge Christmas demand! Samples free! Writewell, 140 Transit Building, Boston.

SELL Garages and airports direct simple machine for washing dirty, greasy metal parts. Liberal commission. Super-Soak Company, West Allis 14, Wisconsin.

FACTORY Salesmen—Sell Charles Chester nationally known cushion shoes direct. Complete line for entire family. Full time or sideline. Full time men earn up to \$20 per day in commission. Big repeats. Samples and equipment free to producers. Chas. Chester Shoe Co., 2001 Chester Bldg., Brockton, Mass.

AGGRESSIVE Salesmen. To keep stores supplied with self-selling 5c and 10c counter-card products. Nationally advertised throughout the year in leading magazines and more than 2300 newspapers. Biggest profits, full time or sideline. Write today. World's Products, Dept. 10-V, Spencer, Ind.

POCKET Pal: The all-purpose cutting tool, wagon jobbers, salesmen. Sell to retailers and jobbers. 50c seller. Steady repeat item. Exceptional profit. Sample 25c. Nelson Manufacturing Company, 222 W. Kellogg, St. Paul 2, Minnesota.

EARN Thousand dollars by Christmas. New, nationally advertised line, sells women on sight. Write Tugee Company (Dept. A), 112 South LaBrea Ave., Los Angeles 36.

MR. Salesman: Your problem is solved. You can't miss making at least \$25.00 daily. Your own business without any investment, offering nationally advertised aluminum cooking sets, pressure cookers at amazing almost wholesale prices, direct to public. Write at once for details. Best-Wear, P.O. Box 31, Bridgeport, Conn.

REPEAT Item. 100% profit; sell individuals, dealers, institutions. Over 10,000,000 sold. Trial selling samples free. Piper Company, Inc., St. Louis 17, Mo.

START Your own business on our capital. Always your own boss. Hundreds average \$6,000 to \$25,000 annual sales. We supply stocks, equipment on credit. 200 home necessities. Selling experience unnecessary to start. Wonderful opportunity to own pleasant, profitable business backed by world-wide industry. Write Rawleigh's, Dept. J-U-PPM, Freeport, Ill.

ADVERTISING Book matches—Cash in on political campaigns. Sell union label matches. Cuts for all businesses and political parties. Free powerhouse selling kit. Low prices. Protection guaranteed on repeat orders. Cash commissions. Superior Match Co., Dept. M107, 7530 Greenwood, Chicago.

AMAZING New zipper shoe sells on sight. Big profits for salesmen. Leads line 200 splendid styles. Territories open. Get free sample outfit. Write. Consolidated Shoe, Dept. S-801, Chippewa Falls, Wis.

MAKE Money selling genuine leather jackets. Prospects everywhere. Top quality, full cut, exclusive features. Big cash commissions. Also 250 styles fine shoes. Sample outfit free. Victor Thomas, Dept. V-816, 610 W. Van Buren St., Chicago 7.

AUTOMATIC Fire extinguishers. Red Ball, Box 1552, Salt Lake City, Utah.

ADD Excellent line advertising pencils. High commission. Repeats. Nassau Pencil Company, 1947 Broadway, New York 23.

SOMETHING New in fire extinguishers. Red Comet Automatics. Company established in 1931. All year job. Exclusive territory. Dealers earning up to \$15,000. Write 503 Red Comet Bldg., Littleton, Colorado.

BRAND New! "Circline" fluorescent sweeping country! Fabulous profits selling stores, offices, homes. Also exclusive fluorescent table lamp. Complete line modern fixtures. Rush name for free sales kit, sample offer. Rose Co., 529LA South Franklin, Chicago.

AGENTS—Salesmen, we start you in business of your own. Earn \$75 and up weekly taking orders fast selling cosmetic line. Write for special outfit offer. Lady Raye Cosmetics, 517 E. 43rd St., Chicago 15, Dept. PM.

PLASTIC—Tablecloths, aprons, new nationally advertised fast selling Firestone Velon kitchen ensemble. K & D Products Co., Room 104-P, 4955 Delmar, St. Louis 8, Mo.

ADVERTISING Specialties. If you sell caps, signs, decals, pennants, memo books, aprons, auto ad-plates, pencils, banners, calendars, celluloid buttons or leather items, we manufacture them. Write for catalog. Universal Advertisers, Inc., 1114 Clinton S. W., Canton, Ohio.

AMAZING Profits selling personal initialed individualized buckles, belts, cap badges, tie holders, flexible cap bands, 2000 emblems to choose from. Repeats. Write today special outfit offer. Hook-Fast Company, Box 480-PM, Roanoke, Virginia.

INDEPENDENT Distributors, \$1000.00 per month class, able to finance self and travel introducing two new small vending machines to operators. Reply giving sales experience, references, etc. Automatic Enterprises, 635 South Kenmore Ave., Los Angeles 5, Calif.

WRITE For particulars on solid rubber custom built mats. Exclusive territories arranged. High commissions if qualified. Campro Company, Cambridge, Ohio.

GOLD Filled expansion watch bands. Men's \$2.50. Sample \$2.95. Pink or yellow gold. Crowe Co., Bristol, Tennessee.

NOW Get into the aluminum venetian blind business. Complete selling kit with sample for only \$7.50. Large demand. Profitable. Prompt made-to-order deliveries. Write. Humphrey Products, Wichita, Kansas.

WAGON Salesmen—Fast moving carded goods and 10c line. Long profits. Free facts. Peerless, 2720 Dodier, St. Louis 7, Mo.

SELL Commercial printing. Good profits. No investment. Every business a prospect. Repeat orders. Modern Press, Box 27-A, Crescent Hill Station, Louisville 6, Ky.

SELL Christmas cards! Choice of forty assortments! Earn 60c on dollar sales! Bulletins free! Elfco, 434 North Wells, Chicago 10.

BONUS Commissions selling photographic creations. Samples. Creative photography, Box 315, Cooper Station, New York 3, N. Y.

FREE! Latest issue Opportunity Magazine. Salesman's Guide. Inspiring, constructive. Shows how to earn money selling for others or in your own business. Hundreds postwar opportunities. Send name and describe what you have sold or are selling. Illustrated copy sent free. Opportunity Magazine, 620 N. Michigan, Dept. 17, Chicago 11, Ill.

AGENCIES WANTED

SURE Success! Appoint William Finau Store, Nukualofa, Friendly Island, Oceania, your distributor, annual sales: \$20,000. Bankers: Bank of New Zealand, Auckland. Interesting lists gratis.

EDUCATIONAL AND INSTRUCTION

CO-OPERATIVE Industrial troubleshooting taught persons competent for field and contact engineers. All localities. Address: Troubleshooters Cooperative, 23535 Margareta, Detroit 19, Michigan.

WORK For "Uncle Sam"! \$1756-\$3021. Prepare now for next examinations. Veterans get preference. 32-page book on civil service free. Write Franklin Institute, Dept. N24, Rochester, New York.

TRAINED Letterers constantly needed. Talent unnecessary. Expert, personal instruction by mail. Information free. Joseph Boiger, 148 Concord, River Edge, New Jersey.

BEST Training U. S. Hobart Welding School. Complete equipment. Non-profit. G. I. Bill. Write for free booklet. Hobart Welding School, Box M-1076, Troy, Ohio.

LEARN Railway telegraphy at home. Instrument furnished. Operators needed. Jobs waiting. Bell Telegraph Ry. Institute, 10 Parker Ave., San Francisco 18, Calif.

PARENTS—Proven system mental stimulation for children under 7. Inexpensive. Lifetime benefits. Free literature. Write today. Harmon, Box 1057, Newark, N. J.

BE The one who directs the work of others. Learn industrial engineering. Free booklet gives you details of our money-making course. Herbert G. Hecketsweiller, Management Engineer, 3355A North Olcott Avenue, Chicago 34, Illinois.

GOOD Jobs and a sound substantial future await you in hotel and institutional field. Men and women—all ages—needed for well-paid positions that offer color, excitement, ever-new and fascinating duties. Record-breaking travel means even greater opportunities for trained men and women in hotels, clubs and institutions. Lewis School receiving calls for managers, assistant managers, stewards, hostesses, purchasing agents and 55 other types of important positions! From coast to coast there are important positions that offer splendid opportunities for advancement in a business where you are not dropped because you are over 40. Previous experience proved unnecessary! No need to leave your job to qualify. A good grade school education, plus Lewis Training qualifies you at home, in spare time. Our National Placement Bureau helps to place you—and our amazing Certified Job Plan—actually certifies you will "make good" when placed. Write today for Free book! Veterans: This course approved for veteran's training. Lewis Hotel Training School, Room LT-368, Washington 7, D. C. (First and only school of its kind—now in its 32nd year.)

BE A pedopractor—Foot correctionist. Extension. Degree. Alaska School of Pedopractic, Box 2894-A, Juneau, Alaska. Stamp appreciated.

LEARN To "speak in public." Gain self-confidence. Speak fluently and effectively. Amazing new method. Easily mastered. Surprisingly low cost! Write for details. Trissel-Heymann, Publishers, Mason City 1, Iowa.

EARN 50 to 200 Dollars weekly. Become a dental laboratory technician. Easy home study. Write for free details. Dental Arts Institute, 1122 Market St., San Francisco 2, Calif.

OIL Painting—Correspondence course. Write Carlos Art Academy, Correspondence Division, Watertown, N. Y.

HOW To land job you desire. Helpful pointers. "Job Seeker's Guide" \$1.00. Herman Publishing Company, Chatham, N. J.

PRACTICAL Course—Automobile radiators, repairing, recoring, cleaning. Ralph Hendry, Galt, Canada.

EDUCATION In a nutshell helps you think and talk intelligently on most subjects. Thousands have used these ideas. Send \$1 to Dad-P, 1310 Sanborn Ave., Hollywood 27, Calif. Information free.

ENGRAVING. Learn latest internal plastic carving, lettering, trophies, etc. Details free. Renzelman, 611 S.W. 23rd Road, Miami 36, Fla.

RAPID Calculation course, worth \$15.00. Introductory offer only \$1.00. Osborne College, San Bernardino, Calif.

3800 **LATEST** Used correspondence courses. Catalog 50c. EG, Elmsford, N. Y.

BOATING. Learn at home. Seamanship and piloting. Cruise scientifically. Prepare for a job on the water. Yacht captains earn to \$500 monthly. Write for particulars. Fairway School, Box 811, Old Greenwich, Conn.

READ, Write, and speak Spanish! Sensational course teaches you in double-quick time. Easy to understand! Money-back if you are not speaking Spanish in 30 days. Complete course only \$1.00. American Stamp Company, Wilmington-P, Delaware.

NOW You can have an office. Learn credit-collection business by new home study course. Many earn up to \$5000-\$15,000 annually. Free bulletin. Franklin Credit School, Dept. 202K, Roanoke 7, Va.

NO Special training needed to make \$1,000.00. If you like working with figures, you can make this much or more in three months spare time. Write without obligation to James A. Sherrod, Pavo, Ga.

WANT Better job? Executive who hired over 500 per year tells how. Only \$1. Money returned if plan fails. Send today sure. Marchner, 74 Park Avenue, Webster, N. Y.

VETERANS Needing guidance in G. I. Bill training send \$1.00 for service. Footcraft, 475 5th Ave., New York City.

PREPARE For Civil Service Examination. Pay for course after securing position. Write Free School, Kokomo, Ind.

UNCOVER Hidden treasure in service station field. "Making Your Service Station Pay" explains. \$1.00 postpaid. Hughes Enterprises, Box 126, Clear Lake, Iowa.

USED Correspondence courses and educational books bought, sold, rented, catalog free. Educational Exchange, Henagar, Ala.

HOME Study course, drugless therapy. Free literature. Institute of Drugless Therapy, Tama, Iowa.

LEARN Auctioneering by mail. Sample lesson free. Write Nelson School, Renville, Minn.

GOOD "Used" self-instruction educational books on all subjects bought, sold, rented, exchanged. Satisfaction guaranteed. Complete information and 100-page illustrated bargain catalog free! Write—Nelson Company, Chicago 5.

USED Educational books on all subjects sold, rented, also bought and exchanged. Moneyback guarantee. Write today for free catalog and details. Lee Mountain, Pisgah, Alabama.

INVESTIGATOR Training. Phillips Secret Service, 1917B North Kenneth, Chicago 39, Ill.

29 LANGUAGES By Linguaphone. Russian, Spanish, Portuguese—Direct conversational method for mastering any language quickly, easily, correctly at home. Available under G.I. Bill of Rights. Send for free book. Linguaphone Institute, 83 RCA Bldg., New York 20.

MEDICAL Laboratory technicians in great demand. We train you in your spare time, in your own home. You can practice while studying. Write for free catalogue. Imperial Technical Institute, Box 973-E, Austin, Texas.

LEARN Photo-engraving at home or in oldest, largest school in America. Work for newspaper or establish own profitable business. New Tasope' Photo-Engraving equipment available soon. Write for information. Veterans ask about G.I. training. The Aurora School of Photo-Engraving, Tasope' Bldg., Aurora, Mo.

SECRET Investigation. Experience unnecessary. Investigators particulars free. George Wagner, M 125 West 86th, New York.

PLAYS, STORIES, MANUSCRIPTS

LEARN Short story writing. Marketing and criticism service. Enter fiction and article contest closing December 31st. 5000 word limit. Three cash prizes. Gates Literary Services, Plasterco, Virginia.

NEW Writers needed. Nonfiction material demand is booming. Many magazine editors buy features and "fillers" from new writers. Our earn as you learn lessons prepare you to meet their requirements. Experience unnecessary. Reasonable price, unexcelled service. Details, sample lesson free on request. Use postcard. No obligation. Comfort Writer's Service, 200-PN S. 7th St., St. Louis 2, Mo.

BUSINESS SERVICE

REPRESENTATION. Business or personal assignments. Surveys, purchasing, selling, research, investigations. Townley Agency, 231 Healey Building, Atlanta, Ga.

CALIFORNIA Office. Mail forwarded daily, \$2.00 monthly. Certified, 1232 Loew's State Building, Los Angeles 14.

SOURCE Of supply on almost any article or material made in the United States. Write on your business letterhead for free details. Kelly, 9544-P Whitcomb, Detroit 27, Michigan.

CHICAGO Mail address. Any legitimate service rendered. Faultless, 3439-C Michigan, Chicago 16.

ANYTHING Manufactured in U. S. 3 wholesale supply sources 25c. Dishong, 116 N. Howard, Moscow, Ida.

TO Whom it may concern. We will represent you in all principal cities of the world. Representatives wanted. Will send you assignments immediately. James W. Farley, Citizens Bldg., Cleveland 14, Ohio.

SPECIAL SERVICES

LOCATE Any article made \$1.00. Business Service, 1101 Kings Highway, Shreveport, Louisiana.

INTERESTED In construction? Worldwide service furnished on all major projects. Write for details. Construction Workers' Assoc., P.O. Box 883, Hollywood 28, Calif.

NIAGARA Falls or Buffalo, N. Y. Have your mail forwarded from either place. Confidential; 25c per item, unlimited \$1.00 per week. Blain's Service, 29 Coe Place, Buffalo, N. Y.

POSTMARK Your mail, "Washington, D. C."! Letters mailed, 10c each. Complete (receiving, re-forwarding) service, \$2.00 monthly. "Hawkins," 1300-L Taylor.

MAIL Forwarded from Rochester, 10c letter. Balch, Sodus Point, New York.

GOOD "Used" self-instructional books on all subjects bought, sold, rented, exchanged. Satisfaction guaranteed. Complete information and 100-page illustrated bargain catalog free! Write—Nelson Company, Chicago 5.

CARTOONING, COMMERCIAL ART, SHOWCARD WRITING, SIGN PAINTING

MAKE Up to \$100 weekly cartooning and illustrating at home. No experience necessary. Big, new, simplified method shows you how. Rush name for free trial offer. National Artists Bureau, Box 4248-A, Dallas 8, Texas.

"HOW To Make Money With Simple Cartoons"—a book everyone who likes to draw should have. It is free; no obligation. Simply address Cartoonists' Exchange, Dept. 910C, Pleasant Hill, Ohio.

WINDOW Sign letters; look like sign artist work. Easily applied. Free samples. Artistic, 74 Edmund Pl., Detroit.

LEARN Animated cartooning. A technical book preparing for movies, television. \$2 complete. Cartoonimator, 5029 Illinois N.W., Washington 11, D.C.

NEED Signs? Write, YD Sign Shop, 19-A Shawmut Street, Boston, Massachusetts.

SIGN Painting taught at home by an old master. Ben Kerns, Box 812, Greenville, S.C.

AMAZING Bargains. Art lessons, studies, magazines. Quick landscape painting. Free literature. Art Book Shop, Arnold, Mo.

GET Into cartooning, the fascinating field of the future. Course \$1.00 postpaid. Jason Creations, Box 135, Station "G," Montreal, Canada.

CUB Artists—Stop dreaming—Sell your work. Successful commercial artist (27 years in business) offers sensational plan. \$2.00 prepaid (refundable) brings beautifully illustrated 1947 copyrighted 88 page commercial art catalog, containing thousands of potential sales opportunity ideas with complete information. Brouillet Syndicate, 30 E. Superior St., Duluth, Minn.

STENCIL Beautiful showcards without practice. Kwiksign Stencils, 30 West Washington, Chicago 2, Dept. M.

TALENT Test free. American School Commercial Art, Box 8066, Dallas 5, Texas.

MAKE Signs. 9 complete alphabet pattern sets. 3 complete numeral pattern sets and catalog \$1.00. Sign Letter Distributors, P.O. Box 101, Mineola, N. Y.

CHALK Talks. Laugh producing program, \$1.00. Catalog 10c. Balda The Cartoonist, Oshkosh, Wisconsin.

ADVERTISING AGENCIES, LETTER WRITERS, FOR ADVERTISERS

FREE:—Advertisers rate and data bulletin covering the southern states. Alabama Advertising Agency, Exchange Building, Birmingham 3, Alabama.

LATE Mailing lists! Teachers, births, automobile owners, etc. Business Service, 1101 Kings Highway, Shreveport, Louisiana.

ANY Mailing list you want. Mail sales letters, ads, folders — Written for you. Print anything. Advertisers Organization, 3439-D Michigan, Chicago 16.

NAMES, Addresses any type business. Lohmer, 825 Lima, Burbank, Calif.

MAIL Order Advtg. with a profit guarantee. 20 yrs. exp. Azrael Advtg. Agency Chas. and Eager Sts., Baltimore, Md.

GARDENERS! Reach 12,000, 4c word. Garden Exchange Magazine. Sample 15c. Johnson, 683 Nevada, Reno, Nevada.

ADVERTISE: 24 Words, 77 weekly newspapers \$5.00. Write for free rate directory. A. Burton Carnes Advertising Agency, 410 South Michigan Ave., Chicago 5.

ADVERTISERS! Reach nearly 18,000,000 readers. 25 Sunday national key newspapers, 18 words, \$42.25. "Terrific pullers." 30 popular newspapers, \$8.50. "Free booklet." Special—One inch display 2,821,198 circulation, \$42.00. Newmark's Advertising Agency, (Established 1893) 217-7th Ave., New York 11.

MAIL Order ads, circulars, letters, by leading advertising agency in mail order field. Low prices. Moran Advertising Agency, Box 104, Wilkes-Barre 3, Pennsylvania.

ADVERTISERS: Mail order ad covering United States—2,200,000 circulation—\$28.00 inch. Classified ad, 24 words, 20 metropolitan Sunday newspapers—\$25. Magazine, newspaper, mailing-list ratebook, adwriting assistance—free. Chicago Advertising Agency, 20-PM West Jackson, Chicago 4.

ADVERTISE: 24 Words, 40 newspapers \$3.50. Lists free. Advertising Bureau, 229-G Dixon Blvd., Uniontown, Penna.

FREE! 1947 Advertisers Rate and Data Directory. 52 pages! E. H. Brown Advertising Agency, 20 N. Wacker, Chicago 6.

ADS Placed in out of town newspapers and magazines. Low rates. Catalogue free. Ideas that pay. Baker Advertising Agency, Successors Ankrum Agency, 189 W. Madison, Chicago 2.

MAILING Lists, certified, productive, inexpensive, \$5.00 1000. Homeworkers, agents, buyers, etc. Write Dixie Service, King, N. C.

24 WORDS In 64 weeklies \$4.96. H. J. Darnell, 730 Hays, Jackson, Tenn.

TYPEWRITERS, DUPLICATORS, OFFICE DEVICES

DUPLICATORS \$9.95 Up. (New.) Immediate delivery. "Free circular." Rucker, 2836-PM Slevin, Louisville 12, Ky.

"PRINTOMATIC" Selffeeding post card stencil printing duplicators \$9.50 up. Office size duplicators, Speedprints, Hilcos, Xcellographs \$33.41 up. Literature free. Pittsburgh Typewriter Supply, 336-WK Fourth Avenue, Pittsburgh 23, Penna.

RECONDITIONED Typewriters, mimeograph, multigraph printing devices, appliances, supplies. Catalog. Dixiegraph Service, King, N. Carolina.

RUBBER STAMPS AND OFFICE SUPPLIES

KNOB Handle, 1 line 35c, 3-55c. Stamp Works, Centerport, N. Y.

LINE 20c; 2-35c; 3-50c. Stamp Works, Auburn, Nebraska.

RUBBER Stamps. Send for catalog. Excello, Box 500, Shreveport, Louisiana.

RUBBER Stamps. Buy direct from manufacturer. Literature free. Lee-Vall Press, Box 1242, Indianapolis 6, Indiana.

PRINTING, MULTIGRAPHING, MIMEOGRAPHING, GUMMED LABELS

1000 BUSINESS Cards prepaid \$2.50. Samples free. Reliable Print Shop, 901 E. Jefferson St., Louisville 6, Ky.

PRINTING Reasonable. Mail copy. Free estimates. Berliner, 3581 Milwaukee, Chicago 41.

VARI-TYPING—Mimeographing, planographing, letters, etc. Sample portfolio free. Cooperative, 609 Woodward, Detroit 26.

ENVELOPES—6 3/4 Printed \$2.85 per thousand in 5,000 lots. #10 \$4.25 in 3,000 lots. Smaller quantities price list free. Michel, Box 76F, New York 16.

500 6 3/4 ENVELOPES \$2.35. Mango, 555-A South 20th, Newark 3, N. J.

1000 BUSINESS Cards (embossed) \$2.95 postpaid. Rubber stamps. Zephyr Printing, Box 312, Venice, Calif.

ENVELOPES Our specialty, free price list. Doerr Printing, Lewiston, New York.

MIMEOGRAPHING—24 Hour service. Reasonable rates. Free samples. Jay Service, 1028m East 63rd, Chicago 37.

BUY Your printing at wholesale! Sell others. Details free. Adams-PM, 30 West Washington, Chicago 2.

PRINTING? Lowest prices, samples free. Basil Churchill, West Medway, Mass.

QUALITY printing: business, personal stationery. State requirements. Samples. Mero Products, 100 Morrison, Punxsutawney, Penna.

DOLLAR Special. 30 Sheets, 30 envelopes, 50 cards. Emagene, Box 11, Station A, Dayton, Ohio.

POSTCARD Brings our samples, prices. Valley Print Shop, St. Elmo, Tenn.

100 VISITING, Business cards, 65c, printed, prepaid. W. Davis, 935 Maxwell St., Chicago, Ill.

SALES Letters multigraphed \$1.00 up. Printing. Send copy for estimate. Ace Printing, Brentwood, Maryland.

MIMEOGRAPHING—Any copy. Save money. Samples free. Radio Shop, Box 748, Freeport, New York.

EXPERT Mimeographing, multigraphing, offset printing, reasonable. Jones Letter Shop, 419 Board of Trade, Portland 4, Oregon.

125 LETTERHEADS (8 1/2 x 11 Hammermill) \$1.00. Postpaid. Envelopes same. Race Printing, Hudson, New York.

QUALITY Mimeographing, accurate, reasonable. Riddle, 360 S. Hill, Los Angeles, 13.

ATTENTION! Send today for attractive raised letter writing outfit. Engrave your own stationery and cards. Make money writing for your friends. Price \$1.00. J. E. Hampton, P. O. Box 1838, Wichita 5, Kans.

HOW To cut printing costs on small and large runs form letters, illustrated circulars, letterheads, pricelists, envelopes, engravings is shown in new standardized printing pricelist. Write for your copy and samples today. Fidelity Company, Parkersburg 14, W. Va.

250 **LETTERHEADS** \$1.75. Envelopes same. Mallo, 767 Leith, Flint 5, Mich.

100 **HAMMERMILL** 8 $\frac{1}{2}$ x 11 Letterheads or 6 $\frac{3}{4}$ envelopes, \$1.00. Get our quotation first. Free layouts. Beco, 229 Main, Totenville, N. Y.

125 **WATERMARKED** 8 $\frac{1}{2}$ x 11 Letterheads \$1.00. Envelopes same. Printed. Postpaid. P. Hussey Art and Printing, Abbeville, Mississippi.

BETTER Grade printing reasonable. Estimates on anything. Economic Press, Leonia, N. J.

QUALITY Printing—Reasonable prices. Fast service on catalogs, folders, publications. Write for prices. Bagby Printing Co., Georgetown, Ohio.

500 $\frac{3}{4}$ x 2 $\frac{1}{4}$ **FOUR** Line gummed stickers, 35c. Moritz Printery, Saginaw, Mich.

SEND 10c Now, for our 36-page 1947 pricelist—refunded first order. McCall Press, 1326 South 27th, Omaha, Nebraska.

MIMEOGRAPHING—Letters, pricelists, formulas, instructions. Lowest prices. Lem's Letter Shop, 5710 Stanton, Detroit 8.

PRINTING OUTFITS AND SUPPLIES

PRINTING Presses, type, supplies. Lists 3c. Turnbaugh Service, Loysville, Penna.

WE Save you money. Send for price list. Stamp appreciated. Brighton Printers Supply, 4234 So. Mozart, Chicago 32, Illinois.

PRINT At home—Send 10c for catalogue—presses, type, supplies. Barnhard Co., 6 Columbia St., Newark 5, N. J.

PRINTERS. Make a quick-etch etcher for cuts, halftones. Details. Charles Medlock, Box 256C, Goodland, Indiana.

CUTS—Make real halftones. Line cuts yourself! Samples 25c. Particulars free. Rapid Chemical Service, Edwardsville, Ill.

PRINTING Presses, type, supplies. Send dime for complete illustrated printer's supply book, details and press samples. Kelsey, Inc., A-11, Meriden, Connecticut.

HOME Made presses. Write Riegel, 1111 Harrison, Philadelphia 24, Penna.

INEXPENSIVE Home-made printing press. Details free. Novelty Shop, Downsville, Louisiana.

PATENT ATTORNEYS

INVENTORS—Patent laws encourage the development of inventions. The Rules of Practice of the U. S. Patent Office advises—unless an inventor is familiar with such matters—that he employ a competent registered attorney or registered agent, as the value of patents depends largely upon the skillful preparation of the specifications and claims. Write for further particulars as to patent protection and procedure and "Invention Record" form at once. No obligation. McMorow, Berman & Davidson, Registered Patent Attorneys, 134-W Victor Building, Washington 1, D. C.

INVENTORS: Learn how to protect your invention. The United States Patent Office advises the inventor, unless familiar with such matters, to engage a competent, registered patent attorney or agent to represent him. We maintain a staff of registered patent attorneys ready to serve you in the handling of your patent matters. Special booklet "Patent Guide for the Inventor" containing detailed information concerning patent procedure with "Record of Invention" form will be forwarded upon request—without obligation. Clarence A. O'Brien & Harvey Jacobson, Registered Patent Attorneys, 71B-K District National Building, Washington, D. C.

PATENT Protection—The U. S. Patent Office recommends—"an applicant is advised, unless familiar with such matters, to employ a competent registered Patent Attorney or registered Patent Agent, as the value of patents depends largely upon the skillful preparation of the specification and claims." Preliminary steps to take to obtain patent protection will be sent upon request. Victor J. Evans & Co., 231-L Merlin Building, Washington 6, D. C.

C. A. SNOW & Co.—M-427, Snow Building, Washington 1, D. C. Registered Patent Attorneys. Write for information.

INVENTORS. For "Record of Invention" form, contact Carl Miller, Registered Patent Attorney, Woolworth Building, New York.

"**INVENTOR'S** Guide" free on request. Frank Ledermann, Registered Patent Attorney, 154 Nassau St., New York 7, N. Y.

PATENTS. "Proof of Invention" folder mailed without obligation. E. E. Vrooman, Registered Patent Attorney, 871 Woodward Building, Washington 5, D. C.

INVENTORS: Without obligation, write us for information as to what steps an inventor should take to secure a patent. Randolph & Beavers, Registered Patent Attorneys, 21-C Columbian Bldg., Washington 1, D. C.

INVENTORS: Write for free brochure "Evidence of Invention." Labiner, World Building, New York 7.

PATENTS—Trade marks. Irving L. McCathran, 315 McLachlen Bldg., Washington 1, D. C. Registered Patent Attorney.

PATENT And Trade-Mark Practice before U. S. Patent Office. Validity and infringement investigations and opinions. Booklet and form "Evidence of Conception" forwarded upon request. Lancaster, Allwine & Rommel, Registered Patent Attorneys, Suite 411, 815-15th Street, N.W., Washington 5, D. C.

FOR INVENTORS

INVENTORS—Victor J. Evans and Co. has a staff of registered patent attorneys, available to assist inventors in the preparation and prosecution of their cases before the U. S. Patent Office. Detailed information and the steps to take to obtain patent protection will be sent to you upon request. Victor J. Evans & Co., 232-L Merlin Building, Washington 6, D. C.

INVENTORS—Patent laws encourage the development of inventions. The Rules of Practice of the U. S. Patent Office advises—unless an inventor is familiar with such matters—that he employ a competent registered attorney or registered agent, as the value of patents depends largely upon the skillful preparation of the specifications and claims. Write for further particulars as to patent protection and procedure and "Invention Record" form at once. No obligation. McMorow, Berman & Davidson, Registered Patent Attorneys, 134-X Victor Building, Washington 1, D. C.

INVENTORS: Learn how to protect your invention. The United States Patent Office advises the inventor, unless familiar with such matters, to engage a competent, registered patent attorney or agent to represent him. We maintain a staff of registered patent attorneys ready to serve you in the handling of your patent matters. Special booklet "Patent Guide for the Inventor" containing detailed information concerning patent procedure with "Record of Invention" form will be forwarded upon request—without obligation. Clarence A. O'Brien & Harvey Jacobson, Registered Patent Attorneys, 71A-K District National Building, Washington, D. C.

I'D Like to show you how I've sold my inventions. Write for free literature. George Pearce, 471 Bartholomew Street, Peabody, Mass.

SPRINGS—For inventors. Wire shapes to your specifications. Spring Service, 4540 No. Mason Ave., Chicago 30, Ill.

PRELIMINARY Search, painstaking care, generally \$7, including reference patents. Reports airmailed 48 hours, excepting Saturdays, Sundays, holidays. Remit \$7 with description; if insufficient, will quote telegraphically prepaid; remittance returned immediately on request—Ironclad proof of invention date by Aabberly Print Routine; instructions on copyrighted master sheet 10c (you buy locally, couple dollars indicated supplies). Out-ranks registered letters, "invention copyrights," other makeshifts. Unrelated to free "invention forms." No disclosure to me or other strangers—Complete applications, patent drawings, etcetera. Rely on 31 years "know how." Nicholas Aabberly, Patent Engineer, Woodward Building, Washington.

INVENTORS—You are inviting financial failure without modern industrial styling and a professional presentation. Assure the success of your invention by increasing its sales appeal. Details free. Guaranteed work. Low prices. Etzel Industrial Design, Room 803, 112 South 106th Street, Seattle 88, Washington.

IF You have inventions get my booklet. Things I've learned from years' experience about inventing and having patent applications filed. Mailed postpaid \$1.00. Don Christoffer, Spirit Lake, Iowa.

INVENTORS: Your ideas developed into manufacturing and patent drawings by engineer designers and draftsmen. Write today. Quality Design and Drafting Service, 613 Atlantic Building, 930 F Street, N.W., Washington, D. C.

FREE Pamphlet! How to develop your inventions. Elo Development Company, Department P, Chatham Phoenix Building, Long Island City 1, New York.

RELIABLE Patent searches complete with patent copies \$6.00. Protection forms free. Write Raymond L. Smith, Patent Searcher, 703-M Albee Building, Washington 5, D. C.

INVENTORS: Avoid unnecessary expense. Write for free booklet explaining how our consulting and advisory service can assist you in deriving greatest profit from inventing. Institute of American Inventors, Dept. 40-A, 1926-Eye St. N.W., Washington 6, D. C.

"**INVENTOR'S** Guide" free on request. Frank Ledermann, Registered Patent Attorney, 154 Nassau St., New York 7, N. Y.

THE inventor who believes he has a new and useful invention, and needs advice, should consult a competent registered patent attorney. Without obligation, write for full information on how to secure patents and trademarks. Randolph & Beavers, Registered Patent Attorneys, 11-E-Columbian Bldg., Washington 1, D. C.

I SELL Patents. Established in 1900. Charles A. Scott, 773PM Garson Ave., Rochester, N. Y.

HIGHEST Royalties and cash for your inventions when we market them. Free particulars without obligation. Universal Marketing Co., 126 Lexington Ave., New York 16, N. Y.

INVENTIONS WANTED

INVENTORS. Write for our sales plan. Complete service for inventors. Visioneering Inc. Security Building, West Bend, Wis.

INVENTORS—Booklet offering assistance "Self-Testing Your Patent or Invention" free on request. Address: Direct Contacts, 11106-A2 Longwood, Chicago 43.

INVENTIONS Wanted—If your invention is not protected by patent write for double service plan of legal patent application preparation, specifications, drawings, analysis, Patent Office filing and prosecution, reasonable charges, payable cash or six installments and help to sell your invention, commission basis. Have manufacturer requests for 507 different inventions. Yours may qualify. Patent search with copies \$6.00, you save 300%. Invention protection forms free. Charles Morton, Patent Broker, Established 1919, 11 West 42nd Street, New York.

WANTED—Practical inventions of all kinds. Write John D. & Son, 285 Howard Ave., Box 3213, Dept. PM10, Bridgeport 5, Conn.

ATTENTION Inventors. List your patent pending and unpatented with us for immediate sales action. Have waiting buyers. Highest royalty and cash paid. Chicago Patent Exchange, Chicago Stock Exchange Building, Chicago 3.

CASH For your idea. 280 manufacturers need inventions, patented or unpatented. List free. Invention Bureau, 208 Clinton, Oak Park, Illinois.

CASH—Royalty. We manufacture, nationally advertise your ideas, patents. Bonded. Federal Identification Co., Robert Burbridge, Pres., Dept. K1, Burbridge Bldg., Oklahoma City 6, Okla.

SMALL Inventions wanted by manufacturers. I'll help you sell your invention. Write for circular. Stanley Hull, 7829 Euclid, Cleveland, Ohio.

MANUFACTURERS Want patented or pending inventions! Send patent copy or complete details. Universal Guaranty Company, Lakewood, New York.

INVENTORS: Hundreds of manufacturers have requested our assistance in locating marketable new products. Complete information, free. Institute of American Inventors, Dept. 40-D, 1926-Eye St. N.W., Washington 6, D. C.

PATENTED, Unpatented inventions wanted. We have tremendous lists of manufacturers who may pay cash royalties. Descriptive booklet free. National Invention Service, 1404-T Mitchell St., Oakland 1, Calif.

LITTLE Library of Useful Information. 102 different books. Catalog free. Popular Mechanics Press, 200 E. Ontario St., Chicago 11, Ill.

PATENTS FOR SALE

PATENTED Paring knife; fast selling 10c store item. Quick sale. Reasonable. Nelson, Box 525, St. Paul, Minn.

BUD Shield—Enables nurserymen to ship budded plants safely the same season they're budded. John Dockery, 749 N. State St., Painesville, Ohio.

WIRE Bending, clinching and cutting tool. Patented in U.S. and Canada. Very practical for tightening wire around the hose, and other objects. Outright or royalty. Wm. Medved, Sappho, Wash.

PARTNER To finance inventor. Unlimited possibilities. 1/2 interest to principals only. No brokers. \$20,000 or more. Inventor, 6422 10th Avenue, Los Angeles 43, California.

FOR Sale—Patent on pneumatic tire valve. Eliminates slow leaks, prevents flats. John Rhodes, Le Grand, Iowa.

PENDING Tractor implement rope holder. Cheap, easily manufactured, proved value through local dealers this season. Cash or royalties. Will mail one to interested parties sending one dollar to cover cost. Write Don Christoffer, Spirit Lake, Iowa.

INVENTORS: Test the commercial value of your patented or unpatented inventions, quickly and inexpensively. Write for free information. Institute of American Inventors, Dept. 40-B, 1926-Eye St. N.W., Washington 6, D. C.

MANUFACTURING

MODELS. Dies, molds made to your drawings. Short run stampings, specialties manufactured. National Machine & Tool Co., 249 Stanton Ave., Akron 1, Ohio.

INDUSTRIAL Sites, city property free with clear title. Locate in Northwest Florida's year round climate. Chamber of Commerce, Lynn Haven, Fla.

SMALL Lot production wanted. Aluminum castings; stampings; screw machine. J and M Company, Burlington, Kentucky.

DESIGNING. Drafting, experimental and development work. Models. Patterns. Assembling. Short run and quantity manufacturing. Henry, 2815 Hudson Boulevard, Jersey City 6, N. J.

CUSTOM Made special die-cut stampings in small lots for experimental work at lowest possible die cost. Write to Dayton Rogers Manufacturing Co., Minneapolis 7, Minnesota.

PERMANENT Moulds for plastics, aluminum castings. Send drawings. Unamit Mould & Machine Company, Bunker Hill, Ill.

EXPERIMENTAL Work, models. Reasonable. Nelson Manufacturing, 948 First, Woodburn, Oregon.

MODELS—Small lot manufacturing. Metals, plastics, etc. Milburn, Burlington, Kentucky.

MODELS AND MODEL SUPPLIES

BRASS Gears and model supplies for the inventors. Send 10c for catalog. Pierce Model Works, Tinley Park, Ill.

"SHIP Models of Lasting Beauty." Copper sails. Construction sets, assembled models. Folder free. Trade Wind Models, P.O. Box 171-B, Lakewood, N. J.

MODEL Gas engine. Build it yourself. Watchmaking precision, usable power, and spectacular high speed in performance packed in just about smallest model possible to build in four-cycle type. Complete set of blueprints 75c. Popular Mechanics Press, 200 E. Ontario, Chicago 11, Ill.

RAILROADERS New 25 watt 100 ohm IRC metallized rheostats. Ideal for controlling train speed. Regular price \$5.20, our price \$1.00 prepaid. Heath Co., Dept. M, Benton Harbor, Mich.

TINY Power steam engines, boilers, locomotives finished ready-to-run. Also castings, prints. New catalog 25c. Chas. V. Arnold, Philomath, Oregon.

SHIP Model supplies, catalog 25c coin. R. E. Hancock, 323 Douglas Ave., Portsmouth, Virginia.

STEAM Engines, boilers, castings. Catalog 25c. Anton Bohaboy, 2297 Price, Rahway, New Jersey.

FREE Estimates on patent models. Wood, metal, plastic. Rogay Industrial Models, 3818 Beecher Street, N.W., Washington 7, D. C.

LIONEL Railroaders—Our ad, on page 266, has hot news for you! See it! Madison Hardware Co., N. Y.

CIRCUS Photos. List and sample 10c. Box 1028, Minneapolis, Minnesota.

SPEED King steam engine for boats and other models. Engines, casting kits, water tube boilers. Literature 5c. H & P Machine Co., 1617 Fulton St., Kalamazoo 25, Mich.

PLASTIC Kits! HO gauge Superchief, \$3.95. Plastiweid, Box 171, Swarthmore, Penna.

PLASTIC Blocks and deadeyes are better. 25c brings samples and lists, refunded. Guilmar, Westhill, Ontario.

POWER Models—Steam and gasoline engines, steam traction engine, metals, tools. Catalog 35c. Chas. Cole, Ventura, Calif.

HOBBYCRAFT Lumber, \$1.00, package of 25 pieces cedar or fir, 10 to 24 inches long, 1/2" thick, 2" wide. State size required. Lincoln, Box 172, Baldwin, N. Y.

SHIP Model kits and fittings, most complete stock in New England. Boucher, Fisher, Marine Model and Model Shipways fittings, blueprints and model yacht equipment at standard prices. Send 25c for new illustrated 1947 catalog and price list. Dept. M, James Bliss & Co., Inc., 220 State Street, Boston, Mass.

RAILWAY Models, complete informative catalog HO and O gauge. 128 pages, 35c. Walther, 247 Erie, Milwaukee, Wisconsin.

LANDLOCKED Sailors! Here's a beautiful, richly illustrated, fully descriptive catalogue of famous model ships—whalers, slavers, corvettes, etc., authentic in every detail. Send for it today. Only 10c. Halesite Yacht Service, Inc., Halesite, Huntington, N. Y.

PUN Building models—Airplanes, trains, ships. Everything furnished. Giant catalog 10c. Ben's Hobby Shop, 72 West Washington, Chicago 2, Illinois.

SHIP Models and yacht supplies complete. Large 64 page catalogue 30c. Bill Wild's, 510 East 11 St., New York City 9.

SHIP and Yacht model fittings; blueprints. Send 25c for illustrated catalog No. 20—listing hundreds of items. A. J. Fisher, 1002-1 Etowah Ave., Royal Oak, Mich.

MINIATURE Steam locomotives, 1/4", 1/2", 3/4" scales. Castings, parts, rail. Through drawings with instructions. Catalog 25c. Little Engines, Wilmington, Cal.

HOME CRAFTSMEN

TEXAS Ebony, America's most beautiful lathe turning wood. Large piece, \$1 prepaid. Sample, dime. Information on southern woods, stamp. Starcraft 1, Edinburg, Texas.

LUMBER. Odd lots tropical and other woods, many rare. Suitable craftsmen, cabinet makers, schools, small mfrs. Send for latest descriptive price list. J. L. Regan, Dobbs Ferry, N. Y.

MAKE Your own jewelry! Findings in metal and plastics; earwires, pinbacks, cameos, stones, beads, clasps, sprays, combs, hairbars, plastic and metal chains. Hobby Art Corp., Dept. 7, P.O. Box 276, New York 18, N. Y.

WAR Surplus for camping or hobbies. 100% down sleeping bags, clothing, tools, machines, skis, and thousands of other articles. We buy direct—Government to consumer. Save half regular retail price. Send now for money saving catalog. 10c. Coast Distributor Corp., Dept. T-D, 9025 Bothell Way, Seattle 5, Washington.

PLYWOOD Cabinet kitchen plans 25c. Payne Cabinets, 4617 Johnson Avenue, Western Springs, Illinois.

PLASTIC Jewelry supplies. Free catalog. J & M Novelties, Box 464P, Griffith, Indiana.

WOODCRAFTERS—40 Pictures of new woodworking projects 10c. Joanez Patterns, P.O. Box 141, Omaha 7, Nebr.

LEATHERCRAFT Instructors. Buy your tools from Hartes Craft Shop, Holyoke, Colorado. Free new catalog.

HOW To set up and run a mirror shop! Resilver mirrors. For price write—John Sprinkle V55, Marion, Indiana.

SHELLS. Flowers molded into Dixie Nuclear Plastic. Latest process. Dollar kits. (Stamp) for illustrated shellcraft catalogue. Dixie Shell Service, Lakeland, Fla.

SHELLCRAFT Dealers: Obtain all your supplies from one firm. Wholesale only. Free catalog. Compare prices with your present source. Letterhead requested. Beachcomber Novelty Company, Dept. P Box 551, Fort Myers, Florida.

CUSTOM Made molds, unpainted art plaster. List, 10c coin. Homemaker, Box 3447, St. Paul 1, Minn.

SHELLCRAFT Supplies. C. A. Werts, 1429-56th Avenue, Oakland 3, Calif.

HUNDREDS Patterns: Plywood novelty furniture, lawn ornaments, silhouettes, weathervanes, letters, numerals. 200 craftsmen's books and booklets. Hundreds decal transfer decorations. Other lines. Large illustrated catalog. Write Wo-Met Shop, Ashburn, Georgia.

BUILD And sell lawn chairs. Plans \$1.00. We tell you how and where we sell. The Woodcraft Shop, Danby, Vermont.

SPECIAL—Five gross 3 1/4" griptooth combs \$13.75. G. Baker Company, River Edge, New Jersey.

SHELLCRAFT Supplies. Beginner's kit with instruction book \$3.00. Price list free. Stelle Shellcraft Industries, 230 Randall Avenue, Trenton 10, New Jersey.

NOVELTIES. Wood action toys, full size plans. Descriptive list 10c. Novelty Products Co., Box 62, Gardner, Mass.

OREGON Myrtlewood turning squares for sale, all sizes. Your correspondence solicited. M. Weaver, 3923 SE Tibbetts, Portland 2, Oregon.

KNOCKDOWN Cedar chests. Lumber and veneers. Free price list. Giles & Kendall Company, Huntsville, Ala.

FOR The best in leather tools, write The Marcraft Co., Skokie, Illinois.

JIGSAW Patterns, full size. Ten toys 50c, baby rocker 25c. Frieders, 609 North Root, Aurora, Ill.

SPECIAL 77 Full sized patterns. Lawn ornaments, toys and novelties \$1.00. Modern Woodcraft, Saginaw, Michigan.

FREE Price list, 34 pages of tools and supplies showing hundreds of items for the leather crafter. A complete selection of leather stock. Yours for the asking. Russo Handicrafts Supplies, 239 S. Spring St., Dept. A, Los Angeles, Calif.

LEATHERCRAFT. Profitable hobby. Easily learned. Mail card for free booklet. Artcraft Leather of California, Dept. PM-10, 271 Twelfth Street, Oakland 7, California.

LEATHER Craftsmen: Don't spend hours tracing design. Start tooling immediately. Our designs on plastic require no tracing. May be used many times. Introductory offer \$1.00. Sample 10c. Lampkin Artcrafts, Box 641-M, Culver City, Calif.

TWO-WAY Telephone. Carries sound 100 feet. Needs no wires or batteries. Complete, ready-to-use. Only \$1.00. American Stamp Company, Wilmington-F, Delaware

PROFIT With your jig saw. It's easy when you use packet of jig saw patterns. 38 popular projects in one grand set. Every project, every part full size, ready for pasting on wood and cutting out. Packet includes wooden-gear clock, wall shelves, clever toys, lamps, wastebaskets, etc. Start now earning money, spare time. Send \$3.00 for complete packet. Jig Saw Guild, 117-M Worth Street, New York 13.

UPHOLSTER Your own furniture with beautiful plastic leathers; four finishes, six gorgeous colors. 10c brings big 64-page illustrated catalog listing hundreds other craft supplies, tools, materials, accessories. Carmen-Bronson, Dept. CA-4, Mount Vernon, N. Y.

PLYWOOD—Birch, gum, cedar, mahogany, walnut, etc., in panel sizes through 48"x96". 10c brings big 64-page illustrated catalog listing hundreds other craft materials, supplies, tools, accessories. Carmen-Bronson, Dept. CA-2, Mount Vernon, N. Y.

MAKE Beautiful seashell jewelry! Scores of beautiful things you can make at home. No experience needed. Earn money selling what you make. (Buy wholesale.) Large catalog 10c. Pace's, Box 279-T, Bradenton, Fla.

SPECIAL Offer: 80 full size toy, novelty, and lawn ornament patterns only \$1.00. Lynds, Medway, Mass.

GENUINE Leather scraps for leathercraft items, assorted colors, 6 pounds, \$2.00. Send 10c for sample. International Cushion Co., 515 No. Halsted, Chicago 22, Illinois.

GUARANTEED: We are America's lowest priced hobby supply house. Write for free price lists. Allcraft Products, Hempstead, New York.

RARE Woods for homecraftsmen. Brazil Rosewood, ebony, cocobolo, beefwood, Goncalo alives, etc. Turnings blocks and dimension. We manufacture every piece ourselves from imported logs. Send for price list. Homecraft Dept. M, The Salisbury Cutlery Handle Co., since 1884, Salisbury, Conn.

LEATHERCRAFTERS: Ready made leather projects simple to complete are fully illustrated in our 1947 catalog of projects, tools, hides and accessories. Write for free catalog. Ester Leather Company, 145 St. Paul St., Rochester 4, N. Y.

NEW 12" Bandsaw; anti-friction bearings; tilting table. Write for circular. Sterling, 2310 W. Warren, Detroit 8, Mich.

LEARN Sea-Shell jewelry and novelty manufacturing. No tools or experience needed. Learn—earn within a week! Complete, beautifully photographed home instruction course, shows you how to make 110 designs of pins, earrings, brooches, hair ornaments, necklaces, bracelets, plaques, ash trays, dolls, animals, miniatures, etc. Explains pearlizing, tinseling, gilding, dyeing, luminous processes. Illustrates 65 species sea shells. Lists 200 raw materials with wholesale prices. Complete course \$1 postpaid. Beginner's kit, \$3 (\$3.50 in Canada). House of Gifts, Box 4550FR, Coral Gables, Fla.

CERAMIC Jewelry supplies, bar pins, ear screws, for ceramic and woodworkers; also glass and seashell assemblers. Free catalog. Philadelphia Badge Co., Dept. B-1, 1007 Filbert St., Philadelphia, Penna.

35 PATTERNS Of action pull toys, trucks, carts, toy furniture, etc. \$1.00. Continental Homecrafters, 907 Birch, Eau Claire 3, Wisconsin.

LEATHERCRAFTERS! Send for free catalog listing leathers, tools, supplies. Kit Kraft, 3203 W. Washington Blvd., Los Angeles 16, Calif.

WHITTLES'S Supplies, Redicut blanks, special woods, tools. Catalog 10c. Old Whittler, 1402 Charles, La Crosse, Wis.

LEATHERCRAFTERS! Belt kits, projects, leather, supplies. Write for catalog. Art Leather, 411 Joseph Ave., Rochester 5, N. Y.

SHELLS, Plastics, findings. Lowest prices. Free catalog. Frances Jones, Box 251, Sarasota, Fla.

EXPERIMENTERS! Interested in electrical, mechanical devices from war surplus? List free. F. Siefke, Box 18, Station E, Buffalo 11, N. Y.

MAKE IT YOURSELF

SEW Your own sequin brooch and earrings, easy to make. We have all supplies. Sequin kit with instruction \$2.50 postpaid. Write for free price list. Russ Renaud, 289 West Flagler Street, Miami, Fla.

MAKE Your own musical novelties. Genuine first quality music movement. Choice of beautiful melodies for children or adults. \$3.50 prepaid. Roger Gift Shop, 31-14 Broadway, Long Island City 2, N. Y.

MAKE Leveling instrument. Learn leveling. Easy. Circular free. Design Service, Box 143-A, Aurora, Nebraska.

BARBECUE Oven—Build your own cheap. Picnic in your back yard. Have fun. Write for free information. Bar-B-Kit, 701 Land Bank, Kansas City 6, Mo.

BUILD Concrete block machines, portable sawmills. Shop, farm, home machines. 70 plans. Catalog-handbook free. Nichols Equipment Co., Dept. 310, Purvis, Miss.

MAKE Shell flower pin. Material, instructions, 10c. Oceanshell, Route 1, Box 249A, Rochester, Michigan.

SPECIAL. Over 100 new toys, full size patterns, \$1.00. Arrangement and simple construction over 20 kitchen cabinets. \$1.00. Free list. Masterprint, White Building, Buffalo 2, New York.

BUILD Concrete block machine, 2 blocks per minute. Build concrete mixer. See illustrated ad, page 262. U-Build-It Service.

HOT Water free—From sunlight. System efficient any locality year round. Standard materials, easily built, low cost, facts free. Solar Water Co., Box 175, Dept. P, Coral Gables, Florida.

GRANDFATHER Clock building system. \$1. Simple, shop-tested, thousands built, with pictured prices fine Westminster weight movements. Kuepfer Clock Plant, Minneapolis 16, Minn.

MAKE Wood turning and spinning lathes. Drawings \$1.50. Henry, 2815 Hudson Boulevard, Jersey City 6, N. J.

COUCHES—Convert boxsprings easily, inexpensively, into space saving Hollywood couches or divans. Free literature. Gutman Company, 1216 Park Row Building, New York 7.

"CONCRETE Block Homes." 24 page booklet: drawings, instructions on how to build. \$1.00. H. C. Lightfoot, Civil Engineer, Richboro 1, Penna.

PLANS AND BLUEPRINTS

YOUR Own home—Rental unit \$990.00 U-Build-It Cottage, 21x24, with plumbing and electricity. Blueprints available. Construction details, diagrams, bill materials. Complete \$1.00 postpaid. U-Build-It, Box 748, Los Angeles 28, California.

FOR THE HOME

"REPLACEMENTS"—Stoves, furnaces, Grates, firepots, linings, Magic, Royal Oak 128, Mich.

INEXPENSIVE Home Turkish bath. Collapsible. Applications cost practically nothing. Information free. Gordon Brothers, 656-M Grand Street, Brooklyn 11, New York.

HAVE You a heating problem? Let us show you how to equalize your steam heating system by vaporizing. Reduce fuel cost. Stop wasting money. Details free! Write, Ralph M. Arato, 1651 East 14th Street, Brooklyn 29, N. Y.

VENETIAN Blinds; custom built; samples; Blind Man, Oradell, N. J.

WATCHES, OLD GOLD, JEWELRY

ZIRCONS, Mystic, genuine Siamese gems. Brilliance of diamonds. Treasured by ancient Egyptian kings as good luck charms. Stand diamond acid test. Diamond facet cut, unmounted. Wholesale \$1.50 carat. Sample \$2.00, two for \$3.00. Will mount in good rings at popular prices. B. Lowe, Dept. PM-10, Holland Bldg., St. Louis, Mo.

OLD Gold; Top price paid. Mail old or broken jewelry, rings, watches, gold teeth, silverware, diamonds. Receive cash immediately. 100% satisfaction or articles returned. Information free. Old Gold Specialist Robert Wyndham, 1035 East 'A' Street, Ontario 1, California.

LEARN Watchmaking. Complete instruction course, \$3.50. Tools, materials. Catalog free. Stewart's, 727 Market St., St. Louis, Mo.

GENUINE Diamonds at out-of-pawn low prices from unredeemed loans and cash buys. We offer beautiful gems at far less than original cost. Shipped free for inspection, appraisal. Write for free list showing fine diamonds at amazing low prices. Lloyd J. Butler, President, Prudential Loan Association, 133 North Clark, Dept. J-107, Chicago 2.

STUN Your friends with genuine, sparkling, brilliant-white zircons. Cut, polished, mounted just like diamonds. Amazing diamond-like appearance. Top-quality. Hard for even experts to tell the difference. Beautiful settings 14K gold. Over 100 gorgeous latest-style rings to choose from. Attractive low prices. Send for big free catalog. U. S. Zircon Syndicate, 139 N. Clark, Dept. ZG-107, Chicago 2.

REPAIR Alarm clocks. Instructions 50c. Clifford Jones, 1210X Dudley, Utica, N. Y.

MAKE Your own costume jewelry. One of the country's most complete lines accessories, findings, 10c brings big 64-page illustrated catalog listing hundreds other craft materials, supplies, tools, accessories. Carmen-Bronson, CA-3, Mount Vernon, N. Y.

RELIABLE Repairing—Cleaning, oiling, complete overhauling, \$3.75; cleaning, oiling, main spring, overhauling, \$4.75; cleaning, oiling, balance staff, overhauling, \$5.00; worn parts replaced, 10-14 day service, literature free, or send watch. Brookins, B-D1975, Little Rock, Ark.

WHOLESALE—Bulova, Elgin, Waltham, Hamilton, rebuilt, like-new watches; 7 jewel \$12.65, 15 jewel \$13.80, 17 jewel \$14.95 and up; minimum, 2 watches; samples \$1.00 extra. Catalogue free. Brookins, B-1975D, Little Rock, Arkansas.

SELP-LOCKING! New "Sure-Stay" non-magnetic unbreakable stainless steel wrist watch band can't come undone accidentally; adjusts to size and shape of wrist automatically. Only \$1 postpaid. Money back if not completely satisfied after wearing ten days. Agents, dealers: Write for attractive proposition. Troy Engineering Co., Dept. A-10, 132 Ferry Street, Troy, N. Y.

GOLD \$35.00 Ounce—Mail old gold teeth, diamonds, jewelry, watches—receive cash by return mail. Satisfaction guaranteed. Free information. Dr. Weisberg's Gold Refining Company, 1500-Q Hennepin, Minneapolis, Minn.

WATCH Repairing easy learned by our home study course. Watch repairers are in demand and are among the highest paid craftsmen today. Write for free information. Houston Chronometer & Watch Co., P.O. Box 1140A, Houston 1, Texas.

WATCHMAKERS Don't be without B&M hairspring straightening vise. Price \$4.50. Meyer Mfg. Co., 3911 N. Figueroa St., Los Angeles 31, Calif.

CASH For old, broken jewelry. Highest prices paid immediately. Mail gold teeth, watches, rings, silverware, diamonds, spectacles. Satisfaction guaranteed. Information free. Rose Smelting Co., 29-A East Madison, Chicago.

GEMS, Precious and semi-precious, all genuine, from world wide sources. Deal direct, no overhead, save money. Catalog 10c. Hill Co., Route 7, Salem, Oregon.

WATCH And clock repairing—Complete practical course in modern horology. 66 illustrated self-instruction lessons. Just out! Low price. Fascinating 100-page illustrated catalog free! Write—Nelson Company, Dept. 3-02, Chicago 5.

TOBACCO, SMOKERS' SUPPLIES

PIPES Repaired—Hard rubber stems fitted \$1.00. Free catalog. Brandon Pipe Hospital, 3740 Richton, Detroit 6, Michigan.

BARGAINS Pipe carving kits, repair parts, reject pipes. Free literature. Carvapipe, 2829 Dixie, Hamilton, Ohio.

FRESH Cigarettes—\$1.50 carton of 200 postpaid. Save money on all popular brands. Minimum 3 cartons, no order too large. Fast service guaranteed. Send remittance or request c.o.d. Delar Sales, Box 61, Dept. PM-10, Clayton, Mo.

CIGARS—Factory—fresh by mail. Andrew Tapia, 1903 Nebraska, Tampa 3, Florida.

PIPE Lovers magazine! Pictures, articles, gadgets, ideas. 532P Pine, Long Beach 12, Calif.

CIGARETTE Bargain! Only \$1.37 per carton for factory-fresh Camels, Luckies, Chesterfields, Philip Morris, etc. Orders shipped immediately! Add 5c per carton for postage and handling on orders within 600 miles. More distant orders add 2c per carton for each additional 300 miles. Minimum order 4 cartons. (Special quantity discount—deduct 3c per carton on orders of 25 cartons or more.) Send money order or check today! Baisson Sales, 7212 Baisson, St. Louis 5, Missouri.

CIGARS, Tobaccos. Write for particulars regarding better smokes for less money, mentioning your favorite brands. Pete Moberly, Box 999, Owensboro, Kentucky.

RAZORS, BLADES, SHARPENING

REJUVENATE Your old safety razor stopper. Amazing improvement in many new stoppers. Complete instructions \$1. (no stamps). Northwest Research and Design Laboratories, P. O. Box 866, Chehalis, Washington.

SURVEYING INSTRUMENTS

GUARANTEED Factory rebuilt transits and levels for sale (cash or terms) or rent (with purchase option). We will repair, trade, or buy old instruments. Ship prepaid for estimate and valuation. For complete information, write for list M-310 Warren-Knight Co., (Manufacturers of Transits and Levels), 136 N. 12th St., Philadelphia 7, Penna.

FOR SALE—MISCELLANEOUS

HULL Automobile compass, for accurate road direction, brand new, \$2.50. Prisms for 6x30 or 8x30 binoculars, brand new, \$1.50 each. Offset prisms to be attached to 7x50 B. & L. binoculars, gives double the field of the ordinary 7x50 binocular. Cost \$98.00, special, \$25.00. Green sunshades for binoculars size 6x30 and 7x50 snap on type, value \$7.50, special \$1.25 per pair. Forward money order. No c.o.d. shipment. Send coin \$1.25 for third annual edition of Gun Digest together with our complete catalog of new and used guns, ammunition, rifles, binoculars and powder flasks. Our separate catalog 25c. Public Sport Shops, 13 S. 16th St., Philadelphia, Penna.

A-2 FLIGHT Jacket. AAF regulation style! First-quality, dark brown leather—windproof, rainproof, lightweight but extra warm. Features solid brass zipper, two big snap pockets, water-repellent lining, pure wool cuffs and waistband. Every jacket new, perfect; no "seconds." Money-back guarantee. Now only \$19.95, postpaid! Send check or money order today, with your height and suit size, to Perry Sales Co., Dept. PM-10, 37-47 82nd St., Jackson Heights, N. Y.

ARMY Goods equipment. Catalog free. N. Y. Salvage, 144 Chambers, N. Y.

BINOCULARS 6x30, Zeiss, used, Bargain. Your offer? National, Woodbine, Maryland.

USED Army raincoats—good serviceable condition. Send no money, pay when received. Satisfaction guaranteed. Light weight \$1.50, heavier weight \$2.00. Buford Butts, Sharon, Tennessee.

WAR Surplus bargains for farmers, sportsmen, home owners. Sensational values, hardware, tools, clothing. Write for free bulletin. Surplus Mail Order, 1614 Reading Road, Cincinnati, Ohio.

REYNOLDS Pen \$1.00. Drinking birds \$1.25. H. Hayes, Blue Earth, Minn.

SPONGE Rubber boxes. All new! Consists of over 1 pound of $\frac{5}{8}$ " thick rubber. Useful for countless purposes. Such as shock absorbers, upholstering, kneepads. Special! Minimum order, 6 for \$2.50. No c.o.d. "Amazing Bachman's," 23 Herman Street, Rochester 5, N. Y.

WANTED MISCELLANEOUS

CASH Paid for anything. Free list. Buyers Bulletin, P. O. Box 415, Evansville, Indiana.

WANTED Binoculars — B&L, Zeiss, Dienstglass, French, etc., highest cash prices. United, 7941 So. Halsted, Chicago.

MERCURY (Quicksilver). Write for quotation stating quantity. Metallurgical Products Co., 35th and Moore Sts., Philadelphia, Penna.

PERSONAL

GREAT Invention! Corrects poor penmanship, few hours. Plenty fun! Write, Inventor Ozment, 9, St. Louis, Mo.

BOSTON—Pretend visiting this famed historical city. 3 deluxe scenic post cards 50c. You address, return, I stamp and mail. Letters forwarded 25c. Dave Coburn, 95 Federal Street, Boston 10, Mass.

LETTERS Forwarded from New York, Boston or Providence! 25c or three 50c. Desmarais, 11 Bellmore, Attleboro, Mass.

YOUR Name on post card will bring information about a \$1.00 handwriting analysis for 25c. P.O. Box 934, Portland, Oregon.

POSTCARD Collectors! Three cards from Grand Rapids, Mich. 25c. Address return, I remail. Grace Van Houten, 1129 Arlington, Grand Rapids, Mich.

3 VIEWS 25c. Address, return, I remail. Letters remailed 25c. E. Grant, Box 3236, Daytona Beach, Fla.

RUPTURED? Improved appliance holds easily. Free trial. Earles Company, Flint, Michigan.

PERSONALITY Decides success, failure. Your personality tested by certified psychologists. Actual test sent free. American Institute for Personal Relations, 475A Fifth Avenue, New York 17.

PERSONALIZED Photo stationery. Fifty sheets \$2.75. Send photo and money order. Wilkinson, 419 Board of Trade, Portland 4, Oregon.

FOOL Friends. Flash billfold-size photo of picture beauty, intimately inscribed to you! 50c each. Blonde, redhead, brunette. Remember how, when, where you met her? Fool friends, Marson, Box 185, Hollywood Station, Hollywood 28, Calif.

SURPRISE Friends, letters forwarded, Los Angeles, 25c. 3-50c. monthly rates on request. "Best," Box 607, Los Angeles 43.

MEXICAN Address. Mail received and forwarded. Free information. Photographic postcards 15c. Remailed free. Leather and silver articles. Questions answered about Mexico 50c each. Tillotson, Aptdo. 1405, Guadalajara, Jalisco, Mexico.

STAMMER? Let me help you. Details free. Sauers, Box 139-4, Mars, Penna.

SWAP! Trade! Anything, everything. Free information. "Swappers" Gazette-PM" Louisville 12, Kentucky.

EMBOSS Signatures on stationery, invitations, etc., in gold or silver. Sample kit 25c. Tri-color Emboss-em kit \$1.00. Francine, Box 6460, Pittsburgh 12, Pennsylvania.

PRETEND Visiting Detroit, Michigan or Pittsburgh. Instructions with three postcards 25c. Francine, Box 6460, Pittsburgh 12, Pennsylvania.

STOP Falling hair. Educational pamphlet entitled "How To Keep Your Hair Till Ninety" free. James Hilton, 4819 Fourth Ave., Brooklyn 20, N. Y.

MEXICAN Law. General Practice Attorney, 1203 Arizona Street, El Paso, Texas.

GREETINGS From Switzerland welcomed by your friends. Send dollar bill, for 4 postcards, or letters. Beautiful photoprints. You write, return, I mail them. Fontana, P.O. Box 80, Zurich, Switzerland.

RUPTURED? Positive comfort, no understraps, no steel, no elastic. Write Smith Manufacturing Company, Preston, Ontario.

HAIR Falling? Dandruff? Write Trichologist, 137 Lewis St., Phillipsburg, N. J.

HOW You can find out! Information discreetly developed, any matter, person, problem, anywhere. Personal-business assignments, representations, undertaken. Nation-wide. Officially licensed and bonded service established 1922. Reasonable. All inquiries confidential. William Herman, 170 Broadway, New York.

MISCELLANEOUS

FIREWORKS: Get the best for your money. Don't be disappointed. Famous Banner Fireworks have all the newest and startling effects. Giant cannon salutes that rock you like a crash of thunder. Whistling devils with those weird unearthly noises. Skyrockets that burst in majestic colorful display. Gasp in amazement as you watch the "Battle in the Clouds." Genuine Chinese firecrackers. Over 200 pieces including sparklers for the little tots. The greatest \$10.00 value ever offered for only \$4.95. Rush order today. Any quantity. Send for big new free catalog. Banner Fireworks Mfg. Co., Inc., Dept. 112, 446 Capistrano, Toledo 12, Ohio.

NEW "Easy-to-See" thermometer, $3\frac{1}{2}$ " transparent dial with glass cover. Attaches firmly anywhere on outside of window pane. Big figures easily read 10 ft. away. Weatherproof, reliable, accurate. \$1.50 postpaid. Brad Lee Gifts, 28 Bedford St., Waltham 54, Mass.

BEAUTIFUL All American door mats, built to give a lifetime of service. 14"x22" \$1.95, 17"x26 $\frac{1}{2}$ " \$2.95, 18"x31" \$3.50. Mats made for every known use. Free circulars. South Bend Fabric Mat Co., 2013 W. Ford St., South Bend, Ind.

50 FLORAL And fruit patterns for painting or needlework. Four large sheets—\$1.00. Color guide included. Design-Prints, Box 669, Madison, Wis.

BUTTERFLIES, Morphos for art work. Anton Maller, Corupa, S. Catarina, Brazil.

PANNING Gold—Learn how—160 page instruction book, three large blueprints \$3.00 c.o.d. Free illustrated literature. Old Prospector, B-42, Dutch Flat, Calif.

TREASURE Hunters! Entirely new Goldak locators. Sensational performance. New light weight model weighs only 11 pounds. Revolutionizes location of gold, silver and minerals. Money-back guaranteed superior any other device. Write The Goldak Co., 1544 W. Glenoaks Blvd., Glendale 1, Calif.

"RECEIVE Mail." Moneymaking offers, opportunities, catalogs. Name listed 10c. Ideal Service, 100, Park Ridge, Ill.

INDIAN Tom-Toms, wholesale. Hand made, genuine buckskin, painted with oil colors, decorated with colored feathers. Complete with beaters. Ten different sizes. Sample \$1.00 prepaid. Indian Artcraft, 4201 N. W. 17th Ave., Miami, Fla.

A THOUSAND Laughs. Unique jackass cigarette dispenser holds 10 cigarettes. Simply press donkey's head down; tail rises—presto—out slips cigarette. Satisfaction guaranteed. Sent postpaid for \$1.00 with order or \$1.15 s.o.d. Ideal for Christmas gifts. Sanimo Industries, Dept. C-15, Spencer, Ind.

BUFFS—Improve your articles by buffing. 14"—\$1.30, 8"—80c. Specify snaf hole. Chicago Buff, 2647 N. Halsted, Chicago, Illinois.

THE Lord's coming! Get plenty free proofs you unbelievers. International, Box 263-X, Duluth, Minnesota.

FREE! Big new "Book of Values" catalog. Everything for the sport, bicycle and hobby fan at lowest prices. Write Minky's, 3330A Roosevelt Road, Chicago 24, Ill.

COAL Saver—Add inexpensive home mixture to coal. More heat from less coal guaranteed. Use. Sell at big profit. Details 25c. Carroll Enterprises, Landover, Maryland.

GOOD "Used" self-instruction educational books on all subjects bought, sold, rented, exchanged. Satisfaction guaranteed. Complete information and 100-page illustrated bargain catalog free! Write—Nelson Company, Chicago 5.

M-SCOPE Metal, mineral locators latest 1947 electronic type ready for immediate shipment. Fisher Research Laboratory, Inc. manufactured some of the finest metal-locators for the U. S. army. Experience gained is yours in the most efficient metal, mineral locator. Free 16-page booklet upon request. Credit plan available. Fisher Research Laboratory, Inc., Palo Alto, California.

SWISS Musical units, music boxes. 131 West 42nd, New York City.

BALLOONS \$2.25 Gross. Price lists. Harry Johnson, 2611 Harriet, Minneapolis 8, Minn.

FREE! Catalog rubber clothing for dress, factory, police, firemen, sportsmen, construction. Lowest prices. Water Master, 19465 Ward, Detroit 21, Michigan.

WANTED—1000 Foot sufferers to test Custom Made Research Foot Balancers at our risk. Amazing foot relief awaits you. Rush name and address for free trial offer. Kindschi Foot Appliances, Dept. A5, 321 W. Jefferson, Dallas 8, Texas.

SOMETHING New. Beautiful ladies' pin made from small seahorse taken from tropical waters. Comes in red, green, aqua. \$2.00 each. Ideal gift for wife, sweetheart. Sunlande, Box 662, Hialeah, Florida.

UNUSUAL Photo novelties, list and useful souvenir 25c. Photo Novelty Co., Box 238, Trinidad, Colorado.

BARTOLET'S 1948 Almanac 25c. 9 East 7th St., Williamsport 10, Penna.

EMBOSS Your own, kit \$1.00. Fedie, Box 708, Huntington Park, Calif.

NAMEPLATE, Bronze casting $5\frac{1}{2}$ "x2 $\frac{1}{2}$ " with $\frac{1}{2}$ " block letters cast in one solid piece. Easily mounted above door bell or mail box, also ideal for office doors or desks. Makes a wonderful gift. Print clearly two initials and name wanted. \$1.00 postpaid. W. W. Thumann, 3220 State St., Salem, Oregon.

GLADIOLAS—Some newer, better. List. Robinsons Glad Heaven, Sebastopol, Calif.

WIND-UP Trains—Famous Hafner all steel powerful engine, cars, track. \$4.95. Pekay's, Box 594-P, Monroe, Michigan.

MEN'S Shoes, sizes 11 $\frac{1}{2}$ to 16, widths AA to EEE. Finest quality, prompt delivery. Free circular. Kingsize, 333, Brockton, Massachusetts.

SQUARE Dance instructions, 25 sets \$1.00. Rayburn, Eureka Springs 1, Arkansas.

CONCRETE Blockmakers. New. All steel. Hand operated. Capacity—200 standard blocks daily. Complete, ready to use, \$37.50. Leeway, Mountain View 19, Oklahoma.

GOVERNMENT Surplus. A thousand bargains. Write for list. A card will do. Army, Navy Surplus Goods, 320 13th St., Richmond, Calif.

SEEK Buried treasure. Methods, mysteries, devices explained. Circulars free. Century Press, Box 151-B, Glen Ellyn, Ill.

"CASE For (Genesis) Creation." 85c. Christian Evidence League, Malverne, New York.

PENCILS—Individual or firm name. Dozen 60c, two dozen same imprint \$1.00, gross \$4.80 cash. Delivered. Pencil Market, 611 15th Street, Knoxville 16, Tenn.

RECEIVE Free samples, magazines, catalogues, moneymaking offers! Mail galore! Your name in all our "surefire" mailing lists two years, \$1.00. Four months, 25c. Stanford, 6220-M 16th, Philadelphia 41.

ATOMIC Laboratory—For few cents, in few hours make and operate remarkable atomic energy devices. All absolutely harmless. Easily made, intensely fascinating. Flash chamber. You actually see vivid, frenzied flashes caused by released atomic energy. Instructions \$1.00. Electro-scope; you test minerals, rocks, earth, etc. for atomic activity. Instructions \$1.00. Wilson chamber; phenomenal display of ionized particles in violent action. Instructions \$1.00. Easily understood scientific explanations. All three above with captivating booklet "Essential Atomic Theory." list of easily obtainable material, much other valuable information, \$2.75 complete. Alpha-Atom, 475 Fifth Ave., New York City 17.

HERE'S To good luck, a real horseshoe. Can be used for paper weight or token, or hang above doorway, \$1.00 postpaid. Roy Hain, 449 Franklin St., West Reading, Penna.

ALNICO Magnets, eight, plus 100 experiments, \$2.00. Experiments, 25c. Powerful disc magnets, pair \$2.00. Micro switches, 120V, 10A., \$1.00. Eljay, Box 891, Newark 1, N. J.

INFORMATION. Any subject. The Roxbys, 747 S. New Hampshire, Los Angeles 5.

CALENDAR 1753 To 2152. 35c postpaid. Tracy Newton, Decatur, Georgia.

70 BIBLE Lessons, 25c. Bulletin, Box 87, Cathedral Station, New York 25.

BUILD Your house as a hobby. No rent. No mortgage. Save 50%. Use spare time. No special skill required. Amazing facts sent free. H. C. Lightfoot, Civil Engineer, Richboro 1, Penna.

AMAZING New book "Tattooing World" for amateurs, professionals, and breeders. Successful method of removing tattoos. 250 illustrations. Sent in plain wrapper. Only \$1.00. Zeis Studio, 728 Lesley, Rockford, Ill.

THIS IS THE BUSINESS YOU DREAM ABOUT

QUICK STEADY PROFITS

CORADIO

The Coin Operated Radio

IT'S the new, fast-growing, depression-proof business. Coin operated radios are

placed in hotels, tourist courts, clubs, hospitals, etc. on a commission basis—play 1 or 2 hours for 25c and produce immediate profits. The best coin operated radio is CORADIO

ACT NOW

Start your own lifetime business, full or part time.

Send For Free Catalogue And Complete Information.

WRITE TODAY Dept. P. M.

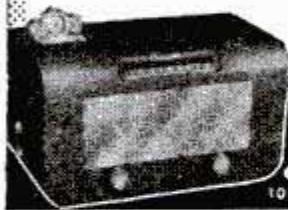

CORADIO

COIN OPERATED RADIO

108 W. 31st ST. N. Y. 1, N. Y. WISCONSIN 7-5902

Be A Writer

Short Stories, Mysteries, Novels, Articles—at home in spare time

THE demand for writers is creating great new opportunities for people with an urge to write. It's not as hard to succeed as you may imagine. Most famous authors come from ordinary walks of life. At home, you too may learn fiction writing, the best basis for all fields—short stories, novels, features, articles, radio scripts. Palmer Institute's Home Study Training (Established 1917) is endorsed by Rupert Hughes, Ruth Comfort Mitchell, Gertrude Atherton, Katharine Newlin Burt and other famous authors and by scores of successful graduates. Complete instruction material and professional coaching to develop your own style. FREE book explains how you may enjoy an ideal part time or full time career. Write today (no salesman will call).

This course is approved for veterans' training

PALMER INSTITUTE OF AUTHORSHIP, Desk T-107

Palmer Building, Hollywood 28, Calif.

Check here () if eligible under G. I. Bill

GARDEN CUTOUTS



Giant Assortment—48 patterns in all. Dutch boys, girls, dogs, birds, chickens, parrot, cats, geese, rabbits, squirrel, frog, bird houses, etc., plus toys, games. Beautiful, entirely new. Easy to make. Big Bargain. Novel method allows you to make project any size you desire. Sell these to your friends—make money. Send only \$1.00 today to JACKSON, Dept. 26, 5440 N. Shoreland Ave., Milwaukee 11, Wis.

\$1.00

TRAIN



Your VOICE!

Results GUARANTEED

We build, strengthen the vocal organs—not with singing lessons—but by sound, scientifically correct silent and vocal exercises and absolutely guarantee complete satisfaction with results. Write for Voice Book, FREE. Sent to no one under 17 years old unless signed by parent.

Perfect Voice Studios, Studio 1357, Kimball Hall Bldg., Chicago 4, Ill.

CORRESPONDENCE COURSES IN RADIO and ELECTRICAL ENGINEERING

Tuition \$25

ELECTRICAL ENGINEERING. Get good grasp of wide electrical field. Modern. Very understandable. Theory made easy. RADIO ENGINEERING. Extra fine course in radio, public address, photo-electric work. Trains you to be super-service man, real vacuum tube technician. Tuition ONLY \$25, either course. Deferred payment plan. Servicemen needed badly. FREE Write for free copies of school catalogs, student magazines, etc. LINCOLN ENGINEERING SCHOOL, Box 931-P106, Lincoln, Nebr.

INVENTING

—FOR PROFIT! If you have an inventive turn of mind, write for free 28-page booklet explaining how the Institute of American Inventors is helping inventors pre-test the profit possibilities of proposed devices to fill today's unprecedented demand for useful new inventions.

INSTITUTE OF AMERICAN INVENTORS

Dept. 4, 1926 Eye St., NW, Washington 6, D. C.

Earn BIG MONEY in ELECTRICITY



Learn By NEW Easy Way WITH

"SELF-ADVANCEMENT GUIDES"



Here is the "short cut" way to enter the big growing field of Electricity. Practical electrical training can quickly help you to Bigger Pay, a steady job, a profitable business of your own. And now, with an entirely new method it's easier than ever before to get the working knowledge you need to start you to success in this money-making field!

• **SENSATIONAL NEW OPPORTUNITY!** Coyne's 7-Volume Instruction Set—"APPLIED PRACTICAL ELECTRICITY" covers the whole field of electricity in easy-to-learn-and-use form! No advanced education or experience needed. The facts are all there—"billed down," simply explained, with amazing new "Self-Advancement Guides" to lead you through every step.

• **SELF-TEACHING** "Self-Advancement Guides" furnished with each volume makes it easy to get ahead fast. They let you set your own pace. Questions and answers at end of each chapter check your knowledge, correct your errors as you go. You "rate" yourself, actually SEE your daily progress! In addition, you receive one-year Free Consultation Service from Coyne.

• **COMPLETE INSTRUCTIONS in 7 Handy Volumes** "APPLIED PRACTICAL ELECTRICITY" brings you complete data on practical electrical operation, maintenance and construction. Here are 10,000 electrical facts, 3,000 subjects, hundreds of wiring diagrams, charts, tables, formulas, methods, — covering electricity, automotive, diesel engines, refrigeration, air conditioning, electronics, etc. And "Self-Advancement Guides" to help you qualify quickly for a good pay electrical job.

• **JOB HELP**—When you own this Set you get, on request, latest information on job possibilities where you can use the training you get from these books. Earn while you learn!

• **SEND NO MONEY—USE SET 7 DAYS FREE** Coyne will send you the entire 7-Volume Set, complete with "Self-Advancement Guides," for 7 days Free Examination. No obligation—if you're not fully satisfied, just return the books at our expense and you owe nothing. If you keep the Set, pay only \$3 after 7 days and \$3 monthly as shown in coupon. This offer is limited—send coupon today!

COYNE BOOK PUBLISHING CO.

329 S. Wood St.

Dept. 77-R6

Chicago 12, Ill.

FREE TRIAL COUPON

COYNE BOOK PUBLISHING CO.
329 S. Wood St., Dept. 77-R6, Chicago 12, Ill.
Send me your new 7-volume set "APPLIED PRACTICAL ELECTRICITY" for FREE Examination. After 7 days I'll either return it and owe nothing, or pay \$3 then and \$3 a month until only \$22.50 is paid. Or I'll pay \$21.25 cash price in 7 days. Include complete set of "Self-Advancement Guides" and 1 year FREE Consultation Service.

NAME _____ AGE _____
ADDRESS _____
TOWN _____ ZONE _____ STATE _____
WHERE EMPLOYED _____
 Send C.O.D. I'll pay postman \$21.25 plus C.O.D. fee. Same money-back guarantee after 7-day trial.

SAY YOU SAW IT IN POPULAR MECHANICS

LEARN A TRADE NOW in Sunny CALIFORNIA

- **REFRIGERATION, RADIO, ELECTRICAL APPLIANCE** Service and Repair . . . a Combination Course in three opportunity fields.
- **PLASTERING**—a busy field these days!
- **UPHOLSTERING**—available, Los Angeles or Chicago.

Here are three career fields offering many opportunities to trained men, either in good paying positions or through a business of your own. GENERAL TRADE SCHOOLS' courses are PRACTICAL, INTENSIVE. Instructors are master craftsmen who know the practical side of each job.

School hours are concentrated so that time is available for taking part-time employment if desired.

Immediate Enrollment. Courses Approved for Veterans Available for Non-Veterans

MAIL THE COUPON NOW FOR COMPLETE INFORMATION

General Trades Schools
1601 S. Western, Dept. PM-10, Los Angeles 6, Calif.

Please send me FREE information on your courses as checked below:
Refrig., Radio, Elect. Appl. _____ Plastering _____ Upholstering _____

Name _____ Age _____
Street _____
City _____ Zone _____ State _____
Veteran _____ Non-Veteran _____

Learn this Profitable Profession



**IN 90 DAYS
AT HOME**

Money-Making Career Open to Men and Women, 18 to 50

Hundreds of men and women between 18 and 50 make \$10 to \$20 in a single day giving scientific Swedish Massage and Hydro-Therapy treatments. There is big demand from doctors, hospitals, sanatoriums and clubs. Graduates earn large full time incomes from these or in private practice in their own offices. Others make good money from home treatments given in spare time. Learn this interesting, money-making profession in your own home, through our home study course. Same instructors as in our nationally known resident school. You can win independence and prepare for future security by qualifying for your Diploma. Course can be completed in 3 to 4 months. Many earn while they learn. Begin your training at once.



Anatomy Charts & Booklet FREE

Enroll now and we will include, at no extra cost, many needed supplies. Fit yourself to help meet growing demand for Scientific Swedish Massage. Send the coupon at once for complete details. Anatomy Charts and 32-Page Illustrated Booklet, FREE, postpaid.

THE COLLEGE OF SWEDISH MASSAGE
Dept. 764M, 100 East Ohio St., Chicago 11, Illinois

Please send me FREE and postpaid, Anatomy Charts, 32-page Booklet and complete details on Home Training.

Name _____
Address _____
City _____ State _____

BE A GOVERNMENT LICENSED AIRPLANE AND ENGINE MECHANIC

Train Now

at LINCOLN



EARN BIG PAY IN
AVIATION

Our new enlarged school now offers these courses:
MASTER AVIATION MECHANICS, CAA Approved 1 Yr. Airplane & Engine Mechanics Course. **REFRESHER AIRPLANE & ENGINE MECHANICS**. Designed for veterans with aviation mechanics experience. Either course is available to veterans under the G. I. Bill of Rights. Write today for complete information.

LINCOLN AVIATION INSTITUTE

UNION AIR TERMINAL DEPT. 10 LINCOLN, NEBRASKA

What Every Mason Wants



We have important Masonic books for Blue Lodge, Chapter, Commandery, Scottish Rite, and Shrine.

Our Rituals Are Used the World Over. Send for free catalog of books and rituals for Masons, Odd Fellows, Knights of Pythias, Knights of Columbus, etc.

EZRA A. COOK, Publisher, P. O. Box 796, P.O. Chicago 90, Ill.

Master Watchmaking

The life-long profitable trade of thousands as taught by the Sweazey System.

"FAMED THE WORLD OVER"

CHICAGO SCHOOL OF WATCHMAKING

Founded in 1908 by Thomas B. Sweazey
1608 N. Milwaukee Ave., Dept. 1107 Chicago 47, Ill.

SUCCEED IN THE! POULTRY BUSINESS!



You can make a good, comfortable living with poultry. For 26 years our course of Home Study training has been helping thousands. With a little study in spare time—you, too, can obtain the "know how" that means extra profits from the start.

Write today for prospectus describing courses, methods, service.

NATIONAL POULTRY INSTITUTE

Dept. 50 Adams Center, N. Y.

GET FRIENDS, PRESTIGE, SUCCESS How to Publicize Yourself

New nine-page folio "Personal Publicity" tells how to make friends enthusiastic . . . how to become favorably known in your business, profession . . . make others sit up and take notice of YOU. Easy-to-follow instructions. Articles you can write about yourself for papers, radio. Nine kinds of attention-getting letters. Mechanics of preparing material, photographs. Great help for publicity chairmen of clubs, societies.

ONLY
\$1.00

PUBLICITY SYSTEMS

Dept. PM10, Box 322 Jacksonville, Illinois

MONEY MEN ALL FREE DATA

THE PLASTEX Industry needs manufacturers on small scale and for big production of Lamp and Clock Stands, Art Goods and Novelties in Plastex and Marble imitation. Experience unnecessary. 1/2c material makes regular 10c store sellers. Rubber moulds furnished for speed production. Small investment brings good returns. Big chain store orders now being placed. Ambitious men have chance for real prosperity. Our Frog booklet will interest and benefit you.

PLASTEX INDUSTRIES, Dept. P.
1085 Washington Ave. New York, N. Y.



Acquiring a superior **VOCABULARY** is basic training for a top position in any profession, trade or business. To get in the upper brackets financially and socially, develop a masterful **VOCABULARY** through the fascinating, entertaining and profitable new science of **LEXIPOWER**. You are judged and rated by every sentence you utter. Executive ability and professional capacity are demonstrated by what you say — not by what your hands do. More **POWER** to you through **LEXIPOWER**. Benefit at once! You start using the **POWER** of **LEXIPOWER** after the first Lesson. Write **NOW** for **FREE** details about **LEXIPOWER** Dime-a-Day **LESSON CLUB**.

LEXIPOWER LESSON CLUB

517-I. W. Deming Place Chicago 14, Ill.

BOYS-IT'S FREE!

Exciting, new book tells about
"ATOMIC ENERGY"

and "THE WONDERS OF CHEMISTRY"

Also shows how to amaze friends with Chemcraft magic and do many exciting home experiments. Free. Send today!

THE PORTER CHEMICAL CO., 23 Prospect Ave., Hagerstown, Md.



WRITERS WANTED!

Business firms now paying writers \$10 to \$100 for writing letters. Wonderful opportunity for people who like to write. Inexpensive new course teaches you all you need to know and where to get the business. Write today.

C. F. ROEHR

936 Van Houten Clifton, N. J.



Hollywood Experts Help You Make Good in RADIO-TELEVISION at Home

Direct from Hollywood, nerve-center of broadcasting, Television, Radio and Sound activities, comes R-T-A's time-proven and tested home training. Here at last—easy to learn, home instruction that quickly qualifies you for steady, good-pay jobs or your own Radio business. Get full details at once! Send postal for **FREE BOOK** "How to Make Good in Radio-Television." **R-T-A APPROVED FOR VETERANS.**

RADIO TRAINING ASS'N OF AMERICA, Dept. PM10
5620 Hollywood Blvd. Hollywood 28, Calif.

CHAPMAN CHINCHILLAS

The originator of the first Chinchilla Farm in the United States. For information on purchasing the finest, selected breeding stock of these aristocratic animals that were virtually trapped to extinction write or visit—

Established 1919 **Chapman Chinchilla Farm**
4987 West 104th Street
Inglewood, California

RUPTURED?

Get Relief This Proven Way

Why try to worry along with trusses that gouge your flesh—press heavily on hips and spine—enlarge opening—fail to hold rupture? You need the Cluthe. No leg-straps or cutting belts. Automatic adjustable pad holds at real opening—follows every body movement with instant increased support in case of strain. Cannot slip whether at work or play. Light. Waterproof. Can be worn in bath. Send for amazing **FREE** book, "Advice To Ruptured," and details of liberal truthful 60-day trial offer. Also endorsements from grateful users in your neighborhood. Write: **CLUTHE SONS, Dept. 31, Bloomfield, New Jersey**

Bigger Opportunities Than Ever in . . .



AUTO BODY AND FENDER REPAIR

●THE FIELD IS STILL GROWING after more than 40 years . . . expanding with the giant auto industry! Millions of new cars are getting to market, millions of old ones are still on the road—THE NEED for **MAN-POWER** in the service field is **INCREASING!**

TRAIN NOW . . . FOR THE OPPORTUNITIES AHEAD!

Don't be stuck in a low-pay job! Opportunity here is big enough for thousands to find big-pay work either in a reliable job or in their own shops. **UEI** teaches Auto Body & Fender Repairing the *easy* way. No special education or experience needed . . . you can start in your spare time, right at home . . . keep your job while you learn. Then, when home study is finished, you continue at the well-equipped **UEI** shops getting practical experience. Fix and refinish damage, replace panels and tops. Learn up-to-date methods in use of tools, spray painting, welding, metal work—all under expert supervision.

GET THE FACTS . . . FREE!

UEI HAS TRAINED THOUSANDS for opportunity fields, and students are making good. If you want to get ahead, send coupon today for free facts on **AUTO BODY AND FENDER REPAIRING**. Don't delay!

AUTOCRAFTS DIVISION
UTILITIES ENGINEERING INSTITUTE
2523 Sheffield Ave. Dept. 1107-X
Chicago 14, Illinois

Approved for training under G. I. Bill

Founded 1927



FILL OUT AND MAIL . . . TODAY!

Autocrafts Division
Utilities Engineering Institute, Dept. 1107-X
2523 Sheffield Ave., Chicago 14, Ill.
Yes, I'm interested! Send me those Free Facts about Auto Body and Fender Repairing.

NAME _____ Age _____

ADDRESS _____

CITY _____ Zone or County _____ STATE _____

If veteran of World War II check here
 Check here for Special Information if under 17.

Learn DRAFTING

I Will Train You at Home Until You Have a GOOD PAY JOB!



Engineer Dobe

Give Yourself a Chance to Make Good in this Big Opportunity Field

Don't be a fellow who "never had a chance"—for your big chance is right here now—in Drafting. The field for draftsmen is bigger now than ever before, for drafting is the basic profession and all new products start with the draftsman.

Get into Drafting now. I will train you at home, in your spare time and give you actual experience on actual work—the same kind of jobs you will do for the best paying firms. I will train you until you are competent, fully experienced and holding a position that will bring advancement and pay raises as deserved. Write me today!

WORKING TOOLS INCLUDED

You get drafting instruments, table and other equipment when you start. Nothing for you to buy.

EXPERIENCE WHILE LEARNING

Don't forget! I train you through practical jobs—I give you experience. And I list this experience as a reference to employers when you are ready to go to work. Lack of starting knowledge or higher education should not hold you back. Low cost—and monthly payments, if desired.

ACT NOW!

Mail coupon to me today! No salesman will call, but you will get my big book and all details. Give your age to get reply.

MAIL COUPON FOR VITAL FACTS

Engineer Dobe, Div. 18, Libertyville, Ill.

Send me the Vital Facts on Drafting and Industrial Designing, your Free Book and advertised list of positions for Draftsmen and Designers wanted.

Name..... Age.....
Address.....
City..... Zone..... State.....

Learn WATCH REPAIRING

From An Approved School
The Largest of Its Kind



EARN WHILE LEARNING

Spare Time Home Training Prepares You For Big Pay

FREE WATCH working tools and watch included as part of our Watch Repairing Course

The demand for skilled watch repairers—men and women—is increasing with the step-up in the manufacture of watches. Now is the time to prepare yourself in this fascinating profession with the aid of our highly practical HOME TRAINING COURSE—in your spare time at home. Start your own business or accept a big pay position.

WRITE TODAY FOR FREE DETAILS

Earn while you learn with an "approved" school. Get the facts—then judge.

ILLINOIS SCHOOL OF WATCH REPAIRING
2870 Elston Ave., Dept. P-10 Chicago 18, Illinois

STUDY AT HOME

With An Educational Institution

Men with specialized training win higher positions, insure larger earnings, and are bigger successes in business and public life. Opportunities NOW greater than ever before. Send for our Catalog.

ARTS and SCIENCES

Courses in Philosophy; Education; Letters; Public Health; Medical Jurisprudence; Psychology; Sociology; Physics; Chemistry; Plastics; Geology; Political Science; Theology; Business and Commerce; Accounting; Mathematics; Statistics; Agriculture.

ENGINEERING

Courses in Electrical, Civil, Mechanical, Drafting, Architectural, Steam, Aeronautical, Radio, Structural, Mining, Industrial, Petroleum, Marine, Chemical, Diesel, Automobile, Refrigeration, and Air Conditioning Engineering.

LAW

Complete Professional Law Course includes 18 Hornbook Series college grade textbooks. Courses also in Commercial Law, Patent Law and Medical Jurisprudence.

McKinley-Roosevelt Incorporated, 4610-K, Sheridan Rd., Chicago 40, Ill.

BUILD THIS SHIP IN A BOTTLE! MAKE BIG MONEY IN SPARE OR FULL TIME!

It's easy to build this beautiful, fully-rigged ship in a bottle when you know the secret. Materials cost less than \$1.00 and you can sell one ship for as much as \$50.00 (depending upon your skill and amount of work involved) to Dept. Stores, Gift Shops, Liquor Stores, Antique Stores, etc. Finished ship or Building Kit makes ideal gift, too.

SPECIAL INTRODUCTORY OFFER! SEND ONLY \$1.00 and pay postman \$3.95 plus a few cents postage on delivery, or send \$4.95 and we will ship prepaid.



HERE'S WHAT WE SEND YOU

One hand-carved hull with all holes drilled, one finished Mast with all holes drilled, enough material to construct three complete ships, and one set of easy-to-read blueprints and directions for building your ship and inserting it in a bottle.

Rush Your Order Today for This Special Offer!

THE OLD MARINER — BOX 2095, WICHITA, KANSAS

LEARN MOVIE PROJECTION THEATRE MANAGEMENT

The Motion Picture Theatre Business offers big opportunities for trained men. Get into a fascinating field with a promising future. Train at home in spare time. Free Catalog. Established 30 years.

THEATRE SCHOOL, 370 Washington St., Elmira, New York

AT HOME • Your Own Manufacturing Business

Making popular \$1 Novelties. Costs you 3c to 15c. We supply everything. Write today!

SO-LO WORKS, Dept. B-803, Loveland, Ohio

ELECTRICAL TRAINING

Intensive 33 weeks residence course in fundamentals of industrial electrical engineering, including radio, electronics. Prepares for technician, engineering aides. Approved for veteran training. 54th year. Catalog.

BLISS ELECTRICAL SCHOOL
7642 Takoma Ave., Wash. 12, D.C.



Learn RADIO TELEVISION ELECTRONICS

Train at home, in spare time, for a good pay job or start a business of your own *without capital*—under our *proven 2-Way* method that helps you get into this money-making field of radio *quicker*. You receive Lessons *plus* Home Shop Practice including 9 kits of radio parts to make hundreds of tests. Many students earn money in spare time while learning. Write for **FREE** book "Your Opportunities in Radio" to Hollywood Radio & Television Institute, (Established 1929), Dept. A-9, 810 W. 6th St., Los Angeles 14, Calif.

Learn by Mail to Mount Birds

Animals, Game-Heads, Fish, Pets, to Tan Skins

Men, Boys!

Be a Taxidermist. Learn at home in spare time. Easily, quickly learned. Grand Fun. A wonderful, profitable hobby, for expert hunters, also for amateurs, even young boys. Mount wild-game, although wild-game is not necessary. Use common, domestic specimens, squirrels, pigeons, even frogs. This famous, reliable school in business more than 35 years. More than 300,000 delighted students. Think of that!

Hunters Save Your Trophies — Have a Home-museum Be a Taxidermy Artist

You will be THRILLED and DELIGHTED. You learn QUICKLY, easily AT HOME. Your friends will be amazed. Hunters from near and far will bring their TROPHIES to be mounted. You can earn fine profits in spare time. Many students earn \$60 to \$100 a month, in season. Rush the coupon today, and learn all about wonderful taxidermy. DO IT NOW!

Save your own hunting trophies. Have a lifelong hobby. Have a home museum that you are proud of, and that makes you popular and well-known far and wide. BOYS, wild-game is not necessary. Use common specimens, squirrels, pigeons, owls, domestic birds and animals. It's wonderful. Inquire today. Kill fewer game-birds. Double your fun and pleasure.

Fun — Fascination — Profit

And so easily learned in spare time. Wild-game is growing scarcer. Help preserve it. Shoot only a FEW fine ducks and other game-birds, MOUNT THEM for home and den, and have MORE FUN and PLEASURE than killing the legal limit every day. Help preserve the wild-game.

Remember you learn to mount expertly, birds, animals, game-heads, fish, pets, to tan skins and furs. Investigate! You will be delighted. Send for free book today. "Eat your trophies and have them too."

THE N. W. SCHOOL OF TAXIDERM, 33-77 Elwood Bldg., Omaha 8, Nebr.

FREE BOOK!

Yes FREE, 44 pages, with 100 unique pictures of taxidermy work. No other book in the world like this. It will amaze and thrill you. Ask today for your free copy. State your AGE.

Send the Coupon!

Write name plainly in coupon or margin, or a post card will do. Rush your request, as free books may be exhausted quickly. Decide now. Don't wait a moment. State your age.

FREE BOOK

Northwestern School of Taxidermy, 33-77 Elwood Bldg., Omaha, Neb. Send me your free illustrated book, "How to Mount Game". Also tell me how I may learn this fascinating art easily and quickly by mail. No obligation. State your age.

Name..... Age.....

Address.....

Do You Make These Mistakes in English?

MANY persons say "between you and I" instead of "between you and me"—or use "who" for "whom"—or don't know whether to spell certain words with one or two "c's" or "m's" or "r's" or with "ie" or "ei," etc. Every time you speak or write you show what you are. Mistakes in English reveal lack of education, refinement. Lack of language power prevents you from presenting your thoughts in the strongest way. Real command of English will help you reach ANY goal. Stop making mistakes in spelling, punctuation, pronunciation, grammar. Increase your vocabulary.



Sherwin Cody

WONDERFUL INVENTION

Only 15 minutes a day with Sherwin Cody's new invention—and you can actually SEE your English improve. It teaches by HABIT—makes it easier to do the RIGHT way. Wonderful self-correcting lessons.

FREE BOOK ON ENGLISH Lack of language power may be costing you friendships, income, every year. See what Mr. Cody can do for you; it costs nothing to find out. Write this very minute for free book. "How You Can Master Good English in 15 Minutes a Day." It will prove a revelation. WRITE NOW. SHERWIN CODY SCHOOL OF ENGLISH, 510 B & O Bldg., Rochester 4, N. Y.



SAVE MONEY

HOBBY BOOK DIVIDEND PLAN

Save up to 15% on your craft and hobby books. All the best and latest books from which to choose. Every hobby and craft covered. The more you buy the bigger the saving. Buy 5 or more books and you save 10%, 10 or more books and you save 15% — just like getting a book free. Our big purchases make these savings possible which we pass on to you in the form of a Book Dividend Certificate. Write for your catalog and Dividend Plan today. Send 25c now to

JACKSON STUDIO, Dept. 31
5440 N. Shoreland Ave.
Milwaukee 11, Wis.

Do you want

- ..to go to College?
- ..or to enter a Profession?
- ..or get an Office Position?

(Such as Accounting, Architecture, Nursing, Dentistry; Teaching, Social Work, Osteopathy, Beauty Culture, Optometry, Embalming, Chiropody, Law, Medicine, etc.)

To get anywhere, you practically MUST finish High School FIRST. You can complete our simplified High School Course in SPARE time at home, as FAST as your time and abilities permit. Equivalent to resident school work—prepares you for college, pre-professional examinations, business, industry. Standard texts furnished. Diploma. Credit for H. S. subjects already completed. Single subjects if desired. Low tuition, easy terms. American School, Chicago, est. 1897—endorsed by educators. Finish your high school education NOW, Write TODAY!

High School Course at Home Many Finish in 2 Years

American School, Dept. H745, Drexel Ave. at 58th St., Chicago 37, Ill.

Gentlemen: Send me FREE information covering special training in subjects checked below. No obligation on my part.

- | | |
|--|--|
| <input type="checkbox"/> High School Course | <input type="checkbox"/> Diesel Engineering |
| <input type="checkbox"/> Architecture and Building | <input type="checkbox"/> Drafting and Design for Men & Women |
| <input type="checkbox"/> Automotive Engineering | <input type="checkbox"/> Plastics |
| <input type="checkbox"/> Business Management | <input type="checkbox"/> Private Secretary |
| <input type="checkbox"/> Electrical Engineering | <input type="checkbox"/> Mechanical Engineering |
| <input type="checkbox"/> Elec. and Gas Refrigeration | <input type="checkbox"/> Aviation |
| <input type="checkbox"/> Air Conditioning | <input type="checkbox"/> Salesmanship |
| <input type="checkbox"/> Railway Training | <input type="checkbox"/> Radio |
| <input type="checkbox"/> Electronics, Industrial | |

Name.....

Address.....

Get into a Big Branch of the Automobile Industry

Body & Fender Rebuilding



Body and Fender Rebuilding one of best paid fields in automobile industry. Body and Fender shops make good profits in garages, service stations. Excellent opportunities for men who look forward to business of their own.

BEGIN TRAINING AT HOME OR COME DIRECTLY TO SHOPS

Begin your training at home in spare time, finish in our big modern shops, or come directly to shops. At home you get C.T.I.'s SHOP PROVED HOME STUDY instruction—actual shop experience has gone into the practical lesson assignments. That is why it is easy for mechanically inclined men to learn by our Home Study training and start on actual Body and Fender Work.

CONSULTATION AND PLACEMENT SERVICE WHETHER YOU ARE INTERESTED IN WORTHWHILE JOB OR SETTING UP YOUR OWN BUSINESS. Opportunities for full and part time earnings.

A NATIONALLY KNOWN INSTITUTION



VETERANS qualifying under "G.I. Bill" have all expenses paid by Government plus monthly subsistence while in school. Just mail coupon, we will handle all details. (LOW TUITION, EASY TERMS if you are not a veteran).

Fill Out, Cut Out, Mail Today

FACTS FREE for Men Who Want to Get Ahead
CHICAGO MOTIVE TRADES INSTITUTE, Dept. F-210
(Division Commercial Trades Institute)
1400 W. Greenleaf, Chicago 26, Ill.
Send free illustrated Brochures and other information about Body and Fender Rebuilding.

Veteran Non Veteran

Name _____
Address _____
City _____ State _____

AVIATION Career

MAXIMUM TRAINING IN MINIMUM TIME

CAL-AERO TECH TRAINING will add dollars to your pay check all the rest of your life. Specializing in AERONAUTICAL ENGINEERING and MASTER AVIATION MECHANICS since 1929, Cal-Aero Tech training is carefully designed for just one thing—TO MAKE MORE MONEY FOR YOU. An alumni of over 6000 successful graduates proves our career training is unsurpassed.

VETERANS —Write us about Aviation Training, as provided under "G.I. Bill of Rights."



CAL-AERO TECHNICAL INSTITUTE
MAJOR C. C. MOSELEY PRES. SINCE 1929
FORMERLY CURTISS-WRIGHT TECHNICAL INSTITUTE

GRAND CENTRAL AIR TERMINAL
GLENDALE 1, CALIFORNIA
LOS ANGELES COUNTY

MAIL THIS COUPON TODAY!

Cal-Aero Technical Institute, Grand Central Airport, Glendale 1, California
Please send full information on Aviation Training FREE—without obligation, Dept. PM-10

Name _____ Birth Date _____

Street _____

City _____ State _____

MAGIC LIQUID CASTS PLASTICS



THE GREATEST THING IN PLASTICS!

A New Liquid Plastic! Pour PLASTICAST into any kind of mold (rubber, metal, glass, plaster, etc.) and it hardens in a few minutes into a solid, clear-as-glass plastic! No machinery or tools required. PLASTICAST has unlimited possibilities... novelties, toys, jewelry, gems, knick-knacks; fascinating, brilliant, clear or colored plastic articles. Being transparent it is ideal for imbedding flowers, butterflies, photos, souvenirs—an endless variety of useful things. Can also be cast into rods, sheets, blocks, ANY SHAPE! Make PLASTICASTING a thrilling new hobby or a profitable business! No experience required; start casting beautiful articles 10 minutes after you receive your outfit! MASTER OUTFIT contains 4 molds, dye, directions, imbedding material, accessories and enough PLASTICAST for making about 200 articles. (C.O.D. orders accepted with \$1.00 deposit)

COMPLETE MASTER OUTFIT, (post paid U.S.A. only) \$3.00

FREE Catalog listing hundreds of molds, mold making materials for casting with PLASTICS, METAL, PLASTER, WAX, RUBBER, WOOD, LIQUID MARBLE, LIQUID IVORY, ETC., sent free for 3c stamp.

PLASTICAST CO., (Dept. C)
5961 Madison St. (Send order to nearest office) Chicago 44, Illinois P.O. Box 987 Palo Alto, Calif.



LEARN To Repair and Service Electrical Appliances, Sewing machines, motors, bicycles, lawn mowers, saw filing, cutlery grinding, etc.

Postcard Brings Free Details
Start with \$20.00 and a few common tools! Build low cost equipment while earning. Make up to \$8.00 an hour! Complete illustrated course and free advisory service only. **\$5.50**

5 Days Free Examination
REPAIRMAN'S SERVICE 222-M10 4th Ave. Janesville, Wis.



CODE-RECEIVING SPEED

Learn to send and receive Radio Code with greater speed. Stop nervous tension. Have confidence. Be proficient. Same system used by radiotelegraph specialists. Thousands of operators needed. Rush name for FREE book.

CANDLER SYSTEM CO.
Dept. 5-L, Box 928, Denver 1, Colo., U. S. A.

ARTISTS MAKE MONEY

Do you like to draw? Send name, address, age and occupation for FREE ART TEST, to find out your ability.

ART INSTRUCTION, Inc.
10137 ART INSTRUCTION BLDG., MINNEAPOLIS 15, MINN.

OLD GOLD JEWELRY WANTED

Dental gold teeth, plates and bridges with metal attached. Any broken pieces of gold jewelry. Immediate payment and free mailing container to you or your friends upon request.
LOWES, DEPT PM Holland Bldg., St. Louis 1, Mo.



Begin today. Write now for our Free Book, "How to Become a Good Penman." It contains specimens and tells how others learned to write in spare time. Enclose 10c for your name beautifully written and a pen point suitable for shaded writing. Write today.

THE TAMBLYN SCHOOL OF PENMANSHIP
N-441 Ridge Building, Kansas City, Mo.

Learn BAKING At Home

Baking is one of America's high industries in wages. Nearly depression-proof. Thorough basic home course lays sound foundation. If you have aptitude, write for FREE BOOKLET, "Opportunities in Commercial Baking."
National Baking School, 1315 Mich. Ave., Dept. 1357, Chicago 5

YOU Pave The Way To INCREASED PAY!

When facts, figures, faces STICK LIKE BURRS, you better your memory. Increase your income. And it's so easy with the new, improved SUPER-MEMORY Course. Est. 1938. Send postcard today for FREE details.
THOR BOOKS, M-10, Box 1210, Chicago, Ill.

SIGNS EASILY AND EXPERTLY PAINTED WITH LETTER PATTERNS AND SHOWCARDS

MANY SIZES & STYLES WRITE FOR FOLDER!

JOHN F. RAHN
1330-31 N. Central Ave. CHICAGO 51, ILL.

NEW MIDGET ELECTRIC ARC WELDER



Plugs into Light Socket—AC or DC

It's new! It's handy! It's efficient! Use the Midget Electric Arc Welder for hundreds of light-metal jobs. Does comparable welding work with a 1/16 inch welding rod on thin metal as that of larger and higher priced welders. Operates on 15 ampere fuse, 110 volt 60 cycle A.C. or D.C. current, by use of our special standard-coated 1/16-inch welding rods. Generous supply of rods supplied with machine. Recommended for all light welding like automobile fenders, etc. Take the Midget Arc anywhere to the job. Sturdily built and fully guaranteed. Comes complete—ready to use. Nothing else to buy. No previous welding experience needed to strike an arc. In a short time, anyone mechanically inclined can learn to weld with this machine.

You'll find hundreds of money-saving, time-saving uses for the Midget Arc around your home, garage, or workshop. Also in garages, factories, repair shops, tin shops, mechanics, farmers, inventors, etc. Order a Midget Electric Arc Welder now! SEND NO MONEY. We'll rush one to you, complete with rods and helmet (equipped with APPROVED welding glass). Pay postman only \$3.95 plus postage charges. If not satisfied, return Midget Arc in 5 days from receipt and we'll refund your money immediately. RUSH YOUR ORDER NOW. MIDGET ARC WELDER CO., Strader Ave., Dept. D-202, Cincinnati 26, Ohio

RETAILS ONLY
\$3.95

Personality Difficulties? Consult our Psychologist

Learn to overcome nervousness, anxiety, fears, physical distress, undesirable habits and personality traits. Enjoy more Happiness, Health, Success. Write today for FREE Personality Check-Up and details of our Personalized Home-Study Course.

SCHOOL OF MODERN PSYCHOLOGY

Rooms: 2-4-8, 134 E. Second St. Dayton 2, Ohio

Learn Public Speaking

Learn theory and fundamentals at home—in spare time. Then acquire actual experience and practice. Send for FREE booklet "Power of Effective Speech."

North American School, Dept. 1357
1315 S. Michigan Ave., Chicago 5, Illinois

LEARN ACCOUNTING SALESMANSHIP SECRETARIAL WORK

Assure Your Future Now!

Hill's, one of America's outstanding Business Schools, offers you the opportunity to enter one of the three fields acknowledged to hold substantial earnings and a secure future. Our FREE book, "Through Hill's to Success," tells how and where the best positions are found and how you can qualify for them by study at home or in our resident school. We have thousands of successful graduates and maintain nationwide employment service. G. I. Approved.

FREE
WRITE
TODAY

USE THIS HANDY COUPON

HILL'S EXTENSION SCHOOL
AND BUSINESS UNIVERSITY
619 W. Main St., Oklahoma City 2, Okla.
Please send me your Free book, "Through Hill's to Success."

NAME _____
ADDRESS _____
CITY _____ STATE _____



WANT A GOVERNMENT JOB?



\$1,756 to \$3,021 a Year
(Veterans Get Special Preference)

Get Ready Now for Next Examinations

Railway Postal Clerks

Railway Postal Clerks get \$2,300 the first year of regular employment, being paid on the first and fifteenth of each month. (\$95.84 each pay day.) Their pay is automatically increased yearly to \$3,400 and \$3,600 in large organizations. Advance may be had to Chief Clerk at \$5,400 a year. Men 18 to 35.

3 Days On—3 Days Off—Full Pay

Railway Postal Clerks on long runs usually work 3 days and have 3 days off duty or in the same portion. During this off duty their pay continues just as though they were working. They travel on a pass when on business. When they grow old, they are retired with a pension.

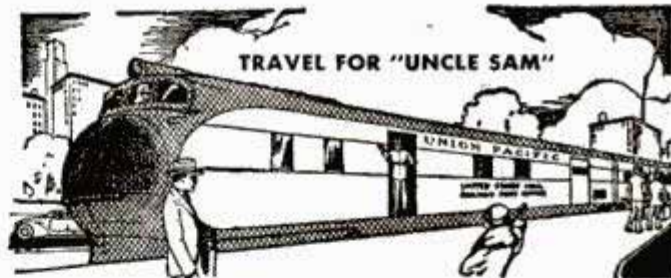

City Mail Carriers, Post Office Clerks

Clerks and Carriers now get \$2,100 the first year of regular employment and automatically increase \$100 a year to \$3,100. Open to Men—Women 18 to 50.

Many Other Positions

Many other positions are obtainable. Rural Carriers—Stenographers—Typists—Patrol Inspectors—Assistant Statistical Clerks—etc. Those wishing these positions should prepare at once.

Get Free List of Positions

Fill out the following coupon. Tear it off and mail it today—NOW, at once.

This investment can result in your getting a big-paid government job.

FRANKLIN INSTITUTE, Dept. N85, Rochester 4, N. Y.

Rush to me, entirely free of charge (1) a full description of U. S. Government Jobs; (2) Free copy of illustrated 32-page book, "How to Get a U. S. Government Job" with (3) List of U. S. Government Jobs; (4) Tell me how to prepare for one of these jobs.

Name.....

Address..... Veteran?.....

Use This Coupon Before You Mislay It. Write or Print Plainly

VETERANS *Learn* WATCHMAKING

A Lifetime Profession

Regardless of Conditions, Age, Sex, or Physical Limitations
Veterans—Civilians!
Your Opportunity—
LEARN WATCHMAKING

Lift yourself from a futureless job into a position paying better than your present work. Fit yourself for the job that will permit you to establish your own shop, or be employed in a pleasant environment.

Watch Repairing—Jewelry—Engraving will always be in ever greater demand. Our graduates wanted everywhere. Dignified positions \$50-\$75-\$100 per week. Veterans write today for latest FREE enrollment requirements.



Approved
G. I. Training

Kansas City School of Watchmaking
Largest Horological School in America
617-621 Wyandotte St. Kansas City 6, Mo.

SAY YOU SAW IT IN POPULAR MECHANICS

New BRUSH Electroplater

ESPECIALLY BUILT FOR
MECHANICS, MODEL MAKERS
HOME CRAFTSMEN



Easy to Plate **GOLD, SILVER, NICKEL, COPPER, etc...** For Pleasure and Profit!

If you have a workshop—at home or in business—you need this new Warner Electroplater. At the stroke of an electrified brush, you can electroplate models and projects—you can replate worn articles, faucets, tools, fixtures, silverware, etc. with a durable, sparkling coat of metal... Gold, Silver, Nickel, Copper, Cadmium, and after a bit of practice, even Chromium! Everything furnished—equipment complete, ready for use. By doing a bit of work for others, your machine can soon pay for itself. So make your shop complete by getting a Warner Electroplater right away. Send today for **FREE PLATING SAMPLE** and illustrated literature. **ACT AT ONCE.**

WARNER ELECTRIC CO., Inc., Dept. P-37
1512 Jarvis Ave., Chicago 26, Illinois

FREE Details & Sample!

WARNER ELECTRIC CO., Inc., 1512 Jarvis Ave., Chicago 26, Ill., Dept. P-37
Gentlemen: Send Free Sample and Details to:

Name _____
Address _____
City _____ State _____

NOW YOU TOO CAN BUILD 15 RADIOS

COMPLETE KIT \$14.75



Absolutely No Knowledge of Radio Necessary
You Need NO Additional Parts

The **PROGRESSIVE RADIO KIT** is THE ONLY COMPLETE KIT. Contains everything you need. Instruction Book, Metal Chassis, Tubes, Condensers, Resistors and all Radio parts. The 36-Page Book written by Expert Radio Instructors teaches you to build radios in a Professional Manner. You start with a 1-tube receiver. Before you are done with this kit, you will have built 11 Receivers, 1 Public Address System and 3 Transmitters.

SPECIAL FREE OFFER!

Electrical and Radio Tester sent absolutely FREE with each Progressive Radio Kit. PLUS FREE membership in Progressive Radio Club. Entitles you to free expert advice and consultation service with licensed radio technicians.

Write for further information, or ORDER your KIT \$14.75 NOW! ONLY.....

Postage prepaid with check or money order (Postage not prepaid with C.O.D. orders)
PROGRESSIVE ELECTRONICS CO., Dept. PM-3
22 Havemeyer Street Brooklyn 11, N. Y.

MAKE MONEY CASTING AT HOME
FREE FACTS SENT



Cast thousands of perfect Plaques, Book Ends, Ash Trays, Etc. Plaster, Liquid Marble, Etc. ENORMOUS PROFITS. Start in basement or garage. LITTLE CAPITAL NEEDED. QUICK. EASY. NO PREVIOUS EXPERIENCE NEEDED. Rubber molds for speed production. MAKE YOUR OWN. Sample Kit \$1.00. Canadian \$1.50. Plastic Arts Studio, Route 5, Dept. 29, Muncie, Ind.

Giant Astronomical Telescope

100 diameters magnification (10,000 area magnification) Steel main tube 3 inches diameter, 50 inches long. Brass focusing tube. Tripod 6 feet tall. Equatorial mounting. Ready to set up and use. Full power and clear vision guaranteed. Price \$15.00. 25% deposit on C.O.D. orders.

SUFFOLK SCIENCE SERVICE, Dept. CT, MANORVILLE, N.Y.

FREE! FREE! FREE!
For NEW VIGOR—STRENGTH—VITALITY...

Mail this coupon now PM-1047

Alan Stephan, Post Office Box 1080, Chicago 90, Ill. Send me, free and without any obligation, your booklet, "Presenting Mr. America . . . Alan Stephan."

NAME _____
ADDRESS _____ CITY _____
STATE _____ DATE OF BIRTH _____

THOUSANDS OF SUFFERERS USE

BREATHEASY

FOR

ASTHMA

CARRY IT WITH YOU
USE IT ANYWHERE

Sold on Money-Back Guarantee

Write To Dept. PM

BREATHEASY DISTRIBUTORS, INC.
65 CEDAR STREET
SEATTLE 1 WASHINGTON



REFRIGERATION

ELECTRONICS

WELDING

Specialize in
6 months to 3 years
COURSES

SERVICE—6 months
Practical Electricity
Practical Welding
Refrigeration Service
Heating Service

TECHNICIAN—1 Year
Electro Technician
Radio Technician
Electronics Technician
Refrigeration, Heating
and Air Conditioning
Technician

PROFESSIONAL—3 Years
Electrical Engineering
Bachelor of Science Degree
—Major in Machinery or
Electronics

PRACTICAL TECHNICAL TRAINING

Our time-tested **CONCENTRIC SYSTEM** enables you to build your career step by step. Each 6-month course is complete in itself. Stay as long as circumstances permit—until you reach your desired occupational objective. For 44 years this school has specialized in technical training. More than 35,000 former students in industries the world over. 1,292 students now enrolled from 48 states and 8 overseas countries. Faculty of 63 specialists. World-wide alumni counselor committee. *Terms start January and April. SEND COUPON TODAY!*

MILWAUKEE SCHOOL OF ENGINEERING

A Technical Institute

Milwaukee School of Engineering, Dept. PM-1047
N. Broadway and E. State, Milwaukee, Wis.

Without obligation, send me free booklet "Career Building" and more details on course in

Name Age

Address

City State



UNLEASH THE POWER "TO PUT IT ACROSS"...

Wake up your personality and become equal to life's demands.

Don't let people or circumstances push you around to your disadvantage. Find out how to conquer your nerves, fears, worry, inferiority. Others have turned the tide of affairs, why not you? Why remain as you are when you can become something better? Our Home-Study Self-Discovery Development Plan may be the very thing you need right now. Money back if you do not get results satisfactory to you. Write for FREE lecture and full details without obligation TODAY.

School of PERSONAL Psychology

Chartered non-profit correspondence Education
1008-09 Washington Bldg. Louisville 2, Ky.

PROTECT YOUR HOME

with these **MODERN**
Low Cost **FIRE**
EXTINGUISHERS



A little foresight now may save LIVES and property later! Equip your home, your garage, your boat with **AUTOFYRSTOP**, the modern fire extinguisher and alarm that is setting new efficiency records. Write for free literature:

AUTOFYRSTOP CO. Dept. PM-1047
2035 Washington Av., Philadelphia 46, Pa.

**KILLS
FIRE
BY ITSELF**

**MONEY MAKING
OPPORTUNITY**

We have openings for high grade salesmen in choice territories. Write for Plan.

STUDY CARPENTRY AT HOME!

complete set prepaid \$7.50

Simplified Stair Layout (57 pgs.) \$1.50
Interior and Exterior Trim (284 pgs.) \$2.00
Use of Hand Tools & Portable Machinery (192 pgs.) \$1.50
Concrete Form Construction (106 pgs.) \$1.25
Framing, Sheathing, Insulation (237 pgs.) \$1.75

For the first time! A clearly written, easily understood, practical series of five large, well-illustrated texts for carpentry students, apprentices, craftsmen, construction foremen, teachers, home owners and hobbyists! Material is prepared by skilled craftsmen and teachers in the order that fundamental carpentry operations are performed. Used by trade and vocational schools in the U.S. and overseas, this series is perfect for home study to supplement apprentice training programs. Save money! Order complete series! We'll refund your money if you're not satisfied.

FREE FOLDER ON REQUEST

DELMAR PUBLISHERS, INC., Dept. A, Broadway & Orange St., Albany 7, New York
Please rush postpaid, books checked, for which I enclose money order (\$), check (\$). If not satisfied, I'll return books, postpaid, at end of 5 days and my money will be refunded. 1. Complete Series at \$7.50 () 2. Simplified Stair Layout () 3. Concrete Form Construction () 4. Interior & Exterior Trim () 5. Framing, Sheathing, Insulation () 6. Use of Hand Tools & Portable Machinery () 7. Free Folder ()

NAME
ADDRESS
CITY STATE

Keep that "TICKING" Car



Every operator and mechanic needs AUDELS AUTO GUIDE.

This book saves time, money and worry. Highly endorsed. It presents the whole subject of auto mechanics:

- 1—Basic principles
 - 2—Construction
 - 3—Operation
 - 4—Service
 - 5—Repair
- Handy Size. Easily understood.

1588 PAGES
1500 ILLUSTRATIONS



NEW FLUID DRIVE, HYDRAULIC SHIFT AND DIESEL ENGINES FULLY COVERED

Over 1500 pages—1540 illustrations showing inside views of modern cars, trucks and buses with instructions for all service jobs.

ASK TO SEE IT!—To Get This Assistance for Yourself Simply Fill in and Mail Coupon Today.

4 COMPLETE • PAY ONLY \$1. A MONTH ←
AUDEL Publishers, 49 West 23rd St., New York
MAIL AUDELS NEW AUTO GUIDE for free examination. If O. K. I will send you \$1 in 7 days; then remit \$1 monthly until price of \$4 is paid. Otherwise I will return it.

Name.....
Address.....
Occupation.....
Employed by..... P M

Please Mention Popular Mechanics When Answering Ads

INVENTORS

The inventor who believes he has a new and useful invention, and finds himself in need of advice, should consult a competent registered patent attorney. The question as to whether a subject matter is patentable can be substantially determined by a search of the United States Patent records. Without obligation, write us for information as to what steps an inventor should take to secure a Patent.

RANDOLPH & BEAVERS
Registered Patent Attorneys
11-D Columbian Bldg., Washington 1, D. C.

RANDOLPH & BEAVERS
11-D Columbian Bldg., Washington 1, D. C.
Please send me full information on how to secure Patents & Trademarks.
Name.....
Street.....
City.....State.....

NEW!

HOBBY HANDBOOK



A GOLD MINE of INFORMATION on NEWEST EQUIPMENT, TOOLS for HOME CRAFTSMEN & MECHANICS

If you work in metals, wood, plastics or glass you need this Giant NEW Book of equipment, tools, parts and materials... including dozens of hard-to-get items you can't find in stores. Many things you must have for your home hobby or shop.

- HELPS YOU GET MORE PLEASURE, MORE PROFIT in**
- HOME CRAFTS
 - METAL CRAFTS
 - WOODWORKING
 - PLASTIC CRAFTS
 - HOME REPAIRS

A WAREHOUSE OF THINGS YOU NEED AND WANT

Over 100 items including Spray Guns; Power Bench Tools; Lathe; Drill Press; Drills; Grinders; Tank and Brush Electroplaters; Telephone System; Tool Chest; Model Tools; "Pin Money" Makers for your sparetime fun and profit! **SEND NAME and ADDRESS and 10c TODAY!** Price of Handbook refunded on first order.

WARNER ELECTRIC CO., Dept. P-14
1512 JARVIS AVENUE, CHICAGO 26, ILLINOIS

LEARN WATCH REPAIRING

GET PRACTICAL SELF-TRAINING IN YOUR HOME through our new and complete book, "Modern Watch Repairing and Adjustment," \$2.75 postpaid. If C.O.D., plus fee. Money back guarantee.—We Supply All Books, Tools, Materials. Complete sets for Students, Watchmakers and Jewelers. Lowest cost. Prompt delivery. **JUST OUT, NEW, ALL INCLUSIVE CATALOG, OVER 450 ILLUSTRATIONS, Send 25c. FREE with above book.**
MODERN TECHNICAL BOOK & TOOL CO., Dept. MMC
55 West 42nd Street New York 18, N. Y.

PATENTS AND TRADE MARKS
C. A. SNOW & CO.
REGISTERED PATENT ATTORNEYS
WRITE FOR INFORMATION TO
428 SNOW BUILDING, WASHINGTON 1, D. C.

PATENTS
TRADE MARKS • COPYRIGHTS
• **Saulsbury, Russell & Squire** •
Registered Patent Attorneys
55 WEST 42nd ST., NEW YORK 18 • WAtkins 9-9194

PATENTS "Proof of Invention" Folder mailed without obligation.
E. E. VROOMAN, Registered Patent Atty.
871 Woodward Building, Washington 5, D.C.

INVENTORS
If you wish to protect your invention, you should take steps to protect it by a U. S. Patent. Write me for "Record of Invention" Form.
CARL MILLER
REGISTERED PATENT ATTORNEY
Woolworth Bldg., 35th Floor, Dept. 107A, New York City
Please send me "Record of Invention" form.
NAME.....
ADDRESS.....

Don't Envy The PLUMBER BE ONE!

Plumbers Make Up To \$15.00 To \$50.00 A Day!

Every skilled workman will tell you that Plumbers have the best of it. WINTER and SUMMER the Plumber is busy at top wages. No skilled Plumber is ever out of a job—compare his opportunities with any trade, plus the opportunities that are offered in this field to have your own shop.

At the Universal Plumbing School you become a Plumber by working with tools (not books) under Licensed Master PLUMBERS—all experts in their line. Here you get plumbing in one of the finest equipped schools in America. Every branch of Plumbing is covered—Leadwork—Blueprint for plan reading—Roughing In—Heating and all the other tricks of the business that mean profits for you.

Own Your Own Plumbing Business —Or Be A Journeyman Plumber

No other field offers more opportunity for the ambitious man to have his own business than plumbing. The trained plumber with a kit of tools stands a better chance of getting into business for himself, than a man with money who has not had the training to do expert work.

Whether you want to become a Master Plumber and OWN YOUR OWN BUSINESS, or work for someone as a Journeyman Plumber our training makes no distinction. The expert Journeyman Plumber is the HIGHEST PAID craftsman in the United States today. We show you how to become a qualified Master Plumber, or a Journeyman Plumber in just 32 weeks . . . No previous plumbing experience is necessary.

Over A Quarter Century's Experience Making Plumbers

School Operated By Master Plumbers

Let us show you how to master this profitable field in just 32 weeks—No need to ever work as an apprentice. It's the training system and our years of experience that does the trick. The Universal Plumbing School is America's oldest school devoted exclusively to plumbing. Since 1923 it has been owned and operated by Licensed Master Plumbers. Over 6,000 successful graduates testify their success was largely due to our proven methods.

For complete FREE information about this school and its proved methods of making plumbers, simply fill out and mail coupon—no obligation—no salesman will ever call. If you like to work with tools you owe it to yourself to investigate. Just send name and address on a 1c postcard for full information.

G. I. APPROVED

MAIL THIS COUPON FOR FREE INFORMATION

No Obligation
No Salesman Will Call

Name _____
Address _____
City _____ State _____

Are you a G.I.? Yes _____ No _____
Fill Out — Paste On 1c Postcard and Mail

UNIVERSAL PLUMBING SCHOOL 801 HOLMES ST. KANSAS CITY, MISSOURI



**AMBITIOUS MEN, HERE'S YOUR CHANCE
TO ENTER FAMOUS BAILEY SCHOOLS**

We'll Teach You Electricity, Air Conditioning, Refrigeration, Radio

Yes, there's room now for more men. You men who want higher pay, better jobs . . . grasp this great opportunity. You may be able to enter this nationally recognized school right away! *By acting immediately.*

It's important to enter the RIGHT school. Bailey has a national reputation for "finest training methods." Bailey is recognized and approved by industry. This increases your possibilities of obtaining the position you want and making rapid, increasingly profitable progress.

Bailey Schools teach you basic principles, fundamentals, plus the practical application of theory in actual shop work. You get the "tricks" of the trade which would take years to learn starting at the bottom of the job.

Bailey Technical Schools are approved for veteran training by the State Department of Education under Public Law 346. Approved for veterans training under Public Law 16. Approved for State Rehabilitation Training by all states which have a rehabilitation program.

**Act now. Send for free catalog.
Cut out application at right and mail TODAY!**

The BAILEY Technical SCHOOLS
INTERNATIONALLY RECOGNIZED
1651 SO. GRAND BLVD., ST. LOUIS 4, MO.

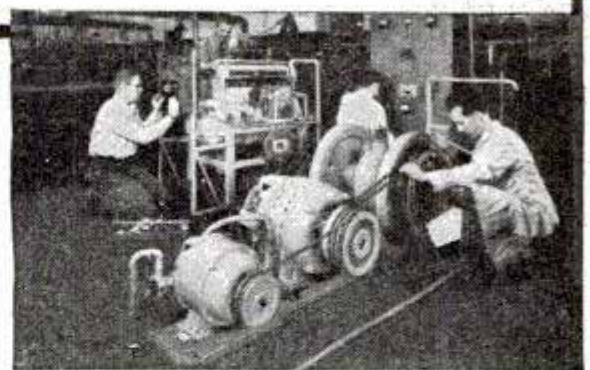

*Shop Practice in One of Bailey's Many
Practical Laboratories.*

SEND THIS APPLICATION to:
Bailey Technical Schools, 1651 South Grand Blvd.
St. Louis 4, Missouri

Please send me free catalog giving complete information about the Bailey Technical School which I have checked below.

Electricity Diesel Diesel-Electric
 Radio Mechanics Air Conditioning
 Refrigeration

Please send information to:

Name

Address

(3)

10,000 HELPS TO BE YOUR OWN BOSS IN THIS BIG BOOK!



IF IT'S RESULTS YOU WANT—GET ACTION QUICKLY WITH THESE PRACTICAL IDEAS

Never before has a more helpful book been printed for those planning a business of their own. Gathered in this large illustrated volume are the formulas, recipes, facts and secrets that have contributed so largely to America's great industrial progress. Capitalize on this information for making most any conceivable product without experience, special equipment or previous knowledge of chemistry or manufacturing. The experts who compiled this book are authorities, and present this information in simple, understandable language. They also give you wholesale supply sources for needed materials, short cuts and methods for the most profitable results.

START AT HOME—Expand out of profits.

Hundreds of good paying businesses have been built on a product made from a simple recipe. Choose from any of the 162,000 facts and 10,000 formulas of which the following are only a very few: Adhesives, Alloys, Anti-Freeze Solutions, Cosmetics, Beverages and Liquors, Candy, Gum, Casein, Celluloid, Oils and Ointments, Paints, Paper, Perfumes, Photography, Polishes, Powders, Remedies for Man, Beast or Fowl, Rubber Products, Refrigerants, Soaps, Solder and Soldering, Tooth Cements, Transfers, Transparencies, Varnishes and Thousands of others for making all sorts of profitable and practical things.

BE FREE!

Work when you wish. Avoid clock-punching, forced lay-offs, payroll deductions. Enjoy life. Be independent.

Formulas, Recipes, Facts and Secrets that have contributed so largely to America's great industrial progress. Capitalize on this information for making most any conceivable product without experience, special equipment or previous knowledge of chemistry or manufacturing.

MANY FORTUNES MADE FROM A SINGLE IDEA!

This comprehensive book is an accepted authority by chemists, schools, industry, etc. and is the largest and most comprehensive book of its kind ever issued. Nothing else like it in existence. A single formula has been worth a thousand times this book's cost to countless owners. Crammed with money-making ideas, invaluable for reference. Ideal for Factory, Home, Farm, Office or Workshop. As necessary as the dictionary and more useful for manufacturers, chemists and salesmen who put up products for profit.



\$3.98 U. S. Funds. Postpaid anywhere in the world. (C.O.D. in U.S.A. only). Immediate shipment. Safe Delivery Guaranteed.

ADAMS BROWN COMPANY BOOKS OF APPLIED SCIENCE
Dept. 710, Chestnut Hill 67, Massachusetts, U. S. A.

75,000 Sold!

REFERENCE DATA for RADIO ENGINEERS

Now Ready—New Printing of Enlarged 2nd Edition

Contains a wealth of important new data needed by every electronics engineer and student. Enlarged from 200 to 336 pages, with over 400 charts and diagrams. Compiled jointly by specialists of Federal Telecommunication and International Telephone and Telegraph Corporations. New edition hailed by educators and communications experts. "Indispensable," says DR. LEE De FOREST.

"A 'Must'" ALLEN B. DUMONT, PRES.

Allen B. Dumont Laboratories, Inc.

"Certain to meet with universal acclaim"—BRIG. GEN. F. L. ANKEN-BRANDT, U.S. Army. "REFERENCE DATA" makes quickly available the answers to problems that normally arise in practical radio work. The large volume of last-word ready reference data is one reason for rapid sale of 75,000 copies.

The new 2nd Edition, in durable green fabrikoid binding, is ready in a new printing. Price \$2.00. Many purchasers take advantage of low quantity price for 12 or more to a single address (\$1.60 each).

Federal Telephone and Radio Corporation
67 Broad St., New York 4

**ORDER NOW!
USE COUPON**



Federal Telephone and Radio Corporation
Publication Dept. A16, 67 Broad St., New York 4, N. Y.

I enclosedollars,
for which send me.....copies,
at \$2.00 per copy. (\$1.60 for 12 or more to one address.)
NAME.....
ADDRESS.....
CITY.....ZONE.....STATE.....



PRACTICAL BOOKS ON HOME PLANNING BUILDING · REPAIRS

MAIL
ORDER
TODAY

Plan Now—Build When You Can
Books Sent C.O.D. Anywhere in U.S.A.

Select from this list of helpful books. In U. S. books sent postpaid if remittance accompanies order. Outside U. S. include 15% extra for shipping charges.

- How to Plan a House.....\$5.00
- House Construction Details\$4.00
- Painting, Decorating.....\$1.75
- Carpentry\$2.50
- Painting, Furniture Finishing and Repairing
Includes floor renewal\$1.50
- How to Remodel a House Complete, practical.....\$5.00
- Building Insulation ..\$4.50
- Concrete Handbook Do work for yourself, others\$1.50
- Blueprint Reading for Building Trades\$1.50
- Practical Bricklaying.....\$2.00
- Simplified Carpentry Estimating\$3.00

FAMOUS PLAN BOOKS

Books contain floor plans, photos, descriptions of homes.
AMERICA'S BEST LOW COST HOMES. 125 designs\$1.00
DE LUXE SMALL HOMES. 210 designs.\$1.00
OUR FUTURE HOME. Wide selection of residences, summer homes, garage apartments. \$1.00
MODERN HOME & GARDENING. 42 popular designs. Improvements, garden short-cuts, etc.50c

Set of
Four
Books
\$3.50



Stair
Building
\$2.50

POPULAR MECHANICS PRESS

DEPT. 640 • 200 E. ONTARIO STREET, CHICAGO 11

FREE! NEW! AMAZING SUCCESS BOOKLET

Words are one of the important tools used by successful people. Yours FREE for the asking, without obligation, the new "ADVANCE-YOU" WORD BOOKLET. It gives you a list of 20 proven phrases which have helped others get promotions.

This list is the result of more than 30 years of research. They are the *power* words most often used by those who reached the top.

Their use can help you get started on the *success road*.

The booklet also outlines *WHAT* to do and *HOW* you can win the game of life on the job, socially and personally . . .

Fill in this coupon now for YOUR FREE copy.

PERSONAL PROGRESS INSTITUTE
Information Division 10-9
20 North Wacker Drive, Chicago 6, Illinois

I want my FREE copy of the "ADVANCE-YOU" WORDS booklet.

NAME.....

ADDRESS.....

CITY.....STATE.....



LIKE TO WORK WITH YOUR HANDS? THEN GET INTO ELECTRIC APPLIANCE Repair & Service

OPEN YOUR OWN SHOP Be Independent!

Here's a great growing field that's getting bigger every day as more houses are wired for electricity. You can start small—even in your spare time—with \$20.00 worth of tools in your basement or garage and GROW AS BIG AS YOU LIKE, with NO FEAR OF LOSING YOUR JOB in a depression. Or, you can take a well paid job, to start... as there is a big need for service mechanics. Let's talk it over by mail.

New Book "HOW TO START YOUR OWN BUSINESS" Sent if you act promptly

This valuable book covers locating your shop, contains drawings of how to build and wire work-benches, where and how to advertise, what to charge, how to hire solicitors, etc. Sent without charge to students who enroll promptly.

Recent University Discoveries prove that one of three major classifications of men are only thoroughly happy when working with their hands. This doesn't mean they don't use their heads, too. But it does mean that nature intended A BIG GROUP of men to be the builders, makers, fixers and servicers of life. If you are in this group—not completely happy in your present work—seeking increased income and handy with tools—A SUGGESTION: Get into electrical appliance service and repair.

LEARN AT HOME In Your Spare Time . . .

Our practical, thorough course teaches you this interesting, good paying business AT HOME—During Your Spare Time. A Grade School education is all you need. We teach repairing washing machines, vacuum cleaners, electric ranges, lamps, irons, motors, etc., and HOUSE WIRING. Our lessons are understandable and easy to grasp. You'll enjoy every minute of them. And you'll enjoy the work itself when you get into it.



H. T. Armstrong, General Manager
PACIFIC TRAINING SCHOOL—Dept. P-110
7217 So. Broadway, Los Angeles 3, Cal.
Please send me your FREE CATALOG without obligation.

NAME _____ AGE _____
ADDRESS _____
CITY _____ STATE _____

BIG MONEY and YOUR OWN BUSINESS in LIQUID IVORY



FREE INFORMATION ON A GREAT NEW MONEY MAKING OPPORTUNITY

Regardless of your age, sex, previous experience, we will send you astonishing free facts about the great possibilities—in your own business—with amazing LIQUID REPLICATED IVORY. To secure this information, absolutely free, fill in coupon below or send a letter or postcard. No salesman will call on you now or ever. Write TODAY! Offer limited!

LIQUID IVORY is one of the most marvelous synthetics developed in years. With it you can easily and simply produce a wide variety of wonderful items that almost defy detection from genuine ivory. No expensive equipment is needed. You can work in a corner of your basement or garage with a few hours of work producing handsome profits. Here is unexcelled opportunity for all ambitious people that want a profitable business of their own.

GREAT OPPORTUNITIES NOW!

Stop being a slave to a time clock! Stop worrying about layoffs and depressions stealing your livelihood. NOW is the time to line up your own money-making business. We offer this great opportunity to aggressive people. Get into your own profitable business with LIQUID IVORY. Get the FREE FACTS today!

Copyright 1947

EMPIRE TRADES and HANDICRAFTS
Box 1340 PM10 St. Louis, Mo.



A MONEY-MAKING BUSINESS FOR THE LITTLE MAN! NO EXTENSIVE CAPITAL NEEDED!

Forget big investment worries. We tell you how to get your own fast-moving business going with very little money. We feature only one sound business course. You will never find us confusing this successful vocation with other diverting business ideas. We tell you all about one great business and how you can make money in it exclusively. Write for full FREE information today!

FREE INFORMATION COUPON

EMPIRE TRADES & HANDICRAFTS, BOX 1340-PM-10, ST. LOUIS, MO.

Please send me free details about your BIG money making LIQUID IVORY. I am anxious to get started in a profitable business of my own. Please rush!

Name.....
Address.....
City.....State.....

Be a NEON Expert

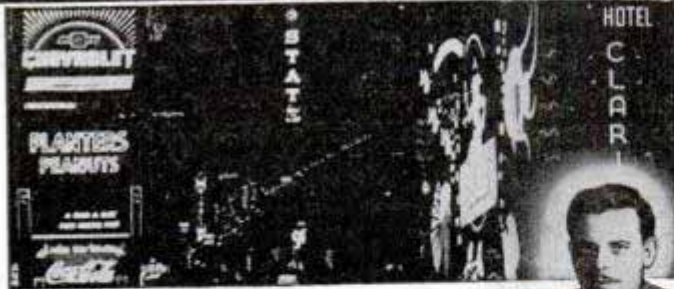

I'll Show YOU How to
Make \$100 a Week
and UP in **NEON**



C. C. Blakely, Executive Director
Acme Neon Institute

★ Today's wide open field for ambitious men who want to make \$100, \$150 and more per week is the colorful, exciting business of Neon. I'll train you for a highly paid place in America's most fascinating industry. At Acme you become a Master Neon Technician. Learn Neon Tube Bending, Color Gassing, Neon Glass Blowing, Cold Cathode Lighting, Bombarding, other important skills.

COAST-TO-COAST OPPORTUNITIES

Demand for Acme Trained Men is greater than we can supply. We're getting calls from coast-to-coast. Today beginners have a once-in-a-lifetime chance to master an art and learn a profession that will pay big dividends for life. Our practical, intensive 500 hour course prepares you for thousands of BIG MONEY opportunities. Get a fine job, or go into business. Other Acme Trained Men are succeeding. So can you. Room Assistance for out-of-town students.

Acme Training Approved under the G.I. Bill of Rights. Rush coupon today.

FREE FACTS

Acme Neon Institute
Dept. M-3, 1648 West Van Buren Street
Chicago 12, Illinois

Send me the FREE FOLDER, "Your Big Opportunity" plus facts about training me for a highly paid job in Neon.

Name _____
Street _____
City _____



YOU CAN LEARN SLIDE RULE AT HOME—QUICKLY, EASILY!

Peg your future security by mastering the many applications of the slide rule in a simplified, proven, step-by-step course. No knowledge of higher math needed. Resident courses also available. Valuable booklet sent FREE on request. No Obligation. WRITE TODAY. You owe this to yourself.

SLIDE RULE TRAINING INSTITUTE

6331 HOLLYWOOD BLVD. HOLLYWOOD 28, CALIF.

AIR RIFLES BENJAMIN AIR PISTOLS

PIONEERS - LEADERS

SEND FOR FREE FOLDER OF LATEST MODELS TODAY
If you want a REAL GUN for PRACTICAL USE inside or outdoors get a SAFE - CLEAN - ECONOMICAL - BENJAMIN with Adjustable Power and Amazing Accuracy. For BEST RESULTS use BENJAMIN H-C PELLETS. WRITE AT ONCE. BENJAMIN AIR RIFLE CO., 812 MARION ST., ST. LOUIS 4, MO.

PROFESSIONAL TRAINING IN A MINIMUM OF TIME

RADIO-ELECTRONICS TELEVISION • BROADCAST ENGINEERING

An Accredited Technical Institute nationally recognized for high calibre training. Prepares high school graduates for technical careers. Classes start every Monday. Comprehensive courses in Radio-Electronics Engineering, Broadcast and Television Engineering, Broadcast and Television Servicing; 2,100 hours classroom and laboratory study. Write today for free informative booklet, "RADIO ENGINEERING AS A CAREER."

CAPITOL RADIO ENGINEERING INSTITUTE

DEPT. P-10, 16th STREET & PARK ROAD, N. W. WASHINGTON 10, D. C.

GENUINE PUT-PUT SPEED BOAT



RUNS and SOUNDS LIKE A REAL SPEEDBOAT

- All Metal—No Moving Parts
- Fuel Supply Included Free
- No Springs or Gears to Break

A wonderful toy for all children and grown-ups. Beautifully enameled in bright, durable colors. Runs half hour on small piece of fuel. (Fuel included free.) Sounds like a roaring speed boat. Any child can operate it. Wonderful gift idea. Order several. Guaranteed. All metal construction, not flimsy plastic.

\$1 Post-paid

Special! 8-PC. HEAVY-DUTY, SAND CAST ALUMINUM "Junior Miss" COOKING SET, postpaid..... \$1.50

DEALERS — WRITE FOR QUANTITY PRICES

L. C. JAY SALES CO.

2625 Lucas Ave. Dept. P-10 St. Louis, Mo.

AMAZING INVENTION!

Guides the hand — Corrects poor Penmanship in few hours — lots of fun. Details Free. Write immediately. INVENTOR OZMENT, 34-N, St. Louis, Mo.

Raise GOLDEN HAMSTERS

The new wonder animals from Syria. Look like Toy Red Bears. Delightful pets. Everybody wants them. Thousands needed by laboratories. Make money, get started now. Send 10c for illustrated literature, or send \$5 for a pair of hamsters and literature.



GULF HAMSTERY, 1536 BASIL ST., MOBILE 17, ALA.

LAW
STUDY AT HOME for PERSONAL SUCCESS and LARGER EARNINGS. 39 years expert instruction—over 108,000 students enrolled. LL.B. Degree awarded. All texts furnished. Easy payments. Send for FREE BOOK. G. I. approved. AMERICAN EXTENSION SCHOOL OF LAW Dept. 82-M, 646 N. Michigan Ave., Chicago 11, Ill.

MYOPATHIC MASSAGE

for big money, dignified profession. Improved, deep massage system. Learned in few weeks. Better than mail course. Write for name of nearby Dean of Extension School. Over 50 in U. S. and Canada. GRANGER SCHOOL OF MYOPATHY 3906-E-W. Belle St. Louis 8, Mo.

LEARN WATCH and CLOCK REPAIRING

Start training now for a better paying job or your own profitable business. Qualified Watch Makers are in demand. Unlimited opportunities. Intensive practical training by experienced watch makers on American and Swiss time pieces. Write for full details. SCIENTIFIC SCHOOL OF WATCH MAKING, Dept. PM-10 3923 San Fernando Road Glendale 4, Calif.

Say You Saw It In POPULAR MECHANICS



POPULAR MECHANICS

You Can Grow With PLASTICS!

Plastics is one of the fastest growing industries—offering you unusual opportunities for an interesting, successful career and security in the years ahead. Trained men, with plastics know-how will fill the important, well-paying positions. YOU can be one of them. Mail the coupon below for a big, colorful, free catalog on Plastics and complete details

about Plastics Institute, America's oldest and largest plastics school. Resident School located in beautiful Southern California. Comprehensive Home Training Courses to prepare you in your spare time at home for a career in plastics. You can enroll immediately! Write Plastics Institute, Dept. PM7-10, 1601 S. Western Ave., Los Angeles 6, Calif.

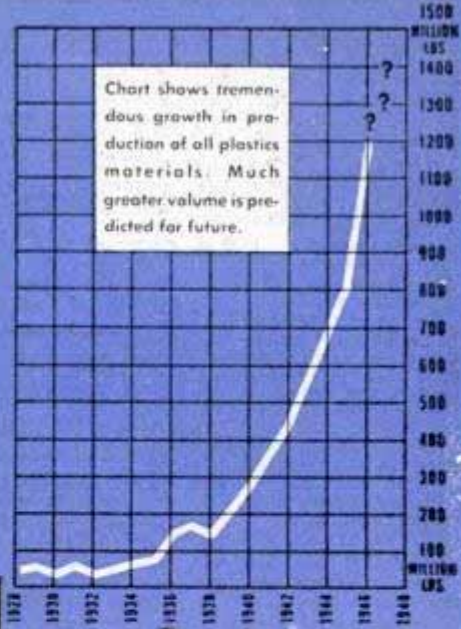

LEARN BY DOING

To give you practical experience we supply colorful plastics to make useful, attractive creations. You can also make and sell plastics articles to earn while learning.

APPROVED FOR VETERANS

Plastics INDUSTRIES TECHNICAL INSTITUTE

NEW YORK CHICAGO LOS ANGELES



PLASTICS INSTITUTE in the heart of sunny Los Angeles. Here modern laboratories and shops give Resident School students facilities for practice on the finest of industry-type plastics equipment. Also the headquarters for HOME TRAINING.

FREE BOOKLET

Plastics Industries Technical Institute
Dept. PM7-10, 1601 S. Western Ave., Los Angeles 6, Calif.

Gentlemen: Please send me free literature and information on your Resident School Courses () Home Training Courses (). I understand there is absolutely no obligation.

Name (PRINT) _____ Occupation _____

Street (PRINT) _____ Age _____

City _____ Zone _____ State _____

Important! Please fill out coupon completely. If nonveteran, please check. () If in Armed Services now, please check. ()

THESE 5 TRADES ASSURE YOU HIGH PAY • Future Security

- **PLUMBING** Every phase of plumbing. Pipe-Cutting and Threading, Lead-Wiping, Rough-in Projects on Installations, Completed Installations of entire plumbing systems. Blueprint reading, Estimating
- **DRAFTING** College-level courses in General Machine and Architectural Drafting, with fundamentals in Drafting Mathematics—all under graduate engineers
- **SHOE REPAIRING** From simplest repairs on boots and shoes to the finest details of reconditioning and rebuilding, under expert craftsmen
- **ELECTRICAL** Technical and shop training include Basic Electricity, Residential Wiring, Industrial Wiring General Testing and Trouble Shooting, and Appliance Repair
- **AUTOMOTIVE & TRACTOR** Applied training on latest model automobiles and tractors, including engine overhaul, transmission and differentials, carburetion, generator and ignition systems engine tune up, Hydramatic and Vacumatic Transmissions, and general service.

"There's Always a Demand for the Man who KNOWS!"

CHOOSE ONE OF THESE 5 LEADING TRADES

Get Out of that Rut... Be a Skilled Tradesman! Have a Lifetime Career... Own Your Own Business and Be Secure in Your Old Age.

NOW while Enrollment is still open, send for FREE information.

THE 5 DIVISIONS OF
NATIONAL TRADE SCHOOL
2610 Grand Ave., Kansas City 8, Mo.

- Plumbing
- Drafting
- Shoe Repairing
- Electrical
- Automotive & Tractor

NAME _____

ADDRESS _____

CITY _____ STATE _____

VETERAN _____ OCCUPATION _____

Choose One of these 5 Essential Trades

Our complete courses of thorough training prepare you to go right into the field as a Qualified Tradesman at High Pay in only 34 weeks (36 in Shoe Repair). All courses under especially trained instructors with practical experience. 6 Hour Classes 5 Days a Week. Our Employment Department helps you.

VETERANS "Approved for veterans' training by the State Department of Education under Public Law 346."
"Approved for veterans' training by the Veterans Administration under Law 16."

Send Coupon for Free Information Now

Here Is a Way YOU Can Get Ready for the BUILDING BOOM
Learn about Earning Opportunities in BUILDING CONTRACTING
FREE FACTS



Do you want to be on the inside in the building boom—where big money is made? Learn about opportunities for Building Contractors whether or not you have previous experience in this field. Millions of dollars are going to be made in home and farm buildings, in construction of stores, garages, small industrial buildings.

USE OUR TRAINING PLAN TO LEARN AT HOME IN YOUR SPARE TIME

The building industry uses men with organizing ability by thousands in construction, supervision, management, sales. Properly trained men needed in production, distribution, finance, installation, and marketing.

Easy to Learn in Nationally Known School
Government estimates housing demand at 40 billion dollars! Others are preparing to get in now! Act immediately—get the facts!

HOME BUILDERS TRAINING INSTITUTE, Dept. D210
DIVISION COMMERCIAL TRADES INSTITUTE
1400 W. Greenleaf, Chicago 26, Ill.

Fill Out, Cut Out, Mail Today

FACTS FREE for Men Who Want to Get Ahead
HOME BUILDERS TRAINING INSTITUTE, Dept. D210
1400 Greenleaf, Chicago 26, Illinois

I am interested in the opportunities in the Building Industry. Please send me free information about getting a start as a building contractor.

Name _____
Address _____
City _____ State _____

SAY YOU SAW IT IN POPULAR MECHANICS



Crammed full of money-saving information on 3 vital subjects. Answers all questions on practical and economical methods for installing and servicing Oil Burners, Refrigerators and Air Conditioning. Completely covers all basic principles of repair, operation, best equipment to buy, etc. A gold mine of valuable information for both layman and mechanic. Each book clearly written by experts, fully illustrated, makes it easy to master all subjects and saves worry plus loads of cash. Order Now on our money-back guarantee. All 3 books \$3 complete, postage prepaid, or individually at listed prices. COD orders, postage extra.

PADELL BOOK CO., Dept. 156 - 830 Broadway, N. Y.

BRUSH PLATING OUTFITS

for re-plating articles in the home and shop. No tanks necessary. Free particulars.
GUNMETAL CO., AVE. M, DECATUR, ILLINOIS

LAWN ORNAMENT-NOVELTY PATTERNS

28 Lawn Ornament Patterns, 25c. Other patterns: 15-20" high; Dutch Girl, Dutch Boy, Pirate, Bull Terrier, Mexican Girl, Mexican Boy, Dwarf, Penguin, Flower Girl, 10c each. 25 Novelty Patterns, 30c. All 62 Full Size Patterns, \$1.00 Postpaid. Strother Pattern Service, Dept. AB-8, Box 383, Belington, W. Va.

RACING CAR

Custom-built equipment to fit all cars. Dual Manifolds, Racing Heads, Special carburetors, Dual Mufflers, etc. Write for Free Literature.

LEE MOTORCRAFT
1412 Great Northern Bldg. Chicago, Ill.

WALL PAPER REMOVER

Helps remove wallpaper quickly, safely and economically. One pint makes five gallons of solution. Merely apply with brush, allow to soak in thoroughly and strip off with scraper or putty knife. One pint \$1.00 postpaid.
BEST WAY PRODUCTS COMPANY, Boston 30, Mass.

LOWEST PRICE IN HISTORY!
Sensationally New **WELDRITE** Electric Welding-Cutting Torch

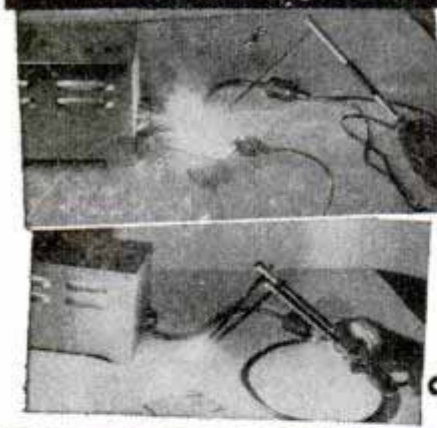

Plugs into any convenient 110 AC—DC socket
WELDS • BRAZES • CUTS • MELTS • SOLDERS • HEAT TREATS

The new—sensationally-priced—WELDRITE Electric Torch makes it possible for you to save money on welding jobs the year round. Complete equipment includes: Carbon-tipped dual copper electrode cutting torch and single electrode welding torch with attached alligator clip. Generous amount of welding materials included at no extra cost. Uses standard welding and brazing materials available at any welding supply store.

Indispensable for manufacturers, garages, machine shops, mechanics, body and fender shops, hobby shops and home workshops.

Invaluable in bicycle, motorcycle, machine, California Buyers add 3% Sales Tax.

NOW ONLY \$12 FULLY GUARANTEED

Send no money. Order your WELDRITE Electric Welding-Cutting Torch today. We will ship immediately. Pay postman \$12 plus postage charges. If not satisfied, return WELDRITE in 5 days from receipt and we'll refund your money immediately.

Welder's mask (with approved safety welding glass) furnished separately, if desired, for only \$2.95.

CALIFORNIA TECHNICAL PRODUCTS COMPANY
8510 Warner Drive • Culver City, California • Dept. A-10

DRAW for MONEY... Be an ARTIST!



Trained Artists are Capable of Earning \$50, \$60, \$75 and MORE a WEEK!

You can learn to draw at home in your spare time the well-known WSA way. **COMMERCIAL ART, DESIGNING, CARTOONING** all in ONE complete course. No previous Art experience necessary—we teach you step-by-step. Prepare for a fascinating hobby or profitable career. For 33 years WSA graduates have been making good—**WHY NOT YOU?**



VETERANS! WSA Approved for Training Under G. I. Bill. Write for **FREE BOOK**, "Art for Pleasure and Profit," fully describes course, our method of instruction and commercial opportunities for you. **TWO ART OUTFITS** included with training.

Washington School of Art, Studio 1210H
1115—15th St., N.W., Washington 5, D.C.

Please send me full information and your Free Book, "Art for Pleasure and Profit."

Name.....AGE.....
Street.....
City.....Zone.....State.....
 I am entitled to training under "G.I." Bill

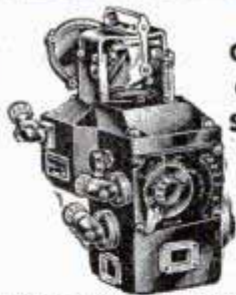

**AIR
CORP
GUN
SIGHT**

Worth many times this low price. Consists of a polaroid filter, top surfaced prism mirror, actuating motors, compensating adjustments, calibrated dials for air speed, drift, straining range, etc. Inventors and experimenters will find many valuable parts in this assembly. All brand new in orig. export packing.
Weight 7 lbs.
No. 215. **\$4.95**
Each only.....

WAR SURPLUS AND HUNDREDS OF OTHER BARGAINS

7 LB. EXPERIMENTER PARTS ASSORT. KIT



A "gold mine" for the radio serviceman. Hundreds of valuable radio parts, new radar and electronic parts and sub-assemblies, coils, resistors, trimming condensers—worth many times this low price.
A130R **\$1.79**
—7 lbs.

HUNTING KNIFE



Has 5 inch blade with keen cutting edge, 9 1/2 inches overall. Dressed leather handle with plastic insets and guard. Sheath included. Wgt. 1 1/2 lbs. No. 197. **\$1.65**
Each.....

TRAINING RIFLE

Regulation size and weight. Looks like the real thing. Fitted with adjustable sights and full size leather sling. Bolt action sets and individually packed. Shipping weight 8 pounds. **\$4.50**
Stock No. 192. Price, Each.....

G.I. PISTOL BELTS



Of heavy canvas webbing. Adjustable. Eyeleted all around. Used but perfect. **98c**
Wgt. 3 lbs.
No. 131. Each.....

RAIN SUITS

New 2 piece rain suits. Of durable wear resisting water and wind repellent OD fabric. Hib style pants, zipper fly. Jacket has parka attached. Guaranteed 100% weather-proof. Small, medium and large sizes. Shp. wgt. 3 lbs. **\$4.95**
No. RS49. Ea.



FISHING KIT 18 Pcs. BRAND NEW

Here is a war surplus special that every fisherman will appreciate. It consists of hundreds of feet of line with lures, hooks, sinkers, etc. Fishing knife and gloves, all packed in a cloth roll up kit that also serves as an apron. Entire assembly of 18 pieces comes packed in a hermetically sealed can. Brand new! A real value. Shp. wgt. 4 lbs. **\$2.95**
Stock No. 413. Each only.....



SATCHEL POUCH

Heavy canvas pouch. Ideal for toting lunches, shopping, books, etc. Has 11x12 inch pocket. Brand new, guaranteed perfect. Has oversize flap with single strap fasteners. A113—**EACH \$1.69**



HAND MICROPHONE

Top quality hand microphone with control button in handle. Highly sensitive. Has rubber covered cord and tel. plug. Fine for use on home recorders, public address systems, etc. Brand new—perfect. Shp. wgt. 2 lbs.
Stock No. 170. Each **\$1.95**



15 JEWEL STOP WATCH U. S. AIR CORPS SURPLUS

Genuine Eigin 15 Jewel movement. Ideal for split second timing in racing, sports, time study, etc. Full sweep split second hand graduated in 1/10th seconds. Stem wind, start, stop and reset. Used but guaranteed perfect. A splendid value. Shp. wgt. 1 lb. **\$9.95**
No. 200—Each.....



BAYONET BLADE

Fine forged steel. Ground but not polished. May be made into throwing or hunting knife or spear. Blade 6 3/4 x 7/8 inches, 11 3/4 inches overall. Will take and hold a fine edge. Shp. wgt. 1 lb.
No. 664-R—Each..... **49c**

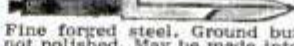

2 Man Mountain Tent

Regulation Army type two man mountain tent, complete with poles, guy ropes, etc. Of durable nylon with reinforced seams. Ideal for outdoorsmen, campers, etc. Shp. wgt. 10 lbs. A splendid value. Stock No. 202—Each.... **\$9.95**

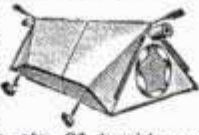

FLEXIBLE NECK FLASH LIGHT

Ideal trouble shooter's flash light. Flexible neck lets you direct light around corners and inaccessible spots. Brand new! Plastic case with BX type neck. Uses 2 standard flash light batteries (less batteries). Shp. wgt. **\$1.69**
2 lbs. No. 205—Each.....



Shatterproof Goggles

All purpose type. Sponge rubber frame. Red shatterproof flexible lens. Adj. head band. With case. New. Wgt. 1 lb. No. 139—Each..... **39c**



FISHING REEL

Full 100 ft. line capacity. Free acting brass bearings. Ratchet drag. Catalin handle. A real value at this low price. All metal Shp. wgt. 1 lb. No. F412. Each **98c**



HORSEHIDE JACKET

The leather coat buy of the year! Brand new Army Air Force Type A2 with full length zipper, shoulder straps, knitted waist band and wrists and full satin lining. Finest horsehide—finest tailoring. Order by chest size. Shp. wt. 5 lbs. No. 201—**EACH \$19.95**



STILLS

Distill your own water with one of these fine portable stills. Purchased from the Gov't. Completely self contained. Has 1 gallon capacity; output 1 1/2 gal. per hour. Fitted with genuine Coleman double burner stove. Operates 5 to 7 hrs. on one filling. Heat output 20,000 BTU's. Stove alone is worth this price. All new and guaranteed. Instr. included. Weight 109 lbs. No. 206 **\$59.50**
Each.....

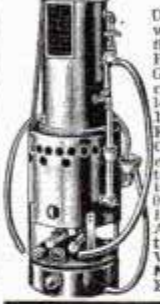

SHIP BELL

Purchased from U. S. Maritime Comm. Measures 10 inches high, 9 3/4 inch flare. Big 6 inch clapper. Weight 15 lbs. Fine for farms, clubs, estates, etc. All new A-541, ONLY **\$9.85**



RUBBER OVERBOARD SUIT

Here is a buy! All rubber suit with parka. Fits over your regular clothes and shoes. Can be cut apart for waist high waders, hip high or knee high boots, also arm length rubber gloves. Heavy gum rubber over fabric. Fine for those who work in the water, commercial fishermen, sewer diggers, etc. Use it as is or cut it up for waders. All brand new! Wgt. 14 lbs. No. 183. Each... **\$4.95**



MEDICAL STERILIZER

Consists of alcohol burner and sterilizing tray in hinged metal case 13x14x2 3/8 inches. Burner may be used separately. Bright nickel finish. All brand new, A125—Ea. **98c**



DECORATIVE CHROME STRIPS

For your car, boat furniture, etc. Highly polished chrome finished strips with clinched edges for flush mounting to any surface. The 3 pound kit provides approx. 15 pieces in lengths from 6 inches to 3 feet and average 3/4 inches wide. Wgt. 4 lbs. No. R224. 3 lb. Assort. **\$2.00**
only.....



ORDER DIRECT FROM THIS AD

Values galore! Hundreds of hard-to-find items for home, shop and outdoors. Make remittances by money-order, bank draft or personal check. Send 25% deposit on C.O.D. orders. No C.O.D.'s on orders for less than \$5.00. Include sufficient postage on parcel-post orders—any overage will be promptly refunded. All quotations F.O.B. Chicago. Used items and materials are guaranteed serviceable and as described. Your money back if not more than satisfied.

BIG ILLUSTRATED CATALOG FREE

STARK'S

Dept. PM1047
509 So. State St.
CHICAGO 5, ILL.

Officers Watch Compass

Brand new gov't. surplus. Army-Navy model. Single jewel mounted needle. Silver colored dial. A splendid value. Shp. wgt. 1 lb. A174—Each... **98c**



BERNARD WIRE PLIERS

Parallel acting jaws. Wire cutter at top. Brand new. Wgt. 2 lbs. No. 168. Each..... **\$1.29**



It's always fair weather
when you've got P.A.*



P.A.* means Pipe Appeal

Women say a man with a pipe looks more rugged, more appealing. Pipe smokers say there's no tobacco like tasty, tongue-easy Prince Albert!

means Prince Albert

P.A. MAKES GRAND-TASTING
CIGARETTES TOO! ROLLS
UP FAST—AND NEAT

● And what a lot of smoking joy and comfort Prince Albert Tobacco provides! P.A. is so rich tasting...so mild and easy on the tongue. It's specially treated to insure against tongue bite! Try it—and see for yourself why more pipes smoke Prince Albert than any other tobacco!

H. J. Reynolds Tob. Co., Winston-Salem, N. C.

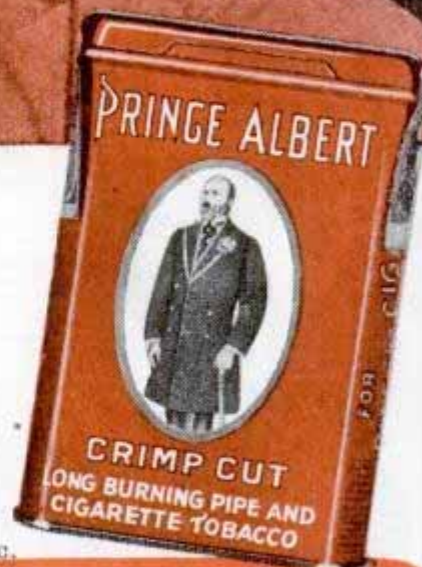

THE NATIONAL JOY SMOKE

Navy scientists install electrical equipment in a plane for tests in an altitude chamber. Motors, generators, wiring systems and instruments are checked this way

POPULAR OCTOBER 1947 MECHANICS

WRITTEN SO YOU CAN UNDERSTAND IT
VOL. 88 NO. 4

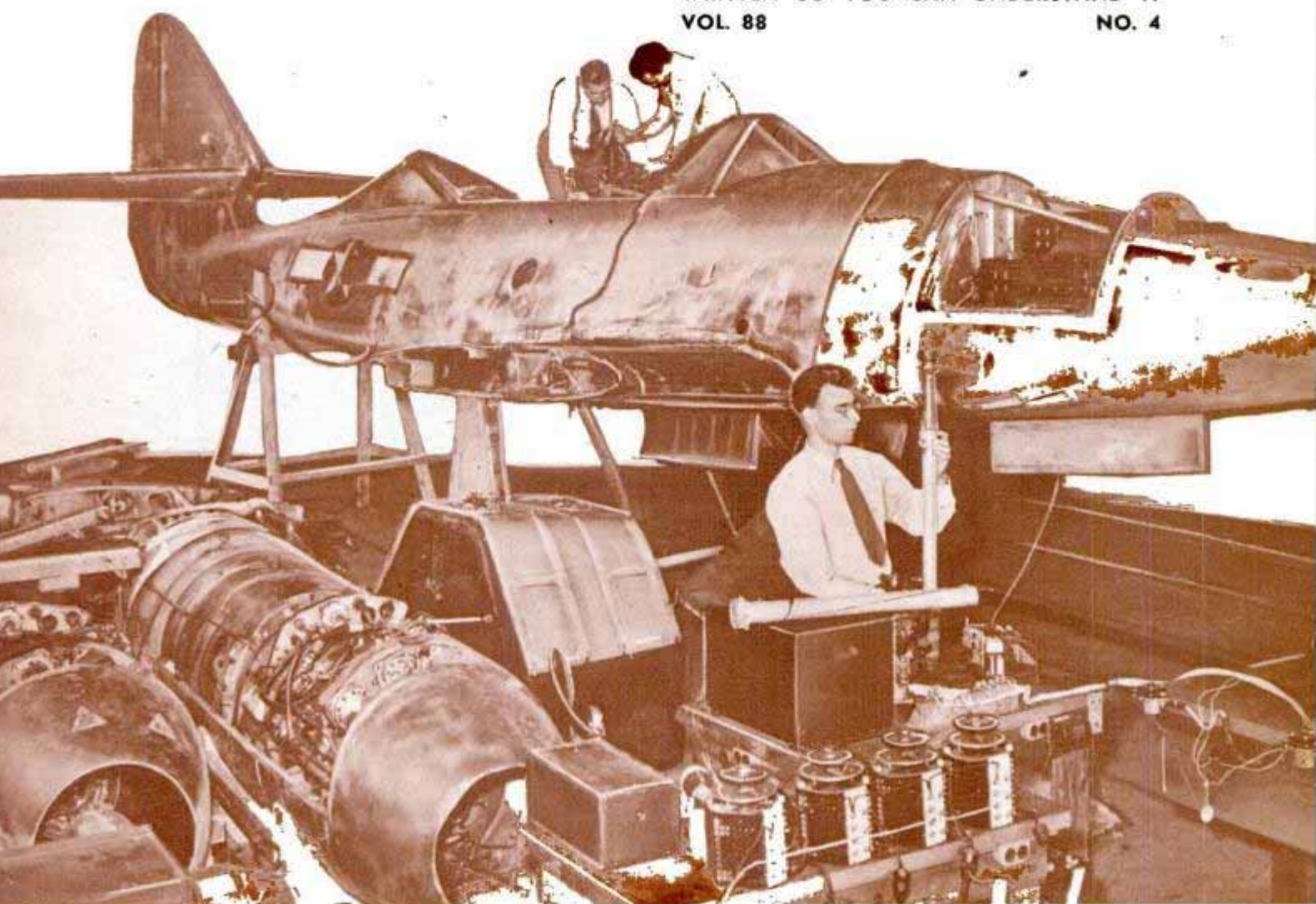

Science HQ of the Navy

THE NAVY'S BIGGEST scientific establishment, where some of the most important new weapons for sea fighting were designed during the war, now has thrown off the cloak of military secrecy.

A group of about 20 enormous buildings—with the appearance of a big industrial plant—beside the Potomac River in a Washington suburb, emerges as one of the two or three largest research laboratories in the United States. Here, under the direction of Commodore Henry A. Schade, more than a thousand physicists, chemists and engineers have turned to fundamental researches in the

basic sciences. They no longer are forging scientific swords; they are making scientific plowshares.

This plant is the Naval Research Laboratory. Before the war it was a small establishment with a limited field of activity. Yet here was born the most important single war development except for the atomic bomb, the radar. Here originated the techniques of determining depths and mapping the bottom of the ocean by sound echoes. Here was developed much of the thermal-diffusion process for separating isotopes of elements which was an essential first step in

By Thomas R. Henry

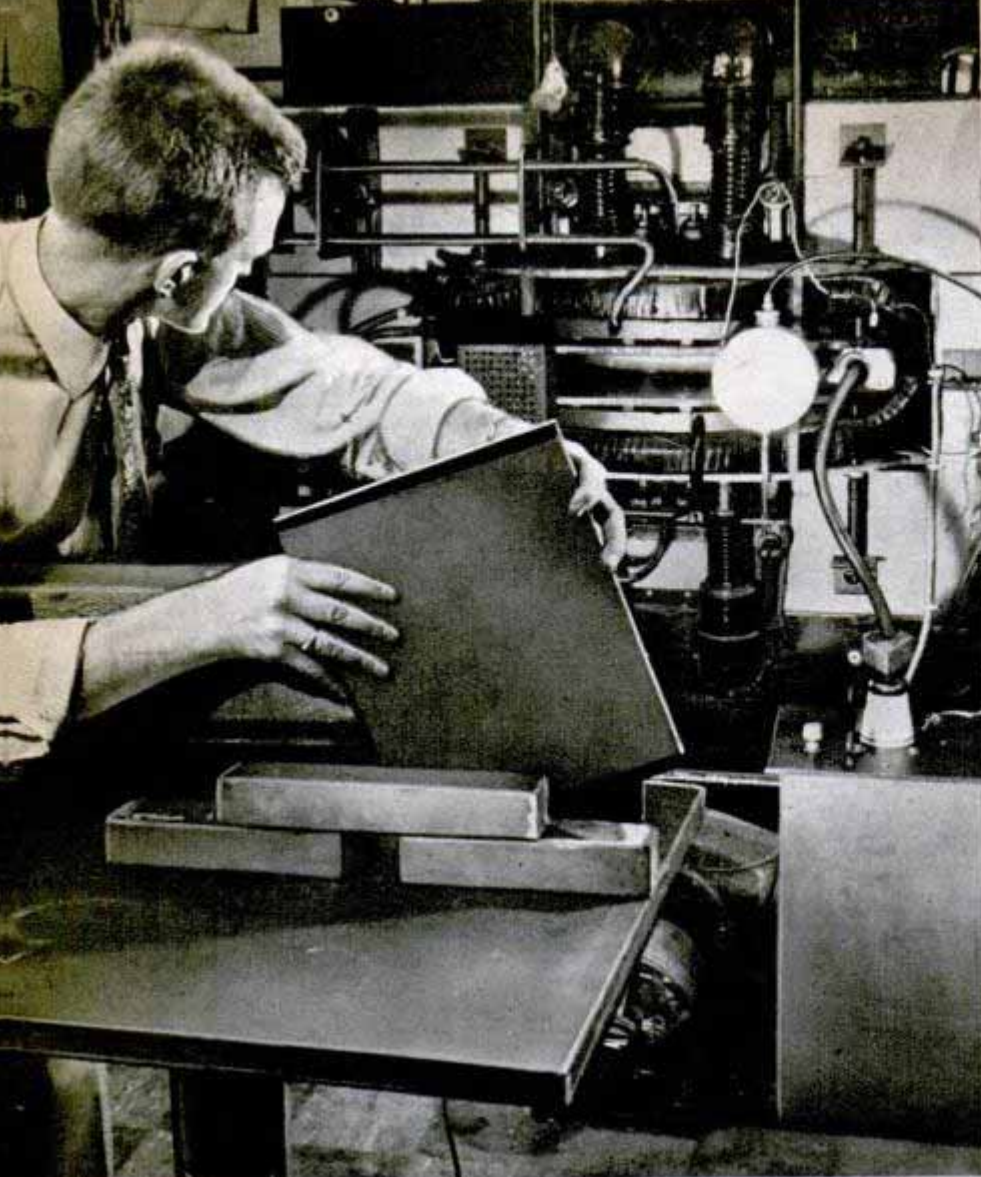

Material sample is tested by a betatron, which emits high-speed beta particles that penetrate metals and other solids. Below, sonar equipment used on warships to detect enemy submarines by sound waves

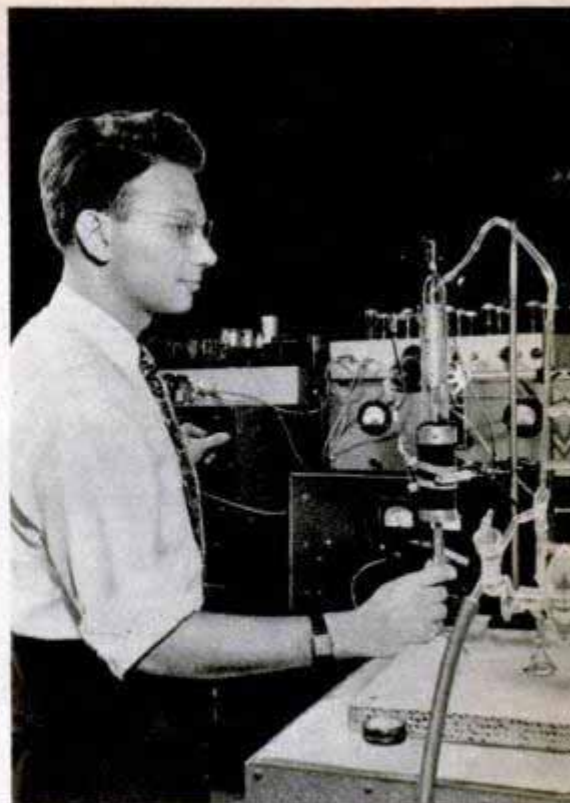
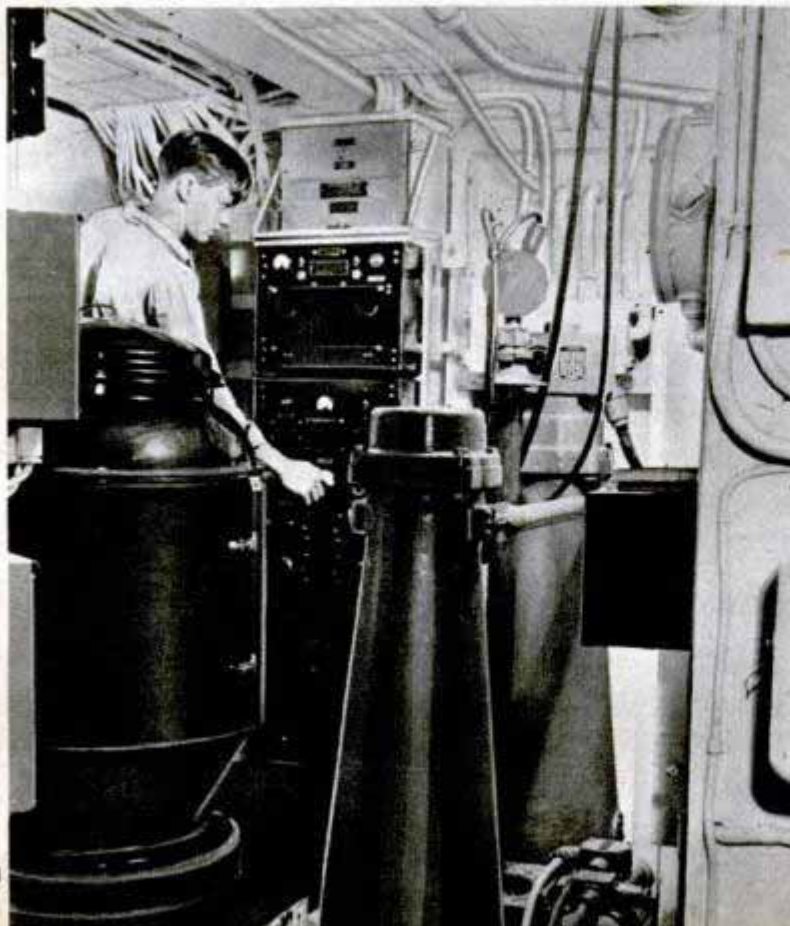

New Geiger-Mueller counter which detects, measures cosmic and radium rays

production of an atomic bomb.

The laboratory grew to its present size as a war enterprise. It is being continued, and its scope of activities increased, in line with the present Navy philosophy that military science must rest on a solid foundation of pure science — and that the potentialities up to now were largely exhausted during the war. So the purely naval aspects of the work have been reduced to a minimum. Among the personnel of more than 3000 scientists, technicians and administrators there are only 40 Navy officers.

Scores of projects with direct application to American life and industry are under way. Many of them are extensions of work undertaken during the war which developed quite unexpected possibilities in fields far removed from immediate military value.

Notable is the work in supersonics, in which extensive studies were carried out in the utmost secrecy through the war years. Mowing grass and dispersing fog over airports with the same supersonic apparatus are two of the present potentialities.

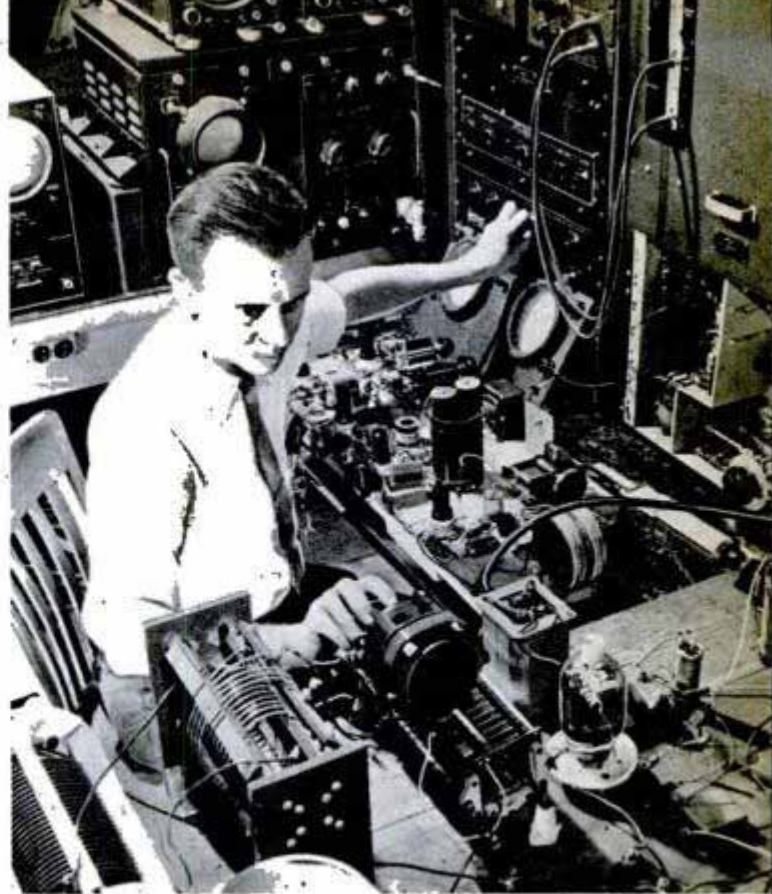

Pouring steel casting in Navy foundry where new techniques for handling metals are studied and experiments with new alloys and molding sands are conducted. Right, laboratory "breadboard" setup for testing radios

In an earlier and cruder form this has been tested to clear the Newark airport of low-lying fog which prevented planes from landing, and to mow the reeds of the New Jersey meadows just south of New York City. In each case it has been shown to have real promise. A much more delicate scale model now is being demonstrated.

The great difficulty aside from expense, it is explained, is that everybody in the neighborhood will be made extremely uncomfortable if the device is used with sufficient power to do any good. Even with the small scale model in operation one feels vaguely uneasy, without knowing why, a foot or more away.

The scheme calls for sending out powerful vibration waves through the air with a frequency just at the edge of audible sound. Some would hear these as a nerve-tearing shriek. Others would not hear them at all but would be sensitive to the waves beating against the body.

Such a supersonic wave, when passed through fog, causes the minute water-vapor droplets to coagulate to about the size of raindrops. As long as the vibration continues, they remain violently agitated and as soon as it stops they drop to the ground. The possibility is only for clearing fog over a relatively small area and usually it would form again in a short time. It would, however, probably be possible to clear a field while a plane was landing. The grass mowing is, at present, more of a stunt than a practical potentiality since the expense of

large-scale use would be so great. It might be valuable in a place like the Jersey meadows which are difficult to mow in any other way. The vibrations, striking the grass stems, agitate them violently, thousands of times a second, until they break.

In another laboratory, quartz is being "grown from seed." The object is to obtain a plentiful supply of perfectly oriented quartz crystals for use in electronic devices, such as underwater sound detectors. There are enormous amounts of this mineral in the United States—it is, in fact, one of the most common rocks in the earth's surface—but very little of it is of any use for that purpose.

Thus far it has been possible to produce only small crystals in the Navy laboratory, but apparatus now is being installed to grow a plentiful supply for all needs. During the war, Germany was short of quartz and was cut off from foreign supplies. Scientists there tried with limited success to work out a growing process, duplicating in the laboratory in a few weeks what Nature required thousands of years to do. U. S. scientists produced a synthetic crystal which was made by the hundreds of thousands for Navy sonar sets. One company alone produced over a million crystals.

Quartz is a mixture of oxygen and silica, the latter being the most plentiful element in the crust of the planet. The mixture occurs only in the form of crystals and these crystals are known as piezoelectric—that is, when a pressure or twist is applied to

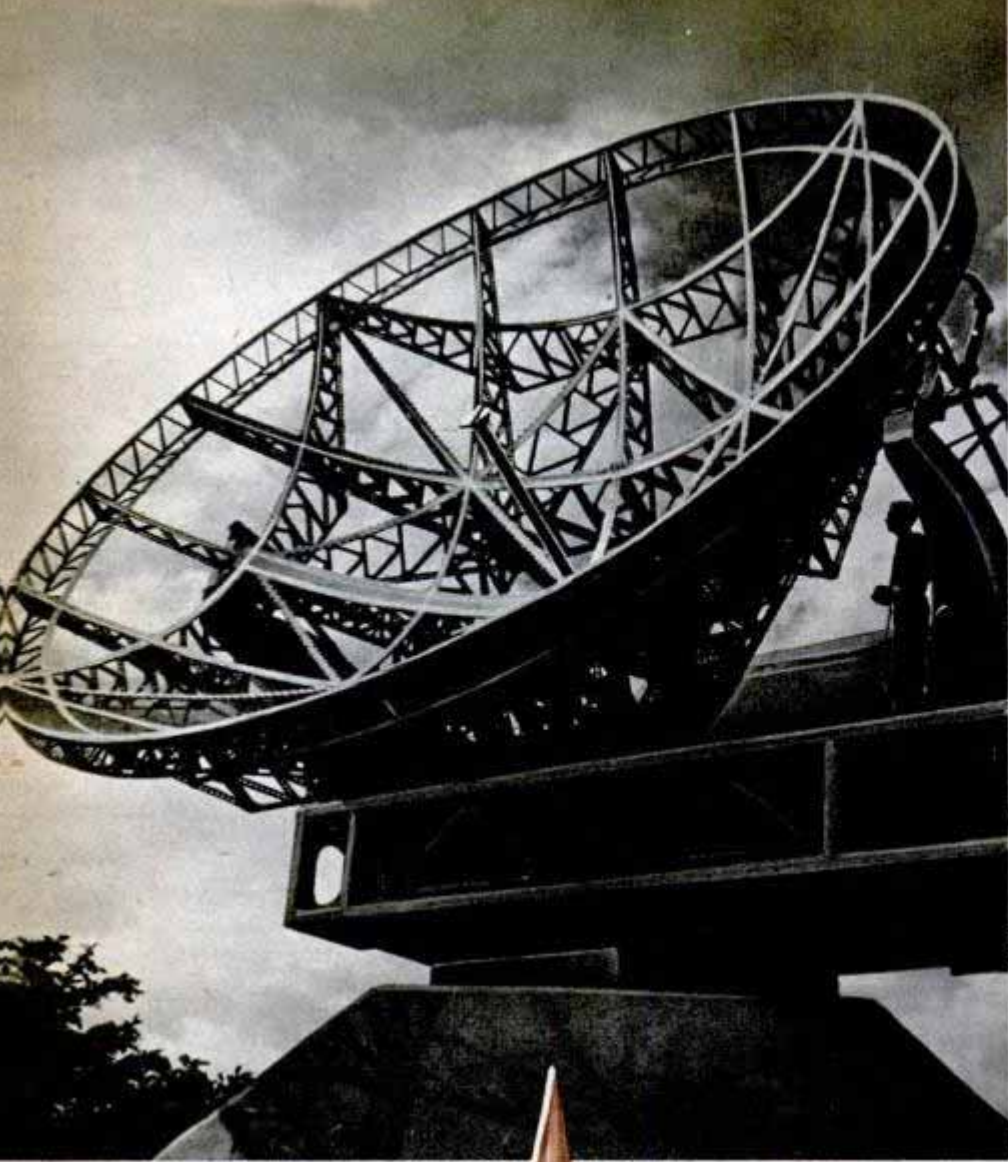

One of many types of radar antenna developed at Naval Research Laboratory. Below, installing instruments in warhead of German V-2 rocket for tests



them, an electric current is produced. Also, when a current is passed through one of them a very rapid vibration is set up. Through its vibrating property the quartz crystal is the most accurate timekeeper known. There are several million vibrations a second and the rate does not change during the life of the crystal. At the Naval Observatory in Washington there is a quartz-crystal clock which is the standard timepiece for the United States.

Crystals can be grown by several methods—the simplest of which is to make a supersaturated solution in water of the elements from which they are to be formed and then either evaporate the water or slowly lower the temperature. If a small crystal, or “seed,” of the desired material has been placed in the water the substances in the solution will form around it in the desired orientations when the liquid no longer will hold them. The difficulty of making quartz crystals has been that silica is a difficult material to hold in solution. In the past 18 months, however, most of the technical difficulties have been overcome by the naval research workers, headed by Dr. P. H. Egli.

In still another section a series of synthetic motor oils and greases good for a temperature range from 100 below to 200 above zero Fahrenheit—compared to a range from 60 below to 250 above for the best products obtainable from petroleum—has been produced. The chief constituent is adipic acid, a by-product of the manufacture of Nylon which hitherto has gone completely to waste. This same acid is found in most animal fats.

At the bottom of the temperature scale the new products will not thicken and they will not evaporate with increasing heat. When the

(Continued to page 264)

Bowler's Stop Light

To protect pin setters against broken bones, a traffic policeman has devised a combination stop-go and foul light for bowlers. A red light shines to indicate the pin setter is at work; a yellow signal for a foul, and a green light for "all clear." Two of the lights operate automatically by means of a treadle working as a hinged floor in the pin-setting pit. When the setter steps off the floor it changes the signal from red to green. The yellow light is controlled by the foul-line judge. Tests of the system are being made on alleys in Kansas City, Mo.



DDT Kills Crawfish

DDT insecticide has been found effective in killing crawfish in experiments by the Mississippi Agricultural Experiment Station. Crawfish cause considerable damage in northern Mississippi and in parts of Alabama. In the experiments, one bushel of cottonseed bait was wet down with a 2½ percent water solution of DDT and scattered over an acre of

land. The following morning 8700 dead crawfish were found on the treated acre and no dead ones on the untreated land.

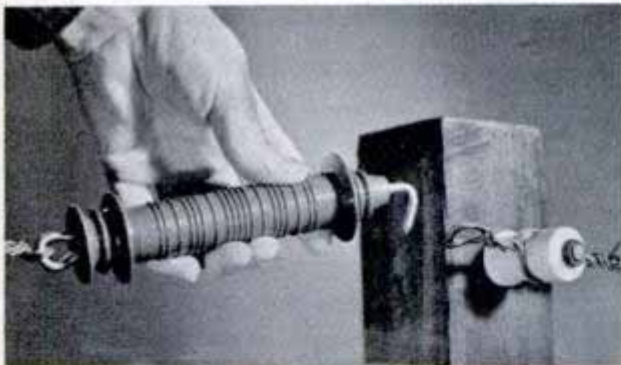

Tennessee Eastman Corp. photo

Electric-Fence Gate Handle

Electric-fence gates with nonconducting plastic handles can be used safely even during wet weather. The bright red handle has ridges molded along its smooth surface and safety guards at either end. Tenite is weather resistant and the metal parts are treated against rust. A metal compression spring encased in the handle maintains contact between the fence-wire ends connected by the gate.

Coal-Mine Tractor "Hugs" the Ground

Hugging the ground almost like a sled, a new coal-mine tractor can be driven from either a seated or reclining position, depending upon the height of the mine roof. The tractor, equipped with rubber tires, is coupled to various types of trailers to haul coal, supplies or men.

☛ Farmers own one third of all the trucks in the United States.





Encyclopedia Britannica photo

UNDERGROUND NEW YORK

What's underground in a big city is shown in a diorama that depicts a cross section of New York's Grand Central area, above and below ground, between Vanderbilt and Lexington Avenues on 42nd Street. It shows the underground transportation

system—the Lexington Avenue subway, the Grand Central-Times Square "shuttle" and the Queens subway, complete to model trains, passengers and advertising posters on the wall. Immediately below the pavement the cutaway reproduces such details as water ducts, telephone conduits, sewer and gas pipes, and mailing tubes.



Line Marker Has Finger-Tip Control

Interchangeable brushes for a mobile paint marker make guide lines two, three or four inches in width. The 22-pound unit holds $1\frac{1}{2}$ quarts of paint and is used to mark traffic lanes, tennis courts, swimming pools and factory floors. The paint is fed to the brush by finger-tip control.

Here's Relief for Accelerator Pushers

Tired leg muscles are given relief by a device that holds the accelerator at any desired speed. In cross-country driving, the motorist accelerates to the speed he wants, pushes a button on the dash, and the throttle is held at that speed. The button operates a pawl on the throttle arm. By touching the accelerator pedal again, the motorist frees the pedal for normal driving.



Cordless Soldering Iron

Delicate soldering work is made easier by a pencil-type soldering iron that has no electric cord. The tip of the tool is inserted in a heating unit screwed on an ordinary soldering iron. When the tip is hot the tool is removed and held like a pencil. The alloy tip holds 680 degrees for nearly one minute and reheats in about 20 seconds when reinserted in the heater. The tool was designed for assembling small switches, electric meters and instruments.

Fast-Drying Lacquer in Artist's Pen

Quick-drying lacquer is used in a capillary-action pen designed for draftsmen and artists. Extending from the barrel is a short length of fine tubing that comes to a rounded sapphire point. Immediate drying of the lacquer prevents it from running under rules, triangles and other drawing aids. A plunger inside the barrel, regulated by the screw top, forces more fluid out for heavy lines or releases pressure to make light lines. Interchangeable points permit different type lines as thin as a few thousandths of an inch. Errors can be removed with sandpaper or an ink or glass eraser.

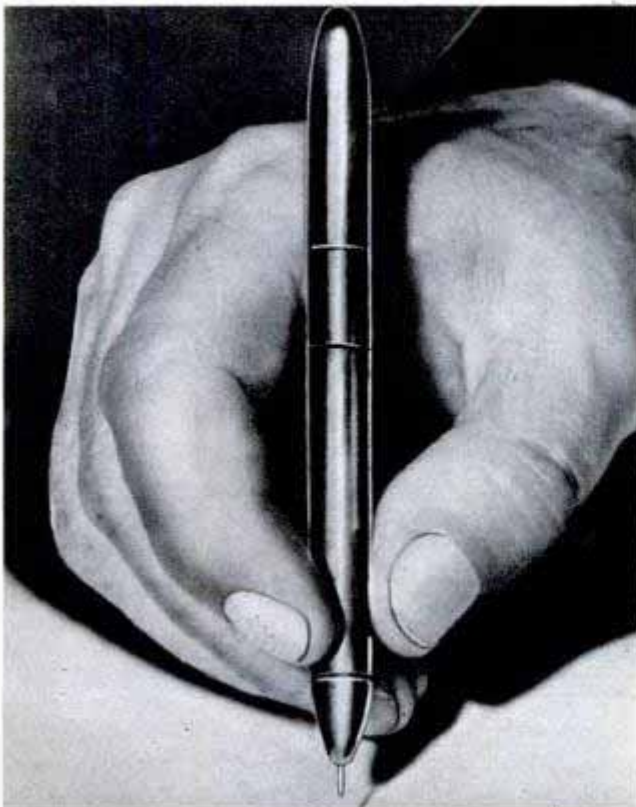

Scale Model of Giant Magnet

Engineers at Carnegie Tech have built a 1000-ampere electromagnet which performs such tricks as supporting a two-pound hammer in the air. The magnet is a working scale model of a giant magnet which will be built into a 200,000,000-volt synchro-cyclotron for atomic research. The model is built to a scale of 1 to 14. When finished the atom smasher is expected to cost \$1,000,000.

Drill Attachment Adds to Uses

Portable electric drills and drill presses are converted for wood chiseling, sawing, filing and sanding by an attachment that changes the drill's rotary motion into a reciprocating action. The attachment fits any drill that will receive a 1/4-inch shank and can be operated at speeds up to 2500 revolutions per minute. An additional attachment for sanding and buffing provides a mounting block for sandpaper or a polishing cloth.

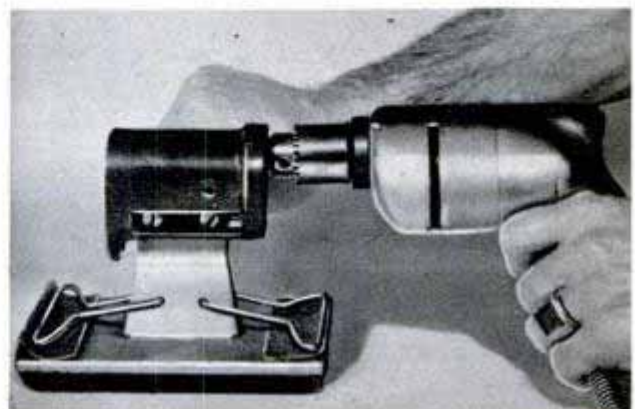

By Estey I. Reed

THERE'S A MAN in Denver who makes heirlooms to order. Donald F. Allen is an artist who designs what he calls marriage plates.

Years ago the young art instructor sought a means of preserving the story of his romance with his wife. On a white pottery plate he painted pictures of a peasant boy and girl. Hearts and lovebirds added a sentimental touch. Around the edge were painted the couple's names. This was the first of hundreds of marriage plates which someday will be family heirlooms.

Allen became interested in ceramic art 16 years ago when he read an account of early Chinese and Egyptian art. The idea of telling intimate stories of individuals through pictures painted on pottery fascinated him.

The first step, Allen decided, would be to obtain the right clay which he knew to be plentiful in Colorado. The clay he uses is segregated into several groups, ranging from low-fired to high-fired types.

Color for all of Allen's work is obtained from oxides of minerals. The underglaze material consists of tin for white paint, copper when turquoise is desired, and magnesium for deep brown. Colors from yellow up to medium brown are made from lead or silver tailings. Gold produces red.

The plates are cast in plaster molds, which readily absorb water. When the clay is deposited in the mold, the moisture evaporates and is absorbed by the plaster. The plate is trimmed and smoothed on a

Allen's wife examines the birth plates made for their children. Above her hangs the first marriage plate he designed

HEIRLOOMS MADE TO ORDER

First step in making the sentimental heirlooms is to pour the liquid clay into a prepared mold

Into the kiln go the plates for baking. Circular holders and tubes keep them from falling out when door is opened





Designs depicting the romance are sketched on the plates in pencil. They are completed with metallic pigments

potter's wheel made from parts of a treadle-type sewing machine.

The plate is taken to the kiln, where it is baked by a low fire. After the plate has cooled, the designs are drawn and painted in appropriate colors with underglaze paints. A fluid consisting of finely ground glass mixed with certain chemical agents is sprayed on to give the finish glaze. Then the plate is baked for 3½ hours at

Allen sprays a coat of finishing paint on a new plate. It is made of chemicals and powdered glass

1950 degrees Fahrenheit and cooled slowly.

Both the pottery and glaze shrink in firing. As the shrinkage is not equal, the glaze is cracked when the plate is removed from the kiln. Allen then rubs an earth color into the cracks, giving each plate a crackle finish that adds to its beauty.

Allen made marriage plates several years for friends and relatives. They showed their gifts to others who wanted him to paint birth, family and anniversary plates. His hobby now is a business.

Most of his marriage plates have peasant figures in the center. Colored borders are painted around the plates. Below the figures are smaller designs telling the story of the couple's initial meeting and other sentimental events. Names and the wedding date are included.

Allen has depicted everything from a dozen red roses and moonlit nights to the tale of a young couple caught in a flood on their wedding day. They were compelled to wade through mud to meet the minister in a railroad station.

A western rancher had his brand painted on a plate. One couple ordered the names of 15 towns in which they had lived, along with figures representing a different job the husband had held in each. A Navy lieutenant and his wife wanted a bowl of strawberries, for they had met over such a dessert at an officers' club. Texans request cowboys dressed in blue jeans.

Although ceramic art is nearly as old as art itself, Allen has added a new twist to produce heirlooms made to order.





Peacetime Proximity Fuse

Industry may be able to use a device similar to the proximity fuse to detect motion in certain research or manufacturing processes. The proximity fuse was responsible for much of the effectiveness of the Allied anti-aircraft fire. Now, General Electric has developed an instrument which uses radio waves to detect movement of an object or person. The device rings a bell or flashes a light as a warning. It detects motion in objects moving as slowly as one mile per hour.



Hand Truck Moves Wire Coils

Coils of wire are moved easily by a hand truck with a protruding arm. The arm is pushed through the center of the coil to prepare the truck for loading. Pulling back on the handles and pressing down on a footrest lifts the load and properly positions it on the truck. The load rides over the wheels to provide good balance. The truck can be used to transport most articles with holes in the center such as box strappings, wheels, tires, lathe chucks, faceplates and strip coils.

Half-Size Bus for Youngsters Made From Scrap Parts

Using parts from a midget auto and a bomb trailer, a California youth built a half-size bus that's a perfect fit for youngsters. Made of sheet aluminum on a

channel-iron frame, it has metal seats, an authentic folding door, lights that work and even a fare box as a realistic touch. The designer, Don Tibbetts of Redondo

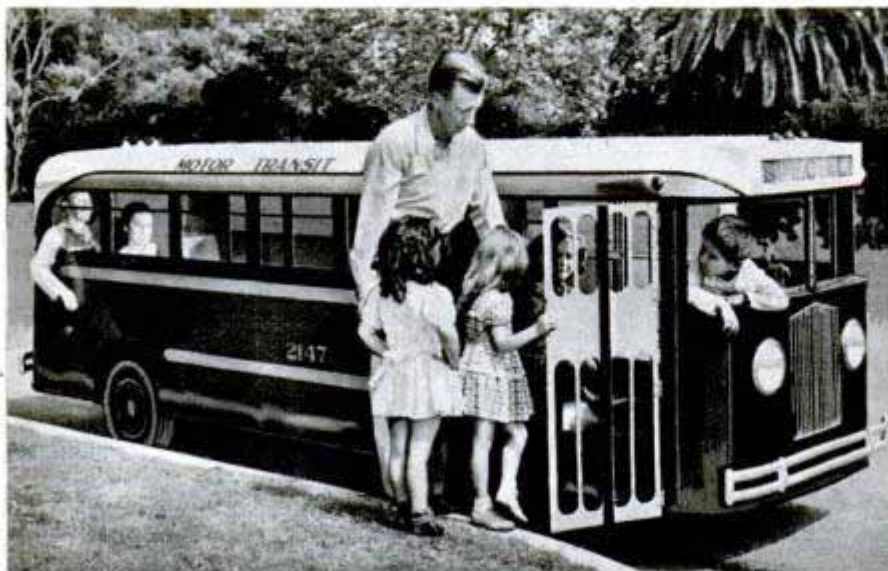

Beach, Calif., used the engine, clutch and transmission from a 1930 midget auto as a power plant. A war-surplus bomb trailer furnished the nine-inch wheels. The miniature bus is 16 feet long, 5 feet high and 4 feet wide, weighs 1800 pounds and has a top speed of 30 miles an hour. Along with a model trolley car and locomotive made by Tibbetts, who developed his skill as a Navy shipfitter, it will haul kiddies at an amusement park.



"BELT LINE" FOR GRAVEL. With an overhead conveyor spanning the road, traffic on a busy California highway moves along as usual while the road is being widened and straightened. The belt conveyor carries dirt and rock 20 feet above the four-lane pavement, permitting autos to pass beneath. Scene of the \$763,000 project is the Ridge Route across the Tehachapi Mountains between Los Angeles and the San Joaquin Valley. Dirt is removed by a Diesel-electric shovel from one side of the road, and then deposited in trucks across the highway

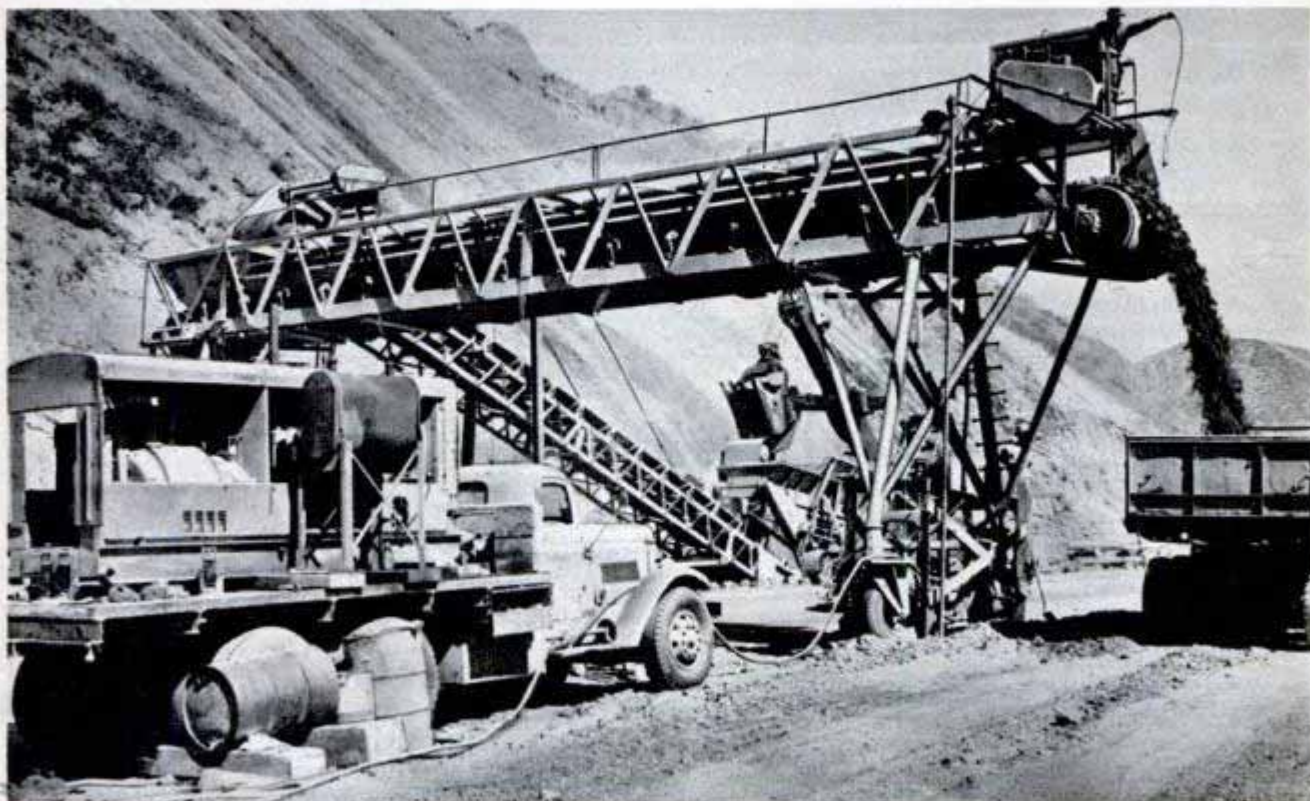

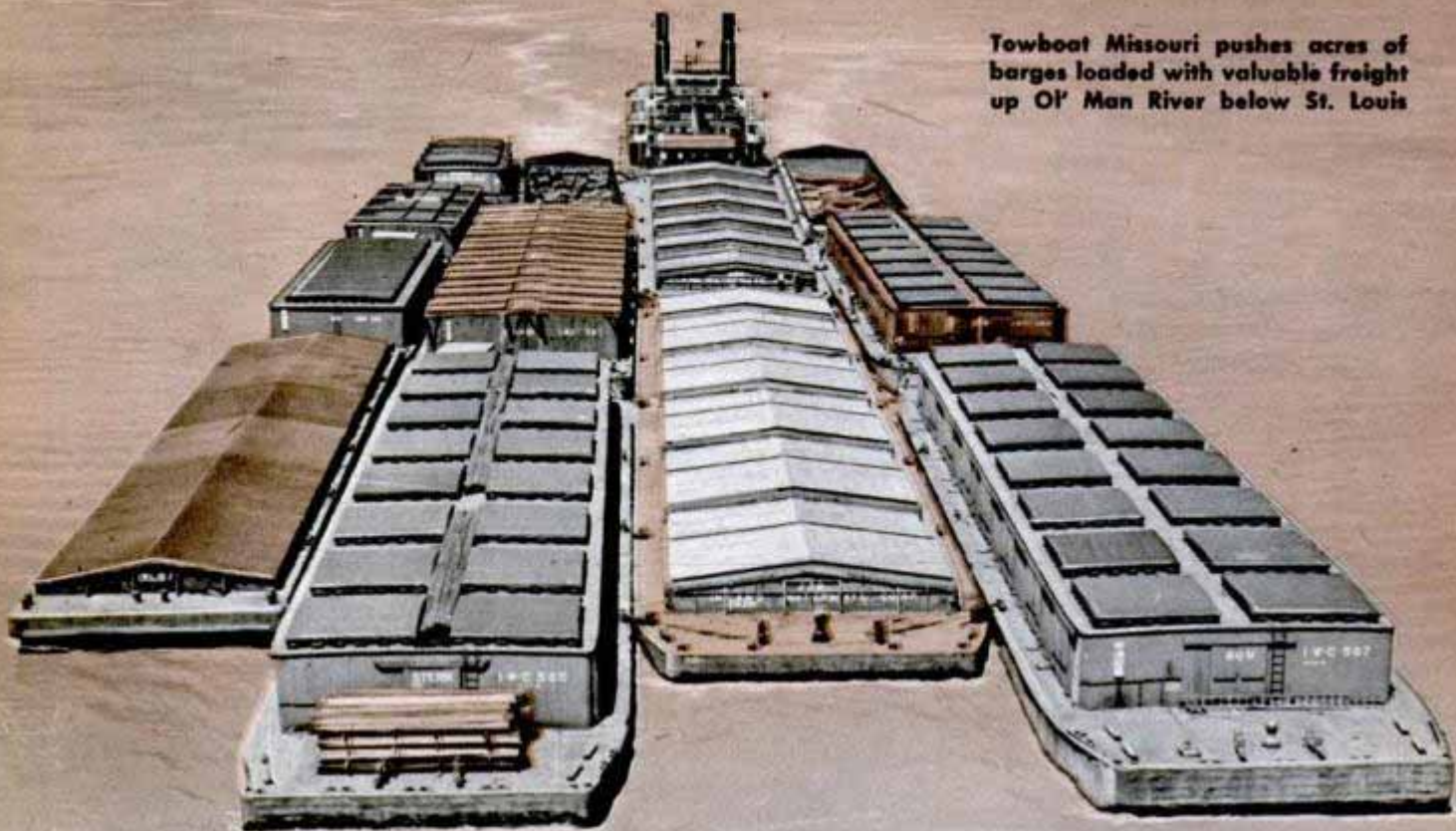

Towboat Missouri pushes acres of barges loaded with valuable freight up Ol' Man River below St. Louis

Fancy Freighters Ride Ol' Man River

By Robert A. Hereford

THE PACKET Robert E. Lee plowed full steam ahead through a Mississippi River fog one night to win history's most famous steamboat race from the Natchez.

That reckless dash of the Lee since has become legendary. But any one of the modern river steamers whose pilothouses are being equipped with radar would have ridden through that fog as easily as though the pilot were navigating the Mississippi on a clear day. Despite the fog, the banks and obstructions in the channel would have shown clearly on the radar screen.

The river steamer of today has another improvement which would have astonished the pilots of Mark Twain's colorful era. It's the wireless ship-to-shore telephone. Through it, the boat's clerk, who is a licensed radio operator, communicates with the home office or any other shore point having telephone equipment. Over its amplifier come the daily river stages and the positions of other craft, informa-

tion that is vital to the steamer's master.

Powerful searchlights illuminate the path of the modern river steamer, enabling the boats to maintain a regular schedule of night as well as day travel.

Oil, for the most part, has replaced the wood and coal with which the fireboxes of the pioneer packets were fed. Giant steel screws now churn the waters in the wake of the modern craft in place of the cumbersome paddle wheels of the packet era.

To communicate his orders to any part of his craft the pilot simply leans over and speaks into the pilothouse microphone. An electric loud-speaker bellows his orders so that they can be heard clearly a quarter of a mile distant by deck hands working on the lead barge of the boat's tow of barges which stretches out ahead.

The kitchens of the old river packets and the sumptuous fare they provided have long been a river tradition. The kitchen of a modern boat not only perpetuates but

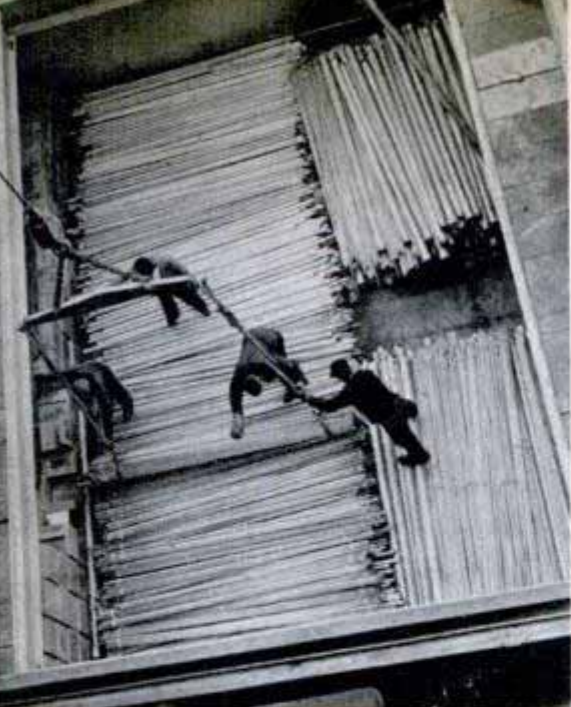

↑ Iron rods are lowered by crane into position on one of the barges. Right, the master of the Ernest T. Weir checks the radar screen. Radar has eliminated many of the navigating hazards met by early packet pilots

enhances that tradition with the aid of modern refrigeration which makes possible a supply of fresh meats and vegetables as well as frozen dishes.

Because the floating palaces, which once provided the nation a principal means of travel, were unable to match the speed of the express train, the airplane or transcontinental bus, passenger transportation on the river has disappeared except on a few excursion boats.

Gone is the splendor of the old packets. The Grand Republic, one of the most famous of the old boats, boasted a carpet valued at \$40,000. It was woven in one

piece and imported from Brussels. Living now only in memory are the silk-waist-coated and cold-eyed gamblers who frequented the packets. Gone also are the coquettish girls who waltzed on the packets' dance floors and flirted on their darkened decks.

But freight continued to move in ever-increasing volume over the nation's water highways. Furs were freighted down the Missouri to help build a business empire, cotton steamed upstream from Dixie in return for steel sent down the Ohio and Mississippi from Pittsburgh mills.

During the rush up the Missouri to the

↓ Deck hand makes fast a heavy line around a barge's timberhead in preparation for a threatening windstorm. Right, the leadsman's "Mark Twain" signifies safe water and echoes the romance of early river-packet days

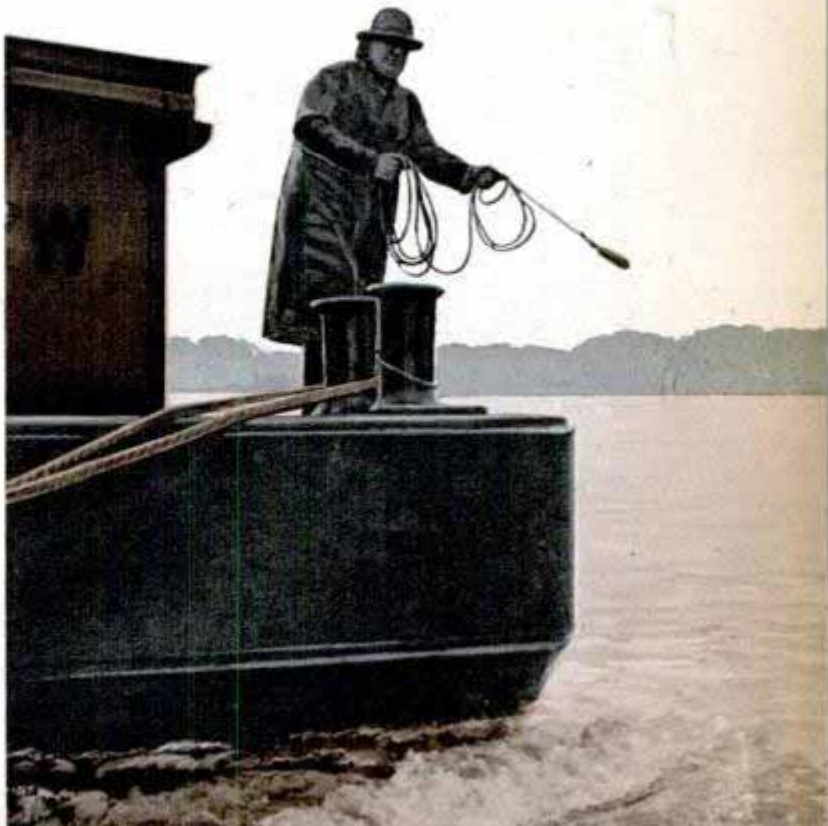



At the St. Louis terminal of one of the barge lines, a crane loads cases aboard a barge for a trip down river

Montana gold fields in 1866, steamboat freight charges were as high as 12 cents a pound, with one boat, the Peter Balen, carrying 341 tons on a single trip. Another packet returned from the gold fields with \$1,000,000 in gold dust in her safe.

But the modern freight movement on the rivers would astound the old packet master. For, as Mississippi Valley Association statistics reveal, 12,000 tons of mixed cargo in one tow of six barges or more is not uncommon. Such a tow is equal to the capacity of 24 packets of the golden age of river transportation. It is equivalent, according to the association's estimate, to 241 average freight cars loaded to capacity or to 14.7 freight-train loads.

A cargo of 26,000 tons of coal has moved over the Ohio-Mississippi River system in a single tow of barges.

A stately procession of these modern towboats, which push their tows instead of pulling them, moves up and down the Ohio, Mississippi and Missouri Rivers and over other river highways.

The modern steel barges, designed to draw in accordance with the nine-foot channel provided by the government on the Mississippi River, range in capacity from 100 to 3000 tons. The snub-nosed towboats, which push before them literally acres of floating freight, range up to 2200

horsepower. They are all-steel craft costing as much as \$500,000 apiece.

In 1944, the latest year for which figures are available, this towboat fleet moved over the Mississippi River system (including the upper and lower Mississippi, the Ohio, Illinois and Missouri Rivers) 101,340,788 net tons of cargo, equal to the capacity of 2,027,000 freight cars.

Steel from Pittsburgh, refrigerators from Cincinnati and shoes from St. Louis are taken down river to New Orleans, with some of the consignment dropped off at such river cities as Memphis and Vicksburg. Other cargo moves from New Orleans to Texas and Louisiana cities over the intracoastal canal. Huge consignments are loaded aboard ocean-going steamships at the port of New Orleans bound for foreign ports.

For a real glimpse of modern river life, climb aboard the steamer Louisiana of the Mississippi Valley Barge Lines, leaving Cairo, Ill., for New Orleans. Likely she'll be pushing about a 21-piece tow.

You climb aboard the lead barge tied up at the dock and it's a quarter-mile hike to the Louisiana. Finally aboard, you stow your gear in a neat room with a bath that includes hot and cold water, a shower and tub. Across a tiny window are black shades. The shades have a double purpose

—to keep light from obscuring the pilot's vision at night, and to prevent light from interfering with daytime sleepers.

Through the window can be seen the crew at work rearranging the tow. The towboat has been cut loose from her barges. Now she is "shepherding" them into a formation that was worked out previously with a set of tiny blocks in the pilothouse. The downstream tow is wider, the tow upstream narrower because of current resistance.

The towboat gently nudges the barges into place where they are made fast by means of wire cable, which ratchet screws pull to fiddle-string tautness. The boat and barges become as solid as a single unit.

In the pilothouse the boat's master, Captain Edward Duckles, stands before two large steering levers and directs the work on the barges through a loud-speaker.

Work goes on continuously on a river steamer in a series of six-hour watches. The relief pilot relieves the master, the second mate the first, the second engineer the first and so on.

Radar is comparatively new to the river and boats not equipped with it tie up during a night fog just as careful pilots did in the days of the river packet. One packet may have carried \$1,000,000 in gold dust in its safe, but any one of the hundreds of

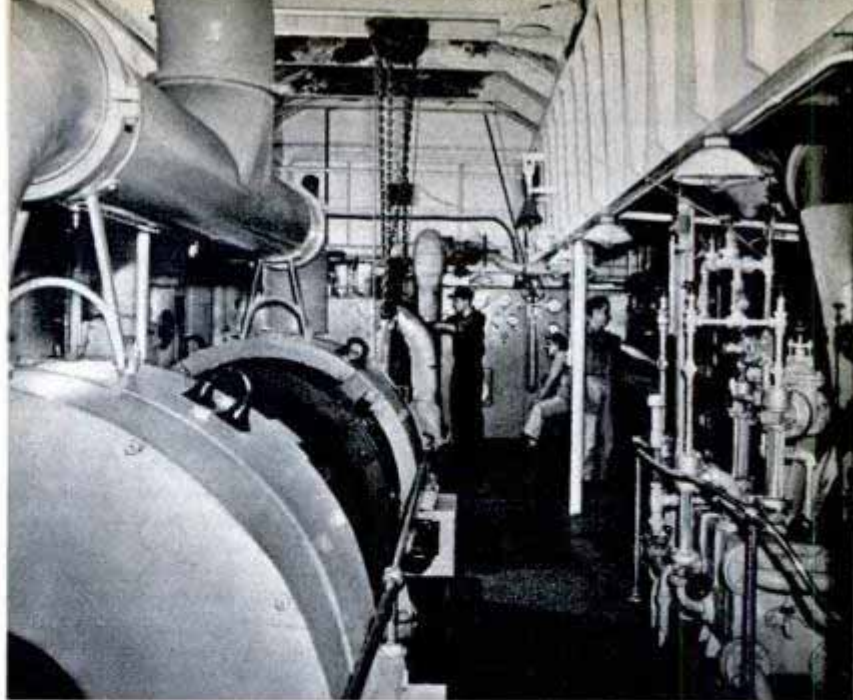

Huge 2000-horsepower engines are spotless aboard the Louisiana. Oil has replaced the coal and wood fuel of the pioneer packets

modern tows may be worth up to \$1,000,000.

You don't risk a \$1,000,000 cargo in a Mississippi fog.

The Louisiana isn't equipped with radar and sometime during the trip Captain Duckles may see a wall of fog advancing across the river. He speaks quietly into his microphone, addressing the first mate who is stationed a quarter of a mile ahead on the lead barge. "Tally, fog's closing in. We'll tie up."

He puts his foot on the pedal of the lead whistle, signaling for a starboard sounding. Sounding is one river operation which has survived the years unchanged.

Chugging down the Mississippi, the Louisiana pushes a tow of 21 fully loaded barges





Tow is brought to dock to drop off one barge. The rest of the load will go to New Orleans for reshipment

The captain wants to determine whether the water is deep enough offshore to float the Louisiana's 15,000-ton cargo. When a tow is grounded or hits the bank, loose barges often must be chased downstream for miles.

A deck hand grabs a line with a lead weight at one end. At intervals along the

line are various colored markers representing the depths. He cat-foots forward over the gunwales to the lead barge and throws the line ahead into the river.

Another deck hand has stationed himself halfway between the sounder and the pilothouse to relay the call.

The sounder studies his line and calls, "Mark Thyree. Oh, Mark Thyree."

"Oh, Mark Thyree," sings the relay man.

The water is 18 feet deep.

"On the Mark Twain," calls the sounder, meaning 12 feet. Then a warning: "Ten feet. Oh, ten-a-feet."

The boat shivers as the engines are reversed. Captain Duckles plays the beam of one searchlight alongshore until it picks out a giant cottonwood tree. The other light he fixes on a crouching deck hand who holds a long ladder in readiness. The shore looms 10 feet distant. The deck hand drops the ladder between boat and land and two other hands, carrying a steel cable, scamper across and make fast to the big tree.

(Continued to page 260)

Dramatic shot shows deck hands scurrying across a ladder from barge to shore to tie up in preparation for bad weather ahead

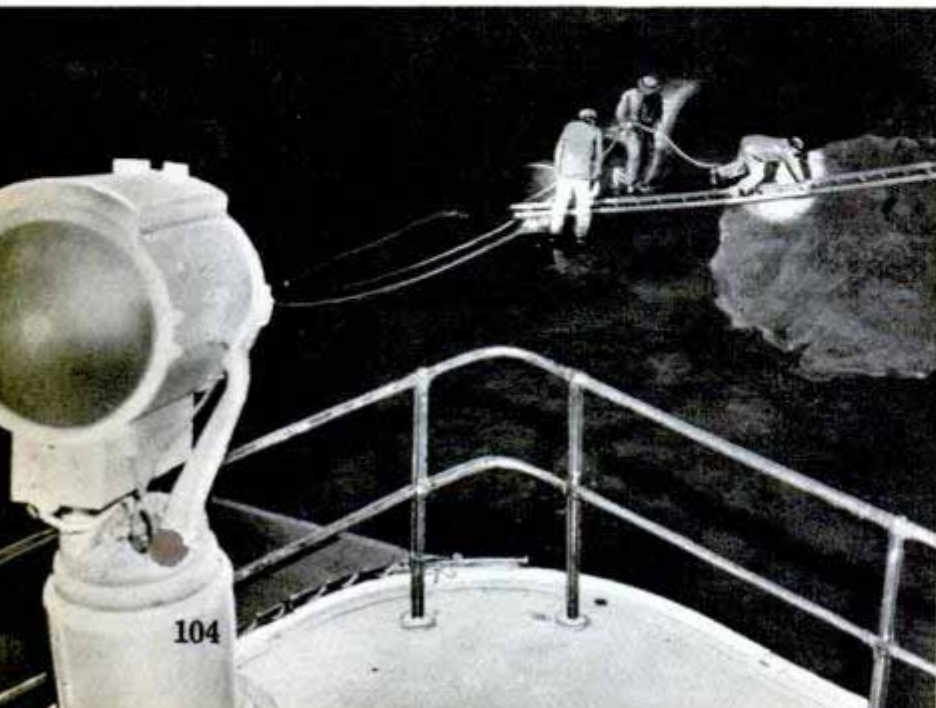

TEST YOUR SCIENCE

By Rex Taylor

i. q.

FROM WHAT POINT on the earth can you

Walk 10 miles south—

Walk 10 miles east—

Walk 10 miles north and arrive at your starting point?

Ordinarily you'd be walking three sides of a square and finish 10 miles east of the spot where you started. But you know the easy answer for this one: It's shown by the diagram at the right. You start at the North Pole. Ten miles down any meridian you turn east for 10 miles, then north 10 miles and you're back at the Pole.

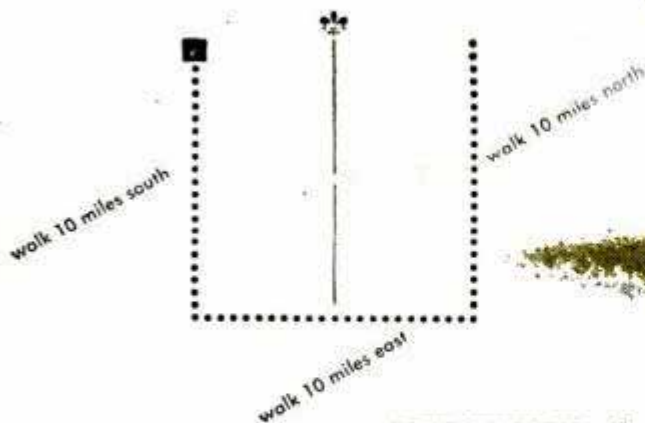
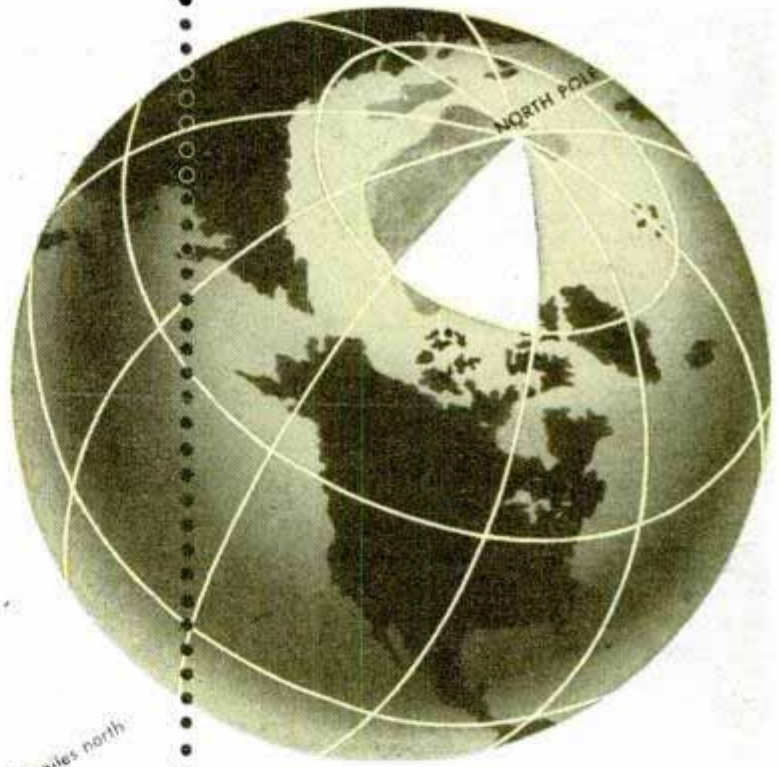

**BUT
HERE'S THE
BRAIN
TEASER**

ARE THERE other points on the earth where the same three-way trip will bring you back to the spot you started from? If so, name one of them.

Get out the globe and the arithmetic book. If you're a genius or a little less, it should take you just a few minutes. Try it . . . No coaching from the audience, please! Well, just a hint: Start somewhere near the South Pole . . . Don't give up! But if you must, turn to page 238 for the answer.

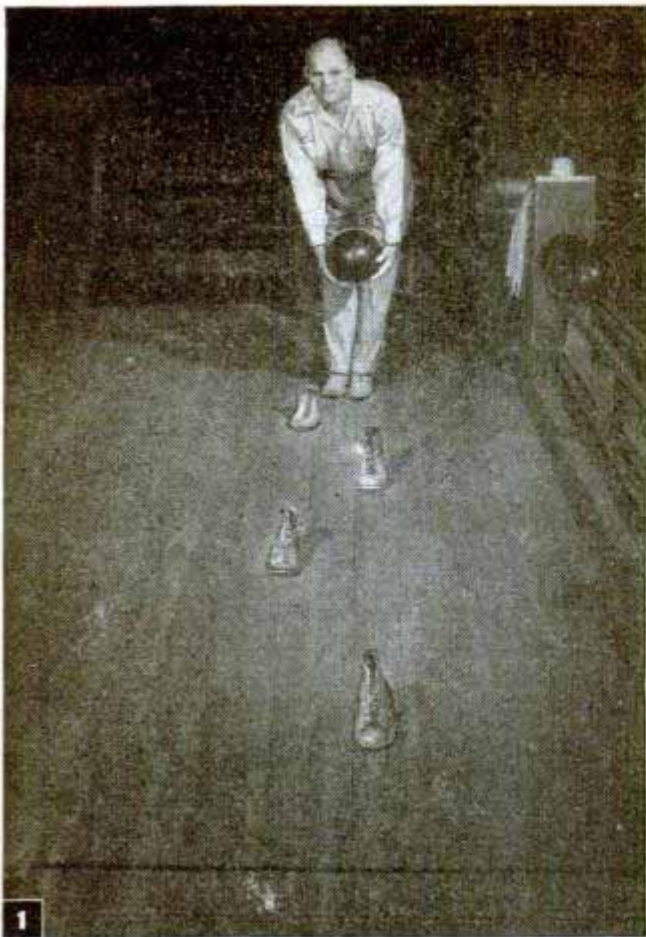

1

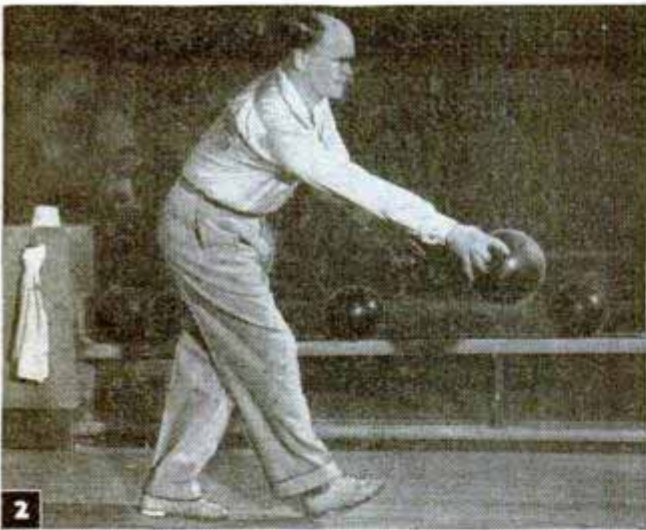

2

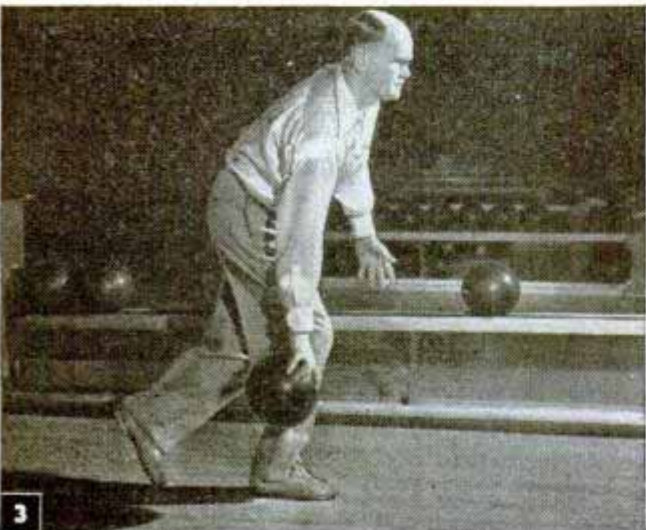

3

FIRST AID for BOWLERS

By John R. Kinsey

Posed by Joe Wilman, "Bowler of the Year" in 1946, and one of the sport's all-time greats

BEFORE JOE WILMAN became one of the world's greatest bowlers, he tried to develop into a boxing champion. He had plenty of "stuff"—hooks and jabs—and good control.

Joe won 19 bouts in succession before an opponent's glove crashed against his chin and the young fighter woke up in his dressing room.

"Right then," Wilman relates, "I decided to give up boxing. I had a fair amount of stuff and control, but I couldn't control my opponent's punches."

The chunky athlete next took up professional baseball and within a few years was pitching in the Nebraska State league and then the Mississippi Valley league. He had excellent control over the ball and a fair amount of stuff, including a good curve.

The Chicago White Sox gave Wilman a tryout. They liked his control but decided he lacked the assortment of pitches, or



4

stuff, to make the grade as a big league hurler.

"That's when I decided to give up baseball and try to become a champion bowler," Joe explains as he looks back on his athletic career.

Wilman, then a better than average bowler, became a champion bowler because of two things: control and "stuff on the ball," bowling lingo for a sharp-breaking hook that churns the pins and makes a lot of strikes.

When Joe was asked to prescribe some first aid to help bowlers improve their game, he suggested that control and "stuff" be emphasized.

Those are the factors to which he credits his average of over 200 in league bowling, in exhibitions and in 11 appearances in the American Bowling Congress—the toughest competition in the world.

What's fun for 18,000,000 bowlers around the country

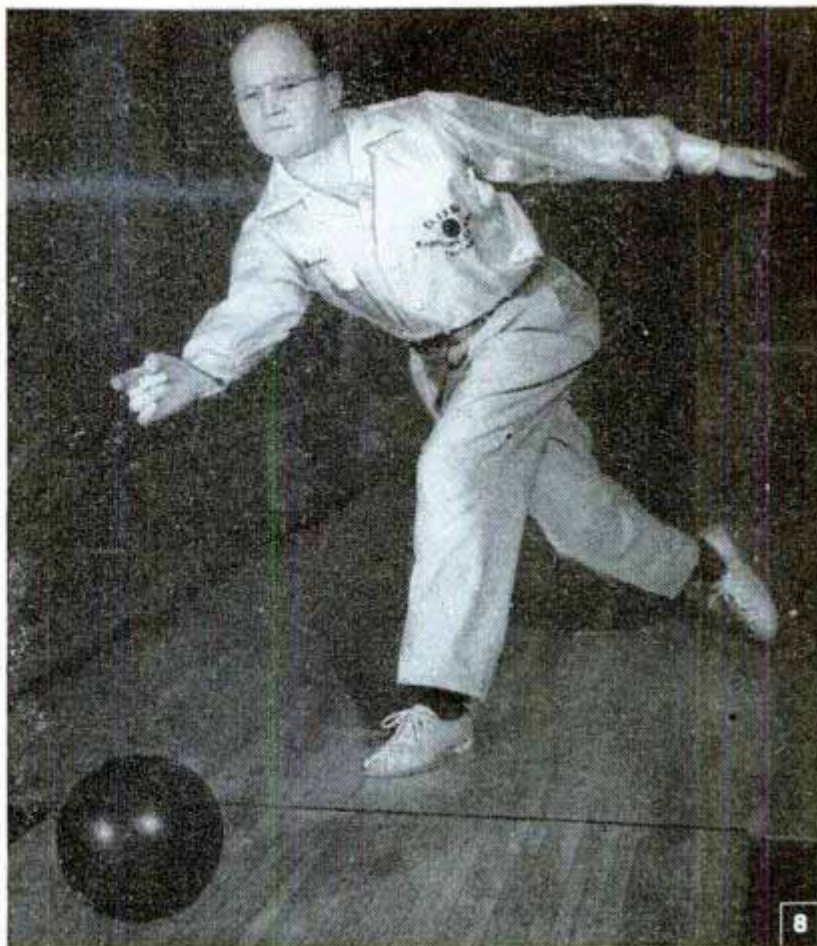

1. Shoes placed to show a four-step delivery

2. First half step, left hand is dropping away

3. Weight on right leg, ball straight down

4. Weight shifted to left leg on second step

5. Ball at top of backswing as third step ends

6. Entire weight on left leg, thumb out of ball

7. Perfect body balance in the follow-through

8. Note how left arm, right leg, aid balance

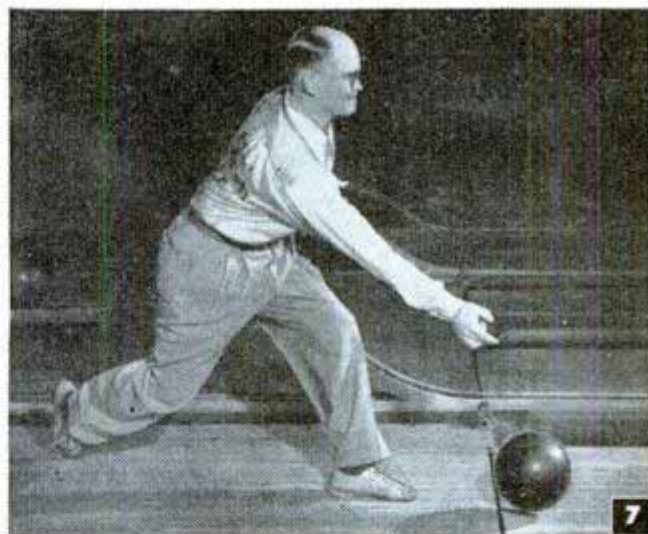

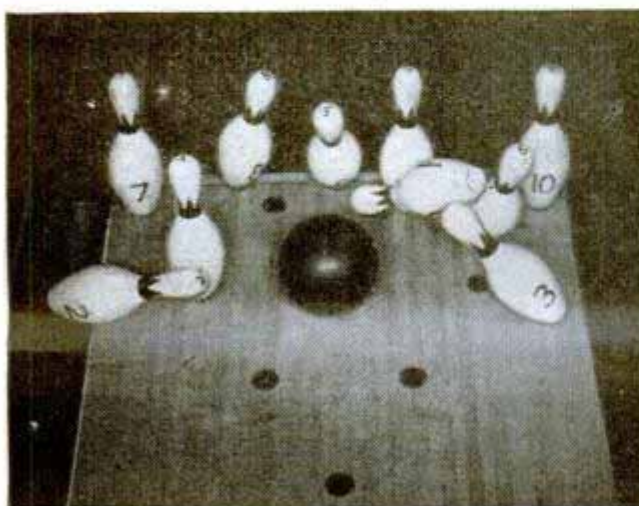
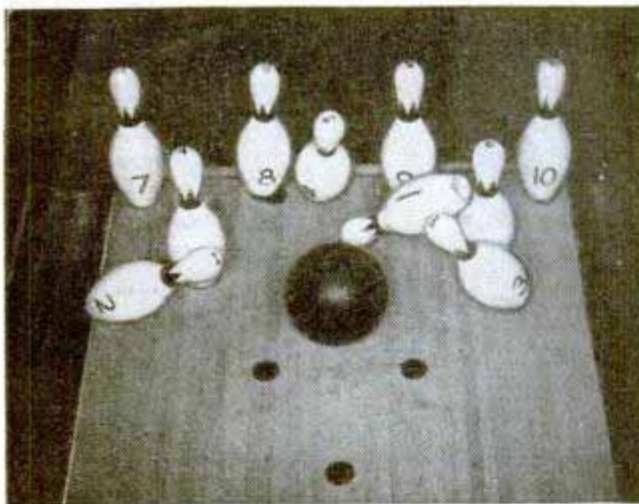
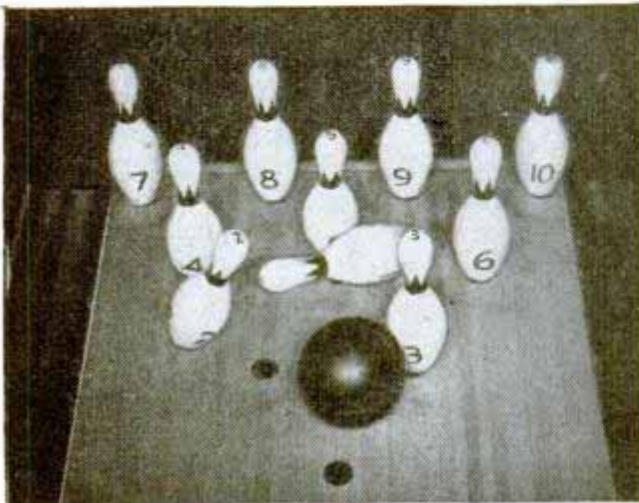
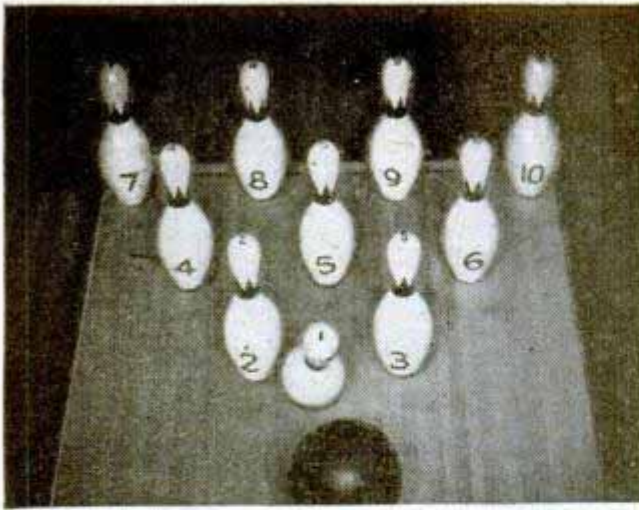

has become a pleasant business for 41-year-old Wilman, who devotes all of his time now to coaching, exhibitions and other appearances in behalf of the Brunswick-Balke-Collender Company, bowling-equipment manufacturers.

The bowling writers of the nation named Wilman "Bowler of the Year" after he compiled an amazing record during the 1945-46 season. To mention one accomplishment, he won the ABC all-events for the second time with 2054 for an average of 228.2.

Not all 200-game bowlers agree on grip and delivery, but a substantial majority of the stars use the two-finger in preference to the three-finger grip, and Wilman is a two-finger advocate. He holds the ball in his left hand until starting his delivery so that his working arm won't be tired. His advice applies, of course, to right-handed bowlers.

Again, some "hot" bowlers do a two-step or some fancy dance of their own to the foul line and still get results, but Wilman adheres to the four-step technique recommended for most bowlers. Taking his position 12 feet behind the foul line and holding the ball at waist level, he faces the pins squarely, feet together, slightly to the right of the alley's center, and lines up his right arm with the 3-pin.

He starts his delivery with a half step with his right foot, then a three-quarter step with the left. His third step covers the full distance for a normal walking step. The final step sends his left foot through a slightly longer stride, ending in a slide.

The first step begins a fraction of a second after Wilman reaches out with the ball to start his approach. As he takes the other steps, his right arm executes the back-

Flying pins at work. In sequence around border of these two pages are high-speed photos showing how ball and pins acted on hit that left the No. 7 pin standing. The No. 1 pin was hit too full to spill the No. 7. A glancing blow on the head pin's right side would have swept all 10 "sticks" off the lane

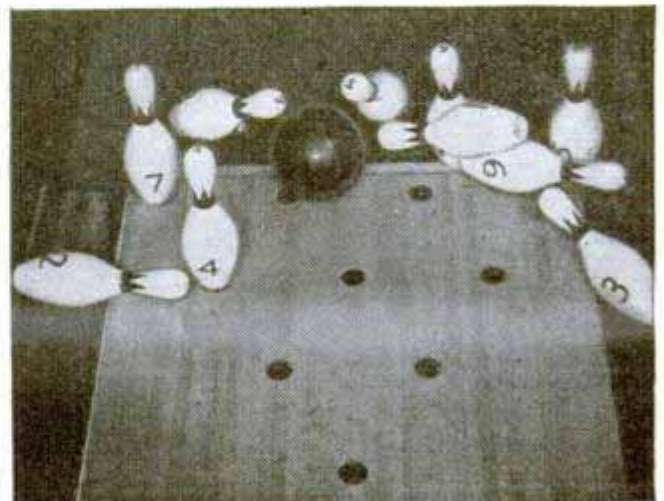

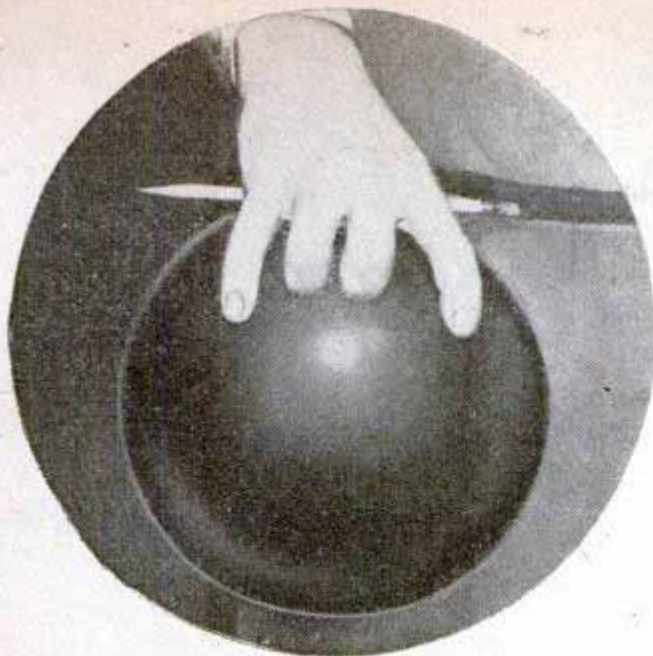

There should be only space enough for the thickness of a pencil between the bowler's palm and the ball

swing and forward swing in perfect coordination with his footwork.

Take it easy as you move to the foul line. Don't rush. Don't overdo your backswing in an attempt to throw a terrifically fast ball.

"And by the way," Wilman adds, "I should have said at the start that having your own properly fitted ball and shoes are fundamentals of good bowling. No par golfer ever wears street shoes on a course or uses different clubs every time he plays. Begin with the right equipment and use it constantly to gain control."

Watching Joe toss in one strike after another and studying his form, spectators are impressed by his pendulum swing. He keeps his right arm close to his body to prevent sidearming, which is the downfall of many bowlers.

Another reason for Wilman's prowess is that he approaches the foul line on a straight line. "Bowlers often fail to hit where they have aimed because they run

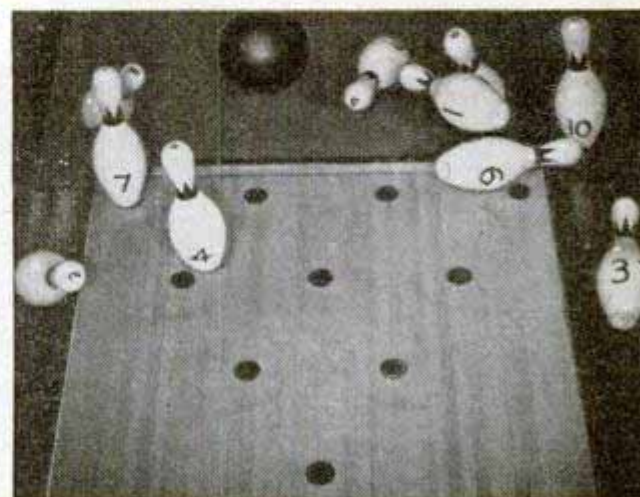
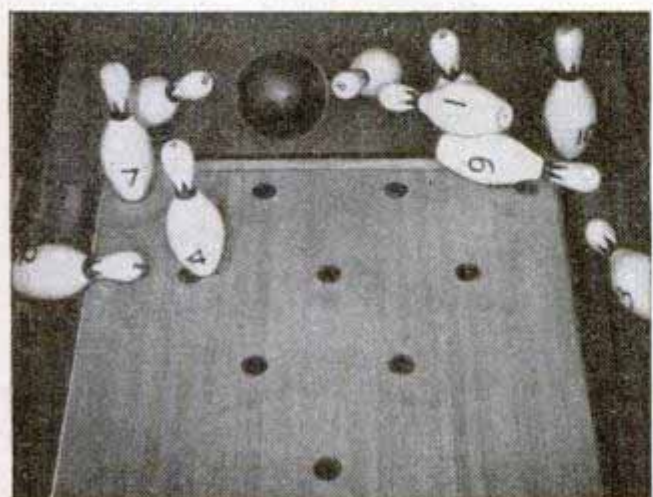
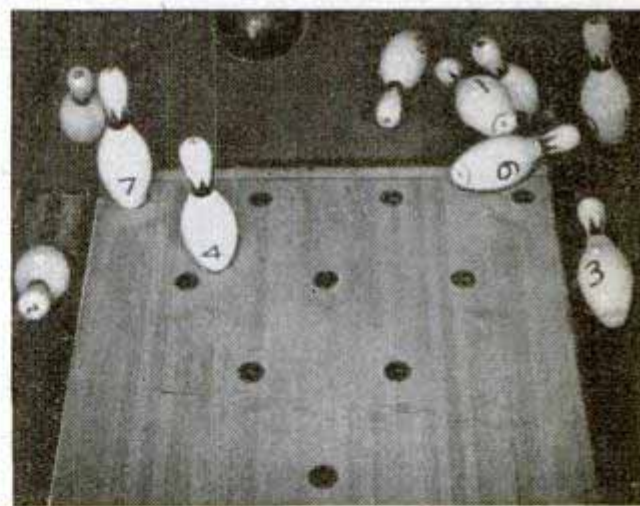
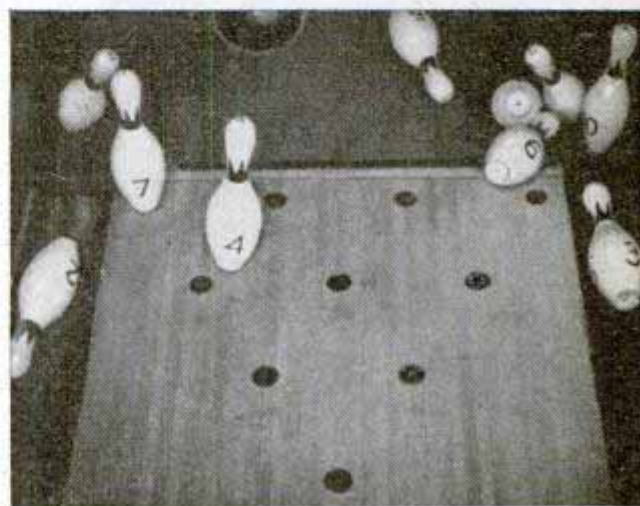
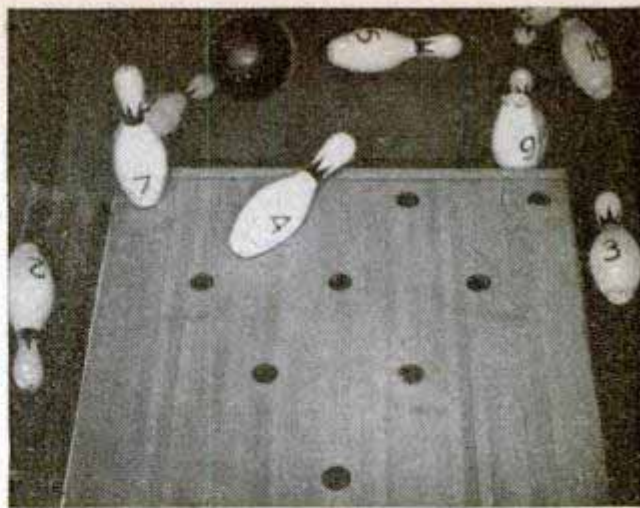



PICKING UP FIVE SPLITS

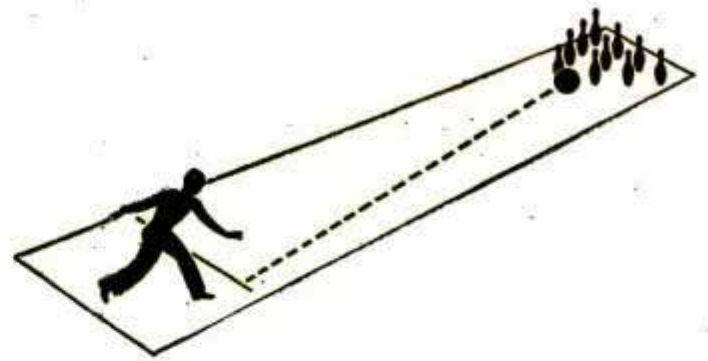
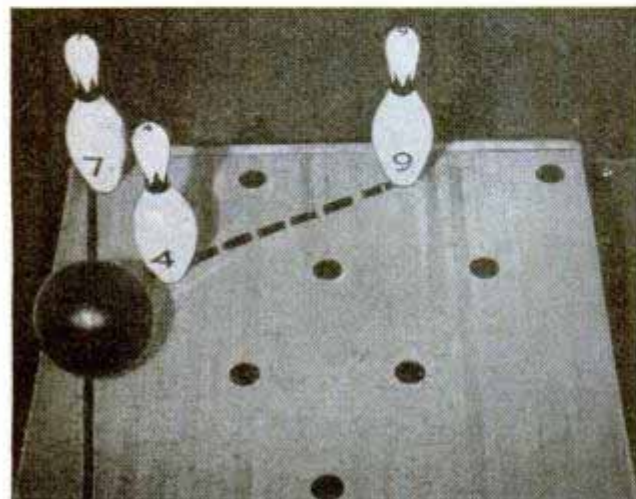
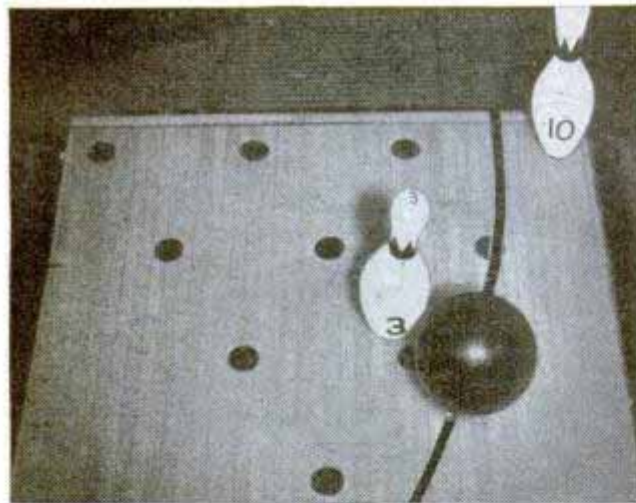
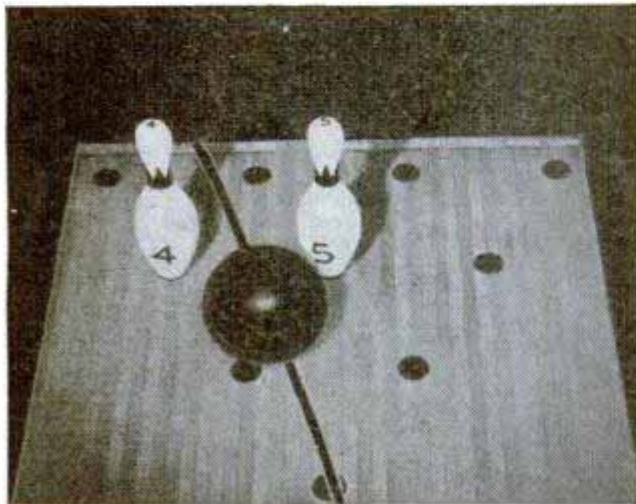

Path of a straight ball, which Wilman recommends for beginners until their delivery is easy and natural

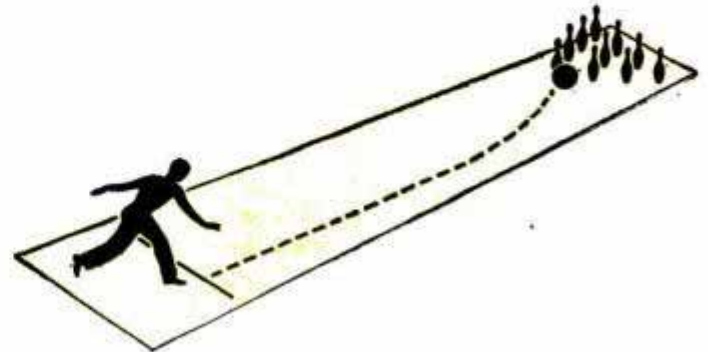

Most top bowlers throw a hook. It heads for No. 1 pin, then breaks sharply into the 1-3 strike pocket

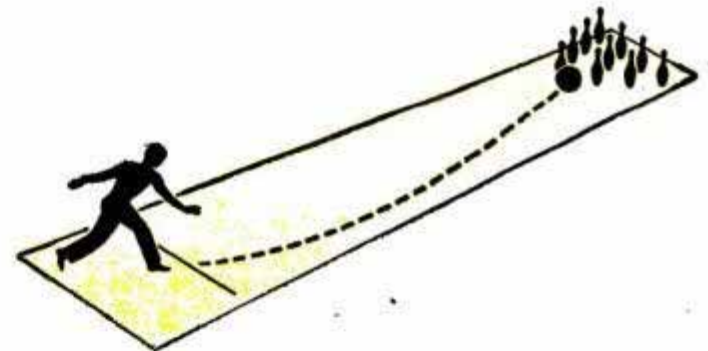

Though effective on highly polished alleys, a curve is hard to throw and not recommended for beginners

These photos show how Wilman picks up troublesome splits. Upper left, among the most common, the 5-7 leave is made by hitting No. 5 thin on right, sliding it over to topple the No. 7 pin. Good judgment is as important as control on shots like these

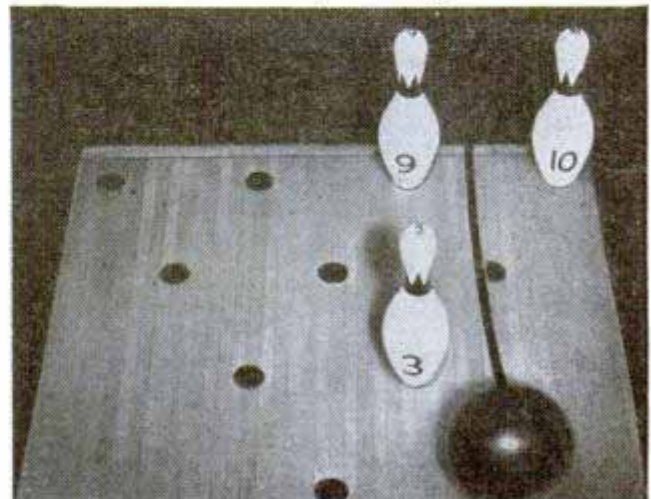

in zigzag fashion or at an angle," Wilman points out.

Most bowlers have one or more serious faults. Maybe they run too fast. Or they fail to move forward on a straight line. Wilman believes that any bowler averaging 180 or less can add a few pins to his score by spotting his major faults and practicing to overcome them.

"If a fellow corrects two faults," Wilman emphasizes, "he will automatically correct certain other troubles and bowl better."

Every suggestion made thus far by Wilman points the way to better control. And control is the first word that Joe mentions when he's asked: How does a bowler improve his spare shooting?

He must get better control of his feet, arms, swing and direction. A good spare bowler is a good bowler because if he can pick up the 10-pin regularly, he can hit the 1-3 pocket and get his share of strikes.

But there are two other factors that Wilman stresses in teaching bowlers to become more adept in picking up spares. They are (1) face the pin or pins (not the alley) squarely, and (2) learn to use plenty of angle.

To illustrate these two points, let's assume that the 10-pin (back row, extreme right side) stands up after the first ball is thrown. The best way to shoot for the 10-pin is to stand at the extreme left side of the alley and face the 10-pin squarely. This provides plenty of angle. The approach is on a straight line toward the pin.

Bowlers who skid the ball along the right edge of the alley to pick up the 10-pin are doing it the hard way. It's very easy for the ball to roll into the gutter or hook to the left, missing the pin in either case.

When shooting for a pin or pins on the

(Continued to page 268)

When shooting for spares, Wilman says, roll the same ball you do for strikes and angle it as much as you can. For spares on the left, move over to the right of the approach, but always come up to the foul line in a straight path from where you address the pins

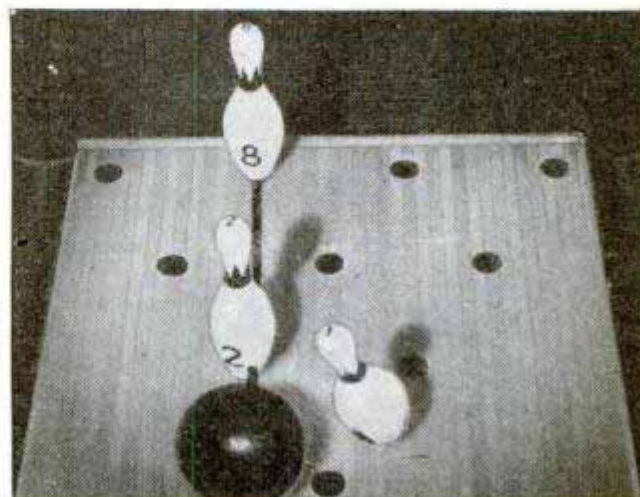
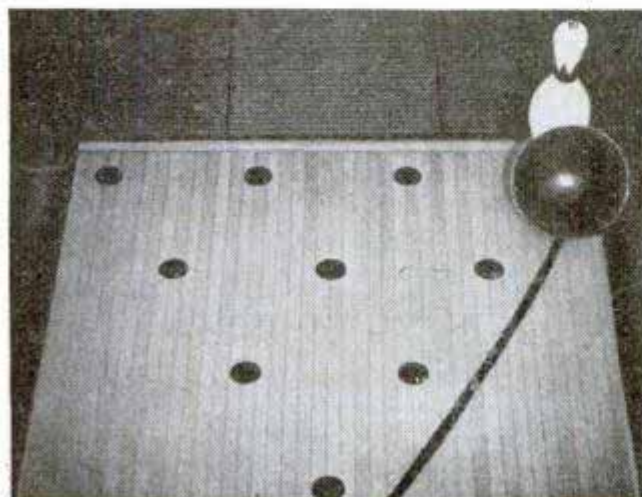
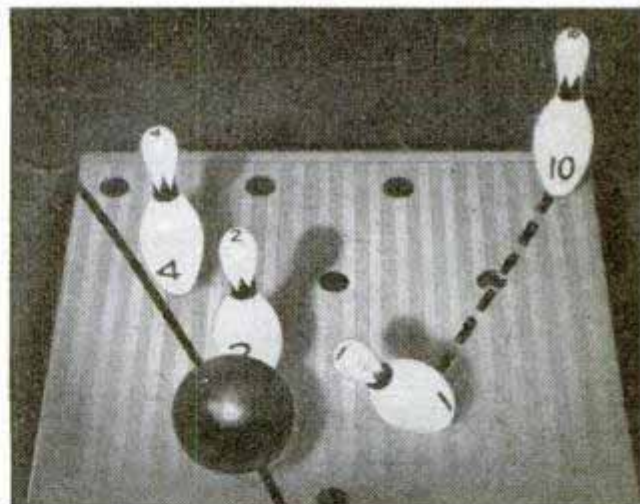
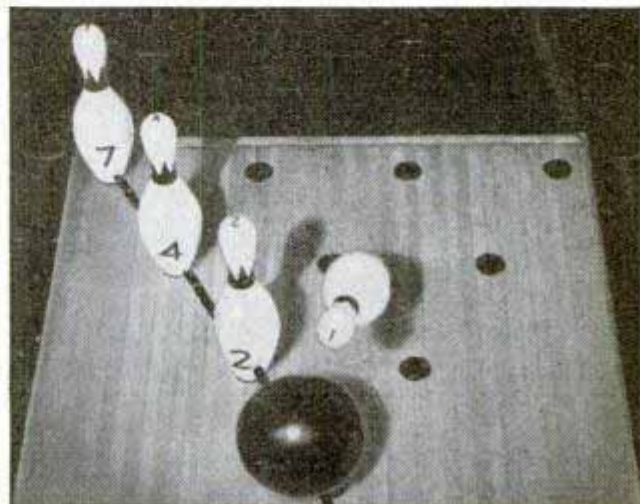
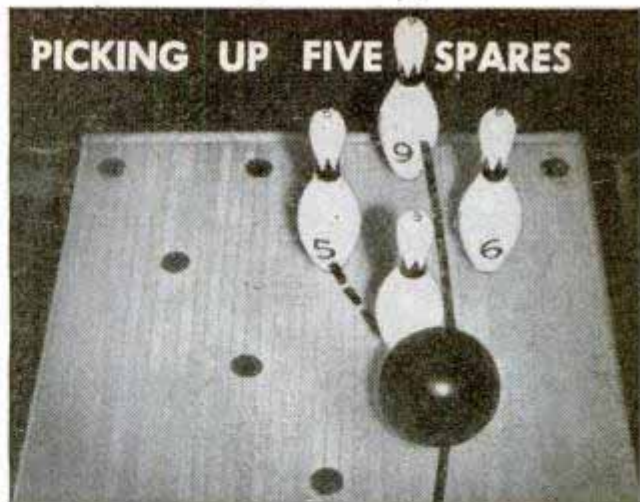



Down Marker for Night Football

Four colored lights above the linesman's marker help night football fans follow the position of the ball and number of downs. Push buttons change the color of the signal at the top of the seven-foot standard. Green light indicates first down; amber light, second down; white light, third down; red light, fourth down. Devised by Paul Rickabaugh, former Nebraska star, it is powered by two flashlight batteries.

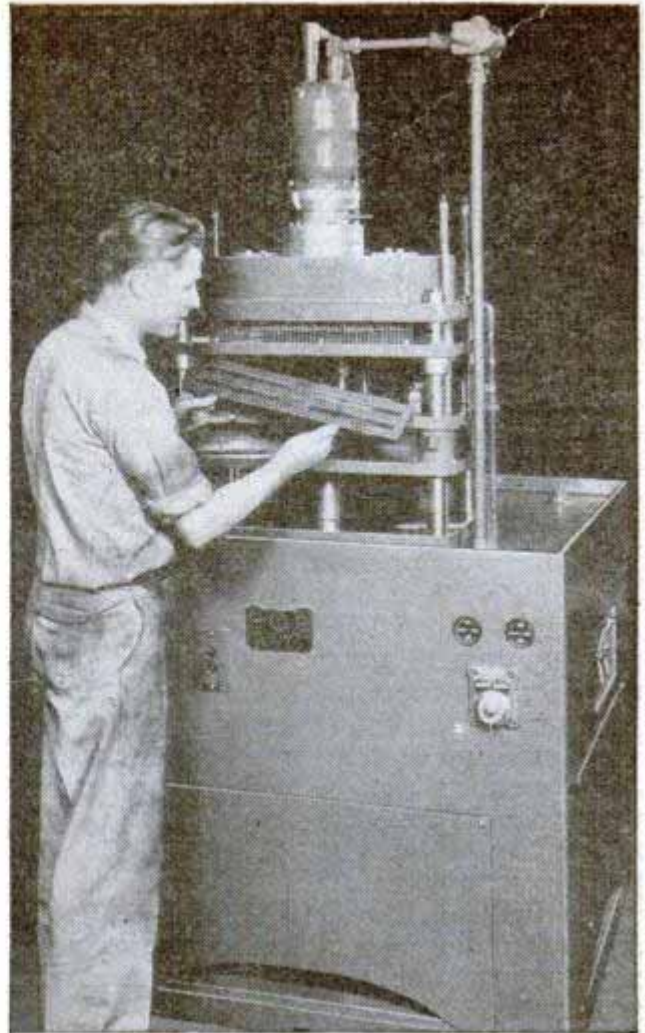

Drilling 385 Holes at Once

With a newly developed gearless hydraulic drilling unit, 385 holes can be drilled simultaneously in a gas burner. The entire drilling cycle is controlled by one operating lever. A hydraulic pumping system in the base operates the motor which runs the drill head, as well as the ram which brings the casting up to the drill head. New drills can be installed with pliers.



Floating Cafeteria

By drinking water and fluid nourishment through a tube, five-year-old Sandra Rhodes received the necessary strength to complete a one-mile endurance swim for which she trained for three months, in Lake Mead, Nev. Her coach, Louis Carter, himself a distance swimmer, accompanied the little girl on a float.

Names and addresses of manufacturers of new products featured in this issue will be supplied promptly by the Bureau of Information, Popular Mechanics, 200 East Ontario Street, Chicago 11

Mapping Planes Fly Aerial "Chalk Line"

You can almost fly a "chalk line" 125 miles long with a precision flight indicator developed by the AAF for aerial surveys. Perfected models will limit the straight-line deviation to less than 100 feet, compared with best previous averages of more than 1500 feet. It operates in combination with shoran, used during the war to pin-point bomb targets through fog or darkness by triangulation. On mapping missions, high-frequency radio waves travel from the plane to two ground shoran stations, which retransmit the signal back to the aircraft. On the basis of the time required for the radio-wave round trip, distances to each ground station are automatically calculated to a thousandth of a mile. The indicator mechanically simulates, in miniature, the flight path. A pointer moving along a grooved metal channel duplicates the plane's progress and direction, while threaded rods, calibrated to scale, show actual distances from the plane to the ground stations. When the aircraft drifts off course the pointer pulls away from center on the simulated flight path and an instrument-board needle swings right or left. Experiments are now in progress at Wright Field, Dayton, Ohio,

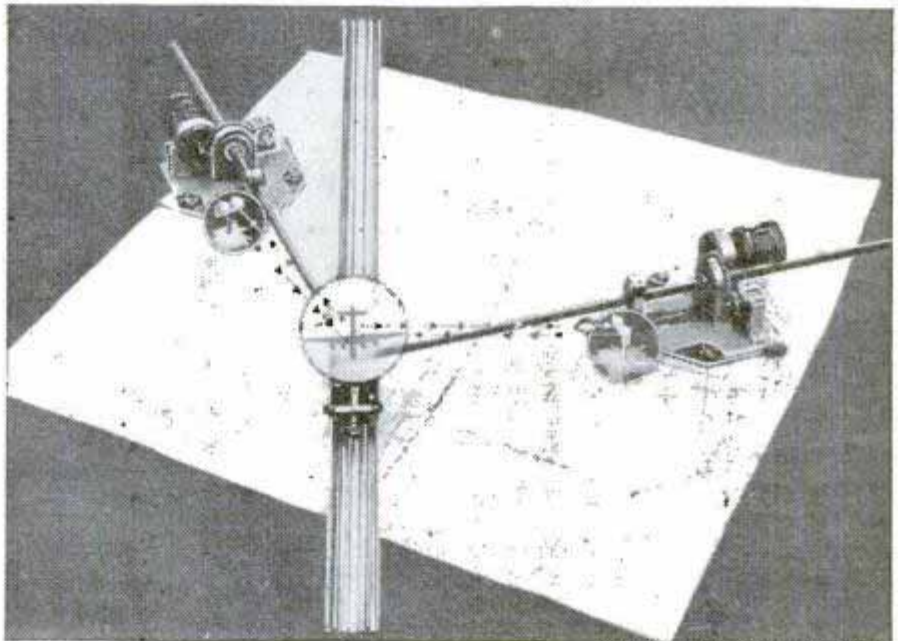
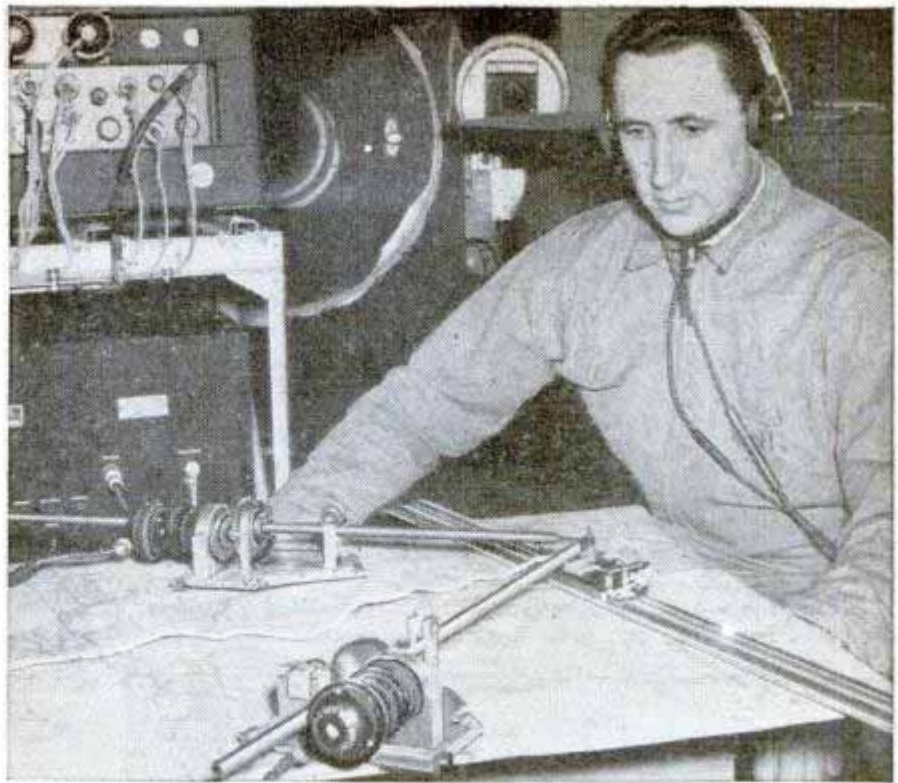

Air Materiel Command photos

to connect the indicator to the automatic pilot so the plane can be held to its predetermined mapping line without attention from the pilot.

Scoop-Scale for Cattle Feed

Feed for cows is weighed in a combination scoop-scale that holds over four pounds. It will give accurate weight when held within 15 degrees of level. The scoop has a large maple handle, weighs 1½ pounds, and is rustproof.

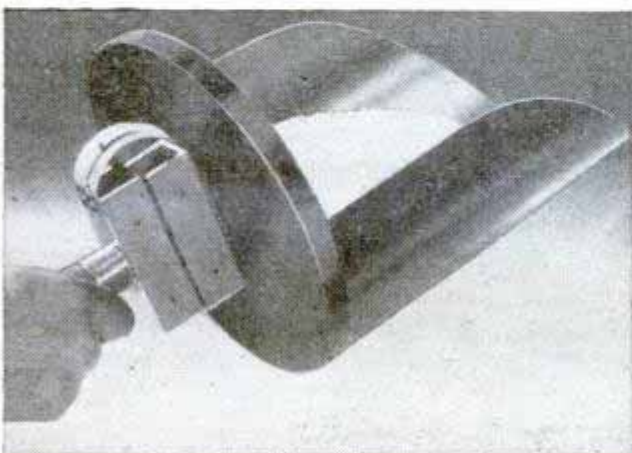

¶ Of the 5,726,000 trucks registered in the United States during 1946, California led the other states with 431,419; Texas ranked second with 369,409 trucks registered, and New York was third with 362,993.

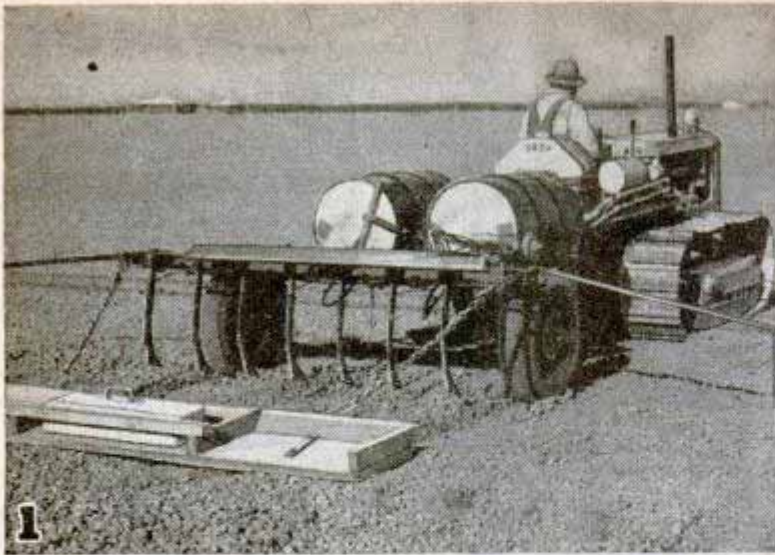

1

Photos by Cy LaTour and Son
 1.—Soil is fumigated before lima beans are planted. Liquid is forced down tubes into soil. 2.—Loading a mechanical seeder

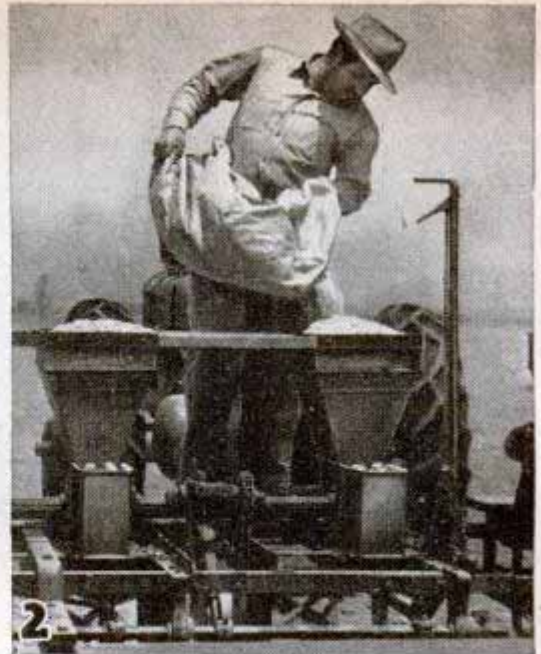

2



3

3.—Mile-long rows of lima beans being planted by tractor-drawn seeders. On large farms, planting takes 21 days

4.—Thresher moves along rows harvesting bean crop. After being separated from pods, the beans are sacked in 100-pound bags and lowered to the ground on a chute. Rotary cart behind thresher gathers chaff and dumps it at intervals. Later, chaff is plowed into the soil as fertilizer

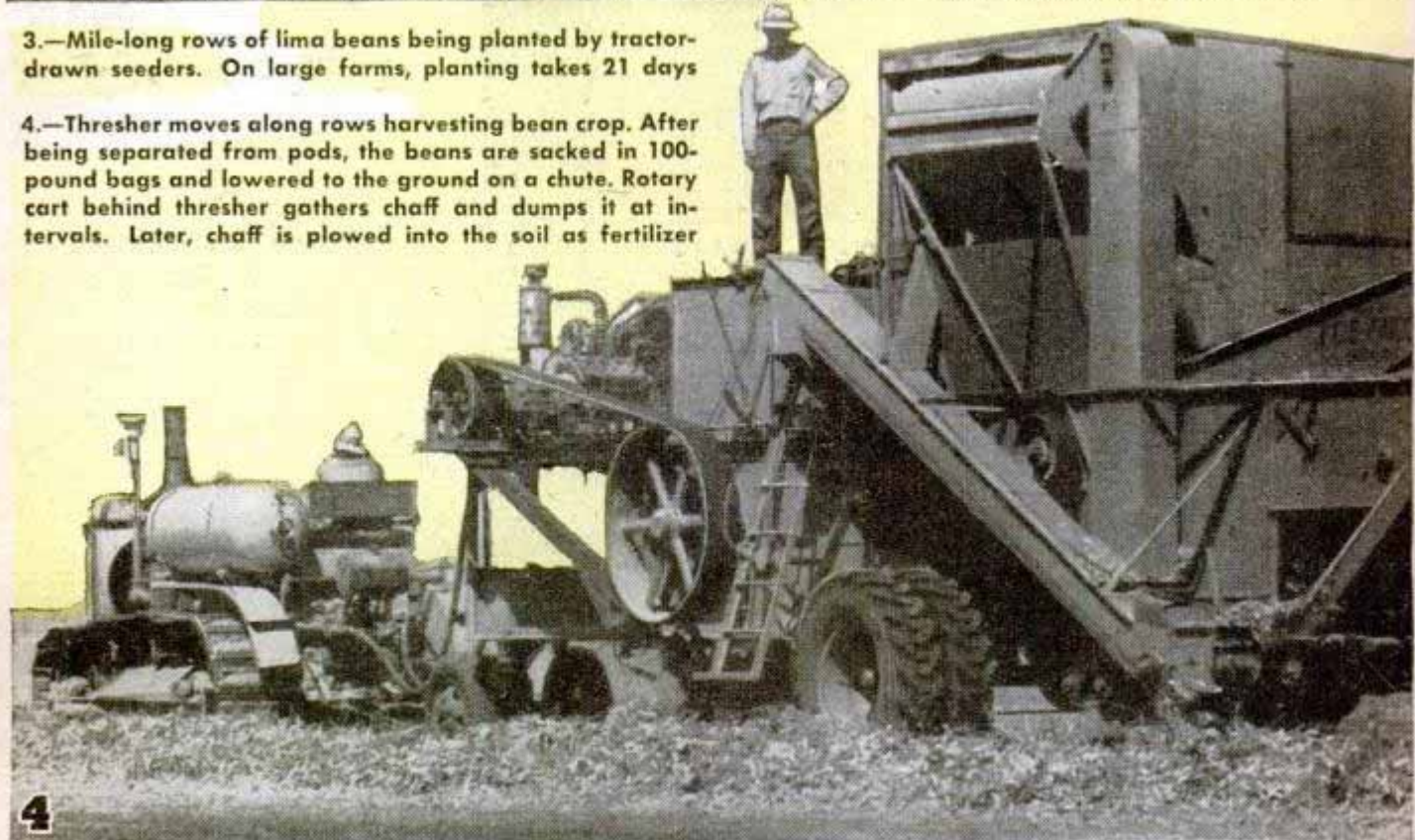

4

BEANS BY THE MILE

HAND-PICKING crops on the mammoth lima-bean farms of California is out of the question. Some rows are more than a mile long. Located on a narrow coastal strip between San Diego and Santa Barbara, lima-bean farms have gone mechanical.

The annual yield is valued at more than \$15,000,000. Lima beans

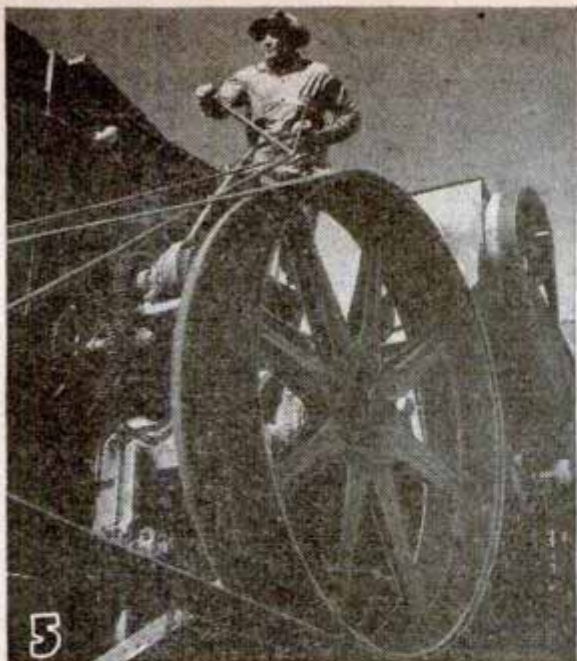

grow best in soil with a high moisture content. Morning fog along the west coast provides the moisture, but also makes harvesting a problem.

Mechanical pickers require dry bean pods. When pods are damp, they're pliable and can't be shucked by machine. So, harvesting starts late in the morning, after the sun has dried the pods, and continues long after dark.

Planting is done in April and harvesting begins in September. Thirty days later, the crop is on its way to the nation's dinner tables.

But beans are not the only useful product. The vines make excellent cattle feed and the chaff is used as fertilizer.

5.—Thresher operator sits atop machine. Large wheel is clutch. 6.—Threshed vines are baled for use as stock feed



7.—Worker inspects beans on conveyor belt in warehouse. 8.—Threshing crew member removes sack from filler rack of moving thresher as work continues in the dark. Harvesting crews work long hours when pods are ready to pick



INDOOR INDICATOR SHOWS WIND CONDITIONS

Wind speed in miles per hour and direction of the flow in degrees of the compass are shown on an indicator for the home or office. The instrument can be used at small airports, yacht clubs or flying schools. The detecting apparatus is a combination wind vane and propeller-type anemometer that is mounted on a stand outdoors in the unobstructed flow of the wind. It transmits wind speed and direction electrically to the indoor indicator, which is about the size of a small table radio. The unit can be plugged into any standard 115-volt a.c. outlet.

Travelers in 1870 could ride all the way from New York to St. Louis on six-foot-gauge railway track, the present standard gauge of 4 feet 8½ inches being adopted by most railroads by 1887.

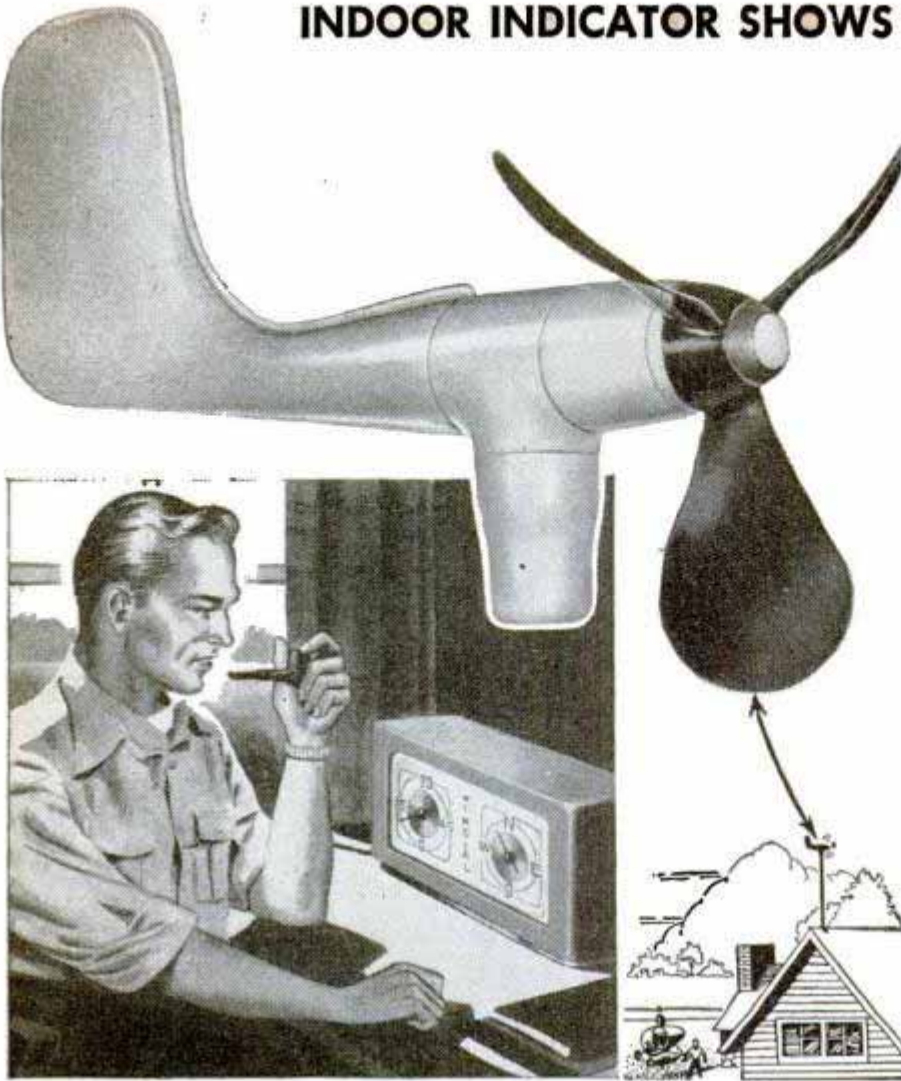

Rotary Planer Has 100 Teeth

With more than 100 saw-steel cutting teeth, a new rotary planer planes hundreds of feet of wood or plastic without adjustment or noticeable wear. When the cutting edge does wear down, the inexpensive blade can be replaced in two minutes without special tools. The aluminum head is fitted with an 8⅝-inch length of ⅝-inch bandsaw blade.

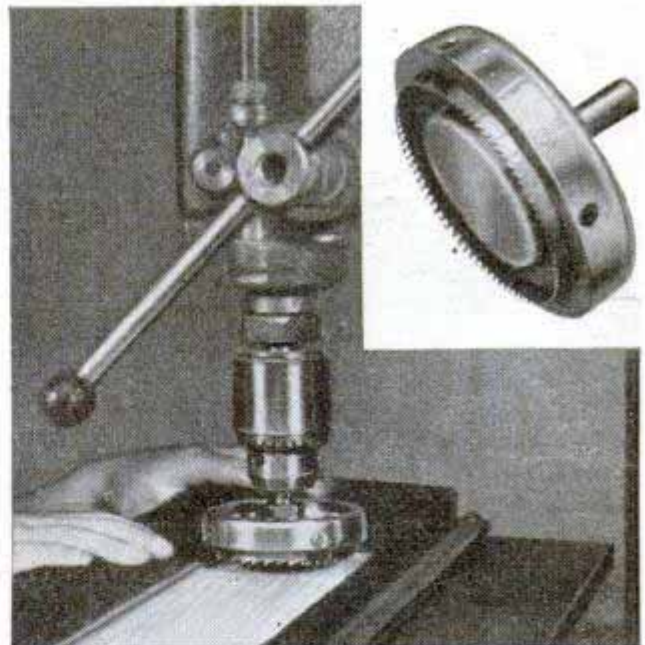
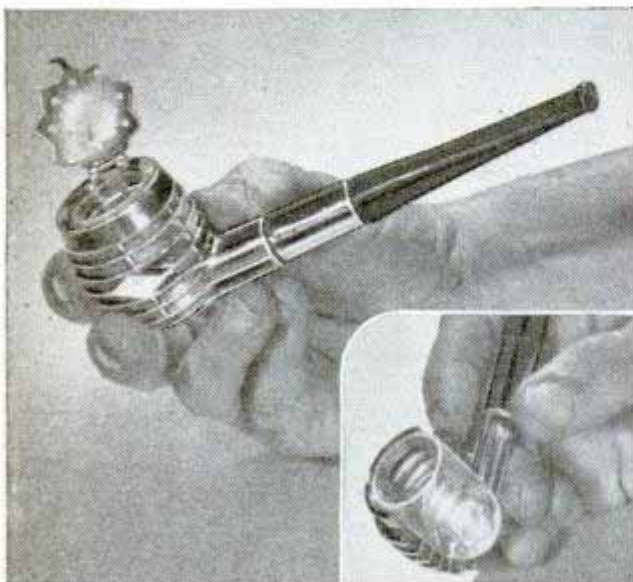

Pipe Has Bowl Made of Quartz

Quartz is used for the bowl of a new pipe to provide a cool, clean smoke. On the outside of the transparent bowl are aluminum ventilating fins which remain cool and make it easy to hold the pipe. A cap fits on top of the bowl to prevent hot ashes from flying out.

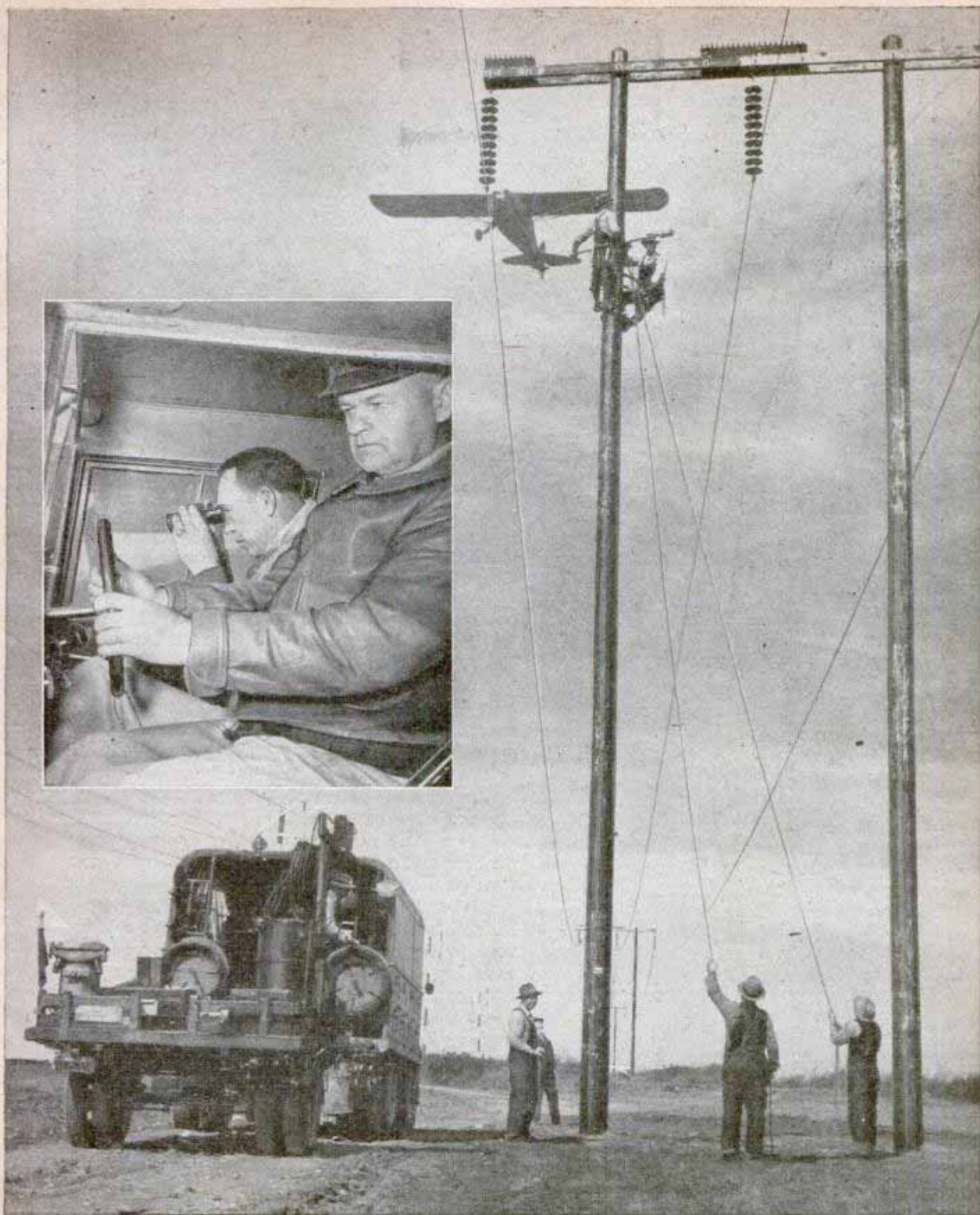

Plane carrying power-line inspector flies close to wires. Observer (inset) uses binoculars to check the line

By Howard E. Jackson

FLYING Trouble Spotters

THE AIRPLANE has replaced the horse for power-line patrol, but it has created a dangerous job for pilot and observer.

During the wartime ban on flying it took eight days to inspect the high-tension lines of the San Diego Gas and Electric Com-

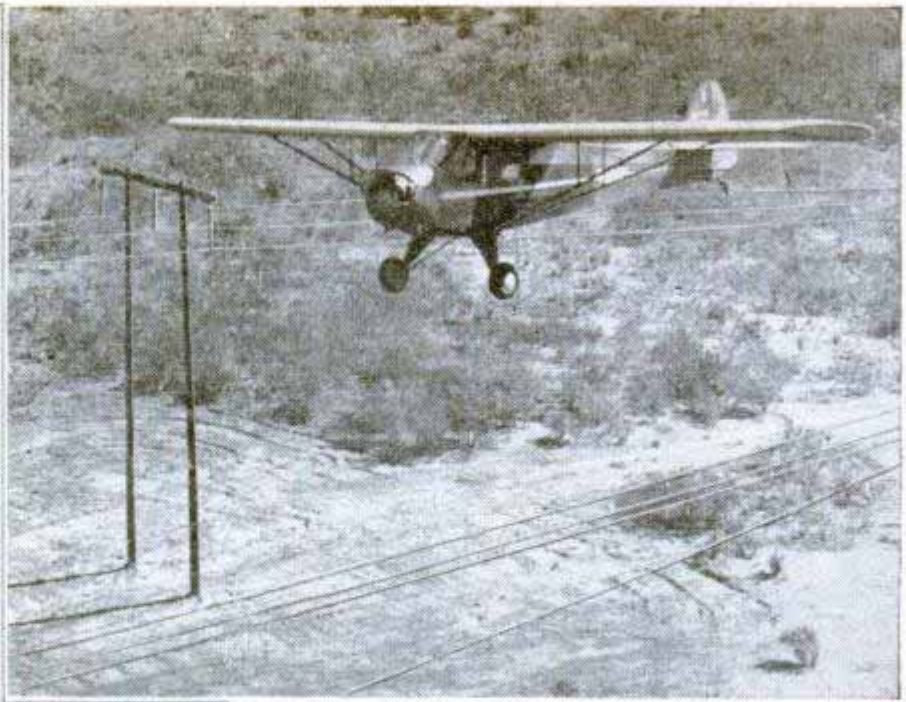
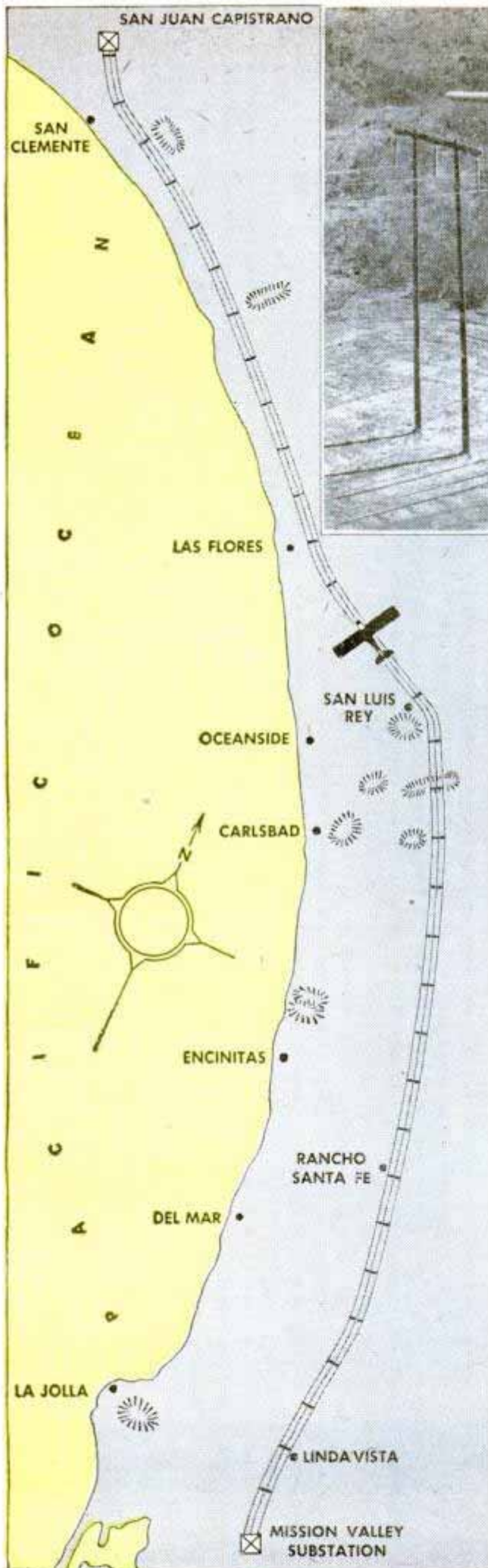

It takes only two hours for the light plane to fly from Mission Valley substation to San Juan Capistrano and back. On horseback, the trip required eight days. Each side of the poles is viewed during the air trip

pany on horseback. Now it takes two hours to fly the same route—from San Diego to San Juan Capistrano, and back.

Every two weeks Arnold H. Peik, pilot, and Walt Stone, inspector for the company, fly this 130-mile round trip. It's Stone's responsibility to note any damage to the lines as they skim alongside at 70 miles an hour.

There are 450 two-pole structures to check, one every 750 feet. By keeping count of the number of poles from points or turns the inspector can mark the location of damaged poles on the map.

Close inspection means constant vigilance on the part of the pilot. Flying a few feet to the right or left of these wires, or crossing over them, is dangerous even for a veteran flyer. If a side gust, or downdraft, blew the plane onto the wires it might mean electrocution for the two men.

During more than 50 flights the "T" craft has never so much as burnt a wing tip, but hot wires are not the only hazards which are encountered. The country is rugged; flight altitudes seldom exceed 300 feet. Should the motor conk, the plane would quickly crash land in a tree or rock-strewn gully. Even though the landing speed is relatively slow, the pilot and observer could be severely injured.

One time the carburetor froze up, the engine started to sputter. Peik gunned it, desperately. The engine caught just as the wheels were skimming the tree tops.

There's plenty of wind and rain, resulting in rough rides, but only once was the plane forced back because of fog and stormy weather.

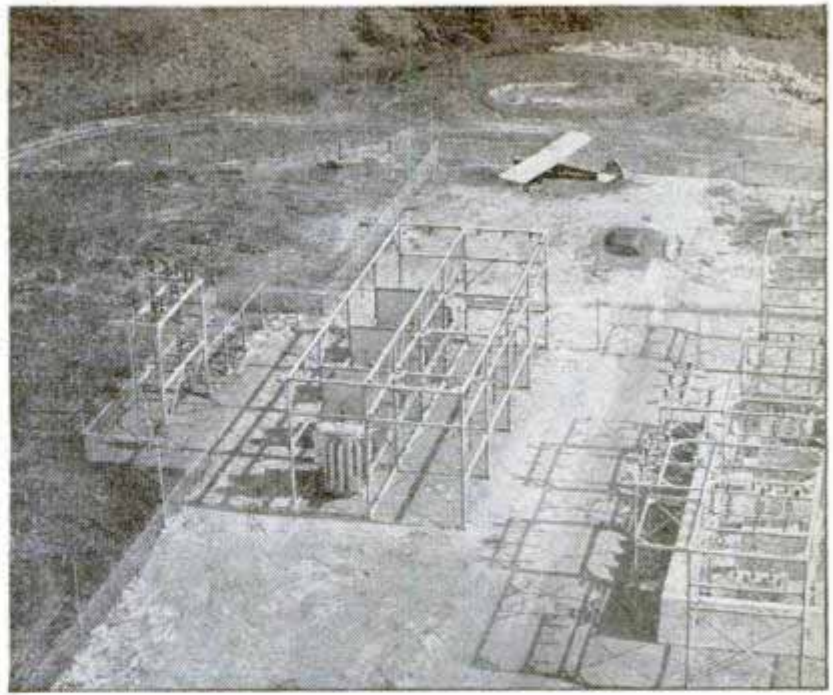

"Paul Revere" of power line is supplanted by inspection plane starting from station near San Diego, Calif.

Civil Aeronautics Authority issues a special permit for this plane to fly at such low altitudes, and the day before each flight the pilot must obtain clearance to fly over Camp Pendleton. Once the plane was almost blown to pieces when a shell exploded beneath it on the ground. The concussion pushed the plane upward, bent the wings violently but did not break them.

Despite the fact that the plane made special periodic flights over the camp during the war, no GI ever took a hasty pot-shot at it. But once a shepherd did. He thought the pilot was trying to frighten the sheep. So he let loose with his double-barrel and filled the fuselage full of holes. The boys at the airport counted 27 of them!

Despite all the hazards, neither pilot nor observer has ever been hurt. Only once did they inadvertently do anything to annoy the people who live near the right-of-way. They were unaware of this until after the lady of the house had sent in a complaint. It seems they flew so close to her home that the bees, which were lodged in her old chimney, got so excited they

swarmed into the house and stung her. Now the trouble spotters fly on the other side of the line.

As soon as the plane returns to the airport the inspector reports all damage and ground crews are directed to the trouble spots by two-way radio from headquarters. Ground crews often run across rattlesnakes and other wildlife on their trips into the back country to straighten up poles or clear out underbrush.

The company has 10 trucks and trouble cars equipped for radio reception. Once, during an emergency, a dispatcher located two trucks, both with two-way radios, and directed them to opposite sides of a deep ravine which was flooded. They were to save the two key poles. The trucks, in turn, communicated with each other across the canyon by radio and saved the long span of line that stretched between them.

After damage has been repaired, word is sent back to the company's own broadcasting station, KROA, in the main service building, and electricity once more flows through the lines.

Taylorcraft taking off for power-line patrol is identified by "Elect. Insp.," marked on underside of wing





Navy Tests Frozen-Food Container

Frozen foods may be part of the everyday Navy diet if experiments with a new container are successful. Climate has been the big barrier to the use of frozen foods by the Navy. Foods that stood even a few minutes in tropical climates would spoil. Designed by a former supply officer, the new container is a canvas-covered, cork-lined bag that holds 200 pounds of food. Before the bag is filled it is precooled for two days in a refrigerator at 10 degrees below zero. After the food is packed inside, the bag is sealed in a cold-storage plant at below-zero temperature. The bag's inside temperature is not expected to rise more than one degree an hour when removed from cold storage and transferred from one ship to another. The Navy hopes to develop a cheap container that can be discarded after use.

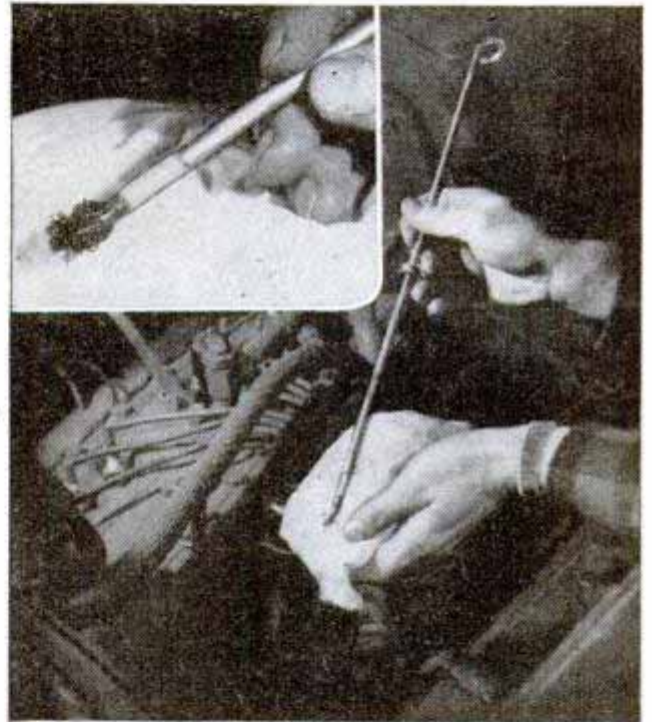

Magnetized Oil Dipstick →

Metal engine particles which chip off into the oil stream are picked up by a magnetized dipstick that will measure the oil level. When the stick is removed and wiped off, the particles adhering to the magnetized end are also wiped off. Magnetic dipsticks have been designed for use in autos, trucks and planes. The stick has a knurled place at top and bottom to indicate full level and low level of oil. The tip is painted red.

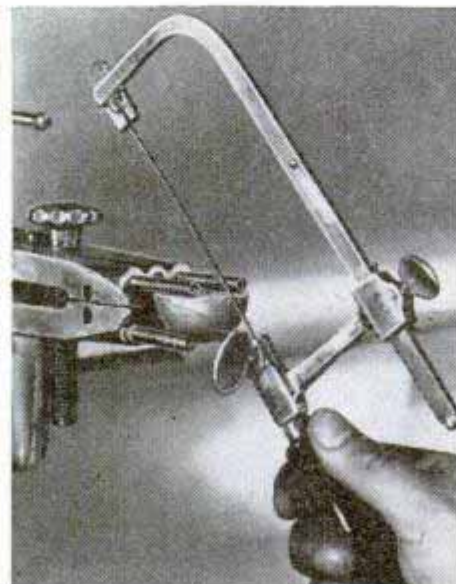
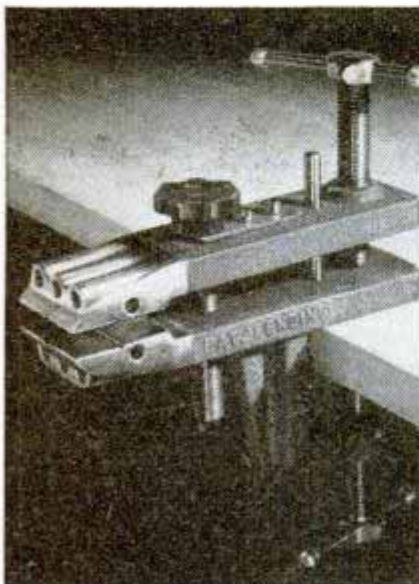

Vise With Fingers Holds Odd Shapes

Balls, disks or irregular-shaped objects are held firmly by a vise equipped with steel extension fingers. Made of solid bronze, the vise has holes drilled in three sides for the steel fingers. The rear clamp screw adjusts the angle of the jaws, while the front adjustment knob controls their relative position. The fingers permit a wide range of adjustment.

X-Raying Oil Fields

By X-raying sand removed from oil-well drill holes, petroleum engineers forecast how much oil, gas and water will flow through rock strata deep underground. In this method, developed by Gulf Oil Corporation, movement of oil, gas and water forced through sand samples is studied with an X-ray machine.

Rock sample is placed in X-ray machine. Inset, rock cast in Bakelite for test

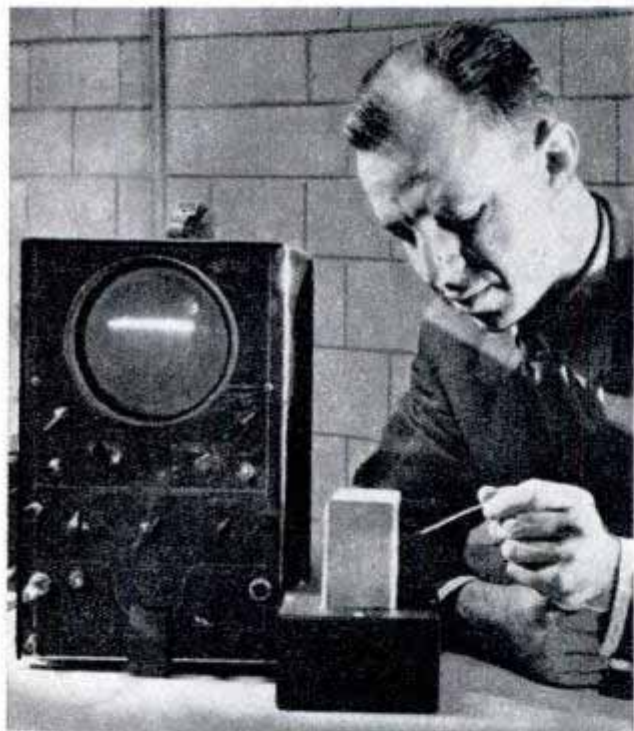

Atomic-Ray Counter

Radiations from exploding atoms are counted accurately at a rate of 100,000 a second by a detector that records any kind of rays or particles thrown off by radioactive atoms. Still in the experimental stage, the detector was developed by Westinghouse scientists. It is 50 times more effective than the Geiger counter which "chokes up" after an intensity of about 2000 radiations a second has been reached. Geiger counters also need separate attachments for the detection of different kinds of rays while the new instrument picks up all radiations. When a piece of wire tipped with radioactive material is held a few inches from the detector, particles from the exploding atoms penetrate a box and produce an electric current which is amplified 1,000,000 times. This current is transmitted to the fluorescent screen of an electronic oscilloscope where the exploding atoms appear as flashing peaks of light.

Tiny Diesel Engine Drives Toy Car

Miniature toy automobiles with real Diesel engines are being built by a German engineer for the export trade. The little cars, modeled after the modern European automobile styles, are less than a foot long. The Diesel engine is about the size of a cigarette package.

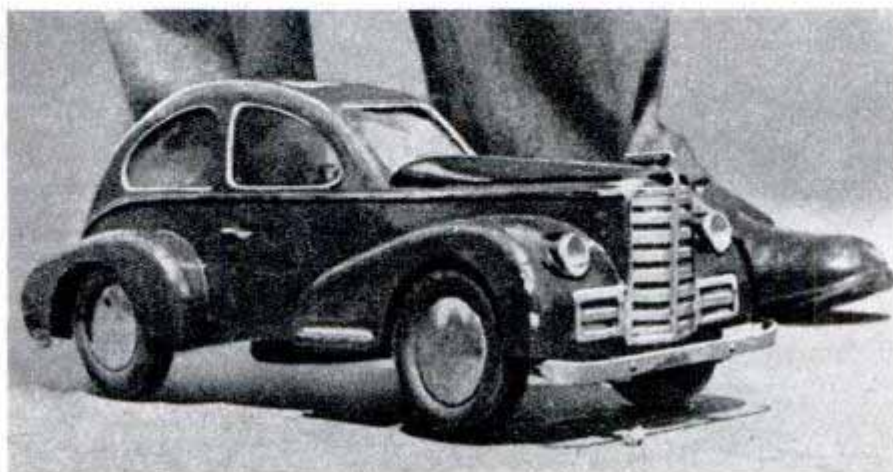

SALT-WATER RAILROAD



Steel framework at Edgewater, N. J., terminal supports two 125-ton cranes which load freight cars into seatrains

FREIGHT TRAINS a mile long, loaded on special ships in five hours, are floating 14,000 tons of cargo a week between New York and New Orleans. This seatrain service was recently resumed after a five-year interruption caused by the war.

The seatrains are loaded by pushing

each freight car onto a special cradle with a Diesel locomotive on the pier. The cradle, a portable section of track and roadbed, is lifted by a 125-ton crane and deposited in an open section of the ship. The cradle is placed at a track level and the car is towed into position by a cable operated from a steam winch. The last car on each of the 16 tracks—four on each of four decks—with its cradle completes the length of track and eliminates waste space. The cradles placed on the top deck are weathertight, protecting the lower decks.

Four rail clamps for each car prevent them from rolling, and chains and turnbuckles draw the cars to powerful jacks, which prevent sideways in heavy seas.

Shipment of cargo in cars by water compares with straight rail in speed. Handling and damage to cargo are reduced to a minimum. Both New Orleans and Texas City were originally serviced, but the facilities at the latter were destroyed in the April disaster and currently all four ships are using the Louisiana port. New Orleans to Havana shipments by a fifth seatrain are scheduled to be resumed.

The seatrains are 480 feet long, with a 63-foot beam. They carry 100 freight cars, a net cargo of 4000 tons and a gross load of 6000 tons including the 100 cars. They cruise at 16½ knots.

View at open section shows three lower decks on which freight cars are loaded. Below decks, cars are moved by means of a special steam-driven gear

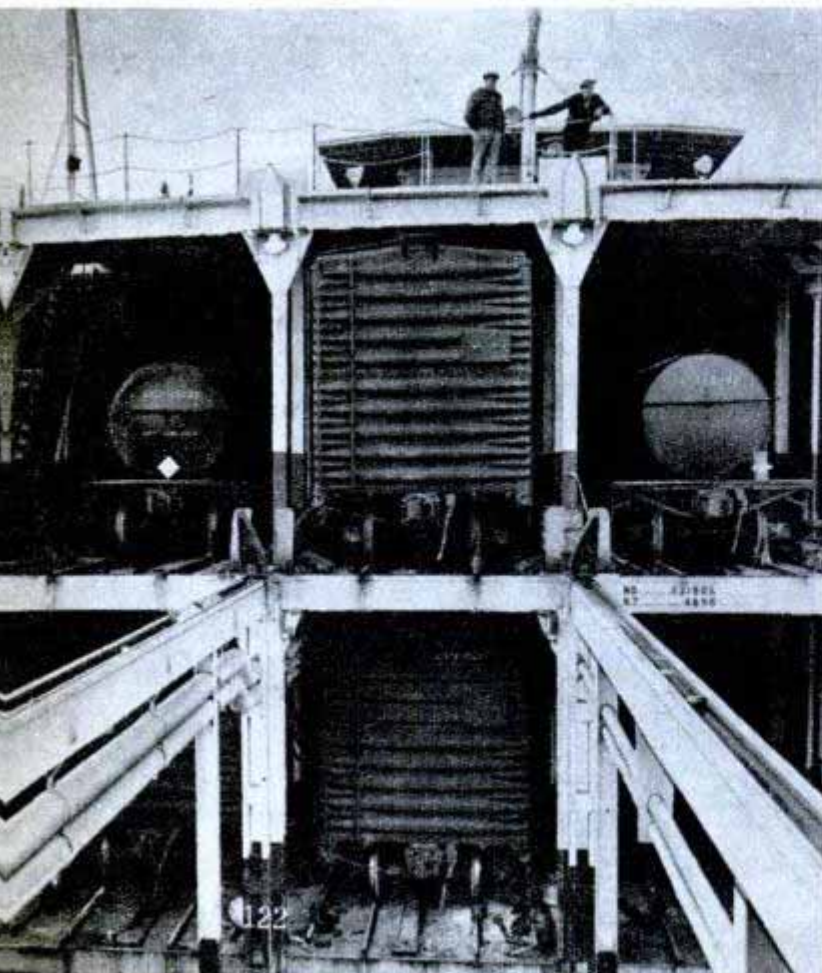

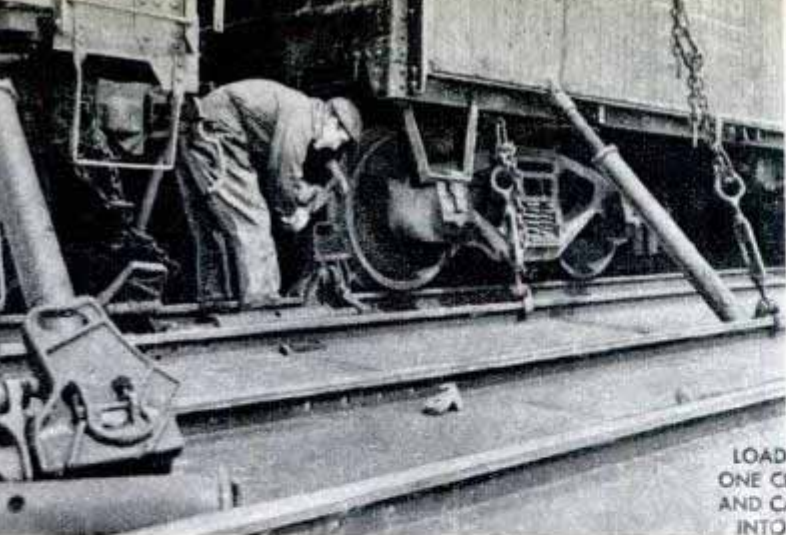

As soon as a car is placed in its assigned position, the wheels are locked by four rail clamps to prevent it from rolling along tracks

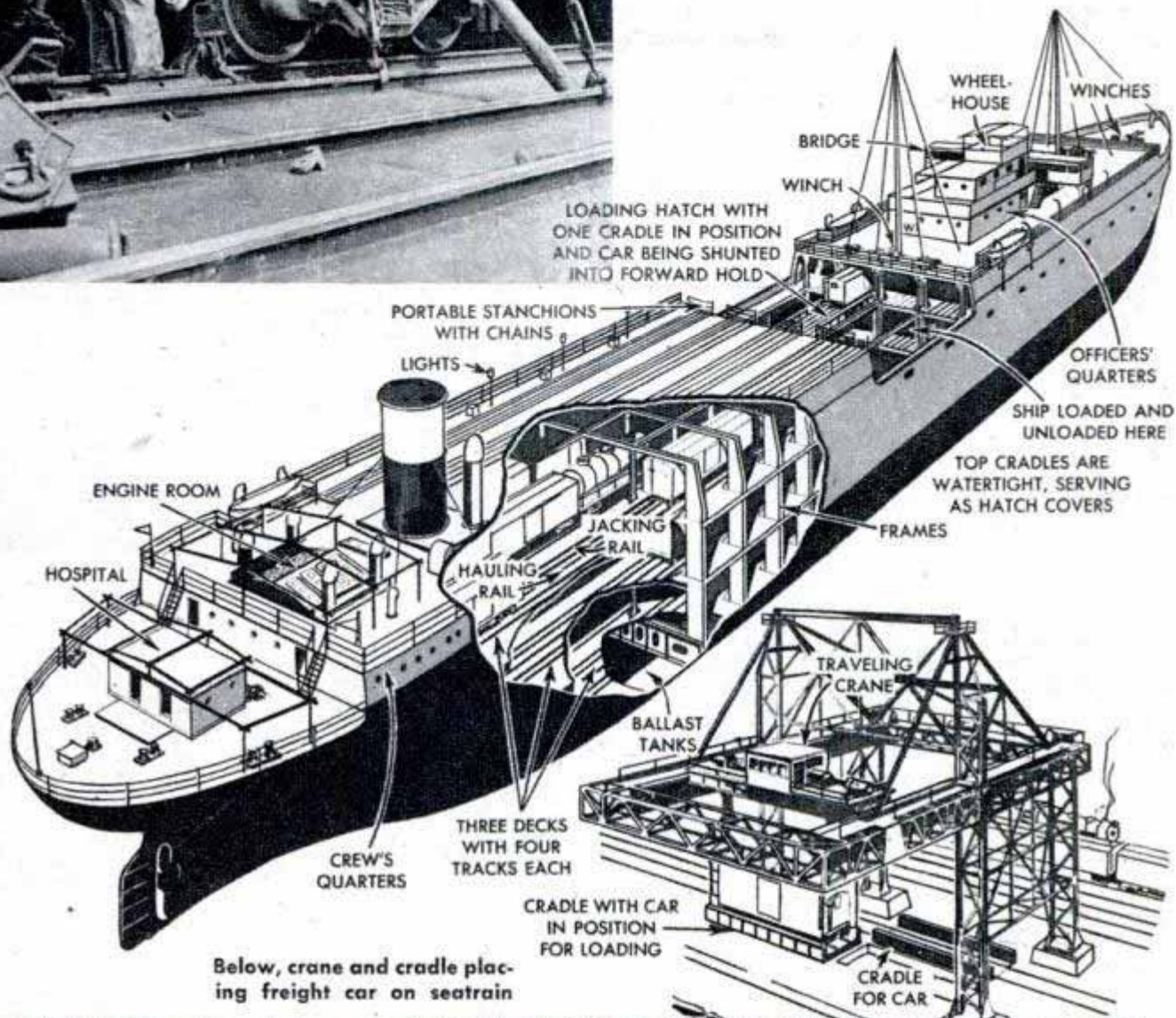

Below, crane and cradle placing freight car on seatrain

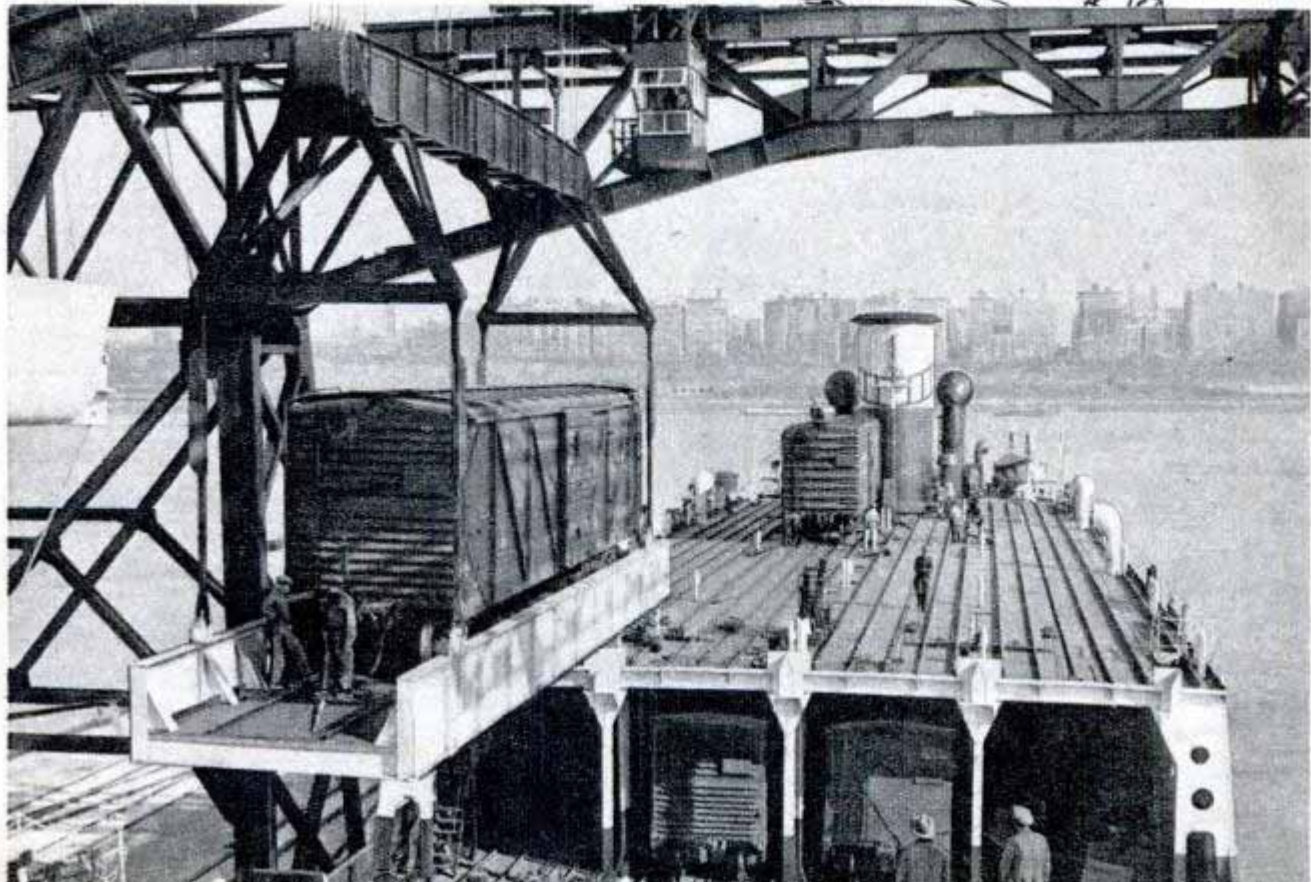



COLLAPSIBLE COPYHOLDER holds papers from 18 to 36 inches wide. After use, it can be folded for storage in the typewriter desk. One lever moves the copy up and down. It is held firmly by the typewriter's weight

SHALLOW-DRAFT HYDROPLANE is powered by a light Franklin airplane motor. Twin pontoons provide buoyancy and a wire screen protects occupants from the propeller. It is used on the Rogue River in Oregon

TRACK-TYPE landing gear may enable heavy aircraft to operate from rough fields. The retractable gear weighs 1075 pounds more than conventional equipment. It is being installed on a troop-carrying Packet for testing

Fairchild Aircraft photo



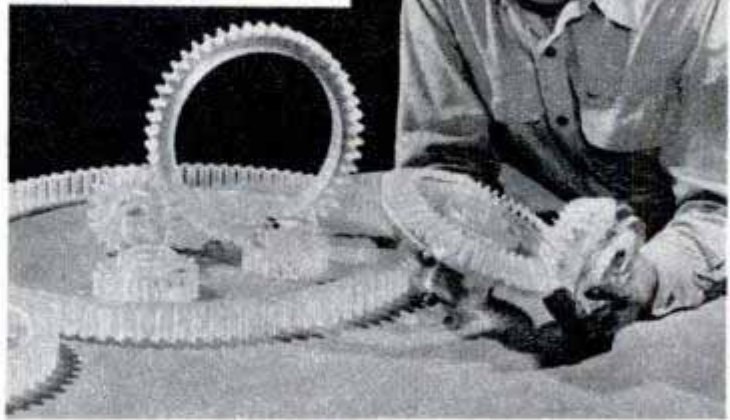
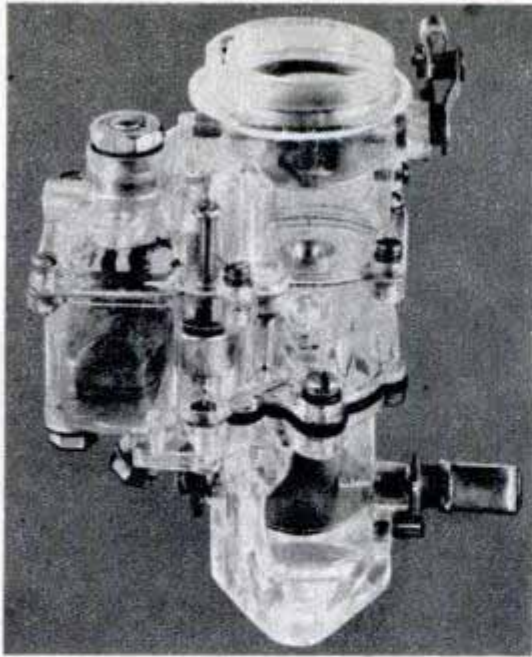

TRANSPARENT MODELS EXPOSE WORKS

His technique developed at Fort Belvoir for low-cost molding of plastic models has been put to use in civilian life by a former Army sergeant, who is molding transparent plastic electric irons and similar products for demonstration purposes. The

method was developed in the Fort Belvoir model shop, where complicated engine parts, carburetors and gears were molded in transparent form for teaching purposes. Dies made of zinc alloy were found to be the most suitable for this purpose.

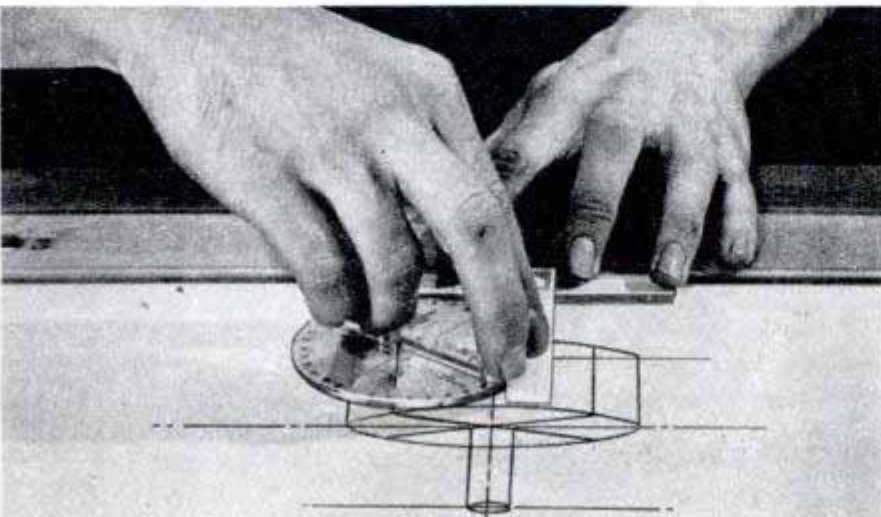
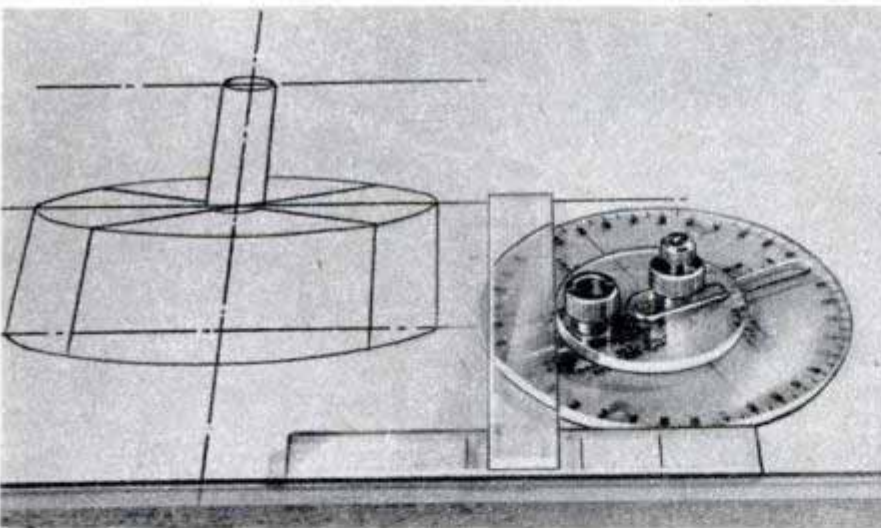

Plastic Instrument Draws Ellipses

Made of transparent plastic, an inexpensive instrument for draftsmen and artists draws ellipses of desired dimensions by setting two adjustable knobs. The unit consists of two disks and a T-shaped guide. In drawing ellipses in which the major axis is less than $1\frac{1}{4}$ inches, both disks are used. For making ellipses up to three by six inches, the small disk is removed and only the larger disk is used with the guide. For extremely fine work, the instrument can be used to draw ellipses the size of a pencil dot. It can be used with pencil or for inking or scribing.

Boeing high-altitude experiments have proved that big planes have shrunk several inches in size by the time they reach 40,000 feet.

*out of business
refer to Sept 48-101*

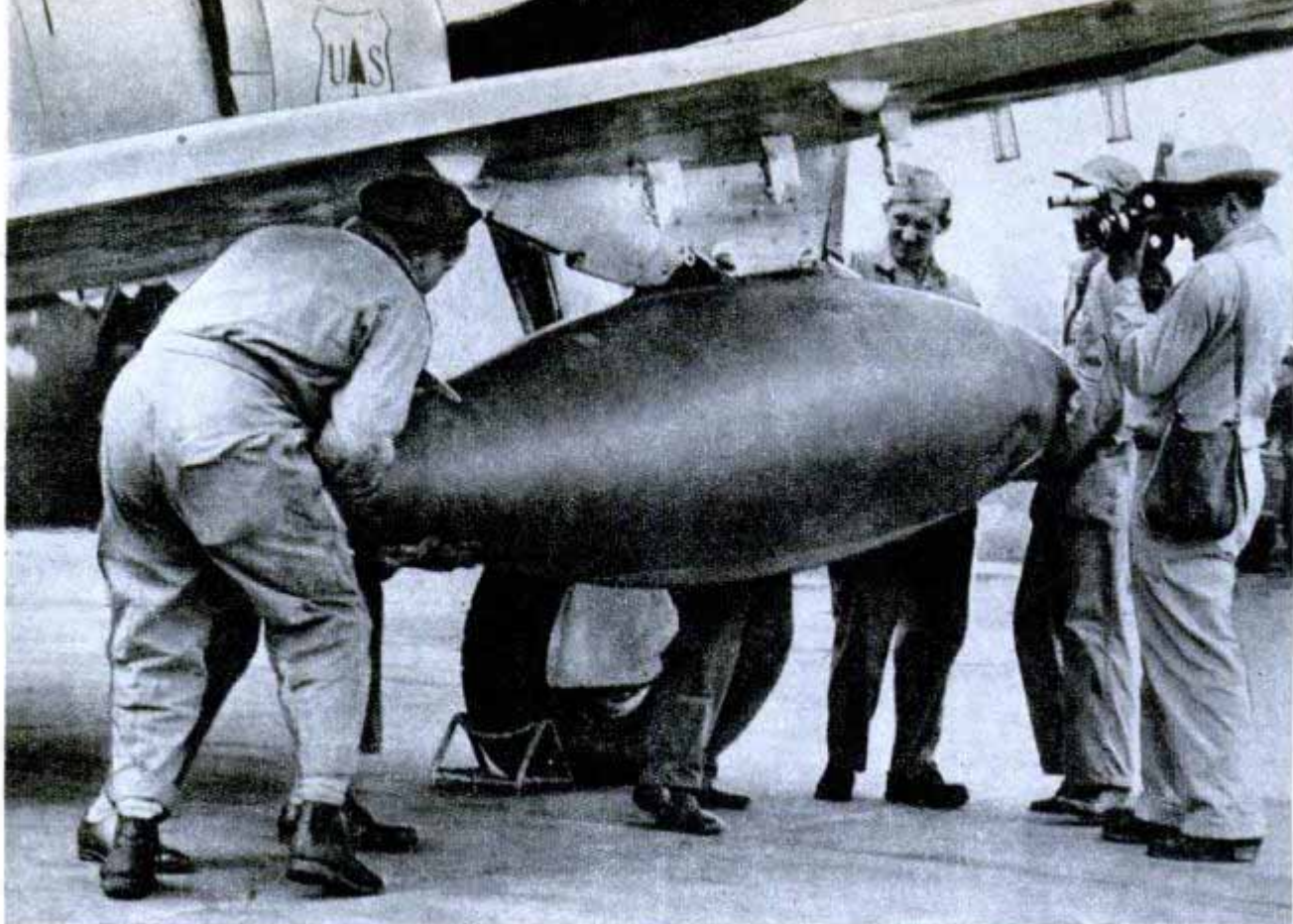

U. S. Air Force photos

Test unit attaching bomb under P-47 wing. To simplify handling, it's done before they're filled with water

WATER BOMBS **for** **FOREST FIRES**

BOMBS whose bursting looses tons of water or chemicals are getting their first tests against western forest fires. In doing it, fighters and bombers that once spread fire and destruction are helping to drench blazes that yearly destroy 31,000,000 acres of valuable timber in the United States.

The experiment sponsored by the Air Force and the U. S. Forest Service is going on over Lola National Forest in Montana, using a B-29 Superfortress and two P-47 Thunderbolts. Fires from 100 to 150 feet in diameter are set for the tests.

In contrast to meager prewar efforts, like kicking five-gallon cans of water out

Bombers can carry the water-filled tanks both inside and out. The test B-29 dropped three 4000-pounders



of plane doors, the three planes at Lola drop water-filled auxiliary fuel tanks weighing 13,000 pounds and more on a single sweep. In the initial test, three 4000-pound containers were attached beneath the B-29 and each P-47 carried a pair of 165-pounders under its wings. Tail fins and fuses added in Forest Service shops converted the thin-shelled tanks into bombs.

To evaluate aerial fire-fighting techniques, two of the big bombs had proximity fuses, set to explode over the target and saturate the flames. The third, and all four small fighter tanks, were fixed to shatter on impact, throwing water, dirt and debris in the inferno's path.

Experiments are also in progress to make water "wetter" with chemicals that reduce surface tension and make it flow better. Instead of forming beads and staying on the surface, the wetter water penetrates and spreads. It is especially effective in knocking out smoldering fire on the ground after the main blaze is stopped.

Speed is the biggest asset in fighting forest fires. Even with more roads, there are thickly wooded sections where foot and horse travel are the only means of access. Crews have taken a week to reach fires in such localities. As a result, in one holocaust, small fires merged to sweep a region



Bombing to halt instead of spread destruction, war-trained airmen drop their water-filled missiles within 25 feet of the blazing "bull's-eye"

150 miles long and 25 miles wide, destroying timber, small towns and taking 87 lives. Lightning frequently starts hundreds of fires in a single afternoon.

In all, some 200 modified fuel tanks will be dropped, along with 100-pound chemical bombs, 184 of which fit into a B-29 bomb bay.

Another facet of the program is aerial delivery of men and equipment to blaze sites. In just one of the Forest Service's regions, 160 trained "smoke jumpers" will parachute this season to otherwise inaccessible small fires.

One of the two techniques being tested by the Forest Service and Air Force is based on air bursts over the fire, drenching the flames. The impact explosion method concentrates more on halting the fire's spread

P-47 DROPS TWO 165-GAL. WATER OR CHEMICAL BOMBS



WATER OR CHEMICALS IN BOMB SPREADS OVER WIDE AREA

PROXIMITY FUSE EXPLODES BOMB AT PRESET ALTITUDE



B-29 DROPS EIGHT 165-GAL. BOMBS

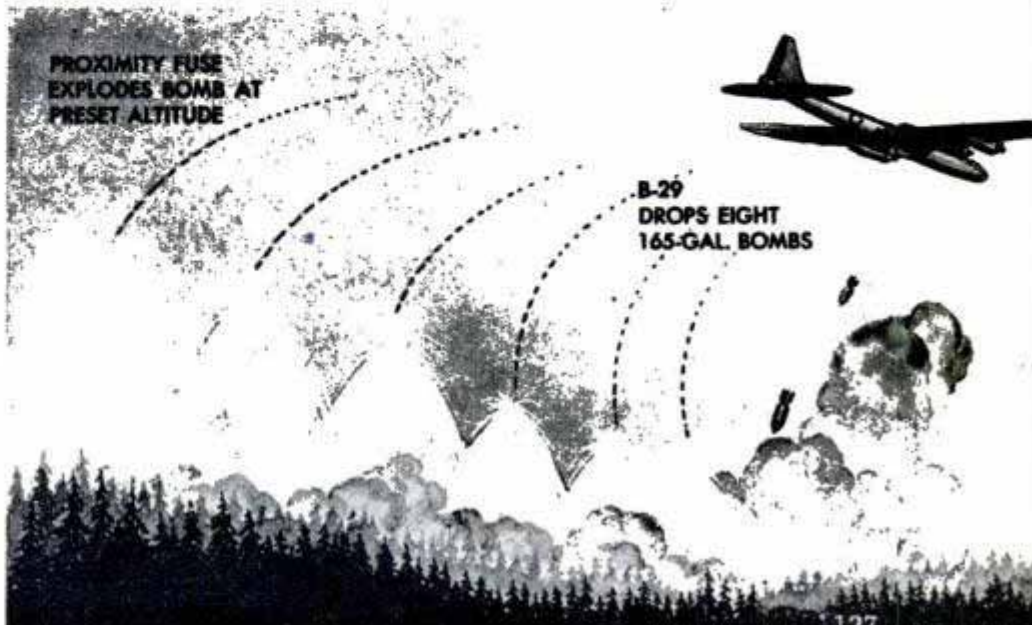



Four-Wheel Steering Guides British Truck

Operated by special steering apparatus, all four wheels of a British truck turn when the driver turns the steering wheel. The engine is equipped with a direct fuel-injection system in which gasoline is fed directly to the cylinders, eliminating the need for a carburetor. The fuel-injection system, which adjusts itself to engine-running conditions, is said to be more economical than ordinary fuel systems.

Steam Cooks "Spuds" By the Truckload

When the federal government gave the Colorado State Hospital at Pueblo 15 carloads of cull potatoes to feed to the hospital's 1000 hogs, officials had to devise a way to cook the "spuds," since a third more food value is obtained by cooking a potato. Boiling two tons at a time would have been an expensive method so the farm supervisor suggested steaming them in a truck body. The truck was filled with potatoes and driven to the hospital's heating plant where a steam hose was connected to jets in the bottom of the truck. Forty minutes after the steam was turned on the po-



tatoes were cooked. They then were mixed with mash and fed to the hogs. About 420 pounds of cooked potatoes have the food value of 100 pounds of expensive corn.

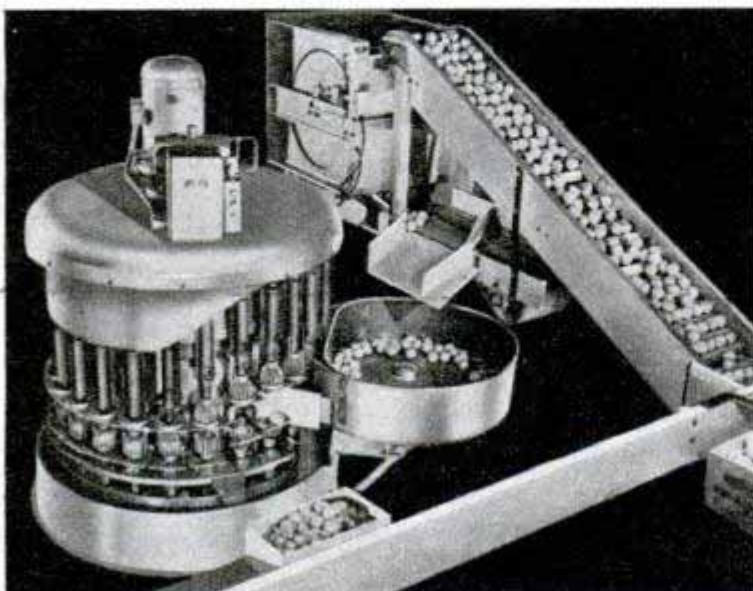

Whole Oranges Handled By Automatic Juicer

Whole oranges instead of halves are squeezed by a new juicer which can handle 480 oranges per minute and produce up to 300 gallons of juice per hour. As two metal cups press together, a hole is automatically punched in the bottom of the fruit through which the juice flows as the pressure is increased. A minimum of pulp and rind oil is mixed with the juice. Rind oil mars the taste and hastens spoiling. By using different sized cups which are easily added to the machine, lemons and grapefruit can be squeezed.

Policing the BERING SEA

By Andrew Hamilton

AFTER an interval of war duty, Uncle Sam's most northerly "cop" is back on his ice-water beat. The U. S. Coast Guard resumed this year its regular, peacetime Bering Sea Patrol with duties ranging from the protection of a multimillion-dollar fishing industry to looking after the welfare of some sick Eskimo trapper in a remote outpost.

Sometimes known as "The American Northwest Mounties" or "The F.B.I. of the Bering Sea," the patrol has been active in the fog-shrouded waters between Alaska and Siberia for 67 years. With world air lines looking toward polar routes and Alaska demanding full statehood, the work of the patrol is more important than at any time in history.

Ten Coast Guard cutters renewed the policing activities last spring from bases at Ketchikan, Seward and Juneau. On an average 50-day cruise, each vessel adds from 6000 to 15,000 miles to its log. Some of the craft assigned to the Bering Sea Patrol include 250-foot, 2200-ton cutters which played gallant roles in World War II. Others include light-house tenders, 180-foot, 935-ton vessels specially designed for icebreaking, tending aids to navigation and supplying lighthouses and lightships. These vessels will be on the job until winter chokes the area with ice in November or December.

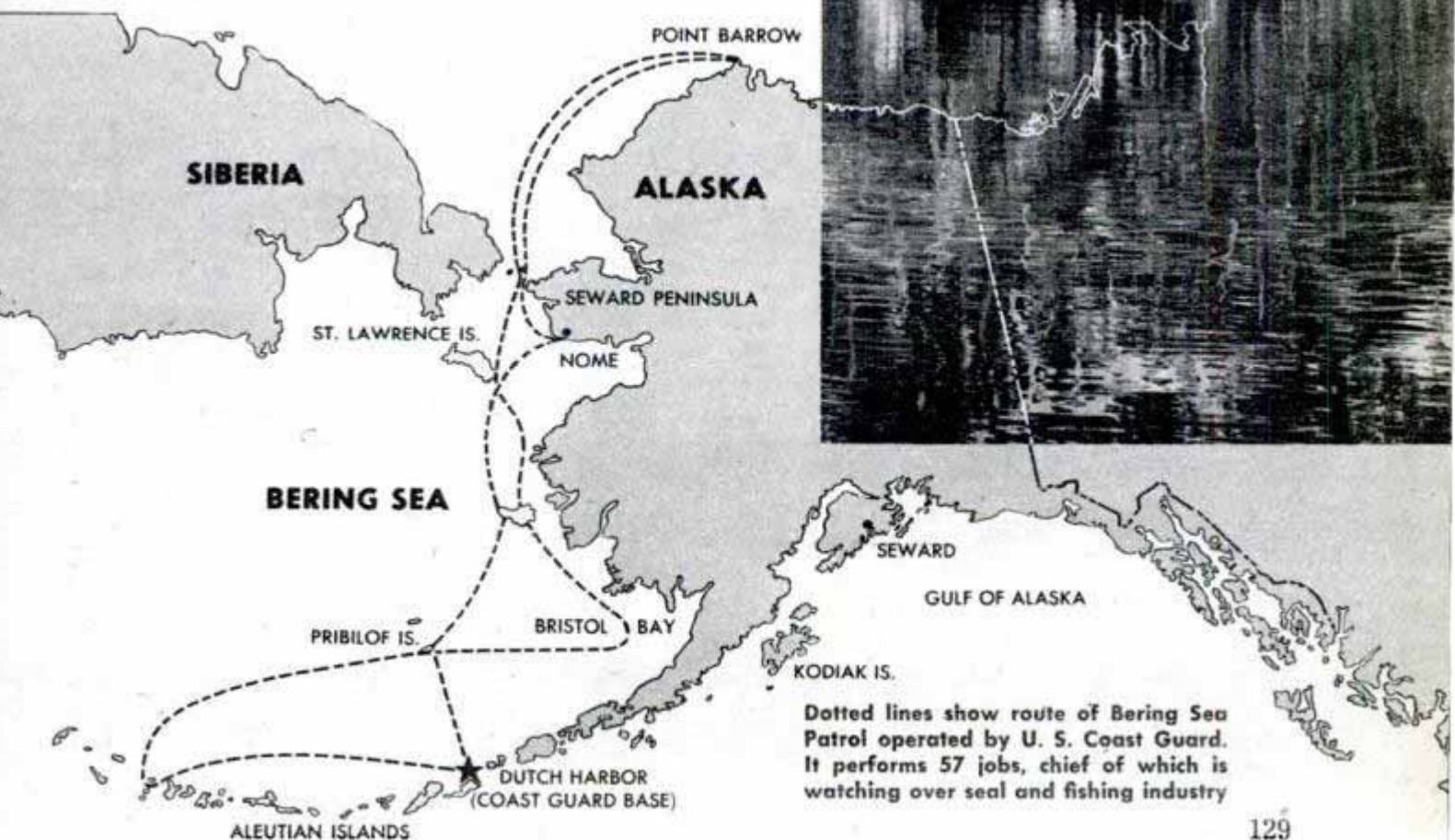

Dotted lines show route of Bering Sea Patrol operated by U. S. Coast Guard. It performs 57 jobs, chief of which is watching over seal and fishing industry

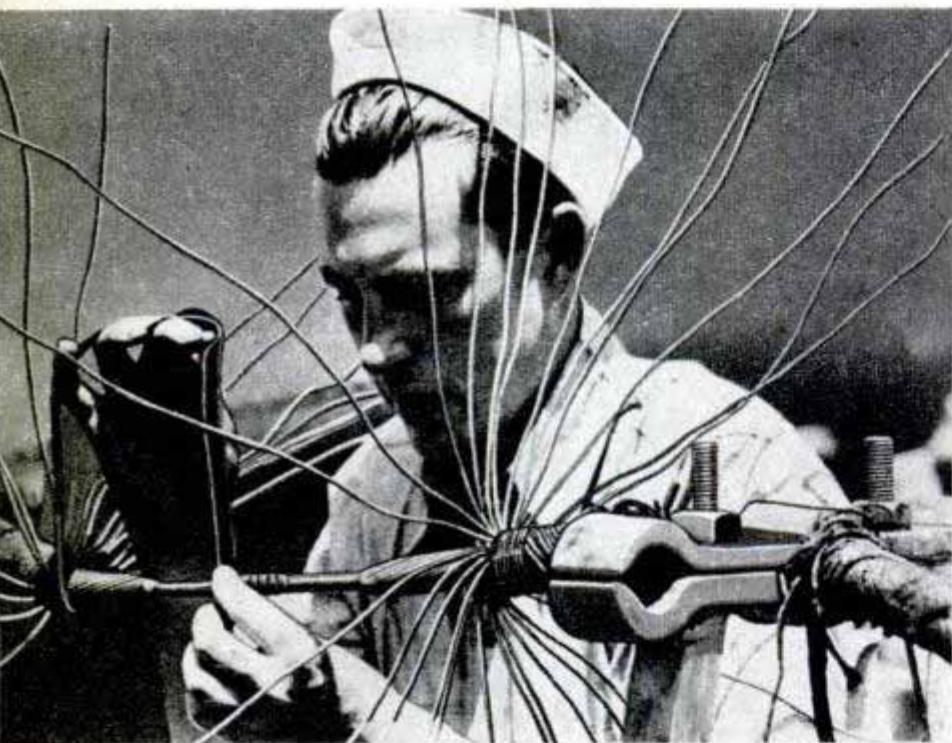

When the Coast Guard vessels arrive in the Bering Sea they find ice extending from the mouth of the salmon rivers in Bristol Bay to the Pribilof Islands and northwest to the Siberian coast. The ice recedes during the summer until the Bering Sea, the Bering Straits and Alaskan coastline to Point Barrow are open to navigation.

Although the Coast Guard has 57 specific jobs to perform on its Bering Sea Patrol, its two main functions are (1) to watch over the seal and fishing activities in Alaskan waters and (2) to provide justice, health and transportation services to the people of Alaska. A seal-and-fisheries patrol is maintained by the Coast Guard from May to October and an arctic patrol from July to September.

Of the three leading industries in Alaska today—fishing, gold mining and sealing—the Coast Guard's Bering Sea Patrol has played an important part in developing the first and third.

The Coast Guard achieved much of its original jurisdiction in connection with sealing and fishing. In earlier days, enormous herds of fur seals and sea otters were slaughtered for the huge profits their hides would bring in China and Russia. Shortly after purchasing Alaska, the United States set aside the Pribilof Islands, 200 miles north of the Aleutians, as a restricted breeding ground.

Since that time numerous executive orders, acts of Congress and treaties among the United States, Russia, Great Britain and Japan have been set up to protect fur seals, sea otters, walrus, sea lions, whales, halibut, oyster and salmon fishing.

Each spring as bull seals head northward toward the Pribilof Islands, Coast Guard cutters stand by to protect them from poachers. Killing seals in the open sea and north of 30 degrees north latitude is prohibited. Later on in the summer as

Part of the day's work of the Bering Sea Patrol: Top, Coast Guardsman lights pipe for aged Eskimo; center, repairing telephone line; bottom, transported by Coast Guard, U. S. Public Health Service doctor examines children at Ketchikan, Alaska

the cows migrate to the Pribilof breeding grounds the Coast Guard stands watch. No vessel is allowed to sail near the islands or stop there except for bad weather.

Each year about 25,000 "bachelor" males are killed. Native Aleut workers, under the direction of Bureau of Fisheries men, club selected victims and skin the hides. Some 80 percent of the hides go to the United States, 20 percent to Canada.

Such strict conservation measures have prevented the Pribilof seals—source of 80 percent of the world's sealskin coats—from being wiped out like the buffalo and the passenger pigeon. In 1910, for example, the seal herd numbered 130,000 animals while today it is around 2,500,000.

The fisheries patrol protects the \$30,000,000 salmon industry of Alaska from alien fishermen. Aided by American school teachers and missionaries in the area, the Coast Guard observes ships that enter the western half of the Bering Sea. Weekly reports are sent to headquarters giving names and locations of all alien vessels.

In keeping such a close watch on Alaskan fishing, the Coast Guard is merely enforcing an act of 1906 to protect all fisheries in Alaska by prohibiting aliens from fishing in its waters. This act was strengthened and amended by another in 1938.

The Alaskan salmon industry and allied industries employ thousands of American citizens and any threat to its future existence will affect shipbuilders, transporta-

Coast Guard "Duck" (right) patrols icy seas and remote beaches in Bering Sea area. Below, the combat cutter Northland returns to duty in Bering Sea after helping clear out Nazis in Greenland during the war

U. S. Coast Guard photos

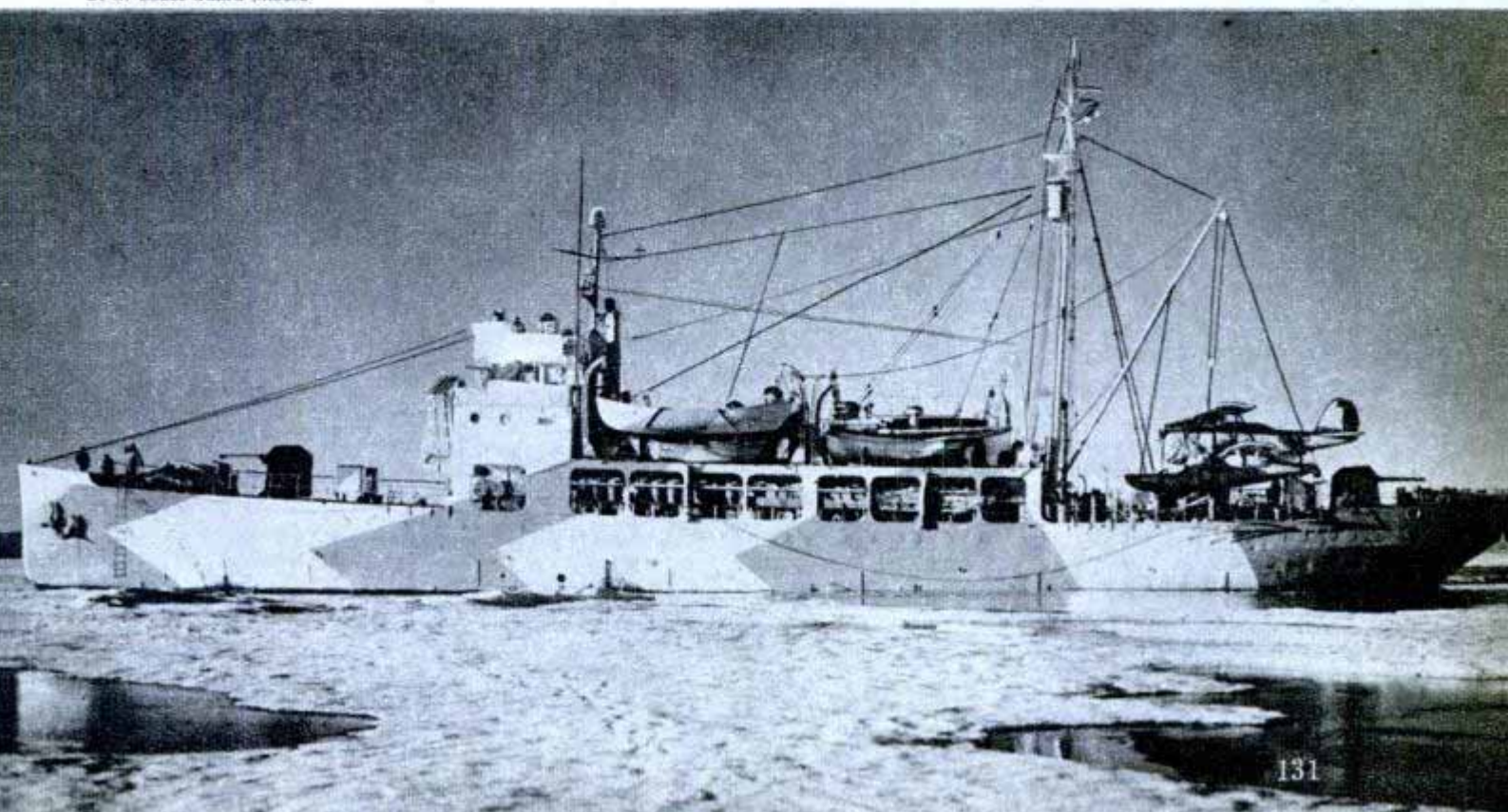



"Cliff-hopping" Coast Guardsmen deliver drum of oil

tion companies, insurance companies, banks and producers of marine supplies and fishing equipment.

In addition to its policing duties in the seal-and-salmon fishing areas, the Coast

Guard's Bering Sea Patrol represents a benevolent Uncle Sam in that part of the world, who assists the people living under the American flag.

One of its most important jobs is that of furnishing medical and dental care to natives on lonely islands and the few white men in the area who serve as fishermen, missionaries and explorers. U. S. Public Health Service doctors carried by Coast Guard cutters may be called upon to check a diphtheria epidemic in an Eskimo village, remove a safety pin that a child has swallowed, help a sick native woman or set broken bones. Medical advice is often radioed to fishing vessels at sea.

Another man-sized job is providing assistance to ships and men in distress. The following are typical patrol-log entries:

"Received a radio message from the motor vessel Fern which needed help because of a broken tail shaft; the ship was towed to Unalaska."

"Found the motor vessel Einar Beyer helpless with two cracked cylinder heads and towed it to Kodiak."

"Sighted an overturned skiff and rescued a man clinging to it."

"Removed a sick man from the Bureau of Fisheries vessel Crane and delivered him to the hospital at Unalaska."

The longest cruise of the Bering Sea Patrol is that to Point Barrow, more than 1100 miles north of Dutch Harbor. Frozen fast in the polar ice most of the year, the far-northern outpost of the Stars and Stripes can be visited only during the summer months. The Coast Guard provides the slender lifeline that supplies food and equipment.

Aleutian homecoming—aboard the transport are Aleuts returning to their home islands. After Pearl Harbor they were moved to mainland for safety



Because of scarcity of transportation in the Bering Sea, Coast Guard cutters carry much freight. On the annual Point Barrow cruise, for example, a Coast Guard cutter would consider the following items a typical cargo:

4400 pounds of freight for the St. Thomas mission at Point Hope.

35 boxes of archeological specimens for the American Museum of Natural History in New York.

1000 pounds of household goods for Point Lay.

1950 pounds of freight for natives at Point Barrow.

1775 pounds of equipment for the Army radio station at Point Barrow.

1 bag of mail, Point Barrow Post Office.

900 pounds of freight for Shishmaref.

1000 pounds of Oogrok hides for Little Diomedes Island and 700 pounds for Nome.

13 boxes of Father Hubbard's films for Santa Clara University.

1 34-foot oomiak (native canoe) for Mariner's Museum, Newport News, Va.

The Alaskan shoreline is 14,899 miles long and thousands of islands, large and small, dot the treacherous waters. Responsible for the safety of ships in this area, the Coast Guard installs and maintains navigation aids such as lighthouses, radio beacons, buoys and fog signals.

In the early days, ship captains were left to shift for themselves and the number of vessels lost in the Bering Sea is a large one. In 1894, however, the first lighthouse was established at Sitka. Today there are 54 lighthouses, 56 lighted aids, 507 unlighted aids, 79 fog signals and 16 radio beacons.

In addition to regular duties for the

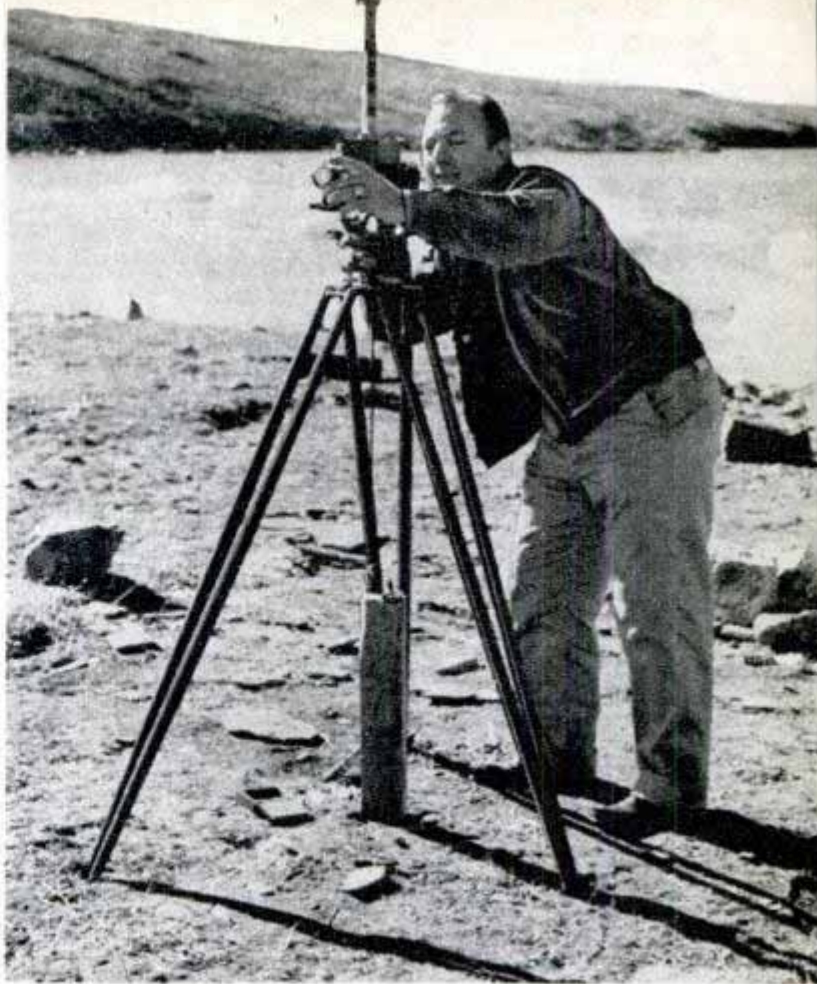

Three hundred miles north of Arctic Circle, scientist records magnetic variations which affect compasses

Treasury Department, the Coast Guard performs valuable services for a number of other federal agencies.

With the Navy Department it maintains a close alliance and cooperates on matters of intelligence. For the War Department it enforces navigation laws and other laws pertaining to anchorage and movements of

(Continued to page 256)

Stricken seaman on merchant ship is transferred to a Coast Guard vessel to receive medical care. Right, unloading sled from Coast Guard cutter into small boat drawn alongside; dogs are hitched to sleds of this type

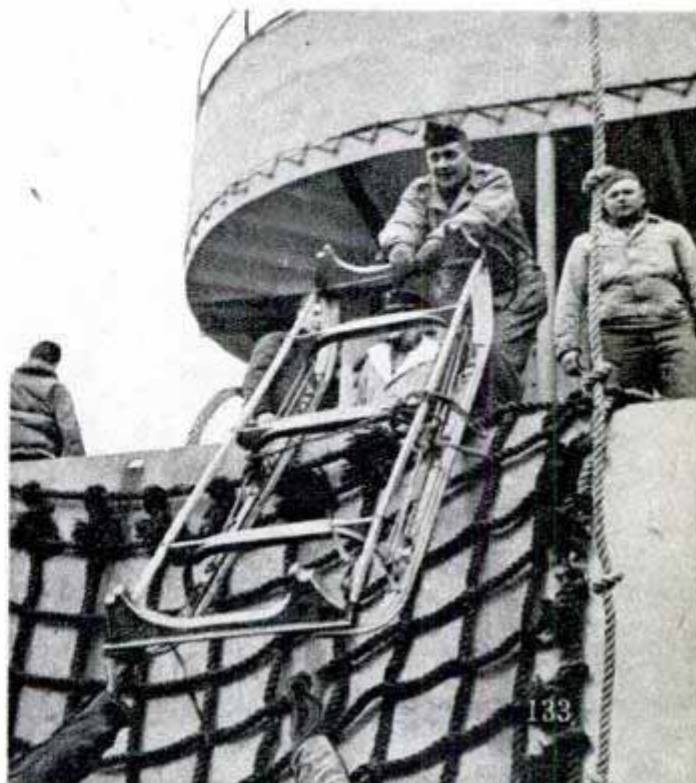
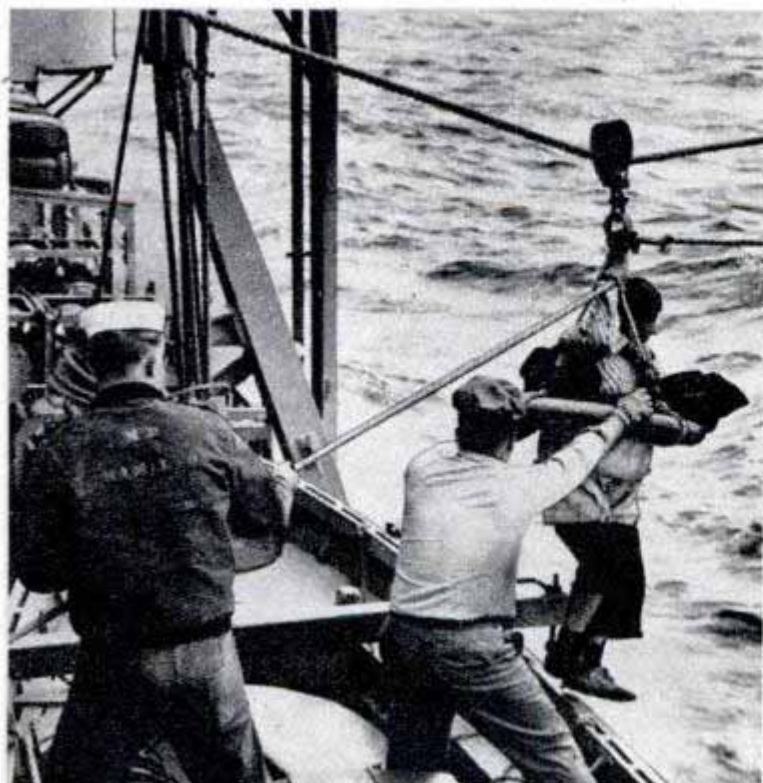



Snowplow attached to homemade tractor saves builder many backaches. With two transmissions, it has 13 speeds forward

OLD AUTO PARTS PLUS SPARE TIME EQUAL TRACTOR

When R. A. Bigham of South Bend, Ind., decided that he needed a tractor he built one from old auto parts. He spent about six months of spare time making the vehicle, which has 13 speeds forward and 7 in reverse. The tractor is powered by a

1928 Chevrolet motor and has a differential from a Ford Model-T truck. The frame is built of 3-inch-square tubing, the tread is 56 inches and the wheelbase 75 inches. According to Bigham, the slow speed is 1 m.p.h. and top speed 40 m.p.h.



Glider Cottage

With vacant houses difficult to find in Southbourn, England, one businessman solved his problem by converting the fuselage of a huge glider plane into a cozy little cottage. The living room is 7 by 15 feet, bedroom 7 by 10, and kitchenette 7 by 8. The glider was the type used by Britain's airborne troops during the war. One building contractor plans to convert other gliders into homes.

Paddle-Boat From War Barges

Paddling around a lake in Barking Park, Essex, England, is a miniature stern-wheeler resembling an old Mississippi River boat. The craft was constructed from two wartime river assault barges by two members of the Barking Borough Council in spare time.

☞ Concrete brake shoes on streetcars in Munich, Germany, save iron.

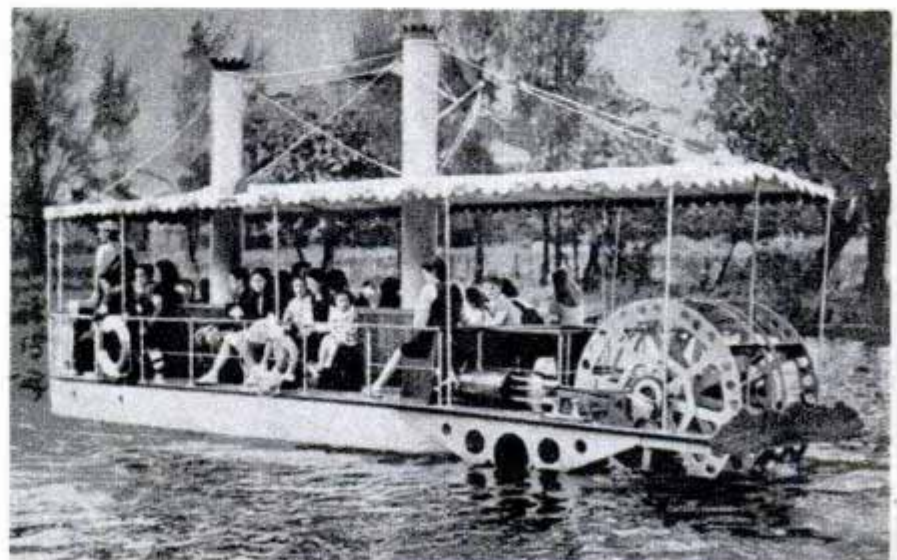

Stereoscopic Camera Moves During Exposure

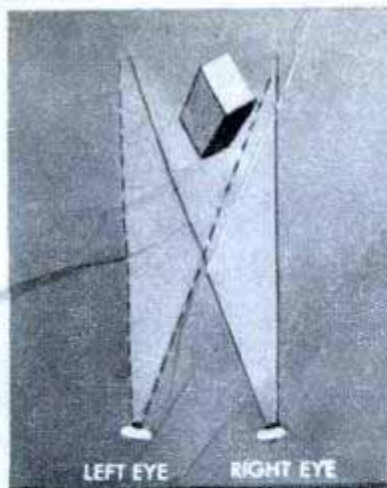

Each eye sees a different view for depth perception

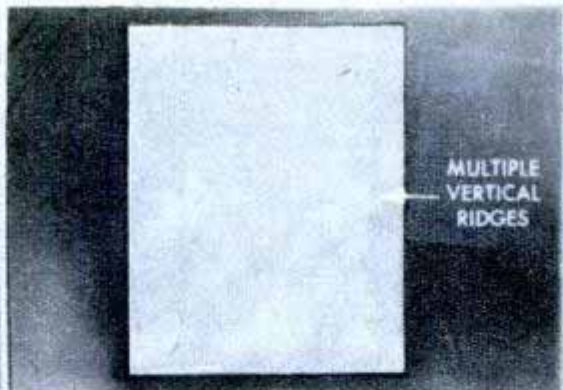

Lenticular screen has many vertical ridges



GLASS

MULTIPLE VERTICAL RIDGES

CELLULOSE ACETATE

Enlarged view of screen shows ridges that add depth to photo

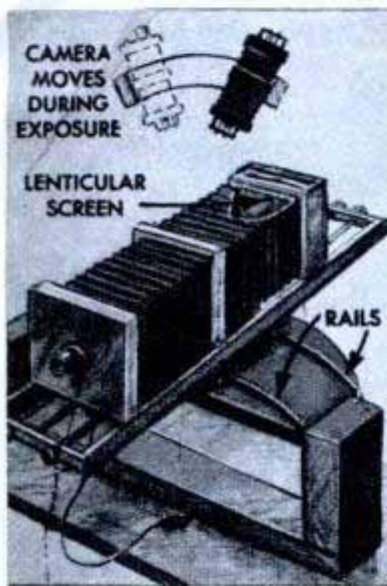

Camera moves 16 degrees during three-second shot

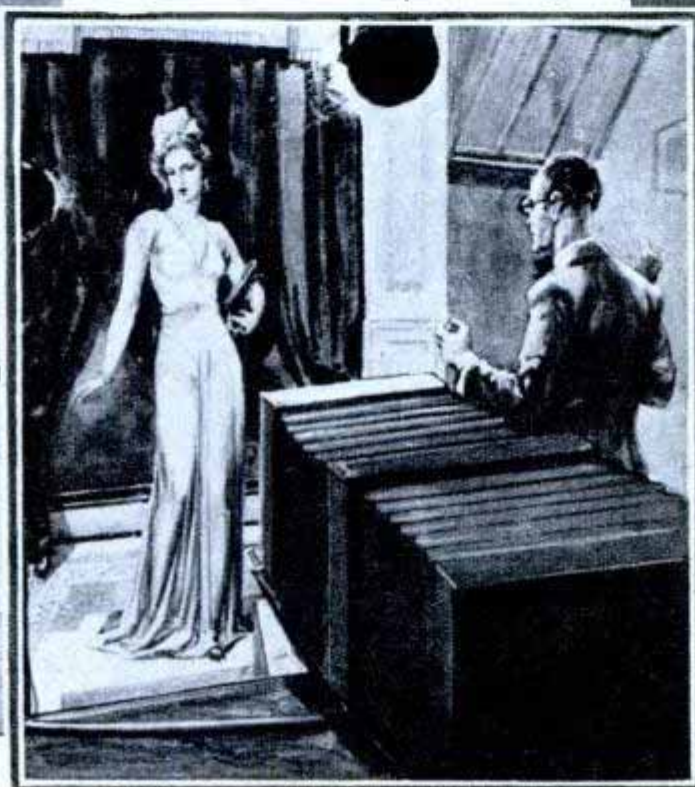

Camera takes left and right-eye views during exposure

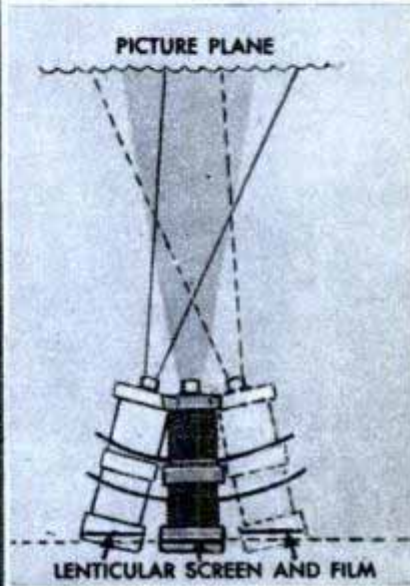

Screen and film pivot to stay parallel to the picture plane

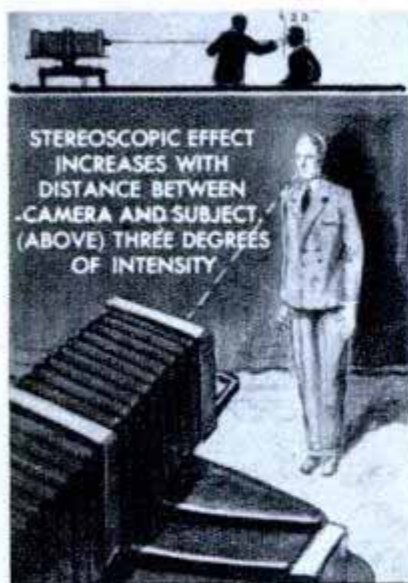

Subject must be motionless during time of exposure

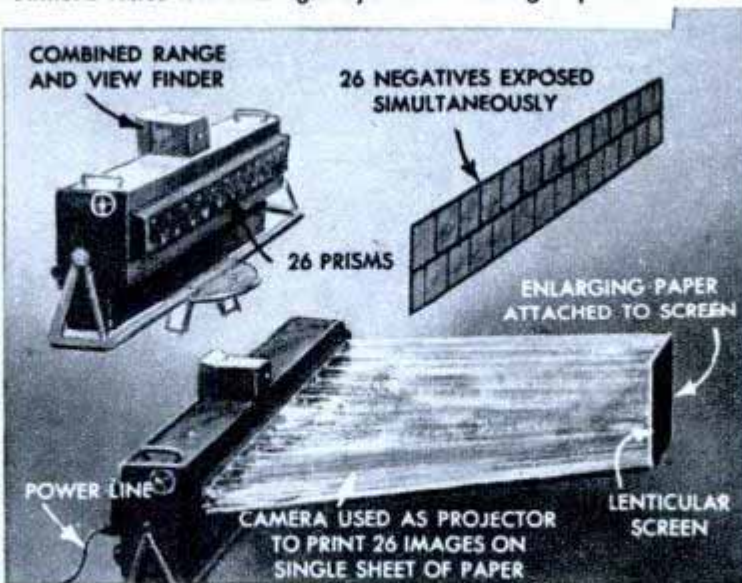

Instantaneous stereoscopic pictures are taken by this unusual camera equipped with 26 prisms instead of a conventional lens. Action of moving vehicles is stopped by camera



Photographs that appear three-dimensional are made by a British camera using a lenticular screen. The screen consists of a series of tiny corrugations. Looking through the screen, each eye sees a slightly different view of the image, thus providing binocular vision. Previously, three-dimensional prints have had to be viewed through two-colored glasses or a stereoscope. A similar process called Trivision was described in *Popular Mechanics* in May 1942. However, Trivision photographs were transparencies only. The new process, invented in France, makes positive prints.

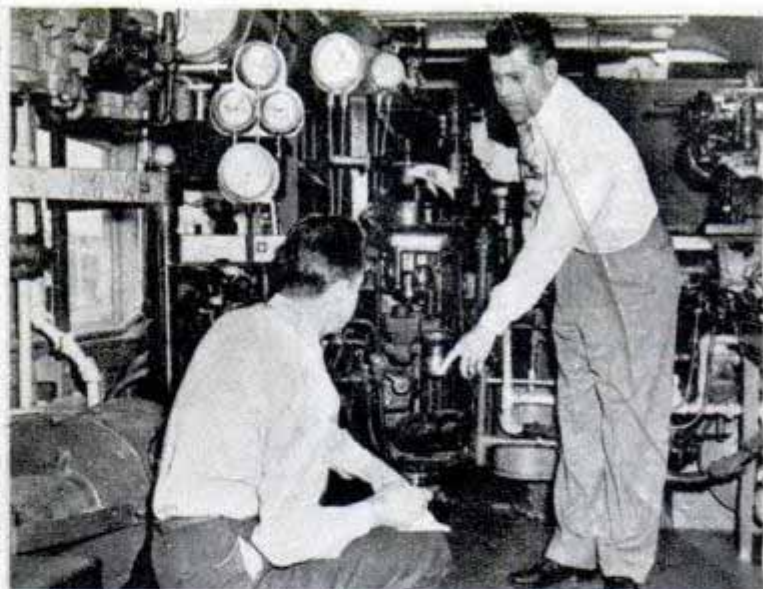
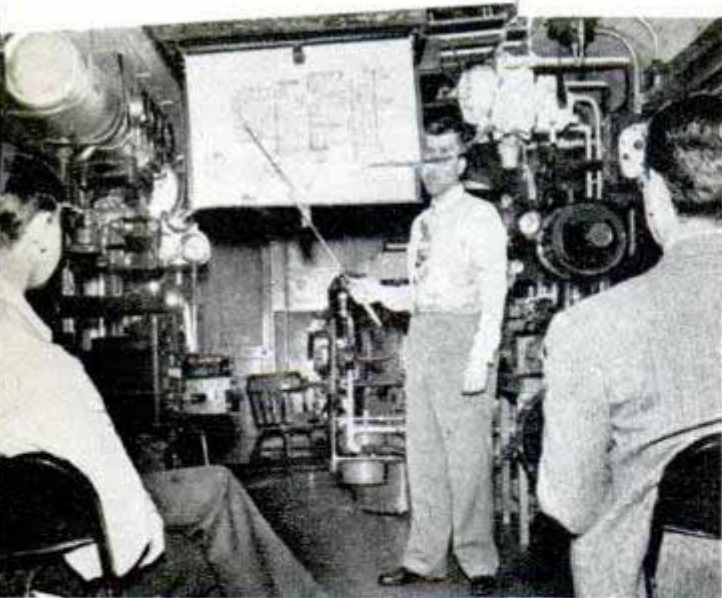

Railway School Has "Course" 10,000 Miles Long

Not only classroom and teacher, but also the latter's home and family will come to railroaders who want to learn more about Diesel air brakes. The instructor and his wife will live in the classroom-car in which he'll lecture twice daily at stops along the Union Pacific's nearly 10,000 miles of main

trackage. The tour is expected to take a year. Working and cutaway models of air-brake equipment valued at \$25,000 are installed in the car to illustrate instruction. The classroom was outfitted by a correspondence school which also provided the instructor, a former railroad engineer.

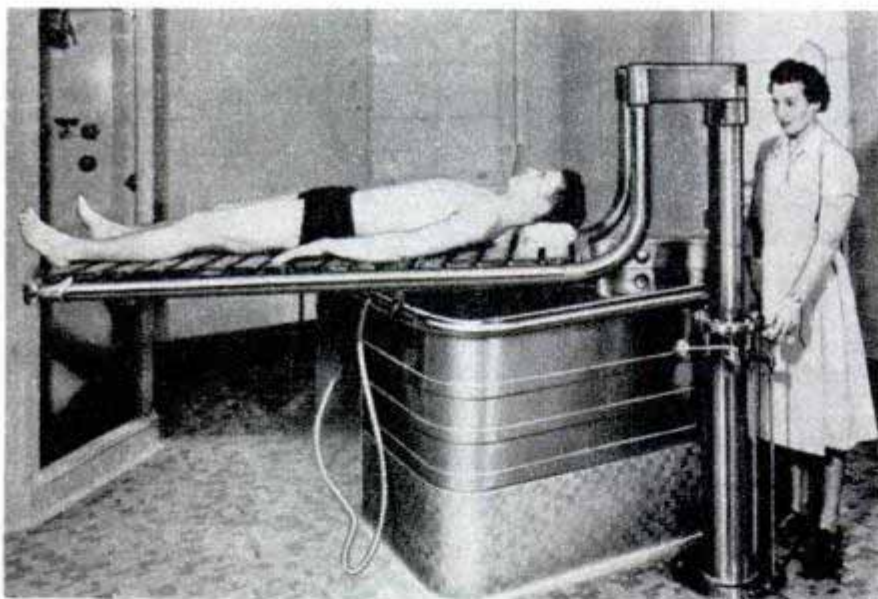

Hydraulic Hoist Lifts Patients

Hydraulic lifts make easy work of lowering patients into hydrotherapy baths. Moved from a stretcher to a pallet of stainless steel and wood, the patient is lifted, then slowly swung to a position above the bath, and lowered into the water. Lifting power is supplied by a six-inch cylinder with a capacity of 500 pounds. Air pressure from a compressed-air line actuates the lift.

Shock Absorbers for Trains

Shock and vibrations in freight cars are reduced as much as 93 percent by direct-action hydraulic shock absorbers. Tests conducted during the past 10 months by the Monroe Auto Equipment Company of Monroe, Mich., demonstrated that the use of modern shock absorbers cuts down lading losses, repairs and roadbed upkeep.

☐ A 12,874-foot oil well has been drilled in the Gulf of Mexico, 10 miles offshore from the mouth of the Atchafalaya River, which is 37 miles south of Morgan City, La.

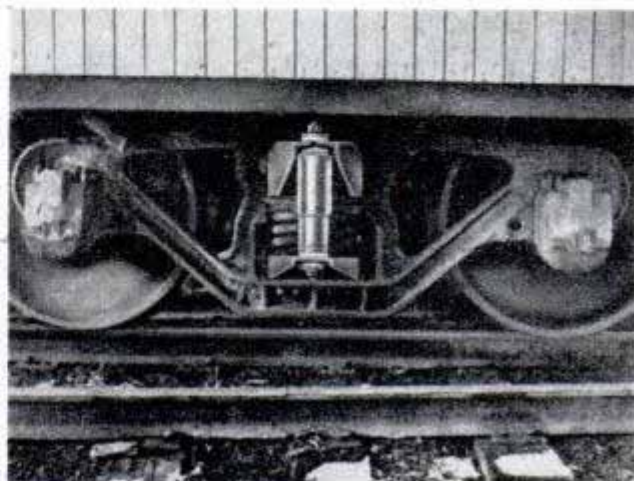



Behind the mask, Chester Morris does a favorite trick with metal globe which appears to rise through the air and roll along edge of the scarf held in his hands

THERE'S MAGIC UP YOUR SLEEVE

By Chester Morris

WHEN THE GREAT escape artist, Houdini, performed his stunt of escaping from a large padlocked milk can, almost full of water, he kept his audience in suspense by sheer acting and theatrical effects.

One assistant held up a watch, calling off the seconds before Houdini would suffocate. Another stood by with upraised ax, ready to smash the airtight container if Houdini failed to emerge on time. Mean-

while, the music built up to a stirring climax. The audience couldn't help cheering when Houdini finally broke loose and stood before them.

The act would have been a flop if the magician had worked his way from the milk can during a dead silence and then had stepped from behind the drape and remarked, "Well, I got out."

The point is, performing magic tricks in

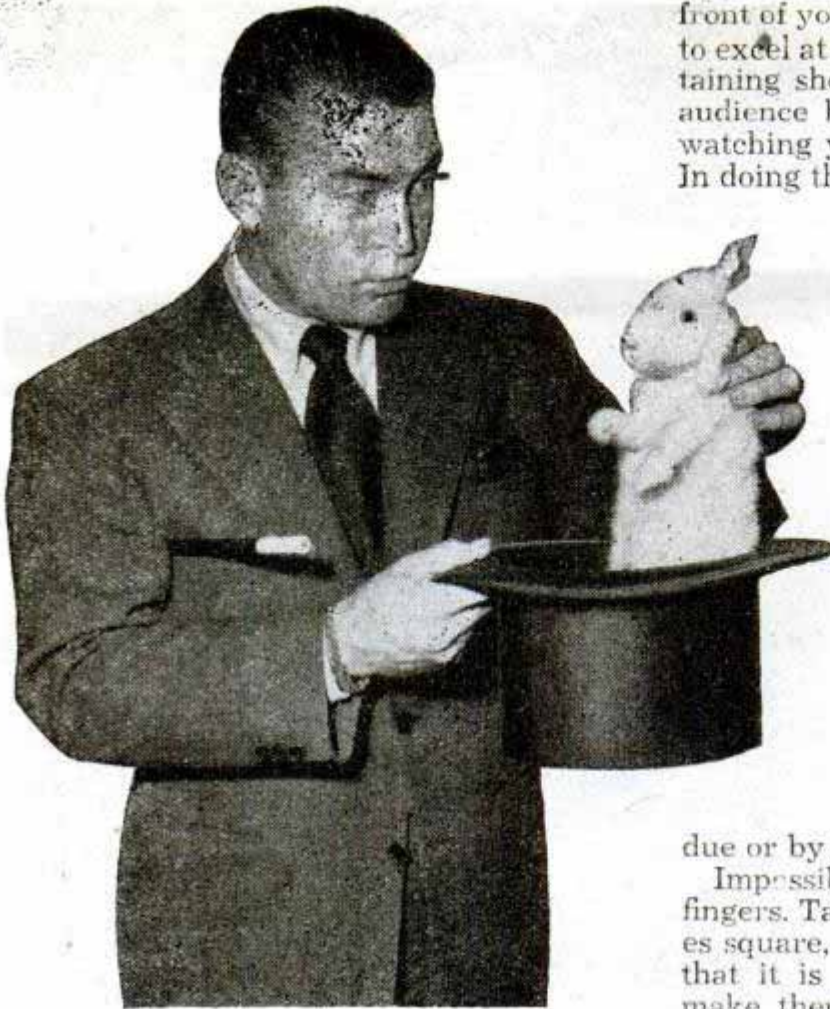

Actor Morris proves his ability by pulling a rabbit out of his hat; spring in rabbit makes it lifelike

front of your friends is a form of acting and to excel at magic you must put on an entertaining show. It's up to you to keep your audience busy listening to what you say, watching you, and obeying your requests. In doing this you can divert their attention from what you don't want them to observe.

A good example of how to keep the audience busy is the "living and dead" trick, a bit of misdirection that has been used with great success by fake spiritualists. The medium hands you a piece of paper, asks you to print on it the name of some friend or relative who has died, and then to fold up the paper. Then he tears the paper into bits and asks you to burn it. Even though you burn it completely and pulverize the ashes the medium is able to spell out the name, letter by letter, by poking through the residue or by gently blowing on it.

Impossible? It's as easy as snapping your fingers. Take a piece of paper about 3 inches square, fold it once and fold it again so that it is quartered. Crease the folds to make them sharp. Open the paper again and draw a circle in the center no larger than an inch in diameter. This circle, you

Below, this easy trick requires only a small-necked vase, cork ball, piece of clothesline and an audience

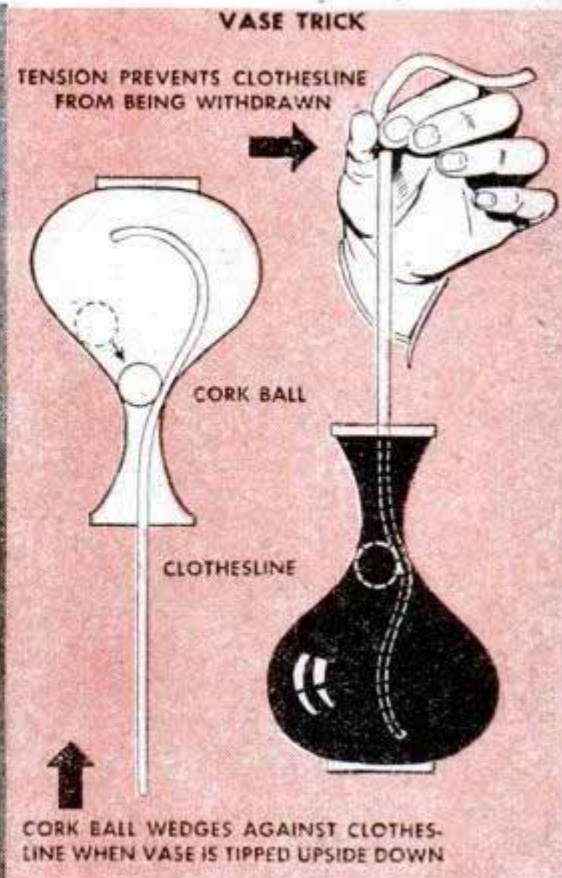

explain to your audience, represents death. Next you draw a series of radiating lines like sunrays outside the circle. These represent the living, you explain.

Now, at your request, a member of the audience prints a name inside the circle and folds the paper twice. He naturally folds along the creases you have already made. Then you tear the paper in two, placing the folded half on top, and tear the pieces in two once more, placing the folded quarter on top. This top piece of paper you retain between your left thumb and forefinger while handing the rest of the pieces with your other hand to the member of the audience. While he is busy burning this paper with a match you have plenty of time to open the folded slip you are holding. Actually it is the center of the original paper. Turn away for a moment and read the name printed there. Then you can be just as mysterious as you please while poking through the ashes and pretending to find a letter here and a letter there until you have the full name.

Another trick that seems positively supernatural is the ability

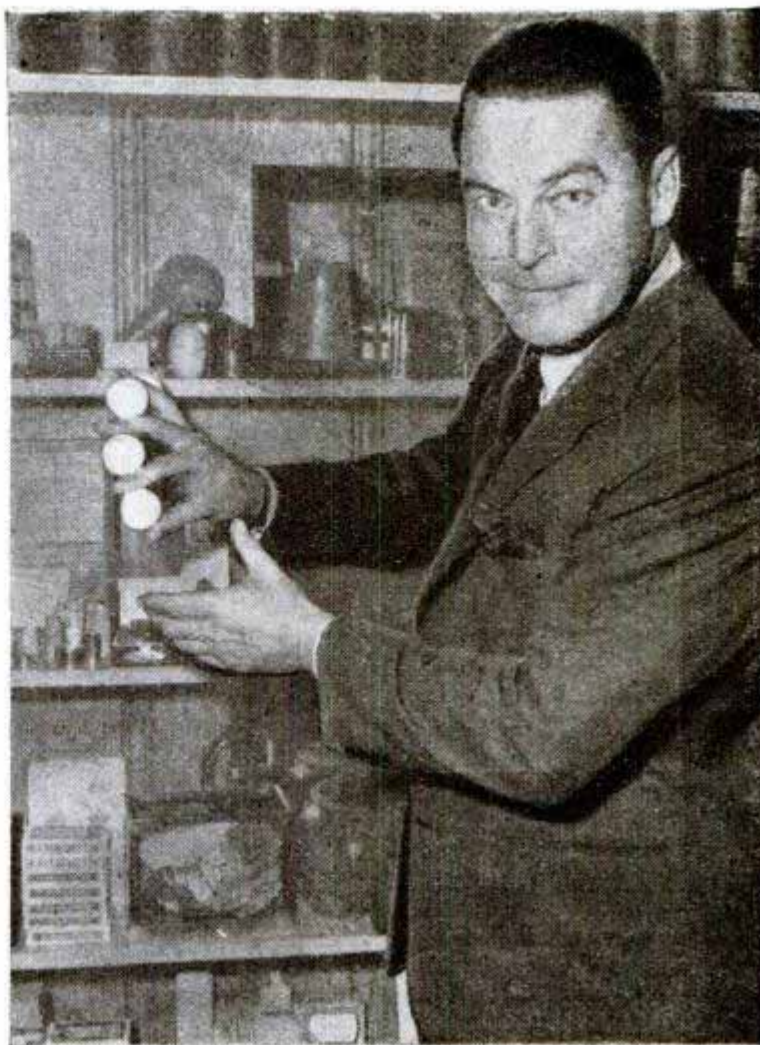

Morris practices finger exercises by holding the small balls

A name written in circled area is retained by the magician who appears to destroy paper. Details in text

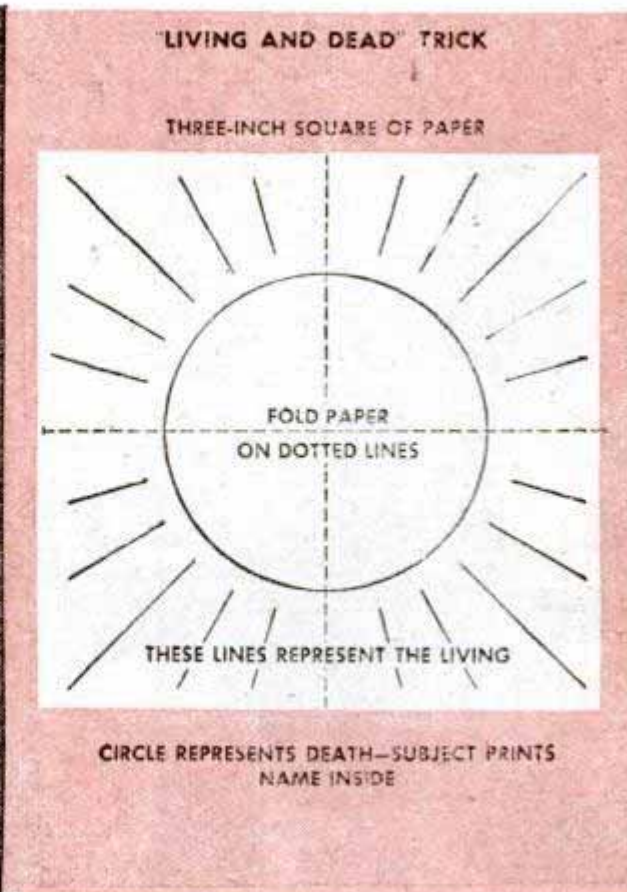



How can he pull all of those silk flags out of an empty metal cylinder? Morris reveals secret below: inside the cylinder is load chamber holding flags



to pick up a folded piece of paper and read the question written on it without a glance and without hesitation. Anyone who knows how can read the questions on a dozen sheets of paper one after the other and never miss. It's known as the "one ahead" technique and to perform it you need a friendly stooge in the audience.

After members of the audience have written their questions, folded their papers, and placed them in the hat, you pick up one of the papers and hold it against your forehead, or even over the top of your head.

"Someone wants to know," you declaim in a strained voice as if you actually are trying to read by power of thought alone, "the date on which the pond will freeze over this winter. Is that right?"

"Yes, that's right," comes back the answer from the helper you have planted in the audience.

"November the twentieth," you might announce in a positive maner, giving any plausible date and at the same time unfolding the piece of paper. After a glance at it you lay it to one side.

Now you can understand how the trick is done. Your stooge was tipped off to answer affirmatively when you asked if the first question was correct. You really made that question up out of your own imagination. Then, when you unfolded the paper and glanced at it you read the question that someone actually had written. This is the question you will repeat when you hold the next paper to your forehead. In

Metal cylinder is first displayed in cabinet with dark lining to match exterior of load chamber. As the cylinder is lifted the cabinet appears to be empty and when trick is over magician lifts load chamber with cylinder leaving audience puzzled. Details in text

CABINET-AND-CYLINDER TRICK

CABINET 6½ INCHES SQUARE, 10 INCHES HIGH
PLYWOOD SIDES AND BACK
PAINTED BLACK

LOAD CHAMBER INSIDE TUBE

OPEN 5-INCH-DIAMETER TUBE
PAINTED WHITE
IS ¼ INCH TALLER THAN
LOAD CHAMBER

GRILLE REVEALS INTERIOR

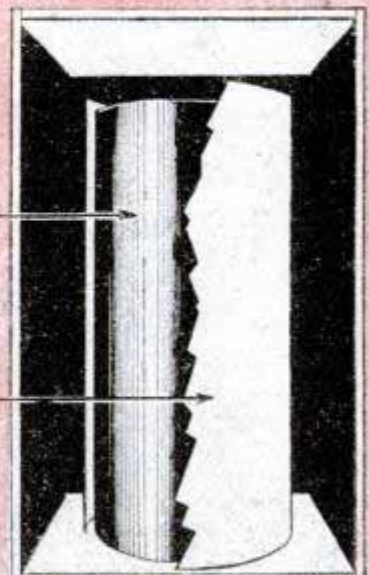

CABINET PLACED ON
BLACK CLOTH

turn you will glance at that paper in laying it aside to learn the question you will "read" next. As long as the audience doesn't learn that you used a stooge for the first question they will gasp at your uncanny ability.

Mystifying friends and intriguing people with magic tricks is a hobby that is popular the world over and many famous amateur magicians delight in putting on performances that have all the finish of professional acts.

Orson Welles, for instance, specializes in big stage illusions that are worthy of the greatest magicians in history. Jimmy Stewart and Henry Fonda have a comedy magic act that convulses audiences. Bert Kaimar, the song writer, is an expert at cards and coins and sleight of hand. Harold Lloyd does a mind-reading act that amazes everyone. Milton Berle puts on a performance in which everything purposely goes wrong and he keeps his spectators howling with glee. Cliff McBride, the cartoonist, has some excellent card tricks and Edgar Bergen is an expert at producing a bowl of goldfish out of thin air.

In my current motion picture "Boston Blackie and the Law," I do a piece of magic that has puzzled tens of thousands of people and that you might like to master. Like most illusions, it's really very simple when you understand it. But as long as you don't disclose the secret to your spectators they will swear you did the impossible.

The trick is merely this: You have a cabinet standing on the table with an open front, top, and bottom. Inside the cabinet there is an empty cylinder. There's nothing else and to prove it you pick up the cabinet and exhibit it in the air. Then you pick up the empty cylinder, look through it at the audience, and show that it's empty. Nevertheless, when you place the cylinder back inside the cabinet you

(Continued to page 252)



Magicians refuse to reveal how this one is done. As the guillotine blade slams down it misses subject's head but cuts celery under his chin! Below, Morris shows rabbit left in coat which went to the cleaners



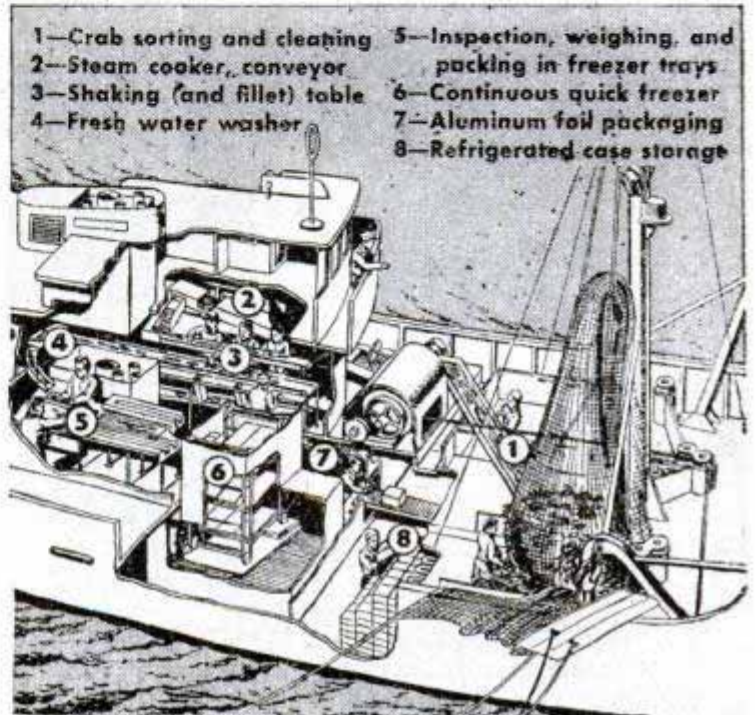
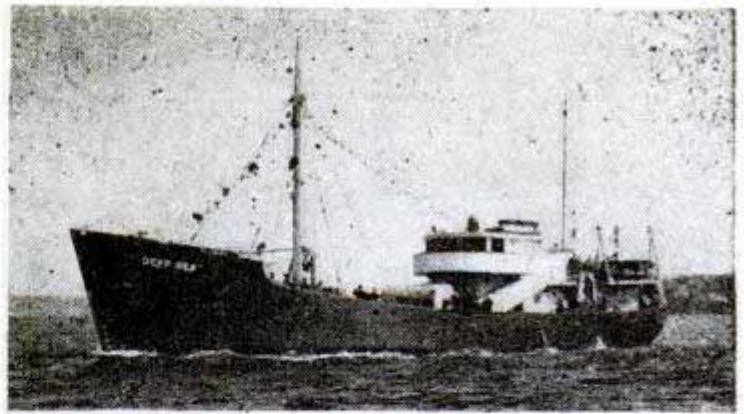

- | | |
|------------------------------|--|
| 1—Crab sorting and cleaning | 5—Inspection, weighing, and packing in freezer trays |
| 2—Steam cooker, conveyor | 6—Continuous quick freezer |
| 3—Shaking (and fillet) table | 7—Aluminum foil packaging |
| 4—Fresh water washer | 8—Refrigerated case storage |

Floating Refrigerator

Quick freezing of crab meat at sea is the latest innovation in deep-sea fishing. A new 140-foot crab trawler, *Deep Sea*, carries a complete processing and packaging plant into Bering Sea waters where the 20-pound king crabs are found. The Diesel-powered trawler has a cruising range of 4000 miles and a speed of 12 knots. Her displacement load is 551 long tons and the refrigerator capacity is 8500 cubic feet. The *Deep Sea* is designed to buck the roughest weather and is fitted with the most modern navigation equipment, loran, and radar for opera-

tions in the foggy Bering Sea. Fish will also be caught and processed. By filleting and processing at sea the vessel can triple the volume of fish per trip. Two thirds of a fish are discarded in the filleting.

Courtesy The Kröger Co.

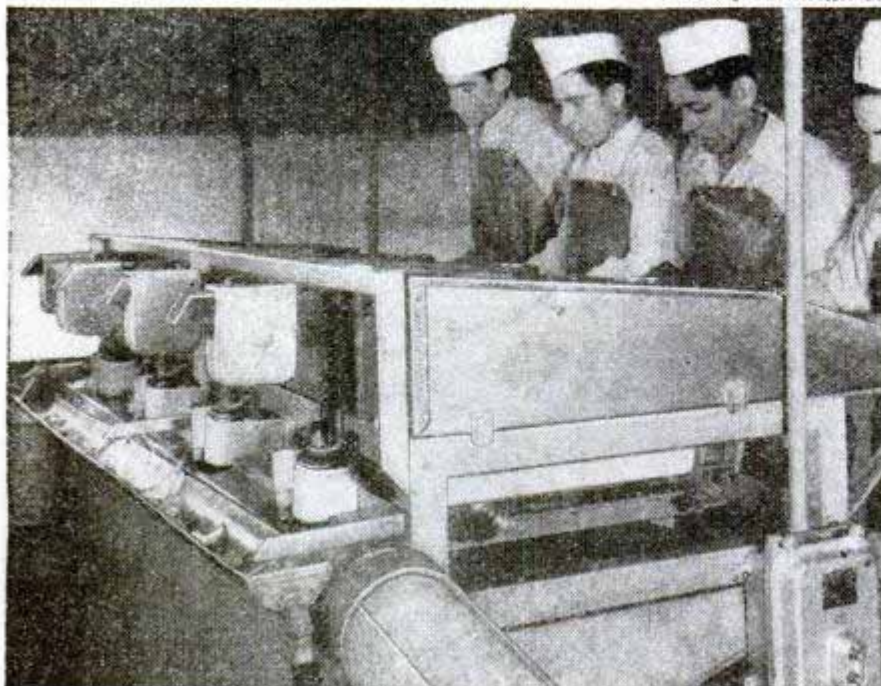

Shrimp Cleaner

Black veins in shrimp are removed by machinery in four packing plants of a national grocery company. The veins run the length of a shrimp's body and must be removed before processing. Small saws cut the shell and a jet of water then flushes out the vein.

☐ The stern half of a Russian tanker wrecked in the Gulf of Alaska a year ago is now moored at Eureka, Calif., where its steam-turbine electric plant furnishes power to inland transmission lines.

Steam Heated "Lake" Reclaims Used Oil

By installing steam heating pipes in an oil-storage lake, the San Francisco Naval Shipyard raised the temperature of contaminated oils and speeded the recovery of usable fuel oil. In five months the reclamation plant produced 13,450 barrels of oil valued at \$18,426. Previously, the Navy paid to have dirty and contaminated Diesel, fuel and other industrial oils hauled away and dumped. The system was developed by Charles H. Kimball, foreman of the yard's power plant.

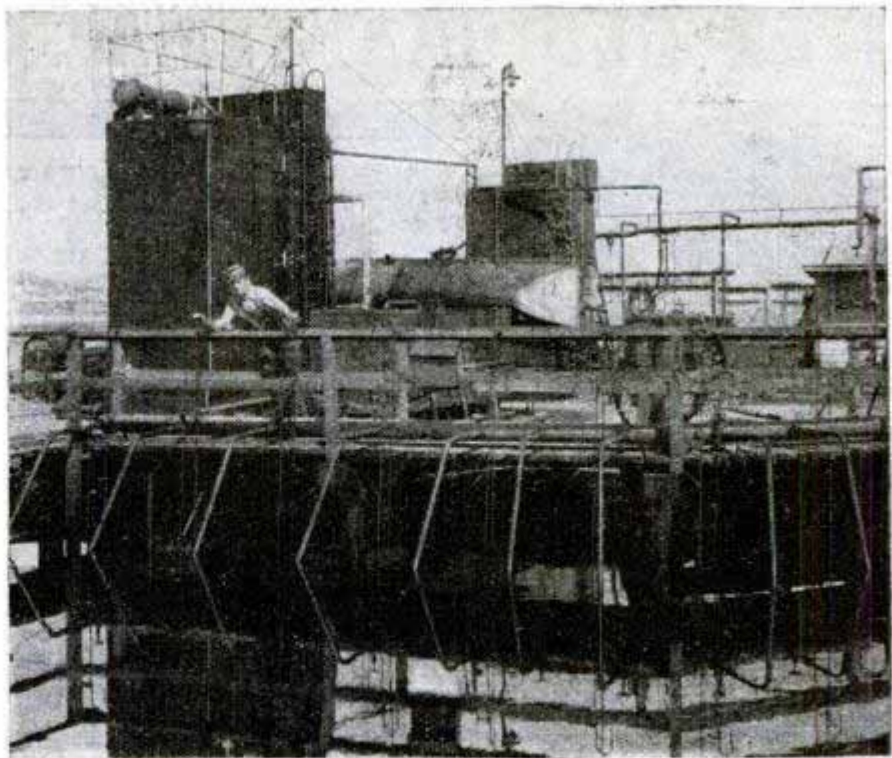

U. S. Navy photo

Wrench With Heavy Handle Shocks Lug Nuts Loose

Badly rusted and jammed lug nuts on truck and tractor wheels are shocked loose by a pendulum wrench that strikes them with the momentum of a free-swinging weighted handle. The operator swings the handle around the shaft and it rotates 120 degrees before striking the lugs on the nut. The result is a hammer-like twisting blow that tends to shock the frozen lug nut loose. Both handle and shaft of the wrench are drop-forged steel, cadmium plated. The wrench, which has a 24½-inch handle, fits all standard ¾-inch drive sockets.



Three-Piece Trailer For Small Boats

Three pieces—two wheel assemblies and a towing attachment—constitute all the parts of a lightweight trailer for boats. Designed to permit motorists to take a boat along on trips, the trailer hitches directly to the car. It weighs less than 50 pounds and fits compactly into the trunk. The wheels snap onto the boat and are held tightly in place. Spring suspension of the wheels permits the boat to ride bumps smoothly.



Popular Mechanics is always ready to supply further information to readers about various products described in any issue. Just write to Bureau of Information, Popular Mechanics, 200 East Ontario Street, Chicago 11, Ill.

AN OLD CRAFTSMAN PRESERVES

Since 1730, generations of one family in the west of England have carried on the traditional craft of a village wheelwright



Master of an ancient art, George Sibley, Berden, England, bores spoke hole in an elm hub
In measuring for a tire, the wheel is revolved and a chalk mark is made on the tire material

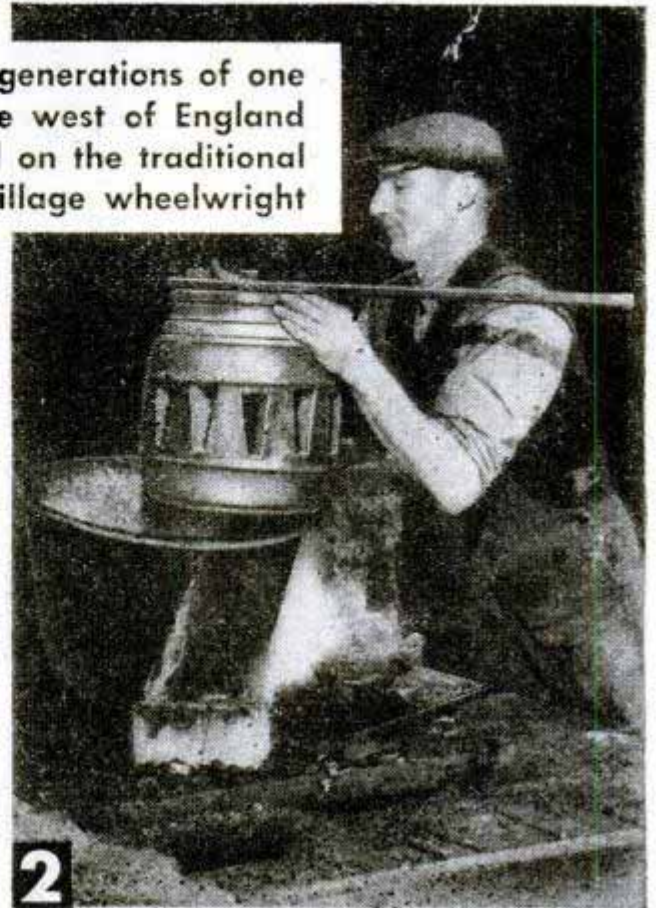

Next, hub is treated for half hour in boiling caldron to assure tight placing of spokes
Tire is bent on a machine to conform to shape of wheel. Proper curving is checked by gauge

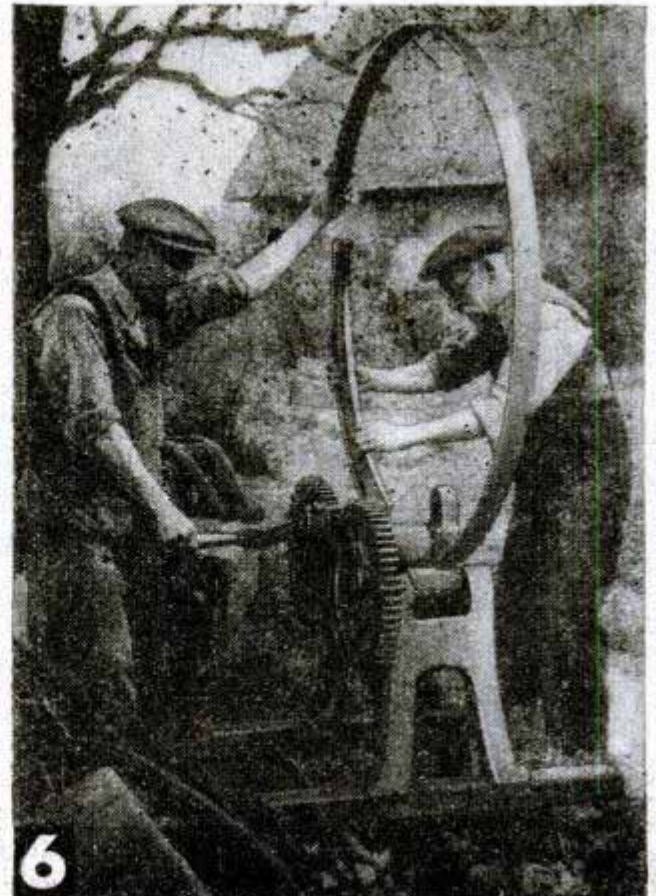

THE WHEELWRIGHT'S TRADE . . .

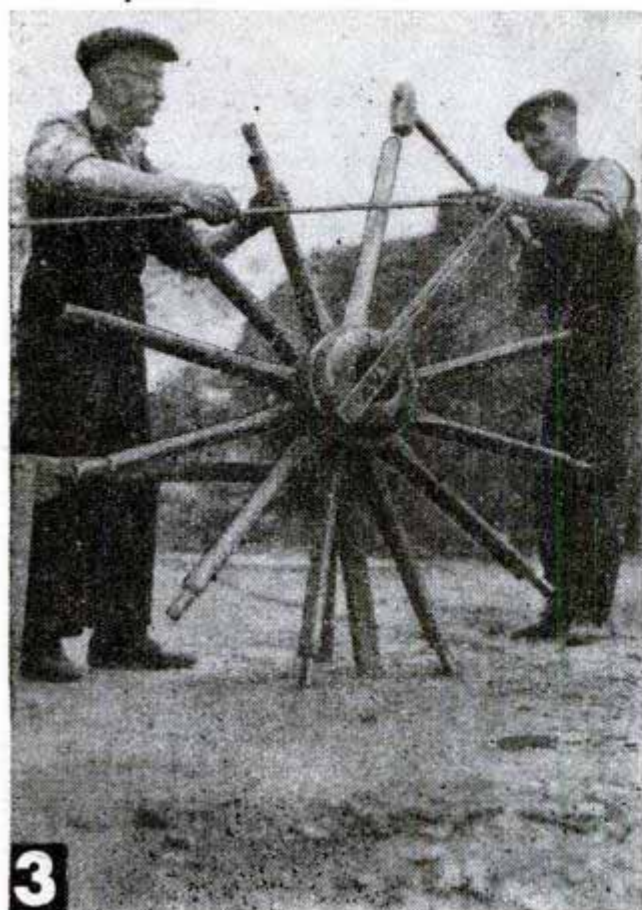

When spoke is "driven home," Sibley uses a straightedge to check alignment of each spoke
With tire ends riveted together and made red-hot in fire, welding is completed on the anvil

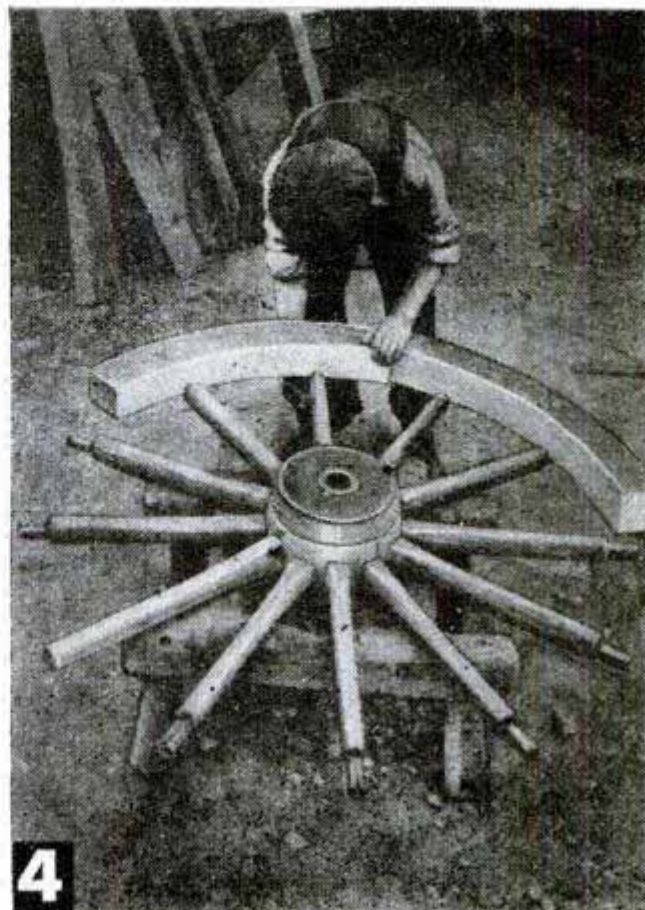

This is called "marking out fellies." Rim segments meet at center point between spokes
After tire is fitted and hammered while hot, quenching with water makes it contract and fit



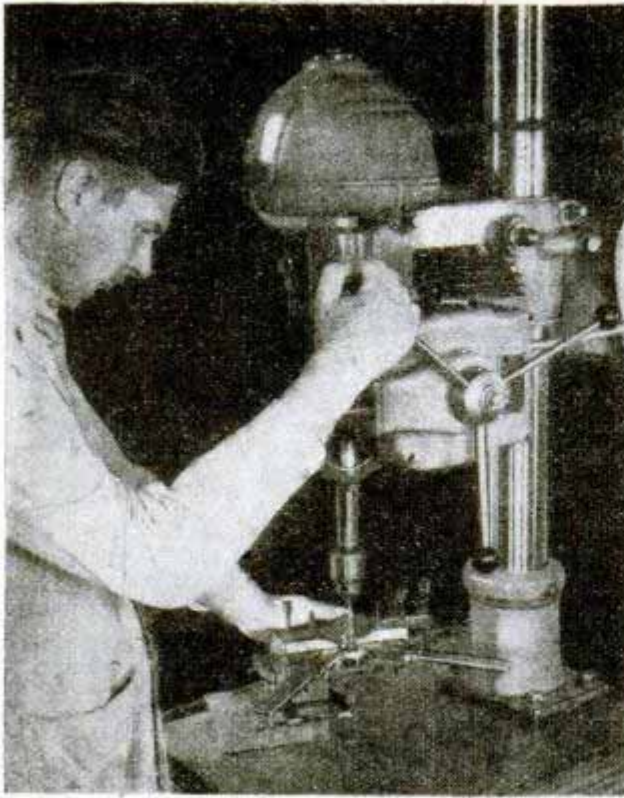

Instrument Used With Drill To Locate Center of Holes

Holes to be drilled can be located accurately with an instrument that uses two sides of the work piece as reference sides. The locator consists of two arms made of tool steel set at right angles to each other. At the exact vertex of the right angle is a tapered hole in which drill bushings are clamped. A vernier stop slides along each of the arms. To locate a hole the two stops are set at the proper dimensions and the instrument is clamped to the work piece with the stops against the reference sides. The center of the tapered hole then is at the exact location desired and may be center punched. The instrument also can be used as a drilling and reaming jig by changing the size of the drill bushing. The centers are located in the same manner.

Clock Has Wooden Parts

Wooden wheels, pinions and springs are the "works" of a clock built by T. C. Merrill, Preston, Idaho, jeweler, to demonstrate watch and clock movements. The clock has 20 wheels and pinions made of oak, cut on a jigsaw and filed to minute exactness. The hairspring consists of two strips of reed from a woven basket. Merrill soaked the strips in a solution for a week, dried them around a metal band for a month and then coated them with lacquer. The clock loses only 10 minutes a day.

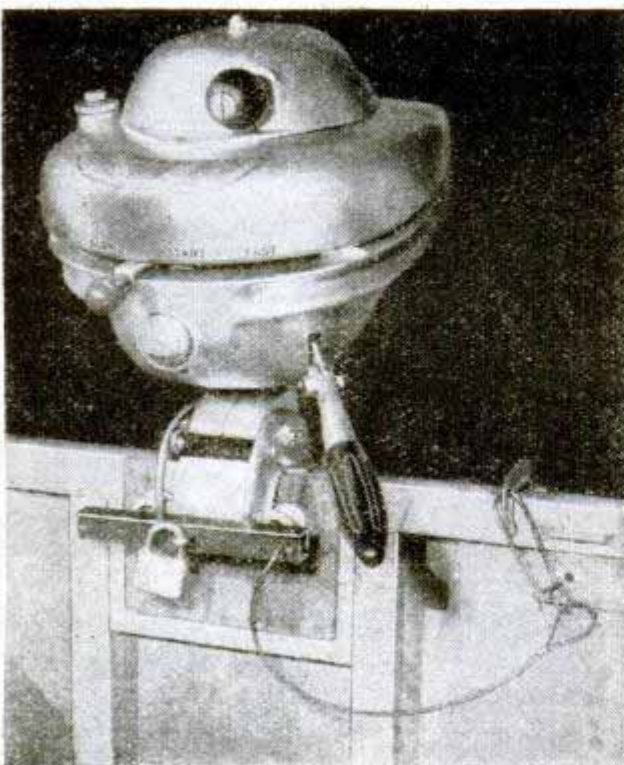
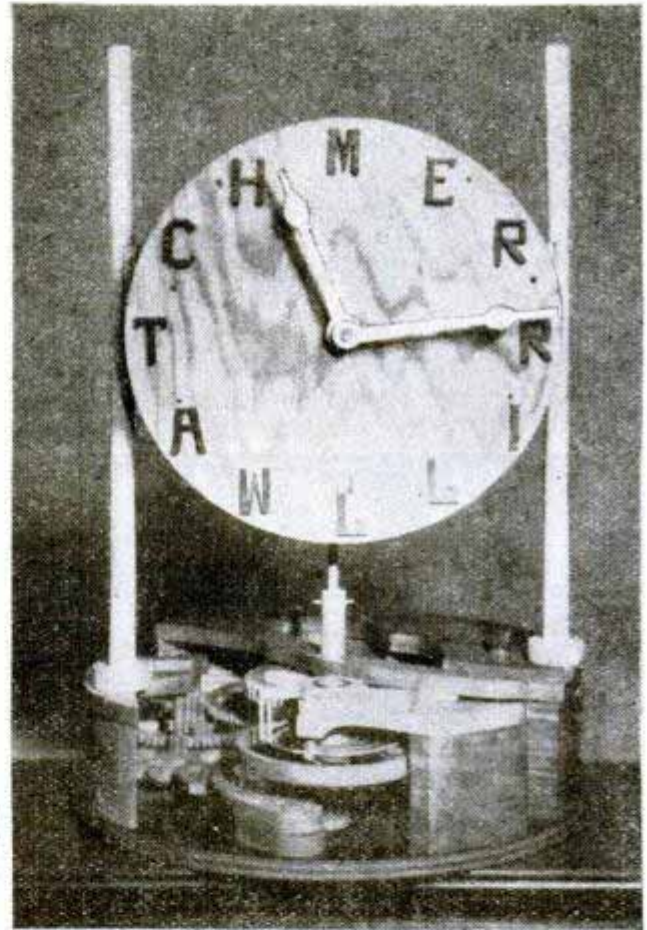

Locking Device Prevents Theft Of Outboard Motor

Outboard motors are protected from theft by a locking attachment that fits over the mounting-bracket clamp screws. Any standard padlock can be used. The motor can be locked either in operating position or with the propeller out of water. In addition, a safety cable prevents the motor from being lost overboard whether it is locked or unlocked.



Helicopter Dusts Crops

Hazards of aerial crop-dusting are reduced to a minimum by using specially built helicopters. In addition, these maneuverable aircraft can provide heavy applications by hovering, or lighter dusting by speeds from a slow walk to 100 miles per hour. Effectiveness of the operation is increased by the downwash of the main rotor blades which swirls the DDT-laden dust onto the underside of the foliage. Two easily attached hoppers behind the cockpit hold 400



Bell Aircraft photos

pounds of dust. They are quickly reloaded and little time is wasted. Tests show it can dust from 100 to 200 acres an hour.

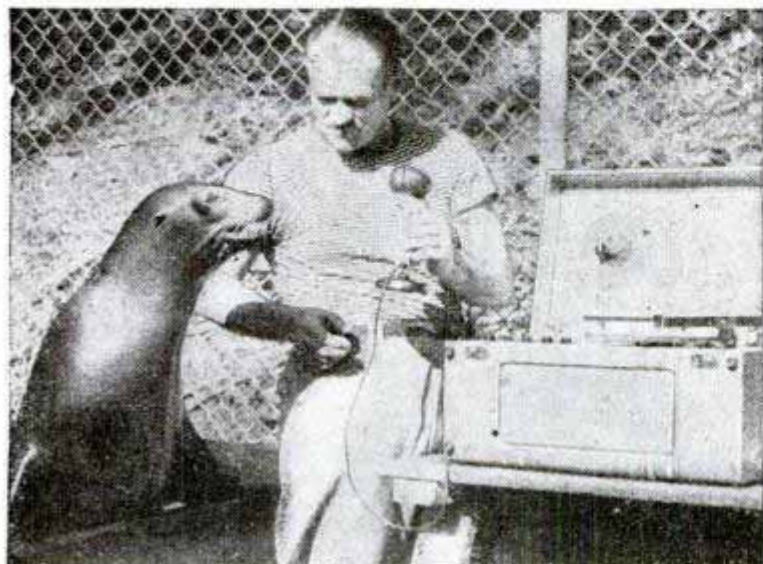

Sea Lion Hums and Talks

One of the San Francisco Zoo's performing sea lions has learned to say "mama" and hum four notes. A trainer taught Flipper to hum by putting his hand on her throat and humming. When she mastered the first lesson, three more notes were added to her repertoire. Then, by gently pressing her neck muscles and repeating "mama" over and over, the trainer taught her to say the word. Flipper is now entertaining daily in a duet with a singing sea lion who carries the "melody" while she hums.

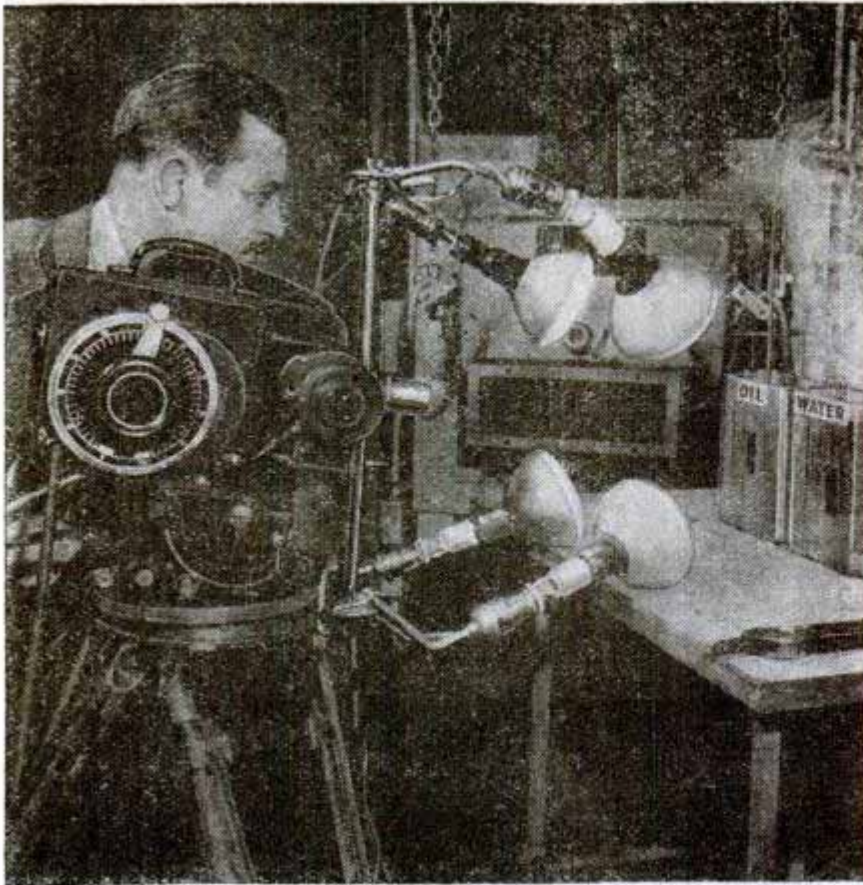

Courtesy Eastman Kodak Co.

High-speed movie camera shows what happens when hot steel is quenched in oil and water; the camera can stretch a second's action into minutes

★
INDUSTRY
has a
MILLION
EYES
★

By Eugene W. Nelson

PHOTOGRAPHY and photographic processes are such important industrial and research tools today that many industries have separate divisions employing hundreds of photo specialists.

Before World War II, there was a trend toward putting photography to work. The demand for increased speed and accuracy in both manufacturing and testing war material speeded up the industrial applications. Photography rapidly took on such diversified jobs as instrument recording, photo-analysis of materials, making templates, duplication of office records, microfilm filing, and personnel training with motion pictures.

These functions proved so valuable in saving time and money that many companies established separate photographic divisions. General Motors, for instance, has a photo department that employs more than 500 persons. Ford Motors also has such a unit, and most aircraft and chemical firms do, too.

One important photographic process which was evolved by the aircraft industry during the war permits the reproduction of engineering and production information directly from engineering drawings to metal templates (patterns). In this technique, the engineering drawing is photographed and the negative used for making contact prints on the specially treated sur-

Starting out as the "odd job boy" around the laboratory and factory, the camera has made itself indispensable to scientific progress and to business efficiency

Bulky drawing is microfilmed to reduce storage space by 98 percent; films provide a convenient reference

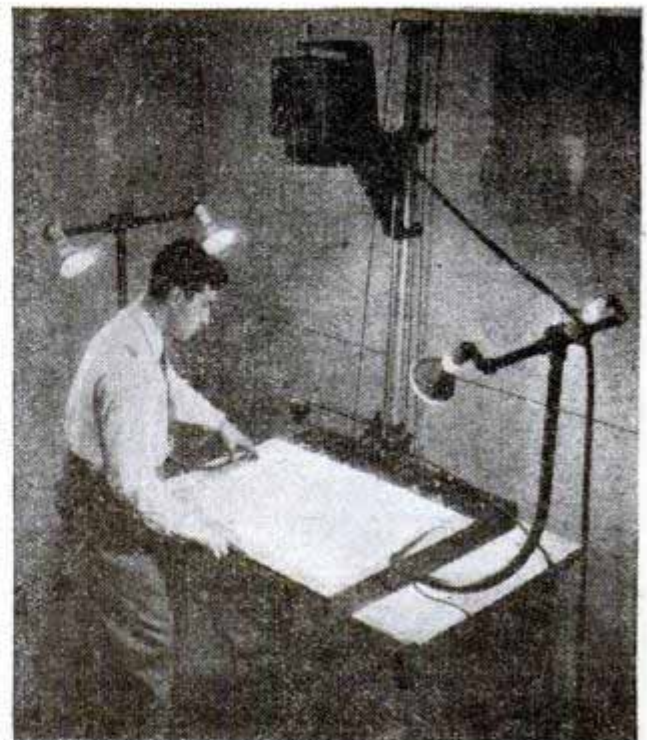

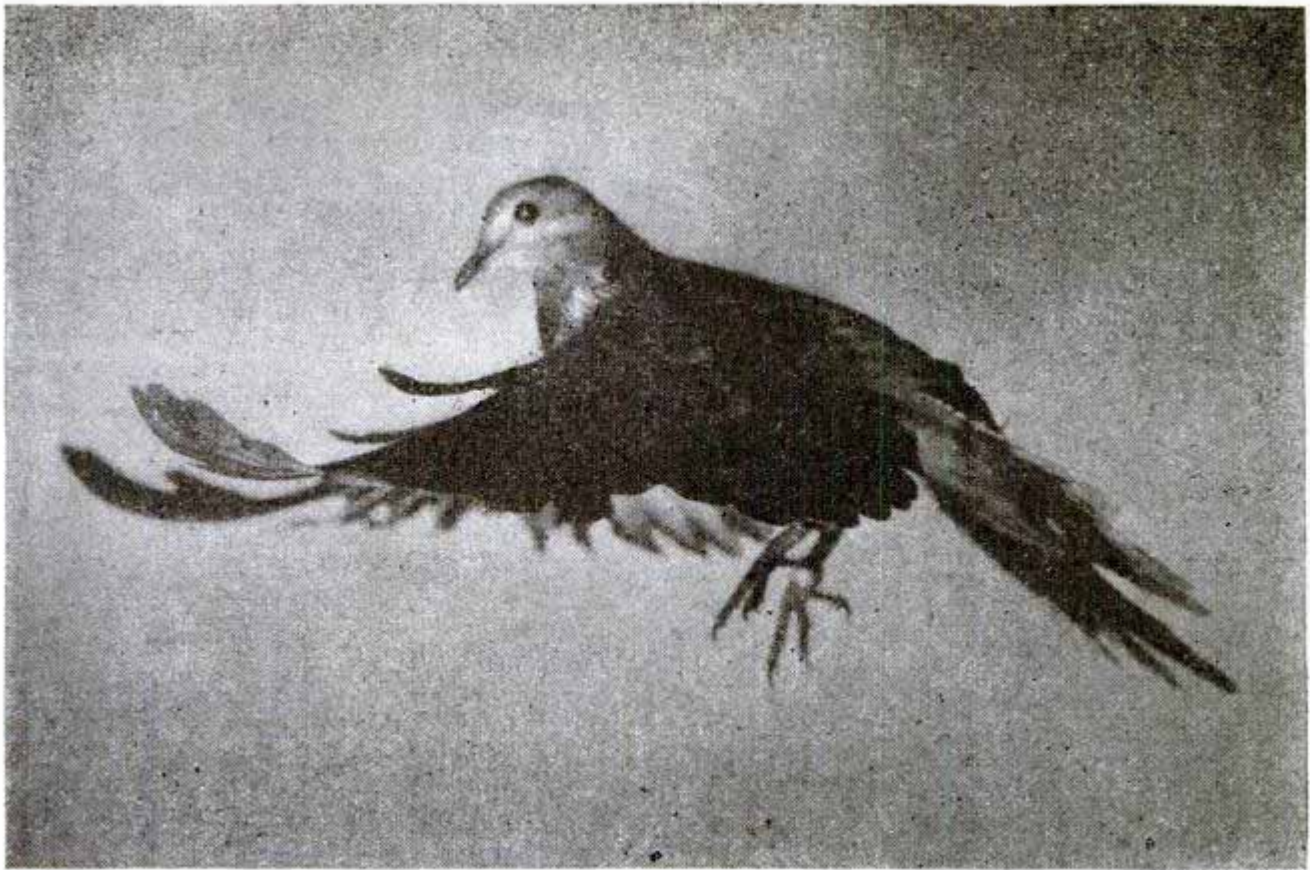

Courtesy M.I.T.

This photograph of a mourning dove in flight shortly after release is an example of high-speed photography

faces of small parts. Large drawings are photographically reduced and optically projected again to the correct scale against the sensitized metal sheets. It is estimated that 50 hours of such photographic work equals 12,000 hours of redrafting time.

A similar process which has recently been perfected for reproducing any draw-

ing, legend, or picture on firm, nonabsorbent surfaces such as metals or plastics. This method—known as the Transfax process—is a light-sensitive process but is not, strictly speaking, a photographic process. The Transfax method permits the transfer of drawing details from the original drawing to a sheet of steel.

Photomicrograph shows what a piece of high chromium tool-steel forging looks like magnified many times

Camera "wedded" to microscope produces photomicrographs with magnifications up to 5000 diameters

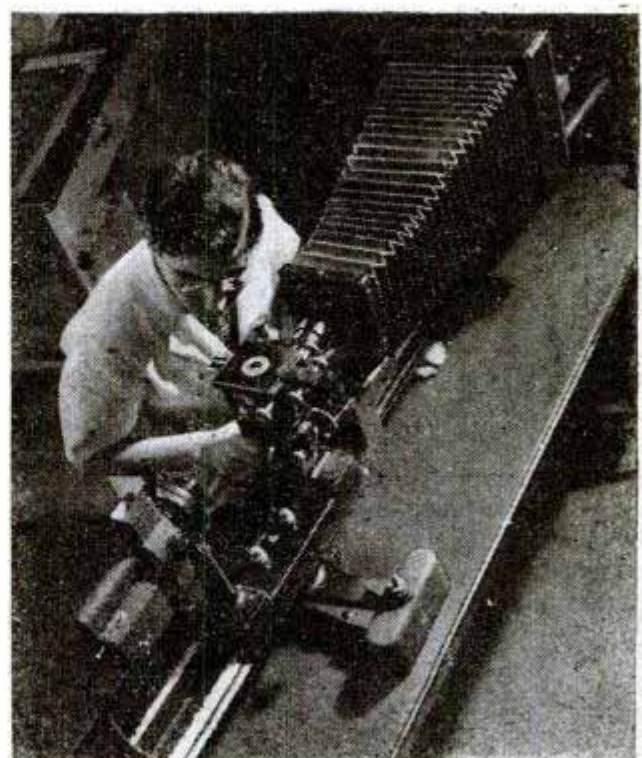
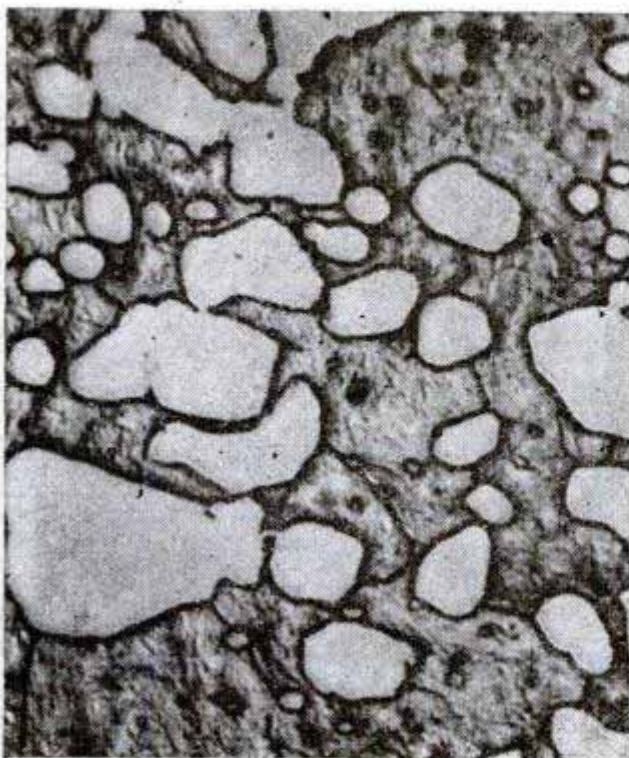

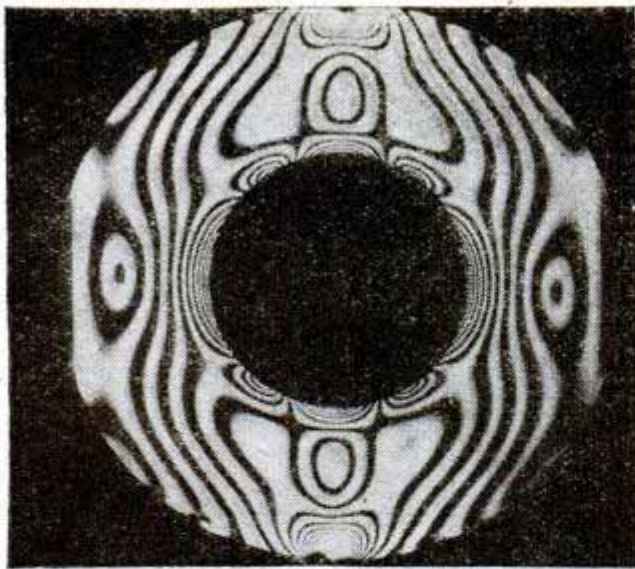

Courtesy Eastman Kodak Co.

Stress-analysis photograph gives engineers and designers advance information on experimental parts

To transfer a drawing, such as a shop layout, to another surface, the surface is first sensitized to light by being sprayed with the quick-drying Transfax solution. A transparent or translucent drawing is placed in contact with this surface and exposed to strong light. The surface is then flooded with a clearing solution, rinsed and coated with a tough primer.

This transferred drawing will not come off when the material is bent, sheared, or cut with the oxyacetylene torch. Transfax faithfully and clearly reproduces lines as close together as .003 inch. This makes possible the quick, inexpensive printing of complicated wiring diagrams on electrical equipment, the layout of lines and working instructions on metal parts that are to be formed or joined together, and putting

dials, labels and nameplates on products.

High-speed, motion-picture photography is a tool that has already proved of immense value to engineers and research scientists in many fields. In high-speed photography, motion pictures are snapped at speeds as high as 3000 frames a second. When the film is projected at the normal speed of 16 frames a second, time is literally magnified almost two hundredfold. Split seconds are stretched out into whole minutes in this manner so that action too fast for the unaided eye is made plain.

In the working of metals, high-speed photography has produced valuable information regarding the proper adjustment of punches and dies to insure the longest service. Ultra-speed photography of welding operations has saved money by pointing the way to faster and better welding techniques. Scientists are enabled to see, measure and analyze the action of flames in internal-combustion engines.

Photography has helped remove the knock from automobile engines. It has also revealed new and startling facts concerning the action of various liquids when hot steel is quenched and hardened in them, leading to stronger steel parts for cars, refrigerators and other products.

Of future value to industry is the use of slow-flying planes equipped with color motion-picture cameras for seeking new mineral deposits. The chief use of aerogeology to date has been to show the presence of likely looking geological formations where minerals may lie.

Treasure-laden rock deposits are seldom visible to a prospector on the ground since they are blanketed under from a few inch-

Millionth-of-a-second camera (shown at right below) has a built-in developer-projector and produces finished projection within 30 seconds. Inventor Nicholas Rohats (left) of General Electric is adjusting hypo storage tank

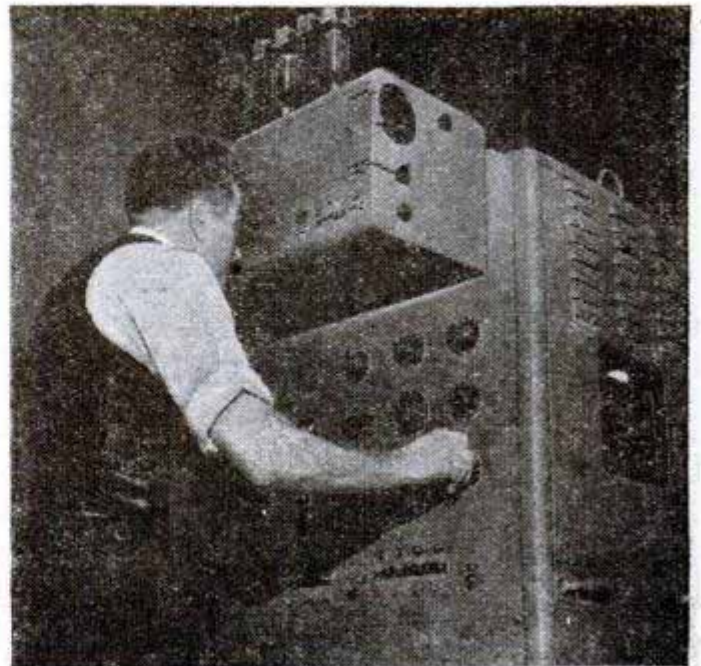

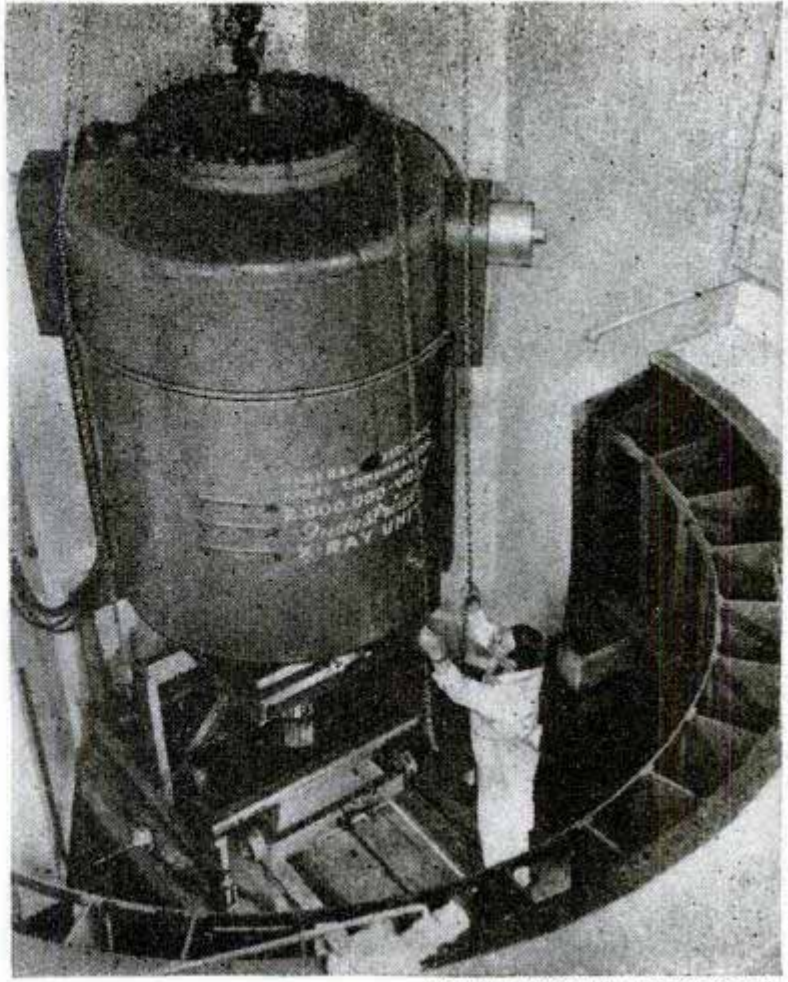
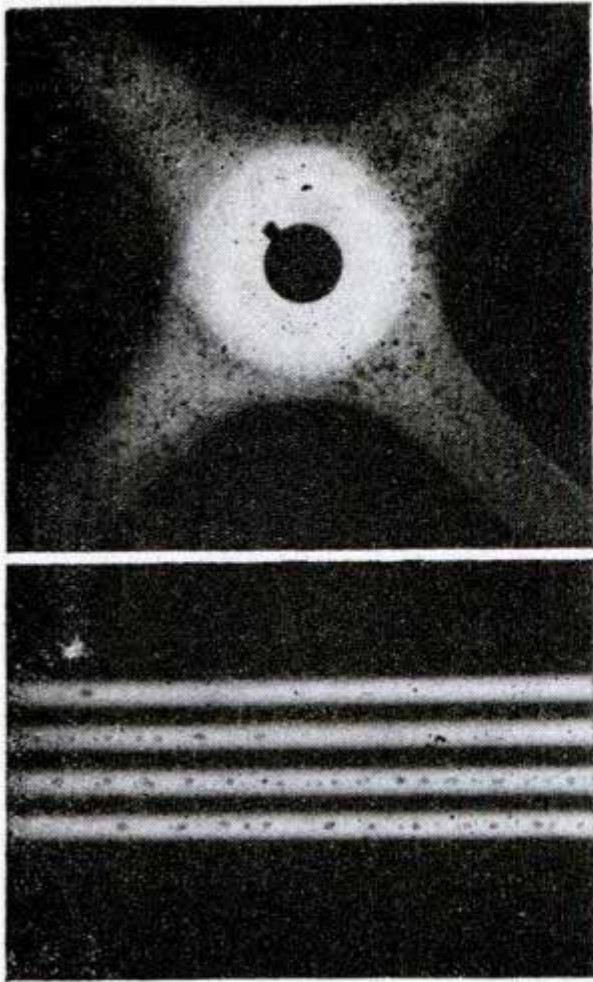

Courtesy General Electric X-ray Corp.

The 2,000,000-volt X-ray machine (right) permits engineers to look through solid parts. Top left, shows radiograph of blowholes (spots of weakness) in aluminum steering wheel and below it are gas cavities in plastic rods

es to hundreds of feet of soil and decayed rock. These formations can be traced by an observer from the air due to slight variations in the color of the land.

Aerogeologists expect that by using new color film and photographic techniques in slow-flying planes and helicopters they soon will be able to get valuable "prospecting" pictures of mountainous regions.

Airborne cameras are at work in other fields, too. The job of mapping our globe—which is said to be aerial photography's most important job to date—will go on as long as we continue to establish new air lines and as long as changes continue to take place on the earth's surface.

An example of the realms into which aerial photographic mapping can be carried is the work of the Beach Erosion Board of the Army Engineers. Assisted by the University of California, the engineers have developed methods for determining the depth of offshore waters to an accuracy measurable in inches from photos taken from altitudes up to six miles. From such photographs, the engineers can determine the exact nature of underwater obstacles to shipping like seaweed, coral reefs, sand bars, rocks, and sunken vessels, and also the depth of water over the obstructions. This technique was developed for planning

naval operations during World War II.

In the 1930s, aerial mapping—by means of cameras operated from captive balloons—was used by the Oriental Institute to map ancient, ruined cities in the Near East. The Shippee-Johnson expedition used airplanes for mapping the 11 square miles of the ruins of the ancient Indian city of Chan-Chan and also the 40-mile-long great wall of Peru. Complete photographic records of finds at archaeological "digs" are today rapidly replacing the old-fashioned hand-drawn diagrams.

An important industrial use of photography is in the field of spectroscopy. In the modern spectroscope, a tiny sample of material to be analyzed is burned and the light given off is photographed on spectrum-analysis plates. Each of the elements has its own particular combination of lines and bands forming its spectrum. Thus, spectrographic analysis is often referred to as "fingerprinting the elements." The cost of such an analysis is much less than for tests made by the "wet" chemical methods, and the photographic plates also furnish permanent records.

Photomicrography—the science of photographing prepared metal surfaces and enlarging them as much as 5000 diameters

(Continued to page 244)

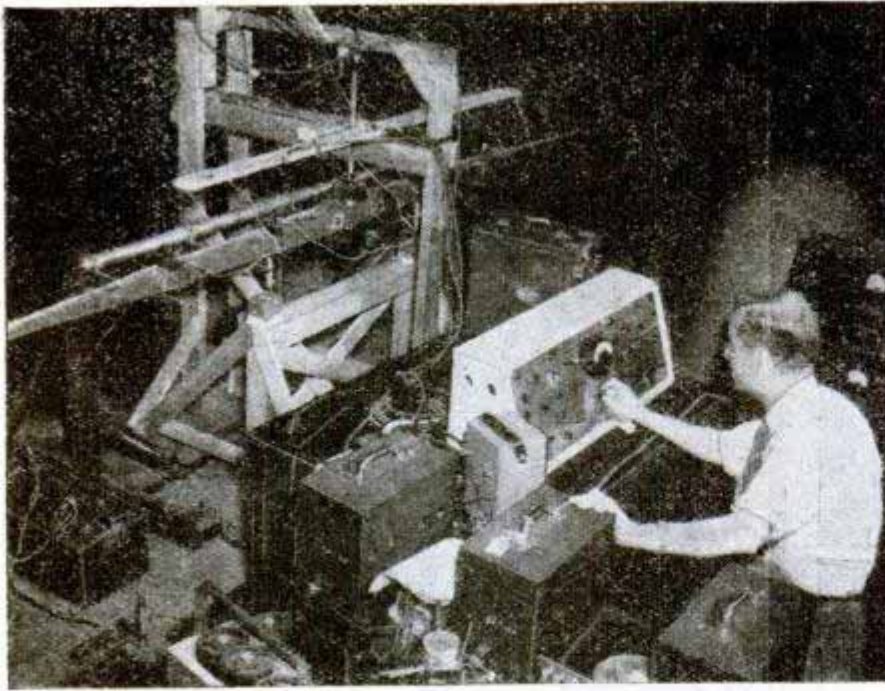

"Crackup Charlie"

"Crackup Charlie" is helping the U. S. Bureau of Standards determine how much punishment airplane wings can take. "Charlie" is a thin piece of reinforced aluminum, just over six feet long, resembling a wing. Electronic tubes and other sensitive instruments are connected to recorders on a nearby control panel. To check stresses engineers drop the model from varying heights and study results recorded on graphs. Findings go to private manufacturers and the government.

Drill Press Doubles As Wood Lathe

Drill presses are converted into wood-turning lathes by an attachment that saves floor space and eliminates the need for an additional motor. The attachment can be used on any drill press with a $2\frac{1}{2}$ or $2\frac{3}{4}$ -inch-diameter column. To make the conversion the column is replaced by a two-piece pivoting tube. No other changes are required. When used as a lathe the cast-iron bed is locked to the drill-press table and the motor and column pivoted until they are parallel with the bed. The adjustment

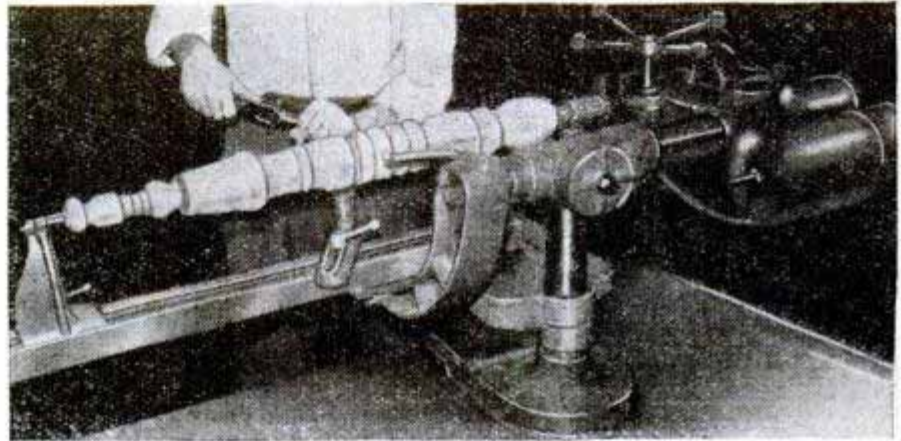

of work between centers is accomplished by moving the drill-press quill, eliminating the need for a handwheel screw. For drill-press work the lathe bed is fastened out of the way beneath the table.

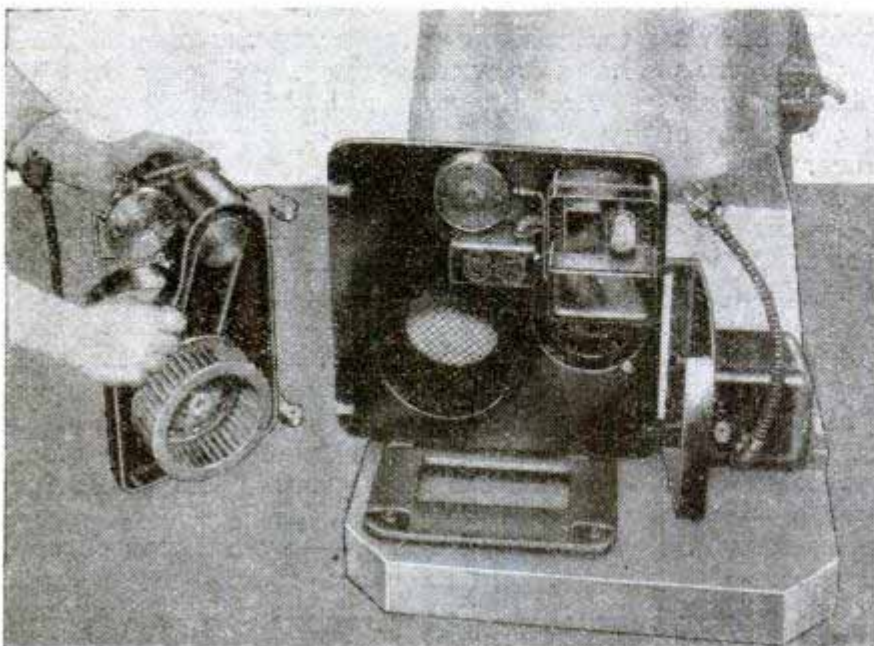

"Plug-In" Oil Burner

All the major parts of a new oil burner can be replaced within two minutes in case of mechanical failure. To make a quick replacement one threaded screw is removed which disconnects three fuel lines. When an electric plug is pulled, all wiring is disconnected at once. The entire casting holding the motor and pump swings out on hinges and can be lifted off and replaced as a unit. The transformer can be similarly replaced.

Paradise for Sidewalk Superintendents

Climb aboard the behemoth of the strip mines—the dragline that walks to work. Its every bite is a carload

SEVERAL MILLION MEN would regard as a fascinating pastime the job of one man who pushes the buttons and pulls the control arms bringing to life a gargantuan earth mover at an Indiana coal mine.

This electrical "toy" is as big as an eight-room house. It lumbers to work on its two great flat feet and in two mouthfuls it scoops enough earth and rock from the surface to fill a railway gondola car.

This walking dragline, one of the most powerful right arms man ever invented for himself, never gets to touch the coal which is the treasure it is hired to uncover.

Its function is to tear away the "overburden" of clay, sandrock and shale lying above a coal seam previously located by drilling. Sometimes the dragline scoops away as much as 76 feet of soil and rock to lay bare a three or four-foot vein of coal. Then the smaller electric shovels move in to scoop up the coal and load it into 30-ton tractor-semitrailers for

With a boom 180 feet long, the dragline can reach out 150 feet to pick up a 25-cubic-yard bite of earth at an Indiana strip mine



HOW THE DRAGLINE WALKS

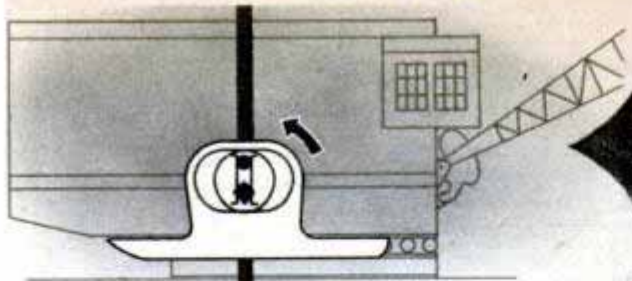

Position of cam and pin for digging and swinging

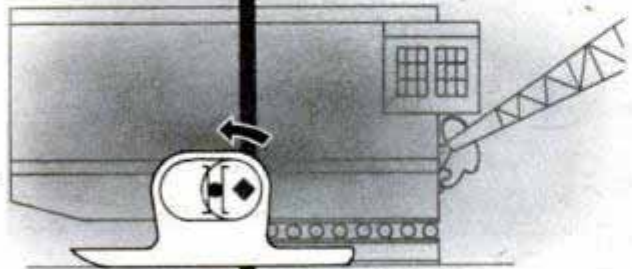

Cams rotate to advance and place shoes on ground

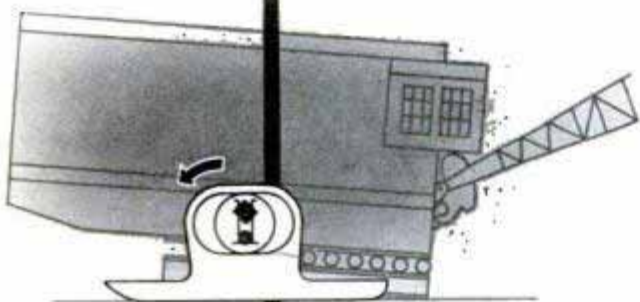

Cams lift and slide base forward. Base tilts so that forward part raises to lift clear of the rim

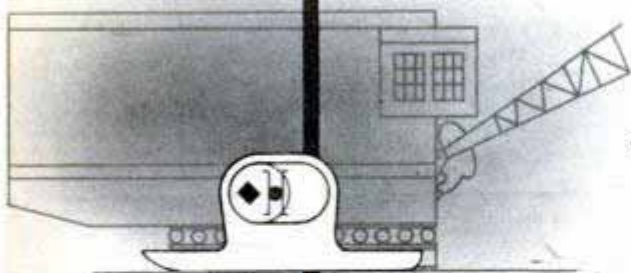

Cams continue to rotate to complete the step. Note that at no time is the entire base off the ground

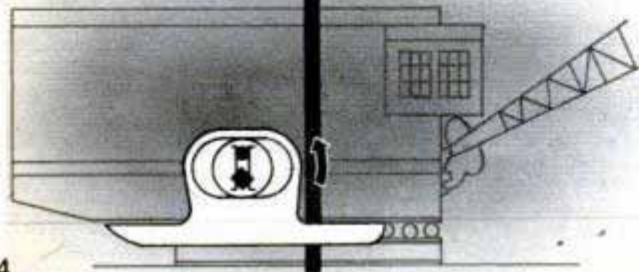

Cams rotate to lift shoes to the digging position

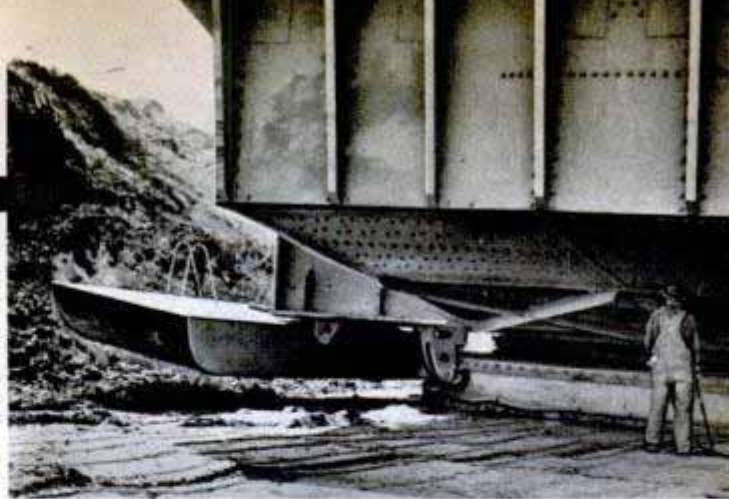

One of the dragline's big shoes which enable it to "leapfrog" forward seven feet four inches at a time

hauling to the processing plant. Once the "black diamonds" have been taken from the strip mine, the ponderous dragline walks back to work and drags the earth back to fill the hole it made.

A day on this Paul Bunyan of earth movers would be a holiday to most grown-up boys. Its steel arm reaches out 150 feet to lower a scoop big enough to take aboard a big truck, then swings on a turntable base 44 feet in diameter.

It took 45 freight cars to haul the parts—and three months to put them together—for this machine which operates at a strip mine near Terre Haute, Ind.

The Maumee Collieries Company operates its Bucyrus-Erie walking dragline constantly to dig as much as 35,000 cubic yards of dirt every 24 hours. That's the equivalent of the dirt excavated from approximately 200 house basements.

It takes a big, powerful, fast-operating machine to move so much dirt in such a short time. This walking dragline meets all these requirements. It weighs 1100 tons and carries 140 tons of gravel for ballast.

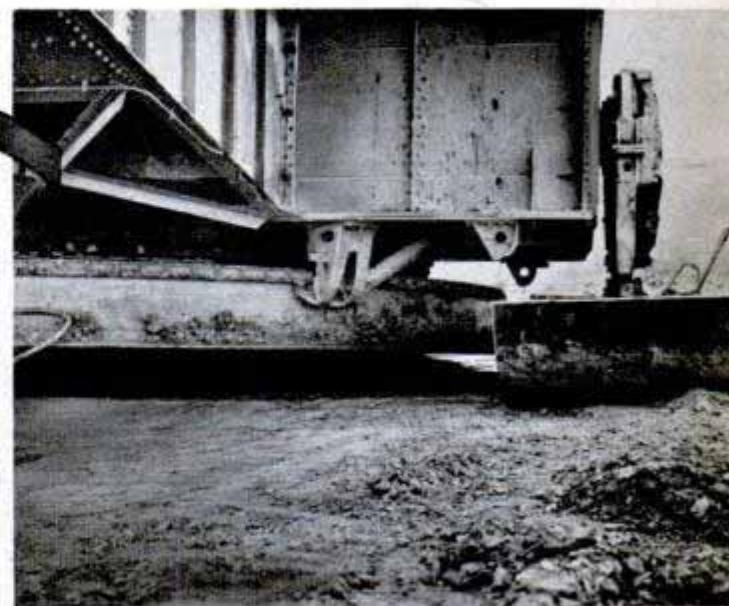

When the shoes are flat on the ground, the base moves to carry machine toward new location as shown at left

The base or tub is circular and consists of seven steel sections welded together. The base forms the foundation for the entire machine and carries the load of the revolving parts. These parts and the gravel ballast are positioned to locate the machine's center of gravity so that during operation it shifts through a limited range. This range has been determined in such a way that there is no danger of the machine tipping over when picking up huge bites of earth.

The steel house mounted above the base is 63 feet long, 30 feet wide and 17 feet 3 inches high. The house contains generators, motors, hoist and drag drums, and other machinery that put the giant dragline through its paces.

The boom is 180 feet long which enables the machine to pick up dirt as far as 150 feet from its base. Steel steps extend the entire length of the boom to provide easy access for inspection and oiling.

Electricity operates the dragline which takes 4000-volt alternating current from a power line and converts it to direct current to drive its motors.

Power equipment includes two motor-generator sets, consisting of two 900-horsepower motors which drive 11 generators. These generators supply the power for two 425-horsepower drag motors, two 425-horsepower hoist motors and three 125-horsepower swing motors.

Despite the maze of motors and machinery, only three men per shift are required to operate the mammoth digger: an engineer who uses four controls (two hand levers and two foot pedals), an oiler

A highly sensitive instrument in the dragline house records the number of swings, when they are made, and the angle and direction for a permanent record



Looking up walkway of the boom which enables the oiler to inspect parts and oil them. Below, operator has two foot pedals and two hand-operated controls

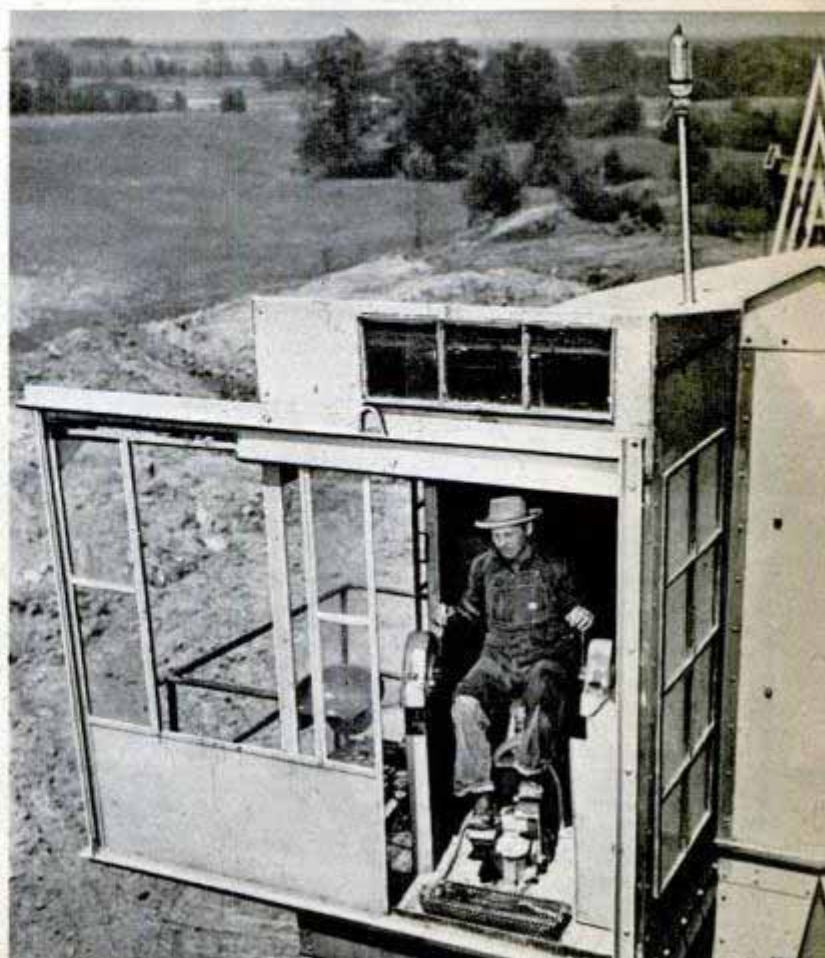

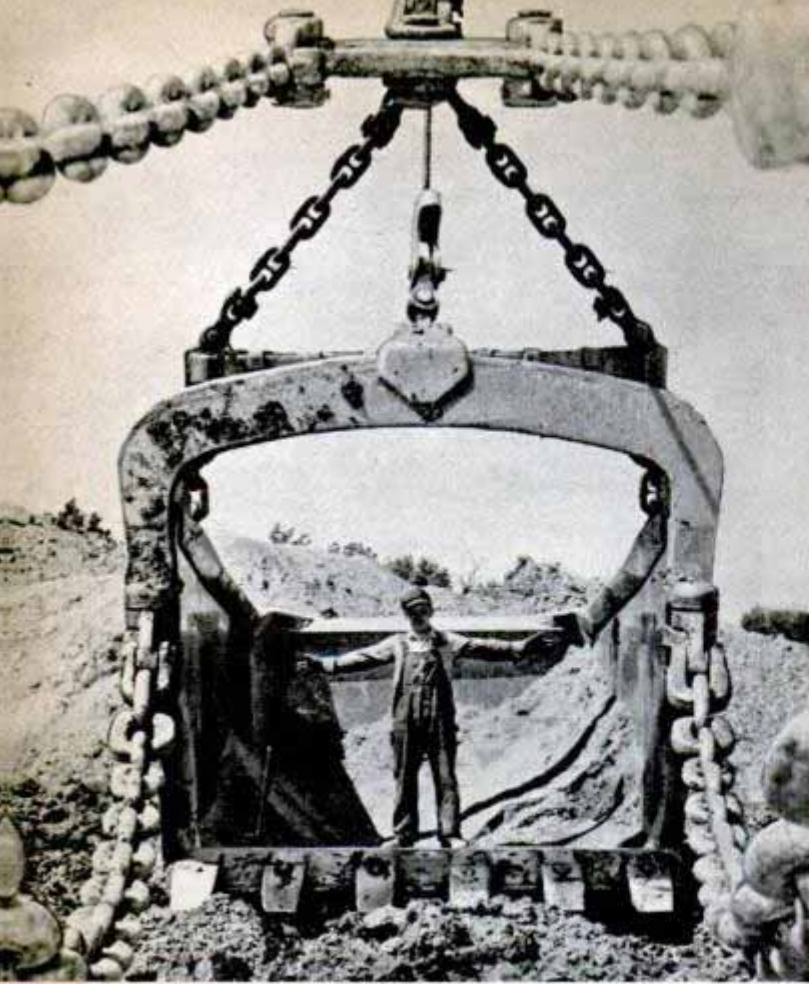

and a groundman who signals where dirt is to be picked up and dumped.

It's quite a sight to see this excavator pick up a big chunk of earth, then swing around swiftly on its base and dump the material. But people who like to watch construction work would get a bigger kick out of seeing it walk.

As shown in drawings accompanying this article, walking is easy for this 1100-ton machine. The walking mechanism consists of three major parts on each side of the revolving frame: an eccentric cam, an elongated circular-track cam frame and a walking shoe 48 feet long and 8 feet wide. The shoe is attached to the cam frame by

The bucket, which dwarfs a tall man, is big enough to hold a truck. The base (left center), 44 feet in diameter, consists of seven sections welded together; the dragline swings on this disk. Motor-generator sets (bottom) include synchronous a.c. driving motors (left) and d.c. generators (right) to power d.c. motors

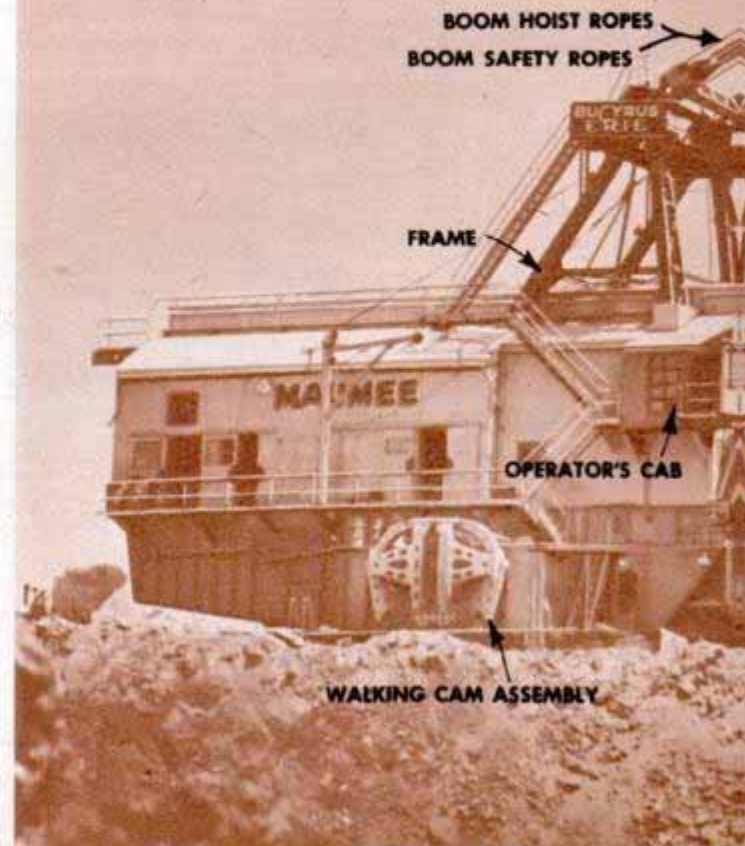
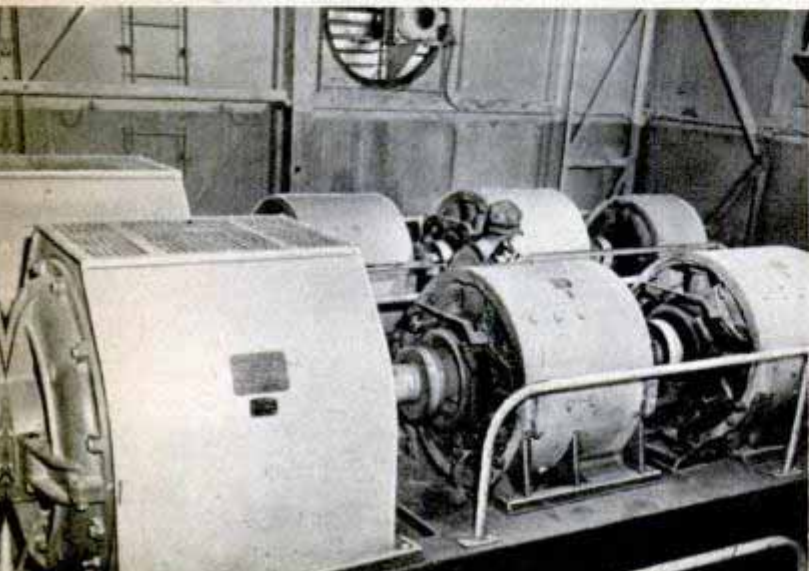
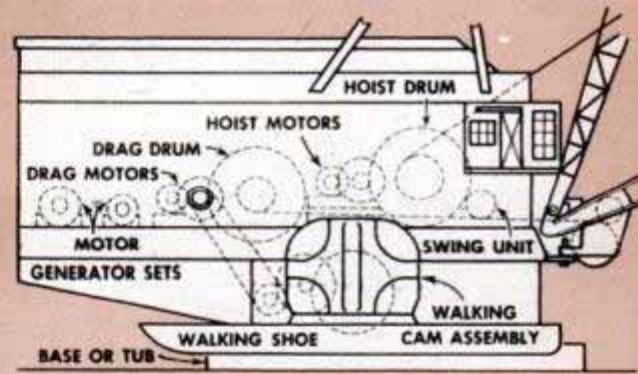
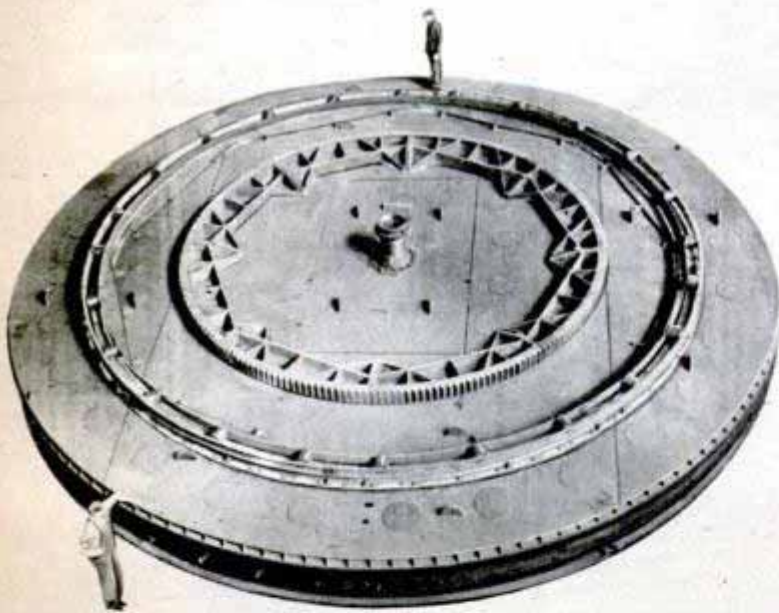

two strong hinges so that it can pivot sideways on the hinge pins as well as fore and aft on the cam.

A walking shaft, extending across the machine and mounted under the revolving frame, carries the cams and binds the two walking assemblies together for simultaneous action. Mounted on the cams opposite the walking shaft are guide rollers which move up and down in vertical slots guiding the cams to advance the shoes or the machine as the cams roll.

The machine walks somewhat in the manner of a boy leapfrogging over another boy's back. The jumper's hands, placed on the bent-over lad's back, are comparable to the base of the machine. And the jumper's feet move simultaneously, as do the immense shoes of the dragline. However, the dragline takes a step seven feet four inches long.

(Continued to page 240)



View inside the dragline shows drag drum in the foreground and hoist drum in background with motor between them. Machine has 2000 feet of steel rope

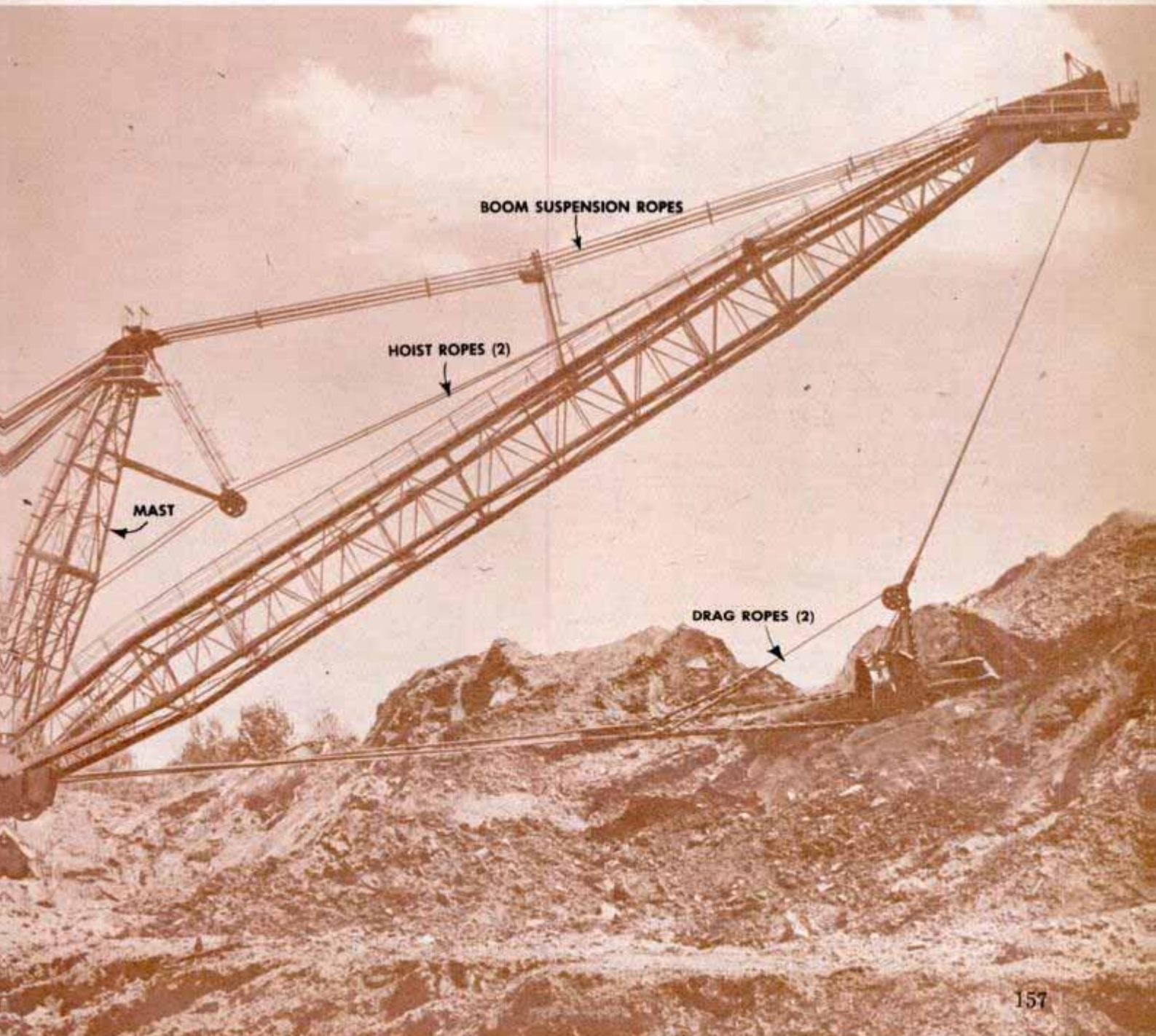

TENT-TRAILER SLEEPS FOUR PERSONS AND FOLDS FOR STORING



Trailer unit serves as roomy tent (above) or roadside sleeper for two (below). When not in use (right) it takes little space

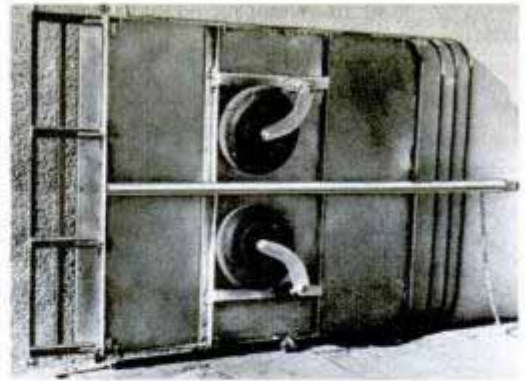

Four campers can sleep in a tent-trailer that collapses to only 13 inches high for storage. The trailer has two wheels that retract into the bottom when the unit is stored. With the wheels in place the trailer becomes a flat bed for general hauling. The canvas cover can be used to protect luggage and other gear. Within five minutes the cover can be pitched as a tent containing a mattress-covered compartment as large as a double bed with additional room for two camp cots. The trailer weighs 360 pounds and has a capacity of 1000 pounds. The wheels are suspended on rubber springs to reduce sway and shimmy.

Foot-Operated Tire Spreader Leaves Both Hands Free for Work

Any size or type tire can be inspected and repaired on a pneumatic spreader operated by two foot-button controls. This leaves the operator's hands free for work. After putting the tire on guide rollers and swinging both gripper arms and hooks inward, stepping on the left button spreads the tire and raises a cylinder platen that pushes the lining inside out. Pressing the right button reverses the process.

Braille Wrist Watch for Blind



Braille dots are raised on the face of an experimental wrist watch for the blind. Most former timepieces for the blind have been pocket models. The new wrist watch was designed at the

request of blinded veterans. The watch will not be produced until reports have been received from several veterans who are wearing the experimental model.

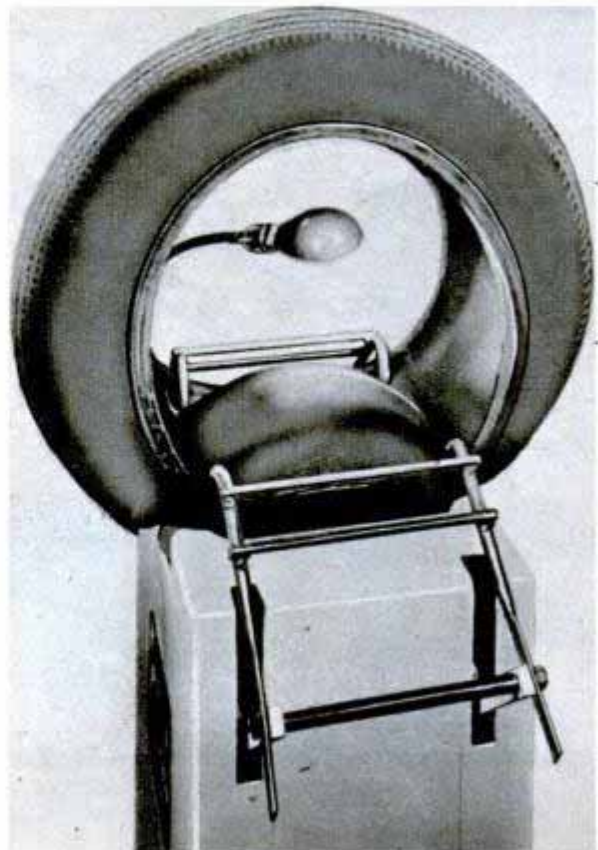

Glass Miniatures

Using a cutter, tweezers, a tube of cement and waste material, Garry Antman of New York has made enough glass miniatures in a year to fill a 10-room doll house. A chair $\frac{3}{8}$ inch high, with a seat $\frac{1}{8}$ inch square, is believed to be the smallest in the world. He gets his raw material from the waste barrel of a manufacturer of mirror-glass objects. Some of the pieces he fashions are only $\frac{1}{32}$ inch wide. Antman, who does the work as a hobby, has also made full-size glass floor and table lamps, flower boxes, clocks and radio cases.

Insecticide Atomizer

Warehouses, storage plants and large barns are kept free of insects and odors by a compressed-air sprayer that atomizes liquid insecticides and deodorants automatically from vents along pipe lines. During the heating season, the sprayer can be used to maintain proper humidity by piping water into it. The device will atomize from one to five gallons of liquid an hour.

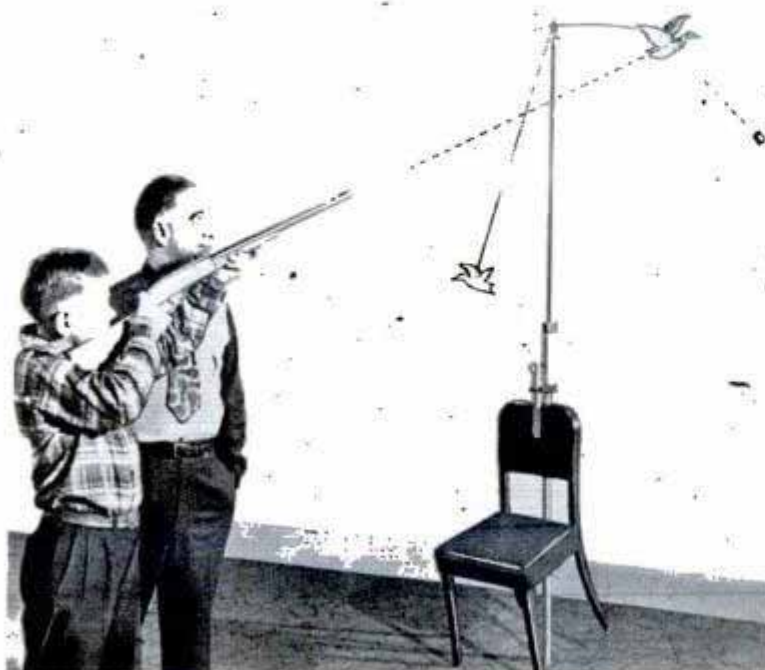
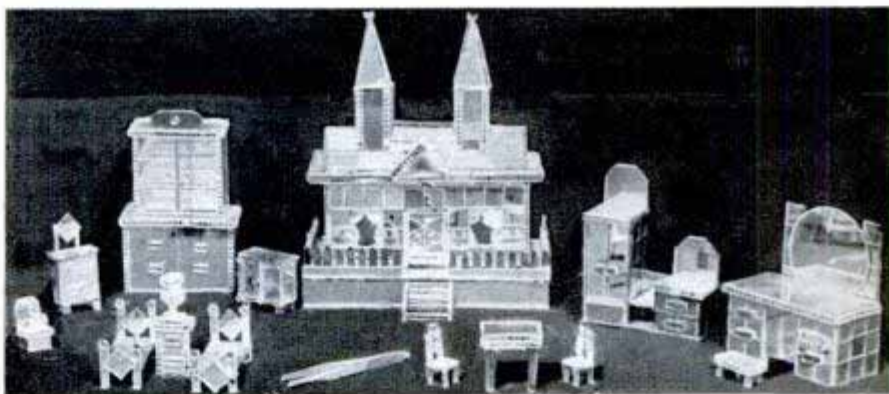
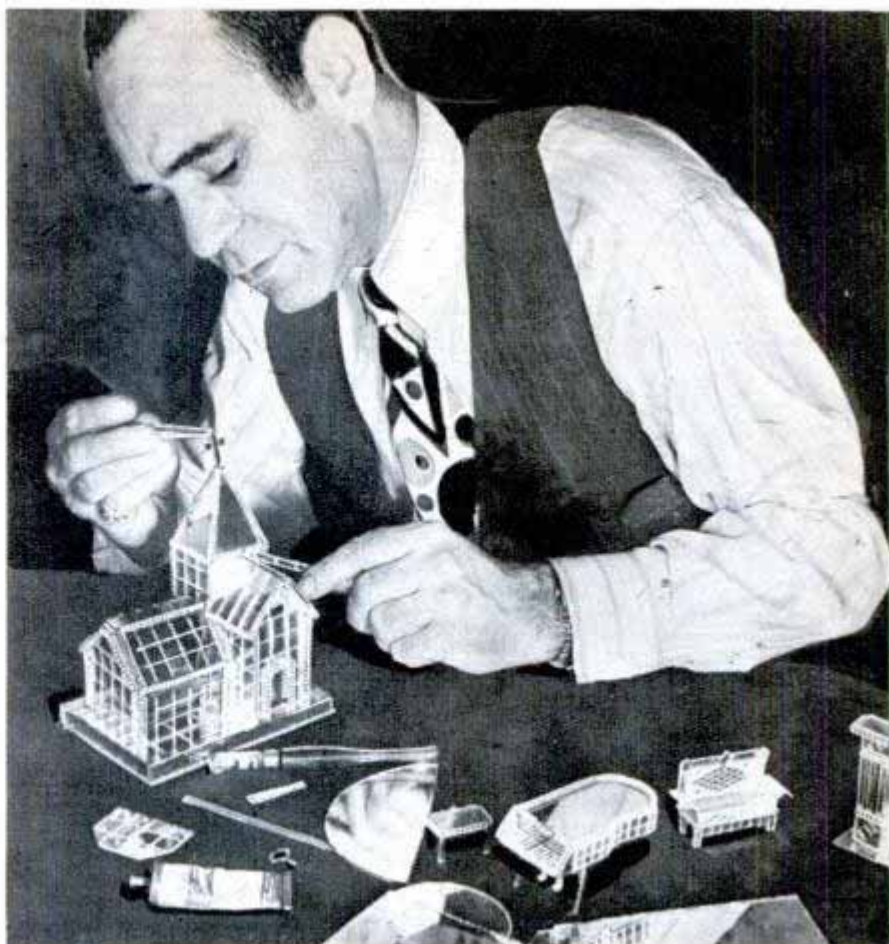

Indoor Wingshooting

Wingshooting can be learned indoors with an outfit that includes rotating target, a cork-firing gun and instruction manual. The three-quarter-size gun, operated by compressed air, is designed so that it will not break glass. Two moving targets, chosen from an assortment of metal ducks, crows, quail and rabbits, are attached to rigid arms that swing from the top of a standard. The standard is adjustable and can be clamped into position on the back of a chair. A slight push or wind from an electric fan sets the targets in motion. The swinging arms, four feet long when fully extended, pivot in a socket at the top of the standard.

SAFETY HOLDER for boiling eggs has timer→

FLAT-PLATE IRONER has 300-square-inch ironing board which can handle several handkerchiefs or hand towels at one time

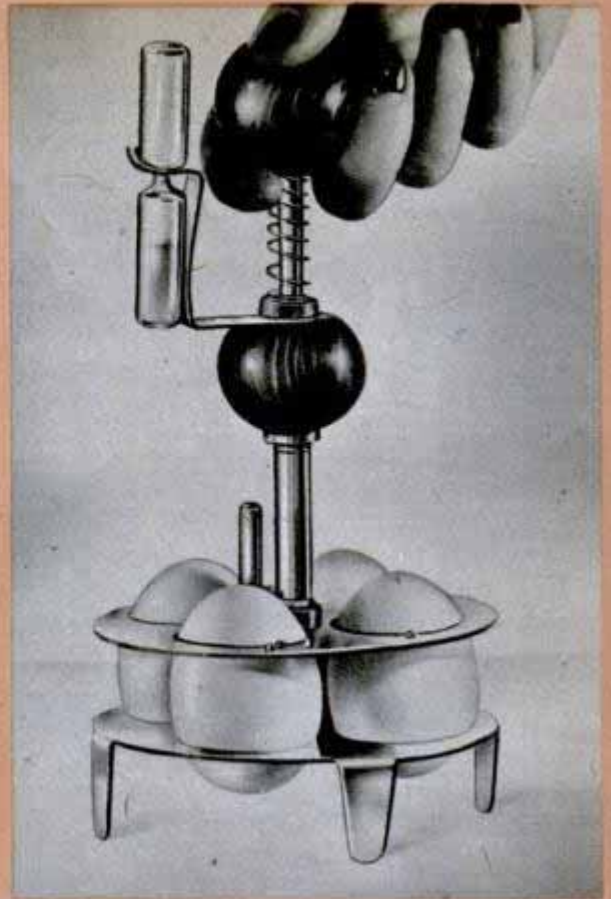

FLEXIBLE PLASTIC ice-cube trays (below) make it simple to remove cubes without use of hot water
STAINLESS-STEEL kitchen tool (lower right) removes core from grapefruit, cuts fruit from rind and divides "meat" into 10 sections—in one operation



WHAT'S NEW *For Your Home*





FLOOR WAXER automatically applies liquid wax as the operator pulls a trigger attached to the handle. The liquid flows from a container to a plush applicator

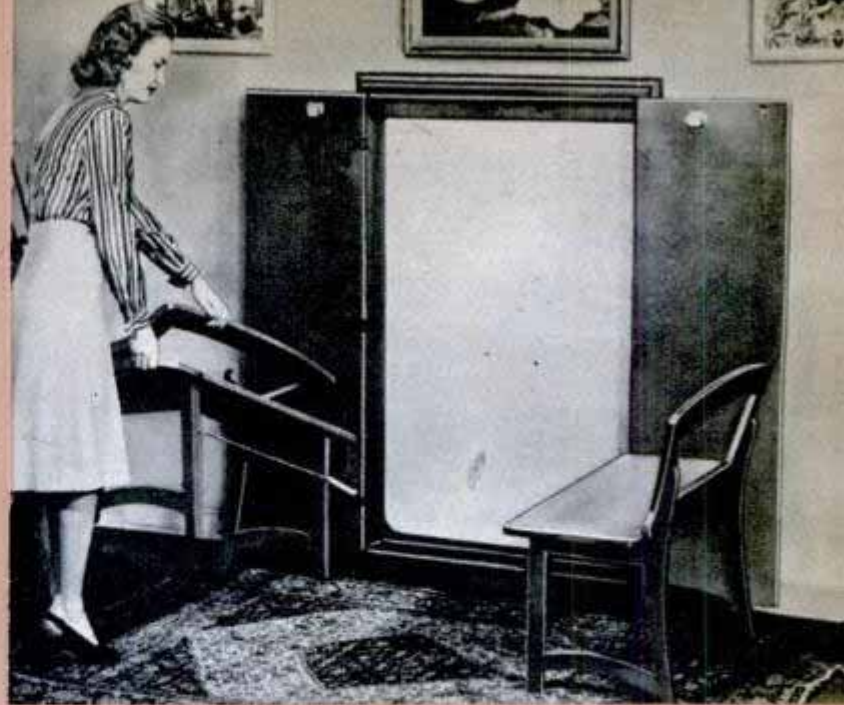

FOLDING DINETTE serves as dining-room table and conserves space in small apartments by fitting into a wall cabinet. Plastic top measures 32 by 48 inches

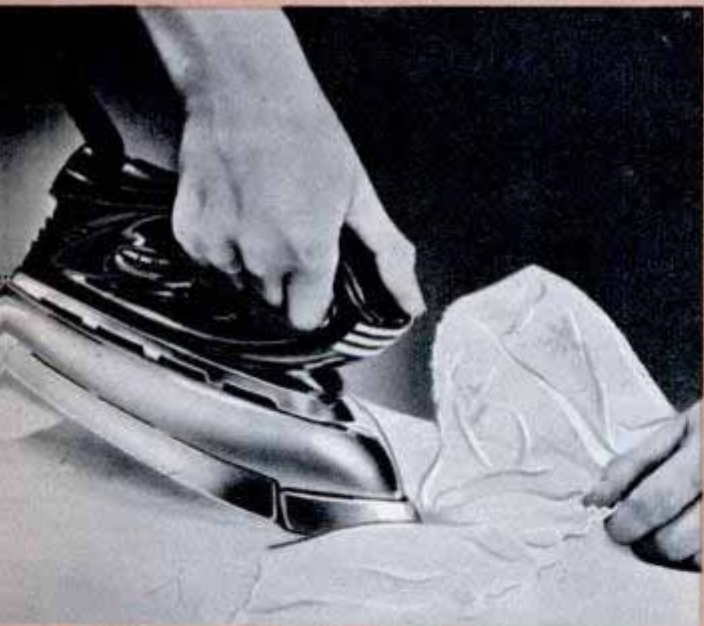

HAND IRON has hinged toe which simplifies the job of ironing delicate work such as gathers and ruffles

SERVING TRAY can also be used as sloping dish drain



AUTOMATIC WINDOW LOCK goes into action when a window is closed. It pulls upper and lower sash together. Lock is easy to open





Rods Cut By Multiple Leverage

Rods made of metal, wood, plastic and rubber are cut without distortion by a rod parter that has a multiple leverage arrangement for ease of operation. The rod to be parted is slipped through a hole of the same size in the cutting head. Several holes permit a wide variation in diameters. Extremely small diameter rods used in the manufacture of delicate instruments can be cut in the machine with close tolerance in concentricity. The cutter is available in two sizes, one taking rods from $\frac{1}{32}$ to $\frac{3}{8}$ inch and the other from $\frac{1}{16}$ to $\frac{5}{8}$ inch.

Three Guesses—What Are They?

Give up? They're plastic eyes for duck decoys. Molded 50 at a time from transparent Tenite, the eyes are painted on the inside with black pupils and brown irises, and later cemented to decoy heads. The plastic sheets are cast by injection.

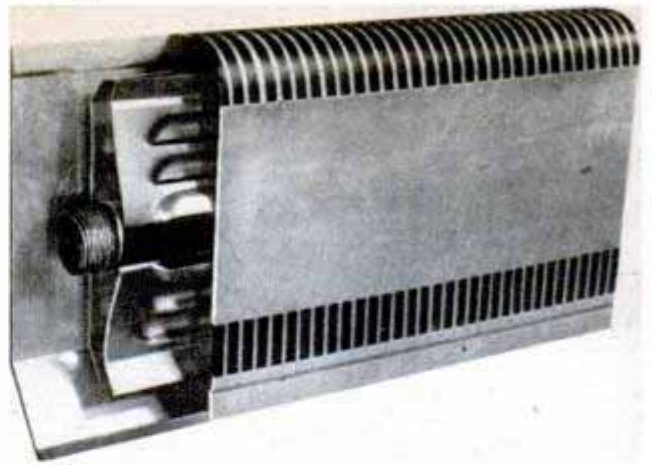
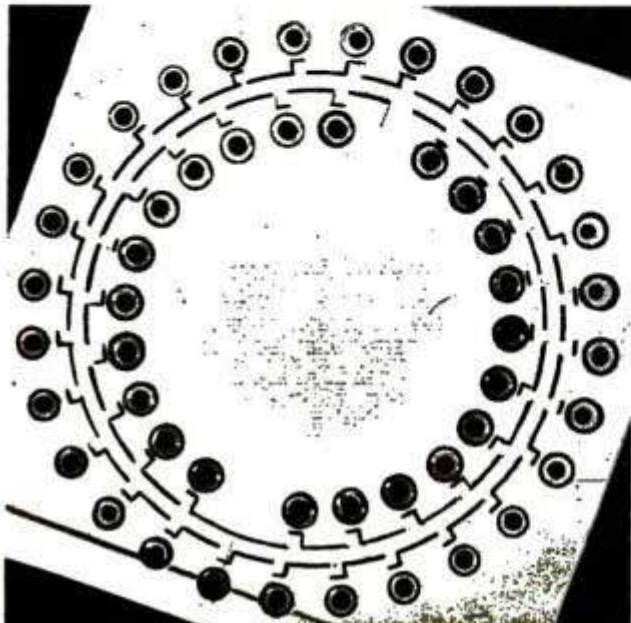

Aluminum Baseboard "Radiators"

Hollow aluminum baseboards with attached aluminum heat reflectors take the place of conventional radiators in a new hot-water heating system. The unit takes cold air from the floor, heats and circulates it through the room. A five-room house is heated with 30 gallons of water. The reflectors are clamped onto pipes along the outside walls. The baseboards and reflectors can be substituted for radiators in existing systems or in new installations.

Football-Shaped Street Lamp

Shaped like an oversize football, an unusual street light illuminates a 20 percent larger area with the same power lamp. The unit also minimizes glare to motorists. Both aluminum reflector and glass refractor are oval. The unit uses a 400-watt, 20,000-lumen mercury lamp.

Westinghouse photo



Machine-Made Check Rows

Two 113-horsepower tractors are required to pull a mammoth "checker" that is preparing land in California for permanent pasture. The machine, more often used in rice fields, makes rows of earth six feet wide and four feet high around the edge of level fields and along the contours of sloping land to retain irrigation water. It constructs $1\frac{1}{2}$ miles of "checks" an hour. Tractors pull the huge machine, 16 feet wide at the open end, along rows previously tilled. The funnel-shaped gathering blades form the soil into the type of check desired. An engine on the machine regulates the depth of the gathering blades and the height of the forming blades.



Caterpillar photo

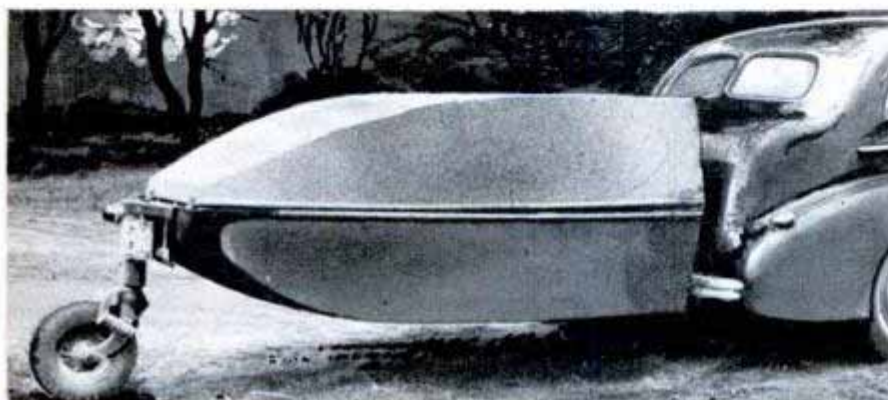

Hinged Boat Folds To Form Trailer

Built in two sections, a collapsible boat can be folded in half and a single wheel installed to make it a trailer. The bow section of the 14-foot craft pivots on hinges and forms a cover for the stern half, to which the single caster-type wheel is attached. The resulting trailer is seven feet long and provides a waterproof storage compartment. Two steel locking pins fasten the center bulkheads together when the boat is in the water and the same pins lock the trailer to a double car hitch for traveling.

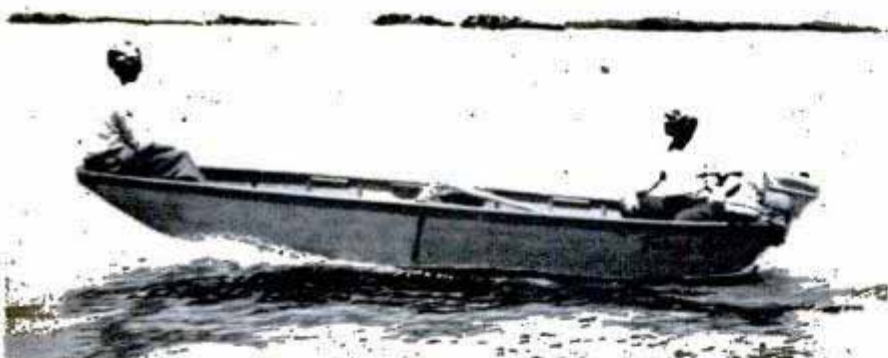

Pedal Taxis

Pedal taxis that are a cross between a jinrikisha and a bicycle are providing cab service in Japan where there is a shortage of regular taxis. The vehicles have an enclosed seat for the rider resting on a pair of wheels directly behind the pedal-pushing driver. Called a Rintaku, the taxi is constructed partly from duralumin.

If you would like additional information concerning the new products described in this issue, including names and addresses of manufacturers and distributors, write to Bureau of Information, Popular Mechanics Magazine, 200 E. Ontario St., Chicago 11



Pan American World Airways photo

Airplane Seat-Bed Has Foldaway Table

Transpacific air travelers are the first to use a seat that becomes a 78-inch-long bed at the touch of a button. Called sleeperettes, each unit has curtains which are quickly installed for complete privacy. Planes using them have been refitted to carry 30 instead of 44 passengers, providing 20 inches additional leg room at each seat. A foldaway table, which is built into the underside of the leg rest, is used for meals, reading and writing.

Shearing Jig

Asbestos-cement panels used in construction work can be cut with a shearing jig into any desired shape six times faster than with a hand-saw. The jig is manually operated, requiring no power. The blade slips along a track on the frame, cutting one foot each stroke. Circular cuts can be made by revolving the piece around a nail. The jig cuts up to $\frac{3}{16}$ -inch stock.



Fuel Atomizer For Gas Turbine

Designed for use on a 2000-horsepower oil-burning gas turbine, a fuel atomizer whips heavy oil into a miniature cyclone of tiny droplets less than $\frac{4}{10,000}$ inch in diameter. By reducing oil to such tiny droplets, 96 percent of the fuel is converted into heat over a wide range of



speeds, according to Westinghouse engineers who developed the new type nozzle. Fuel particles produced by conventional nozzles are at least 10 times larger than wind-driven droplets sprayed by the atomizer nozzle. Key to the new nozzle's atomizing power, even at low pressures, is a blast of air that enters through six very small slots cut at an angle in the nozzle.



Bombing the Desert With Seed

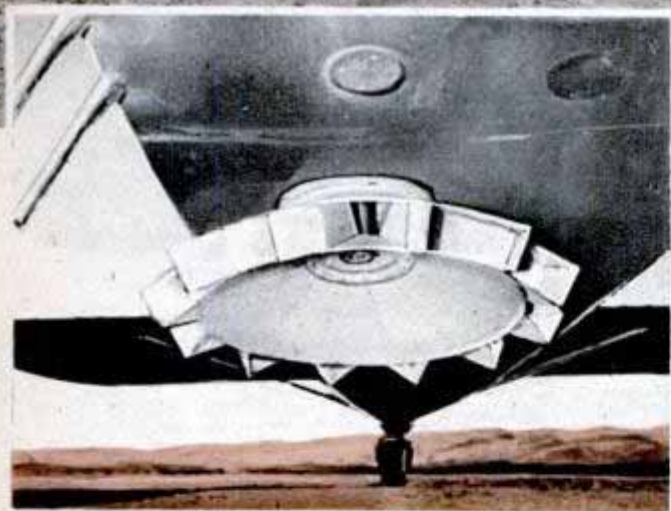

Seed-pellet spreader is attached to plane's fuselage. Rotating vanes spread seeds evenly. Below, movement of seeds from hopper to vanes is shown by the arrows

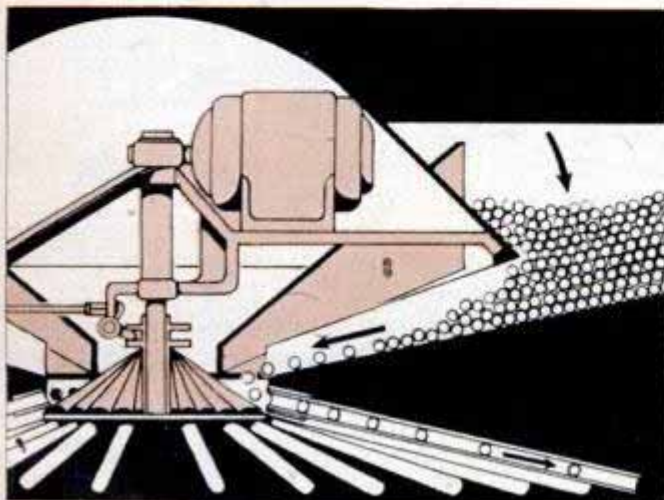

By William Winter

PLANTING GRASS SEED from planes is the newest technique in the fight against erosion—the land scourge that costs the nation \$3,840,000,000 a year.

In the Southwest alone, Indian reservations covering 50,000 acres of once barren land have been seeded by clay-coated pellets dropped from whirling fanlike machines attached to low-flying Cessna Bobcat planes.

More than 135,000 acre-feet, 44,224 from the Indian lands alone, are deposited as silt each year in Lake Mead, behind Hoover Dam, the biggest artificial lake in the world. Each square mile of eroded land contributes enough silt to cover one acre to the depth of two feet. A Reclamation Service survey for the period 1910 to 1939 shows a loss in water storage capacity of the four reservoirs on the Salt River amounting to 7562 acre-feet each year, or enough silt to form a one-acre pile considerably more than a mile in height. Similar reports exist on such dams as the San Carlos, on the Gila River; the Zuni, on the river of the same name; and Elephant Butte, on the Rio Grande. The consequent loss in investment, including cattle sales and crops, runs into hundreds of millions of dollars a year.



The plane is loaded with grass-seed pellets by a tractor equipped with a hopper attached to a hydraulic lift

The trouble is so acute that the Navajos, for example, have been restricted to one third the number of sheep grazed 28 years ago, despite a steady rise in tribal population. Dr. Lytle S. Adams, who did the planting by plane, estimates that between 200,000,000 and 300,000,000 acres support no better than two to four head of cattle for each 640-acre section. Overgrazing has reduced some 90,000,000 acres to semidesert. Only grass can save the bulk of this land and only the airplane can plant it fast enough to halt steady inroads of erosion.

After the burning over of the Los Angeles watersheds some years ago, mustard seed to bind the soil was successfully planted from the air. But usually seed cannot be thrown loose in the wind. African love grass, the best seed for the tough conditions of the Southwest, runs 6,000,000 to 7,000,000 seeds to the pound. Not only would such fine seed drift with the wind, but it would be destroyed by the weather or eaten by insects or animals.

Adams' first problem was how to mass-produce insect and rodent-repellent adobe or clay-coated seed pellets, each containing several of the minute seeds, which would penetrate the earth when dropped, then lie dormant until rain came. Although plantings usually preceded rains, rain might not come in the more arid locations for many weeks. For use in hard-caked earth or for reforestation, metal-covered pellets with tiny moisture holes, could be

used. To make these earth pellets, Adams developed an ingenious machine.

Raw, fine clay is pulverized by running it through a hammer mill. Then it is blown under pressure through a metal pipe into hoppers mounted above troughlike containers. A fine spray of water is blown into the containers and a worm gear kneads the mixture to a doughy consistency. Then the recipe calls for added fertilizer, rodent and insect repellent, fungicides, and finally the grass seed. The dough is then placed in hoppers of a machine that pours out finished pellets from twin chutes at the rate of 48,000 a minute, or three tons a day. This is enough to cover 4500 acres. The pellets may be either one quarter inch or three eighths inch in diameter.

To spread the pellets from an airplane, Adams (who, incidentally, invented an airmail pickup device), dreamed up a disseminator. This is a rimless wheel affair which has sheet-metal chutes for spokes. Whirled by the wind, this blower tosses out pellets by centrifugal force. An electric motor governs the speed of the blower, insuring an even planting pattern. The Bobcats used on present contracts carry one blower, but the ideal plane would provide for four blowers which are necessary to maintain density of pellets when a very wide swath is planted; flying at 500 feet, it would seed a 1000-foot-wide swath at the possible rate of 20,000 acres a day. Ten thousand acres require 240 tons of small

These machines form the → small pellets from moist clay, seed, fertilizer and insecticide

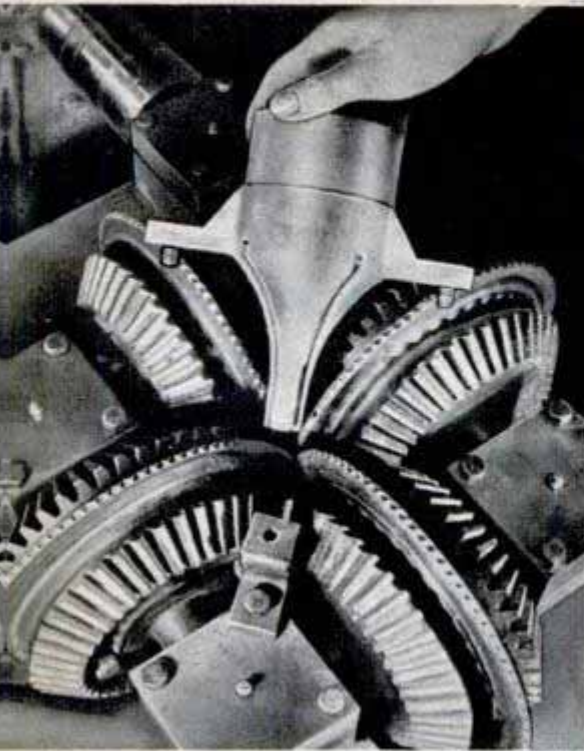

Four disks operated by gears press the materials into pellets. Chemical treatment prevents mold and deterioration, assures proper germination

pellets or 300 tons of the larger pellets. Sky planting costs \$2.03 per acre which includes 28 cents for seed. This compares with \$4.50 for slow and pathetically small-scale hand planting. Adams has refined airplane seeding to the point where one quarter pound of seed may suffice for an acre. To check his ability to plant one pellet to the square foot as demanded by contract, four men held taut an army blanket having about 30 square feet of area. When the plane passed overhead, 26 pellets remained in the blanket and another 6 to 8 bounced off.

On the Papago and San Carlos Reservations, and the Safford Grazing District, Lehman love grass, African love grass, and sand drop seed were employed. Crested wheat grass and western wheat grass proved best on the Hopi Reservation and the New Mexico Grazing District Number Two. Sweet clover is another commonly used seed.

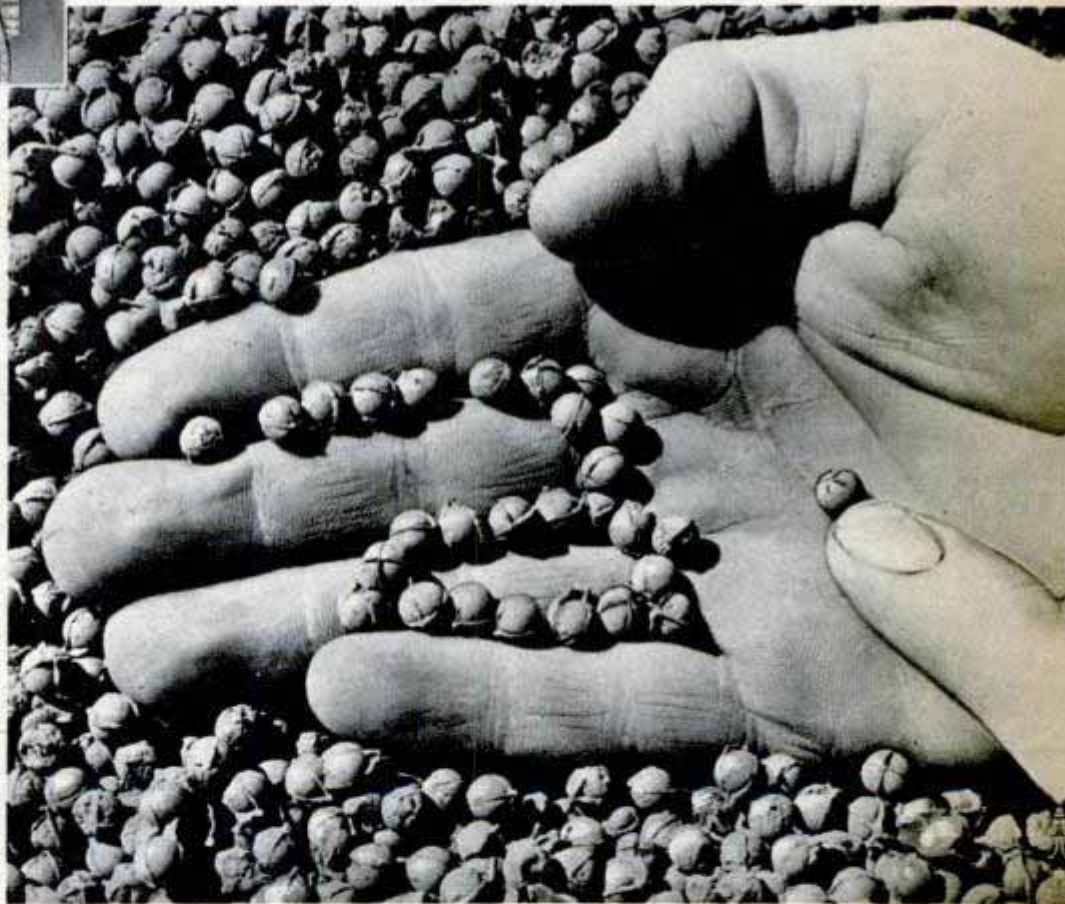

African love grass is particularly good where grazing cattle menace the shoots. The cattle bite off the higher branches, but low shoots run along the ground and take new root at every joint. In test plantings on the Papago Reservation, the animal-carrying capacity of the ground was doubled. Whereas a 10-acre test field grazed two horses for a year, an adjacent untreated 640-acre section carried only the usual two head of cattle.



Blanket catches grass-seed pellets dropped from plane to check ability to plant one pellet for every square foot

The Indian reservation plantings were done for the Department of the Interior by the International Pellet Company. The 50,000 acres so far sowed by plane are only a beginning. Seven million acres of the Navajo Reservation alone require erosion-control measures.

The value of reseeding is shown in a 50,000-acre tract atop the Chuska Mountains along the Arizona-New Mexico boundary. The land was once covered with meadows and thick stands of pine. Today, the grass is sparse; Navajo sheep destroyed most of the forage. Within five years after reseeding, the land will sup-

port almost four times as many sheep per acre as it does today.

Reforestation by aerial sowing of seed offers exciting possibilities. For example, the almost impossible scrubland of Florida could be readily planted by plane. Long-range planes can penetrate almost inaccessible regions. Shifting sand dunes of New Mexico and Arizona can be pinned down with Johnson grass. Irrigation has proved that the alluvial soil of the southwestern river valleys is highly fertile with the addition of life-giving moisture. While putting a stop to erosion, airplane reseeding enables the soil to retain that moisture.

Dr. Lytle S. Adams, who plants grass seed from a plane, inspects a stand of grass specially suited for dry areas



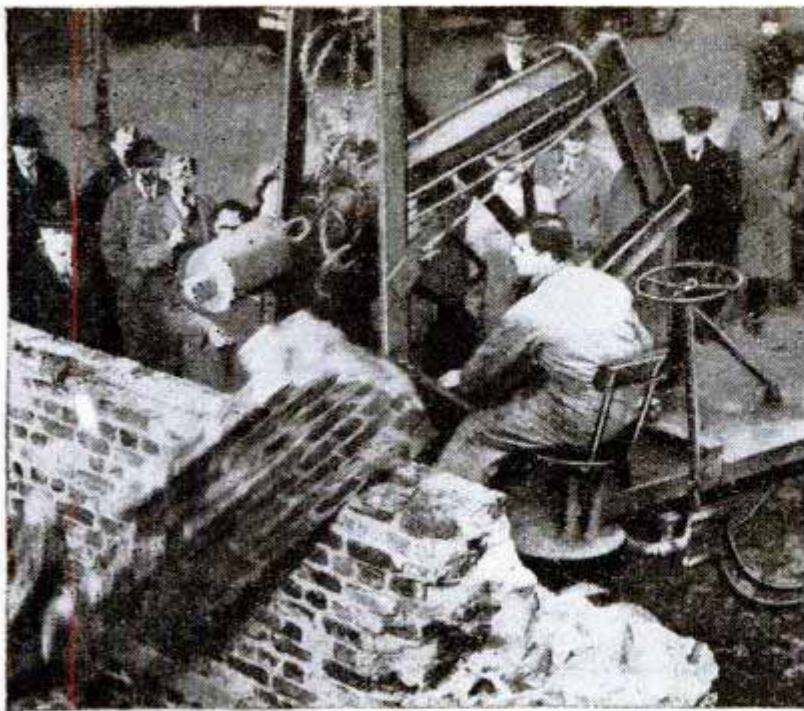

Air-Driven Rammer Clears Remains of Blitzed Buildings

Powerful hammer blows from a compressed-air machine are battering down what remains of blitzed English buildings. The mobile equipment is brought close to

the target to punch out its short, ramming strokes. A square tip on the ramming barrel increases its effectiveness. The machine has speeded the clearing of bombed areas.

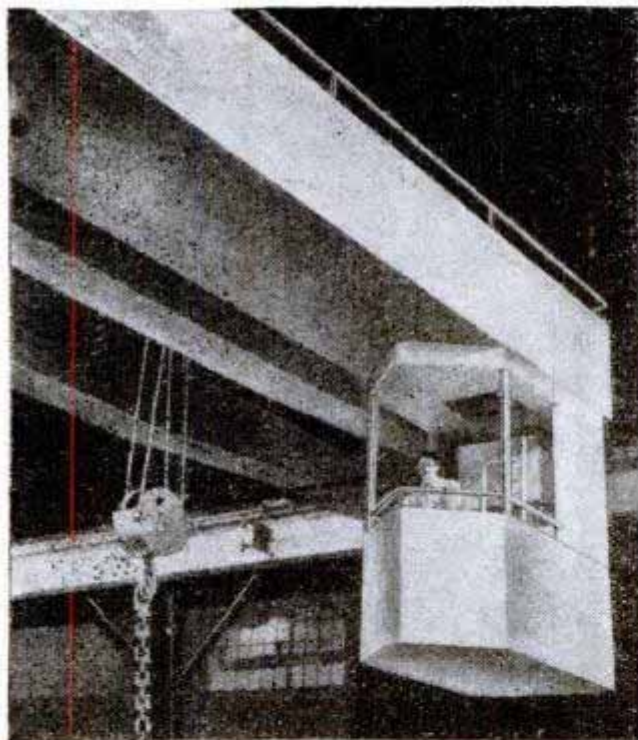

Brightly Colored Crane Safer

Bright colors are useful safety factors in a streamlined overhead traveling crane. The hoisting trolley, lower block and hook, the handrail on the platform and the cage are a brilliant orange which stands out against the blue of end trucks and girders. Because of the strong color contrasts, men working under it are constantly aware of its movements.

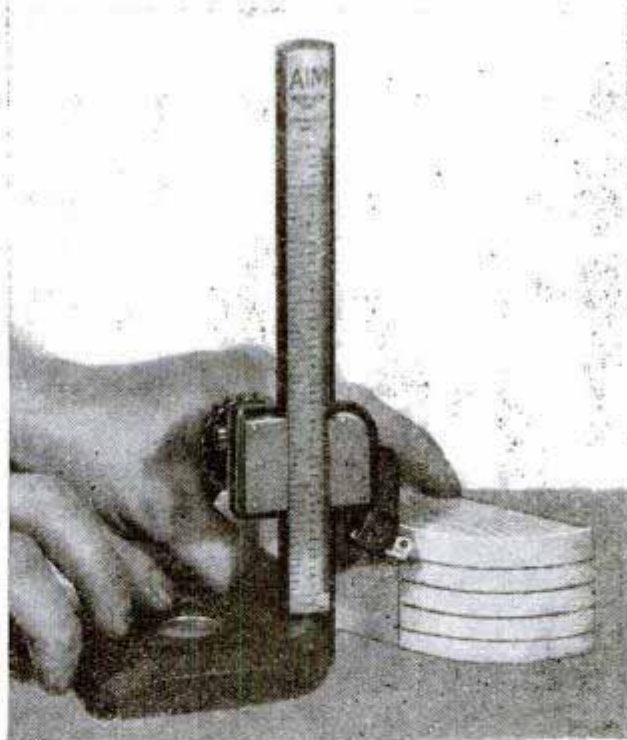

Woodworking Height Gauge

Odd-shaped objects made by the home craftsman are quickly and accurately marked for special cutout work by a new height gauge equipped with a pencil-lead holder. The instrument is adjusted by gear action operated by a plastic knob. The scale is graduated on one side to read from 0 to 6 inches in hundredths of an inch and on the other side in sixty-fourths of an inch.

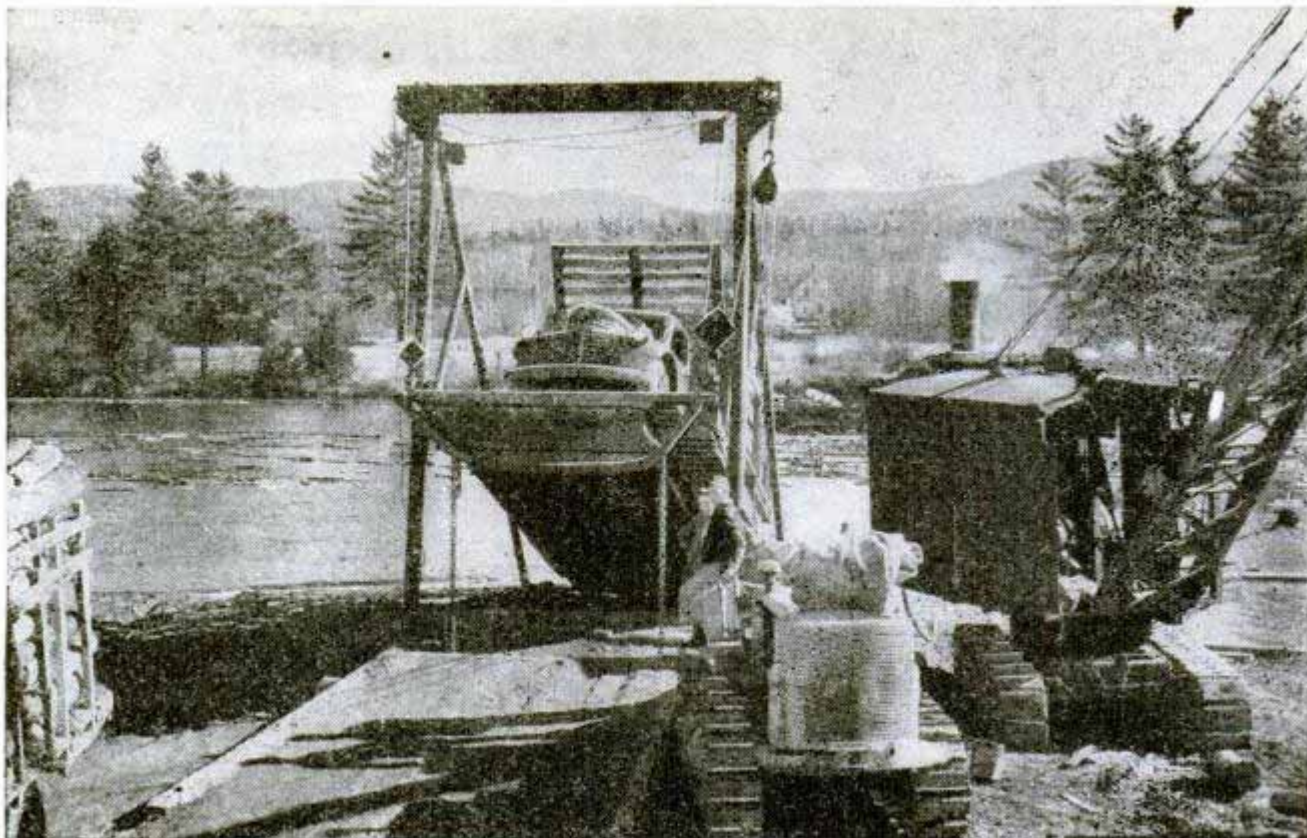

Caterpillar Tractor Company photo

Tractor-Powered Unloading Platform Dumps Trucks

Pulpwood hauled by truck from nearby woods is dumped into a New Hampshire mill storage pond by an unloading platform that raises the front end of the truck several feet. Operating cables suspended from a stationary superstructure are attached to the forward end of the platform and run to

a tractor which provides the power. A truck to be unloaded is driven onto the platform and securely blocked. The tractor winch then elevates the front end, sliding the load directly into the stream. As many as 4000 cords of pulpwood are unloaded in nine hours from the platform.

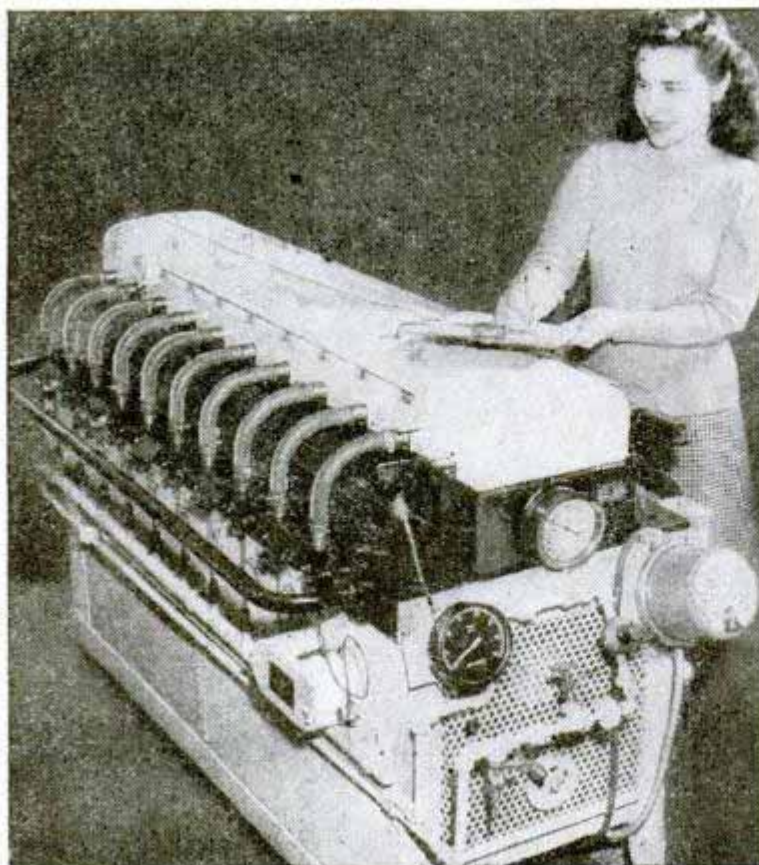

Test Simulates Tire Wear

Whirling spindles in a testing machine tell in a few hours as much about experimental tire fabrics as a 20,000-mile road test. The machine, developed by Goodyear, subjects 20 fabrics to the stresses of hard driving. The fabrics are made of cotton, rayon, Nylon and synthetic materials and are coated with rubber to form the layers of a tire. Previously, the fabrics were made into tires and given expensive road tests. Now they are made into sections of miniature tires about one foot long and as thick as garden hose. The ends of each section are fastened to two spindles and air pumped under pressure into the hose. The spindles revolve to bend the fabric, alternately compressing and expanding it. If the fabric breaks down quickly it is eliminated. Fabrics that pass this test are then given standard road tests.

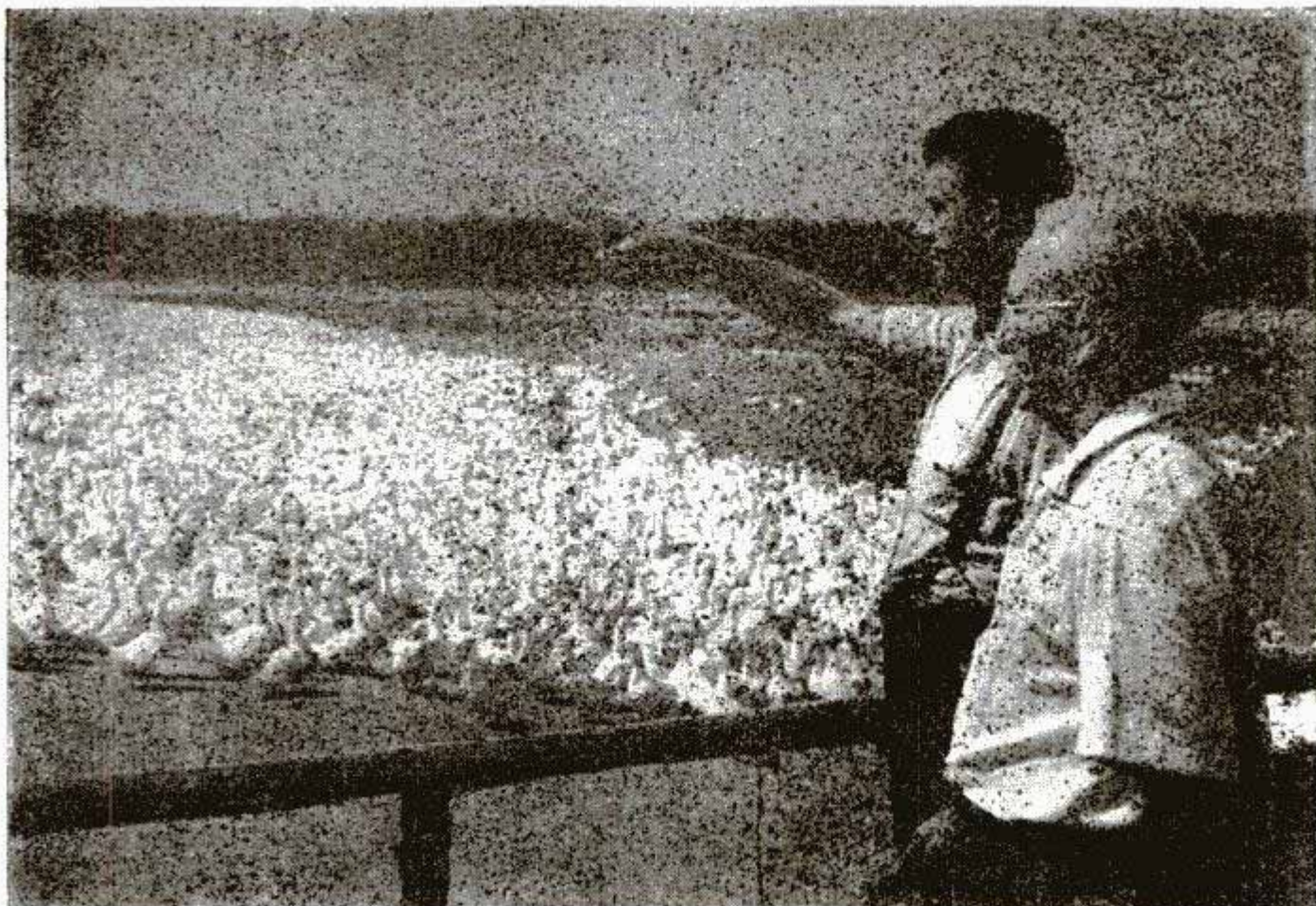

Poultry & Egg Natl. Board photo

Ducks blanket the ground at the New York farm of Hollis Warner (pointing), largest duck grower in the world

THERE ARE ABOUT 300 full-fledged duck farms throughout the United States and a few hundred more where duck raising is a part-time proposition. Over 50 percent of the farms are in New York State, mostly in Suffolk County, Long Island. Suffolk's 77 duck farms account for close to 8,000,000 ducks yearly, out of a national total of some 15,000,000, of which 60,000,000 pounds go to market.

The largest duck farm in the world, owned by Hollis V. Warner, is in the middle of this noisy aggregation of quackeries near Riverhead, the county seat. Warner's duck domain covers 250 acres of sandy soil hugging the mouth of the Peconic River which flows into Peconic Bay. He raises 500,000 White Pekins yearly. A half dozen other farms in Suffolk have annual outputs over 100,000; Harry Corwin's farm raises 400,000 a year.

When you speak of ducks commercially, you mean White Pekins, a breed brought to America from China in 1873 by a sea

captain. Other breeds seen in poultry shows are the Rouen, Muscovy and Aylesbury for meat, and Indian Runner for laying. This article deals with the White or Imperial Pekin.

Duck farming is such a specialized operation, requiring years of experience and considerable outlay of cash and land, that new duck farms develop slowly. The very nature of a duck farm limits the available sites. It must be situated near a body of fresh water. It should be on high, sandy ground, sloping off into a stream, lake or inlet. Since duck markets are limited, farms must be

located close to metropolitan areas, yet far enough away for land to be cheap and plentiful and meet the physical requirements. Duck farms have to be near railroad terminals, or at least have access to a good trucking road so the produce can be shipped to market daily. Suffolk County's duck country fills all of these stringent qualifications.

Warner inherited his farm from his

DUCKS by the ACRE

By Paul D. Green

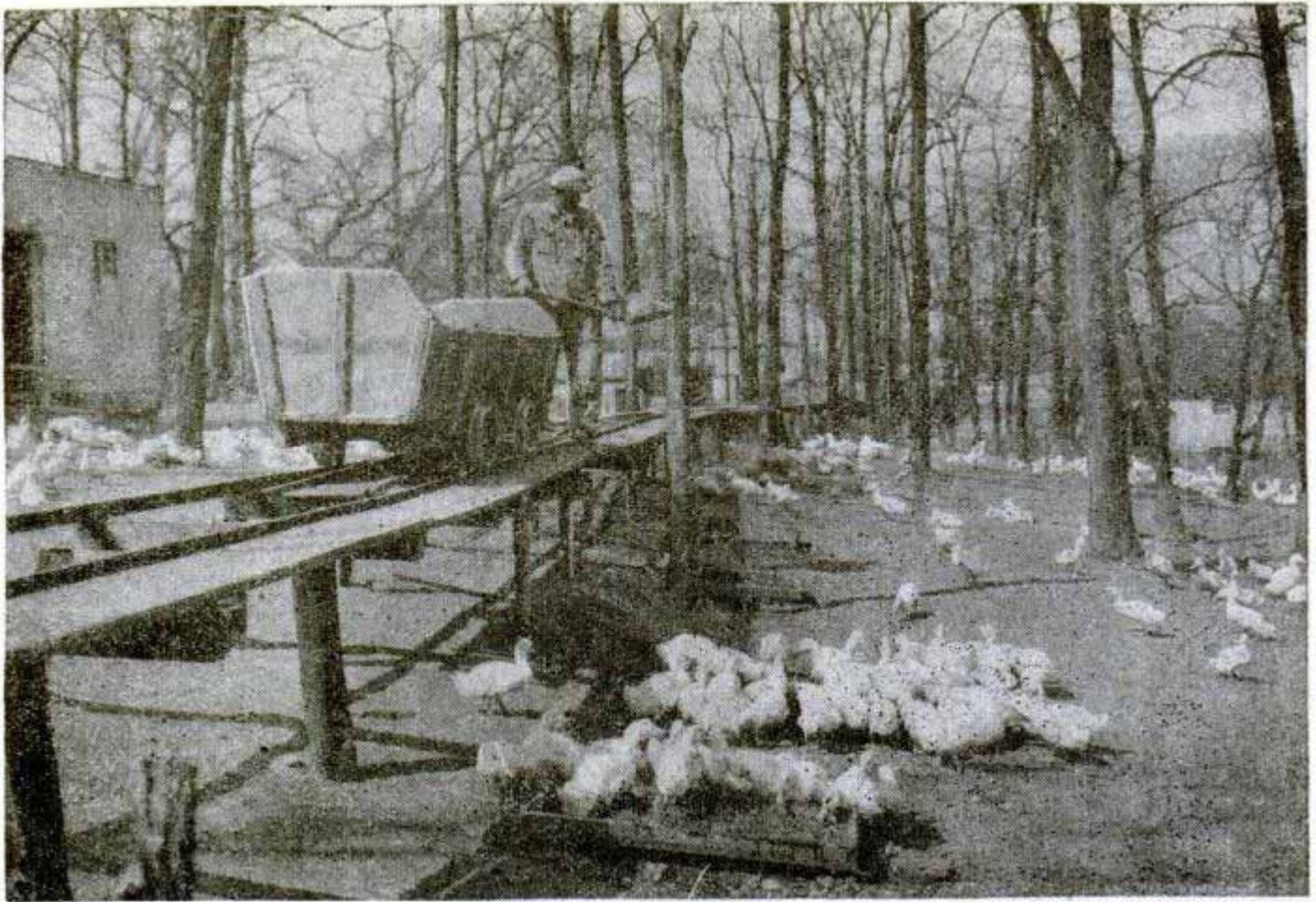

U. S. Dept. of Agriculture photos

Mash is shoveled into the feed pans from hand-pushed carts which travel on two miles of narrow-gauge track

father, and has been working it for over 25 years. He built it up from a medium-sized operation to its present top-ranking position by gradually acquiring one piece of land after another.

To take a tour through the duck farm, a visitor starts with the egg house. The eggs are brought here from the huge laying house next door and stored in a cold box

until setting day. Six huge electric incubators with glass doors line one side of the building, while five hatchers are on the other side. This setup can accommodate 115,000 eggs simultaneously. In addition, during the peak of laying activity in March, Warner also uses old-fashioned coal-heated incubators in the basement of another building. Electric incubators are cleaner, faster and easier to handle, according to Warner, "but we got by with the coal-burners for years without much trouble."

The eggs are set in a cool box in large racks which hold 120 eggs each. They are rotated by hand every few hours so the yolks won't stick to the shells, making the eggs infertile. Culls—imperfects, double-yolks, infertile and otherwise unhatchable eggs—are set aside for the minor egg-eating trade.

When the eggs are set in the incubators, they are rotated by an automatic switch. The boxes are kept at a steady tem-

Tracks pass brooding pens where ducklings six to eight weeks old are fed



perature of 99.5 degrees, through thermostat control, and humidity is maintained at 50 percent. The temperature and humidity must be accurately controlled or large losses may result from spoilage. Water lines feed into the boxes and the water drips down special drainboards which keep the boxes humid and cool, offsetting the warming effect of dim interior lights and Sterilamps.

After 25 days in the incubators, the eggs are removed to hatcher racks covered with chicken wire so the ducklings won't fall out when they emerge.

After the hatching process, the ducklings begin a series of steps which eventually lead them to their doom at the packing plant a mile or so away. They begin at the first hot brooder, next door to the hatchery, where they stay for about eight days, feeding on pellets, washed down with plenty of water. Water is extremely important to ducks at all ages. They die quickly or develop the staggers if they are unable to drink plentifully. Floating-ball water troughs are set up in each broodery.

After eight days in the 70-degree house, the ducklings are moved to the next brooder, kept at 60 degrees, and they stay there a week. After that they go to a third brooder, with temperature controlled at around 50 degrees, and remain another week. By the end of 3½ weeks they are ready for the open and the water, and begin to change color from golden yellow to white. Actually ducklings can take to the water soon after hatching, but they are so frail and susceptible to colds that they are usually kept away from the stream until strong enough to withstand climate changes.

Each week after graduating to the yards, the ducks are driven into newer and larger pens, wire-enclosed on sloping grounds extending from the houses to the water. At all times thousands of ducks can be seen along the banks of the inlet where a wire net prevents wandering.

One part of Warner's farm is devoted to wheat raising to augment feed rations and for straw bedding in the duck houses. Seven large feed buildings are spotted in strategic places from which wet

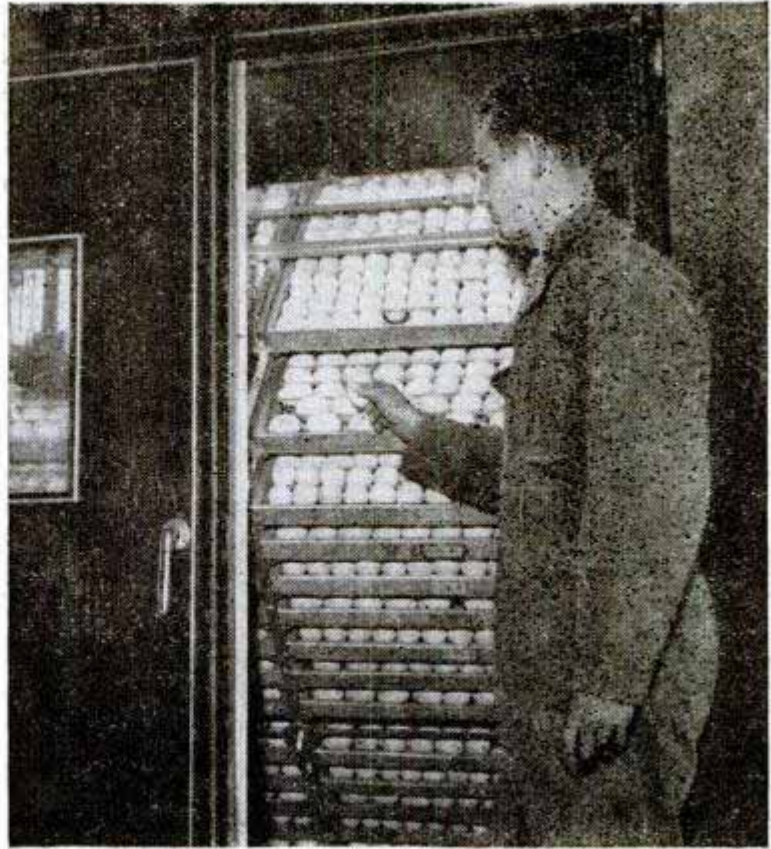

After 25 days of incubation, duck eggs are placed in hatching boxes (above) and three days later ducklings emerge. Sterilamps at top of hatching box (below) kill airborne bacteria





Metal spokes on a revolving wheel of mechanical plucker remove feathers

mash and dry feed pellets are shipped to the various duck yards. The mash is mixed in huge flour mixers and used six days a week. Dry pellets are "week-end and holiday" food, because the help's away then.

The wet mash contains cornmeal, bran, middlings, flour, meat scraps, alfalfa and other ingredients mixed with water. Different farms have varying percentages in their combinations, producing feeds which give distinctive flavor to their ducks. Feed is shipped out in hand-drawn carts on a narrow-gauge track from the feed houses, and distributed in the hundreds of low feed

Drinking troughs equipped with ball-valves provide plenty of fresh water

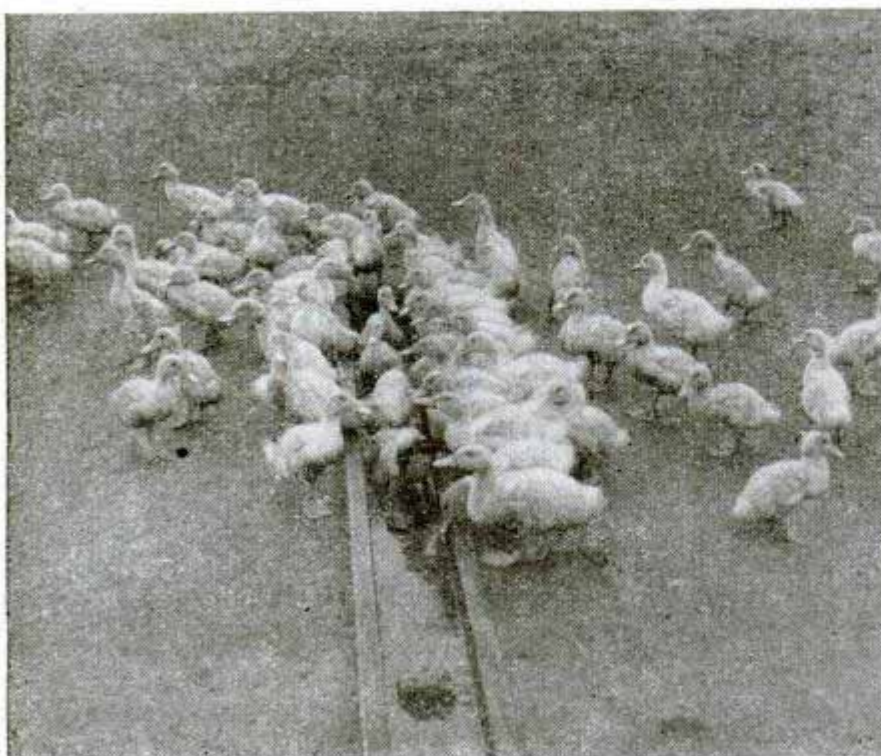

pans along a two-mile route. The Corwin farm in Aquebogue has a two-horsepower engine drawing the feed train around, requiring only one man for handling, whereas the hand-drawn method requires two.

In addition to the feed centers there is a score of other large buildings—incubator house, brooding houses, huge double-decker buildings with long, wide ramps for the ducks to climb when they get older. There are numerous storage houses, a few bungalows where families of workers live, and the killing, picking and packing plant through which the entire crop of ducks is siphoned at the end of their 11 to 12 weeks' career.

The whole operation keeps 150 people busy during the height of the season, and provides a comfortable living for Warner, whose farm grosses over \$750,000 annually. He ships to the New York market close to 2,500,000 pounds of dressed ducks a year. The prevailing price last summer was around 27 cents a pound, but it went as high as 32 cents in wartime winter months. This is considerably higher than prewar.

But it's not all "duck soup." The upkeep and operating costs are terrific. Since each bird consumes in its lifetime approximately 25 pounds of feed, at an average cost of four cents a pound, or \$1.00 a bird, that makes a feed bill of over \$500,000 alone. That pays for over 6250 tons of various grains and feed ingredients. Labor gets at least another \$125,000 a year. The rest of the income has to pay for 3,000,000 pounds of ice yearly, 18,000 barrels, a huge amount of power, a terrific trucking bill, the upkeep and replacement of some \$150,000 worth of heavy equipment and buildings, other operating costs and, of course, the taxes.

In addition to labor, transportation and feed problems, duck farms suffer a high mortality rate

(Continued to page 236)

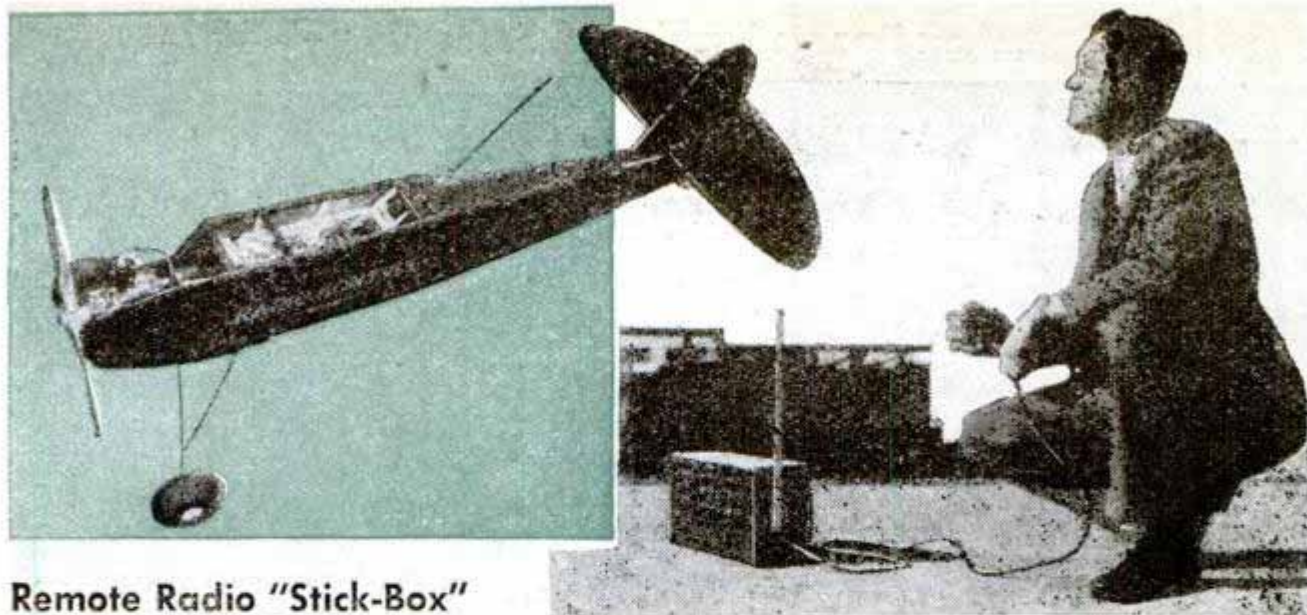

Remote Radio "Stick-Box" Controls Model Planes

Complete flying control over model airplanes is possible with a remote radio "stick-box." The radio "stick" is moved just as the control wheel would be used in a full-size plane. This causes a model to take off or land, bank and turn, climb or dive. The control consists of a small radio receiver and electric motor installed in the plane, a portable battery-operated 144-megacycle transmitter and the stick-box. Movements of the stick are transmitted to the plane where the receiver relays the impulses to the motor which adjusts the controls of the model.

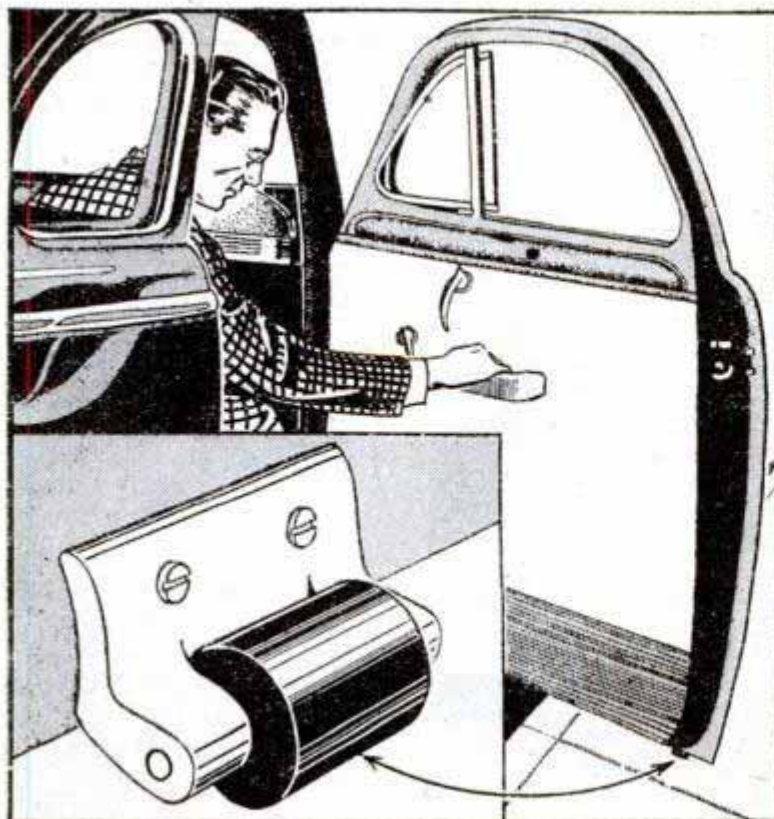
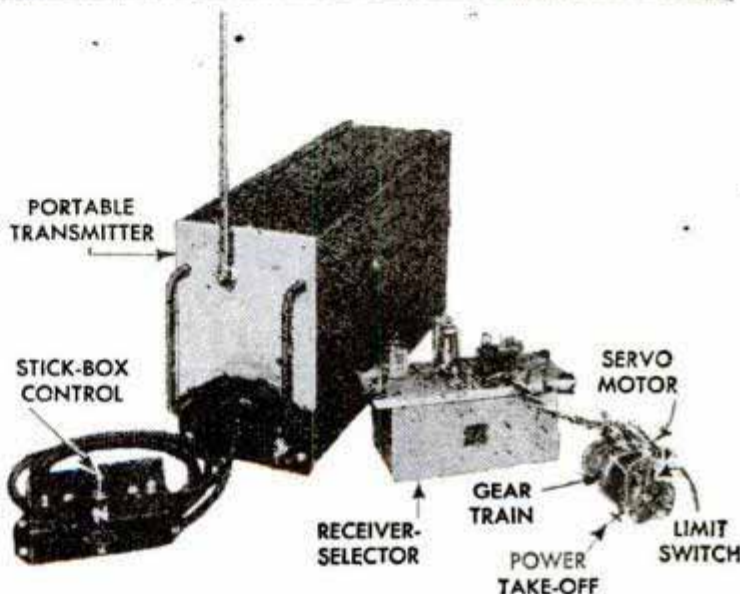

Roller Prevents Doors From Jamming On Curbs

With a roller device at the bottom, car doors jammed down on curbs or sidewalks can be closed without getting out to lift and release them. It is particularly helpful on low-slung-model automobiles. The roller fits in a metal holder that is attached to the outside of the door, at the bottom, with two screws.

Ⓜ A rubber conveyor belt $\frac{1}{2}$ mile long will lift 600 tons of coal per hour from a mine at Birmingham, Ala., to the tippie, 715 feet above the mine bottom.

Information, including manufacturers' names, concerning products described in this issue may be obtained by writing Bureau of Information, Popular Mechanics, 200 E. Ontario St., Chicago 11

Furnished Matchbox-Rooms Fashioned From Household Materials

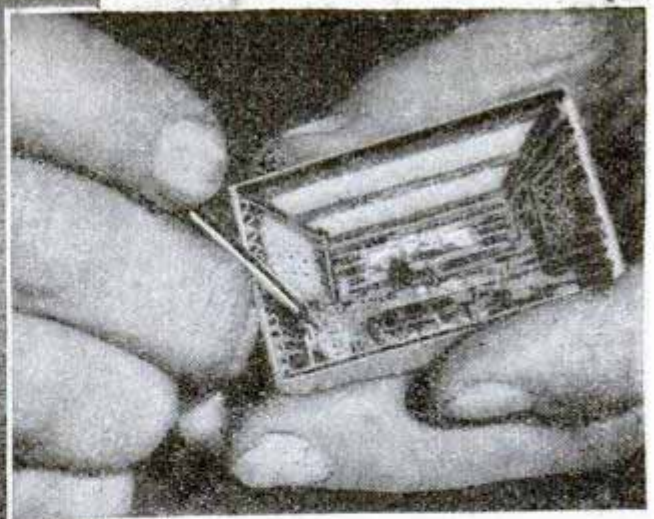

With such ordinary materials as spaghetti, tin foil, screen wire, pinheads, gum, sponges and broom straws Ray A. Herbeck

of Milwaukee, Wis., creates unique three-dimensional room settings and outdoor scenes inside matchboxes. He uses tweezers to install the realistic furnishings in his tiny rooms. Every item in each matchbox is built to a scale of six feet to the inch. Herbeck can complete a room or an outdoor scene in one day. A log-cabin room has spaghetti logs painted brown with tapestries covering the walls. Herbeck started his hobby only a few months ago.

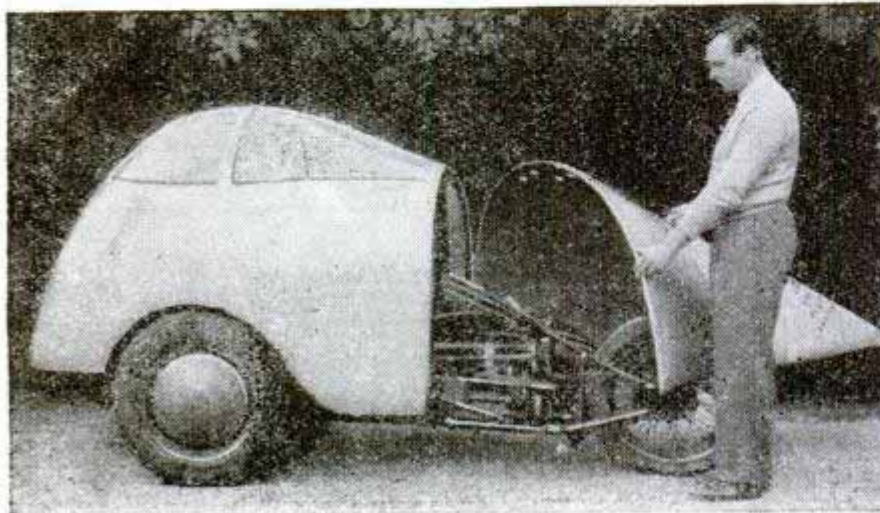
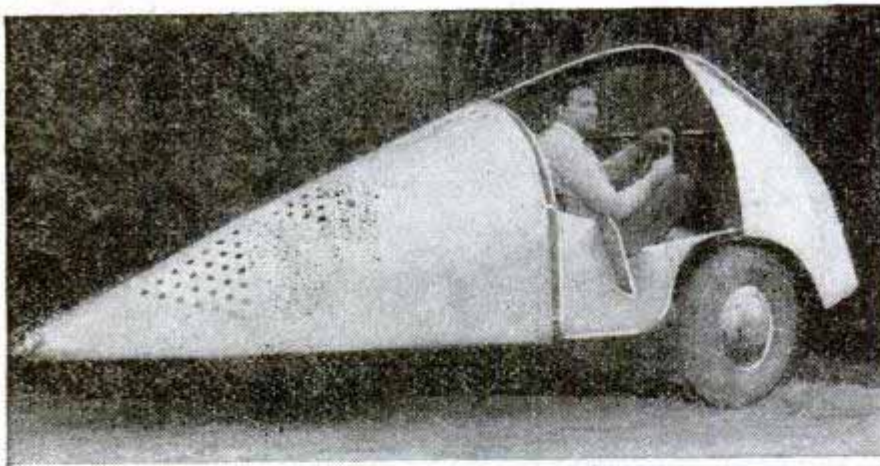

Motorcycle-Car

Salvaged auto parts, an old motorcycle engine and sheet aluminum have been assembled into a three-wheeled car by William Schmidt of Xenia, Ohio. The body is shaped like an airplane cockpit and has a Plexiglas windshield. The body, covered with sheet aluminum, tapers to a point in the rear. A 1930 model four-cylinder engine drives the single rear wheel through a motorcycle transmission. Because the engine is covered, Schmidt had to build an air scoop to cool it. The steering mechanism is taken from an old car and the wheels are made from Ford V-8 rims. The car carries two people, will go 65 miles an hour and travels 45 miles on one gallon of gas. It cost Schmidt about \$400.

The CRAFTSMAN

★ Making "herringbone" trails uphill on skis is no fun for any ski fan. But getting back to the top of a hill is not difficult with a ski tow. We describe how to build a simple, inexpensive one on page 186.

★ In game shooting nowadays every shot must count. That's why modern shotgunners pay close attention to the choke and gauge of the gun they take afield. Essential pointers are given on page 196.

★ "Jet" is the name we've given a boy's iceboat and that should be enough to start you reading the story on page 202.

★ Buying a used motorcycle wisely is merely a matter of knowing the common symptoms of wear on vital parts. A story on page 214 covers most of the angles.

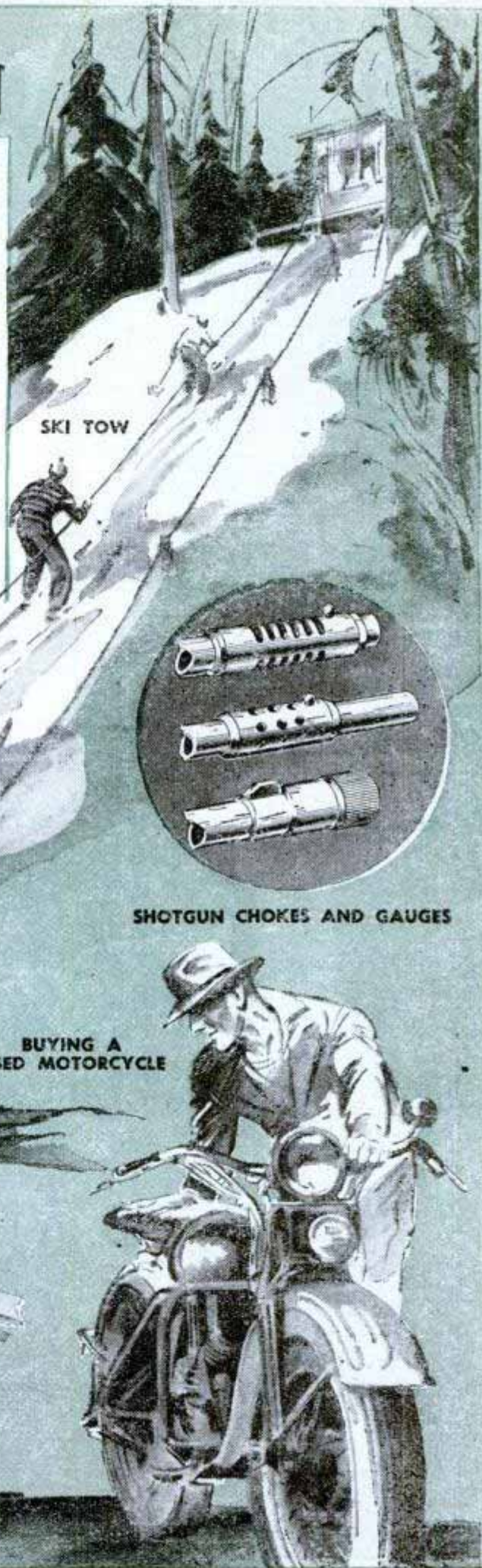

SKI TOW

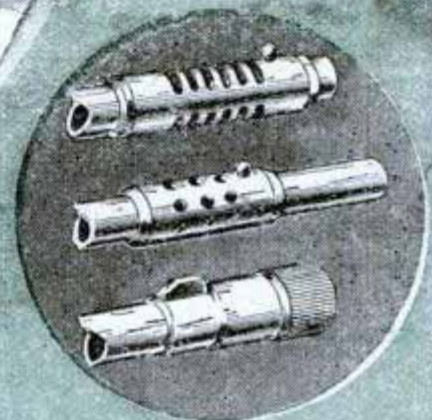

SHOTGUN CHOKES AND GAUGES

BUYING A USED MOTORCYCLE

BOY'S ICEBOAT

Easy-To-Make

It's actually a 5-gal. paint pail fitted with a padded seat and tailored inside and out with a gay-colored slip cover. Seat lifts off for storing shoes inside

By Peter R. Ruppe

UTILIZING a common 5-gal. pail for its framework, this vanity stool is both lightweight and sturdy, simple to make and provides a convenient storage compartment for shoes, hats, etc. Select a pail having straight sides—one in which paint comes will do—remove the handle if it has one, and clean the inside thoroughly by scraping or burning out the old paint.

A tacking strip or ring is fitted inside the pail about 2 in. down from the top and is fastened with flathead screws from the outside as in Fig. 2. The ring need not be in one piece—it can be of several segments



1

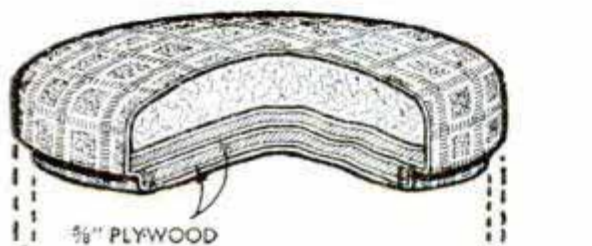

2

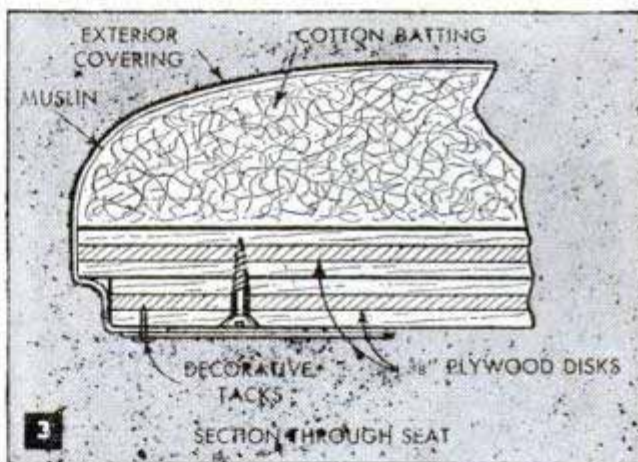

3

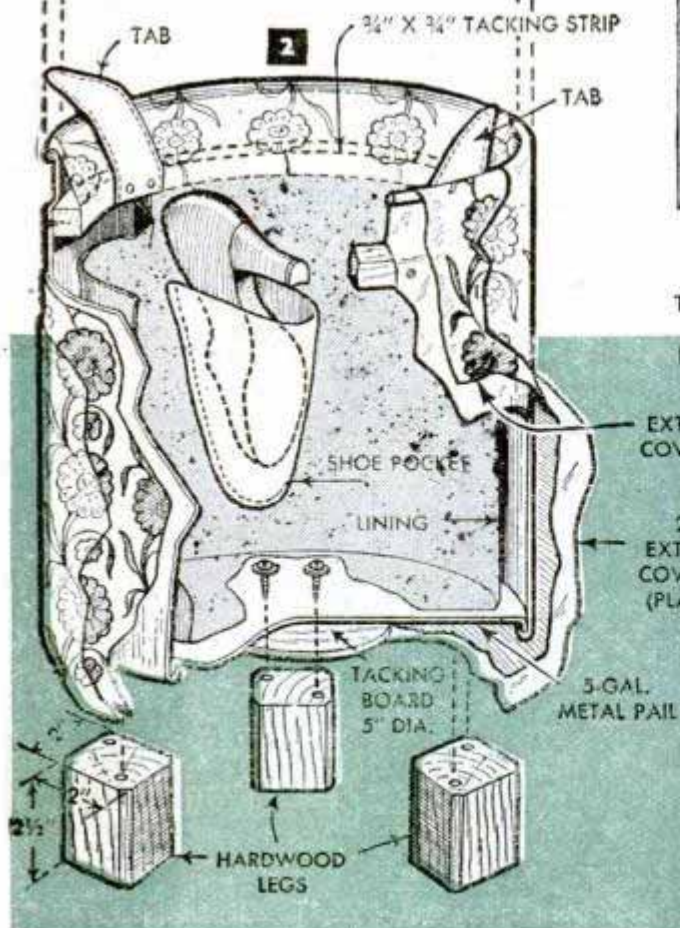

4

VANITY STOOL

as it is hidden from view. Next, the bottom of the pail is drilled for screws to attach the three stub legs. These can be made of fancy hardwood and varnished, or cut from pine and painted. Two 1-in. screws are used to attach each leg. Holes are drilled in the bottom also for fastening a $\frac{3}{8}$ by 5-in. wood disk to serve as a tacking surface for the outer covering. This is located in the center of the pail. The rabbeted edge of the seat board is formed by two $\frac{5}{8}$ -in.-plywood disks screwed together, one being the same diameter as the pail and the other about $\frac{1}{4}$ in. smaller, Fig. 3.

You're now ready to tackle the upholstery. The inside lining is applied first. This can be of a material contrasting with that used on the outside. Make a tubular-shaped bag of it to fit the inside diameter of the tacking ring. If the stool is to be used for shoe storage, pockets should be sewed to the lining before it is tacked in place at the top. The outside covering is likewise sewed in a tubular shape to be pulled snugly over the pail. Fold the upper edge of it under and tack it neatly to the wood ring, forming small pleats where necessary to eliminate wrinkles. After the top edge is tacked, the fabric is pulled down smoothly and tacked to the wood disk at the bottom. Although optional, the outside covering of the stool can be protected from soiling by covering it with any of the transparent plastic materials, tacking it the same as before. See Fig. 4. Finally, two strong tabs of cloth are tacked to opposite sides of the wood ring to provide handles for carrying



the stool. These should be long enough to extend out from under the seat as shown in Fig. 1. This leaves the seat to be padded as indicated in the cross-sectional view in Fig. 3. Cotton batting is first applied generously and is held in place with a muslin cover. Several thicknesses of foam rubber, available in sheet form, could be used in place of the cotton. The outer covering is brought around and tacked neatly to the under edge and finished with a circular piece. Where the material covers the rabbeted edge it should be tacked to the underside of the top disk.

Attractive Four-Piece Picture Frame Can Be Dismantled in a Jiffy

Just four parts make up this novel picture frame, a slotted wood base, two pieces of glass and a slotted wood clip. The whole thing goes together without a fastening of any kind. The slot in the base has a 10-deg. rake to give the glass a slight backward slant. The photo is sandwiched between the two pieces of glass and held together at the top by the slotted clip. The base dimensions given will accommodate a 5 by 7 photo, although it can be made to take almost any size picture.

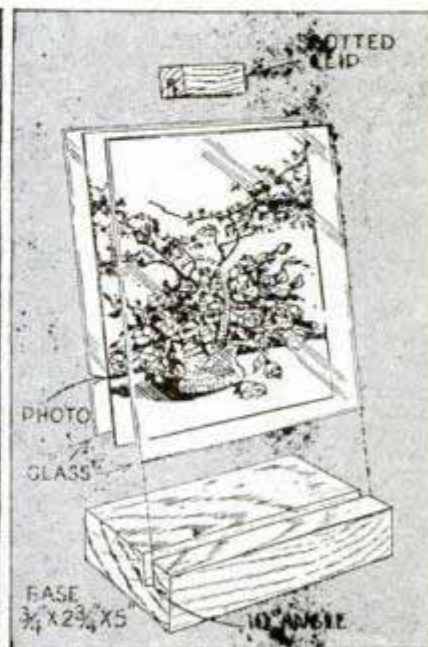

Small Notches in Side-Cutting Pliers Strip Insulation off Wire

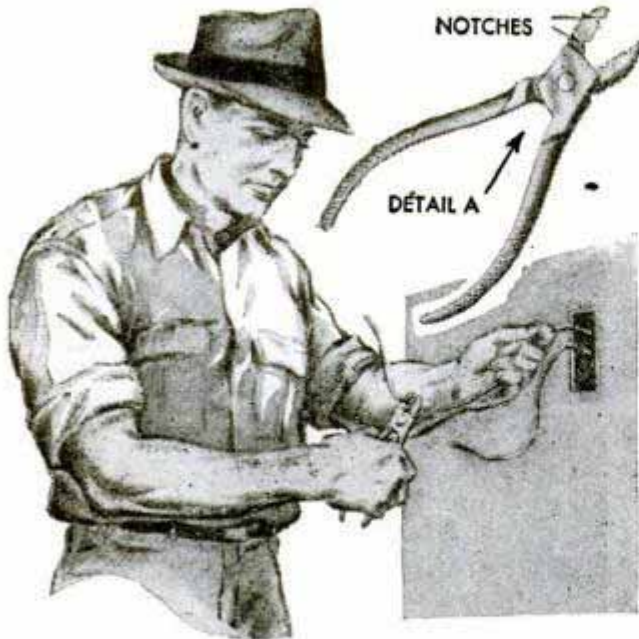

Two sets of notches in the blades of side-cutting pliers will be useful in stripping insulation off electric wire. Vary the size of the notches to handle different gauges of wire. In addition to their utility as strippers, the notches near the point of the pliers can be used to pull cotter pins. Another way to remove insulation is to place the wire between the handles of the pliers, detail A; loosen the insulation by applying pressure and then work it off by pulling on it. This method is handy if there are no notches in the blades of the pliers.

L. A. Potts, Panama City, Fla.

Upper Half of Window Operated From Sash Pulley

To open and close the upper half of a window that is in a hard-to-reach location, such as above a bathtub or other inaccessible place, the rope and pulley arrangement

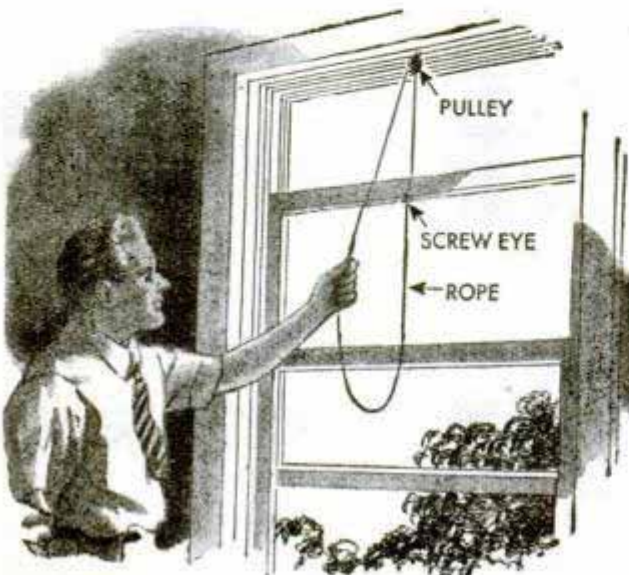

shown here will save a lot of effort. The pulley is attached to the top of the window frame and a rope passes through it, both ends being tied to a screw eye set in the top frame member of the sash. Pulling on one side of the rope will raise the window and pulling on the other will lower it.

Edward Laben, Chicago.

Oilcan Makes Shellac Container

Handling shellac is always something of a problem, but with this converted oilcan, you have a container and brush in one unit. A small brush, which will fit inside the spout, as indicated by the dotted lines, is used. Probably it will be necessary to trim the handle to make a tight fit, but this will seal the opening so air cannot get at the shellac. For convenience, the spout should be shortened as much as possible, leaving it long enough to serve as a handle.—J. W. Kratzer, Raymond, Nebr.

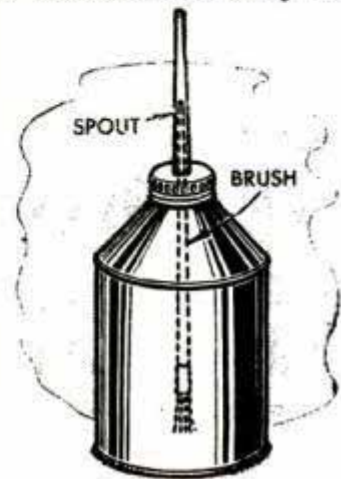

Jar Lid Used as Picture Frame

Two-piece lids that are used to seal fruit jars will make clever frames and pictures. The lid part is placed with the white side out and decorated with a decal, and the sealing ring is used as the frame. Hang the picture with a ring and short length of ribbon. This type of decoration will be found especially attractive for a child's room.—Benj. Nielsen, Aurora, Nebr.



Gilt Finish for Metal Surfaces

Lasting and beautiful gilt surfaces can be applied to metal with spar varnish and powdered bronze. First cover the surface with a light coat of the varnish and allow it to dry until "tacky." Then, using an ordinary powder puff, dust on the bronze. Let this dry for a short time and then polish. The finish will be a lasting one and is ideal for small, decorative pieces.

William M. Maddox, Jackson, Ga.

Rep. L.C.B. #142

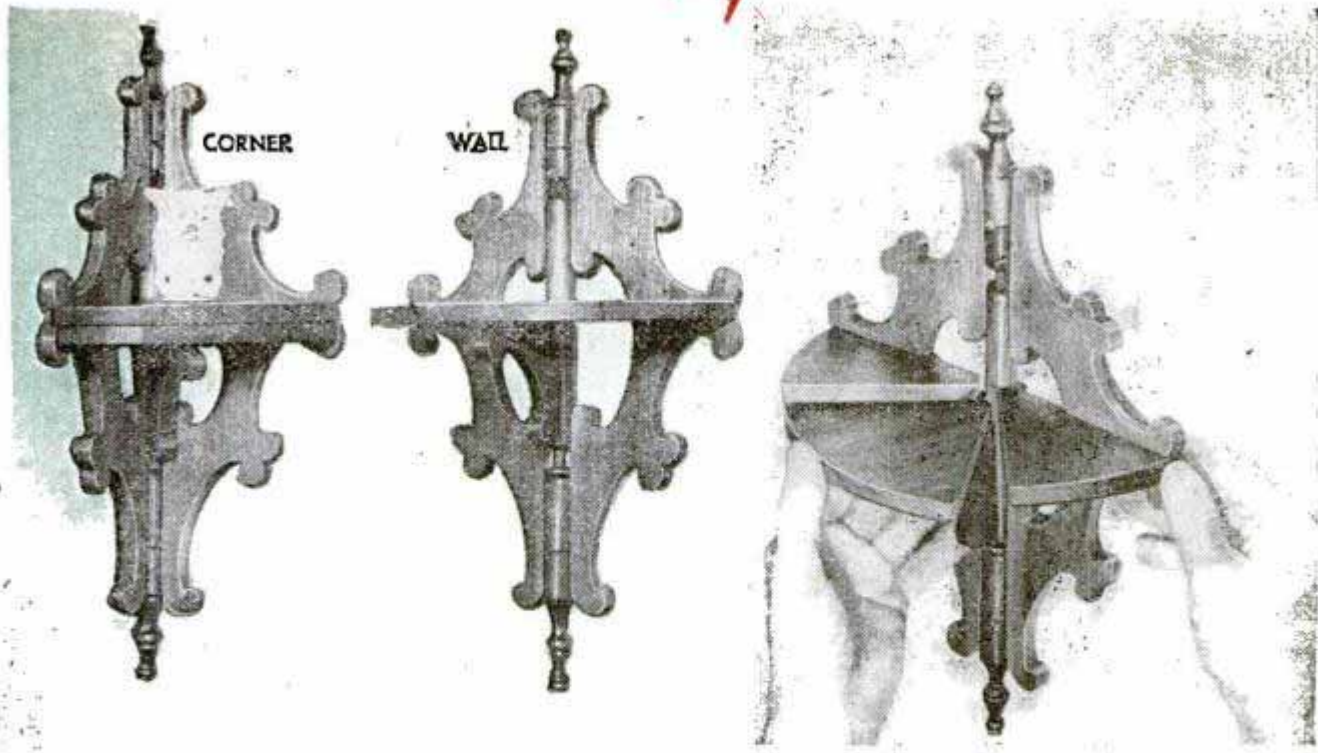

TWO-WAY SHELF

This attractive shelf will either fold to fit into a corner or open to hang flat against a wall. When hanging in a corner, the center section of the shelf fits beneath the two side sections, and raises up to be flush with them when opened. Reference to the right-hand drawing will show that the center post or standard is made up of five pieces fitted with hinge tenons. The middle piece, to which the center section and bracket are attached, slides on tenons to permit raising and lowering. A 5/16-in. hole 1 1/4 in. deep, center detail, is drilled in the top of this sliding piece to allow for an L-hook. All other dimensions and assemblies are given in the drawings. If available, use 3/8-in. walnut for the shelf and brackets

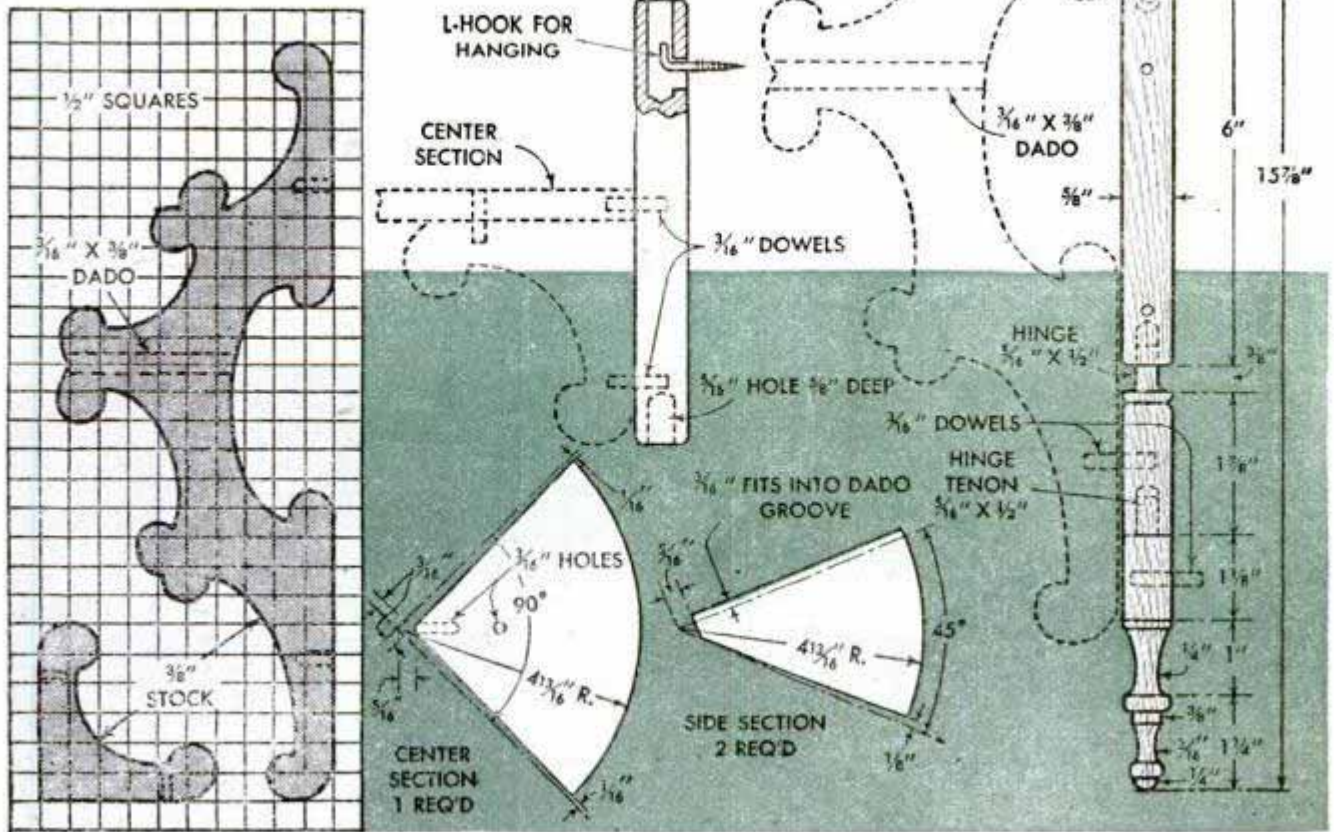

Solving HOME

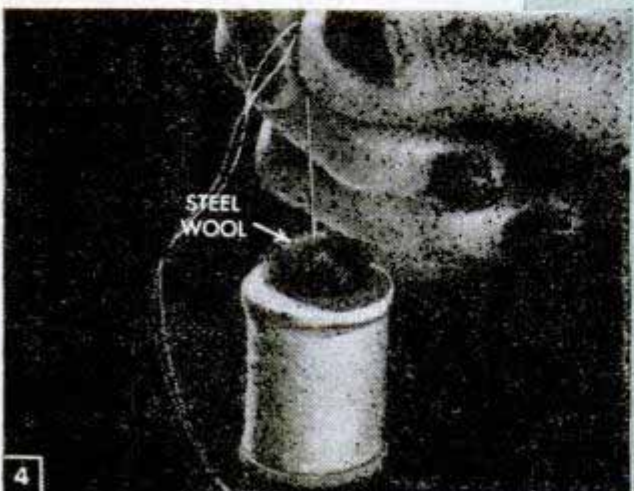
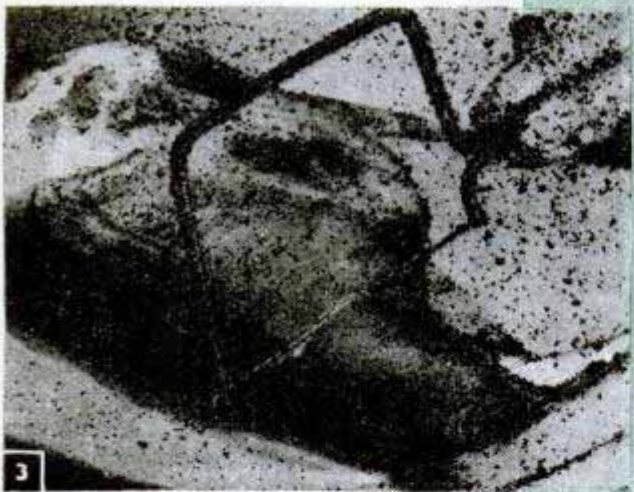
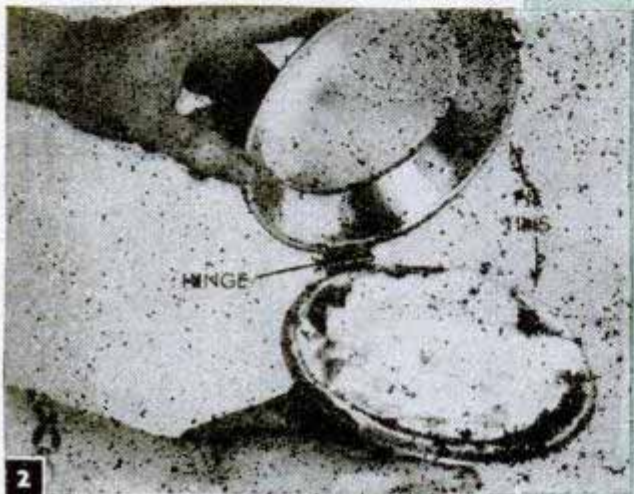
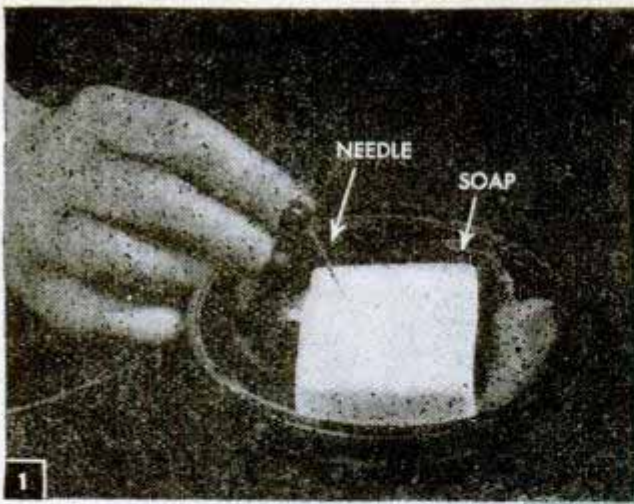

— 1 —

Sewing needles that have become slightly rusted will tend to stick when used. To correct this condition, press the needle into a cake of soap to remove rust

— 2 —

If you don't want "squashed" pie in a lunch bucket or picnic basket, hinge two pie tins together to make a safe container. Even though heavy jars are placed on top of the tins, this won't spoil the pie

— 3 —

Add a small coping saw to your kitchen cutlery set. It will be indispensable for cutting through meat bones when carving or preparing a roast for the oven

— 4 —

It's a common practice when laying sewing aside to insert the needle through threads on the spool. Instead of doing this, put a small wad of steel wool in the hole of the spool and place the needle in it

— 5 —

Carried in this easily made kit, knitting needles can be kept together so that they are easy to find. Flexible corrugated cardboard, covered with decorative paper and tied with cord, is used for the kit

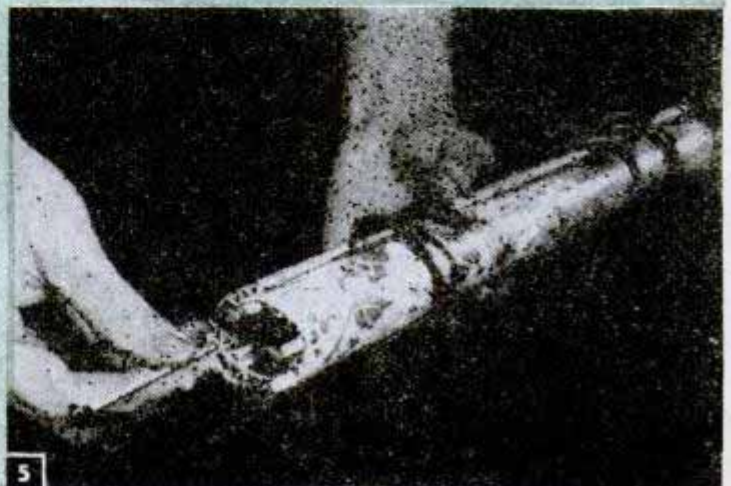

PROBLEMS

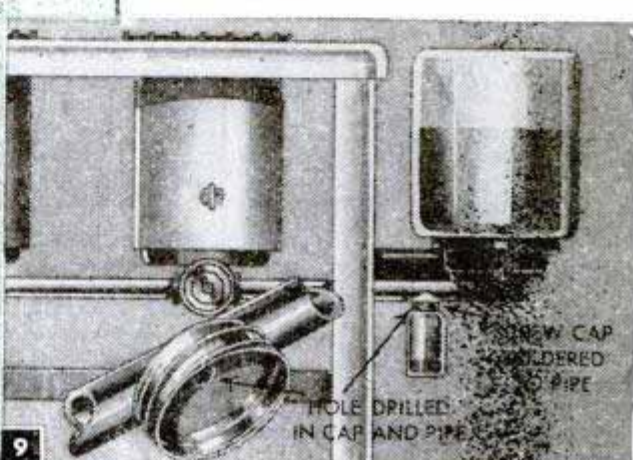
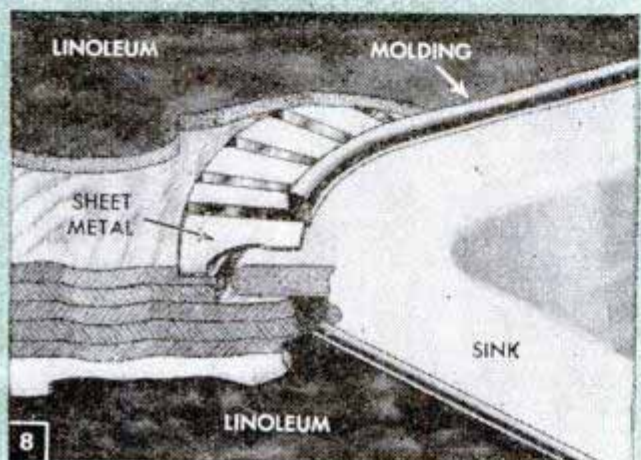
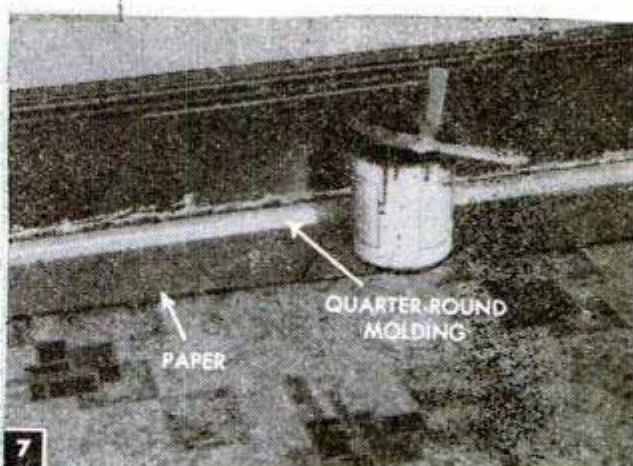
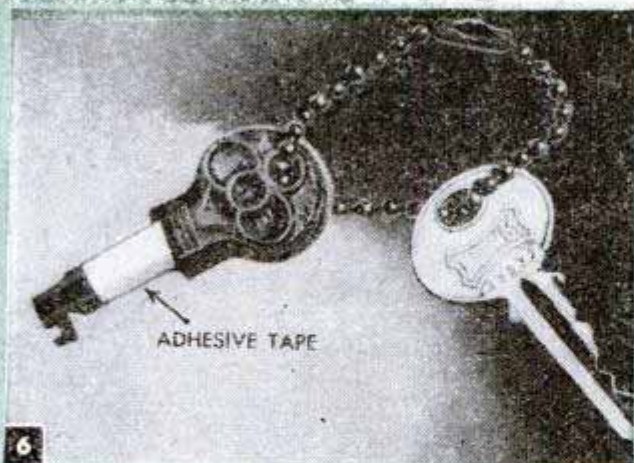

-6-

When carrying several keys on a chain, tape together the ones seldom used. Then the key needed most frequently will be easy to select and the others, being taped together, won't rattle in your pocket

-7-

To lay quarter-round molding over linoleum and, at the same time, mask it for painting, try this method: Place a strip of paper about 6 in. wide against the baseboard and then nail the molding over it. After painting, remove the paper when the finish dries

-8-

Strips of thin-metal backing under curved sections of sink molding will provide a solid base for the application of filler between kerfs in the molding. After the filler has been applied and sanded, you'll have a level surface on which to lay the linoleum

-9-

Attach a sediment bowl to the feed line of a kerosene stove to collect water and dirt. Take a glass jar with a metal screw cap; drill a hole in the cap and another in the bottom of the feed-line pipe. Then solder the cap to the pipe and screw on the jar

-10-

By keeping knives separate from other utensils, cut fingers are avoided. The drawing shows a drawer for this purpose which fits in a kitchen-table drawer



SECTION CUT OUT



Shower-Curtain Pins Are Used When Carrying Small Game



If you slip a few shower-curtain pins over the belt of your trousers, it won't be necessary to wear a hunting coat, or to carry small game and birds and not have both hands free. The narrow part of the pin is slipped over the neck of the animal and the large end is looped over the belt.

Trousers Hanger Holds Floor Mat While Servicing Battery

When servicing a battery or working on parts of a car beneath the floorboard, the floor mat can be held out of the way with a trousers hanger. The hanger is fastened to the mat and the hook is attached to a knob

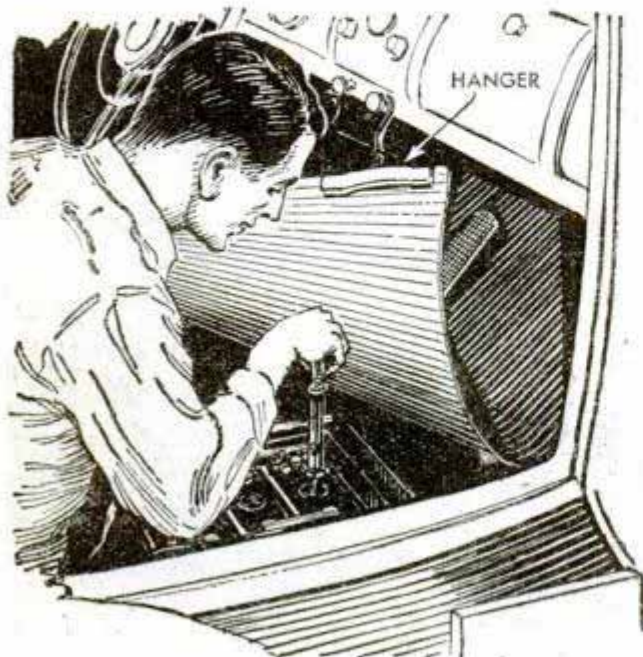

on the instrument panel. To prevent scratching or marring the knob, wrap the hook with adhesive tape.

Rosin Removes Cold-Water Paint

Next time you have to remove cold-water paint from a wall or other surface, try using powdered rosin. Dust it lightly on a cloth which has been dipped in hot water and rub it over the paint. To apply the rosin to the cloth, use a large salt shaker or similar dispenser. This will distribute it uniformly. The rosin has an abrasive action that is effective in removing this kind of paint.

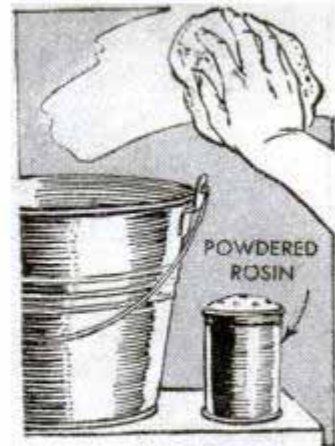

Making Oil Gauge Easy to Read

The oil-gauge stick on many cars is difficult to read, especially when fresh oil has just been added to the crankcase. To overcome this, drill $\frac{1}{64}$ -in. holes at the "empty," "half" and "full" marks that are stamped on the gauge. These small holes will retain the oil so that it will be easy to determine whether the oil level is at any of these marks.

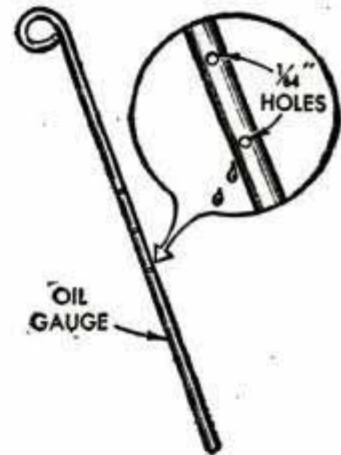

Spencer A. Pease, Wauwatosa, Wis.

Sliding Bolts Will Secure Ladder

Sometimes a ladder will show a tendency to "walk" away from the wall or other object that it is leaning against. To prevent this, attach heavy-duty sliding door bolts to the base of each leg. Then, when the ladder is set in place, hammer the bolts into the ground and the ladder will remain stationary until it is moved.

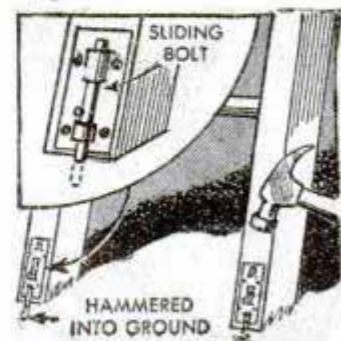

Toy Glider Shot From Hand-Operated Catapult

Easy to make and easy to fly, this toy glider is launched into high, curving flight by means of a hand catapult. "Fuselage" of the glider is a length of tubing with a ferrule soldered to the front end. The balsa-wood wing and tail are glued to the fuselage, and the landing gear, which consists of a washer and two wire braces, is fastened to the wing. Note that the inside diameter of the washer should be just large enough to fit over the $\frac{3}{8}$ -in. rod that forms the body of the catapult.

After the pistol grip has been bent to shape, solder a square-head nut onto the rear of the straight section of the rod to act as a stop for the spring. Use a light coil spring, but one that has strength enough to

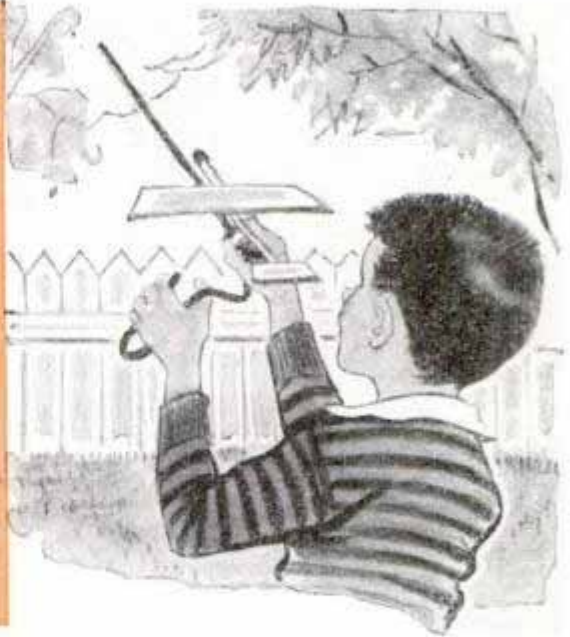
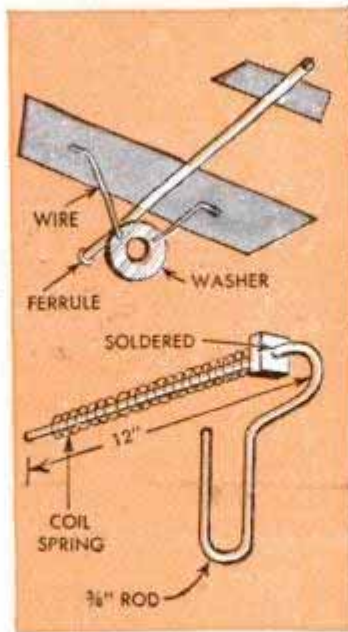

give the plane a fast take-off. To fly the toy, slip the washer over the rod and pull the glider back to compress the spring, then release for flight. For decoration, paint an insignia on the wing and tail.

Acetone Used to Repair Cracks and Dents in Table-Tennis Balls

Here's a way to reclaim table-tennis balls that have been cracked and dented by hard usage. To repair cracks, insert two pins in the ball so it will rotate on its axis and suspend it from a string. Quickly dip the ball in acetone. Then spin the ball to remove excess acetone and hang it up to dry. Leave for about an hour and, after this, remove the pins and touch up the

holes with clear nail polish. When dry, rub the ball lightly with a paste of pumice and oil applied with a soft cloth. Pay special attention to any ridges that show when rubbing with the paste. If, before treatment, the crack is very bad, hold the edges together and paint with clear nail polish, brushing in the direction of the crack. Follow with the acetone bath. For dents, try the following hot-water treatment: Puncture the surface opposite the dent with a needle. Wearing gloves for protection, immerse the dented area only in boiling water. As soon as the ball is removed, blow into the needle hole steadily and evenly. It may be necessary to repeat this several times. After the dent is removed, seal the hole and treat as before.

Simon S. Palestrant, New York City.

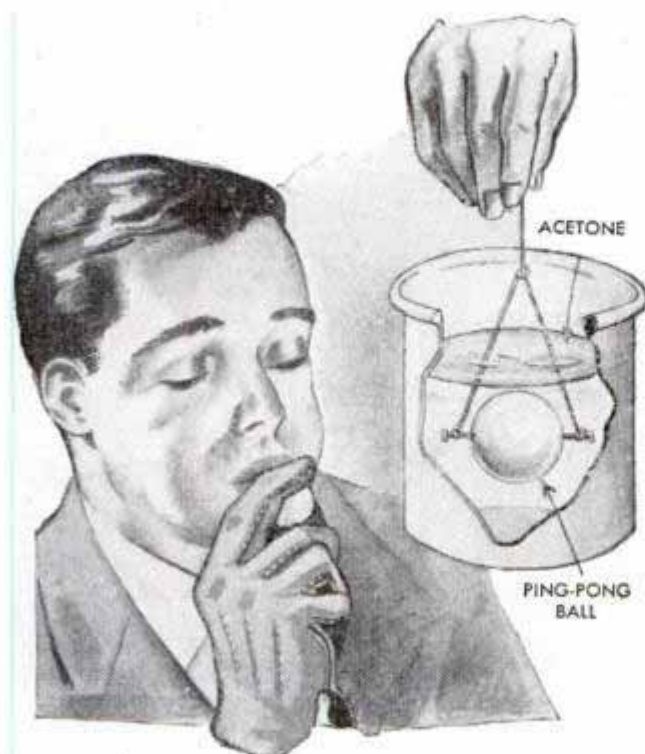

Fine Finish on Interior Woodwork

To get a smooth finish on interior woodwork that has been painted previously, first clean off the old paint with remover and brush over the entire surface with turpentine. After this is dry, sand and apply a coat of the selected color, thinned with turpentine to act as a filler. When this in turn has dried, putty all holes and broken or splintered parts. Then apply as many coats of paint as are necessary, allowing each coat to dry before adding the next one.—Francis W. Henry, Pottsville, Pa.

GOING UP!

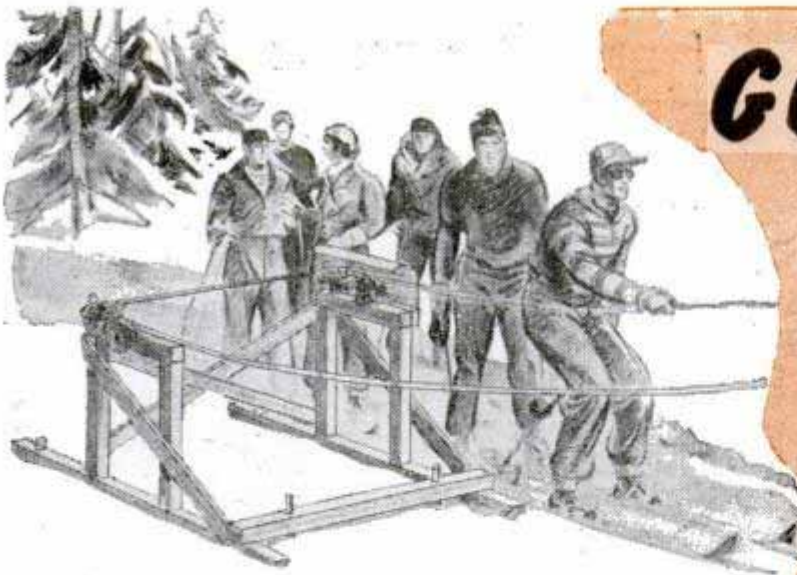

BY POOLING time and money members of a ski club can put this ski tow together at very little cost to each individual, and at the same time add immeasurably to enjoyment of the sport. The first important thing is the selection of the hill on which to build the tow. If possible, locate it on a north slope where the snow is out of the direct sunlight. In such a location you are more likely to have good skiing conditions throughout the winter season. There should be plenty of trees and shrubs to catch and hold snow on the hill, but not so many as to interfere with skiers or the operation of the tow. Ski track over which the "going-up" side of the endless tow rope will operate should be straight, and the slope, although it can be quite steep, should be uniform without dips or sharp rises. Of course, such irregularities can be graded smooth, but this will add to labor

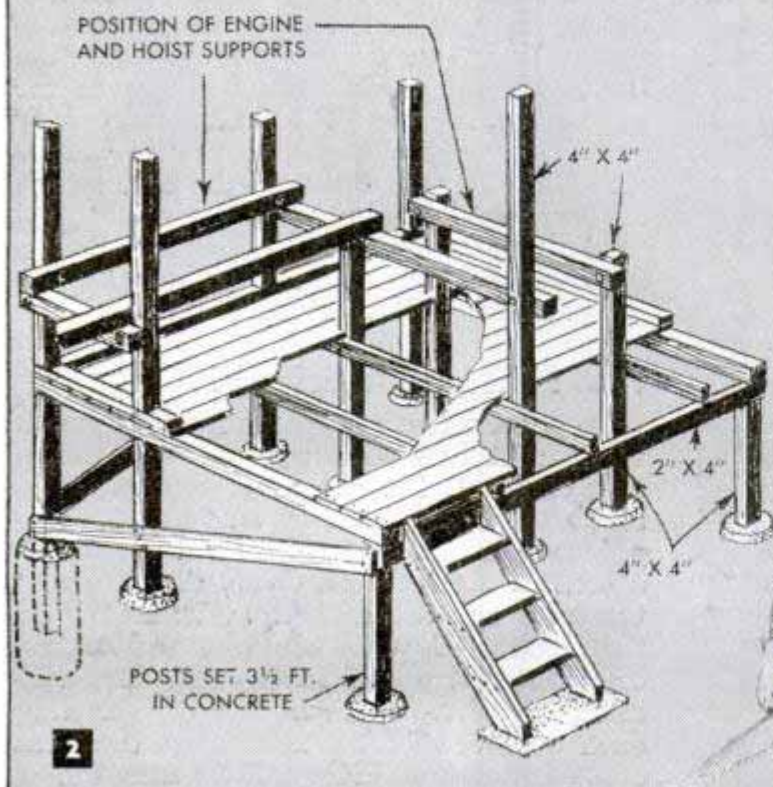
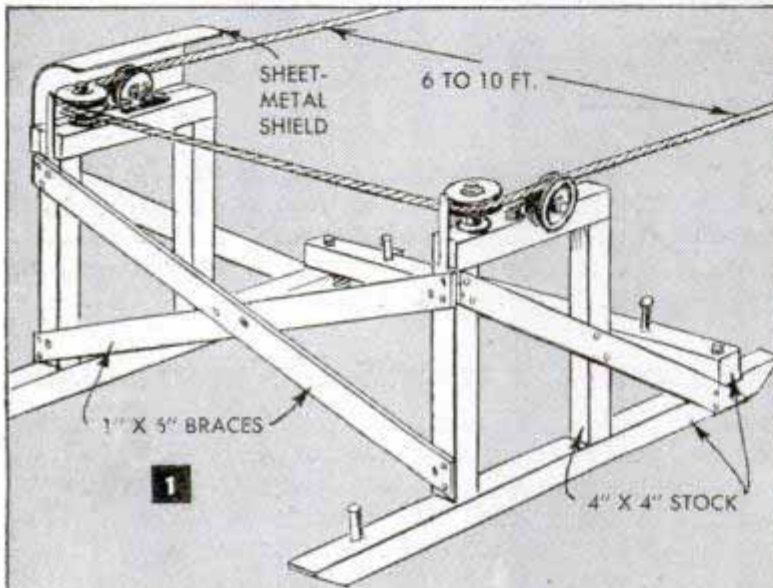

That slow climb back to the top is no fun for even the most ardent ski fan, but this safe, motor-driven tow takes you up just the way you came down—on skis

and cost and require more time.

Towing mechanism and the auto engine which supplies power are built into a shelter, Fig. 3, erected on a level area at the top of the hill. The house should be far enough back from the top of the slope so that skiers coming up can let go of the rope and ski away on the level. At this point the rope should clear the ground by at least 4 ft. To get this height, it probably will be necessary to build the engine house on high supports set in concrete pedestals as in Fig. 2. Anchor the house with $\frac{1}{2}$ -in. wire rope attached to a heavy concrete block buried in the ground at the back, Fig. 8.

Engine and hoist supports are

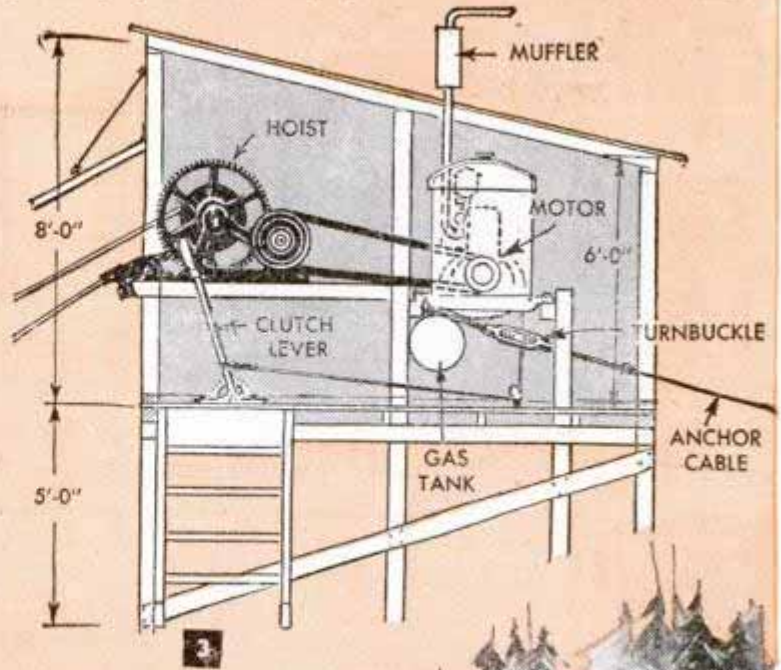

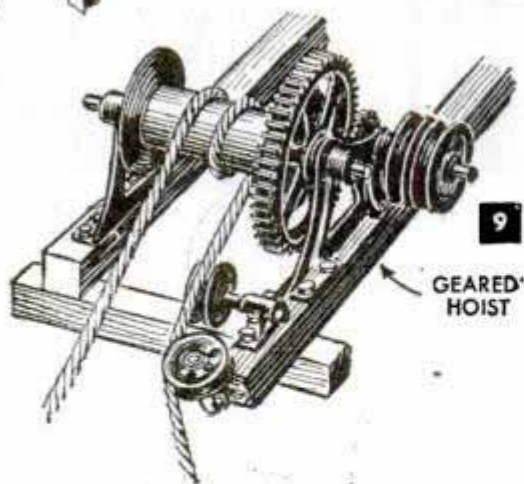
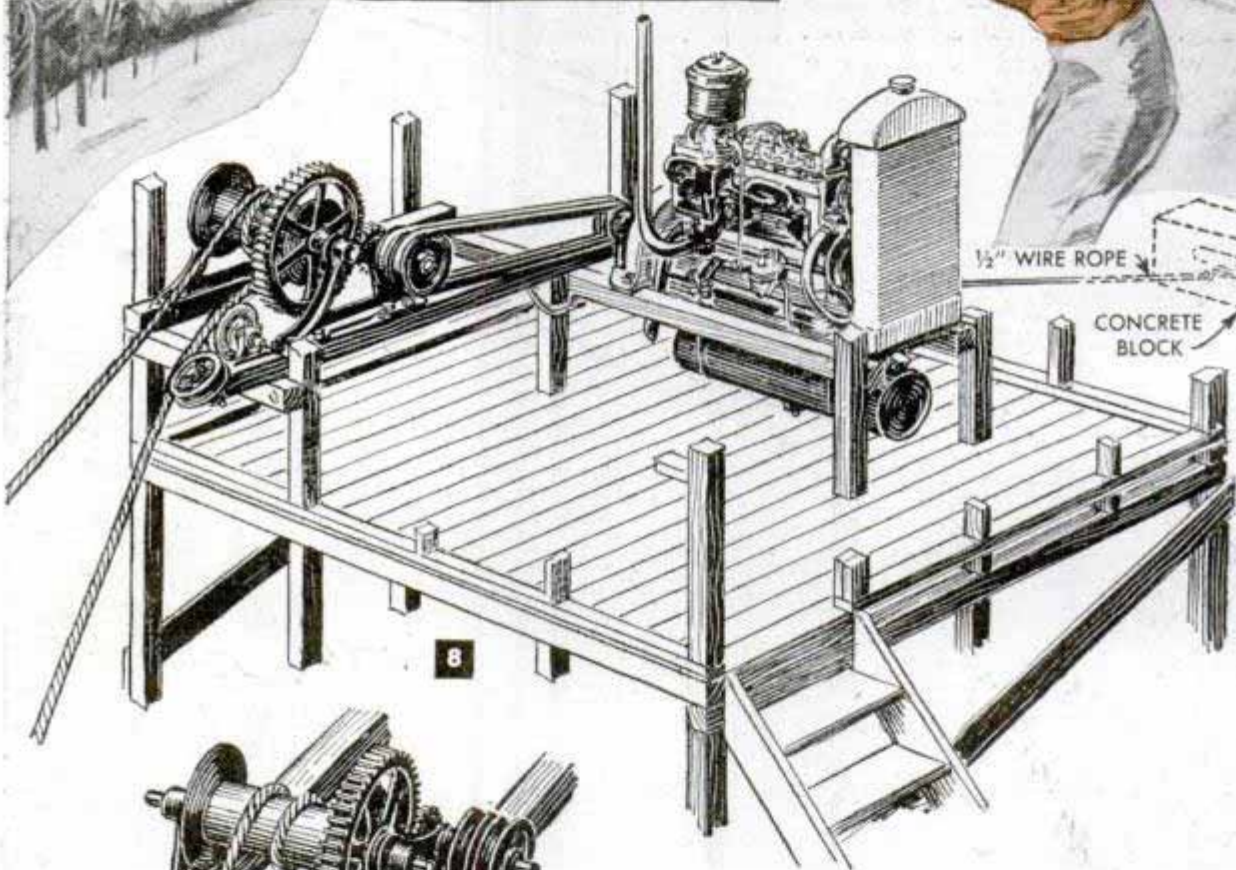
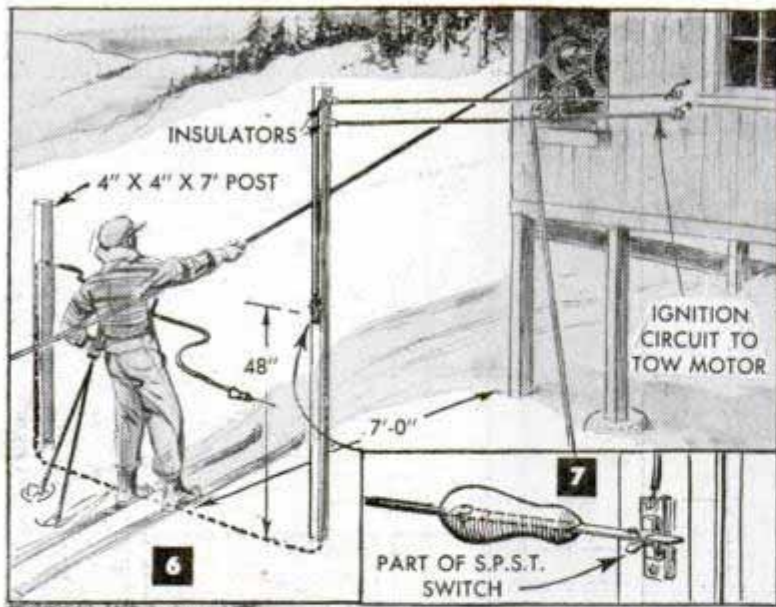

installed as in Figs. 2, 3 and 8. Dimensions and location of the supports must be determined from the engine and hoist at hand. A single-gear hoist, Fig. 9, works very well, although it may be necessary to lag the drum to build up the diameter and give the rope a better grip. The roller-bearing sheaves which carry the slack side of the

tow rope are mounted on posts as in Figs. 4 and 5. They should be located 10 to 15 ft. apart. The lower tow-rope guide or "sled," Fig. 1, is anchored by means of steel stakes which can be driven into frozen ground. Use $\frac{3}{4}$ or 1-in. rope as it is easier to grasp and don't let it drag in the snow at any point. Keep it dry. Speed of the rope should not exceed 1000 ft. per min.

Have an attendant in the engine house at all times when the tow is in operation and provide a safety device as in Figs. 6 and 7, to break the ignition circuit and stop the engine automatically should one of the skiers fail to release the rope in time to clear the house. Keep the rope sheltered when not in use.

Drawing Silhouettes From Models

Even though you're not an artist, it's no trick to draw lifelike silhouettes. Try it at your next party. A flashlight and clamp, large-sized sheets of paper and a charcoal pencil are all that's needed. The flashlight is clamped to the back of a chair and the subject sits between it and the sheet of paper so that the light casts a sharp shadow. The projected silhouette is traced on the paper and later filled in. Some arranging is necessary to get just the right setup. The "pictures" can be drawn quickly and the results are surprisingly accurate. To get as sharp a silhouette as possible, use a flashlight that can be focused.



Secret Drawer in Buffet

Located behind the top drawer of a buffet, a concealed compartment will hold your guest silver and keep it safe from intruders. The hidden drawer is formed by cutting off part of the original drawer and fitting it with a front. The remaining portion is fitted with a back and a pivoted stop to prevent spilling the contents of the drawer if pulled out too far.

Memo Card Gives Correct Sizes To Stretch Curtains

When stretching curtains after laundering them, considerable time can be saved if the correct size for each curtain is written on a card that is attached to the stretcher. Once the measurements are noted, it's a simple matter to refer to the card and set the stretcher correctly for each curtain. Use a water-resistant material for the card and write on it with waterproof ink.



Mixture for Filling Holes in Wood

If you want to fill some holes in wood and there is no plastic filler on hand, try this substitute mixture. Mix fine sawdust and water glass (sodium silicate) to a paste-like consistency. Apply this like putty and, when it has dried, finish in the usual manner.—H. Levy, New York City.

Heated Brick Keeps Putty Warm When Glazing Sash in Winter

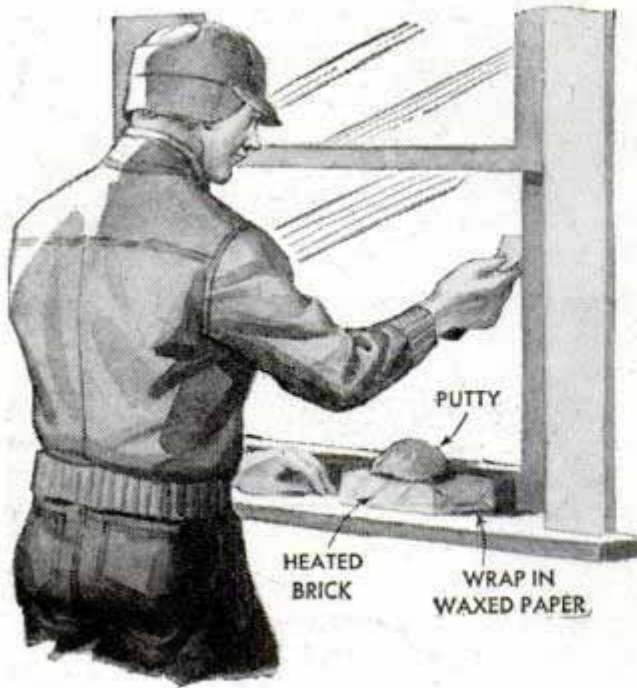

Putty can be kept soft and pliable while being applied outdoors during cold weather, if it is placed on a heated brick. Wrap the brick in waxed paper so the putty will not stick. This "warmer" will keep the putty soft for some time.

Two Ways to Lock Nuts on Bolts

Nuts on bolts that are used to anchor machinery to wooden bases frequently are difficult to keep from loosening because of vibration. Here are two ways to lock the nuts and prevent this. In detail A, the washer used under the nut is drilled to receive a staple, which is driven through into the wood. In detail B, the washer is

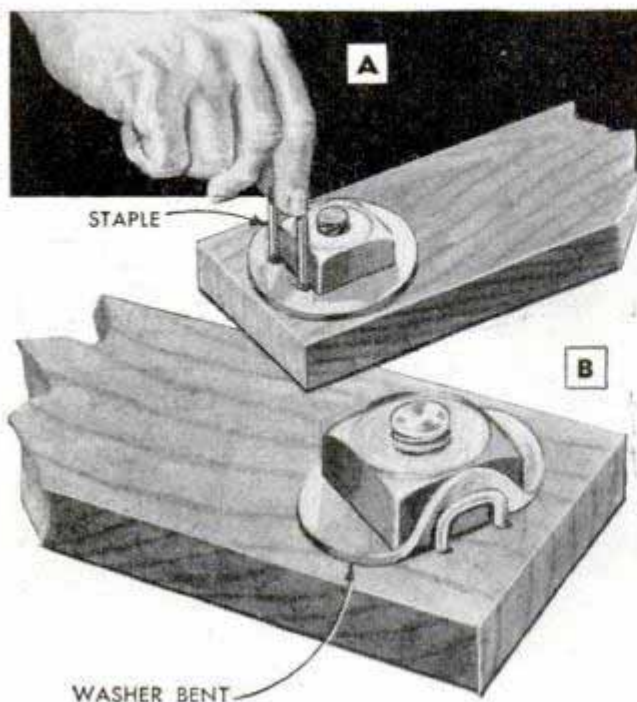

WASHER BENT

bent up against the nut and the staple is driven against the flange thus formed.

Improved Lock for Bathroom Door

To keep a youngster from locking himself in the bathroom, one parent altered an ordinary bolt lock so that, in an emergency, it could be opened from outside the bathroom. The lock is installed in the usual manner, then the outside knob is removed and the end of the shaft is slotted to fit a screwdriver. Finally, the hole in the door for the knob is capped with a snap plug. To unlock the door from outside, remove the plug and turn the bolt back with a screwdriver.

Robert C. Glass, Fraser, Mich.

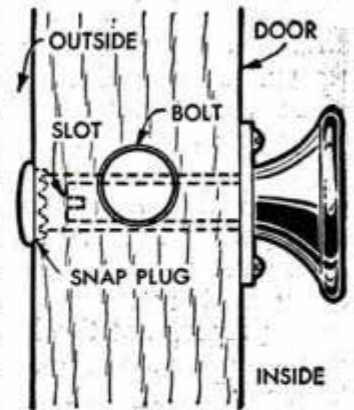

Truck Tail-Gate-Chain Adjustment

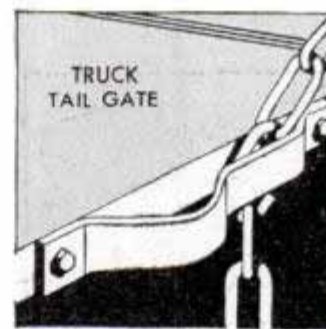

With this chain adjustment, you can set the tail gate of a truck at almost any height. The chains are fastened to the sides of the truck and are inserted through strips of flat iron bolted to the ends of the tail gate. The iron is bent so that the chain will run through it freely when passing through the part that is bowed out, but will catch and hold the tail gate when a link is slipped into the narrow part.—George W. Carter, Olds, Alta., Can.

Paintbrush Applies Shoe Polish

If you have a small, worn paintbrush, it can be used as a shoe-polish applicator. Trim the bristles so they are short and even, as shown, and cut the handle off so it can be gripped properly. Because of the shape of the modified brush, it's easy to get at hard-to-reach spots such as where the upper and the sole are joined.

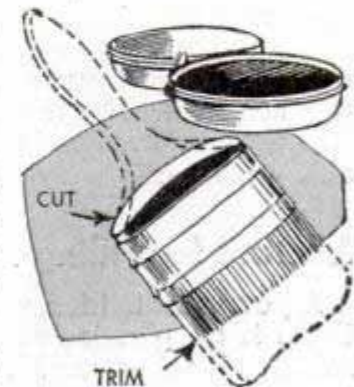

Pewter Bonbon Dish Typifies Homespun Craft

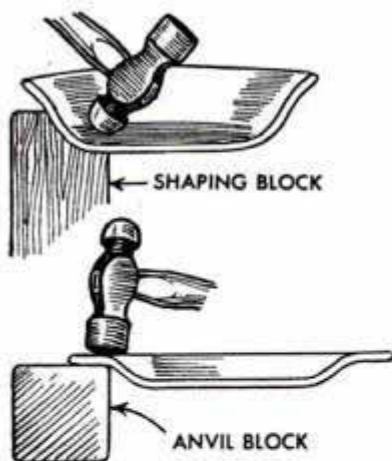

As an example of hand-wrought craftsmanship and design, this pewter bonbon dish is typical of the fine work that can be turned out with only a few hand tools. Material required for the dish is an 8-in. disk of 18-ga. pewter. To begin, locate the center of the disk and scribe two concentric circles, one with a radius of 2 in. and the other 2 $\frac{3}{4}$ in. With the disk flat on an anvil, use a ball-peen or planishing hammer to finish the surface of the inside circle, giving it a texture similar to that shown in the photograph. Then cut a shaping block out of 2 by 4-in. stock and form the bowl, using either a round-head mallet or a 14-oz. ball-peen hammer. Keep rotating the disk as you form it. When the dish has the approximate shape shown in the upper left-hand detail, form the lip on an anvil block, lower left-hand detail. Skill and care are required to produce flowing curves and smooth surfaces. Set the dish on a solid metal plate and, with a rawhide mallet, flatten the bottom so it will not "rock." Then reverse the dish and treat the lip in the same way, this time using a chisel-edged mallet. Referring to the lower right-hand detail, divide the dish into six equal parts. "Step off" this distance around the circumference of the 8-in. circle with dividers set for 4 in. The segments are at an angle of 60 deg. Sketch and cut a template having the outline indicated by the ruled squares and trace this pattern on each of the six segments. With curved shears, cut to the outline, but allow for finishing and smoothing the edge. Then scribe a line parallel to the outline $\frac{3}{16}$ in. inside it and tool in an ornamental border with an engraver's burin. Finish by removing all surface scratches with No. 0 emery cloth and follow by rubbing vigorously with pumice-and-oil paste. A high luster is obtained when the dish is rubbed with fine steel wool. In time the pewter will become dull, but the polish can be restored by washing with soap and water or, if neces-

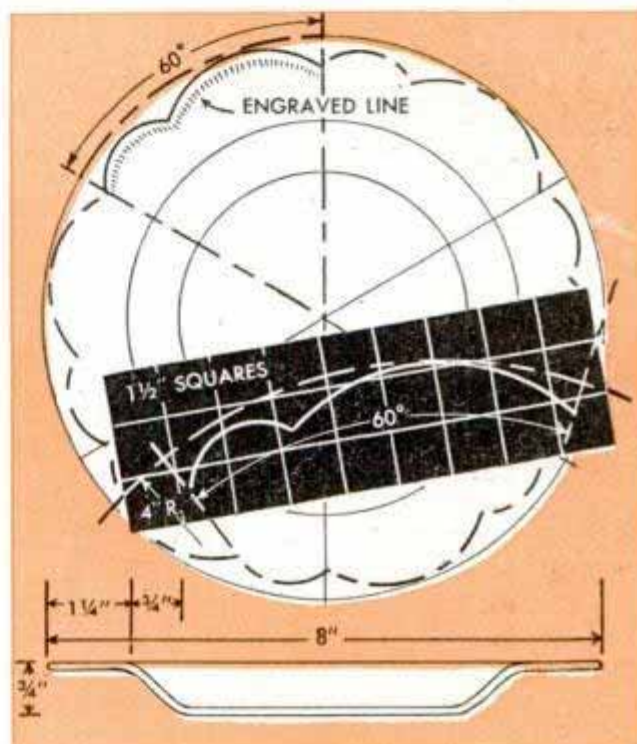

sary, polishing with fine steel wool and soap. Since pewter is a soft metal, care must always be taken not to scratch it.

Soles Protected From Skate Clamps

Children's shoe soles frequently become torn and loosened by the toe clamps on roller or ice skates. But if U-shaped clips are formed from sheet metal and used on the soles as shown, the clamps will have a better grip and they will not cut into the sole. When not in use, the clips are removed from the soles of the shoes.



Winter Bouquets

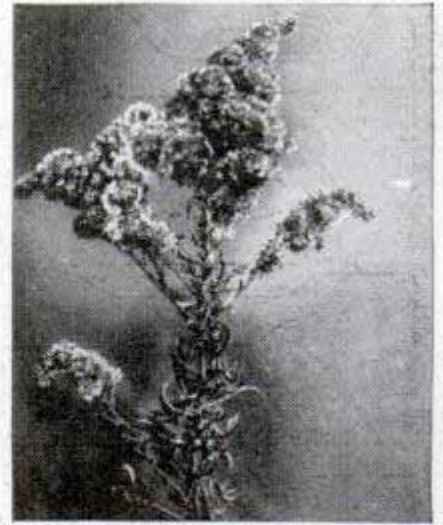

Goldenrod makes a beautiful and lasting bouquet. This was gathered in mid-winter, dried and sprayed with a flat-type paint. You'll find pastel shades give the best results

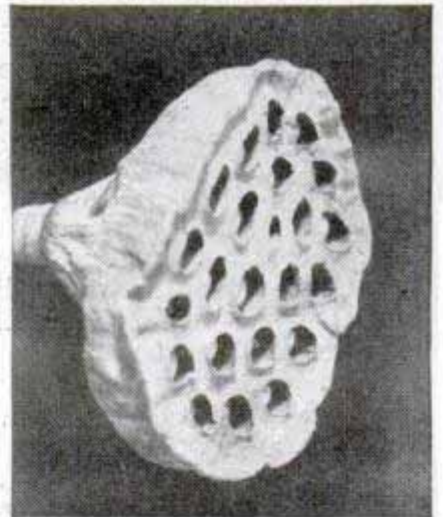

Large seed pods of American water lotus and Yoncopin, gilded, can be used to form the predominant part of a winter bouquet when combined with bushy-type grasses

There's money in making and selling artificial bouquets and it's practically all profit, too, for they can be made of dried flowers, grass or even weeds and decorated with dime-store paint

DRIED AND SPRAYED or painted by hand in a riot of colors, common garden flowers and even lowly roadside weeds become a thing of beauty in the form of a winter bouquet. The best flowers for this purpose are the everlastings as they are of a papery, strawlike quality and when dried retain their shape and color exceptionally well. These include helichrysum (strawflower), cantananche (Cupid's dart) and winged everlastings. Others frequently grown in average gardens are sea lavender, globe amaranth and babies'-breath. To prepare everlastings for bouquet material, pick them when the flowers first open from the bud and hang them upside down in small bunches in a warm room, after first stripping off the leaves. Let them remain until the heat has drawn the last vestige of moisture from the stems. If you wish, the stems can be removed and replaced with ones of wire. Wire stems will permit forming sprays and other unusual arrangements. The bouquet is preserved by

By
**PAUL
HADLEY**

spraying it with clear lacquer which brightens the original colors and gives the bouquet stiffness.

You don't need to stick to flowers alone. Many attractive bouquets can be made up of berries, seed pods and grasses. As for berries, there are those of the bittersweet vine, barberries, Indian currants, coralberries, etc. The hard seed pods of larkspur, primrose, tulip tree and mallow, as well as the globular heads of poppy plants, all lend themselves to forming attractive bouquets. There are also the pods of okra and dried tassel of corn. Roadside weeds, such as the

From Your Summer Garden

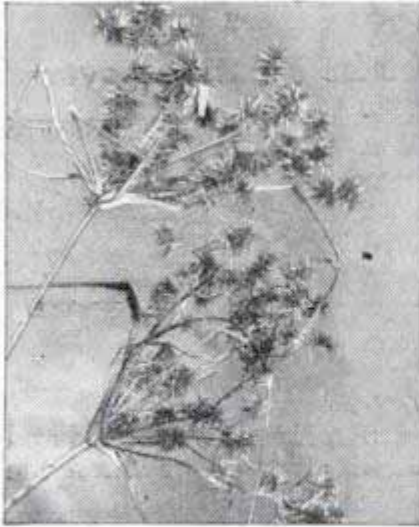

Burr grass, a rough grass, is ideal for winter bouquets. It can be left its natural color and sprayed with clear lacquer to preserve it, or colored by spraying it with paint

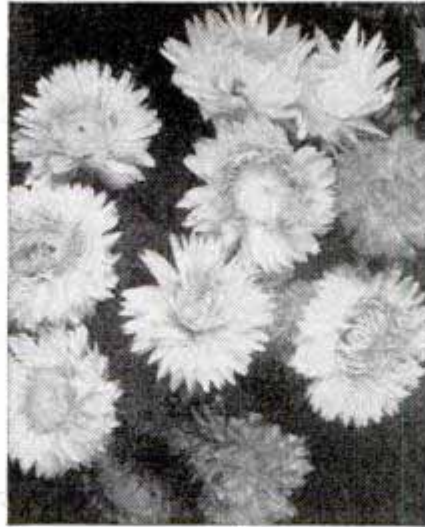

Flowers of the helichrysum plant (strawflowers) when dried retain their shape and colors almost indefinitely. Stems usually are removed and replaced with wire

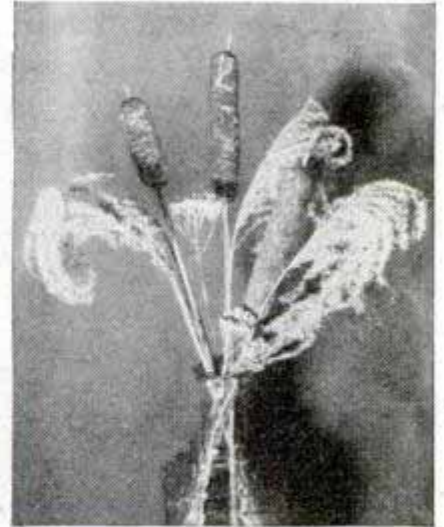

A bouquet combining plume grass with cattails. The grass must be sprayed with thin lacquer to prevent shedding the seed, while the cattails are dipped in collodion

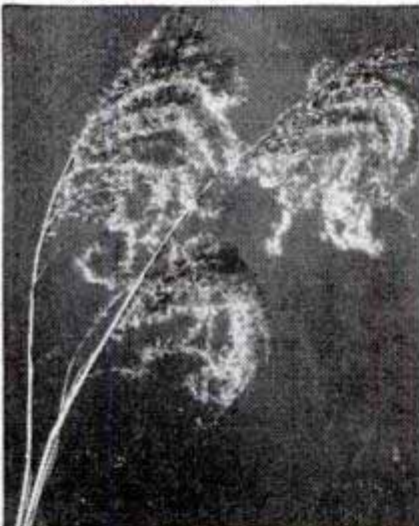

Here's what plume grass, a cultivated grass, looks like when used by itself in a bouquet. This, like pampas grass, must be sprayed with lacquer to prevent shedding

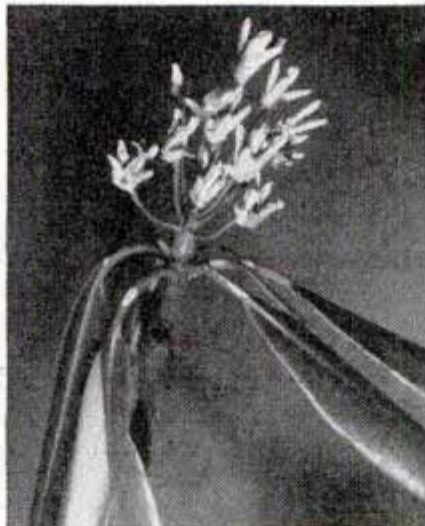

Seed pods of a rhododendron bush when painted pink or orchid color in contrast with its glossy green leaves make a striking bouquet to add a decorative touch to a room

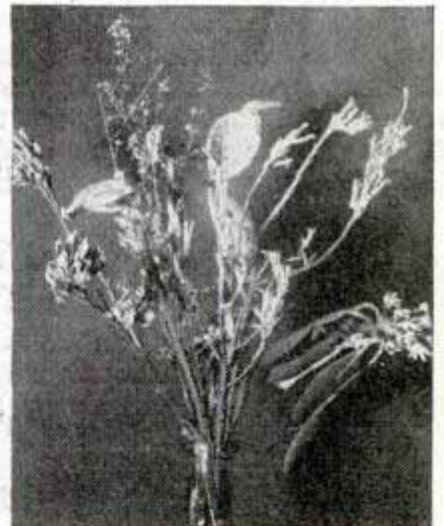

Seed pods entirely make up this bouquet. It combines those of milkweed, wild primrose and mallow. Pods are painted various colors to contrast with green stems

Jimson, milkweed, primrose and many others, are suitable, too. Bouquets of these materials usually are painted with quick-drying paint or enamel, painting the pods in various colors and the stems green.

There are a number of grasses that will do. Plume grass and pampas grass are very good. A variety called sea oats, a tall grass with oatlike panicles, is used commercially. Cattails also are popular in winter bouquets, but like grasses, they have light downy seeds that shed very easily. These can be made nonshedding by coating with collodion cement. Grasses are made non-

shedding by spraying them uniformly with thin, clear lacquer or white shellac.

The accompanying photos show a few of the many combinations of seed pods, flowers and weeds that can be used. An unusual bouquet which is appropriate at Christmas time can be made from a few ordinary tree branches and twigs. These are first painted red or white and then dusted with mica-type artificial snow while the paint is still wet. A rhododendron branch with its flowerlike seed pods forms a novel bouquet when the pods are painted pink or orchid and the leaves green.

Mold Cut in Ground Simplifies Casting Flagstones



Instead of making regular forms for flagstones and then removing the "stones" from the forms and setting them, dig shallow holes in the ground the shape of the stones and pour concrete in them. Smooth the concrete flush with the ground so it will be easy to mow over the flagstones.

Metal Holder for Hand Tools Fastened on Workbench

This tool holder can be fastened to the top of a workbench where it will keep small hand tools in an easy-to-reach position. It is formed of fairly heavy sheet metal bent to a Z-shape as shown in the

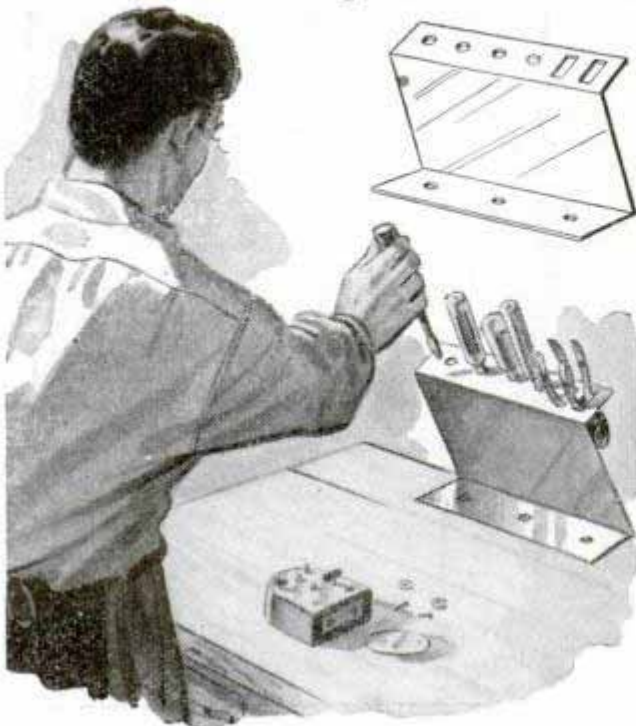

detail. The holes to fit the tools are made to accommodate the ones you have and, naturally, must be varied to suit individual requirements.

Rufus P. Turner, New Bedford, Mass.

Sawdust Absorbs Paint Remover

When refinishing woods, it's a good idea to have a supply of clean sawdust at hand to sprinkle on paint remover as the old finish is scraped off. A cleaner and neater job will result than if rags were used and the sawdust can be disposed of when the work is done.



Safety Razor Serves as Scraper

An old safety razor can be altered to serve as a scraper for small work by filing down the teeth of the guard so that the edge of the blade projects slightly. Discarded razor blades will prove satisfactory for use in the scraper. In fact, until the edge of the blade has been dulled somewhat, it will not work too well. A double-edged blade and razor are used to make the scraper.

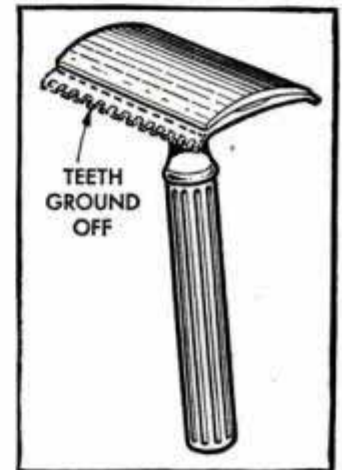

Andrew Stelmach, Millville, N. J.

Screws Hard to Remove From Hinge When "Locked" With Nail

Hinges and hasps are difficult to remove from doors, tool chests, etc., if the screws holding them are locked so they cannot be removed with a screwdriver. To prepare the screw, deepen the slot at an acute angle at one end. Then turn the screw in place and drive a finishing nail into the slot so that the head is below the surface, using a center punch to countersink it.

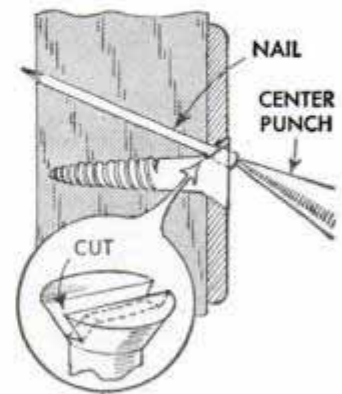

Turn this novel THREAD HOLDER

Here's a novel and practical little project for the beginner in lathe work. It's a doll thread holder which conceals a standard spool of thread on a removable wire rod under the skirt. The doll consists of eleven turned parts, although the neck and body can be pieces of dowel. The six wood rings which form the skirt are first jigsawed roughly to size, sawing the outside diameter of each one about $\frac{1}{8}$ in. oversize. Then they are all glued together, one centered on top of the other, after which a scrap of $\frac{3}{4}$ -in. pine is glued to the top with paper in the joint. Next, the glued assembly is attached to the lathe faceplate and the outside is turned down according to the sectional view, then sanded smooth and pried from the scrap block at the paper joint. A $\frac{3}{4}$ -in. hole is bored in the skirt for the body which is capped with two disks, the top one being bored for the dowel neck. The shape of the arms can be traced directly from the full-size pattern, jigsawed and glued as shown. The doll is completed by adding the muff, paper bonnet, the ribbon bow around the neck and painting to suit. Shellacking it first will keep the end grain from absorbing the paint. The thread is brought out through a hole in the front of the skirt.

N. Bogoch, Winnipeg, Man., Can.

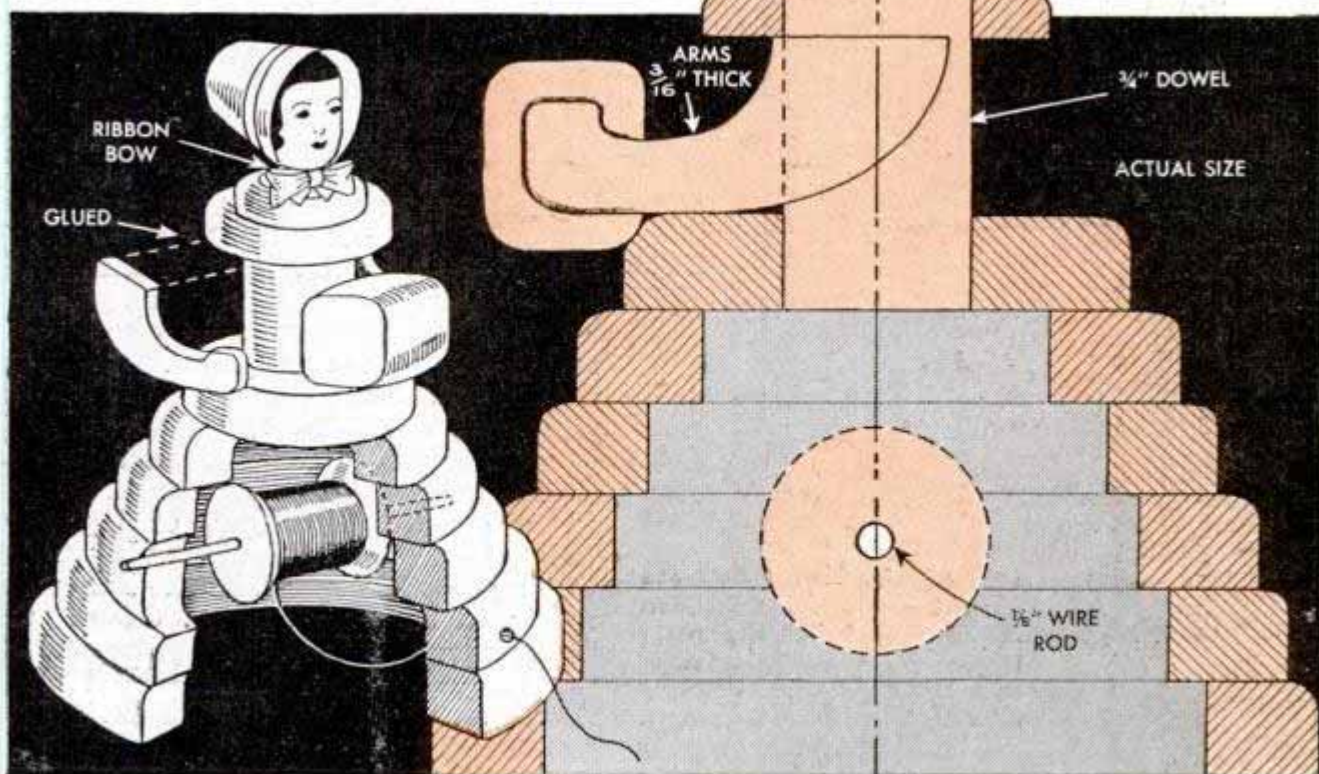
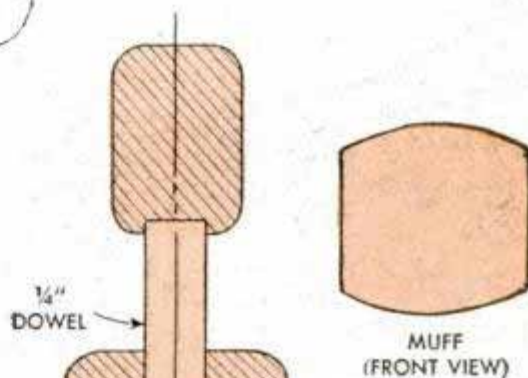
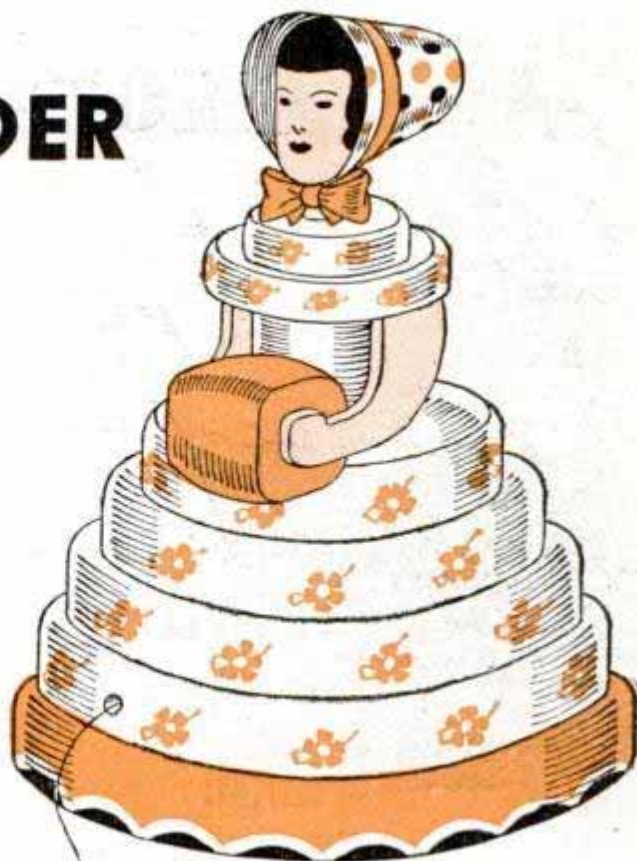

SHOTGUN CHOKES

By W. Clyde Lamme



Photo by Roberts from Underwood

1 POPULAR SHOT SIZES Chilled Shot

No.	No. in Oz.
10	868
9	585
8	409
7½	345
7	299
6	223
5	172
4	136
3	109
2	83
1	73

Left, popular shot pellets are shown in comparative sizes. Common loadings include sizes ranging from No. 9, a standard skeet load, to No. 4, loaded in 2¾ and 3-in. shells for long-range work

CHOOSING A SHOTGUN by gauge alone is not always the best way of determining its suitability and usefulness. For one thing, some good shotgunners find it difficult to get accustomed to the comparatively heavy recoil of the larger gauges, even though they may use the heavier gun over a period of time. To them the larger gauges are a definite handicap to better shooting. Such shooters should settle for a smaller-gauge gun of lighter weight or a gun of the auto-loading type which gives less recoil. In the long run they will bag more game. Others, to whom recoil is no handicap, object to the comparatively heavy weight and slower swing of the big-bore shotguns.

AND GAUGES

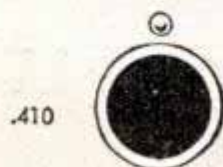
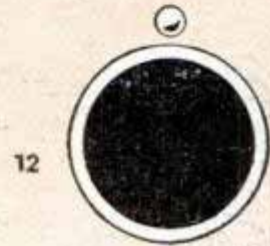
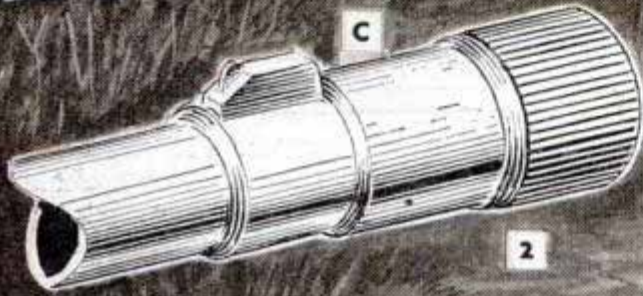
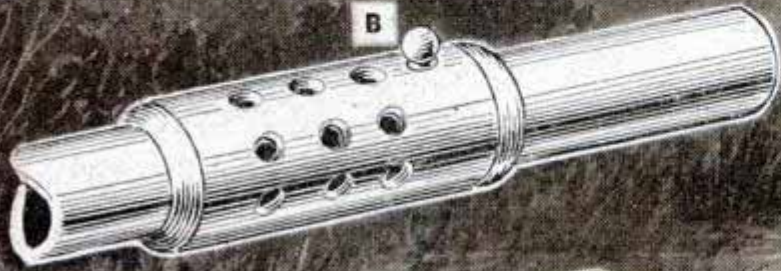
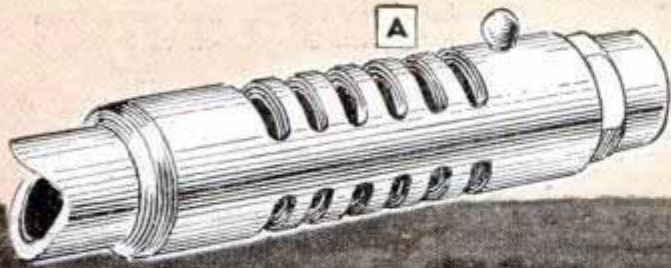

3 GAUGES IN COMMON USE

Variable choke devices fitted to single-barrel guns give consistently uniform patterns and some types known as compensators, or "brakes," aid in reducing recoil

For them the solution also is a lighter, faster gun of smaller gauge. Then there are the hardy wild-fowlers who must sacrifice something in choice to get the extra-long-range killing power generally required to bag their game under average present-day hunting conditions. These special requirements call for a heavy gun, chambered and bored to handle super-long-range loads.

The trick is in selecting the gauge of the gun to fit the personal likes, purposes and inclinations of the shooter. In some cases that's a rather large order, but for ordinary upland shooting a ratio of about 100 ounces of gun weight per ounce of shot is a good average for most shooters. Type of shotgun is optional, of course, and all high-quality shotguns are furnished in a choice of chokes, gauges and barrel lengths. Both the gauge and the choke are determined largely by the game you are after. The degree of choke determines the spread of the pattern. If you are shooting quail over dogs in thick cover you will need a medium-lightweight gun and an open boring

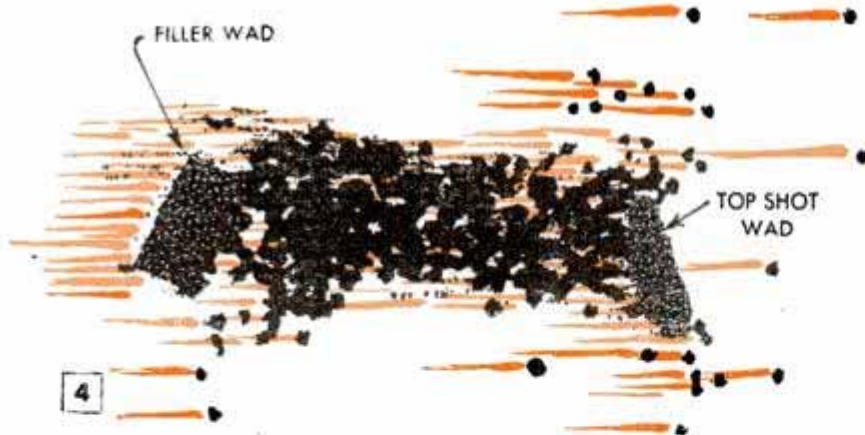

Left, high-speed photos reveal what happens to a shot charge fired from the older-type shot shell closed with a top wad and the conventional crimp. This shot charge is being deflected by the top wad—may form a "cartwheel" pattern as in Fig. 9

Right, shot charge in flight a few inches from the gun muzzle. Note uniformity of shot column. Fired from a shell with the newly developed flat crimp which eliminates the separate shot wad

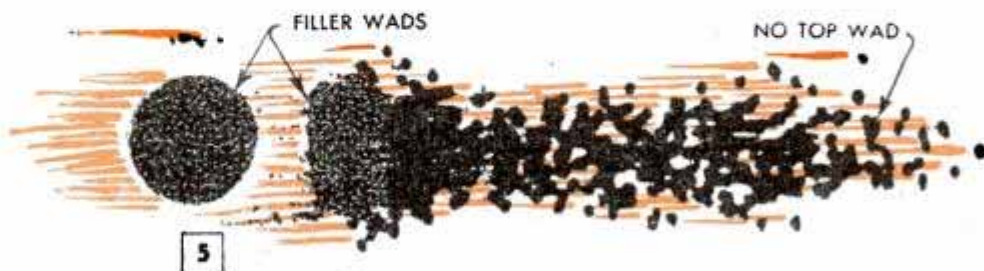

Courtesy Remington Arms Co., Inc.



to give wide-spreading shot patterns. On the other hand, if you are shooting at passing ducks or geese, driven pheasant or doves, the average ranges will be much longer. For this work you'll need a somewhat heavier gauge choked to throw a tight pattern at greater distances.

In the double gun with side-by-side barrels or the over-and-under type with superposed barrels, you can have two degrees of choke in the same gun without additional fittings. But with any of the single-barrel shotguns in single-shot, pump action or the auto-loading type you have only one barrel and, of course, only one degree of choke. The alternatives are to have interchangeable barrels fitted to the gun, each with a different choke, or any one of the three devices shown in Fig. 2, A, B and C, attached to the original barrel. Any of these latter accessories is good, the first two, A and B, giving exceptionally uniform patterns of varying density and spread merely by changing the choke tubes. In addition, the open body of this device, which is permanently attached to the barrel, allows gases to dissipate more rapidly in a lateral direction, thus materially reducing the recoil. The third, detail C, is simply a choke-changing device and is the handiest of all in the field as it permits a change in pattern by merely turning the knurled ring. Index marks indicate the various degrees of choke. However, this accessory does not reduce the recoil of the gun.

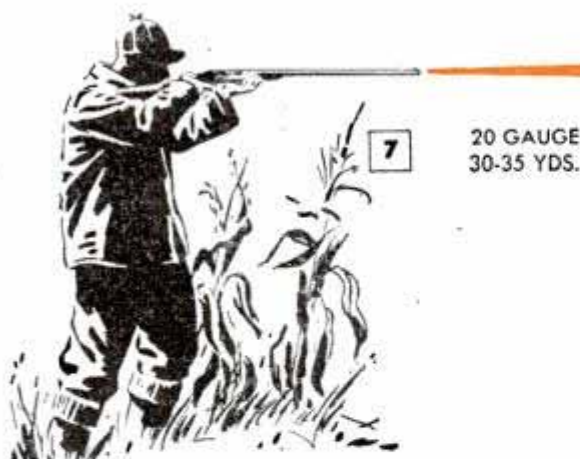

A recent development in shot shells eliminates the top, or shot, wad by a new process of crimping. By use of the high-speed camera researchers verified what had long been suspected—that the top wad was the cause of spotty shot patterns. Notice in Fig. 4 how the top wad is breaking up the shot column only a few inch-

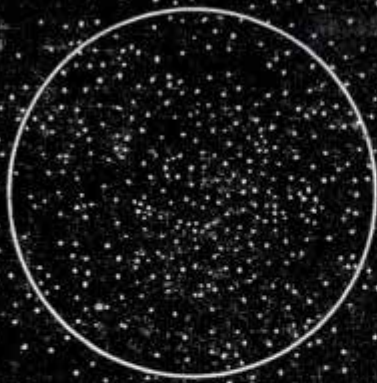

UNIFORM DENSITY

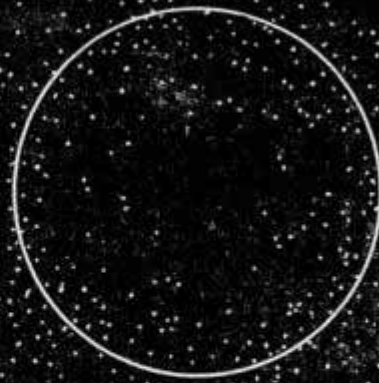

"CARTWHEEL"

9

Courtesy Remington Arms Co., Inc.

es from the muzzle of the gun. This early breakup of the shot column often results in the "cartwheel," or open-center pattern shown in Fig. 9. Fig. 5 is a copy of a high-speed photo showing a shot charge fired from a shell with the new flat-top crimp. This improvement in shot-shell loading has been found to give consistently uniform patterns in barrels bored with varying degrees of choke.

When you consider density of pattern, shot size in relation to gauge is of some importance. Notice in Fig. 1 how the number of shot pellets per ounce falls off as the shot size increases. In 1 oz. of No. 4 shot, for example, there are less than half as many pellets as there are in 1 oz. of No. 7½ shot. A 10-gauge takes 1½ oz. of shot while a 12-gauge gun handles 1¼ oz. in the standard 2¾-in. shell; the 20-gauge takes 1 oz. of shot, while the .410-gauge handles ¾ oz. of shot in the 3-in. shell. From this you can compare easily the variations of pattern density when different sizes of shot are used in gauges ranging from the smallest to the largest, assuming, of course, the same degree of choke in each instance. The 10-gauge gun, Fig. 3, although still preferred by many wild-fowl hunters, has been largely supplanted by the 12-gauge chambered for 3-in. shells. These heavy loadings in specially bored barrels make the 12-gauge gun effective at ranges up to 60 yds. or more. Figs. 6, 7 and 8 show average ranges at which various gauges are considered most effective. The figures given do not in any case represent the extreme ranges. Effective ranges of those gauges between 12, 20 and .410 will vary only slightly.

Shotgun barrels vary somewhat in pattern percentages, the common basis of reckoning



For quail and other small game birds taken in heavy cover at ranges under 40 yds., you'll need a light gun with open-bored barrels for fast handling and wide pattern spread. The 20-gauge gun is a good all-around choice



As a rule pheasant and other large upland game birds found in more open cover flush at greater distances. To bag these birds consistently you need a heavier gauge, larger shot and a somewhat tighter barrel boring



Average duck and goose shooting calls for a gun of the larger gauge, close choke boring and heavily loaded super-long-range shells

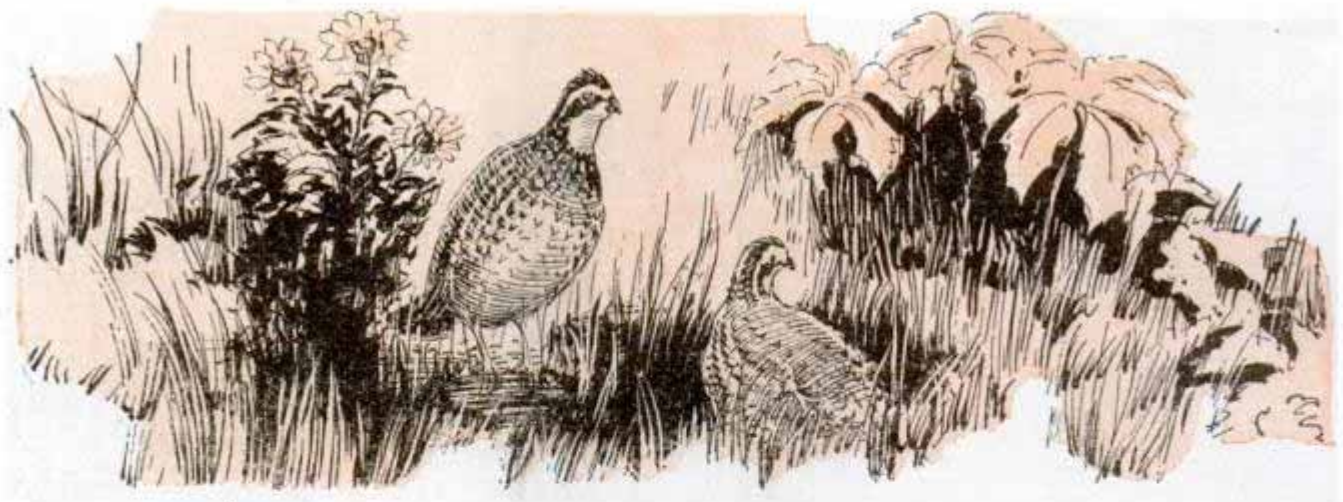

being the number of shot pellets placed in a 30-in. circle at 40 yds. Some full-choked barrels, Fig. 10 A, will hold 75 percent of the shot charge within the circle at this range, using a given shot size. Varying the pellet size will often give different results in the same barrel. For this reason it's a good idea to test a new gun to determine which shot size it patterns best. To do this, cut a number of sheets from heavy paper, each about 48 in. square and paint a 4-in.-dia. black circle on each one to serve as an aiming point. Set up a single sheet on a supporting frame 40 yds. from the muzzle of the gun and fire one test shot at each sheet, using a shell loaded with different size pellets for each test. After each shot draw a circle 30-in. in diameter around the area on the paper containing the greatest number of perforations made by the shot charge in passing through the target. You may have to repeat this test several times in order to determine what shot size gives the most consistently uniform results in the particular gun you are testing.

There is some difference of opinion among shooters as to the proper shot size to use on various game birds. For smaller birds such as quail and doves, most experienced hunters use small shot sizes ranging from No. 7½ to No. 9. For shooting medium-sized game birds, such as grouse and pheasant, shot sizes ranging from No. 4 to No. 7½ are an average choice. Large birds difficult to kill cleanly generally call for the use of the larger bores and shot sizes ranging from No. 4 to No. 1. However, it is density and uniformity of the pattern that count, rather than the shot size. Some shooters prefer the smaller shot sizes even for the larger birds, relying on the density of pattern given by the smaller pellets rather than the greater killing and ranging power of the larger individual pellet. Fig. 10 C shows roughly about what you can expect in shot patterns from full choke, modified choke and cylinder-bore barrels. Percentages for modified choke and cylinder bores also are frequently given as 45-55 and 25-35 percent, respectively.

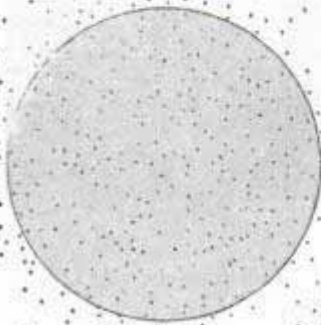

A

FULL CHOKE 65-75%

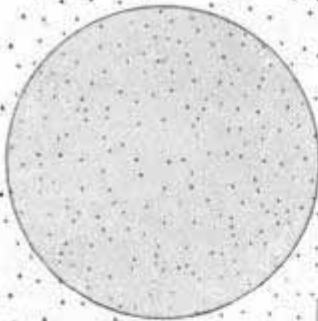

B

MODIFIED CHOKE 55-65%

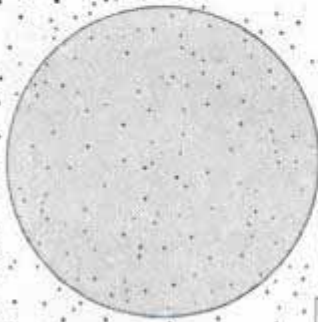

C

OPEN OR CYL. BORE 35-45%

10

Focus Mark Filed on Binoculars Permits Quick Adjustment



To focus a pair of binoculars quickly, scribe an indexing mark on the sliding barrel and adjust to this mark before sighting to make the final setting. Of course, the mark is set for a predetermined

distance and would be of use only where the object to be viewed is within such limits. Looking at football games, races, etc., where the distance is roughly known are examples of this. If several persons are using the glasses at the same time, it's an easy way for the owner to readjust them after letting someone else use them. When scribing the mark, be careful not to leave any burrs on the barrel as this might damage other parts of the instrument.

How to Recondition Jar Covers

After the screw-type covers found on some fruit jars have been used a few times, the edges flatten out and no longer grip the jar rubbers tightly. To recondition the covers, crimp down the edges with a hammer, using a large pipe or round wooden block as an anvil, and remove any burrs with sandpaper. The covers will again be in good condition.—E. J. Murawski, Baltimore, Md.

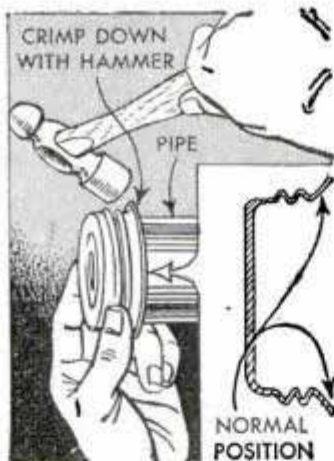

Handle Aids in Emptying Basket



Riveted to the side of a wastebasket near the bottom, a metal handle similar to a drawer pull, will provide a good grip for the hand and make it easy to empty the basket. The handle will be found

especially convenient when it is undesirable to have the contents of the basket come in contact with the hands.



Oil Drum Supports Rural Mailbox And Serves As Package Holder

An oil drum provides an ideal support for a rural mailbox, and, if a door is cut in one side, will also serve as a good container for packages too large to go into the box. The door is made by cutting out a section from one side of the drum and hinging it in place. Provide a latch by welding or riveting on a hasp and staple to take a pin. Since the door naturally will not be rain tight, locate the drum with the door in the direction opposite to that from which most storms come in your locality. Four flat-iron legs braced and then welded to both the drum and mailbox support the latter at the desired height above the drum.

Fastening Rain Gutters Securely

If a gutter is fastened securely at the time it is installed, much needless maintenance work will be eliminated. To fasten the wire hanger to the roof, tack a square of galvanized sheet metal under the shingle and drive the hanger nail through this. Then nail the inside edge of the gutter to a wood strip that serves as a spacer. Finish the spacer with several coats of house paint to keep it from rotting.

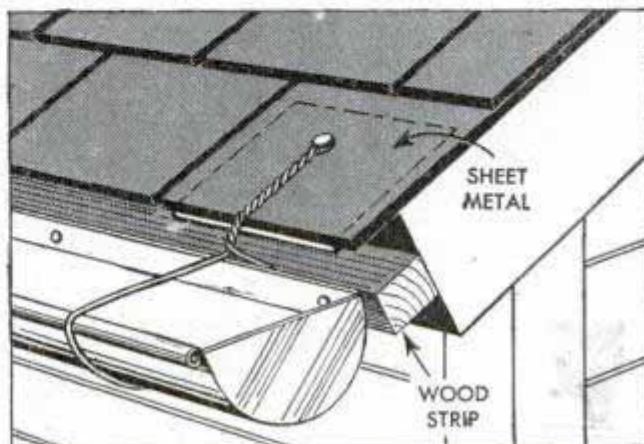

"JET"—ICEBOAT FOR BOYS

It's made boy-size and it can be boy-built, but there's no reason why you can't make it grown-up size by merely increasing the dimensions

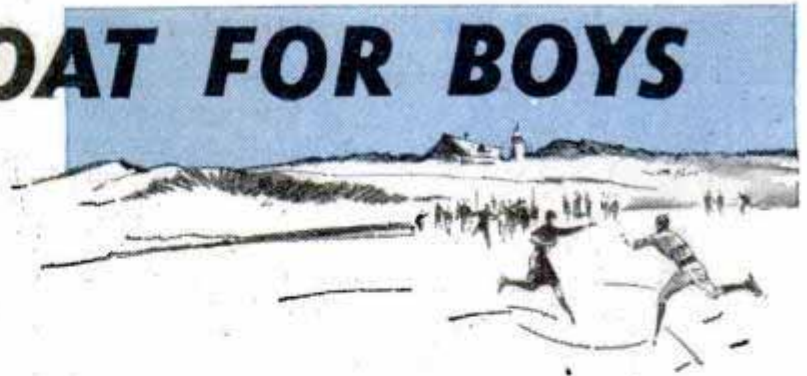

By Hi Sibley

THIS SPEEDY little iceboat has the advantages of unobstructed vision, low center of gravity and spring action to absorb shocks from rough ice. These characteristics make it especially suitable for iceboating on ponds, small lakes and rivers. With the mast unstepped it is compact enough to be carried on top of a car, and light enough to be towed by hand like a sled.

The frame or chassis consists of only two parts, the runner plank and the body plank. The runner plank is bent as shown in Fig. 1, by soaking the piece overnight or steaming it an hour or more and placing in a rough form until it dries and sets. Spruce is the best wood for the runner plank, although selected white pine will do if the former is not available. Figs. 1, 2 and 3 detail the simple construction clearly.

Runners, Figs. 1 and 3, are of steel, ground to a V-shape on the running edge. Forward end of the frame is carried on a coil spring mounted as in the lower left-hand detail in Fig. 3. Upper end of the steering shaft turns in a bushing cut from brass tubing. Rear runners are bolted to hardwood blocks which are attached to the ends of the curved runner plank. The mast, you'll note, is tapered above the step and is held in position when stepped by a transverse pin. Shrouds or stays are made from 1/8-in. steel cable and fitted with turnbuckles. When rigging the craft, draw the stays only moderately tight. This precaution allows the leeward stay to go just slightly slack when in use, which gives better control of the sail and prevents any undue strain on the mast. Unbleached

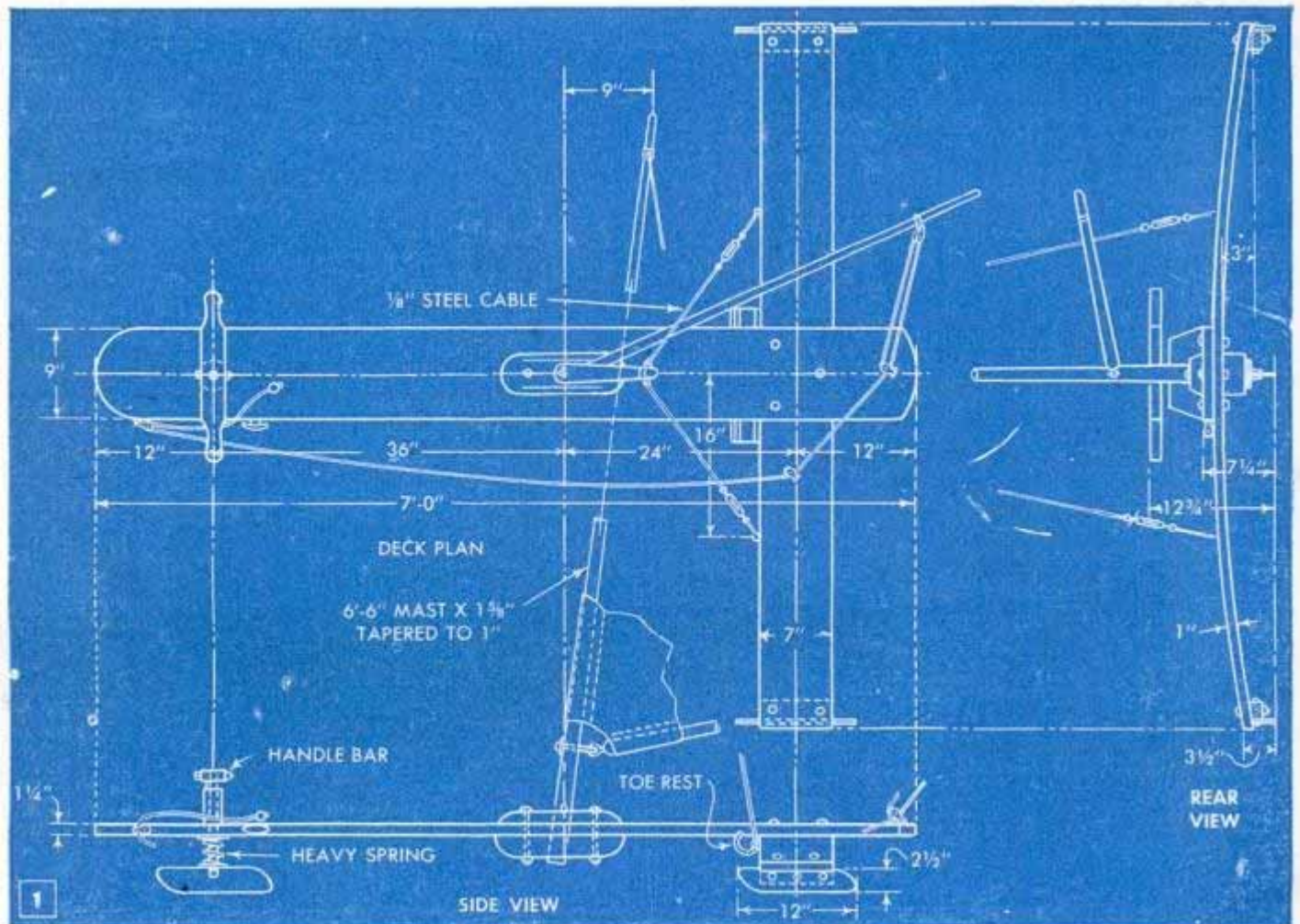

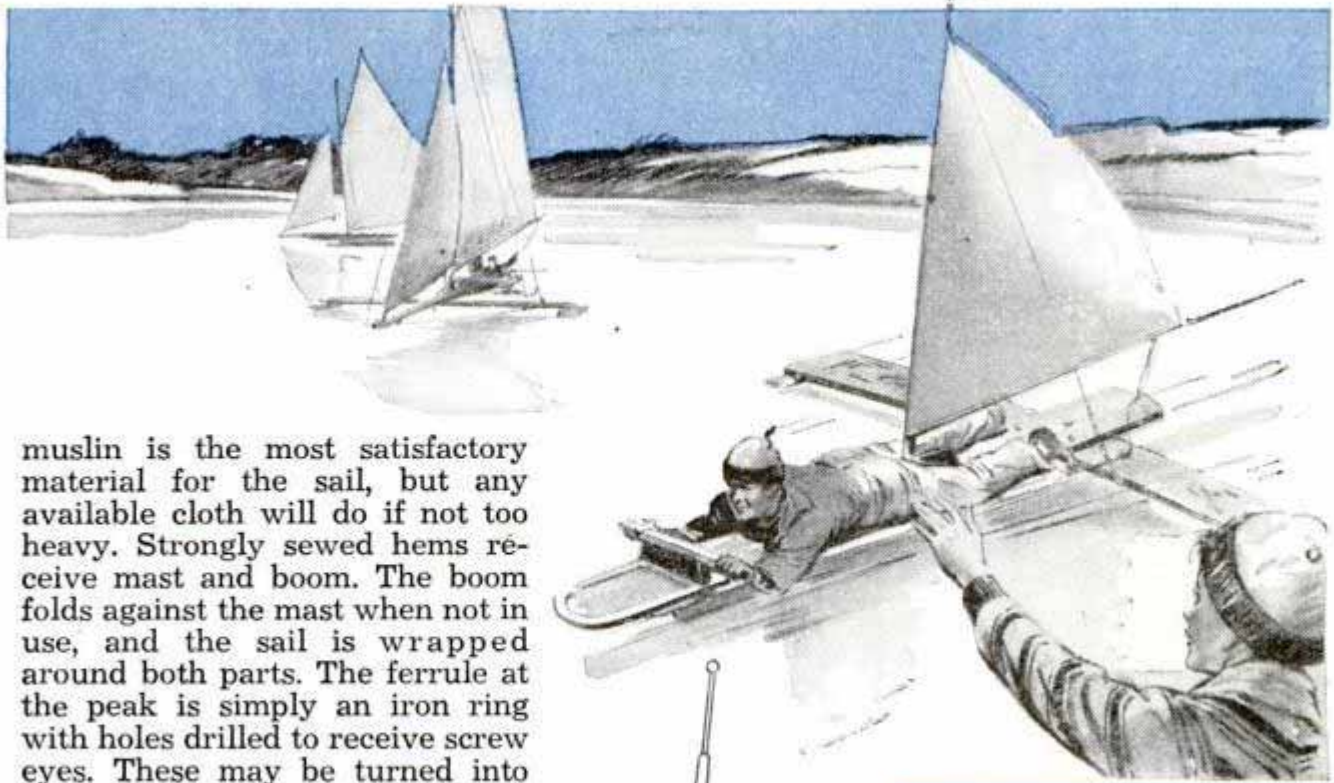

muslin is the most satisfactory material for the sail, but any available cloth will do if not too heavy. Strongly sewed hems receive mast and boom. The boom folds against the mast when not in use, and the sail is wrapped around both parts. The ferrule at the peak is simply an iron ring with holes drilled to receive screw eyes. These may be turned into the wood, or the ferrule can be drilled and tapped, and threaded eyes turned into the ring only. An eyebolt passing through the mast and a heavy screw eye turned into the end of the boom make the gooseneck. The sheet may be rigged on the right or left side, to suit the skipper. Finish the wood in natural color, using a clear sealer and two coats of spar varnish. Decorations in colored enamels can be added, using the black accents as a pattern.

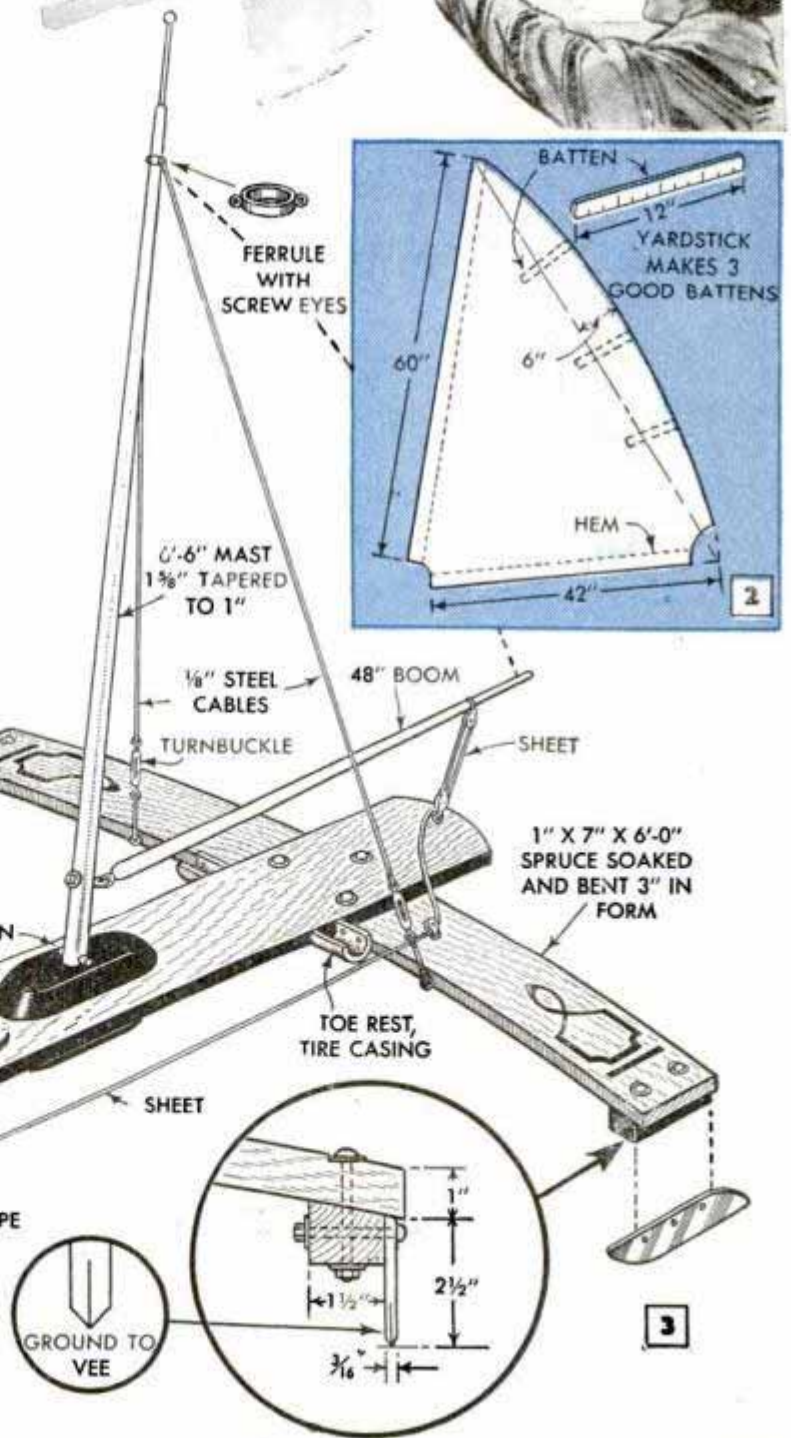

Electric Shaver Used as Eraser



Typed or written matter is erased quickly and neatly with an eraser which can be attached to the power arm of some models of electric shavers. Cut off a wedge-shaped piece of rubber from the end of an eraser and drill a small hole in it that will be a tight fit over the projecting arm of a shaver from which the cutting head has been removed. When using the eraser, apply pressure lightly and the vibrating power arm will do the work.

Implement Seat for Garden



Comfortable to sit in and easy to move about, this portable garden seat is made from a discarded implement seat. A heavy metal rod serves as the supporting standard for the seat and slips through a metal disk, which serves as a base and prevents the standard from sinking into the ground under the weight of the occupant. Two holes spaced $\frac{3}{8}$ in. apart are drilled through the standard to take large cotter pins on each side of the disk.—W. C. Horst, Denver, Colo.

Hammering Pin on Shade Roller



If it's necessary to shorten a window-shade roller and then replace the pin, don't rest the other end on a floor or table when driving the pin. Instead, place it on an empty thread spool and insert the pin. This way, no damage will result.

Sleeve Quiets Oarlock Squeak

An old remedy to stop a squeak in an oarlock is to wet it and stop the noise temporarily. Better than this, however, is a

sleeve or tube fashioned of galvanized sheet metal which fits into the oarlock and acts as a bearing. The tube should be lubricated to lessen friction.

D. E. Horn, River Forest, Ill.

Cutting Strips of Leather Evenly

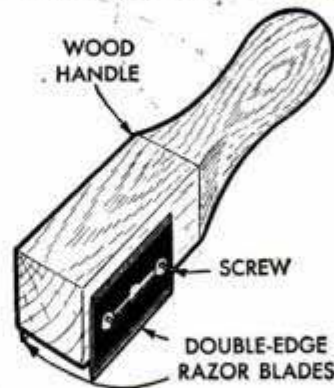

With this handy tool, it's possible to cut strips of paper, leather or similar material to the same width. The handle serves as a spacer block as well as a grip and its width determines the size of the strip. It's not adjustable, of course, but a number of handles can be made to cut any dimensions you require. A double-edge razor blade, which is easy to replace, is fastened to each side of the block with wood screws.

Herbert H. Fey, New Braunfels, Tex.

Money Concealed in Pocket Flap



The flap over the side pocket of a suit coat or overcoat is a handy place to keep valuables and currency if a special pocket is sewed inside the lining of the flap. A slit is cut in one end for removal and insertion of articles.

Lubricating High-Speed Drill

Many times the life of a high-speed drill is shortened because it was improperly lubricated. If a length of loose-fitting rubber tubing is placed over the drill when it is being used and oil is applied through the

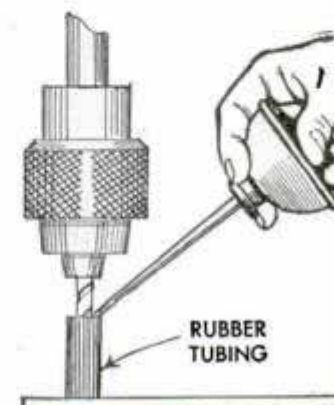

tubing, the drill will last longer. The lubricant that ordinarily is thrown off the drill by centrifugal force will drain down the inner wall of the tubing and flood the work at the point where it is needed.



3 SIMPLE REELS for Developing Movie Film

One holds 100 ft. of 16-mm. film, another 50 ft. and a third one 25 ft. All are inexpensive to make from scrap material

By R. E. Merriman

THERE'S nothing difficult about processing movie film at home with one of these simple developing reels. You merely load the reel, in a darkroom, of course, and run it through the developer solution the same as when processing any black-and-white film. This produces a negative and to change it to a positive you re-expose the film to strong light while it is still on the reel. Then it is run through the developer a second time, after which the film is rinsed, fixed in a hypo bath, washed and finally dried.

You have a choice of three sizes and styles of reels. One is a drum type which is rotated by a hand crank, the others are flat reels which are used in shallow trays. The drum-type reel shown in Fig. 1 will hold up to 100 ft. of 16-mm. or 50 ft. of 35-mm. film. It measures 14½ in. in dia. and 24 in. long. While the reel pictured was made of ¼-in. brass tubing, it can be constructed of soft-iron rod or heavy-gauge wire. The axle of the reel, which should be about 30 in. long, has two 2-in. metal hubs, one soldered 2 in. from one end and the other about 4 in. to permit attaching a hand crank. Each hub has twelve ¼-in. holes drilled ½-in. deep equidistantly in the edge to receive twelve U-shape spokes. If tubing is used for the spokes, it should be heated at the points of bend to keep it from kinking. It's best to make a bending jig of wood to assure all spokes being uniform in shape and length. When made of tubing, one of the spokes can be assembled to expand outward from the hub to take up any slack in the film resulting from stretching. To make the spoke expandable, first cut a 1-in. section out of it about 1 in. from the hub. Do this at each end of the reel. Then place a light coil spring over a short length of metal rod and insert

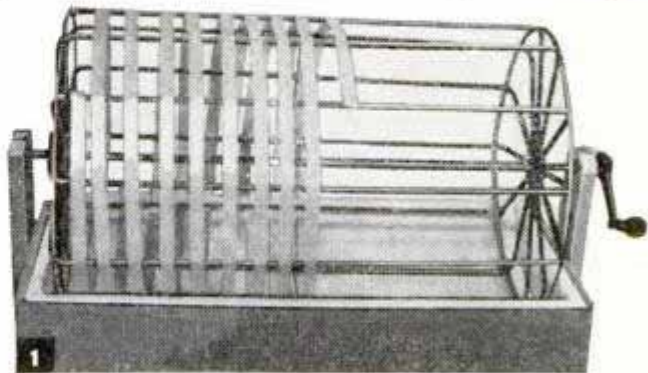

This drum-type reel will handle up to 100 ft. of 16-mm. movie film. While shown partially loaded with the film fairly far apart, ordinarily it is spaced about ⅛ in. apart. You rotate this reel slowly in using it

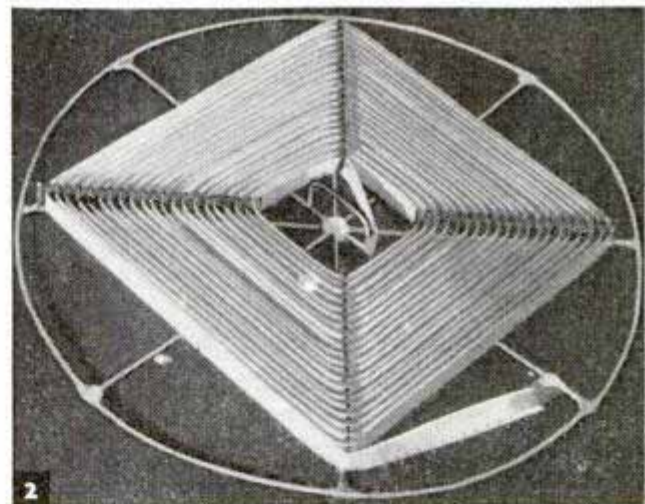

With the film standing on edge, this flat-type reel will hold 50 ft. of either 16 or 35-mm. movie film. The wire framework is coated with a rubber-base paint and in use it is set in a round tray as below

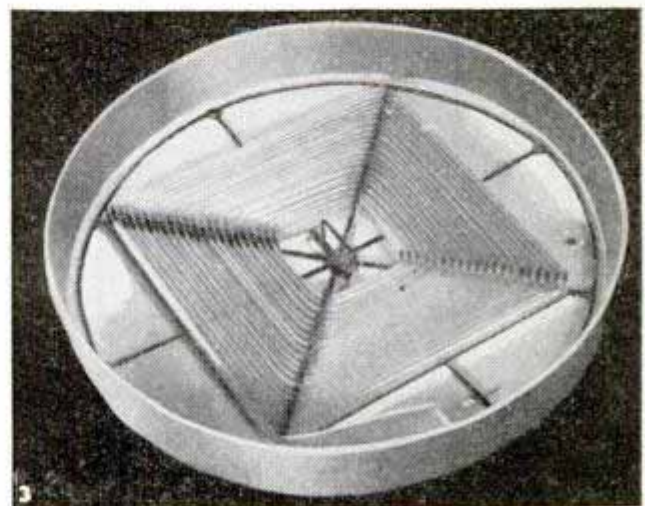

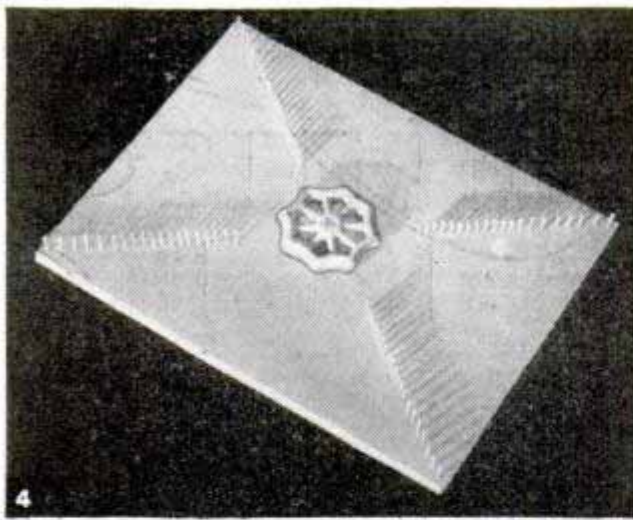

This flat reel consists of nothing more than a nail-studded board, heavily painted, with a handle in the center

the rod inside the spoke so that the spring will bear against the severed ends. Two $\frac{1}{2}$ -in. projections of tubing are soldered to the spoke at a 90-deg. angle, one on each side of the spring, and these serve to keep the spoke depressed when they are held together with a wire paper clip at the time the film is placed on the reel. After the first development, the paper clips are removed, allowing the spoke to expand and take up any slack in the film.

A ring of wire, 11 in. in dia. is soldered to only eleven spokes at each end to complete the drum. Just two trays are actually needed if you plan to develop and fix black-and-white film, such as 35-mm., but for movie film it's best to have four trays so that time is not wasted when changing solutions. These can be formed of light-gauge sheet metal and set in wooden frames as shown in Fig. 1. They should measure 12 in. wide, 25 in. long and 3 in. deep, the bottom being curved to correspond with the shape of the reel. Wood shaft supports should suspend the reel about $1\frac{1}{2}$ in. above the bottom of the tray.

The flat-type reel shown in Figs. 2 and

3 consists of a wheel-shaped framework of $\frac{1}{8}$ -in. wire, 15 in. in dia. Four of its eight spokes have twenty 1-in. lengths of wire soldered upright on them and about $\frac{1}{4}$ in. apart. A wire handle with a sharp barb on it is installed at the center of the reel to which the film can be fastened. This reel will handle 50 ft. of 16 or 35-mm. film. You can use a commercial tray for this reel; a 16-in. one, $2\frac{1}{2}$ in. deep will do.

The most simple reel of the three, which has a capacity of 25 ft., is shown in Figs. 4 and 5. It's made by driving 80 small nails, $\frac{3}{16}$ in. apart and in four groups, into a $\frac{1}{4}$ -in. plywood board measuring $7\frac{3}{4}$ by 10 in. Note that the nails are arranged in a diagonal pattern and that a suitable handle is placed in the center of the reel for removing it from a standard 8 by 10-in. tray. All reels should be given several coats of paint of the type having a rubber base, such as is recommended for painting sidewalls of tires, so that the metal parts will not contaminate the developing solution. Also, in loading the reels, you should remember to keep the emulsion side of the film away from contact with the reel.

"Spigot" in Roll-Film Developing Tank Speeds Draining of Liquid

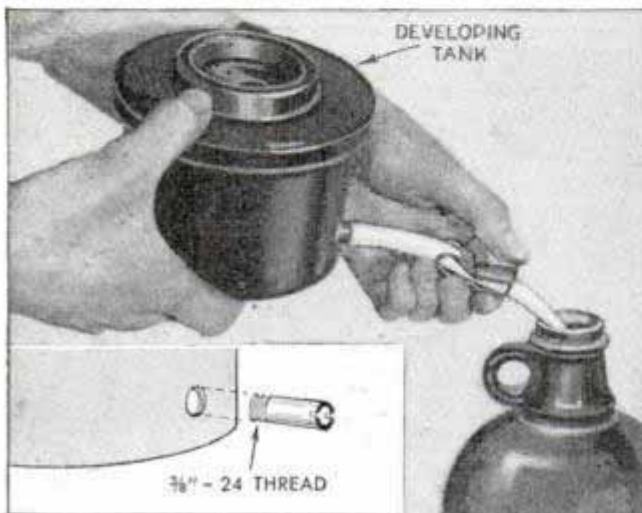

Pouring developing liquid from a roll-film tank into a narrow-neck bottle can be done faster and without a funnel if you install a small drain hose with a shutoff clamp near the bottom of the tank as shown. First, a hole is drilled carefully in the tank and then threaded with a $\frac{3}{8}$ -24 tap to take a 1-in. length of thick-wall, brass or plastic tubing. A cross slot in the end of the tube permits it to be turned into place with a screwdriver, after which sealing wax is used around the joint to make it leakproof. Besides speeding the draining of developing liquids, the outlet also improves the efficiency of the tank for washing film.—Richard Hanscom, Elmhurst, Ill.

CONSTANT-FLOW PRINT WASHER

By Darrel Ward

Photo prints are washed thoroughly in a measured, continuous flow of clean water if this tank is used. As detailed in Figs. 1, 2 and 3, it is nothing more than a tray fabricated from 22-ga. galvanized sheet metal and fitted with an inlet tube soldered to a distributor head. Fig. 1 gives the size and indicates the shape of the sheet-metal cutout for the tray. Drill all holes shown in Fig. 1 and before you bend to shape, score on the dotted lines with a steel scriber. This aids in making a neat, square bend in the metal. One way of soldering the tray corners is to flux and tin the flaps before bending the cutout to shape. Clamp the flaps firmly in place and heat the metal at the corners with a small torch. Withdraw the flame as soon as the solder melts and flows. Solder three 10-ga. wires to the bottom of the tray to prevent prints from sticking. Make up the inlet tube as in Fig. 3 and solder it to the tray, centering it over the row of $\frac{1}{8}$ -in. holes drilled in the end. Smooth all joints and remove burrs from the holes with a file. Paint the tray with two coats of rubber or plastic-base paint. Cover the inlet-spray holes with cellulose tape and fill the tube with the paint. Pour out the excess and allow the whole thing to dry thoroughly before using. In use, adjust flow of water so the outlet holes discharge at full capacity, but see that the tank does not overflow. Wash single-weight prints 15 to 20 minutes; double-weight 35 to 40 minutes.

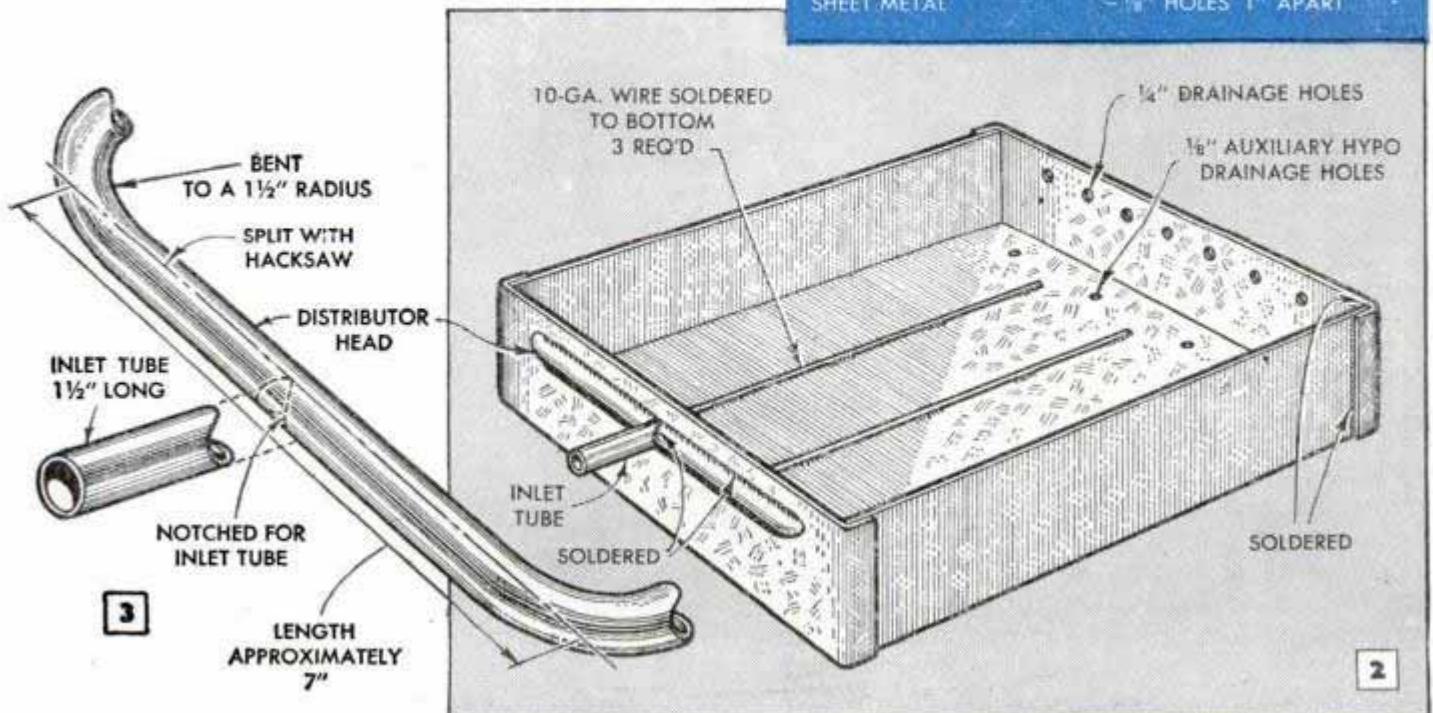
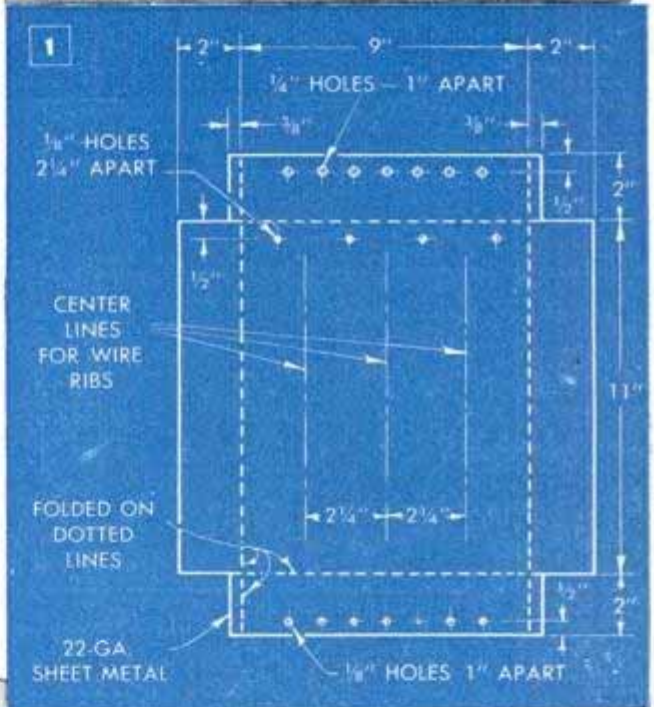

Pad Serves as Built-in "Lens Cap" On Folding Camera



The lens of a folding camera is protected from dust when camera is closed if felt is cemented to the inside of the folding cover, as shown in the detail. Enough thicknesses must be built up so the felt will press against the lens frame when the camera is closed. One advantage of this cover is that it can't be misplaced, as can the conventional kind.

Protective Cover Fits Flash Gun



As protection against the possibility of a shattered flash bulb causing injury when taking close-ups of people, one photographer covers the reflector of his flash gun with a plastic dish cover. The cover should be as nearly transparent as

possible. Although there is a loss of density in the light, additional diffusion is obtained.—R. E. Hedges, Los Angeles, Calif.

Determining Number of Exposures

When using roll-film cameras of some types, it's often confusing to know whether or not the number that shows in the window is for a portion of the film that has been exposed. To avoid double exposure or unexposed film, the following method has been used: After a picture has been taken, turn to the dots that are just ahead of the

next number. Then when you are ready to snap a picture, turn to the number, take the picture and wind the film on to the next group of dots that shows. This eliminates any uncertainty as to whether a picture has been taken.

Safe Connection for Photoflood

Friction on an electric cord at the point where it enters the socket may wear off the insulation and cause a short circuit. This is true of photoflood sockets because they are subject to hard usage. As an added precaution, slip a short piece of rubber tubing over the wire to act as a buffer between the cord and metal socket.

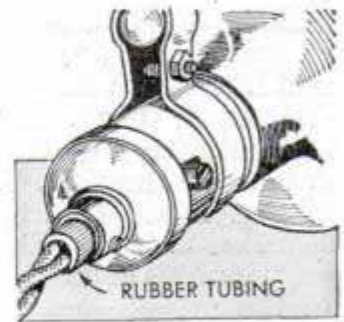

H. Klein, Pittsburgh, Pa.

Typewriter Stand Holds Enlarger In Small Apartment

If space in a small apartment or home is at a premium, a typewriter stand is just about the right size to support a small enlarger. Then when not in use, it can be stored in a closet. When working, always be sure that the stand is steady or fuzzy enlargements will result. To keep the easel from slipping on the stand, drive rubber-covered tacks into the underside at the corners.—Bob Hurst, Chicago.

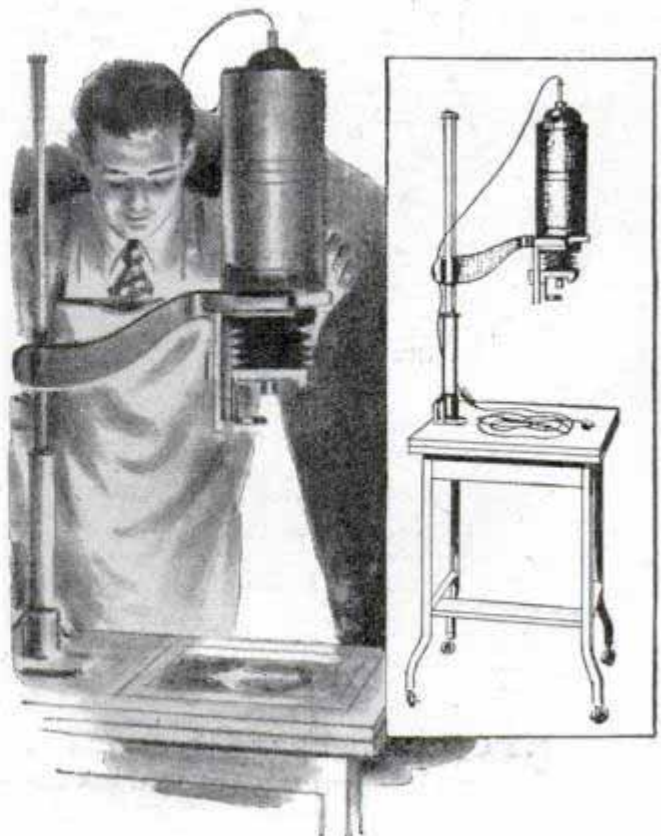

CRAFT QUIZ



1. He is using a—
 (a) Center rest (c) Boring bar
 (b) Slide rest (d) Thread stop



2. One cement for plastics is—
 (a) Lithopone (c) Vinyl trichloride
 (b) Glycerin (d) Methylene blue



3. This popular finish is usually—
 (a) Air-dried (c) Undercoated
 (b) Brushed (d) Baked

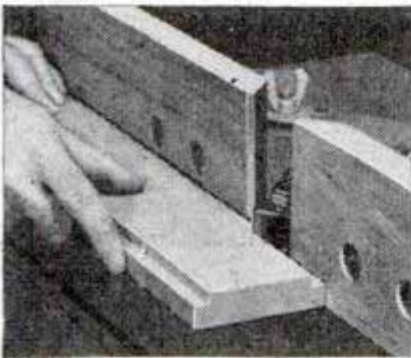

4. What's wrong?
 (a) Cutter on top (c) Feed direction
 (b) Hands (d) Order of cuts

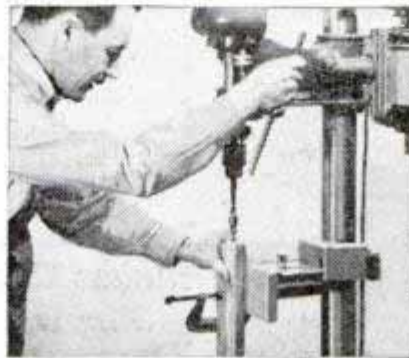

5. Best drill for end grain is—
 (a) Flat cut (c) Single spur
 (b) Solid center (d) Multi-spur



6. This clamp is used by a—
 (a) Carpenter (c) Modelmaker
 (b) Plumber (d) Welder

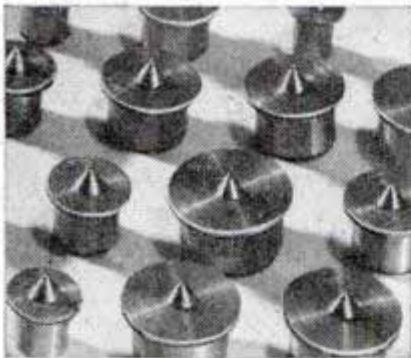

7. What's this?
 (a) Booby trap (c) Moms
 (b) Lathe centers (d) Pops

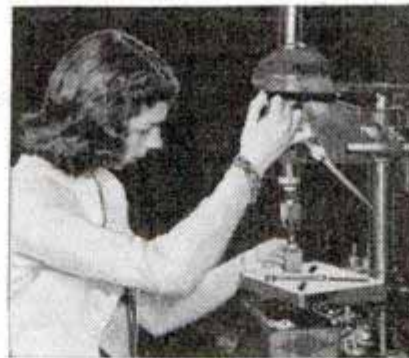

8. Drill operator has—
 (a) Upsweep hairdo (c) Easy job
 (b) Too much jewelry (d) Blue eyes

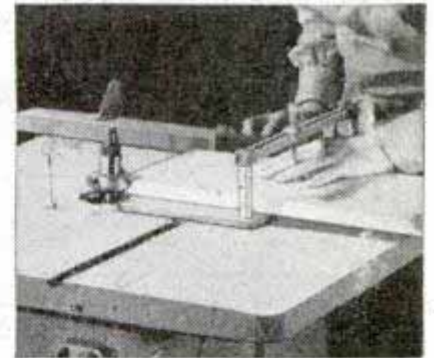

9. Mill men call this shaper a—
 (a) Peeler (c) Hogger
 (b) Slicer (d) Sticker

ANSWERS: 1-b; 2-c; 3-d (some types also air-dry); 4-a (cutting on underside is preferable); 5-a (no spurs); 6-d (screw is shielded); 7-d (dowel pops or centers); 8-b (a hazard in all tool operation); 9-d; 10-c (job is gem polishing); 11-d



10. This worker knows his—
 (a) Dowels (c) Agates
 (b) Marbles (d) Slide rule

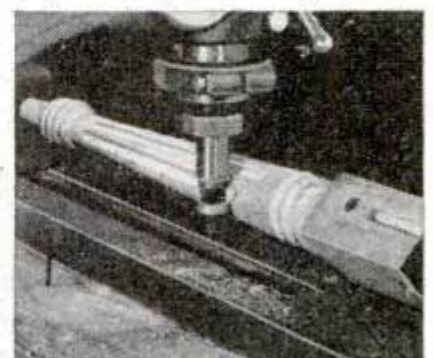

11. This job is—
 (a) Beading (c) Doweling
 (b) Reeding (d) Fluting

Altered Stovepipe Serves as Rack To Keep Miscellaneous Parts

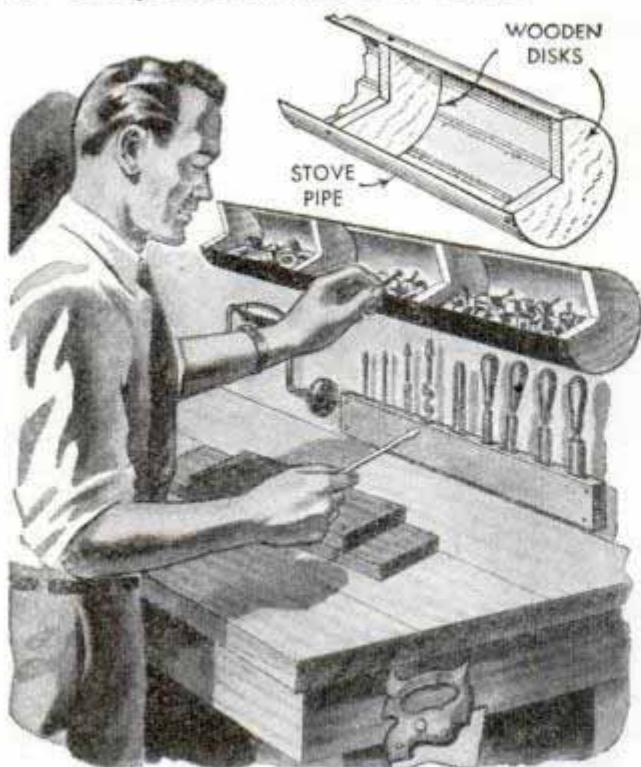

By cutting out a quarter section from a length of stovepipe and then dividing the pipe into compartments with wooden disks, a convenient rack for miscellaneous parts and supplies can be made. The rack is fastened to the wall above the workbench. Use wood 1 in. thick for the dividers as these will make the relatively thin metal of the pipe more rigid.

Depth Gauge on Garden Trowel



If marks are filed in one edge of a garden trowel to indicate depth in inches, planting seeds will be much simpler when using this gauge. After making the marks, check their location by holding the trowel in an upright position against a ruler.

Because of the curvature at the end of the tool, the marks will have to be farther apart than where the edge is straight.

"Lifting" Chipped Fingernail Polish

Often fingernail polish is used instead of other finishes to decorate bric-a-brac and other small objects. At times the polish becomes chipped and it is desirable to remove it and refinish the object. In some

cases this may be done by covering the polish with cellulose tape, smoothing it and then lifting off the tape and polish. This will not work on all surfaces, however, and it's best to do a little experimenting and try a small area first.

Handy Tool When Fishing

To have a multi-purpose "tool" in your fishing-tackle box, take a short steel crochet hook and file a V-shaped notch in the handle end. The notch is used as a hook disgorging and the other end of the tool is used to clear a fishline of snarls and backlashes. As a safety precaution, keep the hook in a fingernail-file case when carrying it in the tackle box.

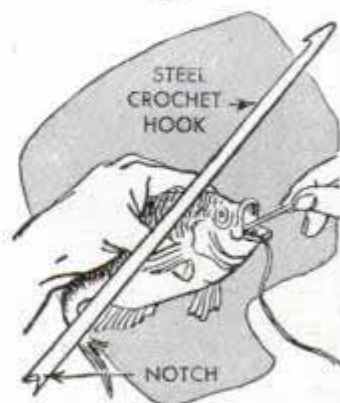

Leaf Guard for Broom-Rake Teeth Makes Cleaning Easier

When raking leaves with a broom rake, it is often necessary to stop frequently and clean the teeth. This nuisance is overcome and the work speeded if a rubber guard is slipped over the teeth. It is cut from a rubber inner tube and the holes are spaced so they will neither spread nor pull the teeth together.

Edward H. Stutz, Cleveland, Ohio.





Shop Notes



POWER DRAG SAW

A small electric motor drives blade 100 strokes per minute, cutting logs up to 24 in. in diameter

By Edward R. Lucas

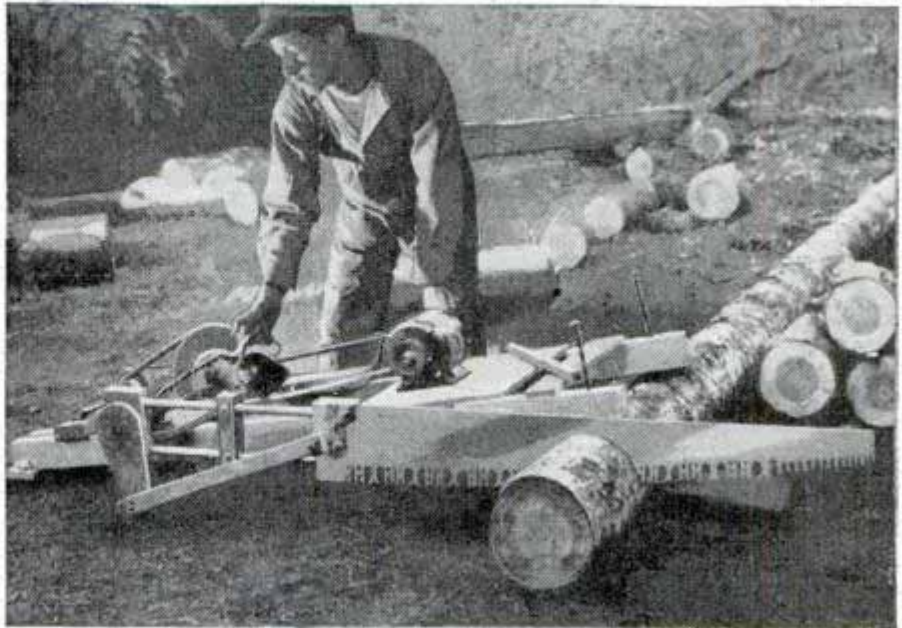

BUCKING LOGS and large limbs into cordwood or stovewood lengths by any hand method is a hard, time-wasting job no modern farmer or woodsman likes to think about. A power drag saw like the one pictured will do this work in less than half the time, and the only labor involved is moving the unit from one cut to the next.

The simple A-frame, Figs. 1 and 4, is made of 2 by 4-in. pine. Also, the base for the jackshaft and the foot at the narrow end of the frame are of the same material. Lower ends of the long frame members are cut at an angle of 15 deg. so that when attached, the foot will rest squarely on the ground. Both the crankshaft and jackshaft run in ordinary pillow-block bearings, and the shafts are held in position with collars. Construction of the pitman-drive assembly is detailed in Figs. 3 and 5, and side and top views are supplemented by sectional details A-A, B-B and C-C, which show the inner construction at various points. The crosshead carriage must be of the floating type to allow the saw blade free movement up and down. Crosshead guides are cut from 1/2-in. black pipe, this grade being used because it is easier to polish than galvanized pipe. Polishing is done by clamping the length of pipe in a vise—being careful not to crush it out of round—and first cutting off the paint and surface irregularities with a coarse abrasive cloth. Loop a strip of the cloth over the pipe and pull it back and forth. Polish in the same manner with a fine-grit abrasive strip 1 in. wide. Light oil makes abrasive cut cleaner.

Make the pivot block, section C-C, of

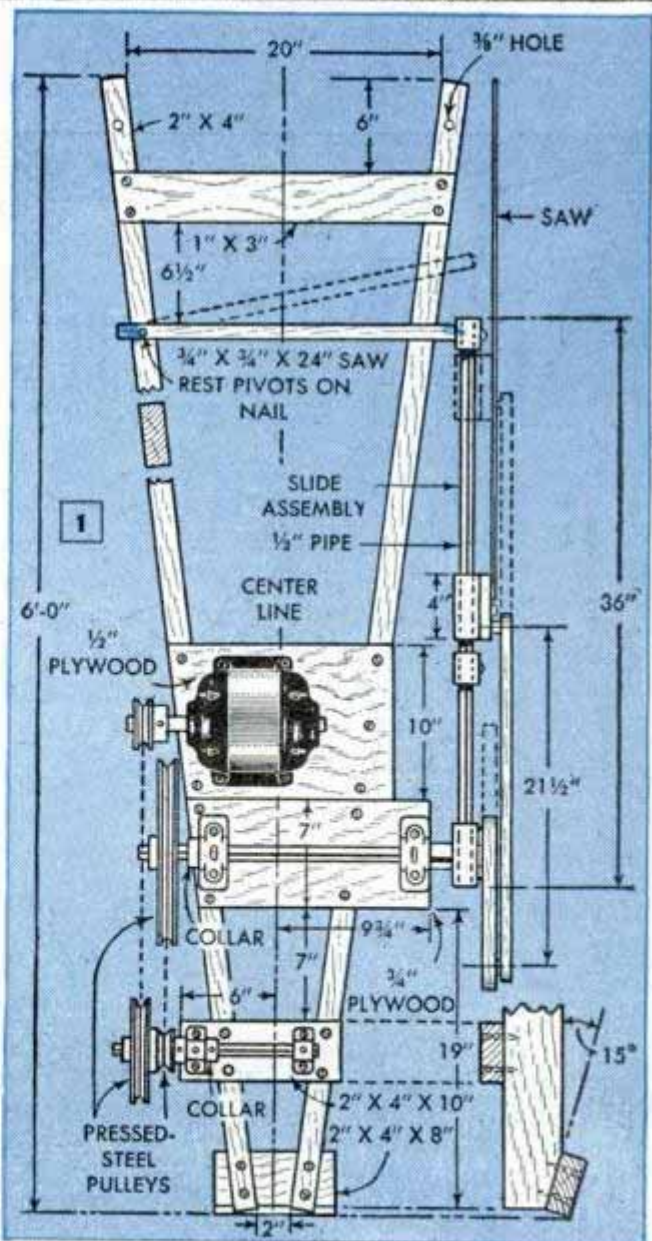

Gauge Marks Electrical Outlets

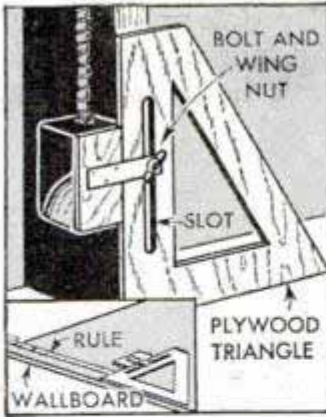

When installing wallboard, locating the areas to be cut for electrical outlets is always a problem. However, with this gauge, the task is simplified. Cut from plywood a template the same shape and size as the front of the outlet and fasten

it to a wooden triangle so that it can be adjusted vertically by means of a bolt and wing nut riding in a slot. Then, using a rule and the triangle, locate the outlet in relation to the studding and transfer these measurements to the wallboard and cut the hole for the outlet.

Pipe and Straps Make Gate Latch

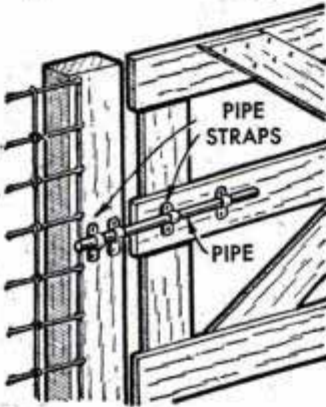

With a length of iron pipe and a few pipe straps, you can make a gate latch that will be satisfactory for most purposes. Two straps are nailed to the fence post and two more are fastened to the gate. Make the pipe a fairly loose fit in the

straps. A stop welded to the pipe between the straps on the gate will prevent it from being pulled out accidentally.

Lantern Fount Packed With Cotton Reduces Fire Hazard



As a guard against barn and stable fires caused by kerosene spilled from overturned lanterns, one farmer packs the founts with absorbent cotton. The cotton absorbs the fuel so that it cannot spill and flow over the

floor or other flammable surfaces, but does not impair the flow of kerosene to the wick. When filling the lantern, use only an amount of fuel that the cotton can absorb.

Jack Bronte, Colfax, Calif.



WALNUTS
ALMONDS

Approximate Weights on Scoop Speed Measuring

By drawing lines on a scoop to indicate the approximate volume of a pound of walnuts, almonds and other foodstuffs, one grocer found that he could save considerable time when measuring out these items. The lines were put on with paint, a different color being used for each product. Although this method is not exact, it is close enough to make it well worth-while.

Sorted File Cards Racked in Spring

You'll do a quicker job of sorting file cards if a coil spring is tacked to the desk to hold the cards upright and in the proper order. The spring should be stretched to separate the coils and allow space for the thickness of the cards. Screen-door springs have about the proper tension and length to make these "racks."

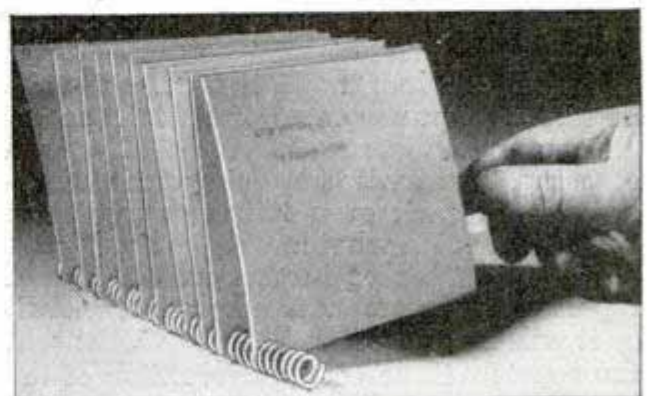

Getting your money's worth in a used motorcycle is a matter of accurately determining the amount of wear on the vital parts. Here's how you do it

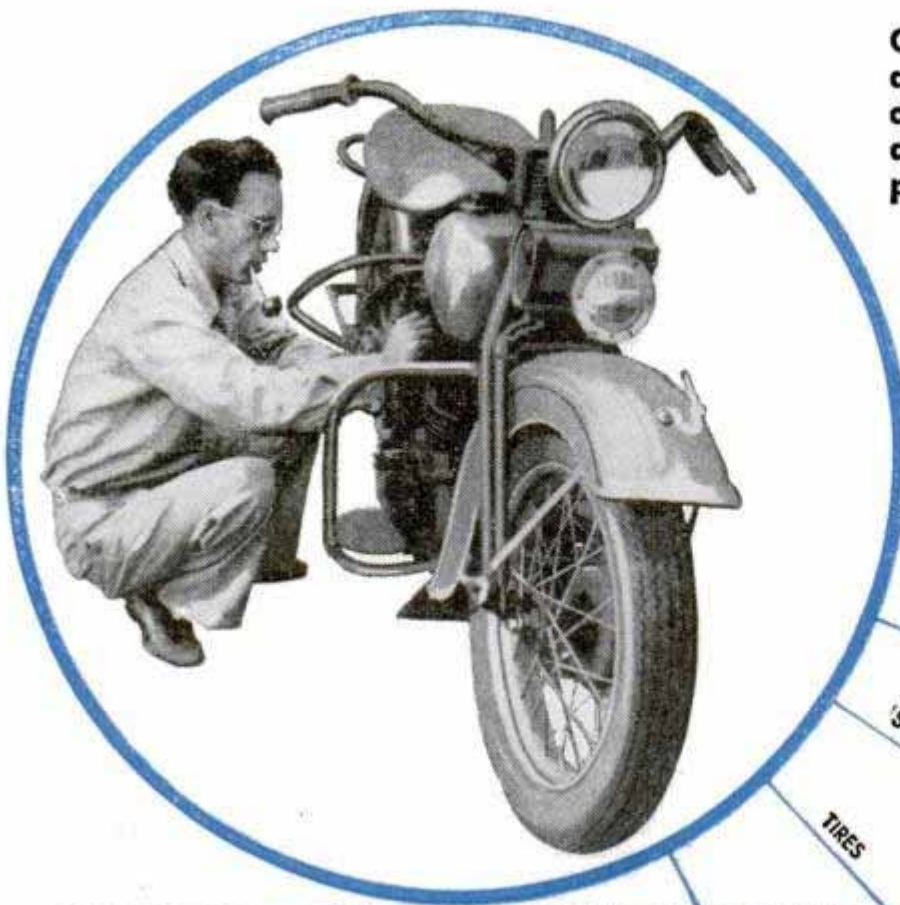

AGE

ALIGNMENT

STRUCTURAL DEFECTS

WHEEL BEARINGS

STEERING-HEAD BEARING

TIRES

HINTS ON BUYING USED MOTORCYCLES

By Manley Mills

BEFORE BUYING a used motorcycle you should make a thorough appraisal of its mechanical condition, and have in mind a clear idea of what type of machine you want, the service and performance you'll expect of it, and the kind of work in which it will be used. For short trips, a lightweight machine has several advantages—less fuel is required, less wear on tires, etc. Also a good rider on a lightweight job can keep going under soft-road conditions where a heavier machine would become unmanageable. There isn't a very wide choice of motorcycles in the lightweight class, only two or three of American manufacture. This excepts the motor bikes and scooters which are not true motorcycles. If the greater part of your riding will include long, overland trips at fast cruising speeds, or other heavy-duty work requiring high performance, it is best to choose one of the heavier types. The heavy job is less tiring on long trips, it holds the road better, and is much steadier at high speeds.

Some wear is inevitable on any used machine. The trick is to determine whether or not a part or unit is actually worn beyond repair, whether adjustment will make it capable of further service, or, if repair or replacement is necessary, whether it will be expensive. If it is evident that the repair will be costly, evaluation of the

BATTERY

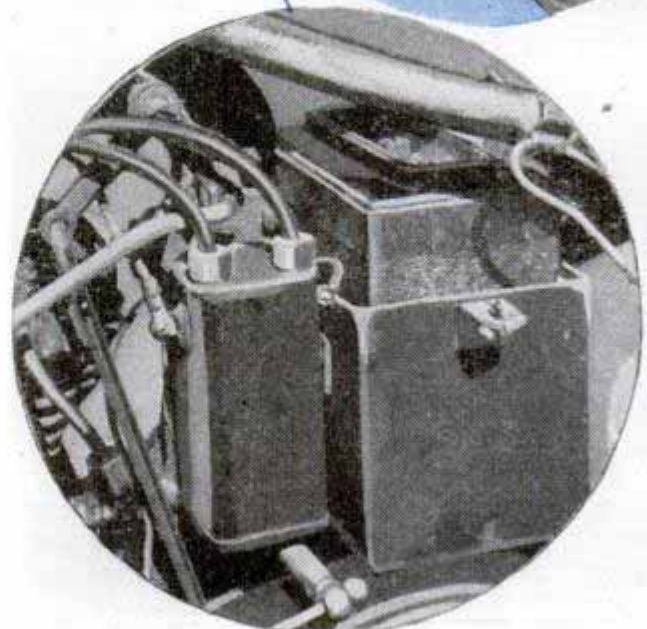
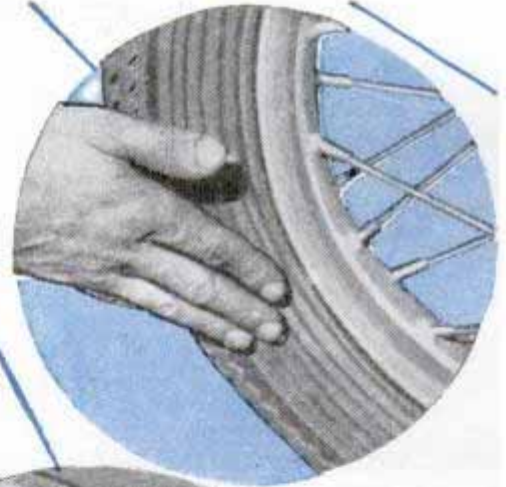

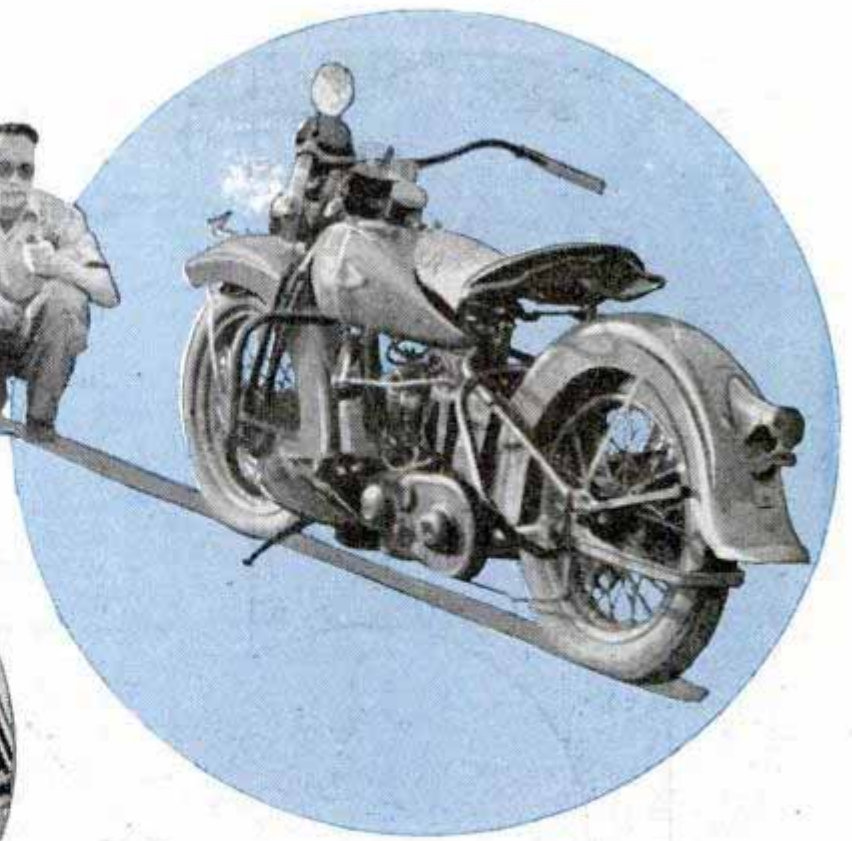
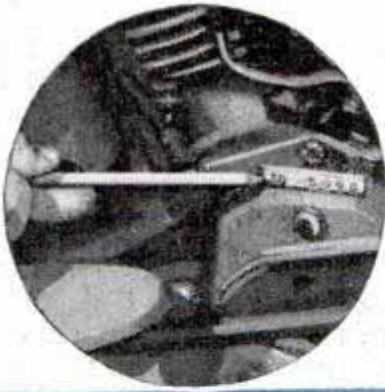

machine should be lowered accordingly. First, learn what year the motorcycle was built. On most well-known makes the first two numerals of the engine number indicate the year, or age of the machine. You'll find the engine number somewhere on the crankcase as in one of the photos. Next, before you get into other details, check the machine as a whole for general appearance and frame alignment. The best way to check frame and fork alignment is to sight from various angles and let your eye be the judge. You can spot anything seriously out of line. Note if the paint job is well preserved, or merely shined up. Using the handle of a screwdriver, or something that won't scratch the finish, lightly tap the fuel tank, while empty, at various points. A dull sound will indicate where the tank has been heavily leaded to fill a dent. This, as well as dented or split fenders and battered boltheads, may mean that the machine has been in a bad spill, which might have sprung the frame or caused other structural defects. Distortions of this kind may seriously affect stability.

Take firm hold of the front fork members with one hand and rock the front wheel from side to side with the other hand. There's no need for alarm if a bit of side-play is evident, because a barely discernible amount is the best assurance that



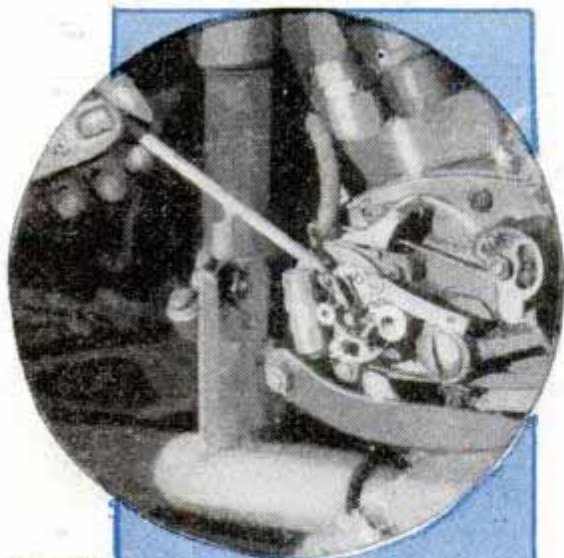

IGNITION



FUEL SYSTEM

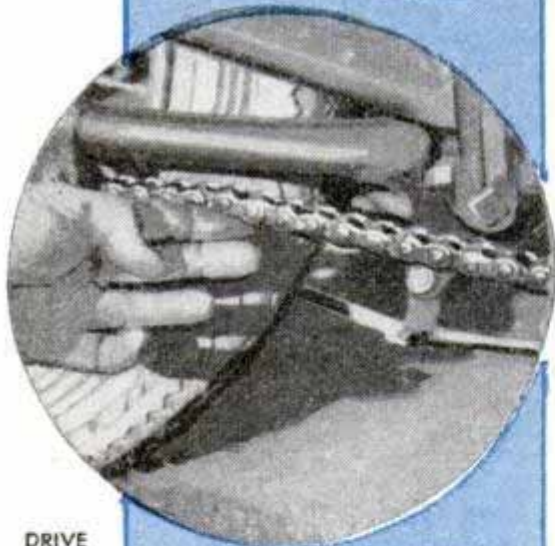

DRIVE CHAINS



COMPRESSION

the bearings are free. Excess play can be taken up, but too tight an adjustment will quickly cut out the bearings. Wheels should spin freely and silently. Clicking, or any other undue noise, often means a damaged bearing. Get astride the machine and pull up strongly on the handle bars, or apply the front brake and push forward. If the steering-head bearings need taking up, it will be indicated by this test. Swing the handle bars from side to side. They should be free, but not too loose, through the whole range of movement. Inspect the tires, giving particular attention to the side walls, for breaks or other signs of damage. Also, see whether the rims are dented or warped, and look for bent, loose or missing spokes in the wheels.

If the spark plugs are fairly clean and the porcelain not badly discolored, you may consider them okay. Inspect the high-tension wires for breaks, and the insulation for cracks, burns or frayed spots. Notice whether or not the battery is anchored securely in place. Inspect the ignition system and check the breaker points to see if they are burned or pitted. The fuel system is quite simple to check, since any leaks around the joints or tank seams would be visible at once. On the fuel line itself, look for pinched or dented places that might develop cracks from vibration. Check drive chains and sprockets for wear. The teeth on a badly worn sprocket are not uniform in size or contour, but have a hooked shape something like a comma. The final drive chain should not be so loose that it can be pulled well away from the sprocket. About 1 in. of slack at a point midway between the sprockets is correct. The primary drive chains from engine to transmission should have no more than $\frac{1}{2}$ in. of slack at the midway point. And don't forget to inspect the chains themselves for cracked or broken rollers and badly-worn joints. A bad chain will quickly ruin the sprockets. Try all controls for free movement and positive operation through the entire range and see if the control cables are frayed or sticking in the guides.

With clutch engaged, and the transmission in neutral, test the compression with the kick starter. This is an important test. If the compression is good and if the clutch holds properly, a twin-cylinder engine will support a heavy person on the starter pedal for 4 or 5 seconds before it lets go. If the compression passes this test, throw your full weight on the starter and note any tendency of the clutch to slip. The clutch should be free from drag when disengaged. If the starter pedal shows any tendency to jam, examine the teeth in the segment. Usually the first two or three teeth will be worn badly or chipped. This

often calls for replacement, but sometimes you can remedy the fault by grinding.

Finally, road-test the machine. After starting the engine, look for blue smoke in the exhaust. If it's absent, you can be reasonably sure that the cylinders, pistons and rings are still in good condition. Don't expect the engine to be as quiet as a new one. There may be a few harmless rattles and clicks, caused by worn valve tappets, chains, etc. Defects in the engine that spell eventual serious trouble are the metallic hammering of loose connecting rods, the rattle of worn wrist pins, or the thud of a main-bearing knock. A connecting-rod knock diminishes or disappears under load and becomes louder on a rapidly closing throttle. A loose main bearing is at its worst under load. Shaky valves and loose wrist pins are audible at all engine speeds but the noise usually increases at higher engine speeds.

Grinding of the gears, especially when going into low, unless it's due to poor shifting technique, may be caused by a dragging clutch. In most cases, clutch drag can be remedied by adjustment, but if this fails, the trouble is likely due to a bent shaft or buckled plates. Apply the brakes gently while running at moderate speed. If the transmission jumps out of gear, and the trouble isn't due to faulty adjustment of the linkage from shift lever to gear box, it means that the transmission gears are worn badly. Test the engine for acceleration and smooth running. If it falters and shows poor response to the throttle on a level road, the fuel mixture may be too weak, or the plug and breaker points need cleaning and adjusting. On a hard pull in high gear, lack of pep is often caused by insufficient valve-tappet clearance which can be corrected easily. Sticking, warped, or burned valves, or badly worn pistons and rings call for more expensive repairs.

Don't forget to try the brakes for smooth stopping within a safe distance. If there is grease or oil on the linings, no slowing effect will be apparent when brakes are first applied, then they may grab suddenly and cause a skid. Chattering noises often are due to loose rivets in the linings. However, as a rule, brake repairs are the least expensive of any.

How to Solder Small Copper Tubing

Soldering copper tubing end to end is difficult as it is hard to keep the ends aligned while doing the job. Here's how you can do this easily: The two lengths of tubing are slipped over a wire that is a snug fit and this holds them in position for soldering. After the work is completed, the wire is removed.

Window-Shade "Blackboard" Aids Stock Clerk



To help him remember daily price changes when marking canned goods and other commodities, a stock-room clerk attached a window shade to his push truck on which he could list, with chalk, the current price of each item.

Small Dots of Solder on Square Make It Easy to Pick Up

Because his square was difficult to pick up when lying on the floor, one linoleum fitter put small dots of solder at the corner and ends. The solder is applied to both sides. This keeps the square from being in actual contact with the floor.

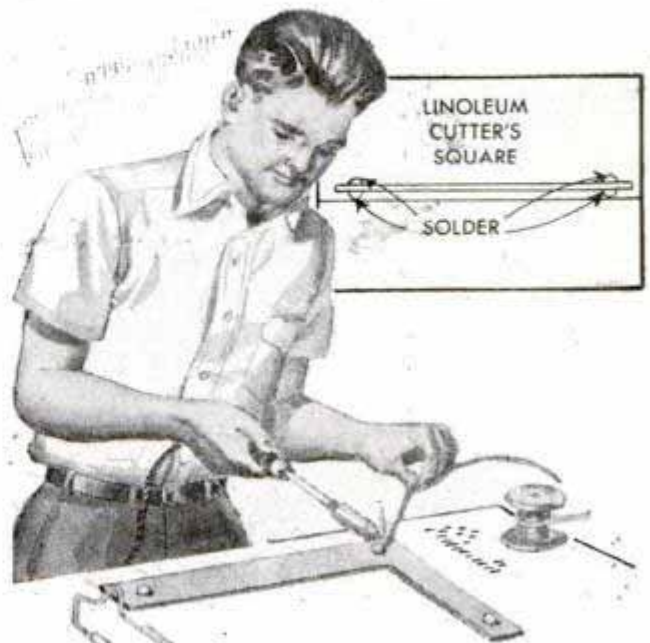

X507

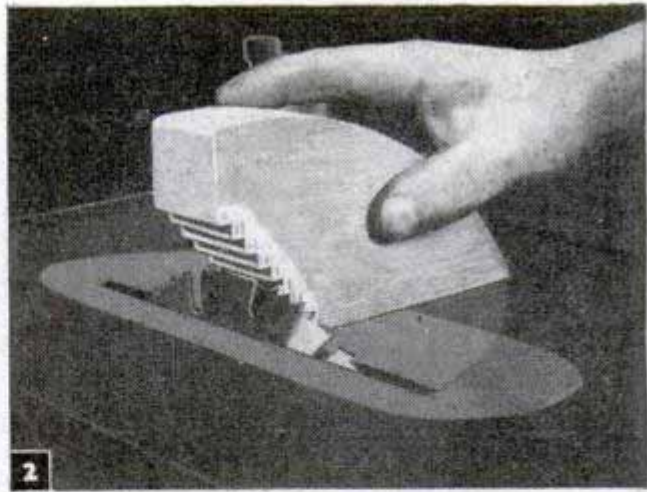

POWER-TOOL

Part I

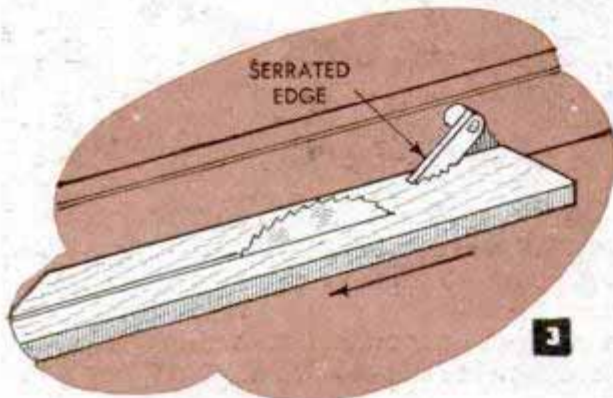

1—When making duplicate angle cuts keep the miter gauge set at 90 deg. and use angle blocks to guide the stock. This saves much time in production work, especially where the angles vary from lot to lot

2—It's easy to get the correct depth of cut when you have a stepped depth gauge. Each step is simply a rabbet cut in the sloping face of a hardwood block

3—If you are making a number of duplicate ripping cuts in thin stock it's a good idea to fit an anti-kick-back pawl on the rip fence. File a serrated edge on a length of $\frac{1}{8}$ x $\frac{1}{2}$ -in. flat iron and bolt to the fence with a spacer between. Pawl should be free to rise as the end of the work passes underneath it

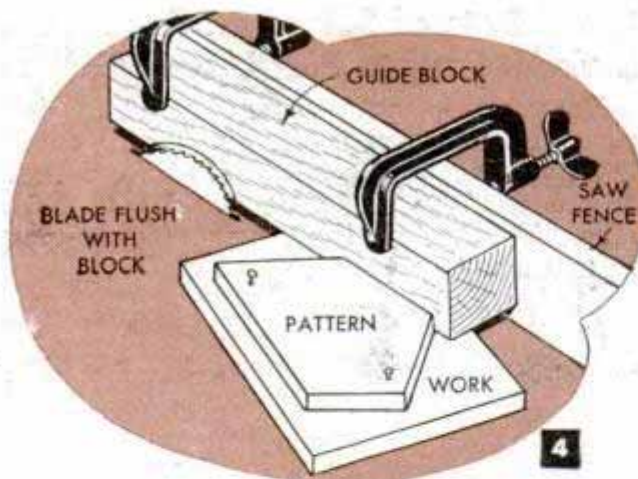

4—Pattern sawing is easy to do if you clamp a wood guide piece to the saw fence at such a height that the work will slide under it. Outer surface of the blade should be flush with the face of the wood guide

5—Tenoning goes much faster with a jig that rides in the table groove and supports the work in a vertical position. Two saw blades are placed on the arbor with a spacer between equal to the width of the tenon. In this way you can make the cuts in one pass

6—Improved clamps attached to a crosscut guide enable you to make some unusual cuts on the shaper. Here's a safe way of holding a disk for cutting flutes around the edge. It's a handy jig for making decorative rosettes of the type having a molded edge

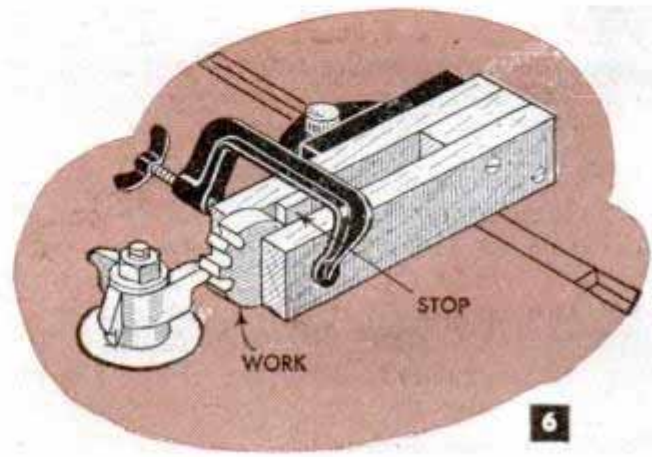
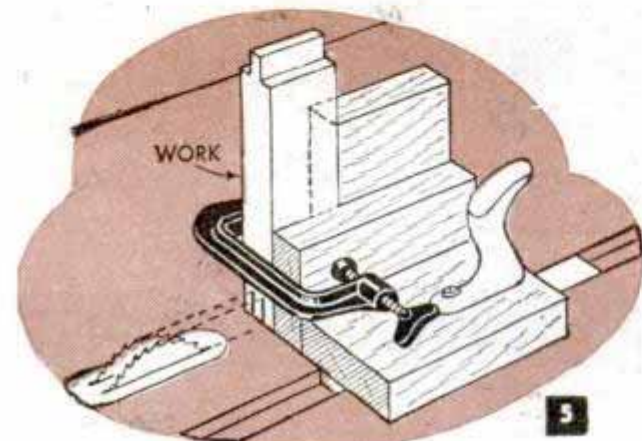

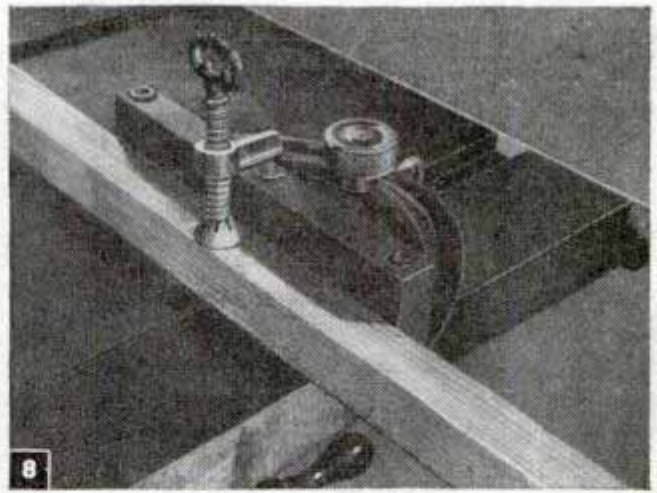
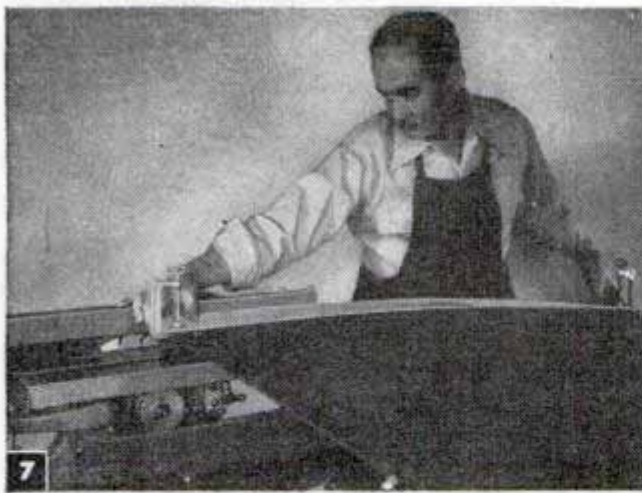

SHORT CUTS

By Kenneth Murray

7—To square large pieces of hard-pressed board on the circular saw, clamp a straightedge to the work so that it projects over one edge and rides against the ripping fence, thus acting as a guide for the squaring cut. Repeat the operation on the four edges

8—A good serviceable hold-down for small pieces can be made from a broken C-clamp. Use the screw part of the clamp as shown and weld a threaded section of rod to it so that it will screw into the crosscut guide in a hole already drilled and tapped for it

9—Another clamp, which is simply a wood cam operated by a handle, can be attached to the crosscut guide by means of a bolt and metal angle. The clamp is handy on shaper when cutting across the grain

10—For sanding small duplicate parts in the lathe make a quick-acting chuck by fitting a length of rubber hose into a turned wood holder. It is not necessary to stop the lathe when changing work

11—A "right-left" miter gauge is a real timesaver for you can miter both ends of a single piece without changing the gauge. The drawing shows how to make it and how it works. Use hardwood for all the parts

12—Ripping duplicate narrow strips on the circular saw is a ticklish business. It can be dangerous, too, unless you take proper precautions. Of course, any careful workman will use a push stick, but another and faster way is to screw a block to the crosscut guide and let it push the strip safely past the saw blade

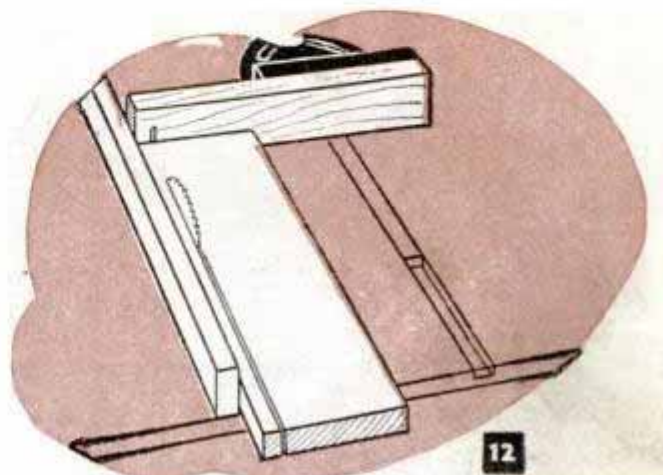
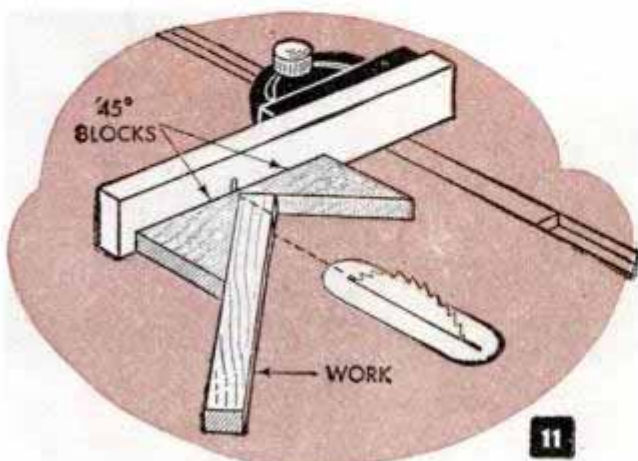
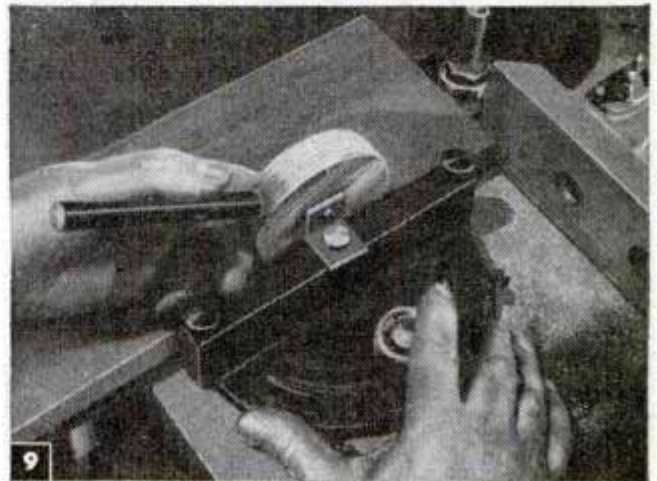

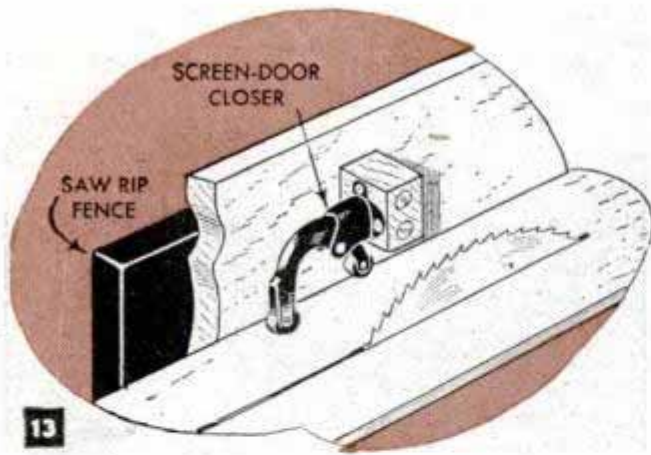

13—A screen-door closer of the snap-action "over-center" type makes a good hold-down when cutting thin stock on the circular saw. It prevents the stock being lifted by the blade and thrown forward and also aids in holding material firmly against the fence

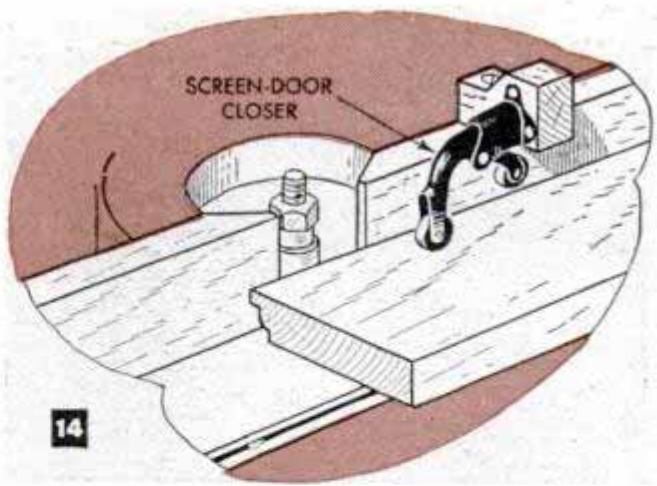

14—This same type of door closer also will serve as a hold-down when molding straight work on the shaper. Moreover, it bears right at the point where you ordinarily have to place your fingers when the shaper cutter is working on the lower corner of the stock

15—Mount a sandpaper disk and another of 1/8-in. plywood on the shaper spindle with a spacer between and you have a good setup for rounding corners. As wood disk guides stock it should be smaller than the sandpaper disk. Wear goggles for this operation

16—A high-speed hand grinder clamped to the jigsaw blade guide gives you a router suitable for light routing and veining operations. The guide gives the necessary depth adjustment. On some operations it's better to move the work rather than the router

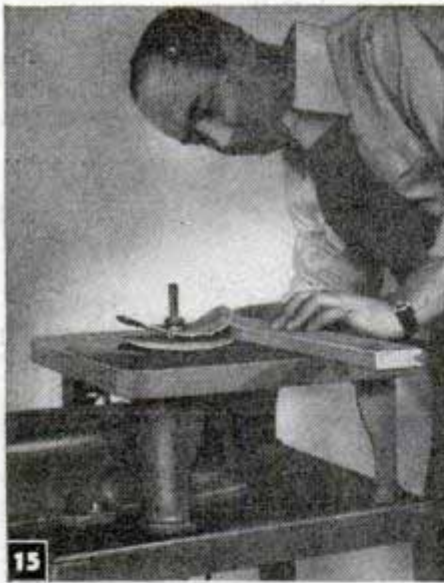

15

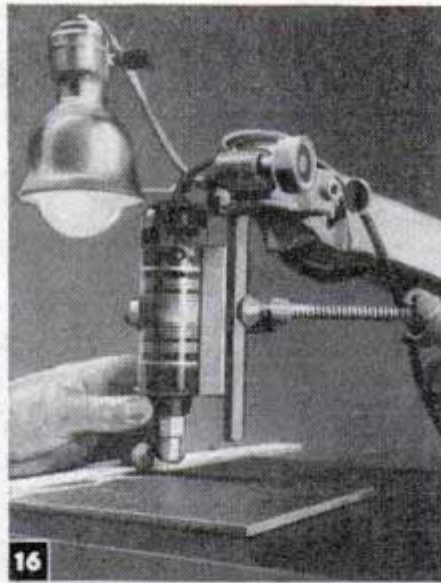

16

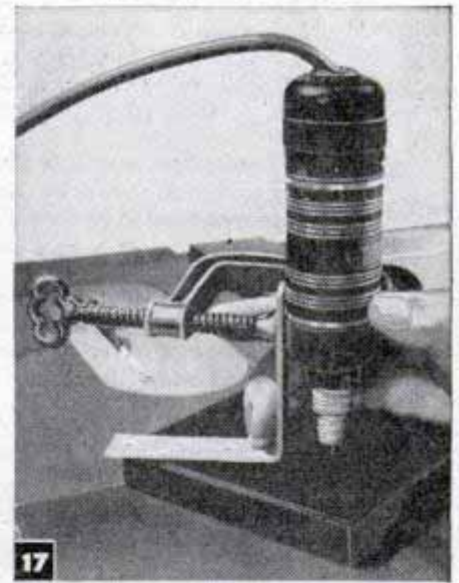

17



18

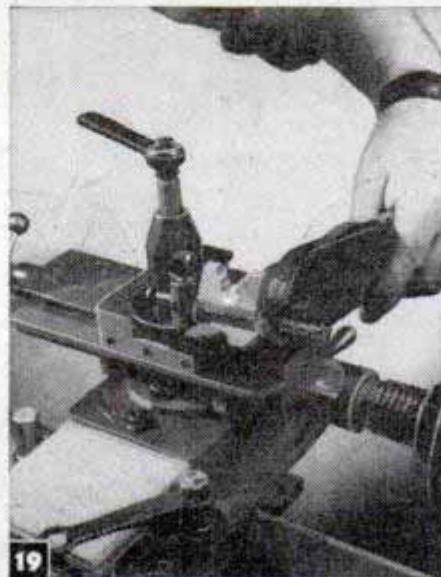

19

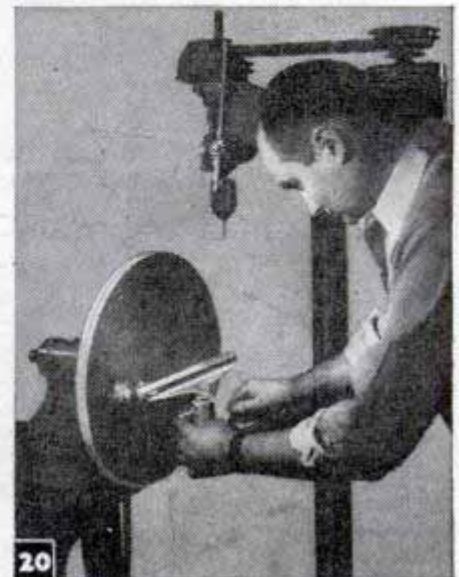

20

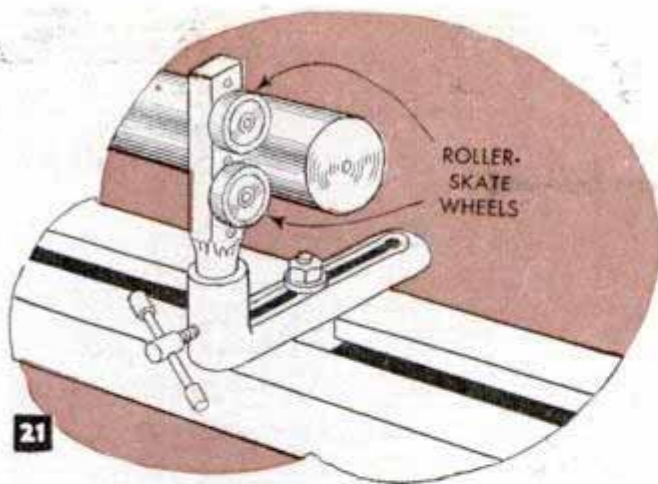

17—Using a metal corner brace, a small C-clamp and a hand grinder you can quickly improvise a high-speed router that can be guided anywhere over the surface of the work. It's especially suitable for cutting shallow recesses for inlay designs of irregular shape

18—The problem of supporting small turning squares in a steady rest is overcome by cutting several plywood disks which slip over the square as shown. Supported in this way the work rides smoothly in the rest. It's easy to make disks for different sized squares

19—A pattern knife, for pattern turning in the lathe, can be made up easily by sliding several shaper cutters over a bolt. Supported in a slide rest, the cutting edges are fed slowly into the work with the cross-feed. Work should be rotated at high speed

20—When you have to turn large-diameter work on the outer end of the lathe spindle, there's no use bothering to construct a makeshift tool rest if you have a floor drill press. Just bolt the lathe tool rest to the drill-press table and you have a solid support for the turning tool with universal adjustments

21—A rolling back rest is usually necessary when turning long spindles in the wood lathe. Two discarded roller-skate wheels bolted to a short length of hardwood will do the trick. Support this improvised rolling rest in the regular tool-rest holder as shown

22—If you require a fine finish on cylindrical turnings, particularly if these are of softwood, try using a block plane as illustrated. Plane should be held at a slight angle with the axis of the work to obtain a shearing cut. It leaves a clear, glass-smooth finish

23—To rough-size a cylindrical turning to a given diameter, clamp two turning gouges between hardwood blocks with both cutting edges projecting the same distance. Then merely slide the block along the tool rest, which has been located parallel with work axis

24—You can check a number of diameters quickly with a single caliper if you first take time to make hardwood gauge blocks for each setting. These act as stops for each predetermined setting. Of course, settings should be carefully checked before using caliper

25—To lay out spiral turnings to almost any pitch an inked "wheel" taken from an ordinary typewriter eraser works fine. The wheel is fitted in a simple holder made from dowel rod. It is held freehand against the work which is supported between centers in the lathe and rotated slowly by hand. Angle of the wheel with the work determines the pitch of the spiral

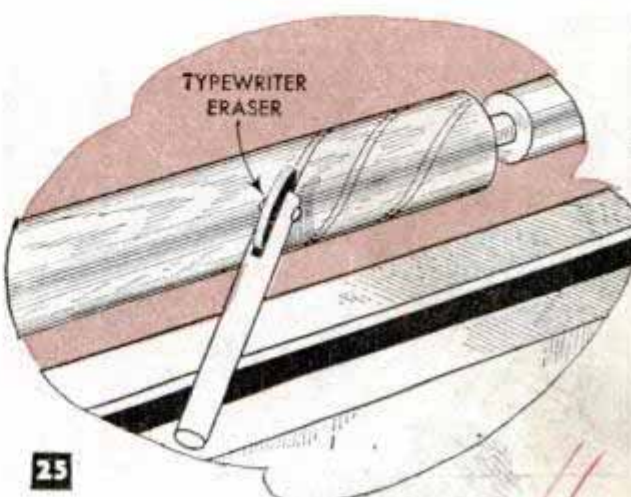
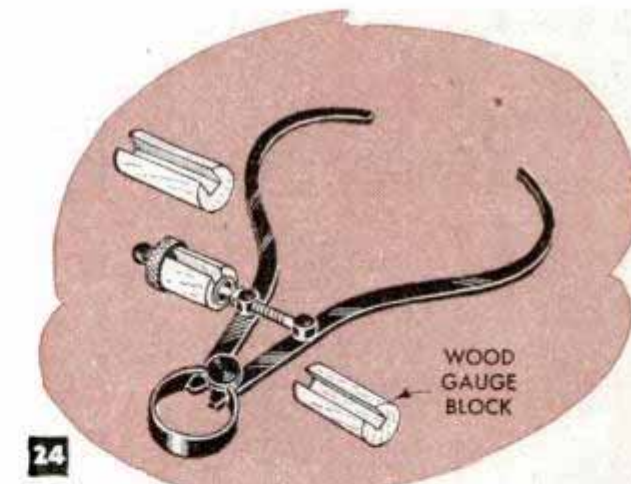
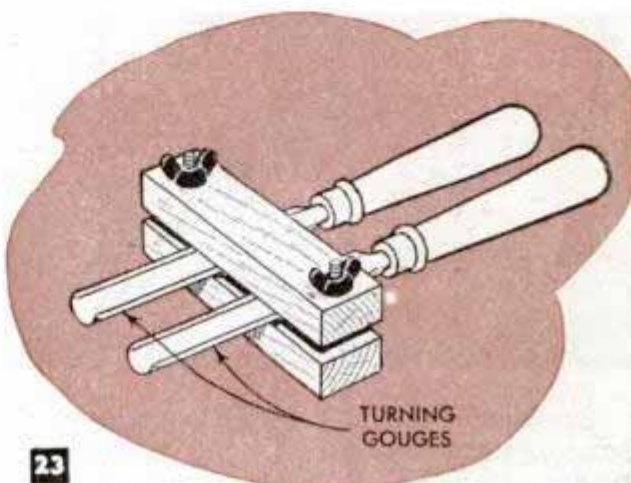
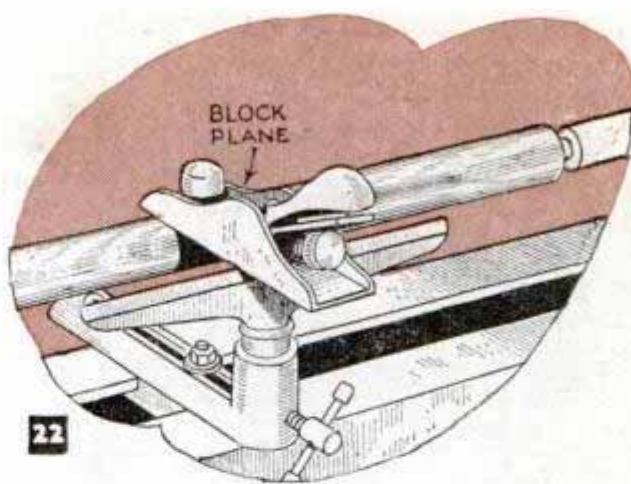

Ends of Molding Are Colored To Indicate Length



One lumber dealer found that he could save considerable time by painting the exposed ends of molding in stock different colors to help in quickly determining length. The code is printed on a chart and when it is desired to obtain several lengths, they are identified by reference to the chart, making it unnecessary to pull the pieces out and measure them. The molding is painted when it is put in stock.

Tool Table Made From Oil Drum Holds Mechanic's Equipment

Here's a tool table that will come in handy around the garage when working under a hoist. The top is cut from the end of an oil drum with a rim left to keep the

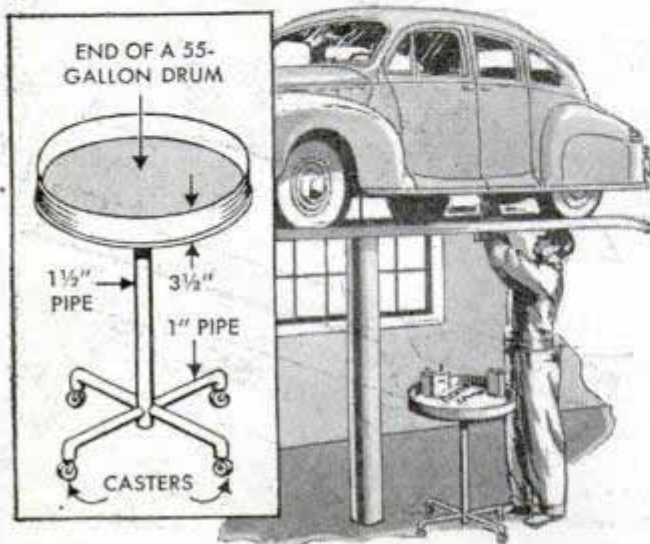

tools from rolling off. Pedestal and legs are a welded-pipe assembly with casters on the feet to make the unit portable.

Paint Scraper Used as Tack Puller

When removing paint from a building, frequently it's necessary to remove tacks and small nails, and this means loss of time in picking up another tool to do the job. However, if a keyhole type of slot is cut in the scraper, it can be used to pull tacks.

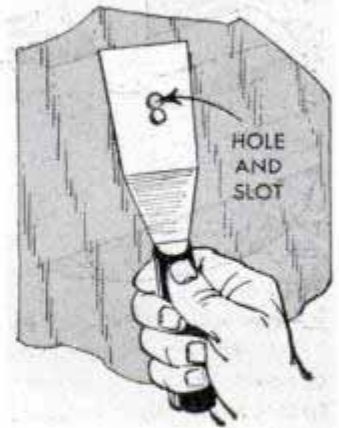

Slip the slot under the head of the nail or tack and lift it out. This tool would not be strong enough for larger nails.

Settings for Adjustable Wrench Marked on Fixed Jaw

Considerable time can be saved when setting an adjustable end wrench if gradations about $\frac{1}{4}$ in. apart are filed or etched on the fixed jaw. In this way it's possible to set the wrench for a particular size of nut without having to try it for size. Nut sizes can be marked on the wrench with a set of stamping dies.

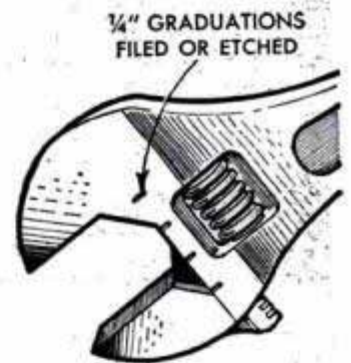

Arthur B. Taylor, Spokane, Wash.

Accessory Clamps Polished Rod

Polished rods and tubes can be gripped safely in a vise if this accessory is used in conjunction with the vise. Two rubber blocks with sides having an area equal to that of the faces of the jaws are bolted to a length of flat spring steel. When placed in a vise, the blocks hold the work but will not mar or scratch it. This accessory clamp will work equally well with either polished metal or plastic materials.

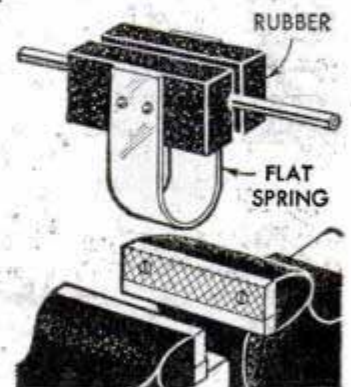

HANDY KINKS for HAND GRINDERS

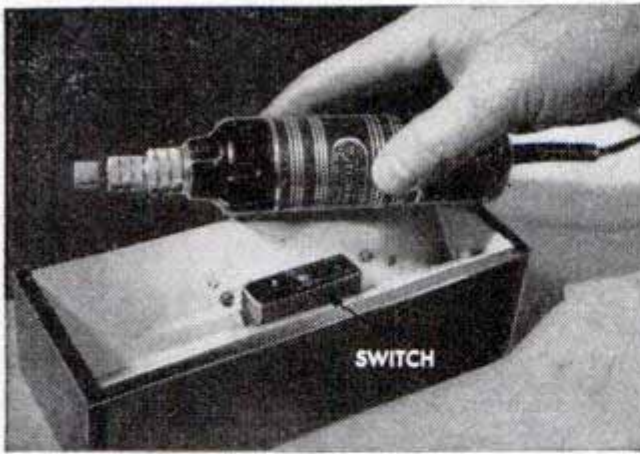

A TOOL CRADLE with a snap-action switch in the bottom, which turns on power when the tool is removed, will be found especially handy by the repairman working at a bench where the tool is used repeatedly. The holder is V-shape and fitted with a midget-type switch



PIPE-CLEANER "BUFFERS" will come in handy in polishing intricate objects carved or cast in plastic. Sections of ordinary pipe-stem cleaners are used and chucked in the tool. The buffers are charged with buffing compound, using rouge first and then tripoli

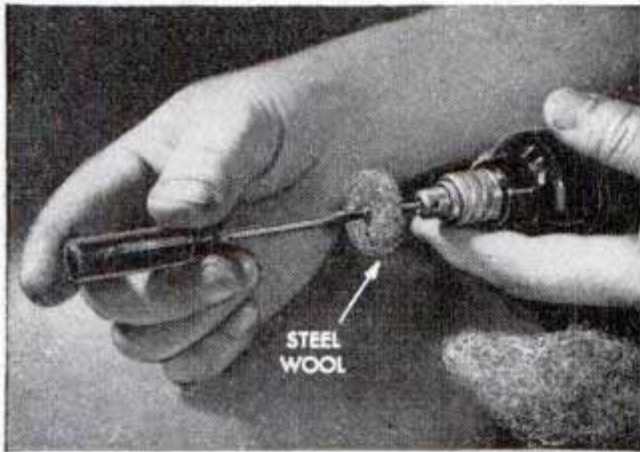

WIRE SCRATCH BRUSHES, which will serve temporarily in place of regular ones, can be improvised from common steel wool. Simply form a piece into a small disk and mount it on an arbor consisting of a machine screw and two washers, then chuck it in the tool

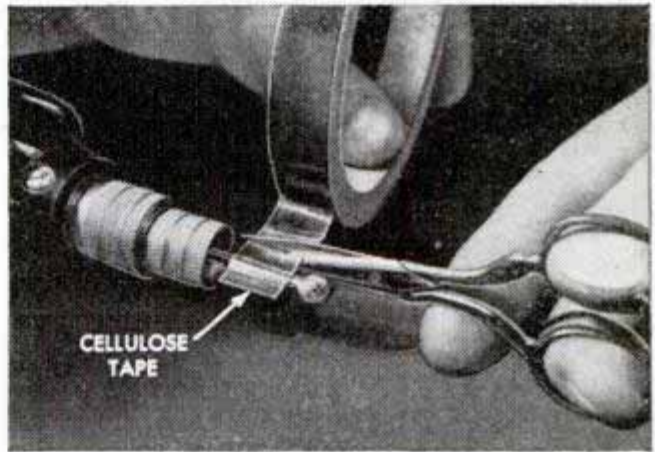

AN EFFICIENT BLOWER that will keep the work free of dust and chips can be made from a piece of cellulose tape. All you need to do is double a strip of it with the shaft between to form a fan blade. Tape is better than metal as it will not mar the work if it strikes it

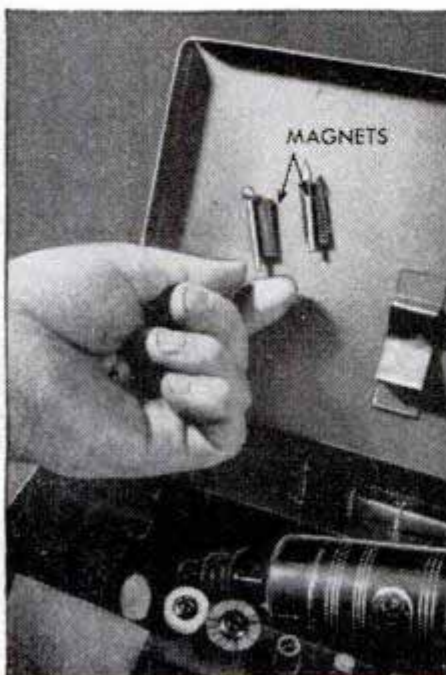

BIT HOLDERS of magnets are handy to keep tiny drills and other tool accessories at finger tip. Place a couple of permanent magnets on the metal lid of the toolbox and use them to keep track of the tool bits most frequently used



AN EYE GUARD of Celluloid should be used whenever there is a possibility that a chip or bit of abrasive may fly and cause injury. Fasten a strip of clear Celluloid to the neck of the tool and hold in place with a rubber band

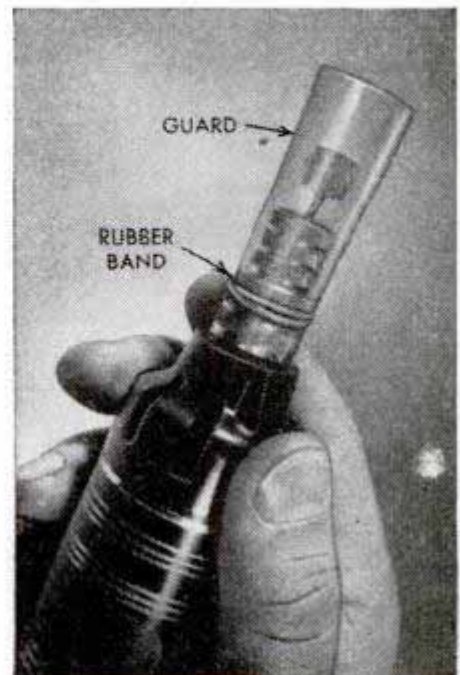

Ovals of Various Sizes Drawn By Using Simple Tools

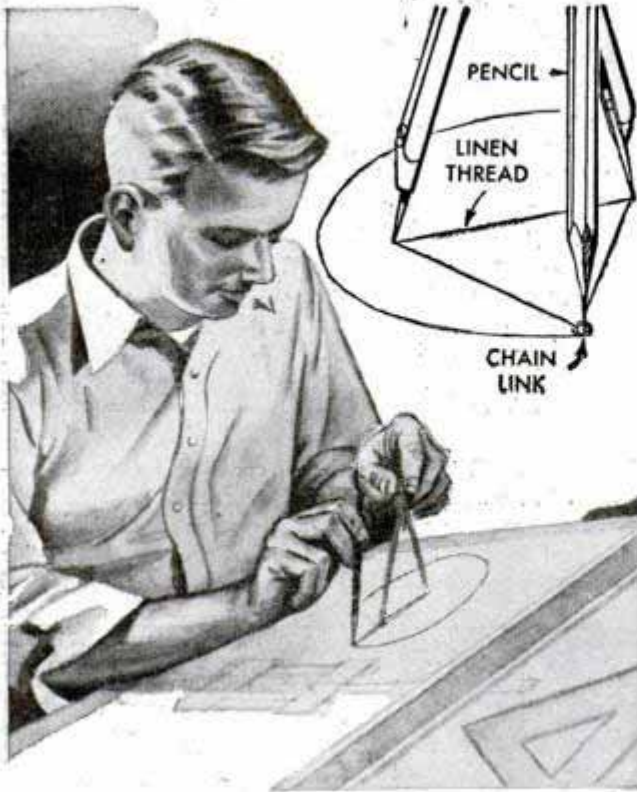

Using only a length of thread, dividers, and a chain link, ovals of many sizes can be drawn easily. The thread is tied to the link. This loop is dropped over a pair of dividers whose points are set in the paper on which you wish to draw the oval. A pencil point is inserted through the hole in the link; the loop is stretched outward and the oval is drawn. Some experimentation will be necessary to get the exact size and shape of the ovals you want.

G. E. Harrington, New York City.

Gauge Glass on Boiler Cleaned Without Being Removed

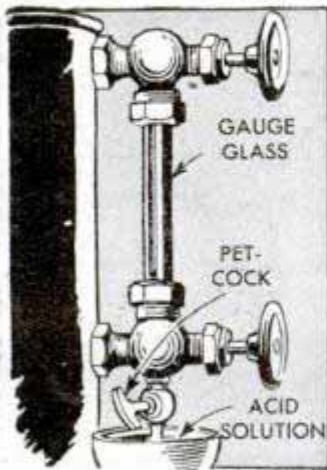

To avoid removal of water-gauge glasses from boilers when cleaning them—and to prevent breaking the glass or losing gaskets—use the following method: Prepare a solution composed of about 1 pint of hot water and several tablespoons of dilute muriatic acid.

Place this in a shallow, acidproof vessel and set it near the gauge. Close both top and bottom shutoff valves on the gauge. Then open the petcock, and bottom and

top valves in that order. Blow the gauge out enough to thoroughly heat the glass and close the top valve. Immediately, immerse the petcock in the acid solution so that the vacuum formed by cooling of air in the glass will draw the solution into it. Close the petcock and let the solution stand for 10 or 15 minutes, or until the glass is clean. Then blow out the gauge and put it back in service.

Combination Cutter and Bale Hook

By welding a knife section to the back of a bale hook, the usefulness of the tool can be increased. Converted in this manner, the hook can be used to handle bales of hay, and cut wire and twine as well. Use a heavy blade and weld it with stainless-steel rod, holding a wet rag against the hook to keep it cool so that the temper will not be drawn from the knife.

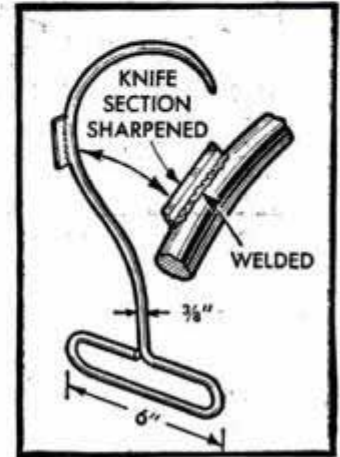

Kenneth Sidal, O'Fallon, Ill.

Tray Holds Mechanic's Tools Close at Hand

Made of plywood and fitted with legs of a suitable height, this tray will hold your tools within easy reach while working on a creeper. The tray legs fit the sides of the creeper. With this arrangement it is not necessary to lay the tools on the floor and waste time searching for them.

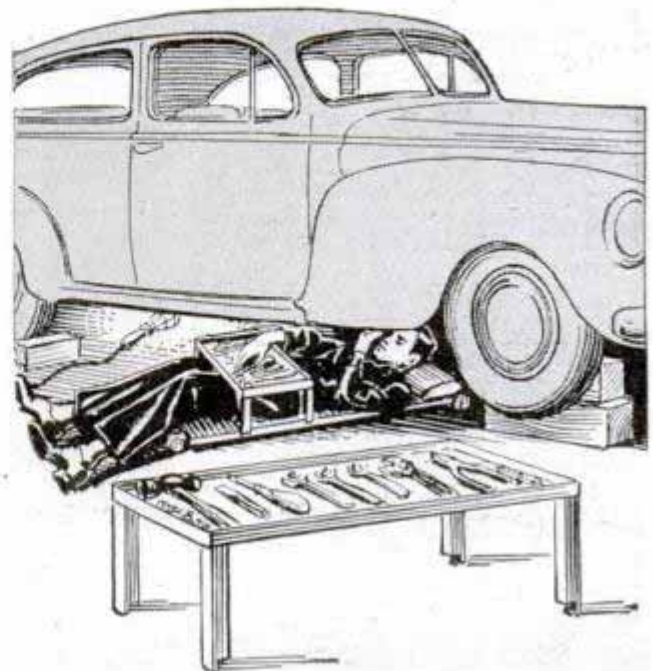

Accurate Circles Are Cut With Jigsaw Fixture

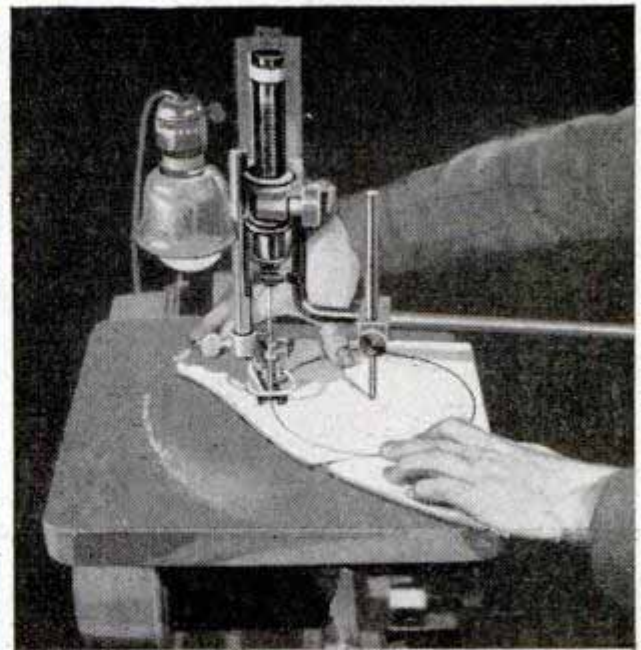
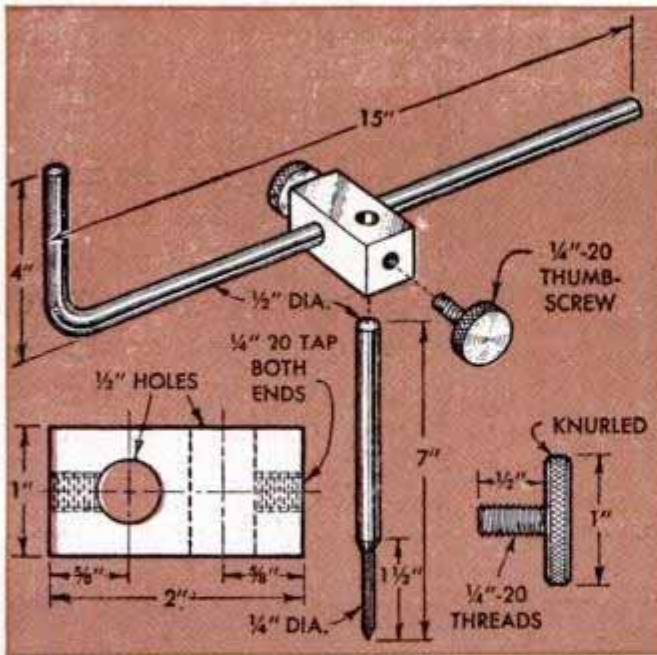

When one or a number of duplicate circles are to be cut on a jigsaw, the work can be done quickly and accurately by using this simple fixture or circle cutter. Only parts required are a length of rod to form the guide arm, another length for the center pivot, a metal block that slides on the guide arm to serve as a holder for the pivot, and two thumbscrews to adjust the holder. The detail gives dimensions for the parts and the method of assembly. In use, the guide arm is locked in the hold-down

bracket at the end of the jigsaw arm and the pivot point is set at the desired distance from the saw blade (the radius of the circle); then the point is clamped down on the work and the piece is rotated. To cut an outside circle, advance the work until the cut is tangent to the circumference; clamp the pivot in place and use the fixture to complete the circle. For an inside cut, drill a hole inside the circle, insert the saw and run the cut to the circumference.

D. J. Bachner, Jackson Heights, N. Y.

Combination Tool for Surveyors Increases Efficiency of Workers

For surveyors who work on streets and highways where it is necessary to drive hubs and stakes in graveled, oiled or black-top surfaces, this combination bar is more efficient and easier to use than a

pick, or gad and hammer. It also means that there are fewer tools to carry. A hole, smaller in diameter than the bar, is drilled in a square steel plate. Then one end of the bar is drawn to fit this hole and the plate is brazed in place. The other end is pointed. In use the plate serves as a hammer head and the point as a pick.

R. H. Eide, Seattle, Wash.

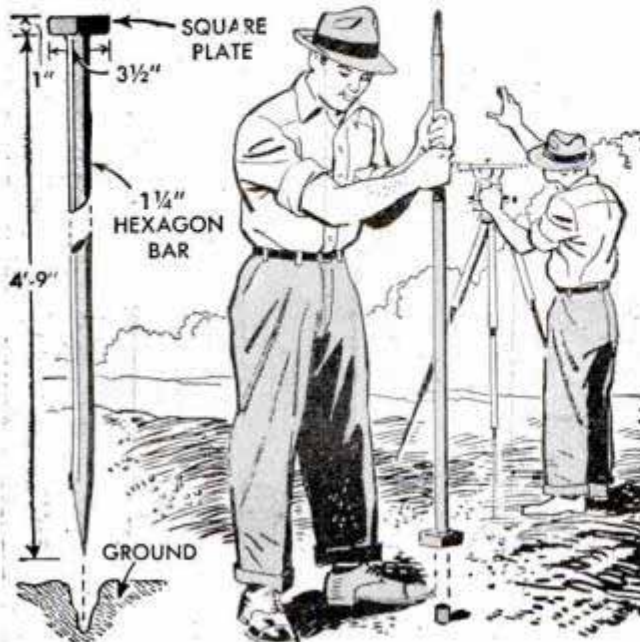

Hole in Muffler Drains Moisture

To prevent the accumulation of condensation inside the shell of a truck or automobile muffler, drill a hole at the lowest point in the shell. In this way, any moisture that collects will drain out and help prevent rusting. One fleet operator was able to report considerable savings by following this procedure.

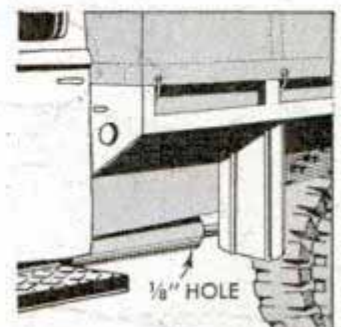

FILE

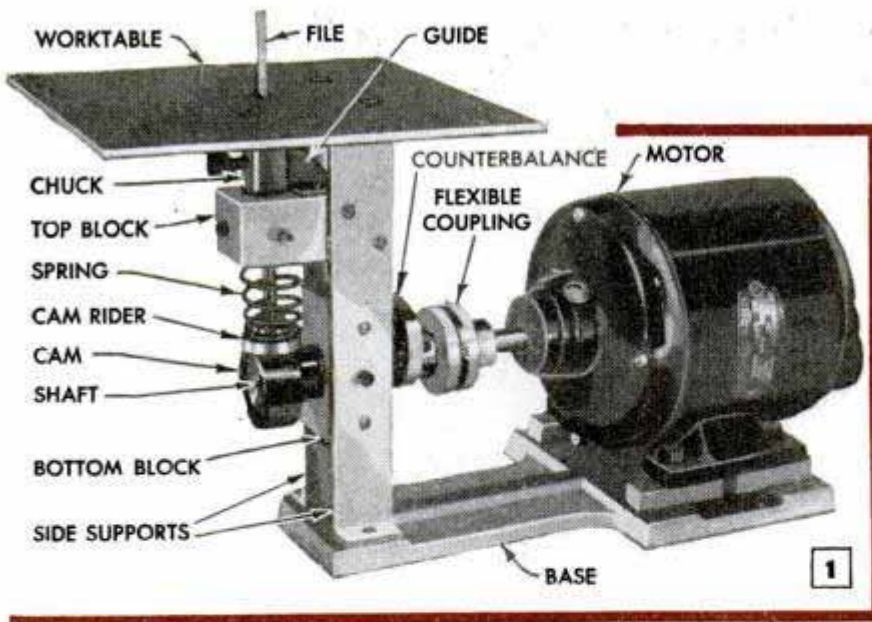

Both modelmakers and die makers will like the precise internal and external filing this machine can do on a wide variety of small intricate work. It uses the standard machine file

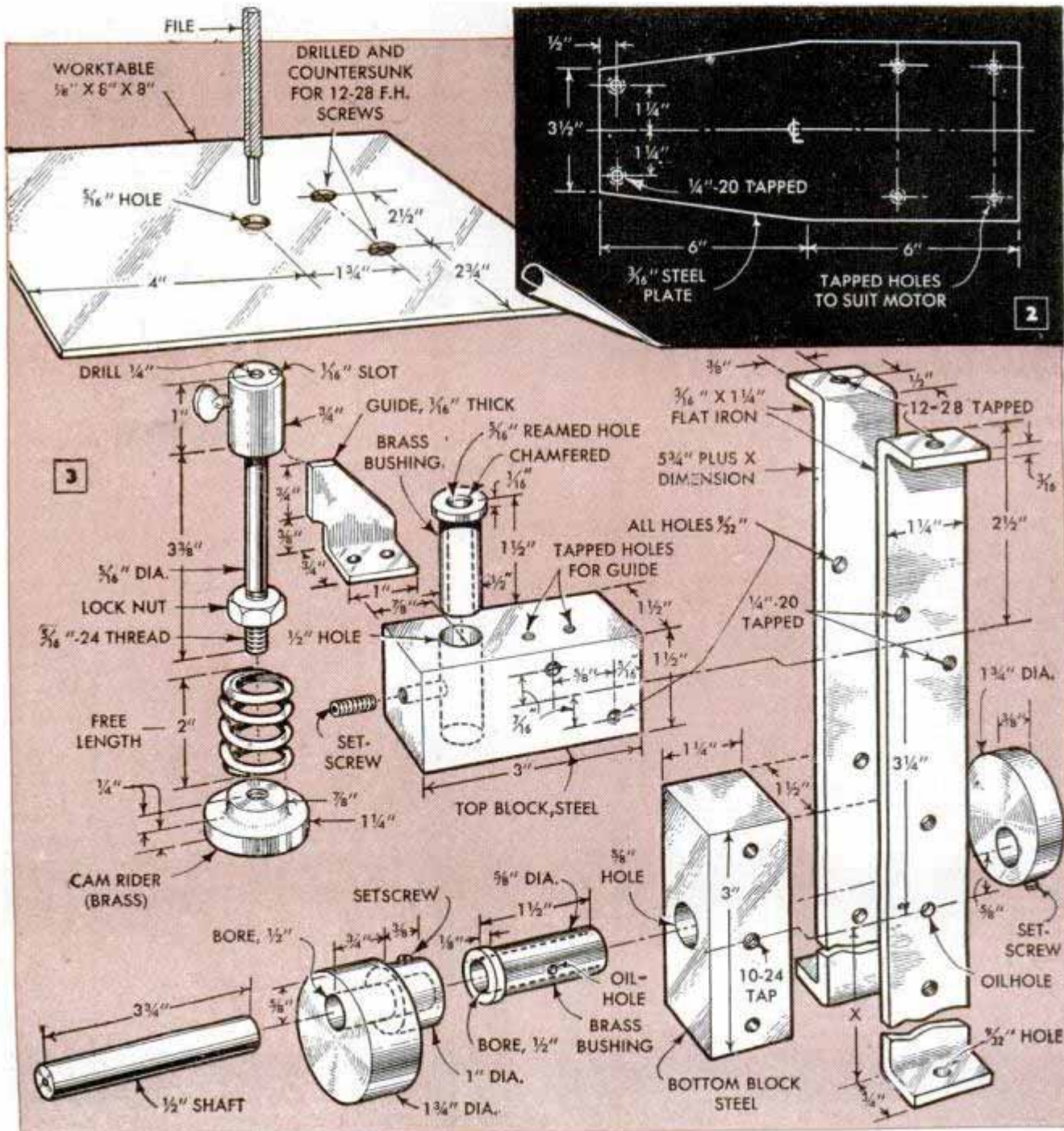

IT FASTER

By Jack Mellinger

INSIDE OR OUTSIDE die filing, squaring small parts, and truing irregular inside or outside shapes in model work—these are jobs for this motor-driven filer. Fit it with a special chuck to take saber-type blades and you have a speedy jigsaw. No castings are used, only cold-rolled round, flat and bar stock in standard sizes. Fig. 1 shows the complete machine and names all principal parts. Dimensions of these are given in Fig. 3, while Fig. 2 details the base. Dimension "X," Fig. 4, determines the position of the bottom or bearing block, Fig. 3. Check this dimension first so that you'll know where to locate holes in the side supports. In order to get the motor shaft and drive shaft in alignment it may be necessary to shim under the motor as in Fig. 1.

Note that there is a flanged brass bushing in the bottom block, which forms the bearing for the main shaft. This bushing should be reamed to a precision fit on the drive shaft. The cam is cold-rolled steel and the cam rider is brass or bronze. Cam and rider are ground and polished on the meeting faces. The top block also is fitted with a flanged bushing of either brass or bronze, and forms a bearing for the file spindle. As these parts travel at fairly high speeds, ream the bushing to a precision fit on the shaft. The spring can be made by winding No. 8 phosphor-bronze wire on a 1/2-in. mandrel in a lathe. Free length of the spring should be 2 in. When removed from the mandrel, the coils will expand to about 7/8-in. inside diameter. A stock spring also can be used. The chuck and spindle are turned from one piece and the body of the chuck is slotted for a guide which prevents it from turning. This slot can be cut with a shaper, milled, or filed by hand. It is essential that the guide be a close fit in the slot.

The counterbalance is of steel, and does not fully balance the cam, for there also is the tension of the spring to overcome. The size of the counterbalance detailed was determined experimentally and was found to be correct for this machine. Use a 1/4-hp. 1750-r.p.m. motor and connect it to the main shaft of the machine with a flexible coupling. When the machine is to be used continuously it's best to fit pressure-grease fittings or snap-cover oil cups provided with felt wicks. A felt washer cut to fit snugly over the spindle just underneath the chuck will prevent metal filings from reaching the bearing.

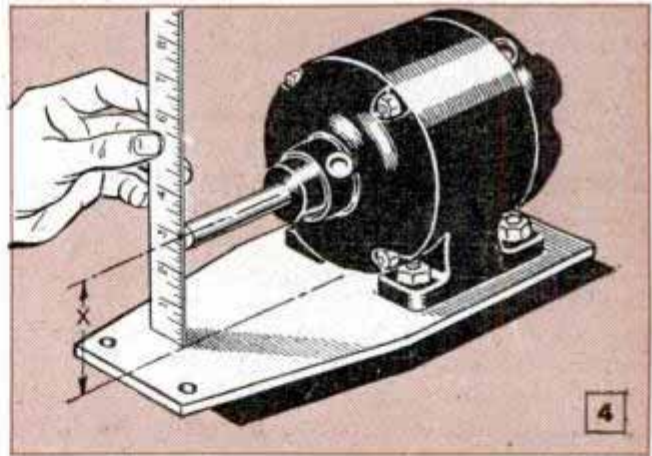
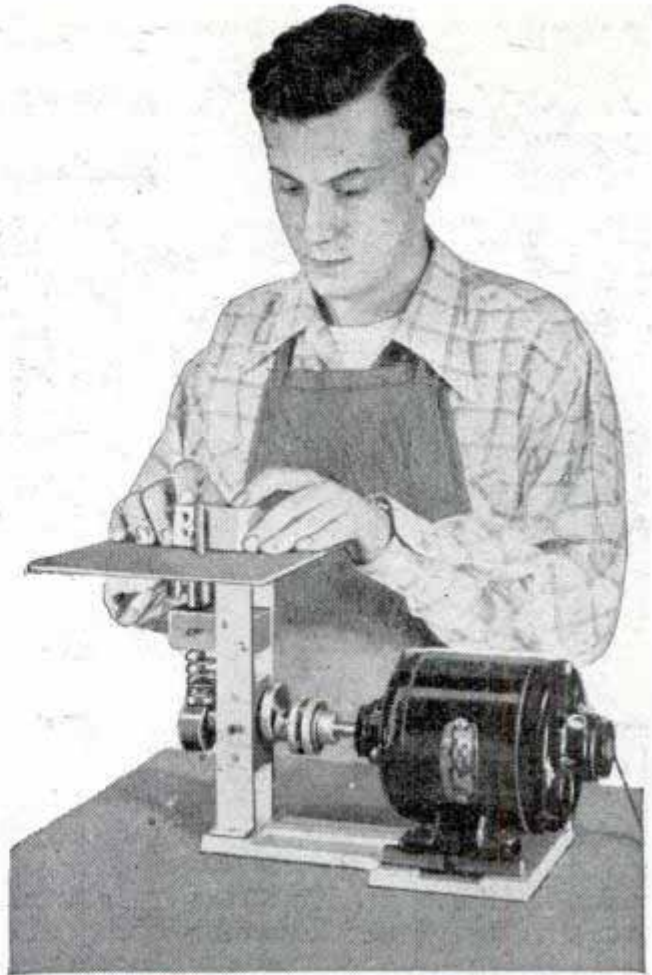

Above, be sure of this dimension as it will vary with different motors. Below, standard machine files with 1/4-in. round shanks are used. By fitting an interchangeable chuck, machine makes a speedy jigsaw

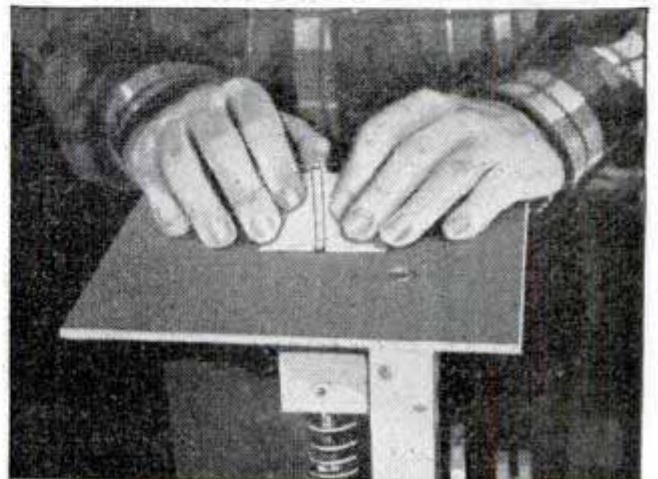

Weight Tied to Sandpaper Block Keeps It Out of the Way

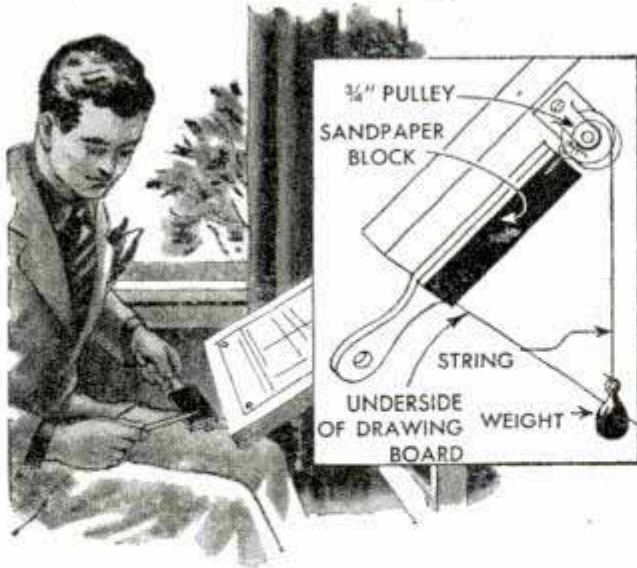

Ordinarily a pencil-sharpening sandpaper block is attached to the drawing board by means of a string and swings free at some distance from the board, soiling the trousers of the draftsman who brushes against it. To prevent this, attach a small pulley to the underside of the board, and insert a string through the pulley with the block attached to one end and a weight at the other. When not in use, the weight will pull the block up against the board where it will be out of the way.

W. B. Eagan, Louisville, Ky.

Durable Farm Gate Formed From Single Pipe

All you need to assemble this farm gate is a length of pipe, some barbed wire, two eyebolts and L-hook screws. To make the bends, fill the pipe with sand that is absolutely dry, plug the ends and heat the pipe at the points where the bending is to be

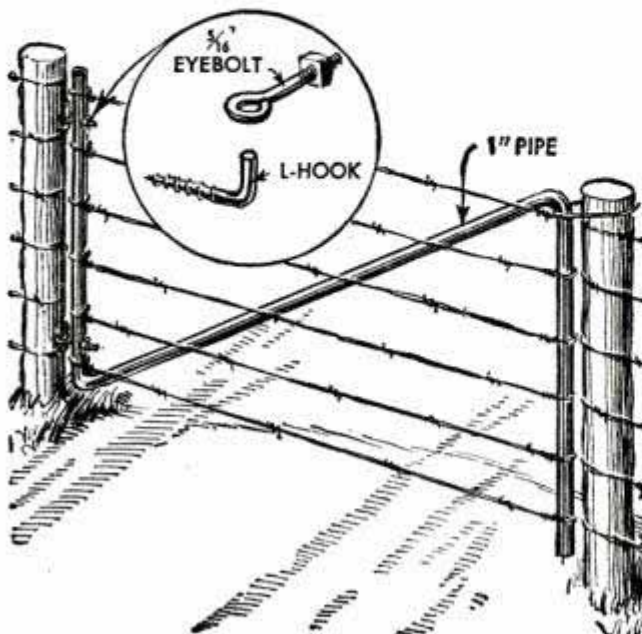

done. After the gate is shaped, drill holes for the barbed wire in the side legs. Thread the wire through these holes and tighten. Ends of the pipe are fitted with caps before painting.—Don Brooks, Chicago.

Making Loop in Ignition Wire

Loop ends in ignition wires are made by stripping the insulation off the ends for a short distance and separating the wire into two strands, detail 1. Then form the loop and twist the free ends, as in detail 2, cutting off the excess wire. Finally, dip the twisted end in solder, detail 3, to prevent unraveling.

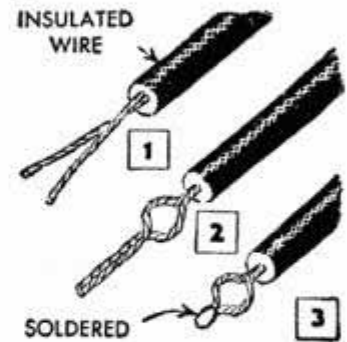

Extension Tip on Mechanical Pencil Is An Aid When Drafting

To keep the lead in a mechanical pencil from being broken, and to hold the pencil steady against a rule or triangle, solder a metal extension tip to the point of the pencil. The extension tip should be about 1/4 in. long to guide the lead and keep the tapered part of the pencil away from the rule.

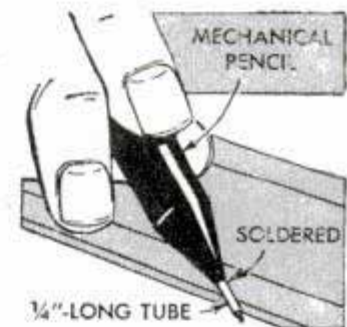

Bottled Tags Identify Trees

To identify young fruit and shade trees or shrubs, and to be sure that the labels do not fade or wash off in the rain, place the labels in tightly corked medicine bottles and tie the bottles to the trees. As an extra precaution use waterproof ink when making the labels. Such labels will remain legible until the trees are easy to identify.



⚠ Naphtha, benzine, gasoline and other flammable liquids employed as cleansing proper conditions. In many localities the use of volatile and flammable liquids will invalidate a fire-insurance policy.



Twelve-Tube Super Covers Nine Bands

WITH ACCURATELY calibrated plug-in coils for efficiency and flexibility, this high-frequency superheterodyne offers top-flight performance throughout its entire frequency range of 50 to 430 kilocycles, and from 480 to 30,000 kilocycles. Incorporating all of the strong points of a favorite prewar communications receiver, this National HRO-7 includes a number of modern refinements. It is housed in a streamlined gray cabinet; the speaker and power supply are separate matching units.

The new features include a double-action noise limiter that effectively reduces interference caused by external noise pulses. There is a 6-position switch for crystal-filter operation; also an accessory connector socket that makes possible the use of a wide variety of accessories such as a narrow-band FM adaptor, phonograph, or HF converter. Two new miniature tubes, a 6C4 high-frequency oscillator and an OA2 voltage regulator, are employed to give a high order of oscillator stability. Photo A shows a top view of the chassis; all panel controls are identified in photo B. One of the nine plug-in coil sets appears in photo C; coil sets for the amateur bands provide separately calibrated band-spread coverage available by merely moving the band-spreading screws indicated. The micrometer-type main tuning dial drives a 4-gang variable condenser through a worm drive having a reduction ratio of about 20 to 1.

Although primarily designed for communication and amateur radio services, it provides excellent broadcast reception as well as clear foreign broadcasts of interest to short-wave listeners. For the amateur, the attractive gray cabinet easily overcomes the wife's former objections to bringing your "rig" into the living room.

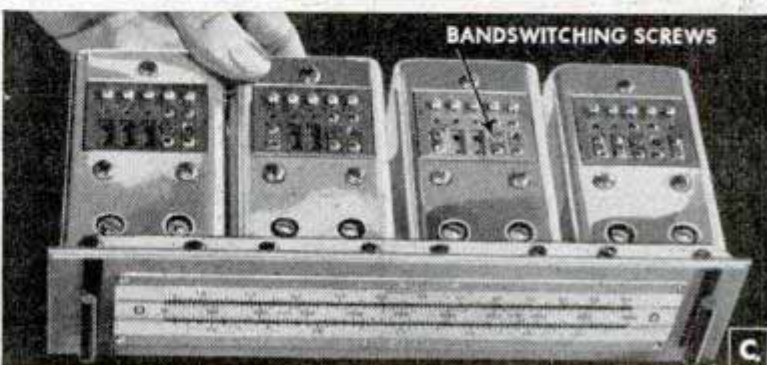
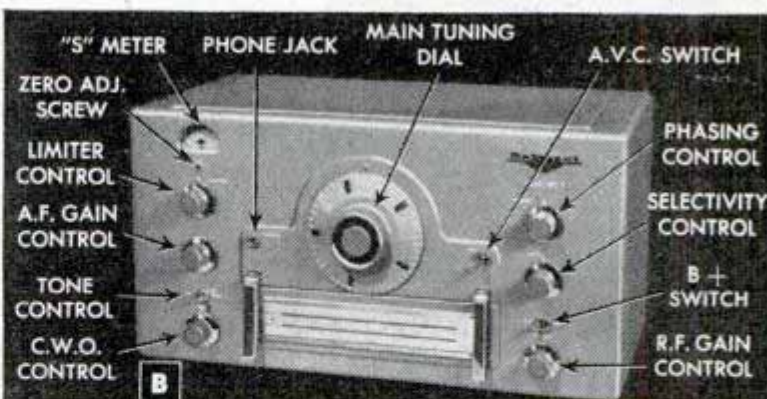
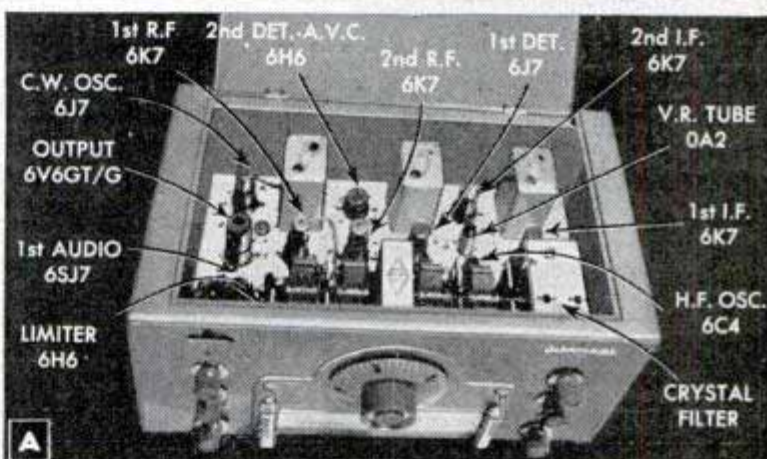
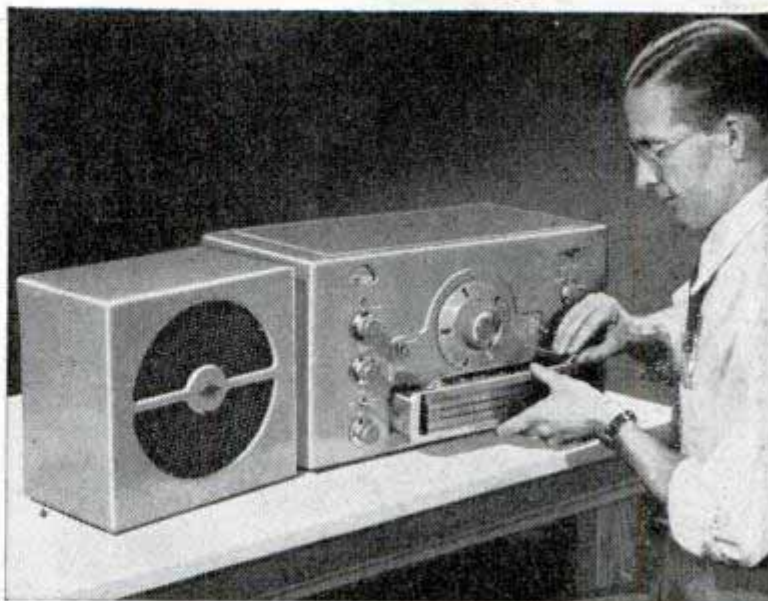

6SG7 SIGNAL "BOOSTER" INCREASES

By S. A. Johnson

SHORT-WAVE LISTENERS who are using simple superheterodynes, with no R.F. stages ahead of the mixer stage, find that they do fairly well on weak signals under ordinary conditions. But when the "going is tough" and they are trying to "pull in" a weak station halfway around the world, these sets lack sufficient sensitivity for satisfactory reception.

A small signal "booster" will solve this problem by means of a 1-tube R.F. section which can be added ahead of most types of short-wave receivers, and the power for it may be obtained from the receiver power supply. The unit illustrated will boost weak signals from "below readability" level to the "perfectly readable" class in a surprising number of cases. It employs a type 6SG7 high-frequency amplifier tube that has good gain but is not tricky to use. Four hand-wound plug-in coils are employed. This gives a frequency coverage of from 2 to 31 megacycles, covering all "ham" bands with plenty of tuning range above and below.

Various views of the simple unit appear in photos A, B, D and E. It is built on a plain $\frac{1}{16}$ -in. sheet-aluminum chassis that is easily bent to shape over a wooden block. The front panel consists of a sheet of the same material rubbed down with fine sand-

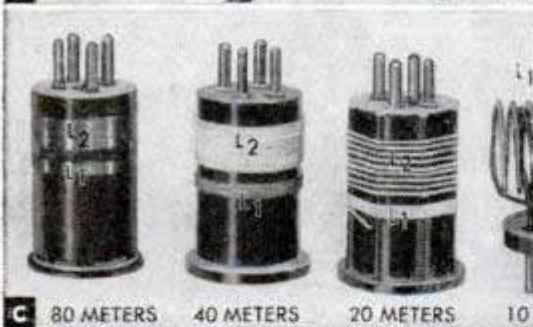
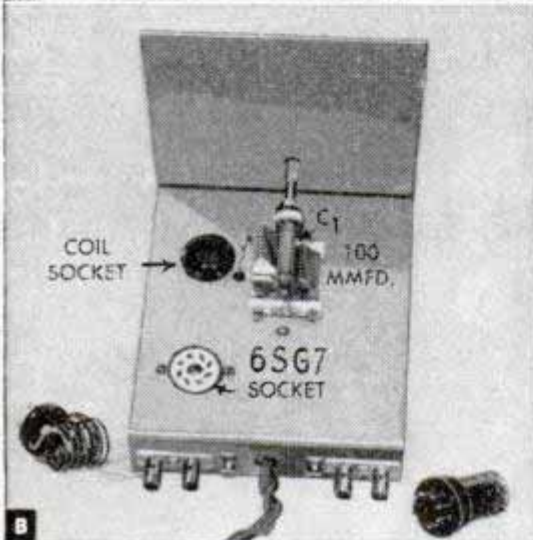
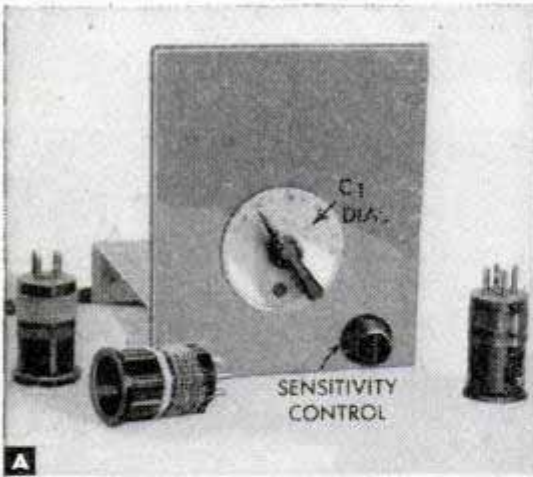

COIL-WINDING CHART	
L-2	L-1
10 meters 7 turns No. 14 enameled wire $1\frac{1}{2}$ -in. I.D. spaced to $1\frac{1}{2}$ in.	3 turns of No. 16 insulated push-back hook-up wire, interwound
Note—This is a self-supporting coil on a 4-prong plug (see text)	
20 meters 9 turns of No. 26 d.c.c. wire spaced to occupy $\frac{1}{2}$ in. on $1\frac{1}{2}$ -in.-dia. 4-prong plug-in coil form	6 turns of No. 26 d.c.c. wire, close-wound and spaced $\frac{1}{8}$ in. from L-2
40 meters 19 turns of No. 24 s.c.c. wire close-wound on $1\frac{1}{2}$ -in.-dia. 4-prong plug-in coil form	8 turns of No. 26 s.c.c. wire close-wound and spaced $\frac{1}{8}$ in. from L-2
80 meters 38 turns of No. 30 enameled wire close-wound on $1\frac{1}{2}$ -in.-dia. 4-prong plug-in coil form	14 turns of No. 30 enameled wire close-wound and spaced $\frac{1}{8}$ in. from L-2

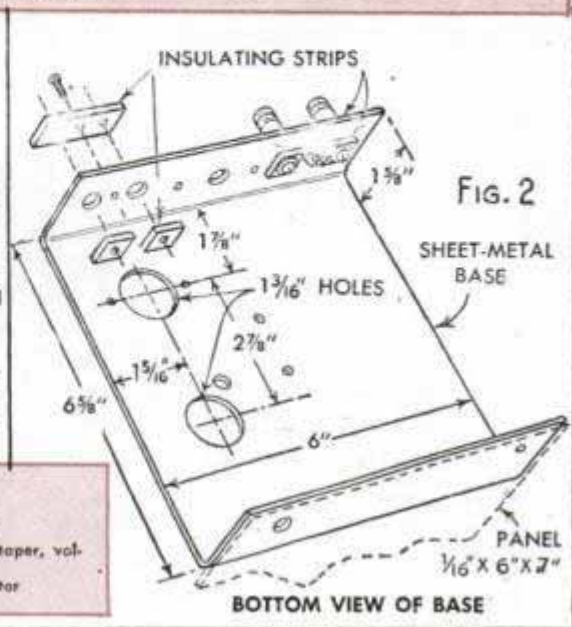
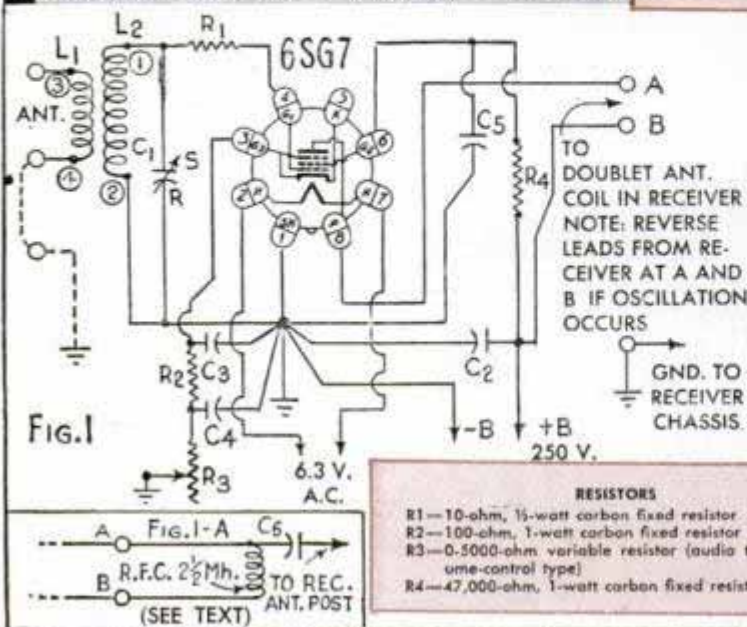

SENSITIVITY of SHORT-WAVE RECEIVERS

paper to give a dull finish. Complete chassis base details are given in Fig. 2; note that large holes are drilled in the rear to permit centering the binding posts on small strips of polystyrene or similar low-loss insulating material. The two Fahnestock grounding clips are mounted directly on the base.

The schematic circuit diagram is given in Fig. 1 and the pictorial wiring diagram is shown in Fig. 3. No. 14 bare copper wire is used for the self-supporting leads running from the antenna posts to the coil socket. All other circuit connections are made as short as possible. Make good soldered connections with rosin-core wire solder and bring all common ground connections to the chassis at a single point by means of soldering lugs held tightly to the chassis base by a short machine screw, lock washer and hex nut. It is difficult to solder sheet aluminum and, therefore, it is necessary to use the method shown.

Three of the plug-in coils are wound on standard forms; the 10-meter coil is wound

(Continued to page 234)

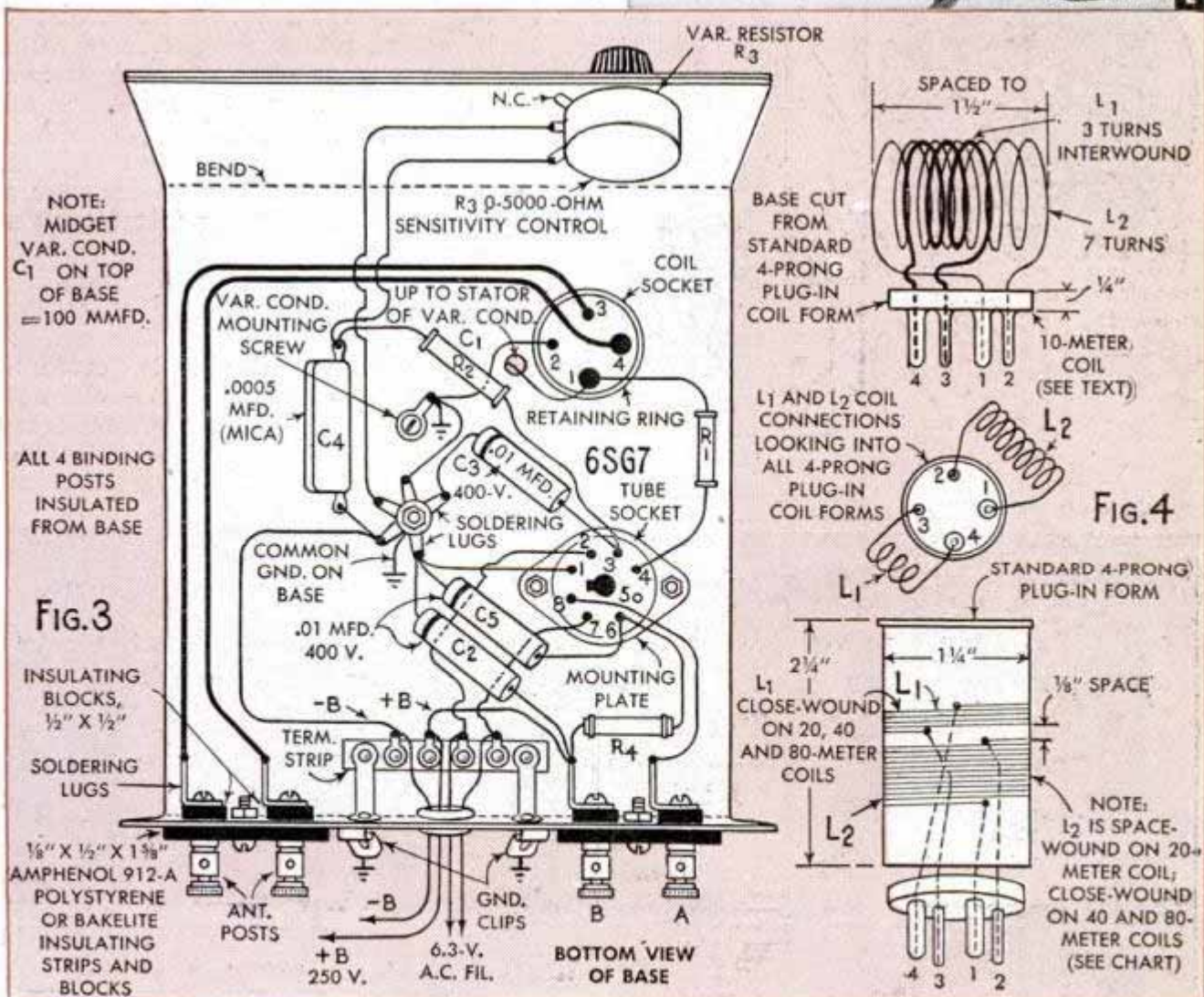

PROPOSED PHONE-TELEVISION SYSTEM

By F. L. Brittin

TELEVISION without commercials, and presenting such unusual entertainment as first-run movies, Broadway plays and similar special features not available for ordinary television because of prohibitive production costs, may be offered soon by means of a telephone pay-as-you-see hookup recently proposed by the Zenith Radio Corporation.

"Phone vision" works by diverting a few key frequencies from the complicated television (video) signal and routing this separate signal through the subscriber's telephone. Without this key signal, the owner of any television receiver sees a distorted image when he tunes in the special pay-as-you-see program. The subscriber to the service merely picks up his telephone (B) and asks the operator (A) for "phone vision" for whichever station or show he wishes to receive. He can then hang up his telephone and the missing key frequencies from station (C) will be fed through his telephone line to his television receiver; he can still use his home phone for ordinary calls. The resulting clear image is shown in photo (D), and the same picture received on another set, without key control, appears in photo (E). A small telephone attachment with a wire leading to the television receiver, supplies the key signal. Regular television programs are received as usual. Use of the telephone enables the television station to bill the customer each month. It is claimed that tests have been successful, but there are still many details to be worked out.

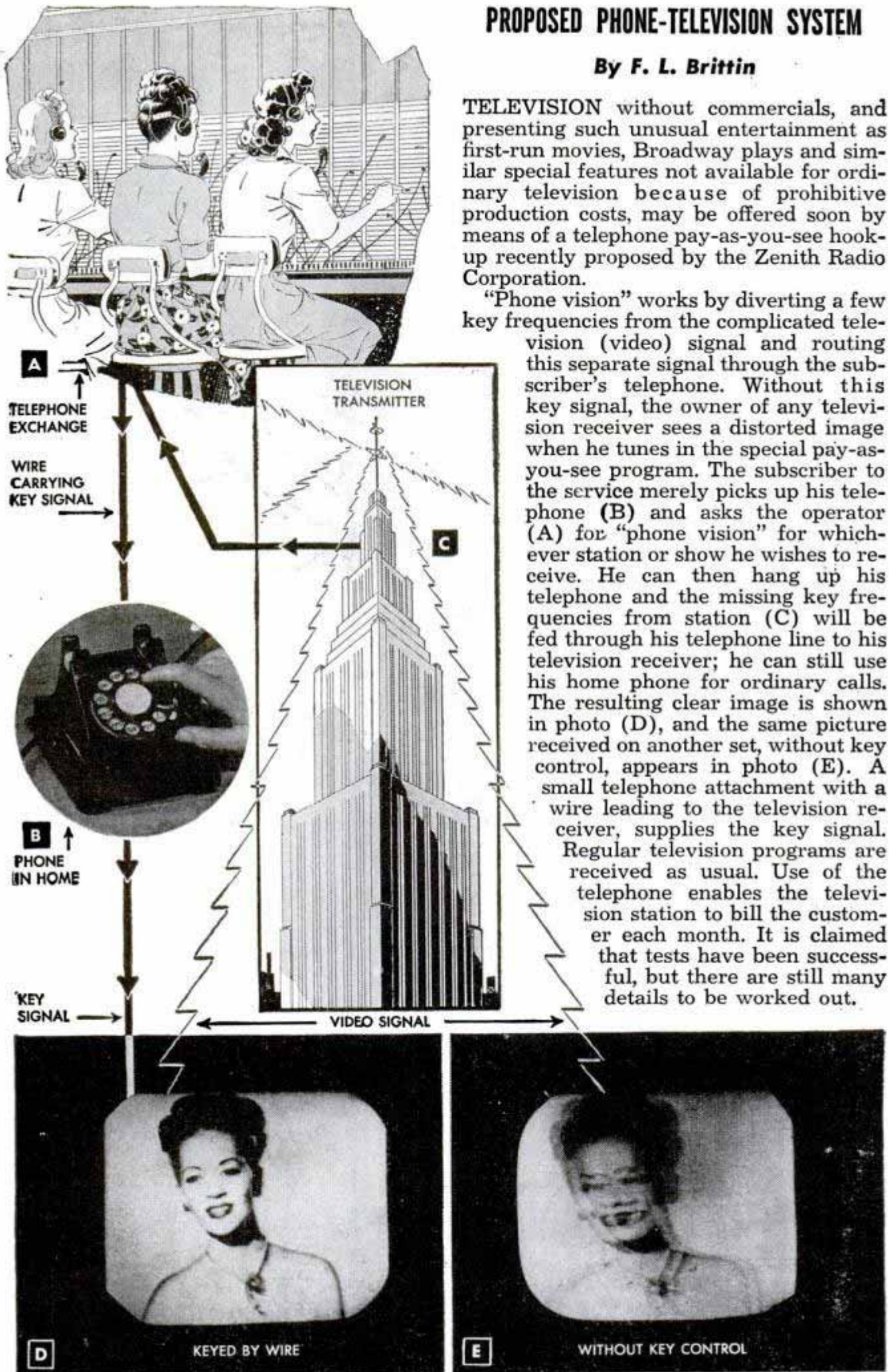

Photo-greeting cards are "personal" — different



You make them yourself or order from your photofinisher

Photo-greeting cards are fun to turn out with Kodak "masks." You start with a pet negative—you use your own printing equipment—all you need besides are the greeting card supplies shown and described here. See your Kodak dealer.

If you are not a darkroom fan, you can still have your own photo-greeting card. Just take a favorite negative to your photofinisher—he will show you a wide variety of attractive designs and do the whole job for you.

EASTMAN KODAK CO., ROCHESTER 4, N. Y.

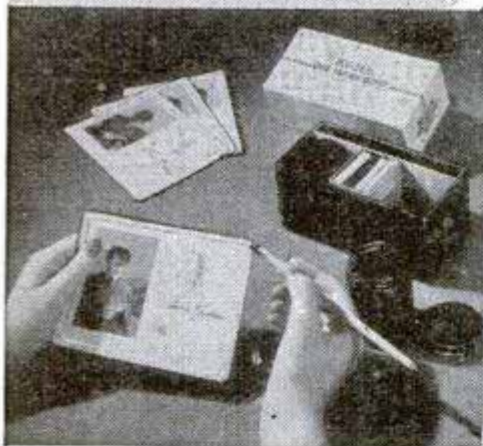

KODAK EDGE TINTING OUTFIT—2-ounce bottles quick-drying red and green ink . . . four felt nibs and holder . . . Price: \$1.50.

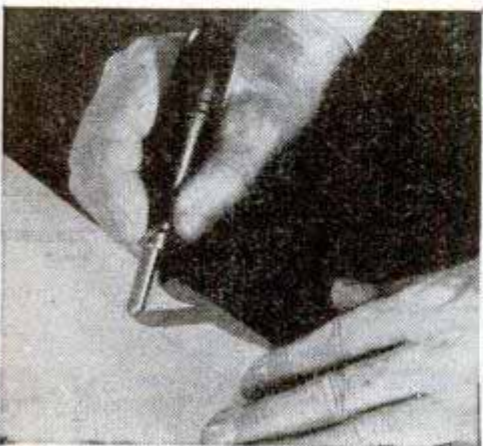

KODAK EMBOSSING GUIDE—easy to use . . . gives each card that custom-made look. Price: 75 cents.



KODAK SERIES 20 GREETING CARD MASKS—each mask is a negative with greeting message and cut-out space for *your* 620 negative . . . 2 designs, horizontal or vertical. Price of each mask: 85 cents plus tax.

KODAK AZO E PAPER—ideal for printing photo-greeting cards . . . double-weight, 4¼" x 5½" . . . straight or deckle edge. Price: package of 25 sheets, 45 cents plus tax; 100 sheets, \$1.60 plus tax.

Kodak

WORKS LIKE THE BIG CRANES!

REAL PLAYTIME FUN for the youngster with this husky Sturdybird! Works like the real ones! Clamshell grab bucket closes with powerful action . . . dumps with a pull on the trip line! Boom hoists and lowers . . . hoist drum's complete with clutches. Cab swivels around. Runs on wide moulded rubber treads. Honest-to-goodness welded steel takes all rough play kids can give! A big heavy job 31 inches long, in bright play colors.

T HIS STURDYBIRD CRANE challenges the skill and imagination of every boy and girl . . . and their big folks, too. They all want to work and play it, indoors and out!



Line production enables us to put a Sturdybird Crane in your home for only \$8.50, express prepaid. Send us check or money order with the coupon below. We'll ship your Sturdybird Crane.

AND the Sturdybird Electro-Magnetic Hoist with battery-powered magnet . . . lifts 10 lbs. Big and strong like the Sturdybird Crane. Express prepaid . . . \$10.00. One of these Sturdybirds . . . or both of them . . . will keep Christmas alive all year!

M ail coupon with your check or money order now so we can get your Sturdybirds off to you before the holiday rush!

TECH-ART, INC., MILFORD 5, OHIO:

Send to me without further charge,

- (Quantity) Sturdybird Cranes at \$8.50 each, express prepaid;
- (Quantity) Sturdybird Electro-Magnetic Hoists at \$10.00 each, express prepaid;
- (Quantity) Matched Sets of both Sturdybirds at \$18.50, express prepaid.

(Ohio residents only add 3% Ohio Sales Tax)

NAME.....

STREET.....

CITY..... STATE.....

Signal "Booster" for S-W Receivers

(Continued from Page 231)

on a wooden dowel rod 1 in. in dia., after which the form is removed and the coils are self-supporting on a plug-in base cut from a standard plug-in coil form, as detailed in Fig. 4. The completed coils appear in photo C. Voltage for the signal-booster unit can be obtained from just about any short-wave receiver that uses 6.3-volt tubes. However, before making connections to one of the tubes in the receiver, check a standard tube chart for that tube's base connections to be certain which are actually the tube heater pins. They are usually the No. 2 and No. 7 pins, but there are exceptions. To obtain the plate voltage in most sets, the "B positive" can be picked up by running a lead to the "screen" prong of the tube socket of the final audio amplifier tube. In practically all a.c.-operated sets "B-minus" is the receiver chassis base. In a.c.-d.c. sets the tube heater voltage must be supplied by a separate 6.3-volt filament transformer. The B-positive voltage can be obtained from the receiver by running a lead to the screen pin of the power tube, and a second lead to the negative side of the filter condenser to pick up the B-negative. Always check these connections with the original schematic circuit diagram of your short-wave receiver. With either a.c. or a.c.-d.c. sets, the chassis base of the signal-booster unit and the chassis base of the receiver must be connected together by means of a short lead, to prevent body capacity effects when tuning.

The booster unit is connected in series with the antenna circuit of your receiver and, in most modern sets, this is very easily done by merely running a short length of 300-ohm Amphenol twin-lead cable between posts A and B on the signal-booster unit and the "doublet" antenna coil posts on the receiver. Before doing this, check the receiver antenna coil to be certain that it is not grounded. If the antenna coil is grounded on one end, or the receiver has no provision for a doublet antenna, use the alternative hookup shown in Fig. 1-A. This 2½ mh. r.f. choke, and .00025 mfd. mica-type fixed condenser (C6) will result in less gain but must be used. To operate the booster unit, tune in a signal on the receiver in the usual manner, then rotate the dial of the booster to the point that gives the loudest signal. The sensitivity of the receiver can be controlled by R3 on the signal booster. Detailed student material list R-360 is available from Popular Mechanics Radio and Electronics department upon receipt of ordinary letter postage.

Dependable **CHAMPION**

AMERICA'S FAVORITE SPARK PLUG



The school bus is symbolic of a whole new generation which has never known the necessity for trudging weary miles to school. We are literally a nation on wheels with buses, cars, trucks and tractors playing a vital part, directly and indirectly, in our daily lives. Engines turn and

wheels roll. Spark plugs are a vital factor in keeping these engines operating efficiently and economically. On sheer merit, Champion Spark Plugs have earned the preference of most users because, in a word, they are *dependable*. Champion Spark Plug Company, Toledo 1, Ohio.

FOLLOW THE EXPERTS DEMAND NEW DEPENDABLE CHAMPIONS FOR YOUR CAR

Listen to the CHAMPION ROLL CALL . . . Harry Wismer's fast sportscast every Friday night, over the ABC network

Smooth-finishing the edges and joints of this handsome sheet-aluminum post lantern was done with a Nicholson Aluminum Type "A" File



"Basement craftsman" who knows his files



Having the right tool for each job not only multiplies the fun of home-workshop hobbying, but also speeds the development of mechanical skill. And no hand tools offer a wider range of applications or conditions than files.

In the Nicholson lines of more than 3000 kinds, cuts and sizes are files designed for use on all kinds of ferrous and non-ferrous materials—including the newer materials, like plastics, magnesium, stainless steel; and for the roughest work down to delicate precision filing, as on jewelry and fine instruments.

Three generations' experience goes into making Nicholson and Black Diamond files in such high quality that it is a pleasure as well as a source of profit to work with them. Their reasonable cost and long efficient life make them *your best buy in files*. At good hardware stores.



NICHOLSON FILE CO.
22 Acorn St.
Providence 1, R. I.



(In Canada, Port Hope, Ont.)



NICHOLSON
FILES FOR EVERY PURPOSE

Ducks by the Acre

(Continued from page 174)

from various poultry diseases. Medicine mash can cure mild cases of sickness, but it is difficult to save many ducks once they become ill. The best over-all preventive for duck diseases is complete sanitation of the grounds, the brooding houses and incubators. All of Warner's buildings are equipped with Westinghouse Sterilamps, ultraviolet-ray lamps which kill bacteria in the air.

Ducks are extremely sensitive creatures, both to change in temperatures and to outside disturbances. A severe thunderstorm can kill baby ducklings by drowning if they are exposed. Sometimes, after a heavy rain, Warner finds hundreds of drowned ducks around the yards. Many of them had just stampeded into the sides of houses and knocked themselves out.

In brooding houses, the slightest footfall sends ducklings skittering away, screeching. Even in maturity they are frightened by a falling leaf or a piece of paper. They bunch together, then march away single-file or in wedge formation after the lead duck, seeking safety. This trait is exploited by duck handlers who drive them easily from one duck house to the next as they grow older.

At night ducks are easily frightened, so farms provide dim artificial light in the brooder houses and in the yards. Artificial light also stimulates the production of eggs in the laying flock. Yet, when in the open, ducks dislike the sun and hover in shaded areas, so duck farms must have ample trees, bushes and overhanging sheds. Despite the utmost care, duck losses average five percent of total production on Warner's farm.

When ducks are 11 to 12 weeks old they weigh between 5½ and 7 pounds, just right for marketing. Ducks are killed on Warner's farm at the rate of 2000 to 4000 daily.

The ducks are scalded in vats containing water heated to just under boiling, to loosen the feathers. Skilled pickers quickly strip the fowl of its feathers in about four minutes. One woman can pick as high as 150 ducks in a 10-hour day, but 100 is a good average. A mechanical picker has been developed and is used extensively in New England. Although it is faster than hand-picking, this mechanical aid has not yet reached Long Island farms. Some duck farmers also pluck the birds by dipping them in hot wax. When it cools and is knocked off, it takes most of the feathers with it.

(Continued to page 240)

NEW

EVEREADY

TRADE-MARK

FLASHLIGHT BATTERIES

*Now last 93% longer!**

**Enough Energy to
Hurl This Daring Miss
Over 100 FEET!**

Imagine!—the girl weighs 110 pounds! Yet the total energy in one tiny "Eveready" flashlight cell—properly expended—is equal to the charge that sends her flying up—up—over the gasping audience, to land over 100 feet away.

PACKED with new dynamic power... dazzling in performance... durable beyond any flashlight cells you've ever known, "Eveready" flashlight batteries give you the year's greatest energy value. That's a 93% increase over the great record made by pre-war "Eveready" cells... nearly double the life of light. Yet you pay no more.

The registered trade-mark "Eveready" distinguishes products of

NATIONAL CARBON COMPANY, INC.

30 East 42nd Street, New York 17, N. Y.

Unit of Union Carbide  and Carbon Corporation

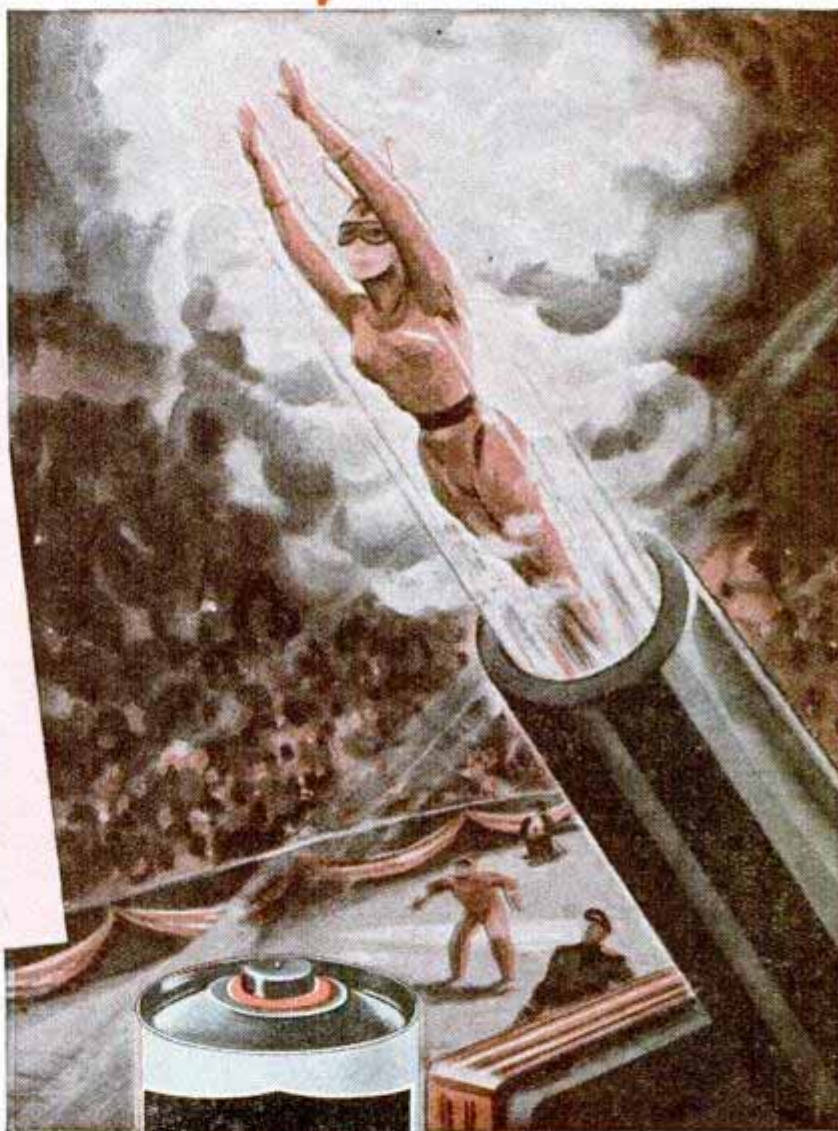

High Energy

**MEANS BRIGHTER LIGHT,
LONGER LIFE**



* To you, this means nearly twice the energy... almost two times longer life of bright white light. And it's yours for the pre-war price... still only 10¢!

TEST YOUR SCIENCE

i.q.

Answer to problem on page 105

Your problem was to name one of many points on the globe from which you can walk south 10 miles, walk east 10 miles, walk north 10 miles and arrive at your starting point. Here's how: Fly down to the South Pole for your start. From the Pole, walk up any meridian approximately 1.59 miles. Drive a stake there. Using the 1.59 miles as a radius, draw a circle centered on the Pole. This circle is a parallel of latitude 10 miles in circumference. Any point 10 miles north of this circle (and there are a limitless number of such points) is the spot for which you are looking. Wrap up for a 30-mile antarctic hike and prove your answer. From your chosen point 11.59 miles north of the South Pole, walk south 10 miles to the circle you have drawn. Walking due east, you follow the parallel of latitude which is your 10-mile circle. Ten miles brings you back to the same meridian, and you turn north, retracing your steps for 10 miles to your starting point.—By Rex Taylor

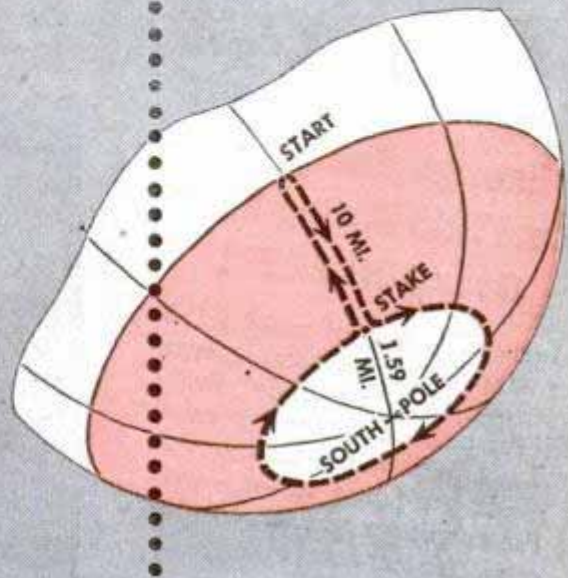

13.5% more accuracy without winding

that's what you get with the

CROTON AQUAMATIC

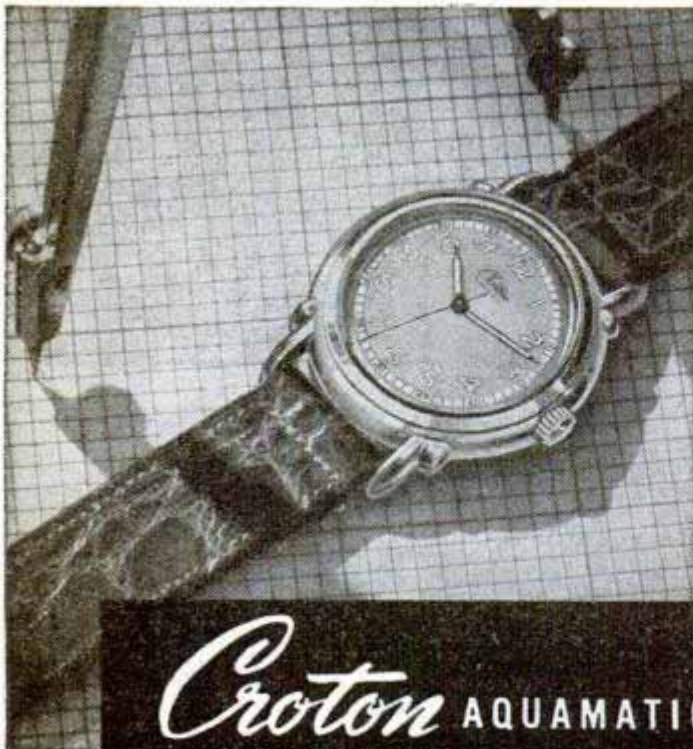

Croton AQUAMATIC

THE WORLD'S MOST CAREFREE WATCH

You're always *on time* because you *don't* wind your watch! Your Croton Aquamatic keeps itself wound just right, by the ordinary motions of your wrist. It can't run down, *can't* overwind. It keeps better time — 13.5% *better time*° than famous hand-wound watches. The Croton Aquamatic quietly and efficiently tends to its own business, while you go about yours. A wonderful idea for a wonderful gift — or for yourself. Made only by Croton — famous since 1878.



AQUAMATIC SHEDS WATER LIKE A DUCK!

Handsome, serviceable — the Aquamatic is certified *waterproof*, before it goes to your jeweler, by United States Testing Co. Inc. Just make sure *only* your Croton dealer opens, closes and services your watch.

Other features — dust-proof, shock-resistant, the dial's easy to read in the dark, *the glass crystal can't shatter!* Only \$57.50, including federal tax.

° 3 Aquamatics were tested against the average of 9 famous watches wound by hand, in a 30-day wearing test by a leading laboratory. Aquamatic proved 13.5% more accurate! Write for free booklet. Croton Watch Co., Inc., 48 W. 48th St., N. Y. 19.

© 1947 Croton Watch Co., Inc.



The RCA Metal Detector "blows the whistle" on any particle of metal that may have crept into the package.

RCA Electronic Metal Detector— arrests "stowaways" in packaged products!

It stands guard over everything from breakfast cereals to after-dinner mints, from cigarettes to cough drops . . . eliminating any bit of foreign metal that might slip by.

It helps American industry—that employs every precaution to assure product purity—to protect automatically the foods you buy. High-frequency radio waves form an invisible wall—sound the alarm, if any metal is accidentally present.

The RCA Metal Detector was developed by RCA product engineers with the co-operation of RCA Laboratories. Moreover, similar pioneer-

ing and research keep *all* RCA products at the top in their fields.

So when you buy anything bearing the RCA emblem—an RCA Victor radio, television receiver, Victrola radio-phonograph, phonograph record or radio tube, you get one of the finest instruments of its kind science has achieved.

"Victrola" T. M. Reg. U. S. Pat. Off.

When you're in New York, don't miss seeing the radio and electronic wonders at RCA Exhibition Hall, 36 West 49th Street. Free admission. *Radio Corporation of America, RCA Building, Radio City, New York 20.*

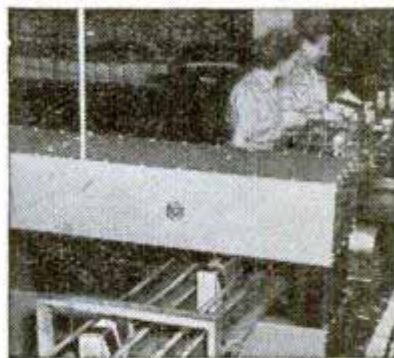

The RCA Metal Detector operates through a rejection device, or by stopping the conveyor belt, or giving an alarm or signal.



RADIO CORPORATION of AMERICA

Now! tests prove-

BRIGHT STAR BATTERIES



give more
bright light
longer

Here is your proof!

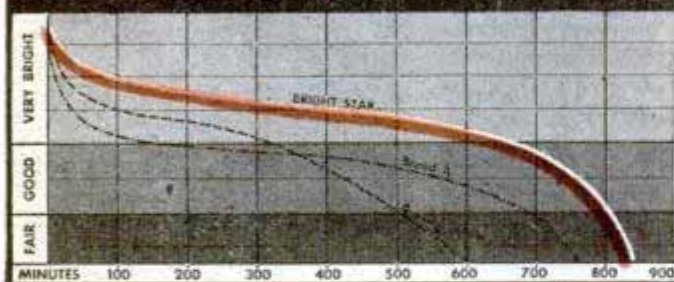

These results of vital service tests* prove that Bright Star batteries give you more *bright light* longer than two other leading brands tested. Insist on the best—it's Bright Star by test!

*Chart based on laboratory tests conducted in accordance with government standards.

Ask for popular Bright Star model batteries.

BRIGHT STAR BATTERY CO., CLIFTON, N. J.

After picking, feathers are barreled for sale to a cooperative. Six ducks yield a pound of feathers, priced at 91 cents. Duck farmers figure the sale of feathers pays for the complete picking operation. The chances are that your pillows are filled with feathers from Long Island farms.

The cleaned birds are tossed into large cold-water boxes to cool for about three quarters of an hour, after which they are ready for packing. They are packed in layers separated by shaved ice, averaging about 27 to 28 fowl to a barrel. They are then stored in a refrigerator until nightfall when they are trucked into New York City to the Farmers' Commission House, which sells direct to consumers or wholesalers. Warner's farm fills 80 to 100 barrels daily.

There was always a large foreign market for "L.I." duckling which disappeared during the war; but is now opening up again. Large quantities used to go to England, Bermuda, South Africa and many other parts of the world. Wartime conditions caused a wide shift in the market, and in part contributed to the increased demand of recent years. Many municipal and government agencies which bought ducks in small quantities before the war earmarked one fourth of the production for themselves as chickens and turkeys became scarce. Consequently, many thousands of people became acquainted with ducks as a food because of conditions, and duck farmers optimistically expect many of them to continue to like them.

Long Island duckling has earned a place on American menus as a culinary favorite alongside of such stalwarts as Vermont turkey, Virginia ham and Idaho potatoes. So well-publicized have Long Island ducklings been that many ducks grown out of state are marketed as "Long Island Style."

Paradise for Sidewalk Superintendents

(Continued from page 157)

The walking mechanism is controlled by the operating engineer, sitting in his cab. First he flips a switch which engages a jaw clutch to the drag shaft. Then he pushes his left-hand lever to make the huge machine walk.

In digging operations, the engineer controls the various movements in this manner: he pushes the right-hand lever to hoist; pulls back on the same lever to lower the bucket. He pushes the left-hand lever to pay out the dragrope, and pulls the handle toward him to take up the drag.

(Continued to page 244)



Pouring new horsepower into an old engine

WHEN your car begins to show its age, burning oil and losing power, there's a sure-fire way to make it young again. You can pour new horsepower into the old engine and eliminate excessive oil consumption by having it reconditioned and equipped with new Sealed Power Piston Rings. By doing this you restore original power, lengthen engine life, save oil, save gas!

Whatever the make or model of car, truck or tractor, whatever the condition of cylinder wear, there's a Sealed Power Individually Engineered Ring Set specifically engineered to do the best possible job in that particular engine. These sets are made up from twenty-six (26) basic designs of piston rings, proud product of 36 years' use as original equipment by major engine builders. See your Sealed Power Franchise Dealer. Send a postal for illustrated, informative new booklet on 7 ways to save oil. It's free and may save you lots of money. Sealed Power Corp., Dept. G-10, Muskegon, Mich.

For better results 26 Basic Ring Designs

No one piston ring design can meet all replacement needs. Sealed Power Individually Engineered Ring Sets are made up from twenty-six (26) basic ring designs, which permit each set to be specifically engineered to do the best possible job in a particular make of engine.

These ring sets are engineered to save gas without sacrifice of oil economy, to save oil without inducing friction and cylinder wear. Each set gives balanced performance in a particular engine.

Piston Rings
Pistons
Cylinder Sleeves
Valves
Water Pumps
Chassis Parts



© 1947.
Sealed Power Corp.

SEALED POWER PISTON RINGS

BEST IN NEW CARS! ★ BEST IN OLD CARS!

FREE!



SEND FOR
ALLIED'S
BIG 164-PAGE
RADIO
CATALOG

Everything in Radio at Lowest Prices!

Here is *everything* you want in Radio! New home radios and phono-radios, Ham receivers and gear, new kits, thousands of parts, tubes, tools, complete PA equipment, diagrams, latest radio books. The most complete stocks anywhere—in one *big* book—all at money-saving low prices!

BUILD THIS AMAZING 5 TUBE RADIO

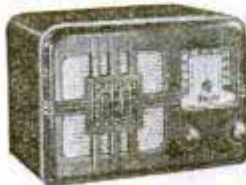

LOW-COST SUPERHET KIT
Complete with Plastic Cabinet,
Loop Antenna, and Tubes

It's here! The first ultra-modern 5 Tube AC-DC Superhet kit at so low a price! Here's what you get—full broadcast band coverage (550-1600 Kc); built-in loop antenna;

latest 5" PM dynamic speaker; handsome walnut plastic cabinet. Unbelievably easy to build; no special tools required. Sockets are riveted in place on chassis base; just assemble, wire and slip into cabinet. Outstanding for power and tone quality. Highest grade components only. Complete with all parts, tubes and full instructions. **ONLY \$14.95** No. 83-275. Complete.....

GET THESE VALUABLE ALLIED RADIO BOOKS!



- Radio Formulas & Data No. 37-752....10c
- Dictionary of Radio Terms No. 37-751...15c
- Radio Circuit Handbook No. 37-753....25c
- Radio Builders' Handbook No. 37-750...15c
- Simplified Radio Servicing No. 37-755...10c
- Radio Data Handbook No. 37-754....25c
- ALL 6 BOOKS above No. 37-799....\$1.00
- Parallel Resistance and Series Capacitance Calculator, No. 37-960....25c
- R-F Resonance and Coil Winding Calculator, No. 37-955.....25c

ALLIED RADIO

ALLIED RADIO CORP.
833 W. Jackson Blvd., Dept. 5-K-7
Chicago 7, Ill.



- Rush FREE 164-page Catalog
 - Send Kit No. 83-275
 - Send 6 Books No. 37-799
 - Send Calculators checked above
- } \$.....enclosed

Name.....
Address.....
City.....Zone.....State.....

FUN TO USE—this fast, easy-to-handle powerful tool for use in home or shop



- Polishing
- Grinding
- Carving
- Drilling
- Buffing
- Plastic
- Glass
- Metal
- Wood
- Bone

You'll be surprised how many interesting, money-saving jobs you can do with the Bantam Grinder. Balanced for easy handling. Precision-built of quality materials for years of dependable service. Plenty of power—operates on 110-115 Volt AC-DC. Speed approx. 20,000 R.P.M. Internal ventilating fan. Finger-tip switch. Weight only 15 oz. 8-ft. cord and plug. 23 useful accessories. Attractive gift box. Get the Bantam now for faster, finer work, for more pleasure in your work shop.



At your dealers—or order from us today **\$25**
—immediate shipment—postpaid—only

SMALL MOTORS Inc

Dept. 80, 2076 Elston Avenue, Chicago 14

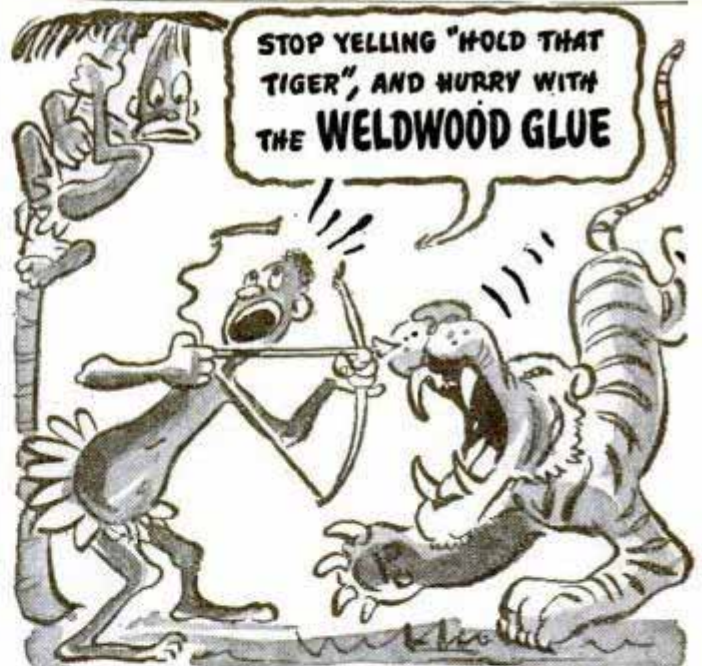

When you want to fix things fast... remember Weldwood Glue. It's quick to mix... easy to use... tremendously strong... stain-free... rot-proof... and permanent. At hardware stores, lumber yards, chain stores.



WELDWOOD
PLASTIC RESIN
WATERPROOF GLUE

United States Plywood Corporation, New York 18, N. Y.

POPULAR MECHANICS

*Before you put
in anti-freeze*



Clean out rust with

DU PONT Cooling System CLEANSER

Don't put anti-freeze into a rust-clogged radiator. Clean out the rust and scale *now* before winter sets in. Just pour a can of DU PONT COOLING SYSTEM CLEANSER into your radiator, run the engine 30 minutes or more, then drain. That's all! It cleans thoroughly without reverse flushing. It's safe, sure, dependable, and easy to use.



Then keep out rust with

DU PONT Acid and Rust INHIBITOR

After cleaning out the radiator, you can keep it free from rust all season by pouring in a can of DU PONT ACID AND RUST INHIBITOR. This neutralizes the acid and prevents damaging rust from forming.



Avoid leaks and loss of anti-freeze with

DU PONT Cooling System SEALER

You can stop leaks quickly and securely—and make the cooling system LEAK-PROOF—by pouring in DU PONT COOLING SYSTEM SEALER. It will not clog the radiator or harm hose or metal parts.

DU PONT

REG. U.S. PAT. OFF.

BETTER THINGS FOR BETTER LIVING
... THROUGH CHEMISTRY

NOW TRY Dustless SWEEPING



**Reduce Germ
Laden Dust
Eliminate
Sweeping Compound**

Dustless brushes used with Arbitrin sweeping fluid eliminate up to 97% of germ laden dust and reduce sweeping costs 20%. Arbitrin fluid, poured into a metal reservoir in the brush back, filters through the tufts and keeps dust down as you sweep. Dustless brushes are used in thousands of schools, factories, offices, stores, and institutions. There is a Dustless brush to fit your needs. Write for sizes, styles and prices today.

Milwaukee Dustless Brush Co.
530 N. 22nd St., Milwaukee 3, Wis.
Please send complete facts about Dustless Brushes.

Name _____

Street Address _____

City, State _____



To swing the machine to the left, he steps on the left-foot pedal; to swing right, he steps on the right-foot pedal.

Two sizes of steel rope are used to maneuver the bucket. The hoist rope which raises and lowers the bucket is two inches in diameter, and the dragrope which pulls the bucket toward the machine to scoop up overburden is 2½ inches thick. Altogether, the machine is equipped with about 2000 feet of steel rope.

All operations of the machine are basically simple. The dragline swings around on its circular base by a system of gears and bearings. The engineer steps on a pedal and a motor transmits power to make the desired swing.

The 25-cubic-yard bucket is raised and lowered by the action of a 65-inch drum winding and unwinding the hoist ropes. The bucket scoops up dirt by the action of another drum (70 inches in diameter) winding the dragropes, which pull the bucket toward the machine.

Because of its out-of-the-way location, the mountainous excavator performs its daily feats for only a small audience of workers. But it would be a paradise for the nation's "sidewalk superintendents."

Industry Has a Million Eyes

(Continued from page 151)

—today rates as industry's basic metallurgical tool. It is of major importance in studying the effect of heat treatments, forging and other processes on metals; photomicrographs provide valuable data for study to improve machining, welding and cutting-tool performance and also give a standard method for quickly comparing the quality of materials and processes with standard specifications.

Going further than ordinary photomicrography is the electron microscope which shows structural details of materials far beyond magnifications previously regarded possible. Using a stream of invisible electrons instead of a beam of visible light to obtain initial magnifications of 20,000 times, these can be increased to 200,000 diameters by photographic means.

Although only recently made available to industry and research, electron micrography has revealed new and heretofore unsuspected facts on the internal structure of metals; has cleared up certain baffling problems about the abrasion and corrosion of metals; is being used to improve the flavor of foods; and in research on solvents, oils, dyes and rubber. In the field of medicine, electron micrography is

(Continued to page 248)

HERE'S WHY NEW AUTO-LITE "Sta-ful" BATTERY...



needs water only

3 times a year!*

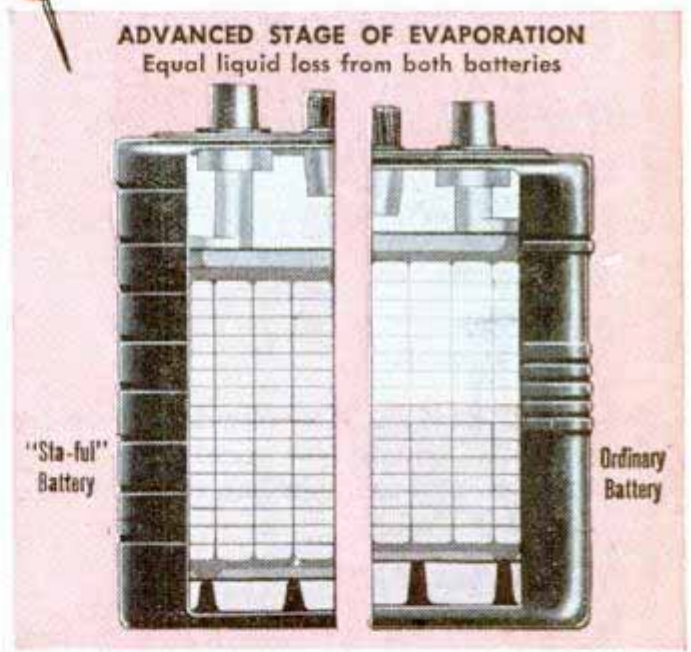
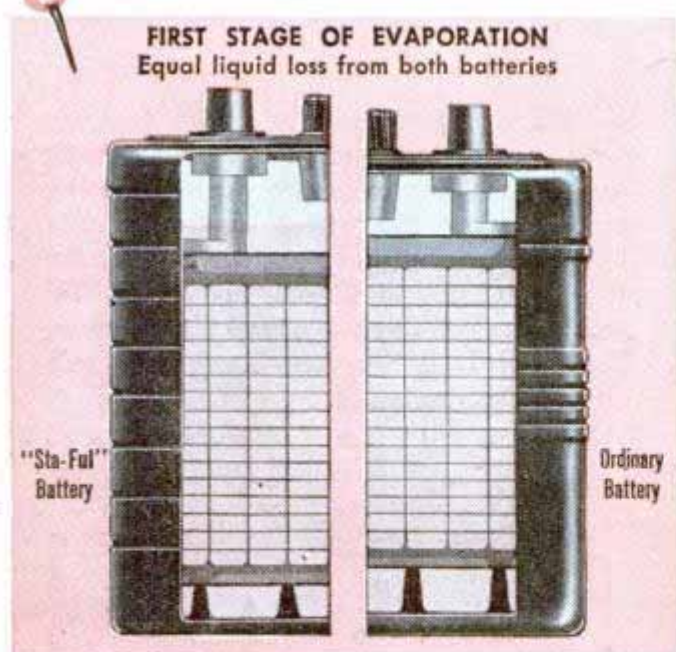
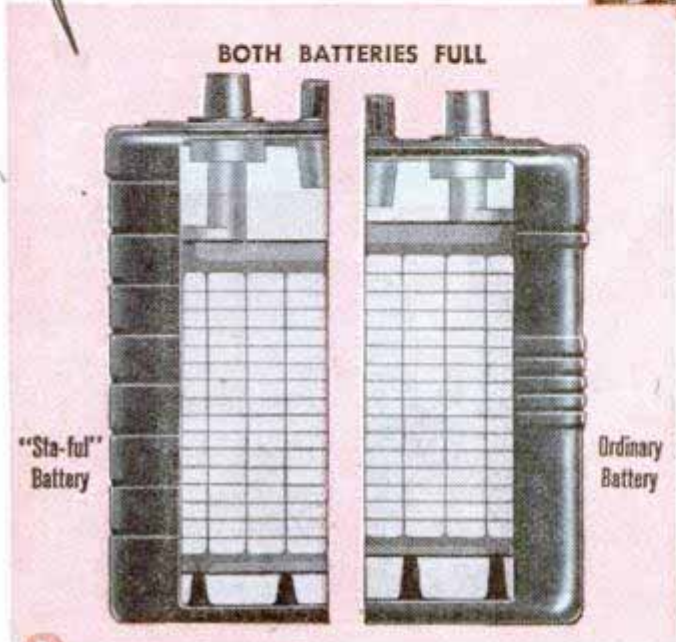

LASTS LONGER TOO! *In normal car use, because of "Sta-ful's" extra liquid reserve, plates are kept submerged to help deliver full life and power, when the same liquid loss leaves the plates in ordinary batteries exposed and inactive. This "Sta-ful" principle, oversize electrical capacity, plus Fibre-glass insulation, give longer life than batteries without Auto Lite "Sta-ful" features.

AUTO-LITE BATTERY CORPORATION
Toledo 1, Ohio

AUTO-LITE

Sta-ful
BATTERIES



"My Dad's smarter'n your Dad"



BETTY:He is not!

BILLY:He is too. How about that wrench your Dad bought last week? It's already broken—and today he had to borrow one from my Dad.

BETTY:What of it?

BILLY:Well, if he'd bought a *good* wrench, like the one *my* Dad has, it wouldn't be broken now.

BETTY:Oh, you think you're pretty smart, don't you?

BILLY:I'm not saying *I'm* smart, but my Dad is. He says people who buy tools at bargain counters are just throwing money away. He gets all his tools at the hardware store, and he always looks for the brand name before he buys. He wouldn't even pay *one penny* for a wrench like your Dad bought—because there's no brand name on it.

Your **HARDWARE DEALER** sells **QUALITY** tools
and hardware... Buy from HIM



POPULAR MECHANICS

IT'S ALWAYS
FUN-
TIME!



When You Own a HARLEY-DAVIDSON

OWNING a Harley-Davidson opens a whole new world of thrills for you! Anytime you get the urge you swing into the saddle and go where there's fun and excitement! The whole outdoors is yours to enjoy — you can do more and see more — as you go "adventuring" on evenings, holidays and weekends. And what a continual round of

good times awaits you as you join other fun-loving riders on pleasure trips and gypsy tours — or take in race meets, hillclimbs and other thrill-packed events that make motorcycling the world's greatest sport! See your Harley-Davidson dealer NOW — and mail the coupon today!

**HARLEY-
DAVIDSON**
Motorcycles



HARLEY-DAVIDSON MOTOR CO.

Dept. P, Milwaukee 1, Wis.

Send me free copy of 24-page ENTHUSIAST Magazine, filled with thrilling motorcycle action pictures and stories; also catalog.

Name.....

Address.....

City.....State.....

Performance goes up in smoke...

when worn
connecting rod bearings
cause oil pumping



Smoky exhaust behind signals *engine trouble ahead!* It warns that, inside your engine, worn bearings are permitting excess oil to enter combustion chambers. There it burns to motor-fouling, performance-stealing carbon. At first sign of smoky exhaust, replace worn engine bearings with genuine Federal-Mogul bearings, *engineered for the job of oil control.* They restore power, pep and economy! *Ask your mechanic!*

FEDERAL-MOGUL SERVICE
DIVISION OF FEDERAL-MOGUL CORPORATION
COLDWATER, MICHIGAN

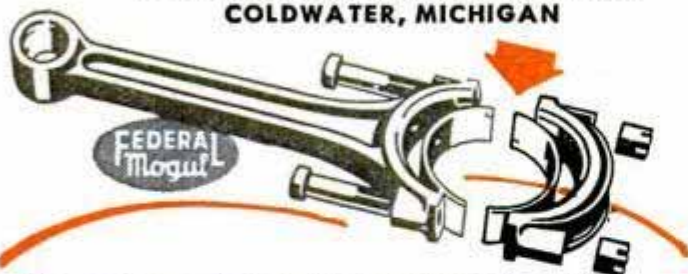

Replace in sets with Genuine
FEDERAL-MOGUL
Oil-Control Bearings

being hailed as a new and potent weapon in the fight against such diseases as cancer and the common cold.

In one branch of engineering, stress studies recorded on film are being used extensively to show the behavior of experimental parts—such as car parts of radical design—under working conditions. A scale model of the object to be tested is made of a transparent plastic. Different stresses are applied and then—by viewing the model through a polariscope—a pattern of light and dark bands can be seen and recorded with the camera. A study of these film records enables engineers, draftsmen and others to shorten the time needed to design and develop new parts to the point where they can be safely incorporated in planes, cars or trains.

Radiography—which uses X-rays and gamma rays—permits foundrymen, engineers and designers to look right through solid parts and study in detail the structure of large parts. Before this tool became generally available, the piece under observation—a crankshaft or cylinder block—had to be cut into pieces if a study of its interior was to be made. Of course, the piece had to be scrapped after the study was completed.

Now, radiography permits the non-destructive examination of such things as welds and castings for points of weakness and soundness. Its use in foundries alone has saved millions of dollars.

The uses of photography today run into the scores. They range from the Recordak microfilm process of putting bulky reports, drawings or charts on tiny rolls of microfilm with a saving of 98 percent in storage space to General Electric's new speed camera which takes pictures at a millionth of a second. The G.E. camera has built-in developing equipment and produces a finished photographic projection within 30 seconds.

A whole new science is developing around the use of photography in law enforcement. Photographs of skid marks in traffic accidents; of evidence taken at scenes of crimes of violence and arson; photographs of death-dealing weapons and of fingerprints—all of these are helping law-enforcement officers gain convictions.

No story of cameras at work could be complete without some mention of teaching "know-how" by "show-how" with slide films and motion pictures. Tests have proved that films are the most effective method of teaching. Thousands of training films were used during the war. Manufacturers and educators are now turning to films to teach people everything from the classics to how to sell can openers.



**MORE
CAPACITY**

**MORE
DURABILITY**

**MORE
VERSATILITY**

**MORE
POWER**



A handgrinder that's
really more than one tool!

The Sensational New Dumore Duplex makes your work easier, faster and twice the fun!



Flexible-shaft attachment doubles the usefulness of your Duplex.



The Duplex can handle 1001 different jobs as a hand tool.



Bench stand converts your Duplex into a third tool.



With a toolpost bracket, your Duplex serves as a lathe-grinder.

If you want a good handgrinder — get a Dumore!

Here's the handgrinder you've always wanted for your workshop — the tool that gives you *more* of everything you want, than any other handgrinder. Its full 1/14 HP motor has the extra power for "heavy" jobs. Its extra-capacity chuck takes all 3 tool sizes — 1/4", 1/8", 3/32".

With a simple, easy-to-use attachment, your Duplex becomes a flexible-shaft tool. Other attachments convert it instantly for bench or lathe work.

Think what you can do with the extra

power, capacity, and versatility of the Dumore Duplex! Work in wood, metal, and plastics is faster, easier — and twice the fun! And the Duplex costs no more than an ordinary handgrinder: 27-accessory Deluxe Kit (as illustrated) — \$27.50; 9-accessory Standard Kit — \$19.75; attachments extra.

The powerful Duplex is the perfect gift for any hobby-minded man or boy. See it in your local hardware store today — or send in the coupon below!

Satisfaction guaranteed — or your money back in 10 days!

Tear out this coupon and mail today!

The Dumore Company, Dept. K-51, Racine, Wisconsin

Please send complete information on Duplex Grinder.

Send me Deluxe Duplex Kit (27 accessories); \$27.50 enclosed.

Send me Standard Duplex Kit (9 accessories); \$19.75 enclosed. Shipping charges C.O.D.

Name.....

Address.....

City..... State.....

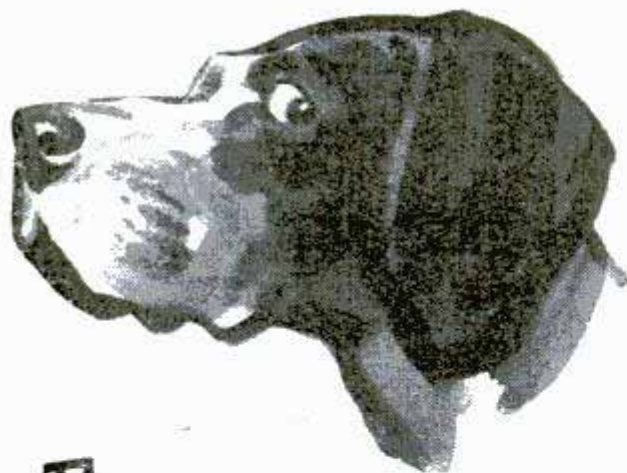

Excuse me for pointing!

• But it's about the only way I know to bring my real point home. I've got worm troubles, and I need attention.

Sergeant's SURE SHOT Capsules kill worms fast and leave me feeling like my old self again. They're safe and dependable, too.

Pups, and small dogs weighing less than 10 pounds, get the same sure relief from worms with Sergeant's Puppy Capsules.

In over 73 years of research and kennel-testing, Sergeant's has developed many reliable dog remedies. Their 19 dog care products enable you to give your pet the fine care he deserves.



• Learn more about your dog's health with Sergeant's new Dog Book. It's FREE for the asking at drug and pet stores. Or write Sergeant's, Richmond 20, Va.

Sergeant's DOG CARE PRODUCTS

Electrically Welded Endless

Paramount

**BAND
SAW
BLADES**



Made in widths from 1/8" to 1-3/4"

Make your band saw do more work for you. The proper width of blade will extend the scope of this important machine. Burrill's Paramount Blades are made from tough Nickel Alloy Steel properly tempered. Teeth accurately set and filed, and all saws carefully straightened. Send order and check today. Delivery will be made as promptly as conditions permit, from a few days to a week or two. You can obtain these saws at the following prices:

3/4"-3/16"-1/4"-3/8" wide, 5'6" long.....\$.90 each
 3/4"-3/16"-1/4"-3/8" wide, 6'6" long..... .95 each
 1 1/8"-3/16"-1/4"-3/8" wide, 7'6" long..... 1.10 each

Other sizes at proportional prices

NO C.O.D. SHIPMENTS ACCEPTED

State Make of Machine

Your satisfaction is guaranteed

BURRILL SAW & TOOL WORKS

407 E. Main St., Ilion, N.Y.

PISTON-TYPE
COMPRESSOR



EASY PROFIT IN PAINT SPRAYING

Paints walls, ceilings, screens, furniture and machinery faster, better. All complete as shown less motor. Carry anywhere. Fully guaranteed. Could be used with 1/4 H.P. motor or less. Price \$35.00 less motor F.O.B. Chicago. \$5.00 deposit balance C.O.D. or see your dealer.

IDEAL AUTOMATIC PUMP CO., Dept. P.M. 8

801 W. Washington Blvd.

Chicago 7, Ill.

HOBBY CATALOG

NEW, BIG COLLECTION OF MATERIALS



Get this catalog for your shop. It lists and shows a wide variety of tools and materials—some hard-to-get items in addition to a big 20 page section on books and project information. A gold mine of practical help. Shows how we test and approve all materials and tools in our own shop before we offer them to you—your assurance that they are tops in quality—everything fully guaranteed or your money refunded. Hurry to get this catalog. save money with our new Book Dividend Plan. Send 25c today—do it now, to

JACKSON STUDIO, Dept. 36, 5440 N. Shoreland Ave., Milwaukee 11, Wis.

The Chief

WORK BENCH

A CHRISTMAS PRESENT
HE'D APPRECIATE

Built to Last a Lifetime!

With Bottom Shelf and 18" Sq. Drawer. 2"x6", Solid Plank, Grooved and Dovetailed Top and 1"x8" Back Rail, Shellacked to a Smooth, Satiny Finish.

• 6 Ft. Long • 34" High • 26"

Deep. Shipped Knock-down, with Bolts, Nuts and Screws and ABC Chart for Quick, Simple Assembly.

Prompt Delivery

MOHAWK LUMBER CO.

14525 W. Chicago Boulevard
DETROIT 27, MICHIGAN



\$16.95
F.O.B. DETROIT

Send Check or Money Order, or Will Ship C. O. D. (\$5 Deposit)

MOHAWK LUMBER CO. Dept. 32
14525 W. Chicago Blvd. Detroit 27, Mich.
Enclosed Check Money Order for \$
Ship..... CHIEF WORK BENCHES at

Quantity
\$16.95 each, F.O.B. Detroit, Mich.
 Send C.O.D., \$5 Deposit Enclosed.

NAME.....
ADDRESS.....
CITY..... STATE.....
No Priority Necessary!

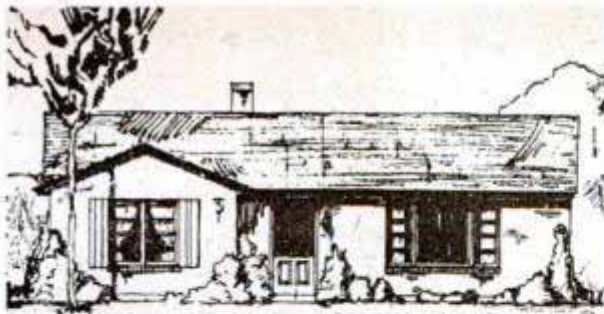

\$327

ALL THE MATERIAL *for only*

**Sufficient to Build
the 8" Exterior Walls of
this Roomy Bungalow**

Or Its Square Foot Equivalent

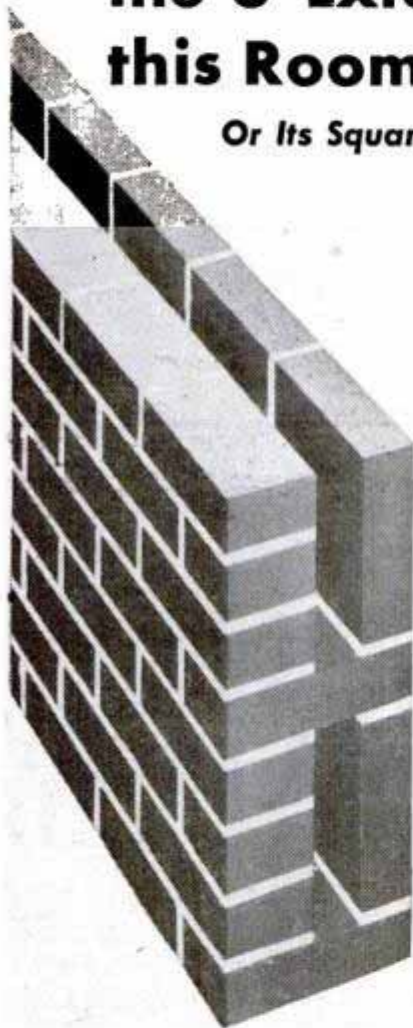
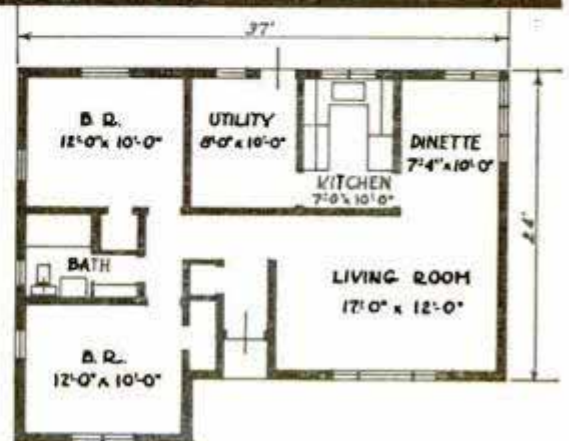

**Dunbrik and Dunstone combine to
create new standards of Colorful
Beauty, Comfort, Long Life . . . for
amazingly low cost of materials**

Here's wall construction at a new peak point of *practical permanence*. All the long-life endurance values of solid 8-inch masonry, combined with a series of 2" wide horizontal chambers which imprison dead air to provide vital insulation.

Face Dunbrik on the outside—in a wide selection of smart colors. Dunstone for

back-up, in a size to fit the job. The two securely tied by a bonding course of 8" x 8" Face Dunstone.

This construction opens up tremendous new opportunities for building contractors and operative builders in the low-cost home field. Especially because it is directly in line with the swing toward masonry.

*Based on a national average selling price of 22¢ per square foot for Facing units, and 15½¢ per square foot for Back-up. May vary slightly according to local costs of raw materials.

Dunbrik and Dunstone are produced by a country-wide chain of regional plants operating under franchise. Write us direct for name of manufacturer nearest you.

New territories for local manufacturing are being arranged. If interested in this opportunity, wire or write for reservation.

Sponsored by
W. E. DUNN MFG. CO.
610 W. 23RD STREET
HOLLAND
MICH.

DUNBRIK **DUNSTONE**

ANCO[†]

SPEED PAD

gives you a
TRULY CLEAN WINDSHIELD
at the gas pump

NEW!

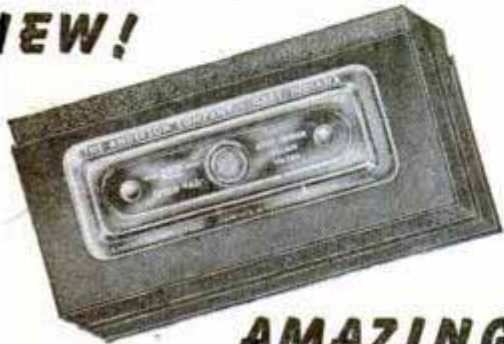

AMAZING!

Removes . . . swiftly and gently . . . from your windshield . . . all stubborn film, bug smear and other obstructions to safe driving vision. Uses only water . . . no chemicals. Leaves glass film-free . . . and crystal clear. Eye strain . . . FILM FATIGUE . . . a serious driving hazard. GONE!

DON'T BLAME YOUR GAS-PUMP MAN!

Sure . . . he knows how your nerves jangle . . . while your eyes strain through that ghost-like film that grows on your windshield. He knows how that film blurs dangerously under your windshield wiper in the next storm. He has tried hard to clear it . . . to please you . . . using the best he has had . . . up to now . . . to work with. Maybe your gas man is discouraged . . . hasn't seen ANCO Speed Pad . . . thinks FILM can't be whipped . . . quickly and completely. You can't blame him for that.

WHO tells HIM?

After all, YOU have a lot to gain . . . in safety and in restful driving comfort. So why not YOU tell HIM . . . about this amazing new ANCO year-round device? Show him this ad. He'll win friends . . . with Speed Pad.

Yes . . . he can get . . . from his ANCO distributor . . . an extra ANCO Speed Pad . . . for your own convenient use . . . in cleaning your windshield . . . or your windows and mirrors at home. And he can equip your windshield . . . quickly . . . NOW . . . with keen new ANCO Wiper Blades and Arms . . . to KEEP that windshield CLEAN . . . in storms ahead. Get yours today!

May save you a costly smashup!

[†]Trade Mark Reg. U. S. Pat. Off.

[‡]Trade Mark of—The Anderson Company

Quality Protected Under Fair Trade Laws
ANCO Patented Products—Patents Make Jobs

THE ANDERSON COMPANY
Established 1918
GARY, INDIANA

There's Magic Up Your Sleeve

(Continued from page 141)

are able to pull all sorts of things out of the cylinder. Half a dozen thin silk flags, feather fans, dollar bills, neckties, and other small objects seem to be drawn out at will.

You can buy this apparatus at a magic store or build it yourself from the accompanying diagram. The cabinet is of plywood, painted flat black inside. The open metal cylinder that fits inside the cabinet is painted white or some other light, bright color. Resting inside the cylinder is a load chamber that is covered with black velour and that contains the objects you will materialize. They are there all the time, invisible to the audience.

The load chamber is concealed by the cylinder that surrounds it when you pick up the cabinet. When you replace the cabinet and pick up the cylinder the audience still can't see the load chamber because its black velour covering blends in perfectly with the black interior of the cabinet.

The load chamber consists of another metal cylinder, $\frac{1}{4}$ inch shorter and about $\frac{1}{4}$ inch smaller in diameter than the brightly painted cylinder that fits over it. The chamber should be heavy enough to resist being tipped over accidentally and it should be open only at the top.

When your stunt is over you may pick up the cabinet in one hand and the visible cylinder in the other, a thumb or forefinger holding the load chamber in place inside the cylinder at the same time. Nothing is left behind and the illusion is perfect.

A simple little trick that will intrigue and exasperate your friends is performed with a short length of cotton clothesline and an ordinary small-necked vase. You merely push the end of the clothesline into the vase and turn the vase upside down. The clothesline should fall out when you release it, of course, but it doesn't. Then you grasp the free end of the line and slowly raise it, letting go of the vase. To everyone's surprise the vase dangles at the end of the line and you can swing it to and fro or rotate it in circles.

It won't work for anyone else even after they carefully examine the rope and vase. There's one little gimmick needed for the trick that they don't have, and that is the small cork ball that you placed in the vase before you started the performance and that you palmed in your hand before passing the vase around. The cork ball automatically acts as a wedge when you stuff in the clothesline and turn the vase over. Then, as long as there's tension on the

(Continued to page 256)



See and Hear



LIONEL TRAINS in Action

This year not alone do we offer you the 32-page full color catalog, but we have provided a Sound Effects Record as well so you can HEAR LIONEL Trains whistle, and thrill to the excitement of LIONEL model railroading. The new LIONELs are simply out of this world. See them! Hear them!



SPECIAL OFFER

For 25c we'll send you the 32-page full color catalog, the sound effects record with narration by Bill Stern, famous Sports Commentator, also a 32-page "FUN With LIONEL" book, a R.R. Guide Wall Chart, and an ideal layout Blue Print. It's a grand package!



SEE THEM —



LIONEL R. R. GUIDE



HEAR THEM —



Not alone can you see the LIONEL Trains in the catalog, but you can HEAR them in action on the 4-inch record.

LIONEL TRAINS

Box No. 418, Madison Square Station, New York 10, N. Y.

Please send me offer checked below. Complete special offer of Catalog, Sound Effects Record, Fun Book, Wall Chart, and Ideal Layout—all for 25c.

I enclose 25c for Special Offer.

I enclose 10c for catalog only.

NAME _____

ADDRESS _____

CITY _____ ZONE _____ STATE _____

LIONEL

a new
extra "car"

for only
\$249⁵⁰



... GET A

SERVI-CYCLE

THE COMPLETE POWERCYCLE!

SERVI-CYCLE IS AMERICA'S FIRST AND FOREMOST POWERCYCLE!

It's not a motorcycle, not a bicycle. It's the lightweight, complete powercycle. Safe? You bet! Top speed 35 m.p.h. Exceeds all International Powercycle Association safety rules! Ride it, park it . . . easy as a bicycle!

100 MILES PER GALLON!

Drive your Servi-Cycle to and from work ...for shopping, errands. Save wear, tear on your automobile. Your Servi-Cycle is built to last . . . and last . . . and what a money saver!

A FEW EXCLUSIVE DEALER FRANCHISES NOW AVAILABLE

Write nearest Servi-Cycle factory, Dept. P, for complete information. Servi-Cycle dealers are backed by national advertising in Saturday Evening Post . . . and other famous publications.

- \$249.50 price includes delivery and excise tax paid.
- Slightly higher on the East and West Coasts.

You're Safe and You Save with
SERVI-CYCLE

SIMPLEX Mfg. Corp. New Orleans 540 N. Carrollton Ave.	SERVI-CYCLE Western Corp. San Francisco 1821 Egbert Ave.	SERVI-CYCLE Eastern Corp. Baltimore 1205 S. Carey St.
---	--	---

SAY YOU SAW IT IN POPULAR MECHANICS

Test-O-Lite the MODERN TROUBLE SHOOTER



← THE NEON GLOW

LOCATES TROUBLE INSTANTLY in electric circuits, fuses, cut-outs, motors, radios, appliances. Tests everything electrical from 100 to 550 volts. Indicates hot or grounded wires. Tells AC from DC. Engineers prefer it because it has patented safety features

↑ PUTS "FINGER" ON THE TROUBLE SPOT -- QUICKLY

Far superior to ordinary clumsy test bulb. Saves precious time. Indispensable in shop or home. Vest pocket size. Lifetime guarantee. (Pat. No. 1,778,883) Purchase through regular electrical dealers.



FUSES



MOTORS



OUTLETS

L. S. BRACH MFG. CORP.

200 Central Ave. Newark, N. J.

A 10-Ton Press at Low Cost

Pressing, separating, bending, and straightening jobs in your shop are easy with this press. Ten-ton capacity provides ample pressure. Adjustable table takes work up to 18 inches wide and 11½ inches high. Send for free bulletin showing press and wide variety of accessories.

UT-10A Press f.o.b. factory \$28.25



DAKE ENGINE COMPANY
624 Seventh Street, Grand Haven, Michigan

ONE-MAN SAWMILL LESS THAN \$200

Easy To Turn Trees Into Money

Makes lumber, ties, shingles, crates, lath, studding, siding.



Belsaw Models

in 10 to 24 foot

sawing lengths.

MECHANICAL FEED, accurate set

works and positive dogs. Use tractor

or old auto engine for low cost power.

Thousands used for commercial sawing.

Pays for itself quickly. Send post card today

for FREE booklet, "How To Make Lumber" and

Catalog of Woodworking Equipment.

BELSAW MACHINERY CO., 2811-R Field Bldg.

315 Westport Road Kansas City 2, Mo.

START YOUR OWN PHOTO COPY BUSINESS!

SMALL investment . . . BIG profits. No darkroom needed. EASY work. Write immediately for FREE 4 page folder and price list.

GENERAL PHOTO PRODUCTS COMPANY

15 Summit Avenue

Dept. PM-2

Chatham, New Jersey

What's easy as a stamp to buy?
What makes your note take off and fly?



Dennison

AIR MAIL LABELS

At Stationery Departments Everywhere

POPULAR MECHANICS

Double Guarantee of Rugged Comfort

You're really set for good-looking work comfort when you wear a Big Yank navy-blue cotton suede shirt. You get features like wet-resistant cigarette pocket, elbow-action sleeves, strainproof yoke—many other exclusive benefits. Coupled with Big Yank corduroy pants with the reinforced crotch, you've got yourself a double guarantee of rugged, cool weather comfort! Full range of sizes at better stores.



BIG YANK

SHIRTS - PANTS

OUTER WEAR

Reliance Manufacturing Co. • 212 West Monroe Street, Chicago 6



QUALITY

8" FLOOR MODEL TILT-ARBOR SAW

**UNCONDITIONALLY
GUARANTEED
1 YEAR**

Complete as shown with Trans-axial Ball Bearing Motor Drive, Ball Bearing Saw Arbor, Table including extension 18" x 25", Aluminum Fence & Saw Insert, Complete Mitre Gauge, 3 1/2" steel column and cast iron base, Precision segments on mitre gauge and cradle.

**SAW
TILTS
•
TABLE
STAYS
LEVEL**

\$79.50 F. O. B.
ROYERSFORD, PA.
**UNUSUAL
VALUE**

BENCH MODEL, \$59.50
Shipping Wt., 118 lbs.

Cast iron table extension bracket furnished. Will support plywood top much larger than 9" x 18". Motor pulley and belt furnished. Blade & Motor NOT included. Overall height 35 1/2", Shipping Wt. 156 lbs.

AMERICAN MACHINE & TOOL CO. Inc.
DEPT. 110 ROYERSFORD, PA.

Write for free illustrated folder.

MARGIE

**DOES THE COLD
BLOW IN?**

**IT'S TIME TO
WEATHER-
STRIP
WITH
Mortite**

KEEP WARM — SAVE FUEL

Don't put up with dangerous, drafty zones in your home when it's so easy and inexpensive to weatherstrip with Mortite. Simply press pliable Mortite around windows, doors, baseboards, etc. It keeps cold out, keeps heat in, shuts out dust and dirt, too! Mortite adheres to any clean, dry surface. No tools, no tacking needed. Anyone can apply it.

3 Sizes: 29c - 98c - \$1.25
Higher cost of the Rockies and Canada
Get at stores or write for free circular

J. W. MORTELL CO., 522 Burch St., Kankakee, Ill.

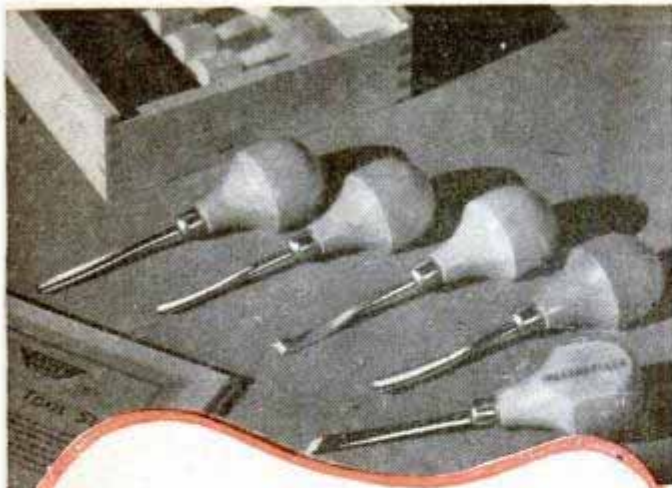

Carve Real Gifts for fun and profit

Pleasure and profit are yours when you work with a Millers Falls Carving Tool Set. With these high-quality tools you can carve wood and linoleum blocks into a variety of useful or fun-provoking objects. Their fine quality, heat-treated steel blades take and hold a razor-keen edge.

You're your own gift-maker with a carving tool set — so get ready for Christmas by carving animals, toys, model airplanes and ships the children will love. Print your own colorful greeting cards from linoleum blocks you can cut yourself. And remember Millers Falls carving sets make fine gifts themselves — for fellow craftsmen.

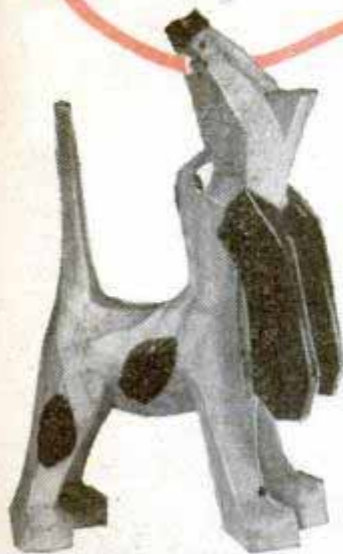

See Millers Falls carving tool sets at your hardware dealers.



MILLERS FALLS COMPANY
GREENFIELD • MASSACHUSETTS

line the cork ball keeps the rope and vase locked together. With practice you can slip the ball in and out of the vase with no one being aware of it. You can use almost any small vase, or obtain the apparatus at a magic store.

Let me suggest that you never give away the secret of any trick that you perform successfully. All of us like to be fooled.

Peter Godfrey, the movie director who is a serious student of magic, ends the shows that he occasionally puts on with a mystifying illusion that has even his fellow magicians guessing. A chromium framework something like a hammock is lowered onto the stage from overhead and Godfrey asks his beautiful wife, who acts as his assistant, to lie in the hammock. He drapes a bit of net over her and then hoists the hammock 20 feet in the air by means of a rope.

He calls up to her, "Are you there?" and in reply she reaches out a hand from the hammock and waves it.

"Then go!" he commands with a clap of his hands and to everyone's horror the hammock crashes to the floor. Godfrey walks over and picks up the gown his wife was wearing. That's all there is. His wife has utterly disappeared. That's an illusion his friends would like to understand.

Policing the Bering Sea

(Continued from page 133)

vessels. For the Department of Justice it maintains "floating courts," performs the duties of a United States marshal and enforces immigration laws. For the Department of the Interior it conducts sociological surveys of Alaskan villages and makes recommendations on living conditions. For the Department of Agriculture it enforces game laws relating to the protection of bird life. For the Department of Commerce it provides transportation for steamboat inspectors. For the Post Office Department it carries the U. S. mail.

In 1939, when war threatened, the Coast Guard's Bering Sea Patrol was entrusted with enforcement of the Neutrality Act and was charged with guarding against espionage and counter-espionage. Cooperating with the Navy and the F.B.I., the Coast Guard began to scrutinize carefully ships of other nations that wandered into western Alaska waters.

When Jap Zeros screamed down on Pearl Harbor, the Bering Sea Patrol was discontinued and the Coast Guard became a part of the Navy. Because of its special knowledge of Alaskan waters, it played an

(Continued to page 260)



MOTO-TOOL ★ The "Pocket-Size Machine Shop"



PRE-WAR PRICES STILL PREVAIL

Moto-Tool Kit No. 2 with 23 accessories (high speed steel cutters, grinding wheels, polishing accessories) and heavy-duty professional Model 2 Moto-Tool in natural-finish, hardwood case . . . \$23.50 (Items purchased separately would cost about \$30.00; you save \$6.50.)
 Moto-Tool No. 2 with one emery point \$16.50.
 Moto-Tool Kit No. 1 with 34 accessories and Model 1 Moto-Tool in wood case \$17.50
 Model 1 Moto-Tool with one wheel point . . . \$9.95.

A TOOL THAT PACKS EXTRA YEARS OF PLEASURE

... LOOK AT THE REST, THEN BUY THE BEST
 Here's a tool to please a man's heart . . . one that holds promise of endless creative hours. Dremel Moto-Tool is a "war-veteran" . . . used by all branches of the Armed Forces in far-flung repair bases . . . helped to set production records at General Electric, Westinghouse, Remington Arms, Ford and others. Hobbyist or expert craftsman, first choice is Model 2 Moto-Tool Kit with its handsome felt-lined, highly finished wood case with rows of tools begging to be put to work. Write for FREE catalog of Moto-Tool attachments and accessories.

14 REASONS WHY MOTO-TOOL'S A BETTER BUY

- Housing has "penell-type" finger grip
- Instant-action, wrenchless chuck
- Oil-less (sealed) trouble-proof bearings
- Patented automatic chuck-lock pin
- Over-size armature shaft, hardened, ground and polished
- 110 volt, universal type (AC-DC) motor
- Easily replaced commutator brushes
- About 27,000 R.P.M. cuts cleaner . . . saves cutters
- Sliding snap-type switch
- Handy hanger hook
- Sturdy, shockproof bakelite housing
- Dust filtered, air-cooling system
- Weighs only 13 oz. . . . shaped to fit the hand
- Dynamically balanced for vibrationless operation.



Do These Better - Faster

Approx. 27,000 R. P. M.

- Cleaning
- Rasping
- Brushing
- Dressing
- Burring
- Grinding
- Routing
- Sanding
- Drilling
- Inlaying
- Sawing
- Scoring
- Carving
- Cutting
- Finishing
- Sharpening
- Burnishing
- Engraving
- Touching Up
- Mortising
- Polishing



Free Both Hands With Moto-Tool Attachments

Moto-Tool Stand (left, made of heavy cast iron, holds Moto-Tool at any position or angle \$4.50

Moto-Tool Shaping Table \$2.50. (Shown with stand, right). Aids accuracy in routing, grinding.



cord protector • Sturdy, shockproof bakelite housing • Dust filtered, air-cooling system • Weighs only 13 oz. . . . shaped to fit the hand • Dynamically balanced for vibrationless operation.

MONEY BACK GUARANTEE

Buy Dremel Moto-Tool from your Dealer. If he cannot supply you, order direct from factory on 10 day trial. Shipped postpaid for payment in full (send check or money order); or send only \$2.00, we will ship C.O.D. You pay balance plus postage.

DREMEL MFG. CO. DEPT. 117-K
RACINE, WISCONSIN

FREE

value packed

RADIO CATALOG

write for it today!

Lafayette Radio

DEPT. LJ7, 100 SIXTH AVE. • NEW YORK 13

Safe Trailering Demands



Safety Engineered

Trailer Parts

- TORQ-LESS AXLES
- BULL DOG HITCHES
- BULL DOG PARKING JACKS

What's behind Safety-Engineering? Drop us a card today with your address and you'll receive the full story in our new FREE Catalog by return mail.

Send for FREE Catalog Today



HAMMER BLOW TOOL CO.

DEPT. 415

WAUSAU, WISCONSIN

Larson

"MAKE YOUR OWN" CARPENTER'S SAW-HORSE SET

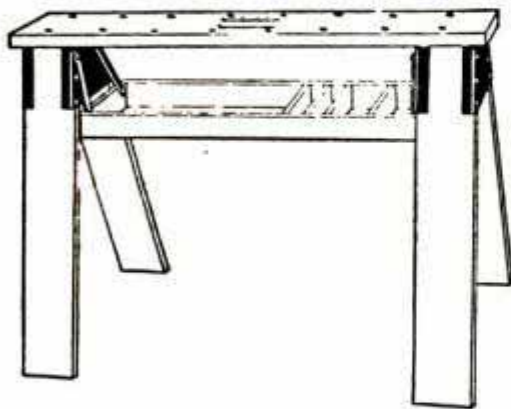

Makes a rigid saw horse that is actually a **PORTABLE HOME WORK BENCH** with many uses. Has a novel **SWINGING TOOL TRAY**. Complete hardware and copyrighted instruction sheet for easy assembly. Lumber is not included.

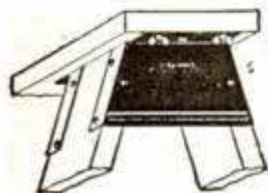

Prepaid \$1.35

CHAS. O. LARSON CO., BOX 358, STERLING, ILLINOIS

Now You Can GET THOSE MOTOR-CLUTCH- TRANSMISSION AND AXLE PARTS in stock

Why worry about parts when we have them . . . All you want, at a **BIG SAVING** . . . We ship within 48 hours . . . We also have **REBUILT UNITS** for **EXCHANGE** at Bargain Prices: **CARBURETORS — FUEL PUMPS — GENERATORS — STARTERS — SHOCKS AND KNEES** . . . It will pay you to **GET OUR PRICES.**
— RUSH YOUR ORDERS — you want

and
**SAVE
MONEY**

Get Our
**BARGAIN
PRICE
LIST**
for parts



If Car Owner Specify Make **IMMEDIATE SHIPMENT**
MECHANICS AUTO PARTS, Factory Warehouse
3807 No. Ashland Ave., Dept. PM-10 **CHICAGO 13**



THE UNIVERSAL LIQUID CEMENT

The "Mr. Fix-it"
for "a million things"

Tops in quality for 37 years. Uses unlimited . . . sticks and mends permanently. Waterproof . . . quick drying. Keep a tube on hand always. Extra quality . . . extra strength. Ready to use. **LOOK!** Get acquainted with Ambroid quality. At your dealers or send 25c for big 2-oz. tube postpaid (U.S.A. 25¢ only). Money back guarantee.

AMBROID CO.

Also 50c 4-oz. tube.
Pts., qts., gals. for
industrial use.

303 Franklin St., Boston 10, Mass.

Save 80% BY ASSEMBLING YOUR OWN ARC WELDER

Buy Only
NECESSARY PARTS

NOW!

BUILD YOUR OWN ARC WELDER

IDEAL FOR ALL
PURPOSE HEAVY
DUTY WELDING!

TAKES UP TO 1/8" ELECTRODES

PLUG INTO ANY 110
OR 220 A.C. LINE

60 LBS. OF READY-MADE PARTS . . . only \$19.95

FREE

WRITE TODAY
FOR FREE
BOOKLET P-10

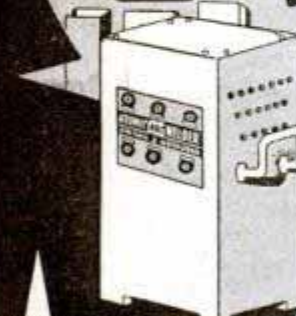

ATOMIC ARC WELDER

1038 SO. 19TH ST.

OMAHA, NEBR.

Ever Sit On A Gold Mine?



YOU can build your own business NOW in the new and flourishing field of coin-operated radios. We can show you the way to big earnings and a steady income with **TRADIO**, the radio functionally designed for coin-operation in hotels, tourist camps, hospitals, etc. Only a small investment is needed to assure yourself of financial independence for life. Write, wire or phone for complete information. No routes sold.

TRADIO, Inc. Dept. N-10, Asbury Park, N.J.
Tel: Asbury Park 2-7447

NO SCREWING WITH WIGGINS NEW QUICK HOSE COUPLING!

Snap hoses on — and off! You get guaranteed leak-proof hose connections — stronger — withstands higher or lower pressures (even vacuum) than any other quick coupling.

WRITTEN GUARANTEE!
LEAK PROOF—or

Try one on your garden water hose. Then you'll see how you can use **WIGGINS Quick-Disconnect Hose Couplings** in your business for air pressure hoses, oils, steam, hydraulic, vacuum, liquids. Won't blow-out under terrific pressures. Won't leak in vacuum. Increases flow 1/3rd. Used by America's biggest firms. Send \$1.50 for sample 3/4" water hose coupling; 1/4" air hose coupling \$1.90. Write for information on other uses in your business. Written guarantee of money back unless delighted! **E. B. WIGGINS OIL TOOL CO., Inc.**
Dept. PM, 3424 East Olympic Blvd. Los Angeles 23, Calif.



Save 75%-90%
of Set-Up Time
in **CENTERLESS
GRINDING**...

Porter - Cable Centerless BELT GRINDER

*Eliminates truing,
balancing... and continued wheel dressing*

Since the Contact Roll is behind the endless abrasive cutting belt, it is not subject to wear. Therefore, it always has a flat, smooth, true-running surface and square edge. Does not nick, round or chip. Furthermore, its *resiliency* eliminates chatter... compensates for irregularities of stock.

For different size stock, simply advance or retract the Regulating Wheel Assembly to or from the abrasive belt. It's simple, fast, *true set-up in just a few minutes!* This Porter-Cable Model L-4 handles a wider range of operations. Takes stock $\frac{3}{8}$ " to $2\frac{3}{4}$ " in diameter, in lengths from $\frac{3}{4}$ " to 2' in one fixture. (Adaptable to longer lengths also).

SAVE MONEY!

Read what the L-4 will do for YOU! Write today for information.

The L-4 is now available at a revolutionary low price! Any shop can afford it!

PORTER-CABLE MACHINE CO.
2050-10 N. Salina Street Syracuse 8, N. Y.

REAL GAS ENGINE \$6.95

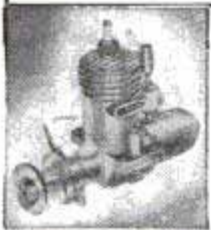

The new THOR "B"—Sensational miniature gasoline engine that **really works**. Superpower performance. Smooth, velvety power that roars into action with a "twist of the wrist." Over 25,000 already sold. 1/16 H.P. Complete with coil and condenser. Ready to run, only \$6.95. In KIT form, fully machined, 5 minutes to assemble, \$6.95, without coil and condenser. Powers all models. Fully illustrated instructions. Send \$1.00—shipped collect same day C.O.D. FREE—Send for 24-page illustrated hobby catalog.

AMERICA'S HOBBY CENTER
Dept. B107 156 W. 22nd St. N.Y. 11, N.Y.

TURNER VT-73 DESK MICROPHONE

Here's the mike you want for your rig. It's got looks, it's tough, and man, oh man how it performs. It's a TURNER! Ask your dealer or write for Free Literature on other low cost Turner Microphones.



THE TURNER COMPANY
921 17th St., N.E., Cedar Rapids, Iowa

\$2.95

TORNADO GAS TORCH

The Modern Way of Soldering

Ideal for hard and soft soldering. Will heat quickly; solder will flow freely and smoothly. No compressed air required. Self-adjusting. Safe. Economical. Can be used for annealing small parts and bending metal parts. Generates a heat of 1700° F. Simply connect to any illuminating gas jet with a rubber hose and operate. Tornado Torch No. 119 comes with three tips, ($\frac{1}{8}$ ", $\frac{1}{4}$ ", $\frac{3}{8}$ " blast).

Tornado Gas Torch No. 119 — Complete with 2 tips, for Natural Gas or Bottled Gas; with 3 tips for Manufactured Gas. \$2.95 per set. See your dealer or order direct. Send check or money order — post paid.

Robco Corporation, 202 E. 44th Street, New York 17, N. Y.

"FAIR" TEST FOR WRENCHES



STRENGTH

More brute strength, in the right places, than you need to easily set 'em down and roll 'em off.

BALANCE



Grab hold of one. It fits your hand like a glove—a comfortable, satisfactory feeling on the long job.

THINNESS



Strength isn't sacrificed to get into those awkward, out-of-the-way places. You'll thank Billings for thinness many times.

LIGHTNESS



It's a pleasure to use a Billings. No need to be a weight-lifter each time you grab a wrench.

TOUGH HEADS



Realize the pleasant sensation of backing off a tough nut without rounding off, spreading jaws or poppin' heads.

EFFORTLESS



Dispositions are happy from morn 'till night—work is fun with Billings Wrenches. Give 'em a fair test—you'll like 'em!

BILLINGS WRENCHES



Buy them at Your Hardware Store

The Billings & Spencer Company, Hartford 1, Conn.
SAY YOU SAW IT IN POPULAR MECHANICS

NO OTHER TOOL LIKE IT



BURGESS vibro-tool

Trade Mark Reg. U. S. Pat. Off.

- WRITES ON STEEL
- DECORATES GLASS
- ENGRAVES JEWELRY
- CARVES WOOD
- TOOLS LEATHER
- CUTS CARDBOARD

Works by Vibration!

Whether you work with metal, wood, glass, plastics or leather, your shop is not complete without a Burgess Vibro-Tool. Totally unlike anything else on the market! Writes like a pencil on hardest steel! Engraves, carves, hammers and cuts. Only \$7.50 at your dealer. If he cannot supply you, write to us and we will arrange for shipment.

**BURGESS
BATTERY COMPANY**
Handicraft Division
Lake Zurich, Illinois

ORDER REPLACEMENT ACCESSORIES NOW!

- V 5 Standard Needle... \$0.15
- V 3 Heavy Duty Needle... \$2.00
- V 80 Diamond Point Needle... \$5.95
- V 81 Point for Frosting Glass... \$0.75
- V 82-87 Leather Tools including punch, liner, deerfoot, spoon, double liner and cupper... \$1.50
- V 23 Straight Edge Surgical Steel Knife... 3 for \$0.50
- V 24 Belly Edge Surgical Steel Knife... 3 for \$0.50
- V 101 Foot Gauge for use with knives to regulate cut depth... \$0.95
- V 51-56 Assorted Carving Chisels... 6 for \$1.50
- V 44-48 Assorted Ball Points 5 for \$0.95
- V 41-43 Assorted Hammer Tips 3 for \$0.25
- V 115 Sharpening Stone \$0.25

DE LUXE KIT only \$16.50

Contains Vibro-Tool and 22 attachments, everything necessary for metal marking, jewelry engraving, leather tooling, wood or linoleum carving, pattern cutting, metal embossing, etc. Includes sharpening stone. Each unit individually packed in handsome, natural finish, wood storage chest. An ideal gift for any hobbyist.



BURGESS BATTERY COMPANY

Handicraft Division, Lake Zurich 1, Illinois

Please arrange for a Vibro-Tool dealer to ship the following:

- Vibro-Tool
- De Luxe Kit
- Accessories
- Enclosed find remittance
- Ship C.O.D.

Please list parts wanted by number

NAME.....

ADDRESS.....

important part in the war of the North Pacific. Its cutters transported troops, escorted vessels, carried ammunition and war cargoes. Some of its ships were assigned to the Northern Surface Search Group Unit and stood special submarine-patrol duty in the Bering Sea. The U.S.S. Arthur Middleton, a transport manned by Coast Guard officers and crew, took part in the occupation of the island of Amchitka.

Now, wartime activities are at an end and the Coast Guard is under the Treasury Department once more. But its peacetime job patrolling the U. S.-Russian border is an important one. Alaska is fast becoming the crossroads of the world.

Fancy Freighters

(Continued from page 104)

A \$1,000,000 cargo rides securely at anchor, tied to a cottonwood tree on a lonely Mississippi River bank.

Maybe you've heard about the system of government shore lights that has simplified river navigation so that the pilot simply lines the bow of the boat on one light and then another to stay in the channel. You ask the pilot about them.

"It's true," he says, "that the government has helped tremendously with its lights and the nine-foot channel. But piloting a modern steamboat isn't as simple as it might appear. The pilot still must know how to read the surface like a map."

He points to a raffle some 50 feet to port. "That raffle there," he says, "marks a hidden reef. You easily could wreck boat and cargo on it. And negotiating these hairpin bends of the lower Mississippi isn't as easy as it might look."

Maybe sometime during the trip one of the pilots will put your hands on the steering levers and say, "You steer for a spell. Just keep the jackstaff trained on the light ahead." Then he disappears into the lounge.

Soon you notice that the jackstaff or forward flagpole is veering slightly off the shore light ahead. You push the port levers but they don't budge. It seemed easy when the pilot did it.

You put your weight behind the levers and shove. They move. You feel a sense of power as the giant tow responds to your direction by slowly altering its course.

Suddenly you notice you're approaching a bend, a very narrow bend. You look at the long tow, then at the bend. It seems impossible that boat and cargo can be steered around that horseshoe curve.

"You'd better take the controls," you call to the pilot.

"Guess we'll flank it," he says.

(Continued to page 264)

The Pipeline

PIPES COAL IN! PIPES ASHES OUT!

WARMTH WITHOUT WORK

All the work of furnace tending is done automatically by *The Pipeline* Coal Burner. Pipes bituminous coal from any bin to your present furnace, burns it smokelessly and efficiently, and even pipes ashes to dust-proof containers! Modulated warmth regulated by automatic controls.

Conversion models and complete winter air conditioners. Field-tested since 1934. Write for free 20-page booklet.

FITS ANY
COAL BIN

FITS ANY
FURNACE

DUSTPROOF
ASH CONTAINER



POCAHONTAS FUEL COMPANY INCORPORATED
Stoker Division • 344 East 131st Street • Cleveland 8, Ohio



Introductions Offer \$1.00 as illustrated with 8 Basic Block Tool Holders.

- KEEPS TOOLS IN ORDER.
 - INTERCHANGEABLE HOLDERS MEAN TOOLS CAN BE ARRANGED IN ORDER DESIRED.
 - SAVES SPACE • EFFORT.
- Your tools can now be arranged in the order you desire. Illustrated folder showing variety of wood block holders and aluminum back strips available is sent with each order.

DEALERS INQUIRIES WELCOMED

Vanco Products Inc. 222 E. CUCHARRAS COLORADO SPRINGS, COLORADO

FINE TOOLS NEED FINE OIL!



• Lubricates



• Prevents Rust

• Cleans • Polishes

SOLD EVERYWHERE

3-IN-ONE Oil

FREE! Send for the chart that solves your gluing problems!



Here it is! The *NEW* Casco Gluing Chart... yours for the asking. Shows you which glue to use for indoor constructions, outdoor projects, gluing metal to wood, fabric to plastic... any combination of materials.

It's big, easy to read, just right for pasting or hanging on the wall of your workshop.

With this Chart and the four great Casco Glues... CASCO CASEIN Glue - CASCAMITE UREA-RESIN Glue - CASCOPHEN RESORCINOL-RESIN Glue - CASCO FLEXIBLE CEMENT... you are ready to tackle any gluing problem... with the right glue for the job.

FREE Send for your FREE CASCO GLUING CHART FREE

Casein Company of America, Dept. PM-07
350 Madison Avenue
New York 17, N. Y.

Please send me FREE the CASCO GLUING CHART.

Name _____

Address _____

City _____ Zone _____ State _____

BE SMART! BE THRIFTY!

Put a Whizzer Motor on your bike. You'll get 125 miles on a gallon of gas! Fits any man's balloon tire bike! Complete with all attachments necessary to motorize your bike! See your local Whizzer Dealer today.

RIDE ONE
AND YOU'LL
BUY ONE



\$97.55
PLUS TAX
F. O. B. Pontiac,
Michigan

WHIZZER

Whizzer Motor Company, Dept. 5210, Pontiac, Michigan
I enclose \$99.97, which includes \$2.42 Federal Excise Tax () check or () money order. Send me one Whizzer Motor complete, ready for installation. If descriptive literature only is desired, check here ().

Name _____ City _____
Street _____ State _____



... BE SAFE WITH PYRENE

The Browns can't live here any more. A Pyrene* Fire Extinguisher would have stopped this fire at the start. Don't you take a chance. Keep a Pyrene handy; it's quick and easy to use. Get yours TODAY! At hardware, home and auto supply stores.

Fire Prevention Week
is October 5-11.

T. M. Reg. U. S. Pat. Off.

Pyrene Manufacturing Company

NEWARK 8 · NEW JERSEY

Affiliated with C-O-Two Fire Equipment Company



OUTDOORSMEN!

Order By Mail NOW

NEW! AAF LEATHER GLOVES

Genuine A-10, with wool lining & knitted wrists. A fine goatskin glove for dress or light work. Medium size only \$1.75 postpaid



NEW! NAVY Foul Weather JACKETS

Water repellent cloth, Alpaca lined zippered front, with button flap over zipper, warm and comfortable. Sizes 36, 38, and 40 \$12.45 postpaid. Slightly used, excellent condition. Sizes 36 thru 40. \$8.45 postpaid.



COMPASSES

Lensatic hand compasses for sighting and surveying \$1.95 postpaid
Genuine Hull out or boat compasses \$2.95 postpaid
Watch type, luminous face \$1.25 postpaid.
Wrist type, luminous face . \$.89 postpaid.

NEW! HUNTING KNIVES

6" steel blade and 5" leather handle, complete with leather sheath \$1.45 postpaid

NEW! CANVAS TARPULINS

Grammeted, 8-1 2 x 10' .. \$7.95 postpaid
10' x 12' \$12.50 postpaid

NEW! NAVY WATERPROOF COVERS

67" x 87" grammeted
Makes excellent
mail tarpaulin
\$2.45 postpaid



Write for FREE
WAR SURPLUS CATALOG

SEND CHECK,
CURRENCY OR
MONEY ORDER

PACIFIC FUR & WOOL CO.

WAR SURPLUS DEPT. - BOX 926-PM - Sacramento, Calif.

BUILD THIS CONCRETE BLOCK MACHINE

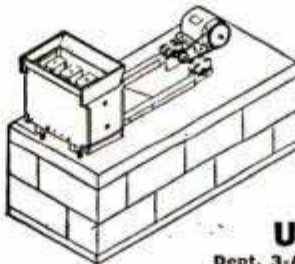

Sell blocks; or build your home, garage, barn at 1/3 cost by making and laying your own blocks.
This simple machine which you can build yourself at a cost of about \$15 (excluding motor) will make a block in 30 seconds using only one form, 2 to 4 forms can be used on each vibrator.
Power driven concrete mixer plans also. Send dime for details and "How to Make and Lay Blocks."

U-BUILD-IT SERVICE

Dept. 3-A, 206 Wilder Ave., Tampa 3, Fla.



"LITTLE WONDER" Crystal Radio

NO ELECTRIC—NO BATTERIES—NO TUBES
One of the smallest genuine crystal radio sets in the world. Slider-contact tuning, binding posts for aerial and ground. Extra long range. SEND NO MONEY. Just send your name and address and when your "Little Wonder" arrives simply pay the postman \$1.99 plus a few cents postage. Sent prepaid if you inclose check or money order with your order.

MART DISTRIBUTORS

Box 3472 Merchandise Mart, Chicago 54, Illinois, Dept. P-16

WOODWORKERS ... Get this

CONSTANTINE MASTER MANUAL

Get the Most Fun From Your Hobby
Indispensable to woodworkers. Newest, biggest edition, more pages, more color, helpful now-to-do-it articles, pre-war and new items, more bargains. Send 25c today and we will include FREE! FULL YRS. SUBSCRIPTION to Chips and Chats, published bi-monthly. Keeps you up-to-date on everything in woodworking, offers big money-saving bargains. Send now.

ALBERT CONSTANTINE & SON, Inc.
791-K 135th Street, New York 54, N. Y.



DIE-LESS DUPLICATING

Many small parts can be formed without dies, to duplicated accuracy of .001" with DI-ACRO Precision Machines. — Benders, Brakes, Shears. Save die expense and time delay. Ideal for experimental and research work, making samples, models, etc., as well as regular production runs. Write for descriptive literature.

O'Neill-Irwin Mfg. Company

341 8th Ave.
Lake City, Minnesota



SHEAR

BENDER

BRAKE

POPULAR MECHANICS

U. S. GOVERNMENT SURPLUS

TRIPODS

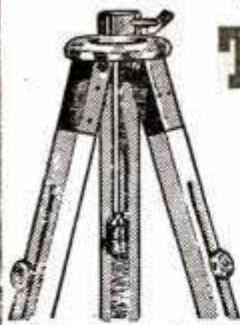

Strong Wooden Tripods with adjustable legs. 5 1/2 foot extension. Used by Government for engineers levels and transits. Can be used for holding Telescopes, Cameras, etc.

Value 24.50 **\$4 95**

WHEATSTONE BRIDGES

Used, in excellent condition. Mfg. by Thompson Lever Mfg. Co., Philadelphia. Value \$150.00 **SPECIAL \$49.50**

Engineers All Metal Army Type Hand-Sighting

LEVELS

\$2.00 PRECISION QUALITY



Send \$1.25 for 3rd Annual Edition of Gun Digest with our complete catalog of new and used guns, etc. Our separate catalog 25c.

PUBLIC SPORT SHOPS

13 S. 16th St., Phila. 2, Pa.

No COD's

New Type OILER! Just Squeeze-It SQUIRTS!

GOLDEN ROD

SQUIRT PUMP OILER

You'll sure like this new-type, Pump Oiler! So much faster, cleaner, easier to operate than ordinary oil cans. Just Squeeze-IT SQUIRTS! Light finger-touch operates pump to discharge a drop or solid stream—in any position, even upward. Pumps out almost every drop. Ideal for every oiling use about home, workshop, garage, farm.



ORDER NOW from your dealer. If he hasn't it, send \$1.25 and we'll mail postpaid. Money-Back Guarantee. Get yours at once!
DUTTON-LAINSON CO. Dept. S Hastings, Nebr.

BUILD YOUR OWN BARBECUE OVEN



PICNIC IN YOUR OWN BACK YARD-HAVE FUN

SAVE MONEY—Now anyone can have a barbecue oven in his own back yard or in the lot next door, and have fun giving barbecue picnics and parties.

Build your own barbecue oven with parts and instruction we furnish. WRITE TODAY for FREE information.

BAR-B-KIT, Dept. A2 704 Land Bank Bldg. Kansas City, Mo.

Write for **FREE** Information

OTTAWA TRACTOR SAW



Costs Too Little To Do Without

350 CUTS PER MINUTE

Make money sawing wood. Use Ottawa—fastest cutting. Cuts large, small logs easiest way. Fells trees. One man operates. Thousands in use. Built to last with heavy, stiff saw blade. Positive safety clutch control; uses power take-off any tractor.
OTTAWA MFG. CO., 3-727 Forest Ave., Ottawa, Kan.

Stop CRACKS IN CONCRETE FLOORS

this way:



Prevent accidents. Fill in cracks, ruts, shallow holes, rough spots, widened seams, etc., in your concrete basement or garage floors and outside walks with Smooth-On No. 7B Quick Floor Patch Cement. Do it yourself—save time, save money.

You just mix Smooth-On No. 7B with water and apply with a trowel. It hardens overnight and makes a tough, hard seal. Clings securely in place, for it expands a little as it sets. Keeps cracks from spreading. Stands heavy traffic.

Order Smooth-On No. 7B in 1-, 5-, 25- or 100-lb. size; a pound will fill in 11 cubic inches.

SO-226

FREE FLOOR PATCH FOLDER AND REPAIR HANDBOOK

Get both free—just mail the coupon. Folder tells all about Smooth-On No. 7B. The 40-page handbook shows you how to make practical, short-cut metal repairs. How to stop leaks, seal cracks, tighten loose parts, etc. Clear directions. 170 diagrams.



— — — Sign and Send NOW — — —

SMOOTH-ON MFG. CO., Dept. 37K
570 Communipaw Ave., Jersey City 4, N. J.

Please send me a Smooth-On No. 7B Folder and a Smooth-On Repair Handbook.

Name.....

Address.....

10-47

Do it with **SMOOTH-ON**
QUICK FLOOR PATCH CEMENT

THE FAITHFUL
HEART
OF YOUR FUEL
SYSTEM



AC FUEL PUMPS

Pulsing steadily, hundreds of times a mile, your AC Fuel Pump is the strong, reliable heart of your fuel system. It has given you long, faithful service because of its inbuilt quality and scientific design.

You can prolong that faithful service indefinitely, if you insist upon an AC when you replace your present pump with a new or rebuilt one.

AC SPARK PLUG DIVISION • GENERAL MOTORS CORPORATION

He cuts off the engines, allowing the big tow to drift with the current so that the fast water catches the head of the tow and swings it gracefully around the curve with only feet to spare between bank and barges. Then he turns on the power again.

The glamorous days when the river packet plied the nation's rivers are gone forever. But despite the many modern inventions and improvements, the character of the swashbuckling river man remains much the same, and there's still plenty of adventure and excitement in river navigation.

Science HQ of the Navy

(Continued from page 92)

final evaporation point is reached they disappear immediately and completely without leaving any waste products to clog up the machinery. Cold-weather tests of these oils and greases were made in the antarctic on the recent Byrd expedition. They proved ideal for the lowest temperatures encountered and are looked upon as one of the answers to problems of lubrication in stratosphere flying of the future. The oils naturally have a considerably wider temperature range than the greases.

A particular advantage of the new substances, the Navy scientists say, is that they can be made to order for the particular use for which they are needed. They also can be made on the production line. A pilot line has been set up at the laboratory. The great advantage is that there is no lost motion. Ordinarily products obtained from petroleum need a lot of chemical juggling before they can be turned out to meet a particular specification. With the synthetic products the chemist knows precisely what he will get when he starts working on a batch. At present, the products are considerably more expensive than those from petroleum and would be used only for special purposes. The high price is due largely to the fact that they are made on a small scale. With quantity production, it is likely that the price will be lower.

Among the major jobs of the Naval Research Laboratory at present is that of analyzing and interpreting the records obtained by instruments carried on V-2 rocket flights above the stratosphere and into the hitherto unknown region of the earth's atmosphere. To date there have been some significant findings.

For example, about 75 miles above the earth the temperature is about 100 degrees Fahrenheit. It rises from approximately 20 below at an altitude of 50 miles,

(Continued to page 268)

We're Out To Undersell The World At The Risk Of

LOSING OUR SHIRTS!

We've Been Warned!

Too Risky!
Too Daring!
Can't Be Done!
.... But

WE'RE DOING IT!

BECAUSE: We believe in big volume at **Penny-Profits** and not big profits on a small volume!
BECAUSE: We believe every reader of this revolutionary, money-saving offer of this wrist watch for himself or a loved one will welcome this chance to buy one or more of these fine Swiss Wrist Watches at almost **HALF PRICE!**
BECAUSE: In addition to our **Penny-Profits Policy** our **direct-from-Switzerland-to-you** low cost contact eliminates all costly middleman profits.

THOUSANDS SOLD AT ALMOST TWICE THE PRICE!

Yes, in the past two years, we ourselves have sold tens of thousands of these fine watches to satisfied customers all over the nation. They were a bargain at only \$8.50 for the men's and \$12.50 for the ladies' because they compare in style and beauty with watches that were sold for many, many times as much. Today—at only \$4.98 to \$6.98 **they're really a steal!**

THIS OFFER MAY NEVER BE REPEATED! Yes, unless we receive the **quick action** in huge volume that this amazing effort to bring you a bargain deserves, our loss may run into thousands upon thousands of dollars. This, naturally would force us to withdraw this offer and raise our prices to almost double the price that these watches are selling for elsewhere. **So don't delay! ACT TODAY!** Now! Remember, **you gain regardless** even though we may lose our shirts!

Direct From Switzerland To You
Price-Cut To The Bone

1947 GENUINE Imported SWISS MEN'S WRIST WATCHES

Out They Go At
This Low Price
Regardless
of loss!

\$4.98
Plus 10%
Fed. Tax

Former OPA Ceiling
\$8.50

SAVE ALMOST
50%

We dare anyone
to meet our
price!

NONE SOLD TO DEALERS

Genuine, Imported SWISS MOVEMENT

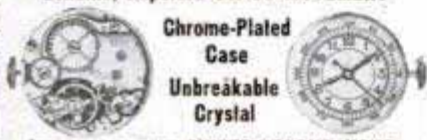

Chrome-Plated
Case
Unbreakable
Crystal

Large, Accurate SWEEP-SECOND HAND
ON MEN'S WATCHES ONLY

EVERY WATCH GUARANTEED

to be in perfect running order. All are brand new, imported direct from Switzerland to our large Southern warehouse to you! Because of the sensational cut-price nature of this money-saving offer, **ALL SALES ARE FINAL!**

SPECIAL SERVICE GUARANTEE

We now maintain a large and competent watch repair service department for the benefit of **our customers only**. In the event one of our watches should fail to render proper service you may return it to us for service or repair together with only \$1—yes, for the one low cost charge of only \$1—we will return your watch to you in perfect running order **postpaid**.

Where Else In America At This Low Price

1947 Genuine, Exquisite LADIES' SWISS WRIST WATCHES

We Reserve the right
to Reject Orders
After Present
stock is
exhausted!

\$6.98
Plus 10%
Fed. Tax

Former OPA Ceiling
\$12.50

SAVE ALMOST
50%

NONE SOLD TO DEALERS

Extra! You've Seen These **STAINLESS STEEL EXPANSION BANDS** Advertised at far higher prices!



Now Only
25¢

Now available to you at a fraction of their original cost with your watch order only!

Now Only
49¢ Ladies

THERE'S NO TIME LIKE THE PRESENT ... AND NO PRESENT LIKE THE TIME
Save Almost Half On These
Ideal Gifts For All The Family

AMERICAN MERCHANDISING COMPANY, Importers—Dept. W-46
9 Madison Avenue, Montgomery 4, Alabama

CHECK ONE: I am enclosing \$..... Ship postpaid.
 Ship C.O.D. I'll pay postman \$..... plus postage.

Quan.	Merchandise	Price	Total
	1947 Imported Swiss Watches WITH SWEEP SECOND HAND.	\$4.98 plus 50c tax	
	1947 Imported Swiss Watches WITH-OUT Sweep Second Hand.	\$3.98 plus 40c tax	
	1947 Imported Swiss Watches with Sweep Second Hand and RADIUM DIAL.	\$5.98 plus 50c tax	
	1947 PETITE LADIES' MODEL, Imported Swiss Watch.	\$6.98 plus 70c tax	
	MEN'S Stainless Steel Watch Band	25c tax-free	
	WOMEN'S Stainless Steel Watch Band	49c tax-free	

LIMIT: 3 watches and 3 bands to customer.

NAME
ADDRESS
CITY..... ZONE..... STATE.....

IF IT'S MADE BY LIONEL, YOU CAN GET IT AT MADISON HARDWARE



**NEW LIONEL
GG-1 PENN.
Electric Type LOCO**
\$29.95



No. 2332

A masterpiece of scale detailing! Designed for third-rail operation; can easily be adjusted for pantograph current from overhead wires. The 2 pantographs can be raised or lowered. 20-wheel drive, realistic horn.

Madison has been World Headquarters for Lionel since 1909. We offer a complete line of Lionel Train Sets, Cars, and Accessories. Write for big Train folder—it's FREE

AUTOMATIC SEMAPHORE

No. 151 . . . \$4.95

Another new touch for your Lionel system! Semaphore arm automatically operates when train passes.

PENNSYLVANIA STEAM-TYPE LOCO WITH SMOKE AND WHISTLE TENDER

No. 675LTS

SEND US YOUR LIONEL REPAIRS



Here's realism. Rugged, powerful! Smoke synchronized with driving mechanism; puffs when in motion. 10 wheels.

"O" gauge \$25.00,

"027" gauge \$24.50

We pay postage on cash orders. C.O.D.'s accepted.

MADISON HARDWARE CO., 103 E. 23rd St., New York 10

Please ship
Quantity _____ GG-1 Penn. Loco @ \$29.95 ea.
_____ Automatic Semaphore @ \$4.95 ea.
_____ 675LTS Loco @ "O" gauge @ \$25.00 ea.
_____ "027" gauge @ \$24.50 ea.
_____ FREE Big Train Folder.

Name _____
Address _____
City _____ Zone _____ State _____
 Cash M. O. Check C. O. D.

MADISON HARDWARE CO., 103 EAST 23rd ST., N. Y. 10, N. Y.

2 GREAT SHOWS

INTERNATIONAL HOBBY, CRAFTS and SCIENCE SHOW

International Amphitheatre

Chicago, Ill., Nov. 1-8, 1947

NATIONAL HOBBY, CRAFTS and SCIENCE SHOW

Exposition Hall, Madison Square Garden

New York City, Nov. 23-30, 1947

For Space

WIRE — PHONE — WRITE

CAMPBELL-FAIRBANKS EXPOSITIONS, Inc.

Park Square Bldg., Boston, Mass.

139 E. 47th St., New York City

or

G. W. ST. AMANT

Hotel Stevens, Chicago, Ill.

NONE BETTER! SUPER DRILL GRINDER



Sharpens round shank drills from 3/32" to 1-1/16" in diameter, up to 11" long. Grinds old drills like new in 4 different point angles, using hand or power grinding wheels. Money-back guarantee.

Price only \$2.95

At Dealers or Postpaid

CRANDALL MFG. CO. 1512 W. Slauson, Dept. FA-22, Los Angeles 44, Calif.

STOP STICKING DRAWERS WINDOWS - DOORS

Use GLIDE - not a liquid or grease, but a New SUPER Discovery -

Used by leading Grand Rapids Furniture Manufacturers. Send \$1 for lifetime supply shipped prepaid with easy instructions. Hasn't failed yet! One treatment lasts years. Every home needs it.

R. H. JOHNSON, 1927 Plainfield, Grand Rapids 5, Mich.

Sand Casting—Forging—Heat Treating—Case Hardening BRONZE FOUNDRY



is again available in limited quantity without priority. Orders filled in sequence as received. INVENTORS—SCHOOLS—CRAFTSMEN use FOUNDRYETTE for making castings quickly for new inventions, for instruction, and general purpose. Order now for early delivery. Three sizes are available capable of making bronze castings of 1½, 3, and 6 pounds weight, aluminum, copper, brass, etc. Domestic gas supply and 110 volt AC or DC energy required for operation.

Write for FREE circular.

KANSAS CITY SPECIALTIES CO.

Box 6022, Dept. PJ-3

Kansas City, Mo.

BUILD YOUR OWN TRAILER

Complete Assembly
ONLY \$67.30
Inc. Axle, Springs, 2
Wheels with tires,
fenders, draw bar and
hitch

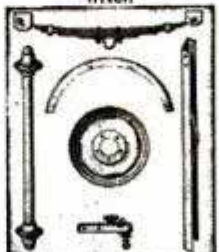

WITH NEW FACTORY-BUILT PARTS

Parts and Assemblies

Axle Assembly—tubular steel, with Timken bearings, hubs, wheel bolts, nuts, dust caps \$13.30
Axle Assembly—complete with steel disc wheels, 6.00x16 4-ply tires . . . 47.25
Spring Assembly—with brackets, U bolt and grease fittings 5.65
Disc Wheels—for 6.00 or 6.50 by 16 tires 4.25
Heavy Fenders 2.10
Draw Bar 2.45
Hitch 2.10
(F.O.B. Milwaukee)

ORDER NOW! IMMEDIATE DELIVERY
10% with order, balance C.O.D.

MILWAUKEE TRAILER MFG. CO.
622 N. WATER ST., DEPT. M, MILWAUKEE, WIS.

ANNOUNCING THE NEW Atlas "QUICK- CHANGE" 10" LATHE

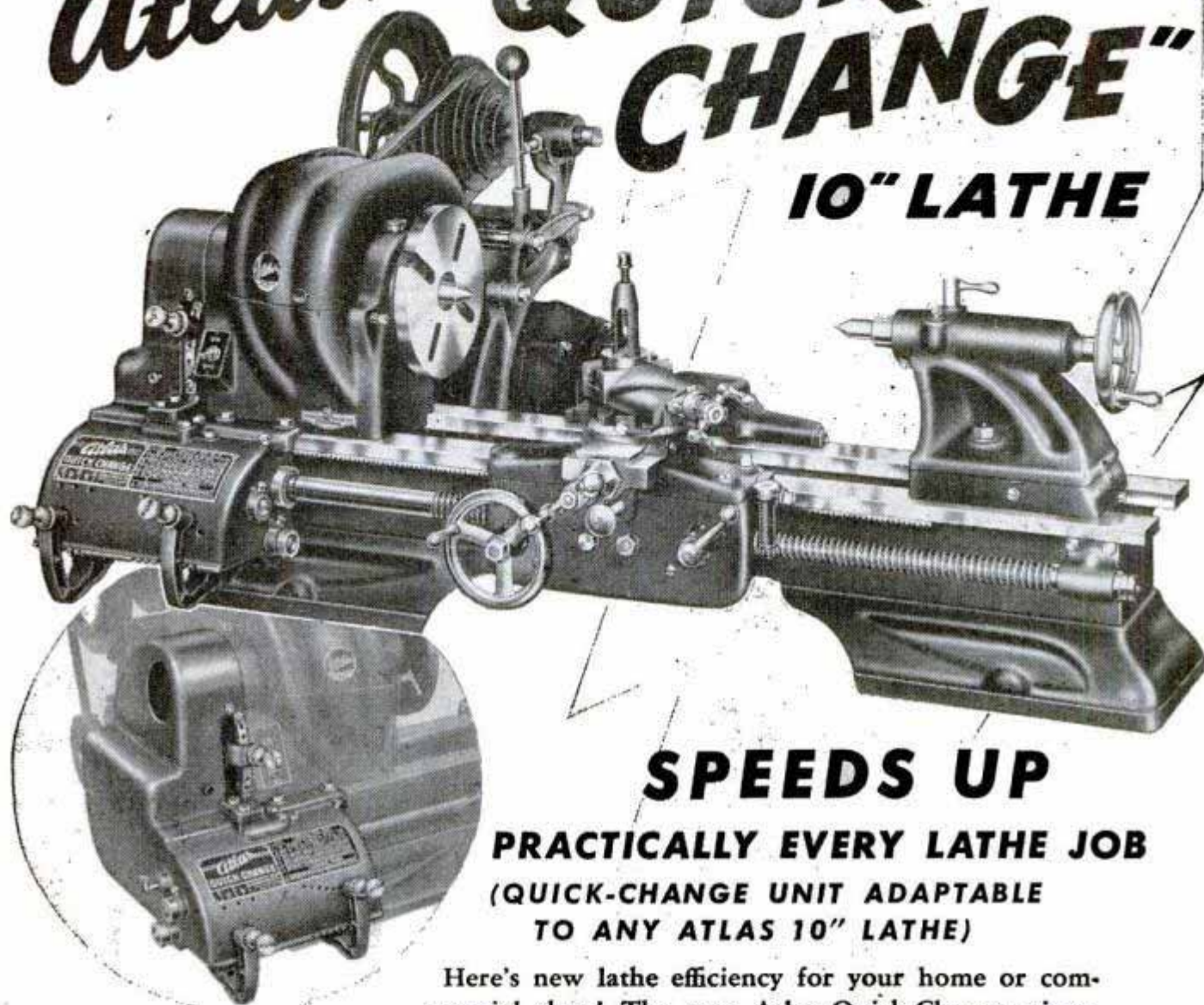

SPEEDS UP PRACTICALLY EVERY LATHE JOB (QUICK-CHANGE UNIT ADAPTABLE TO ANY ATLAS 10" LATHE)

Here's new lathe efficiency for your home or commercial shop! The new Atlas Quick-Change gives you instant fingertip selection of 54 threads or feeds ... speeds every turning operation requiring the use

of power feed ... saves you many hours of set-up time.

Quick-Change does not limit the odd thread and feed capacity of the Atlas lathe. Hundreds of additional threads and feeds are obtained with standard Atlas change gears, extra — for metric threading, special tooling, coil and wire winding, etc. Other outstanding Atlas features include 16 spindle speeds; precision ground bed; Timken tapered roller bearings; back gears; complete V-belt drive; reversible automatic power cross and longitudinal feeds.

New illustrated Quick-Change bulletin gives you full details. Send a postcard for your copy.

Model QC 42 (above) 24"
between centers \$250.00

Also QC 54 — 36" be-
tween centers ... \$280.00

Prices less motor F.O.B.
Kalamazoo

FREE
SEND FOR YOUR
COPY TODAY



ATLAS PRESS COMPANY
1043 N. PITCHER ST. • KALAMAZOO, MICHIGAN

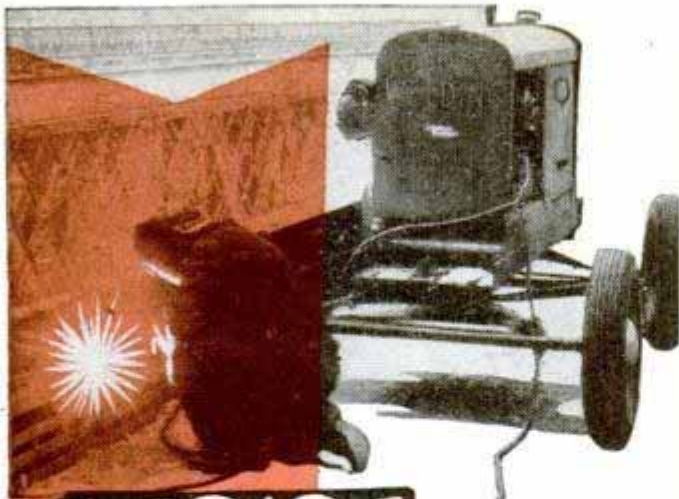

HOBART helps you
 "build your own" portable
 arc welder

Saves You
 \$300 to \$500



Big Profits on "location" jobs

You can build your own and save this amount over the cost of a complete factory built gas drive arc welder. Just think, at this low cost you can have a portable welder to go after big pay maintenance and repair jobs that can't be brought to the shop.

free book shows you how

easy it is to build your own with a Hobart welding generator, a reconditioned auto engine and chassis. This book takes you through a progressive step by step plan, showing actual photographs, plans and ideas for the home built portable welder.

You get the same welding advantages with the Hobart generator only, as with the complete factory built models. Multi-Range Dual Control and Remote Control are two Hobart advantages found on no other welder. **Hobart Bros. Co., Box M-107, Troy, Ohio.** "One of the World's Largest Builders of Arc Welders"

Hobart School of Arc Welding offers an intensive course that will make you a competent arc welder. School qualified under G. I. Bill. Check coupon for FREE booklet "Learn Arc Welding."

Hobart
 arc welders

Hobart Bros. Co., Box M-107, Troy, O.

- Generator Only
- Shaft Extension Electric Drive
- "How to Build Your Own Gas Drive Welder"
- Learn Arc Welding

Without obligation, please send me complete information on items checked. I'm interested in building my own portable welder.

NAME _____

ADDRESS _____

after having dropped from approximately 35 above at 40 miles. This second "inversion layer," or atmospheric stratum where the temperature goes up rather than down with increasing altitude, was almost entirely unexpected. The findings support sensational theories that, after a certain critical distance above the earth, it gets hotter and hotter. The probable explanation, the Naval Research Laboratory scientists say, is that at high altitudes there is an enormous absorption of the shorter, invisible, ultraviolet-light rays from the sun by the gas molecules which make up the extremely thin atmosphere. Very little of this radiation reaches the surface of the earth. Great amounts of heat are created in the absorption process.

Whether there is another stratum of declining temperatures followed by another layer where the thermometer goes up again may be determined by future flights. It seems theoretically possible.

On one flight a few months ago seeds of corn and rye were carried in an effort to determine if cosmic rays would produce mutations resulting in new species. The seeds have been tested at Harvard University, but the results have been entirely negative. The corn apparently was so injured by the great heat that it failed to germinate. The rye grew normally. This was about what was expected because the chance of a direct hit on so small a thing as a seed was very slight.

The laboratory has made other discoveries of interest to science in the outer reaches of the atmosphere 100 miles above the earth. There are no horizons to hold back the research activities of Navy scientists!

First Aid for Bowlers

(Continued from page 111)

left side of the alley, the bowler starts from the right side of the approach to allow for sufficient angle across the alley.

Improved control will cut down the number of splits a bowler gets because he will be scoring more strike hits and staying away from hitting the head pin square "on the nose." Also, he will pick up a higher percentage of the splits he does have to shoot for.

With the most important phases of control covered, Wilman groped for the right words to explain how to put "stuff" or spin on the ball.

"Frankly," he began, "a lot of bowlers would be better off if they'd forget all about hooking or curving a bowling ball. If they'd be content to roll a straight ball

(Continued to page 272)

PRECISION *and* CRAFTSMANSHIP *at* CRESCENT*



Heavy, modern machinery, such as this broach, insures sharp and accurate machining of Crescent Tools.



Frequent inspections during production eliminate size variation and provide a continuous check on quality.

A huge array of gauges including Verniers, Go and No-Go, Dial Micrometers and many others, are constantly checked against standards.

● Complete control of quality throughout manufacturing operations at CRESCENT is more than idle boast...it is reality. Many elements are combined to insure continuous production of quality tools: Heavy, modern machines hold tools firmly, insuring clean, sharp and accurate machining. Forging dies are cut to templates to assure uniformity of parts... resulting in perfect interchangeability for repair parts, even though they are made years later than the tool in which they are used. Frequent inspections during production eliminate the possibility of machines getting out of adjustment and varying from allowable tolerances. Gauges used for inspection are constantly checked against standards.

Beyond this mechanical control is an intensive, never-ending search for new methods to keep CRESCENT production up-to-date. Complaints are immediately investigated and their causes corrected. At regular meetings of CRESCENT foremen, new methods and problems are discussed and solved. All of these precautions are part of a program designed to give users of CRESCENT Tools the best product obtainable through quality production.

***CRESCENT TOOLS**
Give Wings to Work

CRESCENT TOOL COMPANY, Jamestown, N. Y.

*"CRESCENT" is our trade mark registered in the United States and foreign countries for wrenches and other tools. "Crescent" tools are made only by Crescent Tool Company of Jamestown, N. Y., and are sold by leading distributors everywhere.



**PATENTED FILTER
WHIRLCLEANS**

**WHIRLCOOLS
Your Smoke**

**MEDICO
FILTERED
SMOKING**

Frank Medico pipes have the replaceable filter that

- absorbs juices
- collects flakes and slugs
- reduces tongue bite



Only these patented filters have the 66 baffles that whirl smoke cleaner and cooler into your mouth. Replace filter when discolored.

Frank Medico V.F.Q. (Very Fine Quality)
Bowls of rich-grained beauty. Wide variety of shapes. With 10 filters. . . . **\$2**

Frank Medico Standard Quality, still . . . \$1

S. M. FRANK & CO., INC., NEW YORK 22

First Choice

Hand and power grinders to fit all needs. Sold at leading hardware stores.

LUTHER GRINDER & TOOL CO.
Sheboygan, Wis.

Luther
HAND AND POWER GRINDERS

Est. 1896

WHEELS

Spotwelded Heavy gauge steel **REDUCED PRICES!**

5"-5 1/2" solid tire, 3/8" bushing, ea.49c
 8" with 1" solid tire—
 —with 1 1/2" and 3/8" steel bearing, ea.99c
 —with 7/16" bronze bearing, ea.99c
 —with 7/16" KILIAN Ball Bearings, ea.1.19

ADD 10c ea. to all 8" prices for hubcap.
 10", bronze hub, 1/2" bearing, 1.75 semi-pneumatic tire, ea.2.19
 10", 1/2" KILIAN Ball Bearings, 1.75 semi-pneumatic tire, ea.2.29

Add 10% to ALL prices for F.P., 15% west of Miss. Check or money order only. We guarantee satisfaction. **Mail order NOW!**

C. W. YOUNG MFG. CORP.
202-4 Burnet Ave. Syracuse, N. Y.

DOWELS
Make Your Own And **SAVE**

No waiting or waiting for mahogany, cherry, or any dowel with **SPEE-DOWL**. Let this amazing tool start saving its cost now.

FREE LITERATURE on this and new never-dull carbide tipped wood-turning tools. **WRITE TODAY!**

JOHNS MFG. CORP. DEPT. C-13 DUNELLEN, N. J.

DUAL TAIL PIPE EXTENSION FOR YOUR CAR. \$2.95

DEEP TONE, PRODUCED BY 2 1/2 IN. OUTLETS

Chrome Plated - Fits All Cars

Postage Free on Money Order, Check or Cash

LYONS PRODUCTS Co. 2319 Ridgely Dr. Los Angeles 16, Cal.

PAT. PEND.

TRAILER AXLES • HUBS • WHEELS AND SPRINGS

1000 LB. CAPACITY STRAIGHT AXLE
58" Tread - 46" Spring Centers
Axle only, \$6.50—With Springs, \$22.00; Axle, wheels and hubs, \$30.50; Axle, wheels, hubs and springs, \$43.70.

1500 LB. CAPACITY STRAIGHT AXLE
58" Tread - 46" Spring Centers
Axle only, \$8.25—With Springs, \$24.50; Axle, wheels and hubs, \$32.25; Axle, wheels, hubs and springs, \$46.00; If 4" Drop Axle is wanted, add \$5.25 to above prices.

Wheels take 6.00-16 tires • Hubs equipped with roller bearings • Prices F.O.B. Fenton, Mich. • Remittance with order—No. C.O.D.
Write for Descriptive Literature

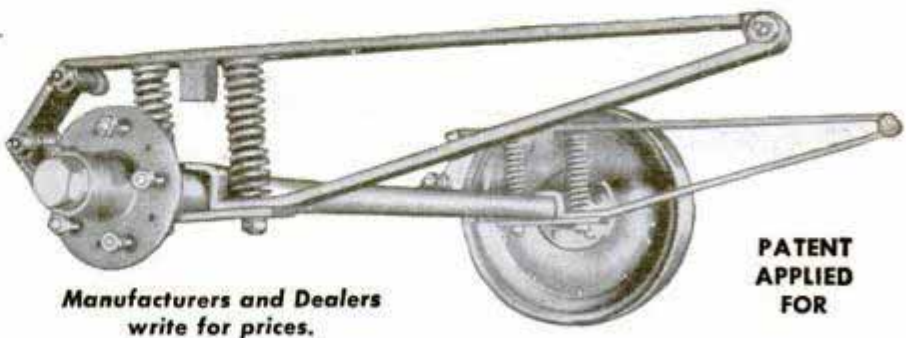

Manufacturers and Dealers write for prices.

PATENT APPLIED FOR

200 S. LEROY ST. INDUSTRIAL MACHINE TOOL CO., INC. FENTON, MICHIGAN

ARMY SURPLUS BARGAINS

Every Item BRAND NEW except Blankets

100% Wool Army Serge Pants, size 28 x 28 only, a real buy. \$2.98
 100% Wool Army Serge Pants, size 28 to 36 W., 28-34 lgths. 6.98
 100% Wool Army Covert Pants, 30 to 36 W., 28 to 33 lgths. 6.98
AIR FORCE SHEEPSKIN LEATHER JACKETS—
 Sheep collar, zipper front, 38 to 48. 22.95

WHIPCORD WORK PANTS—DARK OXFORD GRAY—HEAVY 11
 oz. wt. All sizes. SANFORIZED SHRUNK. Reg. \$3.49
 Value. Direct from this ad. 2.00

NAVY SURPLUS GRAY SLICKERS. WATER-PROOF,
 sizes 36 to 42. 4.98
AIRFORCE COVERALLS, 100% wool O.D. GABAR-
DINE, 34 to 46. 6.95
 100% Wool Army Blankets, used, small repairs
 required. 2.98
BOY'S O.D. Herringbone Twill Dungarees,
 4 to 16. .97
MEN'S 23% Wool, 77% Rayon BROWN GABAR-
DINE DRESS TROUSERS, pleats, zip fly, 28 to
36 w., 31 to 34 lgths., have cuffs. 4.98
 100% WOOL ARMY BLANKETS, select grade, abso-
 lutely perfect. 4.98
ARMY BLACK MECHANICS Socks, merrized cot-
ton, 10 to 11 1/2. 3 pr. .69
GRAY CHINO TROUSERS, 32-34-36 waist; 28 to
36 lgths. 2.98



If sending cash with order add 25c for one garment, 5c Ea. add'l. garment; west of Miss. and Canada 45c one Gar., 20c Ea. add'l. postage and handling chgs.; tax in Ohio. OR PAY POSTMAN ON DELIVERY. SATISFACTION GUARANTEED OR MONEY REFUNDED PROMPTLY.

FREE Illustrated circular of SURPLUS and civilian clothing sent with order, or free on request. Send for your copy today.

ADDISON UNIFORM CO., Dept. P-10, CAMBRIDGE, OHIO

PEDEX POWER TOOL PEDESTAL



- Handy
- Attractive
- Inexpensive

Here is a new streamlined metal base for individual power tool mountings. PEDEX Pedestals give you more pleasure and better results from your hobby or work. PEDEX conserves space, increases tool workability—is adaptable to most power tools—with motor mounting for constant belt tension. Write for descriptive folder. Dealer inquiries invited.

THE PICKWICK COMPANY
 285—3rd St. N.E.
 Cedar Rapids, Iowa

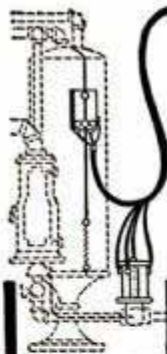

MODERNIZE YOUR GAS WATER HEATER

Step-Saver electric control makes manual gas water heaters automatic. Eliminates worry of turning off heater. Saves up to 50% on gas. **Just Press the Button** in bathroom, kitchen, or laundry. Easy to attach with Bell wire. No new plumbing required. Operates on 10-12 volts. Complete with instructions. 3 Station Unit \$28.50—2 Station Unit \$25.50. Immediate delivery. Cash orders* prepaid. C.O.D.'s, postage added. See your dealer or write Dept. A.

STEP-SAVER MFG. CO.
 DEPT. A BLOOMINGTON, ILLINOIS

IF GLUE WILL FIX IT

FRANKLIN LIQUID HIDE GLUE

will do it better, faster, easier!

Ready-to-use Franklin makes joints stronger than the wood itself. Saves time — no mixing, no heating. Banish unpleasant odors, avoid chilled joints with Franklin Liquid Hide Glue.

The FRANKLIN GLUE CO., COLUMBUS 15, O

AT YOUR HARDWARE DEALER



Put Skill In Your Hands with STANLEY CHISELS

● A few cents extra for Stanley quality in chisels is the biggest tool bargain you can buy. It gives you a blade forged from the finest high carbon chisel steel. Keen cutting edge even after many sharpenings . . . all the way back to the shank. The whole blade is heat treated and tempered to hold a keen edge. Individually tested for temper. Available in a wide variety of types, with hickory handles leather capped or with composition handles. They're a lot of chisel for the money.

Two books that increase your pleasure in tools



The first one's free . . . "The Joy of Accomplishment," an introduction to tools with many helpful suggestions. The other, the famous Stanley textbook, "How To Work with Tools and Wood," clothbound and plentifully illustrated, costs just \$1.00.

STANLEY THE TOOL BOX OF THE WORLD

Stanley Tools, 1107 Elm St., New Britain, Conn. Please send by return mail —

- The FREE booklet: "The Joy of Accomplishment."
 - 188-page book: "How To Work with Tools and Wood."
- \$1.00 enclosed plus state or city sales tax. (In Canada: Send order to Stanley Tool Co. of Canada, Ltd., Roxton Pond, Quebec.)

Name

Address

City.....State.....

SAY YOU SAW IT IN POPULAR MECHANICS

Have

Lovelier Floors...

with Less Care!

You'll enjoy new freedom with Self-Polishing SIMONIZ on your floors. The same durable long-lasting brilliance that makes SIMONIZ so famous for cars saves you lots of work... your floors clean up sparkling beautiful with a damp cloth.

Shines
as it
Dries



Self-Polishing
SIMONIZ
For Floors

and concentrate on control, their scores would improve."

So, the first advice he wanted recorded was that a straight ball, aimed directly at the head pin, is the best ball to throw until a bowler's delivery is easy and natural.

Once the kegler grooves a good swing and develops an effortless approach, he then is ready to concentrate on a sharp hook that picks up more pins than a straight ball.

The hook ball is thrown out of the side of the hand. Spin is imparted to it by lifting up and turning the fingers and wrist smoothly to the left as the ball is released.

This takes practice, as do all phases of good bowling. Wilman cautions that the average bowler will get better results by releasing the ball with an easy, natural hook delivery than by exaggerating the motion to produce an extra-sharp hook. The latter delivery is difficult to control.

Wilman is so machine-like in his approach and delivery that he knows almost to the fraction of an inch exactly where the ball will go.

For that reason, he employs a system he calls "line bowling." He stands at the 12-foot line and puts his left foot directly behind a small dot which is in line with the head pin. Then he picks out a spot on the alley in line with the 3-pin and about 15 feet past the foul line.

Drawing an imaginary line from his starting position to the spot on the alley, he approaches the foul line and rolls his ball toward the spot in line with the 3-pin. He doesn't look at the pins when he releases the ball.

His hook ball, with amazing regularity, heads straight for the 3-pin, then cuts in sharply to the left for a perfect 1-3 strike hit. Wilman's "line bowling," which most bowlers call spot bowling, requires a grooved swing, control and coordination.

Asked to summarize the main requirements for high bowling scores, Joe had this to say:

"I tell hundreds of bowlers to learn the fundamentals—such as the factors that produce a smooth, well-balanced approach and delivery—then practice, work on timing, concentrate when you are bowling. Be as jolly as you wish between frames, but when you throw the ball, mean business. Be relaxed, but try hard.

"Know what you can and cannot do. If you can't throw a hook ball, roll a straight ball. If you don't have terrific speed, be content with what speed you have. Actually, some 'fireball' bowlers get fewer pins because of the speed on the ball.

"Improve your bowling, and you'll have more fun."

\$65,000 IN AWARDS FOR BOYS

More than 700 awards—8 university scholarships, \$1,000 to \$4,000 each, cash awards, trips—in the Fisher Body Craftsman's Guild 1948 model-building competition

Any boy 12 years old or over and not yet 20 on September 1, 1947, may enter the competition to design and build a model car. Junior and Senior Divisions with identical awards let you compete with boys your own age. There are no dues or entrance fees, and awards include Model Builders' Tool Chests, cash, all-expense trips to the Guild convention, and 8 university scholarships worth \$1,000 to \$4,000 each. (Duplicate awards are given if sons of General Motors employes win.)

Judges include deans or presidents of 10 leading technical schools and universities.

Write for free membership. Each new member receives a membership card and button, a full set of plans and instructions, *all free*. Competition closes July 1, 1948. *You can win one of these awards! Mail the coupon NOW and get started.*

FISHER BODY CRAFTSMAN'S GUILD

Sponsored by: Fisher Body Division of General Motors General Motors Bldg., Detroit 2, Michigan

Gentlemen: Enroll me in the Fisher Body Craftsman's Guild 1948 Model Car Competition. Send me full instructions without charge.

Name _____
 Address _____
 City _____ Zone _____ State _____
 I was born on the _____ day of _____ 19____
 Parent or guardian _____
 Name of school _____
 City _____ State _____ Dept. 2 _____



Michael Welther
 Detroit, Mich.
 First award,
 \$5,000 Scholarship



Douglas C. Brown
 Hatboro, Pa.
 Second award,
 \$3,000 Scholarship



Donald F. Schonholtz
 Hutchinson, Kans.
 Duplicate first award,
 \$5,000 Scholarship



Charles Jordan
 Cambridge, Mass.
 First award,
 \$4,000 Scholarship



Wm. Bowman
 Bell, Calif.
 Second award,
 \$3,000 Scholarship



Donald A. Stumpf
 Buffalo N. Y.
 Second award,
 \$2,000 Scholarship



Robert Welther
 Detroit, Mich.
 First award,
 \$5,000 Scholarship



James Mariol
 Canton, Ohio
 First award,
 \$4,000 Scholarship



John R. Chadima
 Cedar Rapids, Iowa
 Duplicate first award,
 \$5,000 Scholarship



Philip Rauth
 York, Nebr.
 Second award,
 \$2,000 Scholarship

Major Award Winners 1947 Competitions

In all the wanted colors
- LUMINALL PAINT

Brighten your rooms at modest cost... Redecorate with Luminall. There's a dealer near you.

Luminall Paints, Chicago 9.

TRUCKS • TRACTORS • AUTOS

SAVE

A TWIST OF THE WRIST AND YOU

WITH **CUNO** AIRCRAFT TYPE OIL FILTER

Keep oil clean without cartridge replacement... fits all cars, trucks and tractors... No parts to wear out... replaces all popular oil filters... installed at home in a few minutes... one turn of handle removes all dirt from permanent element... drain sludge and dirt from filter sump with each oil change... standard equipment on Airline Army and Navy planes...

Every car owner, farmer, truck or fleet operator will save tremendously with the famous CUNO oil filter... lasts for the life of many cars... save big money by ordering direct from this ad. Sent postage prepaid. Address Dept. 1413.

\$9.00

SHEFRIN SALES COMPANY
 1329 W. 9th St. KANSAS CITY, MO.

SAY YOU SAW IT IN POPULAR MECHANICS

Something NEW Has Been Added To —

WALDEN

WORCESTER

BOXTITE WRENCHES

- METAL — New "Power-Packed" Alloy
- FIT — Precision Broached Opening
- WEIGHT — Lighter but Stronger
- USE — Longer — Greater Leverage
- FINISH — Satin Chrome, Rust Resisting
- HEADS — Wide-Arm Offset Design

Boxtite Wrenches with precision broached 12 point openings, 3/8" to 1" Extra tough, drop-forged, the alloy is heat treated and hardened.

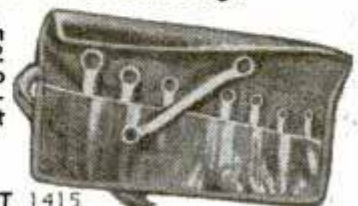

SET 1415

Write for additional information

STEVENS-WALDEN, INC.
 Worcester, Massachusetts

Over Forty Years of Master Toolmaking

**NOW is the time
to buy GOOD tools**

WRENCHES · PLIERS
PUNCHES · CHISELS
SCREWDRIVERS
SPECIAL TOOLS
SOCKETS &
HANDLES
PULLERS
TOOL
BOXES



Representative Plomb
tool values.



You get extra value in Plomb tools today, because prices are close to pre-war levels. Plomb's production of 13 times 1940 makes this possible. Materials, design and accuracy are better than ever before. So get the tools you need from your Plomb dealer *now*. Write for catalog to Plomb Tool Company, 2257G Santa Fe Avenue, Los Angeles 54, Calif.

4764

PLOMB
streamlined
TOOLS

LOW COST COMMUNICATION

For Your Home, Farm, Warehouse
with **ARMY**
FIELD TELEPHONES

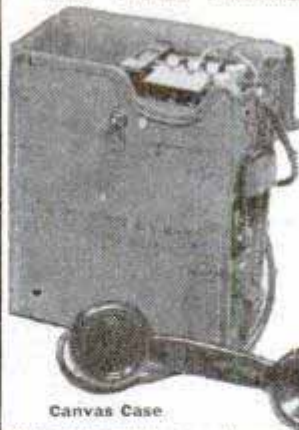

Canvas Case

Battlefield Proven!

Available Now!

Here is convenient, low cost communication for you! Use it from house to garage, to workshop, barn, etc. Easy to install. Just hook up terminals to any two strand wire; several phones on same line if desired. Uses standard flashlight type batteries; long lasting. Good for miles. Complete with canvas or leather case.

NEW complete per pair \$29.50
(canvas case)

USED complete per pair \$32.50
(leather case)

per pair **\$19.50**

SWITCHBOARDS, handle up to 12 telephones, used, \$45.00. New Telephone wire, 500 ft., \$3.50. 1/2-mile reel, \$10.50. 1-mile reel, \$16.00. Subject to prior sales. FOB Sacramento.

Send check or money order to

LORIS SALES

919 Second St., Dept. B

Sacramento, California

Surplus
New
War

HOIST & WINCH

Eliminates Back Breaking Ordeals



Small But Mighty. Were made to be used on B-29s for lifting bombs. 2,000 lbs. capacity. Weight 16 lbs., perfect for lifting or moving loads in trailers or onto trucks, tractors, or any other movable machinery.

Fine for garages, implement stores, warehouses, assembly lines contractors and many other uses. Original cost, approx. \$100.00.

Sale Price complete with mounting brackets, **\$26.30** only

Send check or money order for immediate delivery

SESCO ENGINEERING & SUPPLY CORP.

15th Ave. and Clay St.

Dept. PM

No. Kansas City, Mo.

MINIATURE ELECTRIC MOTORS



Ideal for powering all kinds of models. Runs on 24 V.-D.C. One of the smallest motors made. Only 1 1/2" x 1" x 2". Cost Gov't. nearly 1/20¢. Hundreds of uses.

OUR PRICE BRAND NEW PREPAID IN U.S. **Only \$295**

HEATH COMPANY... BENTON HARBOR, MICH.

heavy duty — ball bearing — all purpose

MANDREL



Length Overall 14"
Diameter OD 1 3/8"
Shaft 1/2" or 5/8" Optional
Lugs 1/4" x 1 1/4" x 1 3/8"
2" between collars
Right or left hand Thread Optional

Postpaid **\$8.00**
in U. S.

Precision ground ball-bearings; Bessemer steel shaft, completely enclosed; seamless steel body. For home, farm and shop—saws, shapers, fans, power take-off, wind mills etc. Be sure to state shaft size and thread (R or L) desired. Send Money Order or Certified Check. Full money back guarantee. If your dealer cannot supply you, write.

TRIO MACHINE CO., Box 187, Dept. PM, Willoughby, Ohio

110 VOLT - 60 CYCLE - 2500 WATT
WAR SURPLUS POWER PLANT GENERATOR
WEIGHT 200 LBS LIST PRICE \$276.00

NEARLY NEW

110-volt single phase 60 cycle A-C generator. Exactly like commercial power. Self-excited. No other equipment required. Fine for ranchers, taverns, sportsmen. Generate your own electricity. Powerful portable plant. (Complete except engine.) Small engines easy to pick up or you can use water or wind power. Fine stand-by power for farms. Contractors use for on-job power saws, drills, etc. Full instr. installing, using. Guaranteed perfect. Order now or write for details.



Only \$89.40
FREIGHT PREPAID U.S.A. ONLY

LECO ENGINEERING CO. Box 908-PM-C, Lincoln, Nebr.



We'll Start You Complete in this **PRODUCTS BUSINESS** And Help You Put It Over

The great building industry is your profitable market for masonry products. Low investment . . . high returns . . . wide-open opportunity to establish a lifetime business.

The biggest building years in the nation's history are just beginning. New construction, involving billions of dollars, means huge demands for block, drain tile, and other masonry products which YOU can manufacture locally, from local materials, with local labor for local consumption. Remember, MASONRY products are in mesh with today's building preference!

Use our modern machines and equipment to insure the finest quality products at pared-to-the-bone manufacturing costs. Sold direct from factory to you. Backed by 40 years of pioneering and manufacturing. Write for new catalog. Describes complete line of equipment with prices plainly marked. Tells how we help you in manufacturing and merchandising. Write TODAY.



CONCRETE EQUIPMENT COMPANY

512 Ottawa Avenue
Holland, Mich.



BUILD YOUR OWN TRAILER



Get these Modern
Complete Plans

Select just the model you want—for hunting—travel—camping—or as a home. Each plan is complete with simple, step-by-step instructions and a bill of materials. Easy to follow. Three models!

- STOCK No. H27 NATIONAL MODEL 27. A sleek 27-foot trailer with 3 rooms, lavatory, etc. Sleeps six. complete plan \$1.00
- STOCK No. H20 NATIONAL MODEL 20. A good-looking, easily-built 20-ft. trailer. 3 rooms; sleeps four. complete plan \$1.00
- STOCK No. H10 NATIONAL CAMPER. A compact unit for traveling, camping, hunting, fishing. Sleeps two. Complete plan .50

Special—Order all 3 of above plans.....\$2.00

FREE! Big parts catalog with any order

NATIONAL TRAILER STORES

Dept. 10 Box 2353 Terminal Annex — Los Angeles 34, Calif.

NAVIGATOR'S SEXTANT TYPE A10-A

(far superior to Type A10)

Regular price, \$300;
now only \$17.50

This famous A10-A Fairchild sextant is a marvel of precision and accuracy and is ideal for MARINE or AIR navigation! Unlike the earlier and cheaper model, the A10-A has the genuine automatic averaging device which alone increases accuracy and timing of celestial observations several hundred percent. The price is only \$17.50 and you get, in addition to the finest sextant, the fine grain wood carrying case (lock type), plastic marking discs, battery holder (for lights), wrench AND the mounting hanger which enables you to hang the instrument on boat, plane, etc.

If you wish the two power telescopic sight attachment at no extra charge please advise with order. Also we send absolutely free the famous AAF Celestial Navigation and Sextant book! Condition: slightly used! Only \$17.50. (Do not be misled; there is only one type sextant like the A10-A.)

- We also offer other sextants: Link A12,\$17.50;
- Bausch & Lomb\$32.50
- AVIATOR'S sun glasses, metal rimmed, gold plated, with case\$ 4.95
- AVIATOR'S flying goggles, clear lensed, metal frames, new, \$ 4.95
- AVIATOR'S flying helmets, gabardine type, tan color Two for\$ 1.00
- AVIATOR'S flying jacket, type A-2, soft pony leather, brown, cloth lining; the esquire in soft light trim jackets ... \$24.50
- AVIATOR'S flying boots, leather with thick pure shearling lining, new zipper enclosures, slightly used, per pair... \$ 5.95
- RADIO headphones, AAF type\$ 1.95
- RADIO hand microphone, Type T17\$ 2.95
- RADIO throat microphone, 95c, three for\$ 2.00

AERO PARTS SUPPLY, Dept. A10-A

MUNICIPAL AIRPORT

HOUSTON 12, TEXAS

COMPLETE HOME WORKSHOP

5 POWER TOOLS IN 1



LATHE 10" swing, 30" between centers, 3/4" spindle, face plate, spur center, tool rest.

\$34⁹⁵

SAW

Takes 6" to 8" blade. Arbor handles scratch brush, grinder, buffer. Saw blade not included.

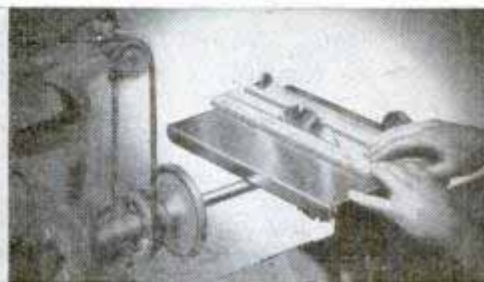

DRILL PRESS

Takes drills to 1/2", 2" travel, 1/2" spindle. Drills to center of 12" circle.



GRINDER

5" Emery wheel furnished. 4 step cone pulley.

Spindles mounted in replaceable bronze bearings.

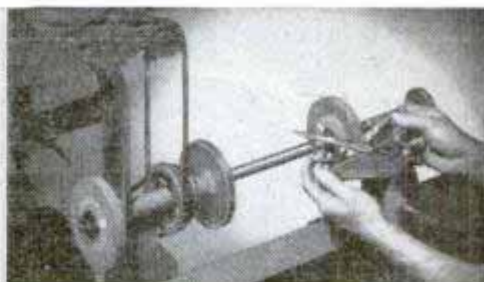

SANDER

8" diameter disc takes any type abrasive. Heavy construction lasts for years. Motor not included in price.

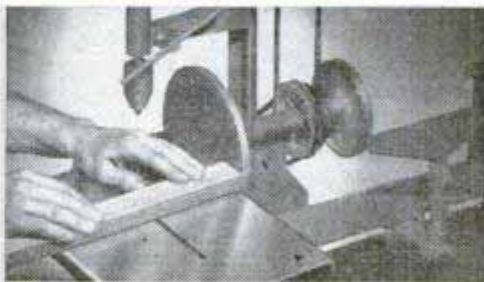

**10
DAY
TRIAL**

EMRICK, Inc., 1740 Clinton St., Kalamazoo 24, Mich.

Ship on 10 Days Trial. I am enclosing \$17.50, balance C.O.D. Send Free Literature Send Free Tool List

NAME _____

ADDRESS _____

CITY _____

Emergency Bottled Power!

New DOUBLE-PURPOSE AIR-O-FLATER

FIRE EXTINGUISHER
TIRE INFLATER



Distributors
WANTED



New
LOW PRICE
\$5.45

Complete with
mounting bracket



A "MUST" FOR CAR OWNERS!

Puts out gas, oil and electrical fires—contains the new CO₂ fire-fighting gas, under high pressure. Safe and easy to operate, non-injurious and quick-acting. Also inflates tires "in a jiffy"—simply attach hose connection to valve stem and turn lever of AIR-O-FLATER—tire is inflated in about 3 seconds.

See your dealer, or mail check (or M.O.) for \$5.45—satisfaction guaranteed or money refunded. Refill—75c.

GENERAL AIR PRODUCTS CORP.

3318 MONTROSE AVE. • CHICAGO 18, ILL.

The easy way to paint!

Speedy Sprayer



Favorite of home owners and craftsmen for 20 years! SPEEDY SPRAYER gives your work that professional paint finish everyone admires. Sprays paint, enamel, varnish, lacquer, etc. . . . 4 to 7 times faster than hand brushing! Lightweight, portable, uses any 1/4 H.P. motor. Improved diaphragm principle assures clean, oil-free air. You'll find dozens of time and money saving uses for SPEEDY SPRAYER, including spraying insecticides 2-4-D and DDT. Complete outfit, without motor, only \$26.95.

At leading hardware, lumber, and auto supply dealers. FREE—write for bandy booklet "How to Spray."

W. R. BROWN CORPORATION

5717 Armitage Ave. • Chicago 39, Ill.

ONLY
\$26.95
LESS
MOTOR

SOLID BRASS 12 FT. PORTABLE

RADIO ANTENNAS

Real \$15 Value Now Only \$4.95 Postpaid
FOR HOMES, BOATS or AUTOS

JUST OUT! Gov't surplus used on Army tanks. These telescopic rustproof antenna have tremendous pickup eliminate dangerous wiring. Solid Brass throughout practically insuring NOISE FREE RECEPTION.



12
Exceptionally
Rugged Sections
compress into 1
ft. 4 in. Handy for
Camping Trips, also
Useful for Transmitting,
FM & Television sets.
Each antenna comes with clamps,
nut, lug, and wire. Easy to in-
stall anywhere.

QUANTITY LIMITED

ORDER TODAY. A real \$15 value for only \$4.95 Postpaid. Mail check or money order now or sent C.O.D. plus postage. Money back in 10 days if not satisfied.

RADIO HOSPITAL 1113 Lexington Ave., Dept. A-10
New York 21, N. Y.

PRESS-TITE CAULKING AND SEALING CORDS

Keep cold out!
Seal holes and cracks!



Soft, rope-like Press-Tite Cords effectively seal windows and doors against cold and dust. Save fuel.

Press-Tite Cords will not harden—they stay soft and seal tight. Use also to fill any cracks or holes in wood, plaster, masonry or brick. Just press into place—no tools needed.



PRESSTITE ENGINEERING CO.

3978 Chouteau Ave., St. Louis 10, Mo.

OK's CO₂ IGNITIONLESS 3/4 OZ. ENGINE

No Spark-Plug • Gasoline: No Coil (Wiring), Batteries
Smallest, lightest expansion-type, reciprocating-action power plant. For model planes (Tractor or pusher types) Race Cars, Speed Boats, CO-2 delivers spectacular power-to-weight: 7000 RPM; 20 to 60 sec. runs from single carbon-dioxide cartridge. Positive "Rip" starting, speed adjustable. 1 pc. steel cylinder, fitted piston-precision to 1/10,000".
Displ. .0175 Bore .275 Stroke .300
CO-2 is made & gtd. by makers of 'OK' TWIN and other palm size gasoline engines. At hobby dealers or write factory.

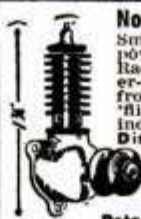

\$4.95
With
Holder

HERKIMER TOOL AND MODEL WORKS, INC.

Pats. Pend'g. Herkimer 4, New York

CARBOLOY-TIPPED

Tools for Wood, Metal, Plastic

Same high quality as used by the big factories. Long-life, high production—a pleasure to use. Performs perfectly on wood, metal, and plastic. In pairs as shown—either 1/4 or 5/16". Cash with order, postpaid. Ask for free catalog.



\$2.
per set

SCHMARJE TOOL & ENGINEERING CO., MUSCATINE, IOWA

DRILL-INDEX

A compact container for indexing and filing twist drills. Eliminates search. Made entirely of steel in ten sizes. See your dealer or write to



HUOT MANUFACTURING CO.

555 No. Wheeler St. Paul 4, Minn.

BECOME A PISTOL EXPERT WITH A HY-SCORE AIR PISTOL

- No Pumping
- Powerful, Fast
- Single Shot
- Precision-Made
- 30 1/2 oz.;
- 10 1/4" long

HY-SCORE
PELLETS
FIT ALL PISTOLS
CAL. 22 3.00
CAL. 22 3.00
NET 1000

SEE YOUR
DEALER
Send For Free Cir-
cular Dept. M10



HY-SCORE ARMS CORP. • BROOKLYN 1, N. Y.

**PROVEN POWER TOOLS FOR A VALUE
AND QUALITY CONSCIOUS MARKET**

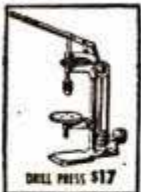

DRILL PRESS \$17



16" SAW \$12.50



LINE SHAFT & HANGER
ASSEMBLY \$7.40

"The Searjeant Line is the result of my 20-year experience as a user, designer, and manufacturer of power tools. Acceptance proves that it is just what craftsmen want." (Signed) Will Searjeant.

**A 6" BENCH
SAW THAT
CUTS 2" STOCK
\$19.00**



Delivered
C.O.D. or outside
U.S.A. add 25c

A husky, durable saw heavily built of grey iron and steel. TOIRING-TON NEEDLE BEARINGS for long life and friction-free operation. 12" x 14" table tilts to 45° angle; adjustable guide; adjustable, removable guard; miter gauge; hardened and ground shaft. Arbor adjustable for depth of cut. Uses standard 6" blade (available at extra cost of \$4.00). A great saw at a really low price.

Send for literature describing entire line
Satisfaction Guaranteed or Money Back

Searjeant Metal Products, Inc. 89-90 Allen St.
Rochester 6, N. Y.

SURPLUS HARDWARE SPECIALS

Hack Saw Blades, High Speed, Star Moly 10-32. Listed for \$40 per gross. Our price \$1.30 Doz., or \$12 gross.

- 4 Phillips Screwdrivers, #1 to 4.....\$1.00 set
- 5 Common Screwdrivers, 1 1/2"-2"-4"-6"-8"..... 1.25 set
- 6 Cold Chisels, Hand Type 4" to 8"..... 1.80 set
- Carton of 10 GE 110 Volt 2 1/2 Watt Argon Glow Lamp
Standard socket listed at \$.50 ea..... 2.00 cart.
- Tool Roll, Brown Duck, 26"x52"-49 Pockets..... 1.25 ea.
- Hack Saw Frames, Adjustable, Mfgd. by Union Hdwe..... .60 ea.
- 12 Assorted Amer. Std. Files 6" to 14"..... 2.25 set
- 24 Assorted Files 4 to 14"..... 4.00 set
- 4 rasps 8 and 14" Cabinet, 14" Half Round, 12" Flat.... 2.10 set

All orders \$5.00 and over sent postpaid.

All orders less than \$5.00 add 10% for postage.

Write for complete list.

INDUSTRIAL SUPPLY CO., 312 E. 33 St., New York City 16, N. Y.

LAW

STUDY AT HOME for PERSONAL SUCCESS and LARGER EARNINGS. 39 years expert instruction—over 108,000 students enrolled. LL. B. Degree awarded. All texts furnished. Easy payments. Send for FREE BOOK. G. I. approved.
AMERICAN EXTENSION SCHOOL OF LAW
Dept. 82-M, 646 N. Michigan Ave., Chicago 11, Ill.

AMAZING NEW "SAW CHIEF" Multi-Purpose Power Saw and File



**Abolishes Tiresome Hand Operations
MAKES HARD WORK . . . EASY**

Saves time, labor, money! Just press trigger and it quickly saws through all metals, stainless, monel, castings, etc. . . . also through wood, plastics and other materials. Used as a power-driven file, it simplifies tough tedious filing jobs. Powered by electricity, air or flexible shaft. Easy to operate. Lightweight. Equip your shop with this valuable new tool. Satisfaction guaranteed. Order Now! PRICE: SAW CHIEF ONLY, \$45.00. DRILL, \$39.50. (MONEY-SAVING COMBINATION, SAW CHIEF and DRILL, \$79.50.) Metal Carrying Case, \$6.50.

CHICAGO PRECISION MACHINE CO.
906 South Michigan Avenue • Chicago 5, Illinois

New Complete CONCORD RADIO CATALOG



MAIL COUPON FOR YOUR FREE COPY NOW

Ready now—the most complete presentation of radio, electronic and television equipment and supplies in Concord history! Packed from cover to cover with thousands of items—Radio Parts, Radio Sets, Amplifiers, Sound Systems, Test Equipment for every purpose, Record Players, Record Changers, Television Equipment, Ham Gear, Receivers, Transmitters—160 pages of everything and anything in Radio and Electronics. Hundreds of money-saving values in standard-make parts, including scores of new items from nationally-famous makers. Immediate shipment from CHICAGO OR ATLANTA. Mail coupon for your FREE copy at once.

Build Your Own Radio, Amplifier, Etc.

Send us your order for the standard parts required for your own experiment for any published kit you plan to build. You will receive the desired parts promptly and at lowest prices. We can supply complete parts, blue-prints, etc. for many of the famous Popular Mechanics Kits, and standard parts for ALL kits. Mail coupon below for the new 160-page Concord Catalog and see why, for 27 years, hundreds of thousands of experimenters have bought from Radio Experimenters Headquarters
- - - Concord Radio Corp.

CONCORD RADIO CORP.

LAFAYETTE RADIO CORPORATION

CHICAGO 7

901 W. Jackson Blvd.

ATLANTA 3

265 Peachtree Street

Concord Radio Corp., Dept. P-107
901 W. Jackson Blvd., Chicago 7, Ill.

Yes, rush FREE COPY of the comprehensive new Concord Radio Catalog.

Name _____

Address _____

City _____ State _____

SAY YOU SAW IT IN POPULAR MECHANICS

NOW! EXTRAORDINARY New GOV'T RELEASE!

Shoots A High Pressure Stream Of 30 Feet!

ALL PURPOSE STIRRUP

PUMP

ONLY **\$1.49**
EACH



The Tool of 100 Uses!

Just the thing for

- FIRE FIGHTING. A very handy tool to have in your workshop in case of fire.
- Spraying Garden
- Washing Cars
- Bailing Boats and Basements

Finest quality all purpose pump on the market! Never before offered at this ridiculously low price. There are dozens of uses for this versatile sprayer. Approximate height 27" overall. Complete with 10 feet of flexible hose, ready for assembly. SEND NO MONEY: Simply send name and address and number of pumps desired and we will promptly mail your order C.O.D. If you prefer send \$1.49 with order and we will pay all postal charges.

S & B SURPLUS SALES CO., Dept. P-40

2905 W. Madison St.

Chicago 12, Ill.

Fill Holes, cracks, dents, gouges . . .

These BETTER FILLERS

● HARDEN FASTER

● SHRINK LESS

● STAY IN!

FILLS HOLES
IN ONLY
1 APPLICATION



TAKES HIGH FINISH

CRACKS ARE
EASILY FILLED

Duratite Wood Dough will fill rough or irregular cavities in wood, metal, plastic or plaster in one application. (Duratite Surfacing Putty for shallow cavities). Can be sawed, cut, milled, sanded; are waterproof, fire resistant. Seven wood colors, in tubes or cans, at Hardware and Paint stores.

Only 25¢ for large tube of Wood Dough and interesting booklet. Write

LARGE TUBE
25¢ Postpaid

WEBB PRODUCTS CO.

228 South G Street, San Bernardino, California
or Webb Company - Dept. M - Norcross, Georgia.



DURATITE

WOOD DOUGH AND SURFACING PUTTY

KAYAKS

AQUA VIR

Easy to Build

**OUTBOARDS
ROWBOATS**

**25¢ COIN
FOR ALL
THREE**

AQUAMOBILE V-18

Designed for Auto Engines. Open or with cab. Length 18 ft.
Fast VEE Bottom Hull

KAYAK BOAT CO., 703P-WHITTIER ST., NEW YORK 59, N.Y.

**BOATS for
Home Assembly**

"U-MAK-IT"

KAYAKS, ROWBOATS, DINGHIES,
INBOARDS, OUTBOARDS, RUNABOUTS
Cut-To-Fit for Quick Assembly. Everything
Complete plus Illustrated Instructions. No Ex-
perience Necessary. Simple as A. B. C.

SEND 25¢ POSTAGE (COIN) TODAY
FOR 3 MONEY SAVING ILLUS. CATALOGS
Showing all '47 Models (marine plywood)
and construction details.

**French Type PHONE
HAND SET**

With butterfly switch on handle. When the switch is pressed, the microphone is connected into the circuit and an additional set of contacts are closed, to operate a change over relay. Has a 6 ft. length of cord, with a PL. 55 plug for earphone and PL. 68 for microphone and switch. Impedance of earphone approx. 2500 Ohm; impedance of microphone approx. 250 Ohm (carbon); connected with batteries it can be used for inter-communication system. They are brand new and the original cost is many times what we are offering them to you . . . while they last.

\$3.95

MICHAEL STAHL, Inc.
39 Vesey St., Dept. PM10 New York 7, N. Y.

BIG Class 'C'

ASSEMBLED-TESTED

Rocket

ENGINE

**POWERFUL! SMOOTH!
FAST STARTING!**

Over 30,000 Sold to Date
Choice of Model Builders
Who Demand the Best

CORPORATE PRODUCTS INC.
409 GRISWOLD ST DETROIT 26, MICH

**DIRECT FROM
FACTORY
ONLY**

\$8.95

LESS COIL AND
CONDENSER

SEND **\$1** WITH
ORDER

SENT C.O.D. OR INSURED
PARCEL POST FOR FULL
PRICE PLUS 25¢

Now CHEAP OIL BURNER

FOR HEATING AND COOKING STOVES-FURNACES

HEAT YOUR HOME, COOK YOUR MEALS
WITH CHEAP FURNACE OIL

NO MORE SHOVELING COAL
OR ASHES. Sensational Fuelizer
Starter Vaporizing System turns Cheap
No. 1 Furnace Oil, also Range, Heater,
Tractor Distillate, Kerosene and like
oils into oil heat—one of the quickest,
hottest fires known. LIFETIME GUAR-
ANTEE. \$1.00 Bonus Offer for Testing.
We will let you try it in your own
stove or furnace for one month. Get yours for intro-
ducing. Big profits QUICK. Be first. Send in your
name today for details and cash in on the tremen-
dous demand for this Amazing Invention.

NORTHWEST MFG. CO., 608-M, Mitchell, S. Dak.

BARGAIN 3X ARMY TELESCOPE

Original Cost \$150.00 — Our Price \$7.50



ALL COATED LENSES — BRAND NEW

An ideal gift for viewing objects, landscapes, seashores, etc. The high resolving power of the six coated lenses, five of them achromats will bring out great details. For the experimenter it can be dismantled and used for hundreds of projects. Length 22½ inches. 36° Field. Postpaid \$7.50.

500,000 Lenses and Prisms. Send 3c stamp for "Bargain" List

A. JAEGER'S

123-26P ROCKAWAY BLVD., SO. OZONE PARK 20, N. Y.

EXHAUST BLOWERS

\$15⁸⁵



FOR PHOTOGRAPHERS
HOSPITALS • LABORATORIES
• WORK SHOPS
LAUNDRIES • OFFICES
RESTAURANTS • PRINTERS
PLAYROOMS

100 CU. FT. FRESH AIR EVERY MINUTE!

Solve your ventilation problems with this **NEW** rugged, built-for-service blower and exhaust. Quick and simple to install. Anyone can do it with ordinary household tools.

110 Volt. A.C., 50-60 cycles. Continuous duty. BALL BEARING motor assures quiet, trouble free operation. Durable Housing Insures Long Life. Send Check, Money Order. No C.O.D.'s. West of Mississippi add \$1.00 for mailing, handling. Immediate delivery.

UNIVERSAL YONKERS CORP. (Dept. M-10) 41 Locust St., Yonkers 2, N. Y.

MYSTERY RADIO ONLY

\$2⁹⁹



post paid
No Tubes
No Batteries
No Electricity

Radio, Fun
Maker, Micro-
phone, under

pillow speaker, ear piece for hard of hearing all in one. Very small unit. For home, camping, trips, etc. Send no money. Order today. Be first in your gang. Pay postman \$2.99 plus C.O.D. Postage on delivery.

CLAIRE DISTRIBUTORS,

P. O. BOX 747, DEPT. PM-4
NORTH HOLLYWOOD, CAL.



WAKE UP YOUR SCALP Want better looking hair? Embarrassed by falling dandruff, itching scalp? Then try VITABRUSH, new electric driven scalp brush that gives your scalp a vigorous and invigorating "workout" in just three minutes of fun. Cleans scalp. Stimulates blood supply. Restful. Pleasant. Write *today* for complete information and satisfaction-guaranteed offer. Hershey Mfg. Co., 149 S. La Salle St., Chicago 3

OCTOBER 1947

A TOOLSHOP IN YOUR HAND!

- GRIND • DRILL • ROUT
- POLISH • ENGRAVE
- CUT • SAND • SAW, etc.

Make Things From
Wood—Plastics—Metals—Glass—Linoleum—Leather—Alloys—Horn—Stone—Bone, etc.

HANDEE

TOOL OF 1001 USES

THE FIRST TOOL OF ITS KIND AND TODAY'S FINEST Smooth, steady power at your fingertips! Perform precision operations not possible with any other portable tool! With a Handee you can turn out professional looking projects for pleasure or profit—ship, plane and train models, delicate, internally carved costume jewelry, wood carvings, puppets, initialed tumblers, etc. AC or DC. 25,000 r.p.m. Wt. 12 oz.

GET A GOOD START GET THE HANDEE KIT

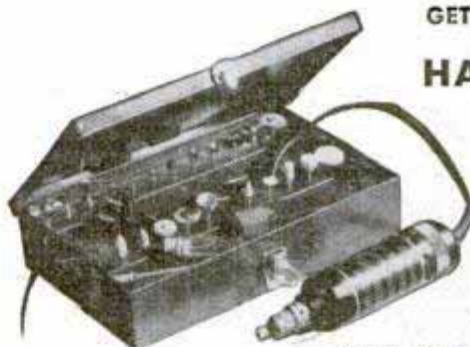

HANDEE Tool and 40 most popular accessories packed in compact steel carrying case. You'll be amazed at what you can accomplish! Complete, \$27.50. Handee only, with 7 accessories \$20.50.

FOR YOURSELF OR A FRIEND...
THE GIFT OF A LIFETIME!

NEW PRECISION ATTACHMENTS

Fit Handee only; enable novice or craftsman to do perfect work. Magically, easily, your offhand carving, routing, shaping will be exact as to depth of cut, accuracy of line. Set of 6 attachments with instructions, \$7.95



Get a Handee at stores everywhere. If they can't supply you we'll send it postpaid. Satisfaction guaranteed! Ask for free 52-page Manual

CHICAGO WHEEL & MFG. CO.

1101 W. Monroe St., Dept. PM, Chicago 7, Ill.

Send Handee Kit Handee Tool Precision Attachments
 C.O.D. Remittance enclosed Send Manual

Name.....

Address.....

Please Mention Popular Mechanics When Answering Ads

279



*Before you
shoot color—*

... remember that the secret of true, life-like color is in the exposure. With a WESTON Exposure Meter to guide you, you'll know when to shoot and, better yet, when not to. Ask your dealer for a demonstration today, or write Weston Electrical Instrument Corp., 622 Frelinghuysen Ave., Newark 5, N. J.

WESTON

Master II

EXPOSURE METER

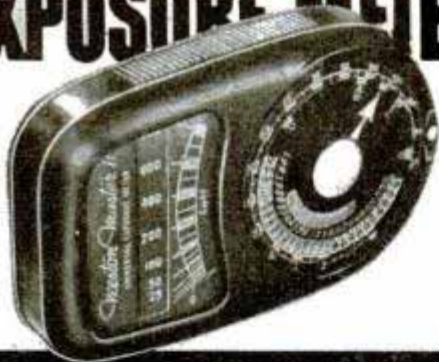

"THE METER MOST PHOTOGRAPHERS USE!"

OWN THIS

Threadwell

TAP AND DIE KIT

\$19.95 Complete with Case

THREAD THESE SIZES (NATIONAL COARSE SERIES)

$\frac{1}{8}$ ", $\frac{3}{16}$ ", $\frac{1}{4}$ ", $\frac{5}{16}$ ", $\frac{3}{8}$ ", $\frac{7}{16}$ ", $\frac{1}{2}$ "

Tap holes, cut threads quickly, easily, accurately in any material! *Threadwell* 50-S SCREW PLATE SET contains Die Stock, Tap Wrench, seven $1\frac{1}{2}$ " O. D. Round Dies and seven Hand Taps for cutting National Coarse Series threads. Each die adjustable for standard, over or under-size cut. Steel guide for each die insures straight, accurate threads. All in handsome, sturdy, fitted box with complete instructions. Order through your dealer or send \$19.95 for prepaid, same-day shipment (C. O. D. \$19.95 — you pay charges). Money-back guarantee if returned in 5 days.



THREADWELL TAP & DIE COMPANY
120 ARCH STREET, GREENFIELD, MASS., U. S. A.

ONLY **60¢** **ELECTRIC MOTOR**
CONSTRUCTION KIT
EASY TO ASSEMBLE
FUN—EDUCATIONAL

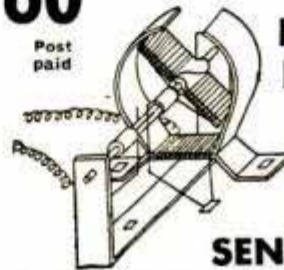

IDEAL GIFT
Runs on a Single Dry Cell (not included). Use it to run Toy Pumps, Pulleys, Etc.

Size 2"x2"x2 1/2"—complete with illustrated instructions and explanations of how the motor works.

SEND CHECK—MONEY ORDER or CASH (at your own risk) to

THE HAYDN CHEM. CO., Dept C-5, Box 27, Kenmore 17, N. Y.

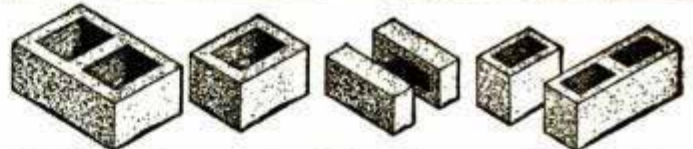

Make Concrete Blocks and Bricks

New superior method makes square, true, easy-to-lay units which will pass any building code. Small investment, high production, big profits. One \$30.00 machine will make four 5"x8"x12" blocks per minute. Pays for itself in a few days. Sell blocks or save 25 building cost by making and laying your own.

POST CARD BRINGS FREE FOLDER

Economy Manufacturing Company
Dept. P Stone Mountain, Georgia

WRITE FOR YOUR **FREE** COPY OF THE NEW
KRW HYDRAULIC PRESS BOOK

Describes all manner of Production and Shop Work on KRW Hydraulic and Bench Type Arbor Presses. 32 pages illustrating the new KRW Hand-operated, Electric-operated and Air-operated Hydraulic Presses.

Write for your copy today.



K. R. WILSON, DEPT. 17, 215 MAIN ST., BUFFALO 3, N. Y.

Builders of Shop Equipment for Ford Dealers Since 1916

new!

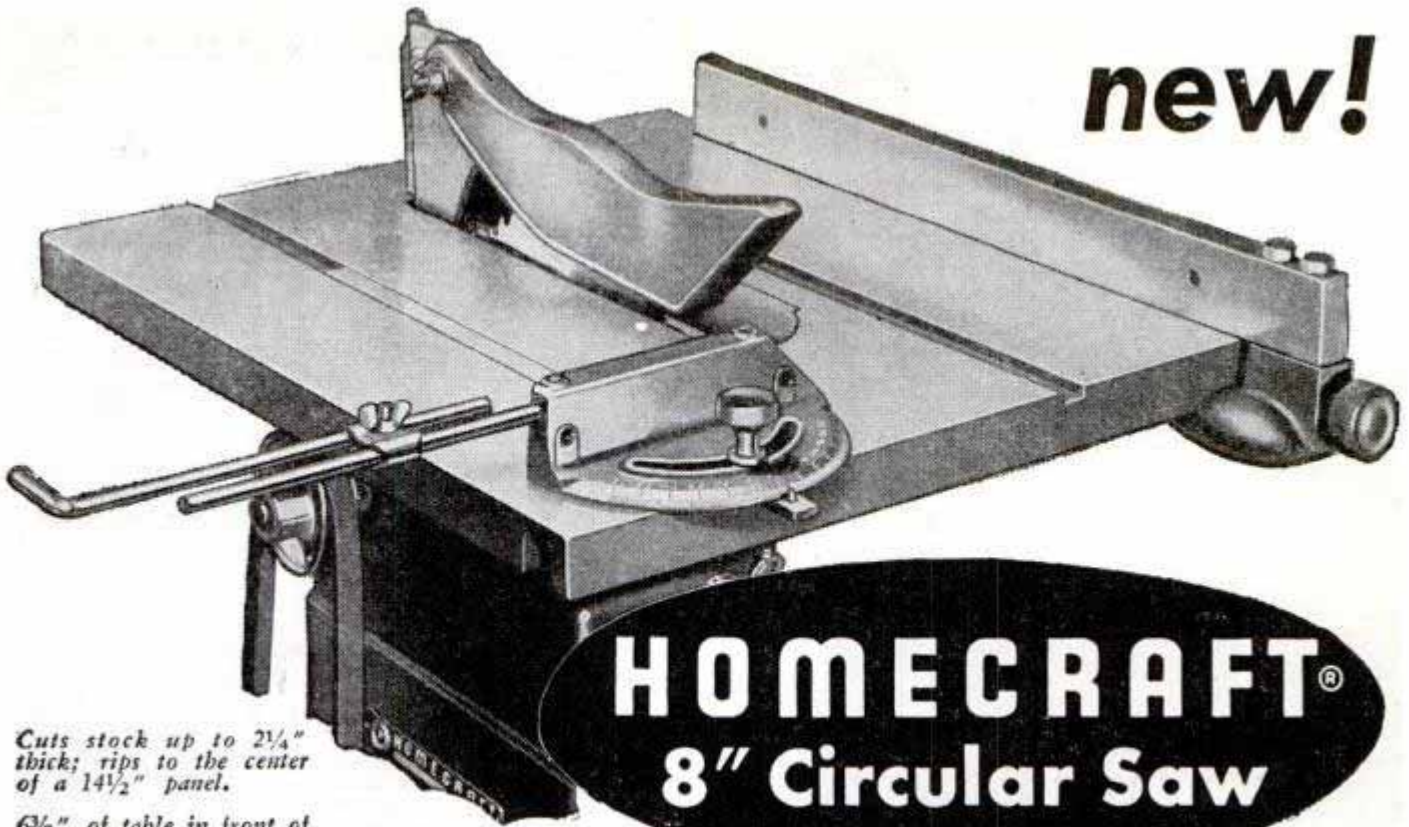

HOMECRAFT® 8" Circular Saw

Cuts stock up to 2 1/4" thick; rips to the center of a 14 1/2" panel.

6 3/8" of table in front of blade supports large stock.

Only \$34.95 for this Dependable Saw Built Expressly for the Hobbyist!

Answers the demand for a moderate-priced tool that delivers all-around satisfaction



The 8-inch saw blade gives you plenty of big cutting capacity.



Swing guard, splitter, and anti-kickback fingers provide safety.

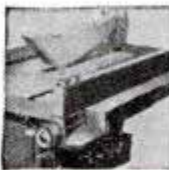

Rip fence locks securely in any position on table.

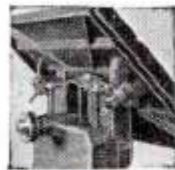

Table tilts 45° to right; firmly locks in place.



Convenient ball-crank handle quickly raises or lowers table.



Miter gauge provides accurate angles of cut — either side of blade.

This good-looking, versatile *Homecraft* Circular Saw is made especially for folks who enjoy the fun and healthful recreation of "puttering around" with woodworking.

With this practical tool, you can rip and cross-cut . . . make mouldings . . . cut mitres and curves . . . do drawer-joint work, rabbeting, etc.

Built by the Maker of Quality Tools
Behind the *Homecraft* Circular Saw is the engineering skill of the men who make Delta Power Tools — the famous top-notch tools that practically every woodworking enthusiast dreams of owning some day.

In schools and factories, as well as home shops, Delta tools have long been recognized as outstanding, for safety, accuracy, and dependability.

A Lot of Saw for the Money!
With the *Homecraft* Circular Saw, Delta meets the long-standing need for a really good, popular-priced tool that is exactly suited to the intermittent use the average hobbyist gives a machine.

Delta engineers have included features that make it just as fine a saw as can possibly be built for its moderate price:

Precision-Ground Steel Arbor — has accurately-cut threads to hold the saw blade, as well as a moulding cutterhead and a dado head up to 13/16" wide.

The arbor runs in oil-impregnated bearings that are constantly wick-lubricated.

Tilting Table — swings on two heavy cast-iron trunnions. A tilt scale indicates the amount of angle in your cut.

Solid-Steel Rip Fence — slides to any position across the table and can be used on either side of the blade.

See It At Your Dealer!

Ask your *Homecraft* dealer to show you this circular saw, and his complete display of *Homecraft* Power Tools that range in price from \$29.95 to \$39.95.

See if you don't agree that you can enjoy a lot of pride and satisfaction working with the reliable *Homecraft* Circular Saw.

Visit your *Homecraft* dealer now!



General Sales Offices—Chicago 2, Illinois

TEAR OUT COUPON AND MAIL TODAY!

DELTA MANUFACTURING DIVISION
Rockwell Manufacturing Company
680L E. Vienna Ave., Milwaukee 1, Wis.

Please send free new catalog of
Homecraft Power Tools

Name.....

Address.....

City..... (.....) State.....

New Catalog! — shows all
Homecraft Power Tools and
accessories. Sent to you free.
Use coupon, for your copy.

NM-52

THE Natural WAY TO LIGHT A PIPE



- Windproof
- Lightweight
- Large Flame

DOWN-DRAFT CHIMNEY-ACTION



\$3.50
AT YOUR DEALER

Unconditionally Guaranteed

Nimrod PIPELITER

If your dealer is unable to supply you, send \$3.50 direct.

WARD-NIMROD COMPANY
Dept. 35-G, 2968 Jessamine St., Cinti. 25, Ohio

STOPS LEAKS PERMANENTLY

Cut your fixture replacement, water and fuel bills with Economy Renewable Seats. Make economical, permanent repairs quickly and easily with the Junior Kit (illus.). Repair bathroom, kitchen and laundry fixtures. Everything you need included in steel box. This is a natural for the "Fixit" shops—get extra income from making permanent repairs on your customers' faucets.

Senior Master Kit also available—repairs faucets and valves up to 1" pipe. At *Better Jobbers and Hardware Stores* or *Write Direct*



ECONOMY VALVE SEAT CO.
2811 W. Fletcher Street Chicago 18, Ill.

FINE Cabinet WOODS

For immediate delivery! Thousands of feet in sizes and grades to exactly meet your homecraft or wood-shop needs. Bargains in Turning Blocks, Mouldings, Plywoods.

CATALOG OFFER: (U.S.A.)
Complete Hobbywoods catalog with periodic helpful supplements sent along with a twenty-five cent can of Waterproof Veriply (urea resin) Glue—Both prepaid for 25c.



Hobbywoods
Eastern Ave. and Cedar Baltimore 3, Md.



Have YOUR OWN Business

SAW FILING

You can have a good, steady, cash business of your own reconditioning saws with the Foley Automatic Saw Filer, which makes old saws cut like new again. The Foley is the **ONLY** machine that files all hand saws, also band and circular saws. Easy to operate—no eyestrain.

SEND FOR FREE PLAN—shows how to start in spare time—no canvassing. Send coupon today—no salesman will call.

FOLEY Automatic SAW FILER

FOLEY MANUFACTURING CO.
1016-7 Foley Bldg., Minneapolis 18, Minnesota
Send Free Plan on Saw Filing business, no obligation

Name _____
Address _____





V. M. MIXER CHANGER
PLAYS 10" and 12" Records at the same time.

MAGUIRE \$10.75
OAK 2 POST \$17.00
G.I. \$14.50
WALNUT BASE \$3.95

\$15.50
SEEBURG .. \$19.50
DETROLA .. 13.75

PHONO AMPLIFIER
Wired Vol. & Tone Control \$2.95



\$7.50

Uses 12SQ7, 50L6, 3Z5. Complete with 3 tubes and 5-inch speaker. Wired and tested. 25% on COD orders—BE-3-8554—FREE CATALOG—ORDER FROM THIS AD

Wholesale Distributors—RISCO ELECTRONICS, 22 Warren St., N.Y. 7

TOOL STEEL DRILL ROD

\$3.50 POSTPAID in Continental U.S. C.O.D.'S ACCEPTED

9 - 18" Bars **SAMPLER KIT** 9 Sizes

1001 uses for CRAFTSMEN, HOBBYISTS, MECHANICS, Etc.

For Making Punches, Chisels, Engraving Tools, Shafts, Etc.

Free machining, easily worked, yet can be made file hard. Hardening instructions included!

ORDER TODAY

FLAT TOOL STEEL
The Precision ground flat tool steel with the satin-smooth finish. Simple to work, easy to harden, ready to use.

SHOP ASSORTMENT — \$4.80
(5 dif. Pieces—1/32" to 1/8" thick; 1/2" wide; 18" long)

BOTH KITS — \$7.95
Include 25c postage on orders under \$5.00.

We can supply ALL your Tool Steel Needs.

BESSEMER STEEL COMPANY OF AMERICA, Dept. FD-10
Small Shops Division, 1958 W. 59th St. Chicago 36, Illinois

FREE

With Every Kit or first order 6" Steel comb, rule & depth gauge with pocket clip.

AMAZING NEW SAFE MAGNETIC SAW!

READY FOR IMMEDIATE DELIVERY!

SYNGRO

DELUXE JIG SAW

For Hobbyists, Craftsmen and Light Production

ONLY
\$17.50

FOB FACTORY

Shpg. Wt. 18 lbs.
Complete with cord, 3 blades

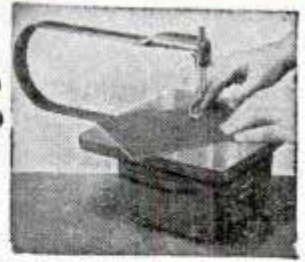

**NO MOTOR NEEDED—JUST PLUG IN!
PORTABLE . . . SAFE . . . CUTS CLEAN
AND SMOOTH—NO SANDING NECESSARY!**

ANNOUNCING a remarkable, PATENTED, MAGNETIC Jig Saw — better-performing, better-quality than famous PRE-WAR SYNCROS — now ready for immediate shipment anywhere! SYNCRO needs NO belt, NO gears, NO oiling, NO motor to buy. The high-speed, short stroke action, and freedom from belts, makes SYNCRO so SAFE even small boys and girls may operate it. Get this husky, powerful, 18 pound saw . . . so easily portable . . . you can use it anywhere—even on the kitchen table . . . so smooth-cutting no sanding is necessary! Cuts intricate designs on $\frac{1}{8}$ " soft wood, $\frac{1}{2}$ " medium hard plywood and thinner hardwoods, plastics, thin metals. Leaves NO ragged undersides on plywood or heavy cardboard. The rapid action blade cuts to the center of a 27" circle. SYNCRO is a rugged, powerful power tool for exceptionally high quality work. Ideal for hobbyists, craftsmen, light production. Perfect for models, displays, puzzles, inlays, silhouettes, toys, marquetry, games, what nots, etc. Order yours NOW on our 10 Days Money Back Trial offer — enjoy a LIFETIME of use!

15 Outstanding Syncro Features

(1) **WORLD'S SAFEST SAW.** (2) **PORTABLE** . . . plugs into 50 or 60 cycle A.C. 110-130 volt wall outlet. (3) **NO ROTATING MOTOR NEEDED.** Syncro's self-contained magnetic power unit transmits A.C. magnetic impulses to armature diaphragm — power transferred to saw blade. COIL contains $1\frac{1}{2}$ lbs. No. 19 insulated copper wire, impregnated, baked. Guaranteed not to burn out! DIAPHRAGM of spring steel, heat-treated under special process, suspended on L-1-V-E rubber mounting cartridges. (4) **14,400 STROKES PER MINUTE!** (5) **NO RECIPROCATING OR ROTATING PARTS TO WEAR OUT!** (6) **NEVER NEEDS OILING.** (7) **TABLE TOP** 10" x 10" a heavy, thick, durable alloy die casting $\frac{1}{8}$ " thick, ribbed base. Surface smooth for easy sliding. Specially finished in half-inch cross sectional engraved lines to assist in accurate cutting. (8) **BASE** 7 $\frac{1}{2}$ " x 6 $\frac{3}{4}$ " . . . a heavy, durable die casting. (9) **ARM** is of specially formed steel stamping $\frac{1}{8}$ " x 1". Return Spring of heavy duty steel. Guide

Slide of plated steel and adjustable to varying wood thicknesses. Adjustment Screw permits easy, quick changes to compensate for voltages of 110 to 130 A.C. (10) **THROAT CLEARANCE** 13 $\frac{1}{2}$ " permitting work on square sheet of wood, metal, plastic, 27" on the diagonal. (11) 5' cord . . . extension Underwriter's approved electric cable with molded rubber plug. (12) **BLADES** are 5", pin end style, of finest steel, 18 teeth per inch. (13) **NO-MAR, NON-SLIP RUBBER FEET.** (14) **DURABLE** — will last a lifetime. (15) **HIGHEST QUALITY**—guaranteed by the trademark name "SYNGRO."

"FAMILY SAW"

"The SYNCRO POWER SAW ordered from you in 1940 is still sawing merrily away. My son (then 8) has used it in the attic, kitchen, his room, and basement shop. I use it too. We never worry about accidents due to its MAGNETIC SAFETY STROKE feature. It's truly a family saw."—Mr. B. H. Smith, Rexburg, Idaho.

SAFEST!

SYNCRO has No continuous cutting blade nor "Long stroke" blade to pull fingers in to teeth—instead there are 14,400 strokes per minute — 7,200 short cutting strokes plus 7,200 upward NON-CUTTING, REPELLING strokes! (Fig. 1) SYNCRO will not even CUT wood unless piece is pushed FIRMLY DOWNWARD AGAINST blade and FIRMLY FORWARD—both actions at SAME TIME! SYNCRO blade teeth cut ONLY on DOWN stroke. (Fig. 2) Teeth raise, repel, push away any object on UP stroke. (Fig. 3) When blade moves UP it KICKS finger away free. On down stroke, blade does not move far enough to accidentally cut finger unless finger is intentionally, deliberately fed into blade like wood is fed in Figure 1. No wonder SYNCRO is the world's SAFEST saw . . . a feature old and young users acclaim!

MODEL NO. 2000
Prices slightly higher in foreign countries

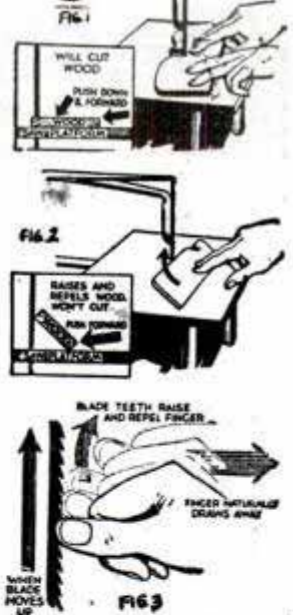

ORDER on 10 DAYS TRIAL!

So you may order with complete confidence, read this SYNCRO TRIAL OFFER: When you get your saw, plug it into any 60 cycle A.C. 110-130 volt outlet and saw according to instructions. Then, if it does not satisfy you perfectly in every way, return it postpaid within 10 days of delivery date, and we will refund your \$17.50 promptly without questioning.

HOW TO ORDER—DO IT NOW!

Mail Coupon with Postal Note, Money Order or check for only \$17.50 plus Parcel Post or Express carrying charges . . . or . . . send \$17.50 only and we will ship saw collect for Parcel Post or Express carrying charges only. Specify type of delivery on Coupon. Shipping weight, packed, 18 lbs. Hurry! Act promptly—order—we'll ship same day order is received. (No complete COD orders accepted.)



EXPORT ADDRESS . . . 120 Wall St., New York City, U. S. A.
DEPT. A-107
ROCHESTER, MICHIGAN

WORLD'S LARGEST MAKERS OF ELECTRIC JIG SAWS

SYNGRO SAW CORPORATION, Dept. A-107 ROCHESTER, MICHIGAN

EXPORT ADDRESS: 120 Wall St., N. Y. City
Gentlemen: Here's my order for one SYNCRO MAGNETIC JIG SAW, Model No. 2000, shpg. wt. packed, 18 lbs., \$17.50 FOB Factory. Please send it complete with electric cable and plug, 3 blades, on your 10 Days Money Back Trial Offer. I enclose \$17.50 as payment. Please ship saw:

- Express charges collect or Parcel Post charges collect.
 Express, for which I enclose an extra \$ _____
 Parcel Post, for which I enclose an extra \$ _____

NAME

ST. & NO.

CITY STATE

I enclose no money—send FREE SYNCRO CIRCULAR.



CONVERTIBLE

6856 MILES for \$34.56

Weighing about $\frac{1}{3}$ as much and operating for about $\frac{1}{2}$ as much as other so-called light cars, the new fine CROSLLEY reverses the trend toward heavy, cumbersome, expensive automobiles—and delivers amazing performance.

For instance, Mrs. Ruth Penn, 833 C St., Sandusky, Ohio, has driven her Crosley 6856 miles at a total expense of \$34.56.

And the Crosley is a FINE car. In the convertible or sedan, you get ample room for 4 husky people plus luggage. You get a smooth, care-free ride.

In the $\frac{1}{4}$ ton CROSLLEY PICKUP, you get true economy for service calls, light deliveries, etc.



In every CROSLLEY you get the startling COBRA (Copper BRAzed) steel engine with $7\frac{1}{2}$ to 1 ratio; delivers 35 to 50 miles per gallon and smooth cruising at 50 miles an hour.

Sedan lists \$888 at factory. Taxes extra.

CROSLLEY

a FINE car

For information and literature, write: Crosley Motors, 2532-HE Spring Grove Ave., Cincinnati 14, Ohio.

SAY YOU SAW IT IN POPULAR MECHANICS



Hands Never Touch the Water—Can be put in Boiling Water. Housewives Like It.

48" Long Handle

Sales QUICK, EASY Every Locality

SALES ARE EVERYWHERE . . . Sells quick to Taverns, Clubs, Hotels, Hospitals, Stores, Restaurants, Large and Small Buildings and the Homes . . . Scores can be sold on a single street . . . Note the Drain Bracket in the illustration . . . This squeezes out the water so thoroughly that HANDS NEVER TOUCH THE WATER . . . Makes no difference what you ever sold, you will like this proposition . . . Your name on a Post Card will bring you FREE PARTICULARS.

CELL-U-MOP CO., Dept. P-10, FREEPORT, Ill.

AMERICA'S LOWEST PRICED
BAND SAW
Now \$16.95 Postpaid

ENGINEERING FEATURES
FOUND ONLY IN
HIGHEST PRICED MACHINES

Practical, modern design; new improved model. Accurate, smooth operation. Cuts to center of large 14" circle, $2\frac{1}{2}$ " thick. Genuine "Oillite" bearings; adjustable ball-bearing blade guide. Upper wheel blade-tension adjustment; safe, fully enclosed mechanism. Thoroughly proved construction, ruggedly designed with sturdy laminated plywood. Stands 24" overall. As illustrated—blade included. Immediate Delivery! See your dealer or send only \$16.95, and we'll pay shipping charges. Or, if you prefer, will forward C.O.D. Absolute Money-Back Guarantee.

SEE YOUR DEALER or write Dept. 102

SERRO MFG. CO. 1933 Olive St. St. Louis 3, Mo.

U. S. SURPLUS BARGAIN

POLAROID GOGGLES

Brand new! In original packing. Each with three interchangeable lenses.

SHOCK PROOF FRAME — SHATTERPROOF LENSES

Use them for all outdoors sports, beach, motor-ing, boating—anything. Heavy windproof sponge rubber ventilated frame with snap button! Adj. elastic head band. Red, green amber flexible shatterproof lenses, all instantly interchangeable. They won't last long at this price—it's smart to buy an extra. Post paid in U. S. A.

\$1.00

POST PAID

GROBAN SUPPLY CO., Dept. PM 10
1522 S. Michigan Ave. Chicago 5, Ill.

HAWAIIAN WIGGLERS

Get Bass!

Write for free catalog on all my baits.

No. 2
Shallow Running - \$1.10

FRED ARBOGAST & CO., 1620 North St., Akron, Ohio

... Quick Easy Way to BIG PROFITS

Read What Others Are DOING!

"Enclosed you will find 56 orders representing $9\frac{1}{2}$ hours' work on Monday and Tuesday."
"Enclosed are twelve orders secured after supper this p.m."

Housewives are Enthusiastic

Everyone that sees this outstanding Cell-U-Mop immediately wants one . . . That's the reason why our distributors are so successful . . . You also have the advantage of our other QUICK SELLING PRODUCTS that step up your Volume Sales and Profits.

• We Teach You How •

Gets down under and around for **MOPPING, DUSTING or WASHING**

DOES THE WORK OF 6 TOOLS IN 1

Get Choice Territory NOW!

Holds 20 times its weight in water.



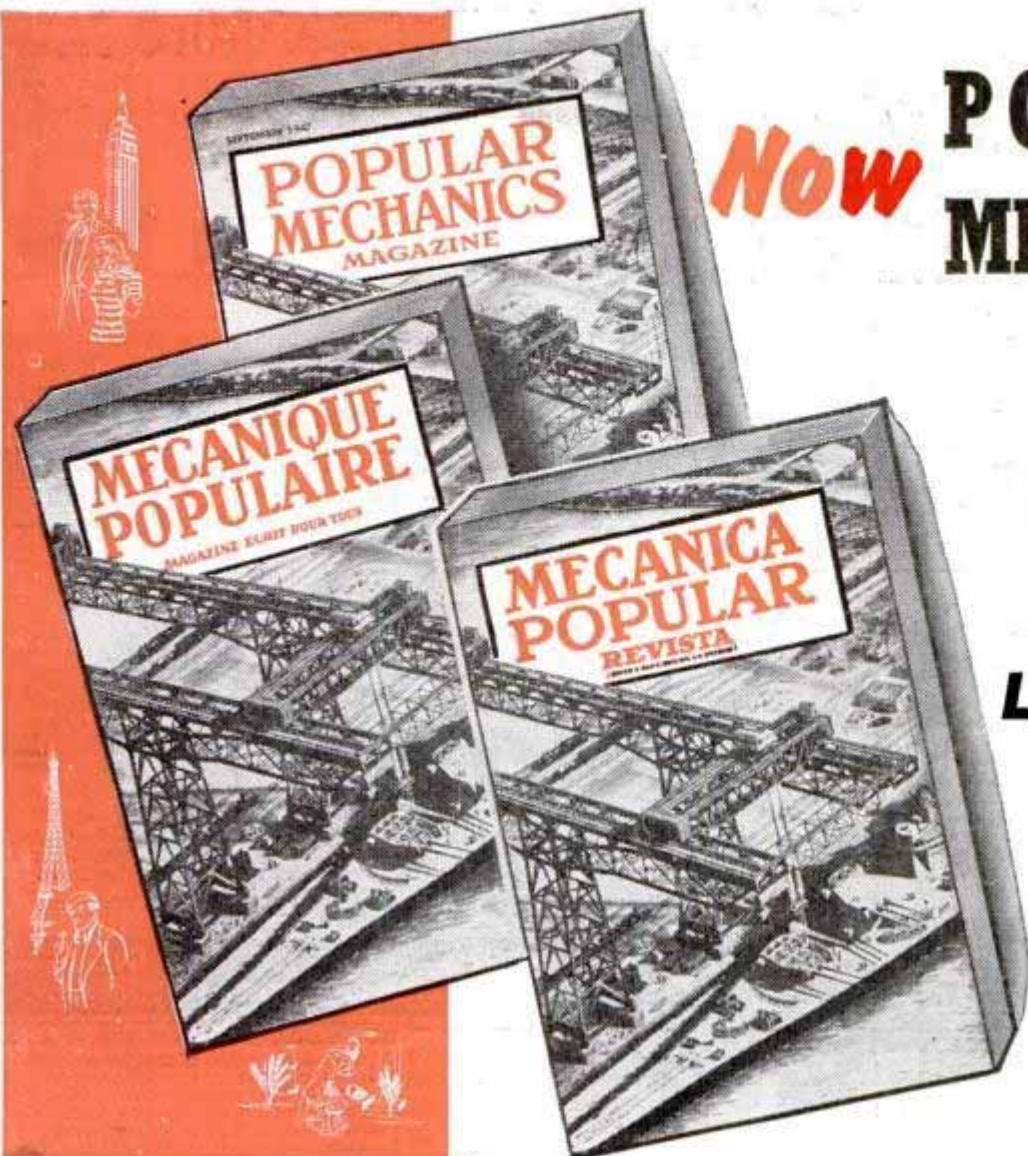

Now **POPULAR
MECHANICS**

**IN
3
LANGUAGES**

*Readers desiring to
subscribe to any
edition may address:*

*Circulation
Department*

POPULAR MECHANICS is now printed in the *French language* and the *Spanish language*.

The *French edition* — MECANIQUE POPULAIRE — with 90,000 copies each month . . . and the *Spanish edition* — MECANICA POPULAR — with over 60,000 . . . add 150,000 interested people to the 131,460 readers* outside the United States already enjoying the parent POPULAR MECHANICS—in *English*.

Advertisers interested in the markets served by the English, French and Spanish editions can learn all details from Popular Mechanics' space representatives.

* POPULAR MECHANICS (in English) alone has a total circulation, foreign and domestic, of 1,027,410.

**POPULAR
MECHANICS**
MAGAZINE

200 E. ONTARIO ST. CHICAGO 11, ILLINOIS
NEW YORK + DETROIT + SAN FRANCISCO + LOS ANGELES

New All-Purpose STEEL SHELVING

FOR FACTORIES, OFFICES, WORKSHOPS and HOME USE

Low as \$16⁵⁰



Immediate delivery for these fine pre-war quality REMLE Utility Steel Shelvings now at long last available. Hundreds of uses in factories, basement shops, homes, garages, offices, grocery shops, etc. Quickly assembled sections can be bolted together and used in any combination. Shelving easily rearranged for changing conditions.

7 FT. HIGH - SIX SHELVES PER SECTION HOLDS 150 LBS. TO 300 LBS. PER SHELF SHELF HEIGHTS ADJUSTABLE!

Angle post construction provides maximum strength and rigidity. Hard to tip over. Not necessary to bolt to floor or wall. Each standard assembly consists of six 36" wide shelves, (3 depths available), four 83" angle corner posts punched on 1" centers, and one 2x36" kick plate. Finished in standard green baked enamel. All shelves channeled—of heavy gauge steel.

Extra parts available: Shelves, back plates, end plates, angles, kick plates, bolts, etc.

A-1220	12 x 36"	20 ga. shelves.....	\$16.50
A-1818	18 x 36"	18 ga. shelves.....	22.25
A-2416	24 x 36"	16 ga. shelves.....	29.00

All Prices F.O.B. WAYNE, MICHIGAN. Send cash with order. Shipped freight charges collect.

IF OUR STANDARD UNITS DO NOT FIT YOUR NEEDS, WRITE US.

Remle CORPORATION

Dept. PM10, 5408 W. Center St. Milwaukee 10, Wis.

AMERICA'S FINEST INDUSTRIAL EQUIPMENT

IMMEDIATE DELIVERY!

Complete as shown

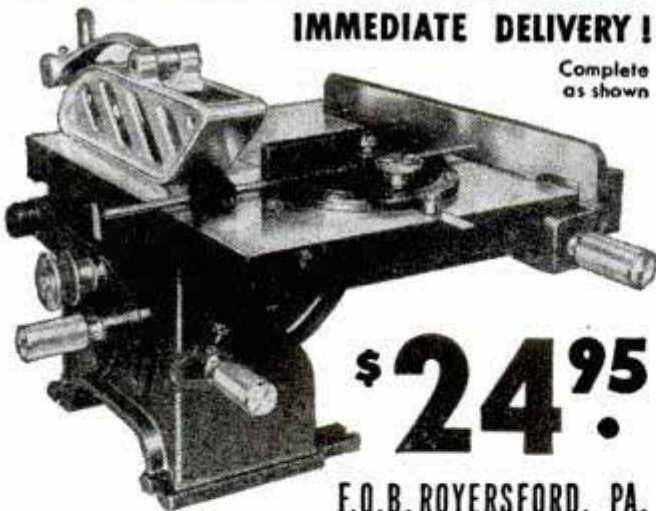

\$24⁹⁵

F.O.B. ROYERSFORD, PA.

QUALITY 8" BENCH SAW
CUTS THROUGH 2⁵/₁₆"

UNCONDITIONALLY GUARANTEED ONE YEAR

(Write for Free Booklet and Guarantee Bond)

Comes complete with Floating motor mount—miter gauge with adjustable stop—aluminum guard—soft aluminum insert—spring steel splitter—heavy gray iron fence—(no motor—no blade). Table 12" x 14". Tilts to 45°—Oilite bearings. Shipping Wt. 50 lbs.

AMERICAN MACHINE & TOOL CO. Inc.

DEPT. 100

ROYERSFORD, PA.

NEW HYDRAULIC AUTO JACK AT NEW LOW COST!

2-TON hydraulic auto and truck jack; also for industrial or farm use—changing tires, straightening frames, lifting loads, raising machinery—

REGULAR VALUE @ \$10.95 ea.
NOW ONLY \$6.45 ea.!



horizontal or vertical lift. Light in weight, easy to handle, effortless to use. Features wide base, ball type valve, precision manufacture throughout. Built to "take it." Unbeatable value. Fully tested, and—

FULLY WARRANTED

Send check or money order today for \$6.45. Delivered prepaid to any point in U.S. Slightly higher elsewhere. Will also ship C.O.D.

"HYDRAULIC JACKS"

1500 West Slauson Avenue
Los Angeles 44, California

**STURDY!
VERSATILE!
EFFICIENT!**

Garden-All
LAWN and GARDEN TRACTOR

There's nothing at all like Garden-All! Instant Tool Attachment, Exclusive Depth Control, A Tool for Every Need. Write for folder.

GARDEN-ALL TRACTOR, INC.

Dept. P, 100 W. UNION STREET, LIBERTY, INDIANA

Signal-Powered Radio
(No electricity, no batteries)

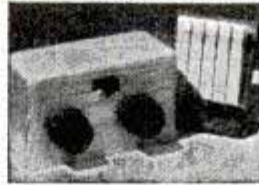

GET YOUR MONEY'S WORTH... Custom-designed to outperform all others of its type. Novelty appeal secondary, a real radio. Tiny cabinet 2¹/₂x1¹/₂x1¹/₂. Two inductively-coupled circuits var. cond. tuned. Single station tuning anywhere. Frequency-dividing switch, all broadcast, some police bands. Radar's Germanium diode detector for strongest reception. Alternate antenna circuit. Jacks for two headsets. Plexiglass back panel, works visible! Never wears out. Complete with sensitive phone. \$6.95 postpaid in U.S. Caring—Box 1308—Chicago 90

STAY HOME AND MAKE MONEY!

—Men! Women! Get into profitable, uncrowded profession you can operate from your home or small office after short home training course. No capital required. No goods to buy. No age limit. Others earn \$50.00 to \$100.00 per week making famous Stephenson corrective foot devices to order. Foot sufferers everywhere pay gladly for relief. Send today for FREE BOOKLET.

STEPHENSON METHOD, Established 1894, 12-28 S. Market St., Boston, Mass.



\$1.00

POSTPAID

SPECIAL OFFER! Famous, patented, lock-stitch sewing awl complete with needles, waxed thread, direction folder. Hundred uses—sewing, repairing leather goods, canvas, belting, old or new harness, saddles, gun cases. Satisfaction guaranteed, or money back. Send currency, check, or money order, no stamps, please. Yates Mfg. Co., 611-H Main St., Lake Geneva, Wis.

BUILD YOUR OWN ZEOLITE WATER SOFTENER



Troubled by water hardness? Build a LAR water softener for as little as \$40.00. Requires only a wrench. Quickly pays for itself by savings in soap and clothing alone. Send \$1.00 for complete plans and operating instructions. Money back if not satisfied. LAKE REGION MFG. CO., Box 2732-P, Minneapolis 7, Minn.

MAKE \$ MORE MONEY

Applying or Selling

CORKSTONE

A General Purpose Magnesium Oxychloride Flooring

THE MODERN PLASTIC FLOORING

EASY TO APPLY
Here's your opportunity to get into business for yourself applying or selling Corkstone, the economical, top-grade plastic flooring. Plenty of profit. Act without delay!

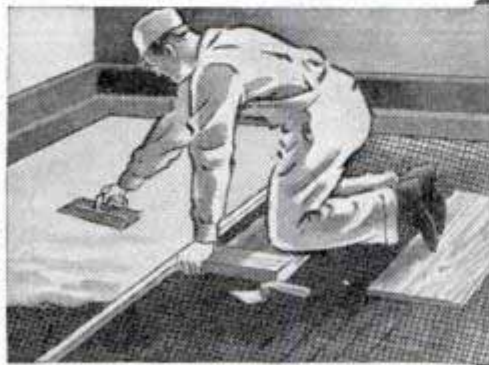

Dealers & Agents Wanted

WRITE FOR DETAILS

LASTING PRODUCTS COMPANY

Franklinton Road Plant,

Baltimore 23, Md.

HEAT BURNERS FURNACES GAS - OIL

L. P. PROPANE Gas Burners, Floor furnaces, Blowers, Oil Burners, Exhaust Fans, Controls. Card for free literature. Wholesale & Retail.

Peerless Sales

4318 Sheridan Lincoln 6, Nebr.

STOP UNDER DOOR DRAFTS

This new all-aluminum WEATHER-TITE DOOR SADDLE also stops driving rain, dust, insects, etc. Positive action of closing door lifts center riser to the closed position (illus.) and seals completely. Easily installed by anyone handy with tools. Nothing to get out of order. Complete \$9.95 with instructions

COLUMBIA INDUSTRIES

19th Ave. & 36th Street, Long Island City 5, N. Y.

WASHING MACHINE PARTS

ALL MAKES

Wringer gears, Agitators, Rolls, Pumps, Gear cases, Shafts, etc. 10,000 parts.

NORTHEAST BURNER, 1358-M H St. N.E., Washington, D. C.

AGENTS 300% Profit SIGN LETTERS

For Store Fronts and Office Windows. Anyone can put them on. Free Samples. Liberal Offer to General Agents.

METALLIC LETTER CO., 430 N. Clark, Chicago 10

HAVE YOUR OWN BUSINESS!

Operate pleasant, profitable Silk Screen Printing Shop. NO experience needed. Work at home in spare room or basement. Big demand! Large profits! Few dollars starts you. Start small, grow big. Real future possibilities! Eye-opening literature FREE.

W. E. WOLFF CO., 817 High St., Anderson, Indiana

SAY YOU SAW IT IN POPULAR MECHANICS

USE AC's FOR

UTMOST RELIABILITY

Dairies and milk producers use factory-recommended AC Spark Plugs to assure utmost reliability in milk delivery. Your AC dealer can supply you with factory-recommended AC's for your car, truck or tractor, designed for today's fuels and driving conditions.

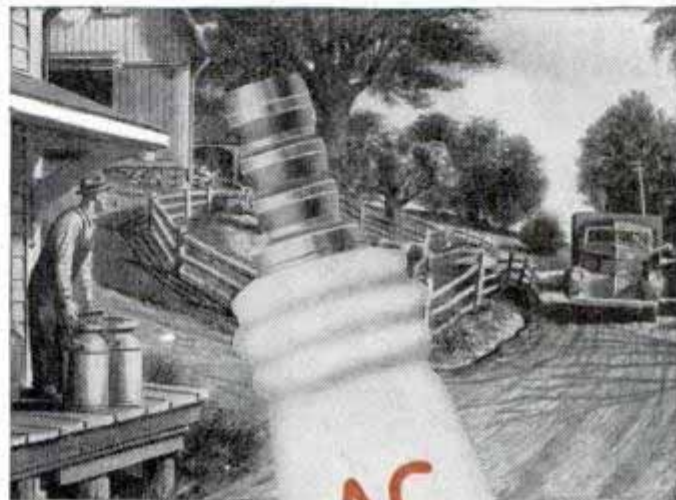

Look for this sign



Spark Plugs cleaned and adjusted "By the AC Method" may save as much gas as 1 gallon in 10

AC SPARK PLUGS

AC SPARK PLUG DIVISION • GENERAL MOTORS CORPORATION

A New Thrill . . .

**FASTER,
SMOOTHER,
EASIER
SKATING**

Streamlined 3 WHEEL ROLLER SKATE

Introducing **JET** The Sensationally NEW Combination ROLLER-ICE SKATES

If you like Roller Skating . . . you will like the New "JET" Roller Skate . . . Its many New Features puts it way out in front of all standard type skates . . . Study the THREE-IN-LINE-ROLLERS . . . this principle alone overcomes many of the objections . . . goes over cracks and irregular surfaces with a new smoothness . . . an enjoyable feature to those who love to roller skate . . . The 3 BALL BEARING WHEELS-IN-LINE Gives MORE SPEED with LESS EFFORT . . . When you want to stop SIMPLY RAISE THE TOE . . . The "JET" Skate is the ONLY SKATE WITH THIS FEATURE . . . Being much lighter in weight than regular skates makes it EASIER TO SKATE FOR CHILDREN and ADULTS; even for the beginner . . . Another feature: you can quickly change to Ice Skates by replacing the rollers with the "JET" Ice Skate Attachment . . . This is another Exclusive with the "JET" Skate . . . A New Experience awaits you in Roller Skating from the minute you PUT ON A PAIR OF "JET" ROLLER SKATES.

Local Agents Wanted . . . Order Yours Today

AFCO PRODUCTS, INC., 4547 No. Clark St., Dept. P-10, Chicago 40, Ill.

50% Lighter Than Most Ordinary Skates
● CHANGEABLE FROM ROLLER TO ICE SKATES



PAT. NO. 2113862

NOTE THE EXCLUSIVE BRAKE

ONLY **\$4.95** A PAIR

3 BALL BEARING WHEELS in line gives MORE SPEED with LESS EFFORT

To QUICK STOP Simply Raise The Toe.

BE FIRST IN YOUR LOCALITY

LARGE, SMALL, MEDIUM STATE SHOE SIZE

Postpaid in U.S.A.

We Ship C.O.D. Plus Postage

Ice Skate Attachment \$2.25 Extra

Mail Your Order Direct To Factory

READY FOR HOMESHOPS!

NEW MEAD ECONOMY BANDSANDER

This remarkable, economical homeshop machine is again available for immediate shipment! Quickly shapes, sands, carves and polishes wood, metal, plastics! Works equally well on inside cut-out openings or irregular outside edges. Gets at places no other can! Patented. Tilting table for beveling, chamfering. Rust-and-sweat proof top. Self-oiling sleeve bearings. Saves time, labor, money. Invaluable to home-craftsmen, hobbyists, model-makers, etc. Normal band speed 1600 ft. per min. gives fast, smooth, clean cuts. 1/4 h.p. 1725 rpm motor recommended. Rush only \$14.95 with order—or \$5, balance COD. Immediate shipment! 5 Days Trial, Money Back Guarantee. Limited supply—so hurry!

QUICKLY SHAPES, SANDS, CARVES, GRINDS, PROFILES, CLEANS, SMOOTHS, and POLISHES WOOD! METAL! PLASTICS!

Cuts Fast and Clean . . . Saves Filing, Sanding Work

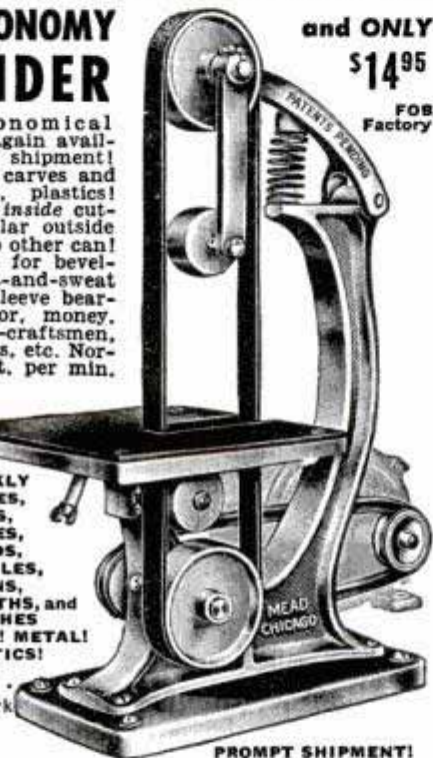

and ONLY **\$14.95** FOB Factory

PROMPT SHIPMENT! ORDER NOW or Circular FREE!

Mail order today—or write for free details on "the machine that amazed the experts!" A postcard will do! (Dealers write!)

MEAD SPECIALTIES CO.
4114 N. Knox Ave., Dept. 1107, Chicago 41, Ill.

ELECTRICITY Anywhere

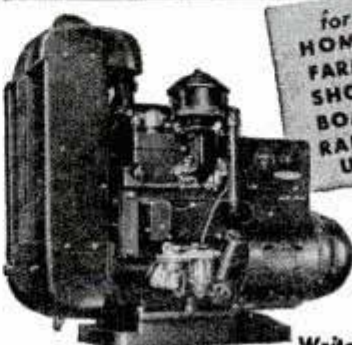

for **HOMES FARMS SHOPS BOATS RADIO USE**

● Onan gasoline-engine-driven Electric Plants supply reliable, economical electric service for any use Portable, stationary or stand-by models. Water or air-cooled, compact and rugged.

A.C.: 350 to 35,000 watts in all standard voltages and frequencies. D.C.: 600 to 10,000 watts, 115 and 230 volts. BATTERY CHARGERS: 500 to 3,500 watts; 6, 12, 24, 32 volts.

Write for folder

D. W. ONAN & SONS INC.
2534 Royalston Ave., Minneapolis 5, Minn.



AIRCRAFT SUPERCHARGER LUBE PUMP

Designed for Pumping Liquids Up to 3 G.P.M.

A gear type impeller pump with two pumping units in one housing. Precision built of aluminum, cast iron, bronze and steel. Compact construction—only 3 1/2" Dia. x 8 1/2" long.

- Vacuum, 29 1/2 inches of mercury.
- 1/2" Dia. Threaded and keyed shaft.
- Brand new! Sealed in Pliofilm.
- With Test Sheet and Instructions.

Immediate delivery. Order now! Post paid anywhere in U.S.A. upon receipt of check or M.O. C.O.D. orders include postage and extra fees.



Pressures up to 200 lbs. per Sq. In.
From 1 to 3900 R.P.M.

Originally cost \$24.00. Now only **\$3.95**

FISCHER LABS 1731 N. MOBILE, CHICAGO, 39, ILL.

DEEP TONE

DUAL MUFFLERS

LONG LIFE

1935 TO 1947—V-8 FORD AND MERCURY

- More Horse Power
- Better Gas Mileage
- Less Back Pressure
- Blow-Out Proof
- Straight Thru Mufflers

FORD & MERCURY DUAL SETS

\$20.00 C.O.D.
F.O.B. LOS ANGELES

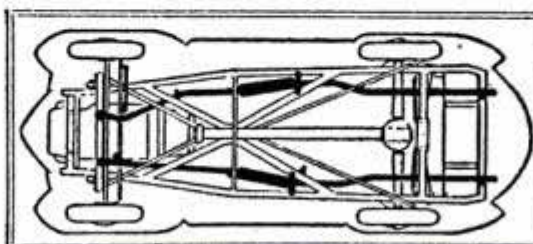

ORDER BY YEAR AND MODEL

- SIMPLIFIED INSTALLATION
No Welding, Cutting, Drilling of Holes.
All Fixtures Furnished
Rubber Insulated Clamps

DEEP TONED SINGLE MUFFLER
Ford, Chevrolet, Ply. \$4.86
All others \$5.50
2 1/2" CHROME TAIL PIPE TIPS. \$1.75

ADVANCE MUFFLERS DEPT. 2 ● 6800 So. Vermont Ave. ● Los Angeles 44, Calif.

New SUPER-Tools . . . SUPER-MONEY-MAKERS

The WORLD-FAMOUS...

4 GREAT KITS . . . with 10 Attachments . . . to make 17 WORLD-BEATING Combinations

.. HERE is Shown the New E-G MASTER-KIT (8MK) . . . the Master of Thousands of jobs of All Kinds, otherwise needing Dozens of Other Tools Costing Many Times as Much, and many times as much Time, Effort and Energy.

.. This MASTER-KIT INCLUDES . . . in a Durable 3-Pocket Holster . . .

1) The 8 1/2" Universal EIFEL-GEARED PLIERENCH, for Most Pliers and Wrench work needing Jaw-openings 0" to 1 1/2".

2) The Instantly Changeable PIPE-Jaw, for PIPE, Rounds, Chewed Nuts, etc.

3) The WIRE-Jaw, giving a 'Round-Nose-against-V' for Bending, etc. . . these are from the REGULAR 8 1/2" Plierench KIT (8-PKT).

.. It INCLUDES in Addition . . .

4) The 4" Universal GIANT-Jaw, which gives a Jaw-Opening up to 3"; otherwise found only in 15" to 18" Wrenches!

5) The 4" GIANT PIPE-Jaw may be had instead of (4), or Extra.

6) The E-G GRIP CLAMP holds up to 1-TON. Grips with Hands Free. Applied in 15 Sec. . . . removed in 2 sec.

7) The E-G TUBING-CUT-TER Set, for cutting Small Pipe and up to 1" O. Diam. Thin-walled tubing . . . it works in Tight places.

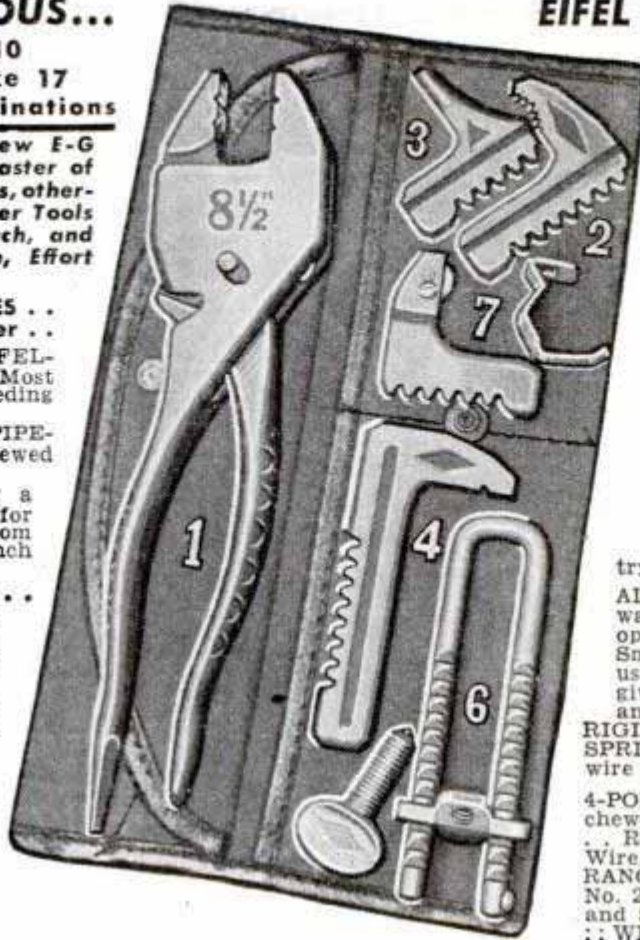

EIFEL - Line SUPER - Tools!

You'll Find NO "Some-thing-like-its" . . . Nothing to approach . . .

YOU CAN'T Imagine what it means to have such a Battery of SUPER-Tools in ONE 28-Ounce KIT . . . Here can be noted only a Few of Many Amazing Features, etc.:

SPEED: One-Second Adjustments for Size in the Range of Any Gear-Jaw. A Jaw can be substituted for another in 5 sec.; No. 6, or 7, can be Applied in 10-15 secs., removed in 2 secs. Instant Speed!

POWER: With ONE Hand you apply a Perfectly Controlled Grip from 1 Ounce thru to 1/2 TON:

.. With an E-G GRIP-CLAMP you apply a "Hand-grip" of 1-lb.-to 250 Lbs. . . Jaw-grips up to 1-TON, Direct Pressure, and . . . NO "Try-try-again," No bruising recoil:

ALL-PURPOSE GRIPS which are always "naturally" PARALLEL at all openings . . . The Universal Grips are Smooth, Non-marring . . . are even used on Jewelry; . . . 4-WAY V-Grooves give 12-Grips-to-a-Turn on hex. Nuts and hold Rounds up to 1/2" diam. RIGIDLY in 4 positions; . . . serve to Make SPRINGS 1/16" to 1" diam. of Music wire .010" to 1/16" diam.!

4-POINT Toothed-V Grips for PIPE chewed Nuts, etc., when ALL else Fails! . . . ROUND-NOSE-against-V Grips for Wire, Chain, Spring-making, etc., etc. RANGE of Jaw-Openings: No. 1, 0"-1 1/2"; No. 2, 0"-1 3/4"; No. 3, 0"-1 1/4"; Nos. 4 and 5, 1 1/4" to 3" . . . for KIT, 0" to 3"! :: WHAT Other Tools Can approach this?

\$1000 Can Not Buy Such SUPER-Tool Service in Any Other Form!

:: New AGENTS and DISTRIBUTORS will need to HURRY to Qualify for HOLIDAY SEASON Quotas . . . when Demand far exceeds the Supply . . .

USERS in places not covered by representatives . . . who ACT NOW . . . will be supplied direct as far as possible.

GET Our Fine, New CATALOG - CIRCULAR . . . 14" x 17", with 100 Cuts . . .

.. Just Print, paste, or tape, this part of Coupon on address side of a Postcard . . .

.. this part on other side, and mark; Print your address plainly, and MAIL

AMERICAN PLIERENCH CORP'N
4611 N. Ravenswood Ave.
CHICAGO 40, ILL. (Dept. PM-7X)

Want Selling Proposition: Full time Part time
Have Sold Your tools before
Want USERS Offer Have Used in past

DECAL SLIDE-ON SIGN LETTERS & NO'S.

Ideal for trucks and windows. Red, Yellow, Silver, Creme, Black. 4 1/2-in. 7c, 3-in. 5c, 2-in. 4c. Guaranteed. Add 10c postage for less than \$1.00 orders. State color and size.

PINNACLE SIGN LETTER CO. DEPT. I, MOUND CITY, ILLINDIS

MICROSCOPES SUPPLIES-ACCESSORIES & SCIENTIFIC INSTRUMENTS
BEL SPENCER NEW & USED LEITZ ZEISS MEDICAL INDUSTRIAL AMATEUR
BOUGHT-SOLD-EXCHANGED-REPAIRED
Send for FREE LIST
NATIONAL SCIENTIFIC INSTRUMENT CO. 119 CHAMBERS ST NY 7

2 BIG SPECIAL BARGAINS at LOW PRICES

BRIGGS & STRATTON LIGHTING PLANTS AND SPERRY S-1 BOMB SIGHTS

Made For the Government: All NEW . . . Never Used

Cost U.S. Gov't \$4,500



Complete With Power Plant . . .
Only **\$129.50**

BRIGGS & STRATTON Portable Lighting Plant priced at a fraction of the original cost. Built to rigid Government requirements. Especially built for Field Use or for permanent installation in Cottage, Farm, Trailer, Boat, etc. Complete with 1 3/10 H.P. Gasoline Engine, Hand Starter, Rated 250 Watts will develop 500 Watts. With Spare Parts and Tools. Mounted on permanent base . . . Rubber cushioned . . . Ready for Immediate Use anywhere . . . At this LOW PRICE they won't last long . . . Better Hurry only \$129.50.

SPERRY S-1 BOMB SIGHT—Here is an unusual opportunity to get one of these MARVELOUS Precision Mechanical Instruments . . . Marvelous beyond description. Contains hundreds of parts usable in 1001 ways . . . Regular and Bevel Gears, Shafts, Approx. 100 Roller Bearings, Electrical Parts, Precision Lenses and Prisms. Countless Gears, Dials, Knobs, Switches, Polaroid Filter, Calibrated Dials for Air Speed, Drift Indicator and Illuminated Spirit Level, etc. . . . Excellent for Inventors, Experimenters, Hobbyists. Schools use for Study Demonstration.

Cash with order or we will ship C.O.D. if 25% deposit accompanies the order. These prices F.O.B. Chicago.



Complete on Metal Base and Strong Box Container with Lock (can be used for valuables)

ALL FOR— ONLY

\$49.50

ACE SURPLUS SALES CO., Inc., 1449 West 69th St., Dept. P-10, CHICAGO 36, ILL.

Let 'em build their own!
JUVENILE TABLE & CHAIR SET



Give your youngster the thrilling satisfaction of building his own furniture with this highly educational set.

It's so simple—so easy to shape table-top and chair seats to fit these durable fabricated aluminum frames.

Working Blueprints and Instructions furnished to guide each step in assembly.

VAN NESS MFG. CO., Inc.
 MIAMI 38, FLORIDA



COMPLETE SET INCLUDES
 Strong fabricated aluminum frames. Screws for finishing, plus Blueprint Instructions and suggestions for material to finish table-top and chair seats.

MAIL ORDERS \$4.95
FILLED PROMPTLY Plus Postage

PALMGREN

No. 000 ANGLE VISE
 For MILLING—DRILLING—GRINDING FITTING—FILING



Solve Difficult Angle Jobs
 Quick, accurate set-ups at any angle. End make-shift methods—time loss—rejections. Ideal for tool rooms or home workshop. Accurately machined and graduated. Once set it stays locked. Jaws of steel—plain or grooved. PRICE \$11.25 complete with Swivel Base. Write for other styles and sizes.

DRILL PRESS VISES
 For tool room, machine shop, school shop, home shop or repair shop. Accurately machined. Best semi-steel castings. Adjusting screw of hardened steel with fine pitch thread and long bearing. Jaws of steel, grooved or plain. Sizes 1 1/2" — 2 1/2" — 4" Jaws.



No. 6
 1 1/2" GROOVED STEEL JAW. \$4.

No. 83 ROTARY TABLE with . . .
DUAL CROSS FEED and ROTARY FEED



Has 8" Circular Table with full 360° movement and 4" crossfeed travel. Free moving adjusting wheels and dials graduated in degrees. Crossfeed adjusting screws have Acme threads with adjustable dials graduated in thousands. Four slots in base and key slots for bolting to table.
 No. 83 Rotary 8" Table . . . \$49.56
 No. 82 Dual crossfeed—with out rotary . . . \$39.75

IMMEDIATE DELIVERY Write for Circular No. 12 — Order from dealer or direct postpaid if he can't supply.

CHICAGO TOOL AND ENGINEERING CO.
 8365 South Chicago Avenue Chicago 17, Illinois
 Telephone — Saginaw 9675

A GREAT SURPLUS BARGAIN
REDUCING GAUGE



The buy of a lifetime in a standard make air pressure regulator. Used on liquid carbonic tanks and air pressure tanks of all kinds to regulate the pressure. Fitted with standard 1/2 inch pipe thread. Dial calibrated 0 to 200 lbs. Made by U. S. Gauge, Air Reduction Co., Walter Kiddie—all famous makers. Used by artists for air brush work, sign painters, retouchers, welders, etc. Used by soda fountains and taverns. All units are brand new. Satisfaction guaranteed.

A \$15 VALUE \$5.95
 Send check or money order. Ship same day.

GROBAN SUPPLY CO.
 1522 S. Michigan Ave., Dept. PM10, Chicago, Ill.

Fully Guaranteed
 All Brand New and in Perfect Condition

Write today for booklet on the new **FLEX-O-SHAFT** Tool Kit, illustrating this improved all-purpose power machine with the hand-piece that works as easily as a pencil. Motor with switch, foot-operated rheostat, and 66 accessories, all at a special low price. **FLEX-O-SHAFT SALES CO.**, Dept. C, Prairieview, Illinois.

ROCKET ROLLERS

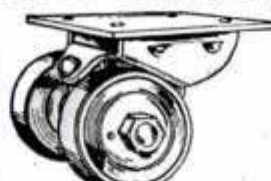

Use them for dollies, hand trucks, scooters, clothes baskets, work tables. Instruction sheet shows many other uses for home, garage and shop. Two-wheel design with double row, hardened steel ball bearings, rubber shock cushion and heavy gauge plated steel frame. Shipped prepaid anywhere in U. S. \$1.50 per pair (two sets wheels). Unconditionally guaranteed; if not satisfied, return within 10 days for full refund.

HEAVY-DUTY TYPE \$1.50 Per Pair (two sets wheels)

ROCKET ROLLERS
 2444 Beverly Road
 St. Paul 4, Minnesota

As INDISPENSABLE to your workshop as ELECTRIC POWER!

BAYFLEX



The three-sided grinding wheel that cuts faster, safer, easier...the wheel that saws, files and sharpens . . . the easiest labor-saving, money-making tool ever offered. Unexcelled for cutting BX cable, conduit, copper tubing, transite, celotex, brass, aluminum, steel, plastics, etc. Excellent for model makers . . . it CUTS, FORMS or SHAPES wood or metal. Start making Xmas gifts now! Send check or money order.

6" — \$1.65 Each 7" — \$2.15 Each 8" — \$2.80 Each
 All wheels 3/32" thick with 1" hole. State size of shaft if smaller than 1". Proper bushing will be sent free.

POSTAGE PREPAID by: Bay State Abrasive Products Co., Westboro, Mass.

Wake up your Horsepower

Your car *wakes up*, with a Casite tune-up. No more sputters, no more jerks—just a smooth surge of power. It's hard to believe that anything could improve performance so quickly, so easily. It's been proved in millions of motors.

and keep it wide awake

Casite cleans your motor . . . speeds lubrication . . . retards formation of sludge and gum. A pint of Casite through the air intake every three months and a pint in the crankcase every oil change, keeps your car free-running and full of pep.

the Guaranteed Way!

Double-Your-Money-Back if your car doesn't run better and smoother with Casite. And Casite makes this famous guarantee no matter what kind of motor oil you're using. Give it a try. Casite is sold by service stations, garages and car dealers everywhere. The Casite Corporation, Hastings, Michigan, and the Casite Division, Hastings Ltd., Toronto.



Cleans Motors
Keeps Motors Clean

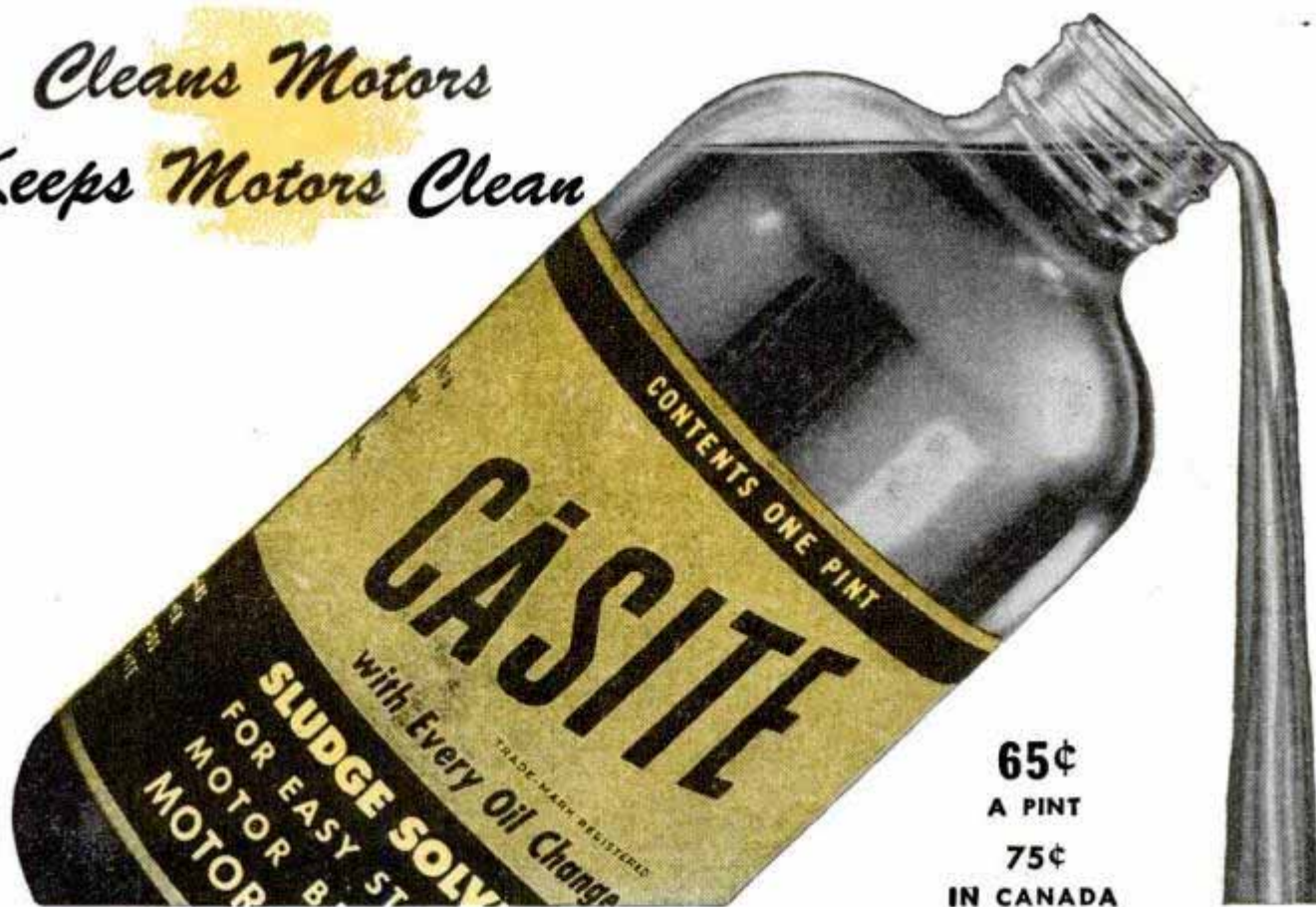

65¢
A PINT
75¢
IN CANADA

"Handie Talkies"

The most famous radio developed by the Army. Same type used with great success on all battlefronts. Sends and receives voice from 1 to 5 miles. Weighs only 5 lbs. including batteries. Preset crystal controlled operation in the amateur radio band on 3885 KC. May be tuned to other frequencies if necessary.

Highly recommended for airports, utilities, surveyors, police and fire departments, explorers, amateurs, boats, etc.

Price only \$49.75 each or \$99.50 per pair F.O.B. Chicago. Limited quantity. Send your check (or M.O.) today.

Brand new — complete with batteries and telescopic antenna — ready to operate. Fully guaranteed.



WELLS SALES, INC.

320 N. LA SALLE ST.
Dept. P-10, Chicago 10, Illinois

LOOK!



WAR SURPLUS

FIELD JACKETS

Ideal for
Farmers • Lumbermen
Truck Drivers • Laborers
and for
Plain and Fancy Loafing

ONLY
\$1.88
EACH

Nothing like it has ever been offered at this low price!

This full-zipper front, bi-swing back, fine poplin Army FIELD JACKET is the favorite of G.I.s all over the world. Although used EVERY jacket is guaranteed to be in perfect condition. Sizes 34 to 40. Send name, address and size and on delivery pay postman \$1.88 plus C.O.D. charges, or send \$1.88 with your order and we will pay postage. Order yours today!

S & B SURPLUS SALES CO., Dept. P30
2905 W. Madison St. Chicago 12, Ill.

ADD TO YOUR INCOME

Profit by Increasing Demand for Belts, Purses, Gloves Woolskin Toys —

with LARSON Leathercraft

No Experience Necessary

Sell popular, useful, easy-to-assemble items from Leathercraft Headquarters. Complete stock. All tools and accessories. Instructions come with materials. Immediate delivery.

101 Ideas

Send ten cents at once for catalog of money-making ideas.

For new, 16-page catalog, write to J. C. LARSON COMPANY
176 N. Wacker Dr., Chicago 6, Ill.



FIND UNDERGROUND MINERALS and METALS with M-SCOPE

Employs same principle as Army Mine Detector. Unsurpassed in Efficiency. Write for Free 16 page booklet.



FISHER RESEARCH LABORATORY, INC.
PALO ALTO CALIFORNIA



SURPLUS BRAND NEW 5 TON

Hydraulic Jacks

Nationally Known—Limited Supply—Rush Orders. Regular List Price \$19.50. Our Sale Price, only **\$8.95** ea.

Prices FOB, K.C. Send money order or check. Get our prices on all Army built Truck Parts. Dodge—Chev.—G.M.C.—Studebaker—Intl., 6x6—4x4—6x4.

AMERICAN AUTO PARTS CO.

1830 LOCUST—DEPT. P. M.
KANSAS CITY, MO.

MACHINE SHOP EQUIPMENT



Just off the press!—Every man who owns a workshop should have a copy of the new, up-to-the-minute, 200 page catalog of Machine Shop Equipment—the latest tools made by the biggest manufacturers in the U. S. Replete with illustrations, descriptions, prices. Prompt delivery on most tools listed in this book. Available at cost of printing—50c a copy—get yours today! **Price of Catalog Refunded on First Order over \$5.00.** Send check or Money Order to

CENTER TOOL CO., 153 Centre St., Dept. C, New York 13

Best for Reels--

..for Guns

LUBRIPLATE

The universal white lubricant reduces friction and wear • Waterproof • Prevents rust • Stays put • Lasts longer

20¢ at your dealers

in U. S. A.

Ideal for the HOME WORKSHOP



MINIATURE ENGINES

Gasoline—Steam
Air—Locomotive



THE WORLD'S MOST FASCINATING HOBBY

Build them yourself — In your own shop

With your own tools



Send 10 cents for my illustrated catalogue listing the world's largest selection of miniature engine castings and drawings.

McADEE MODELS

1313 S. TALMAN AVE.
CHICAGO 8, ILLINOIS

WALKIE SIREN

Formerly \$15.00—Now Only \$3.95



GOV'T SURPLUS. A precision instrument. Easy turn of crank produces CLEAR, FULL SIREN TONE. Can be heard for great distance. Ideal for Boats, Autos, Schools, Sporting Events, etc. Dimensions 7" x 8" x 5". Wt. 4 1/2 lbs. Price includes shoulder strap and waterproof cover. SEND NO MONEY. Just name and address. We'll ship C.O.D. for \$3.95 plus postage, or send money in advance. We'll ship prepaid. Canadian price \$4.50. ILLINOIS MERCHANTISE MART, Dept. 400-C, 1227 Loyola Ave., Chicago 26, Ill.

NEW METAL FORMING TOOLS

12" BRAKE. Fits in vise, or bolts to bench or plank. Forms angles, 1/4" channels and beads, boxes and locks in sheet metal and thin strap iron. \$14.50 PP. in U.S.A.
30" BRAKE. Forms angles in sheet metal 30" wide. Two handles. All steel. Wt. 40 lb. Price, \$24.50. exp. collect.

VISE FORMING TOOL. Makes cylinders, ovals, cones, hoops and round corners in sheet metal, wire and 1/2x2 steel strap, 2" to 6" in dia., 18" wide. \$10.00 PP.
VISE IRON BENDER. Easily bends 1/2" square or round; 1/4" up to 2" wide. Makes hooks, rings, brackets, eyelets, etc. Screw adjustment for accurate work. All steel. Price \$10.00 PP. Immediate delivery.

DRILLEZ drills steel easily with your 1/4 or 1/2-in. electric, or air drill, or brace and bit. 48" chain, lever feed. No screws. Soon pays for itself. Price \$3.50 PP.
SHEET METAL PLIERS, 21 1/2". Forms angles and channels. \$2.00. Sheet Metal and Wire Forming booklet, 50c. All items guaranteed. Order direct, or send for details.
VISE BRAKE MFG. CO., 1318 So. 30th Ave. PM, Omaha 5, Nebr.

HOME WORKSHOPPERS

Here are two tools that belong on every bench.

Better tools mean better work, greater skill — and more fun in the working.



The famous BERNARD Parallel Action Plier (#102), "wonderful with the its shoulders". Serves as plier, wrench, cutter and glass breaker. One ton bite at cutter.



FOR LEATHERCRAFT
The standard for years!
BERNARD complete leathercrafter's kit with interchangeable attachments. Also BERNARD Spring Belt Punches with revolving head and drive tubes.

At Your Local Hardware Dealer's
Send for descriptive folder. Coupon below for your convenience.

Faithful Since Quality 1870

BERNARD

TRADE MARK REGISTERED

WM. SCHOLLHORN CO., 7510 Chapel St., New Haven 9, Conn.

Sirs: Please send me your folder of BERNARD hand tools.

Name

Street

City Zone No. State



CORROSION and FRICTION

Use Fiendoil on tools, electrical appliances, household devices. It actively

Lubricates • Cleans • Prevents Rust

FIENDOIL

"The Enemy of Corrosion and Friction"

3-oz. Spout Can
40c

New "THERMO-SAW" (cuts with heat)

MAKE THINGS FOR THE HOME or FOR SALE

• ANY CHILD CAN USE IT •

No Noise—No Vibration—No Sawdust
Boys and Mechanics thrill over the many interesting things that can be made with this NEW ALL-STEEL THERMO-SAW . . . You can cut out any pattern or design in 1/2 the time . . . Difficult patterns are made QUICK and EASY . . . No turning of work . . . Cuts in every direction! . . . Cuts plywood 1/8" or 1/4" . . . Cuts 14" x 36" board. Will cut 1/8" Plexiglas very well . . . A special transformer produces high frequency current in a tough steel wire "blade" from ordinary Alternating (AC) Current . . . IMMEDIATE DELIVERY!
Extra Blades Machine Measures 11" x 4" x 3 1/2" High. Throat 7" Deep. PATTERN INCLUDED FREE.
ONLY 30c per dozen.
ORDER TODAY

AN IDEAL GIFT

NOTE: Operates on 110 volt Alternating Current; 50 to 60 cycle.
\$6.23 in Canada & Mexico.
\$6.48 elsewhere. On C.O.D. Orders Mail \$1 Deposit.

Pat. No. 2,272,931
D-87-072



DEALERS WANTED EVERYWHERE

A FEW OF THE MANY INTERESTING THINGS YOU CAN MAKE



Manufactured by THE KING COMPANY
6 No. Batavia Ave., Dept. P-10 Batavia, Ill.

ONLY \$5.98 Postpaid

COMPLETE SAW outfit as illustrated with transformer and 12 spare blades. Ready to use.

HEADLINERS

BAND SAWS—12" and 14" Bench
18" Parks Floor model
DRILL PRESSES—12" and 15" Bench
JIG SAWS—15" and 30" Bench
JOINTERS—4 1/2" and 6"
SAW TABLES—7", 8" and 10" Bench
THICKNESS PLANER—12"x4" PARKS
WOOD SHAPER—15"x20" Table 3/4" Spdl.

MOTORS 1/4 HP to 2 HP Single Phase
1/2 HP to 15 HP Three Phase

ELEC. DRILLS—1/4" 110 volt \$17.95

Paint Sprayers \$26.95

Oil-less ball bearing compressor
2 Cu. ft. 15 to 50# pressure

SEND US YOUR INQUIRIES

Ohio Machinery & Supply Co.

420 E. PEARL ST.

CINCINNATI 2, OHIO

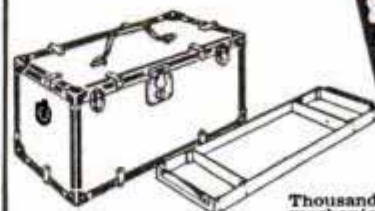

RUGGED IS THE WORD FOR THIS TOOL BOX

MADE IN 5 SIZES

SIZE	PRICE
14x6 1/2 x 8	\$3.50
16x6 1/2 x 8	3.75
18x6 1/2 x 8	4.20
20x6 1/2 x 8	4.50
22x6 1/2 x 8	4.90
Web shoulder strap	65c

Thousands of professional and home mechanics appreciate this tool box because it's . . .
• LIGHT WEIGHT • STEEL BOUND • and made of HARD NON-VULCANIZED FIBRE.
It can carry up to 100 lbs. and is equipped with all steel hardware. "D" rings are provided for shoulder strap. Shoulder strap is extra.
A tray for small parts, screws, washers, etc., is part of the box.
If you have a special idea in mind send us the information and we will be glad to quote on it.
Send your check or money order today. Special Discount to Dealers.

ALLIED • P. O. BOX 52 • NEW YORK 51, N. Y.



DRAIN YOUR CELLAR, POOL, WASH TRAYS, ETC.

LABAWCO Type P Pump keeps garden pools fresh. Circulates oil or refrigerant, etc. DOES NOT CLOG! 1500 Gals. per hr. — 300 Gals. at 30'. Uses 1/2 to 1/2 H.P. motor.

PUMP ONLY \$6.50 POSTPAID

COMPLETE SELF-PRIMING UNIT (less motor): Pump, motor stand, special bracket, 18" flexible shaft, 14" length 1" suction hose, bolts, etc. \$13.95 postpaid

Pump alone \$6.50.
Pump with complete self-priming unit . . . \$13.95
POSTPAID if cash with order. West of Mississippi, add 50c.

SEND ORDER TODAY

LABAWCO PUMPS
BELLE MEAD 4, N. J.

BUILD YOUR OWN SPORTS TRAILER

takes two days . . . saves you \$200

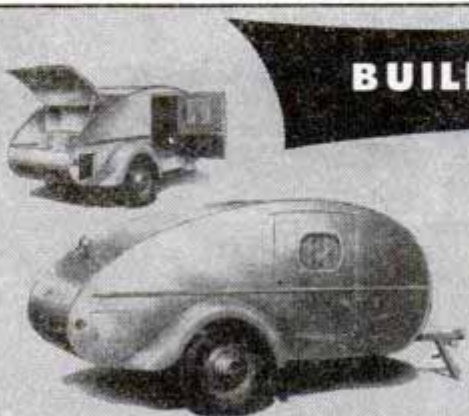

ACTUAL VIEW OF TRAILER ASSEMBLED

Now—this beautifully streamlined sports trailer—made and sold by Modernistic Trailer Manufacturing Co. for years at a price over \$500, is being shipped in a complete, prefabricated kit. Comes to you ready to assemble. It's easy—all you need is a screwdriver and wrench! Anyone can do it! Complete instructions furnished. Trailer has all-aluminum exterior. Accommodates 2 adults. Overall length, 12'7", width 6', height, 5'. Has roomy galley, and plenty of storage space. Total weight slightly over 400 lbs.—hardly noticeable behind your car. Kit comes complete with every part needed, less tires and tubes.

Build this deluxe sports trailer for your own use—or sell it and make money! Order your prefab kit today . . . fit and quality of every section unconditionally guaranteed. Price only \$279.50, plus tax, f.o.b. Los Angeles. Enclose full remittance, or, if you desire C.O.D. shipment, enclose \$50 deposit. If more convenient to you we will ship trailer in two kits—one kit now, the other later when you're ready for it. Price is slightly higher but you pay for each when you order. First kit, containing chassis and outer shell sections, only \$157.50. Second kit, containing balance of trailer, \$139.00. Order today specifying complete kit or first half of kit. Write for free folder.

NATIONAL TRAILER STORES • Dept. 30 • Box 2353, Terminal Annex • Los Angeles 54, California

MORE PROFITS

with

MODERN LAWN MOWER SHARPENER

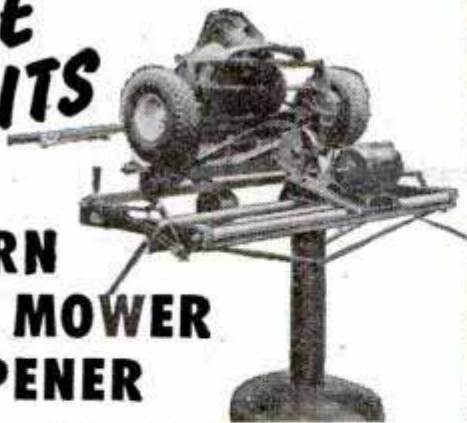

SHARPEN ANY LAWN MOWER from 5-inch Edger to 36-inch Power Mower in ten to twenty minutes with a MODERN LAWN MOWER SHARPENER because dismantling is unnecessary — neither handle, roller, wheels nor motor need be removed when sharpening any mower. . . . the MODERN SHARPENER eliminates all hand filing; it precision grinds to the extreme ends of both left or right reel blades. Bottom knife is held in same brackets for sharpening. NO EXTRA ATTACHMENTS! Order today! Price \$241.50 (less motor) f.o.b. Pasadena. (1/3 or 1/4 H.P. single phase motor recommended.)

Modern Mfg. Co., 156 N. Fair Oaks, Pasadena 1, Calif.

SHOCK ABSORBING

Tow Strap



FITS ALL CARS

Unbelievably strong — fastens to any car or truck bumper like a belt. Attaches in a jiffy. 10" s-t-r-e-t-c-h avoids jerks and car damage when starting and towing. Widely used on farms for pulling stumps, securing heavy loads, etc. Woven linen web — breaking strength 5000 lbs., more than most tow chains. In compact box — fits in corner of glove compartment. Send check (or M.O.) for only \$2.95 and your Motorists' Tow Web will be sent prepaid anywhere in U.S.

Cee-eN Mfg. Co., 7241 N. Hamilton Ave., Chicago 45, Ill.

It's Easy to BUILD YOUR OWN FURNITURE

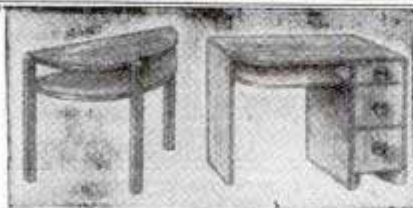

It's so simple to build these smart, sturdy pieces of furniture for your home. Full size plan, printed in ink, makes patterns unnecessary. Wood finishing instructions included. Send \$1.00 cash, check or M.O. for Plans 26 and 33 (shown). Postpaid in U.S. and Canada only.

Send 25c for complete catalog of patterns (refunded on first \$1 order).

CRAFTSMAN DESIGN SERVICE
823 Eckart St. Dept. G-10 Ft. Wayne, Ind.

GASOLINE ENGINE

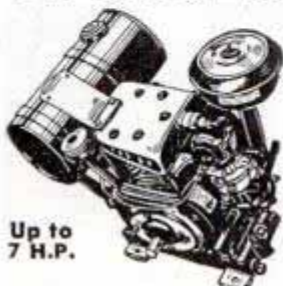

Used Gov't Surplus — Air-Cooled Briggs-Stratton or Wisconsin Engine. Our sale price F.O.B. K.C. **\$74.50**
SPECIAL: 3000 Watt, 110 Volt Light Plants. Bargain Price F.O.B. K.C. **\$124.50**
Write for illustrated circular — Immediate delivery

MIDWEST SURPLUS SALES 1520 Locust St. Kansas City, Mo.

Up to 7 H.P.



Now...
Fractional
Horsepower
Motors by

HOOVER



HOOVER BUILT,
HOOVER ENGINEERED
BY THE MANUFACTURERS
OF THE WORLD-FAMOUS
HOOVER
CLEANER

Now you can have fractional horsepower motors designed with the same electrical engineering skill and know-how that's made the Hoover Cleaner the world's best.

The Hoover name is your assurance that you will get years of efficient service on your toughest motor requirements.

FEATURES OF THE HOOVER MOTOR

- Induction run... single phase... 60 cycles... 1725 R.P.M. ... heavy duty... built for continuous operation.
- Capacitor start... more than 300% full load starting torque with minimum current flow.
- No vibration or "shift"... integral feet, carefully machined to give solid mounting and quiet operation.
- Low temperature... electrical and mechanical design for low-temperature operation. Ventilated open type. 40° C. Rise.
- Laminated steel rotor... carefully ground and balanced for maximum efficiency.
- Centrifugal starting switch... built for trouble-free operation.
- High-grade ball bearings... sealed against dust and grit, give smooth performance and long wear.
- Rotation... clock or counterclockwise.

POPULAR USES OF HOOVER MOTORS

- Lathes...
- Jig saws...
- Drill presses...
- Bench saws...
- Sanders...
- Planers...
- Hobby shops
- Garage tools

THE HOOVER COMPANY

Electric Motor Division, North Canton, Ohio
Hamilton, Ontario, Canada

SAY YOU SAW IT IN POPULAR MECHANICS

SpeedWay



No. 89
1/2" ELECTRIC DRILL
\$29.95

Light in weight, convenient and handy, this improved drill has a special aligning grip that makes straight drilling natural. Backed by 35 years of electric drill manufacturing, produced in great quantities by modern methods, this is today's best drill buy. For every day farm, garage, construction and maintenance use, you can't get a better drill at any price. Specially wound, long life, high torque, fan-cooled motor. Cut steel gears, self-lubricating bearings, sturdy die cast case and a full sized snap action chuck (no key to lose).

With a No. 209 Drill Stand the 89 Drill makes a capable lever operated drill press. Order from your local SpeedWay dealer.



No. 209
Drill Stand
(less drill)
\$12.95



No. 117
Grinder
\$14.95

SPEEDWAY MANUFACTURING CO.
1863 S. 52nd Ave., Cicero, Ill.

WAR SURPLUS AS MADE FOR U. S. NAVY

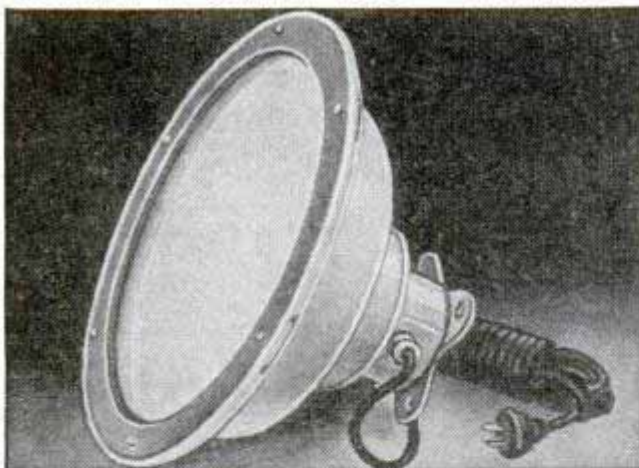

PROTECT YOUR HOME AGAINST BURGLARS AND PROWLERS WITH

ONLY \$15

BRAND NEW

THIS PRICE BELOW FORMER OPA CEILING. ONLY FRACTION OF WHAT IT COST GOVERNMENT.

GIANT FLOOD LIGHT

FOR Industrial Uses • Estates • Photography • Athletic Fields • Farms • Tennis • Churches • Libraries • Gifts • Parking Areas • Ships • Yards • Docks • Beaches • Soft Ball • Foot Ball • Parks • Golf Driving Ranges • Construction Work.

ILLUMINATES LARGE AREA. Easily installed. Base plate on lamp bored for quick mounting. Weather proofed. Has 14 ft. of heavy rubber cord; takes AC or DC current; frosted heavy convex lens; rugged construction; made to Navy specifications.

GIANT (Navy Surplus — Brand New) 14" in diameter; includes 150-watt standard bulb. Wt. 8 lbs. **ONLY \$15**

JUMBO: 12 1/2" Lens; wt. 9 lbs. Built-in swivel to adjust to any position; adjustment for far or near lighting; includes 500-watt bulb. **\$35**

ONLY MONEY BACK GUARANTEE. Terms: Cash with order. Mail order today with money order or check. Shipped Express Charges Collect. **CARNEY'S, INC., 29 Central Ave., Dept. M-3, Tarrytown, New York**

SUPER GIANT — (Brand New) 17" in diameter; includes 300-watt standard bulb; wt. **\$25**

MASTER: 15 1/2" Pyrex Lens; wt. 13 lbs.; built-in swivel to adjust to any position; adjustment for far or near lighting; includes 1500-watt bulb. **ONLY \$45**

The SPEED SAW FILER

Saves You Time, Money

Now you can do expert saw filing at home. Lifetime tool makes precision filing easy for even the most inexperienced. Two simple adjustments make it fit any type hand saw. Keep your saws extra sharp and true-cutting with a Speed Saw Filer. Complete with file, ready to use. Money back guarantee. Cash with order, prepaid (C.O.D. postage extra.)

THE SPEED CO., Dept. PM
2025 N.E. Sandy, Portland 12, Ore.



Now FILE Your OWN SAWS

ORDER NOW!

\$29.95

RUST! RUST! RUST!

WHAT a headache! Here's the answer! A new liquid **RUST REMOVER**—quickly dissolves rust on iron or steel, tools, hardware, machinery, etc. **NO RUBBING** or hard work. Brush, swab, spray or dip. Put **ON**—let **SET**—wipe off—**RUST GONE!** On sale at all Sears Retail Stores in **HARDWARE DEPTS.** 50c and \$1.00 in Mid-West (slightly higher elsewhere.) Valuable manual of rust control **FREE** with each bottle.

SEARS, ROEBUCK and CO.

For further information, write **ALLIED PRODUCTS COMPANY, Dept. L-1, 1133 Newport Ave., Chicago, Ill.** Manufacturers of CorOdex.



CORODEX Liquid **RUST REMOVER**

\$1 PER QT.

PRINT YOUR OWN

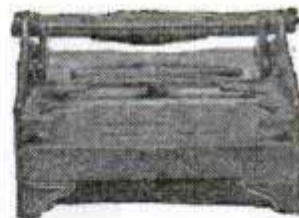

- CARDS
- LETTERS
- POSTCARDS

25% Deposit Required **\$3.95** COMPLETE

Dealers send for Discounts

COASTAL DISTRIBUTORS

553 MARKET STREET

NEWARK 5, N.J.

MAGNETS

OF ALL TYPES—10¢ UP

AMAZINGLY POWERFUL 1/2" 4OZ. ALNICO MAGNET, LIFTS 10 LBS. \$1.00
OUR LEADER, CAT. NO. 510, LIFTS 40 LBS. \$1.25
NEW ALLOY—WILL NOT WEAKEN! USEFUL FOR LIFTING VALVEABLES FROM TANKS, LAKES, OR RIVERS EASILY!
7 SMALL MAGNETS \$1.25 WITH LIST OF MANY SHOP & HOME USES
SATISFACTION GUARANTEED R. EYRICH, 2566 N. 49th ST. MILWAUKEE-10, WIS.

SAVE on Razor Blades

50 Swedish Steel Razor Blades \$1
Equal to Blades Costing Far More



Made by new precision process

Zip through your morning shave—save time, temper, MONEY. Whiskers disappear when the keen cutting edge of this "SUPER" Swedish steel blade hits 'em. Handy box of 50 double-edge blades \$1. Postpaid. Check, money order. No C.O.D.

Sample Blade FREE

JUNG'S Mail Order Dept., 629 N. 8th St., Sheboygan, Wisconsin.

Please send me:

Packs of 50 "SUPER" Swedish Steel Razor Blades, \$1 per pack.

FREE Sample Blade.

Gold Plated Razor with 10 Extra Blades, only 89c.

Enclosed Check Money Order Amount _____

Name _____

Address _____

City _____ State _____

Get in on the ground floor! Be first in your area to enter this

profitable NEW business!

YOU'RE CERTAIN TO SUCCEED

BECAUSE DRYEX SUCCEEDS

WHERE EVERYTHING ELSE HAS FAILED!

DRYEX

makes wet walls DRY
... and keeps them DRY!

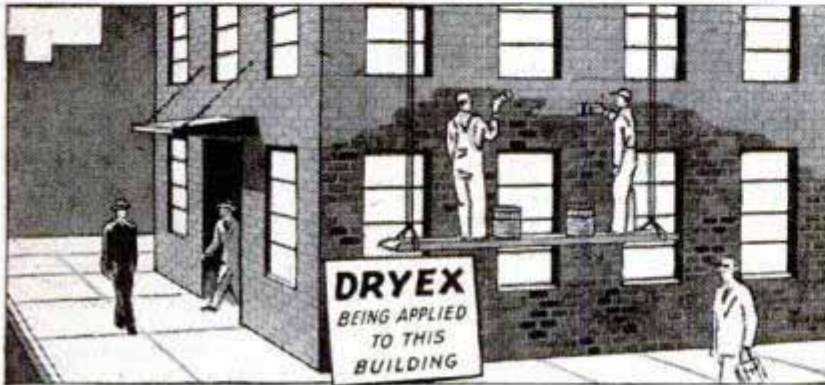

SELL OR APPLY DRYEX . . .

the great wartime discovery that will make big money for you!

Easy to brush on, easy to sell, DRYEX spells "opportunity" for you. Every owner of a leaky wall is your prospect, and there are thousands of them! Amazingly effective, DRYEX is the miracle plastic that seals leaky exterior walls definitely and enduringly. Stays tough, flexible and waterproof in all weather, all climates.

Your Territory May Still Be Open. Write Today for Details.

LASTING PRODUCTS COMPANY

Franklintown Road Plant, BALTIMORE 23, MD.

SAY YOU SAW IT IN POPULAR MECHANICS

New Design Engine

PRECISION BUILT!

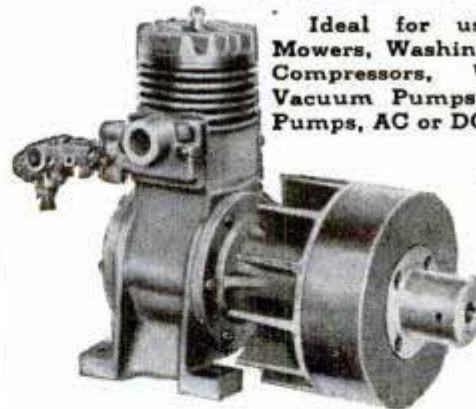

Ideal for use with Power Mowers, Washing Machines, Air Compressors, Water Pumps, Vacuum Pumps, Hydraulic Oil Pumps, AC or DC Generator Sets and most light machines and appliances.

2-Cycle, self contained gasoline unit develops over 1/2 H.P. Bore and stroke, 1 5/8". Speeds up to 6,000 R.P.M. Weight

only 12 lbs., complete. 6-Volt Battery ignition. Ball bearing crankshaft.

Price complete with carburetor, coil, condenser, battery, spark plug, muffler, starter rope and cooling shroud, tested and ready to run. \$37.50 F.O.B. Plus Tax.

ALSO AVAILABLE

BUILD-IT-YOUR-SELF-KIT, containing all rough castings, piston rings, machine screws, carburetor, coil, condenser, spark plug, etc., and a complete set of blue-prints, \$24.50 F.O.B.

We Invite Dealer Inquiries

Daggett Engineering
MEADVILLE, PA.



The Torco utility combination bench and pipe vise is so carefully designed and ruggedly constructed that it will give years of satisfaction without side wear or dead motion. Precisely threaded spindle and replaceable hardened steel jaws.

See Your Dealer as low as \$7.20 With 3 1/2" Jaws

Free Folder Explains Features To Look For In A Good Vise
Wilton Tool Mfg. Co., 936-G Wrightwood Ave., Chicago 14

WILTON VISES

Built by Wilton — they Must Be Good

WHEELS & AXLES

Precision-made steel wheels, red enamel finish.

WHEELS WITH SEMI-PNEUMATIC TIRES

6" X 1.50 with 3/8" Oilite bearing	1.75
8" X 1.75 with 3/8" or 1/2" Oilite bearing	2.25
10" X 1.75 with 1/2" Oilite bearing	2.75

WHEELS WITH SOLID RUBBER TIRES

4" X 1 1/2" tire, 1/4" steel bushing	.65
6" X 3/4" tire, 3/8" steel bushing	1.00

INDUSTRIAL & AGRICULTURAL WHEELS
PAINTED BLACK

10 X 2.75 with Semi-solid lug tire, load cap, 400 lbs. Ballbearings 1 1/2", 3/4" or 3/8". Hub length 3"	7.00
3.00 X 5 with 2-ply Pneumatic tire and tube, Ballbearings 1 1/2", 3/4" or 3/8". Hub length 3"	9.75
4.00 X 8 with 4-ply Pneumatic tire and tube, Ballbearings 1 1/2", 3/4" or 3/8". Hub length 4" or 6"	13.95
Roller Bearings in 5/8", 3/4" or 1" supplied at \$1.00 extra	

AXLES, COLD ROLLED STEEL

THREADED, NICKEL CAP NUTS

1 1/2" x 14" long	.40	1 1/2" x 18" long	.80
3/4" x 16" long	.60	1 1/2" x 24" long	1.00
3/8" axle with washers and cotter pins, per ft.	.75		
3/4" axle with washers and cotter pins, per ft.	1.00		

Shipped postpaid in U. S. on receipt of price. Other wheel sizes available. Send stamp for catalog.
CIRCLE METAL MANUFACTURING COMPANY
4266 E. Pacific Way Los Angeles 23, Calif.



WAR SURPLUS BARGAINS

**U. S. ARMY AIR CORPS
ALL LEATHER, SHEARLING
LINED FLIGHT PANTS**

New \$14.95 Reclaimed \$8.95

**U. S. ARMY AIR CORPS
SHEARLING LINED FLIGHT
BOOTS—Reclaimed
\$7.95**

War proven for exceptional warmth—ideal for hunters, trappers, fishermen, farmers, etc. Pants of heavy, tough-wearing leather with soft, heavy, warm Shearling Lining; suspenders, 5 handy Zippers; sizes 30 to 42. Boots of heavy leather with Shearling Lining; zipper front; sturdy rubber soles. Waterproof for all weather. Sizes medium, small.

Side Pocket Zippers
Full Length Leg Zippers
Flop Zipper
2 Leg Pockets

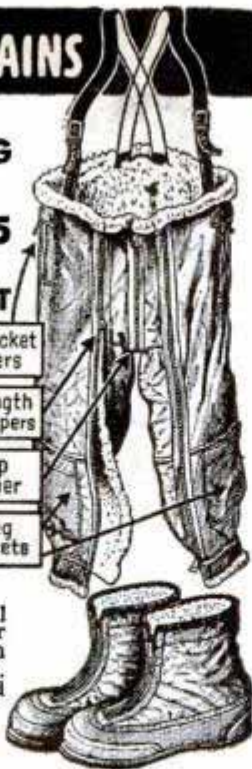

ORDER NOW—Enclose full amount for postpaid delivery. Better order both Pants and Boots at our low prices. Satisfaction or return for refund within 5 days.

A & T WAR SURPLUS SALES CO., Inc.
2476 Lincoln Ave. Chicago 14, Ill.

AT LAST!

**A
WORKSHOP
GRINDER
OF YOUR
OWN
for only
\$14⁹⁵**

(\$15.95 West of Denver)

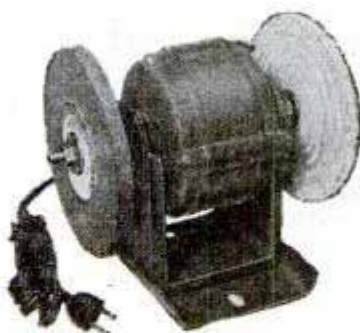

FULL YEAR GUARANTEE

Just what you've been waiting for—this sturdy new, grinder-buffer-polisher. Designed and built especially for the home and hobby shop . . . Perfect for small industrial jobs.

HAS COUNTLESS USES

You will need this amazing home workshop grinder to sharpen knives, scissors, screwdrivers, small tools, lathe bits and many other around-the-house items . . . polish silverware, jewelry, golf clubs and keys.

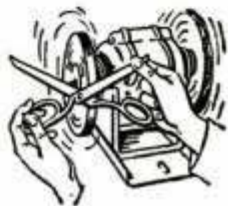

NOTE THESE FEATURES .

Safe operating speeds of 1725 rpm—will withstand stalling for 20 minutes without injury to motor. Oversized rubber cushions make it whisper-quiet—a must for home workshops and offices. Low cost operation—uses same current as 100 watt bulb. Will not interfere with radio. It is light enough to be carried to place of work.



NOTHING EXTRA TO BUY

Comes fully equipped—ready to go to work. Includes rugged six foot cord set, dura-hard, silicon carbide grinding wheel, polishing wheel. Has famous Victron motor mounted on resilient, non-vibration base. Finished in gray baked enamel—equipped with oil reservoirs and felt seals to last for the lifetime of the grinder. Weighs approximately 12 pounds. Can be clamped or bolted to table or work bench. Designed specifically for hobbyist, handyman, housewife, mechanic, doctor, dentist, optician, watch maker and jeweler. Send check or money order today. Postpaid in U. S. A.

VICTOR ELECTRIC PRODUCTS, INC.
2950 Robertson Ave. Cincinnati 9, Ohio

**Build
Your Own
Home
Freezer**



For plans to build this 20 cu. ft. freezer send \$2.00 to

K. G. GARDNER

153 Claremont N.W. Canton 3, Ohio

How to sell your product—

Will your product sell at a profit? Don't guess! A low-cost test, made by experienced men in a recognized sales test area, will give you the answer. Service to fit your needs; a simple market test, or a full sales program. Tell us about your product. We may find markets you never dreamed of!

Write today for free information.

MARKET FINDERS

4430 So. Logan St. Englewood, Colo.



**COLT & LUGER
AMMUNITION**

9MM, P38, .25, .32, &

.45 pistol & revolver & rifle & shotgun ammunition. New guns, repeaters, automatics, single shots & double barrels. Send \$1 for gunsmith course, guns & ammunition catalogue & journals.
NEW YORK CO., BLOCK 800, RIDGEWAY, PENNSYLVANIA

AMAZING NEW TRAP CATCHES ANIMALS ALIVE!

CAN'T HARM CHILDREN, PETS, BIRDS, POULTRY

it's amazing how the new HAVAHART catches rats, rabbits, squirrels and other animals, yet it's harmless to children and

pets. Simple to set, rustproof. No springs! No jaws! Animal walks in to get bait, and the doors close! Send postal for free booklet.



HAVAHART,
33 Water Street
Ossining, N.Y.

MODEL No. 3
for farms and estates

ELECTRIC POWER PLANT

BUY NOW FOR CHRISTmas

No Fire Heat Steam Water!



IT'S REAL FUN!

A complete power unit—boiler, whistle, smoke stack, piston, flywheel, three pulley speeds and a generator housing which contains the heavy-duty drive motor. Ready to operate—simply plug into 110-volt, 60-cycle AC outlet—no transformer needed. Size approximately 7" x 9" x 7". There's never a dull moment when you have a POWER PLANT.

Was \$17.95 Now Only \$8.95

Use Coupon to Order

POWER TOY CO.
P. O. Box 656, Dept. R, Oak Lawn, Ill.
Please ship me a complete Power Plant

Name _____
Street or RFD No. _____
City _____ State _____

Shipment prepaid if remittance is enclosed; otherwise, C.O.D.

You Can Run All of These ...and More!



Air Compressor Blows Built-In Whistle or Operates Models.

Motor Guaranteed for One Year

Free! Booklet with detailed construction plans for ten models.

TOOL BARGAIN

Electric Hand Grinder Assortment

A Super Value

Get this superb assortment of top quality grinding, cutting and polishing wheels and other useful tools, and be money ahead. Save \$35.25. Have JUST THE RIGHT ATTACHMENT for every job. Order today. Send check or send \$2.00 deposit with C.O.D. order.

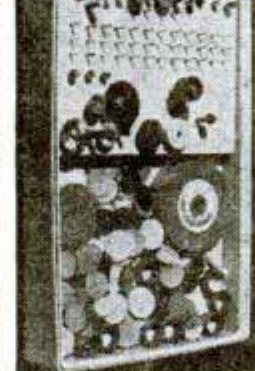

- MASTER KIT**
- Now Only **\$9.75** A \$45 Value
- POSTPAID IN U.S.A.
- 102 Grinding, Cutting and Polishing WHEELS PLUS 150 assorted items for Home or Shop.
 - 2 Grinding Wheels 3" and 2" dia.
 - 2 Rotary Files, High Speed Steel.
 - 6 Rotary Cutters 1/2" Shank.
 - 3 Rotary Cutters 3/32" Shank.
 - 6 Mounted Grinding Wheels 1/2" Shank.
 - 6 Mounted Grinding Wheels 3/32" and 1/4" Shank.
 - 4 Speed Drills 3/32" Shank.
 - 30 Rotary Cutting Burs 3/32" Shank.
 - 2 Mandrels 3/32" Shank.
 - 1 Mandrel 1/2" Shank.
 - 1 Screw Type Mandrel 3/32" Shank.
 - 3 Rotary Bristle Brushes 3/32" Shank.
 - 1 Rotary Wire Brush 3/32" Shank.
 - 1 Circular Saw 1 1/2" dia.
 - 1 Mandrel for Circular Saw 1/4" Shank.
 - 2 Rubber Cylinders and Mandrel 3/32" Shank.
 - 1 Rotary Drum Sander 1/2" Shank.
 - 15 Bands for Rotary Drum Sander.
 - 15 Rotary Felt Wheels 1" dia.

Kit comes in compact container with special rack for drills. Over 250 tools and items in this deal.

D. SCHUPACK, 2256 E. 75th St., Dept. PM-10, Chicago 49, Ill.

GET THE BEST IN MUFFLERS

V-8 DUALS & SINGLES



Finest Norman custom-built muffler sets—steel pack—torpedo type—heavy, perforated steel cores—chrome enamel finish—mellow, deep tone (improves with use)—designed to fit—all ways superior—double economy.

DUALS.....	\$17.50	SINGLES.....	\$7.50
V-8 Ford-Mercury		Buick, Olds., Chrys.	
SINGLES.....	\$5.50	ORDER TODAY! Will outlast three ordinary mufflers.	
Chev., Ford, Plym.		Dealers—Write Today for Full Details	

NORMAN'S MUSICAL MUFFLERS
Dept. PM-5, 1216 W. Slauson Ave., Los Angeles 44, Calif.

Masonry Spraying

... Today's Outstanding Business Opportunity



Beauty and protection are sprayed on old and new buildings... exterior and interior surfaces... by COLORCRETE. It's a plastic, water-resistant material, spread evenly over surfaces and forced into cracks by air pressure. Fuses to masonry with enduring tenacity. Many textures. Range of 30 smart colors. Fully proven by 20 years of actual use under all conditions.

BIG EARNINGS FOR COLORCRETTERS

Colorcrete ties in with today's huge building program. Renews old buildings. Makes new construction more attractive and enduring. Large waiting market, because building owners get long lasting beauty and protective values at low price. Yet your selling price can be several times your basic cost. Machine is easy to operate. Moderate investment. Write or wire for complete information.

COLORCRETE INDUSTRIES, INC.
570 Ottawa Avenue Holland, Mich.

COLORCRETE

MACHINISTS — HOBBYISTS
MECHANICS — HOME CRAFTSMEN

get the

"PROFESSIONAL TOUCH"

ON ALL YOUR WORK



CUMMINS POWER DRILL

MORE WORK WITH LESS EFFORT

Speed your work on wood, metal, plastic and other materials with this powerful Cummins 1/4 inch drill. Scientifically designed for balance and ease of operation. Lightweight — portable — FULL SIZE CONVENTIONAL DRILL — weighs approximately 5 pounds. Popular Saw Handle Grip for accurate control in all working positions. Power switch at thumb tip. Special motor does not stall even under heavy direct pressure! It's the Drill that's favored by men who know and use fine tools. See it today at your favorite dealer. If he does not have it write direct.

Model 120	\$17.95
With Keyless Chuck	
Model 110	\$18.95
With Jacobs Hex Key Chuck (Illustrated)	
Model 130	\$20.95
With Jacobs Geared Chuck	

CUMMINS PORTABLE TOOLS
DIV. CUMMINS BUSINESS MACHINES CORP.
4764 RAVENSWOOD AVENUE, CHICAGO 40, ILLINOIS



SEWING MACHINE MOTOR KIT

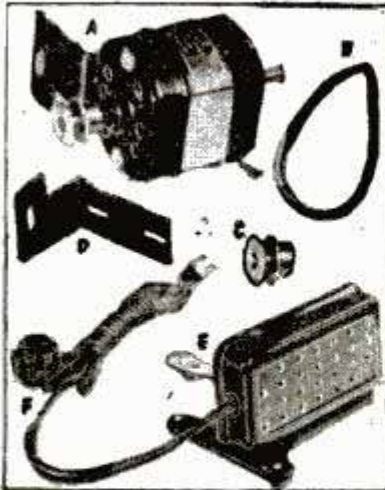

\$18.95
COMPLETE

Shipping Wt. 4 lbs.
ADJUSTABLE FOR USE WITH ANY TYPE OF SEWING MACHINE ANYBODY CAN INSTALL IT!
Takes but a few seconds
Complete set consists of:
A—MOTOR & BRACKET, Universal AC or DC, 40 cycle, 115 V. B—BELT, Long Wearing Rubber Belt. C—PULLEY, Single Grooved Steel Hubbed Pulley. D—BRACKET, New and Improved. E—FOOT CONTROL, 7 Step Rheostat. F—CORD SET, Extension cord fitted with plug and socket.

Also can be used for anything where foot control is needed.

PASAAK'S, Box 153, Canal St., N. Y. 13, N. Y. Dept. PM

Get A SEAMAN ROTARY TILLER

Better Yields—Better Crops



Because this farm-size rotary tiller prepares seedbeds most ideally suited to your soil and crop conditions, it helps produce higher yields and better quality crops. Can be adjusted for fine pulverization, coarse or medium tillage . . . just the way you want it. Mixes fertilizer and humus into the GROWING AREA of seedbed; aerates soil; eliminates air pockets and hard plow soles; conserves moisture; promotes earlier and more complete germination of seed; helps to destroy many crop pests and certain varieties of fungus; provides effective weed control; reduces erosion . . . all with ONE machine!



SEAMAN ROTARY TILLERS are available in power take-off and motorized models 3 to 7 ft. tillage widths. See your Seaman dealer and write for complete information.

SEAMAN MOTORS, Inc. 364 N. 25th Street Milwaukee 3, Wis.

SAY YOU SAW IT IN POPULAR MECHANICS

ACE LATHE TOOL SET

Be permanently tooled-up for every operation on your Metal Cutting Lathe



The ACE Set is complete—there's nothing more to buy. Drop forged by the manufacturers of cutting tools used by 96 per cent of the plants and shops in industry they are correctly designed, are of special steel, are finely finished, are stronger—will last a lifetime. You can cut easier, faster and more accurately with ACE TOOLS.
At your Hardware Store—
Turning Tools, 2 Cutting Tools, 2 Drilling Tools, 2 Boring Tools, 2 Threading Tools, High Speed Steel Cutters and Blades, and 7 Wrenches in Fitted Steel Case.

ARMSTRONG BROS. TOOL CO.
"The Tool Holder People"
368 N. Francisco Ave., Chicago 12, U.S.A.

V-8 DUALS & SINGLES

MUFFLERS
STEELS and ALUMINUMS with a motorboat tone
SINGLES, Chev, V-8, Plymouth, Steels \$5.50, Aluminum \$6.50. Chry., Olds., Buicks, etc., Steels \$7.50, Aluminum \$8.50. V-8 and MERCURY DUALS, Steel \$17.50, Aluminum \$20.00. Aluminums are guaranteed for life of your car.
DEALERS WANTED

SANDEE MUFFLER CO.
7523 S. WESTERN AVE., LOS ANGELES 44, CALIF.

DUAL WHEEL CONVERTER

Now! YOU CAN INSTALL DUAL WHEELS

On Your Car, Trailer, Pick-up Truck, Farm Wagon or Jeep with DROP CENTER DISC WHEELS

IN LESS THAN 10 MINUTES



- INCREASE LOAD CAPACITY
- INCREASE TRACTION
- INCREASE TIRE LIFE

Now you can convert your vehicle to dual wheels without the high expenses of changing to truck-type wheels and hubs or changing the entire rear axle. This

new patented converter does the job at a fraction of the old cost. For use on Ford passenger and 1/2-ton truck, 1928 to 1947 (except 1936-39); Chevrolet passenger and 1/2-ton truck, 1927 to 1947; Dodge-Plymouth passenger and 1/2-ton truck, 1933 to 1947; Willys and Ford Jeep vehicles, all models; all trailers and farm wagons equipped with any of the above type wheels.

GUARANTEED TO DO THE JOB OR YOUR MONEY BACK.
NORTHWESTERN AUTO PARTS CO. MINNEAPOLIS 11, MINN.

Only \$2850 Complete Set

It's EASY as A-B-C
No changing required.
No drilling necessary.
Rim-wrench does the job.

1. Mount the first wheel.
2. Screw on extension bolts.
3. Slip on adapter housing.
4. Mount the second wheel.

THAT'S ALL!

CLIP THIS COUPON NOW

Northwestern Auto Parts Co. PM-10
834 N. Seventh Street, Minneapolis 11, Minn.
Please send me.....Dual Wheel Converters at \$28.50 each.
FORD CHEV DODGE-PLYM JEEP
Also Fits Farm Wagons Using Above Type Hubs

Name

Address

City..... Zone..... State.....

Money Order Check

ATTENTION DEALERS: Many fine territories open.

WAR SURPLUS BARGAIN SPECIAL

BELT DRIVEN
CENTRIFUGAL

PUMP

READY TO
USE ON ANY
LIQUID
PUMPING NEED

NOW ONLY
\$29.75



FOR HOME WATER SYSTEMS, IRRIGATION, FIRE PROTECTION, DRAIN BASEMENTS, PONDS, ETC.

• A super value for all types of intermittent service in pumping large volumes of liquid for stock watering, home and shop water systems, irrigation, draining pools, basements, etc. At 1750 RPM on 23 foot head will pump 42 gallons per minute; at 3600 RPM on 52 foot head will move 88 gallons per minute. Cast aluminum housing. Accurately machined bronze impeller vanes. Complete with mounting bracket and 3 1/2 inch V belt pulley. Run with electric motor, gasoline engine, power take-off on tractor, etc. Shaft rotates on sealed ball bearings with grease gun fitting. Has 1 1/2 inch threaded intake flange, two 1 inch outlets. Use one or both as necessary. Made for Packard Motor Car Co. for use in Rolls-Royce Merlin Aircraft engines. Comes complete with pulley and mounting bracket. Original cost approx. \$147.00. Sold F.O.B. Chicago. Shipping weight 23 pounds. Complete engineering reports and operating instructions free with pump. You can't beat this pump value at anywhere near this price. Satisfaction guaranteed.

ORIGINAL COST APPROX. \$147.00
IMMEDIATE DELIVERY FOB CHICAGO
SPECIAL PRICE, WHILE THEY LAST

\$29.75

GROBAN SUPPLY CO. 1522 So. MICHIGAN AVENUE
DEPT. PM10, CHICAGO 5, ILL.

WAR SURPLUS BARGAINS

MOTOR-GENERATOR

Emerson Electric Mfg. Co. 3 HP Motor ... AAF Type D50 FD-222-0435, 28 Volts DC, compound, 3800 RPM, 115 Amp, windings glass insulated, blower cooled, shaft dimension 5/8", Wgt. 27 Lbs. As Generator, puts out 115 Amps. ... ideal for portable welder ... **\$13.95 each.**

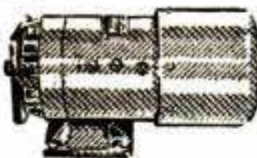

SEND CHECK, MONEY ORDER or CASH

Transformer Automatic Winding Co. Filament Transformer, 6 to 900 Volts, step up or step down, 12 points for variation of voltage, can hook into 110 or 220 Volt and 50 or 60 Cycle Current, Wgt. 14 Lbs., all new ... will work any 6-12-24-28 Volt aircraft gadget off house current ... **\$7.95**



25% DEPOSIT REQUIRED ON C.O.D. ORDERS

ELECTRIC SOLDERING IRON

Underwriter Approved, 100 Watt, quick heat, durable rubber plug, wood heat resistant handle, sturdy and long-wearing ... **\$2.95 each.**



MICROMETER

Chrome plated, 1" Capacity, precision engineered and carefully tooled to give long life and highest degree of accuracy ... **\$7.65 each.**



CLAMPS: Adel Aluminum Co., Rubber lined, assorted sizes, hundreds of users in any shop ... 5 dozen, assorted sizes **\$1.00**

AIRBORNE SALES CO. P. O. BOX 392
CULVER CITY, CALIF.

100 Fireplace Ideas FREE

If you're building a home or remodeling, get our FREE Booklet, picturing and describing 100 Fireplaces. Also gives valuable information on



FYRO-PLACE

The new improved warm-air circulating unit. A modern fireplace will make your home more comfortable and valuable. **WRITE today.**

PRICE Fireplace Heater & Tank Corp.,
7 Austin Street, Buffalo 7, N. Y.

You're in Business
for only **\$15.60**



New Marvel Tool cleans clogged sink drains, toilets, tubs, showers, etc. 25 foot flexible cable goes thru all complicated bends — is hand operated by one person — no mess — no experience necessary. A few jobs give complete satisfaction and pay for the tool.

Agents Wanted

DAVIN MFG. CO., Dept. PM, 209 10th Ave., New York 11, N. Y.

Send at once for full details

PRESS YOUR OWN

PANTS • TIES • LAPELS

SAVE TIME AND MONEY. Plug in AC or DC socket and you're ready to go — no wet cloth, no board, no bother. Two nickel-plated pressing sides do the job. Use at home, office, when traveling. Women like it for skirts, slacks. A fine gift. Free circular.

Presser opens with a flick of the thumb.



Empire Products, Inc. 817 Main St., Dept. PM, Cincinnati 2, Ohio

Empire PRESSER

Quick!
Easy!



\$2.49 at stores or send check or money order. C.O.D. accepted. Satisfaction Guaranteed.

BUILD ARC WELDER FROM OLD GENERATOR

For Light or Heavy Work. 75-200 amperes. Complete PLANS 35c. Send today and we'll include FREE our Big NEW Catalog.

LEJAY MANUFACTURING CO.
1347 LeJay Bldg., Minneapolis, Minn.



Assemble KING MIDGET



Practical highway racer runabout. New model. We supply all parts. Just bolt together. Low cost. Ready for delivery NOW. One or two cylinder, 40 m.p.h., up to 100 miles per gallon. Send 25c for complete new literature with large picture, 4-view drawings, price of parts, or send \$1 (refunded with first order) for the above, plus 24-page assembly book with 42 photographs and drawings.

MIDGET MOTORS, Athens, Ohio

PLASTICS!

Fabricating plastics offers you a fascinating hobby or a profitable business. New Carmen-Bronson Plastics Handbook tells you how; gives construction plans. New Carmen-Bronson Catalog lists all needed materials—Plexiglas, Lucite, Bakelite, Lignolite, Temite II, Lumarith in sheets, rods, tubes, special shapes—clear and glowing colors. Also plastics dyes, cements, accessories and supplies. 25c (refundable with first order), brings you both catalog and handbook. Send for them today.

CARMEN-BRONSON COMPANY
165 EAST 3RD STREET, DEPT. 10-B, MOUNT VERNON, N. Y.

EARN BIG MONEY IN YOUR OWN BUSINESS Sharpening Lawn Mowers

"THE UNIVERSAL WAY"

Here's one of the best and quickest ways we know for you to become your own boss in a profitable year 'round business of your own. Mr. Hardy of Mississippi writes: "Received my Universal Grinder the first part of May and by August 18th had sharpened over 1000 mowers." Mr. Bacon of California writes: "The lawn mower business with the use of my Universal Grinder has been a gold mine in the last two years."

Investigate this opportunity yourself without cost or obligation.

WRITE TODAY

ROGERS MFG. CO.
DEPT. M107 LINDSEY, OHIO



FREE

Full details on the exclusive advantages of the Universal Grinders which have made hundreds successful.

Men's Fully Guaranteed NEW \$13.95 15-JEWEL WRIST WATCH PLUS TAX

ORIGINALLY sold up to \$55

Now sacrificed because they're Gov't surplus

LOOK AT THESE FEATURES:

Luminous dial . . . sweep second hand . . . waterproof . . . shockproof . . . anti-magnetic . . . imported Swiss precision movement and case.

You get them now for a small fraction of original prices. Don't delay! Order now while they last. Send only \$1 down payment with order. Pay balance to postman on arrival, plus postage. Or we pay postage if you enclose \$13.95 plus \$1.39 Fed. Tax. Receive reg. \$2 expansion band FREE with prepaid order. Money back in 5 days if not delighted. Order now.



MARYLAND DISTRIBUTERS, Dept. P-1

501 E. Balto. St. Balto. 2, Md.

\$13.50 Value for Only \$2.49

8000 ohm impedance Head Phones, produced to Air and Signal Corps specs. Extremely sensitive, lightweight (only 9 oz.). With 5 1/2 ft. cord, plug, jack and ear cushions. Every One BRAND NEW

No. 17A37, Special Per Pair. **\$2.49**

Plus 25c each for Postage.



Burstein-Applebee Co. 1012 McGee, Kansas City 6, Mo.

Print Your Own

Cards, stationery, circulars, tags, labels, photo and movie titles, advertising, etc. Save money. Print for Others, Good Profit; easy rules sent. Raised Printing like Engraving, too. Send dime for press samples, supply book, all details and advice on your needs. No obligation. **KELSEY INC., B-37, Meriden, Conn.**

MARCOT KEY MACHINE

Immediate Delivery



Marcot No. 8 Key Machine Mounted on Cabinet. . . . \$ 82.50
Book on Modern Locksmithing. . . . 3.95
Auto Code Book and Auto Depth Keys 12.50
102 Doz. Popular Key Blanks. . . 77.76
Set Key Files, Tools, Pins, Springs, Thimble 10.50
\$187.21

A. J. MARCOTTE CO., 1200 N. KEDZIE AVE., DEPT. PM, CHICAGO 51, ILL.

SAY YOU SAW IT IN POPULAR MECHANICS

Within the reach of ALL . .

No. 325

NEW hi-power RIFLE



"For the shooter who buys a rifle for more than sport"

Here's a brand new rifle—a sturdy, dependable, hi-power bolt action ".30-.30" carbine—selling at an astonishingly low price. Built for years of the hardest kind of all-round service, it fills a long-felt need for a low-priced, well-built rifle. **SAVAGE ARMS CORPORATION**
Firearms Division
CHICOPEE FALLS, MASS.

STEVENS Bolt Action Cal. .30-.30 Carbine Type Repeating Rifle

CALIBER—Chambered for the dependable ".30-.30"
BARREL—"Hi-Pressure" smokeless steel, length 21".
ACTION—Short throw bolt action. Cocks on opening stroke. New design of bolt, sear and trigger mechanism . . . lightning-fast ignition, positive, trouble-free operation . . . clean, crisp, trigger pull. Streamlined bolt handle.
SAFETY—Independent, thumb-operated . . . locks sear and bolt. Conveniently located.
MAGAZINE—Detachable 3-cartridge clip. One cartridge in chamber—4-shot capacity.
SIGHTS—Ramp front—adjustable sporting rear.
STOCK—Stock and fore-end one piece with semi-pistol grip corrugated butt plate. Built to stand up under hard service.
WEIGHT—About 6 1/2 lbs. Overall length 40 inches.

STEVENS

PIONEERING BETTER GUNS
AND GREATER VALUES SINCE 1864

SAVAGE

WORLD FAMOUS FOR DEPENDABILITY
AND ACCURACY

Embed in Plastic

EMBED
real flowers,
butterflies,
coins,
photos,
medals,
FOR
coasters,
plaques,
novelties,
etc.



NEW EASY-TO-USE CASTING PLASTIC MAKES 1001 OBJECTS

Castolite is the new marvel of the plastics world. Cast without heat or pressure. Crystal clear or color brilliantly. Can be sawed, drilled, carved, turned. Illustrative manual gives complete instructions.

Casto-Mold

Flexible Molding Compound for making statuary, models, gears, other parts is now ready. 2 lbs. \$3.00, including instructions. Can be re-melted many times.

CASTO-KIT \$3.50

New special Casto-Kit contains everything needed to make useful objects at once. Send \$3.50 for Kit prepaid. Or order C.O.D. For Instruction Manual alone send 25c.

Dealers write for literature and prices.

The Castolite Co., Dept. L-1, Box 211, Kenilworth, Ill.

Castolite
TRADE MARK
LIQUID CASTING PLASTIC

A NEW SHELDON

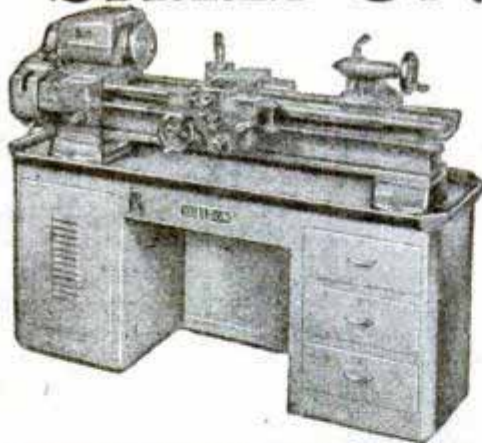

TRB-S56

For the home craftsman who can afford the best, or for those who use lathes in their business, the new SHELDON TRB-S56 is today's most sensational lathe value.

With 11 1/4" swing, 1" collet capacity and a 56" bed, it has capacity. With "Zero Precision" Taper Roller bearings (heretofore available on large and costly lathes) it has extreme accuracy. Mounted on a modern 5-drawer steel bench with enclosed 8 spindle speed, double V-belt underneath motor drive it has convenience, extra power and speeds for both today's and tomorrow's machining, and, frankly, class, not found in ordinary shops.

\$1000.00, as illustrated, less motor f.o.b. Chicago.

Write for TRB-S56 Bulletin

SHELDON MACHINE CO. Inc.
Manufacturers of Sheldon Precision Lathes • Milling Machines • Shapers
4200 N. KNOX AVENUE • CHICAGO 41, ILLINOIS, U. S. A.

CROSMAN Silent RIFLE
Most Amazing Gun Ever Invented for Target and Small Game Shooting
The ideal rifle for year 'round shooting indoors or out. Shoots low-cost SUPER PELLETS without noise, odor or recoil. Requires no cleaning.
At your dealer or write direct.

Adjustable power—rifled barrel for accuracy. .177 and .22 caliber models. Write for information.

CROSMAN ARMS CO., INC.
30 HENRIETTA ST., ROCHESTER 7, N. Y.

Shoot CROSMAN SuperPellets

The BETTER Ammunition for ALL .177 and .22 caliber Air Pistols and Rifles.



.177 cal. . . \$2.50 per M
.22 cal. . . \$3.00 per M

POSTAGE PREPAID
At your dealer or order direct

FOR
GREATER
ACCURACY
MAXIMUM
POWER

CROSMAN ARMS CO. HENRIETTA ST., ROCHESTER 7, N. Y.

SELF LUBRICATING BEARINGS



Over 2 million in stock in 500 sizes of plain, flanged and spherical types in Bronze or Iron. Big savings.



Send for Free Catalogue
THE ARRANDALE COMPANY
SHREWSBURY, NEW JERSEY

GARDEN TRACTORS



SPEEDEX

SAVE UP TO
\$100.00 OR MORE
BY PURCHASING NOW

Immediate delivery in limited quantities. For full information write for free circular.

P-1247-53

POND GARDEN TRACTOR COMPANY
BOX 216 RAVENNA, OHIO

BATTERIES!—START

—a factory at home and re-cast junk batteries into new; latest achievement. We supply complete instructions and everything needed. Big Profits!

Battery Laboratories, Dept. PM, Minneapolis 4, Minn.



IT'S EASY TO
"Trim-it-Yourself"
with
CHROMTRIM
METAL MOULDINGS

The perfected metal trim for wall or floor linoleum and building materials. 6' lengths, B shapes, easy to cut and apply.



Send 10c for "Trim Ideas" 16 page booklet. Over 30 projects and remodeling suggestions on where and how to use CHROMTRIM. Hints on lino-laying.

R. D. Werner Co., 291 Fifth Ave., N. Y. 16
Enclosed is 10c for CHROMTRIM "Trim Ideas" booklet

Name _____
Address _____
City _____ Zone _____ State _____

REMODEL
KITCHEN
BATH • ATTIC



MAKE METAL
PROJECTS
with
CHROMTRIM



3 Easy Ways to KILL Rats OR YOUR MONEY BACK!

K-R-O Powder and Bis-Kits

Kill rats more *safely* with these *red-squill* products. Mix K-R-O Powder (75c) with ground meat, fish, or cereal, or get baked K-R-O Bis-Kits (25c and \$1.00) that are ready to use.

RatStop Contains Du Pont ANTU

Buy RatStop for *fast, easy* rat-killing by the tracking method, or for mixing with baits. 75c can holds enough powder to kill more than 300 rats! Directions for safe use are on every can.

• If these products are not available at your nearest drug, feed, or seed store, order direct. Include 15c for postage and handling.

The K-R-O Company, Springfield, Ohio

REVOLUTIONARY NEW! SUPER-WIRE CUTTER

Never before such tremendous cutting power in so small and compact a unit... fits pocket! Patented leverage action gives you one ton cutting pressure in the palm of your hand! Cuts anything—heavy gauge spring wire, nuts, bolts, etc. Replaces bulky cutters many times its size and cost.

**AGENTS — EARN \$15.00
A DAY AND MORE!**

An indispensable tool for the farm, factory, maintenance shop and garage. Every mechanic, home owner, building superintendent, electrical and construction worker needs this Super-Wire Cutter! Sells on sight at the sensational low price of \$7.50—costs you only \$3.75. You make 100% profit—just 4 easy sales a day nets you \$15.00. Or you can earn even bigger profits operating as our distributor... selling wholesale to dealers and sub-agents.

START CASHING IN NOW!

Send \$3.75 check or money order for demonstrating sample or write for free selling plans. Satisfaction guaranteed or return within 5 days for full refund.

SECURITY SEAL COMPANY, 144 West 27th St., New York 1, N.Y.



**ONE TON CUTTING
PRESSURE IN THE
PALM OF YOUR HAND!**

STA-TI The Aluminum Wonder Knot

EVERY FARMER, TRUCKER AND AUTO OWNER SHOULD HAVE STA-TI

Easy now to hold or pull your heavy loads with Sta-Ti. Absolutely will hold without slipping or scarring any size rope intended. Quickly and easily tied and untied—even when wet. Sta-Ti is ready to do your rugged hauling jobs. Order direct from this ad today. Write Dept. 1411.

REDUCED PRICES
1 in. Sta-Ti \$1.95
7-8 in. Sta-Ti \$1.75
5-4 in. Sta-Ti \$1.50
5-8 in. Sta-Ti \$1.25
1-2 in. Sta-Ti \$1.00
PRICES POSTPAID

SHEFRIN MFG. CO. 1329 W. 9th St. KANSAS CITY, MO.

GOVERNMENT SURPLUS

BRAND NEW

VICKERS HYDRAULIC PUMPS

Hundreds of Practical Uses

BUILD YOUR OWN HYDRAULIC PRESS, ELECTRIC EYE DOOR OPENER, ETC.

\$15.00 F.O.B. DETROIT,
MICH.

JAY-BEE SALES CO.

4554 Gd. River Ave. Detroit, Michigan



SHAW DU-ALL GARDEN TRACTORS and MOWERS

Get FREE FOLDER NOW!

Get details on 1 to 9 H. P. walking and riding tractors. Do 1000 jobs on small farms, estates, orchards, gardens. Low-priced. Send postcard today!

4510 Front Street, Galesburg, Kans.
668G North 4th St., Columbus, Ohio

SHAW MFG. CO.

ELECTRONIC WAR SURPLUS

Priced so low that anyone can afford to own and experiment with these incredible instruments. All brand new!

AMPLIFIER RACK

with Relays and Meters
Government paid \$100.00

YOU PAY ONLY

\$6⁹⁵



Orig. housed amplifiers and other instruments. Consists of magnesium cabinet that mounts 7 DPDT Allied Relays, 1 SPST Relay, a Weston 0-125 AC Volt Meter, a 350 to 450-cycle Frequency Meter, a 115-volt, 400-cyc. Transformer and many other parts. This unit is of special interest to "Hams"! The cabinet would be excellent for small transmitters or receivers. 12 1/2 x 14 x 10"; 22 lbs.

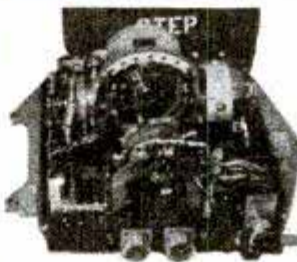

VERTICAL GYRO UNIT

Designed for B-29 Superfort. Aluminum casing, housing one 400-cyc., 115-v., 3-ph. motor-propelled gyroscope; two 24-v. DC shunt-wound motors; 2 electronic relays; auto transformer; hundreds of other parts. A masterpiece of precision and engineering. 15 1/2 x 14 x 10"; 35 lbs. Army paid \$2855.00.

YOU PAY ONLY

\$14⁹⁵

DYNAMOTORS

9 or 18-volt in; 450-volt out. A simple change converts these to run on 110 volts AC. Made by Pioneer and Wincharger Co. Govt. cost, \$34.00 each. 8x4x4"; 7 lbs.



Brand new **\$3⁹⁵**

Others, brand new but
dismounted from ABK sets,

\$3⁵⁰



AMPLIDYNE MOTOR GENERATOR

Govt. paid over \$105.00. No. 5AM31NJ18A, mfg. by General Electric and Edison Co. 27VDC input at 44 amps, 60 VDC, output at 8.8 amps. Approx. 6" dia., 12" long. Easy to mount on 4 1/2 x 5" centers with 3/8" bolts supplied. For aircraft, marine, labs, demonstrators, hobbyists, etc. Shipping weight, 45 lbs.

Specially priced at **\$7⁵⁰**

You pay shipping costs. Send check or money order to:

SURPLEX RETAIL SALES, Inc., Dept. PM-10
2409 S. LaSalle St. Chicago 16, Ill.
Chicago Buyers, Attention: Phone Calumet 9130

THE WORLD'S FINEST SURPLUS BARGAINS

BC223 TRANSMITTER



One of the Army's best. Ideal for amateur use, covers 80 meter band, 25 watt, crystal controlled, supplied brand new with tubes, meters, tuning unit, speech amplifier, and modulator.

Shipping weight, 80 lbs., Express

\$14.95

New Dynamotors

New West. Elec. dynamotors. Consists of 24-volt electric motor, operating 220-volt generator on same shaft. Use for fans, movie projectors. Hundreds of uses. Motor alone worth \$5.00. Shipping weight, 8 lbs. **\$1.50**

Throat Microphone

Brand new Army T-30 throat microphones. Used in aircraft, tanks, etc. Broadcast through your radio, use in noisy factories, for home telephone systems, hundred of applications. Shipping weight, 1 lb. **\$1**



Electronic Kit

Experimenter's paradise. Five lbs. of new condensers, transformers, coils, switches, sockets, resistors, etc. Parts for dozens of experiments. Shipping wht., 6 lbs. **\$1**



Miniature Headphone

Miniature type headphones. Ideal for hearing aids, listening to radio in bed, etc. Complete with headband, cord and two sets rubber ear plugs. Shipping weight, 1 1/2 lbs. **\$1**

INCLUDE POSTAGE FOR WEIGHT SHOWN



AIRCRAFT RADIO

Brand new 6-tube superheterodyne aircraft radios, 3-gang cond., RF stage, 2 IF stages, tunes 6 to 9.1 Mc; built by West. Elec. Complete with tubes in original carton. Easily converted. Shipping weight, 8 lbs. **\$4.95**

Tuning Unit

The heart of the Army Walkie-Talkie. Contains transmitter crystal and tank coil, receiver coil, tuning condenser and crystal; ideal foundation for small set. Shipping weight, 1 lb. **\$1.00**



HEATH COMPANY

305 TERRITORIAL ROAD BENTON HARBOR, MICH.

CARBIDE SCRIBER NON-MAGNETIC



FOR HARDEST STEEL, GLASS, ETC.

Tungsten Carbide—the hardest metal made by man—carefully ground on diamond laps, brazed into stainless steel 6" handle for marking steel and other metals—for etching, marking, cutting glass. Cuts all directions. Easy to follow any contour. In plastic case with pocket clip.



\$2.00

PRICE POST PAID

Dealers, Distributors and Salesmen Wanted

LUCAS-MILHAUPT ENGINEERING CO.
5053 SOUTH LAKE DRIVE • CUDAHY, WISCONSIN

60 POWER TELESCOPE \$2.95

VARIABLE EYEPIECE 20X-40X-60X
NEW! Three telescopes in one, 3 different magnifications. 20 power for ultra-bright images with 40 and 60 power for extra long range. Guaranteed to bring distant objects, people, sports events, ships, moon, stars, etc., 60 times as close.



Most powerful for anywhere near the money. 5 sections. Closes to 1 ft. long. Contains 4 ground and polished lenses. Also used as a powerful compound microscope. Directions included. Mass production enables us to offer this high-powered instrument at the amazing price of only \$2.95. We pay the postage. Get yours immediately.

BROWSCOPE CO. Dept. 10M 24 West 45 St. New York 19, N. Y.

Make Your Own WATER SOFTENER

New, Easy Way. Save \$60 to \$75!



Don't pay high retail prices for a Water Softener. Make one yourself—at home—from simple plans and specifications we send you. Any man "handy with tools" can do it. Best places to buy materials at low cost and full details come with complete set of "failure-proof" Blueprints for only \$1.50! Write today to

DEAN PRODUCTS CO.

141 W. Jackson Blvd., Dept. M Chicago 1, Ill.

AIR or LIQUID TANKS

Airplane oxygen tanks (used) good condition, holds up to 400 lbs. pressure; non-rusting stainless steel, weighs 18 lbs., 10 1/2 gal. capacity, 24" long x 12" diam. **\$4.98.** Same specifications 24" long x 9" diam., weighs 5 lbs., 3 gal. capacity, **\$2.98.** Ends tapped for 1/4" standard pipe thread. Air check-valve to fit tanks, \$5.00 value, 98c. Ideal for compressed air tanks, some bottled gas, or liquids, water supply for house trailers, compressors, floating rafts, buoys, net floats, air horns, air brakes, etc.

Prices FOB, Kansas City — No COD orders

MIDWEST BUY ANYTHING CO.

1520 Locust St. Kansas City, Mo.
Hundreds of other bargains — Write for Circular

SAY YOU SAW IT IN POPULAR MECHANICS

FARMS — BOATS — CAMPERS — TRUCKS — HUNTERS

BRAND NEW—U. S. NAVY

PORTABLE SPOTLIGHT

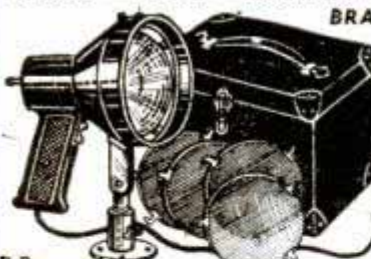

Cost over **\$35.00**

OUR PRICE \$5.95

Complete with case, 4 color lenses, 13 v. sealed beam lamp, long cord and swivel bracket. Has toggle and trigger switches. Throws powerful beam.

J. J. Shannon & Co.

214 N. 22nd St. Phila. 3, Pa.

P.P. PREPAID
Send check or M.O.—No C.O.D.

FREE Sample Of New PLASTIC Shows How To Make Leather and Leatherette LIKE NEW!

Magically Changes Cloth To Imitation Leather

SAVE MONEY-TIME AND EFFORT by renewing Luggage—Leather Covered Furniture—Golf Bags—Auto Seat Covers—Restaurant Furniture, Booths or any Leather or Leatherette item with new plastic discovery called Leather-New. Coat cloth or cloth covered items such as Glider Cushions, Tarpaulins, Porch Furniture, Etc. and make them look and wear like they were leather. Spreads easily with brush or spray gun—leaves NO BRUSH MARKS. Simple Acids, Caustics and Alcohols do not stain this finish—It is sun and mildew proof. Stays Fresh and Clean as long as real leather. Comes in all standard colors. Just mail coupon for Free sample of Leather-New coated material which shows effects.



OWN A PROFITABLE LIFETIME BUSINESS

Cash in on big profits to be made in this new business—Profits up to \$700.00 monthly possible, renewing booths and furniture for bars, restaurants, grills, movie houses, etc. Mail name and address on 1c postcard—I'll show you how. Jack Edwards, Sales Mgr.

JUST MAIL COUPON

No Obligation

Leather-New, 701 Land Bank, Dept. J-1, Kansas City, Mo.

Name.....

Address.....

City..... State.....
Fill Out—Mail Today

LEATHER-NEW 701 Land Bank Dept. J-1 Kansas City, Mo.

What a

Startling Difference

THE NEW RADIANT SCREENS MAKE IN YOUR PICTURES

Exclusive New Radiant Screen Features

- 1 Self-Opening Tripod Legs*
- 2 Screen Leveler*
- 3 Shakeproof Safety Catch
- 4 Feather Touch Adjusting Handle (U. S. Patent)
- 5 Fully Automatic Auto-Lock*
- 6 Built-In Shock Absorbers*
- 7 Automatic Leg-Lock
- 8 Rubber-Ball Tripod Feet
- 9 Triangular Steel Tube Construction
- 10 Automatic Leg Adjustment
- 11 Finger Grip Carrying Handle
- 12 Streamlined Design
- 13 Automatic Leg Closing
- 14 Complete Range of Screen Heights
- 15 Unconditional Guarantee

The complete Radiant line includes Wall, Ceiling and Table Models in sizes 22 inches x 30 inches to 20 feet x 20 feet and larger.

* Pat. Pending

Radiant Screens for 1948 offer you a host of important, basic improvements that bring: *new sharpness, new clearness, new brilliance* to black-and-white projection... a *new rich, natural beauty* to all color pictures. Quick and easy to set-up with the screen *flowing smoothly* into proper position... readily adaptable to a wide variety of projection conditions. Sturdy and trouble-free, these modern, precision-built Radiant Screens *bring out the best in any pictures!*



Send for FREE Screen Guide Today!

"Secrets of Good Projection," a 32-page booklet, gives proper screen sizes, correct projection lenses, tips for improving projection and many other valuable facts. Mail coupon for your FREE copy.

RADIANT

Est. U. S. Pat. Off.

PROJECTION SCREENS

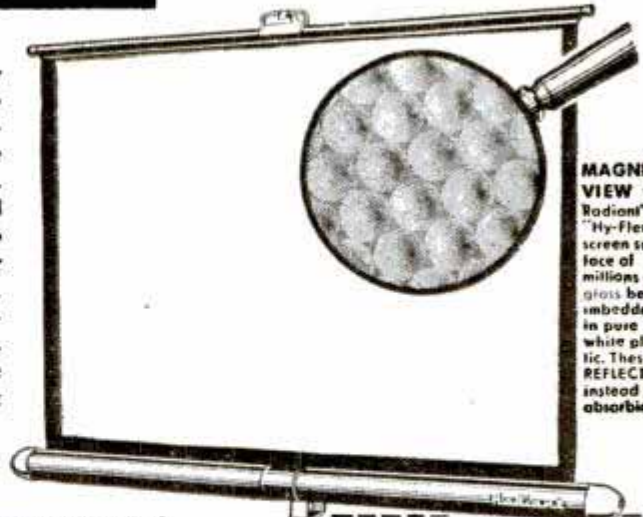

MAGNIFIED VIEW OF
Radiant's "Hy-Flect" screen surface of millions of glass beads embedded in pure white plastic. These REFLECT light instead of absorbing it!

RADIANT MANUFACTURING CORP.
1257 S. Talman Ave., Chicago 8, Ill.
Send me FREE copy of "Secrets of Good Projection"—also latest Radiant Catalog showing complete line of Radiant Portable, Wall, Ceiling and Table Screens.

Name _____
Address _____
City _____
State _____

My Dealer Is _____

For Outdoor Pleasure and Transportation
Ride a **Royal Enfield**



Famous English Lightweight
Motorcycle...takes you anywhere

Royal Enfield's popular Model R. E. has *everything*—Style, Safety, Economy, Flexibility, Performance! Best quality steel tubing; 125 c. c. 2-stroke, single cylinder engine; 3-speed gears. Goes 100 miles per gallon of gas! Folder "C" gives you complete details.

Dealer inquiries given prompt attention.

Write Today:

WHITEHALL DISTRIBUTORS, Inc.
1385 Commerce Avenue, New York 61, N. Y.

BE A SIGN PAINTER!

Learn by QUICK METHOD to paint signs. My artistically true and practical SYSTEM is the result of FORTY YEARS of experience and study in nationwide display work. Write today—NOW—for particulars.

CAHANEY SIGN SYSTEM 1113 SOUTH 3RD ST. DENNISON, OHIO

Now Available by Mail

Famous
HANOVER
SHOES FOR MEN

Send for
New Catalog
Today



A Shoe
For Every
Occasion

FOR 47 YEARS
GREATEST SHOE VALUE ON EARTH

THE HANOVER SHOE, BOX 26, HANOVER, PA.



\$29⁹⁵
POST PAID

The UNI-VISE
Saves Time - Money ●

No limit to the usefulness of this handy universal angle swivel vise. Replaces costly jigs on milling machine, drill press, shaper or grinder. Ideal for home workshop or machine shop. Hardened steel jaws, 3" x 1 1/4". Open to 2 1/4". Practical all-purpose tool. Easy to operate. Weight 13 1/2 lbs. ...

From your dealer or send direct!

UNION TOOL CORP.

360 E. MARKET ST. ● WARSAW, IND.

WAR SURPLUS BARGAIN SPECIAL

BRAND NEW!
VACUUM-AIR
HYDRAULIC

FUEL PUMP

Original Cost
\$45.00
Now Only
\$9.95

Postpaid in U.S.A.

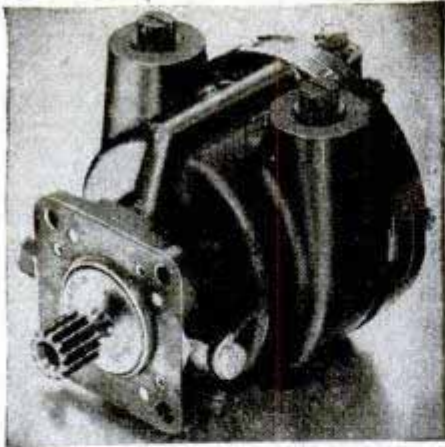

WORTH MANY TIMES THIS LOW PRICE

USE THEM FOR
OIL BURNERS

SPRAYING
MACHINES

MILKING
MACHINES

COMPRESSORS

VACUUM PUMPS

HYDRAULIC
SYSTEMS

MANURE
LOADERS

PRESSES, etc.

Originally cost \$45.00. Used by the Air Corps to drive bomber de-icer boots, gyroscopes, automatic pilots, etc. May be used as air or fluid pump—for pressure or vacuum. Standard 3/8 inch pipe thread with interchangeable ports. Will pump 7 1/2 gal. SAE 30 oil per minute at 300 RPM. Builds air pressure of 30 lbs. per sq. in. at 1000 RPM. Vacuum will draw 26 inches of mercury at 1750 RPM. Develops up to 120 lbs. per sq. inch of hydraulic pressure, which in conjunction with a 3 inch hydraulic cylinder, will lift 840 lbs. minimum. Runs forward or reverse. Self-aligning shaft. Die cast aluminum housing 6x4x4 inches. Has stainless alloy steel vanes and impeller. Made by Bendix Avia, Corp. Spline terminal for direct drive—readily replaced with a pulley. Recommend a 1/4 H.P. or stronger electric motor as source of power. Rated capacity 1500 RPM with high overload factor. Special price for quantity users. Complete illustrated report and instruction booklet FREE with every pump. Send check or money order today. Postpaid in U.S.A.

\$9.95

GROBAN SUPPLY CO. 1522 So. Michigan Avenue
Dept. PM10, Chicago 5, Ill.

Sheppard Diesel
GENERATED
ELECTRICITY
costs less... is more dependable

This 2,000 watt Sheppard generating set operates on low-cost furnace oil. Rugged diesel construction assures long life! Simple to service... easy to operate. Write for detailed information.

R. H. SHEPPARD COMPANY, INC.
56 Middle St., Hanover, Pa.

**DIESEL'S
THE
POWER
Sheppard's
THE DIESEL**

AIRCOOLED FOR MINIMUM MAINTENANCE

Generating sets to 36,000 watts. Power units to 62 H. P.

**STRIPE
WITH
PAINT
EASY
AS
USING
A
PENCIL**

PAINTERS' STRIPING TOOL

NOW you can do your own expert striping on furniture, bikes, model planes, bulletins, autos, toys, signs, linoleum, wall board... make plain walls look like tile! It's easy to paint straight, curved, circular, even parallel lines with any color. Handiest paint tool in your workshop! Type "M" Master Painters' Striping Tool complete with tip for 1/16" stripe, \$1.00. Extra tips 1/64", 1/32", 3/64", 1/16", 5/64", 3/32", 1/8"—75c each. Tool with complete set of 7 tips \$5.00. (C.O.D. orders 25c extra.) WENDELL MFG. CO., 4234 - 1: Lincoln Ave., Chicago 18, Ill.

**A TOOL...
NOT A BRUSH**



Dealers
Write
Today!

**\$1.00
POST
PAID**

Beautiful SWISS WATCHES

MODEL A—All Chrome Case Stream-lined Special **\$5.95**
MODEL B—4-Jewel Fancy Dial **\$7.95**
Stainless Steel
MODEL C—7-Jewel Fancy Dial **\$9.95**
Stainless Steel

All prices are plus 10% Fed. Tax. Each watch tested and checked, delivered to you in perfect condition.



SEND NO MONEY. Tear out this ad and mail with your name and address for prompt C.O.D. shipment. (We pay postage if money sent with order.)

GOLDEN RULE CO., 50 Delancey St., New York 2, N. Y.

Model Makers Lathe

Immediate Delivery



A complete model makers lathe for turning wood, plastics or metal. Never before anything like it for many times the price. Constructed of high grade aluminum, tool steel, bronze. Lathe has 3" swing over bed, 4" between center, bronze bearings. Complete with face plate, dog, spur center, wrench and tool holder. If your dealer cannot supply you, ORDER DIRECT TODAY. Free literature.

Only \$19.95 complete.
THE WAYNE ENGINEERING CO., DEPT 1128, GREENVILLE, OHIO

make your own Gems 29.50

All necessary lapidary equipment is furnished, including a super-charged diamond blade for sawing, and all wheels for grinding, shaping and polishing; also complete instructions. The complete equipment as shown, less motor and belt, for only \$29.50, f.o.b. Burlington, Wisconsin. Write today for information and literature.

B&I MANUFACTURING CO.
Dept. S Burlington, Wis.

UP TO \$600 WEEKLY
with new 5 min. photo equipment.
No experience necessary.

Booth models—for your own small store location, arcades, department, variety, other stores, lobbies, depots, carnivals, parks, beaches, etc. Portable models for street corners, parks, near schools, picnics—anywhere.

Send 3c stamp for BIG PROFITS Plan.

FEDERAL IDENTIFICATION CO.
Dept. A-2, 1012 N.W. 17th
Oklahoma City, Oklahoma

**5 1/2 Power
Telescope!**

NOW OFFERED FOR ONLY \$1.00
Postpaid

This plastic SPEKTRA SKOPE with precision ground and polished lenses will give the whole family countless hours of pleasure.

Send \$1.00 today to
SPECTRA NOVELTY CO.
1342 S. 56th Ave., Cicero (Chicago 50), Ill.

**Useful
Entertaining**

EASY with one hand
and a

"YANKEE"

Quick-Return Spiral
Screw Driver

Got to drive screws where it's hard to use both hands? Easy with a "Yankee" 130A Spiral Driver. "Quick-return" spring in handle keeps bit in slot, returns handle after each push.

Write for the "Yankee" Tool Book.

YANKEE TOOLS NOW A PART OF

STANLEY

THE TOOL BOX OF THE WORLD

NORTH BROS. MFG. CO.

Philadelphia 33, Pa.



GOOD NEWS!

TWO NEW ALL-IN-ONE
HEARING AIDS
BY *Western Electric*

COMPACT MODEL 65

● For the majority of the hard of hearing: new Western Electric Model 65. Weighs only 6 ounces! Offers extraordinary wearing convenience . . . costs less than one cent an hour to operate.



NEW SUPER 66

● For those with severe hearing loss: new Super 66 provides tremendous amplification . . . finest acoustical performance of any hearing aid designed by famous Bell Telephone Laboratories.



FREE! More information on these two new instruments. Write for full-color booklet. We'll also send you, free, the new book, "Modern Science and Your Hearing," full of facts to interest every hard-of-hearing person.

MAIL THIS COUPON NOW!

Western Electric Dept. 380-PM10
195 Broadway, New York 7, N. Y.

Send me the illustrated booklet about two new all-in-one Western Electric hearing aids. Include my free copy of "Modern Science and Your Hearing."

Name _____

Address _____

City _____ Zone _____ State _____

NEW Rotary Drill Press SANDER

No messy gluing. No special discs. No dangerous protruding parts. To change paper just loosen 1 nut. Old paper falls out. Insert 3" square any paper. Tighten nut. Presto! Ready to use. Does a beautiful job. Literature other tools.



\$3.95

MASTERCRAFT 60 South St. Boston, Mass.

AIR COMPRESSORS

Gasoline powered—3 to 5 cu. ft. Immediate delivery. DeVilbiss, Curtis or Kellog. Thoroughly re-conditioned. F.O.B. K. C. **\$95.00**

Supply limited—write for illustrated circular.

MIDWEST SURPLUS SALES

1520 Locust Kansas City, Mo.

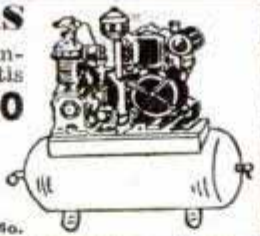

NEW OTTAWA Wood Saw



FOR TRACTORS Makes wood sawing fast; easy. Cuts enough wood to pay for itself quickly. Easily moved while attached. Big blade; send for FREE details. **OTTAWA MFG. CO., 1-727 Oak Ave., Ottawa, Kans.**

LOW PRICE

New MILLING ATTACHMENT



Sizes for 8" to 16" metal lathes

BUILD IT YOURSELF from our sets of semi-machined castings and save \$8. Can be finished on your lathe alone. Complete working drawings and step-by-step instructions furnished with castings.

Mill keyways, slots, splines, dovetails, flutes in reamers, taps, hobs, and special cutters; produce spur, bevel, mitre and worm gears, ratchets and racks; mill flat surfaces, square shafts, mill hexes, spot face, drill spaced holes, bore, etc. on your lathe with this precision attachment. It has a T-slotted table, a vise which swivels for angular milling, a gear cutting fixture and dividing centers.

FREE! Illustrated folder and price list. Includes milling cutters, keyway cutters, drill rod, slitting saws and many hard to get shop items. Mention your lathe. Write today.

HURON MACHINE AND TOOL CO.
YALE 4, MICHIGAN

Our Finest Precision REBUILT
MOTOR BLOCK
ASSEMBLIES



\$5.00
Crating
Charge

FORD BLOCK ASS'Y.

Year	Type	Outright	Exch.
28-31	4 cyl.	\$ 98.00	\$73.00
32-47	6 & 8	139.00	89.00

Mercury Outright Exch.
39-47 V8 149.00 99.00

Chevrolet Outright Exch.
34-47 6 cyl. 117.50 87.50

Sold Outright or Exchange

Rebuilt by skilled mechanics. Assembly Block has Reborn Block with New Pistons, Pins, Rings, Reground Crankshaft, and all New Bearings. Guaranteed 90 Days.

Allowance on Old Motor
We ship at outright price. Send your motor prepaid, must be suitable for rebuilding. Send in notarized bill of sale showing title number if any. We refund difference when we receive your motor.

DODGE—3 1/4" bore

Year	Type	Outright	Exch.
35-47	6 cyl.	\$129.00	\$99.00

Plymouth Outright Exch.
35-47 6 cyl. 129.00 99.00

Specify exact year, make and model when ordering. Send for catalog on motors not listed.

POWER TAKE-OFF for JEEP ENGINE



Boilts to clutch housing on the Jeep engine. Has a spline shaft to engage with clutch and extending from rear is a keyed shaft on which pulley can be mounted. Hand lever controls clutch.
PF4N-231—
Each.....

\$4250

NEW 5 Gal. CANS



FOR GAS, OIL OR WATER. Vented for Safety. Self-locking Safety Cap Extra Heavy Construction Will Float When Full. Size of can, 18" high, 6 1/4" thick, 13" wide. PA35U-60—
Lots of 5, ea. 1.15
Lots of 50, ea. 1.05
Lots of 100, Each 98c

60 HP. JEEP Engines



Reconditioned, Tested and Guaranteed in perfect running order and ready to run. Every part is checked to be perfect and carries a 90 Day Guarantee same as a new engine.

COMPLETE with . . . Generator, Starter, Distributor, Coil, Fan and Fan Belt, Water Pump, Fuel Pump, Intake and Exhaust Manifolds, Carburetor, Oil Filter, Spark Plugs, Flywheel, Clutch and Pressure Plate, Wiring.

Outright, PG58R-003, Each \$12750

New Willys JEEP Enclosed Power Unit

60 HP. 4 cyl. engine, 134.2 cu. in. displacement. 3 1/8 bore 4 3/8 stroke. Complete with radiator, gas tank, governor, clutch power take-off with 1 1/8" keyed shaft, and all accessories. **READY TO RUN. NEW, COMPLETE, PG60N-002, \$32500**
F.O.B. Chicago.

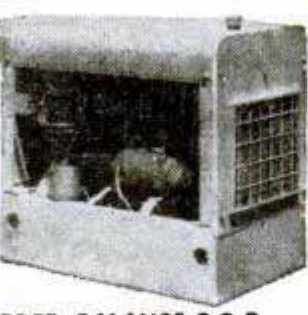

SEND 25% CASH WITH ORDER, BALANCE C.O.D.

J.C. WHITNEY & Co.
1917 Archer Ave. Chicago 16, Ill.

SAY YOU SAW IT IN POPULAR MECHANICS

BUILD YOUR OWN FAST FREEZER PLANS \$1

It's easy to build this household appliance with LeJay Plans. Made from new or used parts. Save up to 75%. No expert knowledge needed. Plans show 5 sizes and are easy to follow. All details clearly explained. Enjoy making one of these freezers. Mail \$1 for set of plans and catalog. **LEJAY MFG. CO., 447 LeJay Bldg., Minneapolis 8, Minnesota**



A BONANZA for the HOME WORKSHOP
ACTUALLY \$50.00 WORTH OF
Grinding Wheels

Abrasive discs, felt and buffing wheels, mandrels, rotary files, sheets, etc.
327 PIECES ASS'T. SIZES FOB CHICAGO ALL FOR ONLY \$6.95

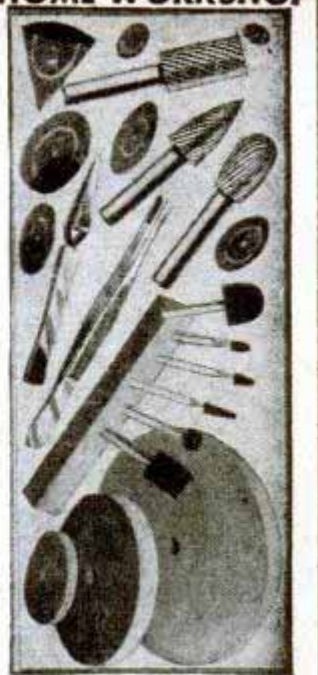

The buy of a lifetime! 327 pieces including 3 1/2 ass't. Grinding and Cut-off wheels up to 10 inches diameter, 1/16 to 1 1/4 in. face, 1/8 to 3 in. holes. Assorted grits—all brand new—made by Norton, Carborundum, Macklin, Bay State, etc. Also included are 100 slotted disc cloths; 100 paper discs; 3 round wire brushes on handles; 2 felt bobs; 2 felt wheels; 1 4" rag buff; 3 honing stones; 10 abrasive sleeves; 10 mounted stones, 1/8 and 1/4 shank; 2 mandrels; 2 rotary files, 1/4 shank; 50 abrasive discs; 2 7/2" abrasive belts; 5 8x11 abrasive sheets. Satisfaction guaranteed. Order today. It's better than \$6.95 a \$50.00 value for only \$6.95

GROBAN SUPPLY CO. 1522 SO. MICHIGAN AVENUE DEPT. PM-10, CHICAGO 5, ILL.

BRUNO EXPANSIVE BITS NEW DESIGN!

For professional and home use! Cut holes to any depth in wood . . . fast and smooth . . . special lead screw gives faster starts.

No. 200-B2, 3/4" to 1 1/8", \$2.45
No. 201-B2, 1 1/2" to 3 1/2", \$3.45

MONEY BACK GUARANTEE
BRUNO TOOLS, BEVERLY HILLS, CALIF.



TOP MONEY MAKER

NEW EXPLODING TIRE JOKE
(ABSOLUTELY HARMLESS TO TIRES)
80c Dz., \$9.00 Gr.
FREE CATALOGUE of QUICK-SELLING PROFIT-MAKERS
ERNIE'S ENTERPRISES, 725 Pine St., St. Louis 1, Mo.

SHOE REBUILDING OFFERS BIG INCOME

Own your own shop or earn big money as skilled shoe rebuilder. Growing demand everywhere at top wages for men who know how. We teach you quickly at only school of its kind in United States. Costs nothing under G.I. Bill of Rights. We help you get big-pay job or start your own shop.
FREE! BIG 16 PAGE BOOK explains everything. Send for your copy today.
C. W. GUSIAS, MODERN SHOE REBUILDING SCHOOL
2935 W. Belmont, Chicago. RUSH POSTCARD TODAY

KNOW about COLGRA SUPERFILM

Moneyback GUARANTEE

CAR OWNERS! MECHANICS!
There's NOTHING like it! Positive 'plated lubrication' to all metal surfaces. Dissolves carbon. Details on request. \$1.50 per can (18 oz.). Postpaid.
Dealers wanted
COLGRA COMPANY
11624 W. Pico, Los Angeles 34, Calif.

A PENNY POSTCARD MAY CHANGE YOUR FUTURE . . .

Get full information on the coin-operated vending machine industry. Start with a few machines and build to a wonderful future. We'll give you complete advantage of our "know-how."
Send For Free Booklet Today—No Routes Sold



PIONEER VENDING SERVICE
Address all mail to Dept. PM
461 SACKMAN ST. • BROOKLYN 12, N. Y.

"PROFITABLE KEY DUPLICATING"

WITH THE

HOUK KEY MACHINE

IS FULLY EXPLAINED IN OUR **FREE** ILLUSTRATED CIRCULAR ... *send for it today!*

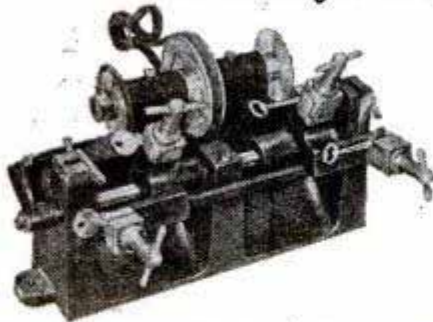

only
\$82.50
EACH FOB NY
IMMEDIATE
DELIVERY

WHITLOCK CORP. 17 WARREN ST. NEW YORK 7

FLASHLIGHT INSPECTION LAMP ASSEMBLY

NEW—Govt. Surplus. Lights up the "Hard-to-get-at" places. Fine for mechanics, electricians, radio repairmen, filling station attendants, in the home, and many other uses. Plastic 12" extension (6" stiff and 6" flexible). Adjustable to any angle. Originally priced over \$4.00. Our price Postpaid.



\$1.80
Ea.

New Electricians **CABLE REPAIR KIT** contains built-in 1500 watt, 110 Volt AC vulcanizer with complete tools and equipment. Gov't cost over \$200.00. Our price FOB. K. C. **\$34.50**

New **G. E. AIR COMPRESSOR** 1/2 HP, 27V-AC-DC. Many uses, paint spraying, etc. 1,000 lb. output. Shipping wgt. 20#. F.O.B. K. C. **\$14.95**

COVERALLS (Flight) New, Gabardine, size 38 postpaid **\$5.75**

Flight Boots A-6, Sheep Shearling lined, (used—excell. cond.) small, medium, large, postpaid. **\$5.75**

Hundreds other items—WRITE FOR CIRCULAR

National Surplus Sales Co. 719 P.M. E. 18th St. Kansas City 8, Mo.

1/100 H. P.

GEARED MOTOR

110 VOLT 60 CYCLE A. C. — 40 R.P.M.

A real Industrial Unit.

Ideal for Model & Experimental work

Send check or money order

Klauber Machine Co.

Manufacturers

3221 Olive St.

St. Louis 3, Mo.



\$8.00 POSTPAID
IN U.S.

LOW PRICED

STEAM CLEANER

Jenz Super Chief

Portable—No moving parts—Cleans anything — Motors — Chassis — Machinery — Floors — Buildings — Remove wallpaper — Dairy & Creamery—Oil Rigs etc. Oil fired —Economical—fully tested and warranted. 75# Steam in less than 10 min. Complete as illustrated. **\$276.00**

F.O.B. factory.

HI-PURE LABORATORIES
EVANSVILLE, IND.

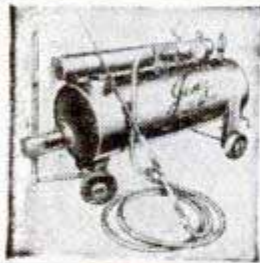

Sterling Silver

SADDLE RING

Authentic replica of championship rodeo saddle! Handsomely formed from solid Sterling Silver, by expert silver craftsmen. Men's, Women's, Children's styles.

SEND NO MONEY! Just clip ad and mail with name, address, ring style and size. Pay postman only \$4.95 (includes tax) plus postage, wear 5 days. If not delighted, return for full refund.

WESTERN CRAFTSMEN, Dept. 672D,
1904 Farnam St. Omaha 2, Nebr.



Repair Storm Windows
and Screens with
PLASTIC WOOD

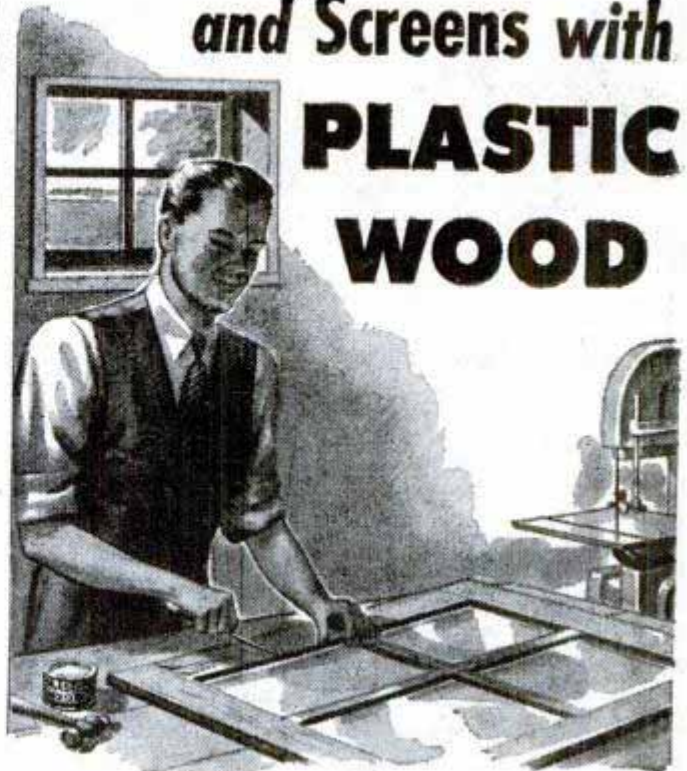

When making new screens, or replacing old rusted screen, apply thin layer of **PLASTIC WOOD** around frame after tacking down screen. This gives greater strength to the frame. **PLASTIC WOOD** can be easily shaped to match broken molding. Valuable in replacing rotted wood in storm windows.

... dozens of other uses

FOR FILLING ...

- Cracks in floors
- Countersunk screws
- Chipped furniture
- Nail and screw holes

FOR REPAIRING ...

- Loose tiles
- Loose casters
- Broken balusters
- Broken furniture

- **PLASTIC WOOD SOLVENT** is indispensable to the home workshop hobbyist for controlling the consistency of Plastic Wood and removing dried Plastic Wood from hands and tools.

T.M. Reg. U. S. Pat. Off.

At all Hardware,
Paint and 10c Stores



PLASTIC WOOD

Tube or Can

A CELLULOSE FIBRE FILLER

U.S. Government Surplus **New Westinghouse Generator**

200 Amp. 5700 Watts 28 Volts

\$39.75 F.O.B. CHICAGO

3 packed in carton \$100.00



Can be converted for use as a Welder, Electro-Plater, Fast Battery Charger, Auxiliary Power Unit. Government Surplus Radio Equipment needs. This unit as quoted in article in Q.S.T. Radio Magazine. Also has many other uses. Government approved. New, Wt. 61 lbs.

Used. Guaranteed Good Condition

AVIATION ENGINE STARTER



Type 1257, Volts 24, Style A, Clutch Set at 1200 ft. lbs. 7" dia., 17" long. 50 lbs. shipping weight.

\$8.95 F.O.B. Chicago
Type G-16, G-17, G-18

Mfg. by Eclipse Aviation Div. of Bendix Aviation Corp.

Higrade STEEL WRENCHES

A good Steel Both Ways
5/8" - 13/16" - 25c
11/16" - 1 1/8" - 35c
1 1/4" - 1 7/16" - 45c
or set of 3 - 95c F.O.B.

Made by such well known Mfrs. as Hinstale

VLCHEK Armstrong Walden



The smallest one regularly is worth the price of the whole set.



Ex. Heavy Duty C-Clamp

2 3/8" throat depth—opens to 3" swivel end on screw 7 1/2" tee handle for good leverage. Printed on casting J. H. Williams & Co. Drop-Forged in U.S.A. Lower than prwar price for this clamp **\$1.45** ea. F.O.B. Price Buy several, Shipping wt. 5 lbs. Another Government Closeout Buy.

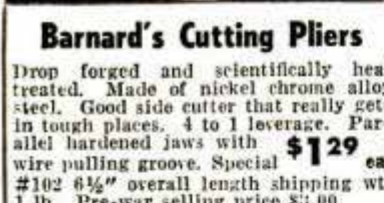

Barnard's Cutting Pliers

Drop forged and scientifically heat treated. Made of nickel chrome alloy steel. Good side cutter that really gets in tough places. 4 to 1 leverage. Parallel hardened jaws with wire pulling groove. Special #102 6 1/2" overall length shipping wt. 1 lb. Pre-war selling price \$3.00.



All prices 10% higher outside of U.S.A. proper. Sorry no C.O.D. or open account orders. All Government Surplus stocks are understandably limited, so first come first served.

GOVERNMENT SURPLUS & HARDWARE SALES

1627 N. Damen Ave. Chicago 47, Illinois, U.S.A. Tel. Armitage 2518

BUILD YOUR POWER TOOLS

with our **BALL BEARING ARBORS**



New Departure Self Lubricating Bearings



- B33—\$4.95 PP. 5/8 x 4 1/2 Spindle
- B15 Plain Spindle \$3.50 PP.
- (No extra charge for left hand threads)
- C4—1/2 x 12 1/2 spindle, housing 2x8 \$8.25 PP.
- C5—3/4 x 12 1/2 spindle, housing 2x8, \$8.25 PP.
- C6—3/4 x 12 1/2 spindle, housing 2 1/2 x 8, \$9.25 PP.
- D8—1 x 17 1/2 spindle, housing 2 5/8 x 11 \$17.00 PP.

PLAIN SPINDLE MODELS less threads and collars C-4-\$8.00, C5-\$8.00, C6-\$9.00, D8-\$16.00 all P.P.

SPECIAL SAW ARBORS with 4 in., 5 in., 6 in., 7 in., housing length, add \$1.40. 1/2, 5/8, 3/4 models. Ask about other designs. (30 day delivery). P.P.

SHAPER ARBORS 3 inches between collars, C4-1/2 \$14.25, C5-3/4 \$14.25, C6-3/4 \$15.25, D8-1 \$23.00. All P.P.

PILLOW BLOCKS—BALL BEARING—HEAVY DUTY—SELF ALIGNING 1/2"—\$3.90 ea., 5/8"—\$3.90 ea., 3/4"—\$4.25 ea., 1"—\$4.95 ea.

SHAPER ARBOR—New design—Ball bearing—10,000 R.P.M. Flange model—1/2 spindle \$5.50 P.P., Std model—1/2 spindle \$5.50 P.P.

BALL BEARINGS—1/2, 5/8, 3/4, 1.

V Belts \$.02 per inch. Pulleys, 2" dia.—\$.33, 2 1/4" dia.—\$.35. State center hole 1/2 — 5/8 — 3/4

POLY PRODUCTS, 406 S. Chester, Ct. 1a, Pasadena 5, Calif.

THIMBLE DROME RACER

The Model Racing SENSATION

Completely Finished



Only **\$3.95** Postpaid

Speed! Action! Can be adapted for Class A miniature engine or other power.

4" high. Weighs 18 oz. Order one today—you can't beat this for fun!

New, accurate scale model of midget racer, the classiest thing you ever laid eyes on. Die cast malleable aluminum body, turned aluminum rubber-tired wheels. Chrome exhaust stacks. Wobble pump. Simulated leather seat and back. Instrument panel and numbers. Equipped with bridle lugs for cable track racing. Car is 9 3/4" long.

HOME-SHOP PRODUCTS CO.

Dept. 17 4821 Sheridan Rd. Chicago 40

Here's the **OUTDOOR FIREPLACE** YOU CAN BUILD YOURSELF!



only **\$29.50** (F. O. B. Youngstown)

The Grill King is a barbecue beauty, a self-contained unit ready for masonry... easy to build and sure to make a hit with your picnic crowd! All you have to do is add stonework or bricks in the design you like best.

Outdoor cooking's a real treat with the Grill King. Made of sturdy steel plate, it has adjustable grids for use with any solid fuel. Grate size is 13-1/2" x 24". Complete assembly instructions and design suggestions are sent with each grill.

Get set for your outdoor parties now—order a Grill King today. Satisfaction guaranteed. Send check or money order to...

GRILL KING BOX B, WEST SIDE · YOUNGSTOWN 9, OHIO

LIKE PUTTING NEW SKILLS INTO YOUR HANDS! **AUTOMATIC BENCH STOP**

A new piece of equipment your workshop needs. Easy to mount. Only 11" long. Holds firm grip on pieces up to 2 1/2". No vise marks. Finger-flip release. Money back guarantee.



NOW **\$2.00** Postpaid

BILBAX PRODUCTS CO. 5533 PLEASANT AVE. S. MINNEAPOLIS 9, MINN.

handy SPRING kit



ASSORTED SPRINGS Compression, extension, torsion. Same quality as used in industry. Several dozen springs in kit. Send check or money order, Dept. B NEW ENGLAND SPRING MFG. CO. Unionville • Connecticut

Made to U.S. Army Specifications!

15-JEWEL ELGIN \$18.95



Sturdy 15-Jewel ELGIN men's wrist watches. Water-proofed. Sweep second hand. Stainless Steel back. Unbreakable crystal. QUALITY! American made. Fully reconitioned with ONE YEAR GUARANTEE! Made for the U. S. Army Air Corps. They HAD to be good. SEND NO MONEY. Simply pay postman \$18.95 plus 10% tax and postage on delivery. Cash orders sent postpaid. Limited supply. **UNITED PRODUCTS CO.** 7941 S. Halsted St., Dept. WES-509, Chicago 20, Ill.

it's so Easy
to...

RE-PAINT IT Yourself



with **EASY-ON**

"Just Wipe It On!" Applicator Furnished

Give your car a new-like, gleaming, factory-finish with amazing paint in one hour. Easy to apply. Nothing like it. Choice of Green, Light Green, Maroon, Gray, Blue, Black, Tan, Yellow, Red. Ask your dealer or order direct. Enclose full cash for postpaid delivery. C.O.D.'s accepted. Distributor, dealer inquiries invited.

EASY-ON, Inc. 3118 Broadway, Dept. PM-10 Chicago 14, Ill.

SAVE MONEY

build your own

SMITH COMPRESSOR



Now, use the world-famous Smith Air Compressor to operate rock drills, paving breakers, spray guns, sandblasting, etc., at low cost! Just order the Smith Compressor Head and Accessories with complete instructions for assembling. All you need is a Ford Motor and shop facilities. Capacity 60 cu. ft.—ample power for most compressor jobs. Pressure up to 100 lbs. per square inch. Head equipped with high speed compressor valves; automatic unloading and idling.

WRITE **GORDON SMITH & CO., Inc.**
TODAY! 410 College Street Bowling Green, Ky.



Please send 10c
for Catalog No. 101

MEIER BRASS & COPPER CO.
1155 Bellevue, Detroit 7, Mich.

BRASS

For Home Work Shops

Free Cutting Brass Rods
Round, Hexagon, Square,
1/2-Oval and Rectangle

Naval Brass Rods
Round and Hexagon.
Brass and Copper Tubing.
Brass Sheet.

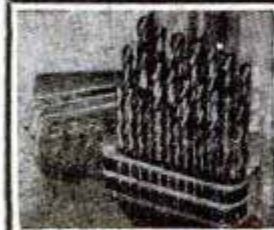

Why Hunt for Drills?

These Complete High Speed Drill Sets
Now Available at Low Prices

#1 to 60 Drills.....\$12.95 Per Set
1/16-1/2 by 64ths.....\$16.95 Per Set
Drill Sets A-Z.....\$15.50 Per Set
(Drill Stands Free)

Send For Free Circular

SID TOOL CO.
MACHINE SHOP SUPPLIES
183 Grand St., New York 13, N. Y.

ONE-MAN SAWMILL LESS THAN \$200.00
Easy To Turn Trees Into Money

Makes lumber,
ties, shingles,
crates, lath,
studding,
siding.



Belsaw Models

in 10 to 24 foot
sawing lengths.
MECHANICAL FEED, accurate set
works and positive dogs. Use tractor
or old auto engine for low cost power.
Thousands used for commercial sawing.
Pays for itself quickly. Send post card today
for FREE booklet, "How To Make Lumber" and
Catalog of Woodworking Equipment.
BELSAW MACHINERY CO., 28115 Field Bldg.
315 Westport Road Kansas City 2, Mo.

HY-ARC POST W A R W E L D E R

SAVE 40% BUY DIRECT FROM FACTORY!

At the
Sensationally
LOW PRICE
of Only

\$19.95

Compares Favorably With Higher Priced Industrial Models

FOUR PURPOSE WELDER

- IT WELDS
- IT BRAZES
- IT SOLDERS
- IT HEATS



MOST REVOLUTIONARY & NEWEST MODEL FOR MACHINE SHOP - FOUNDRY - REPAIR SHOPS - HOME OR FARM WORKSHOP!!!

RADICAL IN CONSTRUCTION AND DESIGN. Originally created for the U. S. Armed Forces. Used on ships . . . in the field . . . and shops. Works on AC or DC. 110 Volts. Remarkable value at this low price. Send check, money-order or \$5 deposit, pay postman \$14.95 balance plus small postage charge on receipt. Welder sent postpaid if you send check for \$19.95 with order.

Here's What You Get With This Outfit!

Set consists of: Power unit, all metal case, heavy duty carbon arc-torch (also to be used as metallic arc electrode holder and ground); also Extra Special welding helmet with unbreakable lens; 1 asbestos block; brazing flux; cast iron flux; ample supply of metallic arc rods, aluminum rods, brazing rods, cast iron rods, copper coated carbons, 6 ft. primary cable, 2 secondary cables with plugs and insulators, complete instruction book. Send in order.

MAIL THIS COUPON TODAY!

HY-ARC WELDER MFG. CO., Dept. PM10
333 N. Michigan Ave., Suite 528
Chicago, Ill.

Gentlemen:

I am enclosing _____ Check Money Order Deposit
for which send Hy-Arc complete outfit to

Name _____

Address _____

City _____ Zone _____ State _____

BALL BEARING STEEL WHEELS

Complete with GOODYEAR, GATES or OSBORN PUNCTUREPROOF Semi-Pneumatic Tires . . . Also Solid and Pneumatic Tires . . . FUN . . . SPEED GALORE . . . BUILD YOUR OWN RACER, ETC.

Made To Outwear Other Type Wheels

SIZE	TIRE	BEARINGS	LOAD	ONE	TWO	FOUR
12" x 2 1/2"	Semi-Pneumatic	Ball 1/2" or 5/8"	150 Lbs.	\$ 5.50	\$10.00	\$18.00
10" x 1 3/4"	Semi-Pneumatic	Ball 1/2" or 5/8"	125 Lbs.	\$ 3.00	\$ 5.50	\$10.00
10" x 2 1/2"	Semi-Pneumatic	Ball 5/8"	250 Lbs.	\$ 5.50	\$10.00	\$18.00
20" x 1 3/4"	Semi-Pneumatic	Ball 7/16"	60 Lbs.	\$ 5.00	\$ 9.50	\$18.00
(the above 20" is Bike type 20 Spokes)						
6" x 1 3/4"	Solid	Ball 3/4"	480 Lbs.	\$ 7.85	—	—
6" x 1 3/4"	Solid	Ball 3/4"	640 Lbs.	\$10.35	—	—
4.00" x 8"	Pneumatic	T.R. 1"	700 Lbs.	\$13.50	\$26.00	\$50.00
(the above 4.00 x 8 is 4 Ply Goodyear with Tube and Taper Roller Bearings for 1 inch diameter straight axle.)						

Add 10% For Prepaid Shipment in U.S.A.

Send 10c For Circular on—Racers—Electric Wheel Chair—Steering Wheel Assemblies—Auto Type Axles—Carts—Electric and Gas Power—Trucks—Pulleys—Belts—and many other interesting items.

OSBORN WHEEL COMPANY, 115 So. Main St., Dept. P-10, Doylestown, Penn.



—NEW— 1948 MODEL "B" RACER

REAL THRILL FOR ANY BOY!
76" Long x 30" Wide, 12" Steering Wheel; Left Side Steering, Two Passenger, 12" Wheels, Foot Pedals, Internal Brakes, 1-H.P. Gasoline Engine, Transmission, Etc., as shown **READY-TO-RIDE . . . ONLY \$175.00.**
Add 10% for Prepaid Shipment in U.S.A.
CHASSIS as shown less power plant, ONLY \$56.00
Add 15% For Prepaid Shipment in U.S.A.

ORDER NOW

Get a **REAL** Drill Press For Your Shop

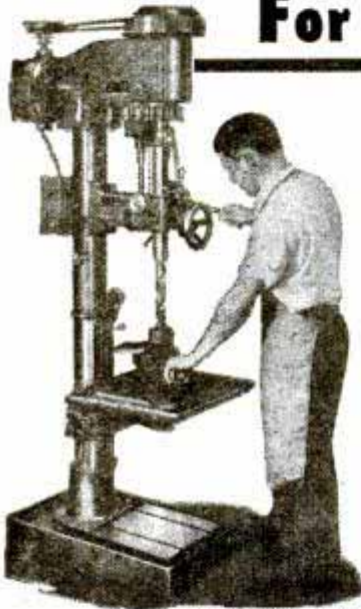

NEW MODEL C-20

SIBLEY

is an industrial drill press—used in leading plants for precision drilling and tapping in metal. Power to drill 1 1/2" in mild steel! Convenient controls make it easy to operate, to increase the quality of your work.

SIBLEY FOUNDRY & MACHINE CORP.
200 E. Tull St., South Bend, Ind.

Drilling Machine Manufacturers since 1876

CLIP COUPON!

Sibley Machine & Foundry Corp.
200 E. Tull Street, South Bend, Indiana

Please send Catalog No. 67, FREE

NAME _____

ADDRESS _____

CITY _____ STATE _____

WAR SURPLUS!

New B-24 Aircraft Lighting **GENERATORS**



28 Volts
300 Amp. D. C.

\$49.50

Original cost \$250

MODEL R. 2, BUILT BY
JACK & HEINTZ, CLEVELAND, O.

Can be converted for use as welder, electric plater, fast battery charger, auxiliary power unit, etc. Small but mighty. Size 16"x7". Air cooled. Shipping weight 68 lbs. Immediate shipment. Original crates. Send check with order to save time.

GREER CO. 460 S. State St., Dept. 4107
Chicago 5, Ill.

H & H FAST CHARGER AND COMPRESSOR

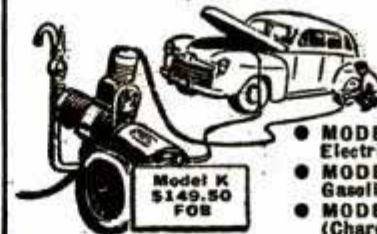

SAFE! • Absolutely Fool-proof • SAFE! 10,000 in use • Proven • Portable • Easy to Use • Charges batteries in 40 minutes; inflates tires in 3. As a Booster, starts car right now!

- MODEL K—Electrically operated \$149.50
- MODEL GKN—Gasoline powered \$199.50
- MODEL SN—(Charger only) \$99.50 FOB

Models K and GKN ONLY DUAL JOBS ON THE MARKET! Real money makers for service station operators and automotive maintenance owners. Can be used for spray gun or any small compression jobs. Model K—output, 2 1/2 CFM . . . Model GKN; 4 1/2 CFM. Also serves as portable power unit. See your dealer or order direct, send cash or money order, Dept. PM-1.

DEALERS AND SALESMEN WANTED
MODERN EQUIPMENT SALES CO.
306 Boyd St. Los Angeles 13, Calif.
As advertised in Sateco Post and Country Gentleman



USE A Professional SKETCH PAD!

Here's the famous Bruning Vellux Pad that's so widely used by draftsmen, architects, engineers, advertising men, etc. Contains 50 sheets, 8 1/2 x 11, of No. 350 Vellux—the white, high grade tracing paper with superior transparency and just the right "tooth" and texture to take ink or pencil easily. Vellux stays white—does not discolor with age. It takes repeated erasures without leaving "ghosts." Pad contains a bristol board sheet ruled on one side 8 x 8 to the inch and on the other side 10 x 10 to the inch. Inserting this ruled sheet under the tracing paper provides a means of making sketches to scale in either fraction or decimals. Find out for yourself why users prefer Vellux—mail coupon for your pad.

BRUNING VELLUX SKETCH PAD

ONLY \$1.25

NO C.O.D. ORDERS

Charles Bruning Company, Inc.
4722-34 Montrose Avenue, Chicago 41, Illinois
Gentlemen: Please send me () pad (s) of Bruning Vellux Prepared Tracing Paper No. 363 at \$1.25 per pad. I enclose \$ _____

Name _____

Address _____

City _____ State _____



STOP LEAKS!

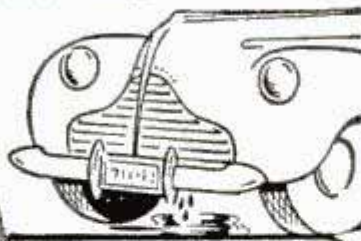

Cooling Systems
Made Leak-Proof QUICKLY

WARNER LIQUID SOLDER—Non-Metallic—Deposits Tiny Fibers to Repair Leaks Anywhere in Cooling Systems. Simply pour in! Finds and REPAIRS every crack or hole. Do it yourself—or see your service man.

Warner-Patterson Co., 920 S. Michigan Ave., Chicago 5



HULL AUTOMOBILE COMPASS

A TRAVEL COMPANION THAT SHOWS DIRECTIONS ANYWHERE, ANY TIME
Write for Circular
At your dealer's
Price \$3.95 and \$5.95

HULL MFG. CO. P. O. Box 246-D9 Warren, Ohio

NEW! LOW COST! RESPIRATOR

Wear when sanding, grinding, paint spraying, sweeping, dusting, furnace cleaning, etc. Handy as a pair of glasses. Just keep mouth closed and breathe through nose is all you do to operate. Protects against nuisance dusts, lint, coal, cement, grain dust, hay fever pollen. Has 9 sq. in. filter. For EYE protection against paint spray, dusts, cinders, fumes, smoke, order our Fog-Proof Rubber GOGGLES..... \$2.00 P.P.



JERRY BRYANT, Dept. PM
919 N. Michigan Ave. Chicago 11, Ill.

Order Today \$1.00 POST PAID

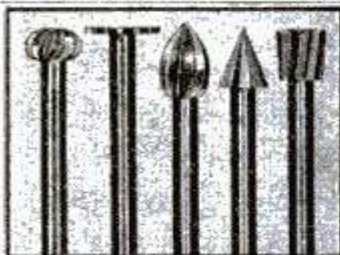

36 ROTARY CUTTERS

Will fit all electric grinders. The ideal tools for cutting wood, metal or plastic in the home or shop. Assorted shapes and sizes on 1/2" shank.

Regular Value \$27.00 NOW ONLY \$9.90
Postpaid in U. S. A.
\$2.00 Deposit on C.O.D. Orders
D. SCHUPACK
2256 E. 75th St., Dept. L-7
Chicago, Ill.

JEWELRY HOBBYISTS

This BEAUTIFULLY ILLUSTRATED CRAFTSMAN'S CATALOG NO. 7 is NEW, DIFFERENT! Contains such items as rosary kits, plastic gems, findings, chains, beads—everything for the serious hobbyist. SEND 25¢ (REFUNDED ON FIRST ORDER) TODAY!
P. O. BOX 90
PITTSFIRE • PITTSFIELD, MASS.



Ottawa Self-Propelled Buzz Master

CLEAR LAND FAST! Powerful 7-HP motor with friction clutch for safe operation. Cuts down timber, brush and hedge; turn blade vertically and saw logs to length. Also furnished with post hole diggers. Has clutch pulley for belt work.



OTTAWA MFG. CO., 1-727 Brush Ave., Ottawa, Kansas
OCTOBER 1947

War Surplus Bargains CHECK! ORDER NOW: SUPPLY LIMITED



Perfect all wool Olive Drab SLEEPING BAG

Comes in handy for fishing trips, hunting, camping, boating, just roughing it or use as auto robe and many other purposes. Has warmth of 2 blankets; zipper slide fastener; tie-strap on bottom; approx. Gov't cost \$12.90, our price Ea. \$3.95

Outside Cover for Sleeping Bag—Water repellent. \$2.39
PUP TENTS Perfect—2 Man Size for Scouting, Camping, etc. Without Pole. \$2.95



NEW GOGGLES Set comes Complete Kit with 1 extra interchangeable shatterproof, flexible, cellulose acetate lense.

Green and white colors. A rubber flexible goggle frame. Back adjustment head strap. Made for A. A. F. Cost Gov't approx. \$4.50. Ea. \$1.00

WATER PURIFIERS "Sunstill" New, used by Air forces and Navy to distill salt water into fresh drinking water. Complete—nothing else to buy. Our price. \$4.95

NEW PARACHUTES (Green Rayon) Approx. 36 sq. ft. Cloth good for making into ties, handkerchiefs, lining, etc. complete with canister, wght. approx. 10# \$2.95

COMFORTERS Army—66x90"—excellent condition \$3.59

BLANKETS All Wool . . . O. D. excellent condition \$4.89

#2 Grade Comforters, can be used for moving vans as padding, etc. \$2.25

NEW WIPING CLOTHS Excellent for home uses, dust cloths, machine shops, mechanics, plants garages, filling stations, industries and other uses. Per lb. prices—25 lbs. 25c; 50 lbs. 22c; 100 lbs. each. 20c

WHITE OIL FILTER WASTE For oil filter. Same prices as cloths.

NEW BENCH LAMPS Adj. type, for work benches and many other uses. Cost Gov't approx. \$15.00. Only \$3.95

SUN GLASSES—CLIP-ON to your regular glasses. Individual case \$1.95

HYDRAULIC JACKS FOR HEAVY DUTY WORK (Perfect) 8 ton \$10.95—20 ton \$44.50

NEW-WOOD BATH SANDALS For swimming, shower rooms, etc. Give size \$1.00

GAS MASKS Trainers (new) complete outfit only \$2.95

ROPE (New) Sisal 1/4" Mildew resistant 2c pr. ft. Grey or Green color—Cotton rope 1/4" 3c pr. ft. —100 ft. min. order. WE PAY POSTAGE—No COD—Send check or money order

AMERICAN SUPPLY CO. Dept. P.M., 5th & Broadway Kansas City, Mo.

SELL MERCHANDISE by mail

OPERATE Profitable Lifetime Business Selling Merchandise by Mail. Large Profits on Fast Selling \$1.00 Items. WRITE TODAY!
POWELL CO. DEPT. A SAMPLER BLDG., CLEVELAND 3, OHIO

Amazing new "Pilotuner"

PILOT F-M TUNER

Makes Every Radio an F-M Radio

for only

\$29.95

You can connect it to your set!



We've all been waiting for this fine little F-M tuner. It's not a gadget, but a real instrument that converts any ordinary Radio Receiver or amplifier for F-M Reception. Made by Pilot, manufacturers of quality receivers. At this sensationally low price, everybody can afford it! Try it, and you'll be amazed at the miracle-clear FM performance from your own set! Pilotuner is so small (8 3/4" x 6 3/4" x 5 3/4") it fits into any small corner. Easily attached. Has 5-tubes plus selenium rectifier, Tuned RF stage, Built-in F-M Antenna, self-contained AC power supply. Handsome walnut cabinet. Complete with tubes, ready to connect, Wt. 10 lbs. Cat. No. 19010. Enclose postage with order.

NEW YORK
Offices & Warehouse
242 W. 55th St., N.Y. 19

NEWARK
ELECTRIC COMPANY, INC.

CHICAGO
323 W. Madison St.
Chicago 6, Ill.

New York City Stores: 115-17 W. 45th St. & 212 Fulton St.

I GET MORE THAN 90 MILES a Gallon on my COMET

Only **\$149.50** UP
F. O. B. MPLS.

COMET Features:

- All-steel frame
- Automatic clutch
- 1 1/2 HP 4-cycle engine
- Separate brake control
- Oversize balloon tires
- Rubber-mounted shock absorbing front fork
- Rubber cushioned engine mount
- Easy operating kick starter

Dealers Wanted

Comet Motor Scooters are handier than a second car for the family! They're easy to ride, economical—they go more than 90 miles to the gallon—and ideal for any use. Ride a Comet to and from school or work, for easy shopping (no parking problem), for deliveries, after-school jobs, sports, vacation trips, fun on the highway. There are four Comet models. All are lightweight, safe, durable. Send coupon below for free booklet.

COMET MOTOR SCOOTER

COMET SCOOTER MANUFACTURING CO.
9253 Nicollet Avenue Minneapolis 9, Minn.
Please send me, without obligation, your colorful, illustrated Scooter Booklet.

NAME _____ ADDRESS _____
CITY _____ ZONE (____) STATE _____

SANITARY TUBE DISPENSER

NO MUSS, NO FUSS

JUST A TWIST OF THE WRIST

New ivory and black plastic bathroom accessory. A new tube dispenser for tooth paste, shaving cream, cosmetics — anything in tubes. The economical ECCO tube dispenser will save you from 15 to 30% of paste. Excellent Xmas gift; order now for early delivery, post-paid only

\$2.00

Agents write for special information.

ECCO MFG. CORP.

111 Bleeker Street

New York 12, N. Y.

\$3.00 Help Prevent Rear End Motor Car Accidents



AUTOMOTIVE FLASHER
Simple to install

For use on all privately owned Motor Cars, Buses, Trucks, Highway Patrol Cars, Ambulances, Cabs, State & City Motor Transportation. Remarkably effective. If your dealer can't supply send check or M. O. for \$3.00. We pay postage. Dealers and Agents wanted.

MACCHI and COMPANY

927 Larkin Street • San Francisco 9, California

Do your own professional

FELT FLOCK FINISHING

with complete spray outfit
Now you can apply a professional, colorful, felt flock finish on hobby crafts, novelties, art objects, lamps, furniture, toys, etc. Velvety, durable, easy-to-apply finish. Available in 10 brilliant colors. Complete outfit (as pictured) includes undercoat, brown and ivory flock, solvent, brush, patented spray gun and instructions. Complete price \$9.25 post paid. Write for FREE circular and color sample card



BEROTT-ROSS • DEPT. 10A 411 No. Foothill Road, Beverly Hills, Calif.

BUILD an ELECT. LAWN MOWER PLANS ONLY **35¢** WRITE TODAY

Make this Battery-Driven, Rotary-Blade mower from an old auto generator and inexpensive parts. Cuts forward, backward, grass or weeds, any height. Plans complete, easily followed.

LE JAY MFG. CO., 847 LeJay Bldg., Minneapolis 8, Minn.

BUILD THESE PROJECTS

For garden or lawn. Easy to build. Easy to sell. Detailed Blueprints Model B-25 Dutch Windmill 50¢; Model OM-60 Old Mill, 85¢. Lawn Figure Patterns—Sunbonnet Girl, Dutch Boy, Tulip Girl, Holland Pair, 35¢ each, all 4—\$1. Catalog illustrating many models, send 10¢, today.

CRAFTSMAN'S MODEL CO., Dept. P-108, 2030 N. 41st St., Milwaukee, Wis.

WANTED MAN WITH CAR

No Time Like Now to Get in McNess Business

It's no trick to make good money when you use your car as a McNess "Store on Wheels." Farmers buy everything they can from McNess Men because McNess Products are tops in quality, represent extra values. Attractive business-getting prizes and premiums; also money-saving deals to customers make selling McNess daily necessities a snap.

We Supply Capital—Start Now!

There's no better work anywhere. Pays well, permanent, need no experience to start, and we supply capital to help you get started quick. You begin making money first day. Write at once for McNess Dealer Book. It's FREE. Tells all — no obligation. (1)

THE McNESS CO., 480 Adams St., Freeport, Ill.



Use Your CAR to Raise Your PAY



For People Who Love to Putter

MOTO-SAW

THE AMAZING ELECTRIC SCROLL SAW

Boys from 8 to 80 (and girls, too) have fun with a Moto-Saw . . . it works more like magic than any tool you ever saw! It takes no effort to run, no perceptible pressure to feed. Runs 7,200 strokes a minute . . . easily cuts intricate scroll designs in medium hard wood up to 3/4" thick. Blade holder faces blade 4 ways . . . permits you to saw sideways as well as forward and backward. No limit to length of stock it will cut . . . saws to center of 19" widths. Moto-Saw is as safe as a hand saw . . . has only two moving parts . . . never needs oiling. Uses 110-120 V. 50 or 60 cycle A.C. (only). Thousands of satisfied users.

MONEY-BACK GUARANTEE: If your dealer does not yet have Moto-Saw, send only \$5.85 . . . we'll pay postage. Or send \$1. and pay postman balance plus postage. Money back if not delighted after 5 days' trial.

DREMEL MFG. CO., Dept. S117-K, RACINE, WIS.



Only
\$5.85
(with 3 saw blades)
Postpaid

Ball-Bearing SPEED WHEELS

Juvenile wheels, solid tire—No Bearings

7" wheels.....60c
6" wheels.....50c
4" wheels.....30c

Semi-pneumatic tired wheels

12 x 1.75".....\$3.25
10 x 1.75".....\$2.75
10 x 1.25".....\$2.00
8 x 2".....\$2.00

Industrial wheels for heavy loads
Semi-Pneumatic

10 x 2.75".....\$6.75
10 x 2.75" Single Tube...\$7.25
8 x 1".....\$4.90
6 x 2".....\$2.80



DEALERS WANTED

Free blueprints with all wheel orders.
Send check with order. Shipments f.o.b. Akron.

JIM BROWN TOY COMPANY
1097 Home Ave. Akron 10, Ohio

HOW TO CUT RAFTERS

New vest pocket book gives lengths, side cuts, Plumb cuts, Deductions. For all rafters for any building from one inch to forty feet wide. Gives numbers to cut on square. Also degrees for same cuts for Radial Saws. All standard pitches from 1/8 to 5/8. Just open book to pitch page and there are your lengths, side cuts, etc. Anyone who knows what a jack rafter is can frame a roof if he has this great book. Price one dollar prepaid. **BUILDERS' TOPICS, Dept. M, Lock Box 828, Seattle, Washington.** Original teachers of the square in five easy lessons by mail. SEND FOR FREE LIST OF TECHNICAL BOOKS. Learn to read blueprints etc.

SAY YOU SAW IT IN POPULAR MECHANICS

MOTOR REPAIR MEN

SEND FOR BULLETINS

AC Motor Winder, winds concentric coils for 1/2 to 2 H. P. motors. Complete \$32.50 Winding head only \$17.50. St. or Winding Tester, tests shorts or partial shorts in single or three phase motors \$50.00

MOTOR INDUSTRIES QUINCY, ILLINOIS

PILOTS' JACKETS

(Left) NEW AIR-CORPS SURPLUS, B-15 Style, Green poplin. Warm alpaca lining, Genuine Mouton fur collar, 4 Pockets. 36-46. . . \$14.75

(Right) SHEEPSKIN LINED JACKET, Brown leather, Army B-3 style, Zipper front. 34-46. \$15.95

PILOT'S CAP (illus.) Brown leather, Lamb's fleece lining and ear flaps. \$2.50

Write for FREE illus. List Army Surplus. Orders sent postpaid except C.O.D.

Satisfaction or Money Back

CONSUMERS CLOTHING CO., Box 2-P, 26 Greene St., New York 13, N. Y.



CRAFT FINISHES SUPPLIES

Materials to produce a professional finish on every type article. Industrial finishes for the home craftsman's use on wood, metal, plastic, plaster, etc. Electroplating and shop supplies, novelty finishes. Catalog free.

CRAFT FINISHES Box M 467 Arlington, Virginia

Amazing PATENTED INTERIOR

WARM MORNING COAL HEATER



Model 616
60-lb. Coal Cap.

• Look inside . . . then you'll see the difference. **WARM MORNING** is the heater with exclusive, patented interior construction that results in abundant heat at low cost.

Heats all day and night without refueling. Holds fire several days on closed draft. Burns any kind of coal, coke or briquets. Start a fire but once a year. Four models, 60 to 200-lb. coal capacity. Sold by Furniture, Hardware, Appliance, Lumber and Coal dealers throughout the nation.



Model 620-B
100-lb. Coal Cap.
Also Model 624-B
200-lb. Coal Cap.

Get This **BIG BOOK** of **HOMES PLANS**

• A beautiful 16-page book in colors containing floor plans and elevations for 12 distinctive, low-cost homes designed by nationally-known architect. A regular 50c book for only 25c. Send a quarter for your copy . . . **NOW!**

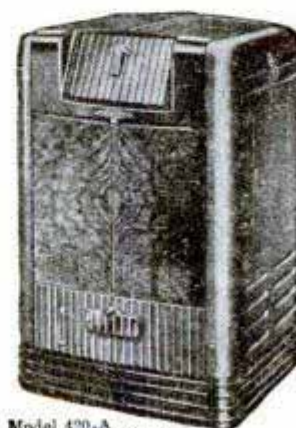

Model 420-A
With Built-in Automatic Draft Regulator.
100-lb. Coal Cap.

LOCKE STOVE CO.
Dept. M, 114 West 11th St., Kansas City 8, Mo.

WORLD'S SMALLEST RADIO

USE ANYWHERE

\$2.98

- No Tubes
- No Batteries
- No Electricity

for DOUBLE fun, attach two RADA-PHONES for a walkie-talkie, hear up to 100 feet. Trim unbreakable hard rubber receiver, 2 attachment clips, 5 feet insulated rubber wire. SEND NO MONEY. Just pay postman \$2.98 each, plus postage or order C.O.D.

New Scientific "GUZZLIN CHARLIE"



MYSTERY DRINKING BIRD WITH ROLY POLY EYES

\$1.95 Complete with stand. No springs, no gadgets, no wires, not mechanical. Amazing "Guzzlin Charlie" drinks and drinks; he is always thirsty. You won't believe your eyes. Young and old go wild over him. Mail your order today.

ELECTRIC LIGHT JAZZ BOW TIE!

Astonish, amaze your friends. Be the life of the party. Have lots of fun. Easily put on. Flashes on and off by simply pressing battery button hidden in your pocket. Complete with attractive bow tie, cord, two bulbs and battery. Mail your order today. Special prices on all articles to dealers.

\$1.95



BERNARD FINE CO., INC.

501 Sixth Ave. Dept. PM5 N. Y. 11, N. Y.

ELECTROPLATING OUTFIT

BRUSH-ON SILVER, COPPER

Only **\$3.95** COMPLETE



Comes Ready to Use—Nothing Else to Buy!

Here's the Handy ELECTRO-PLATER outfit for your home-workshop or business! Only \$3.95 complete! Puts a smooth, shining, silver or copper plating on silverware, toys, models, doorknobs, auto accessories, home fixtures . . . everything with a conductive surface! Simple, easy to use! Complete instructions furnished. Just brush on silver or copper plating! Comes complete—ready to use—with liberal jars of silver and copper plating materials, cleaner, two brushes, battery power unit . . . everything you need to start plating at once! Nothing else to buy.

SEND NO MONEY! GUARANTEED!

Rush order today—a postcard will do. Electro-Plater shipped direct to you by express. Pay only \$3.95, plus express charges, on delivery—or send \$4.60 with order and we ship prepaid. Use 10 days, if not completely satisfied, return outfit and your money will be refunded. Order now.

HANDY ELECTRO-PLATER • Dept. F-413
259 Strader Avenue Cincinnati 26, Ohio

Wanted!

All Types

AIRCRAFT INSTRUMENTS

Generators, Starters, Automatic Pilots, Inverters, Autosyn and Selsyn Motors 60 and 400 cycle, Bendix Pioneer Torque Units, Diehl Two-Phase Motors 75 or 115 volts 60 cycle. Give price, quantity and condition.

INSTRUMENT ASSOCIATES

40-37 172nd Street

Flushing, L. I., N. Y.



Evinrude Catalog Free

Completely describes 1947 line of Evinrude outboard motors — light "singles", smooth "twins" and 3 thrilling four-cylinder models. Gives helpful information on boats, speeds, etc. Profusely illustrated. Address, EVINRUDE MOTORS, 5634 N. 27th St., Milwaukee 9, Wis.

EVINRUDE

Big Money for Workers In Home or Shop



Licensed Concrete Specialists wanted. No experience needed. Make *Colorglazed* concrete pottery without molds. New, low cost, patented method. Cemetery products, novelties, tiles, etc. Basement leaksealing. Other big pay projects. Booklet, details free. Men only.

NATIONAL POTTERIES COMPANY

415 Third Avenue, W., Grand Rapids, Minnesota

MAKE BEAUTIFUL ARTICLES of leather, plastics, metal, veneer and other materials



• It is easy with our complete craft kits. Everything you need. Full instructions. Dozens of kits to choose from including leatherwork, wood carving, veneer and plaster packets, cedar chests, and many others. Make ideal gifts. Send dime for illustrated catalog-handbook describing all kits in detail.

BEAVER CRAFTS, Inc. Dept. K-7

11558 S. WENTWORTH AVE., CHICAGO 28

BROKEN JEWELRY WANTED

All kinds. Highest prices paid for jewelry, rings, spectacles, gold teeth, diamonds, broken and usable watches, etc. Cash mailed promptly. Write for FREE shipping container.

LOWE'S, Dept. PM, Holland Bldg., St. Louis 3, Missouri

GO IN BUSINESS

Before you think!!!

Many fail first 6 months. Avoid pitfalls. Get my guidebook to help you succeed. Auditor, business advisor. Methods used as far as Cal. One pointer may prevent your bankruptcy . . . Only \$1.

GROSNIK, Dept. A, 115 State, Springfield 3, Mass.

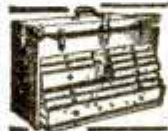

TOOLMAKERS • PATTERNMAKERS

Selected materials in Gerstner tool chests make them outstanding values.

Free Catalog.

GERSTNER TOOL CHESTS

447 Columbia St., Dayton 7, Ohio.

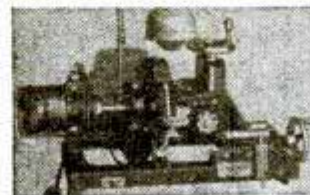

Start a NEW BUSINESS Sharpen Dull Pipe Wrenches

Or Add to Your Present Repair Business

Write for Information.

J. C. MOORE INDUSTRIES P. O. Drawer 276 FREDONIA, PA.

HYDRAULIC JACKS

GOV'T. SURPLUS—HEAVY DUTY

Completely reconditioned—\$65.00 each FOB Washington, D. C. Made by famous manufacturer to lift AAF bombers. Weight 220 lbs. Height closed—18"; open—50". Three extensions. Can be gauge equipped. Capacity—10 ton at full extension of 50"; approx. 70 ton at 15" extension. Can be furnished without wheeled base if desired. Exceptionally useful to engineers, road builders, constructors, movers, aircraft repair stations, riggers, etc. Send check or money order to:



MICHEHL INDUSTRIES

930 F St., N.W., WASHINGTON, D. C.
Phone — EXecutive 5687

LIVE CENTER \$12.95 POST PAID

Double Ball Bearings
Hardened Point
No. 1 or 2 Morse Taper
Slip-on Wood Working
Attachment \$1.50 Extra
FULLY GUARANTEED—SEND CHECK OR MONEY ORDER

G-K MFG. & SUPPLY 5907 Catalina
Mission, Kansas

Say You Saw It in
POPULAR MECHANICS

LAW STUDY AT HOME for PERSONAL SUCCESS and LARGER EARNINGS. 39 years expert instruction—over 108,000 students enrolled. LL.B. Degree awarded. All texts furnished. Easy payments. Send for FREE BOOK. G. I. approved.
AMERICAN EXTENSION SCHOOL OF LAW
Dept. 82-M, 646 N. Michigan Ave., Chicago 11, Ill.

GOODBYE to BURGLARS

Protect your belongings and the lives of your family. Send \$1.50 (or 7/6) by International Money Order for complete plans for combined burglar alarm and automatic locking device (electrical). It's unique. You make it from scrap.

SAFETY INVENTIONS, 110 Cranbourne Ave., Bononi, South Africa

Do You STILL CHANGE MOTOR OIL??

If so—you can END this needless waste and expense forever, with "RECLAIMO"

America's Foremost Oil Re-Refining Filter. Continuously re-refines crankcase oil through an ingenious use of motor heat while driving!

1. Removes solids by filtration
2. (Removes water-fuel dilution by heat and distillation)
3. Prevents acid-sludge formation
4. Maintains stable viscosity
5. ELIMINATES ALL OIL CHANGES!

CAR—TRUCK—TRACTOR and DIESEL OWNERS! U. S. Bu. of Stds. Bul. 86 states: "Oil Does Not Wear Out Mechanically"—"Reclaimo's" re-refining action has fully confirmed that statement. This great oil-saving feature is indeed important, BUT of far greater importance are the savings resulting from "Reclaimo's" tremendous reduction of costly motor wear! Again available—also to dealers. Complete details in FREE Book "Oil Facts". Write now!
NEW 90-DAY NO RISK TRIAL OFFER! Reclaimo is now offered to responsible motor owners for 90 Days Trial—ABSOLUTELY FREE!
RECLAIMO MFG. CO., 5081 Elston Ave., Dept. 55, Chicago 30, Ill.

GET THE FACTS!



BOICE-CRANE POWER TOOLS

for shop men and homecraftsmen.



BAND SAWS



JIG SAWS



DRILL PRESSES



THICKNESS PLANERS



SPINDLE SANDERS



SAW-JOINTERS



LATHES



SPINDLE SHAPERS



BELT SANDERS

Write for literature on this versatile, low-cost, sturdy line.

BOICE-CRANE COMPANY
943 Central Ave., Toledo 6, Ohio

New Advertising Machine



Prints & Illustrates
1¢ Post Cards

FREE! Learn how thousands of merchants and business men are boosting sales in spite of product shortages with 1¢ messages—printed in a few minutes on gov't postcards—with amazing new, patented **CARDMASTER**. Your "todays" ideas for specials, read by prospects next morning. Not a toy, but a sturdy, advertising machine, built to last many years. Low price, sold direct. Guaranteed, five years.

SEND NAME We'll send free illustrated book of money-making ideas for your business and complete, unique advertising plans. Rush your name today.

CARDMASTER COMPANY
4546 Ravenswood Dept. 1310 Chicago 40, Ill.



MILL IT... ON YOUR LATHE!

PALMGREN

MILLING ATTACHMENT

3 SIZES

No. 250 Illustrated

2 1/2" JAW Only

\$24.75

CONVERT LATHE IN 10 SECONDS

Now you can Mill, Slot, Grind, Groove, Square Shafts, Saw at Angles, Recess and many other important jobs. **SAVE TIME and MONEY!** Why send work out or use costly methods when a PALMGREN MILLING ATTACHMENT will solve your problem.

Precision built, it has accurate graduations for rotary angle adjustments, also graduated vertical feed screw. Fits South Bend, Atlas, Craftsman, Logan, Sheldon and all other lathes. Thousands now in use in small and large machine shops, repair shops, railroads, schools, home work shops, etc. **ORDER SIZE NEEDED TODAY!**—It will quickly pay for itself.

IMMEDIATE DELIVERY

No.	Width Jaws	Depth Jaws	Jaws Open	Weight Pounds	Fits Tool Post	Price F.O.B. Factory
150	1 1/2"	1"	1 5/8"	6 1/2	1" Dia.	\$18.75
250	2 1/2"	1 7/16"	2 1/2"	11	1 1/4" Dia.	24.75
400	4"	1 1/2"	4"	25	2" Dia.	39.75

Order From Your Dealer or Jobber: Write for Circular No. 351 Mfrs. of PALMGREN PRODUCTS Since 1915
8365 South Chicago Ave. Chicago 17, Ill.

CHICAGO TOOL and ENGINEERING CO.

JUST A FEW OPERATIONS YOU CAN DO ON YOUR LATHE!

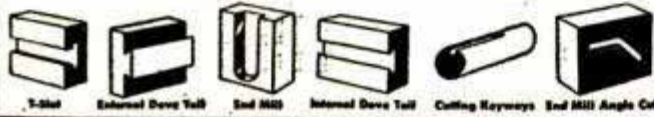

IT'S AUTOMATIC!!

THE WATCH THAT WINDS ITSELF

- Sweep second-hand
- Unbreakable crystal
- Luminous radium dial and hands
- It's Self-Winding (can also be wound by hand in the conventional manner).

This watch comes to you precision-tested and guaranteed for only... **\$38.75**

Tax and postage included.

OTHER FINE NON-AUTOMATIC WATCHES

With all other features of our self-winding model.
No. 522\$26.75
No. 325 (a calendar watch that gives you the date as well as the time)\$39.85

All prices include tax and postage. Send check, money order, or pay postman C.O.D.

THE INDEPENDENCE COMPANY
1593 INDEPENDENCE AVENUE
BROOKLYN 28, NEW YORK

- 17 Ruby Jewels
- Split second accuracy
- Sturdy, non-corrosive stainless steel case
- Shockproof with famous incabloc
 - Non-Magnetic
 - Waterproof



SCALED MODELS that SAIL



The **CAPE COD**, 27" model of sea going Ketch. Bulkhead construction. Kit complete with true scale plastic fittings, all ready shaped parts, and full size plans. \$3.50 postpaid.

The **GRAND BANKS**, 21" model sailing Sloop. 30" high. Full size plans. True shipyard bulkhead construction. All finished parts and sealed plastic fittings. A beauty! \$3 postpaid.

SAIL CHAMP, 22" high, 17" long. 36 plastic fittings. Beautiful, authentic model. Real bulkhead construction. Easy work... all parts preshaped. Full size plans. \$1 postpaid.

At dealers or write today.

ALL STAR 550 W. Harrison Chicago 7



CARPENTERS... CRAFTSMEN... All Aluminum 4" BARTON JOINTER



TABLE—23 3/4" x 5 1/2" BEARINGS—Sealed Ball HEAD—Round 2 7/16", 3 Knives, RABBIT—Full 3/8"

\$57 F.O.B. PORTLAND (With 1/2 H.P. Motor \$90)

ORDER DIRECT FROM IMMEDIATE DELIVERY PALMER D. WEEKS

401 S. W. 1st AVE. PORTLAND, OREGON DEPT. 032

INSTALL-SERVICE OWN OIL BURNER \$1



Save up to \$150! Send for the famous DELTA PHOTO-INSTALLATION MANUAL. Simple, easy step-by-step photos of a complete oil burner installation. Complete with all necessary plans, drawings and easy-to-follow directions. Published under exclusive copyright at \$5.00. SPECIAL OFFER—CLIP \$1 to this ad and mail today!



DELTA HEATING CORPORATION 88-05 NORTHERN BLVD., JACKSON HEIGHTS, NEW YORK CITY

SAY YOU SAW IT IN POPULAR MECHANICS



WORK BENCH

Sturdy, useful bench—ideal for hobbyist or shop worker. Makes home handiwork a joy. Working surface of sanded 2" stock; 2 large drawers; tool rack; strong shelf; bins for nails and bolts. 59" long, 23" wide, 36" high. Shipped unassembled—easy to set up from instructions. FOB PHILA. Check or money order. Money back if not satisfied. **QUALITY CRAFTSMEN, INC., Dept. 23 3431 Market St., Phila. 4, Pa.**



Balance 4" x 9" Base. With either Metric or Avoirdupois Weights... **\$7.00**

Catalog with 3000 illustrations of laboratory apparatus, and over 10,000 prices sent for \$1.00.

LABORATORY MATERIALS CO. 7321 Vincennes Ave. Chicago 21, Ill.

Make & Sell THERM-SOL Tested Fire-Proof

Independence
EVEN WEALTH.
WITHIN
EASY GRASP

Right now this fine fire-Proof is being made and profitably sold by hundreds of people like you who started out by answering our ads. And it's but one of our 15 Private Manufacturing Processes.

We tell you ALL—How to Make—Where to Buy simple inexpensive materials—How to Package, Promote, Sell. If you are SINCERE, if you can follow simple directions, here are 15 Roads to Success.

These are factory-tested processes. Big businesses have been built on them. There's still room for you. The public WANTS the products. You, yes you, can Make & Sell them. Lose no time! Write for details.

CHEMICAL RESEARCH CO. 214 West 42nd Street, New York 18, N.Y.

When convenience counts...

and comfort is important you'll appreciate the central location, the friendly hospitality of Hotel Cleveland. In the very heart of Cleveland, adjoining Union Passenger Terminal, garage, and Terminal office buildings. Convenient to stores, theatres, boat docks, Public Hall, Stadium.

HOTEL CLEVELAND

Cleveland,
Ohio



148 PAGE WOODWORKERS CATALOG

ONLY 15 CENTS-REBATED ON FIRST ORDER
SHOWS IN NATURAL COLOR

22 inlay and overlay insets
22 veneer bandings—matched woods
30 kinds of world's finest woods in character grains and color

31 moulding, rosettes, ornaments and home wood working labor-saving tools and hard-to-find hardware

CRAFTSMAN WOOD SERVICE CO.
2729 S. Mary St., Dept. A-86, Chicago 8, Ill.

LISTS OVER 300
PIECES OF ARTISTIC
FURNITURE SHOWN
including cost of plans, lumber, hardware and finishing material, choice of MAHOAGANY, WALNUT, BIRCH or MAPLE, LUMBER, PLYWOOD, VENEERS, UNMATCHED BARGAINS

Make beautiful furniture at only 20% store prices.

ELECTRO LIFE BOXERS

Static electricity makes this novelty perform like human boxers. Operates by sweeping the hand over the top of the specially processed cover.

\$1.00 EACH POSTPAID

Special price for agents & dealers

\$6.00 PER DOZ. POSTPAID

Also made up in doll dancers

ALAN JOYCE INDUSTRIES
431 So. Dearborn Dept. P.M.
Chicago 5, Ill.

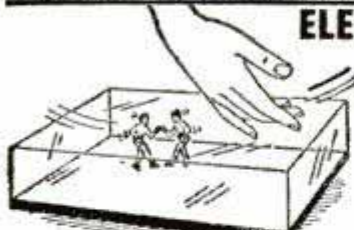

New Designs in FRANZITE GRIPS

Modernize Your Gun! Improve Your Score!

Most durable grips made. Positively unbreakable! For Colt, Smith & Wesson, Hi-Standard, Ortig, Luger & Mausers in a wide choice of beautiful designs in ivory, pearl, walnut, onyx, etc. Low prices. FREE CATALOG. Dealers Wanted.

SPORTS, INC. (Mfrs.) 5501 Broadway, Dept. P-10, Chicago 40, Ill.

NEWEST OTTAWA LOG SAW

SELF-PROPELLED — MOVES ANYWHERE ON OWN POWER

World's fastest Log Saw. Powerful 6 H-P air-cooled motor. Attachments for sawing down trees, busking limbs, post hole digging and pulley for belt jobs. Big demand for wood, pulp, posts. Make big money sawing wood this easy way. Low factory-to-user prices. Nothing like it. FREE details. OTTAWA MFG. CO., 7-727 Pine St., Ottawa, Kansas

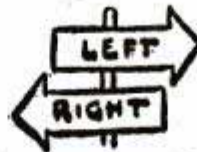

Either way...

right or left-handed the Inkograph writes right! Favorite fountain pen of left-handed people because it has no nib to bend or spread.

Inkograph's unique point, the rounded end of a fine cylinder of extra-hard 14kt. gold, writes in any direction you move it... suits any hand or writing style... makes carbon copies, rules lines... gives years of service! Five smart colors, and black. At all good stores. And... the price is still

only \$2

INKOGRAPH

Inkograph Co., Inc., 200 Hudson St.,
New York City 13, N. Y.

CRANDALL TILTING TABLE SAW

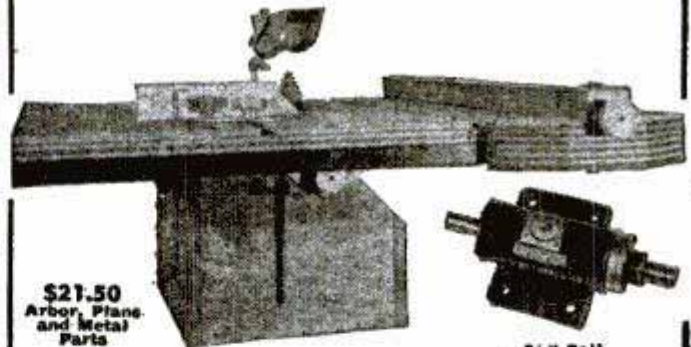

\$21.50
Arbor, Plans
and Metal
Parts

5/8" Ball
Bearing Arbor

BUILD IT YOURSELF

In your own shop — with our Ball Bearing Arbor, Plans and Metal Parts. Here's the saw you've been wanting for your shop! With our easy to follow step-by-step plans and instructions, you can build it with ordinary hand tools for a fraction the cost of all metal saws of comparable size and capacity. Sturdy wood, steel and aluminum construction.

Features—

Big roomy top 27" x 32" with 13 1/2" clearance ahead of saw. Tilts to 45°. Precision built ball bearing arbor lubricated and sealed. No further lubrication required. Self-aligning, full length rip fence. Indexed mitre gauge. Indexed table tilting quadrant. Adjustable saw arm—cuts from 0" to 2 1/4".

Complete Kit—

Includes Ball Bearing Arbor with Saw Plans and instructions, and all metal parts, bolts, washers and screws \$21.50 (less saw blade).....
5/8" Ball Bearing Arbor only—with Saw Plans and instructions \$6.95
Metal Parts only—less Arbor \$14.95

If your dealer cannot supply you, send check or money order — we will ship promptly postpaid in U.S.A. or possessions. DEALER INQUIRIES INVITED

WILLIAM H. CRANDALL COMPANY

1009 Fruitvale Avenue Dept. M Oakland 1, California

SAY YOU SAW IT IN POPULAR MECHANICS

PRESSURE QUEEN

FOUR CYLINDER
PORTABLE AIR COMPRESSOR
SPRAY PAINTING OUTFIT

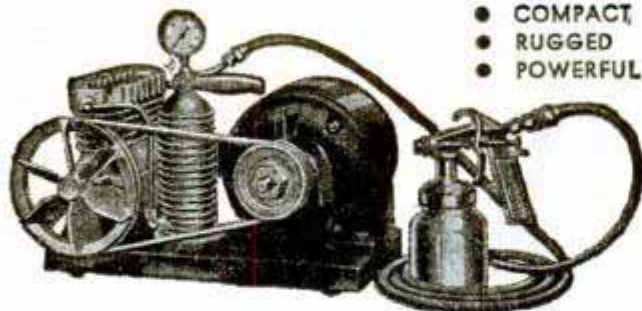

- COMPACT
- RUGGED
- POWERFUL

Immediate delivery on compressor with motor

AMAZINGLY LOW PRICED FOR THE ONLY
FOUR CYLINDER UNIT ON THE MARKET

The ideal air supply for home and farm workshop, machine shop, garage and contracting painter; for product finishing, inflating tires, painting automobiles, trucks, machinery, etc.

This 4 cylinder compressor has drop forged crankshaft, stainless steel, heat treated valves; bronze bearings and positive forced feed lubrication. Maximum pressure 50-60 lbs., free from pulsation. Standard equipment includes the compressor mounted on steel base with carrying handle, belt, compressor pulley, air chamber, air gauge, 15-ft. hose, spray gun; 1/2 or 3/4 h.p. motor or gas engine. Immediate delivery.

If your dealer does not sell Pressure Queen write direct

THE CAMPBELL-HAUSFELD CO.
1046 RAILROAD AVE. HARRISON, OHIO

SAY YOU SAW IT IN POPULAR MECHANICS

GLOWS
in the DARK

FREE
Sample!

Be the first to sell luminous house numbers, light switch plates, wall protectors, pull cords. Also luminous pictures, statues, decals, and a host of religious, nursery and other objects that glow in the dark. Get into this new and growing industry. Enormous demand... no competition... sensational demonstration... big profits. Represent a large manufacturer, established over 34 years. Write today for liberal money-making offer and free sample to show how they glow in the dark.

MADISON MILLS 303 Fourth Ave., New York 10, N.Y.

5



RUBBERGRIP DRILL HOLDER and GAGE

Drills cannot fall out even when holder is shaken or turned upside down.

Has rubber base with metal gage top.

HOLDS 18 DRILLS

SIZES 1/16" TO 21/64"

SIZES APPEAR IN
BOTH DECIMALS AND
FRACTIONS

SEND ONLY

\$1.00

FOR
HOLDER
(Post paid)

GALE & POGUE

4128 FULLERTON AVE. • CHICAGO 39, ILL.

AUTOMATIC IRON TESTER

Pilot Light Flashes on
and off with thermostat.

For checking temperatures and re-setting thermostats. Graduated for RAYON, SILK, WOOL, COTTON, LINEN—Also in degrees from 200° to 700° F. Has a specially designed precision thermometer. Unsurpassed in quality. ONLY \$18.50 postpaid — MONEY BACK GUARANTEE.



Write for circular.

(Pat. Appl. For)

HANLAN CO., 1419-A, W. Jefferson, LOS ANGELES 7, CALIF.

12 lbs. RADIO PARTS \$2.00

A gold mine of parts for repairmen, amateurs, and experimenters... sockets, condensers, resistors, transformers, coils, hardware, wire, etc. An outstanding bargain in usable parts! Send \$2.00 cash, check or M.O. today!

(Pay small express charges on receipt.)

ELECTRONIC DISTRIBUTORS, Inc. Dept. 111 620 W. Randolph St., Chicago 6, Ill.

BENDIX RADIO COMPASS \$18.75

#433G 200-1750kc. Complete with 19 tubes. Ideal for Direction Finder or Radio Receiver.

FLEXIBLE SHAFTS, per ft. . . 15c

Lengths 6 ft. to 30 ft. complete with spline fittings. Specify length when ordering. BRAND NEW.

ASSOCIATED SURPLUS CO., 10838 Ventura Blvd., North Hollywood, California

ASTROGRAPHS

Type AT \$15.00

Used for celestial navigation, complete, with film giving astronomical positions. Cost Govt. over \$300. BRAND NEW in carrying case.

SPERRY K-3 COMPUTING SIGHT \$12.50

Contains hundreds of precision bearings—gears—electronic parts—motor—clutches—shafts—optical system—BRAND NEW in original box.



AUTOMATIC SAW SET

Set saw teeth automatically on hand or band saws — 400 per minute without effort. Perfect hammer and anvil action sets teeth uniformly—No tooth breakage.

BURR MFG. COMPANY 8933-J Venice Blvd. Los Angeles 34, Calif.



**IMMEDIATE
DELIVERY
Write Today**

AUTOMATIC RETOOTHER

Cuts new saw teeth in 50 seconds—any size 4 to 16 points. Old teeth fall off as chips. Easy to operate. A perfect job.

FOR HAND SAWS



CAMILLUS

Keen... because blades are custom made steel, HAND HONED under oil.
Durable... because quality is built-in-to-last.

A wide selection at your hardware or sporting goods store. Remember the name Camillus, pronounced Kă-MILL-us... Ask for Camillus by name.



Kă-MILL-us

CAMILLUS CUTLERY COMPANY, New York 17, N. Y.
Established 1876 . . . Factory at Camillus, N. Y.

No. 41
3 1/4"
closed

Now for EVERY WORK SHOP!

NEW Invention Electroplates by BRUSH



Easy to Plate CHROMIUM GOLD, SILVER, NICKEL, COPPER . . . For Pleasure and Profit!

If you have a workshop—at home or in business—you need this new Warner Electroplater. At the stroke of an electrified brush, you can electroplate models and projects—you can replate worn articles, faucets, tools, fixtures, silverware, etc. with a durable, sparkling coat of metal . . . Gold, Silver, Chromium, Nickel, Copper or Cadmium. Method is easy, simple, quick. Everything furnished—equipment complete, ready for use. *By doing a bit of work for others, your machine can pay for itself within a week.* So make your shop complete by getting a Warner Electroplater right away. Send today for FREE SAMPLE and illustrated literature. ACT AT ONCE! Mail Coupon.
WARNER ELECTRIC CO., DEPT. P-1
1512 Jarvis Avenue, Chicago 26, Ill.

FREE Details & Sample!

WARNER ELECTRIC CO., 1512 Jarvis Avenue, Chicago 26, Dept. P-1

Gentlemen: Send Free Sample and Details to:

Name _____

Address _____

City _____ State _____

NEW BIG POWER SAW

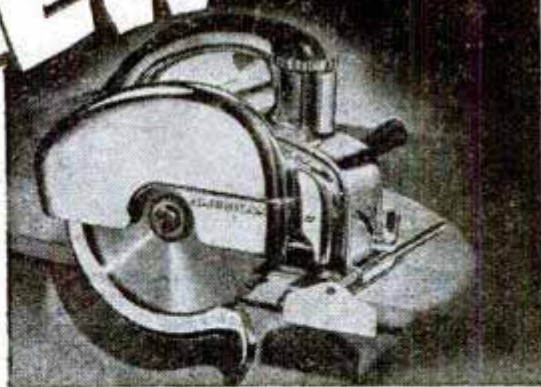

by AMERICAN



Here's the new American Portable Electric Saw—ideal to save time, labor and money in *production work*. Not a hobby tool. Speedy . . . powerful . . . easy for one hand operation. 8" blade. Adjustable. Precision-built, dependable. Write for free details, giving your occupation. The American Floor Surfacing Machine Co., 535 So. St. Clair St., Toledo 3, Ohio.



the BEACON that never fails



Ever-faithful, the BEACON camera will always bring you top precision, miniature camera performance at low cost. The 46mm Whitlar coated lens — color corrected, gives you sharp, sparkling snapshots. **\$9.95** incl. tax.

EVEREADY CASE. Simulated brown leather, beautifully styled. **\$2.50**

Safety lock shutter — no accidental snaps • Speeds 1/50, or time • Uses No. 127 film • Optically ground lenses, fluoride coated



Whitehouse Products, Inc.
360 Furman St., Brooklyn, N. Y.

It's Here!

BARRON ALL METAL SHAPER FENCE

Fits ANY Drill Press

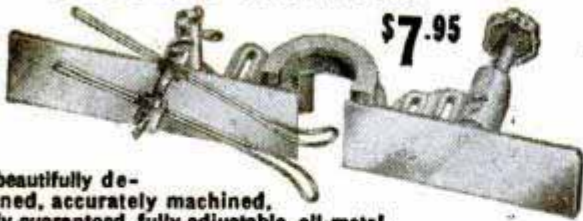

\$7.95

A beautifully designed, accurately machined, fully guaranteed, fully adjustable, all-metal shaper fence. Made throughout of aluminum and non-rusting steel. No cast iron—no wood! Complete with anchor bolts, 2 hold down springs. A real value. See it at your dealer or shipped direct

FAMOUS 5-IN-1 DRILL PRESS PLANER



Planes-Rabbets
Panels
Tenons
Grooves

\$7.50

COMPLETE

NEW 2 1/2" DRUM SANDER

Fits All Makes of Drill Presses or Motor Shafts

\$3.95

Includes 5 sanding sleeves



OTHER DRILL PRESS ACCESSORIES

4" ROTARY SURFACE SANDER \$5.95 1/2" DOVETAIL CUTTER \$1.85
ALL-METAL AUXILIARY DRILL PRESS PLANING AND SHAPER TABLE \$8.85
TAPERED AND THREADED SPINDLE ADAPTERS
ROUTER AND ROUND END MORTISING BITS 1/8" TO 1/2" SET OF 6 \$9.50

Liberal 10 Day Money Back Guarantee

Workshop Guide FREE



BARRON TOOL CO.

569 Architects Bldg., Detroit 1, Mich.

BARRON PRECISION WORK SHOP TOOLS

AMAZING NEW MOTOR KIT

Only \$1



Here's the new electric motor bargain you've been waiting for—you and your friends will be amazed at the clever design of this rugged little motor.

- Complete kit—finest materials
- Easily constructed with simple hand tools
- Connect it to toys, shafts, etc.

SEND NO MONEY

Just send your name and address and when your motor kit arrives merely pay postman \$1.00 plus a few cents postage—or enclose \$1.00 bill, check or money order for postpaid delivery.

HOBBY MOTOR CO. Dept. 101, Box 252, Greenville, Michigan

Learn LANDSCAPE GARDENING

A thorough, interesting, home study course for those who wish to become LANDSCAPERS, GARDENERS, DESIGNERS, etc., for profit or pleasure. Write today for FREE BOOK to

APPROVED FOR VETERANS

NATIONAL LANDSCAPE INSTITUTE
Dept. P.O. 310 So. Robertson, Los Angeles 36

Keep Brushes like New

BEFORE

AFTER

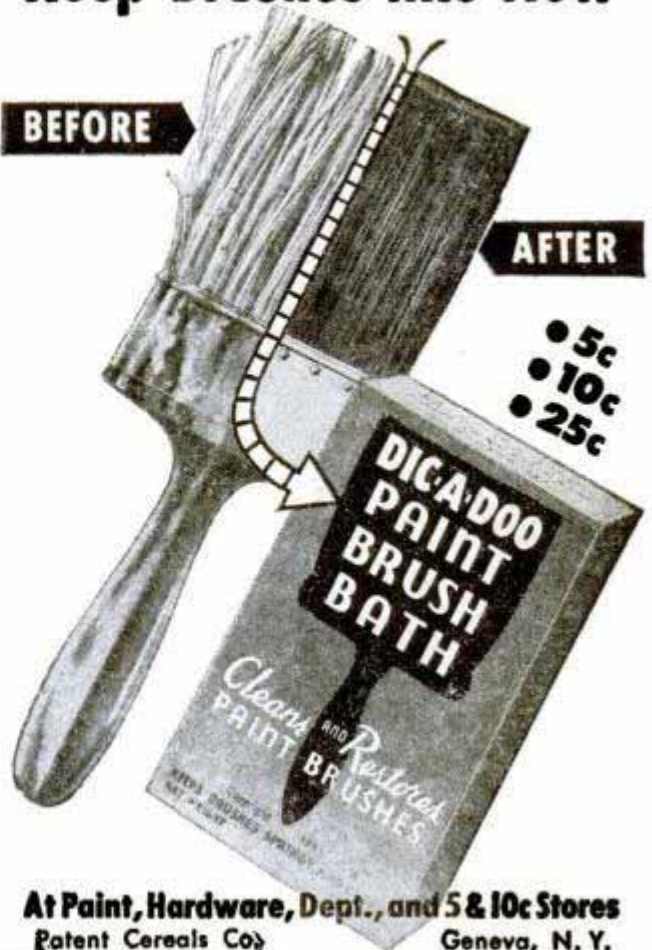

At Paint, Hardware, Dept., and 5 & 10c Stores
Patent Cereals Co. Geneva, N. Y.



MAKE BIG MONEY WITH THIS

Ready CASH for full or spare time

Sensational. Patented Memo-Pal holds 250 feet of paper for long or short notes. Write—tear off. Available with printed forms for all purposes. Every home, office, shop a prospect. Earn big money without experience. Show it—take order—pocket profits. Get FREE facts. Write

OVER 1000 NOTES ON ROLL

PREVUE-RADSELL CO. 343 S. Dearborn St. Dept. PM2, Chicago 4

EQUIPPED WITH FLEXIBLE EXTENSION FOR FLASHLIGHTS

Fits any flashlight. Flexible, yet it will remain rigid after being bent into position. Has thousands of uses—look down pipes, inside motors and other dark inaccessible places. Often worth many times its cost on one job. When ordering, specify flange or screw base to fit your flashlight. Send \$1.00 cash, money order or check and your Extenda-lite will be mailed Postpaid. U.S.A. only.

UNITED STATES SAFETY SERVICE COMPANY
1215 McGee Street Kansas City 6, Mo.



Aladdin's Tool

THE "GENI" OF A THOUSAND AND ONE USES !!!

Complete With 6 Ground Blades — And New Adaptor

Dealers Write for Information

Makes 12 Different Cuts
Makes any cut wood shaping tools costing up to \$300.00 can make—more too. Sturdily built, lasts a lifetime. Complete—makes 12 standard cuts and over 100 variation shapes. See your dealer or if he does not stock, send \$7.95 for immediate delivery to your door. All other orders C. O. D. plus postage.

\$7.95

The Design Co., 2016 E. 31, Dept. P. 38, Kansas City, Mo.



All Types Of Wood Shaping

**1948
Model**

Never Before At Such An Amazing Low Price!

PORTABLE *Modernair* RADIO

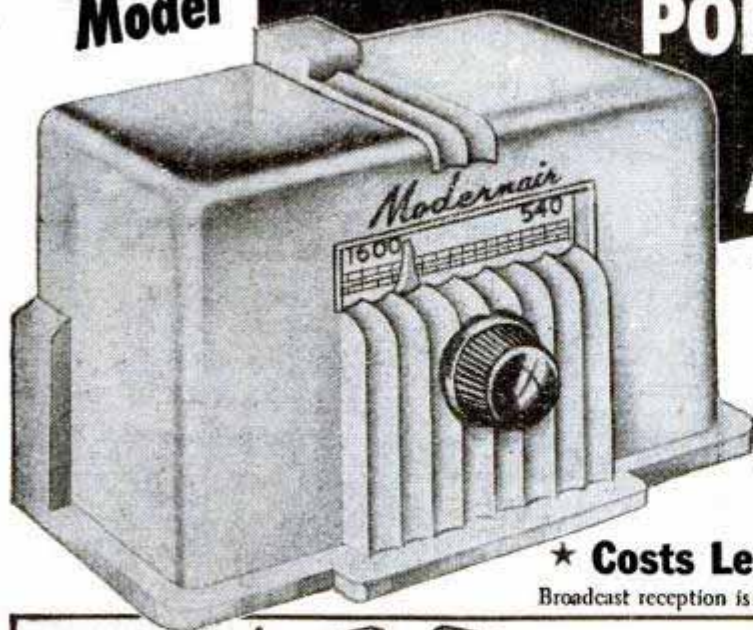

★ Long Life
BATTERY
OPERATION

★ Powerful
VACUUM TUBE
RECEPTION

Not A Toy
But A Real Radio
For Only

\$6.95
Complete
with
EARPHONE

★ Costs Less Than 1c Per Hour to Operate!

Broadcast reception is from 1,600 to 540 kilocycles.

Included
AT NO
EXTRA COST



22½ VOLT "B" BATTERY
approximately 200 hours of playing life

1½ VOLT "A" BATTERY

**USE IT
ANYWHERE**



PRIVATE EAR-
PHONE MEANS
THAT YOU ALONE
CAN HEAR



SMALL
ENOUGH
TO FIT THE
PALM OF
YOUR HAND



Powerful
PENTODE
Receiving
TUBE



POWERFUL
ENOUGH TO
PICK UP
STATIONS 100
MILES AWAY!

The Magic Of Radio In The Palm Of Your Hand!

Yes, it's here at last . . . Radio's mighty postwar *portable midget* . . . at an almost *unbelievable low price!* Look at its streamlined cabinet of lovely, lustrous plastic . . . so tiny you can hold it in the palm of your hand. Listen to its rich fidelity . . . so powerful you can tune in stations 100 miles away. Once you hear it play you'll agree that this *portable midget radio* at only \$6.95 is a postwar dream come true. Yes, astounding as it may sound, we will send your *Modernair portable radio* complete with personal earphone, powerful receiving tube and two batteries for only \$6.95. However, our present supply is limited and we can guarantee *immediate delivery* only if you **ACT NOW!**

CHECK THESE ULTRA-MODERN FEATURES:

- ★ Streamlined Ivory Plastic Cabinet.
- ★ Highly-Selective Tuning Dial.
- ★ Picks Up Stations Within 100 Mile Radius.
- ★ Off-and-On Switch With Silver-Plated Points.
- ★ Private Earphone Prevents Disturbing Others.
- ★ Powerful HI-MU 114 Pentode Receiving Tube.
- ★ Two Long-Life Midget Batteries.
- ★ Patented Compression-Type Condenser.

FACTORY GUARANTEED: Each radio checked and tested at the factory, and is fully guaranteed against defective workmanship and material.

SEND NO MONEY!

You Risk Nothing! Merely clip this ad and mail it today. Then pay postman only \$6.95 plus postage on delivery. Or if you prefer, send cash, and we'll pay postage. We guarantee perfect reception if used as directed. Order yours **TODAY.**



IN BED



IN KITCHEN



ON TRIPS



AT WORK



OUTINGS

AMERICAN MERCHANDISING COMPANY, 9 Madison Avenue, Montgomery 4, Ala. Dept. MR-17

WORLD'S

LOWEST PRICED ADDING MACHINE

VEST POCKET SIZE

Fits vest pocket or purse. Guaranteed Accurate. Operated as easily, and as reliable, as machines costing many times as much. NOT A TOY or GADGET. Substantially made of 28-gauge steel—guaranteed for life against defects in construction. Beautiful looking, modernized design. Finished in Black, Silver and Red. You positively can't buy a Calculator of equal quality for as little money. **ACCEPTED AS THE FINEST LOW PRICED CALCULATOR FOR OVER 30 YEARS!** Operates with a flick of your finger. Adds, subtracts, multiplies, divides—counts up to ten million. Pays for itself over and over in mistake avoided, and time saved.

MAKES IDEAL GIFT
Baby Calculator makes an ideal gift—for every Gift occasion. Birthday—Graduation—Christmas—Anniversaries. For men, women, children—teachers, business people, home or shop use. **COMES PACKED READY FOR GIFT WRAPPING.**

TEN DAY TRIAL
Money Back Guarantee
Because we know that our machine is the very best Calculator to be obtained at this low price, we make this 10 Day Trial offer, on a positive money back guarantee! Don't buy ANY Calculator without this guarantee! Send only name and address, pay postman \$2.95 plus postage (if cash is sent, we pay postage—you save up to 40c). (Send full cash if outside U.S.) Money back within 10 days if not delighted.



IDEAL XMAS GIFT

FREE TRIAL ONLY

\$2.95

AGENTS TOTAL WANTED COST

SEND NO MONEY

FREE!!

Each Baby Calculator enclosed in beautiful rich-looking Leatherette Case—at no extra cost.



CALCULATOR Machine Co. (Mfrs.)
DEPT. 195, P. O. BOX 248, GLENVIEW, ILLINOIS

USE COUPON
CALCULATOR MACHINE CO. (Mfrs.)
P. O. Box 248, Dept. 195, Glenview, Ill.

Your Calculator is just what I've been looking for. Send one at once (C.O.D.) or (I am enclosing \$2.95).

Name _____
Address _____
City _____ State _____

Time & Date AT A GLANCE

BELL GUARANTEED CALENDAR WATCH

Tells time, name of day and date. Day name changes automatically.

- No. KR 382—Calendar watch, 17 jewels water-shock resistant, anti-magnetic, radium dial and hands, stainless steel back. **\$49.75**
 - No. KR 383—Same features as above. **\$55.00**
 - ALL STAINLESS STEEL CASE. WATER-SHOCK RESISTANT**
 - OTHER SPORT WATCHES**
 - Precision tested, 17 jewels, anti-magnetic, radium dial and hands, unbreakable crystal, sweep second hand.
 - No. KR 196—Stainless Steel Back.....**\$24.75**
 - No. KR 220—ALL STAINLESS STEEL CASE.....**\$29.95**
- ORDER BY MAIL:** Send check, money order or pay postman C.O.D. Prices Incl. Fed. Tax and Postage. Write for FREE Booklet "KR".
- Repair Service** → All types and makes of quality watches repaired expertly and promptly. Free estimate on request.

BELL WATCH COMPANY, INC.
Time and Life Bldg., Rockefeller Center, New York 20, N. Y.

HILARIOUS FUN AT HOME **5 NG TALK PLAY** **THROUGH YOUR OWN RADIO**

Cut in on any program. Mystify, amuse your friends. They hear but can't see you. Professional type microphones. Used for serious practice. Attaches easily to any radio. Complete with cord and instructions. **SEND NO MONEY.** Pay postman \$1.88 plus postage. To save postage send check or money order. 10 day money back guarantee.

REGAL CO., Dept. PM7, 345 E. 47th St., Chicago 15, Ill.

SURPLUS AT BARGAIN PRICES

- Save 50% or more, on BRAND NEW high quality U. S. Gov't. Merchandise—Biggest stock in U. S. available—Order Direct From This Ad. **IMMEDIATE DELIVERY**—Stocks subject to prior sale. Order by catalog number.
- BC-847 PUP TENTS—Reg. U. S. Army. Water repellent duck. Sleeps 2. Folds compactly. Complete with poles, ropes, stakes. **\$7.65**
 - WH-149 JUNGLE HAMMOCKS—Complete bed. Roof and lower canopy; mosquito netting. Comfortable, waterproofed, mildew-proofed. Folds to 6½ Lb. package **\$3.98**
 - WS-301 TRENCH SHOVELS—Adj. handle, sturdy steel blade **49c**
 - WG-167 GOGGLES—Fisher brand. Metal frame; adj. bridge, padded chamols lined. Originally made for U. S. Air Corps. Cost Gov't about \$11 pair. Our low price **\$3.95**
 - GF-104 GERMAN NAVY FLEET (Miniature sealed models). Ship hobbyists get these Destroyers, Submarines, Transports of heavy metal. Authentic in every detail. Set of 6 warships (in sizes from 1-7/8" to 8¼") with deck guns, revolving turrets, anti-aircraft guns, etc. **\$2.75**
 - WP-425 SKILLETS—10¼" heavy aluminum, heat-proof plastic handle, 2 pouring spouts **\$1.98**
 - WL-120 MARINE LANTERNS—Illuminating power auto headlight. Waterproof metal gray case. Complete with battery. Regular \$9.00 value **\$4.95**
 - WR-141 HUNTING KNIVES—8" Steel blade in leather sheath. Supply limited—Buy Now at our low price **\$1.98**
 - WM-102 RESPIRATORS—For paint spraying. Use in dusty areas. Plastic eyeshield, 2 filters, hood straps, canvas carrying case **49c**
 - W13-340 NAVY BLANKETS—100% Wool 62" x 86". Field **\$7.25**

FREE—Bulletin listing hundreds of other Amazing Bargains. Send for your copy TODAY!

HOW TO ORDER—
All prices FOB L. A. Send check or money order. Add 10% for postage—any overage will be promptly refunded. Send 25% deposit on COD orders. No COD less than \$5.00. Money back if not satisfied.

UNITED SURPLUS 1665 N. Sycamore, Dept. 10-M
Los Angeles 28, California

Now a DYNAMIC Super-charged WELDER

IDEAL FOR AUTO • HOME APPLIANCE • FARM REPAIRS

SAVES YOU VALUABLE TIME AND MONEY

Designed to Do High-Grade Welding *Inexpensively*

Maintenance men, farmers, mechanics, machine shops, foundries, auto, general repair and job welding shops using the DYNAMIC WELDER find it so indispensable and useful that they cannot afford to be without it. If inexperienced you can easily learn to do a variety of high-grade welding jobs by following the practical, simplified operating and welding instructions furnished.

WORKS ON IRON, STEEL, BRASS, BRONZE and OTHER METALS

Has eight metallic and carbon arc welding heat stages. Does work you would think only possible with a larger, more expensive machine.

READ WHAT USERS SAY . . .

Repair Shop Owner says, "It will do more than you say"

"I want to say I operate a repair garage and am more than satisfied with the welder. It will do more than you say." C. P., Butler, Ohio

It's the Greatest Portable Outfit

"Now I am equipped for all kinds of welding and I must say it's the greatest portable outfit for welding any man could ever wish to own. I wouldn't sell mine for the cost of plenty welders I have seen which were very high in cost but not in convenience. You may put me on file as a booster of your wonderful welding product." W. J. B., St. John, N. B., Canada

Better Than I Expected

"I have done quite a little welding with my welder and will say it is better than I expected. The price, convenience, and variety of work that can be done with the Dynamic are the attractive points." W. R. P., Portland, Ore.

EASY TO OPERATE!

DYNAMIC SUPERCHARGED WELDER

Once you see a DYNAMIC in operation you won't want to be without it. Its simplicity will amaze you. In a year the DYNAMIC only costs you about 6c a day. COMES COMPLETE, READY TO OPERATE, WITH HELMET, RODS, CABLES, ELECTRODE HOLDER AND OPERATING INSTRUCTIONS, ETC. NOTHING ELSE TO BUY. Write today for Free particulars. Act now and get details on our amazingly low-priced Dynamic Welder and 10-day trial offer.

DYNAMIC WELDER CO.

13 East 23rd Street RM, Chicago 16, Ill.

**MAIL COUPON FOR FREE DETAILS
10-DAY TRIAL OFFER**

DYNAMIC WELDER CO.

13 East 23rd Street RM, CHICAGO 16, ILL.

Send me free details of your 10-DAY trial offer.

Name.....

Address.....

City..... Zone.... State.....

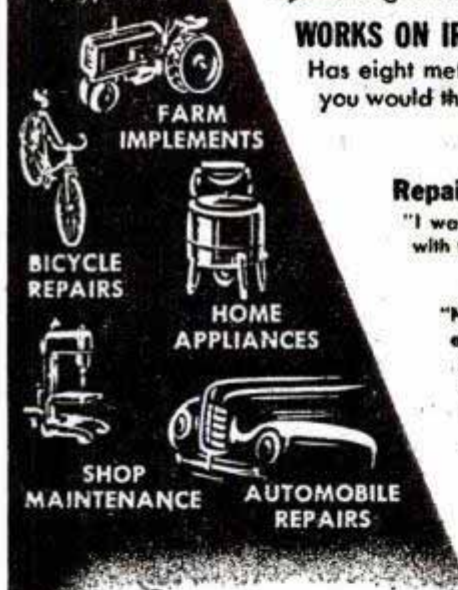

UP TO SAVE 85% in WAR SURPLUS... SENSATIONAL VALUES
 at "GADGETEER'S HEAVEN" IN MANY ITEMS WE HAVE THE WORLD'S LARGEST SUPPLY

20,000 NEW HYDRAULIC Cylinders, Valves, Pumps, Fittings, Hose, Tanks

New! 51 sizes & types.

The World's Largest Supply
 1001 LABOR SAVING ADAPTATIONS for pulling, pushing, pressing, lifting, tilting, squeezing, etc. operations. Finest precision workmanship. Aircraft alloy of aluminum and chrome steel, guaranteeing trouble-free operation. Liquid and air operation, developing terrific power.
PRICE TO SELL AT 15% GOVERNMENT COST
 WRITE FOR CATALOGUE.

A Real Buy! A 1001 USES! WINCH HOIST #100

Capacity 2500 lbs. Controlled worm gear drive winch, with 19 ft. 1/4" diam. alloyed steel cable. Ideal for garages, truck loading, machine shops, boat building, etc.
 #100A Without handle... \$10.75
 #100 With handle... \$12.50

Pneumatic RIVET #180
 Pistol & Goose-neck Type
 121 Uses. Chipping, Riveting, Hammering, Breaking cement and auto body work.

GUNS #188
 Chicago Pneumatic, Cleco, Ingersoll Rand Makes.
 E3, E2, 3K, 2X, OY \$35 Value
\$8.95

PNEUMATIC ALLIGATOR SQUEEZER #198
 \$30 Value
\$15.95

WINDSHIELD WIPER KIT #112

1/8 H. P. 24 volt. D. C. series wound motor, with 30" flexible shaft, switch circuit breaker, 10,000 forward or 5,000 reverse R. P. M. Wiper & wiper bracket, arm blade & switch.
 only **\$7.95**

OPTICAL GYROSCOPE! MARK 18 GYRO-SIGHT #150

An engineering marvel worth hundreds of dollars - Our Price **\$8.95**

AIRFORCE GUNSIGHT #102 Contains triple lens \$1.95 #103, N8A with polarizing variable density lens \$2.95. Lenses in these sights are worth many times the entire cost of these items.

Electric GYRO PILOT Assembly Part 2 solenoids for reverse and forward motor control. 2 solenoids throw clutch to engage drive. With brake assembly. Can be used as boat rudder control, converted for lathe tapping and slow speed motor tool. Wt. 29 lbs. Finest precision workmanship.
 Cost Gov't. Thousands
Your Cost \$8.95

AIR DRILLS CLEVELAND THOR CHICAGO #196

Straight Angle Drill **\$17.95**
 PNEUMATIC 1/4" ICB Chuck Angle Drill **\$19.50**

#506 COMPRESSOR

Complete With Tank And Fittings. General Electric. 2 stage AC-DC. Rated pressure 1000 lbs. per sq. in. with 1/3 H. P. 27 volt. 7 AMP series wound motor, equipped with fan for cooling.
 Thousands now in use for spraying, inflating, laboratory use, etc. Can be adapted to 110 volt A. C. with transformers or 4 1000 heating elements. A tremendous value of approx. 5% of orig. cost Only **\$17.95**

#516 BATTERIES

NEW FULL STRENGTH FOR PORTABLE RADIOS, SIGNAL LAMPS, BOATS, ELECTRIC TRANS, ETC.

#516 9 Volt 8 1/2" x 6 x 4 in. 3 run 24 or 27 Volt motor... 79c
 These batteries are especially suited to portable radios.
 #517 6 7/8" & 1 1/2" Volt Battery... 59c
 #515 90 & 1 1/2" Volt... 59c

NEW AMPLIDYNE MOTOR GENERATOR #511

With 24 volt current, it gives 60 volt output. This unit has been adapted to independent and rural lighting power. Welding and many other uses. Weight 28 lbs. Gov't. Cost Approximately \$237.00
A Steal at \$8.95

ELECTRIC DRILLS CHICAGO PNEUMATIC BLACK & DECKER #197

115 V. A.C. 50-30 cycle. 1/4 drill bit & ICB Chuck. Both side and trigger handle. High Speed. For commercial or home use. The best there are.
 Gov't. Cost Approx. \$60.00
A TERRIFIC VALUE \$17.95

Electric Motors #500

500 New 1/4 H. P. 27 volt D. C. 24 volt A. C.
 This motor is series wound and can be readily adapted to 110 A. C. by simple method of re-arranging armature brush leads. We furnish free diagrams with instructions with each order.
A Sensational Value @ \$5.95
 #501 1/4 h. p. 24 V Series Wound New \$4.25
 #502 h. p. 24 V D. C. motor used \$8.95

VALUABLE GEARS BARGAINS! #113

8 to 1 ratio, spindle drive... \$110 \$2.98
 4 to 1 with screw shaft... \$111 \$4.98
 85 to 1 (can be used for radio, antenna, etc.)... \$112 \$3.95

DC GENERATOR #G-1

140 AMP Direct Current

Generator, especially suited for adaptation to homemade welding unit.
A fast moving item at \$15.95.

NEW PRESSURE TANKS

Stainless steel - Shatter proof. Rustless. 10,000 available in 3 different sizes. 1001 uses.
 G-1 12 1/2" x 24 inches - 2100 Cu. in. capacity 29 cu. ft. \$4.75
 D-2 8 1/2" x 24 in. - 500 Cu. in. capacity - 7 cu. ft. \$3.25
 F-3 6" x 48 in. - 1000 Cu. in. capacity - 14 cu. ft. \$3.95
 Perfect portable air tank to carry in car or trailer. Ideal for painting, cooking, spraying, auto repairs.

PEXTO SIDE CUTTING PLIERS #121

Revised head, top joint. Size 8-5/8". 2 1/2" wire, solid grip, alloyed steel. Ideal for home, electrical, or shop use. A \$15.00 value for **\$1.85**

2 to 1 ratio 90° right angle #113
 10 tooth bevel steel boxed gear \$4.95
 112a 6 to 1 ratio 90° right angle \$4.95

Flexible Gear Shafts With End Drives
 115a 30" \$1.00 each
 115a 50" \$1.50 each

Radio tuning shafts that can be used as flex gear drives
 115a 12 ft. 1/2" nut -15 tooth internal spline \$2.50 ea.
 115b 25 ft. 3/8" nut 12 tooth with internal spline \$4.25
 #115a

Radio ANTENNA Feet #711

Just the thing for tuning beam antenna.
 Powered by 1/2 h. p. 34" O. E. Motor. Reversible "F" Reel-limit Switch - Can Warm gears. Reel gear, Solenoid clutch.
 Motor engaged to see re-rotation only when electrical contact made. Operates in either direction. Ideal for auxiliary power take-off, opening and closing doors, etc.
A TREMENDOUS VALUE \$4.95

Our October Special ELECTRIC SOLDERING IRON #199

110 Volt A. C. "SOLDER MASTER" \$9.50 Value **\$2.95** 200 AMP.

All Purpose HAMMER #107

As & bronze combination for wood & metal work. 2 1/2 lbs. 1 1/2" hardwood handle, hard steel cutting edge. **69c**

Compound METAL SNIPS Action #107

Hard steel blades. Expansion spring. Locking device. **\$2.59**

HOBBYISTS! An Unequaled Value! GADGET MIX

Rivets, spacers, Clamps, bolts, nuts, Radio parts, gears, etc.

A gold mine #104 5 lbs. \$1.19

CLAMPS #121

Adal Aluminum, rubber lined. Mixed. #121 4 dozen **89c**

Aero-Seal. Rust Resistant. Slotted with screw gear top. 1/2" to 3". #120 Regular 27c Now 10c

FIRE EXTINGUISHER Kiddle Lux CO2 Type #601

15 lb. Chgd. CO2 with Horn. \$30.00 value \$10.75
 2 lb. CO2 type \$22.50 value \$8.75
 10 lb. Chgd. CO2 with Horn. \$60.00 value \$24.50
 15 lb. Chgd. CO2 with horn. \$80.00 Value #605 \$27.50

indispensable for small for large planes, trucks, auto, home, factories.

BEARING MIX #170

Needle, ball and roller bearings in excellent assortment. Sizes from 1/2" to 2".
15 Bearings at \$2.95

SPRING MIX

Torsion, compression and tension springs. Assorted sizes. #206
2 lbs. 89c

A treasure chest for emergencies

NEW FLEXIBLE GOOSENECK LAMP

110 V. A. C. 13 ft. wire with socket, switch and plug. In mounting bracket suitable for home or workshop.
 Wire alone worth our price of **.99c** each.

RUBBER GOODS

28 x 24 in. 1 1/2" thick. \$1.95
 Soft & supple. Ideal for use as a mat for workers who stand on their feet. Cashiers, Demonstrators, machinists, etc.

NEOPRENE SHEET RUBBER

Thick.	approx.	Price per area
#129	3/16"	1.44
#130	1/8"	1.28
#131	3/32"	1.12
#132	1/16"	1.00
#133	1/32"	.88
#134	1/64"	.76

ORDER DIRECT FROM THIS AD
 All sales final. Make remittances by money-order, bank draft or personal check. Purchase orders acceptable from D & B firms. All quotations F. O. B. Los Angeles.
BIG ILLUSTRATED CATALOGUE AVAILABLE
 Send 1/5 deposit with C. O. D. orders. Also Aircraft Supply Catalogue

SOUTH BEND

Precision Lathes

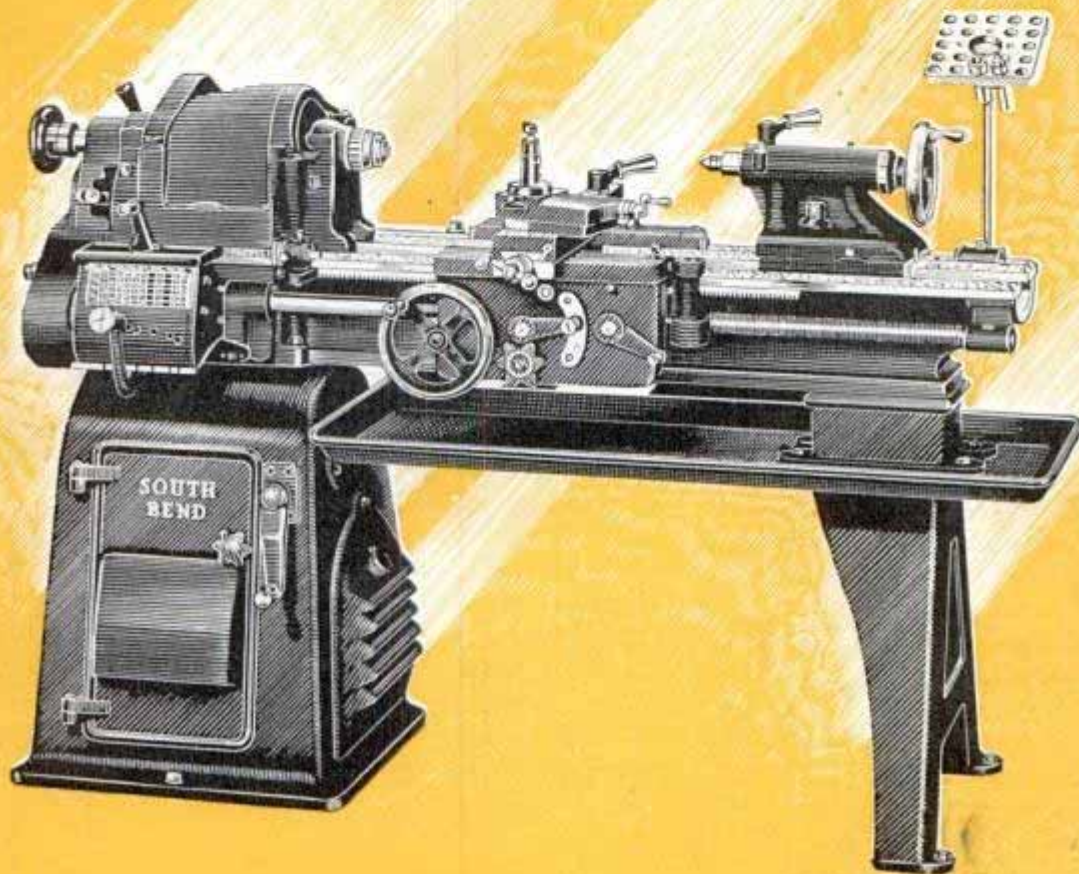

The South Bend Precision Lathes and Lathe Attachments shown on the following pages are the result of forty years of experience in building fine lathes. The workmanship and materials entering into their construction are the best that can be obtained and the highest standards of accuracy are maintained throughout their manufacture.

SOUTH BEND LATHE WORKS



BUILDING BETTER LATHES SINCE 1906 • 543 E. MADISON STREET • SOUTH BEND 22, INDIANA, U.S.A.
CABLE ADDRESS "TWINS" SOUTH BEND

ESTABLISHED 1906
INCORPORATED 1914

PROMPT DELIVERY

Quick deliveries can now be made from distributor's stock in all principal cities, or from factory. For name of distributor see "Machine Tools" in classified section of phone book. If there is no distributor near you, send your orders and inquiries direct to the factory.

PRICES

Prices of South Bend Lathes are reasonable, the average increase over pre-war level being less than 15%. All prices are net f.o.b. factory, crated for domestic shipment.

SOUTH BEND

16", 14½", and 13"
Quick Change
Gear Lathes

South Bend 16" x 6"
Quick Change
Gear Lathe

\$1640.50

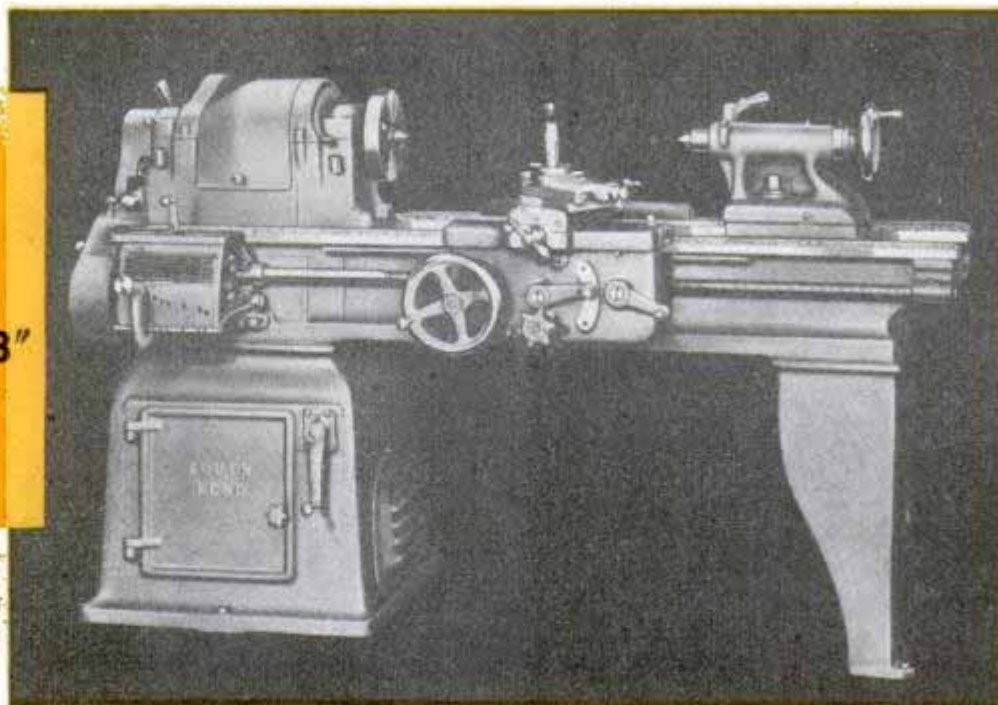

SPECIFICATIONS	16-INCH	14½-INCH	13-INCH
Swing over bed and saddle wings.....	16¼"	14¾"	13⅝"
Swing over saddle, chip guard removed.....	11⅞"	10¼"	8¾"
Swing over saddle with chip guard.....	9⅝"	8¾"	7¾"
Spindle speeds.....	21 to 725 r.p.m.	27 to 800 r.p.m.	34 to 875 r.p.m.
Thread cutting range.....	4 to 224 R.H. or L.H.	4 to 224 R.H. or L.H.	4 to 224 R.H. or L.H.
Power longitudinal feeds.....	.0015" to .0841"	.0015" to .0841"	.0015" to .0841"
Power cross-feeds.....	.0006" to .0312"	.0006" to .0312"	.0006" to .0312"
Hole thru spindle.....	1⅝"	1⅝"	1"
Collet capacity.....	1"	¾"	11/16"
Spindle centers.....	No. 3 Morse Taper	No. 3 Morse Taper	No. 3 Morse Taper
Size motor.....	1½ h.p.	1½ h.p.	1 h.p.

South Bend Quick Change Gear Lathes are equally efficient on precision toolroom work or close tolerance manufacturing operations. Hundreds of nationally known manufacturers select them when streamlining their shop equipment to meet present day needs. Substantial savings in capital investment, power consumption, floor space, and labor costs have resulted from their installation. They will give you the same efficient service.

The Underneath Motor Drive provides an unusually wide range of spindle speeds. The belt drive to the spindle is silent in operation and develops smooth, steady power entirely free from gear vibration.

Price includes 3 ph., 60 cy., 220 v. A.C. motor and drum control, and regular lathe equipment such as belts, centers, face plates, tool post, etc. Chucks and tools are extra. See following pages.

**TIME
PAYMENT
PLAN**

25 per cent down
12 months to pay balance
moderate finance charges

Quick Change Gear Underneath Motor Driven Lathes

Catalog Number	Swing Over Bed Inches	Length of Bed Feet	Distance Between Centers Inches	Approx. Shipping Weight Pounds	Price f.o.b. Factory
16" QUICK CHANGE GEAR LATHES					
117-C	16¼	6	33½	2300	\$1640.50
117-D	16¼	7	45½	2380	1678.50
117-E	16¼	8	57½	2460	1716.50
117-G	16¼	10	81½	2620	1826.50
117-H	16¼	12	105½	2850	1936.50
14½" QUICK CHANGE GEAR LATHES					
183-B	14¾	5	24½	1995	\$1382.50
183-C	14¾	6	36½	2070	1420.50
183-D	14¾	7	48½	2145	1458.50
183-E	14¾	8	60½	2225	1496.50
13" QUICK CHANGE GEAR LATHES					
113-A	13⅝	4	16	1460	\$1117.50
113-B	13⅝	5	28	1510	1153.50
113-C	13⅝	6	40	1560	1189.50
113-D	13⅝	7	52	1615	1225.50

SOUTH BEND LATHE WORKS, 543 E. Madison Street, South Bend 22, Indiana, U.S.A.

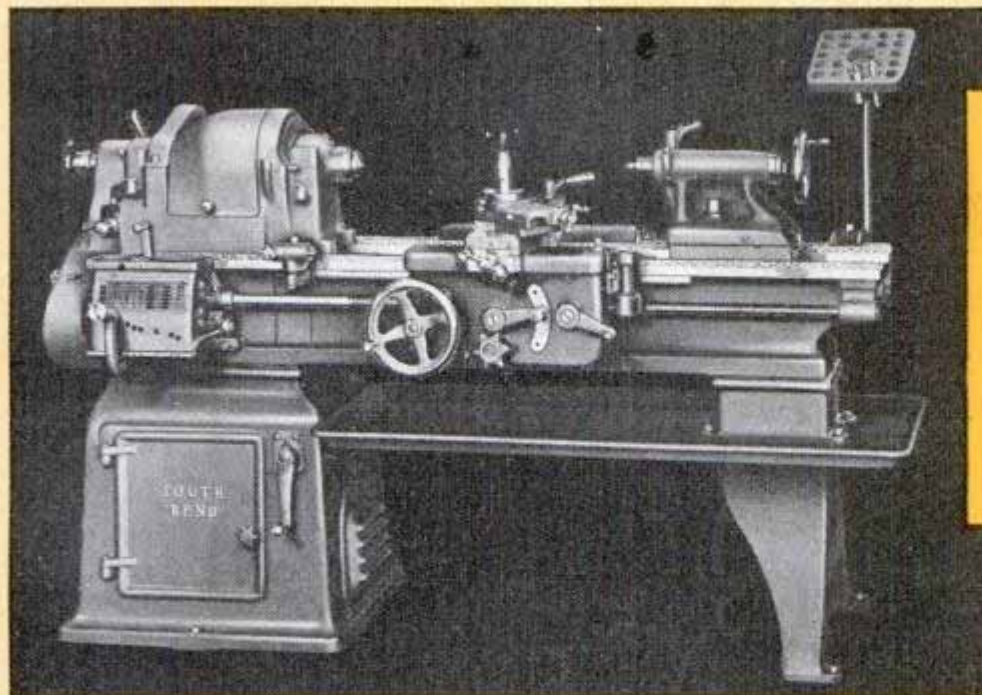

SOUTH BEND

16", 14½", and 13" Toolroom Lathes

South Bend 16" x 6'
Toolroom Lathe
\$2031.50

SPECIFICATIONS	16-INCH	14½-INCH	13-INCH
Swing over bed and saddle wings...	16¼"	14⅝"	13⅞"
Swing over saddle cross slide.....	9⅝"	8-15/16"	8"
Spindle speeds.....	21 to 725 r.p.m.	27 to 800 r.p.m.	34 to 875 r.p.m.
Thread cutting range.....	4 to 224 R.H. or L.H.	4 to 224 R.H. or L.H.	4 to 224 R.H. or L.H.
Power longitudinal feeds.....	.0015" to .0841"	.0015" to .0841"	.0015" to .0841"
Power cross-feeds.....	.0006" to .0312"	.0006" to .0312"	.0006" to .0312"
Hole thru spindle.....	1⅜"	1⅝"	1"
Collet capacity.....	1"	¾"	11/16"
Spindle centers.....	No. 3 Morse Taper	No. 3 Morse Taper	No. 3 Morse Taper
Size motor.....	1½ h.p.	1½ h.p.	1 h.p.

Toolroom Underneath Motor Driven Lathes

Catalog Number	Swing Over Bed Inches	Length of Bed Feet	Distance Between Centers Inches	Approx. Shipping Weight Pounds	Price f.o.b. Factory
16-INCH TOOLROOM UNDERNEATH BELT MOTOR DRIVEN LATHES					
8117-C	16¼	6	33½	2525	\$2031.50
8117-D	16¼	7	45½	2605	2075.50
8117-E	16¼	8	57½	2685	2119.50
14½-INCH TOOLROOM UNDERNEATH BELT MOTOR DRIVEN LATHES					
8183-B	14⅝	5	24½	2180	\$1735.50
8183-C	14⅝	6	36½	2255	1778.50
8183-D	14⅝	7	48½	2330	1821.50
8183-E	14⅝	8	60½	2405	1863.50
13-INCH TOOLROOM UNDERNEATH BELT MOTOR DRIVEN LATHES					
8113-B	13⅞	5	28	1665	\$1481.50
8113-C	13⅞	6	40	1715	1519.50
8113-D	13⅞	7	52	1770	1557.50

South Bend Toolroom Lathes are equally efficient on precision toolroom work or close tolerance manufacturing operations. Their versatility reduces set-up time to a minimum. Smooth, vibration-free operation permits finish turning or boring with such precision that subsequent machine operations can often be eliminated. A convenient arrangement of controls makes for an ease of operation which reduces fatigue and lowers the probability of error. A wide range of spindle speeds permits machining work with maximum tool efficiency.

Improved Features include: alloy steel headstock spindle; replaceable headstock bearings; double wall apron; quick change gear box for threads and feeds; and semi-steel lathe bed.

In Addition to 3-ph., 60 cy., 220 v., A.C. motor and drum control, and all equipment supplied with quick change gear lathe (see preceding page) the following toolroom attachments are included in price of lathe: handwheel type draw-in collet chuck attachment; collet rack; telescopic taper attachment; thread dial indicator; chip pan; and micrometer carriage stop. Chucks, tools, and collets are extra.

SOUTH BEND LATHE WORKS, 543 E. Madison Street, South Bend 22, Indiana, U.S.A.

SOUTH BEND

10"-1" Collet Lathes

SPECIFICATIONS

- Swing over bed and saddle wings.....10 $\frac{1}{8}$ "
- Swing over saddle cross slide.....5 $\frac{3}{4}$ "
- Spindle speeds (12).....50 to 1357 r.p.m.
- Thread cutting range....4 to 224 R.H. or L.H.
- Power longitudinal feeds.... .0015" to .0836"
- Power cross-feeds..... .0006" to .0309"
- Hole thru spindle.....1 $\frac{3}{8}$ "
- Collet capacity.....1"
- Spindle centers.....No. 2 Morse Taper
- Cross slide travel.....5 $\frac{3}{4}$ "
- Compound rest top slide travel.....2"
- Size motor..... $\frac{3}{4}$ h.p.



\$933.60

10-inch Swing South Bend Precision Lathes are capable of the most exacting operations on both tool and production work. This accuracy, together with their speed and versatility, contribute to lower machining costs. They contain all the design features that make the larger models so dependable.

Price includes 3 ph., 60 cy., 220 v., A.C. motor; drum control, and regular lathe equipment such as belts, centers, face plates, tool post, etc. Chucks and tools are extra. Toolroom Lathes also include: handwheel type draw-in collet attachment (without collets); collet rack; telescopic taper attachment; thread dial indicator; and micrometer carriage stop. Bench is included in price of bench lathe.

**TIME
PAYMENT
TERMS**

25 per cent down
12 months to
pay balance
moderate finance
charges



South Bend 10" x 3 $\frac{1}{2}$ ', 1" Collet Toolroom Lathe **\$1168.60**

10"-1" Collet Quick Change Gear and Toolroom Lathes

Catalog Number	Swing Over Bed Inches	Length of Bed Feet	Between Centers Inches	Shipping Weight Pounds	Price f.o.b. Factory
QUICK CHANGE GEAR BENCH LATHES					
187-YS	10 $\frac{1}{8}$	3	15 $\frac{3}{4}$	850	\$933.60
187-ZS	10 $\frac{1}{8}$	3 $\frac{1}{2}$	20 $\frac{3}{4}$	880	949.60
187-AS	10 $\frac{1}{8}$	4	26 $\frac{3}{4}$	950	975.60
187-RS	10 $\frac{1}{8}$	4 $\frac{1}{2}$	33 $\frac{3}{4}$	980	998.60
QUICK CHANGE GEAR LATHES WITH FLOOR LEGS					
187-Y	10 $\frac{1}{8}$	3	15 $\frac{3}{4}$	810	\$863.60
187-Z	10 $\frac{1}{8}$	3 $\frac{1}{2}$	20 $\frac{3}{4}$	835	879.60
187-A	10 $\frac{1}{8}$	4	26 $\frac{3}{4}$	860	895.60
187-R	10 $\frac{1}{8}$	4 $\frac{1}{2}$	33 $\frac{3}{4}$	885	918.60

Catalog Number	Swing Over Bed Inches	Length of Bed Feet	Between Centers Inches	Shipping Weight Pounds	Price f.o.b. Factory
TOOLROOM BENCH LATHES					
8187-YS	10 $\frac{1}{8}$	3	15 $\frac{3}{4}$	960	\$1196.60
8187-ZS	10 $\frac{1}{8}$	3 $\frac{1}{2}$	20 $\frac{3}{4}$	990	1212.60
8187-AS	10 $\frac{1}{8}$	4	26 $\frac{3}{4}$	1060	1238.60
TOOLROOM LATHES WITH FLOOR LEGS					
8187-Y	10 $\frac{1}{8}$	3	15 $\frac{3}{4}$	935	\$1151.60
8187-Z	10 $\frac{1}{8}$	3 $\frac{1}{2}$	20 $\frac{3}{4}$	960	1168.60
8187-A	10 $\frac{1}{8}$	4	26 $\frac{3}{4}$	985	1185.60

SOUTH BEND LATHE WORKS, 543 E. Madison Street, South Bend 22, Indiana, U.S.A.

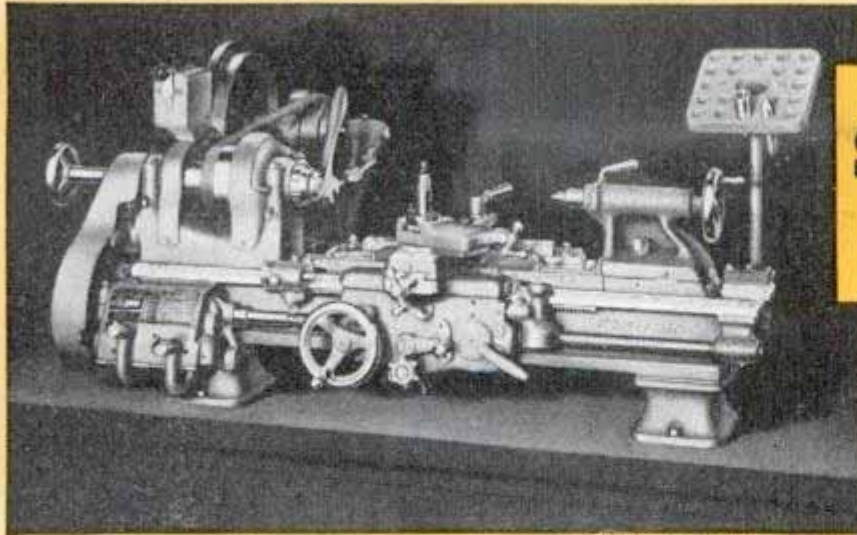

South Bend 9" x 3' Toolroom Bench Lathe **\$486.70**

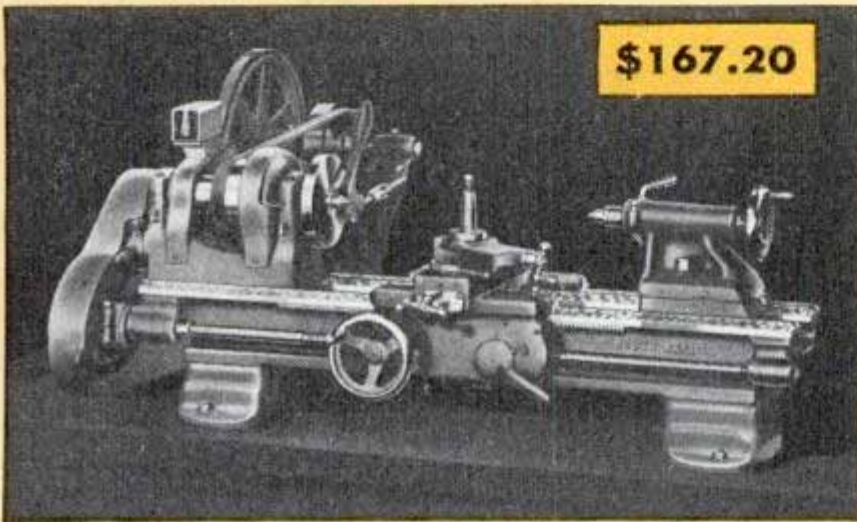

South Bend 9" x 3' Model C Bench Lathe

SOUTH BEND 9-Inch Bench Lathes

SPECIFICATIONS

Swing over saddle wings..... 9 1/4"

Swing over chip guard..... 5 1/2"

Spindle speeds:

6 speed drive..... 41 to 658 r.p.m.

12 speed drive..... 41 to 1270 r.p.m.

Thread cutting range:

Model A..... 48 pitches R.H. or L.H.
4 to 224 per inch

Models B & C... 45 pitches R.H. or L.H.
4 to 160 per inch

Power longitudinal feeds:

Model A..... 48—.0015" to .0853"

Model B..... 26—.0021" to .0155"

Model C..... 14—.0021" to .0156"

Power cross feeds:

Model A..... 48—.0004" to .0252"

Model B..... 23—.001" to .0046"

Belt, width of pulley step for..... 1"

Centers, Morse taper..... No. 2

Collet capacity, maximum..... 1/2"

Headstock spindle hole..... 3/4"

Lead screw 29° Acme Thread..... 3/4"—8

Motor, size required:

For 6-speed drive..... 1/4 h.p.

For 12-speed drive..... 1/2 h.p.

Spindle nose threads..... 1 1/2"—8

Tailstock top set over..... 5/8"

Tool holder cutter bit..... 1/4" sq.

Tool holder shank..... 3/8" x 13/16"

Approx. shipping weights:

3 ft. bed lathe..... 355 lbs.

3 1/2 ft. bed lathe..... 380 lbs.

4 ft. bed lathe..... 405 lbs.

4 1/2 ft. bed lathe..... 430 lbs.

Model A 9-inch Lathes have heat-treated alloy steel spindle, quick change gear box, and friction clutch worm drive for power longitudinal feeds and power cross-feeds.

Model B 9-inch Lathes are same as Model A Lathes except that they have independent change gears, instead of the quick change gear box, for threads and feeds.

Model C 9-inch Lathes are same as Model B Lathes except they do not have the worm drive for power feeds. The cross-feed is hand-operated, and

longitudinal feeds are obtained by engaging half-nuts with the lead screw.

Toolroom 9-inch Lathes are same as Model A Lathes except that they have the following toolroom attachments: collet chuck; collet rack; taper attachment; thread dial; and micrometer carriage stop.

Price includes 1 ph., 60 cy., 115 v., A.C. motor, drum control, and regular lathe equipment such as belts, centers, small face plate, tool post, etc. Chucks, collets, and tools are extra.

9-Inch Swing Horizontal Motor Driven South Bend Precision Bench Lathes

Length Bed Feet	Be- tween Cent- ers Inches	9" TOOLROOM LATHES		9" MODEL A LATHES				9" MODEL B LATHES				9" MODEL C LATHES			
				6-speed drive		12-speed drive		6-speed drive		12-speed drive		6-speed drive		12-speed drive	
		Cat. No.	Price	Cat. No.	Price	Cat. No.	Price	Cat. No.	Price	Cat. No.	Price	Cat. No.	Price	Cat. No.	Price
3	16	8644-Y	\$486.70	444-Y	\$272.20	644-Y	\$317.70	477-Y	\$217.20	677-Y	\$262.70	415-YC	\$167.20	615-YC	\$212.70
3 1/2	22	8644-Z	501.70	444-Z	287.20	644-Z	332.70	477-Z	232.20	677-Z	277.70	415-ZC	182.20	615-ZC	227.70
4	28	8644-A	516.70	444-A	302.20	644-A	347.70	477-A	247.20	677-A	292.70	415-AC	197.20	615-AC	242.70
4 1/2	34	444-R	324.20	644-R	369.70	477-R	269.20	677-R	314.70	415-RC	219.20	615-RC	264.70

SOUTH BEND LATHE WORKS, 543 E. Madison Street, South Bend 22, Indiana, U.S.A.

9" SOUTH BEND V-Belt Horizontal Motor Driven Bench Lathes

\$339.70

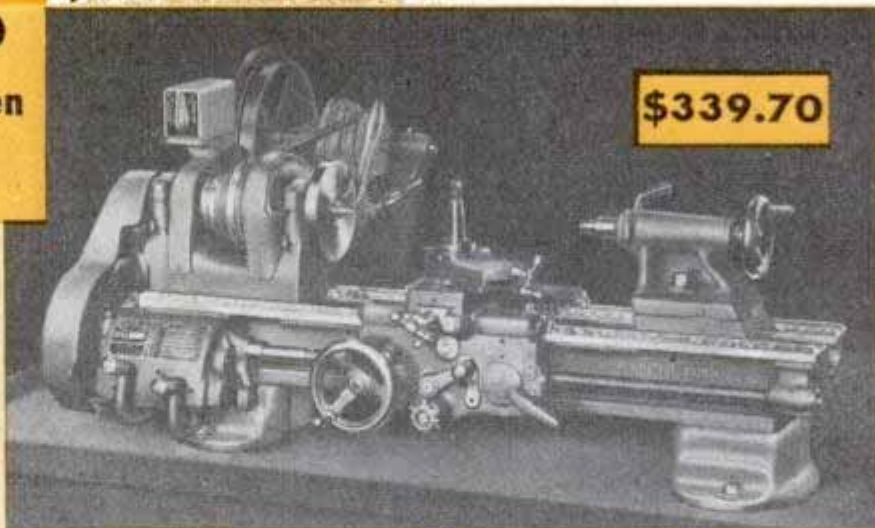

The 9" Bench Lathes with 8-speed and 16-speed V-belt horizontal motor drives offer more spindle speeds—an advantage when surface speeds are critical. These lathes are identical in all other respects to those described on the preceding page.

Price includes 1 ph., 60 cy., 115 v., A.C. motor, drum control, and regular lathe equipment such as belt, centers, small face plate, tool post, etc. Chucks, collets, tools, and bench are extra.

**TIME
PAYMENT
TERMS**

25 per cent down
12 months to pay
balance
Moderate finance
charges

SPECIFICATIONS

Swing over saddle wings.....9 1/4"	Power longitudinal feeds
Swing over chip guard.....5 1/2"	Model A......48—.0015" to .0853"
Hole thru spindle.....3/4"	Model B......26—.0021" to .0155"
Collet capacity.....1/2"	Model C......14—.0021" to .0156"
Spindle speeds	Power cross-feeds
8 speed drive....46 to 609 r.p.m.	Model A......48—.0004" to .0252"
16 speed drive....46 to 1176 r.p.m.	Model B......23—.001" to .0046"
Thread cutting range:	Spindle centers.....No. 2 Morse Taper
Model A.....48 pitches R.H. or L.H.	Size motors
4 to 224 per inch.	8 speed drive.....1/4 h.p.
Models B & C.45 pitches R.H. or L.H.	16 speed drive.....1/2 h.p.
4 to 160 per inch.	

9-Inch Bench Lathes with V-Belt Horizontal Motor Drive

Length Bed Feet	Between Centers Inches	Ship. Wt. Crated Pounds	MODEL A		MODEL B				MODEL C					
			8-speed drive		16-speed drive		8-speed drive		16-speed drive		8-speed drive		16-speed drive	
			Cat. No.	Price	Cat. No.	Price	Cat. No.	Price	Cat. No.	Price	Cat. No.	Price	Cat. No.	Price
3	16	355	544-Y	\$294.20	744-Y	\$339.70	577-Y	\$239.20	777-Y	\$284.70	515-YC	\$189.20	715-YC	\$234.70
3 1/2	22	380	544-Z	309.20	744-Z	354.70	577-Z	254.20	777-Z	299.70	515-ZC	204.20	715-ZC	249.70
4	28	405	544-A	324.20	744-A	369.70	577-A	269.20	777-A	314.70	515-AC	219.20	715-AC	264.70
4 1/2	34	430	544-R	346.20	744-R	391.70	577-R	291.20	777-R	336.70	515-RC	241.20	715-RC	286.70

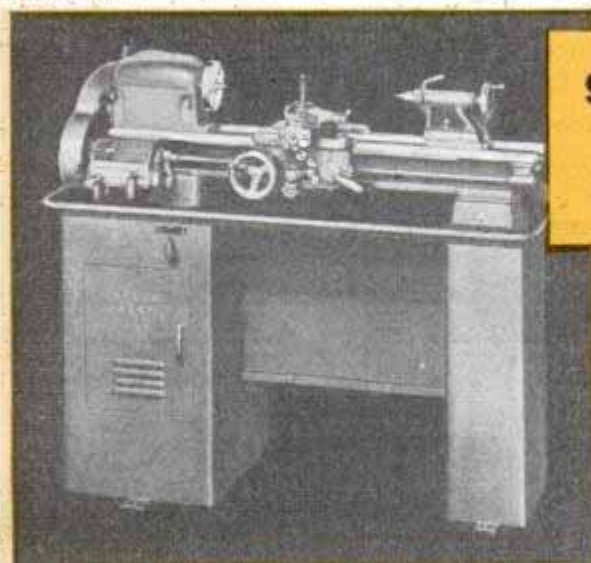

9" SOUTH BEND Underneath Motor Driven Lathe

Capable of machining work to the most exacting tolerances, this lathe is recommended for precision work in the toolroom, laboratory, or machine shop. Fully enclosed motor drive unit provides

twelve spindle speeds, 41 to 1270 r.p.m. See above for other specifications. Price includes 1 ph., 60 cy., 115 v., A.C. motor, drum control, and regular lathe equipment. Chucks, collets, and tools are extra.

9" Underneath Motor Driven Lathes

Catalog Number	Model	Length of Bed Feet	Between Centers Inches	Weight Crated Pounds	Price f.o.b. Factory
344-ZN	A	3 1/2	22	570	\$486.70
377-ZN	B	3 1/2	22	560	431.70
8344-ZN	Toolroom	3 1/2	22	630	655.70

SOUTH BEND LATHE WORKS, 543 E. Madison Street, South Bend 22, Indiana, U.S.A.

SOUTH BEND

Precision Turret Lathes

SPECIFICATIONS	SERIES 900	SERIES 1000	SERIES 2-H
Collet capacity.....	1/2"	1"	1"
Hole thru spindle.....	3/4"	1 1/4"	1 3/4"
Swing over bed and saddle wings.....	9 1/4"	10 1/4"	16 1/4"
Swing over double tool-slide.....	3-9/16"	3-9/16"	6 7/8"
Swing over compound slide.....	5 1/2"	5 7/8"	6 1/8"
Turret tool feed.....	4"	4"	6 1/8"
Turret face to spindle distance, max.....	20 3/4"	19 3/4"	6' bed—28 1/4"
Double tool slide cross travel.....	3 5/8"	3 3/4"	9 3/4"
Thread cutting range, 48..	4—224 per in.	4—224 per in.	4—224 per in.
Spindle speeds, 12.....	41-1270 r.p.m.	50—1357 r.p.m.	16-880 r.p.m.
Carriage power feeds:			
Longitudinal, 48.....	.0015"—.0853"	.0015"—.0836"	.0015"—.0841"
Transverse, 48.....	.0004"—.0252"	.0006"—.0309"	.0006"—.0312"
Carriage longitudinal travel.....	18"	16"	6' bed—22 1/2"
Turret power feeds.....0001"—.0148"
Turret indexing tolerance at 4" from turret face.....	.0005"	.0005"	.0005"
Size motor.....	1/2 h.p.	3/4 h.p.	1 1/2 h.p.

Series 900. This turret lathe is specifically designed for second operations on small, precision parts. Its accuracy, and speed of handling and machining produce appreciable economies in manufacturing that are not possible with heavy turret lathes. Price includes 1 ph., 60 cy., 115 v.,

A.C. motor, drum control, power feed universal carriage, handlever bed turret, handlever cross slide, compound rest cross slide, coolant return assembly, and metal column base with built-in oil pan.

Series 1000. Designed for the same types of applications as the Series 900, these turret lathes with their larger capacities are ideal for machining a wide variety of precision parts. Numerous choices of spindle speeds, power longitudinal and transverse carriage feeds, and thread cutting feeds keep production efficient. Price includes 3 ph., 60 cy., 220 v., A.C. motor, drum control, power feed universal carriage, handlever bed turret, handlever cross slide, compound rest cross slide, oil pan, and coolant return assembly.

Series 2-H. The production of precision duplicate parts in both machine shops and toolrooms is simplified with 2-H Turret Lathes. They are especially suited for exacting second operations on large work because of their accuracy and ease of operation. Price includes 3 ph., 60 cy., 220 v., A.C. motor, drum control, power feed universal carriage with screw feed double tool slide having front and rear tool blocks, power feed ram-type turret, and oil pan.

Prices of turret lathes do not include coolant pump or collet equipment.

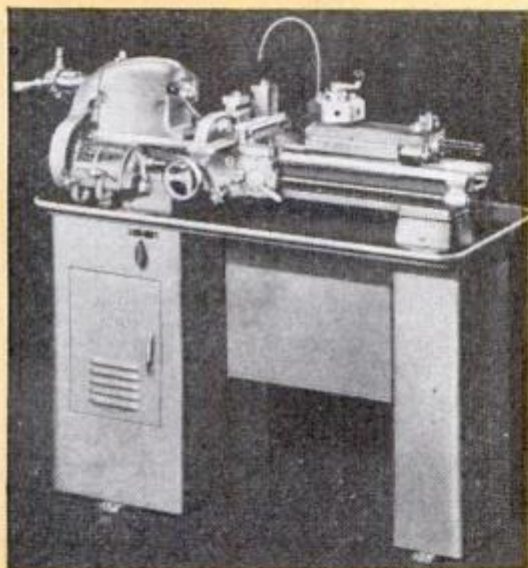

Ser. 900, Cat. No. 930-Z Turret Lathe **\$765.70**

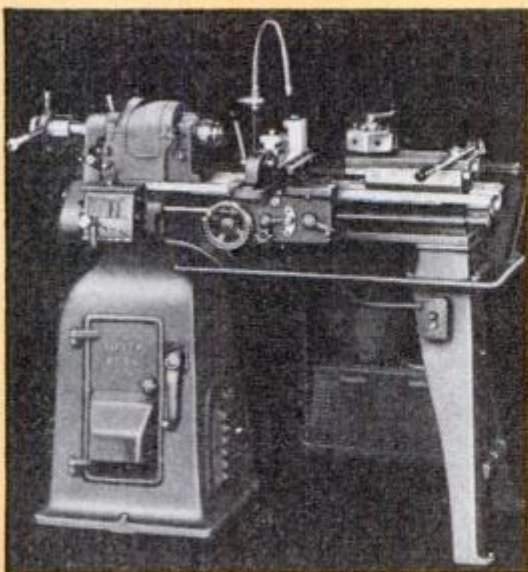

Ser. 1000, Cat. No. 1006-Z Turret Lathe **\$1199.60**

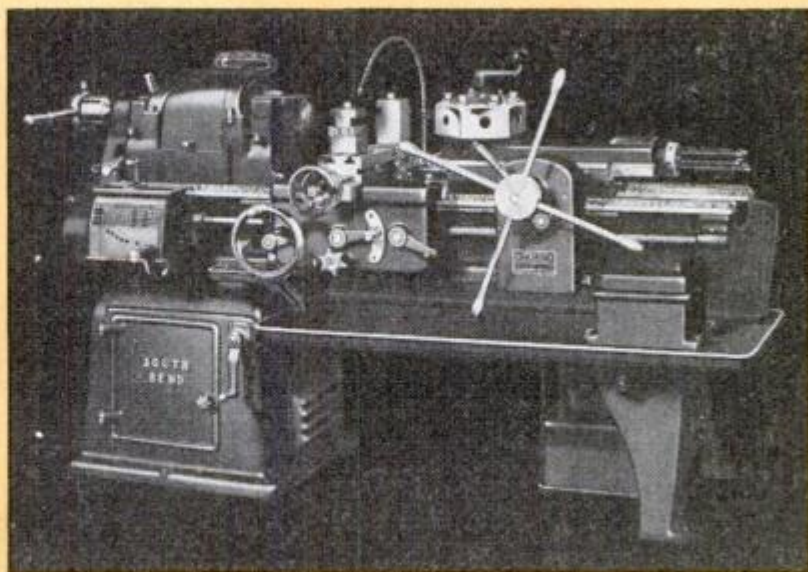

Series 2-H, Cat. No. 2-CT Turret Lathe (6' bed) **\$2500.00**

SOUTH BEND LATHE WORKS, 543 E. Madison Street, South Bend 22, Indiana, U.S.A.

SOUTH BEND LATHE ATTACHMENTS



HANDLEVER COLLET ATTACHMENT

The Handlever Collet Attachment is an aid to rapid production work. Stock can be released and fed through the collet without stopping the lathe.

Collet Attachment HANDWHEEL TYPE

The Handwheel Collet Attachment is a very accurate type of chuck. It is used for precision toolroom work and for the manufacture of small parts, or wherever extremely close tolerances are required. Bar and tube stock can be fed through the hollow draw-bar that operates the collet. Equipment includes draw-bar, spindle nose cap, spanner wrench, and closing sleeve. Collets are not included.

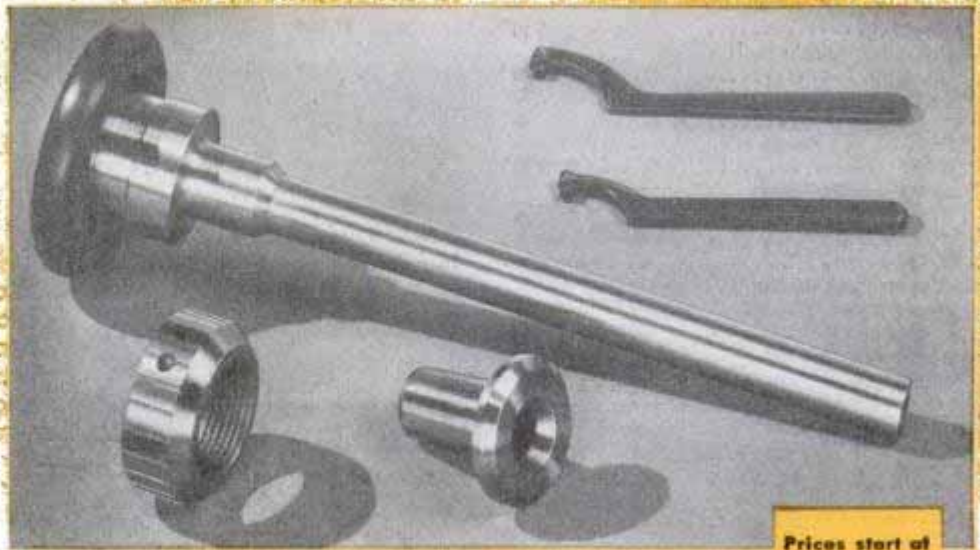

Handwheel Draw-in Collet Attachment

Prices start at

\$25

DRAW-IN COLLET ATTACHMENTS

Size of Lathe	Collet Required	Max. Collet Cap.	Handwheel Type		Handlever Type	
			Catalog Number	Price	Catalog Number	Price
9" and Series 900.....	No. 3	1/2"	4306-W	\$25	5206-W	\$ 85
10"—11/16" Collet.....	No. 2	11/16"	4310	40	5210	120
10"—1" Col. & Series 1000.	No. 5	1"	4312	50	5219	150
13".....	No. 2	11/16"	4313	40	5213	120
14 1/2".....	No. 4	3/4"	4314	45	5214	140
16", 16/24", & No. 2-H.....	No. 5	1"	4316	50	5216	150

Collet Rack and Collet Chest

Collet Rack No. 1770-W holds 19 collets, all others hold 17 collets. Collets are not included.

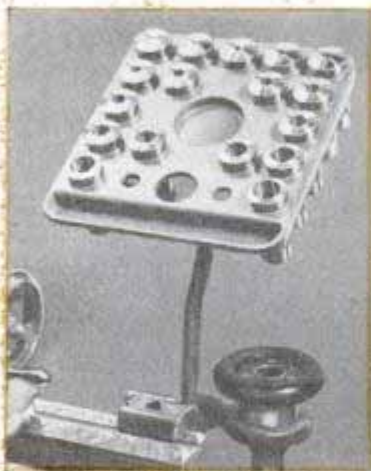

COLLET RACK

Holds collets, centers, spindle sleeve, draw-bar, spindle nose cap, wrench, etc.

COLLET RACKS

Catalog Number	Size of Lathe	Price
1770-W	9" and 900	\$12
1752	10"—11/16" Col.	15
1753	10"—1" Col.	17
1753	Ser. 1000	17
1772	13"	15
1791	14 1/2"	17
1774	16" & 16/24"	17

No. 2225—Collet Chest only, for holding handwheel collet attachment and collets for 9" lathes. Collet attachment and collets not included. Price: \$7.50

No. 2220—Collet Chest, 9" handwheel collet attachment and 29 steel collets for round work, 1/16" to 1/2" by 64ths. Complete: \$122.00



COLLET CHEST

Holds handwheel collet attachment and 29 collets. Well constructed of wood.

**TIME
PAYMENT
TERMS**

When order includes lathe
25 per cent down
12 months to pay balance
moderate finance charges

SOUTH BEND LATHE WORKS, 543 E. Madison Street, South Bend 22, Indiana, U.S.A.

Collets and Collet Sets

South Bend Collets, manufactured with the same exacting care as South Bend Lathes, deliver long, dependable service on precision work. Each collet is carefully inspected and tested, and packed in substantial plastic box with transparent lid through which the size can be read for easy selection.

Steel Collets are carefully heat-treated for maximum service and are precision ground to exceedingly close tolerances.

Brass Collets, a South Bend innovation, have many practical applications.

Their low cost makes them desirable for odd sizes that are used only occasionally. They can be readily machined on the job for holding tapered or irregular shapes. When worn, they can be rebores to larger diameters.

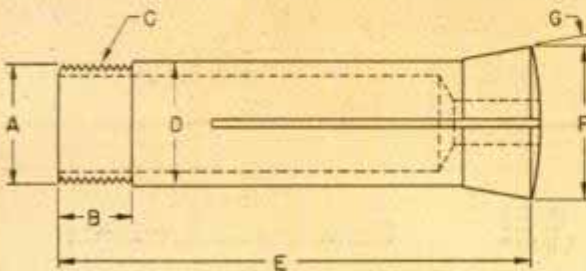

Steel Collet



Brass Collet



Collet Packaged in Plastic Box

Specifications of Steel and Brass Collets

Collet Number	* For South Bend Lathes	A Thread Diameter Inches	B Thread Length Inches	C Threads Per Inch	D Body Diameter Inches	E Collet Length Inches	F Head Diameter Inches	G Angle Length Degrees
3	9" and Series 900	.650	3/4	26	.6495	2-11/16	.852	12
2	10"-11/16" Col. and 13"	.855	13/16	20	.8595	3-5/16	1.095	15
5	10"-1" Collet, 1000, 2-H, 16", and 16/24"	1.250	3/4	20	1.2495	3-9/32	1.452	10
4	14 1/2"	.950	13/16	20	.9495	3	1.150	10

*Collets can also be used on any other lathe or machine which they will fit.

South Bend Collets and Collet Sets

Collet	Description	Steel Collets		Brass Collets	
		Cat. No.	Price	Cat. No.	Price
No. 3	1 Collet, any standard size 1/16" to 1/2" in 64ths.....	609-W	\$ 3.75	1696	\$ 2.00
	Set of 8 Collets in 16ths, 1/16" to 1/2".....	2047	27.00	2235	15.00
	Set of 7 Collets in odd 32nds, 3/32" to 15/32".....	2476	24.00	2534	13.00
	Set of 14 Collets in odd 64ths, 5/64" to 31/64".....	2477	46.00	2535	24.00
	Decimal Collets (.0625" to .500") each.....	769-W	4.00	1856	2.15
	Metric Collets (1.5 mm to 12.5 mm) each.....	773-W	4.00	1702	2.15
No. 2	1 Collet, any standard size 1/16" to 11/16" in 64ths.....	1721	4.00	1697	2.25
	Set of 11 Collets in 16ths, 1/16" to 11/16".....	2432	39.00	2238	23.00
	Set of 10 Collets in odd 32nds, 3/32" to 21/32".....	2478	36.00	2536	21.00
	Set of 20 Collets in odd 64ths, 5/64" to 43/64".....	2479	71.00	2537	40.00
	Decimal Collets (.0625" to .6875") each.....	769-N	4.25	1857	2.40
	Metric Collets (1.5 mm to 17.0 mm) each.....	773-N	4.25	1703	2.40
No. 5	1 Collet, any standard size 1/16" to 1" in 64ths.....	1722	4.75	1698	2.50
	Set of 16 Collets in 16ths, 1/16" to 1".....	2435	68.00	2241	37.00
	Set of 15 Collets in odd 32nds, 3/32" to 31/32".....	2482	64.00	2540	35.00
	Set of 30 Collets in odd 64ths, 5/64" to 63/64".....	2483	127.00	2541	65.00
	Decimal Collets (.0625" to 1.000") each.....	769-R	5.00	1858	2.65
	Metric Collets (1.5 mm to 25.0 mm) each.....	773-R	5.00	1704	2.65
No. 4	1 Collet, any standard size 1/16" to 3/4" in 64ths.....	1713	4.25	1699	2.35
	Set of 12 Collets in 16ths, 1/16" to 3/4".....	2438	46.00	2244	26.00
	Set of 11 Collets in odd 32nds, 3/32" to 23/32".....	2480	42.00	2538	24.00
	Set of 22 Collets in odd 64ths, 5/64" to 47/64".....	2481	81.00	2539	45.00
	Decimal Collets (.0625 to .7500") each.....	769-K	4.50	1859	2.50
	Metric Collets (1.5 mm to 19.0 mm) each.....	773-K	4.50	1705	2.50

SOUTH BEND LATHE WORKS, 543 E. Madison Street, South Bend 22, Indiana, U.S.A.

Chuck and Tool Assortments

The chucks and tools in the assortments shown are recommended for use with the various South Bend Lathes. This is the basic equipment required for the average shop for general machine work, such as turning, boring, drilling, cutting-off, chucking, etc. A 3-jaw Universal chuck can be substituted for the 4-jaw Independent at additional cost.

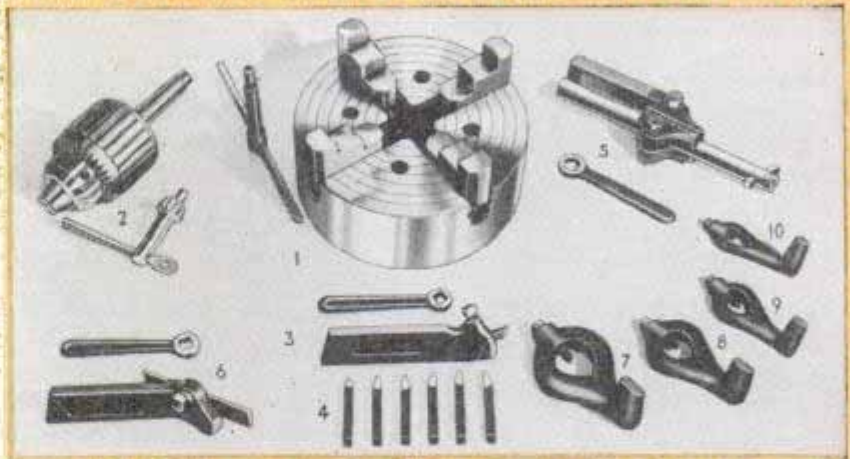

Contents of Assortment

- 4-Jaw Independent Lathe Chuck fitted to lathe. Sizes: 6 in. on 9" and 10" Lathes; 7½ in. on 13" Lathe; 9 in. on 14½" Lathe; 10 in. on 16" and 16/24" Lathes.
- Jacobs 3-Jaw Drill Chuck. Sizes: ½ in. on 9" and 10" Lathes; ¾ in. on 13" and 14½" Lathes; 1 in. on 16" and 16/24" Lathes.
- Arbor Fitted to Above Drill Chuck.
- Straight Shank Tool Holder.
- 6 Ground Cutter Bits for Tool Holder.
- Boring Tool Holder, Style "B." 9" Lathes take Style "D."
- Cutting-Off Tool Holder, Right-Hand.
- 4 Malleable Lathe Dogs. Sizes: ½", ¾", 1", and 1¼" on 9" and 10" Lathes; ½", ¾", 1", and 1½" on all others.

Prices of Complete Assortments

Size of Lathe	Catalog No.	Price
9" & 900.....	105-WT	\$53.44
10"—11/16" Collet.....	110-T	87.87
10"—1" Collet & 1000...	110-L	88.87
13".....	113-T	103.01
14½".....	114-T	115.28
16" & 16/24".....	116-T	135.68

Wood Turning Rest

Mounts on compound rest base to convert lathe for wood turning. See following pages for centers for wood turning.

Prices Start
At \$9

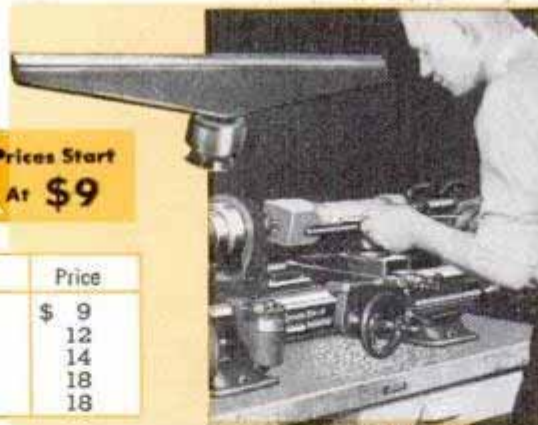

Size of Lathe	Catalog No.	Price
9".....	896-W	\$ 9
10".....	1069	12
13".....	1073	14
14½".....	1165	18
16" and 16/24".....	1075	18

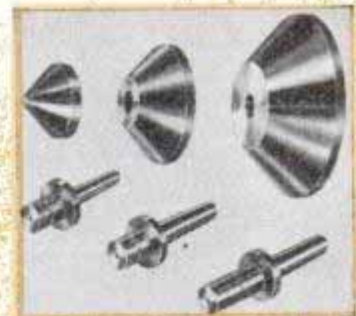

Pipe Centers

Cat. No.	Takes Pipe	Requires Shank	Price
2160	½" to 3"	2172-NR	\$4.50
2161	3" to 5"	2172-TH	6.00
2162	5" to 8"	2173-TH	9.00

Pipe Center Shanks

Cat. No.	Taper	Price
2172-NR	No. 2	\$4.50
2172-TH	No. 3	4.50
2173-TH	No. 3	7.50

Chip Pans and Oil Pans

Oil Pans, Splash Pans, and Chip Pans can be supplied for all South Bend Lathes. Oil Pans should be factory-installed for proper fit. Complete information and prices will be supplied on request.

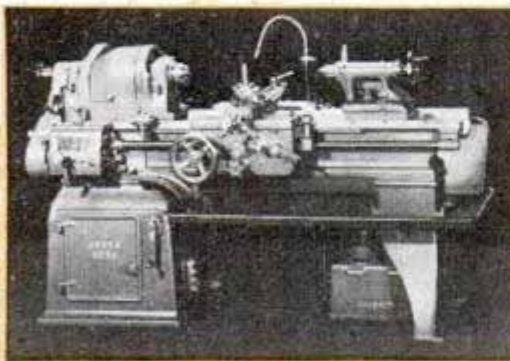

**TIME
PAYMENT
TERMS**

When order includes lathe 25 per cent down 12 months to pay balance Moderate finance charges

Milling and Keyway Cutting Attachment

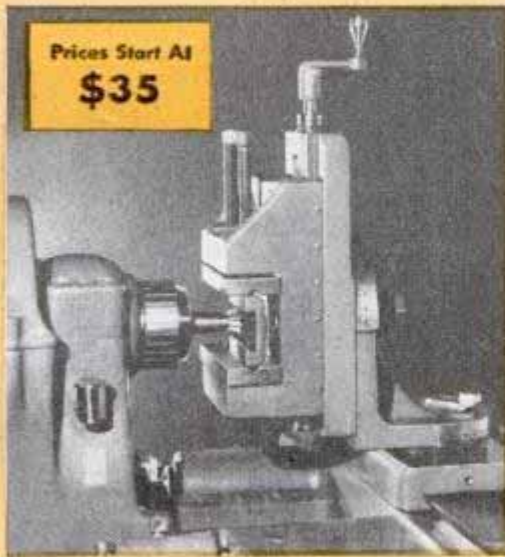

Milling and Keyway Cutting Attachment

This useful attachment is ideal for shops not having enough of this work to justify a milling machine. Mounts on compound rest base of lathe, permitting the power cross and longitudinal feeds to be used for milling, boring and keyway cutting operations on work held in the milling attachment vise. Vise swivels in any direction, 180° horizontal and vertical graduations. Vertical slide adjusting screw equipped with micrometer graduated collar.

Size Lathe	Cat. No.	Vise Cap.	Price
9" & 900	9-W	1 1/2"	\$35
10" & 1000	1-N	1 3/4"	45
13"	3	2 3/8"	55
14 1/2"	4-K	4"	65
16", 16/24"	5	4"	75

Arbors for Milling Cutters



Holds cutters with 1" holes. Capacity between nut and shoulder, 1 1/2". 3 spacing collars furnished. All shanks No. 3 Morse Taper.

Lathe Size	Catalog No.	Price
9" & 900	109-NH	\$7
10" & 1000	109-NH	7
13"	109-NH	7
14 1/2"	109-NH	7
16", 16/24"	109-NH	7

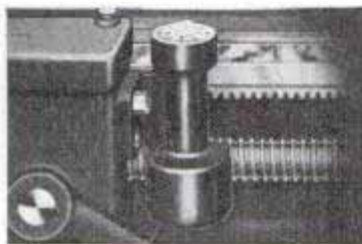

Thread Dial Indicator

Eliminates reversing of lathe spindle when cutting threads. Dial is numbered and graduated to show when to close half-nuts on lead screw to catch the thread on the next successive cut, after returning carriage to starting point.

Lathe Size	Catalog No.	Price
9" & 900	810-W	\$ 8
10" & 1000	1588	13
13"	813	15
14 1/2"	813	15
16", 16/24", 2-H	813	15

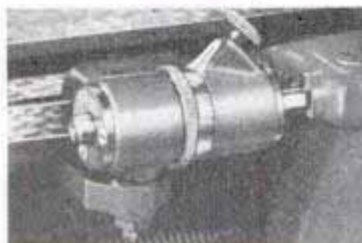

Micrometer Carriage Stop

Locates the carriage at any point along the bed for accurate facing, turning, boring, etc. Has accurately graduated micrometer collar. Stop is hardened on both ends for use on either side of carriage. Can be locked for duplicate work.

Size of Lathe	Catalog No.	Price
9" & 900	968-W	\$15
10" & 1000	1518	16
13"	973	18
14 1/2"	1502	19
16", 16/24", 2-H	975	19



Follower Rest

Supports long, slender shafts being machined between centers. Attaches to, and travels with, the carriage. Adjusting screws and lock screws are provided for setting the jaws in position. Slots in bottom of follower rest permit quick attachment or removal.

Size of Lathe	Catalog No.	Capacity		Price
		Max.	Min.	
9" & 900	34-W	2"	3/16"	\$4.75
10" & 1000	1353	2 1/2"	3/16"	7.00
13"	376	3 1/4"	3/16"	8.00
14 1/2"	1351	4 1/4"	3/16"	9.00
16"	730	4 1/4"	3/16"	10.00
16/24"	1352	4 1/4"	3/16"	15.00



Center Rest

Clamps on inside ways of lathe bed and is used for supporting long shafts, boring spindles, etc. The 3 jaws are adjustable, and are made of cast iron. Top of center rest is hinged to facilitate inserting and removing shafts.

Size of Lathe	Catalog No.	Capacity		Price
		Max.	Min.	
9" & 900	125-W	3"	1/4"	\$ 7
10" & 1000	1177	3"	1/4"	10
13"	341	3 3/4"	3/8"	13
14 1/2"	1174	4 3/4"	3/8"	16
16"	720	4 3/4"	3/8"	18
16/24"	1175	4 3/4"	3/8"	24

Taper Attachments

Telescopic and Plain

Taper turning and boring are as easily accomplished as straight turning on lathes equipped with South Bend Taper Attachments. The Taper Attachments are permanently mounted on the lathe carriages, and must be fitted at the factory. Accuracy and smooth operation are assured by their practical design and rugged construction. The swivel bar is graduated in both degrees and taper per foot.

Telescopic Taper Attachments are used only on 10" and larger lathes. A telescopic cross-feed screw eliminates the necessity of disconnecting the cross-feed nut when tapers are machined. The Plain Taper Attachment used on 9" Lathes requires the disconnecting of the cross-feed screw and nut.

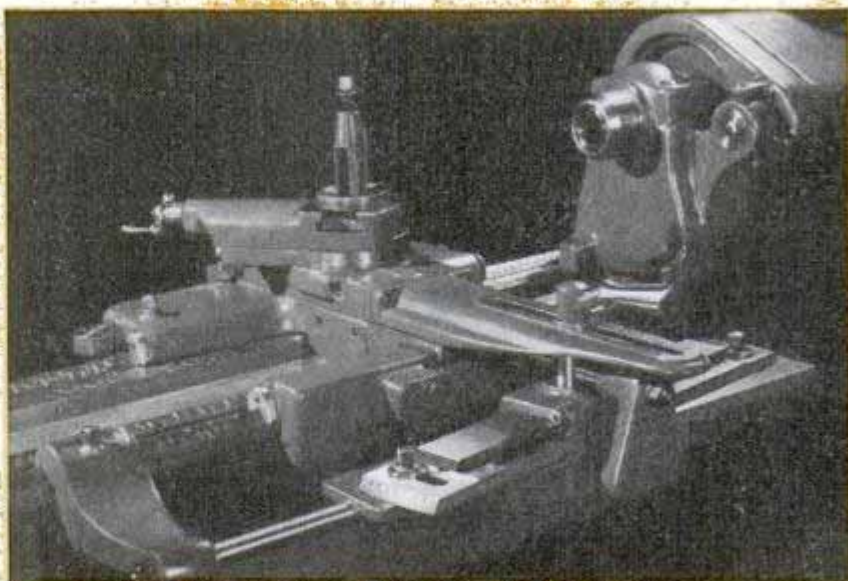

Telescopic Taper Attachment

Size of Lathe	Catalog Number	Max. Length at One Setting	Max. Taper per Foot	Max. Taper in Degrees	Price
9" and 900....	428-W	7"	3 1/2"	16 1/2°	\$ 75
10" & 1000....	1545	8 1/2"	3 1/2"	16 1/2°	137
13".....	379	9 1/4"	3 1/2"	16 1/2°	154
14 1/2".....	399	9 1/4"	3 1/2"	16 1/2°	165
16" & 16/24"..	381	11 1/2"	3 1/2"	16 1/2°	185

**TIME
PAYMENT
TERMS**

When order includes lathe 25 per cent down 12 months to pay balance Moderate finance charges

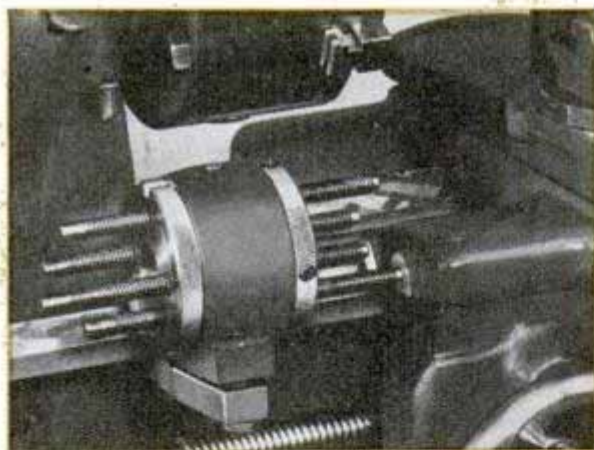

Four Position Carriage Stop

Much time can be saved in positioning the cutting tool for repetitive operations, by using this four position carriage stop. Each of the four adjustable stops may be set for a different tool position, and may be revolved to locate the carriage for each of four successive cuts. This attachment is especially desirable when a square turret tool block carrying up to four cutting tools is used. It may be clamped on either side of the carriage to position the tool either from left to right, or from right to left.

Cat. No.	Size Lathe	Price
2185-N	9".....	Price on Request
2185-R	10".....	
2185-T	13".....	
2185-F	14 1/2".....	
2185-H	16", 16/24", 2-H	

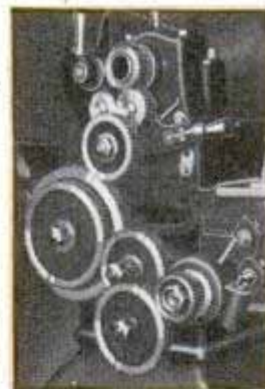

Metric Transposing Gears

Metric screw threads from 6 mm to 0.20 mm pitch (L.H. & R.H.) can be cut when Metric Transposing Gears are used. Prices when ordered with lathe.

Size of Lathe	Catalog No.	Price
Mdl. A 9" & 900...	1955-W	\$10
Mdl. B or C 9" & 900...	1759-W	12
10" & 1000.....	1963	40
13".....	1957	45
14 1/2".....	1961	50
16".....	1959	55
16/24".....	1960	50

Universal Tool Block

The new Universal Tool Block replaces the conventional tool post and various tool holders ordinarily used for general lathe work. It provides rigid support for turning, boring, threading, and cut-off tool bits. In addition, it is equipped with a self-aligning knurling head. Screw adjustments for tool height are easily made, and they stay put. No re-adjustment is required when replacing tools. This tool block can be adapted to fit other makes of lathes.

Size of Lathe	Cat. No.	Price
9".....	1413-N	\$11.25
10".....	1413-R	11.75
13".....	1413-T	13.75
14 1/4".....	1413-F	15.75
16" & 16/24"	1413-H	16.25

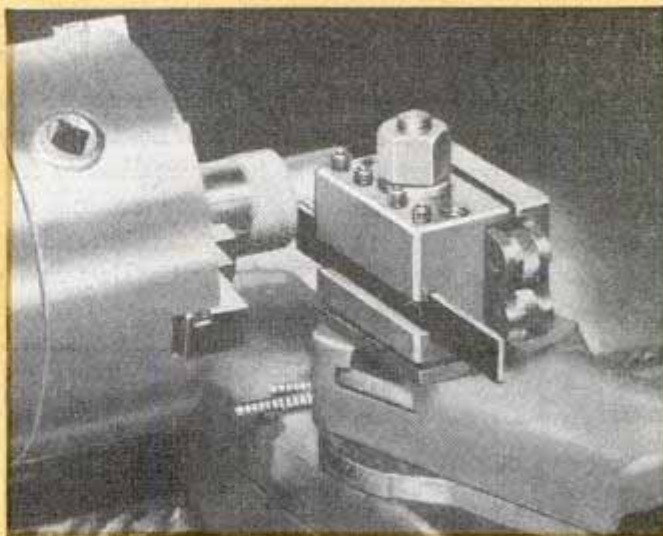

Universal Tool Block

Patent Pending

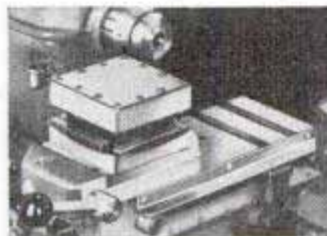

Patent Pending

Square Turret Tool Block

for Double Tool Cross Slide

The turret indexes within .0005", permitting each of four tools to be used in sequence for rough turning, facing, boring, cutting-off, or other operations as required. A quick-acting lever locks the turret securely in each of the four positions. Rocker adjustment is provided for adjusting height of each tool. For use on the double tool cross slides of South Bend Lathes, but can be adapted for use on other makes.

Patent Pending



Patent Pending

Square Turret Tool Block

for Compound Cross Slide

Used on compound cross slides for same purpose as tool block described at left. Turret indexes within .0005" to each of four positions and locks by means of lever. Rocker adjustments provided for tools. Ruggedly constructed. This tool block is for use on compound rest cross slides of South Bend Lathes but can be adapted for use on other makes.

Tool Blocks for Compound Cross Slides

Size of Lathe	Catalog Number	Size Square	Takes Tools	Price
9" & 900.....	40-NC	3"	3/8" x 3/8"	\$45
10" & 1000.....	41-NC	3"	3/8" x 3/8"	45
13".....	43-NC	3"	3/8" x 3/8"	50
14 1/2".....	44-NC	4"	3/8" x 3/8"	70
16" & 16/24".....	42-NC	4"	3/8" x 3/8"	75

Tool Blocks for Double Tool Cross Slides

Size of Lathe	Catalog Number	Size Square	Takes Tools	Price
9" & 900.....	41-ND	3"	3/8" x 3/8"	\$40
10" & 1000.....	41-ND	3"	3/8" x 3/8"	40
16".....	42-ND	4"	3/8" x 3/8"	70



Handlever Double Tool Cross Slide

Ideal for increasing production on repetitive operations. Three 7/16" square cutter bits can be used—two in front tool block, one in rear tool block. Mounts on saddle cross slide in place of compound rest. Can be operated by handlever or power cross-feed.

Size of Lathe	Catalog Number	Swing over Slide	Price
9" & 900..	2030-W	3-9/16"	\$75
10" & 1000.	2031	3-9/16"	90



Handlever Bed Turret

Turret head indexes automatically when lever is moved to extreme right. Each turret face has independently adjustable feed stop screw which accurately regulates length of cut. Effective feed of turret slide 4". Turret indexes within .0005" four inches from turret face.

Size of Lathe	Cat. No.	Price
9" & 900.....	1611-W	\$200
10" & 1000....	1612	210
13".....	1613	225

SOUTH BEND LATHE ATTACHMENTS

Standard and Safety Lathe Dogs

Lathe dogs should correspond in capacity to the diameter of the work if the work is to be held securely. These lathe dogs are made of heavy malleable iron and are properly designed for maximum strength and long service. The Standard Lathe Dog has square head alloy steel set screw. The Safety Lathe Dog has a headless alloy steel set screw.



Lathe Dogs for 13" and Larger Lathes

Cap. In.	STANDARD		SAFETY		
	Cat. No.	Price	Cat. No.	Wrench Required	Price
1/2	3843	\$0.80	3826	2385	\$0.80
3/4	3844	.95	3827	2386	.95
1	3845	1.05	3828	2387	1.05
1 1/4	3846	1.20	3829	2388	1.20
1 1/2	3847	1.40	3830	2389	1.40
1 3/4	3848	1.55	3831	2389	1.55
2	3849	1.70	3832	2389	1.70
2 1/2	3850	1.95	3833	2390	1.95
3	3851	2.20	3834	2390	2.20
3 1/2	3852	3.00	3835	2390	3.00
4	3853	4.00	3836	2390	4.00

Lathe Dogs for 9" and 10" Lathes

Cap. In.	STANDARD		SAFETY		
	Cat. No.	Price	Cat. No.	Wrench Required	Price
3/8	3837	\$0.70	3820	2385	\$0.70
1/2	3838	.75	3821	2385	.75
3/4	3839	.90	3822	2386	.90
1	3840	1.00	3823	2387	1.00
1 1/4	3841	1.10	3824	2388	1.10
1 1/2	3842	1.35	3825	2388	1.35

A complete set of lathe dogs is a must in any shop.

Lathe Centers and Drill Pads

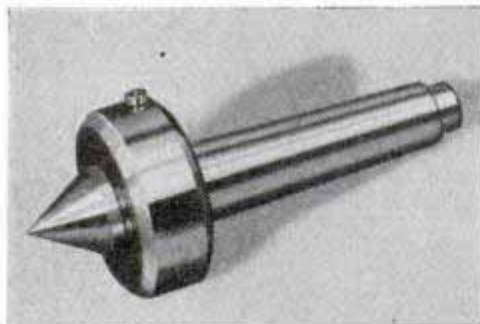

Patent Pending

Ball Bearing Live Center

Designed for maximum strength and rigidity, the Ball Bearing Live Center is recommended for high speeds, heavy roughing cuts, etc. 60° point runs in substantial precision ball bearing which is easily replaceable.

Catalog No.	Shank Taper	Price
3900	No. 2	\$11.50
3901	No. 3	13.50

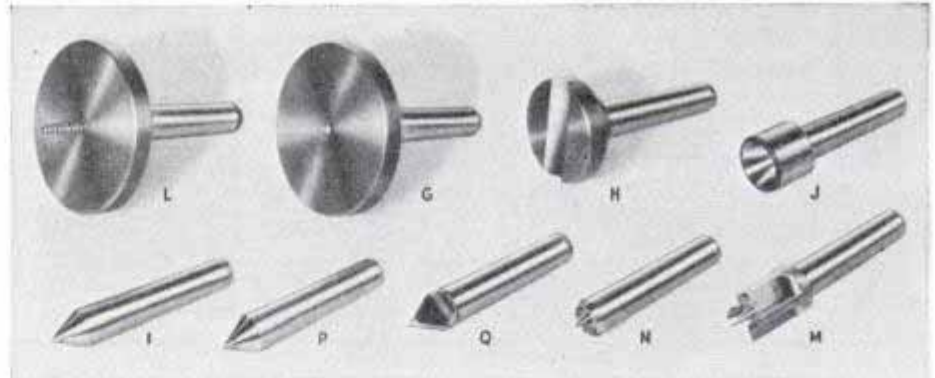

L—Screw Center for wood turning. G—Drill Pad to support flat work for drilling. H—Crotch Center supports round work for cross drilling. J—Hollow Center for supporting centerless shafts up to 3/8" dia. I—60° Center for headstock or tailstock spindles P—Carbide Center. Q—Half Center. N—Cup Center. M—Spur Center, for all wood turning operations.

Description	No. 2 Taper for 9" and 10" Lathes		No. 3 Taper for 13", 14 1/2", & 16"	
	Cat. No.	Price	Cat. No.	Price
L—Screw Center.....	731-NR	\$3.00	731-TH	\$3.25
G—Drill Pad.....	727-NR	2.50	727-TH	2.75
H—Crotch Center.....	728-NR	2.50	728-TH	3.25
J—Hollow Center.....	1896-NR	2.00	1896-TH	2.75
I—60° Center.....	726-NR	2.25	726-TH	3.00
P—Carbide Center.....	1889	4.50	1890	8.00
Q—Half Center.....	926-NR	2.25	926-TH	3.00
N—Cup Center.....	733-NR	2.00	733-TH	2.75
M—Spur Center.....	732-NR	3.00	732-TH	3.25

**TIME
PAYMENT
TERMS**

When order includes lathe
25 per cent down
12 months to pay balance
Moderate finance charges

SOUTH BEND LATHE WORKS, 543 E. Madison Street, South Bend 22, Indiana, U.S.A.

SOUTH BEND LATHE ATTACHMENTS

Coolant Pump and Reservoir

(Not Fitted to Lathe at Factory)

The coolant equipment listed below includes motor driven coolant pump, tubing, reservoir and tray, 1/4 h.p. motor (see table below), switch, and wiring for connecting switch to motor. Pump is self-priming as it is below the oil level. Reservoir intake is fitted with large filter screen. This coolant equipment can be used with lathes and other machine tools. When ordering, specify voltage, phase, and cycle of motor wanted.

Cat. No.	Motor Specifications				Price
	Current	Phase	Cycle	Voltage	
2003-C	A.C.	3	50	220	\$117.00
2003-D	A.C.	3	60	220	117.00
2003-E	A.C.	3	50	440	117.00
2003-F	A.C.	3	60	440	117.00
2001-A	A.C.	1	50	115	105.00
2001-B	A.C.	1	60	115	103.00
2001-C	A.C.	1	50	230	106.00
2001-D	A.C.	1	60	230	105.00
2000-K	D.C.	115	128.00
2000-L	D.C.	230	128.00

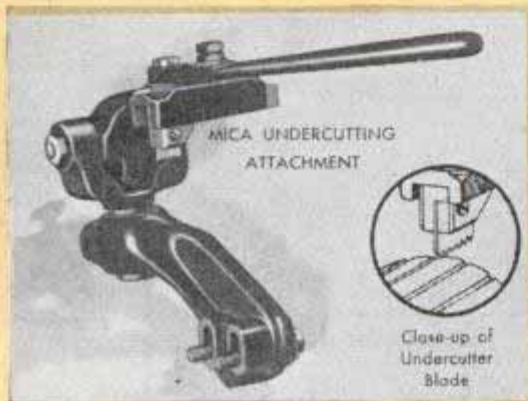

Patented

Mica Undercutting Attachment

Any shop that repairs armatures for motors, generators or starters will have a lot of use for this practical attachment. It attaches to the saddle of the lathe which insures rigidity and alignment. The blade travels parallel to the commutator bars which insures clean, straight cutting. Upper portion is hinged so the blade holder can be swung back so it does not interfere with turning the commutator.

Price includes one blade .020" thick. Extra cutter blades .020" and .015" thick are available as listed below.

Size of Lathe	9"		10"		13"		14 1/2"		16"	
Description	Cat. No.	Price	Cat. No.	Price	Cat. No.	Price	Cat. No.	Price	Cat. No.	Price
Mica Undercutting Attachment.....	675-N	\$18.00	675-R	\$18.00	675-T	\$19.00	675-F	\$20.00	675-H	\$21.00
Extra Blade, .015".....	2028	.15	2028	.15	2028	.15	2028	.15	2028	.15
Extra Blade, .020".....	2029	.25	2029	.25	2029	.25	2029	.25	2029	.25

Adjustable Collet Bushing Chuck

The adjustable collet bushing chuck provides an extremely accurate, but inexpensive equipment for mounting centerless armature shafts, and similar parts, in the lathe. Can be used in either head or tail spindle of lathe. Collets are made of brass, and may be adjusted for either running fit or driving fit on shaft.

Description	Cat. No.	Shank	Price
Adjustable Collet Bushing Chuck Only.....	1615-NR	No. 2	\$6.25
	1615-TH	No. 3	6.75
Adjustable Collet Bushing Chuck with set of 3 collets, 9/16", 5/8" and .637" capacity for popular armatures.....	1608-NR	No. 2	8.95
	1608-TH	No. 3	9.45

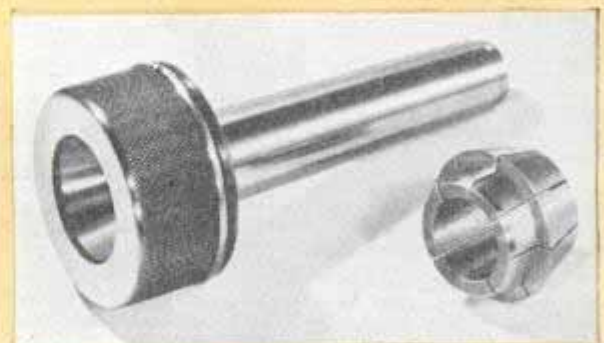

Cat. No. 1659, Extra Collets for round work, any capacity 1/4" to 1" round by 16ths, price each \$1.00.

SOUTH BEND LATHE WORKS, 543 E. Madison Street, South Bend 22, Indiana, U.S.A.

Two Superb Grinding Attachments

South Bend Design and Manufacture

External—This powerful and efficient grinding attachment is recommended for external grinding. Designed to fit the various sizes of South Bend Lathes, it is easily adaptable for use on milling machines, shapers, planers, or other makes of lathes. The spindle revolves on pre-lubricated, precision ball bearings which are sealed to protect them from damage by dust, grit and metal particles produced when grinding. Supplied with $\frac{1}{4}$ h.p., 1725 r.p.m. constant speed continuous duty motor, 4" x $\frac{1}{2}$ " grinding wheel.

Internal—Designed as a companion to the External Grinding Attachment, this grinder is intended for all types of internal grinding. It is equipped with a $\frac{1}{8}$ h.p. constant speed continuous duty motor. Spindle runs in precision ball bearings. Changeable pulleys provide 3 spindle speeds of approximately 13,000, 15,000, and 18,000 r.p.m. Uses standard Norton and Carborundum grinding wheels. Extension quill permits grinding holes up to 2 $\frac{1}{4}$ " deep. Price includes belt and three assorted grinding wheels.

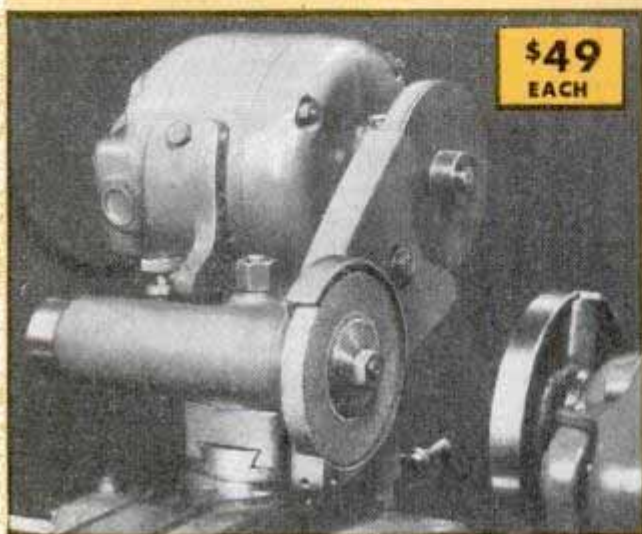

\$49
EACH

External Grinding Attachment

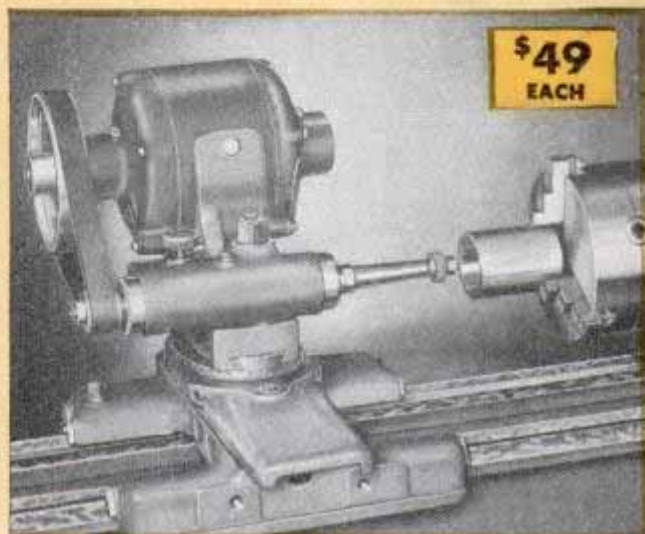

\$49
EACH

Internal Grinding Attachment

Prices include motor for 115 v., 60 cy., 1 ph., A.C. current.
Prices with other motors quoted on request.

TIME PAYMENT TERMS

When order includes lathe 25 per cent down 12 months to pay balance moderate finance charges

Size of Lathe	EXTERNAL GRINDER		INTERNAL GRINDER	
	Catalog No.	Price	Catalog No.	Price
9" & Series 900.....	301-BN	\$49	201-BN	\$49
10"—11/16" Col.....	301-BR	49	201-BR	49
10"—1" Col. & 1000.....	301-BR	49	201-BR	49
13".....	301-BT	49	201-BT	49
14 $\frac{1}{2}$ ".....	301-BF	49	201-BF	49
16" & 16/24".....	301-BH	49	201-BH	49



Above: Grinding a cutter with spring stop in holding fixture. Right: Grinding spiral reamer.

Reamer and Cutter Grinding Stops

Consists of adjustable holding fixture which clamps on lathe bed for holding adjustable grinding stops and diamond dresser for grinding wheels. Also a grinding stop which attaches to grinding wheel guard and travels with grinder for grinding spiral reamers and cutters.

Size of Lathe	9" Ser. 900	10" Ser. 1000	13"	14 $\frac{1}{2}$ "	16"	16/24"
Catalog No.....	1512-N	1512-R	1512-T	1512-F	1512-H	1512-V
Price.....	\$15	\$16	\$18	\$20	\$20	\$29

SOUTH BEND LATHE WORKS, 543 E. Madison Street, South Bend 22, Indiana, U. S. A.

SOUTH BEND LATHES

Are Known Throughout the World for Their

Quality

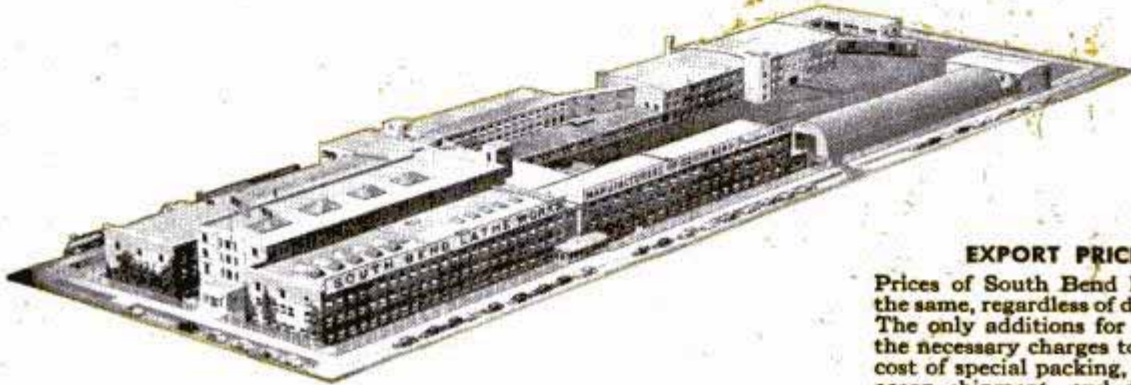

EXPORT PRICES

Prices of South Bend Lathes are the same, regardless of destination. The only additions for export are the necessary charges to cover the cost of special packing, boxing for ocean shipment, and delivery to ship side at U. S. ports.

How to Run a Lathe
A 128-page book on the operation of metal working lathes. Printed in English. Price postpaid 50 cents.

Manual del Tornero
Un libro de 128 páginas sobre el manejo de tornos mecánicos. Editado en español. Precio 50 cents en moneda de los E.U.A.

Manual do Torneiro
Livro de 128 páginas sobre a condução de tornos mecánicos. Editado em português. Preço, 50 cents em moeda dos E.U.A.

Manuel du Tour
Livret à 128 pages concernant le fonctionnement de tours travail sur métaux. Imprimé en français. Prix 50 cents en monnaie des Etats-Unis d'Amérique.

Although prices of South Bend Lathes are low, their quality is unsurpassed. High quality at a low price is made possible by the efficiencies and economies obtained through standardization and large production. This company produces annually a substantially greater number of lathes than any other manufacturer in the United States.

Aun cuando sean bajos los precios de los Tornos South Bend, su calidad no ha sido sobrepasada. Excelente calidad a precio económico se obtiene por medio de la normalización y de una gran producción. Esta compañía fabrica anualmente un número de tornos considerablemente mucho mayor que cualquier otro fabricante de los Estados Unidos.

Embora sejam baixos os preços dos Tornos South Bend, a qualidade destes não é ultrapassada. A alta qualidade a preço baixo é resultante das eficiências e economias conseguidas por meio da padronização e da grande produção. Esta companhia fabrica anualmente um número consideravelmente maior de tornos que qualquer outro fabricante dos Estados Unidos.

Bienque le tour South Bend se vende à bas prix, la qualité en est néanmoins non surpassée. La haute qualité du tour à bas prix provient de l'action productrice et les économies obtenues par la mise en série et la production en grand. Cette compagnie fabrique annuellement beaucoup plus de tours que tout autre manufacturier des Etats-Unis.



SOUTH BEND LATHE WORKS, 543 E. Madison Street, South Bend 22, Indiana, U.S.A.

**SEVENTEEN SAVED FROM
EARLY MORNING BLAZE**

Sub-Zero Temperature Adds to Danger of

*When safety's a must
... it's "Prestone!"*
ANTI-FREEZE

*"No freeze-ups for my car... it's first at
the fire. I've got to be safe—and know it!"*



Charles A. McGinley

*Chief, East Orange, N.J., Fire Dept.
America's most vital cars... the
cars of police chiefs, fire marshals,
doctors, tow-car drivers... and
millions of average motorists de-
pend on "Prestone" anti-freeze
for protection. It's SAFE!*



*In your
car too!*

**NO RUST...
NO FOAM...
NO FREEZE...
NO FAILURE...**

One shot lasts all winter!

YOU MAY never race to fires. Or buck a blizzard to reach a patient's bedside. But *your* car—to *you*—is one of the most important things in the world. Give it the finest protection you can! Like fire marshals and ambulance drivers, you want to be *safe*—and *know* it!

You don't have to *guess* what anti-freeze to choose. The record of "Prestone" brand anti-freeze in cars that *dare not fail* gives you your answer. Like these drivers, you'll be *safe*—and *know* it.

SAME PREWAR PRICE

1926...\$6.90	1933...\$2.95
1929...\$5.90	1935...\$2.70
1932...\$4.95	1939...\$2.65

1947...\$2.65 PER GALLON

**NATIONAL CARBON
COMPANY, INC.**

30 East 42nd Street
New York 17, N.Y.
Unit of Union Carbide
and Carbon Corporation

UCC



PRESTONE

TRADE-MARK

*Anti-
Freeze*

The registered trade-marks
"Eveready" and "Prestone"
distinguish products of
National Carbon Company, Inc.